

Owners Reports: Chevy II and Rambler

# POPULAR MECHANICS

MAR. 1962  
35 CENTS

**WHOOSH!**  
There Goes the  
**PM JET** →

*Be First to Build  
This Go-Anywhere Boat*

**LOST:** Those  
enticing "extras"  
on old-time cars

**"Guest Room"  
In a Table**

**Boaters vs. Anglers—**  
*Here's Your Chance  
To Come Out Fighting!*

**Power Tower  
for Toting Tools**



# WIN YOUR OWN SHOWBOAT!

MADE BY KAYOT, INC.,  
MANKATO, MINN.  
world's leading builders of pontoon boats



## VISIT YOUR EVINRUDE DEALER'S FUN AFLOAT SHOW

**1,023 PRIZES!**

**3 SHOWBOATS**  
(as illustrated)

powered by Evinrude  
40 hp Lark motors.

**PLUS**

**1,020 OTHER PRIZES**

to be given away in  
Evinrude's national  
SHOWBOAT CONTEST!

**2,100 ADDITIONAL PRIZES**

to be given away by  
Evinrude dealers across  
the U.S. as door prizes  
during their

**FUN AFLOAT SHOWS**  
to be announced locally!

Win this EVINRUDE SHOWBOAT — featured at the New York boat show. It's a practical pontoon boat by Kayot, Inc. — powered by a 40 hp Evinrude Lark IV with PUSH-BUTTON electric gearshift . . . as easy to operate as your own car. There's a built-in grill big enough to cook steaks for a boatload of guests. The paddlewheels turn as you move. It's a gay sight to see and practical for day cruising and partying. Three Showboats, plus 1,020 other prizes will be given away in Evinrude's Showboat Contest!

Many Evinrude dealers will hold a FUN AFLOAT SHOW during this contest . . . between now and April 15th. Look for his local announcement. Visit his Fun Afloat Show . . . the whole family will enjoy it . . . and you'll get ideas to help you become a winner!

Get your Official Contest Entry Form and FREE Evinrude FUN GUIDE at your nearest Evinrude dealer now. Look for his name in the Yellow Pages under Outboard Motors. Evinrude Motors, Milwaukee 16, Wisconsin, *A Division of Outboard Marine Corp.*

**EVINRUDE**  
FIRST IN OUTBOARDS



70 American Thermos  
Giant "Pop-Tents"

100 Bolex 8 mm  
Movie Cameras



100 Westinghouse 3-band  
Transistor Radios



250 AMF-Voit  
Water Ski  
Sets



250 Turner  
Camping  
Ensembles



250 South Bend  
Fishing Outfits

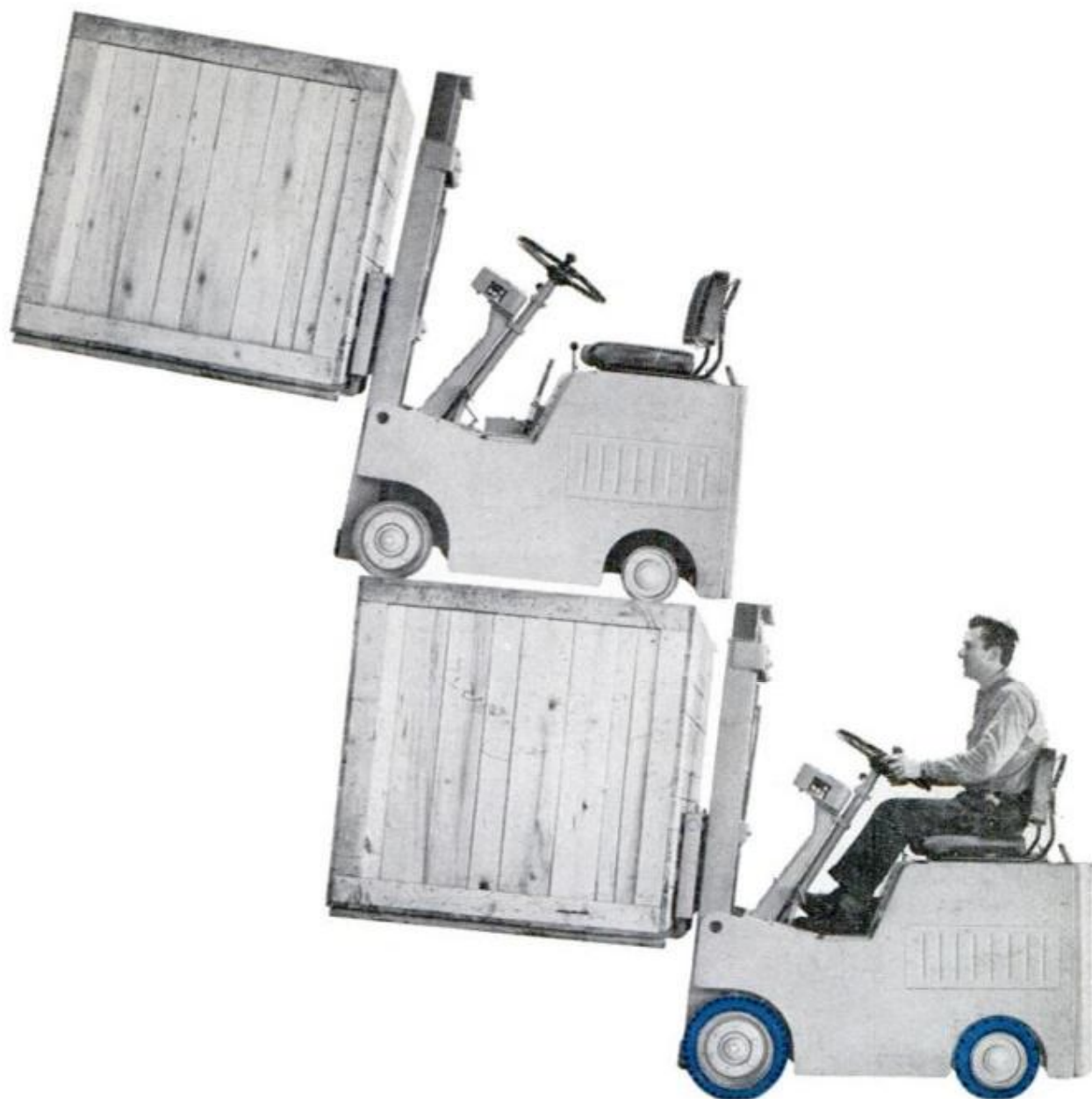

## Blue tire wears even better under twice the load!

We made these tires blue because they're so different from other industrial tires!

How different? For one thing, they give their best traction when they carry 2 to 4 times the load ordinary tires can handle. And tread life is up to four times longer, too.

The reason is they're NEOTHANE tires.

NEOTHANE is our name for a special compound that makes an industrial tire do wonderful things. Such as, roll like rubber but wear like steel—armor itself against stray nails, screws, metal chips and glass.

If your industrial tires suffer from severe overloading, cure your "blues" with extra-capacity NEOTHANE tires. Goodyear, Akron 16, Ohio.

**MORE TONS ARE HAULED ON GOODYEAR TRUCK TIRES THAN ON ANY OTHER KIND**

**GOODYEAR**

This One



H2GO-G9T-WTT4

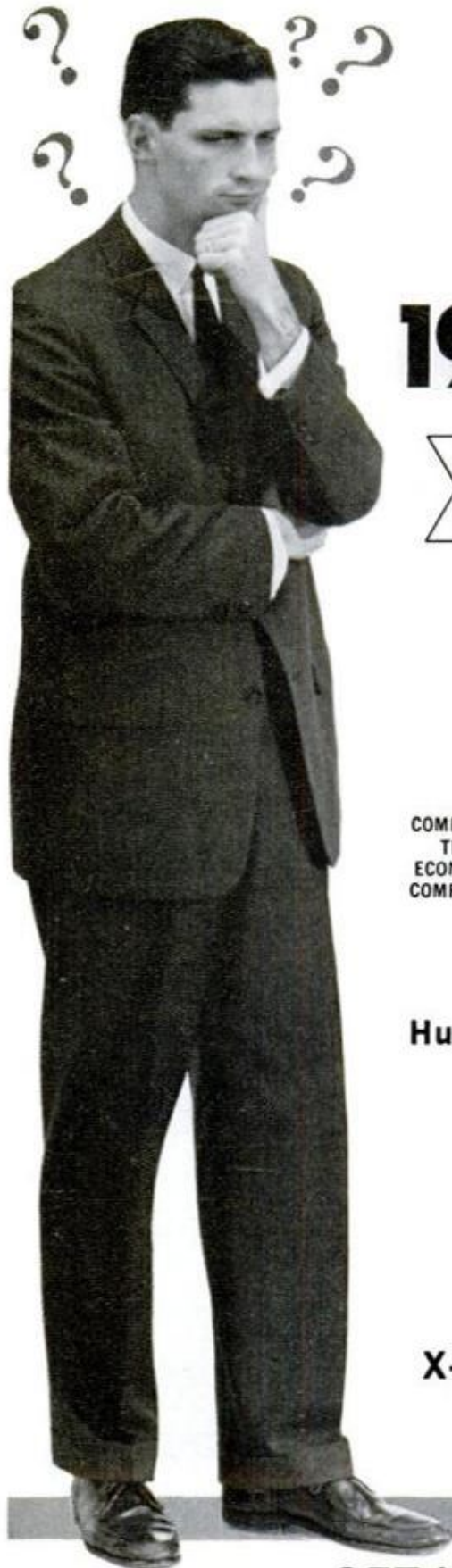

**Confused About The 1962 Cars?**

**Get The Straight Answers FREE**

**In These Two Revealing**

# 1962 AUTOMOTIVE X-RAY BOOKS!

COMPARES  
THE  
ECONOMY  
COMPACTS



COMPARES THE  
POPULAR-PRICED  
SIXES AND V-8's  
STANDARD AND  
COMPACT

**Hundreds of Pictures... Easy-To-Read Language!**

Some manufacturers ask you to "Think Big" when buying a new car. Others ask you to "Think Small." The shrewd buyer will **THINK HARD** . . . get the true facts about each make. The 1962 X-Ray Books help you decide which car is best built—most economical—which car offers the most features and best safety—which car gives you most for your motor-car dollar.

**X-Ray May Save You Hundreds Of Dollars  
On The Purchase Of Your Next Car!**

GET YOUR FREE CAR X-RAY BOOK  
AT YOUR RAMBLER DEALER'S NOW!

**RAMBLER**—World Standard of Compact Car Excellence



...for the  
Space-less  
Age!

*Sea-Horse surprise...compact carries compact.*

**NEW JOHNSON COMPACTS** fit anywhere,  
go anywhere, dependable as only a Sea-Horse can be!

New Johnson *Compacts* . . . above is the 5½, below are the 18 and 10. Their small size is the big news. Clean and simple. Lighter and smarter. Function, not flash. These motors are made to go fishing, not flying.

Each one is a work horse . . . and you get what goes with it. Cushion hub props and built-in gearshifts. Thermostatic cooling and six gallon fuel tanks. Corrosion proofing and powerful piston displacement.

Visit your Johnson dealer's. He's in the Yellow Pages. '62 Sea-Horse motors include Electromatic 75 and 40 hp models (with outboarding's first truly automatic transmission); a high-performing 28; and a 3 we find impossible to improve.

Send for free 1962 catalog. Johnson Motors, 1284 Pershing Rd., Waukegan, Ill. Division of Outboard Marine Corp.

Well over two million quiet Sea-Horse motors prove **JOHNSON DEPENDability**



# POPULAR MECHANICS®

MARCH 1962  
VOL. 117 NO. 3

INTERNATIONAL EDITIONS • SPANISH: Mexico-Caribbean, Southern Hemisphere • FRENCH •

## Features of Special Interest

Driving Chrysler's 1963 Gas-Turbine Cars - - - -	87
Owners Report on the Chevy II - - - - -	94
Owners Report on the Rambler Classic - - - - -	98
Our First Moon Trip - - - - -	108
Detroit, Where Are These Old-Time "Touches"? - - -	116
Mounties Without Mounts - - - - -	120
PM Shopping Guide: Tape Recorders - - - - -	126
The Old Warbirds Are Still Flying - - - - -	130
Your Life Preserver— - - - -	135
Bitter Battle of the Waterways - - - - -	140
Start Your Vacation Home at Home—Part II - - -	144
Building the PM Jet—Part I - - - - -	150

## For the Craftsman

Make Your Own Banjo - - - - -	158
Winking-Eye Clown Radio - - - - -	162
Completing the Triple-Top Fun Table - - - - -	168
Power Tower - - - - -	176
Dual-Purpose Table Stores Guest Bed - - - - -	178
Appliance Fix-It File: Electric Iron - - - - -	180
Battery and Starter Checks - - - - -	186
Coil Winder Counts the Turns - - - - -	194

Address communications to: 200 E. Ontario St., Chicago 11, Illinois. **SUBSCRIPTION SERVICE:** Mail all subscription orders, changes of address, correspondence concerning subscriptions, and Postmaster notices of undeliverable copies to Popular Mechanics, 250 West 55th St., New York 19, N. Y.

Published by Popular Mechanics Company, RICHARD E. BERLIN, *President*

CLIFFORD B. HICKS  
*Editor*

RICHARD E. DEEMS  
*Executive Vice-President*

JOSEPH R. BUELL, JR.  
*Publisher*

*Managing Editor:* DON DINWIDDIE  
*Assistant Managing Editor:* JOHN A. LINKLETTER  
*Shop and Crafts Editor:* WAYNE C. LECKEY  
*Automotive Editor:* JAMES R. WHIPPLE  
*Associate Editors:* W. CLYDE LAMMEY, WALLACE MYERS  
*Electronics Editor:* BYRON G. WELS  
*Assistant Editors:* JAMES BIERY, KEVIN V. BROWN  
ROBERT L. HERING, R. B. KIRKPATRICK  
ARTHUR MIKESELL, BIL TOMAN, RICHARD WILLIFORD  
*Advertising Production:* DOROTHY M. WINER  
*Director, Bureau of Information:* ALLAN CARPENTER

*Art Director:* HENRY M. NEHRBASS  
*Assistant Art Director:* LEO R. WEEKS  
*Art Editor:* RICHARD A. POTTS  
*Chief Photographer:* FRANK P. FRITZ  
*Eastern Editor:* RICHARD F. DEMPEWOLFF  
959 Eighth Ave., New York 19, N. Y.  
*Western Editor:* THOMAS E. STIMSON, JR.  
Suite 1003, 3460 Wilshire Blvd., Los Angeles 5, Calif.  
*International Editor:* HEINZ P. SCHLICHTING  
Ritterstrasse 26, Karlsruhe/Bd., Germany  
*Advertising Manager:* FRANK R. DUPUY  
959 Eighth Ave., New York 19, N. Y.

If you wish additional sources of information for the articles in this issue, or if you wish the name and address of the manufacturer of a particular product shown here, write to Bureau of Information, Popular Mechanics, 200 E. Ontario St., Chicago 11, Ill. Ask for the free "Where-to-Find-It-List" for this issue.

DANISH • SWEDISH • GERMAN • PORTUGUESE • DUTCH

## Departments

Over the Editor's Desk - - - -	10
Sidelights on Aviation - - - -	14
Spotlight on the Rolls-Royce - - -	16
Items From All Outdoors - - - -	28
Science Overseas - - - - -	30
Pentagon Sidelights - - - - -	32
Worth Writing For - - - - -	43
Tune In on the Inventors - - - -	50
Science Bulletins - - - - -	74
Shopping for Tools - - - - -	84
Detroit Listening Post - - - - -	104
What's New for Your Home - - -	124
Solving Home Problems - - - -	174
Better Carkeeping - - - - -	191
Clinic for Homemakers - - - -	202
On the Market - - - - -	256

## Next Month . . .

The finest fishing spot in North America—can you guess where it is? The new Falcon and Pontiac—do you know what their owners think of them? Important tips for tent buyers—any idea what they would be? You'll find these questions answered in the April PM, the same issue that will introduce you to a new armload of power and a "classic" sidewalk car that runs—safely—on one battery.

ADVERTISING OFFICES—Chicago: 200 E. Ontario St., Whitehall 4-0100; New York: 959 Eighth Ave., Columbus 5-7300; Detroit: General Motors Bldg., TRinity 5-8711; Cleveland: Hanna Bldg., 1422 Euclid Ave., PRospect 1-0456; Los Angeles: 3460 Wilshire Blvd., DUmkirk 2-8458; San Francisco: 111 Sutter St., YUKON 2-0823.

Published monthly by Popular Mechanics Company, 200 E. Ontario St., Chicago 11, Ill. Richard E. Berlin, President; Richard E. Deems, Executive Vice-President; Fred Lewis, Vice-President and General Manager; John R. Miller, Vice-President; Joseph R. Buell, Jr., Vice-President; G. O. Markuson, Treasurer; R. F. McCauley, Secretary. Single copy in the United States and Canada, 35 cents. Subscription prices: United States and Possessions, \$4.00 for one year; \$7.00 for two years; \$9.00 for three years. Canada, add \$0.50 for each year. Pan-American Postal Union countries, add \$1.00 for each year. All other countries, add \$2.00 for each year. If you plan to move, notify us at least 30 days in advance so you will not miss an issue. Give both your old and new addresses. Second-class postage paid at Chicago, Illinois, and at additional mailing offices. Authorized as second class mail by the Post Office Department, Ottawa, and for payment of postage in cash. Registered as Second Class Matter at the Post Office at Mexico, D.F., Mexico, June 20, 1950. © 1962 by Popular Mechanics Company. All rights reserved. Printed in the United States of America.

Mounties  
Minus  
Mounts  
page 120



Blinking  
Clown  
Radio  
page  
162



Guest-Bed  
Table  
page 178



Jump Drum  
page 182



## Superfast Polaroid Film

Carrying a speed rating of 10,000 ASA, an extra-fast film has been marketed by the Polaroid Corp. for specialized scientific applications.

Not recommended for general-purpose photography because of its high contrast and grainy structure, the new Type 410 film will be used primarily for recording extremely short-duration oscilloscope traces, photomicrographs, metallographs, etc.

Packaged in 12-roll cartons, each carton will retail at \$27.12. Polaroid's previous highest-speed film was rated at 3000 ASA.

## Machine Takes Voice Commands

Arithmetic problems can be solved by a machine under command of a person's voice. Named Shoebox, the tiny experimental device recognizes 16 words spoken into a microphone, including 10 digits. When words such as "plus," "minus" and "total" are spoken, it instructs an adding machine to calculate and print out correct answers to simple arithmetic problems.

In operating Shoebox, a person first speaks into a microphone which converts his voice sounds to electrical impulses. A 31-transistor measuring circuit classifies these impulses by various types of sounds.

# PRINCE ALBERT has the flavor most favored in the U.S.A.

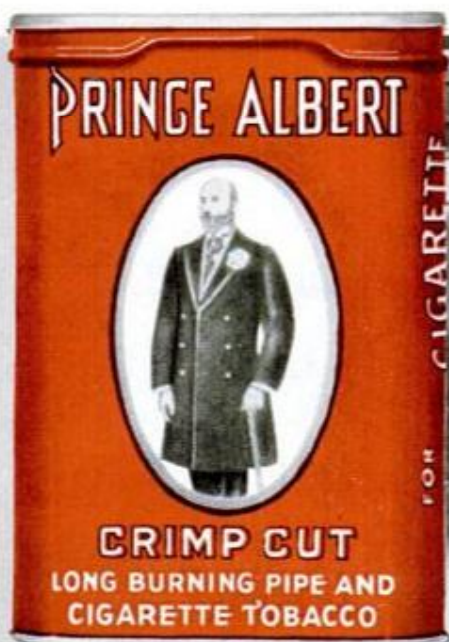

- Tastes fresh
- Smokes cool
- Burns steady

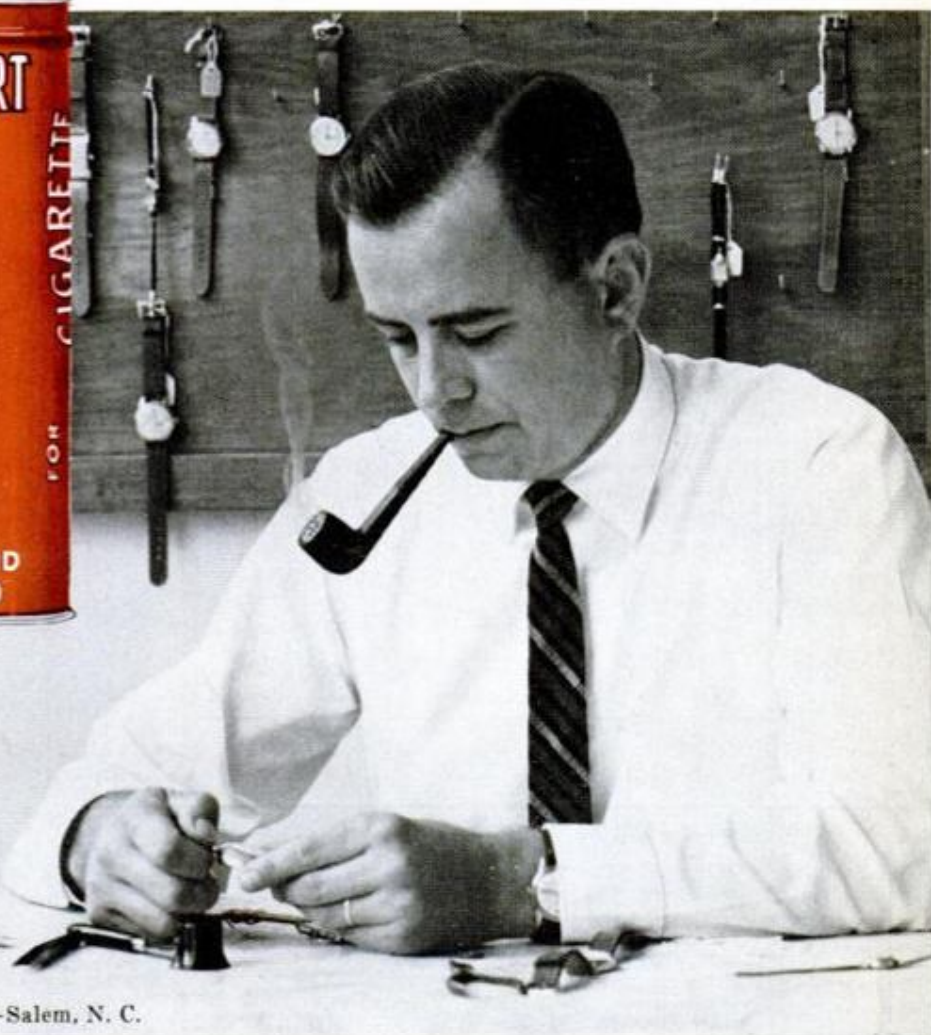

R. J. Reynolds Tobacco Co., Winston-Salem, N. C.

*The proof is in the puffing... try*

# PRINCE ALBERT

POPULAR MECHANICS



# This Free sample lesson can start you on a high-pay career as **ACCOUNTANT, AUDITOR, or CPA**

This same lesson has started hundreds of thousands in one of the world's best-paid professions. Its simplicity will surprise you. Try it, enjoy it, without obligation.

**T**HE demand for trained Accountants far exceeds the supply. Salaries keep going higher, promotions come faster. Why remain in a dull job with insufficient pay when you can qualify easily—in your spare time—for the big rewards offered to the accountancy-trained man?

To prove this to yourself, send for the interesting sample lesson which demonstrates the remarkable LaSalle method of home training. This lesson is yours free of cost or obligation. It will show you how you are guided step by step through actual Accountancy work . . . how you learn by doing . . . how thoroughly you are prepared for every Accounting task you will be called upon to handle in the business world.

### No previous experience required

LaSalle's distinguished faculty of expert Accountants and CPA instructors starts you right at the beginning . . . then supervises, corrects and grades your work all the way . . . right up to qualifying you for the Certified Public Accountant examination, if this is your goal.

You train in your spare time—at your own pace—without losing a single day from your present job.

### Which of today's many Accounting positions do you want?

Regardless of your present job—if you want to qualify as expert Accountant, Controller, Auditor, Income Tax Specialist, Government Accountant, or Public Accountant, LaSalle has the exact plan to prepare you rapidly and inexpensively.

For 53 years, LaSalle has been a world leader in business education. It has provided training at home to more than 1,000,000 ambitious men and women. That is why a LaSalle diploma in Accounting is a credential respected by America's biggest companies. Mail the coupon now for your free sample lesson and the free book "Opportunities in Accounting."

**LA SALLE**  
**EXTENSION UNIVERSITY**  
An Accredited Correspondence Institution  
417 South Dearborn St., Dept. 3-057, Chicago 5, Ill.

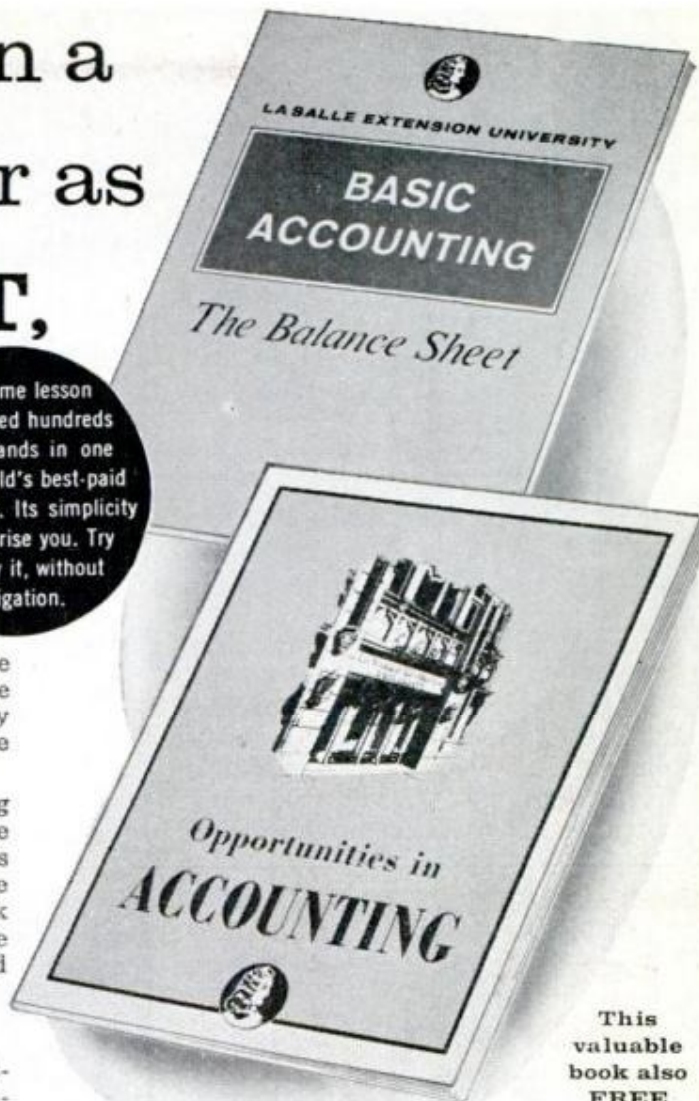

This valuable book also **FREE**

LaSalle students report up to 56% increase in pay the first year



"My income has increased over \$100 a month since I began taking your course. I recommend it highly to anyone."  
—W. G. Hensley, Memphis, Tenn.

"My salary has more than doubled since enrolling with LaSalle and due to my fine training, my salary is still growing."  
—William T. Black, Canoga Park, Calif.

"As a direct result of my LaSalle studies, my salary has increased 400% since I first began my LaSalle success building program."  
—Rudolf Urbatis, Port Chester, N.Y.

**LA SALLE EXTENSION UNIVERSITY**  
An Accredited Correspondence Institution  
417 South Dearborn St., Dept. 3-057, Chicago 5, Ill.

Please send me, free of cost or obligation, your sample lesson and illustrated book "Opportunities in Accounting"

Name.....Age.....

Address.....County.....

City & Zone.....State.....

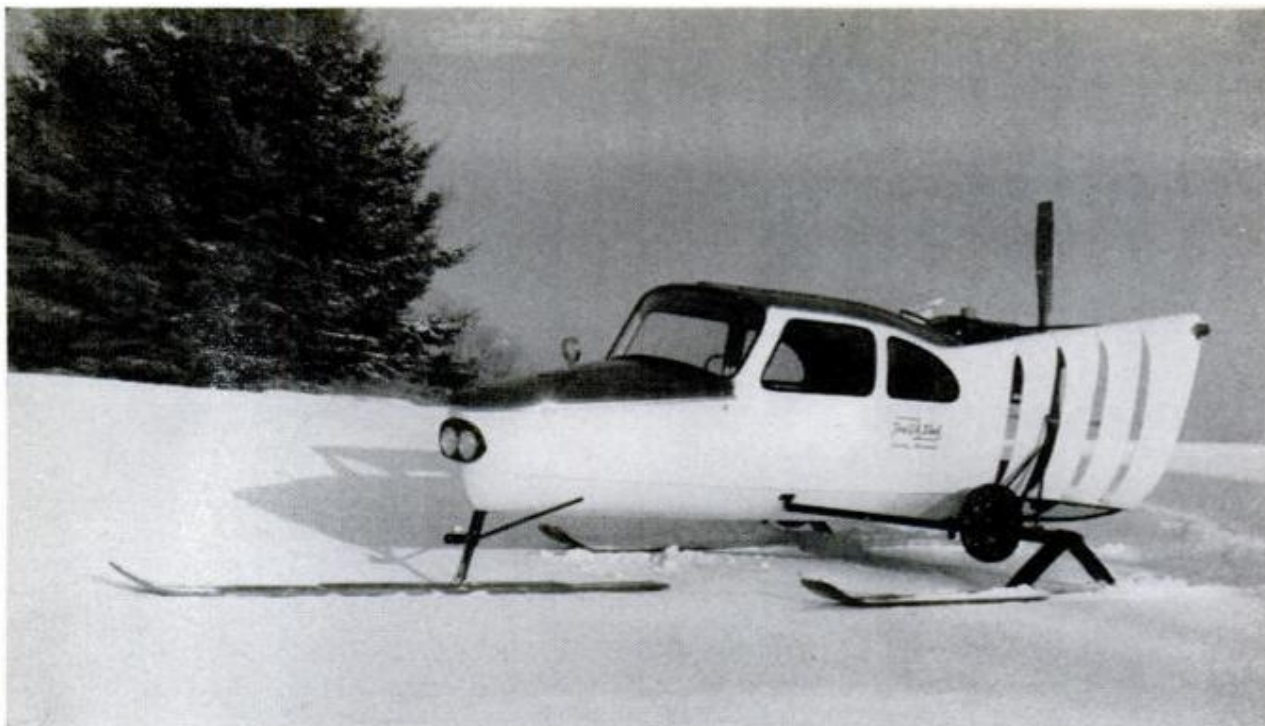

## Power Sled Has Retractable Wheels for Towing

Retractable high-speed trailer wheels that resemble the landing gear of an airplane are a feature of new model propeller-driven snow sled. The craft also has a built-in trailer hitch and removable front ski for

towing over the highway to a suitable area.

The sled, which will travel up to 100 miles an hour, is built by Trail-A-Sled, Inc., Crosby, Minn. Prices range from \$1395 (without engine) to \$2395 (four-place).

# GUMOUT CLEANS CARBURETORS 13 WAYS!

There are at least 13 potential trouble areas in your carburetor—areas where even the tiniest speck of dirt or gum will impair engine economy and performance. You can clean a dirty carburetor quickly, thoroughly and economically with GUMOUT. Just add GUMOUT to your gas tank. It cleans your carburetor while you drive. Get GUMOUT at your favorite service station or auto supply store. You'll get improved engine performance and better gas mileage.

**GUMOUT** DIVISION, PENNSYLVANIA REFINING COMPANY  
CLEVELAND 4, OHIO

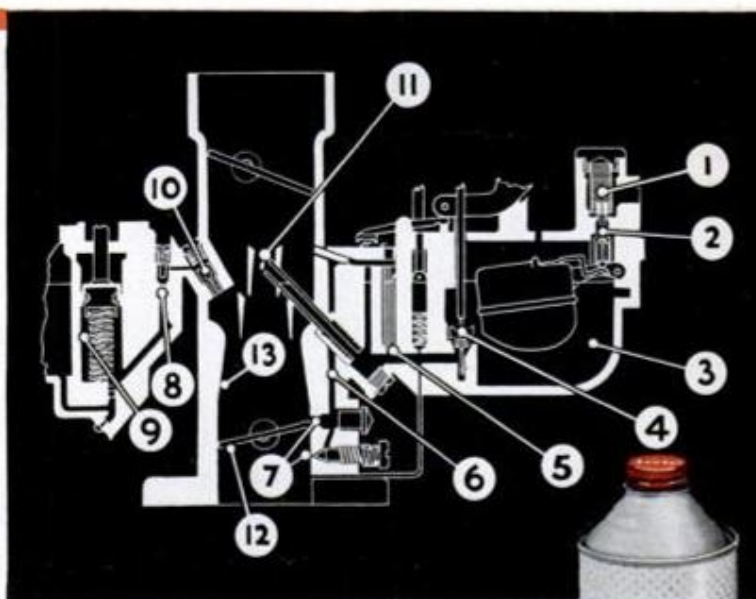

**SPECTACULAR LAND SALE AT ALBUQUERQUE** NEW MEXICO  
**SUNSHINE PARADISE OF THE BOOMING SOUTHWEST**

**NOW! OWN A 1/2-ACRE ESTATE IN THIS  
 \$12,000-AN-ACRE NEIGHBORHOOD  
 FOR ONLY \$795**

RIO RANCHO ESTATES AT ALBUQUERQUE, NEW MEXICO

**LOOK**

what they're getting for land today at sunny Albuquerque!

**COMPARE**

prices of homesite land—up to \$12,000 an acre right to the very doors of RIO RANCHO ESTATES. Prove to yourself that only at RIO RANCHO ESTATES can you obtain choice homesites, right in the path of big-city growth and soaring land values, for a fraction of current market prices!

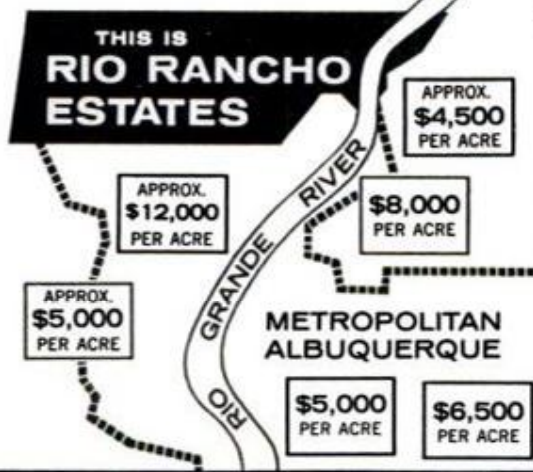

**FOR INVESTMENT!  
 RETIREMENT!  
 YOUR OWN SUBURBAN ESTATE**  
 for only  
**\$10 MONTHLY**

**CHECK THESE MAGNIFICENT FEATURES AT RIO RANCHO ESTATES:**

- A completely planned development! 21 miles of streets and roads already cut through—new houses going up—centrally-piped water supply available to each home in residential area now under construction—power, phone lines on property—community club house, swimming pool facilities now on the way!
- LOCATION:** Directly adjoining metropolitan Albuquerque.
- LAND:** Guaranteed rich, fertile. On gently rolling ground, easy to build on. No mountains, bogs, muckland, barren desert—no flooding.
- CLIMATE:** Albuquerque acclaimed for "best year-round climate in U.S.A."
- STREETS:** All streets give quick access to neighboring Albuquerque; will be maintained by County. State highway 258 and County Road 46 run through property.
- WATER:** Abundant domestic well water available on every site. Piped water available in residential area now under construction.
- RIO GRANDE RIVER:** Three miles of frontage on the romantic Rio Grande River.
- ELECTRIC, PHONES, GAS:** Available to all residential areas at Rio Rancho Estates.
- POLICE, FIRE PROTECTION; FREE SCHOOL BUS AT PROPERTY.**
- TITLE:** Master Title Policy. No cost to you.

**HEALTHIEST SPOT IN U.S.—WHERE THE SUN SHINES 360 DAYS A YEAR**

With 274,000 people now and streaking toward a million, fast-growing Albuquerque, New Mexico, now offers you the opportunity of a lifetime to own choice big-city homesite land for pennies on the dollar—far below current market prices. Learn how you can actually be a big landowner here for only \$10 monthly and get in on the fortune-building potential of big-city land in this booming sunshine resort area, famed for best climate in U.S.

**LET ALBUQUERQUE'S LAND BOOM MAKE MONEY FOR YOU!**

A look at the map above will show you that in most cases you must pay \$4,500 to \$12,000 an acre for remaining land at Albuquerque—indeed pay that much or more for land right up to our very doors. The map clearly shows the last section at Albuquerque where choice homesite land can still be bought at far below current market prices... RIO RANCHO ESTATES, where you pay pennies instead of dollars in comparison with every other choice piece of land in sight. Only \$795 for a half-acre site! You get a big piece of property equal to 10 1/2 standard 20' x 100' city lots at a low, low price that figures out to less than \$74 a lot. Nowhere else in the Southwest can you buy a choice 1/2-acre site so low in price—so close to a major city—and for only \$10 monthly!

**A WONDERFUL NEW WAY OF LIFE**

Picture you and your family living on a rambling, king-size estate of your own, in this friendly Southwestern community where you'll be able to fish, swim, golf to your heart's content—enjoy a lifetime of vacation pleasures

and recreational facilities only minutes away from your door. A sun-drenched beauty-spot where wonders of Nature surround you in all directions—where the sun bathes your body 360 days a year—where winters seem like spring, and summer is so comfortable you never need an air-conditioner.

RIO RANCHO ESTATES slopes along one of the greenest, most fertile valleys in the world, the Valley of the Rio Grande. The gently rolling land is so fertile it awaits only your touch to produce luscious fruits and vegetables—exotic floral gardens ablaze with beauty. And all around you, you'll thrill to "picture window" views of majestic mountains that soar in the distance—the silvery Rio Grande that winds by your door—the gleaming skyline of Albuquerque that lights up at night like a fairyland of color!

RIO RANCHO ESTATES is located directly on the banks of the romantic Rio Grande River, only five minutes from metropolitan Albuquerque, and right next to a \$12,000-an-acre golf course development. Schools, churches, theatres, big-city shopping all just a few minutes downtown from property. Guaranteed ideal land for building, with roads, power, phones, water system already available to those desiring to build homes now or later.

**FREE! LAND INVESTOR'S KIT**

Remember—this is big-city land, with adjacent property already priced at \$4,500 to \$12,000 per acre. Act now! Land prices are starting to skyrocket in this "Sunshine Paradise". Rush coupon for FREE fact book, land maps, photos, details, and comparison prices of land in the Albuquerque area!

**RIO RANCHO ESTATES, Dept. RR-10**  
 A Division of American Realty & Petroleum Corp.  
 1429 Central Avenue, N.W.  
 Albuquerque, New Mexico

Please rush FREE fact book, land maps, photos, and details on the big-city land opportunity you offer at far-below market prices at ALBUQUERQUE, New Mexico.

NAME.....  
 ADDRESS.....  
 CITY.....ZONE.....STATE.....  
 © 1962 Rio Rancho Estates, Inc.

# Over the editor's desk

## Forecaster Krick Replies

I am enclosing verifications our staff prepared for the October forecasts published in *Popular Mechanics*. When forecasts are prepared several years in advance as these were, we must allow some latitude—sometimes as much as 12-18 hours in depicting events of a particular day over a wide area such as North America. We have been able to verify pressure patterns and related weather features over most of the country with acceptable tolerances. An exception is the Oct. 3-4 situation which we regard as the poorest match and considerably below our usual performance level as exemplified in the other charts. . . .

Krick Associates, Inc. IRVING P. KRICK

For the information of latecomers, Mr. Krick's forecasts of certain October 1961 weather periods in the U.S. were sent to PM on June 5, 1961. His charts matching his forecasts against the actual weather—in terms of the percent of U.S. area verified—show 60 percent for the Oct. 3-4 forecast and 80 percent for each of the Oct. 11-14, 18-19 and 20-22 forecasts.

## Finnish SAH-oo-nah

You mention that among forthcoming articles may be one on the Finnish "suana or steam bath." The word is "sauna" and Finns pronounce it "SAH-oo-nah," not "sawna." To Finns the sauna is almost a religion; the sauna may get built before the house does. Finns tend to deny that it is quite a "steam bath." Though water is thrown on the heated rocks while the sauna is going on, apparently the air is so hot that little steam forms.

Greeley, Colo. TOM BURNAM

But there must have been enough steam to fog up our proofreader's glasses, Tom. Incidentally, we didn't promise an article on a sauna—that will depend on how many PM readers ask for it.

## Family Gym

I was pleased and interested to read the article concerning the building of a family gym (Jan. '62 PM). It is heartening to learn that you are as deeply concerned as we are about the vital need for physical fitness. Your success in combining an effort to fulfill this need with an article of such obvious interest to your readers is to be congratulated.

As the Council continues its program, we trust that we will find further opportunity to rely on your support.

The White House BUD WILKINSON  
Washington, D.C. Consultant to the President on Physical Fitness

## Wrong Place, Right Time

When I saw the picture of the near collision of two planes (p. 138, Sept. '61 PM), it brought back instant memories. I was at that air show and took the same picture at a different angle. My photo (top, below) is not as dramatic which probably proves I was in the wrong place at the right time.



The other picture of the girl who was on top of the biplane was taken as the plane taxied to a stop. Her first words were, "anybody have a cold soft drink?"  
Los Angeles, Calif. FRANK H. UNDERWOOD

A proper reply from an already cool chick.

## Where Do They Fit?

I do not understand why you are printing stories like *This Way, Please* or *Football's Fabulous Foremen* (both Nov. '61 PM). Just where do they fit in a publication called POPULAR MECHANICS? I buy the magazine for just what its name implies.  
Bokeelia, Fla. ERNEST J. PERG

We felt that the way Andy Frain engineers the handling of crowds (*This Way, Please*), and the quarterbacking techniques described by Norm Van Brocklin (*Football's Fabulous Foremen*), both involved

(Continued to page 12)

Good News for the Man Who Needs  
a Better Job or Is Ambitious  
for a Business of His Own

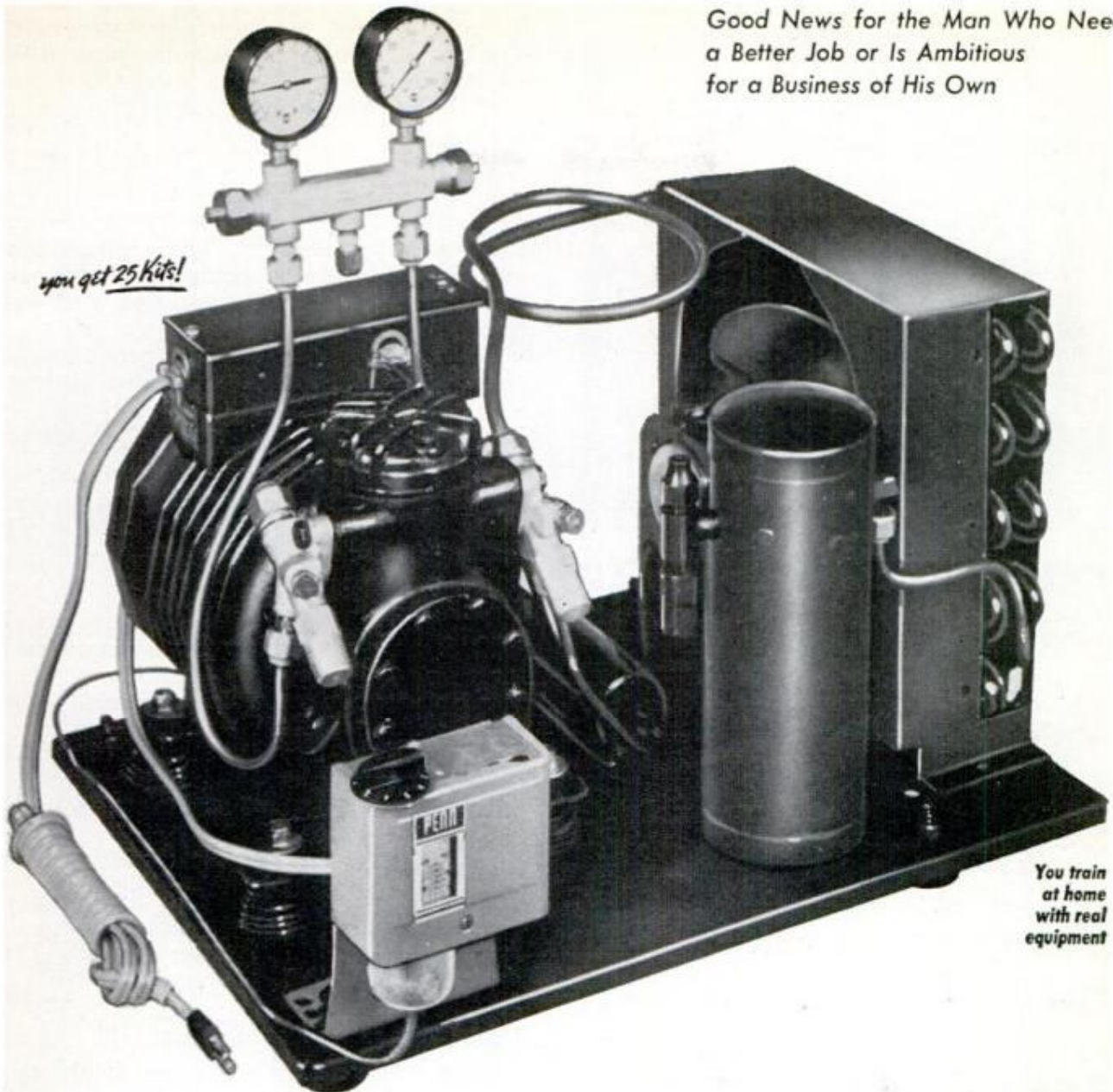

You train  
at home  
with real  
equipment

## Learn REFRIGERATION and AIR CONDITIONING

Thousands of men have found a short-cut to a good job, big money and security—even a business of their own—in the Air Conditioning and Refrigeration field.

This short-cut method is available to you as well. The only investment you make is a few hours of your time each evening and a few dollars of your income each month. And when you're ready for your big-pay job in Air Conditioning and Refrigeration—as a technician or mechanic—you switch over.

You'll find the key to a better future in the condensing unit above. It's the heart of the exclusive CTI Home Training Method. CTI sends you illustrated lessons which supply the knowledge and know-how. However, during your training, CTI also sends you 25 kits of parts and tools to build the condensing unit. With it you work on 20 practical projects. You develop your skill in trouble-shooting, using tools, making repairs and servicing. You learn by practicing!

Many CTI students earn money in spare time as they train. This extra income helps meet tuition payments, buys extra equipment.

Yes, CTI Home training has many parts. We'd like to tell you all about it—and the marvelous opportunities that are waiting. (Did you know that each year the Air Conditioning and Refrigeration industry needs 20,000 more newly-trained men?)

This information is free. You can have it just by filling out and mailing the coupon. Act today! — *Commercial Trades Institute* (a Non-Profit Organization), Chicago 26, Ill.

### COMMERCIAL TRADES INSTITUTE

1400 GREENLEAF AVE. • CHICAGO 26, ILL.

Dept. R-65

Mail me your three free booklets: *Success in Air Conditioning & Refrigeration*; *Proof from Graduates*; and *Lesson Samples*. No obligation.

Name \_\_\_\_\_ Age \_\_\_\_\_

Address \_\_\_\_\_

City \_\_\_\_\_ Zone \_\_\_\_\_ State \_\_\_\_\_



Accredited by National Home Study Council

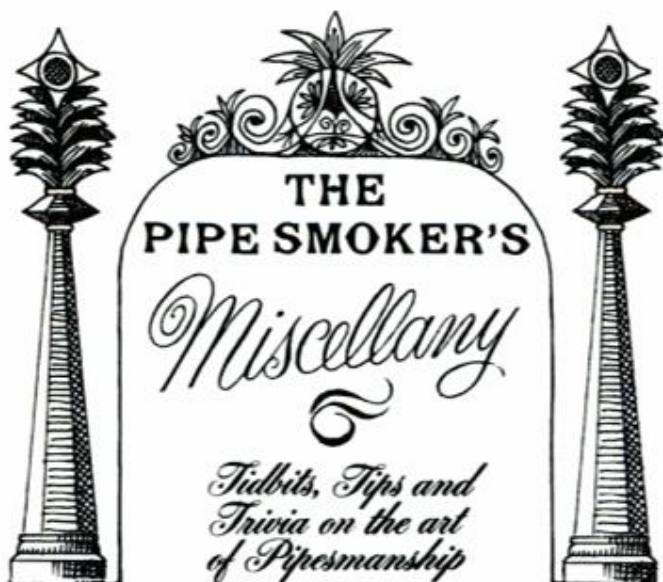

## HOW MANY PIPES DO YOU NEED?



At least two, if only to do justice to the Rule of Pipe Rotation—that is, change pipes at intervals so that continuous smoking doesn't scorch the bowl and shank.

But let's face it, a half dozen pipes is a better and more realistic number. (Of course, the more the merrier!)

How often should you switch pipes? Every 4-6 pipefuls, depending on the heat of the pipe and the taste you're getting.

*Like a good wife, a pipe is a friend and companion for life*

MELVILLE



## THE PIPE TOBACCO THAT STAYS LIT



Bond Street Pipe Tobacco keeps burning because of its old English cut—a combination of flakes for even-burning and cubes for slower-burning. You'll like its aroma of fine imported and domestic tobaccos, too.



some interesting mechanics of today's living. Perhaps other PM readers have ideas on the suitability of such subjects? If so, we'd like to hear your frank expression of them.

## Silk-Screen Fan

Learned a lot from your November article on silk screening. I'm a photo bug anyhow but this working with process films gave me a new education and expanded my photo interest.

Have you published tips on process-type cameras? I have been trying—without luck—to build a small one.

Little Falls, Minn. ROBERT D. POMEROY

We've run tips on using, but not on building, copy cameras. Maybe this is a project other readers would like to have PM work up for a future issue?

## Fun-Table Costs

Your fine December issue contained more interesting articles than I have ever read in any one magazine, especially the two dealing with hobbies: *Table-Top Racing* and *Triple-Top Fun Table*. I would like to know the cost of constructing the three-in-one table and outfitting the pool table.

Annapolis, Md. ROBERT M. ARNOLD

Materials for the fun table, plus playing equipment and HO-gauge track layout, will cost about \$130-\$150, depending on the equipment selected.

## Caution and Invention

Reader Pat Mebus of Ogden, Utah contributes a helpful note of caution concerning a spray painting booth set up in the home. If you're planning to build one, be sure that you equip it with lamps and motors designed to prevent explosion and fire, as outlined in the rigid requirements of the National Electrical Code.

Reader Reinelda Speight, who teaches fifth graders at the Lincoln School in St. Charles, Ill., sends us her youngsters' descriptions of things they would like to see invented. And what are tomorrow's grown-ups dreaming about today? Here are some samples: A desk with built-in drinking fountain or another with an electric book selector; a flying bicycle or a pair of flying shoes; a profit machine for salesmen; an air-kart for kids; and a quiet-room desk enclosure complete with loudspeaker for talking to the teacher.

Wonder what *your* youngsters think of these ideas?

*The Editors*

POPULAR MECHANICS

## NOBODY KNOWS ENTHUSIASTS AS WELL AS CHEVROLET

After all, who introduced the four-speed all-synchro transmission (one of the world's best) in American cars? Chevy. Who started the recent trend to bucket seats? Chevy did. Who built a real honest-to-goodness sports car back when hardly anybody else on this side of the Atlantic even knew what they were? Chevy again. Who pioneered Fuel-Injection for American cars? You guessed it.

Right now, Chevrolet builds a wider variety of models for discerning drivers than anybody, except perhaps a couple of European one-of-a-kind custom builders. Everything from frolicsome two-seaters to full-size family sedans, all available with a fantastic array of equipment designed to suit the more demanding driver.

Imagine a car like the Impala Sport Coupe with such optional-at-extra-cost equipment as bucket seats, four-speed box, 409-cubic-inch engine, Positraction, heavy-duty shocks and springs, and sintered-iron brakes. It'll out-handle and out-run quite a gang of good automobiles, and it'll carry you, your wife, your mother-in-law, two kids, a bird cage and a springer spaniel in the process.

If you're a one-car man with a ten- or twelve-car appetite, try a combination like that—it's not bad, and it'll sure leave a trail of disillusioned sports cars in your wake. Chevrolet Division of General Motors, Detroit 2, Michigan.

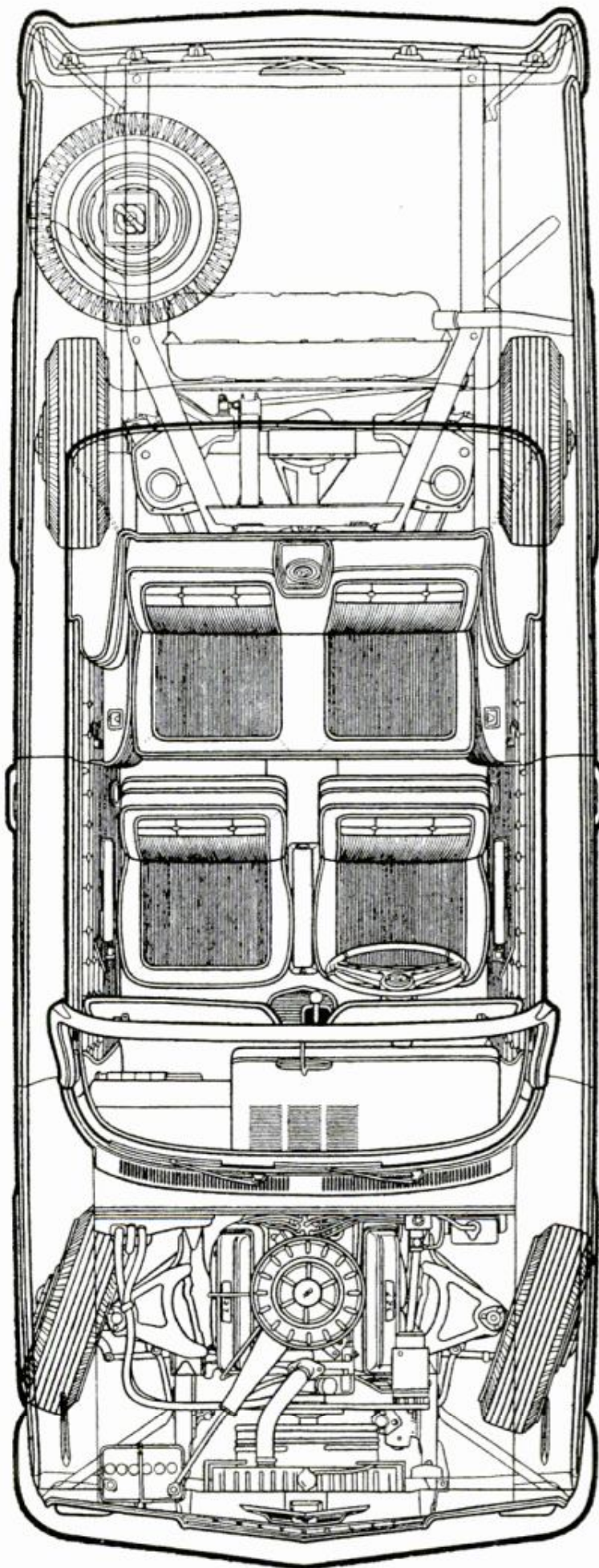

There is an immediate growing need for trained technicians in

- ELECTRONICS
- RADIO-TV SERVICING
- COMMUNICATIONS

For higher pay and a brighter future, investigate training at home in your spare time with NRI—oldest and largest home study school of its kind.



**SPECIAL TRAINING EQUIPMENT INCLUDED**

Except for FCC License training, all NRI courses include—at no extra cost—special training equipment for actual practice at home building circuits, working experiments. Makes theory you learn come to life in interesting, easy-to-grasp manner. NRI catalog we send gives facts about the field of your choice, shows equipment you get and keep. Act now.

**MAIL COUPON NOW FOR FREE CATALOG**

The Amazing Field of Electronics



**NATIONAL RADIO INSTITUTE**  
Washington 16, D.C. 2CA

Please send me free 64 page catalog. (No representative will call. Please print.)

Name ..... Age .....

Address .....

City ..... Zone ... State .....

ACCREDITED MEMBER NATIONAL HOME STUDY COUNCIL

## Sidelights on aviation

Can you "hack it" in the space age? Are you "AOK" and "sitting fat," or are your "eyeballs in"? Is your vocabulary up to date enough to know that "blowoff," "T-time" and "sunseeker" don't refer to loudmouths, crumpets and bikinis?

"Hack it" is the military equivalent of "cutting the mustard." Either you can hack it or you can't.

"AOK," made popular during Comdr. Alan Shepard's suborbital flight, means all systems working perfectly.

"Sitting fat" is about the same as sitting in the "catbird seat"—it means up in orbit and doing fine.

"Eyeballs in" refers to the pressure of G-forces during blastoff.

"Blowoff" is the explosive separation of the payload from the booster rocket.

"T-time" is the blastoff in "10, 9, 8, 7, 6, 5, 4, 3, 2, 1, BLASTOFF! . . ."

And "sunseeker" is not a Miami Beach doll, but a Cape Canaveral gadget that keeps instruments aimed at the sun.

Now, can you hack all that?

**Raising your right hand** is the standard procedure for taking an oath, but how high?

An Air Force sergeant set some sort of a record recently, but it was shattered immediately by a Navy air technician.

The sergeant, assigned to a communications squadron, climbed 1200 feet to the top of the Air Force's tallest transmitting-antenna tower, raised his right hand and was sworn in for another six-year hitch.

The technician climbed into the back of a supersonic McDonnell F-4H Phantom jet, was taken to 38,000 feet, and, while cruising along at 1500 m.p.h., the pilot—his commanding officer—administered the reenlistment oath over the intercom.

An air-car crash boat, capable of 80 m.p.h. over land or water, might be developed by the Navy for rescue service. This new GEM (ground-effect machine) model has been tested "with impressive results," suggesting a prototype 29 feet long, weighing 10,000 pounds and carrying a crew of six. It would be powered by a turbine engine that would drive a fixed-pitch cushion fan and a controllable-pitch propulsion fan.

*Kevin V. Brown*

POPULAR MECHANICS





Here are  
*3 good reasons*

*why I'm glad*

*I became a* **DURACLEAN DEALER**

Raising a family takes a dependable, steady income. Too few jobs offer security and chance for advancement. That's why so many men are going into a business of their own. All around us are local merchants making a good living in respectable businesses where they hold a franchise. The big questions are "What is left to go into?—Which business is profitable?—Which requires only a modest investment?" Many have found the answers in DURACLEAN.

#### **EVERY TOWN NEEDS THIS AMAZING BETTER HOME CLEANING SERVICE**

Duraclean is a scientific method of cleaning carpeting and upholstery in the home. This better process of cleaning by absorption virtually "lifts" the dirt from fabrics, leaves them bright and lively. Almost every home, hotel and many offices are potential customers who will call you again and again.

#### **Check Experience of Other Dealers**

There's no better way to learn of DURACLEAN profit opportunities than by checking with dealers already in business. If there's one near you, call him—or ask DURACLEAN whom to call.

#### **M. LYONS: ILLINOIS**

"Averaged over \$50,000 my first 3 yrs. Headquarters' help makes it possible".

#### **C. RANDALL: OHIO**

"My 2nd year and business keeps growing. Have made as much as \$120 in one day".

#### **E. BAILEY: ARKANSAS**

"I know of no other business which can offer so much".

#### **L. LAWSON: NEW YORK**

"National advertising creates leads. One month, jobs totaled \$1475".

**DURACLEAN COMPANY**

2-163 DURACLEAN BLDG., DEERFIELD, ILLINOIS

#### **DURACLEAN PROVIDES EVERY BUSINESS BUILDING NEED**

DURACLEAN headquarters supplies all equipment and chemicals to put you in business. Regularly held training sessions, cover techniques, methods and means of developing business. Local advertising helps and merchandising ideas are available; and an impressive national advertising program pre-sells customers on the gentle DURACLEAN cleaning process.

Start part time, full time or hire others. **NO SHOP NEEDED.** DURACLEAN service is rendered in the home or customer's place of business. Just 2 average jobs a day can net \$8,750.00 a year.

#### **MORE WAYS TO MAKE MONEY**

5 other DURACLEAN services multiply your profits. DURASHIELD soil retarding service, DURAPROOF mothproofing and DURAGUARD flame retarding are among the other services that mean more money for you. It takes less money to establish this prosperous business. No wonder so many men with vision are becoming DURACLEAN DEALERS. Why don't you? Write today for FREE booklets.

#### **MAIL THIS "FUTURE SECURITY" COUPON**

#### **DURACLEAN COMPANY**

2-163 Duraclean Bldg., Deerfield, Illinois.

Rush me all the facts about DURACLEAN PROCESS and what it takes to become a DURACLEAN DEALER.

NAME \_\_\_\_\_

ADDRESS \_\_\_\_\_

CITY \_\_\_\_\_ STATE \_\_\_\_\_



## Spotlight on the Rolls-Royce

By Jim Whipple

**WHAT'S IT LIKE** to drive a legend? Is Rolls-Royce really "The Best Car in the World" as its modest maker claims? And if so, how much better is it than the best Detroit has to offer? To find out some of the answers we borrowed a standard Silver Cloud four-door sedan from the firm's U. S. distributor, Rolls-Royce, Inc. in New York.

At \$15,655, there's precious little that's "standard" about this basic-model Rolls. It comes equipped with automatic transmission, heating and ventilation systems, power brakes and steering, matched-grain walnut folding picnic tables hinged to the back of the front seats, and a rear window defrosted by hundreds of invisible electric wires, sandwiched between the plies of glass.

The outward appearance of the Silver Cloud, sleek with its 14 coats of preservatives, primers and paint, has an air of stately elegance that makes you think of silver-haired bishops, United States senators and the Queen Mother. So strong is the attitude generated by the car's dignified image that we found ourselves at first driving the car like an elderly chauffeur hauling some haughty dowager to a Park Avenue church.

We were genuinely surprised when we got out into the hilly back country of Connecticut and, summoning our courage, mashed down on the accelerator pedal. Whammo! the world's most elegant motor car moved out right now, for all the world like a full-house Pontiac at the drags.

Frankly shook up, we dug out our stopwatch and tried it again, this time from a

standstill. The traditional 0-60 run was ticked off in just 11.3 seconds. Not bad for a portable London club weighing 4700 pounds.

Motive power for the Rolls' well-bred zoom (no exhaust roar, no tire squeal) is an all-aluminum V8 of 380-cubic-inch displacement.

This relatively understressed engine, with 8-to-1 compression ratio, is of modern, short-stroke design (4.1-in. bore, 3.6-in. stroke). In accord with longtime Rolls-Royce policy, no horsepower rating is given, but interpolating from American cars of this weight and performance potential, we'd be willing to bet that the Rolls V8 would ring up something like 270 on the dynamometer.

Transmission is of Rolls-Royce's own manufacture based on GM's Hydra-Matic patents. (Imitation by Rolls-Royce is indeed sincere flattery.) At any rate their version works very well indeed. The steering column control lever permits you to downshift from 4th to 3rd ratio at part throttle for smooth hill climbing or additional engine braking. With control either in 3rd or 4th, the automatic upshifts to top ratio at about 70 m.p.h. Top speed is comfortably in excess of 100.

The engine is obviously beautifully balanced as there is no vibration at speed. On the test car there was a slight trace of uneven power impulses at idle.

Cruising speeds are pretty much what you make them in the Rolls. With windows buttoned up there's not much audible difference between 50 and 80 m.p.h. At this higher speed we could distinctly hear a fly

(Continued to page 18)

Lighted lamps and burning ambitions. The two go together. And with them in more than 100,000 cases go the famous texts of International Correspondence Schools. The men who receive them are studying to be tomorrow's foremen and supervisors, department heads and office managers. Find out from I.C.S. how you can join them. Simply mark and mail the post card (or coupon). You'll receive a personal Success Kit containing three valuable booklets. All are yours to keep—FREE. They bring full information on how you can become one of tomorrow's leaders. But don't put it off. Mail the coupon now.

### INTERNATIONAL CORRESPONDENCE SCHOOLS

Dean's Office, Box K6419C, Scranton 15, Pa.

(In Hawaii: P.O. Box 418, Honolulu. In Canada: I.C.S. Canadian, Ltd., Montreal)

Please rush me my FREE Success Kit containing 3 valuable booklets.

Name \_\_\_\_\_ Age \_\_\_\_\_

Street \_\_\_\_\_

City \_\_\_\_\_ Zone \_\_\_\_\_ State \_\_\_\_\_

Field of interest \_\_\_\_\_

Employed by \_\_\_\_\_

Working hours \_\_\_\_\_ A.M. to \_\_\_\_\_ P.M.

## ***Tomorrow's leaders are busy tonight***

More than 7,000,000 students have enrolled with I. C. S.

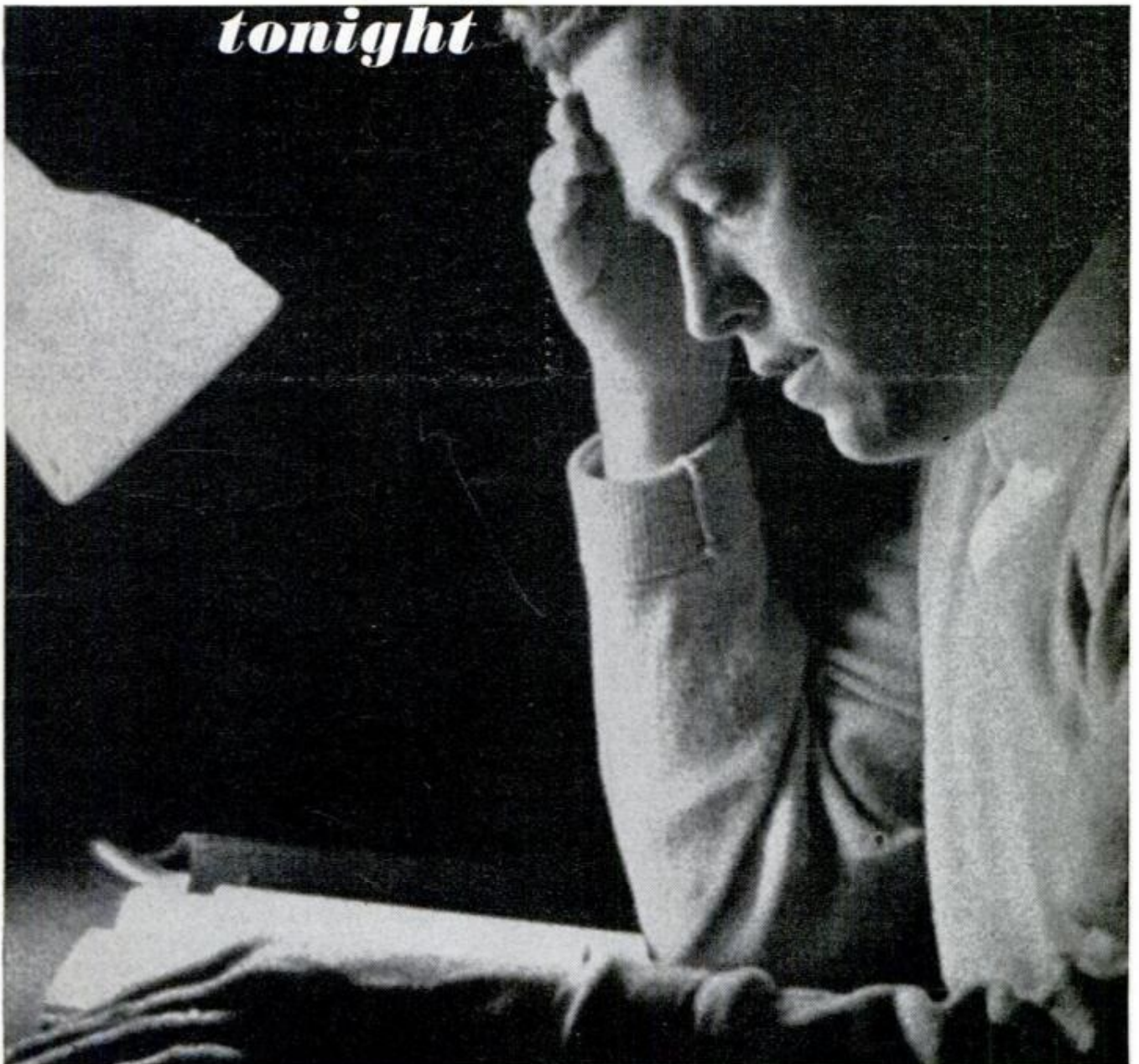

MY SPARE TIME HOBBY MAKES ME  
**\$5<sup>00</sup>** an hour  
**CASH PROFIT**

— Grover Squires

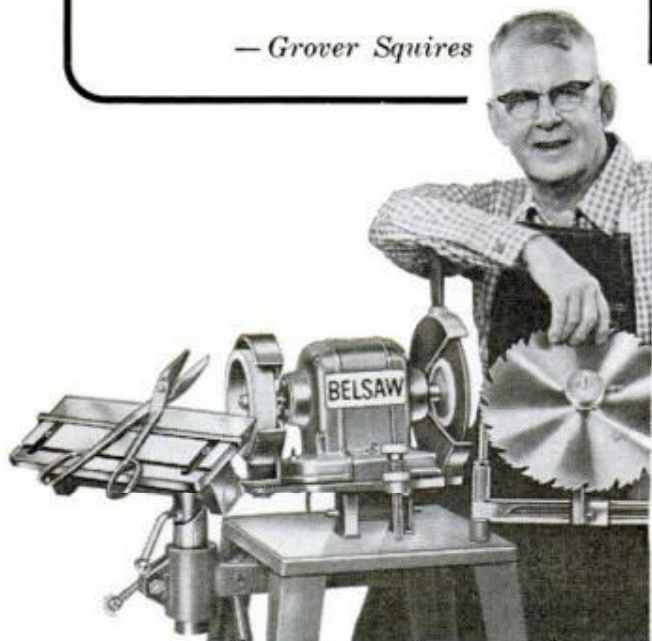

**START YOUR OWN SPARE TIME BUSINESS**



You can turn your spare time into Big Cash Profits with your own **COMPLETE SHARPENING SHOP**... Grind saws, knives, scissors, skates, lawn mower blades...all cutting edges. Your Own Cash Business with no inventory...right at home...no experience needed.

**FREE BOOK** tells how you can start your own spare time business while you are still working at your regular job. Low Cost—time payments only \$15.00 a month. **Send coupon today.**



**BELSAW SHARP-ALL CO**  
 712C Field Bldg.,  
 Kansas City 11, Mo.

Send Free Book "LIFETIME SECURITY". No obligation.

Name \_\_\_\_\_

Address \_\_\_\_\_

City \_\_\_\_\_ State \_\_\_\_\_

(Continued from page 16)



**ASH TRAY** is combined with the sliding walnut picnic table beneath panel with its full set of instruments

buzzing in the back seat. When urged, the engine gives out with a deep power hum many decibels below the vulgar va-va-voom of a big-bore Detroit flat out.

But, even more impressive than the Rolls' vitamin-packed power curve, is the car's handling, roadability and ride.

Once again the car's appearance is misleading. Nine or ten inches higher than the average '62 U. S. product (it's 64 inches high) 212 inches long, with a 123-inch wheelbase, thus you might think that the Rolls would be clumsy or sluggish in response. Nothing could be further from the fact. We took the car over a one-and-a-half-lane, high-crowned lumpy, country road at 55 m.p.h. around curves that make the best U. S. cars heel over and yaw wildly.

The big Rolls took it light and tight—it might have been a Corvair Monza holding the line through the meanest of S bends. At one point we topped a sharp rise, were almost airborne, then came down hard enough to have pounded the rubber bumpers off many cars. But the Rolls never bottomed, thanks in part to its dual-range shock absorbers that can be set for firmer control at the flick of a steering column switch.

This feature gives you the "soft" control to permit the springs (long leaf semielliptic at rear, coils up front) to do a superb job of cushioning rough surfaces. When set on "H," though, the suspension hardens up when you need maximum stability.

At no time during our ride was there a squeak or creak from the body which sits isolated from the frame on 13 rubber insulators, the only metal-to-metal contact

(Continued to page 24)

# NOW... RCA OFFERS A COMPLETE SELECTION OF HOME TRAINING COURSES IN ELECTRONICS



## ELECTRONIC FUNDAMENTALS

40 theory lessons! 40 experiment lessons! 40 service practice lessons! Course includes 15 kits to build a Multimeter, AM Receiver and Signal Generator!

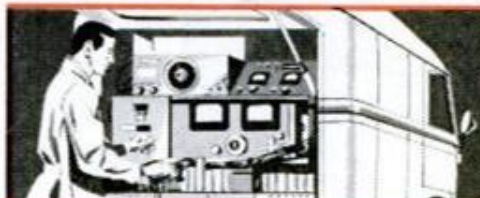

## COMMUNICATIONS ELECTRONICS

9 study groups! 18 lessons! Covers oscillators, power amplifiers, AM, FM, SSB, Mobile Radio—prepares you for an FCC license!



## COMPUTER PROGRAMMING

5 study groups totaling 11 complete lessons, in principles and techniques of programming business computers! High School graduation and 1 year business experience required.

2  
new  
courses  
now  
available

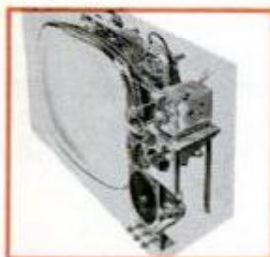

## TELEVISION SERVICING

10 study groups totaling 27 lessons plus 6 complete kits for construction of a modern television receiver!

## COLOR TELEVISION

4 study groups totaling 11 complete lessons! Includes the theory, installation, and servicing of modern color television receivers!



## AUTOMATION ELECTRONICS

5 study units of 4 lessons each! Covers electronic devices used in industry to achieve automatic control of production systems and processes!



## TRANSISTORS

5 study groups totaling 10 complete lessons! Fundamentals, operation, and construction of modern transistor and circuit devices!

With RCA Institutes Home Study training, you set your own pace in keeping with your ability, finances and time. All equipment and components provided are brand new and of prime quality . . . and you never have to take apart one piece to build another. Practical work begins with the very first lesson!

Most important to you, RCA offers a liberal Voluntary Tui-

tion Plan—the most economical home study method available because you pay only for lessons as you order them . . . one study group at a time! If you drop out at any time, for any reason, you do not owe RCA one penny! No other obligations! No monthly installment payments! Licensed by the New York State Education Department. Approved for Veterans.

If you prefer, you may build your electronics career at one of RCA Institutes' Resident Schools in Los Angeles or New York City. Day and evening classes start four times each year. Resident School Catalog sent free on request.

**SEND FOR THIS FREE HOME  
STUDY CATALOG TODAY!**

**RCA INSTITUTES, INC.,**  
A Service of Radio Corporation of America  
350 W. 4th St., N. Y. 14, N. Y.  
610 S. Main St., Los Angeles 14, Calif.



**RCA INSTITUTES, INC.,** Home Study School, Dept. P-M-32

A Service of Radio Corporation of America  
350 West Fourth Street, New York 14, N. Y.

Without obligation, rush me the FREE 64-page illustrated booklet "Your Career in Electronics" describing your electronic home study training program. No salesman will call.

Name..... Age.....

Address.....

City..... Zone..... State.....

**CANADIANS**—Take advantage of these same RCA courses at no additional cost. No postage, no customs, no delay. Send coupon to: RCA Victor Company, Ltd., 5581 Royalmount Ave., Montreal 9, Quebec.



The Most Trusted Name in Electronics

# FREE!

## TRIAL LESSON



# Trial lesson in DRAFTING



### LEARN AT HOME IN SPARE TIME

Check the want ads in any newspaper — SEE the big-pay opportunities open to you as a draftsman. What's more, you can learn this well-paid, prestige profession at home — quickly, easily! No special talent needed! Get complete, step-by-step Chicago Tech lessons in the mail, spend a few pleasant hours studying each week. In a short time you'll be a well-trained draftsman, ready to take your pick of many good jobs. Act now!

### FREE INFORMATION—MAIL COUPON TODAY!

Get FREE TRIAL LESSON plus information about C.T.C. practical training. Learn what successful Chicago Tech graduates say about high pay and opportunities in drafting. No charge, or obligation.

Accredited National Home Study Council

## CHICAGO TECHNICAL COLLEGE

C-200 Tech. Bldg., 2000 So. Michigan Ave.  
Chicago 16, Illinois

Mail me FREE Lesson with information about big opportunities in DRAFTING.

Name..... Age.....  
Address.....  
City..... Zone..... State.....

## BE A BRIKCRETE MANUFACTURER

B-28

Truly — No Clay

### More Local Plants Needed

As a local manufacturing opportunity, Brikcrete has much to offer. Local markets are supplied by local plants using local materials and labor. Savings in freight and distribution enable low selling prices, high income potentials. Plants operate in franchise-protected territories with exclusive privileges. For men of modest capital, machinery is available on long-term payment.

Because Brikcrete gives so much more for so little it is the preferred masonry for homes, schools, motels practically every kind of residential, commercial, and industrial construction.

A lower-than-lumber selling price still permits 100% or more mark-up on basic production costs. And Brikcrete has quality appeal because it is outstanding in design, proportion and color. That is why market possibilities are so broad. Write or wire for Brikcrete Book No. 2.

**Brikcrete Associates, Inc.**  
402 W. 25th, Holland, Mich.

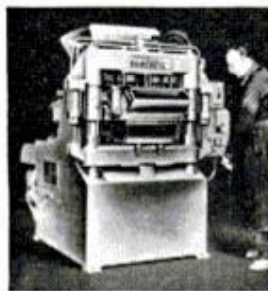

# \$7,108<sup>50</sup> NEW!

## FIRST YEAR Cleaning-Repairing RADIATORS."



—Hank Konter, Newcastle, Wyo.

Make \$6,000-\$9,000 a year servicing auto-truck-tractor radiators with Inland's new 1-Piece Radiator Shop. Easy to do entire job — TEST, CLEAN and REPAIR radiators. Only 11' 7" long. Inland, world's largest radiator equipment manufacturer, trains you free. Small down payment starts you. Easy-pay plan lets you pay from profits. Proved merchandising assures volume. Profitable department for garage or service station. Many set up Radiator Shop in garage at home, make good money working evenings. Write.

INLAND MFG. CO., Dept. PM-3, 1108 Jackson St., Omaha 2, Nebr.

## ADDING MACHINE

\$198 ea. or 2 for \$369

+ — × ÷  
ADD — SUBTR. — MULT. — DIVIDE

Does all 4 operations. Handles 9 columns of numbers. Settle for no less. Leatherette case. Lowest price adder made in America. Beware of cheapened foreign imitations. Money back guarantee. Agents wanted. \$1.98 add 4% tax in Pa.

**TOM THUMB** P. O. BOX 276 BETHAYRES, PENNA. DEPT. M-12



## GET INTO ELECTRONICS

V.T.I. training leads to success as technicians, field engineers, specialists in communications, guided missiles, computers, radar, automation, basic and advanced courses. Electronic Engineering Technology an ECPD accredited Technical Institute curriculum. Assoc. degree in 20 mos. B.S. obtainable. G.I. approved. Start Sept., Feb. Dorms, campus. H.S. graduate or equivalent. Catalog.

**VALPARAISO TECHNICAL INSTITUTE**  
DEPT. D VALPARAISO, INDIANA

## 6-IN-1 ONLY MACHINE OF ITS KIND!

**UNIMAT**  
Compact workshop for all metal, plastic, wood. Precision lathe, milling machine, drill press, surface grinder, polishing/grinding machine, portable drill. Complete basic unit, \$129.50. WRITE FOR FREE CATALOG.

**AMERICAN EDELSTAAL, INC., DEPT. GC 350 BROADWAY, N.Y. 13, N.Y.**

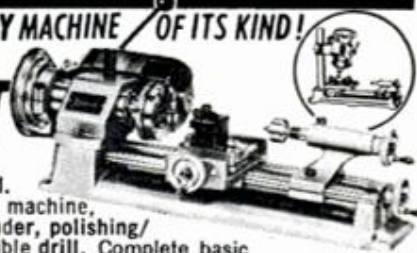

## New Table Top Invention Puts You In... PROFITABLE RUBBER STAMP BUSINESS

Home Operators now make \$9.20 AN HOUR in Business once monopolized by a few big companies

Special rubber stamps bring high prices—cost only pennies to make on new, low-cost table top machine. Take 27 cents worth of material, make perfect stamps, the kind businesses and offices now buy by the dozen at \$1.80 each. Make up to \$9.20 an hour. Start in spare time in your own home. Run machine on kitchen table using ordinary electrical outlet. Make any kind of stamp. We'll send you free information without obligation about this established, highly profitable business. We'll even help finance your start. For free information send name and address today on a postcard to: Rubber Stamp Div., 1512 Jarvis Ave., Dept. R-2-C, Chicago 26



# Don't wish you were a **WATCH REPAIRMAN...**

## **Be one NOW!**

Opportunities for full or part time earnings are the best in years

*Make rapid progress the Sweazey Way*



## **CHICAGO SCHOOL OF WATCHMAKING** *will train you at home in your spare time*

Get set now for lifetime security or a business of your own. Have a second trade for emergencies or after retirement. Watch repairing is light, clean, fascinating. It frees you from the dull drudgery of tiresome or back breaking work. It offers excellent opportunities now for full or part time earnings.

### **Complete professional instruction for only \$5 a month**

No need to leave home or job. Learn in spare time. Chicago School of Watchmaking's exclusive Sweazey System shows you step by step how to repair all types of Swiss and American watches. It's practical, shop method training. You work with watches from your very first lesson. You need no previous experience. Age is no barrier. Diploma awarded. Send today for free sample lesson and complete information. No obligation, of course. No salesman will call.

**CSW has been training men and women for this trade since 1908**

Why not be one of our successful graduates? Learn how Chicago School's streamlined home training can speed *your* success.

**CHICAGO SCHOOL OF WATCHMAKING**  
Founded 1908  
2330 MILWAUKEE AVE., CHICAGO 47, ILL.

### **SPECIAL TOOLS PROVIDED**



This set of tools is offered in your course at no extra tuition cost. They enable you to start repairing right away.

## **FREE SAMPLE LESSON**

**CHICAGO SCHOOL OF WATCHMAKING**  
2330 N. Milwaukee Avenue, Dept. 132, Chicago 47, Illinois

Please rush **FREE SAMPLE LESSON** and full information to tell me how I can learn watch repairing at home.

NAME \_\_\_\_\_ AGE \_\_\_\_\_

Address \_\_\_\_\_

City \_\_\_\_\_ Zone \_\_\_\_\_ State \_\_\_\_\_

**MAIL COUPON TODAY!**

# AUDELS GUIDES

No. 1	AUTOMOBILE MECHANICS GUIDE. 1132 Pages	\$ 6.00
No. 2	HOME APPLIANCE SERVICE GUIDE. 864 Pages	6.00
No. 3	TV & RADIO SERVICE LIBRARY. 2 Book Set	8.00
No. 4	HANDY BOOK OF ELECTRICITY. 1052 Pages	5.00
No. 6	PLUMBERS & STEAMFITTERS GUIDES. 4 Book Set	9.00
No. 8	CARPENTERS & BUILDERS GUIDES. 4 Book Set	9.00
No. 9	DIESEL ENGINE MANUAL. 640 Pages	3.00
No. 10	WELDERS GUIDE. 608 Pages	3.00
No. 11	MATHEMATICS MADE EASY. 672 Pages	3.00
No. 12	MACHINISTS & TOOLMAKERS HANDBOOK. 1250 Pgs.	6.00
No. 13	WIRING DIAGRAMS. 304 Pages	2.50
No. 14	REFRIGERATION & AIR CONDITIONING. 1360 Pages	6.00
No. 15	ELECTRIC LIBRARY. 10 Volume Set	22.50
No. 25	BLUE PRINT READING. 448 Pages	3.00
No. 26	MASONS & BUILDERS GUIDES. 4 Book Set	8.00
No. 27	ELECTRIC MOTOR GUIDE. 1056 Pages	5.00
No. 28	OIL BURNER GUIDE. 416 Pages	2.50
No. 29	SHEET METAL PATTERN LAYOUTS. 1152 Pages	7.50
No. 30	SHEET METAL WORKERS HANDY BOOK. 448 Pages	2.50
No. 43	DO-IT-YOURSELF ENCYCLOPEDIA. 2 Book Set	8.95
No. 44	NEW MECHANICAL DICTIONARY. 712 Pages	6.95

## 7-DAY FREE EXAMINATION

SEND NO MONEY—Pay the postman nothing! We'll send you any of the Audel Guides for FREE examination in your home. If you decide to keep the books you may pay for them under our easy-pay plan of only \$2 a month.

## HERE IS ALL YOU DO

IT'S EASY TO ORDER: In the No-Risk Mail Order Coupon below you need only draw a circle around the number of Audel Guides you want. We will send them to you at once. If you are not completely satisfied, return the books to us.

## MAIL THIS COUPON TODAY!

THEO. AUDEL & CO. — Self Improvement Publishers Since 1879  
49 W. 23rd Street, New York 10, N.Y.

Please mail me for 7 days' FREE EXAMINATION the books I have circled. I agree to mail \$2 in 7 days on each book or set ordered, and to further mail \$2 a month on each book or set ordered until I have paid the purchase price, plus shipping costs. If I am not completely satisfied with my Audel Guides I may return them.

NAME \_\_\_\_\_

ADDRESS \_\_\_\_\_

EMPLOYED BY \_\_\_\_\_

1 2 3 4 6 8 9 10 11 12  Check Here for Free  
13 14 15 25 26 27 28 29 30 43 44 Complete Catalog

SAVE SHIPPING COSTS! Check here if you enclose complete payment with order. We pay postage charges. You have same return privilege.

# 95% PROFITS YEAR 'ROUND

Be your own boss. Operate a **SIMPLEX** lawn-mower sharpening service in your community. One compact machine grinds all mowers, sharpens cutlery. Low investment, 95% profit. Pays for itself in average month.



## SIMPLEX—4 Machines in One!

- **Reel Grinder**—sharpens any mower reel in or out of mower.
- **Rotary Blade Grinder**—hollow grinds any rotary mower blade.
- **Bed Knife Grinder**—grinds with either round wheel or cup wheel.
- **Cutlery Knife Grinder**—sharpens cutlery, tools, scissors.

Send for free, money-making details!

The Fate-Roof-Heath Company, Dept. PM-3, Plymouth, Ohio

# ENGINEERING

Higher income . . . advancement. Major corporations visit us regularly to interview and employ seniors. **B.S. DEGREE IN 27 MONTHS** in Engineering. **IN 36 MONTHS** in Business Administration. Small classes. *Low costs.* Enter quarterly. Write **J. E. McCarthy** for *Catalog and Career Book.*

# TRI-STATE COLLEGE

432A College Avenue • Angola, Indiana



## HANDSET \$2.95 OR 2 FOR \$5.00!

Genuine Western Electric handset with cord, removed from a telephone unit. For talking circuit from two or more points. An excellent item for experimental use. Postpaid. Write for complete list.

## TELEPHONE ENGINEERING CO.

Simpson,

Dept. 382

Penna.



## ROCKETS, OLYMPICS U.N. STAMPS—only 10c

Giant Stamp Collection including: Moonrocket sets. Satellites. Atomic Ship. Boy Scout issue. Cpl. UN Set. Recent Olympics and Sports issues from Togo, Mongolia, Paraguay, Germany, Romania, etc. Plus Big Stamp Dictionary and approvals. Everything 10c!

STAMPEX, Box 47-CM, White Plains, New York



## BIG EARNINGS WAITING

Learn to **REPAIR, REBUILD, RESELL** TYPEWRITERS, All makes—At home

Get industry-proved training in spare time! Earn while you learn with real typewriter, sub-assemblies, professional tools, illus. lessons. **FREE BOOK** shows money-making opportunities. Write **TODAY** to Typewriter Repair School, Div. Tech. Home Study Schools, Dept. C-12, 150 Park Ave., E. Rutherford, N. J. (Lic'd N. J. Dept. of Educ.)

## Secrets of VENTRILOQUISM Now Revealed!



Easy to learn in 60 to 90 days with our Home Study Course. **RESULTS GUARANTEED** Make Money! Be Popular! Have Fun! Big Opportunity! Radio, Television, Stage Appearances! For **FREE** information regarding price and terms **WRITE**. You must state your age. Dummy Catalog 25c.

**MAHER HOME COURSE OF VENTRILOQUISM**  
Box 36, Studio PM-3, Kensington Station  
Detroit 24, Michigan

## NEW Improved Accurate Scope-Shot

Price Complete with 50 **DISINTEGRATING PELLETS** They crack like a rifle when they hit—leave mark—puff of smoke! **\$1.95 P.P.**

World's Finest Precision **SLINGSHOT** Scope-type sight! **Price without pellets \$1.50 P.P.**

Big Bag of **250 EXTRA Pellets** 98c P.P.

Pure gum rubber slings. Beautifully polished cast aluminum stock. Pistol grip. So powerful it kills small game. Fits pocket perfectly! Guaranteed. **FREE** shooting manual.

Order NOW from: **GENERAL SPORTS**  
4184-MC Apple Street, Cincinnati 23, Ohio



NOT A 1/4" ... BUT A BIG  
NATIONALLY FAMOUS

**3/8" Thor**  
POWER DRILL

# 12 POWER TOOLS-IN-1 ... 1,001 USES! ELECTRIC WORKSHOP

A THOR POWERED WORKSHOP MEANS MORE POWER!

Precision made for accurate drilling ...  
Power-Packed for Rugged Sawing,  
Sanding, Polishing, Grinding, Etc.  
A Great "Big Value"

EVERYTHING FOR JUST  
ONE LOW PRICE!

**\$1 DOWN**  
\$1 A WEEK

DURING SALE ONLY **\$39.95** COMPLETE

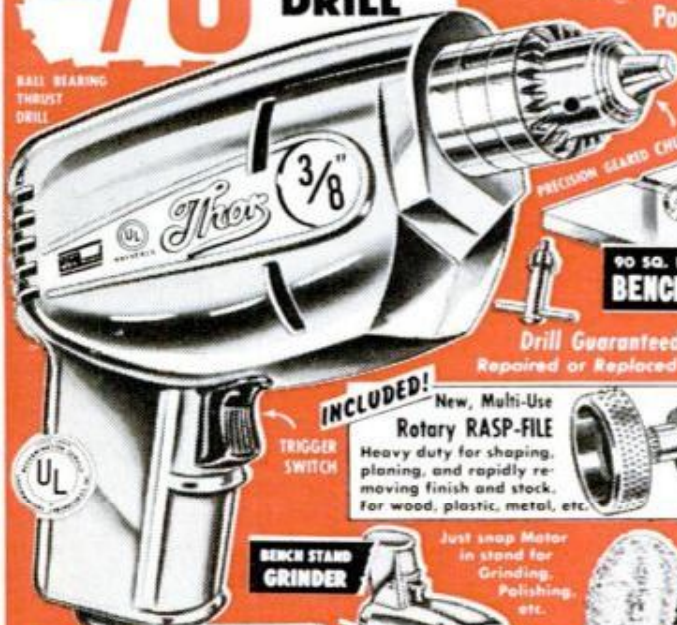

**90 SQ. INCH TOP  
BENCH SAW**

**IT'S BIGGER...  
AND BETTER!**

More uses than a 1/4" Drill!  
Drills up to 3/8" in Steel!

**INCLUDED!** New, Multi-Use  
**Rotary RASP-FILE**  
Heavy duty for shaping,  
planing, and rapidly re-  
moving finish and stock,  
for wood, plastic, metal, etc.

**BENCH STAND  
GRINDER**

Just snap Motor  
in stand for  
Grinding,  
Polishing,  
etc.

**POWERFUL  
POLISHER**

No more aches &  
pains when you use  
a power polisher on  
car, furniture, etc.



**PORTABLE  
POWER SAW**

**SAW TILTS  
FOR ANGLE CUTS  
FROM 0 to 45°**

DEPTH CUT  
ADJUSTMENT  
CROSSCUT AND  
RIP BLADE

**3-WIRE CORD  
& ADAPTER**  
Meets All  
Safety  
Standards!

**LEVER ACTION  
DRILL PRESS**

FOR  
PRECISE  
ACCURATE  
DRILLING,  
ROUTING,  
GRINDING,  
Etc.

**INCLUDED!**  
7-Pc. SET  
Speed Chrome  
Vanadium  
TWIST DRILLS

**YOU GET COMPLETE WORKSHOP ALL FOR 1 AMAZINGLY LOW PRICE!**  
• 3/8" THOR DRILL with Geared Chuck & Access • Drill  
Press & Stand • Rotary Rasp-File • Portable Saw Attachment  
• Saw Table & Mitre Gauge • Screw Driver Attachment  
• 7 Speed Twist Drills • Oscillating Sander • Handy  
Saw Stand • Polish Bonnet, Grind Stone, Paint Mixer

**SANDS SMOOTH!  
LEAVES NO SCRATCHES!**  
Same action as  
in \$40 Sanders!

**INCLUDED! 3-Pc. POWER SCREW DRIVING ATTACHMENT**



**FRICTION CLUTCH  
ACTION!**

Saves time and takes  
hard work out of driv-  
ing screws.

CLUTCH  
SLOWS  
MOTOR SPEED!

BALL BEARING  
ACTION FOR  
YEARS OF  
USE!

**STRAIGHT LINE ACTION  
OSCILLATING  
SANDER**

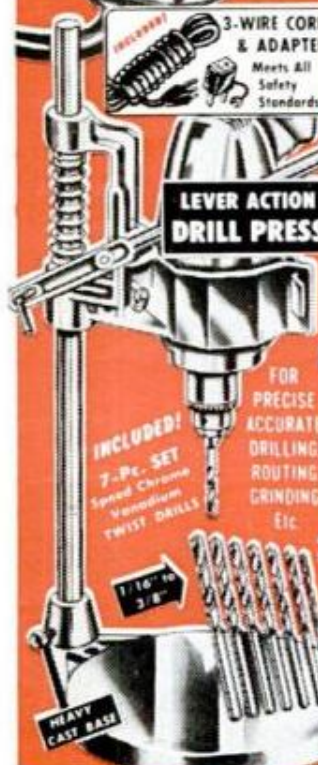

**Klein's  
Sporting Goods**

KLEIN'S—Dept. 81  
227 W. Washington St.  
Chicago 6, Illinois

**YOURS FOR 30 DAYS FREE TRIAL  
MONEY BACK GUARANTEE—CASH OR CREDIT!  
DON'T WAIT! ORDER BY MAIL TODAY!**

I enclose \$1.00 Down Payment. Without obligation, please send me for 30 days FREE TRIAL the complete "Thor" 3/8" Drill—"12 in 1" Workshop with all accessories and attachments. If I'm not 100% satisfied, I'll return the set—and you'll immediately refund my \$1.00. Otherwise, I'll send you only \$1.00 each week (billed monthly) until the low price of only \$39.95, plus a small charge for shipping and credit, is paid.

Credit Order (Enclose Credit Information Requested at Right) →  
 Cash Order  C.O.D. (10% deposit)

NAME .....  
ADDRESS .....  
CITY ..... STATE .....

**CREDIT CUSTOMERS:** To speed your order, send name & address of your employer and name and address of 2 or more companies with whom you have (or have had) credit accounts. Also your age, occupation, no. of dependents, date present job began, and your weekly salary. **THIS INFORMATION IS REQUIRED ONLY ON YOUR FIRST CREDIT ORDER.**  
**SAVE MORE!** Send your check for \$39.95 and we pay shipping and handling charges. Same FREE TRIAL privilege with full refund guaranteed.

Start with a few \$... Build to thousands!



**NEW!**  
**30-SECOND**  
**TIRE REPAIR**  
 Simple Demonstration Makes  
 You \$6.00 on every Kit—  
 Repeat Sales Follow

Your 30-second demonstration sells this remarkable new PUN-SUR-PAK tire repair. You don't have to be a salesman! Just demonstrate it to service stations, garages, car dealers, taxicab, truck and bus companies—you'll get the order, sometimes before you ask for it. Push, pull and a quick slice—PUN-SUR-PAK makes a completely safe tubeless tire repair that lasts for the life of the tire. One tire, punctured 107 times was repaired, and run 33,052 miles. Then it was recapped, and, at last report, was still going after 9,665 miles! Get full details, without obligation. Send coupon today!



**RUSH COUPON FOR DETAILS**

C. J. BELLOWS, Sales Mgr., Dept. PM-362  
 BOWES "SEAL FAST" CORPORATION  
 5902 E. 34th St., Indianapolis 18, Ind.

Yes, I'm interested in the profits I can make with PUN-SUR-PAK repair kits. Please rush complete details.

Name \_\_\_\_\_

Address \_\_\_\_\_

City \_\_\_\_\_ Zone \_\_\_\_\_ State \_\_\_\_\_



...is the **GATOR** WAY!

Transporting your boat the safe way is one thing to consider, and **LOADING AND LAUNCHING** is the major thing to consider. We've got both of them licked with our patented Gator Auto-Launch feature. Words can't describe this terrific development . . . you'll have to see for yourself!

Make a date with your Gator-Champ Dealer today—let him demonstrate Gator's Auto-Launch ease—one of many reasons why . . . "Sooner or Later, You'll Go Gator!"

FOR INFORMATION, WRITE DEPT. PM-62-3A

**PETERSON BROS., Inc.**

1925 East Beaver Street, Box 51, Station G, Jacksonville 6, Florida

(Continued from page 18)

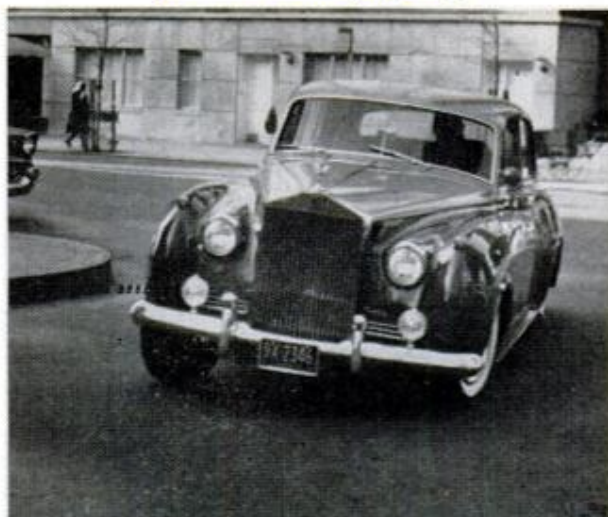

**DIGNITY ON THE MOVE**, the tall, 4700-lb. Silver Cloud handles easily and has good roadability

between body and frame being the speedometer cable.

For those who accept power steering grudgingly as a necessity on a heavy car, the Rolls' assisted wheel is a revelation. Itself a joy with three sturdy spokes of black plastic, the wheel never feels dead, gives just the power aid you need but never overdoes it. It's as nice and precise a setup as we've ever tried.

The brakes are worth a mention, too. They have a dual master cylinder setup, plus backstopping mechanical linkage to rear wheels and the world's greatest power booster. When you press down on the pedal a clutch-like device engages a disk on the drive shaft and transmits torque to the master cylinder via a mechanical linkage. Thus, the faster you're rolling the more pressure you can harness to the generous 240 square inches of lining.

The Rolls' quality is as flawless as any manufactured product we've seen, the result of infinite care that even insists upon matching the cowhides (top grain of course) for evenness of texture of the soft leather upholstery.

Because of its perfection we looked all the harder for faults and found just one. When the individually contoured front seats are moved fully rearward, their raw, metal tracks are exposed on the front floor. These could possibly snag milady's evening gown. And, oh yes, she's a bit thirsty. We logged 11.6 miles per gallon.

To sum it up, Rolls-Royce is a near-perfect motor car, restful, elegant unobtrusive, yet agile and powerful. It is obviously sturdy as a rock, nimble as the best touring sports car and downright fun to drive.

In fact, we can think of no nicer way to spend \$16,000. ★ ★ ★



# Earn **HIGH WAGES** as a **HEAVY EQUIPMENT OPERATOR**

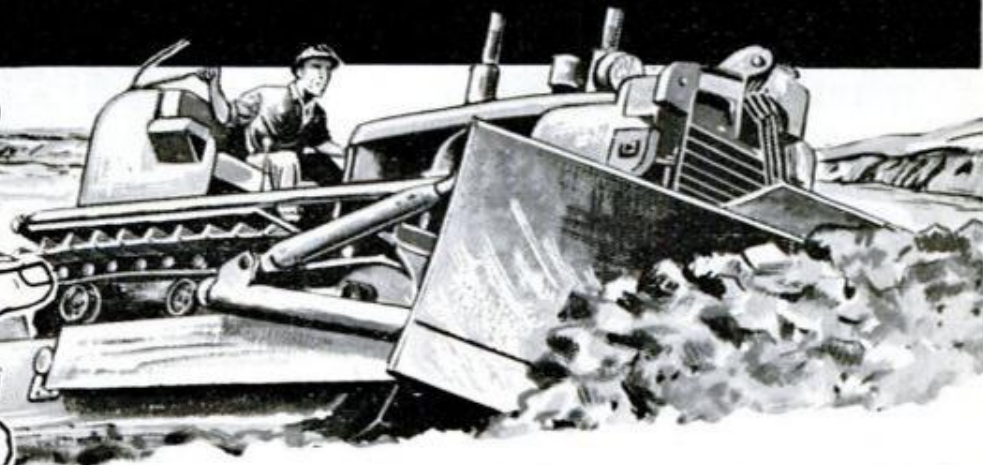

**FIELD-TRAIN  
AT NATIONAL ON  
DIESEL-ENGINE MACHINES**

Learn Operation,  
Maintenance and  
Safety

## **RUGGED OUTDOOR MEN**

up to 56 years old can qualify!

**NO PREVIOUS  
EXPERIENCE NECESSARY**  
No Special Education Needed

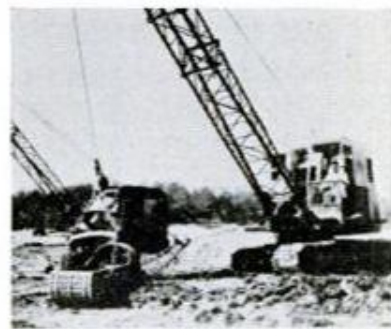

High wages and security NOW and in the years to come are yours as a trained heavy equipment operator. Your chance is TODAY... your opportunity is HERE, if YOU will but take advantage of it! The world's fast-growing multi-billion dollar construction industry needs men NOW for work in this country and overseas — you can be one of them!

As a heavy equipment operator you will "move the earth" on aerospace projects, highway building, and industrial construction. Learn HOW at National, the original school of heavy equipment operation, through actual field training on the same kind of diesel-engined bulldozers, rubber-tired scrapers, motor-graders, and cranes now in use by the industry.

National School is NOT a correspondence school... if your application is accepted, you will field-train on its huge proving ground in the beautiful Piedmont area of North Carolina. Full training courses, VA approved, payment plans available. AND, National maintains its own Job Advisory and Counselling Department with a full-time Director for the exclusive use of its graduates!

Make up your mind NOW that you are interested in high wages and security and mail the coupon TODAY for FREE illustrated school catalog... you are not obligated in any way.

Even if you are presently taking a "course" in heavy equipment operation, write for our free catalog (there is no obligation), and compare the "training" you are receiving with ours.

**MAIL TODAY**  
For **FREE** Illustrated School  
Catalog and complete information

**NATIONAL SCHOOL OF HEAVY EQUIPMENT OPERATION**  
Dept. D-26  
P. O. Drawer 1686, Charlotte, N. C.

Please send one **FREE** illustrated school catalog and complete information about how I can become a Heavy Equipment Operator. I understand there's no obligation.

Name \_\_\_\_\_ Age \_\_\_\_\_

Address \_\_\_\_\_

City \_\_\_\_\_ Zone \_\_\_\_\_ State \_\_\_\_\_

## RADAR SENTRY\*



**warns of radar traffic zones  
...promotes safe driving**

Ingenious miniature electronic detector gives advance warning of radar-controlled speed and danger zones within monitor range. New DUAL-BAND circuit detects all commonly used police radar speed meters and traffic control devices.

When triggered by radar signal, Sentry gives audible warning... alerts you to check speed before entering radar-timed speed zones or dangerous areas protected by radar-operated signal lights.

Miniaturized and completely transistorized, Radar Sentry requires no wires or antenna... operates on 1000-hour mercury cell, self-testing battery. Furnished with clip for sunvisor mounting and magnetic base for dashboard use. Small, compact... will not obstruct vision. Weight: 13 oz. Choice of Beige, Sapphire Blue, or Emerald Green to blend with car interior.

### NEW DUAL-BAND MODEL <sup>° Patent Pending</sup>

only **\$39.95** postpaid  
Send check, money order,  
or charge to Diner's Club  
account (give card number  
and signature). Specify  
color wanted.

**MONEY BACK GUARANTEE**  
Return in 10 days  
if not satisfied.

**RADATRON, INC.**  
2364 Zimmerman St.  
North Tonawanda, N. Y.



**MAKE HUNDREDS OF SALES  
Every MONTH.. You Never Could  
Touch Before with Wonderful**



# BEAVER SHOES

**made of Miracle EVERON**

**Look &  
Feel Like  
Leather—  
Wear Far  
Longer!**

Beaver Shoes are the fastest-growing, hottest sellers of the year! Molded in one piece; no seams to rip. Positively no rubber; can't burn feet. Washable, never need polishing. Sanitized. Made in America. Styles for every member of the family. Customers snap them up for only \$1.99 to \$5.49 a pair. Low price, easy to sell—yet, you pocket terrific commissions on every sale! Write Today For Free Sample Shoe And Exciting Moneymaking Details.

**BEAVER SHOE CO.** Dept. PM-362  
Beaver Meadows, Pa.



## STOP FRONT DRIVE DRAG AND WEAR ON 4-WHEEL-DRIVES!

### WARN HUBS

Free-wheeling 2-wheel drive with Warn Hubs means big savings in gear, engine, tire wear, gas—plus more pep, performance, power in high, and easier steering. Rugged, dependable, proven, with over 400,000 in use. Iron-clad guarantee. Choose Lock-O-Matics that change drive as you shift, or manual Locking Hubs. Models for all 4-w. ds. at dealers, or write for literature.

**WARN MFG. CO.** Riverton Box 6064A  
Seattle 88, Wash.

## JEEP OWNERS

**RE-POWER NOW WITH A V-8 OR 6 CYL. ENGINE — USE  
FORD—CHEV.—MERCURY—GMC—PONT—STUDE—DODGE OR PLYMOUTH**  
In Jeeps, Jeepsters, Sta-Wgn, trucks, Kaiser & M. J. cars.  
Conversion Kits \$45.35 to \$56.90. Want fast action? Give us full  
information, send \$15.00 Dep. and we will ship correct kit. Bal.  
COD. Send full amount for prepaid shipment. Wire, phone or write  
today. Details FREE.

**HOOSIER MACHINE PRODUCTS CO.**  
312 S. E. 6th St. Phone CR 6-3442 Pendleton, Oregon

## AUTOMATIC OIL CHANGE PLUG

PAT. PEND. Cable operated. CHANGE YOUR OIL AT HOME IN 5  
MINUTES, dressed in tuxedo. SAVE \$2.25 PER CHANGE!  
**\$5.75**  
POSTPAID  
★ NO WAITING AT SERVICE STATIONS!  
★ NO PAYING FOR SUPER EXPENSIVE OILS!  
★ NO JACKING — NO CRAWLING UNDER!  
★ PERFECT DESLUDGING EVERY TIME!  
**ABSOLUTELY FOOLPROOF - 5 YR. GUARANTEE!**  
Install it yourself in minutes. Fits opening in pan.  
No holes to drill. Ind. car make, year, cyl. Info on req.  
**COSMOPOLITAN RESEARCH CORP., BOX 5791-PM, DETROIT 39 MICH.**

**ALL FAMOUS BRANDS!** **FARM TRUCK AUTO** **AT LESS THAN WHOLESALE**

**TIRES!** SAVINGS NEVER LESS THAN 50% up to 70% OFF REG. PRICE!  
**HEADQUARTERS FOR ALL SPORT CAR TIRE SIZES**  
**FREE • SEND FOR YOUR FREE CATALOG • FREE!**  
**RELIABLE TIRE DIST., 730 Morgan Blvd., Camden 4, N. J.**

Shop PM Ads for Exciting  
Direct-Mail Offers

**Another NEW Taft Kit!**

**HYDROFOIL BOAT KIT**  
"Fly" on water with less power—save on fuel!

**COMPLETE—\$131.25 down \$20.37 Per mo.**  
**FREIGHT PAID**

**TAFT MARINE WOODCRAFT** **FREE CATALOG OF MANY MODELS**

Dept. PM362, 636 39th Ave. N.E., Mpls., Minn.

**NO JOB WORRIES**

PLASTEX INDUSTRY needs manufacturers on small scale for big production of Lamps, Clock Stands, Art Goods, Novelties in Plastic Marble imitation. No Experience necessary. 1/2c material makes regular 10c store sellers. Moulds furnished for fast production. Small investment brings good profit. Big wholesale orders now being placed. Ambitious men have chance for real prosperity and job security. Our NEW FREE booklet will interest and benefit you.

**PLASTEX INDUSTRIES, Dept. A**  
3400 Third Ave. New York 56, N. Y.

# SENSATIONAL OFFER TO POPULAR MECHANICS' READERS

**SAVE  
MORE  
THAN  
EVER**

## 2 COMPLETE 1962 MODEL FISHING OUTFITS 279<sup>pts</sup>

PFLUEGER, MUSTAD, DUPONT

SMOOTH POWERFUL DIRECT DRIVE  
LEVEL WIND CASTING REEL

**FREE!** If you order NOW!  
LEAKPROOF FLOATING  
TACKLE BOX

POWER ACTION  
GLASS RODS  
STRONGER  
THAN STEEL  
OR BAMBOO

LIVE BAIT BOX

FOLD-A-WAY  
FLOATING  
TROUT NET

FISH KNIFE  
with SHEATH

PRE-WOUND  
ON REEL

SAFETY  
STAR DRAG  
Found only  
on best reels

DETACHABLE  
HANDLE  
FULL CORK  
GRIP

FAMOUS  
JIGS and FLIES

28 Pcs.  
POPPING  
LURE SET

COMPARE!  
with EXPENSIVE SETS

**NEW!** AUTOMATIC  
SUPER "88" REEL

- SMOOTH POWERFUL LIGHTNING FAST FINGERTIP CONTROL
- PUSH BUTTON CASTING ANTI-REVERSE—NO BACKLASH

**\$14<sup>95</sup>**

**BOTH SETS  
FOR THE PRICE OF A  
REEL ALONE**

19 FAMOUS  
CRAFTY  
LURES

**COMPLETE! Nothing else to BUY!**

**NEWEST! EASIEST WAY TO CATCH FISH!**

**SELECTED FOR YOU BY EXPERTS.** This choice fish-getting tackle, used by experts, contains nationally famous brands. Each item carefully chosen—everything you need for all types of fishing. Deadly lures that are all time favorites. Whether you're a veteran angler or an occasional fisherman, you can be proud of this precision-built kit. Nothing else to buy—you can go fishing at once. Compare! You will not find a bargain like this anywhere.

**LOOK! YOU GET EVERYTHING SHOWN.** Super "88"—Automatic Spin Cast Reel with line. Comet X3C Bait Casting Reel—5 ft. (2 pc.) Spin Cast Rod—4 ft. Bait Cast Rod, Live Bait Box, Fish Knife and Sheath, 19 Famous Lures, Tackle Box and Removable Tray, Cable Leader, Clincher Sinkers, Assorted Hooks, Snelled Hooks, Fold-Away Trout Net, Stringer, Hook Remover, Hook Guards, Bobbers, Split Shot, Snaps and Swivels, Practice Plug, 28 pc. Popper Lure Set and Complete Instructions.

**FREE!** "Experts Guide" Over 200 best lakes and streams selected from more than 10,000 FAMOUS FISHING SPOTS IN AMERICA.

**NIRESK DISCOUNT SALES • CHICAGO 47 • ILLINOIS**

**MONEY BACK GUARANTEE!**

NIRESK DISCOUNT SALES • Chicago 47, Ill. • Dept. FC-24  
**ORDER TODAY!** We're so sure that you will be pleased that we make this daring offer. If you're not 100% pleased we'll refund your full purchase price promptly.  
**YOU KEEP FREE TACKLE BOX REGARDLESS!**

Please rush \_\_\_\_\_ 279 pts. 2 Complete Fishing Sets

NAME \_\_\_\_\_

ADDRESS \_\_\_\_\_

CITY \_\_\_\_\_ ZONE \_\_\_\_\_ STATE \_\_\_\_\_

- I enclose \$14.95 plus \$1.00 for postage & handling  
 Ship C.O.D. I will pay C.O.D. charges and postage.



**YOU  
can  
acquire**

**LAW AT HOME!  
EARN LL. B. DEGREE**

LaSalle's famous Law Library—used as reference in many Law libraries and Law offices—has enabled thousands to master Law surprisingly fast, in spare hours at home, for business and professional advancement.

These 14 remarkable volumes, compiled by leading professors and lawyers, cover the whole basic field of Law in condensed, orderly, simplified manner.

You advance rapidly with this great library, plus special lectures furnished. We guide you step-by-step with personalized Problem Method of instruction...you learn by doing—handling legal problems—not by memorizing rules.

Send for two FREE booklets, "Law Training for Leadership," and "Evidence," answering questions about Law and its value to you. Mail coupon below. No obligation.

*Accredited member, National Home Study Council*

**LA SALLE EXTENSION UNIVERSITY  
A Correspondence Institution**

417 S. Dearborn St. Dept. 3-056 Chicago 5, Ill.

Send me your two FREE booklets described above, without obligation.

Name ..... Age .....

Street .....

City, Zone & State .....

**Items from  
all outdoors**

Not all our waterways, fortunately, are as troubled as the one described in Joe Bell's article on page 140 of this issue. A lot of local authorities have had the good sense and initiative to work out plans for sharing the waters peacefully. One excellent example is at Morse Reservoir in Indiana, not far north of Indianapolis.

Dividing the five-mile-long reservoir into four sections, the local authorities set aside the better fishing waters at the head and tail for fishing and closed-throttle boating only. The middle third of the lake, less popular with anglers, is open for boatmen for fast running and skiing. (Fishermen use that water at their own risk, and are required to keep their craft out of the way.) The boatmen's water is also divided into a water skiing area and a no-skiing speed area, for safety's sake.

To preclude any arguments or misunderstandings, the Morse authorities established easily-recognized boundaries—bridges, and a power line across the lake. Then they posted all the access ramps with the big signs shown here. We're told it runs so

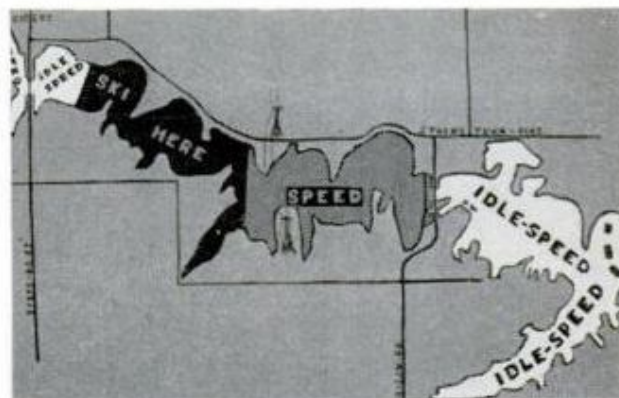

**\$6.44 AN HOUR IN YOUR OWN BUSINESS**



**STEP INTO THIS BOOMING  
\$19 BILLION A YEAR INDUSTRY**

Hundreds of accidents and losses will happen this year in your community.

We'll show you how to investigate and adjust these losses for insurance companies, railroads, government offices. You buy NO tools or equipment. You do NO selling. You need NO prior experience or higher education. And you can operate out of your own home. Right

now independent Accident Investigators average \$6.44 an hour. We'll train you quickly to do the same. Start part-time if now employed. Fill the need for an Accident Investigation specialist in your area. Colorful booklet explains everything. Absolutely no obligation on your part. No salesman will call. Write TODAY for FREE Booklet.

UNIVERSAL SCHOOLS, P.M.-3, 6801 Hillcrest, Dallas 5, Texas

smoothly that the Indiana conservation people are thinking of using a similar system on other large bodies of water.

Score another triumph for science in athletics. The champion Green Bay Packers professional football team used Polaroid photographs during their games to study formations and their opponent's defenses. The photos were made by a scout posted high in the stadium, but he reverted to an older tactic for delivery. He threw the prints down to the bench in a weighted sock. That's real progress.

*Dick Kirkpatrick*

POPULAR MECHANICS



## SHAVE ELECTRICALLY — EVEN IN A ROWBOAT!

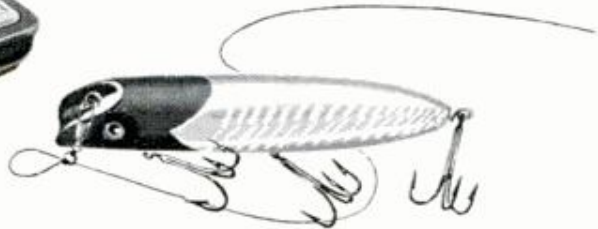

**Pack the  
shaver  
that packs  
its own power**

- Runs on two flashlight batteries tucked into its case.
- World-famous rotary blade shaves, 'flip-top' cleaning.
- Easy to pack, pocket-slim.
- Case houses built-in mirror and quick-recoil cord.

● Ask your Norelco dealer about the whole line of rotary blade shavers.

NEW **Norelco**  
SPORTSMAN

NORTH AMERICAN PHILIPS COMPANY, INC., 100 East 42nd Street, New York 17, N. Y. Norelco is known as PhiloShave in Canada and throughout the rest of the free world.

**Free! SCARCE TRIANGLE COLLECTION**

Start TODAY to enjoy an exciting new hobby! Get this big, valuable collection of gorgeous, multi-colored triangle shaped postage stamps . . . brought to you from strange and mysterious lands in the wilds of Africa, enchanting Europe, exotic Latin America, etc. All genuine, all-different—picturing man-eating reptiles, jungle birds, action-packed sports, ancient clipper ships; PLUS scarce airmails, fabulous commemoratives, giant and midget-sized stamps. EXTRA! Bargain Catalog, "Collector's Manual" plus other exciting offers for your inspection. Enclose 10c for mailing costs.

Jamestown Stamps, Dept. H32PM, Jamestown, N.Y.

## RUPTURED

### BE FREE FROM TRUSS SLAVERY

Surely you want to THROW AWAY TRUSSES FOREVER, be rid of Rupture Worries. Then Why Do you put up with wearing a griping, chafing and unsanitary truss the balance of your life? If you do, it will NOT be through necessity but through choice on your part.

Now there is a new modern Non-Surgical treatment that is designed to permanently correct rupture. These Non-Surgical treatments are so dependable, that a Lifetime Certificate of Assurance is given. Write today for our new FREE BOOK that gives facts that may save you painful, expensive surgery. Tells HOW and explains WHY NON-SURGICAL Methods of Treating Rupture are so successful today. No obligation.

Excelsior Medical Clinic  
Dept. H6125, Excelsior Springs, Mo.

**... TURN CONCRETE INTO GOLD!**

**MAKE UP TO \$75 A DAY IN YOUR OWN BUSINESS**

If you want to have your own business — to start a business on your own — here's your big opportunity! New high speed, low cost General block machine produces up to 1,000 concrete blocks a day. Sell all you make to builders, supply houses, and others for homes, factories, buildings, garages. Cash in on the building boom! You can make profits of 100% to 150% — up to \$75. a day! General block machine equipped with 1/2 h.p. electric motor — or can be supplied with gasoline engine — works anywhere, in little space, indoors or out. Operates from ordinary house light socket. Simple, foolproof 3 step operation — so easy a child can do it. Makes superior 3 core blocks any size from 4" to 12". Also makes chimney, sash, corner and other types. Blocks meet any building code anywhere in the country. Materials — sand, water, cement, available anywhere. Simple illustrated operating instructions and mixing formuloe for cement and cinder blocks supplied with each machine. Write for FREE folder with full information.

**MOTOR DRIVEN**

R. L. T. of New York City reports: "MY GENERAL BLOCK MACHINE PAID FOR ITSELF IN FIRST 2 WEEKS!" Hundreds now in use the world over! Write for FREE details today!

**EXTRA** Amazing illustrated book gives floor plans for 6 sensational concrete block bungalows. Tells how to lay blocks, lay out building lines, mix concrete, build steps, porch and concrete floors all at great savings. Written by experts. Can save many times the cost of the machine! Get it now! No strings attached. Send \$1.

BOOK SENT FREE IF YOU BUY MACHINE.  
\$1 REFUNDED IF YOU BUY LATER.

**GENERAL ENGINES CO.**  
DEPT. PB-32, ROUTE 130, THOROFARE, N. J.

**HOW TO BUILD YOUR OWN CONCRETE BLOCK HOME**  
Only \$1 Prepaid

# AMAZING SCIENCE BUYS

OVER 1000 ITEMS

## WAR SURPLUS AMERICAN-MADE 7x50 BINOCULARS

Big savings! Brand new! Crystal clear viewing—7 power. Every optical element is coated. An excellent night glass—the size recommended for satellite viewing. Individual eye focus. Exit pupil 7mm. Approx. field at 1,000 yds. is 376 ft. Carrying case included. American 7 x 50's normally cost \$274.50. Our war surplus price saves you real money.



Stock No. 1544-H only \$74.80 postpd. (Tax included)  
6 x 30 Binoculars—similar to above and a terrific bargain.  
Stock No. 963-H . . . . . \$33.00 postpd. (Tax included)

## New...PORTABLE ELECTRIC GREENHOUSE FOR YEAR-ROUND GARDENING MAGIC

Now you can practice gardening as a hobby 12 months a year! Grow endless varieties of plants to maturity summer and winter . . . experiment continuously with plant growth and development. Thermostatically controlled temperature and humidity for rapid germination of seed, rooting of cuttings, and maximum growth potential. Size 15" x 18", with styro-foam base, 25-watt heater and thermostat, 2 polystyrene planter trays, clear styrene lid. 2 sizes avail. ea. incl. bag of growing medium.



Stock No. 70,490-H Low-lidded model, 7" high. . . \$14.95 Postpd.  
Stock No. 70,491-H High-lidded model, 15" high. . \$21.95 Postpd.

## OPAQUE PROJECTOR

Projects illustrations up to 3" by 3 1/2" and enlarges them to 35" x 30" if screen is 6 1/2 ft. from projector; larger pictures if screen is further away. No film or negatives needed. Projects charts, diagrams, pictures, photos, lettering in full color or black-and-white. Operates on 115 volt, A.C. current. 6-ft. extension cord and plug included. Operates on 60 watt bulb, not included.



Size 12" x 8" x 4 1/2" wide. Weight 1 lb., 2 oz. Plastic case with built-in handle.  
Stock No. 70,199-H . . . . . \$7.95 Postpaid

## EXPERIMENT IN PLASTICS WITH NEW PLASTICS ENGINEERING SET

Keep pace with advances in plastics technology. Innumerable profit opportunities. Designed for working knowledge for non-plastics technicians, etc. Teaches how to identify and shows unusual properties and behavior of different plastics. Demonstrates heat forming, heat sealing, cementing. Depicts methods of foam casting, solid casting, rotational casting, slush molding. Make plastic products by injection molding and blow molding. Kit 15" x 6" x 11 3/4". Incl. non-tech. instr. manual.



Stock No. 70,456-H . . . . . \$25.00 Postpaid

## 'FISH' WITH A MAGNET

### Go Treasure Hunting On The Bottom

Great Ideal! Fascinating fun and sometimes tremendously profitable! Tie a line to our 5-lb. Magnet—drop it overboard in bay, river, lake or ocean. Troll it along the bottom—your "treasure" haul can be out-board motors, anchors, fishing tackle, all kinds of metal valuables. 5-lb. Magnet is war surplus—Alnico V Type—a terrific bargain. Lifts over 125 lbs. on land—much greater weights under water. Order now and try this new sport.

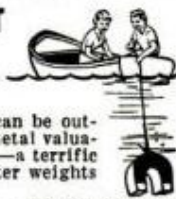

Stock No. 70,183-H. 5-lb. Magnet. . . . . \$9.95 Postpaid

## NEW! CIRCULAR SLIDE RULE!

Pocket Size—Fast—Easy to Use!

Multiplies, divides, figures fractions, percentages, squares, cubes, roots, proportions, circumferences, areas, prices, fuel consumption. Faster, easier to learn and use. Directions included.



Stock No. 30,336-H . . . . . \$4.95 Postpaid

Order by Stock No.—Send Check or M.O.—Money-Back Guarantee  
**EDMUND SCIENTIFIC CO., Barrington, New Jersey**

Clip and Hand to a Friend . . . or Leave  
for the Next Reader of this Issue!

## MAIL COUPON FOR FREE CATALOG "H-2"

160 Pages! Over 1000 Bargains!

EDMUND SCIENTIFIC CO., Barrington, N. J.

Please rush Free Giant Catalog "H-2"

Name . . . . .

Address . . . . .

City . . . . . Zone . . . . . State . . . . .



# Science overseas

By William Kreh

Atomic energy soon may throw the switch for railroad crossing signals in Japan. Engineers, experimentally, are attaching radioactive substances under one coach on a train. When it rolls over a certain section of track some distance from the signal, a Geiger counter picks up the radiation, amplifies the energy, tripping the crossing switch.



Clean-shaven men or men with bushy mustaches make the best Army officers, according to a study made by British psychiatrist Geoffrey Peberdy. He says men with close-cropped "toothbrush type" mustaches turn out poorly.



A large solar furnace nearing completion in Sydney, Australia, will focus sun rays into a beam as small as a man's thumb, producing a 4000 degree C. torch capable of melting steel in seconds. The University of New South Wales also will use the furnace for research in purification of substances.



A satellite-relay ground station, capable of handling up to 600 phone calls simultaneously, will be built by the West German Post Office for operation early in 1964. To be built near Munich, it will consist of four automatic tracking antennas, designed for operation with Telestar and Relay-type satellites.



A potato detector has been developed by Scotland's Department of Agriculture and Fisheries. Using a beam of light, the electronic sensing device can be fitted on commercial potato harvesters, and will automatically tell the difference between potatoes, stones and clods of mud.



Broken bones pinned together with pine-wood rods have been found in the remains of Aztec Indians. According to Dr. Guillermo Polo, consultant to Mexico's National Institute of Anthropology and History, the



wooden rods were inserted through the marrow channel of the bones.

Medical books credit discovery of this technique—known as intramedullary fixations—to German surgeons in World War II. The Germans used stainless steel rods.



**A Japanese atomic scientist** is using himself as a guinea pig to test the rate of elimination and effects of dangerous strontium 85 when taken by human beings.

Teshio Aoki of the Atomic Energy Research Institute swallowed a dose of the radioactive element by mixing it with his coffee. The amount—about one-tenth the level considered dangerous to human bodies—lodged in the bones of his shoulder, hip and spine, according to radiation readings.

It'll be a year before results of the experiment will be known.



**Videophone service** has been started between the Soviet cities of Moscow, Leningrad and Kiev. Calls have to be placed eight hours in advance and appointments arranged. The callers see each other on television sets standing near each microphone. The charge is 75 kopeks (83 cents) a minute, with a minimum of three minutes.



**Electricity in teeth** may be causing some forms of neuralgia and keeping mouth sores from healing.

Researchers at the Clinic of Oral Surgery, Budapest, Hungary, say that teeth cavities filled with metal may develop differences in electrical potential and the resulting voltage, minute as it is, can cause discomfort and keep mouth sores from healing. The researchers replaced metal fillings in patients suffering from various mouth disorders with nonconductive materials and said 80 percent showed improvement. They measured electrical potentials with an electron tube voltmeter equipped with platinum electrodes.



**For the first time in history**, two underwater cables have been laid simultaneously. It was done by the French cable-laying ship, *Ampere*, when she laid France's share of two cables to connect the French and British electricity systems in the English channel.

For just over 16 miles, about half-way across, the *Ampere* uncoiled simultaneously two long cables of copper and steel weighing a total of 900 tons.

The British put the cables down the rest of the way—one at a time. ★ ★ ★

MARCH 1962

# AMAZING SCIENCE BUYS

## See the Stars, Moon, Planets Close Up! 3" ASTRONOMICAL REFLECTING TELESCOPE



60 TO 180 POWER  
Famous Mt. Palomar Type!  
An Unusual Buy!

See the Rings of Saturn, the fascinating planet Mars, huge craters on the Moon. Equatorial Mount with lock on both axes. Aluminized and overcoated 3" diameter high-speed f/10 mirror. Telescope comes equipped with a 60X eyepiece and a mounted Barlow Lens. Optical Finder Telescope included. Hardwood,

portable tripod. FREE with Scope: Valuable STAR CHART plus 272-page "HANDBOOK OF HEAVENS" plus "HOW TO USE YOUR TELESCOPE" BOOK.

Stock No. 85,050-H . . . . . \$29.95 Postpaid  
4 1/4" REFLECTING TELESCOPE—Up to 255 Power.  
Stock No. 85,105-H . . . \$79.50 F.O.B., Barrington, N. J.

### NEW! SCIENCE FAIR PROJECT KITS

**MOLECULE AND CRYSTAL MODELS KIT**—Rods and balls to make atomic models, plus directions.

Stock No. 30,413-H . . . . . \$2.50 Postpaid

**SOIL TESTING KIT**—Basis for many fascinating experiments regarding growth of plants, etc.

Stock No. 60,118-H . . . . . \$2.00 Postpaid

**CRYSTAL GROWING KIT**—Grow breathtaking display of large crystals with this set.

Stock No. 70,336-H . . . . . \$9.50 Postpaid

**MAGNETISM KIT**—Based on magnetism demonstrations developed by UNESCO.

Stock No. 70,325-H . . . . . \$3.75 Postpaid

### SPECIAL PURCHASE—SAVE \$7 ON THIS

### PROFESSIONAL MECHANICAL DRAWING SET



Made to Sell for \$19.95—OUR PRICE ONLY \$12.95. Precision-made for professionals, yet priced within low-budget range. We bought all available stock from one of West Germany's famous instrument makers to bring you this super bargain. Every instrument real chromium on brass—not brass nickel. Wonderful gift for anyone in need of drawing equipment. Set includes: 6" detail

(Swede) pen; 6" divider; 6" hinged divider with pen, pencil and extension; two 5 3/4" ruling pens; 4 1/2" bow divider with center wheel, bow pencils with center wheel; and bow pen, all precision type; 4 1/2" drop compass with pencil and pen attachment; spare parts box; screwdriver for adjusting extra lead box; polishing cloth. All metal parts rust free. Two-flap velvet lined case.

Stock No. 70,440-H . . . . . \$12.95 Postpaid

### WOODEN SOLID PUZZLES



12 Different puzzles that will stimulate your ability to think and reason. Here is a fascinating assortment of wood puzzles that will provide hours of pleasure. Twelve different puzzles, animals and geometric forms to take apart and reassemble, give a chance for all the family, young or old, to test skill, patience, and, best of all to stimulate ability to think and reason while having lots of fun. Order yours now.

Stock No. 70,205-H . . . . . \$3.00 Postpaid

### MINIATURE WATER PUMP



Wonderful for experiments, miniature waterfalls, fountains, Christmas gardens, HO gage railroad backdrops, etc. Tiny (2 3/8" x 1 3/4") electric motor and pump ideal for hobbyists, labs, schools. Pumps continuous flow of water at rate of one pint per minute at a 12" head. With 2 D Batteries in series will pump to 24" high. Works in either direction. Stock No. 50,345-H . . . . . \$2.25 Postpaid

### BUILD A SOLAR ENERGY FURNACE



A fascinating new field. Build your own Solar Furnace for experimentation—many practical uses. Easy! Inexpensive! Use scrapwood! We furnish instructions. This sun powered furnace will generate terrific heat—2000° to 3000°. Fuses enamel to metal. Sets paper atime in seconds. Use our Fresnel Lens—14" diameter . . . f.l. 14".

Stock No. 70,130-H . . . . . \$6.00 Pstpd.

11" Sq. Fresnel Lens F.L. 19"

Stock No. 70,533-H . . . . . \$4.75 Pstpd.

Order by Stock No.—Send Check or M.O.—Money-Back Guarantee  
**EDMUND SCIENTIFIC CO., Barrington, New Jersey**

### MAIL COUPON FOR FREE CATALOG "H-3"

160 Pages! Over 1000 Bargains!

EDMUND SCIENTIFIC CO., Barrington, N. J.

Please rush Free Giant Catalog-H-3.

Name . . . . .

Address . . . . .

City . . . . . Zone . . . . . State . . . . .



OVER 1000 ITEMS

# Pentagon sidelights

By William R. Kreh

Warships have been sunk by microscopic plankton. That's because some of these tiny swarming sea creatures give out phosphorescence when disturbed — by a passing ship, for example. Thus the vessel's position was given away to enemy aircraft.

Scientists under Navy contract are trying to learn when and where phosphorescence will happen, and avoid it if necessary. They will try to invent some antiluminescence measures, too.

Meanwhile, they find other plankton are getting in the way of antisubmarine warfare. Masses of them distort and disrupt the sound of detection systems. They even create false targets. The scientists hope to find a way to overcome this problem, too.

A hip-pocket charcoal grill that a GI in the field can use to boil water has been developed for the Army. It consists of a square aluminum-foil package containing charcoal. Above the charcoal is a flexible metal grid. The device is about a foot square and weighs only a few ounces. It can boil six quarts of water in about 18 minutes.

A rocket radio system for broadcasting information on radiation from 100,000 miles in space has been developed for the Air Force. It requires less power to operate than a flashlight bulb.

An explosive gas that hugs the ground has been developed by the Army, according to several reliable sources. When released over an enemy, even a spark ignites it.

Sixty muscle-sore soldiers are resting up at the Army's Picatinny Arsenal in New Jersey. They recently finished toting 100-pound boxes of ammunition through a series of strenuous tests. Purpose was to try new plastic handles for the ammo boxes that will replace the conventional jute rope.

In the tests, 30 two-man teams carried the four-foot-long boxes around a 70-foot course, lugged them up and down sets of stairs and hoisted them on and off landing platforms. They circuited the course 1450 times, climbed more than 4700 steps and loaded about 1500 boxes. The new plastic rope is strong, light, resists deterioration

and is easily obtained, whereas jute sometimes freezes and breaks, has rough texture and its supply may be cut off in a national emergency.

For the best car care don't mix different brands of greases in it. That's the gist of a report just issued by an Army research team on "the compatibility of greases." The study showed that mixing two types of greases, even though they each meet the same specifications, causes a drop in lubrication ability in 25 percent of the cases and could cause bearing failure.

Top-secret high-powered radar equipment may uncover new information about bird flights.

Throughout months of peak bird movement over New Jersey, a photograph is taken every 12 seconds for four hours each morning of a radar screen in the New York sector of the Air Force's Air Defense Command. The photos are given to Dr. Jeff Swinebroad, an ornithologist with Douglas College, who studies them with a device that flashes them on a screen. A computer helps analyze data.

From his work, Dr. Swinebroad hopes to get new data on the volume and pattern of bird migration and find out if conventional means of studying migration are accurate. The radar not only gives the speed and direction of flocks of birds but also pinpoints individual birds of the larger species.

Collecting ashes around the Naval Supply Center in Norfolk, Va., can be a profitable chore. A Philadelphia firm recently paid the Navy more than \$39,000 for 13,700 pounds of ashes from silver-cell batteries.

These batteries help drive conventional submarines. Every year thousands of them pass through the salvage yard where their plastic coverings are burned off. What's left contains a high amount of pure silver which can be salvaged by the firm.

Skunk scent can put a man into orbit, but not a missile.

Basic research is usually a lonely job, but when the staff at the Army's Redstone Arsenal chemistry lab decided to test mercaptans, they found themselves even more alone than usual. Mercaptans are the chemicals that put the skunk into skunks. Just one of the many chemicals tested in the never-ending search for missile fuel, the pungent liquid was analyzed to determine its possible uses in high-energy rocket fuel. Final conclusion: Although it produces a violent reaction from humans, it can't be used in missiles. ★ ★ ★



## KEEP YOUR CHEVY the CHEVY-EST\* ... specify a genuine GM Chevrolet replacement muffler

Naturally you care what parts go into your Chevrolet—because your Chevy does! Whether you do your own routine servicing or have it done, the important thing is to make sure you get a *genuine* GM Chevrolet muffler if your present one ever needs replacement. Like all genuine Chevrolet parts, they're built specifically for your Chevrolet. Precision built to fit right for easy, fast installation. Durably built with rust-resisting aluminized outer coating and additional aluminum and zinc inner coatings to give you long trouble-free service. They're readily available at your local Chevrolet dealer's and leading independent garages and service stations — wherever you see the familiar Genuine GM Chevrolet Parts sign.... Chevrolet Division of General Motors, Detroit 2, Michigan.



*\*Chevy-est: all Chevy with new-car reliability maintained part by part.*

# Expect more, get more, from L&M

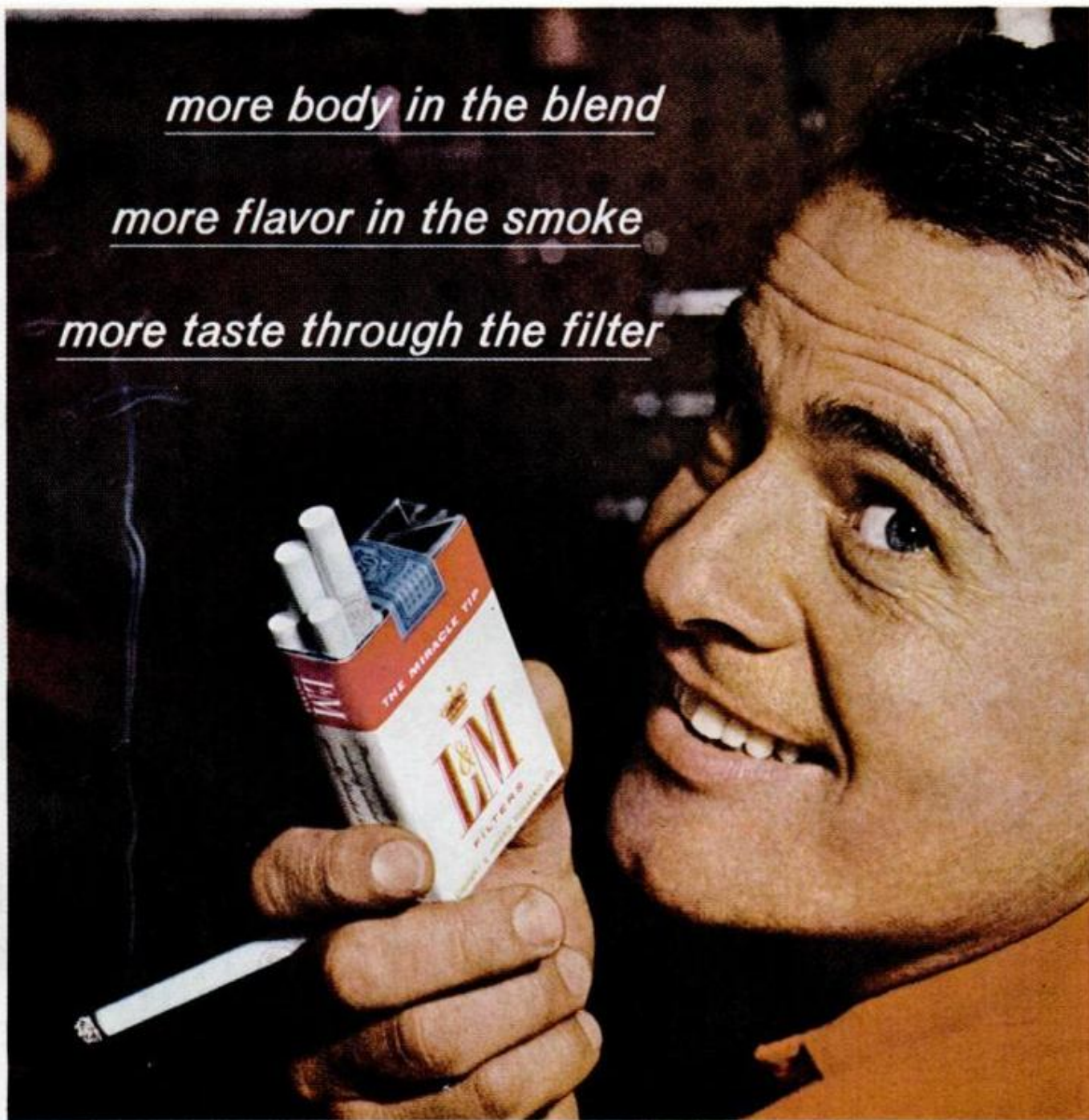

more body in the blend

more flavor in the smoke

more taste through the filter

The filter cigarette for people who really like to smoke.

There's actually more rich-flavor leaf  in L&M than even in some unfiltered cigarettes. You get more body in the blend,  more flavor in the smoke,  more taste through the filter.  So expect more, get Lots More from L&M. And remember — with L&M's modern filter, only pure white touches your lips.

**NOW, FOR THE VERY FIRST TIME,**  
**FOR \$10 YOU CAN INVEST IN 3**  
**SEPARATE FLORIDA GROWTH AREAS**

**...5 CHOICE ACRES IN ALL!**

**JUST \$999 IS THE TOTAL PRICE**  
**FOR ALL 5 ACRES**

**\$10 DOWN • as little as \$10 MONTHLY!**

- Growth in North Florida? **YOU PROFIT!**
- Growth in Central Florida? **YOU PROFIT!**
- Growth in South Florida? **YOU PROFIT!**

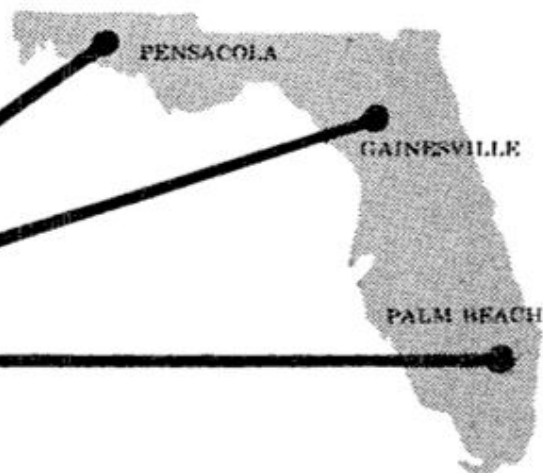

**AREA 1: BETWEEN PENSACOLA, EGLIN AIR FORCE BASE, PANAMA CITY and DE FUNIAK SPRINGS!** 1¼ acres in the booming industrial area of NORTH Florida... high and dry, 200 to 250 feet above sea level.

**AREA 2: BETWEEN GAINESVILLE, BRONSON and OCALA!** 1¼ acres in the beautiful "blue-grass," hunting and fishing area of CENTRAL Florida... high and dry, 75 feet above sea level.

**AREA 3: IN PALM BEACH COUNTY!** 2½ acres in the fabulous county that is making headlines in papers throughout the country in thriving SOUTH Florida... high and dry, 13 feet above sea level.

**DON'T MAKE THE MISTAKE OF  
 "PUTTING ALL YOUR EGGS IN ONE BASKET"**

Your chances for profit are 3 times as great when you invest in *all* of Florida... instead of just one area. As Florida grows—NO MATTER WHICH PART OF FLORIDA GROWS—you're sure to grow with it! You can now own 1¼ acres in industrial North Florida plus 1¼ acres in booming Central Florida plus 2½ acres in Florida's thriving Palm Beach County in South Florida. All 5 acres... all 3 areas... North, Central and South Florida for \$10 down and as little as \$10 a month.

- PROPERTY TITLE INSURED FOR YOUR PROTECTION
- FREE WARRANTY DEED
- NO CLOSING COST
- NO TAXES FOR THE FIRST YEAR
- NO HIDDEN CHARGES
- 50% OIL AND MINERAL RIGHTS IN ALL 3 AREAS
- UNCONDITIONAL MONEY-BACK GUARANTEE AT ANY TIME WITHIN 30 DAYS

**\$999 is an INTRODUCTORY PRICE offer... Act Now!**

Diversified Land Investment, Inc., Dept. PM-1  
 P.O. Box 336 • Coral Gables, Florida

Gentlemen:  I am enclosing \$10 as my down payment toward the INTRODUCTORY PRICE of \$999 for FULL 5 ACRES. Please select for me the finest 3 sites available as soon as you receive this deposit. Send plat map showing where my 5 acres are located as well as Contract for Deed and literature. I HAVE AN UNCONDITIONAL MONEY-BACK GUARANTEE AT ANY TIME WITHIN 30 DAYS.

Please send me a descriptive brochure of tracts totalling 5 acres in 3 separate selected growth and profit areas of Florida... special low terms of \$10 down and as little as \$10 monthly. I am under no obligation to buy.

PRINT NAME \_\_\_\_\_  
 ADDRESS \_\_\_\_\_  
 CITY \_\_\_\_\_ STATE \_\_\_\_\_  
 PHONE \_\_\_\_\_

Sworn statement from CHAS. LEMMING reads:

**"After starting my own business"**



**I've averaged \$100 A DAY —most of it clear profit!"**

• If you want to be independent—free from layoffs, bosses—start profitable, year 'round business of your own. Ours is NOT a lease proposition. You own the machine, you work when and where you please, and all the money you take in is your own. FREE book tells you how.

**MAIL COUPON TODAY FOR FREE BOOK**

**VON SCHRADER MFG. CO.**

**310 "D" Pl., Racine, Wisconsin**

Without obligation rush your FREE booklet about how I can start my own permanent, profitable electric Upholstery Cleaning business.

Name \_\_\_\_\_

Address \_\_\_\_\_

City \_\_\_\_\_ Zone \_\_\_\_\_ State \_\_\_\_\_

Not everyone does as well...

Mr. Lemming owns two machines

In city of less than 50,000, Mr. Lemming started his own business after filling in coupon like one below. He averaged \$100 a day during first year, some days \$200. F. E. Doran grossed \$1050 in single month. Geo. Held grossed \$300 in one week.

How much you earn depends largely on you. No special skill, no large investment required for our electric upholstery cleaning machine. Start spare time until full time justified. Hire helpers as needed.

**NO SHOP NECESSARY** • You clean upholstered furniture on customers' premises—homes, hotels, motels, etc. Auto upholstery, too. No hauling; operate from your home. Watch business grow as satisfied customers tell friends. Supplies cost little, profits high.

**MAKE YOUR HOME WORKSHOP PAY OFF**  
in spare time or full time income  
**ELECTRICAL APPLIANCE REPAIR**



Turn spare hours into cash profits. Millions of Home Appliances need fixing. Every home is your market for Full-Time Career or Spare Time "Second" Income.

Costs Less Than \$1.50 A Week. All you need is a workbench, spare time and N.T.S. Home-Training in Electrical Appliance Repair. You get a professional appliance tester, tools, and easy-to-learn, practical instructions, fully illustrated. Start earning early in course. Mail coupon now. No obligation. No salesman will call.

**NATIONAL TECHNICAL SCHOOLS**

WORLD-WIDE TRAINING SINCE 1905

4000 So. Figueroa Street  
Los Angeles 37, Calif., U.S.A.

**FREE BOOK and ACTUAL LESSON**

**NATIONAL TECHNICAL SCHOOLS**  
Los Angeles 37, California

HB-32

Name \_\_\_\_\_ Age \_\_\_\_\_

Address \_\_\_\_\_

City \_\_\_\_\_ Zone \_\_\_\_\_ State \_\_\_\_\_

**ASSOCIATE IN SCIENCE DEGREE in 90 Weeks**



- ARCHITECTURAL DRAFTING
- INDUSTRIAL TECHNOLOGY
- TOOL AND GAUGE DESIGN

Complete training in less than two years. Free placement service for life. Many excellent positions available to graduates. Start any Monday.

**LAIN TECHNICAL INSTITUTE**

**TWO SCHOOLS:** 603 N. Delaware St., INDIANAPOLIS, IND.  
821 E. Division St., EVANSVILLE, IND.



Transistor Radio with Battery \$3.02



17-Jewel Watch \$2.87



Derringer Pistol \$5.74

**HOME-IMPORT BUSINESS—Make Big Profits**

New Drop Ship Plan offers you first day profits! Deal direct with overseas sources at prices shown. Dazzling bargains with no investment. Full or spare time. Write for FREE BOOK today to...

**MELLINGER, 1554 S. Sepulveda, Dept. D253 Los Angeles 25**

**FREE SAMPLE NEW WONDER AUTO GLAZE**



with Miracle Methyl Silicone Fluids

Given to show how you can make \$55.00 a day profit on your own exclusive route!

**GUARANTEED** to outshine, outlast and outperform ANY wax polish on the market today—or money back!

**FAST REPEAT SELLER!** Needed by 45,000,000 car owners. Demonstrates like magic. Just apply, wipe off. No hard rubbing. Keeps car and chrome like new for months!

**OVER 175% PROFIT!** Retail \$2.00 pint (year's supply). Your profit can be over \$1.35 pint—more on gallons!

**FREE SAMPLE** sent to try on your car. Rush name for FREE sample and FREE money-making details. No obligation!

**ROYALTONE PRODUCTS CORP., Dept. PM-3**  
1035 E. 10th St. • BROOKLYN 30, N.Y.

**FREE SAMPLE**

# Now! Do any car repair this QUICK, EASY WAY

You can "breeze through" engine jobs, tune-ups, front end jobs, brake repairs, steering adjustments, carburetor overhauls, generator servicing — ANY car service or repair job ON THE VERY FIRST TRY!

**1 FIND THE TROUBLE!**  
Just turn to "Troubleshooter" Section in MOTOR'S Repair Manual. Spots any one of 2300 car troubles — indicates the exact repair needed. No guess work!

**GIANT 1100-PAGE ILLUSTRATED GUIDE SHOWS YOU**

**2 FIX THE TROUBLE!**  
Step-by-step instructions, photos, diagrams show you where to start, what tools to use. Factory experts practically guide your hands through every move. You can't go wrong!

## How to Fix Any Part of Any Car

**YES!** MOTOR'S giant new Auto Repair Manual is the answer to practically all your car repair problems. Almost every car repair on every popular car on the road today is explained and illustrated in fool-proof detail. You will develop new speed and confidence on any repair job you tackle.

Try it FREE for 10 Days

Words can't possibly describe the vast contents . . . the thousands of photos and diagrams . . . the easy-as-pie instructions . . . the wonderful feeling when you know you've got that car running like new again!

You've got to see it, use it for yourself! That's why we offer to send it to you, at our risk, for a FREE ten-day trial. Try it. See how it makes even the toughest jobs seem like child's play. If you're not 100% satisfied, just send it back and you won't owe a penny!

Same FREE Offer on MOTOR'S New Truck Manual  
Brand new! Covers practically EVERY job on EVERY popular make gasoline and Diesel truck made — 1952 thru 1962. FREE 10-Day Trial.

Everything You Need to Know to Fix Cars Like a Crack Mechanic

The instructions and pictures are so complete, so clear, you just can't go

wrong. Your hands are guided by the men who actually build the cars, for this book "boils down" the time-cutting and work-saving methods from 176 Official factory shop manuals.

This NEW, REVISED EDITION gives you everything you need to know to repair engines, automatic transmissions, brakes, carburetors, dash gauges, front ends, steering, fuel pumps, generators, alternators, ignition systems, starters, voltage regulators, etc., etc. — practically every part of 31 major makes!

1,100 double-size pages include 2,850 drawings and photographs, 195 Quick-Check charts, 30,000 essential specifications — more than 225,000 individual service and repair facts! Includes all the new compacts.

No wonder you'll see copies of MOTOR'S Manual on almost every garage workbench in the country. No wonder it's used by schools, factories, the U.S. Army & Navy. Over 4,000,000 copies sold.

### SEND NO MONEY

Just mail the coupon. Use the Manual for 10 whole days FREE. If it doesn't pay for itself in time and money saved within 10 days, return it and owe nothing. But act now! MOTOR Book Dept., Desk 213, 250 West 55th St., New York 19, N. Y. (Schools, Bookstores; Write for Discounts.)

**MOTOR'S AUTO REPAIR MANUAL**

Nearly 1 FOOT HIGH  
2,850 Illustrations  
Over 1,100 Pages  
Used by U.S. Armed Forces

**4,000,000 COPIES SOLD**  
PRAISED BY BEGINNER AND EXPERT MECHANICS ALIKE . . .



"Never knew anything about repairing cars until I got this wonderful book." — F. PEMPER, WISCONSIN  
"I amazed myself and my friends. Now do jobs that stumped me before." — M. BA-  
"Have been a mechanic for 25 years, but Motor's Manual still takes me out of the light spots." — V. LAURIA, NEVADA

### MAIL NOW FOR FREE TRIAL

(Attach to postcard for fast action)

**MOTOR BOOK DEPT.**  
Desk 213, 250 W. 55th St., New York 19, N. Y.  
Rush to me at once (check box opposite book you want):

**MOTOR'S New AUTO REPAIR MANUAL.** If O.K., I will remit \$2 in 10 days, \$2 monthly for 2 months and a final payment of \$2.95 (plus 45¢ delivery charges and sales tax) one month after that. Otherwise I will return the book postpaid in 10 days.

**MOTOR'S New TRUCK REPAIR MANUAL.** If O.K., I will remit \$3 in 10 days, \$3 a month later, then \$2 monthly for 2 months, plus 45¢ delivery charges and sales tax with final payment. Otherwise I will return book postpaid in 10 days.

Print Name.....Age.....  
Address.....  
City.....Zone....State.....

Check box and save 45¢ delivery charge by enclosing WITH coupon in envelope entire payment of \$8.95 for Auto Repair Manual (or \$10 for Truck Repair Manual) plus sales tax. Same return-refund privilege.

### COVERS ALL THESE MAKES 1955 thru 1962

Buick	Corvette	Imperial	Olds F-85
Buick Special	Dart	Jeep	Plymouth
Cadillac	De Soto	Lancer	Pontiac
Chevrolet	Dodge	Lark	Pontiac Tempest
Chevy II	Edsel	Lincoln	Rambler
Chrysler	Falcon	Mercury	Rambler American
Comet	Ford	Mercury	Studebaker
Continental	Ford	Metzger	Thunderbird
Corvair	Fairlane	Oldsmobile	Valiant

**FREE 10-DAY TRIAL**  
Return and Pay Nothing If Not Satisfied

# Free!



## BRAND NEW LAFAYETTE ELECTRONICS 1962 CATALOG 620

It's Bigger and Better  
Than Ever!

340 giant-sized page catalog from the world's leading supplier of electronics and stereo hi-fi equipment.

### 340 PAGES

It's a complete shopping center for audiophiles, technicians, engineers, students, hobbyists, servicemen and dealers. Thousands of items at lowest money-saving prices — featuring LAFAYETTE KITS . . . the best value for your money any day.

**SPECIAL! NO MONEY DOWN**

with Lafayette's **NEW EASY-PAY PLAN.**

**MAIL THE COUPON TODAY FOR YOUR FREE CATALOG**

LAFAYETTE LOCATIONS

JAMAICA • BRONX • NEW YORK CITY  
NEWARK • PLAINFIELD • PARAMUS • BOSTON

Lafayette Electronics Dept. LC-2

P.O. Box 10, Syosset, L. I., N.Y.

Send me the FREE 340-pg. 1962 catalog 620.

Name.....

Address.....

City.....

Zone.....

State.....



## Take Your Traction With You

To improve traction for dual-wheel vehicles on snow, ice or in mud, a driver can bolt these specially formed spring steel traction plates ("Tractioneers") to a connector permanently fastened to the wheel spacer. The job can be done in minutes without jacking up the vehicle.

Units are available for spoke or disk wheels in two sizes to fit most dual tires from The Tractioneer Co., 460 Wrigley Bldg., 410 N. Michigan Ave., Chicago 11, Ill.



**FREE**  
**MUSCLE BUILDING**  
**INFORMATION**  
Sensational New Methods  
Less Time—Less Effort—Better results  
BODY-TONE, Box 638, North Miami 61, Fla.

## DON'T PAY FOR THESE GREAT BOOTS!



8" Boot—  
Quilted,  
Air Cushioned,  
Thermal-Insulated

GET THEM WITHOUT COST  
AS A REWARD — PLUS THE CHANCE  
TO "BE BOSS" OF YOUR OWN  
\$10,000 A YEAR SHOE BUSINESS!

Brand new plan! You can earn marvelous new boots instead of paying for them... and develop an extra income for life! Sell friends new Work, Dress, Casual Shoes and Boots in spare time. Amazing Vylt Sole guaranteed the life of the shoe or boot or replaced FREE!

Also earn Advance Commissions up to \$10.00 a pair, plus big Bonus. No experience. Samples supplied. Write for new Selling Outfit — without obligation.

**CHARLES CHESTER SHOE MFG. CO.**  
Dept. C-623, Brockton, Mass.



"When I tell you what the trouble was, you'll laugh."

POPULAR MECHANICS



Processing of **KODACHROME** (Licensed by Eastman Kodak)

**AT DISCOUNT PRICES**

KODACHROME I & II } \$1.00  
 8mm ROLL OR }  
 35mm 20 EXP. MTD. }  
 8mm MAGAZINE ..... .75  
 35mm 36 EXP. MTD..... 1.75

SEND FOR FREE MAILERS and our big FREE CATALOG of Processing, Film and Equipment at DISCOUNT PRICES!



**SOLAR** CINE PRODUCTS 4247 S. Kedzie Dept. ME  
 Chicago 32, Ill.

**make your own Gems 3650**  
 The Gem Maker comes complete with all necessary equipment, including a super-charged diamond blade for sawing, and all the wheels for grinding, shaping and polishing; also complete instructions. The complete equipment as shown, less motor and belt for only \$36.50, f.o.b., Burlington, Wisconsin. Write today for information and literature.  
**B&I MANUFACTURING CO.**  
 Dept. P, Burlington, Wis.

**REAL ESTATE BE A BROKER**

**PAYS BIG! SEND FOR FREE, BIG, ILLUSTRATED CATALOG NOW!** Graduates report making substantial incomes. Start and run your own business quickly. Men, women of all ages, learn easily. Course covers Sales, Property Management, Appraising, Loans, Mortgages, and related subjects. **STUDY AT HOME** or in classrooms in leading cities. Diploma awarded. Write TODAY for free booklet! No obligation. Approved for World War II and Korean Veterans  
**WEAVER SCHOOL OF REAL ESTATE (Est. 1936)**  
 3521P Grand Avenue Kansas City, Mo.

**FREE AMAZING NEW BOOK "HOW TO ANSWER ADS"**



Never before have you seen anything like this. Tells you in simple language the correct way to answer ads. Gets you quicker replies—better results, and greater satisfaction. Will save you time and money and it's **ABSOLUTELY FREE**. No obligation whatever. Every reader of advertising should have this booklet. Send a postcard for your copy NOW. **F. W. JOHNSON, Popular Mechanics Magazine, Room 600-A, 204 East Ontario Street, Chicago 11, Ill.**

**get into operating or repairing EARTH MOVING EQUIPMENT**

Men needed now for good paying jobs in booming road and construction work. Learn operating or repair-rebuilding of heavy road machinery, cranes, bulldozers, earth carriers, etc. Actual "on the job" training. 5 to 13 1/2 week courses. Classes start every Monday. Reserve your space now. Complete catalog and reservation facts **FREE**. Approved for veterans. Write

**Greer TECHNICAL INSTITUTE**  
 Attn.: P.C. Hutch, Box 368, Braidwood, Ill.

**133 PIECE SURPLUS POWER TOOL SET \$2**  
 Made to sell for \$11.00  
 Power Tool Set is brand new Surplus, has 133 pieces including grinding wheels, sanding cart-ridges and discs. Steel cutters, wire wheels, circular blades, etc. Can be used with any electric drill, grinder or flexible shaft. Only \$2.00 plus 35c postage and handling.  
**A & B INDUSTRIES** 342 MADISON AVE. Dept. T-85, New York 17, N. Y.

**"I Made \$510.00**



**in One Month's Spare Time"**  
 — says Earl Reid of Ohio

THE FREE BOOK offered below was a big first step ahead for men like Earl G. Reid of Thompson, Ohio, who says: "In one month I took in \$648, of which \$510 was clear. I work only part time — do a lot of service calls on ranges, dryers — also house wiring and electrical maintenance."

**YOU CAN "BEEF UP" YOUR INCOME, SPARE TIME, OR FULL TIME, WHEN YOU LEARN THIS WAY TO Fix Electric Appliances**

Like Earl Reid, many others, YOU can now have a steady, good-paying "business of your own" right in your home. Spare-time at start, full-time later. No experience needed, no big investment. Learn how to Repair Electric Appliances. Many men now make \$3 to \$5 an hour!  
**FOUR HUNDRED MILLION Electric Appliances**

are in use right now in American homes. Seventy-six million MORE are bought each year. People need them fixed, good times or bad, YOU make good money doing it. Work in your own basement, garage, even on kitchen table. You need only few simple, basic tools. We train you, at home, to make steady money — earn while you learn.

**Quick, Sure Way to Learn Everything You Need to Know**

Our 24-page FREE Book tells how you can "cash in" on America's Electric Appliance Repair boom.

FREE Sample Lesson shows how our easy, clearly pictured instruction prepares you for top earnings and a profitable future in this big field. All for less than 20¢ a day.

At no extra charge we even provide all parts to assemble your own sturdy, portable Appliance Tester. It shows you where to repair, speeds your work,

makes sure each job is done right, ready to collect the cash coming to you.

Here's the big-demand business you've been looking for! — and the chance to train for it with methods proved successful for over 45 years. Get your Free Book, Free Lesson now. Mail coupon, letter, or postcard to: National Radio Institute, Appliance Division, Dept. AC2, Washington 16, D.C. (No obligation, and no salesman will call on you.)

**MAIL COUPON NOW**

**FREE BOOK**  
**FREE LESSON**

**NATIONAL RADIO INSTITUTE, Appliance Division, Dept. AC2, Washington 16, D.C.**

Please send me Free Book about your Electric Appliance Repair Course and a Free Sample Lesson. I am particularly interested in:

Spare Time Earnings  Better Job  
 Business of My Own

Name.....  
 Address.....  
 City..... Zone..... State.....  
 Accredited Member National Home Study Council

## "I Earned \$400 While Learning"



"I Earned \$400 While Learning,"  
Says John Braknis, Burlington, Ont., Canada  
"I earned \$400 during my training period. And  
it was fun! The course was so easy, the instruc-  
tors so helpful that I think anyone can master  
locksmithing, as I did."

## Be a LOCKSMITH

Add 50%-100% to YOUR INCOME with easy spare time earnings. Cash in on nationwide shortage - trained locksmiths in demand! Quickly step into a big-pay opportunity job - high-profit shop of your own.

**Earn Extra Money RIGHT AWAY! All Special Tools, Supplies Furnished FREE.**

Age, education, minor physical handicaps don't matter in this growing trade. You can quickly qualify as a skilled locksmith. Study at home as little as one hour a week. Gain practical experience through well-illustrated lessons. Do real jobs on car locks, house locks, padlocks and safe locks, under the guidance of experts.

**306 pieces** of professional equipment supplied **FREE** for use with course. **FREE Book.**

Approved for Vets.

### MAIL COUPON FOR FREE BOOK

For a future as your own boss or in a high-pay job, write now for FREE illustrated book! Only school of its kind. Lic. State of N.J., Accredited NHSC. Locksmithing Institute, (Div. Tech. Home Study Schools)

Dept. 103-2, 150 Park Ave., E. Rutherford, N.J.

### MAIL COUPON NOW!

LOCKSMITHING INSTITUTE, Dept. 103-2  
150 Park Avenue, E. Rutherford, N.J.

Please send Free Illustrated Book without obligation.

Name \_\_\_\_\_ (Print here)

Address \_\_\_\_\_

City \_\_\_\_\_ Zone \_\_\_\_\_ State \_\_\_\_\_

Check if Veteran @1962, Technical Home Study Schools

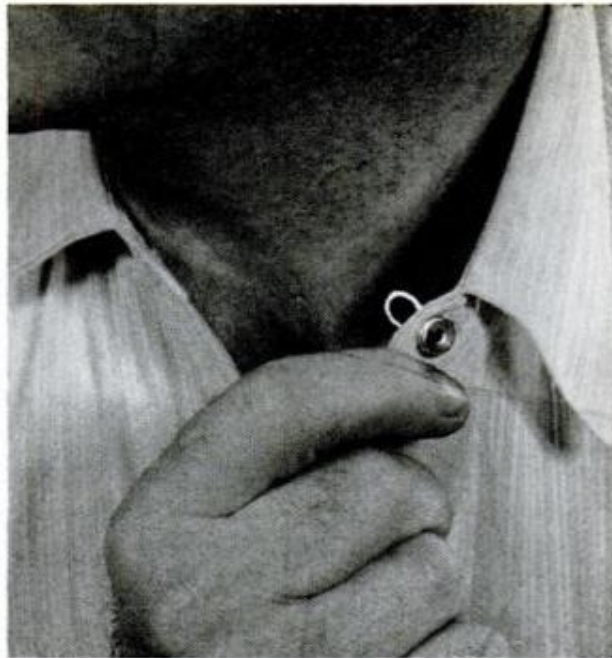

## Your Last Gasp

If your rosy complexion is really due to shirt collars that are too tight, Wonder Button is a handy collar enlarger that will reduce blood pressure, restore faith in mankind and save shirts from the ragbag.

An aluminum button with spring loop, it adds at least a half size. Price—\$1. from Schafer Products, Union City, Mich.

## High School at Home

### MANY FINISH IN 2 YEARS

No classes. No time wasted going to and from school. Progress as fast as your time and abilities permit. Standard H.S. texts supplied. Thousands enroll each year in this 65-year-old school. Send for FREE descriptive booklet.

**AMERICAN SCHOOL, Dept. H345**  
Drexel at 58th St., Chicago 37, Ill.

Without obligation, please send FREE descriptive booklet.

Name \_\_\_\_\_

Address \_\_\_\_\_

Accredited Member National Home Study Council

## New Catalog of 2900 Novelties

Send 10c for amazing catalog of novelties, live animals, scientific supplies, hobbies, funmakers, planes & boats, looms, magic tricks, joke articles, unusual seeds, gadget timesavers, cameras, optical goods, projectors, movies, lucky jewelry, religious novelties, disguises, musical instruments, stamps, coins, puzzles, fortune tellers, radios, auto & bike accessories, telescopes, magnifiers, compasses, banks, smokers' gadgets, artists' supplies, printing sets, engines, motors, shockers, knives, billfolds, guns, rifles, sports, books, games, plants etc. Send 10c.

**JOHNSON SMITH COMPANY Dept. 561 Detroit 7, Mich.**

## YOUR OWN BUSINESS with BIG EARNINGS in..

### ELECTRIC APPLIANCE REPAIRING

100,000,000 Families Are Your Prospects! Repair electrical appliances for friends and neighbors. Service electrical equipment in stores, etc. Earn up to \$5.00-\$6.00 an hour or more! New shop method home study training. Electronic Kit makes it now possible. Rush name for FREE Book, and Special PAY LATER form. **CHRISTY TRADES SCHOOL**  
3214 W. Lawrence Ave., Dept. A-2203, Chicago 25

SEND FOR FREE BOOK!

## The Man Claims That He Knows

the finest fishing spot in North America. See if you agree with him. You'll find his story in the

APRIL

POPULAR MECHANICS

## MAKE \$1000 AN HOUR in your spare time

Start earning CASH immediately in your spare time with Ortho-Vent, America's most comfortable cushion shoes for men, women, children. We will lend you FREE your own Portable Shoe Store with actual demonstrators which sell for you. We send FREE everything you need to get started. New Spring-Step Cushion sells fast. No experience needed. You make up to \$10 on just one sale. We pay you cash commissions, bonuses, free gifts. Qualified dealers receive up to \$20,000 FREE life and accident insurance, up to \$100 weekly when sick. Act now!



**ORTHO-VENT SHOE CO.**  
1123 Brand Road  
Salem, Virginia

**Free Shoes To  
Producers Plus  
Discount For  
Family**

## LAW FREE BOOK THE LAW TRAINED MAN

Write today for a FREE copy of illustrated law book, "THE LAW-TRAINED MAN," which shows how to earn the professional Bachelor of Laws (LL.B.) degree through home study of the famous Blackstone Law Course. All necessary books and lessons provided. Moderate cost; convenient monthly terms. Write for FREE law training book today.

**Blackstone School of Law, 307 N. Michigan Ave.**  
Founded 1890 Dept. 53, Chicago 1, Illinois

## MAKE MORE MONEY

Be in business for yourself year-round. Fast growing company. Travel United States and parts Canada. Paid training. Age 21 or over, pass physical, own or can finance '57 or later 260 cu. in. or larger tractor. Write Mayflower Transit, Box 107, Dept. PM, Indianapolis 6, Ind.

## BUY WHOLESALE

**FREE NAME BRANDS CATALOG WITH  
CONFIDENTIAL PRICE LIST**

Your own high profit business full or part time. More than 2000 items: power tools, sporting goods, jewelry, cameras, hi-fi, appliances, housewares, hardware, almost everything! Orders shipped same day. Send for your Free catalog today.

**H.B. DAVIS CORP.** Dept. PMD

145 West 15th Street, New York 11, N.Y.



## Shrinks Hemorrhoids New Way Without Surgery Stops Itch - Relieves Pain

For the first time science has found a new healing substance with the astonishing ability to shrink hemorrhoids and to relieve pain - without surgery.

In case after case, while gently relieving pain, actual reduction (shrinkage) took place.

Most amazing of all - results were so thorough that sufferers made astonishing statements like "Piles have ceased to be a problem!"

The secret is a new healing substance (Bio-Dyne®) - discovery of a world-famous research institute.

This substance is now available in suppository or ointment form under the name Preparation H®. Ask for it at all drug counters.

MARCH 1962

## 94.6% OF BAILEY GRADUATES ARE EMPLOYED AT TOP PAY IN THE FIELDS WHICH THEY WERE TRAINED!

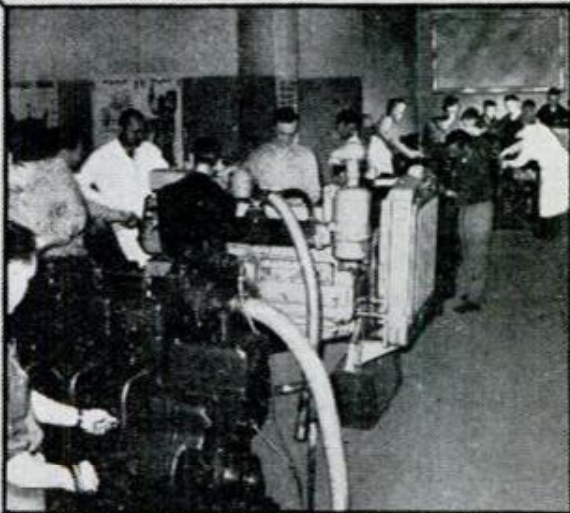

## DIESEL-AUTO MECHANICS DESPERATELY NEEDED!

We have a far greater demand for our students than we can fill!

We can show you an actual waiting list of leading companies throughout the world who have tried Bailey graduates - found them outstanding, and are coming back for more!

**Bailey Graduates are Successful . . . RECEIVE BIG PAY - HAVE SECURE FUTURE!**

The Famous Bailey Course prepares you for BOTH Diesel and Gasoline Mechanics.

This is a must - due to the advent of using Diesel principles, such as 'Fuel Injection' on passenger cars . . . use of gasoline engines for starting Diesel engines, etc. You learn all this at Bailey in the amount of time ordinarily required to learn just one of these subjects, **ALL FOR THE PRICE OF ONE.**

Don't be satisfied with a 'futureless', one-type job - learn how you can make big money now!

Write today for Free Booklet that takes you on a step-by-step camera tour through our spacious, modern shops - See Bailey students in action as they Learn-by-doing with the Famous Bailey Method of training!

We provide you with housing and part time jobs while in school, plus nation-wide placement service for graduates.

## BAILEY Technical SCHOOLS

1634 S. GRAND

ST. LOUIS 4, MO.

### MAIL TODAY!

Please mail immediately this free booklet without obligation.

FREE BOOKLET



Name.....

Address.....

City..... State.....

APPROVED FOR VETERAN . . . NON-VETERAN

**EARN \$125  
A WEEK AND UP**

**BE AN AUTO DIESEL  
EXPERT—LEARN  
A TRADE YOU LIKE**

You learn fast in our shops because you learn with tools on real equipment. Students short of money may earn most of their expenses by doing part-time work. Experienced instructors explain WHY and show you HOW, then you DO IT YOURSELF. Many of our graduates earn \$125 a week and up. Approved for veterans. Day and evening classes. Free bulletin-write today.

**MAIL THIS COUPON TODAY!**

**NASHVILLE AUTO-DIESEL COLLEGE**  
226 7th Ave., No., Dept. 86, Nashville, Tenn.  
Please send without obligation free catalog.

NAME \_\_\_\_\_  
(please print or write plainly)

ADDRESS \_\_\_\_\_

CITY \_\_\_\_\_ STATE \_\_\_\_\_

# ELECTRONICS

Train in the new shop-labs of the world famous  
**COYNE ELECTRICAL SCHOOL** on a  
quarter of a million dollars  
worth of equipment. Est. 1899—Non-Profit Institute.  
Courses: Electronics • Electricity • TV-Radio.

Use this coupon to get our free book  
"GUIDE TO CAREERS"

**COYNE ELECTRICAL SCHOOL** Educ. Serv. Dept. 3  
1501 W. Congress Parkway, Chicago 7, Ill.

NAME \_\_\_\_\_

ADDRESS \_\_\_\_\_

CITY \_\_\_\_\_ STATE \_\_\_\_\_

Unlike most other schools, we do not employ salesmen.

**EARN HIGH SCHOOL DIPLOMA  
AT HOME AT YOUR OWN SPEED**

a program now offered by one of the  
nation's largest educational organizations

Learn fast! Earn more! Enter college,  
professional or technical schools.  
Advance socially. Live a happier,  
fuller life. Individual courses or com-  
plete 4 year schooling. Moderate tui-  
tion. Write for School Catalog.

**ACADEMY FOR ADULTS**

Division, Encyclopaedia Britannica Films, Inc.,  
30 W. Washington, Dept. PM-32, Chicago 2, Illinois

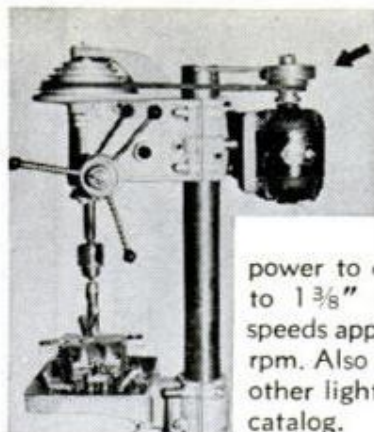

## DOUBLE DRILL PRESS CAPACITY

Motor mounted speed reducer provides the correct speed and power to drill, ream, c'bore etc. to 1 3/8" dia. in steel. Spindle speeds approximately 45 to 3000 rpm. Also used on band saws and other light machinery. Write for catalog.

**PULL-GEAR CO.**

13523 E. Eight Mile Rd.  
Warren, Michigan



## RADIOMETER

AMERICAN MADE. Balanced four arm vane, in a 3" diameter evacuated glass globe, turns upon exposure to light, any light, even a lighted match. Highly decorative, interesting, educational, instructive. A conversation piece. We guarantee yours to operate.

Remit with order. No C.O.D.

\$3.00 p.p. 2 for \$5.00 p.p.

**HARRY ROSS** Scientific & Lab Apparatus  
61-0 Reade St., N.Y. 7, N.Y.

How would you like to **MAKE \$26<sup>52</sup> in 3 HOURS?**



That's what **M. R. Stanley of Calif.** did with amazing **MERLITE FIRE ALARM!**

You can make big money, spare or full time, up to \$1,000 in a month, introducing sensational new automatic Fire Alarm. No installation, hangs on wall like picture. When fire starts, Alarm "howls," can be heard 1/8 mile! Astounding "lighted match" demonstration sells alarms fast. **FREE SALES KIT!** Rush name, address for big Sales Kit with everything you need to make big money first day. All FREE. No obligation. Write: **MERLITE, Dept. F-15R, Alarm Div., 114 E. 32nd, N.Y. 16, N.Y.**



**Learn Profitable Profession  
in few months at Home**

**MEN AND WOMEN, 18 TO 60**

\$4.00 to \$5.00 for 1-hour treatment is the established charge for a skilled operator. Easy to learn and do. Diploma awarded. Open your own office or earn good income from Doctors, Hospitals, Clubs and other health or recreational centers. Wonderful part-time profession. Low monthly payments. Write today for free Anatomy Charts and catalog. No obligation.



**ANDERSON SCHOOL OF SCIENTIFIC MASSAGE**  
Dept. C1, Princeton, Illinois

**SAVE MONEY! MAKE MONEY!  
WITH PORTABLE CEMENT MIXER!**

It's easy, fast, fun to do your own work with the **MIXAL Mixer**. Build barbecues, patios, sidewalks for yourself, for others! Mixes 3' x 8' sidewalk every hour! Uses any 1/4 HP motor. Thousands used by contractors! Try it on **MONEYBACK GUARANTEE!** Send for **FREE HOW-TO-DO-IT CEMENT MIXING BOOKLET.** Dept. PM-3.



**KOL, INC., 2323 Ellis Ave., St. Paul, Minn.**

W. of Rockies)

*Learn* **BAKING at Home**



Baking is one of America's high industries in wages. Not seasonal, but year 'round good field for trained and experienced men. Thorough basic spare time home study course lays solid foundation. If you have the aptitude for this type of work, send for **FREE Booklet, "Opportunities in Commercial Baking."**

**NATIONAL BAKING SCHOOL**  
835 Diversey Parkway Dept. 1353 Chicago 14, Ill.  
Accredited by National Home Study Council

POPULAR MECHANICS

# POPULAR SHOPPING

**Home decorating** is the subject of a free booklet, "101 Ways to Glamorize Your Home." The 32-page book, prepared by William R. O'Neil, California interior decorator, touches on many problems common to all homemakers. Available from International Correspondence Schools, Dept. PR-1, Scranton 15, Pa.

**Scientific and engineering** capabilities of children can be assessed by parents. Battelle Memorial Institute has available a free 30-page guide book, "Is There a Future Scientist or Engineer in Your Home?" The booklet outlines characteristics which may indicate an embryo engineer or scientist. The booklet also lists the subjects and courses which are musts in high school. The Institute's address is 505 King Ave., Columbus, Ohio.

"**Boatman's Guide to Marine Rope**" is a handy, pocket-sized folder that tells, among other things, when to use nylon rope and when to use dacron. Available from West Products Corp., Dept. PM, P.O. Box 797, Newark 1, N. J.

**Welding procedures** are described in a free 85-page book available from the Hobart Brothers Co., Troy, Ohio. Their "Hobart Vest Pocket Guide to Better Welds" ranges through the subject, discussing, among other things, examples of good and bad welds, welding positions, welder qualifications and steel available for welding.

"**Tips for Rug and Carpet Care**" is an 11-page booklet that is available free from the National Institute of Rug Cleaning, Inc., Box PM, 7355 Wisconsin Ave., Bethesda 14, Md. In simple language, the booklet advises how to care



**Fishermen! FREE**  
Giant Fishing  
**DISCOUNT CATALOG**

Real Bargains! Lowest Discounts!  
100's of Unconditionally Guaranteed items . . . highest quality—lowest DISCOUNT prices ANYWHERE! ALSO SURE WAYS to catch fish, anytime, anyplace; tips on bait, fly & spin casting, trolling, jigging, surf, night fishing, etc. **DON'T DELAY! FREE GIFT IF YOU MAIL TODAY! ENCLOSE 25c to cover mailing.**  
FISHERMAN'S DISCOUNT CENTER  
5708 Lankershim, N. Hollywood, 53 Cal.

**MEN! WE FIT W-I-D-E FEET!**

E to EEEEE Only  
Sizes 5 to 13

Men only. Casual, dress, work shoes that really fit. Top quality, popular prices. Money Back Guarantee.

Not sold in stores

Write Today for FREE CATALOG  
HITCHCOCK SHOES, Hingham 28-B, Mass.

**UNUSUAL TOOLS BY MAIL**

**#44 CORNER CLAMP & MITER BOX COMBINED**  
Holds the wood. Holds your saw. Accurate cuts with any handsaw from 0° to 180°. Full 3" capacity. Sides exposed for nailing and gluing. \$2.75 ppd. No. 33. Same as No. 44 without saw guide attachments. \$1.75 ppd.

**EASY SAW FILER**  
No. 11 Gives correct height, depth, pitch, bevel to any 6" to 10" hand or circular saw with no side pull. Includes 8" file. \$9.95 ppd.

**SAW SET**  
automatically sets teeth at 10° or more. \$2.95 ppd.

**DRILL GRINDER**  
Sharpens round shank drills like new with hand or power grinders. \$2.95 ppd.

**MONEY BACK GUARANTEE**  
A. D. McBURNEY, 5908 Hollywood Blvd., Hollywood 28, Cal. Dept. A-32

115 Volt, 60 Cy., Continuous Duty  
SINGLE PHASE  
**A.C. GENERATORS**  
BRAND NEW! SAVE \$\$\$

**750 WATT \$5950 FOR**

**1000 WATT \$7950 FOR**

**2500 WATT \$12500 FOR**

**Fully Guaranteed**

Permanent or stand-by unit for electricity IDENTICAL to house current. Perfect for farms, camps, aboard ship, oil fields, mines, etc. Easily handles lights, refrigerator, deep freeze, oil burner, radio; power for saws, floodlights, drills, pumps, etc.  
All ball bearing. Operates at 3600 R.P.M. Drive with 2 HP to 3 1/2 HP or larger engine — or use power take-off. Voltage self regulating. Self excited! Standard base mounting. Two outlets. Tremendous overload capacity. Operates in either direction!

Order from this Ad  
Phone TAYlor 9-1365  
**ROBERTS ELECTRIC CO., Dept. PM-270**  
849 W. GRAND AV., Chicago 22, Ill.

**BUILD better SAVE more**

with proved home plans

Hundreds of custom feature dream home plans are shown in detail. Plans noted for comfort, lasting beauty, sound economy can save you \$1000 or more in building costs. Builder-proved blueprints available at low cost for every plan. Send for your plan books now.

**SAVE! ANY 3 BOOKS \$2**  
All 6 Books, over 1000 Plans only \$4

- Family Room Homes . . . . . 225 popular plans \$1
- New Trends & Selected Homes . . . . . 357 choices \$1
- Hillside & Split-Level Homes . . . . . 100 plans \$1
- Block Masonry Homes . . . . . 223 low-cost charmers \$1
- Multiple Family Homes . . . . . 85 duplexes and courts \$1
- Leisure Time Homes . . . . . lodges, cabins, 2nd homes \$1

Books Postpaid in U. S. and Canada

**HOME BUILDING PLAN SERVICE**  
STUDIO P, 2454 N.E. Sandy Blvd., Portland 12, Oregon

# HOME PACKAGING

"MADE TO ORDER"  
FOR FOLKS WHO  
DON'T LIKE TO SELL



A. J. Abari, Pres.

An Amazing New Kind of Home Business That Can Bring You a Big **STEADY INCOME**

Profits up to 2500%. Greatest one-man or man and wife team opportunity you ever heard of. Start spare time or full time anywhere—kitchen, basement, garage. We supply everything you need—guide you step-by-step. If you don't like house-to-house selling, this is the type of work you will really go for. Free "no selling plan" reveals big profit spare, full time opportunities. Get complete information in my new book "10 STEP PACKAGING PROFIT PLAN"—sent free and postage prepaid.



## FREE! Mail Coupon Now

A. J. Abari, Pres., Home Packaging Co., 2212 E. Jesse St., Los Angeles 23, Calif.  
Dear Mr. Abari: Please send me your new book "10-STEP PACKAGING PLAN" and details of how I can get started in my own home. Everything you send me now is free and no salesman will call. Dept. R-256

NAME \_\_\_\_\_

ADDRESS \_\_\_\_\_

CITY \_\_\_\_\_

ZONE \_\_\_\_\_ STATE \_\_\_\_\_

DO IT YOURSELF BUT DO IT BETTER  
WITH THE RIGHT MATERIALS!

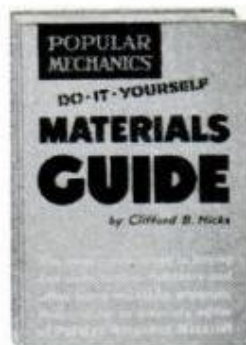

## Get Popular Mechanics DO-IT-YOURSELF Materials Guide

The Key to Buying and Using Lumber, Hardware and Other Home Workshop Materials

The right lumber. The right grade. The right fastenings, nails, screws, glue and other hardware. These are all just as important as the right design and the right kind of workmanship. It's true, whether you're fixing up the house, making a fine piece of furniture or knocking out a time-killing gadget. Get Popular Mechanics Materials Guide. Fills a long-felt need of home owners and home workshop fans. Has how-to-do-it information too. Send only \$2.95 for postpaid delivery. Money back if you want it in 5 days.

### You Need This

How to select and how to use—Lumber, millwork, plywood and hardboard—Exterior wall and roof materials—Hardwood floors and floor coverings—Wall and ceiling materials—Doors, windows, screens and weather stripping—Glass, the material of tomorrow—Plumbing pipes and fittings—Electrical equipment—Nails, screws, bolts, etc.—Hinges, locks and other hardware—Paints and miscellaneous products.

192 Fact filled pages.  
667 how-to-do-it pictures

Popular Mechanics Press, Dept. 362, 200 E. Ontario St., Chicago 11



# PLAY RIGHT AWAY!

Even If You Don't Know a Note of Music Now

NOW it's EASY to learn any instrument. No boring exercises. Start playing real pieces by notes right away. Amazing progress at home, in spare time.

No teacher. Few cents per lesson. 1,000,000 students! Write for FREE BOOK. U. S. School of Music, Studio 303, Port Washington, N. Y. No salesman will call. (Est. 1898.) Tear this out.



## CHILD SAVER

SEAT BELTS, if used in every car, could save at least 5,000 lives a year . . . reduce injuries by one-third, according to the National Safety Council. Many of those saved from injury or death would be youngsters—for *drivers kill and cripple more children* than any disease. Protect *your children* . . . drive with loving care. Give them the security of seat belts.

Published as a public service in cooperation with The Advertising Council

## Announcing A NEW CASH-SAVING, TAX-SAVING WAY TO WEALTH IN A BUSINESS OF YOUR OWN

LEASE PATENTED EQUIPMENT — GET LIFETIME OPPORTUNITY TO OWN THIS SERVICE BUSINESS AND BUILD AN ESTATE FOR YOUR FAMILY THAT YOUR JOB CAN NEVER GIVE YOU.



Service industries are growing 5 times faster than any other . . . Now LEASE YOUR WAY TO SUCCESS in this growth area—get your share of a 4 BILLION a year industry. An exclusive territory, protected franchise with the world's largest lawn and garden spray services—publically owned with franchises in 27 states and Canada. We teach you the business—supply ad mats, contract forms, etc. Rent, with option to buy or rent permanently for BIG TAX SAVINGS. MAXIMUM CAPITAL GAINS FEATURE. TOO. Minimal investment from \$2,950. Write or call —

GENERAL SPRAY SERVICE, INC. Dept. PM-3  
General Spray Bldg., Katonah, N. Y., CE 2-5144

for rugs and carpets and what to do in the event of accidents, as when things are spilled on them.

**Two large maps** (28" by 32") show locations of all national parks and monuments. On the back are descriptions of each area plus information on facilities and special activities. Revised 1961. Send for "Eastern United States" and "Western United States," each 20¢, to Superintendent of Documents, Government Printing Office, Washington 25, D.C.

**Home sanitation** would be a critical problem facing all families in the event of a national disaster. A booklet from the Office of Civil and Defense Mobilization explains how to keep water and food untainted, and describes other sanitary measures. Send 15¢ for "Emergency Sanitation at Home" to the Superintendent of Documents, U.S. Government Printing Office, Washington 25, D.C.

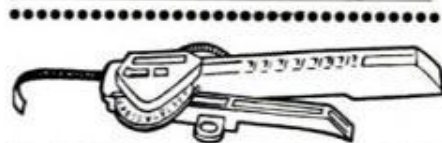

**ON THE SPOT PRINTING**  
 . . . and labelling.  
 This amazing machine—only slightly larger than a pair of pliers prints raised letters in seconds! Print your name plate or any identification on self-adhering tape. Excellent for electronics and all industrial shop file drawer identification.  
**Only \$24<sup>95</sup>** with tape.  
 Send check or money order to  
**R.I.P.S., 814 S. Mullen Ave.,  
 Los Angeles 5, Calif.**



**Miracle** HAND PUMP  
 It's new—has many uses. Easy to use. Just a squeeze does it! Exclusive full flow valves. Nothing can beat it for priming carburetors, transferring fuel, blowing out clogged gas lines. . . . Around the house use the Miracle hand pump for pool chemicals, emptying aquariums. It's a handy plumber's aid—empty basins, stoppage drains. Absorb ship clean out bilges, pump fuel.  
**H. C. S. SHOPS**  
 P. O. Box MP 1904  
 CHATTANOOGA, TENNESSEE



**"Brownlee" SECTIONAL LOG CABINS**



**BUILT IN SECTIONS FOR EASY SITE ERECTION HOMES - COTTAGES - CAMPS**  
 Send 25c for Catalog to  
**Universal Homes Inc. Milan Michigan**  
 Dealer Inquiries Invited

Information not listed on articles in this issue often is given in the WHERE-TO-FIND-IT list, available at no cost from the SERVICE BUREAU, POPULAR MECHANICS, 200 E. Ontario, Chicago 11, Ill.

**LEARN MEAT CUTTING AT NATIONAL** Pay After Graduation



The steady dependable trade of Meat Cutting taught easily in 8 short weeks. **YOU LEARN BY DOING** under actual meat market conditions in big modern school at Toledo.

For beginners or men with experience. Get a profitable store of your own. Remember, **PEOPLE MUST EAT!** Big pay jobs. Free employment help. Thousands of successful graduates.

Buying, cutting, percentage, pricing, advertising, selling, etc. A complete retail meat education. National School established 39 years. Get National training **NOW**. Pay your tuition in easy weekly

payments after you graduate. Send coupon for **FREE** school catalog—**TODAY**. G.I. approved.

**National School of Meat Cutting, Inc., Dept. 50-C, Toledo 4, Ohio**  
 Send me your **FREE** school catalog on National Training at Toledo in Meat Cutting, Meat Merchandising and Self Service Meats. No obligation. No salesman will call.

Name..... Age.....  
 Address .....

City..... State.....  
 Approved for Veterans

# WANTED!

**Mechanically Inclined  
Men to Qualify for  
BIG PAY JOBS  
AND SPECIAL FACTORY  
TRAINING IN DIESEL**



"We need qualified repairmen, operators, mechanics NOW!" say Diesel Manufacturers, Highway Builders, Truck Line Operators in every corner of America. Can you qualify for these High Pay Jobs? We can help you! Interstate's General Course and Cummins-approved Diesel home-training courses are internationally recognized. Advisory placement service for trainees. Don't wait. Men are needed NOW!

**Get the Facts Today!**

**WRITE INTERSTATE TRAINING SERVICE**  
Dept. A-3, Portland 12, Oregon

Rush information on I.T.S. Diesel Courses, Special Factory Training and Diesel Job Opportunities.

Name \_\_\_\_\_ Age \_\_\_\_\_

Address \_\_\_\_\_

City \_\_\_\_\_ Zone \_\_\_\_\_ State \_\_\_\_\_



**ENGINEERING  
SCIENCE  
MATH** **DEGREE IN  
27 or 36 MOS.**

**B.S. degree — 36 mos. • B.E. degree — 27 mos.**  
ACCELERATED YEAR-ROUND PROGRAM prepares for early employment in fields of SCIENCE and ENGINEERING. Regular 4-year program for B.S. Degree completed in 36 months, special engineering degree program in 27. Classes start — March, June, July, Sept., Jan. QUALITY EDUCATION. Graduates employed from coast to coast. Government approved for veteran training. Students from 50 states, 40 countries, 20 buildings; dorms, gym, campus. SAVE TIME AND MONEY. EARN BOARD while studying. Write for catalog and complete information.

## INDIANA TECHNICAL COLLEGE

532 E. Washington Boulevard, Fort Wayne 2, Indiana  
Please send me free information on Bachelor's Degree Programs in Engineering and Science as checked below:

<input type="checkbox"/> Aeronautical Engineering	<input type="checkbox"/> Mechanical Engineering
<input type="checkbox"/> Chemical Engineering	<input type="checkbox"/> Metallurgical Engineering
<input type="checkbox"/> Civil Engineering	<input type="checkbox"/> Physics
<input type="checkbox"/> Electrical Engineering	<input type="checkbox"/> Chemistry
<input type="checkbox"/> Electronic Engineering	<input type="checkbox"/> Mathematics

Name \_\_\_\_\_

Address \_\_\_\_\_

**CIVIL DEFENSE APPROVED PLANS** for fallout shelters, plus expert advice on survival, in handy booklet. Only 25c from Popular Mechanics Service Bureau, Dept. RSB, 200 E. Ontario, Chicago 11, Ill.

# RUPTURE!

An amazing Air-Cushion Invention allows body freedom at work or play. Light, neat, cool, sanitary. Durable, cheap. Day and night protection helps Nature support weakened muscles gently but surely. No risk. Sent on Trial! Write NOW for free Booklet and Proof of Results. All correspondence confidential.



Brooks Company, 143-E State St., Marshall, Mich.

## Revolving Radar Room Sickens Electricians

There's a group of dizzy, staggering men at White Sands, N. M., who get sick and tired helping in the development of a giant acquisition radar for use with the Nike-Zeus antimissile.

They are technicians charged with keeping the experimental set in operation at the proving grounds, and they get sick when they have to hop on the continuously whirling equipment room that hangs below—and contains the electronic marvels for—the continuously revolving radar dome.

The whirling room is the size of a small house and spins around at 10 revolutions per minute, setting up a high-stress environment. Because a technician can't see himself spinning while inside this windowless room, his eyes naturally tell him he's not moving. But his nervous sensors—the labyrinths of the inner ear—know he's whirling. Over-stimulation of the labyrinths versus no stimulation of the eyes produces a conflict of data—called canal sickness—and the brain doesn't know what to believe.

Spinning along, the men become dizzy, drowsy, depressed, indifferent; they experience muscular fatigue, reduced visual acuity, sweating, pallor; they have false impressions of position and trouble walking straight.

And there's more: A force called coriolis comes into play as they spin; it accelerates them away from intended straight paths. When a man extends his arm to operate a control, the hand can miss the target by several inches. Making repairs in the room is like trying to install a light bulb in a jumping socket.

As might be expected, this maintenance job is not for every man. Those performing it work from 5 to 30 minutes and have been weeded out from others as best adapted to work while they spin.

## Seek That Last Drop of Oil

Squeezing the last drop of oil from underground deposits is the aim of a program under way at the University of California. As much as 80 percent of the reserves remain in the ground after wells are closed.

The studies will seek to find new ways to get the remaining oil out of the ground. One method is to flush out the oil by forcing another liquid into the ground. In certain porous areas of earth, however, the pushing process becomes unstable and the pushing liquid mixes with the oil. The studies will seek to discover under what conditions such instabilities develop.



## Constructive and Profitable...

...and enjoyable. Manufacture and sell ornamental concrete items in your spare time. Warning, it could become a rewarding, full-time business. It has for many, many others, why not you?

We manufacture and sell on a direct basis the industry's best molds. Durable, Dependable, High Quality, and of Aluminum. 96-pg. "How To Turn Concrete Into Gold" includes 29 pgs. of priceless instructions for professional results. Describes and Prices over 300 molds for Bird Baths, Benches and Tables, Flower Urns, Statues, Animals, Religious Items, and many more from 2" to 68" high. It gives the full story. Order yours TODAY — Rushed to you by First Class Mail. It's only \$2.00.



Sea Horse Bird Bath  
One of over 300 different Ornamental Concrete Items you can make in CMC Molds.

**HOW TO TURN CONCRETE INTO GOLD** **SEND \$2**

Manufacture And Sell Your Own  
Ornamental Concrete Items  
OVER 300 DIFFERENT DESIGNS

**Concrete Machinery Co., Inc.**  
839 Lenoir Road, N. W. • Hickory 2, N. C.

## PROFIT IN YOUR SPARE TIME



**SMALL ENGINE REPAIR PAYS BIG!**  
Outboard • Powermower • Chain Saw • Tractor  
**MAKE EXTRA MONEY** — or fix your own engines and **SAVE!** Illustrated, easy-to-learn Home Study Course qualifies you as expert. Free information. Write today!

**LINCOLN TECHNICAL INSTITUTE**  
SUITE 3-E, 472 MARKET STREET, NEWARK 5, N. J.

## A POSTCARD CAN PUT YOU IN A FINE BUSINESS!

**Rush Card TODAY for FREE OUTFIT!**

Get into highly profitable, repeat-order shoe business! Sell new line of Air-Cushion comfort shoes to friends, neighbors, folks at work! Over 210 dress, sport, work, safety shoe styles for men, women. Never sold by stores. Just 2 easy orders a day—in spare time—bring you \$217 extra income a month! No investment. Rush name and address TODAY for FREE SELLING OUTFIT!  
**MASON SHOE, Dept. H-237, Chippewa Falls, Wisc.**



## \$47,983.06 ORDERS FROM 12 WORD CLASSIFIED AD.

Amazing — Startling — but TRUE. Terrific story sent free. Request must be made on business letterhead. F. W. Johnson, Classified Adv. Manager, 200 E. Ontario St., Chicago 11, Ill.

## MONEY IN WORMS

Success for you! 5000 of our hybrid red wiggler fishworms produce 5,000,000 in one year using our successful method of worm raising. Read our success story in LIFE MAGAZINE, Dec. 28, 1959 issue. Let us teach you our secrets of success. Write today for FREE INFORMATION on how to raise and sell fishworms and crickets.

**Special Today**—Hybrid Red Wigglers—3000—\$5.95, 5000—\$8.95, 10,000—\$16.95. Postpaid.

**CARTER WORM RANCH, PLAINS, GEORGIA**

## \$500 in 4 months spare time

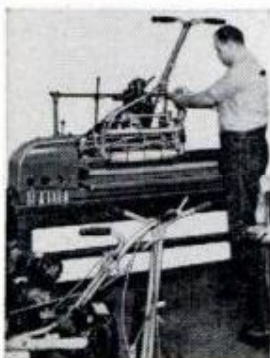

**IS WHAT I MADE WITH the FOLEY LAWN MOWER SHARPENER**  
"No one can go wrong with the Foley machine"—V. J. Patterson wrote us. Get in this CASH business where 99c of every dollar is YOUR profit! The Foley Lawn Mower Sharpener handles up to 3 or 4 mowers per hour. Hand mowers run \$2.00 to \$3.00—power mowers \$5.00 to \$8.00.

Write today for FREE PLAN  
**FOLEY MFG. CO.**  
307-2 Foley Bldg., Minneapolis 18, Minn.

**NOW YOU CAN BUILD A FINE**

# Schober Organ

**FOR ONLY \$550**

You can assemble this new Schober Spinet Organ for \$550 — or half the cost of comparable instruments you have seen in stores. The job is simplicity itself because clear, detailed step-by-step instructions tell you exactly what to do. And you can assemble it in as little as 50 hours.

You will experience the thrill and satisfaction of watching a beautiful musical instrument take shape under your hands. The new Schober Electronic Spinet sounds just like a big concert-size organ — with two keyboards, thirteen pedals and magnificent pipe organ tone. Yet it's small enough (only 38 inches wide) to fit into the most limited living space.

You can learn to play your spinet with astounding ease. From the very first day you will transform simple tunes into deeply satisfying musical experiences. Then, for the rest of your life, you will realize one of life's rarest pleasures — the joy of creating your own music.

For free details on all Schober Organs, mail the coupon now. No salesman will call.

## THE Schober Organ CORPORATION

43 West 61st Street, New York 23, N. Y.  
Also available in Canada and Australia.

**MAIL THIS COUPON TODAY**

The Schober Organ Corporation, Dept. PM-7  
43 West 61st Street, New York 23, N. Y.

- Please send me FREE booklet and other literature on the Schober Organs.
- Please send me the Hi-Fi demonstration record. I enclose \$2 which is refundable when I order my first kit.

Name.....

Address.....

City.....Zone...State.....

# ENGINEERING



Heald's Micro-wave and Radar Laboratory Equipment.

**AMERICAN INDUSTRY NEEDS TRAINED ENGINEERS NOW**  
**BACHELOR OF SCIENCE DEGREE, 30 MONTHS**

**SAVE 2 YEARS' TIME**

**B.S. Degree Courses:**

- Electronic Engineering
- Mechanical Engineering
- Electrical Engineering
- Civil Engineering
- Architecture

**Diploma Courses:**

- Radio-Television Plus Color **TECHNICIAN**
- Architectural Drafting
- Electronic Technician
- Mechanical Drafting
- Structural Drafting

**APPROVED FOR VETERANS**

Send for **FREE** Information

**ENROLL NOW FOR NEW TERM**

**HEALD Engineering College**

Van Ness at Post, Dept. PM San Francisco, California

NAME \_\_\_\_\_  
 STREET \_\_\_\_\_  
 CITY \_\_\_\_\_ STATE \_\_\_\_\_



"Are you sure you've replaced a picture tube before!"



## Choose an **AIRLINE CAREER**

**ADVENTURE! PRESTIGE! PROMOTION!**  
 You can train for opportunity with the airlines. Four-week course for men 18-35, H.S. graduates. Free placement service with 35 airlines. Station Agent—Operations Agent, Ticket Agent, Reservationist, 18th yr.  
**WRITE TODAY FOR FREE INFORMATION**

**McCONNELL AIRLINE SCHOOL**  
 1030 Nicollet Ave., Room P-32, Minneapolis, Minn.

Name.....Age.....  
 Address.....State.....



## Four Cars or 4000 Jets—Have Your Choice With Two Kits



Two model kits—one for cars, the other for jet aircraft—are among those on the market that allow more than one variation of an item from the same materials.

Monogram Models, Inc., for example offers a 1930 Ford Phaeton customizing kit that provides for four ways to build the 1930-model car: classic, street rod, drag-strip rod or jalopy.

Pyro Plastics Corp., Pyro Park, Union, N.J., has a Design-A-Plane kit (complete with a version of an engineer's slide rule) that will permit some 4000 versions of jet planes to be snapped together.

The airplane builder consults his slipstick for the formula, which can be changed, and which guides to select appropriate parts.

**DOUBLE YOUR STRENGTH  
BUILD MUSCLES FAST!  
IMPROVE AT ANY SPORT**

**AMAZING**



The Functional  
Isometric  
Contraction Way

**EXERCISE  
WITHOUT  
MOVEMENT**

**By Bob Hoffman**

Olympic Coach Since 1932



**Do It In Any Doorway!** You read about it in **SPORTS ILLUSTRATED!** University-tested method, now used by champion athletes from coast to coast. Takes only a minute-a-day! Amazing method of exercising without movement quickly builds sustaining strength and terrific muscles. Developed by the scientists of the Bob Hoffman Foundation . . . let them show you the way.

**15,000 WORD COURSE, LAVISHLY ILLUSTRATED** Almost overnight you can feel and see results! Many double their strength in only 20 weeks. Build a magnificent physique. Course is complete with charts of easy to perform, result producing exercises without movement. Ideal for men and women from 7 to 70! Send for your course today!

**QUICK RESULTS GUARANTEED**



**ONLY 1 MINUTE-A-DAY**

**NO SWEAT!  
NO FATIGUE!**

**ORDER BY MAIL  
SEND ONLY \$1**

**The Bob Hoffman Foundation**

DEPT. P-2, York, Pa.

## DOLLARS for DIMES

**YOU CAN EARN UP TO \$20 per hour spare time.** Amazing new Velveting Process instantly makes any object (Lamps, Radio & TV Cabinets, Figurines, Signs, Auto dash boards, Toys, furniture, draperies—anything) worth expensive Dollar Prices . . . Velveting offers a thousand ways to multiply your income, gain security and financial independence. Materials cost only 3¢ per square foot. End your money troubles forever. Add "Velveting" spare time profits to give you 2 incomes at once. Actual sample in Radiant color. Booklet of 50 Home Business Opportunities and complete confidential Details all sent free! Write:

**COAST INDUSTRIES, Los Angeles 61, Calif., Dept. B-3**

Would You Like to Make **\$1,000 A MONTH?**



That's what Stanley Hyman made selling the amazing new Presto Fire Extinguisher! Many others "cleaning up"—so can you! Amazing tiny new extinguisher ends fires fast at 2 seconds. **Guaranteed for 20 years!** Sells for only \$4.95. Write for Free sales kit.

Merlite Industries, Inc., Presto Div.,  
114 E. 32nd St., Dept. P-15R, New York 16, N. Y.



## Gold . . . Silver . . . Precious Gems FORTUNES MADE PROSPECTING

Are you walking over \$\$\$\$\$\$ when hunting, fishing, hiking? Every state has hidden treasures waiting to be discovered. Learn how to locate, identify, sell, stake claims on valuable ore, minerals. New comprehensive "Approved" Home Study Course. **FREE BOOK, "How to Prospect,"** reveals full details. Write: Modern Prospector Dept. H173, 1038 South La Brea, Los Angeles 19, Calif.



## MANUFACTURE THIS BEAUTIFUL CONCRETE OUTDOOR FIREPLACE

Right In Your  
Own Backyard

**\$4.00 Worth of  
Sand & Cement  
produces this  
Attractive  
Fireplace.**

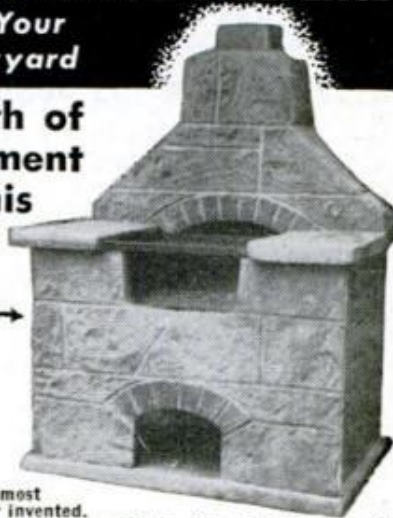

**Sells on Sight  
from \$60. to \$80.  
Easy to start your  
own Profitable  
Business.**

The General Fireplace Molds and Process are the most amazing and foolproof ever invented. Simple to operate. Two men can produce five fireplaces a day.

### BIG DEMAND!!

Sell all you produce to Department Stores, Homeowners, Parks, Nurseries and Picnic Groves. Fireplaces sell on sight. No experience necessary. We supply full operating instructions and equipment plus the know-how that spells **BIG PROFITS.** This is an outstanding opportunity for men of vision and small capital to get into a busy rich paying field. Don't delay, be the only exclusive manufacturer in your own home town. Mail coupon at once for full details as to how you can reserve your territory. **Molds sold only on exclusive franchise.**

**GENERAL ENGINES CO., Inc., Dept. MF-32**  
ROUTE 130, THOROFARE, N. J.

Mr. Tor of Philadelphia writes:  
Sold 250 in first 4 months. Selling to Sears Roebuck, John Wanamaker, and Gimbel Bros. in Philadelphia area.

Name .....

Address .....

City ..... Zone .....

State .....

## LEARN UPHOLSTERY

in your spare time  
run your own  
business  
**AT HOME**



**FREE  
BOOK  
with  
sample  
lessons**

### BE YOUR OWN BOSS

Earn more from the start in spare time. STOP worrying about layoffs, enjoy a steady growing income and independence for life in the booming field of Custom Furniture Upholstery.

Right off, you start upholstering with the tools, complete frames, fabrics and materials, included **FREE** with N. Y. State-approved UTS Home Study Course. You learn skilled professional custom upholstery, reupholstery, furniture finishing, repairs, how to make beautiful slip covers, cushions and draperies. **EARN WHILE YOU LEARN,** in your spare time **AT HOME . . .** the UTS easy way.

**FREE ILLUSTRATED BOOK—FREE SAMPLE LESSON** Get ready for well-paid job and big profits, from steady work, as your own boss, running your own business. Mail coupon NOW for **FREE BOOK!** Training in N.Y. School also available. **VET APP'VD. ACCREDITED BY N.H.S.C.**

**UPHOLSTERY TRADES SCHOOL**  
Dept. TC-310, 721 B'way, N. Y. 3, N. Y.

Please send me **FREE** book, "Your New Way to a Successful Career," and **FREE** sample lesson. No obligation—no salesman will call.

Home Study  Training in N. Y. School

Name .....

(Please Print Plainly)

Address .....

City ..... Zone ..... State .....

Check if Korean Veteran

**With Course  
You Make**

**SLIPPER  
CHAIR**

**CLUB  
CHAIR**

**OTTOMAN**

**PLUS  
SLIP COVERS  
Yours to Keep  
or Sell**

**FOR SALE:  
Half-Acre Ranchette in  
DEMING, NEW MEXICO**

**\$199 Complete \$5 Down \$5 Per Month**

Deming is in the southwest corner of New Mexico and its climate is considered as healthy and ideal as any spot in the nation. A boom has begun here and Deming's present 9,000 population will be 25,000 in the next 2-3 years. Ranchettes are only 5 miles from town in a valley rimmed by gorgeous mountains. Soil is fertile and water pure. At \$199 complete for 22,000 sq. feet, \$5 down, \$5 per month as big a bargain for a lovely piece of land as you'll ever get. Write for FREE color brochure. No salesman will call.

**DEMING RANCHETTES Dept. N-6A  
112 West Pine St., Deming, N. M.**

Please send your FREE portfolio in full color including maps and story.

Name .....  
Address .....  
City..... Zone.... State.....

**FREE**  
**EICO**  
**CATALOG**  
Build Your Own  
Hi-Fi, Radios,  
Ham Gear, Test Inst., — Save 50%



Get started in ELECTRONICS the easy EICO way. No technical knowledge needed to build EICO kits. Simple, step-by-step "Beginner-Tested" pictorial instructions guide you all the way. LIFETIME service & calibration guarantee. Mail coupon now!

EICO, 33-00 Northern Blvd., L. I. C. 1, N. Y.  
Please send FREE catalog & name of local dealer. **PM-3**

Name .....  
Address .....  
City..... Zone..... State.....

**SAMURAI SUICIDE WARRIORS**  
**JUDO KARATE!**  
**BOXING! MUSCLEBUILDING! YOGA!**  
**STRONGMAN STUNTS! STRENGTH & ENDURANCE! HANDBALANCING! ETC.**



**YOU GET ALL THESE COURSES!** \*20 illustrated KARATE blows \*SAVATE foot fighting \*Secret NERVE CENTER and ANATOMY charts \*20 lethal JUDO throws \*20 terrific STRONGMAN STUNTS \*Complete MUSCLE-BUILDING course \*Ancient YOGA secrets \*HANDBALANCING stunts \*Complete BOXING course. Secrets of ENDURANCE \*All picture packed. Super wall charts. (surplus 1961 printing). No C.O.D.'s. Canadian orders 60c.

**K-MAN KARATE PRACTICE DUMMY.** Life like! Shows attack points 15c with 35c order only. Total 50c you get the lot!

**35c**

Oxford Studio, 445 Bromfield, Boston, Mass.

# Tune in on the inventors

Five thousand dollars is the prize being offered in a second inventors' competition for the design of a stair-climbing wheelchair, the Department of Commerce has announced. The prize, offered by an anonymous donor, will go to anyone who can develop the chair to their specifications. Last year's competition turned up three improvements to existing chairs, but failed to turn up a really successful design.

Briefly, the wheelchair must operate effectively as a conventional chair, but must be able to climb and descend curbs and stairs of average size and height—with no damage to the stairs and with a minimum of time lost in adjustments, if any. The chair may be motor or occupant-propelled, though an attendant is permissible.

Design specifications are: Weight, not more than 75 pounds; width, 25 inches or less; turning area, three by three feet; climbing balance, not more than 15 to 25 pounds transferred to attendant; cost, not more than \$500. The chair must be collapsible for storing in cars, and cannot require special ramps, devices or modifications to existing facilities for their use. A booklet listing the specifications in detail and describing the contest is available on request from the National Inventors Council, U. S. Department of Commerce, Washington 25, D. C. The contest will be open until December 31, 1962.

Two of the best inventions across the desk this month are based on the same basic idea; they're attachments for existing electric shavers. First is the invention of Ralph Miller, of Charlotte, N. C., and is a rotary toothbrush attachment which fits onto the power-head of a Norelco rotary shaver. The cleaning head looks and works much like the familiar dentists' brush, driving through a flexible shaft. Mr. Miller has been awarded patent No. 3,012,263 for his invention.

The other, invented by Jacob Waggoner, of Charles City, Iowa, is a hair-trimming attachment for the type of shaver with reciprocating toothed blades. It guides the hair into the shaving head slots, which do the cutting. He won patent No. 3,008,233.

Copies of the original patents may be ordered for 25 cents each from the Commissioner of Patents, Dept. of Commerce, Washington 25, D. C.

## Flip-Top Flitewing

Flitewing, a \$125,000 Dodge dream car, incorporates roof canopies that flip up as doors open.

Inside, a unique speedometer replaces the conventional dial with 13 small windows. Nondriving controls have been moved to the driver's door panel and the full-length console that separates four bucket seats heavily upholstered in top-grain leather.

Powered by a 383-cu.-in., ram-inducted V8 of 330 hp., this show car has an automatic transmission, and full power.



## WANT MORE MONEY? GET INTO PHOTOGRAPHY

Coast-to-coast, high-paying jobs in photography are waiting for people with the "know-how" to fill them. You can quickly, easily qualify at home with the world-famous NYI Learn-by-Doing Method. Write today for free catalog. Also resident training in N. Y. Our 52nd Year. Approved for Veterans.

**NEW YORK INSTITUTE OF PHOTOGRAPHY**  
Dept. 49 10 West 33 St. New York 1, N. Y.

## LEARN TO BE A DENTAL MECHANIC



**SECURITY • PRESTIGE • GOOD PAY**  
Learn at home, in your spare time, to make Crowns, Plates, Bridgework, etc. Dental Mechanics are employed by Dentists, Dental Laboratories or open your own shop, full or spare time. **FULL EQUIPMENT OF TOOLS AND MATERIALS INCLUDED WITH COURSE.** Low tuition. Easy Terms. Write for **FREE BOOK** about this money-making profession that's not affected by automation.

**McCARRIE SCHOOL OF MECHANICAL DENTISTRY**  
207 No. Broad St., Dept. 39, Philadelphia 7, Pa.

C-14



## COLORCRETE CAN BE YOUR OPPORTUNITY

All over the country, men are making money as applicators of Colorcrete—the beauty treatment for old, drab, time-worn masonry surfaces. Stucco, concrete and the like can be transformed in brief time and at relatively low cost into surfaces that gleam in colorful beauty. Colorcrete is good for homes, stores, schools, motels, garages, service stations and other public and commercial buildings. Range of 16 colors.

Every community can support a Colorcretor — and many territories are still available. Investment required is very moderate. Write at once for Opportunity Book.

**COLORCRETE INDUSTRIES, INC.**  
570 Ottawa Avenue, Holland, Mich.



## DRAINS cellars, cisterns, wash tubs; \$7.95 IRRIGATES - CIRCULATES - SPRAYS

1,001 uses. Stainless shaft. Won't rust or clog! Use 1/6 HP motor or larger . . . 3/4 HP for up to 2,400 GPH; 450 GPH 80' high; or 1800 GPH from 25' well. 1" inlet; 3/4" outlet. Coupling included free. **\$7.95.** **HEAVY DUTY BALL-BEARING PUMP.** Up to 5,200 GPH; or 3,000 GPH from 25' well. 1 1/4" inlet; 1" outlet. **\$12.95** Postpaid if cash with order. **MONEY BACK GUARANTEE**

Centrifugal and Gear Pumps in All Sizes  
**LABAWCO PUMPS, Belle Mead 7, New Jersey**



## EARN BIG MONEY... LEARN AT HOME IN SPARE TIME

You don't need previous training or art ability with the "Famous System of Manual Training!" With this modern streamlined method, you learn rapidly and easily...start to cartoon immediately, without tedious study or exercises.

**Wide Demand for Cartoonists—Earn While You Learn...** Magazines, newspapers, movies, television, ad agencies—all are searching for new cartoon ideas and talent. As a successful, Continental-trained Cartoonist, your earnings are not limited.

Many of our students start earning after first few lessons. A wonderful pastime, too.

**We Supply Everything...** As our student, you receive **FREE** of extra cost a big 15-piece Professional Kit containing all equipment and materials you need, and valuable Articulated Model that helps you draw any human pose.

**Get All the Facts FREE...** Big, colorful Free catalog gives all details plus pages of useful information. **FREE** for the asking. Use coupon.

\*U.S. Pat. Applied For



SEND COUPON FOR FREE BOOK

## Continental Schools, Inc.

4201 S. BROADWAY, LOS ANGELES 37, CALIF.

Continental Schools, Inc.  
Dept. E-133, 4201 S. Broadway, Los Angeles 37, Calif.  
Please rush me your Free Catalog and other information by return mail. No charge or obligation.

NAME \_\_\_\_\_  
ADDRESS \_\_\_\_\_  
CITY \_\_\_\_\_ ZONE \_\_\_\_\_ STATE \_\_\_\_\_

Get the **Big Dividend!**  
**Save by Mail! Earn More!**  
**FREE GIFTS!**

**4** %  
 Current Rate Per Annum  
 Money in by the 15th  
 earns from the 1st

Free with  
 \$3,500 Account

**POLAROID ELECTRIC-EYE CAMERA**

The new, fully-automatic J66 Model.



Free with  
 \$1,000 Account

**PHILCO SLIM-LINE CLOCK RADIO**

New 1962 Model. UL approved. AC only.



Free with  
 \$100 Account

**DEBUTANTE 2-in-1 HAIR DRYER**

Home hair dryer with vanity compartment.



54 Years • 1908-1962  
**CITY SAVINGS ASSOCIATION**  
 1656 W. Chicago Avenue, Chicago, Ill.  
**ASSETS OVER \$22,000,000.00**

**LEARN TO EARN**

**HIGH WAGES**  
 AS A HEAVY EQUIPMENT  
 OPERATOR OR MECHANIC

- **WORLD'S ONLY CONTRACTOR OWNED AND OPERATED SCHOOL**
  - **MODERN EQUIPMENT, HIGHLY QUALIFIED INSTRUCTORS**
  - **V.A. APPROVED FOR GI TRAINING**

Learn to operate bulldozers, draglines, cranes, back hoes, scrapers and motor graders **ON ACTUAL CONSTRUCTION PROJECTS!**

Learn by doing . . . no impractical correspondence courses.

**WESTERN SCHOOL OF HEAVY EQUIPMENT OPERATION**

DEPT. B-18, BOX 510  
 WEISER, IDAHO  
 PHONE 549-1112



WRITE TODAY FOR FREE SCHOOL CATALOG

Member American Road Builders Association  
 Associate Member Associated General Contractors

**engineering degree in 27 months**

Industry demands graduates. Enjoy higher income . . . advancement. Major corporations regularly interview and employ seniors. *Bachelor of Science Degree in 27 Months* in Electrical, Mechanical, Aeronautical, Chemical, Civil Engineering. IN 36 MONTHS a B.S. Degree in Business Administration (General Business, Accounting, Motor Transport Administration majors). Small classes. More professional class hours. Well-equipped labs. Campus. New dorms. *Low costs.* Founded 1884. Enter June, September, January, March. Write J. E. McCarthy for Catalog and "Your Career in Engineering and Commerce" Book. Learn more and you'll earn more.



**TRI-STATE COLLEGE**

432 College Avenue • Angola, Indiana

**BEAUTIFY YOUR HOME**

with Pikes Peak Low Cost Quality Plantings

SEND TODAY FOR SPRING CATALOG



**PIKES PEAK Nurseries**

801 WATER STREET INDIANA 11, PA.



**New ALVA ALLEN Power Punch Press HANDBOOK Catalog**

100 pages. Shows 1 to 25 Ton Capacity Punch Presses in hundreds of different model combinations. Full of general detail information on Punch Presses. Gives information on accessories as—Feeds, Punch Units, etc. Most complete Punch Press and Accessories Handbook Catalog. \$1.00 postpaid. Alva Allen Industries, Dept PM, Clinton, Mo.

**SHELTERS AND SURVIVAL**

This new Popular Mechanics booklet gives plans for simple, quick, and inexpensive build-it-yourself blast and fallout shelters, plus additional information on safeguarding your family from the effects of nuclear blasts.

POPULAR MECHANICS SERVICE BUREAU, Dept. R5B,  
 200 East Ontario St., Chicago 11, Ill.

Please send . . . copies of your SHELTER AND SURVIVAL booklet at 25c ea. I enclose . . .

Name . . . . .  
 Address . . . . .  
 City . . . . . Zone . . . . . State . . . . .

# Magic Mail Plan—Make up to \$5 an Hour!



**THIS MAN** ... is taking out of the machine a Plastic Sealing Job — ordered by mail — only 11¢ in material cost brings back \$2.58 in cash by mail. Capacity of machine: **\$25.00 profit per hour of operation.**

Get **ORDERS** and **CASH** from your mailman—do work in **SPARE TIME** at home—or expand into **FULL TIME** business.

Send coupon for Free facts about the newest and most fascinating of all home operated businesses. For the first time a simplified machine brings the fabulous profits of **Plastic Sealing and Plastic Laminating** within the reach of the small operator. Anyone can learn to operate the machine with a few minutes practice—then with our **Magic Mail Plan** can get mail orders pouring in daily with cash in every envelope. **No canvassing—no selling.** We even

**Get into PLASTIC LAMINATING at home**

**WE'LL EVEN HELP FINANCE YOU**

supply the circulars you mail to bring back cash and orders, financing help, too. Rush name. We'll send you **FREE** and postpaid, pictures, prices, details, finance plan, all the facts you need. Mail coupon or send name on postcard. No charge. Warner Electric Co., 1512 Jarvis Av., Dept. L-2-C, Chicago 26, Ill.

## Make Thousands of Beautiful Art Creations

**COSTUME JEWELRY • CIGARETTE BOXES TRAYS • CANDLESTICKS • COASTERS LAMP BASES • BOOK ENDS...ALL IN SPARKLING COLORED PLASTIC**



**WARNER ELECTRIC CO., 1512 Jarvis Av. Dept. L-2-C, Chicago 26, Ill.**

At no cost to me, please rush full details and financing plan, postage prepaid. No obligation.

Name \_\_\_\_\_  
Address \_\_\_\_\_  
City \_\_\_\_\_ Zone \_\_\_\_\_ State \_\_\_\_\_

**FREE CATALOG**



## MAKE YOUR OWN RODS AND LURES

Send for **FREE Wholesale Catalog**. The most complete and fully illustrated catalog of reels, rods, beads, spinners, jigs, lure bodies and parts, sinker molds, feathers, tools, hooks, rod blanks, rod parts, swivels, wire, etc. Over 170 pages.

**FINNYSPO RTS**  
2062X SPORTS BUILDING TOLEDO 14, OHIO

# Magic Made Easy!

**MAGIC & FUN CATALOG!**

160 PAGES!  
Tricks, Jokes, Magic, Illusions, Secrets!  
Puzzles, Stunts, etc. World famous!  
Rush name, address & only 25¢.



**Special Offer**

**FREE CARD TRICK GIVEN with Each Catalog!**  
HOUSE OF 1000 MYSTERIES  
Dept. PM3-62, Trumbull, Conn.

**BIG EXCITING 25c**

## GOVERNMENT OIL LEASES LOW AS \$1 PER ACRE

You do no drilling, pay no taxes, may realize a king-size profit without ever leaving home. Write for free map and literature.

**AMERICAN OIL SCOUTS, Dept. PM**  
619 Cascade Bldg. Portland 4, Oregon

## EARN MONEY FAST!

### REPAIR HYDRAULIC JACKS

Earn while you learn at home. Millions of jacks in gas and auto-service stations, truckers, body-shops, riggers, factories, farms need servicing. We show you **HOW**—easy step by step directions and what tools to use. **EARN UP TO \$5 an hour**, in spare time, in your basement or garage. Start your own business **NOW!**



Write for folder **PM 3** and free bonus offer  
**INSTITUTE OF HYDRAULIC JACK REPAIR**  
P. O. BOX 50 • BLOOMFIELD, N. J.  
A Correspondence School Licensed by N.J. Bd. of Ed.

# MEN PAST 40

**Afflicted With Bladder Trouble, Pains in Back, Hips, Legs, Nervousness, Tiredness.**

If you have these troubles, particularly bladder trouble, then your condition may be traced to Glandular Inflammation... a constitutional disease. Neglect of this condition often leads to premature old age and sometimes incurable conditions.

The Excelsior Medical Clinic has a **New Free Book** that tells how thousands of men have been successfully treated here at Excelsior Springs for Glandular Inflammation by **NON-SURGICAL Methods**. They found soothing relief and a new outlook in the future of life.

This **Free Book** may prove of utmost importance in your life. Write Today. There is no obligation.  
**Excelsior Medical Clinic, Dept. B6129, Excelsior Spgs., Mo.**

## New Model 161 UTILITY TESTER® FOR REPAIRING ALL ELECTRICAL APPLIANCES MOTORS • AUTOMOBILES • TV TUBES

As an electrical trouble shooter the Model 161

• Will test Toasters, Irons, Broilers, Heating Pads, Clocks, Fans, Vacuum Cleaners, Refrigerators, Lamps, Fluorescents, Switches, Thermostats, etc.



- Will test all TV tubes (including picture tubes) for open filaments and burned out tubes.
- Measures A.C. and D.C. Voltages, (both 110 Volt and 220 Volt lines).
- Will measure current consumption (amperes) while the appliance under test is in operation.
- Incorporates a sensitive direct-reading resistance range which will measure all resistances commonly used in electrical appliances, motors, etc.

As an Automotive Tester the Model 161 will test:

- Both 6 Volt and 12 Volt Storage Batteries • Generators
- Starters • Distributors • Ignition Coils • Regulators • Relays
- Circuit Breakers • Cigarette Lighters • Stop Lights • Condensers • Directional Signal Systems • All Lamps and Bulbs
- Fuses • Heating Systems • Horns • Also will locate poor grounds, breaks in wiring, poor connections, etc.

Model 161 comes complete including 56-page book... Only **\$22.50**  
**SEND NO MONEY WITH ORDER—PAY POSTMAN NOTHING ON DELIVERY**

Try it for 10 days before you buy. If completely satisfied then send \$3.00 and pay the balance at the rate of \$5.00 per month until the total price of \$22.50 (plus small P.P. and budget charge) is paid. If not completely satisfied, return to us, no explanation necessary.

**ACCURATE INSTRUMENT CO., INC.**  
Dept. D-177, 911 Faile St., New York 59, N. Y.  
Please rush Model 161. I will pay on terms specified. Otherwise I will return tester.

Name \_\_\_\_\_  
Address \_\_\_\_\_  
City \_\_\_\_\_ Zone \_\_\_\_\_ State \_\_\_\_\_  
All prices net, F.O.B., N.Y.C.

# EARN MORE - LEARN AUTO DIESEL MECHANICS

## OR TRAIN WITH OTHER GREER DIPLOMA COURSES

- |   |  |
|---|--|
| <input type="checkbox"/> AUTO MECHANICS       | <input type="checkbox"/> REFRIGERATION           |
| <input type="checkbox"/> DIESEL MECHANICS     | <input type="checkbox"/> AIR CONDITIONING        |
| <input type="checkbox"/> BODY & FENDER REPAIR | <input type="checkbox"/> MACHINIST-TOOL & DIE    |
| <input type="checkbox"/> GAS, ARC WELDING     | <input type="checkbox"/> AUTOMATIC TRANSMISSIONS |
| <input type="checkbox"/> HELIARC WELDING      | <input type="checkbox"/> MOTOR TUNE-UP           |
| <input type="checkbox"/> DRAFTING             |  |

Civ. or  G.I.

Skilled men are needed in every part of the country. Earn top pay in established shops or start your own business. Greer's expert instruction and actual shop training teaches you how. You learn by doing—quick, easy courses using the latest tools and equipment. Day, evening and part time instructions available.

Job placement aid and convenient living accommodations are yours while training. Contact GREER'S FREE JOB PLACEMENT SERVICE when you enroll if you wish part time or full time employment assistance.

### TECHNICIAN COURSES

- |   |
|---|
| <input type="checkbox"/> DIESEL AUTOMOTIVE TECHNICIAN—21 MONTHS         |
| <input type="checkbox"/> REFRIGERATION & AIR COND. TECHNICIAN—17 MONTHS |
| <input type="checkbox"/> WELDING TECHNICIAN—14 MONTHS                   |

Please rush me free literature on the trade indicated at no obligation.

NAME \_\_\_\_\_ AGE \_\_\_\_\_

STREET \_\_\_\_\_

TOWN \_\_\_\_\_ ZONE \_\_\_\_\_ STATE \_\_\_\_\_

Established 1902

# GREER SHOP TRAINING

Box C, 2236 S. Michigan Ave. Chicago 16, Ill.



FOR SALE  
YOUR NAME  
HERE

## Be a REAL ESTATE BROKER

through home study. Set up your own business in a short time. There is no limit to the money you can earn. Course covers Sales, Property Management, Appraising, Loans and related subjects. Men, women of all ages learn easily and quickly. Write for free illustrated catalog. VA approved. Diploma awarded. WEAVER SCHOOL OF REAL ESTATE 3521Y Broadway, Kansas City, Missouri

FREE  
BOOK  
TELLS  
HOW



NEW HI-FI  
PERFORMANCE

The Exciting NEW **BENJAMIN**  
MODEL 422  
CO<sub>2</sub> 10-SHOT SEMI-AUTOMATIC

**.22 PELLET PISTOL**

\$22.95

Ask Dealer  
for Demon-  
stration.

EFFICIENT—SAFE—  
DEPENDABLE—CONVENIENT  
Famous BENJAMIN Quality

AT LAST—an Amazing New Handgun that incorporates the Characteristics Wanted for Serious Training, Plinking and Match Competition—Indoors and Outdoors—at LOWEST SHOOTING COSTS! Handsome, Dynamic, Mechanically Reliable, MODEL 422 combines Traditional BENJAMIN PEAK POWER and ACCURACY with Incredible Firing Speed—Smooth JAM-PROOF ACTION (no ramrod for cleaning pistol bore required)

WITH  
EXTRA MARGIN

BENJAMIN'S Unique  
DOUBLE SAFETIES

Press TRIGGER Safety "OFF"

Release Hammer Safety as Illustrated.



KEEPS SHOOTING & SHOOTING & SHOOTING & SHOOTING  
AS FAST AS YOU CAN SQUEEZE THE TRIGGER!

FREE

peaters—88 or 177 or 22. Also, Special Offer on Hunting Knives.

Write today! Complete Catalog Benjamin Rifles & Pistols—Single Shot & Repeating—Use Benjamin H-C Pellets in Model 422 for Accurate, Jam-Free Shooting.

BENJAMIN AIR RIFLE CO. 696 MARION ST., ST. LOUIS 4, MO.

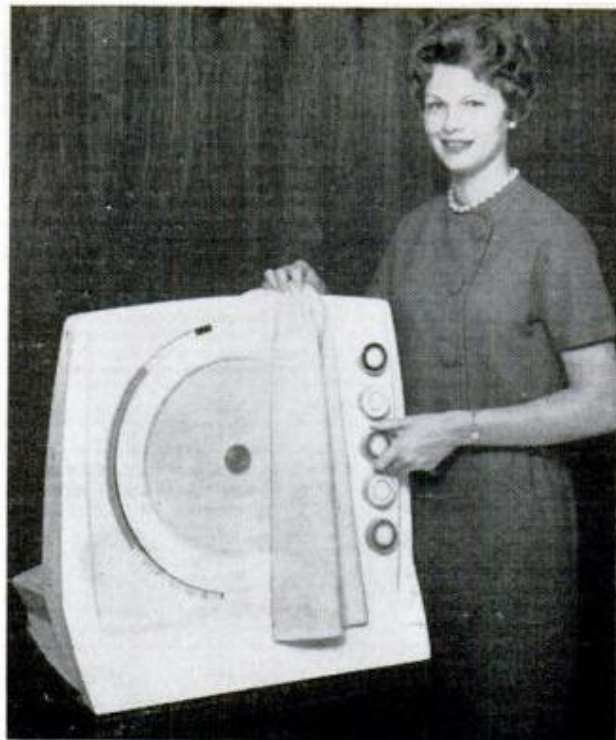

## Spinning Wheel for Painters

Finding a paint formula that matches drapery material is no longer a trial and error job with pigments and paint. By turning dials on the front of a new Telecolor set—each dial representing a basic color—the operator of the unit causes rapidly rotating color disks to meld into a specific color on the "screen" of the machine.

Developed by the Valspar Corp., Rockford, Ill., the color mixer is available to dealers through lease-purchase plans.

*After the city,  
Before the state  
The ZONE keeps your mail  
From being late*

★ ★ ★

The Post Office has divided 106 cities into postal delivery zones to speed mail delivery. Be sure to include zone number when writing to these cities; be sure to include *your* zone number in *your* return address — after the city, before the state.





# CLASSIFIED ADVERTISEMENTS



Advertisements in this section \$1.35 per word, each insertion, minimum 10 words, payable in advance. To be inserted under proper classification, copy must be in our office the 18th of the second month preceding date of issue  
F. W. Johnson, Manager, Classified Advertising  
Popular Mechanics, 200 East Ontario Street, Chicago 11, Illinois

## YOU'LL PROFIT

By reading and answering the classified ads in this section. Hundreds of opportunities for you to make and save money

### AUTOMOBILES, MIDGET CARS

FORD T and A parts? Try best source old model parts, all makes. Wisneski Auto, Milwaukee 4.

DISCOUNTS Books, hotrods, karting, antiques. Catalog 5¢. Fairfax, Box 4283A, Panorama City, California.

AUTOMOBILE Collectors: catalogs, photos, etc. Hobby Club, monthly bulletin. Information. Auto Enthusiasts, Box 451H, Mt. Clemens, Mich.

### AUTO SUPPLIES AND EQUIPMENT

AIR Conditioner for your car. Build it yourself for \$37.50. This is new. Just out. Not an evaporator but real refrigerated air. Use in your car and sell them. Easy plans \$5.00. P.P.P. Co., 1957 S. St. Aubin, Sioux City, Iowa.

NEW And used parts at savings. Complete guaranteed parts service for all models cars and trucks. Largest in the West. Jeep and army parts specialists. Newest type shifting hubs for all jeep and all military and latest production front end drive vehicles. \$27.50 and up. Also, foreign car parts. Write. Pioneer Auto and Truck Parts Co., 734 W. 13th Avenue, Denver 17, Colo.

PARTS, Model "A." List 25¢. (Refundable) Matco, Box 135, San Pedro, Calif.

1909-1934 FORD Parts illustrated catalogs 75¢. Mark Auto, Layton, N. J.

RING-Valve job while driving, \$6.00 postpaid. Guaranteed! Nothing like it! Lasts 100,000 miles! Motaloy, Grantham, Penna.

A Powr-Grip valve grinder grips better. Free circular. Wood's Powr-Grip, Wolf Point, Montana.

JEEP Owners. Four Wheeler magazine. Road tests, V-8 conversions, back country trips, technical articles. \$4.50 year. Box 95P, Tarzana, California.

CRANKSHAFT Grinder. Hand operated. Makes bearings fit without taking engine apart. \$4.00. Literature. L. D. McGee, 719 Cascade St., Wenatchee, Wash.

JUST Out! New 324-page, illustrated catalog offering savings up to 50% on over 100,000 auto parts and accessories, everything to renew, rebuild, renovate '28-'31 Model "A" Fords. All makes (1920 to 1962 models), trucks, foreign and sports cars. Hollywood accessories, custom styling, hi-speed equipment. Send 25¢ for postage, packing—refundable on first order. Whitney, 1919 PM-3, Archer, Chicago 16.

IT'S Easy to adjust all twin and triple S.U. carburetors with the WS SU tool. Synchronizing, tuning, jet centering. Instructions included. \$5.60 ppd. Phil Schleyer, Box 94-C, Pasadena, Calif.

ASPIRIN For battery headaches! Disconnect battery from driver's seat, eliminate battery leakage. Double safety feature grounds generator field. Install in 30 minutes. Westinghouse-made, meets all voltage, amperage requirements. Only \$15.95 postpaid. Sampson Safety Switch Co., Clinton, N. C.

VOLTAGE Regulator fuses, instructions included. Two \$1. Williamsburg Auto Parts, 420 Main, Williamsburg, Kentucky.

AUTO Shop welding repair training in world's largest non-profit welding school. Low tuition. Free booklet. Hobart Welders, Box M-321, Troy, Ohio.

230 NEW "A" parts. List 10¢. Box 423, Bensenville, Ill.

CAR Overhaul. New ring power. Gear wear noise stopped. Either formula \$3.95. Guaranteed. Nulife, 1119 1/2 Yale, Houston 8, Texas.

JEEP Owners—V8 conversions. Read Jeep Owners ad, page 26.

STOP Antifreeze seepage loss. Guaranteed \$1.00. Jarrett, 1550 Delaware, Buffalo, N. Y.

40% DISCOUNT Genuine spark plugs, ignition parts, oil filters, shock absorbers, batteries, fan belts, windshield blades/arms, brake fluid. Inquiries invited showing quantities, part numbers, vehicle names, model, year, 6 or 8 cylinders. Paul Wexler, 1332 East 103rd Street, Brooklyn 36, N. Y.

### AUTO TRAILERS

BUILD Expanding eight foot trailer. Accommodates five. Literature 10¢. Fram-Acar Company, Wilmington, Mass.

### MOTORCYCLES, BICYCLES, MOTORSCOOTERS AND SUPPLIES

GO-CARTS, motorbikes, parts, tires. Wholesale catalog 25¢. Loren Products, Danville, Illinois.

HARLEY-Davidsons — Used bargains. New, used parts, accessories, all models. Bulletin 25¢. Knuth's (Factory Dealer), 1753 Muskego, Milwaukee, Wis.

SIDEWALK Go-cart motor with reverse from 6 V. auto generator. 6 MPH using 12 V. battery. Send \$1.50 for instructions and parts to alter generator. Russell, 1515 E. 83rd St., Minneapolis 20, Minn.

GO Cart \$10, Crosley chassis \$20, Micro-midget \$18, less engines. Engines \$4 up. Cushman motorscooter \$20, Ridging tractor \$45, Isetta \$225. Mailorder only. Send 25¢ (35¢ for first class mailing) for 32 page directory-catalogue Number 106 listing these and hundreds of other bargains in midget cars, motorscooters, homebuilders parts, plans, etc. Midget Motors Directory, Athens, Ohio.

RECONDITIONED Motorcycle motors. Large stock Indian Cushman Vespa Mustang NSU parts. Indian Motorcycle Sales, Kansas City 27, Missouri.

DISMANTLING All American models, 11 imported. Bulletin 25¢. Factory dealer. Les Myers, 813 Ohio, Wichita Falls, Texas.

"MOTORIZE Your Bicycle." Complete plans—send \$1.00. Motor mounting-bracket kit, including clutch, \$24.95. Go-Byk Industries, Fergus Falls, Minnesota.

### AVIATION

PROPELLERS, Plans, supplies for airboats, snowplanes. 125 h.p. Lycoming engines \$135.00. Prompt delivery. Catalog 25¢. Banks-Maxwell Propeller Co., Box 3301E, Ft. Worth 5, Texas.

AIRLINE Careers. Adventure! Prestige! Promotion! Four-week course. Free placement service with 35 airlines. G. I. approved. Free catalog B. McConnell Airline School, 1030 Nicollet, Minneapolis, Minnesota.

GYROCOPTER Rotor blades, marine plywood or aircraft spruce \$29.95. Steel spars and other accessories available. Free brochure. Roto-Float Co., Box 451, Winston-Salem, N. C.

SMALL Helicopters theory and guide manual. Drawings. Construction data. \$2.00. Greater Plains Industries, Box 482A, O'Neill, Nebraska.

HOMEBUILT Helicopter handbook \$1.00. Directory \$1.00. Urshanair, Box 250, Santee, California.

HOT Air ballooning: Illustrated information on proven, inexpensive flying. Photographs, authentic specifications, \$1.00. Ballooning, 732 Park, Mankato, Minnesota.

PULSE Jet engines, \$195.00 each. Brochure, 10¢ handling. Jetspeed Industries, Linton, Indiana.

### BATTERIES, GENERATORS

START Your own battery business. Manufacture, rebuild, repair. Easy with large 121-page manual. No job worries. Batteries, P.O. Box 341, New Castle, Penna.

BATTERY Reconditioning bluebook \$1.00. Little Pal, 1105 5th, McKeesport, Penna.

LEARN Battery repair! Complete manual \$3.00. Hydraulic jack repair manual \$3.00. C.O.D. accepted. Bayer Publications, W938 Betty Avenue, Neenah, Wis.

### ELECTRICAL SUPPLIES

SWITCHES, Guaranteed twelve different for TV, refrigerators, range, etc. \$3.95. Alcor Sales, Box 396, DeKalb, Ill.

WASHING Machine, dryer parts! Illustrated catalog. All makes, models. Save, order direct—pumps, kits, agitator, gears, etc., at discounts; Free "trouble diagnosis chart" included, 25¢, refundable on first order. Jonsal Co., Dept. PM, 291 Atlantic Ave., Massapequa Park, New York.

ILLUMINATED Door bell button. Attractive Tutone design. 10-16 volts. \$1.00 postpaid. Tower Engineering, Valley Stream, New York.

ELECTRO-SCRIBE! Engraves all metals. \$2.00. Beyer Mfg., 10511-H Springfield, Chicago 55.

LAMPS. 25¢ Brings parts catalog. Refunded first order. Gyro, 5208P N.W. 35th Ave., Miami 42, Florida.

LAMP, Electrical parts, wholesale. Thousands of items for repairing, converting. Catalog 35¢. Brown Lamp, Box 305, Clayton 5, Missouri.

BOOK 200 Electric stunts \$1.00. Kuttington, 875 Arastradero, Palo Alto, Calif.

### WELDING, SOLDERING, PLATING

BUILD Yourself. Pickup wire roller for approximately \$5.00. Plans \$1.00. Carson Industries, Faxon 1, Oklahoma.

PLATING Equipment and supplies. Save 50% and more on new fiberglass tanks, DC power units. 50 amp, 6 volt DC power supply \$97.50; 100 amp, 6 volt \$145; other sizes from 5 amps to 250 amps. Easy terms. Mix your own solution and save. Send \$1 for newest formulas and operating data for all types of plating, equipment guide and catalog. HBS Equipment Division, Dept. L5, 3445 Union Pacific, Los Angeles 23, Calif.

ARC Welder manual only 50¢. Regular \$1.00 value. Tells how to weld every job. Emerson Electric, 8100 Florissant, Dept. PM-3, St. Louis, Missouri.

FREE Welder catalog. Kits, build 350-ampere welder using aircraft generator, plans. 25¢. LeJay, Minneapolis 20, Minn.

WELDERS. 110/220, \$39.50. Morris, 1070 Inner Drive, Schenectady 3, New York.

ACETYLENE Outfits \$59.50; arcwelders \$69.50. Eagle Welding, Dept. PM, 5085 Broadway, Chicago 40, Ill.

### MACHINERY, TOOLS, SUPPLIES

FREE New catalog showing only complete line of work holding tools available anywhere. Drill press vises, angle and swivel machine vises, rotary tables, production and heavy duty angle vises. 68 different models, fully described with prices. Palmgren Products Co., 8365 South Chicago Ave., Chicago 17, Illinois.

POWER Tools and accessories. Free list. Roberson, 14M Brooks Drive, Austell, Georgia.

ELECTRIC Paint mixer shaker. From junk parts. Blueprints 50¢. Jerry Moore, 10574 Riviera Beach, Florida.

### SURVEYING INSTRUMENTS

NEW And guaranteed factory rebuilt transits and levels, sale or rent, with purchase option. We will repair, trade or buy old instruments. Write for list M32. Warren-Knight Co. (Manufacturers of Surveying Instruments), 136 N. 12th St., Philadelphia 7, Penna.

### ENGINES, MOTORS, DYNAMOS

DIESEL Injector parts and fuel pumps wanted. GM51-71-110. Bares, 2093 East 19 Street, Cleveland 15, Ohio.

REWIND Motors yourself. Complete instructions, \$1.00. Lewis Manufacturing, Howell, Michigan.

WINDING Data. 275 motors, single and three phase \$1.10. Data Company, 512 Kensington, Kansas City 24, Mo.

NEW 3 HP Briggs engines, Model 81302 recoil start. Regular \$53.30 now \$36.95. 231 North Washington, Twin Falls, Idaho.

REWIND Electric motors yourself. Free details. Modern, Box 8715, Kansas City 14, Mo.

### GOVERNMENT SURPLUS

JEEPS, Boats, airplanes, helicopters, walkie-talkies, radar, tents, typewriters, tires, tools, cameras. Individuals can buy now direct from government. "U.S. Depot Directory & Procedure" \$1.00. Brody, Box 425-PM, Nanuet, N. Y.

JEEPS \$278, Airplanes \$159, boats \$7.88, generators \$2.68, typewriters \$8.79 are typical government surplus sale prices. Buy 10,001 items wholesale, direct. Full details, 627 locations and procedure only \$1.00. Surplus, Box 789-C35, York, Penna.

BUY Surplus direct from government. Complete guide—25¢. Janeczek, 373 East 155th Street, New York 55, N. Y.

TENTS. Government surplus. Hexagonal, Pyramid. Cost \$140. Our price \$39.50. \$225 paint spray unit, \$44.50. Free folder. Imasco, 1829 S. State, Chicago, Ill.

GOV'T Surplus. How and where to buy in your area. Send \$1.00. Surplus Information, PM, Headquarters Building, Washington 6, D. C.

U.S. Government surplus—jeeps, \$264.00; radios, \$2.53; guns; typewriters; cameras; tools; thousands of items. Fabulously low surplus prices. Complete information sent immediately. Send \$1.00 to: Surplus, Box 512-E, New Orleans 12, Louisiana.

SAVE Money. Thousands of government surplus items; tremendously reduced prices. Procedures, depots, \$1.00. Associated Reporters, P.O. Box 1008, Miami 1, Florida.

JEEPS. Televisions, guns, typewriters, cars, radios, cameras, recorders, available through government surplus. Exciting details free. Write: N. Y. Enterprises, Box 402-X2, Jamaica 30, New York.

GOVERNMENT Surplus, radios, jeeps, walkie talkies, guns, etc. Buy direct. Locations & procedures, 50¢. Why pay more? Satisfaction guaranteed. Delta, Box 2262-M, Dallas 21, Texas.

### BOATS, OUTBOARD MOTORS

FIBERGLAS Cloth and resin. Worlds finest cloth and non-run resin. At direct mill prices. Flotation foam. Complete line of plastics. Brass screws. Save 60%. Send for free catalogue. Freight, prepaid. Stiles Boat Supply, Box 11-P Linden Ave., Mantua Hts., N. J.

BUILD Your own boat from our large-scale blueprints. Books of plans give how-to-build help. Hundreds of professional designs—motor, sail or auxiliary—for amateur builders. Free catalog. MoToR Boat-inG, 959 Eighth Ave., New York 22, N. Y.

FISHERMEN, Boating enthusiasts, build convertible top for your utility, pram, runabout. Plans \$1.00. Whiteway Products, Box 312, Webster City, Iowa.

FULL Size, cut-to-shape boat patterns, blueprints, 7½-38 feet. Big new 88-page illustrated "Build a Boat" catalog of naval architect-designed catamarans, cruisers, runabouts, skiffs, outboard boats, sailing, racing, houseboats. 50¢. "How to Build a Boat" booklet, \$2.50. Cleveland Boat Blueprint Co., Box 1651, Cleveland, Ohio.

BOAT Plans, frame kits, full-size patterns prepared specially for amateurs. Send 50¢ for new 80-page catalog illustrating over 40 build-it-yourself power boats from 7' to 28'. "Inboard Motor Installations in Small Boats"—hardcover illustrative book on "how to" of inboard installations—\$6 ppd. Glen Designs, 9152 Rosecrans, Bellflower, Calif.

NEW, Used, rebuilt marine motors. Marine conversions, fittings. Free catalog. Stokes Marine Supply, Dept. 24, Coldwater, Michigan.

FIBERGLAS Your old wooden boat. Make it waterproof. Repaint over fiberglass, wood, or metal with new Poly-Aqua Epoxy paint. Free literature. Ajax Plastic Co., Dept. 6, P.O. Box 1323, Ft. Worth, Texas.

MARINE Conversions and gears for all popular automotive engines. Send 25¢ coin for complete catalogue. Barr Marine, 2706A Castor Ave., Philadelphia, Penna.

OUTSTANDING Clothing and equipment for boat owners. Many not obtainable elsewhere. All guaranteed. Outstanding in quality and value. Free catalog. Write: Captain Bill, 362 Mechanics Street, Longbranch, Washington.

MARINE Conversions. Ford, Chevrolet, Jeep engines. Catalog 25¢. Lehman Manufacturing Company, 800 Elizabeth Avenue, Linden 4, N. J.

FIBERGLASS Pontoons. Build own boat or dock. Free literature. Northside Recreation, Inc., Box 918, Brooksville, Florida.

200 BOAT Plans, kits, catalogs: Powerboat (3) \$1.00. Sailboat 25¢. Marinecraft, Box 161-M, Brighton, Mass.

ALL Fiberglass canoe \$99.95. 15 ft. Lifetime guarantee. For brochure enclose 20¢ to: Queen City Canoes, 6100 Candlewood Drive, Charlotte, N. C.

FREE Literature on how to stabilize your outboard motor. Eliminates pounding and cavitating. Jagiel Research, 3106 Algonquin, Toledo 6, Ohio.

SAVE! Save! Save! World's finest boat kits 25% less! Satisfaction guaranteed! Write for free color catalog. Dept. PM362, Taft Marine Woodcraft, 636 39th Ave., N.E., Minneapolis, Minnesota.

LIGHTWEIGHT Compact four horsepower outboard motor \$99.95. Simms, Warwick, New York.

I Want to send you proof of the wonderful pulling power of Popular Mechanics classified pages. What's your proposition? Write me today. Include literature if possible. F. W. Johnson, Manager Classified Advertising, Popular Mechanics Magazine, 200 E. Ontario St., Chicago 11, Ill.

### ATHLETIC EQUIPMENT, BODY BUILDING COURSES

FREE—Bigger, stronger, muscle information! Centuck, 37 Station, Yonkers 4, N. Y.

BEAUTIFUL Bodies for males, females. Amazing new exercises. Easy. Guaranteed. \$1.00. Jack James, Box 262, Brooklyn 17, N. Y.

"HERCULES Anatomy Chart." Giant 17x22 inch size. Only \$1.50. Gymcraft, G.P.O. Box 1529, New York 1, New York.

PHYSICAL Perfection. Reducing, gaining, muscles, longevity. Mail 25¢ for all 4 courses. (Guaranteed) to Sids System, PM-2, 8421-C Evergreen, Southgate, California.

SECRET Of great strength—Running, for happier life, 25¢. Harold Ashworth, Heuvelton, N. Y.

"GIANT Arms." Dr. Young's, D.C. revolutionary discovery. \$2. Satisfaction or refund. Gaucho, Box 9309-S7, Chicago 90.

OUTSTANDING Physical development! Any age. New guaranteed discovery uses only a rope! Strength, health, muscles. Gain—reduce. Free booklet. Roperise, 4834 Art. San Diego 15, California.

PROF. Wong's Karate Kung-Fu. \$9.95. Order now for new Kung-Fu book (Fighting). 142 Waverly Place, San Francisco 8, Calif.

BARBELL Dynamic! Proven. Train like champions. Complete course, \$1.00. Washington Health Club, Box 4708, Washington 20, D. C.

BARBELLS, Dumbbells, Courses, Booklet 10¢. Good Barbell Co., Silcam Springs, Arkansas.

BARBELLS — Olympic contest. \$34.50 up. Brochure 10¢. Jackson Barbells, Springfield, N. J.

**BECOME Taller.** New scientific method will add inches to your present height even after maturity. Visible results in weeks. Send for free information and trial offer. Height Increase Institute, Dept. PM-4, GPO Box 1902, New York 1, N. Y.

**NEW!** 16-page bodybuilding course. Illustrated wall charts. \$1.00. Gym Equipment, Brooklyn 22, New York.

**BIG Muscles fast—gain up to 4" on arms, 10" on chest in just 7 weeks.** Free details. Sinkram Body Builders, Dept. ME-1, Box 11, Brooklyn 36, N. Y.

### SPORTING GOODS, GUNS, FISHING, SKIN DIVING, ARCHERY

**GUN Replicas.** Authentic. Used in movies and TV. Solid aluminum. \$3.95 ppd. Army 45, Colt 44, Snub Nose, Luger, P38, Belgium. Lytle Guns, Box 2146, Whittier, Calif.

**RIFLES.** Modern military surplus \$7.95. New revolvers \$9.95. Bargain catalog 25¢. Armsco, Box A, Santa Rosa, Calif.

**NEW Yellow illustrated catalog** listing thousands of guns, accessories, relics, ammunition. 25¢. Retting, 11029 Washington, Culver City, California.

**JAP Rifle** altering to 30-06, \$6.00. Jap-shells, \$3.95. Catalog 10¢. T. P. Shop, West Branch 11, Mich.

**BLANK Pistol.** Excellent for athletic events, dog training, etc. Send \$9.90 for gun and 100 blanks. Four Seasons, 1717 Campbell St., Arlington Heights, Illinois.

**COLLECTORS British Plats, Panzer Busters; Britain's "Bazooka,"** Churchill's secret weapon; fascinating addition to your gun collection, den or hunting camp, \$19.95. Century Arms, 54 Lake, St. Albans, Vermont.

**SCUBA Equipment.** Save 1/2. Send 25¢ for list. Four Seasons, 1717 Campbell, Arlington Heights, Illinois.

**MOLDS—For casting your own fishing sinkers.** Free illustrated booklet. Reading Instrument Co., Box PM78, Reading, Penna.

**FREE—Wholesale catalog.** Beads, Spinners, Lure parts, Sinkers, Jigs, Reels, Finnyports (ME), Toledo 14, Ohio.

**BIG Money raising crickets** and 12 inch African fishworms. Free literature. Carter Ranch, Plains, Georgia.

**MOLDS For fisherman's sinkers, jigs, squids, casting and spinning lures.** Free catalog. Sweet's Molds, Tonawanda 1, New York.

**SPORTING Goods.** Wholesale. Information. \$1.00 refundable. Berkshire Wholesale Sporting Goods, Six Lakes, Michigan.

**SMOKE Fish, game.** Build inexpensive electric smoker. Instructions, recipes \$1.00. Eddie Thom, Hope, Idaho.

**GUN Rack, solid pine, holds 3 guns.** Postpaid \$3.50, top \$6.00. Redi-Cut, 4733 W. Center, Milwaukee 10, Wisconsin.

**SKINDIVING Equipment.** Wholesale catalog. Send \$1.00 to Midwest Skindiving Supply Co., 419 University Ave., St. Paul, Minnesota.

**ANIMAL And fish baits and lures.** Guaranteed. Catalogs 10¢. Myers Lures, Marquand, Mo.

**MINNOW Graders, Agitators, dip-nets.** Crescent Mfg., Box 3303, Ft. Worth, Tex.

**MITCHELL Spinning reels 300 type imported \$6.00.** Spin casting reels \$3.25. Plastic lure bodies complete resale. Free circular. Quaker City Mfg., 3514-24 N. Lawrence, Philadelphia 40, Penna.

**WORLD'S Smallest real Derringer.** Caliber .22 short. Replica of very scarce Ethan Allen "hide-away" pistol made almost 100 years ago. Hides in palm of hand. Weight 3 oz. Rifled barrel. Genuine steel and bronze, no slush metal or aluminum. Fine little gun for collector or tackle box. Only \$12.95. A-B Distributor, 4243 North Harlem, Chicago 34, Illinois.

**SIGNAL Pistol.** Small as, and looks like a fountain pen. Clips in your pocket. Shoots 300 ft. high, visible 25 miles by night, 1 mile by day. Indispensable for sportsmen, boat owners, mountain climbers, 4th of July playboys, etc. Complete set includes signal gun, plus box of signal flares, \$6.00. Duty Free Export Shop, 1 Lille Kirkestraede PM, Copenhagen K, Denmark.

### CAMPING EQUIPMENT AND TENTS

**PORTABLE Kitchen-pantry.** Approved by university camping clinics, outdoor writers and veteran campers. Plywood construction. Plans \$1.00. Specify station wagon or sedan. Literature 10¢. Campers Kitchen Company, Box 6062, San Antonio 9, Texas.

**CAMPING Equipment, tents, world's largest selection.** Send 25¢ for new giant catalogue-handbook-camp site directory (print name-address). Morsan Tents, 10-21R 50th Ave., Long Island City 1, New York.

**PICKUP Campers.** Pre-cut kits. Blueprints. Supplies. Literature 10¢. Comstock Trailers, Parsons, Kansas.

**CAMPER For auto top, sleeps two.** Easily assembled camping kitchen. Kits or plans. Free information. Smiths, 2254 Cynthia, Pomona 4, Calif.

**BEST Campers tool available anywhere.** fantastic jackknife saw. Rush \$2.00. Pak-saw, Box 1224, Seattle 11, Washington.

### EARTHWORMS, CRICKETS, FROGS

**RAISE Redworms.** Bamboo fishing poles. Free literature. Nurseries, Rt. 5, Columbia, Miss.

**HYBRID Redworms.** Money back guarantee. 1000 \$3.50, 5000 \$16.00. Medium 5000 \$8.95, 10,000 \$16.85. Postpaid. Free literature. Hall Farm, Hilton, Georgia.

**\$1,000 MONTHLY Possible,** raising earthworms—African giants! Backyard, garage, basement. Complete illustrated booklet, explains raising, feeding, packing, marketing. Send 25¢! Ozark Worm Farm-J, Willow Springs, Missouri.

**TRAP Thousands nightcrawlers, earthworms.** Easy building instructions, drawings, \$1.00. Eddie Thom, Hope, Idaho.

**HYBRED Redworms 1000, \$3.00; 2000, \$5.00; 5000, \$8.00 postpaid** with raising instructions. Brazos Bait Farm, 60 Lincoln, Waco, Texas.

**EARN Money raising fishworms for us!** Exciting details free! Oakhaven—56, Cedar Hill, Texas.

**BIG Money raising fishworms and crickets.** We teach you how to raise and where to sell. Free literature. Medium redworms, 3000, \$5.95; 10,000, \$16.95. Carter Redworms, Plains, Georgia.

### TAXIDERM Y

**SEND Postal for this free book.** Tells how you can learn to mount birds and animals. Also fish, gameheads. Tan skins, make leather. All secrets revealed. Fascinating and profitable hobby for all men and boys. Rush postcard today for your copy. Tells how we have taught over 400,000 successfully by mail. No obligation. Write today. Please state your age. Northwestern School of Taxidermy, 2503 Elwood Building, Omaha 2, Nebr.

### BINOCULARS, TELESCOPES, MICROSCOPES, MAGNIFIERS

**TELESCOPE Kits—Direct from manufacturer.** Other optical hobby kits. Large selection. Free booklet. Esco Products, Oak Ridge, N. J.

**DYNASCOPE — Amazing world-famous reflector telescope.** Request free brochure. Criterion, Dept. DP-89, Hartford 1, Conn.

**CUSTOM Telescopes, lens, tripods, equatorials and accessories.** UPCO, Sunbury, Penna.

**BUILD Your own reflector telescopes.** Complete kits: mirrors, eyepieces, tripods, all other accessories. Request free illustrated literature. Criterion Manufacturing, Dept. KPM-86, Hartford 1, Conn.

**SLIDE Rules 4" precision pocket size** with leather case. Guaranteed. \$6.95. Duffer Co., 8231 Croushore, Indianapolis 19.

**AMAZING New Zoom binoculars! Telescopes! Microscopes! Riflescopes! Free catalog.** Adventure Company, Box 2133, San Diego 12, California.

**REFLECTING Telescope, 60X,** completely assembled. Guaranteed observatory clearness. Free information. Skyscope, P.O. Box 55, Brooklyn 28, N. Y.

**SCIENCE Bargains! Lenses, telescopes, binoculars, microscopes, kits, parts, war surplus.** Send \$1.00 for beginner's 10-lens kit with instruction booklet. Order Stock 2-CH. Request free 144-page Catalog CH. Edmund Scientific Co., Barrington, New Jersey.

### PLANTS, SEEDS, BULBS, NURSERY SUPPLIES

**GINSENG Bringing \$14 pound.** Have seeds, plants, Goldenseal. Full information. K. Collins, Viola, Iowa.

**COMPLETE Line of insect eating plants and supplies; unusual and atomic mutated seeds.** Peter Pauls Nurseries, Bldg. 2, Canandaigua, New York.

**MING Trees! Seeds, instructions, 35¢.** U.S. only. "Specialties," 1439-E Sabraton Ave., Morgantown, W. Va.

### GARDEN EQUIPMENT & SUPPLIES

**BEST Pruning saw available anywhere.** Fantastic jackknife saw. Rush \$2.00. Pak-saw, Box 1224, Seattle 11, Washington.

### PETS—DOGS, BIRDS, HAMSTERS, ETC.

**INTERESTED In pets? Send 15¢** for fascinating list. Mammals, birds, reptiles. 4529 West Pico Blvd. Los Angeles, Calif.

**RAISE Profitable guinea pigs.** Free details. Diamond J. Rabbitry, Colborne, Ontario, Canada.

**HAMSTERS—Ideal pets, \$2.95 pair.** Free booklet. Jer-Ire's Hamstery, 1447 Apple, Muskegon 13, Michigan.

**PETS—Hamsters, mice, rabbits, squirrels, chipmunks, guinea pigs, skunks, raccoons.** Pricelist dime. Picture catalog twenty five cents. Moore's Hamster Ranch, Shepherdstown 25, West Virginia.

**HAWKS, Reptiles, raccoons, skunks, squirrels.** Catalogue 25¢. Trails End Zoo, St. Stephen, S. C.

**MAKE Money raising chinchillas, mink, rabbits, cavies for us.** Free catalog. Keeney Brothers, New Freedom 2, Penna.

### RABBITS—FUR BEARING ANIMALS

**RAISE Rabbits.** Details. Rabbit Enterprises, 548 River Road, Ludlow, Ky.

**EARN \$10,000 Yearly raising Angora rabbit wool for us.** Information 25¢ coin. American Angora Company, Malta 12, Montana.

**RAISE Rabbits on \$500 month plan.** Free details. White's Rabbitry, Mt. Vernon, Ohio.

**RAISE Rabbits. Make money.** Information and prices sent free. Write Johnson, 683, Kansas City, Missouri.

**MINK Raising information free.** Complete. Lake Superior Mink Farm, Superior, EEl, Wisconsin.

**RAISE Rabbits successfully by knowing facts.** 48 page book. 38 illustrations describing 25 breeds. Housing. Breeding. Feeding. Markets and Marketing. Bulletin etc. 25 cents. American Rabbit Association, 36 ARBA Building, Pittsburgh, Penna.

### FARMS, FARM LANDS, REAL ESTATE

**FLORIDA: 2 1/4 Acres, Gulf Coast area:** 50 ft. elevation. \$795.00, \$15.00 down and month. Russell Hancock, Realtor, Brooksville, Florida.

**OZARKIAN Contentment!** Improved acreage \$15 monthly. Descriptions free. Armstrongs, Wappapello, Mo.

**ANOTHER United** standout! Imagine getting a fine 80-acre Minnesota highway farm with buildings insured for \$10,000, all for only \$5,000! Takes only \$1,500 down! Level terrain, 30 tillable acres, pond, well, woven and barb wire, 40 acres woods. Big 8-room 4-bedroom home, basement, bath. Good 40x160-ft. barn, silo, other buildings. On paved highway, mile village, 7 miles town, 85 "Twin Cities." Undoubtedly one of the year's finest bargains at \$5,000, only \$1,500 down! Big free illustrated Spring catalog, bargains coast to coast! United Farm Agency, 2825-PM Main St., Kansas City 41, Mo.

**CANADIAN Tax sale lands.** Our 45th annual series of lists, just begun, describe farms, timber lots, hunting and fishing camps. Average price five dollars an acre; small monthly payments, guaranteed titles. Write today for free sixteen-page booklet containing full information. Tax Sale Service, Room 411-D, 1173 Bay Street, Toronto 5, Canada.

**NORTH Florida** lots beautiful Suwannee County, 50x100, \$295.00 full price, \$5.00 down and monthly. No interest. Free literature and maps. Casper Corporation, 3970 NW 177th St., Carol City, Miami, Florida.

**FLORIDA Campsites**—deep in the heart of the great Ocala National Forest. Abundance of game, best fishing. Warranty deed. Unrestricted—pitch tent, park trailer, build lodge. Free maps and photos. Howard Vernor, DeLand, Florida, AD60088(Q-O).

**OPPORTUNITIES!** Government land, U. S., Alaska, Canada. Sledge Surveys, Macon, Mississippi.

**\$5 MONTHLY Buys 5 acres**—near clear-water lake. Price \$125. Excellent fishing, good cabin sites. Free list. Box 425-P, Carthage, Mo.

**FREE Strout catalog!** Farms, homes, businesses, resorts, retirement properties. Over 3000 values coast to coast. 61 years service. World's largest! Write Strout Realty, 7-CJ S. Dearborn, Chicago 3, Ill.

**CANADIAN Vacation lands:** Full price \$385.00. 40 acres, \$10 month. Suitable cottage sites, hunting, fishing, investment. Free information. Land Corporation, 3768-C Bathurst, Downsview, Ontario, Canada.

**FLORIDA Hillside** lots restricted at Ocala National Forest, three miles from Saint John's River. \$495. \$10 monthly. Write Victor Roepke, Route 3, DeLand, Florida.

**FLORIDA**—For sale: 1/4 acre homesite in Florida—private lake, free country club privileges, white sandy beaches right at property. Fishing pier, club house, dock site, lovely homes, hard-paved roads under construction, electricity, phones, tested pure water—all available. Certified high, dry land only 2 1/2 miles from healthful bubbling waters of Rainbow Springs. Only \$10.00 monthly. Total cost \$795, no hidden extras. Free photos, booklet. Write to Rainbow Lakes Estates, Dept. A-28, 817 Silver Springs Blvd., Ocala, Florida.

**E. Herrick, Margaretville, N. Y.,** 130 miles from New York City in Delaware Co. Farms, campsites, acreage, retirement homes, 5A. mountain retreats, on road. Free list, terms.

**FLORIDA Hills** homesites \$120.00. \$5 monthly. Electric. Thompson, Lecanto, Florida.

**SUNNY Kingman, Ariz.** Acre \$395, \$10 down \$10 month. Fishing, hunting. Free info. Wilo Land Co., Inc., 4339 W. Cherry Lynn, Phoenix 31, Ariz.

**OPPORTUNITY In Brazil.** You can own virgin timber and ranch lands in Brazil's golden west for as little as \$10 down and \$10 monthly. A fabulous new empire is now opening up in Brazil as in America's golden west 100 years ago. Fortunes may be made by those with the foresight to take advantage of this unparalleled speculative land investment opportunity, in undeveloped Brazilian acreage. Get the full, exciting story, without obligation. Write Interbraz, Dept. P3, 4211 Ninth St., N.W., Washington 11, D. C.

**FLORIDA**—Big beautifully wooded tracts on prominent highway. Extra-wide highway frontage. Famous pleasure resort area 28 miles north of Panama City. Wendell Wood, Fountain, Florida. AD62005(Q-O).

## FARM MACHINERY AND SUPPLIES

**3 H.P. Hoing machine.** No other like it. Uproots all weeds in row and between plants. Very simple. Very sturdy. Women operate easily. Also tills. Depth adjustable 0-6". Self propelled. Buy direct at discount. 30 day trial. One year warranty. Write Autohoe, West De Pere, Wis.

## PROFITABLE OCCUPATIONS

**LEARN To color photographs.** Fun, profitable. Complete, concise instructions. \$2.00. Phototint, Box 372, Pleasant Hill, Calif.

**INVESTIGATE Accidents.** Earn \$750 to \$1,000 monthly. Men urgently needed. Car furnished. Business expenses paid. No selling. No college education necessary. Pick own job location. Investigate full time. Or earn \$6.44 hour spare time. Write for free literature. No obligation. Universal, CPM-3, 6801 Hillcrest, Dallas 5, Texas.

**AMAZING Profits in worms.** Free information. Hillaire Wormery, Northville, Michigan.

**BALL Pens,** retractable, less than 3¢, in quantity. Sample 10¢ and stamp. Box 564PM, Houma, Louisiana.

**INVESTIGATE Auto accidents.** Earn \$750 to \$1,000 monthly. More investigators urgently needed. Car furnished; business expenses paid. No college education necessary. No selling of any kind. Pick your own job locality. Meet interesting, important people. We train you at home in spare time. You keep present job until ready to switch. Write for free booklet. No obligation. Liberty School, Dept. C-91, Libertyville, Illinois.

**MAKE Money** writing short paragraphs. Information free. Barrett, Dept. C-27B-N, 7464 No. Clark, Chicago 26.

**BUY Below wholesale!** Thousands of nationally advertised products. Drugs, clothing, housewares, cameras, jewelry, hardware, sporting goods, etc. Postcard brings price list showing actual factory cost. Buy-Rite, 310 Main, Bennington 1, Vermont.

**AUCTIONEERING**—Home study course. Diploma granted. Auction School, Ft. Smith, Ark.

**VENDING Machines.** No selling. Operate a route of coin machines and earn amazing profits. 32-page catalogue free. Parkway Machine Corporation, Dept. #25, 715 Ensor Street, Baltimore 2, Maryland.

**BAKE New greasless doughnuts** in kitchen. Sell stores. Free recipes. Michael, 3605 South 15th, Minneapolis 7, Minn.

**BIG Money raising fishworms and crickets.** Free literature. Carter Wormery, Plains, Georgia.

**BECOME Independent** with your own franchise business. Thousands earning handsome incomes. Request interesting facts today. National Franchise Reports, PM-528, 333 North Michigan, Chicago 1.

**HOME Mailorder** business. Simple, enjoyable. Net \$15,000 year. Write: Mail-order, Box 512-E, New Orleans 1, La.

**SAVE Those boxtops!** They're worth money! Inquire: "Boxtops-MA," Cedar Hill, Texas.

**EARN \$240.00 A month** at home, spare time, doing only two \$5.00 invisible mending jobs a day. Big money paid for service that makes cuts, tears disappear from fabrics. Steady demand. Details free. Fabricon, 1586 Howard, Chicago 26, Ill.

**EARN Money** raising fishworms for us! Write: Oakhaven—58, Cedar Hill, Texas.

**SHARPEN Scissors,** pinkers, clippers. Inexpensive machines, supplies. Blackhaws, Sheldahl, Iowa.

**BECOME A research expert.** Complete instructions \$1. Janeczek, 373 East 155th Street, New York 55, N. Y.

**FREE Book** "990 Successful, Little-Known Businesses." Work home! Plymouth-57W, Brooklyn 4, New York.

**FOR Real earning security** learn to straighten crank shafts, sharpen, repair, and service lawn mowers. Wirt's, 1419 Gnahn, Burlington, Iowa.

**WHOLESALE Magazine subscriptions.** Highest commissions. Bonus! Qualified Agencies, 451MA Kingston, Brooklyn 25, N. Y.

**BECOME Private investigator!** Complete booklet \$4.50! Also bargain catalog \$1.00! Both \$5.00! Milmar, (Dept. PM-PO), Box 1932, Oklahoma City 1, Oklahoma.

**FREE Report:** "609 Unusual, Successful Businesses." Box 1001-PT, Evanston, Ill.

## BOOKS, PERIODICALS, PICTURES, POSTCARDS

**FREE Catalog.** Self-help books. Write: Wilshire, 8721 Sunset, Los Angeles 46P.

**BOOKFINDERS!** All subjects. Send wants! Jaber Book Service, 183 Hazelwood Drive, Westbury, N. Y.

**NATIONAL Geographic** magazines, 1888-1960, any issue. Periodical Service, Box 465-PM, Wilmington, Delaware.

**BOOKS Located fast.** Out-of-print, scarce. Lowest prices without obligation. Book Mark, 51A Walnut, Mt. Clemens, Mich.

**BOOKHUNTERS!** Scarce, miscellaneous books supplied! Atlantic Book Service, Cedar Street, Charlestown 29, Mass.

**BRITISH Book bargains—Any subject.** Catalogues free. Transatbooks, Wantagh, N. Y.

**SIX Colorful ships,** religious, scenes, master pictures 12 x 16 postpaid \$1.00 each set. Irving Sherman, 1270 Broadway, New York City.

**OUT-Of-print books** at lowest prices! You name it, we find it! Fast service. No obligation. International Bookfinders, Box 3003-PM, Beverly Hills, Calif.

**FREE—Large list of books, magazines.** Special offer. Brooklyn Book & Magazine Service, Box 221, Brooklyn 11, N. Y.

**"THE Boy's Book of Physical Fitness"** by Hal G. Vermes. "The Girl's Book of Physical Fitness" by Jean C. Vermes. Published through National Council YMCA. "Any boy, any girl would benefit, now and later, by reading these books," says Dr. W. W. Bauer, Director, Dept. Health Education, American Medical Association. \$1.95 each book (money-back guarantee) from Peter Paperback, Box 614, Flushing 52, N. Y.

**DISCOUNTS Paper backs** and do-it-yourself books. Catalog 5¢. Fairfax, Box 4283, Panorama City, California.

**DO-It-Yourself books!** List free. Had-don House, Box 55, New York City 62.

**PROPHET Elijah** coming before Christ. Wonderful book free. E. Megiddo Mission, Rochester 19, New York.

**OUT-Of-print books** at lowest prices! You name it, we find it! Fast service. No obligation. International Bookfinders, Box 3003-PM, Beverly Hills, Calif.

## GAMES, TOYS, NOVELTIES

**PARTY Games!** Adults'. Children's. Two 64-page books 50¢ postpaid! Sharon, Box 5114A, Kansas City 32, Missouri.

## MAGIC TRICKS, PUZZLES, JOKER NOVELTIES

**WORLD'S Finest professional magic.** Joker novelties. Giant illustrated catalog 10¢. Top Hat, Evanston 12, Illinois.

**3000 TRICKS,** Pocket, parlor, stage. World's finest magic catalog (408 pages), \$2.50. Kanter's, M-1311 Walnut, Philadelphia 7.

**2700 NOVELTIES,** Jokes, tricks, fun-makers, hobbies. World's biggest gadget catalog 10¢. Johnson-Smith, D-549, Detroit 7.

**PROFESSIONAL Catalog,** 175 pages, 25¢. Williams, 900 Plymouth, Ellwood City, Penna.

**500 TRICKS,** New 1962 edition, famous Douglas catalog of magicians tricks and supplies now available just 10¢. Fastest service. Douglas Magicland, Dept. 61, Dallas, Texas.

**400 LAUGH Lines** plus professional comedy catalog. \$1. Orben Publications, Hewlett, N. Y.

BE A magician! Latest tricks. Large professional catalog \$1.00. (refundable with order). Ireland, C-109 North Dearborn, Chicago 2.

VENTRILLO Voice thrower 25¢ Ventriloquist's puppet 75¢. Box 971-PM, Philadelphia 5.

BOOK Of 279 tricks—15¢. Bookmaster, Box 17273-K, Salt Lake City 17, Utah.

MAGICAL Tricks, jokes, gags. Send stamp for catalog. House of Magic, 186-D N. Broadway, Fresno 1, Calif.

SMOKE Bombs 25¢ 7 for \$1.00. Terrific! 6703-N Eleventh, Philadelphia 26.

PRACTICAL Joker merchandise. Catalog, 10 samples, \$1.00. Central, 5807 Bland Avenue, Baltimore, Maryland.

FLAME Thrower! 36" flashes at fingertips! \$1.00. Harmless! Arlane, Philadelphia 44.

CATALOG, Free trick, 25¢. (1,500,399 tricks, jokes). Magico, Box 4373-P, San Antonio 7, Texas.

FUNNY Cards, 50 samples 25¢. Wholesale joke catalog. Dohn-RL-Marks, Broadview, Illinois.

HOUSE Of 1000 mysteries! World famous! Professional magic! Pocket tricks! Jokers novelties! Two big catalogs combined into one giant edition! 160 pages! 700 illustrations! Rush 25¢ (refundable). Free trick too! Vick Lawston, Dept. PM3C-62, Trumbull, Conn.

### COINS, TOKENS, CURRENCY

COINS Wanted. Highest prices paid. List 10¢. Wayne Coin, 1205 California Ave., Fort Wayne, Indiana.

FREE Coin bulletin listing coins for sale at bargain prices. Send self-addressed, stamped envelope to: Ben's Coin Company, 31 North Clark, Chicago 2.

LINCOLN Bargain—25 different 1910-1939 plus 10 different unc. 1957-1961 \$1.95. Len, Box 212, Downey 3, Calif.

INTRODUCTORY: Free confederate dime, foreign coin, coin and medal catalog; send 25¢ postage, handling. Collectors Club, Box 71-C, Rockaway 94, New York.

FREE Coin supplies! Giant coin list 10¢ (refundable). Economy Sales, Mansfield, Massachusetts.

RECTANGULAR Japanese gold coin—\$3.00. Kornegay, 531 Terry, Fayetteville, North Carolina.

WE'LL Pay \$9,000.00 to \$18,000.00 for 1913 Liberty Head nickel. Certain dates: Lincoln cents before 1956—\$250.00; Indian cents \$1,750.00; Flying Eagle cents \$950.00; Dimes before 1943—\$5,250.00; Quarters before 1933—\$5,250.00; Half dollars before 1939—\$7,500.00. Thousands of others worth \$10.00 to \$15,000.00. Such as certain dates: halfcents, large cents, 2¢ pieces, 3¢ pieces, halfdimes, Shield nickels, Buffalo nickels, 20¢ pieces, commemorative coins, paper money, foreign coins, etc. Thousands of persons have sold us coins totaling over \$250,000.00. For complete information, before sending coins, purchase our large illustrated complete guaranteed buying-selling catalog \$1.00. Worthycoin Corporation (K-508-C) Boston 8, Massachusetts.

FREE Brochure describing Presidential Art Medals, a series of finely sculptured medals honoring each president. Kennedy medal selected by President for distribution on good will missions. Unmatched quality. Collection of appreciable value, historic and education interest. Send for free descriptive brochure: Presidential Art Medals, Inc., P.O. Box 187, Englewood, Ohio.

BRILLIANT Proof sets: 1957, \$4.50; 1959, \$4.75; 1960, \$3.95; 1961, \$3.15; 1962, \$3.00. Uncirculated \$20.00 gold \$57.50; 2 different types \$107.50. Pony Express centennial medal \$1.75. Retail guidebook \$1.75. Bebee's, 4514 North 30th, Omaha 11, Nebr.

INDIAN Pennies, 5 for \$1.00, or Liberty nickels, 6 for \$1.00. Joseph Gaidar, 6615 So. Ashland, Chicago, Ill.

NUMISMATISTS. Price list valuable gift, 40¢. Coin Investment—unprecedented, invaluable to small investor—booklet \$1.00. Vanderman, Box 9161, Suitland, Maryland.

FREE Bargain lists. The RJR Coin Company, Astoria 1, Oregon.

COINS & supplies, Lincoln cents our specialty. Catalogue free. Hyles Sales, Box 9566, Dallas 14, Texas.

UNCIRCULATED 1935 silver pony express commemorative medal \$1.00. Coin lists free. Sayers, 1000 Unaka, Johnson City, Tennessee.

COINS, Supplies; Lists 20¢. Lund, 200 Sc. Sycamore, North Platte, Nebraska.

LARGEST Coin magazine. 288 pages, 50¢. Scrapbook, 7320-J Milwaukee, Chicago 31.

NUMISMATICS Largest newspaper. Semi-monthly. Sample 25¢. \$2.00 yearly. Numismatic News, Box 452, Iola, Wis.

RARE 1878 CC mint dollar uncirculated \$5.00. 100pg. catalogue 50¢. Shultz, Salt Lake City 10, Utah.

BARGAIN List! U. S. coins, accessories. Stamp please. Hugh's, Hickory, N. C.

40 PAGE Illustrated United States and Canadian coin list 10¢. Stoney, 260 Washington, Boston 8, Mass.

25 BEAUTIFUL Coins from 25 countries. Mostly uncirculated. Terrific assortment. \$1.00. Hindley, Box 708, Aurora, Illinois.

RARE Unc. 1899 Philadelphia silver dollar, \$5.00. Butts, Torrington, Wyo.

COIN Collector's magazine. On your newsstand or direct. Sample 35¢. \$3.00 yearly. Coins Magazine, Box 274, Iola, Wis.

TWENTY-Four page 1962 retail price list of USA and Canadian coins 10¢. Our selling prices on thousands of coins and coin collectors' supplies. Bryson Incorporated, 612A White, Toledo 5, Ohio.

SIX Different Indian cents with lists. \$1.00. Hutchinson's, Box 6256, Philadelphia, Penna.

GOLD Sale: Bright U.S. twenty-dollars gold \$55; ten-dollars gold \$33; five-dollars gold, \$22. Lincoln cents uncirculated 1941 to 1961 complete 57 pcs. \$20. Lawrence Lake, Clarence, N. Y.

COINS Bought. Illustrated catalog 25¢. Hutchinson's, Box 6256, Philadelphia, Penna.

15 DIFFERENT Lincolns before 1921. \$1.00. Gene Carlton, Box 336, Chandler, Oklahoma.

LINCOLN Cents 23-S, 21-S-P, 24-S, 16-S-D, 18-S-D, 19-S-D, 20-S-D, 55-S, 34-D, 28-S-D, 27-S-D, 38-S-D, 29-S-D, 25-S-D, 09-P, 30-S-D, 32-D, 33-P, 39-S-D, 31-P. Good to fine complete lot \$7.25. Rolls of 55-S Lincoln cents fine to A.U. \$6.50. Berry, Box 306, Westminster, Calif.

LINCOLNS 40 Different 1909-1940 plus 1960D small date, \$1.95. 25 different "S," including rare 1955S \$1.50. Harris, Box 611P, Cupertino, California.

HANSEL Proffitt's booklet "5 Coins for Quick Profit" only \$1. White, Box 10342, Knoxville 19, Tennessee.

SAVE Your slick nickels where date is worn off. Order a bottle of Coin Date. It will bring the date out on Buffalo, V. Shield nickels. It's easy to use. Satisfaction guaranteed. \$1.00 postpaid. Box 276-F, Mooresville, No. Carolina.

LINCOLNS For sale 20¢ each: 1909, 1910, 1911, 1912, 1913, 1914, 1916-P-D, 1917-P-D-S, 1918-P-D-S, 1919-P-D-S, 1921-P-S, 1926-D, 1927-P-D-S, 1928-P-D-S, 1930-D-S, 1931, 1934-P-D, 1938-D-S, 1939-D-S, 1943-P-D-S, 1954-P-D-S, 1955-S. All 42 \$7.25. John Gardner, Box 403, Colorado Springs, Colorado.

PAYING \$3.00 Each for 1922-1923-1925 Canadian cents. Dwayne Heisterkamp, 726 West 4th St., Cedar Falls, Iowa.

HALF Dime \$1.25, 2¢ piece 95¢, 1867 nickel \$1.25. Large cent \$1.75. Half cent \$3.75. Many bargains! Universal, Box 309, Richmond 2, Va.

25 GENUINE Foreign notes \$1.00. Louis D'Alcnzo, 339 Orange St., Newark 3, N. J.

WANTED: Indian pennies. I pay more. Send for my free buying price list. Robert Creps, 1637 S. Michigan St., South Bend, Indiana.

WORLD'S Greatest coin magazine and wooden nickel 10¢. Lawrences, Anamosa, Iowa.

SERIOUS Beginners: Vital information, 10¢. Horseshoe, Box 718, Sioux Falls, S. Dak.

PROOF Sets 1961 \$2.50, 1962 \$2.50. Price list free. Tom Norman, Corinth, Miss.

BU Dollars—1878-CC \$4.50, 1880-CC, 1885-CC each \$13.75; 1899-P \$4.75. Ansonia Coins, Ansonia, Connecticut.

ANCIENT Coin \$2.00. Russian bank-note \$1.00. Hobby, Box 63, Hillside, N. J.

COLLECTOR Buying coins. Write: Al, 2847 Forrester, Los Angeles 64, Calif.

PICKWICK Wants to buy your coins and stamps. Send \$1.00 for new combined illustrated buying prices refundable when we buy your material. See Pickwick before you sell for top prices. Pickwick, Box 34, Stamford 1, Conn.

ROMAN-Egyptian bronze coin. Third century AD, ruler identified, 90¢. Catalogue 10¢. Luviere Coin, 24 Mulford, Hempstead, N. Y.

### STAMP COLLECTING

BEAUTIFUL Laos elephants free. Approvals accompany. Fred Easley, Sterling, Alaska.

CANADIAN Sports set complete 10¢. Approvals. Valley Stamps, Little Valley, New York.

50 DIFFERENT Central and South America, 10¢ with worldwide approvals. Cole, Box 223-A, Buffalo 21, N. Y.

21,000 ALL Different, only pennies a day using our systematic payment plan. Details free. Ejoquist, 1435 Cherrydale, San Jose 25, California.

50, LATIN, British, Orient: 10¢. Approvals. Thiese, 9320-M San Juan, South Gate, California.

U.S. Fully illustrated catalog 10¢ deductible. Simmy's, 45 Bromfield, Boston 8, Massachusetts.

REAL Old U.S. seconds. Bargain prices. K. Swartz, Malden Bridge, New York.

12,000 PENNY Approvals waiting for you. Many from exotic countries, pictorials, airmails, new issues. Tilbury, Box 862, Newark 1, N. J.

OLDER U.S. used. 260 different. \$4.00. Satisfaction guaranteed. Stoess, Wash-tucna, Washington.

100 LARGE Pictorials 25¢. Approvals. Knopp, Box 1381, Bristol, Conn.

U.S. Mission mixture. Guaranteed unpicked. 2 lbs. \$4.00; 5 lbs. \$8.50. Skytop, Box 1022PM Binghamton, N. Y.

CANADA Totem dollar 20¢. Approvals. Daleti, Box 832, Moncton, New Brunswick.

U.S. Approvals. Low prices. Eagle Stamps, Romine Ave., Pittsburgh 26, Penna.

FREE! 25 Different Portuguese; colorful, inexpensive approvals. Elkhart, Box 33, Elkhart, Indiana.

FREE Mint Africa set with approvals. Lithor, Box 51, Canoga Park, Calif.

300 DIFFERENT Given free with approvals. Particulars. Windsor Stamps, P.O. Box 735, Santa Clara, California.

STAMP Collecting outfit, includes packet worldwide stamps, package hinges, watermark detector, millimeter gauge. Everything 10¢ with approvals. Loraine Brown, Marion, Michigan.

FREE 30 Large U. S. commemoratives with approvals. 10¢ handling. Jack Clancy, Box 2187, Portland 14, Oregon.

FREE Sample. Interesting, informative, illustrated. National Stamp News, Anderson, South Carolina.

FREE. 33 Greenland, Congo, Ruanda, others. Approvals. Keating, 2520-P Boulevard, Jersey City 4, New Jersey.

FREE! 25 Egypt, 10¢ handling. Approvals. Bellet, Mapledale, Hazel Park, Michigan.

200 STAMPS, 25¢ With approvals. Smith, 508A Brooks, College Station, Texas.

FREE! 222 worldwide. 10¢ handling. Penny approvals. Jung, 1601 North Stanley, Los Angeles 46.

TERRIFIC Value. Eight complete mint sets 10¢ with approvals. Beatties, Box 4503, Fort Lauderdale, Florida.

U.S., U.N., Confederate states catalog free. Stone, 260 Washington, Boston 8, Mass.

U.S. Mint specials! Flag set, complete \$1.00; 1¢, 2¢, 3¢ famous Americans (21 different), \$1.00. Free list. Brooks, 2323 Avenue X, Brooklyn 35, New York.

TWO \$5.00 United States stamps, 20 others 10¢ with United States approvals. Irwin, Box 1105, Brooklyn 30, New York.

25 DIFFERENT Large American commemoratives. 10¢ with approvals. Linstamp, St. Catharines 101, Ontario.

80 DIFF. U. S. stamps includes 19th Century commemorative. High values. Plus 1943 flag stamp of occupied nations. All for only 25¢. Approvals included. Willett Co., Box 338-C, Yorktown Heights, N. Y.

107 DISTINCT British Colonial stamps, 10¢. Approvals. Linstamp, St. Catharines 401, Ontario.

UNITED Nations 15th anniversary sheet with first day cancel, as commemorated by Russia. Free! While they last, with approvals, Philatelics, R-J, New Paltz, N. Y.

25 COLUMBIA 10¢. Approvals included. Reed, Box 980, Chicago 90, Illinois.

105 DISSIMILAR British Colony stamps, 10¢. Approvals. Crown Stamp Company, Virgil 601, Ontario.

INTRODUCING Our better United States approvals we offer 15 United States stamps including Columbian, Bi-Centennials, famous American, airmails, others; only 10¢. Ocean Stamps, Box 64-PM, Brooklyn 29, New York.

PENNY Approvals. Thousands. Bargains for pennies. Gifts with purchases. Penny Stamps, Orange, California.

GIANT Approvals, thousands different, 1¢ and 2¢ each. Wahl's Stamp Exchange, 7008P Farragut, Chicago 31, Ill.

UNITED States commemorative collection containing 33 different—10¢. Approvals. White, 516-A Avenue L, Brooklyn 30, New York.

103 DIVERSIFIED British Empire stamps, 10¢ Approvals. Niagara Stamps, St. Catharines 501, Ontario.

SELL Your surplus good grade stamps. Write, describing fully what you have. Vanroy Shirk, Lebanon, Pennsylvania.

AMAZING OFFER! 200 United States stamps — including commemoratives, airmails, high denominations to \$1.00. Only 10¢ to approval applicants! Illustrated bargain lists free. Mystic Stamp Co., Dept. 80, Camden, New York.

100 OLD United States between 1861 and 1935. \$1.00. Roush Stamps, 51 Chestnut, Mansfield, Ohio.

UNITED States price list, 116 pages, price 25¢. Mark Hanna, 335 Fifth Ave., Pittsburgh 22, Penna.

STAMP Jungle including Zabu, kookaburra, koalabear, kangaroo, rhinoceros, 10¢. Approvals. Crown Stamp Company, Virgil 301, Ontario.

FREE Monaco nudes. Approvals. Stamp Ranch, 902 Addison, Chicago 13, Ill.

PENNY Approvals! Regardless catalogue! Kloster, 4164—52nd St., San Diego 6, Calif.

60 DIFFERENT U. S. (30 commemoratives) 25¢. No approvals. Seidenberg, Appleton, Wisconsin.

307 WORLDWIDE Different stamps only 25¢. Approvals. Niagara Stamps, St. Catharines 201, Ontario.

225 STAMPS For only 10¢! This mammoth value includes airmails, pictorials; stamps from strange countries cataloging up to 25¢ each! Also approvals. Mystic Stamp Company, Camden 80, New York.

FREE 50 Worldwide, mailed with inexpensive approvals. University Stamps, P.O. Box 44-592, Miami 44, Florida.

FREE Mint set! Approvals accompany. Stampco, Box 737, Memphis 1, Tenn.

111 WORLDWIDE. Includes airmails, midjets, triangles, 10¢. Approvals. Premiums, Faith, 201½ Bushnell, Alhambra, Calif.

100 DIFFERENT United States commemoratives, 1/2¢ to 10¢ values—used \$1.00; Mint \$4.95. No approvals. Gil's, Box 12BA, Brooklyn 29, N. Y.

FREE—All volumes Scott's International albums. Scott's 1962 catalogues—even master global albums free—when you buy our sensational foreign approvals. Bargain Stamps, Redlands, California.

701 U.S.A.—25¢. Plenty commemoratives. Request approvals. Horace Gatewood, Winston-Salem, N. C.

1000 DIFFERENT Worldwide stamps \$1.00. Valued over \$20.00. To adults only requesting our popular packet approvals. Universal, Box 6, Kenosha 5, Wisconsin.

SUPERIOR Worldwide mission mixture. Amazing variety! Five ounces \$1.60, Pound \$4.50. Bay Nielsen, 4545B Harvard, Montreal 28, Canada.

EXCHANGE. Send 100-200 different stamps with 15¢. Receive different. Patterson, Lancaster 10, New York.

FREE Macao mint set, approvals. Coretta, G.P.O. Box 1546, New York 1.

SEVENTY Different United States. Obsolete and current. 25¢. Ed. Keller, Library, Penna.

FREE Stamps to buyers of worldwide approvals. Enormous selection. Fair prices. Handy Stamps, 460 Handy, Orange, Calif.

215 DIFFERENT Worldwide 25¢. Plume, Korea, Laos, Russia, Transvaal. Approvals. Bobb's, Box 3045, Saint Louis 30, Missouri.

BATHING Beauty, spacemen packet—10¢ with approvals. Nugget, 2408 Gillen, Racine, Wisconsin.

FREE! World's largest! Strange, valuable 7"x14" beauty. Send 15¢ handling now! Norrisco, Milwaukee 7, Wis.

PENNY Approvals. 1,000 foreign stamps mounted in Scott order. No assorting! Bulot Approvals, 1359 Coney Is. Ave., Brooklyn 30, N. Y.

ROCKETS! Satellites! 10¢ with approvals. Schaefer, Californiastrasse 16, Wiesbaden, Germany.

FREE—When you buy our foreign approvals you receive absolutely free stamps equaling your purchases. Coast, 1609 S. Park, Santa Ana, California.

MINIATURE Collection Queen Elizabeth mint sets (Antigua, Caymans, Mauritius, Montserrat, Virgins, St. Kitts)! 21 lovely pictorials, only 25¢! Attractive approvals! Gannon Stamps, Box 931, Canton 1, Ohio.

UNIQUE Collection 51 all different world wide religious stamps 10¢! Includes cathedrals, shrines, temples, saints, plus religious dancers, nativity issues and scarce mint Goya Holy Family painting. Wonderful approvals. Darling Co., Ridgway 1, Penna.

AMAZING Triangles, World's smallest stamp, 25 other fantastic novelties. 5¢ approval buyers. Belmont Stamps, Washington 15, D. C.

MILLION Foreign stamps! 2¢ each! Send for thrilling, giant approvals! ABC Stamps, Box 6000-MB, San Francisco 1, Calif.

DEALERS—Wholesale list. Postage 4¢. Frank, 5031 Queensberry, Baltimore 15, Maryland.

30 DIFFERENT Soviet stamps only 10¢! See "behind the scenes" in mysterious Russia. View the Kremlin, satellites, atomic icebreaker, Russian jet plane. Tour Red Square, ancient forts, onion towers. Meet Red leaders. Only 10¢ with approvals. Offer open to adults only. Littleton Stamp Co., Littleton C1, New Hampshire.

TERRIFIC Stamp bargain! Israel, Iceland, San Marino, plus triangle set, plus Antigua, Borneo, Virgin, Scots, Congo, Russia, plus large stamp book. All four offers free. Send 10¢ for mailing cost. Empire Stamp Corporation, Dept. PM, Toronto, Canada.

OLD Scarce U.S. seconds on approvals. Slight imperfections, lowest prices. Hernefield, Clintonhill Sta., Newark 8, N. J.

14,000 DIFFERENT! Amazing new plan builds your collection systematically, country by country. Only 50¢ weekly. Free details. L. G. Ware, Monroe 75, Conn.

FREE! North America plus 87 foreign flag stamps. Big valuable collection of all-different, genuine stamps from Greenland (North Pole), St. Pierre, Newfoundland, Canada—picturing Eskimos, Indians, scarce 1867 Confederation, Northern Territories, Nova Scotia, United Nations, U.S.—Ancient 19th Century; first ship and plane; rare whooping crane; pony express; etc. Also, complete set Colonial and Civil War commemoratives. Plus colorful flag stamps of 87 foreign countries. Extra! Big bargain catalog. Approvals. Send 10¢ for mailing. Kenmore, Milford EF-306, New Hamp.

WOW! 110 All different Germany 10¢! Zeppelins, semi-postals, airmails, high values, etc. Giant catalog, bargain lists included with beautiful approvals. Jamestown Stamp, Dept. A32PM, Jamestown, N. Y.

AFRICAN Dandy collection free. Nifty approvals. Teddie, Crystal Beach, Florida.

104 MINT Pairs \$2.00. King, 330 Alexander, Kamloops B.C., Canada.

25 COMMEMORATIVES 10¢. Approvals. Kert Stamps, Box 343, Parker, Florida.

10 BRITISH Guiana pictorials \$1.00. Travel Unlimited, 718A Ark-Mo Hiway, North Little Rock, Arkansas.

25 JAPAN 10¢. Request foreign approvals. Ronald Paul, 506½ Wickersham, Fairbanks, Alaska.

105 DIFFERENT U. S. stamps 25¢. Approvals included. Shelron, Box 907-K, New York 8, N. Y.

STANDARD Cachets. Next 4¢ release 10¢. Stanets, 1548, Highland, Indiana.

U.S. Stamps. Giant bargain catalog—25¢. Raymax, 35-VZ Maiden Lane, New York City 38.

FREE. Mint British colonials from Maldives, Solomon Islands, Pahang, St. Christopher, Nevis, Sarawak, Cayman Islands, Gilbert Ellice. Free with approvals. Viking, Great Neck 8, N. Y.

UNITED States mint well centered. Famous Americans complete \$7.00. Flags 85¢. 1948 complete \$1.50. Tipex 50¢. SPA 25¢. Cipex 25¢. Fipex 55¢. List 10¢. LeBrecque, 132 Columbia Blvd., Waterbury 10, Conn.

FREE! Giant bargain catalog—new edition listing thousands of bargains including U.S. and B.N.A. stamps, packets, mixtures, albums, accessories and supplies; sent with beautiful approvals. Jamestown Stamp, Dept. E32PM, Jamestown, N. Y.

WEIRD Diamond shape coffee stamps. Lively flower triangle! First American big commemorative. Greenland, Idol Dancer, etc. 10¢ with approvals. Capital Stamp Co., Ferrysburg 2, Michigan.

500 ITALIAN Large commemoratives and pictorials, cataloging up to \$1.00 each, only \$10.00 bill. Beverini, Via Manno 2/12, Ge-Sestri, Italy.

FREE! 25 Different. Attractive approvals accompany. Ginn, 108 Palm, Marlin, Texas.

FREE Sputnik with sparkling approvals. Cambria, Box 2205, Anaheim, California.

"OLD Glory" in flaming colors! U.S.A. flag giant beauty from Honduras. Enormous United Nations Mexican stamp, Plus strange gorilla issue. Duke of Windsor, Morocco, lovely Macao flowers, wild buffalo stamp and others, 10¢ with approvals. Sunny Stamp, Apopka 2, Fla.

BEGINNERS! Try my 2¢ postpaid approvals. Engholm, 2068 Bathgate, New York City 57.

GAMBLER'S Packet, 25¢, with approvals. Lee Kennedy, Box 9497, San Diego 9, Calif.

FANTASTIC Fish triangles! Valuable "Ben Franklin" on Canal Zone! Flaming bi-colored volcano triangle! Lovely Olympics triangle! Plus icy Greenland, weird wild beast issue and others. 10¢ with approvals. Roseland Stamps, Spring Lake 2, Michigan.

50 DIFFERENT Canada 10¢. Joseph Myers, Route 5, Coldwater, Michigan.

FREE Hand picked collection. Approvals. Bech, 5973 Pagent Lane, Dayton 24, Ohio.

\$1.00 YOUR Choice of approvals, free. Rainbow Stamps, Box 821, Dubuque, Iowa.

200 DIFFERENT Worldwide 15¢ with foreign packet approvals. Munson Stamps, Gales Ferry, Connecticut.

10 DIFFERENT Canal Zone 25¢. Approvals! Merkel, 30 Grandview, South Hadley Falls, Massachusetts.

FREE! "Snow Birds" set with approvals. Peterson, Box 6201, Lincoln, Neb.

5,000 STAMP Hinges \$1.00. Doyle, P.O. Box 11102, Kansas City 19, Missouri.

310 DIFFERENT Stamps—25¢! Country packet lists. Bargains! Carling's, B-302, Howard City, Michigan.

111 STAMPS 10¢ With approvals. Ransom, 1333 Pontiac, Ann Arbor, Mich.

STAMPS—1/2¢ to 25¢ ea. MacQuestions, 13544 Woodward, Highland Park 3, Mich.

20 MODERN Pictorials 10¢ with worldwide approvals you'll enjoy. Muzzay, Box 543, Norwalk, Connecticut.

50 DIFFERENT U.S. commemoratives, airmails 10¢. Approvals. Gordon Davison, Henniker 8, N. H.

STAMPLESS Cover from 1831-1850, 50¢ to approval applicants only. Solar, 1616 Newcombe, Flint 6, Michigan.

FREE Surprise set with approvals. Way-out Peachtree, Box 9875, Atlanta 19, Ga.

100 FOREIGN Stamps only 10¢ with approvals. Rorry Stamps, 7521-A Mason, Canoga Park, California.

SENSATIONAL Penny approvals! Pictorials, topicals, etc. Write today! Schmidt, Box 1128, Richmond, Calif.

TOPICALS, Complete and short sets. Linarc Stamp Co., New London, Iowa.

VALUABLE Togo independence issue, 10¢. Approvals. Martin, Box 218, Tustin 11, California.

EXTRAORDINARY! Free! 20 different Finland to those requesting approvals. Rosenbert, Box 1303, Chicago 90.

HUNGARY Race horses, Gabon flowers, Poland birds, astronaut set plus 50 different. Approvals. Berchtold, Troy, Ohio.

ASTRONAUTS, Three different sets 10¢. Approvals. Robbins, 487 Shiloh, Dayton 15, Ohio.

SCREWBALL Fish in natural colors; Pan, the Goat Man; Egypt, Mothers Day; Crawley Bugs set; Jets; Somaliland flower garden; French model; U.S. Revolutionary War; Others free while purchasing approvals. Stamp Farm, MS-42, Oxford, Wis.

STAMP Clearance. Fifty different packets only \$1.00. Norge, Ho-Ho-Kus, N. J.

SPRING Offer, 1000 worldwide stamps \$1.00, 3500, \$3.00. No approvals follow. Harrison's Stamps, 1435 First Ave., Oakland 6, Calif.

GUATEMALA, 100 different, postpaid airmailed, \$2.00 check. Kurt Weiss, Quezaltenango 1, Guatemala.

FREE! Surprise "mystery" packet. Approvals. Premiums. Dancer, 75-P31, Mansfield, Ohio.

10 RUSSIAN Midgets, 53¢ value, 10 unusual Armenia, 44¢ value, 10 Indonesia, 53¢ value—10¢ each, 25¢ complete. With approvals. Mention collection preferences. Postmark, Box 542-M, Great Neck, N. Y.

900,000 STAMPS Sellout! Bargain lot: packets, sets, rare stamps \$1. Giant sell-out assortment \$5. High value packet \$3. Persile, 436 N. Y. Ave., Brooklyn 25, N. Y.

U.S. Bargain. 100 different 25¢, with approvals. Stamps, Kennebunk, Maine.

DIAMOND, Triangle, topicals, U.S. comm., others, 50 different, 10¢, with approvals. Carpenter, Box 310, Claremont, Calif.

250 DIFFERENT Sweden, \$1.00. G. Grann, Vidkarrsstigen 4, Goteborg O, Sweden.

50 DIFF. Canada including \$1.00 totem. 25¢ to approval applicants. Fundy Stamps, Box 431, Saint John, New Brunswick.

START Your own stamp business. Send for free circular. Donald Shepard, Box 1147-P, Chicago 90.

PAPUA Free with 20 Netherlands at 10¢. Adanac, 6884 Briand, Montreal 20.

HUNGARY, Beautiful, sports, animals 10¢ with general approvals. Alex Molnar, 1729-12th, Lorain, Ohio.

1001 DIFFERENT, \$1.00 with approvals only. Alfred Jacobsen, Crompond, New York.

5000 STAMP Grab bags! \$1.00 each. World, mint sets, bargain list. Guaranteed satisfaction. Stamp Service, 1438-W, Huntsville, Ontario, Canada.

ECUADOR, Orchid souvenir sheet, 20¢ in coin, approvals. Howard Moore, 8112 Highland, Kansas City 31, Missouri.

30 CANADIAN Stamps and international exchange magazine 25¢. Exchange, 2144 Althea, Niagara Falls, Canada.

100 DIFFERENT Stamps 5¢. Lake, 1120 Pithon, Lake Charles 62, Louisiana.

BEGINNERS! 11 Different large American 1930's commemoratives 25¢—Approvals. M. B., 1720 Elizabeth, Wichita Falls, Texas.

FREE! Monaco giant elephant! 25 others different. Approvals. White, Box 485, Flemington, New Jersey.

HONDURAS: 17 Different commemoratives 25¢. Approvals. H. Busson, Box 498, Old PO Bldg., Atlanta, Georgia.

60 DIFFERENT Commemoratives, U.S., 35¢, 100, 70¢; or foreign ditto. Approvals. Huey Stamp Co., 280 Highland, Ridge-wood, N. J.

50 DIFFERENT U.S. commemoratives 25¢, 15 sets \$1.00. Penny approvals. Peters Stamps, Box 216, New York 4, N. Y.

GIANT Unesco Madonna, 50 different worldwide, 10¢. Quality approvals. Albstamps, Box 111A, Brooklyn 35, New York.

SALES Agents wanted. Details, samples \$1.00. Zidek, Layton, New Jersey.

DOLLAR Deposit brings exciting penny approvals. Cedro, Box 116PM, Cedarhurst, N. Y.

SELL Stamps to our readers. Your ad in this space will be read by thousands of stamp buyers. I'll prove that to you. Write now for Folder "S." F. W. Johnson, Classified Advertising Manager, Popular Mechanics, 200 E. Ontario St., Chicago 11, Ill.

### ANTIQUES, RELICS, INDIAN GOODS, CURIOS

6 ARROWHEADS, Archaic knife, scraper, \$2.00. Smith, 841 N. Tacoma, Indianapolis 1, Indiana.

SELLING 20,000 Ancient arrowheads, spearheads, etc. List free. Lear's, Glenwood, Arkansas.

3 WAR Arrowheads, scalping knife, thunderbird \$4.00. List. Arrowhead, Glenwood, Arkansas.

GENUINE Indian moccasins. Handmade by Cherokee Indians here on the reservation. Soft sole (for loafing), men's \$4.95, ladies' \$4.95. Hard sole, for shop-yard, etc., men's \$5.95, ladies' \$5.95. Desertan cowhide. Be sure send shoe size. Chief Drowning Bear, Indian Trading Post, Cherokee, N. C.

GIANT 1962 Photo-illustrated Indian relic catalog 25¢ (refundable!). Indian Gallery, 8 Helene Avenue, Merrick, New York.

### PRECIOUS STONES, MINERALS

GOLD Panning dishes 9" 3 for \$3.30, 12" 3 for \$6.00, 15 1/2" 3 for \$8.30, all postpaid. Prospectors Supplies, Box 1514-M, G.P.O., Adelaide, South Australia. Trade enquiries welcome.

FIFTEEN Exceptional mineral specimens \$1.25. Green's, 909-13th, Golden 1, Colorado.

SEMI-Precious uncut gems. Ten different for \$1.00. Request list 28. Prospectors Shop, 201 San Francisco, Santa Fe, New Mexico.

EARTH Science. Rockhound's National Magazine. Subscription \$2.50. Sample 35¢. Box 1357-PM, Chicago 90, Ill.

U.S. And foreign mineral specimens, lists 10¢. Minerals, Winston, New Mexico.

### HOBBIES AND COLLECTIONS

GENUINE Atlantic driftwood for lamps, floral decorating, etc., \$5. NRAS, Box 462, Aquebogue, New York.

50 ORIENTAL Butterflies \$2.00. Free butterfly, seashell, mineral collectors lists, State interest. Haas, Box 2466, New York 8, N. Y.

ADVERTISING Free. Distinctive Hobby Monthly. Dime. Bobbies Hobbies, Quincy 1, Illinois.

COLLECTORS Matchbook covers, 100 different unused, \$1.00. Catalog 25¢. Album \$3.00. Charles Edelman, 1311-C East 84, Cleveland 3, Ohio.

COLLECT Timepieces? Free folder. Nawco, Box 8824, Pittsburgh 21, Penna.

AMERICAN Newspaper, complete, original, dated before 1860, \$1.50. 25¢ stamps brings catalogue. D. R. Spaight, Book-seller, Tall Timbers 1, Maryland.

### PHOTOGRAPHY, CAMERAS, PHOTO SUPPLIES

TEXTURE Screens for photography, formerly manufactured by DuPont, 7 patterns. Price each screen: 8 x 10, \$5; 11 x 14, \$10; 16 x 20, \$15. Seven sample textured photographs \$1. Powell, 21 So. El Molino, Pasadena, California.

BUY At wholesale prices. Cameras, kodak film, Polaroid, all photography products. Free price list. Certified Pop. Photo Supply, 585 East Tremont Ave., New York, New York.

FREE! Send now for 64-page book of new and used photographic bargains. Dept. 1-AR-3, Central Camera Company, 230 So. Wabash Ave., Chicago, Illinois.

PHOTOGRAPHERS! Top prices paid for color, black and white prints. Information. Camera Artists, Rt. 1, Box 365, Grass Valley, California.

PHOTOGRAPHY For pleasure or profit. Learn at home. Practical basic training. Long established school. Free booklet. American School of Photography, 835 Diversey Parkway, Dept. 3451, Chicago 14, Illinois.

### PHOTO FINISHING

COLOR Movie fans! Low cost—high quality processing our specialty, 8mm, just \$1 (or \$3 with fresh film). Mailed back next day. Craftsmanship guaranteed. Send exposed reel or request free mailers and price list of complete photo-finishing services. Direct Mail Photo, Box 8832-PM, Pittsburgh 21, Penna.

A FREE Kodak roll returned with each black and white or Kodacolor developed and printed, fast service, lowest prices, guaranteed quality send for free mailers. Economy Photo Service, Dept. P. M., Box 1111, Albany 1, N. Y.

FAST, Hi-quality finishing. Kodacolor rolls: eight jumbo prints \$1.98. Twelve \$2.49. Twenty \$3.49. Reprints 15¢. Also low B&W prices. Custom Quality Studio, Box 4838, Chicago 80.

TWELVE Exposure rolls 59¢. Wallets 20 for \$1.25. Lincoln Studios, Dept. K, Box 13, Lincoln, Nebr.

EKTACHROME-Anscochrome 35mm, 20 exp. 620, 120, 127, developed, mounted, \$1.00. Kodachrome 8mm, and 35mm., low prices, prompt service. Complete price list—free mailers. Write Trycolor, P.O. Box 123, So. Windsor, Conn.

### MOTION PICTURES AND SOUND EQUIPMENT

BARGAINS 16M.M. sound films, list. Bedner, 5300 So. Talman, Chicago.

FREE 1962 Film and equipment catalog. Tremendous stock 8mm, 16mm features, shorts, all subjects. Bargains. Imperial, 34 Park Row, New York 38.

SAVE Money on B&W, color, 8mm., 16mm. film and supplies. Send 10¢ for bargain catalog. Superior, 448 N. Wells, Chicago 10.

5,000 8-16 MM. Movie films. Free catalogues. International, Greenvale, N. Y.

MOVIE Camera film: 8mm. roll \$1.50. 16mm. 100' \$3.00. Free processing. Better Films, 742 New Lots, Brooklyn, N. Y.

MOVIE Film! Free catalog! ESO-R, 47th Holly, Kansas City 12, Missouri.

16MM. Sound, projectors, films. Sale, rental, exchange. Visit store or write for catalog. National Cinema, 71 Dey St., New York City.

LADY Wrestling. Movies, photos. Free list. Peerless, Box 171-M, New York 13, N. Y.

8MM, 16MM. Movie subjects. Silent, sound. New, used. 2"x2" color slides. Biggest selection anywhere! Free each month, big 24-page newspaper-size catalog. Blackhawk Films, Davenport 14, Iowa.

16MM SOUND—8mm films. New, used. Free list. Entertainment Films, 236 W. 55, New York City.

8MM. Valentino, Fairbanks, Keaton, others. 16mm. sound features, shorts, silent classics. Large assortment. Entertainment Films Co., 236 W. 55th, New York City.

1962 ROSE Parade color movies and color slides 206' 8mm \$18.95, 100 2x2 slides \$14.95. Other California subjects, inquire. Kolor Kade Productions, 5880 Hollywood Blvd., Hollywood 28, Calif.

CHAPLIN Movies 8mm, 16mm. Film Classic, 1926 South Vermont, Los Angeles 7, Calif.

ROSE Parade color movies and slides. 8mm 50' \$4.50; 200' includes all the floats \$17.50; 200' with sound \$24.95. 35mm 2x2 color slides, set of 24 floats \$4.00; 61 floats \$9.95. 20 stereos plus free viewer \$9.95. Guaranteed. Parade Films, Box 89-M, Van Nuys, Calif.

USING 8mm Movie camera? Make \$9.50 hourly. Free details. Lagene's, Pocasset, Mass.

### COLOR SLIDES

TRANSPARENCIES Wanted. Up to \$500.00 each. For information write American Color, P.O. Box 46372, Hollywood 46, Calif.

WESTERN Mountain grandeur. Nature. Indians. Write: Quality Approvals, 711 Columbia Road, Colorado Springs, Colo.

LINCOLN Story in 500 color slides: Hodgenville, Knob Creek, Gentryville, Rockport, New Salem, Springfield, Washington, Gettysburg, statues, memorials, etc. Sample slide 35¢. Catalogue free. Willems, Box 1515-A, Chicago 90.

SHIPS. All largest passenger liners. Billups, Box 286, Staten Island 1, N. Y.

CIVIL War slides. Catalog, sample slide—25¢! Miller, 1420 Ridgely, Los Angeles 19, Calif.

### MUSIC & MUSICAL INSTRUMENTS

PLAY guitar. Teach yourself. \$1.00. Ernie Ball Guitars, Box 308PM, Tarzana, Calif.

ACCORDIONS. Chord organs, guitars! Buy direct—save to 1/2. Famous makes. Free home trial. Easy terms. Trades. Free catalogs. Mention instrument. International Music Mart, Dept. R, 2003 Chicago Avenue, Chicago 22.

ELECTRIC Guitars, amplifiers, wholesale. Free catalog. Carvin, PMM, Covina, Calif.

LOW Quotes: Stereo tapes, components, recorders. HiFi, Roslyn 6, Penna.

SONGWRITERS Send poems. Honest offer. Free recording. Successful Songs, Box 608, Danbury, Conn.

POEMS Wanted for musical setting and recording by America's largest song studio. Send poems. Free examination. Five Star Music Masters, 630 Beacon Building, Boston.

VIOLIN Making supplies. Free catalog. Fred Artindale, 1243 Palm, San Luis, Obispo, Calif.

GUITAR Stunts — 25 amazing new sounds, tricks, secrets: \$1.00. Trebb Sales, Loraine, Ohio.

SONGS. Poems, offer, details. Newart Publications, Box 693, Syracuse, N. Y.

PLAY Piano instantly newest 12 lesson course method. Send only \$1.00 to: Musical Advisor, 15 Almond St., Gloversville, N. Y.

SONGWRITERS — Outstanding, ethical offer free. Hibbeler, C-5, 6608 Oleander, Chicago 31.

ACCORDION-O-RAMA, 874 Broadway, New York 3, N. Y. Tremendous discounts. Top brands. Free brochure.

"HOW To Write, How to Sell Songs," including a practical rhyming dictionary. Complete book—\$2.95 postpaid. Send check or money order to: Belmont Press, 200-A 23rd Ave. N., Nashville 5, Tenn.

SONGPOEMS And songs wanted! Mail to: Tin Pan Alley, Inc., Box 405, Radio City Station, New York 19, N. Y.

POEMS Wanted for musical setting and recording. Send poems. Free examination. Crown Music Company, 49-C West 32 Street, New York 1.

POEMS Needed immediately for new songs and records. Free examination and appraisal. Send poems: Songcrafters, Acklen Station, Nashville, Tenn.

GUITAR Making books, plans, imported woods, tools. List 10¢. Satinwood, 510 East 11th Street, New York 9, N. Y.

SONGS Wanted. Pays royalties. Enclose postage. Olenik Records, Mount Morris, Michigan.

### RADIO, TELEVISION AND ELECTRONICS

RECORDING Tapes. Lowest prices. Free literature. Towers, Box 3095, Philadelphia 50.

TV Servant. Puts your finger quickly on the trouble tube. A true moneysaver. \$1.00 postpaid. TV Service Techniques, Box 71, Passaic, N. J.

CONVERT Any television to sensitive, big-screen oscilloscope. Only minor changes required. Plans \$2.00. Relco, Box 10563-F, Houston 18, Texas.

USED TV tubes. Complete set including free tube tester. \$14.95 (excluding picture tube). Complying with Federal regulations. Written 1 year guarantee. Send requirements. Sales and Service, 2424 Woodstock Ave., Pittsburgh 18, Penna.

SILENCE Annoying TV commercials. Inexpensive method revealed for \$1.00. Norm's 1135 W. Arrow, Claremont, Calif.

NEW Grille cloth, 10¢ sq. ft. Send stamped self-addressed envelope for free samples. Naefly Plastics, Inc., Madison 4, Wisconsin.

SILENCE TV's annoying commercials. Scraps make armchair control. Instructions \$1.00. M. Ryan, Greenbush Drive, Poughkeepsie, N. Y.

"RADIO Explained." 64 page book—15¢. Bookmaster, Box 17273-F, Salt Lake City 17, Utah.

LEARN While asleep with amazing "Electronic Educator" endless tape recorder. Details free. Research Association, Box 24-PX, Olympia, Wash.

DON'T Buy hi-fi components, kits, tape, tape recorders until you get our low, low return mail quotes. "We guarantee not to be undersold." Wholesale catalog free. Easy time payment plan. 10% down—up to 24 months to pay. Hi-Fidelity Center, 220-M E. 23 St., New York 10, N. Y.

RECORDERS, Hi-fi. Free wholesale catalogue. Carston, 125-Y East 88, N. Y. C. 28.

GOVERNMENT Surplus radios, parts. Picture catalog 10¢. Meshna, Malden 48, Mass.

FIX Your own TV. Save 80%! Send for free illustrated chart showing how! We'll include giant electronics catalog. Zalytron, 220-M West 42 St., New York City.

TAPE Recorders hi-fi components. Sleep learning equipment, tapes. Unusual values. Free catalog. Dressner, 1523M Jericho Tpke, New Hyde Park, N. Y.

CRYSTAL Radio kit \$1.00. Amplifier and speaker for same \$4.95. Catalogue. Clearco, Box 1638, Stuart, Florida.

SAVE Dollars on radio, TV-tubes, parts at less than manufacturer's cost. 100% guaranteed! No rebrands, pulls. Request bargain bulletin. United Radio, 1000-M, Newark, N. J.

### BUSINESS OPPORTUNITIES

RAISE Rabbits on \$500 month plan. Free details. White's Rabbitry, Mt. Vernon, Ohio.

\$70.00 WEEKLY — Home, spare time. Simplified mail bookkeeping. Immediate income—easy. Auditax, 34741A, Los Angeles 34.

BUY Direct from factories. Appliances, cameras, watches! Free details! Cam Co., 436 P.M. Bloomfield Ave., Verona, N. J.

\$200.00 MONTHLY. Spare time. With tablesaw, bandsaw or jigsaw. Write. Holiday House, A3800 Harney, Vancouver, Washington.

SHARPEN Saws and lawnmowers the profitable way. Send for free literature. Max Manufacturing Company, 138 Stockton Avenue, San Jose 26, California.

FRANCHISES Make profits! Operate your own exclusive franchised business. Write today for free interesting details. National Franchise Reports, W-528, 333 North Michigan, Chicago 1.

SELL Champion, AC, Autolite spark plugs. Reconditioned, electroplated, guaranteed 10,000 miles. 100% profit. Free sample. Lee Plugs, 1608-A Roberts, Houston 3, Texas.

VENDING Machines. No selling. Operate a route of coin machines and earn amazing profits. 32-page catalogue free. Parkway Machine Corporation, Dept. #27, 715 Ensor Street, Baltimore 2, Maryland.

BUSINESSES, Resorts, motels, investment property, ranches. Our special service dept. at your disposal. No obligation. World's largest. 58 years' service. Strout Realty, 7-MB S. Dearborn, Chicago 3, Ill.

BIG Money raising fishworms and crickets. Free literature. Carter Farms, Plains, Georgia.

TO \$100.00 Weekly. Sparetime, home operated mailorder business. Successful beginner's plan. Everything supplied. Lynn, 10420-M National, Los Angeles 34.

PIANO Tuning learned quickly at home. Tremendous field! Musical knowledge unnecessary. Information free. Empire School of Piano Tuning, Champaign, Ill. (Founded 1935).

COPUBLISH Mail Sale Advertiser, leading mail order paper. Details, latest copy, dime. Vanroy Shirk, Lebanon, Penna.

OPERATE Profitable mail order business. Write Walter Service, 4159A East 112th, Cleveland 5, Ohio.

BAKE New greaseless doughnuts in kitchen. Sell stores. Free recipes. Montgomery, 3605 South 15th, Minneapolis 7, Minnesota.

MAKE \$46 From square foot plywood: jigsaw necessary. Free details. Woodart, Bridgewater, Mass.

\$400.00 MONTHLY Raising giant fishworms. Soilless method. Charlie Morgan, Bushnell, Florida.

HOW And where to obtain capital. Write: Reliable Service, Rome City, Ind.

SELL Books by mail. 400% profit. Royal, Box 368-X, Cleveland 27, Ohio.

PLASTERCRAFT Molds, liquid rubber, plasters, flocks, candle supplies. Catalog and manual free. Blue Rapids Supply, Blue Rapids, Kansas.

WORLD'S Largest wholesale supply. Buy from 679 American, European, Japanese wholesalers. Tailormade suits from Hongkong. 123 dropship catalogs. Rock-bottom prices. Free details. International Buyers, 216-MM Jackson, Chicago 6, Ill.

EARN \$3 hourly, spare, full time, looking up information at your local library. Operate research bureau. Details free. Service, 81C Knickerbocker Station, New York.

RE-CAST Junk batteries into new. Latest achievements. Battery Laboratories, Bayou LaBatre, Alabama.

11,000 NEW Prospects daily. Baby record books, shoes, albums. Sell mailorder. Use our literature. Write: No-Co-Ro, Capitola, Calif.



**SIGNS.** Sell restaurants, bars, etc. Samples \$1.00. Box 9563, Jackson, Miss.

**INTERNATIONAL Mailorder business** made easy. Complete setup service, not just instructions. Hermes, 152 West 42, New York City 36.

**OPERATE Home mailorder business.** Vosacek Printing, 4444AI Ute, San Diego, 17, Calif.

**MAILORDER:** Extra income, spare time. Easy. Write: American Distributors, Box 409, Niles, Michigan.

**COLORGLAZED Concrete pottery** made without molds. Patented method. Cemetery products, novelties, tiles. Basement leak-sealing. Money-making projects. Booklet, details free. Men only. National Potteries Company, Grand Rapids, Minnesota.

**BIG Profit!** Learn to operate auto and iron salvage yard. Box 806, Mason City, Iowa.

**\$10.00 HOUR:** Painting signs with our patterns. Carlayne, 1803 Fremont, Rapid City, South Dakota.

**MUSHROOMS** Quicker, easier, cheaper. Spawn (seed) plus newest manureless growing, various processes, marketing. \$1. Free literature. Luxur, 641 South 19th, Newark 3, N. J.

**MAKE Durable building plastic** easily. Waterproof, fireproof, economical. Bays Laboratory, Cedaredge, Colo.

**CANDIED Popcorn and potato chip** equipment. Eakins, Box 933-A2, Springfield, Ohio.

**MAKE Money making leathers.** 1148 ideas. Free information. Tandy Leather Co., Box 791-F2, Fort Worth, Texas.

**MADE \$10,000.00 Typing at home.** Guaranteed proof. Amazing information 15¢. Lenore Felgen, 30 Washington, Oak Park, Ill., Dept. PM.

**WANT To make big money at home?** \$10.00 profit in an hour possible with invisible mending. Make tears, holes disappear from clothing, fabrics. Steady year-round demand from cleaners, laundries, homes. Details free. Fabricon, 1585 Howard, Chicago 26, Ill.

**LEARN Sewing machine repairing.** To \$125 weekly. Sparetime. Supplies. Add to present business. Write today! Taylor Service, Box 484, Cupertino, Calif.

**EARN Money raising fishworms for us!** Write: Oakhaven—38, Cedar Hill, Texas.

**START Profitable bookkeeping service** without previous experience. R. I. Systems, 1645 Warwick Avenue, Warwick 3, Rhode Island.

**MAKE Money from old tires.** Operators clearing \$400 weekly. Equipment costs \$800. Get facts. S & S Patents, Inc., 3511 N. Lincoln, Chicago 13.

**OWN And operate a collection agency.** Complete instructions \$1. Janacek, 373 East 155th Street, New York 55, N. Y.

**BRONZE Baby shoes:** Instructions, equipment and mountings for genuine electroplating process. Largest supplier of all plating equipment, supplies. Free catalog. Hollywood Bronze Supply, Dept. B-3, 3445 Union Pacific, Los Angeles 23, Calif.

**LIFETIME Home business bottling fabric softener.** Details. Morgan's, Coldspring Street, Norwalk, Conn.

**PLACE Gift displays in stores.** \$500.00 investment required. Big profits! Robbins, 170-G Fifth Ave., New York City 10.

**MAKE \$50,000 Or \$100,000 a year possible.** New clean way in glass. "Suregrow" dried plant food not dusty. Revives new life in old lawns, flowers, gardens, trees, fruit trees, shrubs, etc. Millions homes can become customers. Sell from your home to thousands homes in your district and neighborhood. Free sample and catalog. Suregrow Company, 1019-6th North, Seattle, Wash.

**NEW Prefab house with concrete frame** saves labor, materials. World wide opportunities building, selling, manufacturing parts for New American Home, P.O. Box 7026, Tampa 3, Fla. Details 25¢.

**NATURAL Molding rubber, extra thick.** Free samples. W. Wooley, 2801-A Latrobe, Peoria, Illinois.

**PROFITABLE Catalog mailorder business!** Vikari, 468-PM4 Third Avenue, Salt Lake City 3, Utah.

**GROW Mushrooms.** Cellar, shed, chicken houses, caves, tunnels, etc. First class mushroom spawn. Spawn to plant 50 square feet \$10.50, to plant 100 square feet \$18.00, to plant 250 square feet \$22.00, to plant 500 square feet \$37.00, to plant 1,000 square feet \$67.00. Planting instructions are sent with each order free. Send full cash payment with the order for prompt prepaid shipment. Thomas Company, 1019-6th North, Seattle, Wash.

**10,000 PROFITABLE Formulas, recipes, trade secrets.** Details free. Colen, 7731-M3 Yates, Chicago 49.

**DRIED Mushrooms \$4.50 pound** for large canning company. Receiving warehouse in United States. Growers wanted on contract, everything supplied. Dehydrated Products & Chemicals, No. 548, Calgary, Alberta, Canada.

**BIG Money—Operate own fix-it shop.** Service household appliances, motors, mowers, saws, skates, etc. Free book. Christy Trades School, A-2303, 3214 Lawrence, Chicago 25.

**DOLLS! Dolls! Dolls!** We teach you to make, repair, dress and sell. Study at home. Earn while learning. Free booklet. Doll Hospital School, Studio MC-32, 11826 San Vicente Blvd., Los Angeles 49, Calif.

**EXPORT-Import opportunity, profitable, world-wide, mail-order business** from home, without capital; or travel abroad. Established world trader ships instructions for no-risk examination. Experience unnecessary. Free details. Mellinger, D703, Los Angeles 25.

**LEARN Landscaping and the growing of plants.** Start a profitable business part or full time. Free information without obligation. National Landscape Institute, Dept. MC-32, 11826 San Vicente Blvd., Los Angeles 49, Calif.

**BECOME Tax consultant.** Graduates earn \$1,000-\$3,000 every tax season preparing returns evenings. State approved. Union Institute, Lakewood J-2, N. J.

**MAKE Extra money—Big cash commission plus premiums** for you and your customers. Sell advertising book matches. Sensational new tenor, glamour girls, hill billies; dozens others. All sizes. Quick daily sales; big repeat business. Free master kit makes selling easy. No experience necessary. Superior Match, Dept. MX 362, 7530 Greenwood, Chicago 19.

**GARDEN Golf.** Start amusement center. Invest now. Brockway, Box 3762, Portland 8, Oregon.

**FABULOUS Potential!** Sell nationally advertised coin supplies. Prestige business. \$50.00 minimum required. Bonanza of items available. Illustrated catalogue—wholesale \$1.00. Deductible first order. Cooper's, Box 248, Englewood, Ohio.

**START Your own business on credit.** U.S. only. Your own boss. 1344 dealers sold \$5,000 to \$25,500 in 1960. We supply stocks, equipment on credit. 200 home necessities. Sales experience unnecessary. Pleasant, profitable business backed by world-wide industry. Write Rawleigh's, Dept. C-U-PPM, Freeport, Ill.

**PROFIT With Popular Mechanics' subscription plan.** No investment, no experience needed. Earnings begin immediately when you obtain subscriptions for Popular Mechanics, Good Housekeeping and others. High commissions, bonus. No experience needed. Deal directly with the publisher. Write Popular Mechanics, Room 2B, 250 West 55th St., New York 19, N. Y.

**YOUR Own baby shoe bronzing business.** Instructions, equipment, supplies. Metalizing, glassing. Pearl-Kote. We finance. Free booklet. Dept. A, Box 5036, Inglewood, Calif.

**JUST Published:** The Idea Press, outlines new money-making ideas for ambitious men, housewives, teenagers, oldsters. Copy \$1. Idea House, 46 Asnuntuck St., Thompsonville, Conn.

**\$600.00 PROFIT!** Mailing catalogs. Sample instructions, 25¢. Home Business Digest, GPO Box 972, New York 1.

**AMAZING Profits in exterminating.** Full time, part time. Free details. Baylab 21-M, Cambridge, Maryland.

**MAKE Telephone surveys spare time!** Free home-business details. No selling, choose your own hours. Telephone Institute, Dept. HC173, 1038 So. La Brea, Los Angeles 19.

**"OPPORTUNITY Directory,"** newest source of moneymaking opportunities. Leader in home business promotion. Free details. Jack Donovan Agency, 537 Cranbrook Ave., Toronto 12, Canada.

**TREMENDOUS Profits! Prestige—operate home collecting bureau,** successful method revealed \$1.00 refundable. Ramo's Enterprises, 511 E. 150 Street, New York 55, Hub, N. Y.

**NEW Free franchise plan offers 200%-1000% profit!** Candlecrafting, a multi-million dollar field, offers men, women, families opportunity to start own spare time home business on shoe string, grow big. Start earning almost at once, high as \$5.00 hour, year 'round demand. Custom candles sell for \$2.00-\$20.00 each. Materials cost pennies! Big companies can't compete. Send for free franchise plan and facts on home instruction and how we start you in business. Candle Institute, Dept. X-653, Fallbrook, Calif.

**LEARN How to make money sharpening household, hobby shop, industrial, restaurant, supermarket cutlery, saws, tools, barber-beauty shop scissors and clippers, surgical instruments, etc.** You get personal instruction (not a correspondence course) on Treco grinding methods in worldwide use. Establish your part, full-time or retirement business now! One-day course, \$30. Two days, \$55. Three days, \$85. Enrollments limited. Write for free outline. Treco, N. Tonawanda 25, N. Y.

**OFFICE Homework, sparetime, refundable moneymaking procedure 50¢.** Interstate, 37 Besch, Albany 9, N. Y.

**MOTEL Supply mailorder business.** Excellent opportunity. Free details. Hermes Advertising, 152 West 42, New York City 36.

**INCREASE Mail order sales!** New gummed label mailing lists. McKeon, 103-04 217th Pl., Queens Village 29, N. Y.

**OPERATE Profitable mailorder business.** Free details. Coats, Box 1247-A, Ontario, California.

**FREE Book "990 Successful, Little-Known Businesses."** Work home! Plymouth-572W, Brooklyn 4, New York.

**SPARE-Full time home business opportunities.** Write: Hulan's, Massey 2, Ontario.

**OPERATE Thrilling mailorder business.** Amazing profits. Write: Sax, Milan 1, Ohio.

**FORTUNES Made prospecting!** Are you walking over money when hunting, fishing, or hiking? Learn how to locate, identify, sell, stake claims on valuable ore and minerals. New comprehensive approved correspondence course. Free revealing information! Modern Prospector, 1038 So. La Brea, Dept. HC173, Los Angeles, Calif.

**GOOD Earnings showing, installing inter-communication systems for businesses, homes.** Hold private inter-departmental, house to garage, etc. phone conversations. Requires only household tools. Telephone Repairs, 1760-A Lunt, Chicago 26.

**NEW Imports. New American products.** Largest selection. Wholesale only. Exclusive Reviews, 1186 Broadway, New York 1, N. Y.

**SELL Televisions, stereos, radios, recorders.** Arkay, 380-A Highland, Somerville 44, Mass.

**CAN You enjoy independence and high income?** Obtain a guaranteed program for business planning. \$5.00. Business Advisors, P.O. Box 91, Niagara Falls, New York.

**PROFITABLE Worthwhile food supplement dealerships available.** A growing repeat business of your own. Ultra-Bio, 515F, 5555 Wissahickon, Philadelphia 44, Penna.

**RAISE Nightcrawler. Redworms.** Easy soilless odorless method. Three Oaks Ranch, Dresden, Tenn.

**IMPORT Export opportunity.** Profitable worldwide mail order business from your home without capital. Hong Kong clothing. Drop-ship catalog. Free details. Gale International, P5249 Virginia, Chicago.

**INCREASE Income.** Make, sell natural looking durable stone for homes, patios, fireplaces. Easy, inexpensive. Details free. Complete instructions only \$3.00. William Bittner, 10 Burgess Street, Pittsburgh, 27 Pennsylvania.

**NEW!** Simplified public housekeeping, learn fast—big demand. Write! Metro 6631-B Hartwell, Chicago 37.

**OIL** Reclaiming, profitable, easy. Formula \$1.00. Bel-Tex, 511 Neil Street, Belton, Texas.

**QUIT** Dreaming, so something about starting your own successful business! Take the first step by learning of the profitable franchise field. The authoritative NFR service is aiding thousands of ambitious men in learning of best openings. Alert yourself to opportunities in franchising by requesting free information today. National Franchise Reports, BM-528, 333 N. Michigan, Chicago 1.

**UNIQUE** Process for glaze finishing masonry offers terrific business opportunity. Free photo, details. Plasticon Company, Box 105, Grove City, Penna.

**"MAILORDER** Laws and Regulations." \$2.00. Explains necessary licenses and different taxes. Descriptive "Newsletter" absolutely free. Neil H. Tasker, Shamokin, Pennsylvania.

**PROFITABLE** Mail order businesses directory, 25¢. Mail Dealers Headquarters, Box 64, Rego Park 74, N. Y.

**HAVE** Worthwhile mailorder business. Write Rocky Service, N6740 Waterworks Rd., Norfolk 2, Va.

**MAKE** Money raising redworms. Free literature. Hall Farm, Hilton, Georgia.

**\$1.00 BRINGS** You \$18.00 spare-full time home business opportunity! Amazing new velvet-spray transforms old cheap lamps, TV-radios, figurines, furniture, anything, into valuable products! Free samples. 50 business opportunities booklet. Send no money. Flok-Kraft, MH, Los Angeles 61.

**OPERATE** Profitable mail-order business. Write Wayne's Service, 3016-J Channing, Washington 18, D. C.

**JOIN** Dollars unlimited club. Huge profits. Box 2766B, Kalamazoo, Mich.

**LEARN** Professional TV servicing in one week! Fabulous new simplified system. No big expense. No studying. No tools or equipment. Spare, full time. Own your own big profit business! Save! Amazing but true. Free sample lesson, illustrated "How To" booklet. Write, TV Systems, Dept. FC-173, 1038 So. LaBrea, Los Angeles 19, Calif.

**\$250.00 WEEK** Spare time profit possible. Earn at home with new fascinating printing method. \$5 starts you—send no money now. Free confidential facts and valuable sample. Screen-Print, MH, Los Angeles 61.

**STOP** Looking, start earning! Secure your own profitable franchise. Become dealer, distributor, agency operator or retailer under national franchise program. America's pioneer franchise reporting service, now in 10th year, offers valuable assistance. Request free details today from National Franchise Reports, MM-528, 333 N. Michigan, Chicago 1.

**MAKE** Sell plastic signs. Sample 25¢. Refundable. Dixie Plastic, Lakeland, Fla.

**CAREER** Opportunity selling executives professionally produced advertising, sales promotion programs. Adagar, 114 Tuxworth, Centerville 59, Ohio.

**EARN** \$150 Daily-home mailorder. Flasch, R. 2, Box 414, West Bend, Wis.

**MAIL-ORDER** Opportunities net big profits. 10¢ brings full details. Sinkram, Dept. MP-1, Box 11, Canarsie Station, Brooklyn 36, New York.

**\$20.00 HOUR.** Learn engraving. Engrave glass steel head of pin. Engrave for us. Send 25¢. Engraver, 751 Market, Victoria, B.C., Canada.

**\$100 WEEKLY.** Sparetime home mail order business. Beginners plan. L&D, 109 W 42nd, New York City 36.

**MAKE** Big money. Easy complete instructions "Automotive Fiberglass Repair Manual" \$2.50. RPS Publications 30, P.O. Box 222, Beverly Hills, California.

**SAWDUST** 112 Uses. Tin-cans 63. Newspapers 27. Rubber 67. Glass 20. Rags 35. Instructions \$1.00 each. All six \$3.00. Charles Company, 42-GWGD, Norwood, Ohio.

**HANDSOME** Profits. Instructions on how to make and sell this hot item in your spare time. \$3 to Pritchard, Box 10274, Fort Worth, Texas.

**AUTO** Glass tinting offers excellent profits. Exclusive new process. Investment as low as \$100.00. Tinton Products Co., Rogers, Arkansas.

**MAKE** Money selling spices, paper and janitorial supplies. Complete information \$1.00. Box 413, Gary, Indiana.

**VENDING** Machine catalog. Rakes, 609P Spring Garden, Philadelphia 23, Penna.

**BECOME** Private investigator! Complete booklet \$4.50! Also bargain catalog \$1.00! Both \$5.00 Milmar, (Dept. PM-BO), Box 1932, Oklahoma City 1, Oklahoma.

**PACKAGE** At home for profit! We supply everything. No selling. Free home business details. HPC, 2212BH Jesse Street, Los Angeles 23.

## MONEYMAKING OPPORTUNITIES

**LEARN** Showcard writing in sparetime. Fascinating profitable business of your own. Complete information free. Arcadia, 19-D Corwin St., Dorchester 22, Mass.

**MAKE** Big easy profits making costume jewelry at home in spare time! Quick, easy to make, easier to sell! Details free! Don-Bar, 2934 W. Fullerton, Dept. C-202, Chicago 47, Illinois.

**MAKE** Plastic novelties for extra income. Low cost home training now available. Write for free booklet. Interstate Training Service, Dept. D-3, Portland 12, Oregon.

**\$25.00 WEEKLY** Making jewelry, flowers. Catalog 10¢. Flocraft, Farrell, Penna.

**SECRET** Investigation opportunities. Experience unnecessary. Investigators particulars free. Wagner, M-125 West 86th, New York City 24.

**NEW** Stamping machine. Stamps tags, door name plates, social security plates. Maurer Metal Specialties, Box 934, Springfield, Illinois.

**WANTED—Cartoonists.** Amateurs, professionals. Over 200 markets. Information free. Cartoon Markets-M-3PM, 11620 Lansdowne, Detroit 24, Michigan.

**NATIONALLY** Advertised games. Sales kit \$1.00. "Games," Box 12614, Tucson, Arizona.

**MAILORDER** Money-makers! Cash commissions! No canvassing! Hirsch's, 1301 Hoe, New York City 59.

**"HOME** Businesses" (U.S. Government reprint) 25¢. Dittofax, 5815-PM Compass, Los Angeles 45.

**\$30-\$50 WEEK** Spare time possible with herbs. Grow inside-outside or gather wild. Details free. Whitlow, Dept. A-3, 403 No. Westmoreland, Dallas 11, Texas.

**NEW:** Build waterfalls, fountains. Parts supplied. Priplata Fountains, Pasadena 3, Calif.

**\$35-\$65 WEEKLY** Assembling artificial lures at home for stores. Materials supplied free. Write: Lures, Box 1280, Fort Walton Beach, Fla.

**BAKE** New greaseless doughnuts in kitchen. Sell stores. Free recipes. Melvin, 3605 South 15th, Minneapolis 7, Minn.

**FABULOUS** Profits raising earthworms. Picture folder free. Excello, Kosciusko 6, Mississippi.

**ATTENTION—Aluminum** concrete yard ornament molds—donkey cart planters, beautiful bird baths, urns, etc. Prices slashed. Write for information. Knapp's, 4257 Josephine Street, Denver 16, Colorado.

**WIN** Contest money. General Contest Bulletin gives hundreds of tips. Lists current contests, rules. Sample magazine 25¢. General Contests, 1609½ East 5th, Duluth 12, Minnesota.

**MEN, Women—get in on the huge profit** plastic bonanza. Work home. No direct selling. Send \$1.25 or for free literature. Specialty Sales, Box 365, Haysville, Kan.

**HOW** To win prize sweepstakes, drawings, contests. Lesson 25¢. Winner, Box 304, Columbia City, Indiana.

**CIGARETTES—Make** 20 plain or filter-tip for 9¢. Facts free. Moberly, Box 4012, Owensboro, Kentucky.

**MINK** Raising information free. Complete. Lake Superior Mink Farm, Superior, EE1, Wisconsin.

**EARN** Money evenings copying and duplicating comic cartoons for advertisers. Adservice, Argyle 1, Wisconsin.

**VENDING** Machines. No selling. Operate a route of coin machines and earn amazing profits. 32-page catalogue free. Parkway Machine Corporation, Dept. #26, 715 Ensor Street, Baltimore 2, Maryland.

**EARN** Money raising fishworms for us! Write: Oakhaven—59, Cedar Hill, Texas.

**YOUR** Own, easy-to-start, home mail-order business, sparetime. Fascinating; profitable! Information free. Alfano, 19-PM Pine, Closter, N. J.

**BIG** Money raising fishworms and crickets. Free literature. Carter Hatchery, Plains, Georgia.

**READ** "Progressive Mailtrade," the magazine that tells how to make money by mail. Quarter brings sample and special offer. Progressive Mailtrade, Box 357, Sheboygan, Wisconsin.

**AMAZING** Successes through franchises! Become exclusive franchise holder your territory. Information rushed. National Franchise Reports, MP-528, 333 North Michigan, Chicago 1.

**LEARN** The secrets of repairing junk batteries, generators, starters, profitable, easy, at home. Free particulars. Batteryman, 3465 Forrest, Santa Clara, Calif.

**\$25-\$50 WEEKLY** Possible, re-writing news items, jokes, poems, recipes, for publishers. Some worth \$10 each. Details free. Service, 81-D, Knickerbocker Station, N.Y.C.

**MAILORDER** Business learned easily. Write: Easco, Box 323, Grand Rapids 1, Michigan.

**EARN** \$240.00 A month at home, spare time, doing only two \$5.00 invisible mending jobs a day. Big money paid for service that makes cuts, tears disappear from fabrics. Steady demand. Details free. Fabricon, 6251 Broadway, Chicago 40, Ill.

**EASY** To start rubber stamp business at home in spare time. Make up to \$9.80 an hour without experience. Facts free. Write Roberts, 1512 Jarvis, Room CR-2-A, Chicago 26.

**MEN—Women!** Start money-making plastic laminating business at home in spare time. Material that costs 11¢ brings back \$2.58. No canvassing or selling but mail orders brings in \$20 a day. Write for full particulars free. Rush name on postcard to Warner, Room CL-2-A, 1512 Jarvis, Chicago 26, Ill.

**MAKE** Money writing short paragraphs! No tedious study. I tell you what to write, where and how to sell; and supply list of editors buying from beginners. Many small checks add up quickly. Write to sell, right away. Send for free facts. Benson Barrett, Dept. C-27A-N, 7464 Clark, Chicago 26.

**BIG** Mail, money making offers, samples, for you. Act now. Details. Write: Del Vecchio, Box 74, Newton 95, Mass.

**BIG** Profits selling rubber stamps. No investment needed. Martin, Box 218, Tustin 12, California.

**MAKE** Money ghost-writing for others. Opportunities everywhere! Free details. Career Aids, (PM), Southampton, New York.

**"LUCKY** Day Adpak" is loaded with money making opportunities. Order yours today. 25¢. Arcane, Box 117, Plant City, Florida.

**ALERT** Yourself to America's greatest opportunities for operation of individual businesses. Franchising expansion creates openings for profitable exploitation. Alert yourself to franchise opportunity by requesting free information today from National Franchise Reports, GB-528, 333 N. Michigan, Chicago 1.

**MONEY** Making manuals. Free list. Jackson, Box 66, Takapau, New Zealand.

**AMAZINGLY** Profitable. Start portrait painting service. F. Brassard, 137 Heward, Toronto 8, Canada.

**PRACTICAL** Mail order. Start small. Money-maker, 722-P East Silver Spring, Milwaukee 17, Wisconsin.

**FREE** Details! "211 Lucrative Business Ventures." Work home! Dilley, Box 3854, Milwaukee 5, Wis.

**MAKE** Up to \$8,500 a year sparetime. Complete data \$1, refundable. Janeeck, 373 East 155th Street, New York 55, N. Y.

**EARN** Big money! Be a film wholesaler. Free instructions, price sheets. Perma-color Labs, 1007 6th Ave., New York 18.

**BECOME** Private investigator! Complete booklet \$4.50! Also bargain catalog \$1.00! Both \$5.00 Milmar, (Dept. PM-MO), Box 1932, Oklahoma City 1, Oklahoma.

## EXPORT — IMPORT

**WATCHES!** Airmailed from Switzerland. 152-page catalog 35¢. K-P Imports, 511 Glenwood, Buffalo 8, N. Y.

**LARGE List imports \$1.00.** K & M Enterprises, Box 971, Great Falls, Mont.

**IMPORT Export.** List of oversea sources and products they sell or buy. \$1.00. R. W. Cantrell, 3642 S. Main St., Winston-Salem, N. C.

**RECEIVE—Import catalogs! Circulars! Foreign business opportunities! Get listed, 25¢.** Importico, Enka, N. C.

**OBTAIN 200 free U.S. and foreign wholesale catalogs directly from manufacturers.** Send \$1.00 for directory of manufacturers. Hughes Enterprises, 109 East Etiwanda, Rialto, California.

**"IMPORT Journal" magazine, 10¢.** Zastrow's, 1236 Rose Vista, St. Paul 13, Minn.

**NEWEST Products, fabulous bargains in direct importing.** 475 worldwide firms, classified—\$1.00. Henderson, 2620 Rio Vista, Tampa 3, Florida.

**JAPAN: Direct mail-order 26 page catalogue: dolls, novelties, business information, manufacturers' names, addresses, \$1.00; Japan's Trade Directory, 3000 companies, \$3.00.** Send cash. Clarence Yamagata, 814 Toginbiru, Marunouchi, Tokyo.

**YOUR Own import mail order business.** Deal with over 400 manufacturers exporters of the world. Complete import procedures, international dropship methods. Capitol unnecessary. Details 10¢ refundable. Associated, Box 108-EI, Lincoln 1, Nebraska.

**WORLDWIDE Dropship and import directory \$1.** Janeczek, 373 East 155th Street, New York 55, N. Y.

**"FOREIGN Bargains Directory." \$1.00.** L. J. Finn Company, 140 Virginia Park, Detroit 2, Michigan.

## SCIENCE & CHEMISTRY

**ROCKETS Available now: Powerful new 2-stage model spacecraft! Kits, cones, engines, chemicals, bigger 1962 catalog 25¢.** Central Rocket Company, Waupaca, Wis.

**CHEMICALS And apparatus for industrial, analytical, and private laboratories.** Catalog 35¢. Dept. M-50, Biological Supply Co., 1176 Mt. Hope Ave., Rochester 20, N. Y.

**SCIENCE Treasure chest. Do hundreds of experiments.** Order No. 70.342-CZ—\$5.00 postpaid. Request free Catalog—CZ. Edmund Scientific Co., Barrington, New Jersey.

**232 PAGE Catalog \$2.00.** Laboratory Materials, 7319 Vincennes, Chicago, Ill.

**ILLUSTRATED Catalog: Chemistry, mineralogy, biology 25¢.** Tracey Laboratories, Evanston, Illinois.

**UNUSUAL Chemistry books, courses, kits! Rare chemicals, cheap! Catalog 25¢.** NSC, Box 11133, Palo Alto, Calif.

**ROCKETS: New illustrated catalog 25¢.** Kits, cones, tubes, engines, etc. Estes Industries, Penrose 2, Colorado.

**LABORATORY Conversion charts with bigger catalogue—25¢.** Hagenow Laboratories, Manitowoc, Wisconsin.

**ROCKETEERS! Build high power rockets with our kits, chemicals, supplies.** Illustrated catalog 25¢. Rocket Model Research, Box 716, Newark 1, N. J.

**IMPROVE Well being? Facts, plans for building negative ionizer \$1.00.** Tusp, Box 4114G, Cleveland 23, Ohio.

**SPECTROSCOPE For quick analysis \$3.00.** Kuttintson, 875 Arastradero, Palo Alto, Calif.

**AMAZING New book of science experiments, formulas, and catalogue of laboratory supplies.** Only 35¢. National Scientific Co., 13 S. Park Avenue, Dept. PM-3, Lombard, Illinois.

**DEEP Sea experiments conducted from your home.** Interesting details 10¢. Johnson Exploration, Berth 78, San Pedro, California.

**BUY Chemicals in small quantities.** Complete line glassware and apparatus. Ship anywhere, promptly. Catalog 25¢. Campton Chemical and Supply Co., 705 Lyons Ave., Irvington, N. J.

## FORMULAS, PLANS, ETC.

**10,000 PROFITABLE Formulas, recipes, trade secrets.** Details free. Coien, 7731-MC Yates, Chicago 49.

**PROFESSIONAL Formula books.** Information free. Directory Service, Box 964, Philadelphia 5.

**AUTO Engine overhaul compound formula \$1.** Other auto service formulas included free. Janeczek, 373 East 155th Street, New York 55, N. Y.

**FORMULA Trade secrets. 10,000 to choose from.** Information free. Norris Sales Co., Alpine 3, Tennessee.

**FORMULAS—All kinds. Amazing big catalog, 10¢.** Kemixal, Park Ridge, Ill.

**ANTI-FREEZE, Waterless handsoap, resilvering mirrors, all \$1.00.** Neiko, Box 3462, Merchandise Mart, Chicago 54.

**LATE, Modern manufacturing formulas.** List free. Moon Chemical, Martville, New York.

**FORMULAS For latest money-making discoveries. New! Good! Valuable literature free!** Miller, Chemist, 1517-D, Tampa, Florida.

## PLASTICS

**BOXES, Plastic. 200 sizes. Free list.** Althor, 170 Bay 23 Street, Brooklyn, N. Y.

**NEW Liquid casting plastic, clear, colors. Embed real flowers, butterflies, photos, coins.** Send 25¢ for two handbooks "How to Cast Liquid Plastics" and "How to Make Extra Money at Home." Castolite, Dept. C-101, Woodstock, Illinois.

**NOW! Low priced plastic laminating machine.** Details. Burr, 330 East Center, Kalamazoo, Mich.

**CELLULOID Scrap. Sheets, state thickness, colors.** Box 333, Kearny, N. J.

**PROFITS! Vacuum form plastic! Easy!** Box 1971, San Diego 12, Calif.

**NEW Instruction manual tells how to do plastic embedding and molding.** Manual \$1.00, catalog 25¢. Castacraft Corp., Dept. M-362, P.O. Box 555, Palo Alto, Calif.

## AGENTS WANTED

**BIG Profit selling chamois to service stations, car lots. Steady repeat business.** Free details. Inka Industries, 717-H Fairview, Houston 6, Texas.

**MAKE \$55 A day clear profit! Sell nationally advertised Royaltone Auto Glaze to car owners, dealers, jobbers. Exclusive territories. Rush name for free sample, details.** Royaltone, Brooklyn 30, N. Y.

**RUN A spare-time greeting card and gift shop at home.** Show friends samples of our wonderful new 1962 all-occasion greeting cards and gifts. Take their orders and earn up to 100% profit. No experience necessary. Costs nothing to try. Write today for samples on approval. Regal Greetings, Dept. 67, Ferndale, Michigan.

**SELL Champion, AC, Autolite spark plugs. Reconditioned, electroplated, guaranteed 10,000 miles. 100% profit.** Free sample. Lee Plugs, 1608-E Roberts, Houston 3, Texas.

**FREE Sample. Beautiful curios! Sell on sight!** Apartado 9036, Mexico City.

**PRINTING, Advertising salesmen—Excellent moneymaking sideline selling decalcomania name plates, small quantities. Automobile initials, sign letters. Free samples.** Ralco, XL, Boston 19, Mass.

**YOUR Own business—Used suits \$1.50; overcoats 65¢; mackinaws 35¢; shoes 12½¢; ladies' coats 30¢; dresses 15¢.** Enormous profits. Catalog free. Nathan Portnoy Associates, 2109-AA Roosevelt Road, Chicago 8, Ill.

**MAKE Up to \$50.00 a day soliciting delinquent accounts. Terrific commissions.** Write today. National Credit, 304Y Pickwick Bldg., Kansas City 6, Mo.

**BIG Profits. Stamp social security plates, key protectors. Sample 50¢.** Catalog free. General Products, 11 No. Pearl St., Albany 7, N. Y.

**MAKE Profitable men's-women's wear.** Sample free. Sunmade, Brockton 64, Mass.

**EXOTIC Earrings! Details free. Pair, \$1.00.** Ohga, PH-330, Sigakenkusatu, Japan.

**WAGON Jobbers, route men, \$100.00 extra per week. Guaranteed sales.** Revolutionary new tool holder sells on sight for \$1.98. Makes hooks, peg board obsolete. Information Drawer J, Blue Bell, Penna.

**MAKE Most extra cash with world's biggest line everyday greeting card assortments, gifts. Introduce friends, neighbors, to over 150 assortments, 500 big money-makers. Pocket up to 100% profit plus big cash bonus. Free giant color catalog; samples on approval.** Write Arrow Greetings, 513 Fourth Ave., S., Dept. 83-L, Minneapolis, Minn.

**BUSINESS Kit free! Postcard puts you in business! Complete line 230 shoe styles, jackets. New discoveries pay big commissions. No investment. Send for free kit.** Mason, Chippewa Falls, K-404, Wisconsin.

**WILL You test new items in your home? Surprisingly big pay. Latest conveniences for home, car. Send no money. Just your name.** Kristee 124, Akron, Ohio.

**START Your own business, selling the "World's Most Usable Bible." Sales quick, easy and profitable. Extra bonuses; free insurance; other benefits.** Write International Book Company, Department M3, Box 118, Wichita 1, Kansas.

**SELL Greeting cards. Make extra money. Guaranteed.** All occasion assortments, Easter, stationery, gifts, wrappings, toys, jewelry. Experience unnecessary. Salable samples on approval. Free catalog, free gift offer. Details. Write—Hedenkamp, 361 Broadway, Dept. PM-72, New York.

**SHOW Your free sample. I give you amazing Leth'r-test footwear.** Show on your feet to 10 people and 5 will buy on sight because of beauty, quality. You'll see! Only \$1.99 to \$4.99, none higher. Guaranteed for one whole year. Highest commissions. Rush your size, state if man's, woman's. Perfect-World Co., Dept. 96, Cincinnati 12, Ohio.

**AGENTS Wanted. Miracle silver cleaner works like magic. Granulated form, light, compact. Customer puts in dish pan water. Repeats. \$1.00 retail, you keep 75¢. 300% profit yours. Free particulars.** Davis Co., Box 489, Edmonds, Washington.

**NEW Car thief signal. Lightning seller.** Samples sent on trial. Northwest Electric, Ave. 13, Mitchell, S. Dak.

**\$20.00 FIRST Day introducing distinctive personalized doorplate assortment.** Complete sales kit free. Reeves, Attleboro 7, Mass.

**MAKE Money selling ties, tiekerchief sets, readyknobs. Free catalog.** Philips Neckwear, 22 West 22nd, New York.

**EARN \$50 Weekly in sparetime. New unusual way to earn extra money in your spare-time. No investment necessary! No sales experience needed. Get merchandise on credit. Work your own hours! If you'd like complete details on how to earn money this interesting way, write Greetings Unlimited, Park Square, Room 2-680, St. Paul, Minnesota.**

**HI-DRY Magnetic soap hanger sells on sight. Send one dollar for sample kit.** Hi-Dry, 1175 Dan, Ogden, Utah.

**SPARETIME Profit (men or women) taking orders for small Hoot Gibson California Ranchos. Literature on request.** Tracy Wiley, 440 So. Atlantic, Monterey Park, California.

**EARN Big money selling amazing new Cleaf skin cleanser leaves in a beautiful home dispenser! No woman can resist buying this new discovery that is better than soap. A multi-million market that is yours alone! Free samples and complete details rushed to you by return mail.** Cleaf, Inc., 2 Park Ave., New York City.

**GUARANTEED Easy sales. Beautiful items. Samples, details \$1.00.** Traders, Box 74, Fruitland, Maryland.

**AMAZING. New moneymaking plan. Exciting. Investigate. Gifts, Box 330-K.** Ft. Dodge, Iowa.

**YOUR Ad in this space will get some good agents for you. Yes, I'll prove it. Write for Folder "A" right now.** F. W. Johnson, Classified Advertising Manager, Popular Mechanics Magazine, 200 E. Ontario St., Chicago 11, Ill.

## BUY IT WHOLESALE

100,000 PRODUCTS Wholesale! Terrific bargains! United Wholesalers, 1265-M Broadway, New York 1, N. Y.

EVERYDAY Necessities. Everything guaranteed. Amazing illustrated free catalog packed with exciting bargains. Southland Enterprises, Box 3062, Forest City, Florida.

FREE Gifts. Lowest wholesale prices. Catalog 25¢, information 4¢. George Fitch, 4415-P Edgebrook, Wheaton, Maryland.

FREE! Name brands catalog! Your own high profit business. Sell name brands, full or part time. No inventory, no investment. More than 2,000 name brand items; lowest wholesale prices. Watches, jewelry, cameras, hi-fi, stereo radios-phonos, appliances, housewares, hardware, power tools, luggage, musical instruments, garden equipment, sporting goods, toys, many others. 8 floors of name brands. Million dollar inventory. Orders shipped complete in 24 hours! Send for free, beautifully illustrated catalog now! Separate wholesale price list. H. B. Davis Corp., Dept. PM, 145 W. 15 St., New York 11, N. Y.

BUY Below wholesale! Thousands of nationally advertised products. Drugs, clothing, housewares, cameras, jewelry, hardware, sporting goods, etc. Postcard brings price list showing actual factory cost. Buy-Rite, 310 Main, Bennington 2, Vermont.

NEW Deluxe multicolor below wholesale catalog, automobile catalog, and others. Housewares, appliances, refrigerators, freezers, washers, dryers, television, radios, furniture, clothing, luggage, binoculars, phonographs, recorders, cameras, projectors, tools, typewriters, watches, jewelry. Name brands. Huge discounts to 70%. Postcard: Selbyco, Decatur 15, Ill.

WORLD'S Largest wholesale supply. Buy from 679 American, European, Japanese wholesalers. Tailormade suits from Hong-kong. 123 dropship catalogs. Rockbottom prices. Free details. International Buyers, 216-M Jackson, Chicago 6, Illinois.

USED And new watches \$2 up. Free list. Southern Watches, 5-PM So. Wabash, Chicago 3.

REAL Wholesale prices. Big variety. Free catalog. Ateep, Box 66, Teaneck, N. J.

WHOLESALE Specials. Closeouts. Catalog \$1 deposit. Loeber, 224-A Wvatt, Lincoln, Ill.

LARGEST Wholesale supply source in U.S.! 15 free catalogs. Furniture, clothing, appliances, housewares, automobiles and accessories, tools, sporting goods, hobby supplies, farm equipment, imports, new products, bargain merchandise. Free details. Associated, Box 108-DD, Lincoln 1, Nebr.

GENUINE Wholesale prices. Catalog 25¢. Watonga Company, Box 6792-B, Portland 66, Oregon.

ELECTRIC Guitars, amplifiers, wholesale. Free catalog. Carvin PMW, Covina, Calif.

BARGAINS! Buy retail at wholesale prices. Catalog free. C. Ayres, 1427-A Pickens, Columbia, S. C.

NATIONALLY Advertised products wholesale. Send products name-model for quotation. Coats, Box 1247-A, Ontario, California.

2,000 PAGES Wholesale catalogs! Write: Mosaser, Box 47-B, Newark, Ohio.

BIG Bargains. Wholesale. Hundreds practical items. Large illustrated catalog. 10¢. Gifts, Box 330-A3, Fort Dodge, Iowa.

## SALESMEN—DISTRIBUTORS

EARN Big commission full or part time. Build profitable business of your own selling America's largest line low priced business printing and advertising specialties. 360 page catalog samples hundreds of items used daily by business people. Imprinted ball pens low as \$7.95 for 100. Big line low priced union label political printing included. Free sales kit. National Press, Dept. 8, North Chicago, Illinois.

EXPERIENCED Magazine men, no turn in. Cars, crews furnished. Apply Mark Steele (Magazine King), Steele, Missouri.

MAKE Big money taking orders Campbell's Gro-Green Liquid and 100% soluble crystal fertilizer concentrates. Saves time, money, labor. Feeds foliage, soil. Field proven over 10 years. Increases protein, mineral content grains, forage. Free sample. Selling outfit. Credit given. Ideal for corn and feed men. Campbell Co. (Est. 1928), Rochelle 52, Illinois.

BIBLE Profit 130% — why make less? Literature free. Bible, 4813A Hurford, Chester, Penna.

MAKE Up to \$50.00 a day soliciting delinquent accounts. Terrific commissions. Write today. General Finance, 304V Pickwick Bldg., Kansas City 6, Mo.

IF You're interested in making money in selling, see the hundreds of exceptional opportunities in Salesmen's Opportunity Magazine. Send name for your copy, absolutely free. Tell us what you're selling now. Opportunity, 848 N. Dearborn, Dept. 17, Chicago 10, Illinois.

CALENDARS, Novelties. Full or part time. Liberal commissions. Fleming, 6535-A Cottage Grove, Chicago 37.

MAKE Extra money—Big cash commissions plus premium for you and your customers. Sell advertising book matches. Sensational new tenorrama glamour girls, hillbillies; dozens others. All sizes. Quick daily sale; big repeat business. Free master kit makes selling easy. No experience necessary. Superior Match, Dept. M362, 7530 Greenwood, Chicago 19.

I'LL Send you free stocking sample newest advancement in hosiery since nylon. Patented, full-length. Stays up over-the-knee without supporters, without girdle! Nationally advertised price \$1.95. Make money introducing to friends at \$1.00 pair. American Mills, Dept. 721, Indianapolis, Indiana.

CLEANS Windows without mess. Strange dry cleaning-cloth. Replaces liquids. Windows gleam. Samples sent on trial. Kristee 108, Akron, Ohio.

OPERATE Your own profitable franchised distributorship. Learn how by requesting free details today from National Franchise Reports, SD-528, 333 N. Michigan, Chicago 1.

ADD A money-maker to your line. Whatever you sell, your customers can use Nilodor. 10-second demonstration convinces housewives, businessmen, even government officials! Prestige House, 1509A N. Western Ave., Los Angeles 27, Calif.

LONG Needed invention. Men to contact service stations. Huge profits. Cyclo Mfg., 3816 Dahlia, Dept. 132, Denver 1, Colo.

SEAMLESS Nylons \$6.95 doz. Panty's \$4.75. Free catalog. Lizmar Hosiery, 10409 St. Clair, Cleveland 8, Ohio.

WANT To get ahead! Extra income, new car, vacations, new home, luxuries you always wanted. Salesmen make 122%, distributors 233% with Torco Carburetor Clean Out. 20 second demonstration clinches sale on sight. 78,000,000 prospects. Big year round repeat profits. Guaranteed results. Write Torco, Dept. M, Santa Fe Springs, California.

ENDS Car waxing forever! Miracle new product seeking distributors. Very high return on nominal investment secured by inventory. Write Livingston, 15 E. Reno, Oklahoma City 4, Okla.

HIGH Commission and bonus. Earn \$100 to \$300 weekly. 30 year old company has openings. List delinquent accounts for collection. Experience not necessary. Permanent. Write: Merchants Protective Agency, 1015M Walnut, Kansas City, Mo.

SENSATIONAL New longer-burning light bulb. Amazing free replacement guarantee—never again buy light bulbs. No competition. Multi-million dollar market yours alone. Make small fortune even spare time. Incredibly quick sales. Free sales kit. Merlite (Bulb Div.), 114 E. 32nd, Dept. C-74R, New York 16.

PICTURES! (Washable). Huge profits. Brochure. Rustic Art Sales, Wallace, Mich.

IMPORTED Bargains. Low prices. Wright Company, Matthews, N. C.

\$1,000.00 A Month for making dramatic 3-second demonstration of amazing lightweight Presto fire extinguisher. New chemical used by airforce snuffs out fires instantly. Only \$4.95. Terrific commissions. Millions want it. Free kit. Merlite, 114 E. 32nd, Dept. P-66R, New York 16.

MAKE Extra money selling advertising matchbooks. Free catalog and sales outfit. Matchcorp, Dept. PM-32, Chicago 32.

LEATHER Zipper key case \$42.00 gross P.P. Sample \$1.00. Opal Susi, 2230 Light St., Bronx 66, New York.

AMAZING Opportunity. New low priced fire alarm protects homes, farms, offices, factories, etc. No wiring—hangs like picture. Pays up to \$1,100 a month. Free kit. Merlite (Alarm Div.), 114 E. 32nd St., Dept. F-66R, New York 16, N. Y.

## EMPLOYMENT INFORMATION

DIRECTORY Reports. Construction, aviation, shipping, oilfields, government, manufacturing, trucking, etc. Foreign-stateside. Helpful information plus job-getting tips on preparing application letters. Unconditional money-back guarantee of satisfaction. Act today. Only \$2.00 (\$2.25 airmail). (C.O.D.'s accepted). Research Services, Meramec Building, St. Louis 5-PM, Missouri.

FOREIGN Employment information. Europe, Alaska, Africa, Asia, Canada. Travel, adventure. Up to \$1,600 monthly. Construction workers, truck drivers, clerks, teachers, professionals, etc. Sensational opportunities—most complete information, application form sent immediately by return mail. Send \$2.00 to: Jobs, Box 512-E, New Orleans 12, Louisiana.

MERCHANT Marine jobs. Men and women. Top wages. Travel. Captain, Box 501-P, Reading, Massachusetts.

JOBS On ships. Age 18 to 55. Experience not required. National Seafaring, Box 71881-B, Los Angeles 1, California.

JOB-Getting resumes easily prepared. "Effective Resume Guide" shows you how, makes it simple, step by step. Sample resumes included. Send \$3.00. Richton Company, Dept. A, 1020 Broad, Newark, New Jersey.

FOREIGN Employment. Construction, other work projects. Good paying overseas jobs with extras, travel expenses. Write only: Foreign Service Bureau, Dept. PM, Bradenton Beach, Florida.

CALIFORNIA List of industries hiring in all fields, \$1.00. Hughes Enterprises, 109 East Etiwanda, Rialto, California.

JOBS On ships. Employment directory \$1. Janecek, 373 East 155th Street, New York 55, N. Y.

U.S.A. And foreign jobs, up to \$1600.00 monthly. Construction, shipping, aviation, clerical, supervisory, etc. Skilled, unskilled. Free transportation. Unusual opportunities. Complete information plus worldwide project listings. Only \$2.00 (\$2.50 airmail). Satisfaction guaranteed. International Opportunities, Dept. 66W, 109 W. 42, New York 36, N. Y. or Dept. 66X, Box 621, San Jose 6, California.

CIVIL Service jobs. How to get them, what to do. Circular. Ingills, P.O. Box 1602A, Chicago 90, Illinois.

TREMENDOUS Opportunities — U.S.A., overseas. Choose your job, your location. Bonuses. Free transportation. Free details. International Occupations, International Airport, Box 100C-4, Jamaica 30, N. Y.

CALIFORNIA Jobs. Aircraft, missiles, construction, sales. Many others. Send \$2.00 for latest listings. Airmail. California Opportunities, Box 2463, San Bernardino, Calif.

OVERSEAS Employment information. High salaries. All occupations, professions. Tremendous opportunities. Complete listings, \$2.00. Associated Reporters, P.O. Box 1008, Miami 1, Florida.

EXCELLENT Employment. Job lists. Newest. Nationwide. All occupations—professions wanted immediately. \$1.00. Employment Surveys, 2908 Gawthorn, Oroville, California.

## SPECIAL SERVICES

INFORMATION On anything. Ferguson Research Specialists, 59 Lent Ave., Hempstead, N. Y.

RESEARCH Service. Any subject! Jake Barraco, 478 Gardner, South Beloit 2, Illinois.

INFORMATION Research. All subjects. Free details. Stubblefield, 1801 Burrell, Lewiston, Idaho.

## EDUCATIONAL AND INSTRUCTION

**LEARN** By ear with Dormiphone. While you slumber, the amazing new scientific Dormiphone tools give you a shortcut to learning languages, correct speech; memorizing facts, figures; relaxation, habit training. Saves you time, effort. So simple to use, children benefit. Used by educators, psychologists. Write today for fascinating free book. No obligation. Modernophone, Inc., 320-032 Radio City, New York 20.

**BE A Real Estate Broker.** Insure security for yourself and your family. Study at home. Prepare for state examination. GI approved. Write for free book today. Weaver School of Real Estate, 3519P Broadway, Kansas City, Missouri.

**DRAFTING** Pays big money. Leads to position in automotive, aeronautical, construction, mechanical fields. Learn at home in spare time. All equipment supplied. Pay later plan. Free book. Christy Trades School, D-5703, 3214 Lawrence, Chicago 25.

**"HOW To Train Horses"**—A book everyone who likes horses or ponies should have. Free. No obligation. Simply address Beery School, Dept. 1103-C, Pleasant Hill, Ohio.

**COMPLETE** Your high school at home in spare time with 65-year-old school. Texts furnished. No classes. Diploma. Information booklet free. American School, Dept. X345, Drexel at 58th, Chicago 37, Illinois.

**OVER 75 Million** watches in U.S. waiting repair. Urgent need for watchmakers. Get the facts. Write Kansas City School of Watchmaking, 1228PM Admiral Blvd., Kansas City 6, Missouri.

**LEARN Civil and criminal investigation** at home. Earn steady, good pay. State age. Institute Applied Science, 1920 Sunny-side, Department 163, Chicago 40, Illinois.

**SWEDISH Massage.** Foot technique. Post graduate. Home study. Residential. Diploma. Dr. Swanson's Illinois Licensed School, 3809-PL Alta Vista, Chicago 13.

**NEW Self-teaching course** in memory helps you achieve greater success in business and social world. Free booklet. Memory Studies, 835 Diversey Parkway, Dept. 3433, Chicago 14.

**ATTEND Business school at home!** Save time and expense of attending classes, prepare for secretarial career in typing, shorthand, business procedures, bookkeeping. Write for catalog. Wayne School, 417 S. Dearborn, Dept. 03-520, Chicago 5, Illinois.

**DENTAL Technicians.** Simplified home study. Accredited. A.C.S.C. certificate. Denshire School, Box 762, Boston 2, Mass.

**MASTER Watch making at home.** Free sample lesson. Chicago School, 2328-YU Milwaukee, Chicago 47.

**LEARN Scientific Swedish Massage** in few months at home. Skilled operators earn \$4.00 to \$5.00 an hour. Open your own office or earn good income at health and recreational centers. Wonderful part-time profession. Free anatomy charts and catalog. Anderson School of Scientific Massage, Dept. XC1, Princeton, Illinois.

**GOOD Paying jobs open!** Operate, repair heavy earth moving equipment! Learn "on the job" operating latest cranes, bulldozers, earth carriers! V.A. approved. Free catalog. Write T. C. Hutch, Greer Technical Institute, Braidwood, Illinois.

**PROFITABLE National Camera Repair School training at home!** 174PM, Englewood, Colorado.

**LEARN Realistic oil painting** by correspondence. Amateur and advanced. Walker School of Art, Box 486, Montrose 4, Colo.

**BARGAINS!** Used correspondence courses and instruction books bought, sold, exchanged. List 10¢. Smith's, 124 Marlborough, Salem, Mass.

**GET Bigger job, higher pay.** Develop practical working knowledge of Production Management. Simplified guide shows how. Particulars free. Bid. 2634 Midvale, Los Angeles 64, California.

**BE A memory machine.** Earn \$3700.00 yearly extra. Research Center, Box 7192-H, El Paso 22, Texas.

**WANT To be successful.** Write today. P.O. Box 11457, Sta. A, Palo Alto, Calif.

**ENGINEERING** And Art degrees earned through home study. Electronics, Mechanical, Liberal Arts. When writing specify course desired. Pacific International College of Arts & Sciences, primarily a correspondence school. Resident classes also available. 5719-B Santa Monica Blvd., Hollywood 38, California.

**INVESTIGATE Accidents.** Earn \$750 to \$1,000 monthly. More investigators urgently needed. Car furnished; business expenses paid. No college education necessary. No selling of any kind. Pick your own job locality. We train you at home spare time. You keep present job until ready to switch. Write for free book. No obligation. Universal Schools, CPM-31, 6801 Hillcrest, Dallas 5, Texas.

**LEARN Chinese fast.** New method. Earn \$4,100 yearly extra. Interpreters' Center, Box 67, El Paso, Texas.

**USED Correspondence courses, books.** Satisfaction guaranteed. Catalog 10¢ refundable. Courses bought. Bayles, 78-B Courtright, Wilkes Barre, Penna.

**INEXPENSIVE Correspondence courses**—Science, Engineering, Psychology, Divinity. Free information. Aurecas, Central Valley, New York.

**52 COLLEGES** Offer college, high school, elementary correspondence courses! Directory \$1.00. Soave, Box 518B, Mount Vernon, New York.

**BACCALAUREATE Degree** correspondence course directory: \$2.00. College Research, North Highlands 1, California.

**LEARN How to remember name quickly and easily.** Write for free literature. Human Relations Consultants, Box 10235-PM, Houston 18, Texas.

**BECOME Private investigator!** Complete booklet \$4.50! Also bargain catalog \$1.00! Both \$5.00! Millmar, (Dept. PM-El), Box 1932, Oklahoma City 1, Oklahoma.

**LEARN Fascinating, profitable invisible reweaving at home.** \$10.00 earnings in an hour possible making tears, holes disappear from clothing, fabrics. Steady demand from cleaners, laundries, homes. Details free. Fabricon, 6255 Broadway, Chicago 40, Ill.

**SPEAK, Speak with power.** Self-training records. Amazing! Canfield, 2018-A Fifth Avenue South, Minneapolis 4, Minn.

**USED Correspondence courses and books sold and rented.** Money back guarantee. Catalog free. (Courses bought.) Lee Mountain, Pisgah, Alabama.

**BECOME A personal problem counselor.** Enter dignified profession. Instructions \$1.00 refundable. Hermansen, Box 808, Grand Central Station, New York 17, N. Y.

**WOODWORKING** And cabinetmaking course for beginning and advanced home craftsmen. Only complete low-cost home training program available. Write for free booklet. Interstate Training Service, Dept. G-3, Portland 12, Ore.

**WANT A diesel job? Higher pay? Advancement? We can help you qualify!** Complete diesel, tractor and heavy equipment and Cummins Diesel Engine Shop-method home-training courses available. Write today. Interstate Training Service, Dept. B-3, Portland 12, Ore.

**HIGH School diploma at home.** Licensed teachers. Approved materials. Southern States Academy, Station E-16, Atlanta, Ga.

**BOOKKEEPERS.** Operate your own "Dollar-A-Week" system. Ellis, Box 200, Cedar Grove, North Carolina.

**LEARN Asleep or awake!** Records, tapes, equipment! Free catalog! Drawer PM-697, Ruidoso, New Mexico.

**MEN Wanted.** Earn \$125 a week and up. Master a trade with a future. Learn auto diesel mechanics in our shops. You learn with tools on real equipment. Earn while you learn. Many of our graduates earn \$125 a week and up. Write for free bulletin: Dept. 256, Auto Diesel College, Nashville 3, Tenn.

**PIANO Tuning pays.** Learned easily at home. GI approved. 59th year. Free booklet. Niles Bryant School, Dept. P, 3731 Stockton, Sacramento 20, Calif.

**SWEDISH Massage,** physical culture and weight reduction pay big profits. Men and women. Learn at home. Diploma course. Free catalog. National Institute, Desk 4, 165 E. Ontario, Chicago 11, Illinois.

**INVESTIGATORS Course.** Credentials, diploma. Free information. Southwestern Institute Criminology, 510-A Iowa, Geronimo, Okla.

**FINGERPRINTING** And identification taught at home. Diploma. Details free. Alabama School of Fingerprinting, Fairfield, Alabama.

**LEARN Auctioneering.** Free catalog. Missouri Auction School, 1330 Linwood, Kansas City 9-X3, Mo.

**LEARN Ventriloquism.** Amazing-entertaining! Easy! Details free. B. Davis, B-38, Safety Harbor, Florida.

**SECRET Investigations.** Experience unnecessary. Investigators particulars free. George Wagner, M125 West 86th, New York City 24.

**DENTAL Technician's home study kit!** Instruments, plastic, etc. Write for free illustrated instructions. Grant Laboratory, Haas Bldg., Los Angeles 14, Calif.

**LEARN While asleep with your recorder,** phono. Details, catalog free. Sleep-Learning, Box 24-PX, Olympia, Wash.

**PENMANSHIP Corrector.** Improve poor penmanship quickly. Details free. Ozment, Box 665-34, St. Louis 88, Mo.

**BEGINNER'S Home training course** in drafting. Chickris Engineering, Liberty Building, Rock Island, Illinois.

**PROFESSIONAL Investigator.** Home study. Lapel pin, certificate, future. Box 41197-F, Los Angeles 41, California.

**PIANO Tuning pays.** Big money in spare time. Learn at home in 30 days. No musical knowledge necessary. Phonograph, records, tools and instructions furnished. Electronic tuning also taught. Free catalog. Capital Tuning School, 3160 S.W. 16th Court, Ft. Lauderdale, Fla.

**EARN \$150 Weekly Mechanical, Electronic Drafting.** Send \$2 first lesson, \$25 complete home study course. Prior, Inc., 23-09 169 Street, Whitestone 57, New York.

**FREE Investigator course** as bonus with purchase of 1962 National Detective Directory. Write for full information to: American Detective Association, P.O. Box 478, Santa Ana, California.

## PLAYS, STORIES, MANUSCRIPTS

**WANT Your book published?** Learn how we publish, advertise, promote, distribute. Many successes. Free booklet PM. Vantage, 120 West 31, New York City. Or 6253 Hollywood Blvd., Hollywood 28, Calif.

**WRITERS!** Free list of top-notch U.S.A. markets for short stories, articles, books and plays. Write for your free copy today! Literary Agent Mead, 915 Broadway, New York 10.

## ADVERTISING AGENCIES, ADV. SERVICE, MAILING LISTS

**FREE Radio advertising!** Nationwide. Complete procedure \$1. Janeczek, 373 East 155th Street, New York 55, N. Y.

**ADVERTISE:** 24 Words, 75 Canadian newspapers, \$5.50. Lists free. Advertising Bureau, 10511-C Springfield, Chicago 55.

**ADVERTISING Ratebook** leading newspapers, magazines, free. Chicago Advertising Agency, 28-E Jackson, Chicago 4.

**MAILING Lists** most all kinds 1000 \$5.00. Free folder. Your circulars mailed \$4.00 1000. Dixie Mailers, King, N. C.

**NOW Ready:** New, amazing Classified Advertising Record Book — prepared especially for classified advertisers. Here is a book that tells you instantly whether or not your advertising in any publication is paying you real results. You can tell immediately how many inquiries each publication produced—how much cash received from every ad. Spaces are provided for the name and address of the publication, date of issue, space used, rate, cost of ad, key number, etc. You have a complete record of each publication right before your eyes. Plenty of space to keep accurate record of 28 separate publications. You can have a copy by sending only 10¢ for cover postage and handling. Send for your copy now. W. F. Johnson, Classified Adv. Mgr., Popular Mechanics Magazine, 204 E. Ontario Street, Chicago 11, Illinois.

**AMAZING New Book**—"Profits From Classified Advertising." Tells how and what to advertise. Be sure to read this book before you invest one cent in advertising. Write for your copy now. F. W. Johnson, Classified Advertising Manager, 202-210 East Ontario Street, Chicago 11, Illinois.

### TYPEWRITERS, DUPLICATORS, OFFICE DEVICES

**RECONDITIONED** Typewriters, mimeograph, printing presses \$25.00 up. Write Dixiegraph, King, N. C.

### RUBBER STAMPS AND OFFICE SUPPLIES

**SPECIAL Stamps**, 50¢ per 2" line. Free folder. Tabco, Tomkins Cove, New York.

**DELUXE Rubber address stamp**, Ink pad included. \$2. Stamps by Jaski, 4825 North Winthrop, Chicago 40, Illinois.

**STAMP Makers' supplies**, Lowest prices. O'Brien's, 421 Jackson, Toledo 4, Ohio.

**THREE Line rubber stamp**, Economy mount. Resembles printing. 65¢. Additional lines 15¢. Las Stamp Manufacturers, Box 733PM Campbell, Calif.

**RUBBER Stamps 4 lines** \$1.25. Office printing reasonable. Kays, 172 W. 34th St., Riviera Beach, Fla.

**FREE**—Illustrated rubber stamp catalog. Low prices! Hildreth, 1047-A Inner, Schenectady 3, New York.

**CATALOG**—Rubber stamps, daters, business cards, printing. Martin, 1425 Major, Jefferson City, Missouri.

**3 LINES** \$1.00. Extra lines 25¢. Cushioned mount, knob handle. One day service. Wallace, Box 146, Hanover, Penna.

**SIGNATURE Stamps** \$3.00. Pocket stamps \$1.00. Free literature. Sav-mor Stamps, Adams City, Colorado.

**FREE 32-Page rubber stamp catalog**. Stock stamps, pads, ink. Signature stamps \$3.50. Free label brochure. Youngers Stamp Shop, Princeton, Iowa.

**3 OR 4 Line deluxe pocket stamp** with ink pad \$1.00. Free catalog. Claydon's Rubber Stamps, Red Wing, Minn.

**THREE Line self-inking pocket stamp**, 50¢. Meese, Dept. A, 42 "E," Keyser, W. Va.

### CARTOONING, COMMERCIAL ART, SHOWCARD & SIGN PAINTING, TATTOOING

**"HOW To Make Money with Simple Cartoons."** A book everyone who likes to draw should have. It is free; no obligation. Simply address Cartoonists' Exchange, Dept. 93, Pleasant Hill, Ohio.

**ART**—Learn at home. Earn big money. Learn commercial art, cartooning, lettering, figure drawing, painting, TV art, in spare time. All for 20¢ a day. Send for free 36-page book. No obligation. Washington School of Art, Studio 143, Port Washington, N. Y. Tear this out as reminder.

**LEARN Profitable magazine cartooning**. Free details. Hartman, Box 3097, Lincoln 10, Nebraska.

**WANTED**—Cartoonists. Amateurs, professionals. Over 200 markets. Information free. Cartoon Markets-3PM, 11620 Lansdowne, Detroit 24, Michigan.

**PAINT Signs!** Using patterns! Trial alphabet \$1.00. Harwell, PM-362, Byrdstown, Tennessee.

**SIGN Painting outfit enables profits first day!** Fabulous opportunities! Paulow Signs, Crystal Falls, Michigan.

**LEARN Sign painting**, Easy method. Ellis, 10533 121 Ave. N., Largo, Florida.

**YOU Can entertain with chalk talks**. Catalog 10¢. Balda the Cartoonist, Oshkosh, Wis.

**LEARN Sign painting at home**. Free talent test. Ben Kerns, Box 812-PM, Greenville, S.C.

**LEARN Sign painting with fascinating system**. Straley, 410 S. Western, Springfield, Ohio.

**LEARN Truck lettering**. Information free. Martin, 314 Delatre St., Woodstock, Ontario, Canada.

### PRINTING, MULTIGRAPHING, MIMEOGRAPHING, GUMMED LABELS

**IDENTIFY Your equipment**. Your name, address on 50 attractive decals 75¢ postpaid. 1000 gummed name-address labels 75¢ postpaid. Hallows, 14 Drexel, Cahokia, Illinois.

**OFFSET Printing**. Free prices, samples. Harrison Litho, 248 South Hackett, So. Beloit, Illinois.

**SALESBOOKS**. Duplicate 3 3/8" x 5 1/2", your copy, 20 books \$5.50, 40 books \$8.50, 100 books \$14.75, 200 books \$26.45. Prepaid. Also Manifold books; single, duplicate, triplicate, quadruplicate, up to size 12" x 19", from 10 books up. Your copy. Carroll Printing Company, Box 4068, San Antonio 7, Texas.

**OVERNITE Offset printing** 1000 8 1/2" x 11"—\$6.50. Postage extra. Evergreen, 9420 Trumbull, Chicago 42.

**SIMULATED Engraved business cards**. 1000—\$3.98, postpaid. Woolsey, 1212 Chestnut, Duncan, Oklahoma.

**1000 EMBOSSED Business cards**, \$3.40, samples. Send stamped envelope for list and sample rare booklets. Avere, 112 So. Elizabeth, Wichita 13, Kansas.

**250 BOND Letterheads** \$2.75. 250 envelopes \$2.75 (samples). Patton, Box 248C, South Haven, Mich.

**FREE Descriptive label literature**. Name and address, stock, photographers, religious, record and comic labels. Youngers, Princeton, Iowa.

**1000 EMBOSSED Postcards** \$11.25; samples 5¢. Kormoczy, 1822 1/2 Broadway, Seattle 22, Washington.

**PERSONALIZED Boxed stationery**, letterheads, envelopes, printed scratch pads. Details free. Tobin's, 1114 Marlina, El Cajon, California.

**PRINTING**. Samples, prices. Fred the Printer, Box M-623, Independence, Mo.

**1000 BUSINESS Cards**, raised letters. \$3.75 postpaid. Samples. Routh, PM-3, 2633 Randleman, Greensboro, N. C.

**50 PARCEL-POST!** Labels, \$1.00. Ellis Company, Box 948-Q, Inglewood, Calif.

**MIMEOGRAPHING**, Offset printing. Free samples. Pennway, Drawer 1340, Scranton, Penna.

**PERSONALIZED Stationery**. A gift for everyone. Prices. Printing, Box 931, Rochester, N. Y.

**TWO Color embossed business cards** \$4.95—1,000. Business stationery. Postpaid. Samples 10¢. Medallion, 356 East Alondra, Gardena, California.

**250—8 1/2"x11 BOND Letterheads** \$2.50. 250 envelopes \$2.75. Samples. B. Barsketis, 6540 So. Western, Chicago 36.

**AMAZING Business printing values**. Samples. Print Shop, Box 576, Greenville, R. I.

**DISTINCTIVE Printing**, proofs, cuts, mats, artwork. Writers' office supplies. Logan Enterprises, 6801-A Onyx, St. Petersburg 3, Florida.

**FREE Catalogs postpaid printing**. Rubber stamps. DM Press, Sebastopol, Calif.

**1000 NAME-Address labels** 88¢. Rubber pocket stamp 88¢. Printing, rubber stamp catalog. Jordan's, 552 West O'Connor, Lima, Ohio.

**BUSINESS Cards** \$2.75 thousand postpaid. Free samples. Kavanagh, 607 Knickerbocker Ave., Brooklyn 21, N. Y.

**OFFSET Printing**. 100 8 1/2"x11 \$2.49. Additional 100's 43¢. Add postage. Parks, 3823 Merrick, Seaford, N. Y.

**ADS Running under this heading sell printing**. Ask me for proof. I'll gladly send you amazing facts. Ask for Folder "P." F. W. Johnson, 200 E. Ontario St., Chicago 11, Ill.

### PRINTING OUTFITS AND SUPPLIES

**RUBBER Stamp presses**, hydraulic operated, electrically heated. Sizes 5"x8", 8"x12", 10"x15". Starting outfits, supplies. Printing presses. Custom Manufacturing, 1464-P East Commercial, Springfield, Missouri.

**NEW Type catalog** from world's largest printers' supply house. 9" x 12" book illustrating hundreds of type styles including foundry type, brass type, steel type, wood type. Send \$1 to cover mailing. Refund with first order. Huge inventory of thousands of printers' supply items always on hand. American Printing Equipment & Supply Co., Dept. PM, 42-25 Ninth Street, Long Island City 1, N. Y.

**MAKE Your own self-molding rubber stamps and printing cuts**. Plexirubber, Argyle 1, Wisconsin.

**DO Your own printing**. Save money. Simple rules. We supply everything. Print for others; good profit. Raised printing like engraving too. Have home shop. Details free. Kelsey Presses, V-11, Meriden, Connecticut.

**RUBBER Stamp outfits, supplies**, Kiewit, 2025 Barney Road, Kalamazoo, Mich.

**PRINTING Presses, type, supplies**. Lists 4¢. Turnbaugh Service, Mechanicsburg, Penna.

**TYPE Case catalog**. Manufacturer. King McKay Company, 23179 Telegraph, Southfield, Michigan.

**RUBBER Stamp presses bought, sold**. Poling, Route 5, Staunton, Va.

**TYPE And supplies for printers and rubber stamp makers**. Buy direct. Satisfaction guaranteed. Send \$1.00 for big 96 page catalog and free printers tweezers, deductible from first order. Acme Type, 633 Plymouth Court, Chicago 5, Ill.

### FOR INVENTORS

**PRODUCT Ideas make money**. Manufacturers, ready buyers waiting. Write Inventors Creative Service, PM354 South Spring, Los Angeles 13, California.

**INVENTORS**. Do you want to sell or license your invention on cash or royalty basis? Write Kessler Corporation, C-53-FI, Fremont, Ohio.

**WRITE For information** about our new concept in developing and promoting ideas and inventions. Taylor-Garner Corporation, 1113 Healey Bldg., Atlanta 3, Georgia.

**INVENTORS Seeking cash or royalties** for patented; unpatented inventions or ideas. Write: Casco, Mills Bldg., Washington 6, D. C.

**LEARN How to get free government assistance** in marketing your idea! Patent Info Service, P.O. Box 1971, San Diego 12, Calif.

**I Sold my invention! Can I help you?** Write: Metro, Box 151, Oak Park, Illinois.

**PATENT Searches**, \$6.00, including official patent office copies of related U. S. patents. Certified, airmailed! For free "Invention Record" and "Patent Information," write: United States Inventors Service Company, 1311 "G" Street NW, Washington 5, D. C.

**FREE**. "Vital Information Every Inventor Needs before Selling Invention." Adams, 15 Park Row, New York, N. Y.

**SAVE High fees!** Prepare your patent application yourself! New "do-it-yourself" patent kit now makes it easy. Free "Registration Form." Miss Blaine, 306 Carry Building, Washington 5, D. C.

**PATENT Searches**, professional patent development of inventions by licensed professional patent engineer and U.S. Patent Office former examiner with staff of engineering specialists in all fields of inventions. Expert searches performed in the U.S. Patent Office. Your inventions and ideas engineered for maximum patent protection and greatest commercial value. Inventions developed by us negotiated for cash or royalties with our nationwide contacts. Send for free protection "Invention Certificates" and further interesting, valuable patent information. George Spector, Licensed Professional Patent Engineer, U.S. Patent Office Former Examiner, Woolworth Building, New York.

**PATENT Searches**, including copies of related U.S. Patents, \$6.00. Inventors, attorneys, manufacturers use my "World-wide" airmail service. "Invention Record" form and "Information Every Inventor Needs," sent free! Miss Hayward, 1029 Vermont Ave. NW, Washington 5, D. C.

**PROFESSIONAL** Patent searches, \$6.00, including official copies of related U.S. patents. Prompt, dependable airmail service! For free "Invention Record Folio" and "Information Every Inventor Should Have," write: Congress Invention Institute, 210 McKim Building, Washington 5, D. C.

**FAST** Airmail service on all patent searches; \$6.00, including copies of related U.S. Patents! For free Record Form and vital information, write: Washington Inventors Service, 422 Washington Building, Washington 5, D. C.

**PROFESSIONAL** Searches of the Patent Office. Dependable—reliable \$6.00 including airmail report and related patents. For free protection forms and patent information write Trans-World Patent Service, 500 Walker Building, Washington 5, D. C.

**PATENT** Searches including full, airmail report and closest patent copies, \$6.00. Quality searches, expertly administered. Free protection forms and patent information. Write Professional Patent Office Search Bureau, 709 Albee Building, Washington 5, D. C.

**INVENTORS!** Outright cash sale or royalties for your inventions. Patented. Unpatented. Constant demand from our client manufacturers. Write: United States Invention Brokerage, 78 Wall Street, New York 5, N. Y.

**INVENTORS!** Consider our offer first before selling or licensing your invention on a cash or royalty basis. Patented. Unpatented. Write: Inventions on Demand, 79 Wall Street, New York 5, N. Y.

**PATENT** Searches, including copies of nearest patents, \$6.00. Reports airmailed within 48 hours. More than 200 registered patent attorneys have used my service. For free invention protection forms, write Miss Ann Hastings, P. O. Box 176, Washington 4, D. C.

**WE** Have the markets if you have the ideas. Harvey Engineers, Cambridge 1 Maryland.

**INVENTORS:** Test the commercial value of your patented or unpatented inventions, quickly and inexpensively. Write for free information. Institute of American Inventors, Dept. 40-B, 635-F St., N.W., Washington 4, D. C.

**INVENTORS!** Searches of the Patent Office administered professionally. \$6.00 including airmailed comprehensive report and related patent copies. For free invention protection forms, dependable service, write Washington Patent Office Search Bureau, 1426 G Street N.W., Washington 5, D. C.

**INVENTORS!** Sell your invention for cash or royalties! Our manufacturers constantly seeking new items. Patented. Unpatented. For free information write Gilbert Adams, Patent Broker, 80 Wall Street, Financial District, New York, N. Y.

**PATENTS** Skillfully prepared for maximum commercial value, with useful product development. High record of success in proving and claiming patentability. Valuable market service. Patent prepared for a fee as low as \$200.00. Send for self-protecting record of invention forms free. Patent search with valuable engineering report \$15.00. Foreign patents filed at low cost. Thirty years established. Joseph O'Brien, Patent and Development Engineer, 132 Nassau St., New York 38, N. Y.

**CASH** Or Royalties for inventions! Consider our offer first before licensing or selling your patented or unpatented invention. Write Aladdin Industries, 80 Wall St., New York 5, N. Y.

**PATENTS** Professionally prepared for maximum commercial value. Patent searches including report \$6.00. Patents prepared as low as \$195.00. Valuable market service with cash or royalty sales. 10 years dependable service. For free self-protecting Record of Invention forms write: H. Lawrence Blasius, Patent and Development Engineer, 19 Park Row, New York 38, N. Y.

**INVENTORS:** Save time and money. Prepare and file your own patent application. Our complete "Patent Kit" makes it easy. Includes detailed instructions and all necessary material. Only \$8.95. Money back guarantee. Don't delay. Send check or money order today to National Inventors Service, Box 88, Benjamin Franklin Station, Washington, D.C.

U.S. Patent office searches—\$5.00. Free invention record. Patents engineered. Patent Office Searchers, 233 Broadway, Room 3615, New York.

**IRAMCO** Invention research and marketing corp. For your patents and ideas. Write: 401 S. 15th St., San Jose 12, Calif.

### INVENTIONS WANTED

**WANTED** Inventions, patented or unpatented. Unusual services. Professional Engineer, Box 113-A, Hampton, N. H.

**IF** Your invention is adaptable to promoting we will contract for selling on cash or royalty. Free booklet outlines royalty rates, requirements. Kessler Corporation, C-53-IW, Fremont, Ohio.

**INVENTORS** Seeking cash or royalties for patented; unpatented inventions or ideas. Write: Casco, Mills Bldg., Washington 6, D. C.

**INVENTIONS** Sold, licensed. Cash-royalty basis. Inventions International, Box 560, Wall Street, New York 5, N. Y.

**WE** Develop and promote your product or ideas. Write for information. Product Promotion Development-2, Little Building, Boston 16, Mass.

**INVENTIONS** Wanted. Patented; unpatented. Tremendous manufacturers lists. Global Marketing Service, 2420 77th, Oakland 5, California.

**INVENTORS:** Hundreds of manufacturers have requested our assistance in locating marketable new products. Complete information free. Institute of American Inventors, Dept. 40-D, 635-F St. N.W., Washington 4, D. C.

**ARE** You interested in offers from reliable manufacturers for your invention? Patented, unpatented. Harvey Engineers, Cambridge, Maryland.

**INVENTORS!** Outright cash sale or royalties for your inventions. Patented. Unpatented. Constant demand from our client manufacturers. Write: United States Invention Brokerage, 78 Wall Street, New York 5, N. Y.

**INVENTORS!** Consider our offer first before selling or licensing your invention on a cash or royalty basis. Patented. Unpatented. Write: Inventions on Demand, 79 Wall Street, New York 5, N. Y.

**INVENTORS** Needing help with any problem, financial, development, securing manufacturer, obtaining patent. Write the organization that delivers action and results—not promises. Pioneer Invention Institute, 150 Broadway, New York 38, N. Y.

**INVENTORS!** Sell your invention for cash or royalties! Our manufacturers constantly seeking new items. Patented. Unpatented. For free information write Gilbert Adams, Patent Broker, 80 Wall Street, Financial District, New York, N. Y.

**INVENTIONS** Promoted-for cash-royalty sales with manufacturer contacts. George Spector, Licensed Invention Engineer, Woolworth Building, New York.

**INVENTIONS** Wanted for national promotion. Write: Prometheus, Box 1341, Akron 8, Ohio.

**SELL** Your invention for cash. No commissions. Milburn, Burlington, Kentucky.

**WORTHY** Patented inventions promoted free. Porter, 12 Morgan, Rockland, Mass.

**CASH** Or Royalties for inventions! Consider our offer first before licensing or selling your patented or unpatented invention. Write Aladdin Industries, 80 Wall St., New York 5, N. Y.

### PATENTS FOR SALE

**FLUSH** Tank valve. Patent No. 2,919,447. Best ever. N. H. Wells, Opp, Alabama.

### MODELS—SHIPS, TRAINS, PLANES, ETC.

**SHIP** Models. Kits, fittings, plans, books, tools, engines, motors. Big illustrated catalog 50¢. James Bliss & Co., Dept. SM, 342 Atlantic Avenue, Boston 10, Massachusetts

**LIVE** Steam engine castings kits, boilers, variety. Model maker's lathe, low priced, compact, motorized. Illustrated catalog 35¢. HPK Models, P.O. Box 34, Centuck Station, Yonkers, N. Y.

**STEAM** Powered models! Simple oscillating to advanced triple expansion and Corliss castings. Some finished. Also tractor and locomotive. Illustrated 100 page catalog \$1.00. Chas. Cole, Ventura, Calif.

**STEAM** Engines, tractors, boilers, castings, prints. Catalog \$1.00. Tiny Power, Junction City, Oregon.

**MINIATURE** Gasoline and steam engines—easily machined using our castings and blueprints. Fascinating hobby. Illustrated catalog 35¢. Octura Models, 8148-PM Milwaukee, Niles 48, Ill.

**LIVE** Steam powered backyard railroads! All sizes. Complete "bolt-together-kits", and rough castings. Excellent drawings. 100 page catalog \$1.00. Little Engines, Lomita, Calif.

**SHIP** Model kits and fittings: clippers, frigates, etc. Catalog paint-tool list, book list, 35¢. Model Shipways, Box 85, Bogota, N. J.

**LIONEL** Trains. Big discounts bulletin 10¢. Catalog 25¢. Mack-Bros., 2043P, Chicago Ave., Chicago 22.

**SAVINGS** To 50%. Lionel, Gilbert, Altharn, etc. New trains accessories. Hobby Surplus, P.O. Box 1106, New Britain, Connecticut.

**SHIP** And yacht model fittings; blueprints. Send 40¢ for illustrated catalog listing hundreds of items. A. J. Fisher, Inc., 1002-1 Etowah Ave., Royal Oak, Mich.

**"POWER** Drives Handbook"—36 pages illustrating many types motor drives for model autos, boats, displays, turntables, etc. Mail 25 cents cash, returnable first order \$3.00 or more. Wilson's of Cleveland, Dept. PM, P.O. Box 8995, Ft. Lauderdale, Fla.

**MODEL** Hobbyists! Send 10¢ for catalog. Our 70 powered model plane and boat kits, many radio-control operated, also accessories. Sterling, 501 Wister, Philadelphia 44, Penna.

**BREATH**TAKING! 49" Radio controlled Mustang plans, \$1.75. List, bonus plan, specials, 50¢. Special Edition Plans, Massena, N. Y.

**ROCKETS!** Five blueprints. Plus instrumentation, fuels, electronic firing, parachute systems. \$1.00. Also amazing 2-stage missile, \$2.00. 7 mile altitude. United States Altitude Champion's design. Both publications, \$2.00. Rocketry, Box 4708, Washington 20, D. C.

**CATALOG** Of scale model wheels and pilots 5¢. Williams Bros., Box 1254, Huntington Park, Calif.

**HOBBYISTS**—Miniature jackscrews you can build. Plans, specifications 50¢. Robinson, Box 111, West Tisbury, Mass.

**25% DISCOUNT** On new radio control equipment. All brands. Write: Southwest Hobby, 1345 E. 4th St., Ontario, Calif.

### ENGINEERING SERVICES

**INVENTION** Development. Industrial research. Submit technical problems in confidence for no-cost survey. Todd Consulting Engineers, 430 West 119th, New York 27.

### MANUFACTURING

**FOR** Inventors. Model building. Manufacturing. Research. William Parker, 32 Westminster, Worcester 5, Mass.

**MODELS**—Small lot manufacturing. Metals, plastics, etc. Milburn Burlington, Kentucky

## HOME CRAFTSMEN

**KNOCKDOWN** Cedar chests, also over fifty kits. Catalog 25¢. Giles Kendall Co., Huntsville 2, Alabama.

**FREE!** Leathercraft catalog. Hundreds of new items. Write MacPherson Bros. Leather Company, Dept. E. 730 Mission St., San Francisco 3, Calif.

**SKIL-CRAFTS**—All new '62-'63 catalog. Largest and finest selection of leathercraft, artist and hobbycraft supplies in the world. Free goods gift with first order. 25¢ for latest catalog. Skil-Crafts, Box 167-P, Joplin, Mo.

**PICTURE** Frame moulding, squares and lumber. Kiln dried walnut, cherry, silver maple. Midland Lumber Company, Box 262, Savannah, Mo.

**FREE**, New catalog. 2447 plans, patterns. World's greatest selection things to do, make. Fun. Profit. Craftplans, 1322-A Wabash, Chicago 5.

**GRANDFATHER** Clock movements, case plans, kits. Catalog 25¢. Mason-Sullivan, Noroton 7, Conn.

**FREE** "Do-it-yourself" leathercraft catalog. Tandy Leather Company, Box 791-042, Fort Worth, Texas.

**101 PATTERNS** Of smart gifts, novelties, shelves, action windmills plus "Make Money Jig Sawing." \$1.00. Mastercraft, 35M, 7041 Olcott, Chicago 31.

**BUY** Picture frame moldings at wholesale. All styles and widths. Necessary tools, too. Free deliveries in U.S.A. Write for pricelists. Chesapeake Picture Frame Company, 414-A East Baltimore St., Baltimore 2, Md.

**16 LAWN** Chairs, 22 tables, benches, trellises. Plans and necessary patterns, \$1.00. Mastercraft, 33M, 7041 Olcott, Chicago 31.

**VALUABLE** Lawn ornaments. Cast ducks, etc., from inexpensive concrete. Profitable instructions \$2.50. Write: Knight, 540 Elm St., Boulder City, Nevada.

**FREE** Necklace kit with new jewelry supply catalog. 25¢. Designs, kits, instructions. Big profits! Easy to make! Modern Craft, Box 11088-R23, Saint Petersburg 33, Florida.

**VENEERS**, 1/28" Thick. Send \$1.50 for two square feet each of cherry, mahogany, maple, oak and walnut. Catalog of wood working supplies 10¢. Barap Specialties, P.O. Box 2044, Dept. P-14, Chicago 9.

**89 JIG** Saw patterns. Beautiful shelves, ornaments, novelties, plus "How Where to Sell," \$1.00. Mastercraft, 34M, 7041 Olcott, Chicago 31.

**KLEPOXY** Weld-All Adhesive permanently fastens fixtures, curtain rods, furring strips to concrete, metal, wood, plaster without nails, screws, bolts. Repairs furniture, ceramics, metals. Seals radiators, engine blocks. Easy enough for a child to use. Half pint \$3.95 postpaid. Klee Corporation, Cincinnati 27, Ohio.

**KNOCKDOWN** Cedar chests and lumber. Catalog 25¢. Bedford Lumber Company, Dept. A-2, Shelbyville, Tennessee.

## DO IT YOURSELF

**BUILD** Your own concrete block machine, from either new or salvage materials. Easy. Inexpensive. Motor or hand operated. Then build blocks for 6 room house for \$130. Write C. Lee, Mountain View, Oklahoma.

**SOMETHING** New! Do-it-yourself hand-made wall clock. Send for hand-made blueprint \$3.00. Actual size 24" x 36". 7545 Mead St., Dearborn, Mich.

**FALLOUT** Shelter, 1000 Factor protection, class A, concrete, O.C.D.M. approved for 7 persons. Build for \$500.00. Engineers calc., material list, blueprints, complete details, \$5.00. Plans, Box 451, Stanton, Calif.

**RESILVER** Mirrors; plate. Literature catalog 25¢. Mirrocraft, 18518 Winthrop, Detroit 35.

**BUILD** Bongo drums. Complete plans \$1.25. R. Cormier, Box 297, So. Swansea, Massachusetts.

**MAKE** Hydrogen—Inflate balloons. Make your own generator. Plans \$1.00. P.P.P., 1957 S. St., Aubin, Sioux City, Iowa.

**INSTANT** Laminating: photos, cards. Self-adhesive plastic. Sample, details. Hughes Company, Middletown, Connecticut.

**SHELTERS** Bombproof, stronger our Insulcrete, your stone; Specifications M \$1.00 with plans \$5.00. "Strongcrete." Waterproofing. All purpose. Hardens 5 minutes. 1 pound mail \$1.00. National, Box 4176, Miami Beach, Florida.

**FREE** Check-list covering more than 500 classifications of projects, plans, instructions, service and repair information detailed in Popular Mechanics famous series of instructional booklets, books, patterns, and blueprints. List covers an extremely wide variety of do-it-yourself data on home remodeling, repair and improvement, hobbies, crafts, boating, games, lawn and garden, and hundreds of others. For your free copy of this helpful list, write: Service Bureau, Popular Mechanics, Room 520, 200 East Ontario, Chicago 11, Ill.

## WATCHES, OLD GOLD, JEWELRY

**HIGHEST** Cash for gold, teeth, jewelry, rings, diamonds, watches, silver, platinum. Mail articles today. Free gift with information. Chicago Gold & Precious Metals, 6 E. Monroe, Dept. 3758, Chicago 3.

**WATCH** And clock repairing books. Free catalog. North American, 2320-AQ Milwaukee, Chicago 47, Illinois.

**WATCHMAKERS'** Tools, materials, supplies, watches. Catalog. Gales, Box 1000, Chicago 90, Ill.

**FREE** Watchmaking course! Wholesale catalogue, details, 25¢. Bengal's, Culver City, California.

**CASH** Immediately for old gold, jewelry, gold teeth, watches, diamonds, silverware, spectacles, platinum, mercury. Free information. Rose Industries, Heyworth Building, Chicago 2.

**LEARN** Watch cleaning, repairing. Illustrated. Excellent earnings. Kester, Dearborn, Michigan.

**WANTED**, Gold, silver, platinum, scrap (any form). Information free. Wilmot's, 1067-PM Bridge St., Grand Rapids 4, Michigan.

**WATCHES** Swiss new! Men's 21 jewel calendar, waterproof, antimagnetic, unbreakable main spring, sweep second. Ladies 17 jewel same except calendar, with Flexomatic band—\$10.97 ea. Bands separate \$1.00. Swiss Imports, 6201 Gifford Avenue, Bell, Calif.

**DIRECT** From Swiss watch factory: Gent's watch, automatic (100% self-winding) with calendar, 21 jewels, waterproofed, shockproof, unbreakable main-spring, luxury dial, complete with strap and gift box. U.S.—\$11.00. One year written guarantee! Send money order. Immediate airmail delivery. Itraco Watch Co. Ltd., Zurich 27, Switzerland.

## RAZORS, BLADES, SHARPENING

**100 SHAVES** From every blade! Rotary action blade sharpener. Guaranteed for 10 years. \$2.00. Hammer Enterprises, Asheboro, N. C.

## FOR THE HOME

**UNIQUE** Useful items for home, everyone. Low prices. Illustrated catalog free. Tom's Products, 536 Fourth, San Diego 1, Calif.

**CESS-POOL**, Septic tank non-poisonous cleaner. Dissolves grease, solids. Guaranteed. Introductory offer 1 lb. \$1. Box 26181, Los Angeles 26, Calif.

**HEAT** Your home for almost nothing. Interesting details. Ottawaquechee Products Company, Quechee, Vermont.

## OF INTEREST TO WOMEN

**SELL** Fine fabrics. Get yours wholesale. Box 863, Norwalk, Conn.

**DRESSES** 24¢. Shoes 39¢. Men's suits \$4.95. Trousers \$1.20. Better used clothing. Free catalog. Transworld, 164-G Christopher, Brooklyn 12, N. Y.

**WOMEN!** Make big money at home. \$10.00 profit in an hour possible with invisible mending. Make holes, tears disappear from clothing, fabrics. Steady year-round demand from cleaners, laundries, homes. Details free. Fabricon, 6253 Broadway, Chicago 40, Ill.

**STOP** Throwing away boxtops! They're worth money! Some, 25¢! Inquire: "Box-tops-M." Cedar Hill, Texas.

**LEARN** Candle making, decoration. Send for free facts on world's only professional home study course. Candle, Dept. X-649 Fallbrook, California.

**PERSONALIZED** Home study. Doll Hospital School, Studio MC-32A, Los Angeles 49, Calif.

**HOUSEWIVES**, Teachers, students, office workers, if you need extra cash each week but household or other duties prevent you from taking a part-time job, learn how you can earn by accepting orders to Popular Mechanics, Good Housekeeping and all other magazines. No experience needed. Write Popular Mechanics, Room 2W, 250 West 55th St., New York 19, New York.

**LEARN** Expert cake decorating, candy making. Free details on home instruction method. Candy & Cake, Dept. D-186, Fallbrook, Calif.

**HOW** To make money typing at home! Detailed instructions \$1 (refundable). Ryco Service, 210-G Fifth Ave., New York 10, N. Y.

**"SUCCESS"** 1/2 oz. French perfume \$2.95. Harold Watkins, 6 North Duke, Topeka, Kansas.

**BABY** Plate commemorating baby's birth. Hand painted. State baby's full name, date of birth and hour born and weight. \$3.00 postage paid. Trade Winds, 246 Watchung Avenue, West Orange, New Jersey.

## PERSONAL

**BIBLE** Questions answered. Stamped envelope. Bylon, 17167 Bentler, Detroit 19, Michigan.

**LOANS** By mail, \$100-\$600. Anywhere. Confidential. Write Union Finance, Dept. PM, 323 E. Camelback, Phoenix, Arizona.

**LOANS** By Air Mail, \$100-\$600. Anywhere. Confidential. Easy payments. Write Security Finance Co., 898 Van Ness Ave., Dept. PM, San Francisco 9, Calif.

**NEW!** Borrow \$800. Anywhere. Increased loan limit. Air mail service. Postal Finance, 374 New Brotherhood Building, Dept. 17-C, Kansas City, Kansas.

**DEVELOP** Mind power, personality while asleep. Details free. Research Association, Box 24-N, Olympia, Washington.

**BORROW** \$100 To \$1,000 by mail. Quick, easy, private. No co-signers. Repay in 24 small monthly payments. For the amount you want write today to Dial Finance Co., 410 Kilpatrick Bldg., Dept. C-1, Omaha 2, Nebraska.

**MAIL** Loans. Borrow amount needed for any purpose. Repay 24 monthly payments. Confidential. World Finance Co., Dept. 22-H, 620 Symes Bldg., Denver 2, Colorado.

**MY** Personal experience with personality development explained. Satisfaction or money refunded. \$1.00. Russell, 324 Billerica, Chelmsford, Mass.

**UNUSUAL** Bargains! Booming Wichita classifieds, 50¢. Talk on phone with hands free, details. Rare books. Send stamped envelope for list and sample booklet. Avery, 112-S Elizabeth, Wichita 13, Kans.

**BECOME** Private investigator! Complete booklet \$4.50! Also bargain catalog \$1.00! Both \$5.00! Milmar, (Dept. PM-P), Box 1932, Oklahoma City 1, Oklahoma.



## REMAILING SERVICE

**HAWAII!** Receiving-forwarding \$3.00 month. Write: Fobel, 617 Kuaaina, Kailua, Hawaii.

**ALASKA** Remails \$5.00 month, 50¢ single. Reliable. Confidential. Box 2173, Fairbanks, Alaska.

**WORLDWIDE** Remailing! Confidential mail address, \$3 month. Free details. Worldwide Mail Service, Box 1736, Denver 1, Colorado.

**SECRET** Mail address. Receiving and forwarding. Free information. Henry Labrie, 380 Elgin Street, Room 7, Ottawa 4, Ont., Canada.

**MAIL** Forwarded. \$3.00 month. Rod, 96 Central Ave., Newark 2, N. J.

**FABULOUS** Florida secret address \$2.00 monthly. GLD, 1420 Preston St. S., St. Petersburg 12, Fla.

**YUKON** Territory postcards, 4 for \$1.00. Write message and return to us for remailing. Monthly forwarding service \$3.00. Other remails, 25¢. Yarter, Box 177, Watson Lake, Yukon Territory, Canada.

**SECRET** Mail receiving-forwarding system. Hedgpath, Box 830, Alhambra 23, California.

**LETTERS** Remailed 25¢. Confidential. Robert Carter, Box 742, Los Angeles 53, Calif.

**CONFIDENTIAL** New York City mailing, receiving, forwarding address. Business personal mail \$3.00 month. Remails 25¢. Details free. Birnhan, 109 West 42, New York City 36.

**SECRET** Mail address, \$3 month. Wolfe, 7604 Mack, Detroit 14, Mich.

**REMAILS**, Receiving, forwarding, \$3.00 monthly, 25¢ single, 10437 Lanark Street, Sun Valley 3, California.

**HAWAII** Secret address. Receiving, forwarding, 25¢ or monthly rates. Coe, Box 984, Kailua, Hawaii.

**REMAIL** 25¢. Vetra Hayslett, 4148 Royer Drive, Toledo 16, Ohio.

**CONFIDENTIAL** Receiving, forwarding system, \$3.00 monthly. Free details. H. V. Zinck, Box 934, Lunenburg, Nova Scotia, Canada.

**SECRET** Address. Write: De Graff, Box 14156M, Professionals, Fabulous, San Diego, California.

**REMAILING**—25¢. Seattle. "World's Fair City." Walteo, 1049 7th, Edmonds, Washington.

**REMAILS** 25¢. Monthly \$3.00. Pollock, Box 352, Bayamon, Puerto Rico.

**NEW** Orleans remails 25¢. Monthly rates. Free information. Box 23049, Louisiana.

**REMAILING** And information service. Reasonable. Arcane Service Agency, P.O. Box 3922, Milwaukee 5, Wis.

**CHICAGO** Confidential forwarding service, 25¢ per letter, \$3.00 monthly. Fore-mail, Box 5209, Chicago 80.

**WICHITA**, Kansas. Remails 25¢, \$3.00 month. Franklin, 1423 W. 34th South, Wichita 17, Kansas.

**SAN FRANCISCO** Remails 25¢, \$3.00 monthly. Arnold, 155 Oak Street, San Francisco 2.

## TREASURE FINDERS

**METAL** Locator kits and assembled models from \$39.90. Terms. Transistorized and underwater models available. Free catalog. Electronic Applications, Dept. M, Box 8, Arlington 10, Virginia.

**GOLD**, Silver, coins, Civil War relics, treasures. Choice 5 locators. Established 1933. Free literature. Write The Goldak Company, 1541 W. Glenoaks Blvd., Glendale 1, California.

**TREASURE**, Gold, silver, relics. Find them with new Detectron instruments. Free information. Raytech, Box 715, North Hollywood, California.

**FUN** & profit finding buried treasure, relics with transistor m-scope. Booklet, interesting customer comments free. Terms. Fisher Research, Dept. AX, Palo Alto, Calif.

**JUST Released!** Lost and buried treasure map of great southwest. Ideal for framing, \$1.00 postpaid. Tomac Research, Ltd. 3268-PM Rosecrans, San Diego 10, Calif.

## WANTED—MISCELLANEOUS

**CASH** For used tennis, golf balls. Write American Company, Merrick 7, N. Y.

**CENTS**, Nickels, dimes, buying list 25¢. Snyder, Middlesboro, Kentucky.

**STAMP** Collections, accumulations. Eagle Stamp Co., 2221 Romine, Pittsburgh 26, Penna.

**QUICKSILVER**, Platinum, silver, gold. Ores analyzed. Wholesale Terminal, Norwood, Mass.

## FOR SALE—MISCELLANEOUS

**WAR** Surplus bargains! New government releases arrive constantly. Save up to 80%. Blankets, boots, cots, tents, wearing apparel, etc. Send for free war surplus catalog. Sioux Falls Surplus Store, Sioux Falls, South Dakota.

**HEARING** Aid batteries wholesale. Free list. Habs, Box 51, York, Penna.

**CANNIBALISTIC** Plant! Venus's fly-trap. Catches, devours insects. One bulb, \$1.00. Three, \$2.00. Plants, Box 4708, Washington 20, D. C.

## MISCELLANEOUS

**ARTIFICIAL** Eyes (human). Expert selection sent. Established 1906. Write for free booklet. Denver Optic, 1101 University Bldg., Denver 2, Colorado.

**QUICK**—John for septic troubles, outdoor toilets. New exclusive enzyme-bacterial formula digests solids, grease, paper, etc. Ends backups, odors, pumping, digging. Harmless to plumbing. Six treatments in handy flush packets, \$2.50 postpaid; 12, \$4.50. Money back guarantee! Ryter Co., Madelia 4, Minn.

**AMAZING** Bargains! Tremendously useful family items. Catalogue free. Kelly, 2110 Brown, Flint 3, Michigan.

**SAVE 350%** On silver earrings. Sakalas, Box 1004, Waterbury 20, Connecticut.

**RECEIVE**—Amazing offers, some free. From dealers everywhere. Get listed 25¢. Rorick's, 26086P, Cincinnati 26, Ohio.

**RANCH** Style shoe scraper. With replaceable brushes. Price \$3.00 postpaid. A wife saver. Grosvenor Co., Box 357, Hayfield, Minn.

**HEARING** Aids, only \$29.95 up. Free trial. Terms. Write CaryB Hearing Aids, Inverness, Fla. Agents inquire.

**HARD** To find items. National Buyers, 9325-L Menard, Oaklawn, Illinois.

**EARN** Money raising fishworms for us! Write: Oakhaven—60, Cedar Hill, Texas.

**5" HEEL** Shoes. Illustrated catalog, \$1.00. Monique, Box 85151-R, Hollywood 27, Calif.

**"MEMORY-Lock."** (Dr. Young.) For self-advancement. Clarion, Box 9309-S7, Chicago 90.

**BOOKS** On antiques and their prices. Free circular! P. Warman Publishers, Uniontown, Penna.

**CIGARETTES**—Make 20 plain or filter tip for 9¢. Facts free. Moberly, Box 785, Owensboro, Kentucky.

**SUPER** Memory overnight! Success guaranteed! Bijou, Box 1727-M, Hollywood 28, California.

**WANT** Your name with 1000 mailers? 25¢ lists your name year with our mailings every month. Dixie Mailers, King, N. C.

**100,000 PRODUCTS** Wholesale—Free catalog! Send postcard: Econ-O-Mart, Whippany 15, New Jersey.

**SEND** Us wool for blankets. Write Eldorado Woolens, Eldorado, Texas.

**STAMMER**, Stutter, no more. (Dr. Young.) Write: Gaucho, Box 9309-S7, Chicago 90.

**YOUR** Name written; raised letters. Details free. Stephen Sidella, Pottsville, Penna.

**PERSONALIZED** Pencils your name stamped in gold on 20 high grade pencils \$1.00 postpaid. Matthews, P.O. Box 131, Niles 48, Illinois.

**RECEIVE** Worldwide mails. Details free. Bagby, Box 144-E, Coos Bay, Oregon.

**SEPTIC** Tanks, cesspools, root clogged drains restored to newness by powerful crystal chemicals. Pumping and rodding unnecessary. Details. Testimonials. Chemical Cesspool Cleaning Co., Allston 34, Mass.

**PLAYER** Piano rolls, supplies, parts, books, service. Literature dime. Rodgers, 16381 Shelby, Cleveland 30, Ohio.

**HAND-MADE**. Genuine soft leather bill-folds, secret flap; western designs; semi-nude women, flowers, dogs, horses. Lord's prayer, \$12.00 doz. Southeastern Leather Co., 411 W. Walnut St., Goldsboro, N. C.

**BECOME** Private investigator! Complete booklet \$4.50! Also bargain catalog \$1.00! Both \$5.00! Milmar, (Dept. PM-M), Box 1932, Oklahoma City 1, Oklahoma.



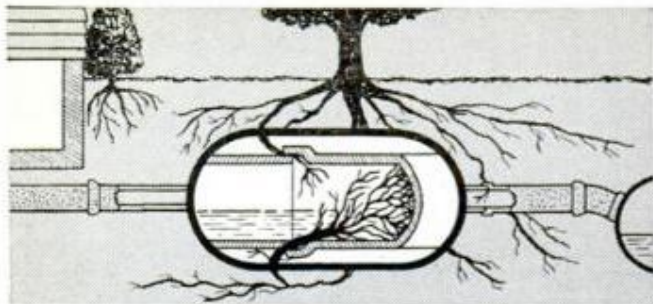

## END SEWER-LINE ROOT MESS, SAVE ON COSTLY REPAIRS!

**Roots are just naturally thirsty.** They force their way through joints in your sewer line, eventually clog it. Toilets and sinks "back up", soon overflow. Now you can avoid costly digging or mechanical cleaning this easy, permanent way.



Pour one box of revolutionary Hercules R-D into toilet bowl. R-D kills and decomposes roots permanently, often overnight. To keep sewer lines root free, apply R-D twice a year. Safe to handle. Safe in septic tanks. Don't wait for trouble. Get R-D now from your plumbing or hardware dealer. It works, or your money back. Only \$3.95 for 2 lb. box. Send for literature.



**HERCULES CHEMICAL CO., INC.**  
416 Broadway, New York 13, N.Y.

make it with 60c worth of sand & cement!

# SELL IT FOR \$2000

every home a prospect for these "LIFETIME"

## CONCRETE INCINERATORS

Make big profits manufacturing rust proof, fire proof, almost indestructible concrete incinerators in your own backyard or garage... full or part time. Sell to home-owners, hardware, department and garden supply stores. Phila. manufacturer doing big volume with Sears, Roebuck; large department stores. Easy to follow instructions and all needed equipment supplied. Exclusive protected franchise—No competition! Territories going fast. Write immediately for full details.



T. C. TOR, Dept. PM-32  
318 Roncocus Ave., Delanco, N.J.

Gentlemen:

Rush full information about your concrete incinerator protected franchise offer.

Name \_\_\_\_\_

Street No. or R.D. \_\_\_\_\_

City \_\_\_\_\_

Zone \_\_\_\_\_

State \_\_\_\_\_

## Science bulletins

**How big is a raindrop?** How many fall a minute?

To answer these questions the Army, aided by New York University, has built a sizer and counter that sorts drops into 13 sizes ranging from  $\frac{1}{100}$  of an inch to more than  $\frac{1}{8}$  inch in diameter and counts drops of each size at the rate of 10,000 a minute, even in a heavy rainfall.

The device does its work electronically as the drops fall through an intense beam of light. Among those who need specs of the drops, says the Army, are weathermen researching how rain is formed, and missile makers who wonder what effects rain has on performance of their products.



**Helium**, a relatively rare gas on Earth, is somewhat less than rare 600 miles above Earth's surface. A shell of helium nearly 1000 miles thick stretches up from that height. That such a shell exists has long been theorized. Information radioed back from the Explorer VII satellite has confirmed the fact, says Dr. Robert Jastrow of the National Aeronautics and Space Administration.



**Motions of stars and planets** no longer will be the yardsticks by which we measure time.

During the next ten years we will grow to rely on the measurement of the vibrations of an atom, possibly an atom of cesium, according to Dr. John M. Richardson of the National Bureau of Standards.

The reason for the change, which will be proposed at a world-wide scientific conference in 1966, is that instruments of modern science can measure the vibration of an atom more accurately than they can measure motion of stars and planets.

Modern technology, says Richardson, demands accurate time: When a satellite, for example, is orbiting, an error of a fraction of a second between tracking stations creates an error in the satellite's position.

*James Biery*

POPULAR MECHANICS

Not everyone does as well, but T. N. CODY, who started a business of his own, reports...

For 12 months I've averaged

**\$800 PER MONTH INCOME**

—most of it clear profit for me!

Many men have discovered how to be independent, to be free of layoffs and bosses. C. G. Naples grossed more than \$200 his first week. A father-son combination grossed \$44,000 their second year. H. Lemon says, "I netted \$133 in one 8-hour day."

How much you make depends largely on you. You need no special skill, no large investment. Start part time if you wish.

**NO SHOP NECESSARY** • Our Electric Deterger shampoos rugs, carpets right on floor—removes dirt and grime and helps to show their natural color and beauty. So efficient and safe it is used by largest railroads and hotels.

► **This is not a lease proposition. You own the machine, you work when and where you please and all the money you take in is your own. You take no risk. Machines fully guaranteed.**



**MAIL COUPON TODAY FOR FREE BOOK**

VON SCHRADER MFG. CO.  
310 "R" Pl., Racine, Wisconsin

Without obligation send me **FREE** booklet about your RUG DETERGER and tell me how I can start my own permanent, profitable business.

Name \_\_\_\_\_

Address \_\_\_\_\_

City \_\_\_\_\_ Zone \_\_\_\_\_ State \_\_\_\_\_

**500 TRICKS** **MAGIC TRICKS**  
**IT'S FUN To Do MAGIC**

Be popular! Amaze—mystify—entertain! For 40 years Douglas has satisfied customers all over the world. Now, you can enjoy this fascinating hobby. Only 10c brings our New 1962 Catalog 500 Tricks, containing brand new tricks for pocket, parlor, stage. Join in the fun—send 10c today!

**DOUGLAS MAGICLAND**  
Dept. M-7, Box 274, Dallas 21, Texas

**KILLS USING NO CHEMICALS GASES, ETC.**

- MOSQUITOES • MOTHS, MILLERS
- FLIES, GNATS • FISH FLIES, ETC.

OVER 1/4 ACRE HANGS ANYWHERE

No insect recovery. Guaranteed. Beautiful outdoor lighting. Plug into any 110 volt socket.

**NO AREA CONTAMINATION**  
Safe, beautiful. Complete with fly attractor, dead insect catcher, cord. Directions, etc. Low cost.

**SING BUG CHAIR, INC.**  
Box P8708, Oak Park 37, Mich.

WEIGHT 12 LBS.  
BOX SIZE 15X15X18

**SEW LEATHER AND TOUGH MATERIALS EASILY**  
**COMPLETE, EASY-TO-USE, HEAVY DUTY STITCHER KIT IN ONE COMPACT TOOL**

Not sold in stores

**\$1.98**  
Postpaid

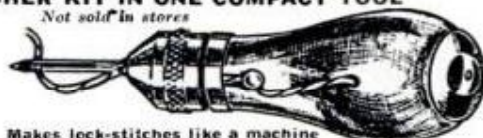

Makes lock-stitches like a machine

**SAVE MONEY** with **HEAVY-DUTY STITCHER**. It's easy to sew or repair anything made of leather, canvas, nylon, plastic, or other heavy materials. Quick "push-pull" action makes firm, even lock-stitches like a machine. Gets into hard-to-get-at places. Just the tool needed for repairing luggage, footwear, convertible tops, awnings, seat covers, sportsgear, rugs, saddlery, etc. Comes complete with 3 different needles (fine, heavy, curved) and bobbin of strong waxed thread (10 yds) all self-contained in **HEAVY-DUTY STITCHER**. Easy-to-follow directions included. Extra needles and thread always available. Send \$1.98 money order or check, and we pay postage. If C.O.D. \$1.98 plus postal charges. Money back Guarantee.

Sportsman's Post, 366 Madison Ave., Dept. A-85, New York 17

**Dazzling new!**



**BSA SUPER ROCKET**

New outstanding power and acceleration matched with new improved brakes. Truly one of the most beautiful motorcycles ever made—now with brilliant metallic red tank, chrome tank panels, chrome fenders, and dozens of other highly chromed parts to dazzle its way into your heart.

**BSA MOTORCYCLES**

The most popular motorcycle in the world

Write to the nearest address for a colorfully illustrated free catalog of the new 1962 models.

Catalog offer limited to U. S. residents only.

West:

**HAP ALZINA**  
Dept. P62  
3074 Broadway  
Oakland, California

East:

**BSA INCORPORATED**  
Dept. P62  
639 Passaic Ave.  
Nutley, New Jersey



Excitement! Security! Good Pay!

# CRIME DETECTION

LEARN AT HOME IN SPARE TIME—START NOW!

Crime everywhere is on the rise! Learn now, in your own home, the profitable profession that enables you to track down criminals and bring them to justice! Hundreds of Identification Bureaus employ I. A. S. graduates . . . trained in finger printing, police photography, handwriting identification, firearms and investigation. Our 44th year! FREE "Blue Book of Crime" . . . packed with crime facts and the full story of famous I. A. S. training. State exact age. No salesman will call. Rush Coupon! A Correspondence School Founded in 1916.

**FREE**  
Blue Book of Crime  
MAIL COUPON

INSTITUTE OF APPLIED SCIENCE, Dept. 1353  
1920 Sunnyside Avenue, Chicago 40, Ill.

Rush Blue Book of Crime . . . FREE!

NAME \_\_\_\_\_ Age \_\_\_\_\_  
ADDRESS \_\_\_\_\_  
TOWN \_\_\_\_\_ STATE \_\_\_\_\_



# PLAY GUITAR IN 7 DAYS

Or Your Money Back Guaranteed

**SURPRISE FRIENDS, RELATIVES. ENJOY POPULARITY AND FUN GALORE!**

In this introductory offer you get TOP RADIO GUITARIST ED SALE'S famous 66 page secret system worth \$3.00 which positively teaches you to play a beautiful song the first day and any song by ear or note in seven days! Contains 52 photos, 87 finger placing charts, etc. Shows how to tune, keep time, build chords, bass runs, dance chords, swing, etc., plus 110 popular and western songs, words and music; a \$1.00 Chord Finder of all the chords used in popular music; a \$3.00 Guitarist Book of Knowledge—**TOTAL VALUE \$7.00—ALL THREE for only \$2.98. SEND NO MONEY!** Just your name and address, pay postman \$2.98 plus C.O.D. postage. (Or send \$3.00 with order and I pay postage.) Same Money-back Guarantee. ED SALE, Studio 153-F, AVON BY THE SEA, N. J.



# BARBELLS

100 POUND SET  
\$12.80

Extra Plates Only 12c Pound

140-Pound, CHROME DELUXE Barbell-Dumbbell set only \$19.80. This is our feature set and is the finest ever manufactured.

Training with adjustable weight is the BEST way to keep fit; the ONLY way to develop great strength and a perfect body. As the oldest and best equipped barbell company, BUR gives value and prices no one can equal.

SEND FOR FREE CATALOG

**BUR BARBELL CO.**  
Lyndhurst 9, New Jersey

# 1 1/4 ACRE Including Easements FLORIDA COUNTRY ESTATES

FLORIDA HIGHLANDS

ONLY \$895

Complete Price

\$10 DOWN MONTHLY

30 Day Money-Back Guarantee

FREE: Warranty Deed Title Insurance

In the very heart of Florida's beautiful "Blue Grass" area, 16 miles from Ocala. Graded roads are in ready to be maintained by purchaser. YOU CAN DRIVE TO YOUR PROPERTY NOW. Each estate can be divided into 4 homesites, each 75' x 135'. Buy for future retirement, vacations, or as an unsurpassed investment in "Space-Age" Florida.

**HIGH, DRY, BEAUTIFUL LAND AT LESS THAN THE PRICE OF A HOMESITE ALONE**

Florida Realty Center, Inc., Broker Dept. E2-3

520 N. E. 79th St., Miami 38, Florida

Please send full information without obligation.

Name \_\_\_\_\_

Address \_\_\_\_\_

City \_\_\_\_\_ Zone \_\_\_\_\_ State \_\_\_\_\_

AD 61094

# A BIG BUSINESS OF YOUR OWN!

THIS BULB OUTLASTS 10 TO 13 ORDINARY BULBS

EARN \$100, \$250, \$500 SPARE TIME—MORE FULL TIME

Work when you want—you're the boss! Supply homes, stores, offices, factories with Sunmaster's guaranteed 5-year light bulbs—outlasts 10 to 13 ordinary bulbs—saves your customer at least \$2.00 per bulb on replacement costs. That's why sales come easy—profits come fast—up to 108% on each sale! Write today for FREE Sales Outfit and 30-Day No-Risk Offer.

IT'S GUARANTEED FOR 5 YEARS

Sunmaster Electric Products Dept. PM32

366 Fifth Ave., New York 1, N. Y.

Send FREE Sales Kit and No-Risk Profit Plan.

Name \_\_\_\_\_

Address \_\_\_\_\_

City \_\_\_\_\_ Zone \_\_\_\_\_ State \_\_\_\_\_

(In Canada, 539 King St. W., Toronto, Ont.)

Regular Price of a Slide Rule \$4 and Up

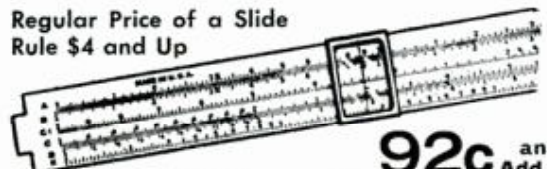

If you can use a pencil, you can use this Slide Rule

92c and this Ad Add 8c Postage

**SLIDE RULE with FREE 28-Page Inst. Book**

For students, accountants, mechanics, hobbyists, salesmen, everybody. Simplifies mathematics for everybody. Easy to calculate instantly, accurately. Multiplying, proportions, division, roots, etc. "High Vision" Clear View Slide. Full 10" Rule, A, B, C, D, C1 and K Scales. LARCH, 118 East 28th Street, Dept. 62-B, New York 16, N. Y.



HOW TO BREAK and TRAIN HORSES

SEND FOR THIS **FREE!**

Make money. Know how to break and train horses or ponies. Write today for this book FREE, together with special offer of a course in Animal Breeding. If you are interested in Galting and Riding the saddle horse, check here ( ). Do it today—now.

**BEERY SCHOOL OF HORSEMANSHIP**  
Dept. 1103-D Pleasant Hill, Ohio

**EARN GOOD MONEY IN SPARE OR FULL TIME.**

Up to \$30 a day With a Universal Grinder

Have a business of your own in your garage or basement, sharpening lawn mowers. Be your own boss. Small investment. We furnish everything you need to start. Write FREE Dept. M-32 today for complete details

**ROGERS MANUFACTURING CO.**  
LINDSEY, OHIO



# FALSE TEETH

That Loosen Need Not Embarrass

Many wearers of false teeth have suffered real embarrassment because their plate dropped, slipped or wobbled at just the wrong time. Do not live in fear of this happening to you. Just sprinkle a little FASTEETH, the alkaline (non-acid) powder, on your plates. Holds false teeth more firmly, so they feel more comfortable. Does not sour. Checks "plate odor" (denture breath). Get FASTEETH at drug counters everywhere.

POPULAR MECHANICS



## Typewriter Has No Carriage

Type bars and carriage of the conventional typewriter have been replaced in a new machine by a printing head that moves across the paper as it prints.

The printing head, in the shape of a truncated sphere, bears 88 characters. It is mounted on a head-and-rocker assembly, which, in turn, is mounted on a small carrier. As the carrier moves, the head tilts and rotates at high speed to bring the proper character into position for printing.

The Selectric typewriter is a product of International Business Machines Corp.



SEND FOR  
YOUR

# ALLIED

## MONEY-SAVING 1962 ELECTRONICS CATALOG

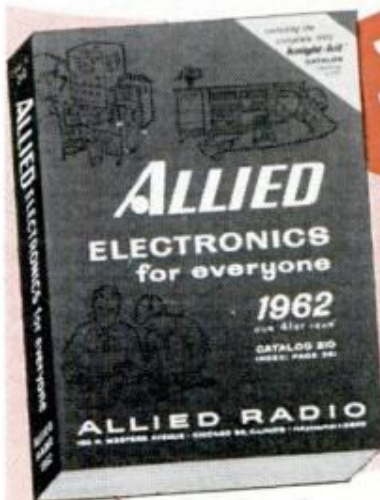

Free

**444 PAGES**  
World's Biggest  
Most Complete!

**NO MONEY DOWN**  
New Credit Plan  
Gives You 50% More  
Buying Power!

### SAVE MOST ON EVERYTHING IN ELECTRONICS

world's largest selection of famous name brands

Send today for this FREE Catalog—the world's biggest, featuring *everything* in Electronics for modern living. Largest selection of all famous name brands, including products and values available only from ALLIED. Whether you're a kit builder, experimenter, hi-fi fan, Amateur, technician or student, you'll save most on:

- KNIGHT-KITS®—Best in Build-Your-Own
- Everything in Stereo Hi-Fidelity
- New Multiplex Stereo FM
- New All-Transistor Stereo Hi-Fi
- KNIGHT® Super-Value Stereo Hi-Fi
- Tape Recorders & Phono Equipment
- Citizens Band 2-Way Radios
- TV Tubes, Antennas, Accessories
- Parts, Tubes, Transistors, Tools, Books
- Amateur Station Equipment
- Public Address & Intercom
- Latest Test & Lab Instruments



**SAVE MOST** on everything in Electronics at ALLIED—the world's largest electronic supply house. Get fastest service, expert personal help, easiest-pay terms. Send coupon today for FREE 1962 ALLIED Catalog.

**Satisfaction Guaranteed  
or Your Money Back**

Free  
CATALOG

## ALLIED RADIO

ALLIED RADIO, Dept. 5-C2  
100 N. Western Ave., Chicago 80, Ill.

Rush FREE 1962 ALLIED Catalog.

Name \_\_\_\_\_  
PLEASE PRINT

Address \_\_\_\_\_

City \_\_\_\_\_ Zone \_\_\_\_\_ State \_\_\_\_\_



**EARN \$5  
PER HOUR**

*in  
your own*

## LAWN MOWER SHARPENING SERVICE

Earn extra money right from the start—average \$5.00 per hour. Full or spare time opportunity. The Modern Lawn Mower Sharpener is a complete shop in one machine. You don't need experience to start—anyone can operate it, and turn out perfect jobs. All operations are done quickly, easily and accurately. Write for full money making details.

### FOLEY MANUFACTURING COMPANY

393-2 Foley Bldg., Minneapolis 18, Minn.

Send information on Modern Lawn Mower Sharpener.

Name \_\_\_\_\_

Address \_\_\_\_\_



**"I'm Looking For  
People Who Like to Use  
Their Off-Time  
Constructively"**

Let me show you how you can turn your "off hours" into cash profits by getting started in a fascinating and profitable activity . . . Modern Leatherwork!

I'm looking for people who want "to make" a successful living. If you like to work with your hands, then you have the first requisite for starting in Modern Leatherwork.

Imagine the fun of having a hobby that pays for itself! You can put the experience you gain through this hobby to work — making extra profits for you right in your own home — while you learn!

ANYBODY can get started in Leatherwork! I would personally testify that you could never find a more rewarding, satisfying experience than Leatherwork!

**FREE**

*Dave Tandy*

blueprints \$1.00

**INSTRUCTIONS**

How to Lace and Carve Leather.  
How to make Tables, TV Benches,  
Leather Garments, plus 23 others.

**LEATHER**

**SPECIAL OFFER**

To Readers of POPULAR MECHANICS:  
Let us send you a FREE copy of our amazing new book, BLUEPRINTS TO LEATHER, with instructions, patterns for making 29 items for home or resale. A \$1.00 VALUE. Write today for your free copy, plus Tandy's new 112 page Catalog.

**TANDY LEATHER COMPANY (Since 1919)**  
P. O. Box 791- ME, Fort Worth 1, Texas



**Assure FRESH AIR for Your  
FAMILY FALLOUT SHELTER**

This rugged Behlen unit gives dependable fresh air ventilation. Even a child can operate to provide ample air. Lifetime lubricated motor never needs attention. Standard equipment in all Behlen atom-bomb-tested Shelters.

**WRITE TODAY** for low price. Also get **FREE** literature on Bendix Radiation Detector Kit. Behlen Mfg. Co., Shelter Division, Columbus, Nebraska.

**ELECTRIC  
OR  
HAND  
POWER**

Meets  
Civil  
Defense  
Requirements

**BEHLEN VENTILATOR  
UNIT**

## BRONZE FOUNDRY

Since 1935

Schools • Home Workshops • Inventors

Make your own castings of aluminum, copper, bronze, silver. Foundry sets are available in six sizes, capacity 1 1/2 lb. to 48 lb. of red brass. 2400 Deg. F. blast furnace included with each. Write for Free Circular.

**KANSAS CITY SPECIALTIES CO. DEPT. P-3  
MARYSVILLE, KAN.**

**"POP"  
MECHANICS** SAYS:

"A man who has an hour to kill usually spends it with one who hasn't."

**FREE GUIDE** Reveals 200 Ways to Make Extra Money

YOU can turn your spare hours into cash (\$25 to \$100 a week) by selling products and services to friends and others. Famous *Salesman's Opportunity Magazine* shows you how. Contains hints, plans, hundreds of offers. No matter what your age, experience or occupation—write TODAY for next 5 issues—absolutely FREE. Send no money just name. OPPORTUNITY, 850 N. Dearborn, Dept. 449, Chicago 10, Ill.

**Now ... Blessed Relief From**

# ARTHRITIS

**Without Drugs or Surgery**

If you act promptly, an amazing illustrated new FREE book that may change your whole life will be rushed to you by return mail.

Send for it today—and discover why drugs give you only temporary relief. How to eliminate the cause of your aches and pains, without drugs and without surgery, a proven non-medical way. How to avoid years of needless agony and deformities that may cripple you for the rest of your life.

You owe it to yourself to send for this valuable FREE book without delay. No obligation. No agent will call. Write: The Ball Clinic, Dept. 756, Excelsior Springs, Missouri. A postcard will do.

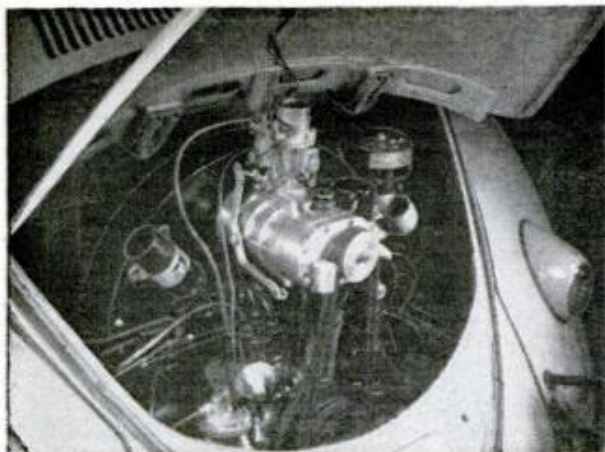

## Supercharger for VW

Want your "beetle" to go like a "bomb"? This supercharger is the real thing, designed especially for Volkswagens by the Crofton Co. of San Diego, Calif.

Blower is of the Rootes-type, with three lobes and two rotors that whip up a pressure boost of five to 8 pounds. Horsepower is increased 30-50 percent and acceleration is 40 percent greater. Maximum speed is higher and engine flexibility is improved. All this occurs, the maker claims, at no sacrifice in fuel economy.

Installed without special tools, the price is \$189.50, F.O.B. San Diego.

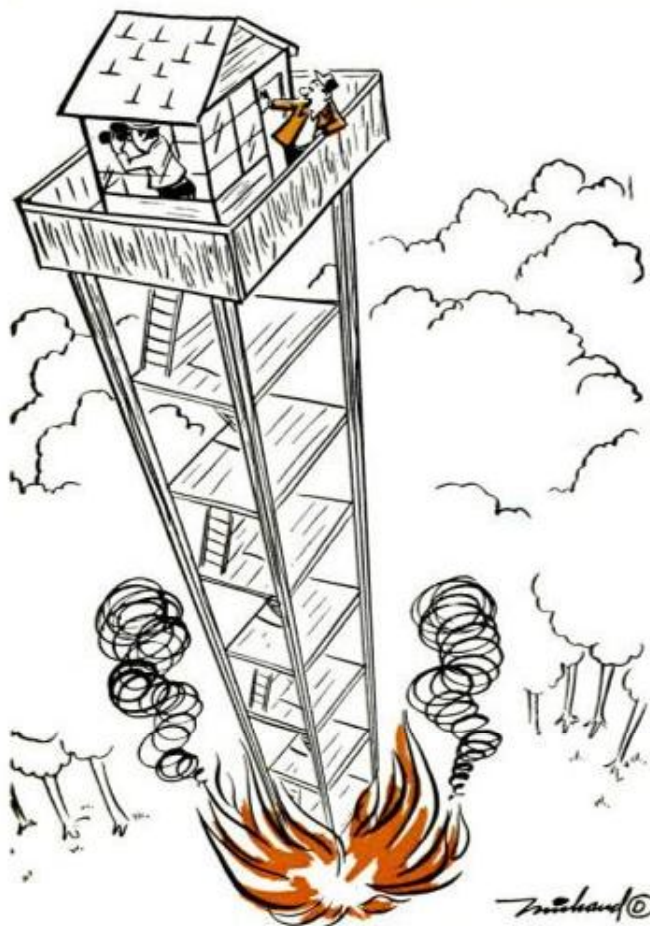

"Hey, Charlie . . ."

MARCH 1962

# Save 1/2 on New ACCORDIONS



Save up to 1/2 Off Prices of Comparable Accordions  
**IMPORTER-TO-YOU PRICES!**  
**5 DAY FREE TRIAL**

**Buy on EASY TERMS!**

Small Down Payment!  
Low as \$9.90 Monthly

**All Famous Makes!**

Get in on these sensational values in world's finest Italian-made accordions! Play most popular instrument of all—**for fun, leadership and profit!** 40 newest models of glorious tone and breathtaking beauty offered at the amazing low prices. Buy

direct from world's largest accordion dealer. Small down payment; easiest terms on balance. Extra bonus gifts **FREE** if you buy during sale. Trade-ins accepted. Try before you buy on **FREE 5-day No-Risk Plan**. Satisfaction guaranteed—Money back guarantee!

**RUSH COUPON TODAY!**

See how easily you can now own and play a fine accordion. Rush coupon now for big new **COLOR Catalogs** and Low Importer to You Prices...**ALL FREE!** No obligation. Write to:

**ACCORDION CORPORATION OF AMERICA, Dept. R-32, 2003 W. Chicago Ave., Chicago 22, Ill.**

**FREE BONUS GIFTS**

- for promptness
- E-Z Lessons
- Music Stand
- DeLuxe Case
- other gifts, too!

**MONEY BACK GUARANTEE**

**FREE COLOR CATALOGS**  
and lowest prices

Send **FREE** Color Catalogs and low importer to you prices.

**ACCORDION CORPORATION OF AMERICA, Dept. R-32, 2003 W. Chicago Ave., Chicago 22, Ill.**

NAME.....

ADDRESS.....

CITY..... ZONE..... STATE.....

Check here if you have accordion.

# SAVE ON YOUR INCOME TAXES

Accurate records are a must for you to make correct income-tax returns. A sure way to gain accuracy is with a Smith-Corona Electric Adding Machine. It adds, subtracts, multiplies instantly, electrically. Saves time, money and nerves. Price? As low as \$129.50, including full excise tax! See your Smith-Corona dealer.

**Special Offer!** Buy now, and get the SCM "Business Money Manager" at a special reduced price. Gives a clear, day-to-day picture of your business or household expenses. Limited offer. For more information about SCM Electric Adding Machines, see your dealer or write Smith-Corona Marchant Inc., 410 Park Avenue, New York 22, New York.



## PM SHOTS THE .460 MAGNUM

SHOOTING THE .460 Weatherby Magnum is an exciting experience. Despite its enormous power, PM's tester fired 15 rounds without damage, other than a bruised bicep from a shot fired without a secure shoulder fit with the stock. A poorly-stocked .30-06 can "kick" harder, and the .460-WM's recoil is certainly less than a lightweight 12-gauge single-shot shotgun can produce.

The secret of its comfortable shooting is partly the excellent design of the California-style mesquite stock, and partly the built-in muzzle brake provided by a pattern of drill holes in the last three inches of the barrel. They direct the gases to each side, and push the rifle against its own recoil. As a result, the recoil is minimized. The muzzle rises somewhat, as shown above, but there is no feeling of lack of control.

The .460 gives good accuracy; the best five-shot group at 100 yards measured  $\frac{7}{8}$  by  $1\frac{1}{4}$  inch. Off-hand snap-shooting produced results comparable to any good field firearm.

Looking for an impressive penetration test, we filled a five-gallon metal can with water and fired into it from about 100 feet away. The container was rent from end to end, the 60-gallon drum on which it sat was thrown to the ground, and water drizzled down on shooter, photographer and bystanders for several seconds. The test proved nothing measurable, but it was impressive.

The .460WM rifle may be the answer to the old controversy of bullet weight versus bullet velocity for killing power on really big game. The .460WM throws a 500-grain solid bullet at a muzzle velocity of 2725 feet per second for a muzzle energy of 8245 foot/pounds. That's well above the energy of the former champ, the .600 Nitro Express (900 gr at 1950 fps for 7600 ft./lb.). The high velocity gives the big bullet a trajectory just two inches high at 100 yards when zeroed in

for 200 yards; nearly identical to the .30-06 with a 180-grain bullet. And the '06 is considered a very flat-shooting rifle.

The designer's objectives were to put that tremendous power into a comfortable-shootable, bolt-action rifle (most of the big guns are double rifles) that would kill anything that walks. It will.

In conclusion, PM's tester reports that the .460WM is ideally suited to its job of killing elephants, rhino and Cape Buffalo with minimum damage to the shooter. The price is a hefty \$525, and ammunition runs about 87½ cents a shot. But for the moment of truth with big, dangerous game, it'll do the job. ★★★

FOR COMPARISON, left to right, the 30-30, .460 Weatherby Magnum, and a .30-06 round





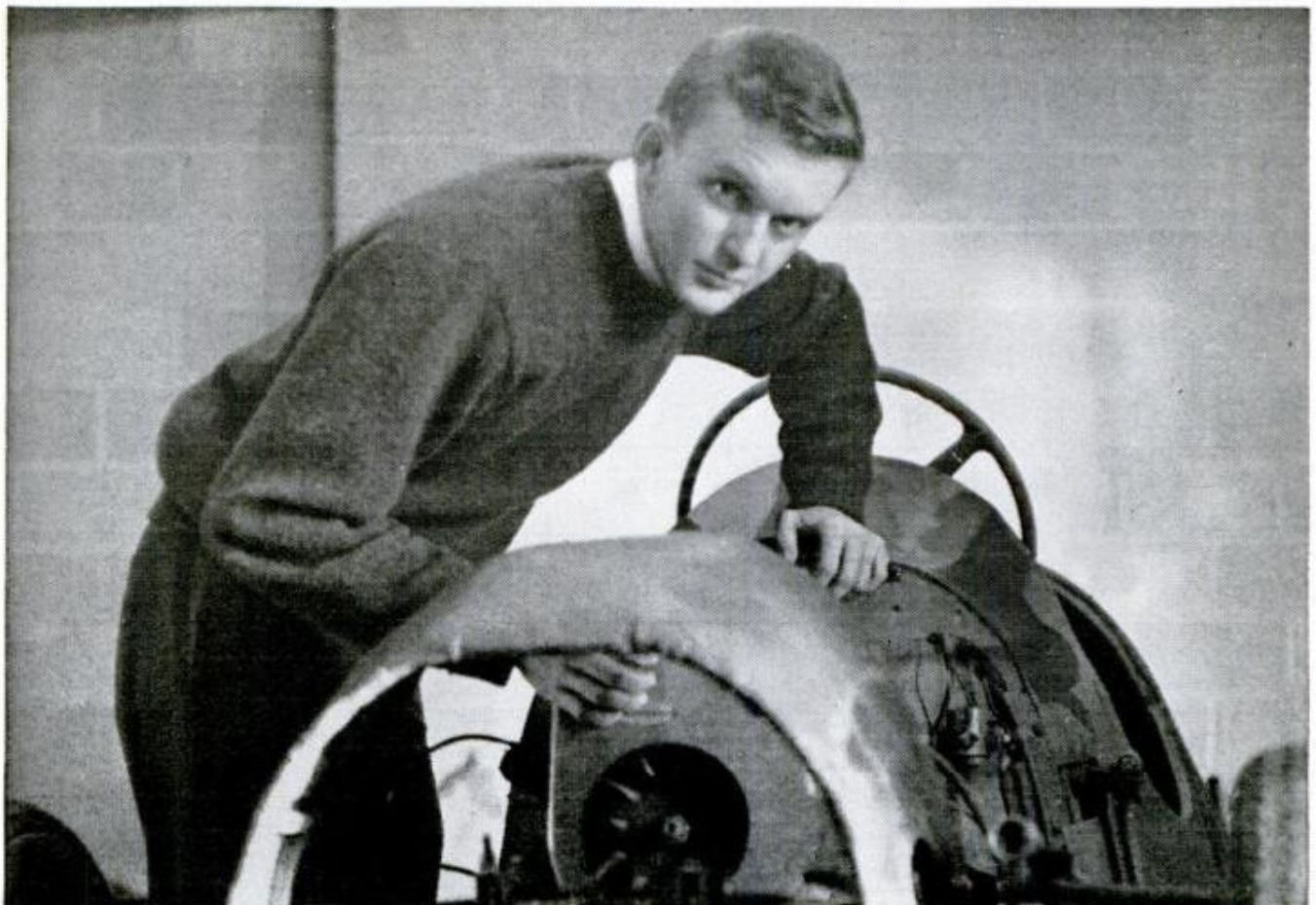

18-year-old Ronald Satterfield of Atlanta, Georgia, asked...

## “Where should I build for the future?”

Ronald Satterfield answered this question last year by joining the Air Force. This year about 100,000 young men will also choose this highroad to the future.

Many will become expert technicians in such fields as airplane and missile maintenance, radar, communications. The future will find others in supervisory positions in important support specialties: administration, supply, air police work.

Numerous personal benefits go with service in the Air Force. Steady advancement, the opportunity for more education, medical and dental care, thirty days' vacation yearly. Most important, the Air Force can help a young man prepare himself for the age in which he will have to make his way—the Aerospace Age.

*Could this be the place for you to build for the future? Use the coupon below. There's no obligation.*

## U.S. Air Force

Airman 2C Satterfield whose civilian hobby was building “hot rods,” is presently enrolled in a 45-week electronic computer course at Keesler Air Force Base in Mississippi.



### Career Information

Dept. MM23, Box 7608  
Washington 4, D. C.

*I am over 17 and a citizen (or resident) of the U.S.A.  
Please send me your illustrated booklet.*

Name \_\_\_\_\_ Age \_\_\_\_\_  
Address \_\_\_\_\_  
City \_\_\_\_\_ County \_\_\_\_\_ State \_\_\_\_\_

## SPECIFIED SERVICE INTERVALS FOR AMERICA'S LEADING CARS

MAKE	GALAXIE AND FAIRLANE	CAR "A"	CAR "B"	CAR "C"	CAR "D"	CAR "E"	CAR "F"	CAR "G"	CAR "H"
1,000 MILES		X	X	X				X	X
2,000 MILES		X	X	X				X	X
3,000 MILES		X	X	X				X	X
4,000 MILES		X	X	X	X	X	X	X	X
5,000 MILES		X	X	X				X	X
6,000 MILES	*	X	X	X				X	X
7,000 MILES		X	X	X				X	X
8,000 MILES		X	X	X	X	X	X	X	X
9,000 MILES		X	X	X				X	X
10,000 MILES		X	X	X				X	X
11,000 MILES		X	X	X				X	X
12,000 MILES	*	X	X	X	X	X	X	X	X

\*Note: Only Ford-made cars have all maintenance scheduled at 6000 mile intervals, twice-a-year for the average motorist.



GALAXIE/500



FAIRLANE 500

Look how  
close Ford  
has come  
to the  
“fill-it-and-  
forget-it”  
car



Only twice a year—or every 6,000 miles—does a Galaxie or Fairlane need an oil change and routine maintenance—that’s all. They purr along for two years between changes of engine coolant-antifreeze and go 30,000 miles—two and a half years for the average motorist—between major lubrications. And they never need a brake adjustment!

The ideal, of course, is the “fill-it-and-forget-it” car . . . the one you never have to do anything for but buy gas. But, unless you have been paying particular attention, you may not know how close Ford has come to this ideal.

The biggest time- and money-saver is the 6,000-mile interval between oil changes and minor lubes. If you buy your Galaxie or Fairlane in the Spring the birds will fly south again before it has to go in for servicing.

Another big advance; all Galaxies and Fairlanes now come with low-cost engine coolant-antifreeze in the radiator. For two whole years—or 30,000 miles—you don’t have to worry about cold snaps or engine corrosion. The 30,000-mile, more worry-free period also applies to major lubrications (compared with many cars, that saves you 23 extra chassis lubrications and \$34.50 in two years). Also, by engineering this continuous protection into your car, Ford virtually eliminates any chance of forgetfulness that might mean injury to engine or running gear. You can’t overlook a 1000-mile lube because it just isn’t needed!

How much this means in a sweeter running, longer lasting car we’ll leave up to you. But you can’t overlook the savings or safety of Ford’s *automatic* brake adjustment. Every time you back up and apply the brake it adjusts any slack there may be in the clearance. During the life of the lining, you never have a “low” pedal because of improper adjustment of brake shoes to brake drums.

By advanced, thoughtful engineering, Ford has made car ownership more carefree—and cost-free—than ever before. This new freedom is something you ought to experience; why not get your first sample at your Ford Dealer’s this week?



Galaxie and  
**AIRLANE** by Ford



2

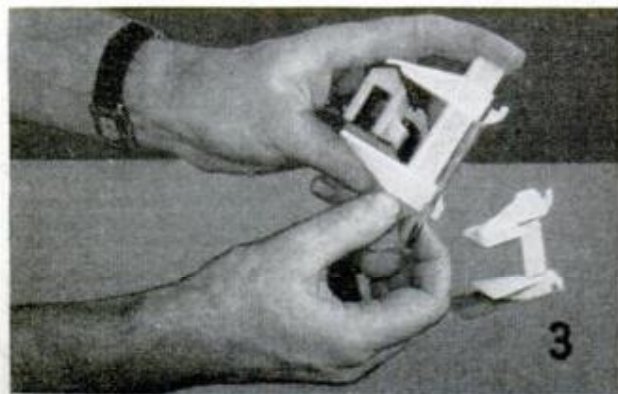
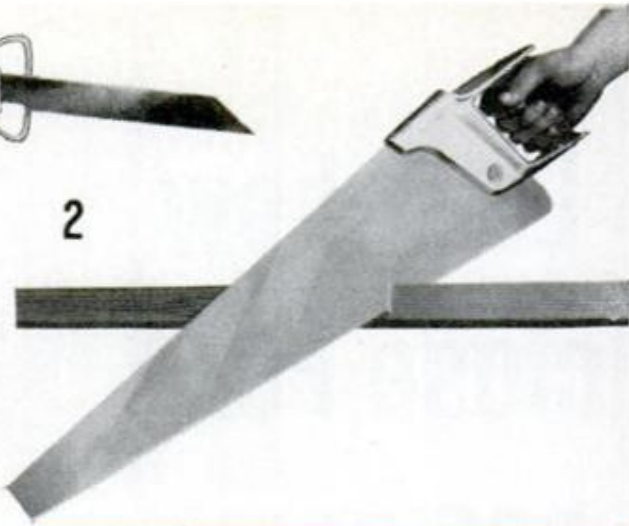

3

## Shopping for tools

**1. HARD-TO-REACH PLACES** are no problem when using this attachment saw. It has a reversible blade for right- or left-hand use—may be operated close to walls or floors. On an electric drill or flexible shaft, saw cuts squares, circles or bevels. With six blades, lubricant and wrench, \$14.75. Grip-Torc Tools, 1780 Shelburne Way, Los Gatos, Calif.



4

**2. TOP-QUALITY HAND SAW**, designed for maximum comfort and control, has aluminum handle. The blade is made of exclusive thick-backed steel, and each tooth edge is ground to same gauge. The handle is attractively inlaid with solid walnut. Saw is priced at \$13.95 and made by Disston Div., H. K. Porter Co., Porter Building, Pittsburgh 19, Pa.

**3. CLAMPS OF DURABLE NYLON** are perfect for those small clamping jobs or for use in close quarters. Held by rubber binders, the clamps develop surprising amounts of pressure. Most glues will not stick to them. Three different small-size clamps with table platens are \$1. Two larger sizes with platens are \$1.29. Made by Miniclamp, Minneapolis 8, Minn.

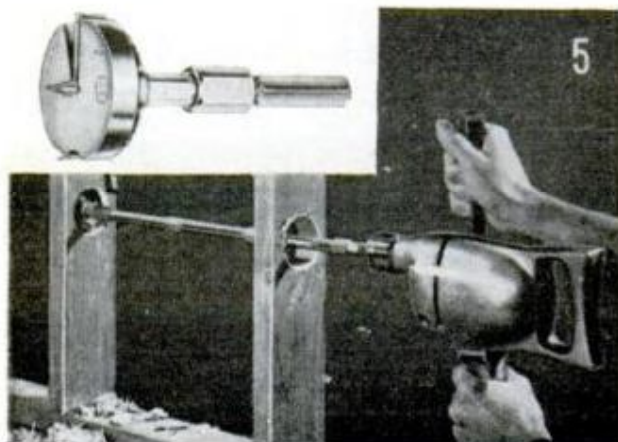

5

**4. COMPACT ARC WELDER** is an all-purpose, 225-amp. unit with ample power for those bigger jobs that require electrodes up to 3/16 in. Entire unit weighs only 102 lb.—small enough for one man to lift into a truck or car. With full set of accessories and ready to weld, unit sells at \$159.50. Made by Bren/Weld Corp., 5114 Third Ave., Brooklyn 20, N. Y.

**5. LARGE-BORE BIT** includes replaceable, high-speed-steel pilot screw, spur and cutters. No sharpening is needed: Simply replace damaged parts in seconds with inexpensive new ones. Bit provides safety to user and it's easy to hold bit in correct alignment. Extensions are made from pipe. Time-Saver Tools, Inc., 27 East Park Ave., Mundelein, Ill.

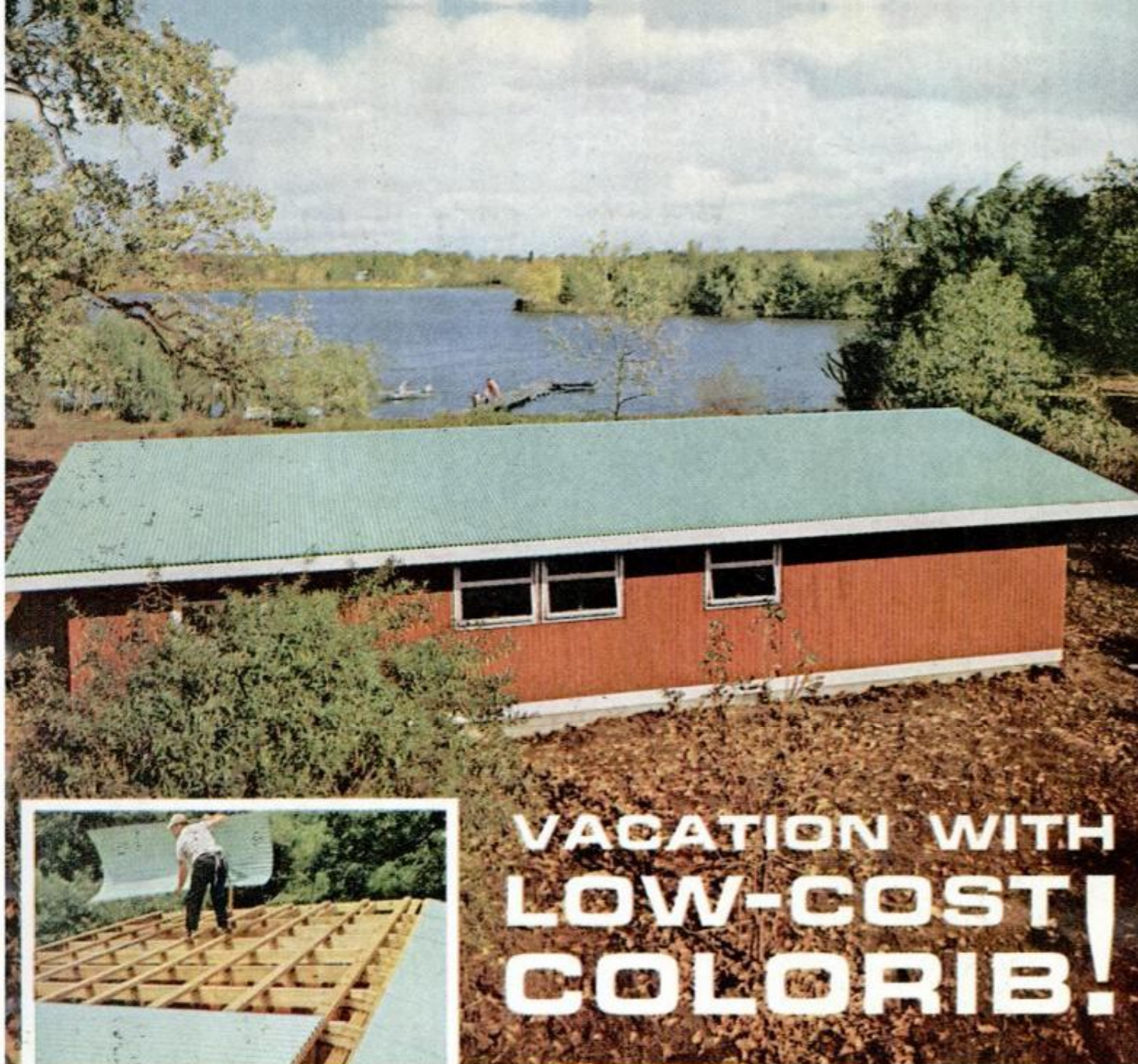

# VACATION WITH LOW-COST! COLORIB!



**BUILD** patios, fences, boathouses and vacation homes with Alcoa® Aluminum Colorib® Panels.

**GOES UP FAST AND EASY**—Use simple hand tools. Heavy-gage yet lightweight, covers fast.

**ONCE UP, NO UPKEEP**—Won't rust, rot or warp.

**TOUGH AND HANDSOME**—Finish won't chip, crack, flake, peel or blister. Baked enamel Colorib Panels stand up to wind, rain and snow.

**WRITE IN TODAY**—for Colorib Panel Idea Folder and where you can get **FREE PROJECT PLANS**. Send handy reply card, or write: Aluminum Company of America, 891-C Alcoa Building, Pittsburgh 19, Pa.



## ALCOA PANELS IN 7 BRIGHT COLORS

Entertainment at Its Best . . . **ALCOA PREMIERE**  
with **Fred Astaire** as host Tuesday Evenings, ABC-TV

**FROM:**  
 NAME \_\_\_\_\_  
 ADDRESS \_\_\_\_\_  
 CITY \_\_\_\_\_ ZONE \_\_\_\_\_ STATE \_\_\_\_\_

1st CLASS  
 PERMIT  
 No. 1174  
 Pgh., Pa.

**BUSINESS REPLY MAIL**  
 No Postage Stamp Necessary if Mailed in the United States

6¢ postage will be paid by  
**ALCOA COLORIB PANELS**  
**ALUMINUM COMPANY OF AMERICA**  
**891-C ALCOA BUILDING**  
**PITTSBURGH 19, PA.**





**Remember  
how great  
cigarettes  
used to taste?  
Luckies  
still do**



**Change to Luckies and get some taste for a change**

© A. T. Co.

*Product of The American Tobacco Company — "Tobacco is our middle name"*



PLYMOUTH TURBO FURY cruising in Los Angeles. Pickup was smooth and swift with no tire-burning takeoff.

## Driving Chrysler's 1963 Gas Turbines

By Don Werner

*Do they accelerate well? Are they noisy? Can they compete on fuel mileage? This report—based on 500 miles in them—has the answers*

**T**WO EXPERIMENTAL VERSIONS of 1963 cars have been touring the U.S. recently. While such advance display of new models by Detroit is rare, the cars themselves—a Dodge Turbo Dart and a Plymouth Turbo Fury—are even more unusual. They're powered by gas turbines.

Chrysler Corporation has said officially it is planning limited production

CRUISING PACIFIC COAST highway in Dodge Turbo Dart. Instruments include tachometer in center console



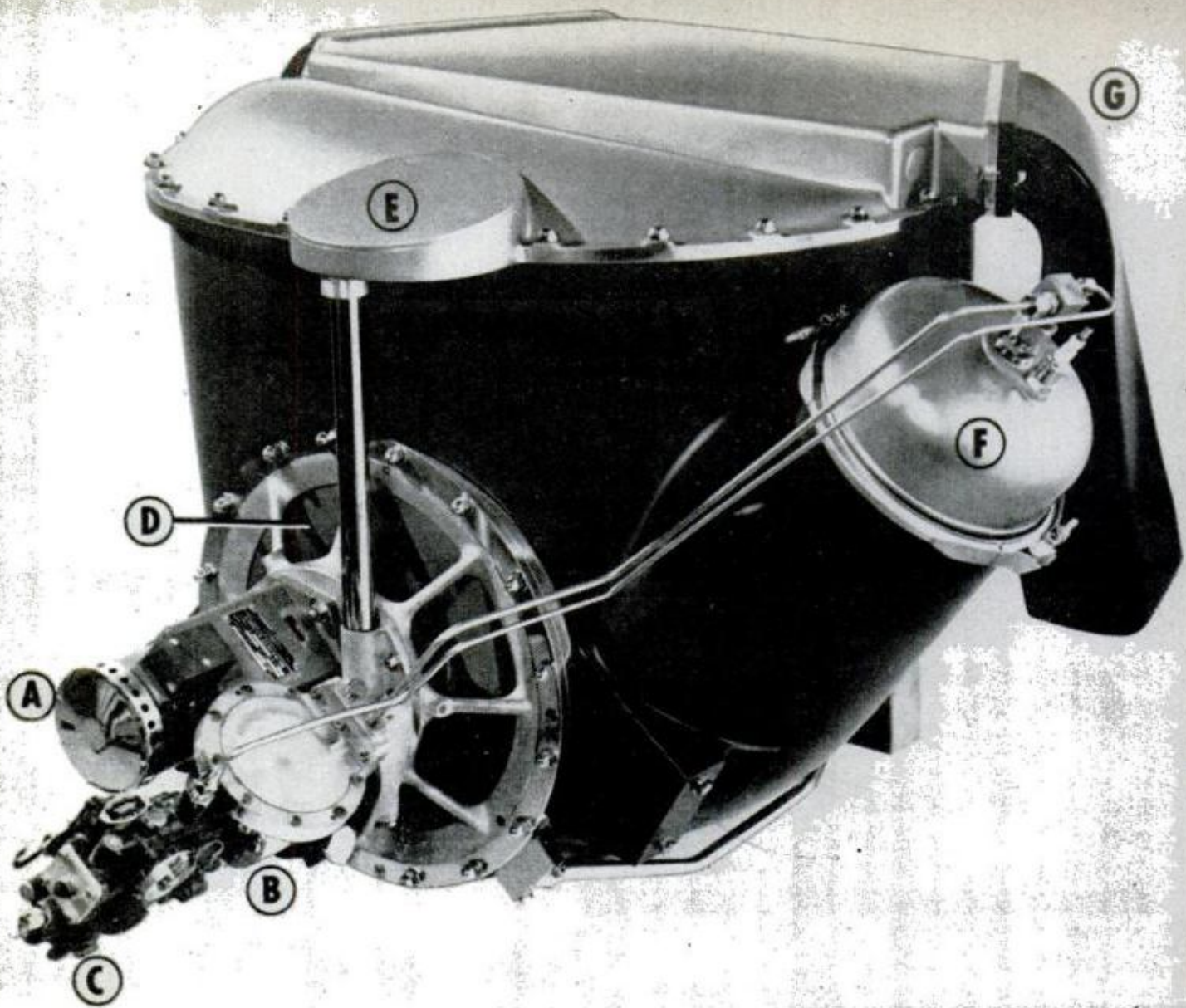

**TURBINE'S EXTERIOR** parts are: (A) starter-generator; (B) fuel pump; (C) fuel control system; (D) compressor air inlet; (E) regenerator gear box; (F) combustion chamber housing one spark plug and fuel nozzle; (G) one of two exhausts: Turbine installed measures 36 inches long, 35 inches wide, 27 inches high

for the public next year of totally new cars which will use these turbine engines.

By why turbines? Are they better than the familiar reciprocating engines? What are they like to drive in traffic? On the highway? Have all the problems been solved? Is Chrysler serious?

Recently, the Turbo Dart was driven 3100 miles from New York City to Los Angeles by George Huebner, the head of Chrysler turbine research, and his crew. The Fury, shipped out, promptly joined the Dart on the road.

For four days the cars roamed separately through southern California. Every day I was in one or the other, in crawling downtown traffic, on high-speed freeways, or out on open country roads. What these gas turbines do—and how they do it—is truly remarkable.

Currently, Chrysler's turbine is rated at 140 hp. Yet I clocked it from a standing start to a true 60 m.p.h. in 8.5 and 8.7 seconds. With more practice and carrying the

driver alone, the time could be cut to less than eight seconds with ease. Top speed is 115 m.p.h.

Such performance came not from a lightweight compact, but from a 4000-pound car. How is that possible with a mere 140 horses? Unlike a piston engine which doesn't peak until well under way, this gas turbine delivers its maximum torque at the start of the acceleration run.

#### **Elastic Smoothness**

The feeling of acceleration is a fresh experience. No vibrating, shaking roar. Only the high-frequency banshee whine of the turbine. During the first few seconds the car seems to move slowly. In fact, it's almost impossible to spin the wheels. Then there's a sense of sinking into the seat cushions as the forward rush increases with elastic smoothness. The speed acceleration buildup is swift, faster than a reciprocating engine's after the early seconds.

At 70 m.p.h., cruising on the Pacific Coast



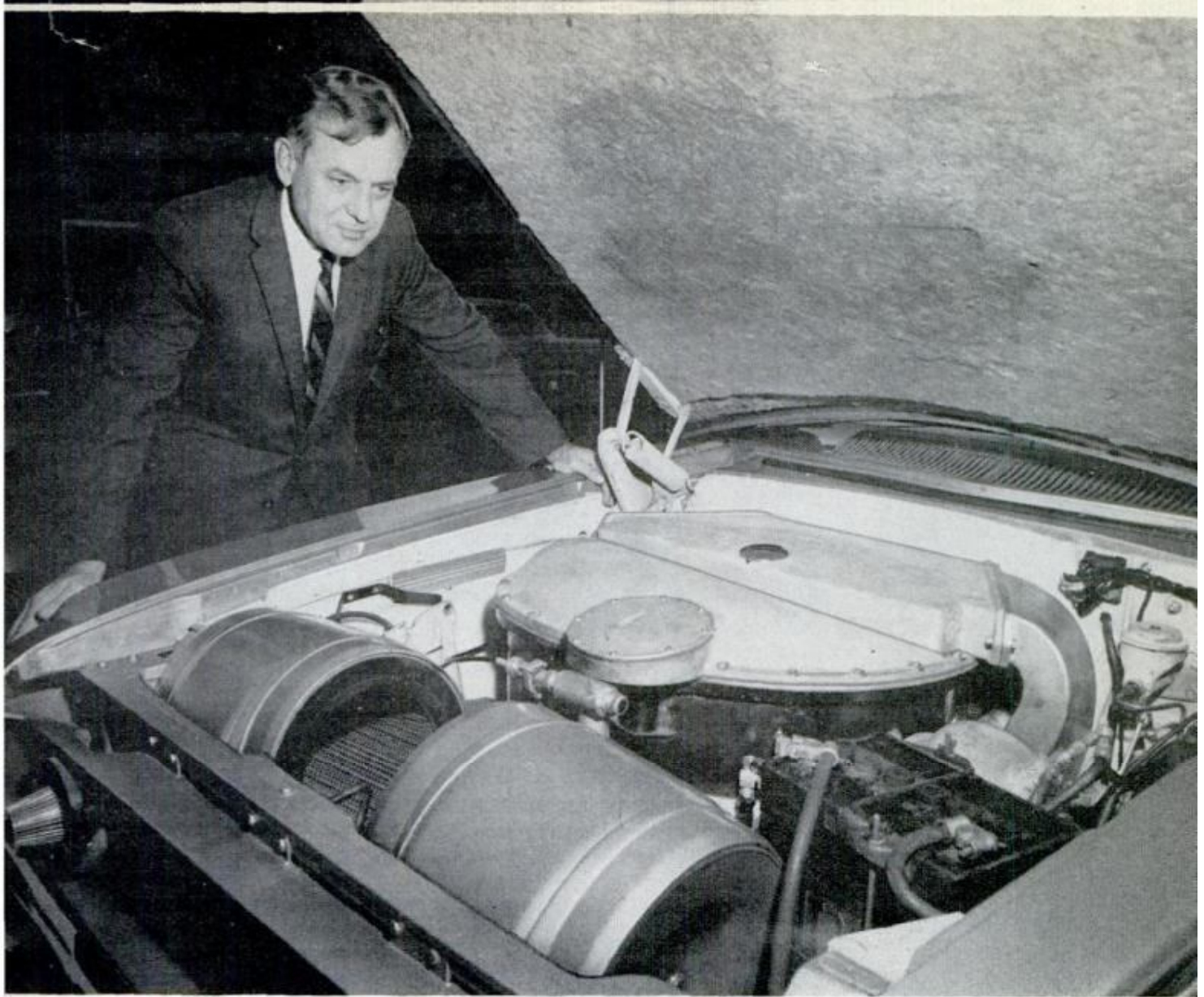

**AUTHOR WERNER** inspects kettle-shaped turbine. Large "cans" in front are air intake cleaners and silencers which engineers say are not easily clogged by dust and dirt. Battery is a standard 12-volt type

**HOW CHRYSLER TURBINE WORKS.** Innovations are regenerator which uses hot exhaust to heat incoming air and variable nozzle (not shown) which directs pressurized gas at 2nd-stage to provide range of power

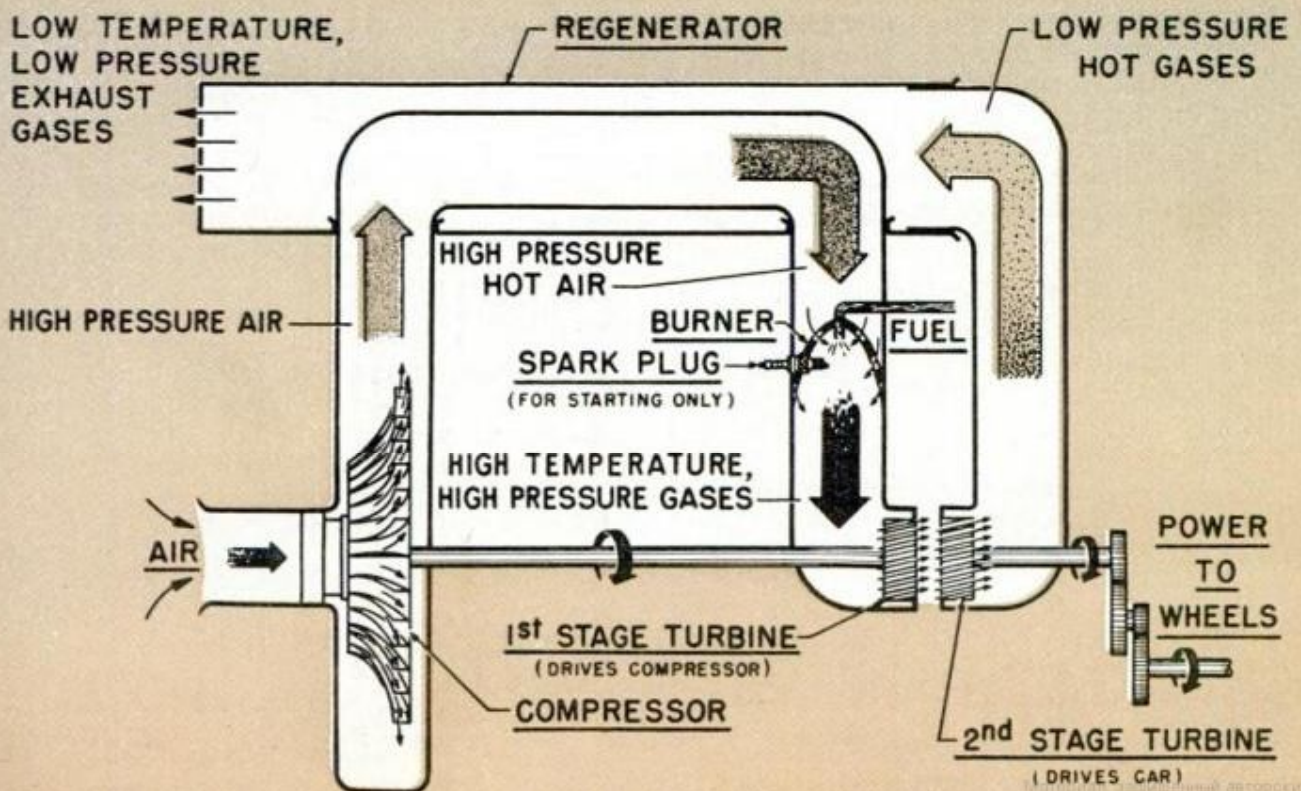



**FEELING 200-DEGREE-temperature exhaust, which comes out under front wheel wells on prototype models**

highway toward Newport and Balboa, over the turbine whine I could hear the breakers spilling onto the sand of the nearby beach. Under the sound of the turbine I caught the hum of tires, even the occasional creak of the torsion bars. The engine was loafing, registering barely 32,000 r.p.m. on the tachometer. Although on full power, it seemed more like coasting out of gear with the engine off.

Actually, the turbine noise—now curbed with silencers on the air intake and insulation around the regenerator—can be suppressed much further, Chrysler engineers say. At the moment, Chrysler wants these cars to sound like jets. It gets attention. Everyone looks to see if a DC-8 is taxiing down the street.

Engine decelerating or braking effects on the inclines seemed about the same as it is with a reciprocating-engine car which has an automatic transmission. And I noticed this even with the Plymouth Turbo Fury, whose turbine nozzles were set to give slightly less decelerating effect than the Dodge.

### **Fuel Economy**

Public tests with these turbines in 1960 resulted in up to 19 m.p.g. fuel economy. In discussing the Turbo Dart's cross-country run, Chrysler engineers were evasive. Severe winter storms with heavy snow and ice probably reduced fuel economy figures to an unimpressive level. But reliable sources reported the average was 17 m.p.g. And that diesel fuel gave eight to ten percent better mileage than gasoline.

The turbine, of course, runs on anything that will mix with air and burn, from good

brandy or hair oil to kerosene, premium gas or jet fuel—with no changeover procedures needed. But expensive leaded gasoline should be avoided, since it tends to leave deposits on the turbine blades. When turbo cars become common, the effect on the oil industry will be revolutionary. Refining processes can be simplified, with no need for exquisite tailoring of fuel.

The low cost of cheaper fuels is only one advantage in a long list. Lubricating oil, which is never exposed to high-heat, gases or outside air, will not need changing. One fill should last the life of the engine. No tune-ups are needed. There is no cooling system. The electrical system consists of a combination starter-generator, standard 12-volt battery, coil and one spark plug. There are 80 percent fewer moving parts than in a piston V8.

The gas turbine starts quickly and easily in any outside temperature, from 60 degrees below zero to 120 above. It needs no warmup. Fuel combustion is nearly complete, so exhaust is clean with little pollution of the air by smoke or unburned hydrocarbons.

Smoothness is an inherent characteristic of turbines. No pistons or valves jerk up and down. All action is rotary, like a windmill or water wheel. Air flows through ducts and smoothly spinning blades in a steady stream. There is very little friction.

Chrysler's gas turbine, designated as CR2A, is a classic layout. It has two sections—one generates power, the other receives it and delivers it to an output shaft that drives the car. There is no mechanical connection between the two operations.

In the first section, air is sucked in, com-

pressed and forced into a cylinder-shaped burner where a continuous spray of ignited fuel heats it. The next section receives the blast of pressurized gas on blades of two consecutive spinning turbines that turn separate shafts — one powering the compressor and one driving the car.

It is in this use of two stages that Chrysler's turbine differs in basic principle from those used on well-known jet aircraft, such as the DC-8 and 707. The second stage, which forms what in aviation is termed a "free turbine," is not involved in pure jets.

In making their turbine efficient and practical for car use, Chrysler engineers came up with two innovations: a rotating regenerator (in other turbines it is fixed) and variable nozzles on the burner end (not the compressor side).

### Rotating Drum

Chrysler's regenerator is an ingenious heat exchanger. It consists of a revolving drum packed with crinkled metal looking much like a giant cigarette filter. This drum is rotated constantly via reduction gearing from the compressor turbine. First it revolves in the exhaust chamber where 1700-degree gases flow through it transferring 1200 degrees of heat to the thin metal. As the drum rotates, this heated porous metal passes through the intake duct where incoming compressed air is raised from 300 to 1000 degrees as it absorbs heat from the metal. Without this continuous cycle of heat transfer the turbine would require much more fuel to raise the temperature of the gases to the point where they would expand and do equal work on the power turbine.

There's another vital regenerator function. Hot exhaust, giving up heat to the mechanically-rotated metal matrix, is cooled to about 500 degrees. Then aspirators blend in cool outside air. What comes out the exhaust pipe is a harmless 200 degrees.

The variable nozzles give the turbine some characteristics essential in a passenger car: Wide performance range, improved fuel economy and engine braking in deceleration. The nozzles are blades, like little airfoils, which automatically vary in adjustment in response to the accelerator pedal and car speed. Pressurized gas is aimed at the driving turbine from an angle appropriate to operating need. When the blades move to reverse position, engine braking is obtained, which turbines otherwise lack.

(Continued to page 250)

**TACHOMETER** on center console shown registering 21,000 r.p.m. at idle speed for first stage compressor

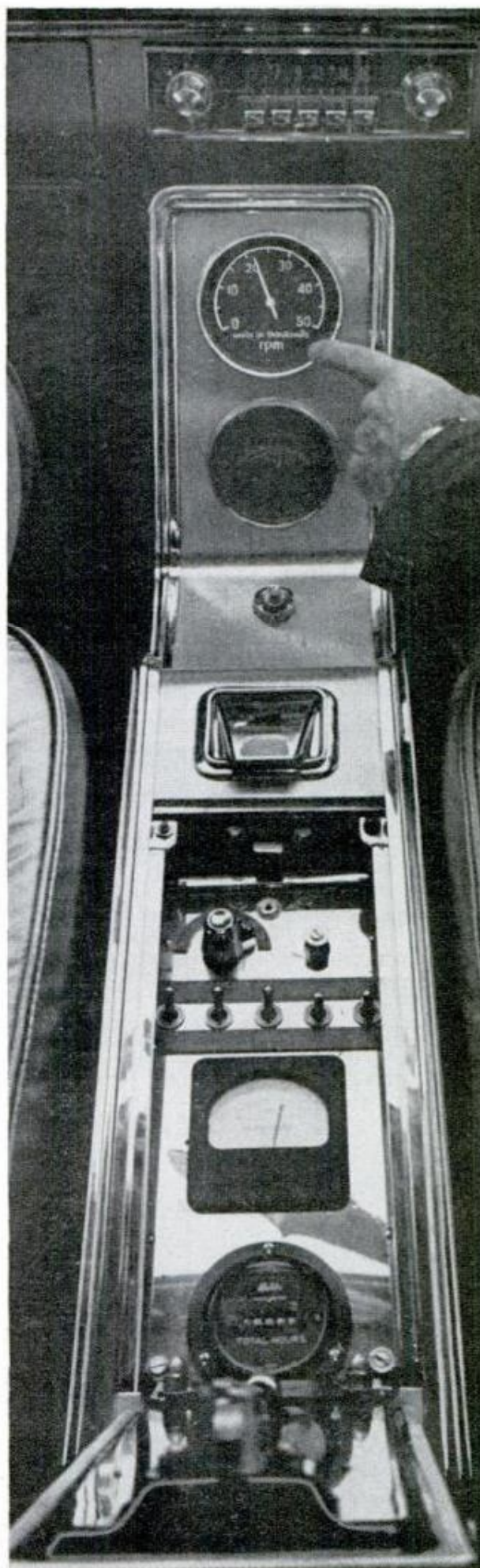

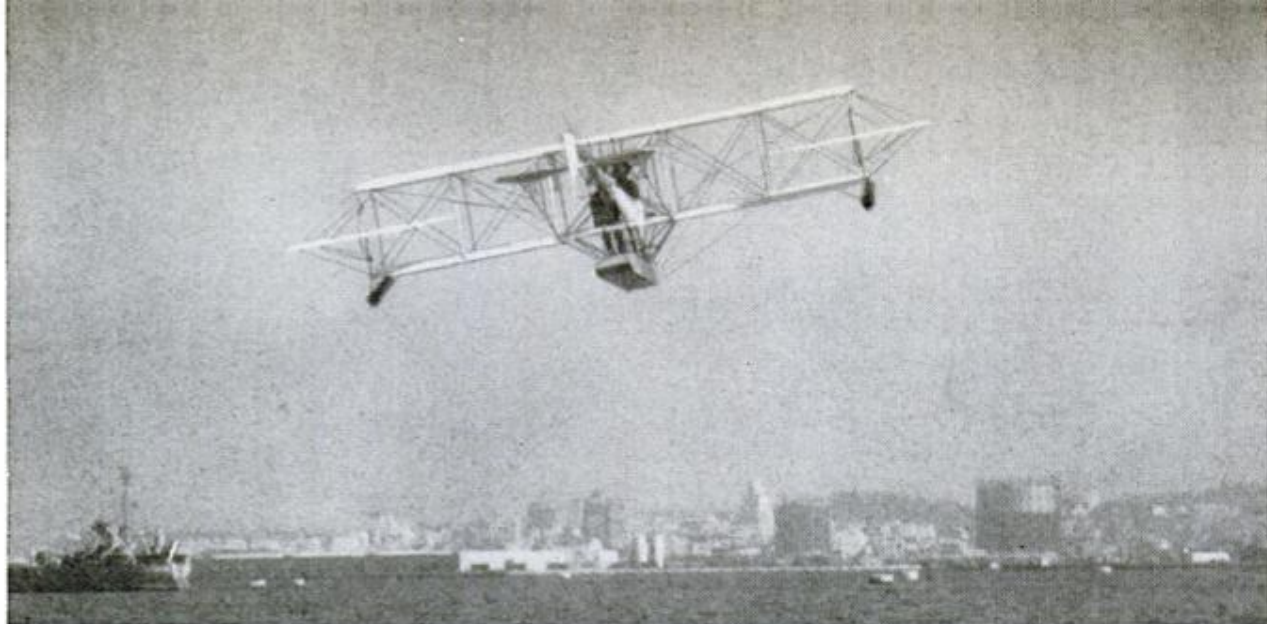

**CURTISS BIPLANE**, rebuilt from original plans, takes to the air where prototype flew some 50 years before  
**A-1 REPLICA** weighs 1500 pounds fully loaded. Powered by 1913 engine, it got up to speed of 60 m.p.h.



## Navy Pusher Biplane Flies Again

Marking the golden anniversary of naval aviation, a replica of the first airplane built for the U.S. Navy — a Glenn Curtiss A-1 pusher biplane — was reconstructed and flown near San Diego. More than 150 members of the Institute of the Aerospace Sci-

ences built the plane in cooperation with the Navy. The plane will be displayed in a new San Diego air museum.

The first A-1 was flown by Curtiss over San Diego Bay in 1911, and later by the Navy's first aviator, Lt. T. G. Ellyson.

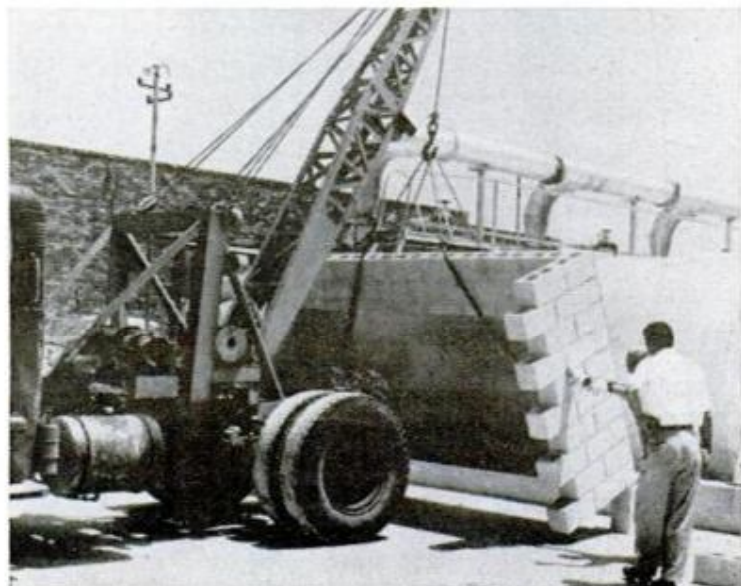

## Epoxy Block House

Epoxy adhesive, shot from a caulking gun, is zippering up the concrete blocks of a mortarless house in Tampa, Fla.

The mortar substitute, batched from cement, lime accelerator and epoxy, cures in 24 hours and reaches full strength in 72 hours.

While the new adhesive costs almost twice as much as conventional mortar, speed of block laying is expected to offset the difference. The masons, for example, were able to lay the blocks end to end and apply the compound while another mason applied it to the top surface of each course.

## Seat Fits Auto Bumper

Motorists can use their autos as the legs of a camp chair by hooking to the bumper a portable seat that attaches with rubber-tipped bolts. The seat has a steel frame and ripple-finish plastic cover.

The bumper seat is available for \$3 from Enon Products Inc., Box 173, Enon, Ohio.



## Mulcher Does Much

Not only does a new multipurpose farm machine shape the seed bed, it mulches the bed with black plastic film, plants the seed and fertilizes it, then punches holes in the film for new plants!

Developed at Texas A&M College, the machine has controlled weeds, conserved moisture and increased the yield of farm crops during a three-year test at locations throughout Texas.

A single mulching with black plastic film—which helps retain water in soil—has increased both early and total yields of such vegetables as squash and peas by 20 to 300 percent.



## And After This Comes the Caldozer

There's a new critter—the cowdozer—moving into the construction field and moseying along among the bulldozers. The difference is that it pulls while the other pushes.

The cowdozer's blade is turned toward

the tractor (in the case of the LeTourneau model, an Army tank), and it pulls dirt to the tractor rather than pushing it ahead as a bulldozer does. This is helpful in moving earth where there's no footing for a tractor, as on a steep hill or muddy stream bottom.



POPULAR MECHANICS

**OWNERS  
REPORT**

A NATIONWIDE SURVEY

# Nimble Handling Pleases, Fuel Mileage Disappoints Chevy II Owners



**BASED ON 1,065, 493 OWNER-DRIVEN MILES**

**CHEVY II OWNERS LIKE . . .**

Neat handling, easy steering  
Sensible size  
Roomy interior

**DISLIKE . . .**

High fuel consumption  
Shoddy paint jobs  
Lax quality control

**GENEROUS HEADROOM**, large doorways pleased owners who were delighted to find them in a compact





A PLEASANT SURPRISE to many Chevy II owners was the maneuverability and easy handling of the new car

**Marginal and boldface comments by Jim Whipple, PM's Auto Editor**

**C**HEVY II arrived on the automotive scene as the latest, and possibly last, of the compacts. It's arrival was welcomed by long-time Chevrolet fans who were waiting for a car easier to maneuver than the big Belairs and Impalas and at the same time easier to sit in than the low-slung Corvair. According to the majority, Chevy II seems to combine the desirable nimbleness and maneuverability of the Corvair with headroom and ease of entry equal to the big Chevrolet.

The six-cylinder Chevy II engine costs \$60 more than the Four and offers 30 additional horsepower. Presumably the Four was offered as an inducement to the ultra-economy minded. But only 13.9 percent of owners reporting bought Fours while 84.6 percent chose the Six. (A few, 1.5 percent, didn't indicate how many cylinders their power plants contained).

This low percentage of four-cylinder cars may not be a true test of the ultimate popularity of this engine. Many more Sixes than Fours were available at dealers early in the season.

The Chevy II is not, at least at the outset of its first year on the market, a standout economy car. Some 41.1 percent of all owners felt that their gasoline mileage was lower than they had expected.

To backstop this report PM drove a Chevy II Nova 400 two-door hardtop with six-cylinder engine, Powerglide automatic transmission and power steering.

Constant-speed fuel consumption to corrected speedometer reading was as follows:

- 25.7 miles per gallon at 30 m.p.h.
- 24.1 miles per gallon at 40 m.p.h.
- 21.6 miles per gallon at 50 m.p.h.

**← Chevy II is much better competition for Falcon, Rambler et al. than Corvair ever was. Now the Ford-Chevy war will be on in earnest**

**← There's a whole tribe of four-cylinder-engine lovers who'll buy Chevy IIs in search of four-banger fun**

**← Fuel economy will doubtless improve as the factory works on engine tuning. Production before perfection seems to be a Detroit custom**



**SEAT WIDTH** is adequate for compact Chevy II, but tall riders will find scant kneeroom in the rear seat

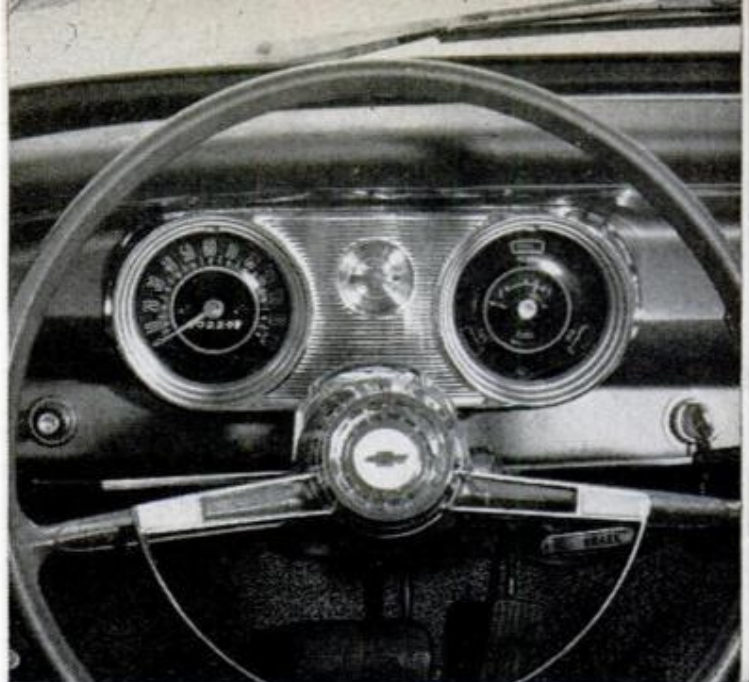

**INSTRUMENTS ARE WELL PLACED** but many drivers resent use of warning lights in place of gauges

**Chevy II is easy to maneuver, but its 39½-foot turning circle is larger than that of most other compacts** →

**Both front and rear doors offer exceptional ease of entry. However, PM's 6'3" driver needed a bit more legroom in driver's seat** →

**So it does, if you use the lower gears and let engine wind up to higher r.p.m. than you're accustomed to using** →

**Chevrolet has announced switch from 3.08 to 1 up to 3.50 to 1 rear axle ratio on stick shift Fours. This should give more power with less shifting, hence better mileage in runabout use** →

19.1 miles per gallon at 60 m.p.h.  
15.7 miles per gallon at 70 m.p.h.

Over-all mileage, including warmup, city, country and expressway driving was 18.3 miles per gallon.

*But, let's find out how the new Chevy II rates with the owners themselves. Here, in the order of frequency of mention, are the first five best-liked features.*

"It handles well on rough, choppy terrain."—Illinois refinery worker.

"Handles like a dream—easy to turn around."—North Carolina mechanic.

"It is no small car and yet it is no boxcar to push around. I just love it for city driving."—Iowa politician.

"Compact, yet room for six adults. Very nimble in traffic."—Ohio crane operator.

"It's about the size cars used to be and has plenty of power."—Tennessee service-station operator.

"I am 6 feet, 2 inches tall and had trouble getting in other compacts. But in my Chevy II, I don't get any bangs on my knees."—Michigan milkman.

"I can get in Chevy II without knocking my hat off and can sit up straight with hat on. This is the fault with most small cars."—Missouri realtor.

"This Six has plenty of power."—Ohio salesman.

"Plenty of pep (4 cylinder), very economical, surprisingly powerful, top speed 90 or more—far more power than a Corvair or Falcon."—Ohio salesman.

"Good pickup with automatic transmission for a four-cylinder car."—New Jersey inspector.

"I get about 25 m.p.g. at 55-65 m.p.h. Under this, we have gotten as high as 28.9 m.p.g. (6-cylinder)."—Wisconsin farmer.

"It has the look of a big car yet the expense (of operation) is that of a compact."—Kentucky retiree.

*A shakedown on an all-new car, of course, includes complaints. Here are the first five in their order of frequency.*

"Chevrolet should drop the 4-cylinder Chevy II or put enough power or the right gear ratio for it to get good gas mileage. If they cannot, the Chevy II 4-cylinder will fail."—North Carolina accountant.

"Gas mileage isn't what they told me it would be. (His Six gets 13 m.p.g. over-all). I bought it for economy but



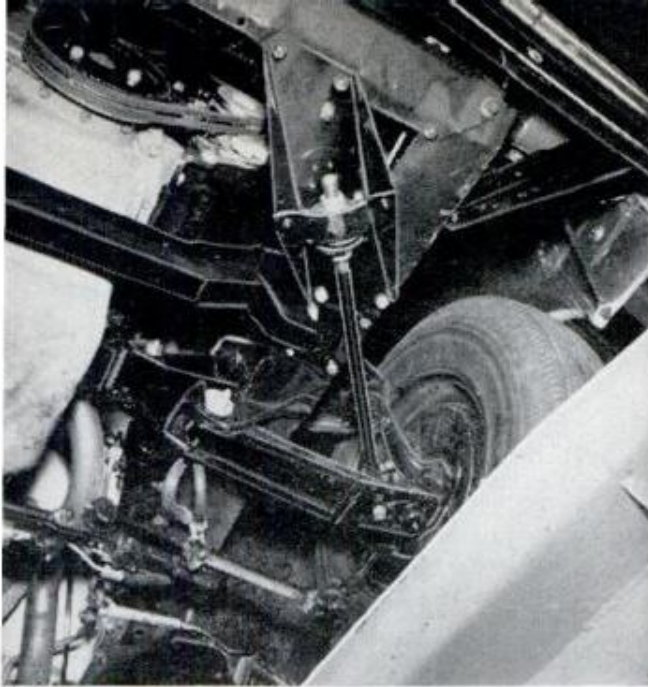

**DIAGONAL TRAILING LINK** connected to lower control arm is rubber insulated to absorb road harshness



**LOW RIM** makes loading of the trunk easy, but full use of the space is hampered by a flat-mounted spare

I got better mileage on the full-sized car I traded."—Tennessee secretary.

"Gas mileage should be at least 20 m.p.g. with an engine of this size (Six).—Iowa telephone worker.

"Shoddy paint job—outside and inside."—Louisiana clerk.

"The paint job was thin in three places that had to be repainted by the dealer."—New Jersey government worker.

"Very poorly assembled—snow drifts in at all four doors."—Wisconsin grocer.

"Door seals are not right and cold air blows in."—Ohio salesman.

"Quit selling them before they are put together."—Illinois coal miner.

"Interior Phillips screws not tightened. A half dozen of them have come out."—New Jersey broker.

"Joints on the body are very rough and crude. In fact, the welds at the front post and roof line are breaking."—Tennessee production planner.

"Poor workmanship on the interior metal parts. And my automatic choke was put on backwards."—Missouri highway patrolman.

"The problems are minor details that the dealer should have taken care of in, at most, two service visits. Instead, they have given it "the alley" treatment and I have had to take it back about six times."—Michigan credit manager.

(Continued to page 268)

He's right unless all your  
 ← driving is stop and go

We found this on some of  
 the Chevy IIs we've driven,  
 but not on others. So it must  
 ← be quality control, not  
 a design problem

Automakers could avoid  
 this if they put the first  
 ← 50,000 cars of a new  
 model through a special  
 "fix-up" line after assembly  
 and before delivery

Dealers who do this are  
 wrong of course, but whose  
 ← fault is it that they're  
 swamped with new cars  
 needing so many  
 "make right" repairs?

## WHAT MILEAGE DO CHEVY II OWNERS GET?

(6-CYLINDER ENGINE)

Miles per gallon:	10-12	13-14	15-16	17-18	19-20	21-22	23-24	25-26	27-28	29-30	Don't Know
<b>Manual Transmission</b>											
City Driving			26.3%	26.3	17.5	1.9	3.5	3.5	3.5		17.5
Long-Trip Driving				3.5%	21.1	19.3	3.5	10.5		3.5	38.6
<b>Automatic Transmission</b>											
City Driving	4.5%	5.7	16.2	29.4	12.8	6.4	2.3	1.5	0.4	0.4	20.4
Long-Trip Driving		1.9%	3.8	10.6	14.3	15.8	10.2	5.3	1.1	0.4	36.6

**BASED ON 1,227,553  
OWNER-DRIVEN MILES**

## Likeable Rambler Marred by Flaws, Say the Owners

*Marginal and boldface comments by  
Jim Whipple, PM's Auto Editor*



*Rambler Classic is about the same length as most compacts, yet has interior room equal to new, "family-sized" Fairlane and Meteor. How right can you get with a 1956 design?* →

*Rambler is no longer the only game in town, so its "compactness" isn't unique. But note how owners appreciate a roomy compact that's "smaller on the outside, bigger on the inside"* →

**R**AMBLER, THE HARDY PERENNIAL of the compacts, rolls along winning new friends and keeping most of the old ones. The wisdom of American Motors in first introducing this car is constantly reaffirmed, as 5000 or more buyers each week take delivery on brand new ones.

The fact that Rambler's sales have held up while a dozen or more new compacts blossomed out speaks well of the car's basic design.

What's more, they're coming back for seconds. The percentage of buyers who've traded an older Rambler in buying their new car has nearly doubled since the previous Rambler Owners Report (PM August 1960, p. 86) on the 1960 model. Some 21.4 percent traded older Rambler's in buying their '60 models, while 39 percent of '62 buyers reporting traded Rambler for Rambler.

Another interesting comparison between the '60 and '62 reports reflects public thinking in regard to the compact automobile generally. In 1960 "Compact Size" rated fourth on the list of best-liked features with a percentage of 22.3. For buyers of the '62 Rambler, "Compactness" dropped in importance to seventh on the list with a percentage of 13.5, as buyers became aware that Rambler was far from being the only compact around. But as they compared Rambler with the raft of new compacts, some of its original virtues took on new meaning. "Roominess" showed up in fourth place on the '62 best-liked features list with 17.6 percent of all owners mentioning it.

All's not hearts and flowers with this year's Rambler however, and as always, the owners are prompt to sound off



**SURPRISINGLY NIMBLE** due to redesigned front suspension and steering, Rambler handles the way owners like

**OWNERS LIKE . . .**

Easy handling, stability  
 Comfort, roomy ride  
 Low-cost operation

**OWNERS DISLIKE . . .**

Door maladies  
 Inadequate power  
 Poor workmanship

**HIGH BUMPERS** clear the sidewalks well and the high-rising hood headroom minimizes any mechanics' stoop



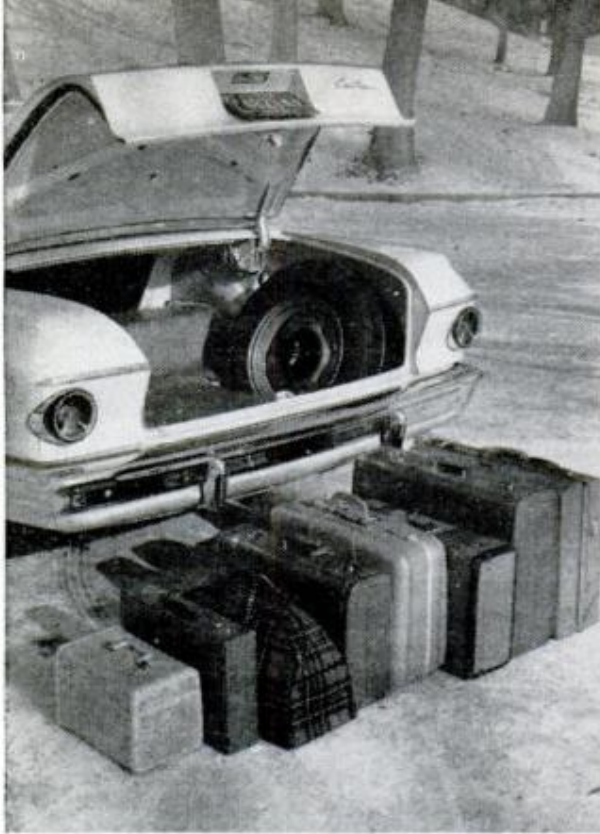

**YAWNING TRUNK** will really hold 'em. Eight bags of various sizes went in with plenty of room to spare



**SEPARATELY ADJUSTABLE** front seats, wide doors would make exit easy but for scant head clearance

**This slump in quality control may be explained, but → not necessarily excused, by the fact that these reports were from buyers of the earliest '62 models, while '60 reports were collected in midsummer after assembly-line "kinks" had been straightened out**

**Much of test mileage → was run up in foul, sub-zero weather with chains on car**

**These cost extra and have advantage over bucket → seats; you can still seat three passengers in front**

with their dislikes. A slackening off in effective quality control has increased the annoying mechanical problems and finish flaws according to the new owners, 5.1 percent of whom complained of Poor Workmanship.

A solid 39.5 percent reported some sort of mechanical trouble on their '62s, while back in 1960 only 20.3 percent reported similar troubles. However, despite gripes, the owners appreciate their Ramblers even more this year. Some 84 percent declared that they would buy another Rambler. Only 51.9 percent of those reporting made the same statement in 1960.

One of the contributing factors to Rambler's popularity is fuel economy which is still very good. PM's test Rambler was a Classic with six-cylinder engine and automatic transmission. Here are its mileage figures at constant speeds:

- 27.0 miles per gallon at 30 m.p.h.
- 25.1 miles per gallon at 40 m.p.h.
- 23.0 miles per gallon at 50 m.p.h.
- 18.8 miles per gallon at 60 m.p.h.
- 18.3 miles per gallon at 70 m.p.h.

Over-all mileage, which included warmup, idling, acceleration and city and country driving, was 20.8 miles per gallon.

*To learn what Rambler Classic owners think about their cars, let's turn to their comments on the first seven best-liked features in the order of frequency of mention.*

"I like the easy handling, especially in heavy traffic, and the comfortable relaxed feeling."—Massachusetts retiree.

"These Ramblers are comfortable; I am 6 feet-1 inch and weigh 225. My wife is 5 feet-4 inches and weighs 114. The individually adjustable front seats make it perfect for our travels."—New Mexico educator.

"It rides better than most heavier cars I have owned."—Florida mechanic.

"I think it has the best balanced ride and stability of any car I have driven."—Ohio steel worker.

"Economical to operate even at high speeds (my gas mileage is 20.8 m.p.g. over-all)."—Alabama buyer.



**SLIDING PULL-TAB** is used for PARK while other automatic transmission controls utilize push buttons



**UPPER REAR CORNER** of Rambler's back-door window frames has been rounded off from '61's sharp points

"For my money there is no other car that can compare with it for economy."—Iowa retiree.

"I like the roominess of the big station wagon, and yet it's so economical (20 m.p.g. over-all).—Pennsylvania therapist.

"Has enough room without giving the feeling of being too long or too wide to be maneuverable."—Ohio supervisor.

"Great for vacations—with all our luggage in the rack on top there's plenty of room for my two youngsters to sleep in the back."—Wisconsin machinist.

"Rambler's steering is the best of any car I have ever driven."—West Virginia chemist.

"I am 6 feet-5 inches, weigh 260 and I have plenty of room in the Rambler."—Illinois construction analyst.

"I like the seat height, headroom and road clearance. The king-size bucket seats are superb."—Florida lawyer.

"There are no rattles and squeaks such as I found in new cars I previously owned."—South Carolina minister.

"I like the marvelously-sound body construction which other makes seem to have lost through the absence of quality control and constant change."—Virginia government worker.

(Continued to page 241)

← **Here's the secret of Rambler's charm; big car room without big car vices**

← **Height's the reason for Rambler's roomy seating, it's 2 to 5 inches taller than other compacts**

## WHAT MILEAGE DO RAMBLER OWNERS GET?

Miles per gallon:	10-12	13-14	15-16	17-18	19-20	21-22	23-24	25-26	27-28	29-30	Don't Know
<b>Manual Transmission</b>											
City Driving	1.8%	1.2	10.6	23.5	22.9	14.1	4.7	1.2	0.6		19.4
Long-Trip Driving			0.6%	1.8	10.6	19.4	22.9	9.4	2.4	1.2	31.7
<b>Automatic Transmission</b>											
City Driving	1.0%	9.1	22.0	27.3	19.1	3.3	1.4	1.0			15.8
Long-Trip Driving		0.5%	1.0	11.0	20.1	21.5	10.5	2.4	0.5	1.4	31.1

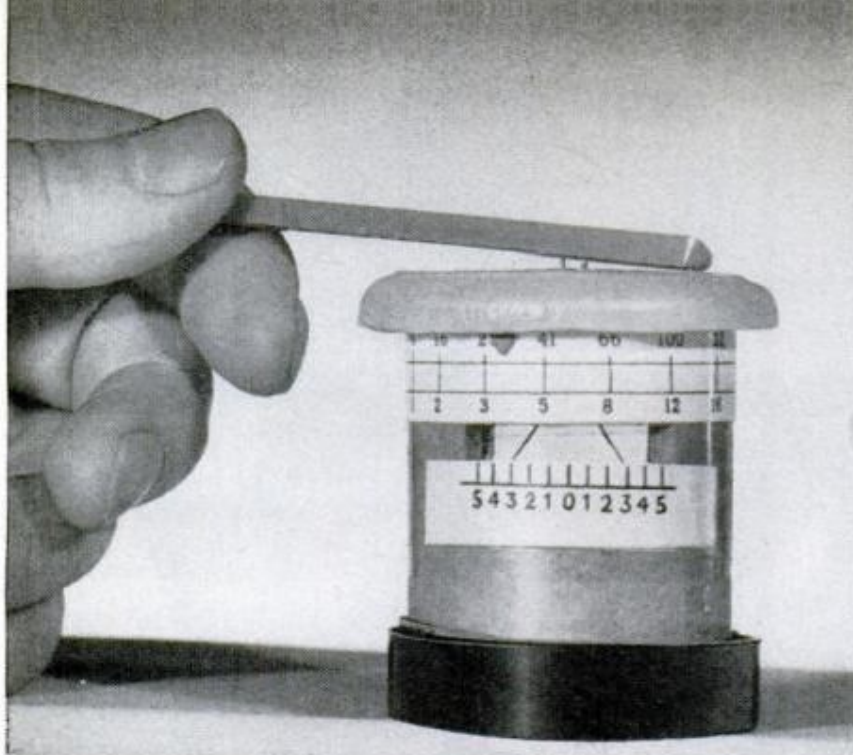

**CHARGING DOSIMETER.** Leaves fly apart in charged position. Rate at which they come together is determined by amount of radiation in air

## Personal Radiation Monitor

By R. L. Patrick, Ph.D.

WHETHER YOUR INTEREST is a novel project for a school Science Fair or an emergency radiation detector, you can build this simple electroscope-type dosimeter quickly from household materials. It has been checked by several testing laboratories who found it to be accurate. The maximum hours safety scale is calibrated for a safe dosage figure recommended by radiation experts.

A section of mailing tube forms the housing or body of the unit. Paddles or leaves and tube lining are aluminum foil. Make the lid by pouring melted paraffin wax into a jar cover, and use a plastic jar cap for the base. Line the base with melted paraffin and seat the housing in it. Cut the pointer from a solder lug or metal scrap. Cut out the scales shown below and cellophane-tape them in place. Wrap clear plastic around the housing for protection.

Place the top so the leaves, when observed endwise, are centered over the zero reading on the scale. Charge the unit by rubbing a plastic rod with wool, or running a comb through your hair. Touch the rod or comb to the staples at the top of the wax and the leaves will fly apart to charged position. Now count the time in seconds that it takes the leaves to deflect toward each other one full scale division. The upper scale will convert this deflection rate to safe exposure time. Set the pointer here as a reminder and reference for the next reading.

A kit containing the foil-lined housing with imprinted scales and cutouts, bottom plate, leaves or paddles, formed hanger wires, paraffin top, film wrapper, charging rod and instructions is available for \$1 from Experimenters Supply Co., 1924 Columbia, Chicago 26, Ill.

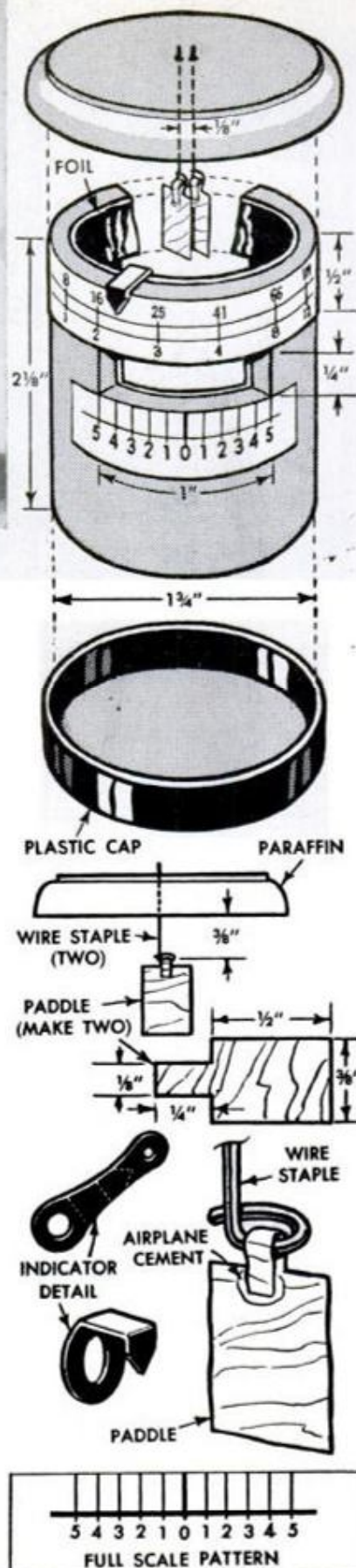

Max Hours Safety	4	8	16	25	41	66	100	132	166	250	330	400	500
Minutes/ 1 Unit													
Scale Deflection	1/2	1	2	3	5	8	12	16	20	30	40	50	60

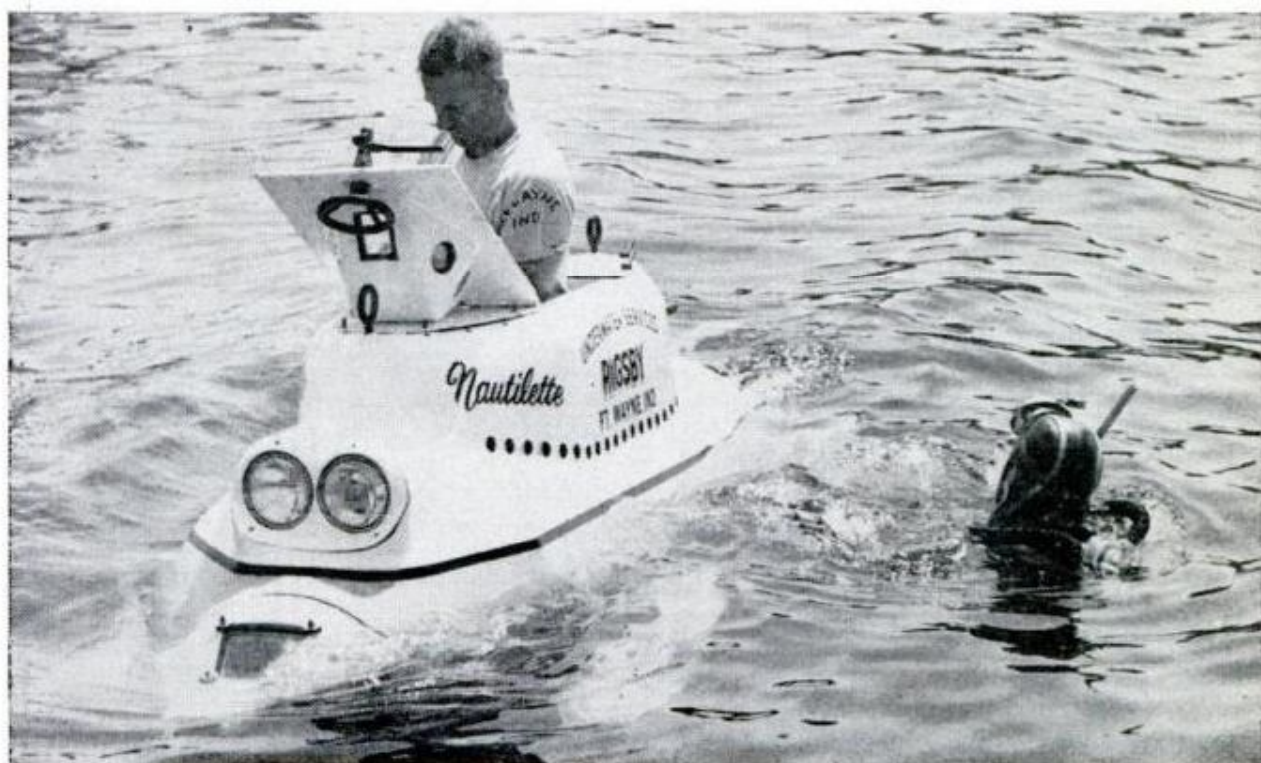

## Tiny Sub Dives to 100 Feet

Though it is big and deep, Lake Tippecanoe, near Fort Wayne, Ind., is an unlikely place in which to maneuver a submarine. Yet Woody Rigsby and his son Frank put their homemade \$5000 *Nautilette*, a two-place sub, into summer search work there.

Four years in building, the *Nautilette*—12½ feet long, 56 inches high and weighing 2600 pounds—has two-inch plexiglass windows and double hull. Underwater it's run by a three-quarter horsepower electric motor; on the surface by a one-cylinder air-cooled engine. It descends by means of diving fins and makes about two knots underwater, going as deep as 100 feet.

The Rigsbys—Woody in conning tower, Frank stretched flat below—search Tippecanoe for wrecks. Their sub carries a five-hour oxygen supply.





By Jim Whipple



## Dodge Dealers Get a "Chrysler" of Their Own. Is There a Rotary Engine in Lark's Future?

This may not be the year that breaks records for auto sales in the U.S., although many of the industry's biggest guns are talking seven million cars for 1962. But we'll bet that you'll have to go back a long way to find more different makes and models offered. Herewith, the latest additions to the line-up.

As we go to press **Dodge** offers another series, the **880**. This one will be a big brother to the **Dart** and **Polara**, having a wheelbase of 122 inches. You guessed it, the **880** is Chrysler Corporation's "C" body shell shared with **Chrysler Newport** and "300."

**Grille and other styling** details will differ, of course, but basically the **880** will be a "Chrysler" for Dodge dealers, who up to introduction of the 1962 **Dart** and **Polara** of 116-inch wheelbase, have always had a "full-sized" car to offer their customers.

According to a Dodge Division executive, the new **880** series was in response to dealer demand which in turn was sparked by a reawakening of buyer interest in large, lower-medium-priced cars. This in spite of the fact that the 122-wheelbase **Dodge Polara** offered in '61 accounted for only six percent of the Division's sales, somewhat less than 10,000 units.

The **880** required no crash program, as it was already fully tooled up as a **Chrysler**. It comes in standard array of hardtops, wagons and a convertible. Inventory will be relatively simple, with a single 361-cubic-inch engine, two-barrel carburetor and choice of manual or automatic transmissions. Price is as yet unannounced but should be slightly below the **Chrysler Newport** starting price of \$2964.

Over at **General Motors** there's activity on the import front with **Pontiac** recently announcing the projected return of England's **Vauxhall** to selected numbers of its dealers, and **Buick Division** following suit with its **Opel**, produced by GM's German subsidiary.

These cars were quietly "de-emphasized" (that's a publicity man's word, meaning dropped) about a year ago. Both these cars are attractive four-cylinder 4 to 5-passenger sedans and station wagons, with prices be-

ginning at under \$2000 (taxes not included), delivered on the East Coast fully equipped. In passenger and luggage capacity these two cars, compare closely with **Rambler's American**.

Coming after **Ford's** re-emphasis of its English lines, **Anglia** and **Consul** (PM Jan. '62, p. 16), the **Opel-Vauxhall** re-entry has the makings of a trend. One explanation for these moves is that **GM** and **Lincoln-Mercury Division** are setting up "instant competitor" ready-made for the much-heralded arrival of **Ford's Cardinal** "subcompact" at **Ford** dealers, in late '62.

The race toward a breakthrough in basic auto power-plant design has warmed up considerably with the rotary combustion (Wankel) engine and the gas turbine entering the home stretch.

**Chrysler** claims that its turbine will be in limited production in 1963 (see page 87), while over in England **The Rover Co., Ltd.** has just unveiled its latest turbine car the **T-4**. Like **Chrysler's** turbine cars, the four-door four-passenger **Rover T-4** is powered with a front-mounted gas turbine rated at 140 hp.

The rotary combustion camp shows an equal bustle of activity. **Curtiss-Wright**, according to unconfirmed reports, has run a two-rotor Wankel-type engine for 200 hours at full throttle on the test stand. This engine is reported to develop 210 horsepower from 120 cubic inches of displacement. Its weight is 400 pounds and it is made of cast iron.

With this sort of reliability testing under its belt, **C-W** could be pretty close to production on this engine. If so it would not be impossible for it to be sold off-the-shelf to an automaker. What a shot in the arm this engine would be for **Studebaker's** 1963 **Lark**, rumored to be an all-new car.

Even as an extra-cost option to the **Lark Six**, the **C-W** rotating piston engine would create as much floor traffic as the **Lark** did itself when introduced back in 1958. **S-P's** dynamic new president, **Sherwood Egbert** (who created the new **Hawk** in 18 weeks) is just the guy to pull off a sleeper play like this. ★ ★ ★



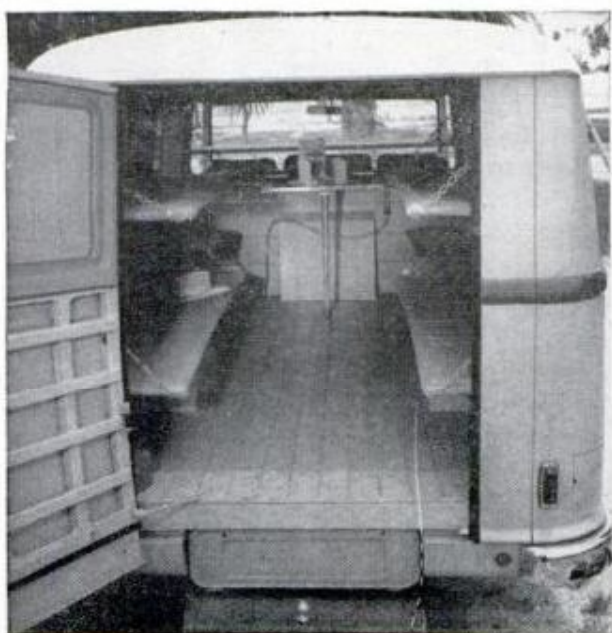
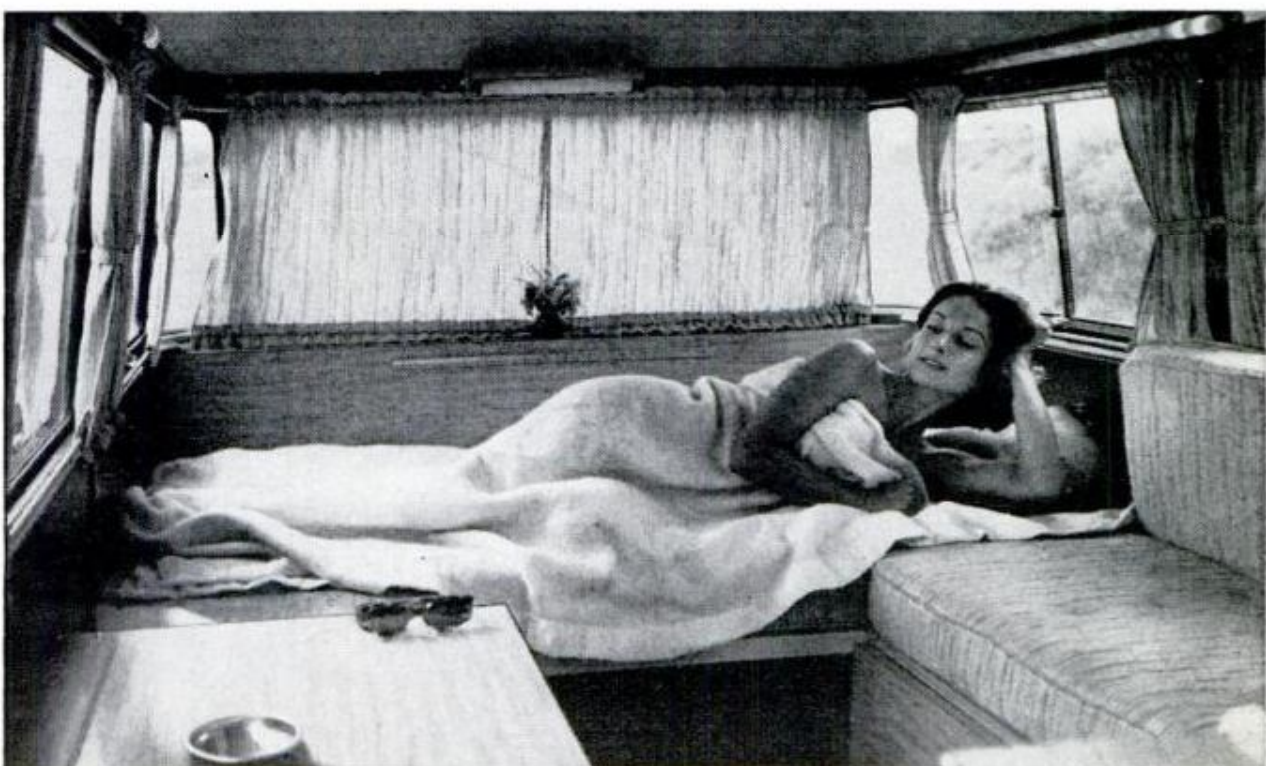

## German Camping Wagons

The booming American auto-camping field has two new entries from Germany—two camping vans by Borgward Motor Co., of Bremen. Both versions are 60-horsepower cab-over-engine vans that deliver 60 miles per hour and 20 miles per gallon; both are delivered stripped-down by the manufacturer to a distributor in West Palm Beach, Fla., for outfitting.

One, the Deluxe Camper, top photo, sleeps five and boasts a tub and shower, hot and cold running water, flush toilet, galley and air conditioning. It costs \$8800. The other, a utility model, shown at bottom, has fold-away furniture and equipment, and can be used as a delivery van. \$4995 from Borgward-Taylor Co., 1710 Okeechobee Rd., West Palm Beach, Fla.

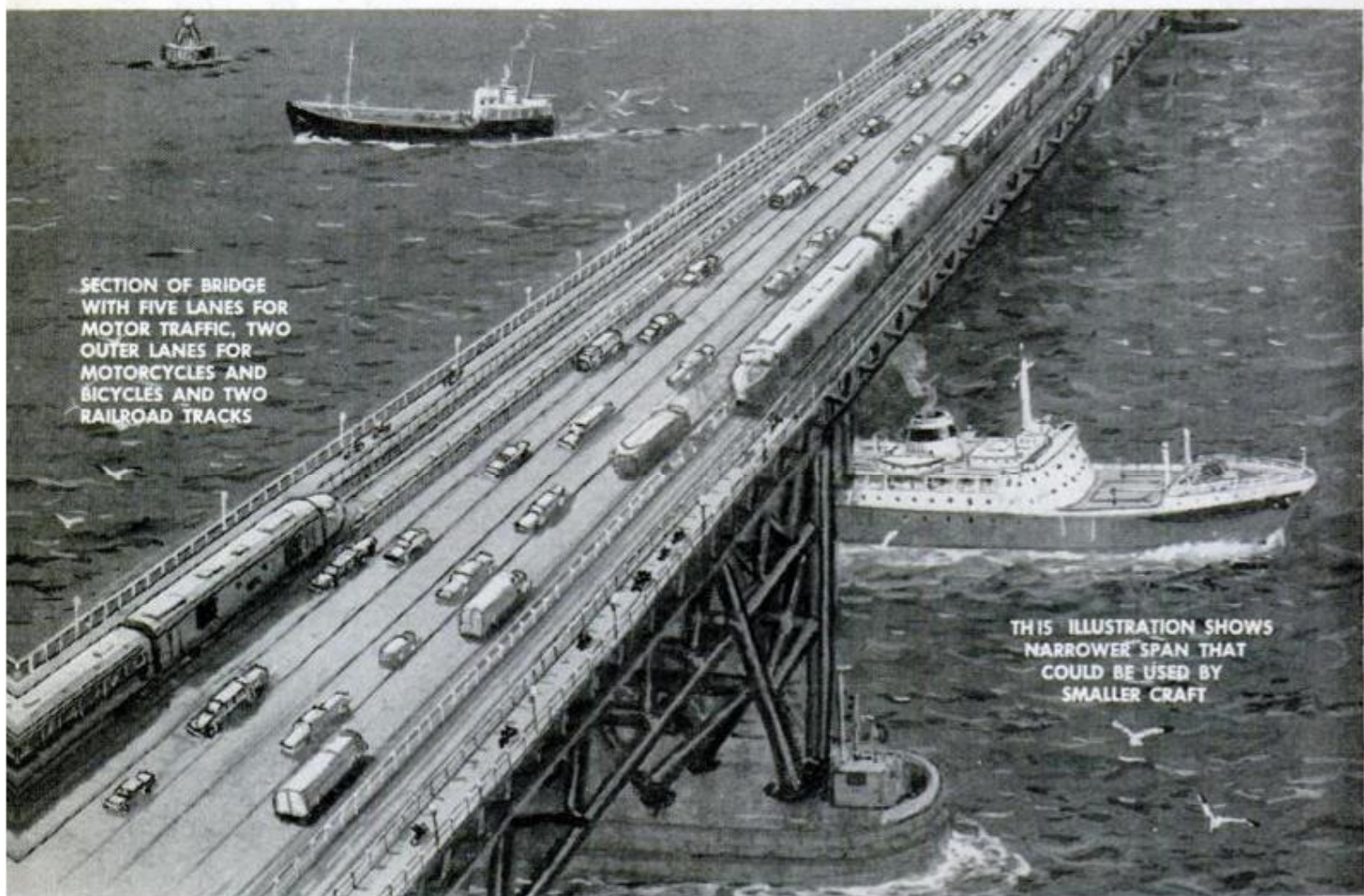
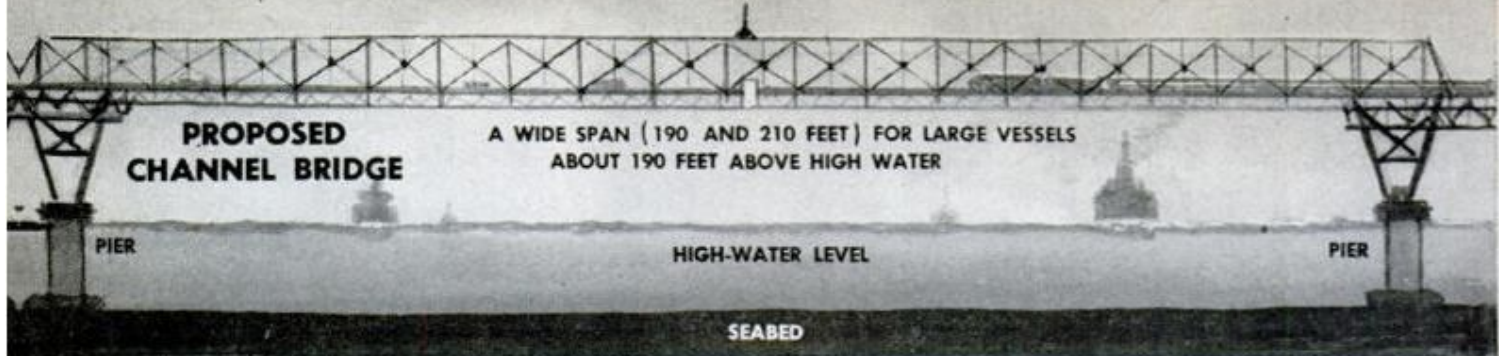

## Bridge or Tunnel Across the Channel?

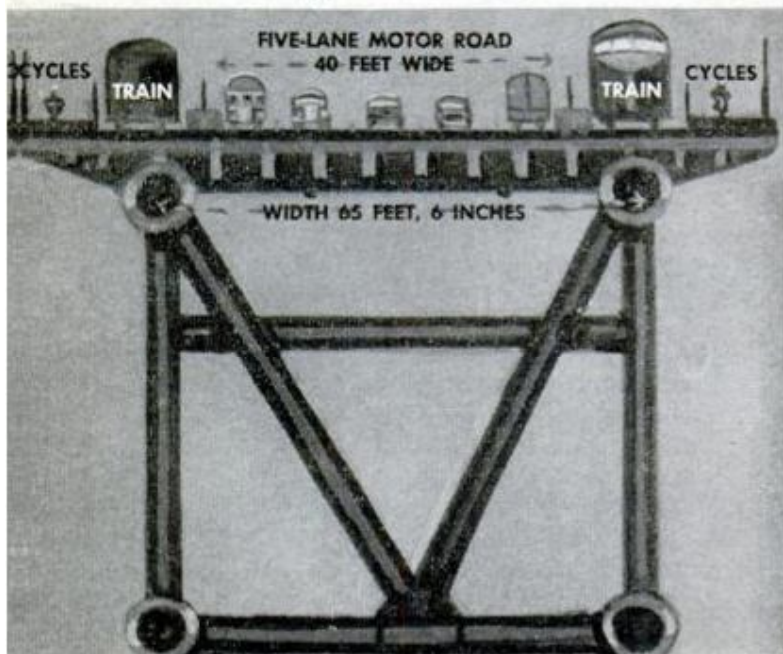

FINAL ARGUMENTS are being given in the 100-year-long debate about whether a tunnel should be drilled under the English Channel to link England and France. Yes, say many, and offer a plan. Good idea, say others, but let's make it a bridge.

Five years from now, claim tunnelers, 60-mile-an-hour electric trains could carry 300 automobiles each through two tunnels. Trains would load in 15 minutes, unload in 10. Cost: \$364,000,000.

But, say bridgers, for \$560,000,000 we could build the bridge and keep in tune with the automobile age: Five lanes for cars, two for cycles, and two railroad tracks.

*Text and illustrations by G. H. Davis*

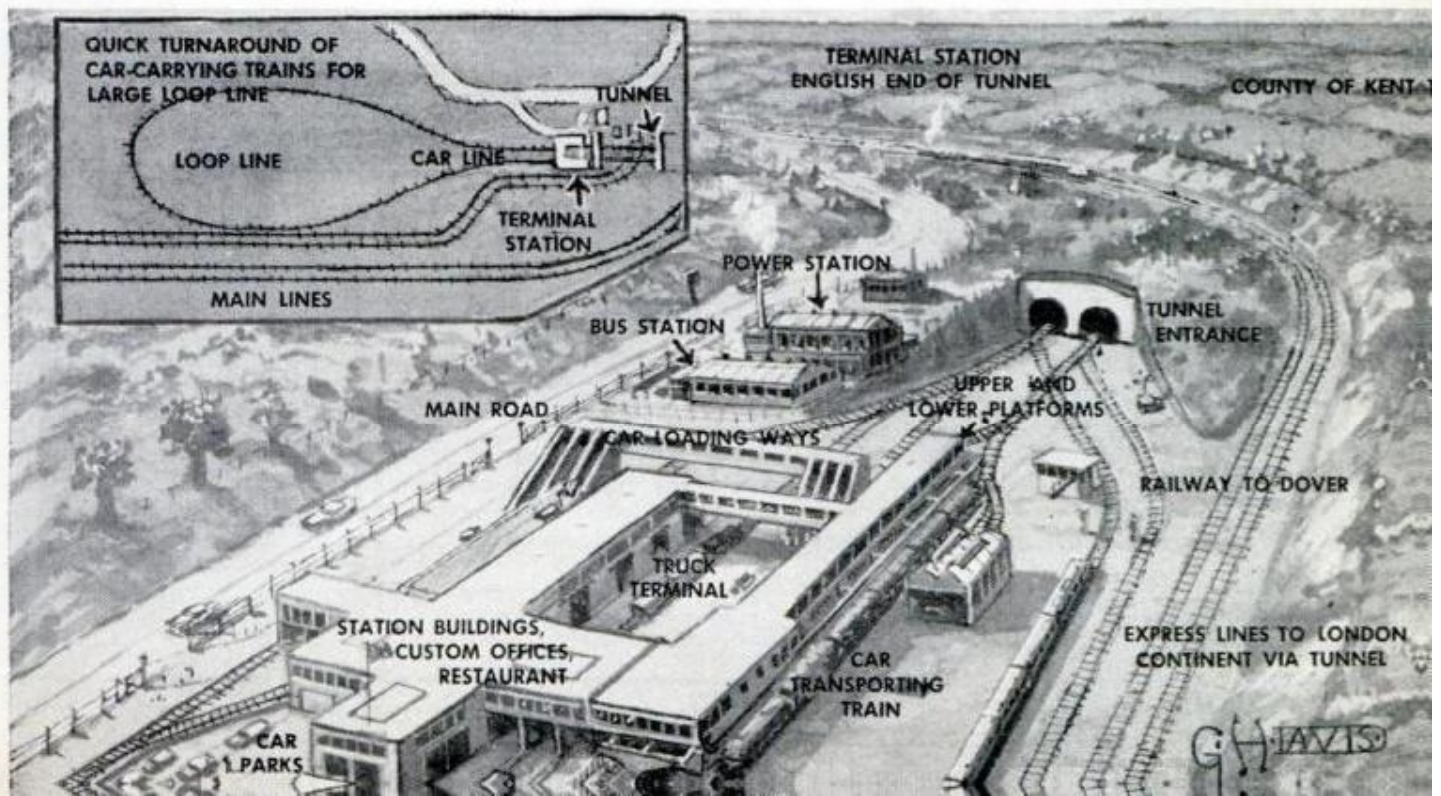
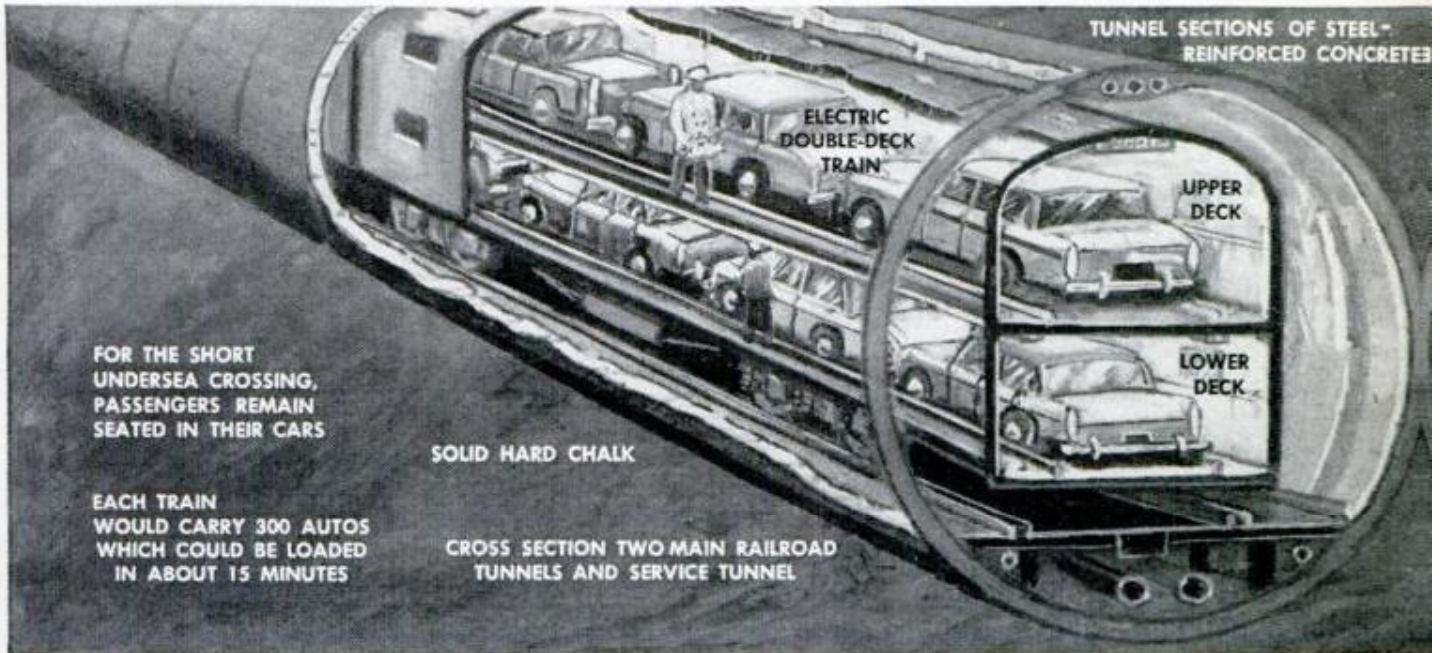
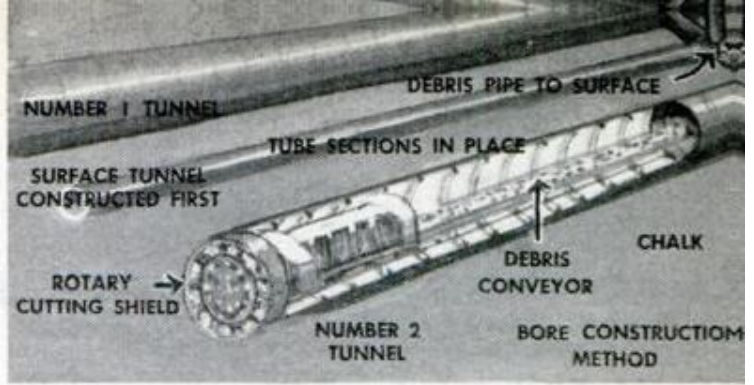
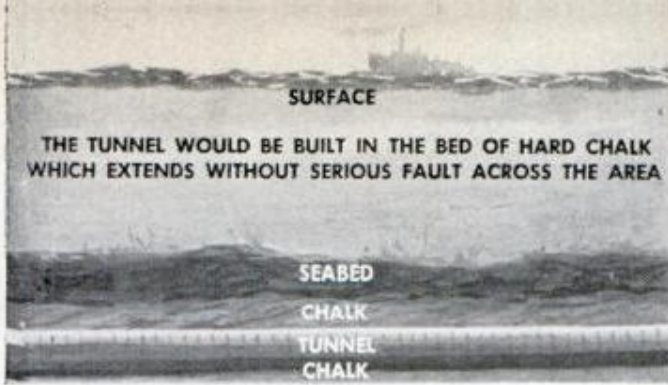

# Our First Moon Trip started at

By S. David Pursglove

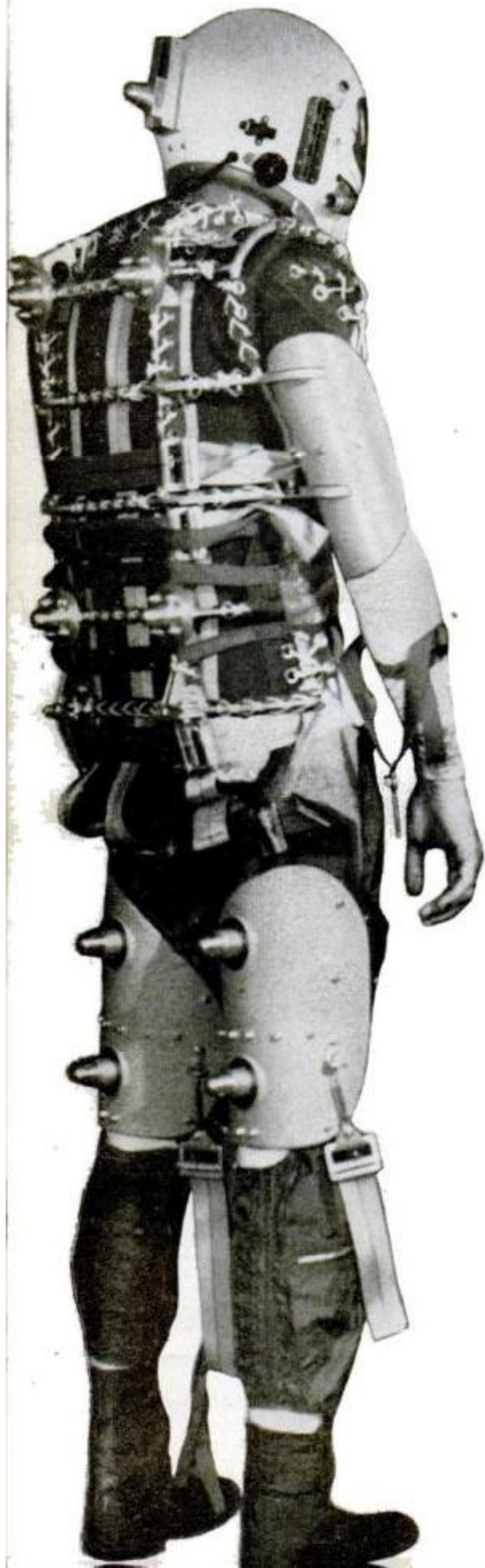

**I**T BEGAN AS an Air Force bus rolled to a stop beside a concrete ramp 1500 yards inside Gate 3 of the new North Section at Cape Canaveral, Fla. Four men got out, clustered beside the bus door, and stared skyward.

Three of the coverall-clad figures showed outward signs of youth. There was a sprinkle of grey through the fourth man's close-cropped hair when he pushed back his baseball cap for a better look at the monster towering above them.

The object of their attention was a white-and-silver shaft jutting majestically 185 feet into the still-cool morning air. Four pairs of eyes followed the ever-broadening sides of the monolith downward until its base disappeared into a canvas shroud that a steel-helmeted crew was removing. As the canvas fell, four enormous funnels were revealed. Each of these nozzles could have accommodated the small group, now walking from the bus to the base of a steel skeleton that towered on equal terms with the enormous rocket.

Lt. Col. Leroy G. Cooper, Jr. (or it could be Shepard, Glenn, or any of the other current astronauts) stepped aside as the group approached a wire cage. He let the three younger men enter first. Then Cooper, now a senior instructor in the manned lunar flight program closed the cage door.

The elevator rose slowly. At 70 feet the rocket shaft tapered inward where the huge solid-propellant booster mated with the smaller second stage. A few feet farther up a coat of white frost indicated that the cage was passing the second stage's unbelievably cold tanks of liquid-hydrogen fuel and liquid-oxygen oxidizer. The frost ended 25 feet higher as the car passed a fairing connecting the

## Express to the Moon—or

Recent news reports have described a NASA plan to place several rockets into orbit, then link them into a space ship while they circle the Earth. This is the so-called "rendezvous" plan. This *Popular Mechanics* article, prepared after detailed discussions with officials responsible for our manned nonflight program, depicts a single large rocket. Why this apparent conflict?

NASA is exploring *both* techniques. *PM* discussed both plans with scientists, officials and even a member of the committee charged with making the final decision. Very likely no decision will be made before 1964. However, in almost every case where *PM* asked for a "best guess," these men gave a marked edge to direct ascent, as shown here, over orbital rendezvous.

The much-ballyhooed Advanced Saturn C-5, a larger

**4:30 the morning of July 1, 1969**

second and third stages. Shortly, more frost appeared to indicate the third stage tanks.

The car stopped alongside a catwalk leading twenty feet across open air to the monster rocket's final stage, the Apollo space capsule. The capsule looked only slightly different from the two others that the Astronauts already had flown in preparation for their voyage to the moon.

The first, more than two years earlier, had been a cone mounted on a drum. Attached behind—or “beneath,” depending on orientation of the viewer—the control capsule and its drum had been a long, cylindrical “trailer” that was home and laboratory for the three men for two weeks in orbit around the Earth.

The next vehicle had been another “cone on a drum,” but the cone was flattened slightly on one side to form the cross section of an extremely thick “wing” with a small amount of aerodynamic control. Six months earlier, this capsule and the engines in the attached module, or drum, were sent around the moon and back to earth. The slight flattening of the cone—the only part of the space vehicle to return to earth—allowed pilot-navigator Henry Collins some slight guidance of the capsule as it reentered the atmosphere.

The capsule that faced Navy Lt. Comdr. Collins, his two companions, and Cooper, again was a cone that appeared very slightly flattened. Its base was 12 feet in diameter; the cone was 14 feet long. Below the cone was the familiar drum containing the two small hydrogen-lox engines that would propel the three men home from the moon. Below the propulsion module was again a trailer, but much longer this time. Here

## **Rendezvous en Route?**

three-stage rocket than the design shown here, exists at this writing only in the form of a contract which has been let for design feasibility studies, and actually is intended for orbital rendezvous and perhaps circumlunar shots, but not direct moon landings. Experts estimate that any Saturn C-5 shot cannot take place until 1966.

There is no doubt that in later years, once a rendezvous technique has been perfected, it will be a cheaper and less complex way to reach the moon than direct ascent. However, this article discusses our *first* moon trip, and all evidence indicates it will be made in the rocket shown here.

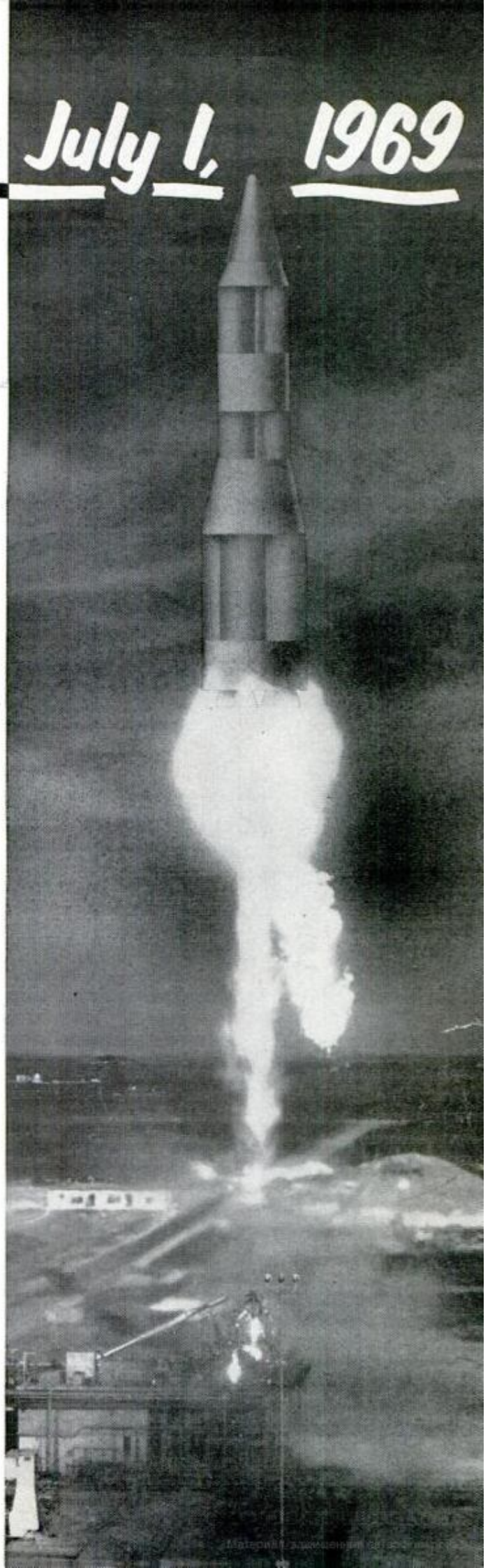

**APOLLO SPACECRAFT**, which will carry three men to moon and return, rests atop three-stage lunar vehicle—185 feet in air. Base of vehicle is 30 feet across. Men ride to moon in nose cone. Cylindrical "trailer" contains engines to ease cone onto Moon

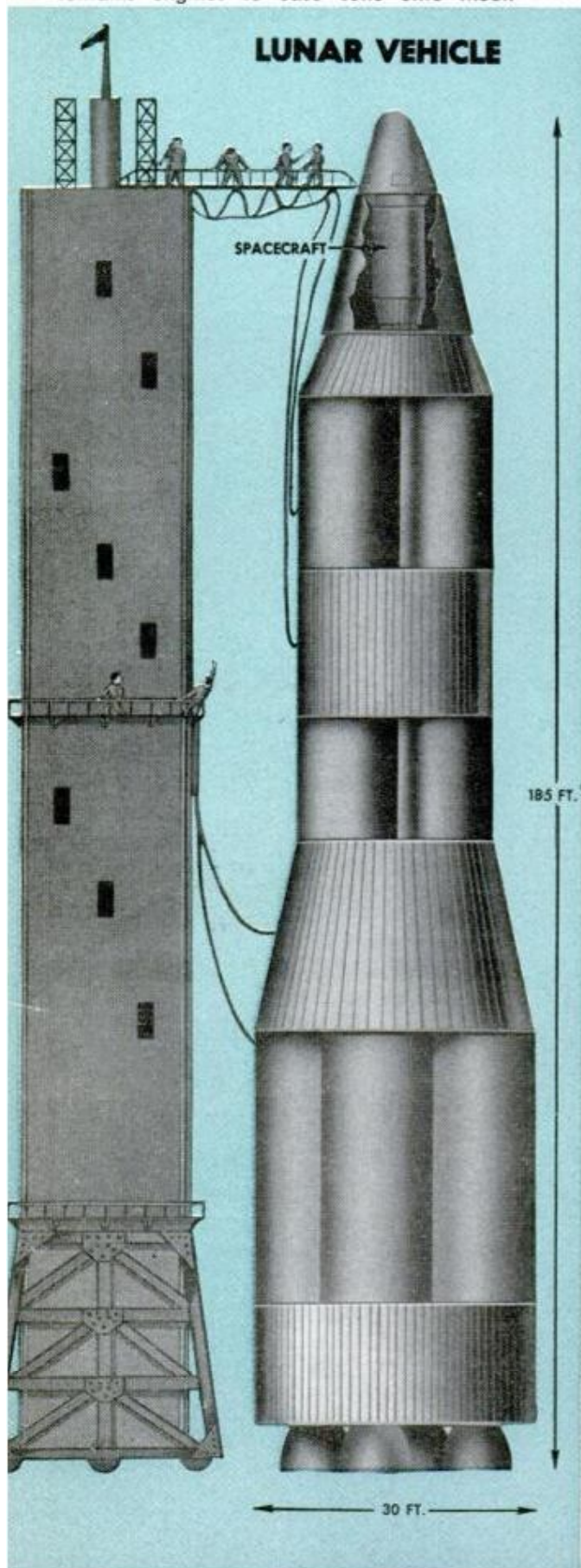

were the hydrogen-lox engines that would ease the Apollo onto the moon.

Collins strode across the narrow catwalk and grasped two small, recessed handles on the entry hatch. An effortless pull and the lid lifted out two inches and then slid downward on tracks. Collins stepped through the hatch into the control cabin, tightly packed with engine control, navigation, communication and life-support equipment. Suspended above him was his "station" for launch and reentry and for control functions during flight.

The station was a form-fitting bunk molded, in hard plastic, to Collins' body contours. It was on a three-way gimbal controlled by a motor and gyroscope to maintain a preset relative attitude as the capsule changed flight directions. Mounted on the gimbaled station were a full set of controls, which would guide the crew's destiny after the ground-controlled launching, and navigating equipment.

Below Collins' station were two others. Almost identical was the pilot-communicator's station assigned to Air Force Major Frank Dinswood. It featured a duplicated set of engine and emergency controls. However, only minimum emergency navigation equipment surrounded the pilot-communicator's station which featured, instead, the major equipment for communication between Apollo and Earth.

Beside Dinswood's station was another form-fitting acceleration couch, molded to the form of Air Force Captain William Hixson. As engineer-medic-scientist for the mission, Bill Hixson would be surrounded by controls for the capsule's oxygen and nitrogen breathing system, air-conditioning controls, instruments to record temperature, humidity, and every other critical factor of crew life and capsule. Hixson's station also featured the mission's tool box. Although he was the crew member most intensively trained in mid-flight repair and the use of the special space tools, Collins and Dinswood also had been checked out on the use of the tools and, of course, were on intimate terms with the rocket and capsule construction and plumbing so that they could also make emergency repairs.

It was Hixson, though, who had spent weeks learning the intricacies of space-tool use. In a weightless condition, there would be no gravity to provide one element of leverage and a major element of friction.

**LUNAR MISSION** includes these three phases. Launch from Earth gets spacecraft to escape velocity with three-stage booster. On lunar takeoff, "trailer" of spacecraft is left behind; only nose cone takes off. On return to Earth, cone maneuvers to land

# LUNAR MISSION

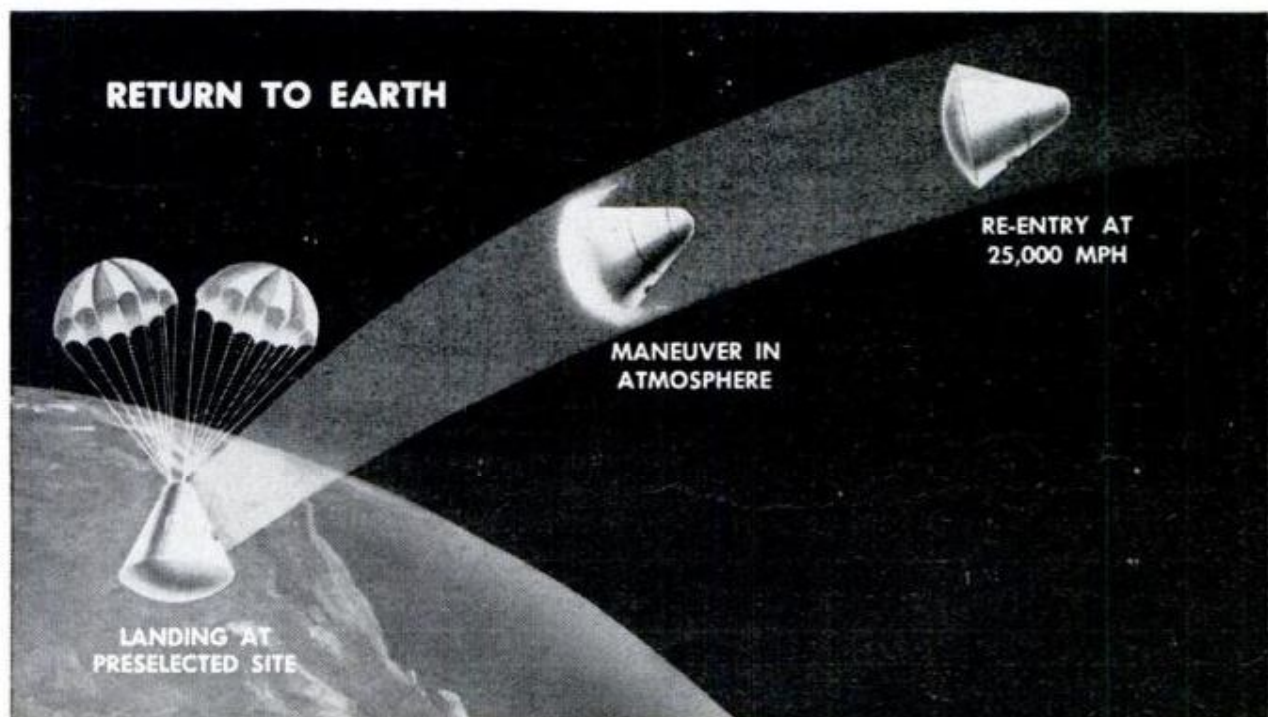
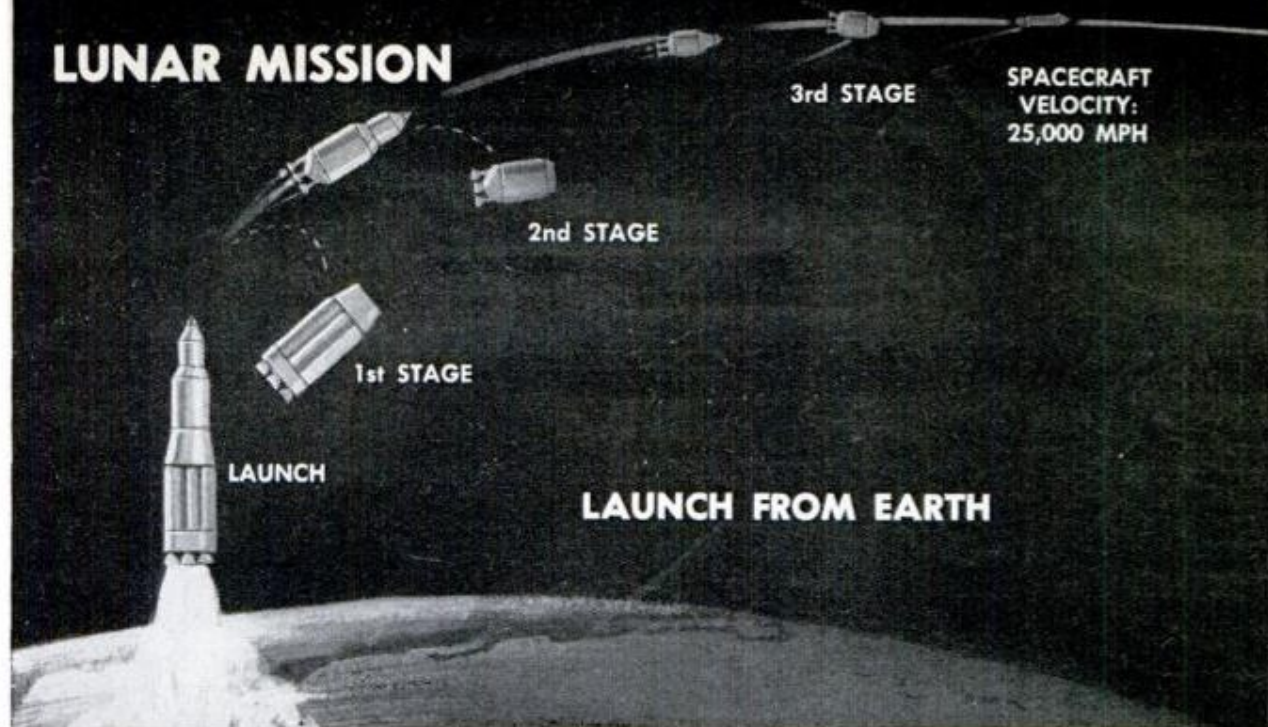

## SPACE TOOLS

PLENCH

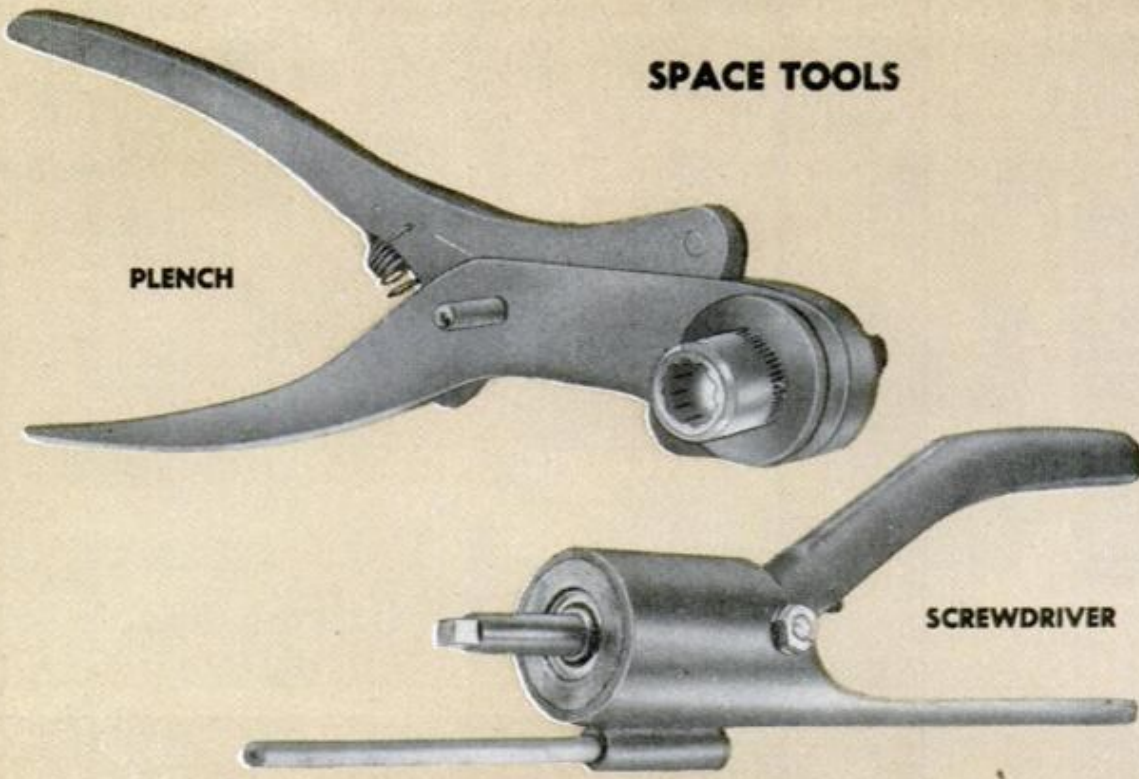

SCREWDRIVER

**SPACE TOOLS**, designed to overcome weightlessness, are squeezed to operate, minimizing violent reaction

A sudden twisting or wrenching movement would send a repairman flying. Most tools had been redesigned to perform their traditional functions through power supplied by a pliers-handle motion. Thus, Hixson had learned to squeeze a screwdriver's handles; the squeeze motion was translated in the tool to a rotary motion that could turn a screwdriver blade. He learned to use a "plench," a ratchet socket wrench in which the working end was actuated by squeezing the plier's handles.

Many small handles were built in throughout the craft to provide handholds. Where handles would interfere with the craft's functions or would be hazardous to the crew, the designers had inset small steel plates. In the tool kit was a portable "handle" containing a battery-operated electromagnet. If Hixson needed a firm grip under a weightless condition, he could temporarily attach his "handle" to the nearest steel plate. A permanent magnet, rather than an on-off electromagnet would interfere with navigation equipment.

As he entered the hatch, Collins squeezed past Dinswood's station and stepped to a round hole in the center of the floor. Stooping, he grasped two recessed handles and raised a pair of stairwell guard rails. Gripping the rails, he lowered himself past the tanks and nozzles of Apollo's moon takeoff engines and into the forward part of the deceleration "trailer." Here were bunks, food storage and a small galley for three men during the 60-hour trip to the moon, three days on the lunar surface and the return trip.

One man always would be on duty in the control module above, and one always would be asleep in the trailer. The third would be awakening, retiring, shaving, eating or playing one of the games devised by Project Apollo psychologists.

After reassuring himself that the countdown crew had properly prepared the trailer, Collins returned to the command module. Neither Collins nor the others would be likely to spot anything needing attention, but the psychologists insisted that a personal check by the crew be a part of the countdown for mental reassurance. Likewise, their senior instructor, Cooper, was not actually needed in the gantry elevator, but his presence was reassuring. Further, it was his face on TV and his voice on radio that would continue to reassure them.

Cooper's job would be at least as hard as theirs. He would receive almost no sleep to their 8 hours of sleep and recreation out of every 24 hours. He would be responsible for decisions and Earth controls that would affect them in flight.

As he climbed back into the control module, Collins saw the pressure suits just where hundreds of practices had taught him they would be: Split into two halves, front and back, lying on the station couches. Much of the back half of the suit was made a part of the couch itself.

When Collins had finished zippering and strapping himself in—Cooper could have done the job before returning to the ground, but there would be no Cooper to do it on blast-off from the moon—he



## ALTERNATE METHOD WITH ORBITAL RENDEZVOUS

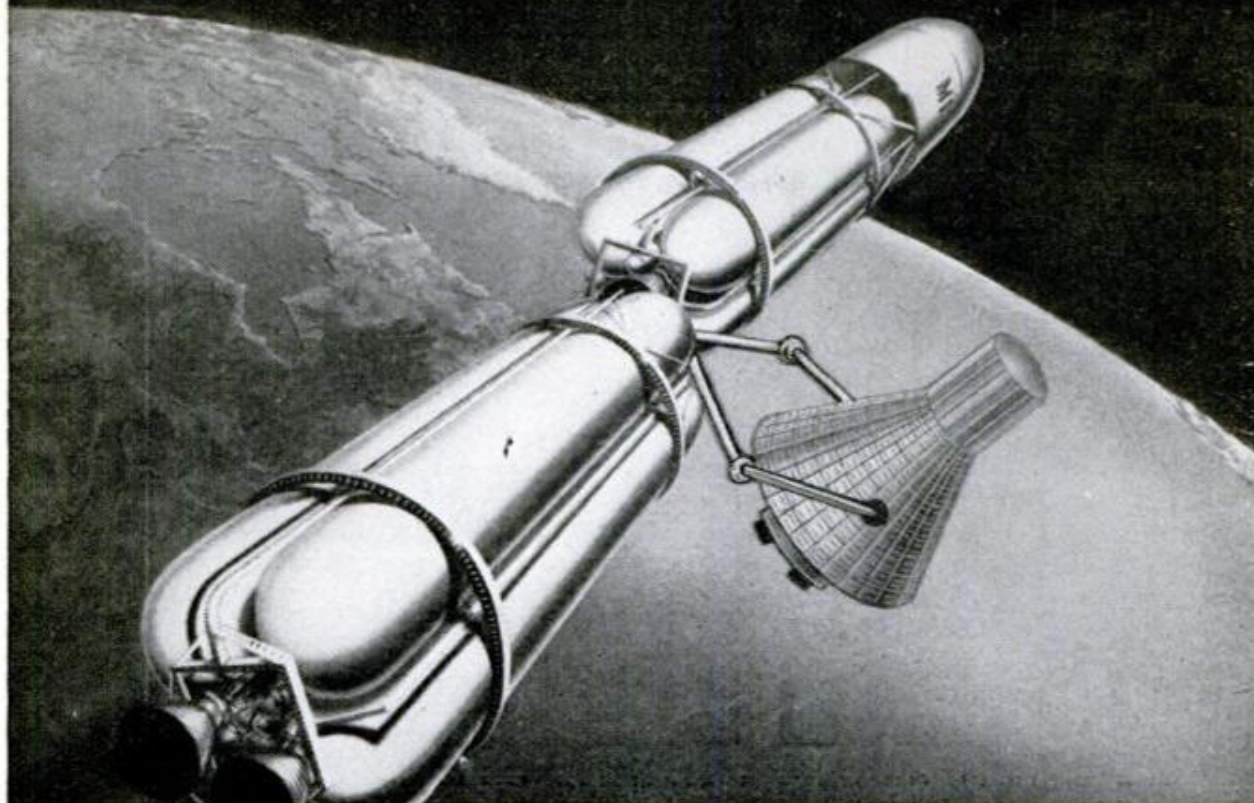

**ORBITAL RENDEZVOUS** sends separate stages into orbit, mates them in space with help of two-man spacecraft

touched a switch with the little finger of his left hand and two padded steel bands dropped over his helmet and clamped it firmly to the couch. Then he activated another switch with his thumb and spoke into his helmet microphone. He told the blockhouse that he was strapped in and there was now room for Hixson to come into the cabin and go through the same procedure. The little finger operated the helmet clamps since that function would be performed only when the craft was at rest or relative rest and no great strength was needed. The strong thumb could activate the principal radio switch even during 15 or more G's of acceleration or deceleration. The even stronger index finger was saved for the manual emergency abort switch. It was separated from the thumb—no room for error here—by nature's own spacing on the hand. No switch was assigned to the third finger as this could lead to confusion.

After Hixson and Dinswood both were strapped in, Cooper gave them an encouraging high sign and departed. Then began the solid hour of checking equipment and checking instruments against their counterparts' readings in the blockhouse.

The principal control panels—those facing Collins and Dinswood—were changed only a little from the instrument consoles of the Mercury-Redstone 4 in which Air Force Capt. Virgil Grissom hopped from Florida to the Bahamas eight years earlier. However, there were *more* panels. There were complete controls over deceleration

and landing on the moon, entry and exit hatch, moon blast-off and, finally, the atmosphere re-entry and landing. Almost all controls operable by the crew were also automatic or semiautomatic in the character of the spacecraft.

The pilot-communicator could relay the navigator's position readings to Earth, or the communication equipment could be commanded to do it automatically at pre-set times. The engineer could willfully control the cabin temperature or humidity in response to what he might call an emergency or a deviation, or he could allow the automatic system to take its course and make probably the same compensations.

While the spacecraft and blockhouse crews were making checks and comparing notes, other crews were checking elsewhere around the globe. At the Goddard Space Flight Center, just outside of Washington, the computers were humming with "programmed dry runs" of the flight and crews were checking each action that would be made later in following the flight so that instant communication to Lunar Program headquarters in Houston could alert a controller to make a ground-command adjustment—if possible—in a wayward flight. At Jodrell Bank, England, the huge radiotelescope was pacing and replacing the first hour's flight. Half a world away, in southwest United States, the giant tracking station at Goldstone was checking frequencies, tracking and re-tracking over the anticipated flight.

(Continued to page 228)

# THIS PARACHUTE GOES UP!

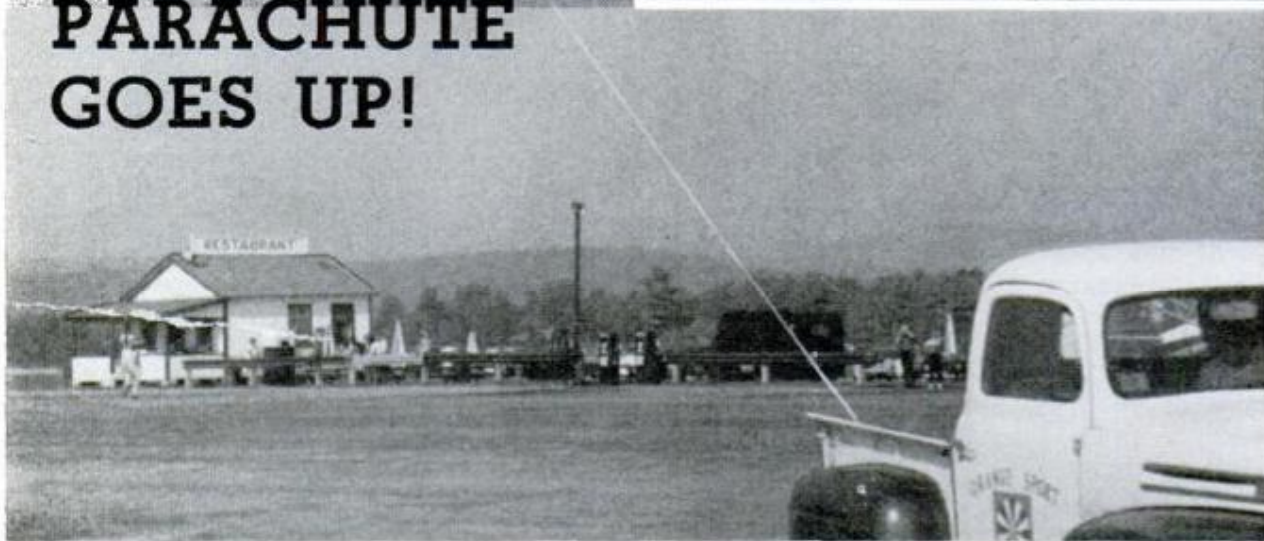

**SKYDIVER** Nate Pond takes off behind a tow truck. With right wind, chute will "fly" without tow (inset)

**COMPLETELY REVERSING** usual performance, the new French "Parachute Lemoigne" lets a skydiver go up as well as descend. Flown like a kite, behind a vehicle or on a fixed towline, the 'chute

spills air through 24 slots in the canopy, creating a low-pressure area above the canopy to produce lift. It allows skydivers to jump without a plane. American distributor is Parachutes, Inc., of Orange, Mass.

**'CHUTIST'S-EYE VIEW** down nylon rope towline. Flight lasts as long as wind or vehicle keep moving

**IN FLIGHT,** 'chute is "a little like riding a kite and a little like riding a glider, but more exciting"



## Supersensitive Rocker

So sensitive to movement is a new test seat that the normal breathing of the occupant is enough to make it move back and forth.

Designed to help potential astronauts learn to handle controls in zero gravity, the 1500-pound "rocker" reacts to any sudden or ill-balanced movement. The student learns the careful, deliberate movements necessary under weightlessness.

Since zero gravity is impossible to duplicate on the ground, and both difficult and expensive to reproduce in the air for a few seconds, the machine is expected to prove useful for training future space travelers.

The seat was developed by Chance Vought Aircraft.

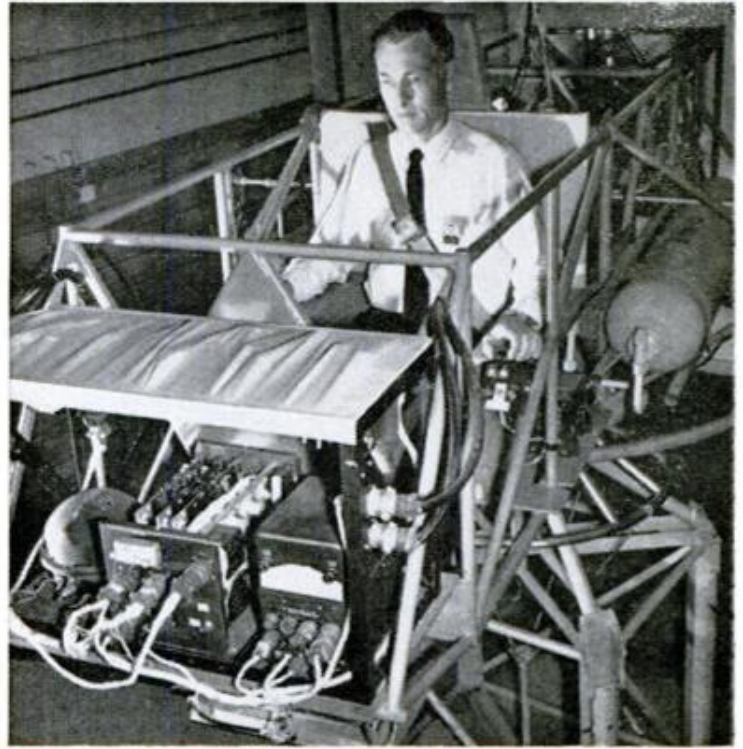

## Mail Merry-Go-Round

Neither stress nor strain nor rips nor tears stopped the mail from making its appointed rounds in recent tests of curved conveyors.

A new system developed by Goodyear eliminates the belt-wrecking edge stress usually associated with curved belts. All restraining idlers are placed along the belt's inside radius to avoid carcass strain and tearing.

The specially-curved belt is in-laid with radial steel rods that keep it flat on the conveyor bed even at high speeds.



## Roll IN the Barrel

Lake Washington, near Seattle, Wash., scene of hundreds of impressive water speed contests, recently floated one of the strangest boats to appear there. It's a barrel-boat built by apprentice piano repairman Dan Grinstead, left, and friend Terry McManus.

Made to take a crew of four, the craft rolls through the water like a free waterwheel, propelled by the occupants' walking up its inside surface like squirrels in a rotating cage. It's eight feet in diameter, built of plywood and achieves a maximum speed of around three knots.

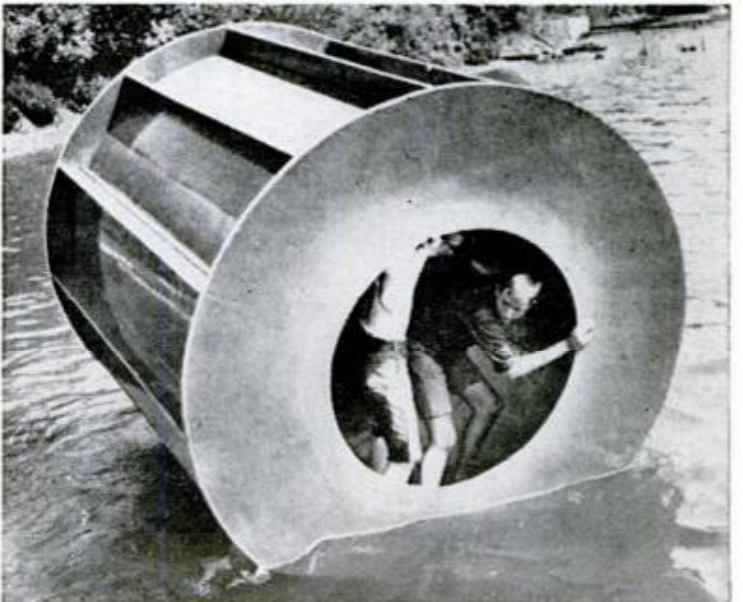

*See Grinstead S.F.  
3261-67th Ave.  
Merret Island, Wash*

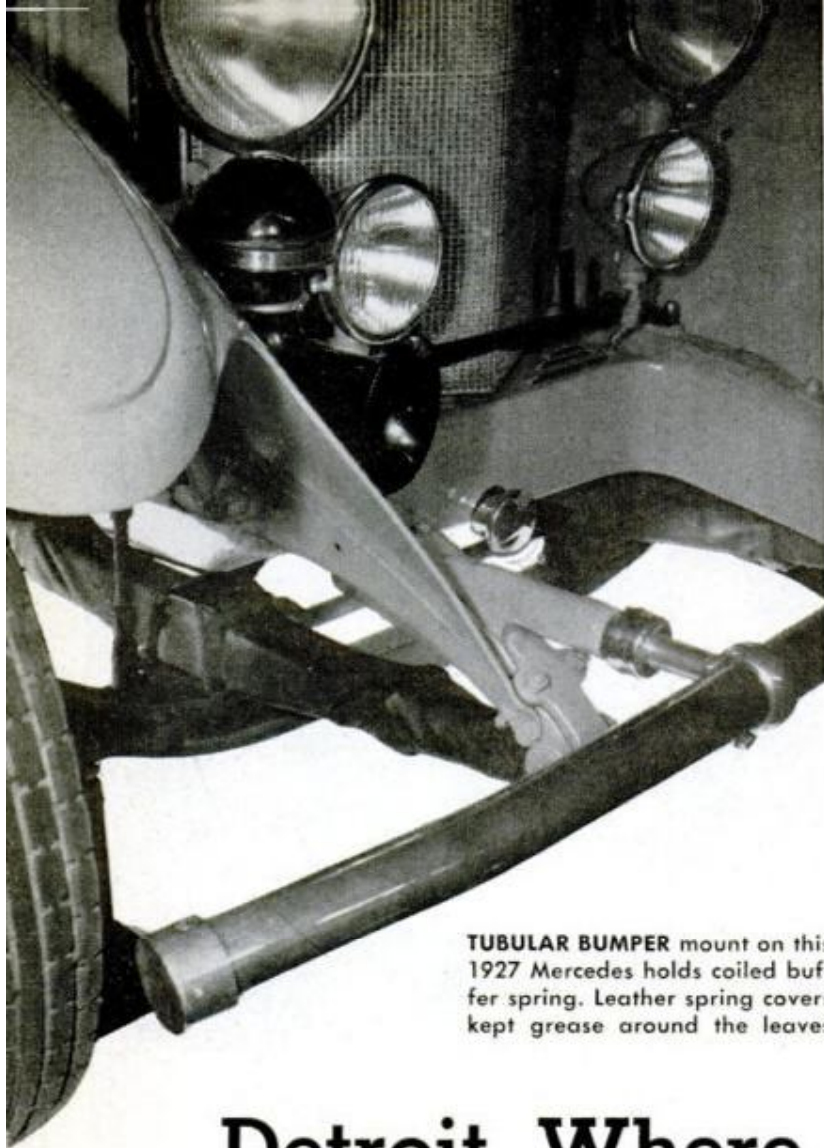

**TUBULAR BUMPER** mount on this 1927 Mercedes holds coiled buffer spring. Leather spring covers kept grease around the leaves



**FENDER LAMPS** like this on 1936 Horch (German) were almost universal in 1930s. They'd be great on today's cars as ultra-visible directionals as well as for parking

## Detroit, Where Are These Old-Time "Touches"?

**FOLDING STEERING WHEEL** featured on 1915 Cadillac might be dubbed The Fat Man's Friend. It pivoted forward to permit plump drivers to enter. Could it have inspired swing-away wheel of current T-Bird?

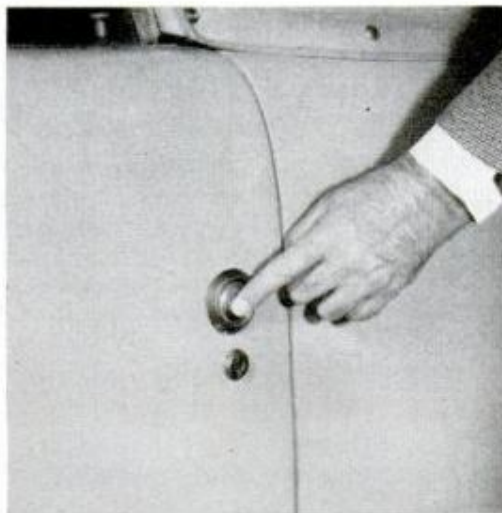

**SIMPLICITY** was the essence of this push-button latch found on 1940-48 Lincoln Continentals. The spring-loaded door popped open whenever you thumbed the button

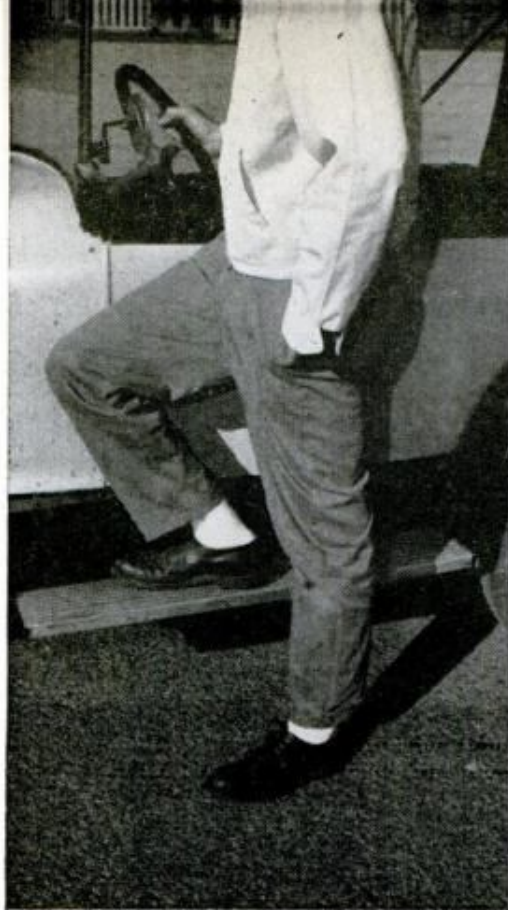

**HIGH-WATER** runabout of '20s needed its running boards for the ascent to seats. Boards are reappearing on some bus-type station wagons in '62

**YESTERDAY'S KIDS** had lots of fun in breezy, cozy rumble seats like this one on a 1926 Wills Sainte Clair coupe



**PROGRESS IN** automotive design is all too often an illusion. Just because a feature or style is labeled 1962 or modern, doesn't always guarantee that 1) it recently burst from the inventive mind of some young engineer or 2) that it represents a superior design.

Take, for example, such a simple item as parking lamps. Back in the '30's, when they were only used to show where your car was, they stood high and

**GUESSING GAMES** were not necessary for drivers of the 1930s and '40s when almost all instrument panels, like this 1940 Chrysler's, had a full complement of gauges to give them the facts about their engines

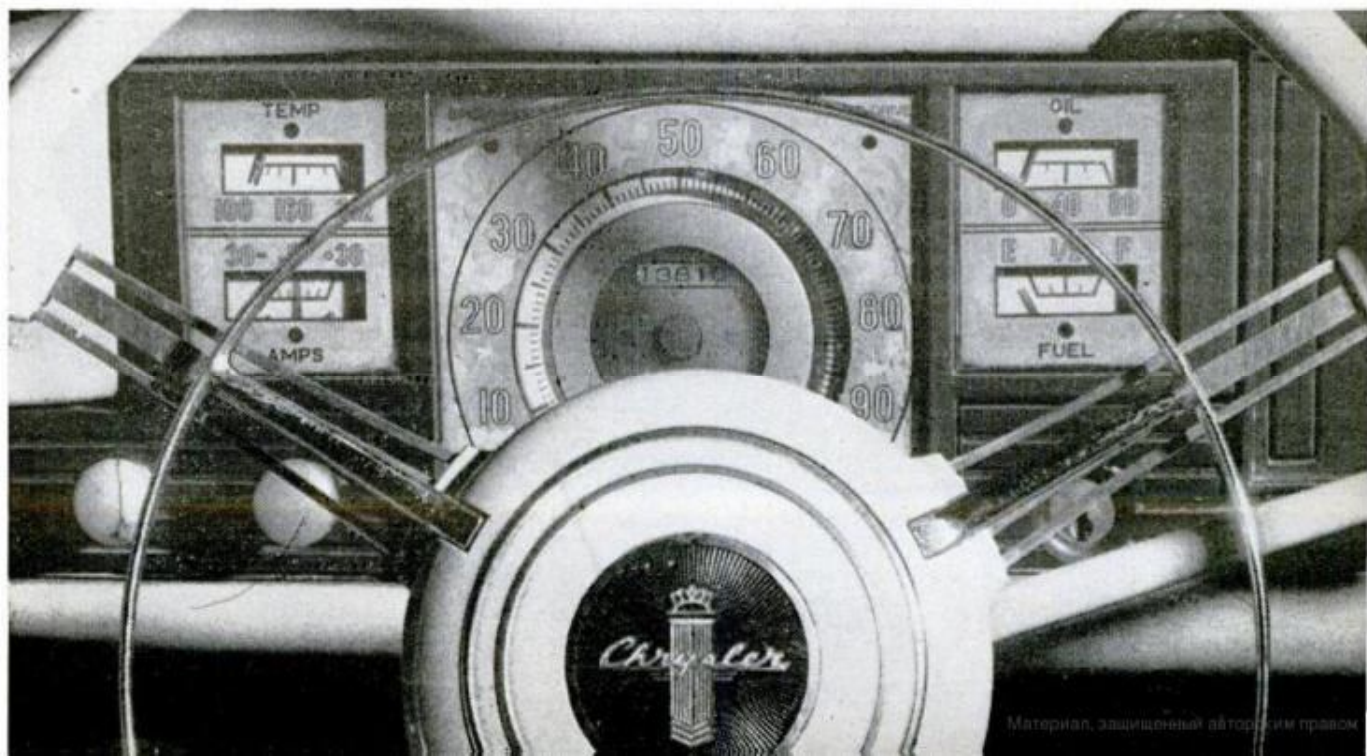

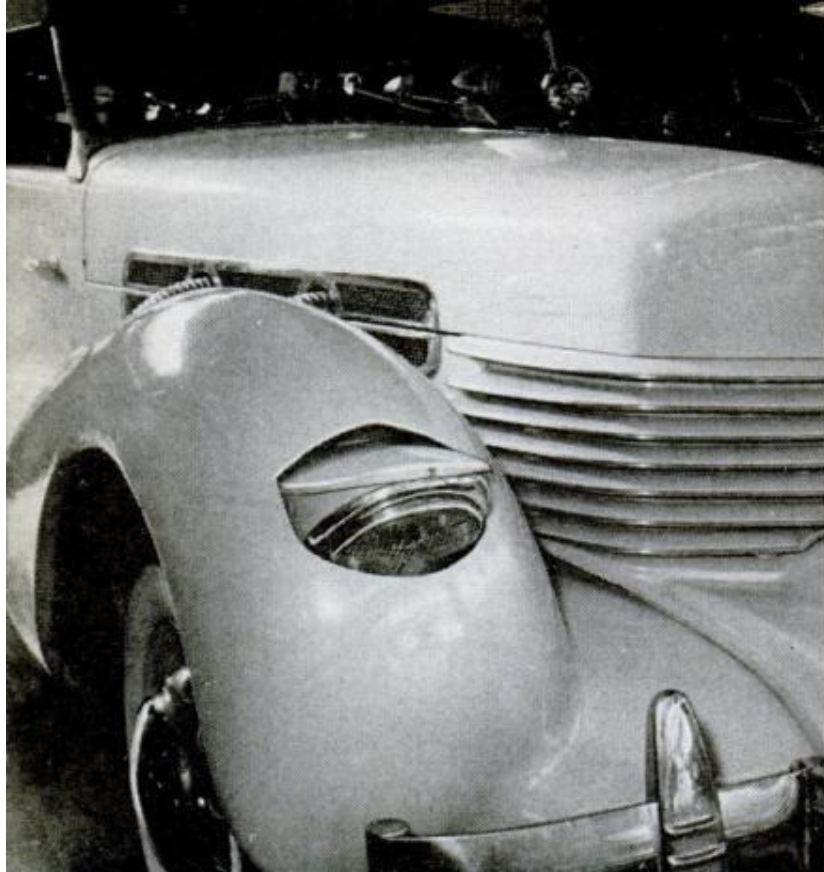

**HEADLAMPS** on this 1937 Cord were kept free of mud and bugs when retracted into the fenders, although the real reason for hiding them behind the pivoted panels was to help cut wind resistance and improve the car's over-all styling



**OPERATION** of Cord's retractable headlamps was by cranks at either end of instrument panel. Flexible cables led to worm and sector gearing which rotated lamp assembly

dry and visible. Today, while these small lamps have taken on the important task of winking your turning intentions, they are all too often hidden in the glittering depths of the grille. Or they may be placed in the bumper itself where they will be first to receive flying mud or stones. Meanwhile, back on the fender top, we frequently have ornamental chrome torpedoes.

Another example of the "two-steps-backward-while-you-take-one-ahead" philosophy is the glove compartment. Today's stylists have been unable to decide where to put it (let alone make it big enough)—in the center, at right

**ONCE UPON A TIME** glove compartments, as on this 1936 Lincoln Zephyr, were big enough to hold a good deal more than gloves. On many 1962 cars they're not big enough to "take" a camera, and their cardboard bottoms are hardly theftproof

**YOU WOULDN'T** have to show every filling station attendant how to open the hood of your new car if it had a handy remote control release like this 1941 Lincoln's

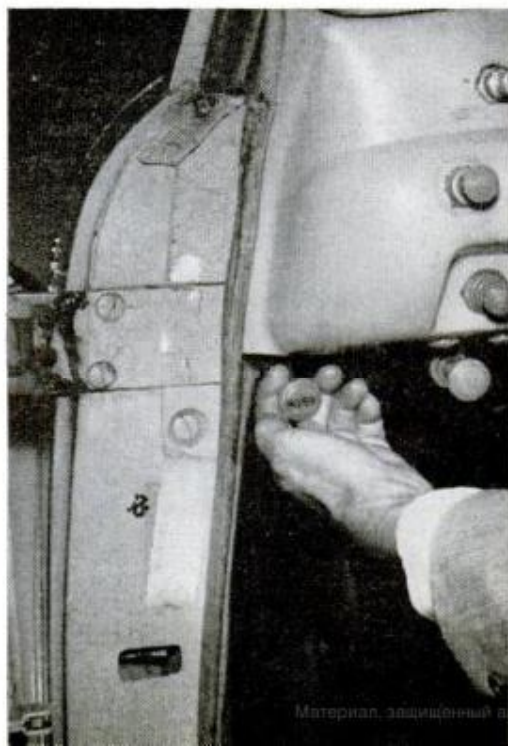



**WHEN A SUN VISOR** was really a visor, as on this 1928 Franklin, it was outside the car body, and helped keep snow off in winter as well as blocking glare. Most cars of the '60s could use a similar device



**MANY MOTORISTS** today could use a real trunk rack like the one on this 1915 Belgian Minerva. The vertical cylinder at lower left of picture is a shock absorber that operated by compressing trapped air

or even below the panel. A 1962 "all-new" car, which we will mercifully leave unnamed, has a small glove box in which the inadequate carrying area is attached to the hinged lid so that when you open it in a hurry, everything falls in your lap.

And so it goes. On these pages, you will see some old fashioned—even down right ancient—automotive features that are worth more than a wistful glance. In view of their obvious virtues, why haven't many of them been updated and retained on our "modern" cars? ★ ★ ★

**LUBRICATION WAS EASY** for the owner of this 1915 Rolls Royce which had central oil reservoir on fire wall. Pushing a foot pedal enabled driver to force lube through thin tubes to various points on chassis

**THE HAND CHOKE**, an ancient and honorable automotive device, found on this 1916 Mercer, has been resurrected by a number of U.S. compacts. For all too many motorists, alas, correct "choking" is a lost art

Photos courtesy Henry Ford Museum

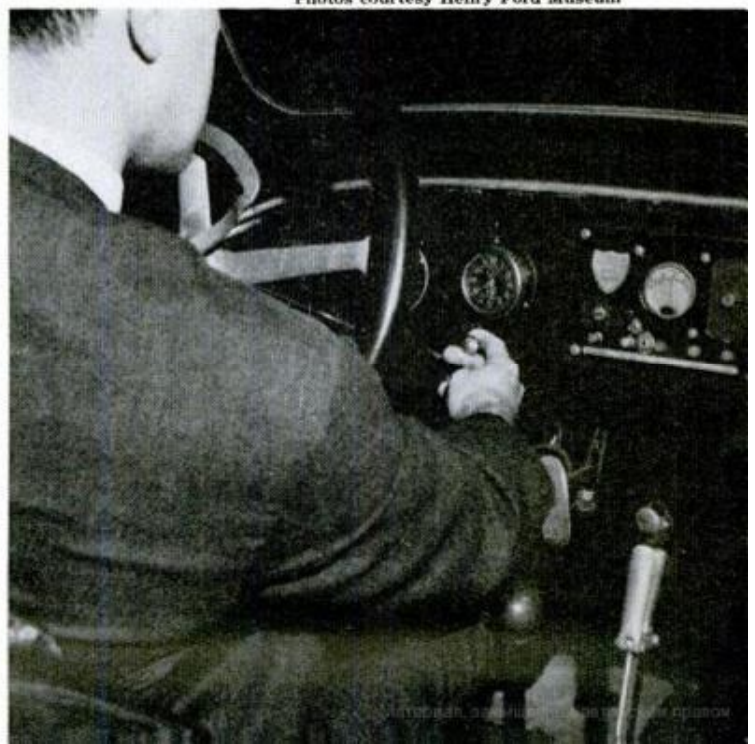
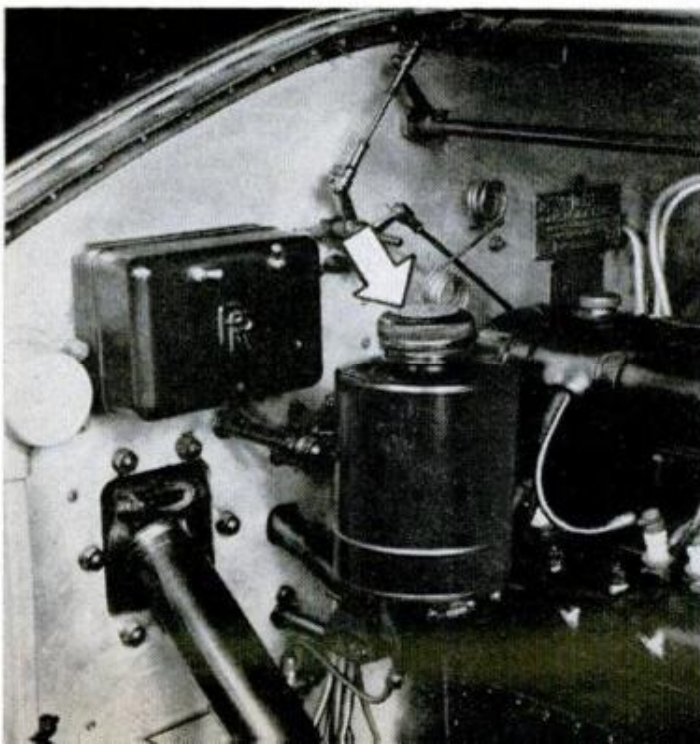



**"Only horses left"**

**MUSICAL RIDE**, a skilled exhibition team, is only group of Mounties now using horses. All recruits, though, get horsemanship training

# MOUNTIES WITHOUT MOUNTS

**TARGET** of cameras is Mounty on duty at Parliament Hill, Ottawa

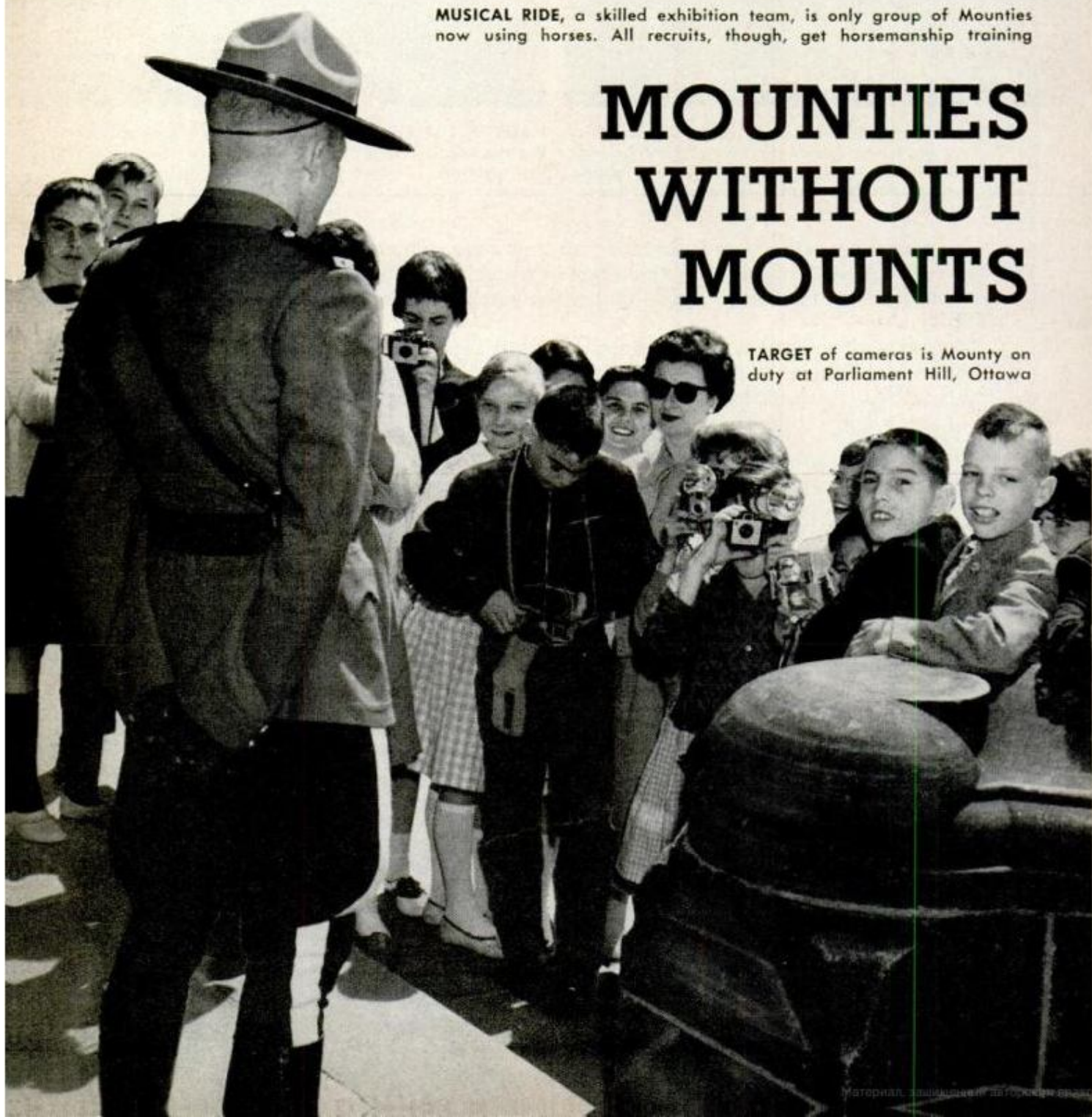





**SNOWMOBILE** is one of many modes of transportation the RCMP uses to patrol the vast area of Canada. Members of the force also use snowshoes and dog sleds when necessary, as well as cars, airplanes, boats and ships

*Planes, boats and snow sleds have replaced their beloved horses—and now the most modern of criminal labs backs them up in their dogged determination to “get their man”*

**By John A. Linkletter**

**T**HERE ARE MORE of them on ships now than on horses—yet they're still called the Royal Canadian Mounted Police.

The mention of Mounties immediately brings to mind the famous scarlet tunic—yet most of the time you'll see them in brown tunics or in business suits. When they do don the “Review” order uniform

for dress occasions, the red tunics of today's policemen resemble those that symbolized law on Canada's plains even before the time of the Custer massacre south of the border.

Their capture of criminals is popularly pictured at the close of a chase on dog sled through a swirling Yukon blizzard. This

**COMPOSITE PHOTO** of a criminal is assembled from descriptions, left; a technician compares bullets, right

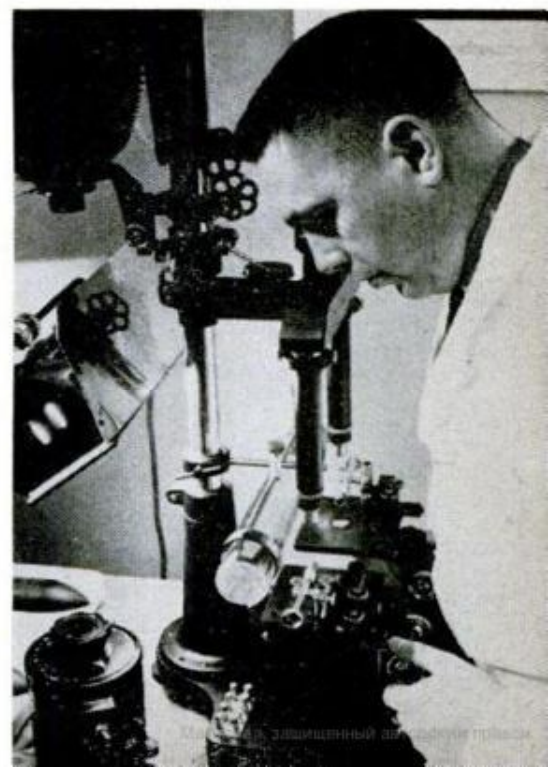



**WOLF BOUNTY** is the subject of solitary conference. The policeman, of the Peace River Detachment, is on game patrol in northern Alberta



**RECALLING** a criminal case in a remote area of Canada is Inspector Andrew Mason-Rooke, head of the RCMP's Crime Detection Laboratories



**NEW BABY** is registered by member of force in Coppermine, N.W.T. A Mounty often represents other branches of the Canadian government in addition to the RCMP. Member in charge of Coppermine detachment is also district registrar for Department of Northern Affairs in connection with the administration of Eskimo affairs

**SMUGGLING** across the U.S.-Canada border is one of the RCMP's headaches. Here police have captured load of smuggled cigarettes





PILOTED BY MOUNTIES, a CF-FHW Beaver and CF-MPG Goose of the Air Division fly over Vancouver, B.C.

can still occur, but arrests are more likely to follow a chase by auto (if there's any chase at all) on evidence gathered by field investigators, fingerprint analysts, ballistics experts or even atomic scientists.

There's little wonder that the perpetually red-coated horse-riding dog-sledding image of the Mounted Policeman persists. They *were* originally a mounted force. Many of their case reports read like legends, filled with the elements of the strong and virile "good guys" pitted against evil in an arena of snow, loneliness and danger. And one of the vivid memories visitors retain of Canada is the brilliance of the Mounties' scarlet tunics on Parliament Hill in Ottawa, Ont.

Today's policemen, though, are occasionally exasperated that the horse, dog sled and parka concept of the RCMP so overshadows the other work they're doing.

Modern scientific methods have been put into use—and many have been originated—by the RCMP to combat the skillful and ingenious modern criminal. Much of the scientific work is done in the force's Crime Detection Laboratories, located in Regina, Sask., Sackville, N.B., and Ottawa.

Heading the laboratory system is a man who well typifies the dog-sled-to-science

range of abilities needed by members of Canada's unique federal police force. Lean, pipe-smoking Inspector Andrew Mason-Rooke, whose uniform is most often a laboratory coat, started his career (like all Mounties) as a recruit and came up through the ranks.

He spent 10 years in the field in western Canada and the Yukon Territory, then was attached to the first crime lab at Regina.

Some of the pioneering work of the Crime Detection Laboratories is found in their records. In 1943, Cpl. A. Mason-Rooke is credited with developing the technique of identifying firearms by the mark on a rimfire cartridge case. In 1944, the lab developed a water-filled bullet-recovery trap now in use all over the world.

In 1958, nuclear physics produced damning evidence that was admitted into a murder trial. According to Cpl. F. M. Kerr, who presented the evidence, the lab's findings would have produced a conviction, had the Mounties not been "scooped" by a surprise witness (to whom the accused had confessed) whose evidence did the job.

Credit for the conviction, though, is not as important as the fact that the court case is believed the first in the Western Hem-

(Continued to page 232)



## WHAT'S NEW FOR

**ADD A PANTRY** to your kitchen with a food storage closet. Swinging doors give access to inner half-doors and removable rear shelves—eight sets in all. This six-footer holds 22 cases of canned goods or doubles as a broom closet. Units are 36 inches wide and 25 inches deep to match most kitchen counters. Made in various heights and choice of hardwood, laminated plastic or paint-grade pine by Modern Cabinet Co., 6611 Salt Lake Ave., Bell, Calif.



**MATCH ANY KITCHEN DECOR** with color inserts in this foldaway range hood by Nutone, Inc., Cincinnati 27, Ohio. It comes in three sizes with a choice of two fan units, starting at \$47.95 plus inserts and fan

**INFRARED HEAT WAVES** from this aluminum refrigerator defroster speed up that bothersome chore. Using ordinary house current, it works on freezers, too. Price is \$6.95 from Osrow Products, Glen Cove, N.Y.

**DESIGNED FOR KITCHEN WORK**, portable, self-powered Scourmaster performs hundreds of home, workshop and garage cleaning and polishing jobs. \$29.95 complete, Minitone Electronics, Inc., New York 10, N.Y.

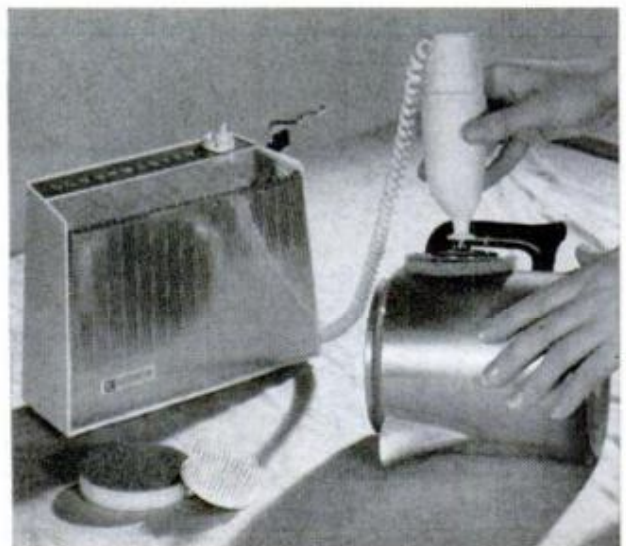
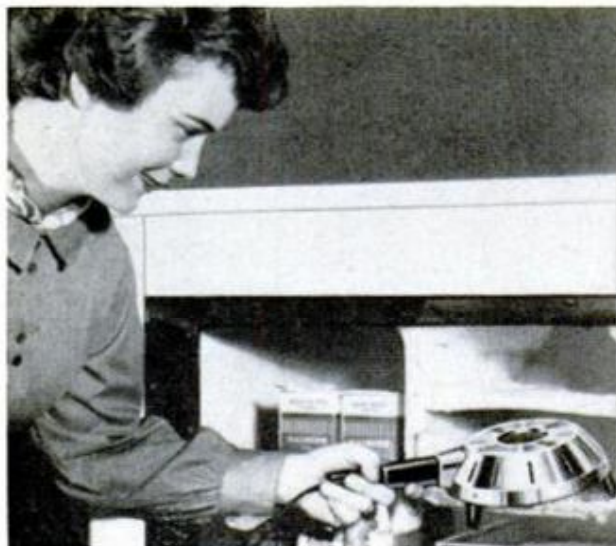



**DON'T UNPACK, JUST STACK** "Lug-a-ture" that combines real portability with the utility of furniture. Drawers pull out of these suitcases and overnighters when stacked to form chests, dressers, desks or night stands. For more information, write the Matralin Co., Inc., 701 N. State Street, Elgin, Ill.

**HANDY** for holding rubber gloves when not in use, these unbreakable plastic hands hang on a wall or back of a door. Good for drying work gloves and mittens and keeping them from being lost. \$2 post-paid from Smith Products, Box 420, Dover, N. J.



**SHOE SHINE MESS** is eliminated with Ambassador Valet Kit. A set of carnauba wax-impregnated polish puffs and buffers for both black and brown shoes, and a clothes brush, are included in a travel case for \$4.95. Royal Master Corp., Burbank, Calif.

**BATHROOM FALLS** can be virtually eliminated with No Skid, a nontoxic, odorless, antiseptic product that's sprayed on tubs and shower stalls to produce a tacky surface. Cornelia Sales Co., Dept. K-8, Cornelia, Ga., sells a three-months' supply for \$1.98



# PM Shopping Guide

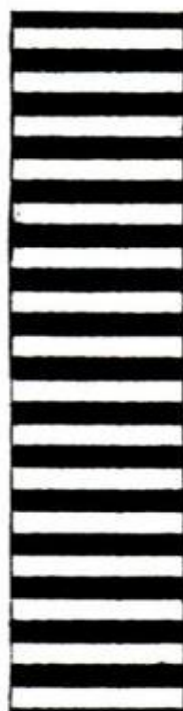

**MOMENT OF TRUTH**, with just the tape recorder between you and the salesman. Here, speed is checked with strobe tape (section of tape shown at right). Lines should show quite clearly under fluorescent lighting. Will not work with incandescent lights

*There are no doors to slam or tires to kick when you buy a tape recorder. But there are important value tests and comparisons you can make, right in the store . . .*

**WHETHER** you want a tape recorder for all-round family fun, a portable for traveling dictation or a hi-fi tape player for your stereo center, it's wise to test before you buy. Although units are available ranging from \$19 up into the thousands, all tape recorders should be able to pass certain quality tests to be acceptable. Here they are . . .

**Is the speed accurate?** Tape recorders operate at  $1\frac{7}{8}$  inches per second,  $3\frac{3}{4}$

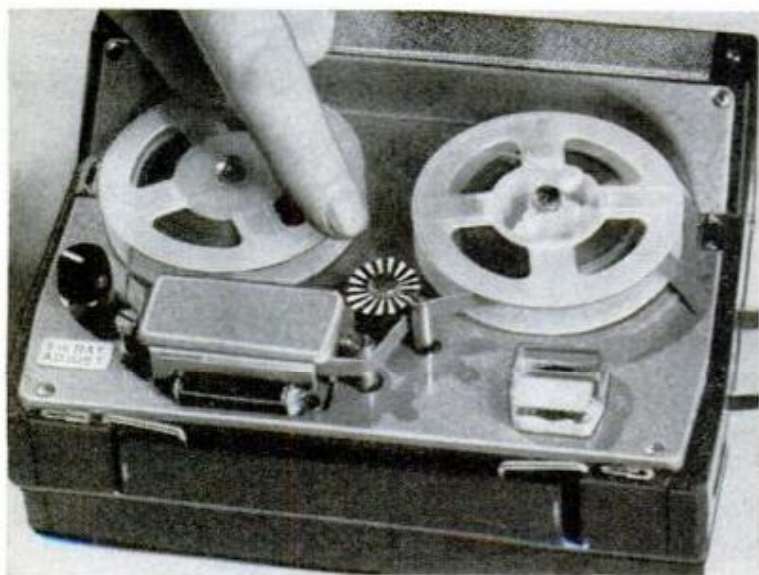

**STROBE DISC** (above) can be cut out and taken to store. Under fluorescent lighting, lines should appear to stand still if the machine operates at proper speeds. Strobe tape can be supplied by store

# Tape Recorders

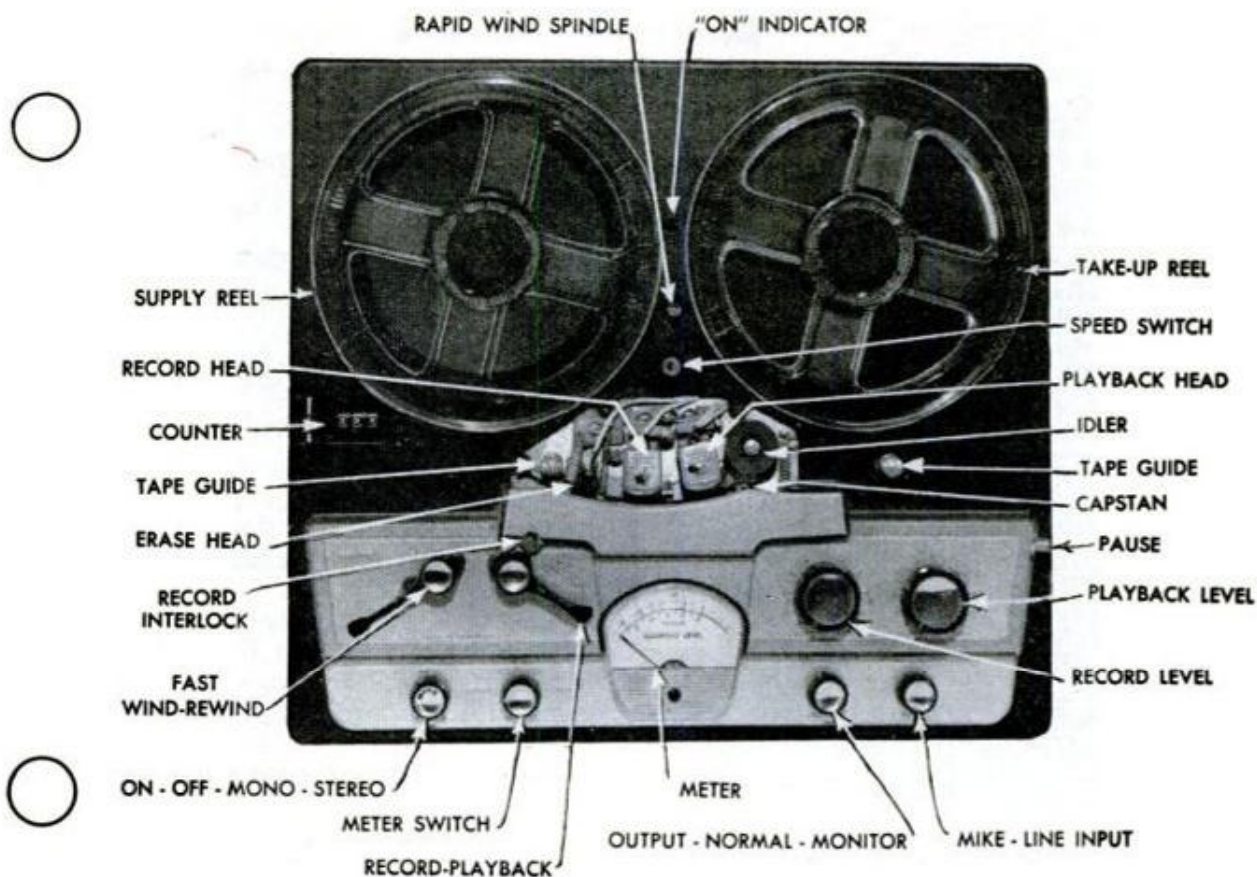

i.p.s. and  $7\frac{1}{2}$  i.p.s. You get better fidelity with the higher speed, an important factor in recording fine music. For lectures or conferences, the lower speed will provide longer playing time.

If you plan to record on one machine and play back on another, accurate speed is important. A capstan that runs too fast or too slow will result in distortion, making voices sound either like chipmunks or draggy brake drums.

**REEL CHECKOUT** calls attention to mounting methods. To operate the machine vertically, reel holders are needed. Rubber friction locks (left) spring-loaded or splined spindles (center) and retractable pin lock (right) are few of many. Note cracked reel in center photo—the spindle held too well! More rigid clear plastic reels might not have cracked. Always test first

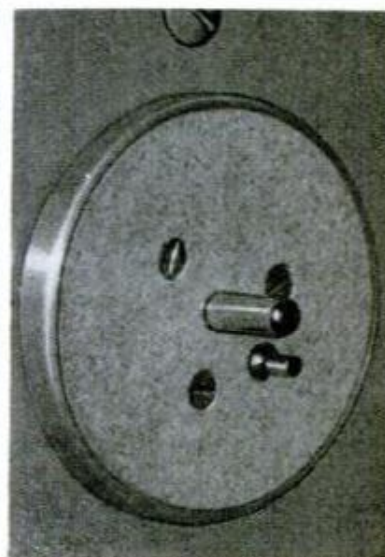
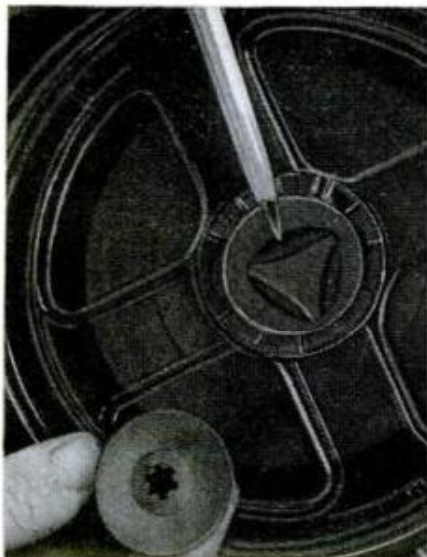

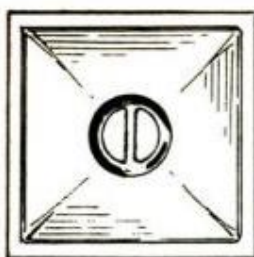

NEON BULB

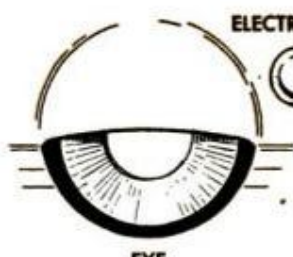

EYE



SLOT

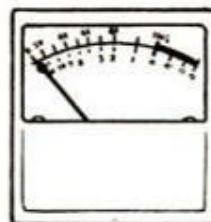

VU METER

**RECORD LEVEL INDICATORS** are the neon lamp, the magic eye electron ray and the V-U meter. Neon blinks only on audio peaks, magic eye closes slightly to indicate low-level audio, completely on high-audio peaks. Meter at right is best indicator, gives continuous monitoring of all levels. You need two for stereo recording, or a method of switching them

**FOR A CHANGE** in speed, use the control switch. Some types pull in and out, others turn left to right. Operate with machine ON to change speed



SPEED CHANGE SWITCHES

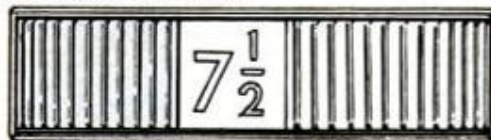

**COUNTER MEASURES.** Upper type counts the turns of the reel, is more precise. Lower type shows feet of tape used from reel

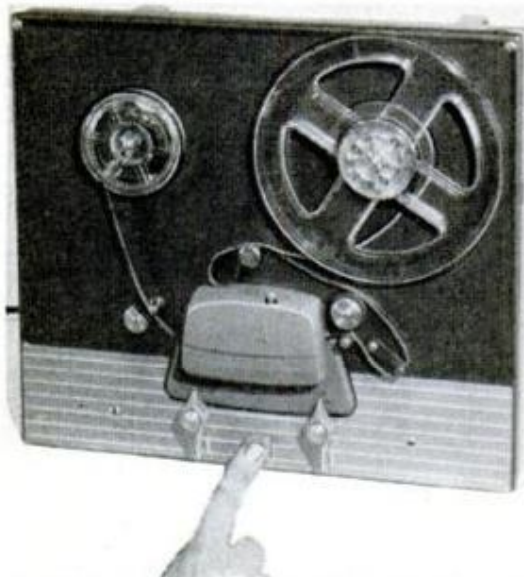

A store test for speed accuracy is shown on page 126. If capstan idler is covered, use strobe tape instead of the disc.

**Are tubes, transistors and wiring O.K.?** Allow the unit to warm up and thread a clean tape in place. Do not connect a microphone. Switch unit to RECORD, and with recording level raised, gently tap the unit at top, front, and sides with your fingertips. Now rewind and play back the tape, listening for tapping or crackling noises. Again, with unit on playback and playback level raised, tap as before and listen for the sound in the speaker. Such noises indicate either a loose connection in the unit or a loose element inside a tube or transistor.

**Is the sensitivity sensible?** If you speak with your mouth almost on the microphone, you get "popping P's" and "hissing S's." The unit you buy should permit you to speak with the microphone at least one foot from your lips, without raising recording-level control to its extreme high setting. Setting should be about half-way, allowing room to increase or decrease to compensate for background noises.

**Can you monitor easily?** The common monitoring methods (top of page) tell you how strong a recording you're making as you make it. The

**ON SOME UNITS,** single braking action may be responsible for spillage with different size reels. Check machine operation in all its functions, for snap, spill or jerky operation



**FOR THE MUSCULAR**, the unit at right—an a.c.-only portable with handle—weighs in at 30 pounds. Below, five pounds with batteries included! But larger unit is hi-fi stereo and costlier

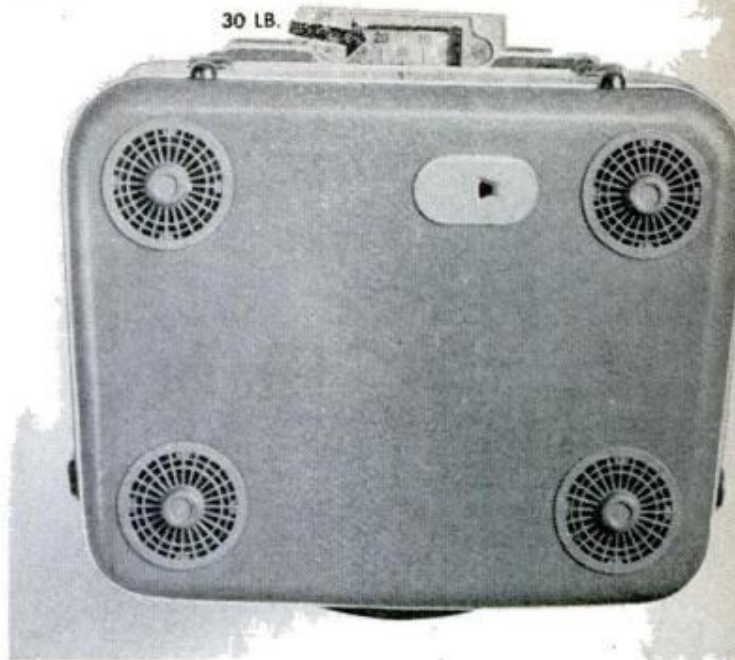
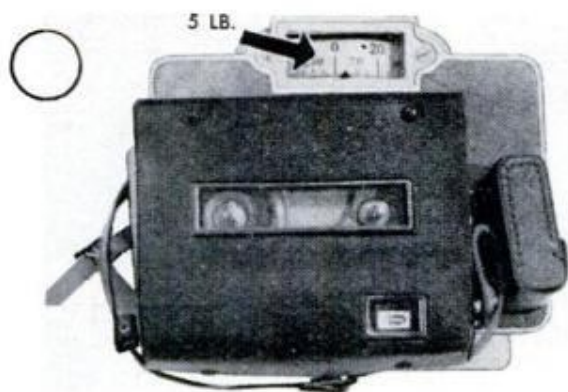

neon lamp is either on or off. It should blink only on voice peaks. If it does not, raise recording level control. If it is on all the time, decrease. The flickering green magic eye gives a better indication than the neon lamp, but is not as accurate as the V-U (volume units) meter which gives you a precise gradation of control.

You require some means for monitoring, as a too-weak recording will not play back. Too strong a recording will result in distortion, noise, or garbled "print-through," which can occur when tape recording winds onto take-up reel. Remember only  $\frac{1}{2}$  mil of tape separates the magnetic fields, and the fields can interact.

In general, a metal deck will better isolate the sensitive heads from electrical disturbances generated by the motor.

**A reel checkout.** Reel holders (page 127) are not needed for horizontal installations, but the portable, or the upright vertically-mounted units require them.

**Counter measures.** To relocate the approximate place on a tape that you want to hear again, a tape counter is usually provided. Mechanical counters count turns of the reel, not inches, feet or time. The type of counter which is engraved or screened on the panel under the reel, counts elapsed footage, and uses the tape remaining on the reel as a guide. Some higher-quality tape machines operate with clock timers to give time in minutes and seconds.

### **Inspection and operation pointers.**

Look at the back of the machine. The number of motors will be a rough indication of quality, ranging from one motor to three. If only one motor is used, then mechanical linkages and belts or pulleys must be used to make the one motor perform three jobs. These linkages can easily get out of whack, causing trouble later.

Using sharp, deliberate movements, operate the control from STOP, to PLAY, to FAST FORWARD, to REWIND. Action on the tape should be smooth with no jerking, snapping or spillage. When the machine is placed in STOP, both reels must stop. One machine we tested allowed the supply reel to continue to spin, spilling tape. Others may throw the tape completely from the head slot or even snap it. You can't blame such failings on the newness of the machine. Break-in will result in a further downgrading of performance, rather than an improvement.

**Can you live with it?** A portable should be capable of being operated entirely from the outside of the case, and have the controls extended to permit this. A great battery saver for portables is the a.c. supply for use in the home. This is usually available as an optional extra, but be sure the machine has provision for connecting it.

If you plan a cabinet-type installation, the microphone connectors should be at the front for easy access. If not, plan on adapter cables and microphone connectors.—*By Wels*

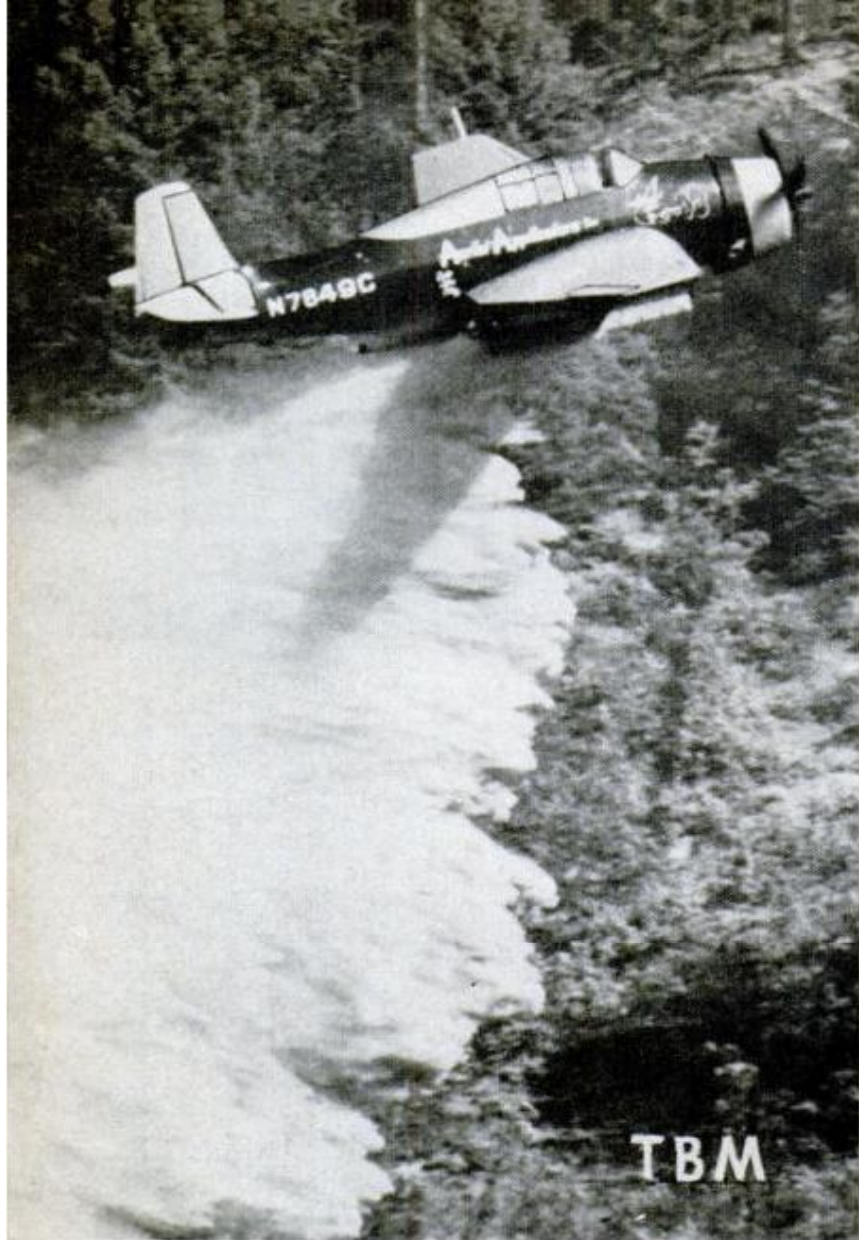

TBM

GM's "AVENGER" or TBM (same as the Grumman TBF), former Navy torpedo-bomber, now fights forest fires in Utah mountains



P-38



P-38 NOSE, that once held cannon, machine guns, now carries aerial camera

## The Old Warbirds Are Still Flying

**O**LD SOLDIERS—and war planes—never die. The soldiers may just fade away, but the war birds keep on flying.

Modified, rejuvenated and converted for many purposes, from nostalgia to commercial expediency, they still cut a noble swath through the sky in an age of jets.

Built before and during World War II, some of the planes are now owned and flown privately purely for pleasure. Some of the owners, like the owners of classic cars, are unabashed sentimentalists.

**CONSOLIDATED PBY "CATALINA,"** venerable patrol-bomber, is used for geophysical surveys



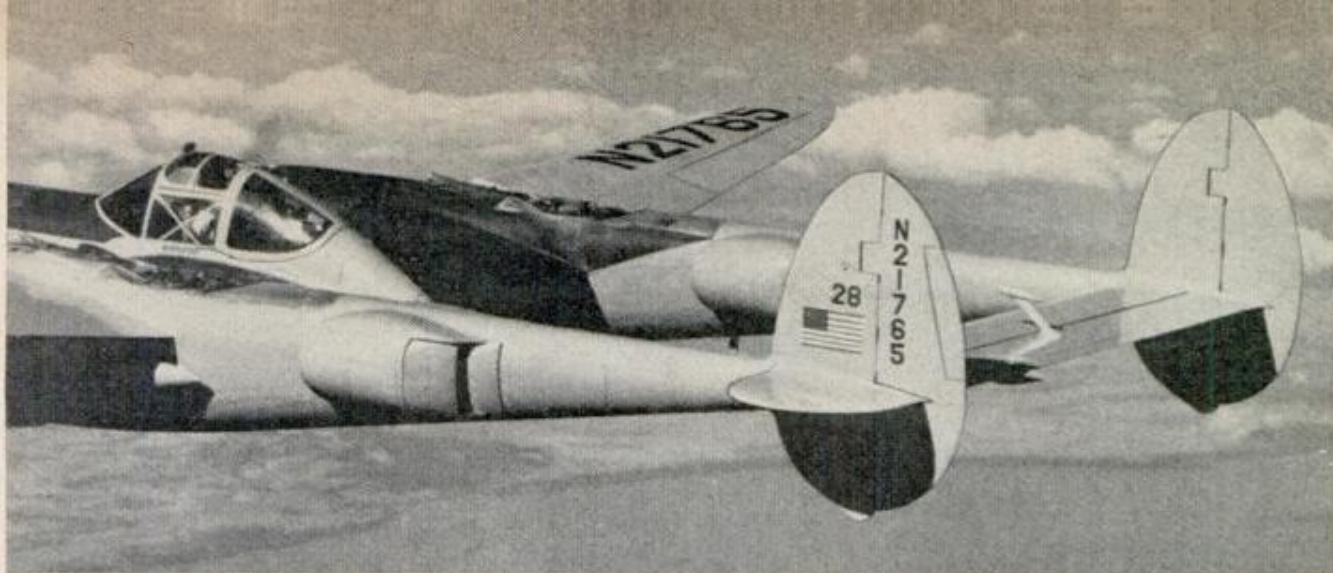

LOCKHEED P-38 "LIGHTNING," South Pacific fighter, is used for high-altitude aerial mapping surveys



NORTH AMERICAN "MITCHELL" (B-25s flew Doolittle Tokyo raid) is executive plane for trading-stamp firm



GM's FM-2 "WILDCAT" (same as Grumman F4F), early Navy fighter, is used as private plane by airline pilot



BELL P-63 "KING COBRA," big brother of P-39, is an Air Force fighter privately owned for "Sunday flying"



DOUGLAS A-26 "INVADER," big brother of A-20, was sold as executive plane by West Coast manufacturer

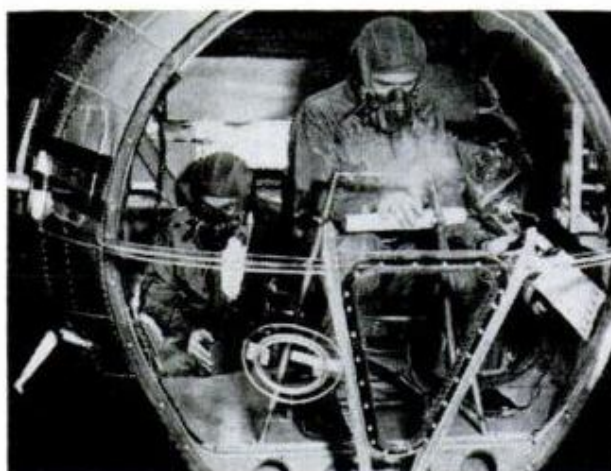

BOEING "FLYING FORTRESS," great bomber, was converted for aerial mapping by Philadelphia firm

Ernie Saviano of La Grange, Ill., an airline pilot who owns two Navy *Wildcats*, says, "Somebody has to see that a few of these great planes survive." The *Wildcats*, used early in the war in the Pacific, still have the old hand crank for retracting the wheels.

Some of the planes have been modified slightly for commercial purposes. They are used for such things as fighting forest fires and aerial mapping. Fairchild Aerial Surveys of Los Angeles, Calif., modified the noses of several P-38s to accommodate aerial cameras and cameramen, pressurized the cockpits and now uses them at

altitudes up to 37,000 feet. Aero Service Corp. of Philadelphia, Pa., uses P-38s and B-17s for high-altitude mapping, and the PBY for low-altitude geophysical surveys, especially in northern Canada where landing fields are scarce and the amphibian can land on water.

Many of the war birds, especially the medium bombers, have been bought from government surplus by firms which specialize in converting them into luxury executive planes and reselling them to businessmen. In many cases it is more economical to fly the rebuilt warbird than it is a new plane. ★ ★ ★



**NORTH AMERICAN P-51 "MUSTANG,"** famed long-range fighter is converted into a tandem-seat executive



**GOODYEAR FG-1 "CORSAIR"** (same as Marine's F4U, but without the folding wings) is private "runabout"

**B-26**



**MARTIN B-26 "MARAUDER,"** medium bomber, was converted by commercial firm into an executive plane

**B-30**



**CONSOLIDATED B-30 "LIBERATOR"** (same as B-24 but with longer nose) carries men for construction firm

MARCH 1962

133

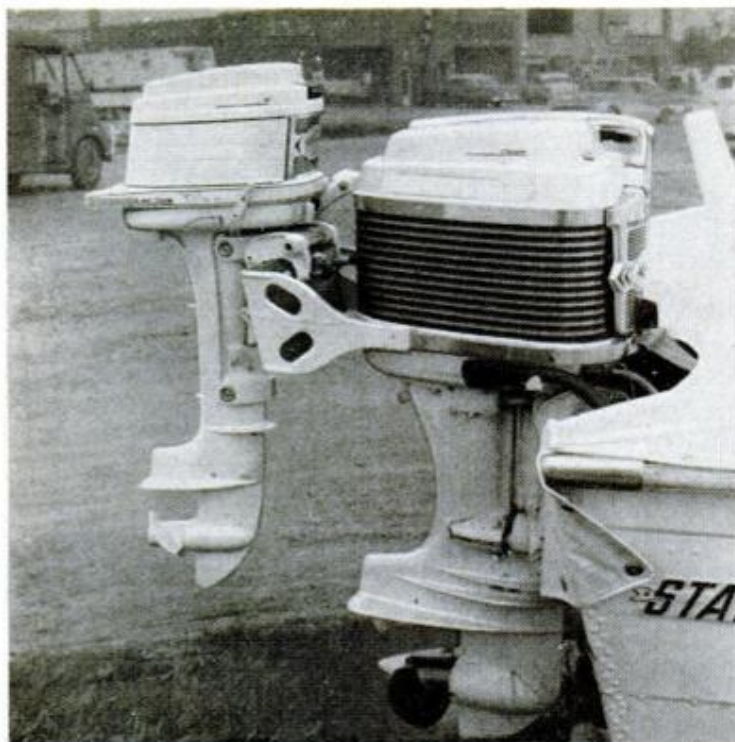

## Piggyback Outboards

Combining two outboard motors—a big one for speed and a small one for trolling—isn't new, but a Denver fisherman, Lou Garber, has worked out the easiest method so far for mounting the unmatched pair. His 10-horsepower fishing motor mounts piggyback behind his 60-horsepower traveling motor.

At speed, the big motor raises the boat onto a plane, lifting the small motor free of the water, so there's no drag. At fishing speeds, the boat lowers until the small motor is at working depth. Since it's attached to the bigger motor, it can be steered with the regular remote steering system. The mount, developed from a stock "flying transom," bolts directly onto the frame of the bigger motor.



## Ragtop Rain Detector

Convertible owners can leave their tops down in rainy weather when using a new electronic rain-sensing and top-raising apparatus that mounts under the dash and rides in the glove box.

When parking with the top down, the owner pulls the sensor out of hiding, switches it on, and leaves it on the seat. The first drop of rain puts the top without draining the battery whether the ignition is on or off. The unit, by Bedol Electronics, 1971 W. 85th, Cleveland 2, Ohio, costs \$39.95.



## Strum and Stroll

With its transistor amplifier and loudspeaker built in, a new electric guitar is completely portable. Four dry cells power it for up to 150 hours.

The amplifier operates from two pickups; either the lower, upper, or both can be selected by push-button switches. Two external jacks permit connection of the guitar to an outside amplifier, or connection of the internal amplifier to extra speakers. Manufactured in Italy, the guitar (called the Bikini) is sold in the U.S. by Hershman Musical Instrument Co., 61-63 West 23 St., New York 10. Price is \$59.

# YOUR LIFE PRESERVER—

How will it behave if you need it?

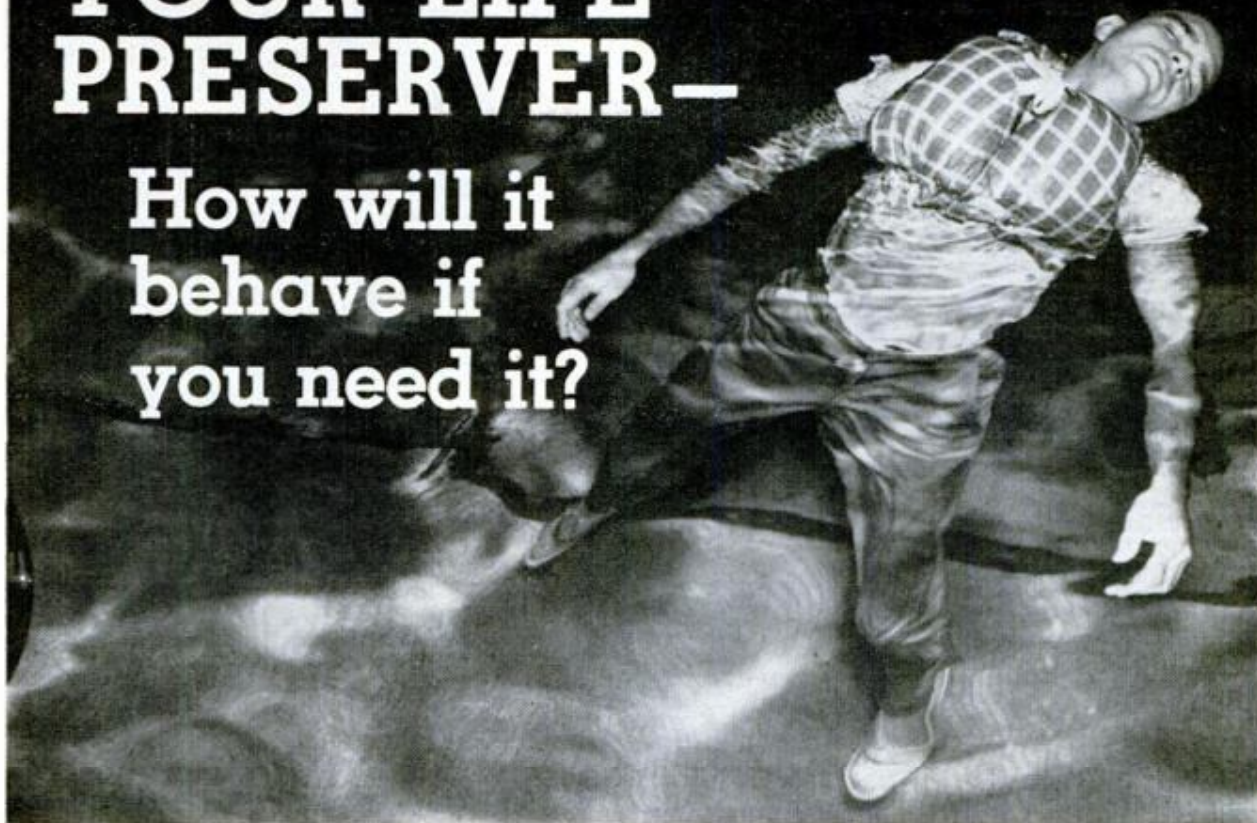

**PLAYING DEAD**, PM's vest tester demonstrates how buoyant vest holds unconscious man's head above water

**WOULD YOUR "LIFESAVER"** really save your life? That sounds like a senseless question, but the answer could be important if you ever have to go over the side with one.

Have you ever actually tested your life preserver? Don't feel guilty if the answer

is no. PM's outdoors editor conducted a summer-long informal survey on the water last year, and of the hundreds of boaters, fishermen and water-sports buffs questioned, only a handful—less than five percent—had ever been in the water with the device they were staking their lives on.

**NORMAL SWIMMER**, below left, rides high and comfortable. Loose vest, right, slides up out of control



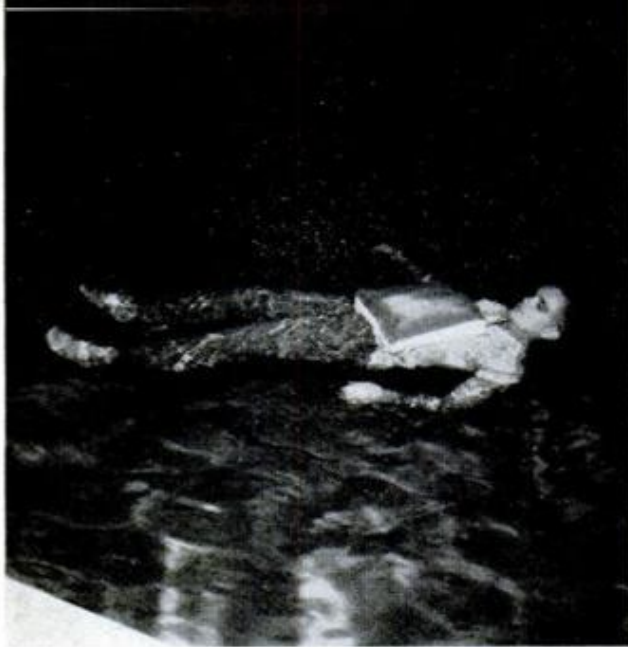

**BUOYANT CUSHION** provides fair flotation if worn correctly, left, but slips away from unconscious swimmer

To get a better idea of how the different types of lifesaving devices work, PM's editors set up a simple testing program. We sent a shopper to a nearby marine-supply store with instructions to buy one of each Coast Guard-approved device, plus a selection of other popular types. We borrowed an average-sized tester, Bayard Richards of the PM promotional staff, and the big Olympic swimming pool at Chicago's Sheraton Towers Hotel. One at a time, we fitted the devices on our "victim," threw him into the pool, and watched to see how he came up. All of the devices worked, but some worked better than others. Here's how:

For our tests, we chose a three-pad buoyant vest, a yoke-type buoyant vest, a buoyant cushion, a water-ski belt, an inflatable fisherman's vest, and a floating coat designed for hunting and fishing in cold weather. That's a good, representative selection of the devices you'll see on any summer afternoon out at the lake.

Incidentally, the much-misused term "life preserver" actually describes *only* the big jacket-type device required on boats over 40 feet or those carrying paying passengers. We didn't include this type which is seldom seen on pleasure boats. Bigger, bulkier, more expensive—and better—than

**YOKE-TYPE VEST** holds swimmer high and upright, left; keeps unconscious man riding high, face out of water





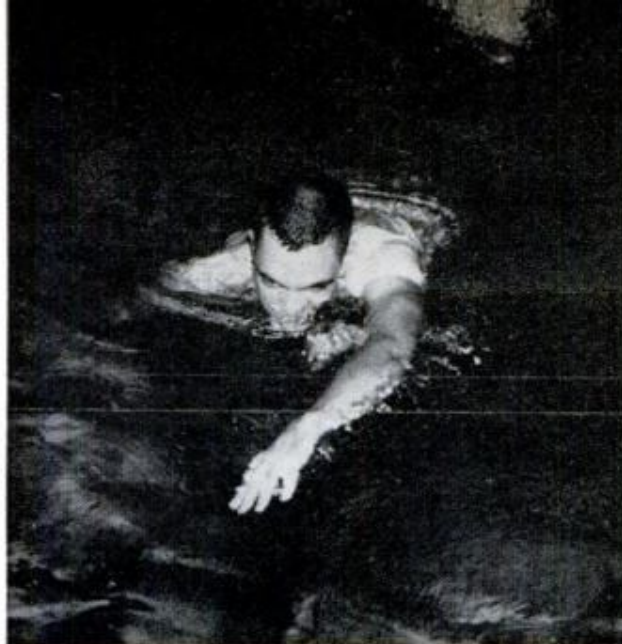

**SKIER'S BELT** proved easiest to swim in, lets swimmer tread water effortlessly—while he's in control

most other devices, such an "official" life preserver is always Indian Orange in color, and bears its identification notice stamped or stenciled (no tags) on the canvas cover. Such preservers are inspected at the factory by the Coast Guard. But there are other *approved* devices, made to Coast Guard specifications without official inspection, which are identified by a cloth tag sewn on the cover.

Coast Guard-approved vests and cushions are made of kapok or fibrous glass sealed in plastic film, or unicellular plastic foam, and covered with fabric or plastic material.

The soft pads are easier to wear and more comfortable; the fairly-rigid foam is more durable and can't be damaged by puncturing. All approved types give about the same amount of flotation, but there is some price difference. The foam types can cost from 25 to 40 percent more than the soft-pad types.

Buoyant vests come in two basic styles; the regular vest, usually made up of three flotation units, two fore and one aft, and worn like a jacket; and the yoke or bib type, which is one big slab of flotation with a neck hole near the top and a waist strap

(Continued to page 218)

**LACKING COAST-GUARD OKAY**, but effective, fisherman's vest, left, and buoyant-insulated jacket tested well



# Show Stoppers for '62



## Cruiser Performance in a Kit Houseboat

ONLY KIT HOUSEBOAT on the market, this new 22-footer is a roomy, sleep-four design with a good V-bottom. It will plane and do 20 m.p.h. with a 40-horsepower outboard. It will pull skiers and do up to 30 with one of the big 75-80-horsepower models. Beam is an inch under 8 feet; headroom is 6½ feet. Galley, head and other facilities are built in. The plywood

kit for this *Vacationaire* boat which bears some resemblance to the 1959 PM houseboat design is priced at \$700. It can be powered by either inboard or outboard motors in almost any horsepower range, and can be assembled by a non-boat-building handyman. The *Vacationaire* kit is sold by Luger Industries, Inc., 9200 Access Road, Minneapolis 20, Minn.



## Runabout Convenience in a Stock Cruiser

ONE INTERESTING SOLUTION to the perennial problem of passenger weight distribution in outboard cruisers is this *Cruis-a-bout*. Cruiser passengers don't like to be cooped up in a forward cabin, but their weight astern in the cockpit makes it hard to plane the boat. The *Cruis-a-bout's* open forward cockpit lets everyone sit in

the sun for pleasure riding, but a snap-on soft top encloses the cabin for foul-weather running or sleeping aboard. Buttoned up, with seats converted to bunks, it's much like the usual outboard cruiser. The boat is 16 feet long, has an 80-inch beam, and will take up to 90 horsepower. It's made by Sea Ray Boats, Oxford, Michigan.

*There's plenty new under the sun at your boat show this year. Here are four good examples . . .*

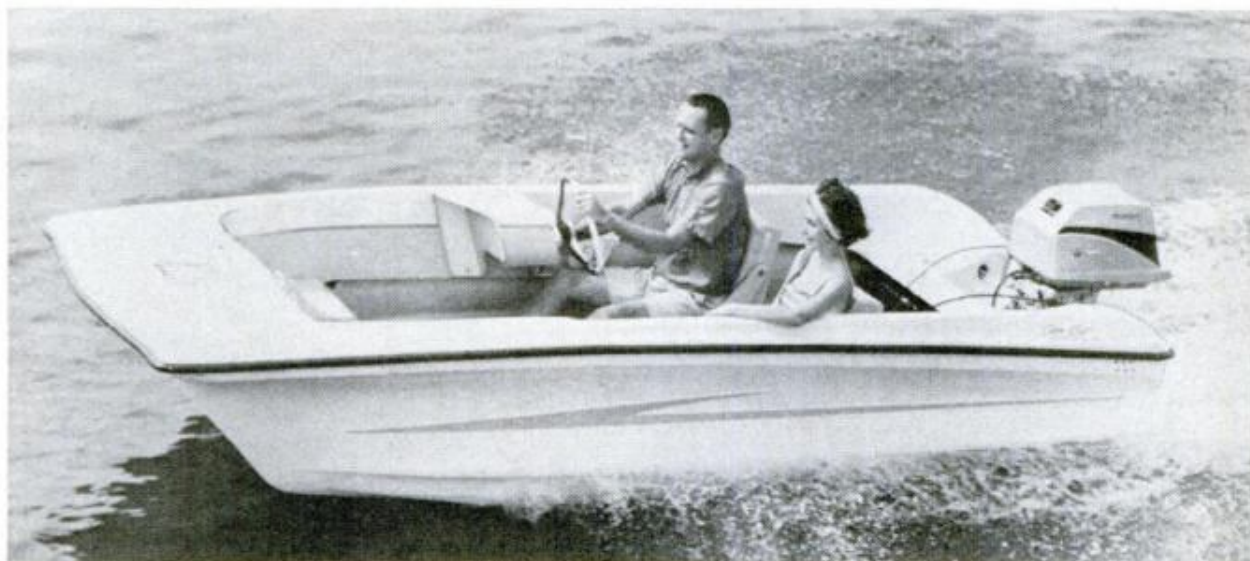
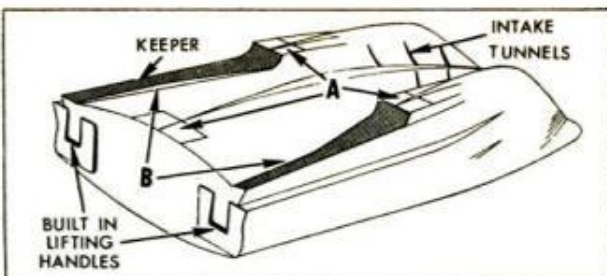

## New Concept in Airlifted Multihulls

**AERODYNAMIC LIFT**, coupled with well-designed three-point stability, give this new outboard hull unusual speed and maneuverability with only one motor of moderate horsepower (shown with a 30-hp. Bundy). Drawing above photo shows how it works: Air coming through intake tunnels lifts hull at speed, reducing wetted bottom area to a minimum. Hull rides on

three points (A) like a hydroplane, while concave "keepers" behind forward points (B) deflect air, water and spray downward and inward, adding to the over-all lifting effect. This new Devil Ray series is available in both sports (shown) and deluxe models in either 14 or 16-foot lengths. They're made by Custom Craft of Buffalo 7, New York.



## An Unconventional Open Runabout for Fun

**LOW-SLUNG, COMPLETELY OPEN**, but very fast and stable, the Sun Sled offers a lot of unconventional comfort in an enormous single cockpit covered with thick upholstered cushions. One wide rear seat holds the driver and three passengers; the rest can sit anywhere they like. Built of mahogany planking except for fiberglass

fore and aft decks, the craft has an unusual triple-V bottom best described as a rounded cathedral hull. Powered by a 100-horsepower Interceptor inboard through an Eaton Powernaut stern drive unit, the 17-foot boat will do over 40 m.p.h. The Sun Sled 17 is made by Century Boat Co., 1860 Broadway, New York 23, N. Y.

# BITTER BATTLE OF

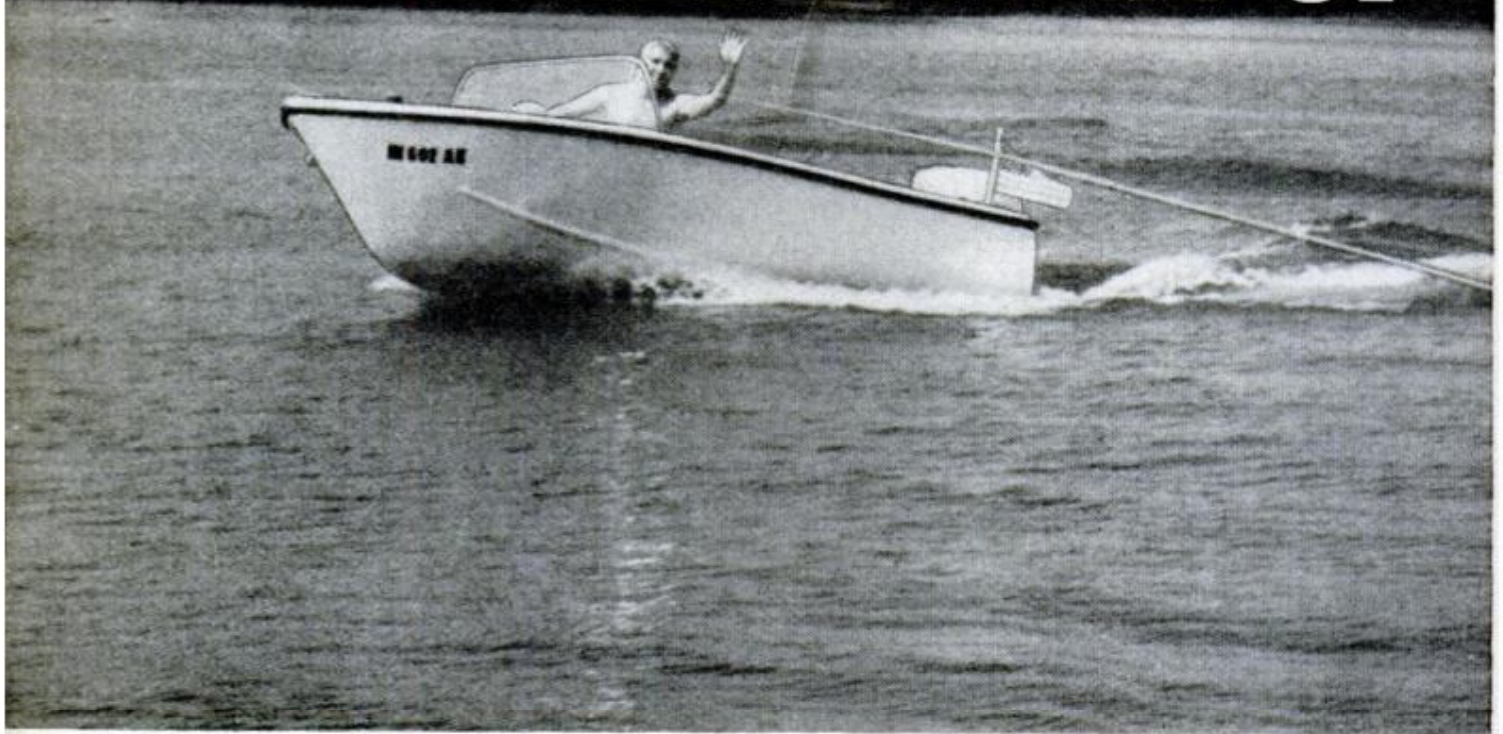

## “Fishermen are out-of-date . . .”

By Joseph N. Bell

(Howard E. Hartman's son-in-law)

**Bell:** I have nothing against fishermen. For the most part, they're pleasant—if somewhat sedentary—citizens who go plodding unimaginatively about their business. I understand the divorce and crime rates among fishermen are low, which is commendable. The big trouble with fishermen is that they accept rigidly and without question two wildly inaccurate myths:

—that confirmed lovers of fishing outnumber all other citizens by a large and growing majority;

—that God created the waterways of the world for the private and exclusive use of fishermen.

Possibly there was a time when the first statement was superficially true—back in the days when hungry citizens found fishing the only alternative to starving. What has escaped the fishermen of today is that things have changed. The power boat has been developed to a remarkable degree of refinement. And it is being used and enjoyed by far more nonfishermen than the anglers will admit.

In Michigan last year, for example, powerboat registrations were so heavy that the State had to put on extra clerks to handle them. And while this was going on, *fishing license sales were actually declining*. There are almost six million powerboats in the United States today, manned in large part by five million people who water ski.

But in the United States—where a majority supposedly calls the tune—a minority of fishermen continue to set the rules for the use of our lakes and rivers. And the public officials who have the final say in such matters are gen-

# THE WATERWAYS



**“We won’t give up our rights . . .”**

By **Howard E. Hartman**

(Joseph N. Bell’s father-in-law)

erally men of fishing persuasion who are determined to perpetuate the myth of the fishing majority. As a result, boaters are second-class citizens.

**Hartman:** Every once in awhile, I have a nightmare about speedboats. I dream that the legal bars that still protect a fragment of our inland waters for fishermen were dropped—as our boating friends so loudly and frequently urge. In my nightmare, the waters of all of my favorite fishing lakes are suddenly and completely clogged with hordes of soft-headed idiots piling into each other at supersonic speeds in overpowered boats. As fast as they go to the bottom, new powerboats take their places. And watching sadly from a safe vantage point ashore are the people who like to swim and fish.

I think of this nightmare frequently—whenever I hear the boating boys sound off. We’ve managed to hold the line fairly well on the little Indiana lake where I’ve had a cottage for 20 years. But I’ve given up trying to fish on other, larger lakes around here. Fishing on them today is like trying to listen to good music beside a buzz saw.

That’s really what fishing is—listening quietly and peacefully to the music of nature. We do far too little of



Here are some bitter words. How do you feel? Choose up sides, and come out with fighting letters addressed to: Outdoor Editor, Popular Mechanics, 200 E. Ontario St., Chicago 11.



"The plodding, unimaginative fishing minority sets the rules . . ."

"Lakes are clogged with soft-headed idiots in overpowered boats . . ."



that these days. Instead, we go screaming off in ten forward gears in all directions headed for absolutely nowhere. I'm not saying that we don't have to put up with a certain amount of this sort of thing as a sop to "progress." What scares me is that someday it will take over completely and there won't be any place left to enjoy nature as God intended we should.

I get a big laugh out of the boaters' claims that they're being discriminated against. If they get much faster or much more frequent, I won't have to dream my nightmare any longer; I can just look out of the window of my cottage. There's no frustration comparable to sitting quietly in a boat, watching a cork bobbing gently on the lake's surface, at a momentary peace with a troubled world—only to have it violated by a maniac in a speedboat who thunders down on you, riling the water, scaring hell out of the fish, and completely destroying whatever peace of mind you had managed. And that's not all they destroy. There were more deaths in the water than on the highways of New York State over the last Fourth of July week end.

This isn't true of all powerboat drivers, of course. As a matter of fact, it's probably only a small group—maybe five or ten percent—that spoils the water for everyone else. These are the jockeys who have never learned consideration for other people—they're just as bad in an automobile—but when you turn them loose in a lake or river with too much horsepower and no restrictions, no one else has a chance.

I'm willing to try and live with the speed boys, *providing they're properly controlled*. But I refuse to give up and turn our waterways over to them. Surely there must still be a place for a quiet contemplation of nature and nature's sports.

**Bell:** I'm glad to know the fishermen feel they are holding the line at my father-in-law's Indiana lake. They're not just holding the line; they're holding the whole lake!

I have a cottage there, too. My family and I like to water ski. Have you ever tried to pull an adult on a pair of water skis at ten miles an hour? It's like trying to run through warm glue. But that's the top speed at our lake—10 m.p.h. This speed limit is perfectly practical for a canoe or a cement barge. But for boating or skiing, it leaves something to be desired.

So the fishermen—bless 'em—have our lake all to themselves. Which is to say that the lake is usually empty in the heat of the day, except for a few intrepid city dwellers who have rented outboards and are putting laboriously around under the careful scrutiny of the local conservation officer.

**Hartman:** Indiana's laws regulate boating speed by the size of the lake. If my son-in-law wants to water ski, he can drive to a half-dozen lakes within 30 minutes of here where he can scare all the fish he wants to—legally.

There has to be some sort of check on these boat jockeys; otherwise, there wouldn't be a decent place to fish in the whole state. Fishermen ask very little. A fisherman requires *one-fiftieth* as much lake surface as a water skier! And I don't think even my son-in-law will contend there are fifty times as many skiers as fishermen.

It seems to me that the method used in Indiana is fair enough. If they ever let down the speed bars completely on our lakes, fishermen might just as well pack up and head for some other state. The speed addicts don't want to share facilities; they want to dominate them. I suppose that's the nature of the powerboat. It's either completely in your hair or not around at all. It's hard to share a bed with a threshing machine, no matter how well intentioned either you or the machine may be.

**Bell:** Wrong. About sharing facilities, I mean. Those of us who enjoy skiing and other water sports would be glad to share our lakes with the fishermen. We'll be happy to give the fishermen the morning and late afternoon hours completely uncontested if we can just have a few hours at midday to run our boats fast enough for the water sports we enjoy. But we can't even get anybody to listen.

**Hartman:** My experience with speed-boaters is that if you give 'em an inch, they'll take the whole lake. Once we open the gates, we've had it—and another fisherman's lake gets boiled in engine oil. No, sir. No compromises. We'll defend this line.

**Bell:** Okay, dad, man the bulwarks. We're strong and we're getting stronger. We want to live with you in peace—but we want to live a little faster than ten miles an hour. ★ ★ ★



### Boat Snaps Onto Roof of Camping Trailer

One of the newest of the multipurpose camping trailers is a reinforced plastic model that carries an eight-foot dinghy snapped onto the roof. The matched components are built of fiberglass and Vibrin;

the trailer sleeps two inside, has a separate cooking and storage area in the rear. The 75-pound boat lifts easily on and off, and latches in place. Built by the Trailorboat Co., San Rafael, Calif., it sells for \$895.



### Thermoelectric Outboard

Making recreational use of a recent scientific development, this fisherman is driving his boat on a gas flame! His electric trolling motor is powered by a thermoelectric generator instead of the usual storage battery.

The generator, the box on the starboard side of the boat, delivers power continuously by maintaining a temperature difference across the semiconductor materials inside. The heat is supplied by a small propane gas flame; water carried through the hose over the stern cools the low-temperature side. The experimental outfit was built by Westinghouse labs.

**IDEA PROJECT**

# START YOUR VACATION HOME at Home

**PART II**

ASSUMING THAT you have the eighteen floor sections for the basic unit completed and stockpiled, you are ready to prefab the exterior and the interior walls of the PM Vacation Home introduced last month. Where 2 x 6s were used in the floor sections, 2 x 4s are used in the walls, and where 1/2-in. sheathing was used to cover the floor sections, 5/8-in. sheathing is used to cover the wall sections. Other than this, assembly of the wall sections is similar to that of the floor sections, these being covered as before on the outside only.

Of the 24 sections required for the exterior walls of the basic home, several are identical, some are made right and left hand, others require only one of a kind. All are 4 ft. wide and 8 ft. long. As with the floor sections, it will pay you to take the time to rig up a building form for positioning and nailing the members together. Stop blocks located on the form as before will assure uniform spacing of the studs and identical over-all dimensions.

There are several things to note in studying the exterior wall sections individually detailed in Fig. 6. First, window and door sections, as well as wall section X-48SP, have doubled 2 x 6 headers across the top, whereas all others have conventional 2 x 4 plates, top and bottom. Secondly, with the

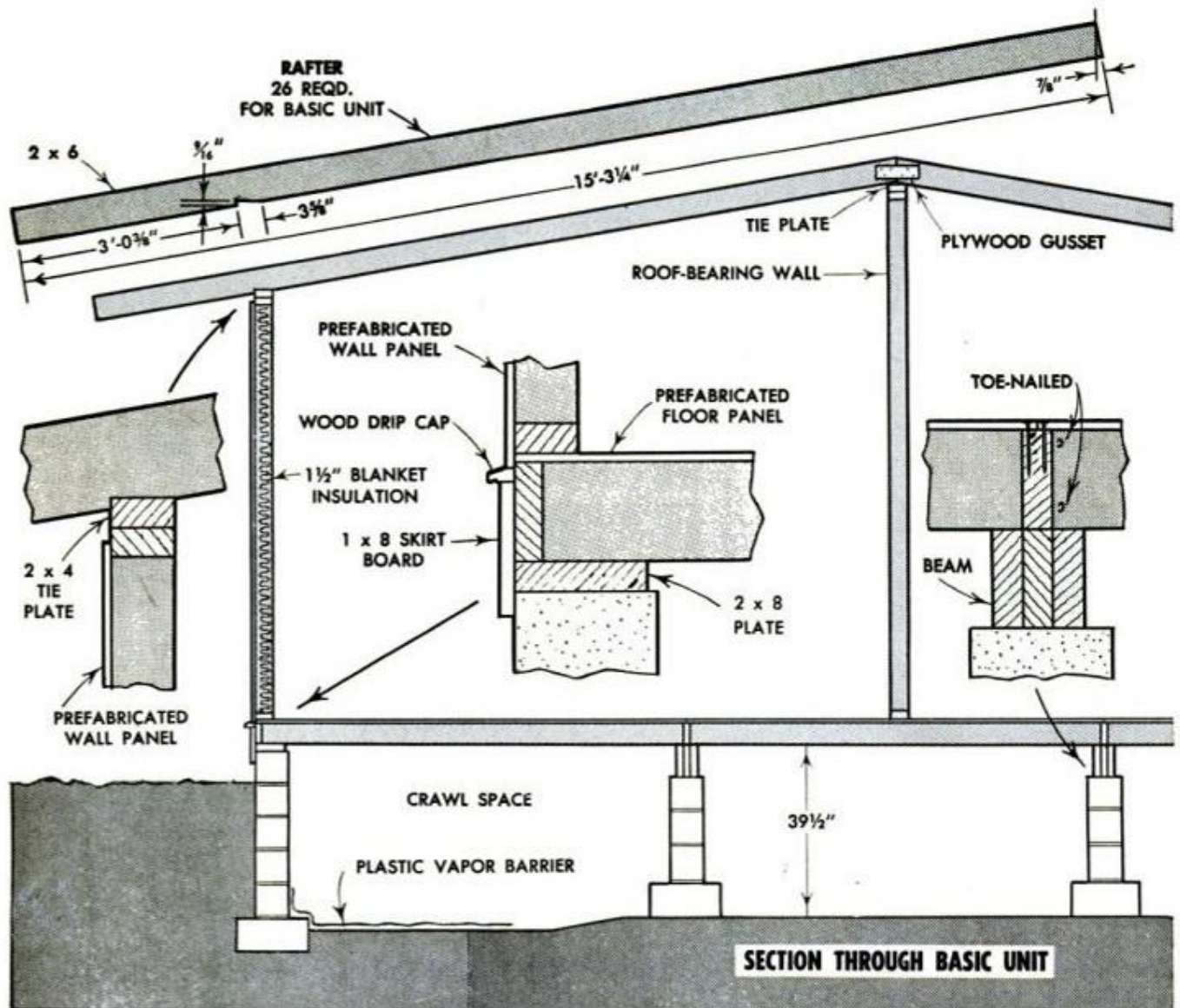



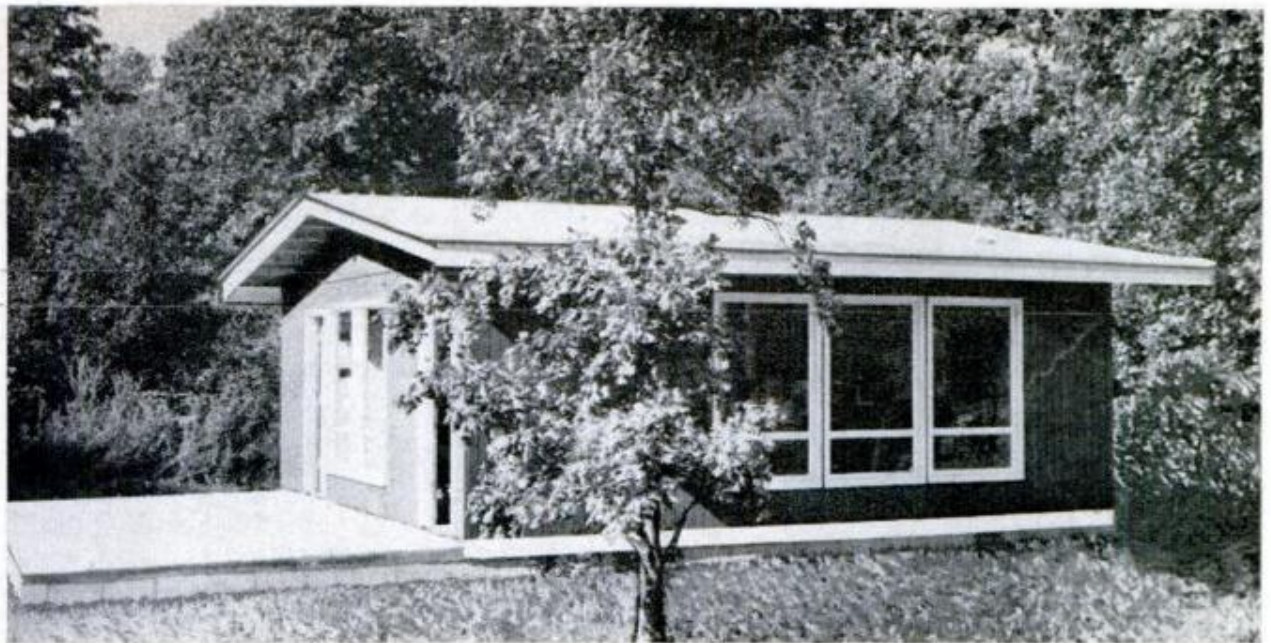

exception of wall section WAF-4854-24, the 4 x 8 sheathing on each section overhangs the bottom plate  $\frac{3}{4}$  in. This is done to prevent water from entering at the floor line and also to make the sections self-aligning during erection. The overhang at the bottom results in the sheathing being  $\frac{3}{4}$  in. down from the top, but this is later covered with a 1 x 3 trim board. All wall sections are made to simply butt together when placed side by side, and except where

noted otherwise, full 4 x 8-ft. sheets are applied as is without cutting. Here the exceptions, of course, are the door and window sections which require only a portion of a full sheet. Both the length and the number of studs required vary with each section, some requiring as few as three studs, others as many as five. True of all sections, the headers and the top and bottom plates are nailed to the ends of the studs, the headers being toenailed.

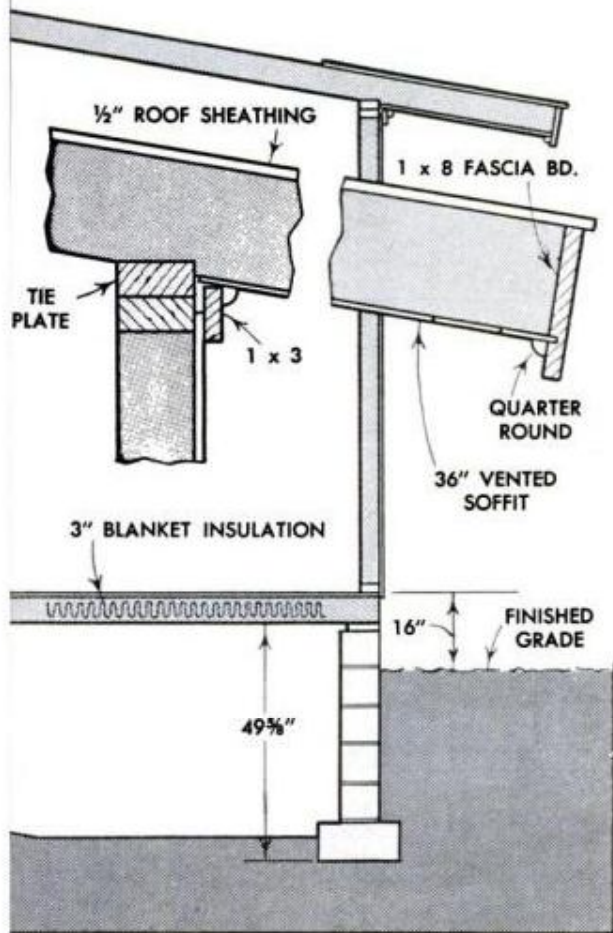

**COMPLETE PLANS**

including a material list, are available for the PM Vacation Home. Each set contains 14 sheets which detail the basic home as well as the add-on units. The cost of the plans is \$20.00 for one set, \$35.00 for four sets. Each additional set is \$5.00 when ordered with the initial set. Order from Plans Department, Popular Mechanics Magazine, 200 East Ontario Street, Chicago 11, Illinois.

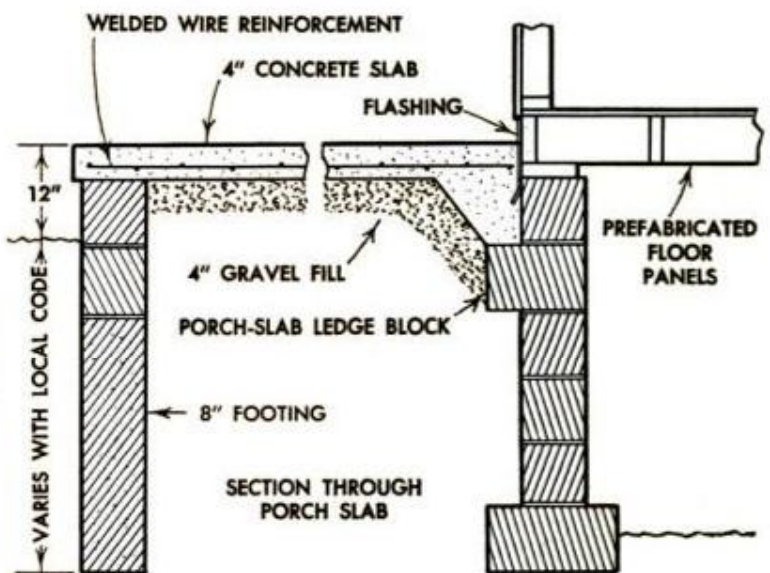

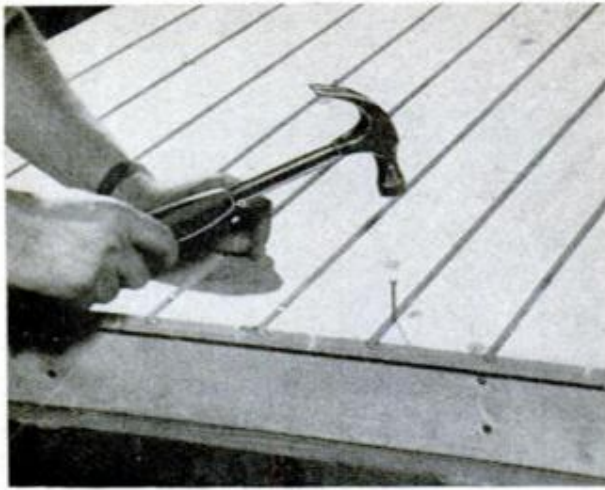

**VERTICAL-GROOVE SHEATHING** makes an attractive exterior siding. Here  $\frac{3}{8}$ -in. plywood is being applied by driving the nails in the grooves where they are hidden. Note how lower edge of plywood panel overhangs bottom plate of 2 x 4 framework

You have a choice of several different materials, both plain and textured, for sheathing. Vertical-groove plywood, called Texture One-Eleven, was used in prefabricating the walls of the pilot home. Similar textured panel boards are available in hardboard, also in coated insulating boards. Whatever is used, the material itself provides the exterior covering, nothing is applied to it. Where a plain panel board is used, battens will be necessary to cover the wall joints. However, with vertical-groove boards, battens are not necessary. The sheets have a rabbet along one edge which when butted against the square edge of the sheet in the adjoining wall section, forms a matching groove and an invisible joint. In applying such material it is necessary to let the rabbeted edge of the sheet overhang the edge of the supporting frame a distance slightly less than the width of the rabbet

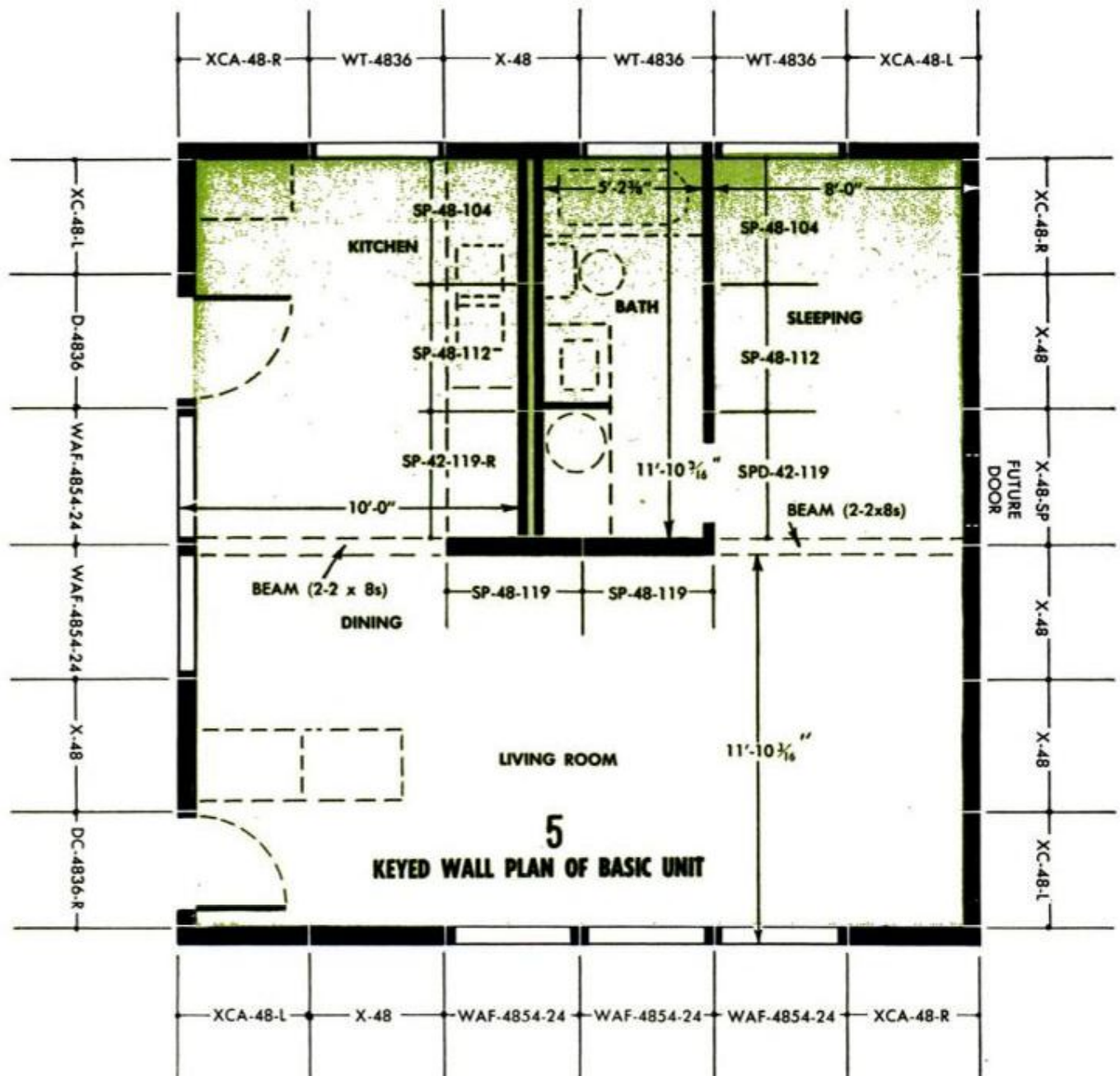

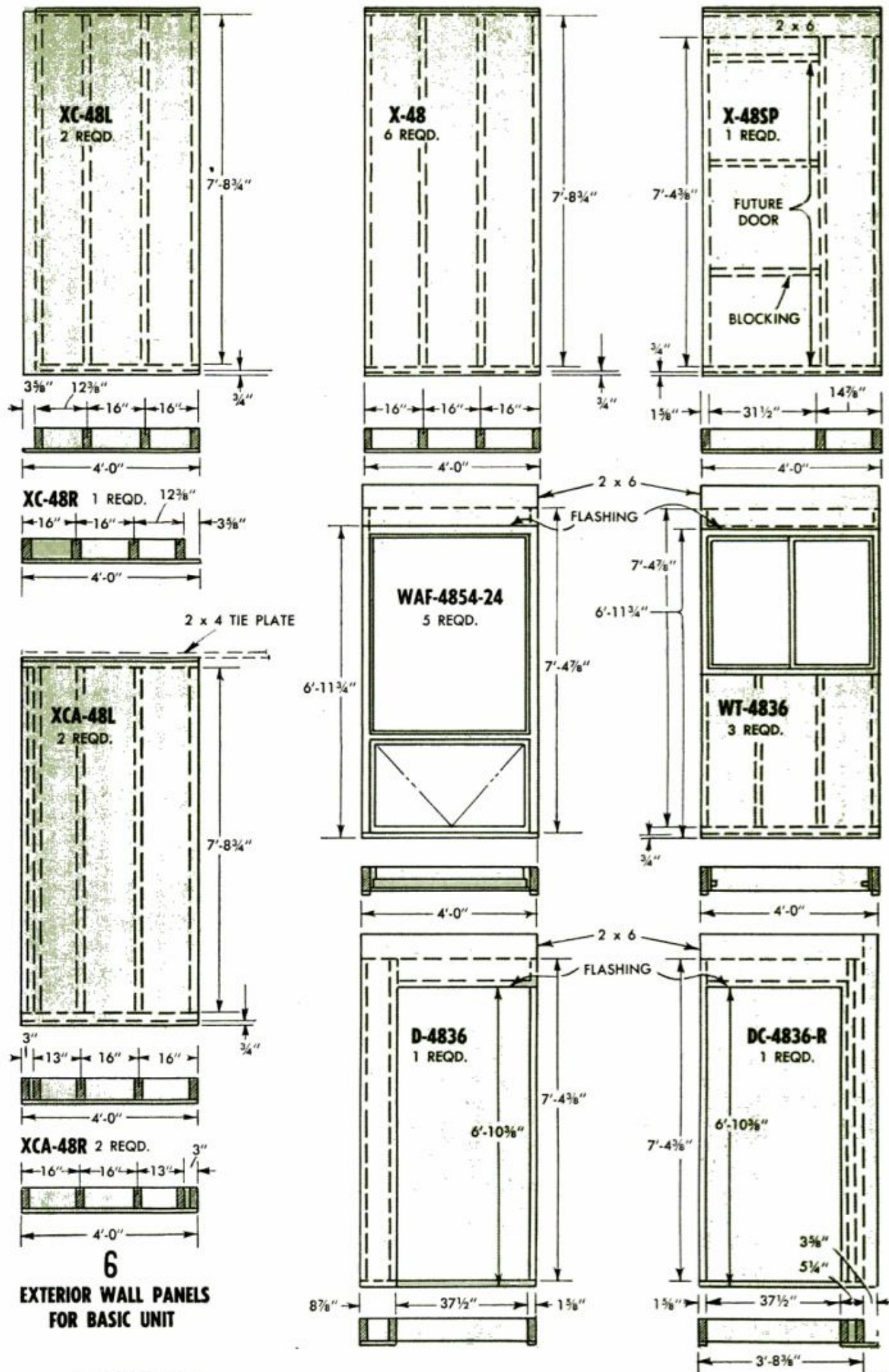



**RAKE PANELS** which form the overhang at gable ends of roof are toenailed to the supporting gable plate

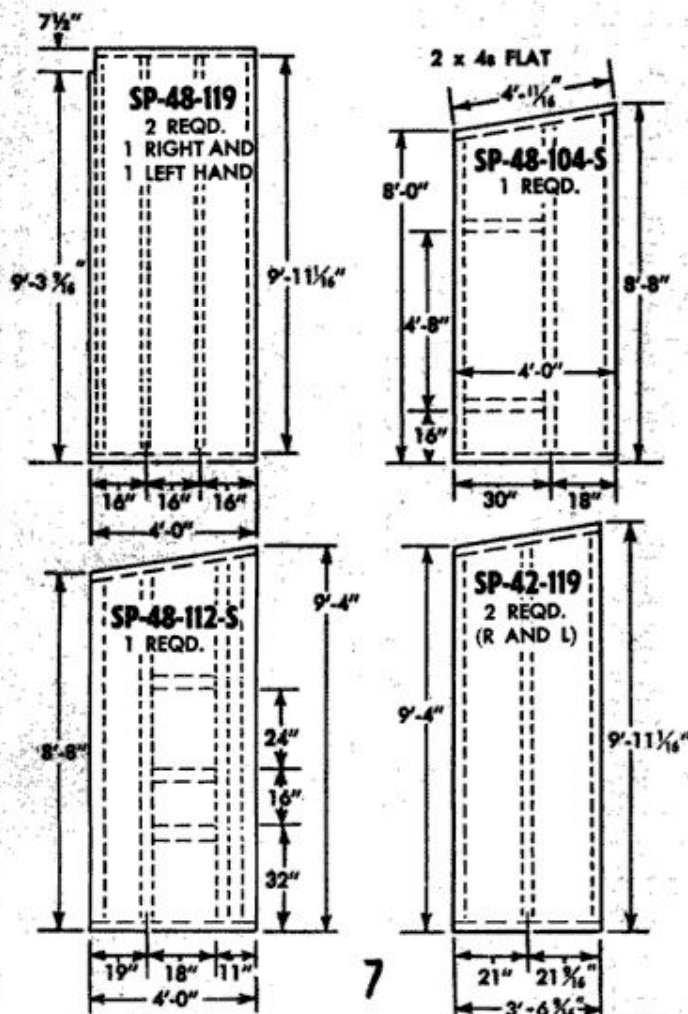

**INTERIOR WALL PANELS FOR BASIC UNIT**

EXCEPT for sections SP-48-119, all interior walls are 2 in. thick, some being made from 2 x 4s placed flatwise, others from 2 x 2s. Where two of each are required, frames are identical but faced on opposite sides to make them right and left-hand wall sections

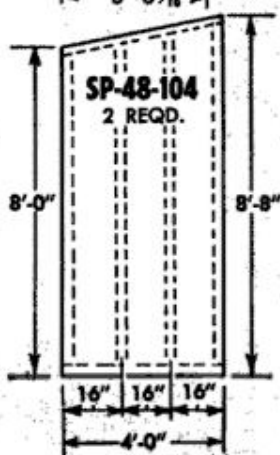

itself. Thus when the wall sections are joined together, the overhanging rabbeted edge laps the 2 x 4 of the adjoining section, effectively sealing the joint between the two abutting sections. A simple gauge block can be used to assure a uniform overhang from top to bottom. In following this method, care must be taken in handling and stockpiling the prefabbed sections so as not to damage the overhanging edge.

Wall sections WAF-4854-24 and WT-4836 show the window sash in place. These, of course, would be installed on the job after the walls are up since there would be too great a chance of breakage if installed beforehand through transporting to the site and in nailing the sections together. Window sections are designed to accept stock sash. In the case of sections WAF-4854-24, the upper sash is fixed, whereas the lower sash opens inward. In the other window sections the windows are of the sliding, or bypassing, type.

The keyed floor plan, Fig. 5, shows where each of the individual wall sections go in making up the four exterior walls of the basic unit, also the location of the interior walls. Note in the case of the interior walls that a plumbing wall is formed by two 2-in. walls positioned 8 in. apart. The space between provides room for the plumbing for the kitchen and bath. Fig. 7 details each interior wall section. With the exception of wall sections SP-48-119, which are assembled like the exterior walls, all other interior sections either are made of 2 x 4s placed flatwise or of 2 x 2s.

Sections SP-48-119, along with two built-up beams of 2 x 8s, form the load-bearing wall for the roof. In actual erection, a second 2 x 4 plate, running the length of the wall, serves to align and tie the whole center wall together. The roof rafters at the ridge rest on this top plate. The two sections required for the interior load-bearing wall require five studs and are assembled right and left hand insofar as the notched

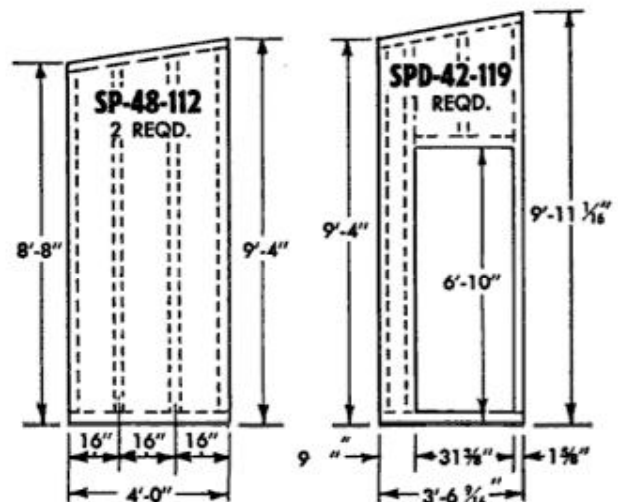

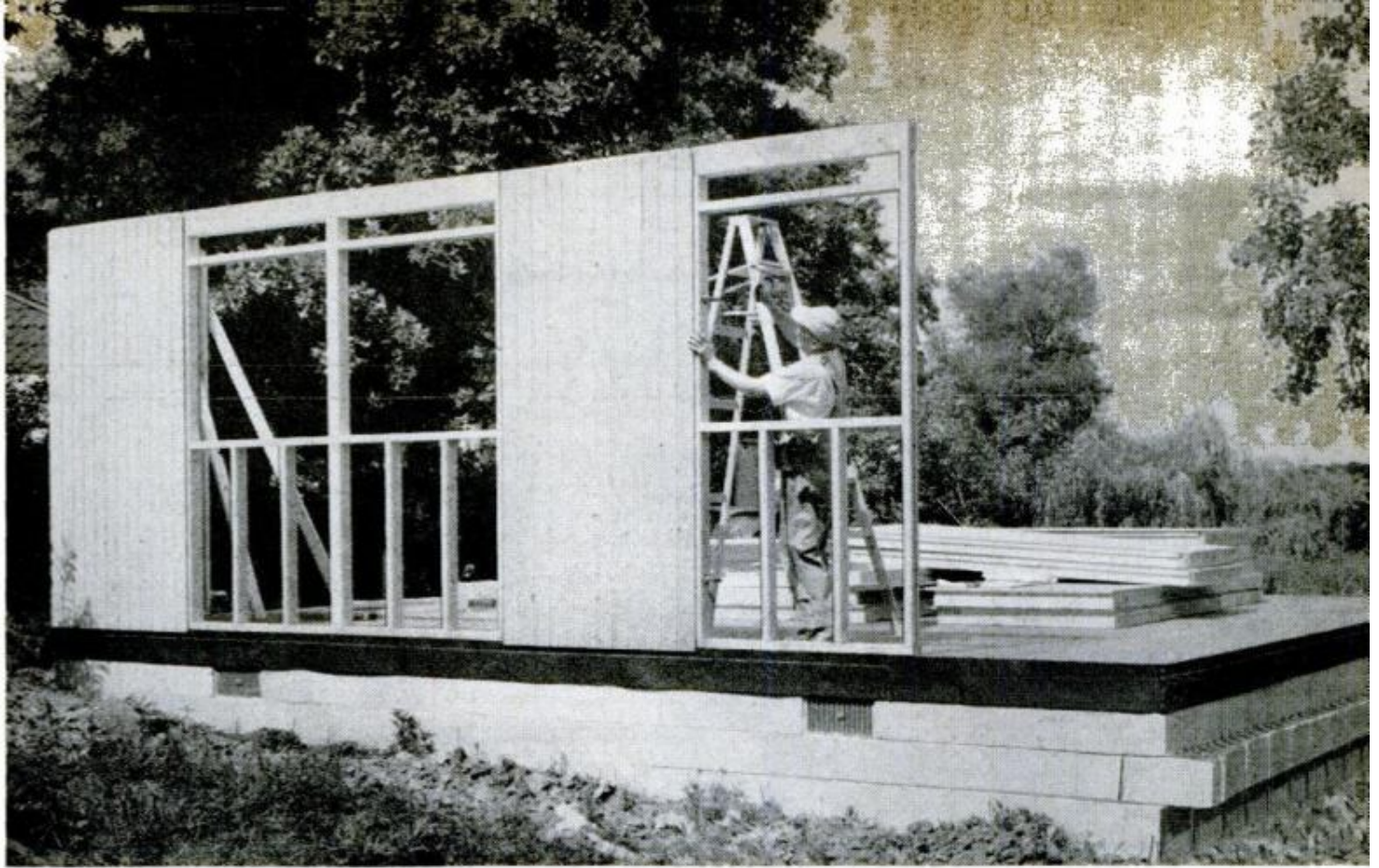

**HERE WALL SECTIONS** across rear of basic unit are being erected. Window sections normally would be faced with sheathing at time of prefabbing. Note how sections are braced to floor to hold them plumb

upper corner is concerned. Actually they are both alike but are positioned when installed to provide support ledges for the two 8-ft. beams. This also is true of sections SP-42-119, both being alike but made right and left hand when it comes to facing them with paneling. It is best to leave the interior-wall sections uncovered for now and then face them later after installation of plumbing and wiring. Then, too, your interior paneling is material you would try to have delivered to the site by a lumber dealer in the vicinity. As each exterior and interior-wall section is completed, label it so you will know right where it goes.

The floor and wall sections are all that are prefabricated, although there are other members which can be precut at home to save time on the job. These include the 26 roof rafters, the two beams for the load-bearing wall and the parts that make up the four rake panels which form the overhang at the gable ends of the roof. Roof sheathing, foundation sill plates, floor beams and other lineal stock is material you would have delivered since it wouldn't pay you to cart it for any distance when it could be obtained in the area.

Next month you'll be shown how the roof is applied, how the walls, floor and roof are insulated and how the window and door frames are installed.



**C-CLAMPS ARE USED** to hold wall sections in line while spiking abutting studs together, above. Time can be saved on the job by priming window and door frames at home before carting them to building site



# For New Thrills Afloat

# Build the **PM JET**

Designed by William R. Nielsen, Jr., S.S.C.D.



First do-it-yourself boat ever designed for turbojet propulsion, this trim runabout will leap to a plane in its own length for skiing. Remove the deck and it becomes a roomy fishing boat which slips easily through shallow snag-filled inlets. An attention-getter on any water, it's also easy to build

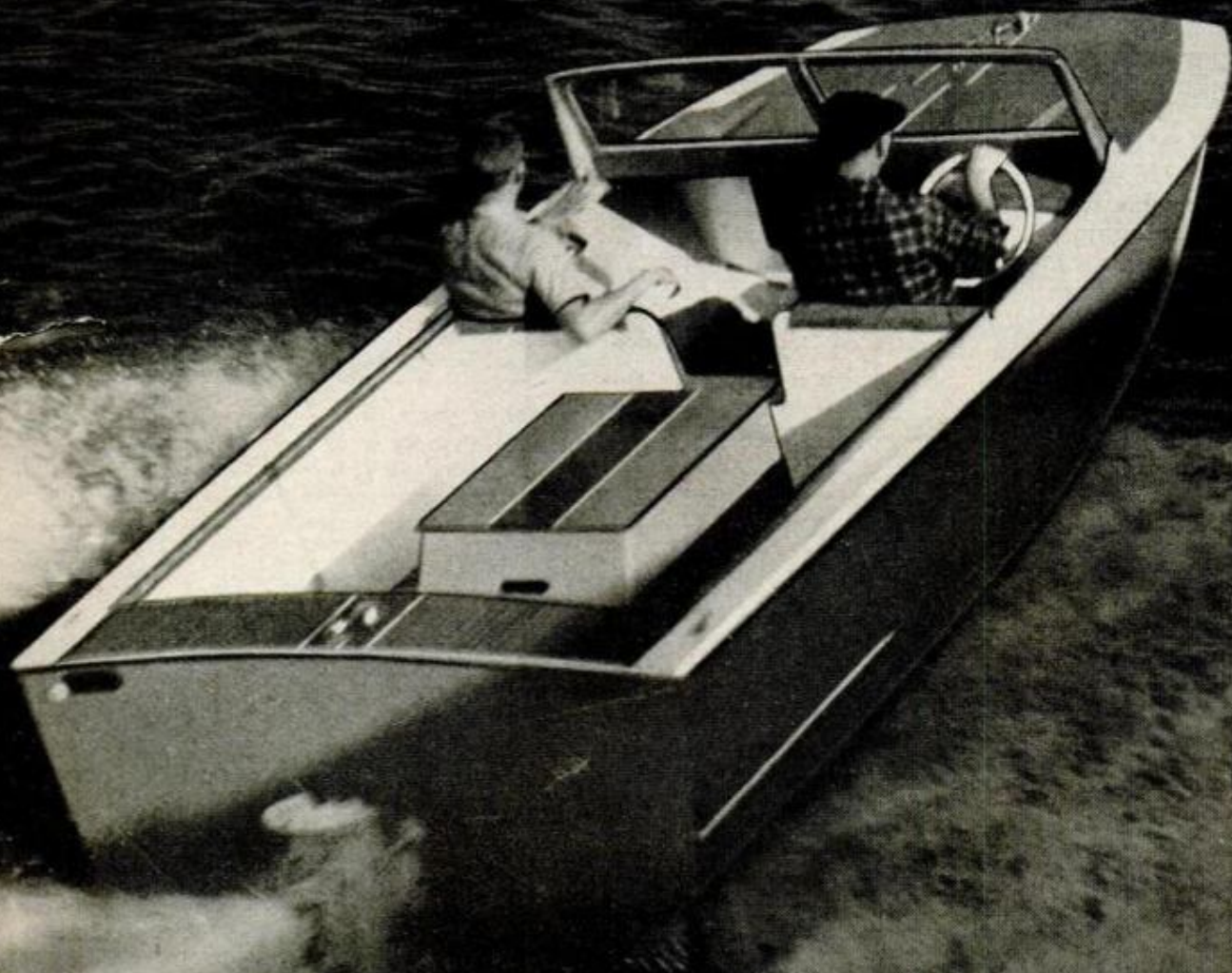

WEIGHS ABOUT 1300 POUNDS



WITH NO LOWER UNIT to worry about, the PM Jet can easily skim through the shallowest, snag-filled water

**By Arthur Mikesell**

**PART I**

**O**VER THE past couple of years we have received a great number of letters asking whether it's possible to install a turbojet unit in a regular outboard hull. Most of these people were particularly enthusiastic about a jet's shallow-draft capability. Skiers liked the strong initial thrust and safety of this propellerless propulsion system. However, few had even seen a jet installation and fewer still were aware of the many problems involved in such a project.

Unfortunately, the special hull characteristics required for efficient jet operation just aren't found in standard boats; in fact they would be considered defects with any other type of drive. In response to so much interest, however, it was decided by the editors that *PM's* 1962 project boat would be a jet, the first build-it-yourself boat specifically designed for this new propulsion system.

To design the boat, we chose jet-specialist Bill Nielsen of the Cole-Nielsen firm

**LIFT OFF THE DECK** and it's a roomy, go-anywhere fishing boat which will take you to those hard-to-reach inlets

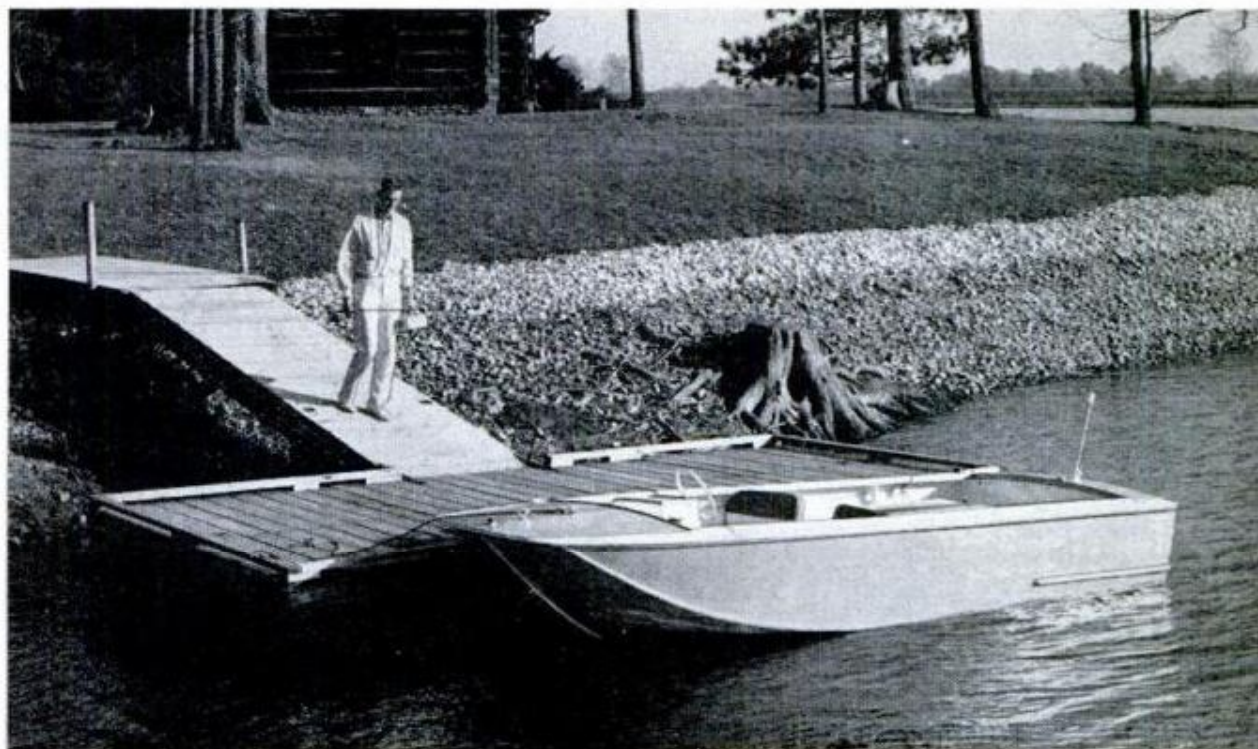

MARCH 1962

151

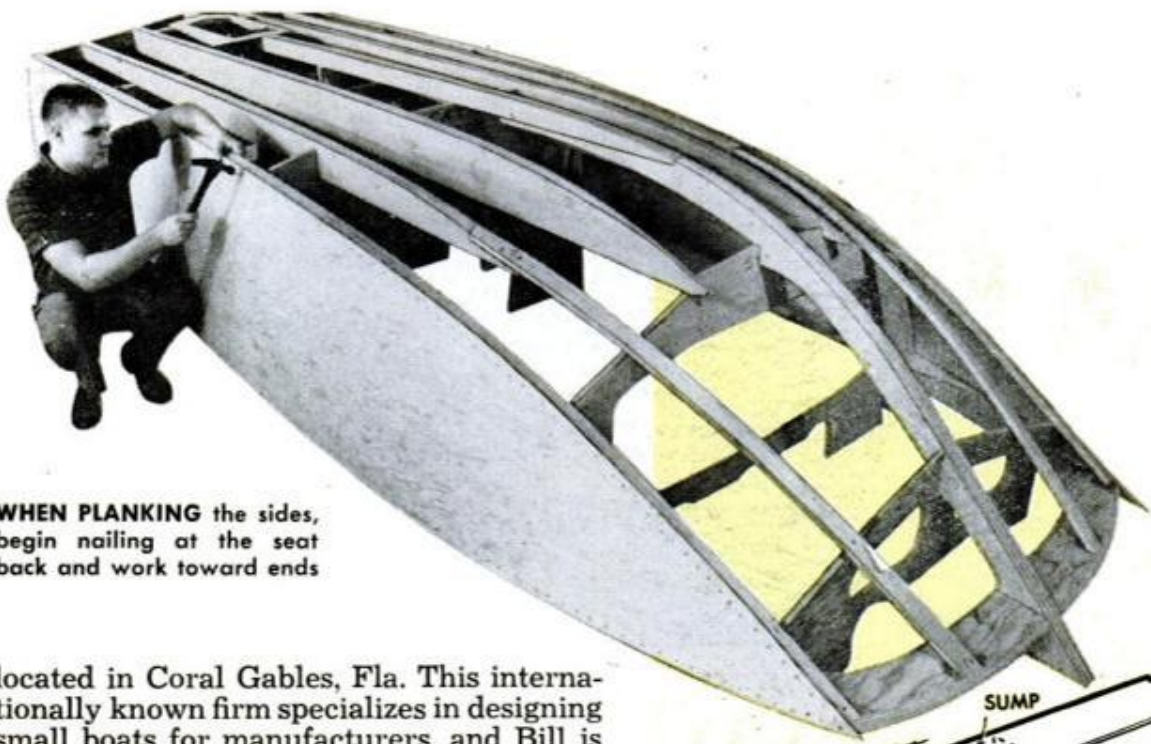

**WHEN PLANKING** the sides, begin nailing at the seat back and work toward ends

located in Coral Gables, Fla. This internationally known firm specializes in designing small boats for manufacturers, and Bill is one of the few naval architects with practical experience in designing jet boats.

At the outset, we decided that this boat should be both exciting and practical, fast and stable. The *PM Jet* turned out to be an outstanding success on all counts. Its 15-ft. 11-in. length and 6-ft. 6-in. beam make it a roomy boat with good load-carrying ability. Since a jet drive requires no lower unit, its use in this modified Garvey hull allows exceptionally shallow draft with no worry about snags. It's a fast boat, too. With the two-stage jet unit driven by an Interceptor 100-hp. engine (a marine conversion on the compact Comet-Falcon block), the pilot model was able to top 35 m.p.h. and do it in shallow, obstructed water where prop boats would have to be coned at an idle.

The exciting features of the *PM Jet* go beyond the jet drive. Lift off the removable portion of the deck and you have walk-around space ahead of the control stand, making the boat ideal for hunting or fishing. As for cost, the jet drive and motor combination compares well with in-board-outdrive installations in the same power range.

Before going on to the construction, one point should be made clear. Jet units are *not* standardized. Each make requires a different shaped intake cutout in the bottom of the boat, different transom cutouts and a different mounting block. The jet unit used in the *PM Jet*, Fig. 4, is the two-stage 75-2 model built by Buehler Turbo-craft of Indianapolis, Ind. Any details included here pertaining to the jet installation apply to this unit only. If you are considering another make of jet, check

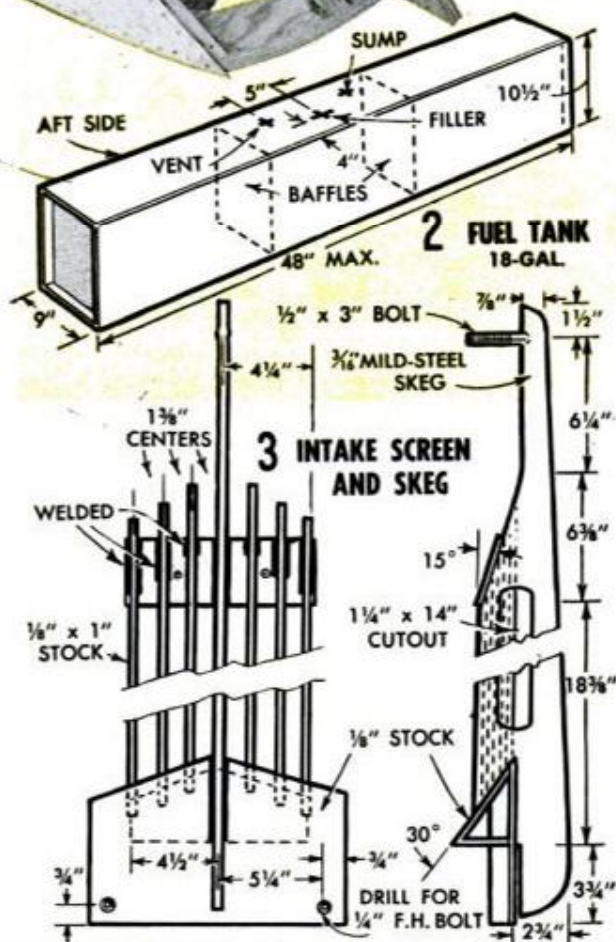

**POPULAR MECHANICS**



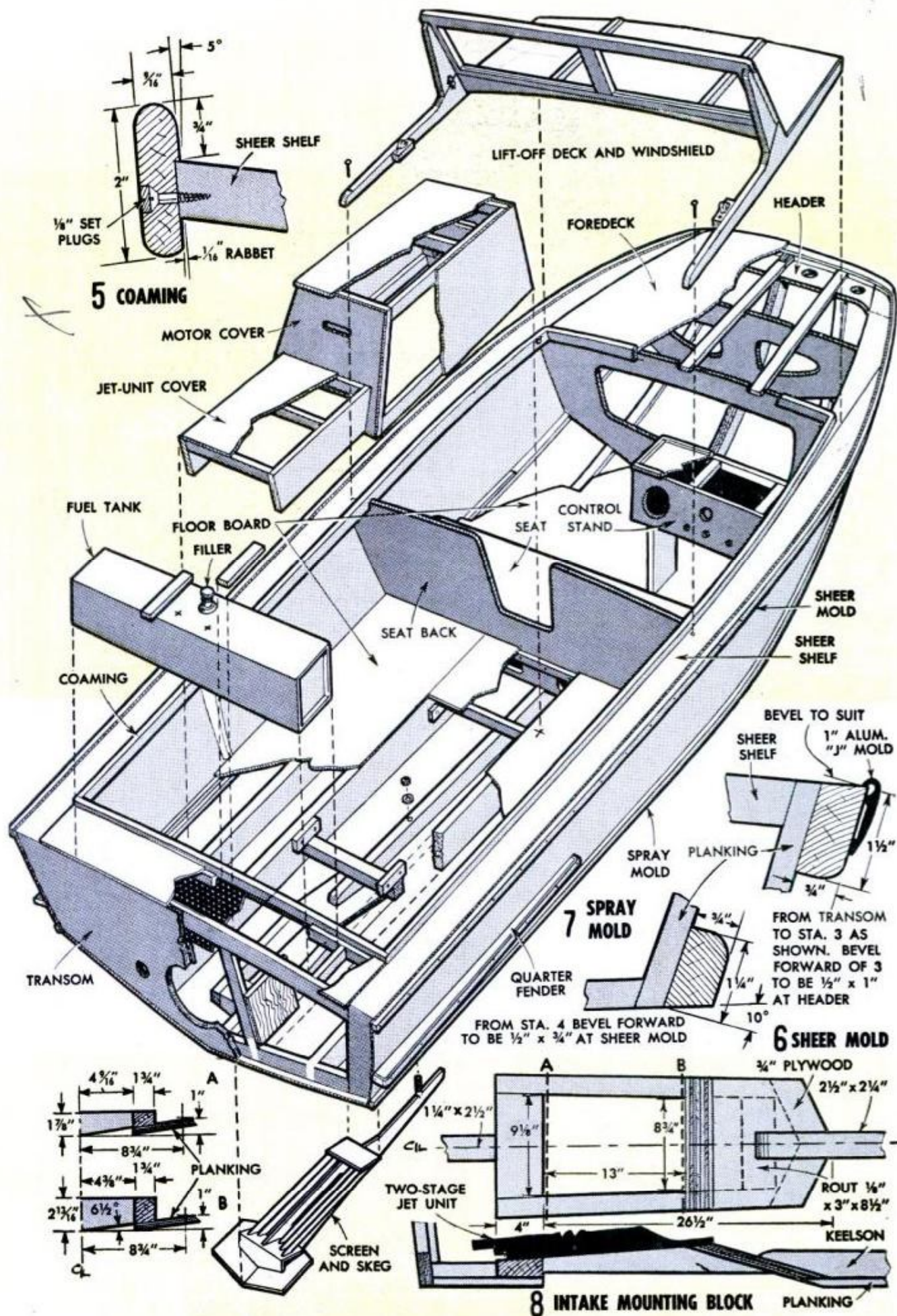

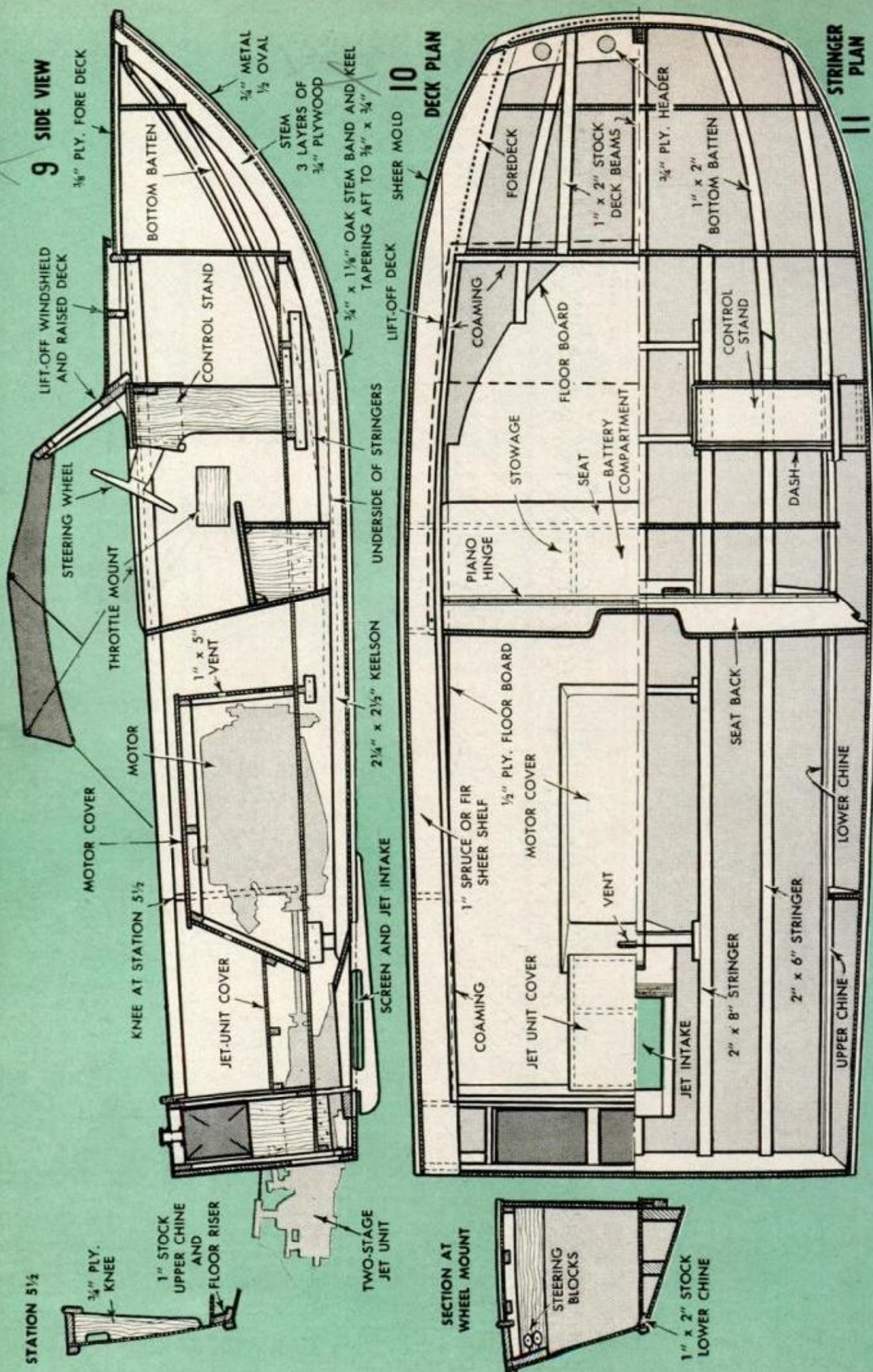

**9 SIDE VIEW**

**10 DECK PLAN**

**11 STRINGER PLAN**

STATION 5 1/2

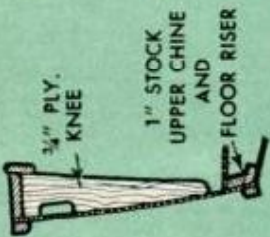

TWO-STAGE JET UNIT

SECTION AT WHEEL MOUNT

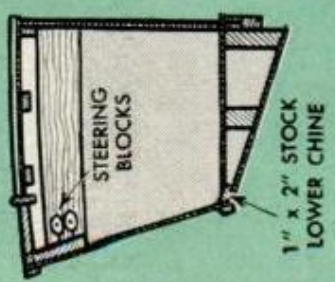

**STEM IS EXTENDED** past header so that extra material serves as a leg to bring header to correct height

with the manufacturer *before* you start building to find out necessary modifications.

A word about materials might also be in order. All planking is  $\frac{3}{8}$ -in. fir plywood, either marine or exterior, grade AB or better. Because the panels required are unusually long, your dealer may not have them in stock. If he has to put in a special order for them, they might not be delivered for a month, so check with him before starting construction to avoid delays later.

The length of all fastenings should be at least three times the thickness of the outer piece through which they pass, wherever possible. In general, serrated bronze nails (Stronghold, Anchorfast, etc.) are used to secure the planking, and these should be at least 1 in. long. Chines, battens, sheer shelf, etc., are mounted with  $1\frac{1}{2}$ -in. No. 10 flathead brass wood screws. Use waterproof glue at all joints and bedding compound under all molds. The bulkheads, transom and stem are all cut from  $\frac{3}{4}$ -in. exterior fir plywood, with the stem consisting of three layers of plywood held together with glue and screws. For a complete list of materials used in the *PM Jet*, turn to page 214.

Since no building frame is used in constructing this boat, it is extremely important that you have a stable, level nailing platform to hold the frame in line. We built the *PM Jet* on a construction floor made from scrap 2 x 4s and plywood. If you don't care to build a complete floor, you can make a rigid frame slightly larger than the outside dimensions of the hull and floor at only those points where bulkheads and temporary molds will be mounted.

Lay out a centerline on the construction floor and mark off the station spacings, being careful to keep them square to this line. After cutting out the bulkheads and transom, Fig. 13, make up the temporary molds from scrap 1 x 3 stock. Use no glue when assembling these molds as they will have to be dismantled later. To bring the bulkheads and transom up to the correct height above the base line, Fig. 14, you may either leave extra stock on the upper part when cutting them out to serve as legs, Fig. 12, or mount temporary 1 x 3 legs on them. Side supports cut to the proper angle should be mounted to the legs on the transom and seat back to add stiffening and give the proper rake.

Draw an accurate centerline on all bulkheads and molds, then position them on the building floor and nail the legs to cleats which have been secured to the floor at the

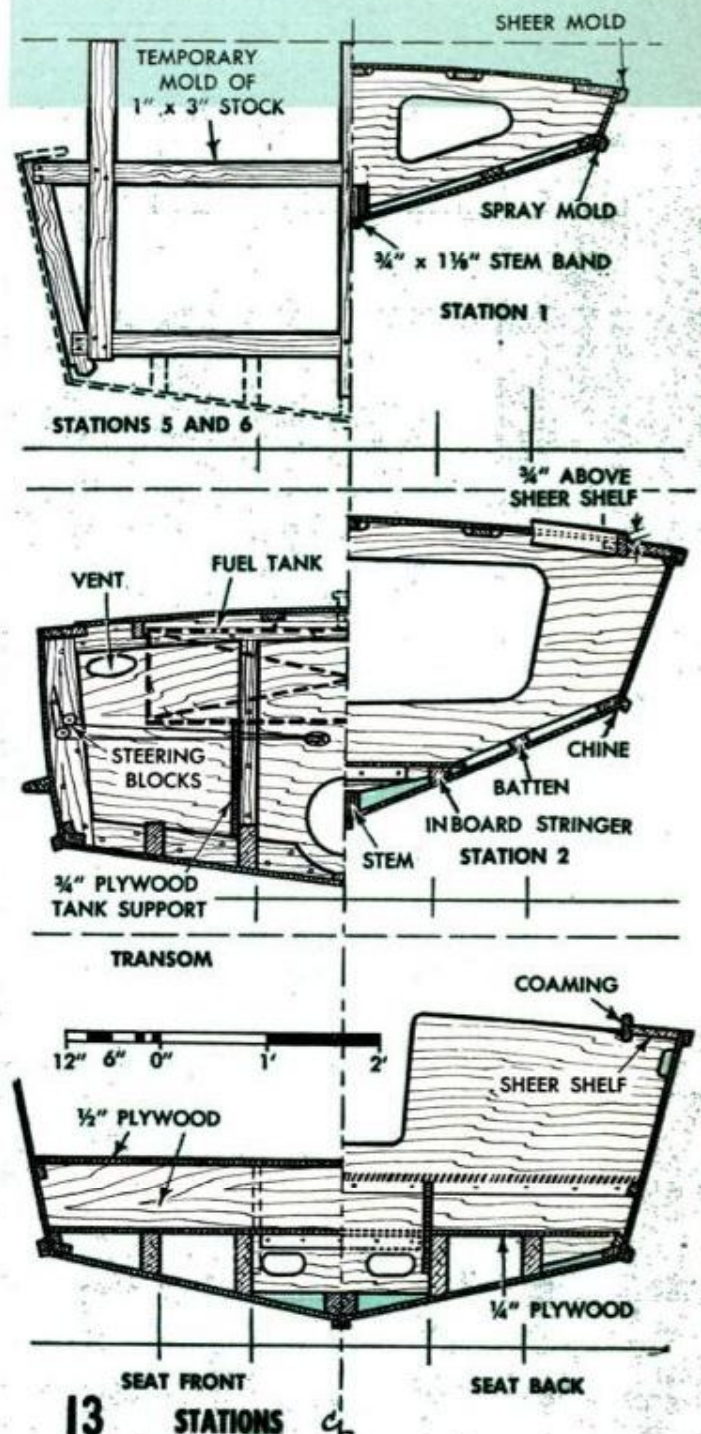
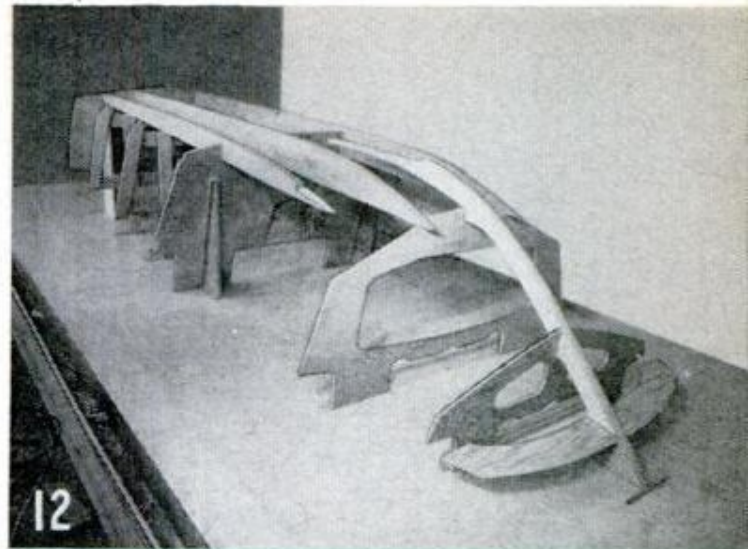

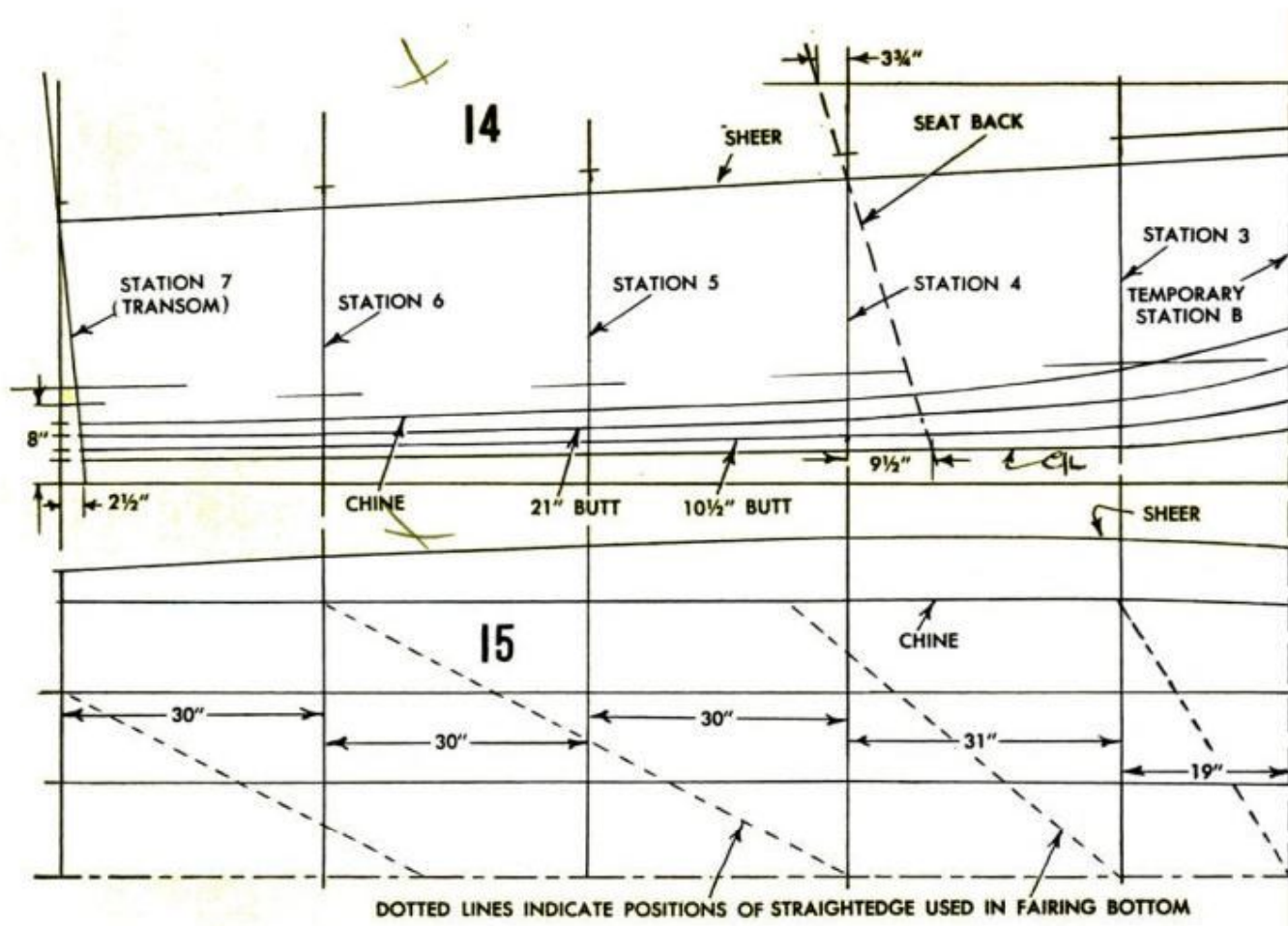

station lines. Next, make up the stem leaving the fore end long as shown in Fig. 12 so that the header can be mounted on it at the correct height above the base line. After mounting the header, set this stem-header assembly in place and add the keelson, making sure that all these members fit snugly at the bulkheads. When all parts have been aligned, secure them with glue and screws.

The four stringers, Fig. 11, are now cut and beveled about 6 degrees on the planking side. All dimensions from Figs. 14, 15 and 16 pertaining to stringers (shown as buttock lines) are for the inboard or deepest side. Notch the fore end of the outer stringers to receive 1 x 2 battens and mount

these battens to the stringers at a slight toe-in angle. Then bend the battens over the bulkheads until the fore ends are hard against the header but forward of the final position and clamp them in place. Saw off the surplus using the lower surface of the header as a guide, draw the battens closer to their final position and saw off more material. Repeat this operation until the battens are in their final position and have the proper angle. Then secure them to the header with glue and screws.

You are now ready to lay out and mount the two-piece sheer shelf. Using temporary cleats attached to the bulkheads, molds and transom, clamp the 1 x 10 board from which the longest part of sheer shelf will be cut

**BOTTOM PLANKING** can be clamped to header to make nailing easier and assure contact at the centerline

**USE PLYWOOD** surface of intake block as a sawing guide when continuing intake angle through planking

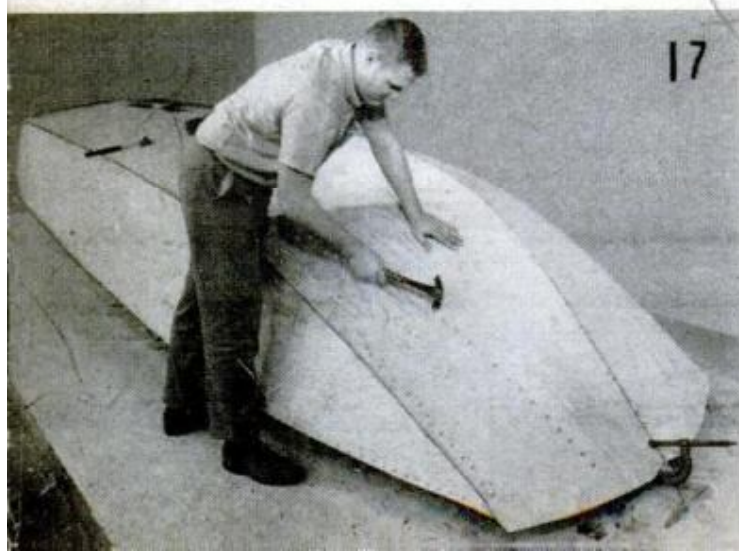

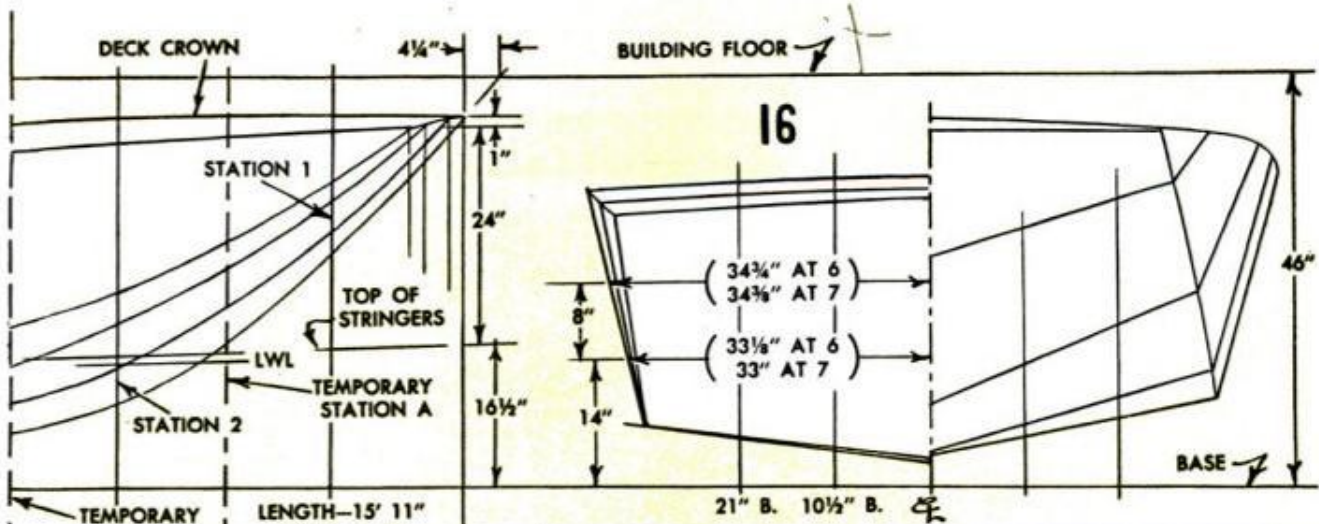

	STATION	7	6	5	4	3	B	2	A	1
ABOVE BASE	CROWN	32"	STRAIGHT LINE		38"	39 3/4"	—	41"	—	41 1/2"
	SHEER	30"	STRAIGHT LINE							39 3/4"
	CHINE	6 1/2"	7 1/8"	8"	9 1/2"	12 7/8"	17 1/8"	21 1/2"	27 1/4"	34 1/4"
	21" BUTT	5 1/8"	5 3/8"	6 1/8"	7 1/8"	9 3/8"	13 1/4"	18"	24 3/8"	32 1/4"
	10 1/2" BUTT	3 3/8"	4 1/2" +	4 7/8" +	5 1/4"	6 3/8"	9 1/2"	13 3/8"	20 1/8"	28 7/8"
		2 1/2"	3 1/8" +	3 3/8"	3 7/8"	4 1/4"	6"	9 1/4"	16"	26 1/2"
FROM GUNWALE	SHEER	35"	36 1/2"	37 3/4"	38 1/2"	38 3/4"	—	35 3/4"	—	29 3/4"
	CHINE	31 3/8"	31 3/8"	31 3/4"	31 3/4"	31 3/8"	—	29 3/8"	—	26 3/4"

MEASUREMENTS TO INSIDE OF PLANKING AND UNDERSIDE OF DECK.  
SIDES ARE STRAIGHT LINES FROM SHEER TO CHINE EXCEPT AT STATIONS 6 AND 7

to the underside of the frame at the proper crown. Then lay a batten on this board so that it is in contact with the outer side of all stations, clamp it in place and use this as a guide for marking. Remove the shelf and make a bevel cut of about 15 deg. with the line marking the narrow side of the cut. It is best to cut on the outside of the line so that a bit of stock is left for final trimming.

After cutting the scarf, Fig. 10, clamp the shelf in position again. Now put the second length of 1 x 10 in place, clamping

**KEEL AND STEM BAND** is mounted after fiberglassing is completed. It can be faced with aluminum molding

it to the header and two forward bulkheads. Use a batten to continue the sheer line of the first piece to the header and then follow the outline of the header. Remove both pieces of the shelf and bevel-cut the sheer line of the second section as you did that of the first. Using plenty of glue, join the two pieces at the scarf cut with a simple butt joint reinforced with a temporary backing plate which will be removed after the coaming line has been laid out and cut.

(Continued to page 212)

**PAINT BOTTOM** of hull before turning it and make sure that hull cradle is padded to protect this finish



SHOP AND CRAFTS

*Make  
Your Own*  
**BANJO**

X38

X 38  
**By Gustav W. Stamm**

*Although making a banjo is less of a challenge than most musical instruments, it can be an intriguing test of skills for craftsmen*

**W**ITH THE possible exception of the fingerboard, calfskin head and a few other parts which you can buy at reasonable cost, you can craft an excellent five-string banjo from hardware and lumber-store materials. With only a few hand tools and the materials at hand you're set to start from scratch.

Begin by making the form on which you laminate the shell, Fig. 1. Sandwich and clamp three pieces of  $\frac{3}{4}$  x  $10\frac{1}{4}$  x  $10\frac{1}{4}$ -in. plywood with glue in both joints. When dry, scribe a center line and bandsaw the block into two parts. Place a length of  $\frac{1}{4}$ -in. stock between the halves, clamp together and then screw two flat-steel cleats to each face as in the lower detail, Fig. 1. Locate the center, scribe a circle on one face on a  $4\frac{7}{8}$ -in. radius. Bandsaw just outside this line and save the waste pieces. Drill four  $1\frac{1}{4}$ -in. through holes located as in the lower detail, Fig. 1. Cut two  $\frac{1}{2}$  x 1-in. grooves 180 degrees apart in the rim for loose-fitting nailing lugs, or blocks, as in the upper detail, Fig. 1. Remove two of the steel cleats, take out the  $\frac{1}{4}$ -in. strip and reassemble. The opening left by removal of the  $\frac{1}{4}$ -in. strip allows the form to collapse sufficiently to permit its removal after the shell has been completed.

The shell consists of eight  $\frac{1}{16}$  x  $2\frac{3}{8}$  x 36-in. strips of maple veneer. The final finishing strip is wood-grained plastic of slightly greater width and the same length. The wood strips are built up (laminated) around the form with the ends butt-joining alternately on the nailing blocks. Both ends of each strip are bradded to a nailing block to hold them temporarily in place. The end result of this procedure is a laminated ring with walls about  $\frac{9}{16}$  in. thick.

The first step is to place the eight strips of wood laminate in soft, warm water and allow them to soak for several hours. Then you remove four of the strips, coil them into a roughly circular ring and hold in place with a cord as in the photo at the right. Do the same with the second lot of four strips.

While the strips are drying, cut the two waste pieces you sawed from the form into four triangular blocks of roughly the same size. Saw off the right angle corner of each to give a flat about 1 in. wide. This gives you four clamping pads, or cauls, each

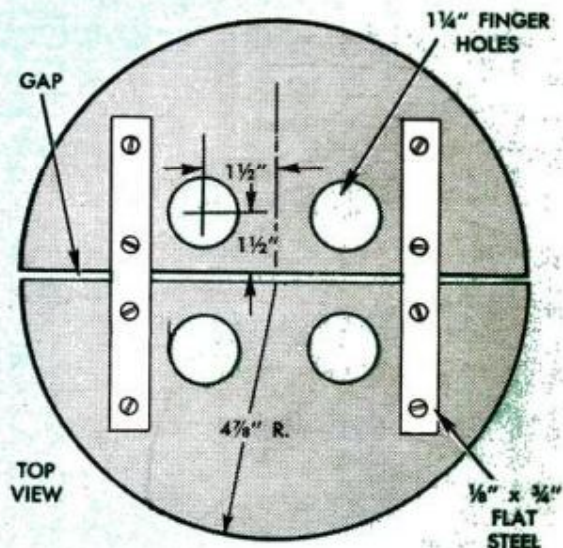
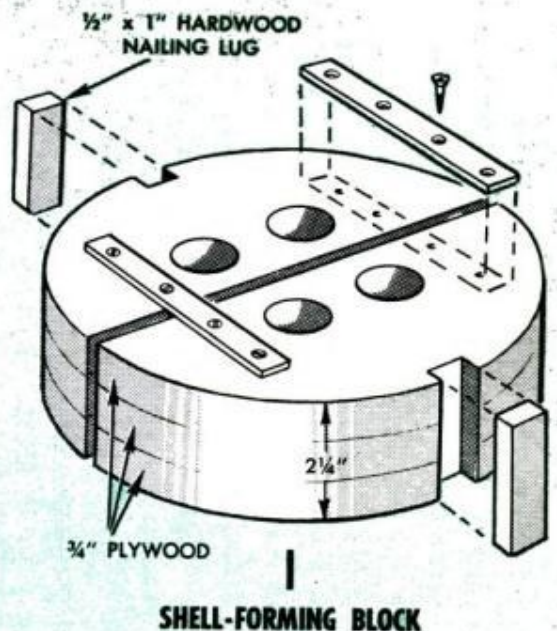

**STRIPS** used in laminating shell are soaked in water and pre-bent by forming four strips into a ring and holding with cord until dry



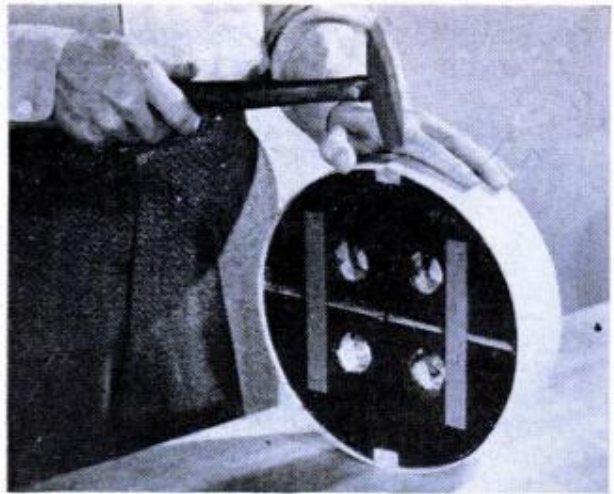
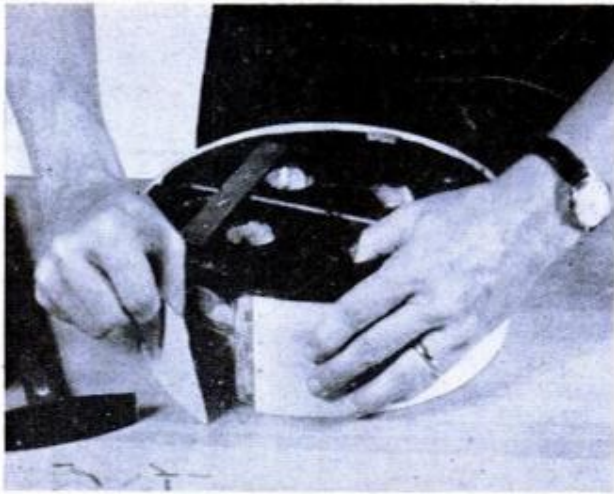

**FIRST STRIP** being attached to form. Ends must butt, not overlap. Note that starting end already is attached to nailing block with brads. Finish end is trimmed about  $1/16$  in. short to prevent buckling

**FINISH END** of first laminate strip being bradded in place. This strip is then coated with glue and starting end of second strip is bradded to nailing block opposite butt joint of first strip. Use  $1/2$ -in. brads

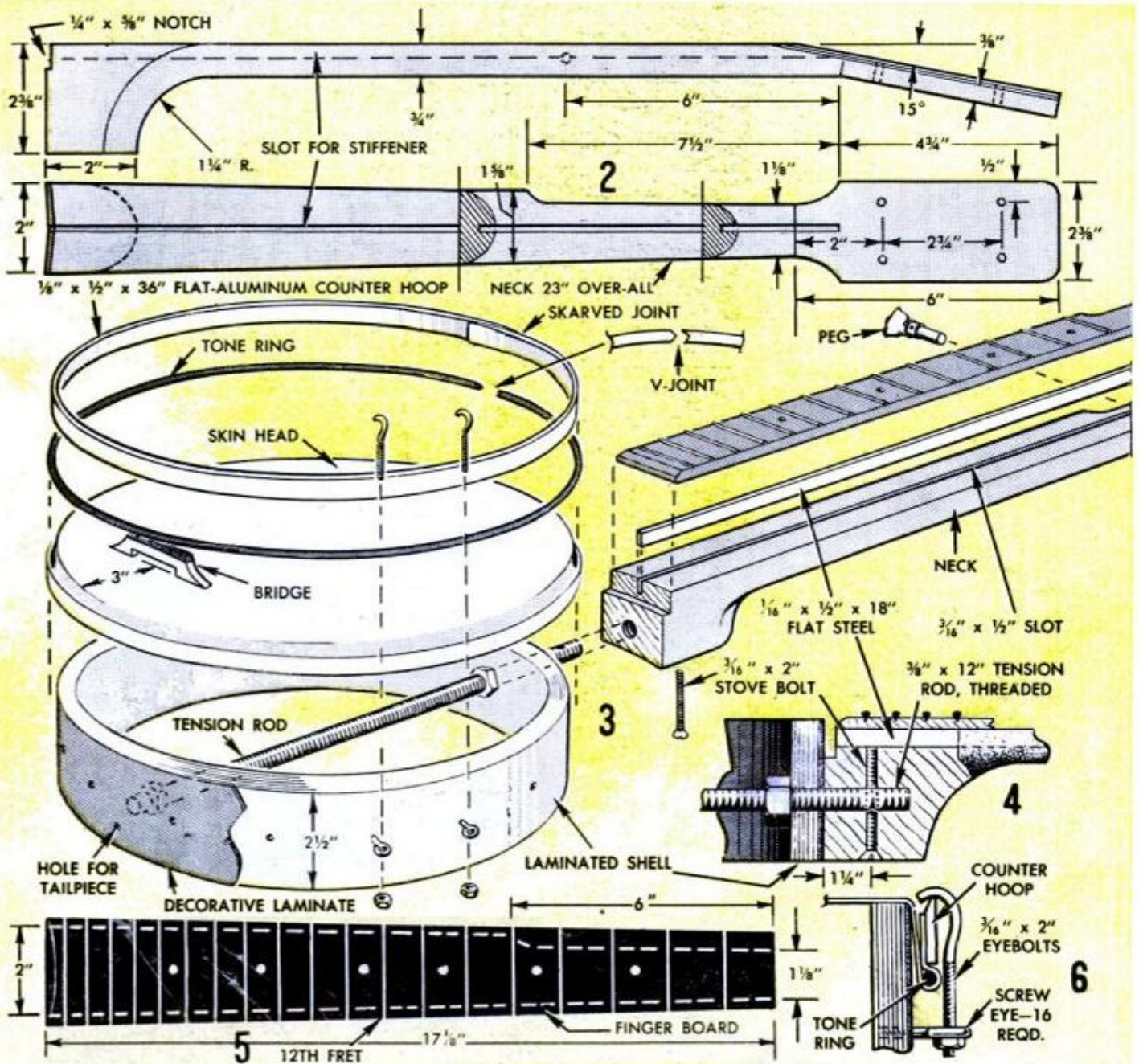



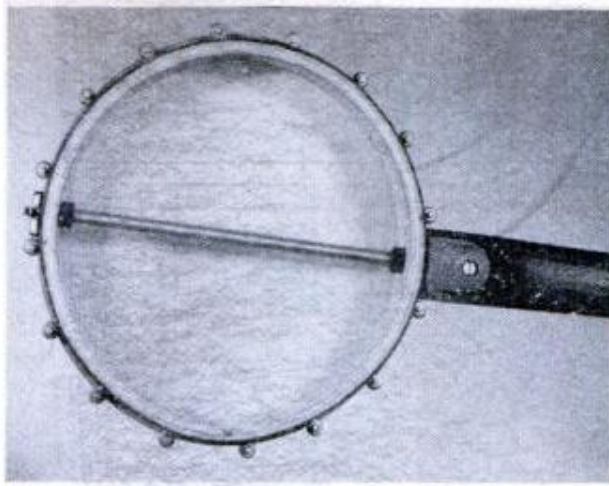

**COMPLETED HEAD** with all parts in place. View is looking up at underside and shows the tension rod and the rounded underside of the neck. Note the location of the tension-rod locking bolt in neck

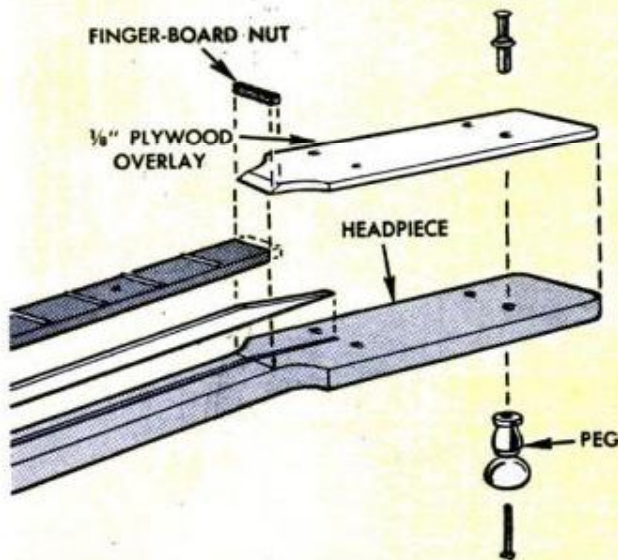

**DOWN VIEW** of the finished banjo head showing the five strings, bridge, skin, hoop, tone ring and a part of the fingerboard completely assembled



suited to the purpose, as the curved face of each one is the same radius as that of the form. Two C-clamps can be used on each caul, the fixed pads of the clamps being inserted in one of the 1 $\frac{1}{4}$ -in. finger holes.

The next step after the veneer is dry, or nearly dry, is to brad one end of the first strip to a nailing block on the form, using  $\frac{1}{2}$ -in. brads. Wrap the strip tightly around the form, cut about  $\frac{1}{16}$  in. short and brad the finish end to the same nailing block. Now you are ready to laminate the shell by gluing strips successively, one over the other, with the butt joints alternating on the nailing blocks. Here's how you proceed: Coat the first strip which is already on the form, with glue (don't use quick-setting white glues) brad the starting end of the second strip to the nailing block opposite the one on which the butt joint of the first strip was made. Locate the first caul with its end near the starting end of the strip. Clamp the caul in place, using two C-clamps, one on each side of the form. Continue the procedure around the form until all four cauls are in place and clamped. Then brad the finish end of the strip to the nailing block, trimming the finish end if necessary to form a butt joint. Remove the clamps and cauls. The butt joints do not need to be tight, but be sure before bradding that the ends do not overlap. Continue this same procedure, step by step in sequence, until you have applied four strips. Then leave the clamped cauls in place until the glue dries thoroughly. Wipe off any excess glue with a damp cloth before it sets. Now, with the first four strips in place you apply glue to the face of the fourth strip and simply repeat the procedure just described step by step in sequence until all eight wood strips have been glued in place.

The finish strip of wood-grained plastic laminate is applied with contact cement. This strip should butt-join over one end of the gap in the form. The material must be applied with contact cement which is brushed onto the surface of the wood laminate and the inner surface of the plastic strip and allowed to dry to a stiff tacky stage (or as directed on the container). Remember that these two coated surfaces will adhere instantly on contact, so be sure you have the starting end of the strip correctly located before bradding it. When you're sure of the location, press the strip into contact about one fourth of the way around the circumference of the shell. Then clamp one of the cauls into position over the area in contact. Continue to press the strip into contact all the way around

(Continued to page 210)

# Winking-Eye CLOWN RADIO

*Familiar magic-eye tubes make this clown come alive!*

**T**HIS AMUSING clown-face radio is a child delighter. Voice or music broadcasts come out of the mouth and the eyes blink in tempo to the sound. You regulate volume by twisting the clown's nose.

The secret of the winking eyes is to mount two 6E5 magic-eye tubes in correct position behind the clown face cutout and wire them into the radio circuit according to the diagram shown at the top of page 164. This is a low-cost circuit of the detector-amplifier type designed to provide the minimum performance which might satisfy youngsters.

You can obtain better performance, if you happen to have a working model of a small a.c.-d.c. radio, by wiring the clown eyes into it, following the circuit shown on the bottom of page 164.

After preparing the metal work for the built-from-scratch receiver, mount the tube sockets and the transformer. Following the schematic diagram, wire the chassis.

When the circuit is wired and checked, prepare an antenna at least 50 feet long. If you are in an ordinarily good signal area, you can probably run the wire around the ceiling of the room. In a less favorable spot, run the wire up to the roof. Connect



the antenna lead to the top of the ferrite coil. We used a Fahnstock clip for this terminal to facilitate removal.

Plug the radio into a 110-volt outlet, and turn the switch on. Allow a short time for warmup, and listen at the speaker for a signal. If none is present, rotate capacitor C1 until a signal is heard. Peak the signal by adjusting ferrite antenna L1. Our unit, operating in downtown Chicago, was able to bring in three different stations with a roof-top antenna.

**Now connect the eyes.** Connect capacitor C7 to the plate of the 50C5 (pin 7). The eyes should deflect quite strongly. If they close and remain closed, this indicates that

## CLOWN RADIO PARTS

L1—Ferrite loopstick antenna  
C1—365 mmfd variable capacitor  
C2—330 mmfd mica  
C3—20 mfd electrolytic, 25 volt  
C4—30 mfd electrolytic, 150 volt  
C5—30 mfd electrolytic, 150 volt  
C6—.02 mfd paper, 400 volt  
C7—.02 mfd paper, 400 volt  
R1—220 k, ½ watt  
R2—470 k, ½ watt  
R3—150 ohm, ½ watt  
R4—1500 ohms, 2 watt  
R5—1 megohm, ½ watt

R6—1 megohm, ½ watt  
R7—1500 ohm, 2 watt  
R8—300 ohm, 5 watt  
V1—12AV6 tube  
V2—50C5 tube  
V3, V4—6E5 tube  
D1—70 MA silicon diode  
D2—1N34 germanium diode  
T1—Output transformer, universal  
T2—Power transformer, 110-volt input, 6.3 volt, 120-volt output. Allied Radio #61 G 410 or equiv.

Prepunched chassis and clown face available from  
Experimenter's Supply Co., 1924 W. Columbia Ave., Chicago, Ill.

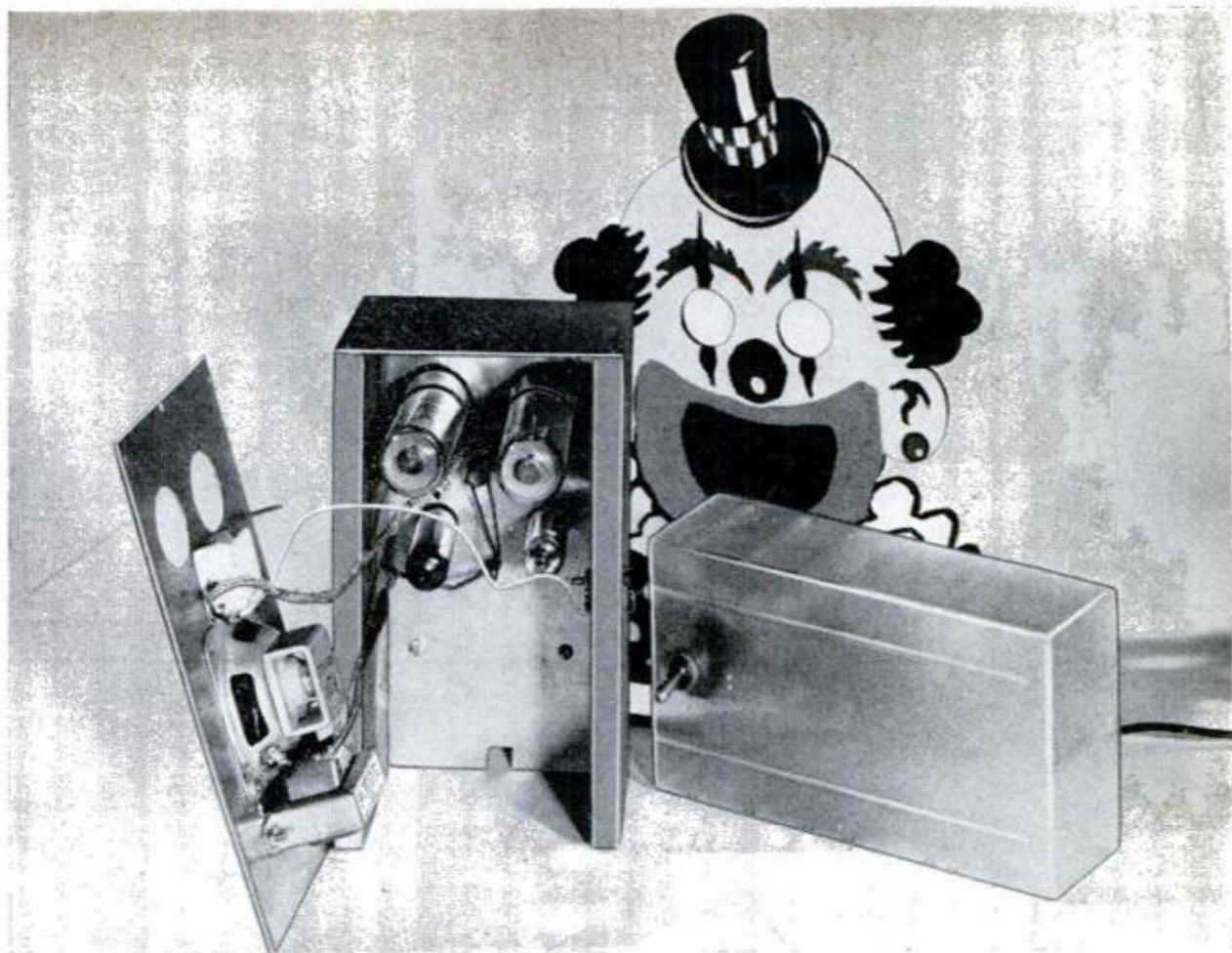

**DISASSEMBLED UNIT**, above, shows relative parts placement. Rear panel pattern is seen below. Use drawing at right to layout a panel for front, as well as clown face. Grids are spaced one inch apart. Plastic cover mounts switch, protects small fingers from electrical jolts. Use hard-board for face, paint with enamel colors

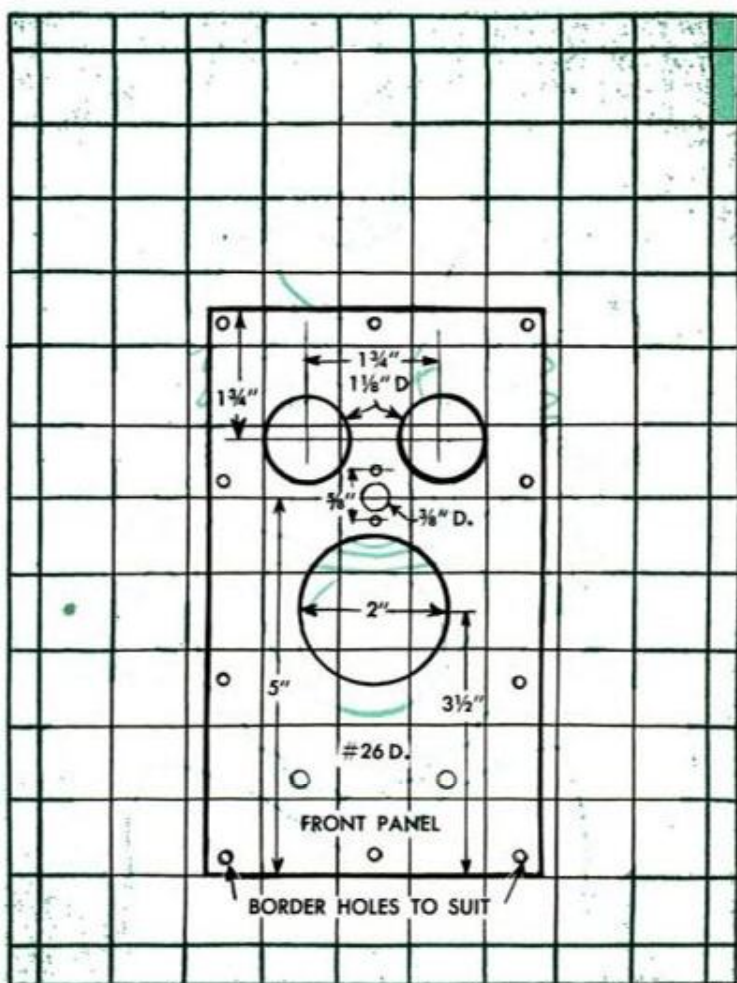
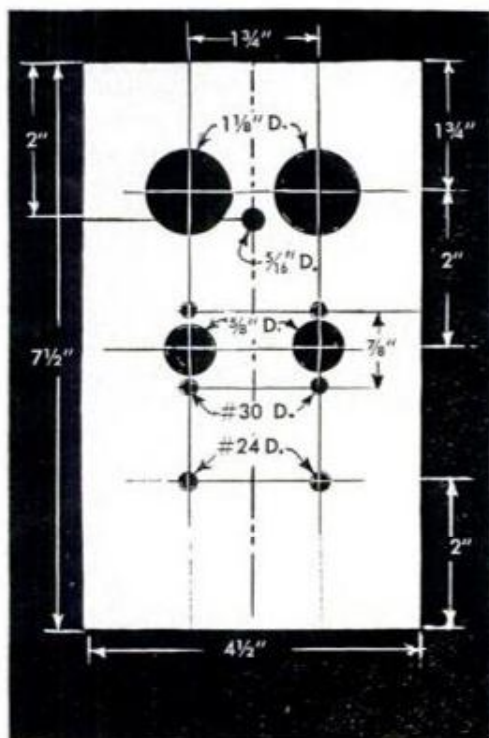

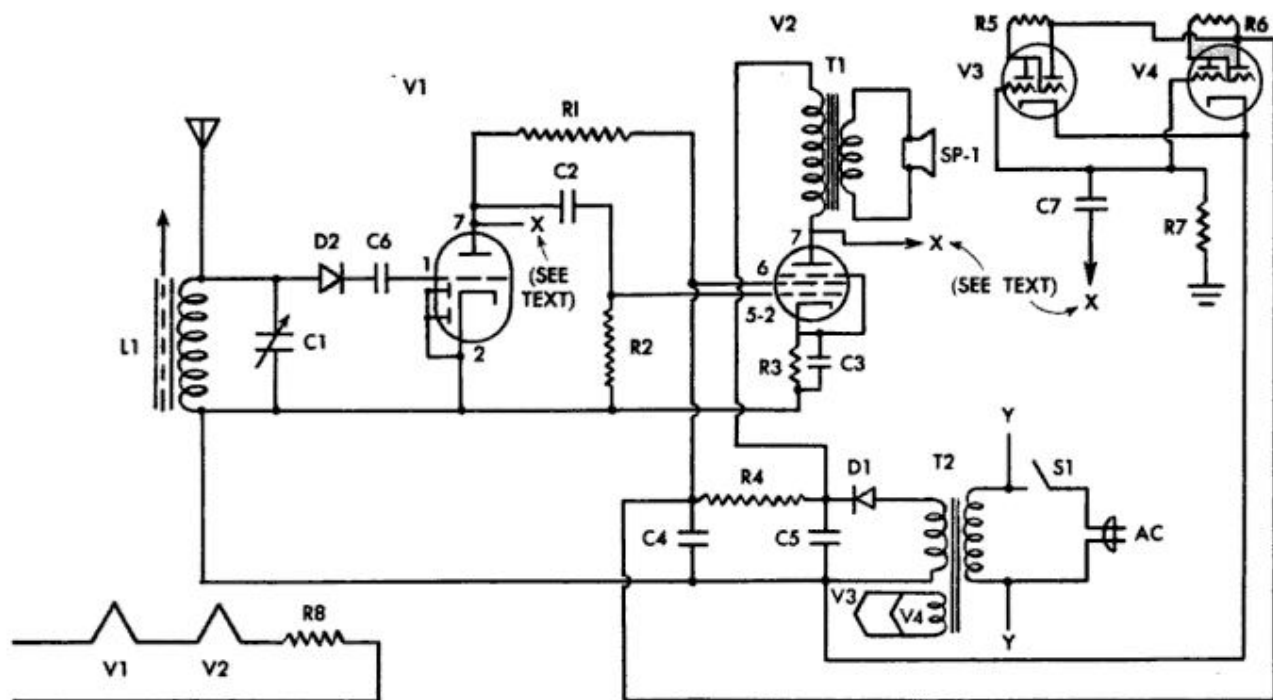

**SCHEMATIC DIAGRAM** shows wiring. C1 mounts on separate panel. Use shielded wire for C1 connections

too strong a signal is being applied. Should this occur, connect the capacitor to the plate of the 12AV6 instead. You will notice, in testing the unit, that the eye action is better on voice than on music. This is because spoken material requires a no-signal space between words. Music peaks from note to note, but often maintains a minimal signal level in the background.

Assemble the front and rear panels using 1/2 x 4-inch boards for the sides.

**Paint the clown face with enamels.** Select

bright, gay colors except for the center of the mouth area which is painted black. You can tape a piece of black cloth over the speaker hole to fill the gap.

Nail the face to the base using wire brads. Now assemble the chassis to the base, using brads through the side pieces. Be sure the shaft of the tuning capacitor comes through the nose opening and the 6E5 tubes appear at the eyes. Select a large diameter round knob for the nose and paint it red with fingernail polish.

## ... Or Make Your Present Radio Into a Blinking Clown

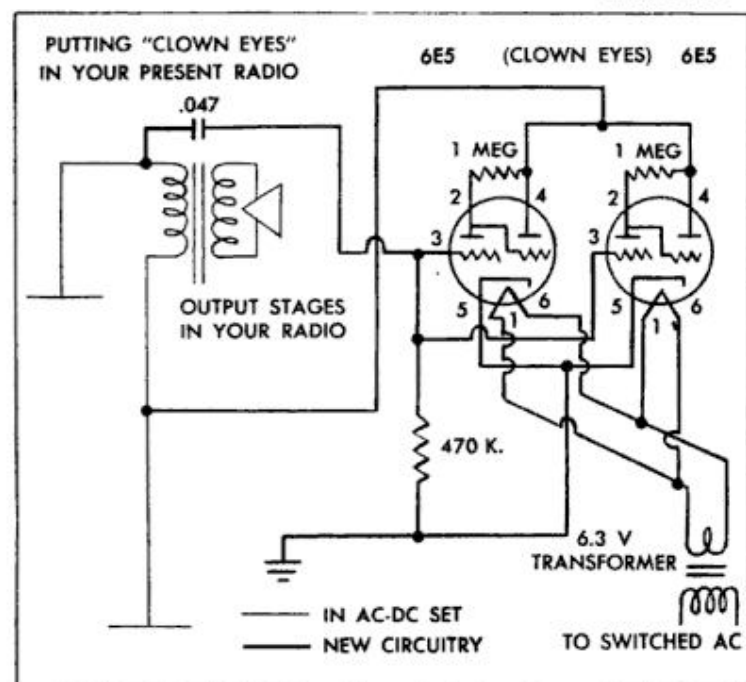

You can improve the reception of the unit by using an a.c.-d.c. receiver. Using the circuit shown at left, wire in the two 6E5 tubes. Connect the primary of the filament transformer to the switched a.c. in the set.

Extend the volume control and switch leads to the clown's nose. You will notice that we have connected the .047 capacitor to the plate of the final output tube. If the eyes do not open sufficiently during no-signal conditions, this means that they are being over-driven. You can correct this by connecting the .047 capacitor to the plate of the first audio tube instead. This will be a 12SQ7 or a 12AV6, and lower the drive.

—Gus Wesenfeld

## QUICK AND EASY

### Quickie Carton Table

A corrugated carton, a sharp knife and 10 minutes is all it takes to make this sturdy playhouse table for the younger set. Obviously, the size of the table depends on the size of the carton you use. Cut off the top just below the opened flaps, being careful, of course to cut it square and straight all around. Then cut away the sides and ends to form legs, rails and braces. If the table is made from a relatively small carton you'll need to leave braces only at the ends when cutting. But if it's cut from a large carton and is near normal table height, the legs will need braces all around. Also, you can strengthen the top by gluing in cardboard ribs underside. Width of the leg webs and braces should be at least  $2\frac{1}{2}$  in. and the braces should be about the same width. If desired, table can be spray-painted in a bright color.—*Frank Shore*



### Model Sander

A small sanding block, for use in model building or wherever light abrasion is required, can be improvised from a spring clothespin. Remove one half of the pin and reverse the spring. Then fold a narrow strip of sandpaper, emery or crocus cloth over the leading edge and anchor each end under the spring. The abrasive can be shifted as it wears. Use only a fine abrasive, as cutting action of the coarser grades will be difficult to control in small areas.—*Bil Toman*

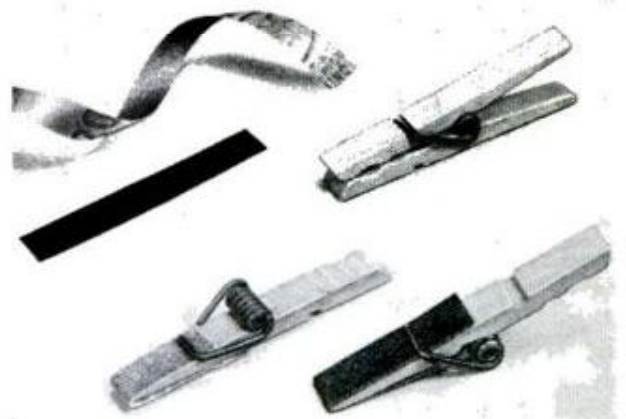

### Hinges for Free

Think twice about tossing away those empty tobacco cans. The hinged lids will provide neat little hinges for toys and other small projects and they won't cost a cent. Simply cut away the top portion of the can, leaving enough metal on each side of the hinge for attaching like regular hinges. Extra tiny hinges can be made by cutting the hinge section into fours rather than two as shown.—*Thomas Taylor*

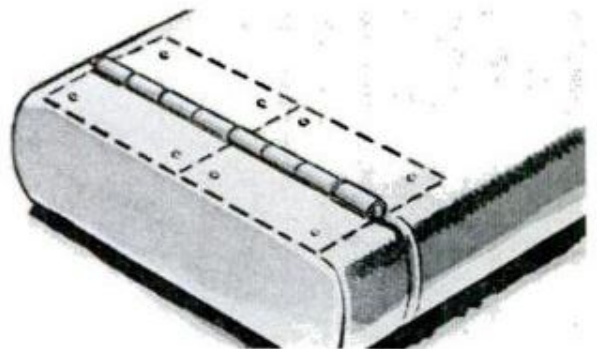

### New Twist

With poultry netting now being used for more than just fencing in the chicken yard, extra width is often required. Two pieces of netting can be joined with a strong, durable seam by placing the edges side by side and twisting them together with a double turn, using a 5 or 6d nail. Withdraw the nail and repeat the operation every four inches. Do not make more than a double turn of the nail as the wire may break.

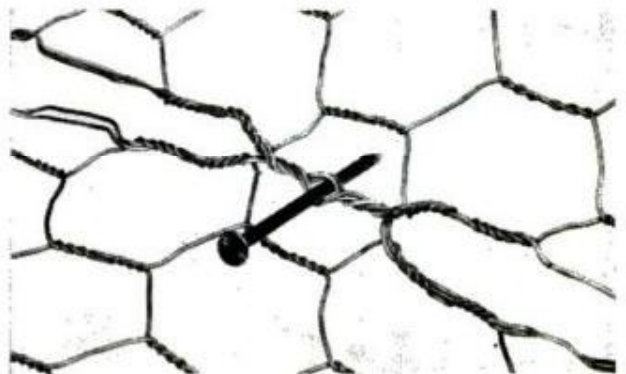



## Dodge City Stage

THE BRIGHT-YELLOW stage comes careening down the narrow mountain road with a whooping Apache war party in hot pursuit! High on his box, the stage driver yells encouragement to his team, and the cowpoke riding shotgun fires away at the screaming redskins.

The stage-coach body is designed to merely rest in a coaster-wagon without fastening. When the wagon is needed for space-age games, the coach body is simply lifted out and stored in a corner of the garage. You can make both sides from a single panel of  $\frac{3}{8}$ -in. plywood 40 in. x 72 in. Framing is cut from  $\frac{3}{4}$ -in. lumber with a solid bulkhead in front on which the driver's seat and footrest are mounted.

Paint the coach yellow and use masking tape to add the black trim. Decals available at your paint store will make the coach look like the real thing. For use with a "two-horse" team, bind an extension to the wagon tongue and add a crossbar at the end. —Hi Sibley

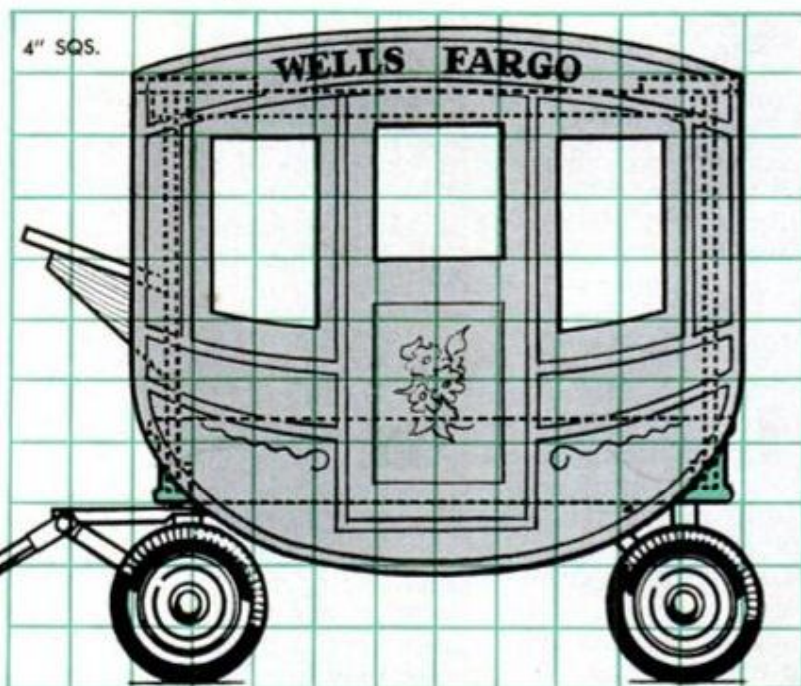
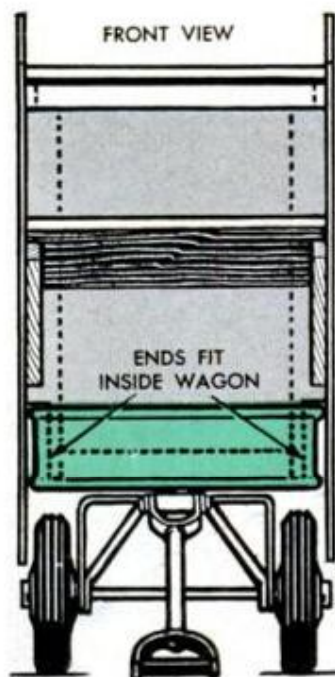

# STROLLER COMPACT

MOM PUSHES and Junior steers this make-believe auto which is an ordinary stroller converted with a steering gear and a corrugated grocery carton into a sidewalk compact with fenders, raked windshield, headlights and painted speed lines. One good look at the lower detail below and you'll know how to build the steering gear. The square-tube steering post is adapted from a discarded towel bar and as you will note the sides of the carton are sandwiched between the rail and arm rest to hold the body securely in place.—Wayne Mullen

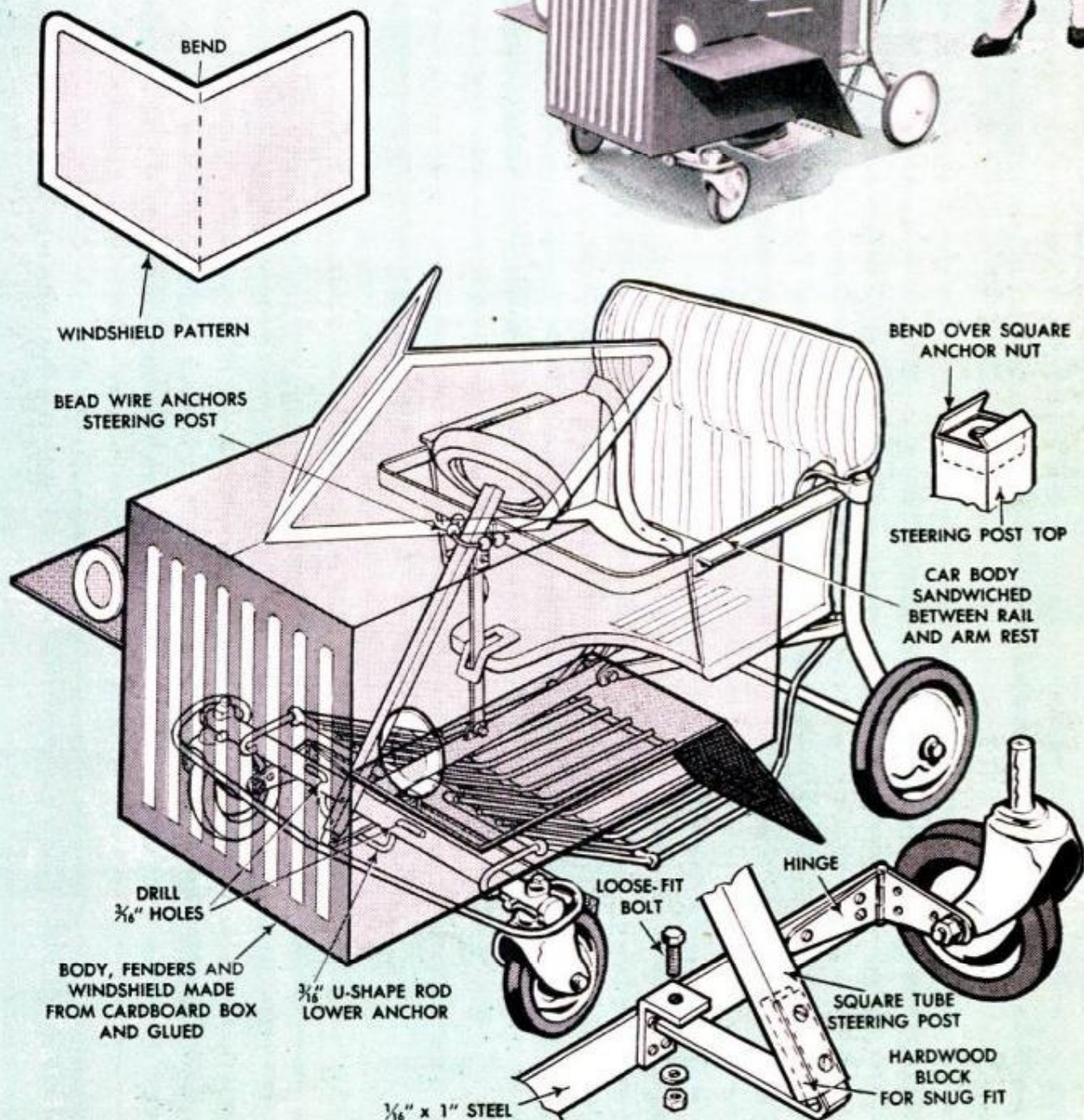



## Completing the Triple-Top FUN TABLE

By John Jetchak

**C**ONSTRUCTION at this point has detailed the building of the pool table and its compartmented base. Now all you have to make is the piggyback top and your fun table is completed. This separate lift-off, flip-over top, which rests on the pool table, lets you play table tennis on one side or operate an HO-ga. train system on the other by merely turning it over. As described in the beginning article of the series, December 1961 issue, the pool table incorporates a storage base which provides a convenient place to keep the rolling stock, scenic mountain and other lift-off train props when you want to flip the top for table tennis or remove it for pool.

Since it could pose a problem of getting so large a panel into the average basement, the piggyback top is made in two sections and hinged to fold flat. You can buy two-piece table-tennis tops from mail-order

168

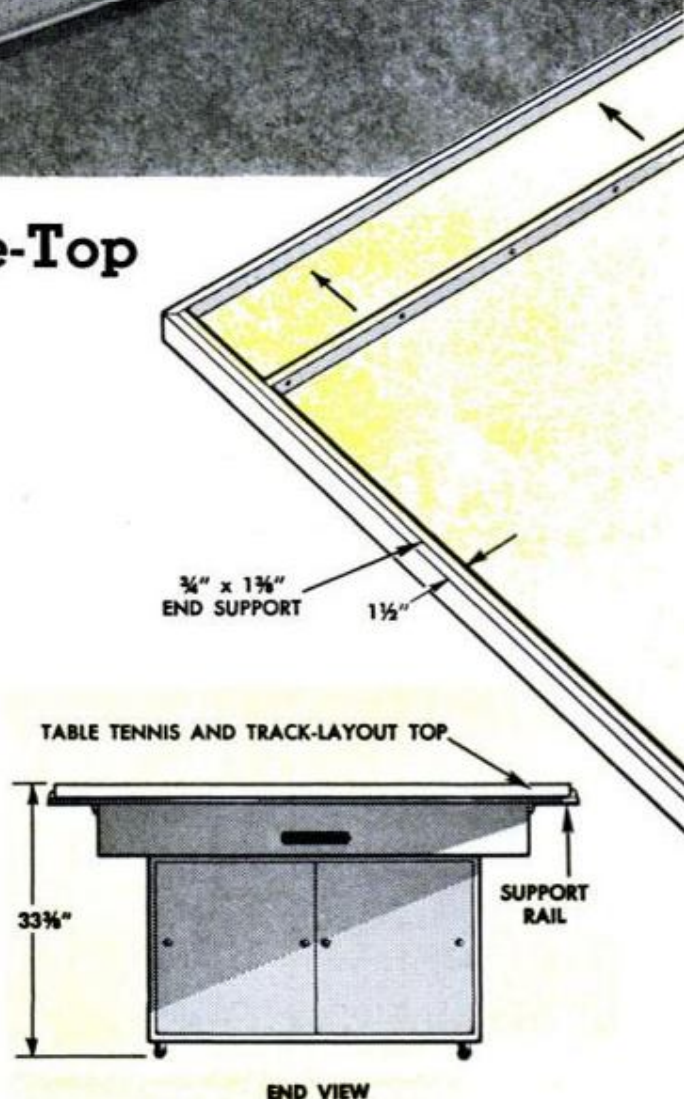
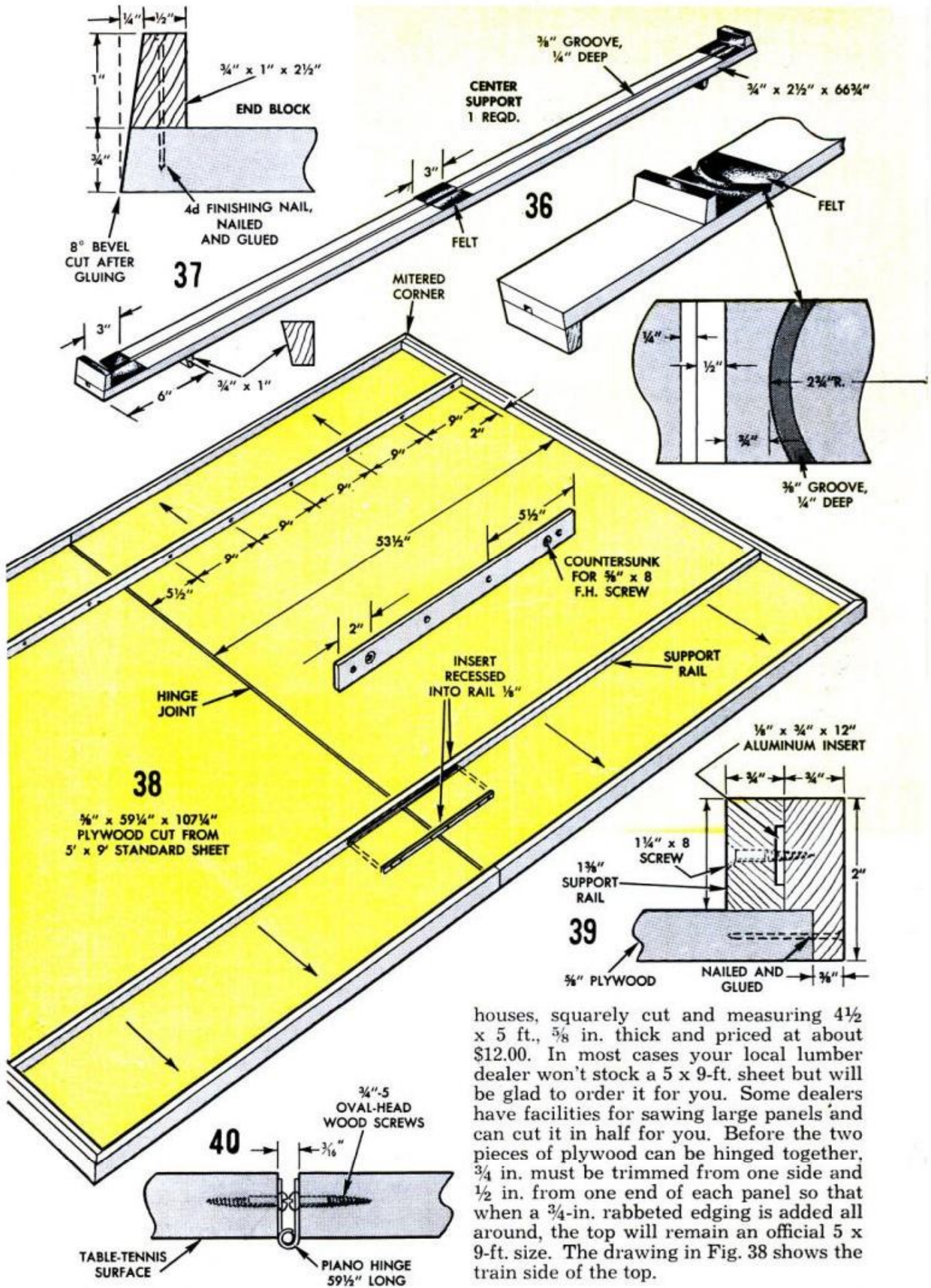

TABLE TENNIS AND TRACK-LAYOUT TOP

END VIEW

POPULAR MECHANICS





houses, squarely cut and measuring 4½ x 5 ft.,  $\frac{3}{8}$  in. thick and priced at about \$12.00. In most cases your local lumber dealer won't stock a 5 x 9-ft. sheet but will be glad to order it for you. Some dealers have facilities for sawing large panels and can cut it in half for you. Before the two pieces of plywood can be hinged together,  $\frac{3}{4}$  in. must be trimmed from one side and  $\frac{1}{2}$  in. from one end of each panel so that when a  $\frac{3}{4}$ -in. rabbeted edging is added all around, the top will remain an official 5 x 9-ft. size. The drawing in Fig. 38 shows the train side of the top.

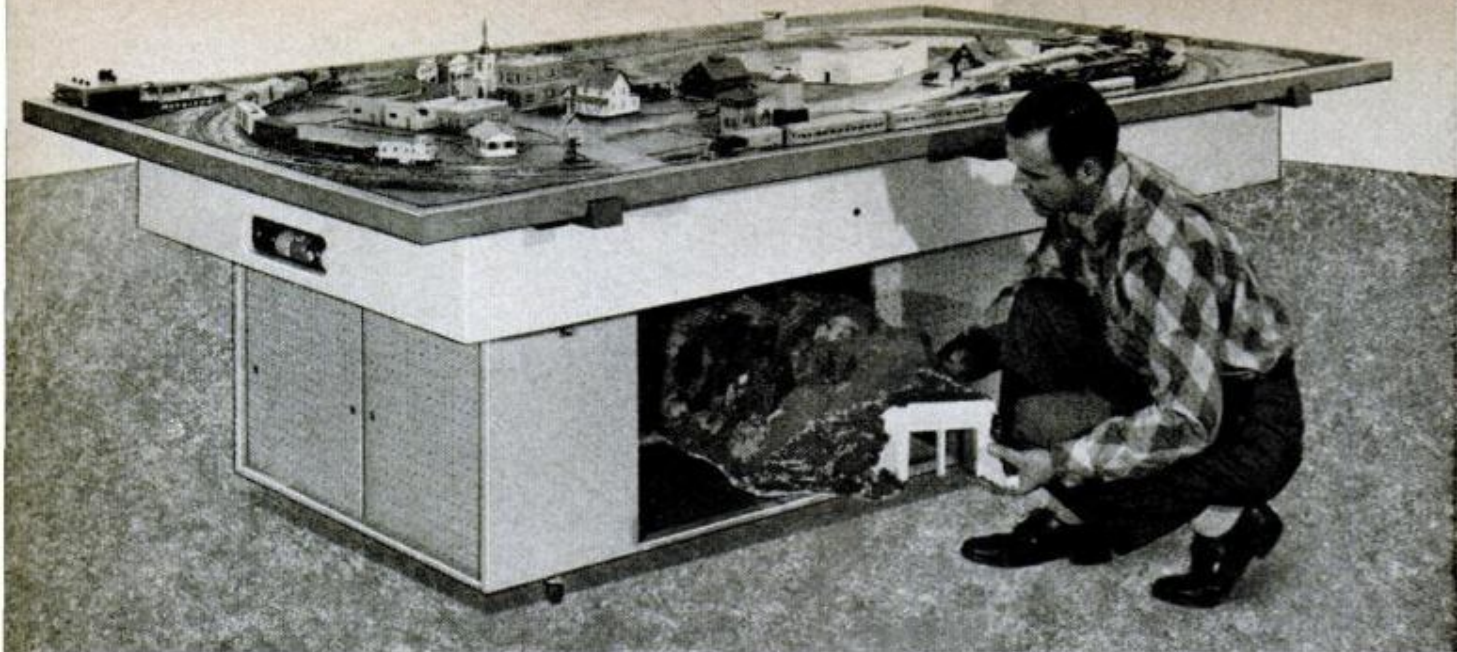
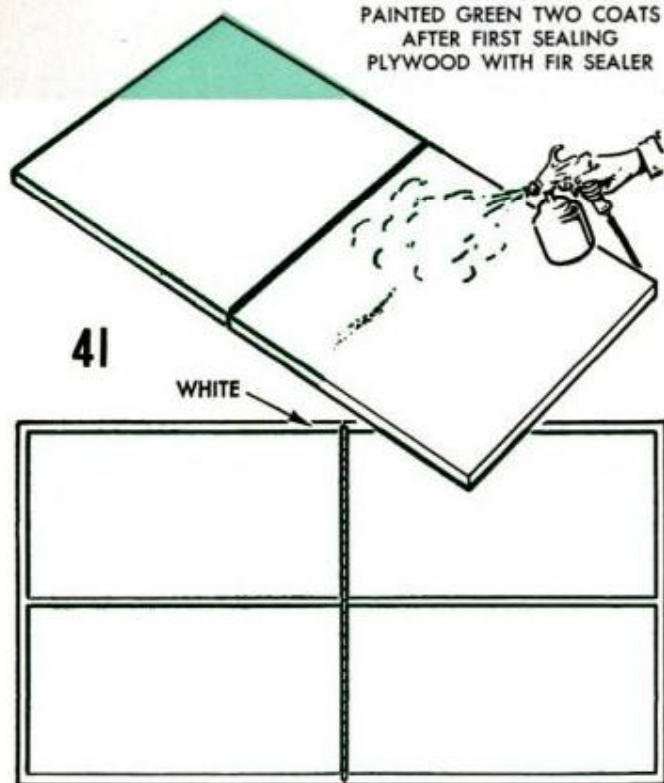

TABLE-TENNIS SURFACE  
PAINTED GREEN TWO COATS  
AFTER FIRST SEALING  
PLYWOOD WITH FIR SEALER

THE LIFT-OFF MOUNTAIN should not be more than 10-in. high so it, along with other model-train props, can be stored in the base of the table when you may want to switch to table tennis or a game of pool



The outer edging is made double-thick all around with an inner one of  $\frac{3}{4} \times 1\frac{3}{8}$ -in. strips. Fit the strips at the ends of the table top first, cutting them to fit between the outer edging, and permanently attach with glue and nails. The full-length strips along the sides of the table are attached with screws only (no glue) so that when you wish to fold the top, the strips can be removed. The side strips really serve as locking cleats which hold the two halves rigid and in alignment. Additional strength at the hinge point may be gained by embedding a flat-metal strip in a recess cut in the inner face of each side strip. The sectional detail, Fig. 39, shows how the metal strip fits flush and is fastened in the recess with flat-head wood screws. Except for final painting, this completes the piggyback top.

The detail, Fig. 40, shows how the two panels are hinged together with a standard 6-ft. piano hinge cut down to 59½ in. long. Note particularly that the barrel of the hinge is placed so it is on the table-tennis side of the top. The edging measures  $\frac{3}{4} \times 2$  in. You'll need two pieces 60 in. for the ends and four pieces 54 in. for the sides. These are mitered and rabbeted like a picture frame and are glued and nailed to the plywood edges so the edging will be flush with the table-tennis surface. The side edging butts together at the hinge joint. The 2-in. edging not only conceals the plys of the wood but also provides the necessary clearance for the track layout when it is placed in a face-down position.

To protect the pool table when the lift-off top rests on it, three cross-rails are placed crosswise and padded with felt where they rest on the rim of the table. These actually support the piggyback top. Two of the crossrails are made alike. The third differs in that it is grooved lengthwise on the top to receive the piano hinge and grooved on the bottom to sit over the curved rims of the side-pocket backs. The hinge groove automatically positions the top when the table-tennis side is placed face down. Two rubber-tipped tacks centered on the locking cleats and spaced 2½ in. apart will automatically seat the top when the table-tennis side is placed face up. Hook blocks are nailed and glued to the ends of all three crossrails and to the underside 8 in. in from the ends. In each case, the blocks are spaced to suit the width of the pool table and the piggyback top.

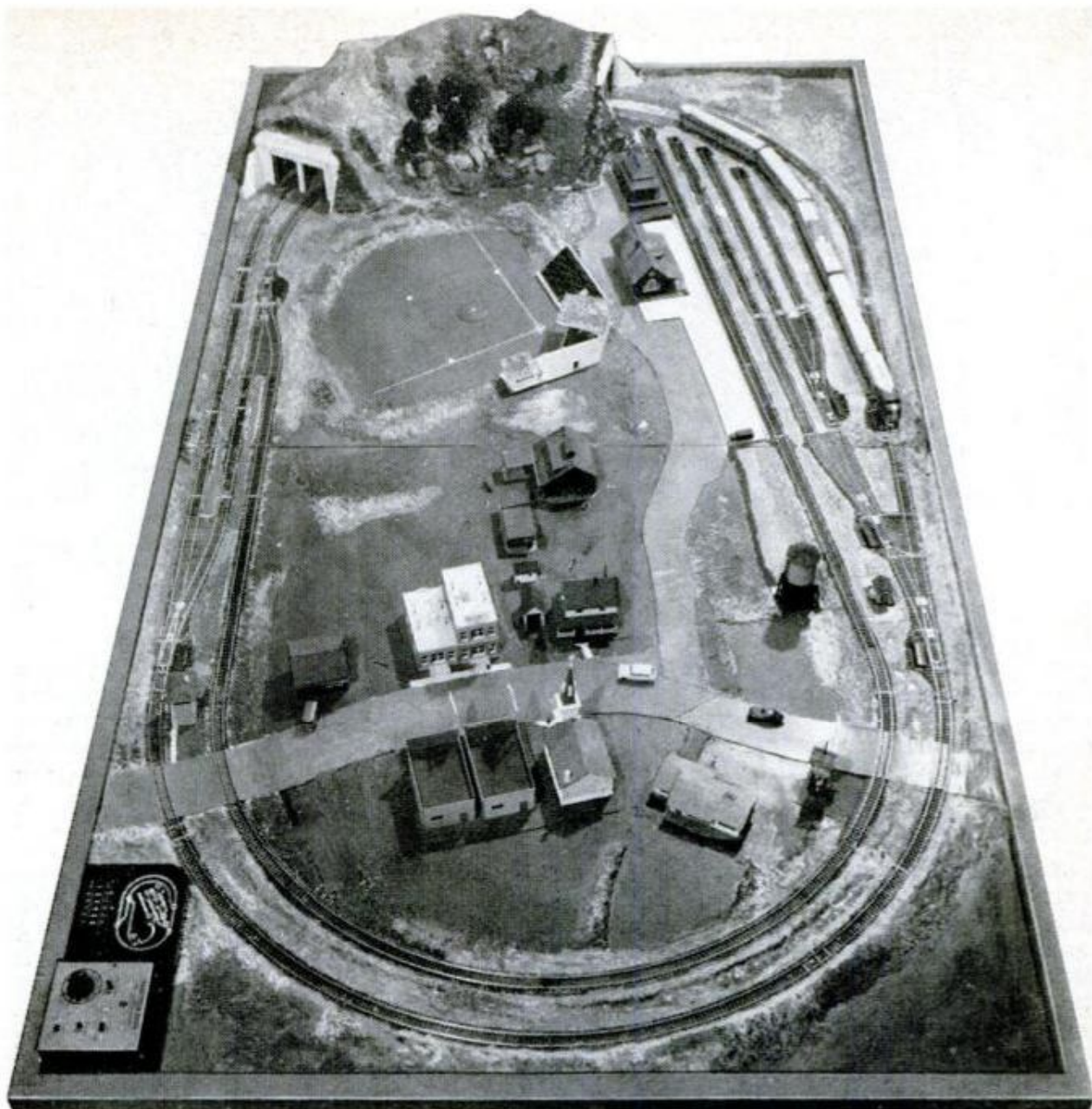

**THIS BIRD'S-EYE VIEW** of the HO-ga. model-train system gives an idea of the fairly extensive layout possible on a 5 x 9-ft. top. Actual track layout and arrangement of buildings and other props is left to the builder

The 5 x 9-ft. top provides the model-train enthusiast with a good size area to work out whatever track layout suits his fancy. As you see in the original, a tunnel was placed over double tracks at the far end of the layout, with the engineer and tower-man controls located at the opposite end. Silhouette bases for the buildings and other lift-off props help to relocate them each time they are replaced. One thing to keep in mind in building roadbeds and terrain is to keep the modeling material away from the locking cleats of the table so it will not interfere with the removal of the cleats if necessary. The tracks, of course, are butted at the hinge joint and current is continued by jumper wires made long enough to permit the top to still fold.

(Continued to page 208)

## MATERIALS LIST

(All dimensions actual sizes in inches)

- 2 pcs.— $\frac{3}{4}$  x 2 x 60—End edging
- 4 pcs.— $\frac{3}{4}$  x 2 x 54—Side edging
- 1 pc.—6' length  $\frac{1}{2}$  x  $\frac{1}{2}$  continuous (piano) hinge
- 60 — $\frac{3}{4}$  x 5 oval-head wood screws
- 2 pcs.— $\frac{3}{4}$  x  $1\frac{3}{8}$  x  $58\frac{1}{2}$ —Inner end edging
- 2 pcs.— $\frac{3}{4}$  x  $1\frac{3}{8}$  x 105—Locking cleats
- 2 pcs.— $\frac{5}{8}$  x  $4\frac{1}{2}$  x 60—Table-tennis playing field
- 2 pcs.— $\frac{1}{8}$  x  $\frac{3}{4}$  x 12—Flat alum. or steel
- 28 — $1\frac{1}{4}$  x 8 F.H. wood screws (for side edging)
- 4 — $\frac{5}{8}$  x 8 F.H. wood screws (for metal strips)
- 4d & 6d Finishing nails
- $\frac{1}{4}$ -lb. can patching compound
- 3 pcs.— $\frac{3}{4}$  x  $2\frac{1}{2}$  x 61-11/16—Table crossrails
- 12 pcs.—Wood blocks  $\frac{3}{4}$  x 1 x  $2\frac{1}{2}$  (for table crossrails)
- Strips of felt— $2\frac{1}{2}$  wide

## Basement Clothesline "Retracts" When Not in Use

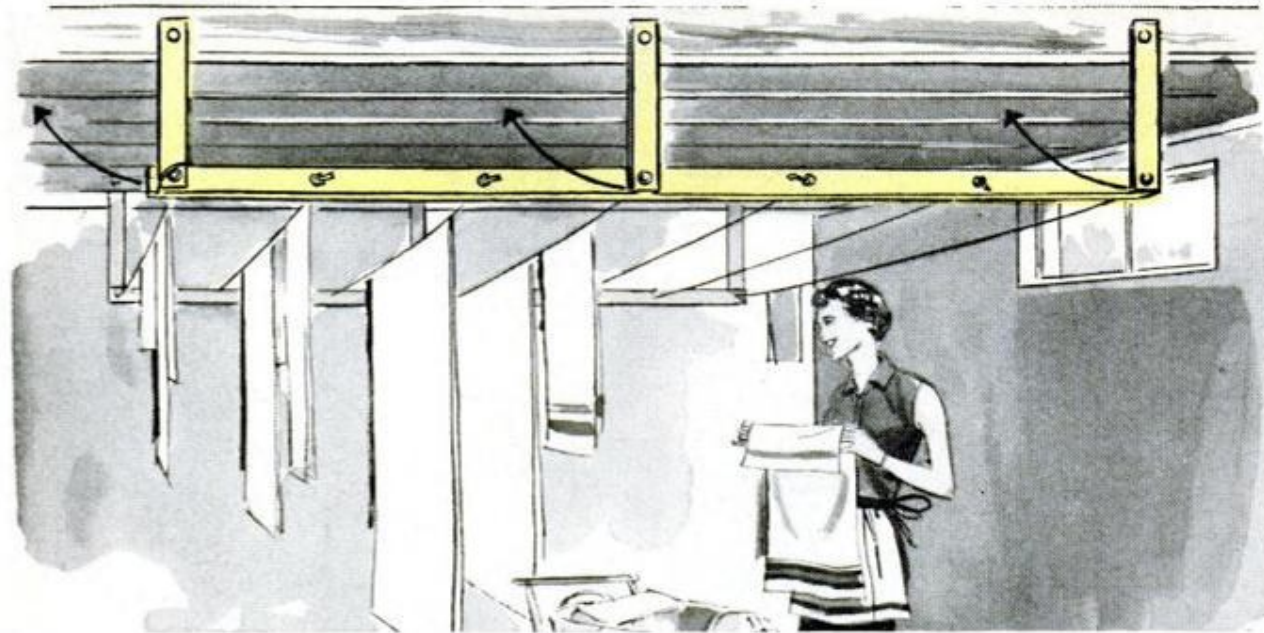

If your basement is cluttered with that wintertime spiderweb of dangling clotheslines, you'll appreciate these self-storing hangers. When not in use, just push on one end of each and up goes hanger and lines against the ceiling joists. Bolt the support-

ing 1 x 2s to the joists and to the horizontal 1 x 2, applying just enough tension to hold the hanger in the up position. Drill spaced holes in the horizontal members and thread the clothesline through the holes, knotting it at each end.—*M. Krucker*

### Higher or Lower

Ever been on a plank painting a ceiling or roof overhang and wished you were, say, 6 in. higher or lower? Holes bored through opposite sides of a stepladder for a removable pipe rung will provide an intermediate spacing between the steps to give you a variation in height which makes working from a plank more convenient.



172

### Out They Come

Those stakes used to support forms for walks, patios and other small concrete jobs, may be pulled without damage and preserved for future use if you bore a hole near the top of each to admit the point of a pick. The head of the pick will provide enough leverage to lift the stakes with little effort.—*G. E. Hendrickson*



POPULAR MECHANICS



### No Grater Shade

A cute idea for a spotlight over a snack counter is to use a common food grater for a shade. Besides being appropriate, the shade when lighted "twinkles" like a star. Simply drill a hole through the handle.

### Warm as Toast

For the cold night that may catch you on a camping trip keep a piece of plastic film in your blanket roll. Place the film between the lower blankets. It wards off dampness, keeps you warm all night.—*John Krill*



MARCH 1962



## Coming Up Next...

**ELECTRIC 1901 SIDEWALK CAR.** As you see, it's just like a 1900 era open touring car cut down to kid size. Seats four and does a sizzling seven miles per hour. It's driven by geared motor or converted auto generator operating from 12-volt battery. You buy hard-to-make parts and build the rest yourself. Look for it next month.

**SWEEPER FROM OLD LAWN MOWER.** Yes, it's been done and in an April craft feature we'll show you how, with step-by-step pictures and drawings, to convert parts of a push-type mower into an efficient sweeper that picks up grass clippings, candy wrappers, twigs, leaves—anything sweepable that litters your lawn.

**ANIMATED EASTER EGG.** The Easter-egg-and-bunny legend gets a new twist in this giant picture egg, made from papier-mache. A window lets you watch bunnies perform inside when a crank is turned. The shell is built up over an inflated toy balloon with strips of paper laid in flour paste. A novel centerpiece for Easter.

**WORKING WITH SHEET METAL.** Working with sheet metal can be impossible or easy. The trick is in knowing how to handle the stuff—how to bend it, cut it, seam it, roll it, hammer it, crimp it, to make all manner of useful items used in everyday living. Shop article coming next month tells in words, pictures and drawings how to work sheet metal.

# Solving HOME PROBLEMS

**1. TYING A NECKTIE** so that the two ends will come out the same length is often difficult since some ties are longer than others. To mark the correct starting length stick a piece of adhesive tape to the inside of the longer end, and you'll always come out right



**2. ELECTRICAL OUTLETS** seem to hold a strange fascination for inquisitive tots and there is always the danger that they could be seriously injured by inserting hairpins or other objects into the slots. To prevent this, cover the slots with strips of tape

**3. TO FORCE RHUBARB,** remove both ends from an old oil drum, place it over the hill of rhubarb and then bank soil around the base. The drum will hold the sun's heat and will protect the early growth from those cold spring winds





4

**4. LABELS ON MEDICINE** bottles will often become so smudged and blurred as to be unreadable. You can protect the label by applying a coat of colorless nail polish right after purchasing the medicine

**5. PIN-UP BOARD** for gardeners provides place to post planting schedules, special seed packets, seasonal memos. It's made from a long, narrow carton with sides and ends cut away to provide a bin at bottom



5

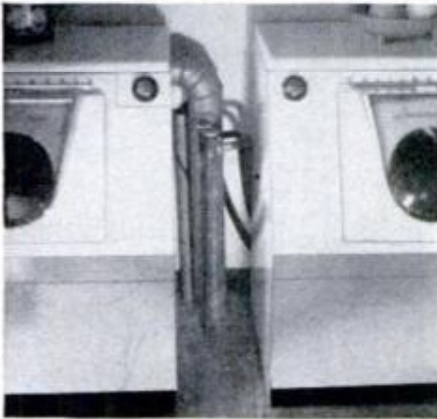

6

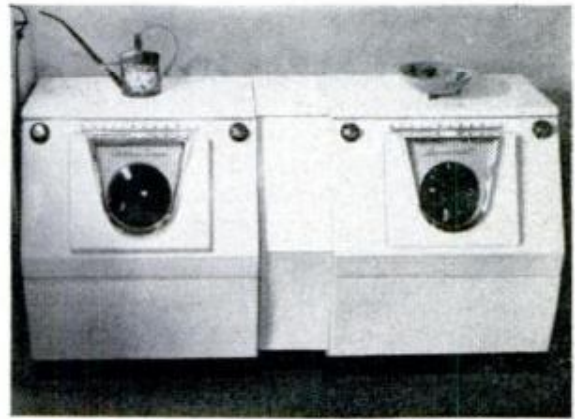

**6. WHEN LOCATION** requires that there be a space between washer and dryer, installation can be made more pleasing by building a matching filler unit of 1 x 2s and plywood cut and fitted to contour of washer-dryer

**7. HANDY DOORSIDE RACK** for milk and bread deliveries can be made by attaching a discarded bicycle basket next to the back door. The rack will also be handy for holding bundles while you unlock the door

**8. FOLLOWING A RECIPE** can be especially difficult if you're interrupted by phone calls or delivery men. To avoid overlooking an important step, mark your stopping point with a bobbypin clipped to the card

8



7

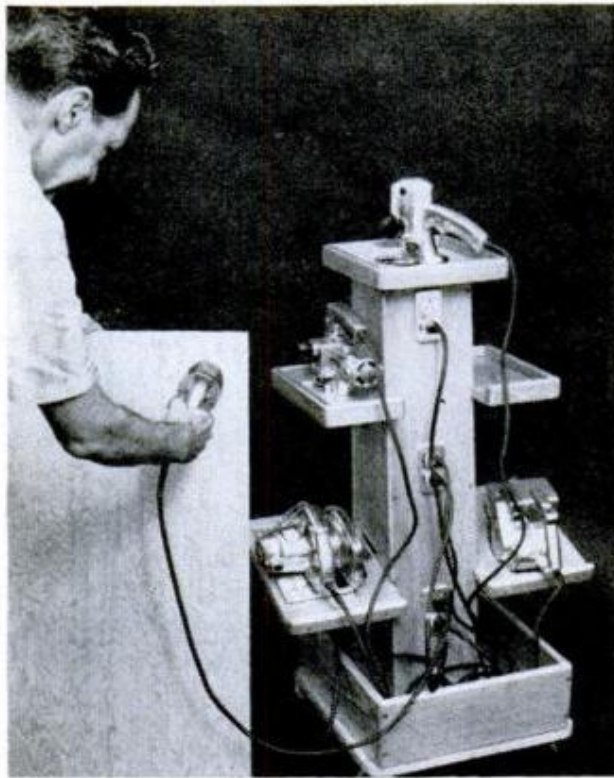

# POWER

ANYONE WHO uses more than one portable power tool in a home shop or on the building site will be quick to see the time-saving features of this tool tower. It has individual storage shelves and outlets for five of the most commonly used portable tools. A boxed base stores the cords when the units are not in use. There are no tools piled up on the bench or floor, no trailing cords underfoot while you're working in an unfinished room or on a project in the basement shop. A single power cord plugged into a wall or ceiling receptacle feeds the six outlets you see in the detail.

Construction is simple butt joinery, all the parts being fastened with glue and nails or screws. The top shelf is square, the second shelf is U-shaped, that is, it is fitted around the column. On the original pictured, the two lower shelves are hinged at an angle of 20-30 degrees for convenience in placing the larger tools such as portable saws; also to permit folding should it be necessary to store the tower in restricted space. These shelves are made with openings to take blades of portable saws so that the tools are supported level and in an upright position.

If you wish to add the light boom, pictured and detailed on the opposite page, cut an opening in the top shelf and support the lower end of the upright at the second shelf with cleats. Use a photo flood lamp of the clamp-on, adjustable type. Fit and hinge a door at the back or the straight side of the tower. Wire the outlets to a single junction box having a receptacle in the cover plate.—Hayden Ricker

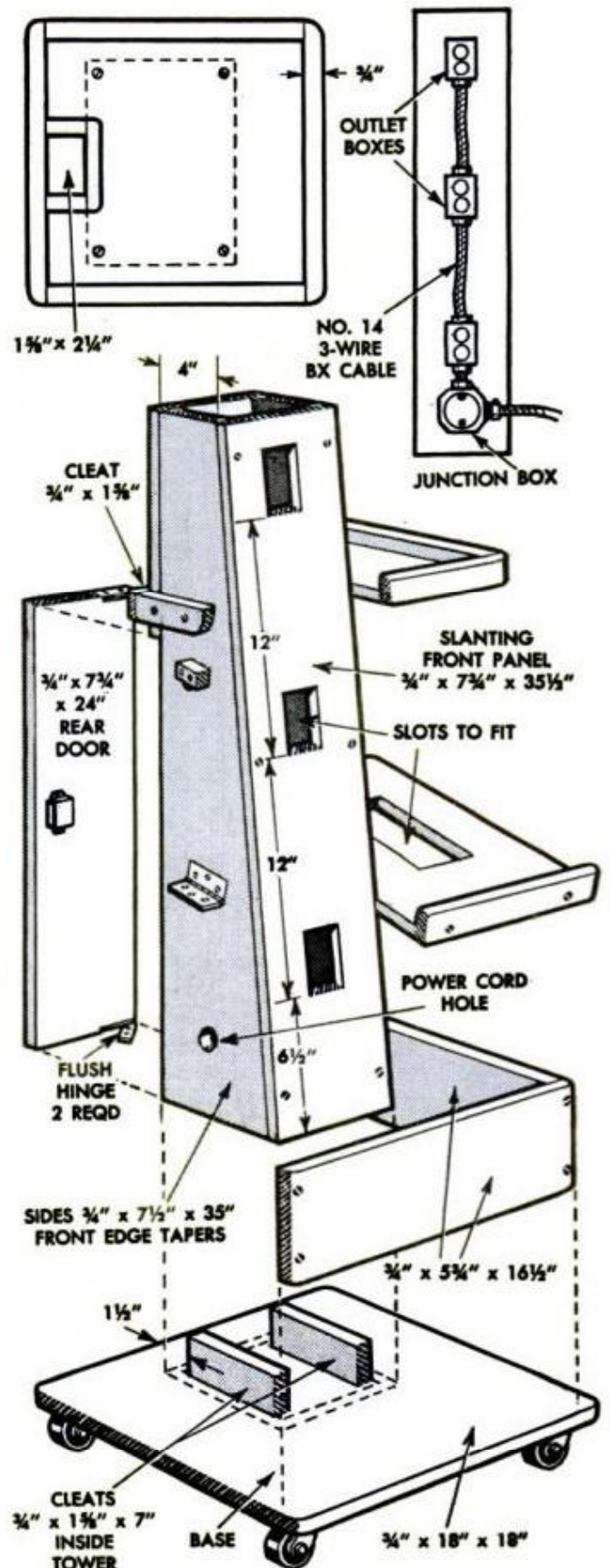



# TOWER

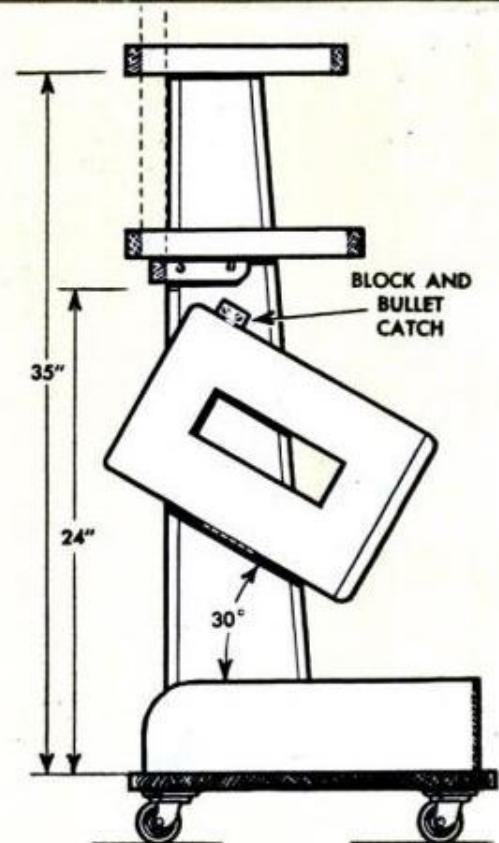
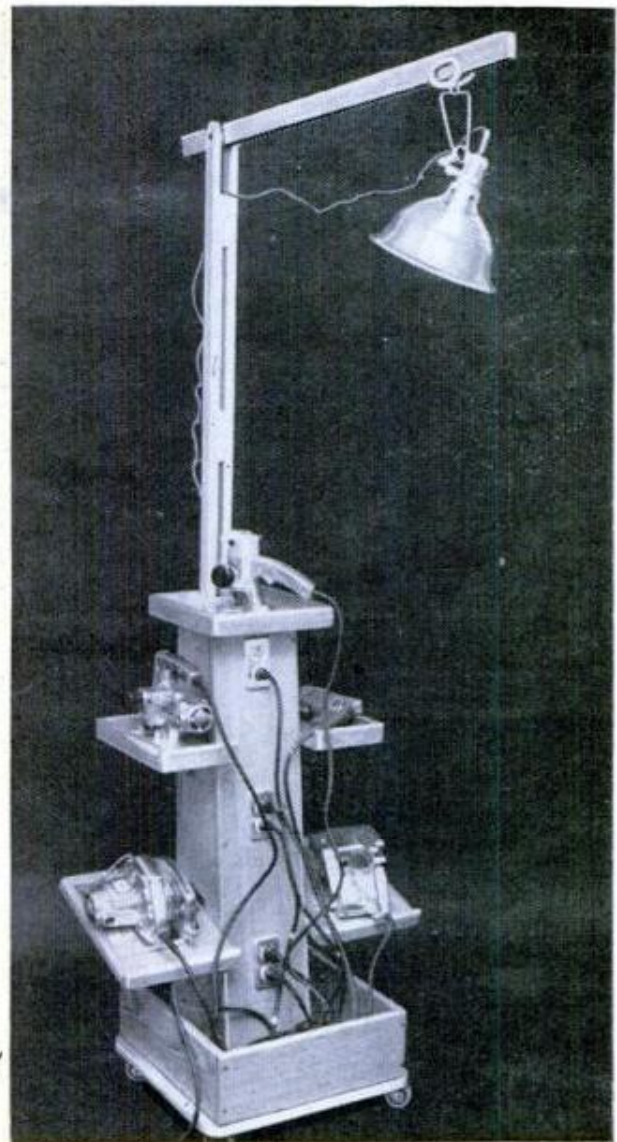
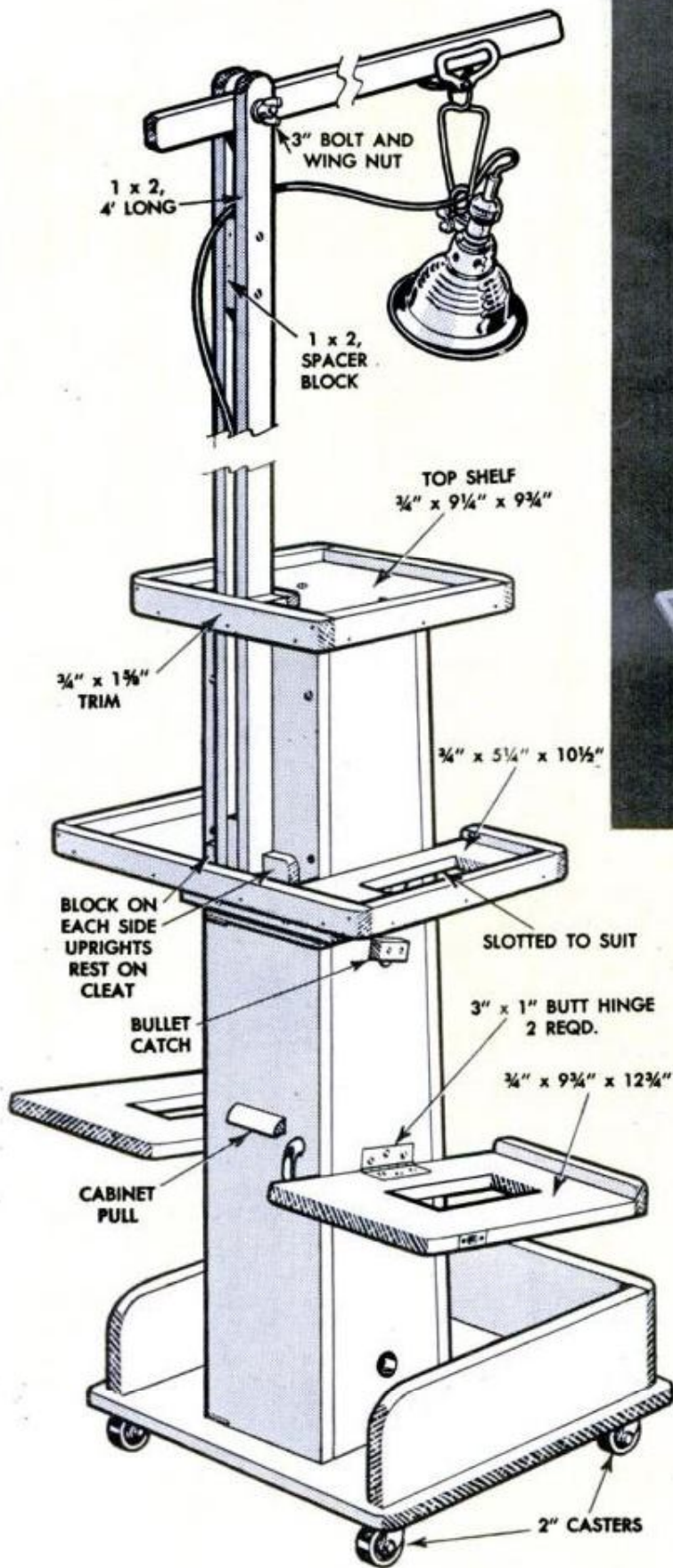



# DUAL-PURPOSE TABLE STORES GUEST BED

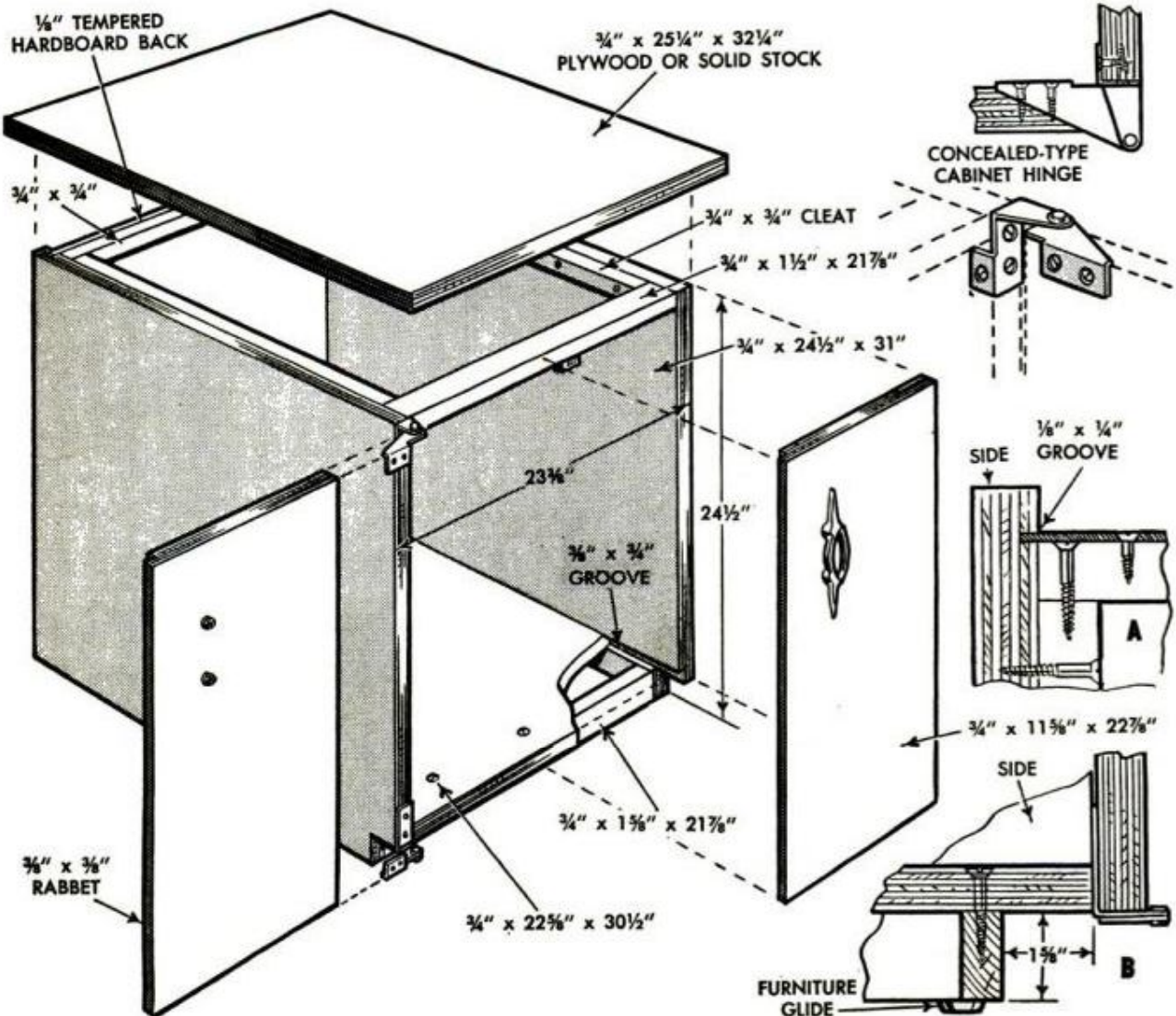



**P**ROVIDING accommodations for overnight guests is always a problem in small homes and apartments. Since most housewives don't want to allot precious closet space to a rollaway bed, the unexpected guest is likely to find himself spending the night curled up on a short sofa which was definitely not made for sleeping. If you're faced with the problem of where to park a stand-by bed here's the perfect solution—simply park it in this dual-purpose cabinet table.

The table can be used in your family room, doing double duty as a game table, TV stand or end table. Two such end tables placed at the ends of your sofa will provide sleeping accommodations for a visiting couple, and you can make up the sofa as a bed for one child. Used as a night stand in the guest room (if you are lucky enough to have one), it will give the room sleeping space for three. In a vacation home, such an arrangement will come in especially handy for those last-minute guests who drop in for a Friday-evening swim and stay the week end.

The table may be constructed of  $\frac{3}{4}$ -in.

plywood or solid stock, from pine or hardwood. If you plan to locate the table with its back to a wall, you may use  $\frac{1}{8}$ -in. tempered hardboard for the back. However, should you decide to use it as an end table where all four sides will show, make the back of the same material used for the sides and top. Assemble the table according to the plan on the opposite page, securing all joints with both screws and glue. The top is attached from the underside with screws which run through  $\frac{3}{4}$ -in. cleats.

Finish and hardware will depend on the decor of the room where you plan to use the table. If made of cabinet wood, you may wish to stain it to match other pieces in the room. If made of pine, the table can be enameled. You might even add a colorful decalcomania or stenciled design on the side panels. As for the handles, either brass or aluminum will blend well with a modern room. For an early-American look, try using hammered-iron handles or plain white porcelain knobs.

The table shown here is dimensioned to fit a Burton-Dixie bed, but dimensions can be altered as required. ★ ★ ★

# ELECTRIC IRON

# Household

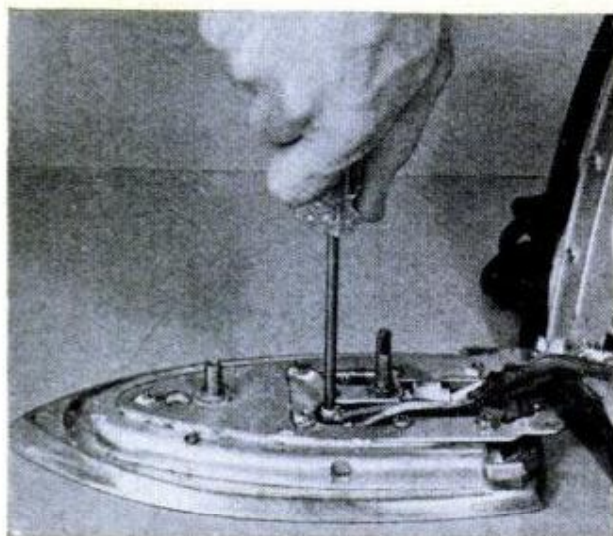
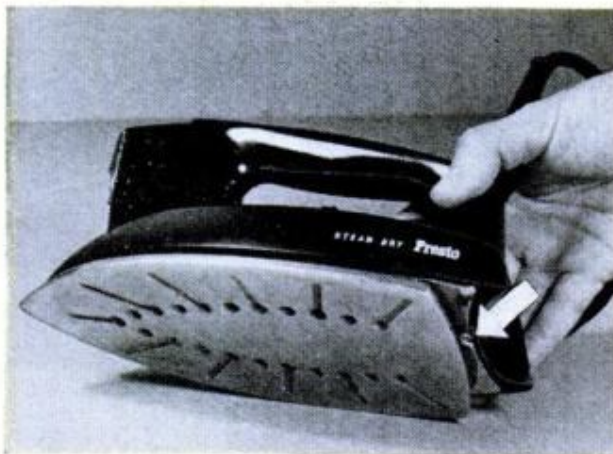

**E**LECTRICAL parts of both the older type dry iron and the newer steam irons are quite simple, consisting of a thermostat and heating element. Broken plugs, worn line cords, defective thermostats and heating elements are the commonest electric-iron troubles. Heating elements deteriorate in time and the points in thermostatic controls become burned and possibly pitted, necessitating a thorough cleaning or replacement.

Usage subjects the cord to flexing, twisting and kinking and even scorching. In time the insulation and even the braided wire are likely to break down. This usually happens at the ends of the cord, either at the plug or the iron. If the iron refuses to heat normally, or not at all, check the cord at the iron and the plug and then go over the insulation closely. If you discover breaks or frayed ends or a damaged plug, it usually is best to replace the cord.

If the cord is okay, then you will have to probe further. On nearly all irons there's a small access plate, usually at the heel of the iron or at the rear of the handle as in the upper left and center photos. Removing this plate lets you see the internal connections, which should be clean and tight. However, on some irons it will be necessary to remove the handle and top housing to get at the terminals, lower left-hand photo.

You may run into difficulty when you come to removing the handle and housing. Sometimes a single small screw or pin is the key to the whole disassembly sequence, and you

# Appliance Fix-It File

may have to do some careful searching to locate it. Don't pry, lift, or pull unduly on parts that refuse to budge. Don't attempt to pry the housing from the base, or iron, and in all this be especially careful not to scratch or nick the sole of the iron.

If the trouble is erratic temperature control, the fault likely will be found in the thermostat. The stat consists of a set of contact points which are in contact, or closed, when the iron is cold, also a thermostatic arm which reacts to the heat by bending closer and closer to the points. At a temperature predetermined by the setting of the temperature control dial on the handle or elsewhere, the arm separates the points, shutting off the current to the element. When the iron cools slightly the arm retracts, allowing the points to close and the cycle repeats. If the points are corroded or pitted, remove the assembly as in the center and lower photos at the right and clean them, using a very fine flat file, fine sandpaper or the fine side of a fingerboard. If the points are pitted, the unit should be replaced.

In most older-type irons the heating element can be removed and replaced simply by disassembling the sole plate and replacing the element itself. But in most of the newer irons the element is sealed into the sole plate and if defective, it will be necessary to replace the sole plate.

Replace all parts in reverse order and be careful not to damage the seals around the water container in a steam iron.—*John Pennington*

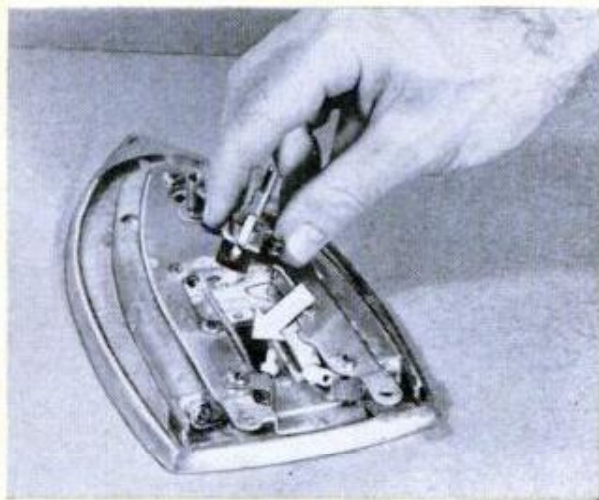
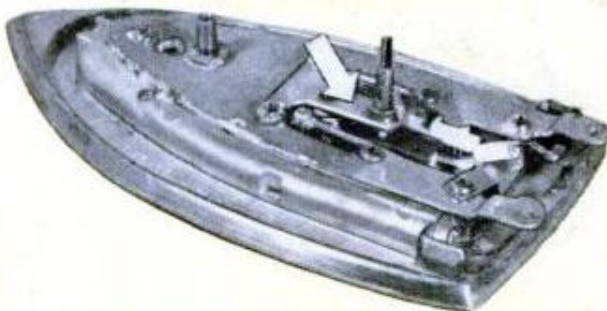

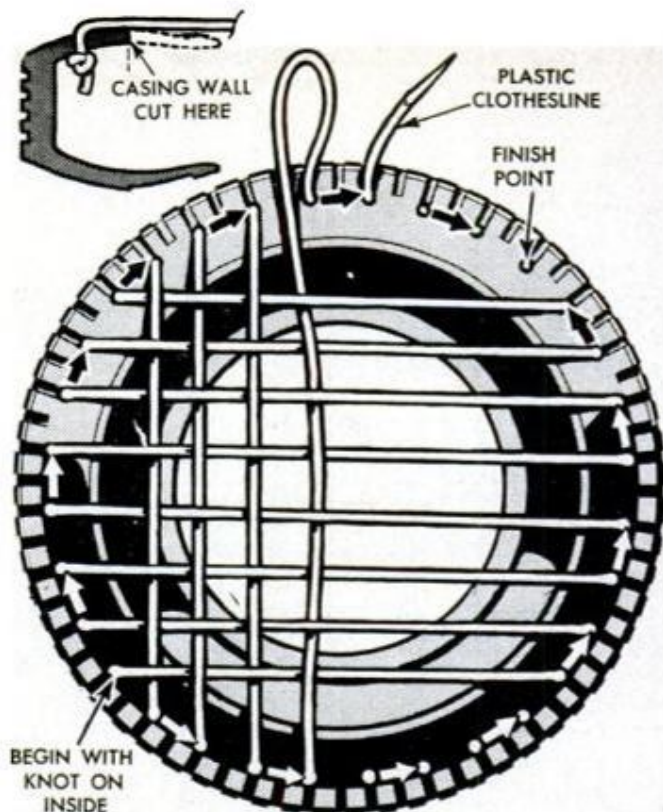

## Make Fun With a **JUMP DRUM**

Youngsters with pep to spare, even tots that are past toddling, will find this jump drum excitingly new and different with more bounce per ounce than they can get out of any bed spring or the sofa cushions. It's made with a length of plastic clothesline and an old auto tire.

Prepare the casing by cutting away the inner portion of one side wall and drilling  $\frac{3}{16}$ -in. holes for the clothesline  $1\frac{1}{2}$  to 2 in. apart around the outer edge next to the

tread. Cut the end of the clothesline at an angle to provide a sharp point to push through the holes in the casing. Use soap to lubricate the line so that it will pass through the holes easier. Be sure that there is no slack in the line before you tie the final knot. Paint the inner tube a bright color to outline the jumping area, slip it inside the casing with the valve stem on the side opposite the clothesline and inflate.

—Richard W. Norton

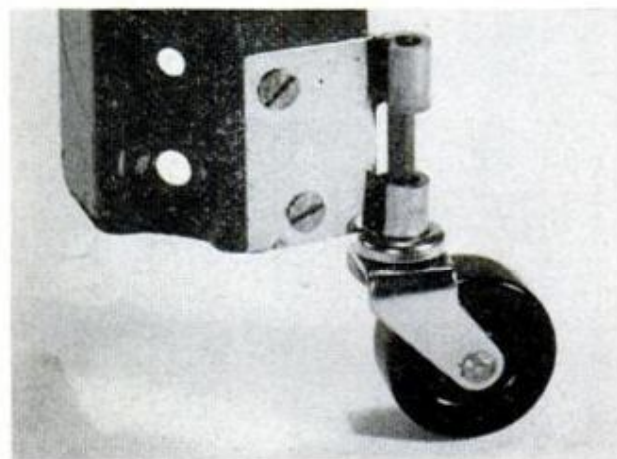

## It Hinges on a Hinge

Taking advantage of the ready-formed socket provided by the loops of common butt hinges, one craftsman solved the problem of mounting swivel casters on his power-tool stands. Hinges of the loose-pin type were used with hinge pins slightly smaller in diameter than the stems of the casters. The loops were spread open enough with a cold chisel to permit the casters to swivel freely, after which part of the hinge leaves were cut off before attaching them to the machine-stand legs with flat-headed stove bolts.—Henry Hanscom

## FOR SHUTTERBUGS

**SLIDE PROJECTOR** has two separate optical systems side by side in single unit. Using a remote-control unit and synchronized irises, operator can fade out one slide while fading in another. With it he can produce lap-dissolves similar to a professional motion-picture production. Sells for about \$300. Bell & Howell, 7100 McCormick Rd., Chicago 45, Ill.

**OMEGA AUTOMATIC EASEL** features a new locking system, automatic paper grips and stops that extend versatility of easel. Tilting attachment corrects the distortion. Paper edges are in sight under masking bands when looking through control windows. Easel is \$67.50; tilting attachment is \$10.60. Simmon Omega, Inc., 257 Park Ave. South, New York 10, N.Y.

**BATTERY-POWERED** flood light features new power pack designed to carry from a shoulder strap. Powered by rechargeable nickel-cadmium cells which connect to ordinary household circuits, light will operate continuously for 32 minutes before recharging. For stills or motion pictures. Priced at about \$400. Sylvania Electric, 730 Third Ave., New York 17, N. Y.

**COMPACT STARMATIC II CAMERA** provides aim-and-shoot simplicity with a fully automatic electric-eye exposure control. When light is inadequate for a proper exposure, warning signal is visible in viewfinder. Flash pictures are easy with this camera. Takes 12 exposures on 127-size film. Priced about \$35. Made by Eastman Kodak Co., Rochester 4, N. Y.

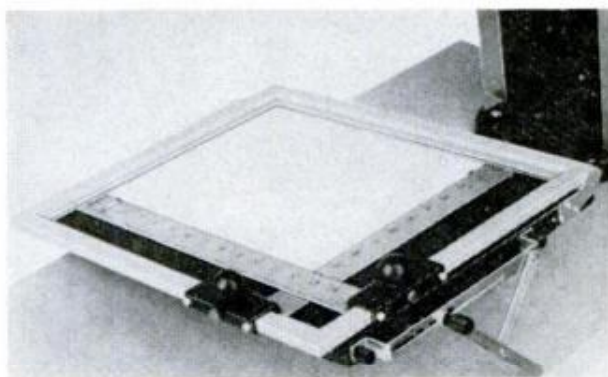
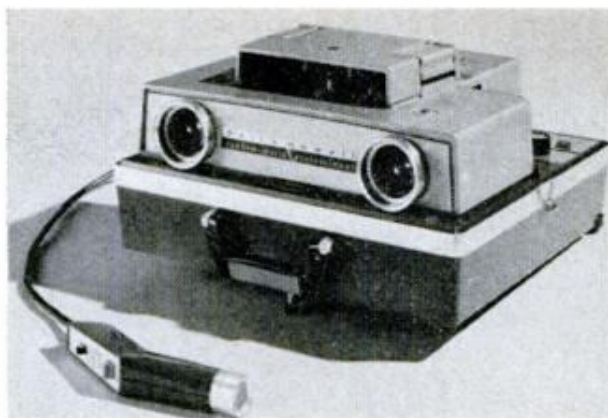

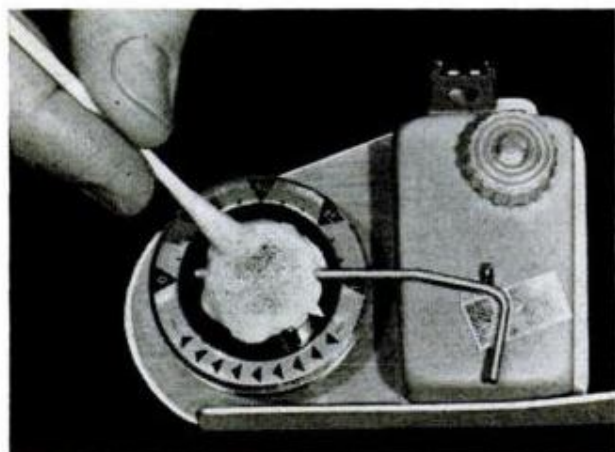
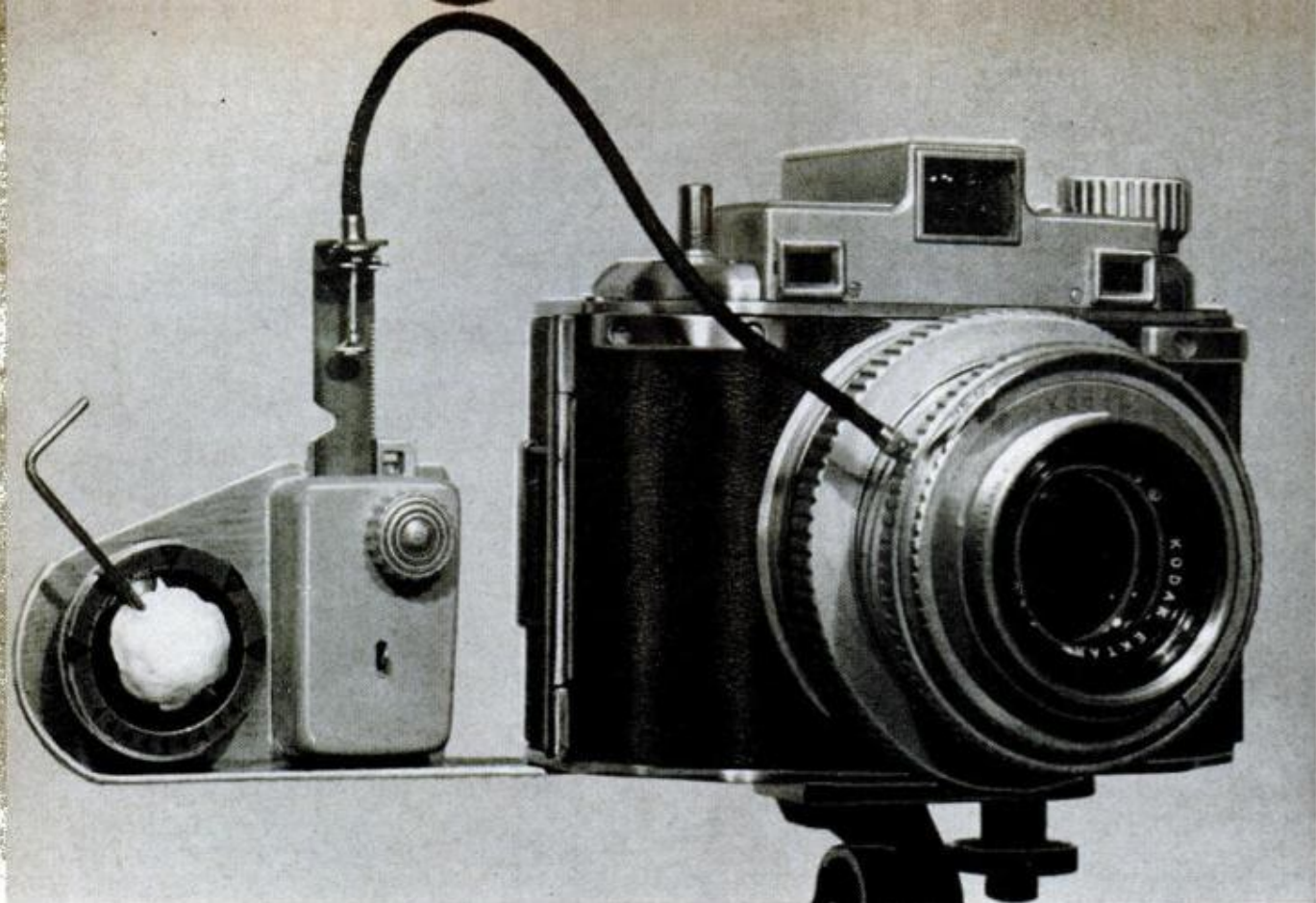

**ACTIVATOR WIRE** is mounted on the face of the pocket timer with epoxy. Note the spacer card at right

**RED FLAG** hung from the activator wire will give a long-distance signal when 10-second timer is tripped



## Super-Delay Shutter Release

HERE'S A compact timer that will do away with those out-of-breath expressions in your delayed-action pictures by allowing from two minutes to an hour of delay instead of the usual 10 seconds. The main component is an automatic pocket timer alarm which can be purchased from Lafayette Radio Electronics Corp. for \$2.95. This timer, originally designed as a parking-meter timer with key-chain attached, is teamed with a Kodak auto-release timer which sells for about \$5 at most camera shops. While the Kodak timer will give only the normal 10-second delay if used separately, it will trip the shutter after much longer delays when activated by the pocket timer.

The aluminum bracket for mounting the two timers will vary with different cameras. In every case, however, the arm of the bracket which attaches to the camera should be no more than  $\frac{1}{2}$ -in. wide so that it will permit the activator wire to swing past. Both timers are attached to the bracket with epoxy. Before mounting the pocket timer, file off the plastic lip which holds the key chain. The faces of the two timers must be parallel in order that the activator wire may trip the release lever on the photo timer. Since the pocket timer is slightly thinner than the photo timer you'll have to





**HERE'S WHAT** the pocket timer looks like. Actually, it's a parking-meter timer with a key chain attached

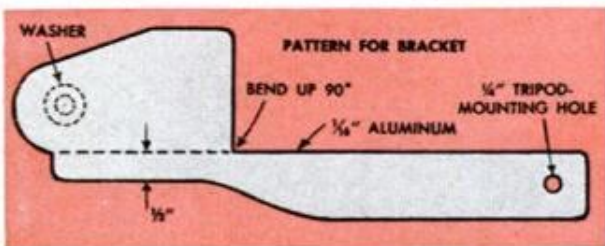

slip a  $\frac{3}{4}$ -in. washer under it to bring the face up to the correct level. Also, make sure that you mount the pocket timer so that its center is exactly in line with the release lever of the photo timer.

The activator wire is mounted on the face of the pocket timer with epoxy and must be bent slightly to avoid tension while the epoxy sets. Place a small piece of  $\frac{1}{16}$ -in. cardboard under the hook in the wire while the epoxy hardens to assure clearance.

The release lever on the photo timer must be given hair-trigger action if it is to be tripped by the activator wire. Unscrew the wind-up knob and pry open the case with a knife. If you flatten the slight kink in the release lever with a screwdriver, you'll find that it will operate much easier. In fact, you'll probably have to hold it down each time you wind up the timer. For a finished appearance, paint the blob of epoxy with black enamel.—*Tommy Thomas*

**RELEASE LEVER** in photo timer must be straightened in order to give the switch hair-trigger operation

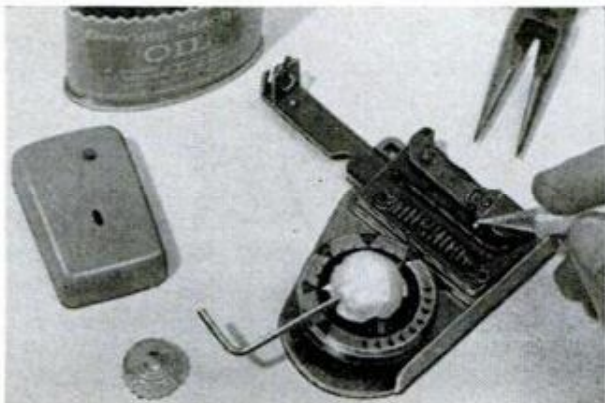

MARCH 1962

## FOR CAMERA BUGS



### String Along With a Cordpod

Easily carried in pocket or gadget bag, this "cordpod" is simply a short length of cord tied to a thumb bolt. To use it, turn the bolt into the tripod socket of your camera and place the cord under your foot. By pulling upward on the cord, you will provide enough tension to steady the camera. If you cut the cord long enough, it can be used in a standing position too.

### Stop Those Diving Tongs

To keep print tongs from slipping down into your developer tray, just clip a spring clothespin to the side of the tray. When you're not using the tongs, slip them over the clothespin. You'll find that the pin won't get in the way but will keep the tongs readily available at all times.

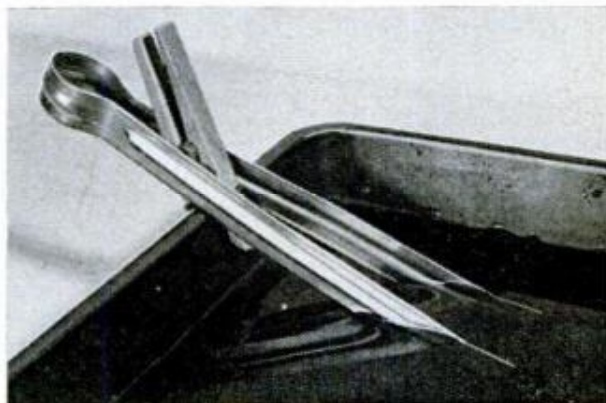

185

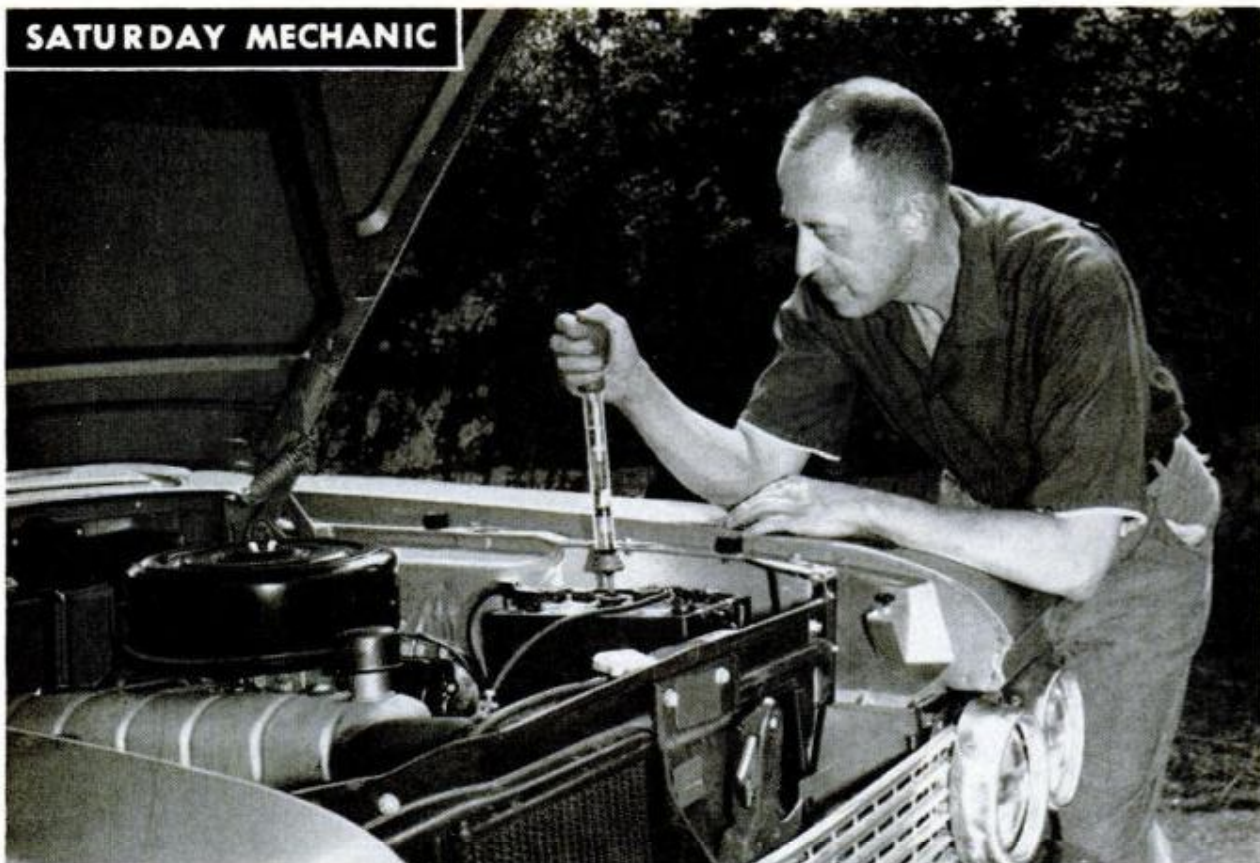

**1. HYDROMETER TEST** will show if the battery is fully charged. Fully charged, the reading should range from 1.275 to 1.300; half charge, about 1.225; very low 1.150. If reading is 1.1250, battery should be recharged

## Battery and Starter Checks

*Carried out periodically, they can give you tip-top performance  
save fuel, reduce wear and replacement costs*

**By William J. Hector**

**2. MOTOR ANALYZER**, with accessories, can run a complete series of accurate electrical tests on your car



**P**RO MECHANICS don't gauge car-performance factors by guess. Even though they may be good guessers they don't risk leaving anything to chance. They use special measuring instruments. Saturday mechanics who like to get peak performance from their cars might also consider purchase of test units that can be put to good use in running routine checks. Car manufacturers provide tune-up specifications which are to be performed with test equipment. Instrument checks will pay off not only in time saved but also in fuel savings, wear and possible early replacement of parts which may not have given a full measure of service.

Ordinary tune-ups are not at all difficult or involved, especially if you use an analyzer like that pictured in Fig. 2. With this unit and its accessories it takes only a few minutes to run checks on the battery, starter, generator, condenser, plugs, cables, timing, distributor and regulator. It tests

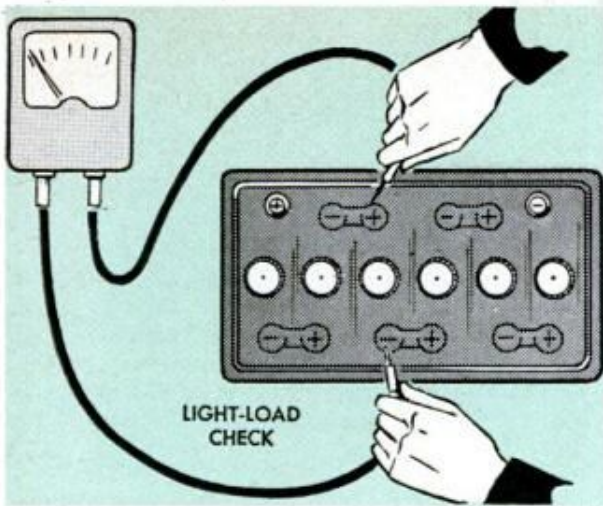

**3. BEFORE MAKING** a light-load battery check be sure electrolyte (fluid) level is up to the indicator mark. Hold starter switch on for three seconds. If motor starts, turn off ignition. Then, with lights on, check cells

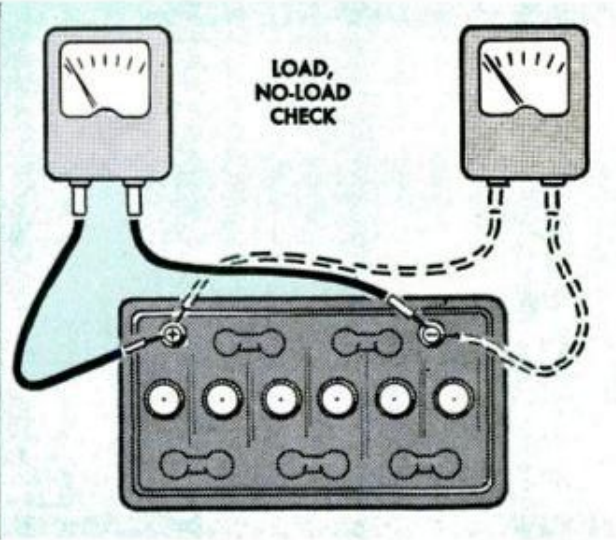
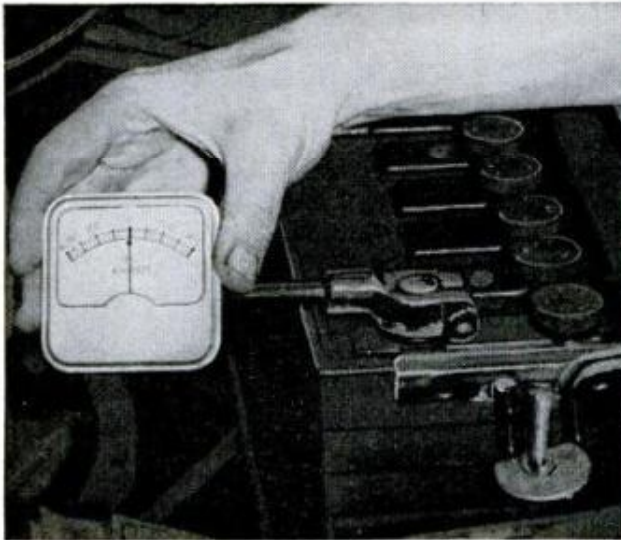

**4. WHEN MAKING LOAD CHECK** observe polarity, positive to positive, negative to negative no matter whether you have positive or negative ground. Induction-type ammeter at left requires no contact with circuit

**5. IT'S IMPORTANT** to check out ground circuit. As starter-motor housing should be at same electrical level as the grounded post on battery, any loss or voltage drop can be measured between the two points. More than .2-v. drop can mean poor connection, cable wire gauge too small, or the cable itself is defective

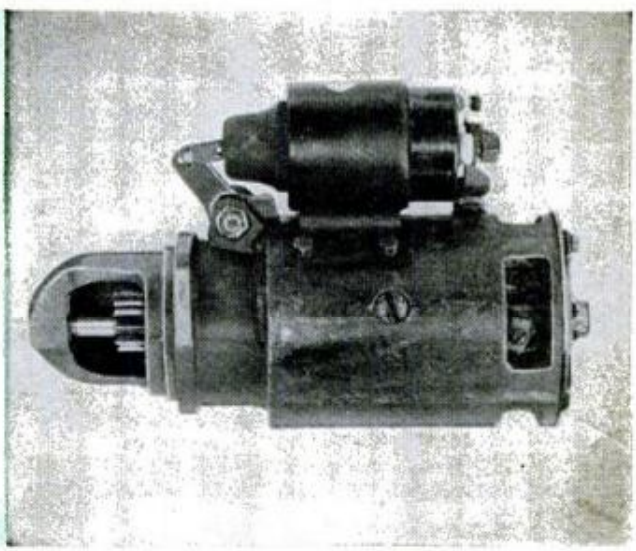
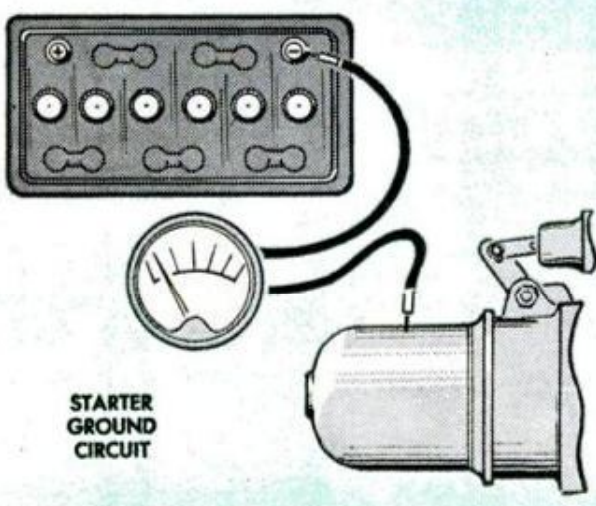

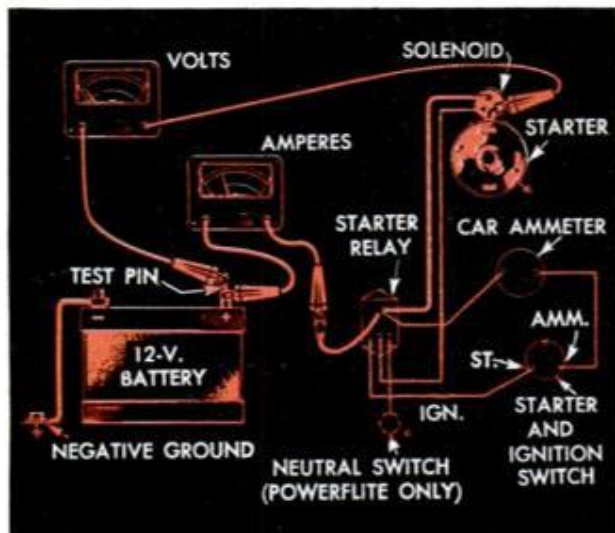

**6. ANOTHER METHOD** of testing for voltage drop in starter-motor circuit on Chrysler cars is to hook up meters as shown. When starting motor is operated voltage drop should not exceed 0.2 v. per 100 amps.

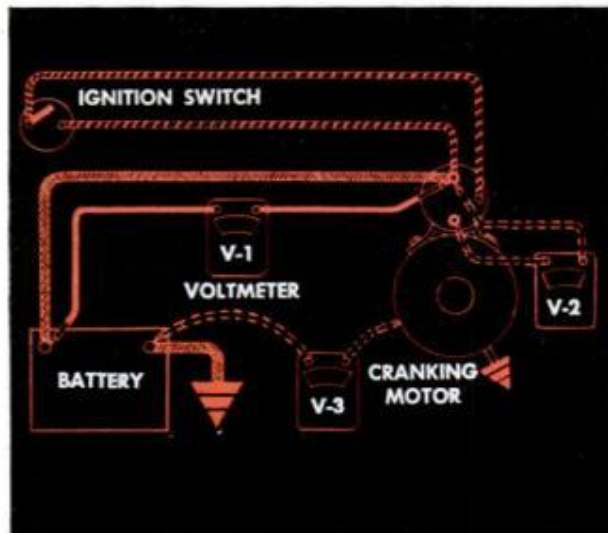

**7. TO ISOLATE** trouble in starter circuit, according to Allen Elec. & Equip. Co., meter leads are moved across each connection until defective one is located by voltage drop. Note three positions of meter

## TOOLS

Box wrenches, ammeter, hydrometer, battery terminal puller, voltmeter reading to .01 v.

## MATERIALS

Grease or petroleum jelly, distilled water, steel wool, baking soda, clear water.

**8. THIS TESTER** checks each cell under load just as if motor were being cranked. Tester is relatively inexpensive, provides a check favored by many experienced auto mechanics over other test methods

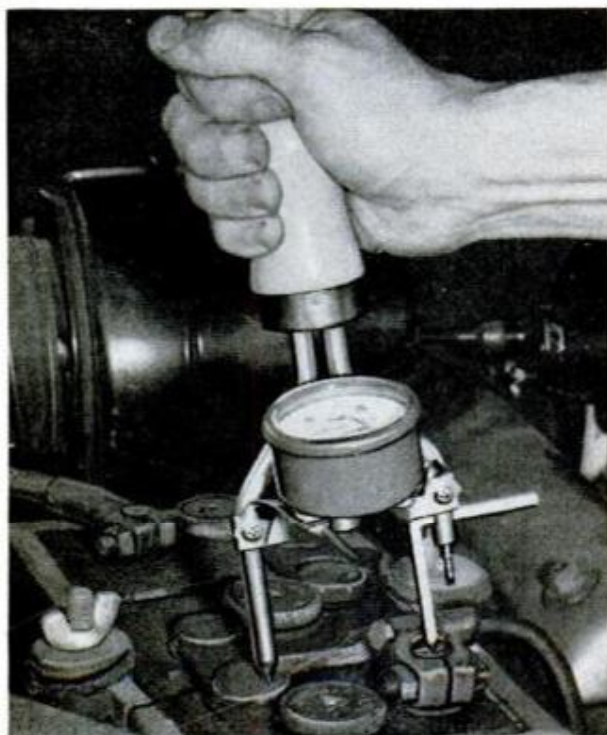

6 and 12-volt systems on 4, 6, and 8-cylinder engines and for good measure you can also check dwell angle and point spacings at all speeds. Such test units with all accessories can cost \$100 or more and the outlay is justified only for those Saturday mechanics who wish to keep car performance up to manufacturer's specs by running periodic checks over long periods of time.

But there are many accurate checks that can be made with much less expensive instruments, such as the voltmeter to measure voltage and the ammeter to measure amperes, or current flow. When using electrical test equipment it is necessary to observe electrical polarity when hooking up the test units. Voltmeters are connected across (in parallel) with electrical circuits. Ammeters are connected in series. Start with the highest range first if you are using a multirange meter. Make connections first before turning on the power.

**Identifying polarity.** It is necessary to know whether your car has a positive or negative ground if your battery markings are unreadable. To find out turn your voltmeter to the highest range and connect the negative test lead to the battery-post cable leading to the motor block. Touch the positive lead to the battery post opposite. If the meter needle goes up normally, you have a negative ground. If the needle reverses off the meter scale, you have a positive ground. Then, when your test equipment instruction book tells you to hook up to positive, or to negative, you will know which way is correct. It is important that the battery, Fig. 13, be at its best. There are several tests you can make.

**Battery no-load check.** Check by turning off any current-consuming devices and switches. The reading should be either 6.3

or 12.6 for a fully-charged unit. If lower, check separate cells, Fig. 4. Figures should not vary more than .05 v. from the lowest to the highest cell.

**Specific-gravity test.** A hydrometer, Fig. 1, gives an accurate picture of the battery condition by testing the specific gravity or density of the electrolyte (battery fluid). This should be done when the fluid is at the proper level. If necessary, add water to the indicated level. Use only distilled water; never tap water. Drive the car before checking.

Take a reading with the hydrometer, compensating for temperature variations as specified. For the tune-up tests you should have readings of 1.250 to 1.275. If below 1.250 recharge the battery with a charger, Fig. 10, using a 5-amp. charging rate. Charger should be of the type that tapers off automatically. After charging and before testing, remove caps and blow out hydrogen gas (it's explosive) that may be present to cause inaccurate readings.

Clean the battery surface and terminals of any corrosion by swabbing with a solution consisting of a teaspoonful of baking soda in about a pint of water, Fig. 9. All cell caps should be on to prevent any of the soda water getting into the cells. Rinse with clear water. Remove the terminal



**9. SODA-WATER SOLUTION** poured or swabbed over corroded battery and rack removes the coating. Use about one teaspoonful of soda in a pint of water. After cleaning, coat parts with petroleum jelly

**10. EFFICIENT BATTERY CHARGER** utilizes silicon rectifiers. It is rated at 10 amps., 6 and 12 volts. Fits in the glove compartment and can be placed anywhere under the hood when in operation

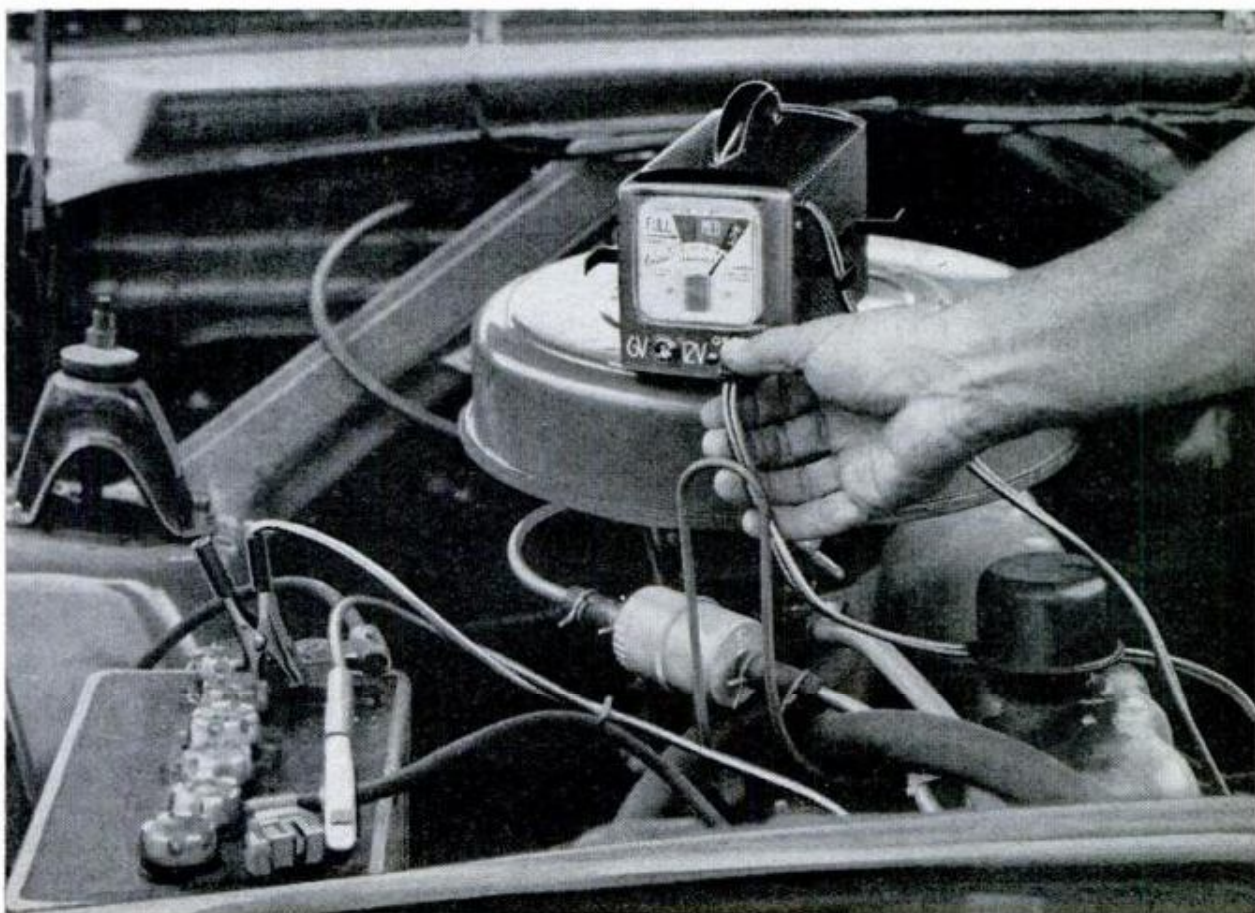



**11. BATTERY-CLAMP PULLER** removes the cable clamp from the post without damage to the post or clamp



**12. HEAVY-DUTY** starter switch enables you to start engine without helper. It's inexpensive, saves time

**13. CUTAWAY VIEW** looking into a typical storage battery shows wooden separators and sediment traps

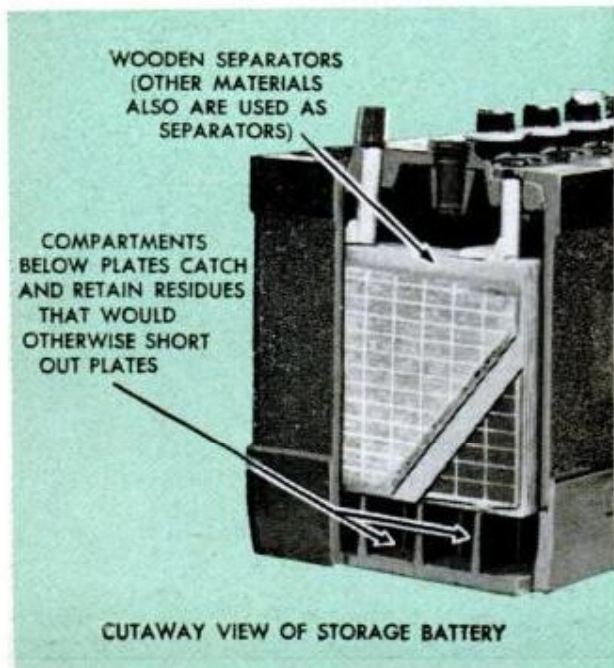

clamps and clean the inside with steel wool or a steel brush. The clamp, or terminal, puller in Fig. 11 will pull the terminals from the posts without damage. Clean the battery posts, ground strap to motor, battery or starter and solenoid to switch. Then apply a thin coat of petroleum jelly to the battery posts before replacing the clamps.

**Battery load check.** Position the voltmeter across the battery posts, Fig. 4. Remember the voltmeter has polarity which must be observed when connecting across the whole battery or individual cells, positive to positive, negative to negative, no matter whether you have a positive or negative ground. Hook up voltmeter leads to battery posts, not to the cables. If the no-load voltage checked okay, the battery should maintain a minimum voltage under heavy load. Special battery loads are used in garages, using a carbon pile to create an artificial load. You can create this load by turning on the headlights, heater, and any other accessories that might be used simultaneously. With the ignition switch off, have someone press the starter, or the separate starter switch, Fig. 12. Take a reading. Repeat. Do not operate the starter more than 20 seconds at a time without allowing a few minutes between tests to cool off the starter motor.

The voltage should not drop below 5 or 10 volts (6 or 12-volt battery) and the starter should not slow down unduly under test. Also, check the individual cells which should test at least 1.65 v. If the starter turns over slowly, either it needs attention or excessive resistance is present in the circuit.

**Light-load check.** Of all the battery tests available this has proven to be most accurate, according to battery manufacturers. Test in this way: Bring electrolyte level up to the mark and hold starter switch on for three seconds. If motor starts, turn off the ignition. Turn headlights on low beam for one minute. Then, with lights still on, check individual cell voltages, Fig. 3. A reading of 1.95 or more on any cell with less than .05-v. difference between any high or low cell is okay. A reading of less than 1.95 on any cell indicates the need for recharging. If any cell shows a reading of more than 1.95 v., a difference of more than .05 v. exists between the lowest and highest cells; replace the battery.

If all cells test less than 1.95 v., recharge the battery one or two times. This necessitates a long charge with the average home battery charger. If a satisfactory reading is not achieved after the second charging period, replace the battery. Of course, it is possible for a low reading to occur due to

(Continued to page 204)

# Better CARKEEPING



● **TRACING AUTOMOTIVE TROUBLES** by ear can be most difficult due to the variety of sounds and high noise level produced by the engine. One serviceman solved this problem by constructing a simple device consisting of a short piece of heavy wire pressed into the top of a discarded auto radio antenna. The lower end of the antenna is threaded to screw into a nut which in turn is brazed to the receiver magnet of an old fashioned wall or desk telephone. By holding rod tip on engine parts, it is easy to pinpoint trouble

● **ENGINEERS** have proven that regular tune-ups will cut gas consumption and reduce hydrocarbons emitted at the tail pipe. A Detroit company which sent its cars to the garage every 5000 miles for a routine check found that these cars used 15 to 20 percent less gas and gave off 60 percent less hydrocarbons than models which had not received this regular service

● **WHEN INSTALLING** a head gasket, try soaking it in hot water for a few minutes before you are ready to use it. The hot water will soften the asbestos core, making the gasket compress more readily and conform to the two metal surfaces. After installing the wet gasket, drop the head into place and tighten it down in the usual way. Engine heat dries the gasket

● **IF YOUR CAR** is equipped with an alternator, be careful that you don't accidentally ground the terminal output screw as this can cause the destruction of both wiring harness and alternator. To prevent such an accident, make sure that the terminal is well covered by the vinyl boot cover, or if no cover exists, protect the terminal with electricians' plastic tape

● **TOUCHING UP** a scratch, nick or chipped paint spot usually doesn't seem worth the bother of cleaning the brush afterward, so such spots tend to be neglected (and begin rusting) until there are enough of them to justify dirtying a brush. Cotton swabs used in baby care make ideal touch-up brushes allowing you to cover scratches when they occur

● **OLD PISTON RINGS** can be used to keep carbon and other debris out of the cylinder bores when doing a valve or ring job on an L-head engine. Cover each cylinder opening with a paper cap. Then force one of the old rings a short distance into the cylinder to hold the cap in place. When you pull the paper and ring out, all the grit will come out with it

● **SOME PEOPLE** apparently are still afraid that spark plugs will be harmed by abrasive cleaning. A plug manufacturer stresses the fact that glaze hasn't been used on the firing ends of spark plugs since the early 1920's when leaded fuels were introduced. When properly done, abrasive cleaning removes only foreign deposits, does not erode or damage porcelains

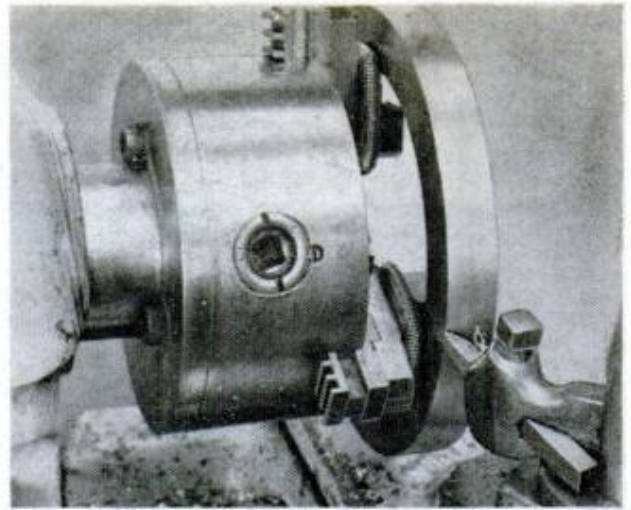
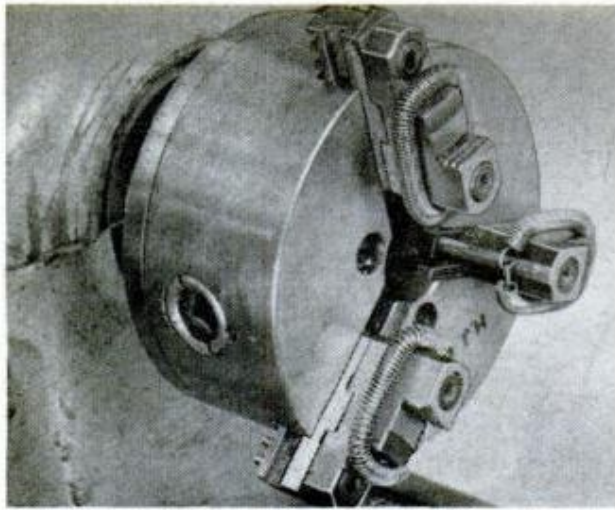

**1** WHEN HOLDING work in three-jaw chuck for turning outside diameters it usually is necessary that the work be held so that the outer face clears the chuck jaws. One reasonably accurate method of doing this is to snap short extension springs over the jaws as in the left-hand photo. Springs of various diameters can be used to hold the work out just the right distance. Example is shown in the right-hand photo

# 10 LATHES HINTS

that machinists can keep in mind for those special jobs

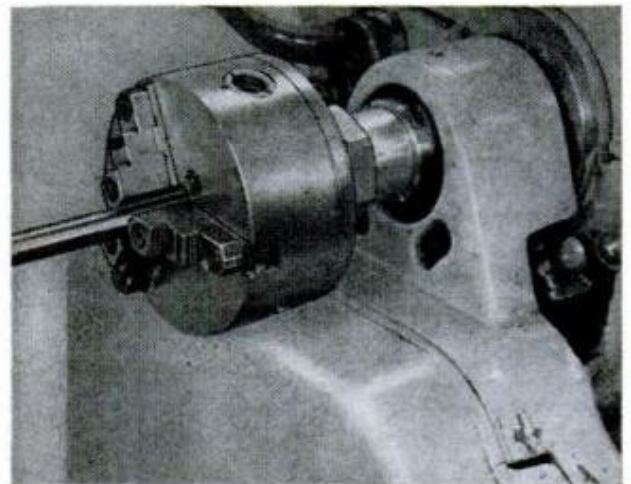

**2** THREE-JAW CHUCK mounted on threaded adapter and force-fitted onto outer end of lathe spindle, centers bar stock which is fed through spindle for duplicate operations. Outboard chuck prevents whip

**3** DRILL BITS seated in the headstock spindle of the lathe may tend to slip in the tapered sleeve. This can be prevented by driving the bit with a dog in the manner pictured. Setup gives a positive drive

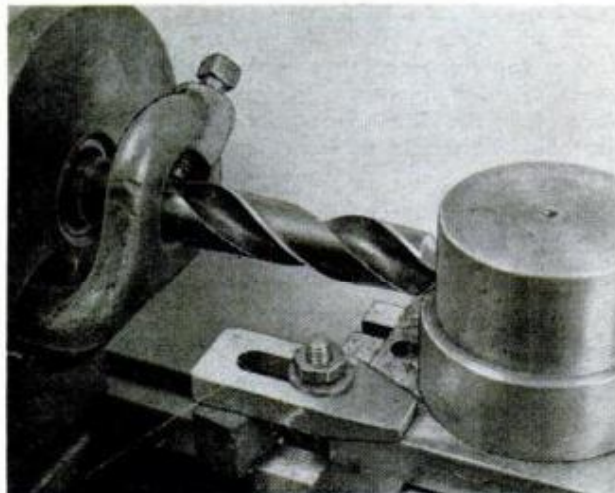

**4** HERE'S A SURE WAY to seat a steady rest on work having a keyway. Bore out a sleeve to fit tightly over work, and turn down outer diameter to take a ball bearing. Then set up job as pictured

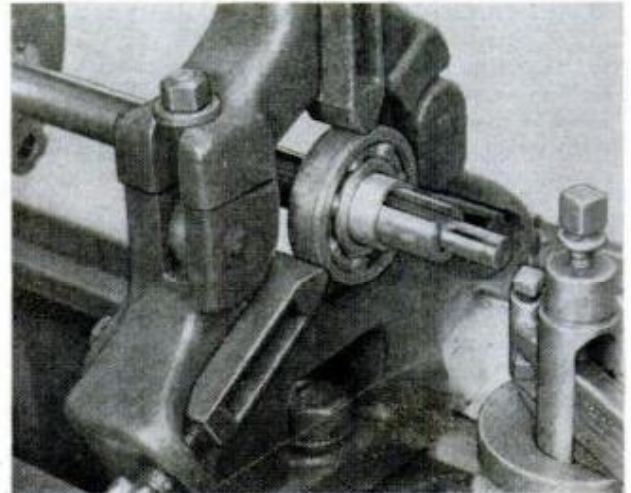



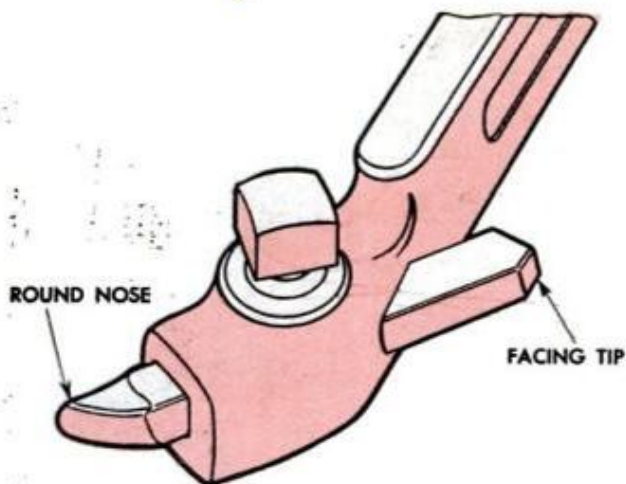

**5 QUICK CHANGE** from one cutting edge to another is often helpful in lathe work. For example, grind round-nosed and facing tips on ends of tool. The switch can then be made in seconds

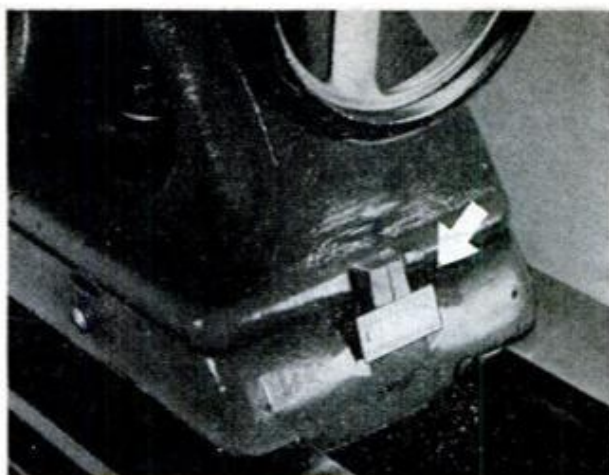

**8 SHORT LENGTH** cut from steel rule and cemented to lower section of lathe tailstock makes it easy to set over for taper turning. Center rule section on witness mark on sliding section of tailstock

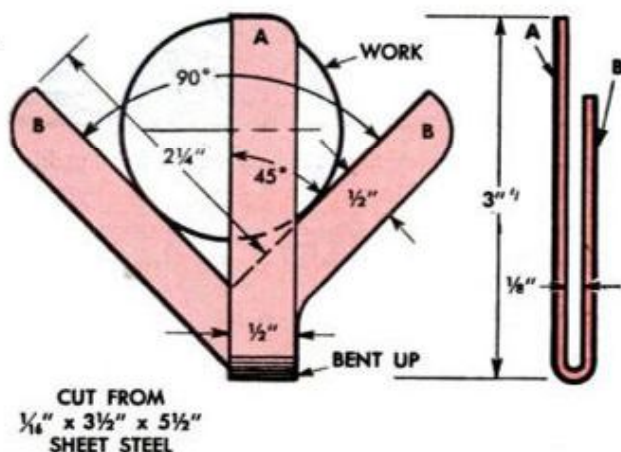

**6 HANDY CENTERING HEAD** can be made from 1/16-in. mild steel. Make a yoke shape and file to 90 degrees between arms, B. Cut leg, A, offset so that when bent up as in detail one edge centers

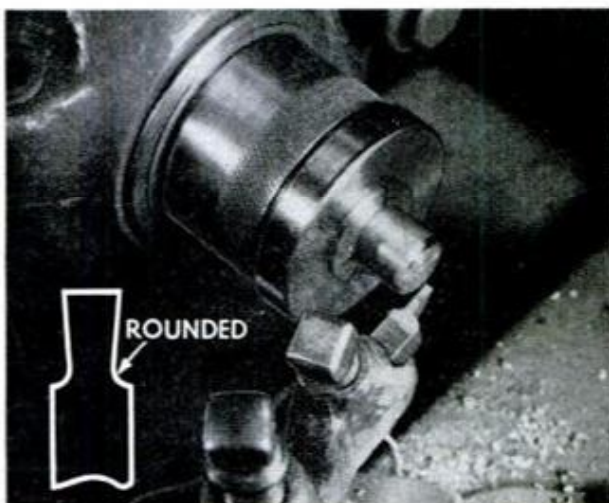

**9 BY GRINDING** square lathe bit as cutoff tool with rounded shoulder at end of grind, tool can be made to do two operations simultaneously—cut off and break one corner of workpiece to a radius

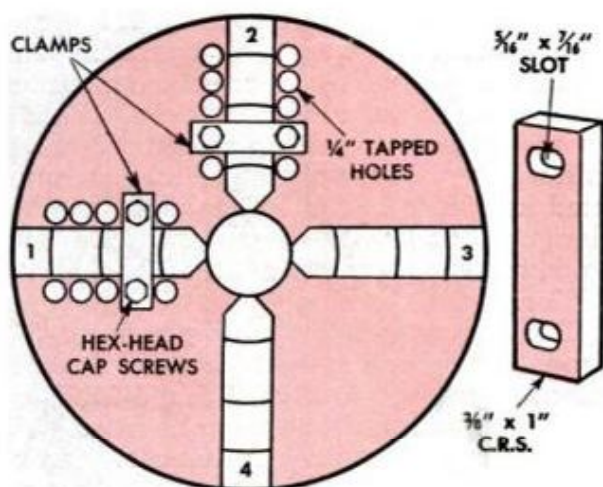

**7 FOUR-JAW CHUCK** works as three-jaw centering type when two jaws are fixed with clamps. Drill and tap holes for screws on each side of adjacent jaws. Tighten and loosen jaws No. 3 and 4 only

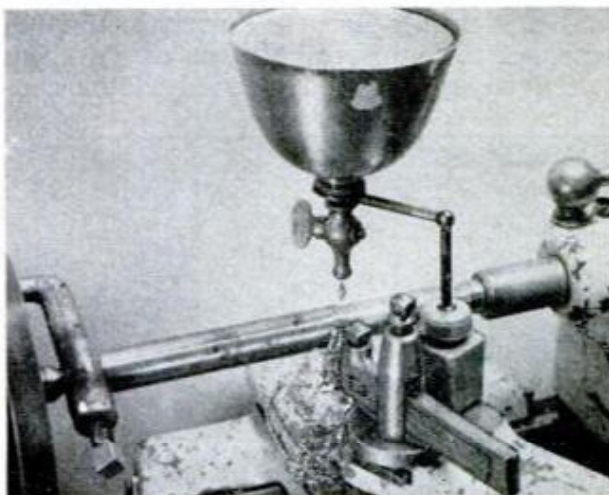

**10 COOLANT DRIP CAN** mounted on magnetic base travels with carriage. Brass pet cock is soldered to threaded base of oil-can spout. Altered can is inverted and carried on the swiveling arm

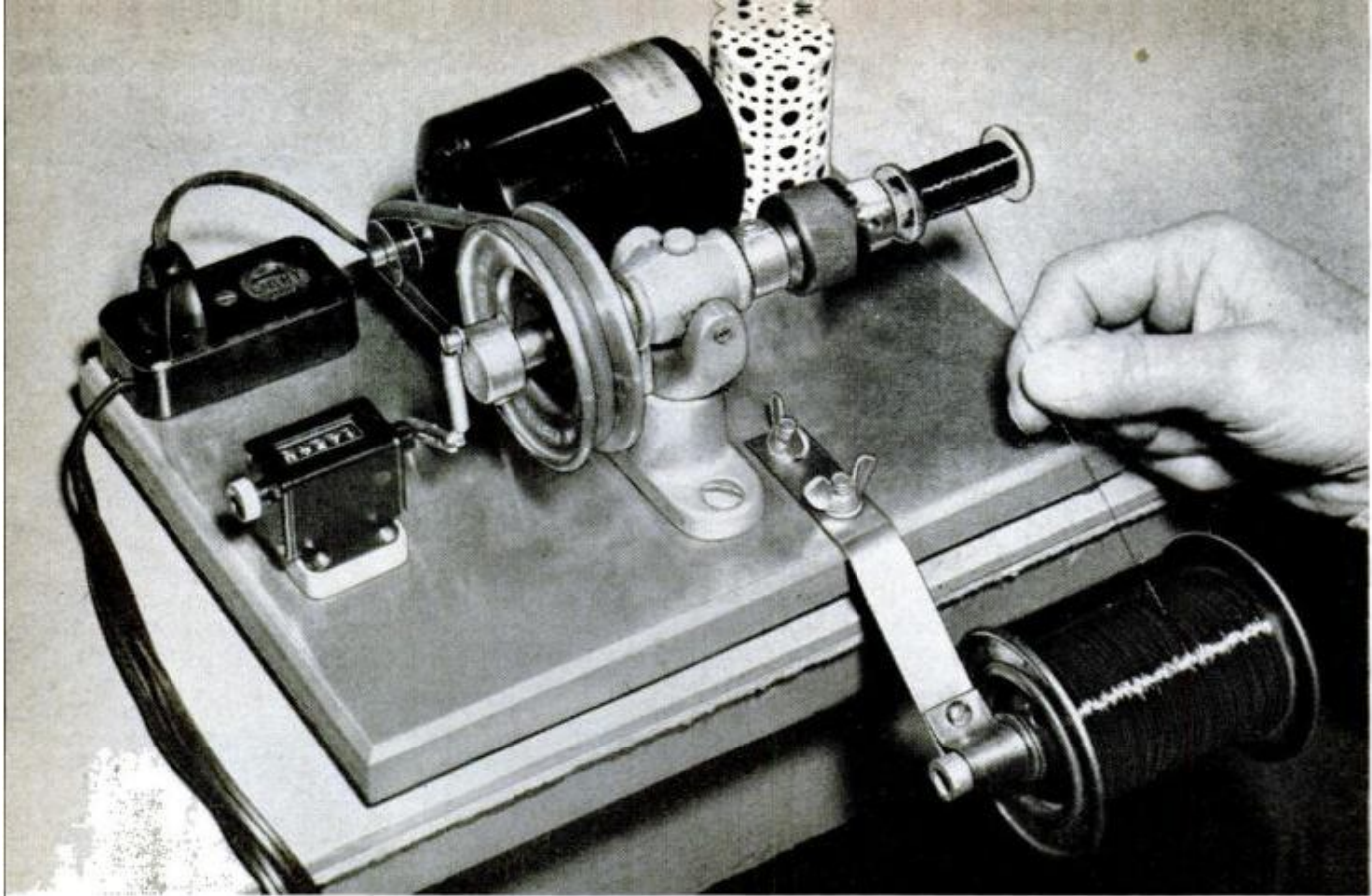

**1. WINDER** is self-contained unit that turns out coils almost as fast as winding bobbins on sewing machine

## Coil Winder Counts the Turns

By Harold P. Strand

**L**ABORATORIES, model shops and electrical experimenters often need to wind special coils for small transformers and other electrical apparatus of an experimental nature. It is difficult, if not impossible, to do a neat, sure job of winding such coils, especially if a large number of turns of wire is involved, without equipment for the purpose.

This coil winder is almost fully automatic, in that it features a counter to keep track of the number of turns of wire and is driven by a variable-speed motor con-

trolled by a foot rheostat, a setup that gives the operator full control of the winding process from start to finish. It's assembled from stock items, a sewing-machine motor and a drill chuck that holds the winding form securely. The total cost for all new items will run about \$25.00. It handles wire sizes from No. 38 to 20. These wire sizes generally cover the range of those commonly used in light electrical equipment.

The counter pictured in Figs. 1, 5, 7 and 8 is a ratchet type with an operating arm and spring driven by an eccentric mounted on the end of the winding spindle. It has a convenient reset knob for resetting to zero, and will serve the purpose well when operated at speeds below 1000 r.p.m. It is not designed for higher speeds and may tend to skip when operated at speeds above 1000 r.p.m.

The motor is a variable-speed a.c.-d.c. type,  $\frac{1}{15}$  hp., and is controlled by the foot rheostat you see in Figs. 7, 8 and 11. Usually motors of this type must be fitted with a suitable base, which, in this case, can be a short length of steel angle bolted to the motor and winder base as in Fig. 8.

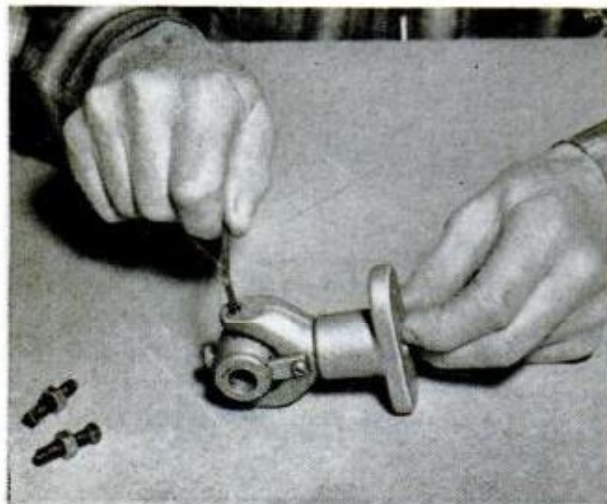

**2. ORDINARY SHAFT HANGER** provides stand and bearing for spindle. Setscrews with locknuts are replaced by socket screws. Note locking braces, Fig. 12

The simplicity of the setup is easily seen from Figs. 1, 8 and 11, but one needs to note the changes made in the shaft hanger that serves as a bearing for the winding spindle. First of all, the setscrews and locking nuts that normally support the self-aligning bearing are removed and socket setscrews substituted as in Fig. 2. Then the body of the bearing yoke is drilled through to take a 1/4-in. stove bolt which holds two braces, or stops, Figs. 2 and 12. The upper ends of these are rounded to fit the contour of the bearing housing and serve to prevent it from tilting. When fitting these braces, be sure that when the bolt is tightened, the braces hold the bearing level with the axis of the bearing parallel with the base.

The drill chuck which holds the winding bobbin has a 3/8-24 thread, so all that is necessary to attach it is to shoulder the end of the 1/2 x 4 1/2-in. spindle and cut a 3/8-24 thread on the shouldered end. Use a shaft collar between the chuck body and the end of the hanger bearing as in Fig. 3. The eccentric at the opposite end of the spindle is a shaft collar drilled and tapped for a 9/32 screw which serves as a crank pin. The offset of the holes center to center is 3/8 in., which gives the crank a 3/4-in. stroke.

When assembling the pulley and chuck on the spindle, Fig. 4, adjust for minimum endplay, but be sure the parts do not bind. Mount the component parts, motor, winder counter and receptacle on a base made as in Fig. 11. Some experimenting will have to be done in order to assure proper operation of the counter. The pitman is a spring, Fig. 10, and the exact location of the counter on the base must be found by experiment. The counter is placed on a base of 1/4-in. plywood. When the crankpin, or pivot pin, is at its position nearest the counter, the arm must be free to permit the

**5. COUNTER** is located by experiment. Counter ratchet should engage and disengage positively as otherwise unit will miss. Speed should not exceed 1000 r.p.m.

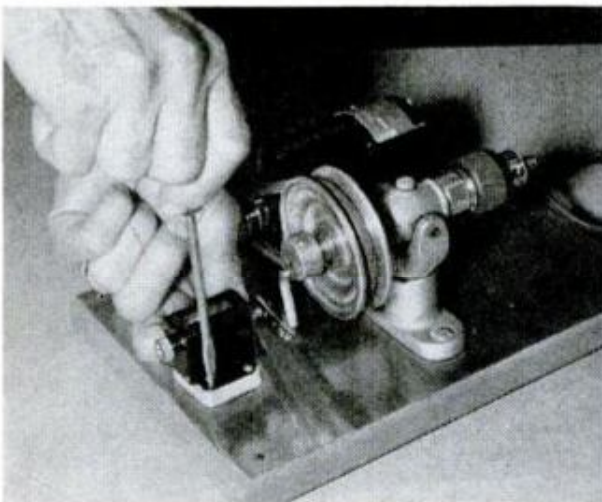

MARCH 1962

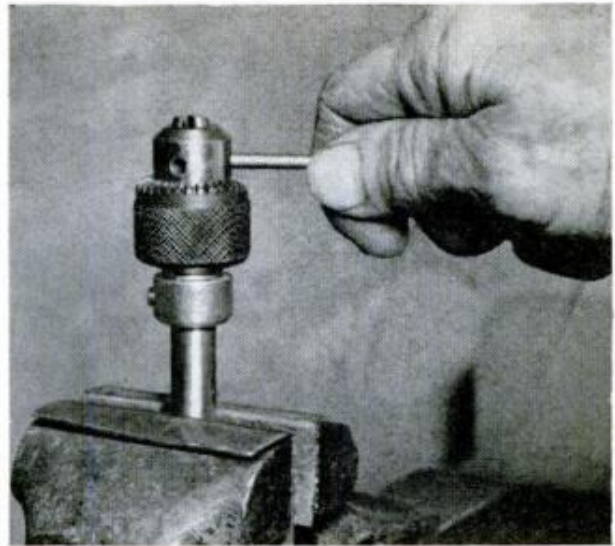

**3. CHUCK IS TIGHTENED** on threaded end of spindle by inserting rod in holes taking geared chuck wrench. Note that shaft collar is placed below chuck



**4. ENDPLAY** in spindle should be reduced to minimum by adjusting pulley and collar so that spindle just turns freely. Lock parts in position with setscrews

**6. CHUCKING** small plastic bobbin in 1/4-in. geared drill chuck. Bobbin spindle is made by cutting head off 1/4-in. bolt. Bolt must be straight, perfectly round

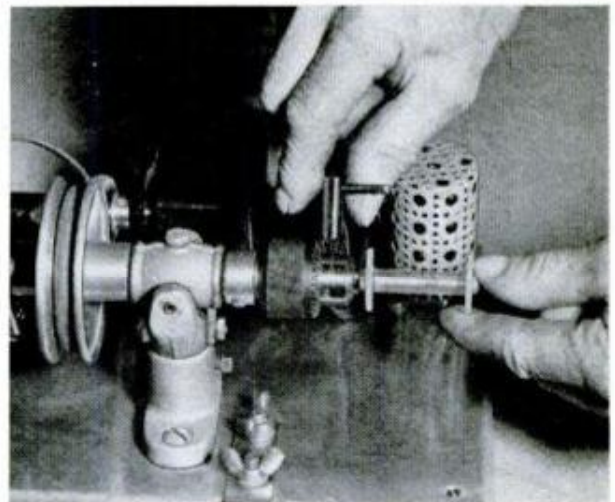

195

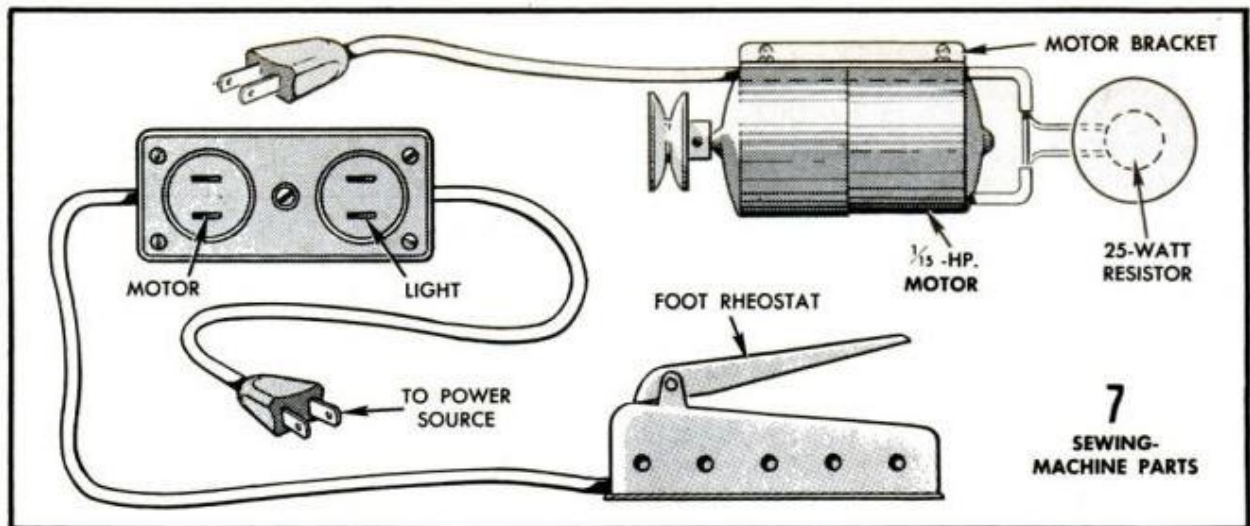

**7. YOU GET** all these parts, except the 25-watt resistor, with the sewing-machine motor. Resistor is optional

## MATERIALS LIST

- 1—Sewing machine motor, 1/15 hp.
- 1—Foot rheostat
- 1—Motor-light receptacle unit with cords
- 1—Pulley,  $\frac{3}{8}$ " dia. bore,  $\frac{1}{4}$ "
- 1—Round rubber belt
- 1—Attachment plug for motor cord
- 1—Tubular resistor, 25 ohm, 25 watt
- These parts obtained from Parker Products Co., 17 Crawford Drive, Tewksbury, Mass. \$15.00 postpaid.
- 1 pc. Fir plywood,  $\frac{3}{4}$ " x  $10\frac{1}{2}$ " x  $7\frac{3}{4}$ "
- 1 pc. Sheet aluminum  $1/16$ " x  $10\frac{1}{4}$ " x  $7\frac{1}{2}$ "
- 1—Shaft hanger for  $\frac{1}{2}$ " shaft
- 1—V-pulley, 3" diameter
- 2—Shaft collars,  $\frac{1}{2}$ "
- 1 pc. Steel shafting,  $\frac{1}{2}$ " dia.,  $4\frac{1}{2}$ " long
- 1 pc. Flat steel  $1/16$ " x  $\frac{3}{4}$ " x 8" (spool holder bracket)
- 1 pc. Steel pipe,  $\frac{1}{4}$ ", 5" long (spool holder spindle)
- 2—Washers to fit over  $\frac{1}{4}$ " pipe (spool holder)
- 1—Cotter pin (spool holder)
- 2—Wing nuts,  $\frac{1}{4}$ " (spool holder)
- 2—Flat-head screws  $\frac{1}{4}$ " x  $1\frac{1}{4}$ " long (spool holder)
- 2—Flat-head wood screws No. 10,  $1\frac{3}{8}$ " long (shaft hanger)
- 4— $\frac{3}{8}$ " Rubber feet,  $\frac{1}{4}$ " (use under base)
- 1 pc. Flat steel  $\frac{1}{8}$ " x  $\frac{3}{8}$ " x  $1\frac{1}{2}$ " (bearing braces)
- 2—Socket setscrews,  $\frac{1}{4}$ -20,  $\frac{1}{2}$ " long (shaft hanger yoke)
- The following available from Lafayette Radio, 165-08 Liberty Avenue, Jamaica 33, N.Y.
- 1—Key chuck,  $\frac{1}{4}$ " capacity, HD-186 \$2.98 plus postage
- 1—Stroke-actuated counter, 5-digit with reset knob

counter ratchet to catch and move the first number into position in the window. At a point opposite the first position the ratchet must release. Once an operating position has been assured, screw the counter to the base as in Fig. 5 and then test again for proper operation with the motor running at top winding speed of 800-1000 r.p.m.

The 25-watt resistor, Fig. 9, is optional. It serves to hold motor speed below that of the low point on the foot control during the initial start of winding. The resistor is cut in in series with the motor. Fig. 11 shows how to make a suitable spool holder and bracket and also suggests a method of making a plastic bobbin for coils having permanent forms. Of course, bobbins can be made to suit almost any purpose. The plastic bobbin is chucked as in Fig. 6 and 11, the spindle being made by cutting the head off a  $\frac{1}{4}$ -in. bolt. Use a round rubber sewing-machine belt from motor to spindle pulley. ★ ★ ★

**8. SELF-CONTAINED UNIT** ready for table-top operation. Resistor at left of motor is shown without cover

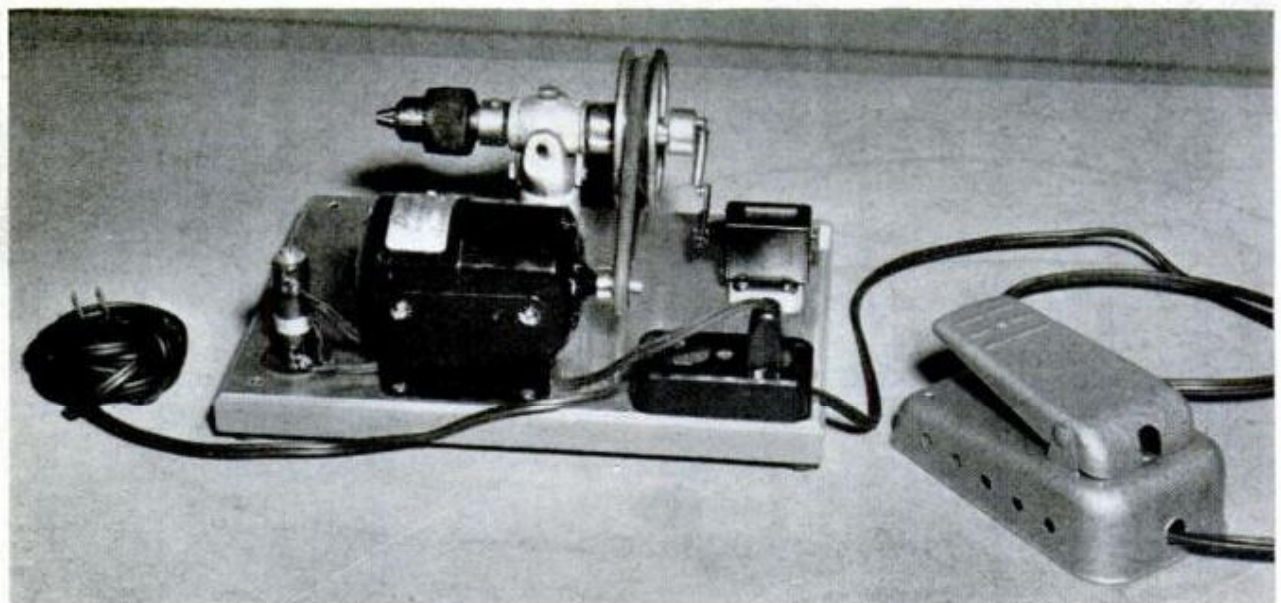

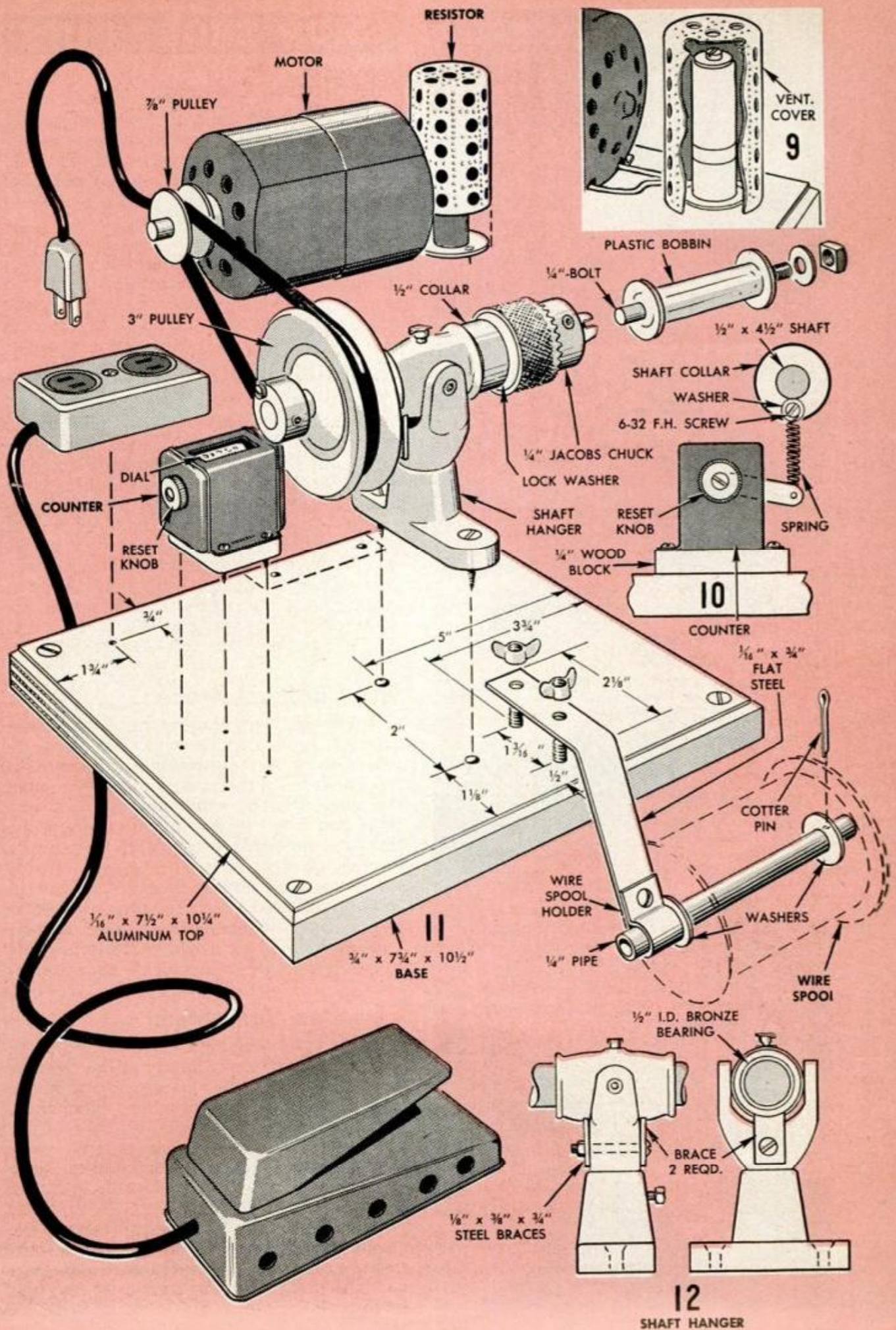

## SHOP SHORT CUTS

### File Under Control

You get better control of a file on a delicate job by cutting away a portion of the handle, leaving a flat as pictured. This not only gives a better and surer sense of lateral tilt of the file, but offers a somewhat easier and more comfortable grip when doing heavier work, such as filing a flat surface. Cut away only the wood portion of the handle back of the metal, ferrule and sand the flat surface smooth, rounding the edges only slightly.—*Martin D. Koehler*



### Auger-Bit Pilot

You've known for a long time about using a short length of dowel as a pilot for an auger bit when enlarging a hole concentrically, but did you ever think of using a faucet washer? It accomplishes the same thing as the dowel—pilots the bit accurately—and it does not split or wedge tightly in the smaller hole, making it necessary to drive it out and start all over again. All you have to do is select a faucet washer of the right size, turn it onto the screw point of the bit and proceed to bore the hole to a larger diameter.—*Bil Toman*

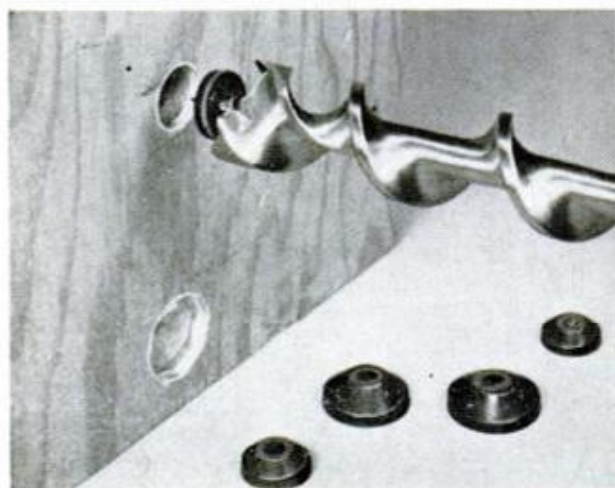

### Short Ratchet Brace

Of course, a regular ratchet brace takes care of most problems in boring holes where there isn't room for a full swing of the sweep. But there are times when even the ratchet brace won't do the trick, and then you have to improvise. Square the threaded hole in a hex nut, drop it into a wrench socket, snap the socket onto a ratchet driver and you've got the short ratchet pictured. Fit the squared hole in the nut over the shank of an auger bit and you can bore a hole in places it's impossible to reach with any other tool.—*H. Hanscom*

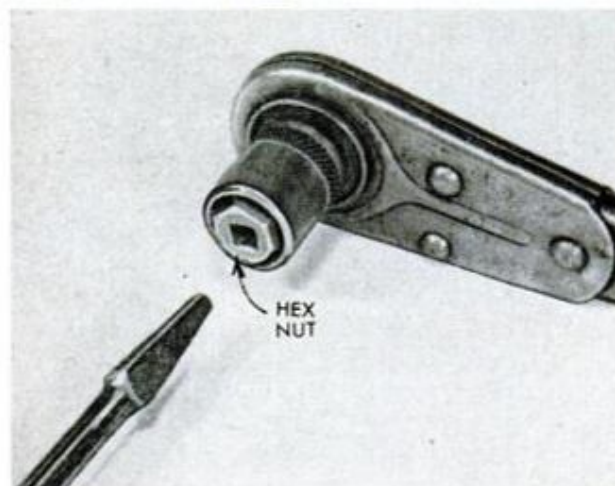

### Two-Step Push Stick

When you make a push stick—and there should always be one handy at the circular saw—cut two notches instead of one in the end as is the usual practice. The extra notch is not only an added utility feature, it's a safety bonus as you can safely handle stock in a wide range of thicknesses. Note the two sizes of notches in details A and B. The smaller notch takes stock  $\frac{1}{4}$  in. thick with just enough clearance to prevent the corner from riding on the saw table, permitting the stock to chatter as it is pushed past the blade. Flip the stick over and you have a  $\frac{1}{2}$ -in. notch for stock up to 2 in.

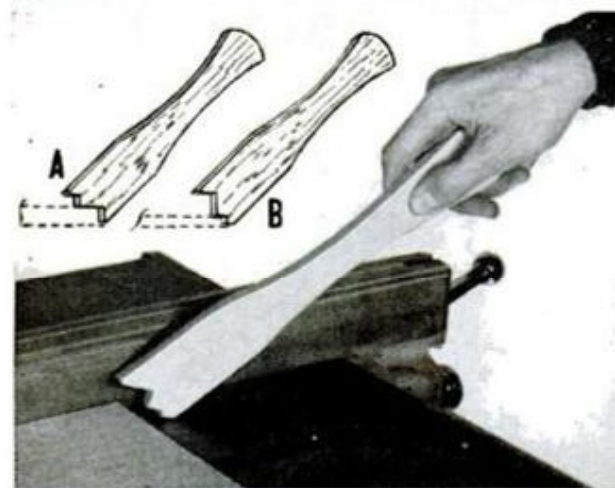

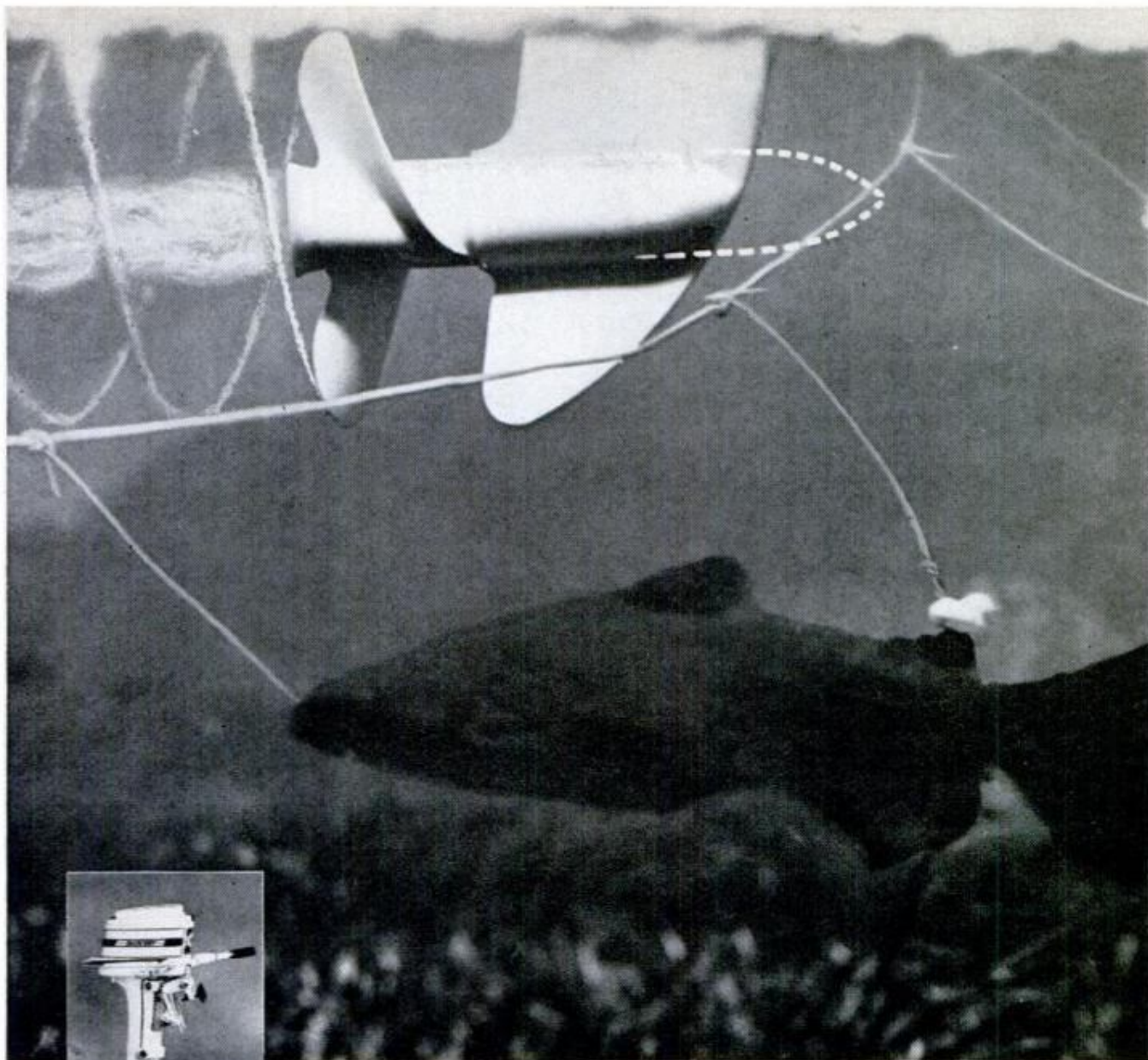

*Photographed underwater at Florida's Silver Springs*



*a MERC doesn't have a nose  
to get in other people's business*

A Merc doesn't have a big nose like some motors. Its lower unit doesn't gather weeds, hook logs, foul trotlines or ski ropes.

Its smooth Glide-Angle contour simply glides over obstructions. Its one-piece design eliminates joints, leaks, misalignment . . . gives maximum strength and smoother slipstream for more power at the prop.

And, a Mercury doesn't have a shear pin to fatigue and give way at embarrassing

moments. (Have you ever tried to change a shear pin at sea?)

You also get quiet, efficient Jet Prop exhaust on all Mercs.

A Merc is built to last . . . to give you more RUN for your money.

**MERCURY**  
100, 85, 70, 50, 45, 25, 9.8, and 6  
horsepower outboards

© 1962, Kiekhaefer Corporation, Fond du Lac, Wis.



**"Imagine *listening*  
to our movies  
as well as  
seeing them!"**

**YOU WON'T BELIEVE IT** till you hear it—the rich, clear-as-a-bell sound of the Kodak Sound 8 projector!

## **Make your 8mm movies come alive**

Now you can add rich, stirring sound to your 8mm movies—new or old. And you can use your present camera.

All this is made possible by Kodak's discovery of a way to put quality magnetic sound on narrow 8mm film—and by the Kodak Sound 8 projector, which both records and plays back the sound.

You simply take your processed film to your dealer. Ask him to have a magnetic stripe, such as Kodak Sonotrack Coating, applied to the film edge.

As you project the "striped" film through your Sound 8 projector, talk into the mike to record voice commentary. For music and sound effects, hook in your record player or tape recorder.

You can play back your new sound movie instantly. To improve any sections of sound, just reverse the film and re-record; erasure of previous sound is automatic.

Kodak Sound 8 projector, with microphone, long-play record and built-in speaker, is less than \$350. See your dealer. Many dealers offer terms as low as 10% down.

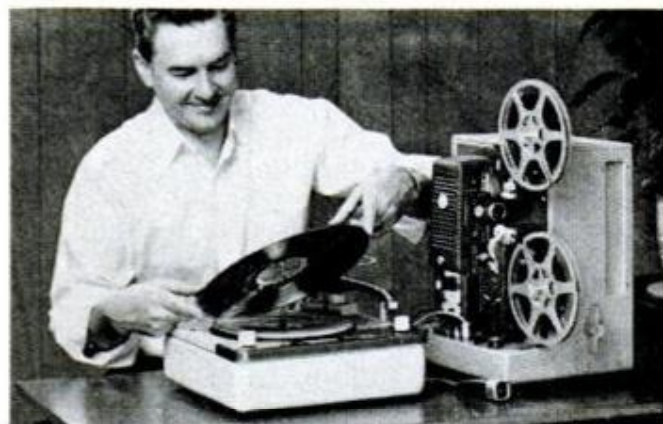

**RECORD RIGHT ON THE FILM** — voices or "live" sound effects through mike, music from your record player or tape recorder. Play back through projector's built-in speaker or your present hi-fi equipment.

*Price is subject to change without notice.*



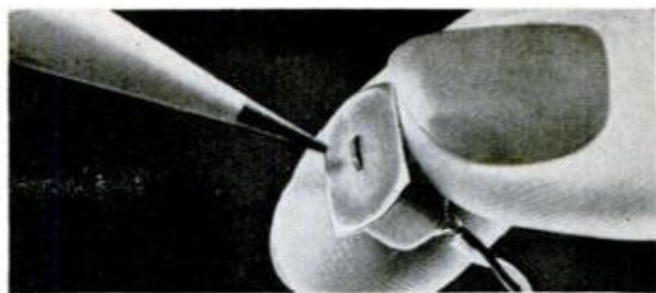

**SOUND PICKUP HEAD** is only  $2/100''$  wide. It would wear away fast if made of the usual magnetic alloy. Kodak head is of new, incredibly hard Alfenol alloy, will record quality sound for countless hours.



**LONG-PLAY (33 $\frac{1}{3}$ ) RECORD OF BACKGROUND MUSIC** and 13 special sound effects comes with your Kodak Sound 8 projector. It's high-fidelity, of course.



**PROFESSIONAL 8mm sound films** are now available for sale or rent. The Kodak Sound 8 projector operates at both 16 and 24 frames per second.

(Below) **TWO FINE INSTRUMENTS IN ONE:** the Kodak Sound 8 is a top-quality 8mm projector, also a fine sound system with frequency response 70 to 9,000 cycles (at 24 fps).

## with sound!

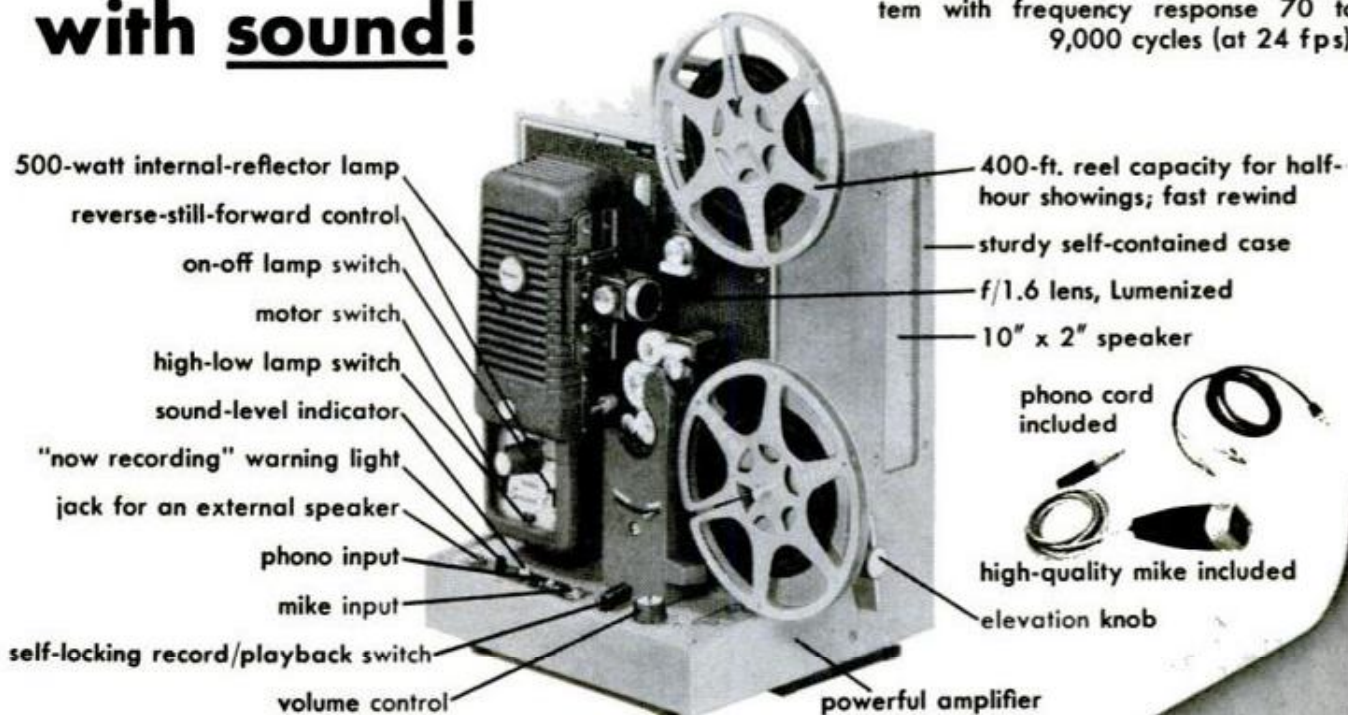

**EASTMAN KODAK COMPANY, Rochester 4, N. Y.**

Enjoy Walt Disney's "Wonderful World of Color" Sunday evenings, NBC-TV

**Kodak**  
TRADEMARK

# CLINIC FOR HOMEMAKERS

As a service to our readers in solving the hundreds of problems pertaining to a home — inside or out — editors of Popular Mechanics invite you to present your problems to The Clinic Editor for help and advice. Address your questions to The Clinic Editor, Popular Mechanics Magazine, 200 East Ontario Street, Chicago 11, Ill.

## Tuck-Pointing Masonry

**Q**—We own a home faced with brick and many of the mortar joints have softened and are starting to disintegrate. How should I repair them?—J. B., Minn.

**A**—Unlike most masonry jobs, tuck pointing is relatively easy, even without previous experience. A good mortar mix consists of one part cement, one part hydrated lime and six parts sand—thoroughly mixed together before the water is added.

Prehydrating the mortar eliminates most of the initial shrinkage. This is accomplished by mixing a third of the required amount of water into a batch about two hours before it will be used. After curing, the rest of the water is added and mortar reworked just before tuck pointing.

All disintegrating joints are raked out at least a half inch in depth. Joints and surrounding areas are soaked thoroughly. Using a denser mixture than normal, joints are packed with mortar, flush with the brick facing. A piece of board is handy for compacting the joints.

When the mix has partially stiffened, joints are smoothed with a striking or raking tool, such as a metal rod or pointing trowel, so that joints match the rest of the wall. Sometimes new areas may be closely



matched with old ones by going over joints with a brush which is practically dry, though this is only for appearance.

## Starting a Compost Heap

**Q**—Our neighbor tells us not to discard leaves, old flower plants and grass. He says we should save them for a compost pile. Do you think it's worth while bothering with one?—J. D., Ind.

**A**—Yes it is. A compost heap doesn't require a lot of work, and it's a good way to dispose of lawn and garden refuse. Primarily, though, it's an inexpensive source of garden humus.

You can start a pile anytime of the year—the sooner the better. On most properties there will be some out-of-the-way spot for hiding compost. The area may be shielded by shrubs, hedges or perhaps a fence. Just



keep in mind that the location should be near water and close to the garden.

There are many ways of handling compost but, whatever you do, a few basics should be kept in mind. A heap should be about four to five feet high. Many prefer using two or three stacks so that compost may be turned periodically, shoveling it from one bin to another. Raw materials may include most organic matter: Leaves, clippings, healthy plants, even coffee grounds. Diseased plants, bones and branches should be omitted.

To retain water, the top of a pile is shaped like a saucer. Debris is kept wet but never soggy so air cannot circulate and stop decomposition. Moisture, air and a build-up of heat are all necessary. A low heap will lose too much heat; a high one will restrict air. If a masonry-block or a wooden bin is used, the sides should be left open for air to circulate.

A stack is made with thin layers of raw materials, using about six inches of plant litter, a thin layer of commercial fertilizer and a thin layer of top soil. ★ ★ ★



The exciting 1962 Chrysler 300 H at the Daytona International Speedway. Like all Chrysler-made cars, it is sparked by new silvery-plated Champions!

Chrysler has recently joined the long list of car manufacturers who use Champion spark plugs exclusively! (More than twice as many car makers the world over use Champions--because they deliver unmatched quality and performance.) Why settle for less in your car?



Материал, эдированный авторским правом

**EASY  
DOES  
IT!**



## **CHAN NEL LOCK**

You'll do every gripping job the easy way with a Channellock worksaver plier. Powerful parallel jaw grip . . . tremendous leverage . . . patented, smooth-working can't-slip adjustments. Your choice of five jaw capacities:  $\frac{1}{2}$ ,  $\frac{7}{8}$ ,  $1\frac{1}{2}$ , 2 and  $2\frac{1}{4}$  inches. *Be sure it's a genuine Channellock. Look for the trademark on the handle. Write for catalog showing complete line of pliers. Made Only By Champion DeArment Tool Company, Meadville, Pennsylvania.*

## **Battery and Starter Checks**

*(Continued from page 190)*

loss of battery acid from filling with water when the cells are discharged. Then, when the battery is charged the fluid will overflow through the discharge vents. The result is diluted acid. You'll have to determine this through an analysis of the hydrometer test.

Now that you've gone over the battery system and know its condition the next in line for checking is the starter or cranking motor. Since it is subjected to heavy-shock loads, the bolts holding the unit to the motor block should be checked and tightened to the specs with a torque wrench.

**Starter-motor amperage draw.** The average 6-v. starter draws between 150 and 250 amps. As this is a very heavy current, special equipment is necessary to measure it. An instrument taking advantage of the inductive qualities of flowing electric current resulted in the design of the inductive ammeter, Fig. 8. Low in cost and simple to put in operation, it will give an adequate indication of the current flow in the starter circuit. The 12-v. system uses half the current of the 6-v. system.

Place the meter yoke over the battery cable and take a reading as the starter motor is turned over with ignition off. If cranking is slow and the amp.-reading high, this would indicate mechanical friction or a grounded armature or field. Low amperage indicates a low battery or poor connection.

**Starter ground circuit.** It is important to check out the ground circuit. Since the starter-motor housing should be at the same electrical level as the grounded post on the battery, any loss or voltage drop can be measured between these two points, Fig. 5, also Figs. 6 and 7. More than .2-v. drop can mean a poor connection, wire gauge too small, or the cables are defective. In these checks the inexpensive portable starter switch, Fig. 12, enables you to control the starter without a helper. The full-load voltage is also an indication of the cranking voltage. Only when battery capacity is checked outside of the car is it necessary to make a separate check.

**Loss at connectors.** While clean connectors reduce voltage loss to the minimum, special tests must be used occasionally because of damage to cables due to corrosion that may not be visible. Also, correct cable size is necessary to avoid current loss. Using your voltmeter, check the voltage from the insulated battery post to the center of the solenoid battery terminal on the starter. Then connect the meter across the

*(Continued to page 206)*

# MAN ALIVE, YOU SAVE A FIVE

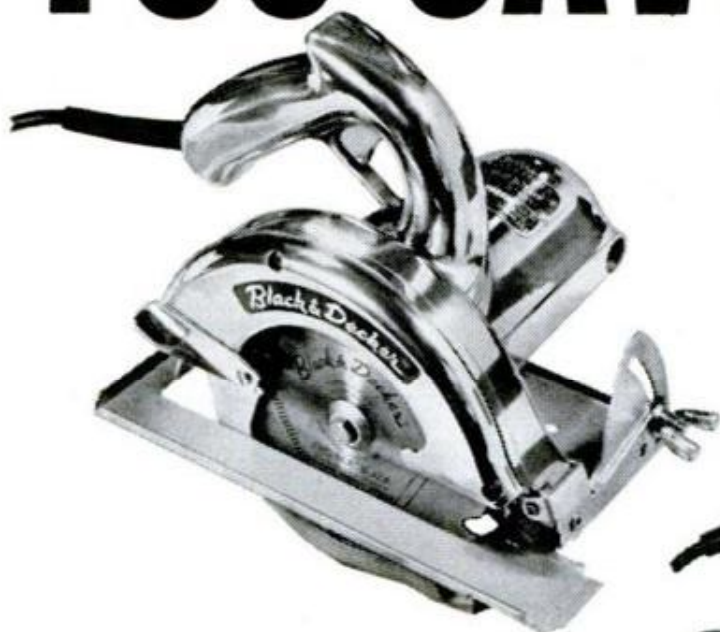

**\$5.00 OFF**

**Black & Decker 6 1/2" Professional Heavy-Duty Saw, U-336 (#63)** Industrially Listed by UL. 1.4 horsepower for durable Heavy-Duty performance. Zips through 2 x 4's, even at 45° bevel. Lubricant-seal ball bearings throughout. Perfectly balanced for one-hand operation. B&D-built motor for 115 volts, A.C. or D.C. 6 1/2" Combination rip-crosscut Blade.

**\$5.00 OFF**

**Black & Decker 7 1/4" Utility Saw, U-137 (#437).** Get big performance, quality construction . . . at low cost. B&D-built motor drives blade through toughest spots with 1.25 horsepower. Industrially Listed by UL. Cuts to 2-7/16" at 90°, 2" at 45°. Guided air-flow keeps cutting line clean. 115 volts, A.C. only. 7 1/4" Combination Blade included in low price.



All Black & Decker Saws are built to take it, and to dish it out. Calibrated depth, bevel adjustments and king-size shoes set the stage for accurate cuts. Powerful B&D-built motors make those cuts fast. Safety features include telescoping blade guard, instant-release trigger switch, 3-conductor cable and plug. Every B&D Saw is backed by the Black & Decker Guarantee of quality materials and workmanship. Own the best; buy the best . . . Black & Decker.



B&D 6 1/2" Utility Saw, Model U-136 (#430)—1.0 hp.



B&D 7 1/4" Professional Heavy-Duty Saw U-337 (#730)—1.9 hp.



B&D 8" Professional Heavy-Duty Saw U-338 (#830)—2.0 hp.



Send 25c for 180 pg. booklet, "How to Choose & Use Power Tools" to: The Black & Decker Mfg. Co., Dept. D-032, Towson 4, Md.



**Black & Decker**

WORLD'S LEADING MAKER OF POWER TOOLS AND  
THE WORLD'S FIRST CORDLESS ELECTRIC DRILL



## Use Weldwood Spar Varnish



... when it'll be out in the rain



... scorched by the hot sun



... attacked by salt!

Rain. Ice. Sunlight. Salt air. Weldwood® Spar Varnish beats them all. It's unexcelled for toughness and durability, by actual lab tests. Resists yellowing, discoloration, checking and cracking—even under the severest conditions. And it also resists fungus and mold! For sidings, boats, outdoor furniture, sports equipment—use Weldwood Exterior Clear Spar Varnish—it protects as it beautifies.



Products of United States Plywood



solenoid motor terminal and solenoid battery terminal. More than 2-v. variation in either test indicates excessive resistance. If the solenoid fails to operate, check for resistance in the solenoid control circuit by closing the starter switch and hooking up the meter from the solenoid-battery terminal to the solenoid-switch terminal. Readings in excess of .75 v. (6-v. system) and 2.5 v. (12-v. system) show excessive resistance. If these figures are not exceeded and the solenoid is inactive, then connect the meter from the ground to the solenoid switch terminal. This should activate the solenoid if the reading is slightly higher and solenoid isn't warm.

If these checks don't add up to a perfect score then there's the question, overhaul the starter motor or replace it? When anything other than replacement of brushes and cleaning is necessary it's safest to replace the starter with a rebuilt unit. This also is a recommended procedure for generators, voltage regulators, carburetors and fuel pumps that prove to be defective under test. ★ ★ ★

## Bumpers for Spaceships

Meteor bumpers on spaceships will be needed to provide psychological protection for astronauts, according to the director of the Smithsonian Astrophysical Observatory at San Antonio, Texas.

Dr. Fred L. Whipple said that the sound of tiny "cosmic puff balls" exploding on the surface of the fast-moving space craft might unnerve the occupant, especially near the earth where the concentration of space dust is heaviest.

He suggests that a thin outer shell around the major walls of the space vehicle would insulate it from the sound, and it might also protect the wall itself from pinholes that some of the meteors could punch in it.

## Russia Expands TV System

There will be 15 million TV sets in Russia by 1965, according to a writer in the Soviet magazine *Literature and Life*. There are now three million sets picking up signals from 70 stations. Prof. P. Shmakov says the relay system will be greatly expanded during the next three years and there will be 160 stations. Additions include three new studios in Moscow, two to transmit programs in black and white and a third for color broadcasting. There will be an increase in the use of television for cultural services and in the interests of science, technology and the national economy, says Professor Shmakov.

# GRAVELY & YOU—power partners!



**GRAVELY**  
doesn't give  
up  
when the  
going gets  
tough!



Performance—Power (6.6 hp)—Productivity . . . that's what your Gravelly power partner gives you. The satisfaction of seeing your place kept perfectly, the garden green and growing clean . . . every tough job licked with power! You'll be proud of your partner, proud of your place, proud of yourself.

You get performance. No pushing, pulling or pampering. You just ride it or guide it. Your Gravelly partner powers 30 different tools and attachments. Tools designed for maximum power and performance at the job. When you have a Gravelly, you get the job done better, faster, easier. (Optional electric starter, too.)

Get the facts before you buy—from Gravelly's big 24 page "Power Vs. Drudgery" booklet. See how Gravelly proves it's best for you before you buy! Write now!

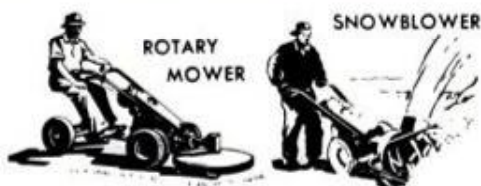

ROTARY  
MOWER

SNOWBLOWER

## GRAVELLY TRACTORS

DIVISION STUDEBAKER-PACKARD CORPORATION

P. O. BOX 601-C

DUNBAR, W. VA.



Sold & Serviced by Authorized **GRAVELLY DEALERS**—our 40th year!

*Sands twice  
as fast...*



... as any other sander at its price

## NEW *Weller* HI-POWERED SANDER

Powerful performance at low price is made possible by Weller's new *heavy duty* reciprocating motor. Full  $\frac{5}{32}$ " stroke—14,400 strokes a minute—and big 26 sq. in. sanding surface. Maintenance-free, too. No brushes, commutators or metal bearings to wear. Lubricated for life. And it's the *safest* sander on the market. Plastic handle, housing and plate, no exposed metal parts that can be energized, and 3-wire grounded power cord eliminate electric shock hazard. *Sands with the grain* for smooth finish unobtainable with circular or orbital sanders. *Guaranteed* 1 year.

Model 77 **\$19<sup>95</sup>**

At your Hardware Dealer

WELLER ELECTRIC CORP., EASTON, PA.

## Triple-Top Fun Table

(Continued from page 171)

Now to finish your fun table. First soften all edges by rounding slightly with medium garnet paper. Patch up any nail holes, dents or knot-holes, especially the voids in the edges of plywood. Allow patching compound to dry thoroughly before sanding down flush. Finally clean off all dust with a vacuum cleaner.

Remove cushions and pocket backs and mask off all areas not requiring a finish, including the casters. Take extra care in masking the felt bed. Use masking tape for sharp lines, along with newspapers for large areas. Remove sliding doors and substitute cardboard. A multicolor spatter paint, called Varichrome, was used to paint the original, Pepper-N-Salt (black and white) being used for the pool table and "Spring Song" (green) for the storage base. First apply the primer coat which is recommended for the color you choose. This dries flat in a matter of minutes. A roller is preferred to a brush when applying the primer to the perforated doors as a brush has a tendency to fill the holes. Spatter paint is applied with a spray attachment of your vacuum cleaner, and if you haven't tried this attractive novelty finish, you'll be surprised how durable a finish it is and how well it covers minor nicks and hides that "plywood look." Apply a clear primer of the type that tames wild grain to the inside surfaces of the storage units if desired. Use the primer also on both surfaces of the table-tennis top. Allow to dry thoroughly. Normally this takes overnight. Then apply at least two full coats of a non-reflecting table-tennis green paint, Fig. 41. Allow the paint to thoroughly set, 24 to 48 hrs. Mask off a  $\frac{1}{2}$ -in. strip for the four outside edges, and a  $\frac{1}{4}$ -in. strip lengthwise down the center, using newspaper along with the tape to cover the large areas. A spray can of flat white held over the top surface and directed toward the edge at about 45-deg. will give you a clean line without spray falling on the sides. Pull off the masking tape very carefully as soon as the paint has set. Paint the table crossrails to match the table-tennis top and the HO-ga. layout. ★ ★ ★

### PLANS ARE AVAILABLE

If you would like to build this Fun Table but have missed parts I, II and III of the series in the December, January and February issues of the magazine, a set of plans, plus an instruction booklet, is available. Write Blueprint Dept., Popular Mechanics, 200 East Ontario St., Chicago 11, and enclose \$3.50.



Buy Your  
**WINCH**  
as Carefully as  
You Buy Your  
**TRUCK!**

Buy the *right* winch for the *right* truck. Buy a BRADEN Winch and be sure. BRADEN... considered the leader in winch manufacturing... has pioneered more improvements in winch design than any other company. BRADEN'S Oil Cooled, Fully Automatic Safety Brake, for example, has never been equalled for quality and safety. If you buy your winch as carefully as you buy your truck, you'll insist on BRADEN.

▶ Look in the Yellow Pages for name of your BRADEN Winch distributor, or write direct to the factory for complete information.

Nation-wide Service Available on all BRADEN Winch Products

**BRADEN WINCH** DIVISION OF  
LYNN LANE AND DALLAS AVE. • BROKEN ARROW, OKLAHOMA NAUTEC CORPORATION

# BRADEN

Your BEST Winch Buy

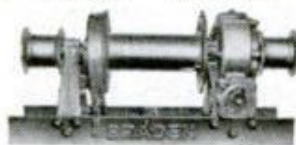

**UPRIGHT MODELS** — Designed for behind cab mounting. Capacities from 8,000 to 100,000 lbs.

**UNDERSLUNG MODELS** — Range from 8,000 to 30,000 lbs. capacity. For front end mounting.

**FRICTION CLUTCH MODELS** — Capacities range from 5,000 to 16,000 lbs. Ideal for small trucks.

**SPECIAL MODELS** — Constant load, constant speed model specially designed for electric utility and telephone industry application.



# GENUINE ALNICO MAGNETS

**AMAZING, PERMANENT, NON-ELECTRIC, HIGHLY PRACTICAL.** Conduct interesting experiments. Hundreds of uses. Retrieve valuable steel items such as guns, tackle from fresh or salt water; tools from tanks & drains. **GUARANTEED.** Try any magnet one week.

Money back if you are not well-pleased.

M-90 (Wt. 3 oz.)	Has pull of 15 lbs. on steel block	..... \$ 3.50
M-500 (Wt. 13 oz.)	Has pull of 50 lbs. on steel block	..... \$ 5.00
M-275 (Wt. 18 oz.)	Has pull of 75 lbs. on steel block	..... \$ 7.00
M-625 (Wt. 70 oz.)	Has pull of 125 lbs. on steel block	..... \$10.00
M-710 (Wt. 53 oz.)	Has pull of 225 lbs. on steel block	..... \$18.00
M-44 Rod Magnets for Electric Guitars 1/4" Dia. x 1 1/4" L	.....	\$ 4.00
M-47 Hot Pad Magnets, 10 for \$1.00	.....	\$ 4.87
M-35 Science Experimenter Kit of 8 magnets	.....	\$ 2.00

Send M.O. or check. We pay postage. Sorry no C.O.D.'s.

MIAMI MAGNET COMPANY, 3240 N.W. 27th Ave., Miami 42, Fla.

Send for your free WHERE-TO-FIND-IT list giving sources of supply or further information on articles in this issue.



Take the "rub"  
out of refinishing  
peel paint off  
WITH  
**KLEAN-STRIP  
PAINT REMOVER**

- Fast • Clean • Non-inflammable
- One application removes many coats

THE KLEAN-STRIP CO., INC.  
Memphis 6, Tenn.—Winnipeg, Man.



Why borrow?  
**Speedy Sprayer**  
now only \$34<sup>95</sup>



New! Speedy Sprayer Outfit complete with motor, ready to plug in and spray! Pays for itself on your first big paint job. Does an hour's work in minutes—spray fences, screens, shutters, furniture, rough walls, floors, etc. Smooth, flawless finish. A real professional tool! Ask for "Compact" 404. Write for "How to Spray" and folder.

**W. R. BROWN CORP.**  
Specialists in Portable Sprayers Since 1921  
2635 North Normandy Avenue • Chicago 35, Illinois

## Make Your Own Banjo

(Continued from page 161)

until the ends meet in a butt joint, clamping the cauls in place as you go. Leave the clamps on for a time as contact cement attains its greatest strength after it "ages" a few hours.

Then remove clamps, cauls and the flat-steel cleats. Loosen the halves of the form from the shell by pressing a pocketknife blade between the inner edge of the shell and the outer edges of the form halves. Once loosened all around, the halves should drop out. Pull the nailing blocks free, catch the projecting ends of the brads with pliers and pull them out of the shell, working carefully so that you do not split the wood. Snip off any brads that will not pull easily and file flush. Finish the edges of the shell to a uniform width and soften the corners with fine sandpaper.

The balance of the construction will be quite clear from Figs. 2 through 6. The neck, Fig. 2, is cut to rough form from a piece of selected mahogany about  $2\frac{3}{8} \times 2\frac{1}{2} \times 24$  in. Work the piece down to the dimensions given, paying special attention to the sectional shapes, lower detail, Fig. 2, and to the shape and finish of the headpiece, Figs. 2 and 3. Note that the neck is grooved on the top face to take a steel spine, one end of which extends past the fingerboard into the headpiece. This projection is covered with a  $\frac{1}{8}$ -in. plywood overlay which is glued to, and becomes a part of, the headpiece, Fig. 3. Sand all surfaces glass-smooth.

### The Fingerboard

The fingerboard, Fig. 5, is a guitar fingerboard adapted to use on a banjo by cutting it down to the size and shape indicated by the dotted lines. The fingerboard and the nut, Fig. 3, are attached to the neck with glue. Now, note closely the assembly sectioned in Fig. 4, which shows how the neck is attached to the shell. Drill the through hole for the tension rod, which is a  $\frac{3}{8}$ -in. threaded rod available from any hardware store, on the joint of the outer lamination of the shell. The hole taking the inner end of the rod is drilled only about halfway through the shell. The outer end of the rod cuts its own threads in a tap-size hole drilled into the big end of the neck. After turning it in tightly drill the tap-size hole for the locking bolt, Fig. 3, right through the tension rod and then tap the hole in both the wood and metal. Countersink the hole for the locking bolt and turn the bolt in tightly. Draw the nuts on the tension rod moderately tight and nick the threads so that they cannot loosen.

Now, note closely the relative positions

of the counter hoop, tone ring and calfskin head in Fig. 3. These parts assemble as in the sectional view, Fig. 6. Here ordinary eyebolts and screw eyes are used as counterhoop clamps, each eyebolt being altered to suit the purpose by cutting away about one third of the eye as in Fig. 6. The location of the holes for the screw eyes in the shell is not detailed in Fig. 3. The position of the holes must be determined after altering the eyebolts. You can, of course, purchase ready-made clamps, also the hoop and tone ring.

Note that the ends of the tone ring meet in a V-joint, while the ends of the counterhoop overlap and are scarved (or skived, if you like). Note also that the top edge of the hoop is beveled as in Fig. 6. This can be done quite accurately with a file. The hoop, being one of the exposed parts, should be highly polished. The wood of the neck should be finished in the natural color with several coats of violin-maker's varnish or a bar-top finish which is semigloss. Addition of the pegs, tailpiece, bridge and strings completes the instrument.

If you'd rather work from a kit, then everything needed, which includes all the parts and materials, is available in kit form for \$19.95 postpaid from Musicraft Studios, 823 Foster St., Evanston, Ill. ★★

**SOURCES OF SUPPLY** and information on articles are published in the free **WHERE-TO-FIND-IT** list. Send stamped, self-addressed envelope to **SERVICE BUREAU, 200 E. Ontario, Chicago 11, Illinois.**

### Built-In Fire-Burglar Alarm

Set off at temperatures above 132 degrees, a fire-alarm system includes a prowler switch which can be flipped to make known the presence of burglars.

A typical system includes four heat detectors, about the size of a dime, mounted in the ceiling in susceptible areas. The main control panel can be mounted anywhere out of view. The wiring is also hidden.

The alarm goes off when the air temperature reaches 132 degrees, well below the level of ordinary flames (paper burns at 363 degrees). The warning is sounded by an alarm bell, heard throughout the building. As optional equipment, there's a red flashing roof-top light.

The system plugs in like any electrical appliance, or is permanently connected. The burglar switch is usually in the bedroom.

The system, which sells for \$113.61, is made by Security Devices Co., 911 Rosehill Drive, Altoona, Pa.



# TRIGGER A NEW TEMPEST LE MANS FIRE ALL FOUR BARRELS!

There's more to Pontiac's new Tempest LeMans than its bucket seats, comfortable as they are, or its full carpeting and special trim, handsome as they are. The real bomb in this baby lies up under the hood.

The standard four comes in 110, 115, 120 and 140 h.p. versions. But if you're willing to lay out a few dollars more, you can have yourself a four-throated version of Tempest's 194.5 cubic inch mill. This little jewel puts out more torque than any other production four in the world—215 ft.-lbs. at 2800 rpm. Maximum h.p. reads 166 @ 4800—again, more h.p. than any other production four in the world. That's a horsepower jump of 11 over last year. Those eleven horses come from improved carburetion, better velocity and distribution in the intake manifold and a freer breathing exhaust. It takes premium fuel, and it delivers premium performance.

Next time you've got a few minutes, drop in at your Pontiac dealer's and borrow a new Tempest for an hour. If he doesn't happen to have the four-barrel job handy, either the standard 4 or optional V-8 engine will do fine, just fine. Go find yourself some road and ease open the throttle.

And then see if you can say no to Tempest.

TOTAL TORQUE MULTIPLICATION\* WITH TEMPEST POWER TEAMS

TRANSMISSION GEAR RATIOS	REAR AXLE RATIO CHOICES				
	3.08:1	3.31:1	3.55:1	3.73:1†	3.90:1†
<b>3-SPEED MANUAL</b>					
1st—2.94:1	N.A.	9.73:1	10.44:1	10.97:1	11.47:1
2nd—1.68:1	N.A.	5.56:1	5.96:1	6.27:1	6.55:1
3rd—1.00:1	N.A.	3.31:1	3.55:1	3.73:1	3.90:1
Reverse—3.32:1	N.A.	10.99:1	11.79:1	12.38:1	12.95:1
<b>4-SPEED MANUAL</b>					
1st—3.65:1	11.24:1	12.08:1	12.96:1	13.61:1	14.24:1
2nd—2.35:1	7.24:1	7.78:1	8.34:1	8.77:1	9.17:1
3rd—1.44:1	4.44:1	4.77:1	5.11:1	5.37:1	5.62:1
4th—1.00:1	3.08:1	3.31:1	3.55:1	3.73:1	3.90:1
Reverse—3.66:1	11.27:1	12.11:1	12.99:1	13.65:1	14.27:1
<b>TEMPESTORQUE AUTOMATIC</b>					
Low (Plus Converter) 3.64:1	11.21:1	12.05:1	12.92:1	13.58:1	14.20:1
Low (Gears Only) 1.82:1	5.61:1	6.02:1	6.46:1	6.79:1	7.10:1
Drive—1.00:1	3.08:1	3.31:1	3.55:1	3.73:1	3.90:1
Reverse—1.82:1	5.61:1	6.02:1	6.46:1	6.79:1	7.10:1

\*The higher the total torque multiplication figure the faster the engine will be turning at a given road speed and the livelier the performance.  
†Must be special-ordered.

PONTIAC MOTOR DIVISION • GENERAL MOTORS CORP.

# TEMPEST BY PONTIAC

## Build the PM Jet

(Continued from page 157)

Next, lay out another line to cut the coaming edge of the shelf. Measuring from the sheer edge, mark points  $4\frac{1}{2}$  in. in at the transom,  $5\frac{1}{2}$  in. in at the seat back and  $2\frac{1}{2}$  in. in at the stem header. Connect these points with a batten bent to a fair line and mark this line. In order to provide support for the decking, move this line in about 1 in. from the header to station 2 and from the transom to a point about  $11\frac{1}{2}$  in. forward of it. Cut this coaming line with a bevel of 10 deg. opposite to that of the sheer bevel. Both the coaming and sheer bevels will be widest at the deck surface and taper toward the underside. Once the coaming bevel is cut, the sheer shelf can be clamped in place and secured. At the header use glue only, since the fore end of the shelf will require quite a bit of shaping when you fair the crown of the deck. Screws can be installed after you have completed this fairing.

### Mounting the Upper Chines

The upper chine and floor riser is mounted next. Bevel the floorboard edge of this member 15 deg. so it will fit flat against the underside of the floorboards and fasten it temporarily in place on the

bulkheads. Use a batten to mark on the inside that will come in contact with the lower chine, bending it over the bulkheads and holding it against the upper chine. Note the angle of bevel at each station and then remove the upper chine so that it can be sawed out to the marks you have made.

The lower, full-length chine is now added. While no beveling is needed to mount this member, you might bevel it about 8 deg. on the outside to reduce the amount of hand planing required later. Note that the bottom surface of the chine will be flat against the bottom planking and thus will require a minimum of planing. However, this means that there will be a slight twist in the member when it is mounted, so be especially careful when bending it. Mount the lower chine as you did the stringer and battens, using nails and glue to fasten it to the upper chine, and screws and glue to attach it to the bulkheads, transom and header. If you are careful, the bending required when mounting the chine can be performed without steaming the wood. Should you run into difficulties, pour a bit of hot water on stiff areas to make them bend easier. The bending job will be much easier if you fasten temporary cleats at the forward bulkheads so that

(Continued to page 214)

## NEED MORE ROOM?



## TURN A DRAFTY PORCH INTO A SPACIOUS YEAR-ROUND FAMILY ROOM

It's easy . . . when you remodel with Andersen Windows. They open wide to welcome sunshine and fresh air, close snug to create extra all-weather living space.

Get many more remodeling ideas free! Just mail the coupon below. For additional planning help, see your lumber or mill-work dealer.

**Andersen**  
**Windowalls**  
TRADEMARK OF ANDERSEN CORPORATION

**REMODELERS!** If you win BETTER HOMES & GARDENS' remodeling contest—and use Andersen Windows in your entry—we will refund the retail price of your windows.

**FREE!** Remodeling Ideas Book...  Check one or both  
Ideas for Window Beauty...

Andersen Corporation, Bayport, Minnesota

NAME \_\_\_\_\_

ADDRESS \_\_\_\_\_

CITY \_\_\_\_\_ ZONE \_\_\_\_\_ STATE \_\_\_\_\_

PM-32

For Perfect Painting

## DO IT YOURSELF!



"Pressure Maid"

### PORTABLE PAINT SPRAYER

Complete — ready to spray—with gun, hose, compressor, and motor. Gives you the features and performance of more costly units . . . fast, easy professional results every time. Also useful for inflating toys and tires, all-purpose spraying, etc. Displaces 4.7 CFM . . . delivers over 2.2 CFM at 40 psi.

Write for Catalog



The Campbell-Hausfeld Co.  
1046-0 Railroad Ave., Harrison, Ohio

**CAMPBELL-HAUSFELD**



### Solves Repair Problems

Durham's fills cracks and holes in plaster, wood and tile. Won't shrink or fall out. Economical, easy to use. Big 4-lb. can, only \$1.40 at lumber, paint and hardware dealers, or shipped direct postpaid in U. S. for \$1.75. Money-back guarantee. Order now. Donald Durham Co., Box 804-T, Des Moines, Iowa.

## DON'T TOSS IT OUT

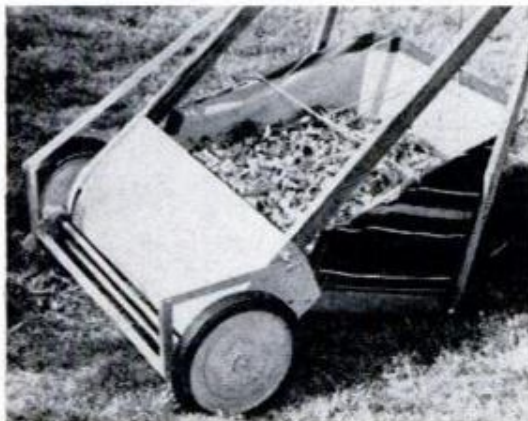

If a new power mower has relegated your old hand pusher to the junk heap, grab it quick. You can use parts from it to make a dandy lawn sweeper. Watch for this timely craft feature in

# APRIL

MARCH 1962

## WINEGARD ELECTRONIC TV ANTENNA INVENTION

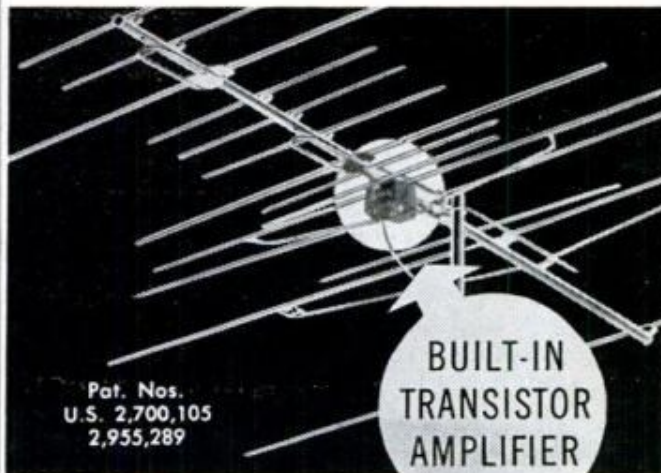

### GIVES YOU POSITIVE TV IMPROVEMENT

clears up snow and interference, increases reception distance.

The Winegard Powertron is a new *electronic* antenna that will make a big improvement in your TV reception. For instance, for long distances, the Powertron will pull in TV pictures hardly visible with an ordinary antenna.

There are two reasons for this unusual performance: The Powertron has a patented Electro-Lens system that intercepts and focuses TV signals on the collector element. Here the signal is *amplified* by a built-in transistor. The result: In most cases, you can enjoy more channels. Pictures that were poor to fair become sharper . . . brighter. Snow and interference is reduced. Excellent for color or black and white.

Besides being electronically superior, the Powertron is mechanically strong and will deliver fine performance for years. It has a lustrous gold anodized finish that won't corrode or turn dull. If you and your family want better reception, the Winegard Powertron is a wise investment. See your TV dealer, or for more information, send coupon for booklet.



Winegard Co., 3001-3 Kirkwood, Burlington, Iowa

- Send FREE booklet on Powertron
- Send folder on easy way to install TV antenna plug-in outlets in each room in my house.
- Send information on long distance FM reception.

Name \_\_\_\_\_

Address \_\_\_\_\_

City \_\_\_\_\_ State \_\_\_\_\_

My nearest TV station is \_\_\_\_\_ miles away

they can be used when clamping the chine in place.

You have now arrived at one of the most critical stages of construction — building the intake block, Fig. 8. To be absolutely safe, make a full-size drawing of the block and take all dimensions from this. The underside of the side pieces and filler block at the aft end should be beveled 6½ deg. The forward side of the filler block is at an angle of 90 deg. to the base, and the underside of the plywood piece forward is at an angle of 15 deg. to the base. Use plenty of glue when assembling the intake block and make sure that it's clamped tightly while drying.

Mount the intake block so that the forward edge of the aft filler block is not less than 10¼ in. nor more than 10⅜ in. forward of the inside face of the transom. *This dimension is critical.* Be sure to take the measurement square to the transom and parallel to the top of the intake block. Cut the aft end of the keelson to an angle matching the upper surface of the plywood face on the intake block and secure the block to the keelson. To complete the keel line, mount a filler piece measuring 1¼ x 2¼ in. between the aft end of the block and the transom.

You are now ready to fair the frame. Lay a straightedge across the keelson, stringers and chine at the angles indicated in Fig. 15. In each position, these angles will permit the straightedge to touch all members it crosses. Bevel all parts as indicated by the underside of the straightedge. The sides of the chines are beveled to follow the flare of the bulkhead and transom sides. The stem bevels are indicated by the straightedge and the shape of the header.

### Planking the Hull

After the frame has been faired, the planking can be done. Starting with the sides, Fig. 1, tack the first panel in place and mark it for cutting. It's a good idea to use one or two screws at each end so that the panel can be replaced in the same position after it has been cut. Now remove the panel and cut it slightly oversize to your marking. Check this panel on the other side of the frame before using it as a cutting pattern for the second side. Cover all side surfaces of the frame with glue (except the temporary molds) and mount the two side panels. When nailing into the chines, use a backing iron to properly set the nails without breaking the chines.

Once the chine edges of the side panels have been trimmed, you can install the bottom panels. If you want to be on the

(Continued to page 217)

## PM JET MATERIAL LIST

### LUMBER (Clear and free of knots)

- 2 pcs.—2 x 6 fir, 12' long: outboard stringers
- 2 pcs.—2 x 8 fir, 14' long: inboard stringers
- 1 pc.—4 x 4 fir, 10' long: keelson
- 2 pcs.—1 x 10 fir 16' long: sheer shelf
- 1 pc.—1 x 10 fir, 8' long: sheer shelf
- 1 pc.—1¼ x 6 white oak, 18' long: keel and stem band, spray mold
- 1 pc.—1 x 12 mahogany, 16' long: chines, battens, molds, fenders
- 1 pc.—1 x 12 mahogany, 6' long: chines, etc., as above
- 1 pc.—1 x 4 mahogany, 6' long: chines, etc., as above
- 1 pc.—1 x 6 mahogany, 12' long: chines, etc., as above
- 1 pc.—1 x 12 mahogany, 8' long: chines, etc., as above
- 1 pc.—1¼ x 12 mahogany, 8' long, header mold

### PLYWOOD (Exterior grade AB or better)

- 5 pcs.—¾" x 4' x 8' fir: bulkheads, transom
- 1 pc.—½" x 30" x 72" fir: seat, control-stand leg
- 2 pcs.—¼" x 4' x 4' fir: removable deck, control stand
- 4 pcs.—¾" x 4' x 18' marine fir: planking
- 1 pc.—½" x 25" x 37" mahogany: engine cover
- 2 pcs.—¾" x 4' x 8' mahogany: engine box, fore deck
- 3 pcs.—½" x 4' x 8' surfaced plywood (Harborite, or similar): floorboards

### HARDWARE, FASTENINGS AND MISC.

- 5—Hold-down clamps: windshield, engine cover
  - 2—3/32" angle mending plates: removable deck
  - 2—3/32" flat mending plates: removable deck
  - 1—Lift-ring bracket aft
  - 1—Lift ring
  - 1—Gas tank nipple
  - 1—Gas tank cap
  - 8 ft.—5/16" copper tubing: gas line
  - 1—Floorshift bracket
  - 1—Floorshift rod
  - 1—Floorshift lever
  - 1—Hand throttle (aircraft type) and cable
  - 1—Instrument panel
  - 1—Bilge pump switch
  - 1—Bow light
  - 1—Stern light
  - 1—Bow chock
  - 2—Stern chocks
  - 1—Light switch
  - 1—Steering wheel
  - 1—Bow eye
  - 1—Gas vent
  - 2—Vent covers (stainless steel)
  - 1—Bilge outlet
  - 1—Bilge pump and hose
  - 6—Swivel pulleys
  - 2—Stationary pulleys
  - 32 ft.—Steering cable
  - 1—Turnbuckle
  - 2—Seat cushions and backs with snaps for attaching to plywood seat
  - 3 pcs.—1" aluminum "J" molding, 12' long
  - 2 pcs.—¼" Plexiglas, 15" x 31"
  - 2—¾" piano hinges, 6' long
  - 1 pc.—¾" aluminum oval molding: quarter fender and cutwater
  - 1—Ignition switch
  - 1—12-v. battery
  - 2—Battery cables
  - 1—Battery box
  - 1—Engine wiring harness
  - 1—Dash wiring harness
  - 5 ft.—Exhaust hose
  - 2—Exhaust hose clamps
  - 1—Exhaust tube and flange
  - 3 qts.—Waterproof glue
  - 23—5/16" bronze carriage bolts, length to suit: installation of jet unit
  - 2½ lbs.—1" 12-ga. serrated bronze nails (Anchorfast, Stronghold, or similar)
  - 3 doz.—2" No. 10 F.H. brass wood screws: attaching stringers and keelson to bulkheads, transom, etc.
  - 1 gross—1½" No. 8 F.H. brass wood screws: attaching chines and battens
  - 6 doz.—1" No. 8 F.H. wood screws: attaching floorboards and transom cover
  - 1 pc.—½" perforated hardboard, 24" x 72"
  - 1—Gas tank, galvanized, either 20-ga. riveted and soldered or 18-ga. welded
  - Jet unit, drive shaft and engine
- NOTE:** If you are planning to build the PM Jet and would prefer to work from larger drawings than those included here, a set of plans on 2½' x 3' sheets will be available next month. To reserve a set of these plans, plus a booklet containing the text and photos, send \$7.50 to Popular Mechanics, Blueprint Department, 200 East Ontario Street, Chicago 11, Illinois.

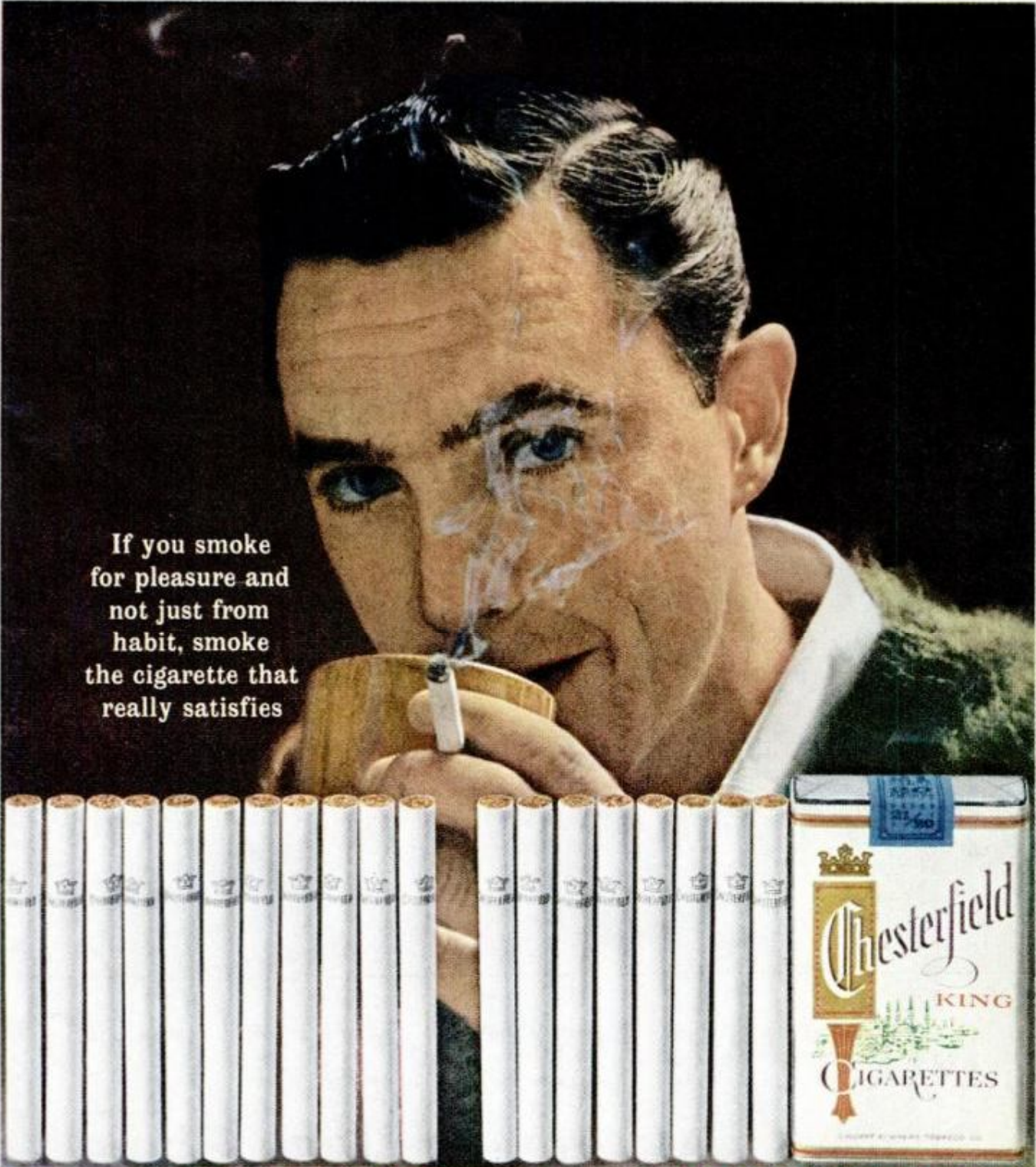

If you smoke  
for pleasure and  
not just from  
habit, smoke  
the cigarette that  
really satisfies



**21 GREAT TOBACCOS** make **20 WONDERFUL SMOKES!!**

**Here's the smoke for a man like you.** You'll go for the true satisfaction of this true cigarette. A Chesterfield is 21 great vintage tobaccos grown mild, aged mild, blended mild—*not* filtered mild. The goodness of 21 great tobaccos is not lost in a filter—*all* the flavor gets home to you. Your smoking pleasure is long, true and filter-free. The same great tobaccos are in both Regular Chesterfield and Chesterfield King. Whichever you choose you'll say . . . **THEY SATISFY!**



# NOTHING ELSE LIKE IT!\*

## Porter-Cable Power Block Plane

You can plane any surface . . . any edge . . . make bevel and rabbet cuts . . . do *dozens* of useful jobs with this new Model 167 Power Block Plane. It's a real problem solver—and it's the only one of its kind on the market.

Compact, lightweight, it fits in the palm of your hand easily. Truly a precision tool, it is built to last. A heavy duty motor and positive belt drive transmit 21,000 rpm to the big capacity steel and carbide spiral cutter at the flick of a finger.

See this amazing tool in action at your

*\*(But the idea is too good to stay exclusive)*

Porter-Cable dealer's today! He's under TOOLS, ELECTRIC in the Yellow Pages.

**FREE FOLDER** illustrates many outstanding features of the Model 167 Power Block Plane, write: Porter-Cable Machine Company, Subsidiary of Rockwell Manufacturing Company, 502C N. Lexington Ave., Pittsburgh 8, Pa. In Canada: Porter-Cable, Ltd., Box 817, Kingston, Ontario.



Материал, защищенный авторским правом



safe side, make a pattern of the forward half of each panel (where most of the curve is) from low-grade 1/4-in. plywood. Using this plywood pattern, cut the 3/8-in. panel slightly oversize and tack it in place. Make sure that the inner edge lines up perfectly with the centerline down the keelson, but leave a bit of extra material at the chine. Now coat all bottom surfaces of the frame with glue (again, excluding the temporary molds) and secure the first half of the bottom in place. You can avoid ripples or bulges in the planking by lightly securing the panel at either end with a few loose screws, then nailing from the middle of the panel toward the ends. Finally, use a saw to continue the shallow forward angle of the intake block through the plywood planking.

Before mounting the second half of the bottom planking, put the panel in place and recheck the fit, especially at the centerline. Trim as necessary and repeat the process of gluing and fastening, Fig. 17. After trimming surplus stock at the chines, plane a 1-in. flat strip down the centerline to receive the keel and stem band. To complete the planking, saw the plywood edge of the intake cutout to match the forward angle of the intake block, Fig. 18.

### Fiberglassing the Hull

If you plan to fiberglass the boat (and we strongly recommend it), this should be done before applying the keel and stem band, spray rails and sheer molds. Following the manufacturer's instructions, apply one layer of 8-oz. cloth with sufficient resin to bond and fill as required. When you have completed this step, the keel and stem band may be applied, Fig. 19. This should be a strip of white oak measuring about 3/4 x 1 in. Use bedding compound under the band, and fasten it with screws. An aluminum half-oval cutwater may be added, if desired, but not until the hull has been painted.

The spray mold is mounted next, Fig. 7, after which the entire hull should be primed and the bottom painted with a good quality marine paint, Fig. 20. Don't paint the sides yet, since some fastenings will have to be made through them when mounting the steering system and control stand.

Before turning the boat right side up, prepare a cradle matched to the underside contour so that it will support the hull at three places—the transom, station 5 and just forward of station 2. This cradle should be level, free of twist and padded so that it won't damage the finish.

Once the hull has been turned, you are

ready to mount the sheer mold and header mold. The sheer mold, Fig. 6, is made from 1 x 2 stock trimmed and beveled as illustrated. Use screws to mount it, running them through the mold and planking into the sheer shelf. Remember to use bedding compound under the mold. The header mold, Fig. 10, is cut from a piece of 1 1/4-in. stock wide enough to follow the curve of the bow. In order to fit the plywood planking, the inner surface of this mold must be beveled. The outer surface may be left square since it will be covered by aluminum molding. When mounting the header mold, make sure that its upper surface is even with the upper surface of the sheer shelf and bend it to a slight crown so that it will be slightly higher amidship. After applying bedding compound, attach this mold with screws running through the planking just above the header.

After fairing and trimming the edges of the header mold, the decking can be installed. Bevel the forward ends of the 1 x 2 deck beams to match the angle of the planking. After installing these, fair the crown of the deck with a batten bent to the correct curve. If you plan to fiberglass the sheer shelf for its full length, don't mount the 3/8-in. plywood fore deck until this job has been completed. The two pieces of the deck are joined at the centerline and overlap the sheer shelf about 1 in. so that the edge of the deck will be a continuation of the line formed by the outside of the coaming.

Construction of the *PM Jet* will be concluded in the April issue.

---

### Camera Stops Light Beams

Events lasting a few micromilliseonds are caught by a camera that converts them from an optical to electronic image, then reconverts them to an optical image for reproduction on film. Even a light beam can be stopped and photographed at several points along its path.

The camera's lens focuses light from an object on the photocathode of a converter tube. There the focused light is converted from an optical to electron image. The electrons carrying picture information are next focused and accelerated to a fluorescent screen at the end of the tube, where they are reconverted to an optical image.

The camera, developed by Space Technology Laboratories, can take both frame and streak photos. With it, scientists expect to photograph some heretofore unobservable events. It may be able to measure the speed of light to an accuracy of one part per million, important in space calculations.

# Test your automotive I.Q!

QUICK QUIZ BY QUAKER STATE

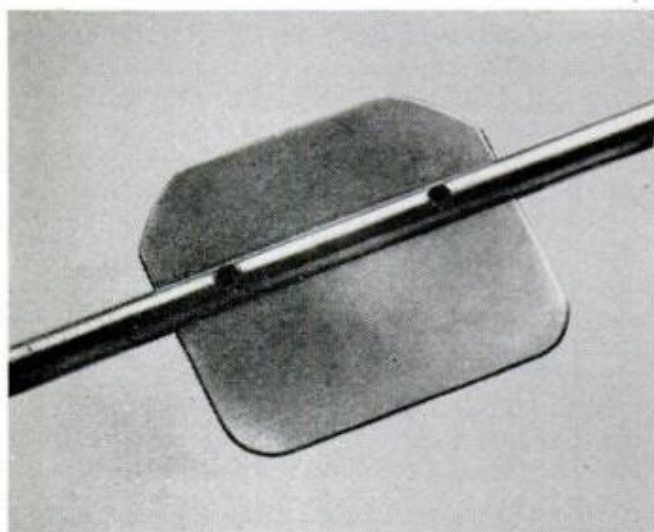

1. Recognize this part found on your automobile?



2. What does this symbol stand for?

The picture at top is a close-up photo of the butterfly valve of a carburetor. The life preserver stands for Quaker State Motor Oil—because it is the best engine life preserver. Refined from 100% pure Pennsylvania Grade Crude Oil, it keeps your car on the road, out of the repair shop—and saves you money. Insist on Quaker State—the best engine life preserver.



QUAKER STATE OIL REFINING CORP., OIL CITY, PA.

## Your Life Preserver

(Continued from page 137)

around the bottom. While both vests are classed alike, the newer yoke type is becoming increasingly popular, since many boaters find it more comfortable to wear, especially when sitting, because it has no pad behind the wearer's back.

Both vests did a good job of floating PM's tester face up and head out of the water, though the yoke vest worked best on an "unconscious" swimmer. The collar on the yoke vest helped turn him upright no matter how he hit the water, and supported his head better in a dead-man float.

While both vests are good, neither is efficient if it isn't worn properly, with all ties fastened and all straps snugly in place. Worn loose, the vests slid up around the wearer's neck, where they got in the way and lost flotation value. They're not very comfortable out of the water.

Both vests made swimming difficult. Their face-up flotation and bulk across the chest made forward strokes of the arms both awkward and tiring. A backstroke proved the best way to swim in either type.

### Buoyant Cushions

Most commonly used—and misused—of lifesaving devices is the buoyant cushion. It's also least expensive and most convenient, but least satisfactory from a lifesaving standpoint. The familiar cushion, about 15 inches square and two inches thick, with grab straps on two opposite sides, is great to sit on, handy for an emergency fender, and easy to throw to a swimmer in the water. It's almost ideal—until you get in the water with it. Then it becomes a tricky, slippery bit of flotation that's hard for even a good swimmer to use, and a real workout for a nonswimmer.

Properly used—with both arms through the straps and the cushion against the chest, or one leg and the opposite arm through the straps and the cushion against the chest—it makes fair flotation. But it won't hold your head up in either position, and you can't swim well with it by any method. While it will buoy you up as long as you can hold on, the cushion certainly isn't for kids, nonswimmers, or an unconscious or injured accident victim.

One big trouble with the cushion is that, since you're not attached to it, you may not go into the drink together. A good trick, if danger threatens, is to tie one of the grab straps loosely to a belt loop with a length of light line so you'll stay together. One deluxe model now on the market has a light harness snap on one grab strap for just that purpose.

(Continued to page 220)

IDAHO WHITE PINE ■ PONDEROSA PINE ■ LODGEPOLE PINE ■ SUGAR PINE ■ LARCH ■  
 WHITE FIR ■ DOUGLAS FIR ■ ENGELMANN SPRUCE ■ RED CEDAR ■ INCENSE CEDAR

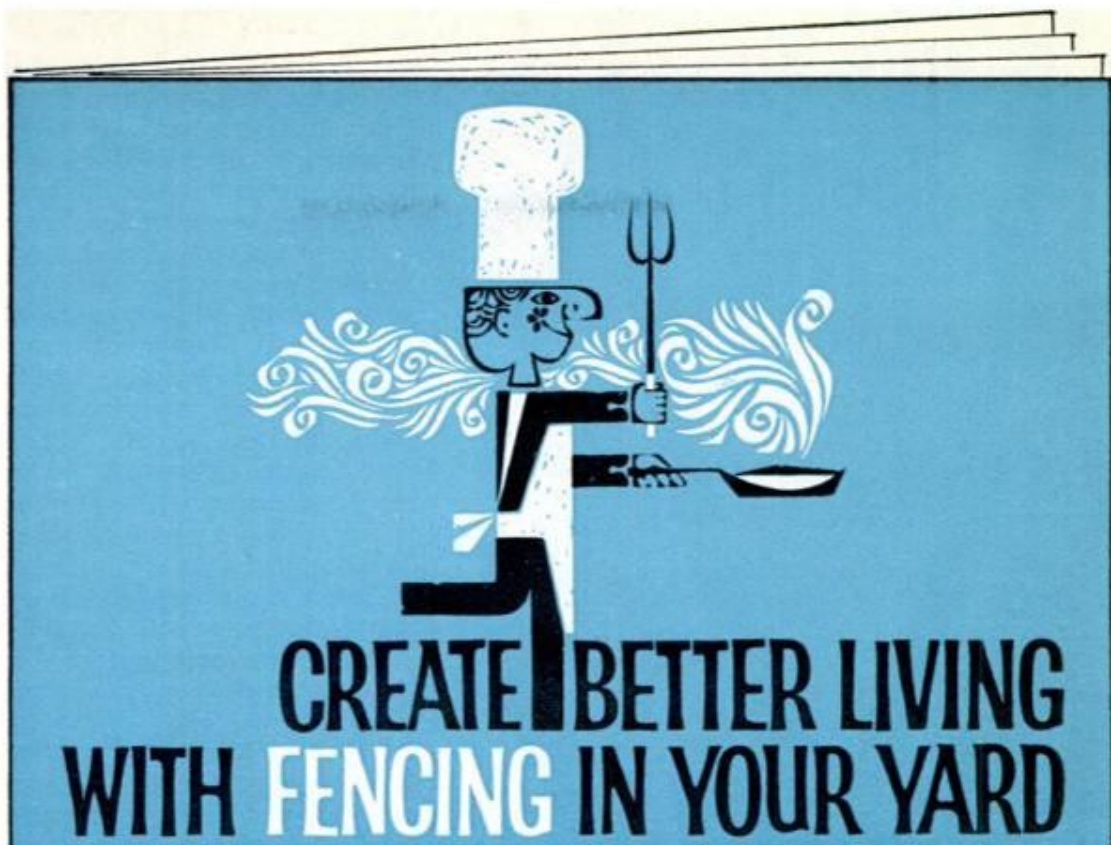

Get your ideas in this **FREE Booklet** (available *now* at your building supply dealer's). Create new privacy and protection for your family. Improve the appearance of your property. See how you can control sun and wind with attractive screens. Here are easily-followed construction plans for patio, garden and play areas . . . how-to-do-it tips and materials specifications. **Western Pine Region Solid Lumber** will give you lasting satisfaction with your yard project. These remarkable woods are the world's finest for sawing, shaping, sanding and finishing. Specify them for a job you'll always consider well done.

**WESTERN PINE ASSOCIATION**  
 QUALITY GRADED LUMBER ■ M-7 Yeon Building ■ Portland 4, Oregon

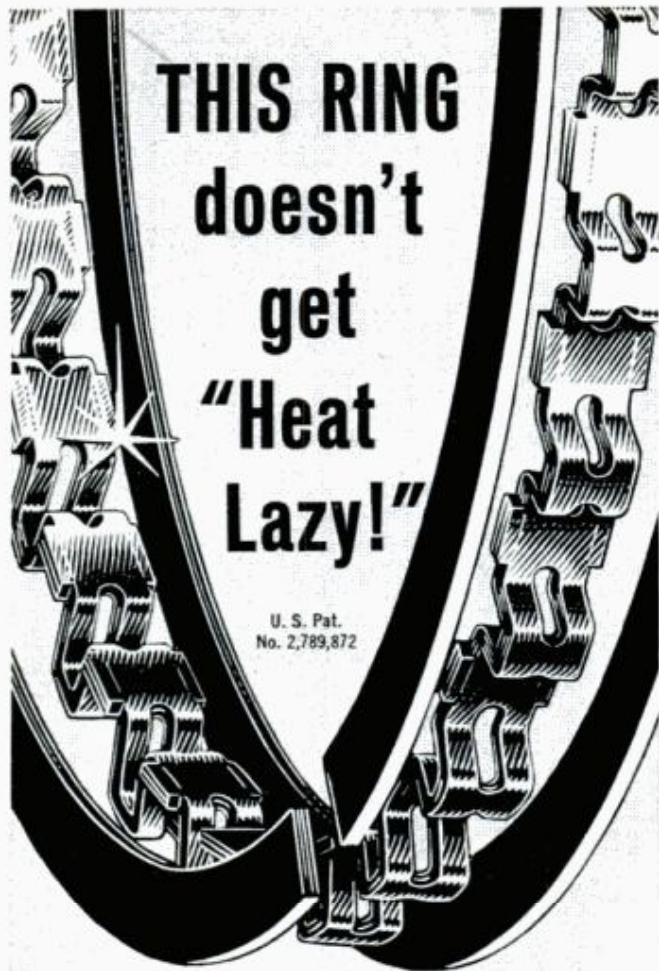

**THIS RING**  
**doesn't**  
**get**  
**"Heat**  
**Lazy!"**

U. S. Pat.  
 No. 2,789,872

■ Two main causes of oil consumption are: (1) loss of ring tension, and (2) plugged oil rings. It's easy to prevent them—simply install a Sealed Power KromeX ring set with Stainless Steel oil rings. Then you get *lasting* penny-pinching oil control.

■ Stainless Steel is a superior metal. It retains tension at high operating temperatures, holds its fit.

■ Sealed Power electro-polishes the Stainless Steel oil rings. They are glass-smooth, stay smooth because Stainless Steel doesn't pit or etch from action of combustion gases. Oil rings don't plug or clog. They stay clean and shiny for free flow of oil, better lubrication, less friction and less wear.

■ These rings are a cinch to install. Proven end-abutment design ends groove depth problems. Proper tension is produced without contact with bottom of the piston groove. Why settle for less? Sealed Power Corporation, Muskegon, Michigan.

**Sealed Power** Stainless Steel  
 oil rings stop oil pumping

Maybe the biggest problem with cushions grows out of their many uses. After a few seasons of being sat on, stepped on, soaked, and used as bumpers and fenders, the plastic film bags can rupture or be punctured, allowing air to escape and water to enter, and the cushion loses its buoyancy. So if you depend on cushions, either use them gently or plan to replace them occasionally.

A popular compromise between flotation, freedom and comfort is the water skier's buoyant belt. Worn around the waist, it provides good flotation for a swimmer, especially when treading water or waiting to be picked up on skis. But the belt is not Coast Guard approved. It will not hold your head out of the water, and will float you face down if you land that way. Skiers can wear the belt while behind the boat, and keep an approved lifesaving device aboard to comply with the law. Be careful, though. Some state and local laws insist on an approved device.

### Inflatable Devices

There are many other lifesaving devices, lacking Coast Guard approval but often useful to supplement approved devices. Most are inflatable, and no inflatable device can be approved. But their easy portability and quality for being built-in makes them handy, as with the inflatable fisherman's vest shown on page 137. The vest can be filled by a CO<sub>2</sub> cartridge or by mouth, and supplies flotation for one man in addition to its regular job of holding small tackle handy on his chest. While it's no substitute for an approved lifesaving device, it can certainly *supplement* the regular equipment; a fisherman can wear the vest and sit on a buoyant cushion and be doubly safe. Remember, though, that an inflatable device can be punctured.

Another effective supplementary safety device tested was a hunting jacket insulated with foam rubber sealed in plastic film. Both the jacket and its matching yellow rubber boots are buoyant—a good idea for cold-weather boaters, duck hunters, and winter fishermen.

A good approved vest can cost as little as \$4; a true life preserver around \$6; a buoyant cushion as little as \$2.50. You can spend a lot more, of course, but the flotation value doesn't increase with the cost. Few devices cost as much as a tank of outboard fuel.

Like insurance, lifesaving devices are hard to value. If you don't need them, they're useless, even a bother. If you do need them, they're priceless. Get the type that suits your need, then take it swimming and try it out. You might be glad you did.

★ ★ ★

# EMERSON ELECTRIC

## PORTABLE WELDER High Capacity ... Low Price

Ideal for farm, home workshop. Cuts, brazes, solders, welds. One man can carry ... only 68 lbs. 9 welding heats up to 180 amps ...  $\frac{3}{32}$ " to  $\frac{3}{16}$ " rod sizes. Write today for prices and receive **FREE WELDING SELECTOR GUIDE** ... gives working data you need in seconds! DEPT. PM-3



EMERSON ELECTRIC of St. Louis  
8100 Florissant • St. Louis 36, Mo.

Works  
in  
seconds!



Loosens Rusted Bolts  
nuts, screws, "frozen" parts!

## LIQUID WRENCH® SUPER-PENETRANT

The super-penetrating rust solvent that quickly loosens rust and corrosion.

AT ALL HARDWARE  
AND AUTO STORES

RADIATOR SPECIALTY COMPANY  
CHARLOTTE, N. C.



## Kiddies' Cartoon Show

Batteries and a spring motor power a tiny movie projector that shows cartoon film strips made especially for the unit.

The film strip moves slowly before two lenses mounted one above the other. A small metal curtain moves up and down to let images project onto the screen, alternately from the top and bottom of the film — causing the cartoon figures to move.

The projector is \$4.95 and film 60 cents from Hertvy Co., Rego Park 74, N. Y.

MARCH 1962

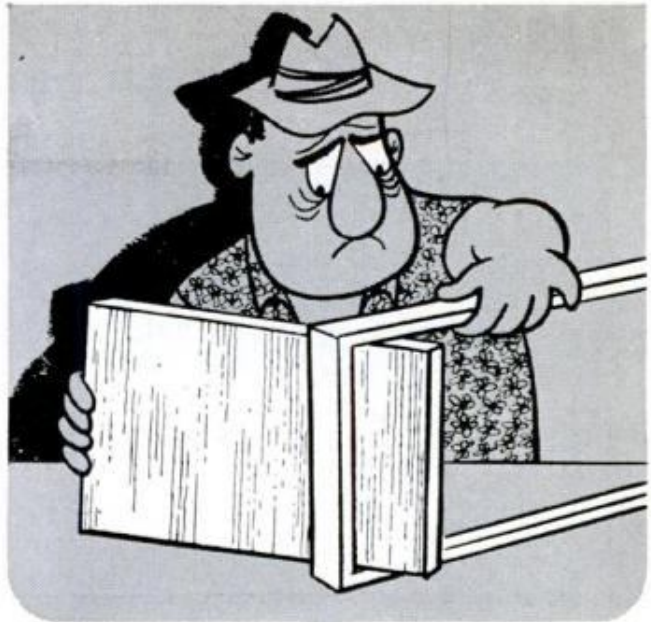

Do it the easy way —

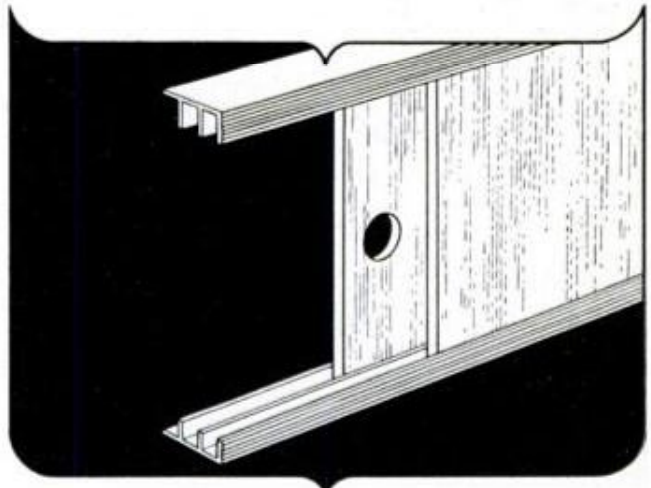

## with Reynolds Do-It-Yourself Sliding Door Track Set!

Reynolds Do-It-Yourself Sliding Door Track Set is designed to slide easily, eliminate counter-sinking of screws. Pre-packed in 4' or 6' lengths, complete with screws, for  $\frac{1}{8}$ ",  $\frac{1}{4}$ " or  $\frac{1}{2}$ " materials. Longer top lip provides handy "lift out" feature for easy removal of doors. And Reynolds Do-It-Yourself Aluminum is endorsed by leading hand and power tool manufacturers. Look for it in the hardware department of your favorite store.

Watch Reynolds exciting TV programs on NBC.

REYNOLDS METALS COMPANY  
RICHMOND 18, VIRGINIA



221

# IDEA PROJECT INFORMATION CENTERS

CHECK THIS LIST FOR THE ONE NEAREST YOU

**LOOK FOR THIS SYMBOL**  
*on their door or window*

**IDEA PROJECT**

MINIMUM MAINTENANCE  
FOR MAXIMUM LIVING

POPULAR MECHANICS

**CENTER**

The lumber and building supply dealers listed below, who display the Idea Project symbol, are the best sources in your area for further product and cost information on the PM Vacation Home. We highly recommend their services to you for this and other Idea Projects you'll see in Popular Mechanics during the coming year.

## ALABAMA

**Jasper**  
North Alabama Lumber  
Co.  
201 West 22nd St.

## ALASKA

**Anchorage**  
Spenard Builders Supply,  
Inc.  
4412 Lois Drive

## ARIZONA

**Scottsdale**  
Hamman McFarland  
Lumber Co.  
6425 East Thomas Road

## ARKANSAS

**Crossett**  
Pierce-Grassi Lumber  
Co., Inc.  
503 West 1st Avenue

## CALIFORNIA

**Marysville**  
Speckert Building Sup-  
plies, Inc.

**Montebello**  
Willis Cashway Lumber  
Co.  
1919 Whittier Blvd.

## COLORADO

**Durango**  
Federal Lumber Co.

**Grand Junction**  
Harbert Lumber Co.  
204 North Avenue

**Littleton**  
Littleton Lumber Co.  
5250 South Santa Fe

**Sterling**  
Broadway Lumber Co.  
101 Broadway

**Wheatridge**  
Wheatridge Lumber Co.  
8995 West 44th

## CONNECTICUT

**Hamden**  
Centerville Lumber Inc.  
2308 Whitney Ave.

## IDAHO

**Caldwell**  
McNeel's  
1024 Arthur St.

**Idaho Falls**  
Bonneville Lumber Co.

## ILLINOIS

**Belleville**  
Signal Hill Lumber &  
Hardware  
9300 West Main

**Bloomington**  
West Side Coal &  
Lumber Co.  
1111 West Market St.

**Blue Island**  
Mathieu Building Center,  
Inc.  
14300 South Western Ave.

**Blue Mound**  
Blue Mound Lumber Co.

**Cambridge**  
Clifford & Clifford

## Chicago

Gee Lumber Company  
2600 West 79th St.  
Republic Lumber Co.  
5584 Northwest Highway

**Evanston**  
Evanston Builders  
Lumber Co.  
1001 Sherman Ave.

**Fulton**  
Brinkman & Pessman  
Lumber Co.  
R. R. 1

**Harrisburg**  
Harrisburg Lumber Co.  
2 blks. North of Square  
on Vine St.

**Jacksonville**  
Henry Neich and Son, Co.  
725 East College

**Joliet**  
Cash & Carry Lumber Co.  
816 South Gardner St.  
I. N. R. Beatty Lumber Co.  
North Broadway &  
Chaney

**Kankakee**  
Troup's Building Center  
111 East Oak St.

**Marseille**  
I. N. R. Beatty Lumber Co.  
322 Main St.

**Morris**  
I. N. R. Beatty Lumber Co.  
824 Liberty Street

**Mossville**  
Hunter Lumber Co.

**Mt. Olive**  
Ervin J. Niemann Lumber  
Co.  
500 East 1st South Street

**Oak Lawn**  
I. N. R. Beatty Lumber Co.  
9537 South 52nd Avenue  
I. N. R. Beatty Lumber Co.  
5167 West 95th Street

**Orland Park**  
I. N. R. Beatty Lumber Co.  
9730 143rd Street

**Peoria Heights**  
Peoria Heights Lumber  
Co.  
838 East Glen

**Pontiac**  
I. N. R. Beatty Lumber Co.  
703 East Howard Street

**Rock Falls**  
Cashway Lumber Co.  
405 Emmons Ave.

**South Holland**  
Wausau Lumber &  
Coal Co.  
236 East 161st Place

**Tinley Park**  
I. N. R. Beatty Lumber Co.  
6721 North Street

**Waukegan**  
Mackemer & McBroom  
123 West Walnut

**Wilmington**  
I. N. R. Beatty Lumber Co.  
Kankakee Street

## INDIANA

**Aurora**  
The Wright Lumber Yard  
Third St. & B & O R.R.

**Chesterton**  
Dunes Lumber & Supply  
Co.

**Columbia City**  
Columbia City Builders  
Supply Co.  
414 South Line St.

**Columbus**  
Wendel's, Inc.  
1416 Sycamore St.

**Decatur**  
Arnold Lumber Co., Inc.  
425 South Winchester St.

**East Chicago**  
Indiana Harbor Lumber  
& Coal Co. Inc.  
3440 Watling Street

**Frankfort**  
Kramer Brothers Lumber  
Co.  
608 West Washington St.

**Ft. Wayne**  
South Side Lumber Co.  
4928 South Hanna

**Gary**  
Grant Street Lumber &  
Supply Co.  
3883 Grant Street

**Greentown**  
Hamer Lumber Co.

**Indianapolis**  
Builders Lumber Co.  
1560 Massachusetts Ave.

**Middletown**  
Middletown Lumber &  
Builders Supply  
107 South 8

**Portage**  
Willow Creek Lumber Co.

**Rensselaer**  
The Lumber Co. of  
Rensselaer, Inc.  
Cullen & Vine

**South Bend**  
Eckler Lumber Co.  
1406 South Franklin St.

**Valparaiso**  
Smith-Nuppenau Company  
360 Indiana Avenue

## IOWA

**Algona**  
Ready Mix Concrete &  
Lumber Co.

**Carroll**  
Kanne Lumber & Supply  
Co.  
814 West Ninth

**Marshalltown**  
Marshall Lumber  
312 South 1 Avenue

**Waterloo**  
Shepherd Lumber Co.  
1162 East Fourth

## KANSAS

**Abilene**  
Central Lumber Co.  
511 N.W. 2nd

**Argonia**  
Mack-Welling Lumber &  
Supply Co.

**Axtell**  
Meyer Lumber &  
Hardware Co.

**Boque**  
Mack-Welling Lumber &  
Supply

**Collyer**  
Mack-Welling Lumber &  
Supply Co.

**Garnett**  
Star Grain & Lumber Co.

**Horton**  
Horton Lumber Co., Inc.

**Hutchinson**  
Kightlinger's  
1301 East Fourth

**Kansas City**  
Logan-Moore Lumber Co.  
47th & Mission Road  
Mack Lumber Co., Inc.  
26th & Metropolitan Ave.

**Lawrence**  
Logan-Moore Lumber Co.

**Lucas**  
Mack-Welling Lumber &  
Supply Co.

**Luray**  
Mack-Welling Lumber &  
Supply Co.

**Marion**  
Mack-Welling Lumber &  
Supply Co.

**Natoma**  
Mack-Welling Lumber &  
Supply Co.

**Palco**  
Mack-Welling Lumber &  
Supply Co.

**Pratt**  
W. R. Green Lumber Co.  
803 N. Olain St.

**Quinter**  
Mack-Welling Lumber &  
Supply Co.

**Russell**  
Mack-Welling Lumber &  
Supply Co.  
122 East Seventh Street

## KENTUCKY

**Ashland**  
Patton Lumber Co.  
53rd Winchester Avenue

**Burlington**  
Burlington Lumber &  
Building Supply, Inc.  
#2 East Park Drive

**Pikeville**  
Pauley Lumber Co.

## LOUISIANA

**New Orleans**  
Simon Streiffer Co.  
2026 Metairie Road

## MICHIGAN

**Adrian**  
Pridd Lumber Co.  
402 College Ave.

(Continued to page 224)

*Motor Trend magazine makes it official:*

# 1962 car of the year!

From the very first we knew we had a winner. Happy owners, car enthusiasts raved about the 1962 Buick Special with the history-making Fireball V-6 engine. And now, the editors of Motor Trend—one of the country's top car magazines—have made it official. After road-testing and evaluating all U.S. cars, they've named the V-6 Special "Car of the Year!" Here's the way they put it . . . "*Motor Trend's CAR OF THE YEAR AWARD to the 1962 Buick for pure progress in design, originaive engineering excellence, and the power concept for the future expressed in America's only V-6 automobile engine.*" Why are the car experts so hot on this exclusive Buick engine? Because only a V-6 can combine the smooth vigor of V-design with the gas savings of a straight six. Because this 135 H.P. V-6 weighs up to 140 pounds less than other sixes of comparable power. Ask your Buick dealer to let you drive a Special V-6. See how easy it is to make the "Car of the Year" your very own.

BUICK MOTOR DIVISION—GENERAL MOTORS CORPORATION

## Buick Special

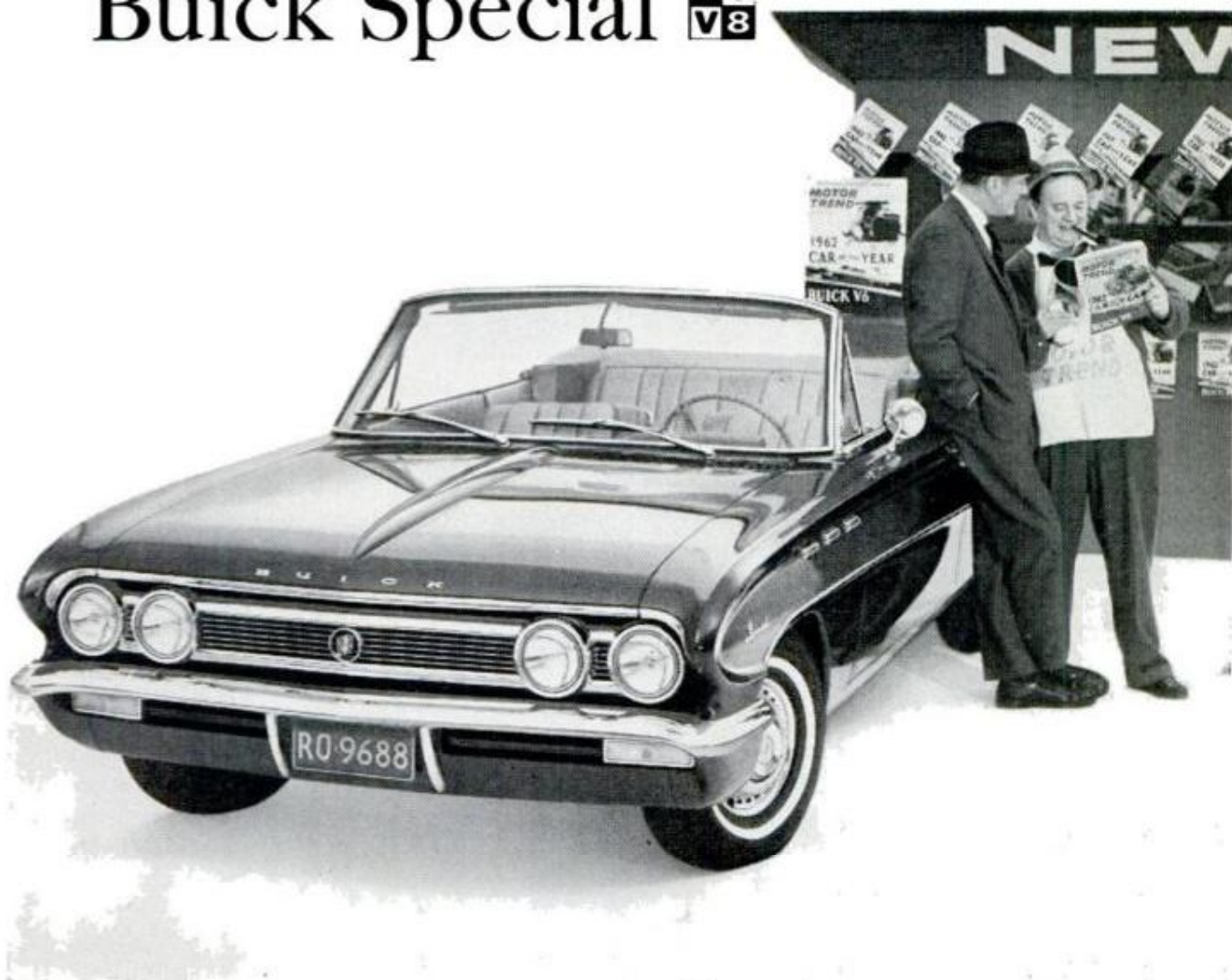



## Amazing new clear finish dries faster—gives twice the wear!

Flecto Varathane is a remarkable new clear plastic finish

that dries dust-free in minutes, and lasts *twice* as long as varnish.

Flows right on *any* kind of wood, inside or out. Needs no sealer. Put it on siding, floors, kitchen cabinets, furniture, even boats. Comes in glossy or satin finish, regular can or easy-to-use aerosol container for quick touch-ups.

Note to users: Clean brush and equipment with mineral spirits. First coat covers 500 sq. ft. per gallon. Second coat covers 600-800 sq. ft.

If your nearby paint, hardware or building supply dealer doesn't carry it yet — or for free brochure — contact . . .

The Flecto Company Inc., P.O. Box 84, Berkeley 2, Calif.  
Flecto Coatings, Ltd., 8850 Selkirk, Vancouver, B.C.

For your **GUARANTEED\*** Camping Pleasure . . .

## THE Sportsman CAMPING TRAILER KIT ONLY \$269<sup>50</sup>



**TREMENDOUS SAVINGS!**  
**FUN TO ASSEMBLE!**  
**EASIEST TERMS!**

### \*Your Money Back If Not Satisfied!

Save Hundreds of Dollars by spending a few enjoyable hours building this full size, luxurious camping trailer. The kit is shipped to you pre-cut and pre-drilled, complete with assembly instructions. Absolutely no welding required!

#### CHECK THESE FEATURES:

Completely assembled high quality fold-out tent • Big porch canopy • Sewn-in floor • Travel Cover • Converts into a utility trailer • Big storage area • Leaf spring suspension • 4.80 x 8 Tires • Twin tall signals • Sleeps 6 • Stabilizer legs • Safety chain • Plus many other outstanding features!

*Our world famous Boat Trailer Kits also available!*

Find out about these exciting trailer kits. Write today for catalog. Please enclose 10¢ for postage and handling.

#### TRAILER PRODUCTS, INC.

DEPT. PM-32, P.O. BOX 176, KINGSPORT, TENN.

Here's my dime . . . Please Rush your 1962 catalog.

Name .....

Address .....

City..... Zone..... State.....

- Ann Arbor**  
Fingerle Lumber Co.  
617 South Fifth Ave.
- Birmingham**  
Erb-Restrick Lumber Co.  
425 South Eton
- Boyns Falls**  
Boyns Falls Log Homes
- Cheboygan**  
Cheboygan Lumber Co.  
892 North Huron St.
- Coldwater**  
Woodward Building  
Materials  
120 West Chicago St.
- Detroit**  
Mohawk Lumber &  
Supply Co.  
East Side Yard  
11500 East Eight Mile Rd.  
Mohawk Lumber &  
Supply Co.  
West Side Yard  
14525 West Chicago Ave.
- Escanaba**  
Stegath Lumber Co.  
1812 Ludington Street
- Gaylord**  
The Otsego Lumber Co.  
123 S. Indiana
- Gladstone**  
Sterling Building  
Supplies  
1122 Delta Ave.
- Jasper**  
Jasper Lumber & Supply  
M 52
- Lincoln Park**  
Mohawk Lumber &  
Supply Co.  
Lincoln Park Yard  
2172 Dix Avenue near  
Southfield
- Livonia**  
Mohawk Lumber &  
Supply Co.  
Livonia Yard  
33600 Plymouth Road
- Muskegon**  
Keene Lumber Co.  
346 W. Laketon Ave.
- Ontonagon**  
Hawley Lumber Co.
- Port Huron**  
Poster Builders Supply  
Co.  
951 Water St.
- Rochester**  
Nowels Lumber &  
Coal Co.  
412 Water Street
- Roseville**  
Mohawk Lumber &  
Supply Co.  
Roseville Yard  
26640 Gratiot Avenue
- Royal Oak**  
Erb-Restrick Lumber Co.  
803 South Main
- Tecumseh**  
Tecumseh Lumber Co.  
2800 E. Monroe Road
- Unionville**  
Unionville Lumber Co.
- Wyandotte**  
Williamson Lumber Co.  
651 Vinewood
- MINNESOTA**  
**Barnesville**  
J. H. Fisch Co.
- Bigfork**  
Westby Lumber Co.
- Butterfield**  
W. E. Schrader Lumber  
Co.
- Hastings**  
Hastings Lumber Mart,  
Inc.  
3rd & Bailey Sts.
- Hopkins**  
Justus Lumber Co.  
2 Excelsior Avenue, East
- Kasson**  
Kasson Lumber Co.
- Litchfield**  
Ideal Lumber Co.
- Madelia**  
S. Hage Lumber Co.  
24 Center Ave., N.
- Minneapolis**  
Crystal Lumber & Mill-  
work Co.  
5353 Lakeland Ave.
- Lowry Lumber Co.**  
111 Lowry Avenue
- Stewart**  
Stewart Lumber Co.
- St. Paul**  
S. Berglund Lumber Co.  
1171 North Snelling Ave.
- South St. Paul**  
Farmers Supply Company  
1030 North Concord
- Wells**  
Wells Lumber Co.
- MISSOURI**  
**Butler**  
Logan-Moore Building  
Material Co.
- Carrollton**  
J. E. Waddill Lumber Co.  
110 East Benton
- Kirksville**  
Adair Lumber Co.  
122 South Elson
- La Belle**  
La Belle Lumber Co.
- La Plata**  
La Plata Lumber Co.
- Lewiston**  
Lewiston Lumber Co.
- Maryville**  
Maryville Lumber Co.  
315 North Market
- Milan**  
Charles Rice Lumber Co.
- Monett**  
Wilks Lumber Co.
- St. Louis**  
Melcher-Schene Hard-  
ware & Lumber Co.  
4800 Natural Bridge
- Salisbury**  
Logan-Moore Lumber Co.
- Tarkio**  
Atchison County Lumber  
Co.  
1st & Main Street
- Vandalia**  
White Lumber Co.  
310 South Main
- MONTANA**  
**Missoula**  
Wright Lumber Co.  
Hiway #10 West
- NEBRASKA**  
**Burwell**  
Burwell Lumber Co.
- Lincoln**  
Johnson Cashway  
Lumber Co.  
1820 "R" St.
- Millard**  
Millard Lumber & Grain  
Co.  
305 South Fifth
- North Platte**  
Field-Birge Co.  
101 West Front Street  
Waltemath Lumber Co.  
800 East Front
- NEW JERSEY**  
**Belmar**  
Stern Coal &  
Lumber Co.  
12th & R.R. Aves.
- Flemington**  
C. Tereshko Lumber Co.,  
Inc.  
Copper Hill
- Fords**  
Fords Coal & Lumber Co.  
922 King George Rd.
- Hackensack**  
Fairmount Coal &  
Lumber Co., Inc.  
Johnson Ave. &  
Lawton St.
- Plainfield**  
Plainfield Lumber &  
Supply Co.  
403 Berckman St.
- Wayne**  
Circle Building Supply  
Co., Inc.  
Route #23
- West New York**  
West New York Lumber  
& Supply Co.  
Park Ave. & 52nd St.
- NEW MEXICO**  
**Carlsbad**  
D & B Lumber, Inc.  
(Continued to page 226)



## Direct Seeding Frustrates Birds

Pine-tree seeding was for the birds until a few years ago.

Foresters had to raise seedlings in nurseries, then transplant the young trees to the desired site. Short cutting the nursery route by throwing the seeds directly on the ground was a waste of money. Meadow-larks ate most of the seeds.

Now it's different. It began in 1954 when U. S. Forest Service researchers at the Alexandria (La.) Research Center discovered a bird repellent containing anthraquinone. Birds now taste one coated seed and leave the rest alone. Hence, it's been possible to reforest about 700,000 acres of forest land across the nation by direct seeding during the last seven years, two-thirds of it in the South.

Seeding is done by every conceivable method — by airplane and helicopters, by planting machines, by hand and by horseback. The quickest, and most expensive, method is by air. Much more seed is required than when it is done by row-planting machines.

In one day, a helicopter reforested 2700 acres in six hours, a job that would require 270 tree-planting machines. This was done as part of a giant 90,000-acre reforestation project in central Louisiana.

Flagmen stood on the ground to mark the route for the helicopter pilot. After the copter passed, the flagmen moved over about 90 feet and got ready for the next pass. With this system, seed fell over the entire area, since the seed scattered in a band about 100 feet wide.

Seed hoppers, resembling holsters on a cowboy's hips, were fixed on the sides of the helicopter. The hoppers fed the seed to a slinger, located at the bottom of the ship. The slinger whirled at 1700 r.p.m., scattering the seed about 50 feet on either side. The pilot controlled the hopper valves with a trigger on his control stick.

Direct seeding such as this is not only faster than conventional nursery-type tree planting, but it cuts the cost in half, too. Savings average from \$6 to \$12 per acre. On the Louisiana project, more than a half-million dollars were reported saved.

Forest researchers claim that with these direct-seeding methods, lagging landowners would "double up and catch up" on reforestation projects, and the nation's 52-million acres of cut-over lands may be restocked decades ahead of schedule.

The bird repellent was the only possible answer to discouraging the birds and allowing direct seeding. Federal laws prohibit the killing of birds, and researchers were not allowed to experiment with poisons.

MARCH 1962

## Easy Reading

# Starrett® STEEL TAPES

FOR FAST, ERROR-PROOF MEASURING



### No. C530 SATIN-CHROME TAPES

Finest tape you can buy. Features hard wearing, multi-plate SATIN-CHROME finish with tough, resilient, clear overcoating . . . resists stains, corrosion, wear . . . won't crack, chip or peel. EASY READING with inch figures and graduations in lustrous black on SATIN-CHROME finish . . . foot figures, quick-reading foot figures (beside every inch) and stud flags in bright red. 25, 33, 50, 66, 75 and 100-foot lengths. Also in decimal, Metric and Metric-English graduations.



### No. W530 WHITE TAPES

Most tape for the money. Features tough, durable WHITE baked enamel on special "Phosphatized" steel, double protected with tough, resilient, clear overcoating. Inch figures and graduations in black . . . foot figures, quick-reading foot figures and stud flags in red. 25, 33, 50, 66, 75 and 100-foot lengths. Also available in Metric.



**WEAR AND WEATHER-PROOF CASES**  
Rugged electroplated steel cases with tough, red Vinyl covering. Heavy satin finish and nickel-plated trim and mountings. Extra-long handle for quick wind-up.

**STARRETT STEEL TAPES**  
are carried by leading Industrial Supply Distributors and Hardware Tool Stores.



SEND FOR FREE TAPE CATALOG

THE L. S. STARRETT COMPANY  
Dept. AP, Athol, Mass., U.S.A.  
Please send my free copy of the new Starrett Tape Catalog showing the complete line of Starrett Steel Tapes.

Name.....  
Occupation.....  
Address.....  
City.....Zone.....State.....

225

Now there's a plastic wood filler that fills deeper holes in a single application!



better  
buy **DURATITE**<sup>®</sup>  
**WOOD DOUGH**

Molds like dough,  
hardens into wood

Write for free Wood Dough folder

DURATITE Division 10, DAP inc., Dayton 31, Ohio

**My Daddy Buys HYDE TOOLS**

... most daddies do when they see this HYDE display of fix-up and paint-up tools in a hardware, paint, building supply or lumberyard store.

**Write for FREE catalog**

**HYDE TOOLS**  
SINCE 1875  
SOUTHBRIDGE, MASS. U. S. A.

**Hobbs**  
Hobbs Lumber & Supply Co., Inc.  
706 West Marland

**Hollywood**  
C & L Lumber & Supply

**NEW YORK**  
**Baldwinsville**  
Tappan Lumber Corp.  
East Genesee St.

**Bronx**  
Square Lumber Supply Co., Inc.  
115 Westchester Square

**Brooklyn**  
Gem Lumber Co.  
286 Ninth Street  
John J. Doody & Son Inc.  
Ave. Y & East 17th St.

**Elmont**  
Village Lumber  
1 Elmont Road

**Medina**  
Lake Shore Lumber Co. of New York, Inc.  
222 Commercial Street

**NORTH CAROLINA**  
**Carrboro**  
Fitch Lumber Co.  
309 Greensboro Street

**Dunn**  
Nu-Home Builders Supply Co., Inc.

**Kinston**  
Grady's Building Supply & Hardware, Inc.  
512-514 East Vernon Ave.

**Rose Hill**  
Herring Supply Co.

**NORTH DAKOTA**  
**Anamoose**  
Hering Lumber Co.

**Bismarck**  
W. T. Jennings Lumber Co., Inc.

**Grand Forks**  
Ireland's Lumber Yard  
123 North Sixth Street

**Jamestown**  
M. Mooney Lumber Co.

**OHIO**  
**Canton**  
The DeVille Lumber Co.  
1225 Gross Avenue, N. E.

**Cleveland**  
The West End Lumber Co.  
7517 Lorain Ave.  
The West End Lumber Co.  
4123 Pearl Road  
The West End Lumber Co.  
4520 West 130th Street

**Conneaut**  
Lake Shore Lumber Co. of Ohio, Inc.  
360 Sandusky St.

**Coshocton**  
Muskingum Valley Lumber Co.  
1247 East Main Street

**Hamler**  
Panning Lumber Co.  
625 Beiton Street

**Painesville**  
Lake Shore Lumber Co. of Ohio, Inc.  
284 Richmond St.

**Uniopolis**  
Shaw Lumber Co.

**Willoughby**  
Lake Shore Lumber Co. of Ohio, Inc.  
3884 Church St.

**OKLAHOMA**  
**Enid**  
Bank Lumber Co.  
302 East Maine

**Tulsa**  
Dale Carter Lumber Co.  
4459 South Sheridan Rd.  
Dickason Goodman Lumber Co.  
2712 West 40th St.

**OREGON**  
**Baker**  
Builders' Supply  
2701 Court St.

**Klamath Falls**  
Swan Lake Molding Co.

**Milton-Freewater**  
J. E. Olinger & Sons  
216 S. Columbia

**Pendleton**  
Van Petten Lumber Co.  
604 S.W. Dorion

**Portland**  
King Building Supply  
4310 S.W. Beaverton-Hillsdale Highway

**PENNSYLVANIA**  
**Cecil**  
Desmet Lumber & Supply Co.

**East Stroudsburg**  
R. C. Cramer Lumber Co.  
320 North Courtland St.

**Erie**  
Lake Shore Lumber Co. of Pa., Inc.  
21st and East Ave.

**North East**  
Lake Shore Lumber Co. of Pa., Inc.  
45 Smedley St.

**Sharon**  
Johnson-Sizer Co.  
369 South Dock Ave.

**TEXAS**  
**Amarillo**  
Lumber & Supply Co.  
2601 East Third  
Seale Amerson Lumber & Building Co.  
4201 N.E. 8th Street

**Austin**  
Texas Lumber Co.  
1313 East 6th St.

**Ft. Worth**  
Chickasaw Lumber Co.  
2701 West Vickery

**Houston**  
Maynor Lumber Co.  
6316 Mykawa Road  
Olshan Lumber Co.  
2600 Canal

**Midland**  
Andy's Lumber Co.  
1801 West Industrial

**New Braunfels**  
Richards & Krueger Co.  
674-686 S. Seguin Ave.

**Orange**  
West End Lumber Co.  
McArthur Drive

**San Angelo**  
Armstrong Brothers Lumber Co.  
801 South Oakes

**San Marcos**  
Tuttle Lumber Co.  
228 South Guadalupe St.

**Shepherd**  
Beeson's Builders Supply Co.

**UTAH**  
**Salt Lake City**  
Lillywhite Building Supply, Inc.  
3025 E. 33rd South

**VIRGINIA**  
**Abingdon**  
Miller & Bradley, Inc.

**Chatham**  
McLaughlin Supply Co.  
Main Street

**Virginia Beach**  
Virginia Beach Lumber & Supply  
Birdneck Road

**WASHINGTON**  
**Mt. Vernon**  
J. W. Copeland Lumber Co.

**Olympia**  
Lumbermens Mercantile Co.  
502 Custer Way

**Yakima**  
Sears Lumber Market  
2318 South 1st St.

**WEST VIRGINIA**  
**Charleston**  
Wright-Bachman Lumber Co. of W. Va.

**South Charleston**  
Evans Lumber Co.

**Weirton**  
The Weirton Lumber Co.  
914 Cove Road

#### WISCONSIN

**Beaver Dam**  
Roedl-Jacobs Lumber Co.  
114 East Third Street

**Fort Atkinson**  
The Hoffman Lumber Co.  
10 Madison Ave.

**Kenosha**  
Andrews Lumber Co., Inc.  
4800 75 Street

**Racine**  
Wecks Lumber Co.  
2000 Douglas Ave.

**Sheboygan**  
Ebenreiter Lumber Co.  
1221 Erie Ave.

#### Wabeno

Twin City Lumber & Fuel  
Co.

**Wausau**  
Schuette Builders Co.  
1330 South 11th Ave.

#### WYOMING

**Lusk**  
Frontier Lumber Co.

**Powell**  
Powell Lumber Co.  
206 South Absaroka

**Sheridan**  
Vickere Lumber Co.  
135 North Gould



### Electronic Stencil Maker

Practically any material a printer reproduces — even photographs — can be transferred to a stencil or to an offset plate for reproduction by an office duplicator through use of a new electronic stencil and offset plate etching machine.

It electronically scans the original copy and reproduces it on the stencil or plate. The machine is made by Electro-Rex Corp., 387 Park Avenue South, New York 16.



### Ready for Rain or Shine

Clamped on the visor of a car, a new compartmented case holds cigarettes, a pen, sunglasses, coins and an emergency umbrella. There's also a zippered map case. Price is \$4.95 from Tod Products, Dept. 58, 12 N. 52nd St., Philadelphia, Pa.

MARCH 1962

# The inside story



of Henry Shakespeare's "Secrets of Successful Fishing" takes the mystery out of bait casting, spinning, push-button fishing and fly casting. Intricate techniques are explained as simply as a bamboo pole, hook and worm. "Secrets of Successful Fishing" is brimming with over 200 pages of step-by-step instructions, charts of balanced tackle, information that gets a fish on your hook and lands him!

Shakespeare Company, Dept. PM 108A,  
Kalamazoo, Michigan.

- Please send "Secrets of Successful Fishing," plus the 1962 Shakespeare Tackle Catalog and Pocket Fishing Calendar. I have enclosed \$5.00 (coin, check or money order).
- Please send only the free 40-page full-color 1962 Shakespeare Tackle Catalog.

NAME \_\_\_\_\_

ADDRESS \_\_\_\_\_

CITY \_\_\_\_\_ ZONE \_\_\_\_\_ STATE \_\_\_\_\_

### EXCLUSIVE DOUBLE-BEARING HEAVY DUTY PUMPS

IRRIGATE • DRAIN • CIRCULATE • SPRAY  
Use 1/4 HP motor or larger . . . 1 HP for up to 3,200  
GPH; 1,000 GPH 60" high; or 3,000 GPH from 25"  
well, 1 1/2" inlet; 1" outlet, stainless shaft.



TYPE X—2 oil-less bronze bearings. **\$10.95**

TYPE XB—Ball bearing model. **\$12.95**

Best for belt drives. . . .

Postpaid if cash with order.

Don't delay—send for yours today!

**MONEY BACK GUARANTEE**

Centrifugal and Gear Pumps in All Sizes  
LABAWCO PUMPS, Belle Mead 2, N. J.

### WELD - BRAZE - SOLDER - CUT

REPAIR MOST EVERYTHING MADE OF METAL



Home Appliances, Auto parts. Make and repair lawn chairs, tables, ornamental iron work, gates, wagons, etc. Solder, heat, bend, and straighten, with terrific heat from arc torch. Cut and weld up to 1/4" steel plate. A million uses for Home, auto, farm, inventors, factories, etc. Works

from any home 110 volt plug-in. Complete with dark welder's mask, arc torch, supply of carbon steel welding and brazing rods and complete Welding Instruction Book. 1 year guarantee.

**SEND ONLY \$3** (cash, ck. mo.) and pay postman \$11.95 plus

COD postage on arrival or send \$14.95 and we will send postpaid. Ideal gift for mechanically minded, relatives, friends. Order now. Available only from:

**MIDWAY WELDER, Dept. DPM-3, Kearney, Neb.**

227

## Our First Moon Trip

(Continued from page 113)

Back in the blockhouse, Leroy Cooper stopped at an instrument check out point before going on to his position at the instructor console where he would talk help, suggestions and confidence to Collins, Dinswood, and Hixson for nearly a week. The short 20-foot walk to the instructor console took a long 20 minutes—also programmed in the countdown—because he had to be personally sure that every check checked.

He spent nearly three minutes observing the check on the lunar navigation transponder. The small receiver-transmitter had been placed on the moon several months earlier by a Surveyor craft. Its job was to transmit navigation homing signals.

Finally, at 8:29, the loudspeaker announced over a three-mile square area: "X minus one minute . . . X minus 50 seconds . . . . . X minus 10 seconds, nine, eight, seven, six, five, four, three, two, one, LAUNCH, X plus one, X plus . . ."

An enormous sheet of red-orange flame ripped through the already-forming dense gray smoke cloud at the monster rocket's base.

" . . . X plus three. . . "

### Blastoff!

An ear-splitting burst, painful three miles away, almost obliterated the voice on the loudspeaker. Miles away, spectators, newsmen, sightseers, relatives watched the giant shaft tremble, waver, right itself and start slowly upward. Just as thousands of spectators heaved a collective sigh of relief, the huge roar from the four solid propellant engines rolled over them. For nearly three minutes the giant engines thundered upward, pushing their precious cargo. Then . . . blank . . . nothing. No more orange-red flame, the exhaust trail was far below. The enormous booster began slowing, but the upper stages and Apollo separated and continued to climb. Then, another red flame, this time bursting from the booster portions of Saturn rockets clustered as the second stage.

Inside the Apollo control module, the sound was terrifying. Acceleration, much less than that encountered by the first Astronauts, seemed to drive eyeballs against the back of heads.

The second stage burned out and separated. The third stage cluster of Saturns and the Apollo spacecraft coasted. The third stage ignited, burned, extinguished and separated. Apollo was in free flight, headed silently toward the moon and a

landing of Americans 60 hours later on July 3, 1969.

Let's now assume the launching was the day before yesterday. Events of the past two days have become almost old hat to a nation that has witnessed preparatory Earth orbits and around-the-moon flights by these same three astronauts and by Russians.

But this flight departs from the routine. In just minutes, pilot-navigator Collins and pilot-communicator Dinswood will take their Apollo from the low moon orbit it has been pursuing for the past few hours and back it down onto the moon's surface.

That orbit will give Collins a final check on the homing beacons already positioned by earlier Surveyor craft. He will begin to lower Apollo so that it will glide in gently, buoyed by one low-thrust engine, barely over the jagged edge of the wide crater chosen a year and a half ago for the landing. Well before reaching the center of the crater's broad plain, Apollo's retro-rockets will slow the craft and bring it almost to a stop. Finally, it will settle on its landing skids.

### Return Trip

Blast-off for the trip home also has been rehearsed many times and every foreseeable problem has already been solved on Earth. There will be no huge booster engines to work with, no stage after stage to ignite, burn and drop off. Just a single small engine to release Apollo from the gentle grip of the moon's feeble gravity. Of course, to Collins, Hixson and Dinswood the blast-off from the moon will involve much more than the launch from the Earth. On the way up, the three astronauts were passive passengers while the launch was handled from the ground blockhouse; every item first had been checked by a 200-man helmeted ground crew. Now, all checks in the countdown on the moon's surface must be made by the astronauts themselves. And they must operate their engines and steer their craft during the moon launch.

Nobody here on Earth knows who won the odd-man-out, but the three already have tossed their coins to decide who will be the first American to step through Apollo's hatch and set foot on the moon. Regardless of who is first, the one who will have the assignment to spend the most time on the moon's surface is engineer-medic-scientist Hixson. He has been trained for the past two years in geology, with emphasis on lunar geology. The Army Corps of Engineers and the U.S. Geological Survey moon specialists have drummed

(Continued to page 230)

NOW...

# ROTUNDA SHOCK ABSORBERS

The quality you look for...  
performance you can count on!

There is no easier way to bring back that "new car ride" than by installing *Rotunda Shock Absorbers*. They help restore new-car riding comfort . . . improve all-round handling ease . . . cut tire wear . . . add to motoring safety through surer car control.

**Rotunda Shock Absorbers** feature large piston exposure and stable viscosity fluid to provide proper spring control and uniform action at all temperatures. They are engineered for most makes of cars (including many imports) and light-duty trucks. You can rely on their high quality to deliver top performance and durability. Yet, you pay no more to reap the benefits of Rotunda Shock Absorbers in action.

Now, as near as your closest Ford Dealer or selected service outlet, you can get quality Rotunda Parts. Ask for Rotunda Oil Filters, Shock Absorbers, Radiator Hoses, and other parts *to be sure*. You'll find them ideal for universal use on cars and trucks. Rotunda Parts are made to the same exacting specifications set for FoMoCo Genuine Parts . . . to fit right, last longer and keep maintenance at a minimum.



When you replace oil filters . . .  
replace with the best . . . Rotunda!



NOW . . . TWO TOP QUALITY LINES  
OF PARTS AVAILABLE THROUGH  
FORD DEALERS AND SELECTED  
SERVICE OUTLETS

PRODUCTS OF  MOTOR COMPANY

screens, upholstery, carpets...

hundreds of other uses.

You name 'em!



## Swingline 101 Staple Gun

Staples practically anything. Exclusive push-button loading and built-in staple extractor. At your stationery, department or hardware store.

only **4<sup>95</sup>**

**FREE!** New 8-page

SEND FOR YOURS TODAY! **"TIPS FOR TACKING"** Booklet . . . shows you how to save time, money and effort — with a SWINGLINE AUTOMATIC STAPLE GUN



**Swingline INC.**

32-00 Skillman Ave., Long Island City 1, New York

into him everything they have learned in many years of studying the moon from afar. He knows what outcroppings are significant, what samples to collect, where to spend his valuable photo film.

Even before he steps from the Apollo a few minutes from now, Hixson probably will be able to see clearly the answer to the question that has caused the most argument in lunar geology circles: Is the moon's surface covered with a hard lava, dust a few inches thick or dust many feet thick?

One of Hixson's first moves will be to collect samples that will indicate whether future moon camps will be able to extract water from the moon's rocks. Next, carefully avoiding pieces of meteors from elsewhere in space, Hixson will seek outcroppings of minerals that definitely belong to the moon. Such samples will indicate the moon's own composition and mineral resources, not those of billions of meteors that have struck its surface unimpeded by an atmosphere.

Finally, Hixson will walk as far as possible from his earth-contaminated Apollo capsule, wearing a sterile suit, and collect surface samples in clean containers. Analysis later will show whether any signs of life might have been brought from other planets.

When the three astronauts return early on the morning of July 10, Capt. Hixson will be the only American able to state with authority whether all the effort has been worthwhile. Whether the moon could be of benefit to man beyond what the most vivid mind has imagined, or whether it is a vast wasteland, useless to anyone. ★ ★ ★

### QUOTE:

"What is needed is a quantum jump in teaching techniques.

"Students—their capacity to learn has repeatedly been demonstrated to be far greater than what is now demanded of them—will learn more, faster and better, by matching their wits where appropriate with central computers programmed in response to the best pedagogues and scholars. Teachers, in turn, will have more time to devote to the more challenging—and rewarding—aspects in the relationship between teacher and student.

"It may well be that our national survival may be dependent upon how completely we accomplish this education revolution."

IVAN A. GETTING

President, Aerospace Corporation

POPULAR MECHANICS

**DIAMALLOY**

**Snips FOR EVERY JOB**

Stay sharp, cut clean. Eleven sizes, patterns. Chrome plated. "There is nothing finer than a DIAMOND." Made only by makers of famous quality Diamond Wrenches and Pliers.

**DIAMOND TOOL and Horseshoe Co.**

DULUTH, MINNESOTA    TORONTO, ONTARIO

## Those Wide-Awake Russians

In the USSR it is now possible to buy a five-pound box that keeps a person in such profound sleep, through electronic pulses applied to the temples, that only one or two hours' sleep is required per day.

Thousands of Russians are said to be using this device, according to Dr. Arthur C. Clarke of Clarke-Wilson associates, Colombo, Ceylon.

Dr. Clarke, a British physicist and fiction writer, described the electronic sleep inducer in a talk before the International Astronautical Congress. He predicted communications satellites in 1945.

## Liquid Movie Projection

Two glass plates between which a thin layer of methyl chloroform is circulated, form the frame holder for a new system of liquid movie projection.

The film passes between the two-plate gate, and is coated and held in place by the liquid. Air knives and a vacuum squeegee remove the liquid from the film as it leaves the gate. A recirculating system carries the methyl chloroform back to the gate for reuse, so none is lost.

Eastman Kodak Company, developers of the system, claim it improves image quality and eliminates film scratches.

## Chopped-Up Conversation

Recently, Newark, N. J., telephone users had their calls "sliced up" and translated to computer codes, keyed and mixed with other calls, and then unscrambled and put together again.

A system developed by the New Jersey Bell Telephone Co. permitted sampling the speaker's voice 8000 times per second, restoring the voice at 6000-foot intervals and then repeating. The Pulse Code Modulation (PCM) method permits many conversations over each wire. The system was designed for distances up to 25 miles. Existing cables can be used.

## Star Bright! Who Needs You?

Engaged in producing advanced navigational systems, engineers at the Norden Company's Norwalk, Conn., plant have a continuing need for true north-south directions. Rather than run outdoors every night looking for the North Star, they built their own indoor true-north reference.

When the plant was under construction, they made star sightings and, using these as a reference, sank two brass plugs in the ground outside the plant. Using these plugs as reference, more plugs were embedded in the floor inside the plant, and sightings are now made in a matter of seconds.

MARCH 1962

## SENSATIONAL EQUIPMENT VALUES GOVERNMENT & FACTORY SURPLUS



**G-1 STAINLESS STEEL TANK**  
2100 cu. inches (9 gals.) capacity, 450 P.S.I. 1/4" pipe thread port at each end. 24" L x 12" dia. Government Surplus. Shpg. wt. 19 lbs. F.O.B. Chicago.  
**No. G63 Price.....\$14.95**  
(Two for \$27.00)

**D-2 AIR TANK.** 450 P.S.I. Aviators Breathing Bottles. 500 cu. inches (approx. 2 gals.) int. vol. 1/4" threaded openings each end. Carbon steel. New. 24" x 6 1/2". Postpaid.  
**No. G391 Price.....\$4.95**  
(Two for \$8.50)

**1 H. P., 12 V. ELECTRIC MOTOR**  
1 H. P., 100 amps., 5600 R.P.M., 12 V., D.C. Double shaft motor, ball bearing const. Can run on 6 volts for lower H.P. 3/4" dia. plain shafts, flange mntgs. 9" x 4 1/2" x 4 1/2". Shpg. wt. 19 lbs. F.O.B. Chicago.



**No. G308 Price.....\$12.50**

**2 H.P. HOBART D.C. ELECTRIC MOTOR**

24 V., 90 amps., 4000 R.P.M. Converts for 6-12 V. use. 1/2" spline shaft on both motor ends. Ball bearing const. 11" x 5" x 6 1/2". Shpg. wt. 21 lbs. F.O.B. Chicago.



**No. GM315 Price.....\$13.00**

### MONROE POWER STEERING CYL. with Integral Valve



Cylinder bore 1 5/8", stroke 11 1/2". 28 1/2" L., 5/8" dia. piston rod, 2 1/2" dia. end caps. Piston rod end threaded for retaining nut. Inlet 1/4" flare fitting, outlet 3/8" flare fitting. Factory Surplus—New. Shpg. wt. 19 lbs. F.O.B. Chicago.

**No. G939 Price.....\$14.95**

### EATON POWER STEERING PUMP

Use with cylinder (No. G939). Max. rated pressure 850 P.S.I. Regulated flow capacity 2 G.P.M. Reservoir capacity 1 qt. 4 1/2" O.D. pulley. 5 1/4" x 8" x 9 1/4". Factory Surplus—New. Shpg. wt. 19 lbs. F.O.B. Chicago.



**No. GP-430-C Price.....\$17.50**



**GROBAN HYDRAULIC LIFT KIT, 7500 LB. CAPACITY.** Lift 7500 lbs. 8" in 30 seconds. Kit includes No. GP1500 hydraulic hand pump, No. G918 single acting cylinder, 48" hose, gal. of oil. Has 2 qt. oil reservoir, adjustable release valve; 24" handle; 2 1/2" bore, 8" stroke cylinder. Pin center-to-center 13 1/2". Clevis mntg. 1 1/4" dia. piston rod. Shpg. wt. 40 lbs. F.O.B. Chicago.

**No. G922 Price.....\$44.50**

**ELECTRIC TACHOMETER.** Two piece set—indicator & generator. (Speed range 0—to—4500 R.P.M.) 2 3/4" dia. dial. 1/4" square drive shaft. Postpaid.

**No. G881 Price.....\$15.00**



**PRESSURE GAUGE.** Hydraulic pressure 0-2000 P.S.I. scale. Brass case, white face, black pointer. Built-in restrictor. 1/4" pipe thread bottom connection. 2 1/2" dia., 1 1/4" deep. Postpaid.

**No. G483R Price.....\$3.95**



### GENUINE SHEFFIELD STEEL CALIPERS & DIVIDERS



Five piece set (\$14.00 value) includes: 4", 6" & 8" Firm Joint Outside Calipers; 6" Spring Joint Inside Calipers, and 7" Spring Joint Dividers. Postpaid.  
**No. G833 Complete set only.....\$5.00**  
(Two sets only \$9.00!)

Write today for free 72 page catalog of other equipment bargains. Big savings on hundreds of items.

## GROBAN SUPPLY COMPANY

1139 S. WABASH AVE., DEPT. G-3  
CHICAGO 5, ILLINOIS • WEbster 9-3793  
Cable: GROBANCO—CHICAGO



## Mounties Without Mounts

(Continued from page 123)

isphere in which evidence from "neutron activation analysis" appeared.

Cpl. Kerr explains that the process "depends on the experimental fact that thermal neutrons are able, by bombardment and capture, to form stable isotopes with many elements." The method, he adds, is so sensitive that in an analysis of hair, only one hair is sufficient.

The case involved a murdered girl who was found in New Brunswick holding some hair in her hand. Under a microscope, there was not much apparent difference between the girl's hair and the suspect's hair. But irradiated so that the phosphorus-to-sulfur-35 ratio could be determined, the RCMP was able to say that the hair she was holding was from the suspect's head, not her own.

Handwriting analyses, typewriter analyses, ballistic tests—all the weapons against crime are constantly in use. In the fiscal year ending March 31, 1961, for example, the Crime Labs did 3403 different laboratory examinations preparing evidence in 1904 cases. Qualified staff members spent 1159 days testifying before criminal law courts. Quite a change from the movie concept of the Mounties!

An easy case came along last year after a Lindsay, Ont., woman complained that she was receiving anonymous obscene letters. Sgt. D. N. Brown of the Crime Lab went with local police to the home of a suspect and had him type a sample letter. Not only did the machine's type match that of the anonymous letter—the suspect typed the sample on the *other half* of the same sheet of paper he had torn in two and used for the letter.

Along with routine forgeries, alterations of documents, etc., the labs cracked a case of phony 1921 five-cent pieces—collector's items worth \$1500 each. Two brothers in western Canada were doctoring 1920 nickels to make them look like the valuable 1921s. By analysis of the spacing of the numerals and acid etching to reveal the original numerals, the lab produced evidence that convicted the men of "defrauding the public" in a Vancouver, B.C. trial.

But all the scientific detection is not going on in the Crime Detection Laboratories.

At another location in Ottawa is the headquarters of the RCMP, a large gray stone structure which houses the administrative offices as well as the files and apparatus that have identified many criminals with their crimes.

Two thieves last year in Winnipeg, Man., for example, learned about the efficient

Single Fingerprint Section in the headquarters building. Breaking into a church, one left a single print that was found by the Winnipeg police. Sent to the Mounties, the print was identified and both men were arrested—clearing up 43 similar cases.

The section, with the elaborate classification necessary for work with single prints, identifies finger marks of some 60 or 70 criminals per year.

Another much larger section, the Fingerprints Section, staffed by 65 people, is Canada's central file of criminal fingerprint records. Each month some 24,000 or more prints come into the section for classification and identification. About half of these are criminal prints and are retained in the files; the others are civil cases and are not retained. The file contains 700,000 master sets of prints.

While observing the 50th anniversary of the fingerprint bureau in 1961 (it's the oldest in North America), the Mounties noted that one "charter member" whose prints were first recorded 50 years ago still "keeps his file active."

There's no law that requires provincial and local police to file prints with the RCMP, but nation-wide cooperation is virtually 100 percent, Mounted Police report.

Another new tool against crime has been devised by the Scenes of Crime Section. It's a facial identification kit by which a composite photo of a criminal can be put together from witnesses' descriptions, using film strips of various-shaped facial features.

These Fingerprint and Scenes of Crime Sections are three of 10 sections (others include Fraudulent Cheque, Crime Index) in the Identification Branch, headed by Supt. R. P. B. Hanson. The Identification Branch and the Crime Detection Laboratories offer their aid and facilities to all police forces in Canada.

The Royal Canadian Mounted Police is a federal force representing the law-enforcement medium of the Canadian government. In the enforcement of federal laws, the force has country-wide jurisdiction. In the provinces, exclusive of Ontario and Quebec, it performs the duties of provincial police. By special agreement it polices a number of towns and municipalities.

The four service divisions of the force include Air (with 17 aircraft) and Marine (with 31 vessels, 21 of which operate in ocean waters); the other service divisions are Depot and Headquarters.

Thus, with a total force of about 7500 (more than 1000 of whom are nonuniformed civil servants), the RCMP polices the vast land, sea and air spaces of Canada in the best traditions of its legendary past with the best scientific techniques of today. ★★ ★



# Owners Report on the Rambler

(Continued from page 101)

## SUMMARY OF OWNERS REPORT:

EXCELLENT  
61.0%

GOOD  
32.4%

FAIR  
3.5%

POOR  
3.1%



<b>Satisfied with automatic economy?</b>	
About as expected.....	50.2%
Better .....	16.9
Not as good.....	32.9
<b>Satisfied with manual economy?</b>	
About as expected.....	64.9
Better .....	13.5
Not as good.....	21.6
<b>Best-liked features</b>	
Handling ease .....	51.2
Riding comfort .....	32.1
Economy .....	28.3
Roominess .....	17.6
Solid, rattle-free .....	14.8
Parking ease .....	13.5
Size, compactness .....	13.5
Heater .....	13.0
Visibility .....	12.8
Styling .....	10.4
<b>Most frequent complaints</b>	
Door problems .....	6.6
Engine sluggish, underpowered .....	5.4
Poor workmanship .....	5.1
Difficult manual shifting.....	4.1
Brake troubles .....	3.6
Rattles, squeaks .....	3.3
<b>Had mechanical trouble?</b>	
No trouble .....	60.5
Some trouble .....	34.2
Considerable trouble .....	5.3
<b>What was trouble?</b>	
Brakes .....	6.6
Carburetor .....	6.4
Oil leaks .....	5.1

<b>Best-liked exterior features</b>	
Clean, smooth lines.....	11.0%
Car-top luggage carrier.....	7.9
Simplicity of styling.....	6.1
Absence of fins.....	6.1
Paint finish .....	5.9
Road clearance .....	5.4
15-inch wheels .....	4.6
No excessive trim.....	3.6
Trunk size .....	3.3
<b>Least-liked exterior features</b>	
Rear window .....	3.1
Bumpers, bumper guards.....	3.1
Taillights .....	2.6
Doors .....	2.6
Tailgate .....	2.0
<b>Best-liked interior features</b>	
Reclining seats .....	26.3
Individual front seats.....	11.7
Upholstery .....	11.7
Headliner .....	11.5
Dashboard .....	9.7
Headroom .....	6.4
<b>Least-liked interior features</b>	
Glove compartment .....	3.6
Uncomfortable seats .....	2.8
<b>Considered another car in</b>	
<b>Rambler's price range?</b>	
Chevrolet .....	58.7
Corvaire .....	35.1
Corvaire .....	5.9
Falcon .....	17.6
Ford .....	17.1
Comet .....	9.0
Tempest .....	9.0
Valiant .....	6.3

<b>Is Rambler only car in family?</b>	
Yes, it is.....	68.9%
No, it isn't.....	31.1
<b>Make of other car:</b>	
Another Rambler .....	3.1
Other AM make.....	1.5
Chevrolet .....	5.4
Other GM make.....	4.8
Plymouth .....	3.8
Other Chrysler Corp. make.....	3.3
Ford .....	3.8
Other Ford Motor make.....	1.6
<b>Decision to buy Rambler based on:</b>	
Economy .....	76.7
Size .....	60.5
Price .....	39.3
Styling .....	38.0
<b>How is dealer service?</b>	
Excellent .....	51.6
Average .....	41.3
Poor .....	7.1
<b>Make of car traded in:</b>	
Rambler .....	35.9
Other AM make.....	3.1
Chevrolet .....	14.8
Other GM make.....	9.7
Ford .....	8.4
Other Ford Motor make.....	4.8
Plymouth .....	5.1
Other Chrysler Corp. make.....	5.1
<b>Would buy another Rambler?</b>	
Yes, would buy.....	84.0
No would not buy.....	5.6
Undecided .....	10.4

"My wife likes the handling and she says it's easy to park."—Illinois machinist.

"Rambler is easy to park and isn't clumsy. There's no excessive, useless exterior."—New Jersey housewife.

**She's right. Overhang has been kept to a minimum.**

"Rambler's size is large enough to be comfortable, yet small enough to park easily. I drive 40,000 miles a year and they (my three Ramblers) have been the most trouble-free cars I've ever owned."—Massachusetts engineer.

*There are complaints, naturally, and here are the first seven in order of frequency of response.*

"Had to get a new seal gasket on the oil pan and the transmission case leaked."—Pennsylvania steelworker.

"Hard for people to enter the rear doors—not enough distance between seat and door frame."—Virginia educator.

"I would like to see the doors made to open wider allowing easier entry and exit."—North Carolina salesman.

**Rear doors open almost a full 90 degrees. If doors were made wider, you'd have to lengthen wheelbase to accommodate them and you'd no longer have a compact car.**

"Doors have to be slammed very hard to latch."—California retiree.

"Outside door locks are too low and hard to get to for a person over six feet tall."—Oklahoma accountant.

"Brake cylinder leaked."—Pennsylvania mechanic.

"Self-adjusting brakes caused much trouble—now corrected by using softer brake linings."—Pennsylvania finance manager.

"Pedal goes below accelerator before the brakes take hold. Had to replace the double master cylinder. All cars I have tried with this arrangement have very poor brakes."—California police officer.

**Rambler must be praised for effort in behalf of safety, blamed for rushing new device into production if not perfectly foolproof.**

"Considerable stalling until my dealer cleaned the carburetor."—Ohio manager.

"Had to have carburetor completely disassembled. Motor was stalling and still not satisfactory because it dies if gas is fed to it slowly when making a right hand turn."—California immigration officer.

**Carburetor problems led the complaint parade on the '60 model too, according to owners. We did not find this problem on PM's test car.**

(Continued to page 242)

# CRUISERS \$369 UP

CATALOG  
FREE

1/4 Down 2 Years to Pay

SAVE UP TO \$1700



20 FT. ISLANDER



22 FT. CARIBBEAN



## 22 FT. HOUSEBOAT-CRUISER \$699

Cruiser performance with houseboat space and facilities. V-bottom design. Planes with 40 HP to 20 MPH. Inboard or outboard power. 6 1/2 ft. headroom. Galley, toilet, lounge, sundeck. Sleeps 4 in comfort. Free catalog explains how anyone easily assembles this cruising houseboat.

## FIBERGLASS \$299 UP RUNABOUTS 14, 16 FT.

ASSEMBLE IN ONE EVENING

3 factory-molded sections interlock; bond into 1-piece molded fiberglass boat. Colors molded in. With Luger's patented method, anyone assembles boats exactly like factory-finished models in one evening. Brush and screwdriver only tools. A scientific triumph of simplicity and ease never known before in boat construction.



SAVE  
\$300 to \$500

FREE CATALOG

## PLYWOOD RUNABOUTS

40 MODELS, 8-16 FT.  
\$41.75 Up, Save 1/2-2/3

EASY  
PAYMENTS

Roomy, comfortable naval architect designs. Smart, modern styling. Equal factory-finished boats in appearance and performance. 8 ft. dinghy \$41.75; 12, 14, 16 ft. fishing boats \$59.95 up; Runabouts 12 ft. \$104 up, 14 ft. \$139 up, 16 ft. \$189 up. Also low mail order prices on fiberglass supplies, accessories, trailers, paint, hardware.

## FREE CATALOG LUGER BOAT KITS

Dep't. B-3, 9200 Access Road, Minneapolis 20, Minn.

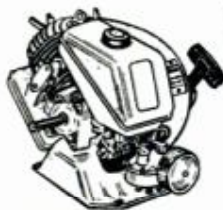

## Brand New 2 1/2 hp Gas Engine Sale!

Regular price \$49.50

30 day Sale

**\$29.95**

1 year factory warranty free service

Unbelievable but true! Chance of a lifetime to buy a brand new Clinton Model A400 2 1/2 hp Engine at nearly half price. Perfect for Go Carts — Scooters — Tractors — Mowers — Generators — Pumps, etc. Built-in throttle control and recoil starter — ready to go. We bailed out a manufacturer who needed cash—his loss is your gain—act fast! 1 for \$29.95, 2 for \$57.50, 6 for \$149.99 quantity limited.

Send 10c for 100 page catalog

MASTER MECHANIC MFG. CO., Dept. A-362, Burlington, Wis.

Southern Customers Order from Dept. A-362, Box 65, Sarasota, Florida

"The '62 carburetor has persistently run over-rich. After working on the carburetor of my '60 Rambler, 25-27 m.p.g. was consistent and I believe the '62 can be corrected to do the same. The company has been very good about correcting all complaints."—Florida aircraft mechanic.

"Not enough power when ascending steep grades."—Pennsylvania boilermaker.

**This might be a problem of individual engine tune. We found Rambler's intermediate speed (automatic transmission) good for fast hill-climbing at 60 m.p.h.**

"With respect to engine size (125 hp.), normal acceleration is often sluggish."—California engineer.

"Oil leak around front main bearing; new pan gasket installed and checked—it still leaks."—California compositor.

"Oil leaks. I use a quart every 100 miles and have had the car in twice for repair."—Illinois telephone worker.

**There's no real excuse for this on an engine that's been around (essentially unchanged) as long as Rambler's Six.**

"On a trip, I began to add oil; the trouble was no gasket on front inspection plate."—Wyoming railroader.

"The power-steering cylinder leaked but was fixed right away."—California refinery worker.

"Used four quarts of oil in first 1000 miles, and about 2 quarts during second and third 1000."—Pennsylvania foreman.

"I enjoy driving it very much, however, if the quality of factory workmanship continues to be as bad on their future models, I certainly will try another make."—Massachusetts sales manager.

**There should be a little red light flashing on Mr. Romney's desk right about now.**

"I have had a bad water pump, a leak in my hot water heater which caused the motor to boil, and now have trouble with dirt clogging the thermostat and no heat from the heater."—Pennsylvania machinist.

"Dimmer switch and turn signals malfunctioned."—Ohio air force officer.

"Air vent in the gas cap was plugged."—Pennsylvania crane operator.

"Improper shifting from low to second gear (automatic)—seems to stick between the two."—Pennsylvania steelworker.

"Automatic transmission was faulty from the factory."—Maryland realtor.

"Valve body trouble in transmission and we had no reverse gear. The automatic transmission leaked because no new gasket was put in when the work was done."—Wisconsin warehouseman.

(Continued to page 244)



## Now! The oil that protects you if you forget to change

We're all human. If you forget to change motor oil on time — *Pennzoil is for you.* It keeps on protecting.

Pennzoil comes from 100% pure Pennsylvania crude, refined by an exclusive process, making it the world's richest motor oil. Z-7 makes it so complete you never need extra additives. Your car performs better . . . your engine lives longer.

Insist on Pennzoil. For your nearest dealer, write Pennzoil, Oil City 61, Pa.



### When to change oil:

Below 32° F. —  
Every 30 days  
Above 32° F. —  
Every 60 days  
Never exceed  
car manufacturers'  
recommendations.

**PENNZOIL Z-7 — World's richest, most complete motor oil . . . now with protection reserve**

ENDS WRONG TURNS FROM BOTH  
ABSENT-MINDEDNESS AND  
ABSENT ROAD SIGNS



THE ORIGINAL  
**HULL AUTO COMPASS**

\$5.95 to \$7.50. At your  
dealer's, write for lit.

HULL MFG. CO., Box 246-D-3 Warren, O.



Junk that old mower? Certainly not. The April Popular Mechanics will show you how to convert it into a handsome lawn sweeper.

**GUNK®** removes grease  
-- scourfully!  
cleans -- degreases -- freshens



- power mowers • engines
- cement floors • kitchen walls • ovens • exhaust ducts
- paint brushes • furnace filters • barbecue grills
- implements • machinery

**AT AUTO SUPPLY, FARM & HARDWARE STORES!**

GUNK CHICAGO CO., River Forest, Illinois  
serving the Midwest and Southwest  
RADIATOR SPECIALTY CO., Charlotte, N.C.  
serving the East, Southeast and far West

## shaw shoes are designed for men whose feet are part of their job!

Here's a sturdy work oxford, with all the styling, fit and comfort of a dress oxford! Shaw's high value features include full cushion insole heel to toe with metatarsal pad and cushion side arch support . . . oil resistant Neoprene sole . . . steel arch . . . Nylon stitched . . . plus the finest leathers and craftsmanship, in black or Cordovan color. **AT STORES EVERYWHERE,** or write us for details.



**IDEAL FOR**  
mechanics, filling station men, mailmen, factory workers—anyone who wants comfort and style in a work oxford! Also available as high shoe.



ARCH

Today's  
top values,  
\$10.95 to \$14.95

**M. T. SHAW, INC.**  
Coldwater, Michigan



"37 Years of Quality Shoemaking"

# FREE

## INTERNATIONAL CATALOG



- Citizens Band Transceivers
- Citizens Band Antennas and Accessories
- Amateur and Citizens Band Crystals
- Commercial Crystals
- Transmitters/Modulators
- Frequency Alignment Equipment
- Auto Radio Converters

YOUR 1962 BUYING GUIDE FOR PRECISION MADE RADIO CRYSTALS AND ELECTRONIC EQUIPMENT.

International Crystal Mfg. Co.  
18 North Lee, Oklahoma City, Okla.  
Rush FREE 1962 Catalog

2

Name \_\_\_\_\_  
Please Print

Address \_\_\_\_\_

City \_\_\_\_\_ Zone \_\_\_\_\_ State \_\_\_\_\_

you can always  
**BE SURE OF A JOB**

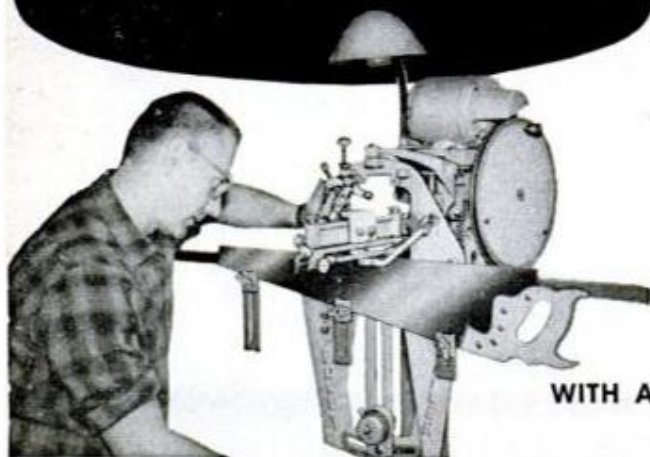

WITH A

## FOLEY SAW FILER

Have you been laid off—or afraid you may be? If you want security, plus a bigger income too—don't look for a job—start your own spare time business. In his first 2 months J. P. Robitaille earned \$300 with his Foley Saw Filer. From his starting day R. T. Hart made \$600 in 4 months. Frank P. Layne wrote—"In our town of 2,800 instead of 200 to 300 saws I did over 1,500 the first year, averaging about \$1.50 each.

FREE booklet "MONEY MAKING FACTS" shows you how to get business. The new Foley "200" sharpens hand, band and both "combination" and crosscut circular saws. Use our Time Payment Plan—pay for the machine out of your CASH profits. Send coupon today—no obligation, and no salesman will call.



FOLEY MFG. CO., 343-2 Foley Bldg., Minneapolis 18, Minn.  
Send Free Booklet and Time Payment Plan on Foley Saw Filer.

Name \_\_\_\_\_

Address \_\_\_\_\_

City \_\_\_\_\_

State \_\_\_\_\_

"Automatic transmission is jerky and the dealer says there's nothing wrong with it."—Illinois airline worker.

*The automatic transmission on PM's Rambler jerked only when "kicked down" from high to intermediate for passing, was commendably smooth on all other shifts.*

*Back to the boosters—here, listed in order of frequency of mention, are the next seven best-liked features.*

"That Weather-Eye heater is the best."—Ohio machinist.

"The heater performs very well in sub-zero temperatures."—Iowa draftsman.

"Good heater—fast warmup."—Ohio retiree.

*We agree. Defroster action, too, was good on PM test Rambler.*

"You sit up straight and high enough to see out well—excellent visibility."—Oklahoma airline engineer.

"Although I don't have power steering, my car handles with exceptional ease."—Pennsylvania educator.

*Rambler has made changes in front suspension that have improved steering ease and roadability as well.*

"I have a powerpack on my car and I really get big-car performance from the 6-cylinder engine."—California bus driver.

"Although a six, it has plenty of pep."—New Jersey clerk.

"Acceleration is very fast for passing in the 50-60 m.p.h. range."—Illinois electrician.

"The new front suspension gives more road stability."—Oklahoma supervisor.

"Wind doesn't seem to sway car on highway, considering its weight."—Minnesota businessman.

"I like the double master cylinder brake system, and foot-operated parking brake."—Florida merchant.

*Once again, back to "knock": Here's the second group of complaints listed in order of frequency of their mention.*

"Manual shift is hard to work in low gear."—West Virginia steelworker.

"Very hard shifting the manual transmission; I have to force it into gear."—Minnesota auto mechanic.

"I have had some trouble with the gear shift not moving freely into position, however, I am told 2500-3000 miles are necessary to break it in!"—Arkansas educator.

*All too often the stick shift mechanism is a "stepchild," Detroit would rather have you buy the automatic.*

"The car has a definite 'lean' to the left as though a spring may be broken, numerous rattles and noises."—Wisconsin insurance adjuster.

(Continued to page 246)



## New idea for Sportsmen...in 4 flavors

It's the new AMERICAN SPORTSMAN 6-ft. tape rule. Handiest measuring tool you ever saw. Smaller than most cigarette lighters. Brilliantly colored face plate identifies your favorite sport. 1/4" steel blade has easy-to-read markings, exclusive White Clad® finish. Blade rolls out and in — butter-smooth. See it soon wherever you buy hardware. Great gift! Only 98¢.

Measure for measure, the finest made...

# LUFKIN

SAGINAW, MICHIGAN

## King Midget

FOR 1962

Drive it for 75c a week.

Rider Agents Wanted. Send 25c for 32 page book, full details, dealer price.

Or send \$1 (refunded first order) for this plus Service and Repair Manual and 16 5x7 photos of car and factory.

MIDGET MOTORS CORPORATION, Athens 1, Ohio



WORLD'S MOST EXCITING LOWEST PRICED CAR

**BUILD A CAMPING TRAILER** for next summer's family vacation. Booklet 200 gives plans for "Two Folding Tent-Trailers." Only 35c from Popular Mechanics Service Bureau, Room 532, 200 E. Ontario, Chicago 11, Ill.

## ECONOMY POWERFUL!

Thousands in Use! Since 1946

### TRACTOR

UNEQUALLED LOW PRICE! TERRIFIC VALUE!

America's finest tractor. Ruggedly built. Easy to operate. 790 lbs. Borg-Warner clutch, trans. and diff. 140 to 1 reduction. 40% more drawbar pull than ordinary tractors. 9 H.P. engine. 20 quick change implements. HOOD-FENDERS.

Write for Catalog.

Engineering Products Co.  
1005 K-3 Anoka Avenue  
Waukesha, Wisconsin



MARCH 1962



## Easy way to strip paint

Wonder-Paste  
PAINT REMOVER

Easy to remove any finish—oil, enamel, varnish, shellac, lacquer, and other hard paints.

IT'S DIFFERENT!  
The hands are off in 10 minutes. Nothing else can do this.

All cracked and peeling paint or enamel should be removed before refinishing. Hard job? No indeed! Just apply Wonder-Paste Remover with a paint brush. It goes to work instantly—softens up coat after coat of the toughest paint or enamel so you can take it off easily right down to the surface... Ideal for doors, windows, trim, furniture and all upright surfaces because it stays put.

To clean NEW wood instantly get CLEANWOOD

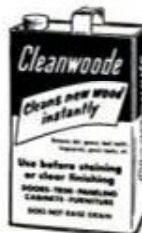

Moisten a rag with this unique solvent and wipe the surface. Instantly removes dirt, grease, pencil marks, heel marks, etc. Evaporates quickly; does not raise grain of wood.

● Send 25¢ for illustrated Refinishing Manual.

Write for free literature.

Wilson-Imperial Co.  
118 Chestnut St., Newark 5, N. J.

Get Wonder-Paste and Cleanwoode at paint and hardware stores

245

# SHOOT A STAPLE WHEREVER YOU'D DRIVE A NAIL!

Same Machine  
uses 6  
Staple  
Sizes . . .



**"ONE  
SQUEEZE  
AND YOU'VE  
NAILED IT!"**

WITH AN **ARROW**  
Brooklyn 12, N. Y.

**No. T-50 All-Purpose STAPLE GUN**

Available at Hardware, Building, Lumber and Stationery Dealers Everywhere.  
ARROW FASTENER CO., INC. 1 Junius St., Brooklyn, N. Y.

**Hottest News  
in Motorcycling**



## The World's Fastest\* Motorcycle T120 BONNEVILLE

This 40 cu. in. (650 c.c.) OHV Twin with dual carburetors is the top model in the complete Triumph line. New performance, mechanical advances and breath-taking maneuverability are built into the new models. See the Triumph dealer in your neighborhood for details and easy terms.

RIDE THE WORLD'S BEST —  
PUT YOURSELF  
ON A TRIUMPH

\*A.M.A. approved absolute speed record, Bonneville, Utah, 214.47 m.p.h.

Johnson Motors, Inc.

267 W. Colorado St.  
Pasadena 1, Calif.

TRIUMPH

Towson, Baltimore 4, Maryland

Please send FREE full-color,  
full-line 1962 Triumph catalog to:

NAME ..... AGE.....  
Please Print

STREET.....

CITY OR TOWN ..... STATE.....

TELEPHONE..... Dept. P

"Rattles in the tailgate of my wagon I assume are to be expected."—Louisiana marine.

*We don't see why wagon buyers can't get tight tailgates. The problem's been around long enough.*

"It tends to rattle a bit."—Florida city clerk.

"I had expected a little better over-all gasoline mileage (19 m.p.g.)."—Wisconsin field supervisor.

"The steering seems a bit slow and hard after driving a heavier car with power steering."—Pennsylvania accountant.

"Car doesn't corner as well as our '57—in fact, cornering is poor."—Ohio salesman.

*Problem here is likely an out-of-line front end. We felt that Rambler's cornering was above average although not in sports-car category.*

"Speedometer sticks in cold weather."—Pennsylvania insulation man.

"Front shock bolts sheared off but both were replaced by the manufacturer."—Illinois foreman.

"Broken shock absorber (dealer received word to call back this particular model and change shock absorbers)."—Virginia editor.

"Defective shock absorbers."—New Jersey accountant.

"Windows rattle and don't work properly."—Pennsylvania pipefitter.

*More best-liked items include this group of four, listed in order of mention.*

"I like the fact that I'm not in need of an oil change and lubrication every two weeks."—California food broker.

"I drive 2000 miles a month in town and get into and out of my car 20-40 times a day. I find it easy to get in and out of."—Oklahoma salesman.

*Here's a real advantage of the higher body and flat floor without that annoying "step-down" feature.*

"Exceptionally good starting in all weather."—Illinois trucker.

"I like the quality of workmanship and attention to details. There are no loose ends. It's a finished product."—Utah engineer.

*To wind up owner's statements, here, in order of response, are the final complaints.*

"Other Rambler dealers wouldn't honor my new car warranty."—Illinois heavy-equipment operator.

"Factory refers owner to dealer; dealer refers owner to factory. Owner gets first-class runaround."—Florida court reporter.

"I attribute 75 percent of my mechanical trouble to little or no dealer preparation of my car before delivery. They also seemed

(Continued to page 248)

The second most important tool...  
for every  
woodworking shop

A VERSATILE

## W&H MOLDER-PLANER

is second only  
to a saw... it  
molds, planes and rabbets.

Models from \$89.95  
From \$27.50 down & \$6.00/mo.

SEND FOR  
FREE BROCHURE

WILLIAMS & HUSSEY MACHINE CORP.  
CLINTON ST., MILFORD, NEW HAMPSHIRE



OUTPERFORMS ANY WELDER IN ITS PRICE RANGE

## NEW ARC-WELDER



Weld-Brace  
or Cut. Ter-  
rific heat for  
bending, solder-  
& working all  
metals up to 1/4"  
thick. Includes,  
Approved hood, car-  
bon & rod holders,  
Welding leads, welding, brazing  
rods, carbon & flux.

No Motor Needed  
Complete Only  
**\$14.95**

Post Paid

Guaranteed

110 V. A-C

I.D.E. ELECTRIC MFGS., Dept. M-4 2833 McNair, St. Louis 18, Mo.

## PAGE FOR TILLING PLOWING MOWING

A FULL LINE — 2 to 9 HP  
with complete gear drive and reverse  
FREE CATALOG • LOW PRICES • EASY TERMS  
Over 40 years experience  
OVER 60 ATTACHMENTS AVAILABLE!



**PAGE** Richfield 4  
Wisconsin

DEALERS  
WANTED

**Animated Easter Egg.** Turn the crank  
and watch the rabbits chase each other  
in and out of their house. You'll find the  
plans for this project in the April PM.

## HEART DISEASE #1 Enemy



Give  
**HEART FUND**  
#1 Defense

MARCH 1962



## grime & punishment

If this oil filter hadn't been so efficient, it wouldn't look this way. The reason it's so loaded with grime is because it's a Fram "Wear-Guard" Oil Filter. Fram Filters remove up to 40% more sludge, and keep it from punishing the moving parts in your engine. But even a Fram gets its fill of sludge, and needs to be replaced. Protect your engine. Ask for a fresh Fram "Wear-Guard" Filter the next time you change your oil. Fram Corporation, Providence 16, R. I.

**FRAM**  
"WEAR-GUARD" FILTERS



247



## What's New in High Fidelity

by Fred Honig

Former Editor of Hi-Fi Guide, well-known writer and authority on high fidelity

### High Fidelity Outdoors

It is common knowledge — or it should be — that a single high fidelity component music system can provide you with stereo or monaural music throughout your home. Not so well known—is that the same set of components (FM stereo tuner, record-playing unit, tape machine, pre-amplifier and amplifier) can also let you listen to music outdoors: on the patio, at the pool, in your greenhouse, garden, garage or central workshop. Simply run as many leads as you need from your central music system in the house, and you can switch the sound to any of these outdoor spots. Then, when you want to listen, just connect a pair of loudspeakers to the wires — in a few seconds you're all set. Some people install plug-in sockets at various spots throughout the grounds. It's simple. You'll find a wide choice of fine speaker systems ideal for the purpose. Many are so compact and light-weight they can easily be carried from place to place.

Wherever you listen, you'll find that your stereo records require precise tracking provided by the fine playback components available ... single play or automatic. Today's highly engineered turntables, and balanced tone arms provide superb listening, without distortion or mechanical interference. Choose units separately or already integrated (as illustrated).



**EMPIRE TROUBADOUR**  
Record Playback System  
Turntable with  
Dynamic Balance  
Tone Arm,  
Mono-Stereo Cartridge \$200

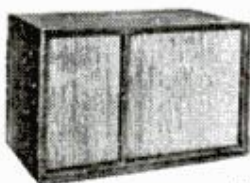

**WHARFEDALE**  
W60, Achromatic Compact  
2-Speaker System.  
True wood, \$116.50  
Unfinished, \$101.50

Whatever the source of your listening pleasure, your speaker system is the fine instrument you depend upon, indoors or outdoors. It must be capable of handling a dynamic range of natural sound. You'll find many types and sizes available for all your purposes, including highly versatile compact speaker systems (as shown)

For helpful information about high fidelity components, send in the coupon below.



**Institute of High Fidelity Manufacturers, Inc.**  
Dept. C-32—516 Fifth Avenue, New York 36

Please send me the free booklet about High Fidelity Components.

NAME \_\_\_\_\_

ADDRESS \_\_\_\_\_

CITY \_\_\_\_\_ ZONE \_\_\_\_\_ STATE \_\_\_\_\_

#### QUOTE:

*"Man has in his head the best computer ever made. With it, he can communicate much better than any machine. On our first moon shots, we'll send instruments for preliminary investigations. But not to send a man later on is illogical."*

MAJ. GEN. LEIGHTON I. DAVIS  
Commander, Air Force  
Missile Test Center  
Cape Canaveral, Fla.

reluctant to help when the car was returned."—Colorado engineer.

**Many Rambler dealer's are not giving the car the support it deserves.**

"Gearshift is noisy,"—North Carolina utility manager.

"It takes too many turns of the wheel to turn."—Illinois postal worker.

"Lousy steering ratio—you have to crank the wheel for ten minutes before turning a corner."—Rhode Island dispatcher.

"Fuel tank was not properly made and it collapsed."—Pennsylvania engineer.

**PM's test car had blocked air vent in tank which caused car to stop. Factory says this has now been remedied.**

"Condensation forms in the fuel system apparently caused by position of the tank."

—Delaware foreman. ★★★

### Machine Exchanges Currencies

International air travelers who need foreign currency in exchange for American money can now get francs, lire, marks or pounds from a machine that accepts U. S. \$5 bills. The machine examines the bill electronically, then, if it's acceptable, dispenses a small box containing the equivalent in the desired currency.

Not designed to put exchange banks and agencies out of business, the machines are intended to supply the traveler with pocket money for small expenditures until he arrives at his overseas destination. The machines are made by National Rejectors, Inc., St. Louis, Mo.

### North Pole Has Come Far

Six-hundred million years ago the North Pole began wandering from its cozy location in the South Pacific, and it is still on the move.

Geologist George W. Bain, Amherst College, Mass., says the main reason the Poles continue to shift is that the rivers of the world wear down mountainous land, transferring large masses of weight from one area to another. During a period of millions of years, the transplanted weight causes the poles to slip. The spinning Earth, acting like a gyroscope, shifts position when it becomes top-heavy in certain areas.

The erosion process going on in southern Asia, where the Indus, Ganges and other rivers are wearing away the Himalaya Mountains, is dumping sediment into nearby seas. This shifting weight will eventually shift the North Pole deeper into Canada, bringing Arctic weather to Montreal.

That is, in a few million years .





## UTILITY TOOL CABINET

- Portable
- Professional Quality
- "Big" Room

Balanced tilt-back unit trucks easily on 2 back wheels. Four roomy drawers and lower storage compartment. Entire unit can be locked. 32 x 26 x 12" reinforced welded heavy gauge steel construction. Red enamel finish.

Ask your automotive jobber, or write us.

**Huot**

**HUOT MANUFACTURING CO.**  
555 N. Wheeler • St. Paul 4, Minn.



## GEARS

**In Stock - Immediate Delivery**

Gears, speed reducers, sprockets, thrust bearings, flexible couplings, pulleys, etc. A complete line is carried in our Chicago stock. Can also quote on special gears of any kind. Send in your blueprints and inquiries.

Send for Complete Catalog No. 10  
**CHICAGO GEAR WORKS**  
440-50 N. Oakley Blvd., CHICAGO 12, ILL.

**KRYLON**

You have a use for

**SPRAY PAINT**

In Ready-to-Use Aerosol

**IF YOU PRIZE IT...KRYLON-IZE IT!**

BUY DIRECT  
• SAVE ON •  
TILLERS • TRACTORS

Full line of attachments for  
mowing, gardening, farming  
2-3-4 H.P. TILLERS 12"-16" CUT

FREE CATALOG  
& PRICE LIST

5-6-7-9 H.P.  
2 wheel 8

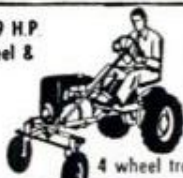

4 wheel tractors

**RED-E TRACTOR CO.**

4th Street  
RICHFIELD, WISCONSIN



## Print Your Own

Cards, Stationery, Advertising, Circulars, labels, photo and movie titles, church work, tags, etc. Save money. Sold direct from factory only. Raised printing like engraving, too.

### Own a Printing Business

Print for Others. Good Profit. Have home shop. Junior press \$15; Senior \$35 up. We supply everything. Easy rules. Pays for itself in short time. Write now for free details.  
**KELSEY PRESSES, Z-37 Meriden, Conn.**

## Fill Flaws In Plywood

Handles like putty. Hardens like wood.

## PLASTIC WOOD®

The *Genuine* - Accept No Substitute.

MARCH 1962

# New Proto locking feature

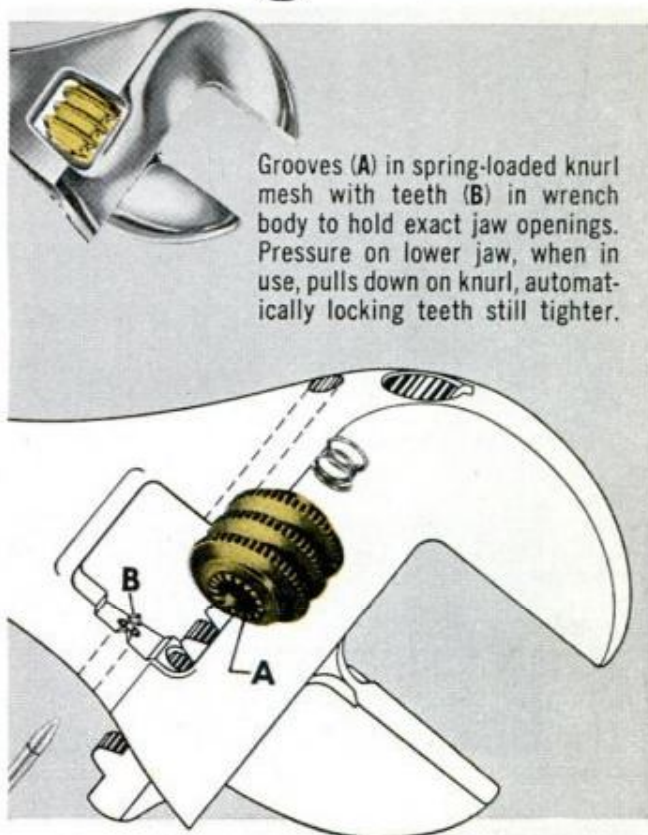

Grooves (A) in spring-loaded knurl mesh with teeth (B) in wrench body to hold exact jaw openings. Pressure on lower jaw, when in use, pulls down on knurl, automatically locking teeth still tighter.

**CLIK-STOP**

ADJUSTABLE WRENCHES  
PAT. PEND.

No knuckle busting here! With Clik-Stop's automatic locking, you do more work in less time...and your hands are much safer.

No need to reset every time you go back to same size fittings. Jaws won't "creep." No levers or gadgets to set. Proto's Clik-Stop is the only locking adjustable available in all sizes, 4" through 20". The locking feature is automatic. Buy Clik-Stops from your Proto supplier. (See the Yellow Pages.)

Available in ALL sizes

704L 706L 708L 710L 712L 716L 720L  
4" 6" 8" 10" 12" 16" 20"

Meets Federal Specifications: GGG-W-631A, Type 1

**PROTO TOOLS**  
PROTO means Professional Tools

PENDELTON  
DIVISION OF TOOL INDUSTRIES  
INC.

2202 Santa Fe Avenue | 502 Allen Street | 1702 Oxford East  
Los Angeles, 54, Calif. | Jamestown, New York | London, Ontario, Canada

249

INCLUDING DOORS...

**Con-Tact**  
the ORIGINAL self-adhesive VINYL

COVERS EVERYTHING



It's a cinch to use this washable, self-adhesive vinyl... 49c yd., 18" w. at stores everywhere

Shown: Knotty Pine, one of many patterns

**STOP WATER DAMAGE...**



Wood Plywood Shingles Asbestos siding Concrete blocks Concrete Mortar Stucco Plaster Brick Paint Wallboard Tile Canvas Leather Linoleum Fabrics

**Prevents warping, swelling, mildew, mold, water stains, seepage, dampness, rot.**

**Keeps moisture out 5 years and longer.**

Use on all woodworking jobs, boats, patio furniture, planter boxes, shutters, screen doors, window sash, shingle roofs. Stops seepage in basement walls, concrete silos, foundations. Waterproofs canvas, tarps, tents, awnings, leather boots, shoes, outdoor clothing. Won't harden or crack leather or fabrics. Perfect underseal for oil base or alkyd paints. Deep penetrating, colorless. Apply by brush, spray or roller. At paint or hardware stores or order direct. 16 oz. spray can \$1.89, Qt. \$1.75, Gal. \$5.35, 5 Gal. \$25.25, ppd., tax incl. Send check or money order to **E. A. Thompson Co** 1355 Market St., San Francisco 3, Calif. No COD's please. (Since 1929.) Dealer and jobber inquiries invited.

## Chrysler's 1963 Gas Turbines

(Continued from page 91)

In jet aircraft variable nozzles are uncommon but not unknown. The Convair 880 employs the device on the compressor. But to locate it at the driving turbine, in 1700 degrees plus pressure, is unusual.

### Driver's-Eye View

Despite the turbine under the hood, driving the Turbo Dart or Fury is similar to driving a car with a reciprocating engine. Dash instruments are unchanged. The console between the bucket seats of the Dart and Fury contained engineering equipment to register temperatures, position of variable nozzles, and length of time the turbine has been operating. The only prototype you might expect on the 1963 production car is the tachometer which indicates r.p.m. in the gas generator.

Controls are standard, with one exception. No neutral button is used on the TorqueFlite transmission, so gears are always in forward or reverse. The TorqueFlite is minus its torque converter. The driving turbine performs a comparable function. Power from the turbine is relayed through an 8.53 reduction gear directly to the transmission gear trains in a range of 4570 to 5360 r.p.m. The 1963 production cars will have a special transmission, probably with a "park" position. A manual gear box is most unlikely.

The ignition key is turned to start the turbine. The starter motor winds the compressor to 20,000 r.p.m. Then the plug ignites the fuel. At this point the starter becomes a generator and the compressor is idling.

Throttle response is startling. Within 1½ seconds the compressor can whirl up to 44,000 r.p.m. But it's only after accelerator pressure is applied that the driving turbine begins to spin upward from near-zero r.p.m. It is red-lined at 45,730 r.p.m., with the 140 hp. coming in at 39,000.

### Is the Turbine Ready?

A few years ago materials of low cost with high temperature strength and corrosion resistance were a barrier to turbine designers. Chrysler says it has developed the alloys needed to overcome these problems, that in fact, no major problems remain unsolved and their CR2A turbine is ready for passenger car production. Cost of gas turbines when they have reached some volume production will be comparable to piston types. Eventually, the turbines should be cheaper.

More improvements will come. The

(Continued to page 252)

# HALT RUST on your car with a **SPRAY!**



Don't let a scratch on your car hatch into a rust spot! Use Martin Senour Automotive Spray Paints for a quick touch-up—protects against rust, preserves the finish. Come in any car color you want, each made to manufacturer's specifications for exact color match.

And to retouch or refinish anything inside or outside the house, use king size Spray Cans of Martin Senour All-Purpose Enamel. They let you do the job like a "pro" with the greatest of ease!

MARTIN SENOUR PAINTS  
2500 S. Senour Ave. • Chicago 8, Illinois



## END NUT and BOLT HANGOVERS

**DOT Teenuts**

Can't Slip ... Steel Threads in Wood  
Flush-Mounted ... Strong ... Versatile!  
The **One Nut That Makes Sense!**



Ideal for permanent work or where easy "knock-down" feature is wanted. Available to fit standard thread bolt sizes: 6-32, 8-32, 10-24, 10-32, 1/4-20, 5/16-18, 3/8-16. Available at

hardware dealers. If not, send \$1 for special mail order package and name of nearest distributor. Specify size.

**COLUMBIA FASTENER COMPANY**  
3229 South Ashland Ave. • Dept. PM • Chicago 8, Illinois

## Planer • Molder • Saw!

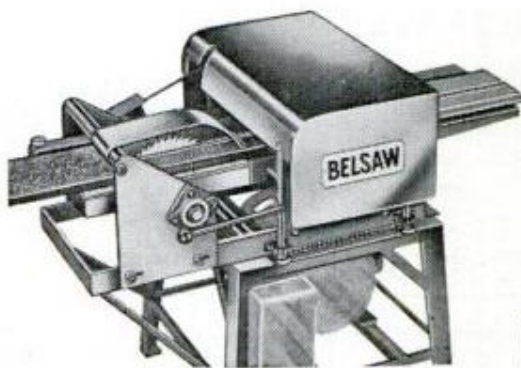

Now you can use this **ONE power feed shop** to turn rough lumber into high-value moldings, trim, flooring, furniture ... **ALL popular patterns.**

**RIP... PLANE... MOLD...** separately or all at once by power feed ... with a one horsepower motor. Use 3 to 5 HP for high speed commercial output.

**LOW COST ...** You can own this **MONEY MAKING POWER TOOL** for only ..... **\$3000** down payment

Send coupon today

**BELSAW POWER TOOLS** 902 Field Bldg., Kansas City 11, Mo.  
Send me complete facts on the **MULTI-DUTY Power Tool.**  
No obligation.

Name \_\_\_\_\_  
Address \_\_\_\_\_  
City \_\_\_\_\_ State \_\_\_\_\_

## SAVE MONEY ON **WOOD**



**World's Largest Selection, Rare, Fancy and Imported Woods, Mosaic Tile, Lamp and Upholstery Supplies, Tools and Hardware! All at Money Saving Prices!**

Send for this complete new wood buying guide and project book. Craftsman is your best, most complete source of finest kiln-dried domestic and rare imported woods, beautiful wood inlays, colorful bandings, matched plywoods, furniture legs, embossed moldings, carved ornaments, newest wood-working tools, "hard to find" cabinet hardware and fittings... more than 1,500 items! Packed with new patterns, project ideas and money making plans. Enclose 25¢ to help pay mailing and handling cost. Write: **CRAFTSMAN WOOD SERVICE CO.** 2729 S. Mary St., Dept. A-3, Chicago 8, Ill.

**NEW 140 PAGE CATALOG**  
Send Today!



**DUCO® CEMENT**  
**DOES IT BETTER**  
*faster, neater! Mends*  
*wood, paper, leather,*  
*china, glass, metal.*

**FIX IT  
 FOR KEEPS**



Better Things for Better Living . . . through Chemistry

**DYNAMIC INDUSTRIAL TYPE  
 TRANSFORMER WELDER**

**WELD-CUT-BRAZE-SOLDER-HEAT  
 IRON-STEEL-BRONZE-BRASS  
 ALUMINUM AND OTHER METALS**



Professional Electric Arc Welder. Ideal for Home, Shop, Farm or Industrial use. The handiest tool in your workshop. Weld, Braze, Solder, Cut. Bend all metals. Do expert work on your first job. Build or repair Boats, Trailers, Auto Bodies, parts, fenders, metal and ornamental iron furniture, fixtures, farm equipment, garden tools, bicycles, toys, etc. Operates on any properly wired 110 V. A.C. line. Complete with helmet, arc torch, electrode holders, flux, rods, cables, instruction book. **FULL YEAR GUARANTEE.** 10 day money back trial. **ONLY \$38.50 f.o.b.**

**Only \$38.50 f.o.b. Send only \$6.00 check or m.o. Pay postman balance plus charges. EASY PAY PLAN. Low down payment. Pay as you weld.**

**DYNAMIC WELDER CO. 1808 SOUTH FEDERAL STREET  
 Dept. D2-C, CHICAGO 16, ILL.**

Turbo Dart and Fury turbines weigh 450 pounds, complete with starter-generator and reduction gear, 250 pounds less than an average cast-iron V8. The maximum temperature burner alloys can now withstand is about 1700 degrees. Since turbine efficiency increases with heat, if Chrysler's turbine could be brought up to 2100 degrees, engine weight could be cut to 300 pounds and fuel mileage would increase three or four miles per gallon. This will not be easy, but it probably will be done.

In addition to the Turbo Dart and Turbo Fury which we met, a third experimental gas-turbine prototype is reported to be running on the test track. And Chrysler engineers and stylists are currently hard at work perfecting the forthcoming 1963 turbo car. The objective is to get these turbine cars out next year in quantity and distribution that will demonstrate their superiority.

The configuration of a turbine car could be quite different. The design could be influenced by the smaller engine, no radiator, smaller transmission, plus the value of a functional air scoop. It depends upon how radical Chrysler feels it can safely be—and be acceptable. And, as one executive said, don't overlook the possibility of the turbine at the rear. **★ ★ ★**

**One Million Miles  
 of  
 Driving by Owners**

is the most revealing way of testing new cars. That's the method PM uses, and in the April issue you'll find two reports on their experiences from registered owners of the 1962

**FALCON and PONTIAC**

You'll enjoy the excitement and pride of accomplishment when you add an attractive and practical deck or patio to your home. West Coast Lumber\* makes it simple with this easy-to-understand building and planning booklet: *West Coast Lumber Patios 'n' Decks*. Natural color illustrations give you ideas for planning... there are suggestions on where to build... how to deflect the prevailing winds... blending the patio and deck with your home style... finishing... and basic plans.

Ask your retail Lumber Dealer for this FREE plans booklet... or write... Dept. 103, West Coast Lumbermen's Association, 1410 S. W. Morrison St., Portland 5, Oregon

## WEST COAST LUMBER

\*Manufactured in the U.S.A. by Coast Region Mills of Washington, Oregon and California.

WEST COAST DOUGLAS FIR • WEST COAST HEMLOCK • WESTERN RED CEDAR • SITKA SPRUCE • WHITE FIR

# BLACK & DECKER TOOLS FIXED

- ✓ FULL GUARANTEE on all recommended repairs
- ✓ NEW PRICE POLICY saves you money
- ✓ FAST REPAIRS in 24 hours or less
- ✓ GENUINE FACTORY PARTS made for your B&D tools
- ✓ ALL REPAIRS MADE by tool experts
- ✓ FREE REPAIR ESTIMATE on request

OVER 100 REPAIR CENTERS. Check the Yellow Pages under "Tools Electric" or write for address of nearest service station.



**Black & Decker**<sup>®</sup>  
Towson 4, Md.

QUALITY TOOL SERVICE



## Marlite Paneling: wash-and-wear walls you can install yourself

Beautiful Marlite paneling goes up without muss or fuss over old walls—needs no paint or further protection. And Marlite's soil-proof baked plastic finish resists stains and mars, stays like new for years. Choose from a wide range of authentic Trendwood reproductions, exciting solid colors and patterns. See your building materials dealer or write Marlite Division of Masonite Corporation, Dept. 342, Dover, Ohio.

**Marlite**<sup>®</sup>  
plastic-finished paneling

ANOTHER QUALITY PRODUCT OF MASONITE<sup>®</sup> RESEARCH



## Highway Scoreboard Gives Advance Warning

Electric signs, operated by remote control, immediately flash warning messages to motorists along the Connecticut Turnpike. They operate like scoreboards at ball parks, the buttons lighting up to form any combination of numbers or letters of the

alphabet, visible even in bright daylight.

The signs will tell autoists of road conditions or accidents ahead, giving them plenty of time to slow down or turn off the turnpike. The signs are operated from a central control at the administration building.

New standard for power and torque in a compact grinder!

**NEW DREMEL NO. 3 INDUSTRIAL MOTO-TOOL**



This new industrial type grinder belongs on your workbench! The No. 3 is a compact "powerhouse" developing 27,000 rpm — and sustains high torque under load. It's easy to handle (fits your hand), runs cool, lightweight. Weighs only 17 oz.! Just the ticket for precision grinding, polishing, drilling, sharpening, modelmaking — working in tight corners. Powerful 110 Volt AC or DC motor is housed in a heavy-duty, shockproof Bakelite case. Handy hanger hook keeps it within reach.



No. 3 Moto-Tool is complete with 1/8" and 3/32" collets, 3-wire grounding cord with 2-prong adapter, finger grip — in steel case. Only \$29.95.

No. 2 Moto-Tool — long time favorite with industry, craftsmen, model makers since 1936 —

No. 2 Moto-Tool with 3-wire grounding cord, \$19.95.

No. 2 Moto-Tool with 23 accessories in steel case, \$29.95.

DREMEL MFG. CO., Dept. 112-C, Racine, Wisconsin

150

See Your Dealer or Write for Complete Power Tool Catalog



**First Choice**

Among toolmakers, machinists, and patternmakers, it has been Gerstner Chests for 3 generations. Free Catalog.

**GERSTNER TOOL CHESTS**  
462 Columbia St. • Dayton 7, Ohio

SOURCES of further information on articles are listed in our free WHERE-TO-FIND-IT list. For your copy just write to the

SERVICE BUREAU  
**POPULAR MECHANICS**  
200 E. Ontario Street  
Chicago 11, Illinois.



CHOOSE A POCKET-SIZE  
**Kirsten**  
"COMPANION"  
PATENTED "RADIATOR" STEM MEANS  
*Cool Smoking!*

**\$3<sup>95</sup>**  
POSTPAID

**WEIGHS ONLY 1 OUNCE!**

WRITE FOR FREE CATALOG  
other pipes 5.00-7.50-10.00

Write to: **Kirsten** PIPE CO., Seattle 7, Wash., Dept. C

**BUILD FINE GRANDFATHER CLOCK NOW**

The simple sensible SPEEDE Red-i-Kut way as thousands have — FOR YOURSELF OR SELL AT A GOOD PROFIT. SAVE HUNDREDS OF DOLLARS. SHOP TESTED PLANS "SPIRIT OF THE CENTURY" Narrow waist 83" tall or stately straight side "SPIRIT OF AMERICA." EASY-TO-FOLLOW photopack PLANS & LIFE SIZE PATTERNS tell all—plus MOVEMENT BROCHURE \$40 up, of heavy brass weight (Kuempel original) Westminster, lube BELL chime, movements, gorgeous bronze-silver MOVING MOON dials, 3/4" solid-mahogany Jiffy Joint-Kwik-Bit case kits. Send \$1.00 today — Both plans RUSH \$1.50 as folks have for over forty years.

Kuempel Chime Clock Works, 16 Kuempel Bldg., Minneapolis 16, Minn.

**OUTWORKS THEM ALL**

Pat'd. & Pats. Pend.

Prepares the toughest soils in one operation. All-purpose tiller-tractor tills to 12" deep —12" to 40" wide. Chain drive delivers equivalent of 2 extra hp! 4 models; rotors, tractor tools for all jobs and soil conditions. Optional reverse. Send for details.

**MERRY TILLER**  
Northern Life Building, Box 1829, Seattle 11, Wn.

**EARN BIG MONEY WITH THESE LOW COST HOBART WELDERS**

**"TROJAN" TIG-182-S** includes accessories—battery charging attachment optional

AC "TROJAN" SHOP WELDER fabricates parts, ornamental railings, furniture, etc. 180 amp capacity. Ideal for repairs, hard-surfacing tools, brazing, soldering, cutting and burning holes. Has 18 current control steps. Meets REA requirements. Used by repair, sheet metal, hobby, plumbing heating shops, garages. Ask for data sheet A-520-G.

DC AIRCOOLED "HUSKY BOY" welds anywhere. Easily mounts on truck or trailer. 200 amp capacity. 500 current control settings make it ideal for fabrication—tough enough for continuous operation in light to medium welding in shop or field. Supplies 2 KW 70 volt DC auxiliary power when not welding. Ask for data sheet A-202-I.

**HOBART BROTHERS CO., BOX M-32, TROY, OHIO, Ph. FE 2-1223**

Model GW-223-S

# On the market



**1. CLEAR POLYURETHANE VARNISH** is a hard, durable finish recommended particularly for use on outdoor furniture. Astro-Var is said to take plenty of wear, hard knocks, alcohol and even acids without marring. Dries to touch in 45 minutes and can be walked on in less than three hours. Made by the Martin-Senour Co., 2500 S. Senour Ave., Chicago, Ill.



**2. RUST DISSOLVER** chemically removes rust from metal surfaces, dissolving it in minutes. At same time the solution combines chemically with metal to protect surface after rust has been removed. It is even said to remove rust from concrete and terazzo floors. Priced at \$1. Marketed by Woodhill Chemical Corp., 1390 East 34th St., Cleveland, Ohio

**3. HARD MASONRY SURFACING MATERIAL**, which is available in a lightweight form, may be installed without expensive foundations and preparations. The stain-resistant, washable brick is available in 12 colors and a wide range of textures and sizes. Useful for room dividers and planters. Made by Century Brick Corp. of America, 4506 W. 12th St., Erie, Pa.

**4. POWERFUL WATERPROOFING MATERIAL** goes on like paint. Used on sound surface, Epoxite is said to withstand water pressure up to 40 p.s.i. It seldom will be necessary to coat an entire wall—only those areas where seepage is present. Material to cover about 40 sq. ft. is \$5.95. Community Waterproofing Co., 37 Saugatuck Avenue, Westport, Conn.

**5. WHITE POLYSTYRENE TUBES**, designed to pull the moisture-laden air by vacuum action from interior of the walls, may be used for reducing the primary cause of paint blistering and peeling. Also, tubes are useful in most confined spaces where moisture is likely to be a problem. Box of 24 tubes sells for \$3.60. Made by Turb-O-Vent, Inc., Elyria, Ohio







# SPECIAL OFFER!

**POPULAR  
MECHANICS**

# VACATION HOME CONSTRUCTION AID MANUAL

## AVAILABLE NOW!

**H**ERE IT IS—complete in one book—step-by-step construction information on the Popular Mechanics Vacation Home. It includes the full story on the vacation home, plus many more how-to-do-it pictures and construction suggestions.



When used in conjunction with the plans for the PM Vacation Home, the Construction Aid Manual simplifies the completion of your home . . . its step-by-step approach will save you time (and help you avoid errors!)



Included in the Manual is an extensive source list of companies and associations who offer plans and/or further information on other types of vacation homes. This is an invaluable aid in planning your vacation home!



The entire Manual is printed on heavy, water-proof paper—you can use it in your shop, at the construction site of your home—even drop it in water—without serious damage.



Popular Mechanics will see that you are provided with information from many manufacturers concerning the types of products to be used in your home. The material will come directly to you — with many, many ideas on minimum maintenance features, conveniences, and new products!



If you should decide to buy the plans for the Vacation Home from Popular Mechanics, the cost of the Construction Aid Manual will be deducted from the cost of the plans!

**Make sure you get your copy of the PM Vacation Home Construction Aid Manual early! Fill in and mail the coupon below today!**

**POPULAR MECHANICS**  
Dept. VHM, 200 East Ontario  
Chicago 11, Illinois

Enclosed is \$1.00 for my copy of the PM Vacation Home Construction Aid Manual. Please rush it to me postpaid as soon as it is available. (Complete plans also available—see page 89.)

(Please Print)

Name .....

Address .....

City and State .....

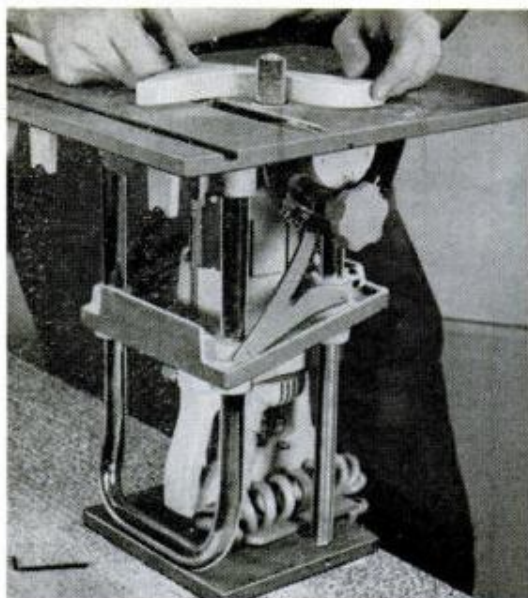

HERE THE BASIC UNIT is set up as a spindle, or drum, sander, using detachable saw table

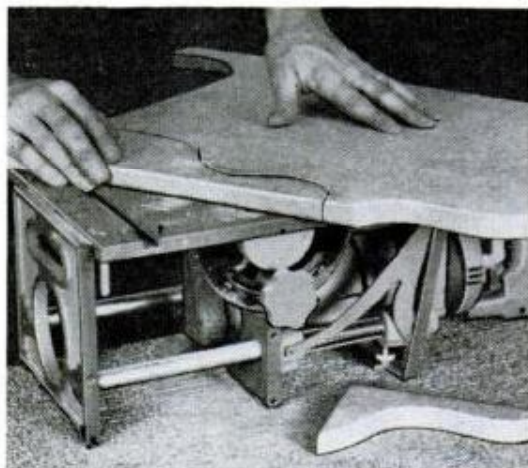

LOWER UNIT to horizontal position, relocate table, attach blade drive and it's a saber saw

ANGLE DRILLING in wood or metal is done with this setup. Permits wide range of angles

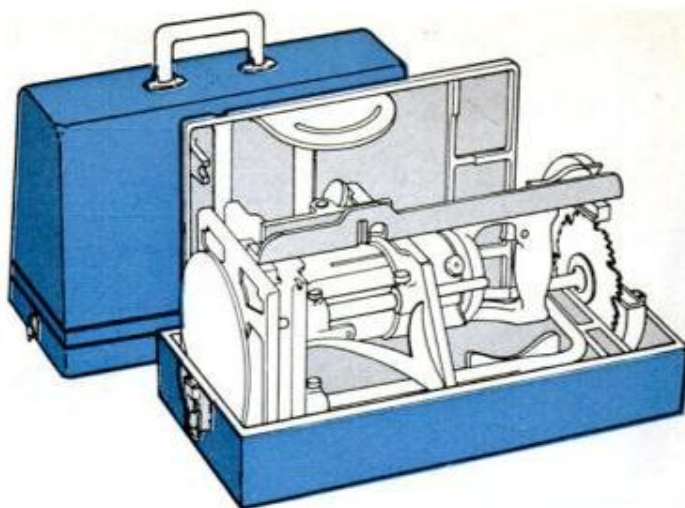
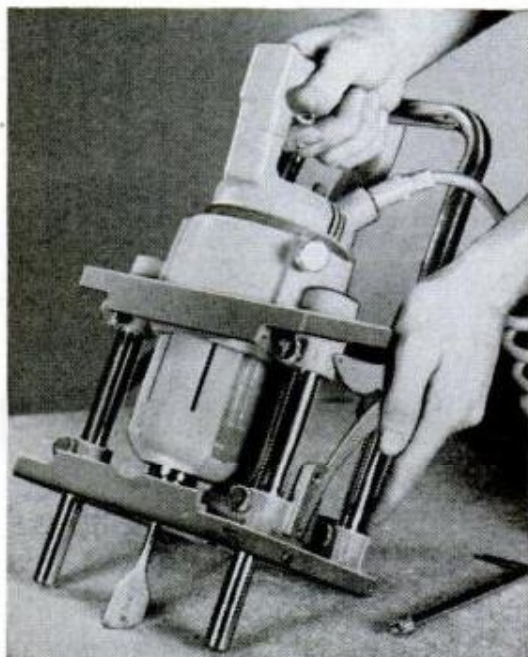

## POWER SHOP IN A SUITCASE

THIS NEW DEVELOPMENT really harnesses a portable electric drill to the job. Only it isn't just a portable drill. It's many workshop machines in one simple frame, or stand, which serves as a carrier and mounting for a saw-handled portable motor that turns up a full  $\frac{1}{2}$  hp. Disassembled the whole thing packs into a small-suitcase-size tool box that goes along with you anywhere.

The three photos at the left show the unit assembled as a spindle sander, a saber saw, a heavy-duty drill. More than that it's a stationary drill press, a portable jigsaw (with accessory), a table saw, a disk sander, a shaper and a portable circle saw. Slide the motor out of the stand, which is part of the basic unit, and you have a powerful portable drill for freehand work on a wide variety of jobs. The tools and accessories are chuck-driven. The drill chuck is housed; only the business end of it projects beyond the motor housing. It is of the geared type and is of 0 to  $\frac{1}{2}$ -in. capacity, which means it will take any portable-drill accessory having a straight shank  $\frac{1}{2}$  in. or less in diameter. The chuck no-load speed is 3500 r.p.m., fast enough to operate a circular-saw blade.

The stand is made from light metal and has a comfortably shaped handle for carrying, upper and lower photo. The saw table doubles as a saber-saw table, center photo, a spindle, or drum-sanding table, upper photo, and a circular-saw table. It is merely shifted from one position to another to serve these multiple purposes. The motor remains in the same general position in the stand for all these operations. Tubular parts of the stand are chrome-plated to resist corrosion. All parts are precision made so that they shift position easily and lock positively. It's called Porta Shop and is available from Precision Tool Corp., 1717 N. Long Beach Blvd., Compton, Calif.

Weld Cable No. 1/0 100' \$21.50.  
50' \$10.95, G-1 160-250 Amp \$12.95.  
R-1 G.E. 300 Amp \$16.95

Accessories Kit For Arc Welder For D.C. Generators has helmet, gloves, elect. holder, volt reg. rheostat, volt meter, Gr. Clamp, including switch. Kit with G-1 160-250 Amp Gen. plus 30' cable & reactor coil \$36.45

Multi-Weld® D.C. Arc Welding Kit Complete with G.E. R-1, 300-350 amp gen. incl. accessories kit reactor Coil w/ solenoid control \$47.50

New Throttle Solenoid idling device for all D.C. gens. \$7.95 with R. Coil arc stabilizer \$14.95

Build Your Own Hydraulic Press 9 Ton Kit consists of new DA cylinder 3" bore x 10 1/2" stroke, 2000 PSI Weaver hand pump, control valve, reservoir, hose fitting & 1 gal. oil. Instructions incl. \$125.00 value. Only \$57.50

New open center 4 way control valve ±10060 with adj relief for 1 to 4 D.A. cyl. 3/8" ports \$14.95. New Hyd. Solenoid C. valves 3 way 12-24VDC 1500PSI \$10.95 per Pair.

HYDRAULIC PUMP BARGAINS 1500 P.S.I. Type RPM GPH \*Reversible  
\*Pesco .447 4500 350 \$14.50  
\*Vickers .410 3750 375 \$19.50  
\*Stratop'r .410 4500 375 \$17.50  
Hyd. hand pump 1.5 cu. in. p. stroke \$6.95

NEW HYDRAULIC CYLINDERS  
Hvy Duty 2000 P.S.I. air-oil  
Special discount Limited Time

Bore	Stroke	F.O.B. K.C. Mo.	D. Shaft	Long	Double Action	Weight	Price
1"	1 1/8"	1 1/2"	6 1/2"	1 1/2"	1 1/2"	1 1/2 lbs.	\$ 2.95
1 1/2"	4 1/2"	1 1/8"	10"	3 1/2"	4 lbs.	3 1/2 lbs.	\$ 3.50
1 3/8"	4"	3/4"	16"	4 lbs.	4 lbs.	4 lbs.	\$ 3.95
1 3/8"	2 1/2"	1"	38"	11 lbs.	11 lbs.	11 lbs.	\$12.95
2 3/8"	13-18"	1 1/4"	30"	11 lbs.	11 lbs.	11 lbs.	\$14.50
1 1/2"	3 1/2"	3/4"	13"	8 lbs.	8 lbs.	8 lbs.	\$ 6.95
2 1/2"	3 1/2"	2 1/4"	13"	10 1/2 lbs.	10 1/2 lbs.	10 1/2 lbs.	\$ 7.95
1 1/2"	12 1/4"	3/4"	24"	10 lbs.	10 lbs.	10 lbs.	\$ 7.50
2 1/2"	16"	1 3/4"	33"	16 1/4 lbs.	16 1/4 lbs.	16 1/4 lbs.	\$18.75
2 1/4"	9"	1 1/2"	24"	12 lbs.	12 lbs.	12 lbs.	\$ 8.50
3 1/4"	10 1/2"	2 1/8"	23"	29 lbs.	29 lbs.	29 lbs.	\$18.50
3 3/8"	10"	1 1/4"	27"	22 lbs.	22 lbs.	22 lbs.	\$15.50
4 7/8"	8"	2"	22"	35 lbs.	35 lbs.	35 lbs.	\$24.50
4"	18 1/2"	1 5/8"	30"	30 lbs.	30 lbs.	30 lbs.	\$27.95

New Water Pressure System For Cottages, Boats, Trailer, etc. ±AM400 Complete automatic has new pump 400GPH, relief, & adj. press. connected to motor 1 1/2 H.P. 7 amp 24VDC runs on 12VDC adj. press switch set for 8 ± on and 20 ±, gauge check valve, filter, overload switch, tank & 8' cord value \$99.95, save \$47.45 price \$52.50. ±AM401 same model less motor including pump mount ready for belt driving requires a 1 1/2-3/4 HP A.C. or D.C. motor. Over-all size 20"x11"x15", wt. 25 lbs. \$57.50

24-12V. D.C. Electric Hydraulic Lift Kit. Ideal for operating light blades, plows, etc. for lifting, turning, push & pull. Has 24-12VDC, reversible motor, reversible electric pump, 1000PSI, 1 D.A. cylinder 2 3/8" bore x 13" stroke, 1" shaft, reservoir, reversing switch. Lift cap. 900 lbs. 3 Way solenoid, control valve, hose & fittings. Size 15"x10"x10". 40 lbs. \$100.00 value \$49.50

New Big Vacuum Air & Compressor Kit. Bendix 4 vane, reversible 17 CFM at 2250 RPM, 7 1/2" suction, 18" HG pressure 2 gal tank, vacuum & pressure gauge hose & pump mount ready for driving with belt or pulley. requires 1 1/2-3/4 HP motor. Size 16"x12"x8". Wt. 30 lbs. O.C. \$135.00 kit price \$47.50

NEW HYDRAULIC SYSTEM KIT -400 K heavy duty Power driven, rated 16,000 lbs. lift. Consists of 2 D.A. hyd Cylinders 3 1/2" bore x 21 1/2" stroke ea. rated 8000 lbs. ea. with 1000 PSI, 1 four way hyd control valve with built in relief ±221. 1 Vickers hyd pump 375 GPH 1000-1500 PSI 3750 RPM, filter, hose & fittings. Value \$169.95. Kit Price \$79.95

GENERAL SALVAGE CO. Check or M.O. 2922 E. 27 St., Dept. 132, Kansas City 27, Mo.



Order your FREE copy of . . .

## What You Should Know About Patents

Comprehensive information on patents and how to secure a patent. Write Popular Mechanics, Bureau of Information, 200 E. Ontario, Chicago 11, Ill.

## New PENN YAN BOAT CATALOG



FREE

Outboards, Inboards, Cabin Cruisers, Hardtops, etc.

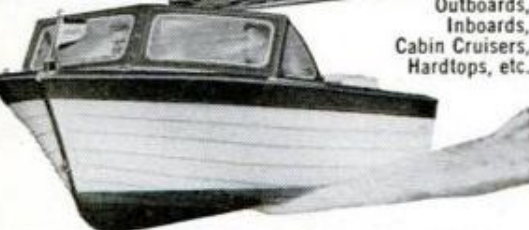

CATALOG loaded with big illustrations in full color. Complete descriptions of Penn Yan line for '62—latest ideas in marine design—boats for cruising, fishing, skiing, for big water, inland lakes and rivers. 7' to 24'. Also Car-tops®, canoes. All clinker-built feature exclusive Penn Yan Vulcanite Bonded Laps—seams flexibly bonded forever.

Your Choice of Wood or Popular Fiber Glass Both types now available. Wood boats protected by amazing Boat Life Process, preventing hull deterioration. New catalog is a must for anyone considering a boat. Write today for yours FREE. Penn Yan Boats, Inc., 34 Street, Penn Yan, N. Y.

The hand-held  
**2-WAY RADIO**  
that outperforms  
'em all...



Anyone can operate—no license required—priced from \$109.50!

In the field or on the job . . . Viking "Personal Messengers" are delivering outstanding performance! Viking "Messengers" are available in compact hand-held units or maximum legal power Citizen's Band transceivers. Used by thousands of businessmen, salesmen and construction crews. Send today for full details.



FREE! SEND FOR COLOR BROCHURE

Please rush "Messenger" details to:

NAME \_\_\_\_\_

ADDRESS \_\_\_\_\_

CITY \_\_\_\_\_ STATE \_\_\_\_\_

E. F. JOHNSON CO.

1401. 10 Av. SW, Waseca, Minn.

**NEW!** TWO TRANSISTOR  
ELECTRONIC IGNITION SYSTEM

the first major improvement in ignition systems since the original Kettering 1910 Ignition System.

THE "SLEPTRONIC" TS-14 WILL



- Eliminate High-Speed Voltage Fall-Off
- Increase Point and Plug Life
- Increase speed 10 to 30%
- Increase Gas Mileage
- Start Instantly in Any Weather
- Eliminate Condenser Break-Down
- Eliminate Over-Heating at Low Speeds
- Increase Acceleration . . .
- Eliminate Mis-Firing
- 250: 1 Turn Ratio Coil

**10-DAY MONEY-BACK GUARANTEE**

Our TS-14 Transistor System was designed, after 5 years of engineering, to give you the very finest in Heavy-Duty Transistorized Electronic Ignition Systems. TS-14 is economical, maintenance-free and you can install-it-yourself in 30 minutes on any type auto.

TS-14 Transistorized Ignition Kit, complete with F-12T 250:1 Ratio Coil for **NEGATIVE** Ground cars. Specify 6 or 12 volt — \$44.95. For **POSITIVE** Ground cars. Specify 6 or 12 volt — \$59.95. F-12T Coil without Transistorized System — 16.50.

**BILL SLEP COMPANY** Automotive Electronics  
P.O. Box 178-P Ellenton, Florida

Please send me:  TS-14 for Neg. Ground  TS-14 for Pos. Ground  F-12T Coil  Free Color Brochure

Name .....

Address .....

City ..... State .....



**NO TOOL SET IS COMPLETE WITHOUT X-ACTO**

X-Acto precision knives are used by skilled craftsmen on the job. They—and you, too, will—count on X-Acto's extra sharpness and perfect balance for accuracy and safety. For doing professional jobs, complete your tool set with X-Acto. X-Acto No. 82 Knife Chest contains three X-Acto knives with nine extra assorted blades in a fitted, natural-finish wood chest . . . \$4.50. See your X-Acto dealer, or write:



X-Acto, Inc.,  
48-41 Van Dam St., Dept. R-8, Long Island City 1, N.Y.

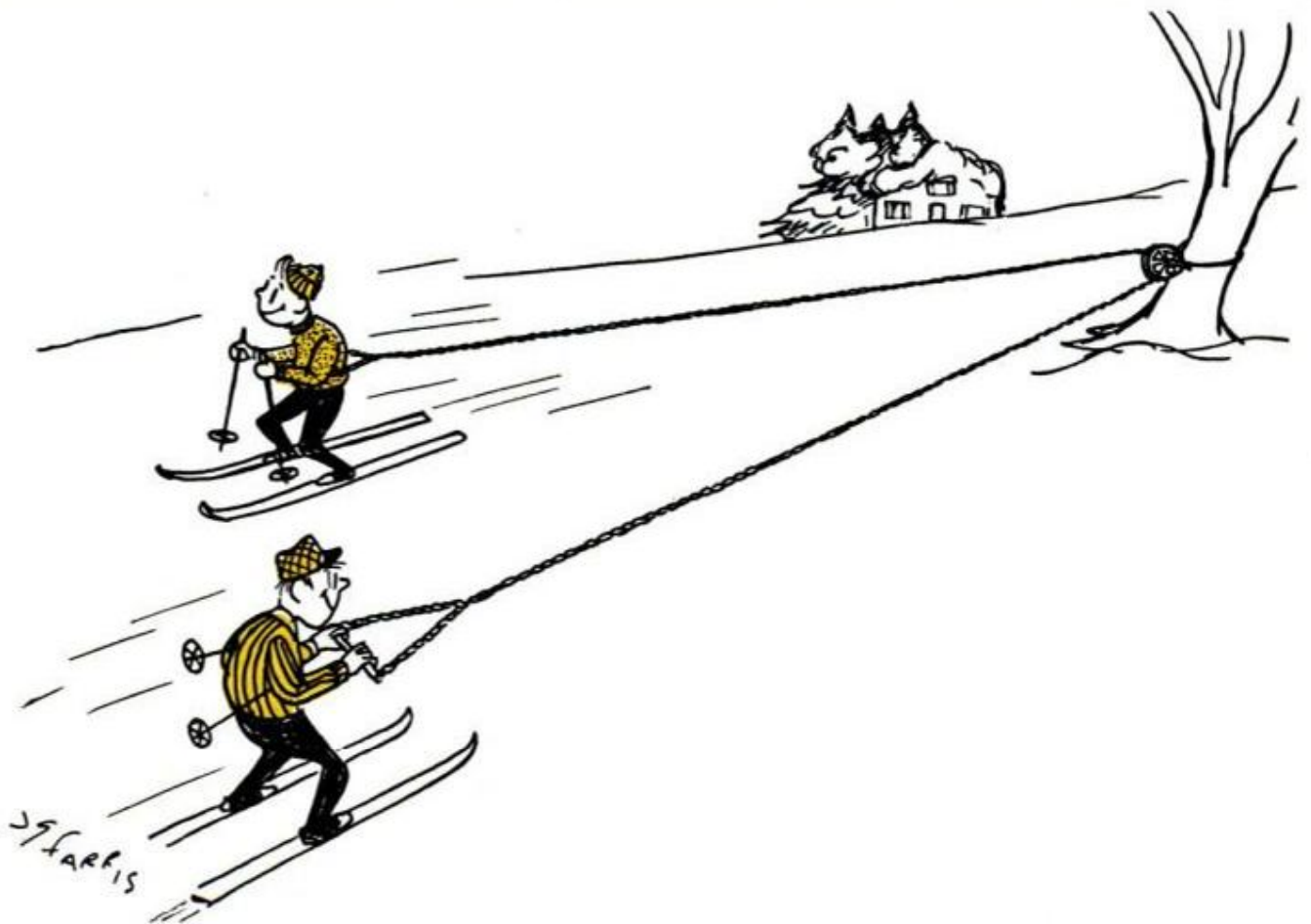

# NOW!

FOR THE FIRST TIME

THE PUSH-BUTTON IS IN THE ROD—



## THE ALL-NEW BRONSON 63

... is the most advanced rod/reel combination, yet so un-usually simple anyone can use it. Nothing like it anywhere. No line pinching or twisting. Level wind. Unitized drag control. All metal, heavy duty precision gearing. Reel finished in rich brown anodized aluminum. Perfect-balance 2-piece 6½' Tubular Glass Rod. Comes with 100 yds. 10 lb. test monofilament. Available in left or right hand crank. Combination complete—sold anywhere. **\$32.95**

**BRONSON** BRONSON REEL COMPANY  
ROCHESTER, MICHIGAN  
Division of Higbie Manufacturing Co.

Send for Free Full Color Bronson Fishing Handbook

Your sidewalk-traveling youngsters enjoy riding in a safe, battery-powered electric car that looks like a 1901 classic. You'll find the complete plans in the April issue of Popular Mechanics.



## Quick-Draw Tees

A quick draw to the hip and a golfer can have a new tee in hand. Made of polyethylene, the tees come in groups of six in a clip which may be fastened to belt, bag or pocket. The loaded clip is available for 25 cents from Horizons Unlimited, Claremont, Calif.

MARCH 1962

**YOU** NEED THIS

# FREE GIANT B-A CATALOG



SAVE UP TO 50% ON B-A SELECTED KITS

HI-FI AND STEREO SYSTEMS & COMPONENTS

TOP VALUES IN POWER AND HAND TOOLS

30 PAGES OF BARGAINS NOT IN ANY OTHER CATALOG

## BURSTEIN-APPLEBEE CO.

Dept. PM, 1012 McGee St., Kansas City 6, Mo.

Rush me New 1962 B-A Catalog No. 621

Name.....

Address.....

City.....

State.....

SEND FOR IT TODAY

# PALMGREN

## ANGLE VISES

precision work at any angle

DRILLING  
MILLING  
GRINDING  
FILING  
FITING  
MARKING



Solve difficult angle jobs



- For Tool Room . . . Production Line . . . Bench • Speed up work . . . End Makeshift Methods • Quick Accurate Setups at any angle • Sturdy Longlife Construction • All Parts Accurately Machined • Jaws . . . Plain or Grooved • Jaw sizes 1½", 2½", 3", 4", 6" and 8"

Write for literature

**CHICAGO TOOL AND ENGINEERING COMPANY**

Mfrs. of PALMGREN PRODUCTS Since 1918—8365 South Chicago Ave. Chicago 17, Ill

USED IN ALL INDUSTRIES . . . EVERYWHERE



# POPULAR MECHANICS

## Books for the Farmer

- to reduce work
- protect and improve livestock
- increase profits



### New Ed. Veterinary Guide for Farmers

Written by farm expert, G. W. Stamm, this amazing book has sold more than a quarter million copies, now completely revised with most modern discoveries and methods fully discussed. Adopted by the U. S. Government for farm training. Used by farmers everywhere to diagnose and treat livestock diseases. Covers virtually every farm animal ailment and tells how to tell one from another; explains treatment or best procedure until the vet arrives. Includes a special, invaluable 12-page diagnostic chart that helps you locate symptoms in short order. A special chapter is devoted to artificial insemination and tells how this breeding method can improve the quality of your herd as well as increase your profits. Noted authorities proclaim this book the finest and most complete guide of its kind. Available to the farmer and stock raiser. . . . **\$3.95**



### New Edition Farm Manual

Helps you step up farm efficiency, improve property appearance and values, increase farm production and income. Every member of the farm family will find something in this book he or she can use to great advantage in farm operation, maintenance and improvement . . . from the building and care of equipment to painting the farm home and fast freezing of fruit and vegetables. Covers every aspect of farm machinery maintenance . . . includes detailed plans for building essential equipment from scrap and discarded materials. Even suggests how to mix and pour concrete that will last longer! Here is a book brimming with short cuts, labor-saving ideas and methods that will simplify farm chores and save you money as well. Adopted by State Farm Training Programs. Hundreds of pictures and clearly drawn diagrams. . . . **\$3.00**

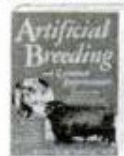

### Artificial Breeding and Livestock Improvement

Now—the secrets of the key to better livestock revealed by farm editor, G. W. Stamm! The first book in ten years to cover the up-to-date principles and practices of Artificial Breeding . . . and written in words every farmer and stockman can understand easily and follow surely. This astonishing book presents the true, approved facts on inbreeding, linebreeding and crossbreeding, plus sections on timing, heat periods, how to pick a good dairy cow, how to choose a herd sire, what to do when a bull fails to perform, what's ahead in the field of frozen semen and many other topics of equal interest. Included is a 13-page directory of semen producers, the areas they serve and the breeds of bulls in their studs. If you are a modern livestock producer interested in the best methods and top profits, you simply cannot afford to be without this book for regular reference. . . . **\$3.95**



### Developing a Profitable Dairy Herd

Here, in a single, practically written book is everything you want and need to know about profitable dairy herd management. Written by Carnation Farms' Merton L. Moore and E. M. Gildow, D.V.M., there is complete information on feeding values, fertilization of pastures, silo practices, breeding, production, pedigrees, management problems and operating economies, vitamins and many other vitally important subjects. A most interesting chapter covers the showing and selling of cattle. Hundreds of charts, photos, drawings and diagrams leave nothing to the imagination. Whether you raise just a few cows or maintain a huge operation involving hundreds of animals—you'll profit from using this book. . . . **\$3.50**



### Hog Profits for Farmers

Hog raising can be highly profitable for the farmer . . . if proper management and feeding methods are employed. Even if you raise only a few hogs you can make a much bigger profit by applying the suggestions and ideas contained in this outstanding Popular Mechanics book. Written by Dr. W. N. McMillen, it offers down-to-earth, practical money-making information on care and management, feeds and feeding, equipment, marketing, breeds and breeding, judging, showing and sales tips. Contributors include many well-known agricultural experts and renowned college instructors. Only a mere 15 minutes of reading time will show you how to apply the six high points of profitable hog raising to improve your profits immediately. . . . **\$3.00**

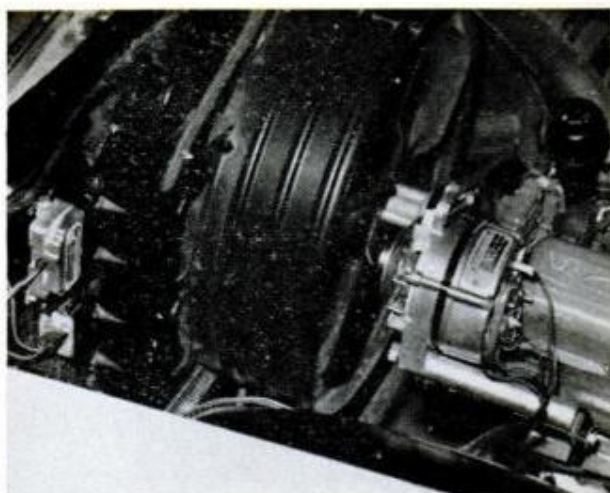

## Replacement Alternator

All-electronic alternator system made by Motorola replaces the standard d.c. generator and regulator. Package includes alternator, voltage regulator and mounting bracket designed to last the life of the car.

System makes battery maintenance easier for vehicles with power accessories or air conditioning, or for taxis and fleet cars that start and stop continuously. Available in 30-amp (\$59.50) or 45-amp (\$79.50) units to fit most 12-volt, post '59 cars. Sold by Motorola distributors and jobbers of automotive equipment.



## Self-Inking Stamp

Porous rubber stamps—the kind you sign your name with or (if fortunate) cancel checks with—have been developed by the National Cash Register Co. to make up to 20,000 markings before they need reinking.

The porous rubber contains its own ink supply and when that supply is exhausted, the stamp can be refilled for more service.

Satisfaction Guaranteed or Your Money Refunded.  
Place your order now. Use coupon below.



**POPULAR MECHANICS PRESS, Dept. 362**  
200 East Ontario St., Chicago 11, Illinois

RUSH books I have checked below. If not pleased, I can return in good order within seven days for full refund.

Remittance enclosed. Send prepaid.

Veterinary Guide     Farm Manual     Artificial Breeding  
 Profitable Dairy Herd     Hog Profits

Name \_\_\_\_\_

Address \_\_\_\_\_

P.O. \_\_\_\_\_ State \_\_\_\_\_

# SURPLUS SALE

GOVT. SURPLUS  
EXCESS INVENTORY  
BANKRUPT STOCK

### GOV'T SURPLUS A-C POWER PLANTS

- Wonderful buys in fine Govt. plants and generators. Save 40% to 70%.
- 1000-w 115-v 60-c ..... \$172.50
- 2500-w 115-v 60-c ..... 269.50
- 3500-w 115/230-v 60-c ..... 329.50
- 5000-w 115/230-v 60-c ..... 479.50
- 3000-w AC generator 60-c ..... 139.50

### GOV'T AIR COMPRESSOR

- Item #453. Expensive Gov't Compressor. G.E. motor 115-v, 60-c. Built-in air filter, relief valve, etc. Very compact and efficient.
- For paint spraying, insecticides, air brush, etc. A "Super Buy." Wt. 55 lbs. Gov't cost over \$250. SALE ..... **\$29.88 FOB**
- Many other bargains in Compressors, Tanks.

### HYDRAULIC SURPLUS BARGAINS

- Great savings. Build loaders, diggers, presses, etc. Brand new equipment.
- 895 Pump, 1000 lb., 14 gpm. .... \$41.60
- 12-v Battery Hyd. Pump ..... 18.49
- Hand Hyd. Pump and Cylinder ..... 27.95
- 839 Hyd. Cyl. 3/8" 2-way ..... 19.70
- Hyd. 2-way 1000-lb. Valve ..... 18.00

### HYDRAULIC SPEED REDUCER

- Item #1304. 1 hp transmission. Variable 0 to 350 rpm. Instantly reversible. Ideal for lathes, midget cars, etc. Roller bearings, and complete with 3-phase 220-v AC ball bearing motor. Size 21"x9"x20". Wt. 200 lbs. Gov't cost over \$900. SALE..... **\$89.50 FOB**

### DIAL TELEPHONE

- Item #716. Std. phone, same used on all phone systems. Use as extension to main phone and on private systems. Directions furnished. Wt. 8 lbs. Cost \$25.00. SALE... **\$7.95**

### SPECIAL OF THE MONTH!

#### SELF PRIMING A-C PUMP

- Item #209. Brand new Gov't expensive self-priming centrifugal pump. Consists of 1/2 hp 115-v AC motor, driving self-priming pump.
- Has 3/4" garden hose connections. Capacity about 900 gph. Good pressure characteristics.
- Use for swimming pools, basement draining, small irrigation, boats, industry. 4-Star Buy! Size 12"x10"x5". Wt. 21 lbs. Gov't cost \$98.75. SALE..... **\$33.60 FOB**

### EXAMPLE BARGAINS IN 1962 CATALOG

- \$325 Battery 12-v Hoist, 1250 lbs. \$68.25
- \$35 Colored Dial Phone ..... 11.95
- \$30 75-Amp 20-v Transformer ..... 15.91
- \$90 Pair 115-v Selsyn Motors ..... 6.95
- \$60 Fuel Oil Pump, 12-v ..... 14.97
- \$75 Centrifugal Pump, 1 1/2" size ..... 19.95
- \$300 Welding Generator, 200 A ..... 14.95
- \$20 Geliger Experimental Tube ..... 6.9
- \$110 Automatic Stepping Switch ..... 12.91

**ALL FOB LINCOLN**  
Write today for large 1962 catalog.  
**SURPLUS CENTER**  
DEPT. 805, LINCOLN, NEBR.

How to work with sheet metal. Watch for this special education-in-a-nutshell on workshop sheet-metal techniques. It's in the April issue of Popular Mechanics.

A national bestseller at \$4.95 - now an AVON paperback at only 75¢



The fascinating, funny and frank account of life at 1600 Pennsylvania Avenue told with warmth and wit by a lady who knows...

Available at your local newsstand or wherever paperback books are sold. For a complete catalog of Avon Books in print, write: Avon Book Division, The Hearst Corporation, Dept. C, 250 West 55th Street, New York 19, N. Y.



Men who know  
**WOOD SCRAPERS**  
say the **BEST** are  
**Red Devil Tools.**

## FREE PLAN

tells how to start your own business

## FILING SAWS

Here is a steady repeat CASH business you can start in your own basement or garage in your spare time and make up to \$3 or \$6 an hour. You can file hand, band and both combination and cross-cut circular saws on the Foley Saw Filer. No eyestrain—no experience needed. "The first saw I sharpened with my Foley Filer came out 100%"—writes Clarence E. Parsons.



Every saw you sharpen with the Foley Saw Filer brings you more customers. "I rented a two-car garage and have all the work I can do"—Charles H. Smith.

**FREE BOOK**  
Shows How to Start

Foley Price Guide gives saw sharpening charges. Send coupon today. No salesman will call.

Send Coupon for **FREE BOOK**

**FOLEY MFG. CO.**  
316-2 Foley Bldg., Minneapolis 18, Minnesota.  
Send **FREE BOOK**—"Money Making Facts," and Time Payment Plan.

Name.....  
Address.....





### Kiddie Safety Belt

Freedom of movement and the security of a seat belt are combined in a new automobile safety belt for children.

The adjustable belt will protect a child up to six years of age. The child is free to stand, sit or sleep while wearing it. The belt, which has a quick-release metal buckle, attaches to the car floor.

It's a product of Rose Manufacturing Co., 2700 West Barberry Place, Denver 4, Colo.



### Fold-Away Diver Warning Flag

Red with a white diagonal stripe and the words "diver below," a regulation skin-diver's warning flag is now available in a neat package that disappears into its own 6-inch plastic buoy for traveling. Both the 36-inch mast and a 12-inch pendulum counterweight telescope into the buoy. A built-in handle serves for carrying or as an eye for an anchor line. Made by Safety Float Corp., 35 S. 5th St., Waterbury, Conn.

### Mold-It-Yourself Plastic Waterfowl Decoys

Easy-to-use expandable plastics, combined with a new aluminum molding outfit, make it possible for waterfowl hunters or shooting clubs to mold their own solid-foam decoys for as little as 50 cents each.

To mold, you place a measure of granulated plastic in the mold, bolt the two halves together, then bake in an oven or

place in boiling water to expand the plastic. Surface details for painting are built into the mold to simplify painting. Molds are available for mallard duck or Canadian goose at \$35 and \$55 per set; 10 pounds of expandable plastic costs \$6.50 and makes 15 ducks or 5½ geese. Made by Decoys Unlimited, Box 69, Clinton, Iowa.

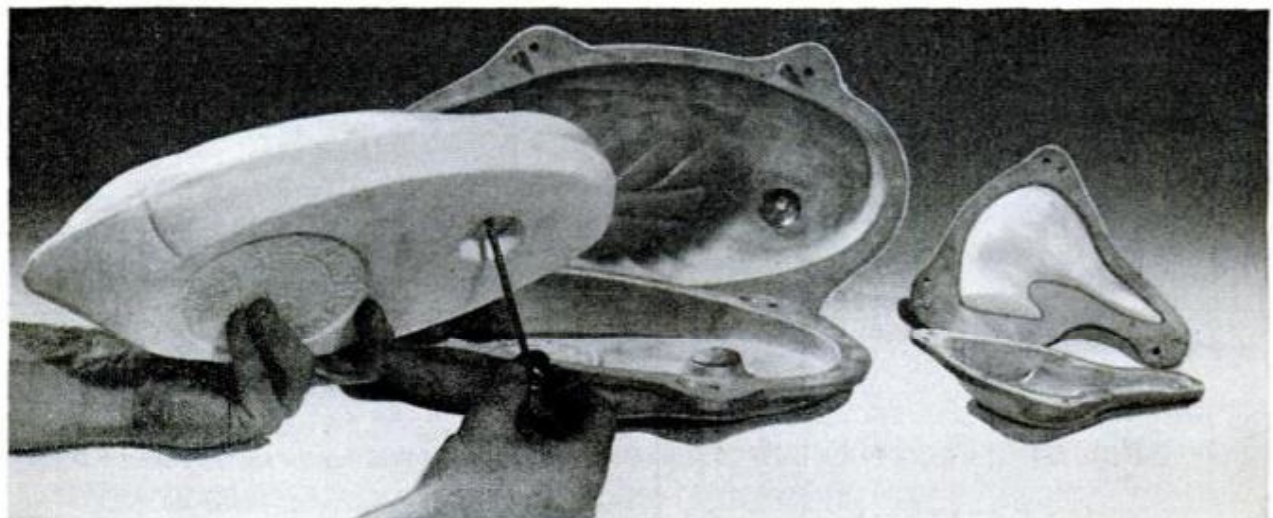



# MFG

## challenges you to...

Before you invest in any outboard boat, compare them all... feature-by-feature... fact-by-fact. Be sure you are buying the boat that's best for you. You'll want the "Challenge Test," a side-by-side comparison guide to outboard boat buying. Ask your MFG dealer for a free copy or write direct. See for yourself how MFG meets the challenge of quality.



# COMPARE THEM ALL!

## MFG BEST BOAT BUILT... Anywhere

Molded Fiber Glass Boat Co., 71 Fourth Ave., Union City, Pa.  
In Canada: Canadian Locomotive Limited, Kingston, Ont.

 World's largest producers of fiber glass reinforced plastics

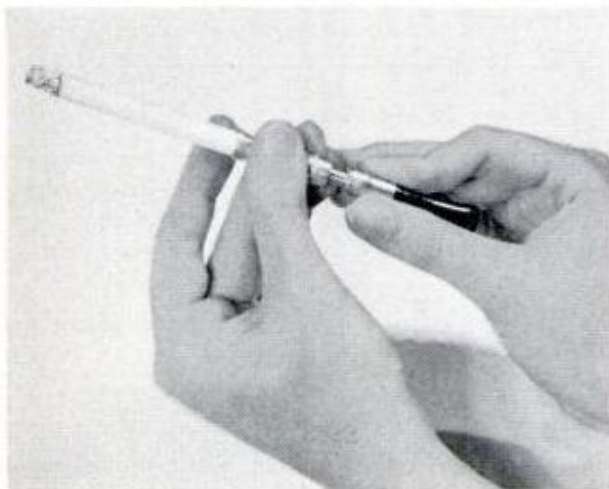

### Less Smoke per Puff

Smokers may select the amount of smoke they wish to receive from a cigarette by using a new holder with a built-in meter. The holder is made of aluminum with a mouthpiece made of black styrene.

There is a 10-notch micrometer adjustment which will allow more (or less) smoke to flow through the holder.

It is designed for those who wish to ease back on smoking or who desire to make their smoke milder. The holder costs \$4.75. It is available from Bonacraft Machine Co., 2312 Boone St., Baltimore 18, Md.

MARCH 1962

### WAR SURPLUS AND OTHER **SAVE UP TO 90%**



**CORNELIUS AIR COMPRESSOR** Ideal for filling underwater diving tanks, air horn tanks, etc. Three stage USAF air compressor. Has built-in 1/2 HP, 27 V. DC electric motor and adjustable cut-out switch. Develops 1500 PSI or may be reset to 2000 PSI. Delivers .4 CFM. Approx. GOVT. COST \$375. Like NEW. **\$29.95.**



**U. S. NAVY SEXTANT (AN 5851)** The finest navigational aid on land, sea or air. Adjustable bubble and nite lite, built-in averaging device. Both artificial and natural horizon. Can be used with or without bubble. Excellent for marine use. Used by many power squadrons. Comes complete with filters, astigmatizer, batteries, carrying case & instruction book. Approx. GOVT. COST \$586. Like NEW. **\$16.50.**



**SOUTH WIND HEATER & ACCESSORIES** Manufactured for govt. antarctic expeditions for jeeps and half-tracks. Heating unit puts out over 20,000 B.T.U.'s. Late recirculating type. Burns any type gas, 12 volt system. Fuel consumption extremely low, 1 gal. per 8 hrs. Terrific for trucks, etc. With service & installation manuals & many components. Approx. GOVT. COST \$550. Shpg. wt. 50 lbs. NEW. **\$39.95.** Limited quantity.



**ELECTRIC STORAGE BATTERY WINCH** New, improved model contains heavy-duty, 2-way drum switch. Fully reversible heavy-duty, two-speed motor, 160 to 1 gear reduction. Ball bearing construction throughout. Drum will handle 70' of 1/4" cable. Can be used on 6, 12, 24 V. battery. Lift cap. 2000 lbs. plus. Ready to install & operate. 19" long x 9" wide x 8" high. For jeeps, trailers, boats, trucks, etc. Complete with mounting flange, safety load locking brake and leads. Shpg. Wt. 60 lbs. Approx. GOVT. COST \$400. NEW. Model E. **\$49.50.**

**DELUXE MODEL ED** Same as above but with extra heavy base & outrigger support bearing. 200' 1/4" cable spool capacity. NEW. **\$69.50.**



**BUILD YOUR OWN ARC WELDER, LIGHT PLANT OR BATTERY CHARGER \$39.50**  
Kit incl. 1 Navy NEA-5 Gen. combination AC-DC type. AC 115 V. DC 24 V., 200-300 Amps. 2 complete generators in 1, yet no larger than gen. Ideal for home, shop and farm lighting plants. Delivers 1200 Watts AC, DC side for charging batteries, welding and operating war surplus motors. Also in kit: 1 DC Voltage Reg., Reverse Current Relay, 1 Voltmeter, Rheostat, Electrode Holder, Toggle Switch, Welder's Shield, Wiring Diagram for kit. Wt. under 100 lbs. Approx. GOVT. COST \$650. Kit—**\$39.50.** Navy NEA-5 Gen. as above, purchased separately, **\$23.50**

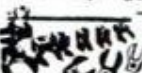

**11 PIECE CROWFOOT WRENCH SETS**  
Wrenches snap onto T-bar in 3 different positions. The only wrenches for hard-to-get-to places. Mfd. by Plomb Tool Co. for U.S. Armed Forces. Finest case hardened tool steel. No shop mechanic should be without this set. Approx. GOVT. COST \$47. NEW. **\$5.95 pd.**



**FRESH WATER SYSTEM PUMP**—For boats, campers & trailers. Output 10 to 200 gal. an hr. Variable rheostat controls output. 1/2" pipe thread into bronze impeller housing. 12 V.D.C. Radio noise filter. 5.2 amp. draw. Explosion-proof const. Shpg. wt. 11 lbs. Complete with mounting instructions & wiring diagram. Approx. GOVT. COST, \$200. NEW. **\$10.95.**



**225-1 REDUCTION GEAR** For beaching boats, winches, hoists. Ideal motor in golf or boy's electric car. DC motor and clutch. Easily reversible wiring diagram furnished. Hi torque. 105 RPM. Runs on 6-12 or 24-32 V. 65 lbs. gross. Approx. GOVT. COST \$300. **\$13.50.** Matched splined gear—**\$3.00 ea.**

**NEW 1962 CATALOG!**

Tremendous catalog — our biggest ever — fully illustrated — 1000s of bargains in war surplus & other items. Send 25c in coin for your copy today or free copy with order. Where ppd. indicated applies to US only. Other prices FOB Culver City, Calif. Send cash, check, money order, 50% deposit for COD.



**AIRBORNE SALES CO., INC DEPT. PM362**  
8501 Stellar Drive, Culver City, Calif

# Fill Cracks And Holes Better

Handles like putty. Hardens like wood.

# PLASTIC WOOD®

The *Genuine*—Accept No Substitute.

# Owners Report on the Chevy II

(Continued from page 97)

## SUMMARY OF OWNERS REPORT:

EXCELLENT  
52.1%



GOOD  
38.4%



FAIR  
7.1%



POOR  
2.4%



<b>Satisfied with automatic economy?</b>	
About as expected.....	45.9%
Better .....	13.9
Not as good.....	40.2
<b>Satisfied with manual economy?</b>	
About as expected.....	40.4
Better .....	16.0
Not as good.....	43.6
<b>Best-liked features</b>	
Handling ease .....	62.1
Size .....	26.0
Roominess .....	25.5
Power, performance .....	22.9
Economy .....	21.1
Parks with ease.....	19.6
Riding comfort .....	10.9
Styling .....	13.7
Visibility .....	11.6
Ease of entry/exit.....	7.7
<b>Most-frequent complaints</b>	
Poor gas economy.....	11.1
Inferior paint job.....	5.0
Poor workmanship.....	5.4
Noisy engine.....	4.4
Inadequate heater.....	3.1
Rattles and squeaks.....	2.8
<b>Had mechanical trouble?</b>	
No trouble .....	69.1
Some trouble .....	27.3
Considerable trouble .....	3.6
<b>What was trouble?</b>	
Carburetor .....	6.2
Automatic transmission .....	5.4
Lights, turn signals.....	2.8

<b>Best-liked exterior features</b>	
Straight, simple lines.....	10.8%
Trim, neat styling.....	4.1
Front-end styling.....	4.1
No excess chrome.....	3.9
Colors .....	2.6
Single headlights .....	2.1
Absence of fins.....	2.1
Rear-end styling .....	1.3
Windshield wipers .....	1.0
<b>Least-liked exterior features</b>	
13-inch wheels too small.....	10.0
Rear-end styling .....	3.9
Single headlights .....	3.6
Gas filler spout and cap.....	3.6
Grille design .....	2.1
<b>Best-liked interior features</b>	
Comfortable seats .....	12.9
Upholstery .....	12.9
Dashboard, instruments .....	12.1
Headroom .....	8.0
Colors .....	3.4
Legroom .....	2.8
<b>Least-liked interior features</b>	
Heater controls .....	7.2
Indicator lights .....	5.2
<b>Did consider another car in Chevy II's price range?</b>	
Falcon .....	31.2
Ford .....	5.9
Comet .....	16.8
Rambler .....	16.3
Corvair .....	6.9
Chevrolet .....	4.5
Tempest .....	6.4

<b>Is Chevy II only car in family?</b>	
Yes, it is.....	61.1%
No, it isn't.....	38.9
<b>Make of other car?</b>	
Chevrolet .....	21.9
Other GM make.....	8.2
Ford .....	2.6
Other Ford Motor make.....	1.3
Plymouth .....	2.3
Other Chrysler Corp. make.....	2.6
Other U.S. make.....	1.8
<b>Decision to buy Chevy II based on:</b>	
Size .....	71.6
Economy .....	60.6
Price .....	36.1
Styling .....	23.7
<b>How is dealer service?</b>	
Excellent .....	61.3
Average .....	31.4
Poor .....	7.3
<b>Make of car traded in:</b>	
Chevrolet .....	44.5
Other GM make.....	15.4
Ford .....	8.0
Other Ford Motor make.....	4.1
Plymouth .....	5.2
Other Chrysler Corp. make.....	2.6
Other U.S. make.....	4.6
Foreign make .....	2.5
<b>Would buy another Chevy II?</b>	
Yes, would buy.....	76.3
No, would not buy.....	9.5
Undecided, don't know.....	14.2

"My motor tends to be noisy."—Ohio salesman.

"Engine is very noisy in high gear when accelerating and hill climbing. Mechanics have worked on it twice and think a new drive shaft may be needed."—Missouri retiree.

"The heater does not warm the car or make it comfortable."—Iowa carpenter.

**This winter's been a rough one, especially in Iowa, but PM found test-car heater just about adequate at 10° above. Today's heaters need a way to block off fresh air intake, recirculate air that's already in the car.**

"The heater does not compare with those in other cars I've had. Have had it checked and nothing's wrong they said—but I freeze."—Michigan clerk.

*In order of mention, the second group of best-liked features, numbers six through ten, look like this:*

"Like the easy parking in small or limited areas."—Pennsylvania railroader.

"I like the flexibility, easy parking."—Pennsylvania broker.

"A very firm ride but a comfortable one."—New Jersey salesman.

**This Jerseyite just voiced a little-known fact: Most people are not truly comfortable in a car with sloppy, marshmallow-soft riding qualities.**

"It is as comfortable as the '59 Mercury we traded in on it."—New Mexico warehouseman.

"I like the absence of extravagant, non-utilitarian ornamentation which for a few years seemed to be Detroit's substitute for good taste."—Tennessee budget analyst.

"Like the neat, plain styling."—Colorado public health nurse.

"The body design has no folds, fins or other unnecessary sheet metal."—Michigan educator.

"All-around vision, able to see over the hood close-up."—California marine.

**Vision is good, it's true, but would be even better if hood were more sharply sloped toward front of car.**

"Easy to get in and out of."—Oklahoma carpenter.

(Continued to page 270)

# BONDS INSTANTLY!



Here's a glue that bonds instantly on contact... Elmer's Contact Cement. No pressure or clamping needed! Works with metals, wood, tiles, leather, rubber, china and most plastics. Spreads easily. Elmer's Contact Cement comes in a handy blister pack with a die-cut trap door on the back of the display card for easy removal and replacement. Send stamped, self-addressed envelope for your free copy of **Elmer's Wood-Gluing Handbook**. Dept. PM32, The Borden Chemical Company, 350 Madison Ave., New York 17, N. Y. (Available in Canada.)



"There's nothing wrong with being a bailing-wire mechanic—temporarily."

## Save on all PLUMBING JOBS

When You Build · When Making Improvements · Repairs · Maintenance

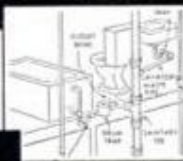

Get POPULAR MECHANICS Home Plumbing Guide



How to plan plumbing installations, select materials and fixtures.

How to save money on all plumbing jobs using approved methods.

Easy to Do Professional-Like Jobs and Save Over One-Half

Get the Popular Mechanics HOME PLUMBING GUIDE. It shows how you can do every kind of plumbing job yourself and save from a few to hundreds of dollars. Covers plans, layouts, installation, maintenance and repair. Shows what materials to get and use, where to get them and how to do a proper job with approved methods. Few, other than the simplest tools are required and some of these can be rented. Don't pay high prices for work you can do yourself. Get the HOME PLUMBING GUIDE for only \$3.50. You will be amazed how jobs you thought difficult are simplified.

Clip This Ad and Mail. Money Back if Not Pleased

Invest only \$3.50. Use the book for 7 days. Then if you are not satisfied return it for full refund of your money.



15 Ways to Save Money  
All about modern home plumbing  
How to use plumbing tools  
Getting acquainted with pipe  
Planning home plumbing systems  
Installing and maintaining home drainage systems  
Private sewage disposal systems  
Causes and cures of drainage troubles  
Installing home water lines  
Private water supply systems  
Water Heaters  
Water Conditioning  
Water system troubles and cures  
Installing and caring for fixtures  
What to do with valves and faucets

Over 500 How-to-do-it Pictures Guide You

POPULAR MECHANICS PRESS, Dept. 362, 200 E. Ontario St., Chicago 11

MARCH 1962



## BOAT OWNERS! BUILD YOUR OWN AUTOMATIC PILOT

Vacuum operated. Fully tested. Has precision aircraft directional gyro control and electric servo motor with a special vacuum balancing valve. A highly sensitive hunting type auto-

SAVE \$400 pilot. Complete with instructions and diagrams. Full details in Cat. below. **ONLY 8950**

USE FOR PONTOONS · STORING WATER, FUEL, OIL

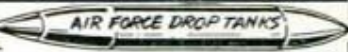

Originally fuel drop-tanks on Army Aircraft. All aluminum for light weight. Watertight. Holds 230 gallons. 14 ft. long. . . . .

**3750**

16 FOOT Drop-tanks. Limited Quantity . . . . . \$49.95



## SPECIAL G-1 Stainless Steel TANKS

Finest WATER, AIR, OXYGEN or CHEMICAL containers. ALSO ideal for BOAT BUOYS, FLOATS, etc. Corrosion proof. Tested to 400 PSI. Capacity 2100 cu. in. air or 9 gallons liquid. In excellent condition. Cost Gov't approx. \$60.00. Order No. G-1 **NOW 1195 EA.**

## WORLD'S MOST AMAZING CATALOG

260 PAGES of BARGAINS

Fully Illustrated! Packed with special values in Gov't Surplus, Factory Closeouts and Nationally Advertised Products.

HAND & POWER TOOLS ★ SPORTING GOODS ★ HYDRAULICS ★ OPTICS ★ CLOTHING ★ GADGETS ★ INSTRUMENTS ★ WINCHES ★ ELECTRIC MOTORS ★ POWER PLANTS ★ PLUS MANY OTHERS

SAVE UP TO 85%

Only 50c Your 50c refunded with first order of \$1.00 or more.

TO COVER HANDLING & MAILING

TO ORDER - Send Check or Money Order. 1/2 deposit with C.O.D.s. All items sent freight or postage collect.

ORDER TODAY CATALOG SUPPLY LIMITED

2263 E. VERNON AVE., Dept. PM-32 LOS ANGELES 58, CALIFORNIA

## EVERLITE\* World's THRIFTIEST Light Plants

(Item 869-10T)



NEW TRANSISTOR ALTERNATOR REPLACES GENERATOR

Now a Service Free Light Plant built with a transistorized alternator. Offers 30% greater efficiency—more power for less fuel. Terrific service life—no brushes to arc and burn. No more commutator to wear, no collector ring trouble. And best of all it costs no more to "go modern with Everlite." Thrifty 1000 watt, 115v. AC plant powered by a rugged easy starting 4 cycle engine—leader priced. Model 869-10T. Wt. 65 lbs. **\$179.50** as illustrated. . . . .

\*Trade-Mark Registered

All sizes available—can finance. Write for catalog. Special models for public utilities—Approved for Civil Defense. Write.

**MASTER MECHANIC MFG. CO., Dept. A-362, Burlington, Wis.**

Southern Customers Order from Dept. A-362, Box 65, Sarasota, Fla.

269

Schupeck's Amazing Tool Bargains! Save up to 100%!

**87 Mounted Wheels & Miniature Cutters.** Regular \$11.00 value  
**\$6.95 P.P.**  
 For cutting and grinding on wood, metal or plastic. Includes 26 mtd. wheels and points on 3/32" shanks; 24 miniature cutters on 3/32" shanks; 25 short shank min. cutters. 12 Bristle Brushes on 3/32" shank. Will fit all electric drills and hand grinders.

**FLEXIBLE SHAFT—ONLY \$6.50 P.P.**

Fits all electric drills & hand power tools 35/64" long. Oilite bearings. Core of specially wound, high carbon steel wire in flexible steel casing. Will accommodate tool shafts up to 1 1/8" dia. For lathes, electric drills, etc.

**2 DRUM SANDERS**  
 With 12 Bands in Assorted Grits, 1 1/2" dia. x 1" long on 1/4" arbor with 12 bands... **\$1.50 P.P.**  
 One drum, 1" dia. x 1" long on 1/4" arbor with 6 extra sleeves **\$1.00 P.P.**

**12 Miniature Cutters.** For cutting wood, plastic or metal. Assorted shapes on 3/32" shank... **\$1.50 P.P.**

**ELECTRIC HAND GRINDER**  
 Fits in the palm of the hand and has an air-cooled motor that runs at 27,000 rpm AC or DC at 110 volts. Comes complete with both 3/32 and 1/4 inch Collets, cord and plug... **\$19.95 P.P.**

**10 Morse Taper Shank Drills** asstd. sizes up to 1". Brand new. **\$6.75 P.P.** (Add 50c postage.)  
**10 Straight Shank Drills** up to 1-7/32" asstd. sizes. Brand new. **\$7.25 P.P.** (Add 50c postage.)

**SPECIAL—101 PIECES for ELECTRIC GRINDERS**  
 Grinding Wheels, Cut-off Wheels, Sanding Discs, Mounted Stones, Honing Stones, Rotary Cutting Burrs, Mandrels, other items. **\$1.95 P.P.**

**12 MOUNTED WHEELS** and points on 1/4" Shank **\$2.95**  
 36 for 7.50 p.p.  
 For grinding on plastic, wood, soft & hard metals. Regular Value \$8.40. **12 Mounted points** on 3/32" shank **\$2.50**; **12 mtd. wheels** on 1/4" shank **\$4.75**.

**12 SHARPENING AND HONING STONES**—Squares, Rounds, Triangles. An assortment from 3 1/2" long to 4" long. Fine, medium and coarse. A real \$9.00 value. **12 for \$4.25 P.P.**

**18 Rotary Cutters** **\$5.85 P.P.**  
**\$13.50 Value.** Assorted size cutters on 1/4" or 3/32" shank. Will fit all hand grinders. Ideal for cutting wood, metal or plastic.

**10 HIGH SPEED STEEL REAMERS**—Straight and Taper Shanks—all brand new and in excellent condition. Reg. \$25.00 value. **10 for \$4.50 P.P.**

**7 H.S. and carbon drills** from 6" to 12" in length. Assorted sizes up to 1/4" diam. for drilling in hard to reach places. A reg. \$18.00 val. for only **\$1.95 P.P.**

No C.O.D.'s. Catalog 25 cents

SCHUPACK SUPPLY CO., 7331 COTTAGE GROVE AVE., DEPT. PM 26 CHICAGO 19, ILL.

"Very easy to get in and out of; comfortable to sit in."—Illinois steel foreman.

The gripers ask to be heard again: In order of frequency of mention, here are the next group of complaints—six through ten.

"Car was not put together very well. It has a lot of squeakes and some rattles."—Michigan dental technician.

"Rough-riding over small bumps."—Missouri mine operator.

"It leans too much on curves; 'bottoms' on bumps when fully loaded."—Ohio banker.

"Too light! Doesn't ride as well as a Corvair."—New Jersey salesman.

**Chevy II is at least 75 pounds heavier than Corvair. The latter's slightly better ride is due to softer springing and independent rear suspension, not weight.**

"A very bad clutch vibration at about 60 m.p.h. (4-cylinder)."—North Carolina farmer.

"You cannot go slow in high gear (4-cylinder) without a tremble."—North Carolina government worker.

"Vibration at 15-25 m.p.h. in high gear (4-cylinder)." — Pennsylvania insurance adjuster.

**That's what we found in tests of Chevy II Fours. Numerically higher rear axle ratio (see above) will do a lot to cure this low-speed shake.**

"There is a vibration or rumble in low gear before shifting to second."—New Jersey housewife.

"There's a leak in the roof over the driver's seat."—New Jersey housewife.

"Windows are too hard to roll up and down."—Michigan butcher.

"Windows on the two-door model don't operate easily and have a tendency to lower themselves while driving."—Illinois park custodian.

**Winding up the survey of best-liked features, here's the last group—11 through 15—listed in order of mention.**

"Can be steered with only one finger."—Ohio welder.

"It handles just as though it has power steering."—Michigan tool and die maker.

"It was surprising how this car would get out and go through snow drifts and on ice."—Iowa farmer.

**Perhaps he had Positraction (limited slip differential). PM's Chevy II (without chains) got stuck like everybody else this winter.**

"Like the way it handles, especially on snow and ice."—Illinois cab driver.

(Continued to page 272)

## For that extra Quality you can actually feel...





The choice of men who make their living with tools. A complete line of sockets, handles, flat wrenches, pliers and adjustable wrenches. Sold by better dealers everywhere.

**FREE POCKET CATALOG** of S-K Lectrolite wrench sets and individual tools. Send this coupon today.

S-K/Lectrolite Tools—Dept. A  
 Chicago 32, Illinois

Name \_\_\_\_\_  
 Address \_\_\_\_\_  
 City \_\_\_\_\_ State \_\_\_\_\_



### Kit for Young Draftsmen

Blueprints, tracings and design drawings can be made by young draftsmen working with a new drafting kit that contains all necessary equipment, including a lightbox.

Price of the Draft-a-Plan set is \$9.95. Manufacturer is Lakeside Industries, 3200 Snelling Ave., Minneapolis 6, Minn.

## IS THE COMMUNIST TIMETABLE FOR WORLD CONQUEST ON SCHEDULE?



Add it up. 1949, China. 1951, Tibet. 1954, N. Vietnam. 1961, Cuba. So far the Communist timetable is *on schedule!* But in Eastern Europe you can fight Communism through *Radio Free Europe!*

**GIVE NOW TO  
RADIO FREE EUROPE FUND**  
Box 1962, Mt. Vernon, N. Y.

Published as a public service in cooperation with The Advertising Council

## "TOOK IN \$217 FIRST 10 DAYS"

*Some make more, some less...*

**We help you to start Your Own All-Year Business**

**Make Big Money!** With our easily operated, highly efficient Wall Washer, Charles Stelle took in \$217 in first ten days. E. L. Goss took in more than \$10,000 in one year. G. H. Jones wrote, "I made a net profit of \$1200 on one job." And no wonder—this machine washes walls 6 times faster and better than by hand and with no mess—no drop cloths needed.



**Your Money Making Opportunity** • We want more men to go into this profitable business for themselves and enjoy independence—freedom from layoffs and bosses. Customers everywhere—homes, offices, schools, churches, hotels, etc. How much you earn depends largely on you. What you take in is mostly profit. No need to rent shop or office; operate from home. Can start spare time until your full time is justified.

*Lose No Time—Send Coupon Today for All the Facts*

### FREE BOOK! MAIL COUPON TODAY!

• **VON. SCHRADER. MFG. CO.**  
• 310 "W" Pl., Racine, Wisconsin  
• Send at once (no obligation) your **FREE** booklet containing information about your **WALL WASHING MACHINE** and how I can start my own permanent, profitable business.  
• Name \_\_\_\_\_  
• Address \_\_\_\_\_  
• City \_\_\_\_\_ Zone \_\_\_\_\_ State \_\_\_\_\_  
• . . . . .

### BIG PROFITS FROM FIREPLACE WOOD

Lickity log splitter eliminates the drudgery of splitting logs up to 48" lengths, any diameter. Does splitting with 18 ton hydraulic power. It's fun to operate. Highly profitable for FIREWOOD MERCHANTS, Farmers, Estate Owners, Country Clubs, Parks, Cities. Write for complete details without obligation to:

**WACO AIRCRAFT CO., Dept. D, TROY, OHIO**



**FREE**  
Write for  
Details and  
Easy Pay Plan

## WELD FOR PLEASURE OR PROFIT

### TRINDL INDUSTRIAL ARC WELDER

Own a Trindl 125 Amp Industrial Welder at less than smaller machines. Welds metals to 1/2" thick. Operates off properly wired 110 or 220 volt line. 16 heat stages from 20 to 125 amps. Make, repair anything of metal in the home, garage, farm or shop. No experience or training needed. Full "do-it-yourself" instructions. Guaranteed 12 months in continuous operation. Complete only \$98.50 FOB or write for details on 125A and other Heavy Duty Trindl Welders. Dealer Inquiries Invited.

**Trindl Products, Ltd., Dept. T2-C 1807 S. Clark St., Chicago 16, Ill.**



**EASY TERMS**  
**\$98.50 FOB**

# WISS CUTS BEST



Cut Metal, Vinyl, Leather—practically anything—with versatile WISS V-13 "Mighty Midget" Snips, Only 7" long, \$2.50. Others 8" to 17" in aviation, combination, and solid steel styles. At hardware and building supply stores.

## OTHER FINE WISS CUTTING TOOLS

**GRASS SHEARS**  
No. 701  
\$2.75



Easiest cutting, fastest cutting grass shears you've ever used, with molded vinyl handle grips and special closing latch. Others from \$1.49 to \$5.50.

**PRUNERS**  
No. 708  
\$3.25



ALL NEW design for easier cutting of heaviest branches. New, unique two position latch. Comfortable grips. \$3.25 wherever fine garden tools are sold.

**J. WISS & SONS CO., NEWARK 7, N. J.**  
World's Largest Manufacturer of Shears, Scissors, Pinking Shears, Skalloping Shears, Metal Cutting Snips and Garden Shears

"I like the quick, easy starts."—Kentucky teacher.

"Good trunk room."—Missouri sales manager.

"I like neatness of the inside features and the convenience of accessories."—Kentucky government employee.

Getting down to the wire on complaints, here's the final five in their order of frequency of mention, numbers 11-15.

"It could be better insulated."—Ohio die maker.

He's right. Even PM's Deluxe Nova 400 was, we thought, too noisy at 65 m.p.h. A free-wheeling fan that idles until engine gets hot would quiet things down. So would better insulation around automatic transmission.

"The sound insulation of the road running gear is inadequate."—Virginia engineer.

"Add soundproofing under the hood and thicker floor mats."—Ohio engineer.

"Tie rods are too low to the ground."—West Virginia service station operator.

"Undercarriage, tie rods stand out—to be knocked off!"—Kentucky radio station executive.

This is just an out-and-out design goof. Surely Chevy II engineers can find a better location for these vital organs.

"Wind noise is excessive because rear windows aren't tight."—Ohio steelworker.

"Climbs hills too slowly."—Colorado barber.

"No pep after reaching 55-60 m.p.h., poor passing qualities."—New Jersey engineer.

★★★

Send for your free WHERE-TO-FIND-IT list giving sources of supply or further information on articles in this issue.

## QUOTE:

"In the field of military intelligence the Soviet Union has no problem. In peacetime, because of our democratic principles, only our most vital technical information can be kept secure.

"On the other hand, the iron curtain has been extremely effective [in keeping their secrets from us].

"Satellite systems, such as Midas, will double the warning time we can get from ground-base systems. Such satellite systems would provide maximum assurance of the survival of our counter-offensive forces if war should be thrust upon us."

LT. GEN. BERNARD SCHRIEVER, Commander Air Research and Development Command U.S. Air Force

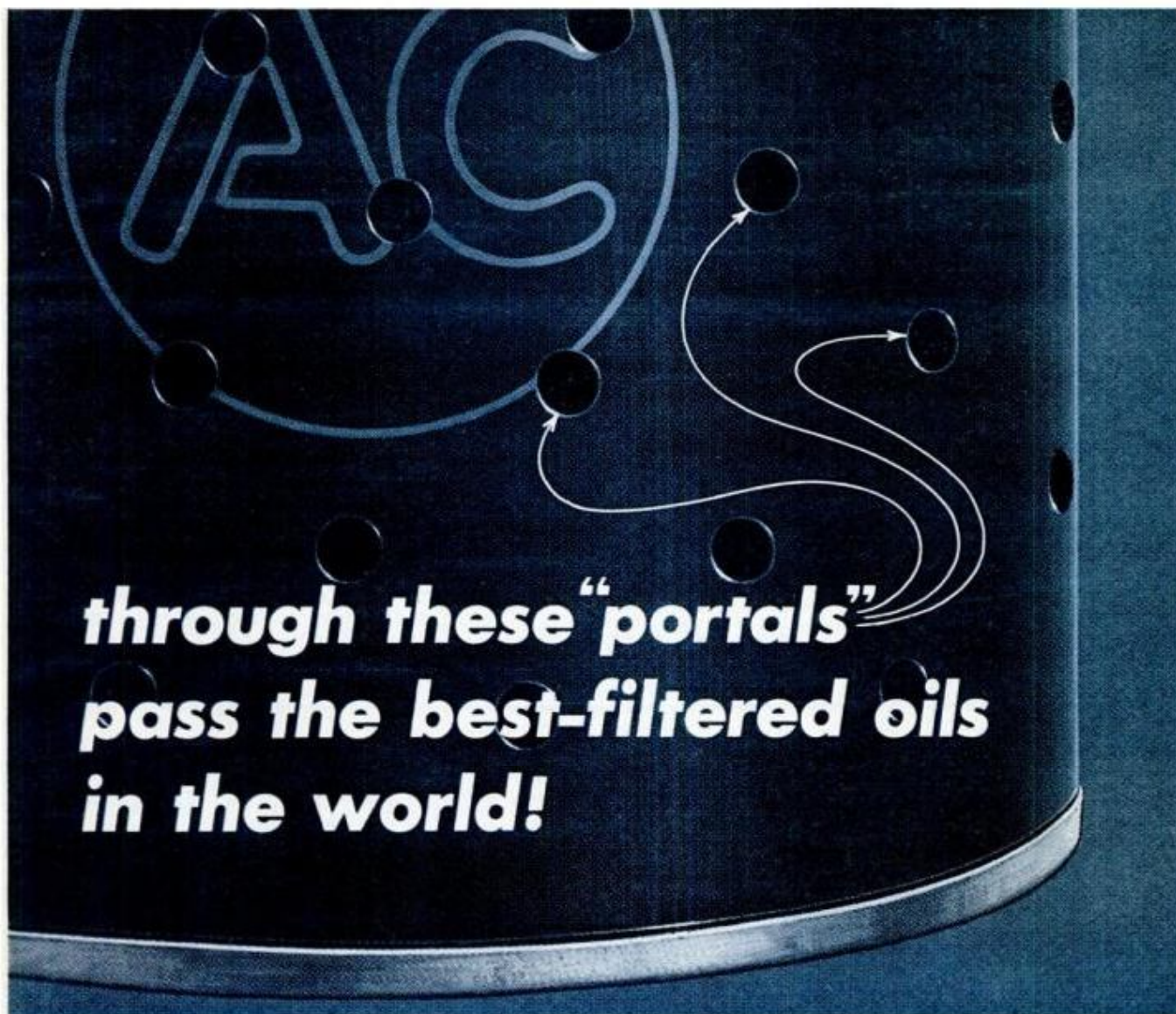

**through these "portals"  
pass the best-filtered oils  
in the world!**

## Spring-clean your engine with an AC Oil Filter

Spring time is clean-up time . . . and the best way to spring-clean your engine is to install a new AC Triple-Trapper Oil Filter. The AC Triple-Trapper provides the finest in oil filtration.

One important reason is the scientifically controlled, specially formulated paper used in every automotive AC Oil Filter. The paper's porosity is designed, engineered and produced to trap and to hold engine contaminants for maximum cleaning effectiveness.

AC Triple-Trapper filtration is best for all cars because *all* of the oil in the engine passes

through the filter in a continual and constant flow. This means contaminants are trapped before they can reach moving parts to cause wear and possible bearing damage.

When you change your oil, change your filter, too. Ask for the finest engine protection money can buy . . . ask for AC.

*protective*  
you get **ACtion** with



AC SPARK PLUG  THE ELECTRONICS DIVISION OF GENERAL MOTORS

MARCH 1962

273

# SAVE AS MUCH AS 80% ON POWER TOOLS

GUARANTEED TO DO THE WORK OF \$40, \$60, \$80 UNITS

- SAVE! BUY DIRECT FROM FACTORY
- PROFESSIONAL QUALITY, LIFETIME ENGINEERED
- UNCONDITIONAL 10-YEAR GUARANTEE

REVOLUTIONARY PATENTS DECREASE COSTS, INCREASE EFFICIENCY. Top quality full scale power tools of heavy duty 100% cast iron and steel. Streamlined design features such as perforations on table tops reduce weight, cut material costs, cut polishing and grinding time—reduce production costs. Special patents provide added efficiency, accuracy, savings. Nothing left out but exp've gingerbread. Parts made, assembled, tested and packed in our own factories, shipped direct to you. No retail store handling or profits to add to your cost.

**\$995**



Exp. Coll.

**8" TILT  
ARBOR  
POWER  
SAW**

Complete as shown, less blade. Incl. precision mitre gauge, ground cast iron table. If desired, RIP FENCE for easier work alignment, \$3.50 add'l.

**DOES THE WORK OF \$50 BENCH SAWS!**

CROSS-CUTS, RIPS, BEVELS, MITRES, DADOES, CUTS COMPOUND ANGLES. Patented motor mount takes any standard 1/4 to 1/2 h.p. motor . . . keeps belt tight, assures perfect alignment at any angle, transmits full power. Table stays level—blade tilts, locks securely at any angle to 50°, raises, lowers 0"-2 1/4". Patented tilt mechanism has accurate etched scale. Takes standard blade, saw insert removes easily for insertion of any STANDARD dadoe heads, cutters, etc. Accessories, table extensions, when wanted, at factory prices. Versatile, rugged performance proven by almost a half-million users.

UNCONDITIONAL 10 YEAR GUARANTEE

**DOES THE WORK OF \$60 UNITS**

Now, at little more than a hand tool price, a guaranteed professional quality precision machine which does same work as skilled hand planing . . . much faster, more accurately. Make accurate glue joints; rabbeting cuts for doors, window frames, table drawers; square taper cuts for chair legs; extremely accurate beveling. Helps amateurs produce quality work—with the sweat eliminated.

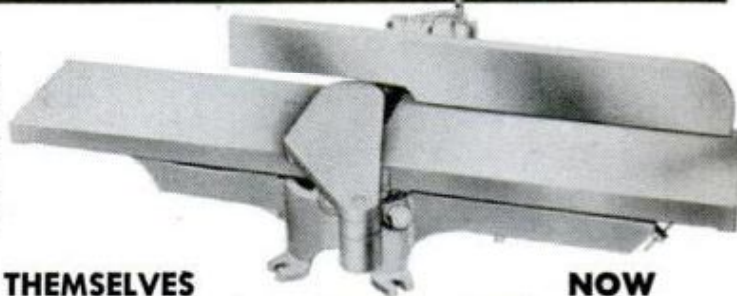

**TOP QUALITY FEATURES SPEAK FOR THEMSELVES**

- Precision ground cast iron tables, adjustable for depth of cut
- Rigid cast iron base
- New patent-pending design holds clearance between knives and tables at any depth
- Rabbet depth 3/8"
- Hardened, ground high speed steel knives
- Patent-pending fence adjustable to any position, any angle 0°-50°
- Patent pending lift-off guard (nothing to loosen!)
- Balanced steel cutter head. UNCONDITIONAL 10-YEAR GUARANTEE.

FULL 22" LONG, 4 1/8"

**JOINTER-PLANER**

100% precision ground cast iron and steel. Exp. Coll.

**NOW  
\$1995**

Complete as shown

**BENCH DRILL PRESS**

DRILLS TO CENTER OF 10" CIRCLE—Rugged, dependable . . . all cast iron and steel. Table to 1/2" handtight chuck: max. 13 1/2". Spindle has combination ball and bronze bearings. Adjustable stop for repetitive drilling. Precision ground cast iron table. Table assembly fully adjustable on column. UNCONDITIONAL 10 YEAR GUARANTEE.

**\$1995**

Less Belt  
Exp. Coll.



**6" SWING  
3-FT. LATHE**

**\$985**  
Exp. Coll.



Complete as shown  
**DOES THE WORK OF \$40 UNITS**—This sturdy all cast iron power tool will turn wood or plastics with the precision and speed of machines selling for 4 times as much. Has tubular steel bed, ball thrust cup center, spur center. T-Rest assembly, lever action tail stock, 2 speed pulley. Fits any motor. Perfect for the home or professional workshop, garage or farm. UNCONDITIONAL 10 YEAR GUARANTEE.

Optional Faceplate for turning bowls, trays, lamp bases, rosettes, etc. **\$250**

**Deluxe WOOD SHAPER KIT**

Ball Bearing  
**DOES THE WORK OF \$100 UNITS** Makes decorator edges on furniture, forms beads and coves, fashions many types of moldings. You do finished cabinet work with tongue-in-groove joints, turn out 1001 projects like an expert. Easy-to-follow plans make assembly a breeze. Everything included but a few pieces of plywood for table and skirt. Has greased-for-life ball bearings in sealed cast iron housing; fully adjustable, easily accessible cutter height control and fence assembly. Precision-machined for smooth, accurate cuts at high speed. Takes 1/4 h.p. or larger motor; standard cutters available at Sears and other retailers. Sensational value! UNCONDITIONAL 10-YR. GUARANTEE.

Exp. Coll. **\$1495** Complete less wood parts

**MAIL COUPON TODAY!**

American Machine & Tool Co., Dept. PM-32 Royersford, Pa.

Please send me the units checked. Payment in full enclosed \$ . . . . . or \$3 deposit each item enclosed, balance C.O.D. . . . . I must be fully satisfied or will return unit within 10 days for full refund. No questions asked.  Jointer-Planer \$19.95

8" Saw \$9.95  8" Saw & Rip Fence \$13.45  Drill Press \$19.95  
 Lathe \$9.85  Lathe & Faceplate \$12.35  Shaper Kit \$14.95

NAME . . . . .  
ADDRESS . . . . .  
CITY . . . . . ZONE . . . . . STATE . . . . .

(please print)

**10 DAY MONEY BACK GUARANTEE**  
You must be satisfied or money refunded, no questions asked.  
**AMERICAN MACHINE & TOOL COMPANY**  
Dept. PM-32, Royersford, Pa.



# New talent needed for commercial art



Magazine illustrating



Advertising layout art



Television art



Lettering



## Art Talent Hunt announced by nationally known illustrator

**Walter J. Wilwerding**

To help fill the nationwide need for new artists today, an Art Talent Hunt is being conducted right now. Artists are needed for advertising, magazine illustrating, television, cartooning, and other fields. Openings have increased around 50% in the last five years, according to a large

employment agency. Earnings are up, even for beginners.

If you'd like to get into commercial art, here is the first thing to do. Find out if you have the necessary talent. You can, now, without cost or obligation. Just take an *Art Talent Test* at home. This test is being contributed, free, by a well-known art school. It's a simple test, yet it will tell

whether you were born with a natural talent for drawing. You take this test by yourself, then mail it back. Professional artists examine and grade it—and if your test shows talent, you get expert counsel as to an art career.

Send today for this free Art Talent Test that has started so many towards profitable careers in some branch of the art field.

Clip and mail postage-free card today!

FIRST CLASS  
PERMIT  
No. 31  
Minneapolis  
Minn.

BUSINESS REPLY MAIL  
No Postage Stamp Necessary if Mailed in the United States

POSTAGE WILL BE PAID BY

ART INSTRUCTION SCHOOLS  
500 South 4th Street  
Minneapolis 15, Minnesota

Studio 3132

FROM  
Name \_\_\_\_\_ AGE \_\_\_\_\_  
Address \_\_\_\_\_ Apt. \_\_\_\_\_  
City \_\_\_\_\_ Zone \_\_\_\_\_  
County \_\_\_\_\_ State \_\_\_\_\_



**IF YOU  
DON'T HAVE  
A TUBE...**

**GET ONE!**

Available at all good hardware, variety, auto accessory and paint stores everywhere

One tube of the original **DURO-PLASTIC ALUMINUM** . . . is sure to save you hundreds of dollars in repair bills . . . it's internationally acclaimed the greatest fix-it product on the market today!



**SAVE MONEY • FIX IT YOURSELF**

**WOODHILL  
DURO-PLASTIC® The Original  
PLASTIC ALUMINUM**

Made With ALCOA Atomized Aluminum

**HUNDREDS OF USES FOR THIS AMAZING METAL IN PUTTY FORM!**

Applied Cold . . . Easy to Use!

**\$1.00**  
LARGE  
5 1/2 OZ.  
TUBE

**SEALS • SOLDERS • REPAIRS**

Air-Dries to a Metal-Like Hardness  
**ANYONE CAN USE IT!**

REPLACEMENT OR REFUND OF MONEY  
**Guaranteed by Good Housekeeping**  
IF NOT AS ADVERTISED THEREIN

Adheres to Metal, Wood, Concrete, Glass and Most Plastics

**• SATISFACTION GUARANTEED**

PIGMENTED WITH  
**ALCOA ALUMINUM**

ADVERTISED IN  
**LIFE**

**FOR YOUR CAR:**

- Repairs Holes and Dents in Auto Bodies
- Seals Gasoline Tank and Muffler leaks



**REPAIR Holes and Leaks in Pots, Pans and Pails**



**REPAIR Holes and Leaks in Wood and Metal Boats**



**REPAIR Holes and Leaks in Laundry Equipment**



**SEAL Plumbing Leaks**



**SEAL and SOLDER Leaky Gutters and Downspouts**



**THERE'S A DURO-PLASTIC® PRODUCT TO MEND EVERYTHING BUT A BROKEN HEART AND THE CRACK OF DAWN!**

- PLASTIC RUBBER • Liquid STEEL • E-POX-E GLUE • MATCHWOOD . . . Wood Filler
- rust REMOVER • Darn Fabric Mender • PLASTIC LOCK WASHER • RUST DISSOLVER
- PLASTIC for PORCELAIN REPAIR • PLASTIC MENDER • AND MANY, MANY MORE

**THE WOODHILL CHEMICAL CORPORATION**

CLEVELAND 14, OHIO • . . . . . TORONTO, ONTARIO, CANADA

"Originators and World's Largest Manufacturers of Plastic Metals"