

# AUTO ISSUE

JAN. 1962  
35 CENTS

ANNIVERSARY  
SPECIAL

# POPULAR MECHANICS

'62 CAR SPECIFICATIONS—  
Pocket-size color chart inside cover



**Drive—comparing the Ford 6,  
Chevy II and slim Plymouth**

**THOSE DREAMS DETROIT BUILT—  
Have they really changed your car?**

***How to save safely on auto insurance!***

**PLUS: Build a fun-to-use  
family fitness gym**

**Complete plans: Flying model air-car!**

**PLUS: Will automation take your job?  
by Secretary Goldberg**

**Miracles from a great new science**

**TEST YOUR QUICK-WIT QUOTIENT!**

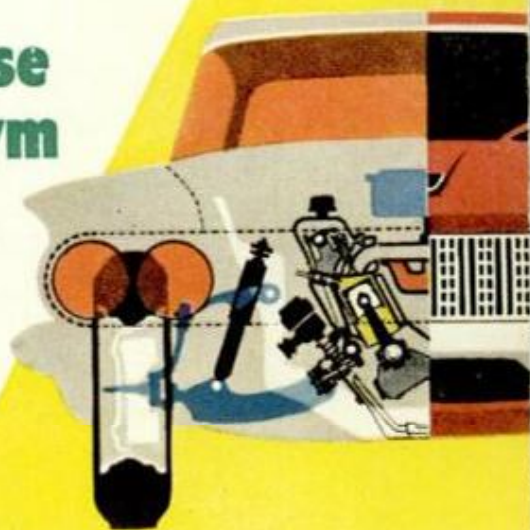

**An engineer  
analyzes the '62s**

*sure-firing*  
**you get A**CT**ion with**



## **AC Spark Plugs' self-cleaning A**CT**ion promotes fast winter starts in All Cars**



In winter's bitter cold, snow and sleet, AC Fire-Ring Spark Plugs' self-cleaning action promotes fast starts and smooth cold-engine performance. Your spark plugs are clean when you turn the ignition key. The self-cleaning action of AC Fire-Ring Spark Plugs is different from other self-cleaning designs—and better, too. First, it not only cleans by the action of swirling combustion gases, but also by the action of AC's exclusive Hot Tip. This famed AC feature is an extremely thin

deeply recessed insulator tip design that heats fast to burn off fouling deposits as they form. Best of all, AC's self-cleaning action works in *all* engines.

When you buy self-cleaning spark plugs, remember—ACs are built to give you sure-firing performance in every kind of weather, every kind of engine and every kind of driving. Remember, too, you get AC quality only under the AC name. Ask for A**CT**ion . . . ask for AC!

AC SPARK PLUG  THE ELECTRONICS DIVISION OF GENERAL MOTORS

**AC FIRE-RING SPARK PLUGS**

IDAHO WHITE PINE ■ PONDEROSA PINE ■ LODGEPOLE PINE ■ SUGAR PINE ■ LARCH ■  
 ■ WHITE FIR ■ DOUGLAS FIR ■ ENGELMANN SPRUCE ■ RED CEDAR ■ INCENSE CEDAR

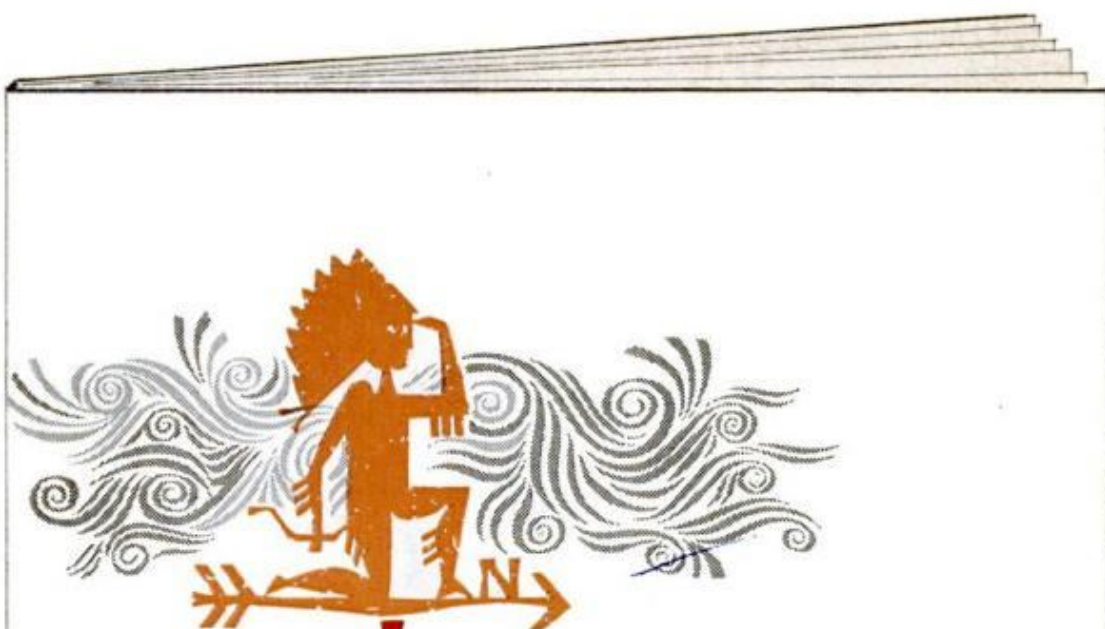

## THERE'S A NEW ROOM HIDING IN YOUR HOME

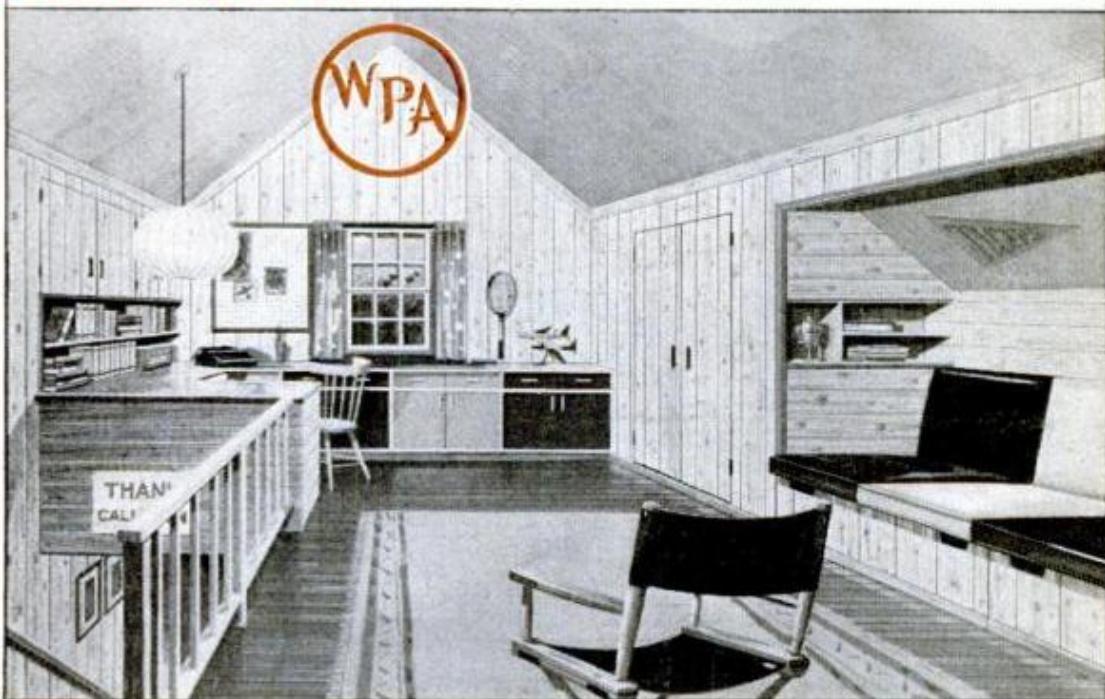

... **FIND IT IN THIS FREE BOOKLET** (available now at your lumber dealer's). It will help you find that extra room in attic, basement or garage. It shows you . . . specific room ideas . . . easily-followed construction plans . . . solutions to common problems . . . materials specifications . . . how to do the job right.

**WESTERN PINE REGION SOLID LUMBER** adds lasting beauty and value to your room project . . . and you can't find easier woods to work with. These are the world's finest woods for sawing, shaping, sanding and finishing. Specify WPA materials for a job well done.

**WESTERN PINE ASSOCIATION** QUALITY GRADED LUMBER  
 Yeon Building ■ Portland 4, Oregon

# NEW ROTUNDA

provide a cleaner engine

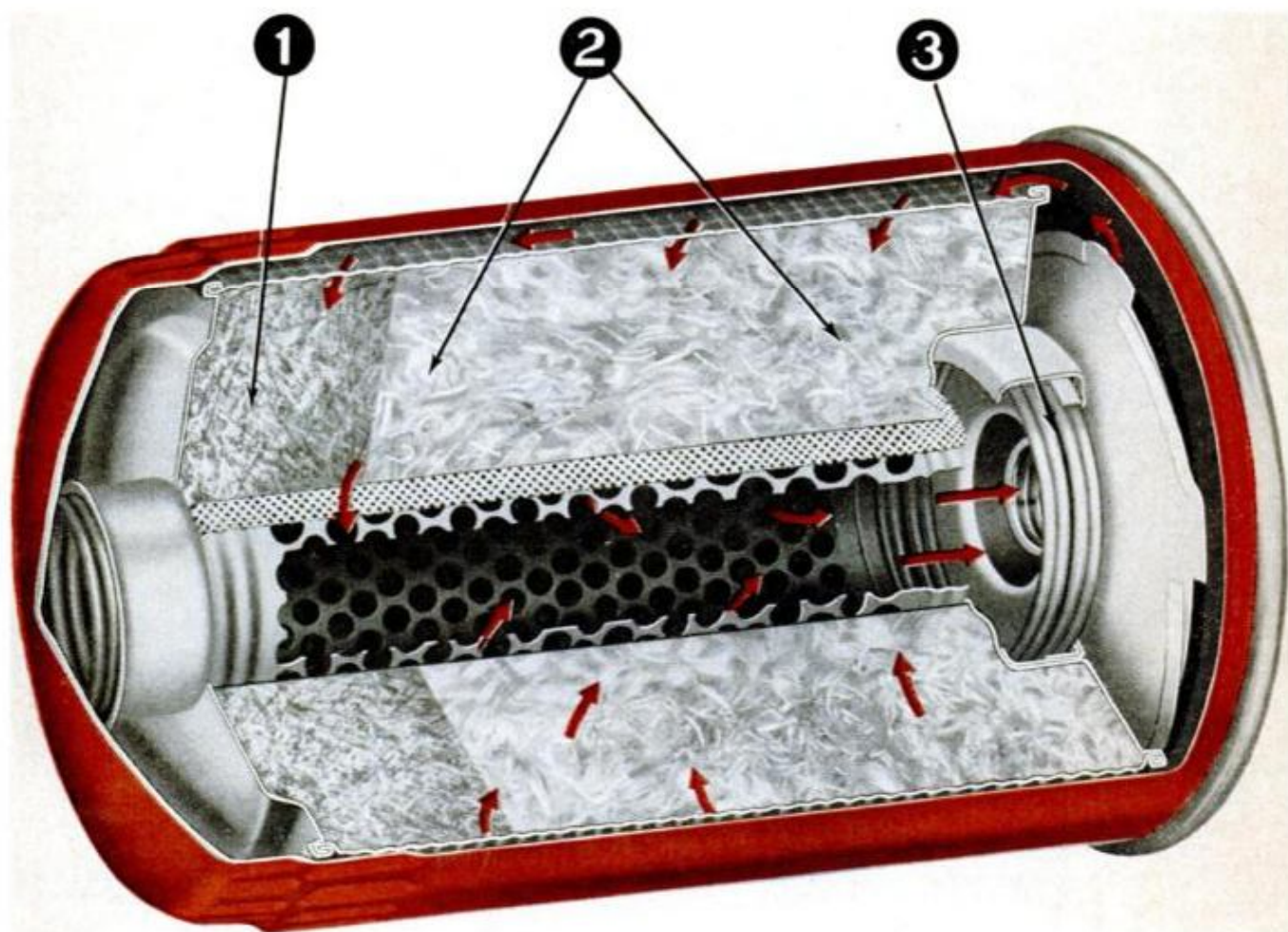

When you have your filter replaced, specify the best and most efficient—ROTUNDA. It has a one-way control valve to keep filter full of oil when engine is stopped, thus providing a ready supply of oil for instant lubrication on engine starts to reduce friction and undue wear. Helps prolong engine life.

The density of materials, rate of oil flow, and particle retention are precisely controlled to give the Rotunda Oil Filter double the useful life of many surface-type filters. The result is a cleaner engine, more satisfactory performance. Red arrows in illustration show precise path of oil flow through filter.

# OIL FILTERS

## and TWICE the filter life!

**New depth-type Rotunda Oil Filters provide more efficient filtration for superior engine protection!**

The depth-type filtration and high-capacity *permanent dirt storage* features of Rotunda Oil Filters keep engine oil superclean and allow full oil flow for maximum engine protection. This two-step filter action extends engine life—reduces maintenance.

Oil filters are but one of many high-quality Rotunda replacement parts now available through your Ford Dealer and selected service outlets.

**Compare these quality features with any other filter you've ever used...**

**1** In the Rotunda depth-type filter, dirt is permanently trapped within a deep filter bed. The exacting Rotunda depth-type filter action traps particles as small as 39 millionths of an inch—finer than talcum powder. In paper surface-type filters, oil passes through only one surface . . . when that surface gets clogged, filtering action stops.

**2** Filter materials used in Rotunda filters offer correct porosity to assure proper oil flow with maximum filtering protection for the engine. In some high-density, stuffing-type filters, the filtering materials are so tightly compacted that they block the oil flow and force the oil directly back through the relief valve.

**3** The Rotunda filter has a spring-loaded, positive-action relief valve that is located at the oil entrance end of the filter. If the filter ever becomes plugged because of extended usage, the relief valve will open to provide a full supply of oil to the engine for proper lubrication.

Over-all design, construction and workmanship of the Rotunda Oil Filter is another reflection of traditional Ford high quality control.



And...when you order Rotunda Oil Filters, ask for Rotunda Shock Absorbers, too!

---

**NOW AVAILABLE THROUGH  
FORD DEALERS AND SELECTED  
SERVICE OUTLETS...**

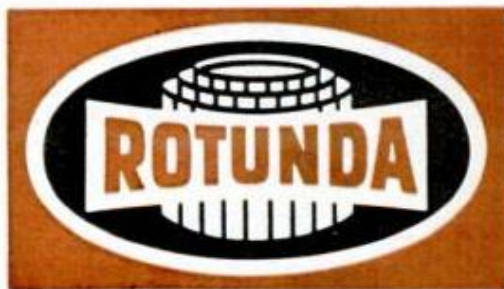

**QUALITY PARTS FOR CARS AND TRUCKS**

PRODUCTS OF  MOTOR COMPANY

This One



LJ54-RY2-LX2L

# POPULAR MECHANICS®

JANUARY 1962  
VOL. 117 NO. 1



INTERNATIONAL EDITIONS • SPANISH: Mexico-Caribbean, Southern Hemisphere • FRENCH •

## Features of Special Interest

The Way-Out World of Solid State - - - - -	86
Auto Review for '62 - - - - -	91
A Serviceman Looks at the '62s - - - - -	100
Drive Comparing Ford Fairlane, Plymouth, Chevy II -	104
An Engineer Analyzes the '62s - - - - -	109
How to Save SAFELY on Car Insurance - - - - -	114
Those New Metallic Brake Linings - - - - -	117
Pressure Caps and Thermostats - - - - -	122
How Will Automation Affect Your Job? - - - - -	126
I Birked the Champ - - - - -	134
Test Your Quick-Wit Quotient - - - - -	138
How to Outwit an Ouzel - - - - -	146

## For the Craftsman

Home Fitness Gym — Part I - - - - -	154
Model Air Car of the Future - - - - -	160
Triple-Top Fun Table — Part II - - - - -	166
Appliance Fix-It File: Waffler - - - - -	174
Ten-Minute Film Dryer - - - - -	182
Lathe Taper Attachment - - - - -	196
Is Your TV a Radiation Hazard? - - - - -	201
Lower Cost Stereo Conversion - - - - -	202

Address communications to: 200 E. Ontario St., Chicago 11, Illinois. **SUBSCRIPTION SERVICE:** Mail all subscription orders, changes of address, correspondence concerning subscriptions, and Postmaster notices of undeliverable copies to Popular Mechanics, 250 West 55th St., New York 19, N. Y.

Published by Popular Mechanics Company, RICHARD E. BERLIN, *President*

CLIFFORD B. HICKS  
*Editor*

RICHARD E. DEEMS  
*Executive Vice-President*

JOSEPH R. BUELL, JR.  
*Publisher*

*Managing Editor:* DON DINWIDDIE  
*Assistant Managing Editor:* JOHN A. LINKLETTER  
*Shop and Crafts Editor:* WAYNE C. LECKEY  
*Automotive Editor:* JAMES R. WHIPPLE  
*Associate Editors:* W. CLYDE LAMMEY, WALLACE MYERS  
*Electronics Editor:* BYRON G. WELS  
*Assistant Editors:* JAMES BIERY, KEVIN V. BROWN  
ROBERT L. HERING, R. B. KIRKPATRICK  
ARTHUR MIKESELL, BIL TOMAN, RICHARD WILLIFORD  
*Advertising Production:* DOROTHY M. WINER

*Art Director:* HENRY M. NEHRBASS  
*Art Editor:* RICHARD A. POTTS  
*Chief Photographer:* FRANK P. FRITZ  
*Eastern Editor:* RICHARD F. DEMPEWOLFF  
959 Eighth Ave., New York 19, N. Y.  
*Western Editor:* THOMAS E. STIMSON, JR.  
Suite 1003, 3460 Wilshire Blvd., Los Angeles 5, Calif.  
*International Editor:* HEINZ P. SCHLICHTING  
Ritterstrasse 26, Karlsruhe/Bd., Germany  
*Advertising Manager:* FRANK R. DUPUY  
959 Eighth Ave., New York 19, N. Y.  
*Director, Bureau of Information:* ALLAN CARPENTER

If you wish additional sources of information for the articles in this issue, or if you wish the name and address of the manufacturer of a particular product shown here, write to Bureau of Information, Popular Mechanics, 200 E. Ontario St., Chicago 11, Ill. Ask for the free "Where-to-Find-It-List" for this issue.

**DANISH • SWEDISH • GERMAN • PORTUGUESE • DUTCH**

## Departments

Over the Editor's Desk - - - -	10
Sidelights on Aviation - - - -	14
Detroit Listening Post - - - -	16
Items From All Outdoors - - - -	28
Science Overseas - - - - -	32
Science Bulletins - - - - -	38
Tune In on the Inventors - - - -	46
Worth Writing For - - - - -	47
On the Market - - - - -	50
Pentagon Sidelights - - - - -	54
Better Carkeeping - - - - -	120
What's New for Your Home - - - -	144
Solving Home Problems - - - - -	178
Clinic for Homemakers - - - - -	208
Shopping for Tools - - - - -	230

## Next Month . . .

You'll see a handsome, roomy vacation home you can build in your basement this winter and assemble on the site next spring. You'll meet some bizarre weapons the U.S. has developed for the little wars in the Near East. You'll learn how an expert shops for the right portable electric drill. And you'll find attractive designs for clean-line contemporary furniture you can make from metal.

**ADVERTISING OFFICES**—Chicago: 200 E. Ontario St., Whitehall 4-0100; New York: 959 Eighth Ave., Columbus 5-7300; Detroit: General Motors Bldg., TRinity 5-8711; Cleveland: Hanna Bldg., 1422 Euclid Ave., PRospect 1-0456; Los Angeles: 3460 Wilshire Blvd., DUNkirk 2-8458; San Francisco: 111 Sutter St., YUKon 2-0823.

Published monthly by Popular Mechanics Company, 200 E. Ontario St., Chicago 11, Ill. Richard E. Berlin, President; Richard E. Deems, Executive Vice-President; Fred Lewis, Vice-President and General Manager; Robert F. MacLeod, Vice-President; John R. Miller, Vice-President; Joseph R. Buch, Jr., Vice-President; G. O. Markuson, Treasurer; R. F. McCauley, Secretary. Single copy in the United States and Canada, 35 cents; subscription rates in the United States and possessions, 1 year \$3.50; 2 years, \$6.00; 3 years, \$8.00. In Canada, add 50 cents per year. In countries of the Pan-American Postal Union, 1 year \$4.50; 2 years \$8.00; 3 years \$11.00. In all other countries 1 year \$5.50; 2 years \$10.00; 3 years \$14.00. If you plan to move, notify us at least 30 days in advance so you will not miss an issue. Give both your old and new addresses. Second-class postage paid at Chicago, Illinois, and at additional mailing offices. Authorized as second class mail, Post Office Department, Ottawa, Registered as Second Class Matter at the Post Office at Mexico, D.F., Mexico, June 20, 1950. © 1961 by Popular Mechanics Company. All rights reserved. Printed in the United States of America.

**Metal Brake-Lining Test-page 117**



**Birling the Champ**  
-page 134



**Smile, Please-page 146**

**Keep-Fit**  
Cycle-page 154

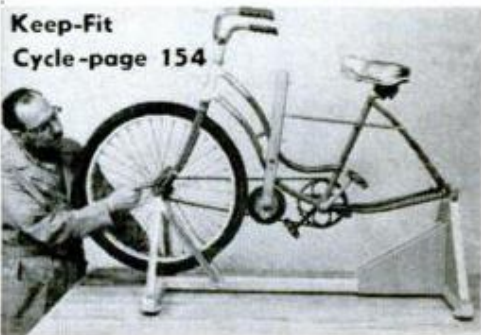

**Flying**  
Air Car  
page 160



# SAVE AS MUCH AS 80% ON POWER TOOLS

GUARANTEED TO DO THE WORK OF \$40, \$60, \$80 UNITS

- SAVE! BUY DIRECT FROM FACTORY
- PROFESSIONAL QUALITY, LIFETIME ENGINEERED
- UNCONDITIONAL 10-YEAR GUARANTEE

REVOLUTIONARY PATENTS DECREASE COSTS, INCREASE EFFICIENCY. Top quality full scale power tools of heavy duty 100% cast iron and steel. Streamlined design features such as perforations on table tops reduce weight, cut material costs, cut polishing and grinding time—reduce production costs. Special patents provide added efficiency, accuracy, savings. Nothing left out but exp've gingerbread. Parts made, assembled, tested and packed in our own factories, shipped direct to you. No retail store handling or profits to add to your cost.

**\$995**



Exp. Coll.

**8" TILT ARBOR POWER SAW**

Complete as shown, less blade. Incl. precision mitre gauge, ground cast iron table. If desired, RIP FENCE for easier work alignment, \$3.50 add'l.

**DOES THE WORK OF \$50 BENCH SAWS!**

CROSS-CUTS, RIPS, BEVELS, MITRES, DADOES, CUTS COMPOUND ANGLES. Patented motor mount takes any standard 1/4 to 1/2 h.p. motor . . . keeps belt tight, assures perfect alignment at any angle, transmits full power. Table stays level—blade tilts, locks securely at any angle to 50°, raises, lowers 0"-2 1/4". Patented tilt mechanism has accurate etched scale. Takes standard blade, saw insert removes easily for insertion of any STANDARD dadoe heads, cutters, etc. Accessories, table extensions, when wanted, at factory prices. Versatile, rugged performance proven by almost a half-million users.

UNCONDITIONAL 10 YEAR GUARANTEE

**DOES THE WORK OF \$60 UNITS**

Now, at little more than a hand tool price, a guaranteed professional quality precision machine which does same work as skilled hand planing . . . much faster, more accurately. Make accurate glue joints; rabbeting cuts for doors, window frames, table drawers; square taper cuts for chair legs; extremely accurate beveling. Helps amateurs produce quality work—with the sweat eliminated.



**TOP QUALITY FEATURES SPEAK FOR THEMSELVES**

- Precision ground cast iron tables, adjustable for depth of cut
- Rigid cast iron base
- New patent-pending design holds clearance between knives and tables at any depth
- Rabbet depth 3/8"
- Hardened, ground high speed steel knives
- Patent-pending fence adjustable to any position, any angle 0°-50°
- Patent pending lift-off guard (nothing to loosen!)
- Balanced steel cutter head. UNCONDITIONAL 10-YEAR GUARANTEE.

FULL 22" LONG, 4 1/8"  
**JOINTER-PLANER**

**NOW \$1995**

100% precision ground cast iron and steel.

Complete as shown Exp. Coll.

**BENCH DRILL PRESS**

DRILLS TO CENTER OF 10" CIRCLE — Rugged, dependable . . . all cast iron and steel. Table to 1/2" handtite chuck: max. 13 1/2". Spindle has combination ball and bronze bearings. Adjustable stop for repetitive drilling. Precision ground cast iron table. Table assembly fully adjustable on column. UNCONDITIONAL 10 YEAR GUARANTEE.



**\$1995** Less Belt Exp. Coll.

**6" SWING 3-FT. LATHE**

**\$985**



DOES THE WORK OF \$40 UNITS—This sturdy all cast iron power tool will turn wood or plastics with the precision and speed of machines selling for 4 times as much. Has tubular steel bed, ball thrust cup center, spur center. T-Rest assembly, lever action tail stock. 2 speed pulley. Fits any motor. Perfect for the home or professional workshop, garage or farm. UNCONDITIONAL 10 YEAR GUARANTEE.

Complete as shown Exp. Coll.

**HIGH SPEED TILT ARBOR BENCH SABRE SAW**



TAKES THE PLACE OF \$100. BAND SAW—Zips through thick stock effortlessly. Makes outside and inside cuts a breeze. Cuts circles, curves, any angle 0°-45°. Ideal for intricate jobs as well as ripping and crosscutting. Multipurpose saw almost a complete workshop in itself! Free-cutting blade eliminates pull up of work piece. This cutting action, unlike conventional portable sabre saws, reduces friction, blade stays cool, breakage and dulling are minimized. Even the most inexperienced do-it-yourselfer can turn out professional work the very first time. Takes any standard 1/4 h.p. motor or larger.

**\$1995** UNCONDITIONAL 10-YR. GUARANTEE! Exp. Coll.

**MAIL COUPON TODAY!**

American Machine & Tool Co., Dept. PM-12, Royersford, Pa.

Please send me the units checked. Payment in full enclosed \$ . . . or \$3 deposit each item enclosed, balance C.O.D. I must be fully satisfied or will return unit within 30 days for full refund. No questions asked.

- 8" Saw \$9.95     8" Saw & Rip Fence \$13.45     Lathe \$9.85  
 Sabre Saw \$19.95     Jointer-Planer \$19.95     Drill Press \$19.95

NAME . . . . .  
ADDRESS . . . . .  
CITY . . . . . ZONE . . . . . STATE . . . . .  
(please print)

**30 DAY MONEY BACK GUARANTEE**  
You must be satisfied or money refunded, no questions asked.  
**AMERICAN MACHINE & TOOL COMPANY**  
Dept. PM-12, Royersford, Pa.





*The more savvy you have about cars the more you'll appreciate how we built this one* No nonsense here. Just refreshingly honest simplicity—like this:

- ① The unique unitized body-frame is designed for long life and low maintenance. Major front-end components, including fenders, are of bolt-on design for easy replacement.
- ② The engines (choice of a 4 or a 6 in most models) are short-stroke, large-bore design. The 90-hp 4 has *five* main bearings for long-lived smoothness. The 120-hp 6 has *seven*.
- ③ The sturdy, easy-riding Mono-Plate rear springs were made possible by breakthroughs in metallurgy and manufacturing. They eliminate the friction and squeaks of multi-leaf springs.
- ④ From the 25.5-cu.-ft. trunk right on, space is used to your advantage. The Chevy II wheelbase is 110"; its overall length, 183" (187.4" in wagons); its weight, about 2,500 pounds. There are eleven models, including a convertible, sedans, a coupe and wagons. Without unnecessary frills or floss, they are practical, durable and (don't you agree?) nice to look at. More facts? See your dealer. . . . Chevrolet Division of General Motors, Detroit 2, Mich.

*new Chevy II*



# BURIED ALIVE!



SIX YEARS ON THE SAME JOB WITH NEVER AN ACCIDENT...  
AND THEN ONE MORNING...

2 A CAVE-IN PUT ME SIX FEET UNDER FOR SIX LONG MINUTES



3 IN THE HOSPITAL, I HAD PLENTY OF TIME TO THINK



4 I'D PASSED OVER DOZENS OF I.C.S. ADS IN POPULAR MECHANICS. BUT I SAW THIS ONE IN A NEW LIGHT



# FREE!

**I.C.S. CAREER KIT**  
Send coupon now...  
get all three books

INTERNATIONAL CORRESPONDENCE SCHOOLS  
BOX 21419A SCRANTON 15, PA.

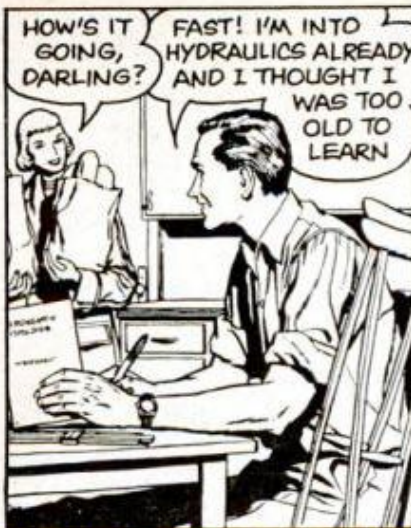

**5** SIGNING UP FOR THAT I. C. S. COURSE WAS THE SMARTEST THING I EVER DID

**6** ONE MONTH LATER... GOOD TO SEE YOU BACK ON YOUR FEET, JIM. IT'LL BE AWHILE BEFORE YOU'RE BACK IN THE FIELD. SO WE'LL FIX A TEMPORARY DESK FOR YOU IN THE OFFICE WHEN YOU'RE READY



**7** THEY GAVE ME SOME SIMPLE ASSIGNMENTS... AND I SURE SURPRISED THEM!

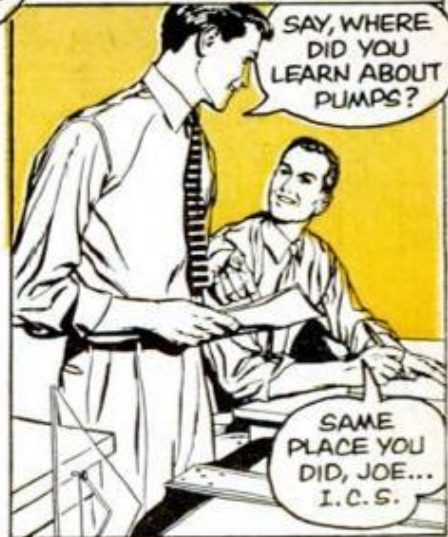

**8** THEN A FEW DAYS LATER, MR. WALSH CALLED ME IN...

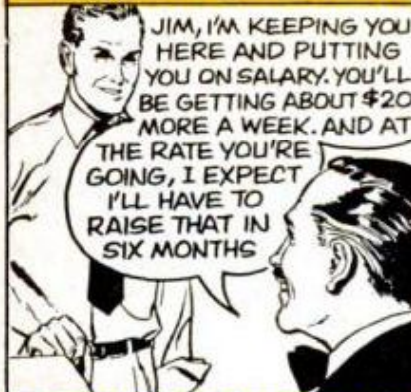

HERE'S WHERE YOU COME IN! LET I. C. S. SHOW YOU THE WAY TO MORE PAY, RAPID ADVANCEMENT, REAL JOB SECURITY! MAIL THIS COUPON TODAY!

**9** THAT EVENING, JANE AND I WENT HOUSE HUNTING



- 1** "HOW TO SUCCEED" A 32-page gold mine of ideas
- 2** CAREER CATALOG Opportunities in the field that interests you most
- 3** SAMPLE LESSON (MATH) Shows the famous step-by-step I. C. S. teaching method



## INTERNATIONAL CORRESPONDENCE SCHOOLS



BOX 21419A, SCRANTON 15, PENNA. (In Hawaii, reply P.O. Box 418, Honolulu)

(Partial list of courses)

Without cost or obligation, send me "HOW TO SUCCEED" and the opportunity booklet about the field BEFORE which I have marked X (plus sample lesson):

**ARCHITECTURE and BUILDING CONSTRUCTION**

- Air Conditioning
- Architecture
- Arch. Drawing and Designing
- Building Contractor
- Building Estimator
- Carpenter Builder
- Carpentry and Millwork
- Heating
- Painting Contractor
- Plumbing
- Reading Arch. Blueprints

**ART**

- Commercial Art
- Magazine Illus.
- Sign Painting and Design'g
- Sketching and Painting

**AUTOMOTIVE**

- Automobile
- Auto Body Rebuilding and Refinishing
- Auto Engine Tuneup
- Auto Electrical Technician
- Diesel Engines

**AVIATION**

- Aero-Engineering Technology
- Aviation Engine Mech.
- Reading Aircraft Blueprints

**BUSINESS**

- Accounting
- Advertising
- Bookkeeping and Cost Accounting
- Business Administration
- Business Management
- Clerk Typist
- Creative Salesmanship
- Managing a Small Business
- Professional Secretary
- Public Accounting
- Purchasing Agent
- Real Estate Salesmanship
- Salesmanship
- Salesmanship and Management
- Traffic Management

**CHEMICAL**

- Analytical Chemistry
- Chemical Engineering
- Chem. Lab. Technician
- General Chemistry

- Oil Field Technology
- Pulp and Paper Making

**CIVIL ENGINEERING**

- Civil Engineering
- Construction Engineering
- Highway Engineering
- Professional Engineer (Civil)
- Reading Struc. Blueprints
- Sanitary Engineer
- Sewage Plant Operator
- Structural Engineering
- Surveying and Mapping
- Water Works Operator

**DRAFTING**

- Aircraft Drafting
- Architectural Drafting
- Drafting & Machine Design
- Electrical Drafting
- Electrical Engineer Drafting
- Industrial Piping Drafting
- Mechanical Drafting
- Sheet Metal Drafting

**ELECTRICAL**

- Electrical Appliance Servicing
- Electrical Engineering

- Electric Motor Repairman
- Elec. Engr. Technician
- Elec. Light and Power
- Practical Electrician
- Practical Lineman
- Professional Engineer

**HIGH SCHOOL**

- Good English
- High School Diploma
- High School General
- H. S. College Prep. (Eng'g & Science)
- High School Math
- High School Science
- Short Story Writing

**LEADERSHIP**

- Industrial Foremanship
- Industrial Supervision
- Personnel-Labor Relations
- Supervision

**MECHANICAL and SHOP**

- Diesel Engines
- Gas-Elec. Welding
- Heating and Air Conditioning
- Industrial Engineering
- Industrial Instrumentation

- Industrial Safety
- Machine Shop Practice
- Mechanical Engineering
- Plumbing and Heating
- Professional Engineer
- Quality Control
- Reading Shop Blueprints
- Refrigeration and Air Conditioning
- Tool Design
- Tool Making

**RADIO, TELEVISION**

- General Electronics Tech.
- Industrial Electronics
- Practical Radio-TV Eng'g
- Radio-TV Servicing
- TV Technician

**RAILROAD**

- General Railroad

**STEAM and DIESEL POWER**

- Combustion Engineering
- Power Plant Engineer
- Stationary Diesel Engr.
- Stationary Steam Engines

**TEXTILE**

- General

Name \_\_\_\_\_ Age \_\_\_\_\_ Home Address \_\_\_\_\_  
 City \_\_\_\_\_ Zone \_\_\_\_\_ State \_\_\_\_\_ Working Hours \_\_\_\_\_ A.M. to P.M. \_\_\_\_\_  
 Occupation \_\_\_\_\_

Canadian residents send coupon to International Correspondence Schools, Canadian, Ltd., Montreal, Canada. . . . Special low monthly tuition rates to members of the U. S. Armed Forces.

# Over the editor's desk

## Dynamite and Bread

I was much interested in the reader comments about the 60-year age of *Popular Mechanics*. In 1902 I was a 15-year-old teamster in Empire, Col., hauling dynamite and bread from Georgetown to the site of the Moffat Tunnel just being started. I subscribed to PM, which was then more like a tabloid, and jumped at your offer of a motorcycle for a certain number of subscriptions. Sorry to say I did not win the bike—nobody in them hills had any money. But since then, I've missed few copies of PM. Congratulations on your first 60 years—and many more of them. Portland, Ore.

TRUMAN NORTHUP

*Here's hoping the second sixty brings us as many loyal friends as the first.*

## Big Vibrators?

Read your article *Engine with Built-in Wings* (Sept. PM). In my opinion you have been "sucked in." I contend that these so-called "uni-directional" machines are nothing more than big vibrators and are completely worthless . . . Southfield, Mich.

WALTER E. RUNKEL

*Inventor Norman Dean points out that his Dean System Space Drive is neither a vibrator nor a ratchet device, frictional or otherwise. Mr. Dean notes that U. S. Patent 2,886,976 issued on his system explains why, makes the system demonstrably clear, and is well understood by industry and others in the trade.*

## Kentucky Invitation

Here's a pontoon boat I constructed from your March 1959 PM plans. A few extras from my own planning are: lantern brackets for night fishing, rubber bumpers to protect the barrels at the boat dock, and removable top guard rails to ease the fishing.



It is built so a canopy can be added later.

My family and friends have certainly enjoyed our many boat rides and fishing trips with this craft this summer. You have my special invitation to take a cruise if you're down near the Ken Lake boat dock at Kentucky Lake.

Nortonville, Ky.

JAMES E. FULLER

*Thanks for the generous invite, Jim. When would you say Kentucky fish are the hungriest?*

## 2416 Pieces of Wood

Hope you can use my latest workshop projects for your magazine. These inlaid card tables were made by cutting, fitting and gluing veneer on plywood. The table



on the left contains over 1100 pieces of 67 different kinds of wood while the one on the right has 2416 pieces of 85 kinds of wood.

Ortley, S. D.

HAROLD J. BUTLER

*Wish we had the skill and patience needed to produce such elegant craftsmanship, Harold.*

## Iron-Curtain Raiser

There is a fine violinist who emigrated to Israel about one year ago from Rumania, where he was Concertmaster of the Radio Orchestra and a musician of much prestige. He was once given a copy of your magazine and he became a most avid reader. Being gifted with his hands he also proved himself gifted at putting into practice what he read.

The difficulty was in getting the magazine. He used to go into the American Embassy library whenever he had a few minutes, to read an issue. After a few months of this, he was suddenly accosted leaving the Embassy and thrown into jail. For six months his wife and children did not know where he was and he did not know what he was charged with. Then, suddenly, he was released, on condition that he speak to no one about his imprisonment and cease all "contact" with the West. Convinced he could no longer live under

(Continued to page 12)

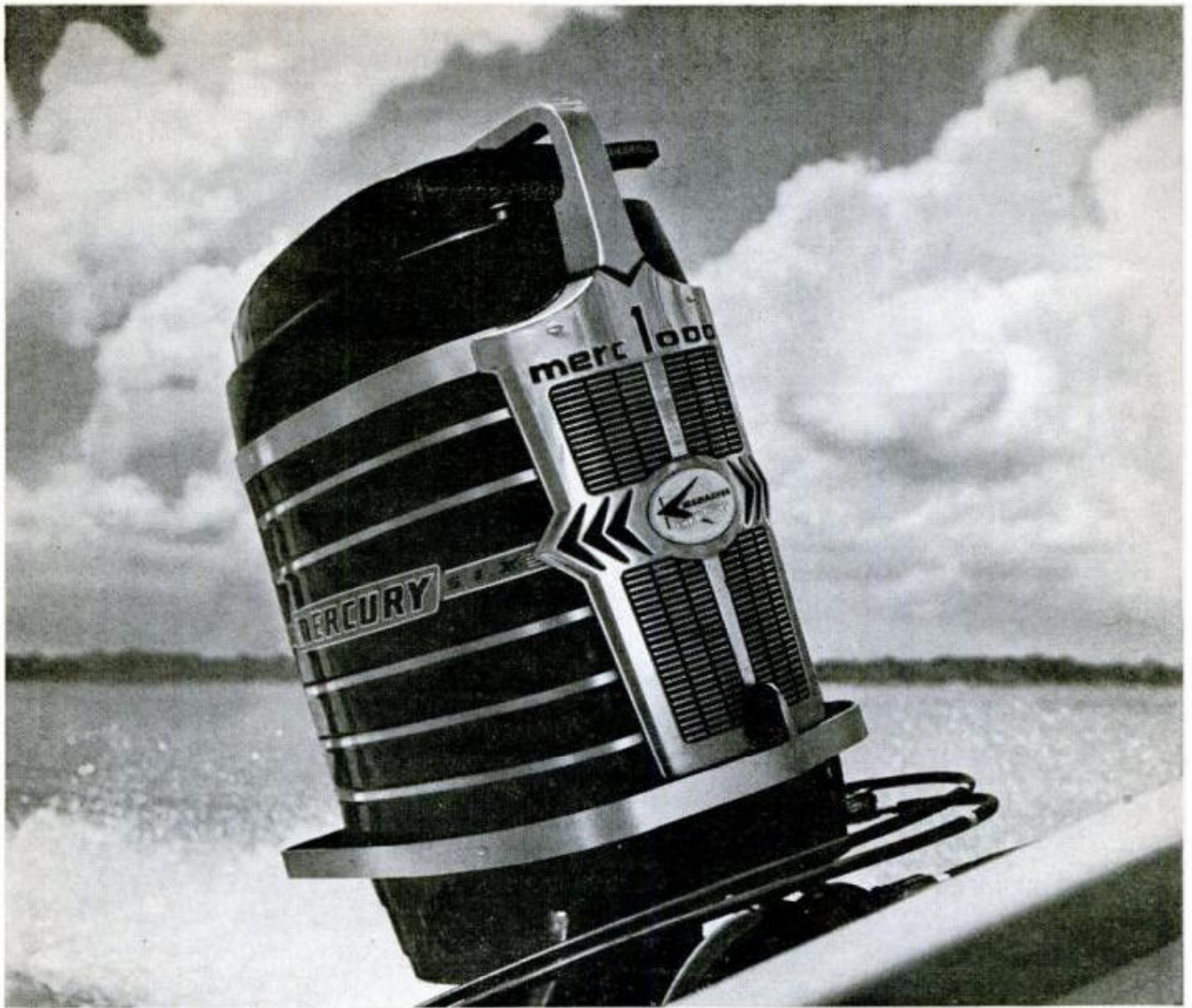

## *The most RUN for your money!*

This black Phantom is the world's first 100 hp outboard motor. This is the new Merc 1000, loafin' along at three-quarters throttle.

This is a man's motor . . . but it's easy-handling enough for a beginner.

It's all new, from prop to 90-cubic-inch powerhead. It was tested over more than one million miles at Lake X, Florida, before the O.K. was given for production.

What can you do with this kind of outboard power?

It's made for larger, deeper, heavier, seaworthy boats. You can pull more skiers. Go farther faster. Ease back on the single-lever throttle and plane along. Get half again the distance on a tank of fuel.

Any place you use it, any way you use it, this new Merc 1000 Phantom will give you the *most* RUN for your money!

**Now is a good time to see the Merc family**

**of family outboards: 6-, 9.8-, 25-, 45-, 50-, 70-, 85-, and 100-horsepower motors!**

# **MERCURY**

©1962, Kiekhaefer Corp., Fond du Lac, Wis.

MY SPARE TIME HOBBY MAKES ME

**\$5<sup>00</sup>** an hour  
**CASH PROFIT**

— Grover Squires

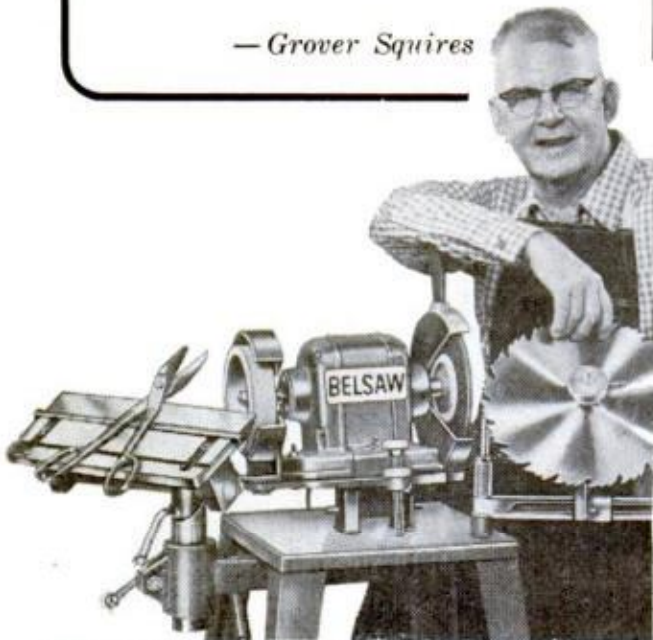

### START YOUR OWN SPARE TIME BUSINESS



You can turn your spare time into Big Cash Profits with your own **COMPLETE SHARPENING SHOP**... Grind saws, knives, scissors, skates, lawn mower blades... all cutting edges. Your Own Cash Business with no inventory... right at home ... no experience needed.

**FREE BOOK** tells how you can start your own spare time business while you are still working at your regular job. Low Cost—time payments only \$15.00 a month. **Send coupon today.**



**BELSAW SHARP-ALL CO**  
712A Field Bldg.,  
Kansas City 11, Mo.

Send Free Book "LIFETIME SECURITY". No obligation.

Name \_\_\_\_\_

Address \_\_\_\_\_

City \_\_\_\_\_ State \_\_\_\_\_

such oppression, he made application to leave Rumania for Israel. At that moment, his job was taken away and he and his family were close to poverty during those last months in Rumania.

What is remarkable to me is that today this man waits anxiously for each copy of *Popular Mechanics* to appear on the newsstand.

Tel-Aviv, Israel

RUTH LEVENSON

*We are indeed grateful that such a devoted reader is now safely in a land where the mind is free to inquire and the hands are free to create. Give him our best wishes.*

### Turning-Circle Champ?

This worked-over 1942 Jeep is very handy for my work as a Forest Warden. It will turn within a 19-foot circle. I rebuilt a front axle and installed it in the rear, then connected the rear steering mechanism



with the front so that the rear wheels turn left when the front wheels are turned right. Now, in following narrow trails or driving between stumps, no thought need be given the rear. But I can't park too close to the curb.

Castle Rock, Wash.

AMON BEBE

### Interesting Requests

Supplementing our last month's list of interesting reader requests are two new beauties: One man wants plans for a circus acrobat's mouthpiece and suspension bar for swinging; another wants plans for a 20-25-foot Chinese junk. It seems his wife likes to sail, but only if the boat is perpendicular to the surface of the water.

And speaking of projects, if you plan to build the vacuum-forming machine shown in our December issue, add a sponge rubber gasket to the rabbeted edge of the lower half of the frame which holds the plastic sheet. This improvement creates a more effective seal at this point.

By the way, we'd welcome seeing photos of vacuum formed projects any of you create with this interesting little machine.

*The Editors*

# How to 'take charge' of a highly-paid job

## in AIR CONDITIONING & REFRIGERATION

Are you interested in a better job, big money and a secure future? Do you prefer work that is interesting, a challenge to your imagination, and loaded with opportunities to go in business for yourself? Then why not consider a career as mechanic or technician in the Air Conditioning and Refrigeration industry!

You see, Air Conditioning is now America's finest opportunity field. The government reports that during the past 12 years, production increased 400%. *No other industry did better!* The fact is, 8,200,000 domestic and industrial units are produced annually. Already 150,000,000 are in use. Experts say that 20,000 technicians must be trained each year to match industry growth! You can qualify for a top-pay job. How? *Train at home in spare time.* The CTI method is easy, practical and resultful. Quick, too. For full information, *mail coupon below.*

### Many CTI graduates go in business



It is relatively easy to start a repair business in the Air Conditioning and Refrigeration field. Armed with up-to-date knowledge, seasoned with skill acquired through practice on kits, and equipped with tools and gauges, many graduates start out on their own. Some expand into retail stores. Others have contracts to service taverns, restaurants, food stores and commercial buildings. The more resourceful become contractors. Conditions for success are excellent.

### Many students earn cash as they train

The average CTI student is eager to put his skill to profitable work, on a part-time basis. Though most students prefer to tie up with local dealers and repair establishments, a surprising number are independents. The extra cash helps meet training cost. Often there's enough to bank, or invest in more equipment.



### Letters prove efficiency of training



"I have a business of my own servicing domestic and commercial refrigerators."—*Paul Humphrey, Colo.* "I made \$1,000 while training, and am now a refrigeration man for a dairy."—*Giles Minton, N. C.* "I opened a little shop and am swamped with work."—*Charles Corley, Kan.* "Doing service work on a part-time basis the past 10 months, I earned \$2,400. Have a nice business."—*Renos Johnson, Ind.* "My firm advanced me to field superintendent."—*Milburn Dougan, Ark.* You can do as well as these graduates!

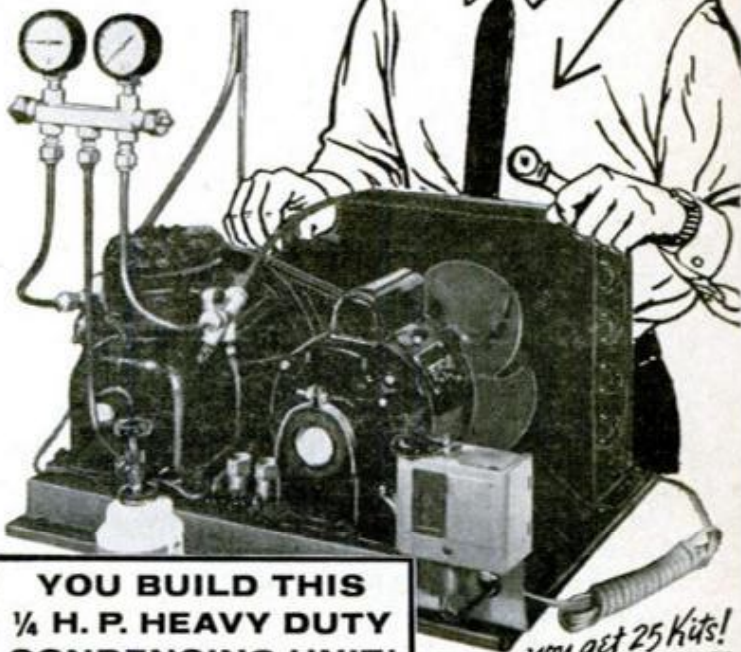

You train at home with real equipment

**YOU BUILD THIS  
1/4 H. P. HEAVY DUTY  
CONDENSING UNIT!**

*you get 25 Kits!*

An exclusive feature of CTI training is that you get parts to build a 1/4 h.p. commercial-type condensing unit (above). You also receive mechanic's tools and gauges (right). After unit is assembled, you can build an air conditioner, freezer, refrigerator or milk cooler. Only CTI sends working kits.



### Learn by practicing—Get valuable experience

The modern way to train is to gain skill and experience with knowledge—not after you graduate. From CTI's simple picture-lessons, you master elemental theory. From experiments and building with kits, you develop skill. In other words, you learn by practicing, pick up solid experience much like on the job. That's the interesting, relaxing way to train after a day's work on your present job. CTI training is exciting!

### Send for fact-filled booklets—Mail coupon now

Exactly what are your opportunities in Air Conditioning and Refrigeration? How does CTI train men for success? Get detailed, accurate answers to these and many more questions by filling out and mailing the coupon below. No obligation. —Commercial Trades Institute, Chicago 26, Ill.

**COMMERCIAL TRADES INSTITUTE**  
1400 GREENLEAF AVENUE DEPT. R-41  
CHICAGO 26, ILLINOIS

Please rush me your opportunity booklet, *Success in Air Conditioning and Refrigeration*; and *Lesson Samples*. Both free.

NAME \_\_\_\_\_ AGE \_\_\_\_\_

ADDRESS \_\_\_\_\_

CITY \_\_\_\_\_ ZONE \_\_\_\_\_ STATE \_\_\_\_\_

A Non-Profit Organization • Accredited by National Home Study Council



## Sidelights on aviation

**Vapor trails** may soon vanish. These contrails (for condensation trails) are caused by the condensation of hot engine gases in the extreme cold of high altitude. They are the amateur sky-watcher's favorite clue to high-flying aircraft.

Now the Air Force claims that it can reduce the size of the water-vapor particles that come from the burning engine fuel by mixing them with tiny dustlike particles in the engine exhaust. The result is a vapor trail of droplets too small to be seen from the ground.

**Babe Ruth and Charles Lindbergh** made the headlines in 1927 when the Babe hit 60 home runs and Lindbergh flew nonstop New York to Paris in 33½ hours.

Last year was a bad year for both. The Babe's record for number of homers in a complete season was broken by Roger Maris. And Lindbergh's record, while it had been broken before, was demolished beyond recognition.

An Air Force B-58 Hustler, named "The

Spirit of St. Louis III," streaked across the Atlantic over Lindbergh's old route in 3 hours and 20 minutes—one-tenth the time taken by the Lone Eagle 34 years before.

**Riding on air** is one solution put forward for safety in air crashes.

An aircraft manufacturer has designed a passenger seat that, except for nylon shoulder straps and seat belts, is almost all air cushion. At the moment of impact, the seat bottom compresses under the load and balloons out, distributing the load forces. Even if the passenger jack-knives over his seat belt, he would not hurt his head because the seat back in front is also an air cushion. The air-bag seat is designed to withstand decelerations up to 50 Gs.

**Neither railroad, road nor river** could stop Denver's Stapleton Airport from its appointed rendezvous with the jet age.

It had to extend a runway to 11,500 feet to accommodate the fast-landing big jets, but the mainline of a railroad, a major highway and the branch of a river were in the way. The airport is now extending the runway over all three obstructions by building underpasses for each.

*Kevin V. Brown*

## GUMOUT CLEANS CARBURETORS

# 13 WAYS!

There are at least 13 potential trouble areas in your carburetor—areas where even the tiniest speck of dirt or gum will impair engine economy and performance. You can clean a dirty carburetor quickly, thoroughly and economically with GUMOUT. Just add GUMOUT to your gas tank. It cleans your carburetor while you drive. Get GUMOUT at your favorite service station or auto supply store. You'll get improved engine performance and better gas mileage.

**GUMOUT** DIVISION, PENNSYLVANIA REFINING COMPANY  
CLEVELAND 4, OHIO

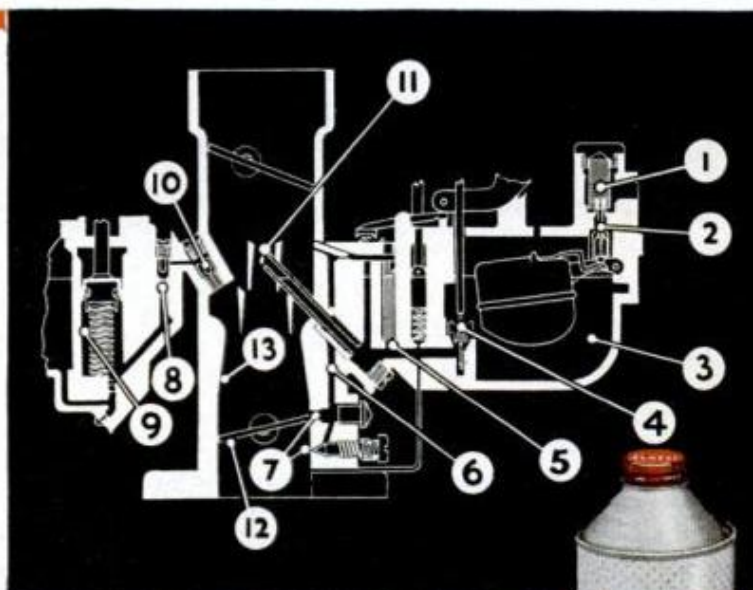



# "Wouldn't some of my high school teachers be surprised if they could see me now"



"I just managed to squeak through my courses in math and science, and a week after finishing high school I went to work on a production line. It didn't take me long to realize I hadn't much future doing that. Now I'm an Electronic Technician. That really would surprise some of the folks who knew me when!"

"How did I do it? Well, I had to earn more money. I had gotten married and pretty soon there were three of us. Then, along came Automation. Push buttons began replacing people in the plant and my future prospects were getting shaky.

"One day I came across an NRI ad. It talked about the Electronics Age . . . that 4 to 7 Technicians were needed *now* for every graduate engineer . . . and how easy it is to learn Electronics at home the NRI 'learn-by-practice' way.

"So I picked out the course I wanted from the free catalog NRI sent me and got started. Pretty soon I was performing home-lab experiments with the equipment NRI sends. I was actually building Electronic instruments myself! There were some rough spots, but with the personal help I got from NRI instructors I even handled the math okay. Now, instead of being replaced by Automation I've had a big jump in pay. I've been reclassified an Electronic Technician and operate the equipment that once threatened my job.

"If that isn't proof NRI can improve a man, I don't know what is. If anyone asks me (and they have) if he should take NRI training, I tell him to hop to it and stop wasting time."

## Pick the Career You Want in Electronics Radio-TV and Train at Home with NRI

Electronics is changing our world—from the TV set in your home to satellites in the sky. Color TV, stereo broadcasting, computers, telemetry, radar, microwave, automation are new advances that offer unusual opportunities for higher pay, brighter futures in the 1960's. Whichever branch of Electronics you select, you'll find NRI training is the time-proved way to get into this big, fast-growing industry *quickly*. Thousands have moved up to careers in Radio-TV Servicing and Communications and Industrial and Military Electronics through NRI training. Job counselors are recommending it. Successful NRI graduates are proving it.

### Get Special Training Equipment

When you enroll with NRI you get special training equipment *at no extra cost*. Makes learning easier, more interesting, practical. NRI is the oldest, and largest home-study school of its kind. Take the first step to a new career now. Mail coupon for FREE CATALOG. National Radio Institute, Washington 16, D.C.



## MAIL COUPON FOR FREE CATALOG



NATIONAL RADIO INSTITUTE  
Washington 16, D. C. Dept. 2AA

Please send your 64-page Catalog without cost or obligation. (No representative will call.) Please print.

Name \_\_\_\_\_ Age \_\_\_\_\_

Address \_\_\_\_\_

City \_\_\_\_\_ Zone \_\_\_\_\_ State \_\_\_\_\_

Accredited Member National Home Study Council

The Amazing  
Field of  
Electronics





By Jim Whipple



## **Needed: Better Safety Belts, Safer Stop Lights.**

## **Transistorized Ignition, More Alternators in '63**

**Safety is very much** in the minds of both automakers and motorists this year. There's a growing trend toward installation and use of seat belts, thanks to manufacturers' built-in front anchor points.

Anchors for easy installation of rear belts are needed on many cars and will come soon, but nobody has solved the problem of keeping a squirming five-year-old strapped in during the 200-mile trip to Grandma's.

**Sooner or later**, the question of lap belts, such as are installed in U.S. cars, versus the combination cross-chest-and-lap belt will arise. The latter installation is increasing in popularity on European cars such as **Volvo**.

**The reason** is that, although lap belts keep you in the car, they do not prevent the upper part of your body from jackknifing forward and hitting something. Recently, a manufacturer conducted an interesting test in which a car with a lap-belted dummy behind the wheel was crashed into a solid wall at 30 m.p.h.

The belt held, but the upper part of the dummy, weighted to approximate the average male, catapulted into the steering wheel, twisting it around the column like a pretzel. Witnessing this won our vote for shoulder-plus-lap belting in a matter of seconds.

**Safety in signaling** is due for a boost soon when the Automotive Manufacturer's Assn. adopts a dual intensity stop light for all cars. It's basically a two-filament stop-light bulb which increases the intensity of the stop-lamp signals two to four times during daylight hours when headlamps are not in use. At night brightness will be lowered so that stop-lamp glare won't shock following drivers into panic stops.

**Other good ideas** on signal lamps may well be copied from European cars now adopting amber lenses for turn signals, red for tail and stop. These can be combined into a single lens and lamp unit that's less costly than the multiple lamps that now flash yuletide greetings across the trunks of some U.S. cars.

Lamps like these might eliminate some of the hundreds of daily "end-to-end" crashes on metropolitan expressways.

After a year or so of limited activity, English Ford is getting back into the game with its **Anglia** and **Consul**, to be marketed by 500 Lincoln-Mercury dealers.

Model lineup will include the recently introduced (in England) Anglia station wagon (Ford's answer to the **Hillman Husky**) and the new **Consul "315 Classic,"** which are sleekly-styled four-cylinder sedans and hardtops with disk brakes.

**Volkswagen has been busily** saying that "We have no plans to import the new **VW 1500,**" while just across the border, VW of Canada says that they'll have 'em by spring.

From a "usually reliable source," however, we hear that they'll be in U.S. showrooms by summer. P.O.E. price of the **VW 1500** sedan is pegged at \$2295 (so says our source), a full \$700 above the 1962 **Volkswagen**. This could introduce something new in U.S. auto marketing, the technique of downtrading.

It might work like this: You go into a VW showroom, examine the **VW 1500**, gasp at the price (and waiting list), then the salesman walks you over to the familiar Beetle and opens with, "Just look at how much car you can get for \$700 less!" So, stunned at the prospect of saving so much, you buy a Beetle, which is what the Volkswagen boys had in mind all along.

**In spite of premature talk** of alternators throughout the industry on '62 models—only Chrysler Corporation has them across the board. Word from a major electronics firm suggests that Ford Motor Co. and American Motors will drop conventional d.c. generators and switch to alternators on their '63s.

Another electronic advance, transistorized ignition, is in the works for more than one '63 model. TI is the system in which transistors take over the switching of the 300-volt primary current into the coil, eliminating the condenser and using breaker points to trigger the transistor with a mere 12 volts. GM's Delco-Remy Division has just announced availability of a complete system.

PM has a conversion kit under test and will report on its performance in an early issue. ★ ★ ★

If reply card  
has been detached,  
mail this coupon

LaSalle, Dept. 1-032  
417 So. Dearborn,  
Chicago 5, Ill.

Please send me, free of cost or  
obligation, your illustrated book  
"Opportunities in Accounting"  
and also your sample lesson.

Name ..... Age .....  
Address .....  
City ..... Zone .....  
County ..... State .....

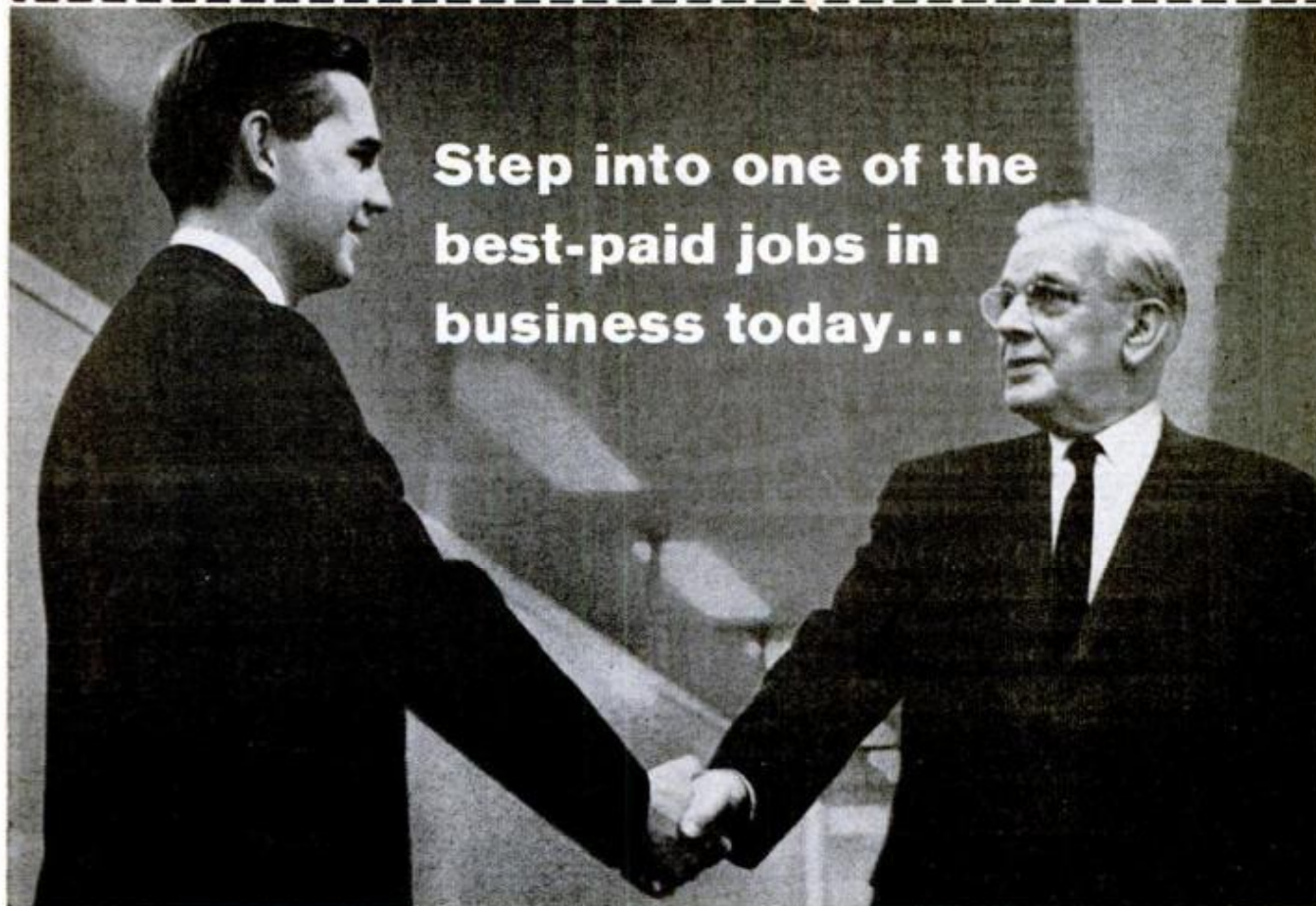

Step into one of the  
best-paid jobs in  
business today...

# Be an ACCOUNTANT

## Train in your spare time with LaSalle

*LaSalle graduates report up to 56% increased pay the first year*

**T**HE demand for trained Accountants exceeds the supply. Salaries keep going higher, promotions are rapid. Many accountancy-trained men are being moved up to important management positions. Why remain in a dull job with insufficient pay when you can reap such big rewards in money and prestige?

You can take LaSalle Accounting training at home, in your spare hours, without any previous bookkeeping experience. LaSalle's distinguished faculty starts you at the beginning; explains every basic Accounting principle and method; gives you actual Accounting problems with your lessons, then corrects and grades your work; shows you exactly how accountants on the job handle these problems. Your training is complete, practical, and enjoyable. You are thoroughly prepared for every Accounting task you will be expected to handle in the business world.

Your career could not be in more experienced hands. For 53 years, LaSalle has been a world leader in business training, with over 1,500,000 students. More than 5,300 of today's CPA's are LaSalle alumni. A LaSalle diploma in Accounting is a credential respected by America's biggest companies.

**Mail Attached Air-Mail Card  
for Free Book and Sample Lesson**

If you are truly seeking a more rewarding job, with higher pay, a solid position in the business world, and all the good things that come with success, you owe it to yourself to read LaSalle's famous book "Opportunities in Accounting". With it you will receive a free sample lesson in Accounting which will demonstrate how LaSalle makes home study easy, interesting and practical. Mail attached card today.

**LA SALLE EXTENSION UNIVERSITY**

An Accredited Correspondence Institution Chicago 5, Ill.

# DRAFTSMEN



**ARE  
NEEDED!**

**LEARN AT HOME IN  
YOUR SPARE TIME**

Check the want ads in any newspaper. See the big-pay opportunities open to you as a draftsman. What's more, you can learn this well-paid, prestige profession at home—quickly, easily! No special talent needed! Get complete, step-by-step Chicago Tech lessons in the mail, spend a few pleasant hours studying each week. In a short time you'll be a well-trained draftsman, ready to take your pick of many good jobs. Decide now to get ahead. Mail coupon today!

**SEND FOR FREE TRIAL LESSON TODAY!**

Get FREE TRIAL LESSON plus information about C.T.C. practical training. Learn what successful Chicago Tech graduates say about high pay and opportunities in drafting. No charge, or obligation. It's yours free.

Est. 1904 • Accredited National Home Study Council

## CHICAGO TECHNICAL COLLEGE

A-200 Tech. Bldg., 2006 So. Michigan Ave.  
Chicago 16, Illinois

Mail me FREE Lesson with information about big opportunities in DRAFTING.

Name \_\_\_\_\_ Age \_\_\_\_\_

Address \_\_\_\_\_

City \_\_\_\_\_ Zone \_\_\_\_\_ State \_\_\_\_\_

**ONLY \$100 TO START  
YOUR OWN  
BUSINESS**

Sample, Automatic Fire Alarm, complete with Battery, postpaid to you for only \$1.00. You can make \$1000.00 a month and more. WE GUARANTEE LEADS FOR YOU. Send today for your Alarm, and complete details... this should be the opportunity you've been looking for.

**WE  
GUARANTEE  
LEADS**

**"FIRE KING"**

819 "FIRE KING" BLDG., ENGLEWOOD, COLORADO



**get into operating or repairing  
EARTH MOVING EQUIPMENT**

Men needed now for good paying jobs in booming road and construction work. Learn operating or repair-rebuilding of heavy road machinery, cranes, bulldozers, earth carriers, etc. Actual "on the job" training, 5 to 13 1/2 week courses. Classes start every Monday. Reserve your space now. Complete catalog and reservation forms FREE. Approved for veterans. Write

**Greer TECHNICAL INSTITUTE**  
Attn.: P. A. Hutch, Box 368, Braidwood, Ill.

## MONEY in WORMS

Sell 20,000 fishworms per week @ \$4 per 1000 from a bed 3 feet wide and 8 feet long. We teach you how to raise and where to sell fishworms and crickets. Write for free literature.

**CARTER WORM RANCH, PLAINS, GEORGIA**  
Read our success story in LIFE MAGAZINE, December 28, 1959 Issue

**ELECTRIFY** PLAYER PIANOS  
PUMP ORGANS

**YOU CAN QUICKLY END TIRESOME FOOT-PUMPING**  
With a Compact Low-Cost Lee Silent Suction Unit



EASY TO INSTALL  
FULLY GUARANTEED  
1000'S IN USE

write to  
**LEE MUSIC MFG. CO.**  
Box 595, Tujunga, Calif.



# INVESTIGATE ACCIDENTS

Train quickly in your own home for repeat income in the exciting, secure Claim Investigation and Claim Adjusting field. Our students and graduates are already earning \$4, \$5, \$6 an hour extra SPARE TIME—and up to \$10,000 a year Full Time. You need NO prior experience or higher education. Your age does NOT matter.

**HERE IS YOUR CHANCE FOR ACTION  
AND REAL JOB SECURITY**

As a trained Claim Investigator you will (1) INVESTIGATE FACTS and (2) DISTRIBUTE MONEY as the representative of wealthy organizations.

No other business offers you greater opportunities for success and security. Here's why: The huge, rapidly expanding Claim Investigation and Adjusting Profession right now distributes more money than any other service industry. And it's growing fast. Over 200 MILLION ACCIDENTS must be investigated this year for Insurance Companies, Airlines, Railroads, Steamship Lines, and Government Offices.

**MAIL NOW for FREE BOOK** ➔

SEND TODAY for Big, FREE, Illustrated Catalog. Learn the exciting facts about Universal Schools' low cost training. No obligation. No salesman will call. GI APPROVED.



**UNIVERSAL SCHOOLS**  
6801 Hillcrest Ave.

Dept PM-1, Dallas 5, Texas

Please rush me your FREE book on Claim Investigation. This does not obligate me and no salesman will call.

Name \_\_\_\_\_ Age \_\_\_\_\_

Address \_\_\_\_\_

City \_\_\_\_\_ Zone \_\_\_\_\_ State \_\_\_\_\_

Approved by Government for Korean Veterans

# WHAT ALL AUTO MECHANICS WANT TO KNOW

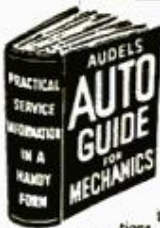

This Big Practical Book gives full information, with working diagrams, covering the principles, construction, ignition, service and repair of modern cars, trucks and buses.

**Air Conditioners, Hydramatic & Fluid Drives Fully Explained.**

A complete guide of 1132 Pages, with over 1000 Illustrations showing inside views of working parts, with instructions for service jobs. Completely up-to-the-minute! Priced at only \$6.



CIRCLE No. 1 IN COUPON

## HOW TO FIX HOME APPLIANCES

REFRIGERATORS WASHERS TOASTERS DRYERS HONERS RANGES VACUUMS FREEZERS

Many other GAS AND ELECTRIC APPLIANCES



Handy Reference for Electric & Gas Servicemen, Mechanics, Dealers and Homeowners. Explains clearly and simply how to locate troubles, how to test, reassemble and connect. Wiring diagrams, 1000 Facts. Easy to read. Answers ALL your questions. 854 Pages. Illustrated. Only \$6.

CIRCLE No. 2 IN COUPON



## TV TELLS HOW TO ANSWER RADIO AND TV QUESTIONS SERVICE LIBRARY

HERE IS LATE INFORMATION IN A HANDY FORM FOR RADIO AND TELEVISION REPAIRMEN, SERVICEMEN AND STUDENTS

TWO COMPLETE VOLUMES - 1598 Pages - 1085 Illustrations and Diagrams. 1001 Important Facts and Figures on Modern T.V. Radio, Electronic Devices, ENCLIDES TRANSISTORS & Transistor Circuits, Rectifiers, Record Changers, P.A. Systems, Phonograph Pick-ups, F.M., Auto Radio, Short Wave.

Basic principles, Construction, Installation, Operation, Shooting. How to get Sharp, Clear T.V. Pictures. Install Aerials. How to Test. Explains COLOR SYSTEMS, Methods of Conversion, Terms, etc. Includes Ultra High Frequency. Quick ready reference or use as a home study course. Only \$8 for BOTH volumes.

CIRCLE No. 3 IN COUPON

## OIL BURNERS

New, complete, explaining in detail both domestic and industrial oil burners. Includes electrical hook-ups and wiring diagrams. Fully covering the theory, construction, installation, operation, testing, servicing and repair of all equipment. Indexed for ready reference. Over 416 Pages. 320 Illustrations and Diagrams. Only \$2.50

CIRCLE No. 28 IN COUPON

## ALL TYPES OF BLUEPRINT READING

How to read scales, the standard symbols, detail and assembly prints, working drawings, short cuts, hints, and suggestions. THIS MAN'S WAY OF READING BLUEPRINTS IS IN LINE FOR A BETTER JOB. This book gives you the secret language, step by step in easy stages. 448 Pages, Very Fully Illustrated. Priced at \$3.

CIRCLE No. 25 IN COUPON

## PLUMBERS AND STEAMFITTERS GUIDES



Practical Trade Assistant & Reference Set. Explains in plain language and by clear illustrations, diagrams, charts, graphs and pictures the principles of modern plumbing practice including Pipe Fitting and Air Conditioning. 4 Vols. - 2624 Pages - 3642 Diagrams & Illustrations. Only \$9 for the complete set of 4 vols.

Sold individually \$2.50 each.

CIRCLE No. 6 IN COUPON

## 7-DAY FREE EXAMINATION

SEND NO MONEY - Pay the postman nothing! We are glad to send you any of the Audel Guides for absolutely FREE examination in your own home. We take all the risks and leave all the decisions up to YOU. There is no obligation! If you decide to keep the books of your choice you may pay for them under our astounding easy-pay plan of only \$2 a month.

### HERE IS ALL YOU DO

IT'S EASY TO ORDER: In the No-Risk Mail Order Coupon at the right just draw a circle around the number of Audel Guide you want us to send you for FREE EXAMINATION. We will send them to you at once to help you build a brighter future by increasing your SKILL. If for any reason at all you are not COMPLETELY satisfied, return the books to us, and that will end the matter! NO STRINGS OR CATCHES TO THIS OFFER.

**THEO. AUDEL & CO.**

49 West 23rd Street, New York, 10, N. Y.

## GAS ENGINE MANUAL

Just off the press! A helpful, practical guide for mechanics, students and homeowners. Maintenance and repairs of modern gas engines of all types and sizes used in almost every field, from motor transportation, to appliances around the home. Includes marine and aircraft engines.



FOR THE EXPERT OR THE DO-IT-YOURSELF

THE FIRST PART explains the operating principles of various types of gas engines, and the function of engine parts and accessories: carburetors, fuel injection methods, cooling and lubrication systems, etc. THE SECOND PART covers trouble-shooting, modern service operations and engine tune-up procedures. Ignition system items are fully listed and illustrated. 48 pages. Only \$4.

CIRCLE No. 48 IN COUPON

## PAINTING AND DECORATING MANUAL

NEW TITLE gives the practical know-how you have been looking for. Concise and late information on the many phases of house painting and decorating. Complete from A to Z.



INSIDE TRADE INFORMATION!

Outside and inside work, how to mix paints, preparation of surfaces, paper-hanging, wood finishes, tools and their proper use, synthetic paints, where and how to use them, the brush care, spray painting, scaffolds, rigging, coats, estimating, better methods and a dictionary of trade terms. Over 585 Pages. Fully illustrated. Only \$4.

CIRCLE No. 7 IN COUPON

## MASONS & BUILDERS GUIDES

A PRACTICAL ILLUSTRATED VOL. SET - Explaining in clear, simple language and profuse illustration, principles, advances, short cuts, trade secrets, based on modern practice - including how to figure and calculate various jobs.

Vol. 1 - Brick work, bricklaying, bonding, designs. Vol. 2 - Brick foundations, arches, tile setting, estimating. Vol. 3 - Concrete mixing, placing forms, reinforced stucco. Vol. 4 - Plastering, stone masonry, steel construction, blueprints. 4 Vols. 1440 Pages. 2067 Illustrations. Complete Set only \$9.

CIRCLE No. 26 IN COUPON Sold individually \$2.50 each

## MATHEMATICS MADE EASY

A COMPLETE HOME STUDY COURSE - Starting with the first principles of arithmetic, advancing step by step through the various stages of mathematics, including the rules and calculations for mechanical and electrical problems. New EASY correct methods. Includes plane and solid geometry, trigonometry, algebra, calculus, etc. Practical tests, reference tables and data. How to use side rule. 672 Pages. 550 Illustrations. Priced at only \$3.

CIRCLE No. 11 IN COUPON

## NEW MACHINISTS AND TOOLMAKERS HANDBOOK

MODERN MACHINE SHOP PRACTICE - For every Machinist, Toolmaker, Draftsman or Student. Tells how to set up and operate lathes, arcs and milling machines, shapers, drill presses and all other machine tools. A COMPLETE INSTRUCTOR AND REFERENCE BOOK. 1250 Pages. Fully Illustrated. Priced at only \$6.

CIRCLE No. 12 IN COUPON

## ELECTRIC MOTORS

THIS GUIDE covers the construction, hook-ups, control, maintenance and trouble shooting of all types of motors. Includes armature winding. Explains entire subject in great detail in simple language. Over 1056 Pages of information. 617 Diagrams. All types of motors fully illustrated and indexed for ready reference. Priced at only \$5.

CIRCLE No. 27 IN COUPON

## REFRIGERATION & AIR CONDITIONING

FOUR BOOKS IN ONE - basic principles, servicing, operation, repair of: Household Refrigeration, 2. Special Refrigeration Units, 3. Commercial & Industrial Refrigeration, 4. Air Conditioning Systems. A GOLD MINE of essential information. Completely up-to-date. 1360 Pages. Fully Illustrated and Indexed. Priced at only \$6. CIRCLE No. 14 IN COUPON

## CARPENTERS AND BUILDERS GUIDES



PRACTICAL STOREHOUSE OF MODERN CONSTRUCTION INFORMATION (4 vol. set) for carpenters and all woodworkers. Explains in easy language and by profuse illustration principles, advances, short cuts, trade secrets, all based on the NEWEST information. Vol. 1 - Tools, steel squares, saw fitting, joinery, furniture, etc.; Vol. 2 - Builders' mathematics, drawing plans, specifications, estimates, etc.; Vol. 3 - House and roof framing, laying out, foundations, etc.; Vol. 4 - Doors, windows, stair building, millwork, painting, etc. 4 vols. 1904 Pages. 3700 Illustrations. Whole set Sold individually \$2.50 each only \$9. CIRCLE No. 8 IN COUPON

## PRACTICAL ELECTRICITY

A COMPLETE HANDBOOK - Quick, simplified, ready reference. Complete instruction and practical information on the rules and laws of electricity - Maintenance of Machinery - A.C. and D.C. Motors - Armatures - Wiring Diagrams - House Lighting - Power Wiring - Meters - Batteries - Transformers - etc. Simple to understand. 1052 Pages. 2600 Illustrations. Priced at \$5. CIRCLE No. 4 IN COUPON

## DIESEL

ALL THERE IS TO KNOW ABOUT MODERN DIESEL ENGINES - Basic principles, starting valves, timing, fuel pumps, fuel injection compressor, air compressors, pistons, cylinders, lubrication, cooling systems, etc. Answers on operation, calculations. 640 Pages. Fully Illustrated. Priced \$3.

CIRCLE No. 9 IN COUPON

## THE NEW ELECTRIC LIBRARY

A COMPLETE ENCYCLOPEDIA explaining in the simplest terms the fundamental principles, rules and applications of applied electricity.

A COMPLETE COLLEGE EDUCATION!

Fully illustrated with diagrams and sketches, calculations and tables for ready reference. Questions and answers. Trial tests for practice study and review. All based on the most modern theory.

Vol. 1 - Principles and rules of electricity, magnetism, armatures, repairs. No. 15  
Vol. 2 - Dynamos, DC Motors, construction, installation, maintenance, etc. No. 16  
Vol. 3 - Testing instruments and tests, storage battery constr. and repair. No. 17  
Vol. 4 - Alternating current, power factor, alternators, transformers. No. 18

Vol. 5 - A.C. Motors, windings, maintenance, converters, switches, fuses, etc. No. 19  
Vol. 6 - Relays, condensers, regulators, rectifiers, meters, switchboards, etc. No. 20

Vol. 7 - Wiring, house light and power, circuits, high tension, plans, code, etc. No. 21

Vol. 8 - Railways, signals, elevators, ignition, etc. No. 22  
Vol. 9 - Radio, telephone, telegraph, television, motion pictures. No. 23  
Vol. 10 - Refrigeration, illumination, welding, x-ray, electrical appliances. Index. No. 24

6,000 fully illustrated pages. Priced at only \$22.50 for the ENTIRE SET. Also sold individually for \$2.50 each.



## ADDITIONAL IMPORTANT TITLES

The following Audel Guides are all the best in their fields, written in clear simple fashion, all lavishly illustrated. Circle the numbers wanted in the MAIL ORDER COUPON below. All books are sent for FREE EXAMINATION.

- No. 5 TRUCK & TRACTOR GUIDE, 1276 Pages..... \$5.00
- No. 7 WELDERS GUIDE, 608 Pages..... 3.00
- No. 13 WIRING DIAGRAMS (Light & Power), 304 Pages..... 2.50
- No. 29 SHEET METAL PATTERN LAYOUTS, 1152 Pages..... 7.50
- No. 30 SHEET METAL HANDY BOOK, 448 Pages..... 2.50
- No. 31 MECHANICAL DRAWING GUIDE, 192 Pages..... 2.50
- No. 32 MECHANICAL DRAWING & DESIGN, 410 Pages..... 3.00
- No. 33 ELECTRONIC DEVICES, 304 Pages..... 3.00
- No. 34 ELECTRICIANS EXAMINATIONS, 272 Pages..... 2.50
- No. 35 ELECTRIC POWER CALCULATIONS, Page 480..... 3.00
- No. 36 ELECTRIC DICTIONARY, 9000 Terms..... 3.00
- No. 37 POWER PLANT ENGINEERS GUIDE, 1508 Pages..... 5.00
- No. 38 ENGINEERS AND FIREMANS EXAMS, 544 Pages..... 2.50
- No. 39 OPERATING ENGINEERS LIBRARY, 3 Book Set..... 12.00
- No. 40 PUMPS, HYDRAULICS AND AIR COMPRESSORS, 1760 Pages..... 6.00
- No. 41 HOUSE HEATING GUIDE, 966 Pages..... 5.00
- No. 42 MILLWRIGHTS & MECHANICS GUIDE, 1248 Pages..... 5.00
- No. 43 DO-IT-YOURSELF ENCYCLOPEDIA, 2 Book Set..... 8.95
- No. 44 NEW MECHANICAL DICTIONARY, 712 Pages..... 6.95
- No. 45 MAGIC OF LANDSCAPING, 128 Pages..... 1.49
- No. 46 WATER SUPPLY & SEWAGE DISPOSAL, 436 Pages..... 4.00
- No. 47 GUIDE TO CREATIVE PHOTOGRAPHY, 400 Pages..... 3.95

## MAIL THIS NO-RISK COUPON TODAY!

THEO. AUDEL & CO. - Self Improvement Publishers Since 1879 - P1

49 W. 23rd Street, New York 10, N. Y.

Please mail me 7 days' FREE EXAMINATION the books I have circled at right. I agree to mail \$2 in 7 days on each book or set ordered, and to further mail \$2 a month on each book or set ordered until I have paid the purchase price, plus shipping costs. If I am not completely satisfied with my Audel Guides I may return them.

1	2	3	4	5
6	7	8	9	10
11	12	13	14	15
16	17	18	19	20
21	22	23	24	25
26	27	28	29	30
31	32	33	34	35
36	37	38	39	40
41	42	43	44	45
46	47	48		

NAME \_\_\_\_\_ AGE \_\_\_\_\_

ADDRESS \_\_\_\_\_

CITY \_\_\_\_\_ STATE \_\_\_\_\_

EMPLOYED BY \_\_\_\_\_

SAVE SHIPPING COSTS! Check here if you enclose complete payment with order. We pay postage charges. You have same return privilege.

# EARN \$125 A WEEK AND UP

## BE AN AUTO DIESEL EXPERT — LEARN A TRADE YOU LIKE

You learn fast in our shops because you learn with tools on real equipment. Students short of money may earn most of their expenses by doing part-time work. Experienced instructors explain WHY and show you HOW, then you DO IT YOURSELF. Many of our graduates earn \$125 a week and up. Approved for veterans. Day and evening classes. Free bulletin-write today.

MAIL THIS COUPON TODAY!

**NASHVILLE AUTO-DIESEL COLLEGE**  
226 7th Ave., No., Dept. 86, Nashville, Tenn.  
Please send without obligation free catalog.

NAME \_\_\_\_\_  
(please print or write plainly)

ADDRESS \_\_\_\_\_

CITY \_\_\_\_\_ STATE \_\_\_\_\_

## 95% PROFITS YEAR 'ROUND

Be your own boss. Operate a **SIMPLEX** lawn-mower sharpening service in your community. One compact machine grinds all mowers, sharpens cutlery. Low investment, 95% profit. Pays for itself in average month.

**SIMPLEX**

—4 Machines in One!  
**Reel Grinder**—sharpens any mower reel in or out of mower.  
**Bed Knife Grinder**—grinds with either round or cup wheel.



**Rotary Blade Grinder**—hollow grinds any rotary mower blade.  
**Cutlery Knife Grinder**—sharpens cutlery, tools, scissors.

Send for free, money-making details!

The FATE-ROOT-HEATH Company • Dept. PM-1, Plymouth, Ohio

### Entertaining and Mystifying



## LIT CIGARETTE VANISHES AND THEN REAPPEARS!

With sleeves rolled up, you make a lighted cigarette vanish! Not a trace remains! Then, like a magician, you reach into the air and presto! Cigarette reappears! Actually 2 tricks in one! You can also make bills, pencils disappear too! Easy to do! Astonish everyone! Be the Life of the Party! Order at once.

**FREE** WITH EACH ORDER YOU GET OUR GIANT SURPRISE CATALOG — 150 Pages of over 1000 other tricks!

Catalog alone 25¢ postpaid. Be sure to order your copy now!

HOUSE OF 1000 MYSTERIES, Dept. PM 1-62, Trumbull, Conn.

# 5 lb. INVENTION Does Printing Like This...

ON PAPER, GLASS, METAL  
OR ANY SURFACE...

**SENSATIONAL  
HOME-BUSINESS  
OPPORTUNITY**

(No Experience Needed)  
Terrific money maker. Few evenings and weekend hours may pay double the income you get from regular job. Amazing 5 lb. invention starts you. Expand quickly to full-time business. For security and independence.



"I MAKE \$400 A WEEK!"

\*Some make less, but these are notable earnings of J. T. Anderson, Inglewood, California

**AMAZING DEVICE**—SETS ON ANY SMALL TABLE—No costly equipment, no extra rent or overhead. And even teen-agers can operate. Yet you can print anything—even some jobs not possible with \$10,000 printing press! Only 5 pounds of equipment does the job. Unbelievable, but true!

**BIG DEMAND**—STORES, OFFICES, FACTORIES—Every business needs this new kind of printing—drug and dept. stores, gas stations, restaurants, theatres, auto dealers, real estate firms, beauty shops. Nothing on earth to match it for colorful displays. No selling. Just show samples and go home loaded with orders. Or get orders by mail. We show how and help you. Start NOW!

Write: **SCREEN-PRINT CO.** Dept. 21  
15127 So. Broadway, Los Angeles 61, Calif.

Print Signs, Displays,  
Menus, Fabrics, Posters

Ordinary printing is done only on paper. You can now print on paper, wood, glass, metal, rubber, plastic, cloth, etc.—also on curved surfaces (glasses or bottles, for example) as well as flat. Opens up new multi-million \$\$ field ordinary printers cannot touch!

**FREE!** SAMPLES  
PLANS  
DETAILS



New York Times photo

## Reflector Gives Winter Sun Tan

When winter winds blow across Long Island, N.Y., beaches, the real sunbathers pack up their umbrellas and unpack aluminum-foil reflectors. They wear individual ones to focus sunlight against their faces, or erect large three-sided reflectors for group tanning. Reflected rays can raise blisters on exposed skin within a couple of hours.

POPULAR MECHANICS

# RCA training at home can be the smartest investment you ever made

Look what you get in the Course in Radio and Electronic Fundamentals

**40** Fascinating THEORY LESSONS



Containing all the basic principles of radio and electronics in easy-to-understand form.

**40** EXPERIMENT LESSONS



Each containing absorbing, practical experiments bound together in 20 books.

**40** SERVICE PRACTICES



Full of practical, time-saving and money-saving servicing tips, bound into 20 books.

## PLUS ALL THIS AT NO EXTRA COST...

**15 KITS**

to build a Multimeter, AM Receiver and Signal Generator. Kits contain new parts for experiments, integrated so as to demonstrate what you learn in the lessons and to help you develop technical skills. Each kit is fun to put together!



**MULTIMETER**

A sensitive precision measuring instrument you *build* and *use* on the job. Big 4½" meter with 50 micro-amp meter movement. 20,000 ohms-per-volt sensitivity d-c, 6,667 a-c.



**SIGNAL GENERATOR**

A "must" for aligning and trouble-shooting receivers. Build it for your own use. 170 KC to 50 MC fundamental frequencies for all radio and TV work.



**AM RECEIVER**

Have the satisfaction of building your own radio receiver with this high-quality 6-tube superheterodyne set. Big 5" speaker, fine tone!

Also, comprehensive, fully-integrated home study courses in • *Television Servicing* • *Color Television* • *Electronics For Automation* • *Transistors*. Stake out your future in electronics with any one of this wide variety of courses. Practical work with the very first lesson! Pay-only-as-you-learn! No long-term contracts to sign! No monthly installments required. Pay only for one study group at a time, if and when you order it!

SEND FOR FREE HOME STUDY CATALOG TODAY!

RESIDENT SCHOOL COURSES in Los Angeles and New York City offer comprehensive training in Television and Electronics. Day and Evening classes. Free Placement Service. Catalog free on request.



**RCA INSTITUTES, INC.**  
A Service of Radio Corporation of America • 350 W. 4th St., New York 14, N. Y. • 610 S. Main St., Los Angeles 14, Calif.

**RCA INSTITUTES, INC.** Home Study School, Dept. PM-12  
A Service of Radio Corporation of America  
350 West Fourth Street, New York 14, N. Y.

Without obligation, rush me the FREE 64-page illustrated booklet "Your Career in Electronics" describing your electronic home study training program. No salesman will call.

Name.....

Address.....

City..... Zone..... State.....

Veterans: Enter discharge date.....

**CANADIANS**—Take advantage of these same RCA courses at no additional cost. No postage, no customs, no delay. Send coupon to: RCA Victor Company, Ltd., 5581 Royalmount Ave., Montreal 9, Quebec.



The Most Trusted Name in Electronics

**MAKE YOUR HOME WORKSHOP PAY OFF**  
in spare time or full time income  
**ELECTRICAL APPLIANCE REPAIR**



Turn spare hours into cash profits. Millions of Home Appliances need fixing. Every home is your market for Full-Time Career or Spare Time "Second" Income.

Costs Less Than \$1.50 A Week. All you need is a workbench, spare time and N.T.S. Home-Training in Electrical Appliance Repair. You get a professional appliance tester, tools, and easy-to-learn, practical instructions, fully illustrated. Start earning early in course. Mail coupon now. No obligation. No salesman will call.

**NATIONAL TECHNICAL SCHOOLS**  
WORLD-WIDE TRAINING SINCE 1905  
4000 So. Figueroa Street  
Los Angeles 37, Calif., U.S.A.

**FREE BOOK and ACTUAL LESSON**

**NATIONAL TECHNICAL SCHOOLS**  
Los Angeles 37, California

HB-12

Name \_\_\_\_\_ Age \_\_\_\_\_  
Address \_\_\_\_\_  
City \_\_\_\_\_ Zone \_\_\_\_\_ State \_\_\_\_\_

**... TURN CONCRETE INTO GOLD!**



**MAKE UP TO \$75 A DAY IN YOUR OWN BUSINESS**

If you want to have your own business — to start a business on your own — here's your big opportunity! New high speed, low cost General block machine produces up to 1,000 concrete blocks a day. Sell all you make to builders, supply houses, and others for homes, factories, buildings, garages. Cash in on the building boom! You can make profits of 100% to 150% — up to \$75. a day! General block machine equipped with 1/2 h.p. electric motor — or can be supplied with gasoline engine — works anywhere, in little space, indoors or out. Operates on ordinary house light socket. Simple, foolproof 3 step operation — so easy a child can do it. Makes superior 3 core blocks any size from 4" to 12". Also makes chimney, sash, corner and other types. Blocks meet any building code anywhere in the country. Materials — sand, water, cement, available anywhere. Simple illustrated operating instructions and mixing formulae for cement and cinder blocks supplied with each machine. Write for FREE folder with full information.

**MOTOR DRIVEN**

R.L.T. of New York City reports: "MY GENERAL BLOCK MACHINE PAID FOR ITSELF IN FIRST 2 WEEKS!"  
Hundreds now in use the world over!  
Write for FREE details today!

**EXTRA**

Amazing illustrated book gives floor plans for 6 sensational concrete block bungalows. Tells how to lay blocks, lay out building lines, mix concrete, build steps, porch and concrete floors all at great savings. Written by experts. Can save many times the cost of the machine! Get it now! No strings attached. Send \$1.

BOOK SENT FREE IF YOU BUY MACHINE.  
\$1 REFUNDED IF YOU BUY LATER.

**GENERAL ENGINES CO.**  
DEPT. PB-12, ROUTE 130, THOROFARE, N. J.



**engineering degree in 27 months**

Industry demands graduates. Enjoy higher income . . . advancement. Major corporations regularly interview and employ seniors. *Bachelor of Science Degree in 27 Months* in Electrical, Mechanical, Aeronautical, Chemical, Civil Engineering. IN 36 MONTHS a B.S. Degree in Business Administration (General Business, Accounting, Motor Transport Administration majors). Small classes. More professional class hours. Well-equipped labs. Campus. New dorms. Low costs. Founded 1884. Enter March, June, September, January. Write J. E. McCarthy for Catalog and "Your Career in Engineering and Commerce" Book. Learn more and you'll earn more.



**TRI-STATE COLLEGE**

412 College Avenue • Angola, Indiana

**ADDING MACHINE**

\$1.98 ea. or 2 for \$3.69

ADD — SUBTR. — MULT. — DIVIDE



Does all 4 operations. Handles 9 columns of numbers. Settle for no less. Leatherette case. Lowest price adder made in America. Beware of cheapened foreign imitations. Money back guarantee. Agents wanted. \$1.98 add 4% tax in Pa.

**TOM THUMB** P. O. BOX 276 BETHAYRES, PENNA. DEPT. J-12

**LEARN FIBERGLASSING at Home in Spare Time**

Interstate's complete home training course in Plastics Fabrication teaches fiberglassing, plastic molding, casting, laminating, internal carving, etc. Shows how to make hundreds of salable articles of plastic. Professionally prepared. Special materials furnished. Send postcard for FREE booklet.

**INTERSTATE TRAINING SERVICE**  
Dept. C-3, Portland 12, Oregon

**6-IN-1 ONLY MACHINE OF ITS KIND!**  
**UNIMAT**

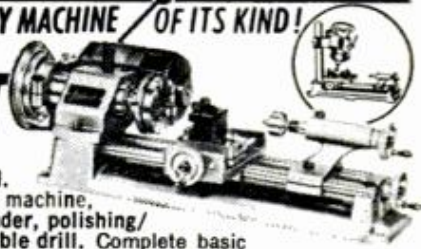

Compact workshop for all metal, plastic, wood. Precision lathe, milling machine, drill press, surface grinder, polishing/grinding machine, portable drill. Complete basic unit, \$129.50. WRITE FOR FREE CATALOG. AMERICAN EDELSTAAL, INC., DEPT. GM350 BROADWAY, N.Y. 13, N.Y.

**MEN PAST 40**

**Afflicted With Bladder Trouble, Pains in Back, Hips, Legs, Nervousness, Tiredness.**

If you have these troubles, particularly bladder trouble, then your condition may be traced to Glandular Inflammation . . . a constitutional disease. Neglect of this condition often leads to premature old age and sometimes incurable conditions.

The Excelsior Medical Clinic has a New Free Book that tells how thousands of men have been successfully treated here at Excelsior Springs for Glandular Inflammation by NON-SURGICAL Methods. They found soothing relief and a new outlook in the future of life.

This Free Book may prove of utmost importance in your life. Write Today. There is no obligation. Excelsior Medical Clinic, Dept. B6129, Excelsior Spgs., Mo.





# MAN GOING PLACES

He's building a money-making, lifetime business as a Duraclean dealer. He could be your neighbor—or he could be *you*.

This man is an expert in one of the most profitable businesses of all—carpet and furniture cleaning in the home. Duraclean trained him, provided all his special equipment and cleaning materials, and backs him with a powerful national advertising campaign.

Duraclean shows him how to get customers, too. They're easy to find. Every homeowner is a potential client. Every theater, church, office building, hotel, school and business is a prospective customer.

The market is there, and Duraclean's unique cleaning process lets the dealer take full advantage

of it. Duraclean cleans by absorption. That is, it literally lifts the dirt from fabrics—leaves them bright, fresh, really clean.

This Duraclean dealer works full time performing Duraclean service. That's only one way to begin in this business. You also can start part-time or you can hire others to do the servicing. There's little overhead, no shop needed, because the work is done in the customer's home or place of business. Three average jobs a day can gross a dealer \$22,500 a year.

For the enterprising man, for the man interested in going places, a Duraclean dealership offers a lifetime of financial security. Interested? Mail the coupon below.

## JOIN THESE SUCCESSFUL DEALERS



**Ed Kramsky (Ill.)** "In two years I now have two assistants, a nice home and real security for my family."

**Ward Whitbeck (Conn.)** "On one hotel job I made \$400.88. In my fifth year am making as much as \$225.00 one day."



**John Kalita (Ind.)** "Instead of making \$2.00 an hour working for someone else, I average \$7.00 to \$9.00 an hour with Duraclean. It's the best investment I ever made."

**RUSH  
THIS  
COUPON  
TODAY**

Duraclean Company, Dept. 2-151  
Duraclean Building  
Deerfield, Illinois  
Please send me all the facts about Duraclean.

Name .....

Address .....

City ..... State .....

**SINCE 1930**  
**Duraclean Company**  
*Flower Fresh Cleaning  
For Carpets and Furniture*

# WORLD'S SMALLEST HOME "MACHINE SHOP"

Pays You 400% Profit for Spare Time

Set up anywhere. Takes up only one square foot of space. Brings in extra cash for spare time work

## No House-to-House Selling

The product turned out by this machine is so small in size that you could carry fifty in one pocket. Yet the demand is so great that FORTY MILLION are bought every year by the public. You and I, your friends and neighbors—everyone—uses from five to twenty of them every day. And—the need is the same everywhere—in small towns or big cities.

Profit mark-up is incredible. Just \$1.00 worth of raw material—plus 15 minutes work—turns out finished products worth \$5.00. And—no house-to-house selling is necessary because we show you nine ways to get orders coming in to you. In fact, neighbors will leave work at your home while you're away on your regular job—work you can turn out in a few minutes before dinner. It's ideal for a one man business or a man-and-wife team because the machine is so simple that a woman can turn out professional work after only an hour's practice.

What is this wonder-money-maker? You'll be surprised when you learn how many hundreds of people are making bigger profits than they ever dreamed of just making America's most used product—the door key. Small, inexpensive, yet so absolutely necessary in every person's life that forty million are lost and replaced every year. We show you how to get a profitable share of this fantastic business and the information is free. Just send your name on the coupon or a postcard for pictures, descriptions, and complete facts, even showing how we help finance your start. No salesman will call. Everything will be mailed to you postage prepaid and you will not be under the slightest obligation. Send name to me, Michael Roberts, 1512 Jarvis Ave., Dept. K-2-A, Chicago 26, Ill.

Mr. Michael Roberts, Dept. K-2-A  
1512 Jarvis Avenue, Chicago 26, Ill.

**FREE!**

Dear Mr. Roberts: Without cost or obligation to me mail complete facts, postage prepaid, showing how you will help finance my start in a profitable one-man business that I can operate at home in my spare time. No salesman is to call.

NAME \_\_\_\_\_

ADDRESS \_\_\_\_\_

CITY \_\_\_\_\_ ZONE \_\_\_\_\_ STATE \_\_\_\_\_

## Tells How You Can Learn to

**FUN! RECREATION! PROFIT!**

**FREE BOOK MOUNT BIRDS!**

**Learn At Home**

Men, Boys, Hunters, Fishermen, mount and save your lovely wild-game trophies. Be a Taxidermist. Mount Birds, Animals, Heads, Fish, Tan skins. YOU learn easily, quickly in spare time. Have a grand home-museum. The finest and the greatest hobby known, for sportsmen. Fun, real profits.

**FREE BOOK**

Yes, FREE, Beautiful strange, valuable Book, telling all about Taxidermy. Contains over 100 beautiful game-pictures. And it's yours FREE, if you rush your request. You can mount all kinds of wild-game, and common specimens too. We can TEACH YOU. So GRASP this opportunity. RUSH letter or postal for this amazing FREE BOOK. Don't delay. State your AGE. N. W. SCHOOL OF TAXIDERMY, 2501 Elwood Bldg., Omaha 2, Neb.

more run for your money!



## WARN HUBS

on your 4-WHEEL DRIVE

That goes for your vehicle as well as Warn Hubs. The hubs stop front end drag in 2-wheel drive, save gears, gas, tires, give your vehicle more life, greater handling ease. And the hubs are the most dependable you can own. Ask your dealer!



WARN MFG. CO.

Riverton Box 6064-A  
Seattle 88, Washington

## JEEP OWNERS

RE-POWER NOW WITH A V-8 OR 6 CYL. ENGINE — USE FORD—CHEV.—MERCURY—GMC—PONT—STUDE—DODGE OR PLYMOUTH In Jeeps, Jeepsters, Sta-Wgn, trucks, Kaiser & H. J. cars. Conversion Kits \$45.35 to \$56.90. Want fast action? Give us full information, send \$15.00 Dep. and we will ship correct kit. Bal. COD. Send full amount for prepaid shipment. Wire, phone or write today. Details FREE.

HOOSIER MACHINE PRODUCTS CO.

312 S. E. 6th St. Phone CR 6-3442 Pendleton, Oregon

## GET INTO ELECTRONICS

V.T.I. training leads to success as technicians, field engineers, specialists in communications, guided missiles, computers, radar, automation. Basic and advanced courses. Electronic Engineering Technology on ECED accredited Technical Institute curriculum. Assoc. degree in 29 mos. H.S. obtainable. G.I. approved. Start Feb., Sept. Dorms, campus. H.S. graduate or equivalent. Catalog.

VALPARAISO TECHNICAL INSTITUTE

DEPT. D VALPARAISO, INDIANA

HEAD-QUARTERS FOR ALL SPORT CAR TIRE STORES

ALL FAMOUS BRANDS!

**TIRES!**

FARM TRUCK AUTO

AT LESS THAN WHOLESALE

SAVINGS NEVER LESS THAN 50% up to 70% OFF REG. PRICE

FREE - SEND FOR YOUR FREE CATALOG - FREE!

RELIABLE TIRE DIST., 730 Morgan Blvd., Camden 4, N. J.

## LAW FREE BOOK THE LAW TRAINED MAN

Write today for a FREE copy of illustrated law book, "THE LAW-TRAINED MAN," which shows how you can learn quickly at home the basic principles of all law topics through the famous Blackstone Law Course. All necessary books and lessons provided. Moderate cost; convenient monthly terms. Write for FREE law training book today.

Blackstone School of Law, 307 N. Michigan Ave.  
Founded 1890 Dept. 51, Chicago 1, Illinois

## GOVERNMENT OIL LEASES LOW AS \$1 PER ACRE

You do no drilling, pay no taxes, may realize a king-size profit without ever leaving home. Write for free map and literature.

AMERICAN OIL SCOUTS, Dept. PM  
619 Cascade Bldg. Portland 4, Oregon

## NEW Improved Scope-Shot

Price Complete with 50 DISINTEGRATING PELLETS They crack like a rifle when they hit—leave mark—pull of smoke! \$1.95 P.P.

World's Finest Precision SLINGSHOT Scope-type sight! Millions Sold Patent No. D-178,837

Pure gum rubber slings. Beautifully polished cast aluminum stock. Pistol grip. So powerful it kills small game. Fits pocket perfectly! Guaranteed. FREE shooting manual.

ROUTS PESTS! Price without pellets \$1.50 P.P.

Order Now!

Order NOW from: GENERAL SPORTS  
4184-MA Apple Street, Cincinnati 23, Ohio

# BUY BELOW WHOLESALE!

Only for the man who wants  
a business of his own!!

Start your own  
big profit business  
with hundreds of  
bargains like this...

**TAPE RECORDER** For Only **\$10<sup>51</sup>** COMPLETE

**Records • Plays Back • Erases  
Rewinds • Built-in Speaker  
Needs No Outside  
Power**

with SPEAKER,  
MICROPHONE,  
TAPE, REELS,  
ETC.

And this is only one of hundreds of import bargains you can get to make fantastic profits of 200% and more... HERE ARE EXAMPLES OF HIGH PROFIT IMPORTS.

Transistor Radio	\$3.02
Derringer pistol	5.74
Star Sapphire ring	6.00
Cigarette lighter	.17
16mm camera, mag. load	2.30
Electric food mixer	1.66
Electric razor	3.40
Seventeen-jewel watch	2.87
Tailor-Made silk suit	17.50
Binoculars	1.00
Teakwood chest	.90



**DISCOVER THE SECRETS OF IMPORT!**  
See what to buy - how to buy it at rock bottom prices.  
Cut out middle-man profits! Buy direct from manufacturers  
abroad. Thousands of items available.

**This is a BIG-MONEY BUSINESS**  
you can start in your spare time!

- ✓ NO INVESTMENT  
IN MERCHANDISE!
- ✓ NO EXPERIENCE  
NEEDED!

Whatever you now do for a living - whether you have your own business or work for someone else, importing offers you profits beyond your wildest dreams. You need no experience! You need no capital investment! You don't even have to pay for merchandise in advance. And the profits are all yours because you deal direct with overseas suppliers. When I give you my secrets of Import profits, I reveal everything you need to know. When you realize that over 30 BILLION dollars changes hands every year in Import-Export, you can easily see there is room for hundreds of beginners in this big profit home business.

Get details about  
**8 FREE IMPORTS**  
Mail coupon today.

**SEND NO MONEY!**  
DO NOT ORDER PRODUCTS FROM ME!  
I show you how to get these bargains  
and hundreds others direct  
from overseas  
suppliers.

I limit this offer to  
serious-minded men  
and women who want to  
start a big profit  
home business. If you  
are ready, act now!



B. L. Mellinger, Jr.,  
Director

**OTHERS HAVE REAPED  
FABULOUS PROFITS!**

Prove to yourself you can make big profits too!  
Send for Free Book showing how others have  
followed my plan to success. No cost, no obligation.

MELLINGER CO., Dept. D251, 1554 S. Sepulveda, Los Angeles 25, Calif.

**RUSH  
Coupon for  
FREE  
DETAILS!**

**When you buy right, you make money!  
Get Free Plan! Mail Coupon Today!**

The Mellinger Co., Dept. D251  
1554 S. Sepulveda Blvd., Los Angeles 25, California

Send me complete Free information about how I can start a  
business of my own. Show me how I can get bargains like  
these and thousands more direct from overseas suppliers.

Name \_\_\_\_\_

Address \_\_\_\_\_

City \_\_\_\_\_ Zone \_\_\_\_\_ State \_\_\_\_\_

## AVIATION CAREER

A solid education is your only key to success in the world of aviation.



A non-profit, private institution of higher education.

Director of Admissions

Embry-Riddle Aeronautical Institute  
Aviation Building, Miami 52, Florida

Without obligation, please send me your Free 80-page Book and full particulars about the course(s) checked.

Print Name.....

Address..... Age.....

City.....State.....

- Executive Pilot—Bachelor of Science Degree
- Business Pilot—B.B.A. Degree
- Aeronautical Engineering—B.S. Degree
- Aircraft Maint. Engr.—B.S. Degree
- Aircraft Maint. Engr. Tech.—A.S. Degree
- Aeronautical Engineering Technology

JA-PM-12

MAIL THIS COUPON TODAY

## LEARN UPHOLSTERY

in your spare time  
run your own  
business  
AT HOME



FREE TOOLS WITH COURSE

FREE BOOK with sample lessons

With Course You Make



SLIPPER CHAIR

CLUB CHAIR

OTTOMAN

PLUS SLIP COVERS Yours to Keep or Sell

### BE YOUR OWN BOSS

Earn more from the start in spare time. STOP worrying about layoffs, enjoy a steady growing income and independence for life in the booming field of Custom Furniture Upholstery. Right off, you start upholstering with the tools, complete frames, fabrics and materials. Included FREE with N. Y. State-approved UTS Home Study Course. You learn skilled professional custom upholstery, reupholstery, furniture finishing, repairs, how to make beautiful slip covers, cushions and draperies. EARN WHILE YOU LEARN, in your spare time AT HOME . . . the UTS easy way. FREE ILLUSTRATED BOOK—FREE SAMPLE LESSON Get ready for well-paid job and big profits, from steady work, as your own boss, running your own business. Mail coupon NOW for FREE BOOK! Training in N.Y. School also available. VET APP'VD. ACCREDITED BY N.H.S.C.

UPHOLSTERY TRADES SCHOOL, Dept. TA-310, 721 B'way, N. Y. 3, N. Y. Please send me FREE book, "Your New Way to a Successful Career," and FREE sample lesson. No obligation—no salesman will call.  Home Study  Training in N. Y. School

Name..... (Please Print Plainly)  
Address.....  
City..... Zone..... State.....  
 Check if Korean Veteran

## Items from all outdoors

Next time your fishing partner boasts of his prowess with a spinning rod, here's a good wet blanket to use on him: The new world record in one-handed spinning, set last fall at the International Casting Federation games in Oslo, Norway, is 291 feet! That's with a 3/8-ounce weight, and not with specialized distance tackle. The winner used familiar sporting gear; a 7 1/2-foot Conolon Rod, a Mitchell spinning reel, and two-pound-test Gladding Platyl monofilament line. Try that in your back yard when you get impatient for the season to open.

A new outboard motor hits the market this year, but with a familiar name and a familiar type of powerhead. It's built by Homelite, the chain-saw manufacturer, and is a four-cylinder, four-cycle kicker that develops 55 horsepower at 5500 r.p.m. (Most two-cycle outboards are hp.-rated at 4200 r.p.m.) The new motor will revive the old argument about whether the four-cycle engine's fuel economy offsets its greater weight. For example, the 55-horse Homelite weighs 227 pounds; a 50-horse Mercury outboard weighs about 140. Portable four-cycle engines also need an occasional oil change and can't be laid down just any way or you'll spill the oil, but these are small inconveniences.

The offsetting economy claims are impressive: "It doubles your miles per dollar at full speed . . . even more at cruising speed." No exact fuel consumption figures are available at this writing, but if it cuts gas and oil costs in half through the usual speed range, that factor will be a big selling point, especially to long-cruise boating fans. The price is \$960 f.o.b. Greer, S. C.

Survival kits of one kind or another are cropping up all over, and getting smaller every time. One of the newest and smallest is a packed pocket-sized model being made by Johnson Associates, Box 1516, Milwaukee, Wis. The little kit is about four by six inches in size, about an inch thick, but holds 20 survival items from fish hooks to burn ointment to a knife and a compass, plus a 16-page first aid and survival booklet. It's intended for sale in retail stores for \$2.49 in a plastic box; \$3.98 with a leather case; \$4.98 with a deluxe case in a gift carton.

*Dick Kiepatnik*

POPULAR MECHANICS

# Profits That Lie Hidden in America's Mountain of Broken Electrical Appliances

By J. M. Smith President, National Radio Institute



**And I mean profits for you — no matter who you are, where you live, or what you are doing now. Do you realize that there are over 400 million electrical appliances in the homes of America today? So it's no wonder that men who know how to service them properly are making \$3 to \$5 an hour — in spare time or full time! I'd like to send you a Free Book telling how you can quickly and easily get into this profitable field.**

**T**HE COMING OF THE AUTO created a multi-million dollar service industry, the auto repair business. Now the same thing is happening in the electrical appliance field. But with this important difference: anybody with a few simple tools can get started in appliance repair work. No big investment or expensive equipment is needed.

The appliance repair business is booming — because the sale of appliances is booming. One thing naturally follows the other. In addition to the 400,000,000 appliances *already* sold, this year alone will see sales of 76 million *new* appliances. For example, 4,750,000 new coffee makers, almost 2,000,000 new room air conditioners, 1,425,000 new clothes dryers. A nice steady income awaits the man who can service appliances like these. And I want to tell you why that man can be *you* — even if you don't know a volt from an ampere now.

#### A Few Examples of What I Mean

Now here's a report from Earl Reid, of Thompson, Ohio: "In one month I took in approximately \$648 of which \$510 was clear. I work only part time." And, to take a big jump out to California, here's one from



J. G. Stinson, of Long Beach: "I have opened up a small repair shop. At present I am operating the shop on a spare time basis — but the way business is growing it will be a very short time before I will devote my full time to it."

Don't worry about how little you may now know about repair work. What John D. Pettis, of Bradley, Illinois wrote to me is this: "I had practically no knowledge of any kind of repair work. Now I am busy almost all my spare time and my day off — and have more and more repair work coming in all along. I have my shop in my basement."

#### We Tell You Everything You Need to Know

If you'd like to get started in this fascinating, profitable, rapidly growing field — let us give you the home training you need. Here's an excellent opportunity to build up "a business of your own" without big investment — open up an appliance repair shop, become independent. Or you may prefer to keep your present job, turn your spare time into extra money.

You can handle this work anywhere — in a corner of your basement or garage, even

on your kitchen table. No technical experience, or higher education is necessary. We'll train you at home, in your spare time, using methods proven successful for over 45 years. We start from scratch — *tell* you in plain English, and *show* you in clear pictures — everything you need to know. And, you will be glad to know, your training will cost you less than 20¢ a day.

#### FREE BOOK and Sample Lesson

I think that our 24-page Free Book will open your eyes to a whole world of new opportunities and how you can "cash in" on America's "Electrical Appliance Boom."

I'll also send you a Free Sample Lesson. It shows how simple and clearly illustrated our instruction is — how it can quickly prepare you for a profitable future in this big field. Just mail coupon, letter, or postcard to me: Mr. J. M. Smith, President, National Radio Institute, Dept. AA2, Washington 16, D.C. (No obligation, of course — and no salesman will call on you.)

#### EARN WHILE YOU LEARN with this APPLIANCE TESTER

— Yours at No Extra Charge



Your NRI Course comes *complete* with all the parts to assemble a sturdy, portable Appliance Tester that helps you earn while you learn. Easy-to-follow manual tells how to assemble and use the Tester *right away*. Locate faulty cords, short circuits, poor connections, etc. in a jiffy; find defects in house wiring, measure electricity used by appliances; many other uses.

With this Tester you save time and make money by doing jobs quicker, making sure appliances operate correctly after repairs.

#### MAIL THIS FOR FREE BOOK and SAMPLE LESSON

Mr. J. M. Smith, President  
NATIONAL RADIO INSTITUTE  
Dept. AA2, Washington 16, D.C.

Tell me how I can "cash in" on the "Electrical Appliance Boom." Send me your illustrated FREE BOOK that outlines the whole NRI Course, tells what opportunities are open to me, answers my questions, describes success of other students, and much more. Also send me the FREE SAMPLE LESSON so I can see how clear and easy your instructions are. I am particularly interested in:

- Spare Time Earnings  Business of My Own  Better Job

I understand there is no obligation on my part; and no salesman will call on me.

Name.....

Address.....

City..... Zone... State.....

Accredited Member National Home Study Council

# ENGINEERING



Heald's Micro-wave and Radar Laboratory Equipment.

**AMERICAN INDUSTRY NEEDS TRAINED ENGINEERS NOW**

**BACHELOR OF SCIENCE DEGREE, 30 MONTHS**

**SAVE 2 YEARS' TIME**

**B.S. Degree Courses:**

- Electronic Engineering
- Mechanical Engineering
- Electrical Engineering
- Civil Engineering
- Architecture

**Diploma Courses:**

- Radio-Television Plus Color TECHNICIAN
- Architectural Drafting
- Electronic Technician
- Mechanical Drafting
- Structural Drafting

**APPROVED FOR VETERANS**

Send for **FREE** Information

**ENROLL NOW FOR NEW TERM**

**HEALD Engineering College**

Van Ness at Post, Dept. PM San Francisco, California

NAME \_\_\_\_\_  
 STREET \_\_\_\_\_  
 CITY \_\_\_\_\_ STATE \_\_\_\_\_

Take Correspondence Courses For a Better Education

## Transistor Pocket Radio Transmitter

Broadcast to Any Radio ★ Secret Wireless Microphone Walkie Talkie ★ 1000 Uses ★ Fun & Entertainment

Broadcast to home, car or portable radios. Useful companion to pocket transistor sets. Use as wireless intercom, field phone, talk from car to car. With one or more radios serves as Public Address System, Electronic Nurse, etc. Practice speech, dramatics, "phony" broadcasts, joke & ghost effects, etc. Fun at parties, celebrations, etc.

**New Electronic Marvel \$9.95**

Carry in shirt pocket. Size of cigaret package. Only 3 1/2 x 2 1/2 x 1". Easily concealed. Compact size & 400-hour battery life made possible by transistor circuit. Crystal microphone. Transmits on regular radio band, adjustable tuning either with regular station or between stations. Certified to meet FCC requirements. No license needed. Ready to operate. Standard 9 v. battery. Guaranteed. (Battery 79c). Complete, except battery. **\$9.95**

Postpaid Only. **JOHNSON SMITH COMPANY, Dept. 120, Detroit 7, Michigan**

## GOVT SURPLUS ELECTRIC GENERATOR

Cost U.S. Gov't \$20.00! While They Last \$3.95—Brand New! Generates Up To 100 Volts. Use to generate electricity, to ring bells, light up lights, as a medical battery, deliver terrific electric shock as joke, many electrical experiments, classroom uses, etc. Hand crank or gear wheel drive. Made by leading electrical companies. Powerful alnico magnets (alone worth more than total cost). **\$3.95** Ready for use. Postpaid. **\$3.95**

**Underwater Electronic Detector**

Gov't Surplus. Cost \$200.00; Special \$7.95. Brand new. Use as detector or use parts for other devices such as mike, pick-up, etc. Wt. 30 lbs. F.O.B. Detroit. **\$7.95**

Only **JOHNSON SMITH COMPANY, Dept. 120, Detroit 7, Michigan**

## Catalog of 2900 Novelties 10c

New Send 10c for amazing catalog of novelties, live animals, scientific supplies, hobbies, funmakers, planes & boats, looms, magic tricks, joke articles, unusual seeds, gadgets, timers, cameras, optical goods, projectors, movies, lucky jewelry, religious novelties, disguises, musical instruments, stamps, coins, puzzles, fortune tellers, radios, auto & bike accessories, telescopes, magnifiers, compasses, banks, smokers' gadgets, artists' supplies, printing sets, engines, motors, shockers, knives, billfolds, guns, rifles, sports, books, games, plants etc. Send 10c. **JOHNSON SMITH COMPANY, Dept. 120, Detroit 7, Michigan**

**10-in. Balanced Throwing Knife** **99c**

Hunt small game. Target work, regular use. Double-edged penetrating point. Hard hitting. Balanced for easy accurate throwing. Cutlery steel. Only 99c (Sheath 50c. Knife Throwing Book 15c). **JOHNSON SMITH Co., Dept. 120, Detroit 7, Mich.**

## Would YOU Like to Make \$1 000 A MONTH?



That's What Stanley Hyman Made Selling PRESTO

**Amazing Midget Fire Extinguisher**

Sensational! Presto does job of bulky extinguishers costing 4 times as much. Ends fires fast as 2 seconds: fits palm of hand. Never corrodes: guaranteed 20 years! Sells for only \$4.95. Show it to owners of homes, cars, boats, farms, etc., and to stores for re-sale—make good income. Write for FREE Sales Kit.



Stanley Hyman

**MERLITE INDUSTRIES, Presto Div.**  
 114 East 32nd St. • Dept. P-15N • New York 16, N.Y.  
 In Canada: Mopa Co., Ltd., 371 Dowd St., Montreal 1, P. Q.



**AN EXCLUSIVE BOOKLET** direct from the files of an internationally known Private Investigator. Reveals Who. Why. When. Where and HOW to become a Private Detective! Send Your Name, Address and \$2.98 for Postpaid copy today! Or we will rush copy C.O.D. plus mailing costs!

**"THE PRIVATE EYE"**

Dept. PMD-1, P. O. Box 98, Oklahoma City, Oklahoma



## MASONS!

Send today for **free** catalog of Masonic & Eastern Star books and rituals

**EZRA A. COOK PUBLICATIONS, INC.**  
 P. O. Box 796 Dept. A-1 Chicago 90, Ill.

**DO IT YOURSELF BUT DO IT BETTER WITH THE RIGHT MATERIALS!**

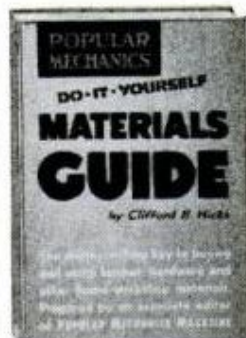

## You Need This

How to select and how to use—Lumber, millwork, plywood and hardboard—Exterior wall and roof materials—Hardwood floors and floor coverings—Wall and ceiling materials—Doors, windows, screens and weather stripping—Glass, the material of tomorrow—Plumbing pipes and fittings—Electrical equipment—Nails, screws, bolts, etc.—Hinges, locks and other hardware—Paints and miscellaneous products. **192 Fact filled pages. 667 how-to-do-it pictures**

**Popular Mechanics Press, Dept. 858, 200 E. Ontario St., Chicago 11**

Get **Popular Mechanics DO-IT-YOURSELF**

## Materials Guide

The Key to Buying and Using Lumber, Hardware and Other Home Workshop Materials

The right lumber. The right grade. The right fastenings, nails, screws, glue and other hardware. These are all just as important as the right design and the right kind of workmanship. It's true, whether you're fixing up the house, making a fine piece of furniture or knocking out a time-killing gadget. Get **Popular Mechanics Materials Guide**. Fills a long-felt need of home owners and home workshop fans. Has how-to-do-it information too. Send only \$2.95 for postpaid delivery. Money back if you want it in 5 days.



# Don't wish you were a **WATCH REPAIRMAN...**

## **Be one NOW!**

Opportunities for full or part time earnings are the best in years

*Make rapid progress the Sweazey Way*



## **CHICAGO SCHOOL OF WATCHMAKING** *will train you at home in your spare time*

Get set now for lifetime security or a business of your own. Have a second trade for emergencies or after retirement. Watch repairing is light, clean, fascinating. It frees you from the dull drudgery of tiresome or back breaking work. It offers excellent opportunities now for full or part time earnings.

### **Complete professional instruction for only \$5 a month**

No need to leave home or job. Learn in spare time. Chicago School of Watchmaking's exclusive Sweazey System shows you step by step how to repair all types of Swiss and American watches. It's practical, shop method training. You work with watches from your very first lesson. You need no previous experience. Age is no barrier. Diploma awarded. Send today for free sample lesson and complete information. No obligation, of course. No salesman will call.

**CSW has been training men and women for this trade since 1908**

Why not be one of our successful graduates? Learn how Chicago School's streamlined home training can speed your success.

**MAIL COUPON TODAY!**

### **SPECIAL TOOLS PROVIDED**



This set of tools is offered in your course at no extra tuition cost. They enable you to start repairing right away.

## **FREE SAMPLE LESSON**

### **CHICAGO SCHOOL OF WATCHMAKING**

2330 N. Milwaukee Avenue, Dept. 112, Chicago 47, Illinois

Please rush **FREE SAMPLE LESSON** and full information to tell me how I can learn watch repairing at home.

NAME \_\_\_\_\_ AGE \_\_\_\_\_

Address \_\_\_\_\_

City \_\_\_\_\_ Zone \_\_\_\_\_ State \_\_\_\_\_

**CHICAGO SCHOOL OF WATCHMAKING**

Founded 1908

2330 MILWAUKEE AVE., CHICAGO 47, ILL.

JANUARY 1962

31

# AMAZING SCIENCE BUYS

OVER 1000 ITEMS

## WAR SURPLUS AMERICAN-MADE 7x50 BINOCULARS

Big savings! Brand new! Crystal clear viewing—7 power. Every optical element is coated. An excellent night glass—the size recommended for satellite viewing. Individual eye focus. Exit pupil 7mm. Approx. field at 1,000 yds. is 376 ft. Carrying case included. American 7 x 50's normally cost \$274.50. Our war surplus price saves you real money.



Stock No. 1544-H only \$74.80 postpd. (Tax included)  
6 x 30 Binoculars—similar to above and a terrific bargain.  
Stock No. 963-H . . . . . \$33.00 postpd. (Tax included)

## CIRCULAR DIFFRACTION GRATING JEWELRY

### A DAZZLING RAINBOW OF COLOR

Shimmering rainbows of gem-like color in jewelry of exquisite beauty—made with CIRCULAR DIFFRACTION GRATING REPLICAS. Just as a prism breaks up light into its full range of individual colors, so does the Diffraction Grating. Stock #30,349-H Earrings . . . . . \$2.20 Ppd.  
Stock #30,350-H Cuff Links . . . . . \$2.20 Ppd.  
Stock #30,372-H Pendant . . . . . \$2.20 Ppd.  
Stock #30,390-H Tie-Clasp . . . . . \$1.65 Ppd.  
Stock #40,519-H Bracelet (6" 1" Gratings) . . . . . \$7.70 Ppd.



## OPAQUE PROJECTOR



Projects illustrations up to 3" by 3 1/2" and enlarges them to 35" x 30" if screen is 6 1/2 ft. from projector; larger pictures if screen is further away. No film or negatives needed. Projects charts, diagrams, pictures, photos, lettering in full color or black-and-white. Operates on 115 volt, A.C. current. 6-ft. extension cord and plug included. Operates on 60 watt bulb, not included. Size 12" x 8" x 4 1/2" wide. Weight 1 lb., 2 oz. Plastic case with built-in handle.

Stock No. 70,199-H . . . . . \$7.95 Postpaid

## Remove Your Retaining Rings— Disassemble Lenses, Cameras, etc.



### ADJUSTABLE SPANNER WRENCH

Made for U.S. Air Force—available at a fraction of Government cost. A top grade, versatile tool that every instrument and camera repair man or just plain tinkerer should own. Adjustable for 1/2" to 12" diameter retaining rings. Complete with six different pairs of points to fit all types of slots and holes. 3", 6", and 12" main bars. All steel and nicely plated. The finest tool we have ever come across for this type of retaining ring work AND a real bargain at our low price. Stock No. 70,355-H . . . . . \$12.50 Postpaid

## NEW PORTABLE ELECTRONIC SPEAKER PROVIDES "VOICE POWER" FOR INSTITUTIONAL AND HOME USE



First low-priced power speaker to do a real job. Carries your voice 500 feet or more—loud and clear. Can be modulated for shorter distances. The "greatest" for speech making—indoors and out—for use in and around schools (especially cheer leaders and athletic directors), hospitals, churches, other institutions, in the home. Wonderful plaything for youngsters. Case—impact-resistant plastic. Power—4 D cell flashlight batteries (not included). Size 8 1/2" x 5 1/2" x 2 3/4". Weight—2 1/2 lbs. Carrying strap. Up to 50 ft. extension cord may be added to make.

Stock No. 70,502-H . . . . . \$12.95 Postpaid.

## NEW! CIRCULAR SLIDE RULE!

### Pocket Size—Fast—Easy to Use!



Multiplies, divides, figures fractions, percentages, squares, cubes, roots, proportions, circumferences, areas, prices, fuel consumption. Faster, easier to learn and use. Directions included.

Stock No. 30,336-H . . . . . \$4.95 Postpaid

Order by Stock No.—Send Check or M.O.—Money-Back Guarantee  
**EDMUND SCIENTIFIC CO., Barrington, New Jersey**

Clip and Hand to a Friend . . . or Leave  
for the Next Reader of this Issue!

## MAIL COUPON For FREE CATALOG "H-1"

160 Pages! Over 1000 Bargains!

EDMUND SCIENTIFIC CO., Barrington, N. J.

Please rush Free Giant Catalog—"H-1"

Name . . . . .

Address . . . . .

City . . . . . Zone . . . . . State . . . . .



# Science Overseas

By William Kreh

**Hunger causes traffic accidents.** British scientists who investigated habits of long-distance truck drivers found that speed of reaction and ability to concentrate are drastically affected by a craving for food.

Their advice to drivers: Don't eat a heavy meal before starting a trip, since this induces drowsiness, but do stop for short light snacks and take vitamin A and C tablets for between-snack support.



**Glaciers are grown** in northern Pakistan. The technique, used successfully in the past, is being employed by the villagers of Bunji to solve a water shortage.

They dig a deep pit on a nearby mountain, then relay teams carry cubes of ice from a nearby glacier and bury them, along with special chemicals and herbs, in the pit. The method of preparation, which deters melting, is a secret tradition.

If the glacier takes root, under care of the icy-thumbed villagers, it will provide them with an ever-increasing supply of water for their crops.



**Glue, not sutures,** is being used to close wounds on some hospital patients in Tokyo. A group of 11 surgeons, directed by Dr. Seiji Kimoto, tested the glue—a synthetic resin adhesive normally used in electrical work—on dogs and rabbits; they then used it to close cuts on the skin, veins, windpipes and intestines of human beings. It sets in minutes.

The glue can be applied on wet surfaces, is harmless to human organs, is easy to sterilize and will not deteriorate at normal body temperatures. It is absorbed into the body safely within a few weeks.



**A shoelace is saving water** in Southern Rhodesia. It's part of a device which limits evaporation from reservoirs and lakes. A gallon cannister, mounted in a floating drum, is filled with a mixture of alcohol and paraffin. Dripped slowly on the surface of the lake, this mixture forms a skin that cuts evaporation.

The valve originally used to release the mixture kept getting clogged. The shoelace, acting as a wick, now spreads the skin smoothly.



An abandoned communications cable running between Hawaii and mainland U.S. will help warn Islanders that a tsunami wave (the type of wave that killed some 90 people on Hilo two years ago) is on its way.

The 4000-mile-long cable will be hoisted and pressure gauges added. Then it will be lowered in several hundred feet of water. The gauges will measure height of the waves by deep-sea changes in pressure. The information will be sent back to the Islands over the cable.



A gas-finding dog has come to the aid of New Zealand technologists who, after using all the modern equipment they could lay their hands on, could not locate leaks in the gas pipelines. This is a big problem, for 20 percent of gas fails to reach consumers.

The dog and its handler (who gets paid \$4 an hour) patrol the pipelines from 2 to 6 a.m. The dog sniffs along at about five-eighths of a mile an hour.



Two Americans, Sam Collins and Emerson Kailey, have a concession to churn the sea bottom along the Southwest African coast for diamonds.

They will search the sea bed at depths up to 100 feet from the low-water mark. They hope to raise diamonds, using this technique:

Two rubber hose-pipes will be lowered to the sea bed from a tug and barge. When pipes fill with water, air jets at the bottom of each will start pumping air into the topsoil. As the soil is disturbed it will whirl about and move up the pipe.

The mixture of air and soil inside the pipe will greatly reduce internal pressure with the result that the outside pressure of the ocean will force the soil (and maybe diamonds) to the top where sorting will take place on deck.

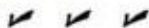

An eight-mile hole is scheduled to be bored into the earth by Soviet scientists, using a new kind of diamond drill. The hole is calculated to penetrate temperatures of about 350 degrees F. The Russians don't expect to find intact oil at such depths, but deposits may be tapped on the way down.



**Weather story.** The U.S. Weather Bureau sent a radio transmitter up in a balloon that was supposed to burst 16 miles high and parachute its instruments back to Earth.

The transmitter landed recently on the roof of a postal worker's home in Karachi, Pakistan—two years later, and a hemisphere away. ★ ★ ★

## AMAZING SCIENCE BUYS

See the Stars, Moon, Planets Close Up!  
**3" ASTRONOMICAL REFLECTING TELESCOPE**

**60 TO 180 POWER**  
Famous Mt. Palomar Type!  
An Unusual Buy!



See the Rings of Saturn, the fascinating planet Mars, huge craters on the Moon. Equatorial Mount with lock on both axes. Aluminized and overcoated 3" diameter high-speed f/10 mirror. Telescope comes equipped with a 60X eyepiece and a mounted Barlow Lens. Optical Finder Telescope included. Hardwood portable tripod. FREE with Scope: Valuable STAR CHART TO USE "OUR TELESCOPE" BOOK.

Stock No. 85.050-H ..... \$29.95 Postpaid

OVER 1000 ITEMS

### NEW! SCIENCE FAIR PROJECT KITS

Edmund Kits are carefully planned to give any boy or girl the fun and excitement of discovering science facts. Such carefully planned projects can lead the student to awards or scholarships. Adults too will find them an excellent introduction to the various fields of science.

**Write for Free Bulletin 47-H**  
"Your Science Project" covering all phases of Science Fair projects

**MOLECULE AND CRYSTAL MODELS KIT**—Rods and balls to make atomic models, plus directions.  
Stock No. 30.413-H ..... \$2.50 Postpaid

**SOIL TESTING KIT**—Basis for many fascinating experiments regarding growth of plants, etc.  
Stock No. 60.118-H ..... \$2.00 Postpaid

**CRYSTAL GROWING KIT**—Grow breathtaking display of large crystals with this set.  
Stock No. 70.336-H ..... \$9.50 Postpaid

**MAGNETISM KIT**—Based on magnetism demonstrations developed by UNESCO.  
Stock No. 70.325-H ..... \$3.75 Postpaid



### SCIENCE TREASURE CHESTS

Extra-powerful magnets, polarizing filters, compass, one-way-mirror film, prism, diffraction grating, and lots of other items for hundreds of thrilling experiments, plus a Ten-Lens Kit for making telescopes, microscopes, etc. Full instructions included.

Stock No. 70.342-H ..... \$5.00 Postpaid

**Science Treasure Chest DeLuxe**—Everything in Chest above plus exciting additional items for more advanced experiments including crystal-growing kit, electric motor, molecular models set, first-surface mirrors, and lots more.  
Stock No. 70.343-H ..... \$10.00 Postpaid

### MINIATURE WATER PUMP



Wonderful for experiments, miniature waterfalls, fountains, Christmas gardens, HO gage railroad backdrops, etc. Tiny (2 3/4" x 1 3/4") electric motor and pump ideal for hobbyists, labs, schools. Pumps continuous flow of water at rate of one pint per minute at a 12" head. With 2 D Batteries in series will pump to 24" high. Works in either direction. Stock No. 50.345-H ..... \$2.25 Postpaid

### BUILD A SOLAR ENERGY FURNACE

A fascinating new field. Build your own Solar Furnace for experimentation—many practical uses. Easy! Inexpensive! Use scrapwood! We furnish instructions. This sun powered furnace will generate terrific heat—2000° to 3000°. Fuses enamel to metal. Sets paper aflame in seconds. Use our Fresnel Lens—14" diameter . . . f.1. 14".  
Stock No. 70.130-H . . . Fresnel Lens . . . \$6.00 Postpaid.

Order by Stock No.—Send Check or M.O.—Money-Back Guarantee  
**EDMUND SCIENTIFIC CO., Barrington, New Jersey**

## MAIL COUPON for FREE CATALOG "H"

160 Pages! Over 1000 Bargains!

EDMUND SCIENTIFIC CO., Barrington, N. J.  
Please rush Free Giant Catalog-H.

Name.....  
Address.....  
City..... Zone..... State.....



Sworn statement from CHAS. LEMMING reads:

**"After starting my own business"**



**I've averaged \$100 A DAY —most of it clear profit!"**

• If you want to be independent—free from layoffs, bosses—start profitable, year 'round business of your own. Ours is **NOT** a lease proposition. You own the machine, you work when and where you please, and all the money you take in is your own. **FREE** book tells you how.

**MAIL COUPON TODAY FOR FREE BOOK**

**VON SCHRADER MFG. CO.**  
110 "D" Pl., Racine, Wisconsin

Without obligation rush your **FREE** booklet about how I can start my own permanent, profitable electric Upholstery Cleaning business.

Name \_\_\_\_\_

Address \_\_\_\_\_

City \_\_\_\_\_ Zone \_\_\_\_\_ State \_\_\_\_\_

Not everyone does as well...

**Mr. Lemming owns two machines**

In city of less than 50,000, Mr. Lemming started his own business after filling in coupon like one below. He averaged \$100 a day during first year, some days \$200. F. E. Doran grossed \$1050 in single month. Geo. Held grossed \$300 in one week.

How much you earn depends largely on you. No special skill, no large investment required for our electric upholstery cleaning machine. Start spare time until full time justified. Hire helpers as needed.

**NO SHOP NECESSARY** • You clean upholstered furniture on customers' premises—homes, hotels, motels, etc. Auto upholstering, too. No hauling; operate from your home. Watch business grow as satisfied customers tell friends. Supplies cost little, profits high.

**BIG HOME PROFITS IN Velvetizing**

Gives any surface a petal-soft finish—Yet tough and durable

JOIN THESE MEN MAKING BIG MONEY "I earned \$10,000 a year from spare-time start"; "Made \$52.50 in 4 hours doing auto trunks"; "Got quick \$140 order from store and lined up 3 others in half a day"

**UP TO \$500 PROFIT FROM \$20 WORTH OF MATERIALS**

Miraculous but simple process, discovered by Swiss scientist, grinds cloth fibers into microscopic stuff. Sprayed on any surface, it creates look and feel of \$10 a yard velvet! Makes old things look new, permits complete redecorating of lamps, pottery, radio and TV sets, even wall paper. We supply hundreds of Velvetizing ideas to bring orders by the bucket-full!

**MAKE YOUR OWN PRODUCTS FOR STORES**  
Velvetized products sell like hot cakes in stores. Toys, ash trays, sport-wear belts, lamp shades, greeting cards, watch bands, card tables with non-slip tops, hundreds more. Get orders by mail. We show how and help you.

**FANTASTIC NEW HOME BUSINESS FOR BIG CITY, SMALL TOWN, FARM**  
End your money troubles forever. Spare-time Velvetizing profits to give you 2 incomes at once. Expand to full-time business as orders increase. Start now. Bench space in garage, basement, or anywhere is room enough. Orders come from homes, stores, factories. Whole family can help, to multiply the profits!

**HUGE DEMAND, AUTO DEALERS**  
Velvetizing auto trunks protects luggage from "scratchy" metal. Auto dealers pay \$7.50 each, takes you 20 to 30 minutes. Also renew soiled, torn door fabrics, decorate dashes. Growing demand.

**WE FURNISH EVERYTHING**  
No expensive equipment needed. We supply materials to Velvetize anything—paper, cloth, glass, plastic, wood, metal, rubber, or you name it! Every rainbow color, including fluorescents. **FREE**, full details. Write today.

Write: **COAST INDUSTRIES, Dept. B-1**  
15133 S. Broadway, Los Angeles 61, California

**FREE! SAMPLES PLANS DETAILS**

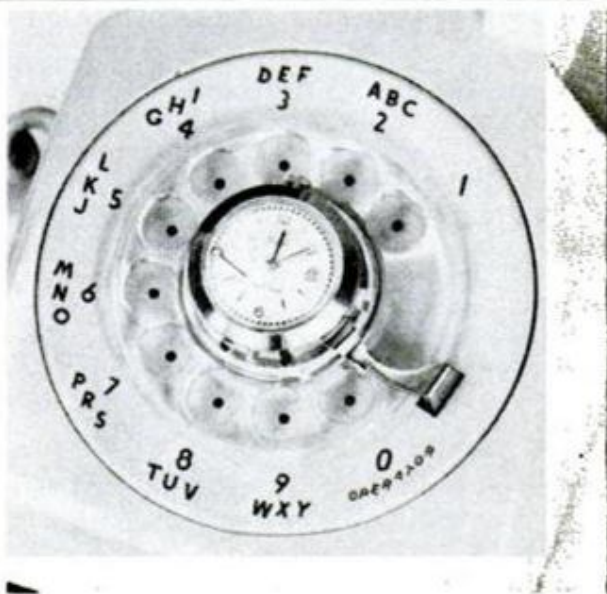

**Timer for Tireless Talkers**

Automatically wound each time the telephone is dialed, a timer that clips to the dial of a telephone records the length of conversations. The timer is started by pushing a small button.

The watch also tells the time of day and the day of the month.

Price is \$19.95 from Branvold Export-Import, 5718 Troost Ave., N. Hollywood, Calif.

POPULAR MECHANICS

# NOW! EARN MONEY IN TV SERVICING WITHIN ONE SHORT WEEK

## Make \$5 to \$10 Per Call IMMEDIATELY

Here is the announcement our Engineering Staff has waited 5 years to make! Here is the final "break-through" in the television industry's giant efforts to perfect a simplified TV servicing system that eliminates the need for expensive training and long study! If you've thought about learning TV Service and Repair . . . if you've awaited any opportunity to have a prosperous, secure business of your own, then this is possibly the most important bulletin you'll ever read!

### WHAT IS THE AMAZING NEW SYMTRONIC TRAINING METHOD?

Symtronic is a dynamic new concept based on the known fact that only a certain number of things can go wrong with any given set. For the first time these troubles, and their causes, have been isolated into three main groups. Through a comprehensive, but easily understood cross-indexing system it's now possible to pinpoint the trouble in one of the 3 groups in a matter of seconds! What previously required long schooling is now available to you immediately through the amazing Symtronic System. Our Free Sample Lesson shows how the Symtronic Method will work on your own set, or a friend's. Write for it today!

### CUTS STUDY TIME EXPENSE

You want to get started servicing TV sets, not building them! So why spend long months studying under old fashioned, outdated methods . . . learning things you'll never use? Why buy lots of equipment to practice with when you don't need it? With the Symtronic System the COMPLICATED TECHNICAL THEORY IS ALREADY TAKEN CARE OF BY OUR OWN SCIENTISTS! There is nothing more you need in this line. What we give you is practical, down-to-earth know-how based on our many years of solid, scientific experience! Our revolutionary Symtronic methods let you compete immediately with servicemen who have had years of experience!

### COMPLETE SYMTRONIC BUSINESS PLAN PROVIDES "BLUEPRINT TO SUCCESS"

To make our training program the most practical available, we also offer a complete Business Plan developed by leading advertising and business consultants. Step-by-step, you learn how to get business, how to operate from your home, how to charge, how to keep records, etc. — a complete "Blueprint to Success" that explains fully how to start, conduct, and ex-

### CASH IN ON THIS BIG PROFIT BIG FUTURE INDUSTRY!

TV servicing is a multi-million dollar industry and it's growing like wildfire! To keep pace, thousands of qualified Servicemen are urgently needed each year. The pay is big and there's no limit to your future success. Television is here to stay! In this field, too, you get paid for what you accomplish, not how long you work. \$5 to \$10 per call is the usual service charge . . . even though the job may take only a few minutes! Add to this the almost 100% profit on tubes and parts and you can easily see how Symtronic can put you into the big money practically overnight!

### SYMTRONIC PUTS YOU IN YOUR OWN BUSINESS NOW!

Imagine — with our amazing training method you know everything needed to handle any make of TV set, within one short week! And without buying any expensive tools or equipment. You learn at home — spare time. A few evenings of fascinating reading is all it takes. This is fact . . . not fiction. In just 7 days or less you will have sufficient knowledge and ability, and confidence in yourself, to make from \$5 to \$10 per service call — earn \$150 a week, working out of your home! Here, unquestionably, is your chance of a lifetime to get into the booming TV business . . . to enjoy the freedom and security that comes with a successful business of your own!

pand your own TV Service Business. In short, we not only offer the most streamlined, effective TV training available but a tested and proved Business Plan that eliminates all guesswork. Here, surely, is a "Business Package" that may easily bring you all the good things you desire . . . a practical education with a lifetime of value!



Get these 3 valuable pieces

**ABSOLUTELY FREE!!!**

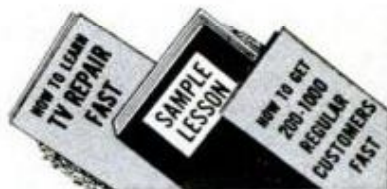

1. "HOW TO LEARN TV REPAIR FAST (overnight)". A real eye-opener that reveals how the amazing Symtronic method puts you in this big-pay field right now!

2. AMAZING SAMPLE LESSON proves how the Symtronic method really works. Convinces yourself by repairing your set — or a friend's — the very first day!

3. "HOW TO GET 200-1000 REGULAR CUSTOMERS FAST (less than 1 week)". See the secret workings of the "Business-in-a-Package" mail plan that does all your selling for you!

These three big gifts can be worth hundreds of times the tiny 4¢ stamp it takes you to get them. Yet they are yours to keep forever — with no obligation.

**ALL FREE — AIRMAIL COUPON TODAY**

100's of customers at 4c each!



### THIS COMPLETE MAIL-ORDER PROMOTION KIT PUTS YOU IN A PROFITABLE TV REPAIR BUSINESS THE VERY FIRST WEEK!

No soliciting. No personal selling. No overhead. This amazing "business-in-a-package" Kit puts you in direct contact with every TV set owner in your area! May bring cash orders immediately, builds a fast-growing list of steady customers to make you independent!

No extra cost. Complete Kit included with Course. Contains everything you need to put Plan into operation, the same day you get it. No advertising expense except stamps.

Most successful business-builder in TV history. Gives prospects an irresistible reason for calling YOU when they need help — makes it impossible to forget you. Nothing like it on the market.

Entire promotion carried on by mail so you can control the flow of business to meet your personal needs. Use small mailing for part-time business without quitting your present job. Larger mailing brings more customers for full-time business. No personal selling. Spend all your time making money!

TV Repair Systems, Dept. H-171, 1038 S. La Brea Ave. — Los Angeles 19, Calif.

TV Servicing Systems, Dept. H-171  
1038 S. La Brea Avenue  
Los Angeles 19, California

Please rush proof that your Symtronic Method is all you claim, and information on how I can have my own TV Repair business with customers calling me within a week. Be sure to include all 3 FREE items mentioned.

Name \_\_\_\_\_  
Street \_\_\_\_\_  
City \_\_\_\_\_  
Zone \_\_\_\_\_ State \_\_\_\_\_

Here's the **EASY, Step-by-Step** Way to

# FIX ANY PART OF

Over 1100 Pages  
Packed With Practical  
"How-to" Help  
Like This:

**Engines, Brakes, Ignitions, Transmissions, Rear Ends**

**NOW**—Whether You're a Beginner or an Expert Mechanic  
—You Can "Breeze Through" ANY AUTO REPAIR JOB!  
MOTOR'S BIG BRAND-NEW AUTO REPAIR MANUAL Shows  
You **HOW**—With 2850 PICTURES AND SIMPLE  
**STEP-BY-STEP INSTRUCTIONS.**

ALL AUTOMATIC  
TRANSMISSIONS COVERED  
IN WORDS AND PICTURES

SPECIAL SECTION  
ON NEW  
POWER STEERING

HERE IS CHEVROLET  
TUNE-UP CHART

## Read These Letters from Satisfied Users



Licks Job in 30 Minutes Another Mechanic Couldn't Handle. "Not long ago, I fixed motor another mechanic had worked on half a day. With your Manual I did it in 30 minutes.—C. AUBERRY, Tenn.

Paid For Itself On First 2 Jobs. "MOTOR'S Manual paid for itself on the first 2 jobs, and saved me valuable time by eliminating guesswork. Now tune up and repair cars on which I've had no previous experience."—W. SCHROP, Ohio



Amazed Self and Friends. "I amazed myself and my friends, too. Now do jobs that stumped me before. Motor's Auto Repair Manual is a great buy.—MICHAEL BALICZKY, Newark, N. J.

## Covers Every Part of Every Car

YES, now it's easy as A-B-C to FIND and FIX any car trouble—from faulty carburetor to breakdown of automatic transmissions.

MOTOR'S NEW AUTO REPAIR MANUAL makes every job a breeze! First, you find what's wrong in a jiffy with amazing new "Trouble-Shooter" section. Then you look up job in quick index. Turn to pages covering job. Follow the clear, illustrated step-by-step instructions. Presto—job is done!

No guesswork: MOTOR'S Manual takes nothing for granted: Tells you where to start. What tools to use. Then it leads you easily and quickly through the entire operation!

Over 2,800 Pictures!  
So Complete, So Simple,  
You CAN'T Go Wrong!

BRAND-NEW REVISED Edition covers everything you need

to know to repair all models of 33 different makes—1953 thru 1961. Over ELEVEN HUNDRED giant pages. 2,850 "This-is-How" pictures. Over 195 "Quick-Check" charts—more than 30,000 essential repair specifications. Over 225,000 service and repair facts. Instructions and pictures are so clear you can't go wrong!

Even a green beginner mechanic can do a good job with this giant manual before him. And if you're a top-notch mechanic, you'll find short-cuts that will amaze you. No wonder this guide is used by the U.S. Army and Navy! No wonder hundreds of thousands of men call it the "Auto Repair Man's Bible"!

### Meat of 176 Official Shop Manuals

Engineers from every automobile plant in America worked out these time-saving procedures for their own motor car



### Covers All Models Of All These Makes Built Since 1953

- |             |             |
|-------------|-------------|
| Buick       | Jeep        |
| Buick       | Lancer      |
| Special     | Lark        |
| Cadillac    | Lincoln     |
| Chevrolet   | Mercury     |
| Chrysler    | Nash        |
| Comet       | Oldsmobile  |
| Continental | Olds F-85   |
| Corvair     | Plymouth    |
| Corvette    | Pontiac     |
| Dart        | Pontiac     |
| De Soto     | Tempest     |
| Dodge       | Rambler     |
| Edsel       | Rambler     |
| Falcon      | American    |
| Ford        | Studebaker  |
| Hudson      | Thunderbird |
| Imperial    | Valiant     |
- COVERS ALL 1961 MODELS**



## Same FREE 7-Day Trial Offer Applies on MOTOR'S New Truck Repair Manual

Covers EVERY repair job on EVERY popular make of gasoline and Diesel truck made since 1953. Over 2000 illustrations; 300,000 facts. Over 800 big pages. A "must" for truck mechanics. For FREE 7-Day Trial, simply check proper box in the coupon at right.

# ANY CAR

QUICKLY...  
EASILY...  
RIGHT!

## Generators—Yes, Any Part

### Now 3 Books in 1

- 1 Completely New "TROUBLE-SHOOTER" SECTION lists over 2,300 car troubles; helps you spot the one you're after in a jiffy!
- 2 How to Service, Repair and Overhaul All Car Parts, Systems and Components—including Generators, Voltage Regulators, ALL Automatic Transmissions, Power Steering and Brakes, etc.
- 3 Step-by-Step Instruction and Pictures for Repairing Parts on Each Specific Make and Model—with all essential specifications and dimensions for 33 different makes.



## Built From 1953 Through 1961

line. Now the editors of MOTOR have gathered together this wealth of "Know-How" from 176 Official Shop Manuals and "boiled it down" into crystal-clear terms in one handy indexed book!

### Everything You Need to Know

This giant manual includes ALL Automatic Transmissions. Covers Power Steering, Power Brakes, latest Carburetors, Engines, Fuel Pumps, Starting Motors, 12-Volt Systems, Generators, Distributors, etc. Plus big new "Trouble-Shooter" section that enables you to spot any one of more than 2,300 specific car troubles in a jiffy!

MOTOR'S brand-new Auto Repair Manual brings you Factory Specifications and Adjustment Tables, Tune-up Charts, Tables of Measurements and Clearances, Overhauling and Replacement Facts—and MUCH MORE.

Used by Armed Forces, hundreds of thousands of auto service men! YOU'LL want to try it, too — on the following GUARANTEE:

### Try Book FREE 7 Days

SEND NO MONEY! Just mail coupon! (Paste to postcard if you prefer.) When postman brings book, pay him nothing. Unless you agree this is the greatest time- and work-saver you've ever seen — return book in 7 days and pay nothing. Mail coupon now to MOTOR Book Dept., Desk 211, 250 West 55th St., N. Y. 19, N. Y.

(Schools bookstores: write for discounts.)

**NEW REVISED! ENLARGED!** Covers all makes and models — including all 1961 cars.

**FREE 7-DAY TRIAL**

Return and Pay Nothing if Not Satisfied



### MAIL COUPON NOW FOR 7-DAY FREE TRIAL (Attach to Postcard if More Convenient)

MOTOR BOOK DEPT. Desk 211, 250 West 55th St., New York 19, N. Y. Rush to me at once (check box opposite book you want):

MOTOR'S NEW AUTO REPAIR MANUAL. If O.K., I will remit \$2 in 7 days, \$2 monthly for 2 months and a final payment of \$2.95 (plus 45c delivery charges and sales tax) one month after that. Otherwise I will return the book postpaid in 7 days.

MOTOR'S NEW TRUCK REPAIR MANUAL. If O.K., I will remit \$3 in 7 days, \$3 a month later, then \$2 monthly for 2 months, plus 45c delivery charges and sales tax with final payment. Otherwise I will return book postpaid in 7 days.

Print Name ..... Age .....

Address .....

City ..... Zone ..... State .....

Check box and save 45c shipping charge by enclosing WITH coupon in envelope entire payment of \$8.95 for Auto Manual (or \$10 for Truck Manual) plus sales tax. Same 7-day return-refund privilege.

3 1/2 MILLION COPIES SOLD

USED BY U.S. ARMED FORCES

# Check the Kind of Body You Want

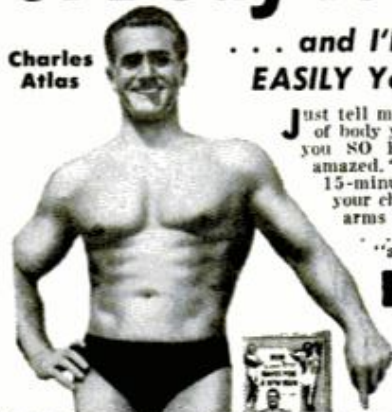

Charles Atlas

... and I'll Show You How EASILY You Can Have It!

Just tell me, in coupon below, the kind of body you want—and I'll give it to you SO FAST your friends will be amazed. "Dynamic Tension," my easy, 15-minute-a-day method, will make your chest and shoulders bulge... arms and legs surge with power... your whole body feel "alive!"

**FREE BOOK** Learn how I became "World's Most Perfectly Developed Man" — Mail coupon! CHARLES ATLAS, Dept. 8N, 115 East 23rd Street, New York City 10, N. Y.

CHARLES ATLAS, Dept. 8N  
115 East 23rd St., New York 10, N. Y.

Dear Charles Atlas: Here's the Kind of Body I want:  
(Check as many as you like)

- |  |  |
|--|--|
| <input type="checkbox"/> More weight—Solid—<br>in the Right Places | <input type="checkbox"/> Powerful Arms, Legs, Grip |
| <input type="checkbox"/> Broader Chest, Shoulders                  | <input type="checkbox"/> Slimmer Waist, Hips       |
|  | <input type="checkbox"/> Better Sleep, More Energy |

Send me absolutely FREE a copy of your famous book showing how "Dynamic Tension" can make me a new man—32 pages, crammed with photographs, answers to vital questions, and valuable advice. No obligation.

NAME..... AGE.....  
(Please print or write plainly)

ADDRESS.....

CITY..... ZONE..... STATE.....  
In England send to: Charles Atlas, Chitty St., London, W. 1

**DRAINS** cellars, cisterns, wash tubs; **\$7.95**  
**IRRIGATES - CIRCULATES - SPRAYS**

1,001 uses. Stainless shaft. Won't rust or clog! Use 1/2 HP motor or larger - 3/4 HP for up to 2,400 GPH; 450 GPH 80' high; or 1800 GPH from 25' well. 1" inlet; 3/4" outlet. Coupling included free. \$7.95. **HEAVY DUTY BALL-BEARING PUMP.** Up to 5,200 GPH; or 3,000 GPH from 25' well. 1 1/2" inlet; 1" outlet. \$12.95. Postpaid if cash with order. **MONEY BACK GUARANTEE**  
Centrifugal and Gear Pumps in All Sizes  
LABAWCO PUMPS, Belle Mead 7-P-XB, New Jersey

**"\$7,108<sup>50</sup> FIRST YEAR  
CLEANING - REPAIRING  
RADIATORS!"**

-Hank Konter, Newcastle, Wyo.



Make \$6,000-\$9,000 a year servicing auto-truck-tractor radiators with Inland's new 1-Piece Radiator Shop. Does entire job—TESTS, CLEANS, REPAIRS. Only 11 7/8" long. Inland, world's largest radiator equipment manufacturer, trains you free. Small down payment starts you. Easy-pay plan lets you pay from profits. Proved merchandising assures volume. Profitable dept. for garage or service station. Many set up Radiator Shop in garage at home, make good money working evenings. **WRITE for 32-page Free Book.**  
**INLAND MFG. CO., Dept. PM-1 1108 Jackson St., Omaha 2, Nebr.**

## Science bulletins

The octopus does not crush open a few shelled mollusks, such as abalone, when he wants to dine; he bores into their shells with radula inside the suction cups of his tentacles. Researchers at Scripps Institution of Oceanography have found he then injects a venom that causes victims to relax muscles keeping shells closed.

Something in your eye? No wonder. National Aeronautics and Space Administration scientists say 10,000 tons of dust rain down on Earth every day.

They base this figure on measurements of interplanetary dust particles, made in Earth's vicinity, from U.S. and U.S.S.R. rockets, satellites and space probes.

The great Asian flu epidemic of 1957 may have spread from a pig, duck or chicken in a Chinese barnyard.

Dr. A. F. Rasmussen of the University of California reports, after a swing through Southeast Asia, that the Asian influenza virus and at least four animal viruses he studied overseas are closely related.

Fifteen-year-old Bill Vaughan of Arlington, Va., has made one of the most unusual and valuable finds ever made by a skin diver of any age.

Scuba-diving with two companions in Devil's Den Springs, near Ocala, Fla., in July, he found some bones buried in silt 45 feet beneath the surface.

The bones now lie in the Smithsonian Institution for they are the only known remains of the ancient Florida "shortfaced bear" which may have lived 1,000,000 years ago. They will be studied by scholars plotting the evolution of the bear.

Many individual Americans are spending their own money to send men into space.

Ever since it was announced that Cmdr. Alan B. Shepard's suborbital flight last year cost at the rate of \$2.25 for each citizen, checks for that amount from proud citizens have been streaming into the National Aeronautics and Space Administration.

James Biery

POPULAR MECHANICS

Processing of **KODACHROME** (Licensed by Eastman Kodak)

**AT DISCOUNT PRICES**

KODACHROME  
I & II } \$1.00  
8mm ROLL OR  
35mm 20 EXP. MTD. }  
8mm MAGAZINE ..... .75  
35mm 36 EXP. MTD..... 1.75

SEND FOR FREE MAILERS and our big FREE CATALOG of Processing, Film and Equipment at DISCOUNT PRICES!



**SOLAR** CINE PRODUCTS 4247 S. Kedzie Dept. ME  
Chicago 32, Ill.



**PLAY GUITAR IN 7 DAYS**

Or Your Money Back Guaranteed

**SURPRISE FRIENDS, RELATIVES. ENJOY POPULARITY AND FUN GALORE!**

In this introductory offer you get **TOP RADIO GUITARIST ED SALE'S** famous 66 page secret system worth \$3.00 which positively teaches you to play a beautiful song the first day and any song by ear or note in seven days! Contains 52 photos, 87 finger placing charts, etc. Shows how to tune, keep time, build chords, bass runs, dance chords, swing, etc., plus 110 popular and western songs, words and music; a \$1.00 Chord Finder of all the chords used in popular music; a \$3.00 Guitarist Book of Knowledge—**TOTAL VALUE \$7.00—ALL THREE for only \$2.98. SEND NO MONEY!** Just your name and address, pay postman \$2.98 plus C.O.D. postage. (Or send \$3.00 with order and I pay postage.) Same Money-back Guarantee. **ED SALE, Studio 153-D, AVON BY THE SEA, N. J.**

**MAKE MONEY! REPAIR HYDRAULIC JACKS**



**Earn While You Learn At Home**  
Make up to \$5 an hour, full or part-time, in the competition-free field of Hydraulic Jack Repair. Millions of jacks in auto service stations, truckers, body shops, riggers, farms, need servicing. We show you HOW. Easy step-by-step directions.

Write for Folder PM-1 and Free Bonus Offer

**Institute of Hydraulic Jack Repair**

P.O. BOX 50 • BLOOMFIELD, N. J.

A Correspondence School Licensed by N.J. Bd. of Ed.

**MAKE BIG MONEY**

**MAKING COSTUME JEWELRY AT HOME!**

Thrilling spare-time, **MONEY-MAKING** hobby! Make newest, beautiful jeweled earrings, necklaces, bracelets, pins, pendants, cuff links, tie clips! Quick, easy to make—easier to sell to friends, neighbors, stores, at big profit! Details **FREE!**

**DON-BAR CO., Dept. A-192**  
2934 W. Fullerton Ave., Chicago 47, Ill.



## Shrinks Hemorrhoids New Way Without Surgery Stops Itch — Relieves Pain

For the first time science has found a new healing substance with the astonishing ability to shrink hemorrhoids and to relieve pain — without surgery.

In case after case, while gently relieving pain, actual reduction (shrinkage) took place.

Most amazing of all — results were so thorough that sufferers made astonishing statements like "Piles have ceased to be a problem!"

The secret is a new healing substance (**Bio-Dyne®**)—discovery of a world-famous research institute.

This substance is now available in *suppository* or *ointment* form under the name **Preparation H®**. Ask for it at all drug counters.

JANUARY 1962

# FREE CAREER BOOKLET



To guide you to a successful future in  
**METALLURGY  
MECHANICAL  
ENGINEERING  
AIR CONDITIONING  
INDUSTRIAL  
TECHNOLOGY**

This interesting pictorial booklet tells you how you can prepare for a dynamic career as a Mechanical Engineer or Engineering Technician in such rewarding fields as:

**DEVELOPMENT • RESEARCH • SELLING  
PRODUCT DESIGN • PURCHASING  
QUALITY CONTROL • TIME STUDY**

Get all the facts about job opportunities, length of study, courses offered, degrees you can earn, scholarships, part-time work — as well as pictures of the Milwaukee School of Engineering's educational and recreational facilities. No obligation — it's yours free.

**MILWAUKEE SCHOOL OF ENGINEERING**

**MAIL COUPON TODAY!**

**Milwaukee School of Engineering**  
Dept. PM-162, 1025 N. Milwaukee St., Milwaukee, Wis.

Please send FREE "Your Career" booklet  
I'm interested in  Metallurgy  Air Conditioning  
 Industrial Engineering  Mechanical Engineering  
 Electrical Engineering.

Name..... Age.....

PLEASE PRINT

Address.....

City..... Zone..... State.....

I'm eligible for veterans education benefits.

Discharge date..... MS-118

**MAKE YOUR HOME WORKSHOP PAY OFF**  
in spare time or full time income  
**ELECTRICAL APPLIANCE REPAIR**



Turn spare hours into cash profits. Millions of Home Appliances need fixing. Every home is your market for Full-Time Career or Spare Time "Second" Income.

Costs Less Than \$1.50 A Week. All you need is a workbench, spare time and N.T.S. Home-Training in Electrical Appliance Repair. You get a professional appliance tester, tools, and easy-to-learn, practical instructions, fully illustrated. Start earning early in course. Mail coupon now. No obligation. No salesman will call.

**NATIONAL TECHNICAL SCHOOLS**

WORLD-WIDE TRAINING SINCE 1905  
4000 So. Figueroa Street  
Los Angeles 37, Calif., U.S.A.

**FREE BOOK and ACTUAL LESSON**

**NATIONAL TECHNICAL SCHOOLS**  
Los Angeles 37, California

HB-12

Name \_\_\_\_\_ Age \_\_\_\_\_

Address \_\_\_\_\_

City \_\_\_\_\_ Zone \_\_\_\_\_ State \_\_\_\_\_

**FREE! 53 ORIENTALS**



Send today for this Spectacular Oriental Collection! More than 50 fabulous genuine postage stamps from Taiwan, Korea, Viet Nam, Japan, Singapore, Burma, Pakistan, Indonesia, Thailand, Hong Kong, Laos, many other strange, remote lands of the mysterious Far East. Sensational stamps picturing weird beasts, birds, ancient ships, queens, kings, beautiful women. Extra! Big Bargain Catalog, exciting offers and other thrilling stamps for your free examination. Send 10c for mailing expense — Double your money back if not delighted!

Jamestown Stamp Co. Dept. C12PM Jamestown, New York  
RUSH my Free Collection of 53 Orientals & other offers.  
I enclose 10c for mailing costs.  
PLEASE PRINT

Name \_\_\_\_\_  
Address \_\_\_\_\_  
City & State \_\_\_\_\_

**LEARN TO EARN**



**HIGH WAGES AS A HEAVY EQUIPMENT OPERATOR OR MECHANIC**

- WORLD'S ONLY CONTRACTOR OWNED AND OPERATED SCHOOL
- MODERN EQUIPMENT, HIGHLY QUALIFIED INSTRUCTORS
- V.A. APPROVED FOR GI TRAINING

Learn to operate bulldozers, draglines, cranes, back hoes, scrapers and motor graders **ON ACTUAL CONSTRUCTION PROJECTS!**

Learn by doing . . . no impractical correspondence courses.

WRITE TODAY FOR FREE SCHOOL CATALOG

**WESTERN SCHOOL OF HEAVY EQUIPMENT OPERATION**

DEPT. B-17, BOX 510  
WEISER, IDAHO  
PHONE 549-1112



Member American Road Builders Association  
Associate Member Associated General Contractors

**AUTOMATIC OIL CHANGE PLUG**

PAT. PEND. Cable operated. CHANGE YOUR OIL AT HOME IN 5 MINUTES, dressed in tuxedo. SAVE \$2.25 PER CHANGE!



- ★ NO WAITING AT SERVICE STATIONS!
- ★ NO PAYING FOR SUPER EXPENSIVE OILS!
- ★ NO JACKING — NO CRAWLING UNDER!
- ★ PERFECT DESLUDGING EVERY TIME!

**ABSOLUTELY FOOLPROOF - 5 YR. GUARANTEE!**

Install it yourself in minutes. Fits opening in pan. No holes to drill. Ind. car make, year, cyl. Info on req. COSMOPOLITAN RESEARCH CORP., BOX 5791-PM, DETROIT 39 MICH.

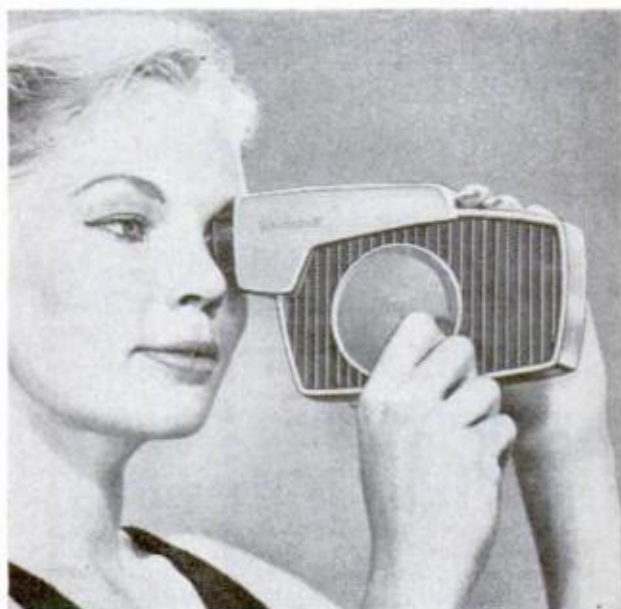

**Learn by Viewing**

Instruction films and a hand-operated movie-viewer teach such subjects as bowling, water skiing, dancing, judo and baton twirling. The film may be turned as slowly as the student desires, or even reversed.

The viewer retails at \$9.95, and each 50-foot reel at \$4.95. Sold by See Do Productions, Highland Park, Ill.

POPULAR MECHANICS



**Reading Time:** Less than two minutes.

**Benefits You Will Receive:** A few moments taken now may save you months of expense later.

*Would you welcome a HOSPITALIZATION POLICY in which:*

**1. ONLY YOU CAN CANCEL**

Regardless of how many times you are hospitalized the Company could never cancel your policy. Each time you were hospitalized you would receive \$100 each week for as long as you remain in the hospital . . . for life if necessary!

**2. NO AGE LIMIT**

Whether you were 1 or 100 you would receive the *same* liberal coverage.

**3. ALL BENEFITS PAID IN CASH**

Claim checks would be made payable directly to you — tax free — to use as you wish!

**4. NO WAITING PERIOD**

All your benefits begin immediately on noon the day your policy is issued.

**IF** you do not drink and **IF** your doctor has not already told you that it's time for you to enter the hospital . . . then you are eligible to apply.



For complete information **TURN TO THE NEXT PAGE.** Read it carefully. See what prominent leaders say about **THE GOLD STAR PLAN.** Read what happy policyholders write. And be sure to read the **MONEY-BACK GUARANTEE.**

# At Last- A HOSPITALIZATION

**Pays \$100.00 Weekly from First Day for Life to Readers of POPULAR MECHANICS**



day in the hospital and will continue paying as long as you are there, even for life!

If you do not drink and are carrying ordinary hospitalization insurance, you are of course helping to pay for the accidents and hospital bills of those who drink. Alcoholism is our nation's #3 health problem, ranking immediately behind heart disease and cancer! With the

If you are the one American in four who does not drink, the Gold Star Total Abstainers' Hospitalization Policy will pay you \$100.00 a week in cash, from your first

GOLD STAR PLAN you are not called upon to help pay the high bills for the ailments and accidents of those who drink. GOLD STAR rates are based on the SUPERIOR HEALTH RECORDS of Non-Drinkers!

For the first time, you can get the newest and most modern type of hospitalization coverage at unbelievably low rates, because the Gold Star Policy is offered only to non-drinkers. And your low Gold Star premium can never be raised because you have grown older or have had too many claims. Only in the event of a general rate adjustment up or down for all policyholders can your rate be changed!

One out of every seven people will spend some time in the hospital this year. Every day over 64,000 people enter the hospital—47,000 of these for the first time!

## LOW RATES FOR NON-DRINKERS

With a Gold Star Total Abstainers' Hospitalization Policy, you receive \$100.00 per week in cash, as long as you remain in the hospital, starting from your very first day there, for either sickness or accident. If your hospital stay is less than one week, you still collect at the rate of \$14.29 per day. Even if you are already covered by another policy, the GOLD STAR PLAN will supplement that coverage, and will pay you directly, in addition to your present policy. And your benefits are tax-free!

This wonderful, generous protection costs only \$4 a month for each adult, age 19 through 64, or \$40 for twelve full months. For each child under 19, the rate is just \$3 for a month's protection. And for each adult of

age 65 through 100, the premium is only \$6 a month, or \$60 for a full year.

And remember, with Gold Star, the NO LIMIT Hospital Plan, there is NO LIMIT on how long you can stay in the hospital, NO LIMIT on the number of times you can collect (and the Company can never cancel your policy), and NO LIMIT on age!

Compare this plan with others. We welcome comparison because the GOLD STAR PLAN pays from the very first day (we can't pay any sooner); and it pays forever . . . as long as you remain in the hospital (we can't pay any longer!).

## OUTSTANDING LEADERS SAY:



**UPTON SINCLAIR, Pulitzer Prize author:** "I think your idea of giving people the insurance discount which they earn by not shortening their lives with alcohol is a brilliant one, and I am glad to be counted in on it."



**DR. DANIEL A. POLING, noted minister and Editor of The Christian Herald:** "The advantages of a hospital plan which is available to non-drinkers only are obvious. The lower rate is made possible because you are not paying the bills for the illnesses and accidents of those who use alcohol."



**J. C. PENNEY, philanthropist, Founder of the J. C. Penney Company:** "I have a sincere conviction that liquor is one of the chief causes of unhappiness both to the people who drink and to those who are near and dear to them. Early in my life I decided not to touch liquor. I am delighted to know of the De Moss Gold Star Total Abstainers' Plan that provides a premium rate so much lower. This is the way it should be because most automobile and other accidents occur because of drinking."

## GUARANTEE

### Money-Back Guarantee

We'll mail your policy to your home. No salesman will call. In the privacy of your own home, read the policy over. Examine it carefully. Have it checked by your lawyer, your doctor, your friends or some trusted advisor. Make sure it provides exactly what we've told you it does. Then, if for any reason whatsoever you are not fully satisfied, just mail your policy back within ten days, and we'll cheerfully return your entire premium by return mail, with no questions asked. So you see, you have everything to gain and nothing to lose.

## READ WHAT A BLESSING THIS PROTECTION HAS BEEN TO OTHERS:

**MR. J. WALTER DANIELS, Fredericktown, Ohio:** "I received payment for my claim and am well pleased with the service you gave. When I took the policy I never thought I would need it so soon. But we never know what will happen. It was my first time to be in the hospital."

**MR. WILLIAM C. MOORE, East Alton, Illinois:** "I want to sincerely thank you for the quick and courteous service. My illness was very sudden and unexpected. I can truly recommend the Gold Star Policy to anyone."

**ROBERT F. HAINES, Ukiah, California:** "It is with high praise I recommend this Company. My experience has been very satisfactory, and when help was needed most, you were there."

**MISS DOROTHY CARROLL, Pleasant Valley, New York:** "Received your check and wish to thank you very much. Although I had the policy only 13 days before I had to go to the hospital, there was no delay of any kind. I am very happy to have insurance with you."

# PLAN FOR NON-DRINKERS ONLY!

**NO WAITING PERIODS  
NO AGE LIMIT**



**ONLY YOU CAN CANCEL  
NO SALESMAN WILL CALL**



## Check These Remarkable Features:

- Only YOU can cancel.
- Good anywhere in the world!
- Pays in addition to any other hospital insurance you may carry.
- All benefits paid directly to you in cash—tax free!
- Claim checks are sent out Air-mail Special Delivery!
- No age limit.
- Immediate coverage! Full benefits go into effect noon of the day your policy is issued.
- No limit on the number of times you can collect.
- Pays whether you are in the hospital for only a day or two, or for many weeks, months, or even years!
- No policy fees or enrollment fees!
- Ten-day unconditional money-back guarantee!
- Every kind of sickness and accident covered except, of course, hospitalization caused by the use of alcoholic beverages or narcotics, pre-existing conditions, pregnancy, or any act of war. Everything else IS covered.

### HERE ARE YOUR GOLD STAR BENEFITS

Pays you \$100.00 weekly for life while you are in the hospital.  
Pays \$2,000.00 cash for accidental death.  
Pays \$2,000.00 cash for loss of one hand, or one foot, or sight of one eye.  
Pays \$6,000.00 cash for loss of both hands, or both feet, or sight of both eyes.

This plan offered exclusively by  
**DE MOSS ASSOCIATES, INC.**  
VALLEY FORGE, PENNA.  
and Affiliates

"Special Protection for Special People"

## HERE'S ALL YOU DO:

- 1 Fill out application below.
- 2 Enclose in an envelope with your first payment.
- 3 Mail to De Moss Associates, Inc. Valley Forge, Pa.  
You will receive your GOLD STAR POLICY promptly by mail.

No Salesman will call.

### APPLICATION FOR Gold Star Total Abstiners' Hospitalization Policy

My name is \_\_\_\_\_ 02-634-0162  
Street or RD# \_\_\_\_\_  
City \_\_\_\_\_ Zone \_\_\_\_\_ State \_\_\_\_\_  
Date of Birth: Month \_\_\_\_\_ Day \_\_\_\_\_ Year \_\_\_\_\_ Height \_\_\_\_\_ Weight \_\_\_\_\_  
My occupation is \_\_\_\_\_  
My beneficiary is \_\_\_\_\_ Relationship \_\_\_\_\_  
I also apply for coverage for the members of my family listed below:

	NAME	AGE	HEIGHT	WEIGHT	BENEFICIARY
1.	_____	_____	_____	_____	_____
2.	_____	_____	_____	_____	_____
3.	_____	_____	_____	_____	_____

To the best of your knowledge and belief, have you or any person listed above ever had high or low blood pressure, heart trouble, diabetes, cancer, arthritis or tuberculosis or have you or they, within the last five years, been disabled by either accident or illness, had medical advice or treatment, taken medication for any condition, or been advised to have a surgical operation? Yes \_\_\_\_\_ No \_\_\_\_\_

If so, give details stating person affected, cause, date, name and address of attending physician and whether fully recovered: \_\_\_\_\_

Neither I nor any other person listed above uses alcoholic beverages, and I hereby do apply for a policy with the understanding that the policy will not cover any conditions existing prior to the issue date, and that it shall be issued solely and entirely in reliance upon the written answers to the above questions.

Date: \_\_\_\_\_  
FORM GS 713-3

Signed: 

**HERE  
ARE  
THE  
LOW  
GOLD  
STAR  
RATES**

	IF YOU PAY MONTHLY	IF YOU PAY YEARLY
Each adult age 19-64 pays	\$4.	\$40.
Each adult age 65-100 pays	6.	60.
Each child age 18 and under pays	3.	30.

SAVE **16 2/3%**  
BY PAYING YEARLY!

THE GOLD STAR PLAN is underwritten by the following leading companies (depending upon your State of residence):

NATIONAL LIBERTY LIFE INSURANCE COMPANY  
Valley Forge, Penna.

OLD SECURITY LIFE INSURANCE COMPANY  
Kansas City, Missouri

WORLD MUTUAL HEALTH & ACCIDENT INS. CO. OF PENNA.  
King of Prussia, Pa.

MAIL THIS APPLICATION WITH YOUR FIRST PREMIUM TO

**DE MOSS ASSOCIATES, INC. VALLEY FORGE PENNA.**



## BIG EARNINGS WAITING

### Learn to Repair, Rebuild, Resell Typewriters All Makes—in your spare time!

NEVER BEFORE could you get industry-proved training at home! Now you can qualify quickly in your spare time for this phenomenal growth field. Thousands more trained typewriter repairmen needed. Learn with real typewriter, sub-assemblies, all professional tools, and step-by-step illustrated lessons prepared by industry experts for home study. Earn while you learn. **FREE BOOKLET** gives vital government facts, describes money-making opportunities. **MAIL COUPON TODAY!**

**TYPEWRITER REPAIR SCHOOL,**  
 Division Technical Home Study Schools, Dept. A-12  
 150 Park Ave., E. Rutherford, N.J. (Lie'd N.J. Dept. of Educ.)  
 Send **FREE** fact-packed Booklet. No obligation.

Name.....  
 Address.....  
 City..... Zone..... State.....



**FREE**  
**MUSCLE BUILDING**  
**INFORMATION**  
*Sensational New Methods*  
*Less Time—Less Effort—Better results*  
**BODY-TONE, Box 638, North Miami 61, Fla.**

## HOME PACKAGING

**"MADE TO ORDER"  
 FOR FOLKS WHO  
 DON'T LIKE TO SELL**



*An Amazing New Kind of Home Business That Can Bring You a Big **STEADY INCOME***

Profits up to 2500%. Greatest one-man or man and wife team opportunity you ever heard of. Start spare time or full time anywhere—kitchen, basement, garage. We supply everything you need—guide you step-by-step. If you don't like house-to-house selling, this is the type of work you will really go for. Free "no selling plan" reveals big profit spare, full time opportunities. Get complete information in my new book "10 STEP PACKAGING PROFIT PLAN"—sent free and postage prepaid.

**FREE! Mail Coupon Now**

A. J. Abarsi, Pres., Home Packaging Co.,  
 2212 E. Jesse St., Los Angeles 23, Calif.  
 Dear Mr. Abarsi: Please send me your new book "10-STEP PACKAGING PLAN" and details of how I can get started in my own home. Everything you send me now is free and no salesman will call. Dept. R-254

NAME.....  
 ADDRESS.....  
 CITY..... ZONE..... STATE.....

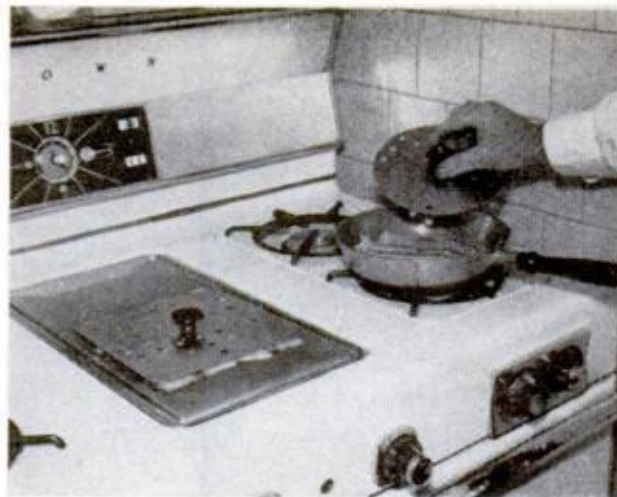

### Keeps the Curl Out of Bacon

Placed on top of bacon while it's cooking, a lightweight metal decurler keeps the strips from curling.

The cooking aid also conducts heat so that both sides of the bacon cook evenly without turning. In addition, the cook can hold the meat in the pan easily while draining grease.

Available in ~~stainless steel~~ <sup>stain</sup> or anodized aluminum, the decurler comes in a round or square shape. The former is \$1 and the square one, \$1.25 from Herbert Oldham, 1111 South Sumner St., Wheaton, Ill.

Worship  
 together  
 this  
 week



*You need not walk alone!*

RELIGION IN AMERICAN LIFE, INC.

Published as a public service in cooperation with The Advertising Council.

# I'm no carpenter but I completed this home myself and **SAVED \$4,275<sup>00</sup>**



This top quality IBC home built on my lot cost only **\$4,780<sup>00</sup>**

You, too, can beat high construction costs by completing an IBC home yourself and save thousands of dollars—without sacrificing quality!

Mail coupon today for full information on IBC Homes No Money Down—Immediate Financing Plan on a quality home you can finish yourself—it's just like paying yourself \$3.50 an hour for the work you do in your spare time. Over 100 plans to choose from, as low as \$1,395.00. Monthly payments as low as \$31.10.



**Mail this coupon TODAY!**



**IBC HOMES • Dept. E-113**

P. O. Box 109, Charleston, Illinois

Please rush me **FREE** literature.

I have a lot  Have your representative call  
I understand this request puts me under **NO OBLIGATION.**

Name \_\_\_\_\_

Address \_\_\_\_\_

City \_\_\_\_\_ State \_\_\_\_\_

County \_\_\_\_\_ Phone No. \_\_\_\_\_



**FREE!** ★ **100 WORLD-WIDE STAMPS** ...just released!

**HURRY! SEND TODAY** for new, **FREE** collection of 100 Worldwide stamps. Get new issues of past 12 months . . . Pakistan Khyber Pass, Queensland "Victoria", Central African Butterfly, Argentina Llama, Mozambique "Arms", many others. Wonderful new additions to your collection. All different, all genuine, topicals, pictorials, mint and used. Many in limited circulation, so get them first. Send today for this new, **FREE** collection, other stamp offers for approval. Rush name, 10¢ for handling, postage. **GARCELON STAMP CO., Dept. 1PSX, Calais, Maine.**

**GARCELON STAMP CO., Dept. 1PMX**  
Calais, Maine. Rush **FREE** 100 Different Stamps, other offers. Enclosed 10c for handling. (PLEASE PRINT).

## Get Into One Of Today's TOP OPPORTUNITY FIELDS

# ELECTRICITY - ELECTRONICS TELEVISION

### RADIO • ELECTRONICS

**COYNE** Train in the New Shop-Labs of Oldest, Best Equipped School of Its Kind in U.S. Founded 1899

in Chicago—Electrical and Electronic Center. Prepare for a better job and a successful future. Train on real equipment — no advanced education or previous experience needed. Lifetime employment service to graduates. Part time employment help to students. Finance Plan—enroll now, pay most of tuition later.

**FREE BOOK**—Mail Coupon or write to address below for Big Free Illustrated Book—"Guide to Careers."

Information comes by mail. No obligation and **NO SALESMAN WILL CALL.**

**COYNE ELECTRICAL SCHOOL**  
Chartered as an Educational Institution Not for Profit  
1501 W. Congress Pkwy., Chicago 7, Ill., Dept. 12-3C

**COYNE ELECTRICAL SCHOOL, Dept. 12-3C**  
1501 W. Congress Pkwy., Chicago 7, Ill.

Send **FREE** Book, "Guide to Careers" and details of all training you offer. I am especially interested in

Electricity  Television  Both Fields

Name \_\_\_\_\_

Address \_\_\_\_\_

City \_\_\_\_\_ State \_\_\_\_\_

( I understand no salesman will call )

"Our 66th Year"

# FIRST FIDELITY SAVINGS & LOAN ASS'N.

Baltimore 2, Maryland



per annum, compounded semi-annually  
Over \$8,000,000 in Assets

Deposits mailed by Jan. 31st earn from 1st



- Savings accounts insured by Security Financial Insurance Corporation, Balto., Md.
- Financial Statement Upon Request.

## Open \$100 account! Take choice of Free Gifts!



- Gifts subject to rules & regulations of Association. Quantities limited.
- Each member of family may open an account and receive a gift. Joint accounts invited.
- Offer void where prohibited by law.

### SAVE BY MAIL—WE PAY POSTAGE

First Fidelity Savings & Loan Ass'n.  
215 E. Fayette Street, Balto. 2, Md.

I enclose \$..... with which to open an account.

NAME.....

ADDRESS.....

CITY..... ZONE..... STATE.....

My gift choice is.....

## Tune in on the inventors

$$10 + 10 = 100$$

Looks like a bad mistake in basic arithmetic, but it isn't. It's right. In the two-digit language of binary mathematics—the system used in the big binary computers—"10" is 2, and "100" is 4. And  $2 + 2 = 4$ , doesn't it? Miles Libbey, of London, England, won patent No. 3,006,082 for a device for teaching addition and subtraction in the binary system. And at least some of our kids will certainly need to learn it in school, so it may be a very successful idea.

Underwater dynamite explosions, fired by oil explorers for their seismic recording instruments, can kill great numbers of fish—a fact that makes that method both wasteful of natural resources and illegal in some waters. Since less-powerful explosives don't work as well, Robert Lawrence invented a sheath of inert materials around a detonating core of ammonium nitrate and nitroglycerine, and produced the underwater equivalent of a "shaped charge." This produces the desirable seismic shock wave, but cuts fish kill to a minimum. He assigned his patent, No. 3,006,279, to the Hercules Powder Co., of Wilmington, Del.

An antihijacking collar for trucks won patent No. ~~3,004,304~~ <sup>3,004,421</sup> for William Bowler of St. Laurent, Quebec. To prevent theft of the trailer when it's standing alone, he designed a locking collar that fits over the kingpin on the trailer hitch, preventing the coupling of the trailer to any hijacker's tractor. It's both difficult and time-consuming to remove, thereby increasing the risk and discouraging a thief.

A split-level station wagon design earned patent No. 3,003,808 for John Swanberg, of Minneapolis, Minn. His design produces a wagon that resembles the familiar Greyhound "SceniCruiser" buses in that the passenger section is raised above the driver's level. The passengers have a fine view, standard seats convert into beds for family camping, and the space between the two floor levels behind the driver makes a big, lockable baggage and storage compartment.

Copies of the original patents may be ordered for 25 cents each from the Commissioner of Patents, Dept. of Commerce, Washington 25, D. C.

# POPULAR SHOPPING

worth  
writing  
for . . .

**Canvas can create** some unusual effects when used as a decorating material in and around your home. On the patio, canvas can provide shade and privacy, yet can easily be taken down when not needed. Many ideas for using canvas are described in "Decorating and Shading with Colorful Canvas." The price is 25¢ from the Canvas Awning Institute, National Cotton Council, Memphis 12, Tenn.

**Woodworkers** will find much to interest them in "Constantine's Catalog and Manual for Woodworkers." Fine woods, materials and tools are listed, along with some how-to information. It contains 128 pages, costs 25¢. Available from Albert Constantine & Son, Inc., 2050 Eastchester Rd., New York 61, N. Y.

**Sewer information** is contained in the 12-page booklet "Home Owners Guide to Better Sewer Service." It features 50 questions and answers about installation and service. Free from Johns-Manville, Dept. TR-240, New York 16, N. Y.

**Space-saving ideas** are featured in a free 12-page pamphlet. A powder room, service partition and storage area are among ideas contained in "20 Valuable Space Saving and Space Appealing Ideas." Address Grant Pulley & Hardware Corp., High St., West Nyack, N. Y.

**Foam rubber** is a handy material for upholstery projects. A 15¢ 8-page booklet outlines the basic steps in cutting, cementing and applying foam rubber in upholstery, and making cushions, pillows and bolsters. Write for "How to Work with Foam Rubber" to Woman's Day, P.O. Box 1000, Dept. WDL, Greenwich, Conn.

**A Florida vacation** sounds pretty enticing about this time of year. The different areas of the state and their attractions are presented in a four-color, 100-page book entitled "A Guide to Florida Vacations." It's free from Florida Development Commission, Dept. D.M., Carlton Bldg., Tallahassee, Fla.

**Our Flag** is the title of a 24-page book that tells of the origin and the history of the Stars and Stripes. Includes instructions for properly displaying the flag.



**MAKE YOUR OWN NATURE TILES** With Colorful Leaves, Flowers, Butterflies, Permanently Preserved in Castoglas.

**Pours Like Honey—Sets Like Glass!** The pansy shown in this photograph was embedded in crystal-clear Castolite in 1946. It is as lovely now as the day we picked it in our garden. NOW—a greatly simplified method enables you to do the same with Castoglas on wood, hardboard, metal or between layers of glass mat.

**What Can You Do With Tiles!** A good example is the way a dark and outmoded kitchen was converted into a bright and cheerful room at surprisingly modest cost. Castoglas was used in three ways: for making the decorative glass screen, for the tiles with embeddings of leaves and butterflies, and for "glassing" the countertop. Castoglas is waterproof, heat- and acid-resistant and easily cleaned. You can also make table tiles, coasters, trays, wall decorations and embed photos, coins, sea shells and many other things. No tools, no heat required.

New illustrated booklet explains in easy-to-follow directions how to do it. Please mail 25c to Dept. 1-A.

**THE CASTOLITE CO., Woodstock, Ill.**



**FOR BIG MEN ONLY!**

**SIZES 10-16**  
**WIDTHS**  
**AAA-EEE!**

SEND FOR FREE CATALOG

We specialize in LARGE SIZES ONLY — sizes 10 to 16; widths AAA to EEE. Over 40 styles in dress, sport, casual and work shoes; golf shoes; insulated boots; sock; slippers; rubbers; overshoes; shoe trees. Also sport and dress shirts, slacks, jackets, sweaters, raincoats, pajamas, underwear — all designed and sized for big or tall men! Enjoy perfect fit in your hard-to-find size at amazingly low cost. Satisfaction Guaranteed. Sold by mail only. Write for FREE Style Book TODAY!

**KING-SIZE, INC.** 1632 Forest St., Brockton 64, Mass.

**SURPRISE YOUR SWEETHEART!**

SEND THE WORLD'S **BIGGEST VALENTINE**

(34" x 44")

DIRECT FROM **LOVELAND** U.S.A.

© 1961 CC

WE WILL SIGN YOUR NAME AND MAIL DIRECT FROM LOVELAND

1.00 PPD

INCLUDE YOUR FIRST NAME AND YOUR SWEETHEART'S FULL NAME AND ADDRESS

**CUPID CARDS** DEPT. P **LOVELAND, COLORADO**



**SUZUKI**

Model **50 MC**

**\$295**

F.O.B.L.A.

ELECTRIC

50 m.p.h. — 4 speeds 180 m.p.g. STARTER

**BOAT DEALERS—SPORTS CAR DEALERS**  
**—SPORTING GOODS DEALERS . . .**

Start making money right NOW! Sell SUZUKI Motorcycles, the high quality, lightweight line from Japan. Ideal ride for everyone, gives you added High Revenue.

Write for full details, no obligation.

**Ken Kay**

**DISTRIBUTING CO.**

13054 SHERMAN WAY, NO. HOLLYWOOD, CALIF.



## ART—LEARN AT HOME!

Be a Commercial Artist for Only 20c a Day!

ENJOY glamorous high-pay career or profitable hobby this easy, proven way. Learn Painting, Illustrating, Cartooning, Fashion Art, Lettering, TV Art, at home in your spare time—for only 20c a day! Two 22-piece artist outfits (worth \$25) given at no extra cost. Cash in on demand for trained artists. Be your own boss or high-pay staff artist. Write for FREE Book describing easy course. No obligation. No salesman will call. So write TODAY to: WASHINGTON SCHOOL OF ART, Studio 141, Port Washington, N. Y. (Est. 1914) Tear out.



**PAINT YOUR OWN WALL MURAL!** Enjoy the beauty, creative satisfaction of painting a lovely 5 to 14 ft. wide mural directly on your wall! New "point-by-numbers" method is fun, incredibly easy. Takes just 3 to 5 hours. Artists charge up to \$500; wallpaper scenes cost \$100 and more. Our complete kits, \$12.95 up! Also fabulous "Black Light" mural kits. Many exquisite modern, provincial, oriental, etc. designs. A stunning prestige touch! Send for FREE Color Catalog. "How to" details (encl. 10¢ for postage handling). MURAL ART CENTER, Dept. H-171, 808 S. LaBrea, Los Angeles 19, Calif.



# PLAY RIGHT AWAY!

ANY INSTRUMENT—even if you don't know a single note now!

NOW IT'S EASY to learn ANY instrument. No boring exercises. Even if you don't know a single note now you can play delightful pieces—from your FIRST lesson! BY NOTE. Make amazing progress. No special "talent" needed. Learn at home in spare time. Without a teacher. Low cost! Soon you can play popular music, hymns, classical and any other music. Over 1,000,000 students, all over the world.



**FREE BOOK.** Send this ad with your name and address filled in below, to: U. S. SCHOOL OF MUSIC, Studio 301, PORT WASHINGTON, N.Y. (No obligation, no salesman will call.) Chartered by N.Y.

State Education Dept. Est. 1898

Name.....  
Address.....  
Include Zone No., if any.



**BUILD**  
better  
**SAVE**  
more

with proved home plans

Hundreds of custom feature dream home plans are shown in detail. Plans noted for comfort, lasting beauty, sound economy can save you \$1000 or more in building costs. Builder-proved blueprints available at low cost for every plan. Send for your plan books now.

**SAVE!** ANY 3 BOOKS \*2

All 6 Books, over 1000 Plans only \$4

- Family Room Homes.....225 popular plans \$1
- New Trends & Selected Homes.....357 choices \$1
- Hillside & Split-Level Homes.....100 plans \$1
- Block Masonry Homes...223 low-cost charmers \$1
- Multiple Family Homes...85 duplexes and courts \$1
- Leisure Time Homes...lodges, cabins, 2nd homes \$1

Books Postpaid in U. S. and Canada

**HOME BUILDING PLAN SERVICE**

STUDIO P, 2454 N.E. Sandy Blvd., Portland 12, Oregon

## Spinning Wheel Electric Clock

Authentic replica of early American at its best. Beautiful wood grain finish. Metal planter and foliage included. Overall size 17" long by 13½" high.



**\$12.95**

Including postage and Federal Tax

**NIRESK INDUSTRIES, INC., Dept. PM3**  
CHICAGO 47, ILLINOIS

## UNUSUAL TOOLS BY MAIL

**#44 CORNER CLAMP & MITER BOX COMBINED**

Holds the wood. Holds your saw. Accurate cuts with any handsaw from 0° to 180°. Full 3" capacity. Sides exposed for mailing and gluing. \$2.75 ppd. No. 33. Same as No. 44 without saw guide attachments. \$1.75 ppd.



**EASY SAW FILER**

No. 11 Gives correct height, depth, pitch, bevel to any 6" to 10" hand or circular saw with no side pull. Includes 8" file. \$9.95 ppd.

**SAW SET** automatically sets teeth at 10° or more \$2.95 ppd.



**DRILL GRINDER**

Sharpens round shank drills like new with hand or power grinders. \$2.95 ppd.



**MONEY BACK GUARANTEE.**  
A. D. McBURNEY, 5908 Hollywood Blvd., Hollywood 28, Cal. Dept. A-12



Send 20c to the Superintendent of Documents, U.S. Government Printing Office, Washington 25, D.C.

**Lapidary**—the art of cutting and polishing gem stones—is discussed in a 12-page booklet. Tips on starting this fascinating hobby and instructions for sawing, grinding, sanding and polishing gemstones are featured. Send for "An Introduction to the Art of Lapidary," free from The Carborundum Co., Dept. A-1567, Buffalo, N. Y.

**Acoustic tile** can make an old ceiling look new, reduce noise in busy rooms. A 36-page book discusses the three methods of applying tile, and contains how-to steps on installing your own. Write for "Ceiling Tile How-to Book" free from Wood Conversion Co., Dept. 700, W-20 First National Bank Bldg., St. Paul 1, Minn.

**Boating books** on almost every conceivable phase of the sport are listed in a free 40-page catalog. Designing or building a boat, planning a cruise, studying the principles of navigation—these are a few of the subjects covered. Includes a list of large-scale blueprints. Write Motor Boating, 572 Madison Ave., New York 22, N.Y.

**Tape recorder uses**, 207 of them, are covered in a free 16-page booklet. Besides listing the many uses for tape recorders in business, education, and at home, "207 Ways To Use A Tape Recorder" also gives help-

POPULAR MECHANICS



worth  
writing  
for...

ful hints on the handling and splicing of tapes. Available from Magnecord Sales Dept., Midwestern Instruments, Inc., P.O. Box 7509, Tulsa, Okla.

**Traveling with children** is much more pleasant if you keep the kids busy. "Travel Fun," a free, colorfully illustrated 16-page booklet, tells how to play five games that will while away the miles. Also includes helpful check-lists, safety suggestions, and logs to record travel data.

Available from Customer Relations Service, Bell Telephone System, Room 540, 195 Broadway, New York 7, N.Y.

**Wood** is the handyman's basic material. The various types of woods, their characteristics and uses, are described in the handsome, 4-color, 56-page book "How to Make Wood a Beautiful Part of Your Home." Filled with information on working with wood and many tasteful projects. Send 50¢ to Rez Wood-Tones, Inc., P.O. Box 142, Springdale, Pa.

**Gluing techniques** for a variety of construction methods and repair jobs are described in a free 12-page booklet. It includes a woodworker's gluing chart listing the various types of glues and their uses. Send stamped, self-addressed envelope for a copy of the "Wood-Gluing Handbook" to Elmer, The Borden Co., 350 Madison Ave., New York 17, N.Y.



**ONLY \$5.98**  
plus 50¢ postage

**LITED AQUARIUM**  
Decorator Lamp • Modern Aquarium

Break-proof, leak-proof, glass-like plastic. Full 11x14x7" size with light in top! 3-gallon capacity—can be used with real fish! Has plants, life-like fish, genuine shells, sand, light and 8-ft. cord! Only \$5.98 plus 50¢ postage.

**NIRESK INDUSTRIES, INC., Dept. PM4**  
CHICAGO 47, ILLINOIS



**NEWEST IN HAND TOOLS**

**SWIVEL WRENCH**

Flexibility in turning that permits you to swivel up or down to clear obstructions; yet torque is always at center. This is an all-new product, engineered with superiority. A tempered tool for craftsmen—made of the finest alloys. Fits standard sockets and adaptors, 3/8" size \$6.50. All other sizes available. Prices on request. Write to:

**T. & P. INC., 5937 N. Oak**  
TEMPLE CITY, CALIF.



**NEW FEATURES!**

the new **POPULAR MECHANICS SHOP PROJECTS ANNUAL**

another big PM special-interest book

Staff-written and staff-researched by PM experts. Complete plans and how-to details on PM's new easy-to-build "Family Hobby Center." Tailor it to your family needs. Working area and storage space for mom's sewing, junior's models, or dad's hand tools.

**ARTICLES ON:**

- SABER SAWS
- RASPS
- WOOD CHISELS
- GLASS CUTTING
- TWIST DRILLS

**PLANS FOR:**

- BOBSLED
- UTENSIL RACK
- FIRE BELLOWS
- PICTURE FRAMES
- ROOM DIVIDERS

**NOW AT YOUR NEWSSTAND**



1



2



3

## On the market

**1. CLEAR EPOXY ADHESIVE** does invisible mending—no heat or pressure is required. Truly transparent, adhesive is useful for repairing clear glass, jewelry, many other items. Equal amounts from two tubes are mixed together and applied with special tube cap. Price: 98 cents. Devcon Corp., Danvers, Mass.



4

**2. ASPHALT PATCHING MATERIAL** for driveways is applied with minimum mess. Rake or hoe is used to tamp material in place—it dries almost immediately. Using ready-mix asphalt cuts waste, since remainder will not harden even when left in bag for long periods. Brewer Co., 7374 Main St., Cincinnati 44, Ohio

**3. CANING KIT** makes replacing chair seats in treasured heirlooms easy. Included with kit is enough natural cane to cover average chair (one sq. ft.), plus awl, moistening sponge, pointed wooden pegs and instruction booklet. Kit is priced at \$2 ppd. Newell Workshop, 47 Ash Street, Park Forest, Ill.

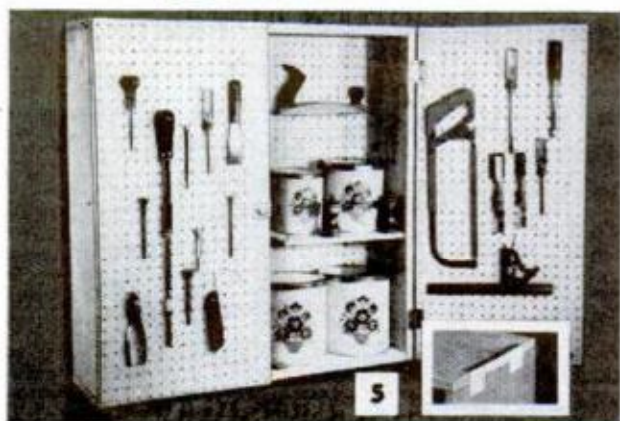

5

**4. CHECKERBOARD DECAL** may be applied to any smooth surface for decorative game board. Decal measures 17 in. sq. Colored sqs. alternate with clear ones through which the table top shows. Choice of white, black, cream or black and red sqs. \$1.25. Deca-Check, Box 1633, Lake City Sta., Seattle 55, Wash.

**5. KIT INCLUDES** all hardware needed for quickly building a tool or storage cabinet. Special brackets reinforce corners, interlocking and aligning sides. Instruction sheet included. Door and back of cabinet may be perforated hardboard. Kit: \$2.95. Stanley Tools, 195 Lake St., New Britain, Conn.

# NEW RUBBER STAMP BUSINESS PAYS BEGINNERS UP TO \$9.20 AN HR.

**START AT HOME  
IN SPARE TIME**  
with Table Top Machine!

**We Help Finance You**

The multi-million dollar Rubber Stamp business—once controlled by a few big companies—is now being taken over by small operators—one in each community throughout the United States. Men and Women who have this inexpensive machine can turn out huge quantities of Rubber Stamps with special wording that buyers once were forced to buy from big cities. Material costing only 27c makes a stamp that sells for \$1.80. The machine that does the work is simple and easy to operate and it turns out as many as six Rubber Stamps at a time, each with different wording such as names, addresses, notices, stock numbers, prices and other "copy" needed by offices, factories and individuals. Working full capacity, it can earn as much as **\$9.20 an hour for the operator!** Now you can get into the big-pay business yourself, with your own home as headquarters. You don't need experience. We supply everything, including complete instructions and eight ways to get business coming in fast. **We even help finance your start.** Start making up to \$9.20 an hour from the very beginning. Cash in on the profitable Rubber Stamp business in your community, right away. We'll mail full particulars FREE and no salesman will call. Be first in your locality. Rush coupon today or send your name on postcard to:

**RUBBER STAMP DIV., Dept. R-2-A**  
1512 JARVIS AVENUE • CHICAGO 26, ILLINOIS



**RUBBER STAMP DIV.**  
1512 Jarvis Ave., Dept. R-2-A  
Chicago 26, Illinois

**FREE!**

Please rush full particulars about your financing plan and the little machine that can get me started in the profitable Rubber Stamp business at home in spare time. Everything you send me is FREE and no salesman will call.

NAME \_\_\_\_\_  
ADDRESS \_\_\_\_\_  
CITY \_\_\_\_\_ ZONE \_\_\_\_\_ STATE \_\_\_\_\_

## IF YOU'VE JUST TUNED IN

and are interested in building the triple-top Fun Table currently running in the craft section of the magazine, large-size plans, plus an instruction booklet, are available to bring you up to date on what has gone before. Write Blueprint Department, Popular Mechanics Magazine, 200 E. Ontario St., Chicago 11, and enclose \$3.50.

## EARNS \$750 WHILE TRAINING!



**H. G. HENDRIX** of Gretna, La., says: "During my training period I was able to earn \$750! I think the school is wonderful. Every step in the Locksmithing course was so easy. Thanks again to your school and to my instructor."

## Be a LOCKSMITH

Add 50%-100% to YOUR INCOME with easy spare time earnings. Cash in on nationwide shortage — trained locksmiths in demand! Quickly step into a big-pay opportunity job — high-profit shop of your own.

**Earn Extra Money RIGHT AWAY! All Special Tools, Supplies Furnished FREE.**

Age, education, minor physical handicaps don't matter in this growing trade. You can quickly qualify as a skilled locksmith. Study at home as little as one hour a week. Gain practical experience through well-illustrated lessons. Do real jobs on car locks, house locks, padlocks and safe locks, under the guidance of experts.

Above are just a few of the professional tools and supplies furnished FREE for use with course.

Approved for Vets.

### MAIL COUPON FOR FREE BOOK

For a future as your own boss or in a high-pay job, write now for FREE illustrated book! Only school of its kind. Lic. State of N.J., Accredited NHSC. Locksmithing Institute, (Div. Tech. Home Study Schools)

Dept. 101-2, 150 Park Ave., E. Rutherford, N.J.

### MAIL COUPON NOW!

LOCKSMITHING INSTITUTE, Dept. 101-2  
150 Park Avenue, E. Rutherford, N.J.

Please send Free Illustrated Book without obligation.

Name \_\_\_\_\_ (Print here)

Address \_\_\_\_\_

City \_\_\_\_\_ Zone \_\_\_\_\_ State \_\_\_\_\_

Check if Veteran

THIS VALUABLE BOOK IS

*free*

TO AMBITIOUS  
MEN WHO WANT TO  
SUCCEED IN BUSINESS

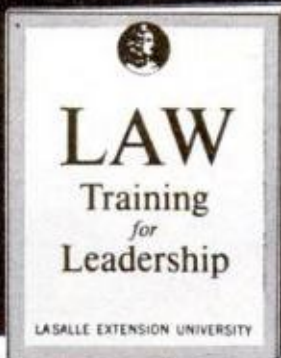

## Study LAW at Home

### Earn an LL.B. Degree from LaSalle

The Law-trained man wins rapid promotion, big income, great personal influence and prestige in any line of business activity. Leading corporations seek out such men for key positions. Under supervision of LaSalle's distinguished Law faculty, you can master Law thoroughly and enjoyably in your spare time. You work with actual legal cases, acquiring real experience. *Famed LaSalle Law Library of 14 volumes given to you as part of course.* Mail coupon today.

#### LA SALLE EXTENSION UNIVERSITY

An Accredited Correspondence Institution  
Dept. 1-047, 417 South Dearborn, Chicago 5, Ill.  
Please send me your free illustrated book  
"Law Training for Leadership."

Name ..... Age .....  
Address ..... County .....  
City & Zone ..... State .....



## Excitement! Security! Good Pay!

# CRIME DETECTION

**LEARN AT HOME IN SPARE TIME—START NOW!**  
Crime everywhere is on the rise! Learn now, in your own home, the profitable profession that enables you to track down criminals and bring them to justice! Hundreds of Identification Bureaus employ I. A. S. graduates . . . trained in finger printing, police photography, handwriting identification, firearms and investigation. Our 44th year! FREE "Blue Book of Crime" . . . packed with crime facts and the full story of famous I. A. S. training. State exact age. No salesman will call. Rush Coupon!  
*A Correspondence School Founded in 1916.*

**FREE**  
Blue Book  
of Crime  
**MAIL**  
**COUPON**

**INSTITUTE OF APPLIED SCIENCE, Dept. 1351**  
1920 Sunnyside Avenue, Chicago 40, Ill.  
Rush Blue Book of Crime . . . FREE!

NAME ..... Age .....  
ADDRESS .....  
TOWN ..... STATE .....



**WHOLESALE Electric Guitars - Parts - Factory to You**  
Professional electric solid body Spanish guitars, amplifiers, electric bass, double-necks, triple-necks, tone changers, double-neck Spanish, electric mandolin, pickups.  
Parts to outfit your own 1962 Models wholesale — Free catalog.  
**CARVIN CO.,** Box 287, PM-1, Covina, Calif.

# PROFIT

## IN YOUR SPARE TIME



**FIX Small Gasoline Engines**  
OUTBOARD • POWER MOWER • CHAIN SAW • TRACTOR



Harry F. Peters, Spokane, Wash., says:  
" . . . your Course led me into a very profitable and enjoyable business."

Be a small engine expert . . . earn **EXTRA MONEY** . . . own your own business. Easy-to-learn **LINCOLN Home Study** method qualifies you. Write for full particulars.

**LINCOLN TECHNICAL INSTITUTE**  
Suite 1-E, 472 Market St., Newark 5, New Jersey

### BUY BELOW WHOLESALE

**SAVE 30 to 70%** on thousands of advertised, name brand products—includes 1962 autos, appliances, T.V., Hi-Fi, washers, dryers, ranges, refrigerators, cameras, drugs, vitamins, furniture, silverware, tires, luggage, phono records, books, sports equip., golf, fishing, guns, musical instruments, toys, garden equip., tools, mattresses, rugs—many others.

WRITE FOR FREE DETAILS

#### CONSUMERS DIGEST

1102 3rd Ave., Dept. PM1, Des Plaines, Ill.



## MAKE BIG MONEY—ALL PROFIT—AT HOME

# INVISIBLE MENDING

**Pays up to \$10 in an Hour!**  
Make moth holes, cigarette burns, tears, rips, disappear from all fabrics. Little-known craft pays extra spare-time profits at home. Write today for exciting details **FREE!**

**FABRICON, 1555 Howard St.**  
DEPT. 321, CHICAGO 26, ILLINOIS



## FREE GERMAN HUNTING KNIFE



**4-INCH BLADE**

We give you handiest hunting and fishing knife you've ever had! Has 4-INCH LONG highly tempered steel blade—VERY SHARP! Attractive handle. We send knife **FREE** to acquaint you with our below-wholesale bargains. Please send 25c for handling. **NO LIMIT**—but send 25c handling for each knife. Order **TODAY!**  
**HUNTING KNIFE, Dept. K-638, Box 881, St. Louis, Mo.**

## FREE GUIDE Reveals 200 Ways to Make Extra Money

**YOU** can turn your spare hours into cash (\$25 to \$100 a week) by selling products and services to friends and others. Famous *Salesman's Opportunity Magazine* shows you how. Contains hints, plans, hundreds of offers. No matter what your age, experience or occupation—write **TODAY** for next 5 issues—absolutely **FREE**. Send no money just name.  
**OPPORTUNITY, 850 N. Dearborn, Dept. 447, Chicago 10, Ill.**

**S**OURCES of further information on articles are listed in our free **WHERE-TO-FIND-IT** list. For your copy just write to the

**SERVICE BUREAU**  
**POPULAR MECHANICS**  
200 E. Ontario Street  
Chicago 11, Illinois.



POPULAR MECHANICS

Материал, защищенный авторским правом

**Just a Few Months NEW and Already One of the HOTTEST Money-Makers for Men Everywhere—even Spare Time!**



**MERLITE Longer-Life Light Bulbs—the Only Bulbs in the World Backed by this SENSATIONAL GUARANTEE:**

**ONCE YOU BUY MERLITE LIGHT BULBS—YOU NEVER HAVE TO BUY BULBS AGAIN—NEVER!**

**Daring NO-TIME LIMIT FREE REPLACEMENT GUARANTEE Does the selling FOR YOU—MAKE up to \$1,000.00 in a MONTH!**

It's fantastic—14 magic words (ONCE YOU BUY MERLITE LIGHT BULBS—YOU NEVER HAVE TO BUY BULBS AGAIN—NEVER!) are making it easy for men everywhere to make a "small fortune"—as much as \$1,000.00 and more in a month, spare time or full time! No demonstrations, no fast-talking sales pitch needed. Almost everyone jumps at the chance to buy Merlite Bulbs with the iron-

clad Guarantee (packed with each bulb) that unconditionally offers to replace FREE any burned-out Merlite Bulbs, no matter when they burn out—in 5 years, 10 years—NO TIME LIMIT! And the Guarantee applies to all Merlite Bulbs purchased or replaced! Every home needs 12 to 24 Merlite Bulbs to replace old-fashioned short-life non-guaranteed bulbs. Make up to 120% profit, easily make \$50 in few spare hours. Merlite men are doing this now!

**Averages \$12 an Hour**

"Merlite Bulbs are the answer to a salesman's prayers. They're fantastically easy to sell. Working only part time, I have averaged \$12.00 per hour."

*Philip Smith, Maine*

**Sold 178 Bulbs First Afternoon**

"The first afternoon I sold 178 bulbs. Am very pleased with reception we get from customers. Please ship my next order at once."

*W. E. Foust, Arkansas*

**Makes \$8.20 an Hour in Just Spare Time**

"These guaranteed Merlite Bulbs surely sell. I've averaged \$8.20 per hour for the time I've spent with them. That makes a nice income and wish I could give full time to the job."

*L. C. Benedict, Virginia*

**FREE Money-Making Details Amazing No-Risk Offer**

Find out for yourself how much money you can make with the sensational Guaranteed Merlite Long-Life Light Bulb. We'll send you—FREE and without obligation—complete money-making Illustrated Sales Outfit and an astounding offer which helps you get started making money without risking a penny. Mail coupon TODAY!

**Merlite Industries, Inc., Dept. C-15N (Bulb Div.) 114 East 32nd Street, New York 16, N.Y.**

**Merlite Industries, Inc., (Bulb), Dept. C-15N 114 East 32nd Street, New York 16, N. Y.**

Rush complete money-making illustrated Sales Outfit and No-Risk Starting Offer—FREE and without obligation.

Name.....

Address.....

City.....Zone.....State.....

In Canada: Mopa Co., Ltd., 871 Dowd St., Montreal 1, P.Q.

**TELLS HOW TO SELL YOUR INVENTION**

If you have an invention that you believe has merit, write us at once for copy of copyrighted booklet "How to Go About Selling Your Invention." We work with manufacturers, and booklet reveals present markets, qualities of a saleable invention, current royalty rates being paid by manufacturers. Booklet is FREE, is offered to encourage new ideas we might submit to manufacturers. Just send name (no drawings, please) to **Kessler Sales Corporation, Dept. D-51, Fremont, Ohio**



**WANT MORE MONEY? GET INTO PHOTOGRAPHY**

Coast-to-coast, high-paying jobs in photography are waiting for people with the "know-how" to fill them. You can quickly, easily qualify at home with the world-famous NYI Learn-by-Doing Method. Write today for free catalog. Also resident training in N. Y. Our 52nd Year. Approved for Veterans.

**NEW YORK INSTITUTE OF PHOTOGRAPHY**  
Dept. 49 10 West 33 St. New York 1, N. Y.

**LEARN MEAT CUTTING AT NATIONAL Pay After Graduation**



The steady dependable trade of Meat Cutting taught easily in 8 short weeks. YOU LEARN BY DOING under actual meat market conditions in big modern school at Toledo.

For beginners or men with experience. Get a profitable store of your own. Remember, PEOPLE MUST EAT! Big pay jobs. Free employment help. Thousands of successful graduates.

Buying, cutting, percentage, pricing, advertising, selling, etc. A complete retail meat education. National School established 39 years. Get National training NOW. Pay your tuition in easy weekly

payments after you graduate. Send coupon for FREE school catalog—TODAY. G.I. approved.

**National School of Meat Cutting, Inc., Dept. 50-A, Toledo 4, Ohio**

Send me your FREE school catalog on National Training at Toledo in Meat Cutting, Meat Merchandising and Self Service Meats. No obligation. No salesman will call.

Name..... Age.....

Address.....

City.....State.....

Approved for Veterans

# EARN MORE - LEARN AUTO DIESEL MECHANICS

## OR TRAIN WITH OTHER GREER DIPLOMA COURSES

- |   |  |
|---|--|
| <input type="checkbox"/> AUTO MECHANICS       | <input type="checkbox"/> REFRIGERATION           |
| <input type="checkbox"/> DIESEL MECHANICS     | <input type="checkbox"/> AIR CONDITIONING        |
| <input type="checkbox"/> BODY & FENDER REPAIR | <input type="checkbox"/> MACHINIST-TOOL & DIE    |
| <input type="checkbox"/> GAS, ARC WELDING     | <input type="checkbox"/> AUTOMATIC TRANSMISSIONS |
| <input type="checkbox"/> HELIARC WELDING      | <input type="checkbox"/> MOTOR TUNE-UP           |
| <input type="checkbox"/> DRAFTING             |  |

Civ. or  G.I.

Skilled men are needed in every part of the country. Earn top pay in established shops or start your own business. Greer's expert instruction and actual shop training teaches you how. You learn by doing—quick, easy courses using the latest tools and equipment. Day, evening and part time instructions available.

Job placement aid and convenient living accommodations are yours while training. Contact GREER'S FREE JOB PLACEMENT SERVICE when you enroll if you wish part time or full time employment assistance.

### TECHNICIAN COURSES

- |   |
|---|
| <input type="checkbox"/> DIESEL AUTOMOTIVE TECHNICIAN—21 MONTHS         |
| <input type="checkbox"/> REFRIGERATION & AIR COND. TECHNICIAN—17 MONTHS |
| <input type="checkbox"/> WELDING TECHNICIAN—14 MONTHS                   |

Please rush me free literature on the trade indicated at no obligation.

NAME \_\_\_\_\_ AGE \_\_\_\_\_

STREET \_\_\_\_\_

TOWN \_\_\_\_\_ ZONE \_\_\_\_\_ STATE \_\_\_\_\_

Established 1902

# GREER SHOP TRAINING

Box A, 2236 S. Michigan Ave. Chicago 16, Ill.

## MANUFACTURE THIS BEAUTIFUL CONCRETE OUTDOOR FIREPLACE

Right In Your  
Own Backyard

**\$4.00 Worth of  
Sand & Cement  
produces this  
Attractive  
Fireplace.**

**Sells on Sight  
from \$60. to \$80.  
Easy to start your  
own Profitable  
Business.**

The General Fireplace Molds and Process are the most amazing and foolproof ever invented. Simple to operate. Two men can produce five fireplaces a day.

### BIG DEMAND!!

Sell all you produce to Department Stores, Homeowners, Parks, Nurseries and Picnic Groves. Fireplaces sell on sight. No experience necessary. We supply full operating instructions and equipment plus the know-how that spells BIG PROFITS. This is an outstanding opportunity for men of vision and small capital to get into a busy rich paying field. Don't delay, be the only exclusive manufacturer in your own home town. Mail coupon at once for full details as to how you can reserve your territory. Molds sold only on exclusive franchise.

**GENERAL ENGINES CO., Inc., Dept. MF-12  
ROUTE 130, THOROFARE, N. J.**

Mr. Tor of Philadelphia writes:  
Sold 250 in first 4 months. Selling to Sears Roebuck, John Wanamaker, and Gimbel Bros. in Philadelphia area.

Name \_\_\_\_\_  
Address \_\_\_\_\_  
City \_\_\_\_\_ Zone \_\_\_\_\_  
State \_\_\_\_\_

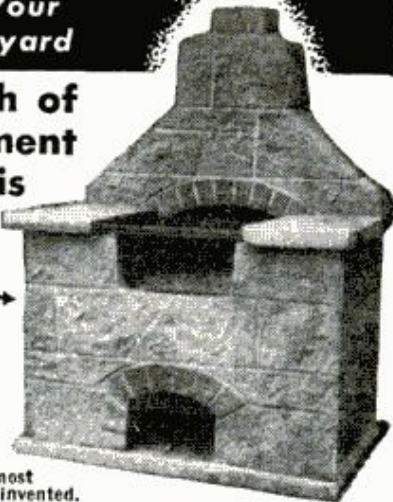

## \$40 for 1 1/2 DAY'S SPARE TIME WORK GRINDING LAWNMOWERS

Yes, J. H. B. writes, "not bad for a 76 year old young fellow earning \$40 for a day and a half's work" . . . and others are making even bigger money with the Universal Model B Lawnmower Grinder. You too, can make good spare or full time profits in your own business in your garage or basement. We furnish everything you need. Write today. No cost or obligation. Dept. M-12.



**ROGERS  
MANUFACTURING CO.  
LINDSEY, OHIO**

**ACT  
TODAY  
ON  
THIS!**



Alert yourself to best franchise offers! Join over 100,000 ambitious men who earn high incomes as franchise holders. Today's choice opportunities are published in the monthly NFR Report, the pioneer and leader in franchise news coverage. Take your first step toward owning a franchised business by writing today for free "Franchise Profit Letter."

**NATIONAL FRANCHISE REPORTS**

333 N. Michigan, Chicago 1

Dept. OP-528



### NEW SLEEPING COMFORT

Sells Electro-Warmth for you with generous profit. Averaging 9 buyers out of 10 triers on Guarantee Sales Plan. Much needed appliance used year around. Completely automatic and patented. Unusual opportunity to get in on the ground floor in your area. Write factory NOW for free information.

PATENTED PRODUCTS CORP., Dept. PM-11, Danville, Ohio

**After the city,  
Before the state  
The ZONE keeps your mail  
From being late**



The Post Office has divided 106 cities into postal delivery zones to speed mail delivery. Be sure to include zone number when writing to these cities; be sure to include *your* zone number in *your* return address — after the city, before the state.

# FREE

## FLORIDA BOOK!

Yes! This amazing new fact-filled digest is yours **FREE!** Discover the true inside story of Florida's fantastic growth and exciting opportunities for vacation . . . retirement . . . investment or year round living! Offer limited—so **ACT NOW!**

**MAIL THIS COUPON TODAY!**

TO: "Florida Book", 557 N.E. 81st St.,  
Dept. PZW-32, Miami, Florida

Name \_\_\_\_\_ (PLEASE PRINT)

Address \_\_\_\_\_

City \_\_\_\_\_ Zone \_\_\_\_\_ State \_\_\_\_\_



AD 58022 (Z-12) CC 381

Send for your free **WHERE-TO-FIND-IT** list giving sources of supply or further information on articles in this issue.

## BRONZE FOUNDRY



Since 1935  
Schools • Home Workshops • Inventors  
Make your own castings of aluminum, copper, bronze, silver. Foundry sets are available in six sizes, capacity 1 1/2 lb. to 48 lb. of red brass. 2400 Deg. F. blast furnace included with each. Write for Free Circular.

**KANSAS CITY SPECIALTIES CO.** DEPT. P-1  
MARYSVILLE, KAN.



WE'LL SEND YOU  
A MONEY-MAKING  
"SHOE STORE BUSINESS"  
**FREE**

Rush postcard today for  
free sales outfit



Run your own profitable shoe store at home. Sell to friends, neighbors, folks where you work. Earn \$217.00 EXTRA monthly on just 2 easy orders a day. You feature 230 styles of quality shoes for men and women. Famous Air Cushion Mason Shoes that sell themselves. Sizes 2 1/2-15. Widths AAAA to EEEE. Many comfort features—stock of over 250,000 pair to draw from. Also horsehide jackets. Represent fast-growing million dollar shoe firm in spare or part time and big profits are yours. Everybody is a customer. You don't need to invest a cent in this wonderful sales opportunity. We'll rush you **FREE** a complete starting outfit that contains everything you need to begin making money. Just send us a postcard today!

**MASON SHOE, Dept. H-235, Chippewa Falls, Wisc.**

## DOLLS!

Learn to make, repair, dress, and sell dolls. Study at home. Excellent money making opportunities. **FREE BOOKLET.** No obligation!  
**NORM & SUE MORRIS'**  
DOLL HOSPITAL SCHOOL Studio M-12  
11826 San Vicente Blvd., Los Angeles 49, Calif.



**EARN BIG MONEY...  
LEARN AT HOME IN SPARE TIME**

You don't need previous training or art ability with the "Famous System of Manual Training!"\* With this modern streamlined method, you learn rapidly and easily...start to cartoon immediately, without tedious study or exercises.

**Wide Demand for Cartoonists—Earn While You Learn...** Magazines, newspapers, movies, television, ad agencies—all are searching for new cartoon ideas and talent. As a successful, Continental-trained Cartoonist, your earnings are not limited.

Many of our students start earning after first few lessons. A wonderful pastime, too.

**We Supply Everything...** As our student, you receive **FREE** of extra cost a big 15-piece Professional Kit containing all equipment and materials you need, and valuable Articulated Model that helps you draw any human pose.

**Get All the Facts FREE...** Big, colorful Free catalog gives all details plus pages of useful information. **FREE** for the asking. Use coupon.

\*U.S. Pat. Applied For



**Continental Schools, Inc.**  
4201 S. BROADWAY, LOS ANGELES 37, CALIF.

Continental Schools, Inc.  
Dept. E-106, 4201 S. Broadway, Los Angeles 37, Calif.  
Please rush me your Free Catalog and other information by return mail. No charge or obligation, no salesman will call.

NAME \_\_\_\_\_  
ADDRESS \_\_\_\_\_  
CITY \_\_\_\_\_ ZONE \_\_\_\_\_ STATE \_\_\_\_\_

# FREE PLAN

tells how to start your own business

# FILING SAWS

Here is a steady repeat CASH business you can start in your own basement or garage in your spare time and make up to \$3 or \$6 an hour. You can file hand, band and both combination and cross-cut circular saws on the Foley Saw Filer. No eyestrain—no experience needed. "The first saw I sharpened with my Foley Filer came out 100%"—writes Clarence E. Parsons.

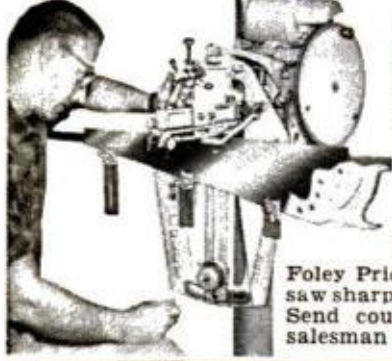

Every saw you sharpen with the Foley Saw Filer brings you more customers. "I rented a two-car garage and have all the work I can do"—Charles H. Smith.

## FREE BOOK

Shows How to Start

Foley Price Guide gives saw sharpening charges. Send coupon today. No salesman will call.

### Send Coupon for FREE BOOK

**FOLEY MFG. CO.**  
143-2 Foley Bldg., Minneapolis 18, Minnesota.

Send FREE BOOK—"Money Making Facts," and Time Payment Plan.

Name \_\_\_\_\_

Address \_\_\_\_\_



## Men! Send for This Handsome SAMPLE CASE—FREE



**I'll Show You How to Make Up to \$40.00 in a Day**

Mail coupon for FREE Tailoring Sample Case packed with scores of beautiful, big-value suit and sport coat fabrics. Take orders from friends, fellow-workers, others, for fine quality, made-to-measure clothes. Pocket big cash profits in advance. Because wearing our suits and sport coats brings more orders, we make it easy for you to get your own clothes without 1c cost. No experience needed. Satisfaction Guaranteed. SEND NO MONEY. Just fill out and mail coupon now!

**W. Z. GIBSON, INC., Dept. H-516**  
500 S. Throop Street Chicago 7, Illinois

**W. Z. GIBSON, INC., Dept. H-516**  
500 S. Throop St., Chicago 7, Ill.

Dear Sir: I WANT A MADE-TO-MEASURE SUIT TO WEAR AND SHOW, without paying 1c for it. Rush details and Sample Kit of actual fabrics ABSOLUTELY FREE.

NAME \_\_\_\_\_ AGE \_\_\_\_\_

ADDRESS \_\_\_\_\_

CITY \_\_\_\_\_ STATE \_\_\_\_\_

# GOV'T SURPLUS

at 2 or 3¢ on the \$1.00

Jeeps \$278., Airplanes \$159., Rubber Boats \$7.86, Trucks \$212., Tractors \$68., Fork Lifts \$187., Typewriters \$7.12, Hyd. Cyl. \$1.09. THESE ARE TYPICAL GOVERNMENT SURPLUS SALE PRICES. Buy 10,001 similar items wholesale direct. FULL DETAILS, 627 locations and procedure only \$1.00. SEND FOR YOURS TODAY!

**SURPLUS INC., Dept. PM-1, Box 789, York, Penna. ©1962 A.S.C.**

# ENGINEERING

Higher income... advancement. Major corporations visit us regularly to interview and employ seniors. **B.S. DEGREE IN 27 MONTHS** in Engineering. **IN 36 MONTHS** in Business Administration. Small classes. *Low costs.* Enter quarterly. Write **J. E. McCarthy** for *Catalog and Career Book.*

## TRI-STATE COLLEGE

412A College Avenue • Angola, Indiana

and evening  
Awards Co  
v.  
ER  
rk as  
bern  
ll  
mer  
Appar  
-12  
TOR  
nite  
Clark

**MEN AND WOMEN WANTED**

WE'LL FINANCE THE RIGHT PARTY in your area in spare time business keeping retail stores supplied. No selling. Just \$24 down starts you in the fast-growing rack jobbing business making up to \$20 an hour. For information FREE—no obligation—write **NOVO**, 3855 Lincoln Ave., Dept. N-18 Chicago 13

knowledge  
review on J  
Avenue  
references  
ER-Ma  
Step job  
pers. Ma  
Disney  
DENT  
A setup m  
DESIG  
Must have

KENSTONE CHEVROLET

**FREE CATALOG**

**MAKE YOUR OWN RODS AND LURES**

Send for FREE Wholesale Catalog. The most complete and fully illustrated catalog of reels, rods, beads, spinners, jigs, lure bodies and parts, sinker molds, feathers, tools, hooks, rod blanks, rod parts, swivels, wire, etc. Over 170 pages.

**FINNYSPORTS**  
2062X SPORTS BUILDING TOLEDO 14, OHIO

Ever wanted a super versatile router guide? One that's easy to set up, works anywhere on a 48-inch panel, makes repeat cuts with machine tool accuracy and can be changed quickly from cut to cut? You'll find plans for it in the February Popular Mechanics.

## Secrets of VENTRILOQUISM

Now Revealed!

Easy to learn in 60 to 90 days with our Home Study Course. **RESULTS GUARANTEED** Make Money! Be Popular! Have Fun! Big Opportunity! Radio, Television, Stage Appearances! For FREE information regarding price and terms WRITE. You must state your age. Dummy Catalog 25c.

**MAHER HOME COURSE OF VENTRILOQUISM**  
Box 36, Studio PM-1, Kensington Station Detroit 24, Michigan

Wooded, High-ground

**HOMESITE (70 x 150)**  
on CAROLINA Coast!

**\$500 DOWN \$500 A MONTH**

14,000 acres—50 freshwater lakes  
... 40 miles of finished roads  
fishing, hunting, golf.

**FREE LITERATURE!**

**BOILING SPRING LAKES, Southport 15, N. Car.**

## Learn BAKING At Home

Baking is one of America's high industries in wages. Nearly depression-proof. Thorough basic home course lays sound foundation. If you have aptitude, write for **FREE BOOKLET**, "Opportunities in Commercial Baking."

**National Baking School, 835 Diversay Pkwy., Dept. 1351, Chicago 14, Illinois**



**EARN UP TO  
\$1,000 A MONTH**  
Car Furnished  
Pick Your Locality  
**NO SELLING  
of Any Kind**

# Compare this Interesting Job to the One You Have Now — then if you'd like to switch—I'll show you how to do it!

I'd like to show you how easy it is to get into one of the best paying professions in America today—the business of investigating auto accidents and adjusting accident claims. Here is why employers are glad to pay top salaries to men in this particular field.

## 25 Million New Claims to Settle This Year!

Every day, throughout the year, 69,000 auto accident claims have to be settled. And there just aren't enough claim investigator-adjusters to handle them. These investigations cannot be put off. The courts demand action! Insurance companies cannot afford to let claims drag on—and mount up! They must be settled, because huge reserves of company money are tied up by law when auto accident claims remain unsettled.

### And That is Where YOU Come In!

Insurance companies everywhere are looking for people who know how to handle this specialized work—and they are prepared to pay a top salary to any man who can fill the bill. In addition, they offer every opportunity for rapid advancement to executive positions and the high bracket incomes that go with them. And because experienced help is so scarce—they offer many fringe benefits



and also other valuable extras practically unheard of in many other kinds of businesses.

### But Money Isn't ALL You Get!

And remember that a Claim Investigator's Life is crammed with exciting new experiences. No two cases are alike. You rub shoulders with lawyers and police officers, doctors and judges. You render an important service to your community. And later on, if you want to set up your own claim adjusting business, we show you how you can begin right in your own home.

### Free Employment Help Given

Even if you have only an average education, you can go far in this new profession. All we ask is the ambition to get ahead! And when you have successfully completed the course, we provide a FREE employment service to get you off to a flying start.

### Just Mail the Coupon Today

I have prepared a Special Booklet in which I explain carefully to you my "20 Steps to Success" as an Automobile Insurance Claim Adjuster. It tells just what to do to get into this fascinating, fast-growing profession. There is no charge for this Booklet—now or any other time. Here's your big chance to eventually make as much as \$12,000 to \$15,000 a year! Mail the coupon below or send a postcard with your name and address to Eric P. McNair, President, Liberty School of Claim Investigating, Dept. 91, Libertyville, Illinois.



### JUST MAIL THE COUPON TODAY

Mr. Eric P. McNair, President Dept. 91  
Liberty School of Claim Investigating  
Libertyville, Illinois

Please rush me your FREE Booklet explaining how I can quickly qualify as an Automobile Insurance Claim Investigator and Adjuster. It is understood that no salesman will call on me, and that everything you send me now is absolutely FREE, and places me under no obligation whatsoever.

My Age is \_\_\_\_\_

My Name \_\_\_\_\_  
(Please Print)

Address \_\_\_\_\_

City \_\_\_\_\_ Zone \_\_\_\_\_ State \_\_\_\_\_  
or R.D. \_\_\_\_\_

**\$6.00 OR 2 FOR \$11.00!**  
With 40 ft of wire. Additional wire 3c ft. **TESTED AND GUARANTEED.** Write for free list of all types of telephones. Shipments FOB Simpson, Pa.  
TELEPHONE ENGINEERING CO., Dept. 1B2, Simpson, Penna.

## High School Course at Home

Many Finish in 2 Years

Go as rapidly as your time and abilities permit. Course equivalent to resident school work—prepares for college entrance exams. Standard H. S. texts supplied. Diploma. Credit for H. S. subjects already completed. Single subjects if desired. High school education is very important for advancement in business and industry and socially. Don't be handicapped all your life. Be a High School graduate. Start your training now. Free Bulletin on request. No obligation.  
American School, Dept. H145, Drexel at 58th, Chicago 37

**SAMURAI SUICIDE WARRIORS**  
**JUDO KARATE!**  
BOXING! MUSCLEBUILDING! YOGA!  
STRONGMAN STUNTS! STRENGTH & ENDURANCE! HANDBALANCING! ETC.

YOU GET ALL THESE! \*20 Illustrated KA-FOR ONLY RATE blows \*SAVATE foot fighting \*Secret NERVE CENTER and ANATOMY charts \*20 lethal JUDO throws \*20 terrific STRONGMAN STUNTS \*Complete MUSCLE-BUILDING program \*Ancient YOGA secrets \*HANDBALANCING stunts \*Complete BOXING program Secrets of ENDURANCE \*211 picture packed, Super wall charts, (surplus 1960 printing). No C.O.D.'s. Canadian orders 50c.

**K-MAN KARATE PRACTICE DUMMY.**  
Life like! Shows attack points 15c with 35c order only. Total 50c

**35¢** you get the lot!  
Oxford Studio, 44P Bromfield, Boston, Mass.

# Magic Mail Plan—Make up to \$5 an Hour!



**THIS MAN**... is taking out of the machine a Plastic Sealing Job—ordered by mail—only 11c in material cost brings back \$2.58 in cash by mail. Capacity of machine: \$25.00 profit per hour of operation.

Get **ORDERS** and **CASH** from your mailman—do work in **SPARE TIME** at home—or expand into **FULL TIME** business. Send coupon for Free facts about the newest and most fascinating of all home operated businesses. For the first time a simplified machine brings the fabulous profits of **Plastic Sealing** and **Plastic Laminating** within the reach of the small operator. Anyone can learn to operate the machine with a few minutes practice—then with our **Magic Mail Plan** can get mail orders pouring in daily with cash in every envelope. **No canvassing—no selling.** We even

## Get into PLASTIC LAMINATING at home

**WE'LL EVEN HELP FINANCE YOU** supply the circulars you mail to bring back cash and orders, financing help, too. Rush name. We'll send you FREE and postpaid, prices, details, finance plan, all the facts you need. Mail coupon or send name on postcard. No charge.  
Warner Electric Co., 1512 Jarvis Av., Dept. L-2-A, Chicago 26, Ill.

### Make Thousands of Beautiful Art Creations

**COSTUME JEWELRY • CIGARETTE BOXES TRAYS • CANDLESTICKS • COASTERS LAMP BASES • BOOK ENDS...ALL IN SPARKLING COLORED PLASTIC**



**WARNER ELECTRIC CO., 1512 Jarvis Av. Dept. L-2-A, Chicago 26, Ill.**

At no cost to me, please rush full details and financing plan, postage prepaid. No obligation.

Name \_\_\_\_\_

Address \_\_\_\_\_

City \_\_\_\_\_ Zone \_\_\_\_\_ State \_\_\_\_\_

# WANTED!

**Mechanically Inclined  
Men to Qualify for  
BIG PAY JOBS  
AND SPECIAL FACTORY  
TRAINING IN DIESEL**



"We need qualified repairmen, operators, mechanics NOW!", say Diesel Manufacturers, Highway Builders, Truck Line Operators in every corner of America. Can you qualify for these High Pay Jobs? We can help you! Interstate's General Course and Cummins-approved Diesel home-training courses are internationally recognized. Advisory placement service for trainees. Don't wait. Men are needed NOW!

**Get the Facts Today!**

**WRITE INTERSTATE TRAINING SERVICE**  
Dept. A-3, Portland 12, Oregon

Rush information on I.T.S. Diesel Courses, Special Factory Training and Diesel Job Opportunities.

Name \_\_\_\_\_ Age \_\_\_\_\_  
Address \_\_\_\_\_  
City \_\_\_\_\_ Zone \_\_\_\_\_ State \_\_\_\_\_

Get the Big Dividend!  
Save by Mail! Earn More!  
**FREE GIFTS!**

**4%**  
Current Rate  
Per Annum

Money in by the 15th  
earns from the 1st

Free with  
\$3,500 Account

**POLAROID ELECTRIC-EYE CAMERA**

The new, fully-automatic J66 Model.



Free with  
\$1,000 Account

**PHILCO SLIM-LINE CLOCK RADIO**

New 1962 Model. UL approved. AC only.



Free with  
\$100 Account

**DEBUTANTE 2-in-1 HAIR DRYER**

Home hair dryer with vanity compartment.



54 Years • 1908-1962  
**CITY SAVINGS ASSOCIATION**  
1656 W. Chicago Avenue, Chicago, Ill.  
**ASSETS OVER \$22,000,000.00**

**109 STAMPS 10¢**

plus 88 FLAGS OF THE WORLD



MONACO  
2  
Queen Kelly - Baisier  
Royal Wedding  
Meadell  
London

What a bargain! You get the stamps shown here - plus Germany Sputnik Stamp, Australia Antarctic Explorers, Formosa Ancient Fortress, French India Mystic Goddess. Grand total 109 stamps - all different! You also receive 88 Flags of the World in full color. All this for 10¢ to introduce our Bargain Approvals. Midget Encyclopedia of Stamps included FREE. Satisfaction guaranteed.

Send 10¢ Today. ASK FOR LOT FO-43

ZENITH CO., 81 Willoughby St., Brooklyn 1, N. Y.

## LEARN TO BE A DENTAL MECHANIC



**SECURITY • PRESTIGE • GOOD PAY**

Learn at home, in your spare time, to make Crowns, Plates, Bridgework, etc. Dental Mechanics are employed by Dentists, Dental Laboratories or open your own shop, full or spare time. FULL EQUIPMENT OF TOOLS AND MATERIALS INCLUDED WITH COURSE. Low tuition. Easy Terms. Write for FREE BOOK about this money-making profession that's not affected by automation.

McCARRIE SCHOOL OF MECHANICAL DENTISTRY  
207 No. Broad St., Dept. PM-1, Philadelphia 7, Pa.



make your own **Gems** 36<sup>50</sup> FOR

The Gem Maker comes complete with all necessary equipment, including a super-charged diamond blade for sawing, and all the wheels for grinding, shaping and polishing; also complete instructions. The complete equipment as shown, less motor and belt for only \$36.50, f.o.b. Burlington, Wisconsin. Write today for information and literature.

B&I MANUFACTURING CO.  
Dept. P, Burlington, Wis.



## LEARN WHILE YOU SLEEP!

Use your phono, recorder. Astonishing details, sensational 300 items catalog FREE! Also info on prayer-plant experiments, self-hypnosis. Sleep-Learning Research Ass'n, P. O. Box 24-D, Olympia, Wash.

## REAL ESTATE BE A BROKER

PAYS BIG! SEND FOR FREE, BIG, ILLUSTRATED CATALOG NOW! Graduates report making substantial incomes. Start and run your own business quickly. Men, women of all ages, learn easily. Course covers sales, Property Management, Appraising, Loans, Mortgages, and related subjects. STUDY AT HOME or in classrooms in leading cities. Diploma awarded. Write TODAY for free booklet! No obligation.

Approved for World War II and Korean Veterans  
**WEAVER SCHOOL OF REAL ESTATE (Est. 1936)**  
2020R Grand Avenue Kansas City, Mo.

FREE BOOK TELLS HOW

## RUPTURED

### BE FREE FROM TRUSS SLAVERY

Surely you want to THROW AWAY TRUSSES FOREVER, be rid of Rupture Worries. Then Why Do you put up with wearing a griping, chafing and unsanitary truss the balance of your life? If you do, it will NOT be through necessity but through choice on your part.

Now there is a new modern Non-Surgical treatment that is designed to permanently correct rupture. These Non-Surgical treatments are so certain, that a Lifetime Certificate of Assurance is given. Write today for our New FREE Book that gives facts that may save you painful, expensive surgery. Tells how non-surgically you may again work, live, play, love and enjoy life in the manner you desire. There is no obligation. Excelsior Medical Clinic, Dept. H6124, Excelsior Springs, Mo.

POPULAR MECHANICS

**STEP UP to BENJAMIN'S TRADITIONAL EXCELLENCE!**  
**DISCOVER the BIG DIFFERENCE that EXPERT CRAFTSMANSHIP can Make in Your SHOOTING PERFORMANCE and FUN!**

25 MODELS - SINGLE SHOT and REPEATERS - FIRST CHOICE of SHOOTERS who want SAFETY - CONVENIENCE - ECONOMY including HIGHEST QUALITY MATERIALS to Assure Them OUTSTANDING POWER - ACCURACY - DEPENDABILITY!

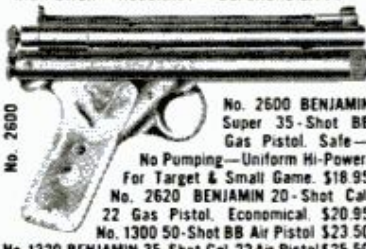

**FREE** Catalog All Models Benjamin Single Shot & Repeaters—Cal. BB or 177 or 22. Also, Special Hunting & Fishing Knife Offer.  
**BENJAMIN AIR RIFLE CO., 896 MARION ST., ST. LOUIS 4, MO.**  
**You Can DEPEND on... BENJAMIN**

**World Famous AIR GUNS and CO<sub>2</sub> GUNS**

No. 3600 BENJAMIN Super 100 Shot BB Gas Rifle. Non-Toxic - Safe - Convenient—Uniform Hi-Velocity Power. →  
 No. 3620 BENJAMIN Super 85 Shot Cal. 22 Gas Rifle . . . \$21.95  
 No. 3100 Super 100 Shot BB Air Rifle. Adj. Shooting Force \$24.95  
 No. 3120 BENJAMIN Super 85 Shot Cal. 22 Air Rifle. . . . \$26.95



**SEW LEATHER AND TOUGH MATERIALS EASILY COMPLETE, EASY-TO-USE, HEAVY DUTY STITCHER KIT IN ONE COMPACT TOOL**

**\$1.98**  
Postpaid

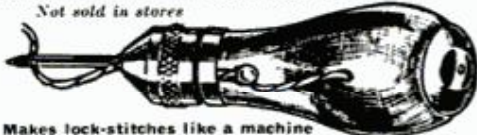

Makes lock-stitches like a machine  
**SAVE MONEY with HEAVY-DUTY STITCHER.** It's easy to sew or repair anything made of Leather, Canvas, Nylon, Plastic, or other heavy materials. Quick "push-pull" action makes firm, even lock-stitches like a machine. Gets into hard-to-get-at places. Just the tool needed for repairing Luggage, Footwear, Convertible Tops, Awnings, Seat Covers, Sportsgear, Rugs, Saddlery, etc. Comes complete with 3 different needles (fine, heavy, curved) and bobbin of strong waxed thread (10 yds) all self-contained in HEAVY-DUTY STITCHER. Easy-to-follow directions included. Extra needles and thread always available. Send \$1.98 money order or check, and we pay postage. If C.O.D. \$1.98 plus postal charges. Money back Guarantee.  
 Sportsman's Post, 366 Madison Ave., Dept. A-84, New York 17

**100 POUND SET \$12.80**  
 Extra Plates Only 12c Pound

**BARBELLS**  
 140-Pound, CHROME DELUXE Barbell-Dumbbell set only \$22.80. This is our feature set and is the finest ever manufactured.  
 Training with adjustable weight is the BEST way to keep fit; the ONLY way to develop great strength and a perfect body. As the oldest and best equipped barbell company, BUR gives value and prices no one can equal.  
**SEND FOR FREE CATALOG**  
**BUR BARBELL CO.**  
 Lyndhurst 9, New Jersey

**OIL LEASES**  
 Many now enjoy "Second Incomes" from Oil Leases up to \$100.00 per day plus Big Bonus payments. Let me tell you how you can be an Oil Lease owner that may mean financial security to you.  
**Chas. W. Crader, P.O. Box 867-PM**  
**Fort Worth 1, Texas**

**Choose an AIRLINE CAREER**  
**ADVENTURE! PRESTIGE! PROMOTION!**  
 You can train for opportunity with the airlines. Four-week course for men 18-35, H.S. graduates. Free placement service with 35 airlines. Station Agent—Operations Agent, Ticket Agent, Reservationist.  
**WRITE TODAY FOR FREE INFORMATION**  
**McCONNELL AIRLINE SCHOOL**  
 1030 Nicollet Ave., Room P-12, Minneapolis, Minn.  
 Name.....Age.....  
 Address.....State.....

**START YOUR OWN BUSINESS!**  
**ELECTRICAL APPLIANCE REPAIRING**

**OVER 100,000,000 PROSPECTS**  
 Millions of electrical appliances used daily . . . in factories, homes, office buildings, on farms. All eventually need adjustment and repairs.



**EARN \$5.00 to \$6.00 PER HOUR WHILE LEARNING**  
 It is not unusual for appliance men to charge on that basis. We teach you how to secure business, make repairs, what to charge, how to buy spare parts wholesale, etc.

**EARN WHILE YOU LEARN ELECTRONIC KIT FURNISHED You!**

**EASY TO LEARN**  
 If you are mechanically inclined you will enjoy CHRISTY Training Manuals written in simple, easy to follow instructions, fully illustrated and CHRISTY Testing Equipment which helps you quickly locate troubles.

**CHRISTY FINANCES YOU!**  
 CTS Shop Method Home Training Program can be had on a Pay as you Learn Plan. Send today for FREE book and special form.



**CHRISTY TRADES SCHOOL**  
 Dept. A-1903,  
 3214 W. Lawrence Ave., Chicago 25

**Send FOR FREE BOOK**

CHRISTY TRADES SCHOOL, Dept. A-1903  
 3214 W. Lawrence Ave., Chicago 25.  
 Send me your FREE book on Electrical Appliance Repairing and instructions for paying later from EARNINGS WHILE LEARNING.

Name..... Age.....  
 Address.....  
 City..... Zone..... State.....



**Earn HIGH WAGES as a HEAVY EQUIPMENT OPERATOR**

... and years of future security in the multi-billion dollar construction industry, in this country and overseas! Actual field training at National, the original school of heavy equipment operation, teaches you how. For men ages 17 to 56. Amount of previous education no barrier. No correspondence courses, no series of required home-study lessons in advance of training. Train on school-owned diesel-engined machines at National's huge proving ground in North Carolina, VA approved. Budget terms available.

Write TODAY for FREE catalog. No obligation. Special information is included for men in the Services and for those subject to call.

**NATIONAL SCHOOL OF HEAVY EQUIPMENT OPERATION, Dept. D-24**  
P. O. Drawer 1686, Charlotte, N. C.

Please send me **FREE** illustrated school catalog and complete information.

Name ..... Age.....

Address .....

City ..... Zone..... State.....

**Make TELEPHONE SURVEYS at Home**



**FULL OR SPARE TIME**  
New home business. Men, women—no experience needed. No selling! Choose your own hours. We show you everything—tell you who to call, what to say, how to make money without ever leaving your telephone.

**FREE COPY**, "How to Make Big Profits by Phone." Write today for full details to—  
**TELEPHONE INSTITUTE**  
1038 S. LaBrea, Dept. H171, Los Angeles 19

Write Now!

**ENGINEERING SCIENCE MATH DEGREE IN 27 or 36 MOS.**



**B.S. degree — 36 mos. • B.E. degree — 27 mos.**

ACCELERATED YEAR-ROUND PROGRAM prepares for early employment in fields of SCIENCE AND ENGINEERING. Regular 4-year program for B.S. Degree completed in 36 months, special engineering degree program in 27. Classes start—January, March, June, July, Sept. QUALITY EDUCATION. Graduates employed from coast to coast. Government approved for veteran training. Students from 50 states, 40 countries. 20 buildings; dorms, gym, campus. SAVE TIME AND MONEY. EARN BOARD while studying. Write for catalog and complete information.

**INDIANA TECHNICAL COLLEGE**

512 E. Washington Boulevard, Fort Wayne 2, Indiana  
Please send me free information on Bachelor's Degree Programs in Engineering and Science as checked below:

- Aeronautical Engineering
- Chemical Engineering
- Civil Engineering
- Electrical Engineering
- Electronic Engineering
- Mechanical Engineering
- Metallurgical Engineering
- Physics
- Chemistry
- Mathematics

Name.....

Address.....

# Pentagon sidelights

**By William R. Kreh**

**Keep noisy fish quiet? Simple. Just feed them.** For that suggestion, a civilian employee of the Navy's underwater-sound laboratory recently received a cash award.

It seems the fish were quite a problem to the lab. Their grunts, groans, whistles and gnashings seriously interfered with tests on underwater sound gear. Engineers tried everything they could think of to keep the fish away from their instruments—such things as repellent chemicals, electric shockers and ultra-high-frequency emitters. Nothing worked.

But a civilian who likes to fish during his lunch hour licked the problem. He punched a few holes in a can of cat food and suspended it in the lake away from the testing pier. The fish were attracted to it and away from the sensitive sound apparatus.

And the ingenious fisherman cashed in twice on his idea. Besides the money, he boosted his catch each day by tossing his line near the cat food.

Speaking of fishing, the Army's going to try it with rockets at its Redstone Missile Arsenal in Alabama. It's part of some tests by the U.S. Fish and Wild Life Service to see if rockets can't be used to shoot large nets over schools of feeding tuna. Under the plan, a gill net 240 feet wide and 350 feet long would be used. The net is folded on the deck of a fishing boat. Rockets whip it into the air and spread it out over a school of tuna up to 500 feet away from the boat. If the rockets work all right on the lake at Redstone Arsenal, further tests will be made in the Gulf of Mexico.

Foam-rubber "falsies" sold so fast at a West Coast department store that it had the sales department baffled. Further investigation showed that pilots at a nearby Air Force base had discovered that falsies worn inside their helmets made perfect ear-warmers at 30,000 feet.

The Army's not talking about it, but there are reports it's experimenting with a plastic auto that has parts so cheap that even a failing engine would be thrown away rather than repaired. The whole car, it's reported, would cost only about \$1300.

(Continued to page 56)

## BE A BUILDING BEAUTIFIER

C-13



### A LOW-INVESTMENT, HIGH-INCOME OPPORTUNITY

Turning dirty drabness into clean, gleaming newness is the purpose of Colorcrete. When stucco, concrete, or other masonry becomes shabby and time-worn — whether it's a home or almost any kind of commercial or public building — there's a job awaiting the local Colorcretor. In the briefest of time, old surfaces are transformed into walls of colorful beauty that outlasts the years — at small cost to the owner and good profit to the Colorcretor. Write for the Colorcrete Opportunity Book.



**COLORCRETE INDUSTRIES, INC.**  
570 Ottawa Avenue, Holland, Mich.

## Build This CAMPER

Save Time and Money with our Plans, Material List and Instructions — **\$15**

Dealers Wanted

Write for: Price List on Factory Built Units.



**Vi-King Camper Co.** 14123 Holly Rd., Hopkins, Minn.



"The best way to improve the flavor of fish is to catch 'em yourself."

## RUPTURE!

An amazing Air-Cushion Invention allows body freedom at work or play. Light, neat, cool, sanitary. Durable, cheap. Day and night protection helps Nature support weakened muscles gently but surely. No risk. Sent on Trial! Write NOW for free Booklet and Proof of Results. All correspondence confidential.

Brooks Company, 143-E State St., Marshall, Mich.



## NEW BENSEN GYRO-COPTER



Plans and kits for one-man "Spirit of Kitty Hawk" now available. Easy to build and fly. 3-view drawings, specs, photo \$2 or simpler Copter Glider \$1. Order today!

**BENSEN AIRCRAFT CORP., Dept. PM-12**  
Raleigh-Durham Airport, Raleigh, N.C.

NAME \_\_\_\_\_  
ADDRESS \_\_\_\_\_

# Make More Money

by moving your savings to Southern California



**FREE BOOKLET...**  
"How to Make Money Moving Your Savings to Southern California."

Trans-World Savings, strategically located in the dynamic heartland of thriving Southern California, supplies the booming demand for home loans in our nation's leading construction market. Start making More Money on your insured savings by air mailing your funds to Trans-World Savings today. Receive your passbook by return air mail.

- Interest compounded quarterly
- Savings accounts insured to \$10,000 by the Federal Savings and Loan Insurance Corporation
- Funds received by the 10th of the month earn from the 1st
- Founded in 1927
- Resources over \$24 million
- Air mail postage paid both ways.

### FREE GIFT

Colorful desk-top World globe bank... open your savings account today, accounts to \$50,000 invited.



AIR MAIL FUNDS TO

# TRANS-WORLD SAVINGS

AND LOAN ASSOCIATION

521 North Euclid Avenue, Ontario 8 California

**94.6% OF BAILEY  
GRADUATES ARE EMPLOYED  
AT TOP PAY IN THE FIELDS  
WHICH THEY WERE TRAINED!**



**DIESEL-AUTO MECHANICS  
DESPERATELY NEEDED!**

We have a far greater demand for our students than we can fill!

We can show you an actual waiting list of leading companies throughout the world who have tried Bailey graduates — found them outstanding, and are coming back for more!

**Bailey Graduates are Successful . . . RECEIVE BIG PAY — HAVE SECURE FUTURE!**

**The Famous Bailey Course prepares you for BOTH Diesel and Gasoline Mechanics.**

This is a must—due to the advent of using Diesel principles, such as 'Fuel Injection' on passenger cars . . . use of gasoline engines for starting Diesel engines, etc. You learn all this at Bailey in the amount of time ordinarily required to learn just one of these subjects, **ALL FOR THE PRICE OF ONE.**

Don't be satisfied with a 'futureless', one-type job — learn how you can make **big money** now!

Write today for Free Booklet that takes you on a step-by-step camera tour through our spacious, modern shops — See Bailey students in action as they Learn-by-doing with the Famous Bailey Method of training!

We provide you with housing and part time jobs while in school, plus nation-wide placement service for graduates.

**BAILEY Technical SCHOOLS**

1634 S. GRAND ST. LOUIS 4, MO.

**MAIL TODAY!**

Please mail immediately this free booklet without obligation.

**FREE BOOKLET** →



Name.....

Address.....

City.....State.....

APPROVED FOR VETERAN...NON-VETERAN

**If you're under 25 and overweight you're more likely to get seasick.**

This was among findings of a study of soldiers riding troopships back and forth across the Atlantic. The tests also showed that those in the forward and after sections of the ship were more often seasick than those amidship; those making their first ocean crossing were more susceptible than more experienced travelers, and the most effective seasickness pills contained the drug mesclizine.



**Want a real Old-Fashioned?** Navy men in the Antarctic have found a new way to make fizz water. They drop a chip of ice from an Antarctic iceberg into a glass of water. The entrapped air makes a popping sound when it's released on melting. This air in most instances is many centuries old.

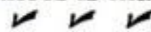

**A unique washdown system** is used on the Military Sea Transportation Service's transport ship *USNS Point Barrow*, thanks to the ingenuity of her chief engineer. He placed numerous nozzles around the ship's regular railing, hooked the railing up to water pumps, thus providing an effective spray and doing away with the need for hoses.



**An insect-repellent pill** is under development by Army researchers. Swallow the pill and your body throws off an odor that is reported to fend off pesky biting insects.



**Radio receivers as small as fountain pens** are undergoing research by the Army. They're made with tiny electronic micro-modules only one-tenth the size of present-day miniaturized circuits.



**A purely mathematical explosion** has been created by the Navy and a movie taken of it. It's all done by computer, which calculates where shock waves, splintered bits of steel container and everything else in the explosion will be at various brief time intervals after detonation. From these calculated positions, the shape of the explosion can be traced and filmed. Play back the film and you get a movie of the explosion from the inside.

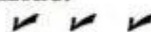

**A portable nuclear power plant** is being developed by Army engineers. It weighs a little more than 38 tons and can be carried on a standard trailer-tractor, by ship or barge, by railroad flatcar, or even—in separate parts—by cargo planes.

It can be set up anywhere troops are located, even under combat conditions at a field headquarters, and is designed to be operable within 12 hours after arrival. ★★★



# CLASSIFIED ADVERTISEMENTS



Advertisements in this section \$1.30 per word, each insertion, minimum 10 words, payable in advance.

To be inserted under proper classification, copy must be in our office the 18th of the second month preceding date of issue

Classified rate \$1.35 per word effective with the March 1962 issue

F. W. Johnson, Manager, Classified Advertising

Popular Mechanics, 200 East Ontario Street, Chicago 11, Illinois

## YOU'LL PROFIT

By reading and answering the classified ads in this section. Hundreds of opportunities for you to make and save money

### AUTOMOBILES, MIDGET CARS

OVER 300 Model cars, table top racing sets, parts, tools and exclusive items available only by mail. Send 25¢ for spectacular 72 page catalog! Auto World, Box 961PM, Scranton, Penna.

AUTOMOBILE Catalogs, photos, manuals; hobby club, monthly bulletin. Free information. Auto Enthusiasts, Box 451H, Mt. Clemens, Mich.

FOR Best deal know factory costs to dealer. Galaxie, Fairlane, Falcon, Mercury, Thunderbird, Econoline, F100, Ranchero. Complete lists with options, accessories. Two \$1. Eight \$2. Clark, Box 51, Holly Hill, Florida.

JUST Out. New build your own car air conditioner for \$37.50. Not an evaporator but real refrigerated air. Use in your car and sell them. Easy plans \$5.00. Ppd. 1957 So. St. Aubin, Sioux City, Iowa.

FORD T and A parts? Try best source old model parts, all makes. Wisneski Auto, Milwaukee 4.

### AUTO SUPPLIES AND EQUIPMENT

STOP Oil pumping, 10,000 mile guarantee \$2.95. Park, 16161 Mark Twain, Detroit 35, Mich.

TRANSISTORIZED Electric ignition systems. The greatest improvement since the original Kettering 1910 ignition invention. Can be used on 6 and 12 volt automobiles, trucks, race cars, boats with negative ground. Complete conversion kit \$44.95. Specify car and voltage. Brochure available. Bill Slep Company, Drawer 178PM, Ellenton, Florida.

ELECTRONIC Ignition analyzer checks plugs, coil, points, condenser, timing, while in motor \$4.95. Guaranteed. COD's. Details free. Teletronix, Box 646, Sandwich, Mass.

NEW And used parts at savings. Complete guaranteed parts service for all models cars and trucks. Largest in the West. Jeep and army parts specialists. Newest type shifting hubs for all jeep and all military and latest production front end drive vehicles. \$27.50 and up. Also, foreign car parts. Write. Pioneer Auto and Truck Parts Co., 734 W. 13th Avenue, Denver 17, Colo.

PARTS, Model "A." List 25¢. (Refundable) Matco, Box 135, San Pedro, Calif.

JEOP Parts! For military and civilian. At great savings. Largest inventory. Catalog for owners and dealers. Inquiries invited. American Auto Parts Co., 1830-PM Locust, Kansas City, Mo.

1909-1934 FORD Parts illustrated catalogs 75¢. Mark Auto, Layton, N. J.

KEYHOLE Antifreeze \$1.00. P.O. Box 4840, Chicago 80, Ill.

AUTO Shop welding repair training in world's largest non-profit welding school. Low tuition. Free booklet. Hobart Welders, Box M-121, Troy, Ohio.

JUST Out! New 356-page, illustrated catalog offering savings up to 50% on over 100,000 auto parts and accessories, everything to renew, rebuild, renovate '28-'31 Model "A" Fords. All makes (1920 to 1962 models), trucks, foreign and sports cars. Hollywood accessories, custom styling, hi-speed equipment. Send 25¢ for postage, packing—refundable on first order. Whitney, 1919 PM-1 Archer, Chicago 16, Ill.

BUY Wholesale, automobile accessories—merchandise. Catalog 25¢. Matthews (5-A7), New York City 36.

CRANKSHAFT Grinder. Hand operated. Makes bearings fit without taking engine apart. \$4.00. Literature. L. D. McGee, 719 Cascade St., Wenatchee, Wash.

AUTOMATIC Transmissions our factory rebuild exchange. Any car \$89.50. Guaranteed. Transparco, 5525 Chicago, Chicago 51, Ill.

JEOP Owners—V8 conversions. Read Jeep Owners ad, page 26.

RING-Valve job while driving, \$6.00 postpaid. Guaranteed! Nothing like it! Lasts 100,000 miles! Motaloy, Grantham, Penna.

DELUXE Chrome Hubcaps for 1935-42 GM cars. State year, make. \$6.75/set, postpaid. Vintage, 8501 Roosevelt, Seattle, Washington.

### AUTO TRAILERS

BUILD Expanding eight foot trailer. Accommodates five. Literature 10¢. Framar Company, Wilmington, Mass.

### MOTORCYCLES, BICYCLES, MOTORSCOOTERS AND SUPPLIES

GO Cart \$10. Midget car \$20. motorscoot \$30. minibike \$60. Whizzer engine \$4. (Mailorder only). Send 25¢. (35¢ for first class mailing) for 32-page directory-catalogue Number 105, listing these and hundreds of other bargains in midget cars, go carts, engines, homebuilders parts, plans, etc. Midget Motors Directory, Athens, Ohio.

NEW Bike motor kit attachments, automatic front wheel drive. Now! \$49.95. Go-Byk Industries, Fergus Falls, Minn.

RECONDITIONED Motorcycle motors. Chrome accessories. Complete stock Indian parts. Expert rebuilding. Fast service. Indian Motorcycle Sales, Kansas City 27 Missouri.

MOTORCYCLE Parts. New, used. List 25¢. Ballak, 811 N. 9th, St. Louis 1, Mo.

HARLEY-Davidsons — Used bargains. New, used parts, accessories, all models. Bulletin 25¢. Knuth's (Factory Dealer), 1753 Muskego, Milwaukee, Wis.

### AVIATION

PROPELLERS, Plans, supplies for airboats, snowplanes. 125 h.p. Lycoming engines \$135.00. Prompt delivery. Catalog 25¢. Banks-Maxwell Propeller Co., Box 3301E, Ft. Worth 5, Texas.

AIRLINE Careers. Adventure! Prestige! Promotion! Four-week course. Free placement service with 35 airlines. G. I. approved. Free catalog B. McConnell Airline School, 1030 Nicollet, Minneapolis, Minnesota.

BE A government licensed aviation mechanic. Write for free booklet. Aero Mechanics School, Municipal Airport, Kansas City, Missouri.

SMALL Helicopters Theory and Guide Manual. Drawings. Construction data. \$2.00. Greater Plains Industries, Box 482A, O'Neill, Nebraska.

HOMEBUILT Helicopter handbook \$1.00. Directory \$1.00. Urshanair, Box 197, Santee, California.

AUTOGYRO Blades. Solid aircraft spruce. Terrific! \$29.50 pair. Vancraft, 7246 North Mohawk, Portland 3, Oregon.

### BATTERIES, GENERATORS

START Your own battery business. Manufacture, rebuild, repair. Easy with large 121-page manual. No job worries. Batteries, P.O. Box 341, New Castle, Penna.

BATTERY Bluebook. Send \$1. Little Pal, DI105—5th, McKeesport, Penna.

PROFIT! Repair batteries! Complete manual \$3.00. Hydraulic jack repair manual \$3.00. Chrysler Corp. Alternator Guide \$3.00. C.O.D. accepted. Bayer Publications, P938 Betty Avenue, Neenah, Wis.

### ELECTRICAL SUPPLIES

LAMPS. 25¢ Brings parts catalog. Refunded first order. Gyro, 5208P N.W. 35th Ave., Miami 42, Florida.

ELECTRO-SCRIBE! Engraves all metals. \$2.00. Beyer Mfg., 10511-H Springfield, Chicago 55.

GARAGE Door operator kits—Edwards KR-50 kit. Available with or without remote car control. Priced from \$59.95. Edward T. Fink Co., Inc., 284 Nepperhan Ave., Yonkers, N. Y., Dept. PM.

APPLIANCE, Lamp, vacuum parts wholesale. 1962 catalogue 25¢. Seco, 112 South 20th Street, Birmingham 3, Alabama.

**ELECTRIC** Motor winder's handbook. Pocket-sized. Over 200 most needed diagrams, tables, formulas. Single and three phase motors. \$1.50. Western, Box 1902, Phoenix 1, Arizona.

**LAMP.** Electrical parts, wholesale. Thousands of items for repairing, converting. Catalog 35¢. Brown Lamp, Box 305, Clayton 5, Missouri.

### WELDING, SOLDERING, PLATING

**WELD.** Solder, cut, braze.  $\frac{1}{8}$ " welder complete \$9.95. Flame-torch \$3.95. Postage 50¢. 75 ampere  $\frac{1}{2}$ " transformer welder \$29.95 complete. F.O.B. Essay Mfg. Co., Dept. C, Quincy 69, Mass.

**WELDERS.** 110/220, \$39.50. Morris, 1070 Inner Drive, Schenectady 3, New York

**ACETYLENE** Outfits \$59.50; arcwelders \$69.50. Eagle Welding, Dept. PM, 5085 Broadway, Chicago 40, Ill.

**FREE** Welder catalog. Kits, build 350-ampere welder using aircraft generator, plans. 25¢. LeJay, Minneapolis 20, Minn.

**FREE** Catalog, welders, kits. Build 350-ampere welder using aircraft generator, plans 25¢. Dunbar, Minneapolis 8, Minn.

**PLATING** Equipment and supplies. Save 50% and more on new fiberglass tanks, DC power units. 50 amp, 6 volt DC power supply \$97.50; 100 amp, 6 volt \$145; other sizes from 5 amps to 250 amps. Easy terms. Mix your own solution and save. Send \$1 for newest formulas and operating data for all types of plating, equipment guide and catalog. HBS Equipment Division, Dept. L5, 1624 E. First St., Los Angeles 33, Calif.

### MACHINERY, TOOLS, SUPPLIES

**SPRING** Assortments. Box of 50 small \$1.75. Medium \$2.75. Spring Distributors, Box 561, Pittsburgh 30, Penna.

**POWER** Tools and accessories. Free list. Roberson, 14M Brooks Drive, Austell, Georgia.

**THE** Most advanced test indicator for machinists. Send \$26.80. Used tools. Free information. RPM Tool Co., 169 Brookline St., Cambridge 39, Mass.

**BANDSAW** — \$29.88 builds \$70.00 machine. Write! Raytools, 1703 Gross, Green Bay, Wisconsin.

**BEARINGS** Any size. List price—60% delivered. C.O.D.'s OK. Guaranteed. Moba, Box 281, Arvada, Colorado.

**6" COMBINATION** Saw blade, \$1.50. Satisfaction guaranteed. Overland's, Independence, Iowa.

### SURVEYING INSTRUMENTS

**NEW** And guaranteed factory rebuilt transits and levels, sale or rent, with purchase option. We will repair, trade or buy old instruments. Write for list M12. Warren-Knight Co. (Manufacturers of Surveying Instruments), 136 N. 12th St., Philadelphia 7, Penna.

### ENGINES, MOTORS, DYNAMOS

**DIESEL** Injector parts and fuel pumps wanted. GM51-71-110. Bares, 2093 East 19 Street, Cleveland 15, Ohio.

**REWIND** Motors yourself. Complete instructions, \$1.00. Lewis Manufacturing, Howell, Michigan.

**WINDING** Data. 275 motors, single and three phase \$1.10. Data Company, 512 Kensington, Kansas City 24, Mo.

**REWIND** Motors yourself. Free details. Modern, Box 8715, Kansas City 14, Mo.

**NATIONAL** Carbon brush set No. 55. List \$25, price \$12. Fits 72 different fractionals. 198 assorted brushes, 130 springs. W. L. Church, 6146 Willer's Way, Houston 27, Texas.

### GOVERNMENT SURPLUS

**JEEPS** \$278, Airplanes \$159, boats \$7.88, generators \$2.68, typewriters \$8.79 are typical government surplus sale prices. Buy 10,001 items wholesale, direct. Full details, 627 locations and procedure only \$1.00. Surplus, Box 789-C35, York, Penna.

**SAVE** Money. Thousands of government surplus items; tremendously reduced prices. Procedures, depots, \$2.00. Associated Reporters, P.O. Box 1008, Miami 1, Florida.

**BUY** Surplus direct from government. Complete guide—25¢. Janacek, 373 East 155th Street, New York 55, N. Y.

**GOVERNMENT** Surplus, radios, jeeps, walkie talkies, boats, binoculars, etc. Buy direct. Send for "Depot Locations & Procedures." 50¢. Satisfaction guaranteed. Delta, Box 2262-M, Dallas 21, Texas.

**TENTS.** Government surplus. Hexagonal, Pyramidal. Cost \$140. Our price \$39.50. \$225 paint spray unit, \$44.50. Free folder. Imasco, 1829 S. State, Chicago, Ill.

**GOV'T** Surplus. How and where to buy in your area. Send \$1.00. Surplus Information, PM, Headquarters Building, Washington 6, D. C.

**U.S. Government** surplus—jeeps, \$264.00; radios, \$2.53; guns; typewriters; cameras; tools; thousands of items. Fabulously low surplus prices. Complete information sent immediately. Send \$1.00 to: Surplus, Box 512-E, New Orleans 12, Louisiana.

**BUY** Surplus direct from Government, 25¢. Box 4008PM, Long Island City 4, N. Y.

**JEEPS** \$223.83, Cars \$38.53, boats \$7.58, radios \$2.45, tires \$1.33, typewriters \$7.15, televisions, guns, cameras, recorders. Typical surplus prices. Buy direct. List of depots, procedure, inspection details, only \$1.00. N. Y. Enterprises, International Airport, Box 402-X17, Jamaica 30, New York.

### BOATS, OUTBOARD MOTORS

**WORLD'S** Largest selection of boat plans and patterns, frame kits, boat kits, marine fiberglass, hardware and accessories. Three, full, new, exciting catalogs, covering all of the above, available now for \$1. Send to: Custom Craft, Mail Order Division #1L, Buffalo 7, New York.

**FIBERGLAS** Your old wooden boat. Make it waterproof. Repaint over fiberglass, wood, or metal with new Poly-Aqua Epoxy paint. Free literature. Ajax Plastic Co., Dept. 6, P.O. Box 1323, Ft. Worth, Texas.

**BOAT** Plans, frame kits, full-size patterns prepared specially for amateurs. Send 50¢ for new 80-page catalog illustrating over 40 build-it-yourself power boats from 7' to 28'. "Inboard Motor Installations In Small Boats"—hardcover illustrative book on "how to" of inboard installations—\$6 ppd. Glen Designs, 9152 Rosecrans, Bellflower, Calif.

**NEW.** Used, rebuilt marine motors. Marine conversions, fittings. Free catalog. Stokes Marine Supply, Dept. 24, Coldwater, Michigan.

**FULL** Size, cut-to-shape boat patterns, blueprints, 7 $\frac{1}{2}$ -38 feet. Big new 88-page illustrated "Build a Boat" catalog of naval architect-designed catamarans, cruisers, runabouts, skiffs, outboard boats, sailing, racing, houseboats, 50¢. "How to Build a Boat" booklet, \$2.50. Cleveland Boat Blueprint Co., Dept. A-66, Box 1651, Cleveland, Ohio.

**BUILD** Your own boat from our large-scale blueprints. Books of plans give how-to-build help. Hundreds of professional designs—motor, sail or auxiliary—for amateur builders. Free catalog. MoToR Boat-Ing, 572A Madison Ave., New York 22, N. Y.

**MARINE** Conversions. Ford, Chevrolet, Jeep engines. Catalog 25¢. Lehman Manufacturing Company, 800 Elizabeth Avenue, Linden 4, N. J.

**MARINE** Conversions and gears for all popular automotive engines. Send 25¢ coin for complete catalogue. Barr Marine, 2706A Castor Ave., Philadelphia, Penna.

I Want to send you proof of the wonderful pulling power of Popular Mechanics classified pages. What's your proposition? Write me today. Include literature if possible. F. W. Johnson, Manager Classified Advertising, Popular Mechanics Magazine, 200 E. Ontario St., Chicago 11, Ill.

### ATHLETIC EQUIPMENT, BODY BUILDING COURSES

**"GIANT** Arms." Dr. Young's, D.C. revolutionary discovery. \$2. Satisfaction or refund. Gaucho, Box 9309-S7, Chicago 90.

**OUTSTANDING** Physical development! Any age. New guaranteed discovery uses only a rope! Strength, health, muscles. Gain—reduce. Free booklet. Ropercise, 4834 Art, San Diego 13, California.

**PHYSICAL** Perfection—reducing, gaining, big muscles and longevity. Agents wanted. Mail 25¢ for all 4 courses. Guaranteed. Sid's System, PMC-62, 8421-C Evergreen, Southgate, California.

**FREE**—Bigger, stronger, muscle information! Centuck, 37 Station, Yonkers, N. Y.

**BARBELLS.** Dumbbells, Courses, Booklet 10¢. Good Barbell Co., Siloam Springs, Arkansas.

**WEIGHT**-Lifters! Bodybuilders! New type weight-lifting belt. Flexible steel backed! \$7.95 postpaid. Satisfaction guaranteed! Gym Equipment, Brooklyn 22, New York.

**BECOME** Taller. New scientific method will add inches to your present height even after maturity. Visible results in weeks. Send for free information and trial offer. Height Increase Institute, Dept. PM-3, GPO Box 1902, New York 1, N. Y.

### SPORTING GOODS, GUNS, FISHING, SKIN DIVING, ARCHERY

**SEND** Me your name and I'll tell you about a method that lets you take giant bass out of waters that other folks say are "fished out." Facts free. Write: Eric L. Fare, Highland Park 73, Illinois.

**GUN** Replicas. Sixteen models. Used in TV and movies. \$3.95 ppd. Catalogue 15¢. Lytle Guns, Box 2146, Whittier, California.

**PLASTIC** Lure bodies. World's famous flattish complete kit 25 for \$3.25. Spinning reels open and closed face \$3.25. Free circular. Quaker City Mfg., 3514-24 N. Lawrence, Philadelphia 40, Penna.

**JAP** Rifle altering to 30-06, \$6.00. Jap-shells, \$3.95. Catalog 10¢. T. P. Shop, West Branch 11, Mich.

**MOLDS**—For casting your own fishing sinkers. Free illustrated booklet. Reading Instrument Co., Box PM78, Reading, Penna.

**FREE**—Wholesale catalog. Beads. Spinners. Lure parts. Sinker molds. Jigs. Reels. FinnySports (ME), Toledo 14, Ohio.

**BIG** Money raising crickets and 12 inch African fishworms. Free literature. Carter Ranch, Plains, Georgia.

**MOLDS** For fisherman's sinkers, jigs, squids, casting and spinning lures. Free catalog. Sweet's Molds, Tonawanda 1, New York.

**NOBODY** Undersells Kleins's! 144 page all-sports bargain catalog free. Kleins-PM, Chicago 24, Illinois.

**SPORTING** Goods. Wholesale. Information. \$1.00 refundable. Berkshire Wholesale Sporting Goods, Six Lakes, Michigan.

**CARTRIDGES** For collectors. 22 page illustrated catalog 50¢. Tillinghast, Marlow, N. H.



**SMOKE** Fish, game. Build inexpensive electric smoker. Instructions, recipes \$1.00. Eddie Thom, Hope, Idaho.

**WANT** To catch pan and game fish? Send only 35¢ for your copy of "Fishing Secrets" to Lucky Fishing, Box 3694, Whitefish Bay, Wis.

**RENOWNED** Fisherman's pliers. 15 needed tools in one. Saves time, temper and tackle. Just \$5.98 ppd. Postcard for facts. Misco, P.O. Box 15D, Paramount, Calif.

### CAMPING EQUIPMENT AND TENTS

**CAMPING** Equipment. Send 25¢ giant catalogue. Morsan, 10-21R 50th Avenue, Long Island City 1, New York.

**BUILD** Your pickup camper. Blueprints and supplies. Literature 10¢. Comstock Trailers, Parsons, Kansas.

**PORTABLE** Kitchen-pantry. Approved by university camping clinics, outdoor writers and veteran campers. Plywood construction. Plans \$1.00. Specify station wagon or sedan. Literature 10¢. Campers Kitchen Company, Box 6062, San Antonio 9, Texas.

### EARTHWORMS, CRICKETS, FROGS

**TRAP** Thousands nightcrawlers, earthworms. Easy building instructions, drawings, \$1.00. Eddie Thom, Hope, Idaho.

**EARN** Money raising fishworms for us! Exciting details free! Oakhaven 56, Cedar Hill, Texas.

**BIG** Money raising fishworms and crickets. We teach you how to raise and where to sell. Free literature. Medium redworms, 3000, \$5.95; 10,000, \$16.95. Carter Redworms, Plains, Georgia.

**\$1,000 MONTHLY** Possible. Raising earthworms—African giants! Backyard, garage, basement. Complete illustrated booklet, explains raising, feeding, packing, marketing. Send 25¢! Ozark Worm Farm-J, Willow Springs, Missouri.

### BINOCULARS, TELESCOPES, MICROSCOPES, MAGNIFIERS

**SCIENCE** Bargains! Lenses, telescopes, binoculars, microscopes, kits, parts, war surplus. Send \$1.00 for beginner's 10-lens kit with instruction booklet. Order Stock 2-CH. Request free 144-page Catalog CH. Edmund Scientific Co., Barrington, New Jersey.

**TELESCOPE** Kits—Direct from manufacturer. Other optical hobby kits. Large selection. Free booklet. Esco Products, Oak Ridge, N. J.

**BARGAINS!** Binoculars, telescopes, microscopes. Catalog free! Adventure Sales, Box 2133, San Diego 12, California.

**DYNASCOPE.** Amazing world-famous reflector telescope. Request free brochure. Criterion, Dept. DP-87, Hartford 1, Conn.

**BUILD** Your own reflector telescopes. Complete kits; mirrors, eyepieces, tripods, all other accessories. Request free illustrated literature. Criterion Manufacturing, Dept. KPM-84, Hartford 1, Connecticut.

**TELESCOPE** Manufacturer's closeouts—telescopes, lenses, kits. Terrific bargains. Many giveaways. Write Hobbycraft Mfg., 1107-W 69th, Chicago 21.

**TELESCOPES.** Binoculars, microscopes \$1.49 to \$99.99. Terrific savings. Free catalog! Quality Optics, 13571 Kentucky, Detroit 38, Michigan.

**CUSTOM** Telescopes, lens, tripods, equatorials and accessories. UPCO, Sunbury, Penna.

**TELESCOPES** And telescope makers supplies. Free catalog. Suffolk Science, Mattituck, New York.

### PLANTS, SEEDS, BULBS, NURSERY SUPPLIES

**MING** Trees! Seeds instructions 35¢. "Specialties," 1439-D Sabraton Ave., Morgantown, W. Va.

**LOW** As 20¢. Latest mountain grown, hardy, heavy-bearing peach and apple trees. Pears, plums, cherry, berries, plants. Grapevines 8¢. Shrubs 13¢. Evergreens 20¢. Catalogue free. Benton County Nursery, Box 542A, Rogers, Arkansas.

### PETS—DOGS, BIRDS, HAMSTERS, ETC.

**HAWKS.** Reptiles, raccoons, skunks, squirrels. Catalogue 25¢. Trails End Zoo, St. Stephen, S. C.

**MAKE** Money raising chinchillas, mink, rabbits, cavies for us. Free catalog. Keeney Brothers, New Freedom 2, Penna.

**HAMSTERS**—Ideal pets, \$2.95 pair. Free booklet. Jer-fre's Hamstery, 1447 Apple, Muskegon 13, Michigan.

**PETS**—Hamsters, mice, rabbits, squirrels, chipmunks, guinea pigs, skunks, raccoons. Pricelist dime. Picture catalog twenty five cents. Moore's Hamster Ranch, Shepherdstown 25, West Virginia.

**REGISTERED** German Shepherd puppies, bred females. George Gober, Jacksonville, Texas.

### RABBITS—FUR BEARING ANIMALS

**RABBIT** Raising details free. Rabbit Enterprises, 548 River Road, Ludlow, Ky.

**MINK** Raising information free. Complete. Lake Superior Mink Farm, Superior, E.E.I., Wisconsin.

**RAISE** Rabbits successfully by knowing facts. 48 page book. 38 illustrations describing 25 breeds. Housing. Breeding. Feeding. Markets and Marketing. Bulletin etc. 25 cents. American Rabbit Association, 36 ARBA Building, Pittsburgh, Penna.

**EARN** \$10,000 Yearly raising Angora rabbit wool for us. Information 25¢ coin. American Angora Company, Malta 12, Montana.

**RAISE** Rabbits on \$500 month plan. Free details. White's Rabbitry, Mt. Vernon, Ohio.

### FARMS, FARM LANDS, REAL ESTATE

**E. Herrick,** Margaretville, New York. Farms, campsights, acreage, country homes—terms. 5 acre mountain retreats on road. \$25 monthly for 20 months. 130 miles from New York City. Delaware County. Free list.

**CANADIAN** Tax sale lands. Our 14th annual series of lists, just begun, describe farms, timber lots, hunting and fishing camps. Average price five dollars an acre; small monthly payments, guaranteed titles. Write today for free sixteen-page booklet containing full information. Tax Sale Service, Room 411-D, 1173 Bay Street, Toronto 5, Canada.

**SEEKING** A bargain? Inspect this Florida place soon if you are! 73 highway acres for only \$1,500 down! Modern 5-room 2-bedroom masonry home in shaded setting. Small barn. High, dry gently-rolling terrain, good truck crop soil. Fronts on corner of 2 highways! Ready to go at \$8,500, only \$1,500 down! New free illustrated Spring catalog, bargains coast to coast! United Farm Agency, 2825-PM Main St., Kansas City 41, Mo.

**NORTH** Florida lots beautiful Suwannee County, 50x100, \$295.00 full price. \$5.00 down and monthly. No interest. Free literature and maps. Casper Corporation, 3970 NW 177th St., Carol City, Miami, Florida.

**CANADIAN** Vacation lands: Full price \$385.00. 40 acres, \$10 month. Suitable cottage sites, hunting, fishing, investment. Free information. Land Corporation, 3768-C Bathurst, Downsview, Ontario, Canada.

**FLORIDA** Campsites—deep in the heart of the great Ocala National Forest. Abundance of game, best fishing. Warranty deed. Unrestricted—pitch tent, park trailer, build lodge. Free maps and photos. Howard Vernor, DeLand, Florida, AD60688(Q-O).

**OPPORTUNITIES!** Government land, U. S., Alaska, Canada. Sledge Surveys, Macon, Mississippi.

**CAROLINA** Coast. \$5 down, \$5 monthly buys large homesite, 70x150, in beautiful Boiling Spring Lakes. Satisfaction guaranteed. 16,000 acres. 52 freshwater lakes. Excellent fishing, hunting. Free literature. Boiling Spring Lakes, Southport 1, North Carolina.

**FREE** Strout catalog! Farms, homes, businesses, resorts, retirement properties. Over 3000 values coast to coast. 61 years service. World's largest! Write Strout Realty, 7-CJ S. Dearborn, Chicago 3, Ill.

**MONTANA**—Fishing and hunting cabin and camp sites on the Kootenai River in the Montana Rockies \$595; \$10 down and \$10 per month. Mountain Empire Co., Box 203-P, Libby, Montana.

**\$5 MONTHLY** Buys 5 acres—near clear-water lake. Price \$125. Excellent fishing, good cabin sites. Free list. Box 425-P, Carthage, Mo.

### PROFITABLE OCCUPATIONS

**DISC** Jockey work available. Learn De Jay Techniques for high paying radio work. Complete instruction book plus demonstration record. Send \$2.98. Robert Lyndon Studios, Dept. PM-1, Tarboro, N. C.

**INVESTIGATE** Auto accidents. Earn \$750 to \$1,000 monthly. More investigators urgently needed. Car furnished; business expenses paid. No college education necessary. No selling of any kind. Pick your own job locality. Meet interesting, important people. We train you at home in spare time. You keep present job until ready to switch. Write for free booklet. No obligation. Liberty School, Dept. C-91, Libertyville, Illinois.

**INVESTIGATE** Accidents. Earn \$750 to \$1,000 monthly. Men urgently needed. Car furnished; business expenses paid. No selling. No college education necessary. Pick own job location. Investigate full time. Or earn \$6.44 hour spare time. Write for free literature. No obligation. Universal, CPM-1, 6801 Hillcrest, Dallas 5, Texas.

**SHARPEN** Scissors, pinkers, clippers. Inexpensive machines, supplies. Blackhaws, Sheldahl, Iowa.

**COLOR** Photographs at home. Learn from expert. \$1.00. Box 372, Pleasant Hill, Calif.

**SELL** By mail! Rare opportunity! Fascinating facts! A. Nelson, 210 Fifth Avenue, New York 10, N. Y.

**WHOLESALE** Magazine subscriptions. Highest commissions. Bonus! Qualified Agencies, 451KA Kingston, Brooklyn 25, N. Y.

**MAKE** Money writing short paragraphs. Information free. Barrett, Dept. C-27B-N, 7464 No. Clark, Chicago 26.

**BUY** Below wholesale! Thousands of nationally advertised products. Drugs, clothing, housewares, cameras, jewelry, hardware, sporting goods, etc. Postcard brings price list showing actual factory cost. Buy-Rite, 310 Main, Bennington 1, Vermont.

**AUCTIONEERING**—Home study course. Diploma granted. Auction School, Ft. Smith, Ark.

**EARN** \$240.00 A month at home, spare time, doing only two \$5.00 invisible mending jobs a day. Big money paid for service that makes cuts, tears disappear from fabrics. Steady demand. Details free. Fabricon, 6236 Broadway, Chicago 40, Ill.

**VENDING** Machines. No selling. Operate a route of coin machines and earn amazing profits. 32-page catalogue free. Parkway Machine Corporation, Dept. #25, 715 Ensor Street, Baltimore 2, Maryland.

**BAKE** New greaseless doughnuts in kitchen. Sell stores. Free recipes. Michael, 3605 South 15th, Minneapolis 7, Minn.

**BIG** Money raising fishworms and crickets. Free literature. Carter Wormery, Plains, Georgia.

**BECOME** Independent with your own franchise business. Thousands earning handsome incomes. Request interesting facts today. National Franchise Reports, PM-528, 333 North Michigan, Chicago 1.

**RAISE Pheasants** on \$10 week plan. Little capital and space can make you independent. Free Details. Great Central System, Columbus 1, Kansas.

**HOME Mallorder** business. Simple, enjoyable. Net \$15,000 year. Write: Mallorder, Box 512-E, New Orleans 1, La.

**EARN Money** raising fishworms for us! Write: Oakhaven 58, Cedar Hill, Texas.

**SAVE Those** boxtops! They're worth money! Inquire: "Boxtops-MA," Cedar Hill, Texas.

**CREDIT Men**—Want a new career? Specialized credit fields are wide open. Little or no capital required. Write: Specialized Credit Service, Box 3927, Sarasota, Florida.

**FREE Book** "711 Bizarre, Successful Ventures." Retired at 47. Work home! Haylings, Carlsbad, Calif.

**FREE Book** "990 Successful, Little-Known Businesses." Work home! Plymouth-57R, Brooklyn 4, New York.

**AMAZING** "53 Money Making Ideas" \$1.00. Elia, Box 222-F, Toronto, Canada.

**HOME Occupations.** Excellent profit possibilities. Information 10¢. Leeco, 3623 Fletcher, Los Angeles 65, California.

**FASCINATING** New career opportunity. Learn professional furniture refinishing. High earnings, steady work, security, your own business. Complete course teaches you everything. Learn the professional way to make old furniture look new. Write for free details. Furniture Refinishing School, 150 Park Avenue, East Rutherford, N. J.

**AMAZING** Profits in worms. Free information. Hillaire Wormery, Northville, Michigan.

## **BOOKS, PERIODICALS, PICTURES, POSTCARDS**

**100,000 BOOKS!** Bargains! Catalog—dime. Treasure-Site, 6990 Aberdeen, Upper Darby, Penna.

**SECRETS** Of success! Send \$1. Book Club, Box 816, Laredo, Tex.

**BOOKS** All subjects. Free catalogues. Delorme, 954 Chatham East, Windsor, Ontario, Canada.

**WORLD** Wide search service, any book. Mrs. Ford, 114 S. Palmway, Lake Worth, Florida.

**BOOKHUNTERS!** Exciting! Unusual world wide books! Catalog 10¢. United States, Box 57M, Dyker Hts., Brooklyn 28, N. Y.

**BACK** Issues magazines. Books all subjects. Reasonable. Manela, 950 Columbus, New York 25, N. Y.

**75¢ BOOKS.** Cars, hotrods, karting, stamps, coins, rocks, science: pocket-novels, all subjects, discounts. Catalogue 5¢. Fairfax, Box 4283, Panorama City, California.

**WHOLESALE:** Any subject, catalog \$1.00 (refundable). Guaranteed. Adirondack Printers, Saranac Lake, New York.

**FREE** Catalog. Self-help books. Write Wilshire, 8721 Sunset, Los Angeles 46P.

**BOOKFINDERS!** All subjects. Send wants! Jaher Book Service, 183 Hazelwood Drive, Westbury, N. Y.

**NATIONAL** Geographic magazines, 1888-1960, any issue. Periodical Service, Box 465-PM, Wilmington, Delaware.

**BOOKS** Located fast. Out-of-print, scarce. Lowest prices without obligation. Book Mark, 51A Walnut, Mt. Clemens, Mich.

**BOOKHUNTERS!** Scarce, miscellaneous books supplied! Atlantic Book Service, Cedar Street, Charlestown 29, Mass.

**OUT-Of-print** books at lowest prices! You name it, we find it! Fast service. No obligation. International Bookfinders, Box 3003-PM, Beverly Hills, Calif.

**BRITISH** Book bargains—Any subject. Catalogues free. Transatbooks, Wantagh, N. Y.

**132 PAGE** Catalog—10¢. All subjects. Bookmaster, Box 17273-H, Salt Lake City 17, Utah.

## **GAMES, TOYS, NOVELTIES**

**POKADOMETER,** The most engrossing family car game ever invented. Keeps children fully occupied for long trips. \$2.00. Moneyback guarantee. Hamburg Game Co., Woodland Drive, Hamburg, N. Y.

## **MAGIC TRICKS, PUZZLES, JOKER NOVELTIES**

**WHOLESALE**—Tricks, gags, funmakers. Sell to friends. Big catalog. 50 gag samples 25¢. Dohn-OW-Marks, Broadview, Illinois.

**BIG** 160 Page professional magic catalog! World's greatest collection of over 1000 tricks, jokes, magic, illusions, secrets, mysteries! Special January offer 10¢ with free trick! House of 1000 Mysteries, Dept. PMIC-62, Trumbull, Conn.

**SMOKE Bombs** 25¢ 7 for \$1.00. Terrific! 6703-N Eleventh, Philadelphia 26.

**84 PAGES,** Completely illustrated catalog. 25¢. Manhattan Magic, Box 334-P, New York City 11.

**CATALOG,** Free trick, 25¢ (1,500,399 tricks, jokes, novelties). Magico, #4037-P, San Antonio 7, Texas.

**BE A** magician! Large professional catalog of latest tricks, 35¢. Ireland, C-109 North Dearborn, Chicago 2, Illinois.

**WORLD'S** Finest professional magic. Joker novelties. Giant illustrated catalog 10¢. Top Hat. Evanston 12, Illinois.

**3000 TRICKS.** Pocket, parlor, stage. World's finest magic catalog (408 pages), \$2.50. Kanter's, M-1311 Walnut, Philadelphia 7.

**500 TRICKS.** Famous Douglas catalog of magicians' tricks and supplies now available just 10¢. Fastest service. Douglas Magicland, Dept. 61, Dallas, Texas.

**FLAME** Thrower! 36" flashes at fingertips! \$1.00. Harmless! Ariane, Philadelphia 44.

**2700 NOVELTIES,** Jokes, tricks, funmakers, hobbies. World's biggest gadget catalog 10¢. Johnson-Smith, D-549, Detroit 7.

**VENTRILLO** Voice thrower 25¢ Ventriloquist's puppet 75¢. Box 971-PM, Philadelphia 5.

**PROFESSIONAL** Catalog, 175 pages, 25¢. Williams, 900 Plymouth, Ellwood City, Penna.

**BOOK** Of 279 tricks—15¢. Bookmaster, Box 17273-K, Salt Lake City 17, Utah.

## **COINS, TOKENS, CURRENCY**

**WE'LL** Pay \$9,000.00 to \$18,000.00 for 1913 Liberty Head nickel. Certain dates: Lincoln cents before 1956—\$250.00; Indian cents \$1,750.00; Flying Eagle cents \$950.00; Dimes before 1943—\$5,250.00; Quarters before 1933—\$5,250.00; Half dollars before 1939—\$7,500.00. Thousands of others worth \$10.00 to \$15,000.00. Such as certain dates: halfcents, large cents, 2¢ pieces, 3¢ pieces, halfdimes, Shield nickels, Buffalo nickels, 20¢ pieces, commemorative coins, paper money, foreign coins, etc. Thousands of persons have sold us coins totaling over \$250,000.00. For complete information, before sending coins, purchase our large illustrated complete guaranteed buying-selling catalogue \$1.00. Worthy-coin Corporation (K-508-C), Boston 8, Massachusetts.

**STARTING** Coin collection? Send only \$18.50, receive 50 different dimes and 75 different cents. Hal-Le's, Box 252, Aberdeen, Maryland.

**NUMISMATISTS.** Price list valuable gift, 40¢. Coin Investment—unprecedented, invaluable to small investor—booklet \$1.00. Vanderman, Box 9161, Suitland, Maryland.

**NEED** Urgently. Paying 2¢ for every penny under 1934 and 5¢ for Indian cents. Will pay postage. Earl Kammerzell, Box 305, Eureka, California.

**FREE** Pricelist all coins. 1960-D small date BU—10¢. Will buy coins. Shay's Coin Co., Dept. PM, 33-44 91st St., Jackson Heights, N. Y.

**1962 COIN** Catalog. 10¢ plus postage. The Coin Mart, Inc., 1604 East Avenue, Eureka, California.

**BRILLIANT** Proof sets. 1957 \$4.95; 1959 \$4.95; 1961 \$2.95. In cases—Queen Elizabeth's coronation \$14.95; Ghana \$10.50; Pakistan \$5.50; South Africa \$6.95. President Kennedy official inaugural medal \$4.50. Bebe's, 4514 North 30th, Omaha 11, Nebraska.

**8 WORLDWIDE** Bills—Yugoslavia, Japan, China—25¢. Jolie, Roslyn Heights, N. Y.

**HAWAII,** Alaska statehood medals \$1.00 each. G. Distributors, Box 35123, Los Angeles 35, California.

**LINCOLN** Cent sets; 1941 to 1961 complete (57 coins). Fine to B.U. in Whitman holder \$3.50. Same set V.F. to B.U. in Library coin album \$6.25. Jack Wright, Box 5585, Washington 16, D. C.

**UNBEATABLE:** 25 Uncirculated choice coins from 25 different countries \$1.00. Ray Mamber, Box 1085, Los Angeles 53, California.

**LINCOLNS** For sale 20¢ each: 1909, 1910, 1911, 1912, 1913, 1914, 1916-P-D-S, 1917-P-D-S, 1918-P-D-S, 1919-P-D-S, 1921-P-S, 1926-D, 1927-P-D-S, 1928-P-D-S, 1930-D-S, 1931, 1934-P-D, 1938-D-S, 1939-D-S, 1943-P-D-S, 1954-P-D-S, 1955-S. All 43 \$7.50. John Gardner, Box 408, Colorado Springs, Colorado.

**ALASKA** 1959 Uncirculated commemorative golden dollar. Collector's item \$4.00 each. Our 1962 buying catalog \$1.00. D & K Coins, P.O. Box 2, Newcastle, Indiana.

**1962 28-PAGE** Coin catalogue 25¢. Hobby Sales, St. Paul 16, Minnesota.

**SAVE** Your slick nickels where date is worn off. Order a bottle of Coin Date. It will bring the date out on Buffalo, V. Shield nickels. It's easy to use. Satisfaction guaranteed. \$1.00 postpaid. Box 276-F, Mooresville, No. Carolina.

**INDIAN** Pennies. Buy, sell, trade. Coin book 35¢. Spadone, 36 Stagecoach Road, Vincentown, New Jersey.

**FREE** Bargain lists. The RJR Coin Company, Astoria 1, Oregon.

**COINS** Wanted. Highest prices paid. List 10¢. Wayne Coin, 1205 California Ave., Fort Wayne, Indiana.

**BARBER** Dimes 10 different \$2.95. Half cents \$3.95. 3¢ silver \$1.25. Flying Eagle cent \$1.95. Vacoin, Box 10, Richmond 1, Va.

**1859 INDIAN** Cent 95¢. Large cent \$1.75, 2¢ piece 95¢, half dime \$1.25. Many bargains! Universal, Box 309, Richmond 2, Virginia.

**WANTED**—Old coins, also roles and proof coins. Send 15¢ for our buying list. Coins, Box 81PM, Sebree, Kentucky.

**PAYING** \$65.00 For certain 1955 pennies, complete lists 20¢. Wesley Road, Hiawatha, Iowa.

**SILVER**—Two select, brilliant uncirculated Mexican silver dollars \$1.00 (refundable). Universal, Box 866, San Antonio 6-D1, Texas.

**TERRIFIC** Bargains! Grab-bags! Lots! 100 different Lincoln cents \$8.50; 7 Liberty nickels \$1.00; 2-cent copper 60¢; 25 foreign \$2. List. Nelson 346-P Rye, N. Y.

**MAKE** Money with Coins, beginners instructions, \$2.00, (refundable). No overhead. Big profits. Free counseling. Coin-Center, 478 So. Main, Mansfield, Ohio.

**COINS** & supplies. Lincoln cents our specialty. Catalogue free. Hyles Sales, Box 9566, Dallas 14, Texas.

**UNCIRCULATED** 1935 silver pony express commemorative medal \$1.00. Coin lists free. Sayers, 1000 Unaka, Johnson City, Tennessee.

**CALIFORNIA** Gold, souvenir tokens 5 different in plastic holder. \$4.10 postpaid! Dealers write. Sample \$1.00. France, P.O. Box 112-PM, Evansville, Indiana.

**LINCOLN** Cents 1921-S, 1924-S, 1918-D-S, 1909-P, 1917-S-D, 1925-S-D, 1920-S-D, 1919-S-D, 1930-S-D, 1938-S-D, 1931-P, 1927-S-D, 1929-S-D, 1928-S-D, 1934-D, 1955-S. Complete lot \$4.00 good to fine rolls of 1955-S Lincoln cents good to A.U. \$5.00 roll. Berry, Box 306, Westminster, Calif.

**HIGHEST** Prices paid for United States coins. Send 10¢ for our buying lists. Wilmot's, 1067-A Bridge, Grand Rapids 4, Michigan.

INDIAN Pennies, six different \$1.00. Also will buy Indians 10¢ each. Joseph Gajdar, 6615 South Ashland Avenue, Chicago 36.

COINS, Supplies: Lists 20¢. Lund, 200 So. Sycamore, North Platte, Nebraska.

LARGEST Coin magazine. 288 pages, 50¢. Scrapbook, 7320-J Milwaukee, Chicago 31.

NUMISMATICS Largest newspaper. Semi-monthly. Sample 25¢. \$2.00 yearly. Numismatic News, Box 452, Iola, Wis.

RARE 1878 CC mint dollar uncirculated \$5.00. 100pg. catalogue 50¢. Shultz, Salt Lake City 10, Utah.

BARGAIN List! U. S. coins, accessories. Stamp please. Hugh's, Hickory, N. C.

WORLD'S Greatest coin magazine and wooden nickel 10¢. Lawrences, Anamosa, Iowa.

FREE Coin supplies! Giant coin list 10¢ (refundable). Economy Sales, Mansfield, Massachusetts.

40 PAGE Illustrated United States and Canadian coin list 10¢. Stoney, 260 Washington, Boston 8, Mass.

25 BEAUTIFUL Coins from 25 countries. Mostly uncirculated. Terrific assortment. \$1.00. Hindley, Box 708, Aurora, Illinois.

RARE Unc. 1899 Philadelphia silver dollar, \$5.00. Butts, Torrington, Wyo.

GIANT Illustrated catalog listing hundreds of bargains in coins and supplies, only 25¢. Ben's Coin Company, 31 North Clark, Chicago 2.

COIN Collector's magazine. On your newsstand or direct. Sample 35¢. \$3.00 yearly. Coins Magazine, Box 274, Iola, Wis.

U.S. Large cent \$1.00 with bargain lists. Hutchinson's, Box 6256, Philadelphia, Penna.

INTRODUCTORY: Confederate coin and foreign paper money, coin-medal catalog, send 50¢, postage, handling; American military medal and catalog, 50¢; amazing values. Collectors Club, Box 71-C, Rockaway 94, New York.

TWENTY-Four page 1962 retail price list of USA and Canadian coins 10¢. Our selling prices on thousands of coins and coin collectors' supplies. Bryson Incorporated, 612A White, Toledo 5, Ohio.

## STAMP COLLECTING

FREE! 25 Different Portuguese; colorful, inexpensive approvals. Elkhart, Box 33, Elkhart, Indiana.

FREE Mint Africa set with approvals. Lithor, Box 51, Canoga Park, Calif.

26 MINT Pairs 50¢. King, 330 Alexander, Kamloops, B.C., Canada.

GAMBLER'S Packet, 25¢, with approvals. Kennedy, Box 9497, San Diego 9, Calif.

FREE 100 Worldwide stamps with approvals. Universal Stamps, Cardwell, Missouri.

300 DIFFERENT Given free with approvals. Particulars, Windsor Stamps, P.O. Box 735, Santa Clara, California.

FREE! Exotic mint Polynesian hula girl stamps! Giant bargain lists included with approvals. Aloha Stamps, 1019-PM Tarryall Drive, Dallas 24, Texas.

50 DIFFERENT Latin America, 10¢ with approvals. Quynn's, Scotland, Penna.

STAMP Collecting outfit, includes packet worldwide stamps, package hinges, watermark detector, millimeter gauge. Everything 10¢ with approvals. Loraine Brown, Marion, Michigan.

FREE 30 Large U. S. commemoratives with approvals. 10¢ handling. Jack Clancy, Box 2187, Portland 14, Oregon.

SENSATIONAL Penny approvals! Pictorials, topicals, etc. Write today! Schmidt, Box 1128, Richmond, Calif.

WE Don't sell stamps. We bring together stamp collectors who have stamps to exchange. Name countries you have to exchange for countries you need. One dollar brings list of exchange names. Stamp Collectors Exchange, 462-466 Baltic Street, Brooklyn 17, N. Y.

100 DIFFERENT Stamps 5¢. Lake, 1120 Pithon, Lake Charles 61, Louisiana.

WINTER Special, 1000 worldwide stamps \$1.00. 3500, \$3.00. No approvals follow. Harrison's Stamps, 1435 First Ave., Oakland 6, Calif.

FREE Sample. Interesting, informative, illustrated. National Stamp News, Anderson, South Carolina.

FREE. 33 Greenland, Congo, Ruanda, others. Approvals. Keating, 2520-P Boulevard, Jersey City 4, New Jersey.

FREE—List of 100 mixtures. Select Stamps, 737 Nottingham, Winnipeg 15, Canada.

FREE! 25 Egypt, 10¢ handling. Approvals. Bellet, Mapledale, Hazel Park, Michigan.

200 STAMPS, 25¢ With approvals. Smith, 508A Brooks, College Station, Texas.

25 ORIENT 5¢; Approvals extraordinary. These, 9320-M San Juan, South Gate, California.

1,000 DIFFERENT Worldwide for approval buyers only. Jacobsen, Crompond, N. Y.

TRADE Your duplicates toward our approvals! (Foreign only.) Complete information, 10¢. Variety Stamps, Box 98-P, Newton Highlands 61, Mass.

FREE! 222 worldwide, 10¢ handling. Penny approvals. Jung, 1601 North Stanley, Los Angeles 46.

TERRIFIC Value. Eight complete mint sets 10¢ with approvals. Beatties, Box 4503, Fort Lauderdale, Florida.

U.S., U.N., Confederate states catalog free. Stone, 260 Washington, Boston 8, Mass.

U.S. Mint specials! Flag set, complete \$1.00; 1¢, 2¢, 3¢ famous Americans (21 different), \$1.00. Free list. Brooks, 2323 Avenue X, Brooklyn 35, New York.

SPUTNIKS, Rockets, space stamps free with sparkling approvals. Cambria Stamps, Box 2205, Anaheim, California.

TWO \$5.00 United States stamps, 20 others 10¢ with United States approvals. Irwin, Box 1105, Brooklyn 30, New York.

25 DIFFERENT Large American commemoratives. 10¢ with approvals. Linstamp, St. Catharines 101, Ontario.

80 DIFF. U. S. stamps includes 19th Century commemorative. High values. Plus 1943 flag stamp of occupied nations. All for only 25¢. Approvals included. Willett Co., Box 338-C, Yorktown Heights, N. Y.

107 DISTINCT British Colonial stamps, 10¢. Approvals. Linstamp, St. Catharines 401, Ontario.

UNITED Nations 15th anniversary sheet with first day cancel, as commemorated by Russia. Free! While they last, with approvals. Philatelics, R-J, New Paltz, N. Y.

25 COLUMBIA 10¢. Approvals included. Reed, Box 980, Chicago 90, Illinois.

105 DISSIMILAR British Colony stamps, 10¢. Approvals. Crown Stamp Company, Virgil 601, Ontario.

INTRODUCING Our better United States approvals we offer 15 United States stamps including Columbian, Bi-Centennials, famous American, airs, others; only 10¢. Ocean Stamps, Box 64-PM, Brooklyn 29, New York.

PENNY Approvals. Thousands. Bargains for pennies. Gifts with purchases. Penny Stamps, Orange, California.

GIANT Approvals, thousands different, 1¢ and 2¢ each. Wahl's Stamp Exchange, 7008P Farragut, Chicago 31, Ill.

UNITED States commemorative collection containing 33 different—10¢. Approvals. White, 516-A Avenue L, Brooklyn 30, New York.

103 DIVERSIFIED British Empire stamps, 10¢. Approvals. Niagara Stamps, St. Catharines 501, Ontario.

SELL Your surplus good grade stamps. Write, describing fully what you have. Vanroy Shirk, Lebanon, Pennsylvania.

AMAZING OFFER! 200 United States stamps — including commemoratives, airmails, high denominations to \$1.00. Only 10¢ to approval applicants! Illustrated bargain lists free. Mystic Stamp Co., Dept. 80, Camden, New York.

100 OLD United States between 1861 and 1935, \$1.00. Roush Stamps, 51 Chestnut, Mansfield, Ohio.

UNITED States price list, 116 pages, price 25¢. Mark Hanna, 335 Fifth Ave., Pittsburgh 22, Penna.

SELL Stamps to our readers. Your ad in this space will be read by thousands of stamp buyers. I'll prove that to you. Write now for Folder "S." F. W. Johnson, Classified Advertising Manager, Popular Mechanics, 200 E. Ontario St., Chicago 11, Ill.

STAMP Jungle including Zabu, kookaburra, koalabear, kangaroo, rhinoceros, 10¢. Approvals. Crown Stamp Company, Virgil 301, Ontario.

14,000 DIFFERENT! Amazing new plan builds your collection systematically, country by country. Only 50¢ weekly. Free details. L. G. Ware, Monroe 75, Conn.

FREE Monaco nudes. Approvals. Stamp Ranch, 902 Addison, Chicago 13, Ill.

PENNY Approvals! Regardless catalogue! Kloster, 4164—52nd St., San Diego 5, Calif.

60 DIFFERENT U. S. (30 commemoratives) 25¢. No approvals. Seidenberg, Appleton, Wisconsin.

500 DIFFERENT. Includes pictorials. 35¢. Knopp, Box 1381, Bristol, Conn.

307 WORLDWIDE Different stamps only 25¢. Approvals. Niagara Stamps, St. Catharines 201, Ontario.

225 STAMPS For only 10¢! This mammoth value includes airmails, pictorials; stamps from strange countries cataloging up to 25¢ each! Also approvals. Mystic Stamp Company, Camden 80, New York.

FREE 50 Worldwide, mailed with inexpensive approvals. University Stamps, P.O. Box 44-592, Miami 44, Florida.

FREE Mint set! Approvals accompany. Stampco, Box 737, Memphis 1, Tenn.

150 DIFFERENT U.S. 50¢, many older issues. Approvals. Winchester Stamps, 45 Winchester Rd., Mansfield, Ohio.

111 WORLDWIDE. Includes airs, midgets, triangles, 10¢. Approvals. Premiums. Faith, 20½ Bushnell, Alhambra, Calif.

100 DIFFERENT United States commemoratives, 1/2¢ to 10¢ values—used \$1.00; Mint \$4.95. No approvals. Gil's, Box 12BA, Brooklyn 29, N. Y.

1065 DIFFERENT Stamps \$1.00 to approval applicants. Klondike, Harrisburg, Illinois.

FREE 60 Different stamps to collectors requesting approvals. Stanley Zajac, 159 Emerson Ave., Toronto, Canada.

50 PAGE Album accessories catalog. Send 10¢ for postage, handling. Approvals. Robert J. Clark, P.O. Box 28-C, Wilmette, Illinois.

LATIN America. More stamps for less money. Packet including elusive issues \$1.00. M. Garcia, Box 71, Bronxville, N. Y.

WOW! 110 All different Germany 10¢! Zeppelins, semi-postals, airmails, high values, etc. Giant catalog, bargain lists included with beautiful approvals. Jamestown Stamp, Dept. A12PM, Jamestown, N. Y.

HOLY Stamp depicting Christ and cross! Plus triangle discus thrower, enormous multi-colored Spanish diamond issue, wonderful map collection from Timor, Macao and Angola. Extra! Brilliant flag set, etc. only 10¢ with approvals. Capital Stamp Co., Ferrysburg 2C, Michigan.

FREE! Triangles, pictorials, others. 55 different attractive, inexpensive approvals. L. Baird, PM-3, Box 8128, Portland 7, Oregon.

100 DIFFERENT U.S. 25¢. Free list. Frederick Buss, 1526 South 44th Street, Milwaukee 14, Wisconsin.

FREE Hand picked collection. Approvals. Bech, 6076 Longford Road, Dayton 24, Ohio.

APPROVALS. T. Miller, RFD 3, Box 198, Berlin Avenue, Mays Landing, N. J.

FINEST British Colonial job lots available, \$2.00, \$5.00. Taaffe, P.O. Box 226, Los Angeles 53, Calif.

VIETNAM C9, catalog value \$2.50-25¢. Approvals. Terra Nova, Box 276, Cathedral Station, New York 25, N. Y.

U. S. Mixture: Commemoratives, airmails, specials, \$1, \$5, postage dues, etc. All 500 stamps \$1.00 postpaid U.S.A. Wessbecher, 7116 Oakland, St. Louis 17, Mo.

ZOWIE! U.S. commemorative collection free, 33 different. Perforation gauge. Approvals. 10¢ handling. Russell Stampco, Uxbridge 5, Massachusetts.

CANADA Mission mixture on paper including commemoratives and hi-values. No approvals. 500 stamps for \$1 postpaid. L. Whitelaw, 928 Wilder, Outremont, Montreal, Canada.

WILL Rogers air! Helicopter triangle! Plus Monte Carlo dove triangle! Stamp printed in solid gold! New York Empire State Bldg. airmail, lovely Congo orchids in full color, etc. 10¢ with approvals. Sunny Stamps, Apopka 24, Florida.

FREE! Giant bargain catalog—New edition listing thousands of bargains including U.S. and B.N.A. stamps, packets, mixtures, albums, accessories and supplies; sent with beautiful approvals. Jamestown Stamp, Dept. E12PM, Jamestown, N. Y.

BUTTERFLIES Triangle — diamond! Enormous Washington! 100 others different, 10¢. Approvals. B & G Stamp Service, 114 West Washington, Sigourney, Iowa.

FREE—All volumes Scott's International albums. Scott's 1962 catalogues—even master global albums free—when you buy our sensational foreign approvals. Bargain Stamps, Redlands, California.

START Approval business. Details 10¢. Steele, Box 553-PH, Pacific Grove, Calif.

DEALERS—Wholesale list. Postage 4¢. Frank, 5031 Queensberry, Baltimore 15, Maryland.

FREE! 177 Worldwide! Colorful approvals. Richard Carson, Box 396, Lawrence, Kansas.

FREE—Upper Volta masks. Approvals. Bacon, 405 Main, Rolla, Missouri.

30 DIFFERENT Soviet stamps only 10¢! See "behind the scenes" in mysterious Russia. View the Kremlin, satellites, atomic icebreaker, Russian jet plane. Tour Red Square, ancient forts, onion towers. Meet Red leaders. Only 10¢ with approvals. Offer open to adults only. Littleton Stamp Co., Littleton C1, New Hampshire.

BEGINNERS! 20,000 Different, 1¢ each. postpaid. Engholm, 2068 Bathgate, New York City 57.

701 U.S.A.—25¢. Plenty commemoratives. Request approvals. Horace Gatewood, Winston-Salem, N. C.

1000 DIFFERENT Worldwide stamps \$1.00. Valued over \$20.00. To adults only requesting our popular packet approvals. Universal, Box 6, Kenosha 5, Wisconsin.

500 MIXED Foreign 15¢. Approvals. Solar, 1616 Newcombe, Flint 6, Michigan.

U. S. Stamps. Giant bargain catalog. 20¢. Raymax, 35-VZ Malden Lane, New York City 38.

SURPRISINGLY Higher cash paid for stamps. Free Booklet! Appraisal! Edel, Carlyle, Illinois.

SUPERIOR Worldwide mission mixture. Amazing variety! Five ounces \$1.60. Pound \$4.50. Bay Nielsen, 4545B Harvard, Montreal 28, Canada.

U.N. COMMEMORATIVE set 10¢ to approval applicants. Fine Stamp Co., Box 71-P, Detroit 24, Mich.

TERRIFIC Stamp bargain! Israel, Iceland, San Marino, plus triangle set, plus Antigua, Borneo, Virgin, Scots, Congo, Russia, plus large stamp book. All four offers free. Send 10¢ for mailing cost. Empire Stamp Corporation, Dept. PM, Toronto, Canada.

DISCONTINUING Business. Fifty different packets only \$1.00. Norge, Ho-Ho-Kus, New Jersey.

VIETNAM Scarce airmail (C9), catalogue \$2.50, mint, only 25¢ with approvals. C. M. Starnes, Box 12236, Norfolk 2, Virginia.

KOREAN Set free. Approvals. W. B. Stamp Co., Wilkes Barre, Penna.

EXCHANGE. Send 100-200 different stamps with 15¢. Receive different. Paterson, Lancaster 10, New York.

10 VATICAN Large pictorials 20¢. Approvals. Zidek, Layton, New Jersey.

30,000 DIFFERENT! \$1.00 weekly builds collection. Free particulars. Holtzman, 95 Terrace Road, Levittown, Penna.

FREE! North America plus 87 foreign flag stamps. Big valuable collection of all-different, genuine stamps from Greenland (North Pole), St. Pierre, Newfoundland, Canada—picturing Eskimos, Indians, scarce 1867 Confederation, Northern Territories, Nova Scotia, United Nations, U.S.—Ancient 19th Century; first ship and plane; rare whooping crane; pony express; etc. Also, complete set Colonial and Civil War commemoratives. Plus colorful flag stamps of 87 foreign countries. Extra! Big bargain catalog. Approvals. Send 10¢ for mailing. Kenmore, Milford EF-306, New Hamp.

25 UNITED States commemoratives, airmails 4¢. Approvals. Gordon Davison, Henniker 8, N. H.

1948 U.S. Mint plate blocks. 5 for \$1.00. Wetterhahn, Box 43074, Los Angeles 43, California.

FREE Macao mint set, approvals. Coretta, G.P.O. Box 1546, New York 1.

25 DIFF. U.S. comms., 1893 up, 10¢ approvals. K & B Stamp Co., Box 70, Brooklyn 23, N. Y.

OLD Scarce U.S. seconds on approvals. Slight imperfections, lowest prices. Hernefield, Clintonhill Sta., Newark 8, N. J.

U.S., Canada price list 130 pages, 700 illustrations, stamp identification 10¢. Thom, 4808, 15th Avenue, Minneapolis 17, Minnesota.

AUTO Stamps 10¢ with approvals. Hopkins, RD 4, Newburgh, N. Y.

FIFTY Fine stamps 5¢ with approvals. Ransom, 1333 Pontiac St., Ann Arbor, Mich.

GIGANTIC Surprise packet, contains hundreds—only 15¢. Approvals accompany. Dresel, Box 128-M, West Englewood, New Jersey.

SURPLUS—American, Canadian varieties. First 100 20¢. Bristol's, Canton Center, Conn.

FREE! Surprise packet. Approvals. Premiums given. Dancer, 75-P29, Mansfield, Ohio.

FREE! Giant Roosevelt diamond! Summit flag stamp! 25 others! Approvals. Hammill, Box 61, Limestone, Maine.

SEVENTY Different United States. Obsolete and current. 25¢. Ed. Keller, Library, Penna.

FREE Stamps to buyers of worldwide approvals. Enormous selection. Fair prices. Handy Stamps, 460 Handy, Orange, Calif.

FREE—Airmails. Complete sets. Singles. Fifteen different countries. Handling 10¢. Approvals. Boger, Box 152, North Wales, Penna.

FRENCH Colonials, mint, 10¢. Request approvals. Norris, 328 Los Padres, Santa Clara, California.

PHILATELIC Spectacular, 21 complete sets 25¢. Mint and used including commemoratives, pictorials, topicals. Approvals accompany. Abbot Stamp Company, Box 245M, Jamaica 31, New York.

UNIQUE World tour; 222 colorful stamps, \$5.00 value 25¢ with approvals. Nations, Box 117-X, New York 51, N. Y.

215 DIFFERENT Worldwide 25¢. Flume, Korea, Laos, Russia, Transvaal. Approvals. Bobb's, Box 3045, Saint Louis 30, Missouri.

MONACO Sports mint set cataloging over \$1.00, your price 50¢ with world wide sets on approval. Lido Stamps, 111 Via Yella, Newport Beach, Calif.

100 DIFFERENT Scandinavian 10¢, approvals included. Hodson, 373½ West Broadway, Winona, Minnesota.

BATHING Beauty, spacemen packet—10¢ with approvals. Nugget, 2408 Gillen, Racine, Wisconsin.

50 DIFFERENT Haiti! \$1.00. Approvals. Stamp Imports, Box 353, Port-au-Prince, Haiti.

FANTASTIC Fish triangles! Valuable "Ben Franklin" on Canal Zone! Flaming bi-colored volcano triangle! Lovely Olympics triangle! Plus icy Greenland, weird wild beast issue and others. 10¢ with approvals. Roseland Stamps, Spring Lake 2, Michigan.

CANADA Totem dollar 20¢. Approvals. Daleti, Box 832, Moneton, New Brunswick.

FREE. Flag stamps. 6 tricolored, beautiful. Approvals. Hughes, 16 Bloomfield, Pawtucket, Rhode Island.

BEGINNERS Packet (122) 8¢. Postpaid. Approvals. Pickering Stamps, Chester Springs, Penna.

250 DIFF. U.S. commem's \$3.00. Erv. Knott, Box 31, Helmer, Indiana.

FREE 15 Canadian stamps with approvals. Stamps, 186 Carlton, St. Catharines, Ontario.

FREE! Monaco giant elephant! 25 others different. Approvals. White, Box 485, Flemington, New Jersey.

50 DIFFERENT Canada 10¢. Joseph Myers, Route 5, Coldwater, Michigan.

UNITED Nations. Five different 10¢. Approvals. Anderson, 1234 Delaware, Santa Cruz, California.

FREE! Giant Roosevelt diamond, 25 others with approvals. Myers, 17592 Ardmore, Detroit 35, Michigan.

100 WORLDWIDE 10¢ With penny approvals. Skytop, Box 1022 PM, Binghamton, N. Y.

FREE! World's largest! Strange, valuable 7"x14" beauty. Send 15¢ handling now! Norrisco, Milwaukie 7, Wis.

25 DIFFERENT Romania pictorials 10¢. Praha, Box 68PM, New York 66, N. Y.

BIG Bag of 1,000 stamps \$1.25. Surprise package of 325 world stamps \$1.00. Other surprise packages, too, ask for list. Stamps, Box 738, Sioux Falls, South Dakota.

EXTRAORDINARY! Free! 20 different Finland to those requesting approvals. Rosenberg, Box 1303, Chicago 90.

PENNY Approvals. 1,000 foreign stamps mounted in Scott order. No assorting! Bullot Approvals, 1359 Coney Is. Ave., Brooklyn 30, N. Y.

50 DIFF. W.W. 10¢. Approvals. Stamp House, Box 824, Hattiesburg, Miss.

COLONIES! British, French, Dutch. 100 different 25¢. Approvals. Munson Stamps, Gales Ferry, Connecticut.

250 DIFFERENT World wide 25¢, colorful. Better-Bilt, 25625 Koontz, Roseville, Mich.

50 DIFFERENT, Topicals, diamond, triangle, U.S., 10¢ with approvals. Carpenter, Box 310, Claremont, Calif.

ROCKETS! Satellites! 10¢ with approvals. Schaefer, Californiastrasse 16, Wiesbaden, Germany.

30 DIFFERENT Beautiful air mails 10¢. Selected sets at reduced prices on approval. Louis Morrison, Milmont Park, Penna.

HUNGARY Gigantic bicolored "horse-racing" commemoratives—free! Approvals. William Deems, 226c Race, Ravenswood, West Virginia.

FREE 50 Stamps U.S. approvals. Rayworth, 321 South Cicero, Chicago 44.

FREE Animal set with approvals. Collier, Box 265, Chamblee, Ga.

SCREWBALL Fish in natural colors; Pan, the goat man; Egypt, Mother's Day; Crawley bugs set; jets; Somaliland flower garden; French model; U.S. Revolutionary War; others free while purchasing approvals. Stamp Farm, MS-40, Oxford, Wis.

5000 STAMP Grab bags! \$1.00 each. World, mint sets, bargain list. Guaranteed satisfaction. Stamp Service, 1438-G, Huntsville, Ontario, Canada.

FREE Surprise set to approval applicants. Wayout Peachtree, Box 9875, Atlanta 19, Ga.

161 DIFFERENT U.S. commemoratives \$1.00. Carstamps, 739 Ordway, Freeport, Illinois.

PRICELIST Of Africans free. Write Dykhorst, Box 4061, San Francisco 1, California.

500 MIXED Worldwide 25¢. Brookside, R.F.D. Box 242, Mendon, Mass.

DISCONTINUING Stamp business. Tremendous values! \$2.00. Conglomeration includes mixtures, packets, sheets, Norge, Ho-Ho-Kus, N.J.

310 DIFFERENT Worldwide stamps 25¢! Bargain packet offers. Carling's, B-162, Howard City, Michigan.

FREE—When you buy our foreign approvals, you receive absolutely free stamps equaling your purchases. Coast, 1609 S. Park, Santa Ana, California.

MINIATURE Collection Queen Elizabeth mint sets (Antigua, Caymans, Mauritius, Montserrat, Virgins, St. Kitts)! 21 lovely pictorials, only 25¢! Attractive approvals! Gannon Stamps, Box 931, Canton 1, Ohio.

FREE! Paraguay Olympic. Approvals accompany. Conover, Route 5, Box 456, Fairfax, Virginia.

MILLION Foreign stamps! 2¢ each! Send for thrilling, giant approvals! ABC Stamps, Box 6000MB, San Francisco 1, Calif.

REPRESENTATIVE Collection Confederate states 19th century United States assortment plus pricelist 10¢. Minuteman, 127 Lincoln, Lexington 73, Mass.

FREE! British Colonials from Penang, New Zealand, Rhodesia, Singapore, Ceylon, Negri-Sembilan, Straits Settlements, Kenya. Free with approvals. The Postmark, Box 542M, Great Neck, N. Y.

1962 U.S. price list, 30¢. Lee's, Box 796, Rockford, Illinois.

BONANZA Packet. Loaded with topicals, birds, flowers, fish, animals, rockets, etc. 10¢ with low cost approvals. Stamp Imports, Peterborough, Canada.

JAPAN 7 Beauty girls and sheet \$1.00. Philatelic Week (1955-61,47). Miss Fumiko, Box 67, Shinjuku, Tokyo, Japan.

NEW Foreign issues 2¢! Old issues 2¢! Commemoratives 2¢! Pictorials 2¢! Airmails 2¢! 1000's bargains 2¢ each! Send for giant selection on free examination. ABC Stamp Company, San Francisco 1-RW, California.

OVER 1,000 Stamps and free bargain list only \$1.25. Order today. Stamps, Box 738, Sioux Falls, South Dakota.

1,000 STAMPS Only \$1.00. Free list. Stamps, Box 1, Lake City, Minnesota.

### ANTIQUES, RELICS, INDIAN GOODS, CURIOS

6 ARROWHEADS. Archaic knife, scraper. \$2.00. Smith, 841 N. Tacoma, Indianapolis 1, Indiana.

10 ANCIENT Arrowheads \$2.00. List 10¢. Redick, 1061 Geers, Columbus 6, Ohio.

SELLING 20,000 Ancient arrowheads, spearheads, etc. List free. Lear's, Glenwood, Arkansas.

ILLINOIS: Gesundheit! Selling hundreds of historical, Confederate, Revolutionary, Civil War, Indian War muskets, carbines, revolvers, swords, bayonets, powderhorns, canteens, bullet molds, duelling pistols, holsters; 50,000 collector's cartridges; 110,000 Stoneage Indian relics, arrowheads, deerheads, steerhorns, bowwood, military insignias, coins, mineral specimens, fossils, frontiers, Confederate money. Large listing, send 35¢ (refundable). Heike's Relics, Wenona, Illinois.

### PRECIOUS STONES, MINERALS

25 MINERAL Rarities, \$2.00. Labeled collection of geologic treasures from far west wilderness, plus detailed brochure. Wilderness Originals, Canyon, Calif.

SEMI-Precious uncut gems. Ten different for \$1.00. Request list 28. Prospectors Shop, 201 San Francisco, Santa Fe, New Mexico.

FREE Bargain gem list. 1961 lapidary and silversmith tool catalog. 50¢. O'Brien's, 1116B Wilcox, Hollywood 38, Calif.

EARTH Science Rockhound's National Magazine. Subscription \$2.50. Sample 35¢. Box 1357-PM, Chicago 90, Ill.

### HOBBIES AND COLLECTIONS

COLLECTORS Matchbook covers. 100 different unused, \$1.00. Catalog 25¢. Album \$3.00. Charles Edelman, 1311-C East 84, Cleveland 3, Ohio.

COLLECT Timepieces? Free folder. Nawco, Box 8824, Pittsburgh 21, Penna.

AMERICAN Newspaper, complete, original, dated before 1860. \$1.50. 25¢ stamps brings catalogue. D. R. Spaight, Bookseller, Tall Timbers 1, Maryland.

CARTOONING—Good money in fields of television advertising, animation, movies, magazines. Famous system of manual training brings amazing new concept of art instruction at home. For profit or pleasure. Send for free details. Continental Schools, Dept. E-120, 4201 S. Broadway, Los Angeles 37, Calif.

CLEARANCE Sale, foreign medals: Iron Cross \$1.00, S.S. Medal \$1.50, German General staff embroidered, 30¢. Catalog 20¢. International, Box 303, Jamaica 31, N. Y.

### PHOTOGRAPHY, CAMERAS, PHOTO SUPPLIES

BELL & Howell 8mm. movie cameras. Write Geo. Thompson, Box 24, Scottsburg, Indiana.

14MM. Miniature spy camera. Clear sharp pictures smaller than stamps. Send \$3 to Bain, Dept. 2111, 812 2nd Ave. N.W., Calgary, Canada.

FREE! Send now for 64 page book of new and used photographic bargains. Dept. 1 AR-1, Central Camera Company, 230 So. Wabash Ave., Chicago, Illinois.

PHOTOGRAPHY For pleasure or profit. Learn at home. Practical basic training. Long established school. Free booklet. American School of Photography, 835 Diversey Parkway, Dept. 3451, Chicago 14, Illinois.

### PHOTO FINISHING

A FREE Kodak roll returned with each black and white or Kodachrome developed and printed, fast service, lowest prices, guaranteed quality send for free mailers. Economy Photo Service, Dept. P. M., Box 1111, Albany 1, N. Y.

KODACHROME-Ektachrome guaranteed kodak processing. Prompt 8mm or 35mm 20 exp. \$1.40 Free list-mailers. Color Pix, Dept. P, CPO Box 30, Kingston, N. Y.

KODACOLOR 12 Exposures \$2.25. Eight \$1.75. Reprints 15¢, black and white 12-60¢. Indiana Photos, Box 707M, Muncie, Indiana.

FAST, Hi-quality finishing. Kodachrome rolls: eight jumbo prints \$1.98. Twelve \$2.49. Twenty \$3.49. Reprints 15¢. Also low B&W prices. Custom Quality Studio, Box 4838, Chicago 80.

SENSATIONAL Offers. Free mailers. Flash Photo Service, Box 3035, Atlanta 17, Georgia.

TWELVE Exposure rolls 59¢. Wallets 20 for \$1.25. Lincoln Studios, Dept. K, Box 13, Lincoln, Nebr.

EKTACHROME-Anscochrome 35mm. 20 exp. 620, 120, 127, developed, mounted, \$1.00. Kodachrome 8mm. and 35mm., low prices, prompt service. Complete price list—free mailers. Write Trycolor, P.O. Box 123, So. Windsor, Conn.

COLOR Movie fans! Low cost—high quality processing our specialty, 8mm. just \$1 (or \$3 with fresh film). Mailed back next day. Craftsmanship guaranteed. Send exposed reel or request free mailers and price list of complete photo-finishing services. Direct Mail Photo, Box 8832-PM, Pittsburgh 21, Penna.

### MOTION PICTURES AND SOUND EQUIPMENT

SAVE Money on B&W, color, 8mm., 16mm. film and supplies. Send 10¢ for bargain catalog. Superior, 448 N. Wells, Chicago 10

BIG Bargains 16mm. sound films. Bedner, 5300 So. Talman, Chicago.

5,000 8-16 MM. Movie films. Free catalogues. International, Greenvale, N. Y.

MOVIE Camera film: 8mm roll \$1.50. 16mm. 100' \$3.00. Free processing. Better Films 742 New Lots Brooklyn N Y

MOVIE Film! Free catalog! ESO-R, 47th Holly, Kansas City 12, Missouri.

16MM. Sound, projectors, films. Sale, rental, exchange. Visit store or write for catalog. National Cinema, 71 Dey St., New York City

8MM. Home movies. Free catalog. Midwest Enterprises, P. O. Box 2062, Milwaukee, Wisconsin.

ROSE Parade 1962. Color movies, 8mm 50' \$4.95, 200' reel \$19.95. 16mm 400' \$40.00. 2x2 color slides, 12 for \$2.75, 24 for \$5.00, 80 for \$14.95. Kolor Kade Productions, 5880 Hollywood Blvd., Hollywood 28, Calif.

16MM SOUND—8mm films. New, used. Free list. Entertainment Films, 236 W. 55, New York City.

LADY Wrestling. Movies, photos. Free list. Peerless, Box 171-M, New York 13, N. Y.

3MM. Rose Parade 1962 color movies—slides. 50', \$4.95. Complete parade 200', \$19.95. 35mm. color slides, set 12, \$2.75; 24, \$5.00; 72, \$14.95. Free! 3 extra bonus slides with slide order. 33 $\frac{1}{3}$  r.p.m. record describing complete parade only \$3.95. Satisfaction guaranteed. Rose Parade Movies, 7266-M Meirose, Hollywood 46, Calif.

ROSE Parade movies (Kodachrome) 200' 8mm. \$19.95; 400' 16mm. \$45.00; 80 2x2 color slides: \$12.00. Dixie Enterprises, Box 42177, Los Angeles 42, Calif.

MOVIES Exchanged \$1.00 per 100'. Genio, 1386, Cleveland 3, Ohio.

### COLOR SLIDES

LINCOLN Story in color slides. Catalogue and sample 35¢. Willems, Box 1515-A, Chicago 90.

8MM. 16MM. Movie subjects. Silent, sound. New, used. 2"x2" color slides. Biggest selection anywhere! Free each month, big 24-page newspaper-size catalog. Blackhawk Films, Davenport 14, Iowa.

TRANSPARENCIES Wanted. Up to \$500.00 each. For information write American Color, P.O. Box 46372, Hollywood 46, Calif.

### MUSIC & MUSICAL INSTRUMENTS

PIANO Play sing along songs at once simultaneously. Grady, 212 South Oak Park Ave., Oak Park, Ill.

ACCORDIONS. Chord organs, guitars! Buy direct—save to 1/2. Famous makes. Free home trial. Easy terms. Trades. Free catalogs. Mention instrument. International Music Mart, Dept. R, 2003 Chicago Avenue, Chicago 22.

GUITAR Stunts — 25 amazing new sounds, tricks, secrets. \$1.00. Trebb Sales, Loraine, Ohio.

VIOLINMAKERS Repairers. Fine tone wood, and all violin supplies. Send for free wholesale new price list. International Violin Co., 414-MPM E. Baltimore Street, Baltimore 2, Maryland.

SONGWRITERS—Send poems. Honest, sincere offer. Free recording. Successful Songs, Box 608, Danbury, Conn.

PLAY guitar. Teach yourself. \$1.00. Ernie Ball Guitars, Box 308PM, Tazana, Calif.

PIANO Tuning. Home study course. Diploma granted. American School of Tuning, Box 707, Gilroy, Calif.

POEMS Wanted by America's largest song and recording studio. Free examination. Five Star Music Masters, 630 Beacon Bldg., Boston.

GUITARS—Famous makes. Big saving. Colored catalog 10¢. Bonne Music, 1421 South Salina, Syracuse 5, N. Y.

1962 ACCORDIONS at 60% off! Save middleman's profits. 20 models to choose from. Money back guarantee—5 day free trial! 40 bass electric chord organ \$99.00. Waltham Importers, Box 3862, Detroit 5, Michigan.

BANJO And guitar making instructions, woods, parts. List 10¢. Musiercraft, 823 Foster, Evanston, Ill.

ACCORDION-O-RAMA. 874 Broadway, New York 3, N. Y. Tremendous discounts. Top brands. Free brochure.

**ACCORDIONS**—All sizes. Free home trial. Color catalog. Save 1/2. Terms. Accordion Import Center, 7120 Galli Dr., San Jose 29, Calif.

**SWISS** Musical movements. Mechanical—electrical. Spielman, 131 West 42nd, New York 36.

**SONGPOEMS** And songs wanted! Mail to: Tin Pan Alley, Inc., Box 405, Radio City Station, New York 19, N. Y.

**POEMS** Wanted for musical setting and recording. Send poems. Free examination. Crown Music Company, 49-C West 32 Street, New York 1.

**POEMS** Needed immediately for new songs and records. Free examination and appraisal. Send poems: Songcrafters, Acklen Station, Nashville, Tenn.

**GUITAR** Making books, plans, imported woods, tools. List 10¢. Satinwood, 510 East 11th Street, New York 9, N. Y.

**ELECTRIC** Guitars, amplifiers, wholesale. Free catalog. Carvin, P.M.M., Covina, Calif.

**SONGS** Wanted. Pays royalties. Enclose postage. Olenik Records, Mount Morris, Michigan.

**SONGPOEMS** Wanted! Collaborate with professional songwriters on equal basis. Share royalties. Songwriters Contact Co., 1619-D Broadway, New York 19.

## RADIO, TELEVISION AND ELECTRONICS

**"RADIO Explained."** 64 page book—15¢. Bookmaster, Box 17273-F, Salt Lake City 17, Utah.

**LEARN** While asleep with amazing "Electronic Educator" endless tape recorder. Details free. Research Association, Box 24-PX, Olympia, Wash.

**DON'T** Buy hi-fi components, kits, tape, tape recorders until you get our low, low return mail quotes. "We guarantee not to be undersold." Wholesale catalog free. Easy time payment plan. 10% down—up to 24 months to pay. Hi-Fidelity Center, 220-M E. 23 St., New York 10, N. Y.

**RECORDERS**, Hi-fi. Free wholesale catalogue. Carston, 125-Y East 88, N. Y. C. 28.

**GOVERNMENT** Surplus radios, parts. Picture catalog 10¢. Meshna, Malden 48, Mass.

**FIX** Your own TV. Save 80%! Send for free illustrated chart showing how! We'll include giant electronics catalog. Zalytron, 220-M West 42 St., New York City.

**TAPE** Recorders hi-fi components. Sleep learning equipment, tapes. Unusual values. Free catalog. Dressner, 1523M Jericho Tpke, New Hyde Park, N. Y.

**CRYSTAL** Radio kit \$1.00. Amplifier and speaker for same \$4.95. Catalogue. Clearco, Box 1638, Stuart, Florida.

**LOW** Quotes: Stereo tapes, components, recorders. HiFi, Roslyn 6, Penna.

**RECORDING** Tape. Stereophonic recordings. Bargain catalog available. Saxitone, 1776 Columbia Road, Washington 9, D.C.

**TELEPHONES**—Antique, French, modern, any model. Also parts and misc. telephone equipment of all kinds. Price list—50¢. Delta, Box 2262-M, Dallas 21, Texas.

**SAVE** Dollars on radio, TV-tubes, parts at less than manufacturer's cost. 100% guaranteed! No rebrands, pulls. Request bargain bulletin. United Radio, 1000-M, Newark, N. J.

**INVESTIGATORS**, Write for free brochure on latest subminiature electronic listening devices. Dept. 8P, 11500 N.W. 7th Ave., Miami 50, Fla.

## BUSINESS OPPORTUNITIES

**MAKE** Extra money—Big cash commission plus premiums for you and your customers. Sell advertising book matches. Sensational new tenor, glamour girls, hill billies; dozens others. All sizes. Quick daily sales; big repeat business. Free master kit makes selling easy. No experience necessary. Superior Match, Dept. MX 162, 7530 Greenwood, Chicago 19.

**\$250.00 WEEK** Spare time profit possible. Earn at home with new fascinating printing method. \$5 starts you—send no money now. Free confidential facts and valuable sample. Screen-Print, JY, Los Angeles 61.

**WORK** Like a millionaire. \$400-\$1000 monthly plus apartment, managing a motel. Learn at home. Free booklet. Motel Managers Training School, PM-21, 612 S. Serrano, Los Angeles 5.

**AUTO** Glass tinting offers excellent profits. Exclusive new process. Investment as low as \$100.00. Tinton Products Co., Rogers, Arkansas.

**"PROFITS** In Mail Order." Brand new book just published, explains everything. \$3.00 postpaid. Imports, Dept. 2, Box 489, Edmonds, Washington.

**SUCCEED** In mailorder! Tested, proven, moneymaking opportunity. Free literature. Mann, 266-D, Hillsdale, New Jersey.

**IMMEDIATE** Profits with no capital or experience. Take orders for all magazine subscriptions. Friends and neighbors are your prospects. Write now for complete, free kit. McGregor Magazine Agency, Dept. CB2, Mount Morris, Illinois.

**\$1.00 BRINGS** You \$18.00 spare-full time home business opportunity! Amazing new velvet-spray transforms old cheap lamps, TV-radios, figurines, furniture, anything, into valuable products! Free samples. 50 business opportunities booklet. Send no money. Flok-Kraft, JY Los Angeles 61.

**OFFICE** Homework, privacy, spare-time. Refundable moneymaking business instructions 50¢. Interstate, 37 Besch, Albany 9, N. Y.

**"TEXBURGER"** sandwich. A smash hit from coast to coast. At last a different unique sandwich sensation. Guaranteed big profit maker for cafes, sandwich shops, etc. Recipe mailed anywhere. Only \$2.00. Haskell D. Boyer, P.O. Box 1486, Fort Worth 1, Texas.

**DOLLS!** Dolls! Dolls! We teach you to make, repair, dress and sell. Study at home. Earn while learning. Free booklet. Doll Hospital School, Studio MC-12, 11826 San Vicente Blvd., Los Angeles 49, Calif.

**BIG** Money—Operate your own fix-it shop. Service all household appliances: irons, fans, refrigerators, automatic washer-dryers, etc. Do house wiring, commercial wiring. Rewind motors of all sizes. Sharpen mowers, skates, saws. Buy needed spare parts wholesale. Free book. Christy Trades School, A-1703, 3214 W. Lawrence, Chicago 25.

**OPERATE** Profitable home mailorder business. Details free. Alto Distributors, Box 253, Palo Alto, California.

**BECOME** Tax consultant. Graduates earn \$1,000-\$3,000 every tax season preparing returns evenings. State approved. Union Institute, Lakewood G-2, N. J.

**LEARN** Professional TV servicing in one week! Fabulous new simplified system. No big expense. No studying. No tools or equipment. Spare, full time. Own your own big profit business! Save! Amazing but true! Free sample lesson, illustrated "How To" booklet. Write, TV Systems, Dept. FC-171, 1038 So. LaBrea, Los Angeles 19, Calif.

**RAISE** Rabbits on \$500 month plan. Free details. White's Rabbitry, Mt. Vernon, Ohio.

**\$70.00 WEEKLY**—Home, spare time. Simplified mail bookkeeping. Immediate income—easy. Auditax, 34741A, Los Angeles 34.

**LIQUID** Molding rubber, free sample. Shellcraft supplies. Chaney's, 1907-A East Road, Jacksonville 16, Fla.

**BUY** Direct from factories. Appliances, cameras, watches! Free details! Cam Co., 436 P.M. Bloomfield Ave., Verona, N. J.

**\$200.00 MONTHLY**. Spare time. With tablesaw, bandsaw or jigsaw. Write. Holiday House, A3800 Harney, Vancouver, Washington.

**SHARPEN** Saws and lawnmowers the profitable way. Send for free literature. Max Manufacturing Company, 138 Stockton Avenue, San Jose 26, California.

**FRANCHISES** Make profits! Operate your own exclusive franchised business. Write today for free interesting details. National Franchise Reports, W-528, 333 North Michigan, Chicago 1.

**SELL** Champion, AC. Autolite spark plugs. Reconditioned, electroplated, guaranteed 10,000 miles. 100% profit. Free sample. Lee Plugs, 1608-A Roberts, Houston 3, Texas.

**WANT** To make big money at home? \$10.00 profit in an hour possible with invisible mending. Make tears, holes disappear from clothing, fabrics. Steady year-round demand from cleaners, laundries, homes. Details free. Fabricon, 6234 Broadway, Chicago 40, Ill.

**VENDING** Machines. No selling. Operate a route of coin machines and earn amazing profits. 32-page catalogue free. Parkway Machine Corporation, Dept. #27, 715 Ensor Street, Baltimore 2, Maryland.

**BUSINESSES**, Resorts, motels, investment property, ranches. Our special service dept. at your disposal. No obligation. World's largest. 58 years' service. Strout Realty, 7-MB S. Dearborn, Chicago 3, Ill.

**BIG** Money raising fishworms and crickets. Free literature. Carter Farms, Plains, Georgia.

**TO \$100.00** Weekly. Sparetime, home operated mailorder business. Successful beginner's plan. Everything supplied. Lynn, 10420-M National, Los Angeles 34.

**PIANO** Tuning learned quickly at home. Tremendous field! Musical knowledge unnecessary. Information free. Empire School of Piano Tuning, Champaign, Ill. (Founded 1935).

**COPUBLISH** Mail Sale Advertiser, leading mail order paper. Details, latest copy, dime. Vanroy Shirk, Lebanon, Penna.

**BRONZE** Baby shoes: Instructions, equipment and mountings for genuine electroplating process. Largest supplier of all plating equipment, supplies. Free catalog. Hollywood Bronze Supply, Dept. B-3, 1624 East First, Los Angeles 33, Calif.

**OPERATE** Profitable mail order business. Write Walter Service, 4159A East 112th, Cleveland 5, Ohio.

**BAKE** New greaseless doughnuts in kitchen. Sell stores. Free recipes. Montgomery, 3605 South 15th, Minneapolis 7, Minnesota.

**EXCEPTIONALLY** Profitable opportunity in tape recording! Free information. Baron's, Lynden, Washington.

**JAPAN** Directory. 145 Japanese manufacturing exporters. Japan and Hong Kong trade journal information. Asia opportunities. Just \$1.00 today. Nippon Annai, Box 1150-P, Spokane 10, Wash.

**MARKETS** Everywhere. Make artistic concrete birdbaths, pottery. Best coloring. Home workshop. Hundred varieties. Free pictures. Hollywood Cementcraft, 8527-S Wonderland, Hollywood 46, California.

**MAKE** \$46 From square foot plywood: jigsaw necessary. Free details. Woodart, Bridgewater, Mass.

**MAKE** Money from old tires. Operators clearing \$400 weekly. Equipment costs \$800. Get facts. S & S Patents, Inc., 3511 N. Lincoln Ave., Chicago 13, Ill.

**\$400.00** MONTHLY Raising giant fishworms. Soilless method. Charlie Morgan, Bushnell, Florida.

**HOW** And where to obtain capital. Write: Reliable Service, Rome City, Ind.

**SELL** Books by mail. 400% profit. Royal, Box 368-X, Cleveland 27, Ohio.

**PLASTERCRAFT** Molds, liquid rubber, plasters, floccs, candle supplies. Catalog and manual free. Blue Rapids Supply, Blue Rapids, Kansas.

**WORLD'S** Largest wholesale supply. Buy from 679 American, European, Japanese wholesalers. Tailormade suits from Hongkong. 123 dropship catalogs. Rock-bottom prices. Free details. International Buyers, 216-MM Jackson, Chicago 6, Ill.

**MAILORDER**. America's most unique no cost beginner's plan. Armstrong's, 154-A Darrington S.W., Washington 24, D. C.

**JOKE Merchandise.** Rack consignment deals. No selling. Rush \$1.00. Ten samples, profit plan. Robbins, 127-G West 17th Street, New York City 11.

**EARN \$3 hourly, spare, full time, looking up information at your local library.** Operate research bureau. Details free. Service, 81C Knickerbocker Station, New York.

**AMAZING Profits in exterminating.** Full time — part time. Free details. Baylab 21M, Cambridge, Maryland.

**EVERYBODY Likes candy and popcorn specialties.** Learn to make professionally home. (Our 50th year.) Ragsdale Canaes, B-107, East Orange, New Jersey.

**RE-CAST Junk batteries into new.** Latest achievements. Battery Laboratories, Bayou LaBatre, Alabama.

**11,000 NEW Prospects daily.** Baby record books, shoes, albums. Sell mailorder. Use our literature. Write: No-Co-Ro, Capitola, Calif.

**\$1,000 MONTHLY Spare time tape recording weddings, radio commercials, sound effects, hundreds of ideas and complete plans!** Famous course "Tape Recording for Pleasure & Profit" measures an inch thick, a foot square, loaded with money-making ideas with a tape recorder! Complete course including 45-minute tape of demonstrations and instructions only \$14.95 plus \$1.00 postage and packing. Or send \$2.00 for complete booklet on "How To Record Weddings" and illustrated literature on the course. Dixieland Sound, Asheboro 17, North Carolina.

**"MAILORDER Laws and Regulations."** Explains mailorder licenses, mailorder taxes and mailorder legal requirements. Avoid trouble with the government. Read latest revised enlarged edition. \$2.00. (Particulars free.) Neil H. Tasker, Shamokin, Pennsylvania.

**SELL By mail.** Mail order specialist shows how to start on low capital. Modern merchandising methods, not crackpot schemes. Free details. Larry's Specialties, 97-06 63rd Drive, Rego Park 74, New York.

**SIGNS.** Sell restaurants, bars, etc. Samples \$1.00. Box 9563, Jackson, Miss.

**INTERNATIONAL Mailorder business made easy.** Complete setup service, not just instructions. Hermes, 152 West 42, New York City 36.

**OPERATE Home mailorder business.** Vosacek Printing, 4444AI Ute, San Diego, 17, Calif.

**EARN Money raising fishworms for us!** Write: Oakhaven 38, Cedar Hill, Texas.

**SEWING Machine, vacuum cleaner repairing, \$3-\$5 hourly.** Gardner, 401 Johnson, Jenkintown, Penna.

**MAILORDER: Extra income, spare time.** Easy. Write: American Distributors, Box 409, Niles, Michigan.

**CAN You enjoy independence and high income? Obtain a guaranteed program for business planning.** \$5.00. Business Advisers, P.O. Box 91, Niagara Falls, N. Y.

**UNIQUE Process for glaze finishing masonry offers terrific business opportunity.** Free photo, details. Plasticon Company, Box 105, Grove City, Penna.

**BEFORE You buy any business or franchise in America find out why 90% fail.** Send \$1.00 for Donoho's Business Buyers Guide. Satisfaction guaranteed. Wm. Donoho, 493 East 8th Street, Chicco, Calif.

**PROSPERITY In garden golf.** Invest now. Details. Brockway, Box 3762, Portland 8, Oregon.

**GUARANTEED Market.** Raise fishworms for us. Free details. Goldan Farms, Lubbock, Texas.

**MAILORDER Beginners "Newsletter."** Absolutely free. Neil H. Tasker, Shamokin, Pennsylvania.

**NATURAL Molding rubber, extra thick.** Free samples. W. Wooley, 2801-A Latrobe, Peoria, Illinois.

**LEARN Landscaping and the growing of plants.** Start a profitable business part or full time. Free information without obligation. National Landscape Institute, Dept. MC-12, 11826 San Vicente Blvd., Los Angeles 49, Calif.

**COLORGLAZED Concrete pottery made without molds.** Patented method. Cemetery products, novelties, tiles. Basement leak-sealing. Money-making projects. Booklet, details free. Men only. National Potteries Company, Grand Rapids, Minnesota.

**BUSINESS Guidance: Select the business you want.** We help you setting it up. Free details. Hermes Company, 152 West 42, New York City 36.

**FREE Report: "609 Unusual, Successful Businesses."** Box 1001-PR, Evanston, Illinois.

**SELL By mail! Rare opportunity! Fascinating facts!** A. Nelson, 210 Fifth Avenue, New York 10, N. Y.

**START A home business spare time.** Make extra money. Choose from several. Particulars free. E. D. MacKnight, 100 So. Clifton Ave., Aldan, Penna.

**WE'LL Finance the right party in your area in sparetime business keeping retail stores supplied.** No selling. Just \$24 down starts you in the fast-growing rack jobbing business, pays you good hourly earnings. For information, no obligation, write Novo, 3855 Lincoln, Dept. N-85, Chicago 13.

**\$600.00 PROFIT! Mailing catalogs.** Sample instructions, 25¢. Home Business Digest, GPO Box 972, New York 1.

**GET Samples, magazines, offers galore!** Your name in 5000 mail directories 25¢. Results guaranteed. Muskoka Mailers, 1438-C5, Huntsville, Ontario, Canada.

**BIG Profit! Learn to operate auto and iron salvage yard.** Box 806, Mason City, Iowa.

**MAKE Big money.** Own and operate your own fix-it shop. Service household appliances, motors, mowers, etc. Every neighbor, every stranger your prospect. Millions of appliances everywhere need fixing. \$5.00-\$6.00 per hour often charged by appliance service technicians. Christy's shop manual home training program, illustrated lesson manuals, professional testing equipment sent on special pay later plan. Write for free book. No obligation. Christy Trades School, Dept. A-1147, 3214 W. Lawrence, Chicago 25.

**BE A sewing machine repairman.** Biggest repair field. Send \$1.00. Vast, Box 162, Bayonne, New Jersey.

**YOUR Own baby shoe bronzing business.** Instructions, equipment, supplies. Metalizing, glassing. Pearl-Kote. We finance. Free booklet. Dept. A, Box 5036, Inglewood, Calif.

**INCREASE Mail order sales!** New gummed label mailing lists. McKeon, 103-04 217th Pl., Queens Village 29, N. Y.

**\$10.00 HOUR: Painting signs with our patterns.** Carlayne, 1803 Fremont, Rapid City, South Dakota.

**MAKE Money mimeographing!** "There's Gold in Your Mimeograph"—concise, illustrated course—25¢. Mozella Mimeo Service, Bonham, Texas.

**MUSHROOMS Quicker, easier, cheaper.** Spawn (seed) plus newest manureless growing, various processes, marketing. \$1. Free literature. Luxur, 641 South 19th, Newark 3, N. J.

**MAKE Durable building plastic easily.** Waterproof, fireproof, economical. Bays Laboratory, Cedaredge, Colo.

**FREE Book "990 Successful, Little-Known Businesses."** Work home! Plymouth-572R, Brooklyn 4, New York.

**RAISE Nightcrawlers, Redworms.** Easy soilless method. Three Oaks Ranch, Dresden, Tenn.

**CANDIED Popcorn and potato chip equipment.** Eakins, Box 933-A2, Springfield, Ohio.

**START Your own business on credit.** U.S. only. Your own boss. 1344 dealers sold \$5,000 to \$25,500 in 1960. We supply stocks, equipment on credit. 200 home necessities. Sales experience unnecessary. Pleasant, profitable business backed by world-wide industry. Write Rawleigh's, Dept. A-U-PPM, Freeport, Ill.

**IMPORT-Export opportunity, profitable, world-wide, mail-order business from home, without capital; or travel abroad.** Established world trader ships instructions for no-risk examination. Experience unnecessary. Free details. Mellinger, D701, Los Angeles 25.

**"HOW" To run mail order business profitably.** Free details. Write: Cox, 2001 W. New Jersey, Midland, Texas.

**FREE.** Spare time dollars. Flocking. 1517 Log Cabin Avenue, Rockford, Illinois.

**FREE Book "711 Bizarre, Successful Ventures."** Retired at 47. Work home! Haylins, Carlsbad, Calif.

**\$20.00 HOUR.** Learn engraving. Engrave glass steel head of pin. Engrave for us. Send 25¢. Engraver, 751 Market, Victoria, B. C., Canada.

**MAKE Money making leathersgoods.** 1148 ideas. Free information. Tandy Leather Co., Box 791-F2, Fort Worth, Texas.

**SECRETS! Secrets! Mail order success revealed by internationally famous expert who discovered how to make home business fortunes.** Beginners: Get free copy "How to Make Money in Mail Order." Disclosed free advertising, profitable products, everything! No obligation. Write Mailco, 1554 Sepulveda, Dept. D701, Los Angeles 25.

**CASH From sawdust, tin-cans, newspapers.** Over 200 methods. Instructions \$1.00. Charles Company, 42-GPS, Norwood, Ohio.

**JUST Published (Profits in Mail Order) \$2.00.** Elia, Box 222-F, Toronto, Canada.

**GROW Orchids at home.** Profitable, fascinating. Successful home grower explains special light, temperature and humidity conditions orchids need. Free—full details. Orchids, 100 S. Vermont, Los Angeles 4, Calif.

**HOW New small business costing less than \$700.00 to start grew to annual volume of \$9,000.00 second year.** 80% profit! Particulars and photo \$1.00. Wyche, Dept. PM-1, Box 926, Albuquerque, New Mexico.

**OPERATE Home manufacturing business.** Newly developed products. Private labels. Tremendous profits. Research, 1735 Kildare, Indianapolis 18, Ind.

**MAKE Up \$600 month.** Operating profitable mail order business. Eye-opening details 10¢. J. Smith, Box 788, Salem, Va.

**NEED Help to make money, start a business? Ask for experienced advice.** Send \$5, Business Counselors, 441 S. Division, Grand Rapids, Mich. Limit 5 questions answered.

**DRIED Mushrooms \$4.50 pound for large canning company.** Receiving warehouse in United States. Growers wanted on contract, everything supplied. Dehydrated Products & Chemicals, No. 548, Calgary, Alberta, Canada.

**PACKAGE At home for profit! We supply everything.** No selling. Free home business details. HPC, 2212BD Jesse Street, Los Angeles 23.

**EARN \$3.00 Hour—home sparetime.** Easy pump lamps assembling. No canvassing. Write: Ougor, Caldwell 7, Arkansas.

## MONEYMAKING OPPORTUNITIES

**CIGARETTES—Make 20 plain or filter-tip for 9¢.** Facts free. Moberly, Box 4012, Owensboro, Kentucky.

**EARN Money raising fishworms for us!** Write: Oakhaven 59, Cedar Hill, Texas.

**EXCITING Puzzles! Cash prizes! Write:** Spence, Box 11569, St. Petersburg, Fla.

**MINK Raising information free.** Complete. Lake Superior Mink Farm, Superior, E.E1, Wisconsin.

**VENDING Machines.** No selling. Operate a route of coin machines and earn amazing profits. 32-page catalogue free. Parkway Machine Corporation, Dept. #26, 715 Ensor Street, Baltimore 2, Maryland.

**EARN Money evenings copying and duplicating comic cartoons for advertisers.** Adservice, Argyle 1, Wisconsin.

**YOUR Own, easy-to-start, home mail-order business, sparetime.** Fascinating; profitable! Information free. Alfano, 19-PM Pine, Closter, N. J.

**BIG Money raising fishworms and crickets.** Free literature. Carter Hatchery, Plains, Georgia.

**READ "Progressive Mailtrade."** The magazine that tells how to make money by mail. Quarter brings sample and special offer. Progressive Mailtrade, Box 357, Sheboygan, Wisconsin.

**AMAZING Successes through franchises!** Become exclusive franchise holder your territory. Information rushed. National Franchise Reports, MP-528, 333 North Michigan, Chicago 1.

**LEARN** The secrets of repairing junk batteries, generators, starters, profitable, easy, at home. Free particulars. Batterymen, 3465 Forrest, Santa Clara, Calif.

**\$25-\$50 WEEKLY** Possible, re-writing news items, jokes, poems, recipes, for publishers. Some worth \$10 each. Details free. Service, 81-D, Knickerbocker Station, N.Y.C.

**LEARN** Plastics fabrication for extra income. Low cost home training now available. Write for free booklet. Interstate Training Service, Dept. D-3, Portland 12, Oregon.

**MAILORDER** Business learned easily. Write: Easco, Box 323, Grand Rapids 1, Michigan.

**SIMPLE**, Pleasant mailorder can net \$12,000 year. Write: Simon, Box 87-PL4, Pelham, N. Y.

**PIANO** Tuning learned at home quickly. Tremendous field! Be independent! Information free. Empire School, Dept. P, Champaign, Ill. (Founded 1935.)

**TEAR** Out this ad, and mail with name, address for big box of home needs and cosmetics for free trial, to test in your home. Tell your friends, make money. Rush name. Blair, Dept. 31FA, Lynchburg, Va.

**MASSIVE** Cash profits with this little known money-making opportunity, making gravestones for pets. Easy to make, small investment, large returns, work home, no selling, free details. Laneville, 5420-B Home Gardens Dr., Reno, Nevada.

**AMATEUR** Artists! Turn your art ability into money. Hamilton, Box 4-G, Astoria 5, N. Y.

**CASH** At once—in profitable lettershop operation. Business-getting manual "Mimeographing Dollars" tells how. Write: Mimeographing Dollars, 1012-C Center Street, Evanston, Wyoming.

**EARN** \$240.00 A month at home, spare time, doing only two \$5.00 invisible mending jobs a day. Big money paid for service that makes cuts, tears disappear from fabrics. Steady demand. Details free. Fabricon, 6251 Broadway, Chicago 40, Ill.

**MEN** — Women! Start money-making plastic laminating business at home in spare time. Material that costs 11¢ brings back \$2.58. No canvassing or selling but mail orders brings in \$20 a day. Write for full particulars free. Rush name on postcard to Warner, Room CL-2-A, 1512 Jarvis, Chicago 26, Ill.

**MAKE** Money in mailorder. "How to Find Money-making Products for Mailorder" tells how. \$1.00 postpaid. Money-back guarantee. Keystone, Box 6-H, Garland, Texas.

**MAKE** Money writing short paragraphs! No tedious study. I tell you what to write, where and how to sell; and supply list of editors buying from beginners. Many small checks add up quickly. Write to sell, right away. Send for free facts. Benson Barrett, Dept. C-27A-N, 7464 Clark, Chicago 26.

**EASY** To start rubber stamp business at home in spare time. Make up to \$9.80 an hour without experience. Facts free. Write Roberts, 1512 Jarvis, Room CR-2-A, Chicago 26.

**READ** Money-making ideas monthly. Sample 35¢. 907 Birch, Eau Claire, Wis.

**MAKE** \$200.00 Monthly spare time with jigsaw. Free details. Elkman, 346 N. Summit, Sioux Falls, So. Dak.

**"NEW, Practical Way To Get Ahead!"** 10,000 formulas for home, farm, workshop. Guaranteed, \$3.95. Berthoff's, 739-P, Sylvania Avenue, Toledo 12, Ohio.

**NOW!** Amazing mail order world of opportunities, \$1.00. Money-making facts free. John Chick, 161-01 89th Ave., Jamaica 32, New York.

**MAKE** Over \$100.00 week with herbs. Grow inside-outside or gather wild. Free details. Whitlow, Dept. A1 403 No. Westmoreland, Dallas 11, Texas.

**POST** Card mailorder. Ideal for beginners. Instructions \$1. Carlson's, Box 424, Rome, Georgia.

**PROGRESSIVE** Mail-mailorder money-makers. Free particulars! Hirsch's, 1301 Hoe, New York City 59.

**MAKE** Big easy profits making costume jewelry at home in spare time! Quick, easy to make, easier to sell! Details free! Don-Bar, 3511 W. Armitage, Dept. A-202, Chicago 47, Illinois.

## EXPORT — IMPORT

**IMPORT** Export. List of oversea sources and products they sell or buy. \$1.00. R. W. Cantrell, 3642 S. Main St., Winston-Salem, N. C.

**RECEIVE**—Import catalogs! Circulars! Foreign business opportunities! Get listed —25¢. Importico, Enka, North Carolina.

**JAPAN:** Direct mail-order 26 page catalogue: dolls, novelties, business information, manufacturers' names, addresses, \$1.00; Japan's Trade Directory, 3000 companies, \$3.00. Send cash. Clarence Yamagata, 814 Tuginbiru, Marunouchi, Tokyo.

**YOUR** Own import mail order business. Deal with over 400 manufacturers exporters of the world. Complete import procedures, international dropship methods. Capitol unnecessary. Details 10¢ refundable. Associated, Box 108-EI, Lincoln 1, Nebraska.

## SCIENCE & CHEMISTRY

**SOLAR** Energy collectors—30" dia. parabolic mirror. Other types. Details free. Cope, Box 71A, West Chester, Penna.

**AMAZING** New book of science experiments, formulas, and catalogue of laboratory supplies. Only 35¢. National Scientific Co., 13 S. Park Avenue, Dept. PM-1, Lombard, Illinois.

**"CHEMISTRY Explained,"** 64 page book —15¢. Bookmaster, Box 17273-G, Salt Lake City 17, Utah.

**CHEMICALS** And apparatus for industrial, analytical, and private laboratories. Catalog 35¢. Dept. M-50, Biological Supply Co., 1176 Mt. Hope Ave., Rochester 20, N. Y.

**232** PAGE Catalog \$2.00. Laboratory Materials, 7319 Vincennes, Chicago, Ill.

**SCIENCE** Treasure chest. Do hundreds of experiments. Order No. 70.342-CZ—\$5.00 postpaid. Request free Catalog—CZ. Edmund Scientific Co., Barrington, New Jersey.

**NEW** Concept of atomic structure. Nuclear theory challenged. 30 pages, 25 cents ppd. C. F. Krafft, 4809 Columbia Road, Annandale, Virginia.

**ILLUSTRATED** Catalog: Chemistry, mineralogy, biology 25¢. Tracey Laboratories. Evanston, Illinois.

**UNUSUAL** Chemistry books, courses, kits! Rare chemicals, cheap! Catalog 25¢. NSC, Box 11133, Palo Alto, Calif.

**"EXPERIMENTER'S** Booklet" and bigger catalogue—25¢. Hagenow Laboratories, Manitowoc, Wisconsin.

**ROCKETS:** New illustrated catalog 25¢. Kits, cones, tubes, engines, etc. Estes Industries, Penrose 2, Colorado.

**ROCKETS:** Powerful new models, kits, tubes, cones, engines, chemicals, instruments. Bigger 1962 catalog 25¢. Central Rocket Co., Box 89, Waupaca, Wis.

**BUY** Chemicals in small quantities. Complete line glassware and apparatus. Ship anywhere—promptly. Camptown Chemical & Scientific Supplies, 705 Lyons Ave., Irvington, N. J.

**ROCKETEERS!** Build high power rockets with our kits, chemicals, supplies. Illustrated catalog 25¢. Rocket Model Research, Box 716, Newark 1, New Jersey.

## FORMULAS, PLANS, ETC.

**10,000 PROFITABLE** Formulas, recipes, trade secrets. Guaranteed. Colen, 7731-MA Yates, Chicago 49.

**FORMULAS** For latest money-making discoveries. New! Good! Valuable literature free! Miller, Chemist, 1517-D, Tampa, Florida.

**ANTI-FREEZE.** Waterless handsoap, resilvering mirrors, all \$1.00. Nelko, Box 3462, Merchandise Mart, Chicago 54.

**LATE.** Modern manufacturing formulas. List free. Moon Chemical, Martville, New York.

**FORMULAS**—All kinds. Amazing big catalog. 10¢. Kemixal, Park Ridge, Ill.

**"FORTUNES** In Formulas." 10,000 trade secrets, 900 pages, \$3.95. Elia, Box 222-F, Toronto, Canada.

## PLASTICS

**BOXES.** Plastic. 200 sizes. Free list. Althor, 170 Bay 23 Street, Brooklyn, N. Y.

**NOW!** Low priced plastic laminating machine. Details. Burr, 330 East Center, Kalamazoo, Mich.

**NEW** Liquid casting plastic, clear, colors. Embed real flowers, butterflies, photos, coins. Send 25¢ for two handbooks "How to Cast Liquid Plastics" and "How to Make Extra Money at Home." Castolite, Dept. A-101, Woodstock, Illinois.

**CREATE** Original artistic gifts now. New instruction manual tells how to do plastic embedding and molding. Manual \$1.00, catalog 25¢. Castacraft Corporation, Dept. M-162, P.O. Box 555, Palo Alto, California.

## AGENTS WANTED

**SELL** Champion, AC, Autolite spark plugs. Reconditioned, electroplated, guaranteed 10,000 miles. 100% profit. Free sample. Lee Plugs, 1608-E Roberts, Houston 3, Texas.

**BIG** Profits selling chamois to service stations, car lots. Steady repeat business. Free details. Inka Industries, 1606-H Roberts, Houston 3, Texas.

**FREE** Sample. Beautiful curios! Sell on sight! Apartado 9036, Mexico City.

**PRINTING.** Advertising salesmen—Excellent moneymaking sideline selling decalcomania name plates, small quantities. Automobile initials, sign letters. Free samples. Ralco, XL, Boston 19, Mass.

**YOUR** Own business—Used suits \$1.50; overcoats 65¢; mackinaws 35¢; shoes 12½¢; ladies' coats 30¢; dresses 15¢. Enormous profits. Catalog free. Nathan Portnoy Associates, 2109-AA Roosevelt Road, Chicago 8, Ill.

**MAKE** Up to \$50.00 a day soliciting delinquent accounts. Terrific commissions. Write today. National Credit, 304Y Pickwick Bldg., Kansas City 6, Mo.

**BIG** Profits. Stamp social security plates, key protectors. Sample 50¢. Catalog free. General Products, 11 No. Pearl St., Albany 7, N. Y.

**MAKE** Profitable men's-women's wear. Sample free. Sunmade, Brockton 64, Mass.

**FREE** Colored portrait sales kit. Portraits, 402-PM Hazlett, Baltimore 29, Maryland.

**BE** The Popular Mechanics representative on your neighborhood and earn big profits in your spare time. Write Popular Mechanics, Room 1-A, 250 West 55th St., New York 19, N. Y.

**MEN**-Women agents: Sensational new moneymakers — beautifully hand-painted, plastic personalized photo enlargements, compacts, rings, bracelets, lockets, etc. Simply take orders pocket 40% commission. We deliver and collect. Sales outfit free. Novelco, 3343 North Ave., Chicago 47.

**BUSINESS** Kit free! Postcard puts you in business! Complete line 230 shoe styles, jackets New discoveries pay big commissions. No investment. Send for free kit. Mason, Chippewa Falls K-402, Wisconsin.

**WILL** You test new items in your home? Surprisingly big pay. Latest conveniences for home, car. Send no money. Just your name. Kristee, 120, Akron, Ohio.

**CLEANS** Windows without mess. Strange dry cleaning-cloth. Replaces liquids. Windows gleam. Samples sent on trial. Kristee 121, Akron, Ohio.

**SELL** Greeting cards. Make extra money. Guaranteed. All occasion assortments, Easter, Valentines; stationery, gifts, wrappings, toys, jewelry. Experience unnecessary. Salable samples on approval. Free catalog. Free gift offer. Details. Write: Hedenkamp, 361 Broadway, Dept. PM-70, New York.

**MAKE** Most extra cash with world's biggest line everyday greeting card assortments, gifts. Introduce friends, neighbors, to over 150 assortments, 500 big moneymakers. Pocket up to 100% profit plus big cash bonus. Free giant color catalog; samples on approval. Write Arrow Greetings, 513 Fourth Ave., S., Dept. 83-J, Minneapolis, Minn.

**SUPER** Brilliant blue white gems. Swiss made, diamond faceted. \$3.00 carat wholesale. Sell \$24.00. Foreman Gem Company, Box 417, Minneapolis 40, Minn.



**SELL** the patented "Home Haircut Guide," with the printed instructions for a smooth tapered haircut, with safety razors, electric shavers, hair clippers. Price \$2.25. Kits include haircut guide, printed instructions, safety razor and 5 blades, \$3.25. Add 25¢ for shipping. Discounts—dozen lots 50%; 1/2 dozen, 40%. Free literature. Home Haircut Co., 2561-PM N. Clark St., Chicago 14, Ill.

**WAGON** Jobbers, route men, \$100.00 extra per week. Guaranteed sales. Revolutionary new tool holder sells on sight for \$1.98. Makes hooks, peg board obsolete. Information Drawer J, Blue Bell, Penna.

**FABULOUS** Picture line. Huge profits (details). Rustic Art Sales, Wallace, Mich.

**DAMASCENE** Earrings! Exotic Orientalism. Huge profit. OHGA, PM-321, Sigankusatu, Japan.

**YOUR Ad** in this space will get some good agents for you. Yes, I'll prove it. Write for Folder "A" right now. F. W. Johnson, Classified Advertising Manager, Popular Mechanics Magazine, 200 E. Ontario St., Chicago 11, Ill.

### BUY IT WHOLESALE

**FREE** Wholesale catalog. Name brands. Richard's, 24680 Roanoke, Oak Park 35, Michigan.

**JUST** Out! 356-page catalog—save to 50% on auto parts, accessories. All makes, models. Send 25¢—refundable on first order. Whitney, 1919 PA-1, Archer, Chicago 16.

**100,000 PRODUCTS** Wholesale! Terrific bargains! United Wholesalers, 1265-M Broadway, New York 1, N. Y.

**FREE!** Name brands catalog! Your own high profit business. Sell name brands, full or part time. No inventory, no investment. More than 2,000 name brand items; lowest wholesale prices. Watches, jewelry, cameras, hi-fi, stereo radios-phonos, appliances, housewares, hardware, power tools, luggage, musical instruments, garden equipment, sporting goods, toys, many others. 8 floors of name brands. Million dollar inventory. Orders shipped complete in 24 hours! Send for free, beautifully illustrated catalog now! Separate wholesale price list. H. B. Davis Corp., Dept. PM, 145 W. 15 St., New York 11, N. Y.

**BUY** Below wholesale! Thousands of nationally advertised products. Drugs, clothing, housewares, cameras, jewelry, hardware, sporting goods, etc. Postcard brings price list showing actual factory cost. Buy-Rite, 310 Main, Bennington 2, Vermont.

**NEW** Deluxe multicolor below wholesale catalog, automobile catalog, and others. Housewares, appliances, refrigerators, freezers, washers, dryers, television, radios, furniture, clothing, luggage, binoculars, phonographs, recorders, cameras, projectors, tools, typewriters, watches, jewelry. Name brands. Huge discounts to 70%. Postcard: Selbyco, Decatur 15, Ill.

**WORLD'S** Largest wholesale supply. Buy from 679 American, European, Japanese wholesalers. Tailormade suits from Hong-kong. 123 dropship catalogs. Rockbottom prices. Free details. International Buyers, 216-M Jackson, Chicago 6, Illinois.

**USED** And new watches \$2 up. Free list. Southern Watches, 5-PM So. Wabash, Chicago 3.

**WHOLESALE** Specials. Closeouts. Catalog \$1 deposit. Loeber, 224-A Wyatt, Lincoln, Ill.

**LARGEST** Wholesale supply source in U.S.! 15 free catalogs. Furniture, clothing, appliances, housewares, automobiles and accessories, tools, sporting goods, hobby supplies, farm equipment, imports, new products, bargain merchandise. Free details. Associated, Box 108-DD, Lincoln 1, Nebr.

**2,000 PAGES** Wholesale catalogs! Write: Mosser, Box 47-B, Newark, Ohio.

**ELECTRIC** Guitars, amplifiers, wholesale. Free catalog. Carvin PMW, Covina, Calif.

**SWISS** Watches through established importer \$3.25, \$5.85, \$9.98, air parcel post inc. Free catalog. Mercury Export, Munich 42, West Germany.

**BARGAINS!** Buy retail at wholesale prices. Catalog free. C. Ayres, 1427 Pickens, Columbia, S. C.

**BUY** Wholesale—why pay more. Thousands items. Tremendous savings. Watches, jewelry, household appliances, toys, radios, many more. Details. Free catalog. Write: Ward Sales Company, Woodford 1, So. Car.

**BELOW** Wholesale! Tools, appliances, housewares, etc. Catalog 10¢. Lant Distributors, 718 Myrtle, Albany 8, New York.

**FREE!** Wholesale catalog. Save 25-75%! Offers, 8440 Michigan, Detroit 10, Mich.

**BELOW** Wholesale, Christmas closeouts. Catalog \$1.00 (refundable). National Wholesalers, Saranac Lake, New York.

**BIG** Bargains. Wholesale. Hundreds practical items. Large illustrated catalog, 10¢. Gifts, Box 330-A, Fort Dodge, Iowa.

### SALESMEN—DISTRIBUTORS

**MAKE** Big money taking orders Campbell's Gro-Green Liquid and 100% soluble crystal fertilizer concentrates. Saves time, money, labor. Feeds foliage, soil. Field proven over 10 years. Increases protein, mineral content grains, forage. Free sample. Selling outfit. Credit given. Ideal for corn and feed men. Campbell Co. (Est. 1928), Rochelle 52, Illinois.

**CALENDARS**, Novelties. Full or part time. Liberal commissions. Fleming, 6535-A Cottage Grove, Chicago 37.

**BIBLE** Profit 130% — why make less? Literature free. Bible, 4813A Hurford, Chester, Penna.

**MAKE** Extra money—Big cash commissions plus premium for you and your customers. Sell advertising book matches. Sensational new tenor guitar glamour girls, hillbillies; dozens others. All sizes. Quick daily sale; big repeat business. Free master kit makes selling easy. No experience necessary. Superior Match, Dept. M-162, 7530 Greenwood, Chicago 19.

**MAKE** Big money taking orders for Stark dwarf fruit trees. Everybody can now grow giant size apples, peaches, pears in their yards. Also shade trees, shrubs, vines, roses, etc. Outfit free. Stark Bros., Desk 30112, Louisiana, Mo.

**MAKE** Extra money selling advertising matchbooks. Free catalog and sales outfit. Matchcorp, Dept. PM-12, Chicago 32.

**PART TIME** Automatic fire extinguisher salesman. Out-O-Matic, 1737J East 31st, Denver 5, Colorado.

**SENSATIONAL** New longer-burning light bulb. Amazing free replacement guarantee—never again buy light bulbs. No competition. Multi-million dollar market yours alone. Make small fortune even spare time. Incredibly quick sales. Free sales kit. Merlite (Bulb Div.), 114 E. 32nd, Dept. C-74N, New York 16.

**EARN** Big commission full or part time. Build profitable business of your own selling America's largest line low priced business printing. 360 page catalog samples hundreds of items used daily by business people. Imprinted ball pens low as \$8.95 for 100. Big full color catalog low priced advertising specialties included. Free sales kit. National Press, Dept. 8, North Chicago, Illinois.

**MAKE** Up to \$50.00 a day soliciting delinquent accounts. Terrific commissions. Write today. General Finance, 304V Pickwick Bldg., Kansas City 6, Mo.

**IF** You're interested in making money in selling, see the hundreds of exceptional opportunities in Salesmen's Opportunity Magazine. Send name for your copy, absolutely free. Tell us what you're selling now. Opportunity, 848 N. Dearborn, Dept. 17, Chicago 10, Illinois.

**\$1,000.00** A Month for making dramatic 3-second demonstration of amazing lightweight presto fire extinguisher. New chemical used by airforce snuffs out fires instantly. Only \$4.95. Terrific commissions. Millions want it. Free kit. Merlite, 114 E. 32nd, Dept. P-66N, New York 16.

**FOG** Shield—Stops fogging instantly cars, mirrors, windows. Keeps ice off windshields. Will last 2 or 3 years—sold money back guarantee. Incredibly quick sales. This is no fly by night deal. Distributors wanted. Send \$1.00 for sample to: Fog Shield, P.O. Box 27, Baker, La.

**BIG** Money taking orders for amazing new automotive and industrial products. Free details. Conklin Inc., 5626 Nokomis Station, Minneapolis 17, Minnesota.

**AMAZING** Opportunity. New low priced fire alarm protects homes, farms, offices, factories, etc. No wiring—hangs like picture. Pays up to \$1,100 a month. Free kit. Merlite (Alarm Div.), 114 E. 32nd St., Dept. F-66N, New York 16, N. Y.

**SEEKING** New products? Get my outfit 47 money-making specialties. Latest conveniences for home, car. Send no money. Just your name. Kristee 150, Akron, Ohio.

**WILL** You wear new suits, sport coats without one penny cost and agree to show them to friends? You can make up to \$40.00 in a day even in spare time, without canvassing. Stone-Field, 532 South Throop St., Dept. H-926, Chicago 7, Ill.

**I'LL** Send you free stocking sample newest advancement in hosiery since nylon. Patented, full-length. Stays up over-the-knee without supporters, without girdle! Nationally advertised price \$1.95. Make money introducing to friends at \$1.00 pair. American Mills, Dept. 719, Indianapolis, Indiana.

**AVAILABLE** Invention tremendous sales potentialities. Klutch, P.O. Box 205, Alhambra, Calif.

**SEAMLESS** Nylons \$6.95 Dz. panties \$4.75. Slips \$14.75. Free catalog. Lizmar Hosiery, 10409 St. Clair, Cleveland 8, Ohio.

**PERFUMES**, Jewelry, watches, transistors. Tremendous profits. Lindback, 1124 Woodside, Muskegon, Michigan.

**LONG** Needed invention. Men to contact service stations. Huge profits. Cyclo Mfg., 3816 Dahlia, Dept. 101, Denver 1, Colo.

### EMPLOYMENT INFORMATION

**FOREIGN** Employment. Construction, other work projects. Good paying overseas jobs with extras, travel expenses. Write only: Foreign Service Bureau, Dept. PM, Bradenton Beach, Fla.

**SKYROCKET** Your income. World-wide jobs—all trades. Free details. International Occupations, International Airport, Box 100-C2, Jamaica 30, N. Y.

**ESCAPE** Jobs forever. Unusual books show how. Retirement, 2325A Bonair, Montreal 35, Canada.

**EUROPE**, Overseas. High paying jobs. Full details \$2.00. North Sea Export(PJ), POB 548, Amsterdam, Holland, Europe.

**CALIFORNIA** Jobs. Aircraft, missiles, construction, sales. Many others. Send \$2.00 for latest listings. Airmail. California Opportunities, Box 2463, San Bernardino, Calif.

**WORK** In sunny Arizona. Information and job listings, \$1.00. Thompson Enterprises, Box 6561, Phoenix 5, Arizona.

**U. S. A.** Foreign jobs, up to \$1600.00 monthly. Construction, clerical, supervisory, etc., skilled, unskilled. Free transportation. Unusual opportunities. Complete information plus worldwide project listings. Only \$2.00 (\$2.25 airmail). Satisfaction guaranteed. International Opportunities, Dept. 66C, 109 W. 42, New York 36, N. Y. or Box 621, San Jose 6, California.

**LOOKING** For a high-paying job! Free, proven result-getting information. Current openings, men-women all trades, anywhere in United States and abroad. Write: Worldwide, Dept. B19, 155 N. Franklin St., Hempstead, N. Y.

**FREE**, National Coverage Bulletin. Expert Publications, Box 598, Roanoke, Va.

**SENSATIONAL** Employment listings. \$2.00. Diamond Publications, Box 6133, Spokane, Wash.

**FREE** Information — U.S.A. overseas jobs, high pay. Transportation. Futures, Dept. M, 215 West 34th Street, New York City 1.

**\$1,600.00** MONTHLY Possible! With "Employment Information." \$1. International, 100 Airport, San Antonio 12, Texas.

**DIRECTORY** Reports. Construction, aviation, shipping, oilfields, government, manufacturing, trucking, etc. Foreign-stateside. Helpful information plus job-getting tips on preparing application letters. Unconditional money-back guarantee of satisfaction. Act today. Only \$2.00 (\$2.25 airmail). (C.O.D.'s accepted). Research Services, Meramec Building, St. Louis 5-PM, Missouri.

**FOREIGN** Employment information. Europe, Alaska, Africa, Asia, Canada. Travel, adventure. Up to \$1,600 monthly. Construction workers, truck drivers, clerks, teachers, professionals, etc. Sensational opportunities—most complete information, application form sent immediately by return mail. Send \$2.00 to: Jobs, Box 512-E, New Orleans 12, Louisiana.

**MERCHANT** Marine jobs. Men and women. Top wages. Travel. Captain, Box 501-F, Reading, Massachusetts.

**OVERSEAS** Employment information. High salaries. All occupations, professions. Tremendous opportunities. Complete listings, \$2.00. Associated Reporters, P.O. Box 1008, Miami 1, Florida.

**JOBS.** Hundreds open. Technical, clerical, sales, executive. No placement fees. Box 205, Houston, Texas.

### SPECIAL SERVICES

**INFORMATION** On anything. Ferguson Research Specialists, 59 Lent Ave., Hempstead, N. Y.

**PERPETUAL** Flower Care. (R. K. Whittington owner.) For Golden Gate National Cemetery, San Bruno, Calif. \$20.00 per year your choice of four days a year. For information and contract write 449 Ferndale Avenue, South San Francisco, California.

### EDUCATIONAL AND INSTRUCTION

**OIL** Coloring photographs. A fascinating hobby or profitable sideline for those with artistic talent. Learn at home. Easy simplified method. Free booklet. National Photo Coloring School, 835 Diversey Parkway, Dept. 3431, Chicago 14.

**DRAFTING** Pays big money. Leads to position in automotive, aeronautical, construction, mechanical fields. Learn at home in spare time. All equipment supplied. Pay later plan. Free book. Christy Trades School, D-5403, 3214 Lawrence, Chicago 25.

**MASTER** Watch making at home. Free sample lesson. Chicago School, 2328-YA Milwaukee, Chicago 47.

**ENGLISH** Course for adults. With my new self-correcting method you can stop making mistakes—speak & write effectively. 15 minutes a day at home. Free 32 page booklet. D. O. Bolander, Career Institute, Dept. 27705M, 30 E. Adams St., Chicago 3, Illinois.

**FREE** List "How To Do It Yourself" books, also home study Civil Service guides. Harry's Book Shop, 4415-PC North 13th St., Tacoma 6, Wash.

"HOW To Train Horses"—A book everyone who likes horses or ponies should have. Free. No obligation. Simply address Beery School, Dept. 1101 Pleasant Hill, Ohio.

**LEARN** Fascinating, profitable invisible reweaving at home. \$10.00 earnings in an hour possible making tears, holes disappear from clothing, fabrics. Steady demand from cleaners, laundries, homes. Details free. Fabricon, 6255 Broadway, Chicago 40, Ill.

**SPEAK,** Speak with power. Self-training records. Amazing! Canfield, 2018-A Fifth Avenue South, Minneapolis 4, Minn.

**LEARN** Civil and criminal investigation at home. Earn steady, good pay. State age. Institute Applied Science, 1920 Sunnyside, Department 161, Chicago 40, Illinois.

**USED** Correspondence courses and books sold and rented. Money back guarantee. Catalog free. (Courses bought.) Lee Mountain, Pisgah, Alabama.

**BECOME** A personal problem counselor. Enter dignified profession. Instructions \$1.00 refundable. Hermansen, Box 808, Grand Central Station, New York 17, N. Y.

**WOODWORKING** And cabinetmaking course for beginning and advanced home craftsmen. Only complete low-cost home training program available. Write for free booklet. Interstate Training Service, Dept. G-3, Portland 12, Ore.

**BE** A Real Estate Broker. Insure security for yourself and your family. Study at home. Prepare for state examination. GI approved. Write for free book today. Weaver School of Real Estate, 2018 P Grand, Kansas City, Missouri.

**HIGH** School diploma at home. Licensed teachers. Approved materials. Southern States Academy, Station E-16, Atlanta, Ga.

**WANT** A diesel job? Higher pay? Advancement? We can help you qualify! Complete diesel, tractor and heavy equipment and Cummins Diesel Engine Shop-method home-training courses available. Write today. Interstate Training Service, Dept. B-3, Portland 12, Ore.

**BOOKKEEPERS.** Operate your own "Dollar-A-Week" system. Ellis, Box 200, Cedar Grove, North Carolina.

**OWN** Collection agency. Little "gold mine." Franklin Credit, Roanoke, Va.

**LEARN** Asleep or awake! Records, tapes, equipment! Free catalog! Drawer PM-697, Ruidoso, New Mexico.

**MEN** Wanted. Earn \$125 a week and up. Master a trade with a future. Learn auto diesel mechanics in our shops. You learn with tools on real equipment. Earn while you learn. Many of our graduates earn \$125 a week and up. Write for free bulletin: Dept. 256, Auto Diesel College, Nashville 3, Tenn.

**PIANO** Tuning pays. Learned easily at home. GI approved. 59th year. Free booklet. Niles Bryant School, Dept. P, 3731 Stockton, Sacramento 20, Calif.

**SWEDISH** Massage, physical culture and weight reduction pay big profits. Men and women. Learn at home. Diploma course. Free catalog. National Institute, Desk 4, 165 E. Ontario, Chicago 11, Illinois.

**INVESTIGATORS** Course. Credentials, diploma. Free information. Southwestern Institute Criminology, 510-A Iowa, Geronimo, Okla.

**FINGERPRINTING** And identification taught at home. Diploma. Details free. Alabama School of Fingerprinting, Fairfield, Alabama.

**LEARN** Auctioneering. Free catalog. Missouri Auction School, 1330 Linwood, Kansas City 9-X3, Mo.

**LEARN** Ventriloquism. Amazing-entertaining! Easy! Details free. B. Davis, B-38, Safety Harbor, Florida.

**SECRET** Investigations. Experience unnecessary. Investigators particulars free. George Wagner, M125 West 86th, New York City 24.

**LEARN** Real Estate business fast. Economical homestudy. Literature free. Howard Schools, Box 8394-A, Kansas City 5, Missouri.

**PROFITABLE** National Camera Repair School training at home! 174PM, Englewood, Colorado.

**DENTAL** Technician's home study kit!! Instruments, plastic, etc. Write for free illustrated instructions. Grant Laboratory, Haas Bldg., Los Angeles 14, Calif.

**SWEDISH** Massage. Foot technique. Post graduate. Home study. Residential. Diploma. Dr. Swanson's Illinois Licensed School, 3809-PL Alta Vista, Chicago 13.

**LEARN** While asleep with your recorder, phono. Details, catalog free. Sleep-Learning, Box 24-PX, Olympia, Wash.

**ELECTRONICS,** Drafting, gunsmithing, auto-mechanics, building trades. Earn AAS degree in 2-yrs. Public, coeducational college established 1925. Technical and engineering levels offered. Moderate costs. Adequate housing. Trinidad State Junior College, Trinidad, Colorado.

**GOOD** Paying jobs open! Operate, repair heavy earth moving equipment! Learn "on the job" operating latest cranes, bulldozers, earth carriers! V.A. approved. Free catalog. Write T. A. Hutch, Greer Technical Institute, Braidwood, Illinois.

**BOOKS,** Free general catalog, 100 pages. Text, vocational, educational, instructional subjects. Millions of volumes, new and used. Bargain prices. Books bought. Est. 1902. Long's College Book Co., Dept. PM, Columbus 1, Ohio.

**PENMANSHIP** Corrector. Improve poor penmanship quickly. Details free. Ozment, Box 665-34, St. Louis 88, Mo.

**BEGINNER'S** Home training course in drafting. Chickris Engineering, Liberty Building, Rock Island, Illinois.

**SUCCESS** Without ulcers! Read "Wilson's Legacy." \$1.00. Personal Publications, Box 6947, Baltimore 16.

**PROFESSIONAL** Investigator. Home study. Lapel pin, certificate, future. Box 41197-F, Los Angeles 41, California.

**PIANO** Tuning pays. Big money in spare time. Learn at home in 30 days. No musical knowledge necessary. Phonograph, records, tools and instructions furnished. Electronic tuning also taught. Free catalog. Capital Tuning School, 3160 S.W. 16th Court, Ft. Lauderdale, Fla.

**CIVIL** Service. Training for U.S. tests. Get full information about this field, home study preparation for high rating. Free booklet. Private organization. No obligation. Franklin Institute, Dept. A21, Rochester 4, N. Y.

**USED** Correspondence courses, books. Satisfaction guaranteed. Catalog 10¢ refundable. Courses bought. Bayles, 78-B Courtwright, Wilkes Barre, Penna.

**MEMORY** Training. Memorology offers adequate instruction. You can master it. Information free. Memorology Studio, 1958 Sunnyside, Chicago 40, Ill.

**COMPLETE** Your high school at home in spare time with 65-year-old school. Texts furnished. No classes. Diploma. Information booklet free. American School, Dept. X145, Drexel at 58th, Chicago 37, Illinois.

**USED** Correspondence courses, books bought, sold, rented. Catalog free. Vernon, Summerville, Ga.

**THE** Private eye! Exclusive booklet, direct from files of internationally known private investigator. Reveals who! Why! When! Where! and How! to become private investigator! Send name, address and \$2.98 for postpaid copy today! Or will rush C.O.D. plus mailing costs. "The Private Eye," Dept. PMC-1, P.O. Box #96, Oklahoma City 1, Oklahoma.

**EARN** Extra money by clock and watch repairing. Learn at home. Kansas City School of Watchmaking, 1228PM Admiral, Kansas City 6, Missouri.

**54** COLLEGES Offer college and high school correspondence courses! Directory \$1.00. Soave, Box 518, Mount Vernon, New York.

**EARN** \$150 Weekly Mechanical, Electronic Drafting. Send \$2 first lesson, \$25 complete home study course. Prior, Inc., 23-09 169 Street, Whitestone 57, New York.

**FREE** Investigator course as bonus with purchase of 1962 National Detective Directory. Write for full information to: American Detective Association, P.O. Box 478, Santa Ana, California.

**FINISH** High School at home. No classes. Texts furnished. Diploma awarded. If 17 or over and have left school, write for free assignment and catalog. Wayne School, Dept. 01-513, 417 S. Dearborn, Chicago 5, Illinois.

### PLAYS, STORIES, MANUSCRIPTS

**WRITERS!** Free list of top-notch U.S.A. markets for short stories, articles, books and plays. Write for your free copy today! Literary Agent Mead, 915 Broadway, New York 10.

**WANT** Your book published? Learn how we publish, advertise, promote, distribute. Many successes. Free booklet PM. Vantage, 120 West 31, New York City. Or 6253 Hollywood Blvd., Hollywood 28, Calif.

### ADVERTISING AGENCIES, ADV. SERVICE, MAILING LISTS

**FREE** World magazine. Rate card for stamp. Harddings's, McLoud, Oklahoma.

**SPECIAL** Introductory offer! \$4,000.00 of professional clip art in line and screened halftones. For printers and ad agencies. In 30 page book. Only \$4.98. D'Artiste Associated, P.O. Box 3444, Bridgeport, Connecticut.

**AMAZING** New Book—"Profits From Classified Advertising." Tells how and what to advertise. Be sure to read this book before you invest one cent in advertising. Write for your copy now. F. W. Johnson, Classified Advertising Manager, 202-210 East Ontario Street, Chicago 11, Illinois.

ADVERTISE: 24 Words, 75 Canadian newspapers, \$5.50. Lists free. Advertising Bureau, 10511-C Springfield, Chicago 55.

ADVERTISING Ratebook leading newspapers, magazines, free. Chicago Advertising Agency, 28-E Jackson, Chicago 4.

MAILING Lists most all kinds 1000 \$5.00. Free folder. Your circulars mailed \$4.00 1000. Dixie Mailers, King, N. C.

NOW Ready: New, amazing Classified Advertising Record Book—prepared especially for classified advertisers. Here is a book that tells you instantly whether or not your advertising in any publication is paying you real results. You can tell immediately how many inquiries each publication produced—how much cash received from every ad. Spaces are provided for the name and address of the publication, date of issue, space used, rate, cost of ad, key number, etc. You have a complete record of each publication right before your eyes. Plenty of space to keep accurate record of 26 separate publications. You can have a copy by sending only 10¢ to cover postage and handling. Send for your copy now. W. F. Johnson, Classified Adv. Mgr., Popular Mechanics Magazine, 204 E. Ontario Street, Chicago 11, Illinois.

### TYPEWRITERS, DUPLICATORS, OFFICE DEVICES

RECONDITIONED Typewriters, mimeograph, printing presses \$25.00 up. Write Dixiegraph, King, N. C.

### RUBBER STAMPS AND OFFICE SUPPLIES

FREE—Illustrated rubber stamp catalog. Low prices! Hildreth, 1047-A Inner, Schenectady 3, New York.

SIGNATURE Stamps \$3.00. Pocket stamps \$1.00. Free literature. Sav-Mor Stamps, Adams City 5, Colorado.

CATALOG—Rubber stamps, daters, business cards, printing. Martin, 1425 Major, Jefferson City, Missouri.

FREE 32-Page rubber stamp catalog. Stock stamps, racks, pads, Christmas stamps, signature stamps \$3.50. Youngers Stamp Shop, Princeton, Iowa.

POCKET, 3 Lines \$1.00. Guaranteed. W. J. Specialty, 8464 Manhattan, Detroit 11, Michigan.

FACTORY Prices. Catalog \$1.00. (refundable). Guaranteed. Adirondack Printers, Saranac Lake, New York.

3 LINES \$1.00. Extra lines 25¢. Cushioned mount, knob handle. One day service. Wallace, Box 146, Hanover, Penna.

RUBBER Stamps, 50¢ per 2" line. Free folder. Tabco, Tomkins Cove, New York.

RUBBER Stamp 4 lines \$1.25. Kays, 172 W-34 St., Riviera Beach, Fla.

THREE Line rubber stamp—50¢. Offers, 8440 Michigan, Detroit 10, Michigan.

FREE Catalog. Introductory bargain price on deluxe 3 line stamp—\$1.00. Jackson's, 1327 Wellington, Chicago, Illinois.

SUPERIOR Rubber stamps, labels, printing. Low prices! Catalogue. Johnson, 443 MacDonough, Brooklyn 33, N. Y.

### CARTOONING, COMMERCIAL ART, SHOWCARD & SIGN PAINTING, TATTOOING

"HOW To Make Money With Simple Cartoons." A book everyone who likes to draw should have. It is free; no obligation. Simply address Cartoonists' Exchange, Dept. 91, Pleasant Hill, Ohio.

PAINT Signs! Using patterns! Trial alphabet \$1.00. Harwell, PM-162, Byrdstown, Tennessee.

SIGN Painting outfit! Complete instructions, supplies! Oilboard, hardboard, plywood letter patterns, 1" to 8". Paulow Signs, Crystal Falls, Michigan.

WANTED—Cartoonists. Amateurs, professionals. Over 200 markets. Information free. Markets-IPM, 11620 Lansdowne, Detroit 24, Michigan.

CARTOONERAMA Teaches you cartooning in a new 24 lesson course. Free brochure. CFA, Box 263-C6, Branford, Conn.

LEARN Sign painting. Easy method. Ellis, 10533 121 Ave. N., Largo, Florida.

SURE! You can draw portraits of relatives and friends. Make money too with Corydon Snyder's "Art-Aids." Write for particulars or send him \$1.00 for complete profile set to 520 North Paulina St., Chicago 22, Ill.

FREE To artists, draftsmen, signwriters! Professional monthly bulletin. New ideas, products, techniques. Graphic Arts, 330 Bridge, Springfield, Mass.

CARTOONING—Good money in fields of television advertising, animation, movies, magazines. Famous system of manual training brings amazing new concept of art instruction at home. For profit or pleasure. Send for free details. Continental Schools, Dept. E-116, 4201 S. Broadway, Los Angeles 37, Calif.

YOU Can entertain with chalk talks. Catalog 10¢. Balda the Cartoonist, Oshkosh, Wis.

LEARN Sign painting at home. Free talent test. Ben Kerns, Box 812-PM, Greenville, S.C.

LEARN Sign painting with fascinating system. Straley, 410 S. Western, Springfield, Ohio.

### PRINTING, MULTIGRAPHING, MIMEOGRAPHING, GUMMED LABELS

1000 GUMMED Name and address labels 75¢. Hallows, 14 Drexel Drive, Cahokia, Illinois.

OFFSET Printing. Free prices, samples. Harrison Litho, 248 South Hackett, So. Beloit, Illinois.

MIMEOGRAPHING: Neat, accurate, fast. Prices, samples free. Valley Letter, Box 328, Port Jervis, N. Y.

FREE Case—1,000 embossed cards \$3.95, colors \$4.95. Letterheads, invoices, statements, \$10.95 set. Postpaid. Samples. Medallion, 356 E. Alondra, Gardena, Calif.

1000 BUSINESS Cards, raised letters, \$3.75 postpaid. Samples. Routh, PM-1, 2633 Randleman, Greensboro, N. C.

OFFSET Printing, 100 8½x11, \$2.49. Additional 100's 43¢. Add postage. Parks, 3823 Merrick Rd., Seaford, N. Y.

GOOD Printing. Reasonable, fast. Samples, price list. Fred the Printer, Box S-623, Independence, Mo.

AMAZING Business printing values. Samples. Print Shop, Box 576, Greenville, R. I.

PERSONALIZED Stationery—A gift for everyone. Prices. Printing, Box 931, Rochester, N. Y.

250—8½x11 BOND Letterheads \$2.75. 250 envelopes \$2.75. Samples. Patton, Box 248B, South Haven, Mich.

250 8½x11 BUSINESS Letterheads \$2.95. 250 envelopes \$2.95 postpaid. (Samples) Davis, 7609 Spruce Road, Baltimore 22, Maryland.

ECONOMICAL Business printing. Free catalog. Golden Glades, Dept. T, Box 64-18, Miami 64, Florida.

DISTINCTIVE Printing, proofs, cuts, mats, artwork. Writers' office supplies. Logan Enterprises, 6801-A Onyx, St. Petersburg 3, Florida.

MIMEOGRAPHING—Letters, pricelists, formulas, instructions. Lowest prices. Lem's Letter Shop, 5710 Stanton, Detroit 8.

ADS Running under this heading sell printing. Ask me for proof. I'll gladly send you amazing facts. Ask for Folder "P." F. W. Johnson, 200 E. Ontario St., Chicago 11, Ill.

FREE Catalogs postpaid printing. Rubber stamps. DM Press, Sebastopol, Calif.

1000 NAME-Address labels 88¢. Rubber pocket stamp 88¢. Printing, rubber stamp catalog. Jordan's, 552 West O'Connor, Lima, Ohio.

OFFSET Printing. Free samples, prices. Pennant Offset, 2441 North Halsted, Chicago 14.

ATTRACTIVE Stickers, labels, cards. Samples. Fame, 291 Ellis, San Francisco 2, Calif.

1000 THERMOGRAPHED Business cards shipped prepaid \$3.25. Samples. Pennsylvania Press, Box 344, Pittsburgh 13.

BUSINESS Cards \$2.75 thousand postpaid. Free samples. Kavanagh, 607 Knickerbocker Ave., Brooklyn 21, N. Y.

### PRINTING OUTFITS AND SUPPLIES

PRINTERS—Bargains, presses, cutters, type, cabinets. Castcraft, 1100 Kostner, Chicago.

FOUNDRY Cast type and supplies for printers and rubber stamp makers. Satisfaction guaranteed. Send \$1.00 for big 96-page catalog and printers tweezers, deductible from first order. Acme Type, 633 Plymouth Court, Chicago 5, Ill.

RUBBER Stamp presses, hydraulic operated, electrically heated. Sizes 5"x8", 8"x12", 10"x15". Starting outfits, supplies. Printing presses. Custom Manufacturing, 1464-P East Commercial, Springfield, Missouri.

MAKE Your own self-molding rubber stamps and printing cuts. Plexirubber, Argyle 1, Wisconsin.

DO Your own printing. Save money. Simple rules. We supply everything. Print for others; good profit. Raised printing like engraving too. Have home shop. Details free. Kelsey Presses, V-11, Meriden, Connecticut.

RUBBER Stamp outfits, supplies. Kiewiet, 2025 Barney Road, Kalamazoo, Mich.

PRINTING Presses, type, supplies. Lists 4¢. Turnbaugh Service, Mechanicsburg, Penna.

TYPE Case catalog. Manufacturer. King McKay Company, 23179 Telegraph, Southfield, Michigan.

LETTERPRESS, Offset, mimeographing. Lowest prices. Barsketis, 6752 So. Campbell, Chicago 29.

HARD Type for rubber stamp making, printing. Introductory offer 10 or 12 pt. 20th Century Medium caps or L.C. \$2.50. Free catalog. Barco Type, 232 Evergreen, Bensenville, Ill.

### FOR INVENTORS

FOR Inventors. Model building. Manufacturing. Research. William Parker, 32A Westminster, Worcester 5, Mass.

PATENT Drawings your invention. No job for an amateur. Our experts have 38 years experience. Costs reasonable. Patent Service Associates, Haverhill, New Hampshire.

HOW To develop, sell your invention. "Guide Book" tells what's needed. Send \$1.00. Inventors Creative Service, PM354 South Spring, Los Angeles 13, California.

IDEAS—10 Ideas for exceptional, marketable products. Send \$1.00 to: Ideas, Box 39794, Los Angeles 39, California.

PROFESSIONAL Searches of the Patent Office. Dependable—reliable \$6.00 including airmail report and related patents. For free protection forms and patent information write Trans-World Patent Service, 500 Walker Building, Washington 5, D. C.

PATENT Searches including full, airmail report and closest patent copies, \$6.00. Quality searches, expertly administered. Free protection forms and patent information. Write Professional Patent Office Search Bureau, 709 Albee Building, Washington 5, D. C.

INVENTORS! Outright cash sale or royalties for your inventions. Patented. Unpatented. Constant demand from our client manufacturers. Write: United States Invention Brokerage, 78 Wall Street, New York 5, N. Y.

INVENTORS! Consider our offer first before selling or licensing your invention on a cash or royalty basis. Patented. Unpatented. Write: Inventions on Demand, 79 Wall Street, New York 5, N. Y.

**DON'T Pay high fees! Obtain U.S. patent yourself.** It's easy with Professional Kit with fill-in forms. Free "Registration form." Patent Protection Institute, 15 Park Row, New York 38, N. Y.

**PATENT Searches**, including copies of nearest patents, \$6.00. Reports airmailed within 48 hours. More than 200 registered patent attorneys have used my service. For free invention protection forms, write Miss Ann Hastings, P. O. Box 176, Washington 4, D. C.

**WE Have the markets** if you have the ideas. Harvey Engineers, Cambridge 1 Maryland.

**INVENTORS:** Test the commercial value of your patented or unpatented inventions, quickly and inexpensively. Write for free information. Institute of American Inventors, Dept. 40-B, 635-F St., N.W., Washington 4, D. C.

**INVENTORS!** Searches of the Patent Office administered professionally. \$6.00 including airmailed comprehensive report and related patent copies. For free invention protection forms, dependable service, write Washington Patent Office Search Bureau, 1426 G Street N.W., Washington 5, D. C.

**U.S. Patent office former examiner's inventors service.** Patent office searches. Free commercial invention evaluation. Cash-royalties promotion. Patent engineering development. Free invention protection certificates. George Spector, Licensed Patent Engineer, Woolworth Building, New York.

**U.S. Patent office searches—\$5.00.** Free invention record. Patents engineered. Patent Office Searchers, 233 Broadway, Room 3615, New York.

**INVENTORS!** Sell your invention for cash or royalties! Our manufacturers constantly seeking new items. Patented. Unpatented. For free information write Gilbert Adams, Patent Broker, 80 Wall Street, Financial District, New York, N. Y.

**PATENTS Skillfully prepared** for maximum commercial value, with useful product development. High record of success in proving and claiming patentability. Valuable market service. Patent prepared for a fee as low as \$200.00. Send for self-protecting record of invention forms free. Patent search with valuable engineering report \$15.00. Foreign patents filed at low cost. Thirty years established. Joseph O'Brien, Patent and Development Engineer, 132 Nassau St., New York 38, N. Y.

**SAVE High fees!** Apply for your patent yourself. New do-it-yourself Patent Kit now makes it easy! Free "Registration Form." Miss Suzan Blaine, 306 Carry Building, Washington 5, D. C.

**CASH Or Royalties for inventions!** Consider our offer first before licensing or selling your patented or unpatented invention. Write Aladdin Industries, 80 Wall St., New York 5, N. Y.

**PATENTS Professionally prepared** for maximum commercial value. Patent searches including report \$6.00. Patents prepared as low as \$195.00. Valuable market service with cash or royalty sales. 10 years dependable service. For free self-protecting Record of Invention forms write: H. Lawrence Blasius, Patent and Development Engineer, 19 Park Row, New York 38, N. Y.

**INVENTORS:** Save time and money. Prepare and file your own patent application. Our complete "Patent Kit" makes it easy. Includes detailed instructions and all necessary material. Only \$8.95. Money back guarantee. Don't delay. Send check or money order today to National Inventors Service, Box 88, Benjamin Franklin Station, Washington, D.C.

**IF Your invention is adaptable** to promoting we will contract for selling on cash or royalty. Free booklet outlines royalty rates, requirements. Kessler Corporation, C-51-FI, Fremont, Ohio.

## INVENTIONS WANTED

**SALES Service** for your ideas, inventions. Ketchum's Invention Service, Springfield, Illinois.

**WE Develop and promote** your product or ideas. Write for information. Product Promotion Development, Little Building, Boston 16, Mass.

**INVENTIONS Wanted.** Patented: unpatented. Tremendous manufacturers lists. Global Marketing Service, 2420 77th, Oakland 5, California.

**INVENTORS—Do you want** to sell or license your invention on cash or royalty basis? Write Kessler Corporation, C-51-IW, Fremont, Ohio.

**INVENTORS:** Hundreds of manufacturers have requested our assistance in locating marketable new products. Complete information free. Institute of American Inventors, Dept. 40-D, 635-F St. N.W., Washington 4, D. C.

**ARE You interested in offers** from reliable manufacturers for your invention? Patented, unpatented. Harvey Engineers, Cambridge, Maryland

**INVENTORS!** Outright cash sale or royalties for your inventions. Patented. Unpatented. Constant demand from our client manufacturers. Write: United States Invention Brokerage, 78 Wall Street, New York 5, N. Y.

**INVENTORS!** Consider our offer first before selling or licensing your invention on a cash or royalty basis. Patented. Unpatented. Write: Inventions on Demand, 79 Wall Street, New York 5, N. Y.

**INVENTORS** Needing help with any problem, financial, development, securing manufacturer, obtaining patent. Write the organization that delivers action and results—not promises. Pioneer Invention Institute, 150 Broadway, New York 38, N. Y.

**INVENTORS!** Sell your invention for cash or royalties! Our manufacturers constantly seeking new items. Patented. Unpatented. For free information write Gilbert Adams, Patent Broker, 80 Wall Street, Financial District, New York, N. Y.

**INVENTIONS Promoted—for cash-royalty sales** with manufacturer contacts. George Spector, Licensed Invention Engineer, Woolworth Building, New York.

**WANTED Inventions,** patented or unpatented. Unusual services. Professional Engineer, Box 113-A, Hampton, N. H.

**INVENTIONS Wanted** for national promotion. Write: Prometheus, Box 1341, Akron 8, Ohio.

**SELL Your invention for cash.** No commissions. Milburn, Burlington, Kentucky.

## PATENTS FOR SALE

**ANCHOR Bolt** for concrete blocks. MacLean 405 Virginia Ave., New Port Richey, Fla.

## MODELS—SHIPS, TRAINS, PLANES, ETC.

**LIVE Steam powered backyard railroads!** All sizes. Complete "bolt-together-kits", and rough castings. Excellent drawings. 100 page catalog \$1.00. Little Engines, Lomita, Calif.

**SHIP Model kits and fittings:** clippers, frigates, etc. Catalog paint-tool list, book list, 35¢. Model Shipways, Box 85, Bogota, N. J.

**LIONEL Trains.** Big discounts bulletin 10¢. Catalog 25¢. Mack-Bros., 2043P, Chicago Ave., Chicago 22.

**SAVINGS To 50%.** Lionel, Gilbert, Althearn, etc. New trains accessories. Hobby Surplus, P.O. Box 1106, New Britain, Connecticut.

**SCALE Model sailplane kits.** List 10¢. Award Miniatures, Williams, Oregon.

**SHIP And yacht model fittings;** blueprints. Send 40¢ for illustrated catalog listing hundreds of items. A. J. Fisher, Inc., 1002-1 Etowah Ave., Royal Oak, Mich.

**"POWER Drives Handbook"**—36 pages illustrating many types motor drives for model autos, boats, displays, turntables, etc. Mail 25 cents cash, returnable first order \$3.00 or more. Wilson's of Cleveland, Dept. PM, P.O. Box 8995, Ft. Lauderdale, Fla.

**CASTINGS And finished steam-gas engines** from simple oscillating to triple expansion. Finest materials and fittings. Catalogue \$1.00. Denison Live Steam Models, 1606 Denison Ave., Cleveland 9, Ohio.

**CATALOG Of scale model wheels and pilots** 5¢. Williams Bros., Box 1254, Huntington Park, Calif.

**MODEL Hobbyists!** Send 10¢ for catalog. Our 70 powered model plane and boat kits, many radio-control operated, also accessories. Sterling, 501 Wister, Philadelphia 44, Penna.

**SHIP Models.** Kits, fittings, plans, books, tools, engines, motors. Big illustrated catalog 35¢. James Bliss & Co., Dept. SM, 342 Atlantic Avenue, Boston 10, Massachusetts.

**MINIATURE Gasoline or steam engines**—easily machined using our castings and blueprints. Fascinating hobby. Illustrated catalog 25¢. Octura Models, 8148-PM Milwaukee, Niles 48, Ill.

**POWER House,** marine, traction, locomotive engines. Live steam, gasoline types. Whistles, gauges, complete line steam fittings. Comprehensive 100 page catalog = 18 \$1.00. Chas. Cole, Ventura, Calif.

**WANT Trains for HO—or?** Lionel catalog 25¢. Weitz Train Service, 2609P North, Chicago 47.

**ROCKETS!** Five complete blueprints. Plus easy instructions for parachute, instrumentation, electronic ignition, 2-stage, fuels. \$1.00. Rocketry, Box 4708, Washington 20, D. C.

## ENGINEERING SERVICES

**INVENTION Development.** Industrial research. Submit technical problems in confidence for no-cost survey. Todd Consulting Engineers, 430 West 119th, New York 27.

**DESIGNING.** Model making, development work, blueprints. Write: Martin, Martindale, Penna.

**DEVELOPING.** Designing, simple or complicated, gadgets, toys, machines, electrical devices. F. Ledermann, Prof. Engineer, 154 Nassau St., New York 38.

## MANUFACTURING

**MODELS—Small lot manufacturing.** Metals, plastics, etc. Milburn, Burlington, Kentucky.

**MODEL Building.** For inventors. Manufacturing, Research, William Parker, 32 Westminster, Worcester 5, Mass.

## HOME CRAFTSMEN

**KNOCKDOWN Cedar chests,** also over fifty kits. Catalog 25¢. Giles Kendall Co., Huntsville 2, Alabama.

**FREE! Leathercraft catalog.** Hundreds of new items. Write MacPherson Bros. Leather Company, Dept. E. 730 Mission St., San Francisco 3, Calif.

**KNOCKDOWN Cedar chests and lumber.** Catalog 25¢. Bedford Lumber Company, Shelbyville, Tennessee.

**SKIL-CRAFTS—All new '62-63 catalog.** Largest and finest selection of leathercraft, artist and hobbycraft supplies in the world. Free goods gift with first order. 25¢ for latest catalog. Skil-Crafts, Box 167-P, Joplin, Mo.

**PICTURE** Frame moulding, squares and lumber. Kiln dried walnut, cherry, silver maple. Midland Lumber Company, Box 262, Savannah, Mo.

**FREE**, New catalog. 2447 plans, patterns. World's greatest selection things to do, make. Fun. Profit. Craftplans, 1322-A Wabash, Chicago 5.

**LEATHERCRAFT**. Send 10¢ for catalog. Saxcrafts, Inc., 1101 N. 3rd, Milwaukee, Wisconsin.

**GRANDFATHER** Clock movements, case plans, kits. Catalog 25¢. Mason-Sullivan, Noroton 7, Conn.

**89 JIG** Saw patterns. Beautiful shelves, ornaments, novelties. Plus "How Where to Sell" \$1.00. Mastercraft J4M, 7041 Olcott, Chicago 31.

**FREE** Necklace kit—with jewelry supply catalog. 25¢. Designs, kits, instructions. Big profits! Easy to make! Modern Craft, Box 11088-R, Saint Petersburg 33, Florida.

**16 LAWN** Chairs, 22 tables, benches, trellises. Plans and necessary patterns. \$1.00. Mastercraft, J3M, 7041 Olcott, Chicago 31.

**FREE** Handcrafts folder. Annual clearance. Bargains. Leather, metal, etc. Larson, Dept. 1827, 820 S. Tripp, Chicago 24.

**WOODWORKING** Catalog and manual. Brand new 150th Anniversary edition! World's largest selection of domestic, imported woods — materials, tools, supplies, do-it-yourself plans, projects. 132 pages, many full color. More than 2,000 items. Send 25¢ for postage and packing. Act now! Constantine, 2050 Eastchester Road, Dept. A-101, New York 61, N. Y.

**BUY** Picture frame moldings at wholesale. All styles and widths. Necessary tools, too. Free deliveries in U.S.A. Write for pricelists. Chesapeake Picture Frame Company, 414-A East Baltimore St., Baltimore 2, Md.

**101 PATTERNS** Of smart gifts, novelties, shelves, action windmills plus "Make Money Jig Sawing." \$1.00. Mastercraft, J5M, 7041 Olcott, Chicago 31.

**veneers**, 1/28" Thick. Send \$1.50 for two square feet each of cherry, mahogany, maple, oak and walnut. Catalog of wood-working supplies 10¢. Barap Specialties, P.O. Box 2044, Dept. P-13, Chicago 9.

**FREE** "Do-it-yourself" leathercraft catalog. Tandy Leather Company, Box 791-042, Fort Worth, Texas.

### DO IT YOURSELF

**SIGNS**—Fluorescent glow letters 2 to 20 inch. Easy application. Free sample. Sharp Shop, 563 Northfield, West Orange, N. J.

**SMALL** Car owners: power kits \$5.95 up. Safety and comfort items. Fish Canadian, Box 26, Willowdale, Ontario.

**RESILVER** Mirrors; plate. Literature catalog 25¢. Mirrocraft, 18518 Winthrop, Detroit 35.

**STEEL** And masonry nuclear fallout shelter plans. Eliminates posts, carpentry and interior waste space. Send \$3.00 to Develco, 316 Cedar Ave., Minneapolis 4, Minnesota.

**BUILD** Your own tractor plans. Free information. Eltraco, Dept. A, Camptonville, Calif.

**PRE-CAST** Concrete plans. Table and benches 50¢, light weight concrete slabs 50¢, barbecue \$1.00. Plans, 4996 Nagle Rd., No. Ridgeville, Ohio.

**SAVE** Money, have fun. Free list of How to Do-It-Yourself books. Write today. Johnny Russell & Company, Dept. B1X1, P.O. Box 1997, San Antonio 6, Texas.

**FALLOUT** Shelter plans \$1.50. Associated Drafting, Box 164, Claymont, Delaware. Plant list 10¢.

**HOMEOWNERS**—Utilize all available storage space. Build your own lavatory cabinet, modern or colonial. Detailed blueprints. \$1.00. Practical Plans, Box 51, Lansing, Illinois.

**RADIATION** Detector. Instructions, including critical materials. \$2.00. Doctor Labs., Box 297-C, Palm Harbor, Florida.

**FREE** Check-list covering more than 500 classifications of projects, plans, instructions, service and repair information detailed in Popular Mechanics famous series of instructional booklets, books, patterns, and blueprints. List covers an extremely wide variety of do-it-yourself data on home remodeling, repair and improvement, hobbies, crafts, boating, games, lawn and garden, and hundreds of others. For your free copy of this helpful list, write: Service Bureau, Popular Mechanics, Room 520, 200 East Ontario, Chicago 11, Ill.

### WATCHES, OLD GOLD, JEWELRY

**WATCH** And clock repairing books. Free catalog. North American, 2320-AO Milwaukee, Chicago 47, Illinois.

**PREHISTORIC** Sharktooth necklace. Stunningly beautiful. \$6.95 each. Leffingwell, Surfside, S. C.

**HIGHEST** Cash paid for old gold, jewelry, gold teeth, rings, diamonds, watches, silver, platinum. Mail articles today. Information free. Chicago Gold Co., 6 E. Monroe, Dept. 3558, Chicago 3.

**WATCHMAKERS'** Tools, materials, supplies, watches. Catalog. Gales, Box 1000, Chicago 90, Ill.

**CASH** Immediately for old gold, jewelry, gold teeth, watches, diamonds, silverware, spectacles, platinum, mercury. Free information. Rose Industries, Heyworth Building, Chicago 2.

**FREE** Watchmaking course! Wholesale catalogue, details, 25¢. Bengal's, Culver City, California.

**LEARN** Watch cleaning, repairing. Illustrated. Excellent earnings. Kester, Deckerville, Michigan.

### FOR THE HOME

**HEAT** Your home for almost nothing. Interesting details. Ottaquechee Products Company, Quechee, Vermont.

### OF INTEREST TO WOMEN

**SELL** Fine fabrics. Get yours wholesale. Box 863, Norwalk, Conn.

**LADIES** Bargain nylons. S-J Sales, 3329 Superior, Ashtabula, Ohio.

**PERSONALIZED** Home study. Doll Hospital School, Studio MC-12A, Los Angeles 49, Calif.

**DRESSES** 24¢. Shoes 39¢. Men's suits \$4.95. Trousers \$1.20. Better used clothing. Free catalog. Transworld, 164-G Christopher, Brooklyn 12, N. Y.

**WOMEN!** Make big money at home. \$10.00 profit in an hour possible with invisible mending. Make holes, tears disappear from clothing, fabrics. Steady year-round demand from cleaners, laundries, homes. Details free. Fabricon, 6253 Broadway, Chicago 40, Ill.

**CANDLEMAKING** And decorating. Terrific hobby. Great business. Learn fascinating molding, dipping, creating and decorating candles for year-round demand—holidays, birthdays, weddings, anniversaries, all events. Spare time fun and extra income now, expand to colorful candle shop later. No age limit. Write for free facts on home instruction method. Candle Institute, Dept. X596, Fallbrook, Calif.

**HOW** To make money typing at home—17 proven ways! Detailed instructions \$1. Refundable. Ryco Service, 210-G Fifth Ave., New York 10, N. Y.

**LEARN** Expert cake decorating, candy making. Free details on home instruction method. Candy & Cake, Dept. D-132, Fallbrook, Calif.

**STOP** Throwing away boxtops! They're worth money! Some, 25¢! Inquire: "Box-tops-M," Cedar Hill, Texas.

### PERSONAL

**BIBLE** Questions answered. Stamped envelope. Bylon, 17167 Bentler, Detroit 19, Michigan.

**LOANS** By mail, \$100-\$600. Anywhere. Confidential. Write Union Finance, Dept. PM, 323 E. Camelback, Phoenix, Arizona.

**LOANS** By Air Mail, \$100-\$600. Anywhere. Confidential. Easy payments. Write Security Finance Co., 898 Van Ness Ave., Dept. PM, San Francisco 9, Calif.

**NEW!** Borrow \$800. Anywhere. Increased loan limit. Air mail service. Postal Finance, 374 New Brotherhood Building, Dept. 17-C, Kansas City, Kansas.

**LOANS** By mail. \$50-\$600 for any purpose. Confidential. 2 years to repay. Free loan application. Write: American Loan Plan, Dept. PM-12251, City National Bldg., Omaha 2, Nebraska.

**BORROW** \$100 To \$1,000 by mail. Quick, easy, private. No co-signers. Repay in 24 small monthly payments. For the amount you want write today to Dial Finance Co., 410 Kilpatrick Bldg., Dept. A-1, Omaha 2, Nebraska.

**MAKE** Your own will. Legal will forms 3 for \$1.00. Frank's, 1902 Randolph St., Florence, Alabama.

**DEVELOP** Mind power, personality while asleep. Details free. Research Association, Box 24-N, Olympia, Washington.

**EVANGELICAL** Books. Free lists. Terminal Tracts, Box 125, Bayport, New York.

"**HOW** To Wake Up Life-Changing Winning Ability" sent free. Write: President, Box 1924-W, Louisville 1, Ky.

### REMAILING SERVICE

**SECRET** Mail address. \$3 month. Hedgpath, Box 830, Alhambra 23, Calif.

**HAWAII** Remails 25¢. Information free. Coe, Box 984, Kailua, Hawaii.

**LETTERS** Remailed 25¢. Confidential. Robert Carter, Box 742, Los Angeles 53, Calif.

**REMAIL** 25¢. \$3.00 Monthly. Henry, 214 Broadway, Dept. 30, San Antonio 5, Texas.

**CONFIDENTIAL** New York City mailing, receiving, forwarding address. Business personal mail \$3.00 month. Remails 25¢. Details free. Birnhan, 109 West 42, New York City 36.

**RENO** Gambling club postcards. Five \$1. Twelve \$2. You address, return for free stamping, mailing. Souvenir gambling club 1962 calendar 25¢. Remails 25¢. Monthly \$3. Garakontie, Box 2876, Reno, Nevada.

**REAIRMAIL**, Panama Canal Zone. \$1.00. Levin, 2942, Cristobal, Canal Zone.

**SECRET** Mail address. Receiving and forwarding. Free information. Henry Labrie, 380 Elgin Street, Room 7, Ottawa 4, Ont., Canada.

**REMAILS**, Receiving, forwarding, \$3.00 monthly, 25¢ single. 10437 Lanark Street, Sun Valley 3, California.

**HAWAII!** Receiving-forwarding \$3.00 month. Write: Fobel, 617 Kuaaina, Kailua, Hawaii.

**REMAILS** 25¢. Monthly \$3.00. Pollock, Box 352, Bayamon, Puerto Rico.

**NEW** Orleans Address \$2.00 monthly. Mardi Gras issue mailed. Box 4218, New Orleans 18, Louisiana.

**SECRET** Mail address. \$3.00 monthly. De Graff, Box 14156, San Diego, Calif.

**CONFIDENTIAL** Receiving, forwarding address. \$3.00 monthly. Free details. H. V. Zinck, Box 934, Lunenburg, Nova Scotia, Canada.

**WORLDWIDE** Remailing! Confidential mail address, \$3 month. Free details. Worldwide Mail Service, Box 1736, Denver 1, Colorado.

**HAWAII!** Receiving-forwarding \$3.00 month. Write: Fobel, 617 Kuaaina, Kailua, Hawaii.

## TREASURE FINDERS

**METAL** Locator kits and assembled models from \$39.90. Terms. Transistorized and underwater models available. Free catalog. Electronic Applications, Dept. M, Box 8, Arlington 10, Virginia.

**FUN & Profit** finding buried treasure, relics with transistor M-Scope. Known worldwide for supersensitivity, dependability. Guaranteed. From \$59.50. Easy terms. Send for free literature, fascinating user experiences. Fisher Research, Dept. AZ, Palo Alto, Calif.

**GOLD, Silver, coins, Civil War relics, treasures.** Choice 5 locators. Established 1933. Free literature. Write The Goldak Company, 1541 W. Glenoaks Blvd., Glendale 1, California.

## WANTED—MISCELLANEOUS

**QUICKSILVER, Platinum, silver, gold.** Ores analyzed. Wholesale Terminal, Norwood, Mass.

## FOR SALE—MISCELLANEOUS

**JUST Out!** 356-page catalog—save to 50% on auto parts, accessories. All makes, models. Send 25¢—refundable on first order. Whitney, 1919 AA-1, Archer, Chicago 16.

**CORRECT** Hundreds typewritten mistakes for pennies. New type correcting slips. Package 49¢. Details. WTC, Wewoka, Oklahoma.

**PLASTIC** Wall packet frames 20 QSL, SWL or scenic cards. 35¢. 3 for \$1.00 ppd. Tenn. Box Co., Gallatin, Tenn.

**FREE Money-saving catalog.** Surplus and newly manufactured equipment and tools for workshop, home, boats, farm, factory. Write: Groban, 1139 South Wabash, Chicago 5, Illinois.

**HEARING Aid** batteries wholesale. Free list. Habs. Box 51, York, Penna.

## MISCELLANEOUS

**"MEMORY-Lock."** (Dr. Young.) For self-advancement. Clarion, Box 9309-S7, Chicago 90.

**BOOKS** On antiques and their prices. Free circular! P. Warman Publishers, Uniontown, Penna.

**CIGARETTES—**Make 20 plain or filter-tip for 9¢. Facts free. Moberly, Box 785, Owensboro, Kentucky.

**EARN Money** raising fishworms for us! Write: Oakhaven 60, Cedar Hill, Texas.

**SUPER Memory** overnight! Success guaranteed! Bijou, Box 1727-M, Hollywood 28, California.

**WANT Your name** with 1000 mailers? 25¢ lists your name year with our mailings every month. Dixie Mailers, King, N. C.

**100,000 PRODUCTS** Wholesale—Free catalog! Send postcard: Econ-O-Mart, Whippany 15, New Jersey.

**SEND Us wool** for blankets. Write El-Dorado Woolens, Eldorado, Texas.

**GRASSCLOTH** Wallpaper. Remodeling? Use this elegant handmade textured wall covering for home or office. Send 25¢ for sample book. Buy direct from importer and save over 50%. \$4.50 per roll. Dept. PM-12, Oriental Grasscloth Wallpaper Co., 7 Front Street, San Francisco, Calif.

**SEND \$1.25** for Scratch Covering furniture liquid for mahogany, Walnut or maple. Mazzullo Furniture Finishes, 447 Sayles, Oneida, N. Y.

**50 ALL Different** Mail order publications \$1.00. Hardding's, McLoud, Oklahoma.

**STAMMER, Stutter, no more.** (Dr. Young.) Write: Gaucho, Box 9309-S7, Chicago 90.

**PROFIT** Adding charts. Send \$1.00. Idea, Box 61, Rogers, Arkansas.

**TEENAGER?** Learn radio announcing! "Disk Jockey Handbook," \$1. Zastrow's, 1236 Rose Vista, St. Paul 13, Minnesota.

**LIFETIME** Listing with thousands of direct mailers—25¢. Indicate interests. Mailist, Box 1143, Rochester 3, New York.

**AMAZING** Bargains for whole family. Tremendous useful items. Big catalog free. Kelly, 2110 Brown, Flint 3, Mich.

**MEN** And women—Interested in full or part time selling? Your name on our mailing lists one year, free. Avers, Box 22, Forest Park, Ill.

**LEATHER** Belt holder; 6" Crestaloy adjustable wrench; C-Tee pliers; complete \$5.95. Lillard's Leathercraft, Friona, Tex.

**BUYING** And engineering problems solved. NBARS, 9235A Menard, Oaklawn, Illinois.

**LET Us** tell you how to turn the reading habits of your friends into profit for you. \$10.00, \$25.000 or \$50.000 can easily and quickly be made under our Popular Mechanics subscription plan. No experience needed. Write Popular Mechanics, Room 1M, 250 West 55th St., New York 19, N. Y.

you can always  
**BE SURE OF A JOB**

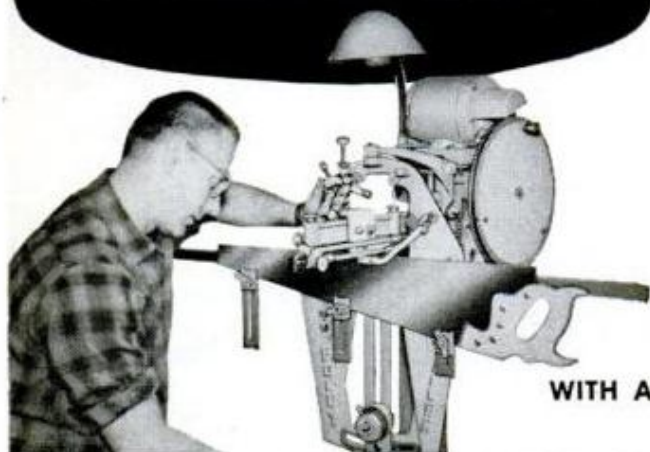

WITH A

## FOLEY SAW FILER

Have you been laid off—or afraid you may be? If you want security, plus a bigger income too—don't look for a job—start your own spare time business. In his first 2 months J. P. Robitaille earned \$300 with his Foley Saw Filer. From his starting day R. T. Hart made \$600 in 4 months. Frank P. Layne wrote—"In our town of 2,800 instead of 200 to 300 saws I did over 1,500 the first year, averaging about \$1.50 each.

**FREE** booklet "MONEY MAKING FACTS" shows you how to get business. The new Foley "200" sharpens hand, band and both "combination" and crosscut circular saws. Use our Time Payment Plan—pay for the machine out of your CASH profits. Send coupon today—no obligation, and no salesman will call.



**FOLEY MFG. CO., 129-2 Foley Bldg., Minneapolis 18, Minn.**  
Send Free Booklet and Time Payment Plan on Foley Saw Filer.

Name \_\_\_\_\_  
Address \_\_\_\_\_  
City \_\_\_\_\_ State \_\_\_\_\_



## Pea-Size Battery

Small enough to fit into a pea pod, a new silver-oxide battery is reported to have an unusually good low-temperature performance.

Designed primarily for use in new battery-powered watches and hearing aids, the battery has a leakproof sealing system. It is made by Union Carbide Corp.

POPULAR MECHANICS

# IS HE TALKING ABOUT YOU?

A. Ribicoff, U. S. Secretary of Health, Education and Welfare, is alarmed by the number of high school students who never earn their high school diplomas. He points out that the unemployment rate for people with less than a high school education is nearly double the rate for those with a high school diploma.

**NOW! HELP YOURSELF TO A MORE SECURE FUTURE**

**EARN HIGH SCHOOL DIPLOMA AT HOME AT YOUR OWN SPEED**

*a program now offered by one of the nation's largest educational organizations*



Learn fast! Earn more! Enter college, professional or technical schools. Advance socially. Live a happier, fuller life. Individual courses or complete 4 year schooling. Moderate tuition. Write for School Catalog.

**ACADEMY FOR ADULTS**

Division, Encyclopaedia Britannica Films, Inc.  
30 W. Washington, Dept. PM-12, Chicago 2, Illinois

## Uranium Puts Bounce in Steel

Your next car may be easier riding and more resistant to corrosion because of uranium, the celebrated fuel for nuclear reactors and atom bombs.

Canadian government scientists have found that a pinch of uranium (the ore is readily available), say 0.20 percent, added to a batch of carbon steel, increases the steel's endurance from 29,000 to 40,000 pounds per square inch. This increases the steel's fatigue strength, an asset for springs, axle shafts and similar parts.

Rods made from the uranium alloy more successfully withstood attacks of hydrochloric acid solution, and a chain made of the stuff greatly withstood salt-water corrosion when placed in the ocean.

One other Canadian discovery was that the new alloy adds strength to steel used in high temperature conditions—such as in auto mufflers and tail pipes.

**LET MECHANIC TRAINING**  
ALSO CONVENTIONAL PLANE COURSES • F.A.A. APPROVED

**TETERBORO SCHOOL OF AERONAUTICS, INC.**  
TETERBORO AIRPORT, N.J. - 20 MIN. FROM N.Y.

PLEASE SEND FREE BOOKLET P. M.

NAME \_\_\_\_\_ AGE \_\_\_\_\_  
ADDRESS \_\_\_\_\_  
CITY \_\_\_\_\_ STATE \_\_\_\_\_

JANUARY 1962

# ACCORDION PRICES SMASHED!



**SAVE UP TO 1/2**

Buy Direct at **BIGGEST IMPORTER-TO-YOU DISCOUNTS!**

Save more than you have ever dreamed possible... up to 50% off retail prices for comparable accordions. Pay no teacher or salesman commissions.

**EASY TERMS!** For just a small amount down (or any old instrument in trade)... and pennies a day... you can own a new 1962 model famous accordion!

World's Largest Accordion Dealer offers biggest selection! Choose from over 35 models for students and professionals, standard or electronic... newest features. Amazingly high trade-in allowance on ANY used musical instrument. **FREE HOME TRIAL. No Risk Offer—Satisfaction guaranteed or Money Back! FREE BONUS GIFTS.** Mail coupon today for **FREE Color Catalogs and Importer-to-You Discounts.**

**FREE 5-DAY HOME TRIAL!**

**ACCORDION CORPORATION OF AMERICA**  
2003 West Chicago Ave., Dept. R-12, Chicago 22, Illinois

**FREE Color Catalog Rush Coupon**

Accordion Corporation of America, Dept. R-12, 2003 West Chicago Avenue, Chicago 22, Illinois  
Rush FREE Color Catalog, Accordion Selection Guide, and the Importer-to-You Discounts.

NAME \_\_\_\_\_  
ADDRESS \_\_\_\_\_  
CITY \_\_\_\_\_ STATE \_\_\_\_\_  
( ) I have an accordion to trade.

## New Model 161 UTILITY TESTER® FOR REPAIRING ALL ELECTRICAL APPLIANCES MOTORS • AUTOMOBILES • TV TUBES

As an electrical trouble shooter the Model 161

• Will test Toasters, Irons, Broilers, Heating Pads, Clocks, Fans, Vacuum Cleaners, Refrigerators, Lamps, Fluorescents, Switches, Thermostats, etc.



- Will test all TV tubes (including picture tubes) for open filaments and burned out tubes.
- Measures A.C. and D.C. Voltages, (both 110 Volt and 220 Volt lines).
- Will measure current consumption (amperes) while the appliance under test is in operation.
- Incorporates a sensitive direct-reading resistance range which will measure all resistances commonly used in electrical appliances, motors, etc.

As an Automotive Tester the Model 161 will test:

- Both 6 Volt and 12 Volt Storage Batteries • Generators
- Starters • Distributors • Ignition Coils • Regulators • Relays
- Circuit Breakers • Cigarette Lighters • Stop Lights • Condensers • Directional Signal Systems • All Lamps and Bulbs
- Fuses • Heating Systems • Horns • Also will locate poor grounds, breaks in wiring, poor connections, etc.

Model 161 comes complete including 36-page book... Only

**SEND NO MONEY WITH ORDER—  
PAY POSTMAN NOTHING ON DELIVERY**

Try it for 10 days before you buy. If completely satisfied then send \$5.00 and pay the balance at the rate of \$5.00 per month until the total price of \$22.50 (plus small P.P. and budget charge) is paid. If not completely satisfied, return to us, no explanation necessary.

ACCURATE INSTRUMENT CO., INC.  
Dept. D-187, 911 Faile St., New York 39, N.Y.  
Please rush Model 161. I will pay on terms specified. Otherwise I will return tester.

Name \_\_\_\_\_  
Address \_\_\_\_\_  
City \_\_\_\_\_ Zone \_\_\_\_\_ State \_\_\_\_\_  
All prices net, F.O.B., N.Y.C.

73

# How the Buzz of a Dying Bee



## Created a Great New Thrill for FISHERMEN!

We learned from a barefoot boy while fishing the Ouachita River. After a full day fishing, we were empty handed. The boy had 30 whoppers on a stringer—all attracted to his bait by a buzzing bee sealed in a mason jar under the water. Now I have had the identical sound scientifically reproduced in a compact, waterproof, battery operated buzzer. My fish caller will bring the big ones racing to it. They can't resist it. Then, using your own tackle, drop your bait alongside my fish caller and you've got a savage bite from any kind of insect feeding or bottom feeding fish. You get the big ones because they scare away the little fellows. But don't buy anything now. Instead, let me mail you—free and postage prepaid—actual underwater photos and testimonials. I'll also tell you how you can test the magic of my fish caller in your own waters six full months at my risk on a money-back guarantee. Just send your name to me on the coupon or postcard. Address Frank Birch, 335 West Madison Street, Chicago 6, Illinois. Room A381.

Frank Birch, Room A381

335 W. Madison St., Chicago 6, Illinois

Please rush free information on your fish caller and your six months trial guarantee.

Name.....

Address.....

City.....Zone.....State.....

**PLANNING TO REMODEL?** Before you begin, read "How to Remodel Kitchens and Bathrooms" for plans and ideas. Only 75c from Popular Mechanics Service Bureau, Room 532, 200 E. Ontario, Chicago 11, Ill.

**1 1/4 ACRE** Including Easements

**FLORIDA**

**COUNTRY ESTATES**

---

**FLORIDA HIGHLANDS ONLY**

**\$895**

Complete Price

**\*10 DOWN MONTHLY**

**30 Day Money-Back Guarantee**

**FREE:** Warranty Deed  
Title Insurance

**HIGH, DRY, BEAUTIFUL LAND AT LESS THAN THE PRICE OF A HOMESITE ALONE**

Florida Realty Center, Inc., Broker Dept. E 2-1  
520 N. E. 79th St., Miami 38, Florida

Please send full information without obligation.

Name.....

Address.....

City.....Zone.....State.....

AD 61094

## Converts Numbers Into Voice

Tape recordings of the human voice are being converted from a set of numbers by a computer in tests which may lead to voice-operated typewriters, voice dialing of telephones or voice-routing of mail.

The "speech-analyzer-synthesizer" program is being conducted by the applied-research laboratory of Sylvania Electric Products. The object is to find a more efficient way to map speech for use in automatic speech-recognition systems, which are essentially the translation of human speech to a mechanistic language that can be operated upon by a computer or used to control a machine. Translating the machine language back into human speech is the process in reverse.

Sylvania's method analyzes the wave forms that comprise speech in terms of a fixed set of 30 orthonormal (uncorrelated) functions, chosen to resemble sound-wave forms that occur naturally in speech. The 30 give sufficient fidelity for most purposes.

## Emergency Brake

In case of brake failure due to fluid loss, a new safety-brake attachment automatically takes over to maintain braking action.

The unit is installed between the vehicle's master cylinder and the two lines supplying the front and rear brakes respectively. Should either the front or rear brakes fail, a nylon piston activated by the flow of escaping fluid blocks off an exit port, leaving the remaining set of brakes fully operative.

The attachment, which sells for \$14.95, is made by Alex Manufacturing Corp., Bldg. 196, N. Y. International Airport, Jamaica 30, N. Y.

## Braille in Plastic

Called the first real change in the method of printing in braille since the process was started about 100 years ago, textbooks for the blind will be made by baking plastic dots onto paper instead of embossing them in the paper itself.

The braille alphabet consists of six dots, in various combinations, within the shape of a domino six. Until now, the dots have been embossed on special Manila paper by distorting the fibers. The dots wear down in time because of the friction of moving fingers. The new method, invented by an officer of the Royal National Institute for the Blind in England, will use solid plastic dots on special thin paper that can stand the curing process in infrared ovens.



Not everyone does as well, but T. N. CODY, who started a business of his own, reports...

For 12 months I've averaged

**\$800 PER MONTH INCOME**



**—most of it clear profit for me!**

Many men have discovered how to be independent, to be free of layoffs and bosses. C. G. Naples grossed more than \$200 his first week. A father-son combination grossed \$44,000 their second year. H. Lemon says, "I netted \$133 in one 8-hour day."

How much you make depends largely on you. You need no special skill, no large investment. Start part time if you wish.

**NO SHOP NECESSARY** • Our Electric Deterger shampoos rugs, carpets right on floor—removes dirt and grime and helps to show their natural color and beauty. So efficient and safe it is used by largest railroads and hotels.

► **This is not a lease proposition.** You own the machine, you work when and where you please and all the money you take in is your own. You take no risk. Machines fully guaranteed.

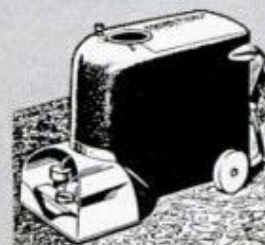

**MAIL COUPON TODAY FOR FREE BOOK**

VON SCHRADER MFG. CO.  
110 "R" PL., Racine, Wisconsin

Without obligation send me **FREE** booklet about your RUG DETERGER and tell me how I can start my own permanent, profitable business.

Name \_\_\_\_\_

Address \_\_\_\_\_

City \_\_\_\_\_ Zone \_\_\_\_\_ State \_\_\_\_\_



"To put it in reverse you just honk the horn."

JANUARY 1962

NOW! COPPER SWEAT JOINTS  
**THE EASY WAY!**

**SWIF SOLDER**

**JUST BRUSH ON**

**...AND HEAT!**

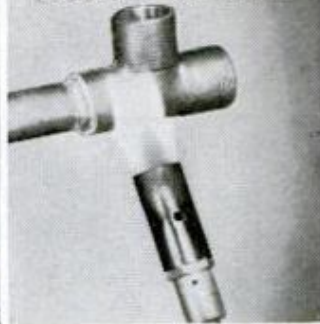

Make perfect leak-proof sweat joints every time with Hercules SWIF Solder, the real 50/50 tin-lead solder pre-mixed with flux in easy-to-use paste form. Save time and money, too. Just brush on, join, and heat for neat, strong joints. SWIF solders all common metals (except aluminum) and works with a torch, soldering iron, or soldering gun. This grade available in economical 4 oz., 1/2 lb., 1 lb., and 3 lb. cans at your plumbing supply or hardware dealer. See for yourself how easy any soldering job is when you use SWIF.

Write for free do-it-yourself soldering folder.



Hercules Chemical Co., Inc., 416 B'way, N.Y. 13

# EARN MORE on INSURED SAVINGS

# 5%

PER YEAR  
Compounded  
Semi-Annually



EACH ACCOUNT INSURED TO \$20,000  
BY SECURITY FINANCIAL INSURANCE CORP.  
Baltimore, Maryland

## THE WEST'S OLDEST SAVINGS FIRM PAYING A HIGHER RATE!

- ASSETS OVER \$18 MILLION
- 43 YEARS OF CONTINUOUS SERVICE
- STATE GOVERNMENT SUPERVISION

## FREE GIFTS

FOR NEW ACCOUNTS AND ADD-ONS

- \$ 100 TO \$ 249 — Six-Piece Manicure Set
- \$ 250 TO \$ 499 — Shaeffer Pen and Pencil Set
- \$ 500 TO \$ 999 — Leatherette Travel Clock
- \$1,000 TO \$1,499 — Dormeyer Hair Dryer
- \$1,500 TO \$2,499 — 52-Piece Stainless Steel Set
- \$2,500 TO \$4,999 — \$59.95 Benrus Wrist Watch
- \$5,000 TO \$9,999 — Westinghouse Elect. Blanket
- \$10,000 AND UP — \$71.50 Gruen Wrist Watch

(GIFT OFFER VOID IN STATES WHERE PROHIBITED)

*Savings Postmarked by Jan. 31st  
Earn From The First of The Year!*

# UTAH SAVINGS

*and Loan Association*

65 North University Avenue, Provo, Utah

PLEASE SEND FURTHER DETAILS **P**

ENCLOSED IS REMITTANCE OF

\$..... TO OPEN MY ACCOUNT

NAME.....

ADDRESS.....

CITY..... STATE.....

Gift Choice:.....

# GET A BIG

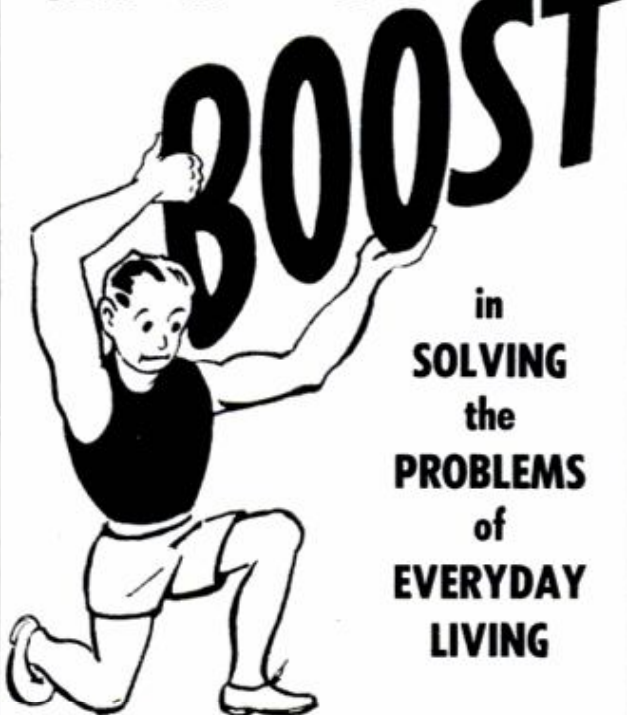

in  
SOLVING  
the  
PROBLEMS  
of  
EVERYDAY  
LIVING

Send for your

## FREE SERVICE FILE

This unique reference guide shows you where to find the answers to the problems of

- HOME REMODELING
- BOAT BUILDING
- FURNITURE FINISHING
- PAINTING
- LAWN PROJECTS
- OUTDOOR FIREPLACES
- PLUMBING REPAIRS
- UPHOLSTERING
- HOUSE WIRING
- SHOP PLANNING
- POWER TOOL TECHNIQUES
- MODELMAKING
- OUTDOOR LIGHTING
- LEAKY BASEMENTS

More than 500 subjects, covering almost every conceivable problem or project that ever faces a home handyman, are covered in this SERVICE FILE of Popular Mechanics' books, booklets, blueprints, and patterns. Send for one today and keep it handy as an invaluable reference guide.

POPULAR MECHANICS SERVICE BUREAU  
Room 526, 200 E. Ontario, Chicago 11, Ill.

Please send me your FREE service file.

Name.....

Address.....

City..... Zone..... State.....

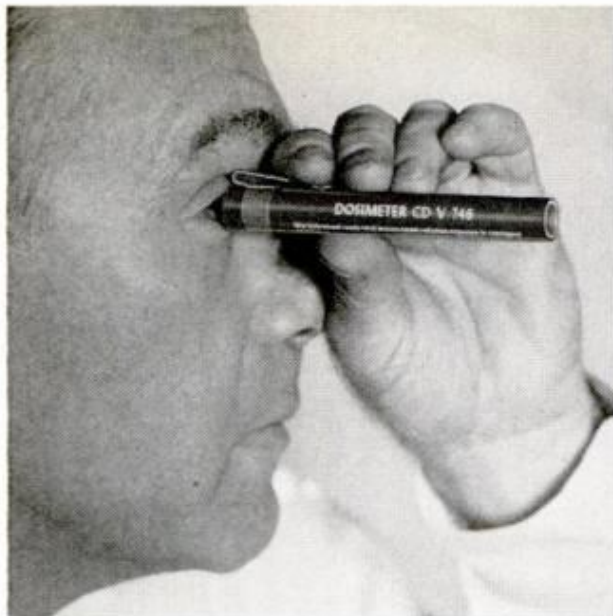

### Kit Measures Radiation

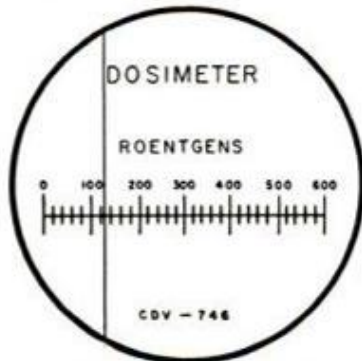

It is now possible, should a nuclear war make it imperative, for individuals to measure rates of radiation received per hour and to chart amounts received over weeks or months. Such information would be helpful in determining when it would be safe to come from shelters. The Bendix Corp., Cincinnati, Ohio, distributes radiation measurement kits, priced at \$24.95. Its ratemeter shows roentgens received per hour; the dosimeter keeps track of long-period doses. A charger, bottom, resets these counters.



space  
age  
hobby

**BUILD-YOUR-OWN  
ELECTRONICS  
FOR MODERN LIVING**

IT'S FUN...IT'S EASY WITH MONEY-**SAVING**

**knight-kits®** 

A PRODUCT OF ALLIED RADIO

← featured in the 444 page

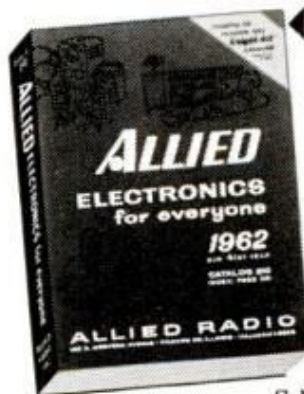

1962 **ALLIED**  
ELECTRONICS  
CATALOG

**free** send  
for it!



Dozens of new hobbyist kits, including amazing Electronic Science Lab—over 100 projects!

Select from more than 70 exciting Knight-Kits! See—Stereo hi-fi, including new Multiplex Stereo tuners and all-transistor amplifiers, short-wave radios, intercoms, Citizens Band radios, electronic science labs, test instruments—all easy to build and a pleasure to own! Send today for your FREE 1962 ALLIED Catalog!



Everything in Stereo hi-fi components: new Multiplex Stereo FM tuners



New—tachometer kit and outstanding test instruments



New all-transistor intercom; many other kits for modern living

**SAVE ON EVERYTHING  
IN ELECTRONICS**



Get the most for your money in: Stereo hi-fi systems and components • Recorders and tape • Citizens Band radios • Amateur station equipment • TV tubes, antennas, accessories • Electronic parts, tubes, transistors, tools, test instruments, books. Send today for your FREE 444-page 1962 ALLIED catalog!

**NO MONEY DOWN**  
Easiest Terms

**FREE  
CATALOG**



**ALLIED RADIO**

ALLIED RADIO, Dept. 24-A2  
100 N. Western Ave., Chicago 80, Ill.

**WORLD'S  
BIGGEST**

Rush FREE 1962 ALLIED Catalog

Name \_\_\_\_\_

PLEASE PRINT

Address \_\_\_\_\_

City \_\_\_\_\_ Zone \_\_\_\_\_ State \_\_\_\_\_

# How to think a full-size car into 197 inches

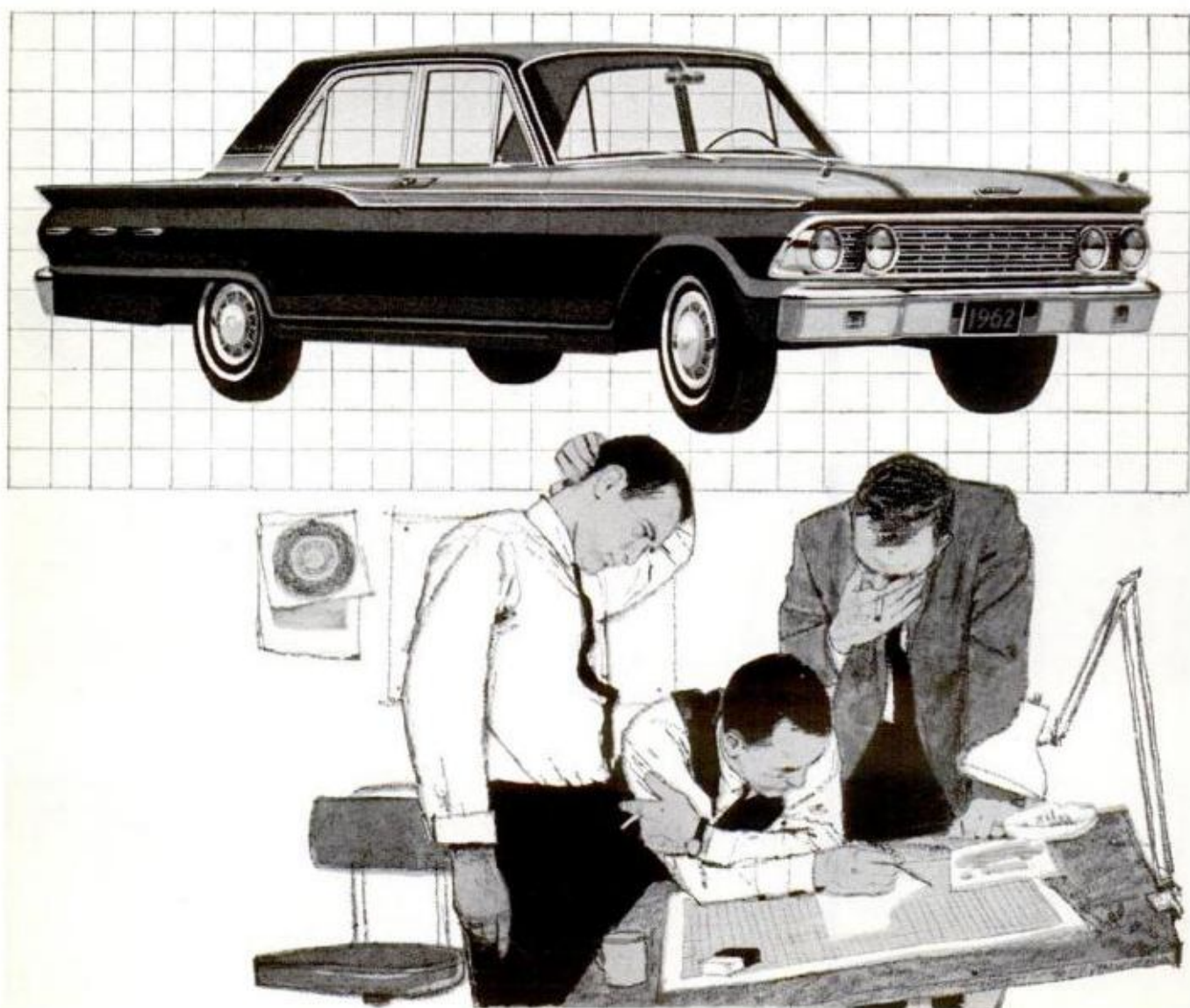

**The new Ford Fairlane 500 is so beautifully logical you may think it was easy to design. But to enclose big-car room, ride and performance inside a handy 197 inches—that demanded the most imaginative engineering of the decade!**

The day Ford engineers started sketching out the Fairlane for 1962, they began the most intricate project of their careers. For the Fairlane was not to be another compact car (a thorny enough problem) but a *full-size* car inside 197 inches of total over-all length.

It had to be lean and nimble outside to suit today's traffic. But it absolutely could not give up the stretch-out room *inside*—the "tall" seats that are so comfortable on long journeys, the extra leg room for long-shanked drivers, the easy-fitting space for six, the cavernous trunk capacity Americans truly need. And, above all, it could not shade by a hair the "feel" of Ford full-size quality—the velvet ride, the silence, the innate craftsmanship. Or the punch and sparkle of full-size performance. One more thing: Fairlane had to have the twice-a-year maintenance schedule introduced by the Galaxie.

### First step—unitized body

The thinking began with unitized body construction—stronger because it becomes a single welded unit, lighter because there is no heavy frame. That saved hundreds of pounds, and permitted smaller engines (they could give the same performance with less power—and less gas—because there wasn't so much weight to lug around). Unitized construction also produced full-size room within the Fairlane 500's trim new dimensions.

### The "Watchmaker's" V-8

They thought up a new engine to go with the standard 101 horsepower 6—a new V-8 with only 221 inches of displacement, an easy 8.7 compression ratio for regular gas—and 145 cream-smooth horsepower. Motor experts predict this will be one of the great "classic" engines of our time. Molded in time-tested cast iron, it uses Ford-pioneered "precision-cast" foundry techniques to pare weight to only 450 pounds complete. Extremely short stroke (2.87 inches), separately mounted shell-cast rocker arms for lightweight valve train, outer-end counter-balancing and hydraulic valve lifters give dynamo smoothness at the highest r.p.m. No two exhaust valves are side-by-

side to build up a hot spot. And typical of the basic sturdiness is the fact that the "valley" cover is *cast* as part of the intake manifold, not stamped metal (less noise, better oil seal). The result is a new kind of engine—one that blends V-8 smoothness and sparkle with six-cylinder thrift.

### "Torque Box" Isolation

Fairlane engineers also thought up a new way of putting velvet into the ride—"torque boxes" welded between the members that hold the suspension and the main body itself. These look like boxes of sheet metal—but they are "tuned" to a subtle, precise degree of flex. Like the plastic-sheathed shank of a golf club they take the sting out of any tiny road vibrations that get past Fairlane's sophisticated suspension system—and they also break the cycle of road noise before it telegraphs into the body. Add this to Fairlane's generous 115.5-inch wheelbase, massive sound-proofing and total quality control and the impression of solid luxury is extraordinary.

But these highlights only hint at the advances 50,000 hours of laboratory study created for America's new kind of family car. You'll have to study it—and *drive* it—before you begin to know how astonishing the new Fairlane really is.



**FORD**  
**AIRLANE 500**

ONLY THE NAME'S THE SAME!



## Downhill Skier Hits Silk Instead of Snow

Beginning skier gets a brake on downhill runs with a parachute braking device designed to keep him from building up dangerous speeds and to help him stay upright.

The triple chute pack is used for beginners; chutes are removed, one at a time, as the trainee gains experience. He graduates when he can ski without them.

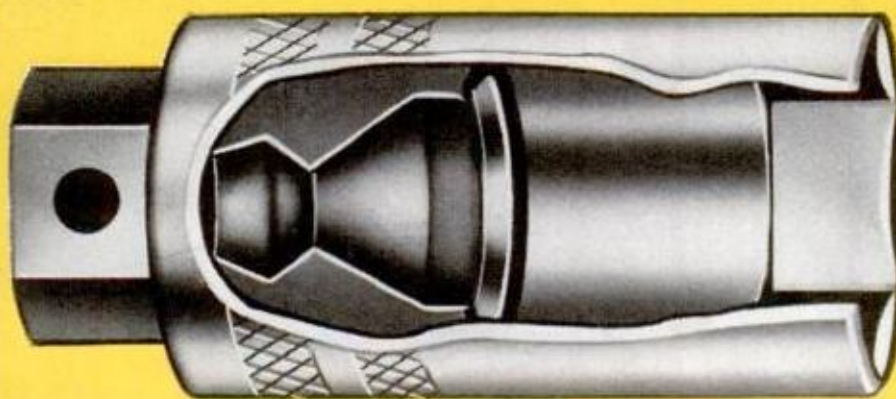

**PROTO'S SPARK PLUG HOLDING SOCKETS.** Revolutionary neoprene insert prevents burned hands, cracked porcelains, damaged electrodes. Available in  $\frac{3}{8}$ " (No. 5026HP) and  $\frac{1}{2}$ " drive (No. 5326HP). Both sockets fit all standard 14mm plugs in domestic and foreign cars. Turn with fingers, flat wrench, ratchet, torquer. Look for counter display-demonstrator. You'll find over 2,200 quality Proto tools at auto parts, hardware and industrial outlets. Professional performance guaranteed.

**PROTO TOOLS**  
PROFESSIONAL QUALITY TOOLS

Division of Pendleton Tool Industries, Inc.

2202 Santa Fe Avenue, Los Angeles, Calif. • 502 Allen Street, Jamestown, N. Y. • 1702 Oxford East, London, Ontario, Can.

A number of one-man mail order enterprises are paying their owners an income of \$40,000 to \$50,000.

## SPECIAL OPPORTUNITIES



Mail order is big business. Annual catalog sales volume of Sears, Roebuck and Co. is over 700 million dollars!

### HOW TO START

# Your Own Mail Order Business

You can make a fortune by mail. New firms will set you up in a fabulous mail order business of your own! They'll make up your catalogs, prepare your advertising, supply mailing lists and even ship your products for you!

### By Robert Stephenson

When Anthony Sambati injured his back and was laid off from work he never dreamed it would be a blessing in disguise. Bedridden for weeks, he decided to start a small mail order business. This was something he could run right from his own home and required very little capital to begin. In fact, Sambati started with less than \$85.00.

(Advertisement)

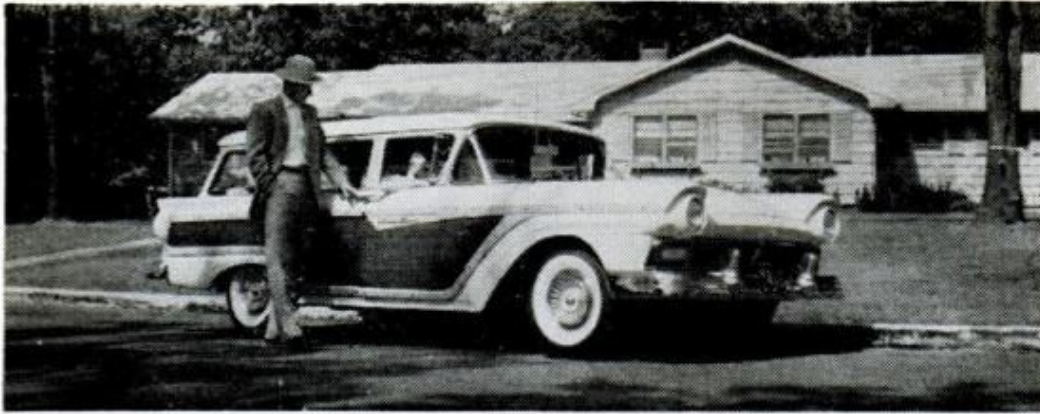

After a short time in mail order, Sambati soon had a beautiful home with all the luxuries of a successful businessman.

He figured that a small mail order business might provide a temporary income to support his family until he got back on his feet. His first step was to obtain a franchise from a large wholesale mail order firm which supplied him with all the necessary catalogs and mailing literature. It wasn't long until his spare-time venture blossomed into a booming enterprise. Drawing a small salary and pouring the rest of the profits back into the business, he soon had others working for him! Today he owns a large retail store, his own warehouse and a beautiful home with all the luxuries of a successful businessman.

Sambati's story is typical of a number of men and women who began a small mail order business with absolutely no previous experience, and made a huge success of it. These 'little' people are quietly pocketing big profits every day—many content to keep the business small . . . spending an hour or two each day in the privacy of their own home. No bosses, time clocks or small pay envelopes. No door to door selling, in fact, you never even meet your customers face to face.

Yes, a small one-man mail order business is ideal for anyone wanting a chance to gain financial security and independence. Yet thousands try mail order each year and fail, simply because they don't learn the few simple secrets of success early in the game.

Take the case of Bud Sheer who had been working for a theatre in a small New Jersey town. With only a few hours spare-time to spend each morning, he tried mail order to supplement his regular income. Like many beginners in this field, Sheer was faced with the problem of finding good mail order items which would have a high mark-up and repeat sales potential. But the biggest obstacle was the expense of printing a catalog.

Then he heard about the A. J. Statile Co. of Hillsdale, New Jersey — an organization set up to aid the small mail order beginner.

He wrote to A. J. Statile Co. for full information, sent in his application for a franchise and within a short time the cash began rolling in. Today Bud Sheer *owns* the theatre he once worked for. Sheer attributes his success in mail order to the A. J. Statile Co. Actually, the theatre he owns has become a side investment.

He still uses the beautiful 300 page mail order catalogs supplied by A. J. Statile Co.

How does the Statile Co. help the beginner get a sound start in mail order? Very simply. Just as Henry Ford made automobiles within the reach of the general public—by mass production and large volume.

Let's take a few specific examples:

(1) All franchised dealers of A. J. Statile are offered ready to mail catalogs and sales literature. Each mailing piece has the dealer's name and address printed right on it. By printing millions of catalogs, Statile is able to offer these at a fraction of their regular cost. The artwork and layout costs for these catalogs would run into thousands of dollars for the beginner if he were starting from 'scratch'.

(2) Since all mailing material and catalogs contain your name and address, all orders come directly to you. Yet you don't have to invest one penny in inventory. All merchandise is stocked for you. In fact Statile has over \$3 million dollars worth of mail order merchandise at your disposal.

(3) All packaging and shipping is done for you. You simply send a shipping label to Statile together with the wholesale cost of the items, and the merchandise is shipped directly to your customers under your own shipping label.

(4) A consultation service is provided to answer any questions you may have. You receive a secret list of over 100 national magazines which run free ads. You'll be shown how to obtain free publicity on your own mail order items. In addition, you obtain trade names and addresses of over 150 other mail order wholesalers who drop-ship top mail order items for you. You'll also be given all the government laws and regulations pertaining to a home operated mail order business. These laws are a 'must' for all beginners.

All this valuable information is covered in the Statile Mail Order Survey which every new franchised dealer receives from Statile before they begin. Formerly sold for \$25.00, this survey has become the 'bible' of the trade. Mr. J. M. of Baltimore, Md., writes, "To tell the truth, all the information in regard to obtaining free ads is alone worth the \$25.00 I paid you . . ." J. D. of Kalamazoo, Mich.,

(Advertisement)



states, "Just a personal note to say I am most satisfied with my \$25.00 investment. Your sales plan is simple and well organized . . ." These are only a few of the many testimonials received praising the Statile Mail Order Survey.

(5) The catalogs and mailing literature offered by Statile Co. cover every conceivable mail order item. You select the field you are interested in . . . BABY ITEMS, TOYS, APPLIANCES, VITAMINS, BOOKLETS AND



**The thrill of receiving money in your morning mail is one you'll never tire of.**

**MAIL ORDER COURSES**, you name it, Statile has the catalog or mailing piece. Select your market, order your mailing literature and you're in business.

(6) You'll be told how to compile your own mailing lists—and this is the most important part of your business. Many a beginner has fallen by the wayside simply because he mails his catalogs to a poor list of names. Suppose, for example, you offered a beautiful scale model of a 40' Chris-Craft cabin cruiser by mail. You would probably make your mailings to boating enthusiasts and the chances are that nine times out of ten your mailings would show a loss instead of a profit. How would Statile help you solve this particular mailing list problem? He would show you where to get the names and addresses of *actual owners* of 40 foot Chris-Craft cabin cruisers! Surely every owner would like to have a scale model of his own boat. Strange as it may seem, such a mailing list is available to anyone. The secret is where to find it. This is just one example of how an experienced mail order expert giving you personal advice, may mean the difference between success and failure!

This same method of obtaining selective specialized mailing lists may be applied to practically any market . . . selling baby items to new mothers, selling toys to young children, etc., etc.

So much for starting your own mail order business. Now, a word of caution. **OBTAIN YOUR MAIL ORDER FRANCHISE FROM A**

**REPUTABLE MAIL ORDER FIRM.** Unfortunately, during the past few years a number of ads have appeared in newspapers and magazines offering to start people in mail order. The ads are grossly misleading. Many imply that you can become a millionaire over night if you use their catalogs. Beware! Particularly if they operate their own mail order business direct to the consumer. These firms compete with their own franchised dealers! They could just as well mail all the catalogs themselves. They don't need you.

Other shady firms fail to drop-ship your orders promptly, thereby losing customers for you. In mail order, prompt shipment is an absolute requirement for a successful operation.

Deal only with firms whose business is preparing catalogs and shipping merchandise. They operate on a strict wholesale basis for franchised dealers exclusively. Such a firm is the A. J. Statile Co. Letters from successful franchised mail order dealers speak for themselves. A woman from Milwaukee writes, "It has been better than my expectations." A gentleman from California states "we are quite pleased with the response we are receiving." Another man from Wisconsin writes, "To say the least, I am more than satisfied."

Yes, a small mail order business offers you an opportunity to earn a second income, or—if you work at it in earnest, a chance to strike it rich. The young housewife in St. Louis may be content to make an extra \$20.00 a week . . . the office worker in Los Angeles may be aiming for \$150.00 weekly full time business . . . and the ambitious schoolteacher in Newark may reach \$20,000.00 a year. What is your objective? Set your own goal, pick your own hours, and the sky is the limit.

Even a government report stated that a number of the most successful one-man mail order enterprises make as high as \$40,000 to



**Big firms will carry all stock for you. They ship orders direct to your customers using your own shipping labels.**

(Advertisement)

# Your Own Catalogs of Top Mail Order Items!



• NAME BRAND GIFTS, BABY ITEMS

• CATALOGS OF TOYS, MERCHANDISE

• CORRESPONDENCE COURSES

A. J. Statile Co. will prepare your catalogs, write your sales letters, supply mailing lists and even ship merchandise for you, using your own shipping labels!

\$50,000 a year! But frankly, this is the exception rather than the rule. Most mail order operators are content to earn a comfortable living doing little physical work, but enjoying their work thoroughly! We don't say you'll be a mail order millionaire or another Sears & Roebuck, but if you're looking for a business of your own with financial security, the answer is mail order. If you've already tried mail order with little or no success, don't give up! Try to analyze what went wrong. Success comes only to those who keep trying and learn from their own mistakes. Again we emphasize, deal only with a reputable firm.

The A. J. Statile Co. has been in business for over twelve years.

They gladly furnish bank or trade references upon request. They are probably one of the largest mail order wholesalers in the country. Whether it be toys, gifts, vitamins or appliances—they've got it ready to ship under your label WITHIN 24 HOURS!

Firmly convinced that no other business offers the tremendous opportunities of mail order, A. J. Statile, president of the firm, is an outspoken advocate of the man or woman who wants to start in business for himself. As Statile puts it, "by all means, start your own business and start NOW! If you want a chance at security and financial independence make your choice mail order. There's nothing like it. Absolutely nothing!"

## FOR FREE DETAILS

Mail coupon below — no obligation

A. J. Statile Co., Dept. 25 • Statile Building • Hillsdale 25, N. J.

Dear Mr. Statile:

Please send me complete FREE details telling me how I may obtain a franchised mail order dealership with your firm. I understand I am under no obligation and no salesman will call on me.

NAME..... AGE..... SEX.....

ADDRESS .....

CITY..... ZONE..... STATE.....

PREVIOUS EXPERIENCE, IF ANY.....

(Advertisement)



1902



1962



## *This month we are sixty years young.*

*We are proud that Popular Mechanics has helped show three generations of readers the excitement of discovery.*

*. . . Discoveries that lie both inward to the heart of all matter and outward to the unfathomable reaches of the universe.*

*. . . Discovery of new ideas—new inventions ranging from the final solution to an age-old problem, to an item as ordinary as a better clothespin.*

*. . . Discovery of the unsuspected skills that lie within each man's hands and mind. Discovery of the quiet enjoyment that can be his in that "inner castle" of his home—his shop.*

*For sixty years PM's purpose has been to scout the frontier of such discoveries. Our partners in this stimulating venture have been the alert readers of Popular Mechanics. Your faithful support testifies to the success of our efforts and the strength of our partnership.*

*In this special anniversary issue we will explore together some of the exciting, significant and rewarding frontiers of discovery.*

*And—most exciting of all—beyond those frontiers are still others.*

JOSEPH R. BUELL, JR.  
Publisher

# The Way-Out World of Solid State

60<sup>th</sup>  
ANNIVERSARY  
SPECIAL

By Richard F. Dempewolff

**AMPLIFIER** in tweezers is smaller than a dime, performs function of conventional amplifier on table



*This startling new science will soon deliver such incredible products as a hi-fi amplifier the size of a dime, picture-frame TV and computers as small as buttons*

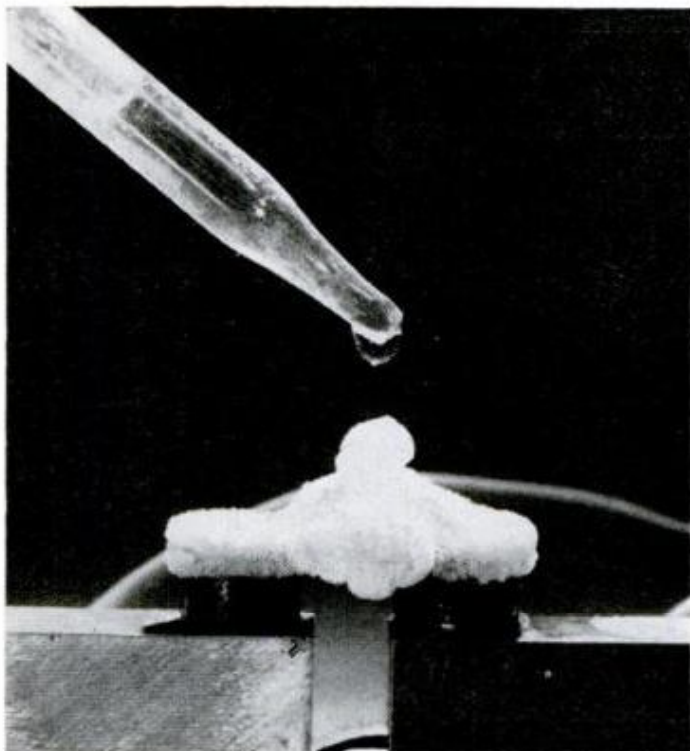

**REFRIGERATOR** without moving parts cools when direct current is applied to junction of semiconductors

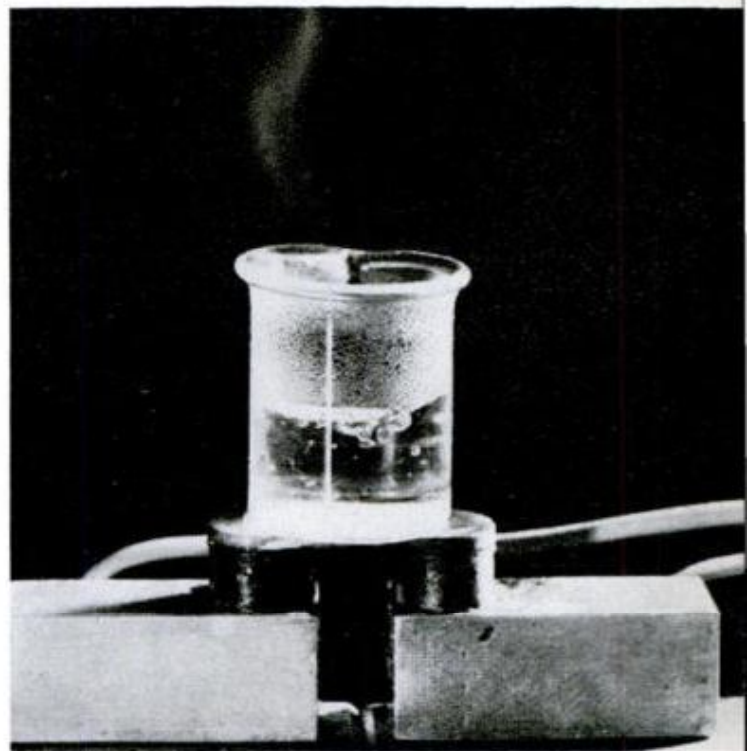

**HEATER** boils water when a direct current is applied to junction of two dissimilar thermoelectric materials

**L**AST MARCH, a technician at Wright Air Development Center in Dayton, Ohio, amazed a group of newsmen by tuning in a dozen stations with a radio consisting of six sequinlike wafers on a thin sheet of plastic the size of a matchbook flap. Since then an engineer in an eastern electronics laboratory has demonstrated a solid chunk of stuff about the size of a BB pellet that contains the entire guts of a two-tube radio.

In Dallas, a group of electronics wizards from Texas Instrument Co. recently showed off a vest-pocket computer. It was about the size of a pack of cigarettes. It can handle all the tasks performed by a miniature transistorized computer (developed last year) that is 150 times its size and 48 times heavier. If you want one, the new 10-ouncer sells for about \$30,000.

At the Westinghouse Labs in Pittsburgh, Pa., technicians will show you a one-pound magnet the size of a doughnut. It is 10 times more powerful than the 20-ton, car-size magnet on a junk-yard magnetic crane, but it is only *half* as powerful as a newer and *smaller* one they're making now! In General Electric's Schenectady, N. Y., headquarters you learn that, within a year or so, you may be listening to matchbox-size

**ELECTRONIC CIRCUITS**—solid blocks of materials on spidery electric leads—get scientist's close-up scrutiny

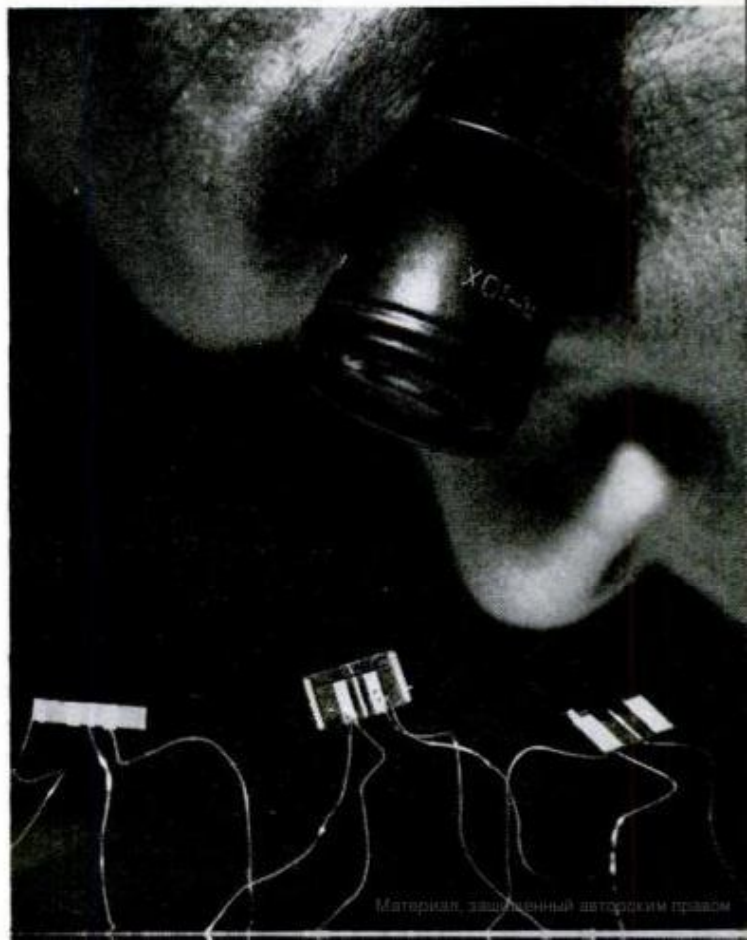

# SOLID STATE TRICKS AND SOME OF THE TOOLS THAT PERFORM THEM

PHENOMENA	DEVICES	JOB PERFORMED	WHAT'S IN IT FOR PEOPLE?
<p><b>Semiconductance:</b> Ability of some materials that are neither insulators nor conductors, to carry current under certain conditions.</p> <p><b>Tunneling:</b> Ability of charged particles to pass through energy barriers at high speeds.</p> <p><b>Hall effect:</b> Ability of semiconductor material, when placed in a magnetic field, to bend a current flowing through itself.</p> <p>By "sputtering" semiconductor material on ceramic wafers, circuit loops can be made. These are stacked to make pill-size elements for radios, computers, etc.</p> <p>Newer techniques involve "doping" areas of semiconductor material with impurities to perform different functions. Result is a solid block that becomes a self-contained circuit.</p>	<p>Transistors</p> <p>Diodes</p> <p>Silicon-controlled rectifiers</p> <p>Tunnel diodes</p> <p>Hall generators</p> <p>Thin-film circuits</p> <p>Monolithic blocks</p> <p>Molecular blocks (block amplifiers, notch filters, etc.)</p>	<p>Amplification, switching, rectification, HF power generation, modulation, conversion of light to electricity, tuning, triggering, logic.</p> <p>Measurement of magnetic fields, and control of flow, pressure and temperature. Experimental power generation.</p> <p>Audio and visual amplification, adder circuits, flip-flops, oscillators, phase shifters, switching, tuning, radio reception, power generation, transmission.</p>	<p>Today's tiny portable radios and TV, smaller than a shoebox. Smaller TV is on the way. Computers, the size of a cigarette pack have already been built, thanks to these tools. So has a crystal the size of a match head, which contains the entire guts of a two-tube radio.</p> <p>Coming up are radio sets the size of after-dinner mints; pill-size wireless "speakers" worn in each ear, so wearer can have stereo music wherever he goes; speakers built into drapery fabric, wall-paper and ceiling material; cordless telephones; tiny computers that can "think"; microminiature power generators for home appliances.</p>
<p><b>Photoelectrics:</b> Ability of light waves, impinging on semiconductor material, to generate electrical effects within the material.</p>	<p>Photoconductors</p> <p>Photodiodes</p> <p>Solar cells</p> <p>Photovoltaic cells</p>	<p>Light amplification, switching devices triggered by light waves, conversion of light to electricity.</p>	<p>Devices that turn the street lights on and off in your home town—triggered by the sun. They'll do it in your home, soon. They'll charge solar batteries to drive home appliances, too.</p>
<p><b>Electroluminescence:</b> Ability of a phosphor to emit light when stimulated by an a.c. current.</p>	<p>Electroluminescent panels</p>	<p>Display for logic and memory circuits; light amplification (when panel is backed by a photoconductive layer).</p>	<p>They'll make picture frame TV; home lighting elements of entire walls, ceilings, floors, draperies. Light intensity and color can be controlled. Panels will also heat and cool your house.</p>
<p><b>Molecular Resonance:</b> Ability of certain materials to produce monochromatic light beams that may be modulated.</p>	<p>Masers</p> <p>Lasers</p> <p>Irasers</p>	<p>Radio microwave, infrared and light-wave amplification.</p>	<p>Tomorrow's communications — on light-wave frequencies. Experiments indicate that a single Laser beam can carry more than a million TV channels. Spread of beam would make a mere 100-mile circle on the surface of the moon. Will likely be basis for space communications.</p>
<p><b>Ferromagnetism:</b> Ability of certain crystals to remain magnetized after a magnetic field has been applied and removed.</p>	<p>Thin-film memories.</p> <p>Logic elements.</p> <p>Multiple aperture cores.</p>	<p>Computer memories.</p> <p>Permanent-magnet applications.</p>	<p>Higher-speed computers capable of storing more information and providing instantaneous responses resembling human thought and judgment.</p>
<p><b>Ferroelectrics:</b> Ability of certain crystals to polarize and remain magnetic, after an electric field has been applied and removed.</p>	<p>Experimental logic and memory devices.</p> <p>Dielectric amplifiers, modulators.</p>		
<p><b>Piezoelectrics:</b> Ability of certain crystals to generate an electric voltage when squeezed, bent or twisted.</p>	<p>Transducers</p> <p>Strain-gauge generators</p>	<p>Controlling, measuring, transduction.</p>	<p>Long-known phenomenon used in microphones, phonograph pickups, sonar, depth finding. Newer applications: noise-free narrow band wave filters.</p>
<p><b>Thermoelectrics:</b></p> <p><b>Seebeck effect:</b> Electrical voltage generated when two dissimilar materials are joined and junctions are held at different temperatures.</p> <p><b>Peltier effect:</b> Ability of an electric current, when passed through a closed circuit of two dissimilar materials, to heat one junction and cool the other.</p>	<p>Thermoelectric generators.</p> <p>Thermionic converters.</p> <p>Plasma diodes</p>	<p>Direct conversion of heat to electricity.</p> <p>Refrigeration.</p> <p>Heating.</p>	<p>Baby bottlewarmers, drink chillers, small refrigeration units. Coming up are gadgets powered with a tiny gas or oil-fueled flame, that will provide electrical power to run a lawn mower, generate power to light a cabin in the woods, pull industrial quantities of electricity from the heat of atomic piles.</p>
<p><b>Superconductivity:</b> Ability of certain materials to lose electrical resistance when cooled to near absolute zero.</p>	<p>Cryotrons</p>	<p>Making microcircuitry ultra-high-speed and noise-free.</p>	<p>From liquid-hydrogen-cooled solid state loops will come ultra-high-speed computer circuits, noise-free radios, tiny electromagnets capable of lifting tons.</p>



**LASER** research: A synthetic ruby crystal is tried in a wave guide component to add power to fantastic beam

transistor radios powered by electricity derived from your own body heat. There's already a boat powered by an electric outboard that gets its juice from a tiny gas flame.

Using a new and revolutionary kind of compact beam that operates like radar, scientists at Hughes Aircraft Corp. in Culver City, Calif., can study the flaws in screwheads and bolts on kitchen tables and wheelbarrows seven miles away. Back East at Bell Laboratory's Murray Hill, N. J., plant, with the same device, physicists are vaporizing carbon at 7500 degrees F. in a millionth of a second and performing knifeless surgery on rabbits. They talk about using their fantastic beam to "spot weld" detached retinas in human eyes. At General Electric's Schenectady labs, experiments in steel welding and fine machining

with this same equipment are under way. The engineers tell you quietly that the beam can carry a million TV channels simultaneously at light-wave frequencies, and probably will provide tomorrow's communications through water, air and interstellar space. This is no pipe dream. The beam is available and waiting for development of materials and systems.

In electronics laboratories across the land there's an air of quiet excitement, a continual flow of reported breakthroughs and talk of things to come that would have qualified as pure science fiction only a few years ago. You hear about pea-size transmitter implants that will permit a doctor to tune in on one patient's heartbeat, or another's breathing rate, while he's making house calls two miles from the hospital. Men talk seriously about electronic brains

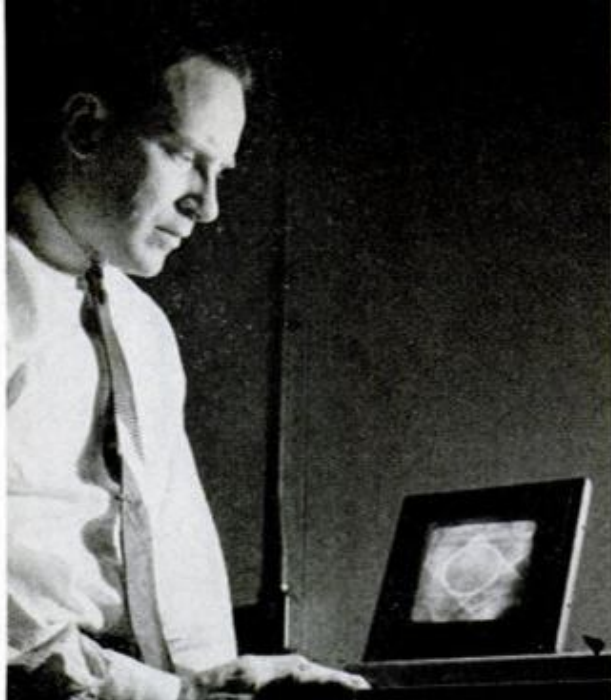

**ELECTRONIC PANEL** less than one-half inch thick uses principle of electroluminescence to produce image

that have reason, judgment and reaction to stimuli like sound, light, or pain. There's candid chatter about flat, picture-frame TV tubes, about walls and draperies that will provide home lighting, heating and cooling—all automatically controlled by outside conditions.

It's a way-out world of confusing semantics and the unfamiliar gobbledygook of a brand-new language. Eavesdrop on the coffee-time gossip in any electronics lab today and you'll get an earful of *notch filters*,

**PURE SEMICONDUCTOR** like silicon, with four electrons per atom, won't conduct. But if doped with five-electron impurity like arsenic, extra electron won't fit and wanders through crystal, acting as a negative carrier

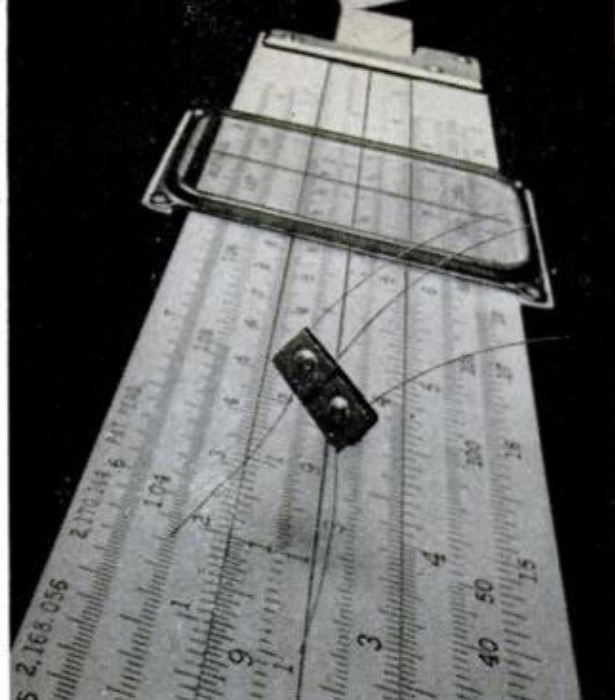
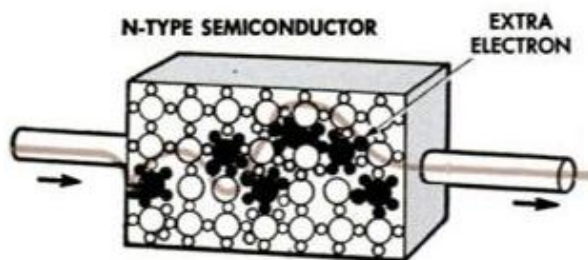

**SLIDE RULE.** Wafer of silicon multiplies and divides in same basic way as does larger, conventional rule

*nanoseconds, nor-gates, multistage flip-flops, half adders, masers, lasers and irasers.* You'll hear about *holes*, which turn out to be electrons that aren't there; and the *n* and *p* materials, that are the heart of much of this strange business.

All of the newly projected wonders have suddenly become genuine probabilities, due to the wildfire growth of a Hydra-headed science, known commonly as solid-state physics. Actually, this is a misnomer. Solid-

(Continued to page 222)

**BY DOPING** silicon crystals with a three-electron impurity like aluminum, holes equal to positive charges are left in crystal lattice. Electrons jumping from hole to hole can then carry current through crystal

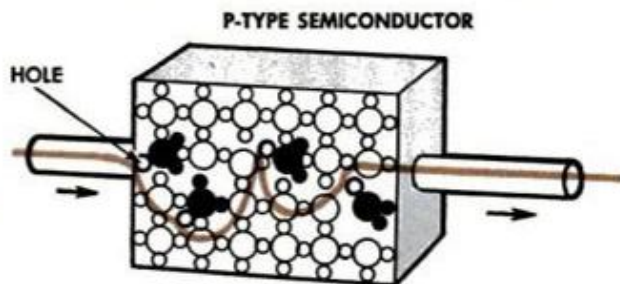

**WHAT IS A DIODE?**

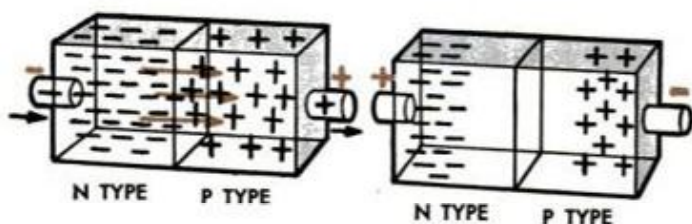

**WHAT IS A TRANSISTOR?**

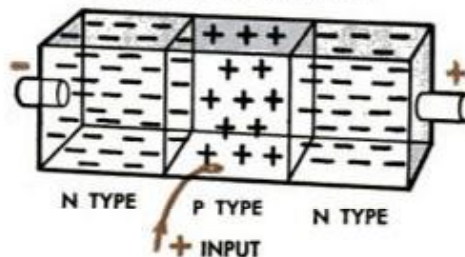

**NEGATIVE CURRENT**, left, repels electrons in *n* region, pushes them to *p* region completing circuitry. Right: If current is reversed, charges in the wires attract opposite ones in crystal, creating circuit breaking void at junction. So diode is one-way electrical gate

**N AND P** forces prevent current flow in a transistor at rest. But when triggered by a tiny plus charge, main current electrons are attracted through barriers. En route they absorb control current characteristics and boost it. Result is that transistor is an amplifier



# AUTO REVIEW FOR '62

On the following pages Popular Mechanics presents under-the-hood and behind-the-wheel reports on the '62 models. These reports answer some pointed questions:

**Drive-Comparing the Ford Fairlane, Chevy II and the new slimmed-down Plymouth . . .** How do these three popular makes stack up on performance, economy and comfort?

**A Serviceman Looks at the '62s . . .** What are the out-of-sight advantages or thoughtless boo-boos which will make a mechanic happy or unhappy (and charge accordingly!)? Do the new maintenance-free features live up to their billing?

**An Engineer Analyzes the '62s . . .** What is truly **all-new** about the new models? What innovations and improvements in engines, suspensions, transmissions, brakes have the '62s introduced, and what will these improvements mean to you?

**Those Dreams Detroit Built—Have They Really Changed Your Car? . . .** Were yesterday's cars-of-tomorrow publicity pipe dreams? Have they really influenced the design of today's cars? Here's a fascinating pictorial review of the design trends.

**PM Tests Those New Metallic Brake Linings . . .** How do they compare with conventional linings when put through a tough series of tests? Here are some surprising answers.

**How to Save Safely on Car Insurance . . .** Are you getting all the discounts you're entitled to? How much can you reduce your yearly insurance costs? This rundown may tip you off to substantial savings.

**Pressure Caps and Thermostats . . .** How do they affect the efficiency of your car, winter and summer?

You'll find answers to these questions — and more — in this special "Auto Review for '62."

#### READY-TO-FRAME REPRINTS AVAILABLE

Reprints of the complete set of dream cars shown on the following pages are available as long as the supply lasts. Send 25 cents to Service Bureau, Dept. 62R, Popular Mechanics, 200 E. Ontario St., Chicago 11, Ill.

#### SPECIFICATION CHART REPRINTS

Additional copies of the auto specifications chart on the cover of this issue can be obtained by sending 25 cents to Service Bureau, Dept. SC, Popular Mechanics, 200 E. Ontario St., Chicago 11, Ill.

**Those Dreams Detroit Built—  
Have They Really Changed Your Car?**



**60<sup>th</sup>  
ANNIVERSARY  
SPECIAL**



## **PLYMOUTH XNR**

Chrysler Corporation gave us a preview of major styling themes to come with the Plymouth XNR sports car introduced in the winter of 1960. Its sloping hood and "wingtip" front fender lines are seen in '62 Plymouth's front-right, while the horizontal and vertical bumper-fin theme appears, above, on its rear deck.

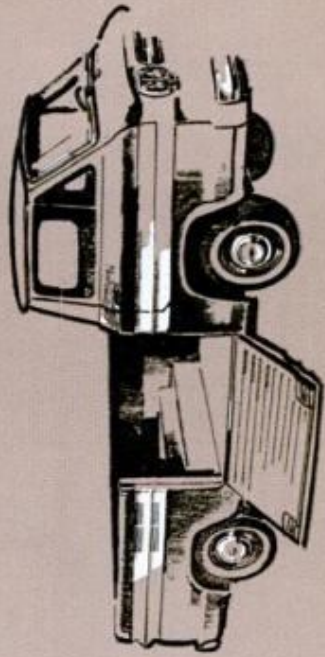
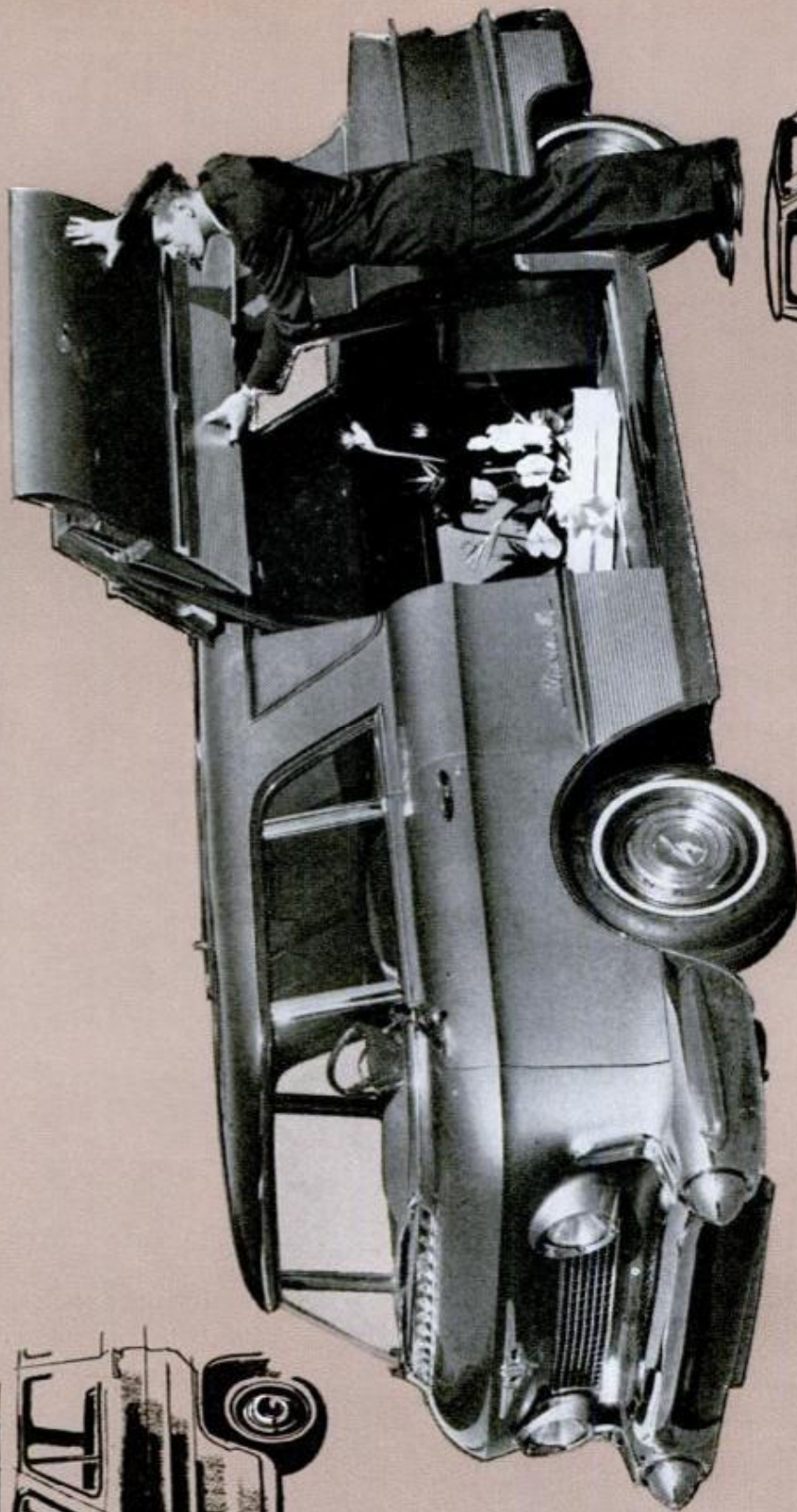

## GM L'UNIVERSELLE

Corvair's Greenbrier station wagon of 1961-62 was foreshadowed by the GMC L'Universelle, a dream truck unveiled in 1955. Its folding-door idea appears on Corvair's Rampside pickup, right. With a forward-mounted V8 of 180 horsepower, it is 188 inches long.

# FORD X-100

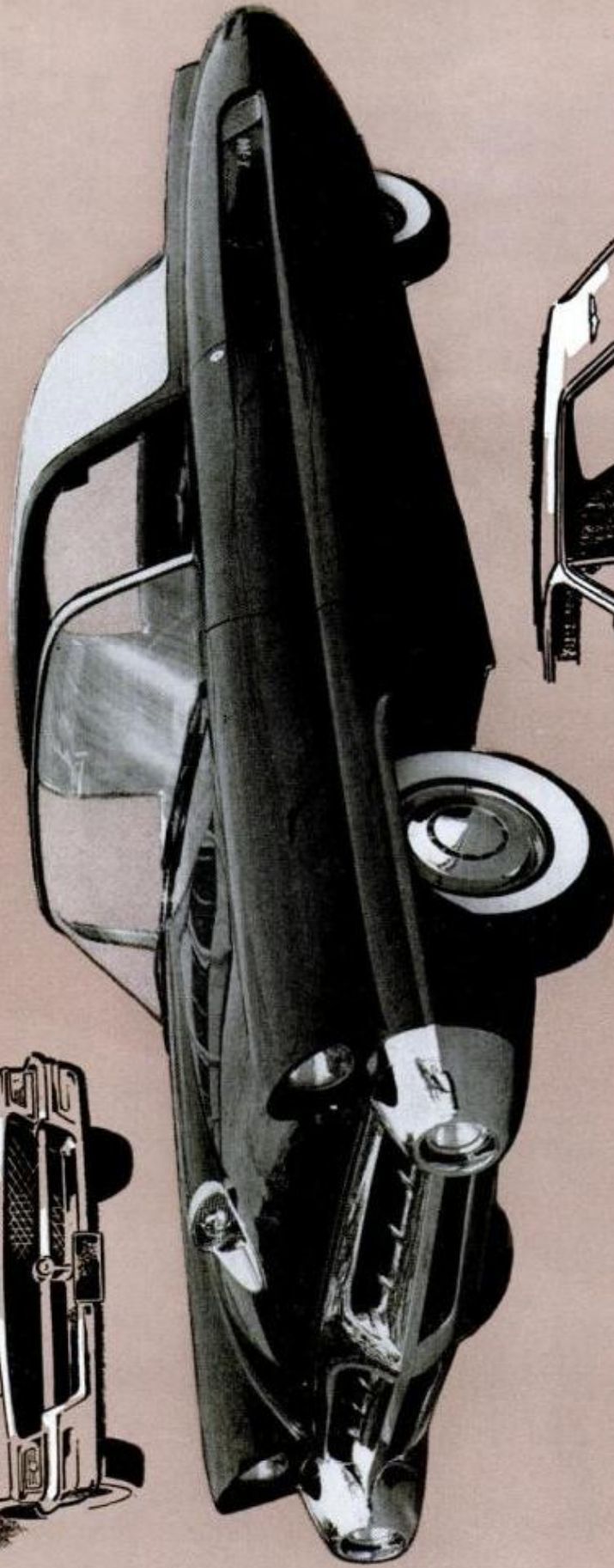

Ford's X-100 was introduced at the Paris Auto Show in 1953. It is 220 inches long, weighs 5900 pounds, seats six. Its sleek lines influenced design of many Ford products. Most striking comparison is with the 1961-62 Thunderbird, right. Hood scoop turned up on the '58 Ford, shown at top.

# CADILLAC CYCLONE

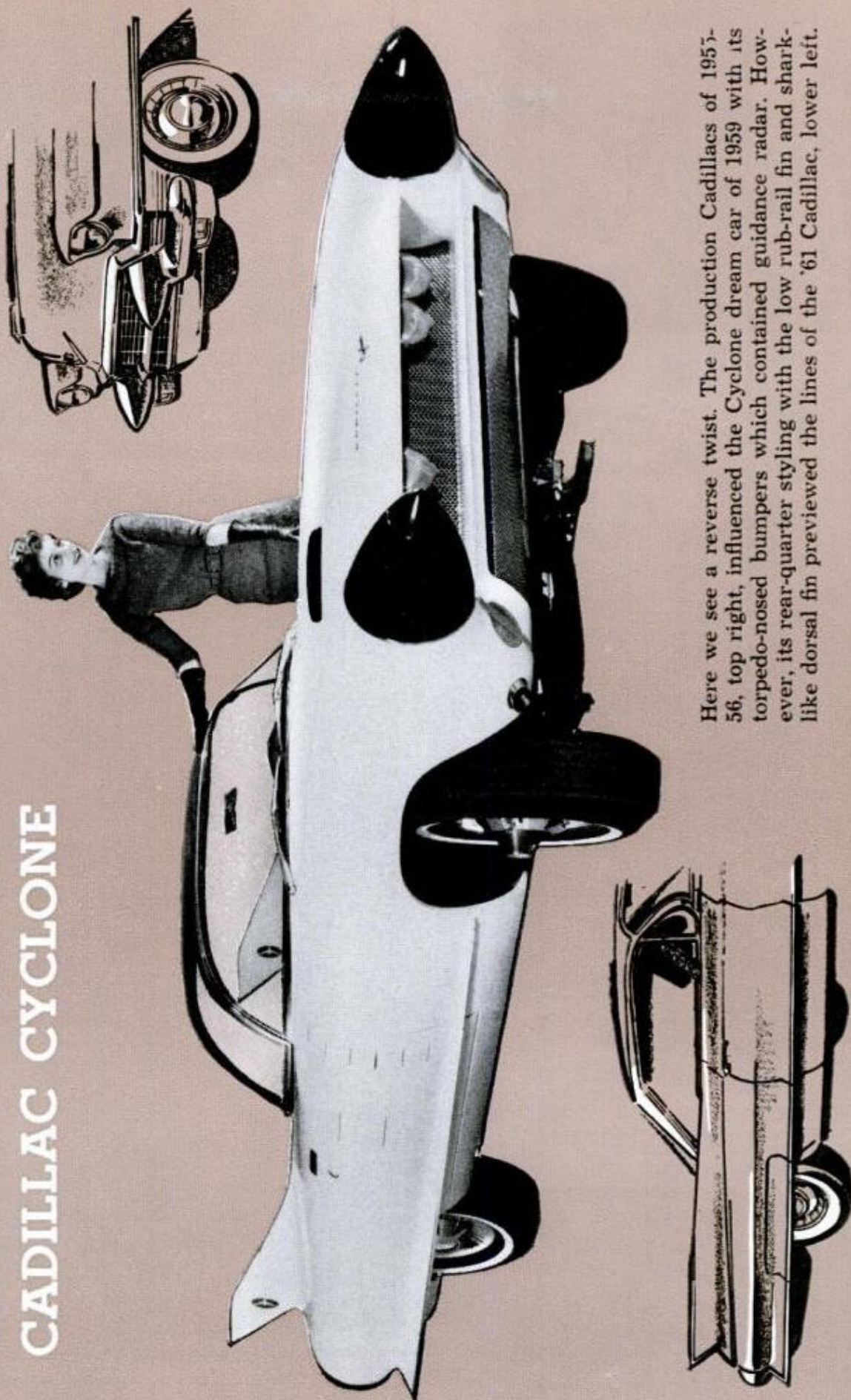

Here we see a reverse twist. The production Cadillacs of 1955-56, top right, influenced the Cyclone dream car of 1959 with its torpedo-nosed bumpers which contained guidance radar. However, its rear-quarter styling with the low rub-rail fin and shark-like dorsal fin previewed the lines of the '61 Cadillac, lower left.

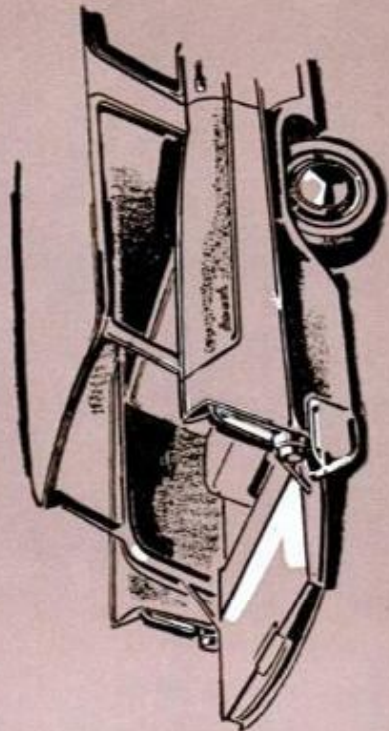
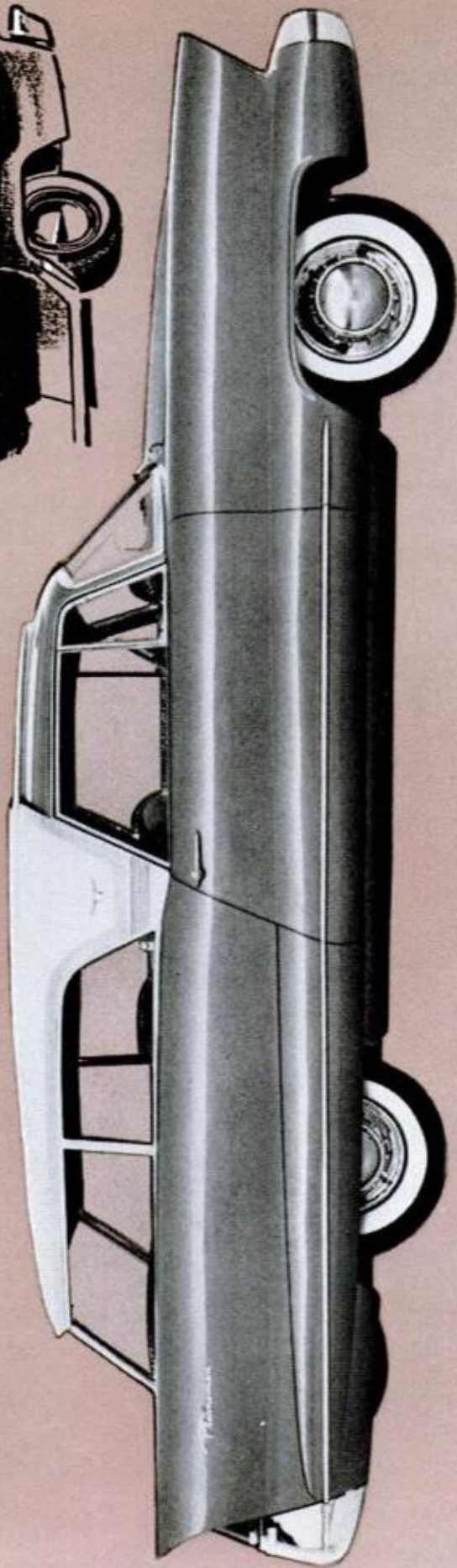

## PLYMOUTH PLAINSMAN

The Plainsman, an "idea station wagon," first shown in 1956, offered the public a chance to prejudice features that appeared later on Plymouth and other Chrysler wagons, such as rearward-facing third seat on '58 Plymouth, left, slanted, cantilevered pillar of roof, top right, and in-fender spare tire stowage on Plymouth's wagon.

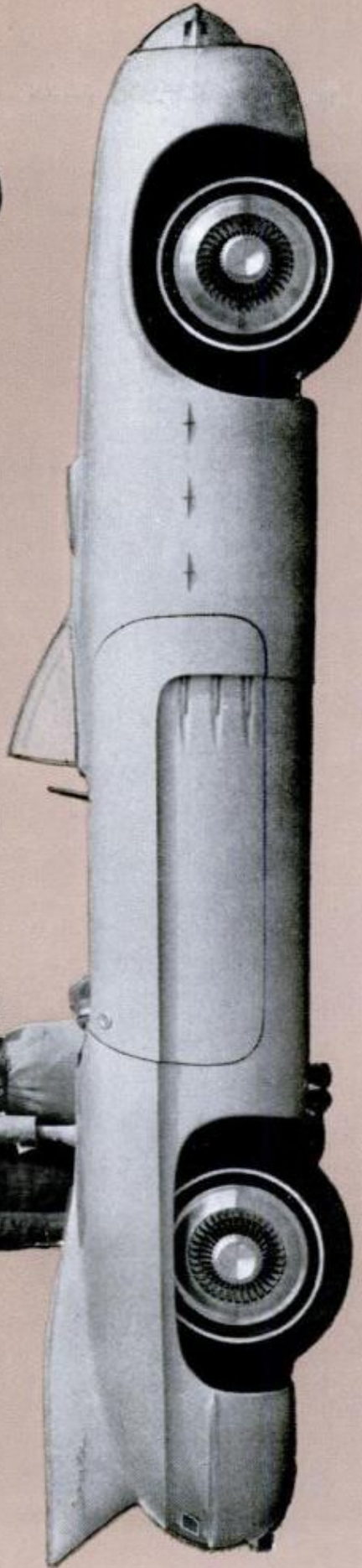

## PONTIAC CLUB de MER

Club de Mer, Pontiac's dream car of 1956, was this sports roadster with body of brushed aluminum. It gave a dominant styling theme, the sculptured recess in the side panel adorned with three chrome windspits, to the Tempest, above, while similar aluminum wheels show up as an option on '62 Pontiac Bonneville, at left.



# This Could Be Your 1967 Car

PM's own dream car, the PM 67, gets a strong assist from two General Motor's dream cars shown on the opposite page.

Its curved aerodynamic shape provides a needed psychological change from today's sculptured breadboxes. It also produces real fuel savings at 80 m.p.h. superhighway cruising speeds.

Note, also, that the PM 67 represents a more practical form of aerodynamics than GM's earlier dream cars. It hasn't any monstrous overhangs,

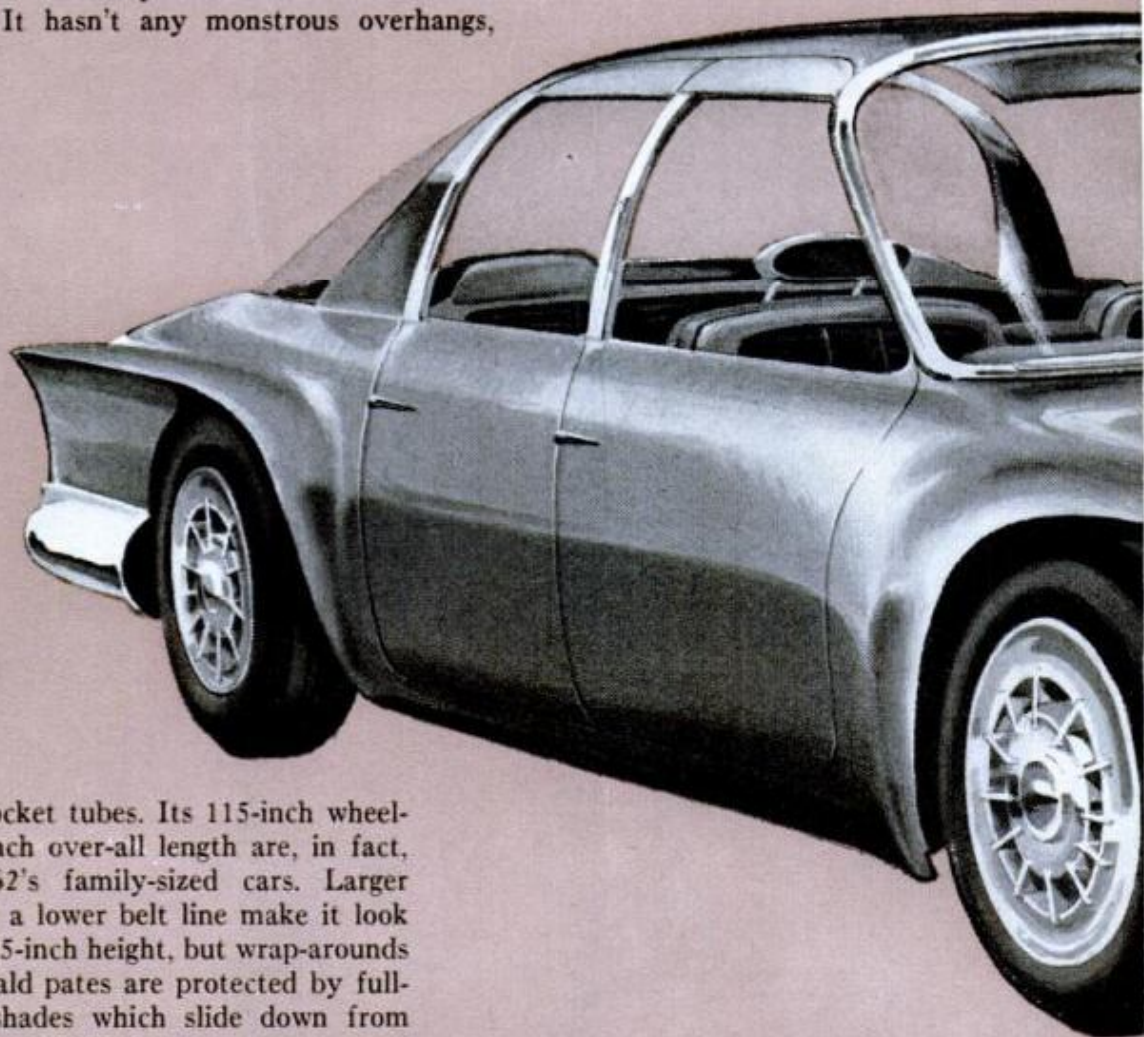

shark fins or rocket tubes. Its 115-inch wheelbase and 190-inch over-all length are, in fact, similar to 1962's family-sized cars. Larger glass areas and a lower belt line make it look lower than its 55-inch height, but wrap-arounds are mild and bald pates are protected by full-width plastic shades which slide down from pockets on the roof liner.

Large, aluminum wheels in full view give car a feeling of purposeful power no tail fin could equal. A cushioned, upright center guard (remember the wartime Jeep's "wirecutters"?) protects the grille.

Hinged panels that flip up above the doors make the PM 67 easy to enter. Spectacular weight savings on this 2200-lb. car stem from using body panels made of honeycombed aluminum foil resin-bonded between metal or glass fiber sheets. Doors are only three inches thick, permitting 62-inch seats within 70-inch width.

The front-mounted power plant is a V6 precision cast of iron and short enough to permit moving seats forward, centering them between the axles for greater legroom. Wider, shorter, slanted radiator and horizontal carburetor permits hood to be low. The engine weighs 300 pounds and develops 150 horsepower to drive the car through a rear transaxle. Suspension is independent by torsion bars, with driver able to select "soft boulevard" or firm "sports car" ride by changing shock absorber settings while under way.



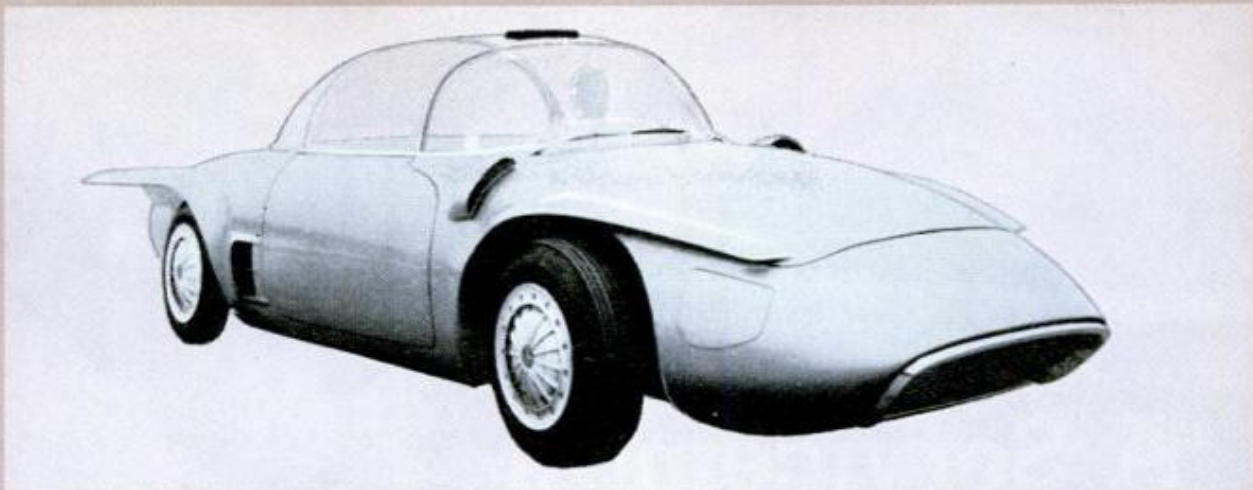

GM's XP-500, an experimental free-piston powered car was unveiled in 1956. Its engine burns animal, vegetable or mineral oil

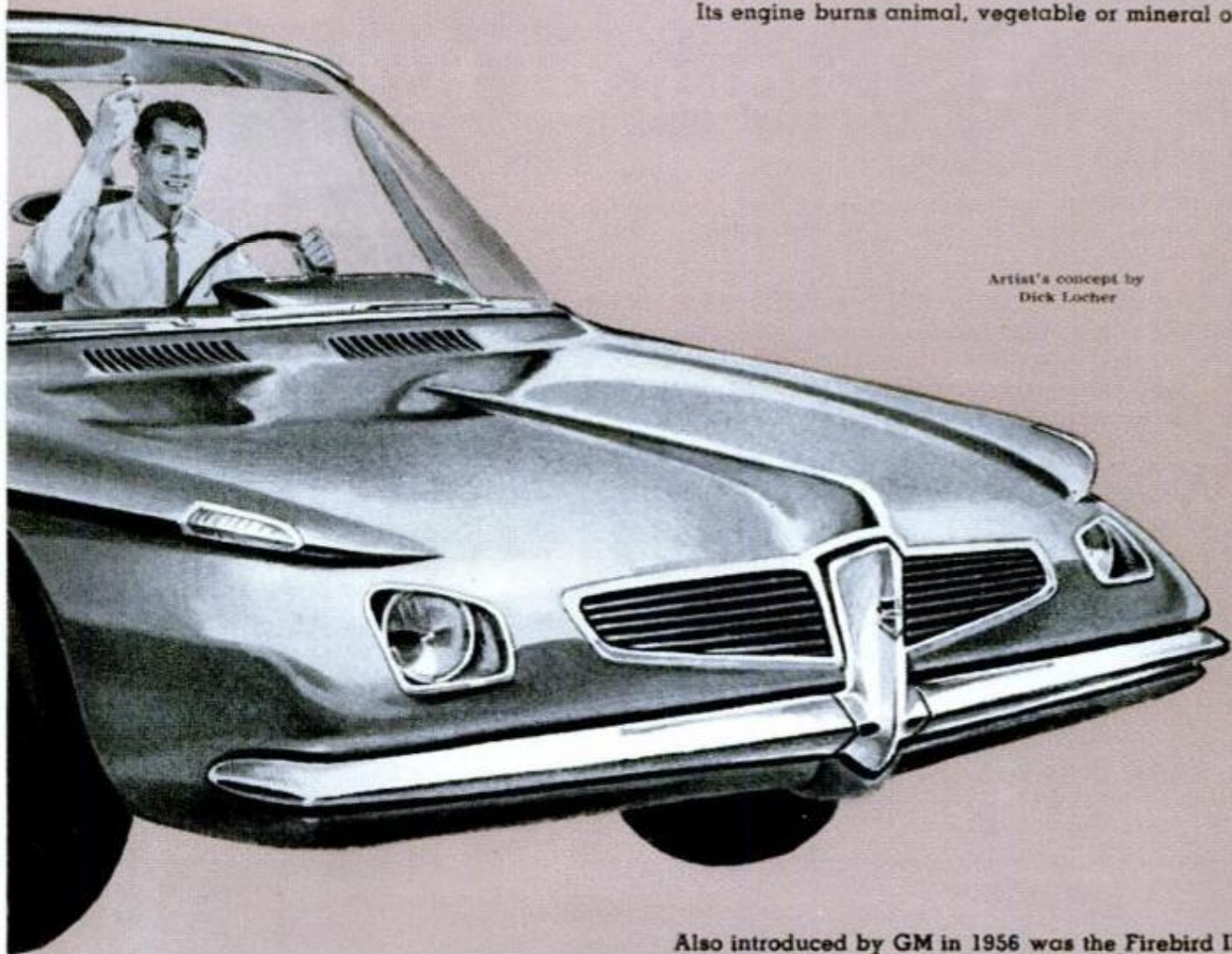

Artist's concept by  
Dick Locher

Also introduced by GM in 1956 was the Firebird II, first U.S. gas turbine-powered car suitable for actual highway usage



DO NOT FURNISH AUTHOR'S NAME AND ADDRESS TO ANYONE — (per Editor's)

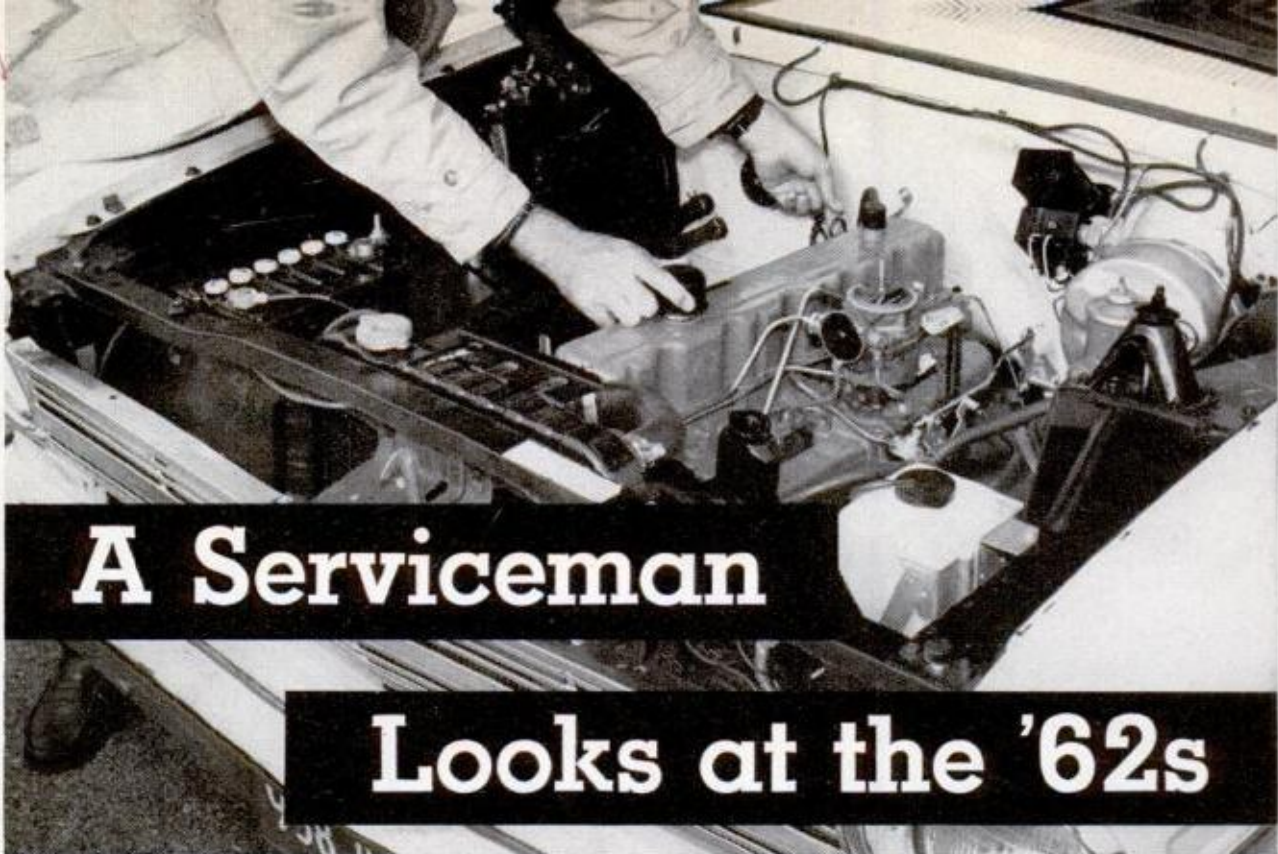

# A Serviceman

## Looks at the '62s

**SOILED CLOTHES** are not the price of carrying out routine service checks on new Chevy II; battery, radiator cap, transmission dipstick, power steering, brake fluid and washer fillers are easily reached

*The author of this article is a well-known expert in the automotive service field who prefers to remain anonymous and thus be free to levy criticism at the industry where it may be deserved.*

**WITH FEW** exceptions U.S. automakers are making real attempts to ease the problems of servicing by reducing the time, money and aggravation involved in routine upkeep.

The reason for this is that car manufacturers have run into a heavy groundswell of owner dissatisfaction with the rising cost of car maintenance. This hurts the manu-

facturer because the more the owner is compelled to spend on maintenance of his current car the less money he has to put into a new car.

Also, there's a sizeable competitive advantage in a car that's easier to service, or better yet, needs practically no service at all.

Freedom from service worries has become as important a selling point as driving ease or luggage space.

Automakers are taking three routes to eliminating service problems: 1) They are making service operations more accessible, therefore quicker (and cheaper); 2) they

**CHRYSLERS OFFER** improved servicing of the electrical system by moving the fuse box inside the glove compartment (left). The Chrysler line, like all 1962 cars of the Chrysler Corporation, is also equipped with the new foolproof disconnect for under-hood circuits (right) that plugs right into the fire wall

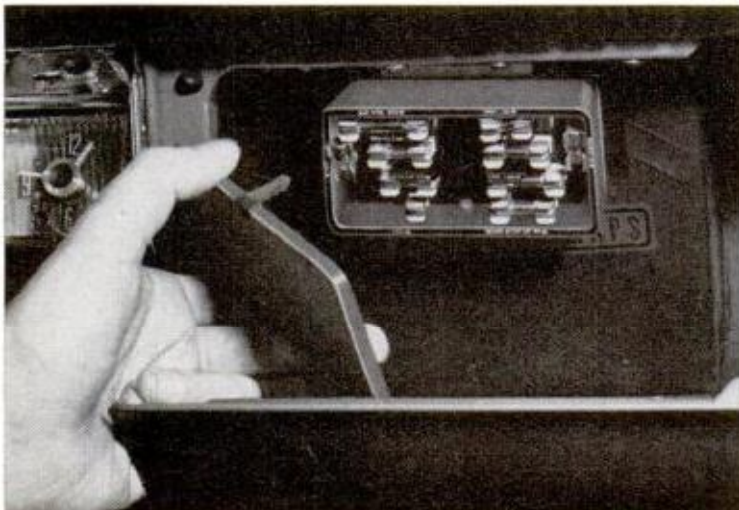



are lengthening the interval between routine service operations; 3) they are eliminating the service operation altogether.

The new '62 compacts have increased the industry's record of service accessibility, especially in the engine compartments.

Chevy II Four and Six sit straight up under their hoods and all accessories are easy to get to and work on. Ford's Fairlane and Mercury's Meteor have Sixes with good accessibility and modern V8s with carburetors, distributors and fuel filters up top and out front.

Older compacts like Rambler, Lark, Falcon and Comet also have "straight up" Sixes with accessible components. Lighter compacts and "family-sized cars" have permitted elimination of power steering, power brakes and other accessories. Even convertibles on Chevy II, Buick Special and Olds F-85 offer manually-operated tops where a trouble-free counterbalance spring takes the place of complicated electric and hydraulic systems with their potential service problems.

Even in bigger cars, service is becoming easier. Any mechanic who has adjusted breaker points on a recent Buick V8 will breathe a sigh of relief when he sees that the distributor, formerly smack up against the firewall, now has a clearance of several inches as a result of this year's movement of the engine toward the front of the chassis. In the same car, the entire top of the instrument panel can be taken out after removing four screws.

Chrysler gets rid of the rat's nest of wires under the dash by joining the trend to printed circuits. Quick disconnects separate the electrical circuits at the firewall, eliminating tedious tracing and threading of individual wires.

Chrysler cars have moved the fuse box up into the glove compartment for the ultimate in ease of replacement. Plymouth, Dodge, Valiant and Lancer not only have printed circuits for instrument-panel wiring but the panels can be detached for bulb replacement by undoing four screws from the front. The entire front end of the Chevy II bolts to the body structure, simplifying damage repair.

Dodge and Plymouth have created a minor problem by lowering the engine to drop the center of gravity and cut the size of the transmission tunnel. This change

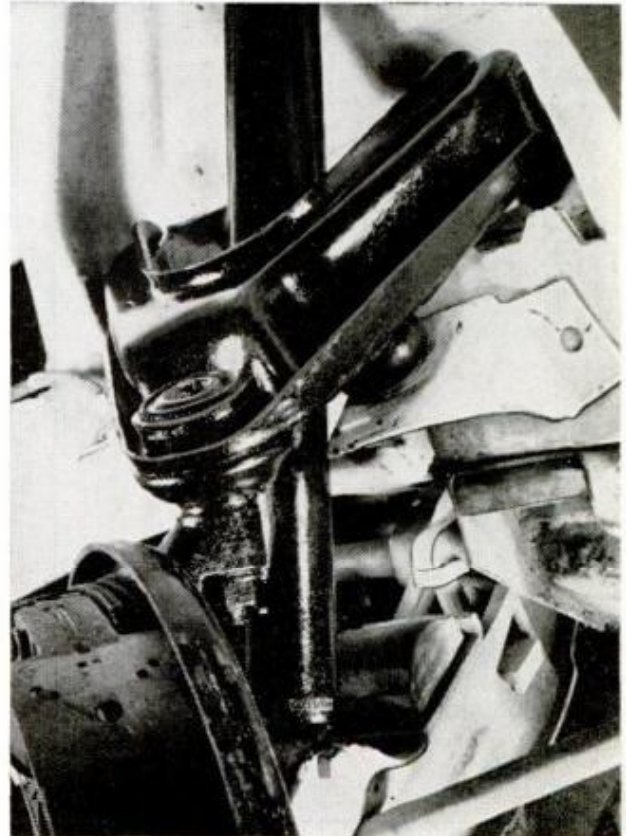

**SEALED FITTINGS** on the steering linkage tie rods of '62 Chrysler Corp. cars (see top) have no filler plugs and never need checking unless seals are damaged. Ball joints on Chrysler products are the only suspension fittings to be serviced (above) via filler plugs, and then only at 32,000-mile intervals

**NEW YORK TAXI** fleet using Fords with 30,000-mile suspension and steering lubrication has cut service intervals to 10,000 miles, installed grease fittings



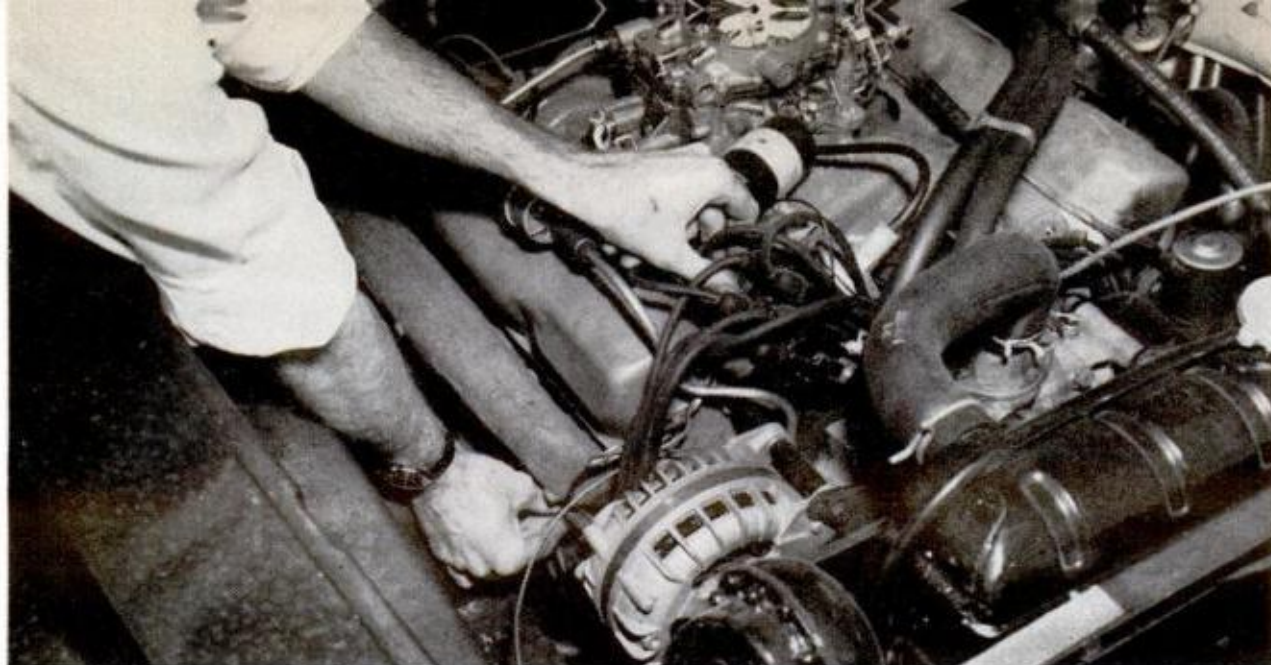

A BRAND-NEW CAR with a choice of two V8 engines, as well as a Six, the '62 Dodge has an accessible distributor but the spark plugs, hidden beneath the hot exhaust manifolds, present a real problem

### PM'S 1962 SERVICE CHECK-LIST

MAKE	Change Engine Oil	Change Oil Filter	Lubricate Chassis	Change Auto-matic Transmission Fluid	Change Rear Axle and Manual Transmission	Change Coolant	Change Gasoline Filter	Adjust Brakes
<b>AMERICAN MOTORS</b>								
Rambler American	4000	4000	2000	25,000	Perm.	2 yrs.	N.A.	Self Adj.
Rambler Classic	4000	4000	33,000	25,000	Perm.	2 yrs.	N.A.	Self Adj.
Rambler Ambassador	4000	4000	33,000	25,000	Perm.	2 yrs.	N.A.	Self Adj.
<b>CHRYSLER CORP.</b>								
All models	4000	4000	32,000	32,000	32,000	Seasonal	32,000	****
<b>FORD MOTOR COMPANY</b>								
Falcon	4000	4000	1000	24,000	24,000	2 yrs.	6000	24,000
Comet	6000	6000	1000	**	**	2 yrs.	6000	Self adj.
Thunderbird	6000	6000	6000	**	**	2 yrs.	30,000	Self adj.
Continental	6000	6000	30,000	**	**	2 yrs.	12,000	Self adj.
All others	6000	6000	30,000	**	**	2 yrs.	30,000	Self adj.
<b>GENERAL MOTORS CORP.</b>								
Corvair	60 days or 4000	60 days or 4000	1000	**	**	—	N.A.	Periodic
Tempest	"	6 mos. or 4000	4000	**	**	Seasonal	12,000	"
Buick Special	"	8000	1000	25,000	**	"	N.A.	"
F-85	"	6 mos. or 4000	2000	24,000	**	"	Periodic	"
Chevy II	"	"	1000	**	**	"	N.A.	"
Chevrolet	"	"	1000	**	**	"	N.A.	"
Corvette	"	"	1000	**	**	"	N.A.	"
Pontiac	"	"	35,000	25,000	**	"	12,000	"
Oldsmobile	"	"	*	24,000	**	"	Periodic	"
Buick	"	8000	1000	25,000	**	"	N.A.	"
Cadillac	"	6 mos. or 4000	*	16,000	**	"	6 mos.	Self adj.
<b>STUDEBAKER-PACKARD</b>								
All models	2500-3000	5000	1000	15,000	10,000	"	Periodic	Periodic

\* Does not require periodic lubrication.

\*\* No periodic drain recommended.

\*\*\* No periodic drain for differential.

\*\*\*\* Self-adjusting brakes on Dodge Dart, Polaras; Plymouths; adjust others when needed.

N.A.—Information not available.

MOST MAKERS ADVISE INSPECTION AND MINOR LUBRICATION AT 4000-6000-MILE INTERVALS

doesn't ease the already difficult job of changing plugs in the 361-cu.-in. V8.

Buick's V6 is easy to work on but holds a couple of surprises. The fuel filter is simple to change, once you've found it in the carburetor float-chamber inlet. An oscilloscope hooked up to this engine shows unevenly spaced cylinder patterns, the result of unequal firing intervals of 90 and 150 degrees. This means that a perfectly-tuned ignition system is an absolute must for smooth running.

The number of cars equipped with mechanically simple, service-minimum manual chokes has increased with Fairlane Six, Mercury Meteor Six, Falcon, Chevy II Four, and Tempest manual transmission using them.

Tire changing is just about as tedious as ever but the switch to cable control of rear brakes for parking on Dodge and Plymouth ends the annoying and dangerous business of the car rolling out from under the jack.

Nobody has yet come out with convenient jacking sockets such as are found on European cars, and a couple of cars like Tempest and Corvair require the unhappy motorist to locate a "dimple" on the underside of the body sill for jacking the rear of the car.

With the exception of Buick, Chevrolet and Studebaker, all manufacturers offer cars which need no chassis lubrication for 30,000 miles or more. Oil-drain periods have been stretched to 6000 miles in Ford products and 4000 miles for most other cars. Ford and American Motors offer factory-fill coolant which can be left in the system for two years. Self-adjusting brakes appear on more makes this year.

These service-free features save time and money for the owner who is willing to follow the manufacturer's recommendations concerning minor lubrication (wheel bearings, U-joints, by-pass valve etc.) and inspection at 4000 to 6000-mile intervals. But the motorist who thinks he can bid a cheerful goodbye to the grease rack for 30,000 miles is just asking for a big repair bill at some future date.

(Continued to page 232)

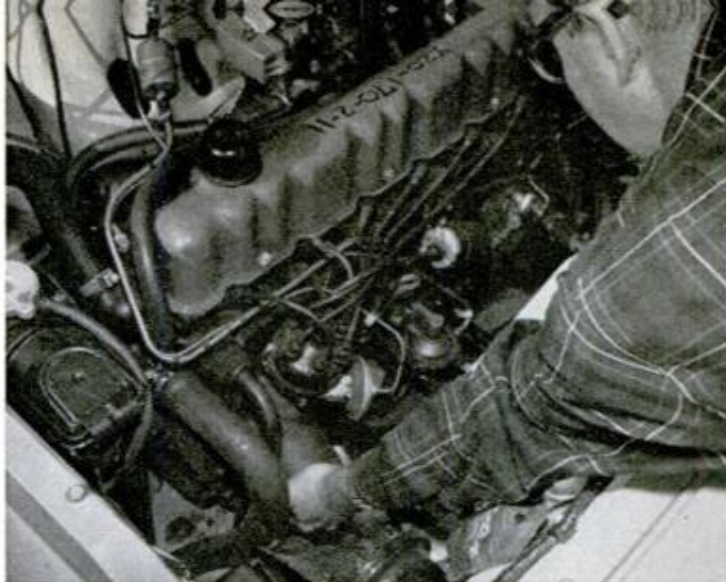

**FAIRLANE AND METEOR SIXES** are very accessible. Oil filter can be reached from topside, spark plugs are at hand. There's plenty of wrench and wrist room around distributor and fuel pump

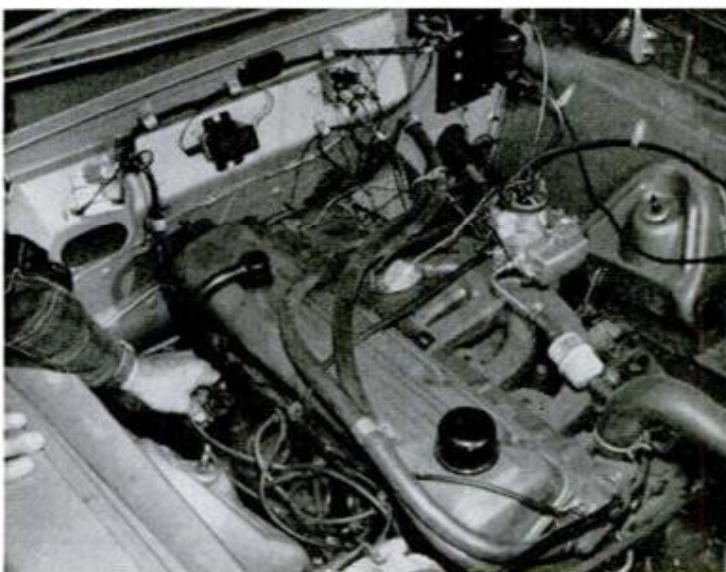

**PLYMOUTH SLANT SIX** doesn't foil spark-plug changers, but a tune-up man or Saturday mechanic will find that servicing the distributor or the oil filter is a knuckle-busting chore

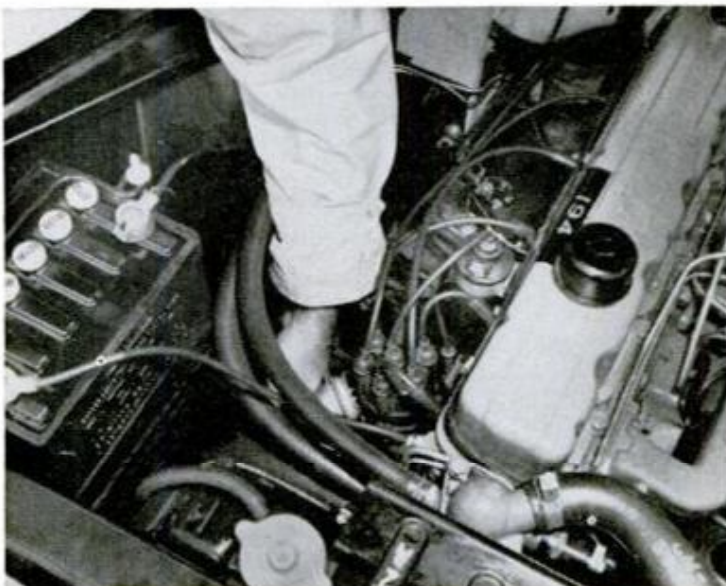

**CHEVY II SIX** (above) and Four, like the Fairlane, are Saturday serviceman's delight. Hand is on the oil filter cartridge near easily-tuned distributor and easy-to-reach fuel pump

# Drive Comparing

By Jim Whipple

**I**T MAY COST YOU 32 cents more for fuel to drive a 1962 Plymouth Six over a 168-mile route than to make the identical run in a four-cylinder Chevy II. Fuel expenses for a Ford Fairlane making the same trip may be 10 cents less than the Plymouth, 22 cents more than the Chevy II's. Those were two things PM learned in the course of a comparison test of three new U.S. economy cars.

The cars were: a Plymouth Belvedere four-door sedan with six-cylinder, 145-horsepower engine and automatic transmission; a Ford Fairlane two-door, with 101-horsepower six-cylinder engine and manual transmission; and a four-door Chevy II sedan with four-cylinder engine, manual transmission and (of all things) power

## DATA ON PM'S THREE TEST CARS

	Weight	Displacement (Cu. in.)	Horsepower	Axle Ratio
Plymouth Six	3172	225	145	2.93:1
Fairlane Six	2854	170	101	3.50:1
Chevy II Four	2557	153	90	3.08:1

steering and power brakes. Neither the Plymouth nor the Ford had power-assisted steering or brakes. The Plymouth's automatic transmission may have added to its fuel bill.

The cars were driven for over 500 miles by several PM staff members under various road and traffic conditions. The main event however, was a 168-mile reliability run in which all three cars followed one another with drivers switching back and forth every 30 to 40 miles.

The route was varied, with 48 miles of turnpike driving at 65 to 70 m.p.h., 29 miles of city driving at 20-25 m.p.h., 28 miles of paved country roads at 40-45 m.p.h., and 63 miles of concrete highway at 60-65 m.p.h.

At the start, odometer readings varied as follows: Plymouth 173.4 miles, Chevy II 169.7 miles and Ford Fairlane 200.2 miles.

All three cars were carefully topped off with fuel at the beginning of the run and refilled and

**FAIRLANE'S TRIPLE-DIAL** cluster, top, is down under the top of the dash panel and doesn't feed light back into windshield at night. Best of the three is Plymouth's efficient instrumentation, center, with a huge, easily-read speedometer. Chevy II's panel, shown in bottom photo, has a speedometer, a fuel gauge and five indicator lights

Ford Fairlane ..  
Plymouth .....  
Chevy II .....

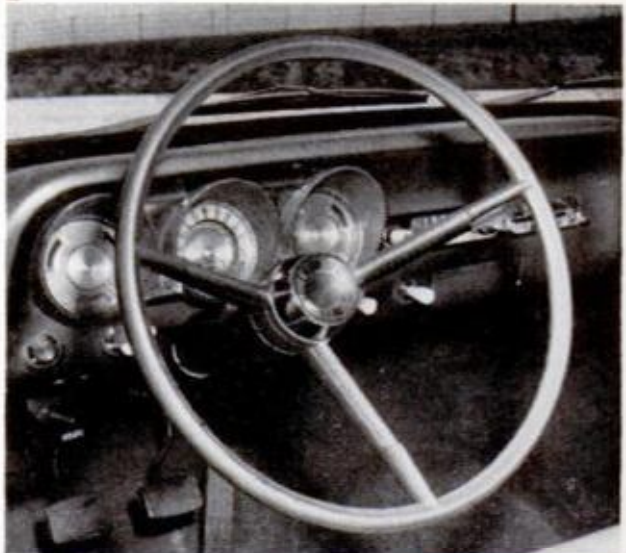

.....a roomy, solid, practical family car  
.....a powerful Six with a quiet, soft ride  
.....a true compact with a spacious body



FORD FAIRLANE



PLYMOUTH



CHEVY II



**PLYMOUTH'S SLOPING HOOD** stands out when parked between high, boxy Fairlane, right, and compromise angled, shorter hood of Chevy II. Ground clearance is about equal but for 5½-inch height of Chevy II's tie rods

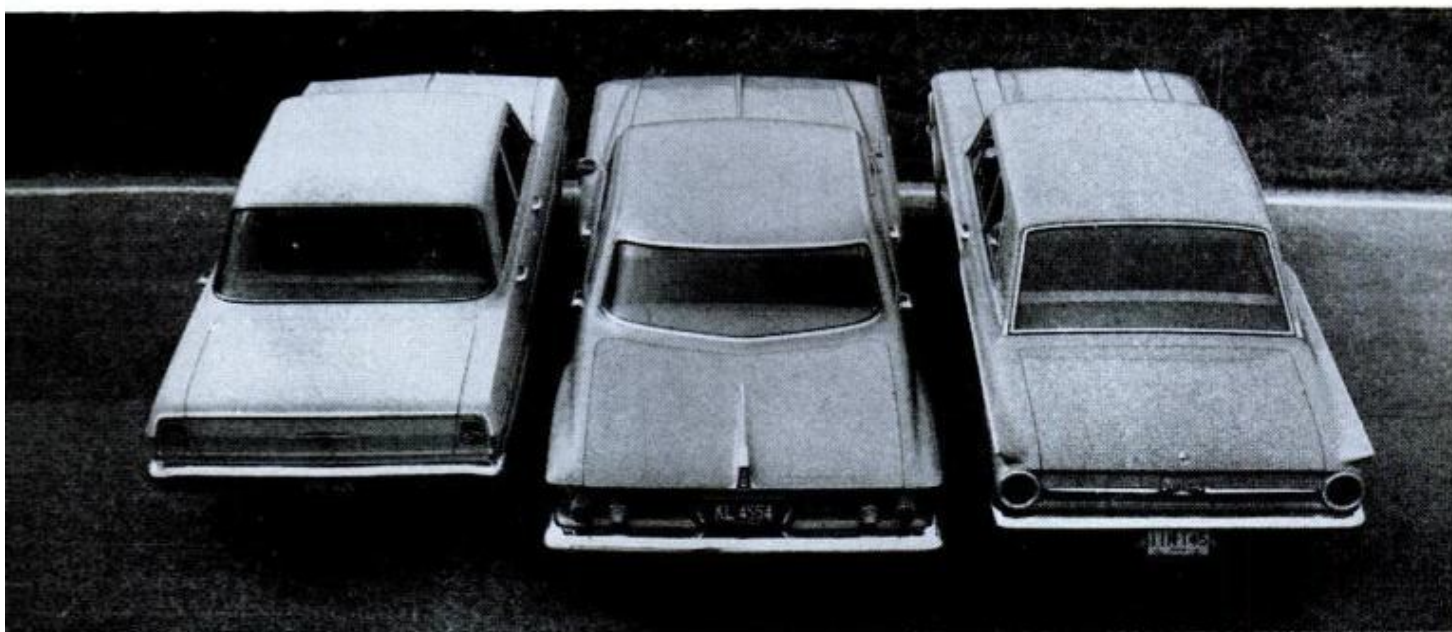

**HERE'S THE SIZE STORY:** Chevy II, left, is a compact, 183 inches long as compared to Plymouth's 202-inch length, center. Fairlane is 197 inches in over-all length. Chevy II has a shorter rear deck and hood

**ALL OF THE BAGS SHOWN** above were packed into the trunks of both the Plymouth, left, and the Fairlane, center. Chevy II's trunk, right, held all the baggage except the large suitcase shown in the foreground





**LINE OF SIGHT** comparison on all three cars was made by measuring distance of driver's eyes from roof and windshield, setting camera's lens in exactly the same location, then sighting over edge of hood or trunk, moving the object until it was fully visible. This gave distance of object from car at ground level. Distances A and B, below left, give length of "blind" areas in front of and behind cars that drivers miss



**FORD**

A = 24'-8" B = 22'-10"

**CHEVY II**

A = 16'-10" B = 22'-8"

**PLYMOUTH**

A = 19'-6" B = 20'-1"

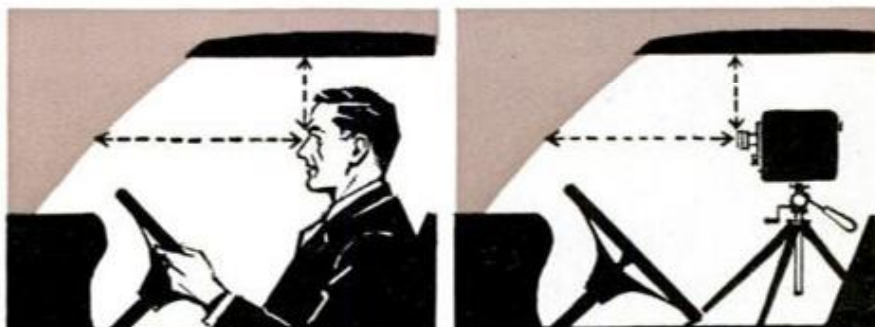

topped at the same pump when the run was completed. Mileage was taken from Illinois state road maps and intracity mileage taken on Chevy II's near-accurate speedometer. Comparative miles per gallon and cost of fuel used were as follows:

- Plymouth 20.0 miles per gallon, \$2.92
- Fairlane 20.49 miles per gallon, \$2.82
- Chevy II 22.55 miles per gallon, \$2.60

Acceleration from 0-60 miles per hour with correction for speedometer error came out to 13.4 seconds for the Plymouth, 15.5 for the Fairlane and 16.5 for Chevy II.

There's a lot more to a car than just fuel economy and acceleration, so we've tried to evaluate all three cars from the viewpoints of several types of drivers on questions of comfort, high-speed driving, performance, riding qualities and driving ease.

**PLYMOUTH**

Everyone felt that the Plymouth was more than adequately roomy and very comfortable. Legroom was quite sufficient for 6'2" drivers with the seat moved fully back. The transmission tunnel in front and the drive-shaft tunnel in the rear were found not to be particularly annoying although their total absence would be preferred.

After driving the other cars, we were instantly aware of greater quietness of the Plymouth's well-insulated and well-sealed body with very low wind noise and well-muffled engine noise.

The car moves up to 70 m.p.h. very smoothly; you hardly know that it's going that fast. Manual steering is light and precise in action, although its higher ratio does call for more wheel winding. You do get a bit of wheel twist that requires correction when you pass a semitrailer at high speed.

Plymouth is a relaxing car to drive in traffic. Its three-speed-plus torque converter automatic transmission gives a smooth, quiet flow of power with no annoying surges or jerks around shift points.

One 5'7" driver remarked that the rear window was high, which made it impossible to see the sloping rear deck and judge the outline of the car when backing into parking spaces.

Plymouth's three-speed automatic was a delight in Rockford traffic and our drivers found no need for power steering.

Plymouth accelerates more quietly from a standstill due to the smoothness of the automatic transmission, a greater amount of sound deadening around the body, and a



**CHEVY II DOORS** are high and wide and seats are wide and comfortable. Kneeroom is below average



**REAR SEAT RAISED** well above floor in Fairlane makes seating comfortable. Tunnel is relatively low



**PLENTY OF KNEEROOM** for tall man in Plymouth with front seat halfway back. Headroom is also good

larger engine working with a lower axle ratio, i.e. turning more slowly.

Over rough pavement the ride is much "happier" than in either the Chevy II or the Ford Fairlane. You feel the bumps from tar strips or rough pavement, but there's less total disturbance to the body due probably to softer springs and a longer wheelbase.

Total impression of the Plymouth is of a "big-car" ride, whereas the ride is less than that on either the Chevy II or Ford Fairlane.

Instruments are extremely readable on the Plymouth. The well-positioned, big speedometer has white numerals on grey dial face. Because of the hood's slope, forward vision is as good on the Plymouth as the other two cars, even though the Plymouth hood is longer.

The windshield's upper edge is lower because its slope angle is greater. It has as much glass from bottom to top, but it seems shallower. There's a little distortion seen by the driver in the upper right hand corner of the Plymouth's windshield. Similar distortion doesn't show up in the Chevy II or Fairlane.

### CHEVY II

Immediately on changing to the Chevy II, from one of the other cars, we were conscious of a tighter, smaller angle between the seat back and seat bottom, which makes it quite uncomfortable for long-legged persons. The seat back is not tilted back far enough, or the seat cushion is tilted too far up.

This dumps the base of your spine down in the seat. The left leg isn't too uncomfortable, but the right leg is the problem. This wasn't as noticeable on the six-cylinder Chevy II Deluxe that we tried later.

At 60 m.p.h., the four-cylinder Chevy II comes close to the vibration-sound level of the compact sixes; in fact, few people can tell that it is a four in this speed range.

The body structure of Chevy II is solid and free from judder and shake; there's not much sympathetic vibration at higher speeds. Basically, Chevy II is a solid, sturdy car but it could use more insulation for the engine.

However, the noise level is no more obtrusive than the Fairlane standard Six. This is not so much a compliment to the Fairlane as a testimonial to Chevy II's soundproofing. A four-cylinder Pontiac Tempest tested a few days later was smoother and quieter than either the Chevy II Four or the Fairlane Six—a tribute to Tempest's engine mounts.

There's a welcome absence of wind roar on the Chevy II Four. Backstop testing on the Chevy II Six, we found wind noise a bit annoying and came to the conclusion that it must be a quality-control problem.

One of the drivers commented that the Chevy II Four vibrated in traffic and he had to use second gear a good deal at 20-25 m.p.h. to avoid annoying vibration of a lugging engine. A few days later, checking the stick-shift '62 Tempest with 110 hp. four-

(Continued to page 244)

# An Engineer Analyzes the '62s



By Roger Huntington, ASAE

## ENGINES

FOR TWO YEARS (1960-61) the big new feature in American car engines was aluminum construction, which was supposed to answer both cost and weight problems. At one time it looked as if no more new Detroit passenger car engines would be tooled for cast iron.

But in 1962 there are four brand-new engine designs—and they're *all* cast iron. There are the new in-line 4 and 6-cylinder engines for the Chevy II, Buick Special's new V6, and the small V8 for Ford Fairlane and Mercury Meteor. All are modern, up-to-date engines with plenty of advanced features; they'll give more performance in relation to fuel



**CAST IRON "LIGHTWEIGHT"** engine is developed with solid coring composed of resin and sand that resist distortion and core shift formerly allowed for by making cylinder wall (and other parts) extra thick. This results in uniform wall, free from unneeded weight and uneven expansion or contraction

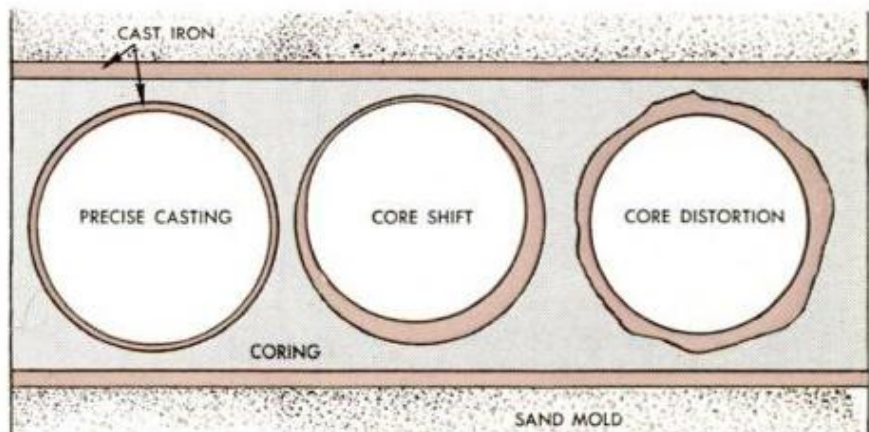

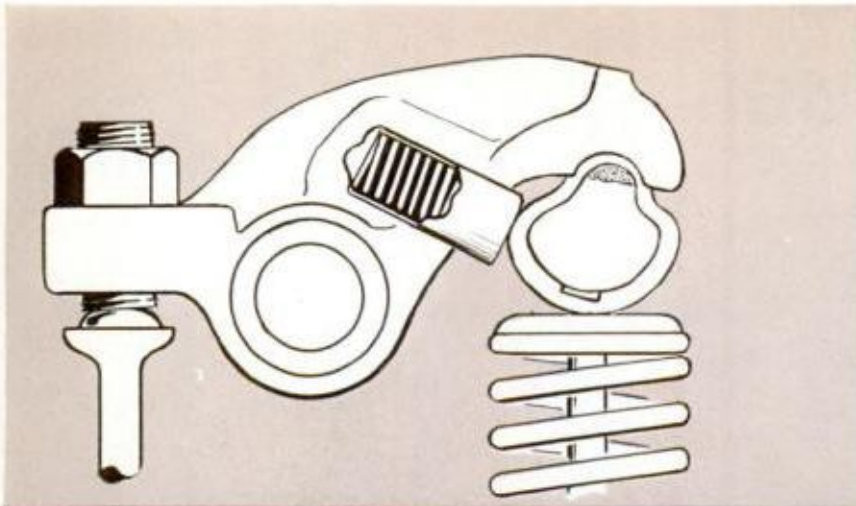

**FORD GALAXIE** and Mercury Monterey incorporate automatic zero-lash feature in their six-cylinder engines. It uses spring load plunger that keeps mushroom-shaped cam in constant contact with the valve stem

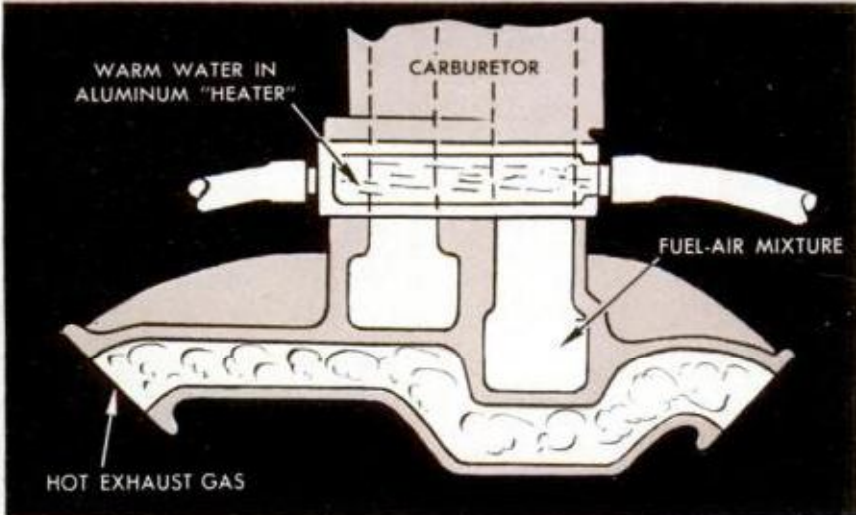

**TWO-WAY CONTROL** of incoming fuel mixture's temperature for Ford's Fairlane V8 is achieved by continuous flow of exhaust gases through crossover, and flow of warm water just below the carburetor throats

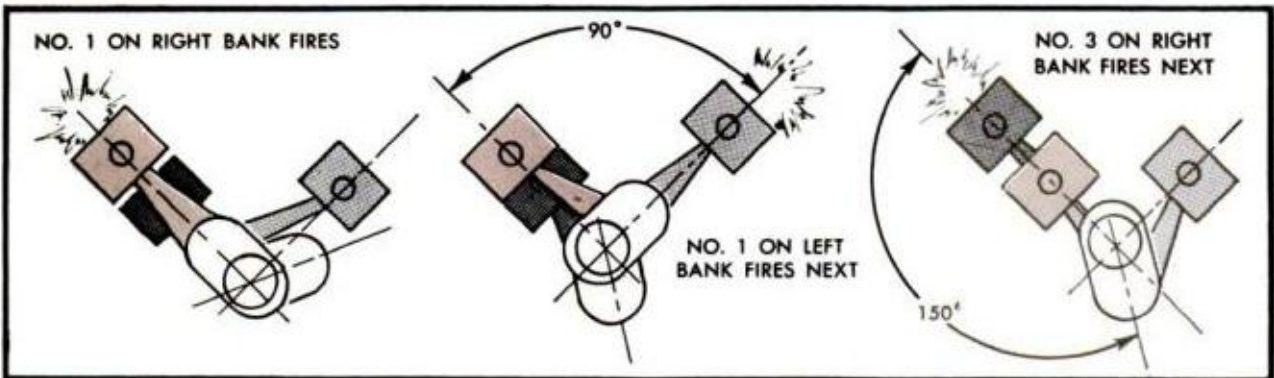

**UNIQUE FIRING PATTERN** used on Buick's new 90-degree V6 works successfully in spite of theoretical problem of uneven spacing between the firing impulses. Diagram is viewed as from front of car with odd numbers 1, 3, 5 on left bank and even numbers 2, 4, 6 on right bank. Thus firing order is 1, 6, 5, 4, 3, 2

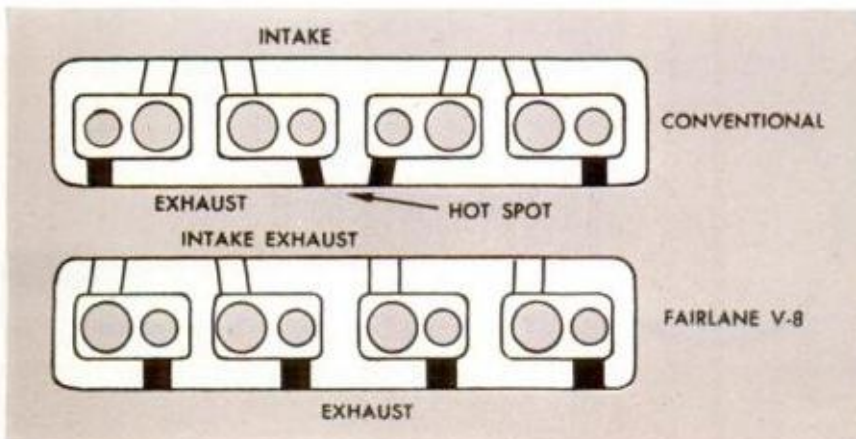

**SIAMESE PORTING** of second and third exhaust valves on conventional V8 cylinder head (top) creates a hot spot resulting in warping. Ford's Fairlane V8 cylinder head (below) avoids this with four, evenly-spaced ports

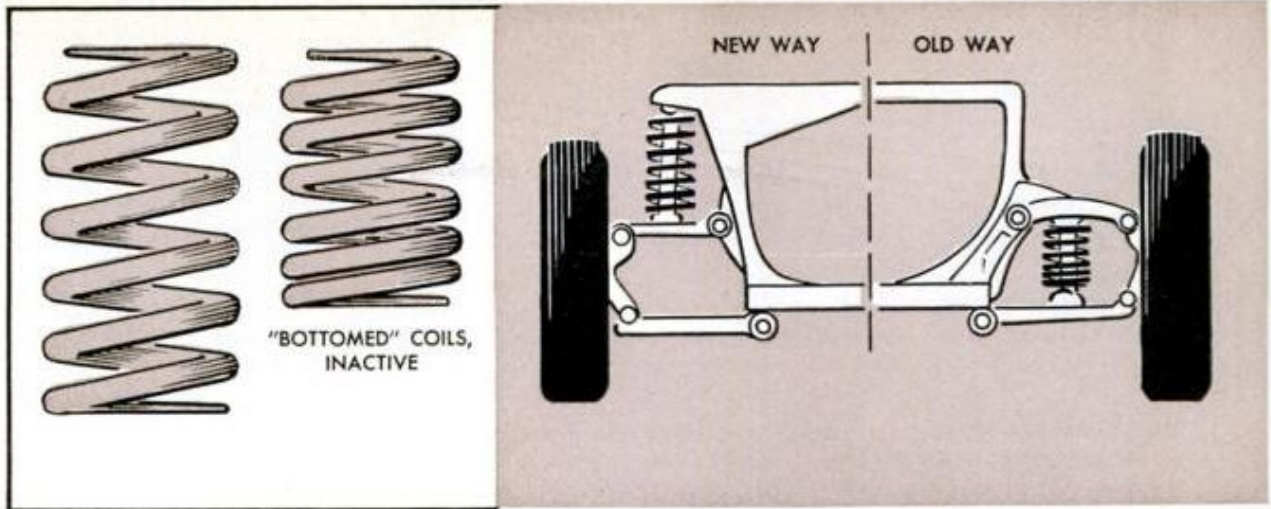

'62 BUICK SPECIAL'S variable pitch rear coils have low pitch end to "bottom" first, to stiffen against bumps

WIDER DISTRIBUTION of suspension loads reduces stress concentration when front coil springs are mounted above suspension arms on new unit bodies of the new Chevy II and Ford Fairlane

consumption, run smoother and last longer. And they're *light*. But they're still made of good old cast iron.

Aluminum engine production proved to be more expensive at the outset due to problems with porous castings, chilled hard spots, tool breakage, etc. All these items added to the greater cost of the metal itself didn't offer tremendous encouragement to the cost-conscious motormakers. These problems were solved but it took time and money. Then too, aluminum as a basic engine material seemed to work no sales magic with the public. As long as there was a light, economical car that performed satisfactorily the public didn't seem to care what the engine was made of.

But economy cars have got to be *light*. Not only do the automakers buy material by the pound, but it takes extra gas to lug dead weight. You can't put 600-pound engines in these cars.

Engine weight has always been a problem with cast-iron construction because the casting walls had to be made overly thick to allow for distortion and shifting of the internal cores, and to prevent too-sudden chilling of the molten iron flowing into the mold. In other words the head and cylinder block castings made were much heavier than strength requirements—just to allow for these casting bugs.

Detroit's answer was a revolutionary new foundry technique known generally as "thinwall casting." This new method includes using new plastic binders for core sand and quick-baking the cores at high temperature in preheated boxes to reduce distortion; or a one-piece core may be used where two or three pieces were used before, to reduce "core shift." Sand may be rammed into the mold with new hydraulic equipment to get a denser, more even mold

surface. New core coatings give smoother surfaces. There are new iron alloys for casting that are stronger, less brittle, and won't chill so suddenly in the mold.

All this means thinner casting walls without loss of strength—and head and cylinder block castings can be 15 to 30 percent lighter for a given size. For instance Buick's new cast iron V6 weighs less than 50 pounds more than their aluminum V8! Chevrolet's new six for the Chevy II is 150 lb. lighter than the old cast-iron six on the "big" car. Ford Fairlane's new V8, at 440 lb. with all accessories, runs about what Detroit figured aluminum engines would weigh a few years ago!

Chevrolet's new four and six-cylinder jobs for the Chevy II use valve gear, pistons, rods and bearings from the small 283-cu.in. Chevy V8. Both four and six are set up for machining on the same production lines and assembly on the same lines. Their layouts are very conventional in every way. These are undoubtedly the most inexpensive engines to produce in the industry. The Four has 153 cu.in. and puts out 90 hp.; the Six gets 120 hp. from 194 cu.in. Fuel economy and durability are excellent—and early road tests indicate unusual low-end torque and flexibility. The unusual bathtub-shaped combustion chambers are necessary in order to tilt the valves up at a straighter angle, so the pushrods can be put on the right side of the engine and all the intake and exhaust ports along the left side of the head (difficulties you run into when adapting V8 parts for in-line engines)!

Buick engineers pulled off the quickest engine tooling job in the history of the U.S. auto industry when they got the new V6 into production within *five months* after the final decision to build it!

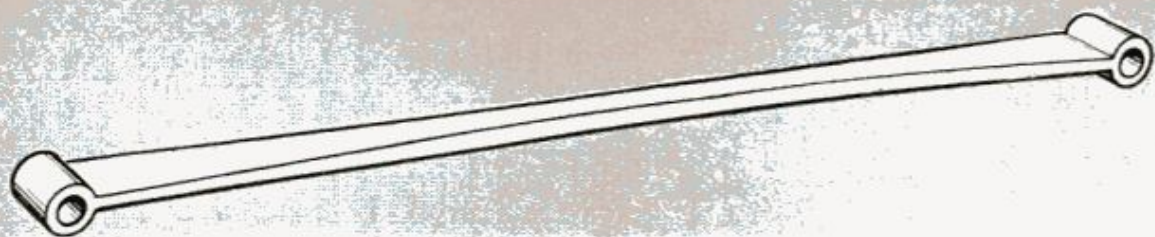

**HIGH BENDING STRESSES** of the new single-leaf spring as used in the new Chevy II, require the leaf to be thicker in the center than at the ends. Chevrolet reduces its production cost by rolling the leaf so that the material spreads out sideways as its thickness is compressed

**MULTILEAF SPRINGS** of the conventional type use more material than is actually necessary because the clamped-down center section does no work. Chevy II's new single-leaf spring is mounted in sliding rubber pads locked to a retaining clamp so the full length of the spring flexes

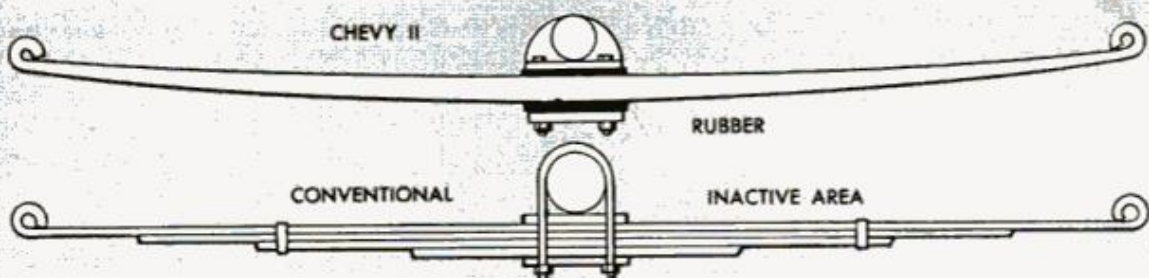

The top brass at Flint wanted to lower the Special line into the Ford-Chevrolet big six price bracket—and a new cast-iron six-cylinder engine was the only way they could do it.

Their answer was to chop the rear pair of cylinders off the aluminum V8 and cast the block and heads in iron. By using the V8 valve gear, die-cast aluminum front cover, accessories, timing chain and sprockets, water pump, oil pump, bearings—and by adapting a lot of the V8 tooling—Buick did the impossible.

Of course the textbook says you're not supposed to build a V6 layout with a 90-degree angle between the cylinder banks. In order to have evenly-spaced firing impulses you must use a 120-degree angle with a 3-throw crankshaft or a 60-degree angle with a 6-throw (see page 110). But Buick had to use the 90-degree angle in order to utilize V8 tooling. Answer: let the explosions come at odd intervals. You can't detect it above idling speed anyway.

On the new 90-degree V6 one explosion will follow the first after 90 degree of crankshaft rotation; then the next will come 150 degrees later—then 90 degrees, then 150 degrees, and so on. It's no problem at all.

Any V6 engine that doesn't use an auxiliary counterweight shaft running at twice crank speed will have a certain amount of secondary unbalance that will tend to shake the block. But, with the new 90-degree layout this shake is in a *crosswise* di-

rection—which is very easy to soak up with soft, flabby motor mounts. Buick is betting that you'll find their new V6 as smooth and silky as any Six you've ever driven. (Ed. note: We agree after testing. PM, Oct. '61, p. 109.)

And the performance is all you'll need in the 2800-lb. Special. With 198 cu.in., 8.8-to-1 compression ratio, and two-barrel carburetor feeding into the unique two-section manifold (where one carb barrel feeds each of the three cylinders on one bank at even 240-degree intervals of crank rotation). The speed and acceleration will be very adequate, yet you should get the fuel economy of a small Six.

Ford's new 221-cu.in. V8 for the Fairlane and Meteor lines appears to combine most of the best features of all the industry V8s designed in the last 10 years. The bore is large in relation to stroke—giving lots of valve area, short connecting rods, and a very stiff lower end. We have big rod bearings and five huge mains. But Ford has abandoned the deep "Y-block" deal, where the block casting is brought down below the crankshaft. The added stiffness in the crankcase proved unnecessary—it was just a waste of metal.

Distributor and oil pump are driven off the front of the camshaft, for improved accessibility. The age-old wedge-shaped combustion chamber is used, as this still seems to give the best compromise between combustion smoothness, octane requirement and easy gas flow.

**ADDING A GEAR** to their conventional three-speed transmission is the way Borg-Warner made their new four-speed gearbox. Second gear takes over the place of low gear and the new low gear moves into the spot formerly occupied by reverse (both are constant-mesh synchro). Reverse gear is now located back in the tailshaft housing

ORIGINAL 3-SPEED

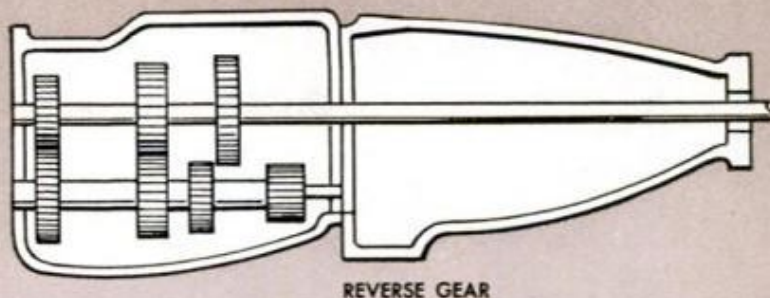

REVERSE GEAR

4-SPEED

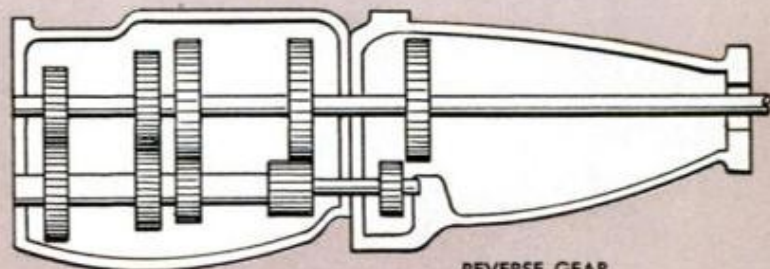

REVERSE GEAR

One of the most interesting features of the new Ford engine is the ball-joint valve gear, patterned after the Chevrolet and Pontiac designs brought out in 1955. GM patents probably prevent a direct copy, so Ford casts its cup-shaped rocker arms instead of stamping them out of sheet steel. But Ford uses the same type of ball-joint rocker, stud and thin, hollow pushrod with oil coming up through it from the hydraulic tappet.

This is not only a relatively inexpensive valve gear (since separate rocker shafts and brackets are not required); but the low reciprocating weight allows higher r.p.m. without valve float. This valve gear may one day be an industry standard.

The claimed 143 hp. from 221 cu.in. on 8.7-to-1 compression ratio may be just a starting point for future development on this design.

As usual there are always a lot of interesting detail improvements on each year's engine crop. Buick's new cast-iron connecting rods for the V6 may start a trend. Rods take a beating, and engineers have usually insisted on making them of tough forged steel, like crankshafts. But forging is expensive. Ford has been casting cranks for years with great success. GM has done it too. Why not rods? New iron alloys are now available that are much stronger and less brittle than old conventional "gray iron," and yet can be cast cheaply with present equipment. Buick has been experimenting with cast con rods

for four years without major trouble. They'll all be using 'em tomorrow.

Most '62 Ford Motor Co. engines are using an interesting water-warmed aluminum "spacer" between intake manifold and carburetor. It acts as a thermal "shock absorber" to prevent sudden overheating of manifold and carb when full exhaust flow goes through the hot spot (which, in turn, can boil gas in the carb and coke oil on the underside of the manifold).

Ford engineers have also come up with a design for zero-lash mechanical valve lifters for the 223-cu.in. Six. A spring-loaded plunger in the rocker arm keeps tension on a swivel against the valve stem to maintain zero clearance—to get the same effect as hydraulic lifters with about half the cost. (This deal was supposed to come out on the 1961 models, but bugs held it back. It now looks like quite an important development.)

Some auto enthusiasts may have been disappointed that there weren't more radical developments in the '62 engine crop, comparable with the Buick-Olds aluminum V8 and Corvair air-cooled engines of recent years; but we must remember that the mass market wants *economy* these days . . . and this is what Detroit is trying to give it.

## TRANSMISSIONS

The recent trend to expensive, complicated, multiturbine torque converters has

(Continued to page 238)

# How to Save SAFELY on Car Insurance

by  
Harris  
Edward  
Dark



**I**NSURANCE AT A DISCOUNT? Sure, but not for everyone, and not automatically. You have to qualify and you have to ask for it.

For competitive reasons, there is a difference even in the basic rates of all insurance companies. One company's percentage of claims on certain coverages may be quite different from another's, and rates are based, generally, on experience.

Again for competitive reasons, some companies offer *special* rates (discounts) to certain kinds of drivers, to drivers who do certain kinds of driving and to those who drive certain kinds of vehicles.

Some of these discounts are new, and it would pay you to investigate them.

The idea, then, is to shop around among insurance companies and get the best combination of low basic rates and discounts. Here are a few of the available discounts:

**Good-Driver Plan**—A discount of about 20 per cent is offered to drivers who haven't had a chargeable accident (your fault, costing the insurance company \$50 or more) during the last five years (three years, say some companies). If later you do have a chargeable accident, your next annual premium may be higher; if you stay clean, you'll continue to enjoy the savings.

**Low-Mileage Discount**—You can save about 10 percent on your personal-liability and property-damage (PL & PD) coverage if you anticipate driving less than 7500 miles during the next year and so advise your agent when he writes or renews your

next policy. If you happen to drive more than 7500 miles during that term, the following year's premiums will be set accordingly. Some companies set the price break at 10,000 miles.

**Compact-Car Discount**—If your car is a compact, you can get a straight 10 percent discount on your liability (PL & PD), medical-payments and collision coverage. To qualify as a compact, your car must generally be a 1954 or later model, and must not exceed 3000 pounds, 200 inches over-all, 125 brake horsepower and a cost of \$2300 f.o.b. domestic or port of entry.

**Total-Abstainer Discount**—If no driver in your family ever uses alcoholic beverages, you can obtain your insurance for a 10 to 15 percent smaller premium from companies which specialize in insuring nondrinkers.

**Multiple-Car Discount**—If you own two or more cars, be sure to let the same company insure them. Your second or third car's premiums can be discounted as much as 25 percent.

**Pickup Truck Discount**—If you happen to be using a pickup truck primarily as a private conveyance, you can get insurance from some companies for almost 25 percent less than the same coverage on an auto.

**Trained-Driver Discount**—If you are, or have in your home, a teen-age boy driver, your insurance costs about three times as much as a lowest-rated adult. But there's a bright side. If a teen-age boy has completed an authorized driver-training course in a high school or recognized educational



institution of secondary or higher status, he can receive a discount of 15 percent from that high premium. Furthermore, if he reaches the age of 19 without having a chargeable accident, some companies will give him an additional discount. So if you're a 19-year-old or have one who is covered by your policy, check this with your agent.

**Safety-Belt Discount**—For several years many insurance companies granted a special discount to policyholders whose cars were equipped with safety belts. "Lack of response" caused this discount to be dropped. But watch for it to stage a comeback. Popularity of safety belts has suddenly catapulted, and companies out for business (that's all of them) may rush to restore the safety-belt discount.

These are some of the discounts available from some of the reputable insurance companies. Now, how do you find a reputable company? This, too, is important,



because doing business with one that is not so reputable might be the most expensive experience of your life. Here are some tips:

1. Check with your family, friends and neighbors, especially those who have entered claims. Ask whether they were satisfied with the kind of service they received after accidents.

2. If you are a newcomer and cannot consult with friends, check with the nearest Better Business Bureau. Their service is free and they will know the reputation, good or bad, of whatever agent or company you choose to do business with.

3. If you are still uneasy, contact the state division of insurance or the state insurance commission at your state capital. This agency can advise you whether your chosen company is in good standing.

4. If you buy insurance by mail, make sure the company you buy from is licensed to do business in your state. This way, you'll have the protection of the state insurance commission in case of dispute.

5. Most experts particularly advise

## Step-by-Step Saving

A typical policyholder might have an insurance setup like this:

Personal-liability coverage, \$25,000 per person and \$100,000 per accident; property-damage coverage, \$10,000; medical-payments coverage, \$2,000; collision coverage, \$50 deductible; comprehensive (fire, theft, windstorm, vandalism, glass breakage), coverage of actual cash value of damage.

### Rates thus:

\$25/100,000 PL .....	\$ 53.10
\$10,000 PD .....	15.20
\$2,000 medical .....	11.00
\$50 deductible .....	36.00
Comprehensive .....	14.00
	<hr/>
	\$129.30

Substituting only \$100 deductible for \$50 deductible:

\$25/100,000 PL .....	\$ 53.10
\$10,000 PD .....	15.20
\$2,000 medical .....	11.00
\$100 deductible .....	23.00
Comprehensive .....	14.00
	<hr/>
	\$116.30

With the good-driver discount, prices are:

\$25/100,000 PL .....	\$42.50
\$10,000 PD .....	12.30
\$2,000 medical .....	10.00
\$100 deductible .....	18.00
Comprehensive .....	14.00
	<hr/>
	\$96.80

If customer drives under 7500 miles per year:

\$25/100,000 PL .....	\$36.90
\$10,000 PD .....	10.70
\$2,000 medical .....	10.00
\$100 deductible .....	18.00
Comprehensive .....	14.00
	<hr/>
	\$89.60

(Note: If he also happened to be a farmer, this man's coverage at this point would only cost about \$59.00.)

(Or, if he used a pickup truck instead of a car the total premium would be about 25 percent less, or about \$67.20.)

If his car is a compact:

\$25/100,000 PL .....	\$33.20
\$10,000 PD .....	9.60
\$2,000 medical .....	9.00
\$100 deductible .....	16.20
Comprehensive .....	14.00
	<hr/>
	\$82.00

His second car will get a special discount:

Premium .....	\$82.00
Less .....	- 20.50 (25%)
	<hr/>
Total .....	\$61.50

## PM Shopping Guide

checking on new, unknown, out-of-state insurance companies. While attempting to get started in your area, a new company might take on risks that have been turned down by established firms.

6. Make sure the company you select has adequate facilities for handling a possible future claim *wherever you might drive your car*, especially outside the U. S.

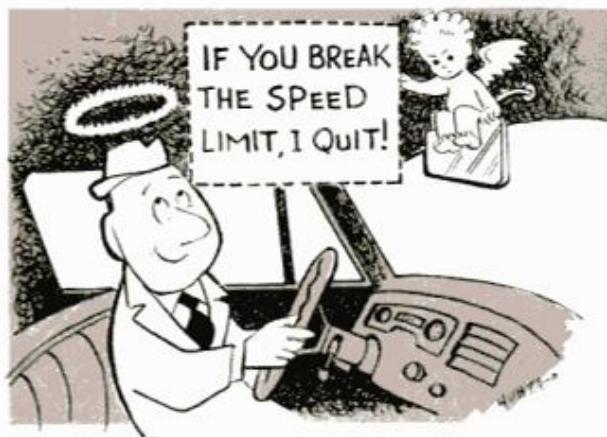

Also, because the auto-insurance business is competitive, the individual judgment of agents often counts for more than is popularly supposed. The agents of many companies can give you special consideration if you have a unique problem or if you press for the best deal you can get.

So, after you've chosen a reputable company, find out whether this company has good *local* representation for best possible service in case of claims. Also, when checking to see if this company has representatives in other parts of the country, and outside it, find out whether it has bonding facilities wherever you plan to go. If it is not set up to post bond for you without charge, better try elsewhere.

As for coverage, this is an individual decision, but here are suggestions:

For personal liability and property damage, the long-popular 5-and-10 policy is today considered inadequate. The huge sums awarded in current liability suits make it wise to consider \$25,000-to-\$50,000 minimum coverage for personal-liability protection. This five-times-greater PL coverage costs only about 30 percent more.

Similarly, the experts agree that \$10,000 should be minimum coverage for property-damage liability. Happily, you can double your PD coverage, from the popular \$5000 level, for only about 10 percent more.

Medical-payment coverage is an economical buy, about \$6 per year for \$500 per person injured in your car. And you can double this coverage for about \$3 more, quadruple it for an additional \$1.

Collision insurance is almost mandatory if your car is less than five years old, but

it's hardly worthwhile to carry \$50 deductible anymore. Suppose \$50-deductible coverage costs \$30 per year for your car; \$100 deductible would run about \$19. So with \$50 deductible you'd be paying \$11 extra per year to protect only \$50 worth of your car, while the entire remaining value was being protected for only \$19. Collision insurance, basically, is to protect you from severe financial loss, not just \$50 worth.

Comprehensive insurance, which covers repair-or-replacement costs of car damage not caused by collision (fire, theft, storms, vandalism, etc.), is the last of the standard insurance coverages. But there are other angles of coverage which some car owners might wish to investigate.

On collision insurance, instead of straight deductible, some companies offer more expensive diminishing-deductible or disappearing-deductible, by which the company pays the entire amount of losses over \$100, the car owner pays all losses under \$50 and they each pay a portion on losses between \$50 and \$100. On another type, the 80-20 deductible, the company pays 80 percent on losses up to \$250, the insured 20 percent. On losses above \$250, it becomes a straight \$50 deductible.

Another new coverage is protection against bodily injury by uninsured automobiles. The company pays all sums to which the insured would be legally entitled to receive from the owner of an uninsured automobile.

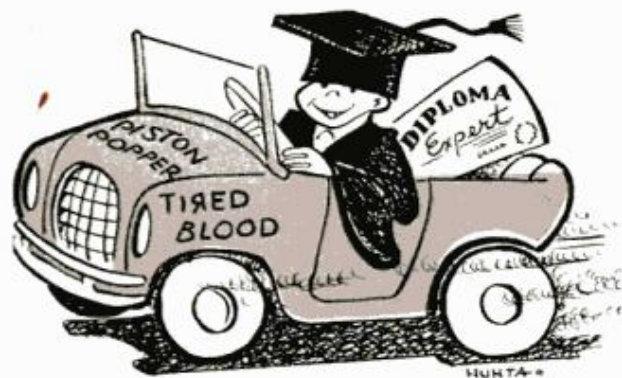

Many farm bureaus (there is generally one in each state) sell auto insurance, and their rates are lower than most. A membership fee, usually \$15 per year, balances it out somewhat, but this is one more possibility when shopping for insurance.

Again, on teen-agers, many insurance companies have differing views (and premiums) on how to insure them as drivers, especially in two-car families. This is one of the most expensive items of coverage and requires the most investigation.

Auto insurance is important to car owners and it can be expensive. Or you can save with safety. It's up to you. ★ ★ ★



**HIGH-SPEED STOPS** showed sintered metallic linings nearly twice as fade-resistant as asbestos linings

**VELVETOUCH** metallic linings are bonded to shoes in separate segments; brakes are otherwise unchanged

**METALLIC LINING** wear after tests was .003 inch, which means an expected life of about 25,000 miles

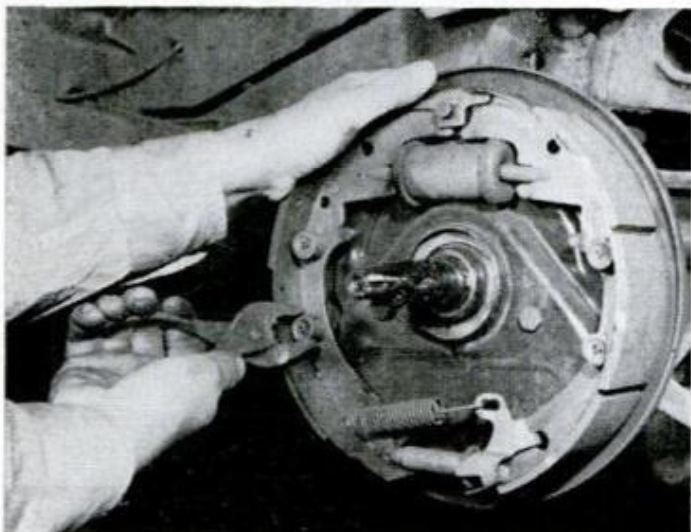

## Those New Metallic Brake Linings —

*How good—or bad? PM makes its own exclusive tests for you*

**R**ECENTLY A Bedford, Ohio firm began marketing a new type of brake lining called Velvetouch Metalik.

The new lining is made of sintered iron powder and graphitic carbon, along with other "inorganic friction-modifying additives," according to the manufacturer, the S. K. Wellman Co.

Molded to brake shoes, these linings are sold in sizes to fit all popular passenger cars, including imports. The primary shoes have two bonded segments; the secondary shoes have three bonded segments.

In general, these linings are similar to the metallic linings offered as a regular production option on Chevrolet's Corvette and the hot new sports Impala.

The Wellman Company makes six major claims for their Velvetouch linings, which,

if true would make them a desirable replacement for conventional asbestos composition linings.

Here are their major claims: (1) no high-speed fade; (2) no heat fade; (3) no downhill fade; (4) no water fade; (5) no squeak or squeal; and (6) superior life.

A modern miracle? Perhaps not, but certainly a genuinely worthwhile improvement in driving safety if the claims are true.

In order to prove (or disprove) these claims PM ran a set of Velvetouch linings through a grueling series of tests to determine if the brakes (and the claims) would fade.

Most of us know brake fade as the loss of braking action experienced after we use our brakes rapidly and repeatedly in steep



**WET-BRAKE-STOPPING** power test was made by driving car into nearby lake to soak the drum and linings

mountain driving, or try to use them after running through water. Technically, brake fade is the reduction of the coefficient of friction between lining and drum caused by heat or introduction of an antifriction agent or lubricant, such as water.

Fade is measured by recording the pedal pressure necessary to apply the linings to the drums with sufficient force to obtain a deceleration rate of 0.2 Gs recorded on a Tapley accelerometer. A rise in pressure would indicate a positive loss of stopping effectiveness of the linings.

PM comparison tests were run on a 1960 Ford Fairlane sedan (V8, automatic transmission) with unassisted brakes in three series: (1) with Velvetouch Metalik linings; (2) with the standard asbestos linings on the car, which had been driven approximately 12,000 miles; and (3) with a new set of replacement asbestos linings obtained from a Ford dealer.

The linings were purchased to fit standard drums and checked to determine whether radius grinding was necessary to size them. The shoes fit, so were installed as purchased. Velvetouch installation instructions specified .004 to .010-inch toe-and-heel clearance and PM's set had .006.

The old standard linings were adjusted for drum clearance and run "as is." New asbestos and metallic linings were run in by driving through across-town traffic and then making approximately fifty decelerations in the 70 to 40 m.p.h. range. Drum clearances were then rechecked and the tests were started.

Fade-inducing conditions were created by subjecting the car to a series of rapid

accelerations and decelerations from 70 down to 40 m.p.h. The car was braked uniformly at 0.2 Gs measured by the Tapley meter, and accelerations were made at wide-open throttle. The results are plotted graphically on page 119. The fade test results speak for themselves. Velvetouch Metalik linings exhibited slightly lower initial pedal effort requirement. Even more interesting, pedal effort requirement had only increased by 7 percent after 16 decelerations, compared to a 53 percent increase in effort for the average of old and new asbestos linings! During break-in, the Velvetouch linings had about 50 percent pedal effort increase, which still resulted in lower pedal effort than for the asbestos shoes. (While we might expect a small decrease in fade for the new asbestos linings after a much longer running period, the fade performance of the old linings will serve to illustrate about the best condition we'd expect. The old linings were well seated and only slightly glazed.)

### Water Tests

PM decided that the best type of test for water-fade susceptibility was to immerse the brakes in water, so that's just what was done. The car was driven into a lake until water was up to the door sills, run slowly for about 200 feet, and immediately accelerated down the lakeside road.

Four successive test stops were then made from 30 m.p.h. Then, back in the water. After about an hour of this, it was decided that wet-brake stopping distances are largely unpredictable. Testing was continued, however, on the theory that while

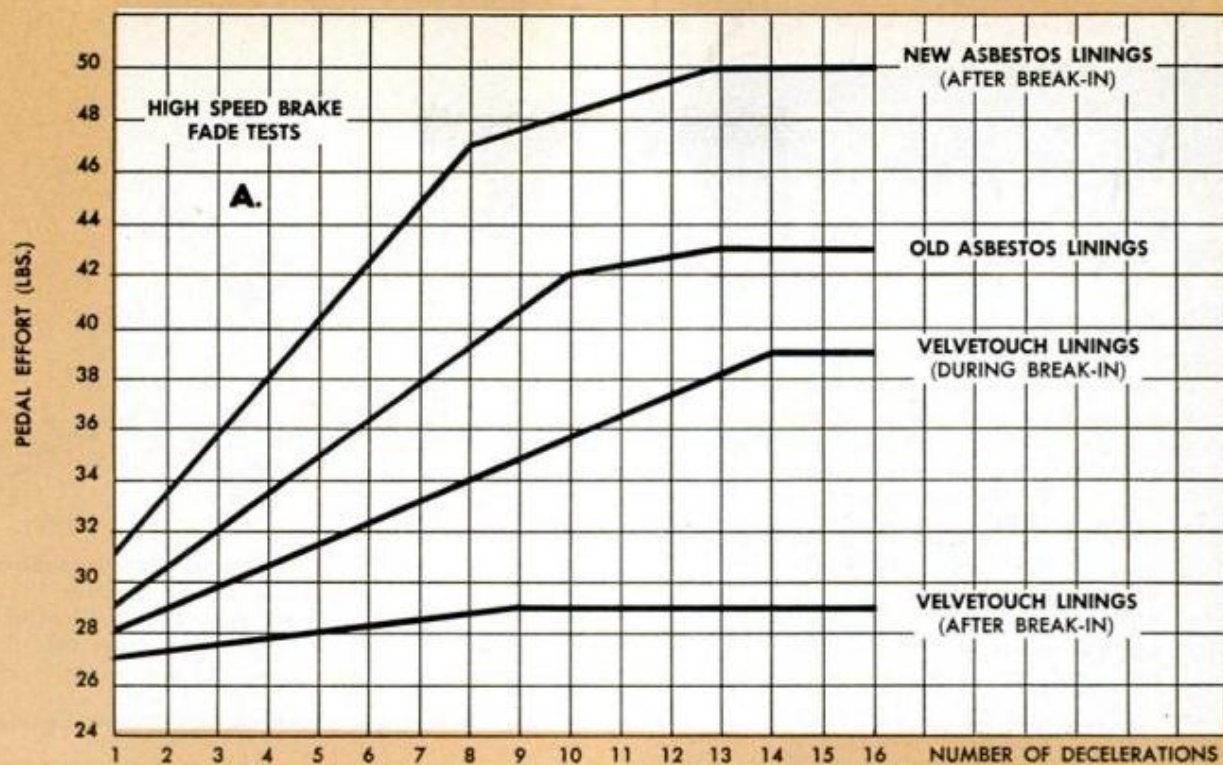

**SUPERIOR FADE-RESISTANCE** of Velvetouch linings was proven (see above) when, after 10 successive stops, 50 percent more pedal pressure was required to achieve equal deceleration on car with asbestos linings. Meter (see right) assured uniform .2-G stops

stopping distances could not be reproduced exactly each time, a range of stopping distances would certainly be an indicator of the brake's capabilities. Here again, the results were interesting indeed!

Maximum distance for the first stop with wet asbestos linings was 163 feet, while the maximum distance for the Velvetouch linings was 65 feet. Probably just as significant was the difference in "pulling" tendencies as the brakes dried. The Velvetouch linings did not grab or pull appreciably, while the asbestos liners would suddenly get a bite on one wheel only and man—you'd best have an iron grip on the steering wheel.

These sudden pulls occurred in the second to fourth test stops. (Perhaps part of the fade resistance of the Velvetouch Metalik linings is due to the segmented, square-edged configuration, which would tend to give a better wiping action.)

No noticeable chatter occurred during any of the tests. Both the new asbestos and the Velvetouch linings squeaked after the high-speed fade tests. The asbestos lining squeak was slightly more pronounced, but disappeared upon readjustment of the shoes.

The Velvetouch liners retained a slight  
(Continued to page 218)

**BRAKING CAR** with thoroughly wetted linings (see chart at right) showed asbestos linings required 2½ times greater stopping distance on the average than metallic linings with the same pedal pressure

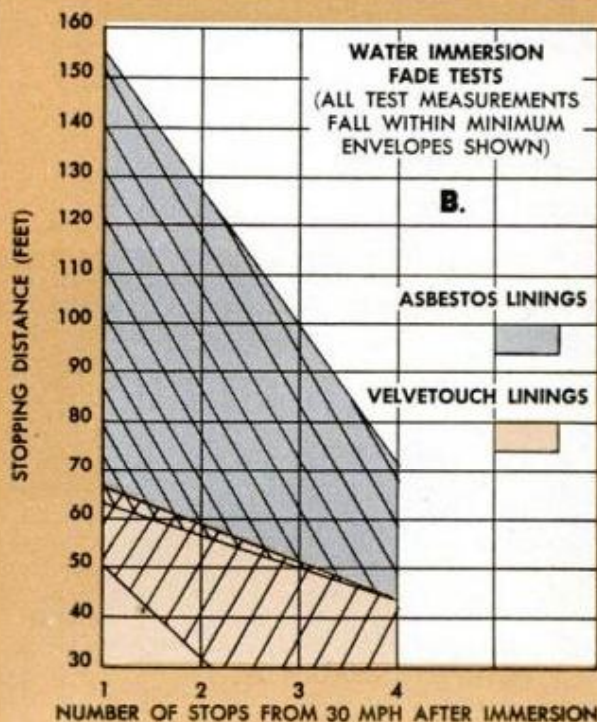
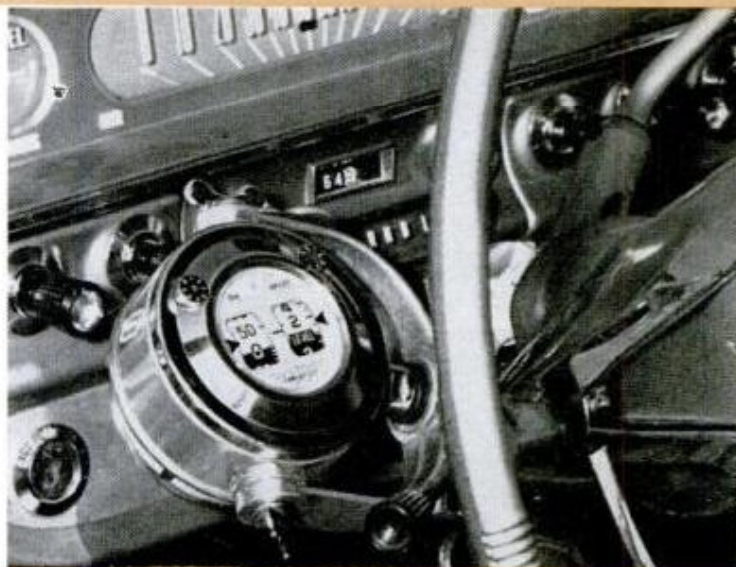

# Better CARKEEPING

● **STALLING**, difficulty in restarting, may be caused by dirt under the carburetor-float valve, producing flooding. Cure this by disconnecting fuel line at carburetor, plugging it temporarily and running engine until it stalls. When you reconnect the fuel line and step on the starter all debris will be flushed out

● **ROCKER PANELS** are susceptible to rust during winter months due to mud, salt and snow being continually thrown against them by the wheels. Therefore, it is particularly important that you clear the drain slots periodically with a wire so that water will drain out before it has a chance to cause any rusting

● **TO SECURE LOAD** in a box-type car-top carrier so that it cannot shift, place a deflated inner tube in box with valve stem accessible, put load on top and tie down. Drive to the nearest station and inflate tube. Inflated tube will force load against tie ropes, preventing shifting. To unload, simply deflate the tube

● **BURNED OUT** ignition switches on 12-v. systems can be caused by overloading due to addition of too many accessories. Twelve-volt switches now carry about 30 amps, but if necessary, you can use a 50-amp. relay actuated by the switch. Remember to use only dry graphite on an ignition switch, never grease

● **IF YOU TEST** resistor-type spark plugs in a tester where spark is observed visually, remember that spark will not appear as strong as that of a nonresistor plug since light-producing high-frequency oscillations are eliminated. It takes close observation to determine quench point for comparison with new plug

● **WINDSHIELD WIPERS** on some older cars often stop working when driving up a grade due to weak compression. As an emergency measure, disconnect tube from right-hand wiper motor and plug end with a pencil. This often gives enough power to motor on driver's side to keep wiper working until you reach a garage

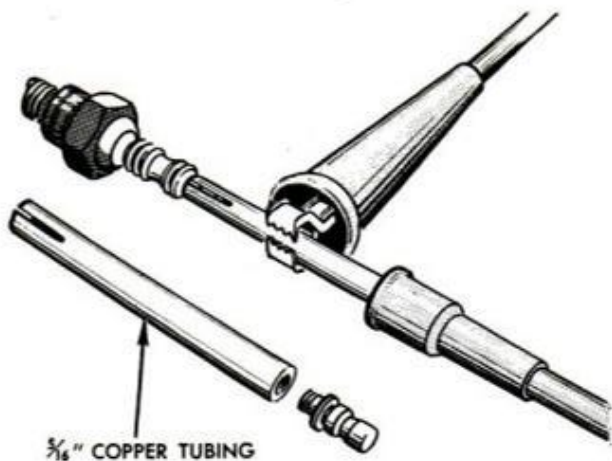

3/16" COPPER TUBING

**SPARK-PLUG ADAPTER** provides a secure mechanical and electrical connection for clip from timing light, making it unnecessary to slit molded waterproof boot on plug lead. Solder terminal post from old plug to a 3-in. length of tubing and slit opposite end

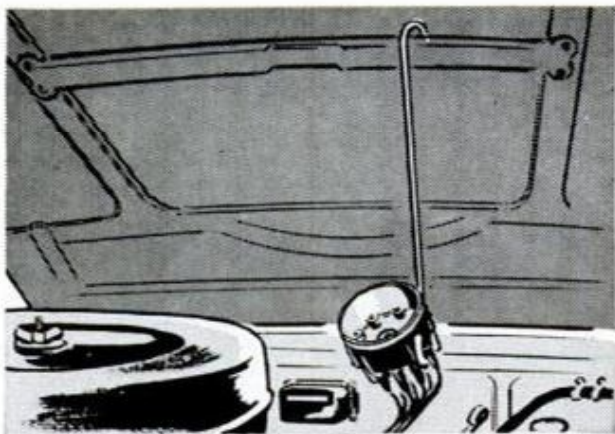

**DISTRIBUTOR CAP** can be kept from obstructing view when installing new points by hanging it from one of the cross members which strengthen the hood. Use a short length of fairly stiff wire to make the hanger, forming a hook of suitable shape at each of the ends

**TWO EXTRA CASTERS** installed on your creeper will make it much easier to roll over holes, cracks, depressions and rough spots in the floor. Since the lower end of creeper is usually moved about more, mount the extra pair of casters 18 in. from that end

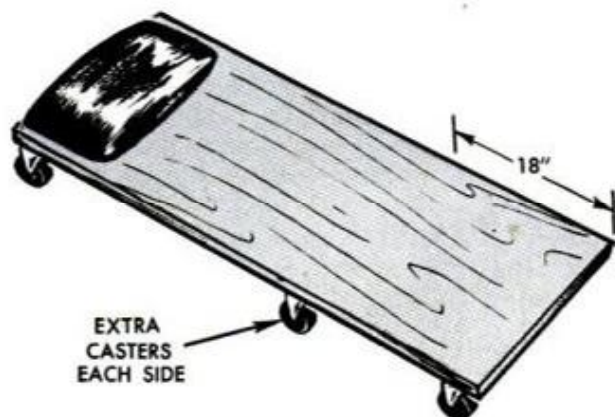

EXTRA  
CASTERS  
EACH SIDE



**ASBESTOS SIDING** can be used to give your car enough traction to walk out of slight depressions and slick spots in the snow. A couple of short pieces of siding carried flat in your trunk will be out of the way, but ready for instant use in case of an emergency



**WINDOW WASHERS** on your car will work with greater efficiency if you add a teaspoonful of liquid detergent to the washer tank. This mild mixture will do a much better job of removing the dirt and oily road film which normally resist plain water

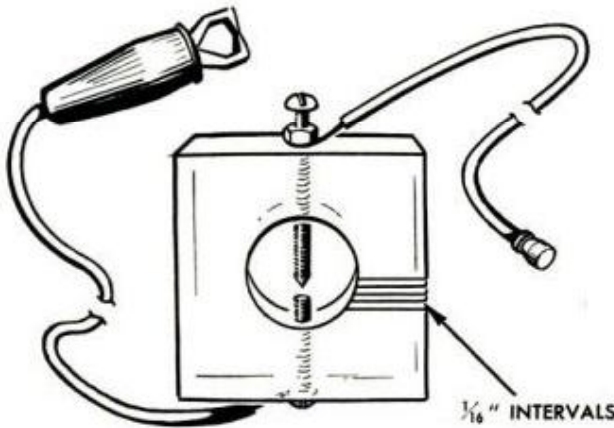

**CALIBRATED GAP** simplifies testing engine ignition by jumping spark. Drill a  $\frac{3}{4}$ -in.-dia. hole through a block of clear plastic, thread it for screws and scribe the interval marks. Connect spark-plug lead to one lead and clip other lead to the engine block

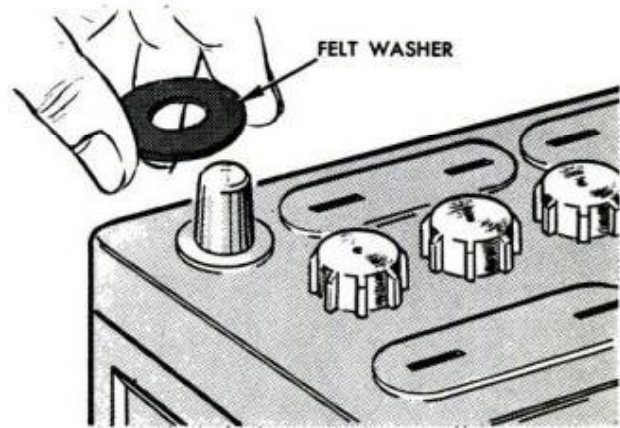

**AVOID CORROSION** on battery posts by cutting 2-in. washers from an old felt hat, wetting them with a few drops of motor oil and dropping them over the posts before putting on the clamps. Oil the felt each time the car is serviced so it won't dry out

**SMALL FUNNEL** connected to a length of small-diameter rubber tubing makes an effective stethoscope for tracking down vacuum leaks around the carburetor and engine manifold where the noises made by such leaks are generally drowned out by other engine sounds



**TDC MARK** on timing pulley will be much easier to see if you clean the pulley thoroughly and paint it with black stove polish, then dab a bit of white or aluminum paint on the TDC mark and pointer. The marks will show up well, even with a low-intensity neon light

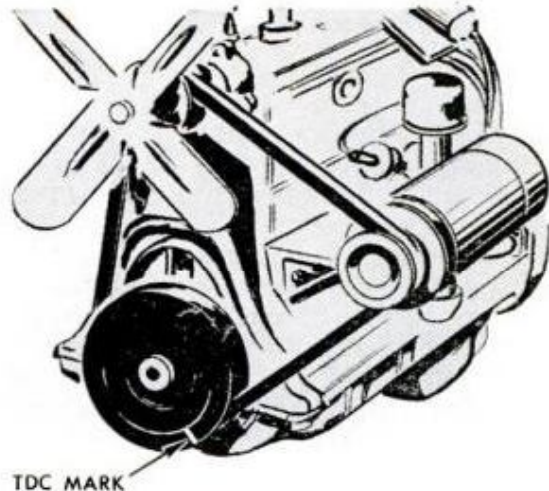

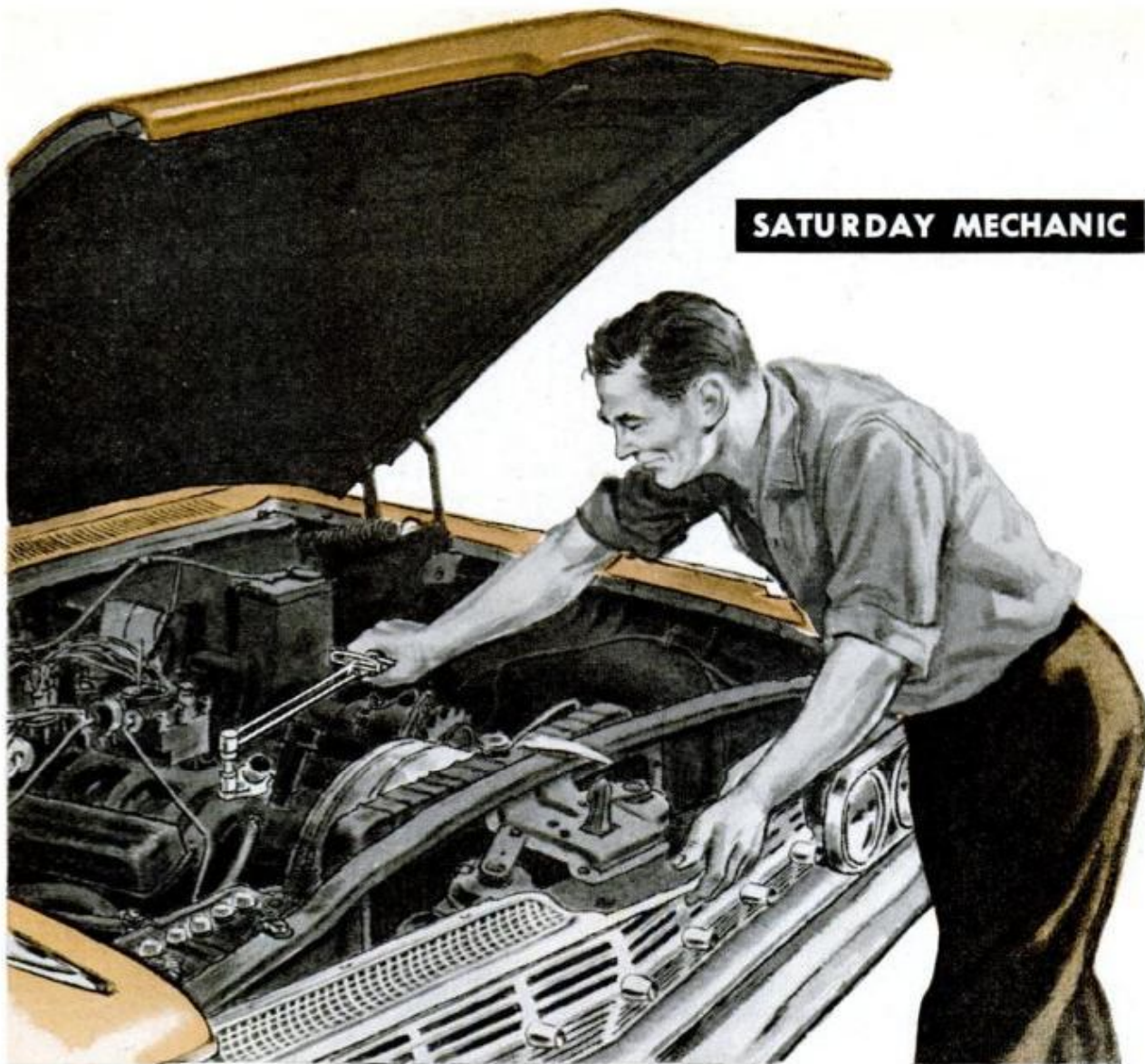

## Pressure Caps and Thermostats

*These out-of-sight units are the everyday work-horses of the system which keeps your car engine at just the right operating temperature*

**By Herb Carrier**

*13803 Fairmount Ave  
Detroit 5, Mich.*

**I**T'S JUST AS important to keep the engine in your car warm as it is to keep it cool. As a rule there is only a few degrees difference between "too cold" and "too hot" when these terms are applied to engine operating temperatures. A few degrees more than too hot or too cold and the engine (also the automatic transmission) can be operating dangerously hot or dangerously cold. Either extreme means greatly accelerated wear or possible failure of wear parts within a very short time. Also there

are side effects such as increased fuel consumption and increased formation of the sludge, gums and corrosive acids that damage wear parts.

A thermostat is an essential part of the cooling system simply because it holds engine temperature within definite limits. In winter the thermostat remains closed for a longer period, restricts coolant circulation and shortens warmup time to the minimum. The thermostat may also operate in a partially open position to tailor coolant circu-



lation to operating conditions. You start your car on a nippy winter morning. The 'stat will be closed. You drive slowly until the engine is very nearly warmed up (this is better practice than allowing long idling periods for warmup) at which time the stat may be partially or fully open. But when the engine finally does reach normal operating temperature you may be cruising on the open road where air rushing through the radiator provides more than adequate cooling. At this point the stat will close partially and restrict circulation of the coolant until the engine temperature comes up to normal again. Or, it may remain partially closed until you are stopped by a traffic light or are slowed by heavy traffic. Then it will open quickly to allow full circulation of the coolant.

That's why it's so very important that you have your car equipped with the right stat for local driving conditions and for summer and winter driving in the colder climates. A thermostat is necessary in summer and it's essential in winter, but not in all climates do you use the same stat through both seasons. If, for example, you live and do most, or all, your driving in southwestern desert country you probably will get along very well with a 155-160-degree-F. stat which begins to open at 155 degrees and is fully open at 160 degrees. But if you drive during the winter months where temperatures may drop to zero F. or below, you'll need a 180-degree stat for winter and a 160-degree unit for summer driving.

### Change Thermostat

This means that you change stats, Fig. 1, when you drain antifreeze in the spring and when you refill with antifreeze in the fall. If you use the wintertime stat through the summer, your engine will be running too hot most, if not all, of the time. Not only that, you risk losing a portion of the antifreeze if you leave it in the cooling system during the summer, a practice not recommended. If you use the summertime stat throughout the winter, the engine will be running too cold, generally with a crankcase (also automatic transmission) full of sludge at the end of the season.

You Saturday Mechanics who like to tinker with the car should always check a stat for proper operation before you install it. Fig. 2 shows one reasonably accurate way to do this. Hang a reliable thermometer in a pan of water, hook a length of fine wire under the thermostat valve (the size of the wire is purposely exaggerated in the illustration) so that you can support the stat just under the surface of the water. Then heat the water and note the tempera-

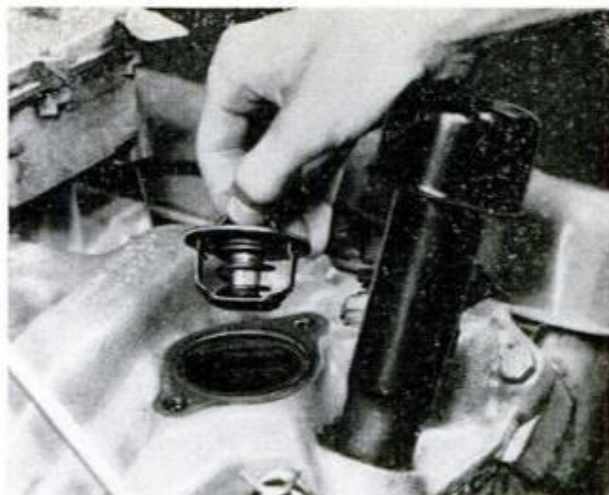

**1. THERMOSTAT** should be changed each time antifreeze is drained in spring or added in fall. Be sure to use 'stat rated for your climate and kind of driving

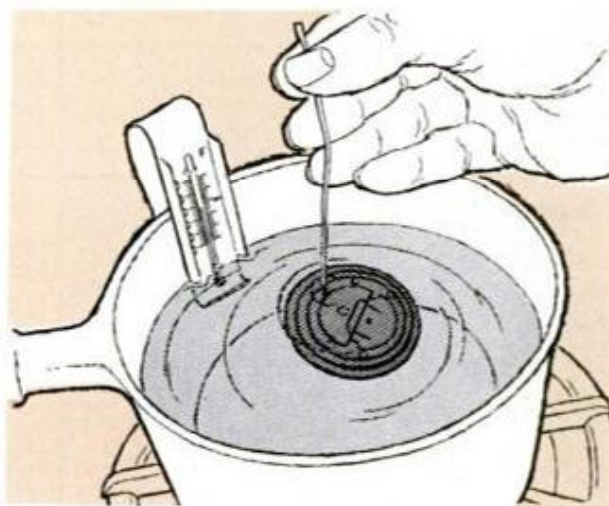

**2. SATURDAY MECHANICS** can check a stat in a few minutes with this setup. Use a reliable thermometer and clean water. Hook thermometer over side of pan with bulb submerged. Stat should open at rated reading

**3. WHEN REPLACING** stat be sure it is properly seated and that the gasket is correctly positioned. Head bolts holding the neck should be tightened with torque wrench to tension specified in recommendations

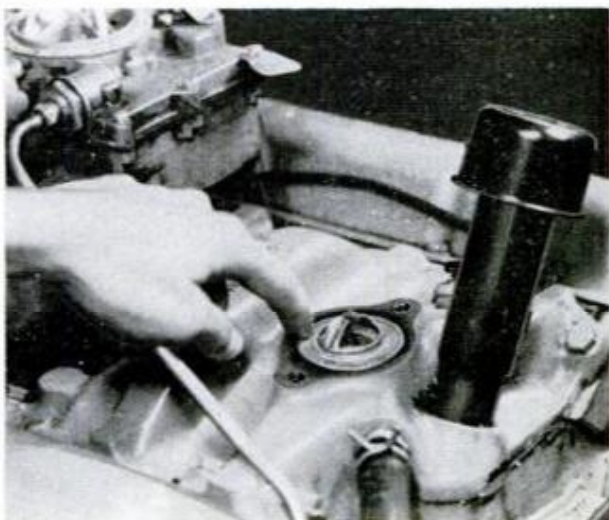

# HEATING AND OVERHEATING

## CAUSES AND CORRECTIONS

TROUBLE SPOT	SYMPTOMS	CONDITION	CORRECTIONS
Lubrication	Noisy engine, low oil pressure, thin oil on dipstick.	Oil dilution. Excessive and chronic oil dilution. Sludge in pan. Clogged oil pump screen.	Oil change. New rings—overhaul engine.  More frequent oil changes. Remove and clean screen and pan.
Timing	Hard starting, sluggish engine, poor moderate-speed operation.	Breaker arm wear (points too close). Loose distributor. Defective spark-advance mechanism in distributor.	Adjust point gap to specifications.  Tighten clamp securely. Repair or replace.
Combustion	Poor moderate-speed operation.	Partially clogged jets in carburetor. Low fuel level in carburetor.	Clean carburetor.  Adjust float level to specifications.
Engine loading	Sluggish performance, high engine temperatures.	Dragging brakes. Constant high speed operation. In-gear loading (manual transmission).	Adjust brakes. Temper driving habits.  Shift gears at recommended road and engine speeds.
Coolant loss	Loss of cooling liquid, gain in oil level, bubbles in coolant, oil in coolant, visible drippings or stains from coolant thrown by pump pulley.	Radiator, hose leaks. Coolant in oil pan. Foaming, pump draws air. Oil in coolant. Pump leaks. Coolant overflow. Alcohol evaporation.	Repair or replace. New head gasket. Repair or replace pump. New head gasket. Repair or replace pump. New head gasket. Replace antifreeze.
Loss of effective radiation surface	Cool spots on surface of radiator core, poor heat dissipation.	Loose radiator fins. Radiator tubes clogged.	Solder, or new core. Boil, or rod out.
Reduction or loss of cooling air stream	Reduced airflow, belt squeal, no air from fan, rapid temperature rise, reduced air flow.	Fan belt slips. Broken belt. Air grilles covered.	Adjust belt. Replace belt. Remove covers.
Restriction of coolant circulation	Soft and expanded hose, lack of circulation, rising engine temperature, poor circulation, engine hotter than radiator, unequal engine heating.	Swollen hose. Loose pump impeller. Loose pump belt. Corroded impeller. Wrong head gasket. Jacket clogged. Corroded water tube.	Replace hose. Repair or replace. Adjust belt. Replace impeller. Install correct gasket. Flush block. Install new tube.
Inadequate heat transfer (from cylinders to coolant)	Engine hotter than radiator.	Scale in jacket. Rust and dirt in jacket. Jacket partially clogged.	Use cleaner, flush. Use cleaner, flush. Flush block.

ture at which the stat begins to open. It should begin to open right on the nose, at 155, 160 or 180 degrees on the thermometer. If it lags appreciably, install a new stat.

Another point: Be sure when installing the stat to use a new gasket and make certain that it is properly positioned, Fig. 3. Then replace the neck and tighten the head bolts, or screws, to the tension specified for your car, using a torque wrench as in the illustration on page 122. Fig. 5 pictures the common types of stats you'll find in cars.

### Pressure Cap

The pressure cap, Fig. 6, works hand in hand with the stat. The main purpose of the pressure cap in present-day cooling systems is to prevent the tendency to develop the condition known as water-pump cavitation. This is similar to fuel-pump vapor lock. When water pumps cavitate there is an almost complete stoppage, or cessation, of coolant circulation, even though the pumps are operating properly and the coolant level is adequate. The spring-loaded seal of the pressure cap seats on the radiator filler neck. This seals out air and raises the pressure inside the cooling system to the figure stamped on the cap. Fig. 4, in this case to 13 pounds per square inch. Should expansion of the coolant due to heat raise the pressure much above the value stamped on the cap, the spring tension of the cap seal will be overcome and the system vented to the atmosphere until pressure returns to normal.

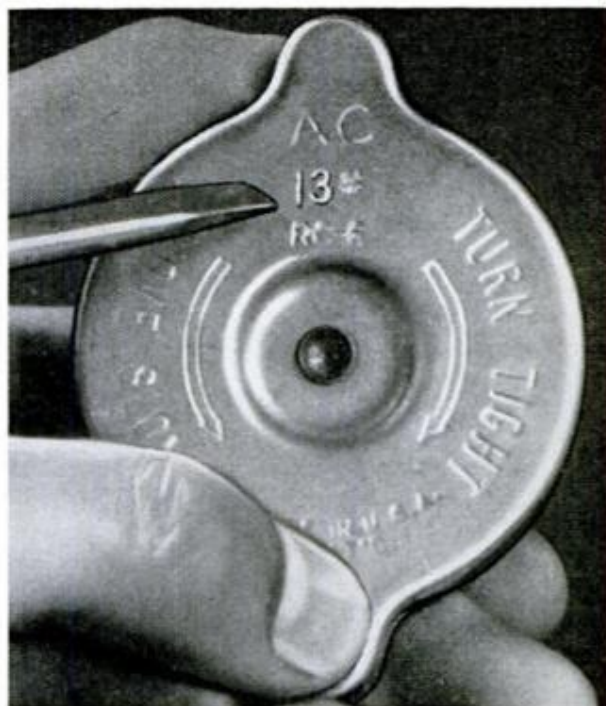

**4. PRESSURE CAPS** are marked with a figure indicating rated pressure in pounds per square inch. If you replace cap, make sure to install one correctly rated

In addition to eliminating the tendency to pump cavitation, the pressure cap also raises the boiling point of water about three degrees for every pound of pressure. This raises efficiency of the cooling system and also prevents loss of coolant. Obviously, a cooling system designed to operate under a specific pressure will not perform prop-

(Continued to page 206)

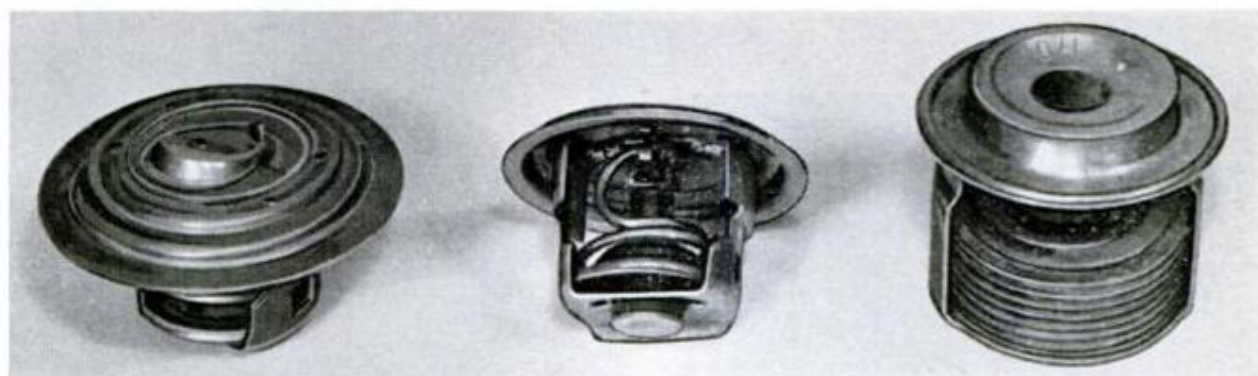

**5. THERMOSTATS** you'll find in most of today's cars. Two at left are pellet type; one at the right is a bellows type. Always test a stat before installing in your car, even a new one, as it may have been damaged

**6. PRESSURE CAPS** may vary somewhat in general appearance but they are all designed to accomplish the same thing—maintain a uniform pressure in the car's cooling system. Here are four common types

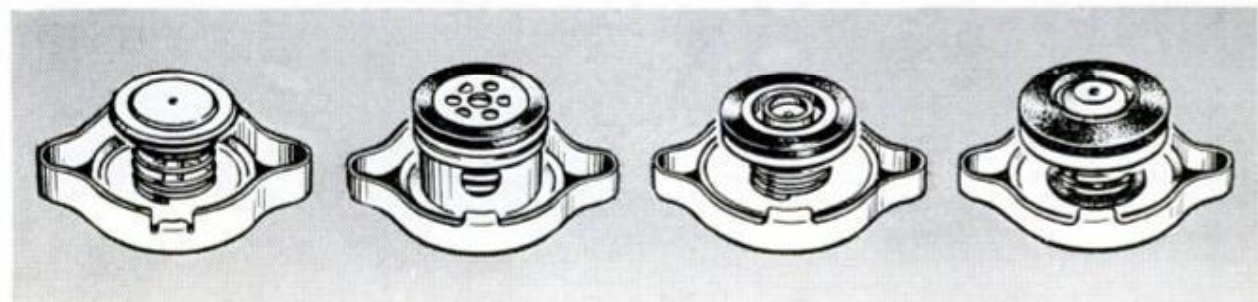



*By Arthur J. Goldberg*  
*Secretary of Labor*

# How will automation affect your job?



**RAILROADING**, right, was nothing like this 50 years ago—or even 10. Typical of growing need for new skills in old-line businesses is the ability to operate New York Central's electronic brain



**FAMILIAR SIGHT** by the middle of the century was a job that didn't exist at the beginning of the 1900s—auto assembly. The existence of cars, of course, creates need for skilled mechanics—a group that has doubled in size in just 25 years

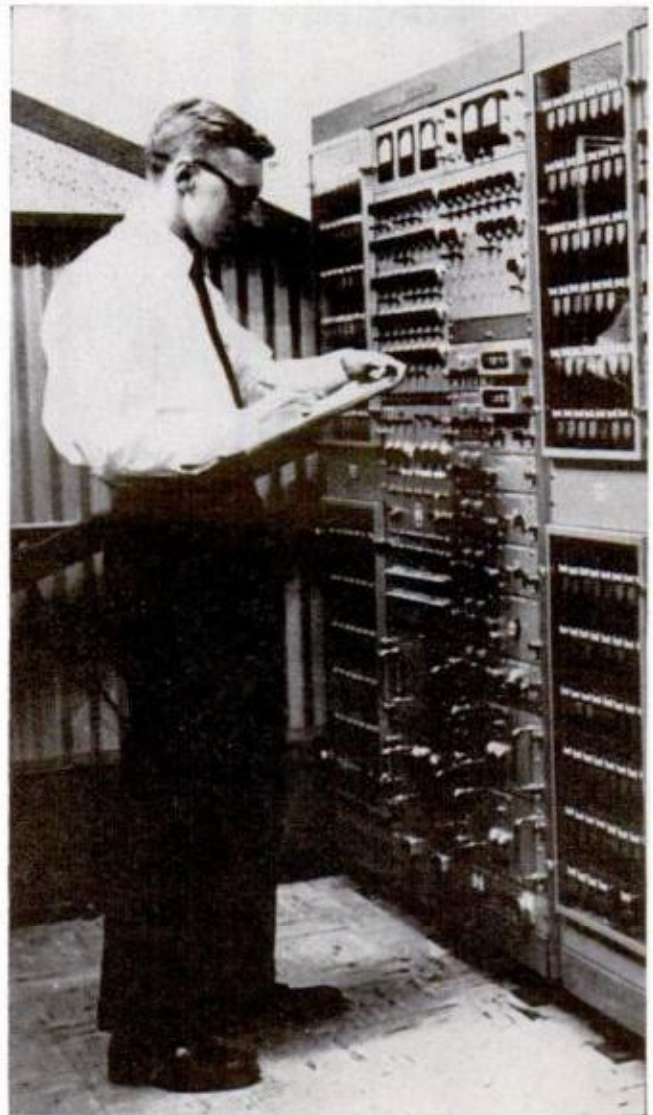

POPULAR MECHANICS

**W**ILL MACHINES and new techniques replace workers of skill and knowledge?

More precisely, will automation take *your* job away? Will the skilled worker of today be the forgotten man of tomorrow, working at a lesser job, or no job at all?

I could answer this with a flat no, but the answer is not that simple. We must first establish a few bench marks, score a few lines, examine a few blueprints of our industrial structure.

The first thing to understand is what we are talking about. There is nothing new about automation except the word itself. It is the latest label for the natural endeavor by man to find an easier way of making and doing things—ways to replace human effort with mechanical or other forms of energy and control. This has been a natural *evolution* through the centuries, speeded up so dramatically since the last great war that we are prone to think of it as a *revolution*—a revolt, so to speak, against the old order of things. A revolt,

however, connotes the overthrow of an old order, a complete change to the opposite pole.

But is this true of automation? Is this so-called second industrial revolution about to replace jobs requiring skill and knowledge with machines?

Of course not, even though the implications of technological changes are enormous. They present us with some of the knottiest problems of unemployment today. And they foreshadow major problems for the immediate future as well. Just the past 15 years have seen dramatic changes where some job fields have already declined significantly, while others have taken on added importance—and still others have appeared for the first time.

In the physical sciences alone we now need people in fields which were completely unknown 15 years ago, fields such as data telemetry, microminiaturization, and transistorized circuitry.

Changing technology has also had important effects on many skilled occupations

*In the next 10 years, we'll need more skilled workers than ever . . . but each must broaden his skills so that he can cope with change*

## MANPOWER CHANGES IN THE 1960s

	1960	1970
	millions	
Labor force will grow dramatically— increasing by 13.5 million . . . . .	73.6	87.1
Young workers (under 25) will account for nearly half of the growth . . . . .	13.8	20.2
Older workers (45 and over) will increase by 5.5 million . . . . .	27.9	33.4
Male workers, 25-44, the primary working group, will show only a small increase . . . . .	22.3	23.2
There will be many more women in the work force . . . . .	23.6	29.6
Part-time workers will account for more than a fourth of the labor-force increase . . . . .	12.1	15.9

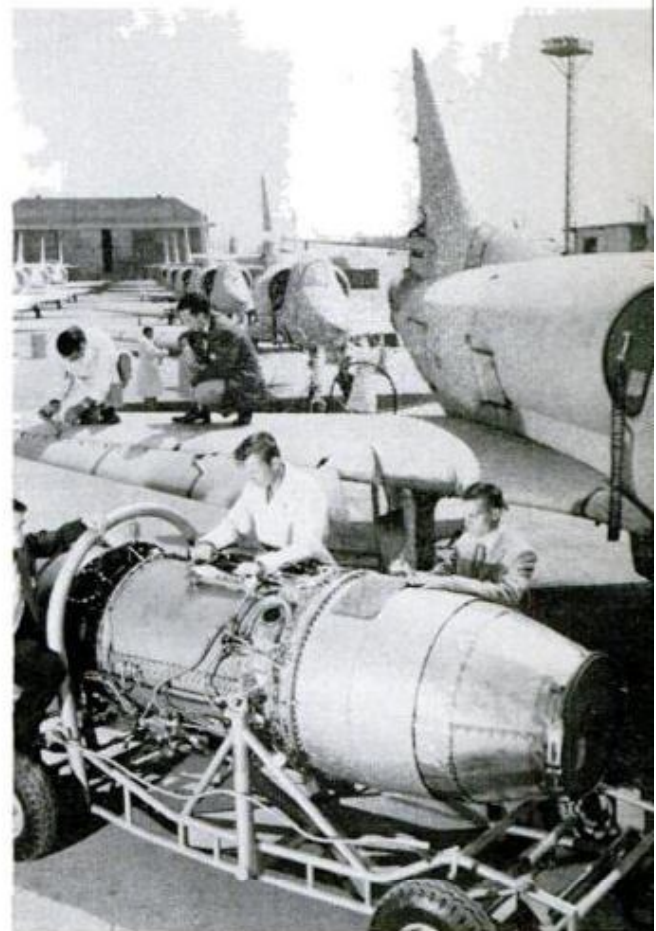

**AERONAUTICAL ENGINEER** follows product from drawing board to customer, so he must be familiar with processes of development, testing and production. Here a Douglas engineer checks a jet engine prior to installation

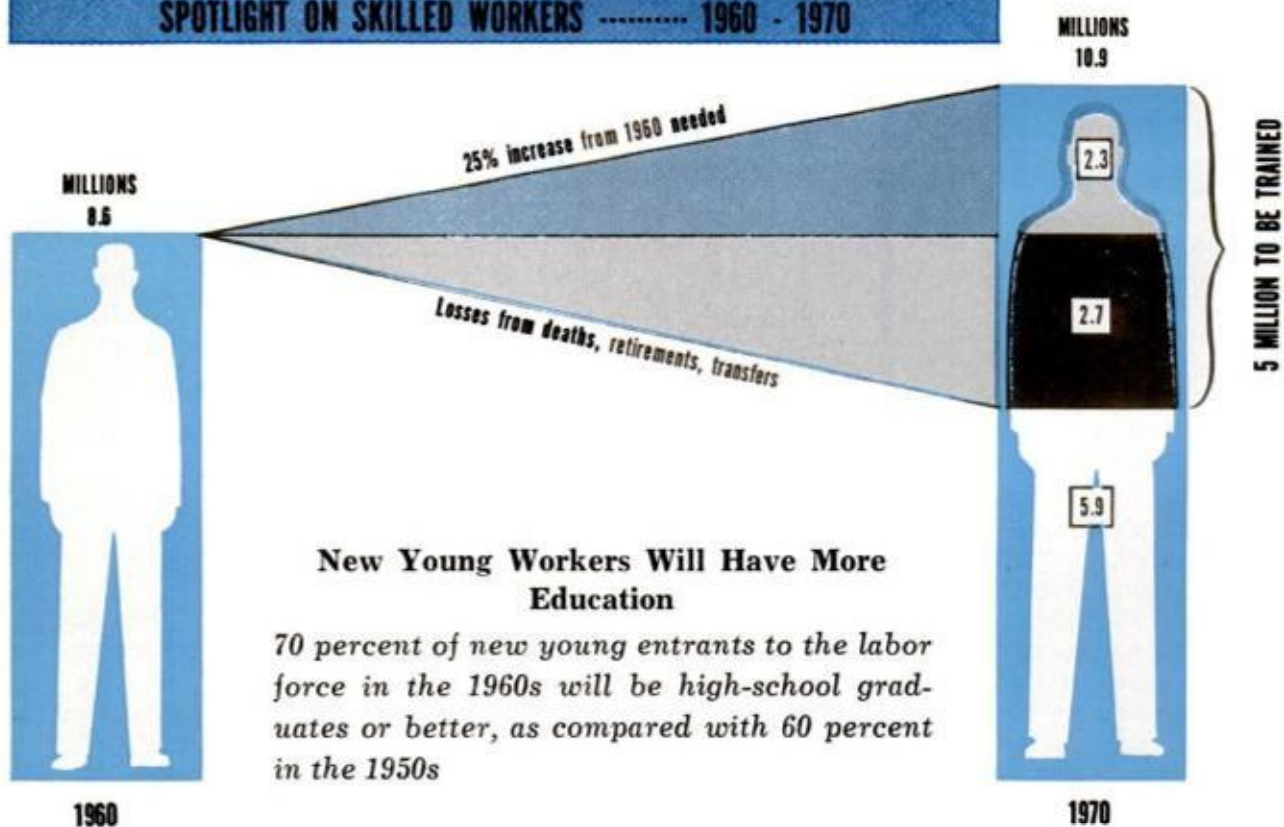

within the craftsman group. Take the case of the blacksmith, whose employment fell from 230,000 a half century ago to only about 40,000 now; the glass blower, when automatic glass-blowing machines took over; the hand cigar-maker, the barrel-maker.

On the other hand, technological changes have favorably affected other skilled occupations. Employment rose for the tool and die maker when the metal-working industries shifted to mass-production methods. More tool and die makers were needed to make the cutting tools, holding devices and dies which were necessary for producing metal parts in large quantities.

Since 1900, mechanization and new inventions have also created many new skilled and specialized occupations. Look at the automobile, airplane, and diesel mechanic; electrical-appliance serviceman; instrument repairman; telephone-equipment installer; and operating engineer (construction-machinery operator).

Some of the new occupations have grown enormously. About 750,000 auto mechanics are currently employed, more than double the number employed 25 years ago.

When the word automation crops up, remember this if you are in the skilled-worker classification: The proportion of the American work force which is skilled has remained remarkably stable during the 20th Century. While most of the rest of the

broad occupational groups changed in size substantially, the craftsmen have accounted for nearly one in nine of all employed workers consistently since 1900.

Look at these figures: In 1900, blue-collar workers represented 36 percent of the total working population. Of these, 31 percent were craftsmen and foremen.

In 1960, the percentage of blue-collar workers to the total work force was almost identical, 37 percent. But the percentage of craftsmen and foremen had risen to 35 percent of the total.

What about 1970? The number of blue-collar workers will increase as the population grows, but the percentage of blue-collar workers to the total labor force will probably remain about the same as it has been for the past 61 years.

Where automation or technological change has hurt has been in the *unskilled laborers* group. In 1900 these workers represented one out of every eight manual workers. In 1960 they were down to one out of every 20!

Getting back to the skilled sector of the labor force, its relative stability underscores the continued importance of this group. But very great changes have taken place *within* the skilled group, and you will see them continue to take place.

At the turn of the century, engravers, locomotive engineers, brick-masons, blacksmiths and forgemen, metal-molders and

## OCCUPATIONAL CHANGE WITHIN SKILLED WORKER GROUPS SINCE 1900

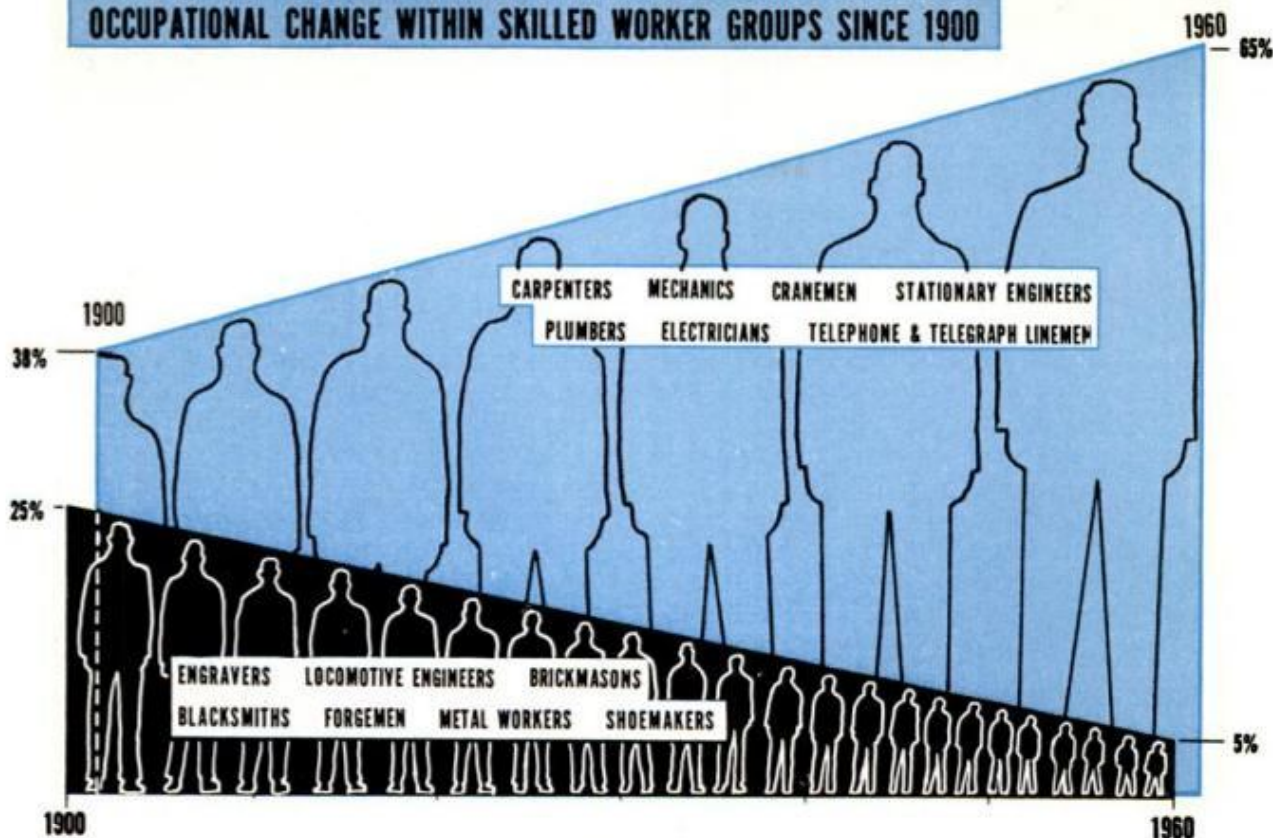

shoemakers were so important in American industry they accounted for one out of every four of the skilled work force. Today, the proportion is down to about one in 20.

Again, back in 1900, carpenters, mechanics and repairmen, cranemen and stationary engineers, plumbers, electricians and telegraph and telephone linemen totaled a little less than two out of every five skilled workers. Today, it is estimated that the figure is closer to two out of every three.

Change, therefore, is one of the major benchmarks of our story, and of great importance and consideration to the skilled working man today.

### More Craftsmen Needed

Against this background, what is the outlook for you if you're the skilled worker, the craftsman, in this decade?

It looks wonderful from the individual craftsman's point of view. The need for craftsmen is expected to rise by about 25 percent, despite all the automation we can expect in the next 10 years. This represents the greatest demand for skilled workers we have ever experienced. We will actually need to train *an additional five million skilled workers by 1970*. We had 8.6 million skilled workers last year. We are going to lose more than 2.5 million by 1970 in deaths, retirements and transfers out of the trades. That leaves approximate-

ly six million from last year's skilled work force still around in 1970.

But by 1970, with our growing population, we will need about 11 million skilled workers. Hence the five million which must be trained in time.

### Toolbox Security

Those of you engaged in the skilled trades must be prepared to take advantage of the times. As of now, we know that about 50 percent of all of our skilled workers are between the ages of 26 and 44. Yet, during this decade, this age group among the men will go up by only four percent. This means that a tremendous demand will develop by 1970 for the man with skill who has experience and on-the-job knowledge. "Security in the toolbox" is no idle phrase today.

This should reassure those of you who have harbored fears about automated technology doing away with skilled jobs. The skilled worker, the craftsman, is definitely here to stay.

The overriding question, then, is not whether automation will take the skilled worker's job, but whether you as an individual skilled worker will be able to withstand the forces of *change in the techniques of your job*.

Let me cite the blacksmith again to explain this point. The need for and therefore, the number of blacksmiths dropped

steadily when the "horseless carriage" began replacing the horse in growing numbers after 1900. This lack of need, this *change*, was stretched over a period of several working lifetimes. It is known as an "absolute displacement." Like the work of the candle dippers, wainwrights and wheelwrights, molders and shoemakers, the blacksmith slowly disappeared as a major skilled-worker group in the U. S.

This illustration of *change* is entirely different today. First of all, it is not taking place over a period of several working lifetimes. Compounded by years of added work-life to the average American worker, *change* is occurring within the period of your working life—even within a decade.

But this change has not been one of absolute displacement except in a few cases such as the coal miner and the automatic coal digger.

### Nibbling Changes

The changes are of a nibbling variety. A few processes here. A technique there. A set of duties in a long operation. But the total effect has been to make the skill requirements of the craftsman even more critical and exacting. An illustration is the recent application of atomic-energy technology to peacetime uses. Craft jobs found

in this activity are similar to those found in related chemical, metalworking, and construction industries. Skill specifications and performance standards, however, are more exacting in the manufacture, installation, and maintenance of material and equipment which may be subject to radiation contamination. Thus, more exacting work and the development of special methods for handling and working with atomic materials and equipment are required to provide adequate leak-proof fittings and joints to shield workers from atomic radiation. Particularly affected by these special requirements have been plumbers, pipefitters, machinists, millwrights, boilermakers, electricians and welders.

There is another area of great interest to you, the skilled worker, and your future—changes coming about for the machining worker and the skill content of his job. There has been a technological breakthrough, known as the numerical control of machine tools, which could have a significant effect on the employment of the more than one million machining workers in the country. It involves the following sequence of operations: Engineers translate part dimensions, tolerances, cutter shapes and sizes, cutting paths and sequence, and other data, all into numbers.

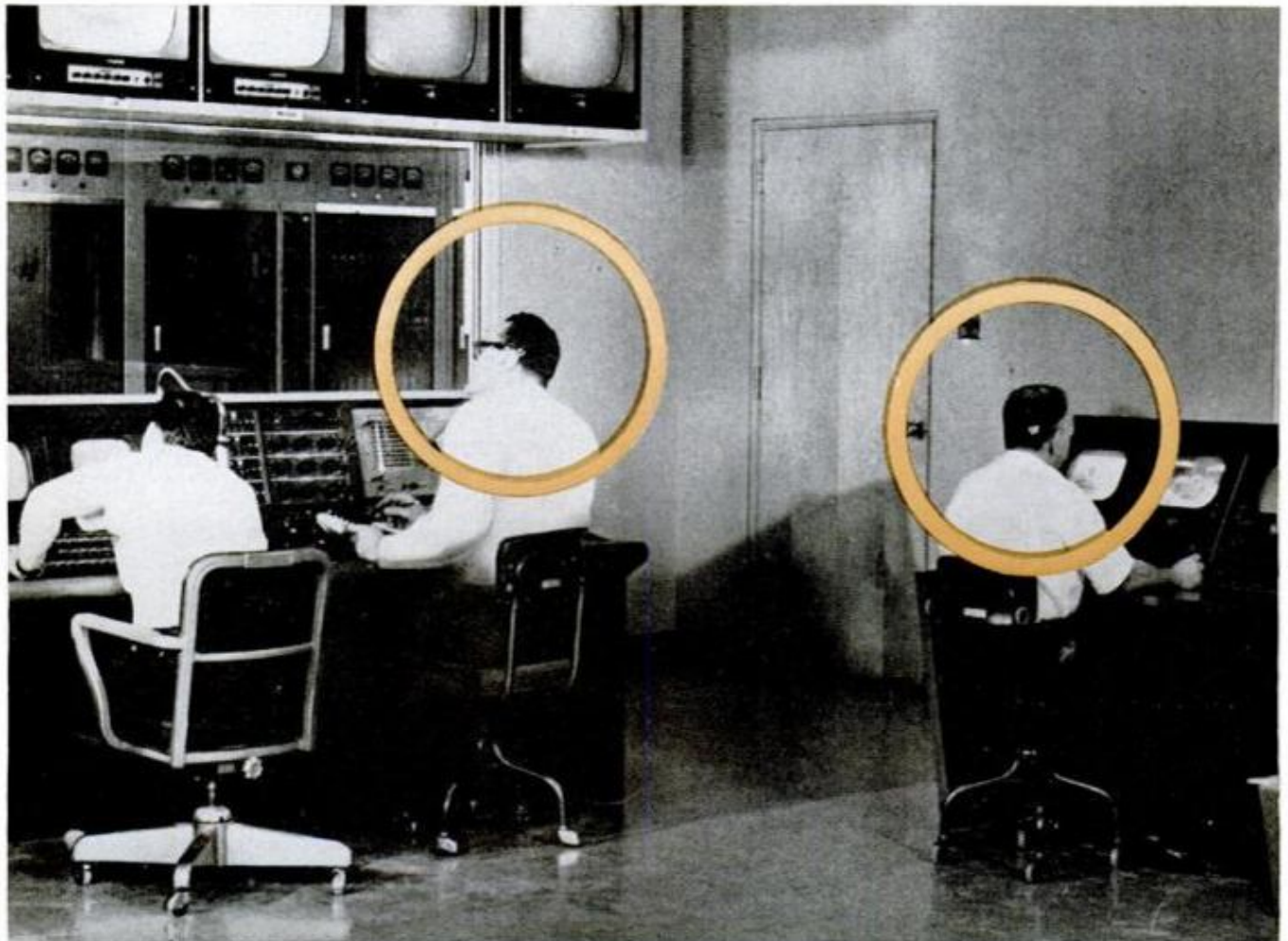



The data are then punched on tapes or cards, inserted into electronic devices which automatically operate the machine tool. The machine-tool operator only installs the tool, inserts and removes the work piece, and changes the tapes or cards.

While it is too early to measure the effect of this development, the consequences should be obvious, if it were applied in industrial production to a great extent immediately.

But the implications of *change* inherent in this example apply to many areas of work, many types of occupations as yet untouched by new processes and inventions sure to come.

You must be prepared with diverse abilities and potential to cope with *change*.

Those of you in the skilled crafts should therefore re-examine your qualifications for the future job market. Many will find that further study and training is needed. Do I have enough reserve education and training to meet unknown future work demands on me? That is the question you should ask yourself. A re-examination should determine your command of arithmetic and mathematics and such added knowledge, for instance, as the ability to read blueprints. Semiskilled workers should be especially aware of such re-

quirements in the future job market, for their jobs are more vulnerable to changing demands, all to the more-skilled levels.

### Melting Demand for Unskilled

High school students have a special need to prepare themselves well. As I stated before, the number of unskilled jobs is melting to a minor portion of the job market. Semiskilled jobs and the skilled jobs are requiring more education and training. A high-school diploma today is an elementary requirement for entry into most of these jobs. Employers are seeking workers who have the potential to learn more and to learn quickly the new skills and techniques blossoming every day in their businesses and factories. And it won't be enough to have just a high-school diploma. It is what was studied and learned well in the classrooms and school shops that will count.

No one is sure today where these swift technological changes are taking us. Both industry and labor are making efforts to train and retrain workers in these fields to meet the new job demands. It is obvious that the skilled worker with better education and training will be prepared best for the job opportunities and changes that are

(Continued to page 220)

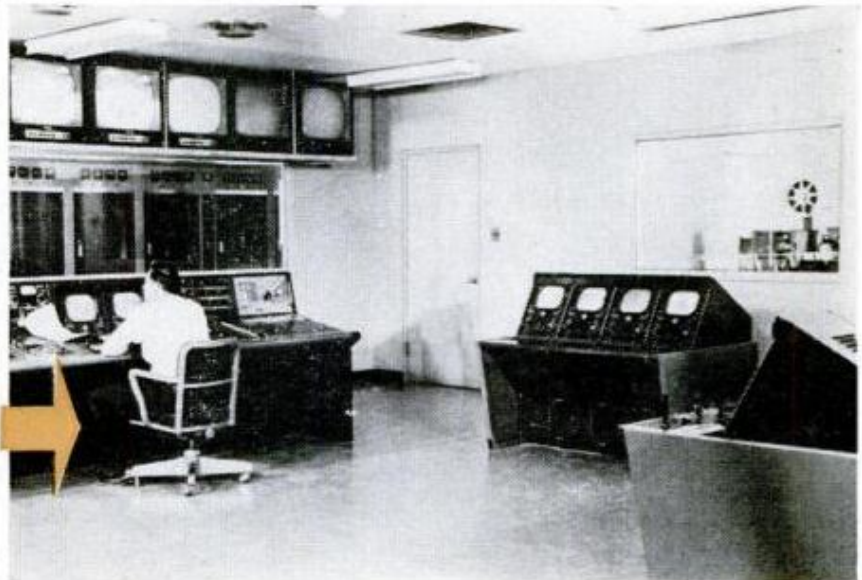

## What Happened to the Other Three Men?

**THEY WENT** with automation—along with 10 others. When WKRC-TV, Cincinnati, Ohio, automated with RCA units, the technical staff dropped from 23 to 10 men. Taped programming, remote-control cameras, etc., have cut costs and almost eliminated all errors



### Dry-Dock Boat Ride

Boat-handling ability and the driver's knowledge of the "rules of the road" are tested on dry land by a new trainer that combines a boat mockup with a movie.

The screen presents 10 common boating situations, and the boat reacts on a curved track to the driver's actions while a mechanical grading device records his score. A score card is automatically ejected at the end of the run.

Developed by the Aetna Casualty and Surety Co., the Sailorometer is touring boat shows to call attention to safe boating practices.

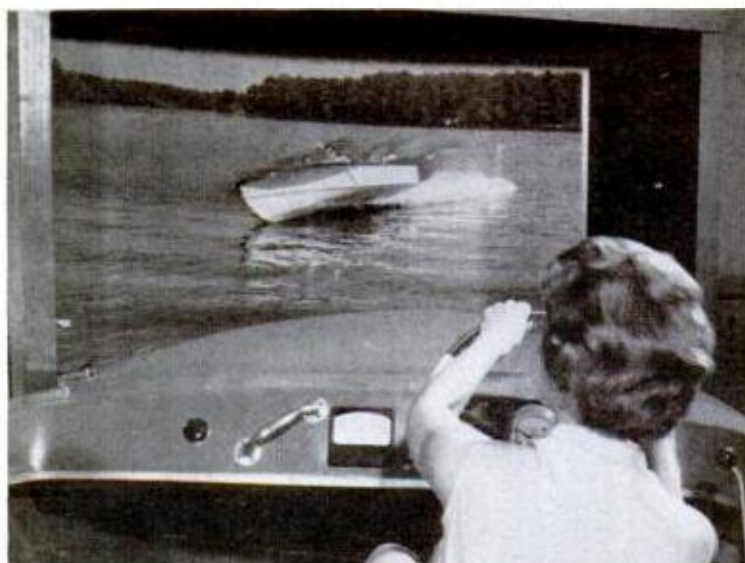

### Aerodynamic Auto Flaps

Borrowing a principle from airplanes, flaps are put on the front end of rear-engine cars to keep the lighter front end from rising at high speeds.

The air-flow diverters force the front end down, increasing traction and avoiding dangerous loss of control. The faster the car goes, the more efficient the stabilizers become.

The safety apparatus won a prize in a recent safety campaign sponsored by the International League for Transportation Safety held in Paris.



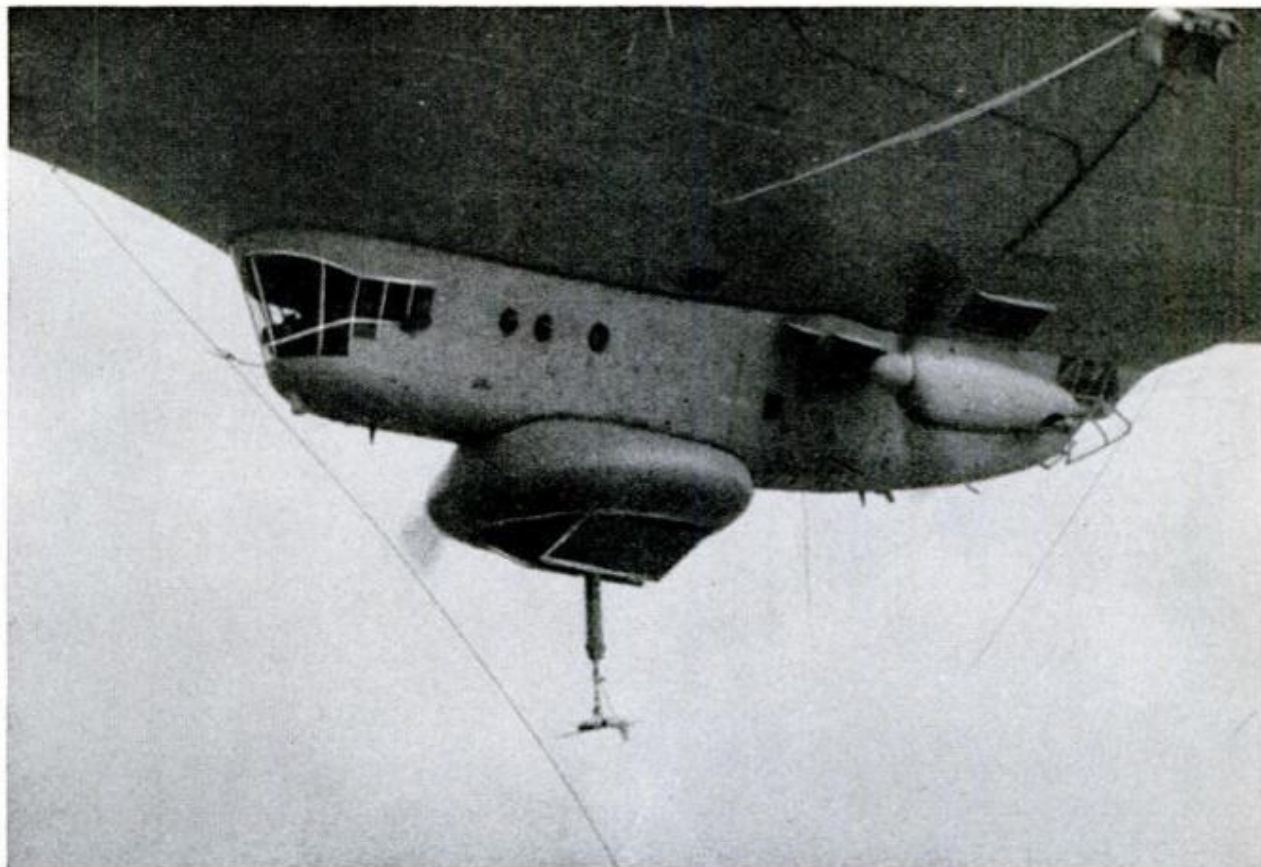

### Flying Wind Tunnel

Navy airships have solved the problem of testing models of vertical-rising and short-takeoff-and-landing aircraft (VTOL and STOL). Because of the slow-speed characteristics of these aircraft, standard wind tunnels were unsuitable.

The airships, however, can maintain zero speed or travel more than 60 knots. They are also smooth and stable in flight.

The models, with wingspans up to 10 feet, are hung from a mechanical umbilical cord (a retractable strut) and all power settings, angle changes, etc., are handled remotely from the gondola.



### Juvenile Jiggler

Each child walking or bouncing on any of six rails of a new piece of playground equipment jiggles the other children, creating an ever-changing, entertaining situation for fun and adventure.

The Jiggle-Rail is 20 feet in diameter. Six four-inch-wide rails of tempered spring steel radiate from the two-foot central hub.

Lucker Mfg. Co., 331 N. 4th St., Philadelphia 6, Pa., sells the unit for \$265.



# I BIRLED

## THE CHAMP

By Patrick K. Snook



**WORLD CHAMPION** Jimmy Running (in plaid) squares off against a Canadian opponent for a practice session. Top, he gets the initial advantage by starting the log in his direction. Second, while his opponent tries to turn around, he kicks water on him. Third, opponent has turned around, and both work log in the same direction. Bottom, a fast foot-shuffle "snubs" the log, and Running's sparring partner goes into the drink. Sudden stops or changes in spin direction usually do the job



*Watching a couple of skilled birlers dig their calks into a floating log and set it spinning, you get the impression that it's an easy sport. I guess that's what made me decide to give it a try . . .*



**I** FOUND world-champion birler Jimmy Running near the end of a dock on a small Wisconsin lake. He and another birler were going through the motions of a flat-out foot race. They weren't going anyplace, but the glistening log beneath their feet revolved at frightening speed.



When I waved, Jimmy made a fast shuffling maneuver with his feet. The log stopped abruptly and his opponent sailed through the air and hit the water with a loud splat.

"That looked easy," I said, and he grinned.

"Well, birling is a peculiar sport." He flicked his feet and the log started to spin again. "It's one of those things that most kids can pick up quickly, but it's almost impossible for an adult to learn." He made a fast, shuffling motion with his feet, and the log reversed its direction.

"Want to try?" he asked. I cautiously stepped onto the end of the log while he steadied it. I found, to my surprise, that balancing wasn't really too difficult.

"You know," he said, "this is what we call a number one, or beginner's log. It's big and stable, so we use it for things like skipping rope, handstands, and rolling with another man on our shoulders. In





**TOUGHEST** kind of birling—block turning—is Running's specialty. Balancing on the short, thick block is hard enough, and only a few besides Running have mastered the technique of turning it end to end



**SKIPPING ROPE** on a number one log is child's play for the pros, but even they slip off sometimes

a birling contest, a big log like this is too easy, so we set a time limit of three minutes. Then the competitors go to smaller logs."

I had now managed to relax a bit and my slippery perch was starting to feel a little more secure under my feet.

"Let's start by getting the feel of a moving log," he said. "Keep your feet pointed at right angles to the length of the log."

"Bend your knees slightly, so you're in a slightly crouched position. Keep one foot just behind and the other just in front of the center of the log. Now use short steps and a heel and toe motion."

The log was now rocking slowly back and forth. Surprisingly, I was still on it.

"Now, let's see if you can roll it," Jimmy said. "Remember, short, quick steps."

The log started to turn and I swung my arms to keep my balance. Jimmy picked up the pace, and I felt as if I were running up a steep hill. I kept my eyes glued to his feet.

"Hey," I yelled, "this isn't so hard."

Jimmy winked. His feet made another of those quick shuffling movements, called "snubbing" in the trade. The log stopped suddenly and I felt myself sail through the air. *Splash.*

The first thing to do when you take up birling is learn to swim wearing shoes.

## Now It's Indoor Skiing

Skiers can get more practice in half an hour on a new indoor "ski slope" than in an average day on a mountain.

The slope is an endless belt of nylon material similar to carpeting, running upward over a ramp at variable speeds. Using short skis with low-friction plastic bottoms and blunt poles, skiers can perform any downhill maneuver—even hold slalom races. Beginners can use a supporting bar.

The Ski-Dek is made in two sizes by Ski-Dek Corp., Caldwell, N. J.  
*(SEE WHERE-TO-FIND-IT LIST IN FRONT)*

## Jolts Jet Jockeys

British pilots can test their ability to control a high-performance aircraft in bad flying conditions in a flight simulator built for the Royal Air Force.

Unlike conventional trainers, which are stationary, the new flight simulator throws the pilot around, giving him the same pitch and roll sensations he would get in the cockpit of a supersonic jet.

The cockpit is mounted on a large movable arm which is powered by two electro-hydraulic servos. It is equipped with standard flying controls which govern its attitude and enable the pilot to "fly" the simulator.

However, to test his reactions to unfavorable flying conditions, a special analogued computer feeds disturbances into the control system in any desired pattern—cross winds, gusts, turbulence, etc. The pilot has to fly the simulator through these conditions as well as through "still air."

The cockpit can move from horizontal to maximum tilt in one second.

## Plastic Landing Gear

Because of frequent landings on rough terrain, the stress on landing gears of light planes is great. A Swedish firm has produced a plastic undercarriage reinforced with glass fiber that, in tests, has shown better shock-absorbing qualities than conventional landing gears.

The gear minimizes bouncing on landing and vibration in taxiing, saving wear and tear on the plane's instruments.



# Test Your Quick-Wit Quotient

By Theodore Berland

**Y**OU'RE SITTING next to an empty seat at a lunch counter, reading your newspaper. Above the din of the lunch-time crowd, you hear the click of high heels. You start reading the same sentence over. As you catch a whiff of perfume, you whip your head to the side to catch in full the young woman sliding into the seat beside you.

This, my friend, is awareness. Being a red-blooded male, you are especially aware of attractive females when they reach the fringes of your perception. And you react quickly.

Awareness, too, with the quick reaction that accompanies it, can help you stay out of trouble by anticipating emergencies.

Take accidents. They don't "just happen" because "your number is up" or because of the law of averages. They happen because the situations are right for them to happen. Part of a situation is often a lack of awareness of what's coming and what to do.

How about you? How would you react in an emergency situation? Here are 10 moments of panic that will give you a chance to determine your **quick-wit quotient**. Score yourself this way:

10 correct—you're a quick-wit genius.

7-9 correct—safe man to be with.

5-6 correct—need improvement.

3-4 correct—bad, but not hopeless.

Under 3—stay in bed.

To take the test, read each item and immediately write down your reaction. When you've finished, turn to page 142 and match your answers against the correct ones.

The authority for answer No. 2 is the Outboard Boating Club of America; for the other nine it is the National Safety Council.

**ANSWERS ON PAGES 142-143**





### SITUATION 1:

It's night, and you are driving along a country road. You come across an old car stalled near the top of a railroad crossing. The car is full of people, and the driver is trying to push it off the tracks. You notice that there's no crossing gate or flasher light. Then you spot the light of an approaching train.



### SITUATION 2:

You're steering your outboard motorboat, throttle open, along a deserted stream. Suddenly, you spot a log in your path. Its ends almost touch either bank.





### SITUATION 3:

You're strolling on a sidewalk near a park on a beautiful afternoon. A ball flies through the air right in front of you, followed by a child running as fast as she can to catch it. She dashes across the sidewalk and into the street—oblivious of the car speeding toward her.



### SITUATION 4:

After dusting your favorite roses, you return to the tool shed to find your three-year-old's hands and face covered with insecticide powder.

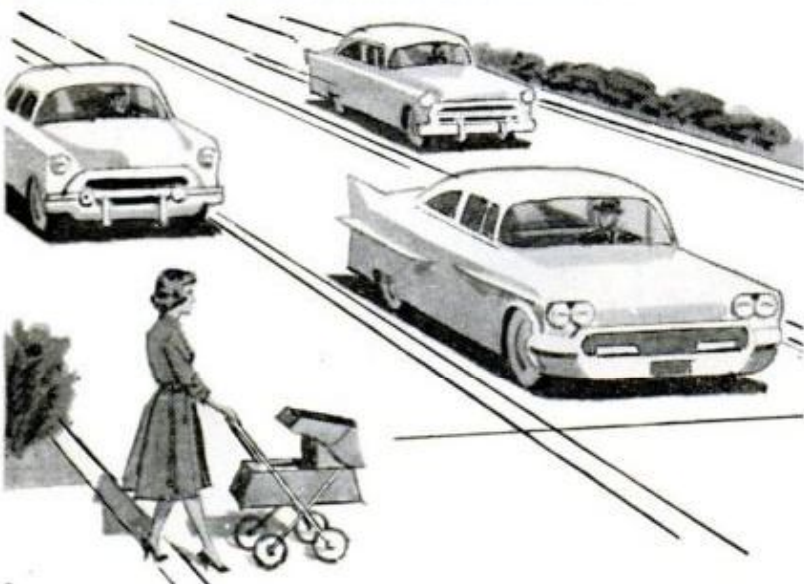

### SITUATION 5:

You're driving in the middle of a one-way, three-lane street. There is no traffic ahead of you. You slow down to a stop as you approach an intersection where a woman wheeling a baby carriage is trying to cross. She pushes the buggy into the street as she sees you stop. Suddenly, in your rear-view mirror, you see two cars—one on each side of you—racing into the intersection. She obviously doesn't see them.

### SITUATION 6:

You and your wife come home late one afternoon to find your children have opened your desk drawers and are playing with its contents. In it, you know, is an automatic pistol and ammunition. As you approach the children, one of them—in fun, of course—aims the gun at you.

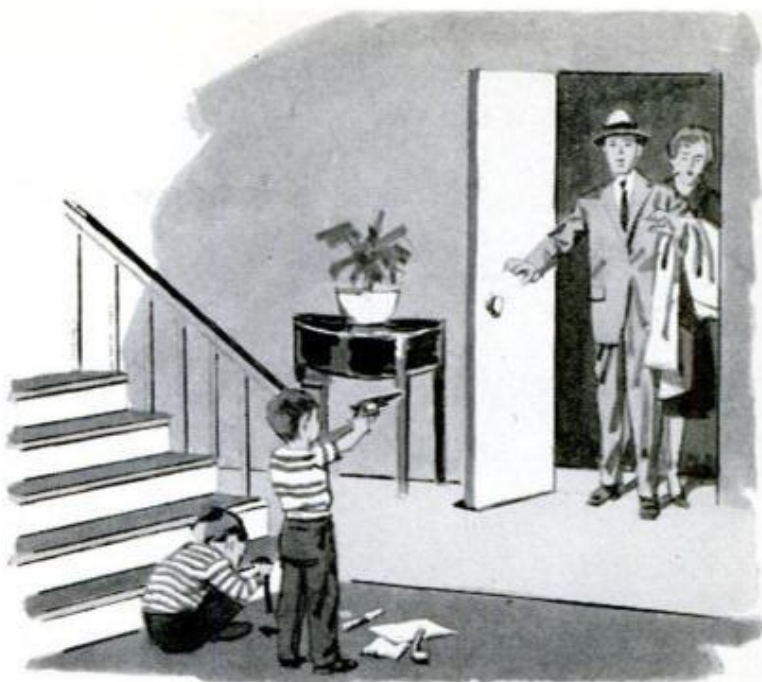

### SITUATION 7:

As you alight from a bus with your arms loaded with packages, the door closes behind you and you feel a tug. Your coat is caught. The bus starts to move.



### SITUATION 8:

You and your two-year-old son are alone in your suburban home. It's the first on the block in a new development. You tell your son to stay at the head of the stairs while you go to the basement. At the bottom, you fall and break your leg on the basement floor. The pain is extreme. Your son, at the top of the stairs, begins to cry. There is no phone in the basement, and the nearest neighbor is blocks away.

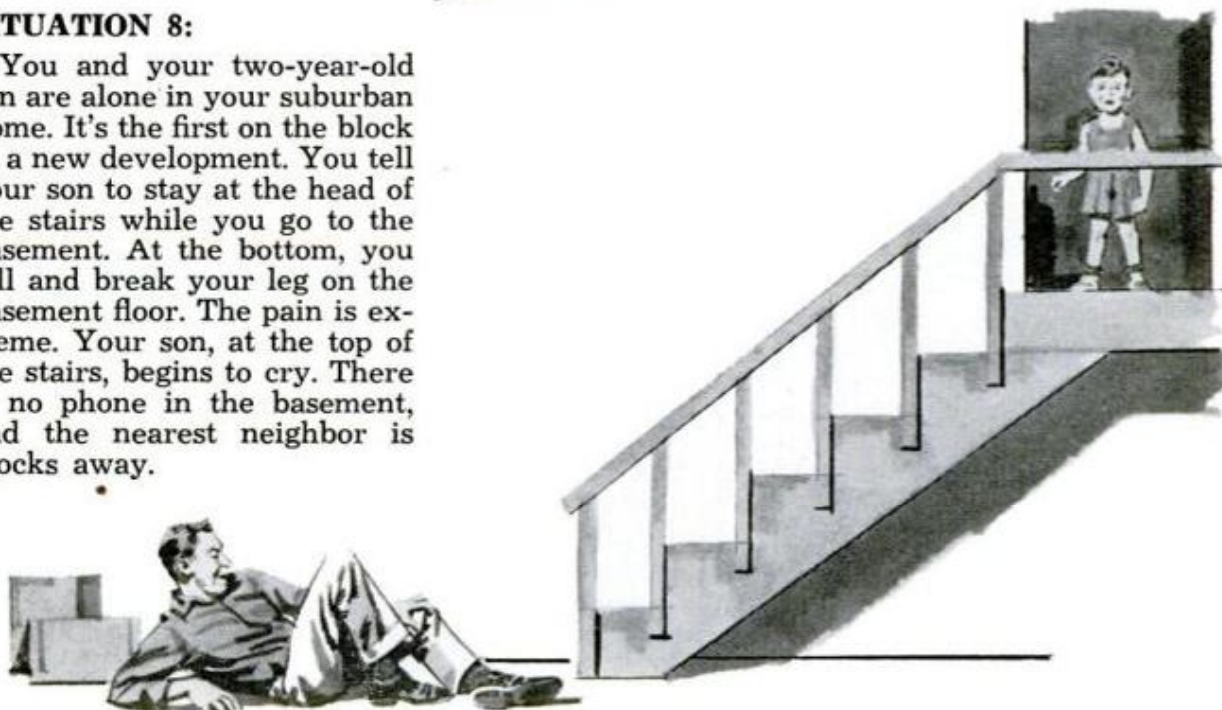

see APRIL 1962, p. 8



### SITUATION 9:

You pull up to the curb, your one-year-old in the seat beside you. You put the transmission in neutral, and, leaving the engine running, dash to the house to leave a note in the mailbox. When you come back to the car, you realize that, as is your habit, you've pushed the button and locked the car door behind you. You have no duplicate key.



### SITUATION 10:

The sky is dark, but it is a sweltering afternoon at the beach of a small resort lake. You walk into the water. It feels refreshing, and you start swimming for a raft out in the water. When you're halfway there, the sky darkens even more. It begins to rain. A stiff wind starts to blow. You hear thunder, and flashes of lightning strike nearby.

## ANSWERS

1. Get the people out of the car immediately! Have them walk back along the road to a safe distance. Forget about the car and don't try to push it with your own auto; it's very difficult to estimate the speed of an oncoming train. It's also virtually impossible to flag it down so that it would stop in time.

The driver, of course, knowing his car was in bad shape, should have gained more momentum to carry the car over the tracks.

2. Cut the throttle! Make a sharp turn—even if it means you'll beach your craft. Brace yourself, and try to yell a warning to your companions to hang on.

You shouldn't be going full throttle down a stream—your speed should be regulated by how far you can see and your stopping distance.

3. Yell at the child as loud and quickly as you can! She can stop in less distance than the car. If the child is close enough, grab her or trip her.

The child, of course, should be taught

not to run into a street. There's one fact you should know, too: If you grab or trip the child, you assume responsibility for the consequences of the act. However, saving a life should be uppermost.

4. Wash his hands and face with water (some pesticides can penetrate unbroken skin), grab the container (the ingredients are listed on the label), and call your doctor! If you can't reach a doctor, have the child drink plenty of water and make him vomit by feeding him warm salt water (two tablespoons of salt in a glass) or by placing your finger far back in his throat. Place his head lower than his hips when he begins retching.

5. Thrust your left arm out the window in a left turn signal and flip your electric turn signal on right blinker. (A driver did this in New Jersey and saved a life.) Four other possibilities: Pumping the brake pedal to flash the rear lights; blasting your horn several times; waving your arms; yelling at the woman.

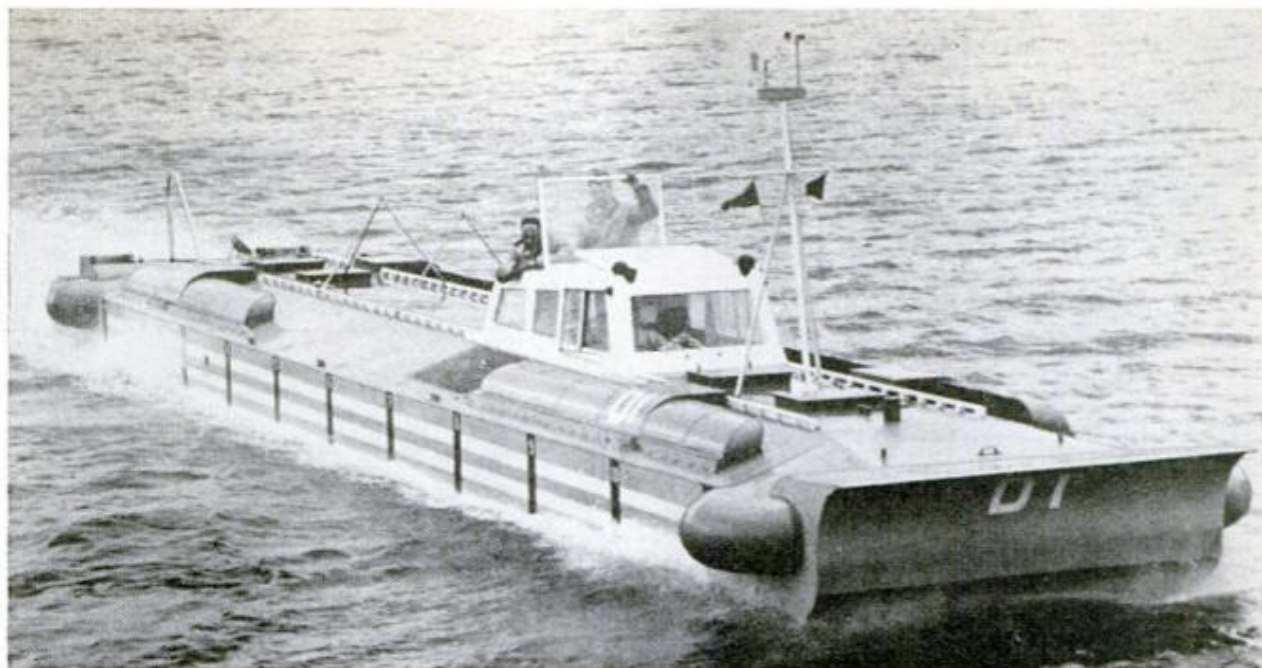

## Hoverbus – An Air Ferry – Makes Debut

The prototype of the Hoverbus, a new ground-effect machine designed to ferry 200 passengers across rivers and estuaries, recently made public test runs in Scotland.

Developed by a ship builder in collaboration with Hovercraft Development, Ltd., the craft measures 10 by 66 feet. It is intended exclusively for marine use. Its "side walls" never leave the water so it never becomes fully airborne.

The walls on each side and downward jets of air at each end contain the air cushion. Propulsion is by outboard motors.

---

### ANSWERS

6. Drop to the floor! Point to an object off to the side and say, "I bet you can't hit that." This will divert the gun from you and give you time to grab it. **Don't** shout, "Don't shoot!" The child might become flustered and pull the trigger. Assume that the gun is loaded at the outset.

7. Yell, so that the driver or a passenger can hear you. Drop the packages. As fast as you can, unbutton the coat and whip it off. You may have to jog a few feet if the bus starts to move, but it takes time for it to reach any speed.

8. Calm down. Control your panic. There's no urgency here. After determining for sure that it's a break, decide if you could stand the pain if you dragged yourself up the stairs. If you can't move, remember that your wife will return in a few hours. If it's a weekday, the milkman or others may come to the door. Instruct your son to tell him daddy is hurt. He might also be able to dial the telephone operator for help. If these don't work, have

your son come down, calm him, and resolve to spend some hours there together.

For safety's sake, it's good to have a telephone at every level of the home.

9. Pick up a brick, rock, stick, or shoe and break the rear side window to get in. Breaking the rear window is less dangerous for the child in the front seat, and the act will help divert his attention from such attractions as the shift lever. If your car is a hardtop or convertible, you could try fishing for the handle with a hook made from a coat hanger.

In most states it's against the law—as well as unsafe—to leave the engine running when you walk away from your car.

10. Go back to shore, get out of the water, and find shelter in a building. Don't try for the raft. Remember that lightning strikes at the highest projection; on a raft, you'd be it.

You'd never be in the situation if you followed the rules: Never swim alone and never swim during a storm.

*Division of Grand Haven Stamped Products Co.*



**INSTANT HOT WATER** comes from an electrically heated dispenser that can be installed anywhere there's water and electricity. Water-Maid, by Shermark Industries, Grand Haven, Mich., costs \$49.95

# WHAT'S NEW FOR Your Home



**MITTEN STORAGE** is as close as the back of a door when the Mitt-Rak is installed. It holds six pairs of mittens so that they dry easily. The item is sold for \$2.00 by Mitt-Rak, 4715 Groveland, Royal Oak, Mich.



**BEAUTY-SHOP HAIR DRYING** right at home is possible with an accessory that may be attached to any Norge automatic clothes dryer. It is adjustable to user's height and hood fits over pin curlers and rollers

**SOFT, GLARELESS LIGHT** from electroluminescent panels keeps stairways easily visible and safe all night. The Rayescent panels are available for \$8.40 each from Solar Sonic Devices, Inc., Hicksville, N.Y.



**STEEL LIFTERS** allow you to handle with ease even the biggest turkey or roast. Set of two sells for \$2.95. Order them from B & G Kent, Box 684, Fontana, Calif.

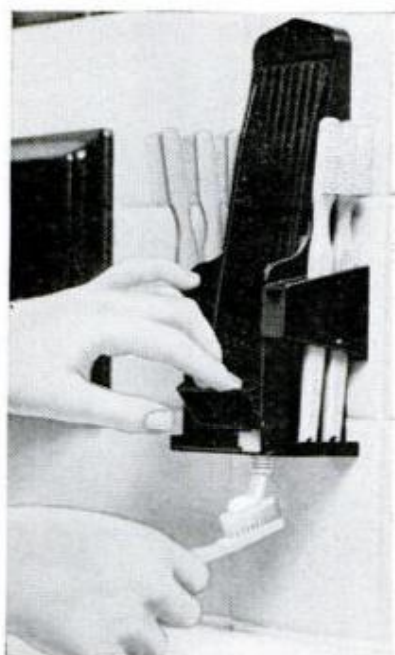

**TOOTHPASTE** is dispensed by brush holder. Price is \$1 from Pact Manufacturing Corporation, 783 State St., Schenectady, N.Y.



**SPRING - WOUND ALARM** sounds bell when heat sets it off. Priced at \$23.95, it's made by Westron Corp., 652 Hudson St., New York 14



**FOOD WON'T STICK** to ovens or cooking utensils sprayed with No-Stick. Made by Devcon Corp., Danvers, Mass. Price: \$1.29 & \$1.98

**BACK SCRATCHING** becomes a luxury with an electric back-scratcher that has five tiny fingers scratching at 3000 times per minute. \$4.98 from Damar's, 768 Damar Bldg., Elizabeth, N.J.

**PLASTIC BIRD FEEDER** pivots in wind so birds are always protected. Cost is \$20.95 from Dilley Mfg. Co., 1657 Doan Ave., E. Cleveland, Ohio

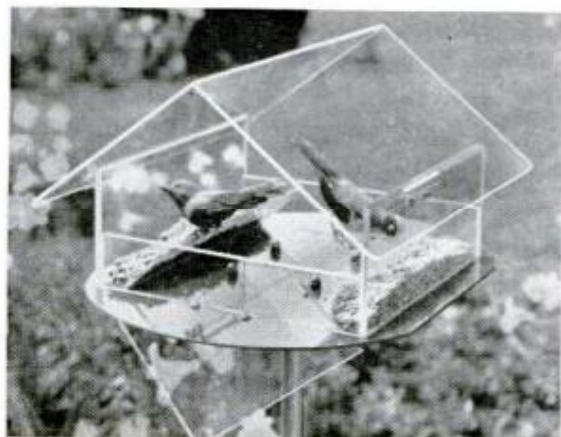



# How to Outwit an Ouzel – or a Baby Pelican



All birds, from the beautiful to the comical, can be captured on film . . . even with a simple box camera. All it takes is a few tricks



## By Frank Tinker

**A**NYONE WHO likes birds or photography will sooner or later try to combine the two.

If the results are less than satisfactory, it's usually because the average snapshotter has overlooked some basic facts.

A bird (1) is usually quite small, (2) is unbelievably fast and (3) doesn't trust people. The basic problem is to get close enough to this tiny creature for the resultant image to be more than a pinpoint on a negative. To do this, you must know your equipment well enough so that when the fleeting opportunity arrives for that one good picture you will make the most of it.

Let's start with the simplest methods. The window feeding station, which many thoughtful people have incorporated as part of their homes, provides an ideal setup for the amateur. The birds become accustomed to their surroundings, a window only a few feet away affords screening for the

**SOARING BIRDS** (left) can be caught with camera by following flight, snapping shutter when they fill frame; not waiting for them to fly through frame

**BABY PELICAN** (inset, left), like most fledglings, is too young to fly. Trick is to find nesting area, then move in as close as necessary (below) for photo

photographer and the birds can often be caught at rest. In this situation, you can either hold your camera, or put it on a tripod, prefocus it on the station and trip the shutter with a long cable or bulb release.

The cameras need not be expensive. Most cheaper box cameras have a fixed focus which requires that the subject be at least six feet away. Those using 35-mm. film will focus to three feet or less, and auxiliary lenses can be added to allow focusing within a few inches.

To show the range of equipment which can be built around this setup, one family has a cheap camera permanently arranged in this fashion and any time a member notices an interesting bird at the station he simply pulls the cord. Another hobbyist with a much larger pocketbook has a layout which includes an electric eye to trigger the shutter whenever a bird lands at the station, a supplementary electronic flash to light the subject and stop its motion, and a spring-loaded film-winding attachment which readies the camera for the next shot automatically.

To approach birds that do not choose to



## Some birds take more study,



**BOX CAMERA** (below) can be used in bird photography. String arrangement trips shutter from remote position when bird alights at predetermined spot

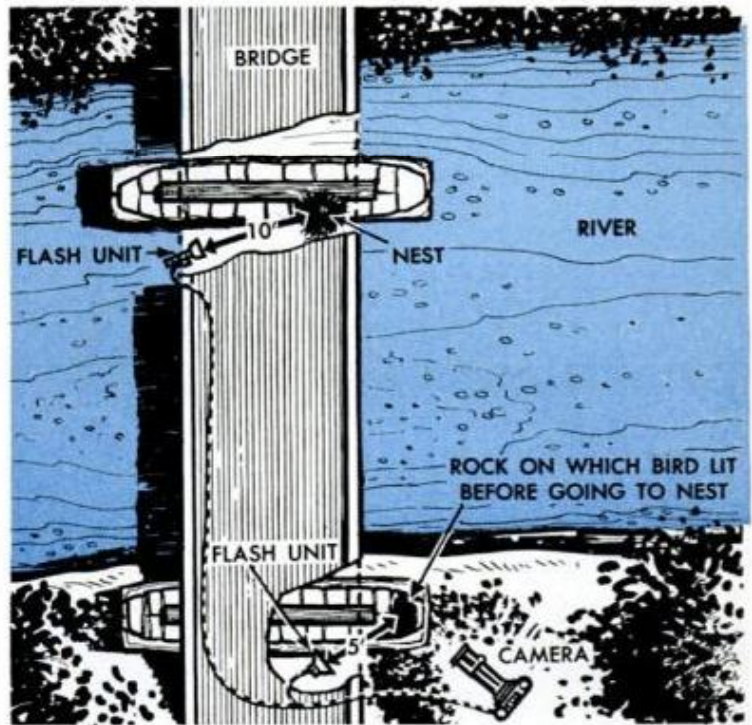

**WATER OUZEL** (top) was photographed with arrangement shown in diagram. Wires attached to flash units were strung along bridge (left) to camera position

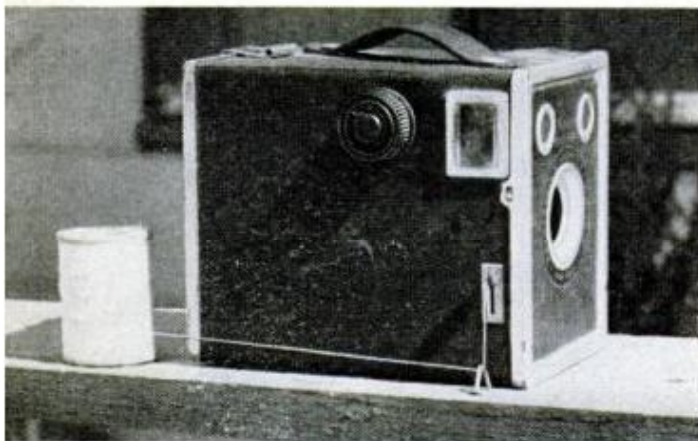

mingling with people, blinds can easily be set up in the field. They can be located near a nest or any place the quarry is known to congregate.

The blind, like your other equipment, can range from the elaborate permanent type, complete with flash reflectors angling on the bird from every angle, to a simple piece of canvas thrown over the person's head. All these blinds have a single objective—to erase the human form and its outline.

The standard blind, however, is a small tent which allows sufficient elevation for the camera and the person sitting behind it

*more equipment, more patience . . .*



**FLASH UNIT** is set up near ouzel's nest. Second unit (as shown in diagram) is set up near rock on which ouzel alights before going to nest. Arrangement was based on studies made of bird's habits before setting up equipment. Pictures were then taken at rock and at nest from same remote camera position

as well as apertures for the lens. Again, as long as the bird does not see the person, the slow movement of this lens poked out the slit in the canvas does not ordinarily frighten him. Since overhead cover is not usually essential, the simplest form of blind consists of several poles driven into the ground with a large tarp wrapped around them. Vertical slits can serve as lens windows or U-shaped flaps can be sewn over larger holes.

The last method for approaching these most elusive creatures is by optical means—binoculars, field glasses or telephoto lens.

The bird photographer is particularly fortunate today, since the recent advances such as the single-lens reflex camera, auxiliary lenses, binocular attachments and cheap telephoto lenses seem to have been designed almost specifically for him. Undoubtedly the best of these substitutes for distance are the telephoto lenses. Usually designed for 35-mm. use, a good 300-mm. or 400-mm. lens can now be purchased for well under a hundred dollars.

Using these long lenses requires a little extra care, however. The focus becomes quite critical, and the slightest movement



**MOTHER SWALLOW** feeding its young required fast shutter speed. Shore bird (above) needed telephoto lens

of the camera will tend to blur the picture. The use of a tripod or other brace is recommended whenever possible. For the same reason, a high shutter speed is usually mandatory. The rule of thumb is to use a speed to correspond with the focal length of the lens—that is, for a 400-mm. lens use  $\frac{1}{400}$  of a second, for a 200-mm. lens use  $\frac{1}{200}$ , etc.

With all this talk of speed, the question immediately arises as to whether or not an adequate exposure can be given the film. In many cases, it cannot without supple-

mentary flash. Birds seek the shade because insect food is more abundant here, because it affords protective obscuration and because most species would be unable to endure the glare of the sun indefinitely. The telephoto lens, though, has a tendency to give a soft monotone to pictures taken in shadow.

Flash lighting is the next answer to some situations found in the field. The type of flash will depend entirely on the circumstances and the type of camera. If this light

**WATER WALKER**, a coot, was caught from hidden shore position, using both fast shutter speed and telephoto

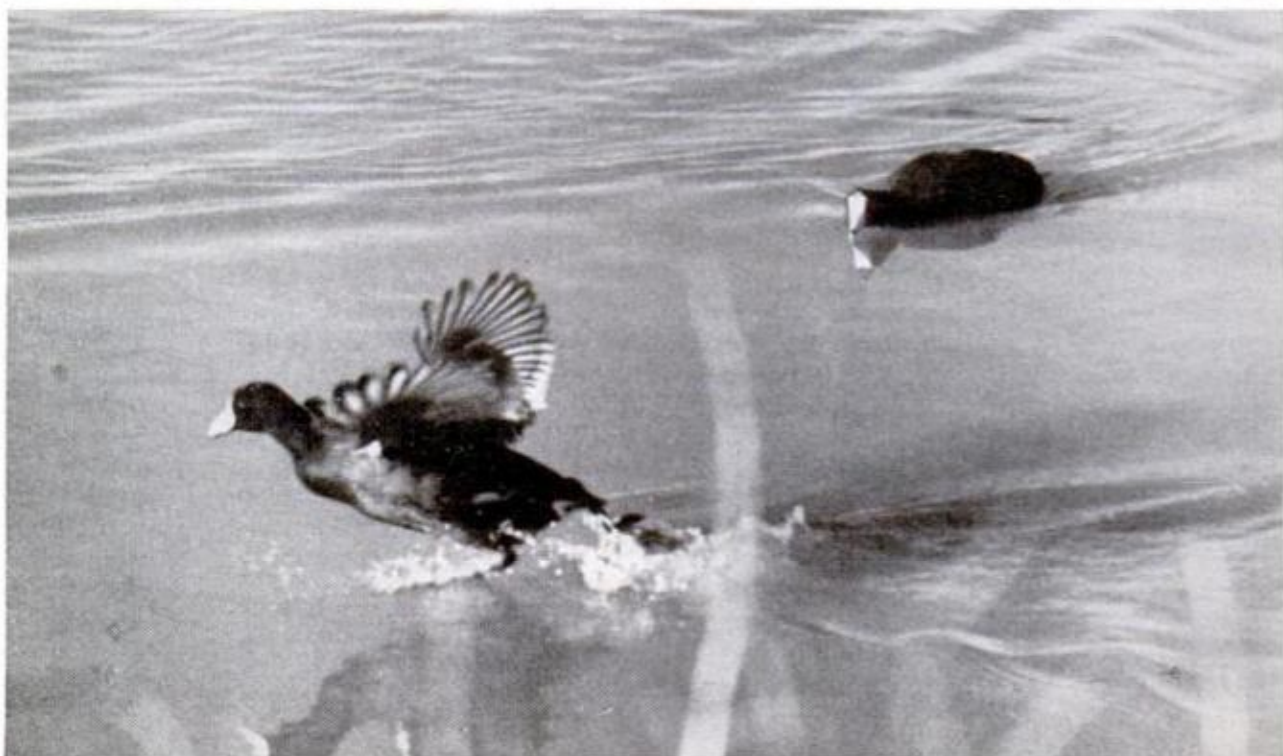

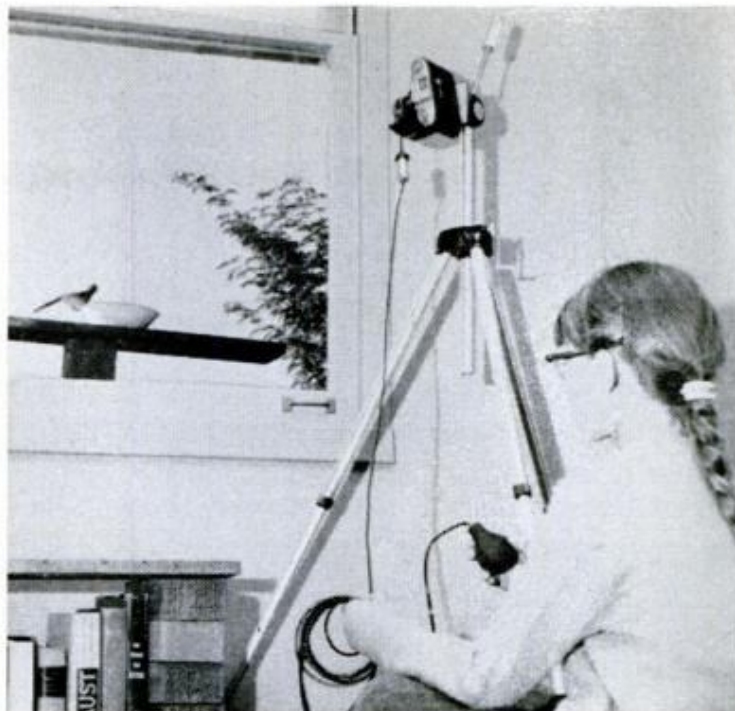

**COMPLETE OUTFIT** can cost less than \$200. Even less expensive equipment can be used for window-station rig

source can be fixed—at a nest, for instance—an electronic unit will eliminate the need for changing bulbs with every shot. The contact wires can be spliced and trailed from the photographer's blind to the unit if he intends to hold the camera, or the whole unit can be operated by remote control. A simple solenoid arrangement can be rigged to trip the shutter at distances too great for regular release cords, and even radio-controlled units are now available.

If the unit is to be carried, however, bulbs

will probably be most serviceable. Most reflex cameras using the telephoto lenses have a focal-plane shutter which can be synchronized with the electronic units only at very slow speeds. Exposure at these speeds will leave "ghost" images or worse on the negative when used in natural light. The #6 or #26 bulbs, made for focal-plane shutters, can be used at any speed and seem to reach out farther than the electronic units.

(Continued to page 212)

**FIELD PHOTOGRAPHY** is possible with simple canvas blind. Dancing grouse was shot from about 10 feet away



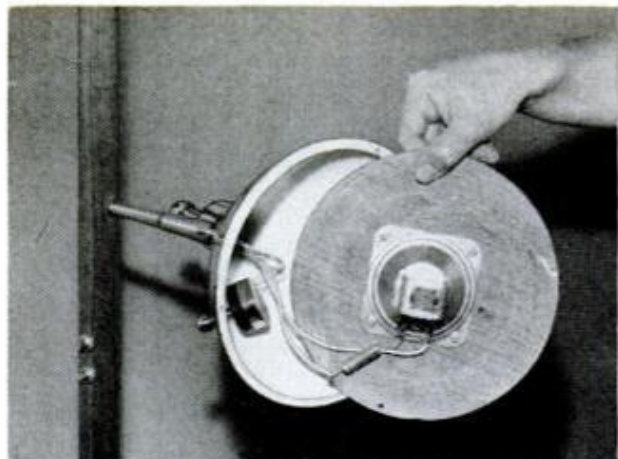

**INSIDE OF BULLET** shows speaker mounted to baffle with volume control and crossover capacitor wiring

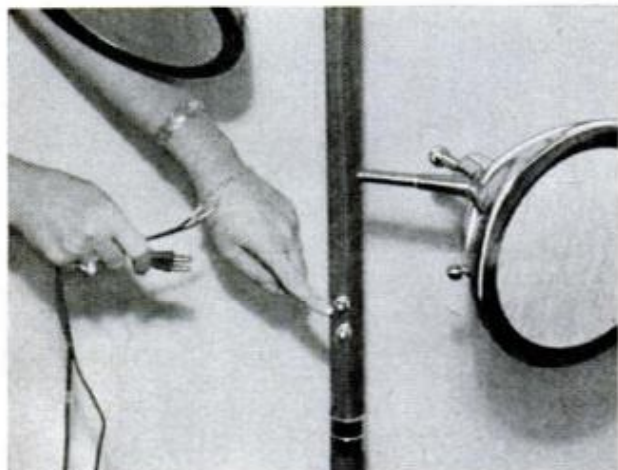

**TWO SWITCHES** provide lamp switching and speaker On-Off. Wires in hand are for lamp and loudspeakers



**AMPLE LIGHT** is provided by unit in use, while loudspeakers are directed and volume adjusted from chair

## Speaker-Lamp Combo Package

New loudspeaker-lamp combinations provide high fidelity sound plus high styling in an assortment of combinations. The unit can be had with three speakers, two speakers plus a lamp, or one speaker and two lamps. A specially damped chamber for the low frequency loudspeaker eliminates sound reflection, allows much better low frequency response. These units can be

used with high-fidelity systems, radios, in offices and shops as well as homes, they make excellent wing speakers for expanding stereo effect.

Available in assorted finishes, the Verti-Sonic speakers are provided as pole lamps or tree lamps. \$129.95, in any combination of three lamps or speakers, with support. Lords Electronics, 10 E. Kinzie, Chicago.



**EASY TO USE CONNECTOR** makes installing new outlets a snap. Simply insert wire in hole, connection is made with no screws. 25c, Eagle Electric, L.I.C., N.Y.



**TURNOVER TURNTABLE** automatically changes records, and plays both sides of each record automatically, or with push button. Lincoln Engineering, St. Louis, Mo.

## Homemade Flying Wing

Powered by an 85 hp. engine, a home-built flying wing measures 13 feet long with an 18-foot wing-span. It can do 130 m.p.h.

Its builder, Marion Baker, is a mechanic in a rocket-testing facility of National Aeronautics and Space Administration. He claims the flying-wing design gets better performance from the engine.



## Aluminum Armor

The 37-mm. high-explosive shell whined through the air at the U.S. Army's Aberdeen, Md., Proving Ground and blasted against the weld of two sections of aluminum. Although the explosion left an ugly pockmark on the experimental armor plate, the aluminum held and thus passed the test for consideration for use in U.S. armored vehicles.

Welded aluminum alloy, it was determined, makes armor effective against small arms fire and artillery shell fragments. It offers the advantage of keeping weight down. Corrosion resistant, it also is easy to fabricate in factory and field.



## Traveling Chow

Munching "on the run" has hit the big time. The lunch truck idea, started in California during the war, is now a busy, mobile catering industry with some 6000 units.

Deluxe installations (about \$5500) are fitted to light truck chassis and offer a wide variety of snacks and light lunches from stainless steel display racks.

Butane gas is used for coffee and hot sandwiches and some units have mechanical refrigeration and small soda fountains with ice cream and charged water.

The average vender makes 25 to 40 stops daily. On his rounds, a typical owner/vender like L. G. Gershman, with changer right, serves up to 100 customers per stop. Offices, warehouses, factories and sports events are visited on a typical route. Stops at offices and industrial operations are all according to a predetermined schedule that enables a driver to arrive for coffee breaks and lunch hours.



## SHOP AND CRAFTS

60<sup>th</sup>  
ANNIVERSARY  
SPECIAL



**ROWING MACHINE**



**BELT MASSAGER**



**HEALTH BIKE**



**ABDOMINAL BOARD**

### **PLANS AVAILABLE**

To fulfill requests for plans for building this home exercising equipment after the magazine article is out of print, we have prepared a set of large-size plans which may be purchased from our blueprint dept. by writing Popular Mechanics Magazine, 200 E. Ontario St., Chicago 11, and enclosing \$2.50.





*Daily workouts on these four homemade exercising machines will keep the entire family fit as a fiddle*

# HOME FITNESS GYM

**By Manly Banister**

**Part I**

**M**USCLES FLABBY? Waistline bulging? Decide now to have your own physical fitness gym by making this low-cost health-building equipment. A few minutes workout each day on any one of these body conditioners (the bike, the rowing machine, the belt massager and the abdominal board) will give you and the rest of the family a trim and healthy figure from head to toe.

In this two-part article, Part I details construction of the bike exerciser and the rowing machine. Part II will show how to build

the belt massager and the abdominal board, plus still another exerciser, a combination affair that helps firm the legs and waistline through the use of weights.

With a bike exerciser you can literally pedal your way to health. A most beneficial exercise, cycling helps firm and condition the body from the hips down. Here you can ride rain or shine in your home on a stationary exerciser built from a discarded bike.

Your first step is to scout around for a standard 26-in. bicycle. Either a boy's or girl's bike will do (I happened to have a

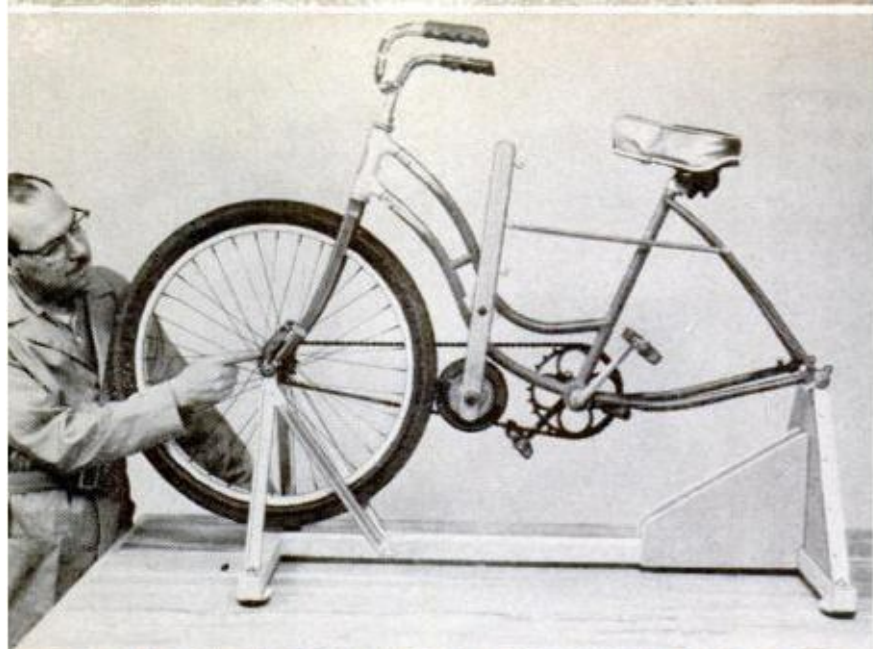

**ASSEMBLED** bike exerciser (left) ready for painting. Note rubber caster-cup feet and hooks for varying tension on friction wheel

girl's bike) although the latter has the advantage of being somewhat easier for all members of the family to get on. You don't need the whole bike so turn it over on its handlebars and remove both wheels, fenders and the chain. The rear wheel is transferred to the front fork. In order to do this you will have to enlarge the axle slots which I found easy to do with a file.

Since the original chain will now be too short you will have to lengthen it by adding a second chain. This is done by taking both chains apart at their connecting links, then joining in one length. The chain is placed around the sprockets, measured for length, cut and finally made into an endless chain with a second connecting link. As there is no reason to steer the bike, the front fork is locked in a straight-ahead position by drilling a No. 7 hole through both the fork and the inner handlebar shaft and tapping the hole with a 1/4-20 tap. A 1/4-20 capscrew holds the front fork rigidly in line with the frame. This is all you have to do to the bike itself.

Construction of the supporting

CENTER-TO-CENTER MEASUREMENT  
EQUALS DISTANCE FROM FRONT  
AXLE TO REAR AXLE OF BIKE

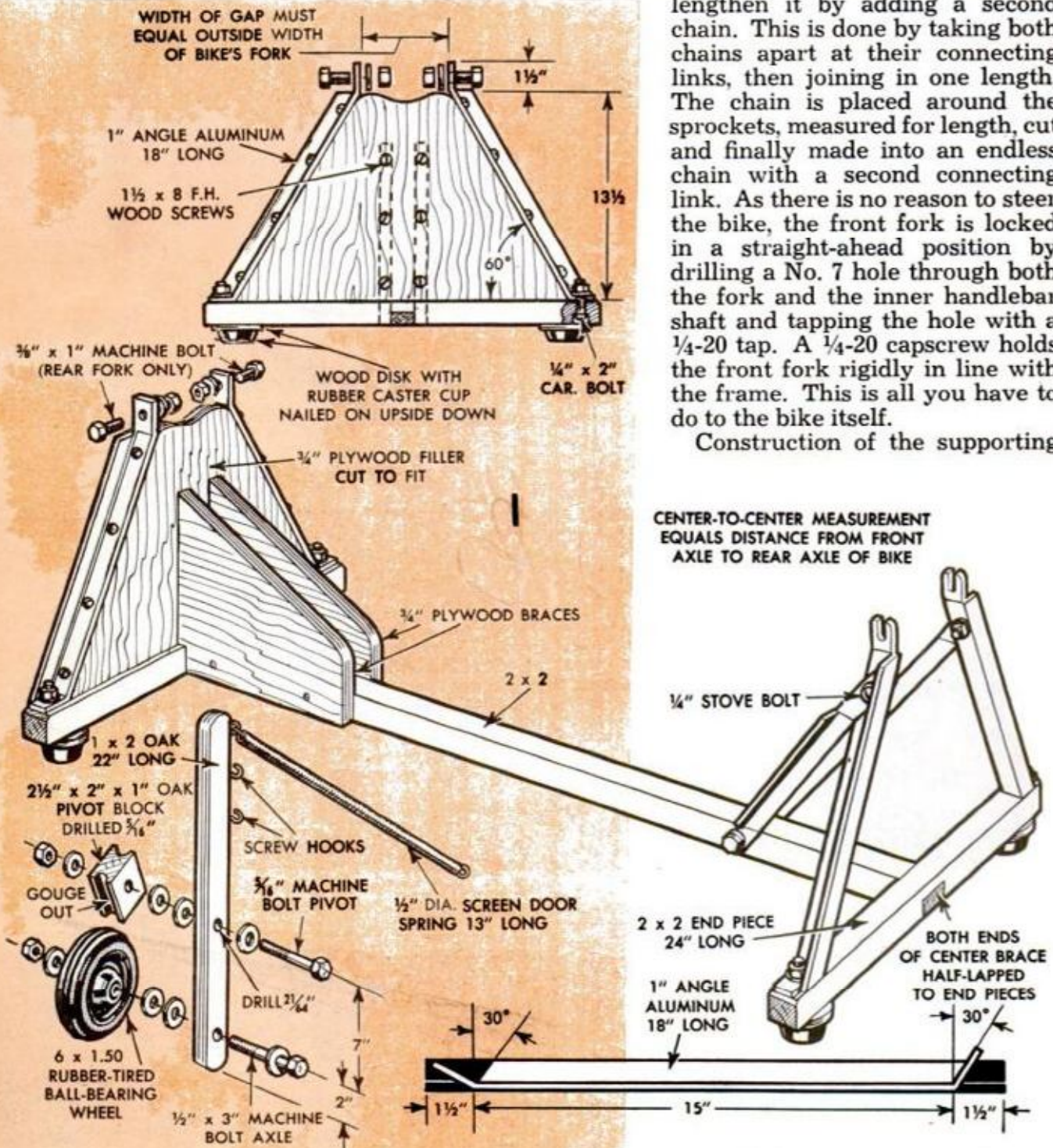

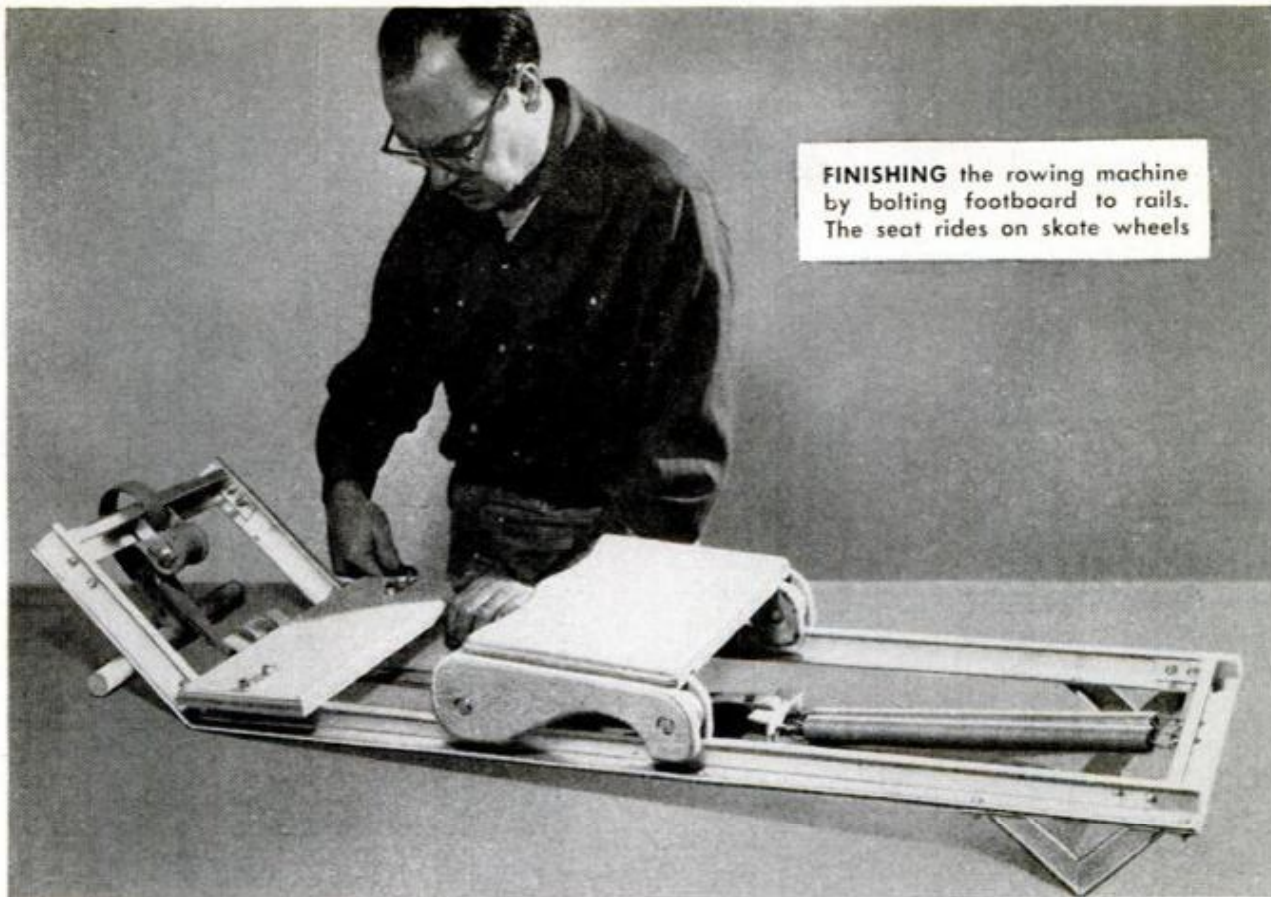

**FINISHING** the rowing machine by bolting footboard to rails. The seat rides on skate wheels

base is clearly shown in Fig. 1, along with the friction-wheel assembly. The latter is nothing more than a rubber-tired, ball-bearing wheel bolted to a 1 x 2 oak lever which in turn is pivoted to make the attached wheel bear against the front-wheel tire. Three screw hooks in the lever and a screen-door spring attached to the bike frame at the seat permits varying the tension on the friction wheel. The lower hook provides easy pedaling, the middle hook makes pumping a little tougher and the upper hook makes you feel like you're pedaling uphill. In the case of a girl's bike, the lever is pivoted to a hardwood block so shaped to wedge securely between the double tubular frame. In the case of a boy's bike, pivoting of the lever will perhaps mean drilling a hole through the frame

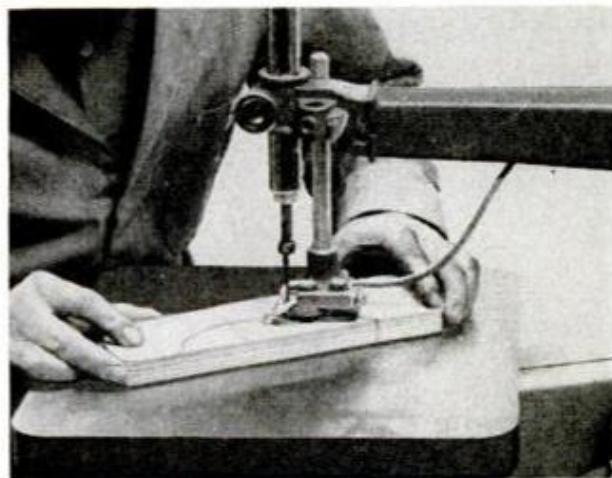

**SIDE MEMBERS** of rowing seat are jigsawed to shape (above), then shaped (below) to relieve all sharp edges. All four side members extend below rails to keep seat from coming off the track as it rolls

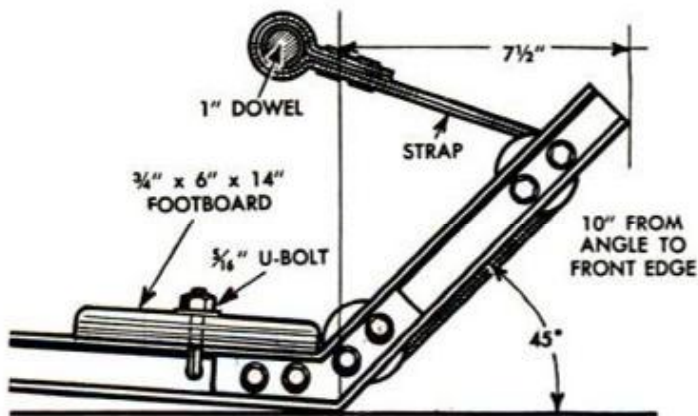

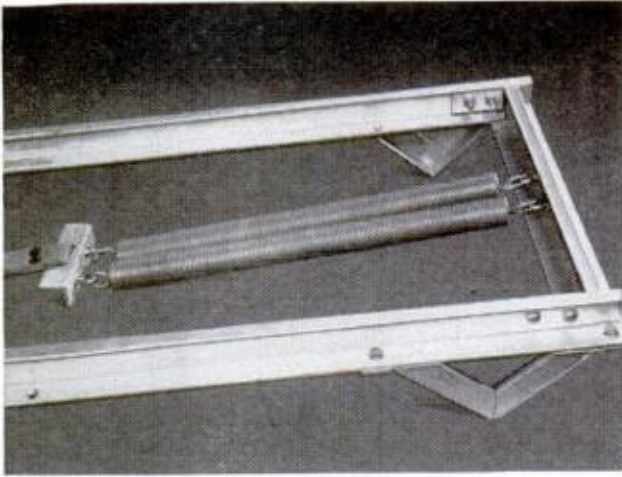

**VIEW OF FRAME** at rear of rowing machine shows how twin coil springs are attached to the pull strap

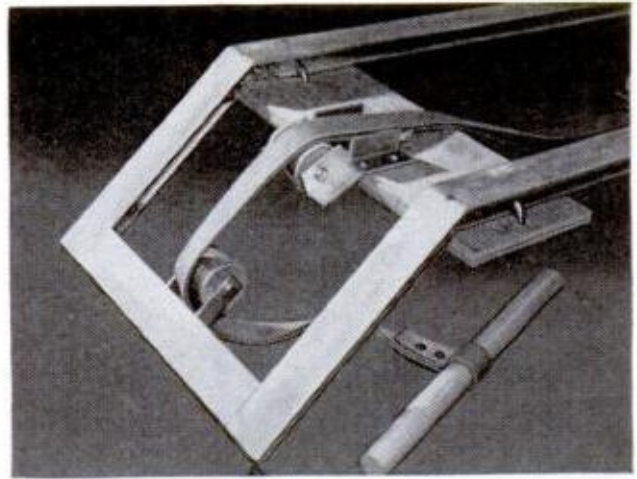

**UNDERSIDE VIEW** of rowing machine at front shows web baggage strap doubled to minimize stretching

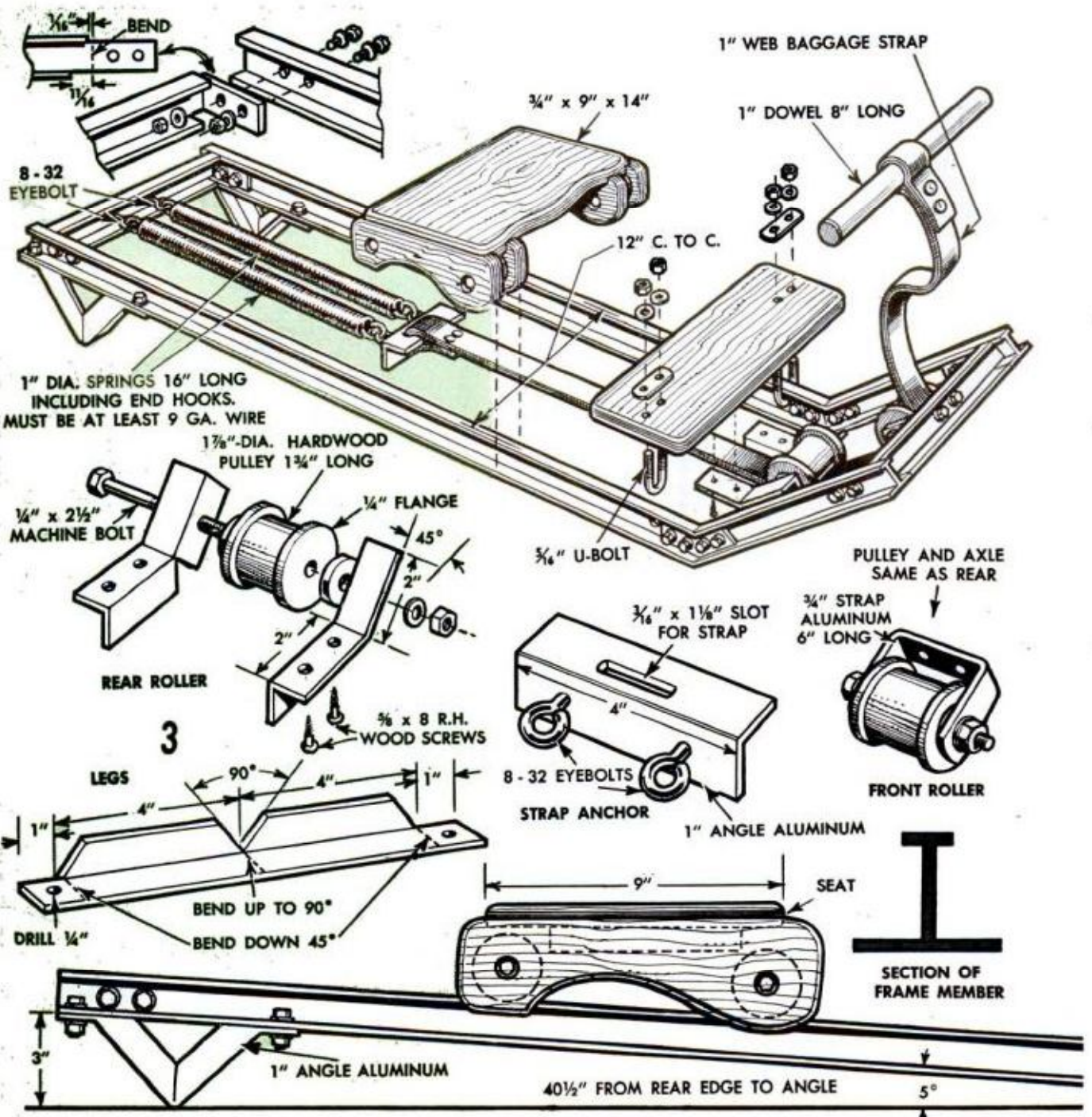

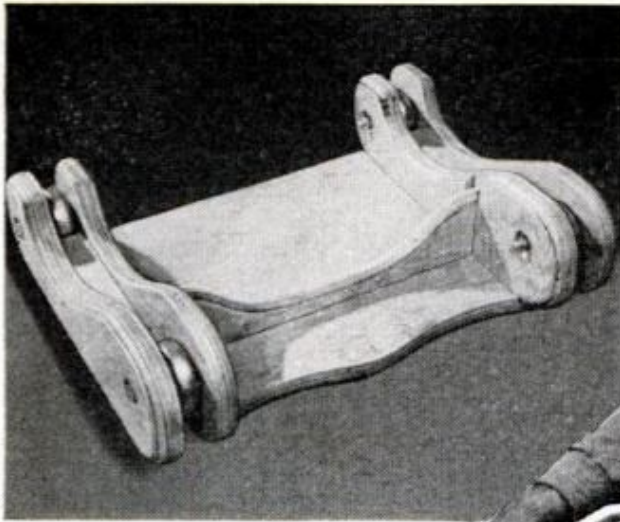

UNDERSIDE of seat shows skate wheels between the dual sides

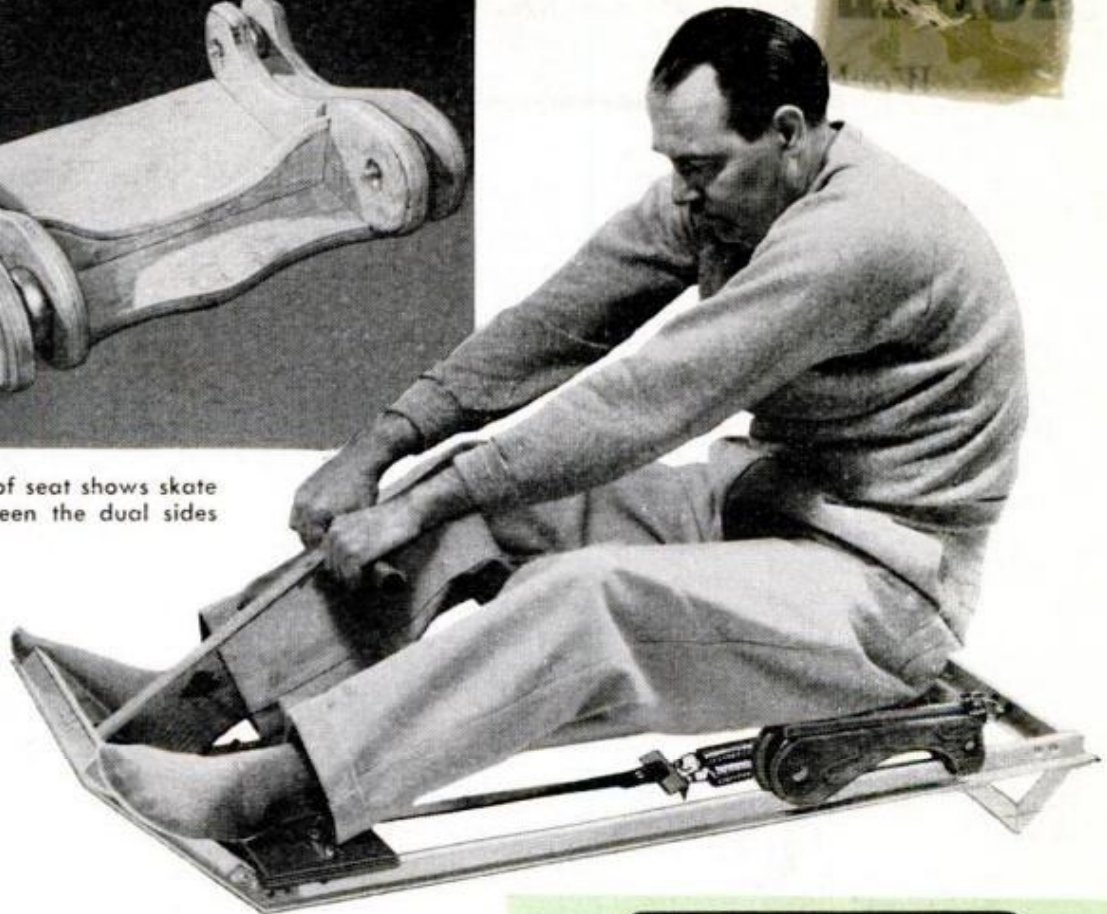

at this point. The actual center-to-center measurement from the front axle to the rear axle of the bike determines the over-all length of the supporting base. The length and actual shape of the aluminum members which brace the two front wheel supports is found by trial in bolting and bending the members to fit. The arm of the coaster brake is anchored to the fork with the same clip originally used at the rear. This completes your bike exerciser. You'll find five minutes a day of steady pedaling will develop the thighs and calves and take the creak out of middle-age knees. By pedaling in your stocking feet you'll get the benefit of massaging the arches and balls of the feet in bearing on the pedals.

The rowing machine is a popular exerciser that simulates pulling on the oars of a rowboat. The seat, which rides free of the mechanism, rolls back and forth on the rails as a pull is exerted on two heavy coil springs attached to the rear of the frame. First study the construction details in Figs. 2 and 3. The inclined rails can be made of anything handy, even hardwood. I made mine from salvaged aluminum extrusion having a T-shape section. Aluminum angle could be used equally as well. Each spring

(Continued to page 206)

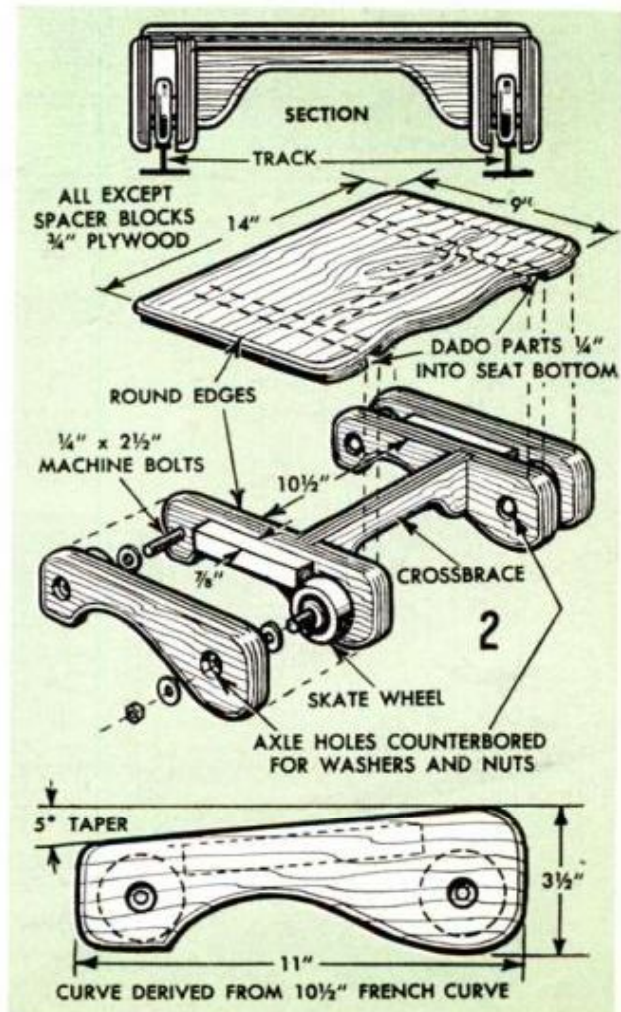

# X493

## MODEL AIR CAR OF THE FUTURE

*Working model of a ground-effect vehicle rides on a cushion of air from a model-airplane engine*

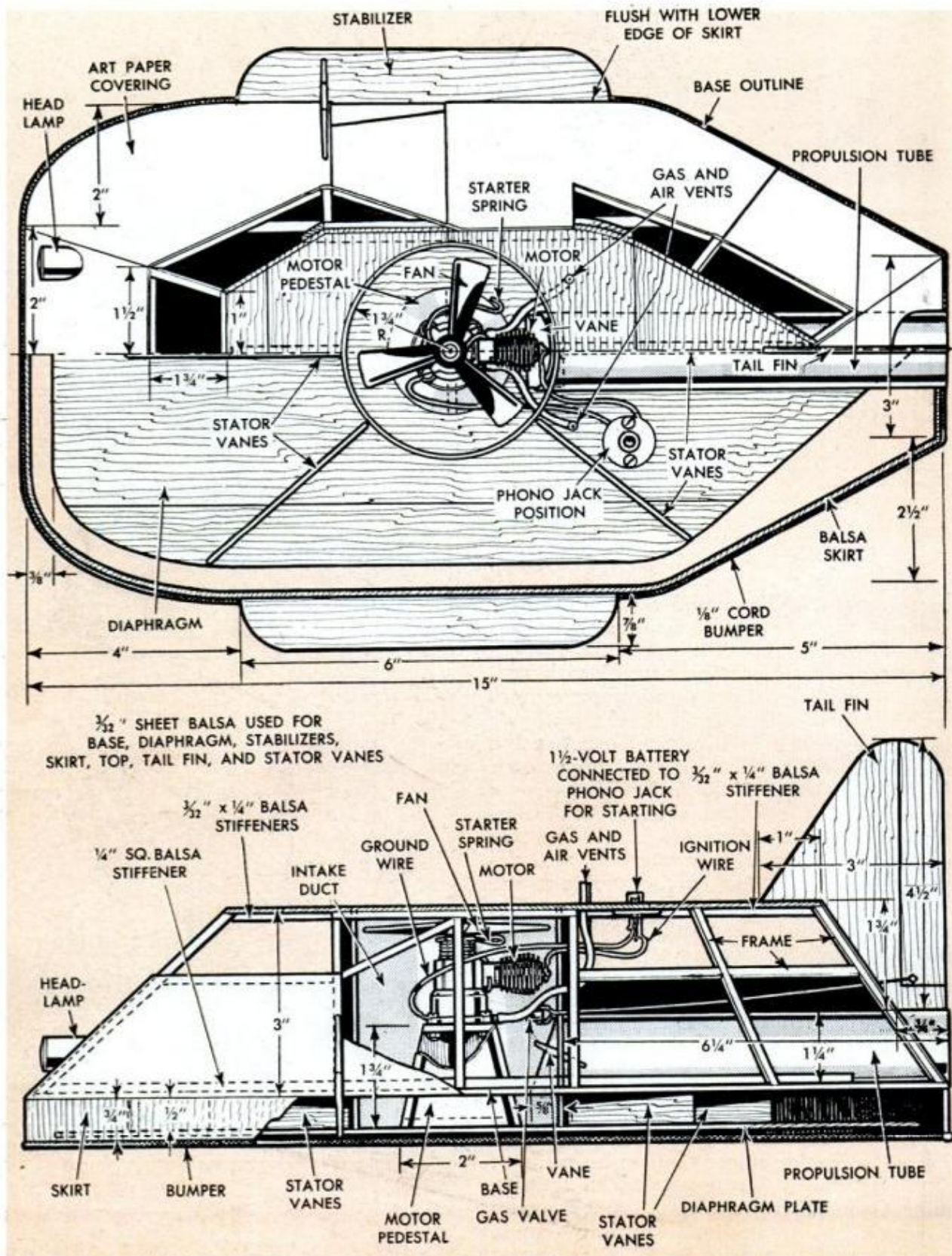

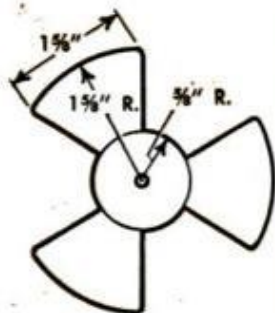

SHEET STEEL FAN

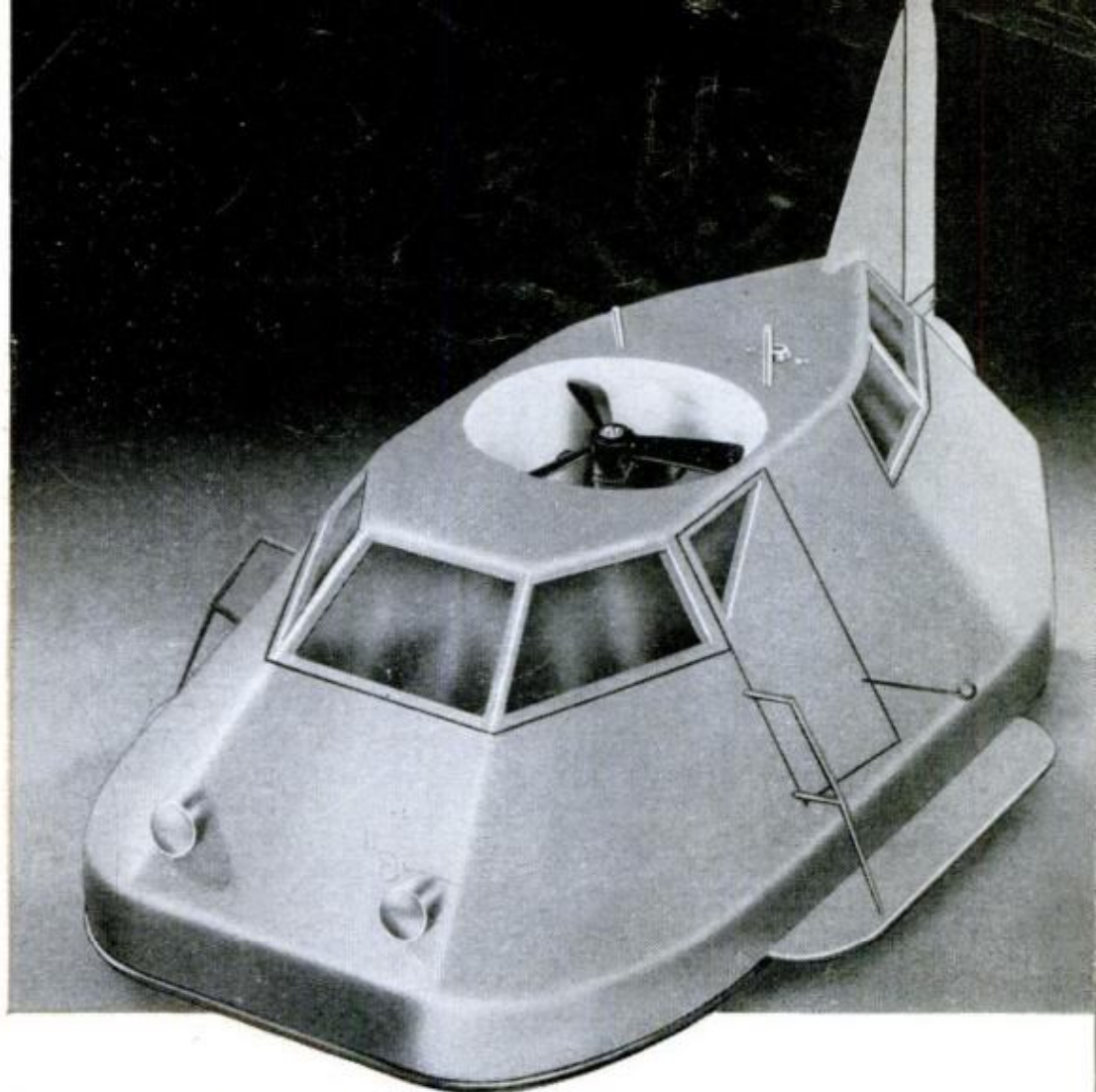

**TETHERED** to a stake the car will skim the floor around and around until the fuel runs out. Free running it will take off following a straight path  $\frac{1}{2}$  in. or so off the floor



**By Roy L. Clough, Jr.**

**W**ITH A hollow whistling note audible over the whine of its tiny engine, this advanced working model of a ground-effect vehicle skims across the floor supported on a cushion of air. What makes it go?

Air is supplied by a prop to a peripheral slot which produces a high-speed wall of air around the edge of the model to retain the lift. A separate propulsion-system tube bleeds off air for reactive propulsion—from the blower section, not the skirt. Supporting pressure is not reduced—a major fault of ground-effect vehicles which propel by dumping air pressure and lifting the skirt on the opposite side from the desired direction of travel. Stabilizers on each side act somewhat like the dihedralled wings of an airplane—if the model tilts to either side, air pressure escaping from the skirt builds up under the vane and returns it to even keel. The result is a model which can buzz along at a good clip on any level surface with a minimum of sideslip due to minor irregularities on the surface. Attached to a tether it will whizz merrily around in a circle until the fuel runs out. It rides a half inch or so off the floor even when running free. Any small airplane engine can be used to power it. If you use the engine in-

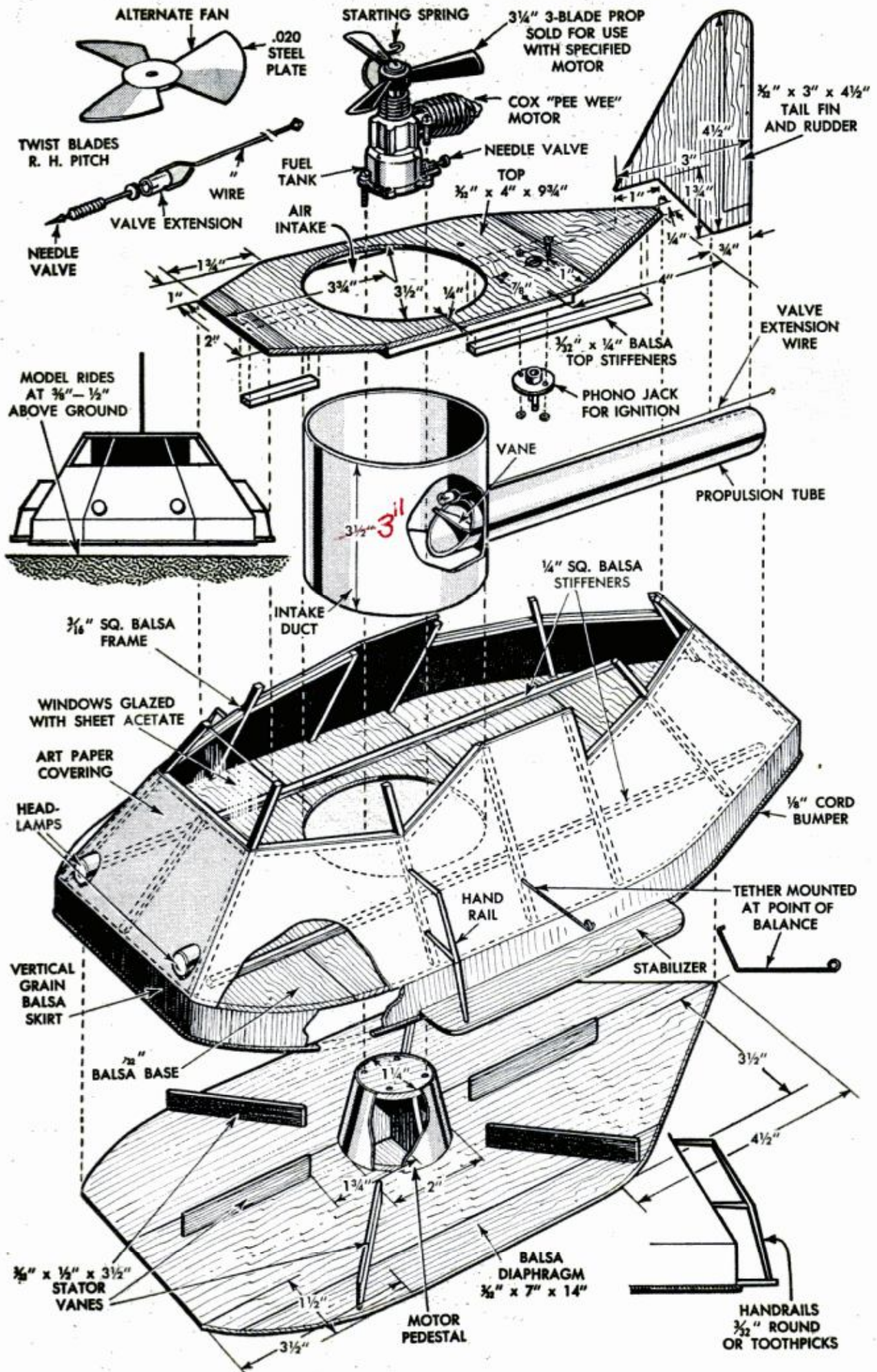



stalled in the original model, which is supplied with a three-blade prop, you won't have to make a prop of sheet metal, a pattern of which is given on page 161.

First study the cutaway drawings given to become familiar with the various parts. Then begin construction by making up the base, top and diaphragm plate from edge-glued  $\frac{3}{32}$ -in. balsa sheet. Use stiffeners where shown and allow to dry on a flat surface. Make up the  $3\frac{1}{2}$ -in. intake duct from art paper and use this as the first structural member to hold the top and base together. When dry, add the  $\frac{3}{16}$ -in. uprights which form the supports for the side covering. Next install the paper propulsion tube. Note the vane to direct airflow within it.

#### Use Balsa for Skirt

The skirt is vertical grained  $\frac{3}{32}$ -in. stock glued around the bottom edge of the base. Use basswood or balsawood and there will be no difficulty in making the bends. Cover the framework of the car body with art paper, one section at a time, beginning at the rear. Add dummy headlights and fin, stabilizing vanes and handrails. Windows may be glazed with sheet acetate or left open. Finally turn the model over and install stator vanes. Coat the interior with at least two coats of hot fuelproof dope (clear). Dope the exterior in your favorite color scheme. The original was painted light blue outside, fire red inside.

#### Engine Sits on Pedestal

Make up the engine pedestal, mount the engine and cement the pedestal to the diaphragm plate. Three coats of clear hot fuelproof dope are advisable here. Attach lead-out wires to the glow plug. Cut out a  $3\frac{1}{4}$ -in. disk of cardboard and use this as a guide in centering the engine. Actual installation is made by cementing the diaphragm plate to the stators. Use a slow-drying cement that will allow time to even up the slot around the skirt and center the engine shaft.

Run out the fuel filler tubes and engine lead-out wires and make up a needle valve extension shaft. The glow-plug wires lead to a phonograph jack—a great convenience in starting. A recoil spring starter is a must and is installed before the prop.

A length of  $\frac{1}{8}$ -in. cord is cemented around the skirt as a buffer. (A round shoestring works very nicely.) Suspend the model by the engine shaft and balance it so that it hangs evenly. Small bits of solder, coated with cement and dropped inside the body on the light side or end will do the trick. If tethered operation is desired, cement a wire hook through the covering to the upright on the central line.

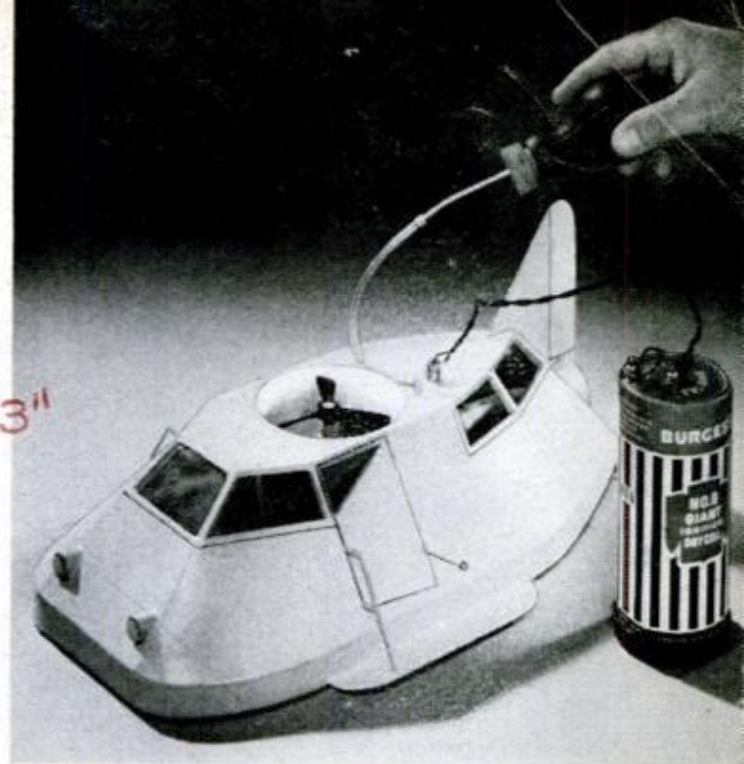

FUEL is added with squeeze bulb to plastic fuel line connecting tank. Dry cell plugs into phono jack

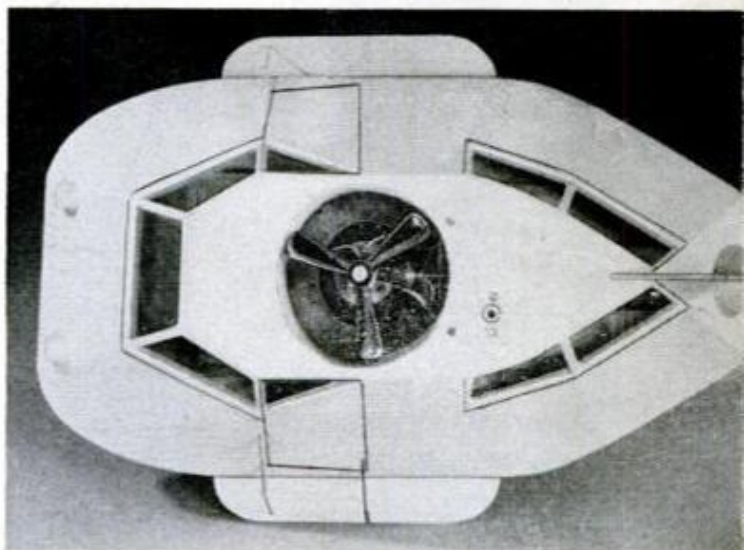

TOP AND REAR views shown above and below show engine mounted in intake duct and propulsion-tube outlet at rear. Note wire hook at door for tethering

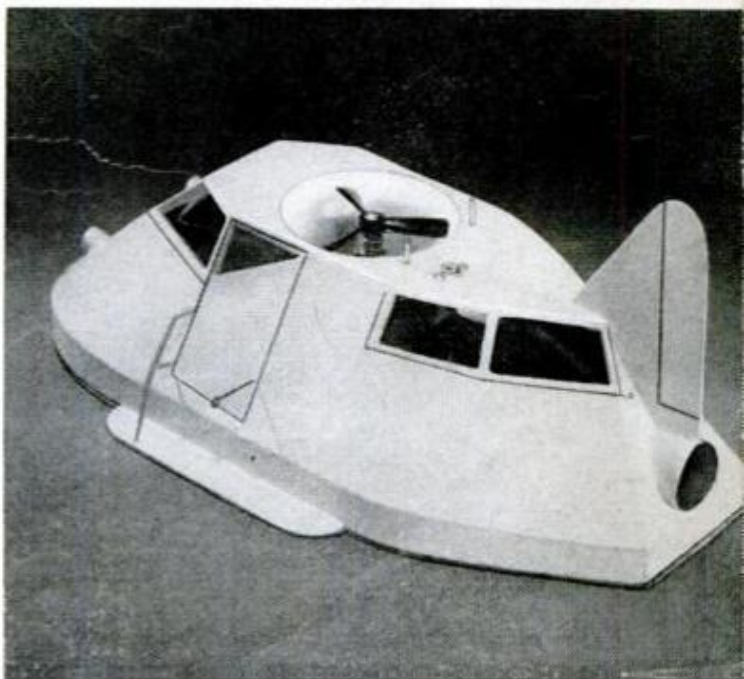

# TEE OFF With Marbles



**CEMENTED IN DIMPLES** formed at corners of trinket box, marbles provide colorful ready-made ball feet

**YOU CAN PLAY** an interesting marbles "game" with colorful glass marbles, epoxy-resin cement and wooden golf tees, combining them into unusual and attractive novelties.

To make a space-age candle holder bore and taper-ream a candle socket in a 2-in. wooden ball, and opposite this socket bore three angled holes to receive the golf tees on which marbles have been cemented.

The secret of using marbles for craft work is in obtaining good adhesion between the smooth surface and mounting cement. The marbles are washed in water and detergent or in a solvent such as lacquer thinner. The two-part epoxy cement is mixed and used according to manufacturer's instructions. When attaching marbles to golf tees, hollow out the tee to match the shape of the marble.—*Walter E. Burton*

**GLASS MARBLE** makes jewel knob for small drawer by cementing to golf tee, then gluing in hole in drawer

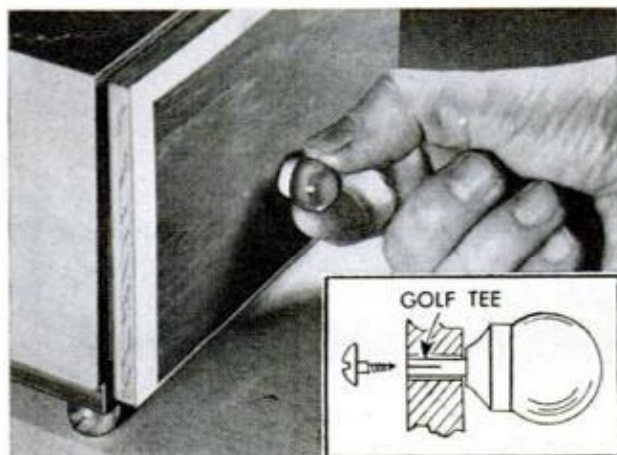

# AGAIN IN '62...

## **New car owners get ACTION with AC Fire-Ring Spark Plugs!**

Once again, AC Fire-Ring Spark Plugs are specified as original equipment on many of America's great new cars and trucks. ACs are naturally best for replacement, too.

There is just one way to assure yourself of the reliable, factory-new quality of AC Fire-Rings. Demand them by name — their *only* name! AC makes no "second line" to sell under another label. AC's rigid quality standards will not permit it.

When you need new spark plugs, consult your AC Dealer. He's a service expert with the knowledge and experience to select the exact spark plug which will give your particular car more pep and power. You'll find a new set of ACs can save you real money on gas, too.

Remember, you get them from your AC Dealer. If you care about your car, he's a mighty good man to know!

*an exclusive brand of*  
**you get ACTION with**



**FIRE-RING  
SPARK PLUGS**



1. Follow instructions on the other side

Inverted Back



GbsSlipBack-0018

Back

1. Follow instructions on the other side

1. Open the foldout page

2. Insert this sheet with

1. Front side touching the free page

2. Arrow pointing to the fold

3. Slice the folded edge

4. Close the page and slip-sheet

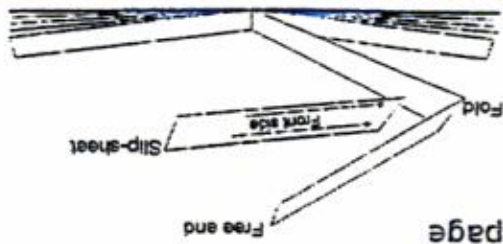

Inverted Foldout slip-sheet

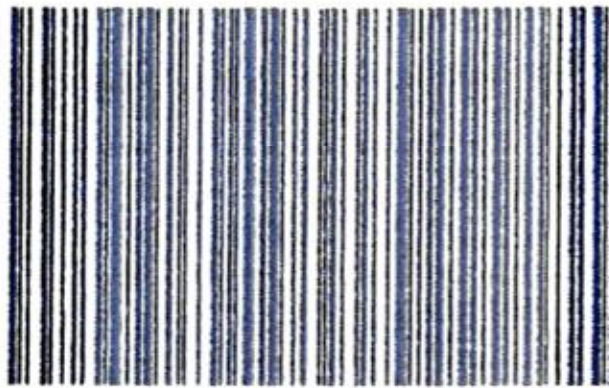

GbsSlipSheet-001



Foldout slip-sheet

Folded edge of the page

1. Open the foldout page

2. Insert this sheet with

1. Front side touching the free page

2. Arrow pointing to the fold

3. Slice the folded edge

4. Close the page and slip-sheet



## WORKSHOP HELPERS

### Glue Spreader

You'll get a better glue joint when joining large surfaces if you apply the glue with a spreader. Remove the napped cover from a screen painter and substitute a section cut from a 1½-in. cardboard mailing tube. Then pour a small quantity of glue on a piece of glass and charge the roller from this. Apply with sweeping strokes and roll out to a uniform film as in painting.—*Ken Murray*

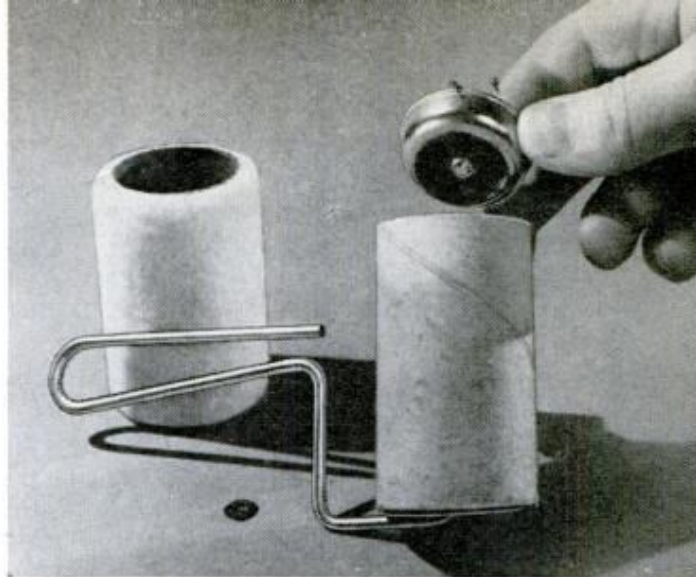

### Handles With Flair

Needle files have knurled shanks, or tangs, which serve as handles for all ordinary jobs but when you're doing some types of work requiring extraordinary precision they often are inadequate and tiring. A larger handle also makes the tiny files easier to control in close quarters. Wooden clothespins are readymade for this purpose. Drill a hole in the end of the pin the same diameter as the tang of the file, squirt in a drop or two of cement and press the tang tightly into the hole. Just split the clothespin if you need to remove it.

—*Martin D. Koehler*

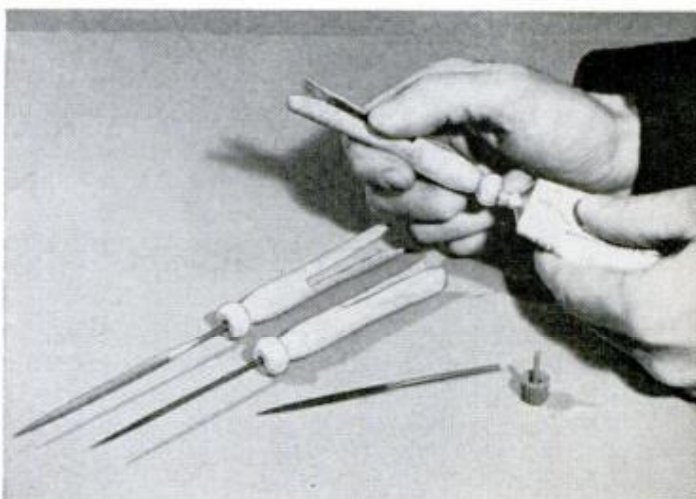

### Nail Starter

Carpenters start nails in places out of reach of both hands simply by placing the head of the nail against the cheek of the hammer and holding it in position with the thumb and third finger. Looks simple but when you try it you may find your fingers all thumbs. But without the carpenter's skill you can still turn the trick by cutting a piece of rubber from an inner tube slitting it near the center and cementing the ends to the hammer cheek as pictured. Just slip the head of the nail through the slit and it will be held in position for starting.

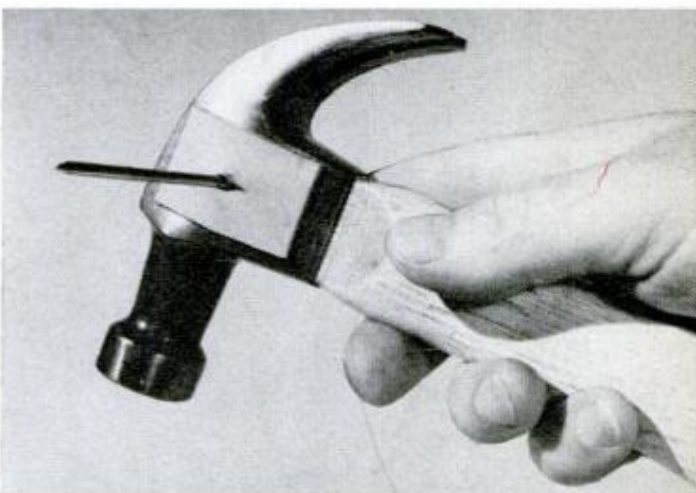

### Edge Tester

Old-timers tested the keenness of the cutting edge on a hand tool by nicking a thumbnail. If the edge was acceptably sharp, it would trim the nail easily. Unless you're skilled at this sort of thing it's not recommended. A better way is to use a scrap of clear plastic in the manner pictured. There's no danger of a slip and a badly cut finger and the plastic gives a good indication of the keenness of the edge. If the tool will trim a paper thin shaving from the plastic, you can be sure it's sharp enough for all practical purposes.

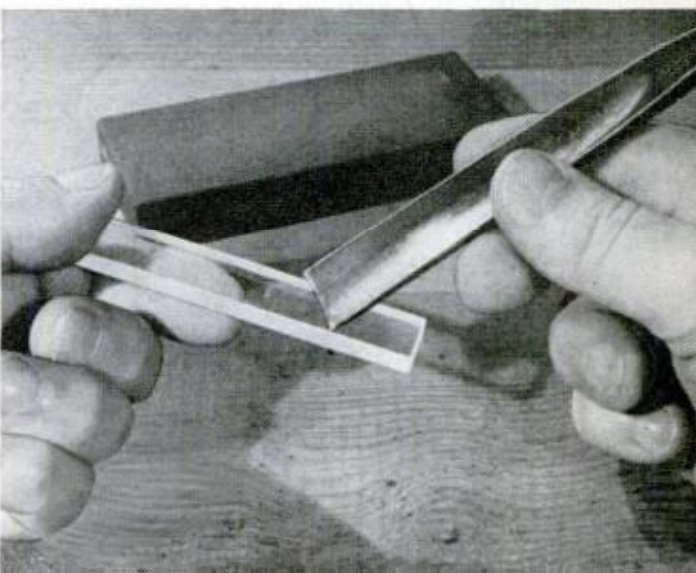

# TRIPLE-TOP FUN TABLE

By John Jetchak

## PART II

**N**OW THAT you are well into the construction of the pool-table top of the fun table, the next step is making and installing the filler blocks which rough-in the side and end pockets. Figs. 13, 14, 16 and 17 give the sizes of these blocks and show where and how they fit into the assembly. Note that the side-pocket filler blocks fit flush into the side-pocket openings already cut in the particle-board bed, Figs. 13 and 14, but that the corner-pocket fillers are fitted and glued in the open corners above the bed shelves, Fig. 17, the right-hand detail. The corner fillers are made by sandwiching and gluing three pieces of  $\frac{3}{4}$ -in. stock, then squaring to the over-all size given and bandsawing to a 2-in. radius as in Fig. 16.

Coming up next are the fillets, Fig. 19. The fillets for the head-corner pockets (those at the end of the table opposite the ball-return opening) are shaped as in the

upper detail in Fig. 19. These serve to give the balls that drop into the head pockets the initial start along the tunnels and into the return at the opposite end of the table. Now note the corner fillets in Fig. 19. The part A, Fig. 19, serves as a deflector for balls coming down the long side tunnels from the head and side pockets, and must be made right and left hand. The whole assembly, including the fillets and deflectors, prevents balls from lodging in the corners. These parts are glued in place. Now the bottoms of the ball returns are covered with flexible countertop material. This material which dampens the sound of the rolling ball, is cemented in place with contact cement and it's important to make sure that it takes the curvature of the round-bottom groove in the ball return.

At this stage you can cover the particle-board bed with felt, or billiard cloth. You should first position the bed beforehand and

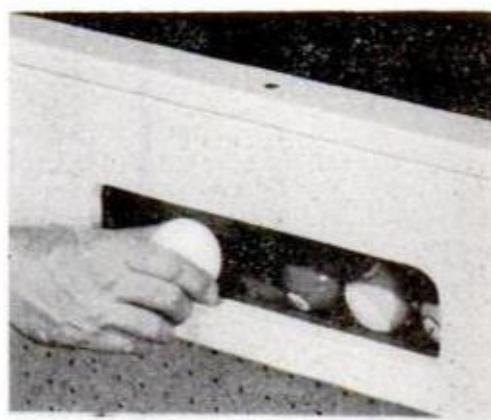

**BALLS IN PLAY** that drop into side and corner pockets are automatically returned to the ball-return opening in the end rail of the table, pictured above and at the left. Balls are easily reached through opening

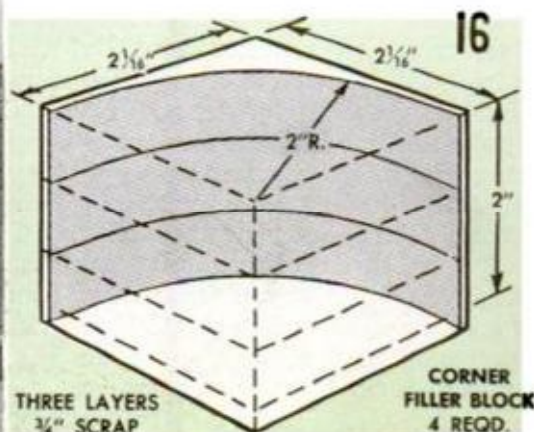



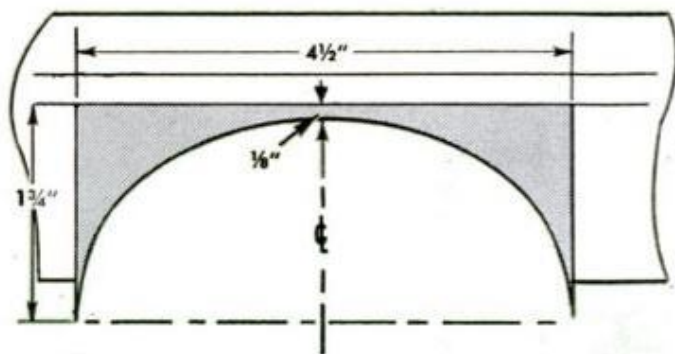

**13** FILLER BLOCK FOR SIDE POCKET CUT FROM 3/4" PLYWOOD SCRAP

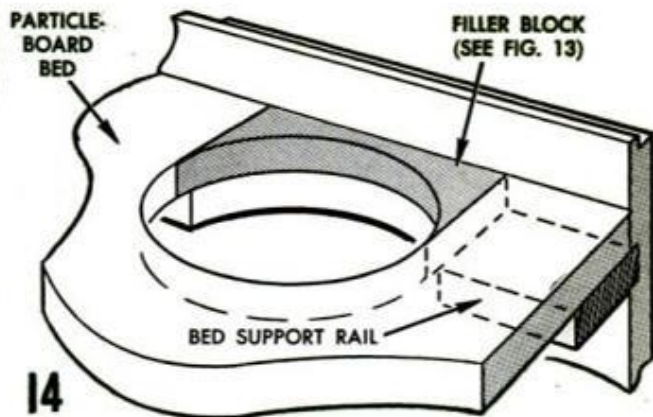

**14**

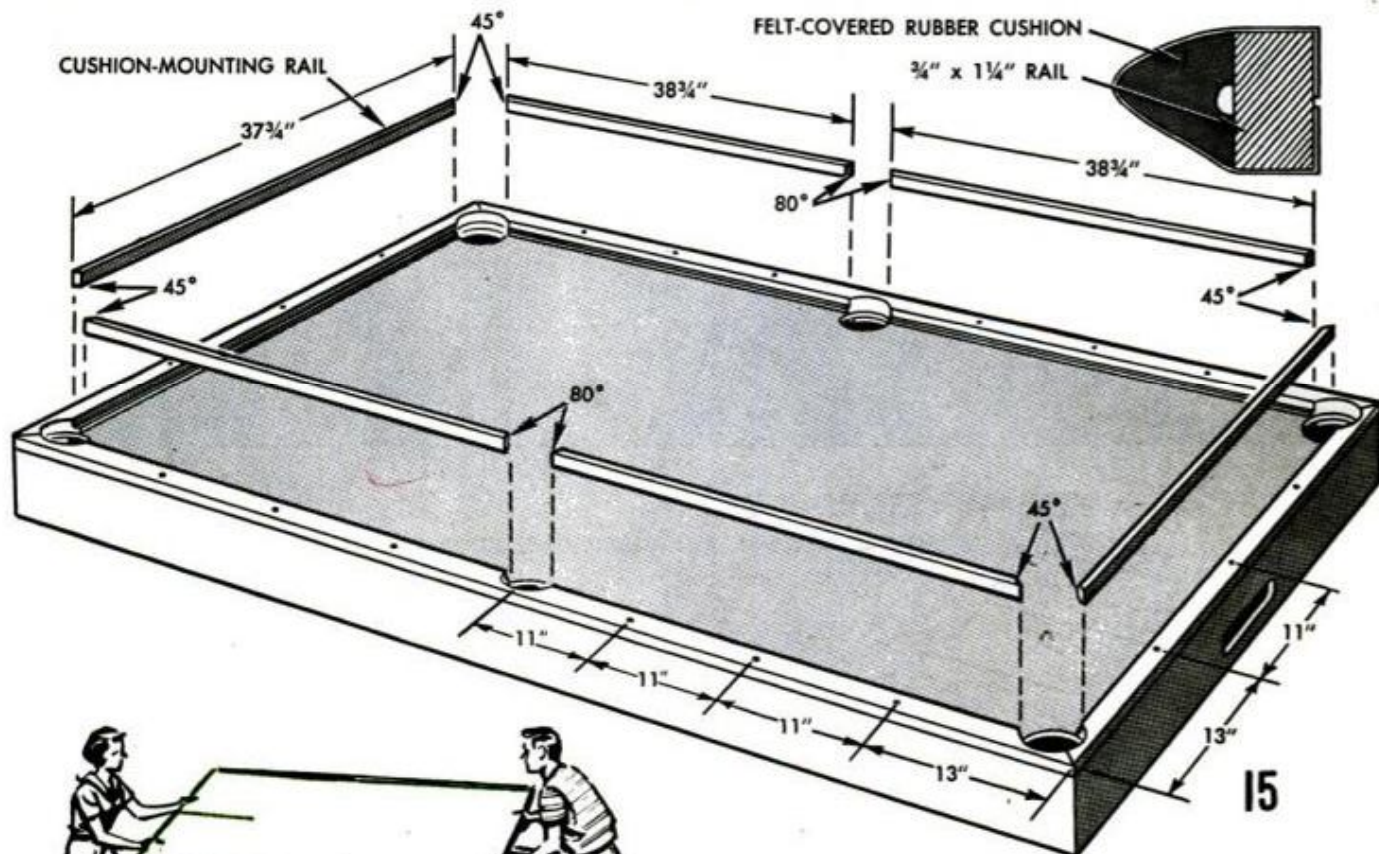

**15**



FILLER BLOCKS for side and corner pockets are shown in position in Figs. 13, 14 and 17 while the cushion-mounting rails are dimensioned above and also in Part 1, Fig. 3. If you tire of billiards, simply place the table-tennis top over the billiard table as at left

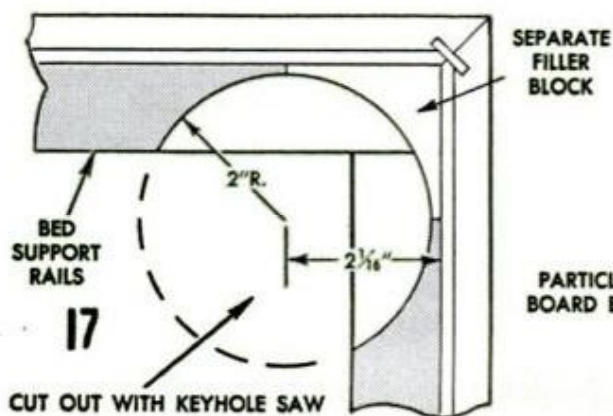

**17**

CUT OUT WITH KEYHOLE SAW

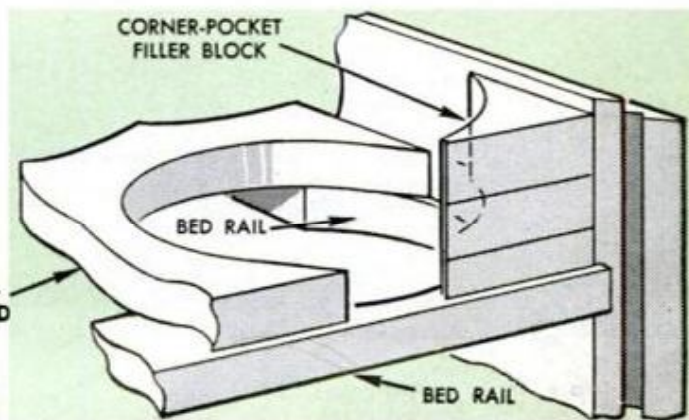

**TRIAL ASSEMBLY** of the several parts of the table rail is pictured below and detailed in Fig. 18. For a sectional view of complete assembly see Fig. 3, Part I

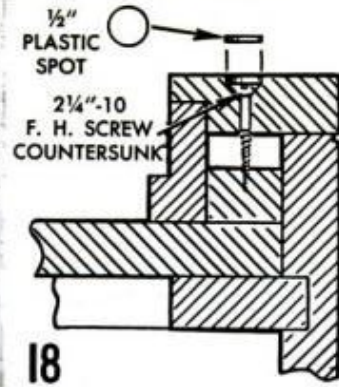

18

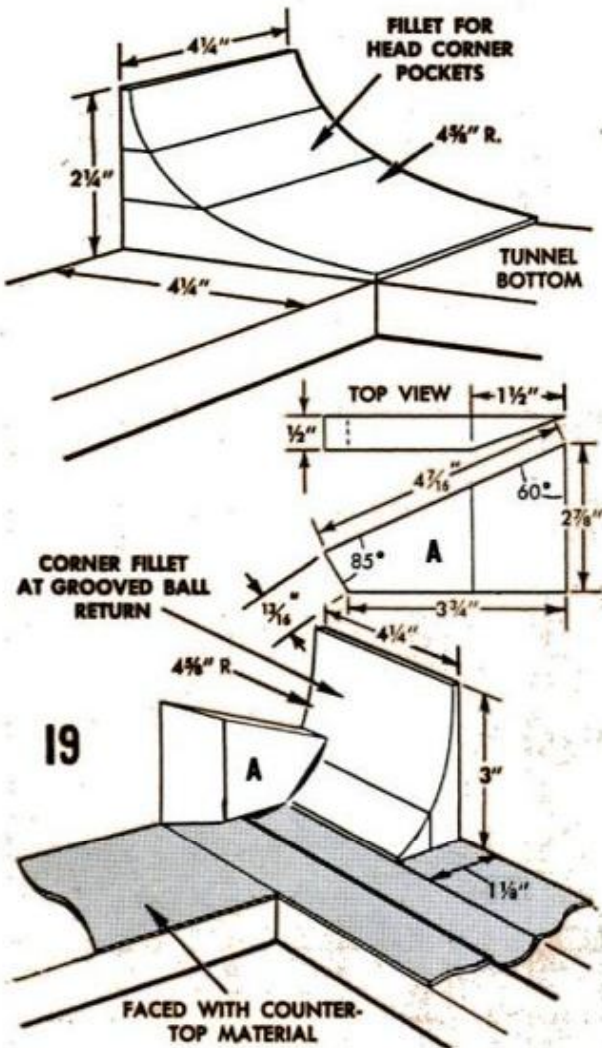
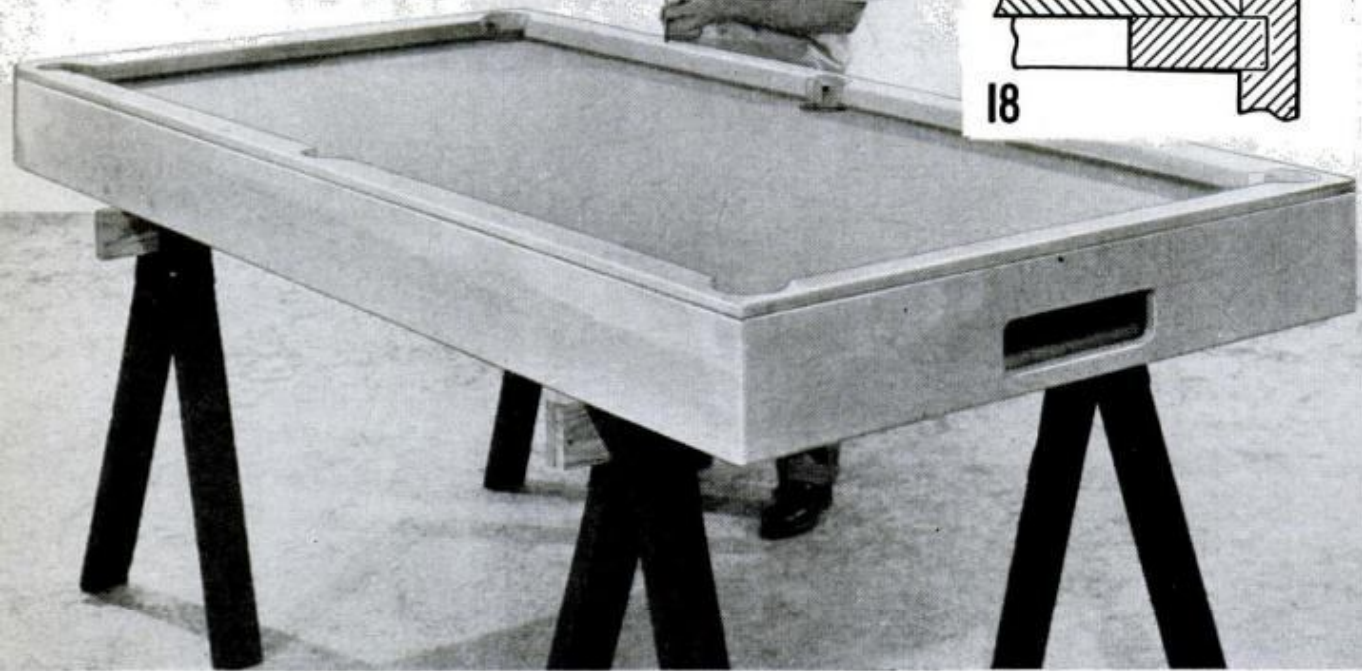

19

fasten it temporarily to the shelf members with one screw on each side of each pocket. Once done it is removed. Cut the cloth about 2 in. larger each way than the overall size of the bed. Position the felt, bring it over the edges of the bed and begin tacking, following the tacking sequence in Fig. 21. It's important that this be followed in detail and that the tension on the felt be just sufficient to remove all wrinkles. Tension should be kept uniform in two directions. When the tacking sequence in Fig. 21 has been completed, work the ball openings as in Fig. 24, making the initial end-pocket cuts as in Fig. 23.

Set the felted bed aside and install the ball-retarding flaps in the side and end pockets next, Fig. 22. The flaps which serve to cushion the straight drop of a ball, are supported with the free end in the pocket openings by means of holders which are three-piece assemblies made up of one piece of 1/4-in. plywood 4 1/4 in. wide and 4 3/4 in. long, a spacer of the same width but only 3 1/4 in. long and a wood block 3/4 x 2 7/8 x 4 3/4 in. The spacer is cut from the same material as the flap. These parts are assembled as indicated and glued in place in the tunnels with the slotted (the slot being formed by the placement of the parts) end flush with the edge of the ball pocket, one holder to each of the six openings. The flaps are cut to size, fingerholes cut through as indi-

cated, and then they are inserted into place in the open slot in each holder, Fig. 22. This manner of assembly permits easy replacement of the flaps after they weaken and possibly break from long usage. Note that the shape of part A, Fig. 19, also serves to tilt the flap as the ball drops.

Now refer to Fig. 15 and also Part 1, Fig. 3. The sectional view, Fig. 3, shows a  $\frac{3}{4}$  x 1-in. clamping strip between the end rail (also the side rails) and the rabbeted riser, part B, which supports the inner rabbeted edge of the top rail. Note that this strip serves a threefold purpose—it clamps the bed firmly to the supporting shelf members, it provides a screw base for the countersunk screws anchoring the top rail and it serves as a nailing strip for the nails holding the riser, B. The whole assembly is easily removed, permitting the bed to be refelted when necessary. Still referring to Fig. 3, Part I, note the  $\frac{1}{16}$  x  $\frac{1}{4}$ -in. rabbet on the lower edge of part A. It is not shown elsewhere on details of part A. Its purpose is to permit shifting the cushion-mounting rail (part A) in order to hold the outer edge, or apex, of the cushion at a point exactly  $1\frac{3}{16}$  in. (for a  $2\frac{1}{4}$ -in. ball) above the



**CORNER AND SIDE-POCKET LINERS** are made from No. 2½ tin cans lined with a flexible countertop material

surface of the felted bed. This is important.

Referring now to Fig. 15, cut the clamping strips, the risers and the mounting rails and try them for fit with the bed in position. Once sure of the fit of the parts, glue the rubber cushions to the mounting rails with a special adhesive and wrap with cord at spaced intervals as in detail A, Fig. 20. Be

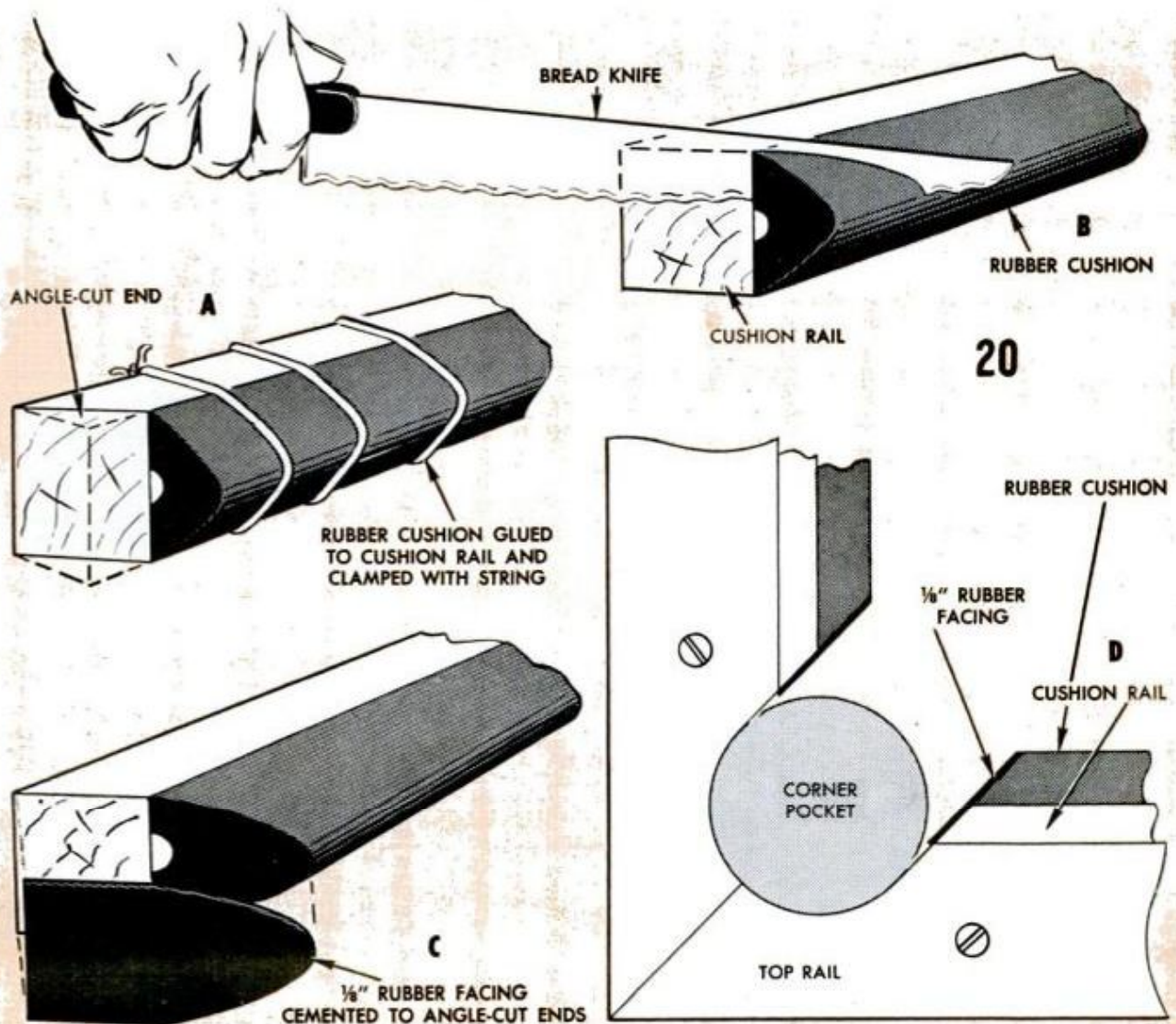

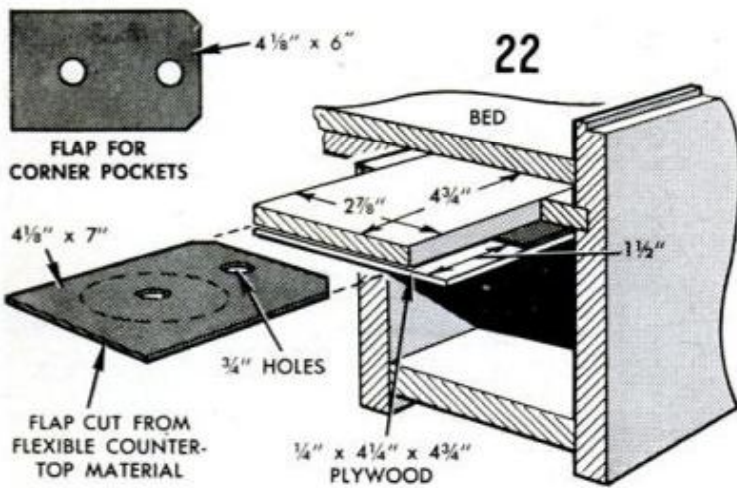
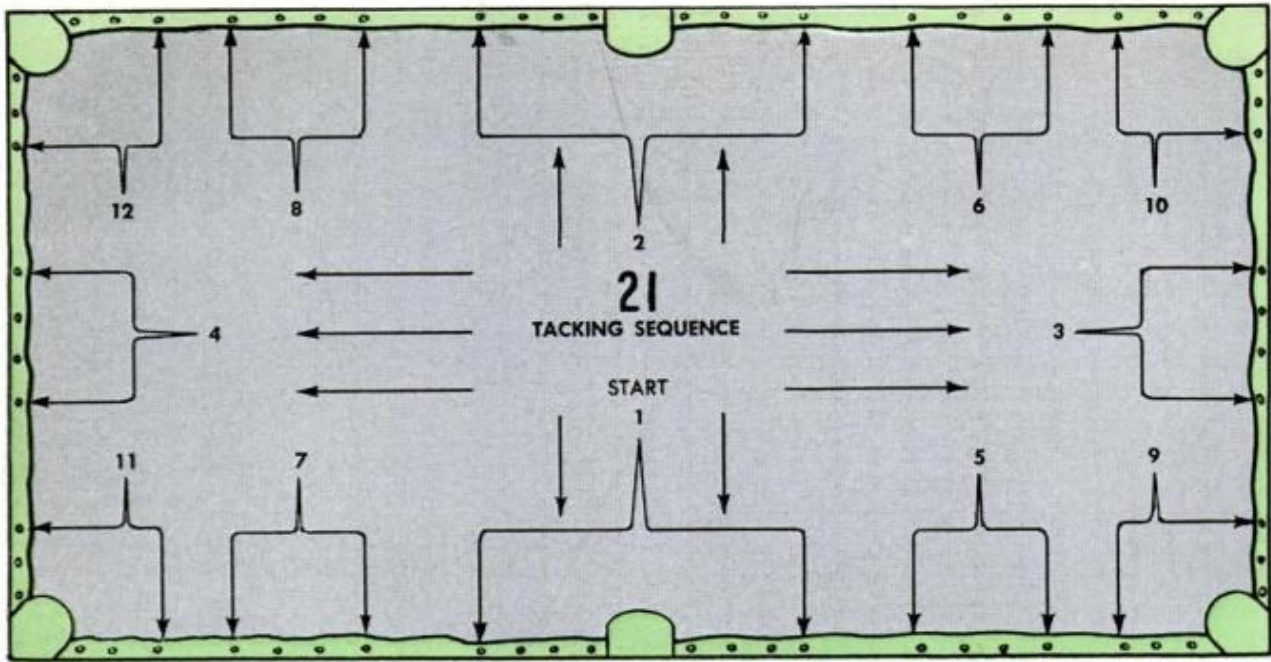

**RETARDING FLAPS** are placed in the side and corner pockets as detailed above. These flaps fit loosely into holders made as detailed and can be replaced when worn after long use. Below, bed felt is cut and fitted around edges of ball-pocket openings in particle-board bed. Patterns show how to make cuts

sure to allow sufficient cushion material at the ends of each member of the mounting rail for trimming as in detail B, Fig. 20. Use a sharp bread knife for trimming flush with the miter at the ends. Then apply the rubber facing as in detail C and trim to the contour at the mitered ends of the mounting rails. Note in detail D, Fig. 20, that the rubber facing extends its full thickness into the pocket.

Now comes the application of the felt covering to the cushions. Note in Fig. 26 that the felting goes all the way around both cushion and rail and is butted and tacked on the back face of the rail. Cut the strips of felt 5 in. wide. Fig. 25 gives the pattern for cutting the felt for a neat fit around the rubber facing at the ends of the cushion

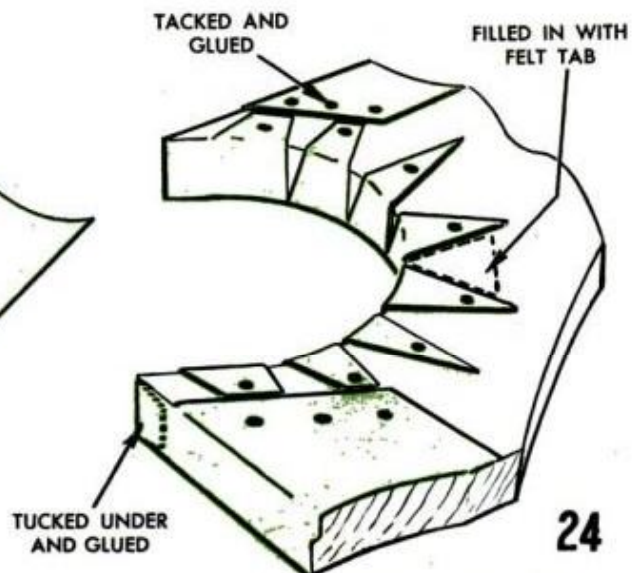
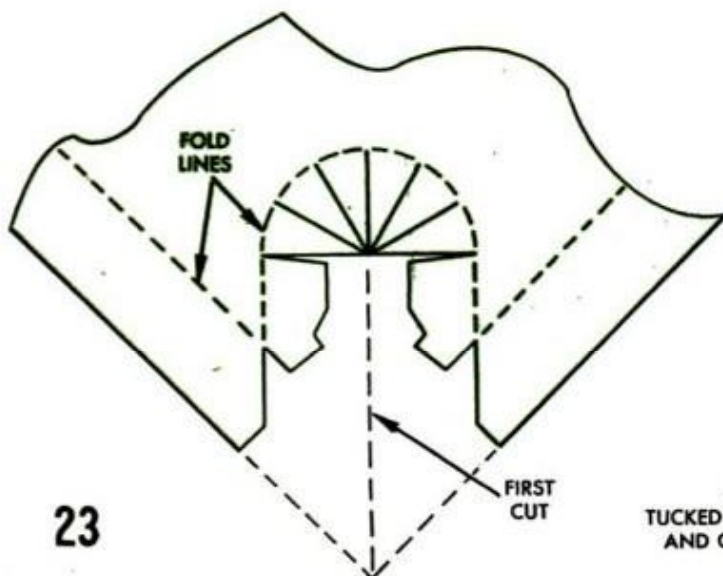

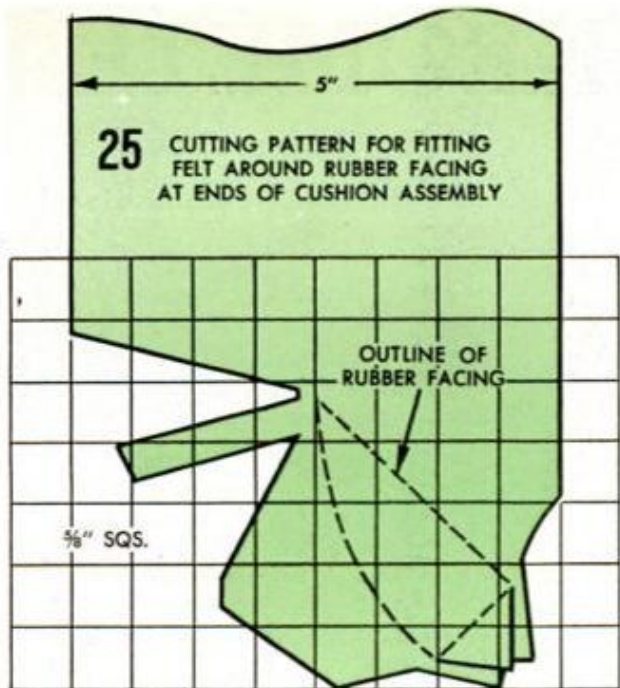

assembly. Work carefully on this job so that you get the felt in place without any wrinkles. Temporary rows of tacks are used to hold the felt while the glue dries. The tacks are later removed.

Refer again to Part I, Fig. 3, parts A and B. Note that in the assembly detailed the riser B is screwed to the cushion mounting rail A and the riser B is then nailed and glued to the clamping strip. Space the nails about 6 in. apart. It's a good idea to drill undersized pilot holes for the nails to prevent splitting of the clamping strip. Four screws are used to fasten each clamping strip to the bed. These are located 3 1/2 in.

(Continued to page 215)

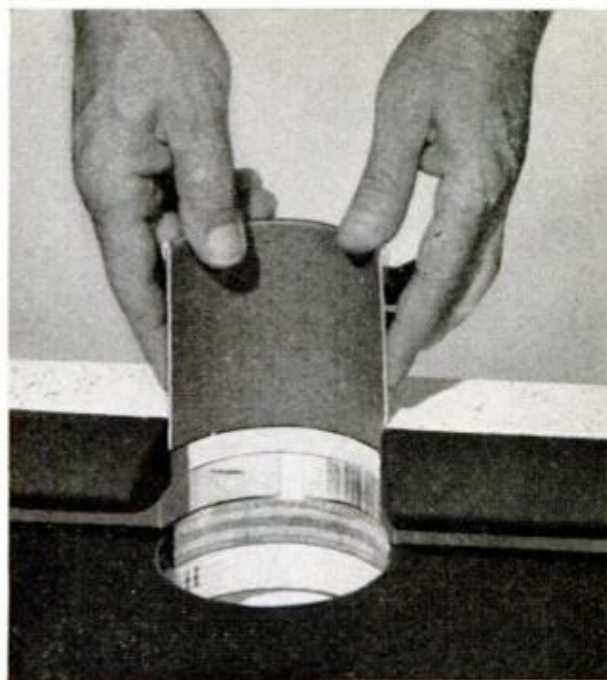

**BALL-POCKET LINERS** for side pockets differ slightly from those fitted into corner pockets as you will see from Fig. 27 and also from photo at the lower left

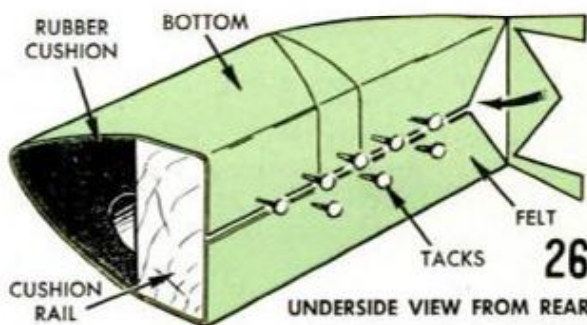

**RUBBER CUSHION** and rail are covered with felt as in detail. Note that rows of tacks are staggered.

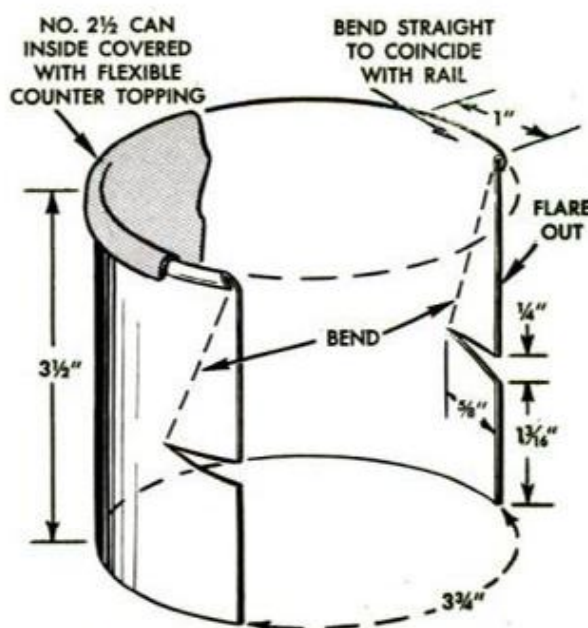
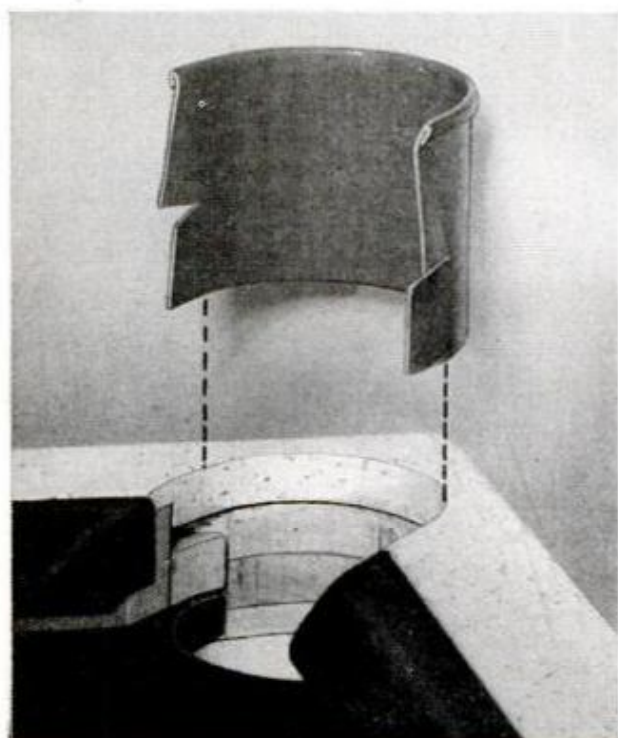

**27** HOW METAL CORNER-POCKET LINERS ARE FORMED FROM TIN CANS

# SLING PSYCHROMETER

By Duane Loewen



IT'S THE high humidity that makes you feel uncomfortable on a summer day. But in winter low relative humidity can make you uncomfortably chilly in a warm room. Modern homes, gasketed and weather stripped, insulated and vapor sealed, are almost airtight. That's why it's becoming necessary to condition the air in the rooms winter and summer by dehumidifying in summer and humidifying in winter to hold relative humidity at comfortable levels during seasonal extremes. But before you can control humidity in the home you must have some method of measuring it accurately. That's why it will pay homeowners to make this simple wet-bulb hygrometer, or more properly, a sling psychrometer.

## HOW IT WORKS

Relative humidity is the percentage of saturation of the air measured from 0 to 100 percent, the latter figure representing the maximum amount of moisture that a given amount of air will hold at a given temperature. This is inversely proportional to the rate of evaporation from any moist object, and is the principle on which the psychrometer works. Evaporation of moisture on the bulb of one thermometer (two are used) lowers its reading relative to the other thermometer which gives the ambient (actual) room temperature. The readings are compared and then are converted to relative humidity, using the table on the opposite page.

## HOW IT'S MADE

Details on the opposite page show clearly how to construct the psychrometer. Two ordinary matched thermometers (they must read alike at any given temperature) are joined back to back and attached to a length of light wire chain. The free end of the chain is joined to a 6-in. length of hardwood dowel. To one of the thermometers you cement a plastic vial to hold a cotton-cloth wick which is inserted in the vial and carried up around the bulb of the thermometer glass. The wick should entirely enclose the bulb; hold it in place with a loop of thread tied loosely just above the bulb. Before using, be sure screws and bolts holding the two thermometers and chain are tight.

## USE OF INSTRUMENT

It will be noted that distilled water is called for in the materials list. This is not essential unless your water is very hard, that is, has a high mineral content. Then it is best to use distilled water. The small quantity required can be obtained by condensing steam from a teakettle. The first step in the use of the psychrometer is to place a few drops of the distilled water in the vial, enough so that the wick is saturated. Then, immediately whirl the thermometers slowly in a clear area in the room at a uniform rate, continuing until the wick is dry and the wet-bulb thermometer will not drop further in temperature. This usually takes two to three minutes. Then quickly take the readings of both thermometers and compare with the table which converts the readings to relative humidity. As an example, suppose the dry-bulb thermometer shows a temperature of 72 degrees, but the wet-bulb thermometer shows only 59 degrees. As you will see from the table the humidity would be 46 percent, which is a good average for health and wintertime comfort.

## MATERIALS

Two matched thermometers (see text)  
Light chain (approximately 12 in. long)  
Plastic vial  
Wick (made of open-weave cotton)  
Hardwood dowel ( $\frac{1}{2}$  x 6 in. for handle)  
Distilled water (see text)

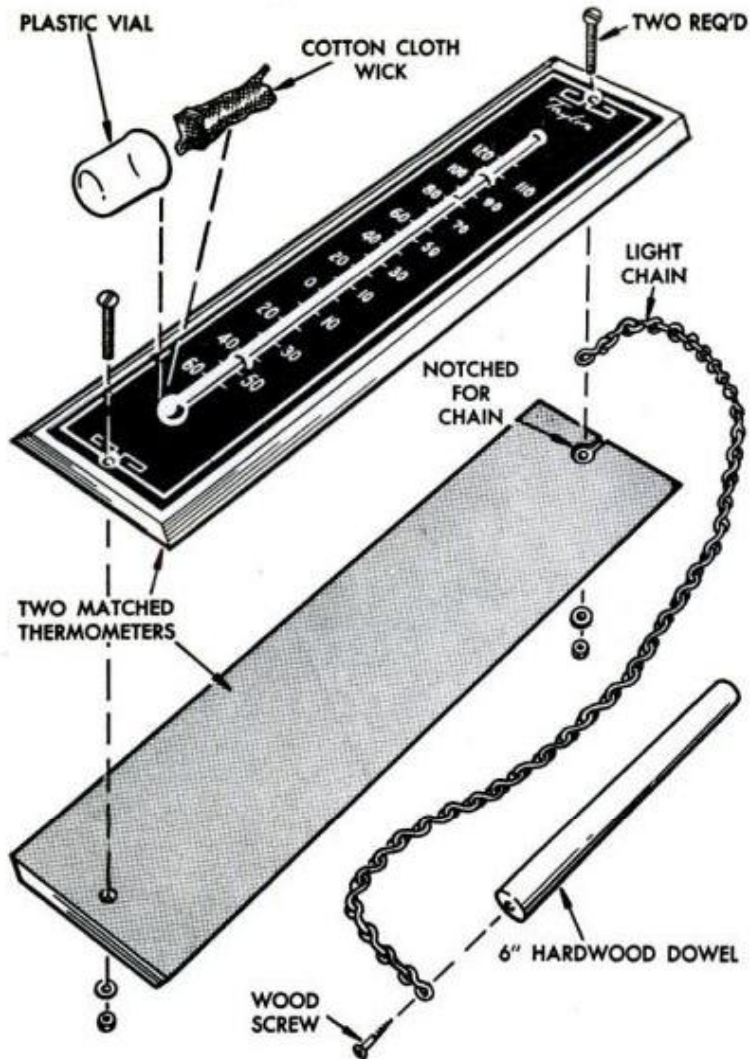

### RELATIVE HUMIDITY TABLE

#### Wet Thermometer (F)

	70	69	68	67	66	65	64	63	62	61	60	59	58	57	56	55	54	53	
	80	61	57	54	51	47	44	41	38										
	79	63	60	57	54	50	47	44	41	37									
	78	67	64	60	57	53	50	46	43	40	37								
Dry Thermometer (F)	77	71	67	63	60	56	52	49	46	42	39	36							
	76	74	70	67	63	59	55	52	48	45	42	38	35						
	75	78	74	70	66	63	59	55	51	48	44	40	38	34					
	74	82	78	74	70	66	62	58	54	51	47	43	40	37	34				
	73	86	82	78	73	69	65	61	58	54	50	46	43	40	36	33			
	72	91	86	82	78	73	69	65	61	57	53	49	46	42	39	35	32		
	71	95	90	86	82	77	73	69	64	60	56	53	49	45	41	38	34	31	
	70		95	90	86	81	77	72	68	64	60	56	52	48	44	40	37	33	30
	69			95	90	86	81	77	72	68	64	59	55	51	47	44	40	36	32
	68				95	90	85	81	76	72	67	63	59	55	51	47	43	39	35
67					95	90	85	80	76	71	67	62	58	54	50	46	42	38	
66						95	90	85	80	76	71	66	62	58	53	49	45	41	
65							95	90	85	80	75	70	66	62	57	53	48	44	
64								95	90	85	79	75	70	66	61	56	52	48	
63									95	90	84	79	74	70	65	60	56	51	
62										94	89	84	79	74	69	64	60	55	
61											94	89	84	79	74	68	64	59	
60												94	89	84	78	73	68	63	



## WAFFLER

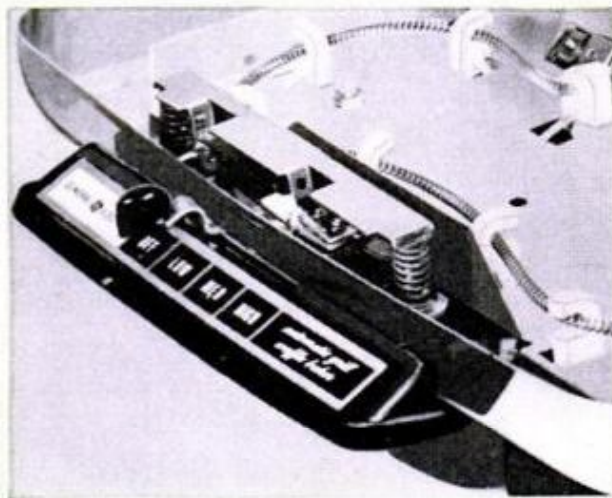
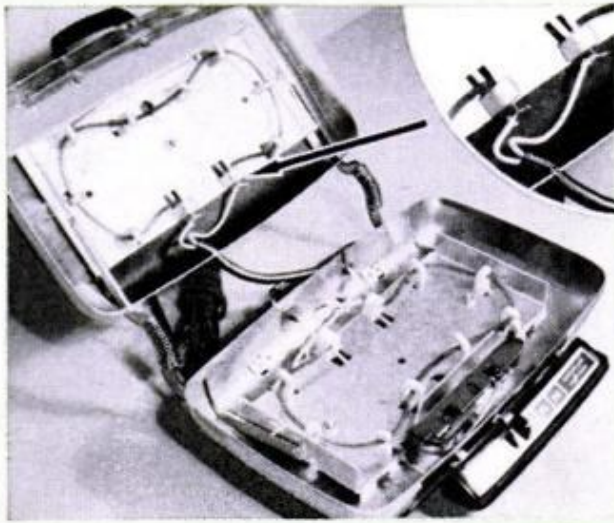

# Household

**L**IKE ALL other household appliances made by reputable manufacturers, electric waffle makers, or waffle irons as they are still very often referred to, will take a lot of usage, many, many hours of it without ever a service break. But some morning your waffle maker may refuse to work. And then what? You go without your favorite breakfast until you fix the appliance.

First, you remove the waffle grids and once you locate the screws, again comes the caution, go easy on that screwdriver! Note the three photos of the insides of a typical automatic waffle maker at the left. Although your waffle maker may not look just like this one when it's opened, in the essential parts they all are pretty much alike. First of all examine the cord and don't just look casually at the ends of it; go over every inch of the cord to catch any breaks or frayed portions, either at the plug, the terminals or any point in between. If the cord shows defects, and it may if it's an older one, it should be replaced. Don't attempt to repair it by taping the breaks.

Other especially vulnerable parts of a waffle maker are the ceramic insulators which support the heating elements. These are shown in the inset and pointed out by the arrow in the upper photo at the top of the page. Take a good look at each of these supports and if any are cracked, replace them. These insulators in most waffle makers are the sole support of the elements and if one or two let go, the element may sag and touch the metal of the housing. Should this hap-



# Appliance Fix-It File

pen one could get a nasty shock when using the waffle.

Then there are the contact points, and the thermostat (see arrows A and B in the photo at the right) which usually is of the bimetal type. The sliding temperature selector at the front of the appliance (on some waffle makers this is the rotating type) limits movement of the thermostat and therefore controls the length of time the elements are allowed to heat. As the points make contact and break often, they are subjected to carbon formation and pitting.

To keep the waffle in working order the points should be cleaned and brightened periodically. This usually can be done by stroking a length of cardboard between the points when they are closed. If they are pitted, then stroking the meeting surfaces with a strip of fine sandpaper should do the trick. Work carefully so that you do not spring the points out of line.

If your waffle operates too hot or too cold at a given temperature setting, this gen-

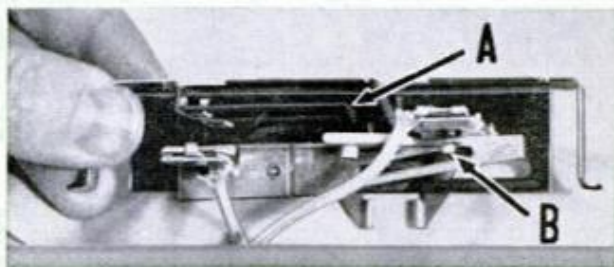

erally can be corrected by bending the thermostat arm closer to, or farther from, the points. Or, if the unit appears to be irreparably damaged, replace it.

Broken elements, lower photo above, should be replaced. Should it be necessary to replace only one element due to breakage, it is advisable to replace both. Then the elements will operate with equal efficiency.—*John Pennington*

---

## How to Clip and Save

DESIGNED to be clipped and punched for insertion in a standard loose-leaf binder, each page of the beginning article of the series (October) should be pasted to a cardboard backing. Then as succeeding articles appear, the left-hand page is pasted to the back of the previously mounted right-hand page and so on, eventually making a durable reference file to check when trouble shooting any common electric household appliance



# FUN WITH "SQUOZEN" SPONGES

Watching these magic seeds and snake pills come to life holds a curious fascination for both young and old. What appears to be a tiny inanimate seed wiggling and squirming in water, growing larger and larger by the second and finally stretching out to many times its former size is simply a highly compressed piece of sponge.

The accompanying picture sequence tells the story. The important thing is that you use only a fine-grain cellulose sponge. Such sponges are readily available at most any local photo shop, and the larger the sponge the better. The compressed pills are "frozen" in compressed form by baking at low heat in the kitchen oven until they are as hard as stones. They can be used over and over by merely recompressing and reheating.—Thomas C. Thomas

*PO Box 236  
Sedona, Arizona*



*Two little pills . . .*



**SLICES OF SPONGE** should be about  $\frac{1}{4}$  in. thick and can be cut with a bread knife or fine-tooth saw. As for the silhouette shapes, below, the sky's the limit



**FOR EXTRA DRAMA** dye the sponge a vivid color with Rit dye before slicing after sponge is dry. Bind the compressed sponge with turns of thread, below

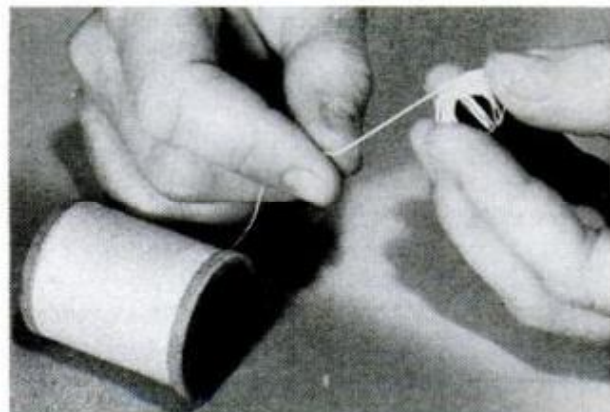

POPULAR MECHANICS



*dropped in water..*



**HOLY MACKEREL!**



**SNAKE PILLS** are easier to make than silhouette seeds. After block of moistened sponge is compressed and dried, pills are punched out with paper punch, below

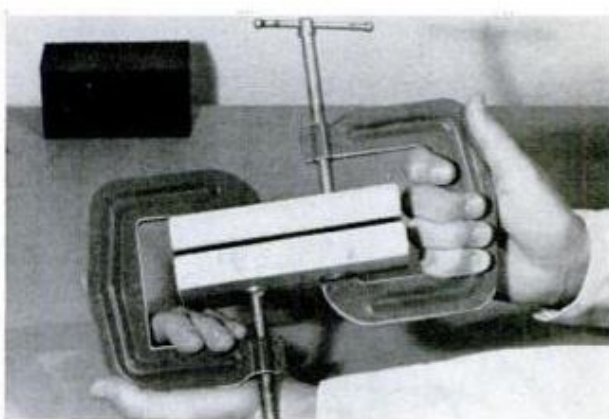

**HERE'S HOW** moistened block of sponge is compressed by clamping between wood blocks until  $\frac{1}{4}$  in. thick. Below, snakes are resqueezed with clothespin for reuse

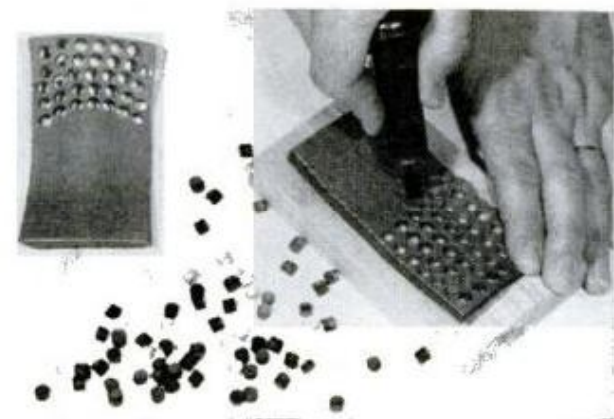

# Solving HOME PROBLEMS



**1. NEXT TIME** friend wife asks you to hold a skein of knitting yarn while she rolls it in a ball, show her how a couple of spring-type clothespins and a waste-basket will do nicely in your sudden absence. All she need do is to clip the pins to the rim of the basket, spacing them to suit the length of the skein, and loop the latter around the upright pins

**2. TO CONCEAL THE CORD** from a wall-mounted clock, drill a  $\frac{3}{8}$ -in. hole about 2 in. below the support hanger and drop a length of furnace chain down inside the wall. Remove a knockout from the outlet box, catch the end of the chain with a paper-clip hook, then use it to lead the cord through a hole drilled in the cover plate and up inside the wall to the hole

**3. PAINTING A PICTURE FRAME** always brings up the problem of finding a place to hold the frame while making those last few strokes with the brush. The next time you finish a frame, try tacking a thin strip such as a wood lath across the back. You'll find that the whole job will go faster, and when the frame is thoroughly dry the strip can be removed easily

**4. FROZEN SINK DRAINS** in vacation cabins and second homes can be prevented by soldering a pet cock to the trap. When closing the premises merely drain the trap, close the pet cock and the sink will be ready for use. If sewer gas is a problem, pour a pint of kerosene or antifreeze into the trap after draining. This can be flushed down the drain later

**5. TWO-O'CLOCK FEEDINGS** will be a lot easier if you fill a thermos with boiling water before retiring. Just a brief trip to the refrigerator to pick up the bottle and you can begin changing the baby while the bottle is warming in a container of hot water nearby. You can empty the container in the morning and return it to the nightstand for use the next night

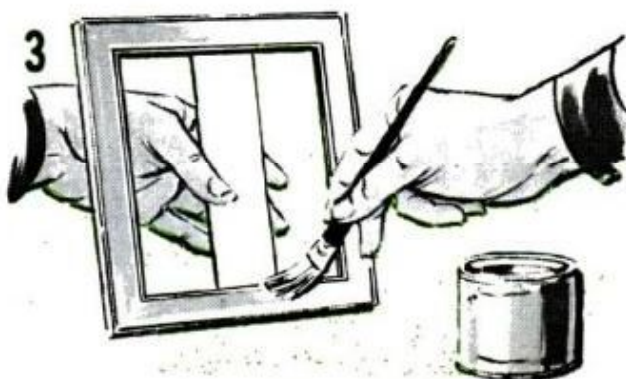
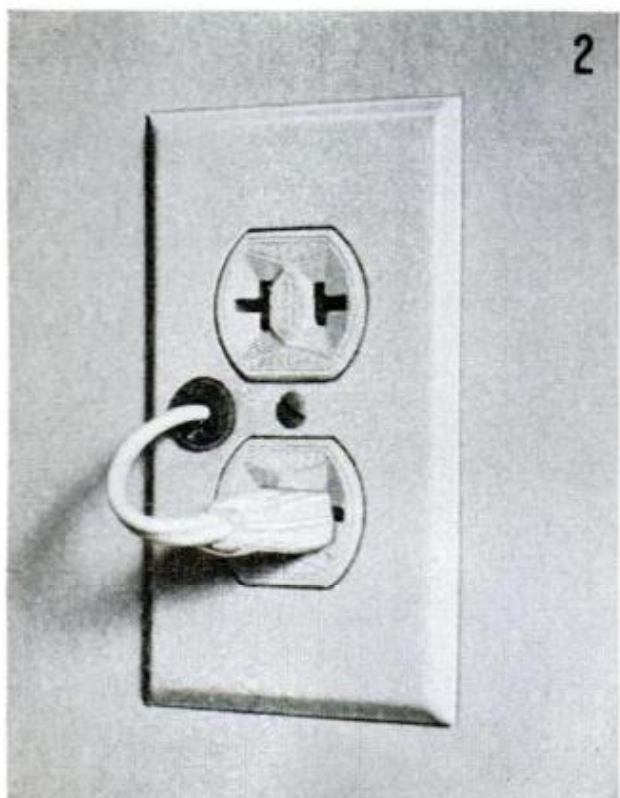

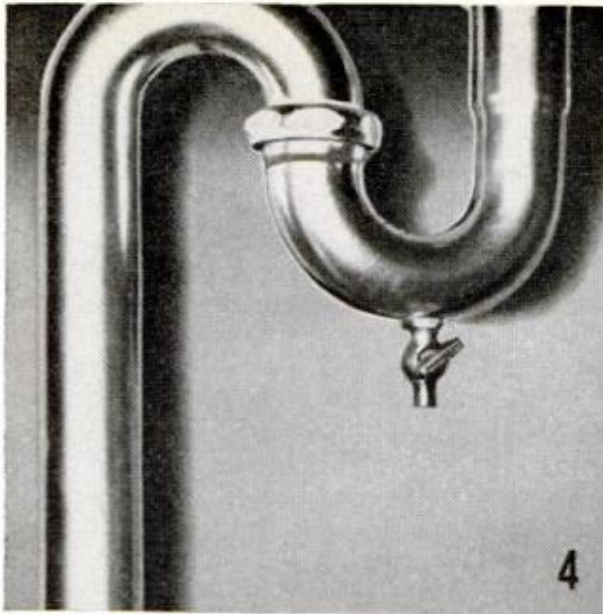

**6. POSTAGE-STAMP HOLDERS** can easily be made from discarded plastic pill containers. Choose a pill container about  $1\frac{3}{8}$  in. in diameter and saw it off to a height of about  $1\frac{1}{2}$  in. Using a thin-bladed fine-toothed hacksaw, cut a slot the length of the container. Smooth the rough edges with a knife

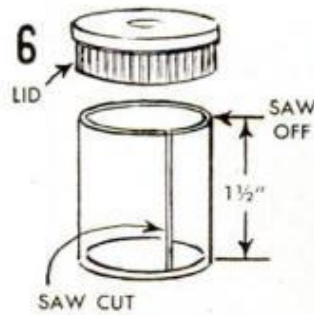

**7. ALARM CLOCK BROKEN?** You have a very accurate emergency alarm clock right in your kitchen if the stove has an automatic time outlet. Plug a table radio into this outlet, tune it to your favorite station and set the volume so that it can be heard in your bedroom. Finally, set the automatic timer



**8. KITCHEN BOOK RACK** which will hold a recipe book open to the right page is easy to make from a wire coat hanger. Straighten the hanger and cut it to a length of about 31 in. Bend a small loop in each end with pliers, and then shape it as illustrated. Mount the rack on a wall or inside a cupboard door

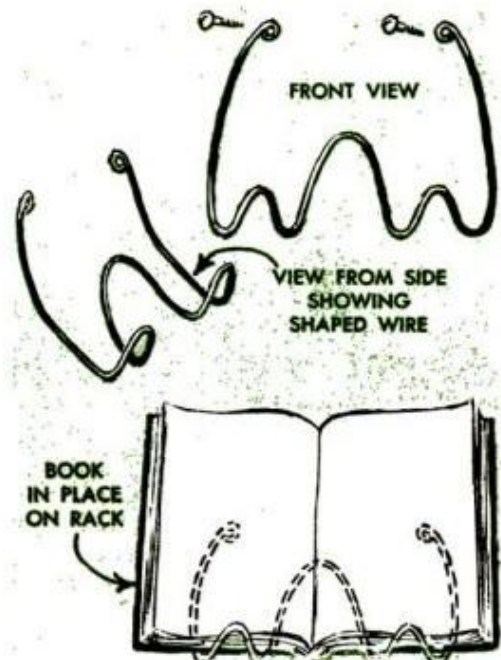
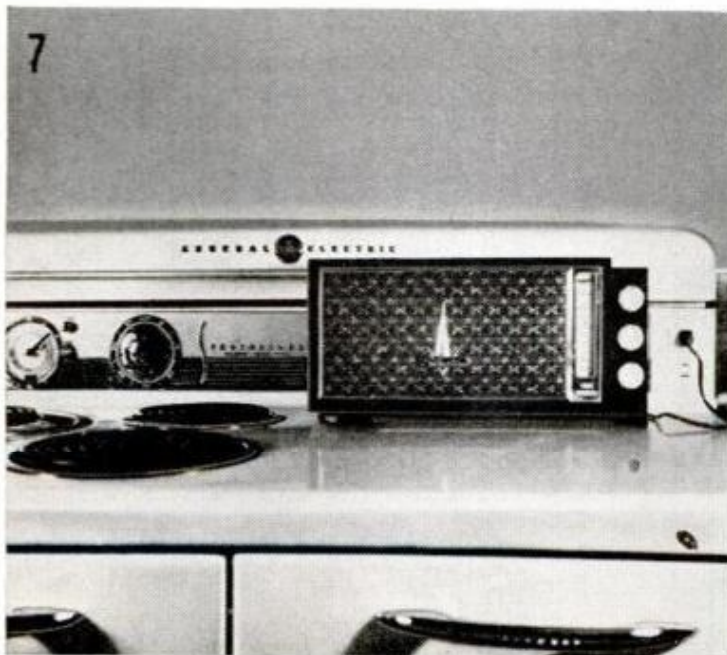



## Grid Ruling Square

Taking advantage of the uniform 1-in. spacing of holes in perforated hardboard, one craftsman found he could rule grid lines quickly with a "framing square" made of the material. Using  $\frac{1}{8}$ -in. hardboard having  $\frac{1}{8}$ -in. holes, he formed the inside (marking) edges along the arm and beam of the square by cutting the material on a line bisecting the perforations. To form the outside (ruling) edges he cut between the perforations so that both edges could be used to rule straight lines.

To rule off a 1-in. grid pattern, make a pencil mark at the center of each hole along the marking edge of the square. Do this across the top and bottom of the paper and up each side. Then using the ruling edge of the square, draw lines between the marks. Skip every other hole for a 2-in. grid pattern. To rule  $\frac{1}{2}$ -in. grids shift the square  $\frac{1}{2}$  in. after making the 1-in. markings.—Ray Moore

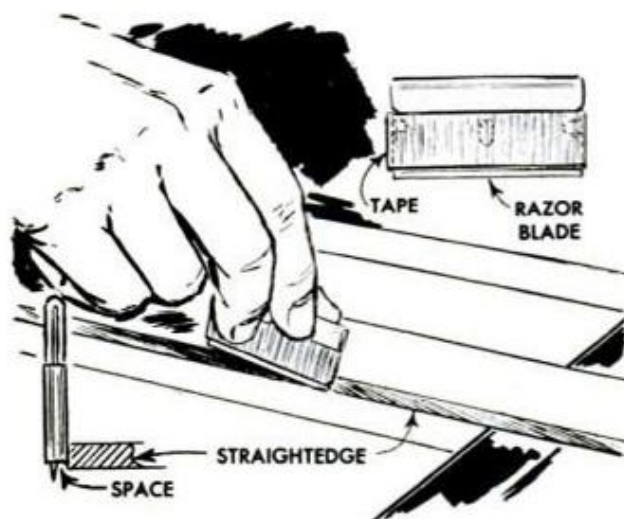

## Free-Wheeling Trimmer

When trimming photos, cutting oil cloth, etc., with a razor blade and straightedge the blade is likely to wander slightly and leave small nicks in the straightedge. To protect the straightedge, wrap the blade with several thicknesses of plastic tape leaving only a fraction of an inch of the cutting edge exposed. The tape will hold the blade away from the straightedge and prevent damage from occurring. As an additional precaution, hold the cutting edge as nearly perpendicular to the material as possible to overcome any tendency of the blade to turn toward the straightedge.

—Fred Lettino

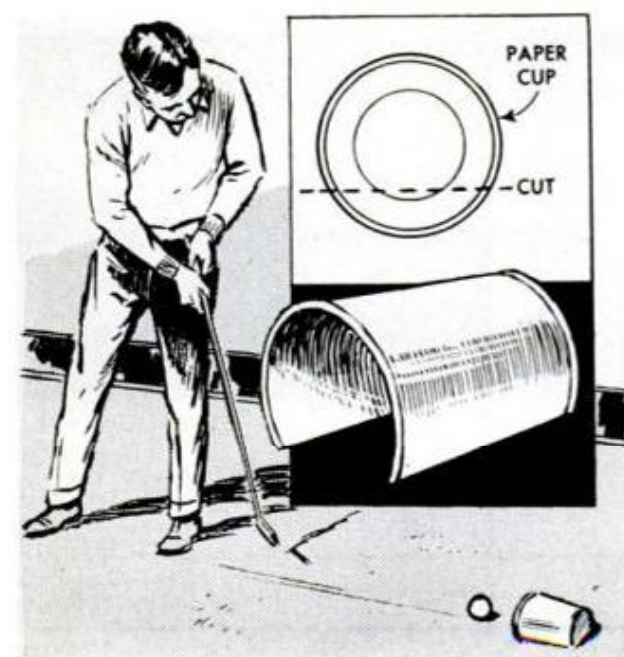

## Parlor Putting

Every golfer knows that putting is half the game, and here's an idea that will let you turn the living-room rug into a practice putting green. Cut part of the side and bottom from a paper cup, as shown at left. Lay this on the carpet and try putting into the open end of the cup. It's light enough so that it will slide over the rug if you use much muscle.—Walter Bamert

One effective way to clean greasy hands after completing a messy repair job is to use granulated sugar as a substitute for hand cleaner. Simply wet the hands and rub about a tablespoonful of sugar between them, rubbing the sugar grains well into the grease. The grease and grime will be removed by rinsing, and the hands left clean enough to finish the job with ordinary soap.

# NEW FOR SHUTTERBUGS

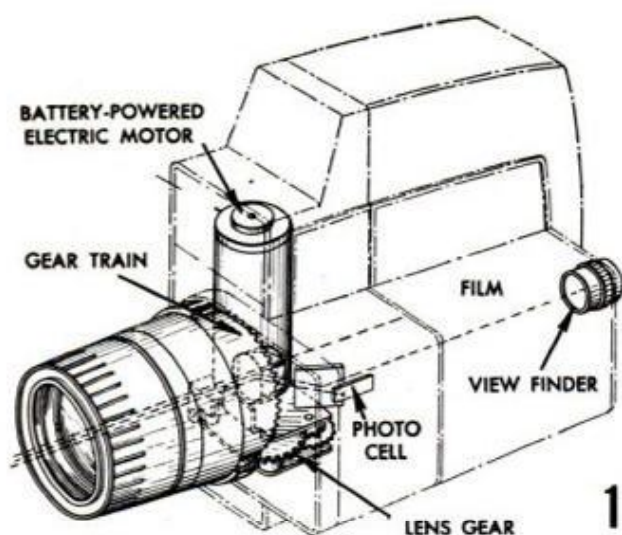

**1. REFLEX 8-MM. ZOOM CAMERA** with through-the-lens electric eye "sees" actual area the film records and is not influenced by light or dark objects outside field of view. Camera provides through-the-lens viewing and focusing, plus an electric-powered, two-speed zoom lens. Price: \$349.95. Manufactured by Bell & Howell, 7100 McCormick Rd., Chicago 45, Ill.

**2. UNIQUE HORIZONTAL 8-MM. sound projector** is easily converted to an animated viewer, a sound unit or a 2x2 slide projector. And the unit even may be used for cutting film. Sitting behind the projector, the operator has all controls arranged directly in front of him. Nizo projectors are distributed by Burleigh Brooks Inc., 420 Grand Avenue, Englewood, N. J.

**3. POCKET-SIZE POLAROID electric-eye camera** does not require focusing or exposure adjustments. Operator simply aims, shoots and lifts out a finished picture 10 seconds later. Built-in flash gun is size of a man's thumb; uses AG-1 bulbs. In closed position camera measures  $7\frac{1}{2} \times 4\frac{1}{2} \times 3$  in. Price is \$74.95. Made by Polaroid Corp., Cambridge 39, Mass.

**4. SELF-ILLUMINATING light box** is designed for sorting and viewing 35-mm. color slides. Constructed of translucent plastic, box has five inclined shelves on which to work. It may also be used as permanent display for color transparencies. For easy storage, sorter folds into compact unit. \$4.95. Hudson Photographic Industries Inc., Irvington-on-Hudson, N. Y.

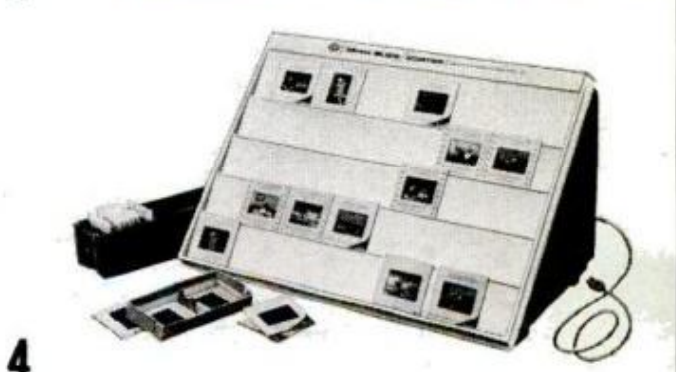



**1. DRYER** handles twenty-four 4 x 5 cut-film negatives or several film strips on upper, lower hangers

**B**UY A 32-gallon galvanized garbage can and you have the main part of this efficient controlled-heat film dryer. It will accommodate up to twenty-four 4 x 5 cut films or several lengths of roll film, and the novel heating element, plus the filtered air flow, together provide a constant circulation of warm air which promotes safe, rapid drying.

Assembled, the whole affair consists of the can, 60 ft. of 300-watt heat tape, a small motorized blower with flexible hose, an electric-iron thermostat, four pieces of T-shaped aluminum extrusion for legs plus the necessary cord, plug and pilot-light

**3. FIBERGLAS FILTER** is placed over holes drilled in garbage-can cover to trap dust entering the dryer

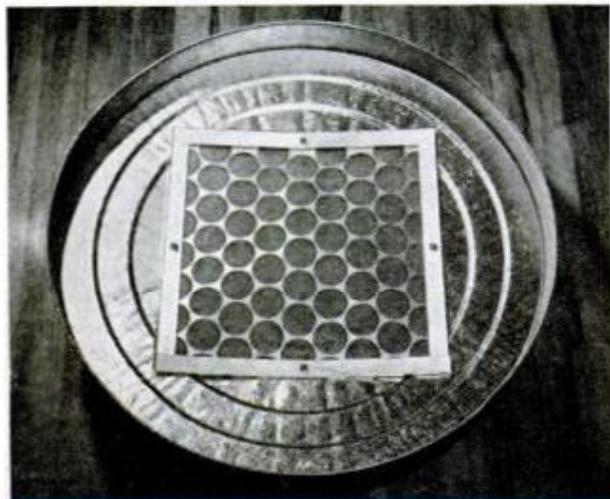

## TEN-MINUTE FILM DRYER



By Manly Banister

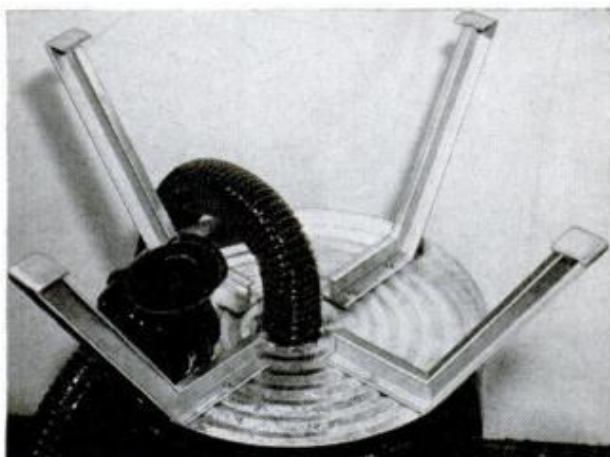

**2. LEGS** can be made by notching and bending aluminum T-shapes. Note how suction hose slips over outlet

switch. Those are the only parts you'll need.

The first step is to clean the inside of the can thoroughly with a solvent such as lacquer reducer or carbon tet to remove all traces of the residues remaining from the galvanizing process. Then sweat spots of acid-core solder in vertically spaced rows to the inside of the can as in the right-hand view, Fig. 11. There should be about six rows of spots equally spaced around the inside of the can, the spots being spaced 2 in. on centers and the first one being located about 2 1/4 in. below the rim of the can. The first spot in the second row is located about 3/8 in. lower to give a spiral

**4. FILTER** is held in place by means of four aluminum straps. Filter should be cleaned occasionally  
1/8" x 3/4" STRAP ALUMINUM  
6-32 x 1/2" MACH. BOLT

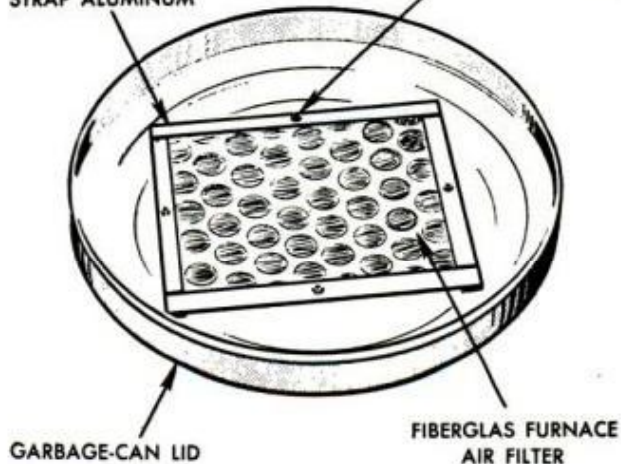



28-GA. SHEET METAL

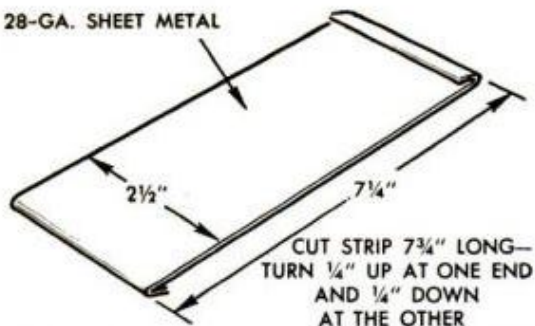

CUT STRIP 7 1/4" LONG—  
TURN 1/4" UP AT ONE END  
AND 1/4" DOWN AT THE OTHER

BEND INTO  
CYLINDER SHAPE  
AND HOOK ENDS  
TOGETHER

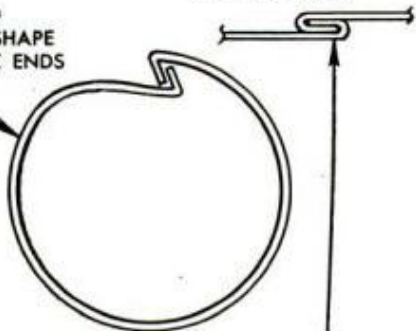

HAMMER SEAM FLAT ON  
PIPE HELD IN VISE

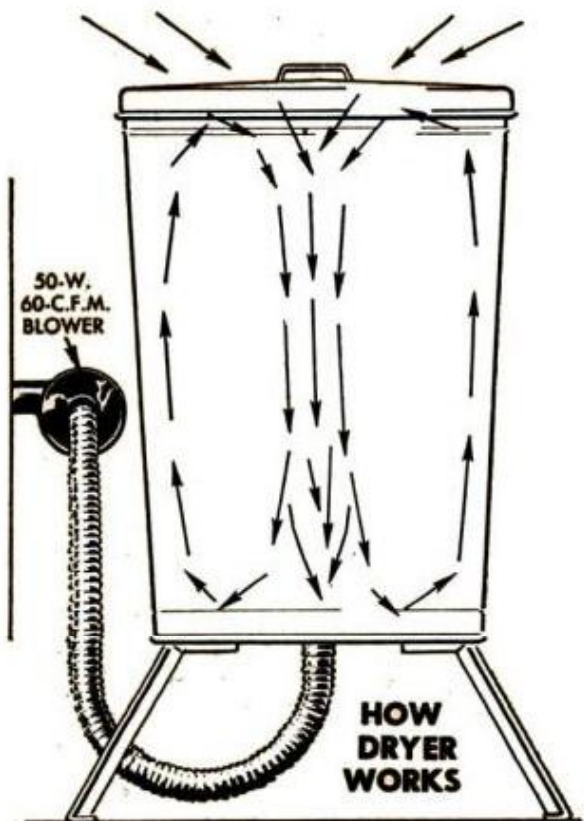
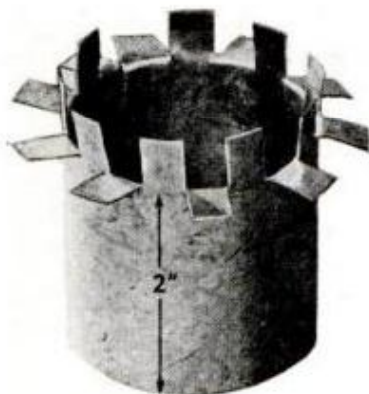

**5. AIR OUTLET**, above, left, is soldered into hole in bottom of can. Above, right, the finished film dryer

progression from top to bottom of the can. These solder spots serve to anchor clips made from 1 1/4-in. lengths of 16-ga. wire. Bend a slight offset, about 1/8 in., near one end of each length of wire, hold the end nearest the offset on a solder spot and sweat in place. These clips support the heat tape which is placed inside the can in a continuous spiral, Figs. 11 and 12.

Next, make the air outlet connector as shown in the detail, Fig. 5, and cut 3/8-in.-wide tabs all around one end, bending every other one outward. Cut a 2 1/8-in. hole in the bottom of the garbage can, insert the tabbed end of the connector and bend the straight tabs over inside the can to form a flange.



**6. HOLES IN** a V-shaped pattern are drilled through can cover. Deburr with reamer to prevent hand injury



**8. AIR OUTLET**, Fig. 5, is soldered into hole cut in bottom of can. Outlet is covered with 1/16-in. felt

**9. FILM RACKS** are made by stringing picture wire arranged in a square with diagonals as pictured here

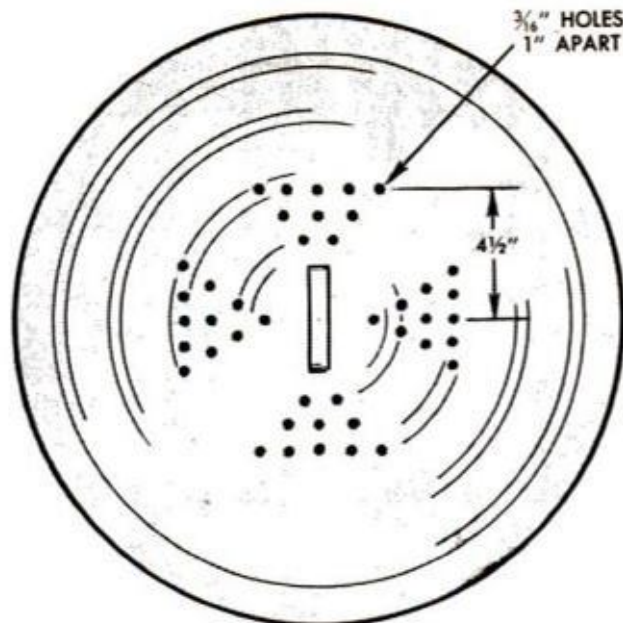
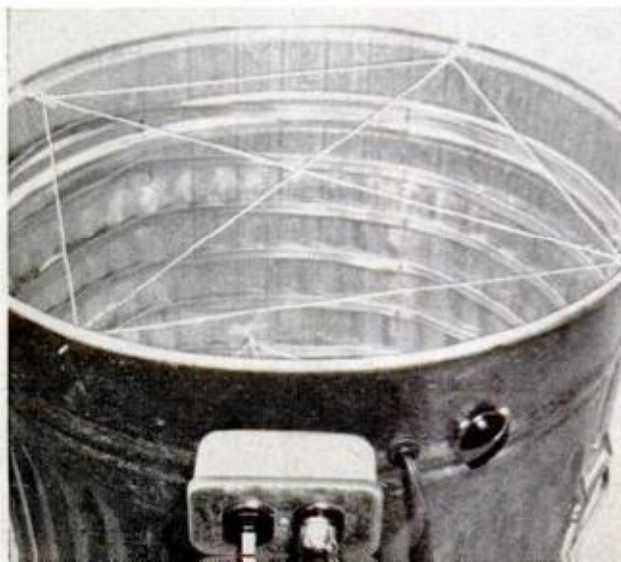

**7. DRILL TEN HOLES** in each group, keeping the holes 1 in. apart, spacing groups 90 deg. as shown

Then solder them to the bottom of the can, Fig. 8. Cement 1/16-in. felt around the outside of the outlet for a nice force-fit of the air hose, Fig. 2. Drill holes in the can cover as in Figs. 6 and 7 and to trap dust, install a filter on the underside of the can cover as in Figs. 3 and 4. The filter is made by stripping off the cardboard frame from a standard 12 x 16-in. furnace filter and cutting it square. Strips of 1/8 x 3/4-in. flat aluminum are used at the edges to hold it in place, the ends being lapped.

Legs can be made of anything handy. T-shaped aluminum extrusion was used for legs on the original although they can be made from 1/8 x 1-in. aluminum angle just as well, Figs. 2 and 12. Fasten them to the can with 3/16 x 1/2-in. stove bolts with

**10. TWO PICTURE-WIRE RACKS** are placed in the can, the second rack about 12 in. below the upper one

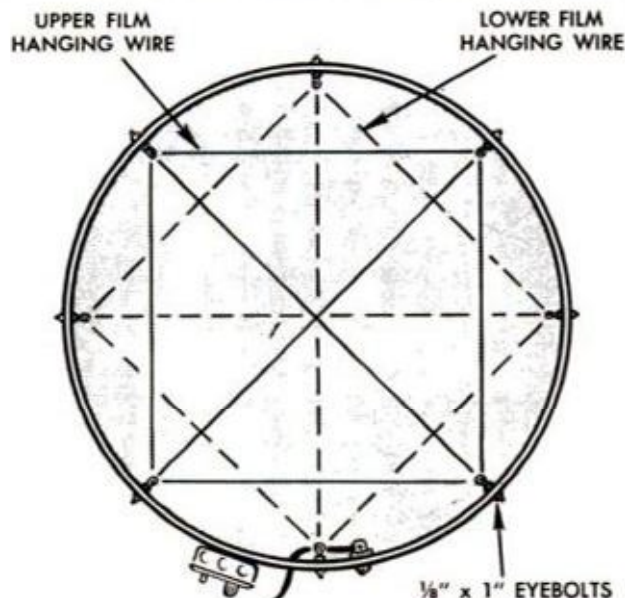

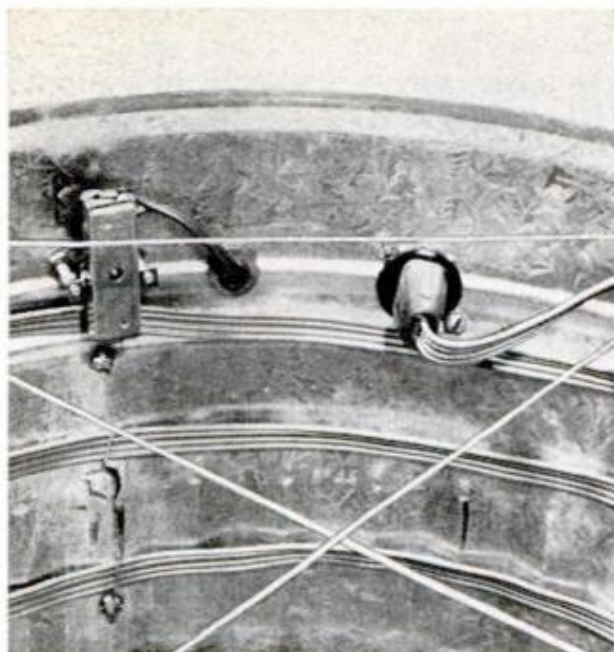

**11. HEATING TAPE**, above, is plugged into wafer-type outlet. Right, solder spots being sweated onto can

heads inside the can. Next locate the hole for the female plug, Fig. 11, by placing the surface box so that it clears the lid. The hole for the thermostat wires should be large enough to accommodate a protective grommet. Drill three holes a few inches from the grommet hole for mounting the thermostat, Fig. 11. Prepare the surface box by removing the center knockout and enlarge the hole to fit the wafer-type female plug, Fig. 12. Install the plug and mount the unit on the side of the can. The switch is a combination single-pole and 6-watt red pilot-light unit installed as



in photo, Fig. 5. The electric-iron thermostat should be grounded either through a 3-pronged plug or directly from the dryer to a water pipe. Plug the heat tape into the wafer-type plug inside the can and as you unreel insert it behind each clip in a uniformly descending spiral. If there is a foot or so left, it can be left loose on the bottom of the can. Finally, install the upper and lower film-hanger wire in Figs. 1, 9 and 10, using common picture-hanging wire.

Attach the flexible exhaust hose to the  
(Continued to page 210)

**12. EACH TURN** of the heat tape descends in a slow spiral to bottom of can as in left-hand detail. Legs can be aluminum angle, aluminum T-shape, anything suitable for the purpose. At right is wiring detail

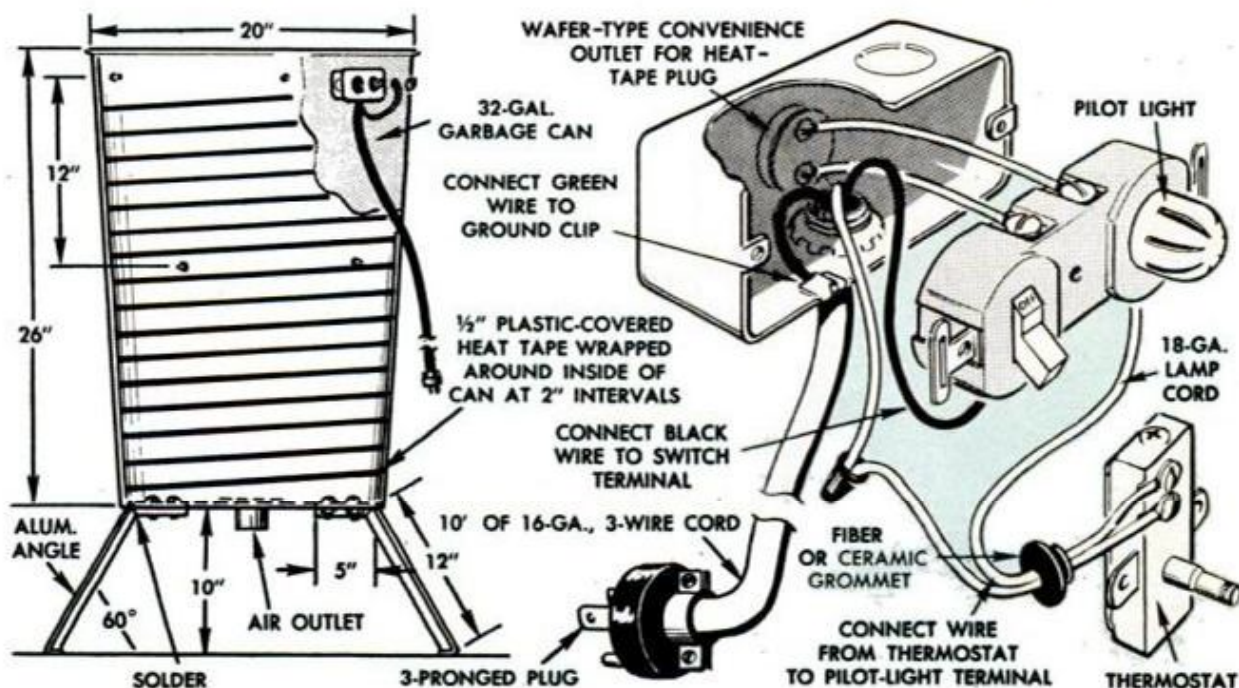



## DIETER'S TRAVEL KIT

**NO MORE FUMBLING** in a crowded glove compartment for can opener and cups. All are handy in the kit



**T**RAVELERS ON reducing diets using the new liquid dietary supplements find that motoring presents a number of problems. Cans, can opener and cups are usually either packed away in a corner of the suitcase or left to rattle about in the glove compartment.

You'll find it easier to carry such liquid meals and a few helpful accessories on week-end drives and other short trips with this "lunch-box" travel kit. The compartmented box holds six small cans, several hot-drink cups, a can opener and an immersion heater. A tube of drinking straws and a package of paper napkins are carried in the spaces above the compartments.

The kit is assembled as detailed with both glue and brads at all joints. To make the rounded grip, cut a 5½-in. section of broom handle in half lengthwise and attach one half to each side of the center panel above the carrying slot. Be sure to stagger the lid hinges a bit so that the screws holding them to the center panel will not interfere with each other. Finish is a matter of personal choice, but try a color which will match or contrast with the car interior.

The drinking-straw carrier is made from



**ATTACH HANDLES** to the center panel, above, before assembling the kit. The inside of the box, below, should be finished before adding the sides and lids

a mailing tube. Glue a cardboard disk over one end and cover the other with a metal jar lid which fits tightly over the tube.

Since the different brands of liquid meals come in cans of different dimensions, you may have to position the partitions to suit.

While these liquid dietary supplements can be consumed at room temperature, many people prefer to heat them slightly. The heater illustrated here operates on standard house current, but you may substitute a heater of the type which plugs into your car's cigarette lighter, thus enabling you to prepare meals on the road.

—Walter E. Burton

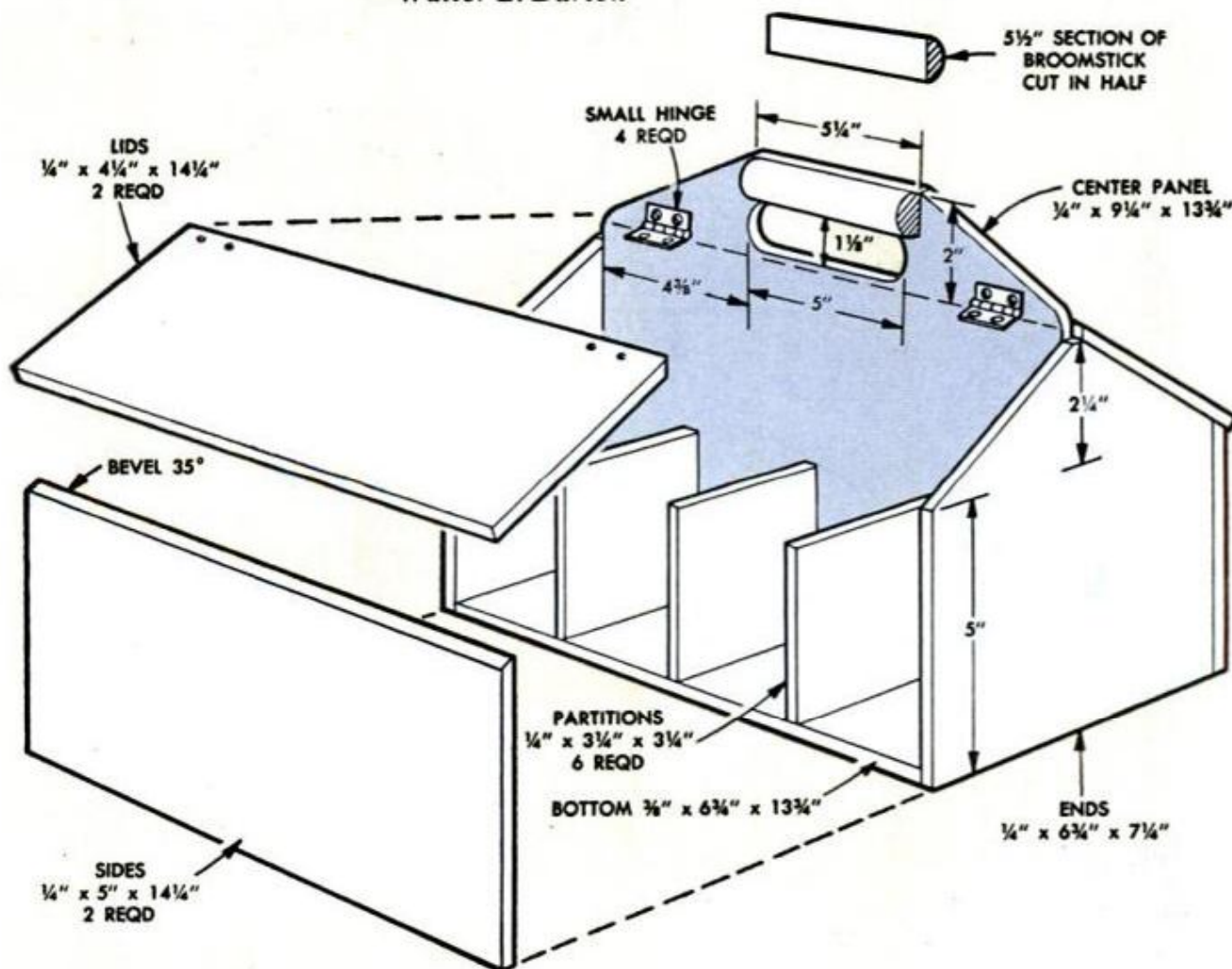
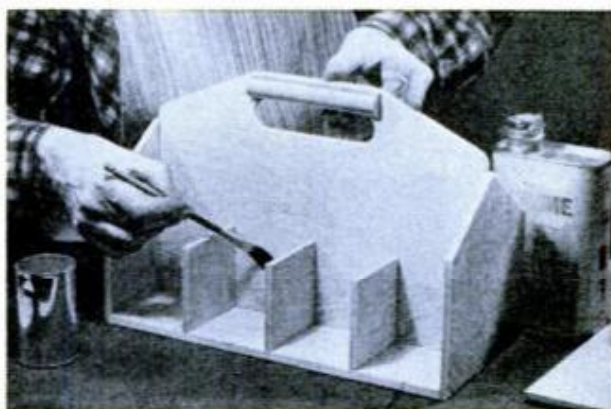

# MR. DO-IT AND BUNGLE



**Bungle finally rings the bell this month after a lesson in doorbell repair, but Mrs. Bungle doesn't seem to show much confidence in her husband's mechanical abilities**



## FARM TIMESAVERS

### Big Push

Farmers with an eye to getting everything possible out of a tractor utilize both ends of it, the drawbar end for pulling heavy loads, the front end for a controlled push. The bumper you see pictured consists of a heavy curved member, the ends of which are bolted to the side frames of the tricycle tractor. The vertical member, or pusher, is a length of heavy steel channel. It projects just far enough to clear the front wheels so it can be used for easing a hoghouse or feeder into place or anywhere a controlled push is needed.

—A. M. Wettach

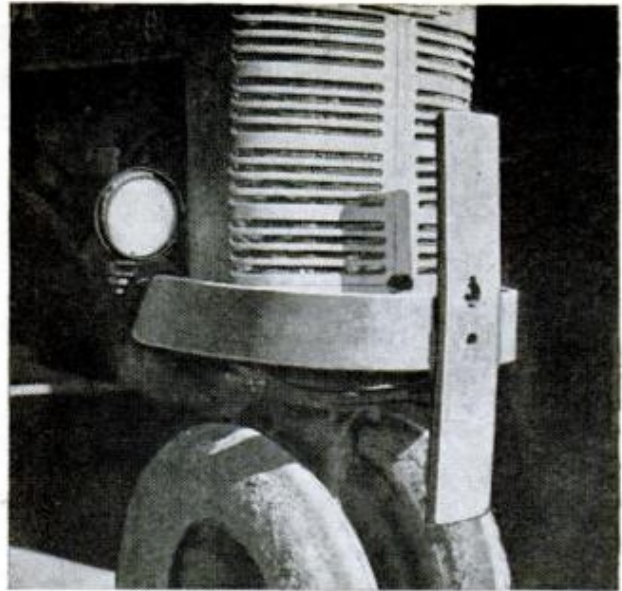

### Gate Crasher

Moving a heavy farm gate, panels of a feedlot fence built in sections, a feed bunk, or a sectional crib is no problem for farmers with tractor-mounted loaders. They simply free the gate, panel or bunk, ease the forks of the loading scoop through an opening between the boards, lift clear and away it goes. With the controls on present-day tractor loaders the load can be transported a few feet or across the farm and placed within an inch of where it's needed.



### Mailbox Merry-Go-Round

Eight farm families get their mail at this one-stop mailbox station. The eight boxes are each labeled with the owners name and are mounted Lazy-Susan fashion on a steel wheel salvaged from an old hay rake. A length of pipe set in concrete serves as the supporting post and a wheel bearing is formed by a flange welded about 6 in. below the top of the post. A pipe cap screwed onto the threaded end of the post prevents the wheel from being lifted off.

—Wayne Floyd

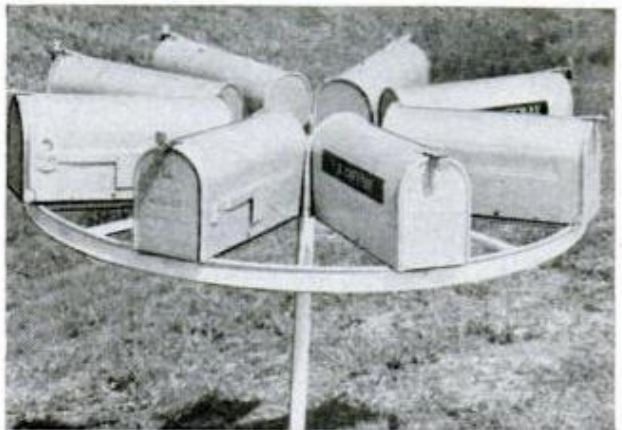

### Plant Hover

In the propagation of certain tropical plants in a greenhouse it is necessary to produce an artificial tropical atmosphere with conditions closely approaching those of the natural habitat. This can be done quite simply and inexpensively by arching short lengths of welded-wire fabric over the bench and covering with muslin in summer and plastic sheeting in winter. A perforated pipe runs the length of the bench under the canopy so that a controlled mist can be maintained, thus simulating natural growing conditions.





Coming up next . . .



### Gauge Blocks

There'll be no mistakes when you use these gauge blocks on the steel square for laying out stair stringers and rafter cuts. The blocks are made from  $\frac{3}{4}$ -in. steel hex rod cut to a length of about  $\frac{3}{4}$  in., slotted, drilled and tapped for a stove bolt which serves as a setscrew.—*J. Hamaguchi*

### Quick Clamp

This quick-acting strap clamp holds pieces of sheet metal securely on the drill-press table. It consists of a length of hardwood faced with canvas belting or leather and a J-bolt which hooks under the lip of the table. After locating the work, adjustment of the wing nut allows it to be held with light hand pressure—*Joseph Federico*

(SEE LETTER—MAY 1962, p. 12)

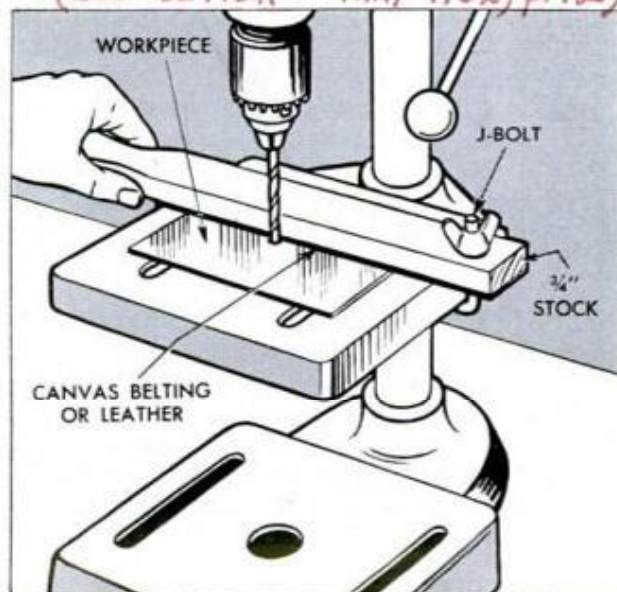

**METAL FURNITURE.** See that desk in the picture above? Neat, isn't it? But it's more than that; it's practically unbreakable because it's made almost entirely of steel—square steel tubing and steel angles, welded. There's also a matching chair and ottoman. Details on all three in next month's PM.

**FORT SNOW.** Defenders of this fort are sure to hold against the heaviest snowball barrage attackers can throw at 'em. It's made of cast—that's right—cast snow blocks laid up masonry-fashion. There's a high tower for special defense strategy. February PM tells all about how to build it.

**ICE FISHERMAN'S SHACK.** Taken apart it's a light car-top bundle. Consists of wood-framed panels of insulating sheathing that bolt together in minutes. No central heating system, of course, but the shack breaks that cold wind and the black coating absorbs heat from the sun. Details in next month's PM.

**ROUTER JIG.** Takes any standard portable router, works from the edge of the material, makes cuts anywhere on panels up to 48 in. wide. All metal parts are made from readily available stock materials, which puts the building of the jig easily within the range of any small shop. See February PM.

# X549

## SEWING TO SAWING

*Only a few minor changes  
convert old sewing machine  
to efficient shop saber saw*



**N**EARLY ALL older type sewing-machine heads contain all the parts necessary for conversion to an efficient jigsaw, even to the drive pulley. Just supply a table, blade and power source and there you are. This conversion is an accessory for a wood lathe but can be assembled for belt drive from a small motor.

The first step is to remove the sewing head from the base. Discard all the mechanism except the main drive shaft. Then remove the cover plate at the end of the arm, remove the needle spindle and substitute the pressure-foot spindle, or rod, which is about 1 in. longer on most machines and is fitted with a holder which can be adapted to serve as a blade chuck. Note the details at the left on the opposite page, which are only representative but do suggest ways of adapting these parts to holding regular saber blades or small files. It is quite possible that some saber blades will require filing down to a narrower width to adapt them to the improvised chuck.

Usually the pitman and pitman disk have adjustments to compensate for wear and length of stroke. Check these adjustments

before putting the mechanism into service as a jigsaw. Although not shown and not used on the original adaptation, it might be well to cut and fit a metal disk about 2 in. in diameter just below the blade holder. This will act as a sawdust slinger, or guard.

To fit the sewing head to a wood lathe as pictured cut a plywood table and mount the sewing head upside down as detailed at the right on the opposite page. The sewing head is supported by the plywood table and also by a stud, A, which is held in the tool-rest holder. The end of the stud fits snugly into the hole which normally takes the spool holder. The outer end of the table, to which the sewing head is attached, is supported on an assembly consisting of a length of  $\frac{3}{8}$  or  $\frac{1}{2}$ -in. pipe, two flanges and a clamp made of two pieces of hardwood and held on the lathe bed by the bolt, B.

To drive from the lathe spindle, weld a 2-in. V-pulley to a No. 2 Morse taper chuck adapter and use the same  $\frac{1}{4}$ -in. V-belt as was used originally to drive the sewing head. Use the four speeds of the lathe headstock to vary speed of the jigsaw, low speeds for filing.—*Henri A. Fluchere*

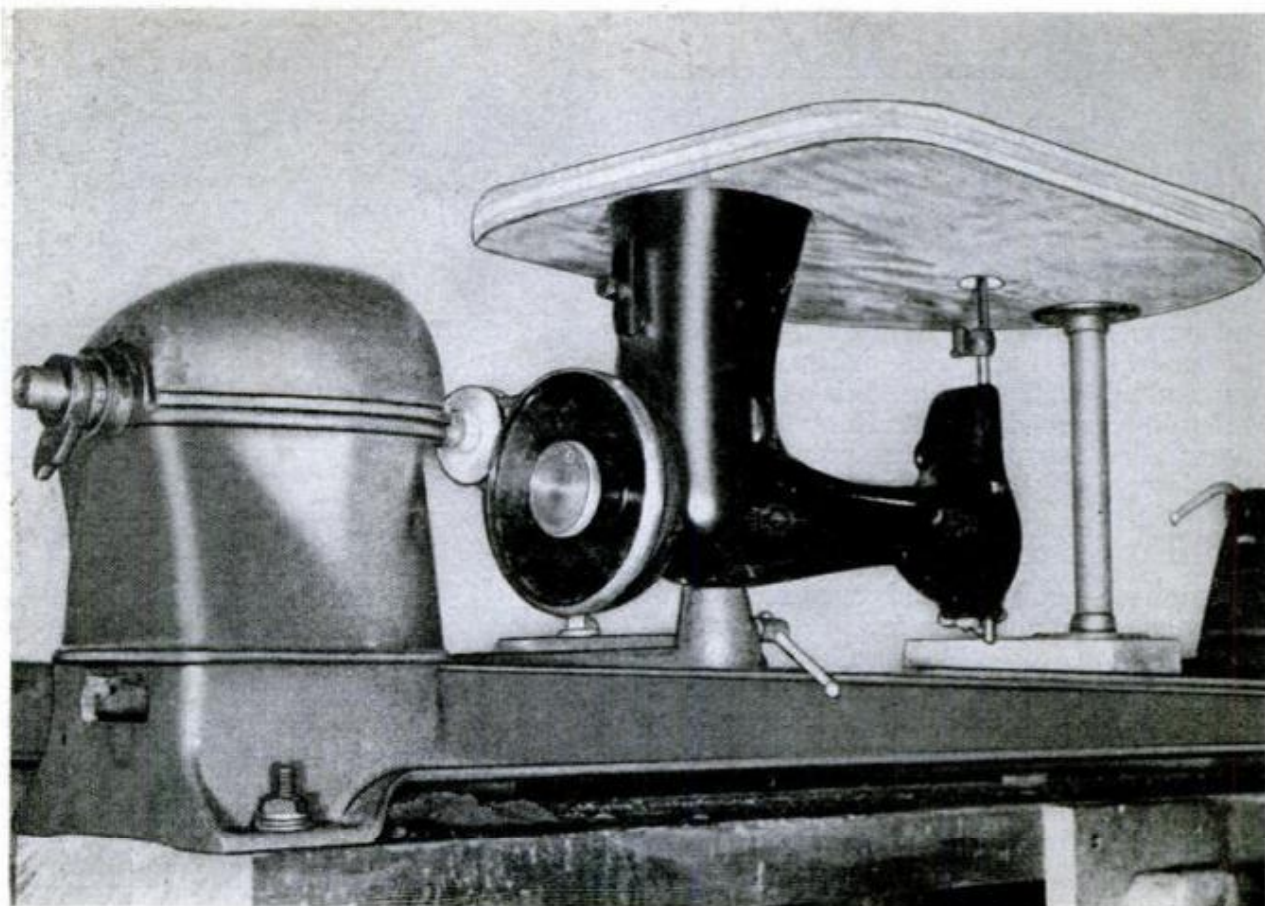

IT RUNS "just like a sewing machine" except that only a part of the original sewing head is used. Table can be somewhat larger than dimensioned but make sure that it's solidly supported by lathe-bed clamp

NEARLY ALL old machines have a pitman assembly that can be adapted to jigsawing

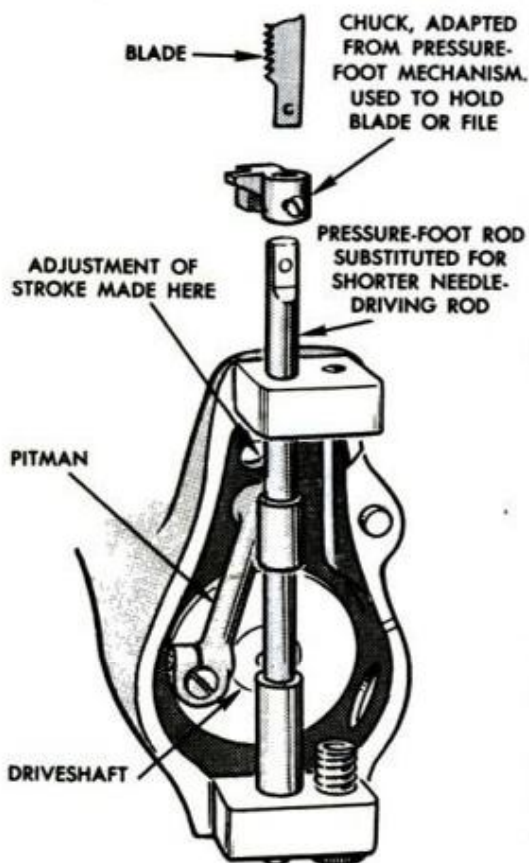

SEWING HEAD can be mounted on a lathe as an accessory or can be adapted to belt drive from a small motor of 1750 r.p.m.

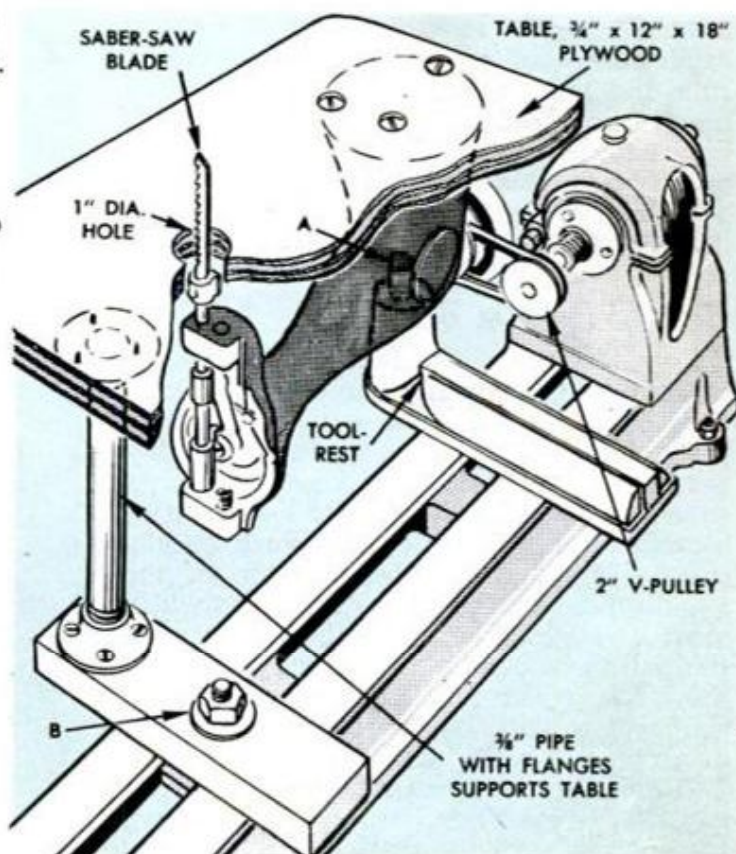

## SHOP SHORT CUTS

### Spin a Countersink

Countersinking thin sheet metal is not always possible or practical with a regular countersink. You'll do this job a lot faster and with a greater degree of uniformity if you first drill the holes for the screws a trifle undersize. Then chuck a short length of hardwood dowel in the drill press, point the end with a file and use this as the countersink. Use medium spindle speeds, apply paraffin or beeswax to the pointed end of the dowel.—*R. J. DeCristoforo*

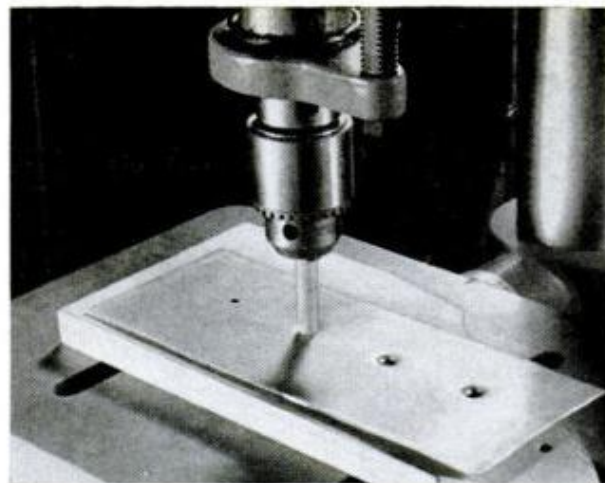

### Hold a Soldering Iron

You've probably already wondered, isn't there some further use for those neat dispensers you get with a roll of cellulose tape? There is. Save the next one you get and use it as a soldering-iron holder. It keeps the hot iron clear of the bench top; no danger of setting things afire or burning your hand and the iron is always within easy reach when you're doing a job requiring intermittent use of the iron.

—*Wayne Floyd*



### Roll on Edge Tape

Here's a helpful gadget for that patience-trying, time-consuming job of applying wood tape to plywood edges. The handle keeps one edge of the tape aligned with the corner of the plywood edge and a roller attached to the handle, which is shaped something like a miniature boomerang, rolls the tape into contact. Bandsaw the handle from a piece of 1-in. stock and drill a tap-size hole through it for a  $\frac{3}{16}$ -in. stove bolt. Turn the bolt into the hole, then cut a 2-in. length from 1-in. dowel, center-drill it, slide over the bolt and turn on the nut.

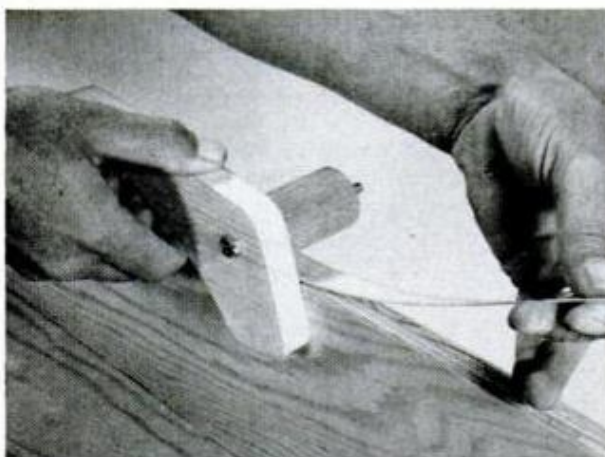

### Center-Drill a Ball

If you've ever tried to center-drill a wooden ball, especially one of small diameter, or a wooden bead, you'll appreciate this special V-block. It's made by running perpendicular V-cuts in one face of a square block of hardwood, the V-cuts intersecting at the center of the block as pictured. The width across the top of the V-cuts must be the same. Also the width must be slightly less than the diameter of the ball to be center-drilled. After cutting the Vees, drill a hole at the center of the intersection, the hole being of the same diameter as that to be drilled in the ball. This gives you an accurate means of centering the V-block by simply running down the spindle until the drill enters the hole.

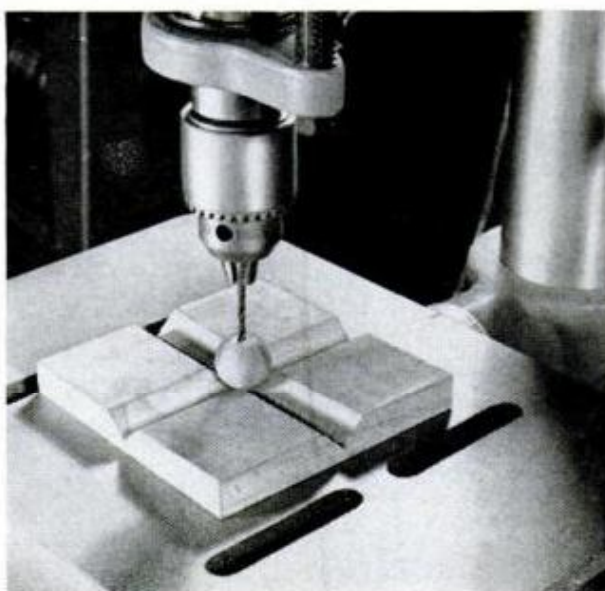

# Tailstock Hand-Lever For Small Lathes



**LEVER-OPERATION** of the tailstock sleeve doubles or even trebles the work capacity of a small lathe when carrying out repeat operations such as drilling, tapping and reaming on semifinished workpieces. This is due mainly to the single stroke of the lever action when compared with the many turns of the conventional handwheel necessary to run the sleeve back and forth within the limits of its travel. The lever action conversion does not interfere with use of the sleeve in a fixed position.

No dimensions are given as you have to determine these from your own lathe. The first step is to measure the maximum travel of the sleeve. Remove the handwheel and the feedscrew, or spindle, and push the sleeve into the tailstock bore as far as it will go and mark its position. Then pull it out slowly, the locking lever being tightened just enough to provide slight resistance to movement of the sleeve. Note the point where the end of the sleeve slips past the locking-lever cam. Slide the sleeve back slightly, just enough so that when the locking lever is tightened the sleeve will be held firmly. Then measure the distance between this and the first, or in, position. This will give you the maximum travel. Use this same measurement to determine the center-to-center distance of the holes in the link and also the two holes in the handle, one hole taking one end of the link and the other the substitute spindle. To find the length of the spindle, push the sleeve all the way back into the tailstock. Measure the distance from its inner end to the outer end of the tailstock bore. To this dimension add the sleeve travel plus 1 in.

—Robert G. Vaughn

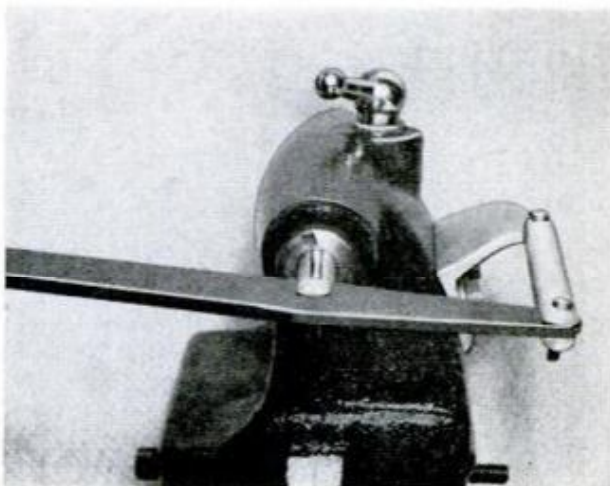
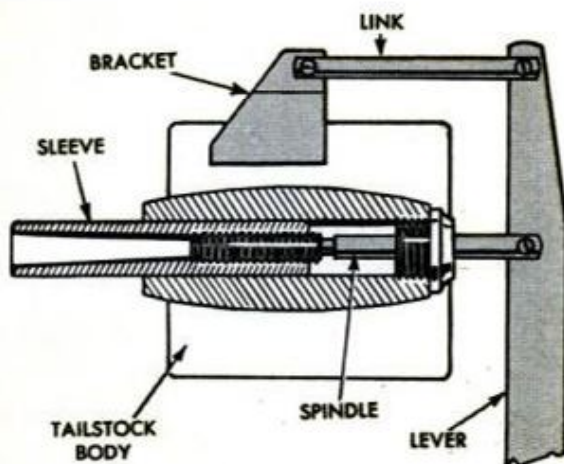

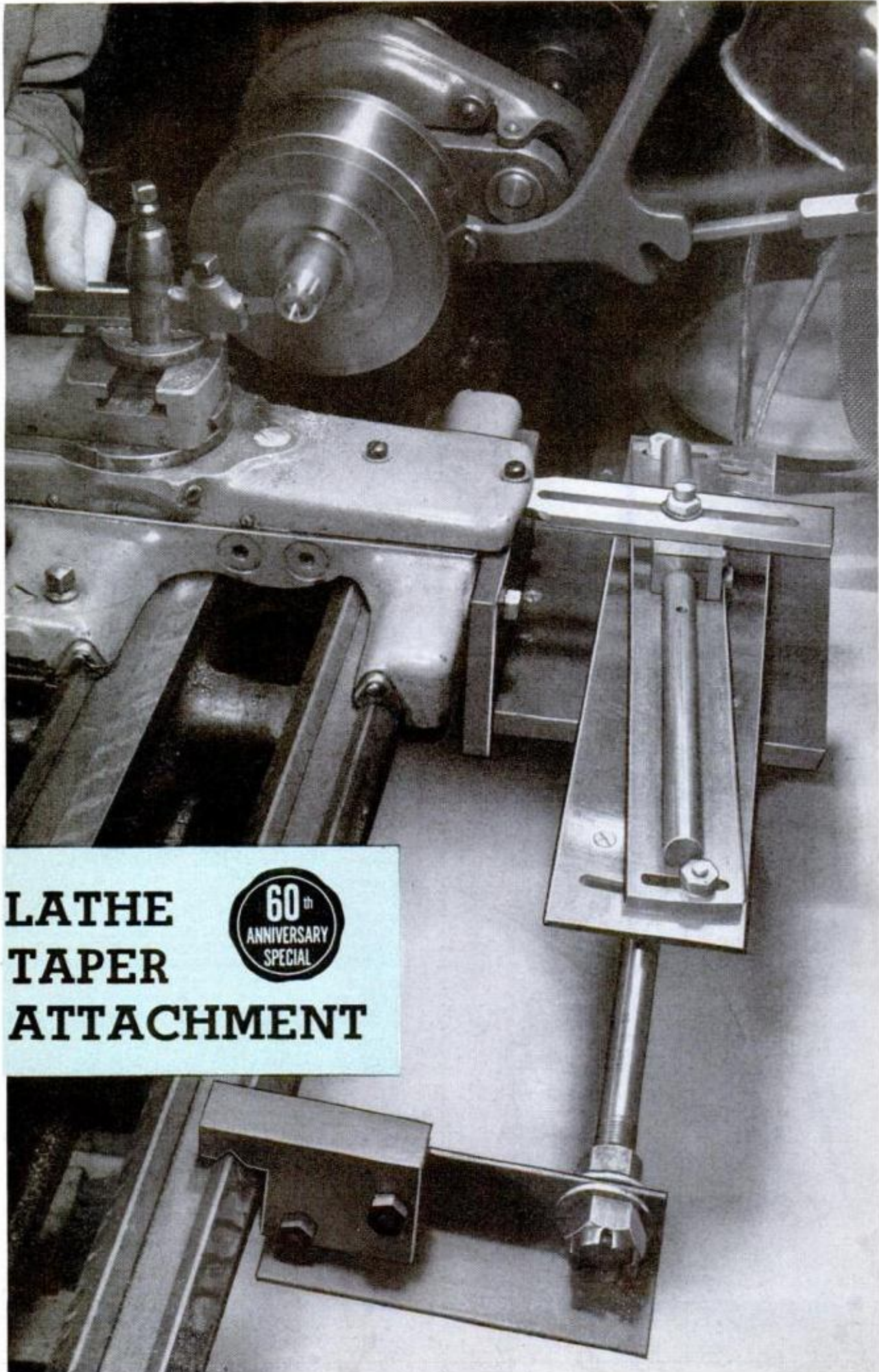

**LATHE  
TAPER  
ATTACHMENT**

**60<sup>th</sup>  
ANNIVERSARY  
SPECIAL**

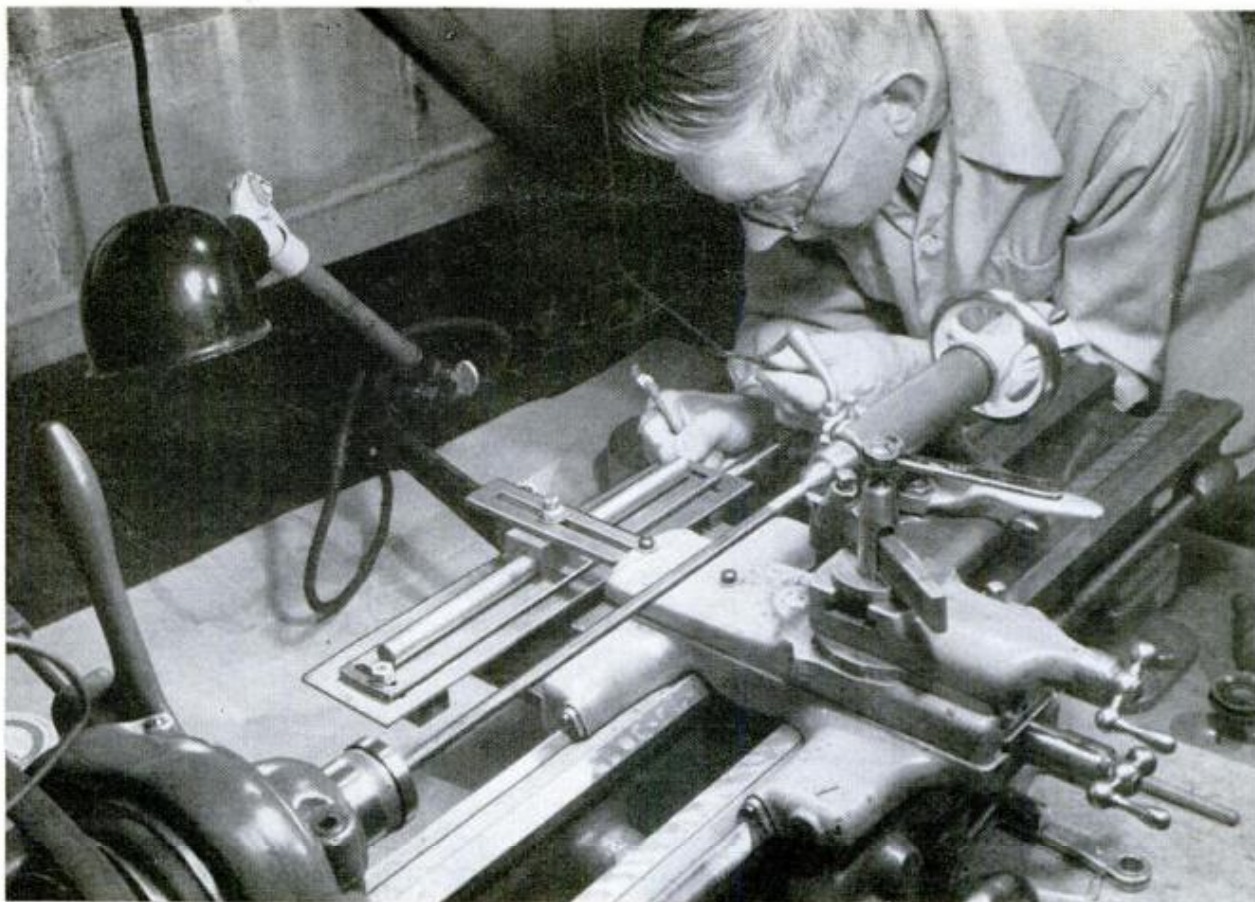

**1. SHOP-MADE TAPER ATTACHMENT** mounted on small lathe can be adjusted to turn outside or inside tapers on work mounted between centers or in a chuck for taper boring. Attachment is made entirely from stock materials

### By Walter E. Burton

**T**URNING A TAPER by offsetting the tailstock of the lathe is a common practice but the method has several disadvantages. In turning a taper by offsetting, the lathe centers are out of alignment which can result in inaccuracies due to burring of the center holes in the work, also possible scoring of the lathe tail center. Only work mounted between centers can be tapered by the offset method; taper boring cannot be done. In small shops where the amount of taper work does not warrant the outlay for a conventional taper attachment it is possible, using stock materials, to make one to fit nearly all small lathes.

The taper attachment pictured in Fig. 1 and on the opposite page was made to fit a 9-in. lathe. As a rule the parts dimensioned in Fig. 6 through 8 will be suitable for various makes of 9-in. lathes and possibly those of slightly larger or smaller swing. Note that two of the parts are not fully dimensioned, the cross-slide connector and the bracket, Figs. 7 and 8. You can use  $\frac{1}{8}$  or  $\frac{1}{4}$ -in. stock for the connector, depending on the clearance. The 5-in. dimension on the bracket was found adequate for the lathe pictured, but may not be for all lathes in this size range. The bracket can be made

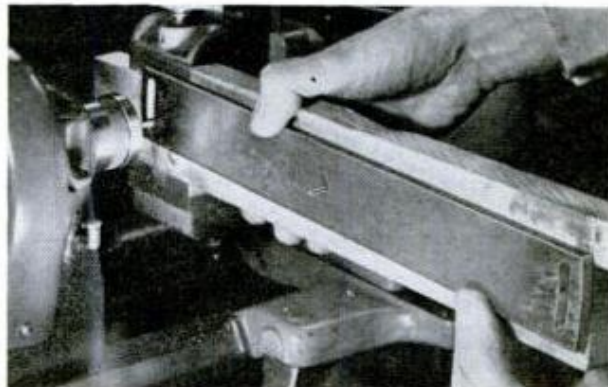

**2. SLOTTED ENDS** of swiveling bar, or carrier, are finished in lathe with milling cutter or rotary file

**3. SLIDE BLOCKS** are first bored offcenter, then reamed. If desired, blocks can be made from brass

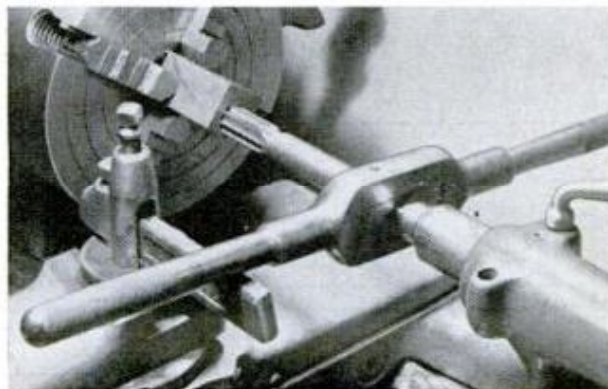

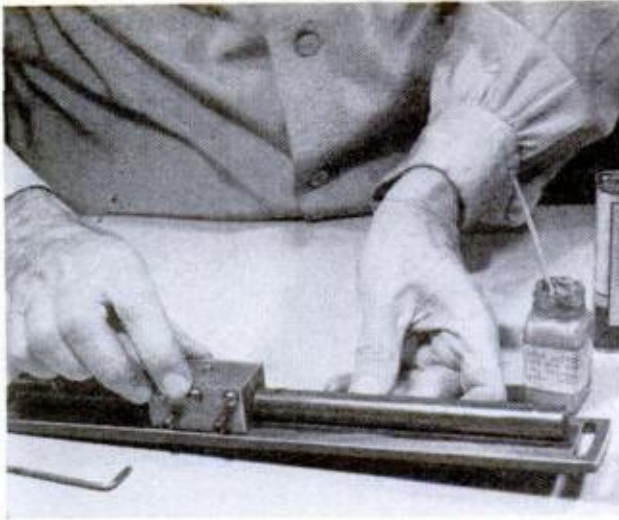

**4. SLIDE BLOCKS** should be lapped after reaming to assure smooth operation. Drill-rod track is coated with lapping compound. Block is stroked by hand

from a short length of heavy steel angle or can be made by welding two pieces of  $\frac{1}{2}$ -in. flat steel at a 90-degree angle. The bracket is screwed to the flat on the back face of the lathe carriage, Fig. 5. The dimensions on the angle bracket carrying the V-way clamp, Fig. 6, also should be checked with your lathe before cutting stock. The lower track, Figs. 5 and 8, should be parallel with the lathe ways.

The slides, Fig. 5, are bored off-center and reamed as in Fig. 3. After reaming, saw cuts (or milling cuts) are run through into the bore and into one side as indicated. Then when the capping piece is screwed in place, the setscrews, with locknuts, provide for clamping the slides at any point along the tracks. Then each slide is lapped to its track, using a lapping compound and a full-length stroke as in Fig. 4. After roughing

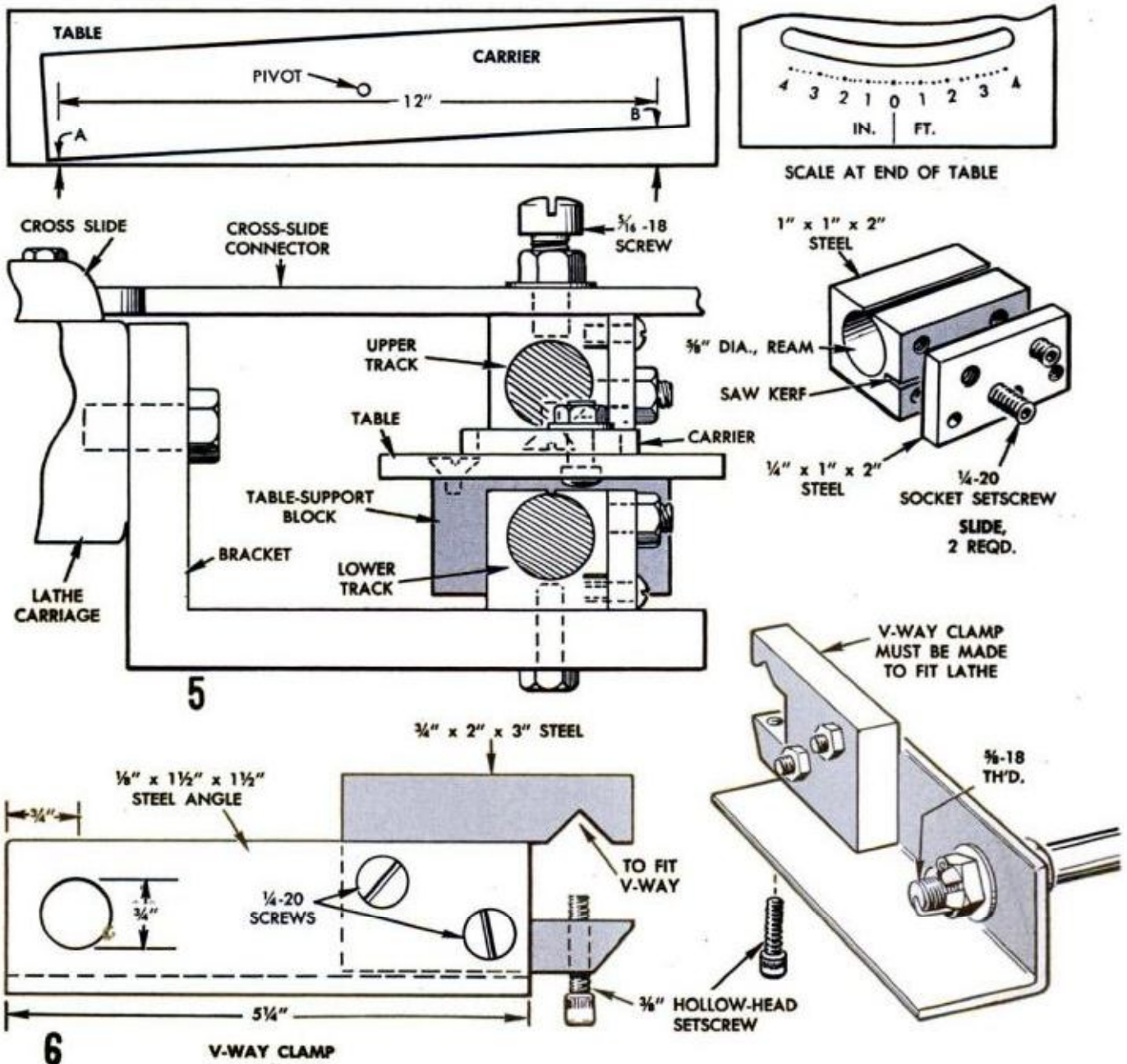



**6-A. DEPTH MICROMETER** is used to make close measurements when calibrating

out undersize with drill and hack-saw, the curved slots near the ends of the carrier and table can be finished with a rotary file (or milling cutter) as in Fig. 2. Each member is pivoted on a piece of hardwood which is locked in the milling vise. Then the work is hand-fed to the file or cutter.

Finished parts and partial assemblies are pictured in Figs. 9 through 12. In Fig. 11 the parts are set for a 1-in.-per-ft. taper. The first step in calibrating is to check alignment of the upper track with the edge of the carrier nearest the lathe and also alignment of the

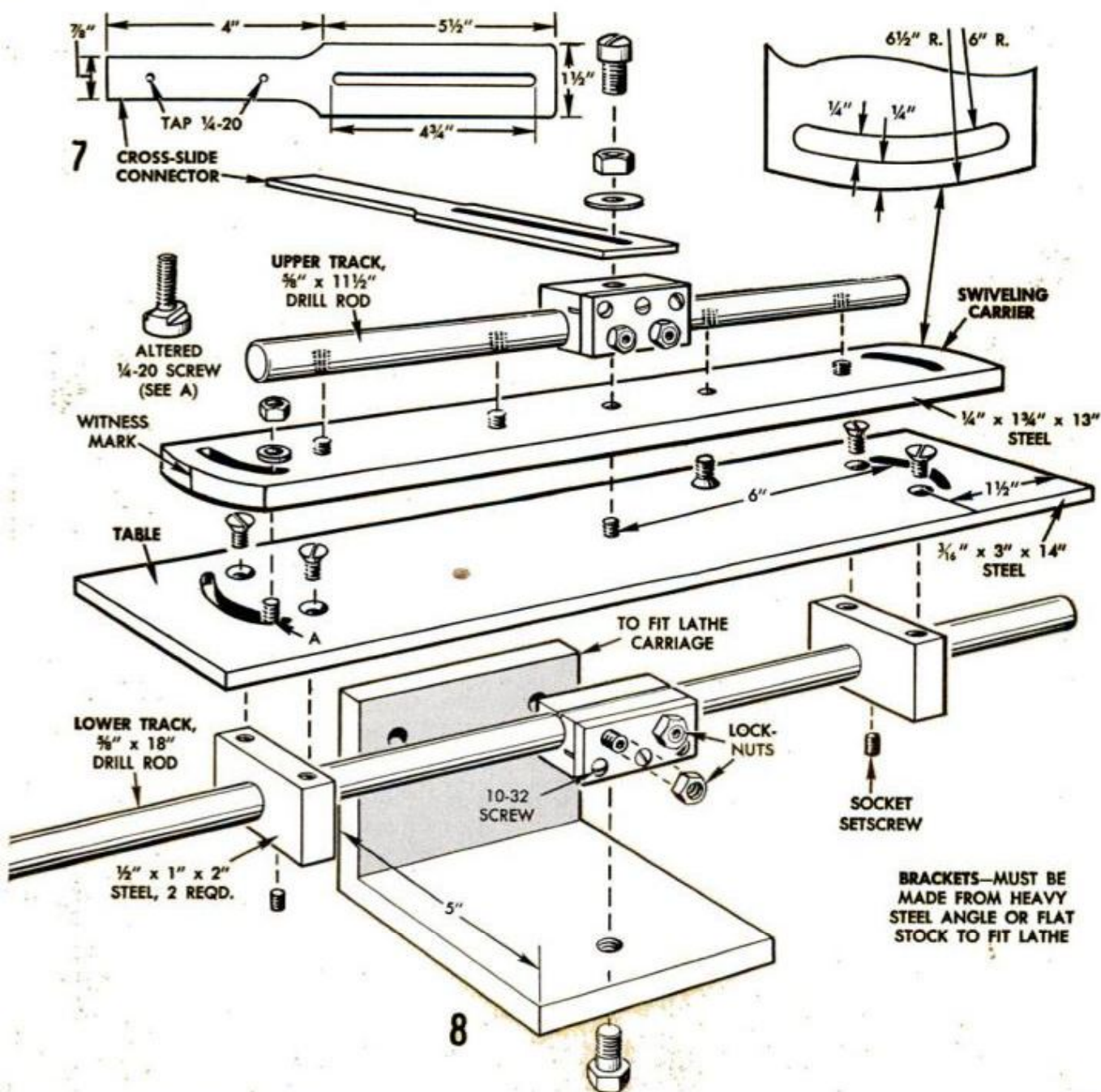
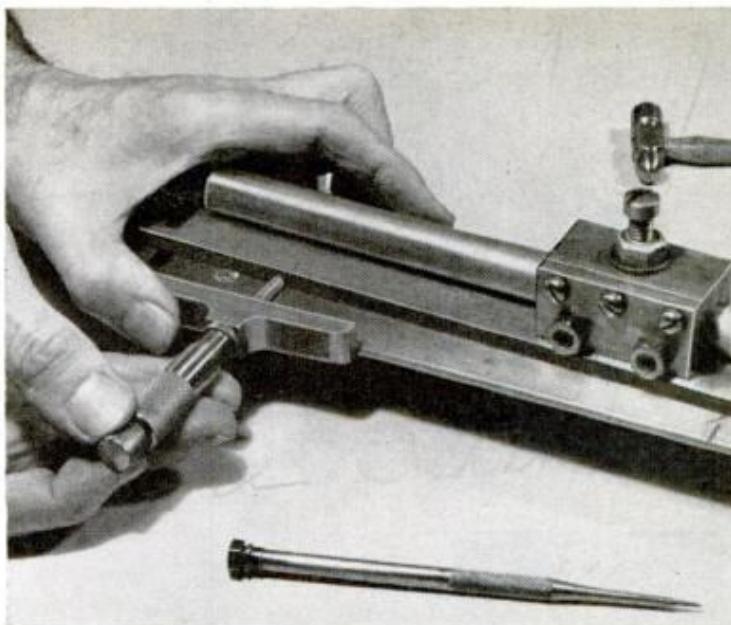

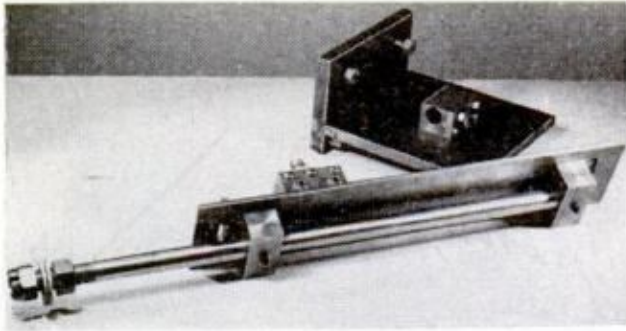

**9. TABLE AND ANGLE BASE** showing lower track and support blocks setscrewed to underside of table. Slide blocks are shown in relative positions on table and base. These parts are all made from stock materials

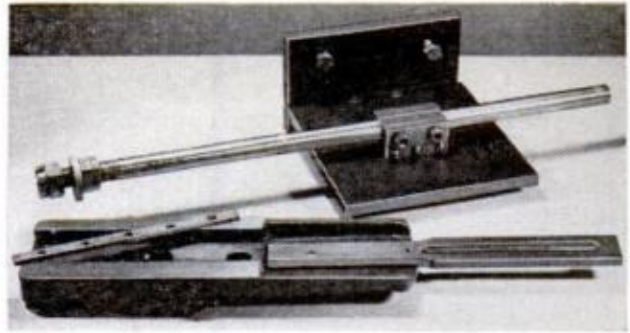

**10. CROSS-SLIDE CONNECTOR** is bolted to underside of lathe compound as in foreground. In background lower block is shown in position on built-up base. Slide block should be lapped to track with fine compound

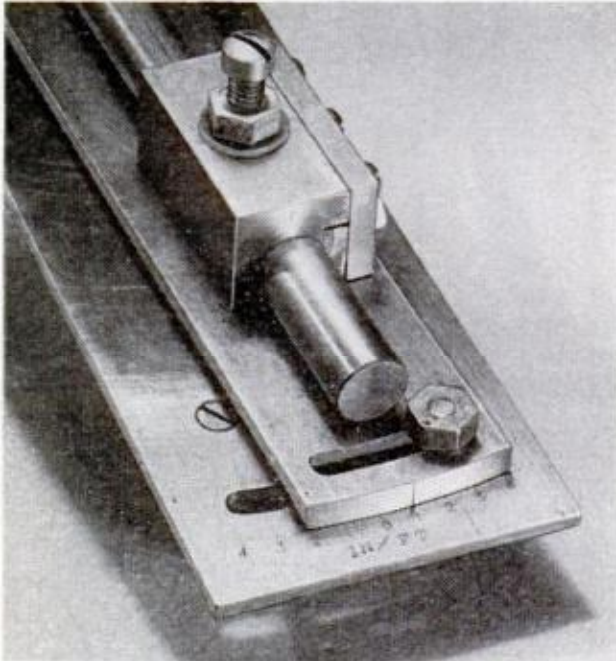

**11. TABLE WITH CARRIER BAR** is set for 1-in.-per-ft. taper. Also shown is upper slide block in position

**12. UPPER SLIDE BLOCK** showing cover plate and screw holding connector. Note the hollow setscrews

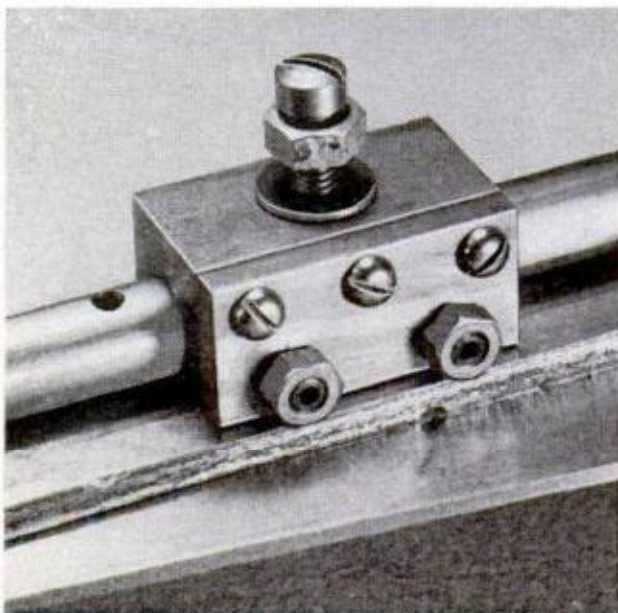

lower track with the edge of the table nearest the lathe bed. The two check points should be 12 in. apart as in the upper detail, Fig. 5. Make a note of any variation. The index mark, or witness mark, at each end of the carrier bar moves along a scale which at one end indicates taper in inches per foot and at the other end in degrees of side angle (half the included angle). To lay out the taper-per-foot make two marks on the table 12 in. apart on the edge toward the lathe. With a depth micrometer, Fig. 6-A, measure, at the marks, the distance from the table edge to the edge of the carrier. At the zero (0) setting these measurements should be equal. For a taper of 1 in. per ft. the difference in the micrometer measurements will be  $\frac{1}{2}$  in. Make a scale mark to indicate this setting. Then lay off the graduations with dividers from  $\frac{1}{8}$  or  $\frac{1}{4}$  in. to 4 in. on each side of zero (0), Fig. 5, the upper right-hand detail. At the other end of the swiveling carrier calibrate a scale indicating to 10 degrees on each side of zero (0), using a protractor.

#### How Attachment Is Used

When the attachment is set up for use, the cross-feed screw on the lathe carriage must be either disconnected or removed entirely, depending on the lathe. Use the compound to control the tool feed. After setting the carrier to turn the taper desired, move the cross slide so the tool is in position to start the first cut. Then tighten the nut that locks the cross-slide connector to the upper slide block on the taper attachment. The slide block should be adjusted so that there is no play in its movement along the track. Back off the cutting tool so that it clears the work for each return of the lathe carriage. Use a slow feed for the final cut. Before starting to turn a taper either inside or outside, make sure that the attachment is held rigidly in place on the lathe, that all nuts have been drawn tight and the slides properly adjusted. Apply light lubricant to all sliding parts. ★ ★ ★

## Is Your TV A Radiation Hazard?

... a special test report  
By Dr. Jan Paul  
Nuclear Consultant

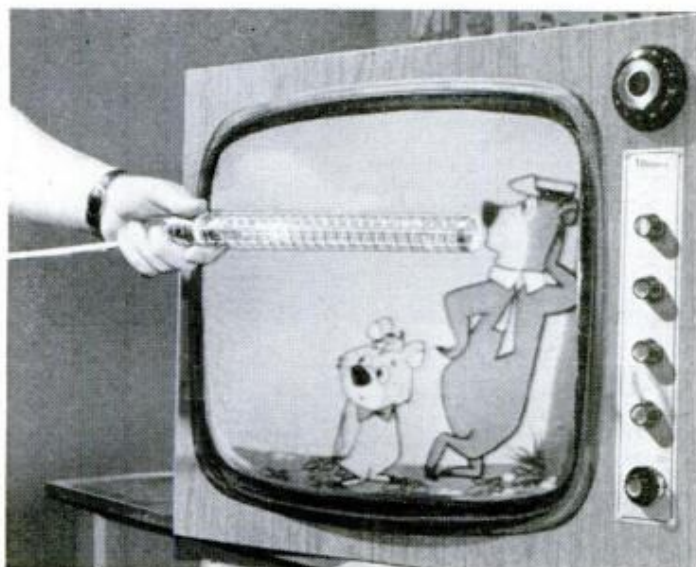

WITH THE current concern over excessive radiation exposure, we wondered if TV was having any ill effects. The X-ray tube and the TV tube are both radiation-emitting cathode-ray types.

In each test, a control was used. Three sets were utilized, using a new tube, a two year old tube, and a tube over five years old. The resultant films were subjected to densimeter analysis to reveal the degree of fogging.

Additional tests were run with dosimeters and scintillators with results that varified the film tests as follows:

If a child kept his nose against the TV screen four hours every day, he would be exposed to less than .08 roentgens per year—less than half he receives from natural cosmic rays. Certainly this is a far cry from the 5 roentgens per year which humans can safely absorb, according to the International Committee on Radiation Protection. At any distance from the screen, readings were too low to be observed.

So if there is any hazard from viewing TV, parents will have to blame it on programming rather than the radiation, which is insignificant. ★ ★ ★

FILM IS INSERTED in paper strips taped to screen. A scintillator (photo above) verifies film findings

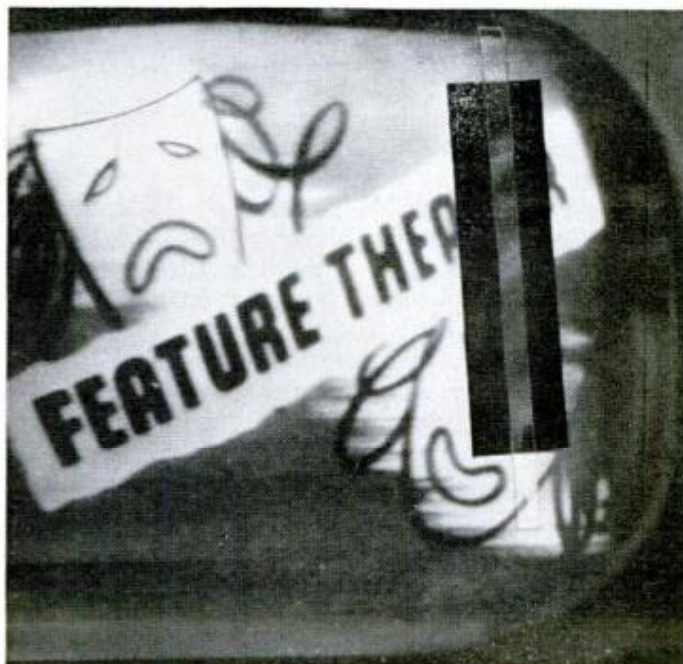

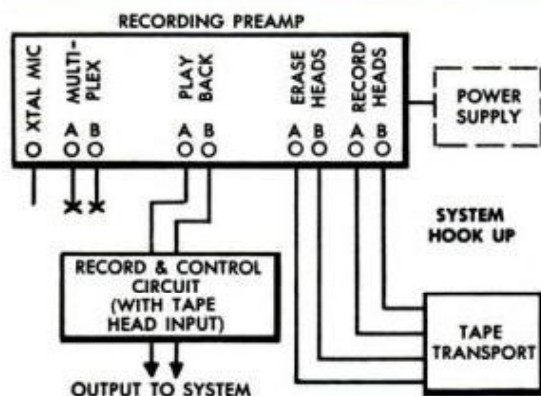
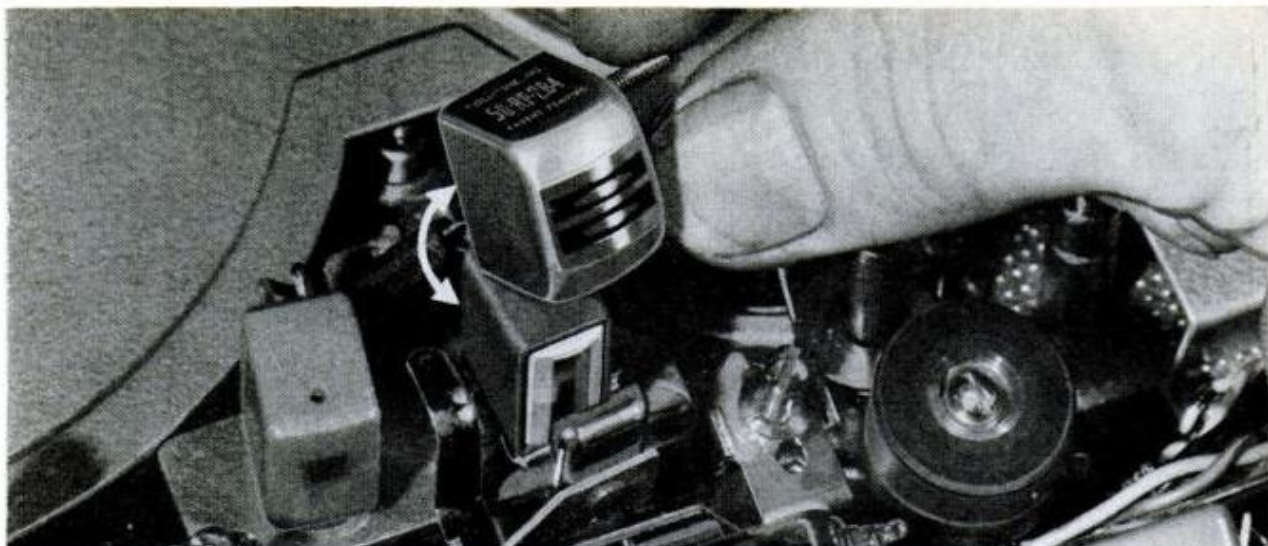

## Split Bias Design Means Lower Cost Stereo Conversion

OWNERS OF old tape recorders who want to convert to stereo have been faced with the unpleasant idea of starting, as it were, from scratch. This meant buying both the stereo recording amplifier and the tape deck. With luck, they could get a trade-in allowance on their old tape deck, but the savings were not substantial.

Now you can at last convert to a stereo tape deck for about \$25 and save most of the cost of buying a complete new stereo machine (about \$150). You are still faced, of course, with the problem of obtaining a stereo record amplifier, because the mono system in your old tape recorder cannot be converted. But here too, you can save as much as \$160 by building your own stereo record amplifier as we show you how to do here. And you can then enjoy those new stereo FM multiplex programs!

The first step in the tape deck conversion is to replace the tape head (see photo). We used a Fidelitone replacement kit which includes the stereo record-playback head, mounting plate hardware, the necessary matched oscillator and plate coils and

an alignment tape. You can order the kit by specifying your tape recorder model and make.

Remove the wiring to your old head. Then with a screwdriver, remove the head and clip the wiring out, as the old record amplifier will not be used.

If you avoid dressing power supply leads which carry a.c. this will cut down the possibility of hum pickup. The unit is plugged into an accessory socket on the tape deck or amplifier. This turns the record amplifier on and off with the unit it is plugged into. If you want a switch, however, add it between the fuse and the connection to T1. Substituting a 750-ohm, 10-watt wire-wound resistor in place of choke L4 will cut your costs about \$3. If installation space is a problem, you can use ganged controls with concentric shafts in place of R7 and R10 which are shown here as separate units. In wiring the unit, use shielded audio cable for all signal leads.

With the wiring complete, insert a stereo signal into J2 and J3. Set R7 and R10 to one-half rotation. If over or under recording results, reset these controls until a

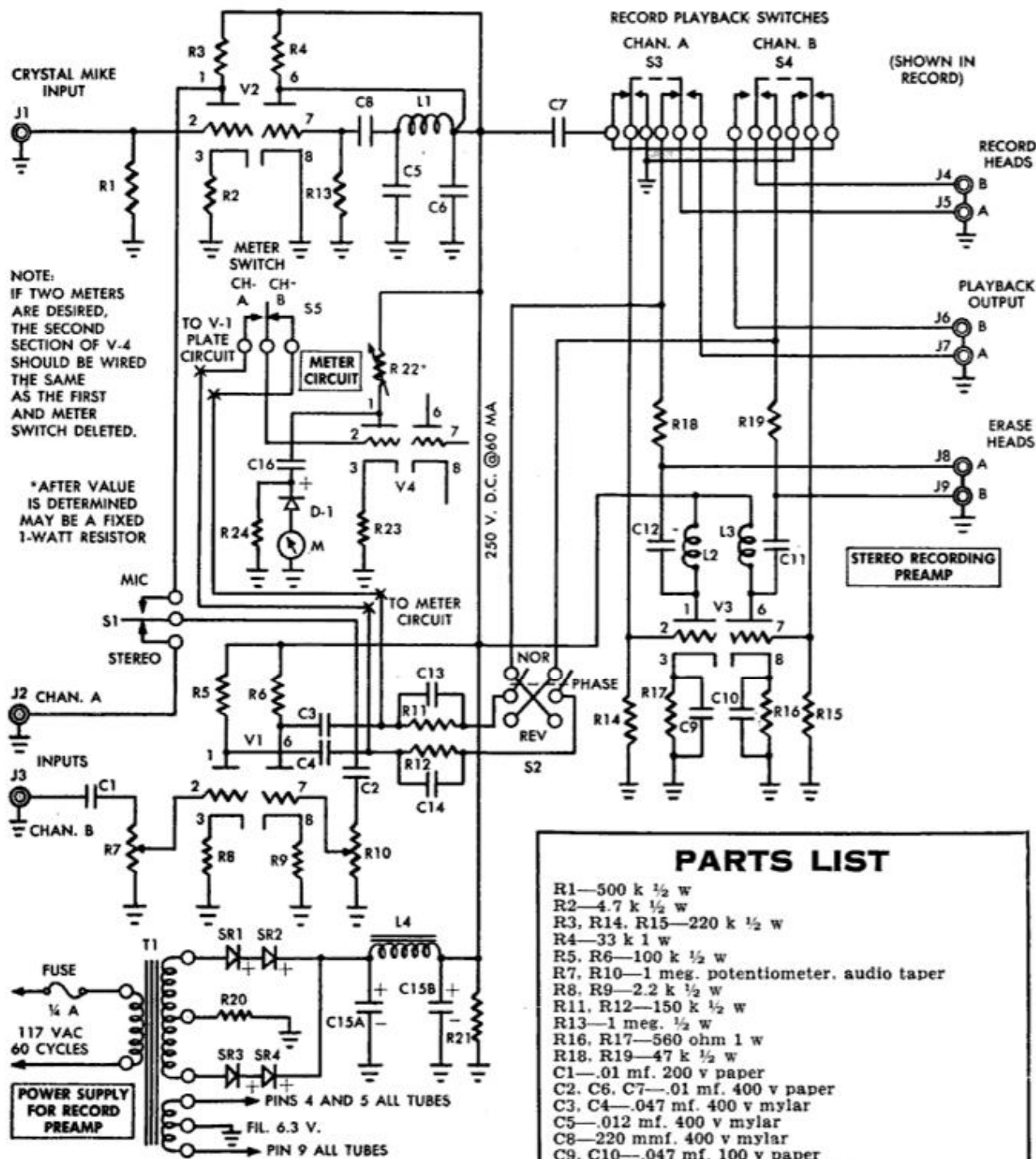

NOTE:  
IF TWO METERS  
ARE DESIRED,  
THE SECOND  
SECTION OF V-4  
SHOULD BE WIRED  
THE SAME  
AS THE FIRST  
AND METER  
SWITCH DELETED.

\*AFTER VALUE  
IS DETERMINED  
MAY BE A FIXED  
1-WATT RESISTOR

## PARTS LIST

- R1—500 k ½ w
  - R2—4.7 k ½ w
  - R3, R14, R15—220 k ½ w
  - R4—33 k 1 w
  - R5, R6—100 k ½ w
  - R7, R10—1 meg. potentiometer, audio taper
  - R8, R9—2.2 k ½ w
  - R11, R12—150 k ½ w
  - R13—1 meg. ½ w
  - R16, R17—560 ohm 1 w
  - R18, R19—47 k ½ w
  - C1—.01 mf. 200 v paper
  - C2, C6, C7—.01 mf. 400 v paper
  - C3, C4—.047 mf. 400 v mylar
  - C5—.012 mf. 400 v mylar
  - C8—220 mmf. 400 v mylar
  - C9, C10—.047 mf. 100 v paper
  - C11, C12—.0047 mf. 600 v mylar
  - C13, C14—.001 mf. 400 v mylar
  - V1—12AX7
  - V2, V4—12AU7
  - V3—12BH7
  - S1—SPDT slide switch
  - S2, S3, S4—DPDT slide switch
  - J1 through J9—phono pin jack (Cinch Jones 81-A)
  - L1, L2, L3—Fidelitone Kit #1149
  - T1—Stancor PC 8403 or equivalent
  - SR1, SR2, SR3, SR4—Sarkes Tarzian F4 280 v at 750 ma silicon rectifier
  - L4—Stancor C 1708 or equivalent 13 hys at 65 ma. —or 750 ohm, 10 w resistor (see text)
  - C15A, C15B—40-40 mfd. at 350 v electrolytic
  - R20—10 ohm 1 w
  - R21—250 k 1 w
  - R22—100 k pot
  - R23—1 k ½ w
  - R24—5.6 k ½ w
  - C16—.1 mfd. at 400 v paper
  - D1—IN34A diode
  - M1—0-1 ma. meter, 2½"
  - S5—SPDT slide switch
- Punched, formed, prefinished chassis available from Experimenter Supply Co., 4301 S. Whipple, Chicago 32, Ill.

proper level is reached. Then adjust R22 for a meter swing of approximately 70 percent. This control can now be removed, measured and replaced with a fixed resistor, or left in for further adjustment.

Now plug the playback leads into a magnetic input on your stereo amplifier and insert the alignment tape. Put the unit on *Play* and adjust the screws at the sides of the head, which cause it to move away from the vertical. At the point where the loudest signal is heard, the adjustments are correct.

If the head is correctly aligned for playback, it is also aligned for recording. This system was use-compared with units in the \$250-\$500 price range and no appreciable difference could be detected.—R. M. Peters

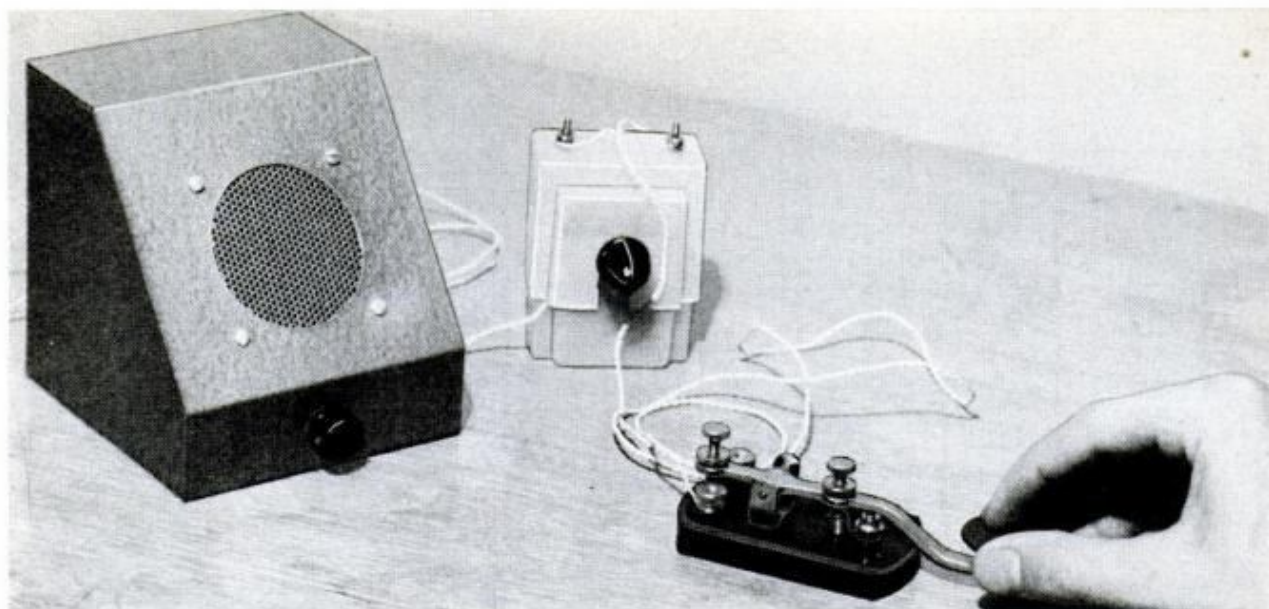

# Multi-Purpose Audio Oscillator

Code Practice • Radio Testing • Stereo Balancing

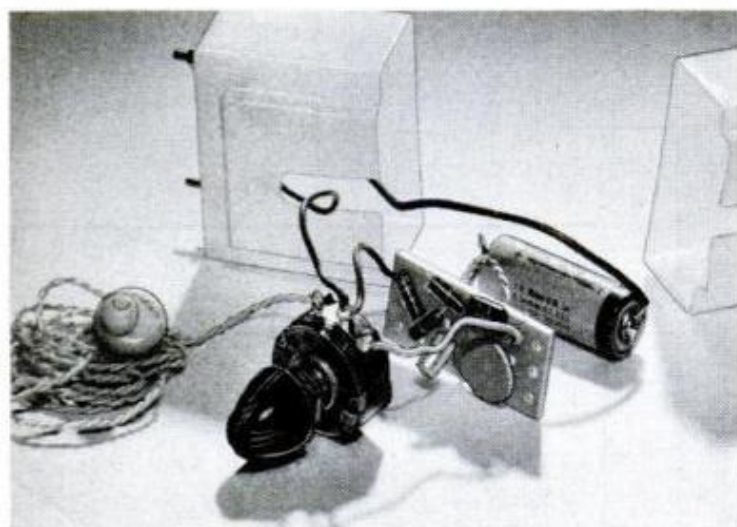

ALL PARTS (above) fit neatly into small cigarette case. The actual size diagram (below) can be used as a building layout

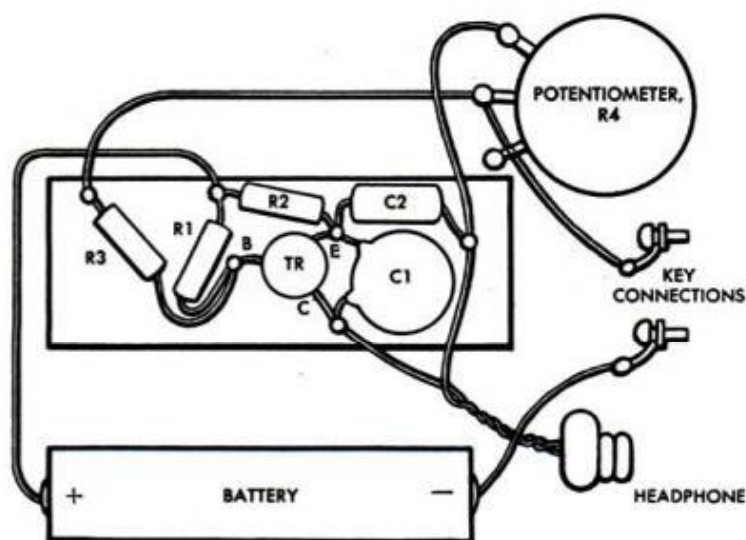

USE THIS handy pocket-sized oscillator with a telegraph key, and you can practice the code. Build two to connect between houses, and the kids can communicate while they learn the code.

For more volume, hook the earphone leads into any small amplifier having a 2000-ohm input, as we have done in the photo above.

Remove the earphone, replace the phone with a pair of paralleled phono plugs, and the oscillator can inject a tone signal into your stereo system to help you properly set the balance control.

If you connect the earphone output through a .01 mfd. capacitor, you can use the oscillator as a signal injector to test the audio portion of radios and television sets. Just apply the other end of the capacitor to the grid terminals of the tube you want to test.

—Otto Fried

## PARTS LIST

- R1—680 ohms,  $\frac{1}{2}$ w,  $\pm 10\%$
- R2—2.7 k,  $\frac{1}{2}$ w,  $\pm 10\%$
- R3—3.3 k,  $\frac{1}{2}$ w,  $\pm 10\%$
- R4—Potentiometer, 50k, linear taper
- C1—.01 mfd. disc
- C2—.15 mfd, 200-v d.c.; paper
- TR—2N217, RCA
- B —5.0-v battery, Mallory TR-164 or any other between 3-6 v.
- Phenolic board 2" x  $\frac{7}{8}$ "
- Cigarette case, hardware, etc.
- Phones—Magnetic 2k

# REDECORATE A ROOM—OR MAKE A TABLE

With a Weldwood Fix  
and Finishes shelf  
in your workshop



**Finish wood paneling** with Weldwood Satinlac®. A complete finish—it seals, primes, finishes! Produces a glowing, soft-sheen luster, and brings out the wood's natural beauty without "plate-glass" shine.

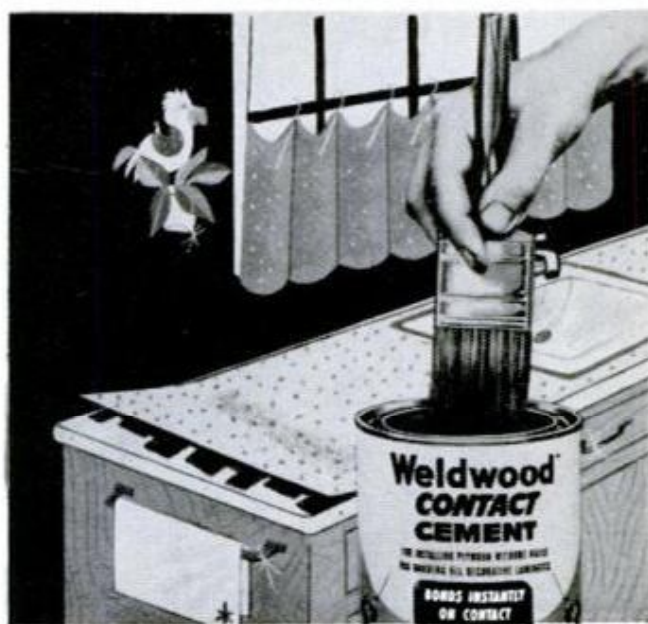

**Install a counter top** with Weldwood Contact Cement. Bonds instantly on contact, needs no clamping. Ideal for installing wood paneling without nails, too! Water-resistant. Stays flexible.



**Edge a table** with Weldwood Flexible Wood-Trim®. Six real woods—birch, oak, walnut, mahogany, Korina®, fir—in 8' rolls. Use to finish plywood, or as a decorative trim. Apply with Presto-Set® Glue.

Best thing about setting up a Weldwood® Fix and Finishes shelf is that when you're in the mood to tackle a job, the materials you need are ready, too! Visit your Weldwood dealer (lumber yard, paint or hardware store) this week, and lay in the adhesives and finishes you're most likely to need in the coming months. Suggestions: Weldwood Contact Cement, and Plastic Resin and Presto-Set Glues; Satinlac; new Deep Finish Firzite® penetrating sealer-finish; and Weldwood Wood-Trim and Putty-Sticks®.

**FREE—8-PAGE BOOKLET!** "Professional Gluing And Wood Finishing Guide." For free copy, write: United States Plywood, Dept. PM 1-62, 55 W. 44th St., New York 36, N. Y.



*Products of United States Plywood*

# Repairs are a cinch...



## with a *Weller*<sup>®</sup> Dual Heat Soldering Gun Kit

Here's a tool you'll use for money-saving household repairs, electrical work and hobbies. It makes soldering simple, sure and fast. Pull the trigger—tip heats instantly and spotlight illuminates work. 2 trigger positions give low 90-watt and high 125-watt heat as your job requires. Tip has superior heat transfer and long life. Guaranteed for 1 year against defects in material and workmanship. Kit includes cleaning brush, soldering aid and solder.

Model **\$795**  
8200K

Other dual and single heat soldering guns  
available from 100 to 275 watts.

WELLER ELECTRIC CORP., EASTON, PA.

## Pressure Caps and Thermostats

(Continued from page 125)

erly unless that specific pressure is maintained. For this reason never install a pressure cap of a higher or lower rating than that allowed for when the system was designed. Fail to follow this rule and you've got trouble—lowered cooling efficiency, possibly a blown hose or even a head gasket, especially if the rating of the cap is much above that specified for your car.

Present-day pressurized cooling systems require a closer watch for coolant leaks. Improperly torqued head bolts, incorrectly seated hose clamps, any loose connections between blocks and radiator may not allow perceptible coolant leaks but may permit air to be drawn into the system, resulting in what is known as aeration. When air bubbles form in the coolant due to aeration its efficiency is greatly reduced. For this reason Saturday Mechanics should own a torque wrench and go over all bolts in the system periodically to assure that uniform tension is being maintained in accordance with the recommendations of the manufacturer of the car. ★ ★ ★

**SOME GAS AND OIL ADDITIVES** make your car run better. Learn how in Booklet 207, only 35c from Popular Mechanics Service Bureau, Room 532, 200 E. Ontario, Chicago 11, Ill.

## Home Fitness Gym

(Continued from page 159)

will extend 16 in. which provides a maximum pull of 40 pounds. Along with friction of the rollers a total pull of 90 pounds or more is exerted on the operator's arms. Screen-door springs are not recommended for the coil springs as they are too light even if several were used. The seat, detailed in Fig. 2, is made of 3/4-in. plywood and is fitted with ball-bearing skate wheels positioned between double skirts. Note that the latter extend below the rails to keep the seat on the track. The edges of all the parts should be rounded to avoid slivers.

To row, brace the legs straight against the footboard and with the seat pushed all the way back, grip the strap handle and pull it toward you, at the same time bending the knees and letting the seat roll forward. At the completion of the full stroke, release the spring tension slowly, at the same time straightening the legs and pushing the seat back to its original position. Workouts of just a few minutes each day go a long way in strengthening leg muscles, reducing hips and thighs and flattening the stomach.

(Continued next month)



# World's First, Finest and Only Complete Line of FUN GUNS!

**SINGLE-Action  
SIX CO<sub>2</sub> Gas Pel-  
gun Revolver**

Fast draw  
with true western  
single action

**"160"**  
CO<sub>2</sub> Gas Deluxe  
Pelgun Rifle

Today's  
deluxe marksmanship  
Pelgun rifle

**"140"**  
High Velocity  
Air Pelgun  
Pump Rifle

Real economy  
for every kind  
of fun shooting

**"V-350"**  
Slide Action  
BB Air Rifle

New high velocity—  
fastest, easiest barrel  
slide-action cocking

**Only Crosman fits a gun to  
every shooter from 8 to 80!**

You're sure to find your  
own favorite gun . . . for  
fun plinking, marksmanship,  
and gun training . . .  
among the twenty-two differ-  
ent models of Crosman  
CO<sub>2</sub> gas and high velocity  
air powered Pelguns® and  
BB guns. Priced from  
\$12.95. See them at your  
Crosman Select Dealers'.

**"600"**  
Pelgun Semi-  
Automatic  
Pistol

"10" shots in less  
than 3 seconds

Write for free literature,  
Crosman Arms Co., Inc.,  
Dept. PM-2101  
Fairport, N. Y.

*"Power without Powder"*  
**Crosman**  
High Velocity Air and CO<sub>2</sub> Gas

PELLGUNS

BB GUNS

WORLD'S LARGEST MANUFACTURERS OF CO<sub>2</sub> GAS-POWERED RIFLES AND PISTOLS

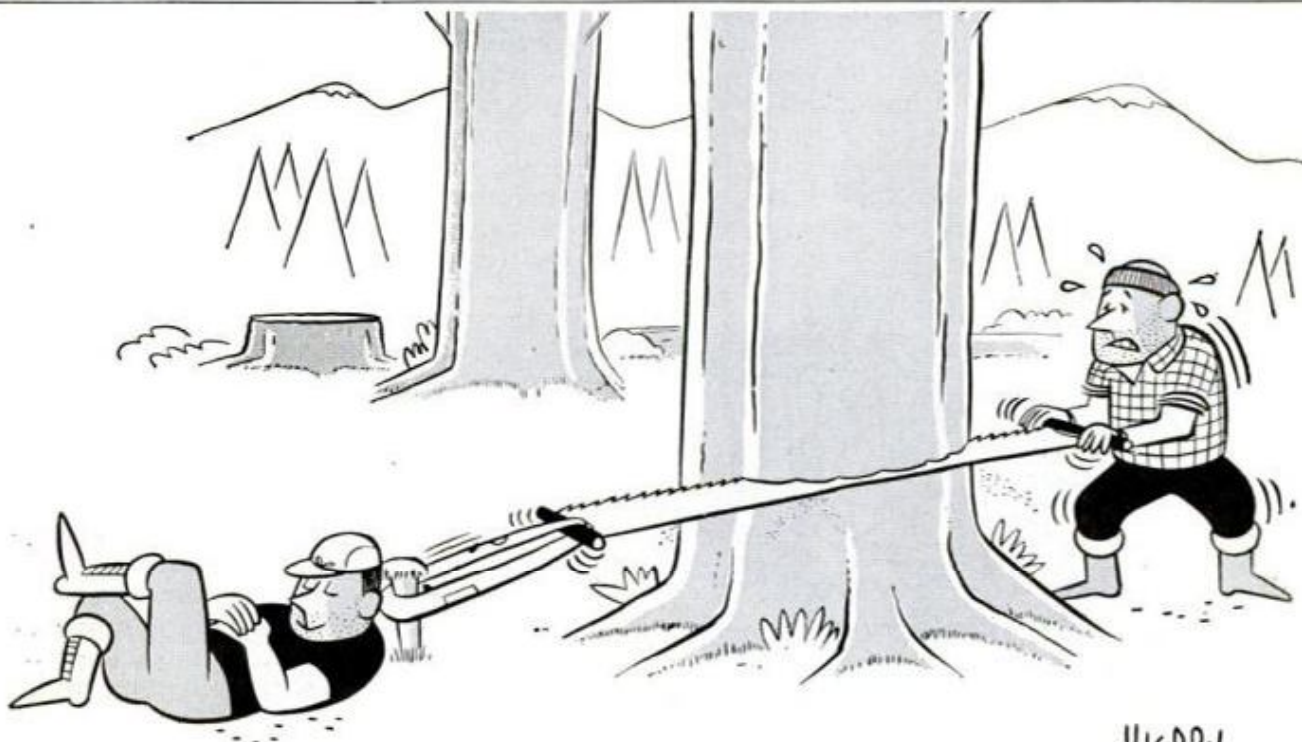

HIGDON

# CLINIC FOR HOMEMAKERS

As a service to our readers in solving the hundreds of problems pertaining to a home—inside or out—editors of Popular Mechanics invite you to present your problems to The Clinic Editor for help and advice. Address your questions to The Clinic Editor, Popular Mechanics Magazine, 200 East Ontario Street, Chicago 11, Ill.

## French Antique Finish

**Q**—We bought a secondhand set of dining room furniture in an ornate pattern. The pieces are all in good condition, except the finish isn't so hot. We'd like to do them over in a white antique effect, but how should we apply the finish?—H.B., Ind.

**A**—There are several good finishing schedules that will produce the French antique effect you have described. The main purpose for using such a finish is to give a piece of furniture the mellowed appearance of age. Here is one finishing schedule which has given excellent results, and the finishing may easily be varied to suit individual tastes.

After the old finish has been removed and the surface sanded, a flat or semiglossy off-white enamel is applied to the entire surface. Once this background finish is thoroughly dry a glaze coating is spread on with a paint brush. For this you can use a bronzing powder mixed with bronzing liquid or raw umber tinting pigment in oil thinned with turpentine.

The glaze is applied to the decorative carvings, then wiped off immediately with a lint-free cloth, leaving color in the low spots of the carvings and corners as desired. Final blending may be accomplished with a dry brush, working from the center towards

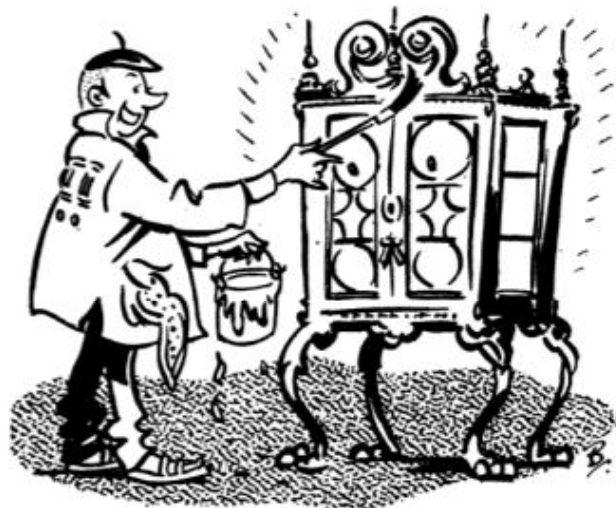

the edges. For the finishing coat, apply a clear, dull-luster varnish or a similar finishing material.

## Street Noises

**Q**—Traffic in our neighborhood was rerouted last summer, and now we get a lot more noise and traffic along our street. The noise hasn't been so bad since we closed the windows last fall, but we'd like to know how we can reduce the noise that is coming into the house, especially during the summertime? One of our neighbors plans on building a brick wall in front of his place to deaden the sound, but we can't afford anything like that. What would you suggest?—W.D., Conn.



**A**—Sounds originating outside a house are more difficult to control than those originating inside, but there are many ways of reducing these outside intruder noises and still not have to spend a fortune.

Probably the least expensive and most effective noise barriers against street rackets are shrubs, thick hedges and trees grown between the street and house and set out in attractive groupings to absorb and deflect unwanted sound.

Wooden fences forming baffles that both gobble up and deflect sound are also effective noise barriers, especially when combined with thick climbing vines.

But a tightly built modern house, which is thoroughly insulated and weather stripped, is your best sound barrier. Heavy drapes at the windows will help muffle the noises coming through the glass areas. By using double-glazed windows and keeping them closed throughout the year (this means air conditioning the house during warm weather) you will be using one of the most effective means of keeping noises at bay.



## Catalina: Stormer out of Pontiac

This one comes on with a rush: a new breed of "Cat" from Pontiac. Touch toe to throttle and watch that Trophy V-8 gobble up road. Arc the wheel and feel Pontiac's Wide-Track unbend the curves. Driving a Catalina is a real kick. No question about it. And a good-sized chunk of the fun comes from the things you choose yourself. Engine power: it ranges from a thrifty 215 h.p. rig to the 348 h.p. Tri-Power screamer. Transmission: standard three-speed manual. Optional at extra cost: four-speed, floor mounted stick or Hydra-Matic. You can tailor this baby to your tastes all the way back to the rear axle ratio. And you'll like the basic package, too. The Catalina is slightly longer this year. (Wheelbase has gone up to 120".) The turning circle is tighter for sharper maneuvering. You'll go for its looks, light handling and lightning action. Check with your Pontiac dealer. He's a man after your own heart. And make it soon! Pontiac Motor Division — General Motors Corporation.



### This is how a **GRAVELY** Plows.

Perfect seedbed, one operation. Easy. Does mowing, every other lawn and garden job as well. 6.6 hp. All-gear drive—30 Tools.

Sold and serviced by authorized Gravely Dealers.  
For free Booklet, in color, write now.



Installation Plan Available

**GRAVELY TRACTORS**  
DIVISION STUDEBAKER-PACKARD CORPORATION  
P. O. BOX 601-A DUNBAR, W.VA.

**ALL  
NEW!**

*150th Anniversary Issue!*  
1962 Edition of Constantine's  
**WOODWORKING  
CATALOG & MANUAL**



Since 1812—World's Largest Source for Rare Woods and Woodworking Supplies, Tools, Hardware, Plans, Projects!

Whether you work with wood for fun or profit—get your copy of this biggest Constantine Catalog & Manual! Hobbyists and professionals say it's the world's one truly complete source for fine rare imported and domestic woods, veneers, plywoods, bandings, inlays, mouldings, carvings—plus hard-to-find hardware, lamp parts, wood finishing and upholstery supplies, patterns, tools, wood-working materials—at bargain prices! Also exclusive Inlaid-Wood-Picture Kits. Includes natural-color Identification Chart of 60 rare woods . . . pages of inspiring projects for furniture, etc. Complete with instructions. We ship same day. Send 25c with coupon for postage and handling.

**ALBERT CONSTANTINE AND SON, Inc.**  
2050 Eastchester Rd.  
Dept. A-5, New York 61, N. Y.

Albert Constantine and Son, Inc.  
2050 Eastchester Rd., Dept. A-5, New York 61, N. Y.

Enclosed 25c for new 1962 Constantine Catalog & Manual.

Name.....

Address.....

City..... State.....

## Ten-Minute Film Dryer

(Continued from page 185)

can outlet and to the blower, Figs. 2 and 5, so it will exhaust the moisture-laden air outdoors. The flexible hose used here was an extension hose for a shop vacuum sweeper. With the heater switch in the off position, plug the cord into an outlet. Insert a long-stemmed dial thermometer into the dryer through the hole for the thermostat wires as in Fig. 5 and turn the thermostat on about a quarter turn. Now flip the heater switch to on. The red pilot light will glow and the tape will heat up. As soon as the thermometer reads 120 degrees F., slowly turn the thermostat control toward the off position until the red light goes out. Plug in the blower and cool the dryer until the pilot light goes on again. Unplug the blower and let the temperature rise until either the red light goes out or the thermometer indicates 120-degrees. If the latter, readjust the thermostat slightly. Repeat this until you are certain the thermostat works at 120-degrees, then the dryer is ready for use. ★ ★ ★

## Automatic Bicycle Transmission

Eliminating handle-bar controls and cables, a new bicycle transmission with a two-speed gearshift is contained entirely in the hub of the rear wheel.

It has a low speed for starting or hill climbing, and a "cruising" speed. A shift from one to the other is accomplished by back-pedaling about two inches.

Also, when the brake is applied, regardless of which forward gear is being used, the unit utilizes the gear ratio of the low-speed shift, which reduces pedal pressures by half, giving the effect of a power brake. The transmission was developed by the Bendix Corporation.

## Tape Controls Giant Gauge

So sensitive it can detect a change as small as 10 one-millionths of an inch in the inside and outside measurements of a part, a 16-ton gauge system is controlled by punched tape.

The universal, five-axis measuring machine is capable of inside, outside and thickness measurements of parts of any shape. Used to measure such critical items as a missile nose cone, it can complete almost 1000 measurements in two hours under the direction of a punched tape. It would require about a month to make the same measurements by other means.

The gauge is made by the Sheffield Corp., Dayton, Ohio.



'62 FORD STYLESIDE PICKUPS offer a wide range of heavy-duty options to fit your job: 5 transmissions, Six or V-8 power, 4-wheel drive.

## Ford's full-time economy only starts with low price !

'62 Ford Pickups save every day you drive !

- Save on gas !
- Save on oil !
- Save on tires !

Low price is only the start of your savings on '62 Ford pickup trucks.

They save full time on gas and oil. Tested against other leading makes over a three-year span, modern Ford Sixes offer a record of consistent gas economy that's unmatched in the field. What's more, with Ford's full-flow oil filter, oil changes are required only every 4,000 miles, instead of the usual 2,000 miles.

Include tire savings, too, in Ford's full-time economy. With true-tracking I-beam front axle, tire wear is far less than with some other types of suspension.

Why settle for anything less — when you can get full-time economy in a pickup as smart, sturdy and smooth riding as the '62 Ford. Only at Ford can you find Certified Test Reports compiled for three years on gas, oil, tire mileage. See your Ford Dealer!

**FORD TRUCKS COST LESS**

SAVE NOW...SAVE FROM NOW ON!

FORD TRUCK CERTIFIED ECONOMY REPORTS

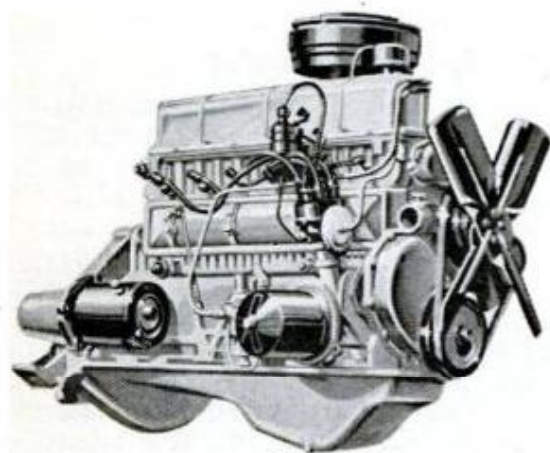

FORD'S GAS-SAVING 223 SIX has a three-year record of superior gas economy — established in competitive tests certified by independent engineers!



**FULL-FLOW OIL FILTER** extends oil changes to 4,000 miles; depth-type filter element keeps oil clean longer, adds to Ford's outstanding reputation for long life and reliability!

PRODUCTS OF  MOTOR COMPANY



**TIRE-SAVING FRONT SUSPENSION.** Ford's truck-type suspension keeps tires tracking true. Delivers far longer tire life than trucks with other type suspensions.

## How to Outwit an Ouzel

(Continued from page 151)

If the camera being used is equipped with a regular leaf shutter, of course, a properly rated electronic unit would be suitable for almost all situations as long as it was not too heavy. Remember that you will frequently be led into rough terrain if you intend to follow the birds very far. Also, remember that with flash you will probably get only one picture at a time. Most birds depart at first when the bulb pops, but become used to it later. The shorter flash of an electronic unit does not disturb them as much.

### Outsmarting a Wary Ouzel

Let's translate all these do's and don'ts into an actual case. This past winter the author set out to photograph one of the most interesting of western birds—the dipper, or water ouzel. This little sparrow-sized bird, although not a water bird as such, has the unique ability to walk on the bottom of mountain streams, clutching the rocks from which he plucks nymphs and other larvae. Unfortunately for the photographer, his coat does not match his colorful ways, being completely gray.

Since feeding stations and/or cameras at the bottom of an icy mountain stream are impractical, the only way to approach the ouzel was by simple stalking through difficult terrain. Also, since he was quite small, very active, and usually frequented the shade, a telephoto lens mounted on a bellows with a flash unit attached seemed to be the answer. Using this rig and much patience, theoretically, would produce good shots of the ouzel.

Making this a reality, however, involved several other things, most important of which was a familiarity with the subject. Few people will try to photograph an auto race, a football game or a movie star without learning first what angles or positions might be best and what might be risky. So it is here, and for really good bird pictures the photographer is advised to obtain a copy of one of the excellent natural history books available in any library. The Audubon Society, at 1130 Fifth Ave., N.Y., is an inexhaustible and cheap source of information about all birds.

Thus armed with much written information on the ouzel, the writer sought out the bird—and soon found that much remained to be written. For one thing, although all the writers had explained that the ouzel was called a dipper because he dipped up and down constantly, none of them had mentioned that this dipping occurred with a surprising regularity, exactly once a sec-

ond. Until the photographer learned this, and timed his shots to occur between the dips, the results were somewhat blurred. Other birds move with the same regular, quick movements, ranging from twice or three times a second for a wren to long intervals for crows. Predatory species such as the hawk and owl lack these rhythmic movements, as do most water birds.

With the coming of spring, the ouzel nested, and the approach shifted accordingly. Flash was provided by an electronic unit attached to the forest footbridge under which a nest was situated and the photographer was concealed in a natural blind at the edge of the stream. Another flash was focused a short distance away from a rock, on which every bird stopped as it bore food back to the nest. Having ascertained these things about the ouzel beforehand, including its pattern of flight, its length of stay at the rock and the nest, a good photographic record of its life could be obtained, whereas a person blind to the bird's habits might have obtained one picture but certainly no more.

The total cost of the ouzel effort was many rolls of film, obtained cheaply by buying it in bulk and respooling it at home, a lot of pleasant time afield, plus a certain amount of penicillin needed to get rid of the pneumonia acquired while crawling through snowbanks. The reward: some excellent shots of a fascinating bird which showed not only the bird itself but proved the fact that the photographer was able to obtain them. Pneumonia is not an inevitable part of bird photography, but the pleasure which comes from a really good picture is always a sort of triumph. Now that the expense has been removed from this challenge, the field is wide open to anyone with the yen and the energy. ★ ★ ★

---

## Man's Time in Space Limited By Food He Can Carry

Storage and weight, rather than nutritional content, are the major factors in space feeding that will limit the time man can spend in space, according to a nutritionist for the National Aeronautics and Space Administration. Each pound of dry weight placed in an earth orbit requires 10 pounds of propellant to get it off the ground. With current launching capabilities, a short round trip to the moon is possible, but a year-long trip to Venus or Mars is not. An adequate supply of ready-to-eat, prepackaged foods would amount to about 1300 pounds per man per year of flight for such a journey which, at present, is economically unfeasible.

## Triple-Top Fun Table

(Continued from page 171)

from the ends, the two other screws being equally spaced between the end ones.

At this stage the assembly is ready for attachment of the top rail, Fig. 18. Spacing of the countersunk holes for the screws which hold it is given in Fig. 15, the spacings being located on the center line of the rail. Drill the body holes for the No. 10 screws all the way through, then use a 1/2-in. countersink, running the latter just deep enough to allow only 1/16-in. above the screw head when the screw is drawn tight.

### MATERIALS LIST

(All dimensions in inches)

- 2 pcs.—3/4 x 1 x 42 1/4—Cushion clamping strip—ends
- 2 pcs.—3/4 x 1-9/16 x 42 1/4—Cushion rail riser—ends
- 2 pcs.—3/4 x 1 1/4 x 37 3/4—Cushion rails—ends
- 4 pcs.—3/4 x 1 x 43 1/8—Cushion clamping strip—sides
- 4 pcs.—3/4 x 1-9/16 x 43 1/8—Cushion rail riser—sides
- 4 pcs.—3/4 x 1 1/4 x 38 3/4—Cushion rails—sides
- 6 pcs.—3/4 x 4 1/4 x 4 1/4—Head corner pocket filllets
- 4 pcs.—3/4 x 3 x 4 1/4—Foot corner pocket filllets
- 2 pcs.—3/4 x 1 3/4 x 4 1/2—Side pocket fillers
- 12 pcs.—3/4 x 2-1/16 x 2-1/16—Corner pocket fillers
- 4 pcs.—3/4 x 2 7/8 x 4 1/2—Flap holders
- 4 pcs.—3/4 x 4 1/4 x 4 1/2—Flap holders
- 1 pt.—Liquid hide glue (Franklin)
- 1 lb.—Plastic resin glue-powdered (Weldwood)
- 1/2 pt.—Super strong glue (Allens)
- 1 set—Rubber cushions—For 4 x 8 table
- 1 pc.—48 x 96—Billiard cloth
- 6 pcs.—5 x 48—Cushion cloth
- 7/16 # 4—Carpet tacks
- 12 Rubber cushion facing
- Flexible plastic countertop material—**BOLTA-FLEX (BOLTA CO. LAWRENCE, MASS.)**
- 1 pt.—Contact cement
- 1 1/4 x 10—F.H. wood screws
- 1 1/2 x 10—F.H. wood screws
- 2 1/4 x 10—F.H. wood screws
- 6 # 2-1/2 Tin cans
- 1 1/2 doz.—1/2—Pearl spots

The screw heads are capped with pearl sighting disks, or spots, as they are often called, which you buy ready-made. They are slightly under 1/2 in. in diameter. The disks are thus loose-fitted purposely, the loose fit permitting them to be lifted out readily when it is necessary to disassemble the parts for replacement of worn or damaged felt on the bed and cushions. In the final assembly of the rail, after painting, a tiny spot of putty placed on each of the screw heads will hold the sighting disks in place yet permit removal when necessary.

The next step toward completion of the top is the making and fitting of the end and side-pocket boots, Fig. 27. Each boot is made from a No. 2 1/2 tin can and lined. The lining material is the same as that used in the ball returns and is applied with contact

## send for your **ALLIED** MONEY-SAVING 1962 ELECTRONICS CATALOG

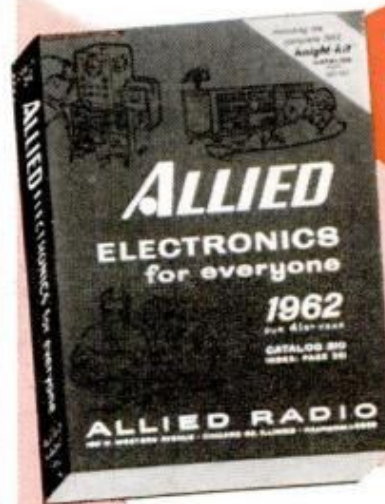

# Free

**444 PAGES**  
World's Biggest  
Most Complete!

...  
**NO MONEY DOWN**  
New Credit Plan  
Gives You 50% More  
Buying Power!

### SAVE MOST ON

### EVERYTHING IN ELECTRONICS

Send today for this FREE Catalog—the world's biggest—featuring everything in Electronics for modern living, including products and values available only from ALLIED. Whether you're a kit builder, experimenter, hi-fi fan, Amateur, serviceman or student, you'll save most on:

- KNIGHT-KITS®—Best in Build-Your-Own
- Everything in Stereo Hi-Fidelity
- New Multiplex Stereo FM
- New All-Transistor Stereo Hi-Fi
- KNIGHT® Super-Value Stereo Hi-Fi
- Tape Recorders & Phono Equipment
- Citizens Band 2-Way Radios
- TV Tubes, Antennas, Accessories
- Parts, Tubes, Transistors, Tools, Books
- Amateur Station Equipment
- Public Address & Intercom
- Latest Test & Lab Instruments



**SAVE MOST** on everything in Electronics at ALLIED—the world's largest electronic supply house. Get fastest service, expert personal help, easiest-pay terms. Send coupon today for FREE 1962 ALLIED Catalog.

Free  
CATALOG

Satisfaction Guaranteed  
or Your Money Back

### ALLIED RADIO

ALLIED RADIO, Dept. 41-A2  
100 N. Western Ave., Chicago 80, Ill.

Rush FREE 1962 ALLIED Catalog.

Name \_\_\_\_\_  
PLEASE PRINT

Address \_\_\_\_\_

City \_\_\_\_\_ Zone \_\_\_\_\_ State \_\_\_\_\_

# HERE'S THE RING that cracks the "Performance Barrier!"



Penny-pinching oil control, longer ring life, longer engine life and Sealed Power KromeX ring sets go hand in hand. No two ways about it.

Tall talk or solid fact? Make up your mind. Here are the facts:

Oil rings in KromeX sets are Stainless Steel. This is a superior metal. It doesn't corrode. It resists pitting and etching of gases produced by internal combustion.

These Stainless Steel oil rings are *electro-polished*—they're glass smooth, they stay smooth so carbon doesn't cling, return oil vents keep clean and free for peak lubrication.

Stainless Steel retains its tension at operating temperatures for lasting fit, far better oil control.

Sealed Power KromeX ring sets with Stainless Steel oil rings are easy to install. No shims, no gauges, no springs to fuss with. Why settle for less? Sealed Power Corporation, Muskegon, Mich.



**Sealed Power** Stainless Steel  
oil rings stop oil pumping

cement. Note that the top edge of the lining material is bent over the lip of the can section. Only the end-pocket boots are notched and bent as detailed in Fig. 27 and shown in the adjacent photo. Edges of the side-pocket liners are cut straight as indicated in the photo at the right of Fig. 25. Here the can is first formed oval shape and then cut. Approximately one half of the can is required, actual measurement being taken between the ends of the cushion facings against which the cans hook. Once fitted, the pocket boots are removed, each one being marked so that all six can be replaced in sequence. Now, remove the rail assembly consisting of the top rail, the assembled parts A and B and the clamping strip. Remove the cushion rail from the riser, again marking the parts so that they can be reassembled in sequence. Cover the felted bed with heavy paper to keep it clean, also to protect it from overspray when painting. Trim the paper to the full size of the bed so that the edges will extend under the clamping strips. Reassemble by placing the bed back in position, replacing the clamping strips, the risers and the top rail, but omitting the cushion rails. In this temporary reassembly of the parts, turn the screws in only moderately tight as the parts must again be disassembled after sanding and painting. Part III next month will describe making the storage base.

---

**MODERNIZE ROOMS** with plywood wall paneling. Simple instructions in Booklet 205, "New Rooms for Old," only 25c from Popular Mechanics Service Bureau, Room 532, 200 E. Ontario, Chicago 11, Ill.

---

## Ceramic Ignition System Pumps Out Steady Charge

Using a switch and a spark plug, a new "spark pump" is said to out perform conventional ignition systems using coils, condensers, points and a host of other parts. According to Clinton Engines of Cleveland, Ohio, the device operates on the principle of *piezoelectricity*, the same principle used in crystal radios and phonograph tone arms. The "spark pump," however, uses a ceramic element in place of the usual slice of quartz crystal. Under a steady pulse of pressure the element is said to emit a constant charge of 20,000 volts at low amperage, regardless of engine speed. Extensive tests promise an end to ignition troubles on power mowers, generators and other small gasoline-powered equipment and manufacturers hope further developments will see wider, more extensive uses for the "pump."



# Weather Station Is Powered by Isotopes

Meteorologists will obtain weather observations from a remote area in the Canadian Arctic by means of an isotope-powered automatic weather station.

It can function up to two years unattended. The station and power source are housed in a cylindrical, insulated container approximately eight feet long, five feet of which will be buried in the permanently frozen ground.

An anemometer, thermometer and barometer will gather information which, supplied to a data processing system, will

go to a radio transmitter for relay, every three hours, to manned stations to the south.

The power source, located at the base of the container, is a strontium-90 heat generator with thermocouples, batteries and a converter. Excess heat from the atomic isotope maintains an interior operating temperature of some 70 degrees F. This element produces thermo-energy to charge a nickel-cadmium storage battery system, which in turn activates the radio transmitter.

*The proof is in the puffing!*

**PRINCE ALBERT** has the flavor  
most favored in the U.S.A.



R. J. Reynolds  
Tobacco Co.,  
Winston-Salem,  
N. C.

- always tastes fresh
- mild, mellow flavor
- cool 'n' steady burning

**PRINCE ALBERT**

NOW you can build your own

# FALLOUT SHELTER

BASEMENT SHELTER

ABOVE-GROUND SHELTER



**New plans booklet shows you how. Choose either of two practical, low-cost shelters**

New from plywood research! Two effective family fallout shelters, well within the means and ability of the average homeowner to build. Fully approved by the Dept. of Defense. Both call for simple, economical construction with big panels of waterproof plywood combined with concrete block (Basement Shelter) or sand or gravel fill (Above-Ground Shelter). Strong, safe, dependable, durable. Send 25c and coupon below for booklet with plans and information:

## NUCLEAR FALLOUT AND FAMILY SURVIVAL

Complete 34-p. guide to family protection against fallout and nuclear attack, including:

- Area and effects of fallout
- Types of shelters
- Food, water requirements
- Sanitation and ventilation
- Financing
- Complete working drawings and materials list for Basement Shelter and Above-Ground Shelter (simplified design for do-it-yourself construction)
- Study plans for Underground Shelter (pressure-treated plywood and lumber, designed for contractor construction)

Also includes plans for Compact Plywood Fallout Shelter, for lowest-cost, effective short-term protection.

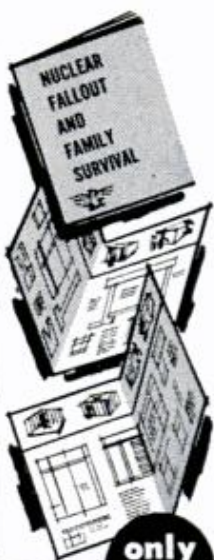

only

**SEND THIS COUPON TODAY 25¢**

**DOUGLAS FIR PLYWOOD ASSOCIATION**  
Dept. PM, Tacoma 2, Washington

I enclose 25c. Send me Nuclear Fallout and Family Survival.

NAME \_\_\_\_\_

ADDRESS \_\_\_\_\_

CITY \_\_\_\_\_

ZONE \_\_\_\_\_

STATE \_\_\_\_\_

## Metallic Brake Linings

(Continued from page 119)

squeak immediately before coming to a dead stop, which although barely noticeable, was still there. None of the linings exhibited squeal during braking.

Out of curiosity, PM sprayed hydraulic brake fluid in one drum and shoe set each of the Velvetouch and old Ford linings. The Velvetouch brakes did not grab and would lock evenly. The asbestos linings showed intermittent grab and chatter. Both sets showed evidence of having been well sprayed when they were removed. This would indicate another bonus factor for the sintered metallic linings.

### Lining Life

The Velvetouch linings showed .003 wear (average of twenty readings taken around the shoes). This .003 wear was the result of approximately 200 miles of driving, including two sets of 16 fairly rugged and consecutive decelerations from 70 to 40 m.p.h. and 50 decelerations in the 70 to 40 range, plus the slower water-fade tests, plus the normal braking requirements for the 200 miles of driving.

PM's estimate is that the normal driving equivalent of this amount of driving would be in excess of 600 miles, and based on the 1/4-inch of lining thickness being only partially used, that puts lining life in excess of 25,000 miles.

Velvetouch Metalik linings showed much less tendency toward high-speed fade than did the conventional asbestos linings, and after break-in they showed almost no tendency to fade in our test.

Water immersion caused much less fade on the average than it did with conventional linings, and braking was even at all four wheels. The Velvetouch linings squeaked very slightly after the high-speed fade tests, but did not chatter.

While PM did not prove or disprove that the Velvetouch linings have superior life, a long, if not superior life is indicated. The price for a '60 Ford is \$15.86 per set (two wheels) compared to \$12.50 for stock Ford replacement linings. ★ ★ ★

### QUOTE:

*"It has been estimated on the basis of current demands alone that for the next 10 years, the country faces annual shortages of some 9000 engineers without including the additional scientists that will be required to keep America in the forefront of technological advancement."*

WILLIAM BERGEN, President  
The Martin Co.



Take the "rub"  
out of refinishing  
peel paint off  
WITH  
**KLEAN-STRIP  
PAINT REMOVER**

- Fast • Clean • Non-inflammable
- One application removes many coats

**THE KLEAN-STRIP CO., INC.**  
Memphis 6, Tenn.—Winnipeg, Man.

**ENDS WRONG TURNS FROM BOTH  
ABSENT-MINDEDNESS AND  
ABSENT ROAD SIGNS**



THE ORIGINAL  
**HULL AUTO COMPASS**  
\$5.95 to \$7.50. At your  
dealer's, write for lit.



**HULL MFG. CO., Box 246-D-1 Warren, O.**

**PAGE FOR TILLING  
PLOUGHING  
MOWING**

A FULL LINE — 2 to 9 HP  
with complete gear drive and reverse  
FREE CATALOG • LOW PRICES • EASY TERMS  
Over 40 years experience  
OVER 60 ATTACHMENTS AVAILABLE!



**PAGE** Richfield 4  
Wisconsin

DEALERS  
WANTED

**ONE-MAN SAWMILL** LOW \$500  
AS... 50 DOWN



Take BELSAW Portable Sawmill right to the trees—turn out valuable lumber for home and farm—sell to local yards—make up to \$50 a day custom sawing for neighbors. BELSAW lasts a lifetime. No crew needed. Power with tractor or auto engine. Beginners get excellent results. Send today for FREE BOOK.



**BELSAW MACHINERY CO**  
3452 Field Bldg. Kansas City 11, Missouri



**G E A R S**

**In Stock — Immediate Delivery**

Gears, speed reducers, sprockets, thrust bearings, flexible couplings, pulleys, etc. A complete line is carried in our Chicago stock. Can also quote on special gears of any kind. Send in your blueprints and inquiries.

Send for Complete Catalog No. 10  
**CHICAGO GEAR WORKS**  
440-50 N. Oakley Blvd., CHICAGO 12, ILL.



**GENUINE ALNICO  
MAGNETS**

**AMAZING, PERMANENT, NON-ELECTRIC, HIGHLY PRACTICAL.** Conduct interesting experiments. Hundreds of uses. Retrieve valuable steel items such as guns, tackle from fresh or salt water; tools from tanks & drains. **GUARANTEED.** Try any magnet one week. Money back if you are not well-pleased.

M-90 (Wt. 5 oz.)	Has pull of 15 lbs. on steel block	\$ 3.50
M-500 (Wt. 13 oz.)	Has pull of 50 lbs. on steel block	\$ 5.00
M-575 (Wt. 18 oz.)	Has pull of 75 lbs. on steel block	\$ 7.00
M-625 (Wt. 20 oz.)	Has pull of 125 lbs. on steel block	\$10.00
M-710 (Wt. 53 oz.)	Has pull of 225 lbs. on steel block	\$18.00
M-44 Rod Magnets for Electric Guitars	1/4" Dia. x 1 1/4" 12 for	\$ 4.00
M-47 Hot Pad Magnets	10 for	\$ 4.87
M-35 Science Experimenter Kit of 8 magnets		\$ 2.00

Send M.O. or check. We pay postage. Sorry no C.O.D.'s.

**MIAMI MAGNET COMPANY, 3240 N.W. 27th Ave., Miami 42, Fla.**



**IMITATED  
...BUT  
NEVER  
EQUALLED**

**CHAN NEL LOCK**

When you buy a Channellock, you get two exclusive patented features you can't get in any other adjustable plier:

- 1 Smooth-working, machined, undercut channels. The tighter you grip, the tighter they lock.
- 2 Reinforcing rib for added strength when you put the muscle to a job.

Only Channellock—the original tongue and groove plier—has these features. Be sure you're getting the genuine Channellock... look for the trademark on the handle. Your choice of five jaw capacities: 1/2, 3/8, 1 1/2, 2 and 2 1/4 inches. Write for catalog showing our complete line of pliers. **Champion Derment Tool Company, Meadville, Pennsylvania.**

# STOP WATER DAMAGE...



Wood  
Plywood  
Shingles  
Asbestos siding  
Concrete blocks  
Concrete  
Mortar  
Stucco  
Plaster  
Brick  
Paint  
Wallboard  
Tile  
Canvas  
Leather  
Linoleum  
Fabrics

**Prevents warping, swelling, mildew, mold, water stains, seepage, dampness, rot.**

**Keeps moisture out 5 years and longer.**

Use on all woodworking jobs, boats, patio furniture, planter boxes, shutters, screen doors, window sash, shingle roofs. Stops seepage in basement walls, concrete silos, foundations. Waterproofs canvas, tarps, tents, awnings, leather boots, shoes, outdoor clothing. Won't harden or crack leather or fabrics. Perfect underseal for oil base or alkyd paints. Deep penetrating, colorless. Apply by brush, spray or roller. At paint or hardware stores or order direct. 16 oz. spray can \$1.89, Qt. \$1.75, Gal. \$5.35, 5 Gal. \$25.25, ppd., tax incl. Send check or money order to E. A. Thompson Co 1355 Market St., San Francisco 3, Calif. No COD's please. (Since 1929.) Dealer and jobber inquiries invited.

## FREE! 1962 CATALOG of World's Largest Selection of AUTO PARTS & ACCESSORIES SAVE UP TO 50%



Save UP TO ONE-HALF on all your automotive needs when you buy from J. C. Whitney, world's largest distributor of parts and accessories. The gigantic new Whitney catalog

lists and illustrates over 100,000 items . . . parts and accessories for every car and truck, foreign and sports cars, hot rods and dragsters! See latest releases of new 1962 items, Hollywood and Custom equipment, newest Hi-Speed parts, plus many hard-to-find replacement items, even for Model "A" Fords. Satisfaction guaranteed. J. C. WHITNEY & CO., 1917 (P1) Archer Ave., Chicago 16.

J. C. Whitney & Co., 1917 (P1) Archer Ave., Chgo. 16  
Please send me your giant 1962 catalog of auto parts and accessories. I enclose 25c to cover part of mailing and handling cost (refunded on first order of \$5 or more). Offer good in U.S.A. only.

Name \_\_\_\_\_  
Address \_\_\_\_\_  
City \_\_\_\_\_ Zone \_\_\_\_\_ State \_\_\_\_\_

## Automation

(Continued from page 131)

coming. The Federal government and the Labor Department are trying to find ways to help. In the past few months a new Office of Automation and Manpower was organized in the U. S. Department of Labor to find some of these answers. We have called upon leaders in labor, business and education to sit on a special Advisory Committee on Automation to work with the new office on this problem.

Under the recently-passed Area Redevelopment Act, we are pushing a comprehensive program to lift whole communities out of depressed job conditions, giving management incentives to build or expand operations in so-called depressed areas and giving workers the opportunity to retrain for new jobs within their own communities.

We have placed before the Congress a Manpower Development and Training bill which would make maximum use of existing training programs, methods and facilities and also stimulate much needed expansion of these programs and the development of improved, new, and diversified programs.

## Youth Employment Bill

We have also placed before the Congress for enactment a Youth Employment Opportunities bill, with three approaches for men and women between 16 and 22 years of age. One offers on-the-job and related training programs, including classroom instruction, to improve the employability of young people and to enhance their chance of advancement in the future.

The second part provides employment and training programs in the so-called public-service, public-work area. It would develop training opportunities for young people for experience with state and local agencies, such as schools and hospitals, as well as in conservation and similar work.

The third portion would set up a Youth Conservation Corps, a camp-oriented program in which the 17 to 22-year-old trainees would perform conservation work for \$70 a month as well as subsistence and equipment, transportation, etc.

As you can see, the Federal government, with the aid of the states and local governments, is making a concerted national effort to lift up the skills of the nation and provide economic opportunities for all.

At this juncture we are sure of one thing: The skilled worker must have the flexibility, the maneuverability and adaptability to survive. To have these three qualities, you must be ready and willing to improve your skills. ★ ★ ★

CHOOSE A  
POCKET-SIZE

**Kirsten**  
"COMPANION"  
PATENTED "RADIATOR" STEM MEANS  
*Cool  
Smoking!*

**\$3<sup>95</sup>**  
POSTPAID

**WEIGHS ONLY  
1 OUNCE!**

WRITE FOR FREE CATALOG  
other pipes 5.00-7.50-10.00

Write to: **Kirsten** PIPE CO. Seattle 7, Wash. Dept. C

**BUILD FINE GRANDFATHER CLOCK NOW**

The simple sensible **SPEEDE** Red-I-Kut way as thousands have — FOR YOURSELF OR SELL AT A GOOD PROFIT. SAVE HUNDREDS OF DOLLARS. SHOP TESTED PLANS "SPIRIT OF THE CENTURY" Narrow waist 8 1/2" tall or stately straight side "SPIRIT OF AMERICA." EASY-TO-FOLLOW photopocket PLANS & LIFE SIZE PATTERNS tell all—plus MOVEMENT BROCHURE \$4.00 up, of heavy brass weight (Kuempel original) Westminster, tube BELL chime, movements, gorgeous bronze-silver MOVING MOON dials, 3/4" solid-mahogany Jiffy Joint-Kwik-Bilt case kits. Send \$1.00 today — Both plans RUSH \$1.50 as folks have for over forty years.

Kuempel Chime Clock Works, — 14 Kuempel Bldg., Minneapolis 16, Minn.

**Print Your Own**

Cards, Stationery, Advertising, Circulars, labels, photo and movie titles, church work, tags, etc. Save money. Sold direct from factory only. Raised printing like engraving, too.

**Own a Printing Business**

Print for Others, Good Profit. Have home shop. Junior press \$15; Senior \$35 up. We supply everything. Easy rules. Pays for itself in short time. Write now for free details.

**KELSEY PRESSES, Z-37 Meriden, Conn.**

**BUILD A CAMPING TRAILER** for next summer's family vacation. Booklet 200 gives plans for "Two Folding Tent-Trailers." Only 35c from Popular Mechanics Service Bureau, Room 532, 200 E. Ontario, Chicago 11, Ill.

**Tool Care**

Precision tools kept safe and orderly. Free Catalog to tool-makers and machinists.

**GERSTNER TOOL CHESTS**  
462 Columbia St. • Dayton 7, Ohio

**ECONOMY POWERFUL!**  
Thousands in Use! Since 1946

**TRACTOR**

**UNEQUALLED LOW PRICE! TERRIFIC VALUE!**

America's finest tractor. Ruggedly built. Easy to operate. 790 lbs. Borg-Warner clutch, trans. and diff. 140 to 1 reduction. 40% more drawbar pull than ordinary tractors. 9 H.P. engine. 20 quick change implements. HOOD-FENDERS.

Write for Catalog.

Engineering Products Co.  
1005 K-1 Anoka Avenue  
Waukesha, Wisconsin

**new Sony**

for portable use\*

**STERECORDER 464-D**

for custom installation

**only \$199.50**

**both stereo recording & stereo playback!**

An unprecedented price for the famed Sony quality! The long-awaited Sony Sterecorder 464-D—dual purpose, dual performance! Dual performance means both 4 track stereo recording and 4 track stereo playback. Dual purpose means custom component installation and portable use. Recording and playback pre-amps are built-in, and such features as sound on sound, language and music training, two speeds, push button track selection and Sony precision engineering make this the most outstanding tape recorder value at \$199.50. ■ All Sony Sterecorders are Multiplex-ready!

\*Carrying case optional  
For literature or name of nearest dealer, write Superscope, Inc., Dept. 9, Sun Valley, California

**SUPERSCOPE** The Tapeway to Stereo

## The World of Solid State

(Continued from page 90)

state physics has been a subject under study ever since mankind learned that all matter came in solids, liquids and gases. The excitement today has to do almost entirely with curious and useful electrical properties in certain solids. A better name for it, suggests General Electric's Rudy Koehler, might be solid-state *electronics*. "Basically," he says, "we deal in electrical engineering because we are involved with charged-particle phenomena."

Useful electrical properties in some solids have been known for more than a century. But it wasn't until three Bell Laboratories physicists — W. H. Brattain, W. O. Shockley and J. Bardeen — perfected something called a transistor in 1948, that the *new* science of solid-state physics really took off. Half a dozen years later, semiconductors and other solid-state devices began spewing over a bewildered public like Roman candles at a Fourth of July picnic.

What are these gadgets? What do they do, and why?

### Odd Behavior

In all solids, atoms are held in a rigid crystal framework called a lattice, bound to their neighbors by positive or negative electrical charges. The odd behavior of these charged particles in certain solids is the secret of the whole business. Some react to electricity in unique ways, some to light, some to heat and cold, some to magnetism, some to twisting and bending.

In a good conductor like copper, the atoms are associated with particles bound to them loosely. These particles can move through the lattice, jumping from atom to atom, and can be used to carry an electric current. Other solids like diamond have no free particles and can't carry electricity. They make good insulators.

A few special materials, however, such as silicon and germanium, are fair insulators in their pure state. But if they are doped with certain impurities, they acquire free charges and become conductive. These are the semiconductors that are causing so much flurry.

The trick lies in the doping — baking, growing or diffusing the impurity into the crystal. If silicon, with four electrons per atom, is doped with arsenic whose atoms have five electrons, the extra arsenic electrons become freewheelers in the tight crystal lattice and are available to carry current. This makes a negative, or n-type semiconductor. But if silicon is doped with aluminum, which has only three electrons, so-called holes are left in the crystal struc-

ture. Holes have a handy way of absorbing free electrons moving through the crystal, then reappearing. In a way, current jumps from hole to hole in this p-type crystal.

By arranging n-type and p-type regions in different areas of a single crystal, scientists have been able to make tiny bits of semiconductor material perform all kinds of fancy electrical tricks that previously required quantities of bulky tubes and gear snarled in a maze of wires. Simple two-region diodes the diameter of a pin prick can take an alternating current in one end and send it out the other as direct current.

A diode can act as a one-way electrical gate in switching and do other useful jobs. A three-region transistor, which really is two diodes back-to-back and may come in sizes down to pinhead diameters, is more sophisticated. It won't conduct electricity until a tiny current applied to the middle region of the sandwich excites the electrons in the crystal (see diagram on page 90). Then, the main current can come through. En route, it picks up the characteristics of the weak control current *and becomes an amplified version of it*. Some transistors can increase a control current 40,000 times! This is the basic magic of electronics — a small current controlling a bigger one. By adding one transistor atop another, a trickle of current from a diminutive power source can be multiplied billions of times until it achieves enough energy to flip a switch in a garage door opener, or run a loudspeaker from a hi-fi pickup's weak signal.

### Complex Circuits in Films

By combining a dozen or more n and p regions in a single crystalline arrangement laid out on a silicon sheet by a process called sputtering, solid-state scientists are already creating highly complex circuits called thin films. A single one of these fantastic gadgets may contain six transistors, as many diodes, plus a number of other features. It can take an electric current and switch it, amplify it, split it up, change its voltage and work it over a dozen different ways. And all this happens in a device the size of a postage stamp one micron thick. These little gems can be stacked to create complete electrical systems. Yet many physicists consider them only an interim device. The ideal solid-state goal is a single, solid crystal with all the discreet regions necessary to do the same job doped right into the crystal structure. Both Westinghouse and Texas Instruments are already producing laboratory versions of these electronic goodies, known variously as molecular blocks, molelectronics devices,

(Continued to page 224)

# New Rambler "E-Stick" rated big '62 auto news

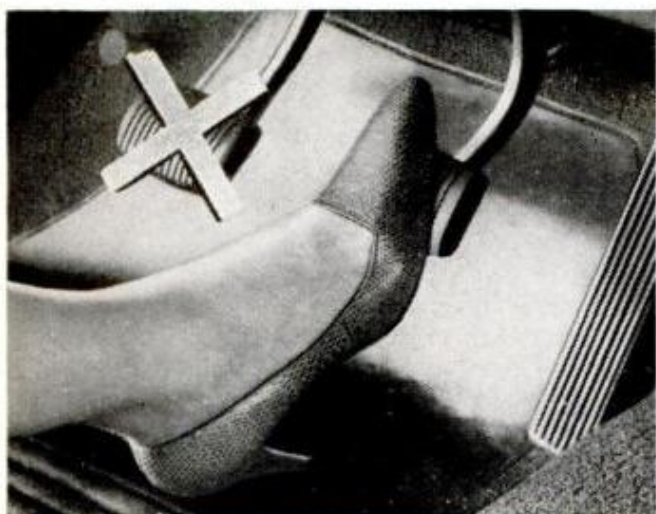

**E for Ease.** No clutch pedal. Most of the convenience of a full automatic at about one-third the cost.



**E for Economy.** Automatic clutch with the gas mileage, performance and control of a stick shift.

## In New Rambler American \$59.50 Buys No-Clutch-Pedal Driving with stick-shift economy and control

**Nothing like it.** Experts call it the biggest automotive news of 1962.

Try it. You have precise control in shifting.

You have full engine braking going downhill. You can rock the car swiftly from low to reverse and back in mud, sand, ice or snow.

You shift without a clutch pedal. An automatic clutch—activated by engine oil pressure—operates the clutch when you move the lever. Quicker, more accurate than your left foot, according to experts who have tried it.

Cost—only \$59.50\*. In fact, the Rambler American Deluxe 2-Door Sedan with the amazing E-Stick costs less than any other U.S. car with standard transmission, but

\*Prices and price comparisons based on manufacturers' suggested factory-delivered prices.

gives you no-clutch-pedal driving ease.

This is but one of many Rambler advances for '62. Rambler progress sharing brings

lower prices on all models—with new Double-Safety Brake System standard—tandem cylinders for front and rear—(as on Cadillacs). Self-adjusting brakes standard, too. Twice as long between engine oil changes. Low-cost engine coolant good for 2 years. 2-year battery.

Compare Rambler with the other best-sellers. See how Rambler's 102 improvements for 1962, plus new lower

prices on all models, give you an obviously better value in product and price.

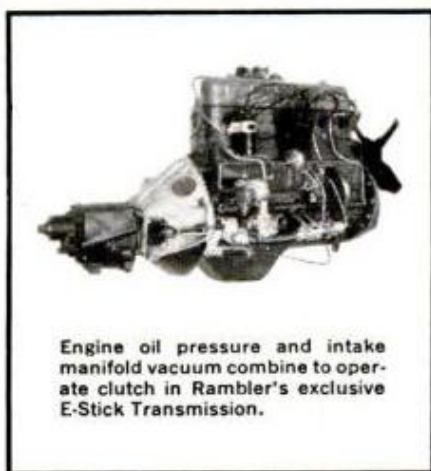

Engine oil pressure and intake manifold vacuum combine to operate clutch in Rambler's exclusive E-Stick Transmission.

# RAMBLER

WORLD STANDARD OF COMPACT CAR EXCELLENCE

# CRUISERS \$369 UP

CATALOG  
FREE

1/4 Down 2 Years to Pay

SAVE UP TO \$1700



20 FT. ISLANDER



22 FT. CARIBBEAN



## 22 FT. HOUSEBOAT-CRUISER \$699

Cruiser performance with houseboat space and facilities. V-bottom design. Planes with 40 HP to 20 MPH. Inboard or outboard power. 6 1/2 ft. headroom. Galley, toilet, lounge, sundeck. Sleeps 4 in comfort. Free catalog explains how anyone easily assembles this cruising houseboat.

18-22 FT. CRUISERS  
EASILY ASSEMBLED  
from Pre-Assembled Units

Luger cruisers assemble easily as small boats; all parts precision cut and pre-formed. Oak frames pre-assembled complete. Inboard or outboard engines: 25 HP up. 40 MPH with large engines, 8 ft. cockpits. Airy cabins, sliding side windows, full opening windshields, full length bunks. 1-piece Fiberglass cabin installs in minutes. Ample storage, folding tables, galleys, toilets; complete for extended cruises in fresh or salt water.

MONEY-BACK GUARANTEE

## FIBERGLASS \$299 UP

RUNABOUTS 14, 16 FT.

WRITE TODAY

ASSEMBLE IN ONE EVENING

3 factory-molded sections interlock; bond into 1-piece molded Fiberglass boat. Colors molded in. With Luger's patented method, anyone assembles boats exactly like factory-finished models in one evening. Brush and screwdriver only tools. A scientific triumph of simplicity and ease never known before in boat construction.



SAVE  
\$300 to \$500

FREE CATALOG



## PLYWOOD RUNABOUTS

40 MODELS, 8-16 FT.  
\$41.75 Up, Save 1/2-3/4

EASY  
PAYMENTS

Roomy, comfortable naval architect designs. Smart, modern styling. Equal factory-finished boats in appearance and performance. 8 ft. dinghy \$41.75; 12, 14, 16 ft. fishing boats \$59.95 up; Runabouts 12 ft. \$104 up, 14 ft. \$139 up, 16 ft. \$189 up. Also low mail order prices on Fiberglass supplies, accessories, trailers, paint, hardware.

## FREE CATALOG LUGER BOAT KITS

Dep't. B-1, 9200 Access Road, Minneapolis 20, Minn.

## DYNAMIC INDUSTRIAL TYPE TRANSFORMER WELDER

WELD-CUT-BRAZE-SOLDER-HEAT  
IRON-STEEL-BRONZE-BRASS  
ALUMINUM AND OTHER METALS



Professional Electric Arc Welder. Ideal for Home, Shop, Farm or Industrial use. The handiest tool in your workshop. Weld, Braze, Solder, Cut, Bend all metals. Do expert work on your first job. Build or repair Boats, Trailers, Auto Bodies, parts, fenders, metal and ornamental iron furniture, fixtures, farm equipment, garden tools, bicycles, toys, etc. Operates on any properly wired 110 V. A.C. line. Complete with helmet, arc torch, electrode holders, flux, rods, cables, instruction book. FULL YEAR GUARANTEE. 10 day money back trial. ONLY \$38.50 f.o.b.

Only \$38.50 f.o.b. Send only \$6.00 check or m.o. Pay postman balance plus charges. EASY PAY PLAN. Low down payment. Pay as you weld.

DYNAMIC WELDER CO. 1808 SOUTH FEDERAL STREET  
Dept. D2-A, CHICAGO 16, ILL.

monolithic blocks, or solid circuits, depending on which company you visit.

"The day is almost here," says John Stelmark of Westinghouse, "when to make a radio or TV set, you will pull six to twelve solid crystals—each about the size of a shirt button—off the stockroom shelf and connect them up. A thousand such blocks plugged together will build any kind of a computer some day. We already have one-chunk oscillator blocks, detector blocks, logic gates, complete radio amplifiers and preamps."

Far more important to electronics engineers than the miniaturization fantasies these devices conjure up, is their tremendous reliability. There are no wires to short out, no soldered connections to break. And they have the endurance of Methuselah. "We have transistors on life test exceeding 26,000 hours," reveals H. Brainard Fancher of General Electric. "That's nine years of operation eight hours a day; commercial vacuum tubes have an expected life of 80-percent survival after 1000 hours." Fancher's group even fired a bunch of solid-state circuits from a mortar one time to test their ruggedness. "They worked afterwards," he reports. "The shock they had withstood was about 15,000 Gs."

### Pea-Size Preamps

Today, at Westinghouse, John Stelmark can show you a five-watt amplifier that looks like a button from your jacket and a preamp resembling a pea. Between them, they perform the same job done by the two shoebox-size affairs that power a modern deluxe hi-fi. And they produce first rate sound. A complete flip-flop circuit, used in high-speed computer switching, now comes in a delicately etched solid crystal smaller than the "D" on a dime.

That's not all. By operating monolithic blocks called cryotrons inside bottles of liquid helium at -450 degrees F., physicists can make their circuitry superconductive. At that temperature, all electrical resistance in matter disappears, and even the smallest trickle of current moves forever, close to the speed of light. Switching in a cryotron is accomplished in billionths of a second. In complex military tactical problems, requiring days of computer programming to solve, hours can be saved by shaving fractional seconds from each step in the system.

Superconductivity is also the secret behind the powerful midget magnet already mentioned. Ordinary electromagnets would melt themselves to copper puddles if operated at full potential. Westinghouse's

(Continued to page 226)



FOR PANELING... BUILT-INS... CABINETS... FURNITURE

## The Complete Interior WOOD FINISH

*in One Can*

READY TO USE

A finer clear, semi-gloss for natural wood beauty. Non-darkening. ANYONE can use Deft... it's so easy.

Wherever paints are sold, or write Dept. SSPM  
Deft, 1526 W. 228th Torrance, Calif.



Free  
Shop  
Chart  
on  
Wood  
Finish-  
ing

Write  
Dept.  
SSPM.



## OUTWORKS THEM ALL

Pat'd.  
& Pats.  
Pend.



Prepares the toughest soils in one operation. All-purpose tiller-tractor tills to 12" deep -12" to 40" wide. Chain drive delivers equivalent of 2 extra hp! 4 models; rotors, tractor tools for all jobs and soil conditions. Optional reverse. Send for details.

## MERRY TILLER

Northern Life Building, Box 1829, Seattle 11, Wn.



## Stereo Recording Amplifier

New Fidelitone recording amplifier design (shown under tape deck in photo) provides exceptionally high channel separation above 40 db. Boasts two record level meters, two level controls, mike and line inputs. Unit includes trap to permit recording stereo FM. Separate record-playback channels permit sound-on-sound recording with headphone jacks. Unit is brushed gold color with white lettering, measures 10½ by 3½ by 8 inches. \$119.50, Fidelitone, Chicago 26, Ill.

JANUARY 1962

## THE EASIEST WAY IN THE WORLD TO DRIVE AND REMOVE SCREWS



1. After drilling pilot holes simply attach a Versamatic to electric drill. Fits any make.

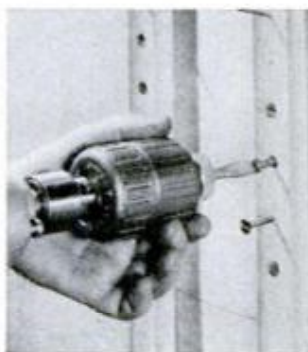

2. Place screw in hole; drive it easily with slight forward pressure... hold housing in fingertips.



3. Your fingers act as a clutch... starting, stopping action instantly. Simple and safe... no blisters.

## Versamatic puts your power drill into low gear...

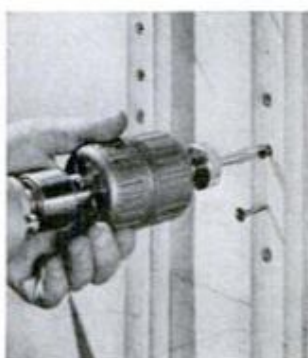

by means of 7 to 1 speed reduction. Gives your drill 7 times more power.

## Supreme Versamatic

4. Versamatic runs in reverse for removing screws. You won't believe how easy it is until you try it.

MADE BY THE MAKERS OF  
SUPREME BRAND CHUCKS

SUPREME PRODUCTS  
CORPORATION

2222 S. CALUMET, CHICAGO

Sold by leading tool dealers...\$14.95 list

Also... ask to see the Supreme Versamate... the non-reversing speed reducer... just \$9.95

225

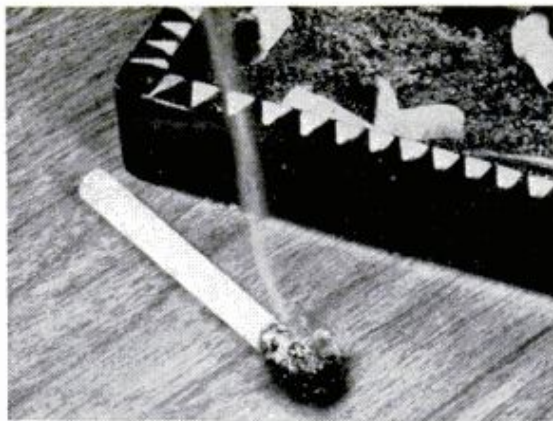

don't say "darn"...say

## DURATITE WOOD DOUGH

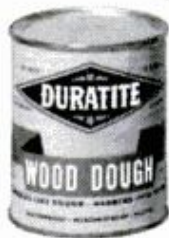

Molds like dough, hardens into wood!  
Preferred by professionals since 1923.  
No other product can match this plastic wood filler for easy, almost invisible repairs of wood and furniture. 9 wood colors. Tops for refinishing.

DURATITE Division, DAP inc., Dayton 31, Ohio

**Antenna hookup** can insure good, small radio reception in anything from an indoor playroom to a fallout shelter. The February PM will show you how it's done.

FREE

EICO®

CATALOG

Build Your Own  
Hi-Fi, Radios,  
Ham Gear, Test Inst., — Save 50%

Get started in ELECTRONICS the easy EICO way. No technical knowledge needed to build EICO kits. Simple, step-by-step "Beginner-Tested" pictorial instructions guide you all the way. LIFETIME service & calibration guarantee. Mail coupon now!



EICO, 33-00 Northern Blvd., L. I. C. 1, N. Y.  
Please send FREE catalog & name of local dealer. PM-1

Name .....

Address .....

City ..... Zone ..... State .....

doughnut-size magnet will not be used to lift steel beams for bridge builders — although it could. Instead, it will work at trying to control the power of the hydrogen bomb, by accelerating atomic particles and compressing them until they fuse and release their potent energy. It may also open new doors to power generation and provide new means for propelling rockets through space.

If it all sounds far out, brace yourself. This is only the crude beginning of a new era in electronic magic. Under the broad heading of *solid state*, a vast array of even more systems and devices are already with us and working (see p. 88).

### Playing-Card Computers

Tiny thermoelectric devices utilizing the same n and p regions that make a diode work, are converting heat directly into electricity. Similarly, photoelectric materials are producing electricity from a light source shining on them, and amplifying light much the way a transistor amplifies electricity. Microscopic electroluminescent phosphors that glow when triggered by an electric current are producing light in wafer-thin sheets of glass and plastic, with scores of uses in home illumination as well as in display panels such as flat TV tubes.

The world of solid state, as one physicist puts it, "will be like a building-supply yard. You'll have many materials that can be combined in different ways to build different structures for different purposes. Two or three tiny pieces, linked together, for instance, will one day make you a combination radio-wristwatch. By adding thermoelectric grids to electroluminescent materials, walls and ceilings will heat and cool homes as well as light them."

Out of it all should come—if the usually conservative researchers are right—a treasure chest of conveniences and marvels the likes of which man has never known. Even the simplest devices haven't begun to hit their useful potential in small practical ways. "Diodes," points out GE's R. W. Solinger, "will one day be used to make fool-proof automobile distributor units that will last the life of the car. They will replace short-lived starters in fluorescent bulbs. Silicon-controlled rectifiers (supertransistors) will provide dimming instead of switching for your home lighting — with photoelectric sensor devices controlling the whole business automatically, depending on the brightness outdoors.

"Motor phase controls will correct the utility companies' errors in the power lines. These devices may also provide the answer

(Continued to page 228)

New standard for power and torque in a compact grinder!

**NEW DREMEL NO. 3  
INDUSTRIAL  
MOTO-TOOL**



This new industrial type grinder belongs on your work-bench! The No. 3 is a compact "powerhouse" developing 27,000 rpm — and sustains high torque under load. It's easy to handle (fits your hand), runs cool, lightweight. Weighs only 17 oz.! Just the ticket for precision grinding, polishing, drilling, sharpening, modelmaking — working in tight corners. Powerful 110 Volt AC or DC motor is housed in a heavy-duty, shockproof Bakelite case. Handy hanger hook keeps it within reach.

DREMEL MFG. CO., Dept. 112-A, Racine, Wisconsin

150



**No. 3 Moto-Tool** is complete with 1/8" and 3/32" collets, 3-wire grounding cord with 2-prong adapter, finger grip — in steel case. **Only \$29.95.**

**No. 2 Moto-Tool** — long time favorite with industry, craftsmen, model makers since 1936 —

**No. 2 Moto-Tool** with 3-wire grounding cord, \$19.95.

**No. 2 Moto-Tool** with 23 accessories in steel case, \$29.95.

See Your Dealer or Write for Complete Power Tool Catalog

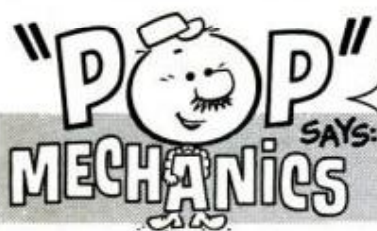

"Some fellows who accomplish the least leave the most sawdust."



Remember those in need across the world. Every \$1 sends one gift package thru the CARE Food Crusade, New York 16, N.Y.

**SAVES TIME, EASES WORK  
WHEREVER SOCKET SCREWS ARE USED**



tightens socket screws EXTRA tight because it turns with utmost torque

You'll marvel at the time and energy you save with the BOWERSOX "T" WRENCH. This one-piece "T" handle wrench with built in steel bit, cuts labor on all assemblies and adjustments. Assures you utmost tightness even in hard-to-reach recesses and counter bores. High grade tempered tool steel bit can't wiggle or fall out to damage machine parts. Won't "round off" or easily break. NO KEYS TO LOSE. Best, most efficient "T" wrench for hex socket screws obtainable.

**GET FREE SPECIFICATION FOLDER AND PRICES TODAY**

Sold by thousands of dealers. REFUSE SUBSTITUTES!

If not easily obtainable locally we'll arrange to supply you promptly — regardless of quantity. Don't delay; write us fast about this time and labor saver. BOWERSOX PRECISION CASTINGS, Dept. PM, 3523 W. 9th St., CHESTER, PENNA.

**BOWERSOX "T" WRENCHES**



**Exclusive Double-Bearing HEAVY-DUTY PUMPS**

IRRIGATE • DRAIN • CIRCULATE • SPRAY  
Use 1/4 HP motor or larger . . . 1 HP for up to 5,200  
GPH; 1,000 GPH 60' high; or 3,000 GPH from 25' well.  
1 1/4" inlet; 1" outlet. Stainless shaft.

**TYPE X**—2 oil-less bronze bearings. Won't rust. . . . \$10.95

**TYPE XB**—Ball bearing model. . . . \$12.95

Postpaid if rush with order. Rush your order today

**MONEY BACK GUARANTEE**

Centrifugal and Gear Pumps in All Sizes

LABAWCO PUMPS, Belle Mead 2, N. J.

**THAW FROZEN WATER PIPES FAST.**



Thaw pipe without digging or creating fire hazards. Just plug this low cost PORTA-THAW into a regular 110/220v AC power line. It's completely safe. Has no connection between power line and output terminals. Provides low, medium, high currents. Clears lines in 5 to 20 minutes. Complete with power cable, plug, receptacles, two thawing cables. Ask for data sheet TH-3-10.



**WELD • SOLDER • CUT METAL**

Repair parts and equipment, build railings, furniture, trailers, hardsurface tools, braze, solder, cut, burn holes. Low cost 180 amp. "TROJAN" has 18 current control steps. Delivers top results in small repair, sheet metal, hobby, plumbing and heating shops, garages. Meets REA requirements. Accessories included. Ask for data sheet A-520-G.

HOBART BROTHERS COMPANY, BOX M-12, TROY, OHIO, PH. FE: 2-1223

to the electric car. There will soon be an electronic caddy. You'll call your golf clubs to you, and they'll come."

The means for all this is available now. All that needs to happen is for industry to pick it up and use it. And the possibilities are endless. "An interesting thing," says Fred Hedding of Westinghouse, "would be to tie in nine-volt thermoelectric power with tunnel diodes. You could come up with a thermoelectric fire alarm in which heat would set off the thermoelectric generator, which would generate current to trigger the tunnel diode that would blow a horn."

### Air-Conditioned Suits

Hedding, an expert in thermoelectrics, sees an endless field. "Refrigerators in space capsules will have to be thermoelectric," he says. "But we can also use them to advantage in aircraft. The basic machinery for a refrigerator in a transport plane would consist of a solid chunk of material one third of a cubic inch in total area, using thermocouples the size of grass seeds to start it and stop it automatically. We already have a back-pack propane furnace that makes its own electricity to power the blower to push hot air through a thermoelectric suit, or suck out heat and blow cool air through it. The day will come when we'll have air conditioned suits for everyday wear. They would keep you comfortable from -40 to +100 degrees F. A home furnace the size of an oil drum, using propane, wood, oil or natural gas fuel, will someday provide its own electricity to run its blowers, and switch itself on and off."

Probably most amazing of all solid state's new tools today is the maser—producer of the fantastic beam mentioned earlier. The letters stand for Microwave Amplification by Stimulated Emission of Radiation, and this incredible device is stirring up more interest among physicists than the transistor did 10 years ago.

### Death Ray

Masers take radio waves or light waves (in which case they're called optical masers or lasers), boost them hundreds of times, then shoot them off in a powerful concentrated beam. The light they generate within the cone is more than a million times brighter than the sun. It is also hot enough to burn a hole through everything from razor blades to people. It could be, in fact, a genuine death ray. Portable versions of it already have been built.

The beam's cone angle is so narrow that some lasers, operating through a telescope from Earth, could send a shaft of light to the moon that would illuminate a spot less than a mile in diameter.

The device is remarkably simple. One type consists of a small ruby rod, anywhere from one to four inches long, with a spiral flash lamp coiled around it. Another is a glass tube filled with neon and helium. When activated by a flash of light, high energy atoms inside these gadgets are excited by the stimulus and boost the light waves as they bounce back and forth between mirrored ends of the crystal or tube. Suddenly the wave charge achieves an energy level that shoots it through the mirror on one end. And away goes the beam—in a coherent shaft of light emitted in pulses about a millionth of a second apart. This means the beam can be modulated like radio waves—something never before possible with light's incoherent scatter.

### 100 Million Calls

Because of the beam's fantastically high frequency, scientists envision giant strides in the field of communications. Contained in a sort of wave-guide tunnel with mirrors to bounce it around bends, a single maser beam could carry 100 million telephone calls simultaneously. Present ocean cables carry 100 at a time. Similarly, more than a million TV channels could be carried by it simultaneously. It can also transmit light in the green frequencies for several miles under water—which hints at possibilities for submarine communications.

Due to the maser's sharply defined focus (it can be squeezed through a hole 50-millionths-of-an-inch in diameter) medical experiments on rabbits are being tried at Technical Research Group on Long Island, N. Y. One bunny had a tumor on the retina removed by laser. The narrow beam aimed at the eye was further reduced by the eye lens itself, and hit a pinpoint of retina for a thousandth of a second—enough to do the job without inflicting damage.

For a long while, masers were stymied because they could only work in short bursts. But a few months ago Bell Laboratories announced a continuous beam had been achieved, and experiments are running high again.

At the Naval Research labs, masers hooked to radio telescopes have already been used to measure energy waves from the surface of Jupiter, establishing the temperature there at 150 degrees below zero F. A maser radar using a four-inch antenna can do a sharper job than ordinary microwave radar with a 60-foot basket. Already it is being talked about as a tool for mapping the moon and planets with pinpoint accuracy. If it does, and it probably will, masers will qualify as the farthest out of all the way-out solid state devices. ★ ★ ★

# HERE'S A MONEYMAKER FOR YOU!

make from \$3 to \$6 an hour with the FOLEY SAW FILER

Ask yourself these three questions: 1. Do I really want to get ahead *faster*? 2. How can I do it? 3. Am I willing to *use* my spare time? If you answer "Yes" to questions 1 and 3—then we have a positive answer for you on No. 2. Men make from \$3 to \$6 an hour sharpening hand, band and circular saws with Foley Saw Filers. No experience needed, to turn out sharp, smooth-cutting saws with this automatic machine. Start in spare time—no canvassing.

### HERE'S THE WAY TO START

Read "Money Making Facts"—shows you how others have added hundreds or thousands of dollars to their incomes in this steady, repeat, CASH business. Start your *own* business in your basement or garage, no overhead, small investment. With *Time Payment Plan* the Foley can more than pay for itself out of profits. Send for "Money Making Facts"—mail coupon now. No salesman will call.

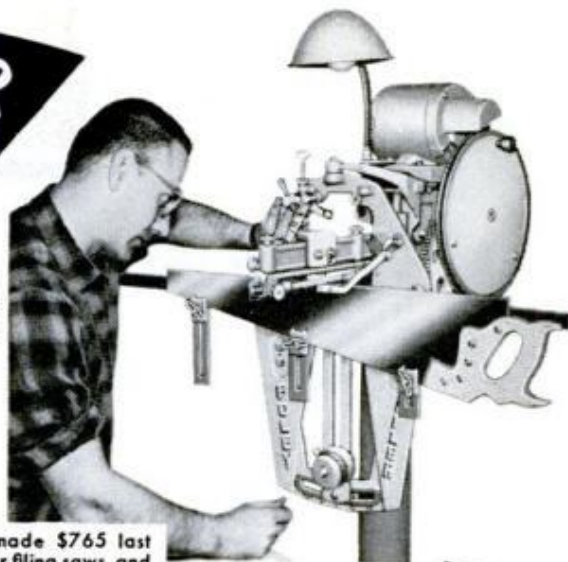

### HERE'S PROOF

"When Mr. Patrick got his Foley Saw Filer in March 1946 he made a good and wonderful investment. He has done so well that we bought a house and paid for it; bought a new car, built an addition to our house. Nicest of all, it's all paid for." Mrs. Leslie Patrick.

"I made \$765 last year filing saws, and it sure comes in handy. I do this work in my spare time." —James B. Williams

"Last year's profit amounted to \$3,000. Not so bad for a one-man outfit." —Charles C. Hough.

"I have done 4 or 5 thousand saws in my spare time in the 4½ years since I got the outfit, and they are all coming back with repeat orders." —Len Crego.



FOLEY MFG. CO., 116-2 Foley Bldg., Minneapolis 18, Minn  
Send me free book "MONEY MAKING FACTS" and Time Payment Plan.

NAME \_\_\_\_\_

ADDRESS \_\_\_\_\_

### SAVE MONEY! MAKE MONEY! WITH PORTABLE CEMENT MIXER!

It's easy, fast, fun to do your own work with the MIXAL Mixer. Build barbecues, patios, sidewalks for yourself, for others! Mixes 3' x 8' sidewalk every hour! Uses any ¼ HP motor. Thousands used by contractors! Try it on MONEYBACK GUARANTEE! Send for FREE HOW-TO-DO-IT CEMENT MIXING BOOKLET. Dept. PM-1



KOL, INC., 2323 Ellis Ave., St. Paul, Minn.

29.95 pp without motor (add \$3 W. of Rockies)

Portable shanty for ice fishing? You'll find plans for this low-cost, easily set-up shack in the February Popular Mechanics.

### ADJUSTABLE WELDING VISE



For accurate welding and soldering. Two swiveling vises holds alignment in any position. Jaws open 4". Adjustable and rotate 360° welding without removing work. Guaranteed. Widely used in schools. Wt. 20 lbs. Free literature.

Direct from Mfg. Ship Prepaid. . . . \$37.50

WELDERS HELPER  
1346A Melrose, Modesto, Calif.

FREE CATALOG!

### TREMENDOUS SAVINGS ON HUNDREDS OF SURPLUS AND NEWLY MANUFACTURED ITEMS!

New 1961 edition contains over 50 pages of tools and equipment for farm, home, workshop, factory. Hydraulic equipment, pumps, motors, construction and diesel equipment and parts! Write for your FREE CATALOG Today.

GROBAN SUPPLY COMPANY

1139 South Wabash Ave., Dept. G-1 Chicago 5, Ill., WEbster 9-3793

**YOU** NEED THIS

## FREE GIANT B-A CATALOG



SAVE UP TO 50% ON B-A SELECTED KITS

HI-FI AND STEREO SYSTEMS & COMPONENTS

TOP VALUES IN POWER AND HAND TOOLS

30 PAGES OF BARGAINS NOT IN ANY OTHER CATALOG

BURSTEIN-APPLEBEE CO.

Dept. PM, 1012 McGee St., Kansas City 6, Mo.

Rush me New 1962 B-A Catalog No. 621

Name \_\_\_\_\_

Address \_\_\_\_\_

City \_\_\_\_\_

State \_\_\_\_\_

SEND FOR IT TODAY



1

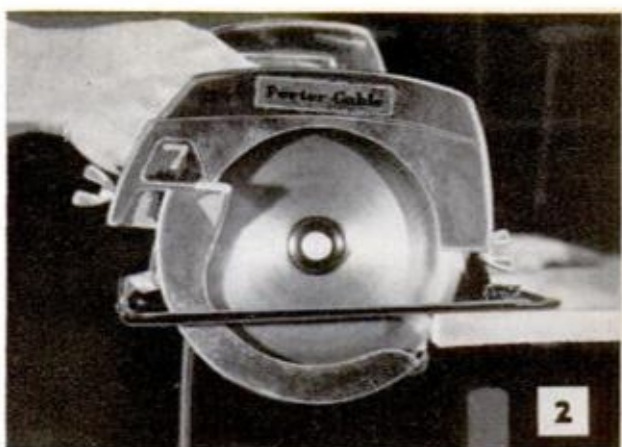

2

## Shopping for tools

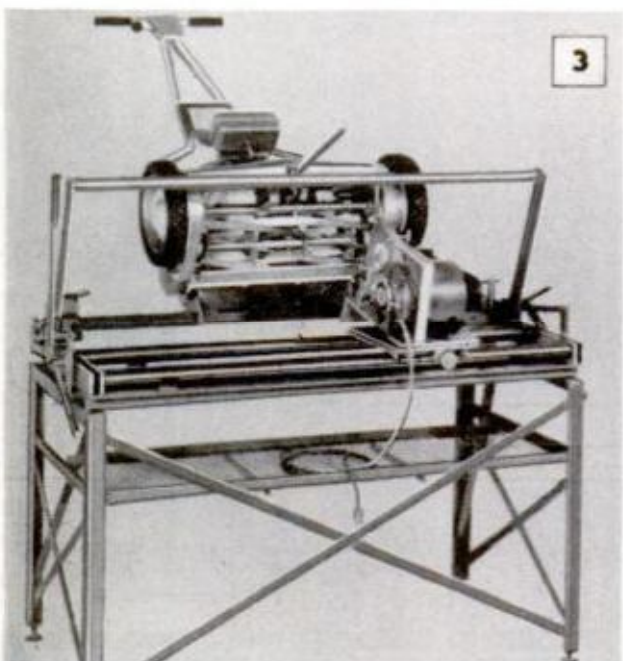

3



4



5

**1. SOLDERING KIT** includes convenient new solder dispenser that keeps solder handy, reduces waste and provides a backup support for solder at point of use. Dispenser is safer to use, eliminating such hazards as finger burns. Gun heats instantly when trigger is pulled. Set is priced at \$9.95. Weller Electric Corp., 601 Stone's Crossing, Easton, Pa.

**2. LIGHTWEIGHT PORTABLE POWER SAW** for home-craftsman is available in two (Porter-Cable) models. Features include guard with miter lip which prevents jamming at start of cut and dragging while sawing. Opening permits checking cut during operation. The 6½-in. model is \$54.95. 7-in. model: \$59.95. Rockwell Mfg. Co., 400 N. Lexington Avenue, Pittsburgh 8, Pa.

**3. LAWN-MOWER SHARPENER** grinds reel and bed knife of reel-type mower while mower remains fully assembled. It's an ideal setup for doing quality sharpening. Grinding unit may be moved from one grinding position to another while mower remains upright at all times. Sharpener is made by Foley Mfg. Co., 3300 N. E. 5th Street, Minneapolis 18, Minn.

**4. INEXPENSIVE CLEANING AUGER** enables anyone to clean out clogged drains without calling plumber or investing in expensive plumbing equipment for an occasional drain-cleaning job. Auger is six feet long with S-shaped tubular handle on one end. Handle rotates cable. Priced at \$1. General Wire Spring Co., S. 9th & Sarah Sts., Pittsburgh 3, Pa.

**5. HAND SPRAYER** completely atomizes most fluids, yet operates without a separate compressor. Besides spraying paints, it sprays insecticides and even mothproofs garments. Sprayer may easily be cleaned by pumping cleaning fluid through it. The complete spraying unit sells for \$29.95 ppd. Sold by the Compressor Corp. of America, Box 1934, Greenville, S. C.

LOOKING FOR LONG WEAR IN SERVICE SHOES?

# TRY **RANGER** SHOES

## WITH **NEOPRENE SOLES!**



More wear—more comfort in every pair. Why? Because RANGERS stay soft and flexible. Their leather insoles won't dry out, curl or crack. Special counters keep their shape even when immersed in water. And a cushioned arch helps guard against fatigue.

Du Pont Neoprene soles and heels provide a solid foundation for all of these comfort features.

You can rely on long wear because Neoprene is highly resistant to oil, grease, chemicals and cold-weather cracking.



Ask for Neoprene soles the next time you buy service shoes.

BETTER THINGS FOR BETTER LIVING...THROUGH CHEMISTRY

### King Midget FOR 1962

Drive it for 75c a week.

Rider Agents Wanted. Send 25c for 32 page book, full details, dealer price. Or send \$1 (refunded first order) for this plus Service and Repair Manual and 16 5x7 photos of car and factory.



WORLD'S MOST EXCITING LOWEST PRICED CAR

MIDGET MOTORS CORPORATION, Athens 1, Ohio

Another **NEW Taft Kit**

### BUILD the WINDMILL

The really hot one-design boat! 15 1/2' racing sloop with special pre-glued masts, booms, etc.

Complete with sail and qualifications for class.

**\$69.75** down  
ORDER NOW

**\$10.85** per mo.  
complete incl. sail

**FREE CATALOG OF MANY MODELS**

**TAFT MARINE WOODCRAFT**  
Dept. PM162 - 635 39th Ave. N.E. - Minneapolis, Minn.

## **GUNK**® removes grease like no detergent can!



Cleans power mowers, engines, garage floors, kitchen walls, ovens, exhaust ducts, paint brushes, furnace filters, bar-b-q grills, machinery! At auto supply, farm, or hardware stores!

**GUNK CHICAGO CO.**, River Forest, Ill. serving the Midwest and Southwest  
**RADIATOR SPECIALTY CO.**, Charlotte, N.C. serving the East, Southeast and far West

## Save Money on **WOOD**

**POWER TOOLS • HARDWARE • KITS  
WORKSHOP SUPPLIES • EQUIPMENT**

**NEW LOW PRICES!**

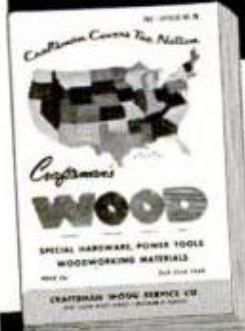

**Hardwoods, Veneers, Plywoods, Mouldings, Mosaic Tile, Tools, LampParts, UpholsterySupplies**

Your complete wood and workshop buying guide—new 140 page edition now ready. Many pages in full color! Startling new savings on everything you need! Craftsman is your best and most complete source of the finest quality kiln-dried domestic and imported hardwoods. Beautiful wood inlays, bandings, matched plywoods, carved ornaments, modern & traditional furniture legs.

**NEW!**  
**140 PAGE CATALOG**  
**SEND FOR IT TODAY**

**Discounts on Stanley Power Tools**  
Craftsman offers startling savings on top name power tools, hard to find cabinet hardware, lamp and upholstery materials. More than 1,500 items. Packed with new patterns, projects. Enclose 25c to help pay mailing and handling costs.

**CRAFTSMAN WOOD SERVICE CO.**  
2729 S. Mary St., Dept. A-1, Chicago 8, Ill.

**CRAFTSMAN WOOD SERVICE CO., Dept. A-1**  
2729 South Mary St., Chicago 8, Illinois

Rush giant new Craftsman WOOD Catalog. I enclose 25c to help cover mailing cost.

Name \_\_\_\_\_  
Address \_\_\_\_\_  
City \_\_\_\_\_ Zone \_\_\_\_\_ State \_\_\_\_\_



## NEW MARLITE COLORS AND PATTERNS for beautiful wash-and-wear walls

Work magic in any room with Marlite paneling. Unlike many "finished" wallpanels that dull with age, Marlite's soilproof baked plastic finish shrugs off grease, stains, marks—even heat! Hard and dent-resistant, it needs no painting; cleans with a damp cloth. Easily installed in a wide variety of colors and patterns. See your building materials dealer or write Marlite Division of Masonite Corporation, Dept. 142, Dover, Ohio.

# Marlite®

plastic-finished paneling

6103

ANOTHER QUALITY PRODUCT OF MASONITE® RESEARCH

## 20 WAYS To Use An ARROW T-50

HEAVY DUTY  
STAPLE  
GUN

Only  
\$12.50



Uses 6  
staple sizes:  
1/4", 5/16", 3/8", 1/2"  
9/16" and CEILTILE

- Install ceiling tile
- Install insulation
- Weatherstrip doors and windows
- Reupholster furniture
- Staple wire fencing to posts
- Repair window and door screens
- Fix loose wiring to floors, walls
- Replace worn window shades
- Tack down carpets
- Lay new linoleum
- Attach vines to trellis
- Affix plywood panels to walls
- Wrap and staple young tree trunks
- Line kitchen and closet shelves
- Hang drapes and curtains
- Make decorative cornices
- Cover valences with material
- Put up Christmas decorations
- Staple down building felt
- Quickly repair odd wood-working jobs

ALSO No. JT-21 Junior TACKER \$4.95  
For Light Duty Tacking Chores

ARROW FASTENER CO., INC. 1 Junius St., Brooklyn, N. Y.

At Hardware, Building, Lumber and Stationery Dealers Everywhere.

CUT THIS OUT AS A HANDY CHECK LIST

## Serviceman Looks at the '62's

(Continued from page 103)

Meanwhile, chassis engineers have gradually reduced the number of points requiring regular lubrication by using rubber, sintered metal containing graphite, and plastics of the nylon type for bushings and other wearing surfaces.

Despite this progress, two areas still presented serious lubrication problems. None of these materials seemed suitable for the heavily loaded front-suspension ball joints. Tie-rod ends and other joints in the steering linkage also required frequent greasing to prevent excessive steering effort.

The breakthrough came with the development of "moly" grease and seals of improved synthetic rubber. When a chassis lubricant is enriched by approximately three percent of molybdenum disulfide, it not only does a better lubrication job but also provides greatly increased resistance to being squeezed or washed out of the bearing or joint. "Moly" particles have a molecular structure in which a layer of molybdenum atoms is sandwiched between layers of sulfur atoms.

The bond between these dissimilar materials is strong, but the bond between adjoining layers of sulfur atoms is weak. Sulfur atoms, however, attach themselves firmly to metal. As a result, "moly" grease clings tenaciously to metal surfaces, while slippage between layers of sulfur atoms cuts friction to a minimum.

### Seals Hold Up

Cadillac and Ford introduced sealed suspension and steering joints packed with "moly" grease in 1961 models. Dealer service managers report surprisingly little trouble. In normal use, sealed joints should stand up for 30,000 miles or more without developing squeaks or excessive wear, if the seals are not damaged.

Police cars, taxicabs and other vehicles operating around the clock in all kinds of weather present the biggest challenge to factory-sealed lube points. So far, most fleets of this type have been more than a little cautious.

One of a group of 1961 Fords patrolling the parkways surrounding a large eastern city was allowed to run 30,000 miles before the front ball joints were pulled for inspection while the rest of the cars in the fleet were lubricated every 10,000 miles with "moly" grease. Despite the fact that joints of the "guinea-pig" car were still in good condition, the 10,000-mile lubrication interval was continued and subsequent orders

(Continued to page 234)



# take off!

'62 West Bends make get-up and go power as standard as their full year guarantee



Bold action! Trigger-quick throttle response! West Bend's magnificent '62 outboards have efficient-engine features like the Hydro-Dart lower unit (on Golden Shark "40's"). Slim fin and dart-like nose slice cleanly through the water to make full use of engine power, increase boat speed up to 10%. From the big Tiger Shark 80 h.p. to the 28 lb. "3 1/2," men who depend on motors recommend West Bend. Full year guarantee on every model.



Outboard Motor Division  
**THE WEST BEND COMPANY**  
Hartford, Wisconsin • Barrie, Ontario



40 h.p.  
Golden  
Shark

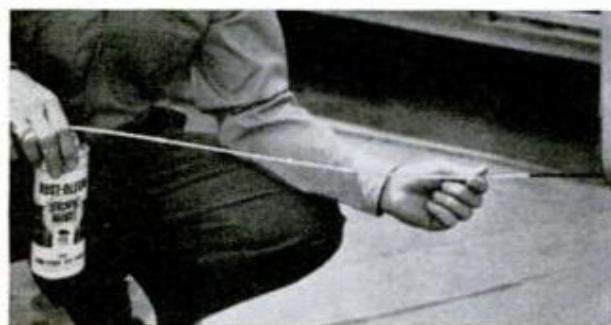

## Snorkel Fights Hidden Rust

Insides of car doors and rocker panels can be kept rust-resistant with new Rust-Oleum Snorkel Kit. A 3 1/2-ft. plastic tube sprays enough rust-stopping primer inside to treat four doors and two rocker panels. Kit (\$3.49) includes punch and cadmium buttons. Available at hardware, auto stores.

JANUARY 1962



**What's New  
in High Fidelity**  
by Fred Honig  
Former Editor of Hi Fi Guide, well-known  
writer and authority on high fidelity

## Add Music Without Adding Furniture

Can't find space to fit another chair into your living room? You can still enjoy all the pleasures of the finest component stereo music system. Where are you going to put it? Right in the furniture you already possess. The FM-stereo tuner, amplifier, record player and even a tape recorder can be installed in your sideboard, breakfront, bookcase, or on an end table. And many of today's stereo loudspeakers are so compact—they'll fit right in your bookshelf. But remember that only stereo high fidelity components make this possible! Each one is brilliantly designed, painstakingly built for its own specific function. Components are flexible, interchangeable, easily installed by yourself or the dealer. Find out how you can enjoy the world's great music—without using up one additional inch of floor space. Mail coupon below.



**Institute of High Fidelity Manufacturers, Inc.**  
Dept. A-32—516 Fifth Avenue, New York 36

Please send me the free booklet about  
High Fidelity Components.

NAME \_\_\_\_\_

ADDRESS \_\_\_\_\_

CITY \_\_\_\_\_ ZONE \_\_\_\_\_ STATE \_\_\_\_\_

## For '62 . . . . Keep in Step with the March of Science!



The editors of **SCIENCE DIGEST**, in their superb January 1962 **SPECIAL 25th ANNIVERSARY** Issue, present a fascinating and colorful record of world-wide scientific accomplishments during the past quarter century.

Significant discoveries in the fields of electronics, space travel, medicine and health, and other areas of scientific endeavor, are brilliantly reviewed by such experts as Willy Ley, David O. Woodbury, Isaac Asimov and others equally famed in their fields.

Plus the top 25 Science Advances and a 25-Year Science Photo History.

All written in crystal-clear, fast reading style and richly illustrated, this January 1962 **Silver Anniversary Issue** of **SCIENCE DIGEST** will delight and inform all who want a better understanding of today's changing world.

This magnificent 25th Anniversary Issue of **SCIENCE DIGEST** is now on sale at all magazine stands. **Get your copy today!**

for new cars specified that they must be equipped with lube fittings. One police shop foreman commented, "I think a car deserves a grease job after 10,000 miles."

New York City's big cab fleets also order their Fords equipped with grease fittings and insist on regular chassis lubrication.

Significantly, those who don't go along with the idea of long-term chassis lubrication seldom question the durability of the sealed joints. They are more concerned over the danger of unseen little troubles developing into big ones.

As Chevrolet's Ed Cole puts it, "We think somebody ought to get under a car and look for trouble every thousand miles or so." Experienced auto repairmen agree that twice-a-year checks just aren't frequent enough to detect such potentially serious troubles as loose or worn steering linkage, leaking mufflers or leaking oil and grease seals. The sealed joints themselves should be inspected whenever the car is on a lift. If there is evidence of leakage, the joint should be repacked with the proper lubricant and a new seal installed.

Manufacturers who have eliminated the need for frequent chassis lube jobs have keyed inspection and minor service to oil-change periods. Conflicting recommendations as to when used oil should be drained have probably created more confusion in the mind of the average car owner than any other aspect of service. Oil companies, through the American Petroleum Institute, recommend drain periods of every 60 days in warm weather, every 30 days during the winter, with maximum mileage not to exceed 2000.

Auto companies specify drain intervals ranging from 2500 to 6000 miles under normal driving conditions. In most cases, more frequent changes are recommended when the car is operated in dusty areas or in short-trip service during cold weather.

Ford hangs its 6000-mile oil change on the stipulation that only MS oils which have passed a sequence of severe tests developed by auto makers and oil companies are suitable. Such oils can be identified by a certification to this effect on the can.

### Old-Maid Test

Supporting Ford's views are results of an "Old-Maid" test given four Lincolns. For seven months, the cars were driven under low-speed, light-load conditions involving frequent starts and stops. After periods ranging from 15 minutes to an hour, they were sent back to the cold room to chill the engine oil, then back on the test track to repeat the cycle.

(Continued to page 236)

# CUT-TO-FIT HOMES CUT BUILDING COSTS

CHOICE OF 57 DESIGNS

ORDER NOW

SAVE UP TO 1/3



Build your own home and save the builders' profit — plus savings in lumber and labor with Sterling Ready-Cut-Homes. Anyone can assemble with simple, easy to follow plans furnished. Every house complete with all lumber, roofing, nails, glass, hardware, paint, doors and windows marked ready to erect. Freight paid. Complete building plans ready for filing at low cost. Sold separately if desired. Write today!

PRICED FROM \$2295 UP

Five Easy Payment Plans

Send 25c for NEW COLOR CATALOG

INTERNATIONAL MILL AND TIMBER CO.  
DEPT. PM12 BAY CITY, MICHIGAN

Shop PM Ads for Exciting Direct-Mail Offers



**SAY YES TO THE NEW MARCH OF DIMES**

BIRTH DEFECTS • ARTHRITIS • POLIO

JANUARY 1962

## Professional Mechanics' TOOL CHEST

FOR YOUR HOME WORKSHOP



This may be the lowest cost full-sized chest in America! 4 sliding drawers in blue-gray rugged steel cabinet. 26" x 12 1/2" x 12 1/2". Keep your valuable tools safe, clean and always at your fingertips.

\$28<sup>50</sup> F.O.B. ST. PAUL

FREE BULLETIN describes this and 12 other models!



HUOT MFG. CO.  
555 No. Wheeler St., St. Paul 4, Minn.

# BLACK & DECKER TOOLS REPAIRED

- ✓ FULL GUARANTEE on all recommended repairs
- ✓ NEW PRICE POLICY saves you money
- ✓ FAST REPAIRS in 24 hours or less
- ✓ GENUINE FACTORY PARTS made for your B&D tools
- ✓ ALL REPAIRS MADE by tool experts
- ✓ FREE REPAIR ESTIMATE on request

OVER 100 REPAIR CENTERS. Check the Yellow Pages under "Tools Electric" or write for address of nearest service station.



**Black & Decker**

Towson 4, Md.

QUALITY TOOL SERVICE

235



## DOUBLE DRILL PRESS CAPACITY

Motor mounted speed reducer provides the correct speed and power to drill, ream, c'bore etc. to 1 3/8" dia. in steel. Spindle speeds approximately 45 to 3000 rpm. Also used on band saws and other light machinery. Write for catalog.

**PULL-GEAR CO.** 13523 E. Eight Mile Rd.  
Warren, Michigan

The NEWEST and FINEST: Buck's 400 Series

**CHROME EDGE CHISELS**  
You get: ★ The Finest Cutting Edges  
★ Tough Tenite II Handles with Inserted Steel Caps  
★ Rust Proof Tools

1" - \$2.90  
3/4" - \$2.70  
1/2" - \$2.40  
3/8" - \$2.30

Plastic pocket Kit - 4 Sizes \$10.30  
Most complete line of Chisels, Gouges and Carving Tools  
CATALOG AVAILABLE!

**BUCK BROS. INC.**  
RIVERLIN WORKS MILLBURY, MASS.



The new APACHE EAGLE off-the-ground camper in mocha-tan

## THERE'S ROOM FOR REAL LIVIN' IN THE NEW APACHE FOR 1962

Room a'plenty for all your camping gear, on the road and when you're set up. Cook, eat, sleep in spacious comfort. See what real camping is like . . . see APACHE.

FREE color catalog of the full APACHE line available at your nearest APACHE Camping Center or write to:

World's largest manufacturer of aluminum camping trailers

**3 GREAT  
APACHE MODELS**  
The EAGLE . . . \$645  
The CHIEF . . . \$525  
The SCOUT . . . \$345  
optional equipment extra  
—prices f.o.b. Lapeer



VESELY MANUFACTURING CO.  
Box 151, Lapeer, Mich. Dept. PM

SOME DEALER TERRITORIES AVAILABLE

When the test was concluded, the car which used regular SAE 20 oil had heavy accumulations of sludge in the oil pan, oil pump pickup screen and other locations. Engines of the other cars, using three different brands of certified MS oils, were almost as clean as new.

Still another appeal to the new-car buyer's pocketbook is the two-year, or 30,000-mile, coolant offered by American Motors and Ford. The cooling system is filled at the factory with an ethylene-glycol-base antifreeze containing inhibitors said to provide protection against corrosion for the specified period. Prolonged testing has shown that these coolants will do the job, as long as the system functions normally.

What can happen to upset the appletart? For one thing, there's always the possibility of leakage. Every time water is added, the solution is diluted, decreasing protection against freezing and corrosion. Secondly, an air leak may admit enough oxygen to neutralize inhibitors and cause rust.

Finally, exhaust leakage into the cooling system, due to a faulty head gasket, forms acids which deplete inhibitors. *These aren't sealed cooling systems.* They should be inspected regularly and serviced promptly if leakage or corrosion develop.

Use of a glycol mixture in hot weather introduces another problem. Since it cannot transfer heat as rapidly as water does, the engine may run slightly hotter, in some engines, hot enough to raise octane requirement as much as four numbers.

The motorist who must switch from regular fuel to premium will spend more money on higher antiknock quality than he'll save on antifreeze.

Except for lubrication and tuneup, brake adjustment is the most common service operation. Self-adjusting brakes, now offered on many cars, employ a simple cable-and-pawl arrangement to take up excessive clearance when the brakes are applied as the car backs up. But some conservative, low-mileage drivers never apply the brakes hard enough in reverse to actuate the self-adjusting mechanism. Eventually, something sticks, necessitating a manual adjustment.

The car owner who doesn't want to automatically adjust his brakes clear through the lining should have a wheel pulled and linings inspected after the first 10,000 or 12,000 miles and every 4000 to 5000 miles thereafter.

Maintaining the new cars isn't the chore it once was, but the sealed chassis and engine which will go 100,000 miles without service is still in the future. ★ ★ ★



**PIPE THAWER TRINDL ARC WELDER**

**THERM-O-TRON PIPE THAWER**, the original, tried & tested way to safely, easily, electronically thaw frozen pipes. All voltages. Portable complete with cables - clamps, instr. Just \$98.50. Also **BRAZE - SOLDER - SWEAT COPPER PIPES**. Indispensable for farmers - plumbers - homes - industry - etc.

Do your own metal work . . . **WELD - BRAZE - SOLDER - CUT** Thrifty & expertly. World-Famous **125A TRINDL WELDER**, 110/220 V marvel gives 16 heats, 20-125 amps. Handles 1/16" - 5/32" rods & 1/2" metal. Only \$98.50 complete. TRINDL mfg'rs. range of heavier models.



**GUARANTEED full year for CONTINUOUS OPERATION. WRITE for details, also time payment plan. Dealer inquiries invited.**

**TRINDL PRODUCTS, LTD. Dept. T2-A 1807 South Clark Street Chicago 16, Illinois**



**Water Filter Removes Chlorine**

For those who don't like the taste of chlorine in drinking and cooking water, there's a filter to remove it. The unit allows a slow stream of water to trickle through a filter element—and chlorine-free water comes out the bottom. Replaceable elements last about six months. Available from Wewoka Trading Co., Wewoka, Okla., the Ilse filter costs \$6.95.

**Fill Cracks And Holes Better**

Handles like putty. Hardens like wood.

**PLASTIC WOOD®**

The Genuine - Accept No Substitute.

JANUARY 1962

**EVERLITE\* World's THRIFTIEST Light Plants**

(Item 869-15T)



1500 watt amazing new alternator. Most efficient trouble-free light plant ever made. Rugged new transistor circuit eliminates commutator and armature—all the old headaches of generators gone. Output is standard current—115v., AC—operate oil burner, freezer, lights, TV, power tools or anything that requires up to 1500 watts. Powered by sturdy fast starting 3 hp Briggs engine guar. for 1 full year. Price is unbelievable, only \$209.50 F.O.B. factory for the finest 1500 w. plant made.

\*Trade-Mark Registered Everlite 1500 watt, Item 869-15T Wt. 60 lbs. . . . \$209.50

**STANDARD DIAL PHONES**

Western Electric dial phones same as used by all telephone companies. Ideal as extensions on any system. Phones are converted to work without central station for use as private communication systems. Merely dial to ring other party. Rings loud and clear. Several may be connected on same line. Fine for long distance. Standard 110 v. current used one end. Needs 4 cond. wire for private line.



Item 855 Wt. 8 lbs. each . . . . . \$8.95  
Wire—4 cond. 22 gauge, 250 ft. coil . . . . \$4.95  
Wire—4 cond. 19 gauge (for distances over 500 ft.) 250 ft. coil \$7.95

**MASTER MECHANIC MFG. CO., Dept. A-162, Burlington, Wis.**  
Southern Customers Order from Dept. A-162, Box 65, Sarasota, Florida



The hand-held  
**2-WAY RADIO**

that outperforms  
'em all...

**Anyone can operate—no license required—priced from \$109.50!**

In the field or on the job . . . Viking "Personal Messengers" are delivering outstanding performance! Viking "Messengers" are available in compact hand-held units or maximum legal power Citizen's Band transceivers. Used by thousands of businessmen, salesmen and construction crews. Send today for full details.



**FREE! SEND FOR COLOR BROCHURE**

Please rush "Messenger" details to:

NAME \_\_\_\_\_  
ADDRESS \_\_\_\_\_  
CITY \_\_\_\_\_ STATE \_\_\_\_\_

**E. F. JOHNSON CO.**  
1401. 10 Av. SW, Waseca, Minn.

## An Engineer Analyzes the '62s

(Continued from page 113)

come to a screeching halt. Now we're turning back to simplicity, low cost, lighter weight. The "ideal" automatic transmission—which lets the engine pump at a more or less constant high r.p.m. as the car accelerates, but keeps it at a very low r.p.m. for cruising—has been shelved for the time being. *Economy* is the watchword now and theoretically-ideal designs are much too expensive.

Proof positive that the worm has turned in U.S. automatic transmission design is the fact that Chevrolet dropped its triple-turbine Turboglide on the '62 models, after producing it only four years.

Buick dropped its similar Flight-Pitch Dynaflo in 1960, after only two years of production. Both designs approached closer to the ideal than any other known transmission. But they were just too big, too heavy, too expensive, too complicated.

### Lighter Transmissions

So it was no surprise to find Chrysler engineers playing it cool when they redesigned their Torqueflite 3-speed torque converter for their '62 V8s. Operating principles, gear ratios, converter layout, etc. are all the same as before. But everything has been trimmed down. The internals have been squeezed into a smaller housing so the floor hump is greatly reduced; there are fewer parts (to reduce costs) and a new aluminum case has cut 60 pounds from the weight.

Chevrolet has put a new aluminum case around the 2-speed Powerglide and saved 85 lb. Actually this swing to aluminum parts on transmissions (and many other components) is not just to save weight.

The soft, low-melting-point metal is actually cheaper and quicker to cast and machine in many applications, even though it costs three to four times as much per pound as cast iron.

American Motors' new "E-Stick" arrangement on the American line is a clever approach to a "poor man's automatic." Essentially it's just an automatic clutch in conjunction with a conventional manual-shift 3-speed gearbox. A servo mechanism utilizing engine oil pressure and manifold vacuum will engage the clutch whenever the engine speed rises above a certain r.p.m. There's no clutch pedal at all. With the engine idling you can shift into any gear.

Then when you press the throttle and as the engine speeds up, oil from the engine's lubrication pump forces the clutch to engage and the car moves away. To

shift you just lift your foot from the accelerator, touch the lever and the clutch automatically disengages as oil is "dumped" from servo cylinder, and the gear lever can be moved to the next gear. The optional price of \$60 is only about one-third the cost of the average automatic transmission.

If you had predicted five years ago that we would soon be able to order optional floor-shift 4-speed transmissions on eight different makes of American passenger cars—well, you'd have been laughed at. Why should a big high-torque U.S. engine need four, close gear ratios? That's for tiny, 40-horsepower foreign cars. Big American cars could get along nicely with two gears forward.

Actually it's not a matter of need. It's what a lot of buyers *want*. It's fun to drive. The short, positive floor shift lever makes shifting a pleasure and the more speeds the better! And it *has* been proved that the four close ratios help acceleration up to 80-100 m.p.h. on the drag strip, because the engine r.p.m. doesn't drop back so much when you shift. Detroit is selling thousands of these things at optional prices up to more than \$300, to the sporty-type buyers of Chevrolets, Pontiacs, Fords, Larks, Hawks, Tempests, Corvairs, and Buick Specials.

Borg-Warner gear engineers did some very clever "cobbling" to make it all possible. Back in 1956, when Chevrolet was starting to push the Corvette as a high-performance sports-racing car, B-W was presented with the problem of bringing out a close-ratio 4-speed at minimum cost.

What they finally did was to take their heavy-duty 3-speed, move the reverse gears back into the tailstock housing, make up a new gearset with four ratios for the main gearcase, and put a neat floor shifting linkage alongside!

And one other interesting "transmission" trend: The limited-slip differential continues to gain popularity. They're now invading the compact field. The new '62 Buick Specials, Olds F-85s, and Chevy II offer the feature. Cadillac has a new design. Most U.S. cars can now be ordered with this useful feature for around \$40.

### CHASSIS

American passenger car chassis design may be following the same trend as automatic transmissions—they seem to be getting *simpler* and less costly instead of more complicated.

The most important new chassis development this year—Chevy's single-leaf rear spring—is aimed at trimming, saving, simplifying. Auto engineers have wanted to

(Continued to page 240)



## New idea for Sportsmen...in 4 flavors

It's the new AMERICAN SPORTSMAN 6-ft. tape rule. Handiest measuring tool you ever saw. Smaller than most cigarette lighters. Brilliantly colored face plate identifies *your* favorite sport. 1/4" steel blade has easy-to-read markings, exclusive White Clad® finish. Blade rolls out and in — butter-smooth. See it soon wherever you buy hardware. Great gift! **Only 98¢.**

Measure for measure. the finest made.

# LUFKIN

SAGINAW, MICHIGAN



**BUY DIRECT • SAVE ON • TILLERS • TRACTORS**

Full line of attachments for mowing, gardening, farming  
2-3-4 HP TILLERS 12"-16" CUT.  
**FREE CATALOG & PRICE LIST**

5-6-7-9 HP  
2 wheel &  
  
4 wheel tractors

**RED-E TRACTOR CO.**  
4th Street  
RICHFIELD, WISCONSIN

## Planer • Molder • Saw!

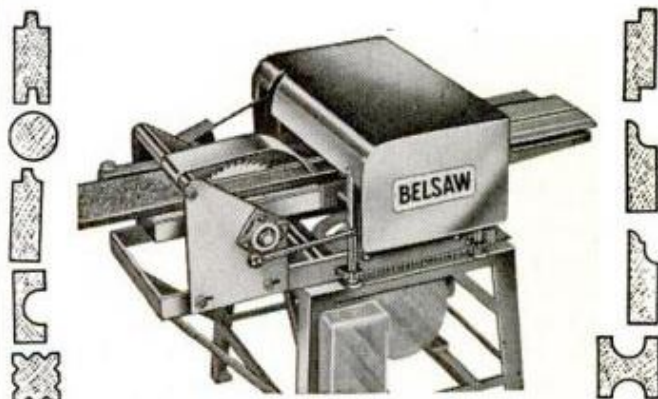

Now you can use this **ONE power feed shop** to turn rough lumber into high-value moldings, trim, flooring, furniture... **ALL** popular patterns.

**RIP...PLANE...MOLD...** separately or all at once by power feed... with a one horsepower motor. Use 3 to 5 HP for high speed commercial output.

**LOW COST...** You can own this **MONEY MAKING POWER TOOL** for only ..... **\$3000** down payment

Send coupon today

**BELSAW POWER TOOLS** 902 Field Bldg., Kansas City 11, Mo.  
Send me complete facts on the **MULTI-DUTY Power Tool.**  
No obligation.

Name \_\_\_\_\_  
Address \_\_\_\_\_  
City \_\_\_\_\_ State \_\_\_\_\_

Works in seconds!

**Loosens Rusted Bolts nuts, screws, "frozen" parts!**

# LIQUID WRENCH

**SUPER-PENETRANT**

The super-penetrating rust solvent that quickly loosens rust and corrosion.

**AT ALL HARDWARE AND AUTO STORES**

**RADIATOR SPECIALTY COMPANY**  
CHARLOTTE, N. C.



MAIL COUPON TODAY FOR FREE BOOK

VON SCHRADER MFG. CO.

110 "W" Pl., Racine, Wisconsin

Please rush your **FREE** booklet about your WALL WASHING MACHINE and how I can start my own permanent, profitable business.

Name \_\_\_\_\_

Address \_\_\_\_\_

City \_\_\_\_\_ Zone \_\_\_\_\_ State \_\_\_\_\_

# "MADE \$1200 ON ONE JOB"...

Some make more, some less...

## We help you start Your Own All-Year Business

**Make BIG Money!** With our easily operated, highly efficient wall washer, G. H. Jones made \$1200 on one school job. E. L. Goss took in more than \$10,000 in one year. E. C. Taber wrote, "I made \$400 gross in two weeks." And no wonder... this machine washes walls 6 times faster and better than by hand—with no mess...no drop cloths.

### Your Money-Making Opportunity

We want more men to go into this profitable business for themselves and enjoy independence... freedom from layoffs and bosses. Customers everywhere—homes, offices, schools, churches, hotels, etc. How much you earn depends largely on you. What you take in is mostly profit. No need to rent shop or office; operate from home. Start spare time until full time is justified.

**Loss No Time — Send Coupon Today for All the Facts!**

use single-leaf springs for 30 years. With more than one leaf you can't stress the material evenly over the whole length of the spring, so you need more pounds of steel to do the job. Also there is a certain amount of friction between the leaves of a spring as it flexes going over bumps. This "interleaf" friction has the effect of "locking" the leaves together preventing flex, especially on very small bumps and tar strips. The single-leaf spring is the ideal way to do the job. It's smoother and lighter.

But there were problems. In order to get even stressing along the length (so the minimum amount of material is required) the leaf must be thicker in the center than at the ends. This makes a tricky production job; it stumped engineers for 30 years. Now Chevrolet has found a way to roll the leaf so that it spread out *wider* at the ends where it is squeezed down *thinner*! Another trick is a new machine that automatically shot-peens the springs while they are compressed under a normal load. This allows higher working stresses, so we get that much more work out of each pound of steel.

Finally, Chevrolet mounts the single-leaf spring to the rear axle and body in a new way. The spring is not clamped solid in the center (to the axle) as is usual. It rides in thick rubber pads in the center

and on big, fat rubber bushings at the ends, so it is completely isolated from the body. This not only eliminates any "dead" area at the clamping point but the rubber insulation also reduces road rumble and vibration.

The trend to the high-mounted front coil springs is continuing. The new Chevy II and Ford Fairlane both use the layout. Normally the front coil springs are placed between the two suspension arms (wishbones). This exerts very high stresses in this area due to the concentration of forces. The new "unit," or box-type, bodies (no separate frame) aren't happy with these stress concentrations. By mounting the coil spring above the arms, seating it in the upper fender well, designers spread these forces out, and ease the load on the front body structure.

Unit body design seems to go in different directions. Chrysler started out in 1960 by bolting on their front body superstructure, then changed to welding it on this year's Dodge, Plymouth. But, on the new Chevy II, unit body is bolted to front structure and fenders. Each method has its advantages. Welding is probably cheaper; but you can rebuild a front end after a crash a lot cheaper if you can unbolt the old stuff and bolt on new panels. Which gives the

(Continued to page 242)



# SURPLUS SALE

GOVT. SURPLUS  
EXCESS INVENTORY  
BANKRUPT STOCK

## POWER PLANTS and GENERATORS



• Item #627. DeLuxe Army 5,000-w plant. One phase and 3 phase water cooled 4-cyl. engine. Full instrumentation. 120/208 3-phase, 120/240 single phase. Ideal for bomb shelter or home and business emergency. Limited quantity. Wt. 890 lbs. Govt. cost over \$1,000. SALE **\$496.50 FOB**

• Item #626. Brand new heavy duty 1,200 rpm 115-v. 60-c. 3000-4000-w ball-bearing generator. Wt. 260 lbs. Govt. cost over \$800. SALE..... **\$139.50 FOB**



## AIR COMPRESSOR BARGAINS



• Build your own outfit for painting, cleaning, tires, etc. Save up to 60%.  
• Single cyl. piston compressor, \$21.50. • 2-cyl. Compressor (150 lbs.) \$54.75.  
• Govt. air tank, \$10.95  
• Paint spray gun, \$11.50  
• Regulator, \$3.95. Many other items.



## HYDRAULIC EQUIPMENT BARGAINS



Build loaders, diggers, presses, etc.  
• Valve \$18.  
• Pump \$41.60. 8" stroke, 2" bore, 2-way cyl., \$17.95.  
• 12-v. Electric Hyd. 1,000 PSI pump, \$16.49.

## GENERATOR-3000W-115V



• Item #633. D.C. coil bearing compound-wound Delco unit. 1" dia. shaft. 2800 RPM. Ideal for portable tools, lights, boats, etc. Will run any 115-v DC-AC tool. Govt cost over \$175. SALE..... **\$54.75 FOB**

## GOV'T AIR COMPRESSOR

• Item #453. Expensive precision Gov't Air Compressor. Direct connected G.E. motor 115-v 60-c. Built-in air filter, relieve valve, etc. Very compact and highly efficient unit.

• Excellent for paint spraying, insecticides, air brush, etc. A "Super Buy." Wt. 39 lbs. Gov't cost over \$250. SALE..... **\$29.88 FOB**



## 115-W WATER HEATING UNIT



• Item #1127. Expensive finest Westinghouse water heating elements. Use for heating water, oil, etc. Makes ideal stock tank heater. Totally enclosed. 1 1/4" pipe threads. 3 heats-800, 400, 200 watts. Very rugged. Real buy. Govt. cost \$17.90. SALE..... **\$3.95 Ppd.**

## DIAL PHONE

• Item #716. W. E. phone, same type used in telephone offices. Use as extension or main line phone. Set up your own private system. Wt. 8 lbs. Black..... **\$7.95**



## BATTERY REMOTE CONTROL WINCH

• Item #322. Powerful Govt. DC hoist with "up-down-off" push-button control switch, 20' cable. • 35' 4000-lb. hi-strength super-flexible steel cable on self-leveling pre-grooved high-strength 5"x6" drum. Winch rating 1000-lbs. on 12-v, 1500 lbs. on 24-v. Fine for boats, loading docks, trucks, jeeps, garages, farms, etc. Easy to install. Electric automatic locking brake. Works off any car-truck 12-v battery. Wt. 90 lbs. Size 12"x14"x8". SALE..... **\$68.25 FOB**



## SPECIAL OF THE MONTH!

### BATTERY POST HOLE DIGGER

• Item #101. Fast easily operated one-man farm post hole digger. Uses surplus ball bearing gear reduction motor. Charged by 12 volt storage battery. Use off truck or tractor battery.  
• Digs a 7" diam., 32" deep hole in less than one minute. Deeper holes can be dug using improvised extension. Digs 10 to 15 holes on single battery charge.  
• Includes two 8-foot cables with battery clips. Weight - 40 lbs. Govt. cost over \$275.00. SALE... **\$89.50 FOB**



### HYDRAULIC SPEED REDUCER

• Item #1304. 1 hp variable speed hydraulic transmission. Variable speed 0 to 350 rpm. Instantly reversible. Ideal for lathes, midget cars, etc. Roller bearings, and complete with 3-phase 220-v AC ball bearing motor. Size 21"x9"x20". Wt. 200 lbs. Shaft fitted with pulley (specify diameter desired). Govt. cost over \$900. SALE..... **\$89.50 FOB**



### AC-DC ELECTRIC GENERATOR

• Item #675. New hi-power Govt. ball bearing unit. Generates 115-v (800-cycle) AC (1200-w) and 30-v up to 200 amps DC.  
• Very versatile. Use for 115-v AC lights or stove or for DC 200-amp welder. Drive with tractor, engine, etc. Size 14"x8"x6". Wt. 55 lbs. Govt. cost over \$250. SALE..... **\$15.85 FOB**



### GOLF CAR MOTOR

• Item #569. Runs on 12-v batt. Build golf or car motor, electric auto. Powerful gear reduction speed 25-80 rpm. Easily reversible. 100s applications. Wt. 35 lbs. Govt. cost over \$275. SALE..... **\$21.79 FOB**



1962  
CAT-  
ALOG

Electronics, Tools, Binoculars, Hydraulics, Plants, Compressors, etc. New 1962 cat. now ready (send dime or stamps).

**SURPLUS CENTER**  
LINCOLN, NEBR. DEPT. 803

# Save on all PLUMBING JOBS

When You Build · When Making Improvements · Repairs · Maintenance

Get POPULAR MECHANICS Home Plumbing Guide



How to plan plumbing installations, select materials and fixtures.

How to save money on all plumbing jobs using approved methods.

Easy to Do Professional-Like Jobs and Save Over One-Half

Get the Popular Mechanics HOME PLUMBING GUIDE. It shows how you can do every kind of plumbing job yourself and save from a few to hundreds of dollars. Covers plans, layouts, installation, maintenance and repair. Shows what materials to get and use, where to get them and how to do a proper job with approved methods. Few, other than the simplest tools are required and some of these can be rented. Don't pay high prices for work you can do yourself. Get the HOME PLUMBING GUIDE for only \$3.50. You will be amazed how jobs you thought difficult are simplified.

Clip This Ad and Mail. Money Back if Not Pleased

Invest only \$3.50. Use the book for 7 days. Then if you are not satisfied return it for full refund of your money. Sent C.O.D. (U.S.A. only) if you prefer.



15 Ways to Save Money  
All about modern home plumbing  
How to use plumbing tools  
Getting acquainted with pipe  
Planning home plumbing systems  
Installing and maintaining home drainage systems  
Private sewage disposal systems  
Causes and cures of drainage troubles  
Installing home water lines  
Private water supply systems  
Water Heaters  
Water Conditioning  
Water system troubles and cures  
Installing and caring for fixtures  
What to do with valves and faucets

Over 500 How-to-do-it Pictures Guide You

POPULAR MECHANICS PRESS, Dept. 162, 200 E. Ontario St., Chicago 11

Order your FREE copy of . . .

## What You Should Know About Patents

Comprehensive information on patents and how to secure a patent. Write Popular Mechanics, Bureau of Information, 200 E. Ontario, Chicago 11, Ill.

## SAVE MONEY... EARN MONEY with the MET-FORMER

ROLLS · FORMS · BENDS



Make screen door guards, wall hangings, plant shelves, room dividers . . . anything you want in light wrought metal and with a truly professional appearance. Form rod, tubing or flat metal.

**\$34.95** PREPAID including material



Write for information and free project folder.

**SWAYNE, ROBINSON & CO.**

Dept., A, 228 E. MAIN ST., RICHMOND, IN

# Free!

## BRAND NEW LAFAYETTE ELECTRONICS 1962 CATALOG 620



It's Bigger and Better  
Than Ever!

340 giant-sized page catalog from the world's leading supplier of electronics and stereo hi-fi equipment.

### 340 PAGES

It's a complete shopping center for audiophiles, technicians, engineers, students, hobbyists, servicemen and dealers. Thousands of items at lowest money-saving prices — featuring LAFAYETTE KITS . . . the best value for your money any day.

**SPECIAL! NO MONEY DOWN**

with Lafayette's **NEW EASY-PAY PLAN.**

**MAIL THE COUPON TODAY FOR YOUR FREE CATALOG**

**LAFAYETTE LOCATIONS**  
JAMAICA • BRONX • NEW YORK CITY  
NEWARK • PLAINFIELD • PARAMUS • BOSTON

Lafayette Electronics Dept. LA-2  
P.O. Box 190, Jamaica 31, N. Y.  
Send me the FREE 340-pg. 1962 catalog 620.

Name .....

Address .....

City..... Zone..... State.....

## NO JOB WORRIES

PLASTEX INDUSTRY needs manufacturers on small scale for big production of Lamps, Clock Stands, Art Goods, Novelties in Plastic Marble imitation. No Experience necessary. 1/2¢ material makes regular 10¢ store sellers. Moulds furnished for fast production. Small investment brings good profit. Big wholesale orders now being placed. Ambitious men have chance for real prosperity and job security. Our NEW FREE booklet will interest and benefit you.

**PLASTEX INDUSTRIES, Dept. A**  
3400 Third Ave. New York 56, N. Y.

## BOAT TRAILER KIT Only \$74.50

620 POUND CAPACITY—FOR BOATS TO 16 FT.  
OTHER MODELS FOR ALL BOATS TO 1000 POUNDS

You can really save on these rugged, perfectly engineered Kits. Guaranteed highest quality parts ready to assemble into a boat trailer with more features and better performance than high priced trailers.

**NEW! CAMPING TRAILER KITS NOW AVAILABLE AT TREMENDOUS SAVINGS!**

Write for 1962 illustrated catalog showing all models and prices. Please enclose 10¢ for postage and handling.

Dealer inquiries also invited!

**TRAILER PRODUCTS, INC.** Dept. PM-12, P.O. Box 176  
Kingsport, Tennessee

## AUTOMATIC RETOOTH

MAKES NEW PROFITS

Cuts new teeth in 50 seconds—any size 4 to 16 points. Old teeth fall off as chips. Easy to operate. A perfect job.



**BURR MFG. CO.**  
8933-J VENICE BLVD.  
LOS ANGELES 34, CALIF.

Send For Free Literature

stronger, quieter, stiffer body is debatable.

A few other suspension developments: Lincoln is using huge 1 5/8-inch pistons in their shock absorbers to further reduce fluid pressures and get smoother, more consistent action. They're using a short cantilever leaf spring to support the transmission on the new Falcons and Comets, to isolate engine vibration and road rumble from the body. The Buick Special features variable-pitch rear coil springs to get a smooth ride with a progressive stiffening of the spring on hard bumps.

We find more and more sound insulation on late unit bodies. (Unit bodies tend to act like a big bass drum to amplify road rumble, so sound insulation is very critical.) Engineers found that a few pounds of sprayed-on asphalt deadener, jute padding and fiberglas blanketing properly distributed around the inside of the body panels were quite effective on controlling rumble. But the more they add the quieter the body seems to get. They went hog wild on some models this year. The only practical limit seems to be how much weight you're willing to add and how much money you're willing to spend to quiet the body!

**Fort Snow**, a modern castle for eager young snowballers, can be built using the February PM plans for a simple snow block casting machine.

Most interesting brake development this year is the dual-master-cylinder layout on Cadillacs and Ramblers. It's largely a safety feature. The brake pedal operates two master pistons in tandem, one feeding the front brakes and the other the rears. They are two separate circuits.

If a brake line should break at either end of the car the other circuit would continue to provide effective braking. On a conventional layout a broken line anywhere would wipe out the whole system. Detroit is thinking about safety.

We also see more self-adjusting brakes on '62 models. This feature should sweep the industry in another two years. A ratchet arrangement on the brake shoes automatically takes up slack whenever the car backs up. Only costs a few pennies, and brakes should never need adjusting. Credit Ford with this development. Another Ford Motor Co. improvement this year is use of aluminum-drum front brakes on Lincolns, for better cooling under rough conditions with this relatively-heavy model. Lincoln doesn't have the cost problems of our big-volume cars, but this *might* just be the start of a trend. ★ ★ ★

# WAR SURPLUS DEALS BEGINS SAVE UP TO 90%



**U. S. NAVY SEXTANT (AN 5851)** The finest navigational aid on land, sea or air. Adjustable bubble and nite lite, built-in averaging device. Both artificial and natural horizon. Can be used with or without bubble. Excellent for marine use. Used by many power squadrons. Comes complete with filters, astigmatizer, batteries, carrying case & instruction book. Approx. GOVT. COST \$586. Like NEW. \$16.50.



**SOUTH WIND HEATER & ACCESSORIES**

Manufactured for govt. antarctic expeditions for jeeps and half-tracks. Heating unit puts out over 20,000 B.T.U.'s. Late recirculating type. Burns any type gas. 12 volt system. Fuel consumption extremely low. 1 gal. per 8 hrs. Terrific for trucks, etc. With service & installation manuals & many components. Approx. GOVT. COST \$550. Shpg. wt. 50 lbs. NEW. \$39.95. Limited quantity.



**ELECTRIC STORAGE BATTERY WINCH**

New, improved model contains heavy-duty, 2-way drum switch. Fully reversible heavy-duty, two-speed motor, 160 to 1 gear reduction. Ball bearing construction throughout. Drum will handle 70' of 1/4" cable. Can be used on 6, 12, 24 V. battery. Lift cap. 2000 lbs. plus. Ready to install & operate. 19" long x 9" wide x 8" high. For jeeps, trailers, boats, trucks, etc. Complete with mounting flange, safety load locking brake and leads. Shpg. Wt. 60 lbs. Approx. GOVT. COST \$400. NEW. Model E. \$49.50.



**BUILD YOUR OWN ARC WELDER, LIGHT PLANT OR BATTERY CHARGER \$39.50**

Kit incl. 1 Navy NEA-5 Gen. combination AC-DC type. AC 115 V., DC 24 V., 200-300 Amps. 2 complete generators in 1, yet no larger than reg. gen. Ideal for home, shop and farm lighting plants. Delivers 1200 Watts AC, DC side for charging batteries, welding and operating war surplus motors. Also in kit: 1 DC Voltage Reg., Reverse Current Relay, 1 Voltmeter, Rheostat, Electrode Holder, Toggle Switch, Welder's Shield, Wiring Diagram for kit. Wt. under 100 lbs. Approx. GOVT. COST \$650. Kit-\$39.50. Navy NEA-5 Gen. as above, purchased separately, \$23.50

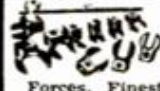

**11 PIECE CROWFOOT WRENCH SETS**

Wrenches snap onto T-bar in 3 different positions. The only wrenches for hard-to-get-to places. Mfd. by Plomb Tool Co. for U.S. Armed Forces. Finest case hardened tool steel. No shop mechanic should be without this set. Approx. GOVT. COST \$47. NEW. \$5.95 pnd.

**DELUXE ELECTRIC STORAGE BATTERY WINCH**

Handles 250' of 1/4" s.eel cable. Operates on 6, 12, 24 V. battery. 160-1 gear reduction. Lift cap. 2500 lbs. Contains heavy-duty mounting base with outrigger bearing and spool support. Rugged construction. Heavy-duty dual speed motor with safety load-locking brake. Dim. 24" long x 9" wide x 8" high. Great for jeeps, trailers, boats, trucks & campers. Shpg. Wt. 80 lbs. Approx. GOVT. COST \$490. NEW. Model E-D. \$69.50.



**FRESH WATER SYSTEM PUMP - For boats, campers & trailers.**

Output 10 to 200 gal. an hr. Variable rheostat controls output. 1/2" pipe thread into bronze impeller housing. 12 V.D.C. Radio noise filter. 5.2 amp. draw. Explosion-proof const. Shpg. wt. 11 lbs. Complete with mounting instructions & wiring diagram. Approx. GOVT. COST, \$200. NEW. \$10.95.

**225-1 REDUCTION GEAR**

For beaching boats, winches, hoists. Ideal motor in golf or boy's electric car. DC motor and clutch. Easily reversible wiring diagram furnished. Hi torque, 105 RPM. Runs on 6-12 or 24-32 V. 65 lbs. gross. Approx. GOVT. COST \$300. \$13.50. Matched splined gear-\$3.00 ea.

**NEW 1962 CATALOG!**

Tremendous catalog - our biggest ever - fully illustrated - 1000's of bargains in war surplus & other items. Send for your free copy today. You're invited to visit our giant warehouse. Where ppd. indicated applies to U.S. only. Other prices F.O.B. Culver City Calif. Send cash, check, money order, 50% deposit for C.O.D.



**AIRBORNE SALES CO., INC.** DEPT. PM162  
8501 Stellar Drive, Culver City, Calif.

**FREE AMAZING NEW BOOK "HOW TO ANSWER ADS"**



Never before have you seen anything like this. Tells you in simple language the correct way to answer ads. Gets you quicker replies - better results, and greater satisfaction. Will save you time and money and it's ABSOLUTELY FREE. No obligation whatever. Every reader of advertising should have this booklet. Send a postcard for your copy NOW. F. W. JOHNSON, Popular Mechanics Magazine, Room 600-A, 204 East Ontario Street, Chicago 11, Ill.

**WHERE-TO-FIND-IT LIST**

WHERE-TO-FIND-IT List for this issue, free on request, gives sources of supply or further information on all editorial items for which this information is available. Send a stamped, self-addressed envelope to



**SERVICE BUREAU**

200 E. Ontario Chicago 11, Illinois

**Catalog of 2900 Novelties 10c**

Send 10c for amazing catalog of novelties, live animals, scientific supplies, hobbies, funmakers, planes & boats, looms, magic tricks, joke articles, unusual seeds, gadget timesavers, cameras, optical goods, projectors, movies, lucky jewelry, religious novelties, disguises, musical instruments, stamps, coins, puzzles, fortune tellers, radios, auto & bike accessories, telescopes, magnifiers, compasses, banks, smokers' gadgets, artists' supplies, printing sets, engines, motors, shockers, knives, billfolds, guns, rifles, sports, books, games, plants etc. Send 10c.

Johnson Smith Co., Dept. 556, Detroit 7, Mich.

Here's 10c. Rush catalog to:

Name .....

Address .....

**CONCRETE BIRD BATHS AND OVER 250 OTHER MONEY MAKING ITEMS**



You've seen them all over the country... concrete bird baths, garden seats, flower boxes, appealing statuary, and many other items that add charm around the house and lawn. They're made by enterprising people, just like you, from our COPYRIGHTED ALUMINUM MOLDS. It's easy. It's fun. It's profitable.

Send \$2.00 today for this 82-page "How to" book, 20 pages of clear instructions. Valuable trade secrets. Over 250 items beautifully pictured (with description, dimensions, and prices of molds). Rushed to you by first class mail.

**CONCRETE MACHINERY CO. INC.**  
HICKORY 2, NORTH CAROLINA

Name .....

Address .....



**LICKITY LOG SPLITTER**

**Ends Wood Splitting Drudgery**

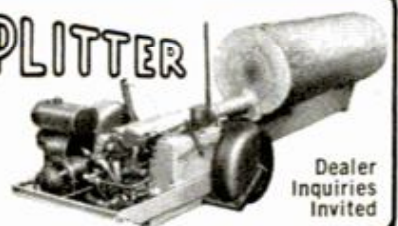

Dealer Inquiries Invited

Smooth 18 ton hydraulic power splits big profits for you from the toughest woods, including American Elm. 7 HP trailer unit squats under own power to receive large logs without "dead" lift. Has 2 speeds, auto-shift and auto-stroke. 26" ram travel splits up to 34" lengths, any diameter - or, with extended frame and adjustable wedge, splits up to 52" lengths, any diameter. Write for detail

**THE WACO AIRCRAFT CO., Dept. D, Troy, I**

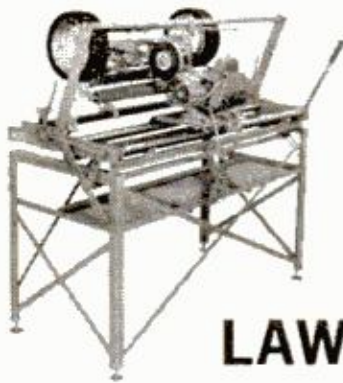

**EARN \$5  
PER HOUR**

*in  
your own*

## LAWN MOWER SHARPENING SERVICE

Earn extra money right from the start—average \$5.00 per hour. Full or spare time opportunity. The Modern Lawn Mower Sharpener is a complete shop in one machine. You don't need experience to start—anyone can operate it, and turn out perfect jobs. All operations are done quickly, easily and accurately. Write for full money making details.

### FOLEY MANUFACTURING COMPANY

193-2 Foley Bldg., Minneapolis 18, Minn.

Send information on Modern Lawn Mower Sharpener.

Name \_\_\_\_\_

Address \_\_\_\_\_

## WELD - BRAZE - SOLDER - CUT

### REPAIR MOST EVERYTHING MADE OF METAL

Home Appliances, Auto parts. Make and repair lawn chairs, tables, ornamental iron work, gates, wagons, etc. Solder, heat, bend, and straighten, with terrific heat from arc torch. Cut and weld up to 3/4" steel plate. A million uses for Home, auto, farm, inventors, factories, etc. Works

from any home 110 volt plug-in. Complete with dark welder's mask, arc torch, supply of carbon steel welding and brazing rods and complete Welding Instruction Book. 1 year guarantee.

**SEND ONLY \$3** (cash, ck. mo.) and pay postman \$11.95 plus COD postage on arrival or send \$14.95 and we will send postpaid. Ideal gift for mechanically minded, relatives, friends. Order now. Available only from: **MIDWAY WELDER, Dept. DPM-1, Kearney, Neb.**

### Close Out! Clinton Engines

65% discount 5 1/2 hp E65 Clinton Engines (right or left). Go-Cart mfg. gone out of business—offering engines at ridiculous prices. Complete with exhaust stack, recoil starter, motor mount, air cleaner, \$34.00 ea. Retail \$96.50. Send check, cash, or money order (no C.O.D.). Add \$2.00 ea. for parcel post, insurance and handling in the U. S.  
Box 337 Warrensburg, Mo.



**FOR CARTS  
SCOOTERS  
AIR BOATS  
GRAIN AUGERS  
CHAIN SAWS**

## Ford, Plymouth, Chevy II

(Continued from page 108)

cylinder engine, we found that it was much smoother below 40 m.p.h. than the Chevy II Four was. The Tempest was tolerant down to 15-18 m.p.h. in high, down to 8 or 10 in second gear when lightly loaded and driven on level city pavement.

The four-cylinder Chevy II accelerates reasonably well from 55 to 75, and holds the road at 65 without much vibration. It could obviously do 85 flat out.

Chevy IIs ride is a little bit "busier" than the Fairlane's. There is a bit more jar felt through the Chevy II's suspension, but it is a muffled jar.

When you concentrate on the ride, you come to the conclusion that the car is a bit smaller and a bit lighter. Ride of the six-cylinder Deluxe-Chevy II was better in this respect, just about on a par with the Fairlane Six. Chevy II's new, single-leaf rear springs are definitely a plus. They give smooth, supple action on big bumps with satisfactory smothering of surface harshness. No real complaint with the ride . . . it's just a bit firmer than average.

There is a feeling that the car is just a little smaller than the Fairlane and you feel that the hood shows a bit less in front of you and that it seems to be shorter and drops off a little bit more, allowing you to see more in front. The windshields of the Chevy II and the Fairlane are almost the same.

### FORD FAIRLANE

There's adequate legroom for a driver of 6'2" height in the Fairlane, with no back discomfort on a 48-mile run. But the tall driver's right leg tends to feel cramped in a Fairlane in traffic.

The car has a pretty good response for a small engine in a 2800-lb. car carrying only a 200-lb. driver.

There's better than average lack of wind noise around the car at 70 m.p.h. with all the windows buttoned up. There was a good deal of exhaust resonance and engine and transmission noise through the rubber carpet. On the V8 Deluxe Fairlane, tested earlier, there was little of this. Acceleration and pickup are satisfactory on the Fairlane; it performed well, had a good ride, but sound and vibration level was annoying. It was the standard model. There seemed to be more difference between the luxury of the Fairlane 500 and the standard trim Fairlane than between the Deluxe and Standard of Chevy II.

Steering on the Fairlane is light and responsive. It's doubtful that anyone would consider the need for power steering on the Six with manual transmission. The V8,

## Fill Flaws In Plywood

Handles like putty. Hardens like wood.

## PLASTIC WOOD®

The *Genuine*—Accept No Substitute.

weighing 75 lb. more, might be marginal. Ford's recirculating ball gear does the job well.

Vision is good in the Fairlane and the rear-view mirror at the top of the windshield doesn't get in the way. Side pillars are adequately thin but the left hand pillar angles so that it blocks too much vision. The hood is flat and not too long, but is fairly high. In spite of this, there's pretty good view over it.

Instruments are a step in the right direction—three hooded dials with fairly dull paint. Center portion of the dials are shiny concentric circles on aluminum discs which feed back a reflection.

In conclusion we feel that Plymouth's Belvedere Six with automatic transmission is a very pleasant transportation package costing little more to run than Chevy II, a true compact.

If you appreciate the extra maneuverability of a car 19 inches shorter than the Plymouth (and some \$200 less in cost), Chevy II would be your choice, although

**pailey's BARGAIN CORNER**

**2000 PSI HYV DUTY HYDRAULIC CYLINDER**

Another of our outstanding Hydraulic Cylinder Bargains. Has a 2-1/4" Bore, 4" Stroke, 1" Shaft and 13 1/2" eye-to-eye length. Ports are 1/4" AN (7/16"-20 thread).  
Cat. No. H-66NSU, New **1795**  
Cat. No. H-66USU, Used **1295**

No. H-84 - Double Action Cylinder  
Cost the Gov't approximately \$68.00  
For pressure to 1500 PSI.  
Bore - 1-1/2", shaft 9/16", stroke adjustable 1-3/16" to 4-3/8", length 14-1/2". A Real Buy at **ONLY 395**

**1500 PSI Double Action HYDRAULIC CYLINDER**  
Ideal throttle control cylinder when used as a master & slave. Has 5/8" bore, 7/16" shaft, 4-1/8" stroke, 9-5/8" closed length. Ports are 1/4" tube.  
Catalog Number H-60 . . . **375**

**Special 1500 PSI HYDRAULIC CYL.**  
1500 PSI Cylinder. Bore 2-3/8", shaft 7/8", adjustable stroke is 7-3/8" to 9-5/8", eye-to-eye length 20".  
No. H-17USU - Used **788**  
Reg. Cat. price \$10.75  
No. H-17NSU - NEW **1488**  
Reg. Cat. price - \$19.75

**SALE!**



**WINCH HOIST**  
**LIFTS 2500 LBS.**  
**NOW 3795**

A small, compact winch hoist with fast action power. Ideal for use in garages, shops, boat yard, on the farm, on trucks, jeep or wherever there is a lifting job to do. Has a bronze, worm-gear drive with a 24-to-1 ratio and a 3-speed hand crank. Comes with 18ft. of 3/16" steel cable. Has a free-spool, pull-out clutch. Without mounting frame (shown).

Winch MOUNTING FRAME - **5.00** extra

**NEW**



**12 OR 24 VOLT SEALED BEAM LAMPS**  
Pistol grip type with a removable stand and a 4-hole foot mount. Has 5" sealed beam lens & built-in aiming sight. Your choice of 12 or 24 Volt type. Operates from a battery. With amber, red & green clip-on lenses. Ideal spot or emergency light on boat, auto, truck, farm, etc. **429 EA.**

SEEK JEEP GASOLINE CANS

# IT TAKES A REAL MAN TO WIN AN I.C.S. DIPLOMA!

Here's training for the man who can take it "straight"—without the fancy trimmings.

With I.C.S., your "classroom" is your home. Your "laboratory" or "shop" is the place you work. Every minute you spend is productive—no commuting, no long-winded discussion groups, no waiting for slower students to catch up.

You gauge your progress not by marks and grades alone but by pay boosts and promotions. And these are likely to come fast.

This is the most demanding kind of training. You select your own subjects, set your own pace, apply what you learn to your own specific needs—all while holding down a full-time job and possibly supporting a family.

For any student who wants to win an I.C.S.

you'd probably like it better with six cylinders. Ford's Fairlane is roomy and solid, but the stick shift Six doesn't offer much greater performance or smoothness and silence than Chevy II or it's own compact little brother Falcon. ★ ★ ★



### Slimmer Dimmer

Small enough to replace the standard wall switch, a full-range electronic light dimmer gives gradual control of room lighting all the way from full dark to full light.

It can be installed in the standard wall box, using standard wiring. It is sold at \$24.95 by Electro-Solid Controls, 8001 Bloomington Freeway, Minneapolis, Minn.

JANUARY 1962

**FOUR** **HYDRAULIC VALVE** No. V-13USU  
Sliding piston type with built-in relief valve to limit stroke. Pressure balanced in neutral position. Has 5/8" AC tube ports. **788**  
Reg. Catalog price \$12.75

**688** **HYDRAULIC HAND PUMP**  
Operates at 1500 PSI Displaces 0.19 GPM at 30 cycles per minute. Capacity 1.5 cu. in. per cycle. Built-in return flow check valve. No. HP-3USU **SAVE**

**25 GPM PESCO PUMP** **ONLY 2795**  
Positive displacement type. Delivers 25 GPM at 3450 RPM. Made to top Gov't specifications. Has a pressure limit of 1000 PSI. Worth twice our low - low Surplus Price. Cat. No. H-P25SU  
**PUMP MOUNT** for above Pesco Pump Has specially designed foot mount and a key slotted drive shaft. High speed bearings. No. H-P25MT **1695**

Top quality Army Surplus. 5 gal. size. Has screw type, self-seal cap. 3 for \$5.00 **198** EA.  
**GAS CANS** as above. **NEW \$4.95 ea.**  
**Jeep WATER CANS** - Newly manufactured. Porcelain lined. **595** EA. Never been used. **NOW...**

**21 to 1 SPEED REDUCER**  
Gives approx. 90 RPM with a direct drive, 1750 RPM motor. Can be belt driven with 1/2 HP motor. Ball bearings throughout. Precision built for Gun Control. **1488**

**AIR FORCE AN 6530 NEW**  
**FLYING GOGGLES**  
Built to rigid Army specifications. These goggles provide all-weather protection. Have adjustable, face-fitting rubber frames with a soft chamois lining. All lenses are precision ground & polished by the American Optical Co. Frames are vented to prevent fogging. Complete with adjustable head band. Ideal for Go-Cart, Auto or Cycle racing. **295**  
A \$6.95 value. Cat. No. GO-65  
**EXTRA LENSES** - In green, clear or amber. Easy to install... **100PR.**

**SPECIAL GOV'T SURPLUS BARGAINS**

**A** - Army PICMATTOCK w/12" steel head - \$1.69 ea.  
**B** - Army BAYONET with scabbard. Has 14" blade... \$2.98  
**C** - Army MACHETE w/Vanadium steel 27" blade & sheath... \$1.98  
**D** - Special Swedish folding BAYONET. 7" blade... \$1.98  
**E** - Officer's LENSATIC POCKET COMPASS - Ideal for Hunter, Camper, Boy Scout, etc. A \$5.95 Value... **349**

**WORLD'S MOST AMAZING CATALOG**  
**256 PAGES** **NATIONALLY ADVERTISED PRODUCTS • NEW & USED GOV'T. SURPLUS • FACTORY CLOSE-OUTS**  
From EVERYWHERE Palley's bring you items of every description—at lower-than-wholesale 'DISCOUNT' Prices. Products include Hand & Power Tools, Sports & Outdoor Equip., Hobby Kits & "Gadgets," Aircraft Instruments and Hardware, Elect. Motors & Generators plus World's largest on-the-shelf stocks of Hydraulic Cylinders, Pumps, Valves, Motors, etc.

**Only 50c** Your 50c refunded with first order of \$1.00 or more. **TO COVER HANDLING & MAILING**

**TO ORDER:** Send check or M.O. 1/3 dep. with C.O.D.'s. All items sent freight or postage collect.

**2263 E. VERNON AVE., Dept. PM-12**  
**LOS ANGELES 58, CALIFORNIA**



fields? I.C.S. has more...  
 now in supervisory and management positions  
 than any other school.

It takes a real man to win an I.C.S. diploma.  
 And the first step is mailing the coupon. Such  
 a simple act sounds easy. Actually, it's the one  
 thing that separates the "planners" from the  
 "plodders." If you're the man we think you are,  
 you'll mail the coupon NOW.

For Real Job Security - Get an I. C. S. Diploma! I. C. S., Scranton 15, Penna.

Accredited Member,  
 National Home Study Council

## INTERNATIONAL CORRESPONDENCE SCHOOLS



BOX 97419A, SCRANTON 15, PENNA.

(In Hawaii, reply P.O. Box 418, Honolulu)

(Partial list of courses)

Without cost or obligation, send me "HOW to SUCCEED" and the opportunity booklet about the field

BEFORE which I have marked X (plus sample lesson):

### ARCHITECTURE and BUILDING CONSTRUCTION

- Air Conditioning
- Architecture
- Arch. Drawing and Designing
- Building Contractor
- Building Estimator
- Carpenter Builder
- Carpentry and Millwork
- Heating
- Painting Contractor
- Plumbing
- Reading Arch. Blueprints

### ART

- Commercial Art
- Magazine Illus.
- Sign Painting and Design'g
- Sketching and Painting

### AUTOMOTIVE

- Automobile
- Auto Body Rebuilding and Refinishing
- Auto Engine Tuneup
- Auto Electrical Technician
- Diesel Engines

### AVIATION

- Aero-Engineering Technology
- Aviation Engine Mech.
- Reading Aircraft Blueprints

### BUSINESS

- Accounting
- Advertising
- Bookkeeping and Cost Accounting
- Business Administration
- Business Management
- Clerk Typist
- Creative Salesmanship
- Managing a Small Business
- Professional Secretary
- Public Accounting
- Purchasing Agent
- Real Estate Salesmanship
- Salesmanship
- Salesmanship and Management
- Traffic Management

### CHEMICAL

- Analytical Chemistry
- Chemical Engineering
- Chem. Lab. Technician
- General Chemistry

- Oil Field Technology
- Pulp and Paper Making

### CIVIL ENGINEERING

- Civil Engineering
- Construction Engineering
- Highway Engineering
- Professional Engineer (Civil)
- Reading Struc. Blueprints
- Sanitary Engineer
- Sewage Plant Operator
- Structural Engineering
- Surveying and Mapping
- Water Works Operator

### DRAFTING

- Aircraft Drafting
- Architectural Drafting
- Drafting & Machine Design
- Electrical Drafting
- Electrical Engineer Drafting
- Industrial Piping Drafting
- Mechanical Drafting
- Sheet Metal Drafting

### ELECTRICAL

- Electrical Appliance Servicing
- Electrical Engineering

- Electric Motor Repairman
- Elec. Engr. Technician
- Elec. Light and Power
- Practical Electrician
- Practical Lineman
- Professional Engineer

### HIGH SCHOOL

- Good English
- High School Diploma
- High School General
- H. S. College Prep. (Eng'r's & Science)
- High School Math
- High School Science
- Short Story Writing

### LEADERSHIP

- Industrial Foremanship
- Industrial Supervision
- Personnel-Labor Relations
- Supervision

### MECHANICAL and SHOP

- Diesel Engines
- Gas-Elec. Welding
- Heating and Air Conditioning
- Industrial Engineering
- Industrial Instrumentation

- Industrial Safety
- Machine Shop Practice
- Mechanical Engineering
- Plumbing and Heating
- Professional Engineer
- Quality Control
- Reading Shop Blueprints
- Refrigeration and Air Conditioning
- Tool Design
- Tool Making

### RADIO, TELEVISION

- General Electronics Tech.
- Industrial Electronics
- Practical Radio-TV Eng'r'g
- Radio-TV Servicing
- TV Technician

### RAILROAD

- General Railroad

### STEAM and DIESEL POWER

- Combustion Engineering
- Power Plant Engineer
- Stationary Diesel Engr.
- Stationary Steam Engines

### TEXTILE

- General

Name \_\_\_\_\_ Age \_\_\_\_\_ Home Address \_\_\_\_\_

City \_\_\_\_\_ Zone \_\_\_\_\_ State \_\_\_\_\_ Working Hours \_\_\_\_\_ A.M. to P.M. \_\_\_\_\_

Occupation \_\_\_\_\_

Canadian residents send coupon to International Correspondence Schools, Canadian, Ltd., Montreal, Canada. . . . Special low monthly tuition rates to members of the U. S. Armed Forces.





When your wheels are off the road...

you can't  
control  
your car!



You bet your life on your shock absorbers. Bouncing wheels are a sign of worn shock absorbers . . . and potential danger. When shocks wear out, steering becomes erratic and your car will sway badly on curves. Monro-Matic® shock absorbers do far more than just cushion your ride. They hold your wheels firmly on the road—even when you hit a sizeable bump or rut—to stabilize your car and prevent loss of control. *Play it safe.* If your present shocks have seen more than 20,000 miles service, replace them with Monro-Matic shock absorbers for the ultimate in control, comfort and safety. *60-day free ride plan guarantees you complete satisfaction.*



LOOK FOR THE YELLOW AND BLUE SAFETY BARREL WITH THE SHOCKS ON TOP!







MONROE AUTO EQUIPMENT COMPANY • MONROE, MICHIGAN • In Canada, MONROE-ACME, LTD. Toronto, Ontario • In Mexico, MEX-PAR, Box 28154, Mexico City • World's Largest Maker of Ride Control Products, including SUPER LOAD-LEVELER® Stabilizing Units

# Expect more, get more, from L&M

more body in the blend  
more flavor in the smoke  
more taste through the filter



The filter cigarette for people who really like to smoke... L&M in the "red-headed" pack or box.

It's the rich-flavor leaf  the longer-aged, extra-cured leaf among L&M's choice tobaccos... that now lets you expect more, and get more, from filter smoking. There's actually more rich-flavor leaf in L&M than even in unfiltered cigarettes. You get more body in the blend,  more flavor in the smoke,  more taste through the filter.  So expect more... and get more... from filter smoking. Have an L&M... the cigarette that smokes heartier as it draws freely through the clean, pure-white Miracle Tip.