

GREAT NEW SPORT: Table-top car racing

POPULAR MECHANICS

DEC. 1961
35 CENTS

First road test: Wankel rotary engine

**Four low-cost shelters
you can build—quickly!**

**Mold anything
with \$5 and your
vacuum cleaner!**



**3-in-1 fun table
build it yourself!**



Make it a **Lucky** Christmas



So great to give



...to get



to serve



... (and especially) to smoke



GET THE GREATEST TASTE IN SMOKING
IN THE HANDSOMEST HOLIDAY CARTON



© A T Co. Product of *The American Tobacco Company* — "Tobacco is our middle name"

self-cleaning
you get Action with

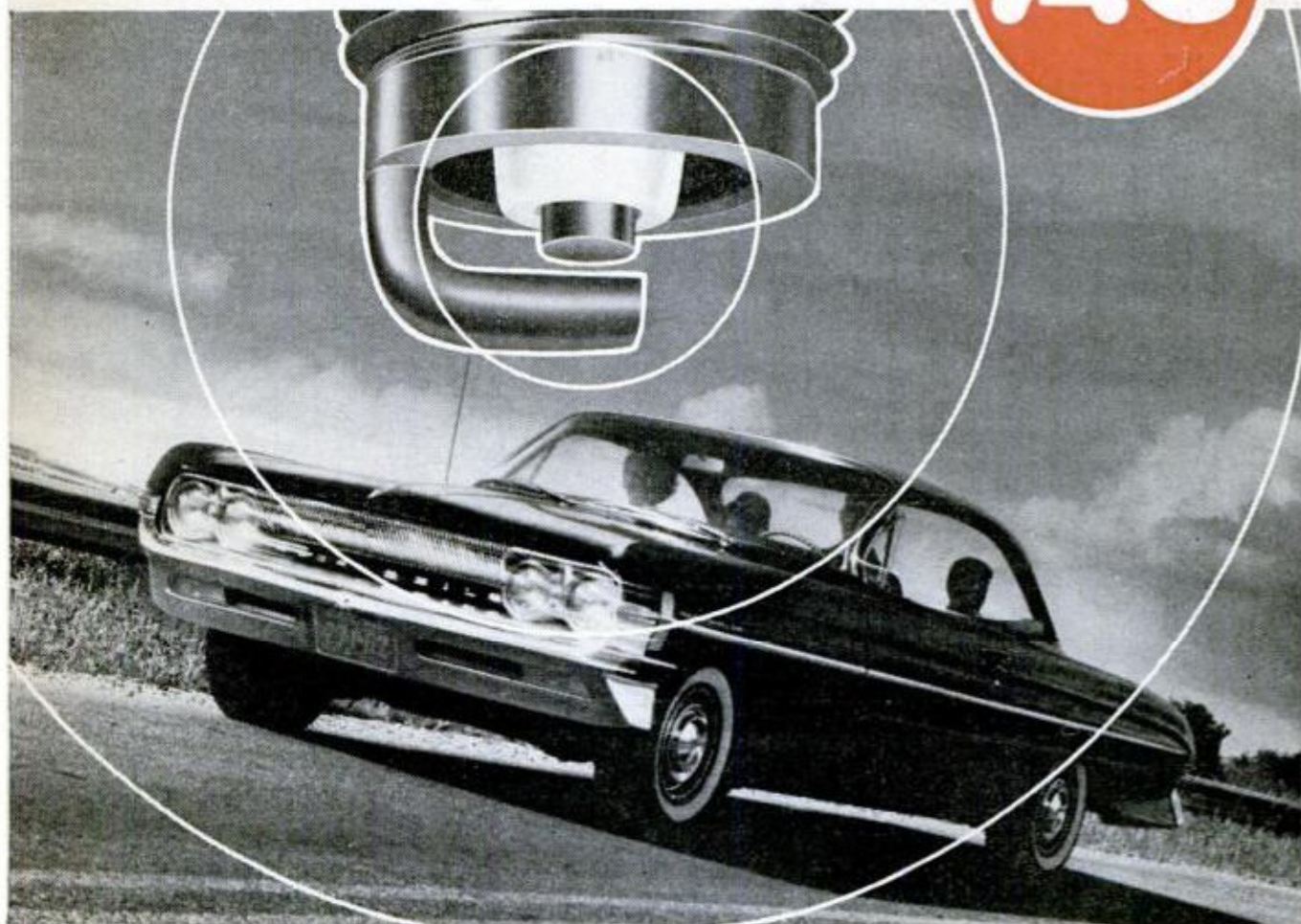

AC Spark Plugs clean themselves —and do it better, in every car engine



Whether you streak along the highway or drive in city stop-and-go, you get spark plugs with self-cleaning action when you install ACs.

AC's exclusive Hot Tip makes the difference. This extremely thin insulator tip heats up fast to burn off fouling deposits as they form. In addition, the recessed structure gives extra space for further cleaning by swirling combustion gases.

Some designs simply rely on added expo-

sure of the insulator tip and electrodes to combustion gases for "self-cleaning" action. What's more, these extended tip spark plugs are for use in certain cars only. For those cars that require them, AC provides extended tip design with the exclusive Extended Shell that gives added protection against "drowning" and insulator tip breakage.

If you want real self-cleaning Action in your car . . . ask for ACs!

AC SPARK PLUG  THE ELECTRONICS DIVISION OF GENERAL MOTORS

AC FIRE-RING SPARK PLUGS

DECEMBER 1961

1

If he's particular,
he doesn't just want tools...
he wants

STANLEY



SPECIAL \$1995

Model H131 1/4" Drill: With geared chuck and key. Designed for comfort, balance, all-round performance, easy maintenance. Perfect for drill attachments. Three-position, non-slip pistol grip. Regular \$24.95

Model H75 Sabre Saw: Heavy-duty, cuts 2" planking—ideal for scrolls, curves, valances, cabinet work, plastics and veneers. Complete with 3 blades for wood, metal and flush cutting; 19 other blade types available. Regular \$44.95



SPECIAL \$3995

Power Tools

Much more than a mere purchase, Stanley Power Tools represent an investment in a lifetime of precision performance to delight the most discriminating home artisan. This Christmas, give the finest... give STANLEY!



Model H272 7" Builders Saw: Heavy-duty construction. "Free Start" blade guard. "Motor Saver" drive, nearly 40% more cutting force at working speeds. Best builders saw for the money.

SPECIAL VALUE \$4995

Model H264 3/8 H.P. Router: Heavy-duty, 23,000 rpm. "Spotlights" working area; brightness increases with work load. Recessed safety switch, and micrometer depth adjustment. Full ball-bearing. Regular \$69.95

SPECIAL \$6495



Model H267 1 1/4 H.P. Router: 27,000 rpm. Reg. \$85.00 — **SPECIAL \$80.00**

STANLEY

REG. U. S. PAT. OFF.

AMERICA BUILDS BETTER AND LIVES BETTER WITH STANLEY

This famous trademark distinguishes over 20,000 quality products of The Stanley Works, New Britain, Conn.—hand tools • power tools • builders hardware • industrial hardware • droptery hardware • automatic door controls • aluminum windows • stampings • springs • coatings • strip steel • steel strapping—made in 24 plants in the United States, Canada, England and Germany.

CANADIAN PLANTS: HAMILTON, ONTARIO AND NOXTON POND, P.Q.

LE MANS 

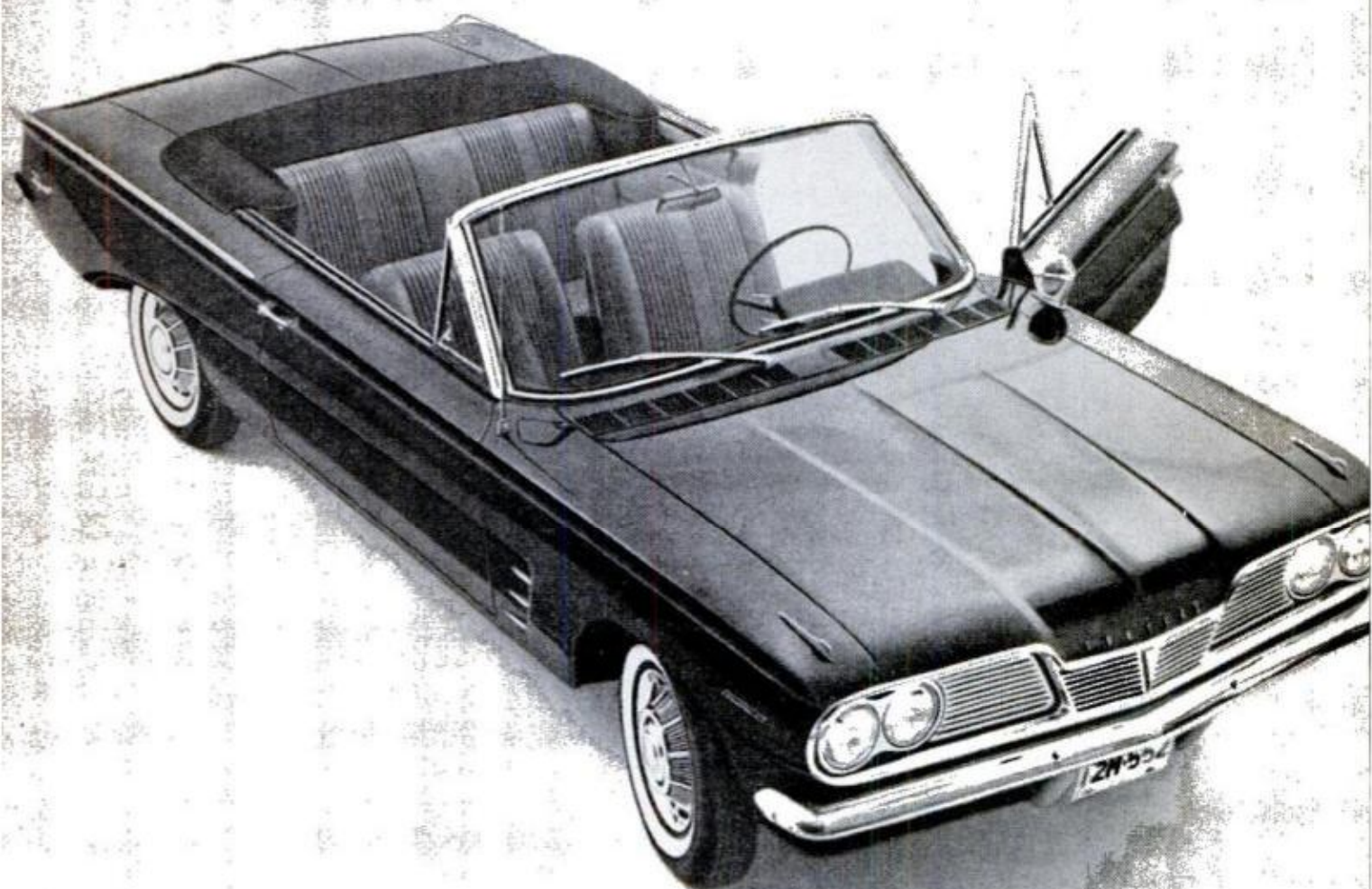

Call it the Tempest LeMans! (Luh-mahnz)

Pontiac's new package of punch...posh...and low price! Convertible or Coupe! A couple of fancy, frisky newcomers. Pull the trigger on a fired-up "4". (Standard power: 110, 115, 120 or 140 h.p. Optional at extra cost: 166-horse "4"; 190 h.p. aluminum V-8; four-speed, floor mounted stick shift.) Plush, sports-type bucket seats and full carpeting are part of the package. Plenty more. Front engine balanced by rear transmission. Independent suspension at all four wheels. Big 15-inch wheels and tires (at no extra cost). Get the good word from your Pontiac dealer. He's very high on the car and very low on the price.

PONTIAC MOTOR DIVISION • GENERAL MOTORS CORPORATION

*Drive America's only front engine/rear transmission car
... it's balanced like none of the others!*

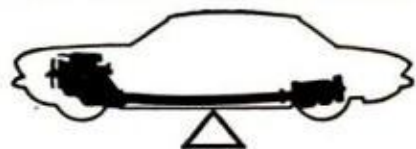

POPULAR MECHANICS®

DECEMBER 1961

VOL. 116

NO. 6

INTERNATIONAL EDITIONS • SPANISH: Mexico-Caribbean, Southern Hemisphere • FRENCH •

Features of Special Interest

I Drove the Wankel-Engine Car 90 m.p.h.!	69
Mercury's Meteor	76
Final Report on Those Baseball Changes	82
You CAN Build a Low-Cost Shelter QUICKLY	85
Great New Sport: Table-Top Racing	90
Boost Your Bowling Score	97
PM Shopping Guide: Ski Equipment	102
Christmas Gift Shopping	108
They're Changing Great Salt Lake	116
Seattle's Floating Prowl Car	128

For the Craftsman

Give Your FM Tuner a Boardinghouse Reach	134
Prowler Alarm	136
Triple-Top Fun Table—Part I	138
Santa's Sugarplum House	150
Add a Boston Rocker	154
Appliance Fix-It File: Toaster	160
Capacitor Flash Box	164
All About Automatic Chokes	168
Vacuum-Forming Sheet Plastic	174
Paint With Air	184

Address communications to: 200 E. Ontario St., Chicago 11, Illinois. **SUBSCRIPTION SERVICE:** Mail all subscription orders, changes of address, correspondence concerning subscriptions, and Postmaster notices of undeliverable copies to Popular Mechanics, 250 West 55th St., New York 19, N. Y.

Published by Popular Mechanics Company, RICHARD E. BERLIN, *President*

CLIFFORD B. HICKS
Editor

RICHARD E. DEEMS
Executive Vice-President

JOSEPH R. BUELL, JR.
Publisher

Managing Editor: DON DINWIDDIE
Assistant Managing Editor: JOHN A. LINKLETTER
Shop and Crafts Editor: WAYNE C. LECKEY
Automotive Editor: JAMES R. WHIPPLE
Associate Editors: W. CLYDE LAMMEY, WALLACE MYERS
Electronics Editor: BYRON G. WELS
Assistant Editors: JAMES BIERY, KEVIN V. BROWN
ROBERT L. HERING, R. B. KIRKPATRICK
ARTHUR MIKESSELL, BIL TOMAN, RICHARD WILLIFORD
Assistant Editor, Makeup: JEAN KAVANAUGH

Art Director: HENRY M. NEHRBASS
Art Editor: RICHARD A. POTTS
Chief Photographer: FRANK P. FRITZ
Eastern Editor: RICHARD F. DEMPEWOLFF
959 Eighth Ave., New York 19, N. Y.
Western Editor: THOMAS E. STIMSON, JR.
Suite 1003, 3460 Wilshire Blvd., Los Angeles 5, Calif.
International Editor: HEINZ P. SCHLICHTING
Ritterstrasse 26, Karlsruhe/Bd., Germany
Advertising Manager: FRANK R. DUPUY
959 Eighth Ave., New York 19, N. Y.
Director, Bureau of Information: ALLAN CARPENTER

If you wish additional sources of information for the articles in this issue, or if you wish the name and address of the manufacturer of a particular product shown here, write to Bureau of Information, Popular Mechanics, 200 E. Ontario St., Chicago 11, Ill. Ask for the free "Where-to-Find-It-List" for this issue.

DANISH • SWEDISH • GERMAN • PORTUGUESE • DUTCH

Departments

Over the Editor's Desk - - - -	8
Tune In on the Inventors - - - -	12
Sidelights on Aviation - - - -	22
Science Overseas - - - - -	26
Items From All Outdoors - - - -	32
On the Market - - - - -	34
Science Bulletins - - - - -	37
Worth Writing For - - - - -	41
Pentagon Sidelights - - - - -	64
Detroit Listening Post - - - - -	80
Solving Home Problems - - - -	146
Better Carkeeping - - - - -	172
Clinic for Homemakers - - - -	194
Shopping for Tools - - - - -	206

PM's 60th Anniversary Special!

NEXT MONTH—Behind the headlines and under the hoods of the 1962 cars, as the driver, the engineer and the serviceman see them. Complete find-by-color specifications. Drive tests on Chevy II, Ford Fairlane and the new slim Plymouth. Famous dream cars undergo analysis. Special tests on remarkable new metallic brake linings. Beginning in the same issue: Plans for your own family fitness gym.

ADVERTISING OFFICES—Chicago: 200 E. Ontario St., Whitehall 4-0100; New York: 959 Eighth Ave., Columbus 5-7300; Detroit: General Motors Bldg., TRinity 5-8711; Cleveland: Hanna Bldg., 1422 Euclid Ave., PROspect 1-0456; Los Angeles: 3460 Wilshire Blvd., DUNkirk 2-8458; San Francisco: 111 Sutter St., YUKon 2-0823.

Published monthly by Popular Mechanics Company, 200 E. Ontario St., Chicago 11, Ill. Richard E. Berlin, President; Richard E. Deems, Executive Vice-President; Fred Lewis, Vice-President and General Manager; Robert F. MacLeod, Vice-President; John R. Miller, Vice-President; Joseph R. Buell, Jr., Vice-President; G. O. Markuson, Treasurer; R. F. McCauley, Secretary. Single copy in the United States and Canada, 35 cents; subscription rates in the United States and possessions, 1 year \$3.50; 2 years, \$6.00; 3 years, \$8.00. In Canada, add 50 cents per year. In countries of the Pan-American Postal Union, 1 year \$4.50; 2 years \$8.00; 3 years \$11.00. In all other countries 1 year \$5.50; 2 years \$10.00; 3 years \$14.00. If you plan to move, notify us at least 30 days in advance so you will not miss an issue. Give both your old and new addresses. Second-class postage paid at Chicago, Illinois, and at additional mailing offices. Authorized as second class mail, Post Office Department, Ottawa, Registered as Second Class Matter at the Post Office at Mexico, D.F., Mexico, June 20, 1950. © 1961 by Popular Mechanics Company. All rights reserved. Printed in the United States of America.



Bowler's three approaches—page 97



Smart ski shopping—page 102



3-in-1 fun table—page 138



Sugarplum house—page 150

Tool of 1000 angles—page 182



This One



3XUS-6W1-2WFP



Can you find all five?

REVELATION USES
5 FINE TOBACCOS TO GIVE
YOU THAT SPECIAL TASTE

Each kind of tobacco has a flavor personality, and Revelation uses 5 to bring out the best in each. Try it soon and get some new pleasure in your pipe.



Kentucky Burley—dark flakes, slow burning
Virginia Bright—bright leaves, even burning
Old Belt Bright—slightly darker, good body
Latakia—deeper brown, extra mild
Perique—very dark, wonderful aroma

REVELATION

MILD SMOKING MIXTURE

Underwater "News" System Operates Without Wires

Up to 10 different types of instrumented information plus the human voice can now be transmitted simultaneously through the sea.

Using a cableless system that combines sonar and telemetry, a diver, for instance, can have his physical reactions and his voice monitored by the ship on the surface. Buoy-type relay stations can be used to relay information via radio as well.

The system has wide application in undersea biomedical problems, oceanography research and geophysical experimentation for oil exploration. Transmission can be reversed and used as command system to control a subsurface unit, similar to a drone in air.

The cableless underwater "news" method is a development of the Pacific division of the Bendix Corporation.

Man on the Moon Research Will Be Handled in Houston

Man's flight to the moon will have its beginnings—in the U.S.—at a \$60,000,000 manned-space-flight laboratory due to be built in Houston, Tex.

The center will be charged with placing men on the moon. It will be used to design, develop, evaluate and test the craft for Project Apollo, train the crew that will fly the missions and then control the moon mission.

The center will contain a flight project facility, an equipment evaluation laboratory, a flight-operations facility and an environmental testing laboratory.

Missiles fabricated at the Michoud Plant near the mouth of the Mississippi River at New Orleans and spacecraft tested at the Houston center can be shipped by water to Cape Canaveral, where the spaceships are scheduled to be launched.

THIS IS MODEL MOTORING

the most exciting road and racing set in the world!

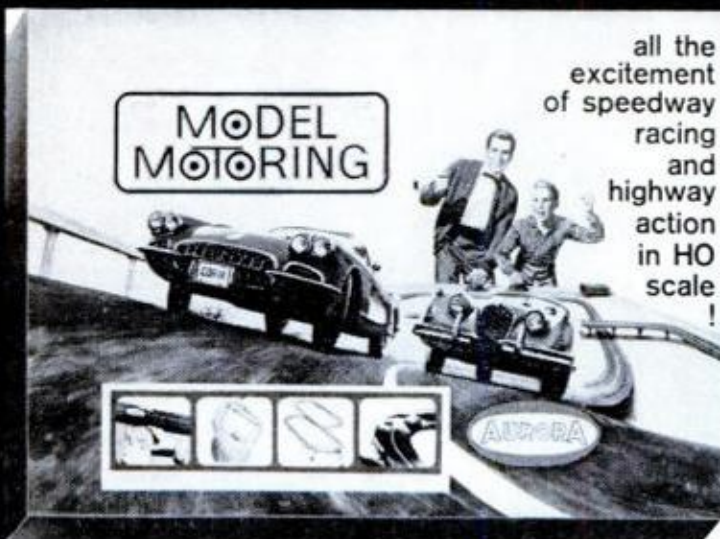

all the excitement of speedway racing and highway action in HO scale!

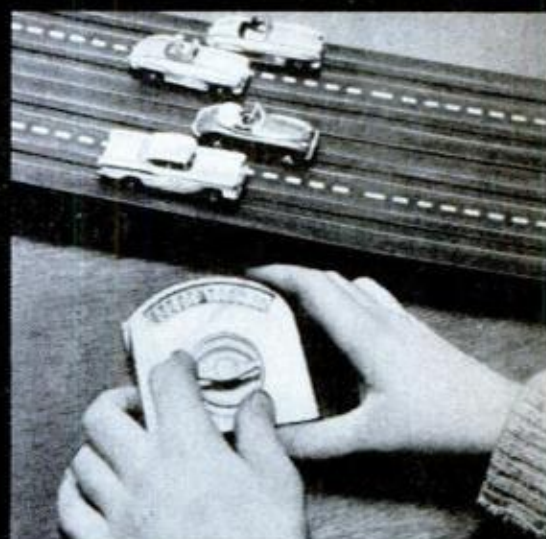

PERFECT HO SCALE



Down goes the green flag and they're off — zooming along the straightaway at 150 scale mph! Watch it . . . here comes a hair-pin curve. Hit that bend at top speed and you're a spin-out for sure! MODEL MOTORING IN HO SCALE is the ultimate in table-top racing, gives you twice the action in half the space, lets you re-create any race course in the world. For the model railroading fan, it's a natural — build it right into your HO train layout. Add a Grade Crossing and get set for hit-or-miss action right out of a Hollywood movie. Choose from 5 complete sets — \$16.95 to \$49.95. All MODEL MOTORING equipment is open stock — add extra track for "professional" 4-lane competition; pick additional racing cars from a wide assortment of models; new 1962 passenger cars and trucks also available. Test-drive it now — at hobby dealers, toy, variety, and department stores everywhere!

IT'S A SPORT, A GAME, A LIFE-TIME HOBBY . . . IT'S THE PERFECT CHRISTMAS GIFT!!!!!!

SEND 10c FOR 1962 MODEL MOTORING BOOKLET
AURORA PLASTICS CORP. DEPT. AD 16 WEST HEMPSTEAD, L. I., NEW YORK

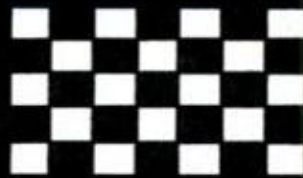

Over the editor's desk

Debating Dean's Machine

For over a year, I have studied the possibilities of the rotating mass. Had just given up the idea when I got my September PM, telling me that Norman Dean had invented it. I predict almost unlimited speeds for this machine.

Denver, Col.

JOHN JENSEN

... Although I haven't gotten around to getting a patent or completing a model, I, too, have been working on this same theory since 1943 ...

Upper Darby, Penna. ANTHONY CARRELLI

... It is nothing new inasmuch as I built such a machine in 1953 ...

Park Rapids, Minn.

EVERETT T. DEMOSS, JR.

Whom are you trying to kid? Norman Dean's machine never lifted itself in its entirety and never will. The principle he harnesses is neither new nor sophisticated. He simply employs a friction ratchet.

Beverly Hills, Calif. WARNER CLEMENTS

We are passing along various comments received on this article to Mr. Dean, and hope to have answers to some of the questions readers have raised in time for an early issue.

Higher Body

Recently made this sidewalk sports car for my 11-year-old son (I had been saving the plans since the August 1955 PM). I made the body higher and of 1/8-inch tempered Masonite, venting the engine and



adding an air grille in front. Am using a 1.6-hp. engine and a pulley ratio that permits 10-12 m.p.h.

Miami, Fla.

WM. C. WHEELER

Peachy Tip

It was a dark and stormy night. I decided to get out of bed and close a window. Alas, the electricity was off. There was a candle on my bedside table but, alas, no candlestick. An empty beer bottle would have served but, alas, I'm an abstainer.

Remembering the hint (p. 218, Sept. '61 PM), I went to the pantry for the suggested can of peaches. There were tomatoes, apricots, beets, soups but, alas, no peaches. Nothing left but to brave the storm and hie me to the corner grocery. In raincoat, rainhat and rubber boots I went. The grocer came downstairs in his pajamas to satisfy my urgent request. Alas, he was fresh out of peaches.

I apologized for troubling him, went home and tried some other fruit in a can. Now all I needed was a rubber band. My garter was too big, so I woke my wife to borrow hers. Alas, they were straight elastic, with a clip at one end to grip the stocking and the other end was attached to, well, never mind. By this time, the electricity was on again. Thanks for the tip anyway.

Maitland, Mo.

TIMOTHY SHAY

It still must have been a peach of a tip to have provoked such an entertaining story as yours, Tim.

Cutting Remarks

The VW on page 70 of your July issue could well be mine, as the same thing happened to me in August, 1960. I attempted to pass a truck when the windshield exploded (or seemed to) cutting me on the face and hands. My wife and four-year-old son in the front seat also suffered many cuts about the face, head and hands. The circular area missing from the glass in your photograph also fell out of my windshield down into my lap, gouging the steering wheel as it did so. The inside of the car was literally covered with bits of glass as were my two daughters in the back seat.

Fortunately, both my wife and I had on glasses which kept us from serious eye injury. The lenses and frames of our glasses were cut and scratched by the flying glass. Never again will I purchase a car that has tempered glass.

Nashville, Tenn.

VIC DURRANCE

Did you buy your car in Europe, Vic? U.S. safety codes call for laminated glass windshields and even imports sold through

(Continued to page 10)

Are You "STANDING STILL" on your job?

**SAME OLD
JOB...
SAME LOW
PAY..?**

You can justify a real pay raise and a better position—by making one simple move—the move that opens the way to more earnings and promotions—*practical training.*

If YOU are "standing still" on your job—no promotions—only token increases in pay—then you had better do something about it. You know that if you are untrained, your chances of getting ahead are slim. **NOW IS THE TIME TO PREPARE.**

WILL RECOGNITION COME?

The only answer, as you know, is that success *does* come to the man or woman who is really *trained*. LaSalle has provided the "key to success" for many thousands of ambitious people who have sought our training for more than fifty years.

Get all the facts. Investigate the opportunities in your chosen field. It costs you nothing to learn about LaSalle's proven and tested accredited correspondence courses in the major fields of business as well as high school and technical courses. You can train in the

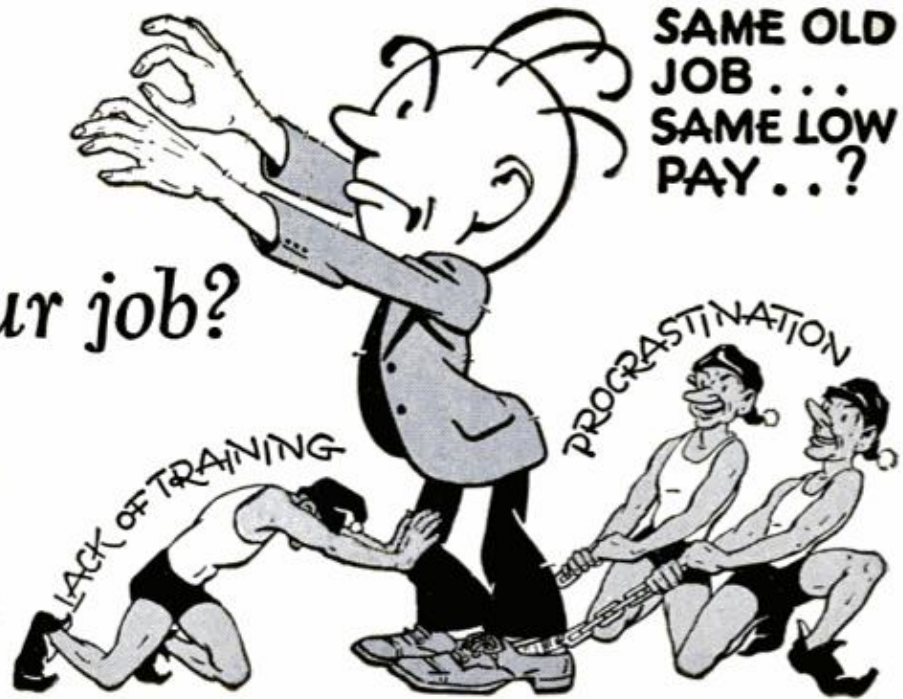

privacy of your own home, progressing at your own rate. You lose no time from work, and your instructors guide you every step along the way through our famous Practical Problem Method. Low cost—easy terms.

Don't let promotions pass you by—do something **TODAY** about your future.

The coupon below is for your convenience. Simply mark the program in which you are most interested, and mail at once. We'll send you, without obligation, free booklets describing that field together with the opportunities and what you must know to be a success.

ACCREDITED MEMBER, NATIONAL HOME STUDY COUNCIL

LaSalle Extension University, A Correspondence Institution, Dept. 1264X, 417 S. Dearborn, Chicago 5, Ill.
Please send me, without cost or obligation, **FREE** catalog and full information on the field I have checked below:

ACCOUNTING

- Modern Bookkeeping
- Basic Accounting
- Practical Accounting
- Principles of Acctg.
- Cost Accounting
- Federal Income Tax
- Accounting Systems
- Business Law
- Auditing Procedure
- Controllership
- CPA Training
- Complete Accounting

- Transportation Law & Regulation
- Rate Making & Rate Cases
- Complete Traffic & Transportation

LAW

- Law of Contracts
- Insurance Law
- Claim Adjusting Law
- Law for Trust Officers
- Business Law I
- Business Law II
- General Law
- First Year Law
- American Law and Procedure (LL.B. Degree)

TRAFFIC & TRANSPORTATION

- Organization & Mgt.
- Classifications, Rates & Tariffs
- Transportation Agency & Services

BUSINESS MANAGEMENT

- Principles of Management
- Psychology in Business
- Selling & Sales Management
- Advertising & Marketing
- Production Problems
- Business Financing
- Credits & Collections
- Office Management
- Managing Men
- Accounting & Statistical Control
- Business Correspondence
- Organization & Reorganization
- Legal Problems
- Complete Business Management

MANAGEMENT COURSES

- Basic Management
- Production Management
- Sales Management
- Advertising & Sales Promotion
- Financial Management
- Personnel Management
- Sales & Executive Trng.
- LaSalle Sales Training
- Foremanship Training

HIGH SCHOOL

- High School Preparatory
- General Business Course
- High School Diploma
- Commercial Course
- Secretarial Course

- Stenotype (machine shorthand)
- Home Management Course
- General Culture Course
- Science Course
- Mechanical Course

DENTAL ASSISTANT

- Dental Assistant

TECHNICAL COURSES

- Auto Body Fender
- Refrigeration-Air Conditioning
- Diesel
- Drafting
- Welding
- Motor Tuneup

Name.....Age.....
Address.....
City, Zone, State.....

**CHECK THIS COUPON AND MAIL
TODAY...SURE!**

Small
Lathe
with a

BIG Reputation

for Dependability and Accuracy

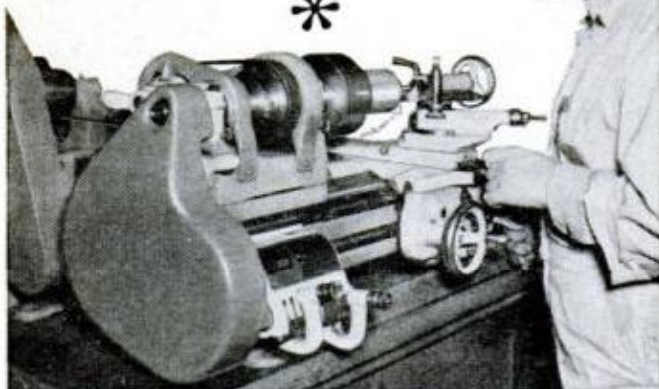

- * Always ready to go . . .
- * Run every day, for years—still going strong . . .
- * No doubts, No worries—if the job goes on the South Bend, delivery's on time . . .

THAT'S DEPENDABILITY

- * The FINISH so FINE, just wash and deliver—grinding or lapping seldom necessary . . .
- When tolerances are tight, "South Bend" does the job . . .

THAT'S ACCURACY

- * Dependable and Accurate—that's how South Bend lathes are built . . . So say thousands of South Bend 9" lathe owners . . . Compared with all others—They're your best lathe investment.

OVER 140 MODELS—FROM \$295.00

Write for free catalog

SOUTH BEND

LATHE, Inc.

SOUTH BEND 22, INDIANA

Builders of Lathes, Milling Machines,
Shapers, Drill Presses, Pedestal Grinders



regular dealers in this country are not supposed to use tempered in windshields. The circular glass insert you mention was not tempered—a practice followed on many European cars to give drivers a quick "see-through" hole when the windshield shatters.

Kitchen Chair for Pilot?

Been studying Korta's fine paintings of flying machines (June PM). In 1916 I saw the Wright machine that Wilbur flew at LeMans. Mr. Korta has apparently introduced a bit of sophistication in the 1903 machine that didn't exist even in the 1908 machine—the streamlined struts. The struts on the 1908 machine were rectangular and broadside to the wind. The pilot's seat was a kitchen chair with legs sawed off and bolted to the top of the lower wing. Northport, N. Y. **DABNEY HORTON**

According to the National Air Museum, the struts on the 1903 plane were tapered. It had no seat and the picture made at the moment of takeoff plainly shows Orville lying face down on the lower wing with the engine beside him. Later versions did have seats, and your impressions of the 1908 version are undoubtedly correct. But our painting of the original 1903 plane is accurate.

Editors, Readers and People

You might be interested in some more unusual ideas for articles we have received from readers lately. They include requests for plans for building an Italian gondola, a bubble-making machine, a wind generator, a starting box for greyhound racing, a Finnish sauna or steam bath and a driveway turntable. If any of these ideas tickle your fancy, let's hear from you.

On a more sober note, Lowell Baker of the National Association of Real Estate Boards (NAREB) points out that we did not distinguish, in our September article on selling your home, between active members of NAREB who may call themselves realtors and nonmembers of NAREB who qualify as real estate brokers but cannot call themselves realtors. He also pointed out that the sales form reproduced in the article which carried an NAREB trademark is not generally circulated.

Our favorite letter from recent mail was the one which was addressed to "Dear Editors or People." Perhaps we have been using the wrong signature on this column, when we signed off with "The Editors." It might be a better idea to sign off with—

*The People
who edit your magazine*

Important News for the man who needs a **GOOD JOB, MORE MONEY AND GREATER SECURITY**

1. Air Conditioning and Refrigeration offers better opportunities in a growing uncrowded field
2. CTI provides proven Home Training which lets you learn by practicing with real equipment

Why worry about a poor-pay or unsteady job when the blessings of a big-money career in Air Conditioning and Refrigeration are within your reach? This fast-growing industry needs 20,000 newly-trained mechanics each year. It is pleading for skilled men who can install the 8 million air conditioners, refrigerators and freezers that are produced annually . . . and service the 150 million units already in use. Send for complete information on how you can qualify for a full-time, top-pay job in a dynamic, uncrowded field!

CTI Home Training Is Easy — Fast — Proven

CTI Home Training is prepared so that even a man of limited education, who has been out of school for years, can understand it. The lessons are written in simple English, and many illustrations are used to explain operating principles. Training kits of parts and tools are provided so that the student can develop his skill and acquire practical experience. CTI instructors are efficient and courteous. The student gets personalized training as well as extra help if he needs it.

Why Many Students Earn Cash as They Train



A CTI student spends a considerable part of his time training with kits we send. The 20 field-type projects provide him with experience. Due to the practical nature of this exclusive training, many students soon do repair work in spare time for profit. They make calls on their own, or develop servicing arrangements with local distributors and contractors. Their earnings often pay the cost of tuition before graduation.

How to Start a Business of Your Own

Once a student begins to do part-time servicing, he actually puts himself in his own business. Some students make contracts with owners of food stores, restaurants, and air conditioned buildings to handle servicing on a monthly fee basis. An impressive number of CTI students follow this success pattern—have a prosperous business under way by the time they graduate. Air Conditioning and Refrigeration is well suited for starting out on a modest basis, with very little capital, and then expanding as service calls increase.



Letters Prove Value of CTI Training

We want to send you a fascinating booklet called *Proof from Graduates*. In their own words, men who have earned diplomas record their successes. Better jobs, higher pay, self-employment, confidence—these are a few of the rewards of a sound training program carried to fulfillment. We'll rush this testimonials booklet, along with other factual information, as soon as we hear from you.



COMMERCIAL TRADES INSTITUTE CHICAGO 26, ILLINOIS
A Non-Profit Organization • Accredited by National Home Study Council

You train at home with real equipment



**YOU BUILD THIS
1/4 H. P. HEAVY DUTY
CONDENSING UNIT!**

you get 25 Kits!

Only CTI sends parts to build a refrigerating unit. You get 25 kits, which also include mechanic's tools. During this practical phase of your training, you complete 20 job projects similar to what you will encounter in the field. If you wish, you may build your condenser into an air conditioner, freezer, refrigerator or milk cooler. The advantages of CTI Home Training are clear: You learn the interesting way—by practicing. You develop your skill, acquire experience, gain confidence.



Opportunities Are Great for a Fresh Start

Whether you are a young man looking for a field with bright prospects, or a mature person who is stuck in a job with no future, you will find the breaks you need in Air Conditioning and Refrigeration. During the past 12 years, the production of air conditioners increased by 400%—a growth matched by just one other industry! Despite this growth, the industry is said to be in its infancy, because only 8% of all American homes are air conditioned. Auto air conditioning is big business, too—Nearly 600,000 units installed annually!

If you are looking for a fresh start in life, consider Air Conditioning and Refrigeration. No industry is growing faster. The pay scale, working conditions, and the 20,000 new jobs that open each year are unique attractions indeed. Send for free information at once.

COMMERCIAL TRADES INSTITUTE

1400 GREENLEAF AVENUE
CHICAGO 26, ILLINOIS

DEPT. R-32

Please send me your three free booklets: *Success in Air Conditioning and Refrigeration*, *Proof from Graduates*, and *Lesson Samples*. No obligation.

Name _____ Age _____

Address _____

City _____ Zone _____ State _____



Tune in on the inventors

The lone inventor, with or without help, still plays an important part in our technology, though. According to the Patent, Trademark and Copyright Foundation at George Washington University, he is responsible for almost 40 percent of the patents issued, and is able to market 60 percent of his inventions. That figure should be encouraging to inventors looking for manufacturing and marketing help. Here are three PM reader-inventors who'd like some leads:

An automobile saddlebag won patent No. 2,979,098 for Mrs. Willis B. Greaves of Atlanta, Ga. Her device is a twin bag which hangs, fore and aft, over the front seat of a car, with pockets for all the odds and ends that clutter up the average car. It folds to glove-compartment size when not in use.

Pick-N-Chicken, a useful toy on a wheeled shaft which picks up items from the floor with its beak, won patent No.

2,996,836 for Justin Tieri of Grand Rapids, Mich. He claims it'll teach the kids to be neat, and to help mother by keeping their things picked up.

A neat double bend in an otherwise-ordinary wire clothes hanger is pending a patent for A. C. Patch of Topeka, Kansas. The simple improvement bends trousers twice, holding them firmly in place so they can't slip off the horizontal bar.

Both profit and pitfalls exist in the business end of inventing, and a new booklet, *Patents for Management*, by patent attorney Worth Wade, gives information on both in layman's terms. Though intended for management use, the book contains material useful to anyone interested in commercial invention. Some typical chapter titles are, "Origin and Nature of Patents, Patent Rights of Employee and Employer, Patent Licensing, Proper and Improper Use of Patents, and Design Patents." The booklet is offered at \$5.50 by Advance House Publishers, Box 334, Ardmore, Pa.

Copies of the original patents may be ordered for 25 cents each from the Commissioner of Patents, Dept. of Commerce, Washington 25, D. C.

*Don't wait for warning lights to tell you
you're already in trouble...get*

**STEWART-WARNER'S
"twin-gauge" panel!**

At-a-glance, the gauges in a Stewart-Warner "Twin-Gauge" Panel warn you of low oil pressure or inadequate generator charging rate—help you avoid trouble. Tell you much more than warning lights.

Attractively styled "Twin-Gauge" Panels are available in choice of panel finishes with Black & White or "Twin-Blue" face dials.

See them at your service station, garage, auto dealer or automotive accessory store. They offer security that costs so little, but can save you so much!

Dept. C-121, 1840 Diversey Parkway, Chicago 14, Ill.

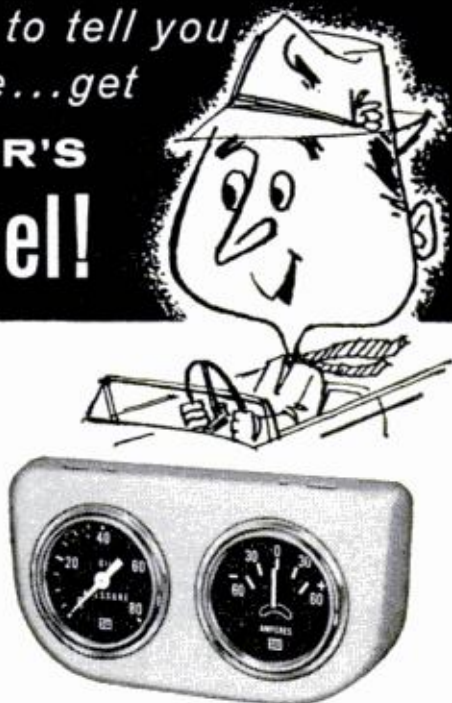

Symbol of
SW
Excellence

INSTRUMENT DIVISION
STEWART-WARNER
CORPORATION

**Courses in Radio and
Electronic Fundamentals—
TV Servicing—Color TV—
Electronics for
Automation—
Transistors**



RCA Institutes, one of the leading technical institutes in the United States devoted exclusively to electronics, offers the finest training-at-home. The very name "RCA" means dependability, integrity, and scientific advance. Practical work with your very first lesson. Pay as you learn. *No monthly installment payments.* You pay for your next study group only when you order it. Remember, in electronics, the more you know the higher you go! Licensed by the New York State Education Dept.



RCA INSTITUTES, INC.,
A Service of Radio Corporation of America
350 West Fourth Street, New York 14, N. Y.

The Most Trusted Name
in Electronics

Resident School Courses in Los Angeles and New York City offer comprehensive training in Television and Electronics. Day and Evening classes. Free Placement Service. Catalog free on request.

SEND FOR THIS FREE 64-PAGE BOOK TODAY!

RCA INSTITUTES, INC., Home Study School Dept. PM-D1
350 West Fourth Street, New York 14, N. Y.

Please rush me your FREE illustrated 64-page book describing your electronic training programs. No obligation. No salesman will call.

Name _____ Age _____

(please print)

Address _____

City _____ Zone _____ State _____

Korean Vets: Enter discharge date _____

Canadians—Take advantage of these same RCA Institutes courses at no additional cost. No postage, no customs, no delay. Send coupon to: RCA Victor Company, Ltd., 5581 Royalmount Ave., Montreal 9, Quebec

Sworn statement from CHAS. LEMMING reads:

"After starting my own business



I've averaged \$100 A DAY —most of it clear profit!"

• If you want to be independent—free from layoffs, bosses—start profitable, year 'round business of your own. Ours is NOT a lease proposition. You own the machine, you work when and where you please, and all the money you take in is your own. FREE book tells you how.

Not everyone does as well...

Mr. Lemming owns two machines

In city of less than 50,000, Mr. Lemming started his own business after filling in coupon like one below. He averaged \$100 a day during first year, some days \$200. F. E. Doran grossed \$1050 in single month. Geo. Held grossed \$300 in one week.

How much you earn depends largely on you. No special skill, no large investment required for our electric upholstery cleaning machine. Start spare time until full time justified. Hire helpers as needed.

NO SHOP NECESSARY • You clean upholstered furniture on customers' premises—homes, hotels, motels, etc. Auto upholstery, too. No hauling; operate from your home. Watch business grow as satisfied customers tell friends. Supplies cost little, profits high.

MAIL COUPON TODAY FOR FREE BOOK

VON SCHRADER MFG. CO.
W10 "D" Pl., Racine, Wisconsin

Without obligation rush your **FREE** booklet about how I can start my own permanent, profitable electric Upholstery Cleaning business.

Name _____

Address _____

City _____ Zone _____ State _____

Turn your spare time into \$\$\$

WATCH REPAIRING



Learn at home the low cost Sweazey Way

Watch repairing pays up to \$6 an hour, part time watch makers report on survey. Unique and modern Sweazey home study System starts you making repairs right away on Swiss and American watches. Professionally prepared training. No previous experience needed. Special tools provided for practice. Tuition only \$5 a month. Diploma awarded. Free sample lesson and opportunity book give all facts. Write today. No obligation.

CHICAGO SCHOOL OF WATCHMAKING

2330 N. Milwaukee Avenue, Dept. 1121, Chicago 47, Illinois

6-IN-1 ONLY MACHINE OF ITS KIND!



Compact workshop for all metal, plastic, wood. Precision lathe, milling machine, drill press, surface grinder, polishing/grinding machine, portable drill. Complete basic unit, \$129.50. **WRITE FOR FREE CATALOG.**

AMERICAN EDELSTAAL, INC., DEPT. GL.350 BROADWAY, N.Y.13, N.Y.

STATEMENT REQUIRED BY THE ACT OF AUGUST 24, 1912, AS AMENDED BY THE ACTS OF MARCH 3, 1933, JULY 2, 1946 AND JUNE 11, 1960 (74 STAT. 208) SHOWING THE OWNERSHIP, MANAGEMENT, AND CIRCULATION OF Popular Mechanics published monthly at Chicago, Illinois, for October 1, 1961: 1. The names and addresses of the publisher, editor, managing editor, and business managers are: Publisher, Popular Mechanics Company, 200 E. Ontario St., Chicago 11, Ill.; Editor, Clifford B. Hicks, 200 E. Ontario St., Chicago 11, Ill.; Managing editor, Don Dinwiddie, 200 E. Ontario St., Chicago 11, Ill.; Business manager, Joseph R. Buell, Jr., 200 E. Ontario St., Chicago 11, Ill. 2. The owner is: Popular Mechanics Company, sole stockholder, The Hearst Corporation, 100 West Tenth Street, Wilmington, Delaware. All of the stock of The Hearst Corporation is held by the following Voting Trustees, namely: Richard E. Berlin, 959 Eighth Avenue, New York, New York; Harold G. Kern, 5 Winthrop Square, Boston, Massachusetts; G. O. Markuson, 959 Eighth Avenue, New York, New York; Charles Mayer, Third and Market Streets, San Francisco, California; William Randolph Hearst, Jr., 959 Eighth Avenue, New York, New York; Randolph A. Hearst, 270 North Canon Drive, Beverly Hills, California; David W. Hearst, 270 North Canon Drive, Beverly Hills, California; J. D. Gortatowsky, 57th Street at Eighth Avenue, New York, New York and Herbert W. Boyea, 410 Park Avenue, New York, New York, under Voting Trust Agreement dated as of February 28, 1958; the beneficial owners of the stock deposited under the aforesaid Voting Trust are The Hearst Foundation, Inc., the William Randolph Hearst Foundation, William Randolph Hearst, Jr., Randolph Apperson Hearst, David Whitmire Hearst, George Hearst, John Randolph Hearst, Jr., Joanne Hearst Herndon, William Randolph Hearst II and Deborah Hearst. 3. The known bondholders, mortgagees, and other security holders owning or holding 1 percent or more of total amount of bonds, mortgages, or other securities are: None. 4. Paragraphs 2 and 3 include, in cases where the stockholder or security holder appears upon the books of the company as trustee or in any other fiduciary relation, the name of the person or corporation for whom such trustee is acting; also the statements in the two paragraphs show the affiant's full knowledge and belief as to the circumstances and conditions under which stockholders and security holders who do not appear upon the books of the company as trustees, hold stock and securities in a capacity other than that of a bona fide owner. 5. The average number of copies of each issue of this publication sold or distributed through the mails or otherwise, to paid subscribers during the 12 months preceding the date shown above was: 1,386,891. Joseph R. Buell, Jr. (Signature of business manager.) Sworn to and subscribed before me this 28th day of September, 1961. Harry P. Cera (My commission expires March 7, 1964).

WHAT ALL AUTO MECHANICS WANT TO KNOW

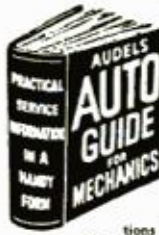

This Big Practical Book gives full information, with working diagrams, covering the principles, construction, ignition, service and repair of modern cars, trucks and buses.

Air Conditioners, Hydromatic & Fluid Drives Fully Explained.

A complete guide of 1132 Pages, with over 1000 illustrations showing inside views of working parts, with instructions for service jobs. Completely up-to-the-minute! Priced at only \$6.

CIRCLE No. 1 IN COUPON

HOW TO FIX HOME APPLIANCES

REFRIGERATORS WASHERS TOASTERS DRYERS IRONERS RANGES VACUUMS FREEZERS

Many other GAS AND ELECTRIC APPLIANCES



Handy Reference for Electric & Gas Servicemen, Mechanics, Dealers and Homeowners. Explains clearly and simply how to locate troubles, how to test, reassemble and connect Wiring diagrams. 1000 Facts. Easy to read. Answers ALL your questions. 804 Pages. Illustrated. Only \$6.

CIRCLE No. 2 IN COUPON



TV TELLS HOW TO ANSWER RADIO RADIO T.V. QUESTIONS SERVICE LIBRARY

HERE IS LATEST INFORMATION IN A HANDY FORM FOR RADIO AND TELEVISION REPAIRMEN, SERVICEMEN AND STUDENTS.

TWO COMPLETE VOLUMES - 1568 Pages - 1085 Illustrations and Diagrams. 1001 Important Facts and Figures on Modern T.V. Radio Electronic Devices. INCLUDES TRANSISTORS & Transistors Circuits, Rectifiers, Record Changers, P.A. Systems, Phonograph Pick-ups, F.M., Auto Radio, Short Wave.

Basic principles, Construction, Installation, Operation, Repairs, Trouble Shooting. How to get Sharp, Clear T.V. Pictures. Install Aerials. How to Test. Explains COLOR SYSTEMS, Methods of Conversion. Terms, etc. Includes Ultra High Frequency. Quick ready reference or use as a home study course. Only \$8 for BOTH volumes.

CIRCLE No. 3 IN COUPON

OIL BURNERS

New, complete, explaining in detail both domestic and industrial oil burners. Includes electrical hook-ups and wiring diagrams. Fully covering the theory, construction, installation, operation, testing, servicing and repair of all equipment. Indexed for ready reference. Over 416 Pages. 320 Illustrations and Diagrams. Only \$2.50

CIRCLE No. 28 IN COUPON

ALL TYPES OF BLUEPRINT READING

How to read scales, the standard symbols, detail and assembly prints, working drawings, short cuts, helps, hints and suggestions. THE MAN WHO CAN READ BLUEPRINTS IS IN LINE FOR A BETTER JOB. This book gives you the secret language, step by step in easy stages. 446 Pages. Very Fully Illustrated. Priced at \$3.

CIRCLE No. 25 IN COUPON

PLUMBERS AND STEAMFITTERS GUIDES

Practical Trade Assistant & Reference Set. Explains in plain language and by clear illustrations, diagrams, charts, graphs and pictures the principles of modern plumbing practice including Pipe Fitting and Air Conditioning. 4 Vols. - 2624 Pages - 3642 Diagrams & Illustrations. Only \$9 for the complete set of 4 vols. Sold individually \$2.50 each.

CIRCLE No. 6 IN COUPON

7-DAY FREE EXAMINATION

SEND NO MONEY - Pay the postman nothing! We are glad to send you any of the Audel Guides for absolutely FREE examination in your own home. We take all the risks and leave all the decisions up to YOU. There is no obligation! If you decide to keep the book of your choice you may pay for them under our astounding easy-pay plan of only \$2 a month.

HERE IS ALL YOU DO

IT'S EASY TO ORDER: In the No-Risk Mail Order Coupon at the right just draw a circle around the number of Audel Guides you want to send you for FREE EXAMINATION. We will send them to you at once to help you build a brighter future by increasing your SKILL. If for any reason at all you are not COMPLETELY satisfied, return the books to us, and that will end the matter! NO STRINGS OR CATCHES TO THIS OFFER.

THEO. AUDEL & CO.
49 West 23rd Street, New York 10, N.Y.

CARPENTERS AND BUILDERS GUIDES



PRACTICAL STOREHOUSE OF MODERN CONSTRUCTION INFORMATION (4 vol. set) for carpenters and all woodworkers. Explains in easy language and by profuse illustration principles, advances, shortcuts, trade secrets, all based on the NEWEST information. Vol. 1 - Tools, steel square, saw filing, joinery, furniture, etc.; Vol. 2 - Builders' mathematics, drawing plans, specifications, estimates, etc.; Vol. 3 - House and roof framing, laying out, foundations, etc.; Vol. 4 - Doors, windows, stair building, millwork painting, etc. 4 vols. 1904 Pages. 3700 Illustrations. Whole set only \$9. CIRCLE No. 8 IN COUPON

Sold individually \$2.50 each

PRACTICAL ELECTRICITY

A COMPLETE HANDBOOK - Quick, simplified, ready reference. Complete instruction and practical information on the rules and laws of electricity - Maintenance of Machinery - A.C. and D.C. Motors - Armatures - Wiring Diagrams - House Lighting - Power Wiring - Meters - Batteries - Transformers - Simple to understand. 1052 Pages. 2600 Illustrations. Priced at \$5. CIRCLE No. 4 IN COUPON

DIESEL

ALL THERE IS TO KNOW ABOUT MODERN DIESEL ENGINES - Basic principles, starting valves, timing, fuel pumps, fuel injection compressor, air compressors, pistons, cylinders, lubrication, cooling systems, etc. Answers on operation, calculations. 640 Pages. Fully Illustrated. Priced \$3. CIRCLE No. 9 IN COUPON

MASONS & BUILDERS GUIDES

A PRACTICAL ILLUSTRATED 4 VOL. SET - Explaining in clear, simple language and profuse illustration, principles, advances, short cuts, trade secrets, based on modern methods including how to figure and calculate various jobs. Vol. 1 - Brick work, bricklaying, bonding, designs. Vol. 2 - Brick foundations, arches, tile setting, estimating. Vol. 3 - Concrete mixing, planing forms, reinforced stucco. Vol. 4 - Plastering, stone masonry, steel construction, blueprints. 4 Vols. 1440 Pages. 2087 Illustrations. Complete Set only \$9. CIRCLE No. 26 IN COUPON Sold individually \$2.50 each

MATHEMATICS MADE EASY

A COMPLETE HOME STUDY COURSE - Starting with the first principles of arithmetic, advancing step by step through the various stages of mathematics, including the rules and calculations for mechanical and electrical problems. New EASY correct methods. Includes plane and solid geometry, trigonometry, algebra, calculus, etc. Practical tests, reference tables and data. How to use slide rule. 672 Pages. 550 Illustrations. Priced at only \$3. CIRCLE No. 11 IN COUPON

NEW MACHINISTS AND TOOLMAKERS HANDBOOK

MODERN MACHINE SHOP PRACTICE - For every Machinist, Toolmaker, Draftsman or Student. Tells how to set up and operate lathes, shapers and milling machines, shapers, drill presses and all other machine tools. A COMPLETE INSTRUCTOR AND REFERENCE BOOK 1250 Pages. Fully Illustrated. Priced at only \$6. CIRCLE No. 12 IN COUPON

ELECTRIC MOTORS

THIS GUIDE covers the construction, hook-ups, control, maintenance and trouble shooting of all types of motors. Includes armature winding. Explains entire subject in great detail in simple language. Over 1056 Pages of information. 617 Diagrams. All types of motors fully illustrated and indexed for ready reference. Priced at only \$5. CIRCLE No. 27 IN COUPON

REFRIGERATION & AIR CONDITIONING

FOUR BOOKS IN ONE - basic principles, servicing, operation, repair of: 1. Household Refrigeration. 2. Special Refrigeration Units. 3. Commercial & Industrial Refrigeration. 4. Air Conditioning Systems. A GOLD MINE of essential information. Completely up-to-date. 1360 Pages. Fully Illustrated and Indexed. Priced at only \$6. CIRCLE No. 14 IN COUPON

New MECHANICAL DICTIONARY

THE AUTHORITATIVE WORD BOOK FOR MECHANICS TECHNICIANS AND STUDENTS

With the revolutionary progress being made today in all mechanical fields, new words and phrases come into use. Any mechanic who wants to be up to date must know this new trade language.

Audels New Mechanical Dictionary gives you all these new words and also the old. Every mechanic will find his job made easier if he knows the exact meaning and use of technical words that come up every day at work. It is an engineer's shop companion and a student's guide.

PRACTICAL TABLES, FORMULAS, PROCESSES

Constant use of Audels New Mechanical Dictionary will increase your knowledge and skill in a matter of days without any conscious effort on your part. The right word at the right time is like the right tool - be sure you have it and use it! Defines 17,000 words - terms phrases - rules and formulas, 712 pages only \$6.95.

CIRCLE No. 44 IN COUPON

THE NEW ELECTRIC LIBRARY

A COMPLETE ENCYCLOPEDIA explaining in the simplest terms the fundamental principles, rules and applications of applied electricity.

A COMPLETE COLLEGE EDUCATION!

Fully illustrated with diagrams and sketches, calculations and tables for ready reference. Questions and answers. Trial tests for practice study and review. All based on the most modern theory.

- Vol. 1 - Principles and rules of electricity, magnetism, armatures, repairs. No. 15
 - Vol. 2 - Dynamo, DC Motors, construction, installation, maintenance, etc. No. 16
 - Vol. 3 - Testing instruments and tests, storage battery constr. and repairs. No. 17
 - Vol. 4 - Alternating current, power factor, alternators, transformers. No. 18
 - Vol. 5 - A.C. Motors, windings, maintenance, converters, switches, fuses, etc. No. 19
 - Vol. 6 - Relays, condensers, regulators, rectifiers, meters, switchboards, etc. No. 20
 - Vol. 7 - Wiring, house light and power, circuits, high tension, plans, code, etc. No. 21
 - Vol. 8 - Railways, signals, elevators, ignition, etc. No. 22
 - Vol. 9 - Radio, telephone, telegraph, television, motion pictures. No. 23
 - Vol. 10 - Refrigeration, illumination, welding, x-ray, electrical appliances, Index. No. 24
- 6,000 fully illustrated pages. Priced at only \$22.50 for the ENTIRE SET. Also sold individually for \$2.50 each.

WELDERS GUIDE

Covers Electric, Oxy-acetylene, Thermit, Unconmet welding for sheet metal, spot and pipe welds, pressure vessels and aluminum, copper, brass, bronze and other metals. Airplane work, surface hardening, hard facing, cutting, bearing, etc. 608 Pages. Fully Illustrated. Only \$3. CIRCLE No. 10 IN COUPON

ADDITIONAL IMPORTANT TITLES

- The following Audel Guides are all the best in their field, written in clear simple fashion, all lavishly illustrated. Circle the numbers wanted in the MAIL ORDER COUPON below. All books are sent for FREE EXAMINATION.
- No. 3 TRUCK & TRACTOR GUIDE. 1276 Pages. \$5.00
 - No. 7 PAINTING & DECORATING MANUAL. 417 Pages. 2.00
 - No. 13 WIRING DIAGRAMS Light & Power. 304 Pages. 2.50
 - No. 29 SHEET METAL PATTERN LAYOUTS. 1132 Pages. 7.50
 - No. 30 SHEET METAL HANDY BOOK. 448 Pages. 2.50
 - No. 31 MECHANICAL DRAWING GUIDE. 192 Pages. 2.50
 - No. 32 MECHANICAL DRAWING & DESIGN. 410 Pages. 3.00
 - No. 33 ELECTRONIC DEVICES. 304 Pages. 3.00
 - No. 34 ELECTRICIANS EXAMINATIONS. 272 Pages. 2.50
 - No. 35 ELECTRIC POWER CALCULATIONS. Page 403. 3.00
 - No. 36 ELECTRIC DICTIONARY. 9000 Terms. 3.00
 - No. 37 POWER PLANT ENGINEERS GUIDE. 1568 Pages. 5.00
 - No. 38 ENGINEERS AND FIREMANS EXAMS. 544 Pages. 2.50
 - No. 39 OPERATING ENGINEERS LIBRARY. 3 Book Set. 12.00
 - No. 40 PUMPS, HYDRAULICS AND AIR COMPRESSORS. 1760 Pages. 6.00
 - No. 41 HOUSE HEATING GUIDE. 986 Pages. 5.00
 - No. 42 MILLWRIGHTS & MECHANICS GUIDE. 1248 Pages. 5.00
 - No. 43 DO-IT-YOURSELF ENCYCLOPEDIA. 2 Book Set. 8.95
 - No. 45 MAGIC OF LANDSCAPING. 128 Pages. 1.49
 - No. 46 WATER SUPPLY & SEWAGE DISPOSAL. 436 Pages. 4.00
 - No. 47 GUIDE TO CREATIVE PHOTOGRAPHY. 400 Pages. 3.95

MAIL THIS NO-RISK COUPON TODAY!

THEO. AUDEL & CO. - Self Improvement Publishers Since 1879 - P12
49 W. 23rd Street, New York 10, N.Y.

Please mail me for 7 days' FREE EXAMINATION the books I have circled at right. I agree to mail \$2 in 7 days on each book or set ordered, and to further mail \$2 a month on each book or set ordered until I have paid the purchase price, plus shipping costs. If I am not completely satisfied with my Audel Guides I may return them.

NAME _____

ADDRESS _____

OCCUPATION _____

EMPLOYED BY _____

SAVE SHIPPING COSTS! Check here if you enclose complete payment with order. We pay postage charges. You have same return privilege.

1	2	3	4	5
6	7	8	9	10
11	12	13	14	15
16	17	18	19	20
21	22	23	24	25
26	27	28	29	30
31	32	33	34	35
36	37	38	39	40
41	42	43	44	45
46	47			



Spotlight on the Jaguar 3.8

Mark II Sedan



"SPORTS SEDAN" is how its maker aptly describes the latest elegant version of the Jaguar 3-8 four-door

PERFORMANCE-MINDED family men whose budgets don't include a sporty second car should investigate Jaguar's 3.8 sedan. The Mark II version of the 3.8 offers sports-car "zip" and taut handling in a compact, safe and luxurious four-door with plenty of room for children and a reasonable amount of luggage space.

The oval grille is unmistakably Jaguar and closely-set headlights emphasize the car's sleek appearance. Steeply-sloped hood and curved one-piece windshield give a fine, commanding view of the road ahead. Vision is also aided by narrow pillars and a larger rear window.

Jaguar engineering is a prime example of competition experience; the 3.8 is powered by the race-proven XK sports car engine, an inline 6-cylinder, double-overhead camshaft power plant. Evolving from the earlier 2.4 and 3.4 sedan's engines, the 3.8s pulls 220 hp. from a piston displacement of 230 cubic inches which will speed it quietly much faster than the law allows, especially when equipped with optional overdrive.

A small, steering-column lever puts you in or out of overdrive which adds a "fifth" speed—an extra-high ratio for quiet, economical and effortless cruising above 40 m.p.h. Limited-slip differential and four-wheel disk brakes are standard equipment.

Quick, efficient and quiet up to 5500 r.p.m., the engine can really accelerate when equipped with the four-speed gearbox. The car is agile for a sedan and both flexible and well-behaved in traffic, though one gets the feeling that it must be kept well tuned or it will go sour in town use.

The aluminum-head engine is really "shoe-horned" under the hood. To reach the dipstick, at the extreme left rear, you must risk a burn on a hot manifold.

Performance is up in the sports car category, but some unexpected resistance is encountered making quick, "snap" shifts, particularly down from 3rd to 2nd gear. There's operation at low r.p.m., but the box gets noisy as soon as you're down on the gas. Strangely enough, first gear isn't synchronized, and for this reason the gearbox might give a woman trouble. The over-all impression of agility and dazzling performance suffers somewhat from the gearbox behavior. However, you can have the Borg-Warner automatic transmission, but it takes away some of the "fun" potential.

Considering the performance the car is capable of, its fuel-consumption range of 16 to 25 miles per gallon is very respectable.

Riding quality is very good; firm with little or no sway, and no braking dip, mostly due to good shocks. Front suspension is independent coil spring ball joint with quarter-elliptic springs at the rear.

Finish and fit is good—the kind you'd expect to find in this car. Interior room is an adequate compromise with compact design. A strong feeling of serenity is imparted by good sound deadening and the rich interior. Bucket seats up front and bench-type rear seat are foam-rubber, covered with real leather. Door panels and transmission tunnel are also leather-covered, while window frames and dash are polished walnut.

(Continued to page 20)

Postage
Will Be Paid
by
Addressee

No
Postage Stamp
Necessary
If Mailed in the
United States

BUSINESS REPLY MAIL

FIRST CLASS PERMIT No. 1000, Sec. 34.9 P. L. & R. :: SCRANTON, PA.

INTERNATIONAL CORRESPONDENCE SCHOOLS
SCRANTON 15, PA.



You can cash in on a new career by mailing this postcard today!



Free Career Kit with 3 valuable booklets is yours as a gift from International Correspondence Schools to prove how you can earn more pay, find new opportunity, enjoy real job security. Includes (1) "How to Succeed," career guide, (2) Career catalog of job opportunities, (3) Sample lesson (math) to demonstrate the famous method used by millions of ambitious men and women to achieve lasting success.

SEE OTHER SIDE FOR FULL DETAILS



BOX 48086M, SCRANTON 15, PENNA.

(In Hawaii, reply P.O. Box 418, Honolulu)

(Partial list of courses)

Without cost or obligation, send me "HOW TO SUCCEED" and the opportunity booklet about the field BEFORE which I have marked X (plus sample lesson):

ARCHITECTURE and BUILDING CONSTRUCTION

- Air Conditioning
- Architecture
- Arch. Drawing and Designing
- Building Contractor
- Building Estimator
- Carpenter Builder
- Carpentry and Millwork
- Heating
- Painting Contractor
- Plumbing
- Reading Arch. Blueprints

ART

- Commercial Art
- Magazine Illus.
- Sign Painting and Design's
- Sketching and Painting

AUTOMOTIVE

- Automobile
- Auto Body Rebuilding and Refinishing
- Auto Engine Tuneup
- Auto Electrical Technician
- Diesel Engines

AVIATION

- Aero-Engineering Technology
- Aviation Engine Mech.
- Reading Aircraft Blueprints

BUSINESS

- Accounting
- Advertising
- Bookkeeping and Cost Accounting
- Business Administration
- Business Management
- Clerk Typist
- Creative Salesmanship
- Managing a Small Business
- Professional Secretary
- Public Accounting
- Purchasing Agent
- Real Estate Salesmanship
- Salesmanship
- Salesmanship and Management
- Traffic Management

CHEMICAL

- Analytical Chemistry
- Chemical Engineering
- Chem. Lab. Technician
- General Chemistry

- Oil Field Technology
- Pulp and Paper Making

CIVIL ENGINEERING

- Civil Engineering
- Construction Engineering
- Highway Engineering
- Professional Engineer (Civil)
- Reading Struc. Blueprints
- Sanitary Engineer
- Sewage Plant Operator
- Structural Engineering
- Surveying and Mapping
- Water Works Operator

DRAFTING

- Aircraft Drafting
- Architectural Drafting
- Drafting & Machine Design
- Electrical Drafting
- Electrical Engineer Drafting
- Industrial Piping Drafting
- Mechanical Drafting
- Sheet Metal Drafting

ELECTRICAL

- Electrical Appliance Servicing
- Electrical Engineering

- Electric Motor Repairman
- Elec. Engr. Technician
- Elec. Light and Power
- Practical Electrician
- Practical Lineman
- Professional Engineer

HIGH SCHOOL

- Good English
- High School Diploma
- High School General
- H. S. College Prep. (Eng'g & Science)
- High School Math
- High School Science
- Short Story Writing

LEADERSHIP

- Industrial Foremanship
- Industrial Supervision
- Personnel-Labor Relations
- Supervision

MECHANICAL and SHOP

- Diesel Engines
- Gas-Elec. Welding
- Heating and Air Conditioning
- Industrial Engineering
- Industrial Instrumentation

- Industrial Safety
- Machine Shop Practice
- Mechanical Engineering
- Plumbing and Heating
- Professional Engineer
- Quality Control
- Reading Shop Blueprints
- Refrigeration and Air Conditioning
- Tool Design
- Tool Making

RADIO, TELEVISION

- General Electronics Tech.
- Industrial Electronics
- Practical Radio-TV Eng'g
- Radio-TV Servicing
- TV Technician

RAILROAD

- General Railroad

STEAM and DIESEL POWER

- Combustion Engineering
- Power Plant Engineer
- Stationary Diesel Engr.
- Stationary Steam Engines

TEXTILE

- General

Name _____ Age _____ Home Address _____
 City _____ Zone _____ State _____ Working Hours _____ A.M. to P.M. _____
 Occupation _____

Canadian residents send coupon to International Correspondence Schools, Canadian, Ltd., Montreal, Canada. . . . Special low monthly tuition rates to members of the U. S. Armed Forces.

Cast your ballot for a successful future!

249 I.C.S. COURSES

Whether you stand at a machine or sit at a desk . . . whether you're making \$85 a week or \$85 hundred a year . . . whether your interest is Power Plants or Paper Pulp, Advertising or Electronics . . . chances are I. C. S. has exactly the course you need to get ahead.

I. C. S. is not only the oldest and largest correspondence school. It also offers the most courses. 249 in all. Each one success-proved by graduates who rose to top technical and administrative positions. Chief engineers. Superintendents. Foremen. Managers. Executive assistants.

I. C. S. Courses cover bedrock facts and theory plus practical, on-the-job applications. Texts are prepared by leading business and industrial authorities working with I. C. S. editors and educators. They are reviewed and revised in line with current developments.

As an I. C. S. student, you study in your spare time, set your own pace. No time lost getting to class or waiting for slower students to

catch up. If you wish, I. C. S. will make progress reports to your employer. You win recognition as a "comer," one who is ready to move ahead. Thousands of students report pay increases and promotions within a few months of enrollment. All graduates win the coveted, approved I. C. S. diploma.

FREE CAREER KIT! Check the subject that interests you in the coupon above. I. C. S. will rush you a free Career Kit including (1) a special booklet outlining your opportunities in this field, (2) the 32-page gold mine of career tips, "How to Succeed," (3) a sample I. C. S. lesson (math) demonstrating the famous I. C. S. Method. "X" MARKS OPPORTUNITY.



For Real Job Security—Get an I. C. S. Diploma! I. C. S., Scranton 15, Penna.

Accredited Member, National Home Study Council

Материал, защищенный авторским правом



Here are
3 good reasons

why I'm glad

I became a **DURACLEAN DEALER**

Raising a family takes a dependable, steady income. Too few jobs offer security and chance for advancement. That's why so many men are going into a business of their own. All around us are local merchants making a good living in respectable businesses where they hold a franchise. The big questions are "What is left to go into?—Which business is profitable?—Which requires only a modest investment?" Many have found the answers in DURACLEAN.

EVERY TOWN NEEDS THIS AMAZING BETTER HOME CLEANING SERVICE

Duraclean is a scientific method of cleaning carpeting and upholstery in the home. This better process of cleaning by absorption virtually "lifts" the dirt from fabrics, leaves them bright and lively. Almost every home, hotel and many offices are potential customers who will call you again and again.

Check Experience of Other Dealers

There's no better way to learn of DURACLEAN profit opportunities than by checking with dealers already in business. If there's one near you, call him—or ask DURACLEAN whom to call.

M. LYONS: ILLINOIS
"Averaged over \$50,000 my first 3 yrs. Headquarters' help makes it possible".

E. BAILEY: ARKANSAS
"I know of no other business which can offer so much".

C. RANDALL: OHIO
"My 2nd year and business keeps growing. Have made as much as \$120 in one day".

L. LAWSON: NEW YORK
"National advertising creates leads. One month, jobs totaled \$1475".

DURACLEAN COMPANY
1-16D DURACLEAN BLDG., DEERFIELD, ILLINOIS

DURACLEAN PROVIDES EVERY BUSINESS BUILDING NEED

DURACLEAN headquarters supplies all equipment and chemicals to put you in business. Regularly held training sessions, cover techniques, methods and means of developing business. Local advertising helps and merchandising ideas are available; and an impressive national advertising program pre-sells customers on the gentle DURACLEAN cleaning process.

Start part time, full time or hire others. **NO SHOP NEEDED.** DURACLEAN service is rendered in the home or customer's place of business. Just 2 average jobs a day can net \$8,750.00 a year.

MORE WAYS TO MAKE MONEY

5 other DURACLEAN services multiply your profits. DURASHIELD soil retarding service, DURAPROOF mothproofing and DURAGUARD flame retarding are among the other services that mean more money for you. It takes less money to establish this prosperous business. No wonder so many men with vision are becoming DURACLEAN DEALERS. Why don't you? Write today for FREE booklets.

MAIL THIS "FUTURE SECURITY" COUPON

DURACLEAN COMPANY
1-16D Duraclean Bldg., Deerfield, Illinois.

Rush me all the facts about DURACLEAN PROCESS and what it takes to become a DURACLEAN DEALER.

NAME _____

ADDRESS _____

CITY _____ STATE _____

DRAFTSMEN



ARE NEEDED!

LEARN AT HOME IN YOUR SPARE TIME

Check the want ads in any newspaper. See the big-pay opportunities open to you as a draftsman. What's more, you can learn this well-paid, prestige profession at home—quickly, easily! No special talent needed! Get complete, step-by-step Chicago Tech

lessons in the mail, spend a few pleasant hours studying each week. In a short time you'll be a well-trained draftsman, ready to take your pick of many good jobs. Decide now to get ahead. Mail coupon today!

SEND FOR FREE TRIAL LESSON TODAY!

Get FREE TRIAL LESSON plus information about C.T.C. practical training. Learn what successful Chicago Tech graduates say about high pay and opportunities in drafting. No charge, or obligation. It's yours free.

Est. 1904 • Accredited National Home Study Council

CHICAGO TECHNICAL COLLEGE

5-219 Tech. Bldg., 2000 So. Michigan Ave.
Chicago 16, Illinois

Mail me FREE Lesson with information about big opportunities in DRAFTING.

Name _____ Age _____

Address _____

City _____ Zone _____ State _____

JEEP OWNERS

RE-POWER NOW WITH A V-8 OR 6 CYL. ENGINE — USE FORD—CHEV.—MERCURY—GMC—PONT—STUDE—DODGE OR PLYMOUTH In Jeeps, Jeepsters, Sta-Wgn, trucks, Kaiser & H. J. cars. Conversion Kits \$45.35 to \$56.90. Want fast action? Give us full information, send \$15.00 Dep. and we will ship correct kit. Bal. COD. Send full amount for prepaid shipment. Wire, phone or write today. Details FREE.

HOOSIER MACHINE PRODUCTS CO.

312 S. E. 6th St. Phone CR 6-3442 Pendleton, Oregon

more run for your money!

WARN® HUBS

on your 4-WHEEL DRIVE

That goes for your vehicle as well as Warn Hubs. The hubs stop front end drag in 2-wheel drive, save gears, gas, tires, give your vehicle more life, greater handling ease. And the hubs are the most dependable you can own. Ask your dealer!



WARN MFG. CO.

Riverton Box 6064-A
Seattle 88, Washington



WRITING DESKS are concealed in the front seat backs

Front window frames are not perfectly tight at the front and this allows drafts to enter just ahead of the vent windows at speed. A severe rainstorm on our test drive proved the weather seal faulty.

Water entered the car at the vent and rear quarter windows and over one of the front door sills. The storm revealed poor ventilation under such conditions, and the need for a bigger defroster blower.

Instrumentation is excellent with big white-on-black dials that are easily read. Speedometer and electric tachometer are right in front of the driver.

Sure-footed and high spirited, the 3.8 is satisfying to own and stimulating to drive, great for sports car fans who have to forego a roadster for family or business reasons, and who can still afford the \$4915 (POE) price tag.—Dick Williford

FLIP-OPEN center dash panel hinges down for easy servicing of smaller instruments, bulbs and wiring



New Model 161 UTILITY TESTER® FOR REPAIRING ALL ELECTRICAL APPLIANCES MOTORS • AUTOMOBILES • TV TUBES

As an electrical trouble shooter the Model 161:

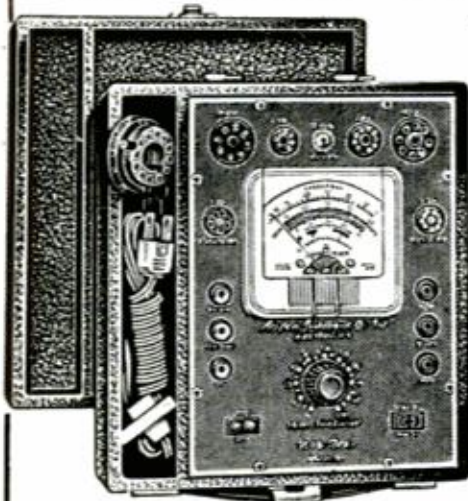

- Will test Toasters, Irons, Broilers, Heating Pads, Clocks, Fans, Vacuum Cleaners, Refrigerators, Lamps, Fluorescents, Switches, Thermostats, etc.
- Will test all TV tubes (including picture tubes) for open filaments and burned out tubes.
- Measures A.C. and D.C. Voltages, (Both 110 Volt and 220 Volt lines).
- Will measure current consumption (amperes) while the appliance under test is in operation.
- Incorporates a sensitive direct-reading resistance range which will measure all resistances commonly used in electrical appliances, motors, etc.

As an Automotive Tester the Model 161 will test:

- Both 6 Volt and 12 Volt Storage Batteries • Generators • Starters • Distributors • Ignition Coils • Regulators • Relays • Circuit Breakers • Cigarette Lighters • Stop Lights • Condensers • Directional Signal Systems • All Lamps and Bulbs • Fuses • Heating Systems • Horns • Also will locate poor grounds, breaks in wiring, poor connections, etc.

IT'S SO EASY!!



with tester's cord in outlet, current consumption of appliance is read direct on meter when line cord is connected to receptacle on panel. This typical iron takes 7 amperes (Good).



Simply insert tube in appropriate socket then follow procedure as outlined in our manual.



Control circuits of most furnaces use 24 volts obtained from step-down transformer. Here's how to check room thermostat to see if wires to it are live.



Small electric fan motor indicates 50 ohms (normal resistance).



Test Generators
READ THIS!



Test Storage Batteries
READ THIS!



Test Circuit Breakers
READ THIS!



INCLUDED FREE!!

This 56-page-book—practically a condensed course in electricity. Learn by doing.

Just read the following partial list of contents:

- What is electricity? • Simplified version of Ohms Law • What is wattage? • Simplified wattage charts • How to measure voltage, current, resistance and leakage • How to test all electrical appliances and motors using a simplified trouble-shooting technique.
- How to test all TV tubes; also simple procedure for determining which specific tube (or tubes) is causing the trouble.
- How to trace trouble in the electrical circuits and parts in automobiles and trucks.

Model 161 comes complete with above book and test leads. Only **\$22⁵⁰**

You don't pay for the Model 161 until AFTER you have examined it in the privacy of your home!

SEND NO MONEY WITH ORDER PAY POSTMAN NOTHING ON DELIVERY

Try it for 10 days before you buy. If completely satisfied then send \$5.00 and pay the balance at the rate of \$5.00 per month until the total price of \$22.50 (plus small P.P. and budget charge) is paid. If not completely satisfied, return to us, no explanation necessary.

ACCURATE INSTRUMENT CO.

Dept. D-160 911 Faile St., New York 59, N. Y.

Please rush me one Model 161. If satisfactory I agree to pay \$5.00 within 10 days and balance at rate of \$5 per month until total price of \$22.50 (plus small P.P. and budget charge) is paid. If not satisfactory, I may return for cancellation of account.

Name _____

Address _____

City _____ Zone _____ State _____

**MY SPARE TIME HOBBY
MAKES ME
\$5⁰⁰ an hour
CASH PROFIT**

— Grover Squires

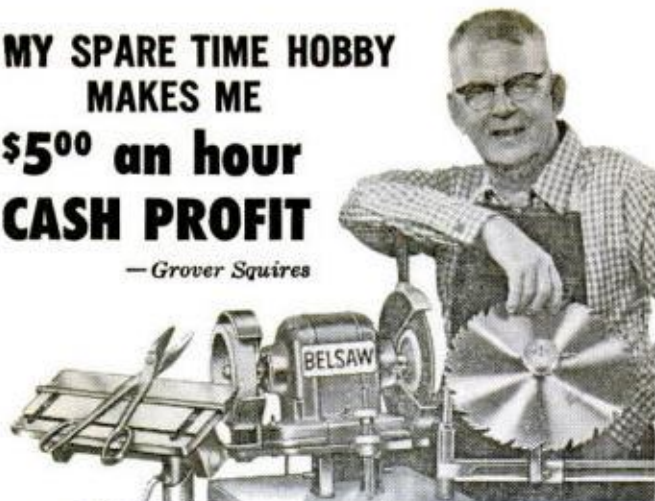

START YOUR OWN SPARE TIME BUSINESS
You can turn your spare time into Big Cash Profits with your own **COMPLETE SHARPENING SHOP . . .** Grind saws, knives, scissors, skates, lawn mower blades . . . all cutting edges. Your Own Cash Business with no inventory . . . right at home . . . no experience needed.

FREE BOOK tells how you can start your own spare time business while you are still working at your regular job. Low Cost — time payments only \$15.00 a month. Send coupon today.



BELSAW SHARP-ALL CO., 712 Field Bldg., Kansas City 11, Mo.
Send Free Book "LIFETIME SECURITY". No obligation.

Name _____
Address _____
City _____ State _____

... TURN CONCRETE INTO GOLD!

MAKE UP TO \$75 A DAY IN YOUR OWN BUSINESS

If you want to have your own business — to start a business on your own — here's your big opportunity! New high speed, low cost General block machine produces up to 1,000 concrete blocks a day. Sell all you make to builders, supply houses, and others for homes, factories, buildings, garages. Cash in on the building boom! You can make profits of 100% to 150% — up to \$75. a day! General block machine equipped with 1/2 h.p. electric motor — or can be supplied with gasoline engine — works anywhere, in little space, indoors or out. Operates from ordinary house light socket. Simple, foolproof 3 step operation — so easy a child can do it. Makes superior 3 core blocks any size from 4" to 12". Also makes chimney, sash, corner and other types. Blocks meet any building code anywhere in the country. Materials — sand, water, cement, available anywhere. Simple illustrated operating instructions and mixing formulae for cement and cinder blocks supplied with each machine. Write for FREE folder with full information.

MOTOR DRIVEN

R. L. T. of New York City reports: "MY GENERAL BLOCK MACHINE PAID FOR ITSELF IN FIRST 2 WEEKS!"
Hundreds now in use the world over!
Write for FREE details today!

EXTRA

Amazing illustrated book gives floor plans for 6 sensational concrete block bungalows. Tells how to lay blocks, lay out building lines, mix concrete, build steps, porch and concrete floors all at great savings. Written by experts. Can save many times the cost of the machine! Get it now! No strings attached. Send \$1.

BOOK SENT FREE IF YOU BUY MACHINE.
\$1 REFUNDED IF YOU BUY LATER.

GENERAL ENGINES CO.

DEPT. PB-121, ROUTE 130, THOROFARE, N. J.



**Sidelights
on aviation**



WILLIAM PIPER, left, turns Cub over to Dr. Donald Shelley of Ford Museum. Right: PM editor Jim Biery

TIME: September 16.

PLACE: Henry Ford Museum, Dearborn, Mich.

OCCASION: William Piper, the 80-year-old president of Piper Aircraft Corp., was presenting a J3 Cub to the Museum for its display of planes that made history. This was a result of the Cub being included among "The Twelve Most Significant Aircraft of All Time" in the June issue of *Popular Mechanics*.

As we waited for the ceremony to start, Mr. Piper spoke of the future for light planes. I was sitting in, that sunny afternoon, for PM aviation editor Kevin Brown, who was pursuing a story in Japan.

"There is a tremendous job open for privately-owned planes, if we are to have a complete system of air travel in the U.S.," he said. "Big planes, which must go from one city to another, can never give us full service. The thing holding back private flying, though, is the availability of places to sit down wherever people want to go—in a state park, at a fishing hole, close to town."

Mr. Piper said this situation, brought on by a reluctance to build expensive, two-directional concrete runways and staff small airports, could be resolved by building small, unmanned landing strips.

"We now have tricycle landing gear," he said. "This means only a strip, say 100 feet wide by a half-mile long, of trimmed grass, is needed. When the nose wheel touches, the plane is down, and is rolling ahead."

(Continued to page 24)



NEW!

SAF-T-RIP

GUIDE

TAKES THE DANGER OUT OF POWER SAW OPERATION

Out . . . with old-fashioned push sticks! Out . . . with bothersome whipping and chattering. Out . . . with slotting, grooving and dadoing troubles.

Most of all, OUT . . . with risking serious hand injuries, especially when working with thin or small pieces of wood, plastics or other cuttable materials.

SAF-T-RIP GUIDE is your answer to a better, SAFER power-cutting job regardless of size or type of material.

- Made of sturdy, lightweight aluminum for easy sliding along work table fence.
- Has laterally adjustable bar with screw for proper adjustment to fit any fence.
- **Holding and Advancing Device** — a pair of dogs. "Top Dog" holds material firmly down to prevent whipping or chattering; "Bottom Dog" pushes rear of material to advance work smoothly.

Works with any model table power saw **To Take the Danger Out of Your Power Saw Operation**

MUST WORK GUARANTEE

We guarantee that SAF-T-RIP GUIDE must work with your model bench or circular saw to your complete satisfaction. IF FOR ANY REASON, you are not delighted, return for immediate refund.

ORDER YOUR SAF-T-RIP GUIDE TODAY **ONLY \$3.98**

ALSON MANUFACTURING CO.
937 N. Evans Street, Pottstown, Pa. Dept. P

Gentlemen: Enclosed is my check, money order for \$3.98 for my SAF-T-RIP GUIDE.

I understand that I may send this back for full refund if not 100% satisfied.

NAME _____

STREET _____

CITY _____ ZONE _____ STATE _____

**100% SATISFACTION
OR YOUR MONEY BACK!**

DEALERS WANTED

ALSON MANUFACTURING CO.
937 N. EVANS STREET, POTTSTOWN, PA.

**EARN \$125
A WEEK AND UP**

**BE AN AUTO DIESEL
EXPERT — LEARN
A TRADE YOU LIKE**

You learn fast in our shops because you learn with tools on real equipment. Students short of money may earn most of their expenses by doing part-time work. Experienced instructors explain WHY and show you HOW, then you DO IT YOURSELF. Many of our graduates earn \$125 a week and up. Approved for veterans. Day and evening classes. Free bulletin-write today.

MAIL THIS COUPON TODAY!

NASHVILLE AUTO-DIESEL COLLEGE
226 7th Ave., No., Dept. 86, Nashville, Tenn.
Please send without obligation free catalog.

NAME _____
(please print or write plainly)

ADDRESS _____

CITY _____ STATE _____

SAMURAI SUICIDE WARRIORS KARATE!
JUDO BOXING! MUSCLEBUILDING! YOGA!
STRONGMAN STUNTS! STRENGTH & ENDURANCE! HANDBALANCING! etc.

YOU GET ALL THESE! *20 illustrated KA-FOR ONLY RATE blows *SAVATE foot fighting *Secret NERVE CENTER and ANATOMY charts *20 lethal JUDO throws *20 terrific STRONGMAN STUNTS *Complete MUSCLE-BUILDING program *Ancient YOGA secrets *HANDBALANCING stunts *Complete BOXING program Secrets of ENDURANCE *All picture packed. Super wall charts, (surplus 1960 printing). No C.O.D.'s. Canadian orders 50c.

K-MAN KARATE PRACTICE DUMMY. Life like! Shows attack points 15c with 35c order only. Total 50c

35¢ you get the lot!

Oxford Studio, 44N Bromfield, Boston, Mass.

Is radiation from your TV set a hazard? Read a scientist's test report on this question in the January issue of P.M.

BE A CLAIM INVESTIGATOR



INVESTIGATE ACCIDENTS!

Many earning \$750 to \$1000 a month. Thousands of insurance companies, steamship lines and Government Offices need Claim Investigators. Also big opportunities for your own spare time business. We train you at home. National Placement Service FREE of extra charge. Bill King writes: "Your course has paid off for me with large earnings. You can quote me — your Adjuster Training Course is worth many times the cost." Write TODAY for FREE book.

UNIVERSAL SCHOOLS

University Park, Dept. PM-12, Box 8202, Dallas 5, Texas

With the old tail-wheel landing gear, planes got pushed around by wind and it was necessary to build runways a mile in each direction."

Mr. Piper added that he advocates many small strips with, perhaps, only one in ten being operated for plane maintenance.

Recalling that more than 30,000 Piper Cubs were sold after being introduced in the 1930s, and that 75 percent of U.S. pilots trained in them in World War II, he commented on the failure of private flying to boom in the direction predicted after the War—a plane for everyone.

"That was a big year in aviation—1946. The industry turned out 31,000 planes; some 30,000 war surplus planes were dumped on the market. Next year was bad. When Uncle Sam stopped paying the GIs, they stopped coming out to the airports. Also, we'd broken the market for light sports planes.

"The planes we're building now—for business, for families—are three and four seaters and have more utility. I'm convinced there is a wonderful future for the family airplane. It won't be low-priced, possibly there will be a lot of renting, but people will fly them if those strips are put down so they can go where they want to. . . ."

The ceremony started and, naturally, there were references to Mr. Piper—who began piloting at 50—as the "Henry Ford of Aviation." And why not? He has so far produced the closest thing to a flying Model-T—the Cub: one of the 12 most significant aircraft of all time.—James Biery



LET FACTORY EXPERTS GUIDE YOUR HANDS THRU ANY AUTO REPAIR QUICKLY-EASILY-RIGHT!

2,850
PICTURES
LIKE THESE SHOW
YOU HOW TO FIX
ANY PART OF
ANY CAR

Illustrated step-by-step manual is **GUARANTEED** to make any auto fix-it job a breeze for you — or you don't pay a single penny!

SUPPOSE you had an automobile factory engineer standing right beside you guiding your hands through every step of even the toughest car repair job!

That's what it's like when you use **MOTOR'S** famous **AUTO REPAIR MANUAL**, the "Bible" of auto mechanics from coast to coast. In detailed step-by-step instructions and crystal-clear "show-how" photos and drawings, the makers of 33 different automobiles give you their "tricks of the trade" for saving time, work, and money!

Eliminates Guesswork

You just can't go wrong because you are following the approved, recommended methods of the men who actually designed and built the cars. Nothing is left to the imagination. They tell you what tools to use, where to start, what parts to replace, how to finish the job fast.

Whether it's a simple carburetor adjustment or a complete overhaul, you just look up the problem in the giant Troubleshooter index, turn to the right page, and follow the easy instructions. Before you know it the job is done — and done right!

Turns Beginner Mechanics Into Experts Saves Experts Time, Trouble, Money

This big, new revised edition brings you the "meat" of 176 Official

Same FREE Offer on
MOTOR'S New Truck Manual
Brand new! Covers EVERY job on EVERY popular make gasoline and Diesel truck made 1952-1961. FREE 7-Day Trial.

Covers These Makes

Buick	Jeep
Special	Lancer
Cadillac	Lark
Chevrolet	Lincoln
Chrysler	Mercury
Comet	Nash
Continental	Oldsmobile
Corvair	Olds F-85
Corvette	Plymouth
Dart	Pontiac
De Soto	Tempest
Dodge	Rambler
Edsel	Rambler
Falcon	American
Ford	Studebaker
Hudson	Thunderbird
Imperial	Valiant

shop manuals at your fingertips — engines, automatic transmissions, ignition systems, carburetors, fuel pumps, power steering, brakes, alternators, generators, distributors — practically every part of every popular American-made car, 1953 thru 1961. Includes all the new compacts.

Everything you need to know is simplified and illustrated in over 1100 double-size pages with 2,850 photographs and drawings. This huge book — almost a foot high — contains 225,000 service and repair instructions, plus 30,000 essential specifications and 195 "Quick-Check" charts.

**THIS GIANT 1,100-PAGE
MANUAL — ALMOST 1 FOOT
HIGH — SENT FREE
FOR 7 DAYS TRIAL**

Whether you're a beginner or expert mechanic, you'll find yourself breezing through jobs that you used to think were tough!

**SEND NO MONEY
— TRY BOOK FREE**

Enclose nothing with the coupon.

Pay nothing to the postman when he delivers your copy. Make the Manual prove what it can do for you by actually trying it for a week. Unless you agree that this is the greatest time and work saver that's ever come along, return it and owe nothing. Mail the coupon today! **MOTOR BOOK DEPT., DESK 11Y, 250 West 55th Street, New York 19, N. Y. (Schools, Bookstores: Write for discounts.)**

3,500,000 USERS CAN'T BE WRONG!

Yes, three and a half million copies sold. Used by U.S. Army and Navy. Praised by beginners and experts.



"I amazed myself and my friends. Now do jobs that stumped me before," says beginner M. Baliczky, New Jersey.



"Paid for itself on the first two jobs and saved me valuable time by eliminating guesswork," says expert W. Schrop, Ohio.

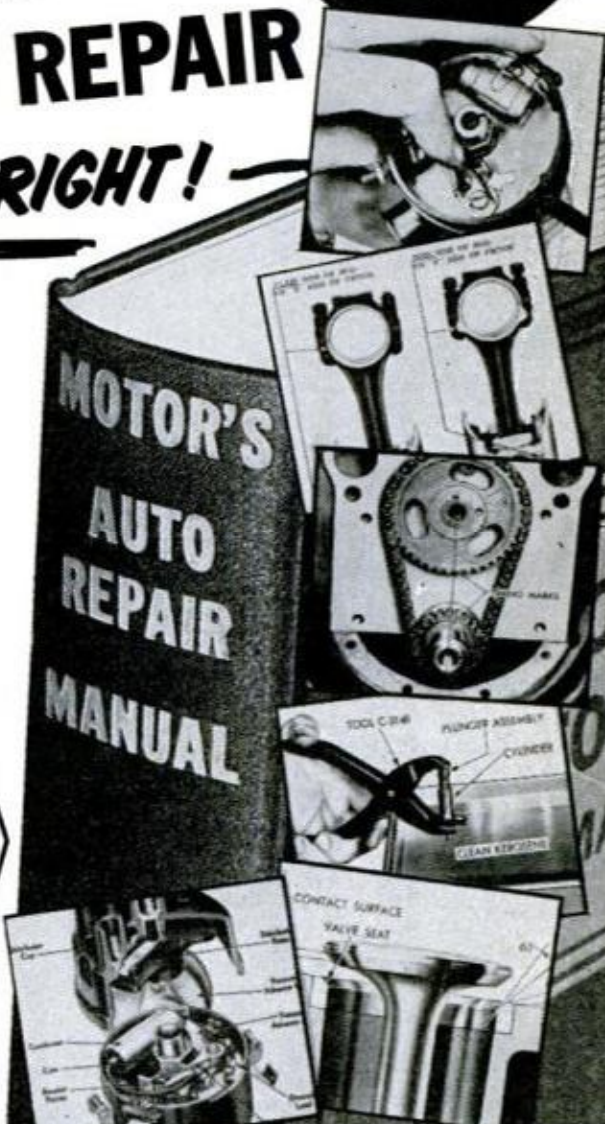

MAIL COUPON NOW FOR FREE TRIAL (Attach to postcard for fast action)

MOTOR BOOK DEPT.

Desk 11Y, 250 W. 55th St., New York 19, N. Y.

Rush to me at once (check box opposite book you want):

MOTOR'S New **AUTO REPAIR MANUAL**. If O.K., I will remit \$2 in 7 days, \$2 monthly for 2 months and a final payment of \$2.95 (plus 45¢ delivery charges and sales tax) one month after that. Otherwise I will return the book postpaid in 7 days.

MOTOR'S New **TRUCK REPAIR MANUAL**. If O.K., I will remit \$3 in 7 days, \$3 a month later, then \$2 monthly for 2 months, plus 45¢ delivery charges and sales tax, with final payment. Otherwise I will return the book postpaid in 7 days.

Print Name.....Age.....

Address.....

City.....Zone.....State.....

Check box and save 45¢ delivery charge by enclosing WITH coupon entire payment of \$8.95 for Auto Repair Manual (or \$19 for Truck Repair Manual) plus sales tax. Same return-refund privilege.

AMAZING SCIENCE BUYS **EXCELLENT XMAS GIFTS!**

OVER 1000 ITEMS

WAR SURPLUS AMERICAN-MADE 7x50 BINOCULARS

Big savings! Brand new! Crystal clear viewing—7 power. Every optical element is coated. An excellent night glass—the size recommended for satellite viewing. Individual eye focus. Exit pupil 7mm. Approx. field at 1,000 yds. is 376 ft. Carrying case included. American 7 x 50's normally cost \$274.50. Our war surplus price saves you real money.



Stock No. 1544-H only \$74.80 postpd. (Tax included)
6 x 30 Binoculars—similar to above and a terrific bargain.
Stock No. 963-H \$33.00 postpd. (Tax included)

CIRCULAR DIFFRACTION GRATING JEWELRY A DAZZLING RAINBOW OF COLOR

Shimmering rainbows of gem-like color in jewelry of exquisite beauty—made with



CIRCULAR DIFFRACTION GRATING REPLICAS. Just as a prism breaks up light into its full range of individual colors, so does the Diffraction Grating.
Stock = 30,349-H Earrings \$2.20 Ppd.
Stock = 30,350-H Cuff Links \$2.20 Ppd.
Stock = 30,372-H Pendant \$2.20 Ppd.
Stock = 30,390-H Tie-Clasp \$1.65 Ppd.

Remove Your Retaining Rings—Disassemble Lenses, Cameras, etc.

ADJUSTABLE SPANNER WRENCH

Made for U.S. Air Force—available at a fraction of Government cost. A top grade, versatile tool that every instrument and camera repair man or just plain tinkerer should own. Adjustable for 1/2" to 12" diameter retaining rings. Complete with six different pairs of points to fit all types of slots and holes. 3", 6", and 12" main bars. All steel and nicely plated. The finest tool we have ever come across for this type of retaining ring work AND a real bargain at our low price.
Stock No. 70,355-H \$12.50 Postpaid

NOW . . . BE YOUR OWN WEATHERMAN!

WEATHER STATION MARK I performs all measurements and computations for professional weather forecasts. Rise and fall of fluid in Cape Cod Glass show changes in barometric pressure. Also compute wind speed and direction, measure rainfall, figure dew point, read wet-bulb temperature, etc. Weather manual included—clear instructions for calculating the Temperature-Humidity Index and relative humidity. Fully portable. Panels and packaging of heavy polystyrene.

Stock No. 70,488-H—15" x 6" x 8 1/4" \$9.95 Postpd.
DELUXE ADVANCED MODEL MARK II
Stock No. 70,489-H—15" x 6" x 11 1/2" \$19.95 Postpd.

NEW PORTABLE ELECTRONIC SPEAKER PROVIDES "VOICE POWER" FOR INSTITUTIONAL AND HOME USE

First low-priced power speaker to do a real job. Carries your voice 500 feet or more—loud and clear. Can be modulated for shorter distances. The "greatest" for speech making—indoors and out—for use in and around schools—especially cheer leaders and athletic directors, hospitals, churches, other institutions, in the home. Wonderful plaything for youngsters. Case—impact-resistant plastic. Power—4 D cell flashlight batteries (not included). Size 8 1/2" x 5 1/2" x 2 3/4". Weight—2 1/2 lbs. Carrying strap. Up to 50 ft. extension cord may be added to mike.

Stock No. 70,502-H \$12.95 Postpaid.

NEW! CIRCULAR SLIDE RULE! Pocket Size—Fast—Easy to Use!

Multiplies, divides, figures fractions, percentages, squares, cubes, roots, proportions, circumferences, areas, prices, fuel consumption. Faster, easier to learn and use. Directions included.

Stock No. 30,336-H \$4.95 Postpaid

Order by Stock No.—Send Check or M.O.—Money-Back Guarantee
EDMUND SCIENTIFIC CO., Barrington, New Jersey

Clip and Hand to a Friend . . . or Leave for the Next Reader of this Issue!

MAIL COUPON For FREE CATALOG "H-1"

160 Pages! Over 1000 Bargains!

EDMUND SCIENTIFIC CO., Barrington, N. J.

Please rush Free Giant Catalog—"H-1"

Name

Address

City Zone State



Science overseas

By William Kreh

Do sheep chomp, munch or chew? Do they bolt or savor their meals? Agriculture scientists in Australia are attaching radio signaling units to sheep jaws to find answers to these questions, to learn more about the sheep's grazing habits.

Living without light was investigated by nine Italian scientists who recently spent a month 2650 feet down in a cave. When they came out, their pulse rates were above normal, they were tense and nervous and their sense of smell had become more acute. Knowing the effects, they now are searching out causes.

A lost inch has been discovered by Swedish researchers. They found that a pilot ejected from a jet plane may be an inch shorter when he lands than when he took off because the jolt presses his vertebrae together. It's temporary, however, as the vertebrae eventually work back to normal.

Everybody's throwing things into space. Latest entry in the rocket pitching contest is Japan. Scientists at Nagoya University, Tokyo, hope to send a monkey into space late next year, and are training a one-year-old Macaca, for the flight.

The Japanese rocket program—growing rapidly—is concentrated primarily on space biology and space medicine. A launching center at Kogoshima on the Pacific coast is under construction and a new rocket capable of hurling instruments more than 100 miles high is being built.

Aerial prospects from Chile's Institute of Geological Research, using low-flying electronically equipped planes, have found a rich vein of iron ore 90 miles long beneath the sands of the Atacama Desert in the north part of the country. The hitherto unknown deposits have been estimated in the hundreds of millions of tons.

Remember flying saucers? Now they've shown up behind the Iron Curtain. The newspaper *Pravda* disclosed widespread reportings of saucer spotting in the Russian interior.

One photograph, ostensibly taken of a flying saucer, was announced to be a fake by the Soviet Academy of Sciences. The

Kremlin says the flying saucer rumors are spreading too wildly and that the populace should stop reporting them "no matter how interesting they do seem to be."

The Russians, as yet, have not claimed they invented the saucers.



Instant Easter eggs. The German Information Service reports that a German professor on a trip to South America discovered that Araukanian chickens, named after an Indian tribe, laid eggs with blue shells. He took some of the chickens home, crossed them with German chickens and raised offspring that laid eggs with green shells. He is continuing his experiments hoping to broaden the palette of poultry colors.



It isn't what penguins say so much as how they say it, according to scientists back from a study of penguin communications in Antarctica. They found that the birds recognize each other by their voices. Thus, the Adelie penguin always rejoins its last year's mate at the beginning of each new mating season and continues doing so the rest of its life. Tests with tape recordings indicate the bird does this by distinguishing voices among its flock.



Golden-green coal? English housewives soon will be able to buy coal colored to match their living room drapes. National Coal Board technicians have perfected a process to dye artfully shaped lumps gold, silver, red, purple or green for use in fireplaces.



A 22-acre antenna will be part of a new radio observatory for studying electron densities of the upper atmosphere and outer space. The Jicamarca Observatory is being built 17 miles east of Lima, Peru. This location was chosen by the sponsors—the U.S. Bureau of Standards and the Instituto Geofisico de Huancayo—because, in that area, the lines of forces of Earth's magnetic field are nearly horizontal, a condition that makes possible experiments that can't be performed elsewhere.



Television and some radar and radio, could be knocked off the air for as long as a year if a supernova, or star explosion occurred around 10 light years from Earth, says C. M. Cade, a British scientist. There are three stars within 16 light years away that could develop into supernovae—Sirius, Procyon and Altair.

Cade says that even an explosion within a 1000 light years of Earth would set up so much cosmic radio noise that it would have serious effects on communications. ★ ★ ★

EXCELLENT
XMAS
GIFTS!

AMAZING SCIENCE BUYS

See the Stars, Moon, Planets Close Up!

3" ASTRONOMICAL REFLECTING TELESCOPE



60 TO 180 POWER
Famous Mt. Palomar Type!
An Unusual Buy!

See the Rings of Saturn, the fascinating planet Mars, huge craters on the Moon. Equatorial Mount with lock on both axes. Aluminized and overcoated 3" diameter high-speed f/10 mirror. Telescope comes equipped with a 60X eyepiece and a mounted Barlow Lens. Optical Finder Telescope included. Hardwood, portable tripod. FREE with Scope: Valuable STAR CHART plus 272-page "HANDBOOK OF HEAVENS" plus "HOW TO USE YOUR TELESCOPE" BOOK.

Stock No. 85.050-H \$29.95 Postpaid

OVER 1000 ITEMS



MINIATURE WATER PUMP

Wonderful for experiments, miniature waterfalls, fountains, Christmas gardens, HO gage railroad backdrops, etc. Tiny (2 5/8" x 1 3/4") electric motor and pump ideal for hobbyists, labs, schools. Pumps continuous flow of water at rate of one pint per minute at a 12" head. With 2 D Batteries in series will pump to 24" high. Works in either direction. Stock No. 50.345-H \$2.25 Postpaid



OPAQUE PROJECTOR

Projects illustrations up to 3" by 3 1/2" and enlarges them to 35" x 30" if screen is 6 1/2 ft. from projector; larger pictures if screen is further away. No film or negatives needed. Projects charts, diagrams, pictures, photos, lettering in full color or black-and-white. Operates on 115 volt, A.C. current. 6-ft. extension cord and plug included. Operates on 60 watt bulb, not included. Size 12" x 8" x 4 1/2" wide. Weight 1 lb., 2 oz. Plastic case with built-in handle.

Stock No. 70.199-H \$7.95 Postpaid



SCIENCE TREASURE CHESTS

Extra-powerful magnets, polarizing filters, compass, one-way-mirror film, prism, diffraction grating, and lots of other items for hundreds of thrilling experiments, plus a Ten-Lens Kit for making telescopes, microscopes, etc. Full instructions included.

Stock No. 70.342-H \$5.00 Postpaid

Science Treasure Chest DeLuxe—Everything in Chest above plus exciting additional items for more advanced experiments including crystal-growing kit, electric motor, molecular models set, first-surface mirrors, and lots more.

Stock No. 70.343-H \$10.00 Postpaid



NEW TAPE RECORDER AT AN AMAZING \$29.95

American Made—For Business, School or Hobby

Latest type, super-sensitive transistors in place of expensive bulky tubes is secret of low price. Excellent tone and quality. Real handy item for teachers, students, engineers, salesmen, etc. Single, foolproof control changes from rewind, off, play, record. All-transistor circuit sensitive crystal microphone, built-in Alnico V dynamic speaker for clear, loud amplification. Compact, lightweight, 8 1/2" x 9 1/4" x 3 1/8". Operates on 2 size D and one 9 V transistor battery (not included). Two 3" reels and 150 ft. magnetic tape, plus instructions (included).

Stock No. 70.480-H \$29.95 Postpaid



BUILD A SOLAR ENERGY FURNACE

A fascinating new field. Build your own Solar Furnace for experimentation—many practical uses. Easy! Inexpensive! Use scrapwood! We furnish instructions. This sun powered furnace will generate terrific heat—2000° to 3000°. Fuses enamel to metal. Sets paper aflame in seconds. Use our Fresnel Lens—14" diameter . . . f.1. 14".

Stock No. 70.130-H . . . Fresnel Lens . . . \$6.00 Postpd.

Order by Stock No.—Send Check or M.O.—Money-Back Guarantee
EDMUND SCIENTIFIC CO., Barrington, New Jersey

MAIL COUPON for FREE CATALOG "H"

160 Pages! Over 1000 Bargains!

EDMUND SCIENTIFIC CO., Barrington, N. J.

Please rush Free Giant Catalog-H.

Name

Address

City Zone State



ACCORDION PRICES SMASHED!



SAVE UP TO 1/2

Buy Direct at **BIGGEST IMPORTER-TO-YOU DISCOUNTS!**

Save more than you have ever dreamed possible... up to 50% off retail prices for comparable accordions. Pay no teacher or salesman commissions.

EASY TERMS! For just a small amount down (or any old instrument in trade)... and pennies a day... you can own a new 1962 model famous accordion!

World's Largest Accordion Dealer offers biggest selection! Choose from over 35 models for students and professionals, standard or electronic... newest features. Amazingly high trade-in allowance on ANY used musical instrument. **FREE HOME TRIAL.** No Risk Offer—Satisfaction guaranteed or Money Back! **FREE BONUS GIFTS.** Mail coupon today for **FREE Color Catalogs** and **Importer-to-You Discounts.**

FREE 5-DAY HOME TRIAL!

ACCORDION CORPORATION OF AMERICA
2003 West Chicago Ave., Dept. R-121 Chicago 22, Illinois

FREE Color Catalog Rush Coupon

Accordion Corporation of America, Dept. R-121
2003 West Chicago Avenue, Chicago 22, Illinois
Rush **FREE** Color Catalog, Accordion Selection Guide, and the Importer-to-You Discounts.

NAME.....
ADDRESS.....
CITY..... STATE.....
() I have an accordion to trade.

AVIATION CAREER

SPECIALIZED EDUCATION / PROFESSIONAL TRAINING... only 16 months to 2 years

Top-pay prestige positions, bright future in aviation. Job opportunities waiting for you as soon as you're ready. Airframe and Powerplant Technician, Aeronautical Engineering 4-year course, Business or Executive, Pilot. Classes in Miami.

SEND FOR FREE 80-PAGE BOOK

Embry-Riddle Aeronautical Institute
Dept. B Miami, Florida (Founded 1926)

Name.....
Address.....
City..... Zone..... State.....

\$47,983.06 ORDERS FROM 12 WORD CLASSIFIED AD. Amazing—Startling—but **TRUE.** Terrific story sent free. Request must be made on business letterhead. F. W. Johnson, Classified Adv. Manager, 200 E. Ontario St., Chicago 11, Ill.



DAN LURIE
World's Most Famous Body Builder, TV Strongman

A BODY LIKE MINE IN SHORT TIME with famous DAN LURIE BARBELLS!

SEND FOR NEW GIANT CATALOG \$9.48

Factory Prices	Cast Iron	Semi-Steel	
50 lb. Set.. \$9.48..	\$10.48		\$9.48
100 lb. Set.. 15.98..	18.98		
150 lb. Set.. 23.48..	27.48	Plus Free	
Extra Wts. 16c lb..	18c lb.	\$10 Course	

MONEY BACK GUARANTEE—Send 50% in check or money order F.O.B. Plant Brooklyn, New York. Balance C.O.D.

DAN LURIE BARBELL CO. 1661-M12 Utica Ave., Dept. 59M, Brooklyn 34, N.Y.

START NOW - EARN TOP PAY!

Become a **MASTER CRAFTSMAN**—train in the **LARGEST TRADE SCHOOL IN THE WORLD: AUTO MECHANICS** □ **TUNE-UP** □ **DIESEL** □ **BODY & FENDER** □ **AUTOMATIC TRANSMISSIONS** □ **WELDING** □ **REFRIGERATION** □ **AIR CONDITIONING** □ **MACHINIST** □ **TOOL & DIE** □ **DRAFTING** □ **FREE PLACEMENT SERVICE** during and after training. **CHECK COURSE INTEREST, TEAR OUT, AND MAIL TO BOX 1.**

GREER SHOP TRAINING

2236 S. Michigan Ave., Chicago 16, Ill.

REAL ESTATE BE A BROKER

PAYS BIG! SEND FOR FREE, BIG, ILLUSTRATED CATALOG NOW! Graduates report making substantial incomes. Start and run your own business quickly. Men, women of all ages, learn easily. Course covers Sales, Property Management, Appraising, Loans, Mortgages, and related subjects. **STUDY AT HOME** or in classrooms in leading cities. Diploma awarded. Write **TODAY** for free booklet! No obligation. Approved for World War II and Korean Veterans.

FREE BOOK TELLS HOW

WEAVER SCHOOL OF REAL ESTATE (Est. 1936)
2020 Grand Avenue Kansas City, Mo.

LEARN TO BE A DENTAL MECHANIC

SECURITY • PRESTIGE • GOOD PAY
Learn at home, in your spare time, to make Crowns, Plates, Bridgework, etc. Dental Mechanics are employed by Dentists, Dental Laboratories or open your own shop, full or spare time. **FULL EQUIPMENT OF TOOLS AND MATERIALS INCLUDED WITH COURSE.** Low tuition. Easy Terms. Write for **FREE BOOK** about this money-making profession that's not affected by automation.

MCCARRIE SCHOOL OF MECHANICAL DENTISTRY
207 No. Broad St., Dept. 118, Philadelphia 7, Pa.

Send for your free **WHERE-TO-FIND-IT** list giving sources of supply or further information on articles in this issue.



HOME-IMPORT BUSINESS—Make Big Profits

New Drop Ship Plan offers you first day profits! Deal direct with overseas sources at prices shown. Dazzling bargains with no investment. Full or spare time.

Write for **FREE BOOK** today to...
MELLINGER, 1717 Westwood, Dept. T25C, Los Angeles 24

LEARN WHILE YOU SLEEP!

Hypnotize with your recorder, phono. Details, catalog free!
Sleep-Learning Research Ass'n. P. O. Box 24-A Olympia, Wash.

SIGN PAINTING

Home-Study Course — Only \$5.95

Teaches you commercial sign painting and sign building as it is being done **TODAY** in leading shops all over the country. Complete practical course for self-instruction. Shows latest methods of truck lettering office doors, wood letters, reflecting signs, plastics, sprayed signs, gold leaf, silk screen process, up-to-date alphabets, money-making business information, etc.

SATISFACTION GUARANTEED OR REFUND!
Contains all the instruction of a high-priced correspondence course. Full price, only \$5.95, postpaid. Or C.O.D. plus postage. No risk—order today. Satisfaction or money back! Order "Sign Painting Course..." **NELSON-HALL CO., 325 W. Jackson Blvd., Dept. 2MN-2, Chicago 6, Ill.**

NO JOB WORRIES

PLASTEX INDUSTRY needs manufacturers on small scale for big production of Lamps, Clock Stands, Art Goods, Novelties in Plastic Marble imitation. No Experience necessary. 1/2c material makes regular 10c store sellers. Moulds furnished for fast production. Small investment brings good profit. Big wholesale orders now being placed. Ambitious men have chance for real prosperity and job security. Our new **FREE** booklet will interest and benefit you.

PLASTEX INDUSTRIES, Dept. A
3400 Third Ave. New York 56, N.Y.

Processing of **KODACHROME** (Licensed by Eastman Kodak)

AT DISCOUNT PRICES

KODACHROME I & II } \$1.00
 8mm ROLL OR
 35mm 20 EXP. MTD. }
 8mm MAGAZINE75
 35mm 36 EXP. MTD..... 1.75



SEND FOR FREE MAILERS and our big FREE CATALOG of Processing, Film and Equipment at DISCOUNT PRICES!

SOLAR CINE PRODUCTS 4247 S. Kedzie Dept. ME
 Chicago 32, Ill.

GOVERNMENT OIL LEASES LOW AS \$1 PER ACRE

You do no drilling, pay no taxes, may realize a king-size profit without ever leaving home. Write for free map and literature.

AMERICAN OIL SCOUTS, Dept. PM
 619 Cascade Bldg. Portland 4, Oregon

Print Your Own



Cards, Stationery, Advertising, Circulars, labels, photo and movie titles, church work, tags, etc. Save money. Sold direct from factory only. Raised printing like engraving, too.

Own a Printing Business

Print for Others, Good Profit. Have home shop. Junior press \$15; Senior \$35 up. We supply everything. Easy rules. Pays for itself in short time. Write now for free details. **KELSEY PRESSES, Z-37 Meriden, Conn.**

Learn LANDSCAPE GARDENING

AND GROWING OF PLANTS. Latest information on propagation, soil-testing, plant growth regulators, garden design. Start a profitable business or wonderful hobby. Unique and modern home study course - accredited. Earn your certificate at home. May I send FREE, and without obligation, my informative booklet? **NORM MORRIS NATIONAL LANDSCAPE INSTITUTE DEPT. M 121, 11826 SAN VICENTE BLVD., LOS ANGELES 49, CALIF.**

Antique TELEPHONES

As is complete, decorative purpose \$12.00. Working order, inter-comm. \$15.00. Ext. on dial \$17.50, talking circuit only. Write for complete list. All shipments FOB, Simpson, Pa.

TELEPHONE ENGINEERING CO.
 Dept. 1281, Simpson, Pa.



MEN PAST 40

Afflicted With Bladder Trouble, Pains in Back, Hips, Legs, Nervousness, Tiredness.

If you have these troubles, particularly bladder trouble, then your condition may be traced to Glandular Inflammation . . . a constitutional disease. Neglect of this condition often leads to premature old age and sometimes incurable malignancy.

The Excelsior Medical Clinic has a New Free Book that tells how thousands of men have been successfully treated here at Excelsior Springs for Glandular Inflammation by NON-SURGICAL Methods. They found soothing relief and a new outlook in the future of life.

This Free Book may prove of utmost importance in your life. Write Today. There is no obligation.

Excelsior Medical Clinic, Dept. B6129, Excelsior Spgs., Mo.

DECEMBER 1961

Learn Electronics Radio-Television

by Practicing at Home in Your Spare Time

WITHOUT EXTRA CHARGE you get kits to make training easier, faster.

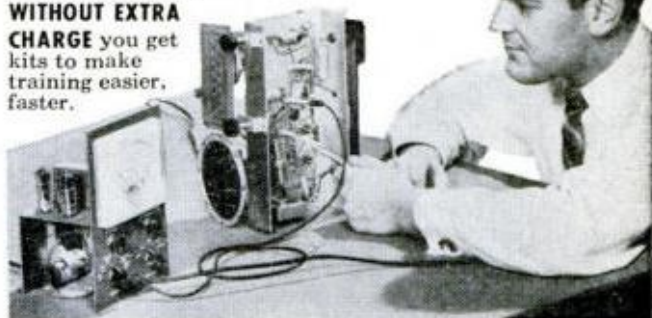

Fast Growth Offers Prestige High Pay—Bright Future

Above average jobs with bright futures await men with Electronics training . . . jobs for which YOU could qualify through NRI. Train right at home in spare time, while you hold your present job. Earn high pay in jobs with TV and Radio Stations, industrial plants, or in a profitable business of your own.

Train with the Leader

For 45 years NRI has featured the best Radio-TV Electronics training for beginners—for men without high school diplomas or previous experience. NRI is the oldest and largest home-study Radio-TV Electronics school. NRI "learn-by-doing" training is supplied at low cost. It's the easy way to get into the field of Electronics.

NRI TRAINED THESE MEN



Own Business. "I was working in a textile factory. Now I own a modern TV Radio service shop." **A. TAYLOR, Glasgow, Ky.**

Broadcasting.

"I am now chief engineer of Station WARA. NRI was the foundation." **R. ARNOLD, Attleboro, Mass.**



Industrial. "Four months after starting your course I went to work at Raytheon. Now I am an engineering assistant in Microwave Power Tube Research." **L. J. BLOOM, Newton Centre, Mass.**

Start Soon to Earn More

Soon after enrolling, NRI shows you how to earn extra money in your spare time repairing sets. Many start a profitable business this way. Others get good paying jobs within a year. Take the first step to a new career NOW. Mail coupon for descriptive catalog. National Radio Institute, Washington 16, D.C.

64 PAGE CATALOG FREE



MAIL THIS COUPON NOW

NATIONAL RADIO INSTITUTE, Washington 16, D.C. 1NA
 Send me full information without cost or obligation. No salesman will call. (Please print)

Name.....Age.....

Address.....

City.....Zone.....State.....

Accredited Member National Home Study Council

I'LL FINANCE YOU

... in your own
SCREEN PRINTING BUSINESS



Yes, I'm prepared to train you and establish you in your own spare time Business... even if you are now employed. I'll give you Credit, Financial Assistance. Mail Coupon Now!

PRINT WITHOUT A PRINTING PRESS!

Amazing but true! The Screen Print method requires no expensive Press and can be done in your own home. Start in Kitchen, Spare Room, Garage! Easy! Fascinating!

PRINT BEAUTIFUL SIGNS, POSTERS, BANNERS, FABRICS - anything in hundreds of colors. Use fabulous new "glowing" fluorescent colors. Can be seen for miles. No Art ability needed - we supply everything.

HELP SUPPLY DEMAND IN YOUR AREA! Just about every kind of business (drug, department stores, hardware, liquor stores, gas stations, theaters, jewelers, mortuaries, auto dealers, florists, beauty shops, real estate, etc.) can use Screen Printed things to increase business.

SOME \$100 JOBS USE LESS THAN \$10 WORTH OF MATERIALS... you pocket the difference for your labor and know-how. \$400.00 A WEEK EARNINGS POSSIBLE? Yes, some earn less, but Mr. J. T. Anderson reports he earns over \$400.00 a week printing Greeting Cards certain times of year. Get your share Now. Mail Coupon Today!

FREE SAMPLES - MAIL COUPON NOW

Mr. C. J. Nowak, Screen Print Co., 15127 S. Broadway
Los Angeles 61, California, Dept. 212

Dear Mr. Nowak! I am genuinely interested. Please rush your "FINANCIAL ASSISTANCE PLAN" Revealing Screen Print HOME BUSINESS Details, Real SAMPLES, and "HOW TO" BOOKLET. I am under no obligation now or ever.

Name _____

Address _____

City _____ Zone _____ State _____

ENGINEERING DEGREE IN

SCIENCE 27 or 36 MOS.

MATH

B.S. degree - 36 mos. • B.E. degree - 27 mos.

ACCELERATED YEAR-ROUND PROGRAM prepares for early employment in fields of SCIENCE AND ENGINEERING. Regular 4-year program for B.S. Degree completed in 36 months, special engineering degree program in 27. Classes start—January, March, June, July, Sept. QUALITY EDUCATION. Graduates employed from coast to coast. Government approved for veteran training. Students from 50 states, 40 countries. 20 buildings; dorms; gym. Campus. SAVE TIME AND MONEY. EARN BOARD while studying. Write for catalog and complete information.

INDIANA TECHNICAL COLLEGE

5121 E. Washington Boulevard, Fort Wayne 2, Indiana

Please send me free information on Bachelor's Degree Programs in Engineering and Science as checked below:

<input type="checkbox"/> Aeronautical Engineering	<input type="checkbox"/> Mechanical Engineering
<input type="checkbox"/> Chemical Engineering	<input type="checkbox"/> Metallurgical Engineering
<input type="checkbox"/> Civil Engineering	<input type="checkbox"/> Physics
<input type="checkbox"/> Electrical Engineering	<input type="checkbox"/> Chemistry
<input type="checkbox"/> Electronic Engineering	<input type="checkbox"/> Mathematics

Name.....

Address.....

ANALYZE HANDWRITING

MORE INCOME... MORE PRESTIGE and Greater PERSONAL Success!

YOU CAN learn how to identify character and personality traits from ordinary handwriting. Fascinating home-study training. Many career opportunities for both men and women, full or spare-time. Just send your name, address for a FREE sample lesson and big illustrated catalog. Free. No salesman will bother you. (State age).

Free!
GRAPHO ANALYSIS LESSONS

INTERNATIONAL GRAPHO ANALYSIS SOCIETY, INC.
325 W. Jackson Blvd., Dept. MN-2, Chicago 6, Ill.

WE'VE GOT the FORMULA



For Solving Your Problems

Planning to build your own garage? Need instructions to make a burglar alarm or bunk bed? Want help on plumbing or television repairs? Looking for plans for a model clipper ship or child's dollhouse?

SEND FOR YOUR FREE POPULAR MECHANICS SERVICE FILE

More than 600 subjects covered in Popular Mechanics library of books, booklets, blueprints, and patterns are listed in this tremendous reference file. Here's the handy guide which shows you where to find the answers to almost any do-it-yourself problem.

**POPULAR MECHANICS, Service Bureau, Room 528
200 East Ontario St., Chicago 11, Illinois**

Please send your free SERVICE FILE to:

Name

Address

City Zone State

New Table Top Invention Puts You In... **PROFITABLE RUBBER STAMP BUSINESS**

Home Operators now make
\$9.20 AN HOUR in Business
once monopolized by
a few big companies

Special rubber stamps bring high prices—cost only pennies to make on new, low-cost table top machine. Take 27 cents worth of material, make perfect stamps, the kind businesses and offices now buy by the dozen at \$1.80 each. Make up to \$9.20 an hour. Start in spare time in your own home. Run machine on kitchen table using ordinary electrical outlet. Make any kind of stamp. We'll send you free information without obligation about this established, highly profitable business. **We'll even help finance your start.** For free information send name and address today on a postcard to:
Rubber Stamp Div., 1512 Jarvis Ave., Dept. R-2-P, Chicago 26

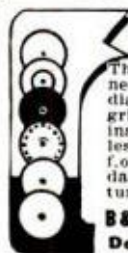

make your own *Gems* **36⁵⁰**
F.O.B.

The Gem Maker comes complete with all necessary equipment, including a super-charged diamond blade for sawing, and all the wheels for grinding, shaping and polishing; also complete instructions. The complete equipment as shown, less motor and belt for only \$36.50, I.O.B., Burlington, Wisconsin. Write today for information and literature.

B&I MANUFACTURING CO.
Dept. P, Burlington, Wis.



OPERATE A FIX-IT SHOP

Big money. Service household appliances, rewind motors, sharpen mowers, saws, do house wiring, etc. Every neighbor, stranger a prospect. We show you how to: get business, charge, buy spare parts wholesale, etc. **FREE BOOK.** Christy Trades School, Dept. A-1503, 3214 W. Lawrence, Chicago 25.



It's FUN to do **MAGIC TRICKS**

Amaze — mystify — entertain! Latest catalog 500 TRICKS showing new tricks, best magic for pocket, club, stage entertainment. Send 10¢ Dept. M-5, DOUGLAS MAGICLAND, BOX 274, DALLAS, TEXAS

A BUSINESS OF YOUR OWN REPAIR HYDRAULIC JACKS



Earn while you learn at home. Millions of jacks in gas and auto-service stations, truckers, body-shops, riggers, factories, farms need servicing. We show you HOW — easy step by step directions and what tools to use. **EARN UP TO \$5 an hour**, in spare time, in your basement or garage. Start your own business NOW! Write for folder PM 12 and free bonus offer
INSTITUTE OF HYDRAULIC JACK REPAIR
P. O. BOX 50 • BLOOMFIELD, N. J.
A Correspondence School Licensed by N. J. Bd. of Ed.

LAW FREE BOOK THE LAW TRAINED MAN

Write today for a FREE copy of illustrated law book, "THE LAW-TRAINED MAN," which shows how you can learn quickly at home the basic principles of all law topics through the famous Blackstone Law Course. All necessary books and lessons provided. Moderate cost; convenient monthly terms. Write for FREE law training book today.

Blackstone School of Law, 307 N. Michigan Ave.
Founded 1890 Dept. 59, Chicago 1, Illinois

75 POWER TELESCOPE 25X-45X-75X \$398

NEW 3 in one telescopes, 3 variable 25X, 45X-75X magnification. Brass bound, 25 power for ultra bright images 45 & 75 power for long range. Guaranteed to bring distant stars, moons, objects, sports 75 times closer.



Most powerful scope sold anywhere near this amazing low price. American made, 5 sections.

Opens 36", closes 1 ft.; contains 4 ground & polished lenses. Can also be used as powerful compound microscope. Mass production enables us to offer telescope complete at \$3.98 postpaid. Money back guarantee.
CRITERION CO., Dept. PMB-100; 331 Church St., Hartford, Conn.

94.6% OF BAILEY GRADUATES ARE EMPLOYED AT TOP PAY IN THE FIELDS WHICH THEY WERE TRAINED!

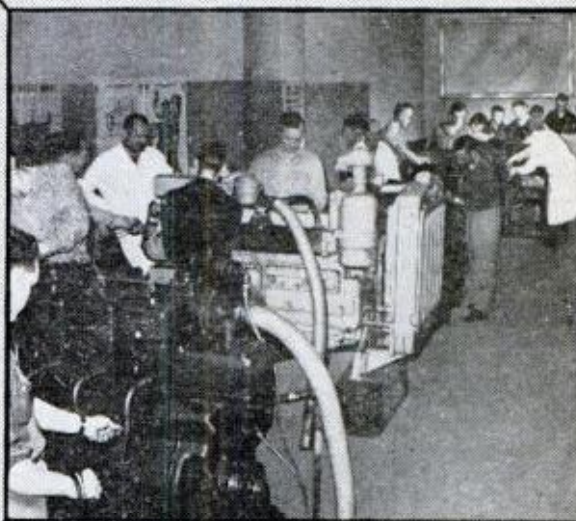

DIESEL-AUTO MECHANICS DESPERATELY NEEDED!

We have a far greater demand for our students than we can fill!

We can show you an actual waiting list of leading companies throughout the world who have tried Bailey graduates — found them outstanding, and are coming back for more!

Bailey Graduates are Successful . . . RECEIVE BIG PAY — HAVE SECURE FUTURE!

The Famous Bailey Course prepares you for BOTH Diesel and Gasoline Mechanics.

This is a must—due to the advent of using Diesel principles, such as 'Fuel Injection' on passenger cars . . . use of gasoline engines for starting Diesel engines, etc. You learn all this at Bailey in the amount of time ordinarily required to learn just one of these subjects, **ALL FOR THE PRICE OF ONE.**

Don't be satisfied with a 'futureless', one-type job — learn how you can make big money now! Write today for Free Booklet that takes you on a step-by-step camera tour through our spacious, modern shops — See Bailey students in action as they Learn-by-doing with the Famous Bailey Method of training!

We provide you with housing and part time jobs while in school, plus nation-wide placement service for graduates.

BAILEY Technical SCHOOLS

1634 S. GRAND ST. LOUIS 4, MO.

MAIL TODAY!

Please mail immediately this free booklet without obligation.

FREE BOOKLET



Name.....

Address.....

City..... State.....

APPROVED FOR VETERAN . . . NON-VETERAN



PLAY RIGHT AWAY ANY INSTRUMENT

—even if you don't know a single note now!

Now it's EASY to learn ANY instrument. No boring exercises. Even if you don't know a single note now you can play delightful pieces — from your FIRST lesson! BY NOTE. Make amazing progress. No special "talent" needed. Learn at home in spare time. Without a teacher. Low cost! Soon you can play popular music, hymns, classical and any other music. Over 1,000,000 students, all over the world.



FREE BOOK. Send this ad with your name and address filled in below, to: U. S. SCHOOL OF MUSIC, Studio A3012, PORT WASHINGTON, N. Y. (No obligation, no salesman will call.) Chartered by N. Y. State Education Dept. Est. 1898.

Name

Address

Be Sure to Include Zone No., if any.



Helps You Overcome FALSE TEETH Looseness and Worry

No longer be annoyed or feel ill-at-ease because of loose, wobbly false teeth. FASTEETH, an improved alkaline (non-acid) powder, sprinkled on your plates holds them firmer so they feel more comfortable. Avoid embarrassment caused by loose plates. Get FASTEETH at drug counters everywhere.

STEP UP to BENJAMIN'S TRADITIONAL EXCELLENCE!

DISCOVER the BIG DIFFERENCE that EXPERT CRAFTSMANSHIP can Make in Your SHOOTING PERFORMANCE and FUN!

25 MODELS — SINGLE SHOT and REPEATERS — FIRST CHOICE of SHOOTERS who want SAFETY — CONVENIENCE — ECONOMY including HIGHEST QUALITY MATERIALS to Assure Them OUTSTANDING POWER — ACCURACY — DEPENDABILITY!

No. 3600
\$19.95

No. 2600

World Famous AIR GUNS and CO₂ GUNS

<p>No. 2600 BENJAMIN Super 35-Shot BB Gas Pistol. Safe — No Pumping — Uniform Hi-Power. For Target & Small Game. \$18.95</p> <p>No. 2620 BENJAMIN 20-Shot Cal. 22 Gas Pistol. Economical. \$20.95</p> <p>No. 1300 50-Shot BB Air Pistol \$23.50</p> <p>No. 1320 BENJAMIN 35-Shot Cal. 22 Air Pistol \$25.50</p>	<p>No. 3600 BENJAMIN Super 100 Shot BB Gas Rifle. Non-Toxic — Safe — Convenient — Uniform Hi-Velocity Power. →</p> <p>No. 3620 BENJAMIN Super 85 Shot Cal. 22 Gas Rifle \$21.95</p> <p>No. 3100 Super 100 Shot BB Air Rifle. Adj. Shooting Force \$24.95</p> <p>No. 3120 BENJAMIN Super 85 Shot Cal. 22 Air Rifle \$26.95</p>
---	---

FREE Catalog All Models Benjamin Single Shot & Repeaters — Cal. BB or 177 or 22. Also, Special Hunting & Fishing Knife Offer.

BENJAMIN AIR RIFLE CO., 896 MARION ST., ST. LOUIS 4, MO.
You Can DEPEND on... BENJAMIN

Items from all outdoors

PM's baseball detectives turned up an interesting sidelight during their investigation of the "jackrabbit baseball" (see page 82). They picked up a hot lead that the ping-pong ball ain't what it used to be, either. Some table tennis players and sporting-goods dealers claim that the modern ball is neither as lively nor as durable as the ball of a few years ago, though the manufacturer of the tournament ball insists that it's still made with the same materials and by the same processes. The argument seems to be as hot as the baseball controversy was this summer. Anyone interested in a full-scale investigation?

Russell Tinsley's survival article in the August and September issues of PM aroused a lot of interest among PM's outdoor readers. Several asked for sources of information on wilderness survival techniques for the nonwoodsman. The same mail brought a letter from Mr. G. C. Stanley, of Orlando, Fla., who recommended George and Jacques Herter's *Professional Guide's Manual, volume one*, as the best book he'd seen on the subject.

I found a copy of the 260-odd page book, originally written for the North Star Guide Assn., and spent an interesting week end browsing through it.

I'm inclined to agree with Mr. Stanley — the book covers subjects I've never seen in print, and should make a good guide for anyone suddenly stuck with outdoor living.

It is divided into sections on fishing, hunting, camping, cooking, boating, first aid, clothing and dogs, and is crammed with such subjects as how to make jerky and pemmican, how to get rabbits out of their burrows, how to fish through thin ice, how to make "brush butter," how to eat algae, and a thousand other things.

Between useful sections you'll find such interesting odds and ends as the odds on twin births among elephants, the Kodiak bear's method of catching salmon, and how to get a dog to drop a retrieved bird when he won't let go. (Blow in his ear.) (But pick a friendly dog.)

The manual is published by Herter's, Inc., of Waseca, Minnesota, and is available by mail for \$1.60.

Dick Kieckhefer

POPULAR MECHANICS

Only \$29.95 STARTS YOU IN YOUR OWN BUSINESS

Place these self service tube testers in Drug, Grocery, or Hardware stores. And have a profitable full or part time business of your own.

- 22 Socket, 2 Control Tester Panel
- Large Attention Getting Back Sign
- Tests Over 900 Tubes
- Locked Tube Storage for 600 Tubes
- Console Cabinet 20" Wide, 18" Deep, 66" High, Weight 55 Lbs.

Used (Tested Before Shipment) \$29.95, Reconditioned \$39.95. Accessory Kit contains 3 fibre tube trays with partitions and suggested inventory sheets plus 2 fluorescent tubes for back sign \$8.95.

All Prices F.O.B. Indpls., Ind., or Phila., Pa.
25% Deposit on All C.O.D. Orders Subject to Prior Sale

DELMAR ENGINEERING CO.
3602 DELMAR ROAD, INDIANAPOLIS 20, IND.

TELEPHONE HANDSETS



Use as inter-house phone, talk house to garage, as loud speaker system, etc. You receive transmitter, receiver, 3 conductor cord and simplified, illustrated installation diagrams. Handsets are guaranteed to be the same as used in our great National Telephone System. Price delivered \$2.95. Two for \$5.00! Private telephone system's for offices, factories, motels and drive-in restaurants. Information on request.

TELEPHONE REPAIR AND SUPPLY CO.
DEPT. PM-139 1760 Lunt Ave., Chicago 26

PROFIT IN YOUR SPARE TIME
SMALL ENGINE REPAIR PAYS BIG!

Outboard • Powermower • Chain Saw • Tractor
MAKE EXTRA MONEY — or fix your own engines and SAVE! Illustrated, easy-to-learn Home Study Course qualifies you as expert. Free information. Write today!

LINCOLN TECHNICAL INSTITUTE
SUITE 12-E, 472 MARKET STREET, NEWARK 5, N. J.

FREE GERMAN STEEL HUNTING KNIFE

4-INCH BLADE

We give you handiest hunting and fishing knife you've ever had! Has 4-INCH LONG highly tempered steel blade—VERY SHARP! Attractive handle. We send knife FREE to acquaint you with our below-wholesale bargains. Please send 25c for handling. NO LIMIT—but send 25c handling for each knife. Order TODAY!
HUNTING KNIFE, Dept. K-629, Box 881, St. Louis, Mo.

CONCRETE BIRD BATHS AND OVER 250 OTHER MONEY MAKING ITEMS

You've seen them all over the country . . . concrete bird baths, garden seats, flower boxes, appealing statuary, and many other items that add charm around the house and lawn. They're made by enterprising people, just like you, from our COPYRIGHTED ALUMINUM MOLDS. It's easy. It's fun. It's profitable.

Send \$2.00 today for this 82-page "How to" book. 20 pages of clear instructions. Valuable trade secrets. Over 250 items beautifully pictured (with description, dimensions, and prices of molds). Rushed to you by first class mail.

CONCRETE MACHINERY CO., INC.
HICKORY 2, NORTH CAROLINA

Name _____
Address _____

HOW TO TURN CONCRETE INTO GOLD

FREE CAREER BOOKLET

YOUR CAREER
M.S.O.E.

To guide you to a successful future in

ELECTRONICS RADIO-TV COMPUTERS ELECTRICAL ENGINEERING

This interesting pictorial booklet tells you how you can prepare for a dynamic career as an Electrical Engineer or Engineering Technician in many exciting, growing fields:

- MISSILES • AVIONICS • AUTOMATION
- SALES • DEVELOPMENT
- ELECTRICAL POWER • ROCKETRY
- RADAR • RESEARCH

Get all the facts about job opportunities, length of study, courses offered, degrees you can earn, scholarships, part-time work — as well as pictures of the Milwaukee School of Engineering's educational and recreational facilities. No obligation — it's yours free.

MILWAUKEE SCHOOL OF ENGINEERING

MAIL COUPON TODAY!

Milwaukee School of Engineering
Dept. PM-1261, 1025 N. Milwaukee St., Milwaukee, Wis.

Please send FREE "Your Career" booklet

I'm interested in

Electronics Radio-TV Computers

Electrical Engineering Mechanical Engineering

Name _____ Age _____
PLEASE PRINT

Address _____

City _____ Zone _____ State _____

I'm eligible for veterans education benefits.
Discharge date _____

MS-117

On the market



1. PEPPER-MILL KIT with matching salt shaker consists of all necessary hardware to put together your personally designed set. Now you can make use of that choice piece of hardwood you've had around so long. Kit includes detailed instructions. The 4-in. size sells at \$2.98; 8-in. size at \$3.25 ppd. Peppermill Kits, 1972 Fullerton, Costa Mesa, Calif.

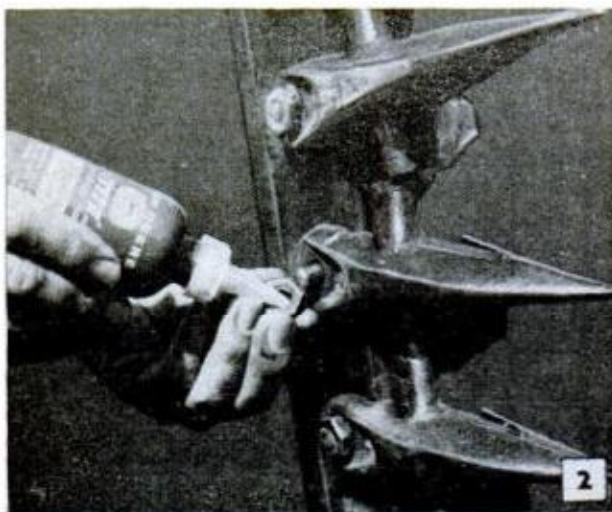

2. LIQUID LOCKING COMPOUND for studs and bolts permits selecting the amount of locking friction you desire. Loctite sealant remains wet while exposed to air. When confined between close-fitting parts, metal catalyzes material into tough, plastic bond. Makes any threaded part self-locking. Comes ready to use. American Sealants Co., Hartford 11, Conn.



3. HATE TO CHANGE sanding disks? Temporary spray adhesive allows you to apply and peel off disk five times before another application is needed. Not a glue. Now you can use your own disks cut from large sheets. Adhesive may be sprayed on paper and other materials. Acts as third hand. Priced at \$1.39. Stanley Tools, 195 Lake St., New Britain, Conn.



4. LIQUID RUBBER squeezed from a tube permanently eliminates battery terminal corrosion. The flexible rubber coating may be stripped away whenever terminals must be removed. Other uses include repairing rusted mufflers, auto body holes, upholstery tears and similar work. Retail at 98 cents a tube. Manufactured by Devcon Corp., Danvers, Mass.

5. ABRASIVE-COATED MYLAR sandpaper (Flex-I-Grit) may simply be flexed to clean. Tough plastic back is said to last much longer than ordinary sandpaper. You can fold, roll or crumple it—perfect for irregular shapes and hard-to-get-at places. Pack of five sheets (4½x5 in.), in different grades, 49 cents. Raybestos-Manhattan Inc., Passaic, N. J.

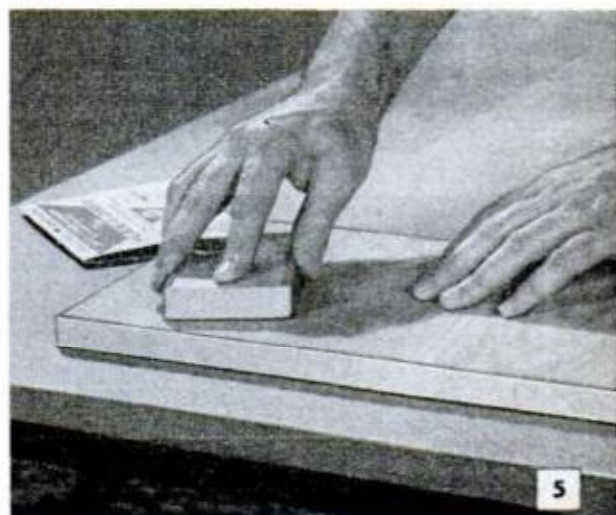

MAKE MORE MONEY

Be A **MASTER TECHNICIAN**
In One Of
AMERICA'S BIG 3 INDUSTRIES



FREE BOOK

ELECTRONICS TELEVISION-RADIO



Includes...
**RADIO SET
TV SET
MULTITESTER**

Business of Your Own or High-Pay Career in...
Service & Repair
Broadcasting & Communications
Hi-Fi & Stereo Sound Systems
Electronics for Guided Missiles
TV-Radio Manufacturing
Industrial Electronics
Automation & Computers
Radar & Micro Waves
TV-Radio Sales
FCC License Preparation

DON'T BE HALF-TRAINED

A Successful Career... Security...
Are Yours NOW in Modern Industry!

RIGHT NOW IS THE BEST TIME for you to get into the field of your choice! You can be a part of its growth, you can increase your earning power, you can really build a Successful, Secure Future. Send coupon for complete facts by mail...NO SALESMAN WILL CALL!!!

N.T.S. TRAINS YOU RIGHT, FAST and EASY! Incomplete "short-cut" training limits your earning power, disqualifies you for top-pay jobs. N.T.S. Shop-Tested Home Training is...

- ★ BETTER—classroom developed, lab and shop-tested, industry-approved, home study designed.
- ★ MORE COMPLETE—you learn All Phases and you receive Everything You Need for Success...
- ★ LOWER COST—One Master Course at One Low Tuition gives you more training at lower cost.

TRAINING PAYS FOR ITSELF AND MORE... Earn your tuition—and more—while in training. We'll show you how. Many students have...so can you!

RESIDENT TRAINING AT LOS ANGELES

If you wish to take your training in our famous Resident School in Los Angeles—the oldest and largest school of its kind in the world—write for special Resident School catalog and information.

ACCREDITED
MEMBER



NATIONAL HOME STUDY SCHOOLS
World-Wide Training Since 1905
4000 South Figueroa Street
Los Angeles 37, Calif., U.S.A.

AUTO MECHANICS & DIESEL



FREE BOOK

Includes...
**TOOLS
SOCKET SET
ANALYZERS**

Business of Your Own or High-Pay Career in...
Service & Maintenance
Motor Tune-Up
Automatic Transmissions
Diesel & Fuel Injection
Overhauling & Rebuilding
Automobile Air Conditioning
Electrical Systems
Automatic Power Devices
Industrial & Marine Engines
Foreign Car Sales & Service

AIR CONDITIONING REFRIGERATION ELECTRICAL APPLIANCES



FREE BOOK

SEE
OTHER
SIDE

Includes...
**TOOLS
GAUGES
TESTER**

Business of Your Own or High-Pay Career in...
Air Conditioning—Refrigeration
• Domestic & Commercial
• Industrial & Mobile
Installation & Contracting
Automobile Air Conditioning
Electrical Appliances
• Small & Major
• Heating, Motor & Comb.
Sales, Service & Repair
Mfg. & Distribution

GET THE BENEFIT OF OUR OVER 50 YEARS EXPERIENCE

**SEND FOR
FREE BOOK**

(FULLY-ILLUSTRATED) AND
ACTUAL LESSON
IN FIELD OF YOUR CHOICE

**NO POSTAGE
NECESSARY**

NO POSTAGE NECESSARY

CUT OUT AND MAIL THIS CARD TODAY

For **FREE Fully-Illustrated Opportunity Book** and **Actual Lesson** In the Field of Your Choice.

**CHECK
ONE
ONLY:**

- ELECTRONICS-TV-RADIO
 AUTO-MECHANICS & DIESEL
 AIR CONDITIONING-REFRIGERATION-
ELECTRICAL APPLIANCES

**CHECK
ONE
ONLY:**



Name _____ Age _____

Address _____

City _____ Zone _____ State _____

Check here if interested **ONLY** in Resident Training at Los Angeles.

Dept. B-121

Veterans: Give date of discharge _____

NO SALESMAN WILL CALL... THERE IS NO OBLIGATION

DON'T BE HALF-TRAINED...

your N.T.S. Master Course gives you everything you need for success in **ANY ONE** of these "BIG THREE" Fields.



ELECTRONICS TELEVISION-RADIO

YOU ARE NEEDED in All Phases of Electronics-TV-Radio... Servicing, Communications, Broadcasting, Manufacturing, Automation, Radar and Micro-Wave, Missile and Rocket Projects, plus all the other high-pay

branches of this vigorous industry. N.T.S. Shop-Tested Home Training gives you ONE MASTER COURSE... at ONE LOW TUITION... to train you for these unlimited opportunities, including many technical jobs leading to supervisory positions.

YOU BUILD MANY EXPERIMENTAL AND TEST UNITS with parts we send you. You advance step-by-

step, perform more than 100 experiments, and build a TV set and a Superhet Receiver. You also receive a valuable Multitester for your repair, service and trouble-shooting job projects.

A FULLY ILLUSTRATED Book and an Actual Lesson are yours for the asking. Check card below and mail NOW... TODAY!

AUTO MECHANICS and DIESEL

TAKE YOUR CHOICE. Be a successful all-around car, truck and heavy-engine Mechanic... Or specialize in your favorite field: Tune-Up, Automatic Transmissions, Farm Mechanics, Trucks and Buses, Stationary Installations, Foreign Cars

... Or get into Auto Air Conditioning, Engine Rebuilding, Diesel and all the other high pay fields... Or go into business for yourself. Remember... a qualified ALL AROUND MECHANIC always has a good job!

YOU GET AND KEEP VALUABLE PROFESSIONAL EQUIPMENT. We give you the tools of your trade: a Complete Set of Mechanic's Tools

in an ALL-Metal Tool Box... a Motor Analyzing Set... plus a Top Quality Socket Wrench Set with Fittings.

PROVE IT TO YOURSELF. Our streamlined lessons, manuals, and other training materials are easy to understand, completely practical and right up-to-date. N.T.S. gives you everything. Mail card TODAY and find out for yourself!

AIR CONDITIONING REFRIGERATION and ELECTRICAL APPLIANCES

FUTURE BRIGHT FOR TRAINED TECHNICIANS. Over 30,000 new Technicians must be trained annually to help service and repair the 50 million air conditioners, refrigerators and appliances that will need fix-

ing this year alone. You can go places in your own business or with a manufacturer, dealer, distributor or department store. With N.T.S. All-Phase training, your earning power is unlimited!

JOB TRAINING AT HOME. You get Professional Technician's Tools, Precision Instruments, plus a Factory-Made Appliance Tester... for your

experiments and job projects, for your Spare Time Work while in training, and for your service and repair work later on.

DON'T LOSE OUT—FIND OUT. We'll rush you our big, fully illustrated Book and Actual Lesson. No obligation and it costs you nothing to find out. Mail card TODAY... DO IT NOW!

SEE OTHER SIDE

FIRST CLASS

Permit No. 3087

Los Angeles, Calif.

BUSINESS REPLY MAIL
NO POSTAGE STAMP NECESSARY IF MAILED IN THE UNITED STATES

— POSTAGE WILL BE PAID BY —

NATIONAL TECHNICAL SCHOOLS
WORLD-WIDE TRAINING SINCE 1905

4000 So. Figueroa Street
Los Angeles 37, California

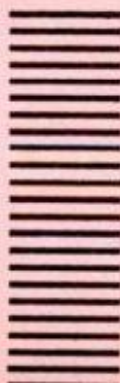

ACCREDITED MEMBER



Train With Confidence... N.T.S. is an Accredited Member of the National Home Study Council... The only nationally recognized accrediting agency for private home study schools.



NATIONAL TECHNICAL SCHOOLS
WORLD-WIDE TRAINING SINCE 1905

Address correspondence to Dept. B
4000 So. Figueroa Street
Los Angeles 37, California

Science bulletins

Men soon may be able to dive 3000 feet to the ocean floors and work there for several hours without suffering ill effects. One effect, "rapture of the deep," has up to now, prevented such deep plunges. When seized by the rapture divers were apt to do foolish things, such as cutting off their air supply.

Dr. Hannes Keller and Albert Beuhlmann, Swiss biochemists, have made experiments indicating the rapture develops when high-pressure oxygen and carbon dioxide accumulate in the blood. They have worked out a formula employing new gas mixtures that will be fed to the diver at the proper depth. Also, they propose new rates of ascent and decompression.



When immature male mosquitoes get too hot, they grow up to be females, say University of Illinois researchers. Except for a slight difference in certain feelers, the males are indistinguishable from normal females.



Earn money sleeping? University of Texas researchers have found that even a sleeping person can perform better, if he is motivated. They promised more money to volunteers for an experiment to determine how sleeping people can respond to sounds if they would wake up each time they heard a telephone ring or bagpipes play.

With the promise of extra pay, the volunteers differentiated between telephone bells and doorbells, and collected.



One bee sting can bring another, according to two Cornell scientists. After pulling out 5000 honeybee stingers (from the bees), the busy men found the bees secrete an "alarm odor" on their stingers which tags an intruder who comes near the hive. He is then a marked target for more stings.



Tense modern pigs are getting ulcers maybe because they are kept in confinement, according to a report from the University of Wisconsin. Scientists there plan a four-year study to see if pig ulcers are similar to people ulcers.

James Biery

DECEMBER 1961

Especially for APPLIANCE REPAIRMEN! YOU NEED ELECTRIC APPLIANCE SERVICE NEWS

EASN—now in its 12th year—is the Only Publication Serving the ENTIRE Appliance Repair Field.

EASN LISTS sources of supply for parts on all types of household electric appliances, such as washing machines, dryers, ironers, vacuum cleaners, ranges, sewing machines, toasters, irons, mixers, coffeemakers, and so forth.

EASN OFFERS a "Buyers' Guide," listed alphabetically by product name, to help you get the parts you need.

EASN ADVERTISERS send free mailings of catalogs and other pertinent market data to readers from time to time.

EASN BRINGS NEWS of appliance repair schools and clinics in your area.

EASN OFFERS editorial material covering industry news with articles on techniques used by service firms, technical information, and industry trends.



505 N. LA SALLE ST.

CHICAGO 10, ILL.

TRIAL OFFER

ELECTRIC APPLIANCE SERVICE NEWS

(Published Monthly)

505 N. La Salle St., Chicago 10, Ill.

GENTLEMEN: Enclosed find Check Money Order Stamps

Cash to cover my subscription as I have indicated below:

\$1.00 for 4 months trial subscription, or

\$2.00 for 1 year \$3.00 for 2 years \$4.00 for 3 years

By (Individual)

Firm Name

Street

City..... Zone..... State.....

(Please enclose your business card or letterhead stationery) PM

DECORATIVE MASONRY CAN EARN BIG PROFITS



Patio stones, screen block, and brick are among the many items of garden masonry which can allow a mark-up of 300% or more on basic costs. And yet sold at prices low enough to build a large volume of sales. No other line of concrete products is so rich in market and income potentials.

You can make these profit-producing quick selling items on the new, compact Versacrete machine. With hydraulic movements and automotive controls it makes manufacturing easy and reduces labor costs. Self-contained; can be set up anywhere. Requires only a modest investment—which can be paid on time when preferred. Write for interesting literature.



W. E. DUNN MFG. CO.
401 W. 24th Street
Holland, Mich.

VERSACRETE

V-4

THE MAIL-ORDER BUSINESS CAN BRING YOU FULL-TIME OR SPARE-TIME PROFITS

*Scores of goods and services are sold by mail every day.
Here's how you can make profits with this opportunity.*

by F. L. Krimston

A story is told about the door-to-door salesman who decided to advertise his product and sell it by mail. His business increased so greatly that in one week he made more profit than he had in a whole year of door-to-door soliciting.

This story emphasizes the fact that there are profits to be made in direct mail selling. It's the type of business that offers a unique opportunity to start your own enterprise without the necessity for a large financial investment. In fact, some of the largest companies in the country started as mail order operations.

You can start your own direct mail business on a part-time basis without interrupting your regular job. It can be a valuable source of extra income, and profits can be used to expand the business to a full-time operation.

Thorough Preparation Needed

To be successful a mail order business must be established on a sound basis. This means that you must thoroughly study all the ins and outs of mail order selling by reading mail order journals and publications and possibly by interviewing successful businessmen in the field. It's also important that you use plenty of that good old American talent, ingenuity in selecting the product or products to be sold and in bringing these products to the attention of your potential customers.

Many a successful mail order business

has begun with an investment of less than \$1,000. Success isn't as dependent on the amount of money invested as it is on good judgment, the right type of sales promotion and sound budgeting.

Probably the most important factor in product selection is your own knowledge and interest in the product. You must thoroughly understand the product you intend to sell; know its uses, values and exclusive features. You must be so enthusiastic about your product that it is relatively easy for you to "sell" the need for the product to potential customers.

For example, one successful direct mail operation is based on the sale of a booklet on fishing secrets. The booklet was prepared by an avid fisherman who became convinced that his fishing techniques could help other fishermen. Specially selected advertising and mailing lists enabled the author to promote the sale of his booklet to other fishermen; and, before long, he had underway a small but profitable business.

Honesty Essential for Success

Although honesty is an important quality for any businessman, it is of particular importance to the mail order dealer. The growth of any mail order business depends in large part on the sale of new products to customers that have already purchased other products from you. If you do not live up to your advertising claims, your customers will not buy from you again and one

(Continued on page 40)

Magic Mail Plan—Make up to \$5 an Hour!



THIS MAN ... is taking out of the machine a Plastic Sealing Job—ordered by mail—only 11¢ in material cost brings back \$2.58 in cash by mail. Capacity of machine: \$25.00 profit per hour of operation.

Get **ORDERS** and **CASH** from your mailman—do work in **SPARE TIME** at home—or expand into **FULL TIME** business. Send coupon for Free facts about the newest and most fascinating of all home operated businesses. For the first time a simplified machine brings the fabulous profits of **Plastic Sealing** and **Plastic Laminating** within the reach of the small operator. Anyone can learn to operate the machine with a few minutes practice—then with our **Magic Mail Plan** can get mail orders pouring in daily with cash in every envelope. **No canvassing—no selling.** We even

Get into PLASTIC LAMINATING at home

WE'LL EVEN HELP FINANCE YOU supply the circulars you mail to bring back cash and orders, financing help, too. Rush name. We'll send you **FREE** and postpaid, pictures, prices, details, finance plan, all the facts you need. Mail coupon or send name on postcard. No charge. Warner Electric Co., 1512 Jarvis Av., Dept. L-2-P, Chicago 26, Ill.

Make Thousands of Beautiful Art Creations

COSTUME JEWELRY • CIGARETTE BOXES TRAYS • CANDLES/TICKS • COASTERS LAMP BASES • BOOK ENDS...ALL IN SPARKLING COLORED PLASTIC



WARNER ELECTRIC CO., 1512 Jarvis Av. Dept. L-2-P, Chicago 26, Ill.

At no cost to me, please rush full details and financing plan, postage prepaid. No obligation.

Name _____

Address _____

City _____ Zone _____ State _____

BARBELLS

100 POUND SET \$14.80

Extra Plates Only 14c Pound

140-Pound, CHROME DELUXE Barbell-Dumbbell set only \$22.80. This is our feature set and is the finest ever manufactured.

Training with adjustable weight is the **BEST** way to keep fit; the **ONLY** way to develop great strength and a perfect body. As the oldest and best equipped barbell company, BUR gives value and prices no one can equal.

SEND FOR FREE CATALOG
BUR BARBELL CO.
 Lyndhurst 9, New Jersey

LEARN TO MOUNT BIRDS

ANIMALS, FISH, PETS

Be a Taxidermist. Save your hunting **TROPHIES**. Have a fine home-museum. Hunters, save and **MOUNT** your beautiful **DUCKS, QUAIL, DEER, TAN** skins and **FURS**. Great Fun. Sure-time **PROFITS**.

FREE BOOK Tells ALL about it. 100 fine wild-game pictures. 48 pages. Send **TODAY**, don't delay. Get this **WONDERFUL FREE BOOK, MEN AND BOYS**. Learn Taxidermy. Double your hunting pleasure. Rush letter or **POSTAL** today. **STATE AGE**. N.W. SCHOOL OF TAXIDERMISTRY, Dept. 2512 Omaha, Neb.

FREE to everybody in America!

RADIO SHACK'S exciting 1962 Electronics CATALOG



Plus every new issue for one full year. Each is packed with values like these:



New Realistic Tube Checker Kit \$15.95 Realistic 2-speed Tape Recorder \$54.95 Realistic Stereo Amplifier Kit \$10.95 10-Transistor Portable Radio \$29.95

We want everyone to have a free subscription to Radio Shack's famous catalogs! All you have to do is clip out a coupon below (there's one for you, one for a friend) and mail it right away to start your catalogs coming. Through the year, you get at least 5 books loaded with the latest and best in electronics.

You receive our latest 340-page book and timely supplements illustrating over 100,000 items. 30 pages of fascinating new kits to build yourself and save. Stereo, Hi-Fi, Ham Radio, Tape Recorders. Vast selection of records, pre-recorded tapes. Parts and Accessories... all guaranteed to satisfy you. No Money Down credit terms.

Mail a Coupon to **RADIO SHACK Corp.** 730 Commonwealth Ave., Boston 17, Mass.

Please send one year of Radio Shack Catalogs FREE		Please send one year of Radio Shack Catalogs FREE	
Your Name _____	61M3	Your Name _____	61M3B
Your Address _____		Your Address _____	
City _____ State _____		City _____ State _____	
Name of a friend _____		Name of a friend _____	
Address _____ 61M3A		Address _____ 61M3C	
City _____ State _____		City _____ State _____	

CASH FOR YOU-



Electric APPLIANCES

Learn at Home • \$3 to \$5 an Hour
Spare Time, Full Time • Be Your Own Boss

FREE BOOK tells about profitable business you can run — right at home. Repair Electric Appliances, using simple tools. Pays \$3-\$5 an hour!

CASH IN ON THIS BIG BOOM 400 MILLION Appliances are in American homes right now. People need them fixed. You make good money doing it. In your basement, garage, even your kitchen.

QUICK WAY TO GET STARTED For less than 20¢ a day our

easy, pictured instruction — backed by 45 years of success in home-training — prepares you for top earnings. Earl Reid of Thompson, Ohio says: "Made \$510 in one month spare time." At no extra charge you get Appliance Tester, too. Finds trouble-spots, checks your work.

Get your **FREE Book** and **FREE Sample Lesson!** Mail coupon below, letter or post-card, now.



NATIONAL RADIO INSTITUTE, Appliance Div.
Dept. AN1, Washington 16, D. C.

Send Free Book, Free Appliance Repair Course Lesson. Am interested in:

- Spare Time Earnings My Own Business
 Better Job

Name.....

Address.....

City.....Zone.....State.....

Accredited Member National Home Study Council

Free World's Biggest Catalog of 2900 NOVELTIES

Send 10c for new 1962 catalog of novelties, live animals, scientific supplies, hobbies, funmakers, planes & boats, looms, magic tricks, joke articles, unusual seeds, gadget time-savers, cameras, optical goods, projectors, movies, lucky jewelry, religious novelties, disguises, musical instruments, stamps, coins, puzzles, fortune tellers, radios, auto & bike accessories, telescopes, magnifiers, compasses, banks, smokers' gadgets, artists' supplies, printing sets, engines, motors, shockers, knives, billfolds, guns, rifles, sports, books, games, plants etc. Send Stamp or coin for postage.

JOHNSON SMITH COMPANY Dept. 545 Detroit 7, Michigan

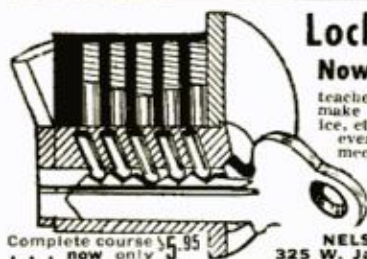

Locksmithing AND KEY MAKING

Now Made Easy! Practical up-to-date course teaches you how to pick locks, de-code, make master keys, repair, install, service, etc. New self-instruction lessons for every handyman, homeowner, carpenter, mechanic, service station operator, fix-it shop, hardware dealer, gunsmith. 53 easy illustrated lessons. Full price only \$5.95 postpaid; or C. O. D. plus postage. Satisfaction or refund guaranteed.

NELSON-HALL CO., DEPT. MN-2
325 W. Jackson Blvd. Chicago 6, Ill.

Complete course \$5.95
... now only \$3.95

Saber saw from an old sewing machine head? Plans for this clever conversion will appear in the January issue of **Popular Mechanics**.

RUPTURE!

An amazing Air-Cushion Invention allows body freedom at work or play. Light, neat, cool, sanitary. Durable, cheap. Day and night protection helps Nature support weakened muscles gently but surely. No risk. Sent on Trial! Write NOW for free Booklet and Proof of Results. All correspondence confidential.



Brooks Company, 143-E State St., Marshall, Mich.

of your most important sources of extra sales will be eliminated.

There are three types of direct mail business: those offering a product for sale, rendering a service, or supplying information. The products sold by mail today are extremely varied. They include houses, worms, furniture, stamps, jewelry, insects, coins, magic tricks—the list is almost endless. Many direct mail businesses supplying information sell books or pamphlets on a particular subject. Booklets on such varied subjects as "How to Get a Raise," "How to Make Money" have been successful mail order sellers. Photo developing and watch repair are examples of the many services sold by mail.

Buyers Like Unusual Products

In deciding the product or service you would like to sell, it's important to keep in mind that mail order shoppers like the unusual, the product that can't be bought in the local store, or the product or service with some special appeal.

After your product or service has been decided, you have to examine manufacturing costs, advertising and mailing expenses so that you can determine an asking price. Markups have to be high enough to cover all costs and still allow a margin of profit. Markups range anywhere from one-third to three-fourths of the original price, depending on the nature of the product or service and the demand.

Selecting a source of supply is a step that should take a good deal of consideration. If your product is something made at home, there is no problem, unless it might be in supplying the demand. If the product is manufactured elsewhere, however, a reliable source must be found. If possible, several manufacturers should be compared as to cost, quality, distance and delivery time. It's important that suitable transportation be available so that your product can move from the manufacturer to you at minimum cost and maximum speed.

How to Sell

The next step in setting up your own direct mail business is to decide how you will sell your product.

Many profitable direct mail businesses have started with an inexpensive classified ad in a newspaper or magazine. In most

(Continued on page 42)

POPULAR SHOPPING

worth
writing
for...

"Home Painting and Color Guide" is the title of 48-page, 4-color booklet available for 10¢. It shows many attractive color combinations and takes you step-by-step through painting interior and exterior surfaces. Write to the Du Pont Co., Dept. PM-61, Wilmington 98, Del.

Pruning is vital to good plant growth. A 25¢ booklet contains 38 pages of valuable information on how and when to prune shrubs, trees, flowers, hedges, vines and lawns. Ask for "How to Prune" from Seymour Smith & Son, Inc., Dept. PM-62, Main St., Oakville, Conn.

Workshop projects are featured in the 25¢ booklet "101 Home Workshop Projects for Wood Rasps and Files." File techniques are also included. Write Nicholson File Co., Dept. "Proj.," Providence, R. I.



NATIONAL BRAND VITAMINS 25% to 50% Discount

Government Protection. Registered pharmacists fill every vitamin order. Same day service. Geritol Tablets 100's \$4.75, postpaid. Write for free price catalog.

APPROVED MEDICAL SUPPLY
SERVICE, Dept. PM
900 RUSH ST., CHICAGO 11, ILL.

UNUSUAL TOOLS BY MAIL

#44 CORNER CLAMP & MITER BOX COMBINED

Holds the wood.
Holds your saw.
Accurate cuts
with any handsaw from 0° to 180°.
Full 3" capacity. Sides exposed for
mailing and gluing. \$2.75 ppd.
No. 33. Same as No. 44 without saw
guide attachments. \$1.75 ppd.



EASY SAW FILER

No. 11 Gives correct
height, depth, pitch, be-
vel to any 6" to 10"
hand or circular saw with
no side pull. Includes
8" file. \$9.95 ppd



SAW SET

automatically
sets teeth
at 10° or more
\$2.95 ppd



DRILL GRINDER

Sharpens round shank
drills like new with hand
or power grinders \$2.95
ppd.



MONEY BACK GUARANTEE
A. D. MCBURNEY, 5908 Hollywood
Blvd., Hollywood 28, Cal. Dept. A-12

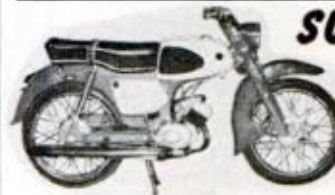

SUZUKI

Model
50 MC
\$295
F.O.B.L.A.

50 m.p.h. — 4 speeds 180 m.p.g. **ELECTRIC STARTER**

**BOAT DEALERS—SPORTS CAR DEALERS
—SPORTING GOODS DEALERS . . .**

Start making money right NOW! Sell SUZUKI Motorcycles, the high quality, lightweight line from Japan. Ideal ride for everyone, gives you added High Revenue.

Write for
full details,
no
obligation.

Ken Kay

DISTRIBUTING CO.

13054 SHERMAN WAY, NO. HOLLYWOOD, CALIF.

FOR EVERY SPORTSMAN

NEVER • LOSE ANOTHER LIGHTER
• RUN OUT OF FLUID
• RUN OUT OF FLINT

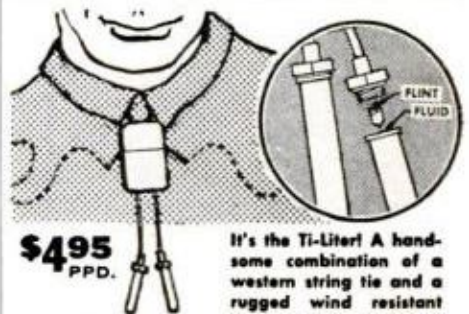

\$495
PPD.

It's the Ti-Liter! A hand-
some combination of a
western string tie and a
rugged wind resistant
lighter. You can't lose it
once you've put it around your neck. Hollow
metal tips on tie hold extra supply of flints
and fluid, so you can't run out. It's ideal for
the active, outdoor man. Order yours today.

SEND CHECK OR MONEY ORDER TO
TI-LITER INC., P. O. BOX 1026 N
SIOUX CITY, IOWA

\$6.95

DORMEYER

COMPLETE HOME
HAIRCUTTING SET
SAVE \$50.00 A YEAR
ON HAIRCUTS

So easy to use, anyone who
can comb hair can get
professional haircutting re-
sults. The professional
electric clippers actually
work on a comb principle.
Special instruction book.
Set includes guide for
tapering neck and sides—
blend guide for fine trim-
ming—plus all items pic-
tured—only \$6.95. SU-
PER DELUXE SET with
deluxe adjustable taper
clipper, plus right and left
taper adjustments, neck
duster, sharpening com-
pound and bang cutter only
\$8.95 postpaid.

NIRESK INDUSTRIES, Inc.
Dept. PM-2
CHICAGO 47, ILLINOIS

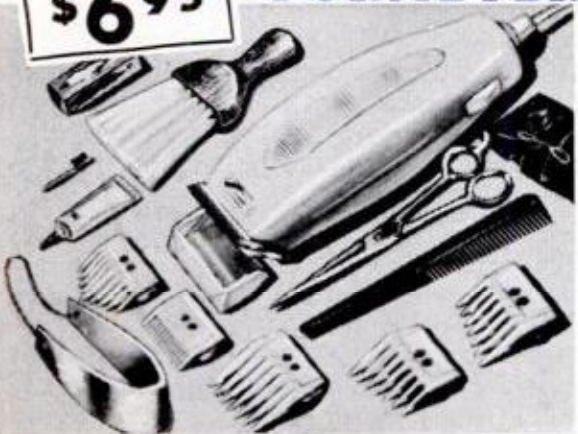

9' x 12'
PLASTIC TARP

33 1/3 c
min. order
three tarps

These giant transparent, durable plastic
tarps protect floors, upholstery, carpets,
furniture, cars, boats, bikes, etc., from
weather, paint, dust, grease, dampness.
Scott Mitchell's tremendous quantity buy-
ing facilities now make this amazing offer
possible:

MINIMUM ORDER 3 TARPS for \$1 plus
25¢ for postage and handling. Just think of
it—three 9 x 12 foot tarps, 324 square
feet of rugged protection for just \$1.25.
That's how much just one of these fabulous
tarps formerly cost.

SCOTT MITCHELL HOUSE, INC.
Dept. PM5-1, 415 S. Broadway, Yonkers, N.Y.

LEARN UPHOLSTERY

in your spare time
run your own
business
AT HOME



FREE BOOK
with
sample
lessons

With Course
You Make

**SLIPPER
CHAIR**

**CLUB
CHAIR**

OTTOMAN

PLUS
SLIP COVERS
Yours to Keep
or Sell

BE YOUR OWN BOSS

Earn more from the start in spare time. STOP worrying about layoffs, enjoy a steady growing income and independence for life in the booming field of Custom Furniture Upholstery. Right off, you start upholstering with the tools, complete frames, fabrics and materials. Included **FREE** with N. Y. State-approved UTS Home Study Course. You learn skilled professional custom upholstery, reupholstery, furniture finishing, repairs, how to make beautiful slip covers, cushions and draperies. **EARN WHILE YOU LEARN**, in your spare time **AT HOME** . . . the UTS easy way.

FREE ILLUSTRATED BOOK—FREE SAMPLE LESSON
Get ready for well-paid job and big profits, from steady work, as your own boss, running your own business. Mail coupon NOW for **FREE BOOK!** Training in N.Y. School also available. **VET APPV'D. ACCREDITED BY N.H.S.C.**

UPHOLSTERY TRADES SCHOOL
Dept. PX-310, 721 B'way, N. Y. 3, N. Y.

Please send me **FREE** book, "Your New Way to a Successful Career," and **FREE** sample lesson. No obligation—no salesman will call.
 Home Study Training in N. Y. School

Name

(Please Print Plainly)

Address

City Zone State

Check if Korean Veteran

MAGIC TRICK BARGAIN



FUN, MAGIC, MYSTERY FOR ALL!
Chance of lifetime! Amaze & mystify others! Be Life of Party! Get double your money. Only 1.00 brings you Tricks with Eggs, Cards, Cigarettes, Mind Reading, and lots of others! You can do them all! Hurry! Limited offer. Act now and get 160 Page Giant Catalog of 1000 other Tricks too!

CATALOG ALONE 25¢ TERRIFIC!

OVER \$200 WORTH OF TRICKS for only \$1.00 POSTPAID

HOUSE OF 1000 MYSTERIES, DEPT. PM1261, TRUMBULL, CONN.

NEW BENSEN GYRO-COPTER



Plans and kits for one-man "Spirit of Kitty Hawk" now available. Easy to build and fly. 3-view drawings, specs, photo \$2 or simpler Copter Glider \$1. Order today!

BENSEN AIRCRAFT CORP., Dept. PM-121
Raleigh-Durham Airport, Raleigh, N. C.

NAME

ADDRESS

Excitement! Security! Good Pay!

CRIME DETECTION

LEARN AT HOME IN SPARE TIME—START NOW!

Crime everywhere is on the rise! Learn now, in your own home, the profitable profession that enables you to track down criminals and bring them to justice! Hundreds of Identification Bureaus employ I. A. S. graduates . . . trained in finger printing, police photography, handwriting identification, firearms and investigation. Our 44th year! **FREE "Blue Book of Crime"** . . . packed with crime facts and the full story of famous I. A. S. training. State exact age. No salesman will call. Rush Coupon!

A Correspondence School Founded in 1916.

FREE Blue Book of Crime MAIL COUPON

INSTITUTE OF APPLIED SCIENCE, Dept. 1359
1920 Sunnyside Avenue, Chicago 40, Ill.
Rush Blue Book of Crime . . . **FREE!**

NAME

ADDRESS

TOWN STATE

cases this classified ad would offer free descriptive sales literature on the product or products sold. Names of readers who replied to the ad are kept on record for future mailings of sales literature, and the names of readers who actually bought the product are separated and also kept for future use.

This is usually the most inexpensive and effective way to start a mail order business. The cost of classified ads vary according to the publication in which they appear. They are invariably an economical means of informing the public about your product, if they are carefully prepared and placed in a publication whose readers might be expected to be interested in your product.

In all cases, it is important that you insert a special key number in each ad you run. In this way you can be sure you are getting good results from the publications you use and you can test the quality of the copy you use in your ad.

As your profits grow, you buy more advertising, and you continue to expand in this way until you are ready to offer a new product. Then you can send your sales letter, brochure or catalog to those who have replied to your advertising. If your new product is related to the original item (for example, you might have offered a type of fishing equipment as your original product and then branch out with a different type of fishing equipment) you can expect good returns from your original customers and inquirers.

Mailing Lists Available

It is also possible to buy selected mailing lists from companies who specialize in providing such lists. If you are selling a product that would appeal to new mothers, for example, you can buy or rent a list of new mothers. Ordinarily, you can find mailing list houses in your local phone directory.

Usually, you can expect that a mailing list built up from inquirers and customers who have responded to your ads will produce better results than a list bought or rented from an outside source.

When making promotional mailings, you should keep in mind that your mailing piece actually takes the place of a salesman. Your mailing piece must "close the deal" for you and has to be carefully prepared. You must stress the exclusive features of your prod-

(Continued on Page 44)

twenty to one dividend . . .

that's the reward you can receive from a college education in engineering or business. Employers like Tri-State graduates . . . interview seniors on campus. Qualify faster. Bachelor of Science Degree in 27 Months in Electrical (Electronics or Power major), Mechanical, Aeronautical, Chemical, Civil Engineering. IN 36 MONTHS a B. S. in Business Administration (General Business, Accounting, Motor Transport Management majors). For earnest, capable students. Small classes. More professional class hours. Modernized buildings, well-equipped labs, new dorms. Modest costs. Year-round operation. Enter January, March, June, September. Founded 1884. Write J. E. McCarthy, Director of Admissions for Catalog and "Your Career" Book.



TRI-STATE COLLEGE

4121 College Avenue Angola, Indiana

HELP WANTED—SPARE TIME

SENSATIONAL NEW LONGER-BURNING LIGHT BULB. Amazing Free Replacement Guarantee—never again buy light bulbs. No competition. Multi-million dollar market yours alone. Make small fortune even spare time. Incredibly quick sales. Free sales kit. MERLITE (Bulb Div.), 114 E. 32nd, Dept. C-15M New York 16, N.Y.

In Canada: Moga Co., Ltd., 371 Dowd St., Montreal, P.Q.

LEARN MEAT CUTTING



Train quickly in 8 short weeks at Toledo for a bright future with security in the vital meat business. Big pay. Full-time jobs—**HAVE A PROFITABLE MARKET OF YOUR OWN!** Pay after graduation. Diploma given. Job help. Thousands of successful graduates. Our 38th year! Send NOW for FREE catalog. No obligation. GI approved. NATIONAL SCHOOL OF MEAT CUTTING, Dept. 50-Z, Toledo 4, Ohio



get into operating or repairing EARTH MOVING EQUIPMENT

Men needed now for good paying jobs in booming road and construction work. Learn operating or repair-rebuilding of heavy road machinery, cranes, bulldozers, earth carriers, etc. Actual "on the job" training. 5 to 13 1/2 week courses. Classes start every Monday. Reserve your space now. Complete catalog and reservation facts FREE. Approved for veterans. Write

Greer TECHNICAL INSTITUTE
Attn.: P. O. Hutch, Box 368, Braidwood, Ill.

NEW WESTERN HAIG .12 CALIBER SPECIAL FACTORY OFFER!



\$300 post-paid

USES POWDER CHARGE

This small bore gun shoots .12 cal. lead bullets fired by small 4.4 mg. powder charge. Not a CO₂ gun! You'll like the handsome lines, grip, and balance. Western in style, but patented ball and cap action allows this low price. 9 3/4" steel barrel cased in knurled styrene stock, overall 13 1/2". Develop pistol form, accuracy at a fraction of cost of large caliber pistols. Comes with 50 lead bullets. Satisfaction guaranteed. Send \$3 to: HAIGMFG. CO., P.O. Box X-4, Alhambra, Calif.

DECEMBER 1961

EARN \$750 WHILE TRAINING!



H. G. HENDRIX of Gretna, La., says:
"During my training period I was able to earn \$750! I think the school is wonderful. Every step in the Locksmithing course was so easy. Thanks again to your school and to my instructor."

Be a LOCKSMITH

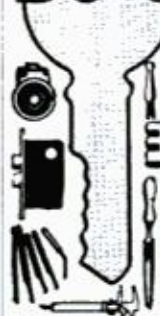

Add 50%-100% to YOUR INCOME with easy spare time earnings. Cash in on nationwide shortage—trained locksmiths in demand! Quickly step into a big-pay opportunity job—high-profit shop of your own.

Earn Extra Money RIGHT AWAY! All Special Tools, Supplies Furnished FREE.

Age, education, minor physical handicaps don't matter in this growing trade. You can quickly qualify as a skilled locksmith. Study at home as little as one hour a week. Gain practical experience through well-illustrated lessons. Do real jobs on car locks, house locks, padlocks and safe locks, under the guidance of experts.

MAIL COUPON FOR FREE BOOK

For a future as your own boss or in a high-pay job, write now for FREE illustrated book! Only school of its kind. Lic. State of N.J., Accredited NHSC. Locksmithing Institute, (Div. Tech. Home Study Schools) Dept. 112-1, 150 Park Ave., E. Rutherford, N.J.

MAIL COUPON NOW!

LOCKSMITHING INSTITUTE, Dept. 112-1
150 Park Avenue, E. Rutherford, N. J.
Please send Free Illustrated Book without obligation.

Name (print) _____
Address _____
City _____ Zone _____ State _____

Check if Veteran _____

ELECTRONICS

Train in the new shop-labs of the world famous



COYNE ELECTRICAL SCHOOL

on a quarter of a million dollars worth of equipment or learn at home in your spare time with Coyne's modern television training.

Use this coupon to get our FREE BOOK "GUIDE TO CAREERS"

COYNE ELECTRICAL SCHOOL training at Coyne training at home
1501 W. Congress Pkwy. Dept. of Electronics 41-Y Chicago 7, Ill.

NAME _____
ADDRESS _____
CITY _____ STATE _____

Unlike most other schools, we do not employ salesmen.

WANTED!

**Mechanically Inclined
Men to Qualify for
BIG PAY JOBS
AND SPECIAL FACTORY
TRAINING IN DIESEL**



"We need qualified repairmen, operators, mechanics NOW!", say Diesel Manufacturers, Highway Builders, Truck Line Operators in every corner of America. Can you qualify for these High Pay Jobs? We can help you! Interstate's General Course and Cummins-approved Diesel home-training courses are internationally recognized. Advisory placement service for trainees. Don't wait. Men are needed NOW!

Get the Facts Today!

WRITE INTERSTATE TRAINING SERVICE

Dept. A-3, Portland 12, Oregon

Rush information on I.T.S. Diesel Courses, Special Factory Training and Diesel Job Opportunities.

Name _____ Age _____
Address _____
City _____ Zone _____ State _____



BIG MONEY OR EXTRA INCOME Home Appliance Repair

**LEARN
TO EARN
MORE...
QUICKLY
AND
EASILY!**

Wide-open field for men of all ages. Millions of Home Appliances need fixing... Every home is your market for Full-Time Career or Spare-Time "Second Income" opportunities. Save on your own repairs. N.T.S. Shop-Tested HOME TRAINING is streamlined, modern, low-cost, practical. Qualifies you fully and you start earning early in your course. Includes Tools and Appliance Tester. Send for FREE Opportunity Book and actual lesson. No Obligation. No Salesman Will Call!

**NATIONAL TECHNICAL SCHOOLS Dept. HB-121
Los Angeles 37, California**

Name _____ Age _____
Address _____
City _____ Zone _____ State _____

**FREE
BOOK**



CARTOONING IS * EASY NOW

Famous System of Manual Training brings a complete new conception in Art Instruction at home... Cartooning is a wonderful profession that offers Men and Women a wide field rich in unequalled opportunities to make good money. It is worth while to get the facts. Ask for free information today.

Continental Schools, Inc.
DEPT. E-82, 4201 S. BROADWAY, LOS ANGELES 37, CALIF.



WHOLESALE Electric Guitars - Parts - Factory to You

Professional electric solid body Spanish guitars, amplifiers, electric bass, double-necks, triple-necks, tone changers, double-neck Spanish, electric mandolin, pickups. Parts to outfit your own 1962 Models wholesale — Free catalog.

CARVIN CO., Box 287, PM-4, Covina, Calif.



FREE

MUSCLE BUILDING INFORMATION

Sensational New Methods

Less Time—Less Effort—Better results

BODY-TONE, Box 638, North Miami 61, Fla.

(Continued from page 42)

uct or service—show how these features can benefit the reader. Try to put on paper all your enthusiasm for your product or service in such a way that your own feelings will be transmitted to your potential customers.

Keep Mailing List Current

You should take steps to keep addresses on your mailing list up to date so that you don't waste the money you invest in your direct mail selling. Third class mailings are not returned to you if you have used a wrong address unless you imprint "Return Postage Guaranteed" on your envelopes. If you imprint "Request Form 3547" on your envelopes, the Post Office will, for a small charge, return misdirected mail and notify you of address changes.

Postal regulations are an important governing factor in direct mail selling, and you should be thoroughly familiar with the various types of mail and size and weight restrictions. A copy of "Postal Guide" is available from the Superintendent of Documents, Government Printing Office, Washington 25, D. C. and this will give you the information you will need on postal regulations.

You should also be familiar with the rulings of the Federal Trade Commission which prevents unfair methods of competition and deceptive practices in the sale of goods in interstate commerce. For information, you can write the Federal Trade Commission, Washington 25, D. C.

Fill Orders Promptly

Now that you have a manufacturer for your product and a method to sell your product by mail, you must be ready to fill orders. A system should be devised so that orders can be handled quickly and efficiently. Records should be kept on each shipment for future reference and follow-up business.

Find the best possible way of packaging your product and take precautions to prevent breakage. It can be costly to have to replace shipments that have been damaged while in transit.

Careful record keeping is a must in the direct mail business. Not only is this necessary for tax purposes, but it gives you a good indication of how business compares

with previous years and months, lets you know whether or not you're increasing your sales, and gives you an indication of what kind of profits you might expect in future months.

Unless strict zoning ordinances prevent it, you can operate your mail order business from your home. If this is not possible, or undesirable for any reason, you might want to use a Post Office box number as the address for your orders and correspondence. This can be disadvantageous in that some people have more confidence in sending their money to a street address rather than a Post Office box. Careful selection of a company name can help give potential customers extra confidence in dealing with you for the first time.

Another Way to Get Started

There are companies who specialize in helping you get started in the operation of your own mail order business. Some of these companies sell you advice on how to get started, others sell a plan telling you steps to take, and others sell you products and literature.

Before taking advantage of such offers, examine them carefully. Seek advice from those who are already selling by mail to get their opinions and be sure before you invest your money.

It is possible for such companies to save money by ordering goods, promotional literature and catalogs in large quantities, quantities far larger than you would be apt to order for your own use. These savings are passed on to you by a reputable company. Such services can be of value if you anticipate selling a wide variety of merchandise, rather than specializing in one product or a group of related products.

Satisfaction, Plus

To men who have been in direct mail selling for many years, there is no greater satisfaction than arriving at their place of business on Monday morning to find a stack of orders waiting to be filled.

It's a money-making satisfaction that can be yours. For additional information write Popular Mechanics, Department MO, 200 East Ontario Street, Chicago 11, Illinois.

DECEMBER 1961

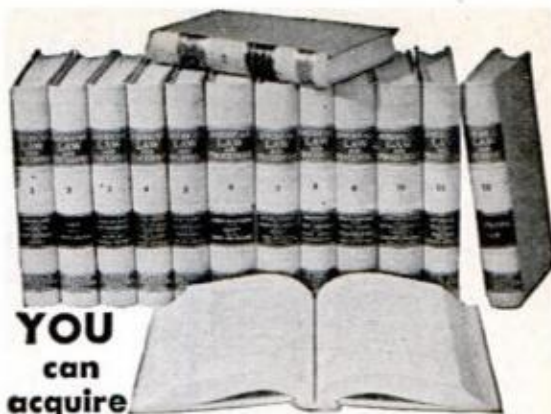

**YOU
can
acquire**

LAW AT HOME! **EARN LL. B. DEGREE**

LaSalle's famous Law Library—used as reference in many Law libraries and Law offices—has enabled thousands to master Law surprisingly fast, in spare hours at home, for business and professional advancement.

These 14 remarkable volumes, compiled by leading professors and lawyers, cover the whole basic field of Law in condensed, orderly, simplified manner.

You advance rapidly with this great library, plus special lectures furnished. We guide you step-by-step with personalized Problem Method of instruction...you *learn by doing*—handling legal problems—not by memorizing rules.

Send for two FREE booklets, "Law Training for Leadership," and "Evidence," answering questions about Law and its value to you. Mail coupon below. No obligation.

Accredited member, National Home Study Council

LA SALLE EXTENSION UNIVERSITY **A Correspondence Institution**

417 S. Dearborn St. Dept. 1264-L Chicago 5, Ill.

Send me your two FREE booklets described above, without obligation.

Name

Age

Street

City, Zone & State

GET INTO ELECTRONICS

V.T.I. training leads to success as technicians, field engineers, specialists in communications, guided missiles, computers, radar, automation. Basic & advanced courses in theory & laboratory. Assoc. degree in 29 mos. B.S. obtainable. ECPD accredited. G.I. approved. Graduates with major companies. Start Feb., Sept. Dorms, campus. H. S. graduate or equivalent. Catalog.

VALPARAISO TECHNICAL INSTITUTE
DEPT. D VALPARAISO, INDIANA

"\$7,108⁵⁰ NEW!"

**FIRST YEAR
Cleaning-
Repairing
RADIATORS."**



—Hank Konter, Newcastle, Wyo.

Make \$6,000-\$9,000 a year servicing auto-truck-tractor radiators with Inland's new 1-Piece Radiator Shop. Easy to do entire job—TEST, CLEAN and REPAIR radiators. Only 11' 7" long. Inland, world's largest radiator equipment manufacturer, trains you free. Small down payment starts you. Easy-pay plan lets you pay from profits. Proved merchandising assures volume. Profitable department for garage or service station. Many set up Radiator Shop in garage at home, make good money working evenings. Write.

INLAND MFG. CO., Dept. PM-12, 1108 Jackson St., Omaha 2, Nebr.



Earn **HIGH WAGES** as a
HEAVY EQUIPMENT OPERATOR

... and years of future security in the multi-billion dollar construction industry, in this country and overseas! Actual field training at National, the original school of heavy equipment operation, teaches you how. For men ages 17 to 56. Amount of previous education no barrier. No correspondence courses, no series of required home-study lessons in advance of training. Train on school-owned diesel-engined machines at National's huge proving ground in North Carolina, VA approved. Budget terms available. Write TODAY for FREE catalog. No obligation, no salesman will call. Special information is included for men in the Services and for those subject to call.

NATIONAL SCHOOL OF HEAVY EQUIPMENT OPERATION, Dept. D-23
P. O. Drawer 1686, Charlotte, N. C.

Please send me **FREE** illustrated school catalog and complete information.

Name Age.....

Address

City Zone..... State.....

MAKE YOUR HOME WORKSHOP PAY OFF
in spare time or full time income
ELECTRICAL APPLIANCE REPAIR



Turn spare hours into cash profits. Millions of Home Appliances need fixing. Every home is your market for Full-Time Career or Spare Time "Second" Income.

Costs Less Than \$1.50 A Week. All you need is a workbench, spare time and N.T.S. Home-Training in Electrical Appliance Repair. You get a professional appliance tester, tools, and easy-to-learn, practical instructions, fully illustrated. Start earning early in course. Mail coupon now. No obligation. No salesman will call.

NATIONAL TECHNICAL SCHOOLS
WORLD-WIDE TRAINING SINCE 1905
4000 So. Figueroa Street
Los Angeles 37, Calif., U.S.A.

FREE BOOK and ACTUAL LESSON

NATIONAL TECHNICAL SCHOOLS
Los Angeles 37, California

HB-121

Name Age.....

Address

City Zone..... State.....

ONLY \$1.00 TO START YOUR OWN BUSINESS

Sample, Automatic Fire Alarm, complete with Battery, postpaid to you for only \$1.00. You can make \$1000.00 a month and more. **WE GUARANTEE LEADS FOR YOU.** Send today for your Alarm, and complete details... this should be the opportunity you've been looking for.



"FIRE KING"

819 "FIRE KING" BLDG., ENGLEWOOD, COLORADO

Secrets of VENTRILOQUISM Now Revealed!



Easy to learn in 60 to 90 days with our Home Study Course. **RESULTS GUARANTEED** Make Money! Be Popular! Have Fun! Big Opportunity! Radio, Television, Stage Appearances! For **FREE** information regarding price and terms **WRITE.** You must state your age. Dummy Catalog 25c. **MAHER HOME COURSE OF VENTRILOQUISM** Box 36, Studio PM-12, Kensington Station Detroit 24, Michigan

Don't miss PM's exciting 60TH ANNIVERSARY SPECIAL next month!

TOOLS WHOLESALE

\$1.00 PUTS YOU IN BUSINESS

Start your own business, sell tools to your friends and neighbors, or buy tools for your own use and **SAVE MONEY \$\$\$**

A MILLION DOLLAR INVENTORY AT YOUR FINGERTIPS. NO STOCK TO CARRY. ORDER AS YOU NEED IT.

BUY AT WHOLESALE PRICES. Extra \$25.00 profit on your accumulated purchases. \$1.00 refund on first purchase or refunded if you are not 100% satisfied.

THOUSANDS!! of Nationally Advertised items of Hand Tools, Power Tools, Machinist Tools, Tool Chests, Paint Sprayers, Light Fixtures, Appliances, Guns, Gifts, Toys and other items too numerous to mention.

WE SHIP COAST TO COAST Wholesale Disc. up to 50% off

Dept. **SILVO HARDWARE CO., PM-12107 Walnut St., Phila. 6, Pa.**

Shrinks Hemorrhoids New Way Without Surgery Stops Itch - Relieves Pain

For the first time science has found a new healing substance with the astonishing ability to shrink hemorrhoids and to relieve pain - without surgery.

In case after case, while gently relieving pain, actual reduction (shrinkage) took place.

Most amazing of all - results were so thorough that sufferers made astonishing statements like "Piles have ceased to be a problem!"

The secret is a new healing substance (Bio-Dyne®) - discovery of a world-famous research institute.

This substance is now available in suppository or ointment form under the name Preparation H®. Ask for it at all drug counters.



CLASSIFIED ADVERTISEMENTS



Advertisements in this section \$1.30 per word, each insertion, minimum 10 words, payable in advance. To be inserted under proper classification, copy must be in our office the 18th of the second month preceding date of issue
F. W. Johnson, Manager, Classified Advertising
 Popular Mechanics, 200 East Ontario Street, Chicago 11, Illinois

YOU'LL PROFIT

By reading and answering the classified ads in this section. Hundreds of opportunities for you to make and save money

AUTOMOBILES, MIDGET CARS

AUTOMATIC Transmissions our factory rebuilt exchange. Any car \$89.50. Guaranteed. Transparco, 5525 Chicago, Chicago 51, Ill.

HORSELESS Carriages, 1899; The Pierce-Arrow; More About 1899 Horseless carriages; Romantic Tales a Century Ago; \$1.35 each. Life, Love, and Living, 1857; Body and Mind, 1857; News Kaleidoscope, 1857; Susie Garland, 1869; \$1 each. Entertaining scrapbooks by author of Those Were The Good Old Days. All 8 for \$8. Box 1015, Schenectady, N. Y.

SMALL Car owners: power kits \$5.95 up. Safety and comfort items. Fish Canadian, Willowdale, Ontario, Box 26.

1960 **FORDS**, Dodges \$599. Stamp brings details. D. Nickell-C, 637 Federal, Bend, Oregon.

HOTSPARKK. Starting, pep, mileage \$4.50. Airoplugs, varitypers, mimeos, multiliths. EG, Elmsford, N. Y.

AUTOMOBILE Literature: Catalogs, photos, manuals; antique, modern. Monthly bulletin. Non-profit hobby club. New members get free premium. Write: Auto Enthusiasts, Box 451B, Mt. Clemens, Michigan.

AUTO SUPPLIES AND EQUIPMENT

BIG New line electric switches and switch panels. Nothing like them available before. Hundreds uses cars, trucks, trailers, planes, boats. Attractive. Rugged. Free brochure. Grgreg Accessories, Rtes. 1 and 13-P. Morrisville, Penna. An affiliate of Autosport, Inc. BMC, Daimler, Jaguar.

PARTS And accessories catalog for Ford Model "A." Everything to renew, rebuild and renovate your '28-'31 Model "A" Ford. Send 10¢. J. C. Whitney, 1919 QM-12 Archer, Chicago 16, Ill.

HYDRALIC Jack repair kits. Free catalog. Free "Silent-Salesmen" with each kit. Hydraulic Jack Packing & Tool Co., P.O. Box 50, Bloomfield, N. J.

AUTO Shop welding repair training in world's largest non-profit welding school. Low tuition. Free booklet. Hobart Welders, Box M-1211, Troy, Ohio.

STOP Oil pumping, 10,000 mile guarantee \$2.95. Park, 16161 Mark Twain, Detroit 35, Mich.

JUST Out! New 356 page, illustrated catalog offering savings up to 50% on over 100,000 auto parts and accessories, everything to renew, rebuild, renovate '28-'31 Model "A" Fords. All makes (1920 to 1961 models), trucks, foreign and sports cars. Hollywood accessories, custom styling, hi-speed equipment. Send 25¢ for postage, packing—refundable on first order Whitney, 1919 PM-12, Archer, Chicago 16, Ill.

RADAR King plans \$1.00. Wardell Smith, 65 Glenwood Road, Upper Montclair, New Jersey.

SAVE Your tires. New type tire pressure gauge. Accurate, easy to read 1 1/4" dial. Includes leather case \$3.10. Omega, Empire State Bldg., New York 1, N. Y.

END Oil changes. Double engine life. Box 1296, Denver 1, Colorado.

SNO-DRIVE, Traction units. Be the first to use this amazing new invention. Emergency type fits all disc wheels. Price \$9.00 ppd. Permanent type, keep on wheels all winter. Fits all General Motors, Ford and other flush axle cars and small trucks. Price \$19.00 ppd. No c.o.d. Units fit under wheel covers, cannot be seen. Amaze others driving through snow, etc. without chains. Works on new propulsion principle. Order now. Give year—make of car. Money back guarantee. Bateson's Inc., Dept. C, 4408 Market St., Wilmington 2, Dela.

TRANSISTORIZED Electric ignition systems. The greatest improvement since the original Kettering 1910 ignition invention. Can be used on 6 and 12 volt automobiles, trucks, race cars, boats with negative ground. Complete conversion kit \$44.95. Specify car and voltage. Brochure available. Bill Slep Company, Drawer 178PM, Ellenton, Florida.

JEEP Owners—V8 conversions. Read Jeep Owners ad, page 20.

ELECTRONIC Ignition analyzer checks plugs, coil, points, condenser, timing, while in motor \$4.95. Guaranteed. COD's. Details free. Teletronix, Box 646, Sandwich, Mass.

"CPM 1000" \$1.00. Space technology compression power. Maintenance, Box 4159, Los Angeles 54, California.

PARTS, Model "A." List 25¢. (Refundable) Matco, Box 135, San Pedro, Calif.

JEEP Parts! For military and civilian. At great savings. Largest inventory. Catalog for owners and dealers. Inquiries invited. American Auto Parts Co., 1830-PM Locust, Kansas City, Mo.

RING-Valve job while driving, \$6.00 postpaid. Guaranteed! Nothing like it! Lasts 100,000 miles! Motaloy, Grantham, Penna.

NEW And used parts at savings. Complete guaranteed parts service for all models cars and trucks. Largest in the West. Jeep and army parts specialists. Newest type shifting hubs for all jeep and all military and latest production front end drive vehicles. \$27.50 and up. Also, foreign car parts. Write. Pioneer Auto and Truck Parts Co., 734 W. 13th Avenue, Denver 17, Colo.

COPPER Tubing. For all purposes. 50 foot coils, 1/4", \$4.85; 5/16", \$5.99; 3/8", \$7.49. All other sizes in stock. Freight prepaid. B and H Metal Company, P.O. Box 615, Boston 2, Massachusetts.

1909-1934 **FORD** Parts illustrated catalogs 75¢. Mark Auto, Layton, N. J.

WILLYS Jeep tops, \$87.50. Mor-Nan, Box 141, Beverly, Mass.

INCOMPARABLE "Voxon" theft-alarm. Proven, untouchable! Cameron, Box 2131, Cleveland 8, Ohio.

TUBELESS Tire repairs—on the wheel. Kit of ten with tool \$1.50. Twenty \$2.00. Woodmont, 123P Hampton, Winchester, Ky.

AUTO TRAILERS

BUILD Expanding eight foot trailer. Accommodates five. Literature 10¢. Fra-Mar Company, Wilmington, Mass.

BUILD 5 Different camping travel trailers. Manual plans \$2.00. Circulars 30¢. Kamcraft, Box 1153, Milwaukee 1, Wis.

MOTORCYCLES, BICYCLES, MOTORSCOOTERS AND SUPPLIES

RECONDITIONED Motorcycle motors. Chrome accessories. Complete stock Indian parts. Expert rebuilding. Fast service. Indian Motorcycle Sales, Kansas City 27, Missouri.

BIKE Motors, front wheel drive \$69.95. Go-Byk Industries, Rothsay, Minn.

GO CART \$10. Servicycle \$5. midget car \$10, less engines. Engines \$7.50 up. 3 wheel Cushman \$40. (Mail order only). Send 25¢ (35¢ for First Class mailing) for directory-catalogue Number 104 listing these and hundreds of other bargains in go carts, motorscooters, homebuilders parts, plans, etc. Midget Motors Directory, Athens, Ohio.

MOTORCYCLE Parts. New, used. List 25¢. Ballak, 811 N. 9th, St. Louis 1, Mo.

HARLEY-Davidsons—Used bargains. New, used parts, accessories, all models. Bulletin 25¢. Knuth's (Factory Dealer), 1753 Muskego, Milwaukee, Wis.

AVIATION

PROPELLERS, Plans, supplies for airboats, snowplanes. 125 h.p. Lycoming engines \$135.00. Prompt delivery. Catalog 25¢. Banks-Maxwell Propeller Co., Box 3301E, Ft. Worth 5, Texas.

AIRLINE Careers. Adventure! Prestige! Promotion! Four-week course. Free placement service with 35 airlines. G. I. approved. Free catalog B. McConnell Airline School, 1030 Nicollet, Minneapolis, Minnesota.

BE A government licensed aviation mechanic. Write for free booklet. Aero Mechanics School, Municipal Airport, Kansas City, Missouri.

SMALL Helicopters Theory and Guide Manual. Drawings. Construction data. \$2.00. Greater Plains Industries, Box 482A, O'Neill, Nebraska.

HOME BUILT Helicopter handbook \$1.00. Directory \$1.00. Urshanair, Box 197, Santee, California.

BATTERIES, GENERATORS

PROFIT! Repair batteries! Complete manual \$3.00. C.O.D. accepted. Bayer Publications, N938 Betty Avenue, Neenah, Wisconsin.

BATTERY Bluebook. Send \$1. Little Pal, D1105-5th, McKeesport, Penna.

START Your own battery business. Manufacture, rebuild, repair. Easy with large 121-page manual. No job worries. Batteries, P.O. Box 341, New Castle, Penna.

ELECTRICAL SUPPLIES

BOOK 200 Electric stunts \$1.00. Kuttington, 875 Arastradero, Palo Alto, Calif.

LAMPS. 25¢ Brings parts catalog. Refunded first order. Gyro, 5203P N.W. 35th Ave., Miami 42, Florida.

ELECTRO-SCRIBE! Engraves all metals. \$2.00. Beyer Mig., 10511-H Springfield, Chicago 55.

GARAGE Door operator kits—Edwards KR-50 kit. Available with or without remote car control. Priced from \$59.95. Edward T. Fink Co., Inc., 284 Nepperhan Ave., Yonkers, N. Y., Dept. PM.

LAMP, Appliance, vacuum, range parts wholesale. Illustrated dealers catalogue 25¢. Seco, 112 South 20th Street, Birmingham 3, Alabama.

LAMP, Electrical parts, wholesale. Thousands of items for repairing, converting. Catalog 25¢. Brown Lamp, Box 305, Clayton 5, Mo.

WELDING, SOLDERING, PLATING

WELDERS. 110/220. \$39.50. Morris, 1070 Inner Drive, Schenectady 3, New York.

PLATING Equipment and supplies. Save 50% and more on new fiberglass tanks, DC power units. 50 amp, 6 volt DC power supply \$97.50; 100 amp, 6 volt \$145; other sizes from 5 amps to 250 amps. Easy terms. Mix your own solution and save. Newest formulas and operating data for all types of plating, equipment guide and catalog \$1.00. HBS Equipment Division, Dept. L5, 1624 E. First St., Los Angeles 33, Calif.

ARC Welder Manual only 50¢. Regular \$1.00 value. Tells how to weld every job. Emerson Electric, 8100 Florissant, St. Louis, Missouri.

ACETYLENE Outfits \$59.50; arcwelders \$69.50. Eagle Welding, Dept. PM, 5085 Broadway, Chicago 40, Ill.

FREE Welder catalog. Kits, build 350-ampere welder using aircraft generator, plans. 25¢. LeJay, Minneapolis 20, Minn.

MACHINERY, TOOLS, SUPPLIES

STRAIGHT Edge, accurate, extra hard, tool steel 30" long, \$3.00 p.p. Daco Mfg. Co., Woodsville, N. H.

SAW Set \$1.50, free list. Overland's Saw Service, Independence, Iowa.

POWER Tools and accessories. Free list. Roberson, 14M Brooks Drive, Austell, Georgia.

ENGINES, MOTORS, DYNAMOS

SAVE \$200. Brand new Wisconsin VF-4 25 h.p. complete \$215. Save \$30. Brand new Briggs & Stratton 5 1/4 h.p. horizontal w/ recoil starter, 1 year guarantee, complete \$65. Gest, 2925 Ridge, Philadelphia, Penna.

DIESEL Injector parts and fuel pumps wanted. GM51-71-110. Bares, 2093 East 19 Street, Cleveland 15, Ohio.

REWIND Motors yourself. Complete instructions, \$1.00. Lewis Manufacturing, Howell, Michigan.

WINDING Data. 275 motors, single and three phase \$1.10. Data Company, 512 Kensington, Kansas City 24, Mo.

SAVE \$60. Brand new water pumps w/ Briggs-Stratton engines, portable, self priming, centrifugal, 1 1/2", 5500 g.p.h. \$124. Also 2" 7500 g.p.h. only \$129 delivered. Top quality, guaranteed. Gest Motors, 2925 Ridge, Philadelphia, Penna.

REWIND Electric motors yourself. Free details! Modern, Box 8715, Kansas City 14, Mo.

SAVE \$175. Complete electric generating plants, brand new 1961 top brand, 3500w, AC115/230V, 60 cycle, w/volt meter, battery charger, electric starting, w/9 h.p. Briggs & Stratton eng. only \$349. Satisfaction guaranteed. Also 2500 w, AC, 60Cy, 115V, w/5 1/4 Briggs & Stratton w/electric starting only \$279. Satisfaction guaranteed. Gest Motors, 2925 Ridge, Philadelphia 21, Penna.

INSTALL Your 220V 3-phase motor on 220V 1-phase line. Information available for \$2.50 by return mail. No gimmicks, ballasts, condensers, rewinding, or reconnecting. Just technical know-how. Strang Elec. & Eng. Co., P.O. Box 555, Hawthorne, Calif.

GOVERNMENT SURPLUS

BUY Surplus direct from government. Complete guide—25¢. Janecek, 373 East 155th Street, New York 55, N. Y.

GOVERNMENT Surplus, radios, jeeps, walkie talkies, boats, binoculars, etc. Buy direct. Send for "Depot Locations & Procedures," 50¢. Satisfaction guaranteed. Delta, Box 2262-M, Dallas 21, Texas.

TENTS. Government surplus. Hexagonal, Pyramidal. Cost \$140. Our price \$39.50. \$225 paint spray unit, \$44.50. Free folder. Imsco, 1829 S. State, Chicago, Ill.

SUBSCRIBE To Government Surplus Weekly. Lists all sales. Buy Jeeps, trucks, boats, tents, tires, etc., direct from government. Next 10 issues \$2. Government Surplus, Paxton 20, Illinois.

JEEPS \$223.83. Cars \$38.53, boats \$7.58, radios \$2.45, tires \$1.33, typewriters \$7.15, televisions, guns, cameras, recorders. Typical surplus prices. Buy direct. List of depots, procedure, inspection details, only \$1.00. N. Y. Enterprises, International Airport, Box 402-X16, Jamaica 30, New York.

GOVERNMENT Surplus clothing, etc. Price list 50¢. Medford Surplus, Medford, Wis.

GOV'T Surplus. How and where to buy in your area. Send \$1.00. Surplus Information, PM, Headquarters Building, Washington 6, D. C.

U.S. Government surplus—jeeps, \$264.00; radios, \$2.53; guns; typewriters; cameras; tools; thousands of items. Fabulously low surplus prices. Complete information sent immediately. Send \$1.00 to: Surplus, Box 512-E, New Orleans 12, Louisiana.

JEEPS \$278. Airplanes \$159, boats \$7.88, generators \$2.68, typewriters \$8.79 are typical government surplus sale prices. Buy 10,001 items wholesale, direct. Full details, 627 locations and procedure only \$1.00. Surplus, Box 789-C20, York, Penna.

BOATS, OUTBOARD MOTORS

WORLD'S Largest selection of boat plans and patterns, frame kits, boat kits, marine fiberglass, hardware and accessories. Three, full, new, exciting catalogs, covering all of the above, available now for \$1. Send to: Custom Craft, Mail Order Division #1L, Buffalo 7, New York.

MARINE Steam engine casting kit, drawing, \$1.00, (refundable). Rasmussen, 34403 Joel St., New Baltimore, Michigan.

AIRBOATS—That's our business, not our hobby! Send 25¢ for literature to: Hurricane Fiberglass, Recker Hiway, Auburndale, Fla.

FIBERGLAS Your old wooden boat. Make it waterproof. Repaint over fiberglass, wood, or metal with new Poly-Aqua Epoxy paint. Free literature. Ajax Plastic Co., Dept. 6, P.O. Box 1323, Ft. Worth, Texas.

BOAT Plans, frame kits, full-size patterns prepared specially for amateurs. Send 50¢ for new 80-page catalog illustrating over 40 build-it-yourself power boats from 7' to 28'. "Inboard Motor Installations In Small Boats"—hardcover illustrative book on "how to" of inboard installations—\$6 ppd. Glen Designs, 9152 Rosecrans, Bellflower, Calif.

NEW. Used, rebuilt marine motors. Marine conversions, fittings. Free catalog. Stokes Marine Supply, Dept. 24, Coldwater, Michigan.

FULL Size, cut-to-shape boat patterns, blueprints, 7 1/2-38 feet. Big new 88-page illustrated "Build a Boat" catalog of naval architect-designed catamarans, cruisers, runabouts, skiffs, outboard boats, sailing, racing, houseboats, 50¢. "How to Build a Boat" booklet, \$2.50. Cleveland Boat Blueprint Co., Dept. A-66, Box 1651, Cleveland, Ohio.

BUILD Your own boat from our large-scale blueprints. Books of plans give how-to-build help. Hundreds of professional designs—motor, sail or auxiliary—for amateur builders. Free catalog. MoToR Boat-ing, 572A Madison Ave., New York 22, N. Y.

MARINE Conversions. Ford, Chevrolet, Jeep engines. Catalog 25¢. Lehman Manufacturing Company, 800 Elizabeth Avenue, Linden 4, N. J.

200 BOAT Plans, kits. Catalogs. Powerboat, \$1.00, sailboat, 25¢. Marinecraft, Box 161-M, Brighton, Mass.

AIRBOAT-Snowplane engines, propellers, supplies. 125 h.p. Lycoming engines \$135.00. Catalog 25¢. Banks-Maxwell, Box 3301F, Ft. Worth 5, Texas.

MARINE Conversions and gears for all popular automotive engines. Send 25¢ coin for complete catalogue. Barr Marine, 2706A Castor Ave., Philadelphia, Penna.

CONVERT Your automobile engine for marine use easily and inexpensively. Send 25¢ for big catalog to Star Marine Engine Works, Dept. AC, 2920-7th St., Berkeley, Calif.

FIBERGLAS Cloth and resin. World's finest cloth and non-run resin, at direct mill prices. Flotation foam, complete line of plastics. Brass screws, save 60%. Send \$1.00 for catalogue. Stiles Boat Supply, Box 11P, Linden Ave., Mantua Hts., N. J.

I want to send you proof of the wonderful pulling power of Popular Mechanics classified pages. What's your proposition? Write me today. Include literature if possible. F. W. Johnson, Manager Classified Advertising, Popular Mechanics Magazine, 200 E. Ontario St., Chicago 11, Ill.

ATHLETIC EQUIPMENT, BODY BUILDING COURSES

BECOME Taller. New scientific method will add inches to your present height even after maturity. Visible results in weeks. Send for free information and trial offer. Height Increase Institute, Dept. PM-2, GPO Box 1902, New York 1, N. Y.

STEAM Bath. Make your own. Cost \$10.00. Weight 6 lb. Instructions \$1.00. Johnson, 2373M, Juneau, Alaska.

BODYBUILDERS! Weightlifters! Build your own modern barbell gym. Details free. Gymcraft, G.P.O. Box 1529, New York 1, New York.

"GIANT Arms." Dr. Young's, D.C. revolutionary discovery. \$2. Satisfaction or refund. Gaucho, Box 9309-S7, Chicago 90.

PROF. Wong's Karate Kung-Fu. Break bricks bare-handed. \$9.95. Oriental Book Sales, 142 Waverly Place, San Francisco 8, Calif.

OUTSTANDING Physical development! Any age. New guaranteed discovery uses only a rope! Strength, health, muscles. Gain—reduce. Free booklet. Ropercise, 4834 Art, San Diego 15, California.

PHYSICAL Perfection—reducing, gaining, big muscles and longevity. Agents wanted. Mail 25¢ for all 4 courses. Guaranteed. Sid's System, PMC-62, 8421-C Evergreen, Southgate, California.

SPORTING GOODS, GUNS, FISHING, SKIN DIVING, ARCHERY

ANIMAL And fish baits and lures. Guaranteed. Catalogs 20¢ Myers Lures, Marquand, Mo.

PLASTIC Lure bodies. World's famous flattish complete kit 25 for \$3.25. Spinning reels open and closed face \$3.25. Free circular. Quaker City Mfg., 3514-24 N. Lawrence, Philadelphia 40, Penna.

JAP Rifle altering to 30-06, \$6.00. Jap-shells, \$3.95. Catalog 10¢. T. P. Shop, West Branch 11, Mich.

MOLDS—For casting your own fishing sinkers. Free illustrated booklet. Reading Instrument Co., Box PM78, Reading, Penna.

FREE—Wholesale catalog. Beads. Spinners. Lure parts. Sinkers molds. Jigs. Reels. Finnyports (ME), Toledo 14, Ohio.

BIG Money raising crickets and 12 inch African fishworms. Free literature. Carter Ranch, Plains, Georgia.

MOLDS For fisherman's sinkers, jigs, squids, casting and spinning lures. Free catalog. Sweet's Molds, Tonawanda 1, New York.

NOBODY Undersells Kleins's! 144 page all-sports bargain catalog free. Kleins-PM, Chicago 24, Illinois.

HUNTING Guide free! Experts tell you how to be crack shot; dress game; care for weapons; camp cookery; and how to have convenient heat and light in the woods. Supply limited. Write A. W. Thacker Co., Dept. P, Clermont, Fla.

EYEGUARD Shooting glasses, amber, green, \$3.95. Bargain catalog, 5,000 guns, \$1.00. Agramonte's, 41 Riverdale, Yonkers, N. Y.

154 PAGE Catalog—A real dream book for fishermen. It's free! Netcraft Company, Dept. B-12, Toledo 13, Ohio.

MINNOW Graders. Agitators, dip nets. Crescent Mfg., Box 3303, Ft. Worth, Texas.

SPORTING Goods. Wholesale. Information. \$1.00 refundable. Berkshire Wholesale Sporting Goods, Six Lakes, Michigan.

THE Modern Kentucky rifle. How to build your own. A new book, 75 pages, 100 pictures, full size plans. \$2 postpaid. R. H. McCrory, Box 13-P, Belmore, New York.

NEW Archery exercisers, sight. Kilbow, Box 966, Frazier Park, California.

AMAZING Fish lure. Guaranteed to catch fish or costs nothing Write B & J Mailorder, Gulliver, Michigan.

CAMPING EQUIPMENT AND TENTS

PRIMUS And Therm'x stove and heater literature free. Davis Imports, Dept. H, Box 489, Edmonds, Washington.

BUILD Your pickup camper. Blueprints and supplies. Literature 10¢. Comstock Trailers, Parsons, Kansas.

WORLD'S Biggest variety of American and French tents, sleeping bags, camping, hunting supplies, outdoor clothing, boots, shoes & Government surplus shown in new 116 page catalog. For free copy write to: I. Goldberg, Dept. PM-12, 429 Market Street, Philadelphia 6, Penna.

CAMPING Equipment. Send 25¢, giant catalogue. Morsan, 10-21R 50th Avenue, Long Island City 1, New York.

EARTHWORMS, CRICKETS, FROGS

BIG Money raising fishworms and crickets. We teach you how to raise and where to sell. Free literature. Medium redworms, 3000, \$5.95; 10,000, \$16.95. Carter Redworms, Plains, Georgia.

EARN Money raising fishworms for us! Exciting details free! Oakhaven 56, Cedar Hill, Texas.

BINOCULARS, TELESCOPES, MICROSCOPES, MAGNIFIERS

BUILD Your own reflector telescopes. Complete kits: mirrors, eyepieces, tripods, all other accessories. Request free illustrated literature. Criterion Manufacturing, Dept. KPM-83, Hartford 1, Conn.

REFLECTING Telescope, 60X, completely assembled. Guaranteed observatory clearness. Free information. Skyscope, P.O. Box 55, Brooklyn 28, N. Y.

SCIENCE Bargains! Lenses, telescopes, binoculars, microscopes, kits, parts, war surplus. Send \$1.00 for beginner's 10-lens kit with instruction booklet. Order Stock 2-CH. Request free 144-page Catalog CH. Edmund Scientific Co., Barrington, New Jersey.

7-12 X 35 W/A ZOOM Binoculars \$49.99 plus 10% tax. Free catalog. Quality Optics, 13571 Kentucky, Detroit 38, Mich.

TELESCOPE Manufacturer's closeouts. Telescopes, lenses. Terrific bargains. Many giveaways. Write Hobbycraft Mfg., 1107-W 69th, Chicago 21.

MICROSCOPES, Surveying, recorders. Everything Japanese. Catalog 25¢. Magnification Instrument, 2 East 45th, New York 17.

TELESCOPE Kits—Direct from manufacturer. Other optical hobby kits. Large selection. Free booklet. Esco Products, Oak Ridge, N. J.

BARGAINS! Binoculars, telescopes, microscopes. Catalog free! Adventure Sales, Box 2133, San Diego 12, California.

DYNASCOPE—Amazing world-famous reflector telescope. Request free brochure. Criterion, Dept. DP-86, Hartford 1, Conn.

CUSTOM Telescopes, lens, tripods, quatorials, accessories. UPCO, Sunbury, Penna.

PLANTS, SEEDS, BULBS, NURSERY SUPPLIES

BEAUTIFUL Live cactus plant makes wonderful gift. \$1.00. Postpaid. Danny's, P.O. Box 1189, Tucson, Ariz.

PETS—DOGS, BIRDS, HAMSTERS, ETC.

ANT Farm. Complete \$3.95 ppd. Free leaflet. Box 5185-PM, Augusta, Georgia.

HAMSTERS—10 different colors. Free booklet. Pair, metal cage, \$4.00. Hamster House, Box 5185-PM, Augusta, Georgia.

HAWKS, Reptiles, raccoons, skunks, squirrels. Catalogue 25¢. Trails End Zoo, St. Stephen, S. C.

MAKE Money raising chinchillas, mink, rabbits, cavies for us. Free catalog. Keeney Brothers, New Freedom 2, Penna.

PETS—Hamsters, mice, rabbits, squirrels, guinea pigs, chipmunks. Literature and price list dime. Moore's Hamster Ranch, Shepherdstown 25, West Virginia.

HAMSTERS—Ideal pets, \$2.95 pair. Free booklet. Jer-fre's Hamstery, 1447 Apple, Muskegon 13, Michigan.

RABBITS—FUR BEARING ANIMALS

EARN \$10,000 Yearly raising Angora rabbit wool for us. Information 25¢ coin. American Angora Company, Malta 12, Montana.

RAISE Rabbits on \$500 month plan. Free details. White's Rabbitry, Mt. Vernon, Ohio.

RABBIT Raising details free. Rabbit Enterprises, 548 River Road, Ludlow, Ky.

MINK Raising information free. Complete. Lake Superior Mink Farm, Superior, EEL, Wisconsin.

RAISE Rabbits successfully by knowing facts. 48 page book, 38 illustrations describing 25 breeds. Housing. Breeding. Feeding. Markets and Marketing. Bulletin etc. 25 cents. American Rabbit Association, 36 ARBA Building, Pittsburgh, Penna.

FARMS, FARM LANDS, REAL ESTATE

CANADIAN Vacation lands: Full price \$385.00. 40 acres, \$10 month. Suitable cottage sites, hunting, fishing, investment. Free information. Land Corporation, 3768-C Bathurst, Downsview, Ontario, Canada.

FLORIDA Campsites—deep in the heart of the great Ocala National Forest. Abundance of game, best fishing. Warranty deed. Unrestricted—pitch tent, park trailer, build lodge. Free maps and photos. Howard Vernor, DeLand, Florida, AD60088(Q-O).

SILVER Springs area lots. \$195.00 full price—\$5.00 month. Free colored pictures. Write Lake Weir, Box 568V, Belleview, Florida.

CAROLINA Coast. \$5 down, \$5 monthly buys large homesite. 70x150, in beautiful Boiling Spring Lakes. Satisfaction guaranteed. 16,000 acres. 52 freshwater lakes. Excellent fishing, hunting. Free literature. Boiling Spring Lakes, Southport 1, North Carolina.

FREE Strout catalog! Farms, homes, businesses, resorts, retirement properties. Over 3000 values coast to coast. 61 years service. World's largest! Write Strout Realty, 7-CJ S. Dearborn, Chicago 3, Ill.

MONTANA—Fishing and hunting cabin and camp sites on the Kootenai River in the Montana Rockies \$595; \$10 down and \$10 per month. Mountain Empire Co., Box 203-P, Libby, Montana.

\$5 MONTHLY Buys 5 acres—near clear-water lake. Price \$125. Excellent fishing, good cabin sites. Free list. Box 425-P, Carthage, Mo.

WORLD'S Best! Low cost multipurpose lands. Booklet free. Armstrongs, Shook, Mo.

OPPORTUNITIES! Government land, U. S. Alaska, Canada. Sledge Surveys, Macon, Mississippi.

COLLECTOR'S Item. Picturesque 13-acre New York estate with century-old home and swimming pool! In historic Otsego County, 4 miles village. Modern 8-room 5-bedroom Early American, cheerful fireplace. Lovely grounds. Trout stream across road. Barn, garage, storage building. Family orchard, several springs. Pasture for about 10 head stock. A place the entire family will love at only \$7,500, terms on part! Immediate possession, too! Big free illustrated Fall-Winter catalog, bargains coast to coast! United Farm Agency, 2825-PM Main St., Kansas City 41, Mo.

KENTUCKY Lakeshore homesites \$195, \$10.00 monthly. Free booklet. Edgar Garland, Burnside, Ky.

NORTHERN Ontario, Canada. Land near lakes. \$7.00 per acre. E. J. Nether-ton, R.R.1, New Liskeard, Ontario, Canada.

PROFITABLE OCCUPATIONS

BUY Below wholesale! Thousands of nationally advertised products. Drugs, clothing, housewares, cameras, jewelry, hardware, sporting goods, etc. Postcard brings price list showing actual factory cost. Buy-Rite, 310 Main, Bennington 1, Vermont.

AUCTIONEERING—Home study course. Diploma granted. Auction School, Ft. Smith, Ark.

EARN \$240.00 A month at home, spare time, doing only two \$5.00 invisible mending jobs a day. Big money paid for service that makes cuts, tears disappear from fabrics. Steady demand. Details free. Fabricon, 6236 Broadway, Chicago 40, Ill.

VENDING Machines. No selling. Operate a route of coin machines and earn amazing profits. 32-page catalogue free. Parkway Machine Corporation, Dept. #25, 715 Ensor Street, Baltimore 2, Maryland.

SHARPEN Scissors, pinkers. Inexpensive machine. Clipper sharpener. Black-hawks, Sheldahl, Iowa.

BAKE New greaseless doughnuts in kitchen. Sell stores. Free recipes. Michael, 3605 South 15th, Minneapolis 7, Minn.

BIG Money raising fishworms and crickets. Free literature. Carter Wormery, Plains, Georgia.

BECOME Independent with your own franchise business. Thousands earning handsome incomes. Request interesting facts today. National Franchise Reports, FM-528, 333 North Michigan, Chicago 1.

FREE Book "711 Bizarre, Successful Ventures." How I retired. Work home. Hayling, Carlsbad, Calif.

FREE Report: "609 Unusual, Successful Businesses." Box 1001-PL, Evanston, Illinois.

FREE: "How to Win Contests." Conte-Star, Box 51-PE, Des Plaines, Illinois.

INVESTIGATE Accidents. Earn \$750 to \$1,000 monthly. Men urgently needed. Car furnished; business expenses paid. No selling. No college education necessary. Pick own job location. Investigate full time. Or earn \$6.44 hour spare time. Write for free literature. No obligation. Universal, CPM-12, 6801 Hillcrest, Dallas 5, Texas.

PROFITABLE Career waiting. Free information. Davis Imports, Dept. D, Box 489, Edmonds, Washington.

WHOLESALE Magazine subscriptions. Highest commissions. Bonus! Qualified Agencies, 451HA Kingston, Brooklyn 25, N. Y.

RAISE Pheasants on \$10 week plan. Little capital and space can make you independent. Free Details. Great Central System, Columbus 1, Kansas.

HOME Mailorder business. Simple, enjoyable. Net \$15,000 year. Write: Mail-order, Box 512-E, New Orleans 1, La.

AMERICA'S 700 Best be-your-own-boss opportunities. Annual, New York City 8.

EARN Money raising fishworms for us! Write: Oakhaven 58, Cedar Hill, Texas.

FREE Book "990 Successful, Little-Known Businesses." Work home! Plymouth-47P, Brooklyn 4, New York.

BOOKS, PERIODICALS, PICTURES, POSTCARDS

BOOKS 50%-90% off! Catalog free. Werewolf Bookshop, Verona, Penna.

FREE Catalog. Self-help books. Write: Wilshire, 8721 Sunset, Los Angeles 46P.

BOOKFINDERS! All subjects. Send wants! Jaher Book Service, 183 Hazelwood Drive, Westbury, N. Y.

NATIONAL Geographic magazines, 1888-1960, any issue. Periodical Service, Box 465-PM, Wilmington, Delaware.

BOOKS Located fast. Out-of-print, scarce. Lowest prices without obligation. Book Mark, 51A Walnut, Mt. Clemens, Mich.

BOOKHUNTERS! Scarce, miscellaneous books supplied! Atlantic Book Service, Cedar Street, Charlestown 29, Mass.

OUT-Of-print books at lowest prices! You name it, we find it! Fast service. No obligation. International Bookfinders, Box 3003-PM, Beverly Hills, Calif.

BRITISH Book bargains—Any subject. Catalogues free. Transatbooks, Wantagh, N. Y.

WHOLESALE: Any subject. 2 catalogs \$1.00, refundable, guaranteed. Adirondack Printers, 38 Olive, Saranac Lake, New York.

SPECIALIZED Magazines — Current copies all trades, hobbies, sports. Also self-help books. Free list. Commercial Publications, P.O. Box 55429, Indianapolis 5, Indiana.

ALGER Books wanted. Send 20¢ stamps or coins for list of rarest Algers. Ralph Gardner, 135 Central Park West, New York 23, N. Y.

132 PAGE Catalog—10¢. All subjects. Bookmaster, Box 17273-H, Salt Lake City 17, Utah.

GAMES, TOYS, NOVELTIES

POKADOMETER, the most engrossing family car game ever invented. Keeps children fully occupied for long trips. \$2.00. Moneyback guarantee. Hamburg Game Co., Hamburg, N. Y.

MAGIC TRICKS, PUZZLES, JOKER NOVELTIES

108 MAGIC Tricks explained, illustrated \$1.00. Mack the Magician, Box 1088, Albuquerque, New Mexico.

84 PAGES, Completely illustrated catalogs, 25¢. Manhattan Magic, Box 334-P, New York City 11.

CATALOG, Free trick, 25¢ (1,500,399 tricks, jokes, novelties). Magico, #4037-P, San Antonio 7, Texas.

BE A magician! Large professional catalog of latest tricks, 35¢. Ireland, C-109 North Dearborn, Chicago 2, Illinois.

WORLD'S Finest professional magic. Joker novelties. Giant illustrated catalog 10¢. Top Hat, Evanston 12, Illinois.

INDIA Rope trick and magic catalog 25¢. Hocus Focis, 209 West Capitol, Jackson, Mississippi.

500 TRICKS. Famous Douglas catalog of magicians' tricks and supplies now available just 10¢. Fastest service. Douglas Magicland, Dept. 61, Dallas, Texas.

3000 TRICKS, Pocket, parlor, stage. World's finest magic catalog (408 pages), \$2.50. Kanter's, M-1311 Walnut, Philadelphia 7.

FLAME Thrower! 36" flashes at fingertips! \$1.00. Harmless! Arlane, Philadelphia 44.

VENTRILLO Voice thrower 25¢ Ventriloquist's puppet 75¢. Box 971-PM, Philadelphia 5.

2700 NOVELTIES, Jokes, tricks, fun-makers, hobbies. World's biggest gadget catalog 10¢. Johnson-Smith, D-549, Detroit 7.

SMOKE Bombs 25¢ 7 for \$1.00. Terrific! 4463-PM Greene, Philadelphia 44.

GET Your tricks, gags wholesale. Sell to friends. Big catalog. 50 gag samples 25¢. Dohn-OV-Marks, Broadview, Illinois.

PROFESSIONAL Catalog, 175 pages, 25¢. Williams, 900 Plymouth, Ellwood City, Penna.

ONE Thousand tricks, stunts, magic, jokes, gags! Terrific jumbo catalog! 160 pages thick! Rush only 10¢. Free trick given! House of 1000 Mysteries, Dept. PM12C-61, Trumbull, Conn.

"**VENTRILLOQUISM** Selftaught"—complete book 25¢. Greenview, Box 61-B, Whitestone 57, New York.

BOOK Of 279 tricks—15¢. Bookmaster, Box 17273-K, Salt Lake City 17, Utah.

MAGICAL Tricks, jokes, gags. Send stamp for catalog. House of Magic, 186-D N. Broadway, Fresno 1, Calif.

COINS, TOKENS, CURRENCY

FIVE Genuine foreign bills sent free with our price catalogue of United States coins. 25¢ & 5¢ mailing. Choice approvals included with every order. Tatham Stamp and Coin, Springfield, Mass.

UNCIRCULATED 1935 silver pony express commemorative medal \$1.00. Coin lists free. Sayers, 1000 Unaka, Johnson City, Tennessee.

CALIFORNIA Gold, souvenir tokens 5 different in plastic holder. \$4.10 postpaid! Dealers write. Sample \$1.00. France, P.O. Box 112-PM, Evansville, Indiana.

LINCOLN Cents 1921-S, 1924-S, 1918-D-S, 1909-P, 1917-S-D, 1925-S-D, 1920-S-D, 1919-S-D, 1930-S-D, 1938-S-D, 1931-P, 1927-S-D, 1929-S-D, 1928-S-D, 1934-D, 1955-S. Complete lot \$4.00 good to fine rolls of 1955-S Lincoln cents good to A.U. \$5.00 roll. Berry, Box 306, Westminster, Calif.

HIGHEST Prices paid for United States coins. Send 10¢ for our buying lists. Wilmot's, 1067-A Bridge, Grand Rapids 4, Michigan.

INDIAN Pennies, six different \$1.00. Also will buy Indians 10¢ each. Joseph Gaidar, 6615 South Ashland Avenue, Chicago 36.

COINS, Supplies: Lists 20¢. Lund, 200 So. Sycamore, North Platte, Nebraska.

LARGEST Coin magazine. 288 pages, 50¢. Scrapbook, 7320-J Milwaukee, Chicago 31.

NUMISMATICS Largest newspaper. Semi-monthly. Sample 25¢. \$2.00 yearly. Numismatic News, Box 452, Iola, Wis.

NUMISMATISTS—Price list with valuable gift—40¢. Vanderman, Box 9161, Suitland, Maryland.

RARE 1878 CC mint dollar uncirculated \$5.00. 100pg. catalogue 50¢. Shultz, Salt Lake City 10, Utah.

BARGAIN List! U. S. coins, accessories. Stamp please. Hugh's, Hickory, N. C.

WORLD'S Greatest coin magazine and wooden nickel 10¢. Lawrences, Anamosa, Iowa.

FREE Coin supplies! Giant coin list 10¢ (refundable). Economy Sales, Mansfield, Massachusetts.

40 PAGE Illustrated United States and Canadian coin list 10¢. Stoney, 260 Washington, Boston 8, Mass.

25 BEAUTIFUL Coins from 25 countries. Mostly uncirculated. Terrific assortment. \$1.00. Hindley, Box 708, Aurora, Illinois.

RARE Unc. 1899 Philadelphia silver dollar, \$5.00. Butts, Torrington, Wyo.

GIANT Illustrated catalog listing hundreds of bargains in coins and supplies, only 25¢. Ben's Coin Company, 31 North Clark, Chicago 2.

1961 Brilliant Proof set \$3.00; or set encased in glittering lucite cube paper-weight \$10.50. General MacArthur set \$3.75. Pope John Vatican set \$4.50. 15 different Indian cents \$3.75. Retail Guidebooks-U.S. \$1.75; Canada \$1.75. Bebee's, 4514 North 30th, Omaha 11, Nebraska.

SEND \$3.00 For 5 Indian cents, 5 Liberty nickels, and 10 Lincoln cents before 1921. All different. Price list included. Stroud's Coins, Kinston, N. C.

UNCIRCULATED Cents 16, 1955 through 1961D inc. 60D small date, \$2.50 set. John G. Doran, 2006 St. Clair, Brentwood 17, Mo.

LINCOLNS 1910S, 1913S, 1915S, \$2.00 each. 1912S, 1914S, \$3.00 each. 1911S, 1924D \$5.00 each. 1921S, 1923S, 1924S, 60¢ each. 1912D, 1926S, 1922D, 1931D \$1.30 each. United, 348 Grotto, Providence, R. I.

COINS—Peru, Finland, Yugoslavia. 7 different 25¢. Jolie, Roslyn Heights, N. Y.

LINCOLN Pennies, 75 different, Whitman folder \$2.95. Marso, 321 Morris, Joliet, Ill.

COINS Wanted. Catalog 25¢. Capo, 1030 Morris St., Philadelphia 48, Penna.

COINS From Formosa. Vatican, plus foreign banknote. 10¢ with coin approvals. Littleton Coin Co., Littleton 51, N. H.

COINS Wanted! New list 25¢. Highest prices paid. Coin Searcher, Box 332, Hollywood 28, California.

BRITISH Coppers — 12 Different \$1; Singles, send want list. Callahan, Box 121, Flushing 65, New York.

COIN Collector's magazine. On your newsstand or direct. Sample 35¢. \$3.00 yearly. Coins Magazine, Box 274, Iola, Wis.

WANTED—Paying 2¢ for Lincoln cents under 1927. 5¢ for Indianheads. Will pay postage. Earl Kammerzell, Box 305, Eureka, California.

SILVER—Two select brilliant uncirculated Mexican silver dollars—\$1.00 (refundable). Universal, Box 866, San Antonio 6—D12, Texas.

COINFINDER'S Valuable secrets and buying list (including common coins) \$1.00, refundable. \$10.00 catalog value coins, only \$5.00! California gold souvenir token, \$1.00. Five different in custom holder, \$4.10; dealers write. Numismatics, Box 635, Evansville, Indiana.

BUYING United States and Canadian coins! Fully illustrated, 56 page, buying catalog, 50¢. Williams, Box 481, Oshkosh, Wisconsin.

U.S. Large cent \$1.00 with bargain lists. Hutchinson's, Box 6256, Philadelphia, Penna.

WE'LL Pay \$9,000.00 to \$18,000.00 for 1913 Liberty Head nickel. Certain dates: Lincoln cents before 1956—\$250.00; Indian cents \$1.75.00; Flying Eagle cents \$950.00; Dimes before 1943—\$5,250.00; Quarters before 1933—\$5,250.00; Half dollars before 1939—\$7,500.00. Thousands of others worth \$10.00 to \$15,000.00. Such as, certain dates; halfcents, large cents, 2¢ pieces, 3¢ pieces, halfdimes, Shield nickels, Buffalo nickels, 20¢ pieces, commemorative coins, paper money, foreign coins, etc. Thousands of persons have sold us coins totaling over \$250,000.00. For complete information, before sending coins, purchase our large illustrated complete guaranteed buying-selling catalogue \$1.00. Worthycoin Corporation (K-528-C), Boston 8, Massachusetts.

CANADIAN Small cents 1939-1961, fine condition, 5¢ each. 5¢ postage extra. P.C., 48 Thornton, Buffalo, N. Y.

LINCOLNS: 40 1909-1940 \$1.85. 25 "S" \$1.45. All different, wholesale pricelist included. Amazing buying list 25¢. Harris's, Box 611, Cupertino, California.

INTRODUCTORY: Confederate coin and foreign paper money, coin-medal catalog, send 50¢, postage, handling; American military medal and catalog, 50¢; amazing values. Collectors Club, Box 71-C, Rockaway 94, New York.

INDIAN Cents: dealers and investors lots, graded, priced, \$25 catalog only \$9.95, \$100 catalog \$35. Return privilege. Universal, Box 309, Richmond 2, Virginia.

INDIAN Cents. Paying 10¢ each. Any quantity. Sigmon's, Charleston 2, W. Va.

FLYING Eagle cents, \$1.95 each. set of 3 different, \$6.95. Vaccino, Box 10, Richmond 1, Va.

TWENTY-Four page 1962 retail price list of USA and Canadian coins 10¢. Our selling prices on thousands of coins and coin collectors' supplies. Bryson Incorporated, 612A White, Toledo 5, Ohio.

BRILLIANT Uncirculated United States gold coins: \$1—\$39.50, \$2½—\$23.50, \$5—\$23.50, \$10—\$35.00, \$20—\$67.50. C.O.D. orders accepted. The Falcon, Box 3392, Merchandise Mart, Chicago 54, Illinois.

STAMP COLLECTING

FREE 400 Genuine postage stamps! Worth \$10.00 at catalogue prices. Africa, Europe, Asia, British Emp.—a fascinating, valuable mixture from foreign convents. Also free valuable booklet. Adults only. Banks, etc. Who knows what you will find. Approvals enclosed. Frasek Co., PM-12, White Plains, N. Y.

FREE! Giant bargain catalog—New edition listing thousands of bargains including U.S. and B.N.A. stamps, packets, mixtures, albums, accessories and supplies; sent with beautiful approvals. Jamestown Stamp, Dept. E121PM, Jamestown, N. Y.

FREE—Mint British Colonials from Maldives, Solomon Islands, Pahang, St. Christopher, Nevis, Sarawak, Cayman Islands, Gilbert Ellice. Free with approvals. Viking, Great Neck 8, N. Y.

WE Don't sell stamps. We bring together stamp collectors who have stamps to exchange. Name countries you have to exchange for countries you need. One dollar brings list of exchange names. Stamp Collectors Exchange, 462-466 Baltic Street, Brooklyn 17, N. Y.

"OLD Glory" in flaming colors! U.S.A. flag giant beauty from Honduras Enormous United Nations Mexican stamp. Plus strange gorilla issue. Duke of Windsor. Morocco, lovely Macao flowers, wild buffalo stamp and others, 10¢ with approvals. Sunny Stamp, Apopka 2, Fla.

GIGANTIC Collection free. Includes triangles, early United States, animals, commemoratives, British Colonies, high value pictorials, etc. Complete collection plus big illustrated magazine all free. Send 5¢ for postage. Gray Stamp Company, Dept. PM, Toronto, Canada.

WEIRD Diamond shape coffee stamps. Lively flower triangle! First American big commemorative. Greenland, Idol Dancer, etc. 10¢ with approvals. Capital Stamp Co., Ferrysburg 2, Michigan.

GAMBLER'S Packet, 25¢, with approvals. Kennedy, Box 9497, San Diego 9, Calif.

FREE! "Snow birds" set with approvals. Peterson, Box 6201, Lincoln, Nebraska.

FREE 100 Worldwide stamps with approvals. Universal Stamps, Cardwell, Missouri.

AFRICANS—65 Different, \$1.00. Johan Dykhorst, Box 4081, San Francisco 1, California.

BRITISH Colonies—3 complete mint sets, 10¢ with world wide approvals. Peter R. Cope, 639 130th Avenue N.E., Bellevue, Washington.

500 DIFFERENT Latin America \$2.00. Erv Knott, Box 31, Helmer, Indiana.

FREE! 25 Different Portuguese; colorful, inexpensive approvals. Elkhart, Box 33, Elkhart, Indiana.

FREE Mint Africa set with approvals. Lithor, Box 51, Canoga Park, Calif.

26 MINT Pairs 50¢. King, 330 Alexander, Kamloops, B.C., Canada.

105 DIFFERENT U.S. stamps 25¢. Approvals included. Shelton, Box 907-K, New York 8, N. Y.

MALAYA: 75 Different \$1 bill. Chew-seng, 2C-L1, Yahyawal, Johore Bahru, Malaya.

UNITED States mint special 934 up, 3 & 4 cent issues, one cent over face. Save More Stamps, Box 115, Tewksbury, Mass.

WOW! 110 All different Germany 10¢! Zeppelins, semi-postals, airmails, high values, etc. Giant catalog, bargain lists included with beautiful approvals. Jamestown Stamp, Dept. A121PM, Jamestown, N. Y.

300 DIFFERENT Given free with approvals. Particulars. Windsor Stamps, P.O. Box 735, Santa Clara, California.

DISCONTINUING Stamp business. Tremendous values! \$2.00. Conglomeration includes mixtures, packets, sheets. Norge, Ho-Ho-Kus, N. J.

FREE! Exotic mint Polynesian hula girl stamps! Giant bargain lists included with approvals. Aloha Stamps, 1019-PM Tarryall Drive, Dallas 24, Texas.

UNBELIEVABLE! Afghanistan to Zanzibar, 10¢ Approvals. Weiss, 2021 Alcazar, Hollywood 1, Florida.

50 DIFFERENT Latin America, 10¢ with approvals. Quynn's, Scotland, Penna.

STAMP Collecting outfit, includes packet worldwide stamps, package hinges, watermark detector, millimeter gauge. Everything 10¢ with approvals. Loraine Brown, Marion, Michigan.

200 COMMEMORATIVES \$2.00. 70% off approvals. Rosato, 1159-229 North, New York 66, N. Y.

CANADIAN Commemoratives, 50 different \$1.00. Brosz, 168 4th Street SW, Medicine Hat, Alberta.

HELICOPTER, Bird triangles! Set American, British flags! Gorilla, 25 others 5¢. Approvals. Atnip, 49A Greenbrea Boardwalk, San Rafael, California.

U.S.A. Commemoratives 40 different mint face \$1.00. Approvals. Siesta Stamps, Box 338, Venice, Florida.

GABON, Poland, Bulgaria beautiful new topicals and handsome Christmas stamps plus 50 different 10¢. Approvals. Berchtold, Troy, Ohio.

60 COMMEMS \$1.00 or 100 U.S. \$1.00. All different. Robbie's, Bethel, Conn.

FREE 30 Large U. S. commemoratives with approvals. 10¢ handling. Jack Clancy, Box 2187, Portland 14, Oregon.

CANADA Totem dollar 15¢. Approvals. B. Daleti, Box 832, Moncton, New Brunswick.

FREE! Surprise "Mystery" packet. Premiums. Approvals. Dancer, 75-P28, Mansfield, Ohio.

REGISTRY Stamp "F1" of 1911—U.S. used 25¢. Approvals included. Todd Mansfield, P.O. Box 591, Sunnyvale, Calif.

TOGO, Congo, Ruanda free with approvals. Delval, Box 142, Palmyra, New Jersey.

SENSATIONAL Penny approvals! Pictorials, topicals, etc. Write today! Schmidt, Box 1128, Richmond, Calif.

153 DIFFERENT U.S. commemoratives \$1.00. Carstamps, 739 Ordway, Freeport, Illinois.

EXCEPTIONAL Quality lots. Pictorials, sets, better grade singles. Includes British Colonies, Switzerland, Vatican. Valuable get-acquainted sample \$2. Griffiths, 28443 Thackeray, Hayward, Calif.

100 DIFFERENT Stamps 5¢. Lake, 1120 Pithon, Lake Charles 61, Louisiana.

WINTER Special, 1000 worldwide stamps \$1.00, 3500, \$3.00. No approvals follow. Harrison's Stamps, 1435 First Ave., Oakland 6, Calif.

500 MIXED U.S. various issues 25¢. Monjar, Fairmount, Cincinnati 14, Ohio.

500 FINE Mixed U.S. 15¢. Wright, 201M Mealey, Hagerstown, Maryland.

FREE Sample. Interesting, informative, illustrated. National Stamp News, Anderson, South Carolina.

FREE. 33 Greenland, Congo, Ruanda, others. Approvals. Keating, 2520-P Boulevard, Jersey City 4, New Jersey.

POLAND, Bicolored "bird" diamonds. Free with approvals. William Deems, 2266 Race, Ravenswood, West Virginia.

PEARL Harbor! Bataan! Japanese commemorative set, 10¢. Approvals. Reiniche, 718 Wilson, Johnson City, Tenn.

U.S. Mint =929-1185 face plus 1¢ each: =907-928 and all 5¢ and 8¢ stamps plus 2¢ each. Postage extra. Wilhelm, 16566 Mendota, Detroit 21, Michigan.

JAPAN Flower series (12) \$1.00. 1961 complete year set (35) \$3.00. Miss Fumiko, Box 67, Shinjuku, Tokyo.

FREE 50 India to approval applicants. Walter Kotowski, 19265 Eureka St., Detroit 34, Mich.

FREE—List of 100 mixtures. Select Stamps, 737 Nottingham, Winnipeg 15, Canada.

AUSTRALIA, 25 Different, 10¢ handling. Approvals. Reinhardt's, Box 93ML, Troy, Michigan.

\$10.00 CATALOG Pictorials, complete sets, etc., \$1.00. Wenaas, Magrath, Alberta.

UNITED States commemoratives, mint, never hinged, 100 different \$4.00. Golden's, 6721 Eastwood, Philadelphia 49, Penna.

FREE! 25 Egypt, 10¢ handling. Approvals. Bellet, Mapledale, Hazel Park, Michigan.

200 STAMPS, 25¢ With approvals. Smith, 508A Brooks, College Station, Texas.

25 ORIENT 5¢; Approvals extraordinary. Thiese, 9320-M San Juan, South Gate, California.

700 COSMOPOLITAN For 25¢. Request approvals. Horace Gatewood, Winston-Salem, N. C.

GIANT Topical collection: Moon-rocket sets, satellites, atomic ship, Boy Scout issue, complete UN set, recent Olympics and sport issues from Togo, Mongolia, Paraguay, Germany, Romania, etc. Plus big stamp dictionary and approvals. Everything 10¢. Stampex, Box 47-CM, White Plains, N. Y.

1,000 DIFFERENT Worldwide for approval buyers only. Jacobsen, Crompond, N. Y.

TRADE Your duplicates toward our approvals! (Foreign only.) Complete information, 10¢. Variety Stamps, Box 98-P, Newton Highlands 61, Mass.

FREE! 222 worldwide, 10¢ handling. Penny approvals. Jung, 1601 North Stanley, Los Angeles 46.

FREE. 250 peelable hinges and 20 different Brazil with approvals. Jaydee, 218 Dickinson S.W., Grand Rapids 7, Mich.

TERRIFIC Value. Eight complete mint sets 10¢ with approvals. Beatties, Box 4503, Fort Lauderdale, Florida.

PENNY Approvals, 1000 foreign stamps mounted in Scott order. No assorting! Send \$1.00 deposit deductible from first order. Bullot Approvals, 1359 Coney Is. Ave., Brooklyn 30, N. Y.

U.S., U.N., Confederate states catalog free. Stone, 260 Washington, Boston 8, Mass.

U.S. Mint specials! Flag set, complete \$1.00; 1¢, 2¢, 3¢ famous Americans (21 different); \$1.00. Free list. Brooks, 2323 Avenue X, Brooklyn 35, New York.

MILLION Foreign stamps! 2¢ each! Send for thrilling, giant approvals! ABC Stamps, Box 6000-HH, San Francisco 1, Calif.

SPUTNIKS, Rockets, space stamps free with sparkling approvals. Cambria Stamps, Box 2205, Anaheim, California.

ALBUMS! Hundreds of spaces! Only 25¢. Postpaid! Stampmart, Hartford 1, Conn.

TWO \$5.00 United States stamps, 20 others 10¢ with United States approvals. Irwin, Box 1105, Brooklyn 30, New York.

25 DIFFERENT Large American commemoratives, 10¢ with approvals. Linstamp, St. Catharines 101, Ontario.

80 DIFF. U. S. stamps includes 19th Century commemorative. High values. Plus 1943 flag stamp of occupied nations. All for only 25¢. Approvals included. Willett Co., Box 338-C, Yorktown Heights, N. Y.

107 DISTINCT British Colonial stamps, 10¢. Approvals. Linstamp, St. Catharines 401, Ontario.

25 DIFFERENT Commemoratives 1893 up 10¢. U. S. approvals. K & B, Box 70, Brooklyn 23, N. Y.

UNITED Nations 15th anniversary sheet with first day cancel, as commemorated by Russia. Free! While they last, with approvals, Philatelics, R-J, New Paltz, N. Y.

25 COLUMBIA 10¢. Approvals included. Reed, Box 980, Chicago 90, Illinois.

105 DISSIMILAR British Colony stamps, 10¢. Approvals. Crown Stamp Company, Virgil 601, Ontario.

INTRODUCING Our better United States approvals we offer 15 United States stamps including Columbian, Bi-Centennials, famous American, airm, others; only 10¢. Ocean Stamps, Box 64-PM, Brooklyn 29, New York.

PENNY Approvals. Thousands. Bargains for pennies. Gifts with purchases. Penny Stamps, Orange, California.

GIANT Approvals, thousands different, 1¢ and 2¢ each. Wahl's Stamp Exchange, 7008P Farragut, Chicago 31, Ill.

UNITED States commemorative collection containing 33 different—10¢. Approvals. White, 516-A Avenue L, Brooklyn 30, New York.

103 DIVERSIFIED British Empire stamps, 10¢. Approvals. Niagara Stamps, St. Catharines 501, Ontario.

SELL Your surplus good grade stamps. Write, describing fully what you have. Vanroy Shirk, Lebanon, Pennsylvania.

AMAZING OFFER! 200 United States stamps — including commemoratives, airmails, high denominations to \$1.00. Only 10¢ to approval applicants! Illustrated bargain lists free. Mystic Stamp Co., Dept. 80, Camden, New York.

100 OLD United States between 1861 and 1935. \$1.00. Roush Stamps, 51 Chestnut, Mansfield, Ohio.

UNITED States price list, 116 pages, price 25¢. Mark Hanna, 335 Fifth Ave., Pittsburgh 22, Penna.

SELL Stamps to our readers. Your ad in this space will be read by thousands of stamp buyers. I'll prove that to you. Write now for Folder "S." F. W. Johnson, Classified Advertising Manager, Popular Mechanics, 200 E. Ontario St., Chicago 11, Ill.

STAMP Jungle including Zabu, kookaburra, koalabear, kangaroo, rhinoceros, 10¢. Approvals. Crown Stamp Company, Virgil 301, Ontario.

14,000 DIFFERENT! Amazing new plan builds your collection systematically, country by country. Only 50¢ weekly. Free details. L. G. Ware, Monroe 75, Conn.

FREE Monaco nudes. Approvals. Stamp Ranch, 902 Addison, Chicago 13, Ill.

ECONOMICAL 1/2¢-3¢ Approvals, 39,000 varieties. Dressel, Box 128-N, West Englewood, New Jersey.

PENNY Approvals! Regardless catalogue! Kloster, 4164—52nd St., San Diego 5, Calif.

60 DIFFERENT U. S. (30 commemoratives) 25¢. No approvals. Seidenberg, Appleton, Wisconsin.

500 DIFFERENT. Includes pictorials. 35¢ Knopp, Box 1381, Bristol, Conn.

307 WORLDWIDE Different stamps only 25¢. Approvals. Niagara Stamps, St. Catharines 201, Ontario.

225 STAMPS For only 10¢! This mammoth value includes airmails, pictorials; stamps from strange countries cataloging up to 25¢ each! Also approvals. Mystic Stamp Company, Camden 80, New York.

DEFECTIVE Old U.S., 1/6 catalog. Approvals. K. Swartz, Maiden Bridge, New York.

LOOK! Six Queen Elizabeth mint sets from Antigua, Caymans, Mauritius, Montserrat, Virgins, St. Kitts! 21 brilliant pictorials. 25¢. Attractive approvals! Gannon Stamps, Box 931, Canton 1, Ohio.

U.S. Stamps. Giant discount catalog—20¢. Raymax, 37-VZ Maiden Lane, New York City 38.

FREE 50 Worldwide, mailed with inexpensive approvals. University Stamps, P.O. Box 44-592, Miami 44, Florida.

FREE Mint set! Approvals accompany. Stampco, Box 737, Memphis 1, Tenn.

150 DIFFERENT U.S. 50¢, many older issues. Approvals. Winchester Stamps, 45 Winchester Rd., Mansfield, Ohio.

111 WORLDWIDE. Includes airm, midgets, triangles. 10¢. Approvals. Premiums. Faith, 20 1/2 Bushnell, Alhambra, Calif.

100 DIFFERENT United States commemoratives, 1/2¢ to 10¢ values—used \$1.00; Mint \$4.95. No approvals. Gil's, Box 12BA, Brooklyn 29, N. Y.

SOUVENIR Sheets Czechoslovakia 1937 plus Japan 1947, 10¢ with approvals. Kingman, 30 Empire, Yonkers 4, N. Y.

SEND 25¢ for four beautiful sets! Evenden, Box 5001, Eugene, Oregon.

1065 DIFFERENT Stamps \$1.00 to approval applicants. Klondike, Harrisburg, Illinois.

FREE 60 Different stamps to collectors requesting approvals. Stanley Zajac, 159 Emerson Ave., Toronto, Canada.

SPACEMEN, Rockets packet plus bathing beauty—10¢ with approvals. Nugget, Gillen, Racine, Wisconsin.

TREASURE Of stamps, catalog over \$10.00, all different, only \$1.00. Gaidar, 6615 South Ashland Avenue, Chicago 36, Ill.

100 FOREIGN Stamps only 10¢ with approvals. Rorry Stamps, 7521-A Mason, Canoga Park, California.

50 PAGE Album accessories catalog. Send 10¢ for postage, handling. Approvals. Robert J. Clark, P.O. Box 28-C, Wilmette, Illinois.

U.S. Commemoratives 100 Mixed 25¢. Rayworth, 321 So. Cicero, Chicago 44.

1¢ EACH Over face. Mint commemoratives, 922 to date. United States catalog. 10¢ handling. Hille, 51 Lake, Arlington 74, Mass.

PHILIPPINES. 15 Commemoratives 10¢. Approvals. Norton, Box 926, San Antonio 6, Texas.

LATIN America. More stamps for less money. Packet including elusive issues \$1.00. M. Garcia, Box 71, Bronxville, N. Y.

ANTIQUES, RELICS, INDIAN GOODS, CURIOS

SELLING 20,000 Ancient arrowheads, spearheads, etc. List free. Lear's, Glenwood, Arkansas.

AFRICAN Carvings catalog 50¢. Lilliput, Box 7474, Mombasa, Kenya.

SWORD, "Knights of Malta." \$50,000 or best offer. William Hetrick, Box 464, Janesville, Wisconsin.

ILLINOIS: Gesundheit! Selling hundreds of historical, Confederate, Revolutionary, Civil War, Indian War muskets, carbines, revolvers, swords, bayonets, powderhorns, canteens, bullet molds, duelling pistols, holsters; 50,000 collector's cartridges; 110,000 Stoneage Indian relics, arrowheads, deerheads, steerhorns, bowwood, military insignias, coins, mineral specimens, fossils, frontiers, Confederate money. Large listing, send 35¢ (refundable). Heike's Relics, Wenona, Illinois.

PRECIOUS STONES, MINERALS

SEMI-Precious uncut gems. Ten different for \$1.00. Request list 28. Prospectors Shop, 201 San Francisco, Santa Fe, New Mexico.

FREE Bargain gem list, 1961 lapidary and silversmith tool catalog, 50¢. O'Brien's, 1116B Wilcox, Hollywood 38, Calif.

EARTH Science Rockhound's National Magazine. Subscription \$2.50. Sample 35¢. Box 1357-PM, Chicago 90, Ill.

ARIZONA Gemstone jewelry and souvenirs. Free catalog. Desert Gems, Box 9334, Phoenix 20, Arizona.

FREE Jade! Tiny green jewel plus comprehensive catalogue for serious jade fanciers, 25¢ handling. Wilderness Originals, Canyon, California.

15 MINERALS Of the west. Boxed, labeled. Eberle's, 2727 West Slauson, Los Angeles 43, Calif.

GEMSTONE Treasures! Turquoise, jade, opal, garnet, chrysoptase, idocrase, rhodonite, alabaster, plus seven additional. \$2.00 with catalogue. Wilderness Originals, Canyon, California.

GET Free catalog no serious rockhound, gem cutter, jewelry maker, hobbyist or craftsman can be without. Full of bargains, exclusive items, low prices from largest suppliers and authorities in the field. Free—new catalog just off the press, yours for the asking! Write Grieger's, Dept. C-12, 1633 E. Walnut, Pasadena, California.

HOBBIES AND COLLECTIONS

COLLECT Timepieces? Free folder. Nawco, Box 8824, Pittsburgh 21, Penna.

AMERICAN Newspaper, complete, original, dated before 1860, \$1.50. 25¢ stamps brings catalogue. D. R. Spaight, Bookseller, Tall Timbers 1, Maryland.

COLLECTORS Matchbook covers. 100 different unused, \$1.00. Catalog 25¢. Album \$3.00. Charles Edelman, 1311-C East 84, Cleveland 3, Ohio.

EUROPEAN And Nazi military curios. Authentic and reasonably priced. Colonel John Stoddard, 4906 Field St., San Diego 10, Calif.

U.S. Made hobbies. Giant catalog \$1.00 deductible. Robbies, Bethel, Connecticut.

MAGIC Is a great hobby! It's easy—it's fun! Amaze and astonish everybody! Start now! Rush only 10¢ for world's greatest magic and fun catalog! Deluxe giant edition! 1000 tricks! 160 pages thick. House of 1000 Mysteries, Dept. PMHC-12C, Trumbull, Conn.

WANTED Cigarette, tobacco cards. Write Charles Bray, East Bangor, Penna.

PHOTOGRAPHY, CAMERAS, PHOTO SUPPLIES

FREE! Send now for 64 page book of new and used photographic bargains. Dept. 1 AR-12, Central Camera Company, 230 So. Wabash Ave., Chicago, Illinois.

WHOLESALE Catalog free. Photo Distributors, Box 4203M, San Diego 4, Calif.

AMATEUR Photographers! Create remarkable professional photographic equipment for pleasure or profit. Thousands doing it. Save 50%! Now \$1.00 brings complete amazing secrets. Satisfaction or money back. Falcon Institute, Box 425, Wautoma 2, Wisconsin.

PHOTO FINISHING

FREE Enlargements. Send for sample, details. Chas. Hogan Photo's, 2625 Sherman Ave., Rockford, Illinois.

3-DAY Service on beautiful, personalized slim-line Christmas cards made from your photo or negative. Dramatic black-and-white or dazzling color cards. Write for free samples and price list. Lincoln Studios, Box 13, Dept. K, Lincoln, Nebraska.

A FREE Kodak roll returned with each black and white or Kodachrome developed and printed, fast service, lowest prices, guaranteed quality send for free mailers. Economy Photo Service, Dept. P. M., Box 1111, Albany 1, N. Y.

2-8x10 ENLARGEMENTS Any photo, \$1.00. Dick's Photo, Louisville 12, Ky.

CUSTOM Professional enlarging. Commercial or portrait. 11x14 \$1.25, 3-8x10s \$1.75, 6-5x7 \$2.00, 12 wallet \$1.00. Postage 25¢. No c.o.d. Alpha, Box 6315, Dallas 22, Texas.

TWELVE Exposure rolls 59¢. Wallets 20 for \$1.00. Lincoln Studios, Dept. K, Box 13, Lincoln, Nebr.

KODACHROME-Ektachrome guaranteed kodak processing. Prompt 8mm or 35mm 20 exp. \$1.40 Free list-mailers. Color Pix, Dept. P, CPO Box 30, Kingston, N. Y.

MOTION PICTURES AND SOUND EQUIPMENT

FILMS For home, school, and church. Free catalog. Thunderbolt Productions, Box 272, Detroit 31, Michigan.

SAVE Money on B&W, color, 8mm., 16mm. film and supplies. Send 10¢ for bargain catalog. Superior, 448 N. Wells, Chicago 10

BIG Bargains 16mm. sound films. Bedner, 5300 So. Talman, Chicago.

16MM. Sound — 8mm. Film bargains. Gaines, Box 32430, Van Nuys, Calif.

ENTIRE Life of Christ. 8mm, silent, 16mm, narrated, sacred music for sale. Hemenway Film Co., 424 Little Building, Boston 16, Mass.

BARGAINS On 16mm. features. Private library. List free. Box 1334, Escondido, California.

8MM-16MM Movies. Introductory offer 50' reel \$1.25 each. Comedies, cartoons, travel, fishing, hunting, adventure, thrills. Send \$5.00 for 5 subjects. MovieLand, Box 10-M, Van Nuys, Calif.

5,000 8-16 MM. Movie films. Free catalogs. International, Greenvale, N. Y.

MOVIE Camera film: 8mm. roll \$1.50. 16mm. 100' \$3.00. Free processing. Better Films, 742 New Lots, Brooklyn, N. Y.

MOVIE Film! Free catalog! ESO-R, 47th Holly, Kansas City 12, Missouri.

16MM. Sound, projectors, films. Sale, rental, exchange. Visit store or write for catalog. National Cinema, 71 Dey St., New York City.

COLOR SLIDES

LINCOLN Story in color slides. Catalogue and sample 35¢. Willems, Box 1515-A, Chicago 90.

8MM., 16MM. Movie subjects. Silent, sound. New, used. 2"x2" color slides. Biggest selection anywhere! Free each month, big 24-page newspaper-size catalog. Blackhawk Films, Davenport 14, Iowa.

ALASKA Film, Box 5-621, Mt. View 8, Alaska. Movies, slide samples \$1.00.

TRANSPARENCIES Wanted. Up to \$500.00 each. For information write American Color, 1008 N. Stanley Ave., Hollywood 46, Calif.

MUSIC & MUSICAL INSTRUMENTS

SONGWRITERS—Send poems. Honest, sincere offer. Free recording. Successful Songs, Box 608, Danbury, Conn.

"PRACTICAL Violin Making" with patterns \$2.00. Supplies. Chelsea Fraser, 2025 Stark, Saginaw 4, Mich.

PLAY guitar. Teach yourself. \$1.00. Ernie Ball Guitars, Box 308PM, Tarzana, Calif.

1962 ACCORDIONS at 60% off! Save middleman's profits. 20 models to choose from. Money back guarantee—5 day free trial! 40 bass electric chord organ \$99.00. Waltham Importers, Box 3862, Detroit 5, Michigan.

BANJO And guitar making instructions, woods, parts. List 10¢. Musicraft, 823 Foster, Evanston, Ill.

SONGPOEMS Wanted. Free appraisal. Hollywood Tunesmiths, 1651 Cosmo, Hollywood 28, California.

FREE Christmas chime recordings catalog! Buy three, one free. Chimes, 1818 Outpost, Hollywood, Calif.

BANJO'S, Mercury, Venus. Write. Particulars. Garlepy, 263 E. Forhan St., Long Beach 5, Calif.

ACCORDION-O-RAMA, 874 Broadway, New York 3, N. Y. Tremendous discounts. Top brands. Free brochure.

ACCORDIONS—All sizes. Free home trial. Color catalog. Save 1/2. Terms. Accordion Import Center, 7120 Galli Dr., San Jose 29, Calif.

SWISS Musical movements. Mechanical—electrical. Spielman, 131 West 42nd, New York 36.

SONGPOEMS And songs wanted! Mail to: Tin Pan Alley, Inc., Box 405, Radio City Station, New York 19, N. Y.

POEMS Wanted for musical setting and recording. Send poems. Free examination. Crown Music Company, 49-C West 32 Street, New York 1.

POEMS Needed immediately for new songs and records. Free examination and appraisal. Send poems: Songcrafters, Acklen Station, Nashville, Tenn.

GUITAR Making books, plans, imported woods, tools. List 10¢. Satinwood, 510 East 11th Street, New York 9, N. Y.

ELECTRIC Guitars, amplifiers, wholesale. Free catalog. Carvin, PMM, Covina, Calif.

SONGS Wanted. Pays royalties. Enclose postage. Olenik Records, Mount Morris, Michigan.

SONGPOEMS Wanted! Collaborate with professional songwriters on equal basis. Share royalties. Songwriters Contact Co., 1619-D Broadway, New York 19.

ACCORDIONS. Chord organs, guitars! Buy direct—save to 1/2. Famous makes. Free home trial. Easy terms. Trades. Free catalogs. Mention instrument. International Music Mart, Dept. R, 2003 Chicago Avenue, Chicago 22.

SWISS Musical movements, \$1.90. Helax, 218 W. 72nd St., New York City 23.

RADIO, TELEVISION AND ELECTRONICS

SAVE Big money on ham equipment, radio and TV parts, tubes, hifi, changers, speakers, kits, etc. Send for free catalog. Al-Lan Electronics, 1511 Greenwood Rd., Glenview, Illinois.

LISTEN To European, African, South American stations six transistor 2 band, portable radio, \$24.50. Nine volt 006P transistor batteries 39¢. A. Johnson, 233 Barrett Ave., Jamestown, N. Y.

DO Negative ions improve your well being? Get facts, plans for building ionizer. \$1. Tusp, Box 4114F, Cleveland 23, Ohio.

IDENTIFY Your equipment with personal decals. Name and address on 50 attractive decals only \$1. Alma Products, G.P.O. Box 1690, New York 1, N. Y.

"RADIO Explained." 64 page book—15¢. Bookmaster, Box 17273-F, Salt Lake City 17, Utah.

TRANSISTOR Radios repaired. \$5.00 covers parts labor, return postage. Mail radio and \$5.00 to: Mannington TV Co., 23 Pyles Ave., Mannington, W. Va. Guaranteed.

TV Tubes 50% off. Complete set tubes (excluding pic. tube) for your TV \$29.95. Brand new. Unconditionally guaranteed. Repair set in minutes. No delay. No service call. Tube checker free with order, \$5.95 value. Send make and model number. National Tube Distributors, Room 822, Marshall Field Annex Building, 25 East Washington Street, Chicago 2, Ill.

FREE Confidential list of supplies and equipment. Low anywhere. Knapp, 3174 1/2 8th A Largo, Florida.

LEARN While asleep with a "Electronic Educator" endless tap, recorder. Details free. Research Associa., Box 24-PX, Olympia, Wash.

GOVERNMENT Surplus electronics by the pound: 100 lbs. \$8.00; 50 lbs. \$4.50; 10 lbs. \$1.00. Full payment with order, shipping charges collect. Send for free catalog of the world's finest government surplus electronic bargains. Fairradio Sales, Box 1105, Lima, Ohio.

FREE! 1962 Heathkit catalog, world's biggest electronic kit catalog. 100 pages, over 250 kits we guarantee you can build regardless of experience. Save up to 50% on stereo/hifi, citizen's band, marine radio, portables, amateur radio, test equipment, educational kits; all illustrated, described, specified. Write: Heath Company, Benton Harbor 56, Michigan.

DON'T Buy hi-fi components, kits, tape, tape recorders until you get our low, low return mail quotes. "We guarantee not to be undersold." Wholesale catalog free. Easy time payment plan. 10% down—up to 24 months to pay. Hi-Fidelity Center, 220-M E. 23 St., New York 10, N. Y.

RECORDERS. Hi-fi. Free wholesale catalogue. Carston, 125-Y East 88, N. Y. C. 28.

GOVERNMENT Surplus radios, parts. Picture catalog 10¢. Meshna, Malden 48, Mass.

RADIO And TV tubes at manufacturer's prices! 100% guaranteed! Brand new! No re-brands or pulls! United Radio, Box 1000-M, Newark, N. J.

FIX Your own TV. Save 80%! Send for free illustrated chart showing how! We'll include giant electronics catalog. Zalytron, 220-M West 42 St., New York City.

TAPE Recorders hi-fi components. Sleep learning equipment, tapes. Unusual values. Free catalog. Dressner, 1523M Jericho Tpke, New Hyde Park, N. Y.

CRYSTAL Radio kit \$1.00. Amplifier and speaker for same \$4.95. Catalogue. Clearco, Box 1638, Stuart, Florida.

HI-FI From Japan. Finest imported tuners, amplifiers, recorders, etc. Free catalog. KPJ Sales, Box 1252-P, Studio City, California.

BUSINESS OPPORTUNITIES

RAISE Rabbits on \$500 month plan. Free details. White's Rabbitry, Mt. Vernon, Ohio.

DRIED Mushrooms \$4.50 pound for large canning company. Receiving warehouse in United States. Growers wanted on contract, everything supplied. Mushroom Salt Co., No. 548, Calgary, Alberta, Canada.

OPERATE Profitable home business by mail. Write: American Distr., Box 409-P, Niles, Michigan.

\$70.00 WEEKLY—Home, spare time. Simplified mail bookkeeping. Immediate income—easy. Auditax, 34741A, Los Angeles 34.

BUY Direct from Japan! Cameras, binoculars, hi-fi, electronics, tools. Manufacturers' directory \$2.00. KPJ Sales, Box 1252-P, Studio City, Calif.

LIQUID Molding rubber, free sample. Shellcraft supplies. Chaney's, 1907-A East Road, Jacksonville 16, Fla.

BUY Direct from factories. Appliances, cameras, watches! Free details! Cam Co., 436 P.M. Bloomfield Ave., Verona, N. J.

\$200.00 MONTHLY. Spare time. With tablesaw, bandsaw or jigsaw. Write. Holiday House, A3800 Harney, Vancouver, Washington.

SHARPEN Saws and lawnmowers the profitable way. Send for free literature. Max Manufacturing Company, 138 Stockton Avenue, San Jose 26, California.

CANDIED Popcorn and potato chip equipment. Eakins, Box 933-A1, Springfield, Ohio.

FRANCHISES Make profits! Operate your own exclusive franchised business. Write today for free interesting details. National Franchise Reports, W-528, 333 North Michigan, Chicago 1.

IMMEDIATE Profits with no capital or experience. Take orders for all magazine subscriptions. Friends and neighbors are your prospects. Write now for complete, free kit. McGregor Magazine Agency, Dept. 116B, Mount Morris, Illinois.

SELL Champion, AC, Autolite spark plugs. Reconditioned, electroplated, guaranteed 10,000 miles. 100% profit. Free sample. Lee Plugs, 1608-A Roberts, Houston 3, Texas.

WANT To make big money at home? \$10.00 profit in an hour possible with invisible mending. Make tears, holes disappear from clothing, fabrics. Steady year-round demand from cleaners, laundries, homes. Details free. Fabricon, 6234 Broadway, Chicago 40, Ill.

LEARN Sewing machine repairing. To \$125 weekly. Sparetime. Supplies. Add to present business. Write today! Taylor Service, Box 2126, San Bernardino, Calif.

VENDING Machines. No selling. Operate a route of coin machines and earn amazing profits. 32-page catalogue free. Parkway Machine Corporation, Dept. #27, 715 Ensor Street, Baltimore 2, Maryland.

BUSINESSES, Resorts, motels, investment property, ranches. Our special service dept. at your disposal. No obligation. World's largest. 38 years' service. Strout Realty, 7-MB S. Dearborn, Chicago 3, Ill.

BIG Money raising fishworms and crickets. Free literature. Carter Farms, Plains, Georgia.

TO \$100.00 Weekly. Sparetime, home operated mailorder business. Successful beginner's plan. Everything supplied. Lynn, 10420-M National, Los Angeles 34.

PIANO Tuning learned quickly at home. Tremendous field! Musical knowledge unnecessary. Information free. Empire School of Piano Tuning, Champaign, Ill. (Founded 1935).

COPUBLISH Mail Sale Advertiser, leading mail order paper. Details, latest copy, dime. Vanroy Shirk, Lebanon, Penna.

BRONZE Baby shoes: Instructions, equipment and mountings for genuine electroplating process. Largest supplier of all plating equipment, supplies. Free catalogue. Hollywood Bronze Supply, Dept. B-3, 1624 East First, Los Angeles 33, Calif.

OPERATE Profitable mail order business. Write Walter Service, 4159A East 112th, Cleveland 5, Ohio.

BAKE New greaseless doughnuts in kitchen. Sell stores. Free recipes. Montgomery, 3605 South 15th, Minneapolis 7, Minnesota.

\$3.00 HOUR—Home, sparetime, assembling pump lamps. Easy. Free details. Ougor, Caldwell, Arkansas.

EXCEPTIONALLY Profitable opportunity in tape recording! Free information. Baron's, Lynden, Washington.

JAPAN Directory. 145 Japanese manufacturing exporters. Japan and Hong Kong trade journal information. Asia opportunities. Just \$1.00 today. Nippon Annai, Box 1150-P, Spokane 10, Wash.

MARKETS Everywhere. Make artistic concrete birdbaths, pottery. Best coloring. Home workshop. Hundred varieties. Free pictures. Hollywood Cementcraft, 8527-S Wonderland, Hollywood 46, California.

MAKE \$46 From square foot plywood: jigsaw necessary. Free details. Woodart, Bridgewater, Mass.

MAKE Money from old tires. Operators clearing \$400 weekly. Equipment costs \$800. Get facts. S & S Patents, Inc., 3511 N. Lincoln Ave., Chicago 13, Ill.

\$400.00 MONTHLY Raising giant fishworms. Soilless method. Charlie Morgan, Bushnell, Florida.

HOW And where to obtain capital. Write: Reliable Service, Rome City, Ind.

SELL Books by mail. 400% profit. Royal, Box 368-X, Cleveland 27, Ohio.

PLASTERCRAFT Molds, liquid rubber, plasters, flocks, candle supplies, Catalog and manual free. Blue Rapids Supply, Blue Rapids, Kansas.

WORLD'S Largest wholesale supply. Buy from 679 American, European, Japanese wholesalers. Tailormade suits from Hongkong. 123 dropship catalogs. Rock-bottom prices. Free details. International Buyers, 216-MM Jackson, Chicago 6, Ill.

MAILORDER. America's most unique no cost beginner's plan. Armstrong's, 154-A Darrington S.W., Washington 24, D.C.

JOKE Merchandise. Rack consignment deals. No selling. Rush \$100. Ten samples, profit plan. Robbins, 127-G West 17th Street, New York City 11.

EARN \$3 hourly, spare, full time, looking up information at your local library. Operate research bureau. Details free. Service, 81C Knickerbocker Station, New York.

RUN Your own business. Operate a United Rent-Alls store, the store that rents most everything. 300 home-owned stores coast to coast. Profitable business. Franchises available. \$7,000 cash required. Additional financing available. Write for free brochure to United Rent-Alls, Inc., Box M, 2627 North 27th Street, Lincoln, Nebraska.

AMAZING Profits in exterminating. Full time — part time. Free details. Baylab 21M, Cambridge, Maryland.

YOUR Own wholesale business. No inventory. No investment. Thousands of nationally advertised brands direct from factories. Write: A & H. Wholesalers, 97 Pulaski St., Brooklyn 6, N. Y.

EVERYBODY Likes candy and popcorn specialties. Learn to make professionally home. (Our 50th year.) Ragsdale Candies, B-107, East Orange, New Jersey.

RE-CAST Junk batteries into new. Latest achievements. Battery Laboratories, Bayou LaBatre, Alabama.

11,000 NEW Prospects daily. Baby record books, shoes, albums. Sell mailorder. Use our literature. Write: No-Co-Ro, Capitola, Calif.

REPAIR Hydraulic jacks. Easy, profitable. Write: Hydraulics, Box 4104, El Paso, Texas.

YOUR Own baby shoe bronzing business. Instructions, equipment, supplies. Metalizing, glassing, Pearl-Kote. We finance. Free booklet. Dept. A, Box 5036, Inglewood, Calif.

EARN Good income sending us information. Weekly paycheck. Details 10¢. Thomas, Mount Wilson 8, California.

\$1,000 MONTHLY Spare time tape recording weddings, radio commercials, sound effects, hundreds of ideas and complete plans! Famous course "Tape Recording for Pleasure & Profit" measures an inch thick, a foot square, loaded with money-making ideas with a tape recorder! Complete course including 45-minute tape of demonstrations and instructions only \$14.95 plus \$1.00 postage and packing. Or send \$2.00 for complete booklet on "How To Record Weddings" and illustrated literature on the course. Dixieland Sound, Asheboro 17, North Carolina.

SPORTING Goods—Mail order business. We print your 32-page color catalog and pay postage on all orders. Hunting, fishing, camping, athletic equipment and family games. Every home a prospect. Send \$1.00 for franchise certificate, sample catalog and details—no other fees. D. C. Enterprises, Inc., 1643 South State Street, Ann Arbor, Michigan.

"MAILORDER Laws and Regulations." Explains mailorder licenses, mailorder taxes and mailorder legal requirements. Avoid trouble with the government. Read latest revised enlarged edition. \$2.00. (Particulars free.) Neil H. Tasker, Shamokin, Pennsylvania.

WORK Like a millionaire. \$400-\$1000 monthly plus apartment, managing a motel. Learn at home. Free booklet. Motel Managers Training School, PM-J, 612 S. Serrano, Los Angeles 5.

LEARN Professional TV servicing in one week! Fabulous new simplified system. No big expense. No studying. No tools or equipment. Spare, full time. Own your own big profit business! Save! Amazing but true! Free sample lesson, illustrated "How To" booklet. Write, TV Systems, Dept. EC-17C, 1038 So. LaBrea, Los Angeles 19, Calif.

LEARN Landscaping and the growing of plants. Start a profitable business part or full time. Free information without obligation. National Landscape Institute, Dept. MC-121, 11826 San Vicente Blvd., Los Angeles 49, Calif.

\$1.00 BRINGS You \$18.00 spare-full time home business opportunity! Amazing new velvet-spray transforms old cheap lamps, TV-radios, figurines, furniture, anything, into valuable products! Free samples. 50 business opportunities booklet. Send no money. Flok-Kraft, DR Los Angeles 61.

BIG Money — Operate your own fix-it shop. Service all household appliances; irons, fans, refrigerators, automatic washer-dryers, etc. Do house wiring, commercial wiring. Rewind motors of all sizes. Sharpen mowers, skates, saws. Buy needed spare parts wholesale. Free book. Christy Trades School, A-1603, 3214 W. Lawrence, Chicago 25.

IMPORT-Export opportunity, profitable, world-wide, mail-order business from home, without capital; or travel abroad. Established world trader ships instructions for no-risk examination. Experience unnecessary. Free details. Mellinger, T70C, Los Angeles 24.

MAKE Extra money—Big cash commission plus premiums for you and your customers. Sell advertising book matches. Sensational new tenorrama, glamour girls, hillbillies; dozens others. All sizes. Quick daily sales; big repeat business. Free master kit makes selling easy. No experience necessary. Superior Match, Dept. MX 1261, 7530 Greenwood, Chicago 19.

\$34.70 TWO Hours manufacturing concrete products. No selling. Castings #3, P.O. Box 1721, Rapid City, South Dakota.

SELL By mail. Mail order specialist shows how to start on low capital. Modern merchandising methods, not crackpot schemes. Free details. Larry's Specialties, 97-06 63rd Drive, Rego Park 74, New York.

START Your own business on credit (U.S. and Canada). Your own boss. 1344 dealers sold \$5,000 to \$25,500 in 1960. We supply stock, equipment on credit. 200 home necessities. Sales experience unnecessary. Pleasant profitable business backed by world-wide industry. Write Rawleigh's, Dept. L-U-PPM, Freeport, Illinois.

MAILORDER To motels, churches, institutions. Complete setup. Not just instructions. Hermes Advertising, 152 West 42, New York City 36.

MOST Profitable aspect of mailorder is cheapest to try! Write: Simon, Box 87-PM8, Pelham, N. Y.

\$250.00 WEEK Spare time profit possible. Earn at home with new fascinating printing method. \$5 starts you—send no money now. Free confidential facts and valuable sample. Screen-Print, DR, Los Angeles 61.

PROFIT With Popular Mechanics' subscription plan. No investment, no experience needed. Earnings begin immediately when you obtain subscriptions for Popular Mechanics, Good Housekeeping and others. High commissions, bonus. No experience needed. Deal directly with the publisher. Write Popular Mechanics, Room 12B, 250 West 55th St., New York 19, N. Y.

HOW To sell books by mail. Box 51-PZ, Des Plaines, Illinois.

FREE: "How to Win Contests." Contestar, Box 51-PD, Des Plaines, Illinois.

FREE Report: "609 Unusual, Successful Businesses." Box 1001-PN, Evanston, Illinois.

SIGNS. Sell restaurants, bars, etc. Samples \$1.00. Box 9563, Jackson, Miss.

BECOME Tax consultant. Graduates earn \$1,000-\$3,000 every tax season preparing returns evenings. State approved. Union Institute, Lakewood F-2, N. J.

INTERNATIONAL Mailorder business made easy. Complete setup service, not just instructions. Hermes, 152 West 42, New York City 36.

PROFITABLE Mailorder business. Write: Vikari, 468-PM2 Third Avenue, Salt Lake City 3, Utah.

PACKAGE At home for profit! We supply everything. No selling. Free home business details. HPC, 2212BC Jesse Street, Los Angeles 23.

MORE Profit selling stainless steel gift sets! Free brochure. Alvin Products, 79 Wall, New York 5, N. Y.

FREE Book "990 Successful, Little-Known Businesses." Work home! Plymouth-472P, Brooklyn 4, New York.

CASH From sawdust, tin-cans, newspapers. Over 200 methods. Instructions \$1.00. Charles Company, 42-GPR, Norwood, Ohio.

FREE Book "711 Bizarre, Successful Ventures." How I retired. Work home! Hayling, Carlsbad, Calif.

OPERATE Home mailorder business. Vosacek Printing, 4444A Ute, San Diego, 17, Calif.

MOLD Statuary, pottery, tiles, novelties. 5¢ materials makes dollar sellers! Particulars free. Marbleizing Service, Edwardsville, Illinois.

EARN Money flocking Christmas trees. Send for "Spare Time Dollars." Free. Flocking, 1517 Log Cabin Ave., Rockford, Illinois.

UP To \$150.00 weekly in your own advertising business. No buying, selling, mailing or investment. Work anywhere in the country. Complete "Secret Instructions"—\$2.00. Satisfaction guaranteed. Charles Redmond, 120 West 45th, New York 36, New York.

EARN \$12,000 in 7 months with a freezer-fresh "Dairy Bar on Wheels," most complete soft ice cream mobile unit available. No franchise, no royalties. Also available, oven-fresh pizza-refresher units and traveling food caterers. Distributors needed. Dept. PM, Tri Metal Works, Inc., Riverton, N. J.

PROFITABLE Formulas, recipes, trade secrets. Information free. Colen, 7731-MX Yates, Chicago 49.

PAWNBROKER. Be one. Professional instruction. Complete only \$10. Or write: Pawnbroker Thayer, Western Ave., Bath, Maine.

A Business for added income without investment? Yes! Annual, New York City 8.

EARN Money raising fishworms for us! Write: Oakhaven 38, Cedar Hill, Texas.

MONEYMAKING OPPORTUNITIES

MAKE Money by mail! Spare hours, a few dollars, will start you. Webster, 2038-26 Mockingbird Road, Columbia, South Carolina.

MAKE \$5,000 Yearly spartime raising mink, chinchillas, nutria, etc. Free booklet reveals proved plans. Write: Furs, 588 Mt. Pleasant Road, Toronto 1, Canada.

AMATEUR Artists! Turn your art ability into money. Hamilton, Box 4-F, Astoria 5, N. Y.

SIMPLE, Pleasant mailorder can net \$12,000 year. Write: Simon, Box 87-PL3, Pelham, N. Y.

CASH At home—in profitable lettershop operation. Business-getting manual "Mimeographing Dollars" tells how. New machines available. Write: Mimeographing Dollars, 1012-C Center Street, Evanston, Wyoming.

WANTED, Factory assembly outlets and distributors. Fiberglass-plastic products. Small investment. Free details. Northside Recreation, Inc., Box 918, Brooksville, Florida.

CHOICE Spartime moneymakers. Literature free. Harrison, 248 So. Hackett, So. Beloit, Illinois.

AMAZING Way to make money—full or spare time. Entertain others with magic! Fun! Profitable! Easier than you think! Start now. Rush 10¢ for giant fun & magic catalog—1000 tricks, jokes! Tells all! House of 1000 Mysteries, Dept. PMM-12C, Trumbull, Conn.

FREE Catalog fast selling jewelry plus a beautiful goldplated necklace, bracelet, earring set giftboxed \$1.00. Jacoby, 1715 East Mercer, Seattle 2, Wash.

CIGARETTES—Make 20 plain or filter-tp for 9¢. Facts free. Moberly, Box 4012, Owensboro, Kentucky.

OPPORTUNITY Advertiser, copy 10¢. Opportunity Advertiser, P.O. Box 4207, Bakersfield, Calif.

EXCITING Puzzles! Cash prizes! Write: Spence, Box 11569, St. Petersburg, Fla.

START Your own business. Fortunes in formulas. \$3.95. Berthoff's, 739 12-P Sylvania Avenue, Toledo 12, Ohio.

PROFITABLE Spare time ideas. E. Jones, Box 92, Downsview, Ontario, Canada.

PROFITABLE Formulas, recipes, trade secrets. Information free. Colen, 7731-MX Yates, Chicago 49.

EARN Money raising fishworms for us! Write: Oakhaven 59, Cedar Hill, Texas.

FREE! Amazing new book of money making opportunities and mail order bargains. Write today! Dept. PM, P.O. Box 1123, Chicago 80, Illinois.

MEN — Women! Start money-making plastic laminating business at home in spare time. Material that costs 11¢ brings back \$2.58. No canvassing or selling but mail orders brings in \$20 a day. Write for full particulars free. Rush name on postcard to Warner, Room CL-2-L, 1512 Jarvis, Chicago 26, Ill.

EASY To start rubber stamp business at home in spare time. Make up to \$9.80 an hour without experience. Facts free. Write Roberts, 1512 Jarvis, Room CR-2-L, Chicago 26.

MINK Raising information free. Complete. Lake Superior Mink Farm, Superior, E.E. Wisconsin.

VENDING Machines. No selling. Operate a route of coin machines and earn amazing profits. 32-page catalogue free. Parkway Machine Corporation, Dept. #26, 715 Ensor Street, Baltimore 2, Maryland.

EARN Money evenings copying and duplicating comic cartoons for advertisers. Adservice, Argyle 1, Wisconsin.

YOUR Own, easy-to-start, home mail-order business, spartime. Fascinating! Profitable! Information free. Alfano, 19-PM Pine, Closter, N. J.

BIG Money raising fishworms and crickets. Free literature. Carter Hatchery, Plains, Georgia.

READ "Progressive Mailtrade," the magazine that tells how to make money by mail. Quarter brings sample and special offer. Progressive Mailtrade, Box 357, Sheboygan, Wisconsin.

AMAZING Successes through franchises! Become exclusive franchise holder your territory. Information rushed. National Franchise Reports, MP-528, 333 North Michigan, Chicago 1.

LEARN The secrets of repairing junk batteries, generators, starters, profitable, easy, at home. Free particulars. Batterymen, 3465 Forrest, Santa Clara, Calif.

\$25-\$50 WEEKLY Possible, re-writing news items, jokes, poems, recipes, for publishers. Some worth \$10 each. Details free. Service, 81-D, Knickerbocker Station, N.Y.C.

LEARN Plastics fabrication for extra income. Low cost home training now available. Write for free booklet. Interstate Training Service, Dept. D-3, Portland 12, Oregon.

WIN Contest money. General Contest Bulletin gives hundreds of tips. Lists current contests, rules. Sample magazine 25¢. General Contests, 1609½ East 5th Duluth 12, Minnesota.

OFFICE Work—home, spartime. Refundable moneymaking instructions 50¢. Interstate, 37-1 Besch, Albany 9, N. Y.

RECEIVE Moneymaking offers galore. Name listed 6 months \$1.00. Satisfaction guaranteed. Homeworkers Guide, King, N. C.

MAILORDER Business learned easily. Write: Esasco, Box 323, Grand Rapids 1, Michigan.

MAKE Money with your power saw. Boyce, 3956PM West End, Chicago.

EXPORT — IMPORT

JAPAN: Direct mail-order 26 page catalogue: dolls, novelties, business information, manufacturers' names, addresses, \$1.00; Japan's Trade Directory, 3000 companies, \$3.00. Send cash. Clarence Yamagata, 814 Toginbiru, Marunouchi, Tokyo.

BUSINESS Firms—Boost your sales with imports. Try our foreign offers, services. Importico, Enka, North Carolina.

YOUR Own import mail order business. Deal with over 400 manufacturers exporters of the world. Complete import procedures, international dropship methods. Capitol unnecessary. Details 10¢ refundable. Associated, Box 108-EI, Lincoln 1, Nebraska.

SCIENCE & CHEMISTRY

AMAZING New book of science experiments, formulas, and catalogue of laboratory supplies. Only 35¢. National Scientific Co., 13 S. Park Avenue, Dept. PM-12, Lombard, Illinois.

ROCKETEERS! High power rocket kits, supplies, chemicals, optics. Illustrated catalog 25¢. Rocket Model Research, Box 716, Newark 1, N. J.

"CHEMISTRY Explained." 64 page book—15¢. Bookmaster, Box 17273-G, Salt Lake City 17, Utah.

CHEMICALS And apparatus for industrial, analytical, and private laboratories. Catalog 35¢. Dept. M-50, Biological Supply Co., 1176 Mt. Hope Ave., Rochester 20, N. Y.

FREE Chemical catalogue. Enclose 10¢ postage. Fairview, Box 1116, New York City 8.

ROCKET Model supplies. Fuel chemicals, engines. New Catalog 25¢. Central Rocket Company, 89P Waupaca, Wis.

232 PAGE Catalog \$2.00. Laboratory Materials, 7319 Vincennes, Chicago, Ill.

CHEMISTRY Catalog 25¢. Bargain lists. Laboratory Sales, Box 161-A, Brighton, Mass.

SCIENCE Treasure chest. Do hundreds of experiments. Order No. 70.342-CZ—\$5.00 postpaid. Request free catalog—CZ. Edmund Scientific Co., Barrington, New Jersey.

NEW Concept of atomic structure. Nuclear theory challenged. 30 pages, 25 cents ppd. C. F. Krafft, 4809 Columbia Road, Annandale, Virginia.

ILLUSTRATED Catalog: Chemistry, mineralogy, biology 25¢. Tracey Laboratories, Evanston, Illinois.

UNUSUAL Chemistry books, courses, kits! Rare chemicals, cheap! Catalog 25¢. NSC, Box 11133, Palo Alto, Calif.

"EXPERIMENTER'S Booklet" and bigger catalogue—25¢. Hagenow Laboratories, Manitowoc, Wisconsin.

ROCKETS: New illustrated catalog 25¢. Kits, cones, tubes, engines, etc. Estes Industries, Penrose 2, Colorado.

FORMULAS, PLANS, ETC.

FORMULAS For latest money-making discoveries. New! Good! Valuable literature free! Miller, Chemist, 1517-D, Tampa, Florida.

ANTI-FREEZE, Waterless handsoap, resilvering mirrors, all \$1.00. Nelko, Box 3462, Merchandise Mart, Chicago 54.

FORMULA Trade secrets. 10,000 to choose from. Information free. Norris Sales Co., Alpine 3, Tennessee.

LATE, Modern manufacturing formulas. List free. Moon Chemical, Martville, New York.

FORMULAS—All kinds. Amazing big catalog, 10¢. Kemixal, Park Ridge, Ill.

PLASTICS

MIX Acrylic repair plastic. Tough, machinable. Kit \$1.20. Acryjel, Box 306, Oklahoma City, Oklahoma.

NEW! Plastic vacuum forming machines. Hobby. Easy. Profitable. Details. Burr, 330 East Center, Kalamazoo, Mich.

NEW Liquid casting plastic, clear, colors. Embed real flowers, butterflies, photos, coins. Send 25¢ for two handbooks "How to Cast Liquid Plastics" and "How to Make Extra Money at Home." Castolite, Dept. P-101, Woodstock, Illinois.

LAMINATING Supplies. Free price list. Solomson, 4 Beacham, Everett 49, Mass.

CREATE Original artistic Christmas gifts. New instruction manual tells how to do plastic embedding and molding. Manual \$1.00, catalog 25¢. Castacraft Corporation, Dept. M-1261, P.O. Box 555, Palo Alto, Calif.

PLEXIGLAS— $\frac{1}{8}$ " \$1.13 sq. ft. Sheets, rods, tubings; fabricating, models made. Catalog 25¢. Plastic Shop, 2025 Nevada, Butte, Montana.

BOXES, Plastic. 200 sizes. Free list. Althor, 170 Bay 23 Street, Brooklyn, N. Y.

AGENTS WANTED

MAKE Most extra cash with world's biggest line everyday greeting card assortments, gifts Introduce friends, neighbors, to over 150 assortments, 500 big money-makers. Pocket up to 100% profit plus big cash bonus. Free giant color catalog; samples on approval. Write Arrow Greetings, 513 Fourth Ave., S., Dept. 83-H, Minneapolis, Minn.

AGENTS—300% Profit selling genuine gold window letters; stores and offices. Free samples. Metallic Sign Letter Co., 1217-D West Newport, Chicago.

NEW \$1.00 Houseware item. Every housewife a prospect. Write Clayco Products, 350 Portland Place, Minneapolis 20, Minnesota.

SELL Low-priced plastic laminating machines and supplies. Sipco, 4469M East Olympic, Los Angeles 23, Calif.

FOG-STOP Windshield cloth. Instantly removes blurry mist, frost, sleet, snow. Stops windshield fogging. Samples sent on trial. Kristee 88, Akron, Ohio.

SELL Champion, AC, Autolite spark plugs. Reconditioned, electroplated, guaranteed 10,000 miles. 100% profit. Free sample. Lee Plugs, 1608-E Roberts, Houston 3, Texas.

PRINTING, Office supplies wholesale 10,000 items. Save 50% Literature free. Printer, 31 Lehigh Place, Irvington, New Jersey.

AT Last! An adding machine you hold in palm of hand. Just slide dial to numbers and release. Ideal for warehouse inventories, checking super market shopping, keeping score, etc. Send \$2 for sample. Kittredge Sales, 2011 Stecher Ave., Union, N. J.

DEALERS Only men's quality second-hand suits \$40.00 dozen (auction list 10¢). Samples. Millen, 306-K East 92nd, New York 28.

AGENTS—Spanish jewelry, low prices, illustrated catalogue sent. Spanish Trading Company, Ramblas 27, Barcelona 2, Spain.

BIG Profits selling chamois to service stations, car lots. Steady repeat business. Free details. Inka Industries, 1606-H Roberts, Houston 3, Texas.

FREE Sample. Beautiful curios! Sell on sight! Apartado 9036, Mexico City.

START Your own business, selling the "World's Most Usable Bible." Sales quick, easy, and profitable. Extra bonuses; free insurance; other benefits. Write International Book Company, Department M, Box 118, Wichita 1, Kansas.

PRINTING, Advertising salesmen—Excellent moneymaking sideline selling decalcomania name plates, small quantities. Automobile initials, sign letters. Free samples. Ralco, XL, Boston 19, Mass.

YOUR Own business—Used suits \$1.50; overcoats 65¢; mackinaws 35¢; shoes 12 $\frac{1}{2}$ ¢; ladies' coats 30¢; dresses 15¢. Enormous profits. Catalog free. Nathan Portnoy Associates, 2109-AA Roosevelt Road, Chicago 8, Ill.

MAKE Up to \$50.00 a day soliciting delinquent accounts. Terrific commissions. Write today. National Credit, 304Y Pickwick Bldg., Kansas City 6, Mo.

BIG Profits. Stamp social security plates, key protectors. Sample 50¢. Catalog free. General Products, 11 No. Pearl St., Albany 7, N. Y.

YOUR Ad in this space will get some good agents for you. Yes, I'll prove it. Write for Folder "A" right now. F. W. Johnson, Classified Advertising Manager, Popular Mechanics Magazine, 200 E. Ontario St., Chicago 11, Ill.

MEN, Women, teenagers, thirty second demonstration sells hottest English import. One case starts you in business. Quantity orders gain bonus deal. Send \$28.80 for 36 or \$1.00 sample. Pac-Man, Box 99, Swartswood, New Jersey. Money back guarantee.

MAKE Profitable men's-women's wear. Sample free. Sunmade, Brockton 64, Mass.

FREE Colored portrait sales kit. Portraits, 402-PM Hazlett, Baltimore 29, Maryland.

PERFUMES, French type, imported essence. Saleable. 12 assorted sample bottles \$1.00. Catalogue. Parfums Dijon, 122 East 25 St., New York 10.

BUY IT WHOLESALE

100,000 PRODUCTS Wholesale! Terrific bargains! United Wholesalers, 1265-M Broadway, New York 1, N. Y.

100 FREE Wholesale catalogs! Complete directory, \$1.00. (Refundable). Parmelee's Supply, Marshfield, Wisconsin.

FREE! Name brands catalog! Your own high profit business. Sell name brands, full or part time. No inventory, no investment. More than 2,000 name brand items; lowest wholesale prices. Watches, jewelry, cameras, hi-fi, stereo radios-phonos, appliances, housewares, hardware, power tools, luggage, musical instruments, garden equipment, sporting goods, toys, many others. 8 floors of name brands. Million dollar inventory. Orders shipped complete in 24 hours! Send for free, beautifully illustrated catalog now! Separate wholesale price list. H. B. Davis Corp., Dept. PM, 145 W. 15 St., New York 11, N. Y.

BUY Below wholesale! Thousands of nationally advertised products. Drugs, clothing, housewares, cameras, jewelry, hardware, sporting goods, etc. Postcard brings price list showing actual factory cost. Buy-Rite, 310 Main, Bennington 2, Vermont.

NEW Deluxe multicolor below wholesale catalog, automobile catalog, and others. Housewares, appliances, refrigerators, freezers, washers, dryers, television, radios, furniture, clothing, luggage, binoculars, phonographs, recorders, cameras, projectors, tools, typewriters, watches, jewelry. Name brands. Huge discounts to 70%. Postcard: Selbyco, Decatur 15, Ill.

WORLD'S Largest wholesale supply. Buy from 679 American, European, Japanese wholesalers. Tailormade suits from Hongkong. 123 dropship catalogs. Rockbottom prices. Free details. International Buyers, 216-M Jackson, Chicago 6, Illinois.

USED And new watches \$2 up. Free list. Southern Watches, 5-PM So. Wabash, Chicago 3.

BELOW Wholesale. Name brands. Catalog \$1.00 (refundable), guaranteed. National Wholesalers, 38 Olive, Saranac Lake, New York.

WHOLESALE Specials. Closeouts. Catalog \$1 deposit. Loeber, 224-A Wyatt, Lincoln, Ill.

BALL Gum. Factory prices. Free list. Vending, Coldspring Street, Norwalk, Conn.

JUST Out! 356-page catalog—save to 50% on auto parts, accessories. All makes, models. Send 25¢—refundable on first order. Whitney, 1919 PA-12, Archer, Chicago 16.

LARGEST Wholesale supply source in U.S.! 15 free catalogs. Furniture, clothing, appliances, housewares, automobiles and accessories, tools, sporting goods, hobby supplies, farm equipment, imports, new products, bargain merchandise. Free details. Associated, Box 108-DD, Lincoln 1, Nebr.

2,000 PAGES Wholesale catalogs! Write: Mosaser, Box 47-B, Newark, Ohio.

"BARGAINS Direct Overseas." Sent postpaid, airtel airmail, for sale or resale. "Wholesale U.S.A." "Book Bargains"—Three stupendous catalogs, \$1. Hundreds of items, one source. Kittredge Sales, 2011 Stecher Ave., Union, N. J.

APPLIANCES, Housewares, furniture, bedding, jewelry, tools, etc. 125-page below wholesale catalog \$1.00. Wholesale Supply, 42 East Pembroke Rd., Danbury, Conn.

ELECTRIC Guitars, amplifiers, wholesale. Free catalog. Carvin PMW, Covina, Calif.

SALESMEN—DISTRIBUTORS

TAKE Over your area—Agents, dealers, farmers make \$250 up weekly selling nationally advertised Campbell's Gro-Green concentrated plant food supplements, increase protein and mineral content of grains and forage. No investment. Credit given. Everything free. Ideal proposition for corn and feed men. Campbell Co. (Est. 1928), Rochelle 52, Illinois.

AMAZING, Folding, easy connecting, pickup tow-bar. Inexpensive. Guaranteed. Salesman making terrific profits. Literature free. Carson Industries, Faxon 1, Oklahoma.

EARN Big commission full or part time. Build profitable business of your own selling America's largest line low priced business printing. 360 page catalog samples hundreds of items used daily by business people. Imprinted ball pens low as \$8.95 for 100. Big full color catalog low priced advertising specialties included. Free sales kit. National Press, Dept. 8, North Chicago, Illinois.

MAKE Up to \$50.00 a day soliciting delinquent accounts. Terrific commissions. Write today. General Finance, 304V Pickwick Bldg., Kansas City 6, Mo.

IF You're interested in making money in selling, see the hundreds of exceptional opportunities in Salesmen's Opportunity Magazine. Send name for your copy, absolutely free. Tell us what you're selling now. Opportunity, 848 N. Dearborn, Dept. 17, Chicago 10, Illinois.

WILL You wear new suits, sport coats without one penny cost and agree to show them to friends? You can make up to \$40.00 in a day even in spare time, without canvassing. Stone-Field, 532 South Throop St., Dept. G-926, Chicago 7, Ill.

MAKE Extra money—Big cash commissions plus premium for you and your customers. Sell advertising book matches. Sensational new tenorrama glamour girls, hillbillies; dozens others. All sizes. Quick daily sale; big repeat business. Free master kit makes selling easy. No experience necessary. Superior Match, Dept. M-1261, 7530 Greenwood, Chicago 19.

MAKE Big money taking orders for Stark dwarf fruit trees. Everybody can now grow giant size apples, peaches, pears in their yards. Also shade trees, shrubs, vines, roses, etc. Outfit free. Stark Bros., Desk 30162, Louisiana, Mo.

SENSATIONAL New longer-burning light bulb. Amazing free replacement guarantee—never again buy light bulbs. No competition. Multi-million dollar market yours alone. Make small fortune even spare time. Incredibly quick sales. Free sales kit. Merlite (Bulb Div.), 114 E. 32nd, Dept. C-74M, New York 16.

MAKE Extra money selling advertising matchbooks. Free catalog and sales outfit. Matchcorp, Dept. PM-121, Chicago 32.

CLEANS Windows without mess. Strange dry cleaning-cloth. Replaces liquids. Windows gleam. Samples sent on trial. Kristee 51, Akron, Ohio.

BIBLE Sales. Pays \$10.00 per order. Time payments financed. Delaware Valley Bible House, Camden 5, New Jersey.

COPYRIGHTED Tolerance motto, beautiful gloss 9x12. Hailed by civic leaders. Homes, businesses eager to display. Sample \$1.00 refunded first order. Tolerance, Box 1107, Glendale 5, California.

FREE Wholesale discount price list. Sell fluorescent pennants, decorations, banners, nuggets, spinners, flags. 50 other items. Aash Specialties, 3011 Greenmount, Baltimore 18, Maryland. (7 color, 50 page catalog \$1.00 refunded first order.)

NEW Rubber heel plates for rubber heels. Quiet, cushion-like, long-wearing. Save repairs. Fit all shoes. Applied with adhesive. Retail at 25¢ pair. Mease Sales, 1434-PM 17th, Des Moines, Iowa.

HIGH Commission and bonus. Earn \$100 to \$300 weekly. 30 year old company has openings. List delinquent accounts for collection. Experience not necessary. Permanent. Write: Merchants Protective Agency, 1015 Walnut, Kansas City, Mo.

SELL Sanitary and industrial hair covering to bakeries, frozen food, packaging industries. Liberal commission. American Safety Net, 3040 W. Montrose, Chicago 18.

INTRODUCING New automotive E-Z-Squeeze front coil spring compressing tool. E-Z-Squeeze is the mechanic's dream that can do front end jobs easy, safe, with hours saved. Earn \$50.00 or more daily. Proven seller. Excellent for sideline salesmen. Write: E-Z-Squeeze Tool Co., 726 Julia Street, New Orleans 12, La.

EMPLOYMENT INFORMATION

DIRECTORY Reports. Construction, aviation, shipping, oilfields, government, manufacturing, trucking, etc. Foreign-stateside. Helpful information plus job-getting tips on preparing application letters. Unconditional money-back guarantee of satisfaction. Act today. Only \$2.00 (\$2.25 airmail). (C.O.D.'s accepted). Research Services, Meramec Building, St. Louis 5-PM, Missouri.

FOREIGN Employment information. Europe, Alaska, Africa, Asia, Canada. Travel, adventure. Up to \$1,600 monthly. Construction workers, truck drivers, clerks, teachers, professionals, etc. Sensational opportunities—most complete information, application form sent immediately by return mail. Send \$2.00 to: Jobs, Box 512-E, New Orleans 12, Louisiana.

FOREIGN Employment. Construction, other work projects. If interested in overseas work, good pay, extras, write: Foreign Service Bureau, Dept. PM, Bradenton Beach, Florida.

FOREIGN Employment. Now open. World wide. Four books in one, merchant marines, aviation, civil service, all this for only \$3.00 airmail. Send money order to International Employment, P.O. Box 115, Boston 27, Mass.

FOREIGN Jobs—Latin America, Alaska, Canada, up to \$1500 monthly. Up-to-date 1961 foreign service directory gives complete information; hot list of firms hiring for military and civilian construction, aircraft, oil, exporters-importers, mining. How-when-where to apply. 13th successful year. \$1.00. Global Reports, Box 5201, Inglewood, Calif.

HIGH Paying foreign employment now open. Construction, aviation, Civil Service, Merchant Marines, jobs on ships, thousands of jobs open right now. Travel to Far East, Europe, South America. This is your chance to earn big money. Do not delay. Write for free information to: International Employment Information Center, Boston 27, Mass.

MERCHANT Marine jobs. Men and women. Top wages. Travel. Captain, Box 501-P, Reading, Massachusetts.

PLENTY Of jobs. U. S. A. and overseas. Up to \$1600.00 monthly. Construction, supervisory, clerical, etc. Skilled, unskilled. Free transportation. Unusual opportunities. Complete information plus worldwide project listings. Only \$2.00 (\$2.25 airmail). Satisfaction guaranteed. International Opportunities, Dept. J, 109 W. 42, New York 36, N. Y. or Box 621, San Jose 6, California.

OVERSEAS Employment information. High salaries. All occupations, professions. Tremendous opportunities. Complete listings, \$2.00. Associated Reporters, P.O. Box 1008, Miami 1, Florida.

ALASKA Employment guide, 25¢. Janecek, 373 East 155th Street, New York 55, N. Y.

SUNNY California jobs-want ads \$1.00. Douglass, Box 492-A, Ontario, Calif.

GET A good job. 53,748 worldwide job openings listed—mechanics to top administrators. Ask for free details or send \$1 for full report. Who's Hiring Who (PM2), 2020 M St., NW, Washington 6, D. C.

EXCELLENT Employment. California, Oregon opportunities. All occupations. Men. Women. Indicate area, occupation-employment preferred. Airmail, \$1.00. Employment Surveys, 2908 Gawthorne, Oroville, California.

JOB-Getting. Original treatise, copy-righted, \$1.00. Educators, 1026 NW 22nd Street, Gainesville, Florida.

CHOICE U.S. and overseas jobs. All trades. Firms, addresses, hiring, procedures, pay scales, benefits. For info, write: World Wide, Dept. B18, 155 N. Franklin St., Hempstead, N. Y.

CAPE Canaveral—Missile employment opportunities \$1.00. Canaveral Classified, Box 3445, Cocoa, Florida.

HOT List of firms hiring Electronics and other fields. Palo Alto-San Jose area \$1.00. Royal Personnel, 422 S. Murphy, Sunnyvale, Calif.

SPECIAL SERVICES

NAME Painting stencil 75¢. 1000 address labels (boxed) \$1.00. Pocket stamp \$1.00. Posly, Box 363, Roseville, Michigan.

RESEARCH Service. Any subject! Get facts promptly, reasonably. Write today. No obligation. Jake Barraco, 478 Gardner, So. Beloit, Illinois.

WHAT'S Your problem? Financial, Business career matters solved confidentially by expert staff. Alliance, P. O. Box 1984, Trenton, N. J.

INFORMATION On anything. Ferguson Research Specialists, 59 Lent Ave., Hempstead, N. Y.

EDUCATIONAL AND INSTRUCTION

BECOME A personal problem counselor. Enter dignified profession. Instructions \$1.00 refundable. Hermansen, Box 808, Grand Central Station, New York 17, N. Y.

EARN \$150 Weekly mechanical, electronics drafting. Send \$2 first lesson, \$25 complete home study course. Prior Inc., Dept. 121, 23-09 169 Street, White-stone 57, New York.

PROFESSIONAL Investigators. Home study. Lapel pin, certificate, future. Box 41197-F, Los Angeles 41, California.

WOODWORKING And cabinetmaking course for beginning and advanced home craftsmen. Only complete low-cost home training program available. Write for free booklet. Interstate Training Service, Dept. G-3, Portland 12, Ore.

USED Correspondence courses and books sold and rented. Money back guarantee. Catalog free. (Courses bought.) Lee Mountain, Pisgah, Alabama.

BE A Real Estate Broker. Insure security for yourself and your family. Study at home. Prepare for state examination. GI approved. Write for free book today. Weaver School of Real Estate, 2018 P Grand, Kansas City, Missouri.

HIGH School diploma at home. Licensed teachers. Approved materials. Southern States Academy, Station E-16, Atlanta, Ga.

WANT A diesel job? Higher pay? Advancement? We can help you qualify! Complete diesel, tractor and heavy equipment and Cummins Diesel Engine Shop-method home-training courses available. Write today. Interstate Training Service, Dept. B-3, Portland 12, Ore.

BOOKKEEPERS. Operate your own "Dollar-A-Week" system. Ellis, Box 200, Cedar Grove, North Carolina.

OWN Collection agency. Little "gold mine." Franklin Credit, Roanoke, Va.

LEARN Asleep or awake! Records, tapes, equipment! Free catalog! Drawer PM-697, Ruidoso, New Mexico.

MEN Wanted. Earn \$125 a week and up. Master a trade with a future. Learn auto diesel mechanics in our shops. You learn with tools on real equipment. Earn while you learn. Many of our graduates earn \$125 a week and up. Write for free bulletin: Dept. 256, Auto Diesel College, Nashville 3, Tenn.

STRENGTHEN Your voice— for more success in business, social life! Free booklet. Give age. PV Institute, 325 Jackson, Studio 2EN-2, Chicago 6.

ANALYZE Handwriting for profit, pleasure. Free sample lesson, catalog reveals plan. Write International, 325 Jackson, Dept. 2CN-2, Chicago 6.

SING, Speak with power. Self-training record. Amazing! \$9.95. Canfield, 2018-A Fifth Avenue South, Minneapolis 4, Minn.

PIANO Tuning pays. Learned easily at home. GI approved. 59th year. Free booklet. Niles Bryant School, Dept. P, 3731 Stockton, Sacramento 20, Calif.

BOOKKEEPERS. Operate your own profitable bookkeeping service. Whiteley, 1645 Warwick Avenue, Warwick, Rhode Island.

PIANO Tuning pays. Big money in spare time. Learn at home in 30 days. No musical knowledge necessary. Phonograph, records, tools and instructions furnished. Electronic tuning taught also. Free catalog. Capital Piano Tuning School, 3160 S.W. 16th Court, Fort Lauderdale, Fla.

SPEAK Spanish by comparing it with English. New booklet explains how. Pre-paid 50¢. Spanish by Comparison, Box 5313, El Paso, Texas.

SWEDISH Massage, physical culture and weight reduction pay big profits. Men and women. Learn at home. Diploma course. Free catalog. National Institute, Desk 4, 165 E. Ontario, Chicago 11, Illinois.

INVESTIGATORS Course. Credentials, diploma. Free information. Southwestern Institute Criminology, 510-A Iowa, Geronimo, Okla.

FINGERPRINTING And identification taught at home. Diploma. Details free. Alabama School of Fingerprinting, Fairfield, Alabama.

EARN More if you learn more! Write asking for training information for one of the following: Civil Service, high school diploma, art training. Write your preference to: N.T.S., Box 500-PM, Greenwich, Connecticut.

LEARN Auctioneering. Free catalog. Missouri Auction School, 1330 Linwood, Kansas City 9-X3, Mo.

LEARN Ventriloquism. Amazing-entertaining! Easy! Details free. B. Davis, B-38, Safety Harbor, Florida.

SECRET Investigations. Experience unnecessary. Investigators particulars free. George Wagner, M125 West 86th, New York City 24.

LEARN Real Estate business fast. Economical homestudy. Literature free. Howard Schools, Box 8394-A, Kansas City 5, Missouri.

PROFITABLE National Camera Repair School training at home! 174PM, Englewood, Colorado.

"ERROR Guide." Amazing book for bookkeepers, auditors, accountants, cashiers. Details free. Error Guide, P.O. Box 253, Minot, N. Dak.

FREE List "How To Do It Yourself" books, also home study Civil Service guides. Harry's Book Shop, 4415-PB North 13th St., Tacoma 6, Wash.

MASTER Watch making at home. Free sample lesson. Chicago School, 2328-YY Milwaukee, Chicago 47.

LEARN Civil and criminal investigation at home. Earn steady, good pay. State age. Institute Applied Science, 1920 Sunnyside, Department 169, Chicago 40, Ill.

"HOW To Train Horses"—a book everyone who like horses or ponies should have. Free. No obligation. Simply address Beery School, Dept. 11012 Pleasant Hill, Ohio.

GOOD Paying jobs open! Operate, repair heavy earth moving equipment! Learn "on the job" operating latest cranes, bulldozers, earth carriers! V.A. approved. Free catalog. Write T. O. Hutch, Greer Technical Institute, Braidwood, Illinois.

COMPLETE Your high school at home in spare time with 64-year-old school. Texts furnished. No classes. Diploma. Information booklet free. American School, Dept. X-945, Drexel at 58th, Chicago 37, Illinois.

PENMANSHIP Corrector. Improve poor penmanship quickly. Details free. Ozment, Box 665-24, St. Louis 88, Mo.

PIANO Tuning. Home study course. Diploma granted. American School of Tuning, Box 707, Gilroy, Calif.

DENTAL Technician's home study kit!! Instruments, plastic, etc. Write for free illustrated instructions. Grant Laboratory, Haas Bldg., Los Angeles 14, Calif.

HIGH School and college drop-outs: Turn your education into cash! Bulletins, 25¢. Personnel Advisory Services, Adams, Massachusetts.

AMBITIOUS Organization men—"Gardner Wilson's Legacy" is for you! \$1.00. Personal Publications, Box 6947, Baltimore 16.

ANNOUNCING: Residence, correspondence, self-study courses, 27th year successful placement. National Academy of Broadcasting, Washington 10, D. C.

SWEDISH Massage. Foot technique. Post graduate. Home study. Residential. Diploma. Dr. Swanson's Illinois Licensed School, 3809-PL Alta Vista, Chicago 13.

CIVIL Service. Training for U. S. tests. Get full information about this field, home study preparation for high rating. Free booklet. Private organization. No obligation. Franklin Institute, Dept. A112, Rochester 4, N. Y.

BLUEPRINT Reading and estimating—learn at home. Complete professionally prepared instruction—easy to master. Qualify for advancement opportunities. Folder free. Superior Publishers, Dept. PM-12, 34 East 12th St., New York 3, New York.

INEXPENSIVE Correspondence courses—Science, Engineering, Psychology, Divinity. Free information. Aurecas, Central Valley, New York.

PLAYS, STORIES, MANUSCRIPTS

WRITERS! Free list of top-notch U.S.A. markets for short stories, articles, books and plays. Write for your free copy today! Literary Agent Mead, 915 Broadway, New York 10.

WANT Your book published? Learn how we publish, advertise, promote, distribute. Many successes. Free booklet PM. Vantage, 120 West 31, New York City. Or 6253 Hollywood Blvd., Hollywood 28, Calif.

ADVERTISING AGENCIES, ADV. SERVICE, MAILING LISTS

FREE! 40 Word adv. in Photo magazine to sell-buy-exchange any photo equip., films, etc. Send adv. for free publication in next issue. Box 591, Lynn 4, Mass.

ADVERTISE: 24 Words, 75 Canadian newspapers, \$5.50. Lists free. Advertising Bureau, 10511-C Springfield, Chicago 55.

ADVERTISING Ratebook leading newspapers, magazines, free. Chicago Advertising Agency, 28-E Jackson, Chicago 4.

MAILING Lists most all kinds 1000 \$5.00. Free folder. Your circulars mailed \$4.00 1000. Dixie Mailers, King, N. C.

AMAZING New Book—"Profits From Classified Advertising." Tells how and what to advertise. Be sure to read this book before you invest one cent in advertising. Write for your copy now. F. W. Johnson, Classified Advertising Manager, 202-210 East Ontario Street, Chicago 11, Illinois.

NOW Ready: New, amazing Classified Advertising Record Book—prepared especially for classified advertisers. Here is a book that tells you instantly whether or not your advertising in any publication is paying you real results. You can tell immediately how many inquiries each publication produced—how much cash received from every ad. Spaces are provided for the name and address of the publication, date of issue, space used, rate, cost of ad, key number, etc. You have a complete record of each publication right before your eyes. Plenty of space to keep accurate record of 28 separate publications. You can have a copy by sending only 10¢ to cover postage and handling. Send for your copy now. W. F. Johnson, Classified Adv. Mgr., Popular Mechanics Magazine, 204 E. Ontario Street, Chicago 11, Illinois.

TYPEWRITERS, DUPLICATORS, OFFICE DEVICES

RECONDITIONED Typewriters, mimeograph, printing presses \$25.00 up. Write Dixiegraph, King, N. C.

RUBBER STAMPS AND OFFICE SUPPLIES

FREE 32-Page rubber stamp catalog. Stock stamps, racks, pads, Christmas stamps, signature stamps \$3.50. Youngers Stamp Shop, Princeton, Iowa.

3 LINE Pocket stamp \$1.00. To introduce our complete service. Signet Stamp Co., Box 694, Riverhead, L. I., N. Y.

POCKET, 3 Lines \$1.00. Guaranteed. W. J. Specialty, 8464 Manhattan, Detroit 11, Michigan.

SIGNATURE Stamp specialist \$3.95. O. Linneman, 84 Harding Ave., Runnemede, N. J.

FACTORY Prices. Catalog \$1.00 (refundable), guaranteed. Adirondack Printers, Tupper Lake, New York.

RUBBER Stamps, 4 lines, \$1.25. Kays, 172 W-34 St., Riviera Beach, Fla.

THREE Line pocket or office type stamp \$1.00. W. Atherton, Box 61, Randolph, Massachusetts.

CARTOONING, COMMERCIAL ART, SHOWCARD & SIGN PAINTING, TATTOOING

YOU Can entertain with chalk talks. Catalog 10¢. Balda the Cartoonist, Oshkosh, Wis.

LEARN Sign painting at home. Free talent test. Ben Kerns, Box 812-PM, Greenville, S.C.

LEARN Sign painting with fascinating system. Straley, 410 S. Western, Springfield, Ohio.

ART—Learn at home. Earn big money. Learn commercial art, cartooning, lettering, figure drawing, painting, TV art, in spare time. All for 20¢ a day. Send for free 36-page book. No obligation. Washington School of Art, Studio 1412, Port Washington, N. Y. Tear this out as reminder.

CARTOONING—Good money in fields of television advertising, animation, movies, magazines. Famous system of manual training brings amazing new concept of art instruction at home. For profit or pleasure. Send for free details. Continental Schools, Dept. F-100, 4201 S. Broadway, Los Angeles 37, Calif.

SIGN Painting outfit! Complete instructions, supplies! Patterns, cut-out letters, personalized rustic signs. Paulow Signs, Crystal Falls, Michigan.

"HOW To Make Money With Simple Cartoons." A book everyone who likes to draw should have. It is free; no obligation. Simply address Cartoonists' Exchange, Dept. 912, Pleasant Hill, Ohio.

WANTED—Cartoonists. Beginners, professionals. Over 200 markets. Information free. Markets-12PM, 11620 Lansdowne, Detroit 24, Michigan.

LEARN Profitable, fascinating tattooing. Illustrated information \$1. Zeis, 728-C Leslie, Rockford, Illinois.

LEARN Sign painting. Easy method. Ellis, 10533 121 Ave. N., Largo, Florida.

SIGN Painting: Paint professional signs instantly. No lessons. No practice necessary for show cards, banners or road signs. Send \$2.00 for details and samples. Ace Manufacturing Co., Box 803, Fayetteville, Tennessee.

PRINTING, MULTIGRAPHING, MIMEOGRAPHING, GUMMED LABELS

MIMEOGRAPHING—Letters, pricelists, forms, letterheads. Quality work, reasonable prices, fast service. Free price list, samples. Valley Letter, Box 328, Port Jervis, N. Y.

250 8½x11 BUSINESS Letterheads \$2.95. 250 envelopes \$2.95 postpaid. (Samples) Davis, 7609 Spruce Road, Baltimore 22, Maryland.

PERSONALIZED Book matches. Your name in gold on 50 book matches for just \$2.50 postpaid. Hardison's, 1117 Capitol Towers, Nashville 3, Tenn.

ECONOMICAL Business printing. Free catalog. Golden Glades, Dept. T, Box 64-18, Miami 64, Florida.

MIMEOGRAPHING: Special new process. Black and colored inks. Prices, samples free. Excellograph, Orchard Lane, Philadelphia 14, Penna.

MIMEOGRAPHING, Offset printing. Reasonable. Samples. Pennway, Drawer 1340, Scranton, Penna.

100 PRINTED Letterheads and envelopes \$2.00 postpaid. Nixon, Nevada, Texas.

QUALITY Printing, quick, reasonable, samples. Patton, Box 248A, South Haven, Michigan.

ADVANCE Printing stationery set, 500 5½x8½ to 8½x11—\$13.50 prepaid. Rubber stamps, 3-line 2"—\$1.15. 1204 N. York, Muskogee, Okla.

100 EACH, Quality letterheads, envelopes, cards, set, \$2.50 postpaid. Americana Press, 723 5th Ave. So., St. Cloud, Minn.

LETTERHEADS, Envelopes, statements, billheads, advertising novelties. OKay-printers, Martins Ferry, Ohio. (Samples 25¢)

1000 BUSINESS Cards, raised letters. \$3.75 postpaid. Samples. Routh, PM-12, 2633 Randleman, Greensboro, N. C.

DISTINCTIVE Printing, proofs, cuts, mats, artwork. Writers', office supplies. Logan Enterprises, 6801-A Onyx, St. Petersburg 3, Florida.

MIMEOGRAPHING—Letters, pricelists, formulas, instructions. Lowest prices. Lem's Letter Shop, 5710 Stanton, Detroit 8.

ADS Running under this heading sell printing. Ask me for proof. I'll gladly send you amazing facts. Ask for Folder "P." F. W. Johnson, 200 E. Ontario St., Chicago 11, Ill.

FREE Catalogs postpaid printing. Rubber stamps. DM Press, Sebastopol, Calif.

1000 NAME-Address labels 88¢. Rubber pocket stamp 88¢. Printing, rubber stamp catalog. Jordan's, 552 West O'Connor, Lima, Ohio.

OFFSET Printing. Free samples, prices. Pennant Offset, 2441 North Halsted, Chicago 14.

DISTINCTIVE Letterheads, colors, embossing, golds, samples. Tuff, 4279-M Viola, Philadelphia 4, Penna.

ATTRACTIVE Stickers, labels, cards. Samples. Fame, 291 Ellis, San Francisco 2, Calif.

100 BOND Letterheads, envelopes \$2.95. Davies, 187 Austin, Old Bridge, N. J.

FREE—Quality case! 1,000 embossed business cards \$3.95. Two color \$4.95. The luxury look! Postpaid. Samples. Medallion, 356 E. Alondra, Gardena, Calif.

PRINTING, Mimeographing, offset. Low-cost prices. Barskettis, 6752 So. Campbell, Chicago 29.

PRINTING OUTFITS AND SUPPLIES

RUBBER Stamp presses, hydraulic operated, electrically heated. Sizes 5"x8", 8"x12", 10"x15". Starting outfits, supplies. Printing presses. Custom Manufacturing, 1464-P East Commercial, Springfield, Missouri.

MAKE Your own self-molding rubber stamps and printing cuts. Plexirubber, Argyle 1, Wisconsin.

DO Your own printing. Save money. Simple rules. We supply everything. Print for others; good profit. Raised printing like engraving too. Have home shop. Details free. Kelsey Presses, V-11, Meriden, Connecticut.

RUBBER Stamp outfits, supplies. Kiewiet, 2025 Barney Road, Kalamazoo, Mich.

PRINTING Presses, type, supplies. Lists 4¢. Turnbaugh Service, Mechanicsburg, Penna.

TYPE Case catalog. Manufacturer. King McKay Company, 23179 Telegraph, Southfield, Michigan.

FOR INVENTORS

INVENTORS: If you have an invention for sale, patented or unpatented, write for free brochure outlining manufacturers requirements, royalty rates. Kessler Corporation, C-512-FI, Fremont, Ohio.

IDEAS—10 Ideas for exceptional, marketable products. Send \$1.00 to: Ideas, Box 39794, Los Angeles 39, California.

PROFESSIONAL Searches of the Patent Office. Dependable—reliable \$6.00 including airmail report and related patents. For free protection forms and patent information write Trans-World Patent Service, 500 Walker Building, Washington 5, D. C.

PATENT Searches including full, airmail report and closest patent copies, \$6.00. Quality searches, expertly administered. Free protection forms and patent information. Write Professional Patent Office Search Bureau, 709 Albee Building, Washington 5, D. C.

INVENTORS! Outright cash sale or royalties for your inventions. Patented. Unpatented. Constant demand from our client manufacturers. Write: United States Invention Brokerage, 78 Wall Street, New York 5, N. Y.

INVENTORS! Consider our offer first before selling or licensing your invention on a cash or royalty basis. Patented. Unpatented. Write: Inventions on Demand, 79 Wall Street, New York 5, N. Y.

DON'T Pay high fees! Obtain U.S. patent yourself. It's easy with Professional Kit with fill-in forms. Free "Registration form." Patent Protection Institute, 15 Park Row, New York 38, N. Y.

PATENT Searches, including copies of nearest patents, \$6.00. Reports airmailed within 48 hours. More than 200 registered patent attorneys have used my service. For free invention protection forms, write Miss Ann Hastings, P. O. Box 176, Washington 4, D. C.

WE Have the markets if you have the ideas. Harvey Engineers, Cambridge 1 Maryland.

INVENTORS: Test the commercial value of your patented or unpatented inventions, quickly and inexpensively. Write for free information. Institute of American Inventors, Dept. 40-B, 635-F St., N.W., Washington 4, D. C.

INVENTORS! Searches of the Patent Office administered professionally. \$6.00 including airmailed comprehensive report and related patent copies. For free invention protection forms, dependable service, write Washington Patent Office Search Bureau, 1426 G Street N.W., Washington 5, D. C.

U.S. Patent office former examiner's inventors service. Patent office searches. Free commercial invention evaluation. Cash-royalties promotion. Patent engineering development. Free invention protection certificates. George Spector, Licensed Patent Engineer, Woolworth Building, New York.

U.S. Patent office searches—\$5.00. Free invention record. Patents engineered. Patent Office Searchers, 233 Broadway, Room 3615, New York.

INVENTORS! Sell your invention for cash or royalties! Our manufacturers constantly seeking new items. Patented. Unpatented. For free information write Gilbert Adams, Patent Broker, 80 Wall Street, Financial District, New York, N. Y.

PATENTS Skillfully prepared for maximum commercial value, with useful product development. High record of success in proving and claiming patentability. Valuable market service. Patent prepared for a fee as low as \$200.00. Send for self-protecting record of invention forms free. Patent search with valuable engineering report \$15.00. Foreign patents filed at low cost. Thirty years established. Joseph O'Brien, Patent and Development Engineer, 132 Nassau St., New York 38, N. Y.

SAVE High fees! Apply for your patent yourself. New do-it-yourself Patent Kit now makes it easy! Free "Registration Form." Miss Suzan Blaine, 306 Carry Building, Washington 5, D. C.

CASH Or Royalties for inventions! Consider our offer first before licensing or selling your patented or unpatented invention. Write Aladdin Industries, 80 Wall St., New York 5, N. Y.

PATENTS Professionally prepared for maximum commercial value. Patent searches including report \$6.00. Patents prepared as low as \$195.00. Valuable market service with cash or royalty sales. 10 years dependable service. For free self-protecting Record of Invention forms write: H. Lawrence Biasius, Patent and Development Engineer, 19 Park Row, New York 38, N. Y.

QUALITY Patent searches \$15.00. Send disclosure. Development Research Service, Box 682, Washington 4, D. C.

INVENTORS: Save time and money. Prepare and file your own patent application. Our complete "Patent Kit" makes it easy. Includes detailed instructions and all necessary material. Only \$8.95. Money back guarantee. Don't delay. Send check or money order today to National Inventors Service, Box 88, Benjamin Franklin Station, Washington, D.C.

INVENTIONS WANTED

CASH Obtainable for good ideas, inventions. Ketchum's Advertising, Springfield, Illinois.

INVENTORS: Hundreds of manufacturers have requested our assistance in locating marketable new products. Complete information free. Institute of American Inventors, Dept. 40-D, 635-F St. N.W., Washington 4, D. C.

INVENTIONS Wanted. Patented; unpatented. Tremendous manufacturers lists. Global Marketing Service, 2420 77th, Oakland 5, California.

ARE You interested in offers from reliable manufacturers for your invention? Patented, unpatented. Harvey Engineers, Cambridge, Maryland.

INVENTORS! Outright cash sale or royalties for your inventions. Patented. Unpatented. Constant demand from our client manufacturers. Write: United States Invention Brokerage, 78 Wall Street, New York 5, N. Y.

INVENTORS! Consider our offer first before selling or licensing your invention on a cash or royalty basis. Patented. Unpatented. Write: Inventions on Demand, 79 Wall Street, New York 5, N. Y.

INVENTORS Needing help with any problem, financial, development, securing manufacturer, obtaining patent. Write the organization that delivers action and results—not promises. Pioneer Invention Institute, 150 Broadway, New York 38, N. Y.

INVENTORS! Sell your invention for cash or royalties! Our manufacturers constantly seeking new items. Patented. Unpatented. For free information write Gilbert Adams, Patent Broker, 80 Wall Street, Financial District, New York, N. Y.

INVENTIONS Promoted-for cash-royalty sales with manufacturer contacts. George Spector, Licensed Invention Engineer, Woolworth Building, New York.

WANTED Inventions, patented or unpatented. Unusual services. Professional Engineer, Box 113-A, Hampton, N. H.

INVENTIONS Wanted for national promotion. Write: Prometheus, Box 1341, Akron 8, Ohio.

SELL Your invention for cash. No commissions. Milburn, Burlington, Kentucky.

INVENTIONS Needed immediately for manufacturers. For additional information write Kessler Corporation, C-512-IW, Fremont, Ohio.

INVENTIONS: Bought and sold. Ideas surveyed. Reasonable rates. International Search, Dept. A, Box 1214, Camden 5, N. J.

PATENTS FOR SALE

PATENTED Cheat-proof examination form for schools, industries, armed forces, insurance. P.O. Box 1113, Princeton, W. Va.

MODELS—SHIPS, TRAINS, PLANES, ETC.

CIVIL War model plans. Revolvers, muskets, cannon, swords, ships; over 100. Catalog 50¢. Refundable. Butrick, 2961 Fairfax, Cleveland Heights 18, Ohio.

WANTED! Live steamers. Everything for building steam, gasoline, traction, locomotive engines. Castings, machined kits, finished. Steam fittings, boilers. 100 page comprehensive catalog #18, \$1.00. Perfect Christmas gift! Chas. Cole, Ventura, Calif.

LIVE Steam powered backyard railroads! All sizes. Complete "bolt-together-kits", and rough castings. Excellent drawings. 100 page catalog \$1.00. Little Engines, Lomita, Calif.

SHIP Model kits and fittings: clippers, frigates, etc. Catalog paint-tool list, book list, 35¢. Model Shipways, Box 85, Bogota, N. J.

LIONEL Trains. Big discounts bulletin 10¢. Catalog 25¢. Mack-Bros., 2043P, Chicago Ave., Chicago 22.

SHIP Models. Most complete line in New England, kits, fittings, plans, books, tools, engines, motors. Illustrated catalog 35¢. James Bliss & Co., Inc., Dept. SM, 342 Atlantic Ave., Boston 10, Mass.

SHIP And yacht model fittings; blueprints. Send 40¢ for illustrated catalog listing hundreds of items. A. J. Fisher, Inc., 1002-1 Etowah Ave., Royal Oak, Mich.

"POWER Drives Handbook"—36 pages illustrating many types motor drives for model autos, boats, displays, turntables, etc. Mail 25 cents cash, returnable first order \$3.00 or more. Wilson's of Cleveland, Dept. PM, P.O. Box 8995, Ft. Lauderdale, Fla.

CASTINGS And finished steam-gas engines from simple oscillating to triple expansion. Finest materials and fittings. Catalogue \$1.00. Denison Live Steam Models, 1606 Denison Ave., Cleveland 9, Ohio.

STEAM Engines, tractors, boilers, castings, prints. Catalog \$1.00. Tiny Power, Junction City, Oregon.

ENGINEERING SERVICES

DESIGNING, Model making, development work, blueprints. Write: Martin, Martindale, Penna.

DEVELOPING, Designing, simple or complicated, gadgets, toys, machines, electrical devices. F. Ledermann, Prof. Engineer, 154 Nassau St., New York 38.

MANUFACTURING

FOR Inventors. Model building. Manufacturing. Research. William Parker, 32 Westminster, Worcester 5, Mass.

MODELS—Small lot manufacturing. Metals, plastics, etc. Milburn, Burlington, Kentucky.

HOME CRAFTSMEN

WOODWORKING Catalog and manual. Brand new 150th Anniversary edition! World's largest selection of domestic, imported woods—materials, tools, supplies, do-it-yourself plans, projects. 132 pages, many full color. More than 2,000 items. Send 25¢ for postage and packing. Act now! Constantine, 2050 Eastchester Road, Dept. T-101, New York 61, N. Y.

KNOCKDOWN Cedar chests, also over fifty kits. Catalog 25¢. Giles Kendall Co., Huntsville 2, Alabama.

101 PATTERNS Of smart gifts, novelties, shelves, action windmills plus "Make Money Jig Sowing." \$1.00. Mastercraft, 125M, 7041 Olcott, Chicago 31.

VENEERS 1/28" thick. Send \$1.50 for two square feet each of cherry, mahogany, maple, oak and walnut. Catalog of wood-working supplies 10¢. Barap Specialties, P.O. Box 2044, Dept. P12, Chicago 9.

SAVE 90% On your spray-painting compressor! Build your own! New, amazingly simplified unit. Complete instructions, \$1.00. Robert Vaughn, 357 Church St., Greensboro, N. C.

FREE! Leathercraft catalog. Hundreds of new items. Write MacPherson Bros. Leather Company, Dept. E. 730 Mission St., San Francisco 3, Calif.

KNOCKDOWN Cedar chests and lumber. Catalog 25¢. Bedford Lumber Company, Shelbyville, Tennessee.

SKIL-CRAFTS—All new '62-63 catalog. Largest and finest selection of leathercraft, artist and hobbycraft supplies in the world. Free goods gift with first order. 25¢ for latest catalog. Skil-Crafts, Box 167-P, Joplin, Mo.

PICTURE Frame moulding, squares and lumber. Kiln dried walnut, cherry, silver maple. Midland Lumber Company, Box 262, Savannah, Mo.

FREE, New catalog. 2447 plans, patterns. World's greatest selection things to do, make. Fun. Profit. Craftplans, 1322-A Wabash, Chicago 5.

LEATHERCRAFT. Send 10¢ for catalog. Saxcrafts, Inc., 1101 N. 3rd, Milwaukee, Wisconsin.

FREE "Do-it-yourself" leathercraft catalog. Tandy Leather Company, Box 791-V41, Fort Worth, Texas.

GRANDFATHER Clock movements, case plans, kits. Catalog 25¢. Mason-Sullivan, Noroton 7, Conn.

DO IT YOURSELF

RESTYLE Your old piano to look like modern spinet. Manual tells how. \$2.98. Mayhew, 135 Elliott Street, Beverly, Mass.

STEEL And masonry nuclear fallout shelter plans. Eliminates posts, carpentry and interior waste space. Send \$3.00 to Develco, 316 Cedar Ave., Minneapolis 4, Minnesota.

BUILD Your own tractor plans. Free information. Eltraco, Dept. A, Camptonville, Calif.

BUILD This exciting vacation cabin for \$200. Complete blueprints \$3.50. A. Beck, LeMars, Iowa.

BUILD Your colonial style grandfather clock. Plans \$1.50. New movements. Wilson Miller, Palmyra, Penna.

INSULCRETE Fallout shelters. Mix additive with local aggregate, stronger than concrete. Information plans \$1.00. Box 4176, Miami Beach, Florida.

FREE Check-list covering more than 500 classifications of projects, plans, instructions, service and repair information detailed in Popular Mechanics famous series of instructional booklets, books, patterns, and blueprints. List covers an extremely wide variety of do-it-yourself data on home remodeling, repair and improvement, hobbies, crafts, boating, games, lawn and garden, and hundreds of others. For your free copy of this helpful list, write: Service Bureau, Popular Mechanics, Room 520, 200 East Ontario, Chicago 11, Ill.

WATCHES, OLD GOLD, JEWELRY

LEARN Watch cleaning, repairing. Illustrated. Excellent earnings. Kester, Deckerville, Michigan.

WATCH And clock repairing books. Free catalog. North American, 2320-AN Milwaukee, Chicago 47, Illinois.

DIRECT From Swiss watch factory: Gent's watch, automatic (100% self-winding) with calendar, 21 jewels, waterprotected, shockproof, unbreakable mainspring, luxury dial, complete with strap and gift box. US—\$11.00. One year written guarantee! Send money order. Immediate airmail delivery. Itraco Watch Co. Ltd., Zurich 27, Switzerland.

PURCHASE Diamonds, watches, jewelry, direct from manufacturer. Catalog 25¢ refundable. Northeast Distributors, 36 Atwood Rd., Haverhill, Mass.

SELL Them to us! Gold, silver and platinum articles. Electro Company, 1042 Highland Avenue, Buffalo 23, New York.

RAZORS, BLADES, SHARPENING

100 LEE Double-edge razor blades. \$2.00 post paid. Disabled Veteran Distributor, P.O. Box 6634, Long Beach 15, California.

OF INTEREST TO WOMEN

LEARN Candle making—decorating at home. Send for free facts on famous home study course. Candle, Dept. X-578, Fallbrook, Calif.

LEARN Expert cake decorating, candy making. Free details on Home Instruction Method. Candy & Cake, Dept. D-113, Fallbrook, Calif.

HOUSEWIVES, Teachers, students, office workers, if you need extra cash each week but household or other duties prevent you from taking a part-time job, learn how you can earn by accepting orders to Popular Mechanics, Good Housekeeping and all other magazines. No experience needed. Write Popular Mechanics, Room 12W, 250 West 55th St., New York 19, New York.

SELL Fine fabrics. Get yours wholesale. Box 863, Norwalk, Conn.

LADIES Bargain nylons. S-J Sales, 3329 Superior, Ashtabula, Ohio.

PERSONAL

NEW! Borrow \$800. Anywhere. Increased loan limit. Air mail service. Postal Finance, 374 New Brotherhood Building, Dept. 17-B, Kansas City, Kans.

BIBLE Questions answered. Stamped envelope. Bylon, 17167 Bentler, Detroit 19, Michigan.

LOANS By mail, \$100-\$600. Anywhere. Confidential. Write Union Finance, Dept. PM, 323 E. Camelback, Phoenix, Arizona.

LOANS By Air Mail, \$100-\$600. Anywhere. Confidential. Easy payments. Write Security Finance Co., 898 Van Ness Ave., Dept. PM, San Francisco 9, Calif.

LOANS By mail, \$50-\$600 for any purpose. Confidential. 2 years to repay. Free loan application. Write: American Loan Plan, Dept. PM-11251, City National Bldg., Omaha 2, Nebraska.

BORROW \$100 To \$600 by mail. Quick, easy, private. No co-signers. Repay in 24 small monthly payments. For the amount you want write today to Dial Finance Co., 410 Kilpatrick Bldg., Dept. N-1, Omaha 2, Nebraska.

MAKE Your own will. Two simplified will forms \$1.00. Superior Products, Dept. 311, Box 102, Van Wert, Ohio.

REMAILING SERVICE

SWITZERLAND Remails \$1. Postcards 50¢. Pariat, 27 Riantmont, Lausanne, Switzerland.

SECRET Mail address. \$3 month. Hedgpeh, Box 830, Alhambra 23, Calif.

HAWAII Remails 25¢. Information free. Coe, Box 984, Kailua, Hawaii.

LETTERS Remailed 25¢. Confidential. Robert Carter, Box 742, Los Angeles 53, Calif.

AMAZE Your friends with letters from Switzerland. Airmailed \$1.00. Remailing Service, Brunnen, Switzerland.

REMAIL 25¢. \$3.00 Monthly. Henry, 214 Broadway, Dept. 30, San Antonio 5, Texas.

CONFIDENTIAL New York City mailing, receiving, forwarding address. Business personal mail \$3.00 month. Remails 25¢. Details free. Birnhan, 109 West 42, New York City 36.

REMAIL 25¢. Davis Imports, Dept. 5, Box 489, Edmonds, Washington.

FABULOUS San Diego secret remails. \$3.00 month. Box 14-156, San Diego, California.

LAS VEGAS Confidential remails, 25¢. Receiving, forwarding, \$3.00 monthly. Nelson, 1411 South "A" St., Las Vegas, Nev.

WHISKEYTOWN, California, Box 33. Remails 25¢. Month \$3.00.

RENO Gambling club postcards. Five \$1. Twelve \$2. You address, return for free stamping, mailing. Souvenir gambling club 1962 calendar 25¢. Remails 25¢. Monthly \$3. Garakontie, Box 2876, Reno, Nevada.

REAIRMAIL, Panama Canal Zone, \$1.00. Levin, 2942, Cristobal, Canal Zone.

MAIL Address \$3.00 monthly. Eberle's, 2727 West Slauson, Los Angeles 43, Calif.

LOVED One remails from America's nationally known "Sweetheart Town," Loveland. Each letter receives the "Sweetheart" imprint. That something special on cards, letters, etc., for holidays, birthdays, anniversaries or any day. 35¢ each. \$4.00 month. Berryman, Box 335, Loveland, Colorado.

YOUR Cards mailed with Santa Claus, Indiana postmark. Twenty-five cents (25¢) each. Send cards, check or money-order to 1651 Olive, Evansville, Indiana.

MIAMI Remailing stamped letters 25¢. Monthly \$3.00. Kath, Box 1896, Miami, Florida.

SECRET Mail address. Letters 25¢ each. Monthly rates. Confidential service. H. V. Zinck, Box 934, Lunenburg, Nova Scotia, Canada.

TEXAS—Remails 25¢. Monthly rate \$3.00. Free information. Chambers, 8316 Hanon, Ft. Worth 8, Texas.

LETTERS Forwarded 25¢, \$1.00 with postcard of Reno, clubs, hotels, gambling, state kind. Leave envelopes open or send for cards, six for \$1.00. Laneville, 5420-B, Home Gardens Dr., Reno, Nevada.

HOLIDAY Remails from California, Nevada, Arizona, Santa Claus Town, principal cities. 25¢ singles, monthly rates. Western Dispatch, Box AA, Carmel Valley, California.

NATIONWIDE Organization offers confidential remails from any U. S. city. 50¢. National, Box 144-A-2, Woodbridge, Va.

CONFIDENTIAL Remails, 25¢ each. \$3.00 monthly. Newell, Box 184, Covina, California.

SECRET Mail address. Receiving and forwarding. Free information. Henry Labrie, 380 Elgin Street, Room 7, Ottawa 4, Ont., Canada.

REMAILS—25¢, \$3.00 month. Donmar, 5644 E. Pima, Tucson, Arizona.

A Letter from Santa Claus, Arizona? Christmas cards and letters remailed 25¢ each. Elmo, Yucca, Arizona.

REMAILS, Receiving, forwarding, \$3.00 monthly, 25¢ single. 10437 Lanark Street, Sun Valley 3, California.

TREASURE FINDERS

DISCOVER Buried loot, sunken treasure, gold, silver, coins; battlefield and ghost town relics, with powerful transistorized locators pioneered and perfected by Goldak. Low as \$79.50. Free, exciting information: literature on maps. The Goldak Co., 1541 West Glenoaks Boulevard, Glendale 1, California.

METAL Locator kits and assembled models from \$39.90. Terms. Transistorized and underwater models available. Free catalog. Electronic Applications, Dept. M, Box 8, Arlington 10, Virginia.

TREASURE! Handbook, map, 25¢. Locators. Howe, 811 Kansas, Atchison, Kansas.

FUN And profit finding buried treasure, relics with transistor M-scope. Booklet, interesting customer comments free. Terms. Fisher Research, Dept. A-12, Palo Alto, Calif.

WANTED—MISCELLANEOUS

STAMP Collections, accumulations. Eagle Stamp Co., 2221 Romine, Pittsburgh 26, Penna.

QUICKSILVER, Platinum, silver, gold. Ores analyzed. Wholesale Terminal, Norwood, Mass.

FOR SALE—MISCELLANEOUS

FREE Money-saving catalog. Surplus and newly manufactured equipment and tools for workshop, home, boats, farm, factory. Write: Groban, 1139 South Wabash, Chicago 5, Illinois.

HEARING Aid batteries wholesale. Free list. Habs. Box 51, York, Penna.

HEARING Aid battery charger. Guaranteed to increase battery life three to four times. Charges batteries 675, 630, 625, 520, 400, 312. Only \$4.75. C. Lane, Box 125X, Castella, Calif.

JUST Out! 356-page catalog—save to 50% on auto parts, accessories. All makes, models. Send 25¢—refundable on first order. Whitney, 1919 AA-12, Archer, Chicago 16.

MISCELLANEOUS

NEW Hearing aids only \$29.95. Free trial, terms, agents. Inquire: Write Cary-B—Sales, Inverness, Fla.

YOUR Name translated into Chinese character writing on scroll suitable for framing \$1.00. Matching birthdate God scroll \$2.00. Sent direct from HongKong to you. Nanyang, 186 Knowlton, Kenmore 17, N. Y.

"MEMORY-Lock." (Dr. Young.) For self-advancement. Clarion, Box 9309-S7, Chicago 90.

SEND Us wool for blankets. Write El-Dorado Woolens, Eldorado, Texas.

LIFETIME Listing! Receive valuable free samples—25¢. Ply-O-Film, 30G12, Berea, Ohio.

IMPORTED Cuckoo clocks \$2.00. Guaranteed. Sadler, 2306 N. Evergreen, Phoenix 6, Arizona.

FREE Information concerning longer life. Please send self-addressed envelope. Alfred Yeske, 901-16th Ave., Menominee, Michigan.

DECORATIVE Old west wagon wheels, hubs and ox yokes. Ideal for dressing up patio, den, entrance to home, lodge, club. 36-inch wagon wheels with 4-inch steel tire. Wagon hubs 12 inches long, 8 inches in diameter, make beautiful lamp bases. Ox yokes are 5 feet long; unpainted. Write for free information and prices or send \$1 for design brochure complete with plans and specifications to Pickering, 416 N. State, Suite 9, Jackson, Mississippi.

BOOKS On antiques and their prices. Free circular! P. Warman Publishers, Uniontown, Penna.

BABY Shoes bronzed \$5.50. Sell used equipment. Ozark, 1209 Iowa, Rolla, Mo.

ARTIFICIAL Eyes (human). Expert selection sent. Established 1906. Write for free booklet. Denver Optic, 1101 University Bldg., Denver 2, Colorado.

UNHEARD-Of holidays! 1962 "Saturnalian Calendar." Christmas novelty. \$1.50. Box 1023, Berkeley 1, Calif.

DELUXE Ribbon bookmarks. Attachable. Changeable. \$1.00. Box 71, Maumee, Ohio.

5" HEEL Shoes! Illustrated catalog, \$1.00. Monique, Box 85151-R, Hollywood 27, Calif.

CUCKOO Clocks. Widest selection. Buy through importer and save. Free catalog. Simmons Bros., 10575 Robinson, Arlington, California.

CIGARETTES—Make 20 plain or filter-tip for 9¢. Facts free. Moberly, Box 785, Owensboro, Kentucky.

BALL Pen, ruler, magnifying glass, letter opener. All-in-one 69¢. Unbreakable combs 59¢. Assorted colors. Debbie Lynn, 4425 E. 57th St., Maywood, California.

RECEIVE Mails, magazines, samples. Your name in numerous mailing lists 25¢. Greenwood, Box 1116-M, New York City 8.

COMPLETE Tool-marking kit, including your name, address on 1/2" x 2" stencil, \$1.00. Robert Humbert, 5514 South Adams, Marion, Indiana.

MAIL From everywhere. Details 10¢. Bagby, Box 144, Coos Bay, Oregon.

INDEPENDENCE. Prosperity possible. Details for dime. Goding Specialty, Gambrills, Md.

EARN Money raising fishworms for us! Write: Oakhaven 60, Cedar Hill, Texas.

SEPTIC Tanks, cesspools, clogged drains restored to newness by powerful crystal chemical. Details. Testimonials. Chemical Cesspool & Drain Cleaning Co., Allston 34, Mass.

SUPER Memory overnight! Success guaranteed! Bijou, Box 1727-M, Hollywood 28, California.

WANT Your name with 1000 mailers? 25¢ lists your name year with our mailings every month. Dixie Mailers, King, N. C.

100,000 PRODUCTS Wholesale—Free catalog! Send postcard: Econ-O-Mart, Whippany 15, New Jersey.

FLUORESCENT Tubes rejuvenated at no cost. Instructions \$1.00. Rejuvenators, 172 Bolton St., Portland, Maine.



SEAT BELTS, if used in every car, could save at least 5,000 lives a year . . . reduce injuries by one-third, according to the National Safety Council. Many of those saved from injury or death would be youngsters—for *drivers kill and cripple more children* than any disease. Protect *your children* . . . drive with loving care. Give them the security of seat belts.

Published as a public service in cooperation with The Advertising Council

You Can Have a HE-MAN Voice

STRENGTHEN your voice this tested, scientific way. Yes—you may now be able to improve the **POWER** of your speaking and singing voice . . . in the privacy of your room! Self-training lessons, mostly silent. No music required.

FREE BOOKLET

Write today for Eugene Feuchtinger's great booklet "How to Develop a Successful Voice." It's absolutely FREE! You must state your age. Booklet mailed postpaid in plain sealed envelope. No salesman will bother you. Send your name and age **RIGHT NOW!**

PREFECT VOICE INSTITUTE, 325 W. Jackson Blvd., Studio MN-2, Chicago 6, Ill.



CHORD ORGANS SAVE UP TO 1/2

FREE **Importer-to-You Prices**
5 Day FREE Home Trial
Catalog Startling value and performance! Buy direct from importer—amazing savings. Hand-crafted in Italy. Anyone can play. E-Z-Terms. Bonus Gifts. Free Home Trial. Money Back Guarantee. Piano-keyboard models. New! Send for color catalogs, low discount prices.

and **Discount**

Prices.

Write **FREE** **Color** **Catalog** **Rush** **Coupon**

PHILHARMONIC ORGAN CORP., Dept. R-121
 2003 W. Chicago Ave., Chicago 22, Illinois
 Rush color Catalogs and Discount Price List.

NAME

ADDRESS

CITY & ZONE STATE

FREE PLAN

tells how to start your own business

FILING SAWS

Here is a steady repeat CASH business you can start in your own basement or garage in your spare time and make up to \$3 or \$6 an hour. You can file hand, band and both combination and cross-cut circular saws on the Foley Saw Filer. No eyestrain—no experience needed. "The first saw I sharpened with my Foley Filer came out 100%"—writes Clarence E. Parsons.

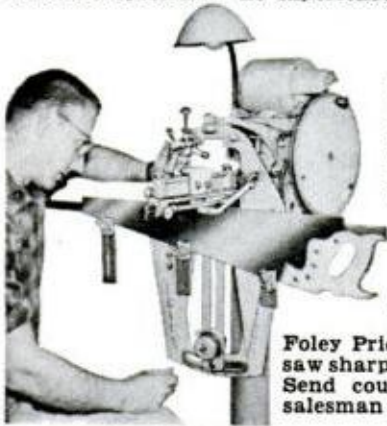

Every saw you sharpen with the Foley Saw Filer brings you more customers. "I rented a two-car garage and have all the work I can do"

Charles H. Smith.

FREE BOOK

Shows How to Start

Foley Price Guide gives saw sharpening charges. Send coupon today. No salesman will call.

Send Coupon for **FREE BOOK**

FOLEY MFG. CO.
1243-1 Foley Bldg., Minneapolis 18, Minnesota.
Send **FREE BOOK**—"Money Making Facts," and Time Payment Plan.

Name.....

Address.....



Kit for Beginning Geologists

Actual fossils of prehistoric life are part of a new laboratory set that is designed as an introduction to the study of geology. Twenty-five mineral and rock specimens are also in the kit.

Laboratory tools include a graduate and flask, mortar and pestle, alcohol lamp, thermometers and test-tube rack.

A product of Porter Chemical Co., Hagerstown, Md., the set sells for \$17.

NOW! COPPER SWEAT JOINTS THE EASY WAY! SWIF SOLDER



JUST BRUSH ON



...AND HEAT!

Make perfect leak-proof sweat joints every time with Hercules SWIF Solder, the real 50/50 tin-lead solder pre-mixed with flux in easy-to-use paste form. Save time and money, too. Just brush on, join, and heat for neat, strong joints. SWIF solders all common metals (except aluminum) and works with a torch, soldering iron, or soldering gun. This grade available in economical 4 oz., 1/2 lb., 1 lb., and 3 lb. cans at your plumbing supply or hardware dealer. See for yourself how easy any soldering job is when you use SWIF. WRITE FOR FREE TRIAL SAMPLE and a do-it-yourself soldering folder.

Hercules Chemical Co., Inc., 416 B'way, N.Y. 13

SWIF—the solder featured in the Otto Bernz Plumbing Kits.



New-Auto Analysis

Under the hoods and behind the wheels of the 1962 cars, as the driver, the serviceman and the engineer see them. It's all in the January PM Anniversary Special issue, together with find-by-color specifications and drive-comparison tests on Chevy II, Ford Fairlane and the trim new Plymouth. There is also a special performance report on some remarkable metallic brake linings, and an analysis of the influence famous dream cars have had on today's new models.

IT'S EASY TO ROLL OUT THIN LINES with

Master PAINT STRIPER

You can do professional striping on furniture, boats, autos, bikes, plywood, etc. Master Striper rolls out uniform lines on wood, glass, plastic, ceramics, almost any surface with paint, temperas, glue, textile-paint or underglaze; also used in industry.



- DOUBLE STRIPE KIT—5 combinations... \$3.50
- SINGLE STRIPE KIT—7 size tips..... 5.50
- TYPE M TOOL with 1/16" roller tip..... 1.50
- OTHER SIZE TOOLS 1/64", 1/32", 3/64", 5/64", 3/32", 1/8" each..... 2.00
- Extra roller tips, sizes above ea., \$1.00; 1/4" tip, 1.25 (C.O.D.'s, Postage Collect)

MAKES CLEAN, STRAIGHT OR CURVED LINES; VARIOUS WIDTHS AVAILABLE.

Dealers: Write today!

WENDELL MFG. CO., 4234 LINCOLN AVE. DEPT. 44 CHICAGO 18, ILL.



Marshall's NEW PHOTO PAINTING PENCILS

Make an exciting holiday discovery anyone can easily color treasured photos, snapshots, Polaroid Land prints, Xmas and holiday cards with beautiful results. No talent needed. Complete Coloring Kit with 18 pencils and step-by-step instructions \$4.98. MARSHALL'S 149 N. 9th St., B'klyn 11, N. Y. At photo, art, hobby, drug & stationery stores everywhere.



AND JUST BETWEEN US, THEY MAKE A WONDERFUL GIFT AT ANYTIME OF THE YEAR.



ALVA ALLEN Heavy Duty PUNCH PRESSES

1 to 25 Ton Capacity Punch Presses—in hundreds of different model combinations Moderate in Price Fully Guaranteed

Model B-2 2-Ton Punch Press

Write for Free literature giving complete information and prices on Alva Allen Heavy Duty Presses.

Alva Allen Industries, Dept. PM, Clinton, Mo.

MONEY in WORMS

Sell 20,000 fishworms per week @ \$4 per 1000 from a bed 3 feet wide and 8 feet long. We teach you how to raise and where to sell fishworms and crickets. Write for free literature.

CARTER WORM RANCH, PLAINS, GEORGIA

Read our success story in LIFE MAGAZINE, December 25, 1959 Issue

Wooded, High-ground
HOMESITE (70x150)
on CAROLINA Coast!

\$500 DOWN \$500 A MONTH

14,000 acres—50 freshwater lakes
... 40 miles of finished roads ...

FREE LITERATURE!
BOILING SPRING LAKES, Southport 15, N. Car.



RUPTURED

BE FREE FROM TRUSS SLAVERY

Surely you want to THROW AWAY TRUSSES FOREVER, be rid of Rupture Worries. Then Why Do you put up with wearing a griping, chafing and unsanitary truss the balance of your life? If you do, it will NOT be through necessity but through choice on your part.

Now there is a new modern Non-Surgical treatment that is designed to permanently correct rupture. These Non-Surgical treatments are so certain, that a Lifetime Certificate of Assurance is given. Write today for our New FREE Book that gives facts that may save you painful, expensive surgery. Tells how non-surgically you may again work, live, play, love and enjoy life in the manner you desire. There is no obligation. Excelsior Medical Clinic, Dept. H6124, Excelsior Springs, Mo.

"MADE \$1200 ON ONE JOB"

Some make more, some less...

We help you start Your Own All-Year Business

Make **BIG Money!** With our easily operated, highly efficient wall washer, G. H. Jones made \$1200 on one school job. E. L. Goss took in more than \$10,000 in one year.



E. C. Taber wrote, "I made \$400 gross in two weeks." And no wonder...this machine washes walls 6 times faster and better than by hand—with no mess...no drop cloths.

Your Money-Making Opportunity • We want more men to go into this profitable business for themselves and enjoy independence—freedom from layoffs and bosses. Customers everywhere—homes, offices, schools, churches, hotels, etc. How much you earn depends largely on you. What you take in is mostly profit. No need to rent shop or office; operate from home. Start spare time until full time is justified.

Lose No Time — Send Coupon Today for All the Facts

FREE BOOK! MAIL COUPON TODAY!

VON SCHRADER MFG. CO.
W10 "W" Pl., Racine, Wisconsin

Send at once (no obligation) your FREE booklet containing information about your WALL WASHING MACHINE and how I can start my own permanent, profitable business.

Name _____
Address _____
City _____ Zone _____ State _____

discounts by mail up to 40%!

Save on 1,001 famous U.S. products for workshop, garden, boat, paint jobs... Skil, Wen, Du Pont, Kidde — dozens of name brands.

Satisfaction guaranteed. Send now for valuable, 68-page Catalog — free for limited time only (regular price, 50¢).

GATES GENERAL CORPORATION
P.O. BOX 355 PM • FARMINGTON, CONNECTICUT



948
TRAILER
\$4.75

THE TIME TO



#150
ROLLS
ROYCE
\$1.50

START YOUR

#816
JEEP
\$1.20



#105
TRIUMPH
\$.85



DINKY TOY

#576
TANKER
\$2.35



COLLECTION IS NOW!

Dinky Toys are precise scale models of cars, trucks, buses, military vehicles, airplanes and farm equipment—made with fine European craftsmanship of heavy die-cast metal. Ideal for model railroad layouts, collectors, hobbyists. Independent 4-wheel suspension, fingertip steering, lead-free paint. At all leading toy, hobby and department stores. From 75¢

DINKY TOYS

MADE BY MECCANO, LTD. ENGLAND—FRANCE

send for color catalog!

DINKY TOYS

P.O. BOX 1851, DEPT. M, NEW HAVEN, CONN.

Please send Dinky Toys catalog. I enclose 10c in coin to cover postage and handling.

NAME _____

STREET _____

CITY _____ ZONE _____ STATE _____

Pentagon sidelights

By William R. Kreh

"Go fetch it," may become a standard command at White Sands, N. M., after a missile firing.

Ex-Marine L. Wilson Davis, working under a long-term government contract, already has two canines—a Weimaraner and a German pointer—trained to hunt out missile fragments. They may eventually form the nucleus of a missile-locating K-9 squad for the Army to use on its firing ranges at White Sands. The dogs would hunt pieces of any missile which misfires so that scientists may find the reason for the malfunction.

In a recent test at White Sands, the two missile mongrels were able to locate 147 out of 150 fragments that had been scattered about the desert over a wide range.

What's in a name? The Air Force was all set to name an office at Vandenberg Air Force Base, Calif., the Strategic Aerospace Division, Strategic Air Command, until someone pointed out that in the military's abbreviation language this would become SAD-SAC. The Air Force quickly changed it to STRAT-AD.

How fast does a man fall? The Air Force has done some tests with dummies that show that a 200-pound man jumping from 83,000 feet will reach at least 400 miles an hour. This velocity would be reached in the first 14,000 feet. After that, air resistance and other aerodynamic forces would slow the descent and, if he didn't use a parachute at all, he'd hit the ground doing 116 miles an hour.

Chances are, though, he'd never feel it. The research showed that a parachutist with an unopened pack would spin clockwise in a horizontal position to a built-up rate of some 465 revolutions a minute during his first 33,000 feet of fall. The fatal spin rate for man is calculated to be about 150 revolutions a minute. That's why sky divers and others who parachute must learn to keep their body out of a spinning position while free-falling through space.

How high the "Pi"? Two scientists at the Navy's David Taylor Model Basin have

(Continued to page 66)

Current Rate **4%** Per Annum

MONEY IN BY THE 15th EARNS FROM THE 1st!

Earn this high rate of dividend and get one of these valuable free gifts . . . from this modern 53 year old Association. Save by Mail . . . and we will handle all details for you.



POLAROID CAMERA KIT
Free with \$3,000 Account



G.E. CLOCK RADIO
Free with \$1,000 Account



G.E. ALARM CLOCK
Free when opening account for \$100 or more.

53 YEARS • 1908-1961
CITY SAVINGS ASSOCIATION

1656 W. Chicago Avenue • Chicago, Ill.
ASSETS OVER \$22,000,000.00

BRONZE FOUNDRY

Since 1935
Schools • Home Workshops • Inventors

Make your own castings of aluminum, copper, bronze, silver. Foundry sets are available in six sizes, capacity 1 1/2 lb. to 48 lb. of red brass. 2400 Deg. F. blast furnace included with each. Write for Free Circular.

KANSAS CITY SPECIALTIES CO. DEPT. P-12
MARYSVILLE, KAN.

Don't miss PM's exciting
60TH ANNIVERSARY SPECIAL
next month!

BUILD FINE GRANDFATHER CLOCK NOW

The simple sensible **SPEEDE** Red-i-Kut way as thousands have — FOR YOURSELF OR SELL AT A GOOD PROFIT. SAVE HUNDREDS OF DOLLARS. SHOP TESTED PLANS "SPIRIT OF THE CENTURY" Narrow waist "33" tall or stately straight side "SPIRIT OF AMERICA." EASY-TO-FOLLOW **photocopy** PLANS & LIFE SIZE PATTERNS tell all—plus **MOVEMENT BROCHURE** \$40 up, of heavy brass weight (Kuempel original) Westminster, tube **BELL** chime, movements, gorgeous bronze-silver **MOVING MOON** dials, 3/4" solid-mahogany **Jiffy** Joint-Kwik-Bit case kits. Send \$1.00 today — Both plans **RUSH \$1.50** as folks have for over forty years.

Kuempel Chime Clock Works, # 13 Kuempel Bldg., Minneapolis 16, Minn.

VERSA-MAGNET

45 lb. pull permanent Alnico V magnet equipped to hold lights where you want them — around the shop — on your car. Adjustable ball-swivel clamp fits trouble-light handle or standard light socket.



SEND **\$3.50** each, postpaid

CHECK OR MONEY ORDER

DeMAMBRO LABORATORIES • Mayville, New York

magnet base measures 2 1/4" x 2" x 1"

send for your **ALLIED** MONEY-SAVING 1962 ELECTRONICS CATALOG

Free

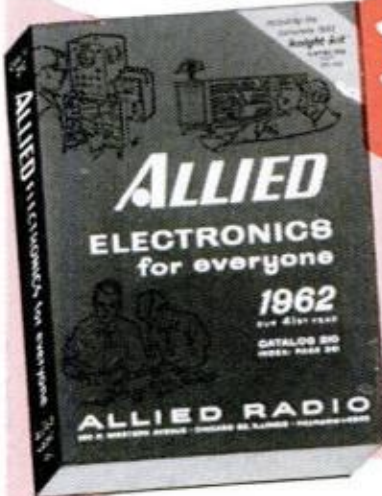

444 PAGES
World's Biggest Most Complete!

NO MONEY DOWN
New Credit Plan Gives You 50% More Buying Power!

SAVE MOST ON EVERYTHING IN ELECTRONICS

Send today for this **FREE** Catalog—the world's biggest—featuring everything in Electronics for modern living, including products and values available only from **ALLIED**. Whether you're a kit builder, experimenter, hi-fi fan, Amateur, serviceman or student, you'll save most on:

- **KNIGHT-KITS®**—Best in Build-Your-Own
 - Everything in Stereo Hi-Fidelity
 - New Multiplex Stereo FM
 - New All-Transistor Stereo Hi-Fi
 - **KNIGHT®** Super-Value Stereo Hi-Fi
 - Tape Recorders & Phono Equipment
 - Citizens Band 2-Way Radios
 - TV Tubes, Antennas, Accessories
 - Parts, Tubes, Transistors, Tools, Books
 - Amateur Station Equipment
 - Public Address & Intercom
 - Latest Test & Lab Instruments
- 

SAVE MOST on everything in Electronics at **ALLIED**—the world's largest electronic supply house. Get fastest service, expert personal help, easiest-pay terms. Send coupon today for **FREE** 1962 **ALLIED** Catalog.

Satisfaction Guaranteed or Your Money Back

ALLIED RADIO

ALLIED RADIO, Dept. 5-M1
100 N. Western Ave., Chicago 80, Ill.

Rush **FREE** 1962 **ALLIED** Catalog.

Name _____
PLEASE PRINT

Address _____

City _____ Zone _____ State _____

DURO
has the answer to all your "fix-it" problems!...

THESE FOUR and a dozen more.
Available at all better hardware, dept., auto, paint and variety stores from 59¢ to \$1.00.

THE WOODHILL CHEMICAL CO.
"ORIGINATORS & WORLD'S LARGEST MFRS. OF PLASTIC METALS"
Cleveland 14, Ohio

IN CANADA: 840 Montee De Liesse Rd., Montreal 9, Quebec

used a high-speed electronic computer to calculate the value of "Pi" to 100,000 decimal places. The previous record, computed in Paris in 1959, was 16,167 decimal places. It took the computer only eight hours to do the job.



A new tank-killing missile called the Tomahawk uses reflected ultraviolet light to hit its target. With the system, one soldier shines a narrow beam of ultraviolet light on the enemy tank while another aims the missile launcher and fires. As the missile nears the tank, a homing device in its nose locks onto the invisible reflection of ultraviolet light and guides it to destruction.



Electric eels may provide an antidote for nerve gas. Navy scientists say the fish contains large amounts of cholinesterase, an enzyme vital to the transmission of nerve impulses and that a nerve gas antidote can be synthesized from it.



Rattlesnake venom consists of 14 parts and each part is deadlier than the whole, the School of Aerospace Medicine has found. So if some disability keeps the snake from producing one or more parts of the venom, the rest is still deadly.

The poison isn't deadly to the snake itself because of some built-in neutralizing agent, but this agent fades away when the poison is injected into another body. If this could be isolated, man would have a first-class defense against rattlesnake poisoning.

In one experiment, Air Force scientists tried to test the idea of flushing out the poisoned blood in veins of a victim with fresh blood. But when the blood was drained, no evidence of the venom was found, and what happened to it is still a mystery. It may cling to the walls of the veins or change into something else and enter the body's glands, the Air Force reported.



Sharks use water vibrations instead of smell to locate victims, according to Navy researchers.



Automatic "blinders" to protect eyes from the extreme brilliance of nuclear explosions have been developed by the Navy. The brightness of a nuclear explosion is powerful enough to burn out the sight organs in unprotected eyes, but a new material has been found by the Navy which clouds over when an extremely bright light hits it. Used in goggles or portholes of ships, it becomes transparent again when the light fades.

Professional STAPLE GUN KIT for the HOME HANDYMAN

ARROW
SHOOTS A STAPLE wherever you'd drive a nail

T-50MP Multi-Purpose KIT

Contains—

- T-50 Staple Gun
- Wire, Screen and Window Shade Attachments.
- 5000 Multi-Staple Pak
- Staple Lifter

\$17.50 COMPLETE If purchased separately, items in this kit would cost **\$19.50**

With Arrow's versatile T-50 Heavy Duty STAPLE GUN and these handy accessories . . . you'll handle 1001 home and workshop fastening jobs with professional speed and ease! Comes in portable, carrying case. Buy it as the perfect Christmas gift . . . or try it for yourself — at hardware, lumber, building or stationery stores.

Write for 1001 Uses

Arrow Fastener Company, Inc.
1 Junius St. • Brooklyn 12, N. Y.

**best outdoor protection
—aluminum roof coating
made with pigments**

from **ALCOA**

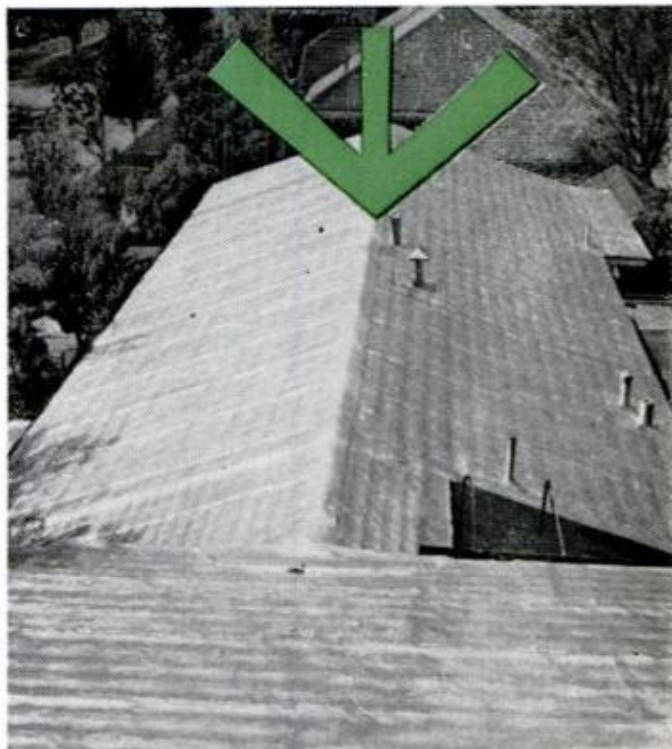
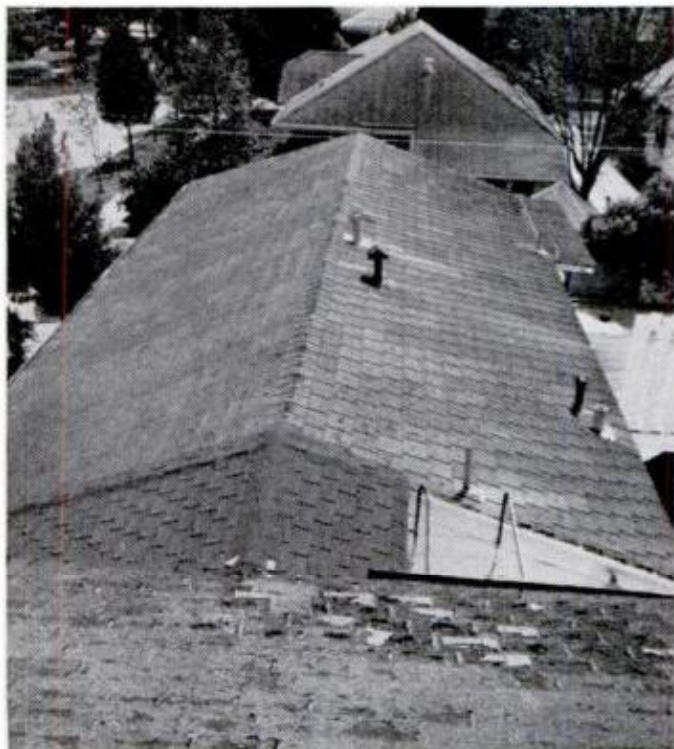

20-year roof— before and after Gulf States aluminum coating

The most interesting roof-restoration pictures submitted by R. E. Spell, sales manager of Specialty Products Div., Gulf States Asphalt Co., Inc., Houston, Texas, show his own apartment house. Better than words, they point up the dramatic results possible with an aluminum roof coating.

Mr. Spell writes: "The asphalt shingle roof of my apartment house was 20 years old and badly deteriorated. After preparing the roof with our asphalt impregnated sheets, we applied *Gulf States* Aluminum Roof Coating, which adds smart, modern appearance and a durable, water-proof surface. It stands up in any climate, stays firm on top and pliant underneath, reflects the sun's rays to make interiors cooler. Our tenants enjoy this last feature."

Made with Alcoa® Pigments, aluminum coatings like *Gulf States* are ideal for built-up composition roofing, asphalt shingles and felts, slate, concrete, cinder block, stucco and metal surfaces. These coatings come ready mixed; require no thinning or heating. Apply with ordinary roofing brush or stiff-bristle paint brush. Ask

your dealer for one of the fine brands made with Alcoa Pigments.

Alcoa does not make roof coatings, but we will be happy to refer you to reputable manufacturers who do. Please send the coupon for our booklets.

Entertainment at Its Best
ALCOA PREMIERE with Fred Astaire as Host
Tuesday Evenings, ABC-TV



ALCOA ALUMINUM

PIGMENTS, PASTES & POWDERS

Aluminum Company of America
1758-M Alcoa Building, Pittsburgh 19, Pa.

Please send your free booklets:

- Painting With Aluminum in Color*
- Aluminum Roof Coatings Make Time Stand Still*

Name _____

Address _____

City _____ Zone _____ State _____

**MORE
"GO"
PER
GALLON**



Standard on every *OLDS* Dynamic 88!

New 280-h.p. Rocket Engine with Fire-Swirl Combustion . . . new low-ratio rear axle . . . give the '62 Dynamic 88 extra sass with savings to match!

There's rocketing new high-compression performance in the Oldsmobile Dynamic 88 for '62!

With 30 more horsepower than its previous counterpart, the '62 Rocket V-8 features a 10.25-to-1 compression ratio and a unique Fire-Swirl combustion chamber that improves both fuel-air blending and firing efficiency.

The chamber is shaped much like a partly flattened ball, with a concave piston head forming the lower half. The valve opening is positioned to swirl the fuel mixture in the cylinder; and as the mixture orbits before ignition, the gas is thoroughly vaporized. The swirling continues after ignition, spreading the flame uniformly and effecting more complete combustion.

And the ultra high-compression Rocket is teamed with a new 2.56-to-1 rear axle ratio that gives it *economy*, along with its *responsiveness*! Each dollar's worth of gas buys as much actual mileage as previous Dynamic 88 owners

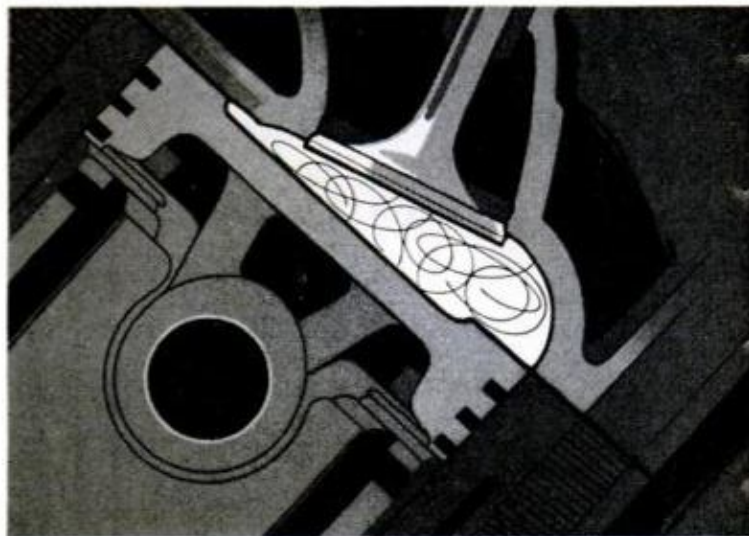

Unique Fire-Swirl combustion chamber provides better fuel-air mixing and improved firing to squeeze top performance out of every gallon of gas!

enjoyed . . . with a tremendous new reserve of power as a bonus!

The real proof of Oldsmobile's new engine advancements is, of course, on the road. One mile in a Dynamic 88 should convince you that Olds engineers have hit the right combination of performance and economy. Take a test run today in the car that delivers more "go" per gallon—the dazzling, dollar-saving new Olds Dynamic 88!

OLDSMOBILE DIVISION • GENERAL MOTORS CORPORATION

There's SOMETHING EXTRA about owning an OLDS!



EDITOR FISHER, above, after 90-m.p.h. test run in coupe powered by the Wankel engine, (shown below)

I Drove the Wankel-Engine Car 90 m.p.h.!

By
**Joachim
Fisher**

EDITOR'S NOTE: PM is fortunate in getting this first-hand driver report on the revolutionary Wankel rotating piston engine. Joachim Fisher is the editor of "Motor Rundschau," leading West German automotive magazine, and one of the very few men outside of the NSU organization to have an opportunity to test drive a Wankel-engined automobile.

IT WAS RAINING when I arrived at the NSU-Werke in Neckarsulm to test drive the KKM 400 engine. (The letters KKM abbreviate the word Kreiskolbenmotor, which in German means literally, "rotating piston motor." The number 400 stands for the combustion chamber volume of 24.4 cubic inches, expressed in centimeters.)

I was there because reports from the

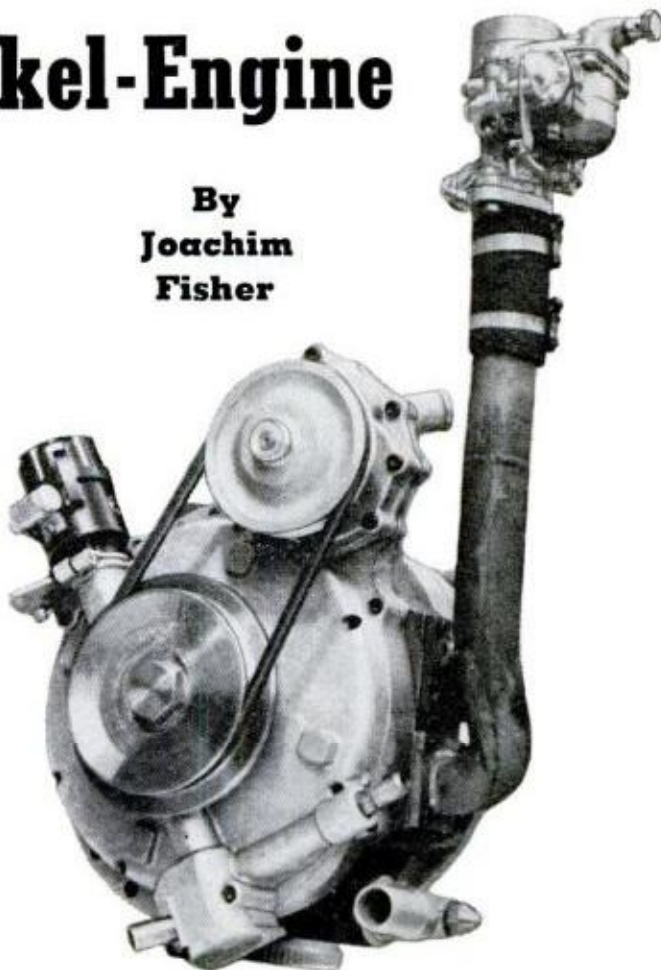

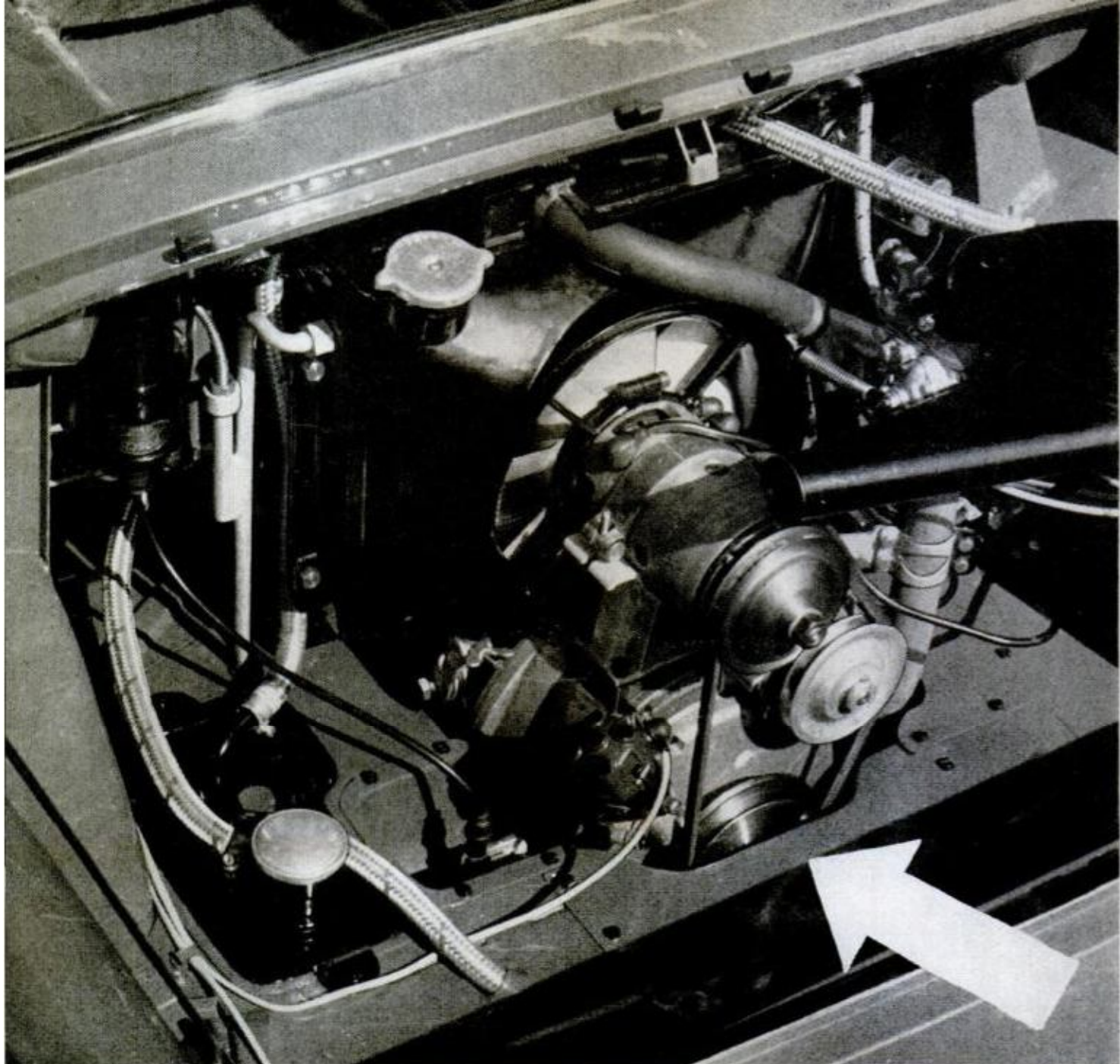

LOOKING FORWARD into the rear engine compartment of NSU's Sport Prinz shows KKM 400 engine (arrow) below generator, radiator and pump

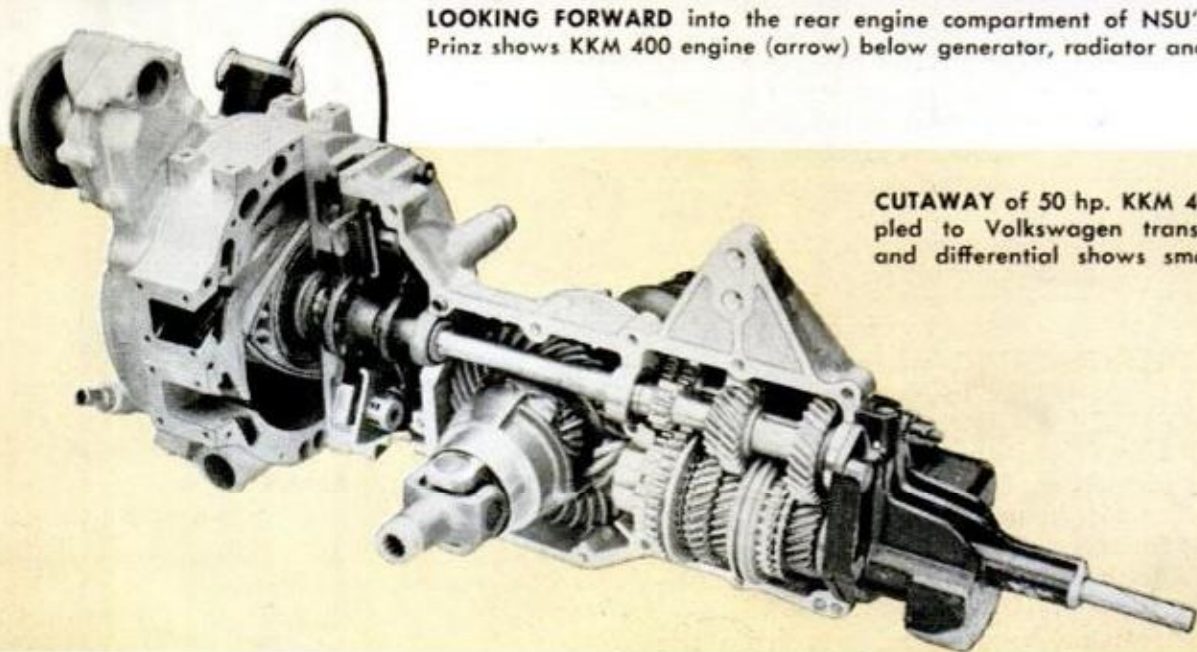

CUTAWAY of 50 hp. KKM 400 coupled to Volkswagen transmission and differential shows small size



AIR-COOLED version of the rotating piston engine, below, displaces 3.65 cubic inches, could be used for a motor bicycle or power lawn mower

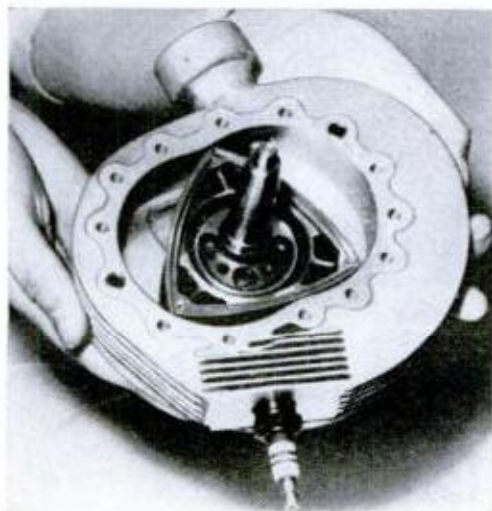

DECEMBER 1961

HORSEPOWER CURVE

KKM 400 WANKEL-EQUIPPED NSU PRINZ

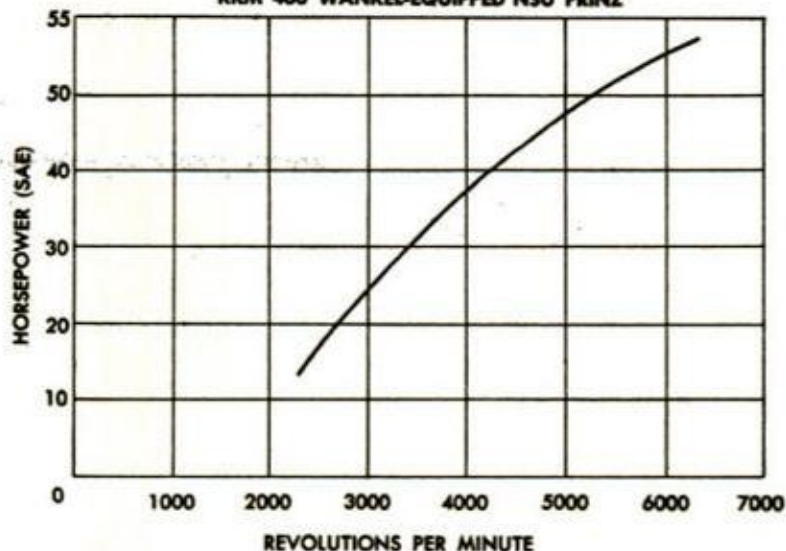

HOW MANY MILES PER GALLON?

KKM 400 WANKEL-EQUIPPED NSU PRINZ

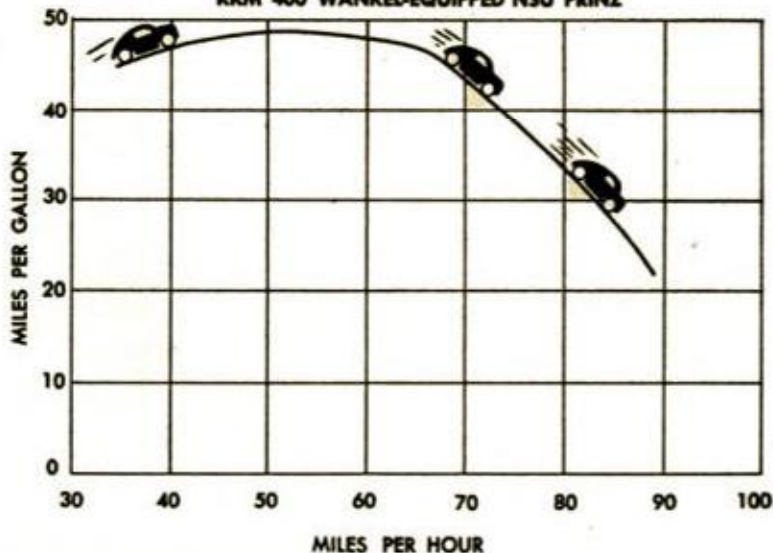

REMARKABLE power output of KKM 400 engine is shown in top graph; engine hits over 50 hp. Constant-speed economy, below, is terrific

NSU Research Department indicated that development of the NSU-Wankel or KKM had reached an advanced state so that the engine now had the flexibility to withstand the constantly changing loads and speeds characteristic of automotive operation. But no performance figures can substitute for actual operation in a car and on the road, so I persuaded the NSU officials to let me have a test drive.

The engine was installed in an NSU Sport Prinz two-passenger coupe, a car normally powered by a conventional, air-cooled two-cylinder engine of 26 horsepower and weighing approximately 1200 pounds.

The KKM 400 engine was fitted to a Volkswagen transmission and transaxle assembly, inasmuch as the Prinz is already a rear-engine car and because these Volkswagen components are strong enough to transmit the peak power of the rotating piston engine. Its rating is

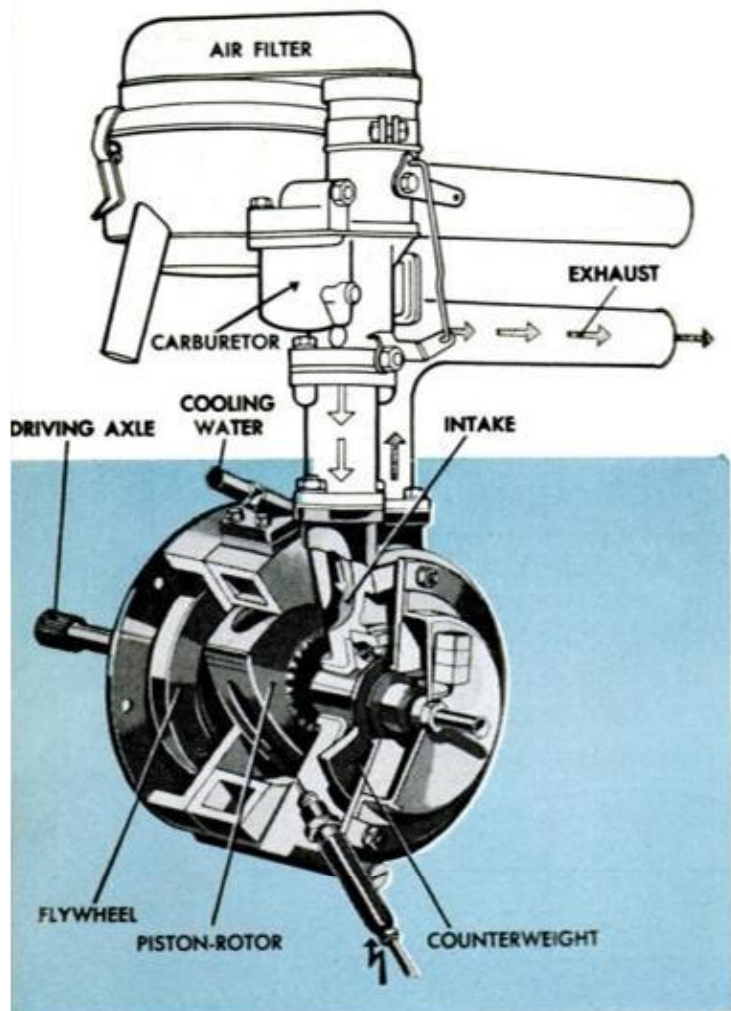

COMPACT single rotor version of Wankel engine is shown in drawing above. Oil enters rotor's interior through crankshaft to cool it and lube the eccentric

WORKING CYCLE of Wankel engine is shown in drawings from right to left, below. Rotor orbits eccentrically in clockwise direction around crankshaft. There is one firing for each third of a revolution described

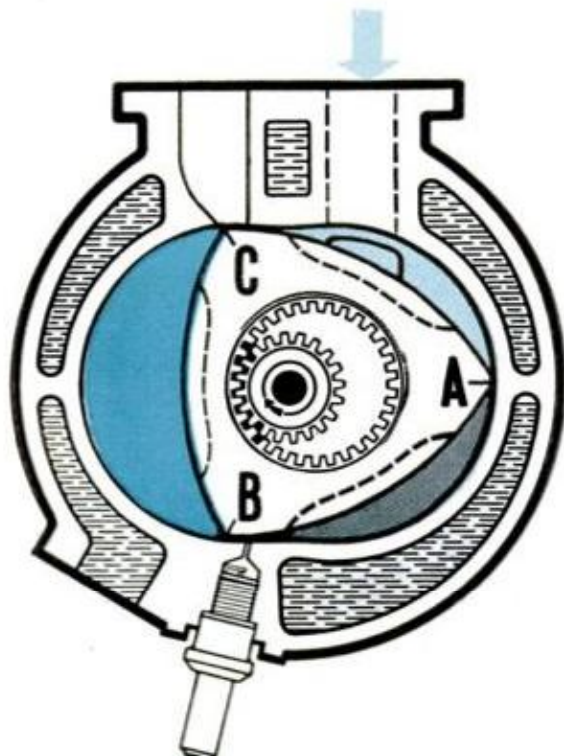
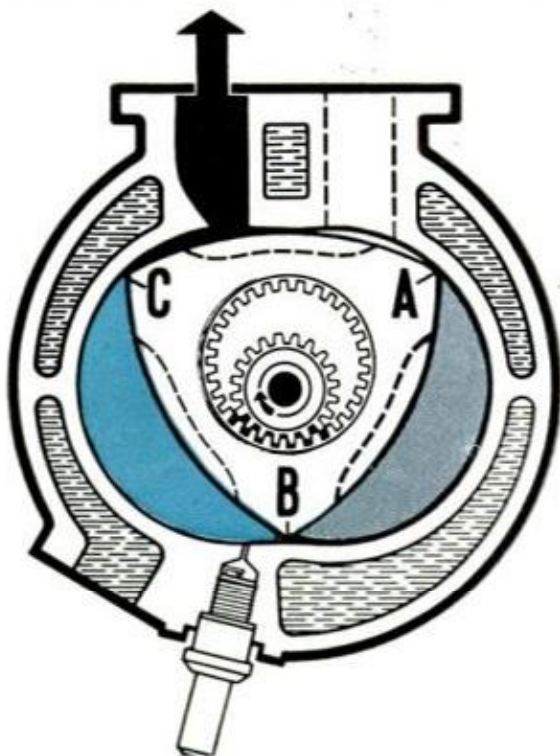

close to 50 horsepower (SAE rating) at 6000 r.p.m., roughly twice the speed and output of the Prinz's original two-cylinder conventional engine.

Transmission Mismatched

The gear ratios of the VW transmission were designed for a 40-horsepower engine which delivered its power at about half the speed of the KKM engine and the Prinz coupe of course weighs a lot less (400 lb.) than the VW. And other parts, such as the simple, Solex carburetor and the Ford radiator, etc., were also not designed to complement the rotary engine by any means. Nevertheless, NSU felt that their basic product would prove interesting.

The engine started at the turn of the key. It idled a bit roughly even at 1400 r.p.m., more than twice the idle speed you'd expect with a conventional reciprocating engine.

But, when I put my foot down on the throttle and engaged the clutch I realized very quickly that I had something special in hand. From 2000 to 6000 r.p.m., the engine might have been a gas turbine, so smoothly did it run.

It accelerated easily under load through the operating speed ranges from 2000 to 6000. Out on the road I found that this could be translated into actual road speeds of from 35 to 90 miles per hour in direct (high gear) drive. I did not take any timed acceleration runs due to the mismatch between the high-speed engine and the VW transmission and the less-than-perfect mat-

ing of a carburetor designed for a different engine.

I drove the KKM 400-equipped Prinz over the wet roads around Neckarsulm and was able to test the rotating piston engine under various conditions: everything from driving slowly through traffic, accelerating abruptly or slowly, passing, climbing, or speeding down the highway at full throttle.

The engine makes a smooth, powerful, sound, much like a multicylindered sports-car engine, and there is very little vibration transmitted to the car throughout the operating range and no trace of power impulses are felt above 2000 r.p.m.

Up to 47 m.p.g.

I had no opportunity to judge fuel consumption for myself, so must for the moment accept NSU's own figures of 21.5 to 47 miles per gallon (U. S.) at various constant speeds (see graph page 71). Likewise the power output figures are also from NSU-Werke. The KKM engine weighs 51 lb. dry and not counting the separate radiator and hoses.

Its performance of 90 m.p.h. in the Sport Prinz would make the rating of 50 horsepower seem quite reasonable.

The performance was almost too good for what was obviously a pretty experimental combination of engine, gearing and automobile. The KKM 400 Prinz did everything very well without incident or complaint, so that I did not have the feeling of pioneering a brand-new invention. It was

more like driving a new sporting version of some engine and a commendably quiet one at that.

After driving the KKM 400 Prinz I have no doubt that this engine has a future in automotive use. Whatever problems there may yet be to solve before going into production, they are not major ones, as the performance and operating characteristics are convincing.

As to when initial production may come I would hesitate to make a definite statement. However, I think if necessary a rotating piston engine could be released from the NSU research department (for production) in the near future. It would be better, however to grant this research team another year. Even then there will be some time from complete prototype to daily commercial production of this engine.

Paging a New Car Design

In addition, this new engine cries for a new car. The possibilities for design brought about by the extremely light, compact KKM engine are intriguing. Such a KKM-powered car might be of practical aerodynamic design with luggage space both in front and rear and with the engine stored away just behind the rear seat with the radiator at the side."

How the Wankel Engine Operates

The Wankel rotating piston combustion engine, or KKM, as the German engineers call it, has no conventional valves, springs,

(Continued to page 218)

BLACK—EXHAUST STROKE
PALE BLUE—INTAKE STROKE

GRAY-BLUE—COMPRESSION STROKE
BRIGHT BLUE—POWER STROKE

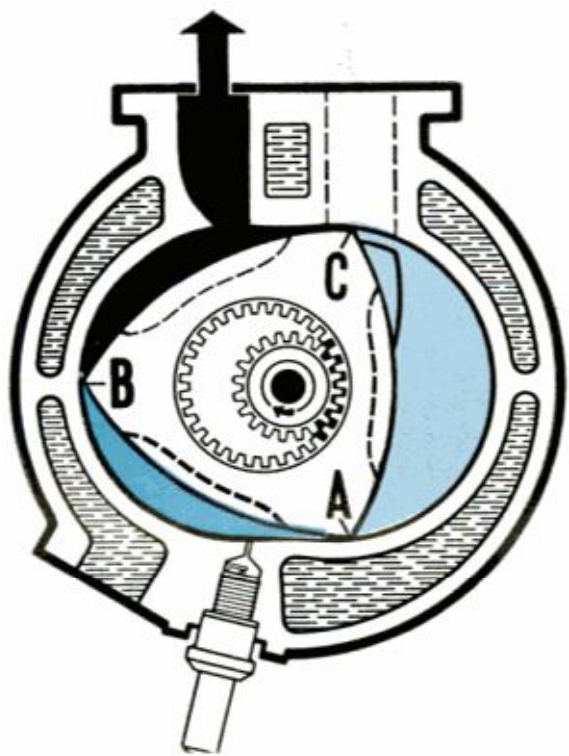
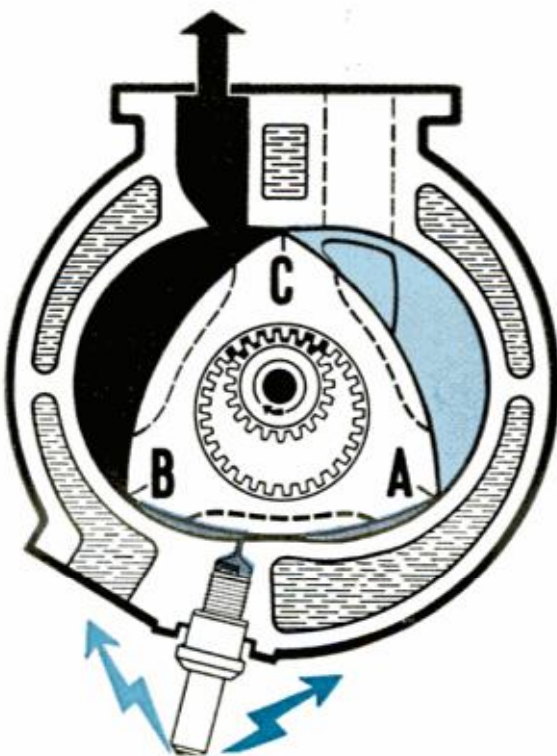

Trotters' Winter Track

Undaunted by snow-choked tracks, New England harness-racing fans go right ahead with their sport in the middle of winter by moving out onto the frozen lakes.

With horses shod with spiked shoes and bundled in blankets, these trotting fans do their racing on Sunapee Lake near Newbury, N. H. A special wool nose protector keeps flying ice chips out of the horses' faces, but the harness, sulky and equipment is otherwise the same as for summer racing. The sulkies often reach speeds of 30 miles an hour over the ice.

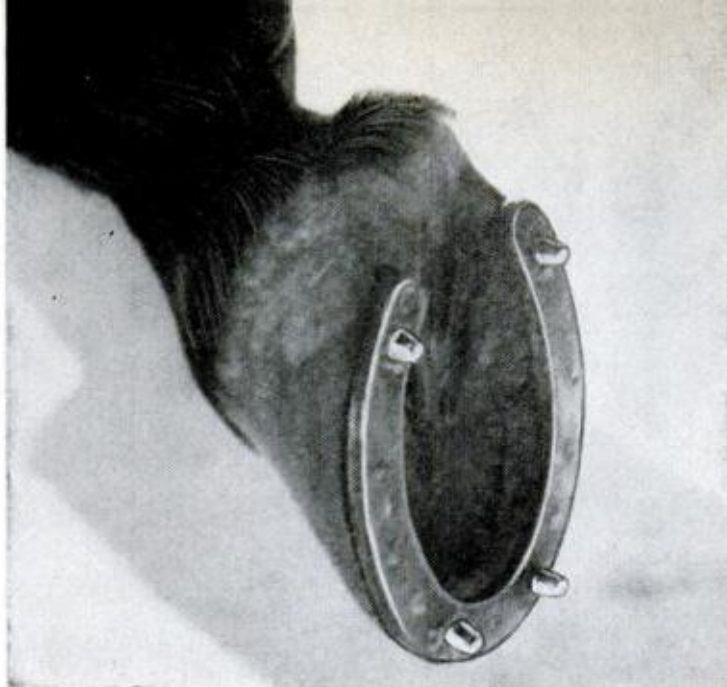

Eight-Wheel Dream Car

When the driver of an eight-wheel car tools around Red Wing, Minn., he also is displaying parts of cars made in every year since 1915. The car actually is in a state of growth; owner Nickie Johnson adapts new items to its home-hewed lines every year or so.

The frame, made of tubular steel, carries water for cooling the engine back to the rear trunk radiator. The car, a rakish 28 inches high, is powered by a 250-horsepower V8 engine. It has four-wheel drive. Instead of an automatic choke for starting, there's a propane-gas tank between driver and passenger for this job. The steering column has 12 switches to control lights and accessories.

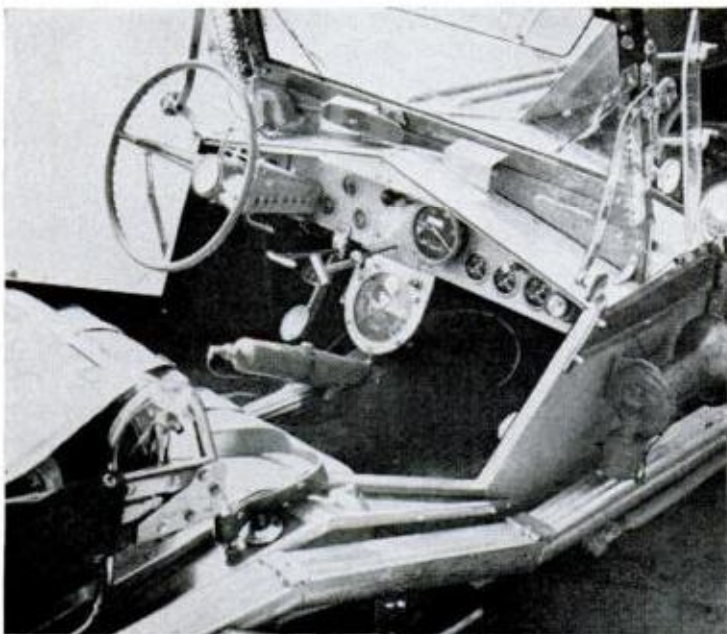

Instant Bridge

Designed by a Frenchman during World War II but never built until recently, a portable bridge can propel itself over land or water and, with proper accessories, span rivers up to 130 feet wide.

It is powered by two 220-horsepower engines that can move it at 40 miles per hour over level ground or climb 50-degree grades. Inflatable pontoons float it in water, so that, with two extensions used in tandem, it can span a 130-foot waterway quickly. For wider rivers, several of these portable bridges can be floated sideways and bridge tracks laid across their backs, according to *France Actuelle*, which first published these S.C.A. photographs.



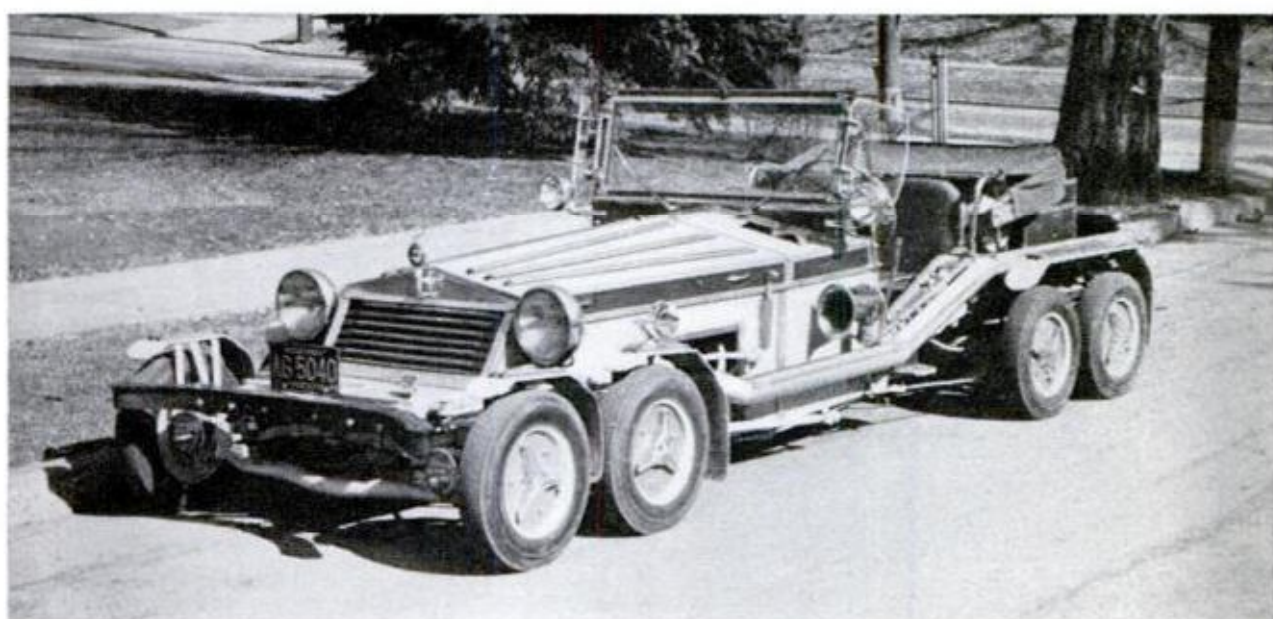

Mercury's Meteor— a new family-sized car

A light V8 and "two-way stretch" suspension team up for some nimble comfort

By Jim Whipple

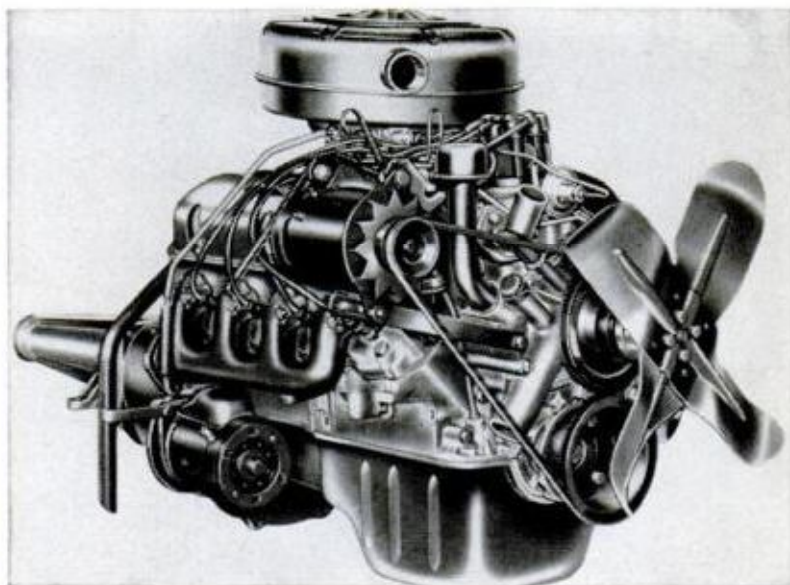

METEOR'S new lightweight short-stroke V8, above right, is extremely compact, weighs only 75 pounds more than the 170-cubic-inch standard six. It develops 143 horsepower from 221 cubic inches of displacement. Precision casting of alloy iron in head and block, shown at left, has eliminated gas-wasting excess weight

LAATEST OF THE '62 models to be introduced is Mercury's Meteor, a brand-new car to be sold by Lincoln-Mercury dealers. It holds a place in the Mercury lineup between the compact Comet and the full-size Monterey.

Since it shares its basic unit body shell with Ford Fairlane, interior and over-all dimensions are similar, as is true of other "paired" cars such as Falcon and Comet or Galaxie and Monterey. But front and rear fender panels, hood, grille, rear deck, door panels, bumpers and trim are different.

The Meteor is 203.8 inches long over-all compared to Fairlane's 197-inch length. Wheelbase is one inch longer than Fairlane's at 116.5 inches. Width and height at 71.3 and 56.1 inches respectively are within a half inch of the Ford Fairlane.

Weight of the manual-transmission, six-cylinder, four-door sedan is 2874 pounds.

The basic engine offered is Ford Motor Company's lightweight, cast-iron in-line six of 170-cubic-inch displacement. With a compression ratio of 8.7 to 1, it is rated at 101 horsepower and 156 lb.-ft. of torque.

This is the optional "big" engine used on Falcons and Comets. It is over-square in design with a bore of 3.50 and stroke of 2.94 inches. As used in the '62 Meteor it has a larger carburetor venturi, a die-cast aluminum timing gear cover, new crankshaft center weight and a front vibration damper of the rubber friction disk type.

Meteor's optional engine is Ford Motor Company's brand-new, compact, lightweight cast-iron V8 which weighs only 75 lb. more than the standard (170) Six.

This new V8 is another triumph of design and manufacture from Ford's foundry, a leader in the art of precision casting. The new engine is also over-square with a bore



METEOR CUSTOM four-door sedan, at top, shows family resemblance to other Ford Motor Company products in its flat hood, broad grille and T-Bird roof line. Plainer Meteor, above, eliminates chrome-rocker panel strip, chrome on rear fender skirt, shows typical Mercury touches in rocket-tube tail lamps, roof line.

of 3.50 and stroke of 2.87 inches, making for a displacement of 221 cubic inches.

Horsepower of the V8 is 143 at 4500 r.p.m., while peak torque of 217 lb.-ft. occurs at 2200 r.p.m. Compression ratio is a conservative 8.5 to 1. A unique feature of the new power plant is its fuel mixture temperature control system. This involves a permanently-open exhaust crossover to heat the intake manifold, combined with a hollow aluminum spacer or collar just below the carburetor. Hot water from the cylinder-head water jacket is routed into this collar, around the intake throats, providing more direct heat to fuel mixture and reducing icing tendency.

Valves of the "221" V8 are operated by a newly-designed valve train with individual, precision-molded iron rocker arms pivoted

on ball-shaped studs. Lubricating oil for this valve train flows from the hydraulic tappets up through hollow push rods to the rocker arms.

Standard transmission is a three-speed synchromesh with column shift lever. Overdrive is optional on the V8 only, while a two-speed and torque-converter automatic transmission is available with either six or V8. Shifting between high and low speeds in the automatic's planetary gearing is controlled by engine vacuum instead of by linkage for smoother shifting.

Axle ratios are: 3.50 to 1 and 3.25 to 1 on manual and automatic six-cylinder cars respectively while V8 ratios are 3.25 to 1 manual, 3.50 to 1 overdrive and 3.00 to 1 automatic.

Meteor's suspension system is meant to

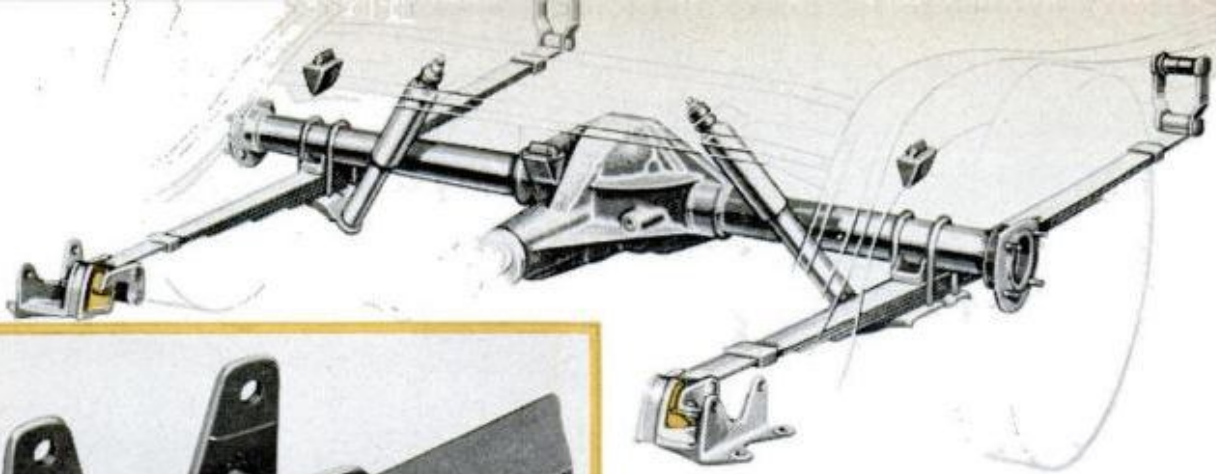

METEOR'S "Cushion Link" rear suspension recesses with horizontal bump thrust absorbed by arm embedded in rubber attached to swing shackle

provide an extremely quiet car with a soft, luxurious ride not generally found on cars of this size and weight. Front suspension is conventional independent with coil springs and ball-jointed spindles. However, the coil springs are longer and mounted above the upper control arms, terminating in rubber pads mounting high in the body structure.

The lower control arm is triangular with its forward leg incorporating a shackle and short coil spring that permits the lower arm, and thus the wheel itself to "recess" up to one-half inch to the rear as well as absorb vertical bump displacement. This combination of actions absorbs additional harshness from rough roads.

A similar setup, Mercury calls it "Cushion Link" is incorporated into the leaf-

spring Hotchkiss drive rear suspension. It consists of "tension" shackles that permit the springs and axle to have fore-and-aft movement. The front shackle has a lever arm with its end sandwiched in a rubber block. The rubber permits the shackle, and thus the entire assembly, to recess slightly "giving" with the force of the bumps and thus absorbing some of their shock.

Meteors have self-adjusting brakes as standard equipment. To insure perfect shape and prevent distortion, brake drums are annealed to relieve stress before final finishing. Power brakes are optional.

Suspension and steering linkage, front-wheel bearings and universal joints are scheduled for service only every 30,000 miles. ★ ★ ★

SMALL SPRING (inset color) absorbs shock of horizontal thrusts on front suspension lower control arm

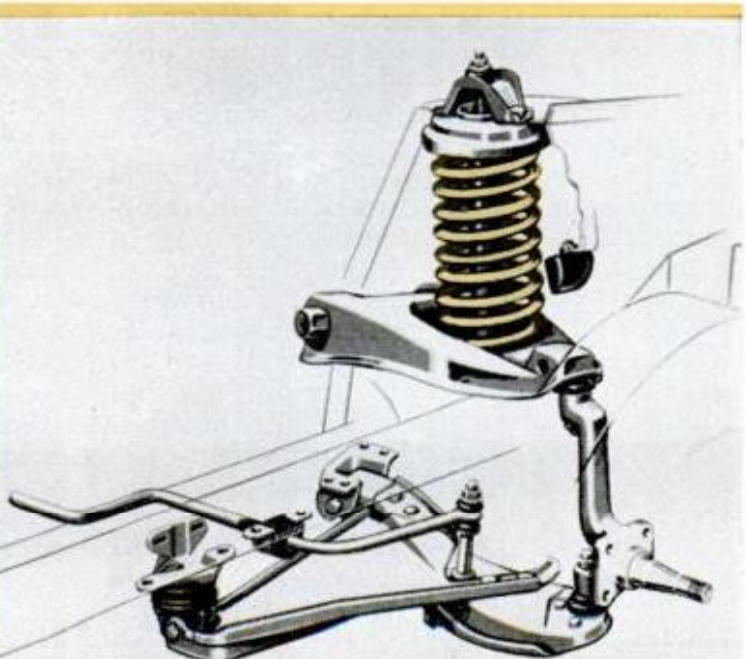
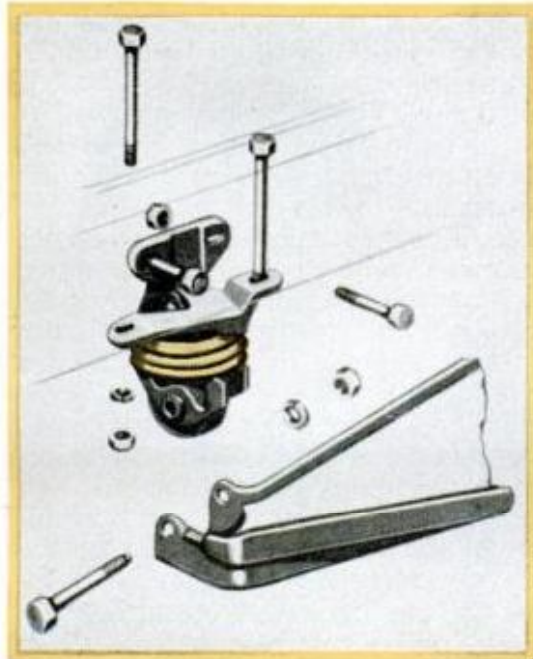

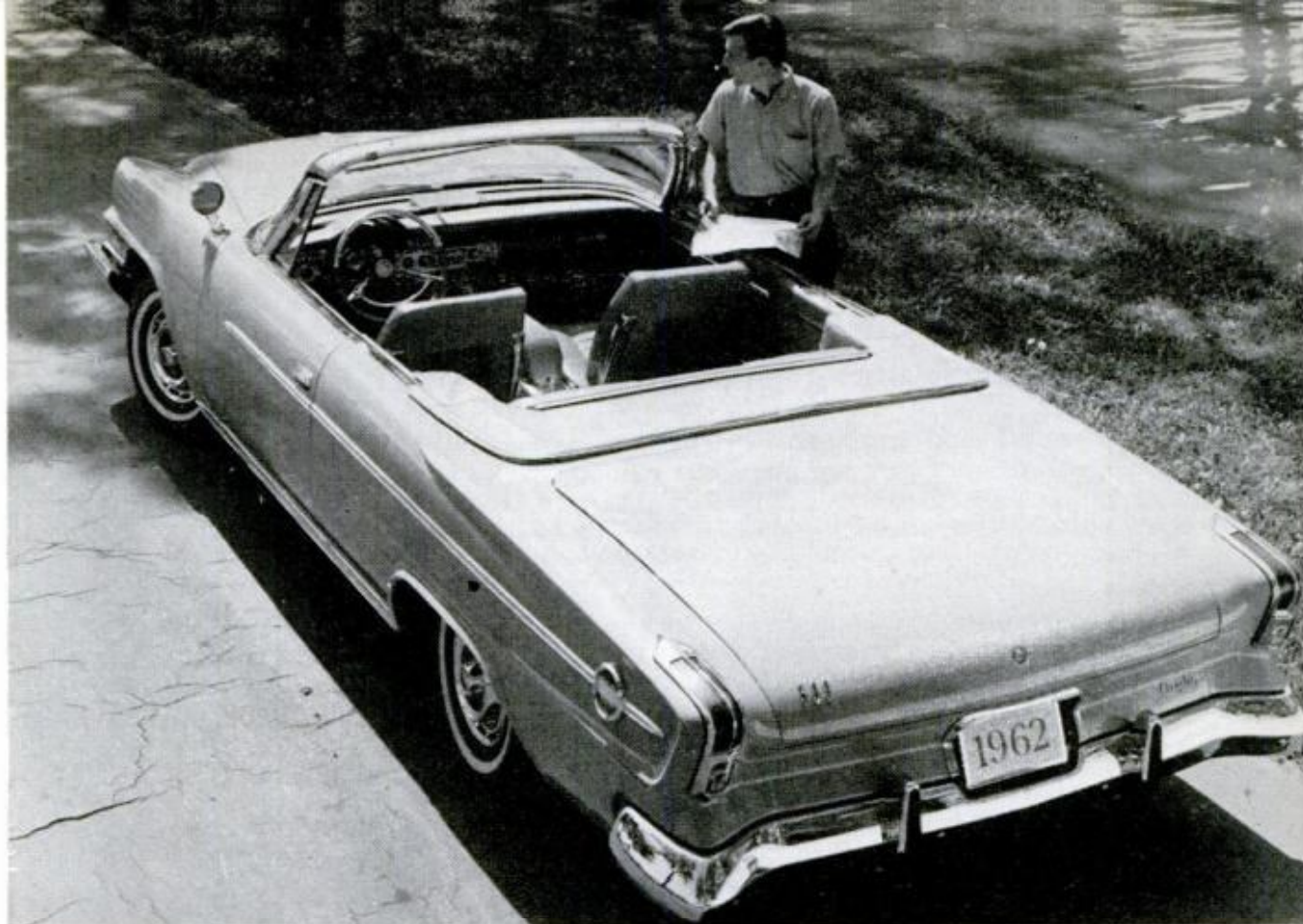

CLEAN, SIMPLE styling is carried through on rear deck of the distinctive 300-H

LONG CONTROL console separates the leather bucket seats

CHRYSLER 300-H

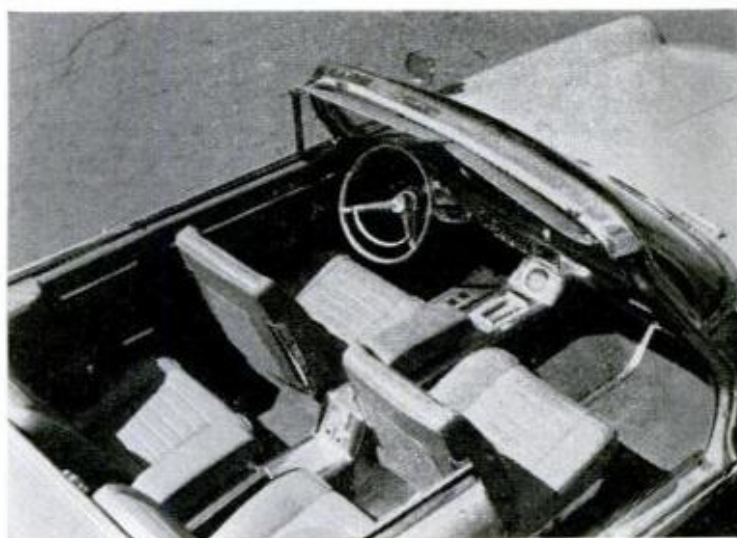

CHRYSLER has broadened its line of "300" models, but the king is still the high-performance powerhouse with the letter after its name. This year it's the 300-H (for *hot?*). Displacement is the same as last year's 413 cubic inches but five more horses have been added to push the total to 380.

Carburetion is through a pair of four-barrels, and the mixture is subjected to a 10.1:1 compression ratio. Camshaft is a special, high-performance grind used in combination with mechanical tappets. Heavy-duty shocks and brakes and a sway bar are installed to help you hold it down.

The 300-H will be produced only in a two-door hardtop or convertible model. Both have power steering, power brakes and auto-

matic transmission as standard equipment.

Interiors are elegant in a sporty manner, with individual bucket seats, front and rear. Each of the individual bucket seats has its own adjustment and is upholstered in genuine leather. Under that hide is five inches of foam rubber contoured to fit the body.

The center instrument console that divides the seats runs from front to rear. It contains an ash tray, power window controls and a tachometer up front. In the rear is another ash tray, a lighter and the rear window controls.

The newest 300-H edition carries on the reputation its predecessors acquired for smashing acceleration, exceptional handling and considerable comfort. ★★★



By Jim Whipple



Compacts, In-Betweens Look Good for '62.

Rambler's Great New Feature — a Built-In Price Cut!

They're off and running. Prices are posted, salesroom doors are open, the supply pipelines are filled (or rapidly filling in the case of Ford after the short strike). And some indication of the public's preference is already shaping up.

The word was out among dealers by the end of October. "It looks like a year for compacts," said one. And there was already a scarcity of **Buick Special V6s**, **Chevy IIs** and **Pontiac Tempest** convertibles.

It's not hard to understand why compacts look big for '62 when you read the latest figures for eight full months of registration in 1961. Compacts sold 1,246,051 out of a total of 3, 812,063 units. And 1961 started off as a slow year for the industry.

Then too, the compacts are seasoned; all but one of them, Chevy II, will have been on the market for a year and will have won acceptance from all but the doubtingest of Thomases.

Although it's pretty early to tell much, the prospects of the new "family-sized" or "senior" compacts **Plymouth**, **Ford Fairlane**, **Dodge Dart** and **Mercury Meteor** look good. All these cars fall in the up-to-\$2700 price class which accounted for 80.74 percent of all registrations for the first eight months of 1961.

A look at some of the comparative base prices of these 115-117-inch-wheelbase cars is interesting: **Plymouth Six Savoy** four-door sedan, \$2262; **Dart Six** four-door, \$2297; **Fairlane** and **Meteor** prices have not been announced at press time, but the **Ford Galaxie Six** is pegged at \$2507 and the **Chevrolet Six** at \$2378. Now in all fairness it should be pointed out that the **Galaxie** as "lowest priced full-sized Ford" doesn't quite compare with **Chevy's Biscayne** at \$130 less. The **Fairlane** will probably be priced between the \$2262 of the **Plymouth** and the \$2378 price tag which is being carried by the **Chevrolet**.

This is a good time to point out that all **GM** and **Ford** products include the heater in their base price. Those who live in lower Florida or Hawaii may have to get their prices escalated downward and the heater

removed. (Heaters in the under-\$2700 brackets run about \$75, so add this figure to **Dodge** and **Plymouth** prices and you'll even up the score.)

These "in-between cars" should enjoy quite a play from the thrifty folks who trade only every five years or so and who have held off swapping in their '57s and '56s in the hopes that cars like the 57 **Ford Custom** (116-inch wheelbase, 202 inches overall) might return again.

Then too, there will appear for the first time, especially within the ranks of **Ford**, **Chrysler** and **GM**-oriented owners, a new breed. Perhaps we could call this new breed "The Compact Traders."

A million or two owners of 1958-60 **Ramblers**, 1959-60 **Larks** and 1960 **Falcons**, **Corvairs** and **Valiants** will be back in the game and eligible for trading.

These are the original pioneers of the compact movement who followed George "The Pied Piper" Romney in flight from the "Gas-Guzzling Dinosaurs." These good people should find nothing monstrous about the size or appetite of the "new-sized" **Ford Fairlane**, **Plymouth**, **Dart** or **Mercury Meteor**, especially if they shop the sixes, or in the case of **Fairlane** and **Meteor**, option an overdrive with their V8s.

Remember, in 1959 and '60 (and '61 for that matter) there were no cars, not even imports, in between the economical compacts and heavyweight full-sized cars. Now there are, and the fallout of the 1962 market pattern will be exciting to watch.

The Big Three haven't taken the play away from **American Motors** by a long shot. In case you might have gotten the impression that **Rambler** was a fading star, some 237,000 of them were registered in the first eight months of 1961 and now the irrepressible Romney has come out swinging for 1962 with a load of improvements topped off with a price cut of \$176 on the popular Custom Classic 108-inch-wheelbase sedan. Americans are cut up to \$98. Three cheers. George really knows how to lick inflation! ★ ★ ★



Rear-Engine Test Plane

Built to study flight at supersonic speeds and also at low speeds necessary during landings and takeoffs, a new British jet aircraft is billed as the trailblazer for supersonic airliners.

The Handley Page 115 "Arrowhead," unveiled recently at Bedford, England, has a rear engine and intake and a delta wing. It was designed to test flight problems that will be encountered by a 1400-miles-per-hour airliner now planned by the British.

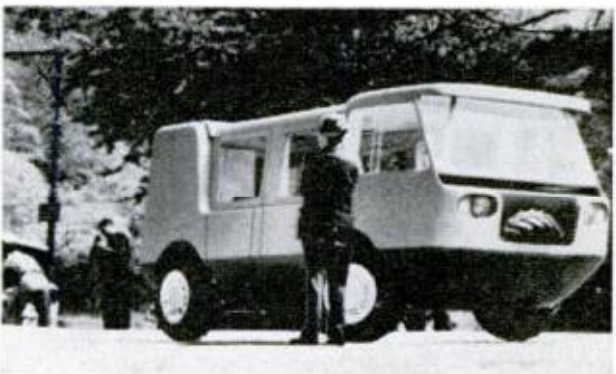
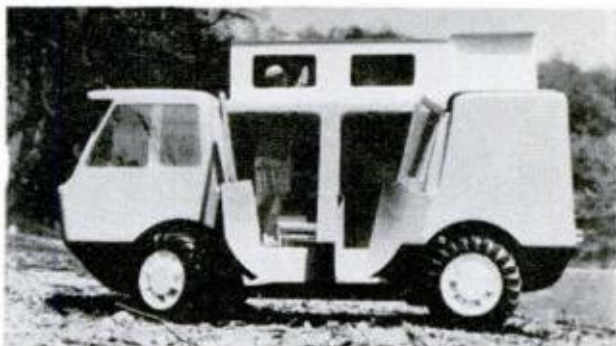

Dream Camper

Applying the dream car theory to the camper field resulted in the Amphicamper. Conceived by John H. Bowers, Jr. of Pratt Institute, and executed in aluminum, a model of this all-purpose vehicle won an Alcoa Student Design Merit Award.

Amphicamper is intended to serve five people as an overland and water vehicle and a living shelter. Length is 16 feet. Top speed is 60 miles per hour on land and 5 knots in water.

Where-To-Find-It List

If you want to find out more about the articles in this issue, write for sources of supply or further information which are given in the free WHERE-TO-FIND-IT list. Send stamped, self-addressed envelope to SERVICE BUREAU, 200 E. Ontario, Chicago 11, Illinois.



For the hot-stove league: Final Report on Those Baseball Changes



LAMINAR-FLOW wind-tunnel tests, run for PM by Jim Miller, an engineer from Illinois Institute of Technology, proved that a smooth baseball isn't a fast one. The opposite turned out to be the case

AFTER FOUR MONTHS of chemical and mechanical tests, the editors of *Popular Mechanics* and a team of researchers at Armour Research Foundation are satisfied on two counts: One, the baseball has undergone changes since the Ruth era. Two, the baseball being used in the major leagues today is "livelier" in the sense that

it can be hit a greater distance—under some circumstances—than the ball used in the late twenties and early thirties.

Some very interesting discoveries were made during the tests. Here's an outline of the findings:

Chemical tests showed that, while a lot of effort has been made to keep the ball

1927 BASEBALL, left, shows smaller seam and tighter, flatter stitching that make it smoother than the 1961 ball, right. Though the number of stitches is the same, their difference in size and width shows strongly here

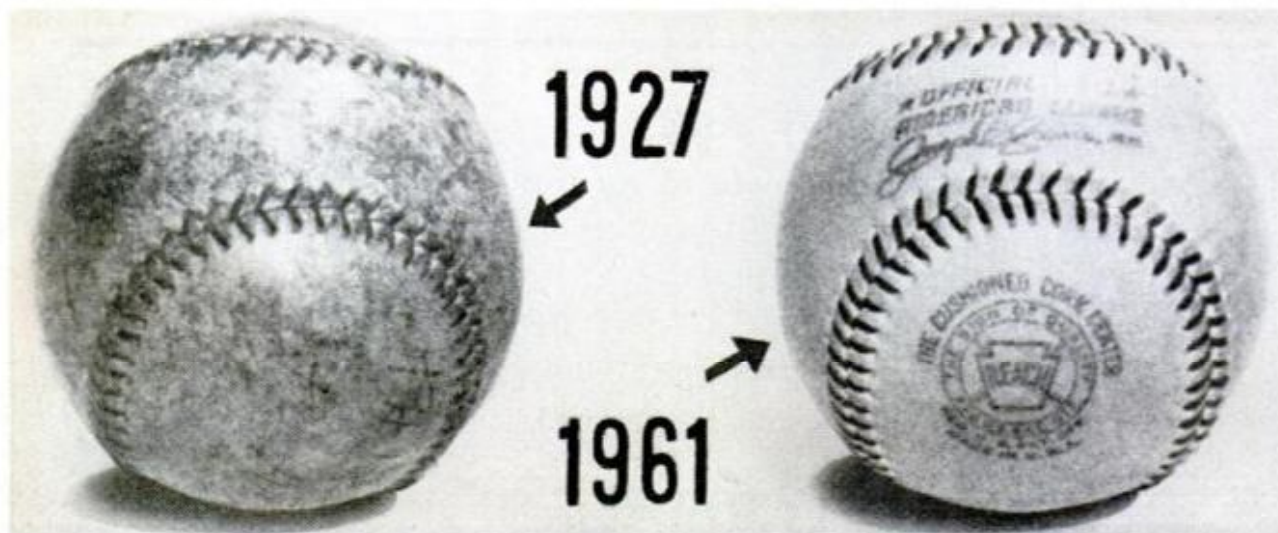

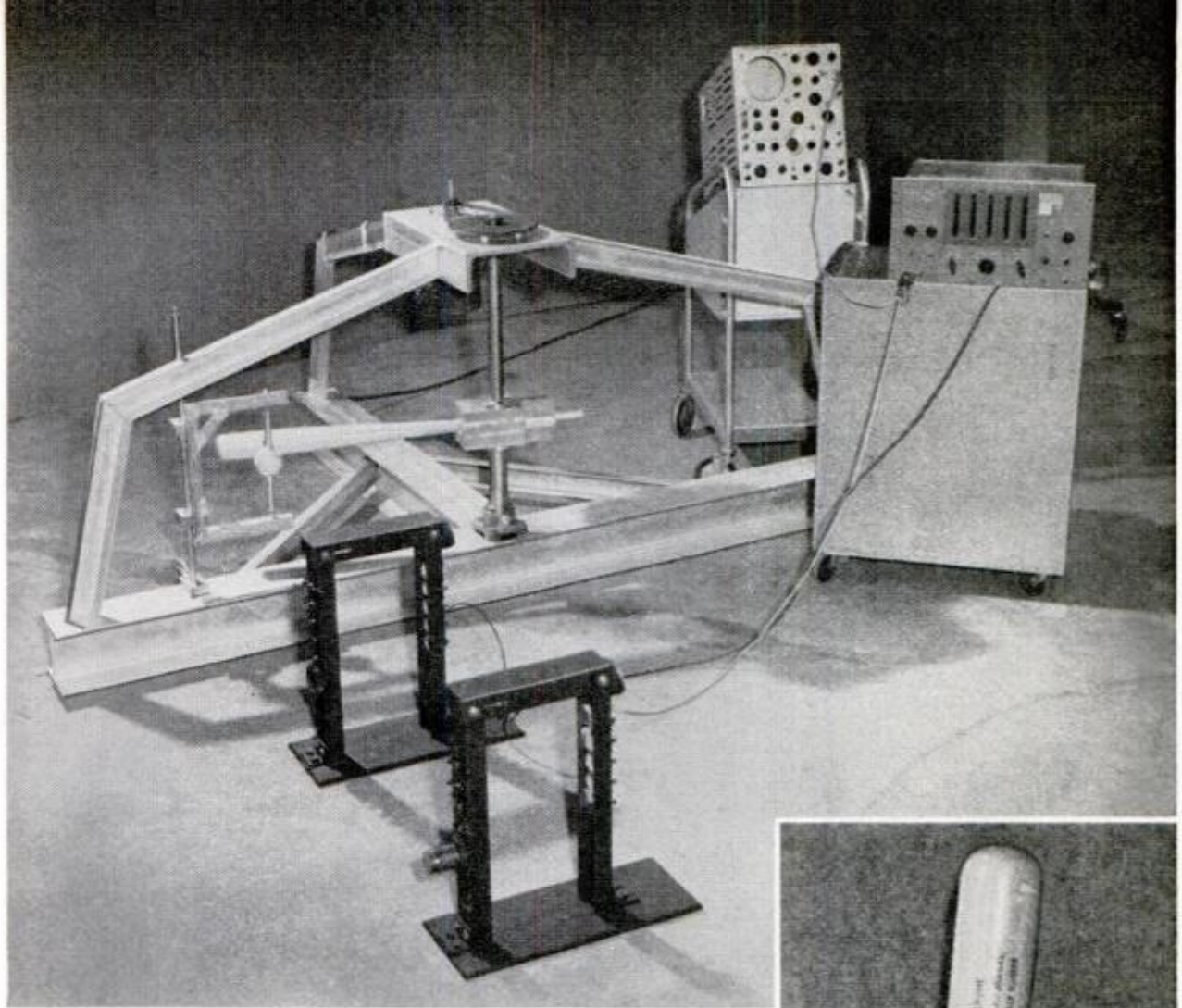

BATTING MACHINE, designed for PM tests, allowed balls to be hit at any speed. Ball was hit out through double photoelectric screens, and oscilloscope measured speed between the traps. Polaroid camera focused on oscilloscope screen gave photographic record of results in 10 seconds; 5000-frame-per-second movies showed ball reaction

SIMULATED HANDS held the test bat, mounted in live rubber, then mounted in turn inside aluminum block on batting-machine axle

BUSINESS END of the batting machine shows test ball mounted between cone coiled springs on solenoid-operated placement mechanism

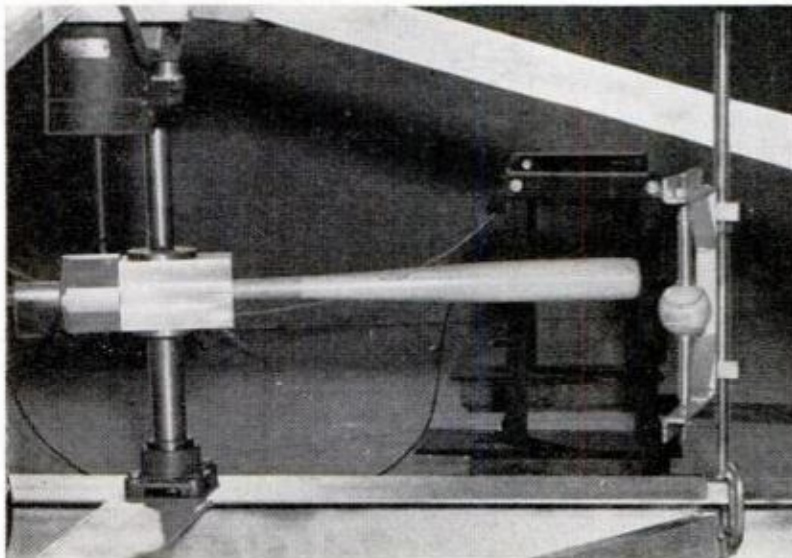

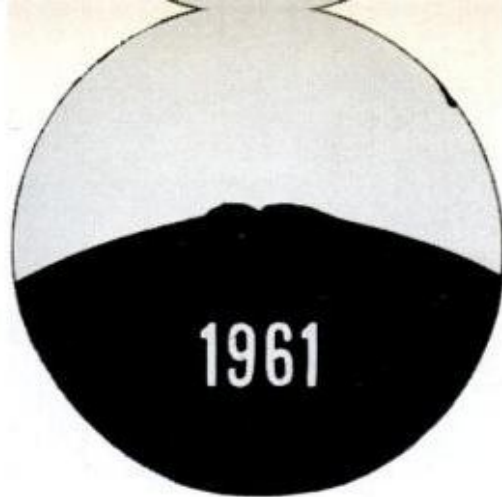
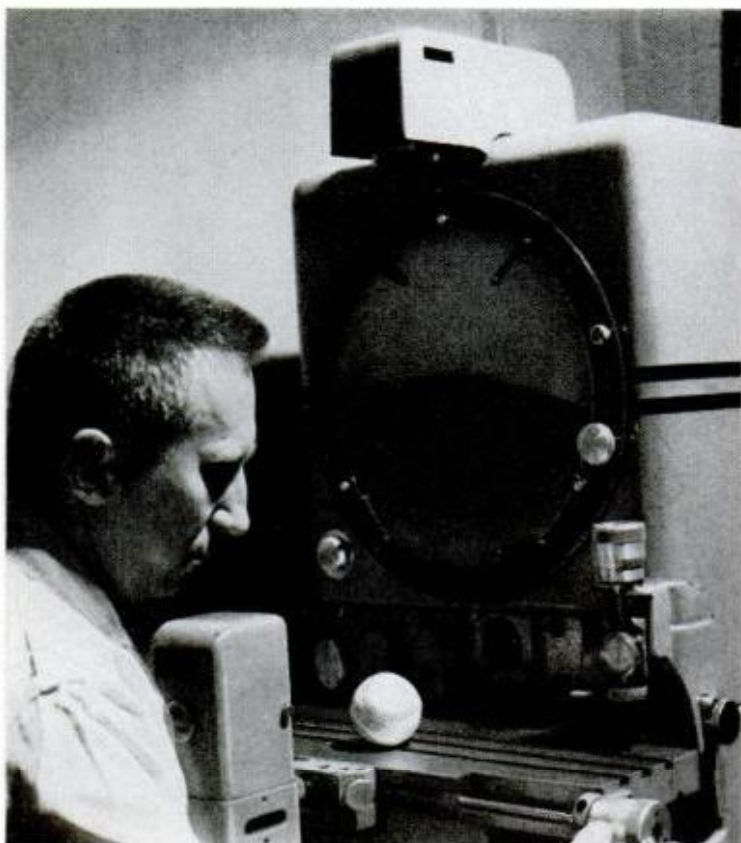

SHADOWGRAPH inspector Ed Swider demonstrates method of measuring seam size. Inserts show comparison

consistent through the years, there have been changes in yarns, rubber and cork core materials, and manufacturing processes. A few greatly different compositions were discovered—one 1927 ball was wound entirely with one continuous type of wool yarn instead of the specified three types. (One ball whose owner stated he had caught in the stands at a major league game in 1925 even had a solid rubber core with no cork at all. The modern ball was first produced for the 1925 World Series, but the 1925 regular season ball was supposed to have a cork core inside a single layer of rubber.) Even in apparently-identical balls, the tensile strength of the wool windings and the cork-and-rubber composition cores showed inconsistencies. While the effect of these irregularities on “liveliness” is hard to predict, it’s almost certain that they would not have performed identically.

The chemical tests indicated that the age of our sample balls should not make the mechanical tests meaningless.

Wind tunnel tests were started after the earlier tests showed that many of our baseballs from the late twenties had a much different seam structure than the 1961 sample balls. The older seams were narrower, tighter, seemed to be sewn with lighter thread, and were much flatter than the 1961

seams. As a result, the contour of the older balls was smoother.

Several years ago, during a series of tests on golf balls, the Armour wind-tunnel experts found that, in many cases, golf balls with dimpled surfaces showed *less* aerodynamic drag than perfectly smooth balls, and could be hit faster—and therefore further, than the smooth balls. Someone suggested that the difference in the seams on our sample baseballs might produce the same effect.

They did. Wind tunnel tests showed that the higher, coarser seams on the 1961 balls caused a surface turbulence in the air flow over the ball. The turbulent “boundary layer” results in a smaller trailing wake, reducing the ball’s over-all drag. The same effect showed on the older balls, but to a much lesser degree; they showed 10 to 15 percent *more drag* than the 1961 balls. The test engineers estimate that the difference in drag coefficients could result in a five to ten percent distance advantage for the new ball. That’s enough to boost a 350-foot fly ball to a 385-foot home run.

Impact tests were conducted on 24 sample balls—12 brand-new Reach American League game balls contributed by the Chicago White Sox from their game locker,

(Continued to page 210)

You Can Build a Low-Cost Shelter Quickly

\$30 . . . \$97 . . . \$280 — This can be the cost of materials for a family fallout shelter

NUCLEAR SCIENTISTS who have built shelters to protect their families against possible fallout radiation have, in many cases, put up simple, inexpensive structures that can be erected quickly. Following this example, *Popular Mechanics*

presents on these pages the construction details of three previously unpublished plans prepared by the office of Civil Defense and one by a nuclear engineer. They include some of the low-cost and most rapidly-built shelters available.



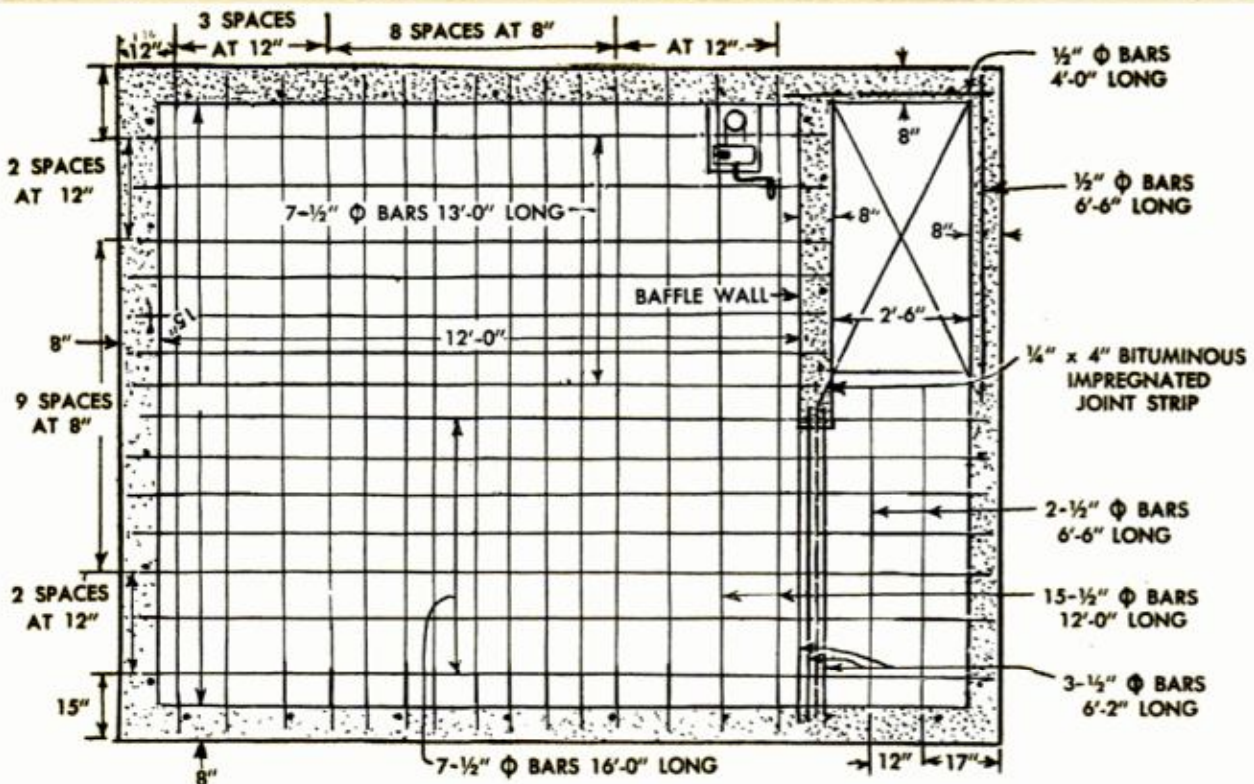
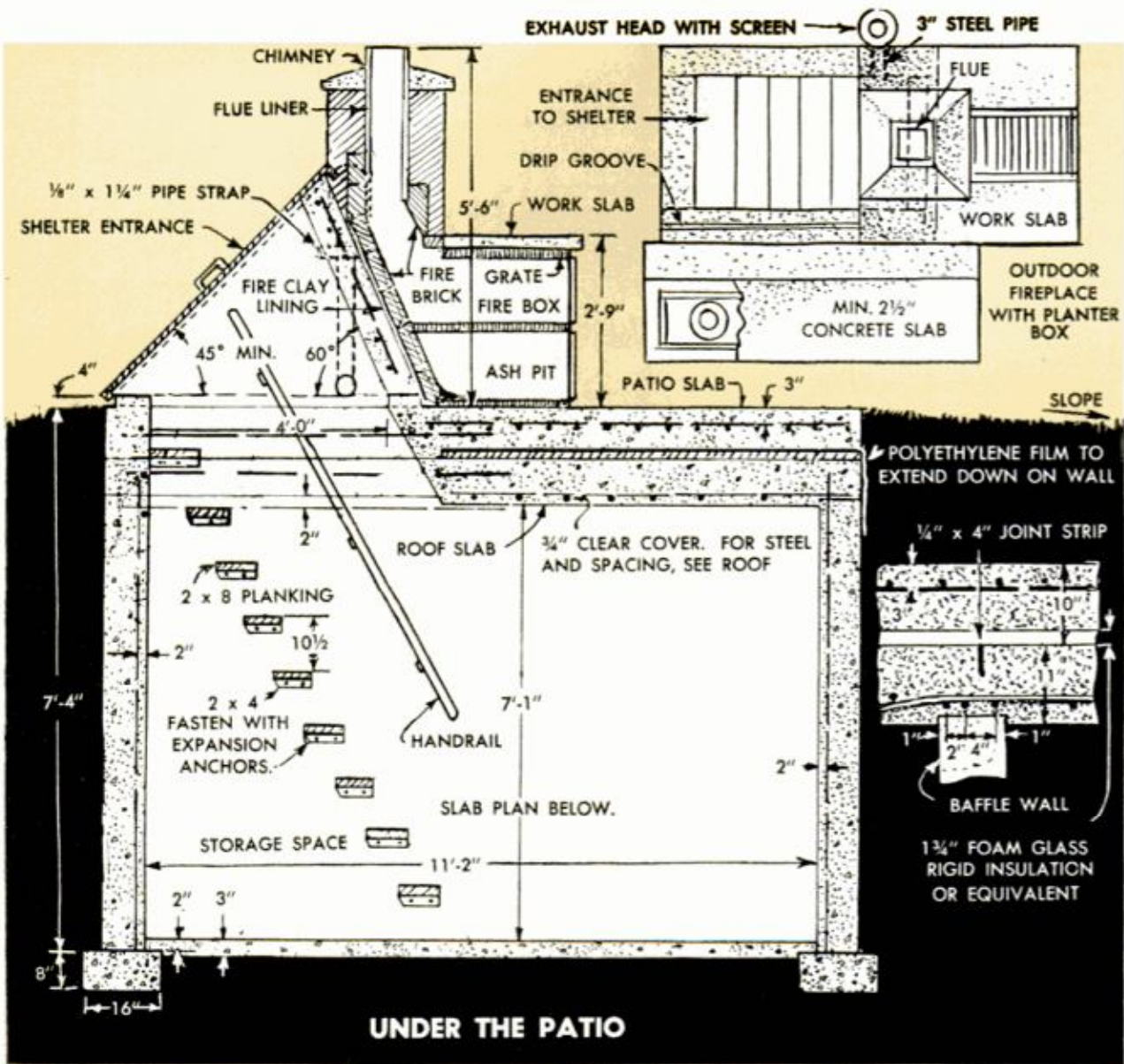

UNDER-THE-PATIO Shelter is typical of some constructions being offered by commercial builders—for a family or cooperative group desiring to house up to eight people. Because the official plans call for the building of a room underground and making a structure that has another use, this shelter is the costliest PM is presenting. Its cost estimate, obtained through the Mason Contractors Assn., totals \$1841, a

figure that includes \$776 for installing footings and top slab and is a figure that could serve as a cost guide for anyone contemplating having any similar shelter installed commercially.

Drawn up by the Office of Civil and Defense Mobilization this year for inclusion in its to-be-revised edition of the Family Fallout Shelter booklet, the plan is Number S.O. 20.

SIMPLEST SHELTER OF ALL is the design of R. M. Stephenson, professor of nuclear engineering at the University of Connecticut. He based his shelter on experience gained from 10 years working with the atomic energy program and a successful design concept used by the British in the last war. Prof. Stephenson says:

"Recent tests by the AEC show that this type of shelter will reduce radiation levels by a factor of from 200-1000. This means that even in a region of high fallout, the radiation exposure of a person in this shelter would be no more than what he might get from a series of X rays.

"I want to emphasize that this shelter has been designed only on the basis of cheapness. Depending on the size of your family, you may want to have a bed or cot, or chairs, etc. I would suggest that before starting a shelter, you assemble the family in a corner of the room and decide the size and height of the shelter required."

The bill of materials came to \$30 for Prof. Stephenson. It consisted of 100 sandbags,

20 x 30 in.; 10,000 pounds (four yards) of dry sand; lumber as shown; one pound of 4-in. spikes, 2 pounds of six-penny common nails, and 100 feet of strong cord for tying sandbags.

"If you leave small holes when you stack the first layer of bags," says Stephenson, "this, combined with the door into the shelter, should provide plenty of ventilation. If you have a basementless house, the same shelter can be used except that two more walls of sand bags are required and the opening into the shelter must be a little more elaborate to prevent direct entrance of radiation."

Prof. Stephenson also suggests closing and locking all doors and windows of the house since it will protect against the entrance of fallout dust; shelters protect against radiation from such dust.

To get Popular Mechanics' booklet on shelters and survival information, send 25 cents to Popular Mechanics, Department RSB, 200 E. Ontario St., Chicago 11.

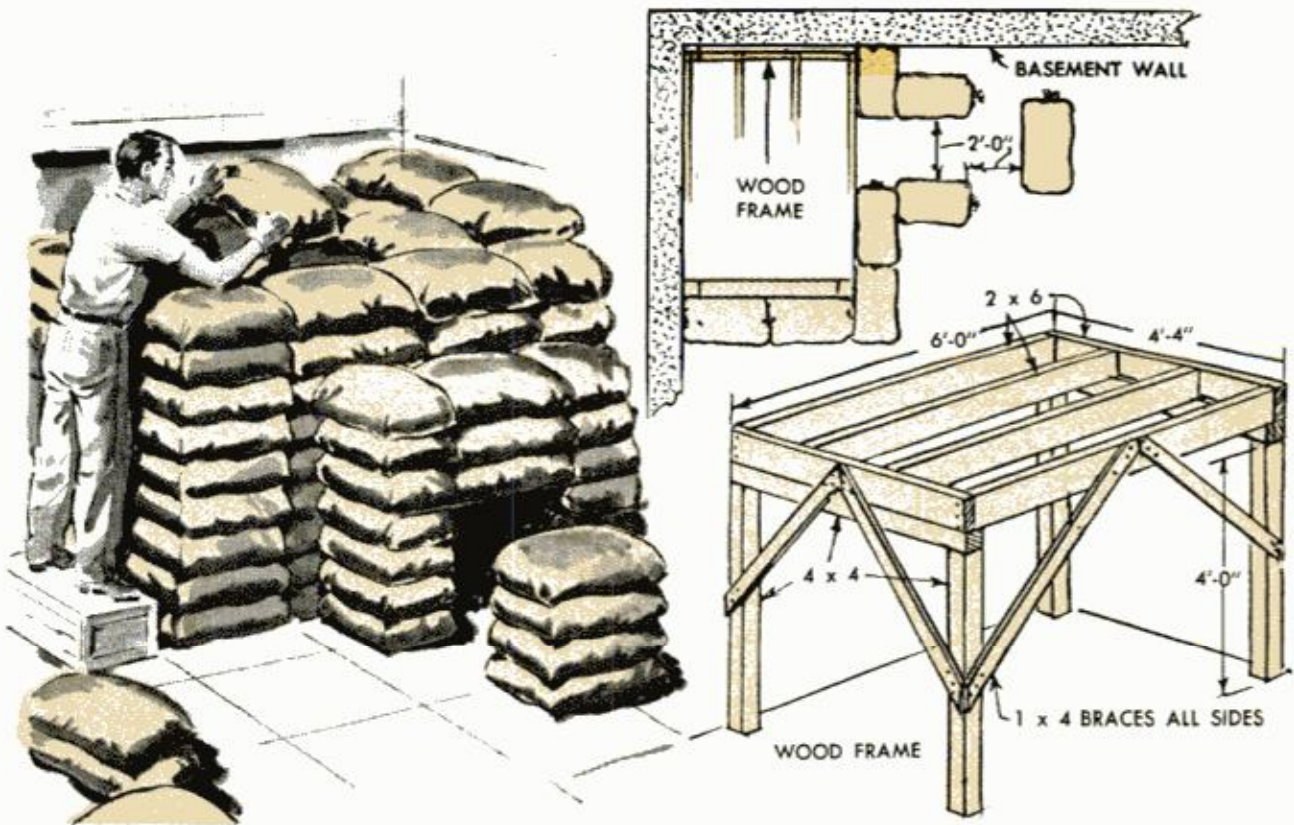

STORE-AWAY SHELTER CAN BE REBUILT IN TWO HOURS

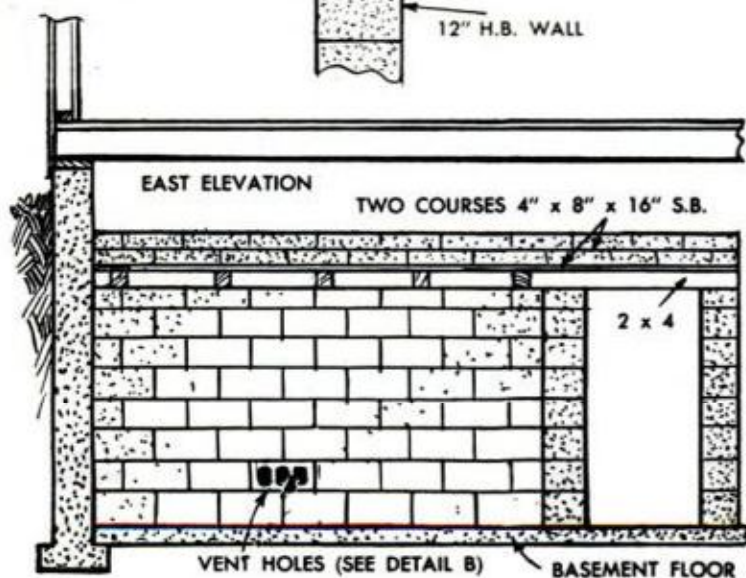
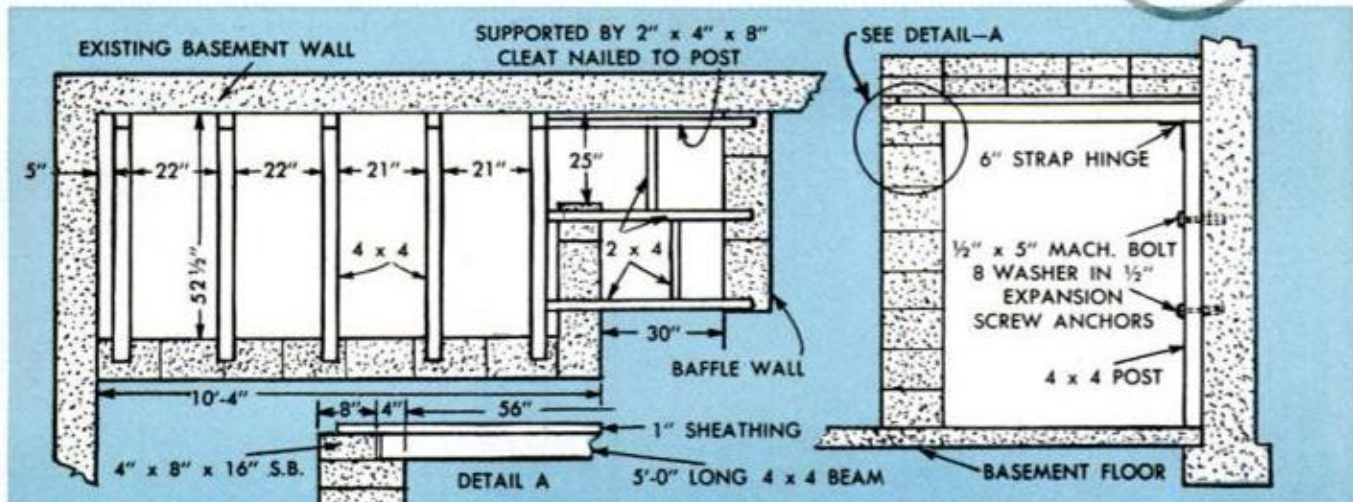
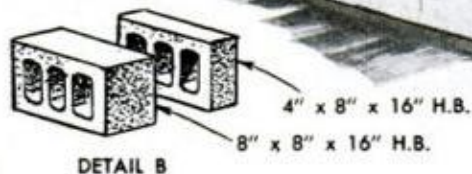
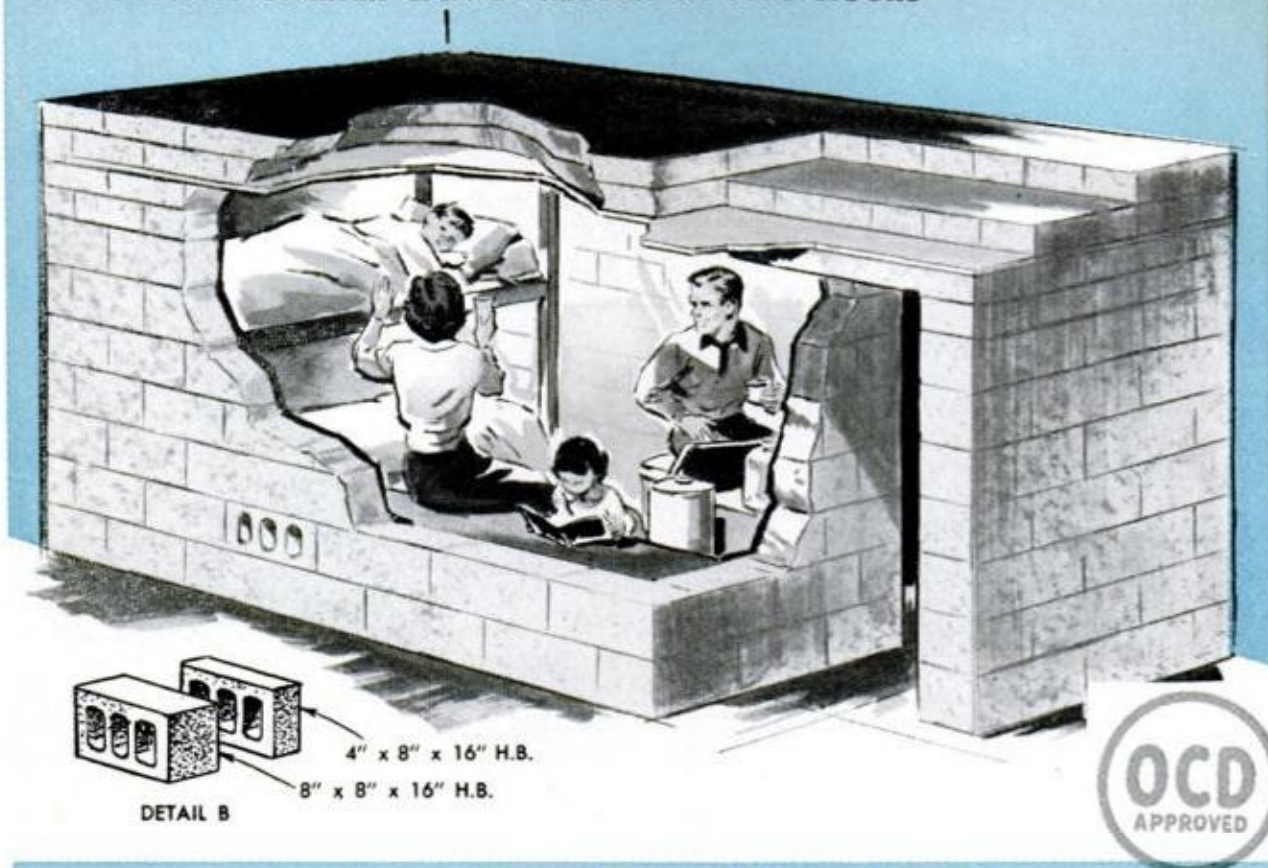

THIS SPACE-SAVING DESIGN (OCDM No. S.O.29) can be set up by one person from its store-away position in two hours or less, once the initial construction work has been done. Cost of material, according to Portland Cement Assn., amounts to about \$97. Total time of the initial construction is about 33 man-hours, including drilling wall, drilling and cutting lumber and placing blocks. Wood frame top is hinged to fold against wall. No motor is used.

All food and water is stored outside the shelter. Upon taking shelter, one or two days' supply of food and water can be carried in.

BASIC SIT-DOWN SHELTER FOR BASEMENT

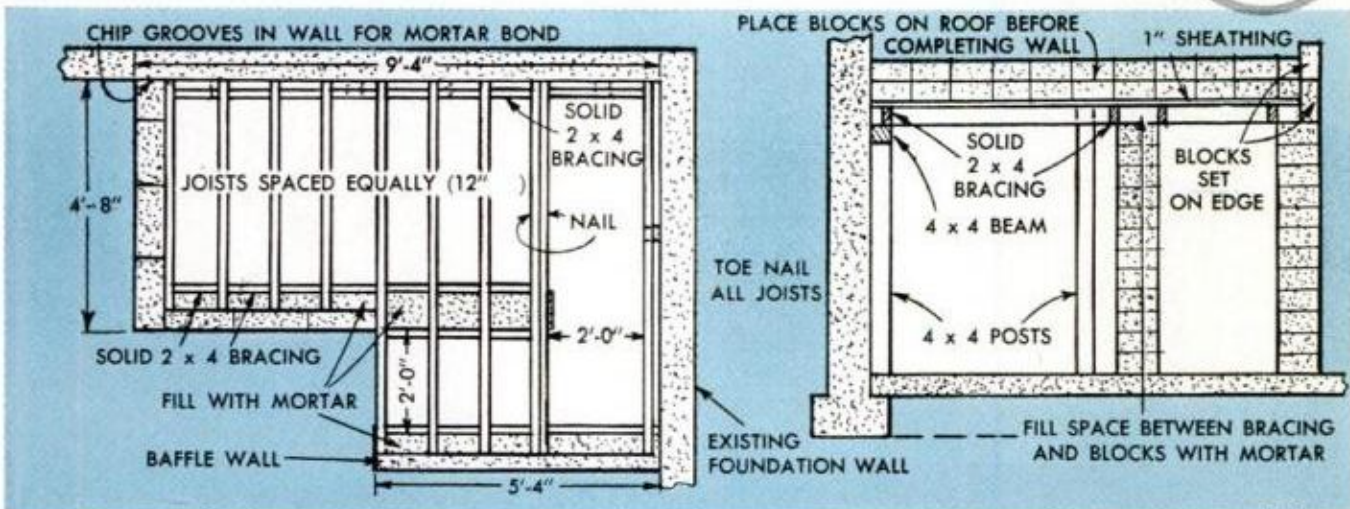
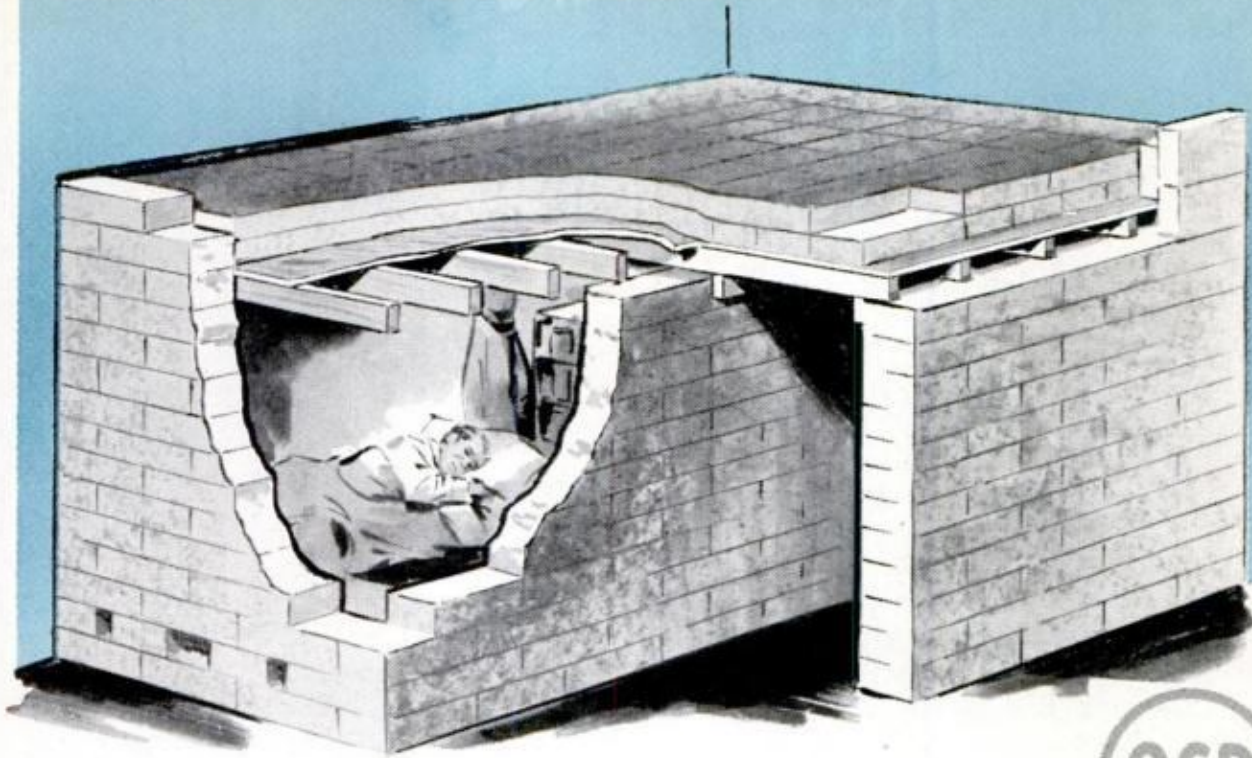

FOUR PERSONS can be sheltered in this structure which costs an estimated \$280.

Taken from OCDM drawing number S.O. 2, it is made basically of concrete block, and designers suggest that lumber surfaces in contact with existing walls or floor be coated with tar or white lead paste to prevent rot.

Those who desire more elaborate, blastproof underground shelters should request the Family Blast Shelters Interim Technical Bulletin from the Office of Civilian Defense, Department of Defense, Pentagon, Washington 25, D. C. It is free.

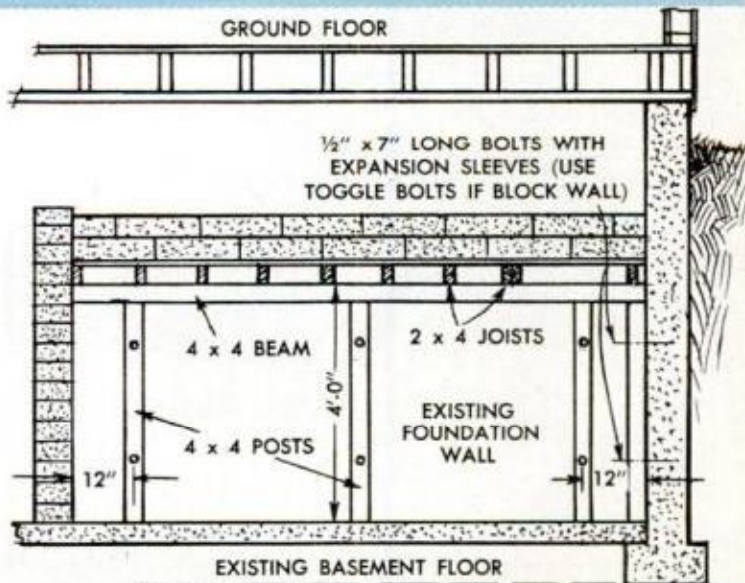

Great New Sport: TABLE-TOP RACING

*You have to be a savvy driver with
a lead foot to guide a hot
Maserati to victory*

By Richard F. Dempewolff

BILL PROCTOR'S MASERATI screamed down a long grade between hedgerows of greenery, and nosed into the tightest turn on the course. You could hear the whine as he poured on the coal. The car began to drift. Proctor eased off on the juice too late. A split second later, the "Mazzer" spun out, sideswiped Bob Fennelly's speeding D-Jag, which slithered into an uncontrollable spin, then ploughed into Prentice Cookman's Ferrari as it came from behind on the outside. Both cars flipped, hurtling into the spectators.

"Not bad, not bad—that was ten whole laps without a spill," Proctor observed as he picked up the Maserati. He put it back on the road-racing course that snaked over hills, through curves, tunnels and mountain scenery all over the basement of Bob Fennelly's home in Hamden, Conn.

Proctor, whose name has appeared on the starting line-up at many a genuine road race, is one of a growing army of enthusiasts applying driving

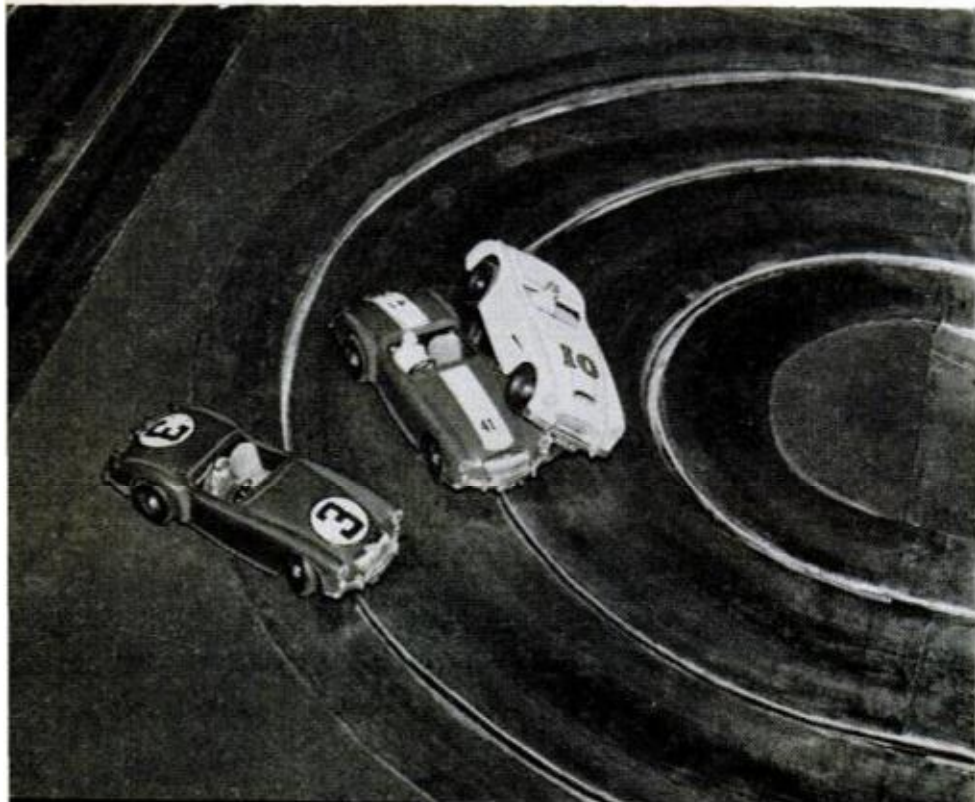
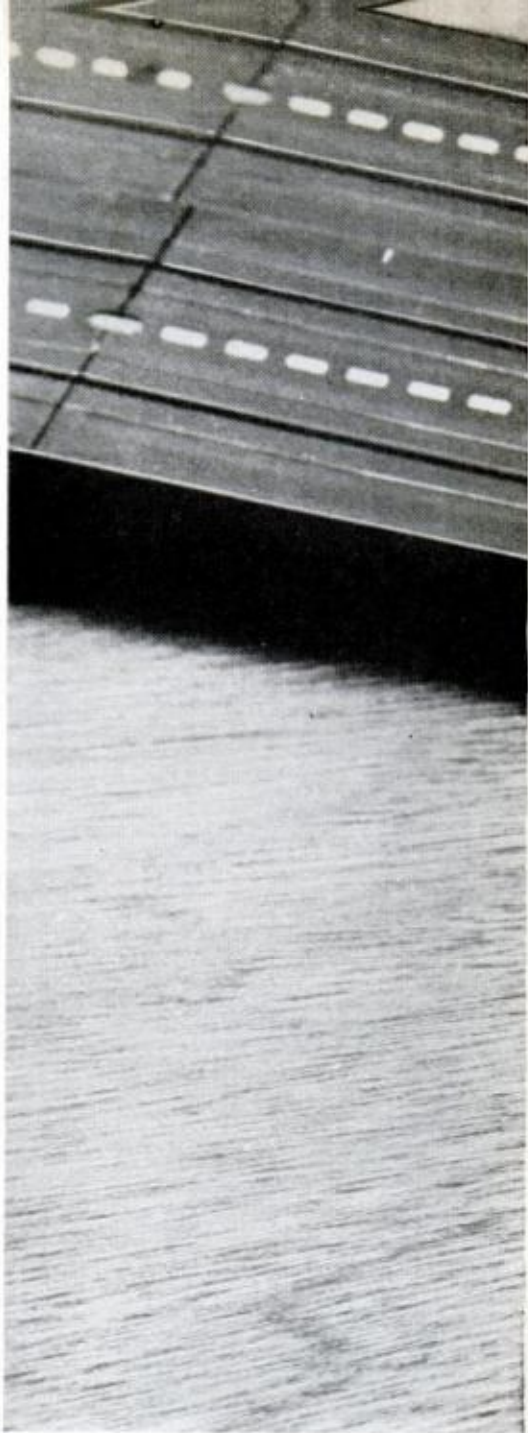

POURING IT ON, driver turns up rheostat, supplying more juice to car motors via contacts on track

SPINNING OUT, Car 10 is booted along by Car 41. Both smashed into Car 3. None of drivers was injured in the spectacular crash

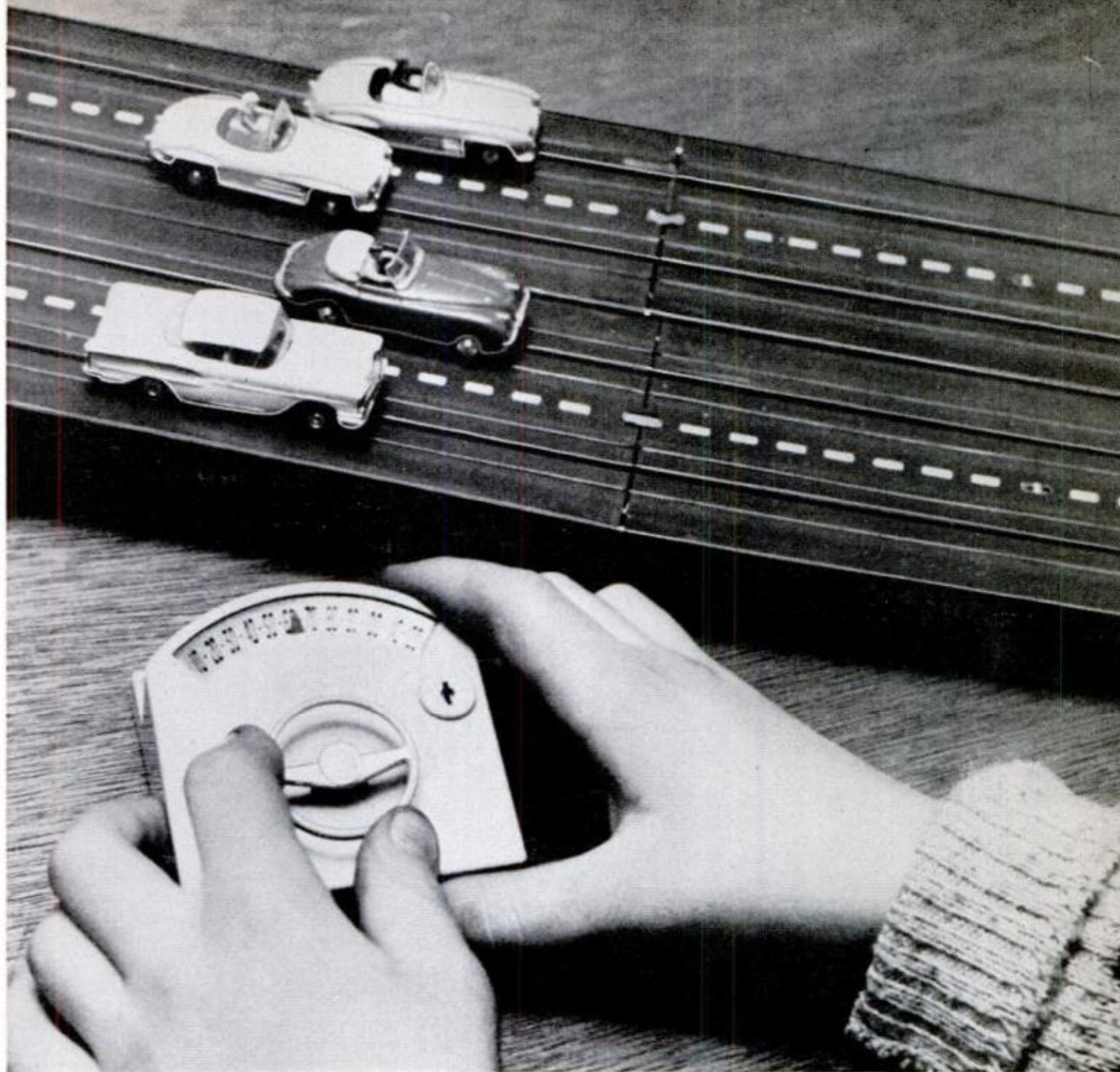

skill and a keen knowledge of road vehicle behavior to a fascinating new kind of sport. It involves *driving* precision-scaled electric models of free-rolling cars around equally precise scale courses. These may range from simple loops that fit on a card table to elaborate raceways that weave through an entire game room like a deluxe model train layout.

But unlike electric trains, the baby cars aren't irrevocably committed to a pair of metal rails. Road tracks, made to accommodate two to six cars at a time, provide the little vehicles with plenty of latitude for slithering and roaming if they're not properly controlled. If the operator's skill is up to par, his car will drift on the curves and fishtail into the straightaways under added power; if he misjudges, his car may spin out, crash into competing cars, and

wind up in the pits with a smashed body, stripped gears—or any one of a number of failures familiar to full scale automobiles.

Instead of a major repair bill, however, the broken vehicle can be back on the road at the cost of a few cents and a little tinkering. Or the owner can assemble another, new car from a kit for about \$2 total.

Scale model electric-drive cars first began to whiz around table-top tracks in England only eight years ago. The sport was known as "rail racing," because the cars were guided by a raised rail that also supplied the power. It was three years later before the first home made layouts, using plywood roadways and rolling stock assembled from plastic hobby kits, showed up in this country. Since then, rail racing—as it is still called by the purists—has taken off like an ICBM.

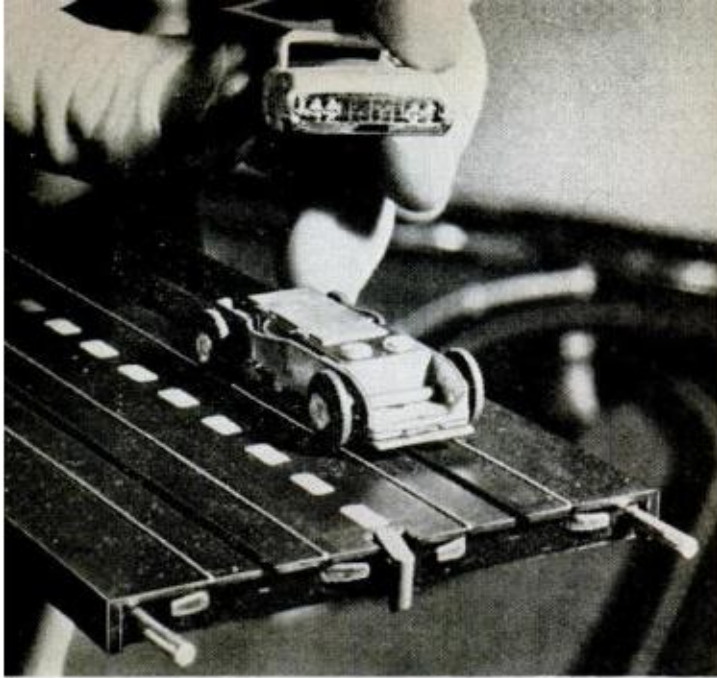

UNDER THE HOOD. Spark-gap motor picks up electricity from silver-nickel strips running down each track lane. Center groove is for the guide post under car

More than half a dozen toy manufacturers here and in Britain have jumped on the bandwagon with ready-made cars, kits and track, varying in size from HO scale to 1/29 and 1/24 scale vehicles. The bigger cars, running to six or seven inches in length, make far and away the most spectacular layouts because of the detail that can be achieved.

No longer does a rail jut from the track. Circuits are sunk flush with the road surface, or in a slot beneath it. Current is picked up by spring wire "feelers" under the cars, by delicately sprung brushes, or by rollers of varying design. In most layouts, ordinary house current is fed through 6 or 12-volt transformers (depending on motors used), thence to rheostats that control the speed of the cars. Great ingenuity is displayed in the speed controls. Some outfits use hand-held pistol-grip squeeze throttles; others are floor pedal affairs simulating car accelerators; some are op-

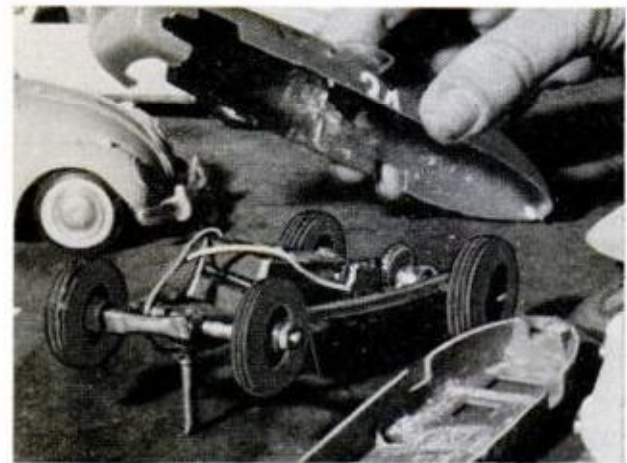

PLASTIC BODY and wheels are taken from kit, axles are specially made. Guide pin projects down, front

IN THE PITS. Prentice Cookman of Hamden racing team solders crash bar on a disabled Maserati

WORM DRIVE and motor assembly are adopted from standard hobby equipment, operate on house current

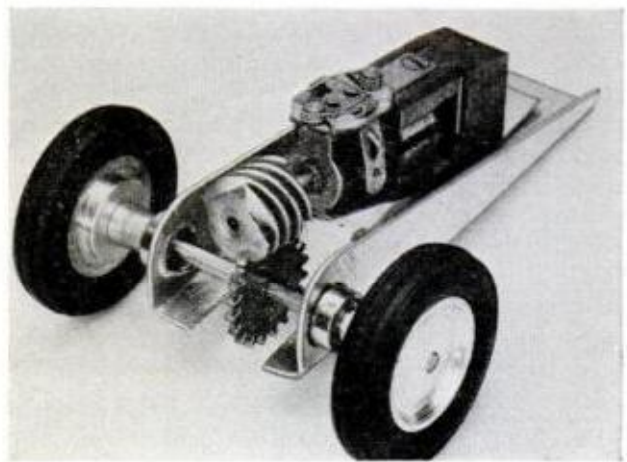

POPULAR MECHANICS

erated like airplane throttles from a control console. All are wired to the pairs of metal contact strips on the track, from which the cars pick up juice to power their tiny motors. In the 1/24 and 1/29-scale cars, these may be 6-volt model motors, or conversions from HO gauge locomotive motors.

Guidance Methods Vary

Cars are guided by various means. Some employ a nylon rod jutting from under the front end into a slot between the contact strips in the track surface. Others use a roller that rides a groove in the track. One outfit employs a nylon fin under the front end, which is connected to tie rods. It fits in a slot in the track, and when the road curves, the fin turns with it, automatically turning the car's front wheels. Devotees of this system claim that it greatly increases roadability and performance. Kits

include plastic bodies, complete down to such details as rear-vision mirrors, knock-off wheels with rubber tires, 6-volt motor, gears, axles, chassis and a scale model driver with helmet and goggles. Molded plastic track sections in curves, straight-aways and crossovers can be accumulated one at a time, or whole hog—along with endless scenery accessories.

For people who don't like assembling models, there are lines handled by most big hobby shops which provide a whole stable of sports and racing models in 1/29 scale—complete and ready to go. Naturally, they cost more. But one outfit will put anyone in business with two slick, molded plastic Grand Prix type cars, a speed controller for each, a five-foot-long oval of track sections complete with guard rails, and a dry cell powerhouse—all for something under \$30.

TIGHT RACE. Models slither out of curve on Hampden course. It has two highway levels, crossovers and tunnels

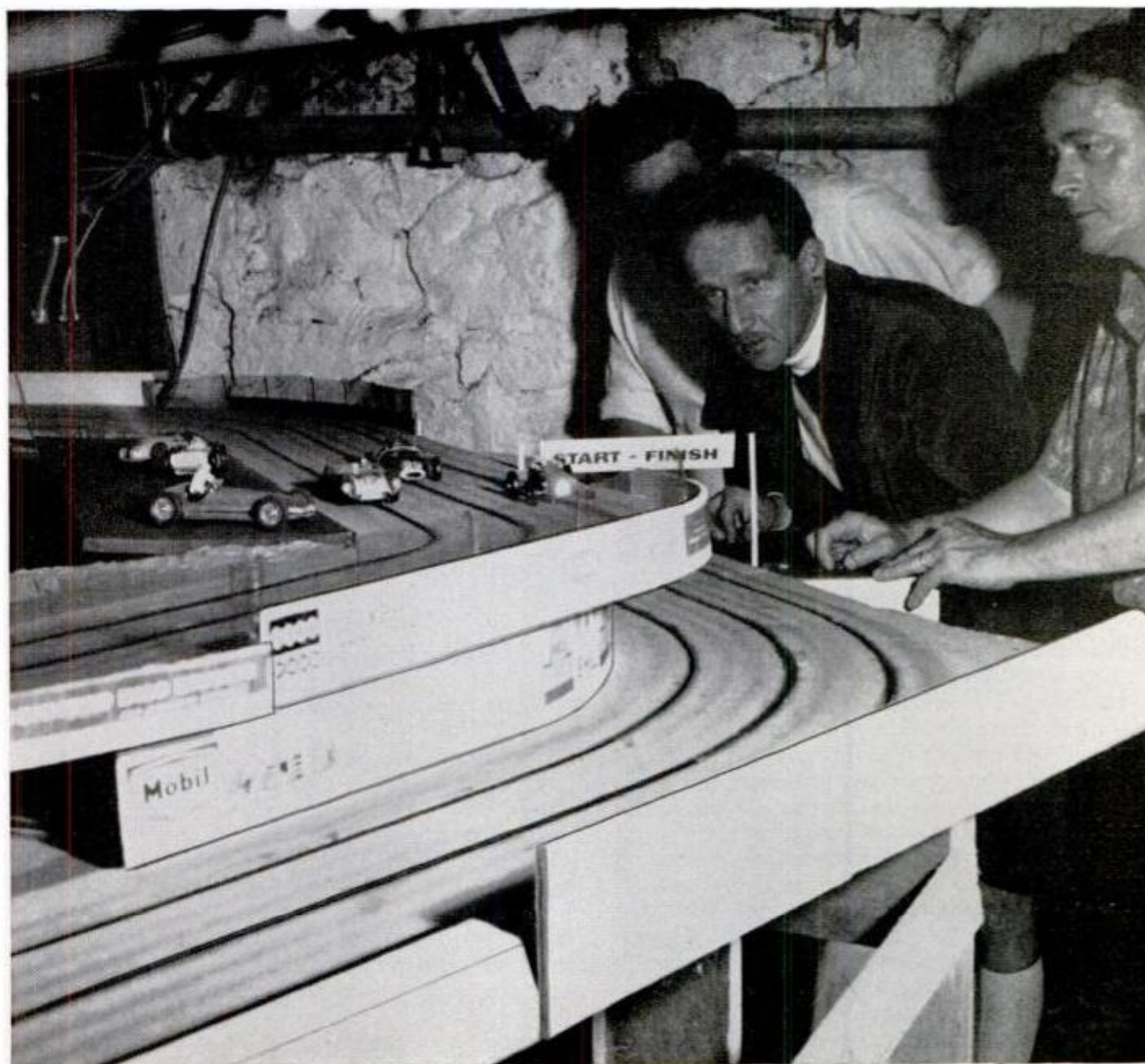

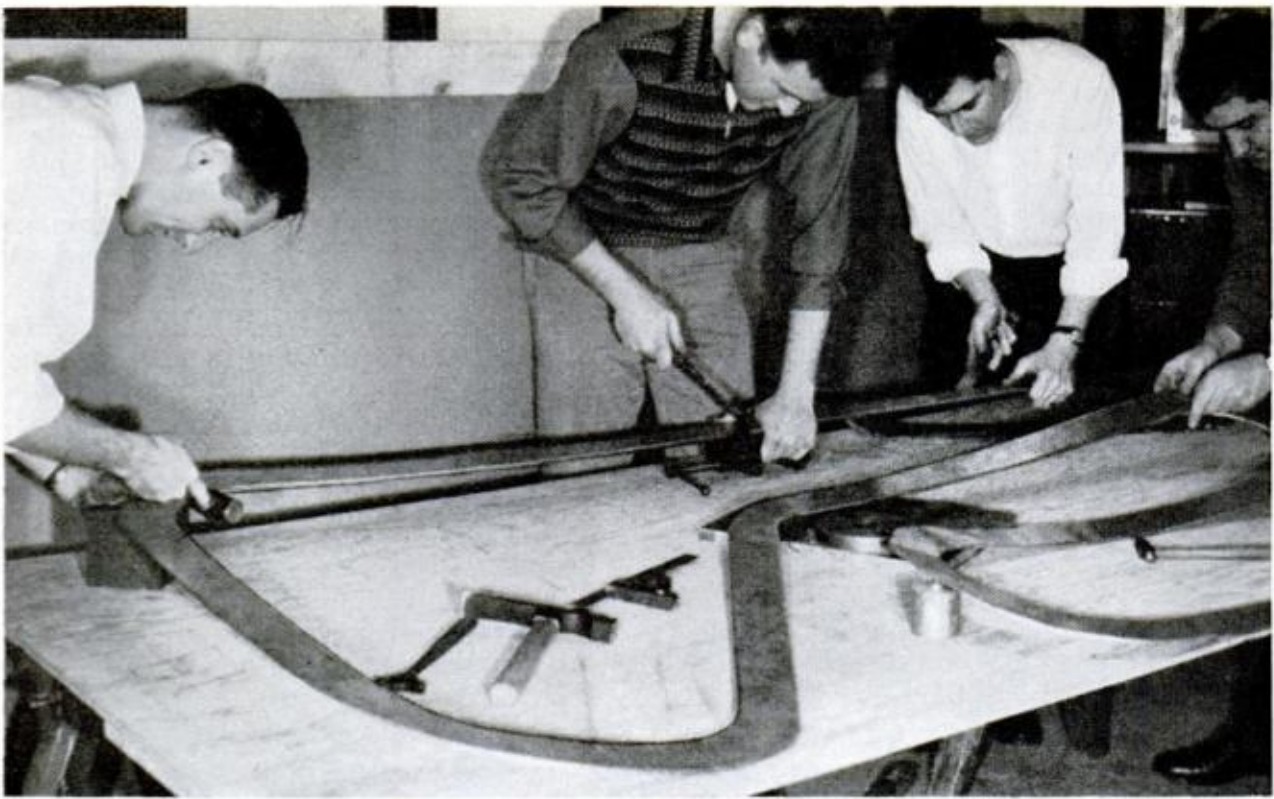

HOME-BUILDING of a track of sheet copper is done one section at a time, carefully hammered out to close tolerances. Most rail-racing enterprises involve groups of men who share expenses and labor, and know-how

Home-Built Layouts

To build and maintain the kind of layouts that will provide them with the ultimate in atmosphere, plus dozens of yards of convoluted roadway with every conceivable hazard built into it and huge stables of cars, fans have formed neighborhood rail-racing clubs. This helps defray the costs of a big layout, and spreads the labor of building it. Such purists as Bob Fennelly and his brother Joe, in Connecticut, and Ted Mathews (who provided many of the pictures for this story) frown on most ready-made products. They do, however, use built-up cars sometimes, which they modify to suit themselves. And their home-built tracks are embellished with all sorts of hobby shop atmosphere.

Stand beside Bob Kennelly's track while it's in operation and, before long, the cellar walls fade away and you're looking at the real thing. The four-lane roadway starts in front of the pits. Here, 20 or more cars, bathed in light from scale model floods, are being worked over by scale model mechanics. Scale engine blocks sit on scale racks. Tiny knock-off wire wheels and rubber tires rest against scale-size walls pasted up with scale-size billboards and posters, advertising everything from Michelin-X tyres to Amoco white gas. Thimble-size gasoline cans and tiny tool chests are scattered here and there. Goggled drivers stand around watching the work.

Cars whine by on a broad four-lane cir-

cuit that doubles back over and under itself for a total lap distance of some 90 feet. Sweeping around a banked curve guarded by an aluminum screen fence, the cars zing across meadows dotted with farms. Then they swing up a plaster-on-screen hillside, covered with vernal, plastic-sponge bushes and trees, zip through a tricky chicane (a wrecked D-Jaguar lies crumpled in the gulch below), and circle the field once more on an outside loop that comes past the pits again through an underpass.

"You can't really duplicate anything as big and elaborate as this successfully with fabricated track sections," Bob explains. "So we built the track ourselves out of plywood. That's what most clubs do."

Chew Up the Track

Bob Fennelly's plywood track is surfaced with a carpet of 1/4-inch sponge rubber. "It provides good traction, but the cars still move around on it in the corners," he points out. "It produces something pretty close to scale drifts and slides. But it does get chewed up—you can see the ruts on the curves."

Bob's brother Joe has a similar track of his own, but it is covered with painted cork. Ted Mathews' group in Flushing, N. Y., built its entire track of plywood strips covered with a surface of sheet copper. The surface of the track itself provides the current. The strips of copper roadway, separated by guide slots, carry

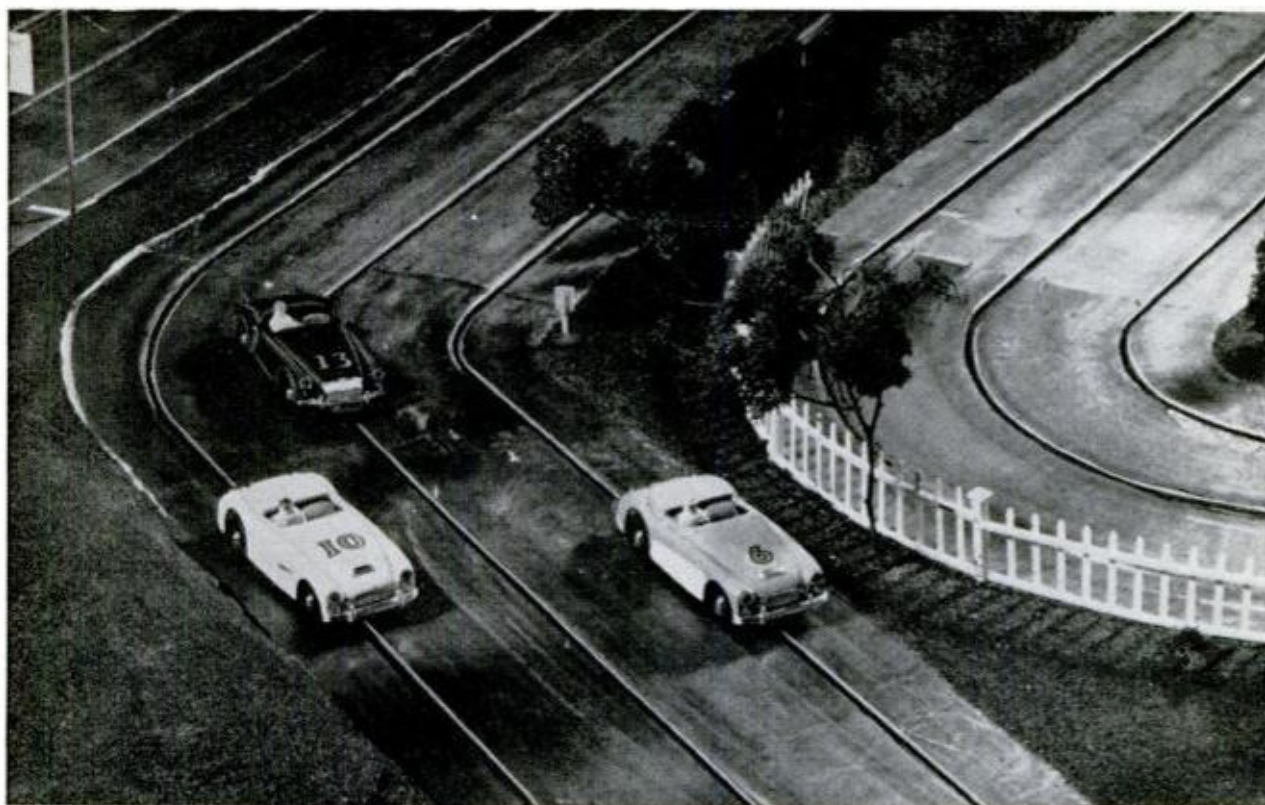

TRACK DETAILS on this layout were achieved with plastic sponge for foliage, sawdust for grass and accessories from HO-gauge model railroad equipment. The effect is realistic. Cars hit scale speeds of 70 m.p.h. here

alternate polarity. All that the cars need are simple brushes kissing the roadway surface on each side of any slot.

When it comes to rolling stock, you're likely to find anything tearing around a do-it-yourself rail-racing track. The hobby already has a set of international regulations calling for 1/32-scale cars. This means the bodies must be hand-carved, since few, if any, acceptable body castings are made in this size. The staunchest purists—among them the Kalamazoo Valley Miniature Auto Club which, under one Thomas Cook pioneered rail-racing in this country and has sent competition teams to England and entertained foreign teams here—turn out fastidious models in balsa wood, with soldered tubular chassis and truly ingenious power trains.

But most buffs, anxious to put a lot of rolling stock on the road fast, settle for the larger scale that toy manufacturers reproduce nicely in plastic. "We use the bodies and sometimes the wheels of car kits made by the model outfits," Joe Fennelly explains. "In some cases that's about all you get, anyway. So we make our own sheet metal channel-type chassis, which is simple and easy. We use stock wheels, tires and axles from good model shops. Our motors usually are units from HO-gauge locomotive kits, and we adapt 12-to-18-volt HO power packs. We fabricate our own drive shafts and rear ends from standard hobby equipment. Some cars are propelled

by worm gear drives, some by rack and pinion gears. That way we can adapt a large variety of plastic car kits."

You can see what he means when you look at Joe's own stable of rolling stock. Besides a wide assortment of Grand Prix and Grand Turismo models, his landscaped parking areas are cluttered with a regular classic car concourse of Model "T" Fords, Volkswagens, Rolls Royces, Corvairs and the like—all contrived from plastic hobby kits and powered up with HO motors. Joe's layout, which runs along an entire wall of his basement game room, consists of a single circuit with a variety of curves at each end of the 25-foot straight-aways. Working this one is more like attending a gymkhana at an antique car rally. His brother Bob's layout is really a junior Le Mans.

Adapt Your Railroad

Suppose you're an HO fan, with an elaborate layout of hand-built trains and scenery, and don't want to get mixed up with a whole new layout in a different scale size calling for different equipment. Then the HO scale highway layout is for you. Recently, some outfits have come along with roadway sets ranging in price from \$11 to \$50. These micro miniature go-buggies can be worked right into a train layout.

Available tiny vehicles include everything from stock cars and trucks to sports

(Continued to page 208)



Water-Filled Tree Base

Falling needles can be retarded with a dome-shaped Christmas-tree base that holds a gallon of water to keep the tree fresh.

The dome shape keeps the water away from children and pets, and the enclosed seamless pan of tin plate is leakproof.

Three adjustable prongs hold the tree in place. The base is made of rustproof spot-welded steel, which has a white baked-enamel finish with gold flecking.

Retail price is \$4.95. It's made by Ward Manufacturing, Inc., 2530 Spring Grove Av., Cincinnati 14, Ohio.



Medical Data by Telephone

Electrocardiographs, X rays and other, similar medical data may soon be transmitted to remote recording instruments or consulting specialists anywhere in the country by telephone over a special Data-Phone system being developed by the Bell Telephone Laboratories.

With the electrocardiogram system, a technician attaches electrodes to the patient, then dials the telephone number of the recording device at the other end of the circuit. By pushing a button, he transmits the heart pulsations to a visible recorder, which produces a graph instantaneously. A connection can be made on a patient undergoing surgery, for instance, and a heart specialist across the country can "sit in" on the operation, commenting through a regular voice telephone circuit. Trial runs between New York, Ohio and Pennsylvania have been successful.

Heart of the system is the Bell 600 series data-phone setup, which permits sending and receiving of handwriting, charts and diagrams between stations equipped with the system. Regular telephone circuits supply the connection anywhere that telephone service is available.



Do-It-Yourself Optics

Forty-nine different optical instruments can be assembled from the components of a new kit. The pieces fit together easily and can be disassembled for construction of other items.

Among the instruments that can be made are field glasses, telescopes, microscopes, periscopes and magnifiers.

Each part is numbered, and the instructions explain the order in which the various pieces go together.

The Optic-Variant 49 kit, a product of Germany, sells for \$59.95. It's available from the Hertvy Co., Inc., Rego Park 74, New York, N.Y.



To Boost Your Bowling Score: PLAY THE ANGLES!

Only three easily "spotted" angles of delivery will take care of 90 percent of the pin combinations you'll meet. Learning to use them can add 20 points to your average. Here's how:

By Bob Kelly

ARE YOU A "STRIKE-HAPPY" BOWLER? Most bowlers are. If their first ball fails to clear the lane, they lose interest in the second delivery, and they miss spares from simple lack of interest—or from a lack of knowledge of how easy it is to learn the formula for picking up spares.

How important is the spare to your score? If you bowled a line, downing nine pins each

time and "picking the cherry" with each second delivery, your score would be a fat 190 without a single strike!

The average more-than-occasional bowler bowls 154, getting two or three strikes and leaving three or four open frames in each line. He picks up four or five spares in the line. But if he'd take the time to learn the facts about picking up spares, Mr. Average Bowler could pick them up around 90 percent of the time—and could boost his score by 20 pins.

What's the secret? It's simple. Barring splits or freak hits, one of three basic angles of delivery will pick up every spare in the book. And they're predictable enough that you can learn to spot-bowl the magic deliveries as easily as you can learn to spot-bowl for the strike pocket. No need to change your form or speed—it's better if you don't. Just learn to position yourself and start the ball over the right alley target spot, and the spares come tumblin' down. Turn the page to see how it's done.

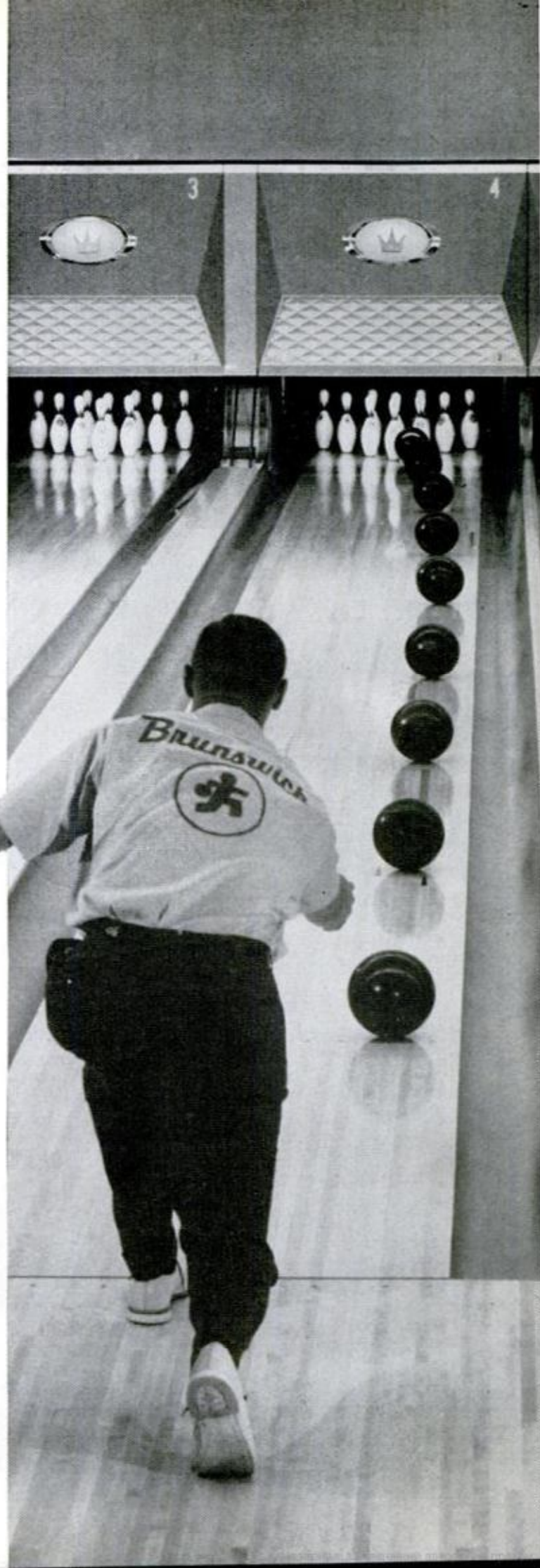

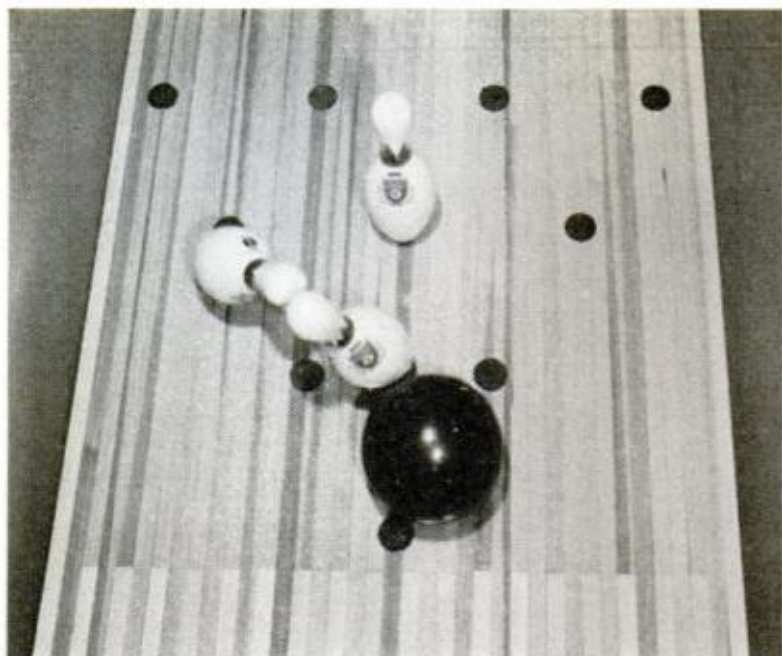

The "Strike Ball" Spare

THE FIRST THREE common spares are easy—you can pick them up with exactly the same delivery that you use for the 1-3 strike pocket. Since half the balls you roll are (or should be) aimed at that pocket, these should be a snap. Start with your feet in the normal strike position, and deliver the ball over your normal strike target on the alley.

The experts say it's best to forget the urge to aim toward the left on the 1-2-5; your consistent strike delivery will be more likely to connect, and if you overcorrect to the left, you could miss the 5 pin. The 5-8 doesn't offer as much temptation to would-be sharpshooters.

With the 1-2-9 spare, accuracy becomes very important, since a ball too far right will send the king pin across without taking out the 2, and a ball too far left will miss the 9.

The same delivery picks up the single 2 and the 2-8 spares, but for a sure hit, don't aim from your usual position. Position your feet a pin's width (about 4½ inches) to the left of their usual starting spot, and bowl over a spot the same distance to the left of your usual strike-ball target. The ball follows the same path, adjusted leftward, but otherwise, the delivery is the same as for a strike. You'll pick this one up more often with that delivery than you will with an aimed ball.

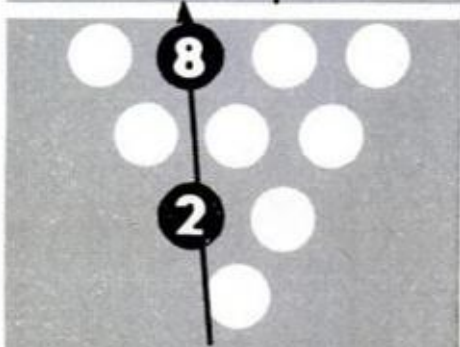
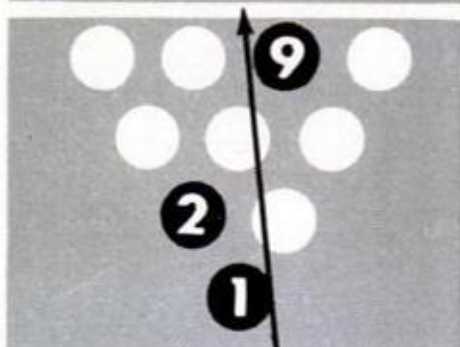
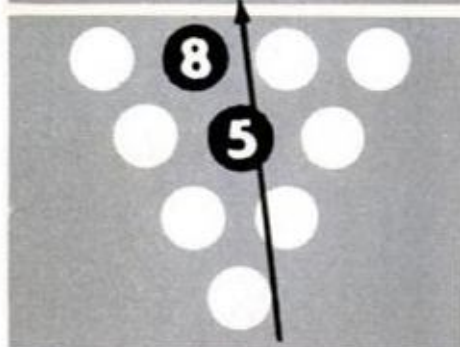
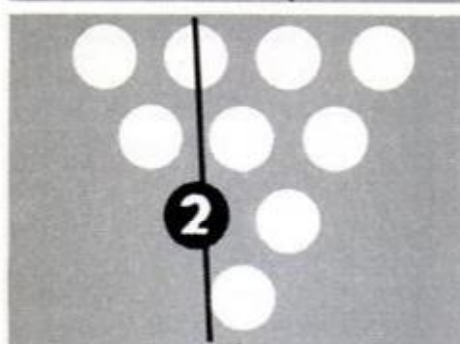
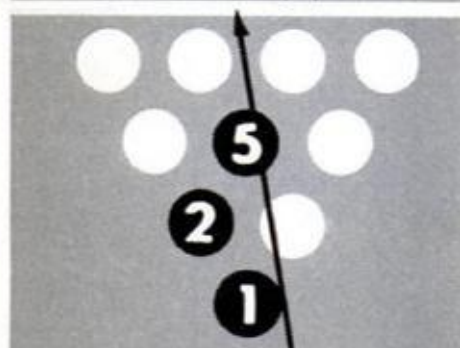
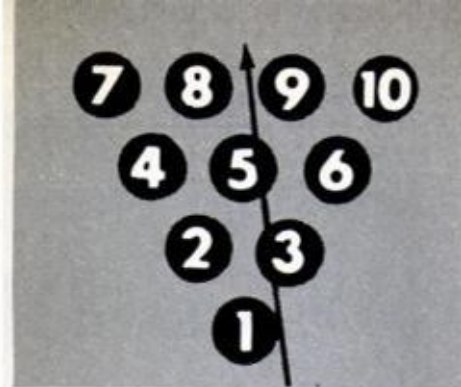

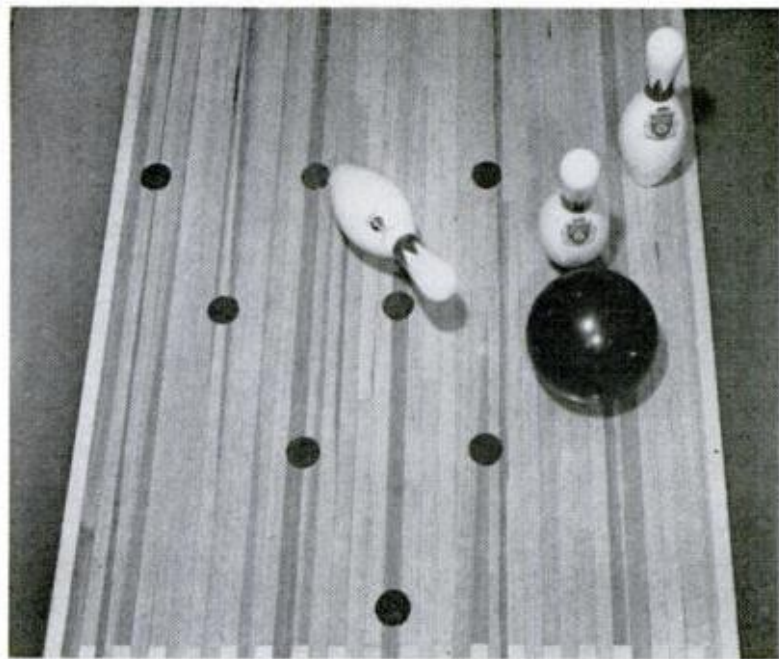
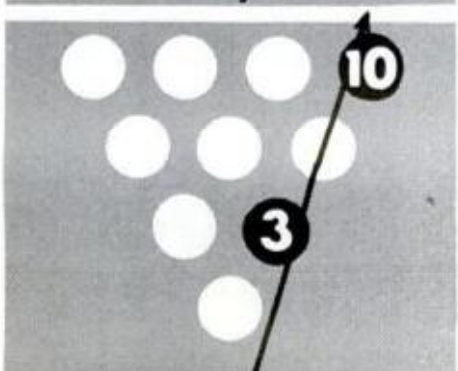
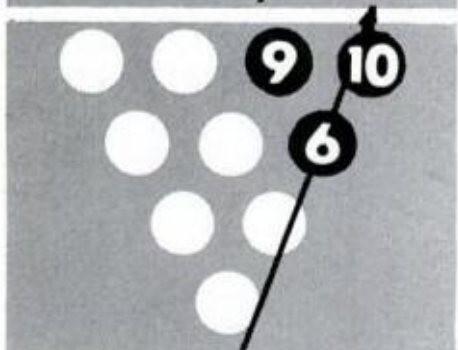
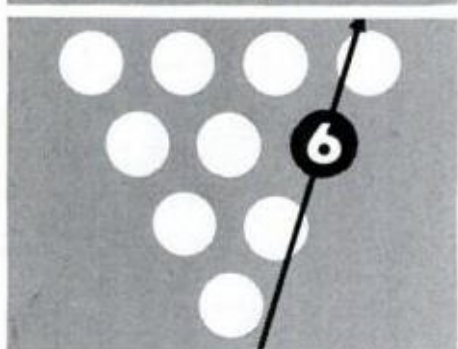
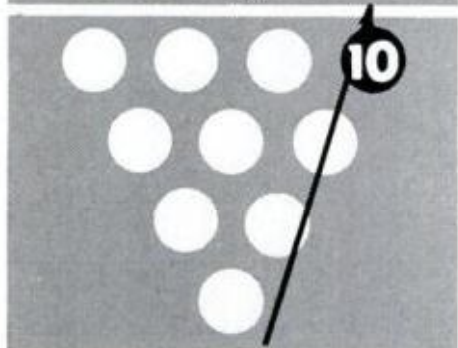
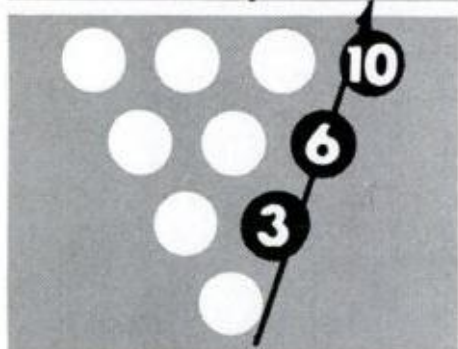
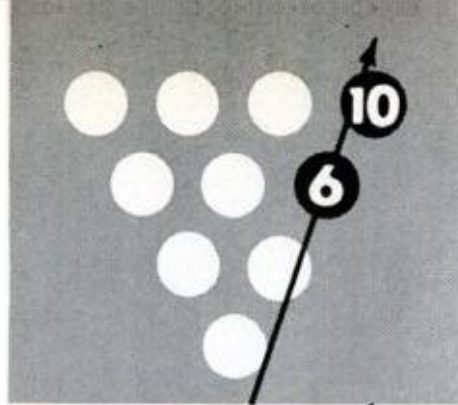

The Right-Side Spare

TOUGHEST OF THE COMMON SPARES for the right-handed bowler are those on the right side of the lane. A standard delivery from the right side gets a narrow sweep of the standing pins, and a natural curve or hook, pushed too far to the right, can drop into the gutter before it reaches the pins.

To play it smart, move as far as possible to your left, face the pins and bowl cross-lane. Unless your curve or hook is a natural one, and hard to change, switch to a straight ball. The result is a ball that moves down the 1-10 side of the pin cluster, leaving a maximum margin for error in those spares.

For the six common situations shown here, the delivery path is identical; the ball is aimed to cover the 6-pin. And if it's on target, there's little left to luck and pin action; the ball covers the spots well.

One variation of the right side spare delivery is needed when a light hit leaves the head pin standing, too, as in a 1-3-6-10. With that situation, use the extreme left-side delivery, but alter your aim to hit the 1-3 pocket, heavy on the 3 side.

Again, with a single 6 or 10-pin standing, it's better to stay with the same right-side spot delivery instead of an aimed ball. If your "automatic" delivery is right, it'll go down.

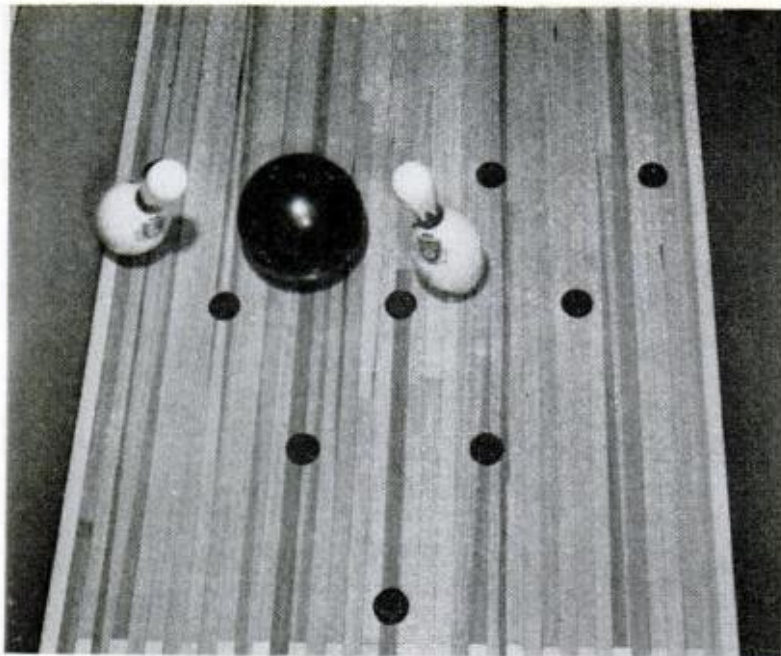

The Left-Side Spare

EASIER FOR RIGHT-HANDED BOWLERS, the left-side spares allow a more natural delivery to sweep down the 1-7 side of the cluster, allow a sharper cross-lane delivery angle, and let you use a curve or hook more effectively than on the right-hand spares. But for best results, move as far to the right as possible, face toward the pins, and bowl across a target that will put the ball right on the 4-pin.

On the 7-8 spare, the ball is only two inches wider than the space between the pins. But if you aim on the 4-pin target, you'll split them right down the middle. It's that advantage that prevents the 7-8 from being classified here as a split, as are the 4-5 and 5-6 leaves. But in some areas, the 7-8 is still called a "small split."

The pin clusters shown on all these pages are not, of course, all the possible situations you might face, but they're the most common in each category for right-handed bowlers. (If you're a southpaw, your leaves—and everything else—will be reversed; you'll have your easiest time with right-hand spares, and should switch to a straight ball for those on the left side.)

We haven't tried to show the exact foot position and target to bowl over, since lanes vary somewhat and the ABC rules still don't specify the exact position of the markings or designs used for targets.

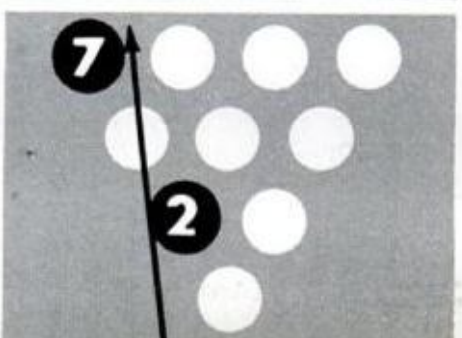
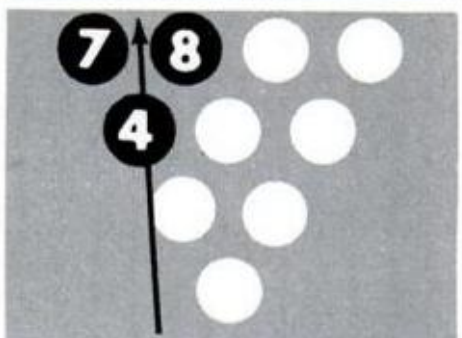
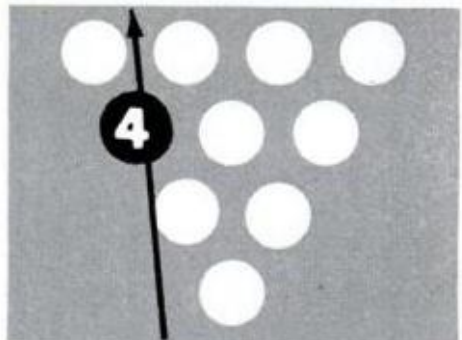
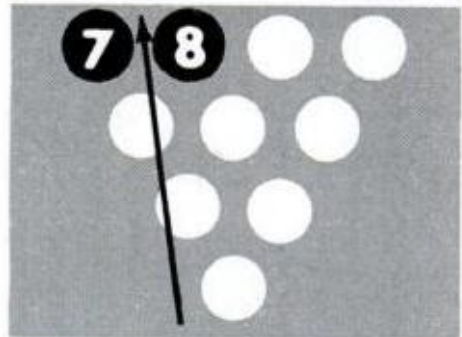
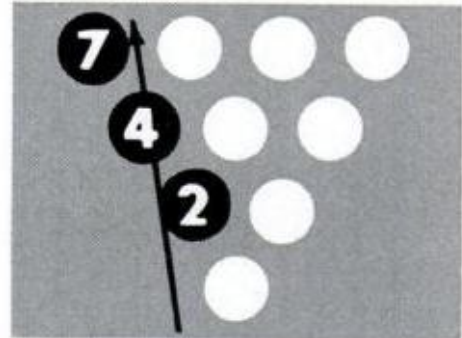
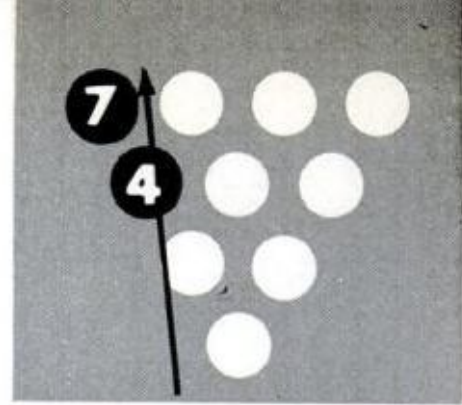

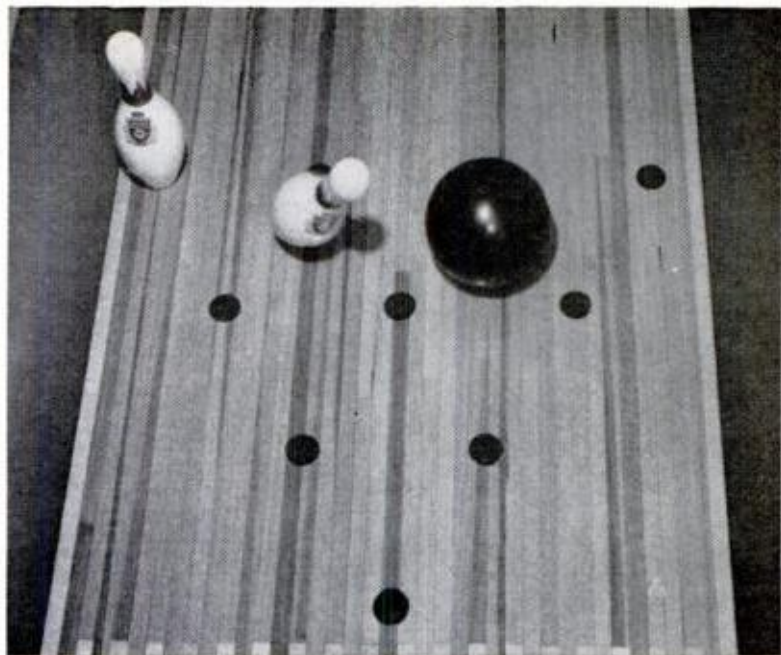
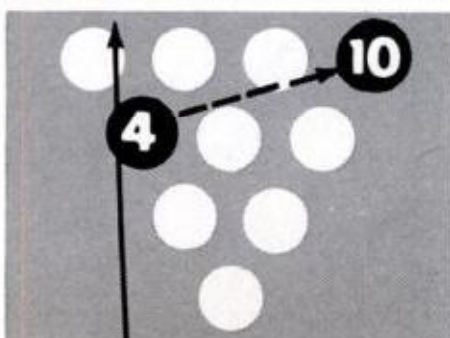
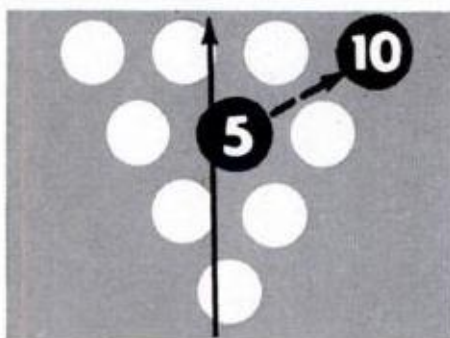
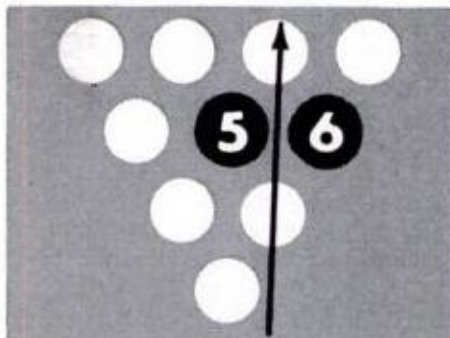
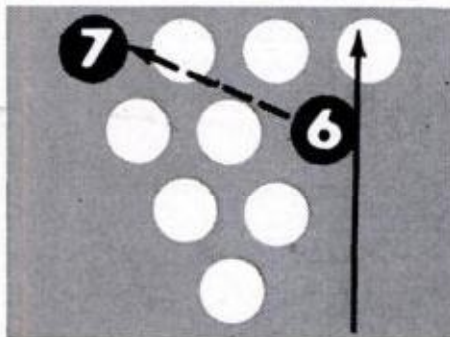
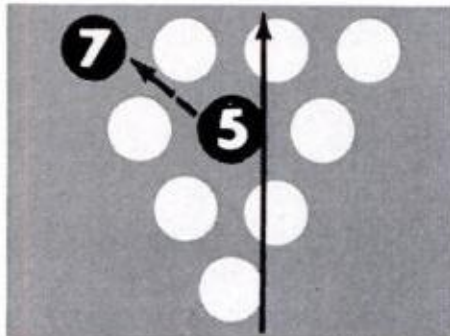
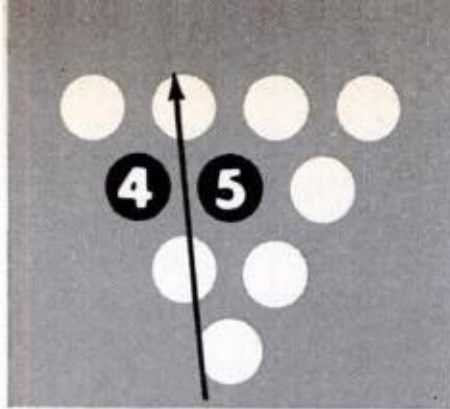

The Exceptions—Splits

SPLITS, OR RAILROADS — pins left standing with no other pins between or in front of them—are the toughest shots in bowling and the least amenable to formula treatment. But don't let them worry you. Any split can be converted, and it's a real test of your ability.

Since split conversion requires your steadiest and most accurate delivery, most of the pros recommend that you start from a comfortable spot just to the right of center and aim the ball straight toward the contact point with whatever type of delivery is easiest and most accurate for you. Since the wide splits are almost as demanding as billiards, your ability to shave the edge of a pin is all-important.

The 4-5 and 5-6 situations are classed as splits even though both pins can be struck by the ball at the same time. With only two inches of hitting area between the pins, a straight-ahead, dead-center shot is considered best.

Three splits aren't shown. The 6-7-10 and 4-7-10 are handled just like the 6-7 and 4-10; the corner pin is automatic if you hit the front pin properly.

The other one? The 7-10. For this impossible-to-predict, freak or trick shot, take a tip from the pros and go for one single rather than take a chance on missing both. If you learn how to get it every time—go on the stage.

PM Shopping Guide

This is the first article in a new PM series that will show you how to test and rate merchandise right in the store and without special equipment. Future articles will cover hi-fi, TV, tape recorders, sporting goods, appliances, and power tools. To build up a file of money-saving information, clip and save each article as it appears

THREE IMPORTANT personal factors that affect your selection of skis and ski equipment are: first, your height and physical strength; second, your athletic ability and age (which foretell how rapidly you'll learn); and third, where and how often you'll be going skiing.

If you're a tall, rugged type who picks up sports fast, you'll be able to use a longer, stiffer ski than your short, nonathletic neighbor, who'll need a shorter, softer ski, especially if he's only an occasional skier. The fun in skiing is in the turns, especially if you're using slopes that are well used and likely to be fairly crowded, and the shorter, softer ski is easier to turn on, though the longer, stiffer ski gives a better ride and crisper turns if you can handle them.

Aside from quality, then, the two factors to consider in ski selection are length and stiffness. The tables on pages 104-105 will give you the basic

JUDGING STIFFNESS is tricky. Go down the rack and bend several skis as shown at left to get the feel of an "average" flexible ski

METAL SHOES at tip and heel protect skis, especially from others' skis. Mark of quality is shaped fit, mounting with several screws



Ski Equipment

length; go up or down from there in accordance with your personal characteristics.

When in doubt, go a little short—and a little soft.

Materials give you the best yardstick of quality in skis. They're made of maple, ash, laminations of ash, hickory, laminations of hickory with other woods, laminations of pure hickory, laminations of aluminum alloy with various wood materials, and reinforced plastic, better known as fiberglass. The experts agree that, with the exception of fiberglass, the materials are listed here in order of their excellence, with the aluminum laminations on top. Fiberglass offers great promise, but hasn't yet proven itself over a long period of time.

The same experts admit that there's little need for the beginner to go over \$40 for his first pair unless he wants to spend the extra money for refinements. *Warning:* You'll probably

DECEPTIVELY soft-feeling "Kofix" bottom shows up on skis from about \$60; makes a fine, almost-frictionless plastic surface. Skis from about \$30 have sheet plastic bottoms; less expensive skis have painted plastic, okay for occasional skiing or deep powder snow, but which wears through with hard use. Edges here are interlocking steel—superior to plain bevelled joints. Sharp steel edges are important for grip on hard snow; essential on icy slopes; not so important in powder snow

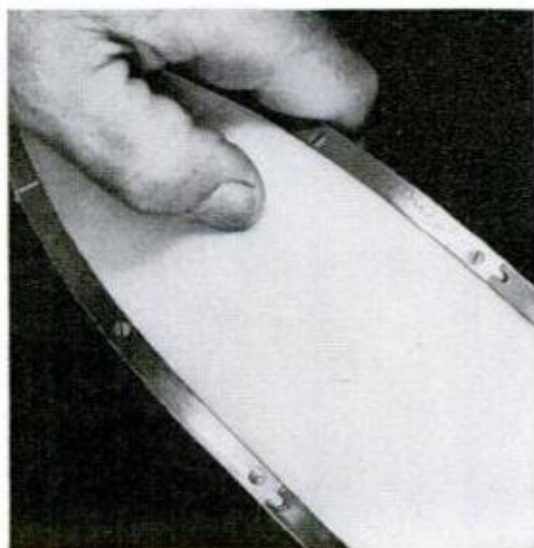

want another, better pair later, when you've learned enough to know more about your requirements.

Most ski shops rent skis and equipment, too. If you're in doubt, you can usually rent skis, poles and boots for a week end for six to ten dollars. The field test will eliminate a lot of guesswork in your choice of length, stiffness and material that's best for you.

Higher prices in skis usually means better wood, better bottoms, better edges, better tops, better tips and heels. But not always. Look close and ask questions, especially on imported skis. For example, thick, shiny paint on edges and tops can look like desirable protective plastic, but it isn't. Read the tag of laminated skis. Such skis are usually better than solid wood skis, since they have uniform strength and flex, and resist warping. But a "hickory" lamination isn't always all hickory unless it says so.

Ski poles are easier to pick. Wood

SAFETY is all-important in bindings. Both heel and toe must release, and release tension should be adjustable. Most important are sideward toe release, as shown, and forward heel release. Best of all are slow-release types which give under strain but return to position if strain eases before reaching release point. Binding position is critical for easy turning; toe piece goes one inch behind center of ski's running surface for regular slopes; half-inch more for powder snow



PM Shopping Guide



SPRING-POWERED bindings offer good release; easy in-and-out. They require some installation, but you can save by doing it yourself

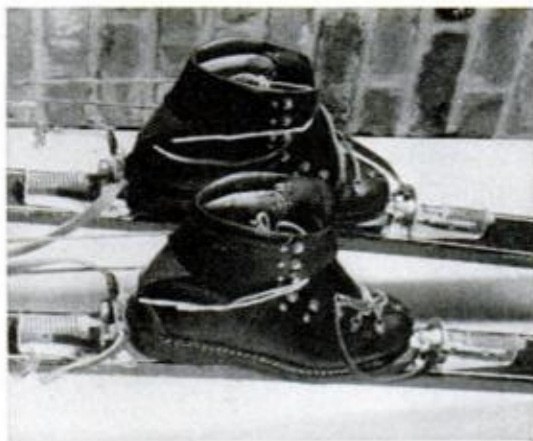

HARDWARE for spring types makes it impossible to use boot trees, but you can prevent curling by leaving the boots locked in the bindings

has all but vanished from the scene, and has been replaced by aluminum and steel. Some good skiers, however, stay with wrapped split bamboo poles. They're inexpensive, light, and strong enough. When you break one, you buy another.

Be sure to look at the new plastic-web types. With no ring, the web doesn't catch on twigs. Another safety factor in poles is a breakaway strap in case it does catch.

Best clue to workmanship on poles is the leather (or plastic) work around the handle. You'll need a wide, strong strap to withstand the soaking and strain you'll give it.

You can almost sum up the boot

situation with a dollar sign. \$30 will buy a good safe pair. The occasional skier will probably never need to pay more, though the more expensive boots do have some good features. Here's what to look for in your boots: Double construction; an inner boot for your foot and an outer boot to protect it. A heavy sole with a steel shank and extra heavy heel leather to take the cable binding. A transverse slit in back to allow maximum forward lean without ankle discomfort.

Get your boots fitted properly. Get them fitted with your regular-weight ski socks on, and, to really get the right fit around your ankle, with your ski pants on, too.

SKI AND POLE LENGTHS FOR MEN . . .

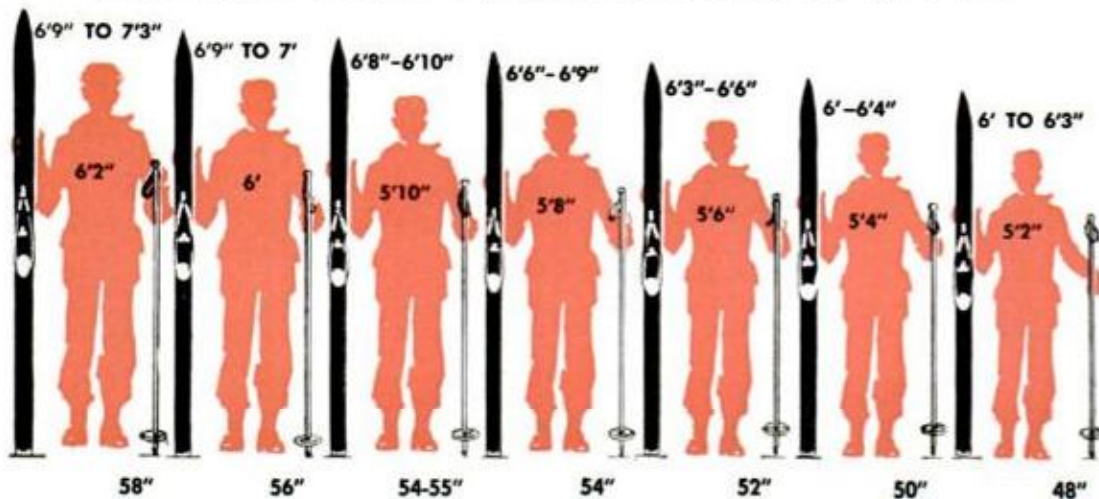

Ski Equipment



"LONGTHONG" bindings look good on instructor, and are convenient, but stick with conventional bindings until you learn to fall safely

SKI POLES are best measured with handle on floor. Web should just reach armpit. This compensates for distance tip sinks into snow



A ski boot should "take hold" of your heel, but ordinary shoe-fitting methods don't work. When you try the boot on, kick your heel into the floor to force your foot back into the heel section where it belongs. Lace your foot back hard with the inner boot before you check with your toes for the fit in front. A proper fit will be the right length and width, and will hold your foot firmly but without binding. You'll need that kind of support to ski all day without tiring.

Centimeter-to-feet conversion table for European-made skis.

175	centimeters = 5 feet, 9 inches
180	centimeters = 5 feet, 11 inches
182.5	centimeters = 6 feet
185	centimeters = 6 feet, 1 inch
190	centimeters = 6 feet, 3 inches
195	centimeters = 6 feet, 5 inches
200	centimeters = 6 feet, 7 inches
205	centimeters = 6 feet, 9 inches
210	centimeters = 6 feet, 11 inches
215	centimeters = 7 feet, 1 inch
220	centimeters = 7 feet, 3 inches

SKI AND POLE LENGTHS FOR WOMEN . . .

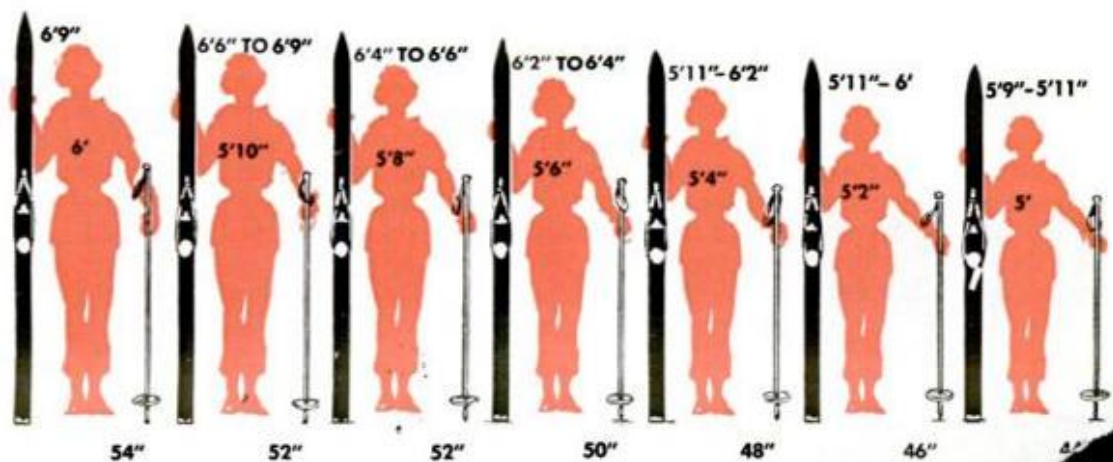



WIDER, EXTRA-STRONG supertires, right, replace conventional duals as shown on cement-hauling truck



"SUPER" PUTS 12 inches of tread on the road as compared to only 15 inches for two tires it replaces

SUPERTIRES for Trucks

By James Joseph

HAVE YOU PASSED a heavy truck on the highway lately that looked like it was missing half its tires? Most likely it was a vehicle chosen to road test a new, single, extra-wide, superstrong, low-pressure truck tire.

These new "supertires" have been road tested from coast to coast on selected truck fleets and are destined to replace the familiar "duals" on heavy trucks. A big rig that used to roll on 22 tires now needs 12.

The new supertires are essentially two tires in one and, for their size, cross section and weight, are probably the strongest tires ever built. A super weighs 100-150 lb. less than the two tires it replaces, yet is nearly as wide as both of them. Tread sizes average 80 percent of the dual width. With its thick sidewalls and heavy-ply construction the super can handle twice the weight of standard tires or the normal load of a dual-treaded combination.

Designed to do the job of two tires, the super is superstrong. The Duplex 10-16.5, one of 11 sizes of supers to be turned out by Firestone, with a ply-rating probably half again or double the 6.00-16's usual six plies, can shoulder an amazing 3000-lb. load. In contrast, an average run-of-the-road 6.00-16 has a maximum load rating of only 1250 lb.—500 lb. less than the super. The replacement Duplex has a 10-inch cross section, but two inches narrower than the combined widths of two 6.00-16s. The super actually puts more tread on the road because it carries only 45 lb. of pressure as compared to the 90 lb. required by the two it replaces, making it more flexible. In addition, more of its tread touches the road to distribute the load. In theory,

each partner in a pair of duals should bear its share of the load.

They seldom do. On crowned roads, in rough terrain, or where there's a mismatch in tread depth, one tire often bears all or most of the load while its mate just goes along for the ride.

Supertires run smoother and cooler, giving longer tread and carcass life. Road maintenance is easier, too, with only one half the number of tires to check.

Supertires provide improved roadholding and reduce skidding and the chance of jackknifing. In tread-tracking tests, deliberate efforts to jackknife a supertired rig were unsuccessful.

Truckers will be glad to know that supertires will cost about 25 percent less than a pair of regular tires. A big western trucker who's switching to supers as soon as they're available puts it this way:

"Duals are a pain in the neck, and in the pocketbook, too. It plain doesn't make sense to use two of everything—rims, wheels, tubes, flaps and tires—to get the load distribution the average big rig needs."

Firestone believes a trucker can cut his inventory in half, with supertires, by eliminating extra rims and wheel spacers needed to separate duals. Twenty-four pieces, eight tires, eight rims and eight wheel spacers, could be eliminated from a tandem tractor and trailer. Weight savings alone in this instance amount to 1000 lb. Some truckers figure the weight savings alone will pay for their new supers in a few months' time.

Used in place of a conventional light truck tread, of course, a super won't replace two tires but will add inches to tread width, hold far more weight and ride softer.

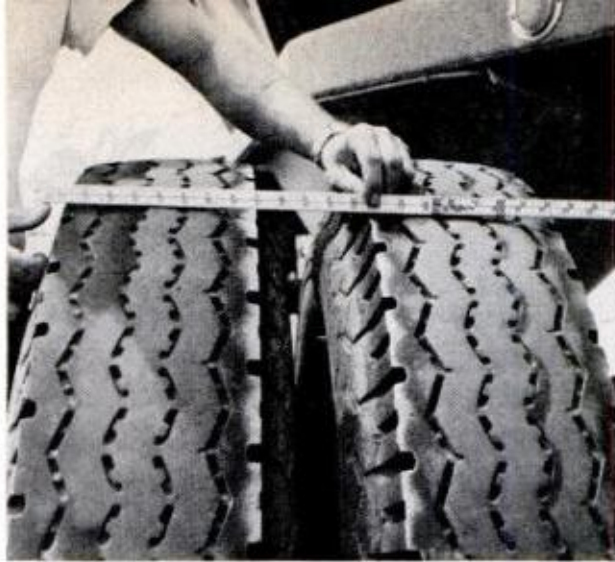

TREAD OF DUALS totals 15 inches, just a few more than super. Note wasted space between the wheels



LESS AXLE room can foster radical frame redesigning

and Trailers

Four of Firestone's 11 new supers are designed to replace conventional light truck tires ranging from 6.00-16s (used on some boat trailers) to 8-19.5s, an oversized tubeless carcass for 1/2 to 3/4-ton pickups. Other supers would fit campers (often treaded with 7.17.5s or 8-17.5s), Jeeps and the like.

The super's over-wide tread and generally lower inflation is calculated to float it on sandy or soft terrain and should prove to be a boon to boaters whose trailers often

bog down during off-road launchings or loadings. The U.S. Rubber Co., whose "Uni-Master" supertire is also under test, says the new design has a superior flotation quality, particularly in off-road use.

Super-width tires should also make the transport of mobile homes and trailers safer. Low pressures mean fewer blowouts. Even when punctured, the low-pressure supers lose air but slowly, even without a puncture-sealing compound. ★ ★ ★

CONVENTIONAL Size Tires	DUPLEX Replacement Sizes	Load (lbs.)	DUPLEX Inflation (lbs.)
LIGHT TRUCKS			
6.00-16	10-16.5	2320	45
7.00-15	12-16.5	3000	45
7-17.5			
8-17.5			
7.00-17	13-16.5	3,680-4570	45-65
7.50-15	13-17.5	4000	50
8-19.5			
HEAVY TRUCKS			
7.00-20	13-19.5	5040	65
7.50-20			
7-22.5			
8-22.5			
8.25-20	15-19.5	5700	70
9-22.5			
9.00-20	17-19.5	7800	70
10-22.5			
10.00-20	18-19.5	9000	75
11-22.5			
10.00-22	18-22.5	9600	75
11-24.5			
11.00-20	19-22.5	10,900	75
11.00-22			
12-22.5			
12-24.3			
11.00-24	23-23.5	15,600	60
12.00-20			
12.00-24			
13.00-20			

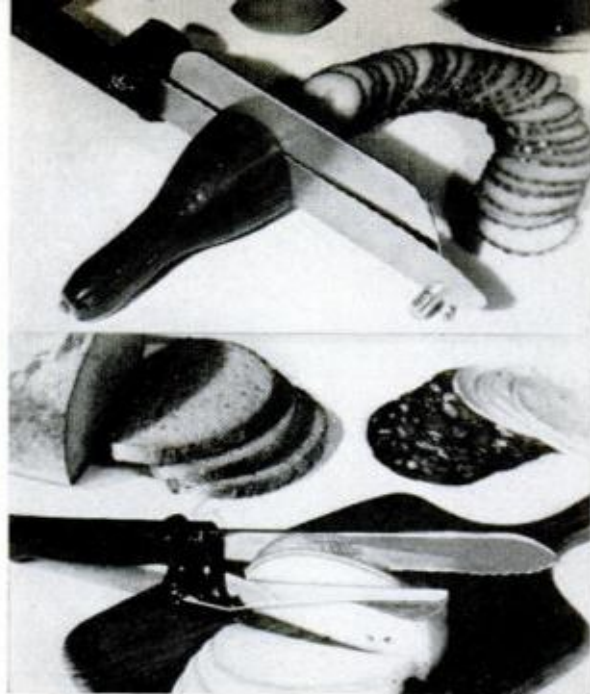

Gifts for Her



KITCHEN KNIFE can be used three ways, as all-purpose knife, as automatic slicer with slicing attachment setting thickness, and as automatic shredder with shredding attachment setting size of slice. \$4.95. Hollis Company, 1133 Broadway, New York 10, N. Y.

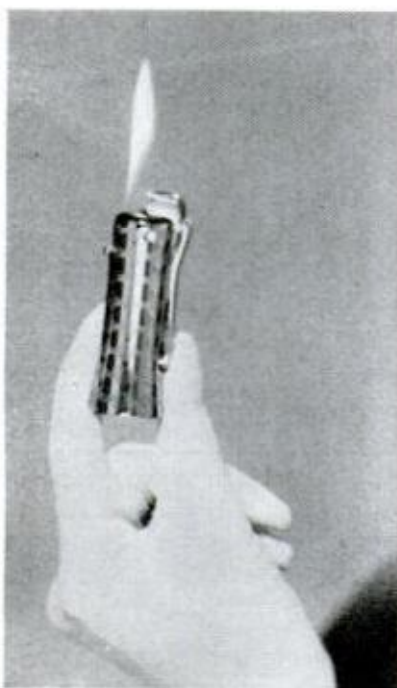

LIPSTICK LIGHTER looks like a lipstick but is a ladylike lighter. Special flame adjustment allows "dialing" flame to desired height. \$20. Ronson Corp., Woodbridge, N. J.



TILTED VANITY angles mirrored sliding doors for viewing either standing or sitting. Includes three shelves, outlet for electric hair dryer, two-way lighting (up for room, down around mirrors). Comes in three sizes. Lau Blower Co., 2027 Home, Dayton, Ohio



SPAGHETTI MAKER grinds pasta like meat grinder grinds meat. Assorted heads shape pasta into spaghetti, macaroni, ravioli, lasagne and various noodles. Italian recipes included with instructions. \$16.95. M. A. Scalise Co., 119 S. 1st St., McAllen, Texas



PLASTIC LUNCH BAG adds colorful accessory to working girl's daily wardrobe, eliminates paper bags. Insulated, waterproof. Five colors. \$1.25. Rosanna, 1419 N. LeClaire, Chicago 51, Ill.



ONE-CUP COFFEE MAKER uses real coffee, brews it as easily as instant. Coffee is placed in filter, covered with perforated lid and boiling water is poured in. 98¢. RMS Electronics, 34 W. 74th, New York 23

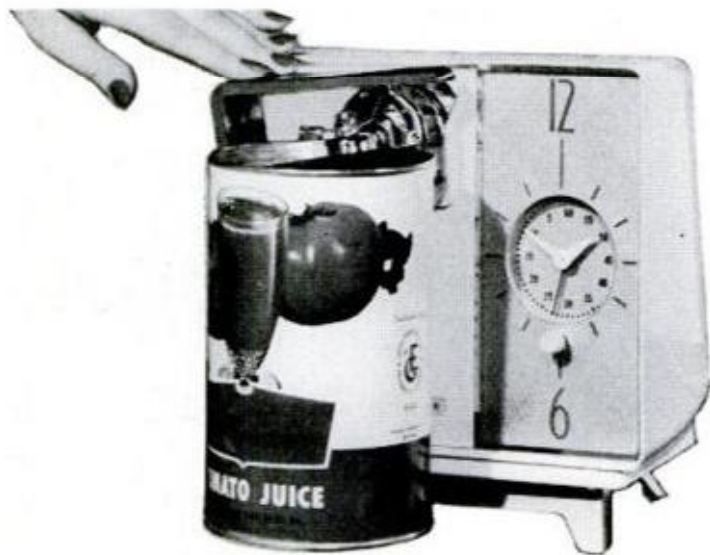

ELECTRIC CAN OPENER with clock-timer opens cans, tells time, has signal alarm. Comes in white with chrome trim or sandalwood. \$34.95. Rival Manufacturing Co., 36th & Bennington, Kansas City 29, Mo.

ELECTRIC OVEN toasts, bakes or browns. For toasting and baking, top and bottom heaters are used, bottom is turned off for browning. \$34.95. General Electric, Bridgeport, Connecticut



CLOTHESLINE reels out of shower wall for use, reels up out of way when clothes are dry. Eliminates inevitable clutter of clothes over shower rod, wash basin, etc. \$14.95. Santo Bros., East Elmhurst 69, N. Y.

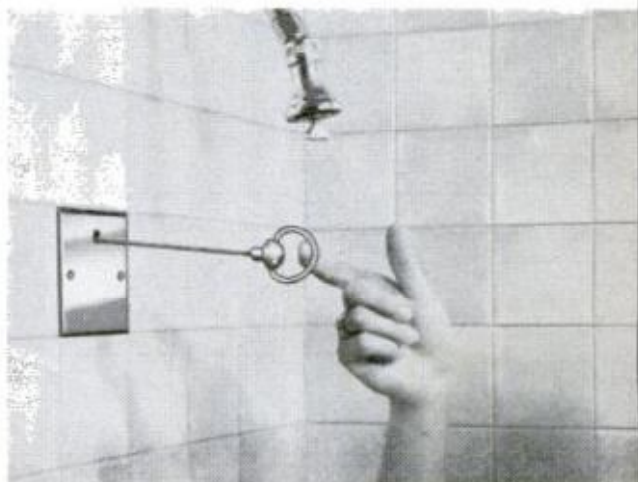

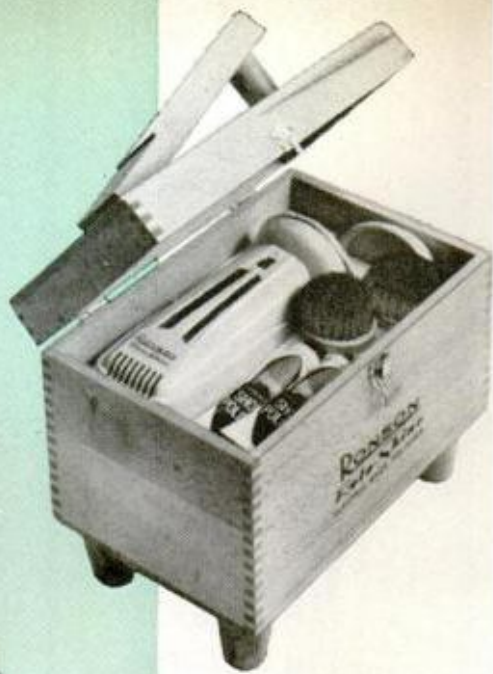

ELECTRIC POLISHER for shoes includes brush and buffer attachments. \$23.50. Ronson Corp., Woodbridge, N. J.



PUSH-BUTTON LIGHTER plugs into a.c./d.c. outlet, lights cigarettes when button is pushed. \$1.98. Young's, Burlingame, Calif.

Gifts for Him

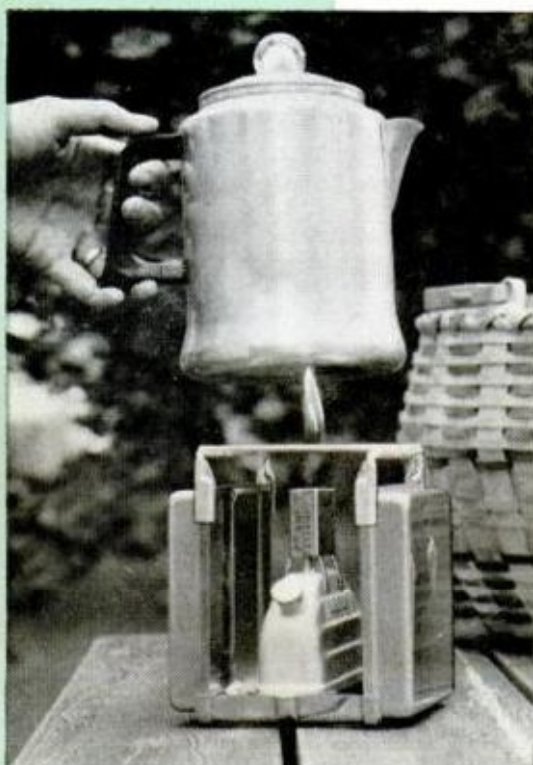
COMPACT STOVE folds up into pocket-size kit. Burns 1½ hours on single filling of fuel. Burner detachable. Taykit, 4407 16th Street NW, Washington, D. C.



SHOOTING GLASSES fit over regular glasses. \$1.98. Haack Enterprises, Fond du Lac, Wis.



POWERED OUTCASTER extends the range of fly casts. Avocation Products, Box 624, Santa Clara, Calif.

BRUSH ROD breaks down to 22 inches. \$5. Louis Johnson Co., Highland Park, Ill.

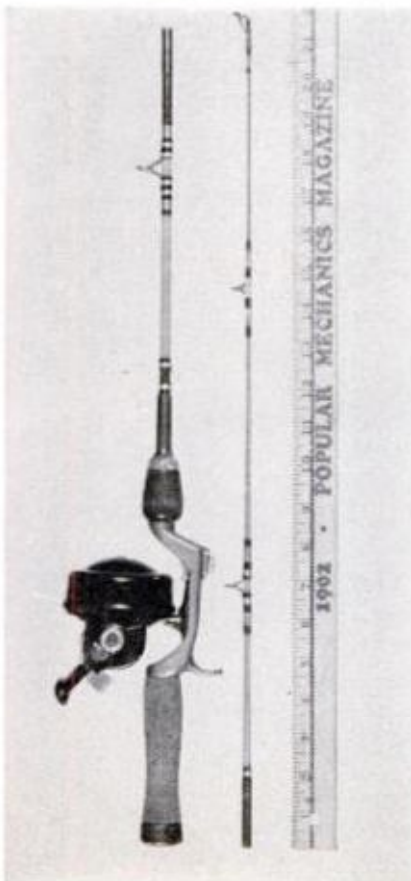

DECEMBER 1961



LIVE NET hangs from waist, has no sharp edges to puncture waders. \$6. S & M Products, Troy, Ohio



MODERN BUTLER has tie and shoe racks, hangers, jewelry tray. \$20. Concord Shear Co., 49 W. 23rd, N.Y.C.

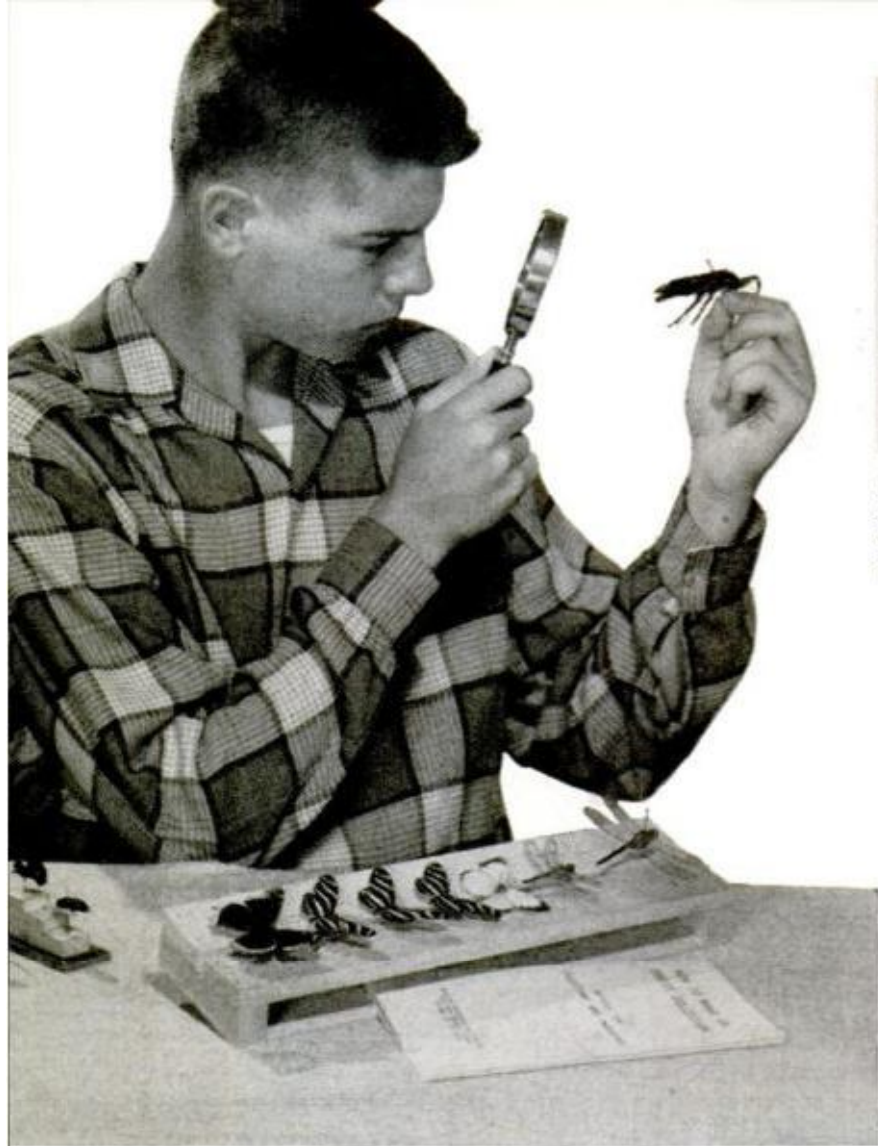

BASIC COMPUTER does simple arithmetic, statistical analysis, plays logic games. Six instruction books. \$85. Central Scientific Co., 1700 Irving Park, Chicago, Illinois

Gifts for Future Scientists

BUG-COLLECTING KIT includes nets, mounting boards, insect pins and instruction book. \$6.95. American Entomological Supplies, 7528 W. Catalpa Ave., Chicago

MATHCRAFT SET is basic introduction to mathematics. Includes slide rule, abacus, protractor, compass, etc. \$7. Porter Chemical Co., Hagerstown, Maryland

SCIENCE BOOK-LAB series includes one on seeds with real seeds. Others on jets, magnets, air. \$3.95. Science Materials Center, 59 Fourth Av., N. Y. 3, N. Y.





CHEMICAL LAB provides basic glassware for experiments in chemistry. Professional shapes. \$10. The Perfect Parts Co., 1500 N. Chester, Baltimore, Md.

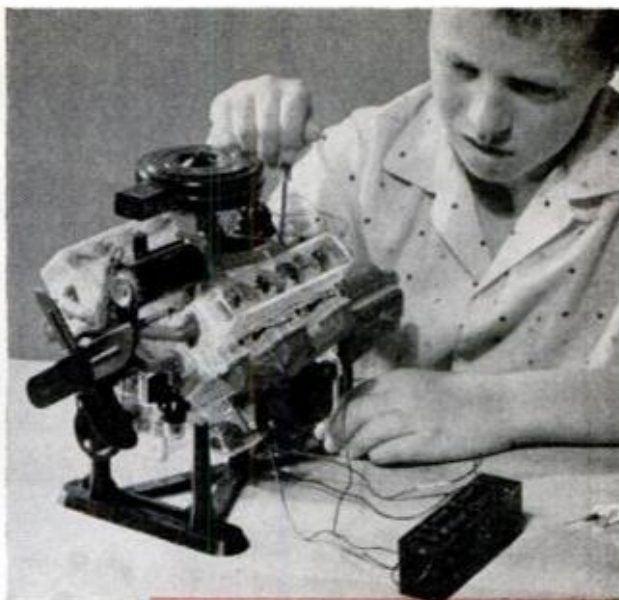

VISIBLE V8 ENGINE comes in kit form and, when assembled, runs on D-size batteries. \$10.95. Distributed by Edmund Scientific Co., Barrington, N. J.

VISIBLE ORGANS teach anatomy of eye, ear, touch, smell, taste, the heart and head. In kit form from \$2 to \$10. Superior Plastics, 426 N. Oakley, Chicago 12, Ill.



PLASTICS SETS supply materials for casting with real plastics. \$8 to \$25. Lionel Corp., 15 E. 26th St., New York 10, N. Y.

WEATHER STATIONS perform measurements and computations for predicting weather, instructions for calculating temperature-humidity index, relative humidity, etc. \$10 to \$20. Lionel Corp.





More Gifts for Children



ROBOT obeys voice commands, moves forward and backward, turns, fires rockets, throws missiles. Ideal Toy Corp., 200 Fifth, New York

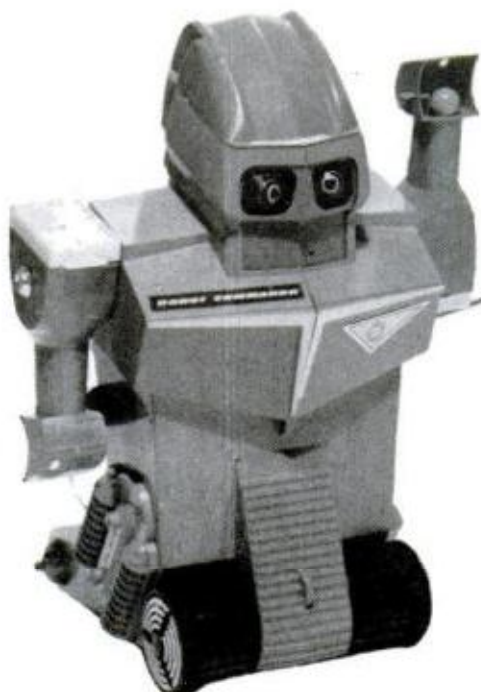

SEWING MACHINES for tots include manual and electric models. Third model only cuts paper dolls. \$5 to \$25. Singer Sewing Machine Co., 149 Broadway, New York

TINY TAPE RECORDER transcribes voice, music, etc., has switch for reverse, playback, transcribe. \$30. Made by Bell Products Co. Distributed by Edmund Scientific Co., Barrington, N. J.



BB SIX-GUN, single action 12-shot repeater, is replica of original Peacemaker. \$7.95. Daisy Mfg. Company, Rogers, Ark.



FOOTBALL TARGET for passers, endorsed by Johnny Unitas of Baltimore Colts, bounces ball back to man who throws it. \$9.95. Tigrett Industries, Jackson, Tenn.



FREE-WHEELING tricycle features rear wheels that turn 360 degrees when control level is shifted. American Machine & Foundry Co., 269 Madison Ave., New York, N.Y.



BATTERY TRANSMITTER controls model aircraft from ground. \$70. Wen-Mac Corp., 11511 Tennessee Ave., Los Angeles 64, Calif.

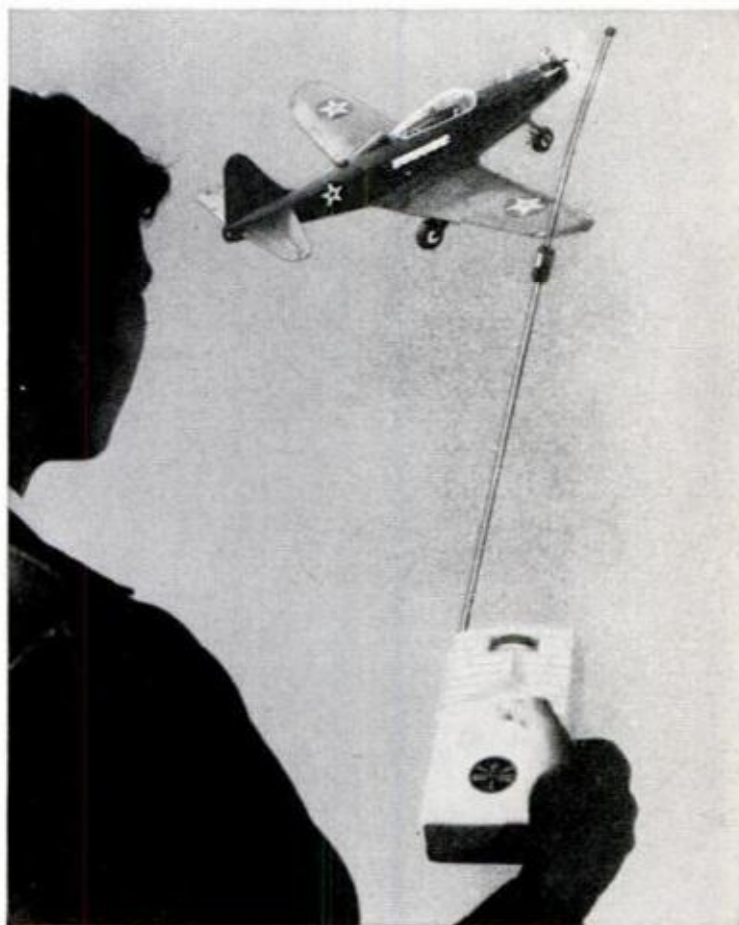

PUSH-BUTTON STARTER for gas-engine model airplane keeps fingers free of propeller. Complete aircraft, \$9.75 each. Comet Model Hobbycraft, 501 W. 35th St., Chicago



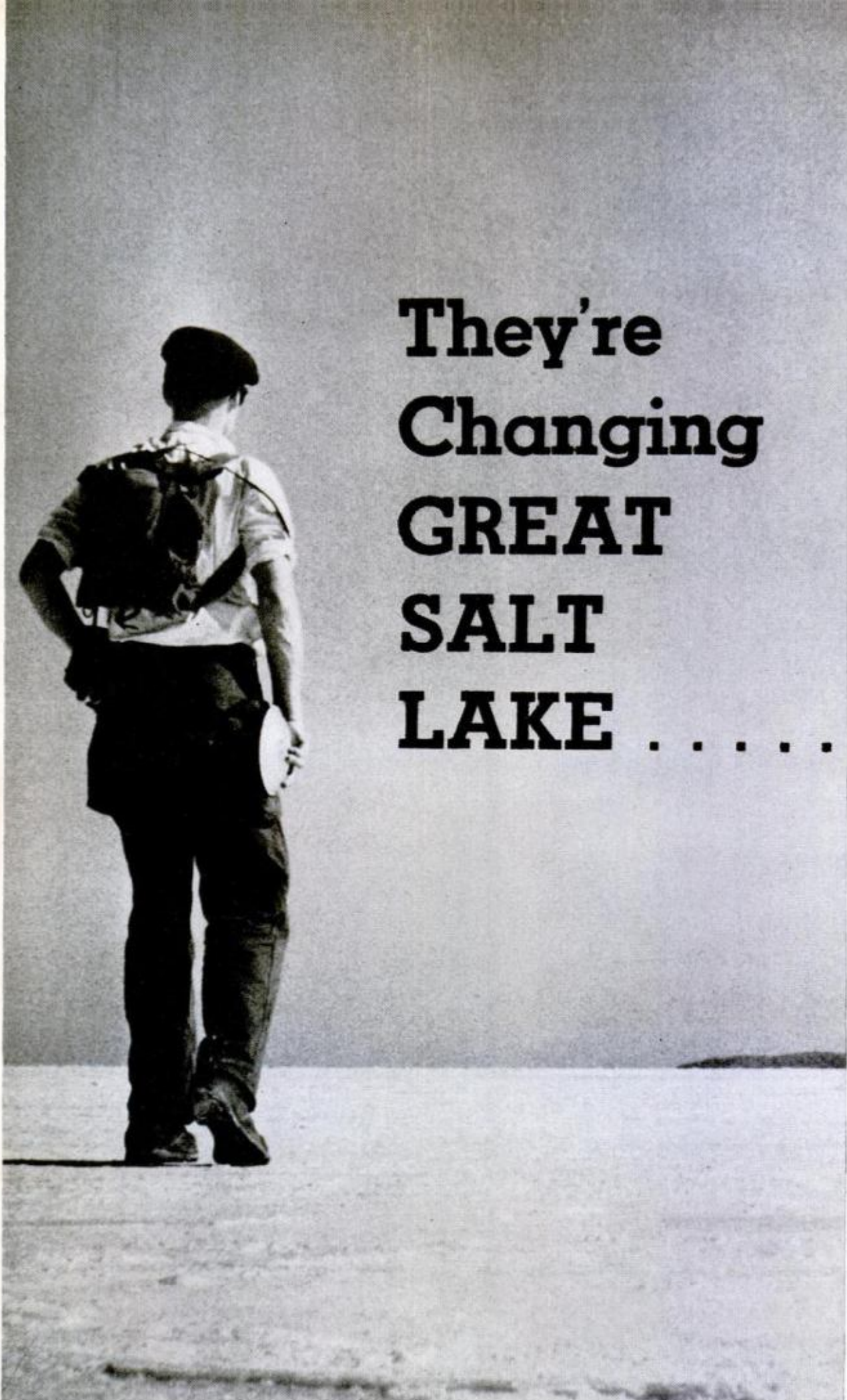

**They're
Changing
GREAT
SALT
LAKE**



. into a Fishpond

By Frank A. Tinker

SAUERMAN TOWERS gouge out huge ditches at edge of Salt Lake. Hole will become fresh-water reservoir

SOME 75,000 YEARS AGO the waters of what was the huge Lake Bonneville receded and became the Great Salt Lake. Ever since then, the rivers draining Utah's main Wasatch range have been wasted as they drained into this huge brine pool. The Great Salt Lake is not merely salty—it is so loaded with chemicals that during cold weather long bars of various compounds simply precipitate out of the water and line the shores like pilings, sometimes to a depth of several feet.

This brine is five times as salty as the ocean—a quart will yield a full cup of various salts when evaporated. Fresh water, until it has had a month or so to mix into the lake, actually skates over the heavy brine. Occasionally it freezes into grotesque icebergs which float high in the supercooled solution and are driven around the lake by winds.

Like most of the West, the surrounding countryside now has to rely heavily on the mountain waters for irrigation, and house-

←
SALT LAKE has receded in sections, revealing bed of salty clay. Lake gets its brine from this bed



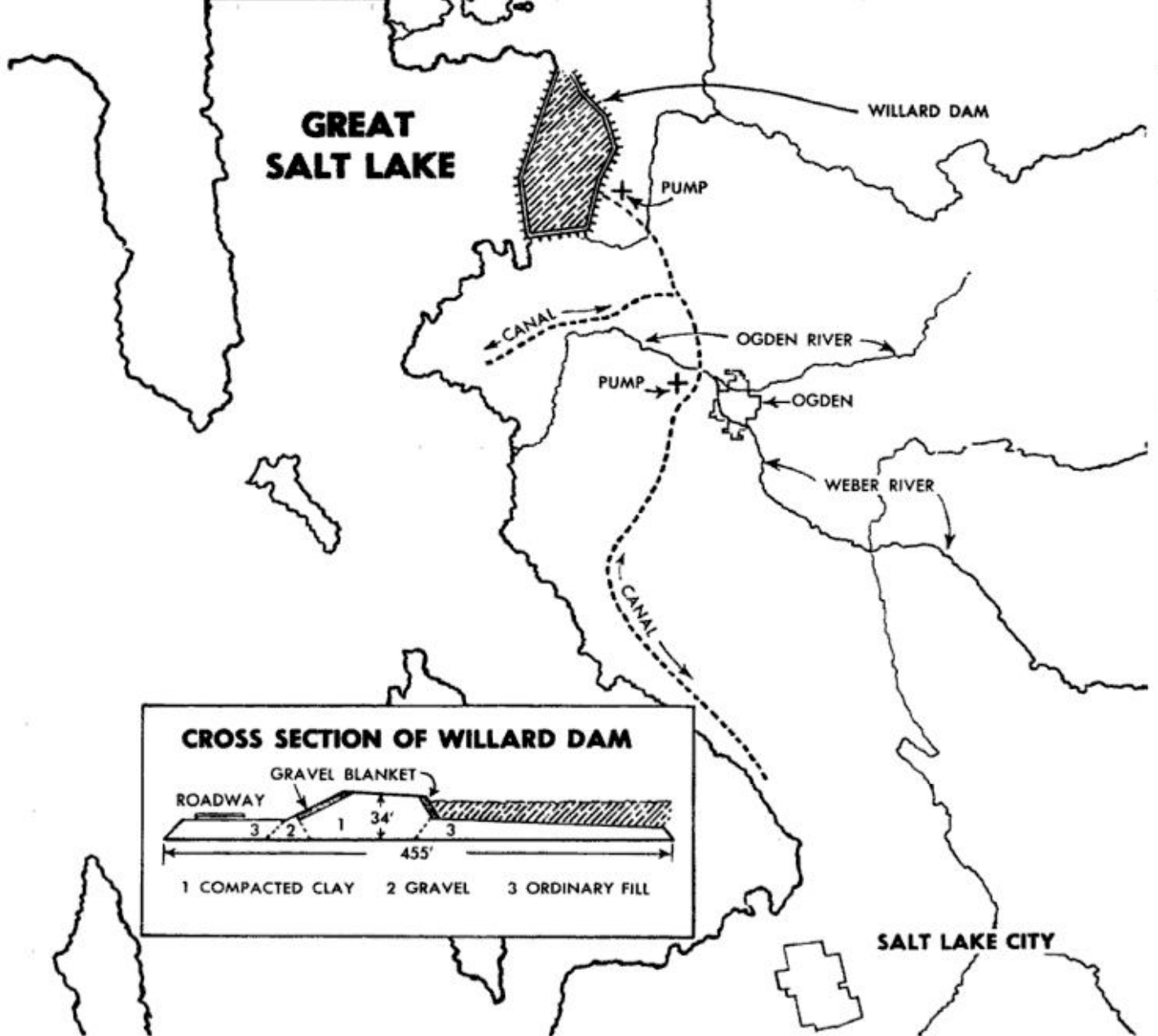

MAP SHOWS reservoir site near Ogden which will impound fresh water from Ogden and Weber rivers. When needed, pumps will reverse flow through canals to irrigate surrounding area. Insert shows dam construction

hold and industrial use. Thus it has been painful to residents here to watch the rivers drain down and discharge their valuable loads into the lake.

Now, however, this situation is about to be changed. In effect, a small part of the Great Salt Lake will become a huge, fresh-water pond, from which water can be pumped in time of need, and over which water skiers and bathers may frolic.

This is being accomplished by laying one of the world's largest earthen dams around a selected area in the northeast corner of the lake. This area has been flushed for years by fresh water floods as the brine receded, and thus is suitable as a reservoir bottom. The bay is being enclosed by a dam $12\frac{1}{2}$ miles long and 450 feet wide at the base, which slopes gently to a crest of 34 feet. When completed in 1963, part of its basin will already have filled and a few years afterward, depending on the precipitation, there will be a lake 30 feet deep

covering 11,000 acres standing where once there was only salt and mud flats. A total of 215,000 acre-feet of water will be impounded here, enough to solve the water problem in Utah's principal valley for years to come.

The dam itself has a strange dual purpose. Not only does it retain the fresh water of two major inlet rivers, the Ogden and Weber, but it will keep out the brackish floods which sweep over the bay at times, and even prevent the Salt Lake's brine from invading should a sudden rise or shift occur.

To build Willard Dam, Bureau of Reclamation engineers have been faced with some stiff problems, entirely unique to this area. First, dikes had to be built to provide not only a dry base but dry fill material. Even several years of natural drying did not prove sufficient, however. When the contractor gouged out this basic clay, it was found that the salt it contained acted like



WILLARD DAM will have dual purpose, keeping out salt water from Salt Lake (right) and impounding fresh water in basin now under construction (left). Aerial view shows north portion of dam which will be 12 miles long

a sponge and kept the soil so wet that it had to be spread out a second time and plowed and turned with dozers to dry.

Further, the dam could not be erected at top speed, but had to wait for nature. The several hundred feet of lake sediments on which it sits is a treacherous base. Thoroughly saturated, the same soft muds have caused railroad embankments which cross the lake nearby to slip and slide out of sight many times. It was found that as the tremendous weight of the dam is applied at the center of the structure, the pressure caused by this weight fans out beneath the surface, then rises and "blows out" at the surface again. Such a blowout might occur a hundred yards on either side of the middle of the dam. To counter these shifting pressures, the structure had to be given a base half again as wide as a football field is long.

Old railroad construction records, as well as those of the engineers who built Holland's earth dikes, were consulted before

work was begun. Tests showed that a dam of only 18 to 30 feet in height could be erected here. To avoid the buildup of pressures beneath, which might cause the slippage and failure the huge earth pile had to be constructed in slow stages, letting the soft subsurface shift gradually to adjust to the weight.

Even spreading the construction over a period of five years, however, did not eliminate the danger. At several points along the dam a series of gauges have been sunk into the sediments beneath. These devices, called pisometers, are simply porous stones which reflect the pressures at their depth, and are connected by long plastic tubes to meters at the surface. A constant check is maintained to avoid any excessive underground pressures as the thousands of tons of earth are piled onto the dam overhead.

Basically, building Willard is the familiar process of taking various kinds of earth fill and placing it in a very precise pattern,



RECEDING WATERS on west side of Great Salt Lake make some wonder whether lake will eventually dry up because of new reservoir. Geologists doubt it because much of lake water is from underground seepage

layer upon layer, until the desired shape and height has been attained. When finished, 17 million yards of such fill will have been transported and laid here.

Like most dams of this type, the Willard has a basic core of high-grade clay, almost impervious to water. Along the face of this core and the beaches of the lake which will result are laid "blankets" of gravel. Drainage is provided by another large section of loose, gravelly fill directly behind the clay core. The rest of the dam is solid earth.

To transfer the fill from "borrow" areas to the dam site, a six-lane highway has been built. Trucks carrying 30 cubic yards of fill roar along here at 60 m.p.h. Without stopping, these trucks open the bottoms of their hoppers, the fill cascades out onto the dam, and the trucks continue on for their next load. Immediately, the dropped fill is scraped into place by dozers, watered, compacted, dried, and the dam grows another fraction of an inch.

In addition to these trucks, four 100-foot Sauerman dragline towers rise over the flats. From them cables stretch far out into the basin and are attached to movable anchors. Five-yard buckets pulled by these lines scoop deeply into the clay and are hauled up onto the dam. These Sauerman rigs, powered with 400-hp. GMC B-12 diesel units, had to be used in place of the conventional earth-movers here because the soil was too soggy and soft—a dozer might sink out of sight at any time.

Work has already started on a canal to divert the waters of the Ogden and Weber rivers, which at times of top flow will fill the Willard lake. Pumping stations will simply reverse the flow along this canal when irrigation water is needed in the valley.

Falling Lake

And what of the Great Salt Lake itself? Is it destined to dry entirely, and become one shimmering expanse of salt? Actually, geologists say this has probably happened several times during the life of the lake, although not within human memory. It has no outlet of any kind. Since much of the water now flowing into the lake will later be impounded by the Willard dam as well as in other smaller reservoirs, the level of the lake will certainly fall—and has already done so. Of the four sizeable streams emptying into the lake, three will have been impounded when the Willard dam is complete. On the west side of the Great Salt, vast new stretches of mud and salt have been uncovered.

However, much of the water which makes its way into the lake does so through underground seepage. Theoretically, any water entering the valley eventually winds up in the great sink, either through such seepage, surface flow, or rain. After an initial lowering, then, the Great Salt Lake may rise again as the seepage caused by these storage projects increases.

To find out, we may have to wait a hundred years or so. Right now, the character of this freak of nature is being changed radically by engineering genius. ★ ★ ★

ADDRESSES of manufacturers and persons mentioned in this issue are published in the monthly Where-to-Find-It list, available free from Service Bureau, 200 E. Ontario St., Chicago 11, Ill. Send a stamped, self-addressed envelope.

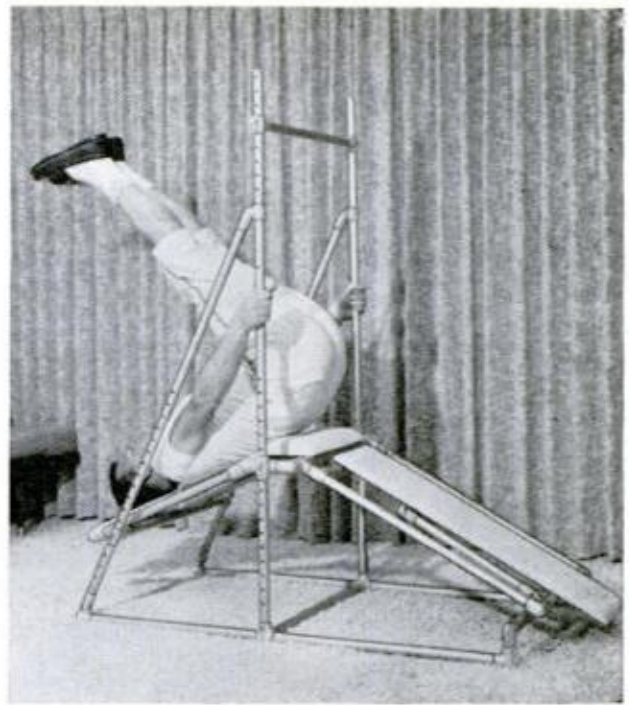

Adjustable Table Is Compact Gym for Keeping Trim

Developed by a surgeon, a new rest and exercise table uses progressive position settings and the body's weight to flex and stretch muscles, either with easy exercises

or simply by lying on it. The Arch-Gravity table is made by Ryan Research and Development Co., Box 821, Cleveland 22, Ohio. A steel model costs \$150, aluminum \$225.

Cave Dwellers Never Had It So Good

Not an urban penthouse apartment, as you might think, but quite the opposite—this comfortable living room is located half a mile beneath the Kansas prairie. Built by

Underground Vaults and Storage Co. in a salt mine at Hutchinson, Kans., the room is part of a complete apartment for entertaining the firm's storage-service clients.



MIDGET SUB:

Ghost of Pearl Harbor

*Buried in a watery grave since Dec. 7, 1941,
a 2-man Japanese subsurface craft is salvaged*

SUB'S DISCOVERER was Clifford Buhl, (left), diving instructor. When salvaged, sub was corroded with rust. No sign of crew was discovered

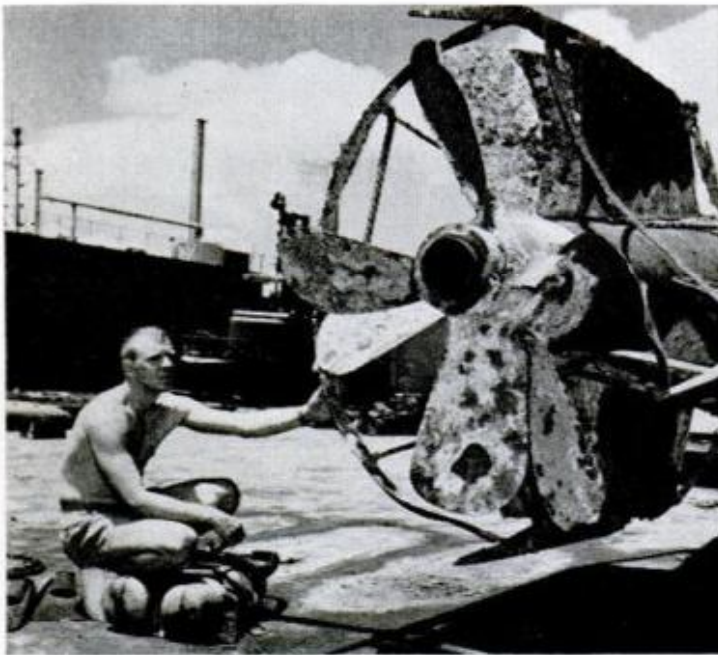

TWENTY YEARS AGO this month, Japanese naval forces attacked Pearl Harbor. Recently, a grim reminder of the "day that will live in infamy" was resurrected there.

It was a midget Japanese submarine. A Navy man, Clifford Buhl, shipfitter first class, discovered it accidentally while giving diving instructions. He spotted the vessel resting on a bed of coral 70 feet underwater off the entrance to the harbor.

The sub, believed to have been with the Japanese invasion during the attack on Pearl Harbor on Dec. 7, 1941, was lifted from the depths by a salvage crew.

The midget sub was raised slowly to permit draining and as a precaution against escaping dangerous gases that might have accumulated during the little craft's 20-year entombment.

Navy bomb experts dismantled two 12-foot torpedoes which had not been fired.

Only the bottom of the 80-foot submarine was badly deteriorated. Damage inside and outside indicated the sub might have been depth-charged by a U.S. ship. The inside was covered with silt and badly rusted.

No bodies were found. The conning tower was open and Navy authorities believe the occupants escaped before the sub sank.

It is believed that five of the two-man Japanese subs were involved in the attack on Pearl Harbor. One was sunk inside the harbor, another was beached on the shore and a third was thought to have been sunk outside the harbor entrance by the destroyer USS *Ward*, which fired the first U.S. shots.

The 80-footer brought up from the coral reef may have been the *Ward's* victim.

The sub has been returned to Japan where it will become a memorial. The torpedoes were dumped at sea.

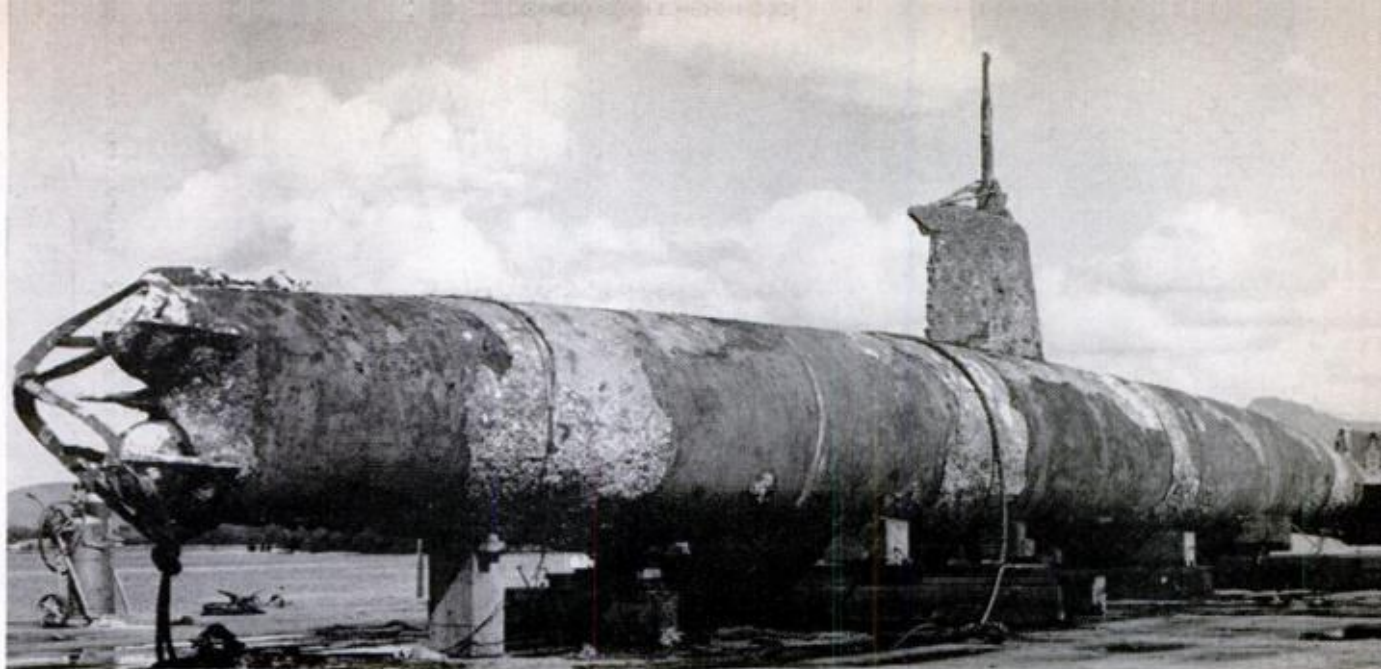

MIDGET SUB, with torpedoes still in bow, was pictured shortly after salvage. Divers (below) worked in 70-foot depths to resurrect it





Tractor Runs Under Ice

Its spiked wheels gripping the *underside* of ice on a lake, a battery-driven vehicle designed at the University of Wisconsin pulls scientific equipment through the waters of winter-closed lakes.

The tractor, an airtight aluminum box, floats against the ice. It has a hydrophone to sense sound impulses sent to control it.



Inflated Space Station

Boosted into orbit in a package carried by a rocket, expandable space stations shaped like doughnuts could be inflated into shape to provide living quarters inside for one or more persons, according to the Goodyear Aircraft Corp.

Goodyear is building a 24-foot-diameter station for test use by the National Aeronautics and Space Administration, and says even larger manned stations could be put into orbit within three years.

Inflated in space, the structure would be made rigid by injection of quick-setting plastic between its walls.



Boon to Batching

Dumping operations are easier and take less time with cab-controlled batch trippers on a dump body made by Hercules, Galion, Ohio.

Hydraulic locks hold batches in place until released by the driver. The body isn't lowered between batches and no helper is needed to release them. The truck backs into a skip, trips and clears in 9 to 11 seconds because it moves in and out with the bed elevated.



Dome Houses Dry Cleaner

Wooden geodesic domes house the new coin-operated automatic dry-cleaning establishments being installed across the country by the RCA-Whirlpool Corp.

The domes have a diameter of 26 feet, a peak height of 13 feet and a floor area of approximately 485 square feet.

They will hold six dry cleaners, necessary mechanical and electrical equipment and furnishings.



Instant Intercoms

Transistor intercoms use house wiring instead of inter-unit wires. Drawing less current than an electric clock, they remain plugged in at all times. Press to speak or lock for baby-sitting. Each unit has separate adjustable volume control. \$74.50. Webster Productomatic, 182 Ave. D., Rochester, N. Y.

This Christmas . . . Decorate With Music

If you like the idea of carols at Christmastime, use a continuous loop tape, such as the Cousino tape vendor. Record the carols from your phonograph and when the tape is finished it automatically starts again without the clicking and attention a phonograph needs. To keep from ruining good quality indoor loudspeakers, use weather-proof outdoor types such as the Electro-Voice (A) or the Jensen (below). The tape recorder (B) must be equipped—as most are—with a free-wheeling spindle to operate with the tape vendor.





Pretty Motorcyclists Are Zipping Their Lids

Lady cyclists can ride all day with hair blowing in the breeze—and still arrive with as neat a coiffure as they had when they started. The secret is a wig that zips onto the cyclists' helmet, protecting the lady's hair from the wind.

There's a choice of three wig colors—

blonde, brown, or auburn—and all are made of synthetic fiber that can be combed, brushed or shampooed without losing its curl. The helmet is glass fiber with a cork lining and foam-rubber headband.

Manufacturer is Kangol Ltd., 39 Fitzroy Square, London, W.1, England.

Electronic Camera Speeds Up Star Photography

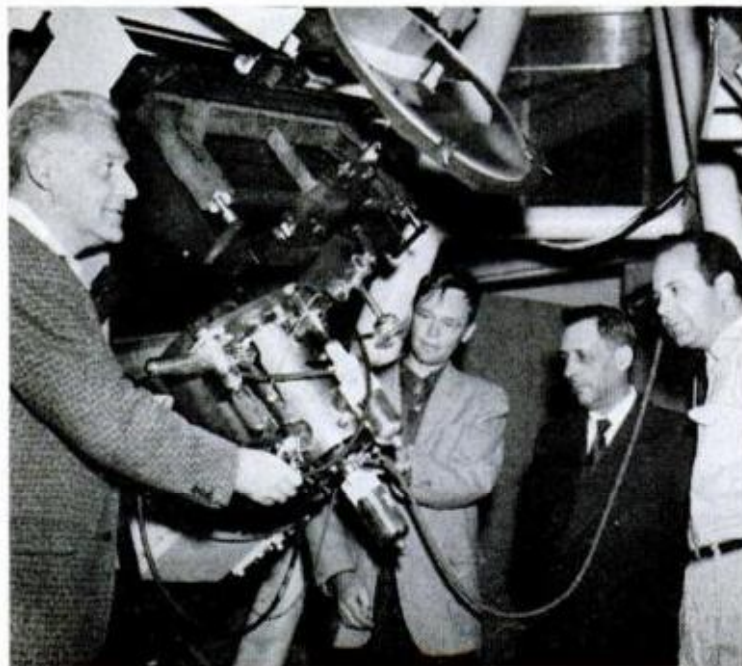

Capable of recording images of the solar system in 15 minutes that might take as much as four hours by conventional photographic methods, a new camera promises deeper penetrations of space with large telescopes and a new life for smaller telescopes that were becoming obsolete.

Developed by a French astronomer, Prof. Andre Lallemand (second from right), the camera converts the weak light of stars to electricity, amplifying it and using the electrons to form an image instead of photons of light energy.

An extremely complicated camera—parts of it have to be baked in an oven before use—it is being used only in France and at Lick Observatory in California.

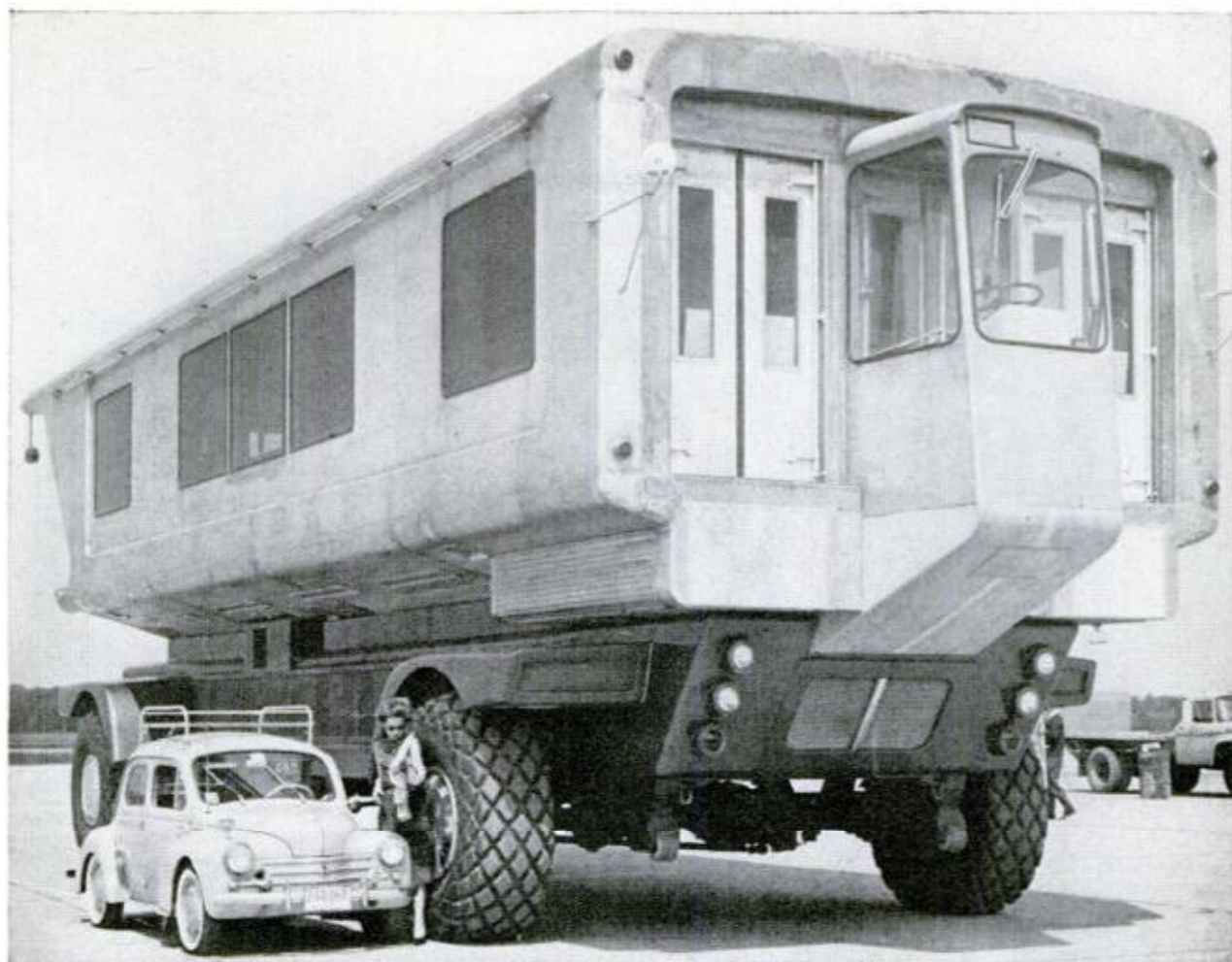

Mobile Airport Lounge

Washington's Dulles International Airport has inaugurated service with a monster mobile lounge that carries 90 passengers—in living-room comfort—from the terminal to the aircraft.

Since the 38-ton behemoth is too ungainly to back up, there is a motor and a driver's cab at each end. The \$1,500,000-prototype is operated by a former test driver for Army tanks.



Vibration-Free Platform

While the bottom section of a new platform may be subject to movement, the upper section remains motionless. It is designed as a support for electro dynamometers, balances, surface-roughness measuring devices and other sensitive equipment.

A variation of the platform may be used to support a vibrating machine and to prevent the vibration energy from being transmitted to the surrounding area. The platform is made by Tenlo Research Corp., Minneapolis, Minn.

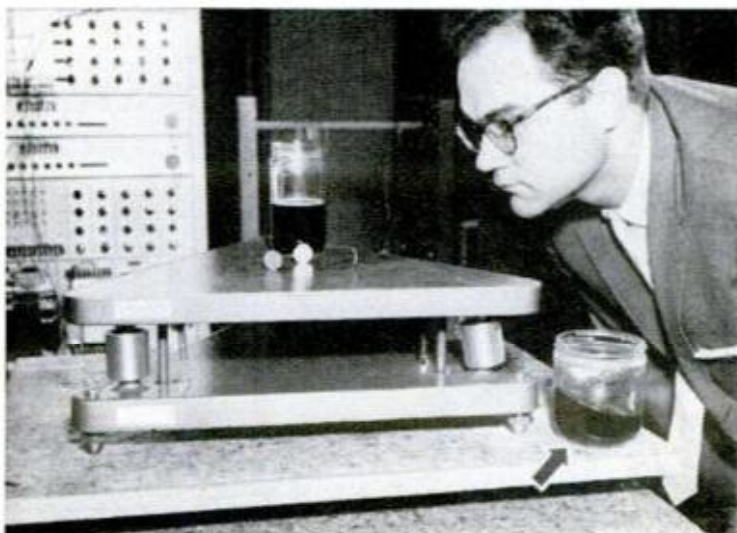



SEATTLE'S FLOATING PROWL CAR.....



RESCUE WORK is also facilitated by the fold-down tailgate on Patrol Boat No. 1. The motorboat cops, as can be seen on map below, have a long watery beat to patrol. There are 65,000 small boats in and around Seattle

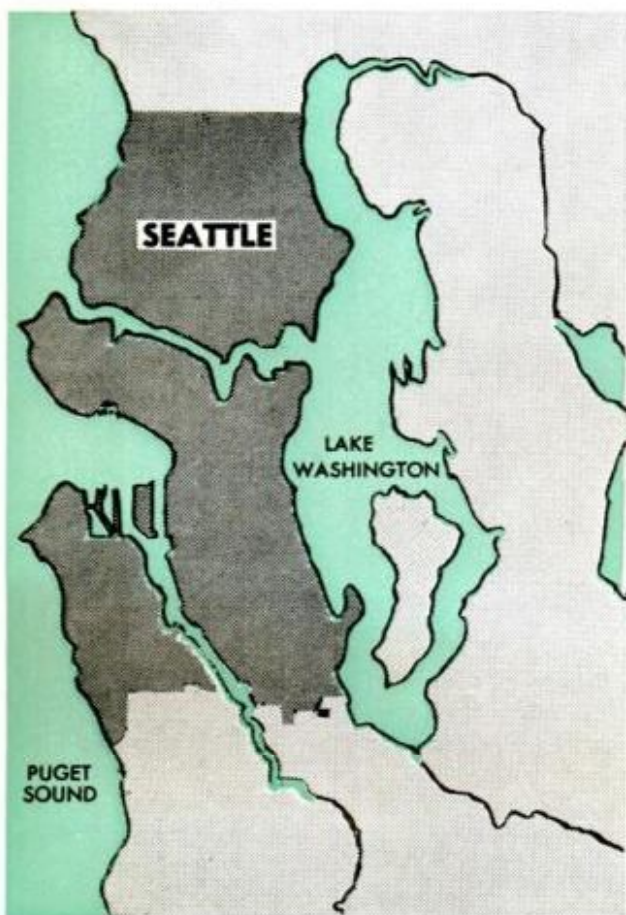

problems now being experienced throughout the nation. Patrolling the waterways calls for the most modern equipment. That's why the Seattle police have designed the latest in patrol craft—a mother boat with a faster one riding piggyback.

The hull of the mother boat is made of plastic so tough a rifle bullet won't go through it; the decks are of fiberglass and the cockpit is self-bailing. Rimming the craft is a rub rail of iron bark—the same material used on Coast Guard icebreakers. Aft is a hoisting davit capable of lifting more than a ton of deadweight from the sea.

For emergency fire fighting, powerful pumps can shoot out 1000 gallons of water a minute. (The same amount can be sucked from a sinking craft.) When the fire hose is operating, the jet force is so powerful that one of the boat's two engines must operate to keep the boat from being driven from its target. Engines are 220 hp. diesels.

The searchlight lights up waters a mile away; the siren can be heard over a greater distance; the public address system can bawl instructions across the water. There is an electronic depth finder for plying areas of unknown depths. Radio contact can be kept with land squad cars, a pon-



HELPING HAND is given to fisherman whose boat ran out of gas. He'll be towed to a dock. Police boats on occasion are pressed into service to fight fires on neighboring docks. The department won a fire-fighting award

toon-equipped police helicopter and with any radio-equipped boat.

Capt. Stanley Stevenson is acting chief of this harbor force. While most of his 25 years' service was spent on a motorcycle, chasing highway speeders, his heart has been in boats. He owns a modest one, has raced in water events, and during World War II he was a chief bosun's mate on a mine sweeper.

As I talked with him at the Ballard Dock police station, a gill netter docked his boat and stuck his head inside the station door.

"I need a check-out on my forward light," he said. "Salt water corroded the wires and the light wouldn't work. One of your boys gave me a warning ticket yesterday."

In all my years as a police reporter for a newspaper, I'd never seen a man pull up to a station in a boat to square a ticket.

Stevenson grinned. "Repairs to lights on fishing boats are going on at all the docks. We give one warning ticket. Our police boats are like floating prowls. We use them for investigation and enforcement work and for just being handy. We have learned where we are likely to be most needed. Look . . ."

He held up a map of Seattle. On the water

areas were hundreds of numbered and varicolored thumb tacks.

"The tacks represent trouble calls during the past year. The colors and numbers tell us the different kinds of trouble. We know where to concentrate our efforts."

All call cards are run through an electronic machine and tabulated. Speeding represented almost 50 percent of the harbor ordinance violations in the past year. Main offenders: boaters in the 20 to 24 age bracket; next, those from 25 to 34. Several arrested speeders were in their 60s.

"It's a funny thing," Stevenson said: "People who wouldn't think of speeding on a clear highway will race through a congested harbor. People who don't drive automobiles when they are drunk think they are capable of operating a boat in that condition. Not since the Model-T days have I caught anyone riding on the hood of an automobile, but many persons try riding on the foredeck of a speeding boat. Accidents can happen in the water without encouraging them."

Seattle's worst water accident in recent years occurred to a 40-foot pleasure boat, the *Lois Ann*, in mid-afternoon while a 40-

(Continued to page 202)



CHRISTMAS 'TREE' of scrap metal is sprayed with water which freezes to form beautiful pattern of icicles.

Deck the Iron With Ice and Be Jolly



Men of the North American Air Defense Command (NORAD), who man the radars of the ballistic-missile early warning system in Greenland, weren't about to go through the Yuletide season without a Christmas tree.

But in Greenland—which is *not* green but mainly ice—trees are rare. So they built their own.

Using scrap pipe, iron and sheet steel, they built a "tree" that stands 35 feet high—almost as tall as the giant radar towers. They used a fire hose to add icicles—they just kept spraying it until the frigid Greenland weather froze the water in beautiful natural patterns—then trimmed it with about 150 red and blue bulbs.

To make sure the tree would stand erect, they blasted a hole in the ground, filled it with water, set the base of the tree in it and let it freeze solid.

The Greenland site is the northernmost in the NORAD system.

NORAD MEN in parkas stand around do-it-yourself Christmas tree and sing carols

POPULAR MECHANICS



Small Car for Big Cities

Paris traffic jams have caused French science-fiction writer Henri Viard to propose a radical solution—a long-term policy that would result in banishment of all but the tiniest autos from the city's streets. Full-size cars would be allowed to park for only a limited time during the next two years, after which they would be banned altogether.

Then, only the Bulle (air bubble), designed for Viard by motor engineer Francois Boufort, could be used. This tiny car, about six feet long, seats two or three passengers and takes up only a quarter of a normal parking space. Its two-cylinder engine delivers about 70 miles per gallon and a top speed of about 40 miles per hour. Price, according to Viard, would be about half that of the smallest car now being made, and running expenses less than the cost of public transportation.



Push-Button Tooth Cleaning

Spinning 3600 revolutions per minute, the power unit of a new battery-operated dental treatment kit actuates attachments that do a complete job of dental cleaning—from brushing teeth to massaging the gums.

Attachments include a nylon brush, cleaning disk and cone-shaped gum massager. Also included in the kit is a cleansing paste.

The complete kit is available for \$3.98 from Modalities, Inc., Dept. P, 3101 Steinway St., Long Island City 3, N. Y.



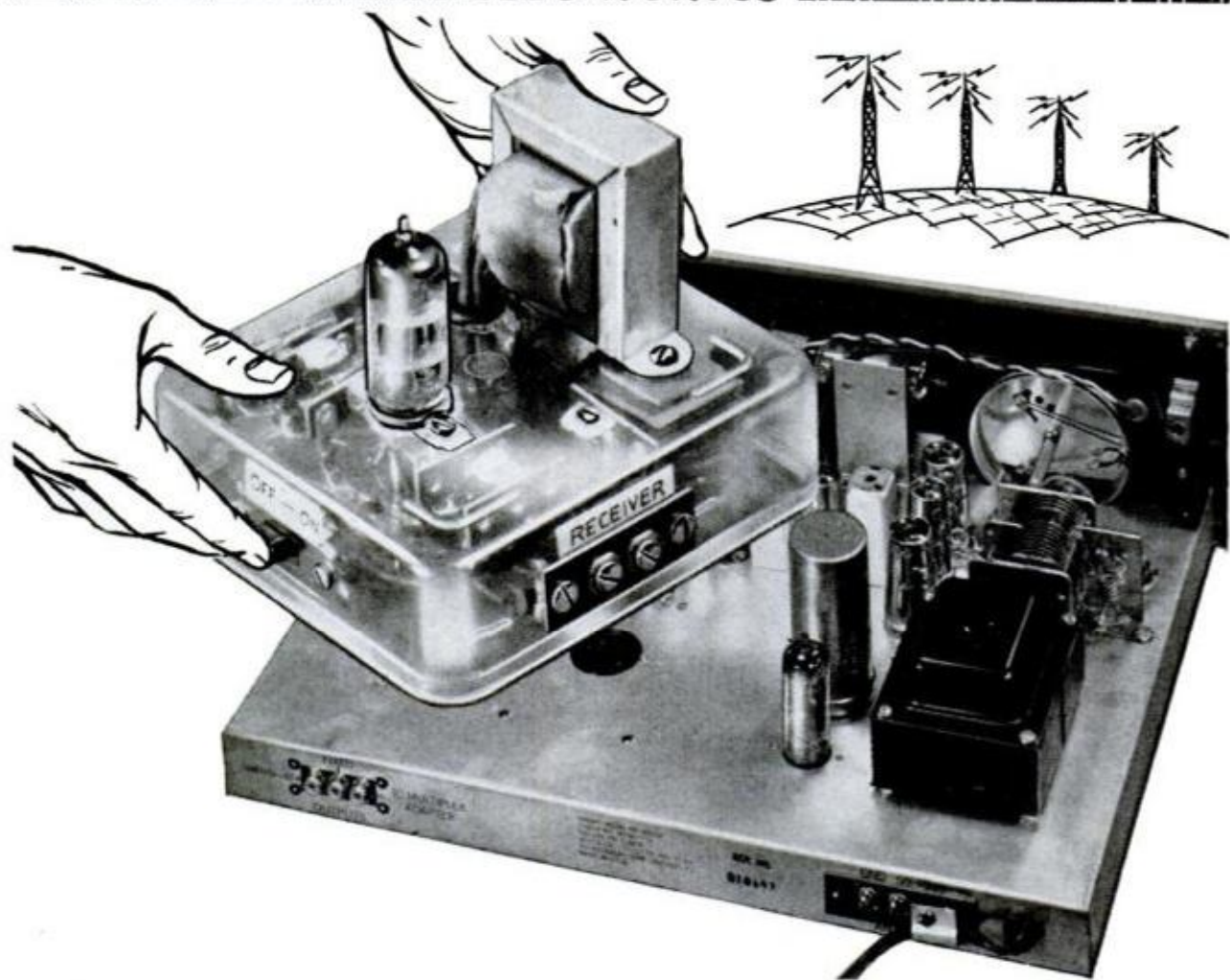

Give Your FM Tuner a Boardinghouse Reach

By Joseph R. Noonan

BY ADDING THIS useful "signal sucker" to your tuner, you can make stations that sound weak seem as if they were just around the corner—and bring in some stations you were never able to receive before. Such a booster is almost a "must" if you are 50 miles or more from the nearest FM station, or if you are fussy (as we are) about noise-free listening.

Use a plastic sandwich box as the chassis. Save the lid as a bottom cover when the wiring is complete. Holes for parts mounting can be made either by careful drilling, or use a heated nail for small holes and a

heated knife-blade for larger ones. Parts placement is not critical, but keep all leads as short as possible. Mounting strips can be used to support small components such as resistors and capacitors. When mounting the coils L1 and L2, place them on opposite sides of the tube socket.

The coils use 5600-ohm, two-watt resistors as coil forms. Start by soldering one end of the coil wire to one of the resistor pigtails, close to the body. Evenly space the turns until the required number is reached. Where a tap-off is required, twist the wire into a small pigtail before continuing the

coil. When the coil winding is finished, wrap the free end of the wire around the remaining resistor pigtail and solder snugly near the body. To prevent the wire from unraveling, coat the entire coil with Polystyrene "Q"-Dope.

After the wiring has been completed, check it carefully against the diagram. Connect terminal strip TS-1 to the antenna, and TS-2 to the FM receiver. Make these connections with standard 300-ohm twin-line. Turn on both the FM receiver and the booster. In order for a booster to operate properly, it must first be neutralized. While this is usually done with elaborate test equipment, here's how you can accomplish a fine neutralization simply with basic tools and a sharp ear. Adjust trimmer capacitors C5 and C6 to the point midway between where oscillation begins, as indicated by an excess of noise and distortion. Tune these for maximum noise.

Then, adjust coils L1 and L2. Tune a station near the center of the dial and using a toothpick, compress and spread the coil windings along the resistor body. Watch the FM tuning indicator, or listen very critically while adjusting and space the windings for maximum signal boost.

Check station reception at both ends of the dial as well, to be sure a good compromise has been affected. When satisfied that maximum signal is coming through, coat the coil with Polystyrene "Q"-Dope to prevent accidental shifting of the windings.

Your booster will require no additional attention, except to turn it on and off. If you live in a fringe reception area, you will want the unit on at all times when the FM is on, in which case it might be wise to leave the switch in the *on* position and plug the booster line cord into the switched accessory outlet on the rear of the FM tuner if one is available. This will turn the booster on and off with the tuner.

Should you find some stations in your area which are too strong when the booster is used, you can turn the booster off, and it will provide some measure of attenuation, reducing the signal to a usable level.

★ ★ ★

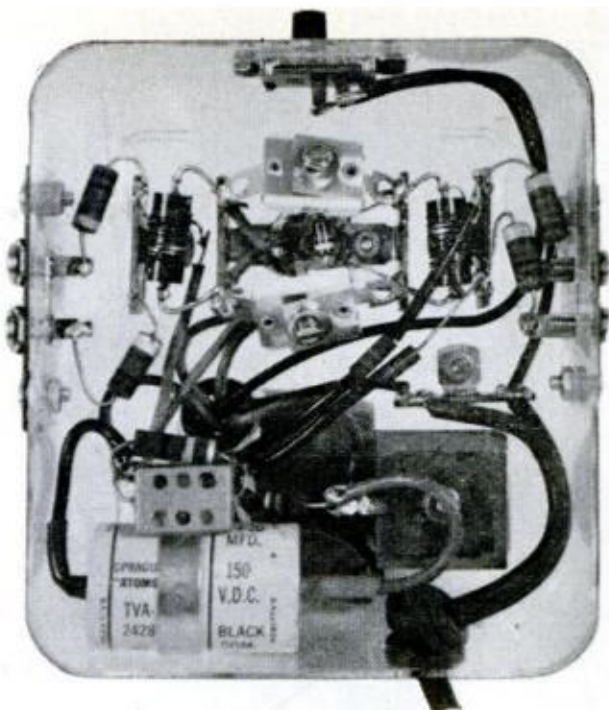

BOTTOM OF CHASSIS shows one possible arrangement of parts. Below, schematic diagram and coil data

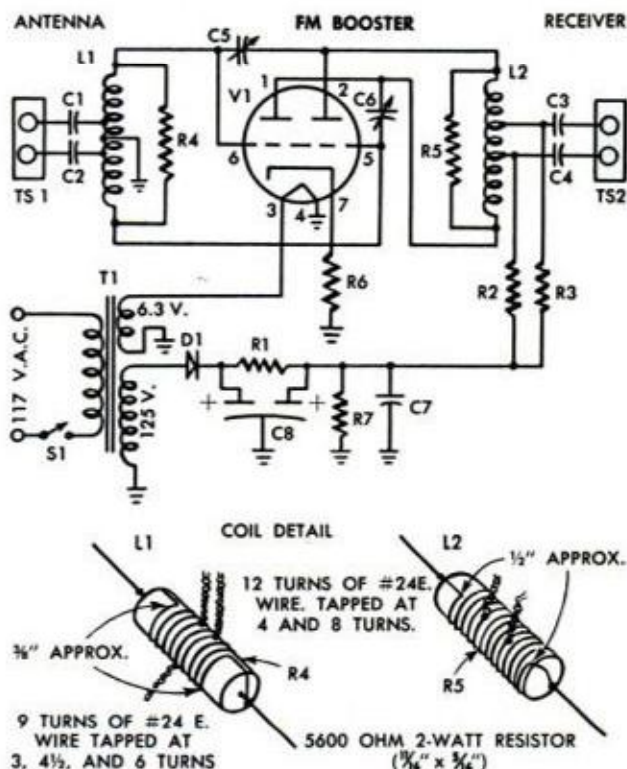

FM BOOSTER PARTS LIST

C1, C2, C3, C4—51 mmf., 1000-v. ceramic capacitor
 C5, C6—3-30 mmf. midget trimmer capacitor (BUD MT 833 or equivalent)
 C7—100 mmf., 500-v. mica capacitor
 C8—20-20 mfd., 150-v. electrolytic capacitor (Sprague TVA 2428 or equivalent)
 D1—50-75 ma., 130-v. selenium rectifier
 L1—9 turns of #24 enameled wire wound on resistor R4, and spaced $\frac{3}{8}$ ", tapped at 3 turns, $4\frac{1}{2}$ turns, and 6 turns (see text)
 L2—12 turns of #24 enameled wire wound on resistor R5, and spaced $\frac{1}{2}$ ", tapped at 4 turns and 8 turns. (See text)
 R1, R2, R3—1000-ohm, $\frac{1}{2}$ -watt resistor

R4, R5—5600-ohm, 2-watt resistor ($11\frac{1}{16}$ "x $5\frac{1}{16}$ ")
 R6—47-ohm, $\frac{1}{2}$ -watt resistor
 R7—100,000-ohm, $\frac{1}{2}$ -watt resistor
 S1—SPST switch
 T1—Power transformer: primary 117 v. a.c.; secondaries 125 v. a.c. @ 15 ma., and 6.3 v. a.c. @ 0.6 A. (Knight 61G410; Stancor PS-8415, or equivalent)
 TS1, TS2—2-lug screw-type terminal strip
 V1—6J6 tube
 1—7-pin miniature tube socket
 1—plastic sandwich-box $4\frac{1}{2}$ "x 4 "x $1\frac{3}{8}$ "
 6—2-terminal mounting strips
 Misc.—Grommets, power cord, etc.
 (Approximate cost of parts: \$7)

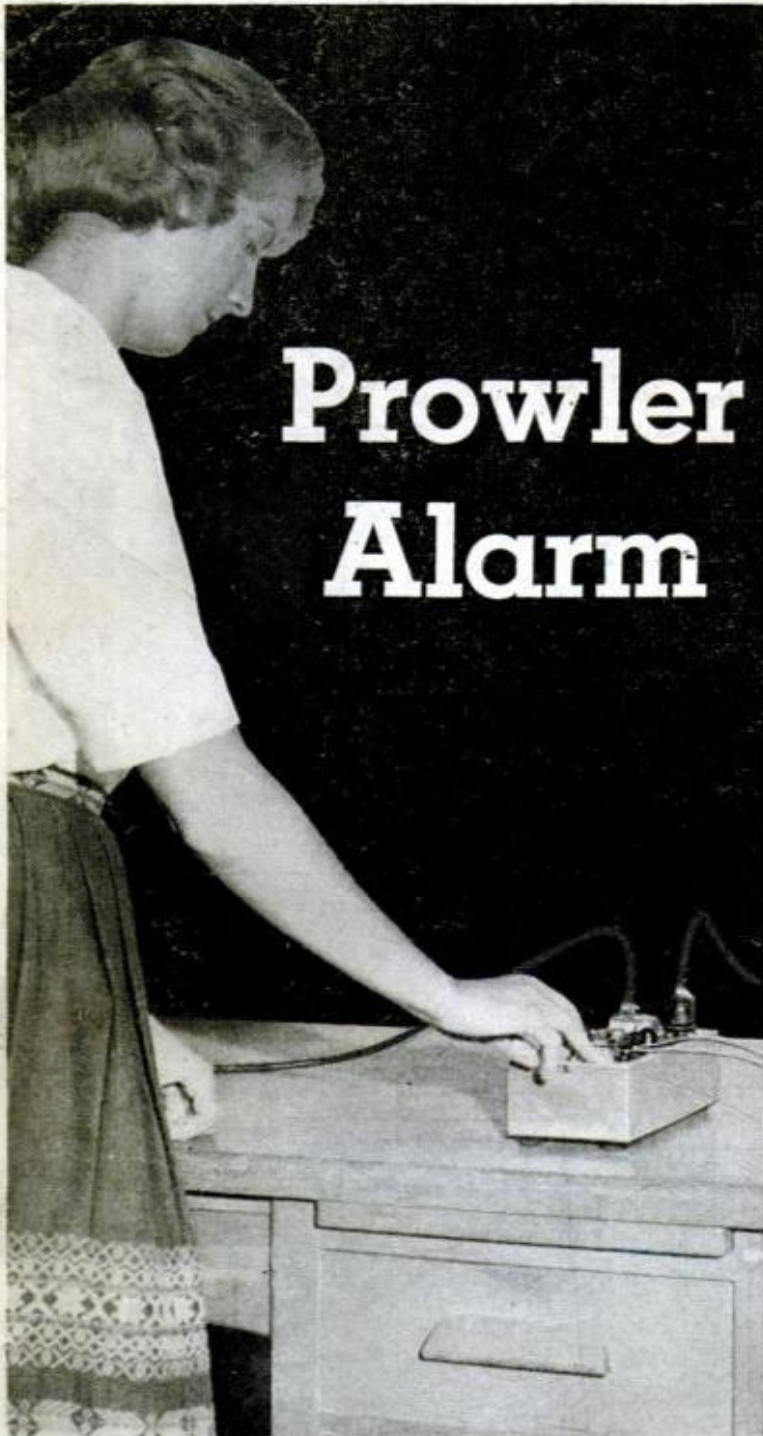

Prowler Alarm

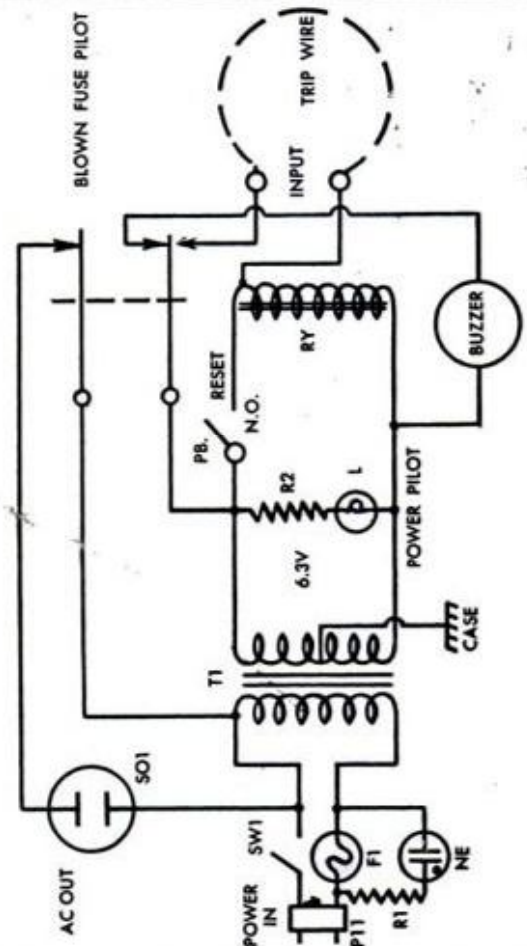

TURN ON THE POWER, press the reset button and your house and property are safe even if nobody's home

AS A burglar discourager, this prowler alarm does a fine job. The unit operates with a trip wire which keeps a relay in a locked position. Should the wire break, the relay opens and whatever you have plugged into the a.c. outlet will then be activated. The alarm can be either a floodlight, a bell, or a combination of these.

As the unit is electrical rather than electronic, there is no serious problem concerning lead dress or parts placement. Keep the leads as short and direct as possible, and avoid short circuits.

The trip wire should be very fine, such as a number 38 enameled. This will be invis-

ble in the dark, yet will break readily under pressure. As line voltage isolation is provided by transformer T1, there is never more than 3.15 volts through the wire.

For stringing the alarm wire around the doors and windows, note the setups suggested in the sketches shown above. If the wire is strung tautly over a partly open window further to gain entry will break the wire and sound the alarm. Similarly, a door can be protected by looping the wire over the knob. A garage door can be guarded simply by using two nails. Attach them so that in the closed position the nail on the door

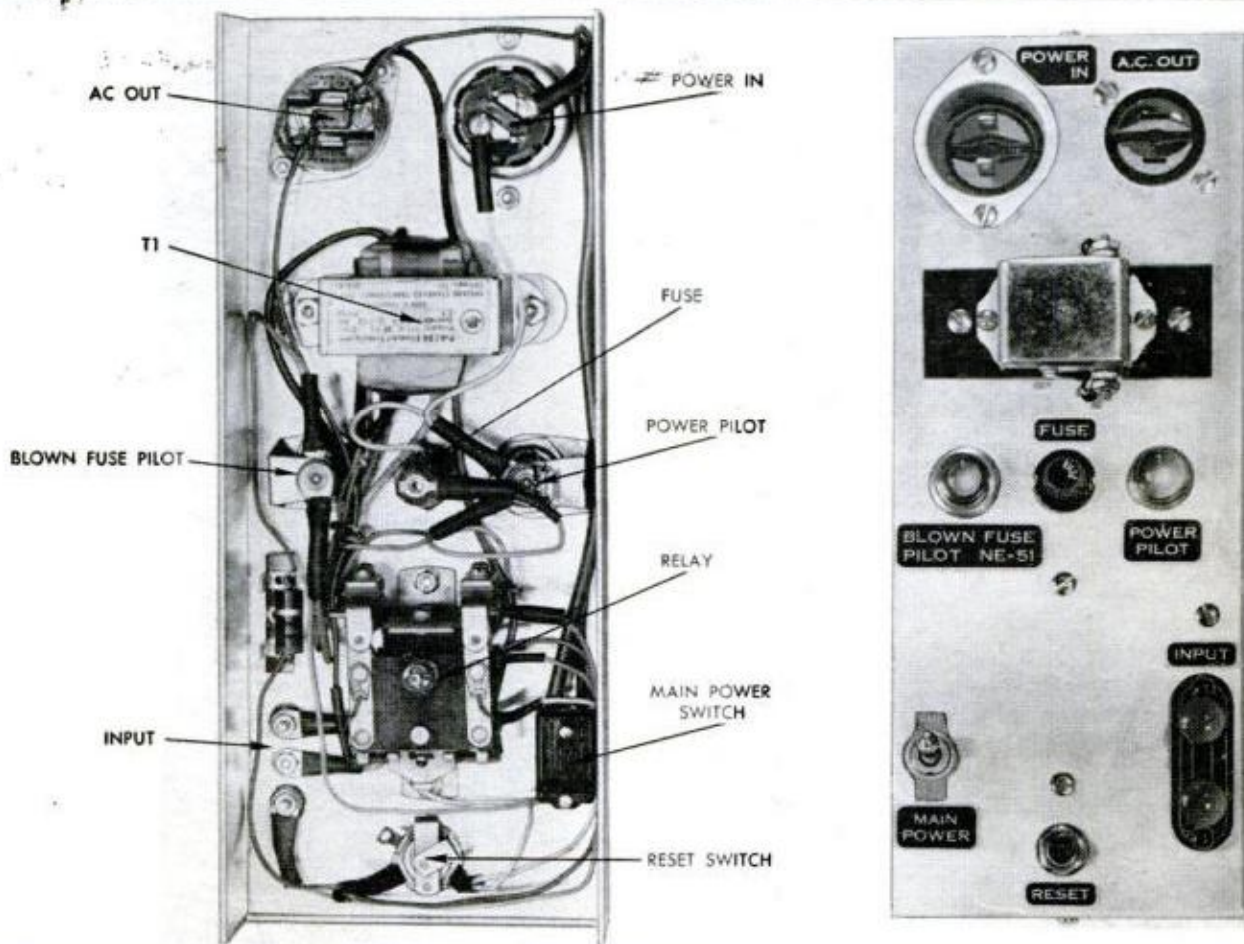
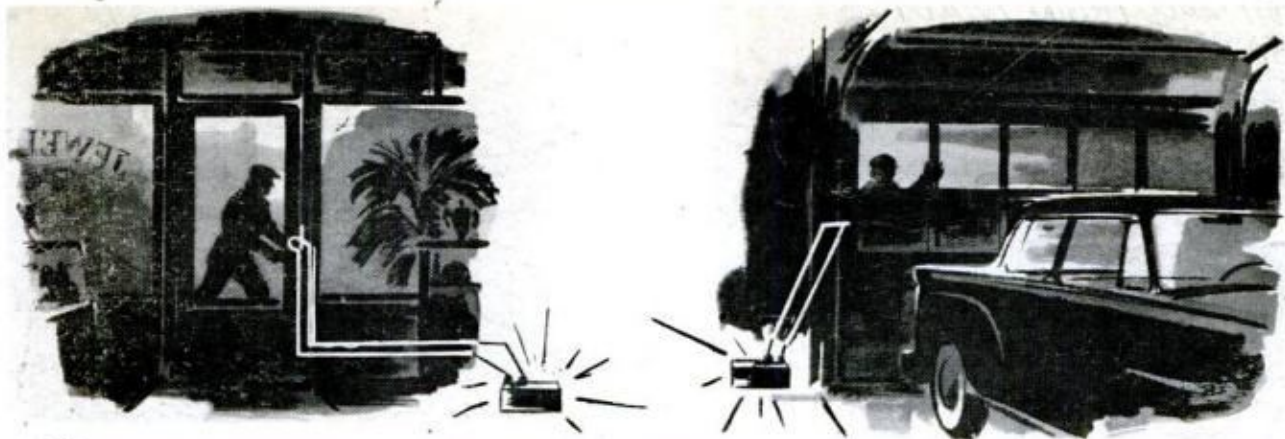

UNDERCHASSIS VIEW above left shows uncomplicated circuit. Top view, right, indicates author's layout

makes contact with the nail in the jamb. Connect one trip lead to each nail, and as long as the door is closed, the alarm will be silent. You will need a switch outside the garage to let yourself in, however. You will probably be able to devise numerous other methods yourself.

Using the Unit

In use, turn the power switch on and press the reset button. The unit is now "on guard." When the wire breaks, the a.c. out socket is activated and the internal buzzer sounds, or the floodlight lights, if you are using a light for an alarm.—*Ronald L. Ives*

PARTS LIST

- P1—Recessed male a.c. plug
- SO1—Flush female a.c. receptacle
- Case—Aluminum chassis box 10"x4"x2½", LMB No. 144 or equiv.
- R1—100,000-ohm, ½-watt carbon
- R2—10-ohm, 2-watt carbon
- SW1—SPST toggle switch and plate
- F1—1-amp. fuse in holder
- RY—6-3-volt DPDT a.c. relay, Potter and Brumfield MR-11-A or equiv.
- NE—NE-51 bulb with jewel and socket
- L—Mazda 44 with jewel and socket
- T1—6-3-volt, 1.2-amp. filament transformer, Stancor P-6134 or equiv.
- Buzzer—6-volt adjustable buzzer
- PB—Push button, normally open
- Miscellaneous—2-terminal tie point, 2 terminal binding posts (Eby 21-5 or equiv.), cable ties, etc.

COST OF MATERIALS, PLUS PLAYING
EQUIPMENT AND TRAIN LAYOUT:
\$ 130-150 (see MARCH 62, 12)

TRIPLE-TOP FUN TABLE

By John Jefchak

PART I



Piggyback, flip-over top lets you switch from pool to table tennis to model railroading at the mere suggestion—all on the same table

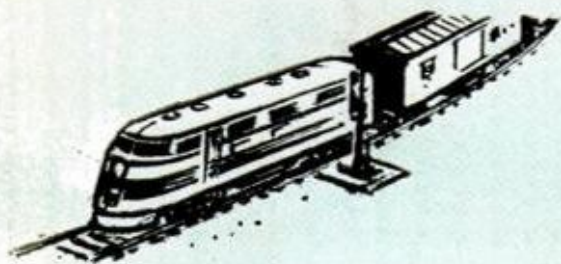

WANT TO GIVE the family a real Christmas gift? Promise them you'll start building this exciting fun table. It's a 6 to 60 gift the whole family will enjoy and well worth waiting for even though you won't have it ready by the 25th.

Basically it's a home-size pool table with an extra two-faced top which lets you enjoy table tennis or HO-ga. railroading on the same table by merely flipping over the piggyback top. For pool, you simply lift off the extra top and lean it against the wall. This space-saving feature makes the affair ideal for the average basement playroom where there would not be room enough for three individual tables.

Roomy compartments in the base of the table provide a convenient place to store rolling stock, the scenic mountain and other lift-off props of the model track layout, also the table-tennis equipment; and there's room to spare for other games and playroom toys. The whole thing rolls about on casters and is designed to dismantle in easy-to-handle sections for moving in and out of the house. In lieu of the model train layout, the reverse side of the table-tennis surface can be used by the youngsters as a paste-and-color table, as a birthday-party table or as a nice big area for spreading out table-top games.

A logical beginning is to construct the pool-table top first and Fig. 1 shows the



SHOP AND CRAFTS

basic assembly at a glance. Begin with the side rails, using $\frac{3}{4}$ x 8-in. solid stock (or plywood if you prefer). Hardwood is best, the original top was made of poplar and painted.

Rip the rails to a width of $7\frac{1}{2}$ in. The sides measure 92 in. long, while the ends are 48 in. in length. Cut a rabbet $\frac{1}{4}$ x $\frac{1}{2}$ in. along the outer edge of each board, with the remaining tongue, or tenon, considered as being on the inside. This is accomplished with two passes on the table saw. Next, cut a $\frac{3}{8}$ x $\frac{3}{4}$ -in. dado on the inside, at a point $2\frac{1}{4}$ in. down from the top of the tongue. Use either a standard saw blade or, preferably, a dado head, which will cut the groove in one pass. Mark out the ball-return opening on one end rail, Fig. 12. Cut out, using a portable electric saber saw or a key-hole saw (if done by hand), and smooth and round off all edges. Cut a 45-degree miter at each end of each piece, eight miters in all. Take care to retain a small flat edge, about $\frac{1}{32}$ in., on the ends



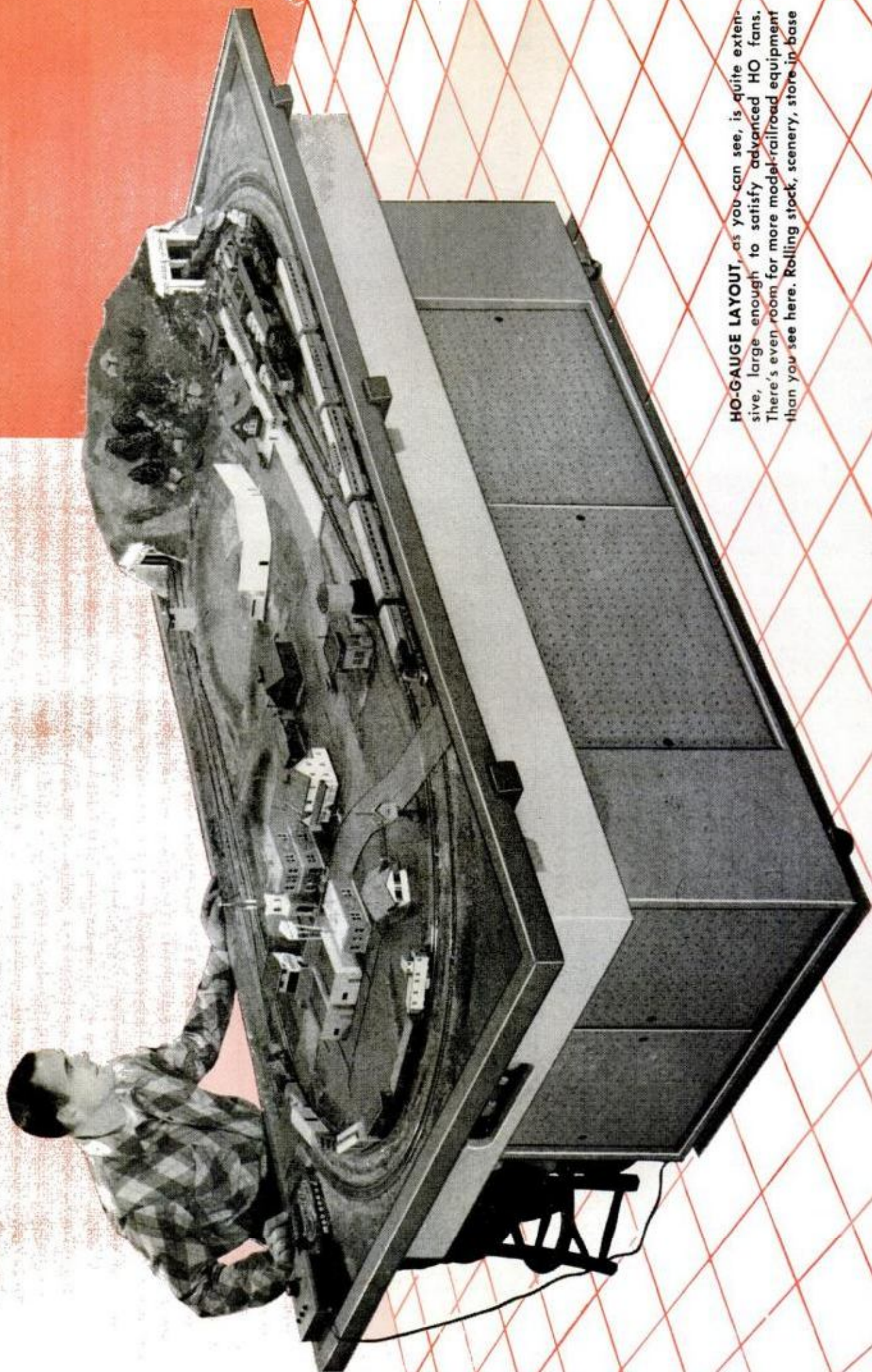

HO-GAUGE LAYOUT, as you can see, is quite extensive, large enough to satisfy advanced HO fans. There's even room for more model-railroad equipment than you see here. Rolling stock, scenery, store-in-base

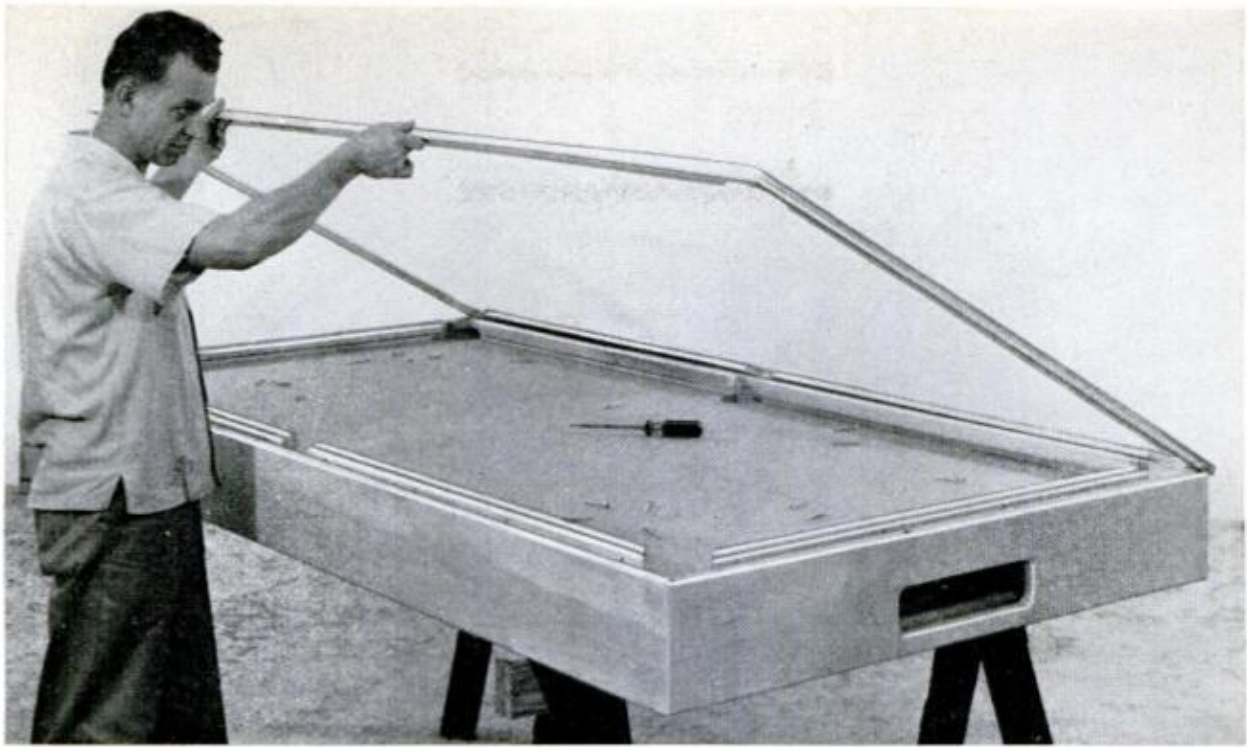

HERE YOU SEE the top completely framed with playing board in place and mitered top rail being tried for fit

of the miters in order to maintain the true dimensions. Now cut a groove $\frac{1}{4} \times \frac{3}{8}$ in. across each mitered surface, $\frac{1}{8}$ in. in from the inside corner, to receive a $\frac{1}{4} \times \frac{5}{8} \times 8$ -in. plywood spline, Fig. 4.

Cut 24 triangular clamp blocks from $\frac{3}{4}$ -in. stock. Using a water-soluble hide glue, place three blocks equally spaced, at each end, about $\frac{1}{8}$ in. from the mitered edge. Make certain that corresponding clamp blocks are in line in order to receive the clamps for permanent clamping as in the photo to the left of Fig. 4, and for trial fitting. Prime the mitered edges with a thinned mixture of plastic-resin glue to insure a good bond. Allow to dry thoroughly. Then apply glue to the spline and both mitered edges and clamp together, using an equal pressure on all clamp blocks. It takes twelve clamps to complete the four corners at one time. Otherwise, work as many corners as there are clamps available.

Check for squareness before the glue sets, since it is essential that all four corners be joined at 90 degrees. Use a framing square in each corner, then hold in position with diagonal strips. Use a wood chisel to remove excess glue down to the glue line of each joint. Remove any glue residue from the wood with a damp cloth. Allow glue to set for at least 24 hours, then carefully trim off the clamping blocks with a wood chisel and trim the splines off flush at each end.

Cut out two pieces of plywood $\frac{3}{4} \times 5\frac{1}{4} \times 86\frac{1}{4}$ in. These are the side walls for the ball-return tunnels running lengthwise,

Fig. 1. Cut out two pieces $\frac{3}{4} \times 5\frac{1}{4} \times 36\frac{1}{2}$ in. to serve as side walls for the ends, one of which blocks off an unused space at the end opposite the ball-return opening. The bottom piece for this unused space measures $\frac{3}{4} \times 4\frac{1}{4} \times 36\frac{1}{2}$ in. There is a rise in the bottoms of the side tunnels of $\frac{5}{8}$ in. from one end to the other lengthwise, Fig. 2. The ends therefore require an angle cut of approximately 1 degree. Allow at least $\frac{1}{4}$ in. for fitting and trimming. The tunnel bottom at the ball opening is made from solid stock, measuring $\frac{3}{4} \times 4\frac{1}{4} \times 46\frac{1}{2}$ in., Fig. 3. A groove with a $1\frac{1}{8}$ -in. radius runs down the center for the entire length and is cut out on the table saw by passing the work repeatedly across the saw table at an angle as in Fig. 10. This is done by raising the blade slightly with each pass of the work. The piece is curved by forcing down the center $\frac{1}{2}$ in. below the ends which rest on two $\frac{1}{2} \times \frac{3}{4} \times 5$ -in. supporting blocks, glued and nailed to the side rails, Fig. 1. Ends of the grooved piece are cut at approximately $1\frac{1}{2}$ degrees on the table saw. The length is approximately $\frac{1}{32}$ in. longer than the dimension of $46\frac{1}{2}$ in. between the side rails.

Cut out parts for the bed shelf, two pieces $\frac{3}{4} \times 1\frac{3}{4} \times 91\frac{1}{4}$ in. for the sides and two pieces $\frac{3}{4} \times 1\frac{3}{4} \times 43\frac{3}{4}$ in. for the ends. Apply glue and insert into the $\frac{3}{8} \times \frac{3}{4}$ -in. dadoes in the rails, the long pieces first, followed by the short ones. Mark off the $\frac{5}{8}$ -in. incline with a pencil on the inside of the side rails, $\frac{1}{2}$ in. at the ball-opening end, and $1\frac{1}{8}$ in. at the other end, Fig. 2. Likewise mark off the same incline on the two

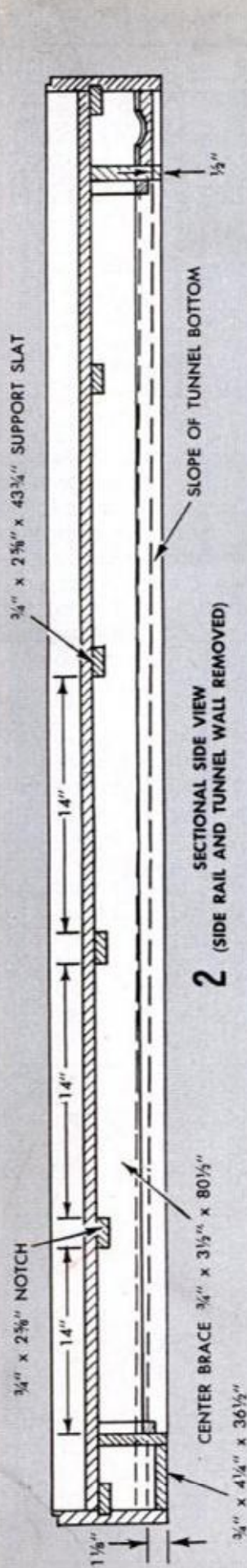

2 SECTIONAL SIDE VIEW (SIDE RAIL AND TUNNEL WALL REMOVED)

side walls of the tunnel returns. Now glue and nail the bottoms to the sides, placing glue liberally on the edges that come into contact with the side walls. Follow the guide lines and clamp into position.

Check for squareness. The bottom edges of the side rails and the sides of the ball-return tunnel should be flush, Fig. 3. Follow the same procedure at the end opposite the ball opening. Glue in place the remaining tunnel end wall (ball opening end) and hold in place with several nails driven in at the top edges. When glue in these joints has set, spread glue on the edges of the grooved ball-return bottom, force into position and nail from both sides. Set exposed nails on the side rail and putty over.

Mark off $\frac{3}{4}$ in. from the lower edge on the inside of the tunnel walls and nail and glue $\frac{3}{4}$ x 1 x 80 $\frac{1}{2}$ -in. cleats above this line along the sides and $\frac{3}{4}$ x 1 x 35-in. cleats along the ends, Fig. 3. These cleats support and register the pool-table-top on the storage base. Lay out and cut a center brace $\frac{3}{4}$ x 3 $\frac{1}{2}$ x 80 $\frac{1}{2}$ in. which serves as the center support underneath the particle-board bed. Cut $\frac{3}{4}$ x 2 $\frac{5}{8}$ -in. notches in it, spacing them 14 in. apart. Next cut four pieces $\frac{3}{4}$ x 2 $\frac{5}{8}$ x 43 $\frac{3}{4}$ in. These serve as support slats

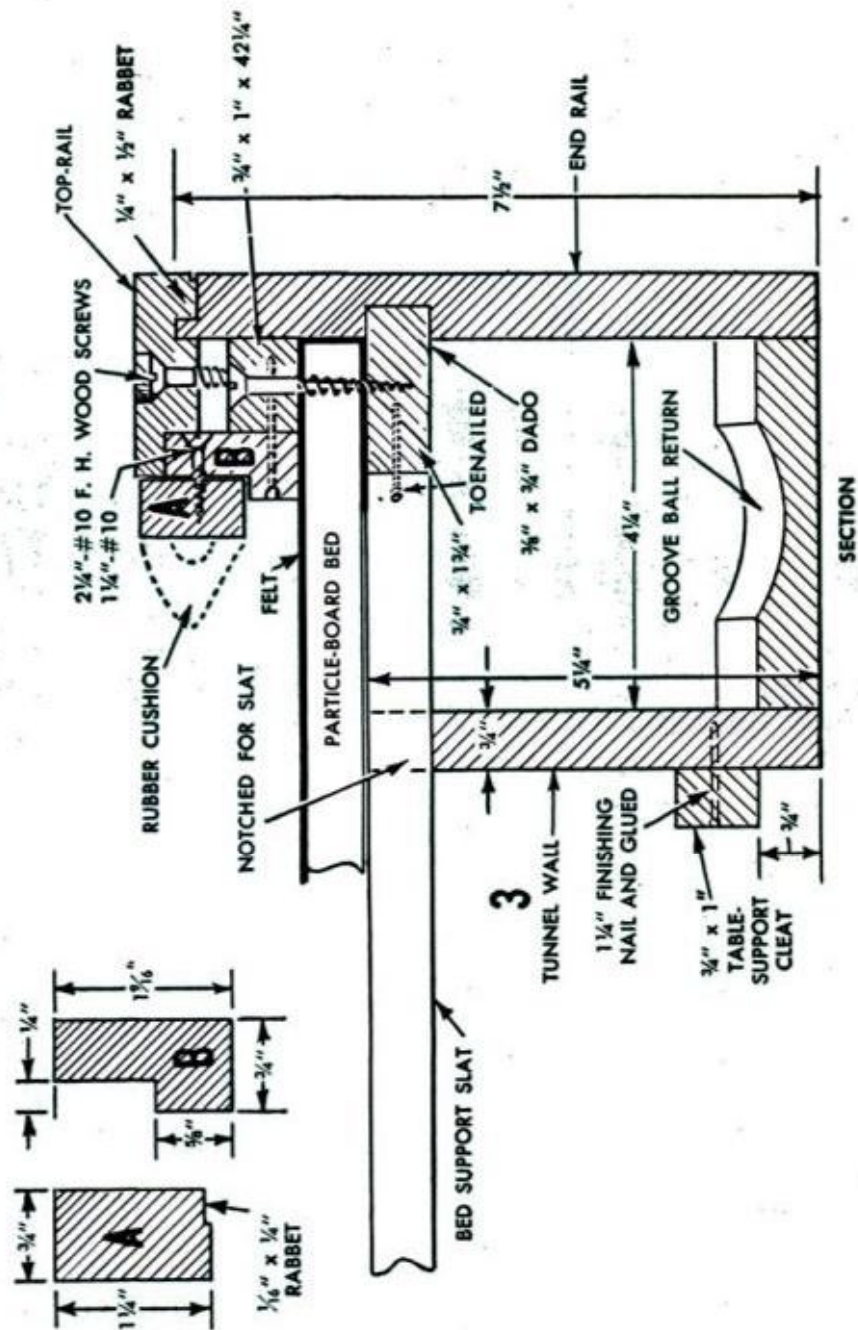

SECTION

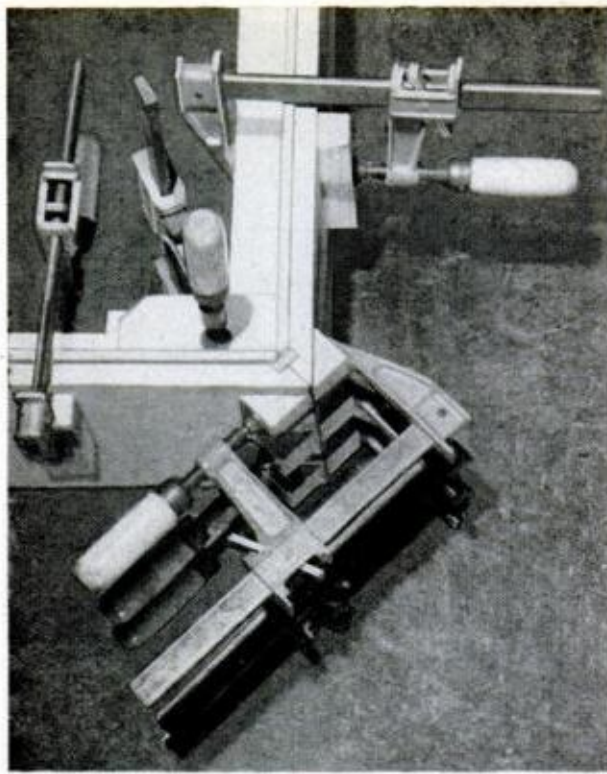

MITERED AND SPLINED corners of the side rails are glue-blocked and clamped as you see here. Note that three clamps and six blocks are used per corner. Note also the spline and refer to Figs. 4, 6 and 8

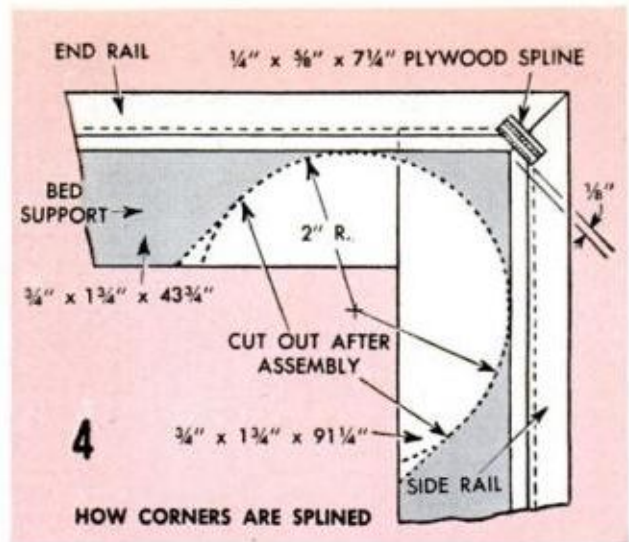

for the bed, Fig. 1. Since these butt against the shelf members, $\frac{3}{4} \times 2\frac{5}{8}$ -in. notches also must be cut in the tunnel side walls to receive the slats, using a miter or back saw and chisel to cut the notches. Apply glue generously in the notches and to the ends of the slats, and nail into place. Toenail the ends of the support slats to the support shelf. Nail $\frac{3}{4} \times 1\frac{1}{2} \times 3\frac{1}{2}$ -in. corner blocks on each side of the center support at the ends, Fig. 1.

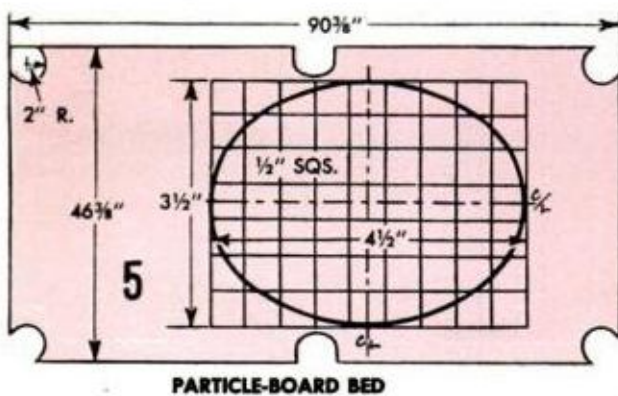

Lay out the $\frac{3}{4}$ -in. particle-board playing bed, following Fig. 5. The detail below Fig. 1 shows how to scribe the corner pockets, a pattern is made for the elliptical side pockets. Cut out the pockets, using either a portable saber saw or a coping saw. Now place the bed on the $\frac{1}{8}$ -in.-wide shelf and check the fit. There should be at least $\frac{1}{16}$ in. clearance equally around the edge. Plane down to fit, reducing the given dimension of $46\frac{3}{8} \times 90\frac{3}{8}$ in. to $46\frac{1}{4} \times 90\frac{1}{4}$ in. should the thickness of the cloth, or felt,

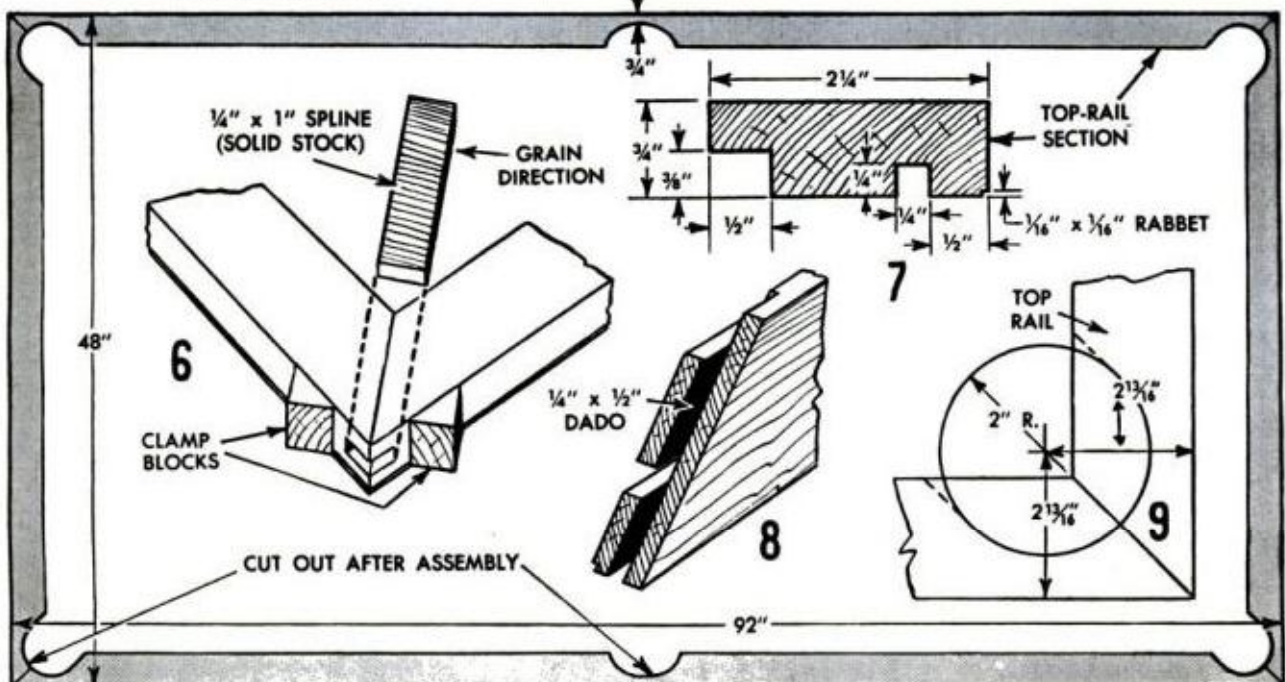

UNDERSIDE VIEW of pool-table top and inset photo below show how wedge shims are inserted at center support to remove any sag in center of particle board

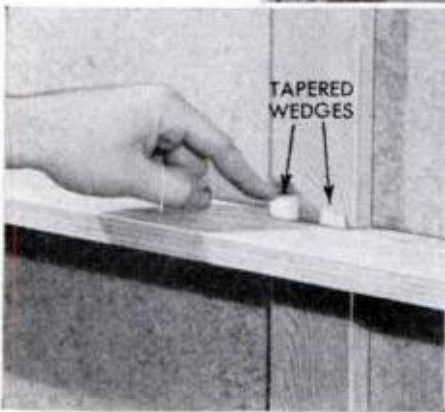
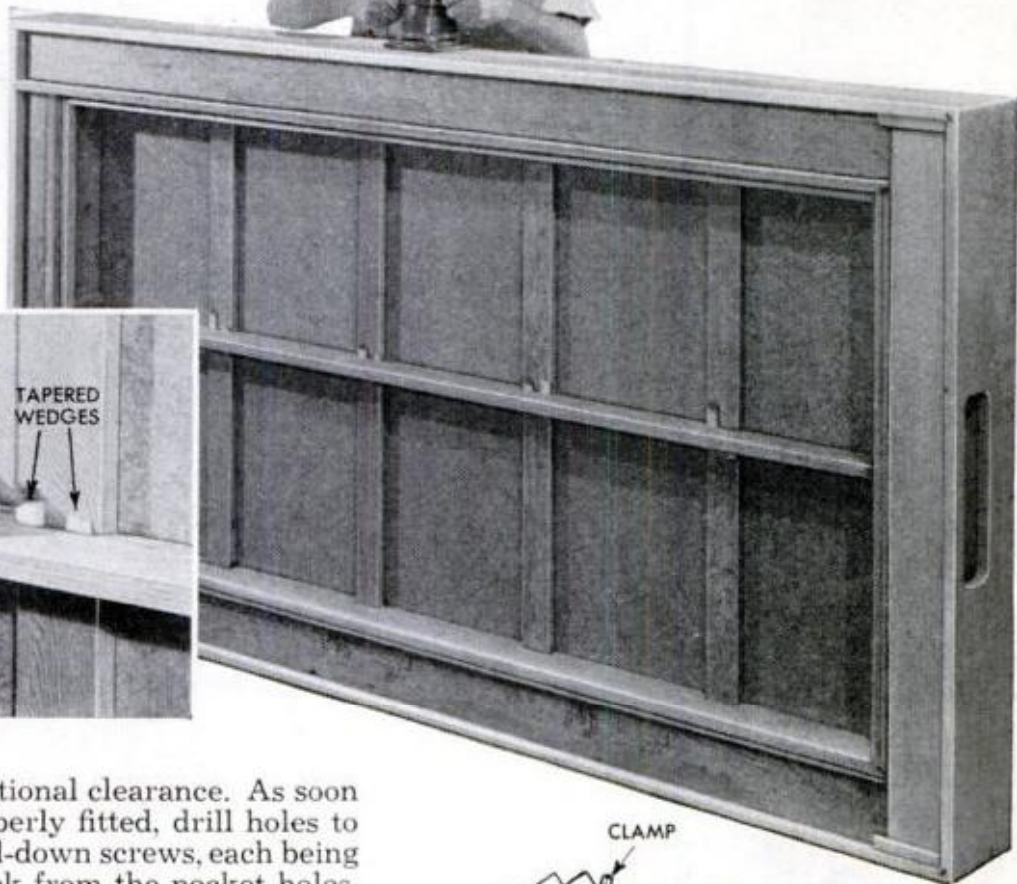

used require additional clearance. As soon as the bed is properly fitted, drill holes to receive the 12 hold-down screws, each being placed 2½ in. back from the pocket holes. Countersink the heads for 1¼ in. No. 10 flathead wood screws. With the bed in place trace the outline of the pockets on the bed-support rails. Fig. 4 shows how a compass is used to strike a 2-in. radius at the corner pockets. This is done similarly in the case of the side pockets except that the elliptical pattern is used to mark the outline instead of a compass. A keyhole saw is used to cut out the pocket openings.

Next comes the top rail, Figs. 6 through 9. Like the side rails of the table, the top-rail members are mitered like a picture frame and grooved for a spline as shown in Fig. 6. This is done first, after which the members are rabbeted and dadoed on the underside

(Continued to page 200)

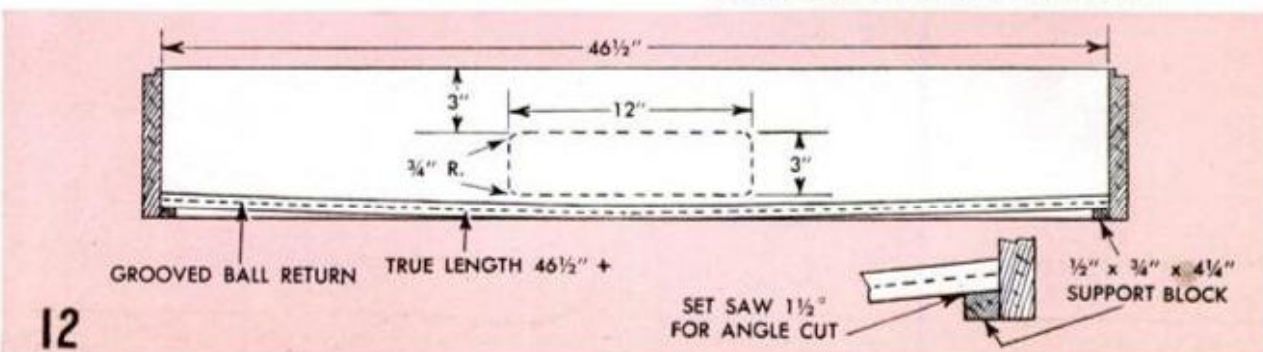
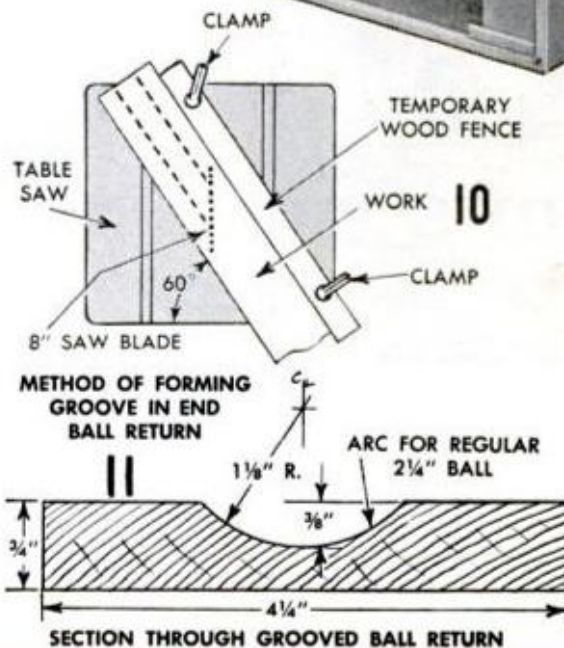

12

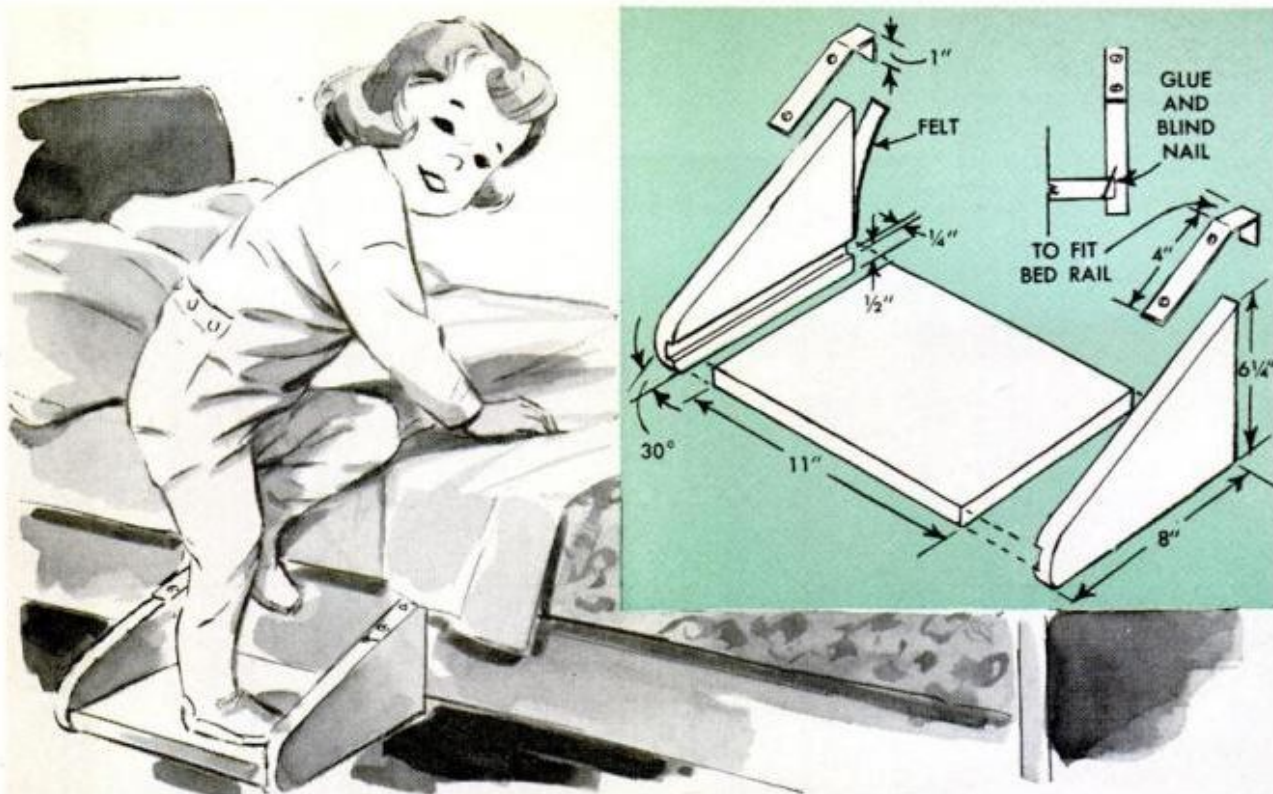

DETACHABLE BED STEP is a welcome accessory when a child is switched to a youth bed while she is quite small. All joints are glued and nailed for rigidity. Hanger clearance depends on thickness of the bed rail

Solving HOME PROBLEMS



WHEN YOU TAKE A BREAK while painting, slip a plastic bag over the roller and twist it tight to keep the paint from drying

FIDO'S DINING AREA is likely to be sprinkled with bits of spilled food after each meal. A drainboard tray placed under his eating dish will protect the floor better than newspapers and is easy to wash



WRAPPING CHRISTMAS PACKAGES for mailing? Try placing your ball of twine under an inverted saucepan and threading the end through hole in handle. Such a "twine holder" also works well with knitting yarn

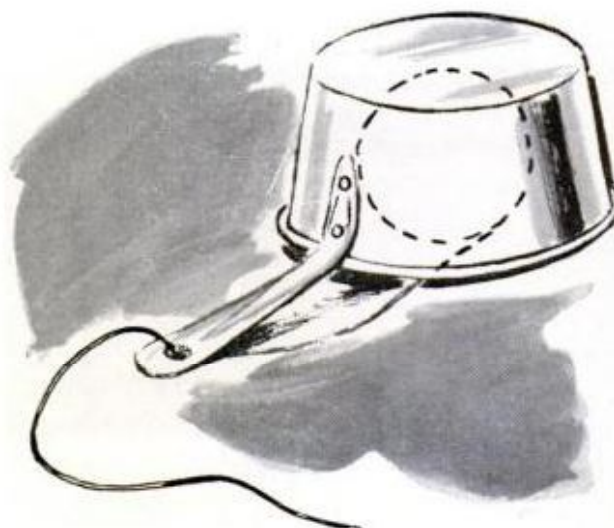

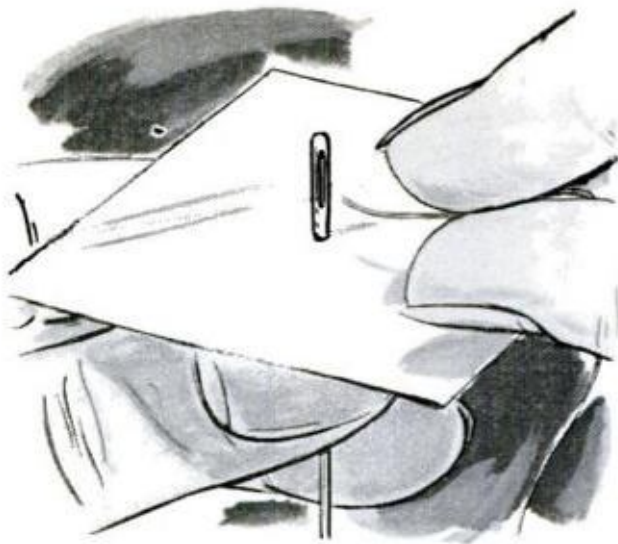

TO THREAD A NEEDLE easily and quickly, push the head through a small sheet of white paper until just the eye is visible. The white background makes it easier to see both thread and eye, thus avoiding eyestrain



YOU CAN TELL from the house when rural carrier has picked up outgoing mail by soldering L-shaped flag to red flag which becomes visible when latter is down

EXTRA SILVER which won't fit into your silver chest can be stored in a quart fruit jar. Since the silver is sealed from air, this helps prevent tarnishing

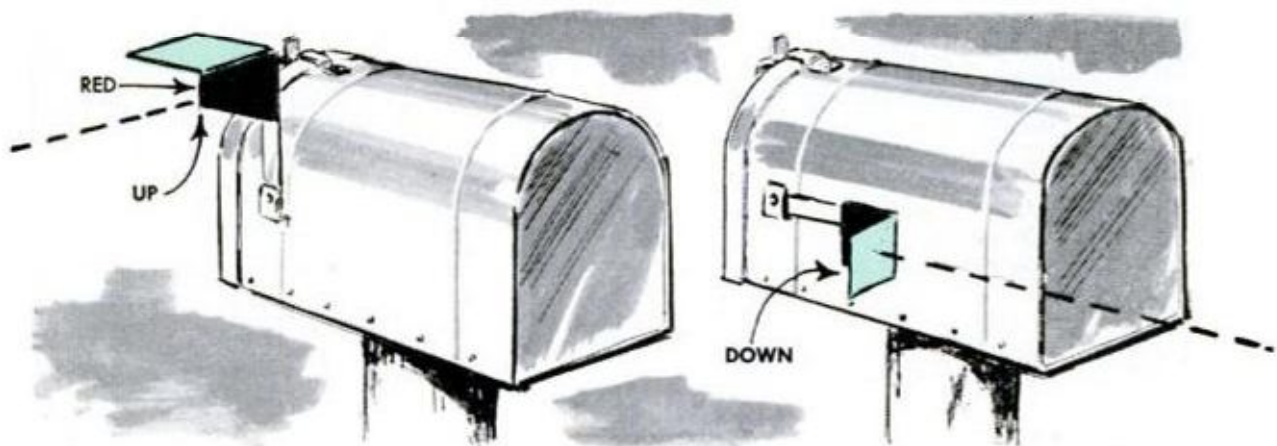

STAMP COLLECTORS will find that it is easy to remove canceled stamps from envelopes by passing a steam iron over them to provide the necessary moisture and peeling off the stamps before they become dry

TORN WINDOW SHADES can be mended with masking tape. While light tape was used on a dark shade here for picture clarity, the tape will blend well with most light shades and can be colored with a crayon

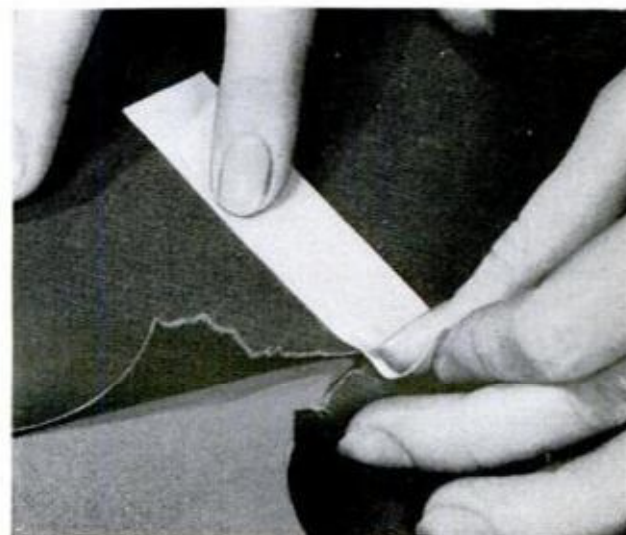

Coming Up Next . . .



HOME HEALTH SALON. In two parts, beginning in January PM, Part I will show in plans and pictures how to build a bike exerciser and a rowing machine to provide daily workouts for the entire family. Part II will detail and picture construction of a belt massager and abdominal board.

FILM DRYER. This efficient circulating film dryer delivers a negative ready for printing in ten minutes flat. Main part of it is adapted from a 32-gal. metal garbage can and heat is supplied by plastic-insulated electrical tape wound spirally around the inside of the can. Holds twenty-four 4 x 5 negatives. See January PM.

HYGROMETER. Or, more properly, a psychrometer, an instrument for measuring the vapor (moisture) in the atmosphere or in your home. Psychrometer is a big word but the instrument is simple and can be built in an hour or two by anyone, using two ordinary thermometers. It's accurate, too. Next month's PM tells how.

LATHE JIGSAW. It's an old sewing-machine head turned upside down and mounted on your wood lathe; you supply the plywood table and there's your jigsaw almost ready-made and running. Only slight alterations of the sewing head are necessary to adapt it to jigsawing. Uses regular saber blades. You'll find photos and plans in the January PM.



When You Need Three Hands

When installing roll or batt-type insulation to sound-deaden a basement ceiling, cut several 1x2 strips to fit snugly between joists. Wedge them under the batt or roll, every 4 or 5 ft. to hold it for stapling.

Short Order for Birds

Birds that stay the long winter through will be regular customers at this hanging feeder. To make it nail bottle caps to two or four sides of a 2 x 2 about 12 in. long. Fill caps with suet or peanut butter.



QUICK AND EASY

Shelf Sufficient

Looking for a way to add additional shelves in a closet without driving nails in the wall? Make a pair of ladders from 1 x 2s and wedge the shelves between them. As shown, the ladders rest on top of the baseboard of two facing walls and each shelf is notched at the four corners to fit inside the upright members. With the notches cut a bit shallow, the shelves will wedge securely in place without marring the walls. Note that the "rungs" of the ladders are applied to the outer face of the uprights to support the shelves their entire width.—*Bernard Draper*

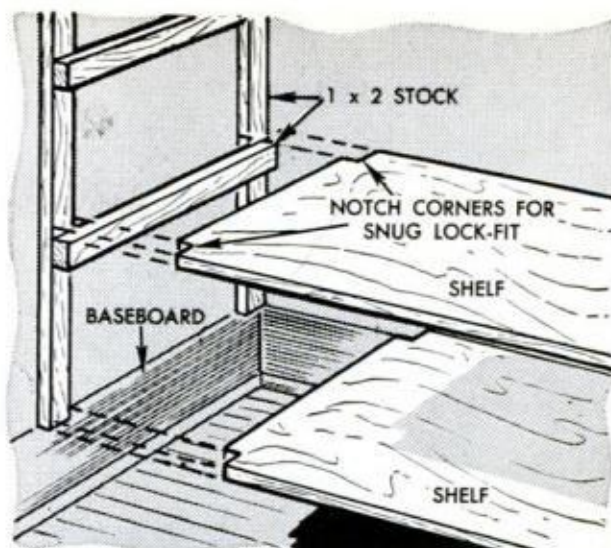

Stop Right There

When it's necessary to drill a number of 1/8-in. or so holes to a given depth with a portable drill you'll need a depth stop. What to use? Reach for your box of faucet washers and turn several onto the drill bit, running them up tightly one against another. Locate the lower washer a distance from the cutting end of the bit to give the depth hole required. Then when drilling ease up on the pressure just before the stop contacts the work. This will assure holes of uniform depth.—*Bil Toman*



Warning Marks

No doubt at some time you have pulled a drawer all the way out and—c-r-r-a-s-h! You spent the next half hour picking up things scattered far and wide over the floor. To help prevent a recurrence of this kind of thing, determine just how far you can pull the drawer out safely. Paint a red warning stripe across the top edge of each of the drawer sides at the rail. Then paint a black stripe on each of the drawer sides about 2 in. from the red stripe. Pull the drawer out no farther than the black mark and you'll be safe.—*Bernard W. Draper*

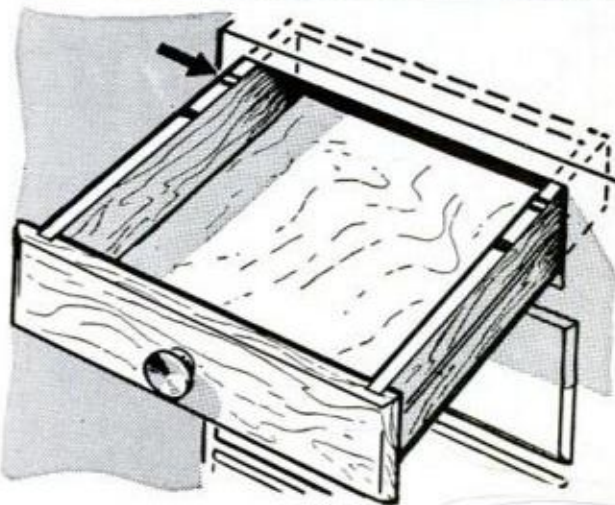

Paint-Can Bib

If you like things clean and neat, then you just can't abide paint smears on the rim of the pail. And it's sure to become coated when in use. This makes it difficult to close the friction cover tightly, unless of course, you take time to shape a protective covering, or bib, of aluminum foil all the way around the rim. This will catch all the drippings, keep the top of the pail as clean as new and also protect the label should you wish to refer to the number when ordering a matching color. Household foil will serve the purpose very well.—*Wayne Floyd*





Santa's Sugarplum House

LITERALLY good enough to eat, this cookie-and-candy house will make an enchanting centerpiece for your Christmas table. Just add a few candle figures—Santa, reindeer or elves—and you have the makings of any youngster's night-before-Christmas dream.

Cut the pieces for the house from heavy, corrugated grocery cartons, following the patterns on the facing page. To prepare both upper and lower stories, score the cardboard along the dotted lines using a

table knife and straightedge. Bend up the four sides of each story and tape them together at the corners. Finish the upper story by taping on the roof support pieces. Then turn the lower story over so that the open side is on the bottom and add the door and windows. These are cut from yellow construction paper. Pencil in all details and cover the windows with pieces of cellophane before attaching them to the house with cellophane tape.

Three kinds of cookies are used in the

DOORS AND WINDOWS of the house are made from yellow construction paper. Details are added with pencil

SUGAR GLUE is used to stick the different kinds of cookie siding to the two boxes making up the house

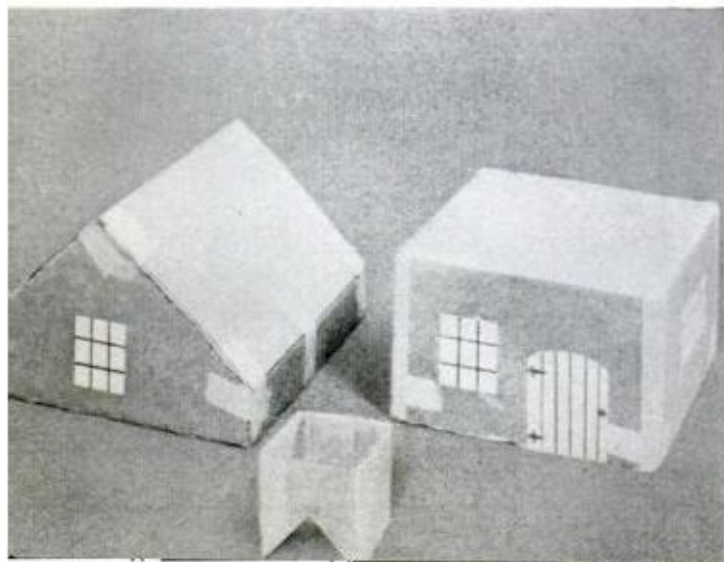

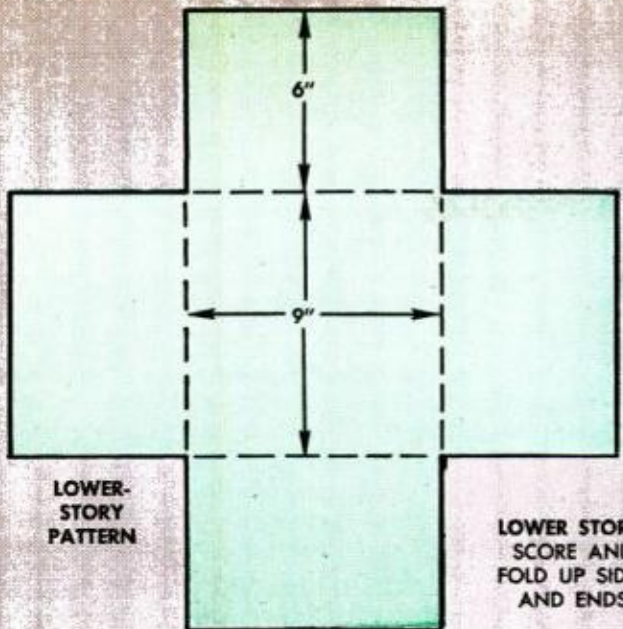

LOWER STORY, SCORE AND FOLD UP SIDES AND ENDS

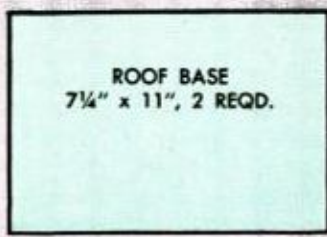
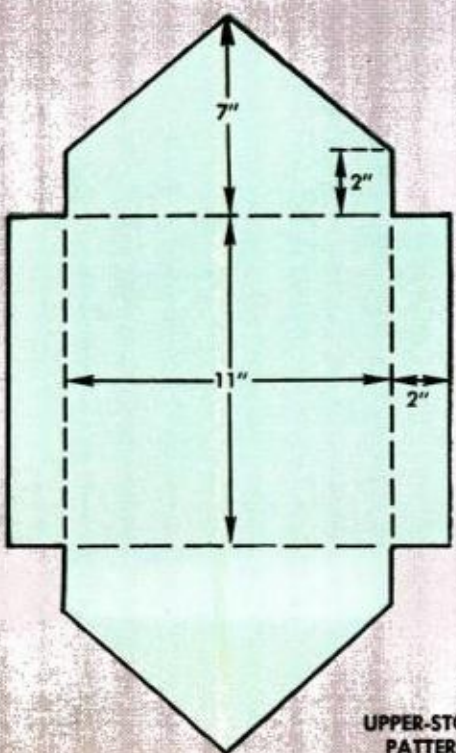
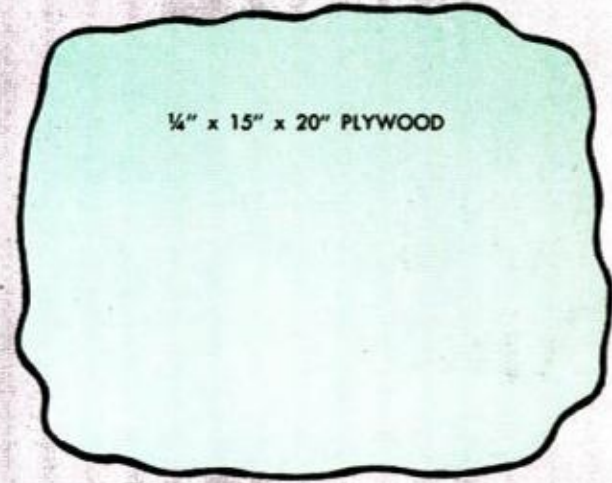
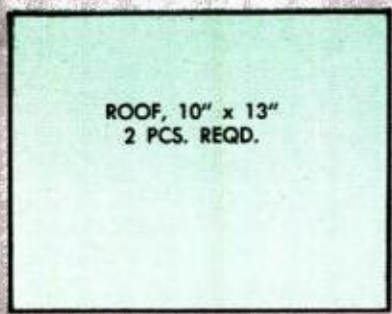
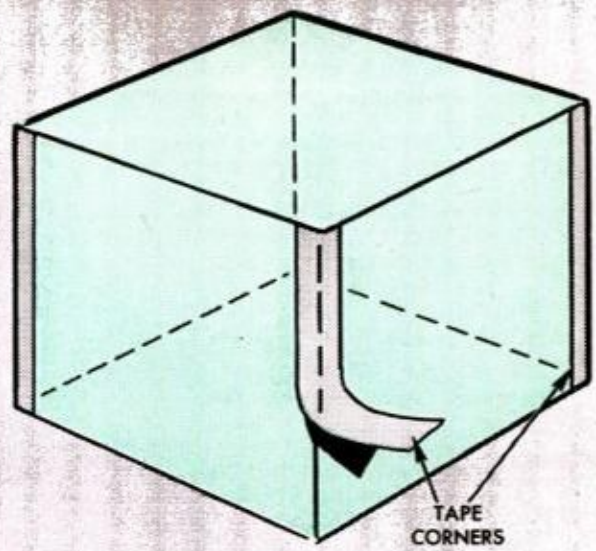

FOLD AND TAPE CORNERS

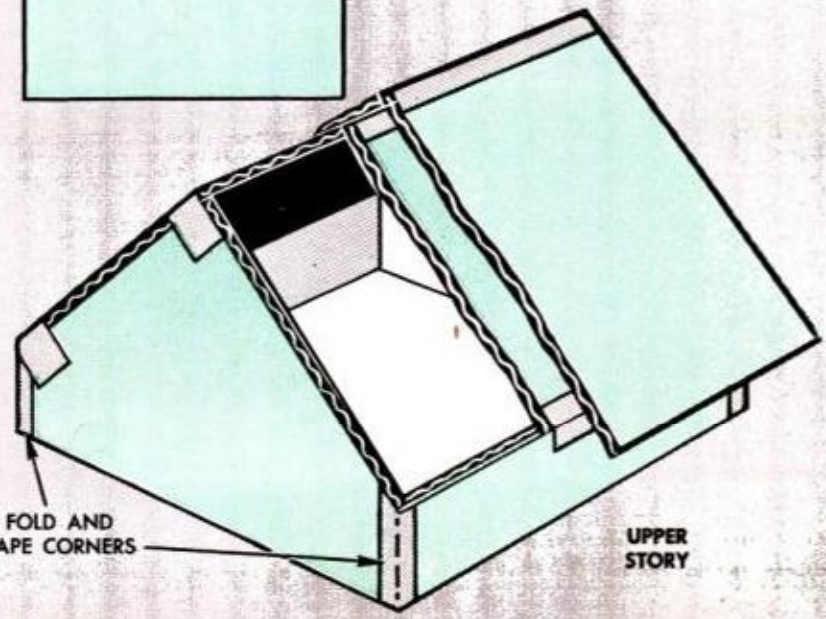

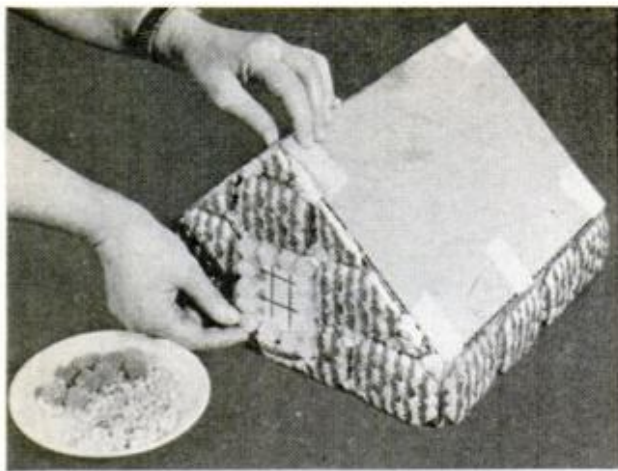

CANDY TRIM should be used lavishly to decorate the house. The windows here are framed with gumdrops, though any other candy can be substituted. Each piece should be stuck in place with a dab of sugar glue

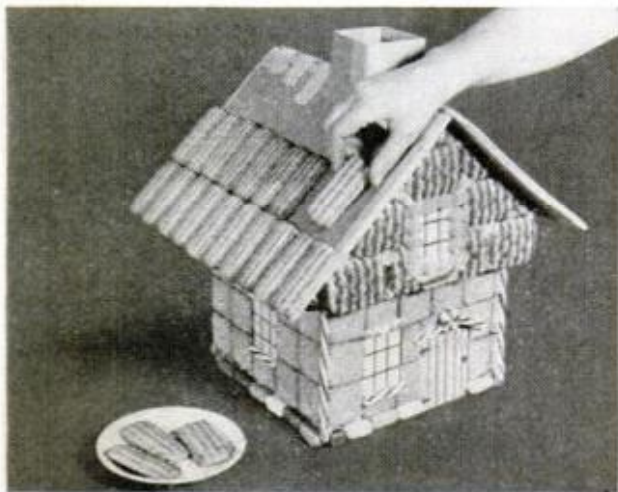

UPPER STORY overlaps the lower story about 1 in. on all sides. After cookie siding has been applied to each, the two are glued together and roof pieces added. The roof is then ready for tiling with cookies

COCONUT SQUARES make excellent chimney bricks, but you may substitute any other square or oblong candies. Leave enough space at the top of the chimney to add a row of lifesavers or other bright-colored candies



house. Siding for the gable ends of the upper story is oblong cookies striped with chocolate. Approximately one pound should be enough for the job. Ribbed coconut bars make fine tiles for the roof. As for the lower story, separate square sandwich cookies, remove the frosting and use the halves individually. When a cookie must be shaped to fit, lay it on a flat surface and trim by pressing straight down with a sharp knife. To stick the cookies to the house use a sugar glue made of one cup powdered sugar and approximately one tablespoon water. Stir this until smooth, but remember that the glue must be stiff.

After covering the sides of the house with cookies, glue the upper story to the lower story. Then glue the two overhanging roof sections to the upper story and attach the chimney. After tiling the roof with ribbed coconut bars, build up the chimney with coconut squares or small square marshmallows and top it off with a colorful row of lifesaver mints. Apply candy decorations with a lavish hand, using whatever type of candies you wish with a dab of sugar glue to hold each piece.

After decorating, glue the bottom of the house to a free-form base cut from $\frac{1}{4}$ -in. plywood and cover the base with cotton. The split-rail fence is made of stick candy.

The fanciful little gnomes pictured with the cottage have pine-cone bodies and colored pipe cleaners for arms and legs. Their heads are balls of cotton covered with crepe paper, and they wear felt hats.

This candy cottage can serve as a centerpiece for children's parties throughout the year by changing the color of the base and using different accessory figures. For instance, cover the base with paper grass and add small bunnies and jelly-bean eggs for an Easter theme.—*Elma Waltner*

LOG FENCE which surrounds the house is made from striped stick candy assembled with sugar glue. As for figures, you may either make the pine-cone gnomes or buy a small Santa and reindeer at the dime store





Christmas Quickies

All three of these novel Christmas-candle holders are made from tall fruit-juice cans. To make the flicker one, you merely remove the top of the can, drill vari-sized holes completely around it and paint. In the case of the glittering angel and the holder with the handle, the seam of the can is left as a "backbone." The angel pattern is cut after the can has been partially cut away and opened up flat. Twist the curls on the ends of the wings as in the photo and bend the narrow strips at the top of the head to form a halo. Finish by spraying gold and decorating with sequins.

The handled holder is made by cutting a $\frac{3}{4}$ -in. strip down the seam to a point $1\frac{3}{4}$ in. from the bottom and cutting away the rest. Vertical slits are made almost to the bottom, then curled with long-nose pliers. Whole thing is painted flat black and handle is wrapped with red yarn.

—A and B Joselyn



DECEMBER 1961

153



New Gift Stickers

Looking for something unusual to decorate your Christmas packages this year? You can make up your own contemporary stick-on figures with a new kit manufactured by the Avery Label Co., Monrovia, Cal. Called "Decoroids," it includes 119 self-adhesive parts in different shapes and colors. Since they require no moistening, you simply peel off the desired shapes and stick them in order on the package. Also included in the kit are gold foil and white felt to use in trimming the figures. The kit sells for about \$2.00



Материал защищенный авторским правом

Add a Boston Rocker

to your Colonial collection. This simplified rocker is one of the easiest chairs to build in your shop

X535

By Frank Hegemeyer



POPULAR MECHANICS

BOSTON ROCKERS have been rocking people for well over 100 years and still offer the comfort of a well designed chair having a pleasing simplicity of line that goes well with modern or traditional furnishings. This one has been purposely simplified in certain details, mainly the seat and the back rail, or headrest, which in the originals had deeply rolled edges.

Dimensions given in the detail drawings are actual sizes of the parts, but those in the material list are oversize to allow for cutting and fitting. Note in Fig. 2 that the seat is made the required width by edge-gluing three pieces, three dowels being used in each joint. It is important that the boards be arranged for gluing with the heart and sap faces alternating. After the glue is dry plane the piece to a uniform thickness of $1\frac{1}{8}$ in., working both sides. Bring to the width dimensions given in Fig. 3, then lay out the locations of the holes taking the leg tenons as in Fig. 2.

Now note especially the legends on Figs. 2 and 3, and also the dotted lines referred to as swing lines. Note especially how these lines are positioned on both drawings, and that the abbreviations R.T. and L.T. mean right tilt and left tilt respectively. Now look at the setup in Fig. 1 and you'll see how all this works out in locating and drilling the holes for the legs at the proper angles. You need an auxiliary drilling table which is cut from $\frac{3}{4}$ -in. stock, measuring about 8 in. wide and 30 in. long. A line is scribed along the center line of the table to serve as an alignment line to which the swing lines are set. Now clamp the auxiliary table to the regular drill-press table

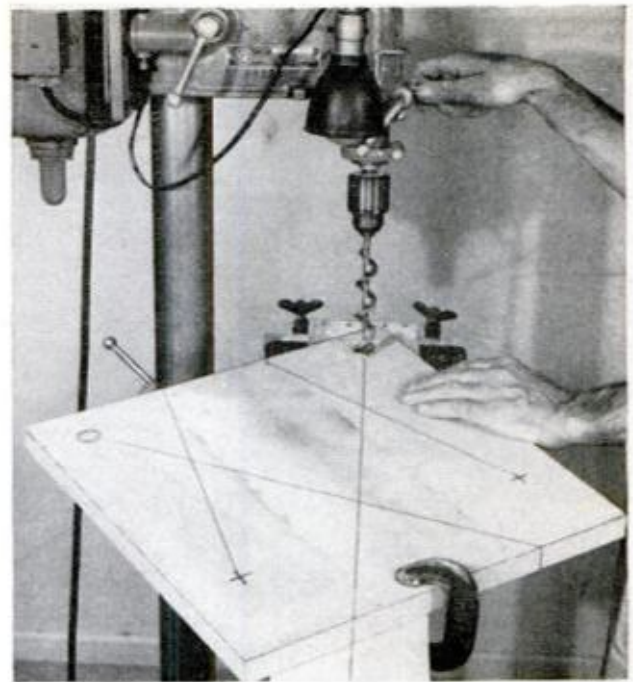

1. SETUP for drilling leg holes in chair seat at compound angles. Method saves hours of layout time

MATERIAL LIST

No. pcs.	Size (all dimensions in inches)	Parts
3	$1\frac{1}{4} \times 6\frac{3}{4} \times 18\frac{1}{4}$	seat
1	$2 \times 2 \times 21\frac{1}{2}$	roll edge
1	$1\frac{1}{2} \times 1\frac{1}{2} \times 12$	front legs
1	$1\frac{1}{2} \times 1\frac{1}{2} \times 11$	rear legs
1	$1\frac{1}{2} \times 1\frac{1}{2} \times 17$	front rung
1	$1\frac{1}{2} \times 1\frac{1}{2} \times 15\frac{1}{2}$	rear rung
1	$1\frac{1}{2} \times 1\frac{1}{2} \times 15$	side rungs
2	$2 \times 2 \times 14$	arms
1	$1\frac{1}{2} \times 1\frac{1}{2} \times 12\frac{1}{2}$	arm posts
1	$1 \times 1 \times 11\frac{1}{4}$	arm spindles
1	$1 \times 1 \times 11$	arm spindles
1	$1\frac{1}{2} \times 1\frac{1}{2} \times 26\frac{1}{4}$	back posts
3	$\frac{3}{4} \times \frac{3}{4} \times 26$	back spindles
3	$\frac{3}{4} \times \frac{3}{4} \times 25$	back spindles
1	$3 \times 4 \times 24$	back rail
1	$\frac{3}{4} \times 6 \times 29\frac{1}{2}$	rockers

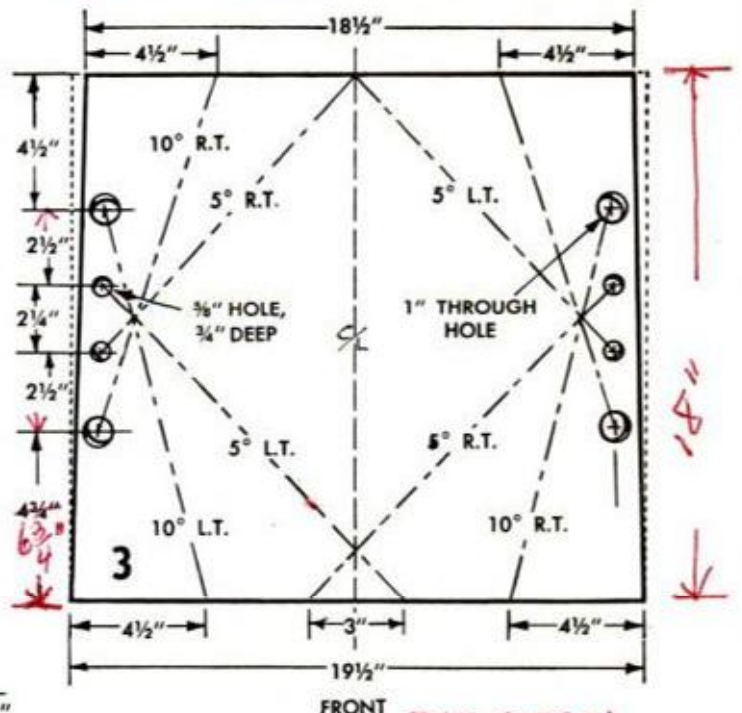
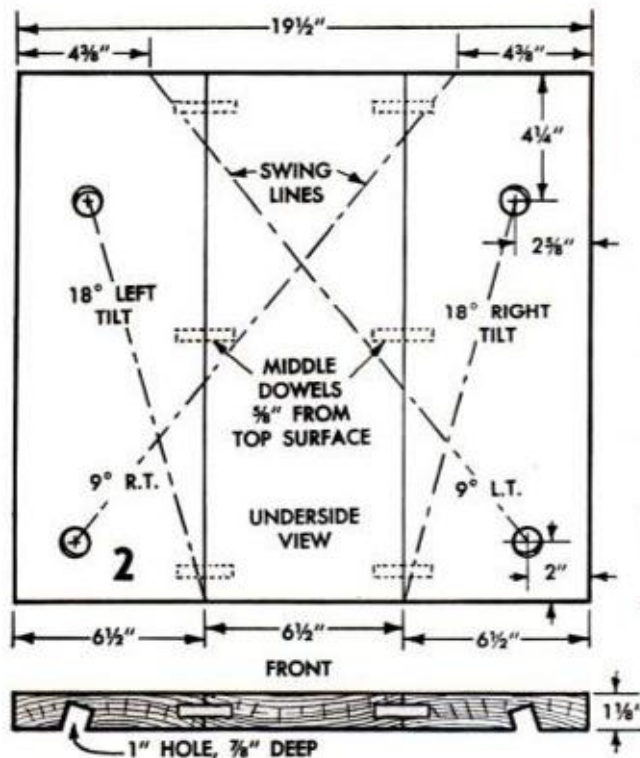

THE HOLES IN FIG. 3 ARE $\frac{3}{4}$ " FROM THE SIDES OF THE SEAT.

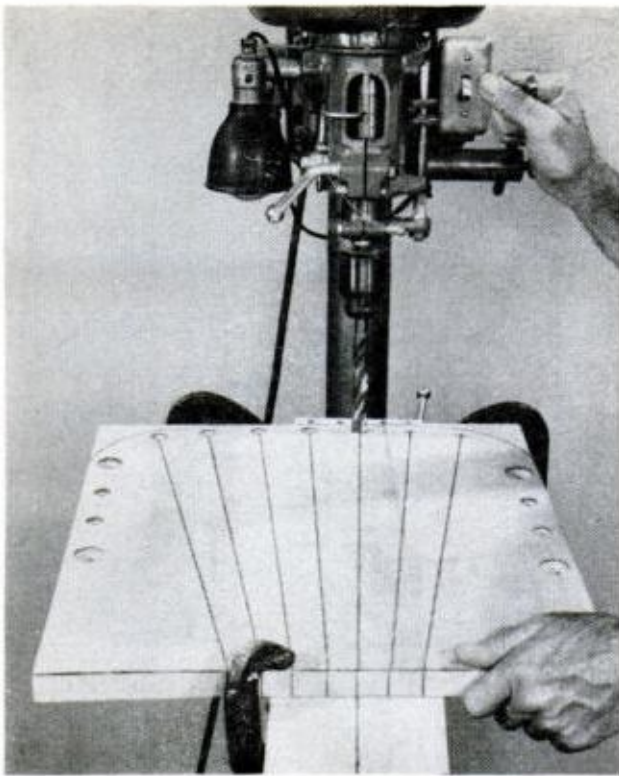

4. SETUP for drilling holes in seat for back posts and spindles. Compare with Fig. 1 and note similarity

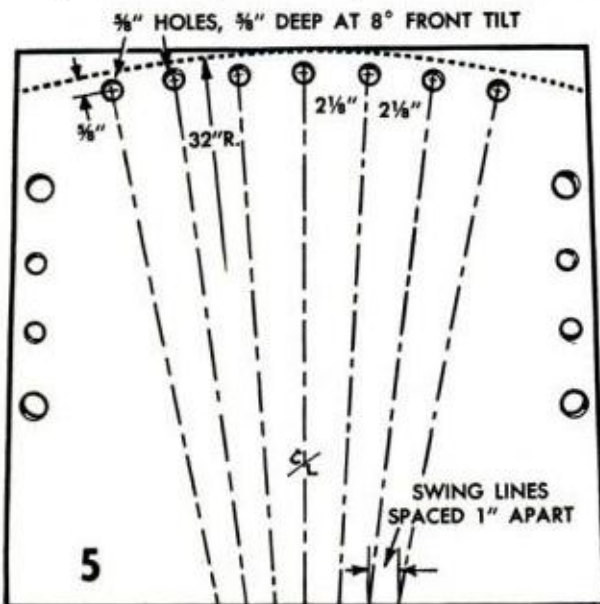

7. RECESSING of chair seat can be done with hand scraper, using wide gouge for deepest cuts at center

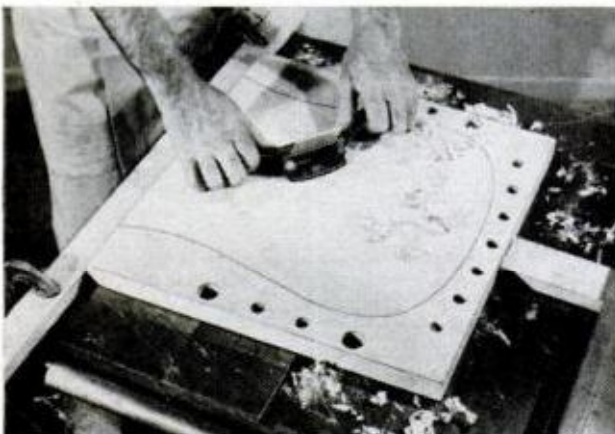

with the alignment line directly below the center of the bit. For a left tilt the free end of the auxiliary table extends to the left; for a right tilt, to the right, the drill-press table being tilted to 9 degrees and 18 degrees right and left as in Fig. 2. This method greatly simplifies the drilling of the holes at compound angles. In the actual drilling you simply clamp the chair seat to the auxiliary table with the swing line directly under the center of the bit and in alignment with the center line on the auxiliary table as in Fig. 1. Proceed in the same fashion when laying off and drilling the holes for the arm posts and spindles, Fig. 3. Note that these holes are drilled clear through while those for the legs are drilled only to a depth of $\frac{7}{8}$ in.

Use the same general procedure when drilling the holes for the back, Figs. 4 and 5, except arrange the auxiliary table for an 8-degree front tilt by nailing a cleat to the rear end as in Fig. 15, the lower detail. These holes are drilled clear through. Next step is

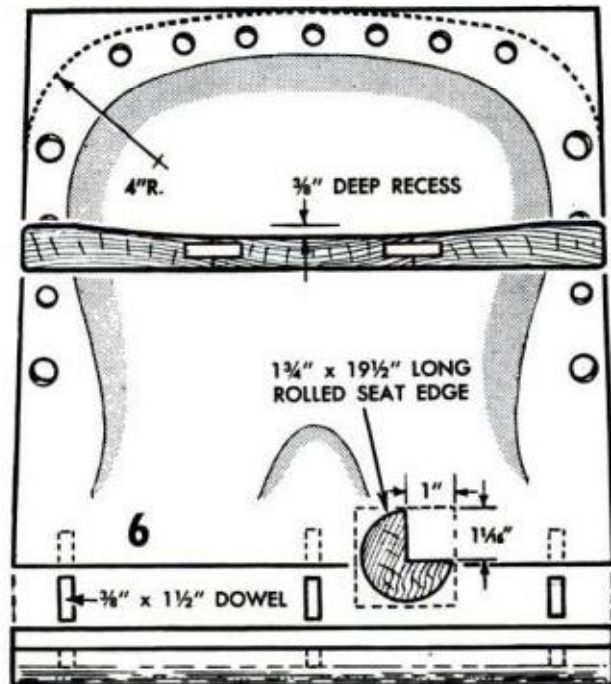

8. SEAT EDGING is doweled and glued in place. Use three bar clamps and be sure part is uniformly seated

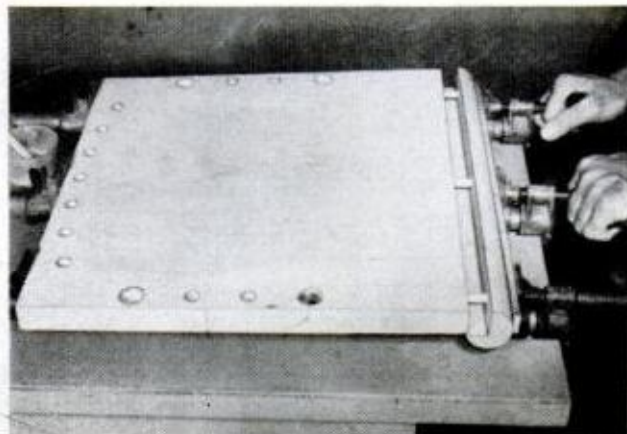

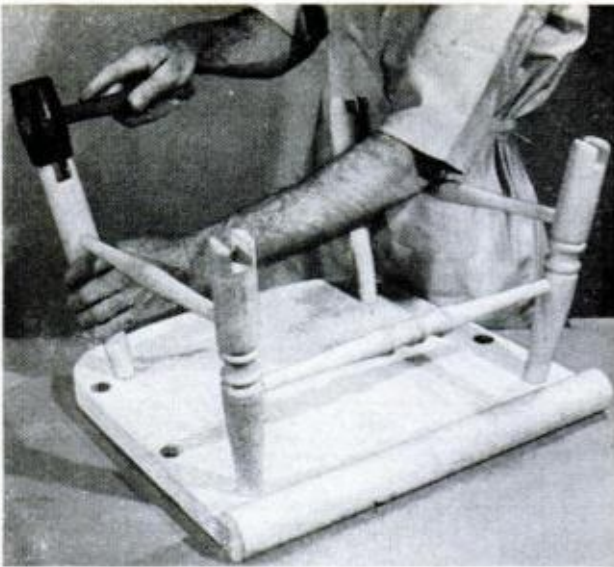

10. MAKE TRIAL assembly of all parts, beginning with legs and rungs. Top parts in place with soft mallet

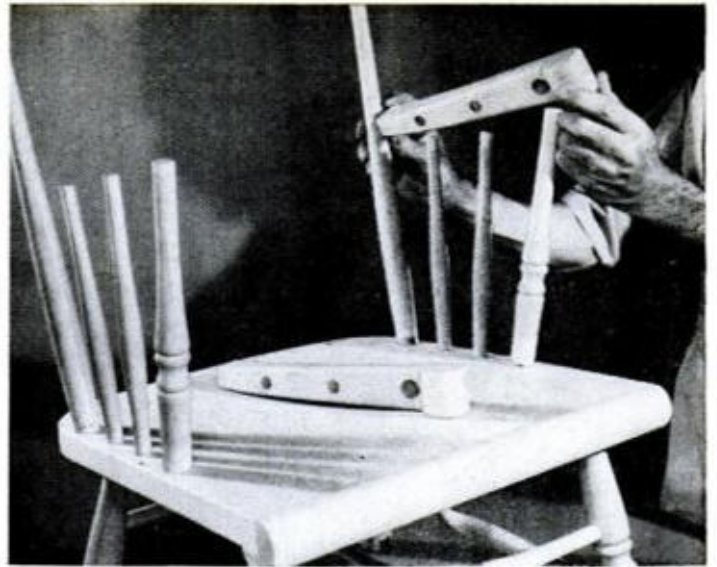

11. TRIAL ASSEMBLY of arms, posts and spindles is necessary to catch any inaccuracies before gluing

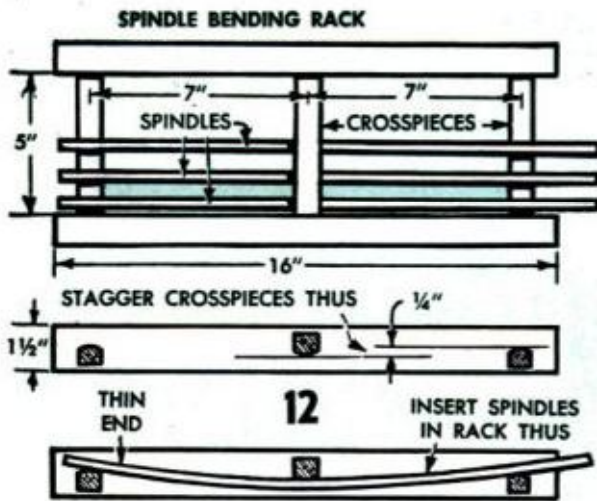

13. BACK SPINDLES are bent in this jig which is detailed in Fig. 12. Spindles should be of selected, straight-grained stock and should be soaked overnight in water before bending. Cut to length before bending

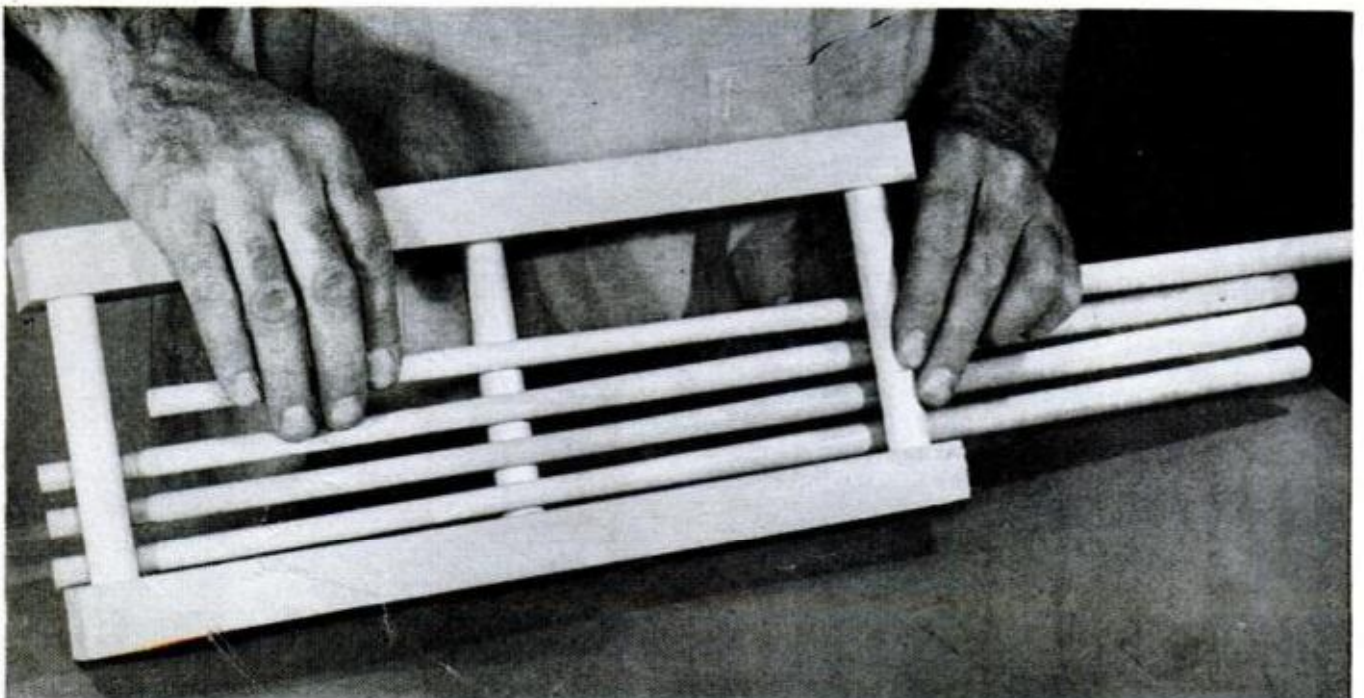

to recess the seat top as in Figs. 6 and 7 and fit the rolled seat edge as in Figs. 6 and 8. To make the roll you start with a 2-in. square and cut a rabbet on one corner as in the end view, Fig. 6. A pine filler strip is fitted in the rabbet and held with screws driven in the waste just beyond the cutoff point at each end. After the stock is turned into round and the waste cut off at each end, the filler strip is removed.

Next you cut the back rail and arms to contour as in details A and H in Fig. 9. The back rail is sawed to curvature from solid stock as in Fig. 15 and the holes for the posts and spindles are drilled as detailed. Drill four holes in each of the arms for post and spindles and note especially how the



concavity is formed in the small end of each arm for the post, Fig. 9, detail H.

Next you turn the legs, C and D, Fig. 9, from $1\frac{3}{4}$ -in. squares. Slot one end of each leg to take the rocker and fit a plywood pad as in detail C to take the lathe center. This done you continue making the turnings for arm and back posts and spindles, parts I through N in Fig. 9. The long back spindles are only tapered and can be made by hand from $\frac{5}{8}$ -in. dowels. All others must be turned in the lathe. You'll need a steady

(Continued to page 204)



14. BENT SPINDLES must be correctly positioned before gluing in place. Once spindles have been correctly located make registering marks on the parts

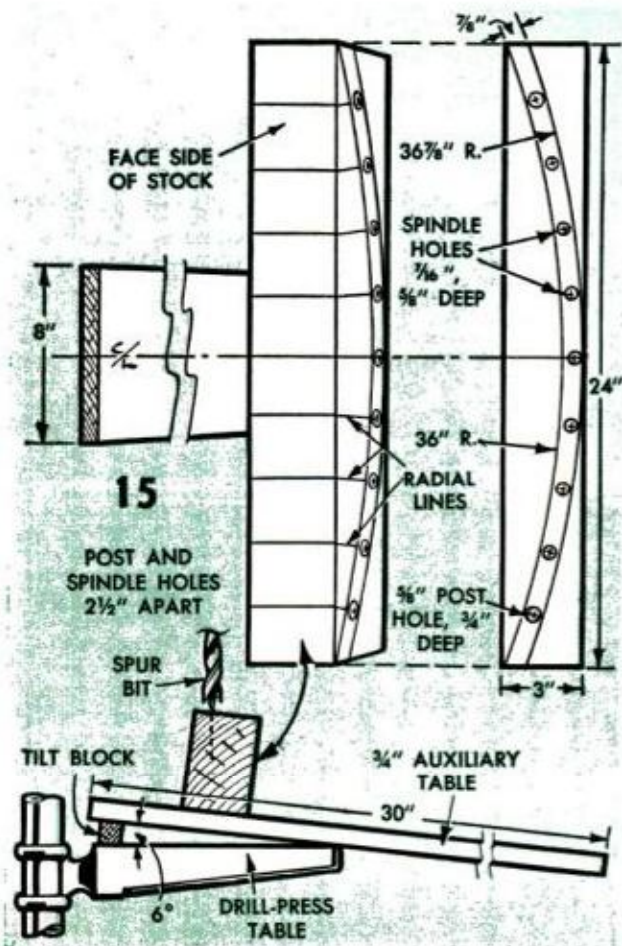

16. ROCKERS must be a snug fit in slots before being glued and pinned in place. Some hand fitting with a rasp may be necessary here. Note use of soft mallet



TOASTER

X711

Household

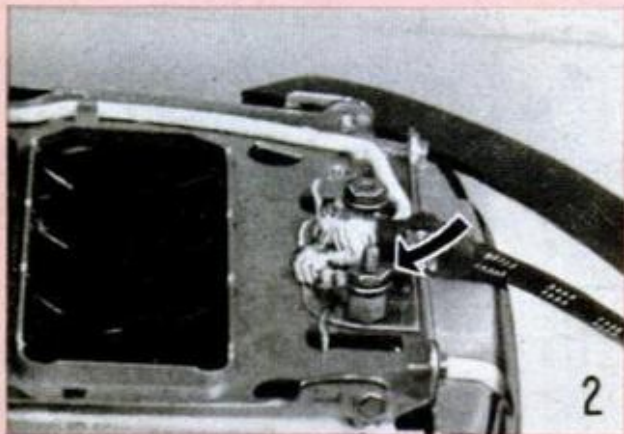
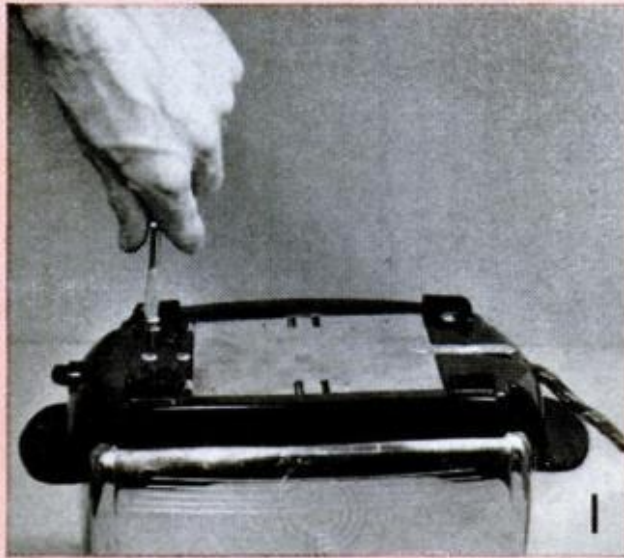

LIKE SO MANY other home appliances that operate electrically your automatic toaster can take it daily for years and then, without much of any warning, there's the morning when you go without that tasty, browned toast. The toaster simply quits and that's it. Unless, of course, you know how to fix it.

All good toasters, automatic or not, are pretty tough gadgets and quite simple in construction and assembly, but there are certain parts that just won't take careless, rough handling or poking with a screwdriver, so take it easy when you turn a toaster upside down and begin taking things apart. Or maybe you don't turn it upside down; some toasters come apart right side up. Find out before you pull or pry too hard on something you think should come loose.

First of all, open or pull out the crumb tray and brush out everything reachable with a small brush, Fig. 4. When you get the bottom off, Fig. 1, take a close look at the terminals; the arrow in Fig. 2 shows these on a typical automatic toaster. Check closely for looseness of the terminal nuts and eye every inch of the wires for frayed insulation. In order to get at the operating mechanism and elements you generally have to remove the outer shell. On the toaster pictured you do this with a wrench on small nuts or screws at the corners, Fig. 3. Again the caution—take it easy on the wrench!

When you get the outer protective shell, or housing, off you'll likely see something

Appliance Fix-It File

like that pictured in Fig. 5, with the arrow pointing out the thermostat and the mechanism that controls the length of the toasting cycle. These are the critical operative parts and they should be examined closely for any defects. Usually you'll find the points coated with a carbonlike deposit and possibly rather deeply pitted. If you see the latter condition, it probably will be advisable to replace the entire control unit. Otherwise, a thorough cleaning and a light (very light) touch of fine sandpaper on the points may restore them to working condition, at least for a time.

Heating elements can become weak with age before they actually burn out and quit for good. Look them over carefully; replacement of any that appear doubtful will pay off in the end for if any or all of them are nearing the end of a useful life, they are likely to go at any time. Loosen the electrical connections to the elements first, then loosen the screws that hold the elements as in Fig. 6. Be careful not to damage hex heads, strip threads or bend any parts in this operation. Replace new elements in reverse order. While you have the toaster apart, clean everything thoroughly before reassembling in the reverse order.

One other thought, and it applies to any appliance you may already have or are planning to purchase: Always save the instruction sheet, parts list and any other informative material that may come with the appliance. File where it is easily located when needed.

—John Pennington

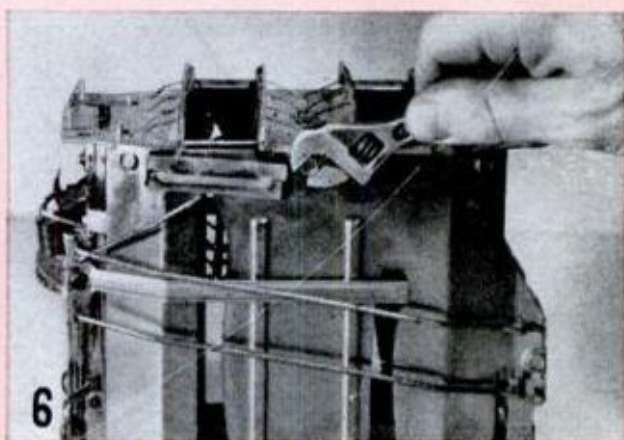
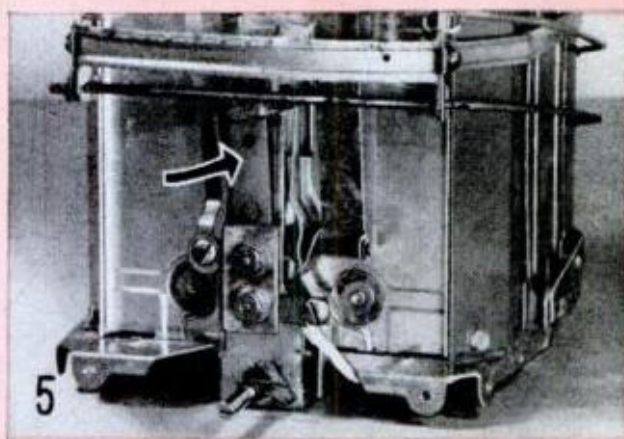

X284A



Hood for a Fireplace

MODERN FIREPLACE walls often pose problems for home decorators, especially when the wall expanse is relatively large. For such walls a fireplace hood of a simple design usually proves to be the answer. Not only does it introduce certain decorative values in both line and proportion, but a hood can serve a functional purpose as well in helping to offset any tendency of the fireplace to smoke when draft conditions and temperatures vary.

Instead of metal, this hood is made of $\frac{1}{4}$ -in. asbestos-cement board, a tough, durable, fire-safe material available from any

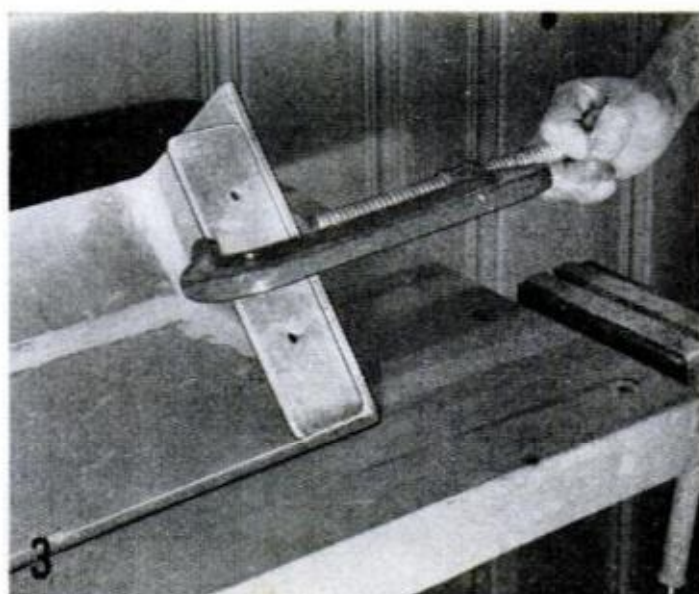
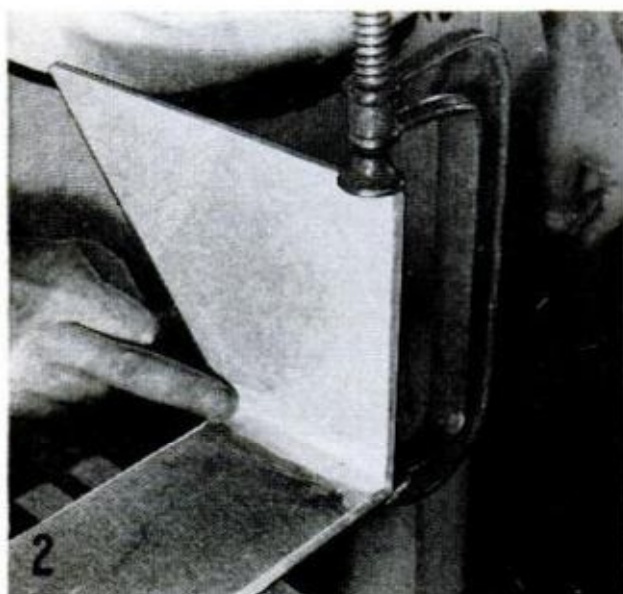
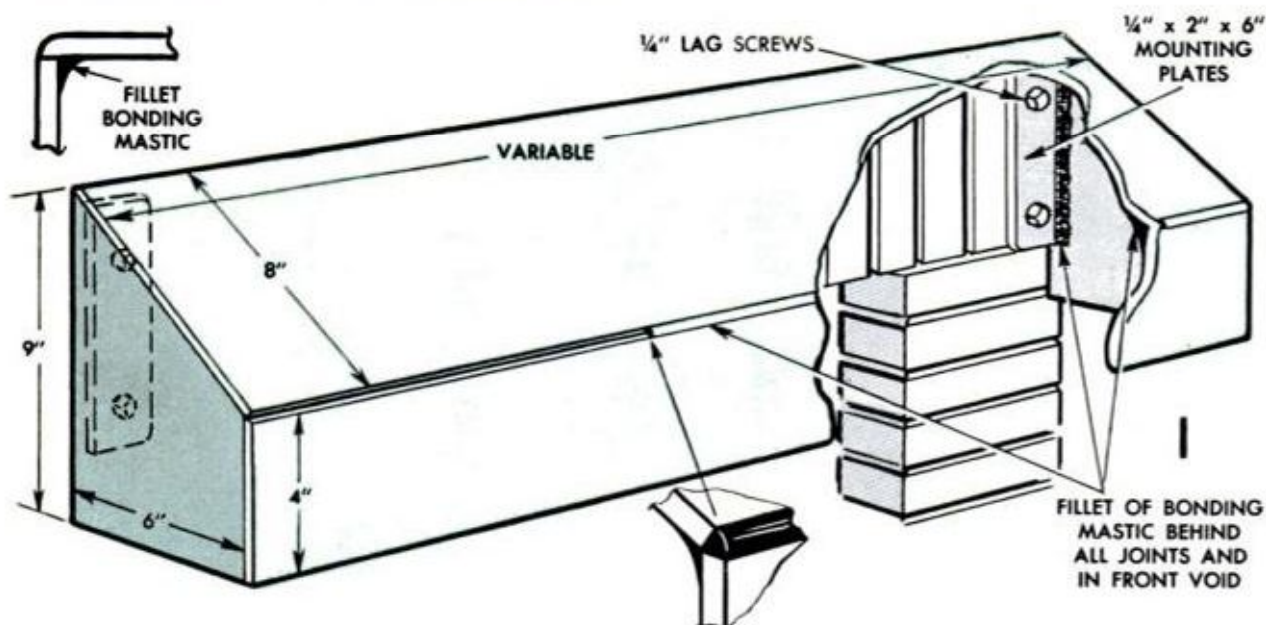

building materials dealer. You will require about six square feet for the average fireplace. The board can be cut with an ordinary hand saw or with an abrasive wheel on a power saw. After you have cut the six pieces to size, square and smooth all the edges with a file, then drill two $\frac{1}{4}$ -in. holes in each of the asbestos-board mounting plates Figs. 1 and 3. Clamp the end pieces to the front panel and make sure the assembly is square. Then join by building up a fillet of epoxy cement at each joint, using your finger to get a good spread on both surfaces, Fig. 2. Don't apply the cement to the area of contact as you do with other adhesives. It's the built up fillet that makes the bond. Hold the top panel in place with strips of transparent tape and fill the V-shaped gap where it meets the front panel with epoxy to finish it off, Fig. 1. Turn the hood upside down and form fillets of mastic along the other joints. Now put it aside until the epoxy sets which usually takes about five hours. No heat or pressure are necessary and when dry, the pieces are permanently bonded together. Round the front edges with a file and go over the hood with fine sandpaper.

You will have your own ideas about matching finish and trim. The hood pictured was given two coats of dull black lacquer, the type available in a pressure can, and decorated with wood-fibre trimmings attached with epoxy and painted gold color. With a star drill make two holes in the masonry on each side of the fireplace opening, Fig. 4, insert expansion plugs or lead anchors and fasten the hood in place with four lag screws.

In working with epoxy cements mix only the amount needed since once the hardener is added to the mastic any left over cannot be reused. When cured epoxy cement becomes as hard as stone.—*Robert E. Russell*



DECEMBER 1961



Wax Coatings Prevent Rust

Where applications of oil or grease are undesirable, rust can be prevented on bright metal surfaces by coating with melted paraffin or paste wax, whichever material is most convenient to apply. Clean the object or surface to be protected, then brush on melted paraffin or coat with paste-wax, making sure that all the surface is covered.—*R. Hanscom*

Pour Without Spilling

Measuring liquids almost to the drop without waste is no problem when you can control the air intake into the container. Drill two holes in the metal screw cap and solder in two short lengths of tubing as indicated. The $\frac{1}{8}$ -in. tube is $2\frac{1}{2}$ in. long and bent as indicated. A finger over the end of this tube controls the amount you pour. The other tube is $1\frac{1}{2}$ in. long and serves as the spout.—*Walter Fehlberg*

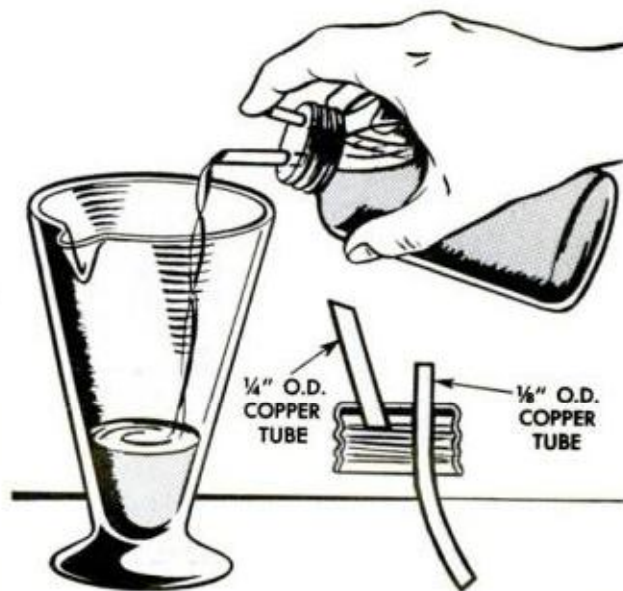

X474A

CAPACITOR

By Frank P. Fritz

PM's Chief Photographer



COMPONENTS can be installed in any size box to fit camera or special needs. The box can be mounted directly on the camera, above, or on a bracket, below

WITH A SPEED GRAPHIC, you may attach the box to the bottom of the camera and the reflector to the top, so the whole unit can easily be mounted on a tripod

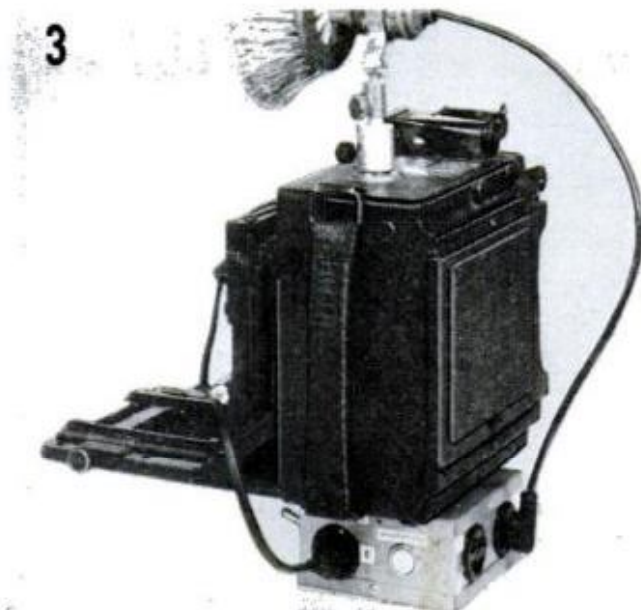

FLASH BOX

MANY SHUTTERBUGS have synchronized or solenoid-operated flash cameras but either don't own flash guns or else have guns which are only powerful enough to fire one flash bulb at a time.

This low-cost, battery-capacitor flash box will fire several flash lamps simultaneously from a synchronized shutter or trip solenoids without flash and even some with flash (i.e., Heiland). It also saves bulbs because if the circuit is broken by the absence of a bulb in one flash lamp, a bad lamp or a switch in the "off" position, none of the lamps will fire. The box houses a 22½-volt battery with a capacitor in an R-C circuit, and the battery will last a year or more, depending on its use.

The flash box either can be mounted on the bottom of the camera, Figs. 1, 3 and 5, or on a bracket attached to the camera, Figs. 2 and 4. By mounting a socket and reflector directly on the camera or on the box, you have a simple one-lamp flash gun. You can obtain the mounting stud from any store which carries Graflex accessories.

For natural lighting or studio effects, all flash lamps may be located remote from the camera. However, when you use more than two lamps with a sync shutter you must plug them into a series-wired double socket formed by wiring two female plugs and one male plug together in series. A common double socket is wired in parallel and thus cannot be used, nor can side-light flash guns not wired for B-C.

The box can be any size, Figs. 6 and 7,

DIMENSIONS OF BOX and layout of components within the box will depend on personal requirements. The two shown here, below and below-right, are examples



IF YOU WISH to take color and black-and-white shots simultaneously, you can mount a second camera on a bar connected to the first and attach box between



SOLENOID IS BEING USED when box is mounted on the base of an old model Rolleflex. If additional side lights are desired, they may be connected through box

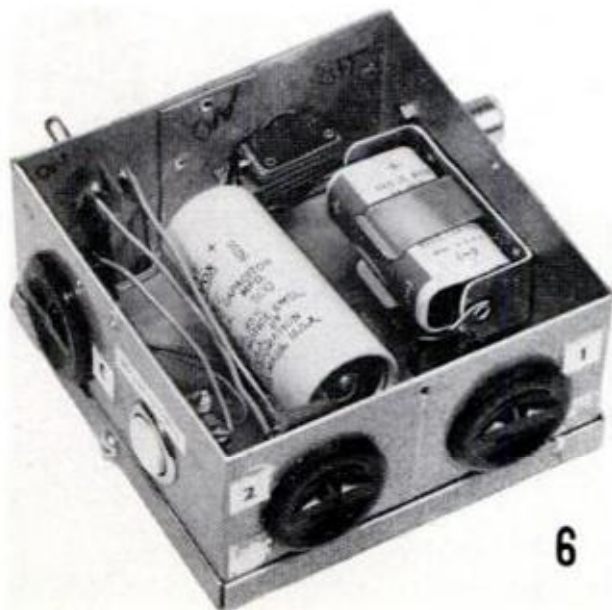

DECEMBER 1961

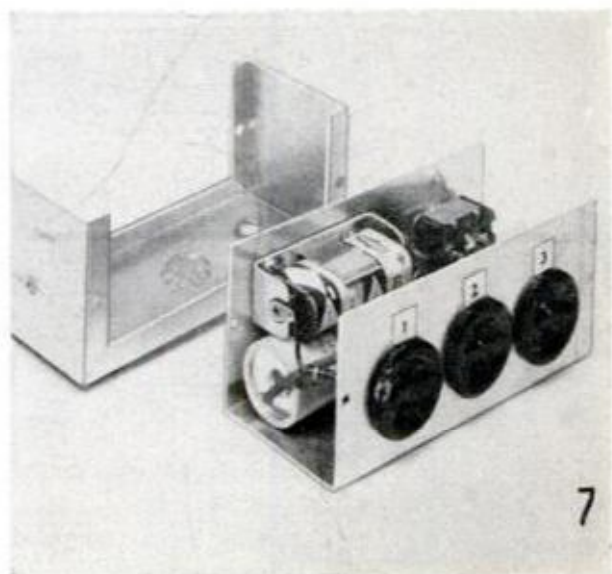

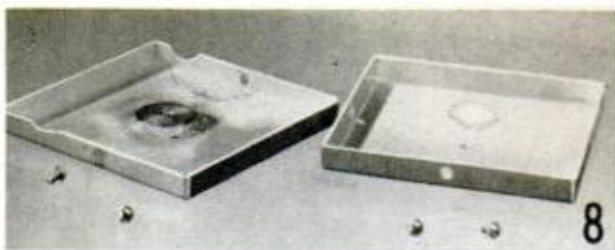

TOP AND BOTTOM of the flash box, above, contain tapped holes for the tripod screw and camera mount

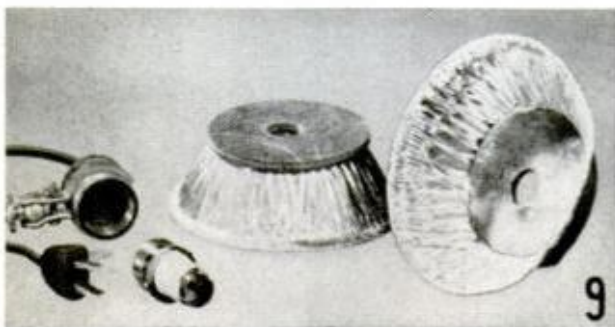

POT-PIE REFLECTORS, above and below, right, will help to reduce "hot spots." The commercial reflector, below-left, is wired in parallel and cannot be used in series setups where more than one flash lamp is desired. On such occasions, use pot-pie reflectors



PICTORIAL WIRING DIAGRAM

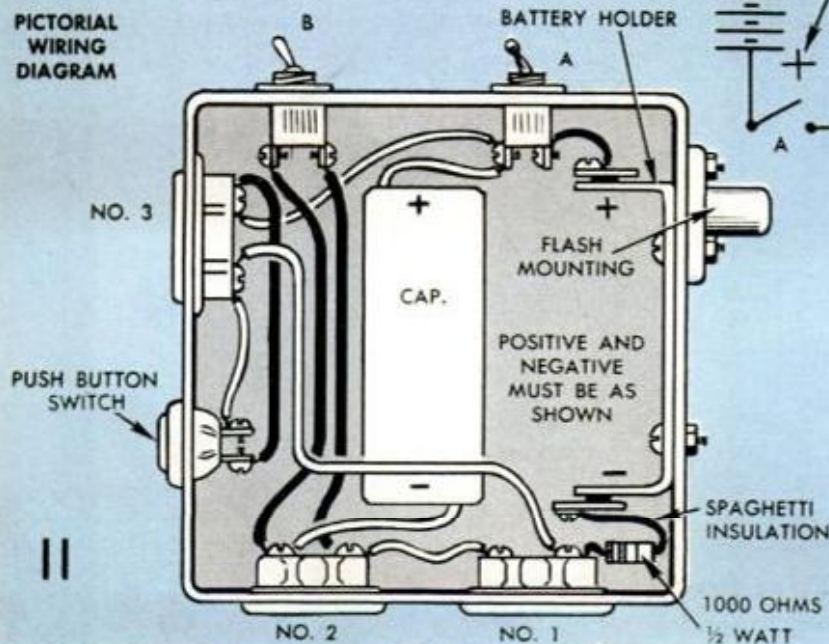

but holes for the flush-mounted Amphenol female plugs should be made by your radio serviceman who has the proper tools for a neat job. Follow the wiring diagram carefully, Fig. 11, adding the capacitor last to avoid possible damage from the soldering gun. To provide for tripod mounting, solder a small aluminum plate inside the bottom using liquid aluminum solder, Fig. 8. Drill and tap a hole for the $\frac{1}{4}$ -20 tripod screw and another hole in the top of the box for the $\frac{1}{4}$ -20 camera mounting screw.

To make a pendant push-button switch for tripping the solenoid from a distance, press a standard flush-mounted push button in the end of a short section of pre-drilled broom handle, draw the wire through and add a male plug on the end.

The "hot spots" so common when ordinary flash reflectors are used with a wide-angle lens can be reduced by using homemade reflectors, Figs 9. and 10. Cut a hole large enough for the socket of a mid-geet flash-bulb adapter in the center of a small foil pie pan. Then cut a hardboard disk to fit the bottom of the pan, drill a hole for the adapter socket and glue the disk to the bottom of the pan. Insert the adapter in an ordinary light socket and attach it to a bracket or ball-clamp mounting. Finally, wrap the outside of the adapter with masking tape to insure a tight fit and push it into the hole in the pie pan. A slight increase in exposure may be necessary when using the reflector. ★ ★ ★

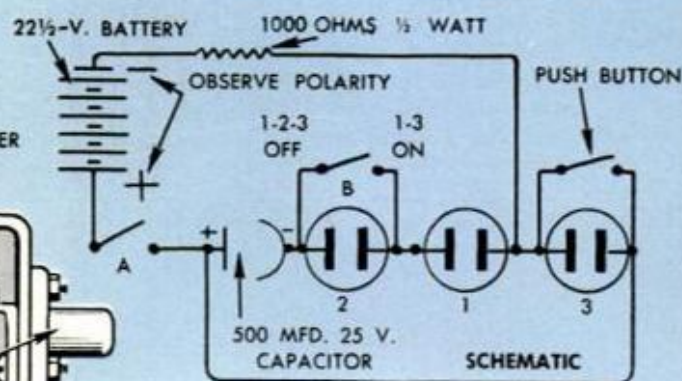

LEGEND

- A—POWER SWITCH
- B—CONTROL SWITCH
- 1—FLASH OR SOLENOID PLUG
- 2—FLASH PLUG
- 3—PUSH BUTTON OR SYNC. SHUTTER CORD

CONTROL SWITCH

- OFF — USE ALL PLUGS, 1, 2 & 3
- ON — USE ONLY PLUG 1 WITH PLUG 3 TO SHUTTER OR PUSH BUTTON FOR SOLENOID USE

NEW FOR SHUTTERBUGS NEW

1. TURNABOUT POLE SCREEN becomes charming decorator planter when not in use. Installs anywhere, adjusts up to 9-ft. ceilings. Screen stores vertically behind planter panel. Standard 40 x 40-in. screen, complete with flowerpots and spring tension pole, retails at \$26.95 from Da-Lite Screen Co., Warsaw, Ind.



2. STAK-PAK SLIDE FILE is an inexpensive plastic container for storing three individual trays. Several units may be stacked and held securely by an interlocking device that makes it possible to remove individual trays without disturbing others. Tray unit sells for about \$4.00. Ansco, Binghamton, N. Y.

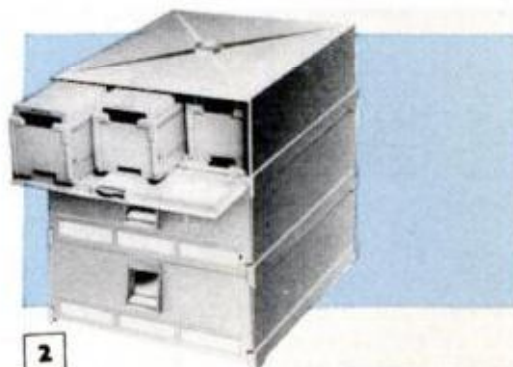

3. CLEANING AND FINISHING pad of nonwoven nylon makes it easy to keep studio and darkroom equipment clean. Use one on that dingy reflector or stained tray. Scotch-brite pads may be used with hot water and detergents and then rinsed for re-use. Made by Minnesota Mining and Mfg. Co., St. Paul 6, Minn.



4. REMOTE TELE-SONIC 8-mm. projector permits you to sit back and enjoy home movies. With the hand-held wireless control, user can start, stop and reverse image on the screen from as far away as 40 ft. Control is no bigger than a nickel candy bar. Bell & Howell, 7100 McCormick Rd., Chicago 45, Ill.

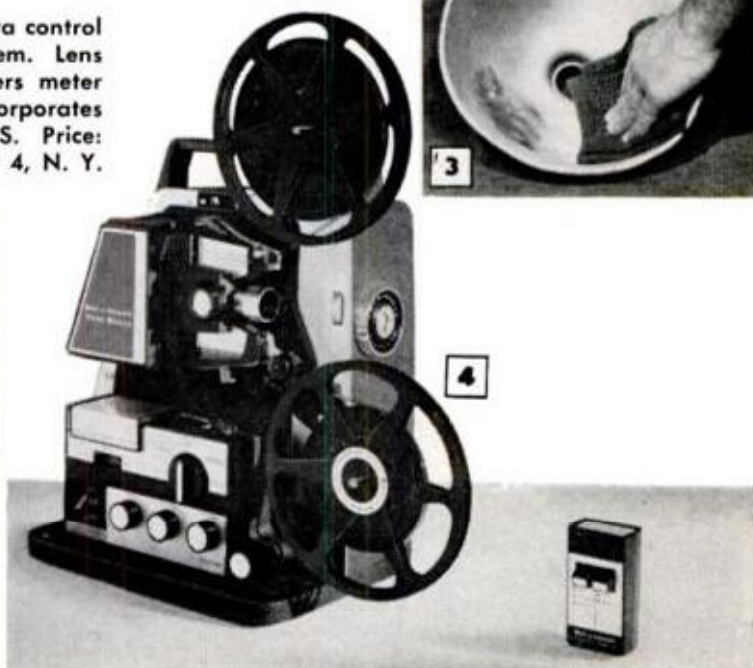

5. RETINA REFLEX III offers complete camera control with the dual photo-electric exposure system. Lens opening is set automatically as user centers meter needle in view-finder brackets. Model incorporates all other basic features of Retina Reflex S. Price: about \$215. Eastman Kodak Co., Rochester 4, N. Y.



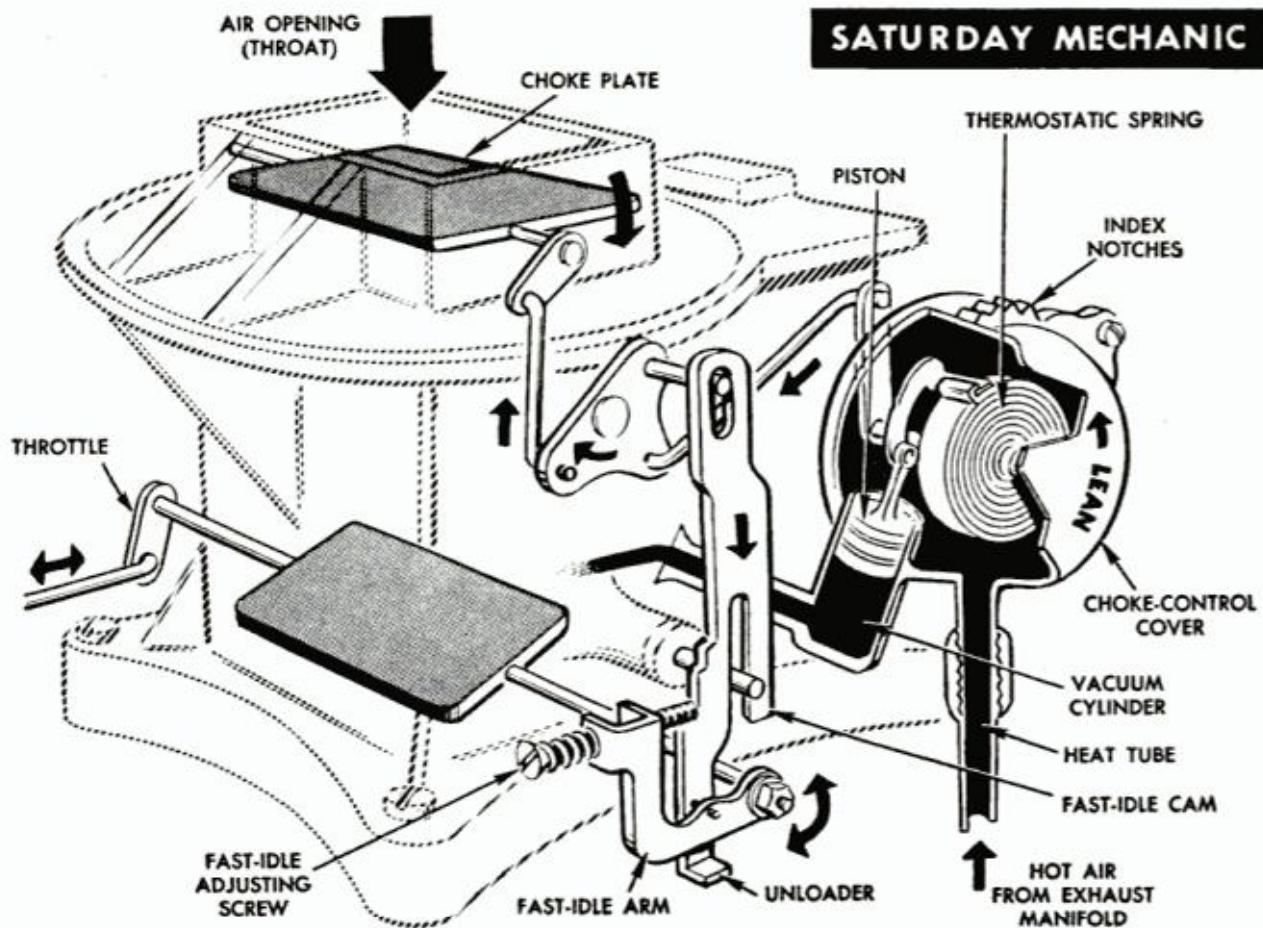

All About Automatic Chokes

By Morton J. Schultz

CAUSES OF hard starting, flooding, and poor gas mileage are sometimes traced to your car's automatic choke, a simple mechanical device which is in operation every time you start your car, winter, summer and in-between seasons. When it's working properly, and it usually is, it varies the fuel-air mixture according to engine temperature.

The three views in Fig. 1 and 2 show

how the choke mechanism operates the choke plate. In starting a cold engine the choke plate is closed, Fig. 1, causing a rich fuel mixture to enter the engine. As soon as the engine starts, the choke plate moves to the half open position.

As the engine warms up, the choke plate continues to open and when the engine reaches normal operating temperature it is fully open as in Fig. 2.

1. CHOKE PLATE, shown here in closed and half-open positions, is typical of those in common types of carburetors. Choke-plate positions control amount of gasoline in fuel mixture, varying from rich to lean

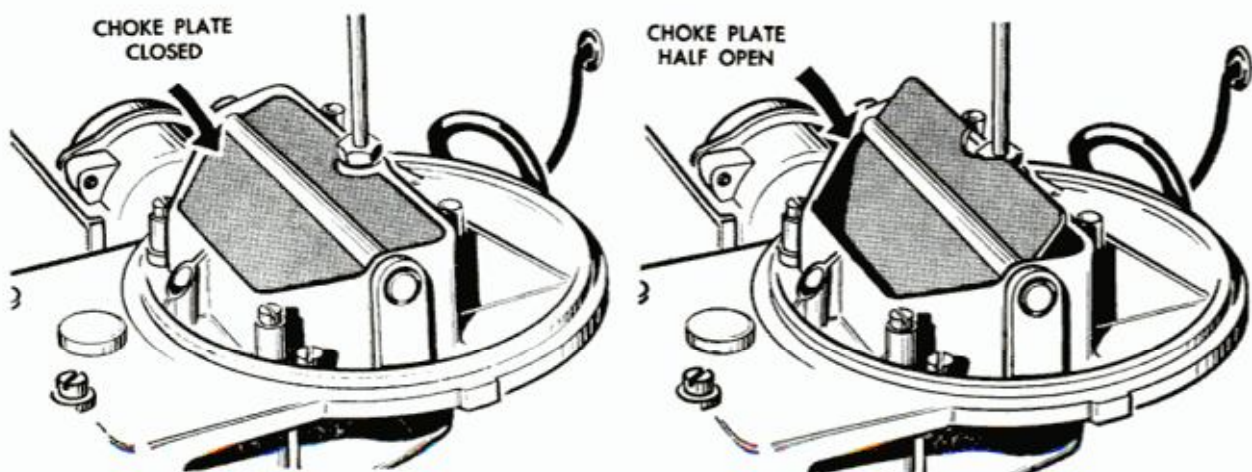

This is the general procedure carried out by the automatic choke and here's how it does its job: the cutaway drawing of a typical automatic-choke device on the opposite page will help in understanding its operation. In warm weather the engine probably will start simply by turning on the ignition and kicking the starter switch. But this isn't good practice, especially with late-model cars. If you drive under average conditions, it's well to form the habit of depressing the accelerator pedal once before starting. This action, which is recommended by many car manufacturers, does three things simultaneously, trips the fast-idle cam, closes the choke plate and primes the carburetor.

Choke-Control Piston

As the engine catches, intake-manifold vacuum pulls the choke-control piston downward (note the cutaway) causing the choke plate to open partially. Hot air from the exhaust manifold enters the choke-control unit through the heat tube, causing the thermostatic spring to lose tension as the engine warms up.

And that isn't all. The choke-control piston also assists in opening of the choke plate. It helps to pull the thermostatic spring down as the spring loses tension and, as it moves, it uncovers heat bypass slots permitting more heat from the manifold to enter the choke control unit and affect the

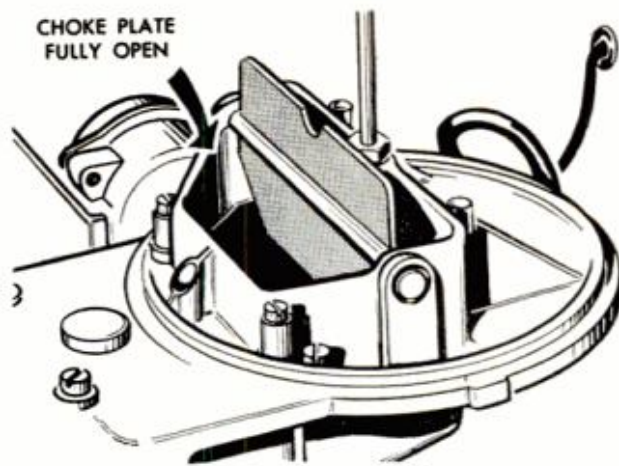

2. CHOKE PLATE in wide-open position, reached only after engine is at or near operating temperature



CHOKE OPERATION

PROBLEM	CAUSE	FIX
Hard starting when cold.	Choke not closed.	Depress accelerator once before starting engine. This trips the fast-idle cam, closes the choke, and primes the carburetor.
Hard starting when hot.	Depressing or pumping accelerator when engine is hot. This loads intake manifold with raw gas and closes the choke, leading to flooding.	Hot engine should start immediately without pumping. If not, check functioning of choke control unit and plate.
Flooding.	Using accelerator too enthusiastically when starting.	Dump over-rich mixture from manifold by bringing unloader into play. Depress accelerator to floor and hold it there while turning engine over.
Poor gas economy.	The driver.	The choke operates in relation to engine temperature. The colder the engine, the richer the mixture. If you take-off at wide-open throttle with a cold engine, the partially closed choke restricts the flow of air. Cylinders pull fuel out of the carburetor in a stream. Go easy on the throttle until the engine reaches normal operating temperature, at which point the choke is fully opened.



thermostatic spring. As the thermostatic spring loses tension, the choke linkage, which pulls the choke plate open, is activated. At the same time, the action of the linkage causes the fast-idle adjustment screw to drop away from the fast-idle cam. When the engine reaches normal operating temperature, the thermostatic spring has lost all tension, opening the choke plate to the maximum.

An automatic choke should give good performance for the life of a car and you can assure continued service by checking the parts periodically. These are inspection of the choke linkage, choke plate, heat tube, and choke control unit, setting of thermostatic spring tension and adjusting of the fast-idle mechanism.

Collections of dirt and moisture are the main causes of malfunction of the automatic choke. To prevent trouble from this source check the unit periodically for freedom of movement of the parts. Have a

3. CHECK PARTS by hand to see that there is no rough movement or binding. In some cases it may be necessary to replace parts not operating efficiently

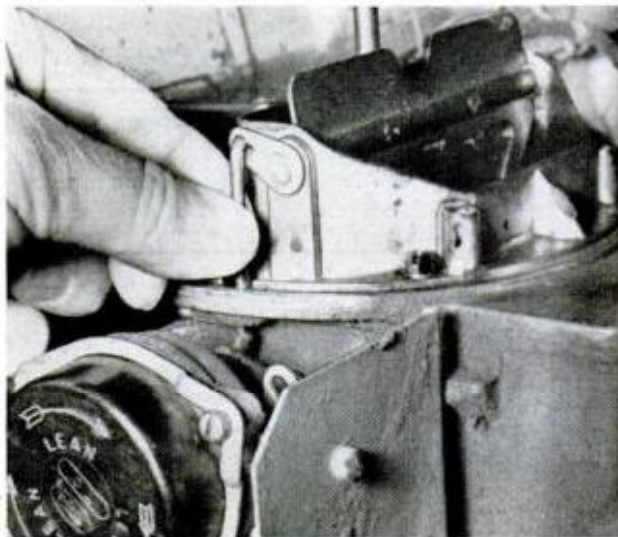

170

helper step on the accelerator (ignition off) to hold the throttle open and prevent interference from the fast-idle cam and unloader as you manually operate the linkage throughout its full range of travel, Fig. 3. If the choke plate does not open and close smoothly, or if it binds noticeably at any point, the cause could be foreign deposits on the linkage, in the housing, or cover, or on the edges of the choke plate itself.

Manual Check

To make sure, disconnect the linkage from the choke plate and manually operate the plate with your finger. Binding of the plate can be caused by damage to parts or dirt and moisture accumulation. Blow dirt out from around the choke plate with an air hose. If this does not relieve binding, probably the parts are bent, sprung, or otherwise damaged and need replacing.

If the trouble seems to be in the linkage, first wipe clean with a cloth. This may turn

4. BEFORE DISMANTLING parts of the automatic choke be sure there is a witness mark on the cover. If not, make a mark so that you know how to reassemble

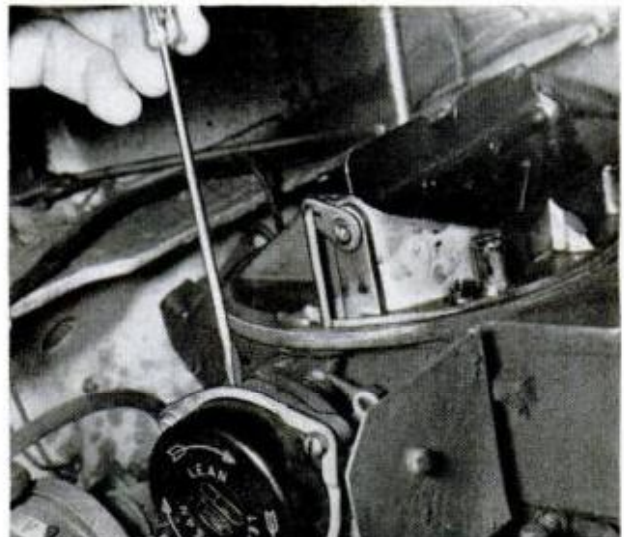

POPULAR MECHANICS

out to be the remedial measure needed. But if it fails, then investigate the control cover. Caution: never oil the linkage. Oil on the linkage will collect dust and cause malfunction of the entire choke assembly.

First note at what setting the index on the choke control cover is set. All new cars have this setting plainly marked, but in some older models it may be necessary to mark the setting by scribing a witness mark on the control cover, Fig. 4. Then remove the choke-control cover and inspect for carbon deposits and moisture, Fig. 5. Clean with solvent. If this cleaning does not free all moving parts, replace the unit.

Moisture and especially carbon deposits inside the choke-control housing indicate that exhaust gases may be escaping through pinholes and cracks in the heat tube. If the condition continues, sufficient foreign material will accumulate to prevent proper operation of the choke assembly. If the tube appears flattened or otherwise damaged, replace it, Fig. 6.

Choke-Control Unit

If the linkage and choke plate are operating properly, the final check is to determine whether sufficient vacuum is being built up inside the choke control unit to operate the piston. To do this, have someone start the engine (cold) and notice the action of the choke plate. It should operate in the sequence and timing diagrammed in Figs. 1 and 2. If it does not operate properly or if resistance is not noticeable as you try closing the plate manually, the choke control piston is sticking or there is insufficient vacuum. If the piston sticks, it should be removed and cleaned with a solvent such as carbon tetrachloride.

Lack of vacuum usually indicates a leak in the tiny circular gasket between the control unit body and the carburetor, or a warped or cracked choke control cover. Replace any defective parts.

Thermostatic Spring Tension

The index setting of the choke control cover controls the tension of the thermostatic spring which is inside the unit. If the setting is too high, the choke plate remains closed too long when starting the engine, may never fully open. This can result in flooding and, of course, high fuel consumption and rapid engine wear.

An index set too low (lean) can result in hard starting. To make sure your choke's index setting is correct, Fig. 7, first check to determine the index setting recommended for your car. This usually is given as "zero," "two notches lean," or "one notch rich." Move the cap to the correct setting. ★ ★ ★

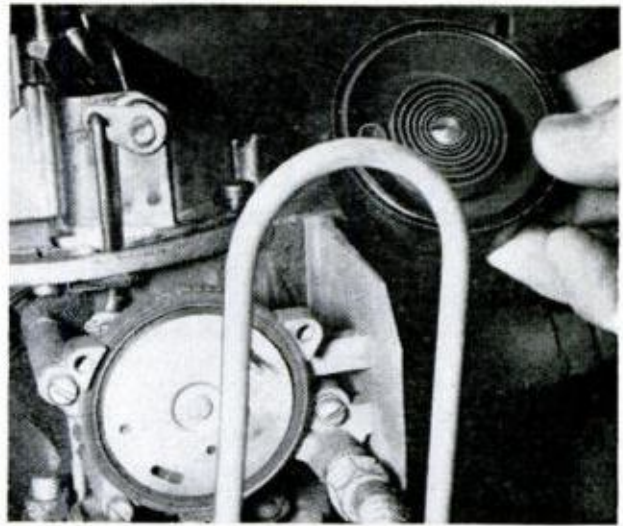

5. INSPECT CHOKE-CONTROL COVER closely for carbon deposits and moisture. Clean with a solvent. Excessive carbon deposits indicate that exhaust gases may be getting into housing through breaks in heat tube

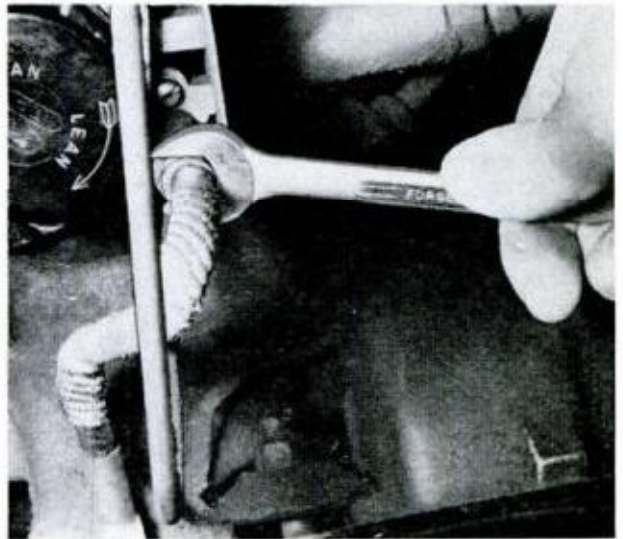

6. IF HEAT TUBE appears flattened or otherwise damaged, it usually is best to replace it. Take it easy on wrench, otherwise you may damage fittings

7. BEFORE SETTING choke control check manufacturer's recommendations for your car. Then, after reassembly, move choke-control cover to correct setting

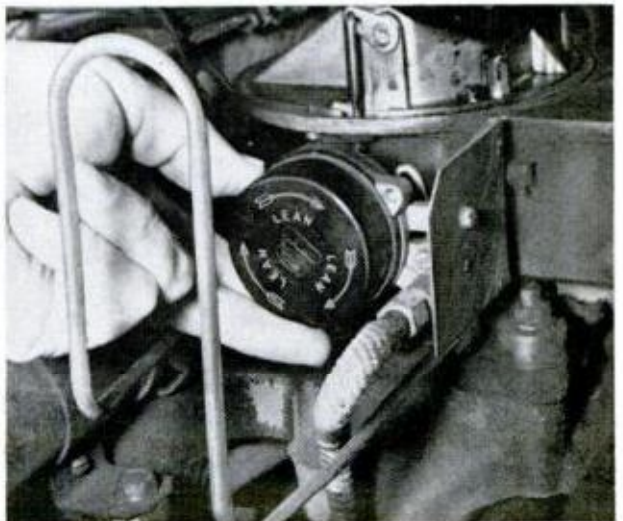

Better CARKEEPING

● **WHEN USING** a tank for testing tubeless tires for leaks the job will be made a lot easier if you place a handful of lead shot in the tank. You can obtain the pellets from shotgun shells or possibly in bulk. The round pellets will not corrode and they cause the tire to roll easily in the tank

● **FROZEN BRAKE CABLES** can be freed quickly by attaching cables from a booster battery, or the regular car battery, to each end of the brake cable sleeve. Just a few seconds of this treatment will thaw ice from the cable. There will be no damage if you allow the current to pass only a few seconds

● **SMALL DENTS** in car tops can be repaired easily by drilling a small hole at center of dent, driving in a sheet-metal screw and then using a hammer to "pull" the screw as you would a nail. A light, easy lift on the hammer handle and the dent will pop out. Repair with filler, grind smooth and paint

● **WHEN WASHING** ball bearings don't dry them with the air line. The high-pressure air stream spins the balls at high speeds in dry races and can be the cause of early bearing failure. Allow to dry normally and apply fresh lubricant before installing. This avoids any possibility of damage

● **WHEN IT IS DIFFICULT** to attach timing light to spark plug, or where it is difficult to locate proper wire in distributor cap, connect timing light to high-tension terminal on ignition coil. You'll have proper synchronization and the light will be brighter and much easier to read accurately

● **LOCATE HARD-TO-FIND** leaks in the windshield or rear window by coating the inside surface with a glass cleaner. Then allow the cleaner to dry. When dry, play a light stream of water from a hose on the outside of the glass and all around the moldings. Leaks will show up on the inside



REFLECTING TAPE placed inside the hub cap or wheel disk on each of the four wheels can serve as a warning to other drivers when you're changing a tire. Set cap or disk on edge near roadside so that the tape will pick up headlight beams of oncoming cars

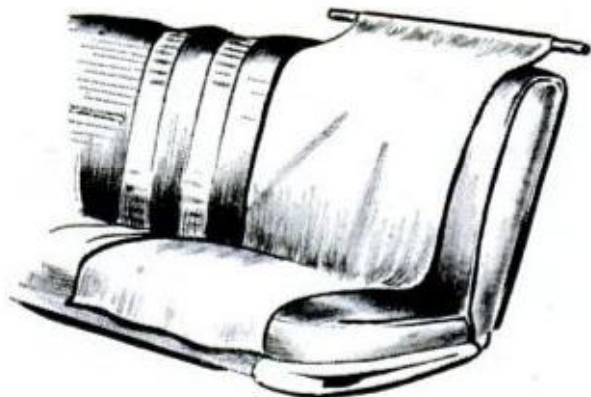

CAR MECHANIC'S cover cloth will spread smoothly over a seat back or fender and stay in place if a large dowel is inserted in a hem at one end. Dowel should fit fairly tight in the hem so that it will stay in place. Weight of dowel keeps cloth from falling down

WINDOW SQUEEGEE, about 6 in. long, gets that heavy, slushy snow-sleet mixture off the windshield and rear window with all the effectiveness of a shovel, yet it will not score the glass. Make a 25 or 30-in. handle from a 3/4-in. dowel and fit into squeegee tang

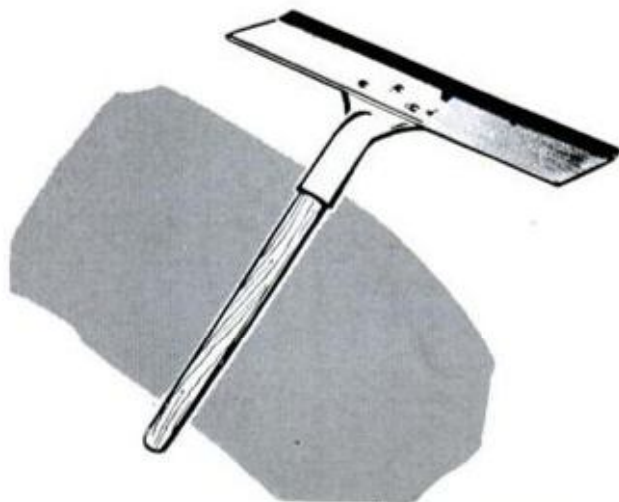

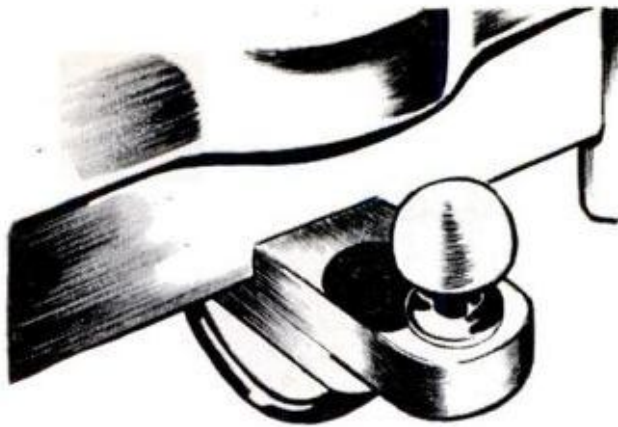

HOLLOW RUBBER BALL makes a good protector for trailer hitch ball. Just slit the rubber ball about a third of the way around, place a small dab of petroleum jelly inside the ball and slip over the hitch ball. Protector prevents rust and keeps out dust and mud

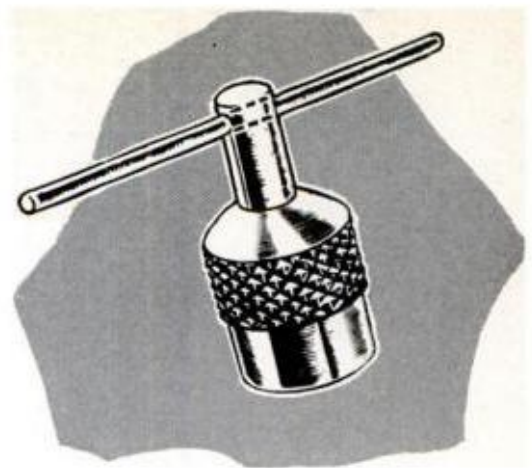

CUT HEAD AND BODY from a brass screw, discard the threaded portion and solder screw head to a valve cap. Drill small hole through body of screw and solder in short length of wire. Screw onto stem to prevent stem from working under rim when changing tire

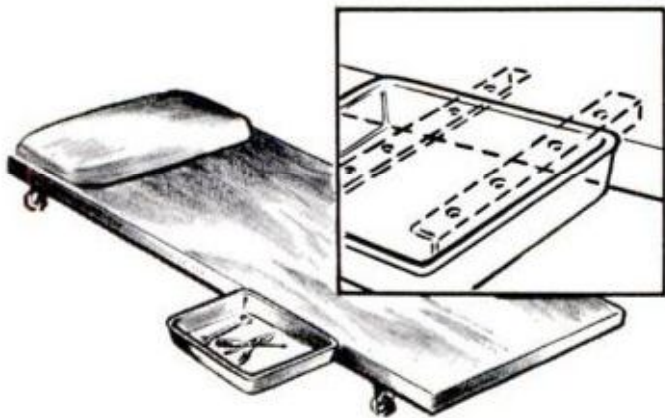

TOOL TRAY attached to side of creeper keeps needed tools always within easy reach. Rivet or bolt a shallow baking pan to two short pieces of light steel angle. Then bolt the projecting ends of the angles to side member of the creeper, using stove bolts



MEASURE CYLINDER TAPER almost as accurately as with an inside mike by using a worn piston ring and a feeler gauge. Press ring into cylinder with piston so you know it's square. Then measure distance between ends of ring with gauge. Repeat at lower end of cylinder

IF YOUR ignition condenser goes out and leaves you stranded, you can use the radio suppressing condenser as a substitute. This condenser usually is found near the voltage regulator. Ground it and connect its pigtail to the insulated binding post on distributor



TIRE CHANGING at night is something no one looks forward to, but it can be a lot easier and safer if you carry a flashlight and a 6-in. square of cardboard with a hole cut in it to take the light in a snug fit. Just insert flashlight and set on edge as pictured

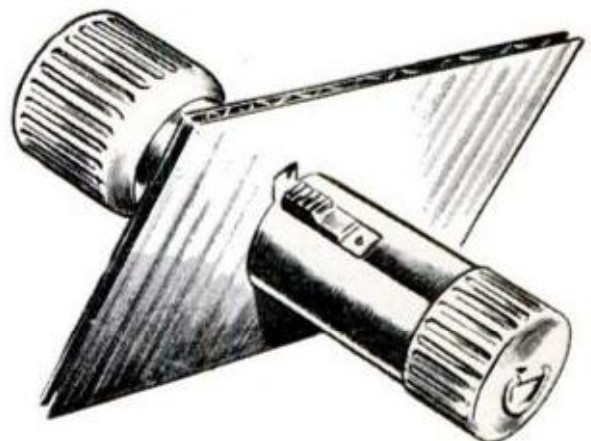

VACUUM-FORMING SHEET PLASTIC

Here's a simple vacuum box that offers hours of fun and even spare-time income

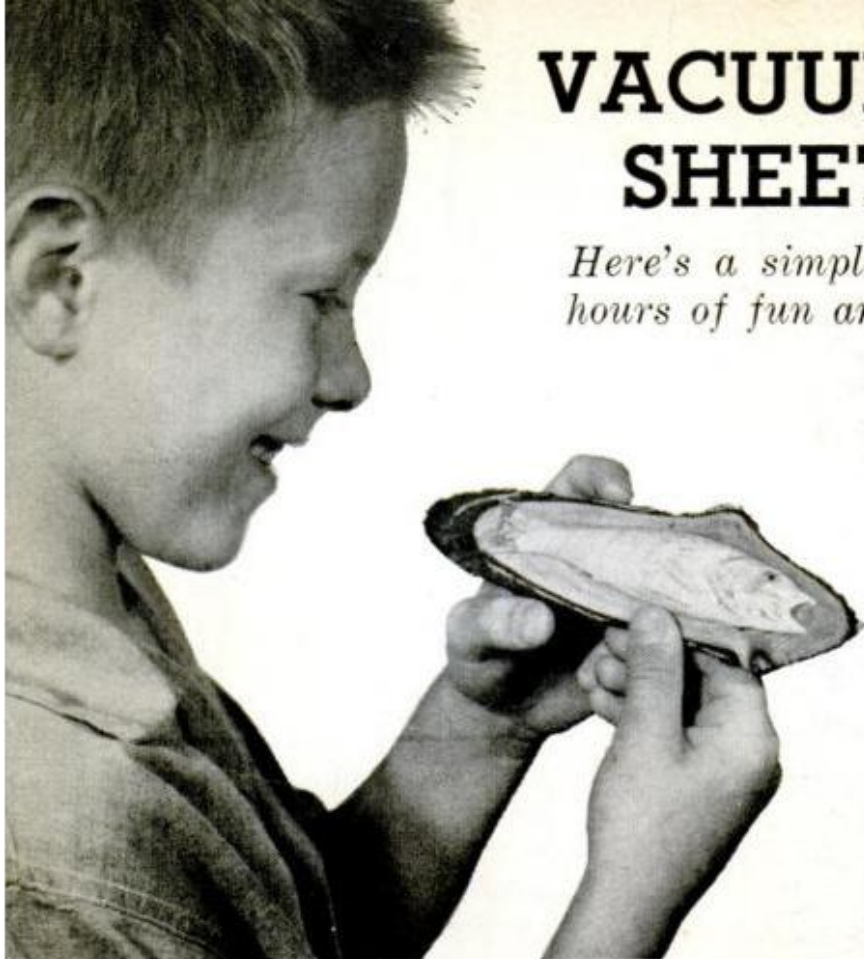

1. THIS FISHERMAN is on the way to bigger things. Here he's looking at a vacuum-formed plastic replica of that first fish

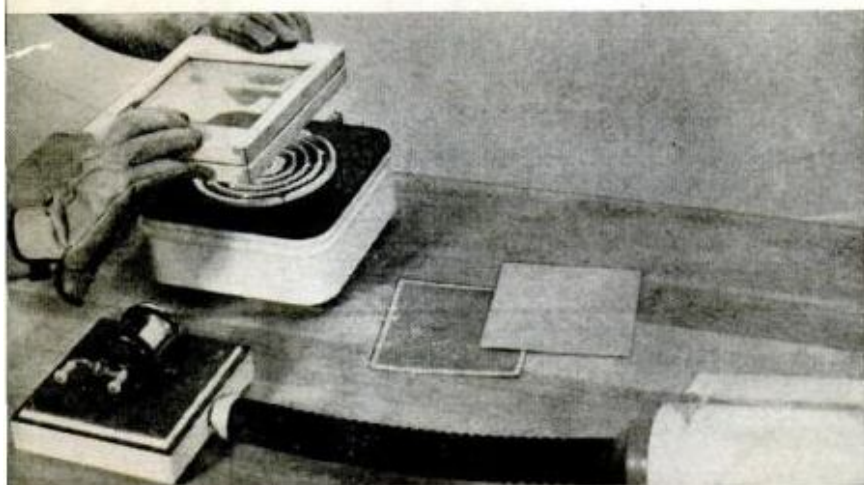

2. PLASTIC SHEET, above, is heated on both sides over electric plate to bring it to right degree of plasticity for forming. Then holder and sheet are placed over pattern on vacuum box. Air pressure, below, forces plastic into contact with pattern



INSTANTANEOUS forming of a plastic shell over almost any small object is done with this simple kit of parts you put together yourself. When you get it assembled you have a vacuum box, or chamber, which is attached to your vacuum cleaner, and a plastic-sheet holder consisting of two nesting frames. A close look at the pulled-apart view and the sectional views on page 177 will show how these parts are assembled and how the plastic-sheet holder fits over the vacuum chamber. Figs. 3, 5 and 6 picture steps in assembling the vacuum chamber.

The two views in Fig. 2 show clearly how the assembled unit works. As the first step in the process, you hook your vacuum cleaner hose to the vacuum chamber as pictured. Then you place the plastic sheet in the holder and the object to be used as a pattern is centered on the platen of the vacuum chamber as in the photo at left (in this instance a fishing reel is pictured). Now, turn on the cleaner and then hold the plastic sheet, in the frame as pictured, over an electric hotplate (never over a flame) applying heat alternately to each side. As soon as the sheet becomes pliable and sags slightly at the center, quickly place it over the vacuum chamber as in the lower photo. The sudden vacuum created causes air pressure to force the sheet not only to take the precise over-all contour of the pattern but also to contact the whole exposed surface of the pattern, thus reproducing faithfully in relief every surface detail.

And that's all there is to it. From here on you let your own imagination take over, remembering that almost any object you can get on the perforated platen with only a little space all around it, can be reproduced in detail with this setup.

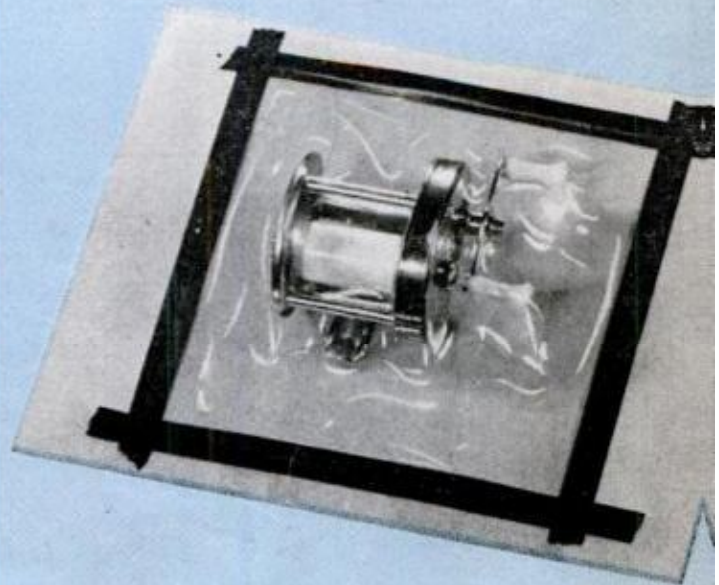
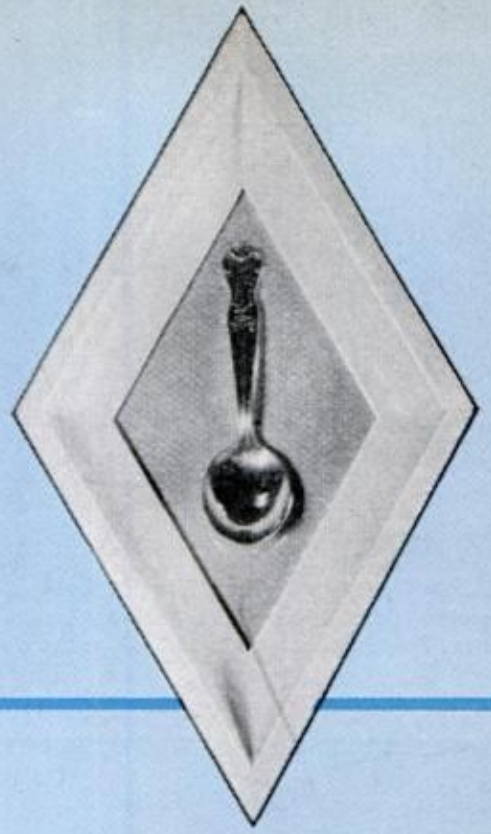

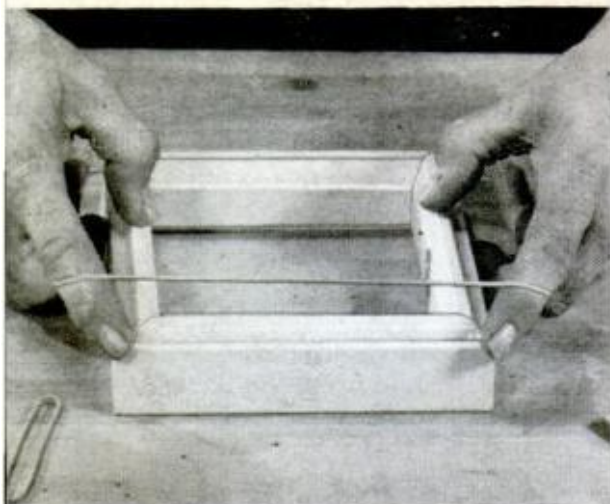

3. TWO HEAVY RUBBER BANDS serve as gluing clamps when assembling vacuum box. These wooden parts come with the kit



4. SMALL-PARTS TRAYS can be duplicated in vacuum-formed plastic. Or you can assemble a small tray from thin stock and use it as a pattern for forming any number of duplicate plastic trays



5. BOTTOM of vacuum box is plywood. It must fit tightly to prevent air leaks. Corners of box are made airtight with tape

6. SELF-ADHERING rubber sealing strip forms airtight seal between vacuum box and holder when latter is placed in position

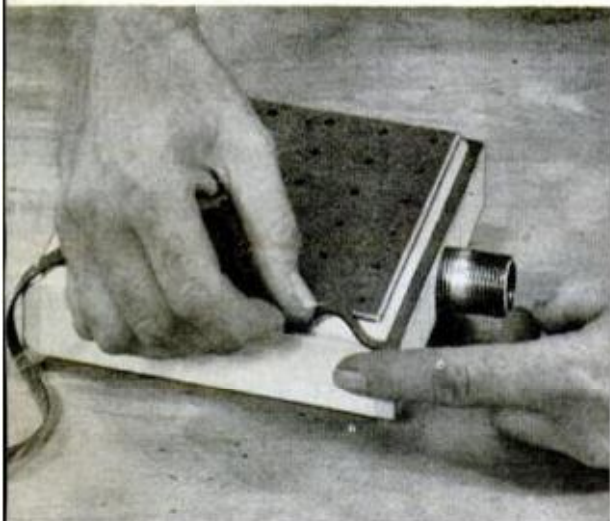

For example, take the fish plaque the boy is admiring, Fig. 1. Of course, this fish isn't big as some catches go but maybe it's his first one and if this is so, he's entitled to admire it. Here's how it was made: The live fish was used as a pattern for the plastic shell which was vacuum-formed as described. This shell can now serve as a mold for a plaster-of-paris casting or the shell only can be colored like the original live fish, mounted on a plaque made by sawing a section diagonally from a tree limb. One face of this is smoothed and varnished and the casting or the colored plastic shell mounted on it as in the photo. Sharp? Of course, because it's a copy of the original catch, fin for fin, scale for scale, size for size.

Then there are other stunts. You need a tray for drafting instruments or small tools. Lay the tools or instruments on the platen, pop a piece of plastic down over them, lift off the holder, remove the formed plastic, turn it over and there's your tray. Or, suppose you want to shape a plastic cocoon over each of baby's shoes to preserve them as mementos. Proceed as already described, only use black plastic. Then, leaving the shoes inside the covering, run a bead of household cement in the space between the soles and the fold of the plastic. After the cement has hardened trim off the projections of plastic at the soles and heels. When the black plastic covering is sprayed with a mist coat of bronze, permitting the black to show through, the effect is remarkably similar to shoes cast in bronze.

If you wish to protect valuable tools or instruments, the fishing reel or any metal object against rust and corrosion, just form a plastic cocoon over it and tape the edges of the formed cocoon to a sheet of cardboard. The fishing reel, lower right-hand illustration on page 175, has been "mothballed" in this fashion. Other illustrations on the same page show the wide range of vacuum forming possible with this unit.

Of course, if you wish, you can make the parts of the vacuum chamber by following the details given on the opposite page for the frames and other parts. Care must be used as the finished job must be air-

MR. DO-IT AND BUNGLE

HMPH—DOEY SITS ON HIS BIG FAT PATIO WHILE I SLAVE OVER A BROKEN SASH CORD—OH, WELL, THIS TIP FROM POPULAR MECHANICS TO PRY STOP FROM INSIDE IS SURE A GOOD ONE



NEXT, I'LL LIFT THE LOWER SASH OUT OF THE FRAME—OOPS, DROPPED MY HAMMER! SAY, DOEY, WILL YA GET MY HAMMER FOR ME WHILE I REMOVE TH' WEIGHT POCKET DOOR



WELL, ALL DONE... I'VE LUBRICATED THE SLIDING SURFACES AND REPLACED THE STOP. SAY, DOEY, HOW 'BOUT A ROUND OF GOLF?

SORRY, BUNGLE, I'M TOO TIRED

WHAT'S THE MATTER WITH YOU, DOEY? HOW COME I DO ALL THE WORK YET YOU GET TIRED?



5

IT ISN'T THE WORK, BUNGLE. IT'S THE RUNNIN' AFTER IT THAT GETS ME!

SO LONG HONEY, I'M GOIN' NOW



6

tight Cost of materials, including a few sheets of plastic, should not exceed \$5.00. On the other hand you can spend a couple of dollars more and get a kit that includes all wood and hardboard cut to rough size, sponge-rubber gasket, suction-cup feet, some thirty plastic sheets and instructions, for \$6.95. A second kit comes at \$12.95, ppd., with all parts cut to size ready to assemble, also, glue, masking tape, brads, pipe nipple and full instructions for using, including suggestions for utilizing the unit for spare-time income. Both kits are available from Bench-Craft, 3011 Starling Lane, Rolling Meadows, Illinois. ★ ★ ★

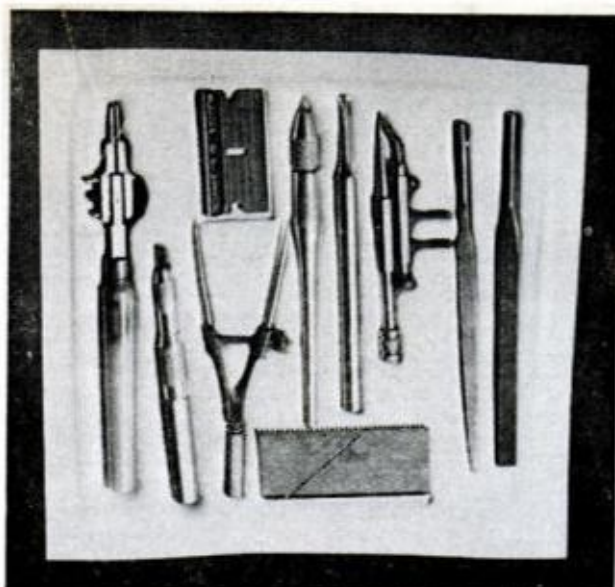

7. SPECIAL TRAY for instruments, small tools is made by placing tools or instruments directly in the platen

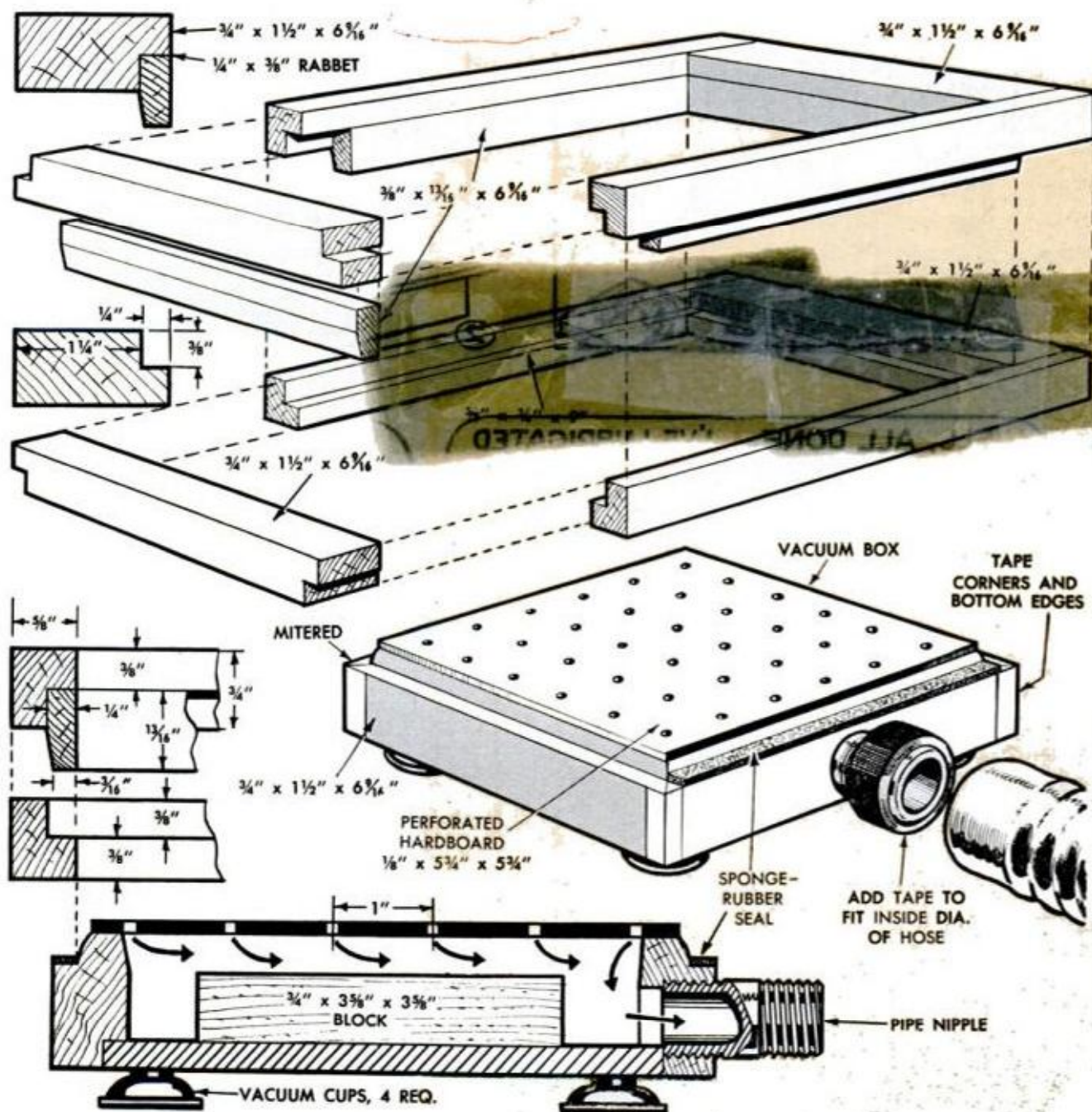

Bungle finds that he can replace a broken sash cord in no time at all. Give him enough rope and he'll hang anything, even his helpful neighbor, Mr. Do-It

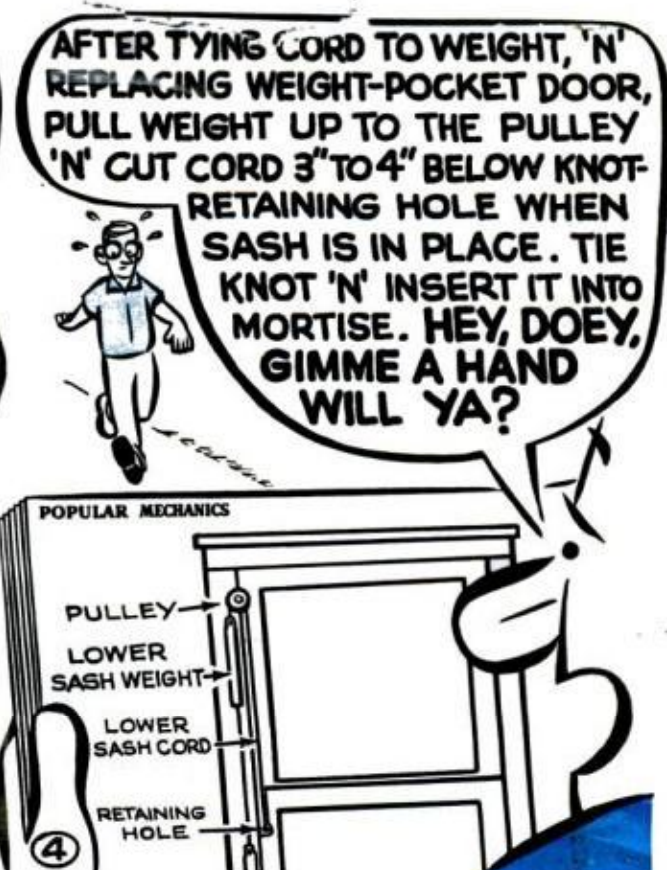



PERFORATED HARDBOARD template must be clamped so it cannot shift while each set of holes is drilled

Design Drilling With Perforated Hardboard

WITH ITS PRECISE, uniformly spaced rows of holes, perforated hardboard provides a ready-made template for drilling a variety of decorative geometrical designs in plywood, sheet aluminum and similar panel materials. Such decorative drilling can be used for embellishing cabinet doors, trivets, trays, hot-dish pads, table tops, wall panels, screens, picture frames, shutters and so on. The drilled holes themselves can form the decorative design, or they may be filled with dowels or a plastic material to produce an inlaid effect.

To develop a design with the aid of a hardboard template, you either can use certain holes in a fixed template, patterns A, D and F below, or vary the patterns by rotating the template to successive positions around a fixed peg, designs B and E. You may vary the pattern still further by shifting the template laterally or changing the angle, pattern C. It is best to work out the design on paper before you begin to drill.

Use a drill bit the size of the holes in the hardboard template. If your design requires pivoting the template on a peg, drill the hole for the dowel first. Clamp the template so it cannot shift while you drill each set of holes. After drilling the second hole insert another dowel to serve as an extra guard against shifting, regardless of how many clamps are used.

When most materials are drilled, burrs form around the holes. You can remove these by sanding the panel surface or by lightly touching up each hole with a countersink. However, some materials cannot be sanded, and if you are working with prefinished paneling or similar materials, a conventional countersink may chip the finish. In such cases a conical abrasive wheel touched lightly into each hole, while being rotated in a drill press, hand drill or even with the fingers, will quickly polish off the burrs.—Walter E. Burton

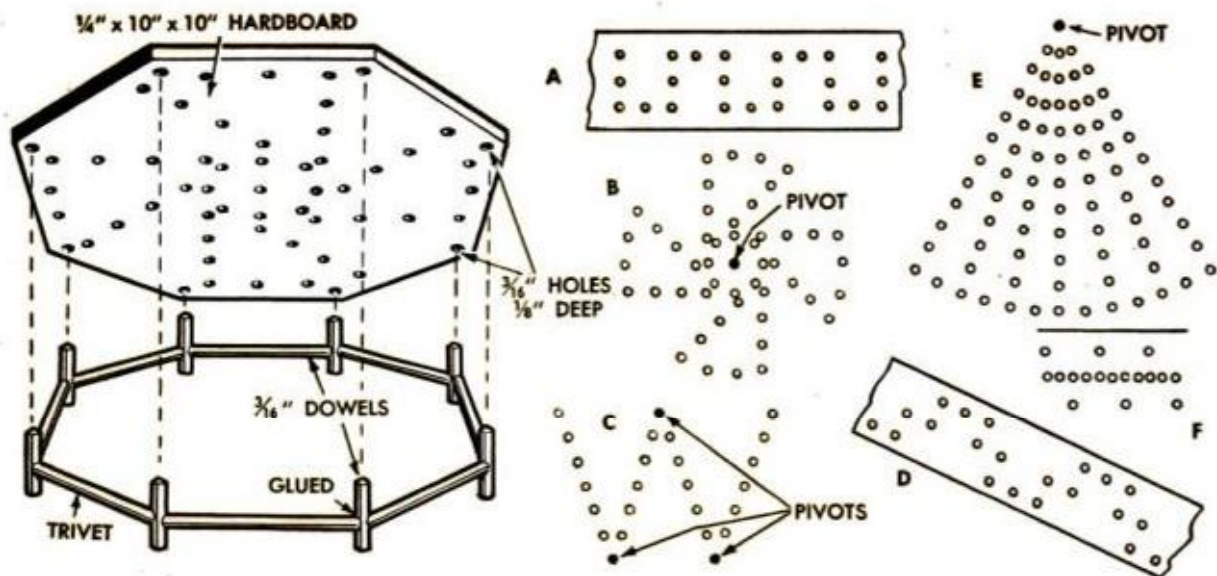

SHOP SHORT CUTS

Cleaning Sanding Disks

When a sanding disk becomes clogged with accumulations of paint, resin or other materials, you can get a lot more service out of it by cleaning the surface with a length of common screen rolled up tightly to form a round wire brush. Simply start the sander and move the end of the wire brush back and forth across the surface of the disk until all accumulations are removed. If desired, the brush can be taped or wired to form a hand grip and hold the screen firmly in place. Such a brush will serve for a considerable length of time if renewed occasionally by applying the end against a grinding wheel.

—G. E. Hendrickson



Lubricating Boring Bar

A simple arrangement for lubricating a boring tool is shown in the detail, above right. First, plug one end of a short length of $\frac{1}{4}$ -in. copper tubing and drill a small hole in the side of this tube near the plugged end. Lay the tube along the boring bar so that the small hole is centered over the cutting tool. Friction tape can be used to hold the tube parallel to the boring bar, or if a more permanent connection is desired, the tube can be brazed to the bar. Bend the open end up so that it is easily reached with the oil can spout. A few drops of cutting oil forced into the tube occasionally will keep the cutting tool lubricated continuously.—Robert Hill

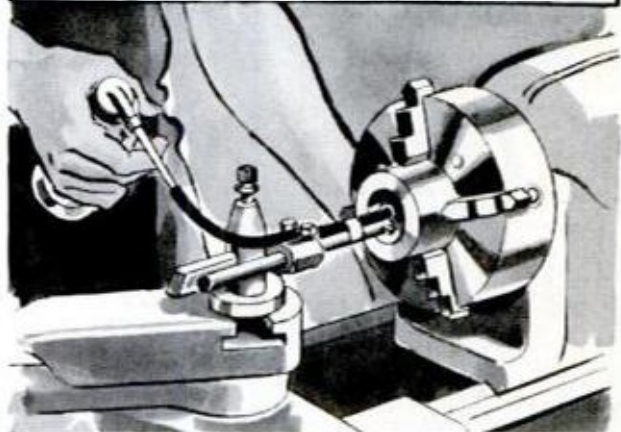
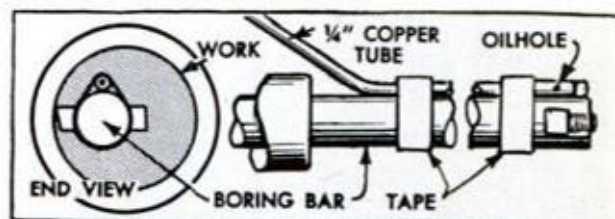

Checking Lathe Centers

Alignment of lathe centers can be quickly and accurately checked by the simple method illustrated. The collar is made from a piece of suitable round stock and has two 60-deg. centers drilled in line. Drill a $\frac{3}{32}$ -in.-dia. hole for the length of wire and drill and tap a hole for a set screw to hold the wire in place. The bent end of the wire should be rounded off and adjusted so that it just clears the faceplate. Bring the centers up against the collar friction-tight, yet permitting it to be turned. Check the clearance between the faceplate and wire with a feeler gauge. Then rotate the collar one-half turn and check the clearance at the new position. One half the difference between the two readings is the amount of misalignment. Before testing the centers, check the faceplate for runout, and if necessary, correct this with light cut across the face.

—M. W. Loftus

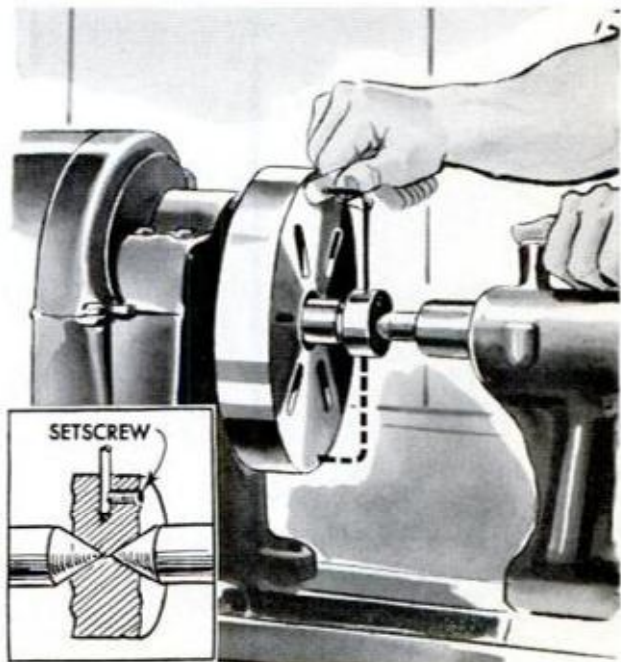

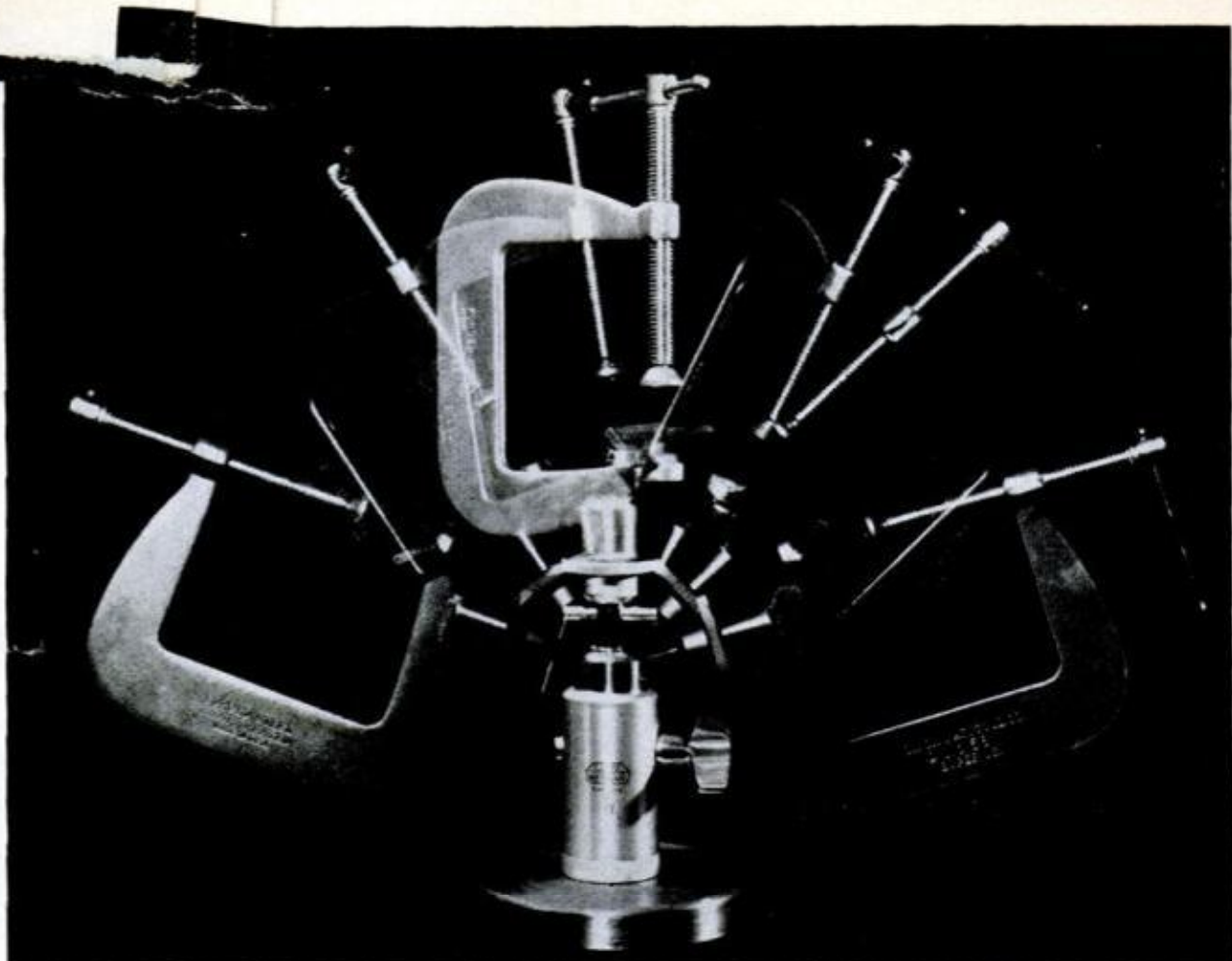

HOLD IT!

Here's your third hand—grips, clamps, holds almost anything

By Martin D. Koehler



ALL YOU NEED to make this universal bench-top holder are a C-clamp, a ball-joint tripod head, a 4-in.-diameter steel disk $\frac{1}{2}$ in. thick, or a square piece of the same size, and a short length of $\frac{5}{8}$ or $\frac{3}{4}$ -in. steel angle. The heavy disk or the square of steel serves as a weighted base, but, of course, you can use a thinner piece and attach it to the bench top with screws.

The pulled-apart detail on the opposite page shows how the parts are assembled. The tripod head, of the ball type, you obtain from a camera shop and attach it with a screw to the round or square base as in the detail. Then you weld the short length of steel angle to the stationary pad of the C-clamp. Next you drill and tap a short length of round brass to take the tripod-head screw. Braze this to the clamp jaw in approximately the position indicated.

The ball-joint tripod head gives you a universal adjustment of the clamp. The clamp with the work held in the V-jaw, can be positioned at any convenient angle, right, left, up or down, or any angle between. The holder will support tools or round work in any desired working position as you can see from the three photos on the opposite page.

MICROMETER can be converted to a bench instrument by clamping it in the holder and adjusting the angle

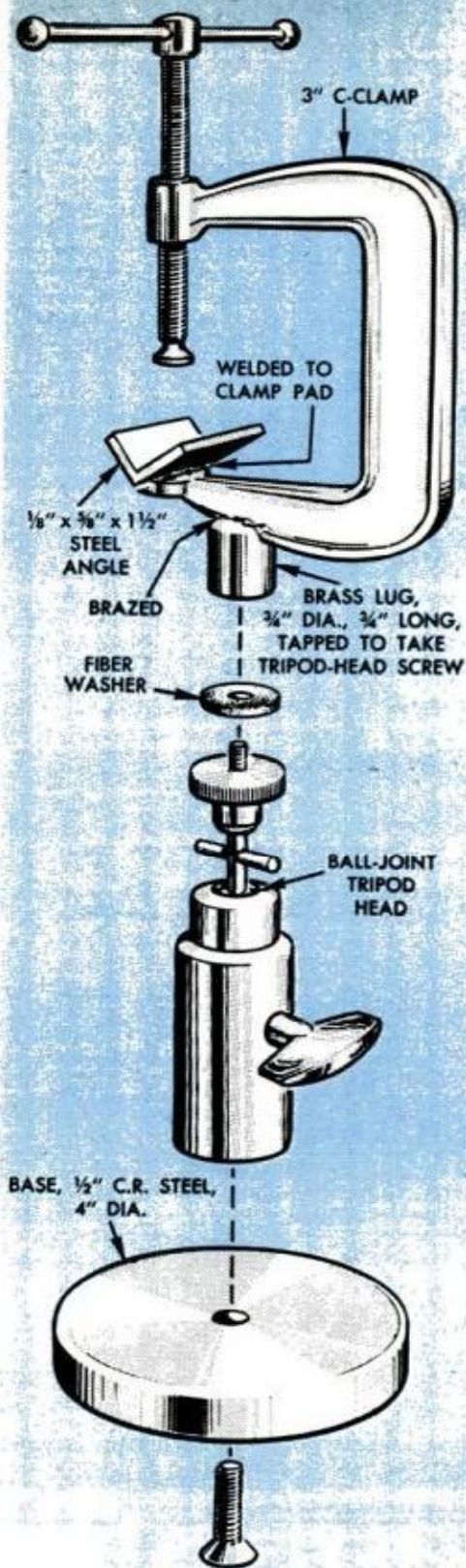

BALL-JOINT HEAD can be mounted directly on the base or attached to a steel rod to elevate the C-clamp to a greater height. If you use the rod extension, increase the diameter of the base, since the higher mounting will tend to make the holder less stable

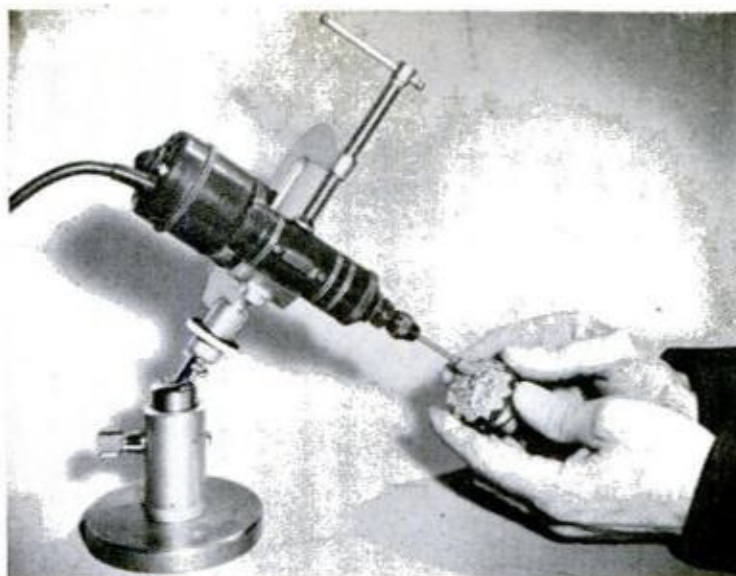

FINE GRINDING OR POLISHING will be much easier if the grinder is clamped in the holder and adjusted to the most comfortable angle. With both hands free, you're sure of an accurate job

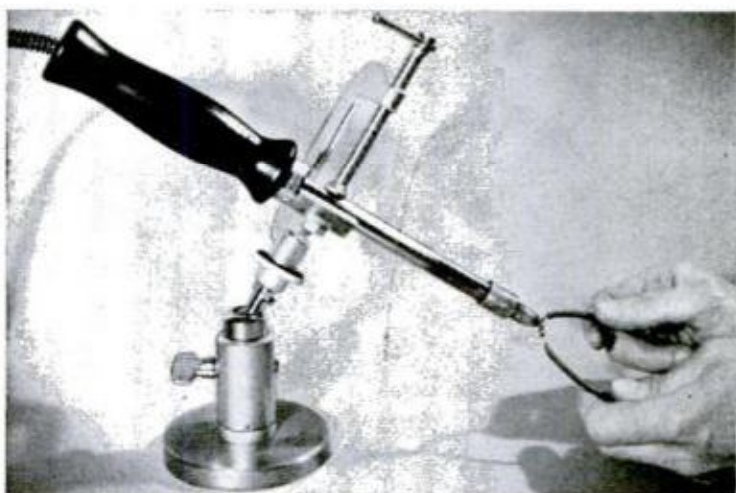

SOLDERING SMALL PARTS which must be held by hand is no trick at all when you clamp the iron in the holder. Also, this will prevent the hot iron from damaging the bench top

BRAZING at odd angles is another chore which often requires holding two or more parts. With the aid of this angle clamp, it is as easy as any simple brazing job and takes no more time

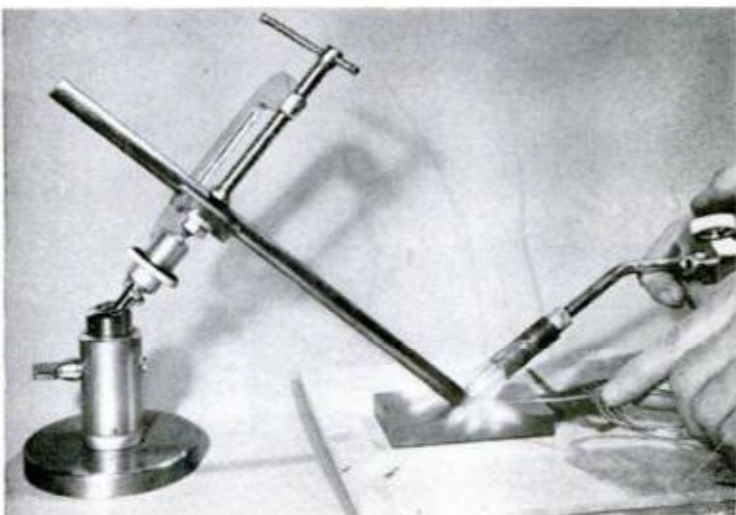



1. DIAPHRAGM SPRAYER, above, has direct-connected motor, separate gun. Sprayer at right has turret nozzle, gives three spray patterns



PAINT WITH AIR!

By **E. R. Haan**

2. WHEELABOUT SPRAYER with a belt-driven compressor and separate gun. Unit is diaphragm type



3. WHEELABOUT SPRAYER has engine-driven, piston-type compressor. Used where electricity is not available





4. COMPACT UNIT with direct-connected motor and compressor. Gun with attached cup is the bleeder type

SPRAY APPLICATION of paints, enamels, lacquers, stains and clear finishing materials gives you the perfect finish on almost any paintable surface and in a fraction of the time necessary to brush-finish the same area. There are no brush marks in spray finishing, no laps, no sags or runs. You simply point the gun or the nozzle of the pressurized spray can, pull the trigger or press the button. It's almost, but not quite, as simple as that. There are a few tricks in handling a spray gun you should know before you begin.

For jobs such as picture frames, small pieces of furniture or touch-up work on your car, the simplest paint-spraying device is the pressurized can. There's no gun to clean, no thinning or straining of finish-

5. NEARLY ALL TYPES of sprayers can be used for spraying insecticides effectively. Gun is adjusted to give fine-mist spray pattern for full, uniform coverage



6. EVER BRUSH-PAINT a picket fence? Then you can appreciate the speed and ease with which a spray unit gets the job done—on both sides of fence, too

7. THIS GUN attaches to your vacuum cleaner and also to the 1-quart can the paint comes in. Just hook up the two and you're in business. Simple to use, adjust





8. THIS SPRAY UNIT has a portable paint cup, or container. Unit is operated on an air line from a compressor. Gun and container are small and readily carried from room to room or job to job as needed

9. INTERNAL-MIX GUN of type used by pros. Legends point out important parts of gun which is of the type used with a cup, usually of 1-quart capacity. Gun has wide range of adjustment for varying patterns

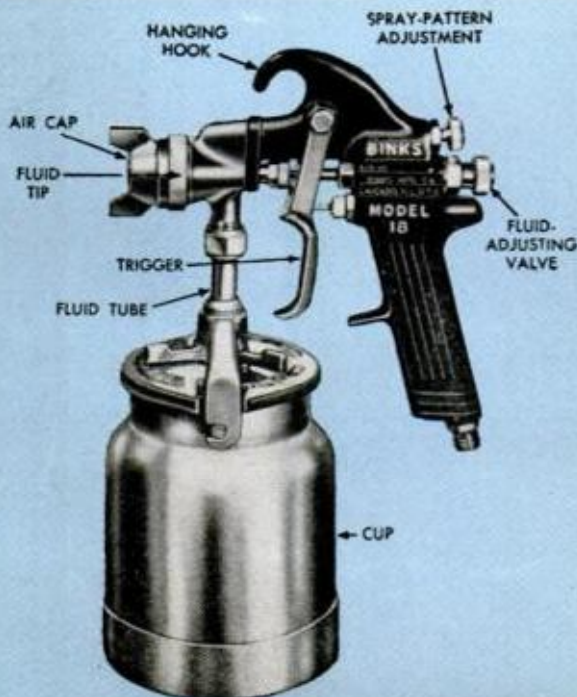

ing materials. But for more extensive work you'll find a regular spray gun practically indispensable around the house and home workshop. You can use it for interior and exterior painting, lacquering linoleum, applying floor sealer, finishing furniture and other miscellaneous jobs such as mothproofing, and applying weed killers and insecticides, Fig. 5.

Small spray units: There are several types of paint-spray units available at modest cost. Good results can be obtained with paint-spray attachments for vacuum cleaners. There are handy, lightweight spray units that have built-in vibrator-type motors. One has a triple-nozzle turret Fig. 1, giving a fan spray for large, flat surfaces, a circular spray for general painting of small articles, and a fog spray for insecticides.

Most spray guns are designed to operate either directly from an air compressor, Figs. 5 and 6, or from a pressure tank. The latter may be connected to a compressor, Fig. 11, or it may be a prefilled, replaceable tank fitted with a reducing valve to dispense air at desired working pressure, Fig. 8.

A compressor generally is operated by an electric motor, Figs. 1, 2 and 4, but units driven by a small air-cooled engine, Fig. 3, also are available. In some sprayers the motor is direct connected to the compressor, Figs. 1 and 4. In other types the compressor is belt driven as in Figs. 2 and 6. Most home owners will find it best to purchase a kit consisting of gun, compressor and hose. Compressors may be of the diaphragm type, Fig. 2, or the piston type, Fig. 3. The former is the least expensive and will serve all the needs of the average home owner. The diaphragm will last many hours and is simple and inexpensive to replace. Piston-type compressors are used for heavy-duty work. Most light-duty guns have an attached paint cup but there is one

10. STRAIN PAINT before spraying, especially paint in can which has been opened and contents partially used. Right, pattern for use on vertical surfaces

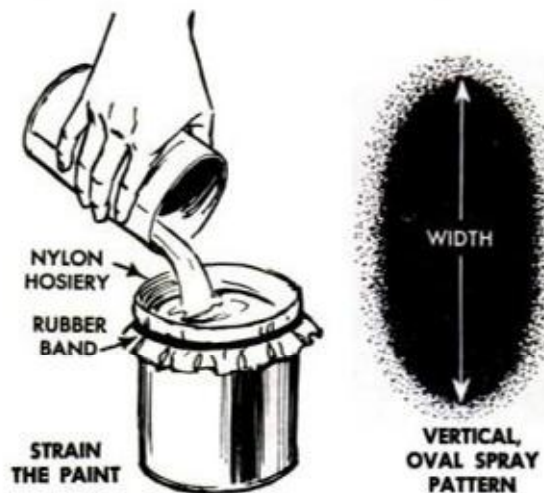

which is made for quick attachment to any quart can of paint, Fig. 7. This gun can be operated from a vacuum cleaner, or from a special electric air blower which is available.

For heavy-duty jobs painters often use a gun with a remote paint cup, or container. Paint is forced to the gun by air pressure. A gun not weighted by a paint cup is much lighter and easier to manipulate. Large remote paint containers of 1 to 5-gal. capacity or more, often hold enough paint for an entire job.

Variations in spray guns: Spray guns differ as to the way paint is fed to the nozzle. In a suction-feed (or siphon-feed) gun, air passing over the fluid-tip causes a partial vacuum and thus permits atmospheric pressure on the paint to force it up to enter the air stream. This type of gun is identified by the fluid tip extending slightly beyond the air cap, and by an air vent in the cover of the paint cup on the gun. In a pressure-feed gun, Fig. 9, part of the air is diverted to a closed paint container to force the paint to the fluid tip. This type of gun is capable of spraying heavier liquids than is possible with a suction-feed gun. A remote paint container requires the use of a pressure-feed gun.

Spray guns that operate directly from small air compressors having no pressure-controlling device, are

12. MEASURE DISTANCE from nozzle to wall by this rule-of-thumb method, right. You'll have nozzle at just the right position

13. WEAR RESPIRATOR on all paint-spray jobs, especially indoors. Right, study this diagram; it tells its own story for painters



11. HERE'S SPRAY RIG for big jobs, such as painting a house or maybe your car. Remote container holds enough paint for entire job. Paint in container is under pressure



USE A RESPIRATOR

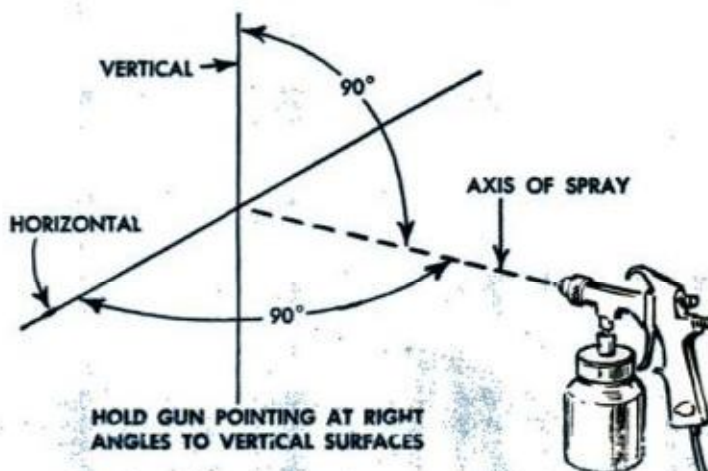

HOLD GUN POINTING AT RIGHT ANGLES TO VERTICAL SURFACES

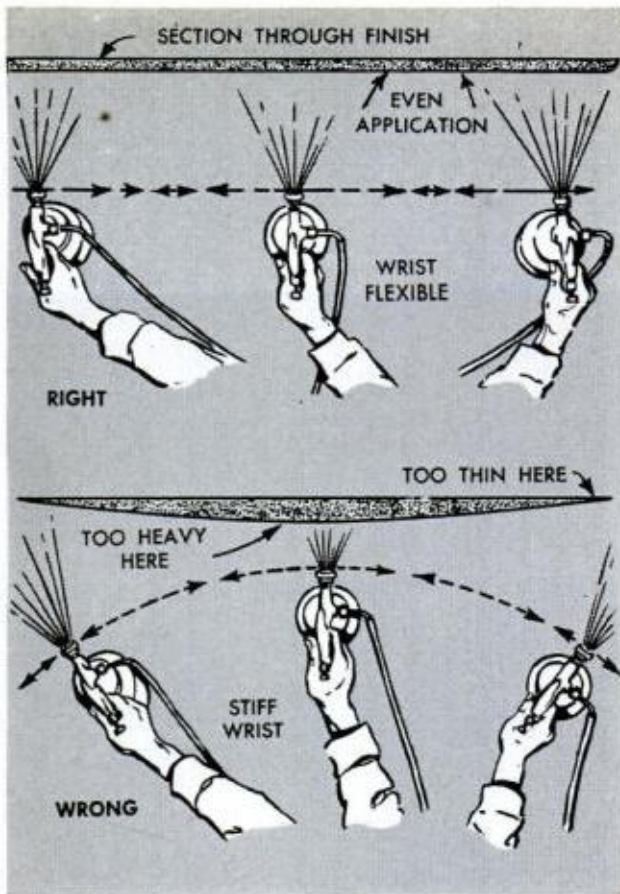

14. RIGHT AND WRONG ways to handle spray gun when painting vertical surfaces are diagrammed at left. Here's the real trick in uniform spray application

of the bleeder type made to pass air at all times and so prevent a pressure buildup in the air lines. Non-bleeder guns are used on controlled pressure lines where the gun trigger controls both air and paint flow. Guns mix air and paint either inside or outside of the nozzle, and are referred to as internal and external-mix types.

Preparations for spraying: Paints formulated for brush application can be sprayed with a pressure-feed gun. Some paints come in both brushing and spraying consistencies. Usually ordinary paints and lacquers must be thinned for use with suction-feed guns.

As a rule, paint should be sprayed at a temperature not less than 70 deg. F. The viscosity of a cold paint often makes it difficult to spray. Always strain paint to be sprayed through a 60-mesh screen or a piece of nylon hose, Fig. 10.

For operator comfort and safety, use a respirator, Fig. 13, to avoid breathing pigment particles. Never spray in a room where there is an open flame as nearly all finishing materials are highly flammable. Always provide ventilation, preferably by means of an exhaust fan in a window to draw paint fumes outside. Objects not to be sprayed should be removed from the room, or covered to prevent over-spray from being deposited on them. Where considerable paint-spraying is to be done in a home workshop, provide a ventilated spray booth, Fig. 19.

Spraying techniques: You can acquire

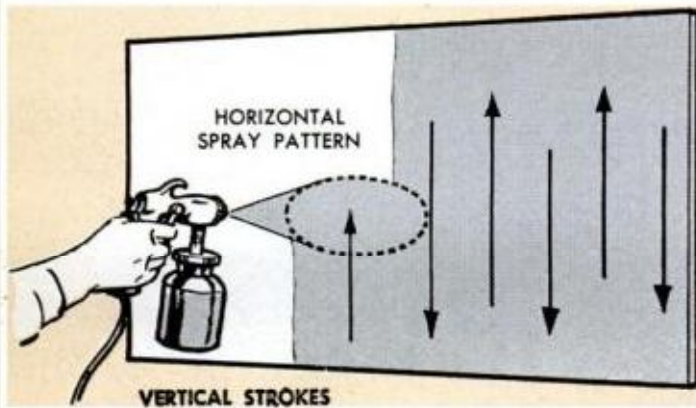
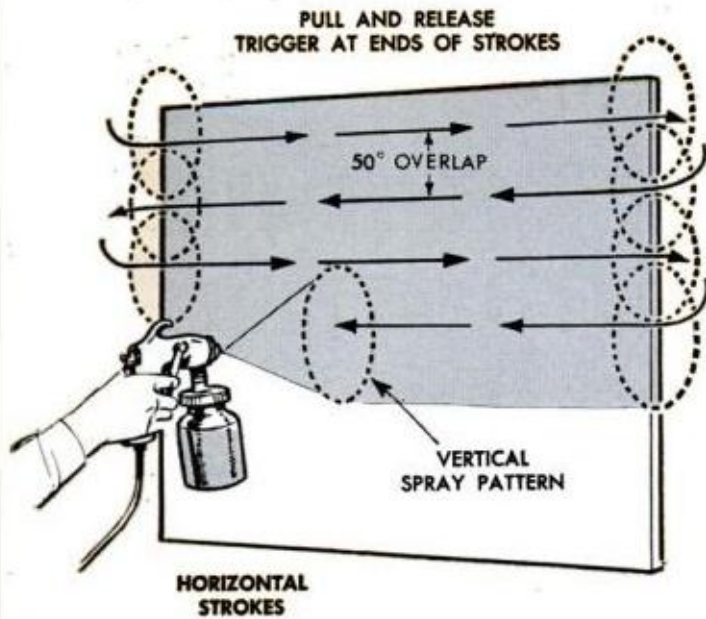

15. SPRAY TECHNIQUES that work are diagrammed for you at the left and below. Note especially the use of both vertical and horizontal spray patterns

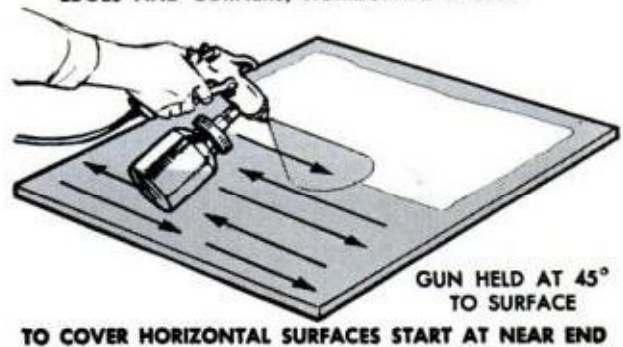
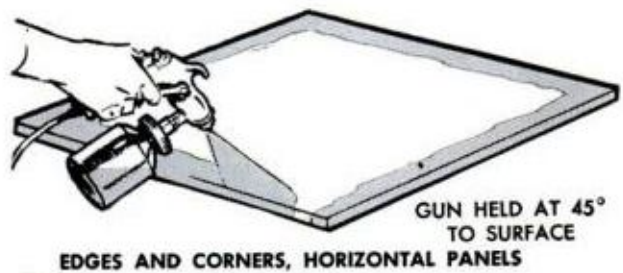

needed skills in handling a spray gun by practicing on newspapers taped to the side of a large carton. Experiment with the full range of fluid adjustment, starting from the nearly closed nozzle position that produces a pattern of about one inch wide when the trigger is pulled back fully. Many spray guns produce a fan-shaped spray that forms an oval pattern but some produce a round pattern, and others can be adjusted for either pattern. The longer dimension of an oval pattern is referred to as its width, Fig. 10.

As you adjust for a wider pattern and increase the flow of liquid, atomization becomes coarser. A pattern having a width of 6 to 8 in. when the gun is held 6 to 8 in. from the surface is practical for wall painting. For most other work the pattern should be of a lesser width. The air cap on the gun is turned to produce either a vertical or a horizontal pattern, Fig. 15.

Distance of the gun nozzle from the work surface should be between 6 and 8-in., which can be measured quickly by hand, Fig. 12. A lesser distance than this causes a heavier deposit of paint in a smaller area unless the speed of stroking is increased. For vertical surfaces, the gun should be aimed so that the axis of the spray cone is at right angles to the work surface, Fig. 13. This produces a coating of uniform thickness. On each stroke the gun is moved parallel to the

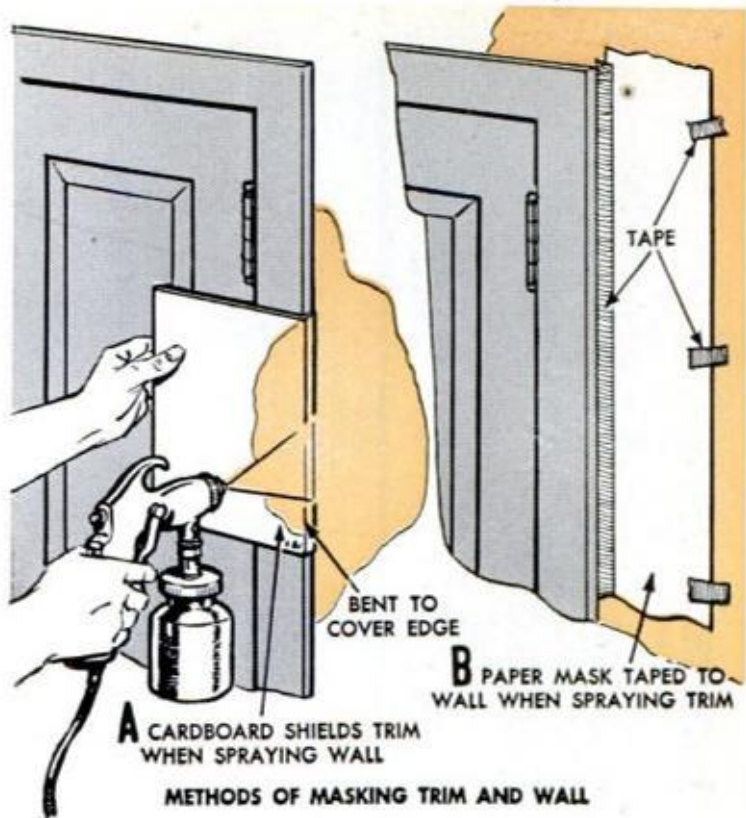

16. HOW DO PAINTERS get that neat, straight line where two colors meet? Answer is by masking as you see it done above, details A and B. Use newspaper, cardboard as masking material

work, using a free arm movement and flexing the wrist at the ends of the stroke, Fig. 14.

Each stroke should overlap the previous one about 50 percent. A lesser overlap may result in streaks. When coating a panel with horizontal strokes the nozzle is adjusted to produce a vertical spray pattern,

17. DETAILS A and B at left and details A through D at right cover important points in the technique of spray painting. Note especially two methods of handling an inside corner, use of angle nozzle

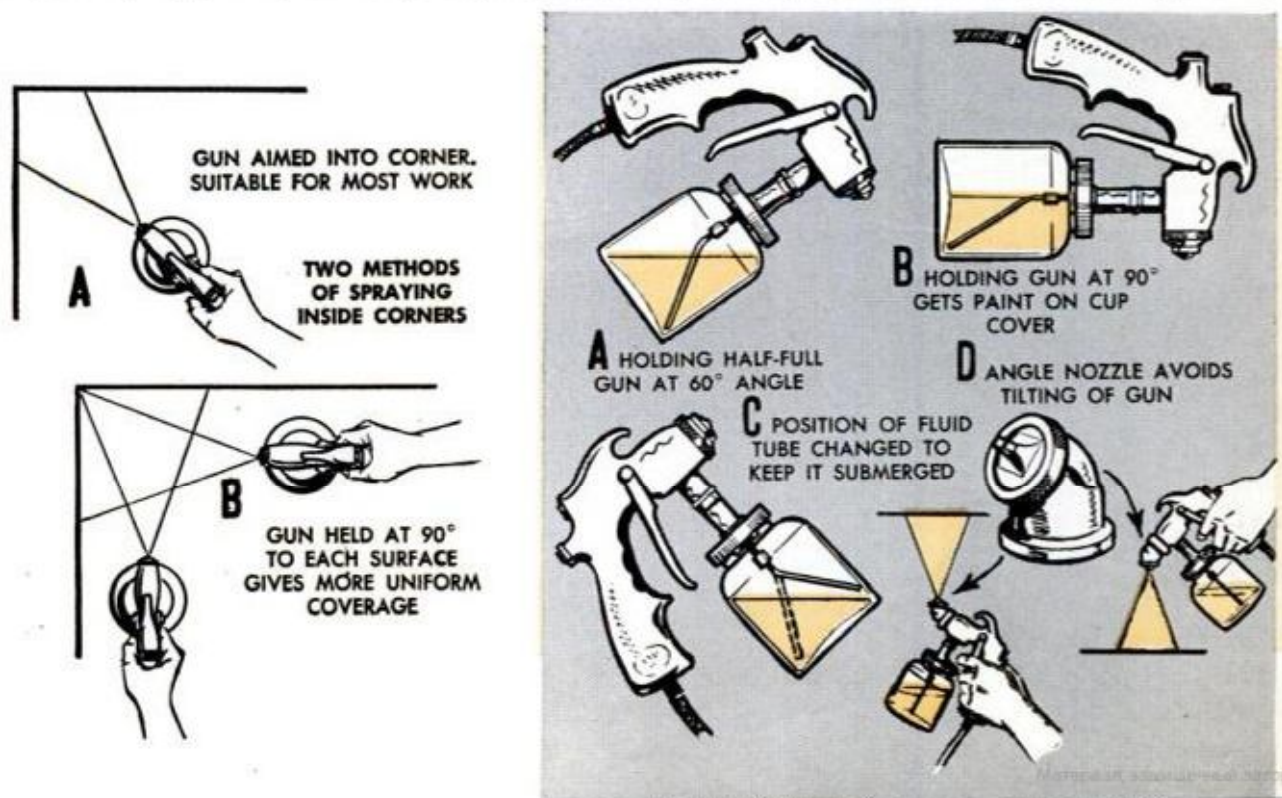

COMMON DISTORTED SPRAY PATTERNS

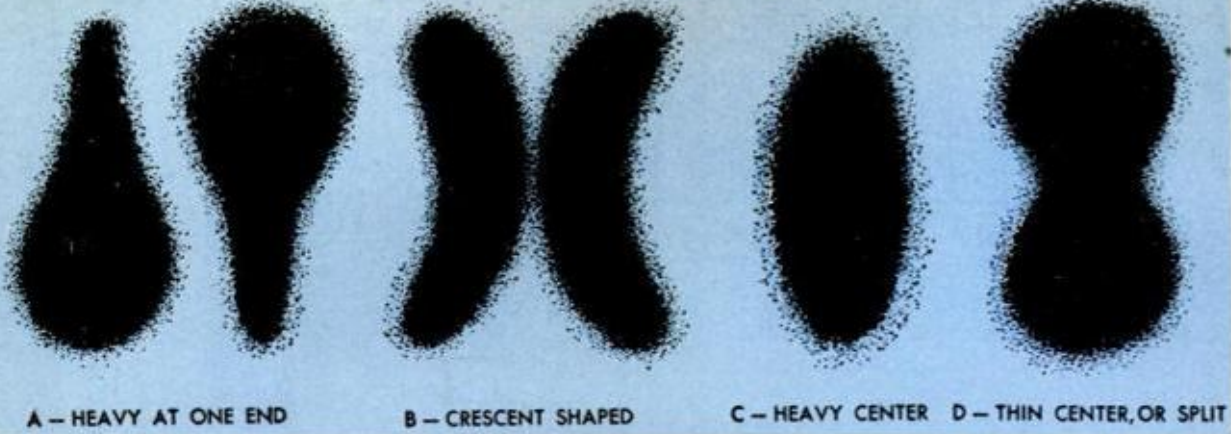

A — HEAVY AT ONE END

B — CRESCENT SHAPED

C — HEAVY CENTER D — THIN CENTER, OR SPLIT

18. DISTORTED SPRAY PATTERNS like those above usually mean your gun needs cleaning thoroughly, or new nozzle parts

Fig. 15. Consecutive strokes are made in opposite directions.

On long, narrow panels the strokes can be made vertically with the nozzle adjusted to produce a horizontal pattern, Fig. 15. When spraying large surfaces where horizontal strokes must be overlapped, the ends of the strokes are feathered. Similar feathering of adjacent strokes will build up the paint coat to proper thickness at the overlap.

On horizontal surfaces such as table tops the edges and corners are sprayed first, holding the gun at a 45-deg. angle, Fig. 15. Then the center area is sprayed. To finish an inside corner, usually it's

(Continued to page 196)



SPRAY BOOTH

19. SPRAY BOOTH, left, is a help in spray finishing. Below, number sequence shows you how to proceed in finishing a table

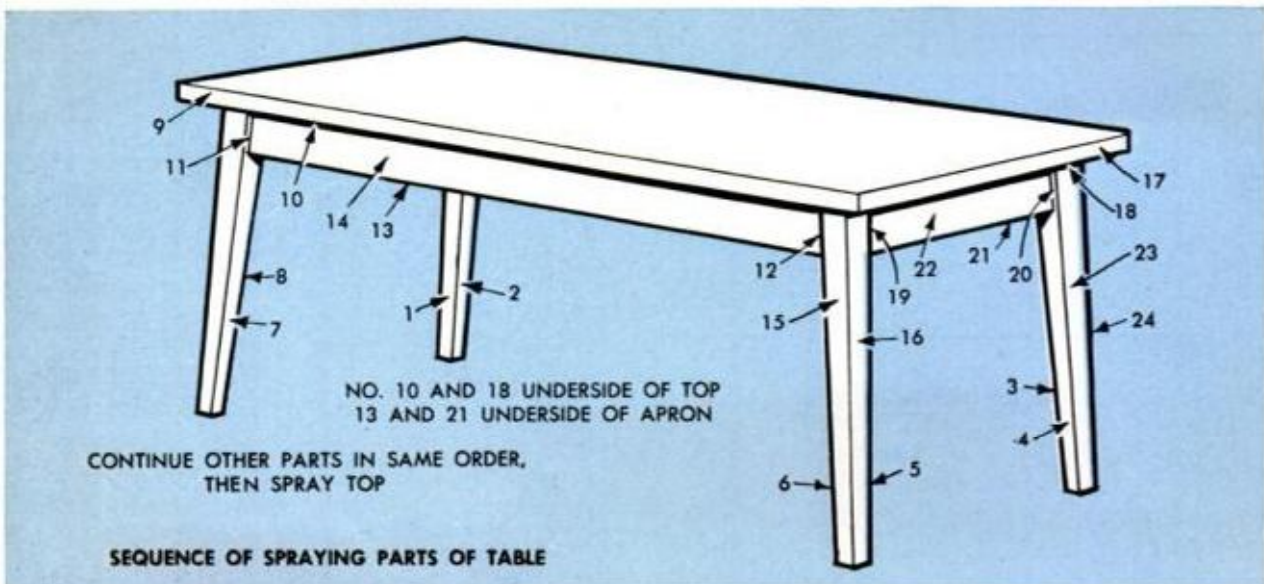

FARM TIMESAVERS

Timber Hitch

This heart-shaped ring of welded steel grips a post, sapling or small timber in a manner similar to a timber hitch tied in a rope—the greater the pull the tighter the grip. It was designed originally for pulling fence posts with a tractor-mounted loader. Notice that the inside edges near the bottom of the heart shape are beveled and that an eye is formed at the opposite end to take a heavy chain. A trip rope knotted to a ring releases the load.—A. M. Wettach

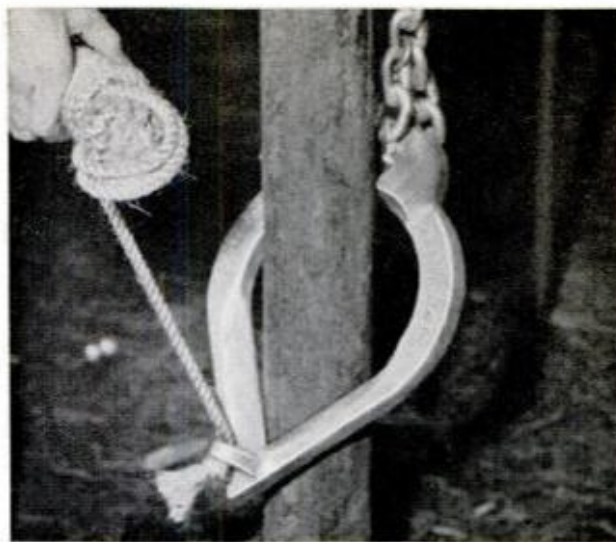

Walk-Through

You don't open this gate; you just walk through and that's how it gets its name. There's nothing to step over or climb over, nothing to unlatch. The two wings projecting from the fence row form an angle just sharp enough to prevent livestock from attempting to make the turn which is necessary to pass through the opening between the line posts. One person passes through easily but a group would have to take it single file. This same walk-through can also be built into a wire fence.

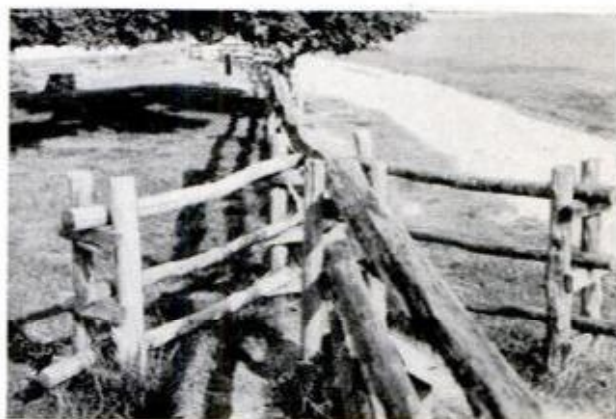

Spider-Web Guard

No matter what you have to use to cover that dangerous tumbling rod, it will cost less than a broken leg, or worse, which can happen in the wink of an eye if one should accidentally get a trouser leg caught in it. One way to guard the rod is to use sections of steel crib ventilators, placed end to end, with the half-round sections anchored to the ground on each side of the rod as pictured. The guard should extend far enough over the ends of the rod to cover the universals, which are just as lethal as the rod itself.—A. W. Ranniger

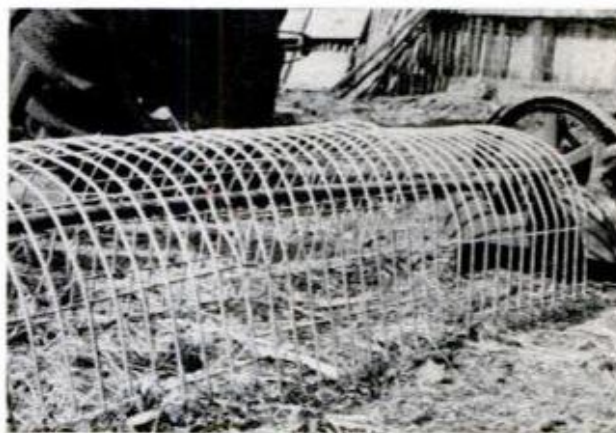

Self-Unloader

When it was designed, a truck-type lime-spreading box was intended only for handling limestone. But with a few simple changes, such as adding a swinging endgate and side and end boards to increase capacity, it can be used to handle shelled corn, any of the small grains, and even ear corn. The built-in drags can be arranged for power-takeoff drive so that when parked at the elevator the box will unload itself without any necessity of elevating the front end with a wagon jack. The hinged rear endgate is a necessary addition in order to control the flow of grain to the elevator hopper.

—Paul D. Andre





Brownie Super 27 Outfit includes camera, film, flashbulbs, batteries. Open it *first* to record all the thrills of Christmas. Camera has built-in flash, sure-grip shape, $f/8$ lens. Complete outfit, less than \$19.

Kodak gifts say ...and picture all your

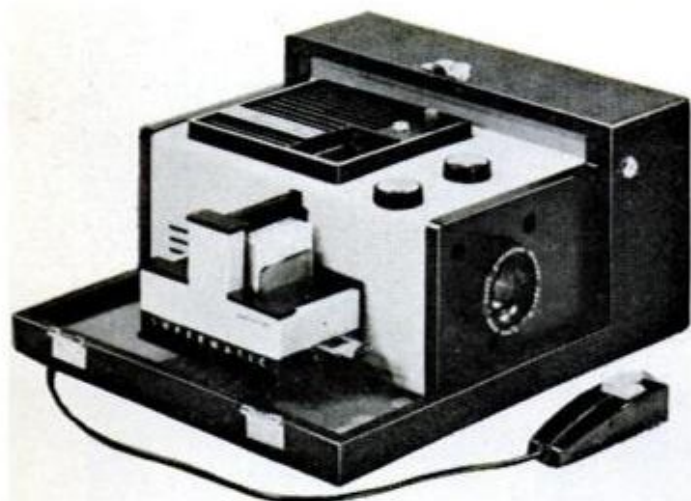

Kodak Supermatic 500 Projector needs no trays. Lets you change slides and focus by remote control—while you relax with your guests. Less than \$95. See, too, Kodak's revolutionary new Carousel Projector. Circular tray on top holds 80 slides! Less than \$140.



Sun or shade, these two fine Kodak 35mm cameras adjust exposure automatically. Both have electric-eye lens setting for daylight shots . . . ingenious automatic flash control for indoor pictures. Both have fine, fast $f/2.8$ lenses. *Kodak Motomatic 35 Camera*, left, winds film *automatically* after each shot! Less than \$110. *Kodak Automatic 35B*, right, is less than \$90.

EASTMAN KODAK COMPANY,

Prices are subject to change without notice.



Kodak Automatic 8 Movie Camera's electric eye automatically sets lens opening. Just aim and shoot. Built-in filter. Less than \$50. Gift kit includes camera, light bar, lamps. Less than \$58.

"Open me first" Christmas fun!



Kodak Super Showtime 8 Projector (A25) threads self, starts show automatically. 3-position lamp-saver control. Screenings up to 5 feet wide. Less than \$125. With zoom lens, less than \$140.



Kodak Zoom 8 Automatic Camera. You make exciting 8mm zoom movie shots by merely rotating the lens barrel. Viewfinder zooms, too! Has electric eye, focusing $f/1.6$ lens. Less than \$110.

See your dealer—for both cameras and film. Many dealers offer terms as low as 10% down.



Brownie Starmite Camera is a handsome little handful! Always in focus. Built-in flash holder uses thrifty AG-1 "jellybean-size" bulbs. Makes clear pictures in color and black-and-white, indoors or out! Famous Kodak quality . . . less than \$12.

Rochester 4, N. Y. ENJOY WALT DISNEY'S "WONDERFUL WORLD OF COLOR" SUNDAY EVENINGS, NBC-TV

Kodak
TRADEMARK

CLINIC FOR HOMEMAKERS



As a service to our readers in solving the hundreds of problems pertaining to a home—inside or out—editors of Popular Mechanics invite you to present your problems to The Clinic Editor for help and advice. Address your questions to The Clinic Editor, Popular Mechanics Magazine, 200 East Ontario Street, Chicago 11, Ill.

Heating With Electricity

Q—We're planning on building next year and are considering heating our new house with electricity. Is this type of heating system practical?—J. S., Wash.

A—Yes, electric radiant heating is certainly practical. For new construction, especially, it has many advantages. The local electric rates, of course, must be low enough to compete with other heating fuels, but even in relatively high-cost areas some homeowners willingly pay extra to enjoy the convenience of electric heating.

Many electric utility companies are now promoting electric heating by offering reduced rates in order to use up the surplus which is available during winter months when air conditioners are not in use.

In roomy old uninsulated houses heating by electricity generally is considered too expensive. But in new construction the use of extra insulation reduces the number of kilowatts needed to heat a house.

Ceilings, for example, should be insulated with at least six inches of mineral wool and outer walls with a minimum of three inches. All standard construction methods are used, of course, to insure a tightly constructed house, including double-glazed windows, weather stripping and caulking around door and window frames.

Installing and maintaining a radiant resistance heating system is less expensive

than other systems. Rooms may also be independently heated and controlled by room thermostats. In a room warmed by radiant heat one feels comfortable at lower temperatures than with convection heating systems. It's a clean, odorless heat with no drafts. The space needed for ducts, registers and heating plant is eliminated, since wires are embedded in ceilings and walls.

In an older home with an inadequate heating system one or two electric radiant units with independent thermostats may easily be added to furnish additional heat.

Squeaky Floors

Q—Our hardwood floors in the living room and upstairs hall squeak in several places whenever we walk on them. The living room subflooring is open to the basement, but the subflooring in the hall cannot be reached. What should we do to stop these annoying squeaks?—W. A., Ohio



A—Where floors are squeaking, chances are the carpenter goofed and didn't use enough nails to nail down the flooring. If subflooring is exposed in the basement, you can correct the condition easily. Sometimes only two or three small wedges, inserted between the joists and subflooring, will be sufficient to stop the annoyance. If this fails, you can drill several holes through the subflooring into the top flooring and pull boards together with screws which are long enough to reach into the top flooring.

But in the upstairs hall it will be necessary to work from above. Where appearance is important, several round plugs should be cut from scraps of matching flooring, or precut plugs may be purchased. Blind holes are drilled in the upper flooring to the depth and diameter of the plugs. Screw holes are then drilled and flathead screws used to stiffen the flooring. Repair is completed by gluing plugs in the holes.

If appearance is not a prime consideration, finishing nails may be driven at an angle through the tongue and groove joints, the nail heads set below the surface and holes filled with wood putty.





Upper Left: World's First $\frac{1}{4}$ " Cordless Electric Drill* by Black & Decker—a marvel of modern design and convenience. Completely portable. No cord! No plug! No outlet! Use it anywhere—at home or away.

The amazing Power Pack, inside handle, takes over 400 charges. Simply connect with compact Black & Decker Power Pack Charger. One charge, for example, provided ample power to drill 300 $\frac{1}{8}$ ", 200 $\frac{1}{4}$ " or 75 $\frac{1}{2}$ " holes in $\frac{1}{4}$ " fir. Shockproof. Only 4 pounds. A thrilling gift. C-601. Only \$59.90 complete with Power Pack Charger. *Patents Pending ©1961

Upper Right: Unique New Air-Cooled Deluxe Jig Saw. U-251. Smoothest, coolest plain or fancy cutting. Saddle horn grip. 3000 Cycloid strokes per minute. No splintering. Jig Saws from \$29.95.

Powerful New $\frac{3}{8}$ " Utility Drill. U-120. More torque for tough jobs. True double reduction gears. Special low price. Drills from \$16.95.

Only 25¢! 180-page book "How to Choose and Use Power Tools." Write: The Black & Decker Mfg. Co., Dept. D-121, Towson 4, Md.

Bottom: Handsome 30-Piece Drill Kit for priceless pleasure on countless jobs. Exceptional quality. New Black & Decker $\frac{1}{4}$ " Drill with most-wanted accessories for drilling, sanding, grinding, buffing, polishing. U-111 includes Picture Hanger Kit, 5 Drill Bits, Grinding Wheel, 12 Sanding Discs, Wire Wheel Brush—lots more. Smart steel case. Kits from \$26.95.



Black & Decker®

WORLD'S LEADING MAKER OF POWER TOOLS
AND THE WORLD'S FIRST CORDLESS ELECTRIC DRILL



Also available in Canada



Paint With Air!

(Continued from page 190)

best to work one side first then take the adjacent side, Fig. 17, left-hand details A and B. When applying clear coatings or stain in an inside corner each side should be coated separately to obtain an even coating.

Areas not to be painted, such as door and window trim, can be shielded with pieces of cardboard of suitable size, which are moved along with the gun, Fig. 16, A. Wall areas adjacent to trim can be covered by paper masks held with tape as in detail B. Window panes are similarly covered.

When it is necessary to tilt a gun, as for spraying table tops, ceilings, and the underside of shelving, the cup should not be more than half full. It then can be tilted up to 60 degrees without getting paint on the lid. See details A to D, Fig. 17. On most guns the position of the fluid tube can be changed to work special jobs. Where considerable spraying of horizontal surfaces is to be done, an angle nozzle, Fig. 17, detail D, can be used.

Distorted spray patterns: When spray patterns are distorted, Fig. 18, heavy at the top or bottom or are crescent shaped, either the air cap or fluid is partially clogged, and requires cleaning. A heavy center pattern may be due to too low a setting on a spreader-adjustment valve; too low an atomizing pressure on a twin-jet cap, paint too thick, too much fluid pressure (with pressure-feed guns) or an excess flow of liquid beyond the normal capacity of the air cap.

A split or narrow-center spray pattern is caused by improper balance between air and fluid. This is remedied by reducing the width of the spray pattern or increasing the fluid pressure. A fluttering spray is caused by air getting into the fluid line, which happens when the cup becomes empty or the gun is tilted so the fluid tube is only partly submerged. It also can be caused by a loose fluid tube that allows entrance of air. On a suction-feed gun, jerky spraying can result from using too thick liquid, a clogged vent hole in the lid, a loose coupling nut on the lid, or a loose needle packing at the fluid valve.

Furniture finishing: In furniture finishing, a small spray pattern from 3 to 5-in. wide is best as it permits close control of overspray. For easy handling and accessibility to all parts, the work should be placed on a turntable, and spraying done in a ventilated and illuminated spray booth, Fig. 19.

To minimize spray dust on areas already

(Continued to page 198)

CRESCENT WRENCHES HAVE WHAT IT TAKES

CRESCENT open-end and box wrenches have what it takes to get the job done quicker, easier, safer. They're drop-forged from special alloy steel for greater strength. They're made thinner for easier handling, better balance. Openings are accurately machined for sure holding. CRESCENT wrenches feel better, work better, last longer—because they're made better. See them at your nearest hardware dealer.



SEND for this 40-page illustrated booklet telling how to do the job safer, easier and better with 30 different hand tools. Tips on care and maintenance.

CRESCENT TOOL COMPANY
Jamestown, N. Y.

CRESCENT TOOL COMPANY, DEPT. PM 12
Jamestown, N. Y.

Please send me
"HOW TO USE HAND TOOLS"

Name _____

Address _____

City _____ State _____

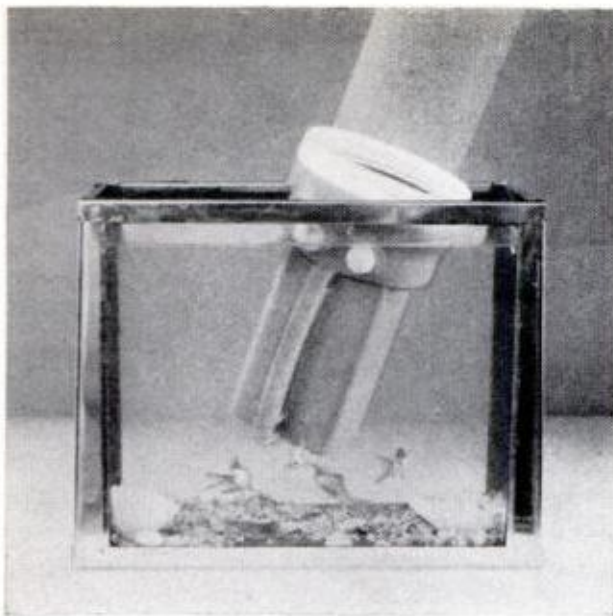

Flashlight Beams as It Floats

Equipped with a flashing red warning light and a straight white beam that reaches a quarter of a mile, a new plastic-cased flashlight is particularly suited for outdoorsmen — it's waterproof and it floats. The lights operate independently or in combination.

Without battery, the Uni-Float sells for \$6.95 from Protect-O-Seal Corp., 600 East 17th Ave., North Kansas City, Mo.



Sleepy Driver Blows Own Horn

You have to keep both feet in action, and eyes open, when you drive a car equipped with a safety device that blows your horn if you begin to drowse off.

The safety alarm, called the Alertmaster, fits to the floorboard at left of accelerator. When you begin to feel sleepy a switch is touched on with the toe; your horn blows, but is silenced when you bear down on the pedal.

Should you begin to doze, your body relaxes, pressure on pedal eases off, and the horn blows again. Made by Alertmaster Corp., P.O. Box 25101, Houston, Tex.

RESEARCH MAKES THE DIFFERENCE*

SONY®



NEW STEREO TAPE DECK

Now, for less than the cost of a good record changer, you can add a versatile new dimension to your hi fi system. ■ The Sony 262-D tape deck has a 4 track stereo erase head and 4 track stereo record/playback head. Heads are wired to six output and input facilities for connection of external electronics to play and record four track stereo. This is the same quality mechanism used in the most expensive Sony Superscope tape recorders.

\$89⁵⁰

NOW AVAILABLE!

Complete your 262-D stereo system: the long-awaited Sony SRA-2 stereo recording amplifier provides instant connection to the Sony 262-D stereo tape deck for complete 4-track stereophonic and monophonic recording. Track selector switch, record safety interlock, microphone and radio inputs. No modifications necessary. \$89.50.

■ For literature or nearest dealer, write: Superscope, Inc., Dept. 9, Sun Valley, Calif.

*TM

SUPERSCOPE Tapeway to Stereo

The Handiest Plier of them All

use it
as a
PLIER

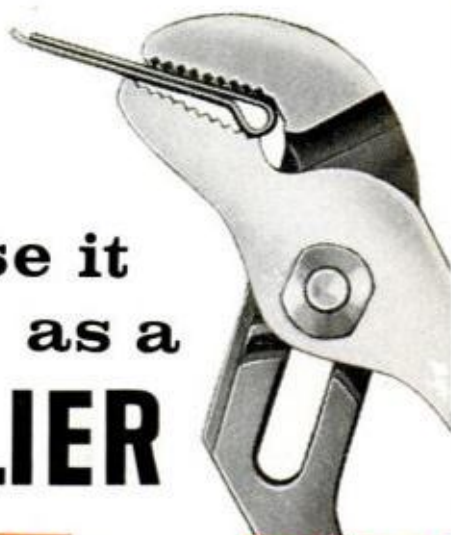

CHANNEL LOCK[®]

use it
as a
WRENCH



You'll do hundreds of jobs faster, easier with a CHANNELLOCK Plier. Gives you terrific, parallel-jaw gripping power. Five undercut, machined channels can't slip . . . the tighter you grip, the tighter they lock. Long and compact . . . a jim-dandy on hard-to-reach jobs. Available in three jaw capacities: $\frac{7}{8}$ ", $1\frac{1}{2}$ " and 2". Ask your tool supplier for a genuine CHANNELLOCK Plier. If he's out of them, ask him to order one for you.

Write for Catalog of Complete Line of Pliers

CHAMPION DEARMENT TOOL COMPANY

MEADVILLE 1, PENNSYLVANIA

coated, edges and out-of-way places are done first. Turnings such as table legs should be sprayed with vertical strokes and a horizontal spray pattern slightly wider than the legs. When spray-finishing a small table, Fig. 19, the legs are done first from the inside. For square legs, two sides of each can be sprayed from one position of the gun, the table being rotated for each leg. For round legs, all are first sprayed from the inside, then each is finished separately. Next, the edges of the table top are done, then the underside of the extending top and the apron and the outside of the legs. The table top comes last. On cabinets and casework, the inside is done first, then the outside.

Cleaning spray guns: Always clean your spray gun thoroughly and immediately after using it. Fill an extra paint cup about one-quarter full of solvent used for the particular paint sprayed. Usually pint-size fruit jars make ideal extra cups for suction-feed guns, but metal cups should be used on pressure-feed guns. Solvents are as follows: water for water-base paints, turpentine for most paints and varnishes, alcohol for shellac, and lacquer thinner for lacquer.

With the compressor turned off, allow the fluid tube to drip a few seconds before wiping off excess paint from the tube and inside of the cap. Now turn on the compressor and spray solvent through the gun four or five times for two-second durations, against a newspaper or cloth to catch the spray. Then hold a cloth tightly against the nozzle and pull the trigger a few times to agitate the solvent violently inside of the cup and fluid tube. Next, wipe the cap and outside of the gun. Empty the remaining solvent into the paint cup to clean this. Be sure to get paint residue from the threaded portions of both cup and cover if these screw together. Remove the air cap, fluid tip and needle, submerging these in solvent. Don't use a caustic alkaline cleaner as this can damage aluminum parts. ★★

QUOTE:

"The time span between basic discoveries in science and their application in technology has been decreasing. Although the two areas are difficult to compare, I would guess that in the last two decades, advances in basic sciences have not kept pace with technological applications. Our national welfare and our ability to maintain ourselves as a free nation are increasingly dependent on our progress in basic science."

LELAND J. HAWORTH, Commissioner
U.S. Atomic Energy Commission

POPULAR MECHANICS

LASTS 100% LONGER

This super durable clear finish in GLOSS and SATIN outperforms all others on wood — interior, exterior, marine.



Write for free folder, name of dealer.

PRATT & LAMBERT-INC.

Dept. M12, 75 Tonawanda St., Buffalo 7, N. Y.



GENUINE ALNICO MAGNETS

AMAZING. PERMANENT. NON-ELECTRIC. HIGHLY PRACTICAL. Conduct interesting experiments. Hundreds of uses. Retrieve valuable steel items such as guns, tackle from fresh or salt water; tools from tanks & drains. **GUARANTEED.** Try any magnet one week. Money back if you are not well-pleased.

No. M-710 (Wt. 5.3 oz.) Has pull of 225 lbs. on steel block... \$18.00
 No. M-825 (Wt. 7.0 oz.) Has pull of 125 lbs. on steel block... \$10.00
 No. M-575 (Wt. 1.8 oz.) Has pull of 75 lbs. on steel block... \$ 7.00
 No. M-500 (Wt. 1.3 oz.) Has pull of 50 lbs. on steel block... \$ 5.00
 No. M-90 (Wt. .5 oz.) Has pull of 15 lbs. on steel block... \$ 3.50
 No. M-44 Rod Magnets for Electric Guitars, 1/4" Dia. x 1 1/4" 12 for \$4
 No. M-47 Hot Pad Magnets 10 for \$1.00... 50 for \$ 4.87
 No. M-55 Science Experimenter Kit of 8 magnets... \$ 2.00

Send M.O. or check. We pay postage. Sorry no C.O.D.'s.

MIAMI MAGNET COMPANY, 3240 N.W. 27th Ave., Miami 42, Fla.

FOR QUALITY LUBRICATION CHANGE TO

KENDALL MOTOR OILS

KENDALL REFINING COMPANY • BRADFORD, PENNA.

THE GIFT THAT DELIVERS BEST WISHES FOR HAPPY DRIVING EVERY DAY FOR YEARS



HULL COMPASS FOR CARS AND BOATS

\$5.95 AND \$6.95

At your dealer's or write for circular.

HULL MFG. CO.
BOX 246-D-12 Warren, Ohio

HULL — THE COMPASS THAT WORKS



Works in seconds!



Loosens Rusted Bolts nuts, screws, "frozen" parts!

LIQUID WRENCH® SUPER-PENETRANT

The super-penetrating rust solvent that quickly loosens rust and corrosion.

AT ALL HARDWARE AND AUTO STORES

RADIATOR SPECIALTY COMPANY
CHARLOTTE, N. C.



DECEMBER 1961

NEW WINEGARD TRANSISTOR ANTENNA INVENTION

Improves TV Reception Instantly!

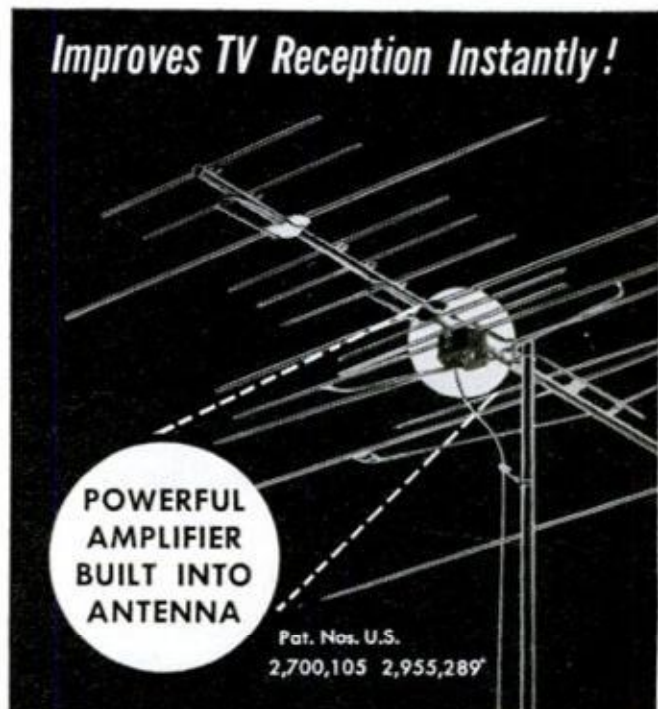

**POWERFUL
AMPLIFIER
BUILT INTO
ANTENNA**

Pat. Nos. U.S.
2,700,105 2,955,289

ELECTRONIC POWERTRON TV Antenna gets amazing reception distance, clears up snow and interference

Now an antenna has been invented that makes an instantaneous improvement in your TV reception. The transistor amplifier built into the antenna makes the new gold anodized Winegard Powertron by far the world's most powerful TV antenna. Imagine the difference *amplified* TV signals can make.

Your TV reception improves instantly!

You'll get clear, sharp pictures, black and white or color. Snow and interference are virtually eliminated. You'll pull in stations ordinary antennas can't reach.

Get the ultimate in TV reception!

Have your TV service dealer install a Winegard Powertron today... only \$74.95—Super Powertron \$104.95. Write for free detailed brochure.



Winegard

3001-12 Kirkwood, Burlington, Iowa

199



don't say "darn"...say

DURATITE



Best White Glue you can buy!

Ask for DURATITE WHITE GLUE to solve mending problems like this in a hurry. Dries fast. Makes a tough bond as strong or stronger than the materials you repair. Mends so many different materials so easily you'll want two big plastic bottles... one for household, one for workshop. Get other DURATITE products, too — Wood and Metal Fillers, Household Cement, many more—at hardware, paint and building supply stores. Write for free DURATITE folders.

Say DURATITE for the best in Glues, Cements, Wood and Metal Fillers... say DAP for fine Caulking-Glazing-Sealing-Spaulking products.

DURATITE, A Division of DAP inc.
Dept. 35, Dayton 31, Ohio

Triple-Top Fun Table

(Continued from page 145)

as in the sectional detail in Fig. 7. Note the $\frac{1}{16} \times \frac{1}{16}$ -in. rabbet that is made along the outer edge. This serves as a parting line at the joint so there is no chance of chipping the finish when it is necessary to lift off the top rail at a future date. Clamping blocks are glued temporarily on each side of the mitered joints as before, Fig. 6, and splines are cut from solid stock with the grain running crosswise. Now you can glue and clamp the joints. Pocket openings in the rail itself are laid out and cut after the glue is dry, the corner pockets being scribed as in Fig. 9. When placed over the tongue, or tenon, on the side-wall members, the rail should come flush with the outside surfaces.

Part II next month will describe the fitting of the filler blocks at the pockets, cutting the cushion rails and the steps in covering both the bed and the rubber cushions with pool-table cloth. ★ ★ ★

MATERIALS LIST

(All dimensions actual sizes in inches)

2 pcs.	$\frac{3}{4} \times 7\frac{1}{2} \times 92$	Side rails
2 pcs.	$\frac{3}{4} \times 7\frac{1}{2} \times 48$	End rails
2 pcs.	$\frac{3}{4} \times 5\frac{1}{4} \times 86\frac{1}{4}$	Side wall of tunnel—sides
2 pcs.	$\frac{3}{4} \times 5\frac{1}{4} \times 36\frac{1}{2}$	Side wall of tunnel—ends
1 pc.	$\frac{3}{4} \times 4\frac{1}{4} \times 36\frac{1}{2}$	Unused tunnel bottom—end
2 pcs.	$\frac{3}{4} \times 4\frac{1}{4} \times 86\frac{1}{4}$	Side tunnel bottoms
1 pc.	$\frac{3}{4} \times 4\frac{1}{4} \times 46\frac{1}{2}$	Bottom-ball return bottom
2 pcs.	$\frac{3}{4} \times 1\frac{3}{4} \times 91\frac{1}{4}$	Bed—shelf—sides
2 pcs.	$\frac{3}{4} \times 1\frac{3}{4} \times 43\frac{3}{4}$	Bed—shelf—ends
2 pcs.	$\frac{3}{4} \times 1 \times 80\frac{1}{2}$	Cleats for table support—sides
2 pcs.	$\frac{3}{4} \times 1 \times 35$	Cleats for table support—ends
1 pc.	48x96 (Particle boards)	—Playing bed
1 pc.	$\frac{3}{4} \times 3\frac{1}{2} \times 80\frac{1}{2}$	Center brace under bed
4 pcs.	$\frac{3}{4} \times 1\frac{1}{2} \times 3\frac{1}{2}$	Center-brace glue blocks
4 pcs.	$\frac{3}{4} \times 2\frac{5}{8} \times 43\frac{3}{4}$	Support slats under bed
2 pcs.	$\frac{3}{4} \times 2\frac{1}{4} \times 48$	Top rail—ends
2 pcs.	$\frac{3}{4} \times 2\frac{1}{4} \times 92$	Top rail—sides
4 pcs.	$\frac{3}{4} \times \frac{5}{8} \times 8$	Splines for side rails
2	$\frac{1}{2} \times \frac{3}{4} \times 5$	Support blocks for ball return
4	$\frac{1}{4} \times 1 \times 3\frac{3}{4}$	Splines for top rail

SAVE MONEY ON WOOD

POWER TOOLS
WORKSHOP SUPPLIES



World's Largest Selection, Rare, Fancy and Imported Woods, Mosaic Tile, Lamp and Upholstery Supplies, Tools and Hardware! All at Money Saving Prices!

Send for this complete new wood buying guide and project book. Craftsman is your best, most complete source of finest kiln-dried domestic and rare imported woods, beautiful wood inlays, colorful bandings, matched plywoods, furniture legs, embossed mouldings, carved ornaments, newest wood-working tools, "hard to find" cabinet hardware and fittings... more than 1,500 items! Packed with new patterns, project ideas and money making plans. Enclose \$2 to help pay mailing and handling cost. Write:

CRAFTSMAN WOOD SERVICE CO.
2729 S. Mary St., Dept. A-12, Chicago 8, Ill.

NEW 140 PAGE CATALOG
Send Today!

Oceans Running Out of Fish

All countries must cooperate toward the most effective use of the ocean's food, for careless use is taking a toll of ocean life, says Dr. Robert Cushman Murphy, American Museum of Natural History zoologist.

He says new ways of harvesting the ocean must be discovered to feed the mushrooming world population, but that these new sources could be quickly exhausted through man's own carelessness or lack of planning.

World's First, Finest and Only Complete Line of FUN GUNS!

**SINGLE-Action
SIX CO₂ Gas Pell-
gun Revolver**

"160"
CO₂ Gas Deluxe
Pellgun Rifle



Today's
deluxe marksmanship
Pellgun rifle

"140"
High Velocity
Air Pellgun
Pump Rifle



Real economy
for every kind
of fun shooting

"V-350"
Slide Action
BB Air Rifle



New high velocity—
fastest, easiest barrel
slide-action cocking

Fast draw
with true western
single action

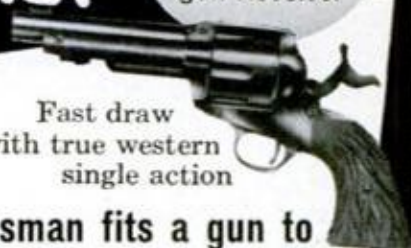

**Only Crosman fits a gun to
every shooter from 8 to 80!**

You're sure to find your
own favorite gun . . . for
fun plinking, marksmanship,
and gun training . . . among
the twenty-two different models
of Crosman CO₂ gas and high
velocity air powered Pellguns[®]
and BB guns. Priced from
\$12.95. See them at your
Crosman Select Dealers'.

"600"
Pellgun Semi-
Automatic
Pistol

"10" shots in less
than 3 seconds



"Power without Powder"
Crosman
High Velocity Air and CO₂ Gas

PELLGUNS

BB GUNS

WORLD'S LARGEST MANUFACTURERS OF CO₂ GAS-POWERED RIFLES AND PISTOLS



"Next!"

Seattle's Floating Prowl Car

(Continued from page 131)

mile-an-hour wind was blowing. A seacock broke loose, the bilge filled with water and the boat tipped over. Seven persons drowned, some while trying to swim to shore. A Navy helicopter plus help from the Coast Guard and Harbor Police saved six others, including a two-month-old baby.

"They'd have been better off to stick with the boat," Stevenson said and cited an example of a person who had followed this procedure in another accident. The police were called to go to the aid of a capsized 16-footer. There was no sign of life. Then came a muffled call from beneath the boat. A policeman dived under and brought up a gasping woman. She had been clinging to a seat and holding her head in an air pocket.

As we talked, a call squawked over the radio: "... Three kids on a raft. The raft is just some inner tubes tied together."

Two officers scrambled into a patrol boat and roared off.

Outdoing Huckleberry Finn

"Kids sometimes will ride things today that even Huck Finn wouldn't have considered," Stevenson said. "We recently picked up some boys astride a timber in rough water. They had stolen the timber—it was 12 by 12 inches thick and about 25 feet long—and had attached an outboard motor to it. They were lucky we caught them before they drowned."

Ordinarily, Seattle's fire department fights all fires at docks with high-powered fire boats. In the last couple of years though, police boats have played major roles in answering emergency calls.

There was, for example, a fire at Renton, a nearby city. It started with the burning of a scrap pile of timber. Wind fanned the flames toward a shipyard. Land-based pumpers sped toward the scene, but couldn't get at the fire. A fast police boat with a pumper got the fire under control. Then, only a stone's throw from the Ballard dock station, fire broke out at the Seattle Cedar Mill. Again the police roared into action. The damage was kept to a minimum.

In both cases the police boat, with its equipment limited in power, had to approach dangerously close to the flames. Windows on the boat cracked from heat and two men were badly burned. The police are justly proud of a bronze plaque that hangs in the Ballard station. It is for heroism in fire fighting and comes from a group of men not easily impressed—the Maritime Press Association.

"It's careless smoking on a boat—especially during refueling—that usually brings a call for our fire-fighting equipment," said Stevenson.

Modern Pirates

With all the boats in the many coves around Seattle, thefts are surprisingly few. Police, however, will long remember a crew of four juvenile pirates. Small boats started disappearing from moorings on Lake Washington. The total reached seven. At the same time, dock warehouses were being broken into at night and seafaring equipment stolen. There was no clue to the robbers, except that most operations would have required use of a boat.

Then came a big theft—a 26-foot sailing ketch. You just don't hide a boat that size easily so the police started combing every inlet. Finally, a police boat nosed among the bullrushes in a little-traversed section of Lake Washington. There was the ketch; four boys were working on it. The seven boats were hidden there also, along with much of the loot from the warehouse. There was a ninth boat, and it was the most interesting. It was a rowboat they had used in boarding other craft and in slipping up to warehouses. Its sides were covered with rubber hosing to eliminate thumping and other noises as it moved into congested dock areas at night. The pirates were, of course, punished.

"Modern developments make it easier to cope with the trickiest situations encountered because of the increase in boating," said Capt. Stevenson.

"Now, with our helicopter, we have added air coverage to the waterfront. Suppose a man collapses from a heart attack in his boat during the night. We couldn't spot his boat easily from water, but the helicopter can find it, drop a flare. Or a diver can leap from the 'copter and swim to the boat.

"No," he concluded, "I wouldn't want to be back on highway patrol. It's too interesting here." ★ ★ ★

QUOTE:

"Technology has taken its place as a vital growth force in the economic system the world over and is considered by many economists now to outweigh in significance the traditional factors of production—land, labor and capital. Thus the technical man is not just another soul working to make a living. In a world that relies increasingly on scientific advancement, he is the builder of the future."

E. V. MURPHREE, President
Esso Research and Engineering Co.

**NOW
SAVE
\$66⁴⁵**

Limited time only at
your DeWALT dealer

Get this double value!

DeWALT *plus*

33-PIECE CHEST FULL O'TOOLS

Chest contains all these
genuine DeWalt tools



Plywood Saw



Sander Disc



Tool Guard



Wire Wheel



Boring Bit Set



Cup Wheel



Buffer-Polisher



Dado Knives



Dado Cutters



192-Page Book



Shaper Cutters
Drum Sander



This is the biggest bargain you've ever had! Now, with your purchase of a new DEWALT POWER SHOP, you can get a custom-made steel chest complete with select tools...33 pieces in all...and all are genuine DEWALT brands that shopwise men use for quality work. Buy this great combination...DEWALT plus CHEST FULL O' TOOLS and SAVE BIG \$66.45. For limited time only. Hurry to your DeWalt dealer and take home your biggest buy ever.

DEWALT, Inc., Dept. PM-1261
A *Black & Decker* SUBSIDIARY
Lancaster, Pa.

- Send me special Chest Full O' Tools information.
- Send name of nearest dealer.

Name _____

Address _____

City _____ State _____

STOP WATER DAMAGE...



Wood
Plywood
Shingles
Asbestos siding
Concrete blocks
Concrete
Mortar
Stucco
Plaster
Brick
Paint
Wallboard
Tile
Canvas
Leather
Linoleum
Fabrics

Prevents warping, swelling, mildew, mold, water stains, seepage, dampness, rot.

Keeps moisture out 5 years and longer.

Use on all woodworking jobs, boats, patio furniture, planter boxes, shutters, screen doors, window sash, shingle roofs. Stops seepage in basement walls, concrete silos, foundations. Waterproofs canvas, tarps, tents, awnings, leather boots, shoes, outdoor clothing. Won't harden or crack leather or fabrics. Perfect underseal for oil base or alkyd paints. Deep penetrating, colorless. Apply by brush, spray or roller. At paint or hardware stores or order direct. 16 oz. spray can \$1.89, Qt. \$1.75, Gal. \$5.35, 5 Gal. \$25.25, ppd., tax incl. Send check or money order to **E. A. Thompson Co** 1855 Market St., San Francisco 3, Calif. No COD's please. (Since 1929.) Dealer and jobber inquiries invited.

Add a Boston Rocker

(Continued from page 159)

rest to prevent whipping of the long back posts when turning. Finally, cut the rockers to contour from $\frac{3}{4}$ -in. stock.

Assemble a spindle-bending jig, or rack, as in Fig. 12 for bending the back spindles as in Fig. 13. Place the spindles in a wash boiler or any other suitable receptacle and add enough water to cover them completely. Allow to soak overnight. Then bring the water to a rolling boil and continue for fifteen or twenty minutes. Remove spindles from the water immediately and slide each into the bending jig as in Fig. 13. Allow to dry before removing from the jig.

Final Sanding

Now sand all parts, except the turnings which should be sanded while still in the lathe, to finish smoothness. Round all exposed edges slightly and then make a trial assembly, beginning with the legs and rungs and proceeding as in Figs. 11, 14 and 16. To make sure that you get the bent back spindles in the correct positions when making the final assembly saw a strip from $\frac{3}{8}$ -in. stock to the same curvature as that of the back rail and drill a pattern of slightly oversize holes through the strip, the holes on the same centers as those in the back rail. Set the back spindles and posts in place as in Fig. 14 and place the strip over the ends. Locate the strip at the same height as the bottom edge of the back rail in the finished chair. Now, using a yardstick or any suitable straightedge, you can adjust each spindle so that the bends are in the correct position. Once they are positioned, make registering marks on each spindle and on the seat, also number the spindles and posts. This will enable you to return them to position when making the final assembly with glue in the joints.

You'll undoubtedly have to do some hand fitting of parts in the trial assembly in order to make sure they will all fit together properly when you make the final assembly. Note in Fig. 9 that the arm-rest posts, I, are slotted for wedges and that the arms are doweled to the back posts, also that the rockers are pinned to the legs. Spread glue in the holes and tap the parts into place, using a soft hammer or mallet as in Figs. 10 and 16.

What kind of wood to use? You have a choice of maple, birch and cherry. The first two can be stained a brown or ruddy maple color and cherry can be finished in the natural color with a clear finishing material. Or the chair can be painted a dull black or a medium red. Rub the final coat down with fine steel wool. ★ ★ ★

All you do is steer! NEW *Simplicity* SNO-AWAY

This self-propelled, 23-in., rotary snow thrower features an adjustable spout (controlled from operator's position), gear driven reverse, and fingertip controls. See your Simplicity dealer.

Simplicity Manufacturing Co.
6241 Spring St.,
Port Washington, Wis.



Makers of Simplicity Garden Tractors, Simplicity '725' Riding Tractors, Wonder Boy Riding Lawn Mowers



- * DRY SOFT
- * STAY SOFT
- * WEAR LONGER
- * LEATHER

..... where better
work gloves
are sold

WOLVERINE GLOVES



GEARS

In Stock - Immediate Delivery

Gears, speed reducers, sprockets, thrust bearings, flexible couplings, pulleys, etc. A complete line is carried in our Chicago stock. Can also quote on special gears of any kind. Send in your blueprints and inquiries.

**Send for Complete Catalog No. 10
CHICAGO GEAR WORKS**
440-50 N. Oakley Blvd., CHICAGO 12, ILL.

BUILD YOUR WORKSHOP LIBRARY

Seven handsome hard cover books, 120 pages each, tell and show you with photos and drawings how to get the most out of your: CIRCULAR SAW & JOINTER, DRILL PRESS, LATHE, ABRASIVE TOOLS, BAND SAW AND SCROLL SAW, SHAPER and RADIAL SAW. Your choice—\$1.00 each. Mail check or money order to Deltacraft Books, Rockwell Manufacturing Company, 502M N. Lexington Ave., Pittsburgh 8, Pa.

CAR WITHOUT WHEELS



A miniature of things to come—a balsa-and-paper model of the air car you may be riding a few years hence. Skims along just above the floor on a tether. Model airplane engine powers it. Look for it in

JANUARY

DECEMBER 1961

2 NEW RIGGID® CHAIN WRENCHES



give real Action-Grip
in Tightest Places

No. C-14 for up to 2" Pipe and Fittings
No. C-18 for up to 2½" Pipe and Fittings

Work on Round, Square or Irregular Shapes Other Wrenches Can't Reach!

In extra close quarters there's nothing that'll beat these new RIGGID Chain Wrenches for getting the job done. Fast, ratchet-like action in either direction . . . from either side. Give tight grip without crushing. Large, easy-to-grab end ring for fast chain adjustment. Tempered steel chain locks securely . . . releases quickly. Rugged, comfort-grip, I-beam handle, guaranteed not to break or warp . . . handy hang-up hole.

Light and easy to use, these new RIGGID Chain Wrenches do everything a regular wrench can do . . . and much more. Stop at your Hardware or Building Supply Dealer's and get one today!

RIGGID®

The Ridge Tool Company • Elyria, Ohio, U.S.A.

Shopping for tools

1. PNEUMATIC PORTABLE GUN operates from compressed air line, driving corrugated fasteners into wood. Operator sets gun on wood surface and pulls trigger. Fasteners feed automatically from chamber into gun. There's adjustable pressure for soft or hard woods. Practical for many service shops. Saurenman Co. Inc., 1517 N. Potrero Ave., El Monte, Calif.

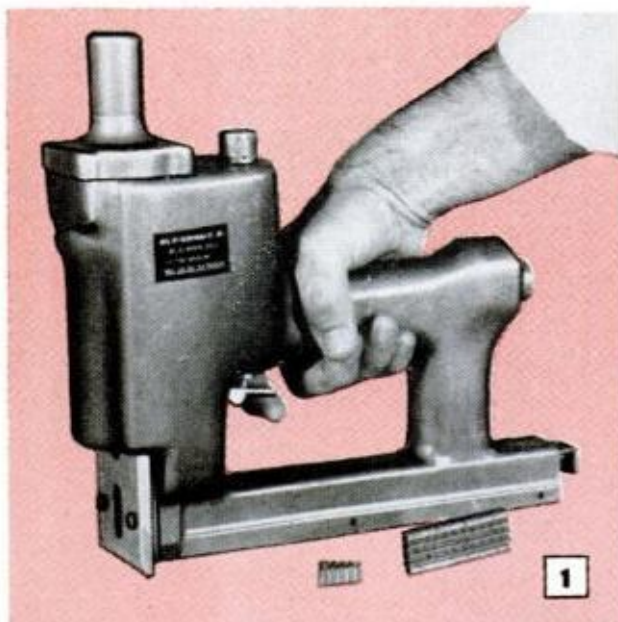

2. STICKLEBACK SAW-RASP may be used as either file or rasp. Provided with both coarse and fine teeth, the tool works equally well on plastics, veneers, wood, plaster and painted surfaces without loading. Even after edge has worn extensively the teeth can be resharpened. Price: 69 cents. Distributed by TEC Imports Inc., 15001-03 Califa St., Van Nuys, Calif.

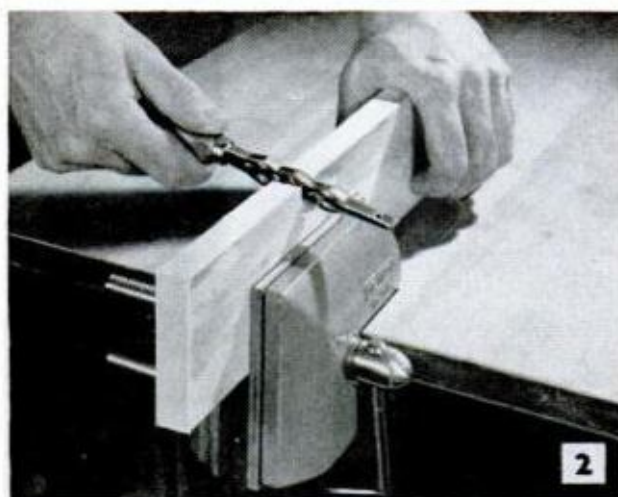

3. UNIQUE DESIGN of this rotary wood planer is said to make it impossible for tool to kick back and injure operator. May be used to cut rabbets, tenons, moldings and similar work. Fits any drill press with 1/2-in. chuck. Kit includes three blades, grinding wheel, arbor and wrench. Priced at \$11.75 ppd. Gilmore Pattern Works, 1164 North Utica, Tulsa, Okla.

4. JET TORCH includes interchangeable soldering tip and blowtorch with pinpoint flame operating from tiny cylinder of butane gas the size of thumb. May be turned off or on with twist of wrist. Torch is particularly useful in tight spots or on camping or boating trips. Kit with two cylinders is \$2.95. Bitt Imports, 261 Kempton Drive, Berea 10, Ohio

5. JAMMED GARBAGE DISPOSERS are easily cleared with this 18-in. steel tool. Even a housewife can quickly release a jam. Also handy for removing articles from sink drain and other hard-to-reach places. Kit includes complete instructions and brush to clean housing interior. Price: \$3.98. Columbus Kitchen Equipment Co., 426 E. Kossuth St., Columbus 6, Ohio





Walkie-Talkies From Kits

Built from kits, two-way radio transceivers transmit and receive up to a quarter mile on citizen's band frequencies. Each unit has telescoping antenna, transistorized circuit, push-button operation — push the button to transmit, release to receive.

Another portable transistor unit (below) broadcasts without wires into nearby AM radios through a crystal microphone.

List price on walkie-talkies is \$29.95 each, on the broadcaster, \$9.95. They're made by Heath Co., Daystrom Products Corp., Box 167, St. Joseph, Mich.

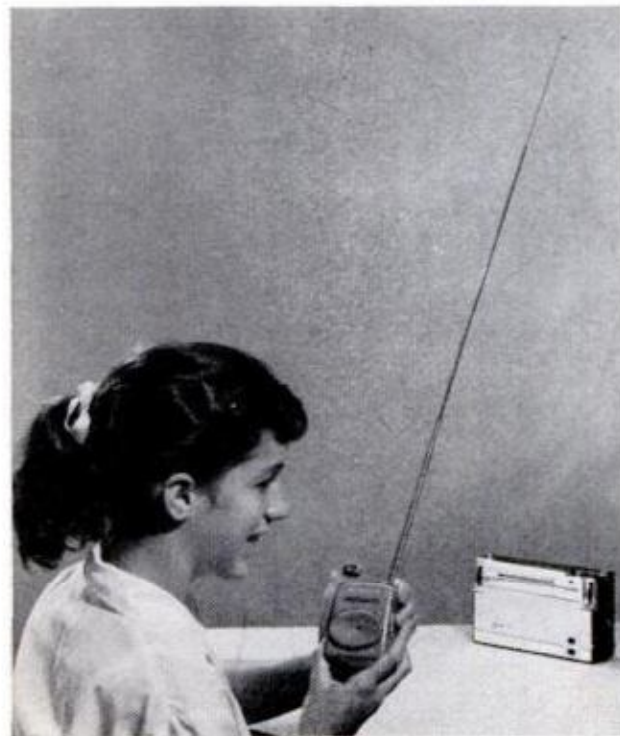

NOW . . . BRAND NEW HOLLEY REPLACEMENT CARBURETORS FOR CHRYSLER-BUILT CARS!



*Holley "PEP" carburetors are
factory-new, original equipment
quality—not rebuilt*

You can give your car new Pep, Economy and Performance with a brand new Holley PEP Carburetor. One Holley single bore, downdraft model for all 1960-1962 six-cylinder Chrysler-built cars, including Dodge, Lancer, Plymouth, Valiant. Holley PEP Carburetors are brand-new . . . *not rebuilt*. They are made to the same *original equipment quality* specifications as carburetors Holley is supplying for 1962 Chrysler-built sixes, and are factory inspected and sealed. See your Authorized Holley Distributor or Dealer today. Give details on car-year and engine model.

★ ★ ★

Holley Carburetor Company has been a supplier of original equipment carburetion and ignition for over 55 years. For genuine Holley parts for American Motors, Chrysler, and Ford cars, see your Holley Authorized Holley Distributor or Dealer, listed in the Yellow Pages. He carries a complete stock of Holley carburetor and ignition repair kits and parts, plus brand-new Holley PEP Carburetors . . . all *original equipment quality*.

ORIGINAL EQUIPMENT MANUFACTURERS
OF CARBURETION
AND IGNITION PRODUCTS
FOR OVER 55 YEARS

HOLLEY
Carburetor Co.

11955 E. Nine Mile Road, Warren, Michigan

C-8

NEW!



Easy-to-Use... Compressorless **SPRAY GUN** DOZENS OF USES!

Just plug Mistral Miniature Spray Gun in 110V outlet and spray-paint, apply floor wax, fumigate, disinfect, spray lawns, gardens, reach hard-to-get-at places with paint, insecticides, cleaning compounds, atomizes liquids completely. Dozens of home and industrial uses.

Mistral Miniature operates without a compressor, is direct piston-driven. German precision built. Output volume and cone width quickly adjusted. Spray-coats up to two gallons per hour. Parts and workmanship warranty.

\$29.95 delivered.

Order from **COMPRESSOR CORPORATION OF AMERICA**
Dept. 313, Box 1967 • Greenville, S. C., U.S.A.
Enclose check or m. o. Dealer inquiries invited.

Table-Top Racing

(Continued from page 95)

cars two inches long. Two-lane roadway comes in curved or straight sections of black plastic, and in an assortment of lengths and diameters so that four lanes of traffic can be achieved by running track sections in parallel. Pairs of nickel silver strips are imbedded lengthwise in the center of each lane, carrying current via transformer and rheostat to two contact pickups under the vehicles. Miniature spark-gap motors about the size of three stacked dimes drive rubber-tired wheels (less than half an inch in diameter) fast enough so that cars achieve scale speeds up to 150 miles an hour. One outfit even makes a speed control with built-in dial which provides a continuous scale speed readout.

The fact is that table-top car racing has begun to sweep the country the same way electric trains did in the early 1900's. A group of Dodge executives recently called the new baby cars "the ultimate in compacts," and tipped their hats to them in a significant discussion of the new craze. "There may be more than 300,000 of these little electric-powered cars in use before the end of the year," they predicted. "Model trains took 30 years to become a \$100,000,000-a-year business. Model automobiles may match them in five years."

★★★

Don't miss PM's exciting 60TH ANNIVERSARY SPECIAL next month!

QUOTE:

"The idea of buses, trucks or nuclear automobiles is completely out of the question. Even if you could afford to pay several hundred thousand dollars for a reasonably safe nuclear engine, by the time you have surrounded this engine with the heavy shielding, several feet thick, which would be necessary to protect the passengers and passers-by from dangerous radiation, you would not have a pleasure or commercial vehicle, but something more like one of the heaviest tanks developed during the last war. Atomic locomotives might be technically feasible, but do you think any city or state would permit such a device to operate, in view of the disaster which might conceivably result if a serious wreck of such a locomotive occurred in a crowded city?"

DR. ROBERT E. WILSON, Commissioner
U.S. Atomic Energy Commission

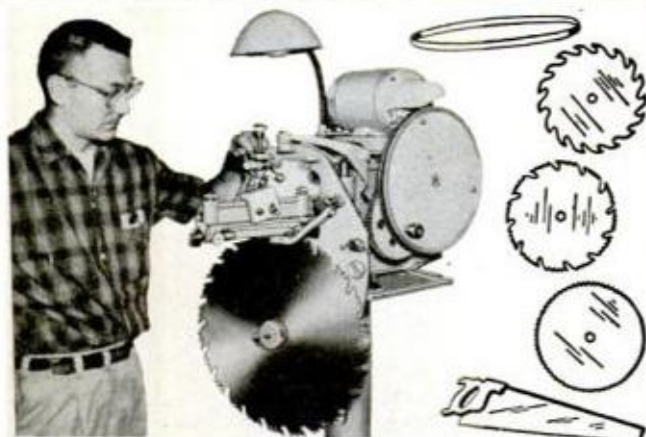

CASH FILING SAWS

Here is a steady repeat CASH business you can start at home. No experience needed—no canvassing—every saw you sharpen will bring new customers. You can make up to \$3 or \$6 an hour—\$20 to \$30 a week in your spare time as a starter. "My spare time saw filing business has made me \$952 these first ten months," says R. T. Chapman.

The new model 200 Foley Saw Filer automatically sharpens combination (rip and crosscut) circular saws, hand saws, band saws and crosscut circular saws.

Free Book—"MONEY MAKING FACTS" shows you how to get into this CASH business. Time Payments if desired. Mail coupon now. No salesman will call.

FOLEY MFG. CO.

1216-1 Foley Bldg., Minneapolis 18, Minn.

Send me free book "MONEY MAKING FACTS" and Time Payment Plan.

Name _____

Address _____

City _____ State _____



only
PROTO
 makes screwdrivers
 like this



Round or square. Forged Protoloy® alloy steel resists wear and distortion. Heat-treated full length. Polished, plated for added protection.

Plastic molded around flattened tang. Locked for life. (UL) listed. Wide flutes. Bigger handle for more power. Smooth end prevents sore palm.

Gradual taper, squared tip for snug fit.

Proto Screwdrivers are available in a complete range of sizes and types, including: plastic and wood handles; keystone, cabinet, Phillips, and clutch-head tips; round and square shanks; lengths up to 2½ feet; offset type; screwholding drivers; and screwdriver sockets.

See your Proto Auto Jobber; Builders Supply, Hardware Dealers and Industrial Distributors for professional quality tools, parts, equipment.

PROTO TOOLS
 PROFESSIONAL QUALITY TOOLS



Send 25¢ with your name and address for fully illustrated Catalog of over 2300 Proto Tools.

2202 Santa Fe Ave., Los Angeles 54, Calif • 502 Allen St., Jamestown, N.Y • 1702 Oxford East, London, Ontario, Can.



Giant Earthmover Is Model for Child's Toy

Five-year-old Debra McIntyre can, like her contractor father, Ellis, take on earthmoving jobs, only on a smaller scale. He has built her a "Playscraper" modeled after

the International Pyscraper he operates in Marion, Va. The model is powered by a 4.5-horsepower air-cooled engine. It has a capacity of nine cubic feet.

Graefin "Scat" Sailor Complete for only \$79 F.O.B.

A new kit with patented construction that can be completely assembled in 3 to 5 hours. All plywood covered with fiberglass resin (needs no finishing). Graefin is an 8' sail boat with 11' mast, colored nylon sail, centerboard, rudder, rigging and brass hardware. Colors in White, Red, Blue, Yellow, Green with contrasting trim. Nothing more to buy—no finishing needed. Write for literature. Complete Kit \$79.00



Graef MARINE

P. O. BOX 125, LIBERTYVILLE, ILL.



MAGNETS

- TSX-15 Magnet Assembly (150 lb. pull) Each....\$9.50
 TSX-14 Magnet Assembly (100 lb. pull) Each.... 7.25
 TS-1 Magnet Assembly (50 lb. pull) Each..... 2.95
 TS-2 Alnico 5 Pot Holder Magnets 50 for \$3.50, 20 for 1.50
 TS-5A Rectangular U's (4 lb. pull) 10 Magnets..... 3.25
 TS-6 Sample Magnets & Catalog (over 200 sizes listed)..... 25c

Money Back Guarantee—Send check or money order, sorry, no C.O.D.'s
TERRY SALES CORP., 1045 Silver Beach Rd., Riviera Beach, Fla.

GUNK® removes grease like no detergent can!



Cleans power mowers, engines, garage floors, kitchen walls, ovens, exhaust ducts, paint brushes, furnace filters, bar-b-q grills, machinery! At auto supply, farm, or hardware stores!

GUNK CHICAGO CO., River Forest, Ill.
 serving the Midwest and Southwest
 RADIATOR SPECIALTY CO., Charlotte, N.C.
 serving the East, Southeast and far West

Don't miss PM's exciting
60th Anniversary Special
next month!

EMERSON ELECTRIC

PORTABLE WELDER High Capacity... Low Price

Ideal for farm, home workshop. Cuts, brazes, solders, welds. One man can carry... only 68 lbs. 6 welding heats up to 180 amps... 3/32" to 3/16" rod sizes. Write today for prices and receive **FREE WELDING SELECTOR GUIDE**... gives working data you need in seconds!

DEPT. W-6



EMERSON ELECTRIC of St. Louis
8100 Florissant • St. Louis 36, Mo.

Those Baseball Changes

(Continued from page 84)

and 12 verified game balls from 1909 to 1937, loaned and donated by PM readers.

For the tests, a batting machine was designed and built by the Armour staff under project engineer Bernard Juskie. It was designed to swing a mounted bat at controllable speeds, then to place a test ball in its path with a solenoid-operated mechanism built to deliver the ball to the same spot on the bat each time. After the impact, the ball was driven through two photoelectric screens six feet apart, then on into a soft backstop. The speed of the bat in its arc and the speed of the ball through the traps were registered and photographed on an oscilloscope for positive, accurate measurement. At the same time, a Fastex motion picture camera recorded the impact at 5000 frames per second for studies of the ball's performance.

Two types of batting device were used. With the first, a whole bat was mounted in live rubber to simulate a hand-held bat and to minimize any effects of a rigid "hammer." The second used a split bat mounted on a steel I-beam. The rigid I-beam mounting was found to be more desirable for consistent results.

What is "Lively"?

The impact tests were set up to measure the "coefficient of restitution" of the test balls—their ability to rebound from a blow, or in one word, their liveliness. The mathematical equation is $V_b = (1 + e) V_h$; V_b is the velocity of the ball, V_h is the velocity of the "hammer," and e is the coefficient of restitution.

The first puzzling discovery was that, though our 12 sample 1961 balls were all from the same carton, their coefficients of restitution varied from .50 to .68; enough variation to account for a 12 percent difference in distance when hit by a bat at the same speed. While the older balls showed a similar tendency to vary, the 1927 balls tested had less variation than the modern balls tested.

The results of the impact tests were as surprising as those of the wind-tunnel tests. Though individual performance varied widely, a trend showed up which held through the entire impact series: The 1927 (and other, older) balls showed almost exactly the same coefficient of restitution as the new balls at high bat speeds. The curves on our graphs are identical at high bat speeds. *But at lower bat speeds, the 1961 balls were much "bouncier" than the older samples, and the slower the bat speed,*

(Continued to page 212)

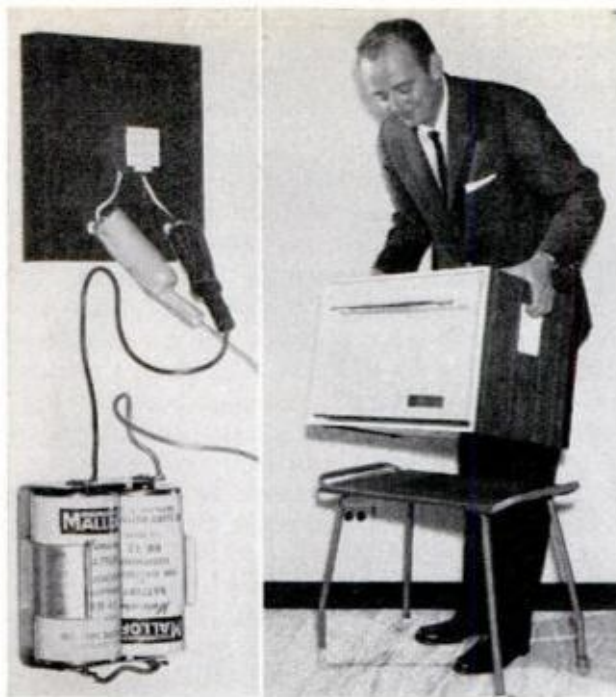

SAMPLE MODULE (left, above) is covered with layer of frost, seconds after being connected to battery. Portability of unit is demonstrated by lifting. Total weight of entire refrigerator, only 37 pounds

Thermoelectric Refrigerator

A wide assortment of shapes and sizes in the new thermoelectric refrigerators is now available. The units operate either from a.c. line voltage, or can operate, in the case of the picnic chest, from rechargeable wet cells. The picnic chest features a thermostatic control, provides up to 50 hours refrigeration on one battery charging.

The new units require no liquid refrigerant, nor mechanical compression for operation, but depend, instead, on transistorized solid-state thermoelectric modules. The portables, those which operate from a.c. lines, can be placed on shelves, mounted on roll-around tables, or built into existing furniture.

Two ice-cube trays are furnished, and freezing time is comparable to a standard home refrigerator.

The picnic chest can be recharged by plugging into a.c. household current or 12-volt car or boat battery. The refrigerator operates only on standard house current.

Picnic chest \$99.95, Portable refrigerator \$129.95. Wright Mfg. Co., 2902 W. Thomas Rd., Phoenix, Arizona.

**Don't miss PM's exciting
60th Anniversary Special
next month!**

DECEMBER 1961



**Starrett
TOOLS**
the perfect gift
CRAFTSMEN
for MECHANICS
HOBBYISTS

The man or boy who loves fine tools always welcomes STARRETT tools. Choose the perfect gift for handyman, mechanic, skilled craftsman or hobbyist from more than 3000 STARRETT items — at hardware tool stores or industrial distributors.



STARRETT TOOL CHESTS
Mechanics' tool chests in wood or metal — available with or without Starrett tools.



**STARRETT
MICROMETER**
No. 436 0-1"



**STARRETT
COMBINATION
SQUARE**
No. 11 12" blade



**STARRETT DIAL INDICATOR
POCKET GAGE**
No. 1010 Range 0- $\frac{1}{4}$ "



**STARRETT
TOOLMAKERS' HAMMER**
No. 815
with magnifying glass

3,000 GIFT IDEAS Ask your Starrett distributor to show you the many gift-worthy items in the complete line of Starrett tools — or write for free Catalog No. 27. Use the coupon.

STARRETT TOOLS are carried by leading Industrial Supply Distributors and Hardware Tool Stores.

THE L. S. STARRETT COMPANY
Dept. AP, Athol, Massachusetts

Please send my free copy of Catalog No. 27 describing over 3,000 Starrett tools for professional and amateur craftsmen.

Name.....

Occupation.....

Address.....

City.....Zone.....State.....





What's New in High Fidelity

by Fred Honig

High Fidelity in a Closet

"I would like to have a stereo high fidelity system but I don't have the room for it," is a complaint frequently voiced by music lovers. But you *do* have the space—it's right there in your closet. Use components! High fidelity components don't require big, elaborate cabinets that take up valuable living space. A few shelves mounted on one inside wall of a clothes closet will hold your FM stereo tuner, record player, tape recorder, amplifier, etc. In a linen closet, just use one or two of the existing shelves. Close the door and take a look around: not an inch of visible space has been used. Now you merely add two of today's compact, well-designed loudspeaker systems to suit your decor and space requirements—and you are now the owner of a custom component high fidelity system. For further information about components, send in the coupon below.



Institute of High Fidelity Manufacturers, Inc.
Dept. M-31—516 Fifth Avenue, New York 36
Please send me the free booklet about
High Fidelity Components.

NAME _____
ADDRESS _____
CITY _____ ZONE _____ STATE _____

Constantine's Catalog & Manual for WOODWORKERS

ALL-NEW! 1962 Edition. More than a catalog—
a manual, too! 132 pages—exciting new items!
Since 1812, world's most complete source for rare
imported & domestic woods at rock-bottom prices.
Inlays, bandings, carvings, hard-to-find hardware,
inlaid wood picture kits, new brass hardware, etc.
Plus tools, plans, projects. Enclose 25c for postage
and mailing. Write for Catalog and Manual now.
ALBERT CONSTANTINE AND SON, INC.
2050 Eastchester Rd., Dept. T-5, New York 61, N.Y.



EXTRA
VALUE



GERSTNER CHESTS offer more
than ordinary value. Ask the tool-
makers and machinists who use
them. Free catalog.

GERSTNER TOOL CHESTS
461 Columbia St. Dayton 7, Ohio

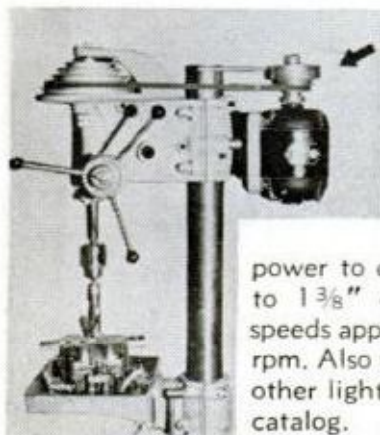

DOUBLE DRILL PRESS CAPACITY

Motor mounted speed
reducer provides the
correct speed and
power to drill, ream, c'bore etc.
to 1 3/8" dia. in steel. Spindle
speeds approximately 45 to 3000
rpm. Also used on band saws and
other light machinery. Write for
catalog.

PULL-GEAR CO.

13523 E. Eight Mile Rd.
Warren, Michigan

the greater the difference. So the light
hitter, not the home run king, is the one
who should really be profiting from a
livelier ball. That might partially explain
the home run exploits of some of the lighter
men who've cropped up in recent years,
and the larger number of home runs being
hit in the major leagues over-all.

A statistical survey of the number of
home runs hit by individuals, teams and
leagues showed that, with the exception of
Roger Maris' 61 homers this year, the gen-
eral trend in home runs required to lead
either league is down since the Ruth era.
At the same time, batting averages, both
individual and team, are down from the
"golden twenties." But six times as many
home runs are being hit today as were hit
at the turn of the century, and twice as
many as were hit during the Babe's heyday
in the twenties. But Ruth's season record
stood until this year, and still hasn't been
beaten in 154 games.

Maybe it adds up. The ball isn't much
livelier for the "home run king" types like
Ruth and Mantle and Maris. But it re-
sponds better to the lesser efforts of light-
er, less powerful players. Coupled with the
other factors that affect home run hitting,
this low-speed liveliness could explain the
increase in over-all home run hitting while,
at the same time, individual performance
has not improved.

What other factors? There are several.
Perhaps the most important is that baseball
management, recognizing the crowd-draw-
ing power of the Ruths and Mantles and
Marises, are paying more for long balls
than for batting averages. Ralph Kiner,
asked by a newsman why he didn't choke
up on his bat and swing for singles and a
good batting average, answered, "because
the Cadillacs are at the end of the bat."
And he was right.

Today's players are using lighter, shorter
bats, which more players can swing fast
enough to hit the ball out of the park. Even
the big hitters are following this trend.

Players themselves are bigger and
stronger than they were in 1927—or in
1957, for that matter. Their training is bet-
ter, and their understanding of batting
techniques has grown yearly. Columnist
Dick Hackenberg wrote "if Ruth had Man-
tle's training and exercise program back in
1927, he might have hit 100."

Baseballs, whatever changes have taken
place, are fresher at any given moment,
simply because more balls (about 50) are
used in each game. A fresh ball is more
resilient than one that has been hit a great
many times.

Pitching has suffered, both from the re-
(Continued to page 214)



Pyramid for University

Pointing skyward on the campus of Gakushuin University, Tokyo, is a pyramid-shaped building designed to hold 700 students for lectures.

The base is roughly 100 feet square and the height of the lecture hall is some 80 feet. One unusual feature of construction is that no vertical columns were used in the construction. All columns are angled. The pyramid is part of a new University project.

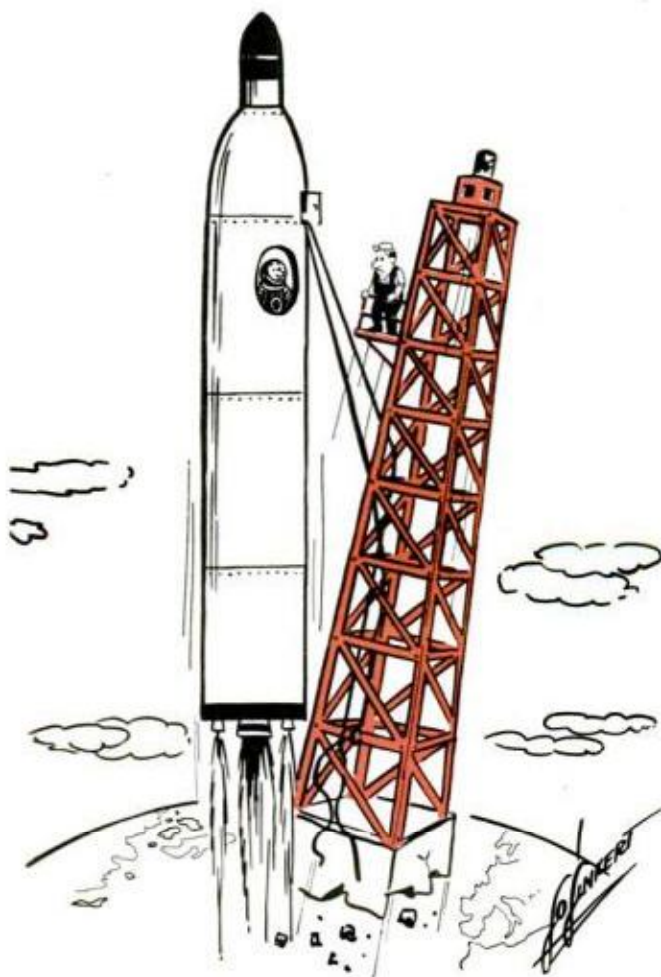

Dr. Grabow goes Continental



Imported Briar
 "Starfire" ... \$ 3.95
 "Viscount" ... \$ 5.00
 "Eldorado" ... \$10.00

PRE-SMOKED
 Need No Breaking In

New Continental shapes—strikingly handsome—excitingly different—perfectly balanced—moderately priced! Like all Dr. Grabows they're mechanically pre-smoked with fine tobacco. Never need breaking in—sweet, cool, satisfying from first puff. Write for FREE BOOKLET D

Dr. Grabow Pre-Smoked Pipes • Greensboro, N. C.

IDEAL CHRISTMAS GIFT FOR ANY MAN

4-WAY WELDER \$14.95
 WELD - BRAZE - SOLDER - CUT Complete

NO OTHER WELDER AT THIS PRICE
 Complete with SAFETY FOOT SWITCH, FULL FACE SHIELD, twin carbon arc torch, welding rod holder, clamp, carbons, welding & brazing rods, flux, fuses, instruction book. **FULL YEAR GUARANTEE.**

More than a quarter million in use in homes, garages, farms, shops, factories. **NOW** anyone can weld, braze, solder, cut, heat, without experience. Does 1001 jobs on all metals. Save & earn money. Make & repair auto bodies, parts, fenders, trailers, boats, metal furniture, fixtures, ornamental iron, farm equipment, garden tools, bicycles, toys, etc. Operate on any properly wired 110 V AC line. **SEND ONLY \$2.** Pay postman \$12.95 plus C.O.D. charges. Ideal lifetime gift for hobbyist, mechanic, hot rodder, homeowner. Order on 10-day money-back guarantee.

FOUR WAY WELDER CO. DEPT. F2-N, 1810 S. FEDERAL ST. CHICAGO 16, ILL.

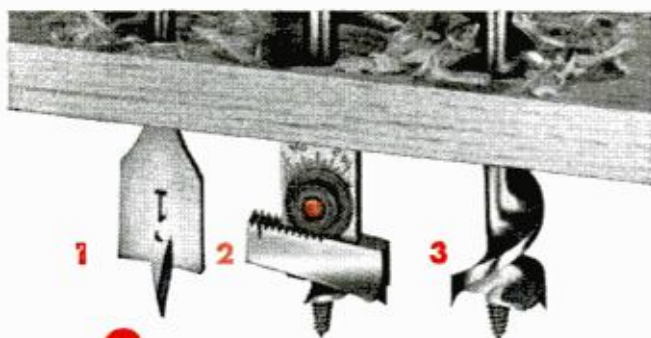

3 easy ways to bore holes faster

1. Irwin Speedbor "88" for all electric drills. Bores up to 5 times faster in any wood, at any angle. Sizes $\frac{1}{4}$ " to 1", \$.75 each. Sizes $1\frac{1}{8}$ " to $1\frac{1}{2}$ ", \$1.25 each.

2. Irwin No. 22 Micro-Dial expansive bit. Fits all hand braces. Just dial your size. Bores 35 standard holes, $\frac{7}{8}$ " to 3". Only \$4.00. No. 21 small size bores 19 standard holes, $\frac{5}{8}$ " to $1\frac{1}{4}$ ". Only \$3.60.

3. Irwin 62T Solid Center hand brace type. Only 16 turns to bore 1" holes through 1" wood. Double-cutter boring action. Sizes $\frac{1}{4}$ " to $1\frac{1}{2}$ ". As low as \$1.05 each.

EVERY IRWIN BIT made of high analysis tool steel, heat tempered, machine sharpened and highly polished, too. Buy from your independent hardware, building supply or lumber dealer.

Straight-Line Chalk Line Reel Box

only \$1.25 for 50 ft. size

New and improved Irwin self-chalking design. Durable aluminum alloy box. Practically damage-proof. Fits pocket or hand. 50 ft. and 100 ft. sizes.

IRWIN every bit as good as the name at Wilmington, Ohio, since 1885



King Midget FOR 1962

Drive it for 75c a week.

Rider Agents Wanted. Send 25c for 32 page book, full details, dealer price. Or send \$1 (refunded first order) for this plus Service and Repair Manual and 16 5x7 photos of car and factory.



WORLD'S MOST EXCITING LOWEST PRICED CAR

MIDGET MOTORS CORPORATION, Athens 1, Ohio

END NUT and BOLT

HANGOVERS

DOT Teenuts

Flush-Mounted ... Can't Slip
Steel Threads in Wood
Strong ... Versatile!



The One Nut That Makes Sense!



Ideal for permanent work or where easy "knock-down" feature is wanted. Available to fit standard thread bolt sizes: 6-32, 8-32, 10-24, 10-32, 1/4-20, 5/16-18, 3/8-16. Available at hardware dealers. If not, send \$1 for special mail order package and name of nearest distributor. Specify size.

COLUMBIA FASTENER COMPANY
3229 South Ashland Ave. • Dept. PM • Chicago 8, Illinois

striction against trick pitches like the spitball and from dilution of talent because of new teams in both leagues.

Even the umpire gets into the act, according to the pitchers and managers who complain that the strike zone has shrunk in the last few years, forcing the pitcher to stay away from the corners and put it down the middle.

Short parks have added to the number of homers, too, though temporarily in most cases. Many parks show fields hopefully designed to favor the strong pull hitter—even Yankee stadium, "the House that Ruth Built."

So everything has changed, including the baseball itself. And there is a ball that will go greater distances and does help less-powerful hitters substantially. Maybe that will settle the argument for a while. Or maybe it'll start a new one.

We hope that the Baseball Commissioner and the league officials will take note, since they've been involved in the controversy as much as anyone. Perhaps they can take some kind of action to tighten up the allowable tolerances in size, weight and resiliency of the big-league ball in the future, to eliminate the arguments.

EDITORS' NOTE: PM's baseball tests could never have taken place without the cooperation of the nation's news media, who generously publicized our request for old baseballs, or their and our many readers who loaned or donated souvenir baseballs or assistance for the tests. Our thanks, especially, go to these friends:

Mr. George ("Rube") Walberg, Miami, Florida

Mr. E. H. Wyman, Pittsburgh, Pennsylvania

Miss Madeleine Thiess, Maywood, Illinois

Mr. Jim Devero, Chicago, Illinois

Mr. Flynn McGuire, Chicago, Illinois

Mr. Frank Vrchota, Chicago, Illinois

Mr. Fred Rappuano, Weehawken, New Jersey

Mr. Bernard Long, Chicago, Illinois

Mr. Bill Madigan, Middletown, New York
Mr. Rudie Schaffer, Business Manager, Chicago White Sox

Dr. Caroline Miller, Armour Research Foundation

Dr. Robert A. Eubanks, Armour Research Foundation

Mr. Bernard Juskie, Armour Research Foundation

Mr. A. McKinlay, Jr., Armour Research Foundation

DREMEL MOTO-SHOP

Complete All-Family Power Work Shop

Dremel Moto-Shop is the first real multi-purpose workshop designed for the whole family. In one compact, portable unit you have a jig saw, disc sander, buffing wheel, bench grinder, and a flexible shaft machine. 5 power tools in 1 unit that do 1,001 jobs. For the kids it provides hours of constructive, creative recreation. It's invaluable to Dad, and even Mom, for hobby work and home maintenance. Moto-Shop is not a toy, but a professional-quality power tool with a ball bearing rotary motor. It's super-safe; cuts 3/4" wood, metal, plastics, etc.; sets up anywhere, can be carried from room to room. Outperforms heavier, more expensive jig saws. See your power tool or hobby dealer today.

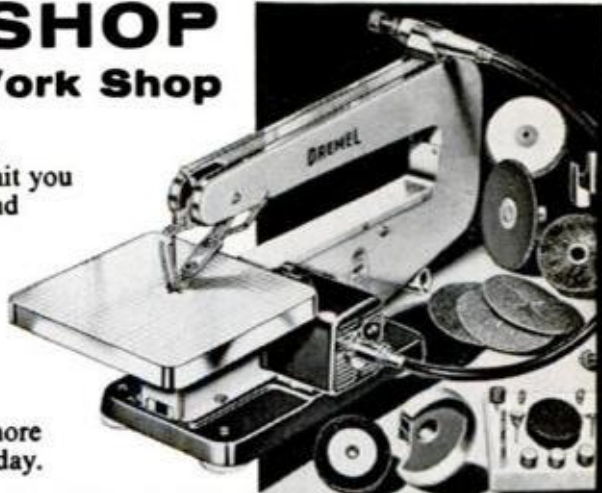

FREE! Moto-Shop Catalog. Write Today!
Dremel Mfg. Co., Dept. 111M, Racine, Wisconsin

Model 571 (jig saw with disc sander)...\$33.95
Model 572 (all attachments shown)...\$49.95

154

A national bestseller
at \$4.95 - now an AVON
paperback at only 75¢



The fascinating, funny and frank account of life at 1600 Pennsylvania Avenue told with warmth and wit by a lady who knows...

Available at your local newsstand or wherever paperback books are sold. For a complete catalog of Avon Books in print, write: Avon Book Division, The Hearst Corporation, Dept. C, 250 West 55th Street, New York 19, N. Y.

Is your family fit or flabby? You'll find some ideal build-it-yourself equipment for keeping them in trim in the January issue's Home Health Studio.

YOU NEED THIS

FREE GIANT B-A CATALOG



BURSTEIN-APPLEBEE CO.

Dept. PM, 1012 McGee St., Kansas City 6, Mo.

Rush me New 1962 B-A Catalog No. 621

Name.....

Address.....

City..... State.....

SEND FOR IT TODAY

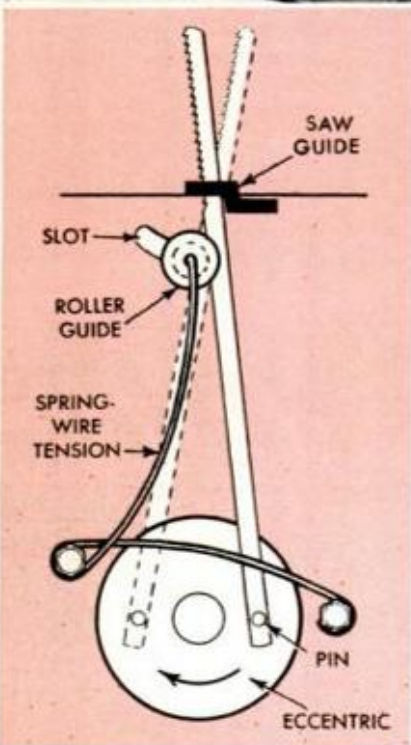
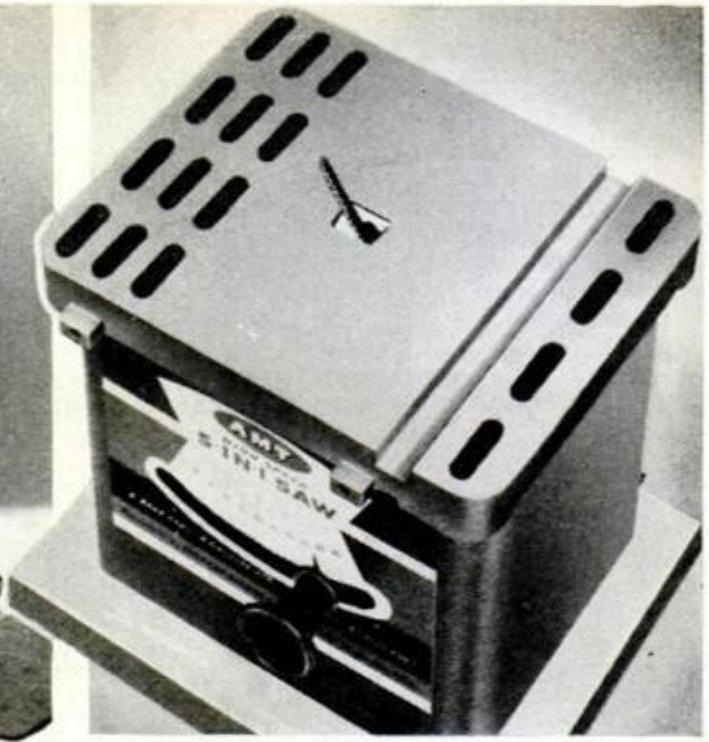

Jigsaw Has Orbital Blade

IN THE DETAIL at the left you're looking at something new in the blade action of a bench-type jigsaw. The blade is the pitman, or, the pitman's the blade, whichever way you like to say it. But notice that on the down, or cutting stroke, the blade really leans into the work while on the up, or idle, stroke, it retracts and clears the work. This simple action, similar to that of a handsaw where you put everything you've got into the down stroke but slack off on the up stroke, almost, if not quite, doubles the average cutting speed of a saber-type saw blade. It cuts—but fast, even through a 2 x 4.

Machine does crosscutting, ripping, compound-angle cutting, any common straight or curved inside or outside cut you can make with circular saw, bandsaw or jigsaw. Blade tilts to 45 degrees. Comes equipped with ripping fence, miter gauge, motor and switch. Made by American Machine & Tool Co., Royersford, Pa. Price \$29.95.

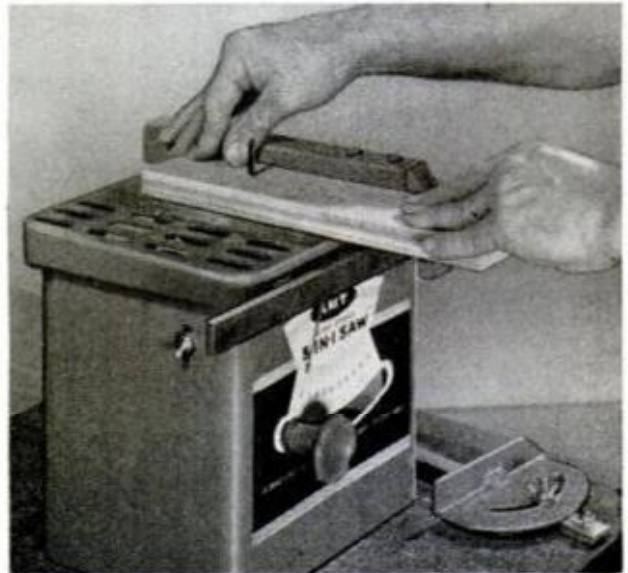
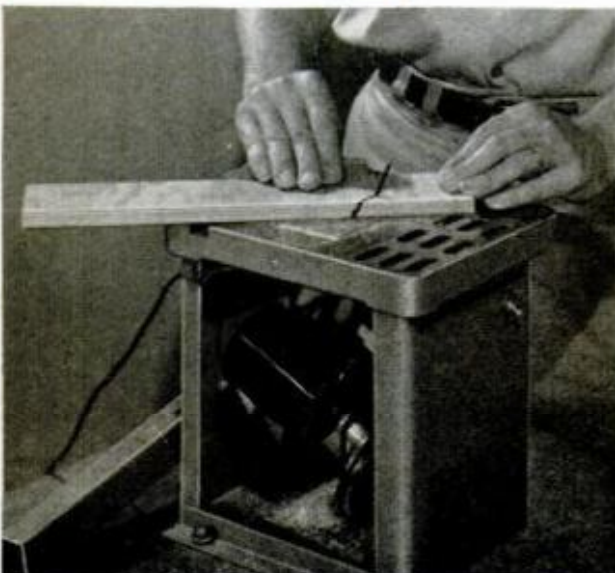

CUT-TO-FIT HOMES CUT COSTS UP TO 40%

Save labor cost up to 100%, reducing completed home cost up to 40%. You can assemble any of 57 designs from easy-to-follow plans. No measuring or cutting . . . every piece precision machine pre-cut and marked. **BUY DIRECT FROM MILL.** Eliminate all between overhead, profit and labor

costs. Nothing to plan or figure. Complete with all lumber, hardware, paint, nails, glass, roofing, etc. Sterling Home quality material throughout. Freight paid most areas. Write today. Send 25c for illustrated, color catalog, floor plans and details.



PRICED FROM \$2295 UP

CHOICE OF 57 DESIGNS

FIVE EASY-PAYMENT PLANS

INTERNATIONAL MILL & TIMBER CO. Bay City, Michigan, DEPT. PM121

RETARDED CHILDREN CAN BE HELPED



SUPPORT YOUR LOCAL ASSOCIATION FOR RETARDED CHILDREN

FREE CATALOG!

TREMENDOUS SAVINGS ON HUNDREDS OF SURPLUS AND NEWLY MANUFACTURED ITEMS!

New 1961 edition contains over 50 pages of tools and equipment for farm, home, workshop, factory. Hydraulic equipment, pumps, motors, construction and diesel equipment and parts! Write for your FREE CATALOG Today.

GROBAN SUPPLY COMPANY

1139 South Wabash Ave., Dept. G-12 Chicago 5, Ill., WEbster 9-3793



DRAINS cellars, cisterns, wash tubs; \$7.95 IRRIGATES - CIRCULATES - SPRAYS

1,001 uses. Stainless shaft. Won't rust or clog! Use 1/8 HP motor or larger . . . 3/4 HP for up to 2,400 GPH; 450 GPH 80' high; or 1800 GPH from 25' well. 1" inlet; 3/4" outlet. Coupling included free. \$7.95. HEAVY DUTY BALL-BEARING PUMP. Up to 5,200 GPH; or 3,000 GPH from 25' well. 1 1/4" inlet; 1" outlet. \$12.95 Postpaid if cash with order. MONEY BACK GUARANTEE

Centrifugal and Gear Pumps in All Sizes

LABAWCO PUMPS, Belle Mead 7, New Jersey

Fill Cracks And Holes Better

Handles like putty. Hardens like wood.

PLASTIC WOOD®

The *Genuine* - Accept No Substitute.

WELD - BRAZE - SOLDER - CUT

REPAIR MOST EVERYTHING MADE OF METAL



Home Appliances. Auto parts. Make and repair lawn chairs, tables, ornamental iron work, gates, wagons, etc. Solder, heat, bend, and straighten, with terrific heat from arc torch. Cut and weld up to 1/4" steel plate. A million uses for Home, auto, farm, inventors, factories, etc. Works from any home 110 volt plug-in. Complete with dark welder's mask, arc torch, supply of carbon steel welding and brazing rods and complete Welding Instruction Book. 1 year guarantee. SEND ONLY \$3 (cash, ck. mo.) and pay postman \$11.95 plus COD postage on arrival or send \$14.95 and we will send postpaid. Ideal gift for mechanically minded, relatives, friends. Order now. Available only from: MIDWAY WELDER, Dept. DPM-12, Kearney, Neb.

The hand-held 2-WAY RADIO that outperforms 'em all...



Anyone can operate—no license required—priced from \$109.50!

In the field or on the job . . . Viking "Personal Messengers" are delivering outstanding performance! Viking "Messengers" are available in compact hand-held units or maximum legal power Citizen's Band transceivers. Used by thousands of businessmen, salesmen and construction crews. Send today for full details.



FREE! SEND FOR COLOR BROCHURE

Please rush "Messenger" details to:

NAME _____

ADDRESS _____

CITY _____ STATE _____

E. F. JOHNSON CO.

1411-10 Av. SW, Waseca, Minn.

**FREE CARBURETOR
TUNE-UP KIT
WITH THE NEW PACCO
INSTRUCTION HANDBOOK**

★ **—————** ★

ONLY \$2.25 POSTPAID

Order your new PACCO Handbook with goof-proof instructions for carburetor tune-ups *today*, and we'll send you free a \$2.25 (List Price) Pacco Tune-Up Kit for 1950-56 6-cyl. Chevrolets (for Rochester applications). Offer good while supply lasts, so hurry.

MAIL THIS COUPON NOW

Enclosed is \$2.25 (check or money order). Send my Handbook and free Tune-Up Kit.

Name.....

Address.....

City.....State.....



PRECISION AUTOMOTIVE COMPONENTS CO.
Manchester, Missouri

ECONOMY POWERFUL!
TRACTOR

Thousands in Use!
Since 1946

UNEQUALLED LOW PRICE! TERRIFIC VALUE!

America's finest tractor. Ruggedly built. Easy to operate. 790 lbs. Borg-Warner clutch, trans. and diff. 140 to 1 reduction. 40% more drawbar pull than ordinary tractors. 9 H.P. engine. 20 quick change implements. HOOD-FENDERS.

Write for Catalog.

Engineering Products Co.
1005 K-12 Anoka Avenue
Waukesha, Wisconsin



PLANER • MOLDER • SAW!



Now you can use this ONE power-feed shop to turn rough lumber into moldings, trim, flooring, furniture... ALL popular patterns. RIP... PLANE... MOLD... separately or all at once with a one HP motor. Use 3 to 5 HP for high speed output. Low Cost... You can own this power tool for only \$30.00 down payment.

Send postcard today for complete facts.

BELSAW POWER TOOLS, 902 Field Bldg., Kansas City 11, Missouri

The Wankel-Engine Car

(Continued from page 73)

camshaft or connecting rods. The engine has a single combustion chamber (a slightly flattened circle in cross section), faintly resembling a cell about to divide. This chamber, or cylinder if you will, is closed at both ends by plates which contain the valve ports.

Inside this chamber is one of the engine's two moving parts, a rotor with the shape of an equilateral triangle. The other moving part is the crankshaft around which the rotor is fitted. The rotor makes an eccentric orbit inside the chamber so that its three corners are in contact with the chamber sides at all times.

An inset metal strip at each corner of the rotor acts as a piston ring. As the rotor's tips pass around the walls of the combustion chamber the three cavities formed between them and the chamber's walls increase and decrease in displacement in accord with the eccentric action of the rotor revolving about the shaft.

As a given cavity expands or contracts it parallels the working cycle of a four-stroke piston engine. The mixture is drawn in as a cavity expands while passing an intake port in the end wall. As the rotor turns further the cavity is closed and compressed. Then it passes a recessed spark plug and enlarges again to absorb the expanding force of the mixture during the power stroke.

Finally, the cavity is compressed as it passes the open exhaust port in the opposite end of the combustion chamber. Thus, it becomes clear that there are three firing or power strokes per revolution of the rotor. This makes for a very smooth and fast engine, a fact confirmed by this performance report. ★ ★ ★

**Don't miss PM's exciting
60th Anniversary Special
next month!**

QUOTE:

"It is of great importance that the general public be given an opportunity to experience—consciously and intelligently—the efforts and results of scientific research... Restricting the body of knowledge to a small group deadens the philosophical spirit of a people and leads to spiritual poverty."

ALBERT EINSTEIN

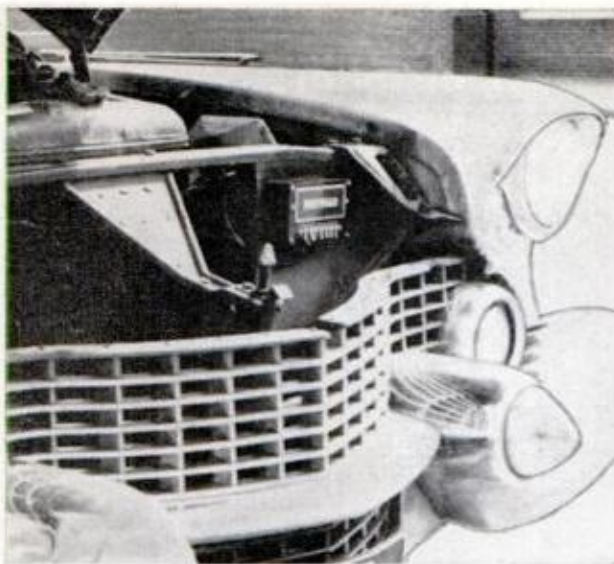

An Alarming Thing

Vandals and thieves meet their match when the Sentinar alarm is connected to the existing electrical system of a car, boat or plane. Any tampering with doors, hoods, tank lids or hatches to which Sentinar is connected, causes it to alternately blow horn or siren and flash lights for two minutes before it resets itself.

It is controlled by special registered keys. Price—\$28.95, F.O.B. Sentron, Inc., 119 Dover St., Somerville 44, Mass.

Here's to Your Health

Now that the touch football season is over, your family can make good use of the family fitness gym equipment we'll show you in the January issue of Popular Mechanics. The easy-to-build and fun-to-use projects include a stationary bike and rowing machine. Other projects will follow in the February Popular Mechanics.

EVERLITE* World's THRIFTIEST Light Plants

(Item 869-15T)



1500 watt amazing new alternator. Most efficient trouble-free light plant ever made. Rugged new transistor circuit eliminates commutator and armature—all the old headaches of generators gone. Output is standard current—115v., AC—operate oil burner, freezer, lights, TV, power tools or anything that requires up to 1500 watts. Powered by sturdy fast starting 3 hp Briggs engine guar. for 1 full year. Price is unbelievable, only \$209.50 F.O.B. factory for the finest 1500 w. plant made.

*Trade-Mark Registered Everlite 1500 watt, Item 869-15T Wt. 60 lbs. \$209.50

HEATING AND VENTILATING FAN

(Item 10) Easily installed in furnace pipes. Forces even heat to all rooms. Over range removes kitchen smoke and odors. Powerful, continuous duty motor, 110-120 v. AC. Mount in wall or ceiling to ventilate any area. Quiet, super-efficient fan moves huge volume of air. (400 to 600 CFM).

- 8" Pipe, wt. 5 lb. \$6.85
- 9" Pipe, wt. 6 lb. \$7.85
- 10" Pipe, wt. 7 lb. \$8.85
- 12" Pipe, wt. 8 lb. \$9.85

HEAVY DUTY FAN. Semi-enclosed motor, suitable for spray booths, restaurant exhausts, poultry houses, etc. \$11.95
 10" Fan, wt. 8 lbs. (Item 10E) \$12.95
 12" Fan, wt. 10 lbs. (Item 10D) \$12.95



Brand New 2 1/2 hp Gas Engine Sale!

Regular price \$49.50
30 day Sale

\$29.95

1 year factory warranty free service

Unbelievable but true! Chance of a lifetime to buy a brand new Clinton Model A400 2 1/2 hp Engine at nearly half price. Perfect for Go Carts — Scooters — Tractors — Mowers — Generators — Pumps, etc. Built-in throttle control and recoil starter—ready to go. We bailed out a manufacturer who needed cash—his loss is your gain—act fast! 1 for \$29.95, 2 for \$57.50, 6 for \$149.99 quantity limited.

STANDARD DIAL PHONES

Western Electric dial phones same as used by all telephone companies. Ideal as extensions on any system. Phones are converted to work without central station for use as private communication systems. Merely dial to ring other party. Rings loud and clear. Several may be connected on same line. Fine for long distance. Standard 110 v. current used one end. Needs 4 cond. wire for private line.



Item 855 Wt. 8 lbs. each \$8.95
 Wire—4 cond. 22 gauge, 250 ft. coil \$4.95
 Wire—4 cond. 19 gauge (for distances over 500 ft.) 250 ft. coil \$7.95

HEAVY DUTY D-C ARC WELDER

Use as portable or shop welder. Up to 300 amps, senior model. Made for years of trouble-free, continuous service. Will handle light or heavy jobs. Easily welds up to 3/4" plate using 1/4" rods. Built-in air cooling system. Arc is easy to strike and hold, because of specially designed arc stabilizer. Hi-lo switch and dial control gives wide range of welding heats. Run welder at 2600 rpm. with tractor, jeep or 15 hp. gas engine, and triple V belt or flat pulley. You can pay more, but you can't buy a better welder.

Wt. 110 lbs. \$400.00 value \$119.50
 WELDING KIT. Two 10 ft. leads, welding helmet, electrode holder, ground clamp. Sold only with welder at \$10.50

Heats instantly anything from a cup of water to a wash tub full . . . much faster than any stove or costly heater. Indispensable for laundry, dishes, baths, etc. Terrific for coffee, tea, soups. Made of unbreakable shock proof "Nyalite." Simple and cheap to operate . . . just plug it in. 1200 watts. 115 v. A.C. Money back guarantee. Item 856. Shipped prepaid. \$3.95 only \$3.95



Send 10c for 100 page Catalog — FREE with order. Prices f.o.b. factory — Send check or M.O.

MASTER MECHANIC MFG. CO., Dept. A-121, Burlington, Wis.
 Southern Customers Order from Dept. A-121, Box 65, Sarasota, Florida



Garage
Basement
Shed, Shop
Barn

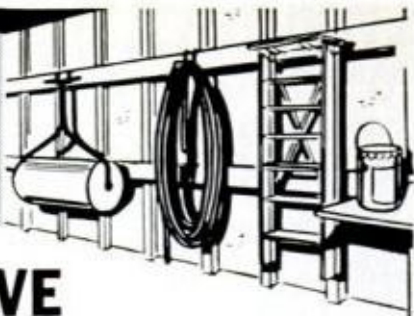

SOLVE STORAGE PROBLEMS

startling
NEW

HERCULES HOOKS

Patent applied for

obsoletes every other method of
HEAVY DUTY WALL STORAGE

These giant steel hooks are approx. 1/4" thick. They fit over the common 1" x 4" wood board. Simple to put up. NO perforated wallboard is used.

Hold the heaviest tools, equipment, shelves, etc. **HOLDS EVERYTHING.** Ask for them by name at your dealer. **HERCULES HOOKS!**

Sample hook sent direct to you. Enclose 10c for mailing.



Literature FREE!

K THE KERR WIRE PRODUCTS CO.
937 N. Cicero Avenue • Chicago 51, Illinois

Save on all PLUMBING JOBS

When You Build • When Making Improvements • Repairs • Maintenance

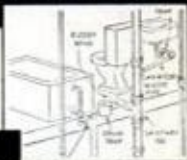

Get POPULAR MECHANICS Home Plumbing Guide



How to plan plumbing installations, select materials and fixtures.

How to save money on all plumbing jobs using approved methods.

Easy to Do Professional-Like Jobs and Save Over One-Half

Get the Popular Mechanics HOME PLUMBING GUIDE. It shows how you can do every kind of plumbing job yourself and save from a few to hundreds of dollars. Covers plans, layouts, installation, maintenance and repair. Shows what materials to get and use, where to get them and how to do a proper job with approved methods. Few, other than the simplest tools are required and

some of these can be rented. Don't pay high prices for work you can do yourself. Get the HOME PLUMBING GUIDE for only \$3.50. You will be amazed how jobs you thought difficult are simplified.

Clip This Ad and Mail. Money Back if Not Pleased

Invest only \$3.50. Use the book for 7 days. Then if you are not satisfied return it for full refund of your money. Sent C.O.D. (U.S.A. only) if you prefer.

15 Ways to Save Money

- All about modern home plumbing
- How to use plumbing tools
- Getting acquainted with pipe
- Planning home plumbing systems
- Installing and maintaining home drainage systems
- Private sewage disposal systems
- Causes and cures of drainage troubles
- Installing home water lines
- Private water supply systems
- Water Heaters
- Water Conditioning
- Water system troubles and cures
- Installing and caring for fixtures
- What to do with valves and faucets

Over 500 How-to-do-it Pictures Guide You



POPULAR MECHANICS PRESS, Dept. 1261, 200 E. Ontario St., Chicago 11

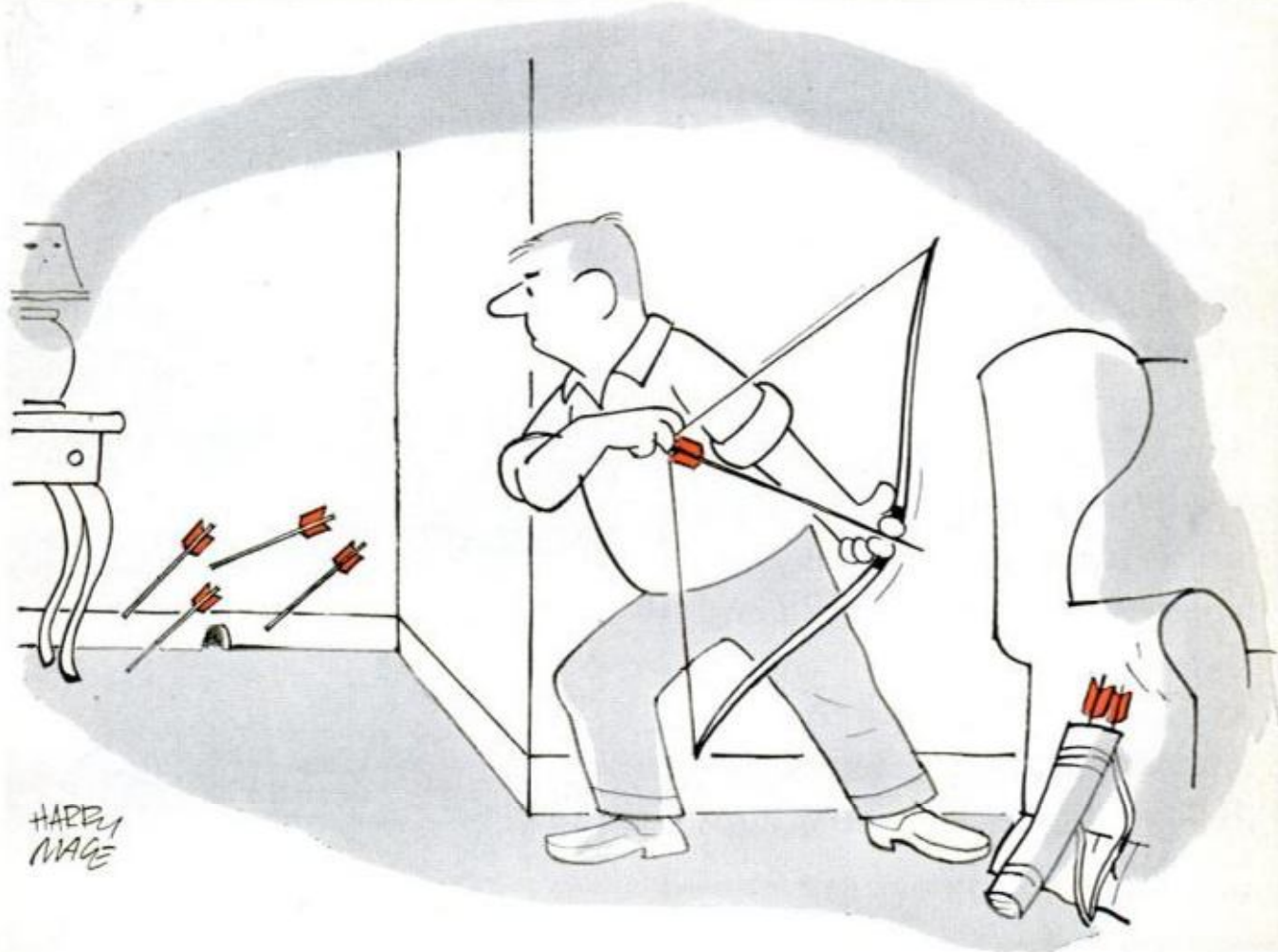

New standard for power and torque in a compact grinder!

**NEW DREMEL NO. 3
INDUSTRIAL
MOTO-TOOL**



This new industrial type grinder belongs on your work-bench! The No. 3 is a compact "powerhouse" developing 27,000 rpm — and sustains high torque under load. It's easy to handle (fits your hand), runs cool, lightweight. Weighs only 17 oz.! Just the ticket for precision grinding, polishing, drilling, sharpening, modelmaking — working in tight corners. Powerful 110 Volt AC or DC motor is housed in a heavy-duty, shockproof Bakelite case. Handy hanger hook keeps it within reach.

DREMEL MFG. CO., Dept. 111-L, Racine, Wisconsin

150



No. 3 Moto-Tool is complete with 1/8" and 3/32" collets, 3-wire grounding cord with 2-prong adapter, finger grip — in steel case. **Only \$29.95.**

No. 2 Moto-Tool — long time favorite with industry, craftsmen, model makers since 1936 —

No. 2 Moto-Tool with 3-wire grounding cord, **\$19.95.**

No. 2 Moto-Tool with 23 accessories in steel case, **\$29.95.**

See Your Dealer or Write for Complete Power Tool Catalog

INCREASE HOME VALUE—MAKE NEEDED IMPROVEMENTS NOW



**Air Foil on Roof
Keeps Rear Window Clean**

Saab station wagons are now equipped with a transverse air foil, mounted on the rear of the roof. This serves to deflect a good portion of the air flow downwards over the rear window, thus dispersing dust and helping to overcome the dirty rear window problem which has plagued wagon owners for so long. In addition to keeping dust off, manufacturers also claim the air foil cuts down on mud splash when one is driving over wet and muddy surfaces.

DECEMBER 1961

BUILD THE FINEST TV KIT

On Easy "Pay as You Wire" Plan

Only \$15 for the Starting Package

The "PROFESSIONAL" Series TV KITS:
Easy to assemble. No technical knowledge required. An ideal "Learning" Kit with a Complete Course of Study is available.

Over 50,000 satisfied users!

LEARN ELECTRONICS this interesting way

Complete a Kit — and get the finest TV performance, even in fringe areas. Has Hi-Fi Sound and latest professional quality features. 23", 24" or 27" picture tubes. Prices: from \$119 to \$199, on Easy-Pay Plan.

Beautiful Cabinets available. See how EASY it's to assemble a Transvision Kit. Send Coupon with 10¢ for complete BROCHURE.

Also available: WIRED CHASSIS for custom installations

TRANSVISION
New Rochelle, N.Y.

TRANSVISION Electronics, Inc., New Rochelle, N.Y. Dept. P M

Enclosed is 10¢ for complete Brochure on TV Kit... Enclosed is \$15 for Starting Package. I understand that I can buy packages one at a time.

Name _____

Address _____

City _____ Zone _____ State _____

221



Gadget Clicks, Lights to Groove Golfer's Swing

About the size of a cigarette lighter, the Swing-Chronizer fastens to the shaft of a golf club and, when the club is swung, a light automatically switches on and an audible click is heard, indicating the moment of maximum power. In a proper

swing, the explosion of power should coincide with the moment the clubhead hits the ball, so the Swing-Chronizer is intended to tell the golfer whether he's releasing the power too soon or too late. \$12.50 from Burgess Battery Co., Freeport, Ill.

Biggest Aluminum "Cat" Has All the Comforts

Largest aluminum power catamaran ever built, the 60-foot *AWOL III*, heads down the Ohio River on her way from Louisville, Ky., to Florida for delivery. Powered by twin Graymarine V8 238-horsepower engines, the craft cruises at

20 miles an hour with a top speed of 25. With a 16-foot beam and 3-foot draft, the boat will sleep 12 in twin staterooms, has a full sized galley, air-conditioning, and complete electronic systems. Built by Aluminum Cruisers, Inc., of Louisville.



WAR SURPLUS AND OTHER BARGAINS SAVE UP TO 90%



ELECTRIC STORAGE BATTERY WINCH

New, improved model contains heavy-duty, 2-way drum switch. Fully reversible heavy-duty, two-speed motor, 160 to 1 gear reduction. Ball bearing construction throughout. Drum will handle 70' of 1/4" cable. Can be used on 6, 12, 24 V. battery. Lift cap. 2000 lbs. plus. Ready to install & operate. 19" long x 9" wide x 8" high. For jeeps, trailers, boats, trucks, etc. Complete with mounting flange safety load locking brake. Shpg. Wt. 60 lbs. Approx. GOVT. COST \$400. NEW. Model E. \$49.50.

"SUPER 9" 200 AMP WELDING KIT With Deluxe accessories consisting of one 200 AMP. Gen., adjustable helmet, electrode holder, ammeter & shunt, rheostat, giant toggle switch, voltmeter, voltage reg., 1 pr. heavy-duty welder's gloves and 30' cable. All units guaranteed pre-tested. Approx. GOVT. COST \$500. Most items new — all perfect. \$27.50.



SOUTH WIND HEATER & ACCESSORIES

Manufactured for govt. antarctic expeditions for jeeps and half-tracks. Heating unit puts out over 20,000 B.T.U.'s. Late recirculating type. Burns any type gas. 12 volt system. Fuel consumption extremely low, 1 gal. per 8 hrs. Terrific for trucks, etc. With service & installation manuals & many components. Approx. GOVT. COST \$550. Shpg. wt. 50 lbs. NEW. \$39.95. Limited quantity. Also available in 6 volts. \$39.95.

DELUXE ELECTRIC STORAGE BATTERY WINCH



Handles 250' of 1/4" steel cable. Operates on 6, 12, 24 V. battery. 160-1 gear reduction. Lift cap. 2500 lbs. Contains heavy-duty mounting base with outrigger bearing and spool support. Rugged construction. Heavy-duty dual speed motor with safety load-locking brake. Dim. 24" long x 9" wide x 8" high. Great for jeeps, trailers, boats, trucks & campers. Shpg. Wt. 80 lbs. Approx. GOVT. COST \$490. NEW. Model E-D. \$69.50.



FRESH WATER SYSTEM PUMP

For boats, campers & trailers. Output 10 to 200 gal. an hr. Variable rheostat controls output. 1/2" pipe thread into bronze impeller housing. 12 V.D.C. Radio noise filter. 5.2 amp. draw. Explosion-proof const. Shpg. wt. 11 lbs. Complete with mounting instructions & wiring diagram. Approx. GOVT. COST, \$200. NEW. \$10.95.

225-1 REDUCTION GEAR

For beaching boats, winches, hoists. Ideal motor in golf or boy's electric car. DC motor and clutch. Easily reversible wiring diagram furnished. Hi torque. 105 RPM. Runs on 6-12 or 24-32 V. 65 lbs. gross. Approx. GOVT. COST \$300. \$13.50. Matched splined gear—\$3.00 ea.



NEW 1962 CATALOG!

Tremendous catalog — our biggest ever — fully illustrated — 1000's of bargains in war surplus & other items. Send for your free copy today. You're invited to visit our giant warehouse. Where ppd. indicated applies to U.S. only. Other prices F.O.B. Culver City Calif. Send cash, check, money order, 50% deposit for C.O.D.



AIRBORNE SALES CO., INC. DEPT. PM-1261

8501 Stellar Drive, Culver City, Calif.

KROIL LOOSENS RUSTY FROZEN PARTS

creeps in

Frozen bolts, pipe threads, bearings, etc., yield to Kroil, the chemical lubricant that creeps into millionth inch spaces, dissolves rust and dried grease. Harmless to metal or skin — used by 25,000 shops for 20 years. Now available in half-pint spout cans, 65c at your dealer.

KAND LABORATORIES, Nashville 11, Tennessee

SOURCES of further information on articles are listed in our free **WHERE-TO-FIND-IT** list.

For your copy just write to the

SERVICE BUREAU
POPULAR MECHANICS
200 E. Ontario Street
Chicago 11, Illinois.



Heavy Duty, All Steel
TOOL CHEST
\$28⁵⁰ F.O.B. ST. PAUL

WHERE ELSE
can you get 4 drawers with built-in locking system, sliding on compound glides—at this price! Baked blue-gray enamel. 26" x 12 1/2" x 12 1/4". Your money back if not satisfied! Write for bulletin describing this and all other models.

HUOT MANUFACTURING CO.
555 No. Wheeler St., St. Paul 4, Minn.

at hardware stores—or order direct

You have a use for
KRYLON SPRAY PAINT
In Ready-to-Use Aerosol
IF YOU PRIZE IT...KRYLON-IZE IT!

SAVE MONEY...EARN MONEY
with the **METL-FORMER**

ROLLS • FORMS • BENDS

Make screen door guards, wall hangings, plant shelves, room dividers... anything you want in light wrought metal and with a truly professional appearance. Form rod, tubing or flat metal.

\$34⁹⁵ PREPAID including material

Write for information and free project folder.
SWAYNE, ROBINSON & CO.
Dept., A. 228 E. MAIN ST., RICHMOND, IND.

LICKITY LOG SPLITTER

Ends Wood Splitting Drudgery

Dealer Inquiries Invited

Smooth 18 ton hydraulic power splits big profits for you from the toughest woods, including American Elm. 7 HP trailer unit squats under own power to receive large logs without "dead" lift. Has 2 speeds, auto-shift and auto-stroke. 26" ram travel splits up to 34" lengths, any diameter—or, with extended frame and adjustable wedge, splits up to 52" lengths, any diameter. Write for details.

THE WACO AIRCRAFT CO., Dept. D, Troy, Ohio

THE PERFECT CHRISTMAS GIFT

DYNAMIC INDUSTRIAL TYPE TRANSFORMER WELDER

**WELD-CUT-BRAZE-SOLDER-HEAT
IRON-STEEL-BRONZE-BRASS
ALUMINUM AND OTHER METALS**



Professional Electric Arc Welder. Ideal for Home, Shop, Farm or Industrial use. The handiest tool in your workshop. Weld, Braze, Solder, Cut, Bend all metals. Do expert work on your first job. Build or repair Boats, Trailers, Auto Bodies, parts, fenders, metal and ornamental iron furniture, fixtures, farm equipment, garden tools, bicycles, toys, etc. Operates on any properly wired 110 V. A.C. line. Complete with helmet, arc torch, electrode holders, flux, rods, cables, instruction book. **FULL YEAR GUARANTEE, 10 day money back trial. ONLY \$38.50 f.o.b.**

Only \$38.50 f.o.b. Send only \$6.00 check or m.o. Pay postman balance plus charges. EASY PAY PLAN. Low down payment. Pay as you weld.

DYNAMIC WELDER CO. 1808 SOUTH FEDERAL STREET Dept. D2-N, CHICAGO 16, ILL.

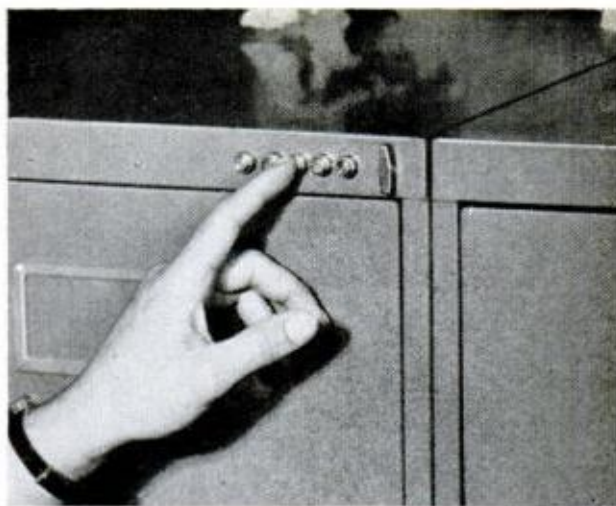

Lock Buttons Up Things

As it must to all things (probably), the push button has come to the combination lock.

Five push buttons and a lever make up a new device made by Simplex Lock Corp. The buttons provide over 1000 combinations, and the lock, says the company, cannot be opened by pick-lock, X ray, stethoscope or touch.

It is adaptable for industrial or home use and the combination may be changed in six seconds, without tools. The company address: 150 Broadway, New York 38, N.Y.

AUTOMATIC

MAKES NEW PROFITS

RETOOTHER

for HAND SAWS

Cuts new teeth in 50 seconds—any size 4 to 16 points. Old teeth fall off as chips. Easy to operate. A perfect job.



BURR MFG. CO. 8933-D VENICE BLVD. LOS ANGELES 34, CALIF.

Send For Free Literature

ALCORT

**Sailfish
Sunfish**



SAVE ON KITS!

ALCORT, INC. DEPT. PM-121, BOX 1345, WATERBURY, CONN.
IN CANADA: SAILFISH SPORTSCRAFT, LTD., 59 INDUSTRIAL RD., RICHMOND HILL, ONT.
PLEASE SEND FULL INFORMATION ON SAILFISH-SUNFISH KITS

NAME.....

ADDRESS.....

CITY..... ZONE..... STATE.....



Metered Tire Compressor

Available for either direct or alternating current, a hand compressor can be used to put air in tires, clean the car, paint, etc.

An electric motor drives an air pump, and an attached meter indicates when the tire has the right amount of air.

Made in West Germany by H. Brennenstuhl of Tuebingen-Pfrondorf, it will be exported to the United States.

SURPLUS SALE

GOVT. SURPLUS
EXCESS INVENTORY
BANKRUPT STOCK



SELF PRIMING WATER PUMP



• Item #204. New Govt. units. Fine for boat pumping, sump pump, etc. Timken bearings, 1 1/2" intake and discharge ports, 3/4" shaft. Size 12"x10"x18".
Wt. 32 lbs. Cost \$97.50. **\$19.49 FOB SALE.**

MISC. ELECTRONIC BARGAINS

- \$20 Govt. Geiger Tube.....\$.69 FOB
 - \$6.50 Photo Electric Cell..... 1.29 FOB
 - \$7.25 Dual Thermister 1.21 FOB
 - \$90 110-v A-C SelsynsPr. 6.95 FOB
 - \$6.95 Laboratory Solenoid79 FOB
 - \$5.50 110-v A-C Relay DPST... 1.49 FOB
 - \$8.25 Giant 110-v A-C Solenoid. 2.98 FOB
 - \$15 Elec. Massage Vibrator-110v. 7.69 FOB
 - \$10 Fish and Worm Shocker-110v. 3.49 FOB
 - \$90 Automatic Telephone Switch. 12.91 FOB
 - \$10 W.E. Telephone Handset... 3.35 FOB
 - \$50 Fire-Burglar Alarm System. 12.95 FOB
 - \$20 Electro-mag. Veeder Counter 4.67 FOB
 - \$135 Mobile 12v. P.A. Amplifier 9.79 FOB
- Hundreds electronic bargains in catalog.

HYDRAULIC EQUIPMENT BARGAINS



Savings to 80%. Build loaders, diggers, presses, etc. All brand new.

- Control Valve, 1 or 2 way.... \$18.00 FOB
- \$100 Gear pump, 1000 psi.... 41.60 FOB
- 12-v Motor & Pump 1000 psi... 18.49 FOB
- 2-Way cyl. 3" bore, 8" str.... 19.70 FOB
- Hyd. Press-gauge 1500 lb.... 2.95 FOB

DIAL PHONE

• Item #716. W. E. phone, same type used in telephone offices. Use as extension or main line phone. Set up your own private system. Wt. 8 lbs. Black..... \$7.95

Color (specify) Coral, Yellow, Lt. Green, Buff..... \$11.95 FOB



GOV'T SURPLUS PLANTS

Ideal for bomb shelters, emergency power, etc.

- \$275 1-cyl. 1500-w 115-v 60-c... \$182.50
- \$425 1-cyl. 3500-w 115-v 60-c... 329.50
- 1150 4-cyl. 5000-w 115-v 60-c... 449.50

Also many other plants, AC generators, DC generators, at savings to 50%. See catalog.



ARMY AC GENERATOR

• Item #626. Brand new, original crate, all ball bearing DeLuxe heavy duty 115-v 3,000 to 4,000-w, 60-c generator. 1,200 rpm. With voltage control and voltmeter panel, etc.

• Drive with tractor, old auto engine, etc. Ready to use. Great emergency unit for farm, etc. Size 21" x 14" x 20". Wt. 260 lbs. Govt. cost over \$600. **\$139.50 FOB SALE.**

• A four star buy—141 units available.

GOVT. GEARED BATTERY MOTOR



• Item #569. Powerful geared-down motor. Runs on 6 or 12-v. Use for golf cart, boat, farm winch, etc. Reversible. Speed 25-85 rpm. Wt. 35 lbs. Govt. cost \$250. **\$21.79 FOB SALE 12 Volt.**

6 Volt, \$20.79 FOB

AIR COMPRESSOR BARGAINS

For painting, cleaning, tires, control termites. Assemble your own outfit. Lowest prices in U.S.

• **DELUXE KIT.** Compressor, tank, gauge, regulator, paint gun, fittings. How to build instructions. List \$52. **\$49.50 FOB SALE.**

• Compressor 1-cyl. \$21.50. 2-cyl. \$54.75. Govt. Air Tank. \$10.95. Regulators. \$3.95. Pop Off \$1.75. Pres. Gauge \$1.75. Finest paint gun, \$11.50. Auto switch, \$4.75 FOB.

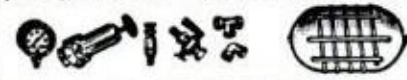

SPECIAL OF THE MONTH!

GOV'T AIR COMPRESSOR

• Item #453. Expensive precision Gov't Air Compressor. Direct connected G.E. motor 115-v 60-c. Built-in air filter, relieve valve, etc. Very compact and highly efficient unit.



• Excellent for paint spraying, insecticides, air brush, etc. A "Super Buy". Gov't cost over \$250. **SALE, \$29.88 FOB**

HYDRAULIC SPEED REDUCER

• Item #1304. 1 hp variable speed hydraulic transmission. Variable speed 0 to 350 rpm. Instantly reversible. Ideal for lathes, midget cars, etc. Roller bearings and complete with 3-phase 220-v AC ball bearing motor. Size 21"x9"x20". Wt. 200 lbs. Shaft fitted with pulley (specify diameter desired). Govt. cost over \$900.



\$89.50 FOB SALE.

GENERATOR—3000W—115V



• Item #633. D.C. ball bearing compound-wound Delco unit. 1" dia. shaft. 2800 RPM. Ideal for portable tools, lights, boats, etc. Will run any 115-v DC-AC tool. Govt cost over \$175. **\$54.75 FOB SALE.**

BATTERY REMOTE CONTROL WINCH

• Item #322. Powerful Govt. DC hoist with "up-down-off" push-button control switch, 20' cable. • 35' 4000-lb. hi-strength super-flexible steel cable on self leveling pre-grooved high-strength 5"x6" drum. Winch rating 1000-lbs. on 12-v, 1500 lbs. on 24-v. Fine for boats, loading docks, trucks, jeeps, garages, farms, etc. Easy to install. Electric automatic locking brake. Works off any car-truck 12-v battery. Wt. 90 lbs. Size 12"x14"x8". **\$68.25 FOB SALE.**



1962
CAT.
ALOG

Electronics, Tools, Binoculars, Hydraulics, Plants, Compressors, etc. New 1962 cat. now ready (send dime or stamps).

SURPLUS CENTER
LINCOLN, NEBR DEPT 814

Don't miss PM's exciting
60th Anniversary Special
next month!

Fill Flaws In Plywood

Handles like putty. Hardens like wood.

PLASTIC WOOD®

The *Genuine*—Accept No Substitute.

The second most important tool...
for every
woodworking shop

A VERSATILE

W&H

MOLDER-PLANER

is second only
to a saw... it
molds, planes and rabbets.

Models from \$89.95
From \$27.50 down & \$6.00/mo. **SEND FOR FREE BROCHURE**

WILLIAMS & HUSSEY MACHINE CORP.
CLINTON ST., MILFORD, NEW HAMPSHIRE



Thousands
in Use!

Free!



BRAND NEW LAFAYETTE ELECTRONICS

1962

CATALOG 620

It's Bigger and Better
Than Ever!

340 giant-sized page catalog from the world's leading supplier of electronics and stereo hi-fi equipment.

340 PAGES

It's a complete shopping center for audiophiles, technicians, engineers, students, hobbyists, servicemen and dealers. Thousands of items at lowest money-saving prices — featuring LAFAYETTE KITS... the best value for your money any day.

SPECIAL! NO MONEY DOWN
with Lafayette's NEW EASY-PAY PLAN.

MAIL THE COUPON TODAY FOR YOUR FREE CATALOG

LAFAYETTE LOCATIONS
JAMAICA • BRONX • NEW YORK CITY
NEWARK • PLAINFIELD • PARAMUS • BOSTON

Lafayette Electronics Dept. LL-1
P.O. Box 190, Jamaica 31, N. Y.
Send me the FREE 340-pg. 1962 catalog 620.

Name.....
Address.....
City..... Zone..... State.....

Top Tank Sealer Keeps Radiators Cool

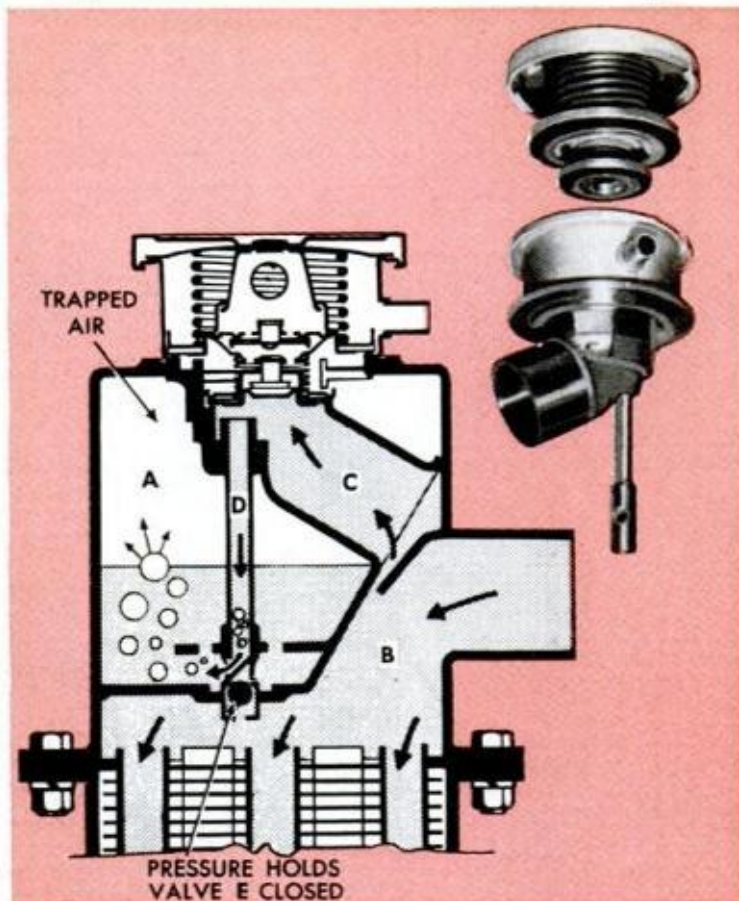

Cooling system hot spots are eliminated and engine efficiency increased with new Liquid Seal unit installed in a radiator. It maintains a constant coolant level and traps air from the system.

Unit divides top tank into two separate sealed tanks—surge tank A and manifold tank B—with connection at inlet neck C. Outlet is at valve E. Manifold tank is always full. Inlet neck traps air escaping from system. Core is always covered with coolant and air can't circulate.

Expanding coolant enters valve assembly D, driving air down pipe ahead of it. Pressure against valve E seals hole, forces air and expanding coolant to enter surge tank where air rises to the top and is trapped from the system.

Coolant then contracts and suction opens valve E so coolant can reenter manifold tank and cooling cycle. Complete details on the top tank sealer are available from the Wood Co., 1609 Wildwood Drive, NE, Cedar Rapids, Iowa.

Information not listed on articles in this issue often is given in the WHERE-TO-FIND-IT list, available at no cost from the SERVICE BUREAU, POPULAR MECHANICS, 200 E. Ontario, Chicago 11, Ill.

CHOOSE A
POCKET-SIZE

Kirsten
"COMPANION"

PATENTED "RADIATOR" STEM MEANS
Cool Smoking!

\$3⁹⁵
POSTPAID

**WEIGHS ONLY
1 OUNCE!**

WRITE FOR FREE CATALOG
other pipes 5.00-7.50-10.00

Write to: **Kirsten** PIPE CO., Seattle 7, Wash. Dept. C

HANDIEST SAW YOU EVER HELD!
Cuts Wood -- Metal -- Plastic -- up to 4 1/4" thickness
with Finger-Tip Control

Just **\$14.75** including 6 assorted blades, lubricant and wrench (F.O.B. Los Gatos (postage prepaid if cash with order). Wt. 2 1/2 lbs.

GRIP-TORC Saw gives YOU control of the blade because of its right angle pivoting on electric drill. Compact 6 1/4" length gets at hard-to-reach places . . . cuts squares, circles, bevels, and close to wall or floor. Reversible blade for right or left hand use, with push or pull movement. Provides unexcelled cutting speeds. Unconditionally guaranteed. Order today!

GRIP TORC tools 17480 SHELBURNE WAY
LOS GATOS, CALIFORNIA

THAW FROZEN WATER PIPES FAST •



Thaw pipe without digging or creating fire hazards. Just plug this low cost PORTA-THAW into a regular 110/220v AC power line. It's completely safe. Has no connection between power line and output terminals. Provides low, medium, high currents. Clears lines in 5 to 20 minutes. Complete with power cable, plug, receptacles, two thawing cables. Ask for data sheet TH-3-10.



DC WELD • RUN AC TOOLS

New low cost welder/power combination furnishes DC current for welding and 110/220 v. AC power. Runs lights, tools, motors, pumps, sprays, etc. Can be invaluable as an emergency power source for brooders, milking machines, furnaces, etc. Ask for data sheet A-279-J.

HOBART BROTHERS COMPANY, BOX M-121, TROY, OHIO, PH. FE: 2-1223



He Stands by for Salutes

In the missile age, a gunner is all but obsolete. Gunner's Mate 3/c Q. L. Ray, a member of the crew of the newly commissioned guided-missile aircraft carrier USS *Kitty Hawk*, mans a 40-mm. gun, one of only two guns aboard. Since the carrier is equipped entirely with Terrier missiles for defense, the two guns are kept there to fire salutes for visiting dignitaries.

**After the city,
Before the state
The ZONE keeps your mail
From being late**



The Post Office has divided 106 cities into postal delivery zones to speed mail delivery. Be sure to include zone number when writing to these cities; be sure to include *your* zone number in *your* return address — after the city, before the state.

DECEMBER 1961

palley's BARGAIN CORNER

NEW! REMOTE CONTROL JEEP WINCH

Specially engineered for years of trouble-free service... extra rugged. Dozens of uses — towing, dragging, lifting, dumping, etc. Designed to mount behind front bumper of any Jeep, Pick-up Truck, 4x4 or Gypsy. Operates on 6 or 12 volt current. Lifts or pulls 3500 lbs. with 12 V. **Only 167⁵⁰**
Has ball bearing motor. Write for list of other Models... W/O CABLE
1/4" CABLE — Far above winch, Steel, 7x19 aircraft quality. **15¢** per foot
Cut to your length specification.



Has 20 power magnification yet is small enough to fit in a gun case or knapsack, etc. Lenses are precision ground and polished. Objective lens is fully coated. Eyepieces are adjustable focus. Comes with steel tripod and leatherette carrying case. Weighs only 15 ounces. Length 8-3/8".



Has a 2" objective lens, a Kellner eyepiece and an Amici erecting prism. The cross hair reticle is illuminated. Has 3 built-in light filters. Field — 325ft. at 1000 yds. **988**

A Government Surplus Bargain!

NEW 3-3/4 HP ELECT. MOTOR

An ideal motor to operate a portable winch such as tow truck or utility boat. Series wound for continuous duty. Rated 3.75HP at 2300 RPM. Draws 240 Amps on 24 volt DC. Has 5/8" diameter drive shaft. **1295**
NEW 8.95
USED 8.95

100 to 1 GEAR HEAD MOTOR 24.50

Gives tremendous take-off power to 24 V. DC motor. 375 ft. lbs. clutch setting. Reversible.

G.E. RI GENERATORS

Aircraft type. Easily converted for use as Arc Welder. Rated 300 Amps, 24-32V, DC. 3750 to 4000 RPM, counterclockwise. 3/4" splined shaft. Instructions for Arc Welder conversion FREE! **1695**
Mfg. General Electric.

WELDER PARTS

1. WELDING REACTOR — Use with the above generator. Takes up to 400 Amps current load. **10.95**
2. Throttle Control SOLENOID — Use as welder or motor control. Has 5" shaft, 1" travel. **7.95**

256 PAGES WORLD'S MOST AMAZING CATALOG

NATIONALLY ADVERTISED PRODUCTS • NEW & USED GOVT. SURPLUS • FACTORY CLOSE-OUTS
Packed with thousands of bargains in Machinery, Hydraulic Cylinders, Pumps, Valves, etc. PLUS special values in Tools, Aircraft Instruments, Aircraft Hardware, Hobby Motors & Tools, Clothing, Camp & Sports Equipment. Optical bargains, etc. Send for Your Copy Today.....

Only 50¢ Your 50¢ will be refunded with your first order of \$1.00 or more. TO COVER HANDLING & MAILING.

palley's

STAINLESS STEEL TANKS FOR FALL-OUT SHELTER - JEEP

Store chemicals, water, air, oxygen or use for storing emergency drinking water supply. Has 1/4" ports. Lgh. 24", dia. 12", Wt. 19 lbs. Capacity 2100 cu. in. (9 gal.) Ex. Cond. No. G-1 **1195**

3-1 Stainless Steel TANKS — Tested to 400 PSI. Same use as above tanks. Holds 18,000 cu. in. of air or 77 gallons of liquid. Size: 45" long x 24". No. J-1 — Worth \$400.00... **9500**

SPECIAL PRECISION GEARED GOVT SURPLUS SERVO MOTOR 838

Originally part of Norden Bomb Sight. Has Solenoids which operate the precision reversing gears. Gear reduction is 165 to 1. Operates on 24 to 28 V. DC. Can be used where extreme sensitivity and instant forward & reversing operations are required or use for parts. **COST GOVT \$1500.00**

SAVE UP TO 65% ON SURPLUS HYDRAULICS

2000 PSI HYD DUTY HYDRAULIC CYLINDER

Another of our outstanding Hydraulic Cylinder Bargains. Has a 2-1/4" Bore, 4" Stroke, 1" Shaft and 13 1/2" eye-to-eye length. Ports are 1/4" AN (7/16"-20 thread). Cat. No. H-66NSU, New **1795**
Cat. No. H-66USU, Used **1295**

1500 PSI HYDRAULIC CYLINDER

Has Bore of 3-1/8", Shaft 1-1/2", Stroke 26", Length 34". Ports are 3/8" AN (9/16"-18 thread). Cat. No. H-27-U ... **USED 2275**
Cat. No. H-27-N ... **NEW 3750**

1500 PSI Dbl. Action CYLINDER

Has 2-1/2" Bore, 1-1/4" Shaft, 9-3/4" Stroke, 16-1/2" closed length. 3/8" AN ports. Metered Stroke. Cat. No. H-1185U **1175**

4 WAY HYDRAULIC VALVE 395

No. H-V7A-1
Spring loaded, poppet type valve. Has 1/4" tube ports. Pressure balanced. Off in neutral position. Orig. cost \$30.00

NEW SURPLUS GYRO Only 1095

Turns to 50,000 RPM. Electric motor drive is integral with balance wheel which is ball bearing mounted. Will operate on 24 Volt, DC-AC current. Ideal for hobbyist, science lab or experimental work.

TO ORDER: Send check or M.O. 1/2 dep. with C.O.D.'s. All items sent freight or postage collect.

2263 E. VERNON AVE., Dept. PM-121
LOS ANGELES 58, CALIFORNIA

SAVE AS MUCH AS 80% ON POWER TOOLS

GUARANTEED TO DO THE WORK OF \$40, \$60, \$80 UNITS

- SAVE! BUY DIRECT FROM FACTORY
- PROFESSIONAL QUALITY, LIFETIME ENGINEERED
- UNCONDITIONAL 10-YEAR GUARANTEE

REVOLUTIONARY PATENTS DECREASE COSTS, INCREASE EFFICIENCY. Top quality full scale power tools of heavy duty 100% cast iron and steel. Streamlined design features such as perforations on table tops reduce weight, cut material costs, cut polishing and grinding time—reduce production costs. Special patents provide added efficiency, accuracy, savings. Nothing left out but exp've gingerbread. Parts made, assembled, tested and packed in our own factories, shipped direct to you. No retail store handling or profits to add to your cost.

\$995



**8" TILT
ARBOR
POWER
SAW**

Complete as shown, less blade. Incl. precision mitre gauge, ground cast iron table. If desired, RIP FENCE for easier work alignment, \$3.50 add'l.

Exp. Coll.

DOES THE WORK OF \$50 BENCH SAWS!

CROSS-CUTS, RIPS, BEVELS, MITRES, DADOES, CUTS COMPOUND ANGLES. Patented motor mount takes any standard 1/4 to 1/2 h.p. motor... keeps belt tight, assures perfect alignment at any angle, transmits full power. Table stays level—blade tilts, locks securely at any angle to 50°, raises, lowers 0°-2 1/4". Patented tilt mechanism has accurate etched scale. Takes standard blade, saw insert removes easily for insertion of any STANDARD dadoe heads, cutters, etc. Accessories, table extensions, when wanted, at factory prices. Versatile, rugged performance proven by almost a half-million users.

UNCONDITIONAL 10 YEAR GUARANTEE

DOES THE WORK OF \$60 UNITS

Now, at little more than a hand tool price, a guaranteed professional quality precision machine which does same work as skilled hand planing... much faster, more accurately. Make accurate glue joints; rabbeting cuts for doors, window frames, table drawers; square taper cuts for chair legs; extremely accurate beveling. Helps amateurs produce quality work—with the sweat eliminated.

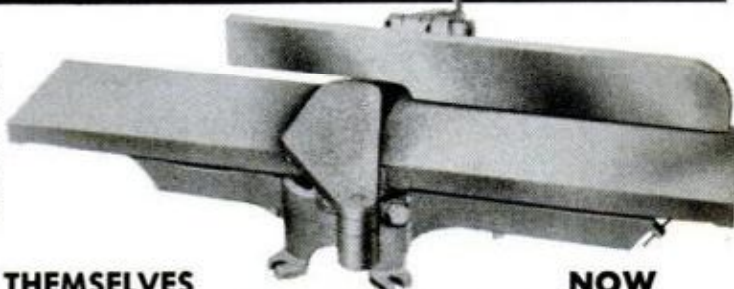

TOP QUALITY FEATURES SPEAK FOR THEMSELVES

- Precision ground cast iron tables, adjustable for depth of cut
- Rigid cast iron base
- New patent-pending design holds clearance between knives and tables at any depth
- Rabbet depth 3/4"
- Hardened, ground high speed steel knives
- Patent-pending fence adjustable to any position, any angle 0°-50°
- Patent pending lift-off guard (nothing to loosen!)
- Balanced steel cutter head. UNCONDITIONAL 10-YEAR GUARANTEE.

FULL 22" LONG, 4 1/8"
JOINTER-PLANER

NOW
\$1995

Complete as shown
100% precision ground cast iron and steel. Exp. Coll.

BENCH DRILL PRESS

DRILLS TO CENTER OF 10" CIRCLE—Rugged, dependable... all cast iron and steel. Table to 1/2" handlite chuck: max. 13 1/2". Spindle has combination ball and bronze bearings. Adjustable stop for repetitive drilling. Precision ground cast iron table. Table assembly fully adjustable on column. UNCONDITIONAL 10 YEAR GUARANTEE.

\$1995

Less Belt
Exp. Coll.



6" SWING 3-FT. LATHE

\$985



DOES THE WORK OF \$40 UNITS—This sturdy all cast iron power tool will turn wood or plastics with the precision and speed of machines selling for 4 times as much. Has tubular steel bed, ball thrust cup center, spur center. T-Rest assembly, lever action tail stock. 2 speed pulley. Fits any motor. Perfect for the home or professional workshop, garage or farm. UNCONDITIONAL 10 YEAR GUARANTEE.

Complete as shown
Exp. Coll.

HIGH SPEED TILT ARBOR BENCH SABRE SAW



TAKES THE PLACE OF \$100. BAND SAW—Zips through thick stock effortlessly. Makes outside and inside cuts a breeze. Cuts circles, curves, any angle 0°-45°. Ideal for intricate jobs as well as ripping and crosscutting. Multipurpose saw almost a complete workshop in itself! Free-cutting blade eliminates pull up of work piece. This cutting action, unlike conventional portable sabre saws, reduces friction, blade stays cool, breakage and dulling are minimized. Even the most inexperienced do-it-yourselfer can turn out professional work the very first time. Takes any standard 1/4 h.p. motor or larger.

\$1995
Exp. Coll. UNCONDITIONAL 10-YR. GUARANTEE!

MAIL COUPON TODAY!

American Machine & Tool Co., Dept. PM-121, Royersford, Pa.

Please send me the units checked. Payment in full enclosed \$..... or \$3 deposit each item enclosed, balance C.O.D. I must be fully satisfied or will return unit within 10 days for full refund. No questions asked.

- 8" Saw \$9.95 8" Saw & Rip Fence \$13.45 Lathe \$9.85
 Sabre Saw \$19.95 Jointer-Planer \$19.95 Drill Press \$19.95

NAME.....

ADDRESS.....

CITY.....ZONE.....STATE.....

(please print)

10 DAY MONEY BACK GUARANTEE
You must be satisfied or money refunded, no questions asked.

AMERICAN MACHINE & TOOL COMPANY
Dept. PM-121, Royersford, Pa.

What **STANLEY**[®] means on hammers

Stanley means quality, superb craftsmanship in tools. It is especially evident in this "STEELMASTER" Hammer...



FREE!
Leather belt holster with No. XST1½ "STEELMASTER"—a special value at your dealer's.

Heft it . . . try the balance. Swing it . . . sense the power. Enjoy the comfortable, cushioned, non-slip neoprene-rubber grip. Now whack away! The exclusive "rim-tempered" face minimizes chipping. It's safer! The head is super-heat-treated—extra tough from face to claw. So swing over to "STEELMASTER", a great hammer by Stanley. **Only \$5.25.**

GIFT REMINDER . . . Add a quality Stanley hammer to her Christmas list for you!



No. 11½—Made for those who prefer a wood handle. Power balanced. Head forged from alloy steel, scientifically heat treated. "Rim-tempered" for safer use. **Now only \$4.50.**



No. SC1¼ "STEELMASTER" Camp Axe. A rugged, all-steel, perfectly balanced cutting tool for camping and general all-around outdoor use. Safe, non-slip grip. **Now \$6.70.**

You get what you pay for in tools! If you lose tools, are careless with them in your work—get cheap ones. If you value good help for your hands . . . if you are proud of your work—buy Stanley Tools.

STANLEY

[®]
Stanley Tools
A Division of The Stanley Works
New Britain, Conn.

*For real gift excitement
and year 'round use...*



Weller® POWER TOOLS



HI-POWERED SANDER

Sands twice as fast as any other sander at its price. New heavy-duty reciprocating motor provides full $\frac{5}{32}$ " stroke, 14,400 strokes a minute. Big 26 sq. in. plate sands with grain for satin smooth finish unobtainable with disc or orbital sanders. Safety design plus 3-wire grounded power cord prevents electric shock hazard.

\$19⁹⁵
MODEL 77

Weller Finishing Sander
Model 700, **\$13.48**



SABRE SAW

Portable jig saw makes every kind of cut through plywood, composition board, plastics, etc. Even makes its own starting hole. No need to drill for inside cuts. Exclusive strain-relief design prevents blade breakage. Lubricated for life. Two wood cutting blades and metal cutting blade are included. 3-wire grounded power cord.

\$14⁹⁵
MODEL 800

250 Watt Soldering Gun
Model 8250A, **\$12.95**



**DUAL HEAT
SOLDERING
GUN KIT**

Features Weller Dual Heat Gun. Heat and spotlight come on instantly. 2 trigger positions give 2 soldering temperatures. Switch instantly to 90-watt low heat or 125-watt high heat as your job requires. Tip is copper for maximum heat transfer and iron-plated for long life. Kit includes soldering aid, cleaning brush, solder.

\$7⁹⁵
MODEL 8200K

Heavy Duty Soldering Kit
Model 8250AK, **\$14.95**

All Weller tools are guaranteed 1 year • WELLER ELECTRIC CORP., EASTON, PA.