

EXCLUSIVE: I Flew the Flex-Wing

POPULAR MECHANICS

NOVEMBER, 1961

35 CENTS

KEYS TO LOWER-COST APPLIANCE REPAIRS

*Head-
starters
for Christmas*

- **Silk screen your own cards**
- **15 fun-to-do gifts and decorations**

**BUILD A PORTABLE
5-MINUTE
CAR WASH!**



**'62 Ford Fairlane
with an all-new V8**

Material, attached to the car.



Porter-Cable

PARADE OF POWER SPECIALS

Yours at special low prices

Here's one parade you won't want to miss. Spectacular savings! Tremendous tools! Colossal values! Home workshop enthusiast or professional craftsman, you'll recognize these buys:

- NEW! Power Block Plane Model 167.....\$54.50
- 1/4" Drill Model 161A.....\$19.95
- NEW! 6 1/2" Power Saw Model 76.....\$49.95
- NEW! All-purpose Router with Scroll Saw Attachment Model 155.....\$54.95
- Electric Hand Saw Model 152A.....\$49.95
- NEW! 7" Power Saw (not illustrated) Model 170.....\$54.95
- Finishing Sander Model 106A. Check your dealer's local promotion price!

Porter-Cable Machine Company
Subsidiary of Rockwell Manufacturing Company
502L N. Lexington Ave., Pittsburgh 8, Pa.

*In Canada: Porter-Cable Ltd., Box 817, Kingston, Ontario
Canadian prices slightly higher.*



Get on the bandwagon! Write now for name of your nearest dealer and illustrated folder.

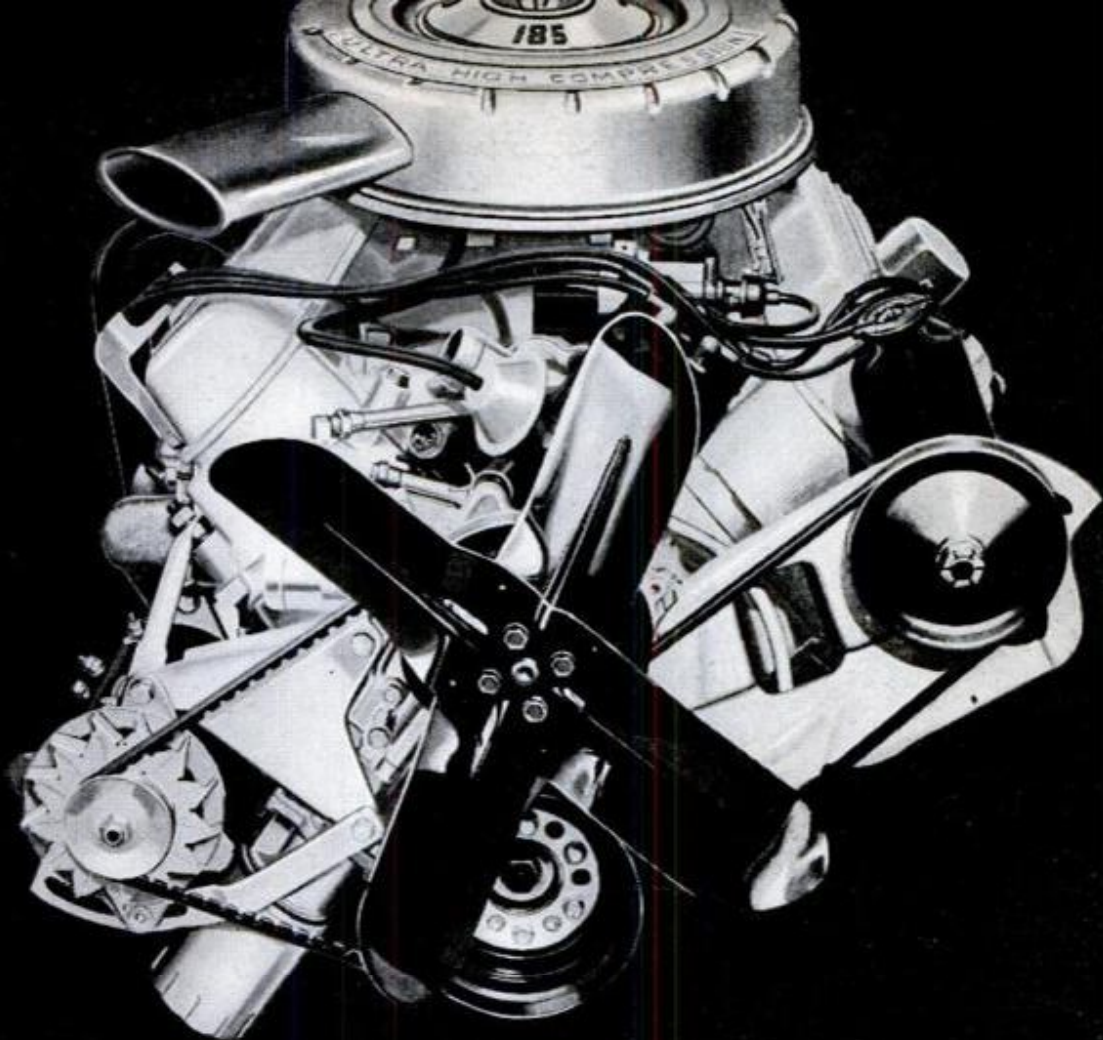

NO MATTER HOW YOU SLICE IT... YOU CAN'T BEAT A V-8

THERE'S SMOOTH POWERFUL V-8 ACTION IN EVERY OLDS!

A car the size of an Olds F-85 needs the lively get-up-and-go . . . the zip and dash that only a V-8 can deliver!

And the ultra high-compression Cutlass 185 aluminum V-8 Engine does just that! What's more, the inherent balance of its proven V-8 design gives you the extra smoothness that no "four" or "six" can match.

The top-performing Cutlass 185 is standard at no extra cost in every Cutlass Coupe and Cutlass Convertible —available at slight extra cost in all other F-85 models! Ask your local Oldsmobile Quality Dealer for a test drive in a Cutlass—the car with a V-8 engine that's in a class by itself!

Cutlass 185 Engine: 185 h.p., 10.25-to-1 compression ratio; 230 lbs.-ft. torque at 3200 r.p.m.; Multi-Jet 4-barrel carburetor; High-torque 3.36-to-1 axle ratio. All standard equipment on both Cutlass models!



Cutlass CONVERTIBLE



Cutlass COUPE

OLDSMOBILE DIVISION • GENERAL MOTORS CORPORATION

There's "SOMETHING EXTRA" about owning an **OLDS** →



That is correct.

When charged, this amazing drill drills without an electric cord, plug or outlet of any kind. Quite a tool.

The Black & Decker $\frac{1}{4}$ " CORDLESS Electric Drill* does not replace our corded tools. It's a new addition—has extraordinary virtues.

For example, from cellar to roof top the CORDLESS is a miracle of convenience.

Outdoors it gives you the freedom of all outdoors. Fix or build where you please. On a boat. In a woods. On farmland.

On a single charge it easily drills 200 $\frac{1}{4}$ " holes in $\frac{3}{4}$ " fir. Recharging the Power Pack, inside the handle, is a very simple matter.

The CORDLESS is built with watch-like precision. It has a unique, ultra-efficient motor, and is completely shockproof.

It feels, handles, sounds, and performs like no other drill in the world. That's because it is the only one in the world. Price? The C-601 CORDLESS is just \$59.90 complete with Power Pack Charger.

*Patents Pending ©1961



Black & Decker

WORLD'S LEADING MAKER OF POWER TOOLS
AND THE WORLD'S FIRST CORDLESS ELECTRIC DRILL



Send for FREE Xmas Buying Guide. For nearest Black & Decker retailer or service, check Yellow Pages or write: The Black & Decker Mfg. Co., Dept. D-111, Towson 4, Md.

YOU'RE READY FOR ANY EMERGENCY WITH

A Weldwood Fix
and Finishes shelf
in your workshop



Refinish antique furniture with new Weldwood Deep Finish Firzite®, penetrating sealer-finish. Produces a beautiful Danish-type oil finish "hand-rubbed" effect without laborious rubbing.



Repair a chair with Weldwood Plastic Resin Glue. Makes joints even stronger than the wood itself. Mixes instantly, is water-resistant. Bonds leather, hardboard, plastic, too.



"Erase" table scratches with Weldwood Putty Stiks®. Fill nail holes, other wood blemishes after the wood has been finished and waxed. Assorted colors to match almost any finish.

Why scurry down to the store every time a problem comes up? Save time and trouble by having the Weldwood® wood finishes and glues you need most *on hand*, on your workshop shelf! Weldwood Plastic Resin and Presto-Set® Glues, new Deep Finish Firzite, Satinlac® self-sealing natural finish, assortment of Weldwood Putty-Stiks, and Flexible Wood-Trim® for edging plywood! Don't wait. Stock up now! These and other Weldwood products are on sale at most lumber yards, paint and hardware stores.

FREE—8-PAGE BOOKLET! "Professional Gluing And Wood Finishing Guide." For free copy, write: United States Plywood, Dept. PM 11-61, 55 W. 44th St., New York 36, N. Y.



Products of United States Plywood
This One



2H34-U4Y-1B7Q

Материал, защищенный авторским правом

POPULAR MECHANICS®

NOVEMBER 1961

VOL. 116

NO. 5

COVER PHOTO BY DON HONICK

INTERNATIONAL EDITIONS • SPANISH: Mexico-Caribbean, Southern Hemisphere • FRENCH •

Features of Special Interest

I Flew the Pterodactyl Flex-Wing	- - - - -	85
This Way, Please!	- - - - -	92
Hot-Stove Hassle: More on Those Baseball Changes	-	100
Performance Report on the New Ford Fairlane	- - -	104
Must Appliance Repairs Cost You So Much?	- - -	112
Football's Fabulous Foremen	- - - - -	124
The Gas Turbine Goes to Sea	- - - - -	130
Guns for the Blue and Gray	- - - - -	136
Wild Animals Pose Here	- - - - -	141
They're Farming Super Salmon	- - - - -	148

For the Craftsman

MERRY CHRISTMAS—Nativity in Paper	- - - - -	154
Take-Apart Playhouse	- - - - -	160
All Aboard!—Pull-Toy Train	- - - - -	164
Kiddie Kitchen	- - - - -	170
Say It With Silk	- - - - -	174
Appliance Fix-It File: Coffeemaker	- - - - -	182
Five-Minute Car Wash	- - - - -	184
Regular Lubrication Pays Off	- - - - -	190
Toe-Touch Air System for Shop	- - - - -	198
Stereo Super-Sorter	- - - - -	208

Address communications to: 200 E. Ontario St., Chicago 11, Illinois. **SUBSCRIPTION SERVICE:** Mail all subscription orders, changes of address, correspondence concerning subscriptions, and Postmaster notices of undeliverable copies to Popular Mechanics, 250 West 55th St., New York 19, N. Y.

Published by Popular Mechanics Company, RICHARD E. BERLIN, *President*

CLIFFORD B. HICKS
Editor

RICHARD E. DEEMS
Executive Vice-President

JOSEPH R. BUELL, JR.
Publisher

Managing Editor: DON DINWIDDIE
Assistant Managing Editor: JOHN A. LINKLETTER
Shop and Crafts Editor: WAYNE C. LECKEY
Automotive Editor: JAMES R. WHIPPLE
Associate Editors: W. CLYDE LAMMEY, WALLACE MYERS
Electronics Editor: BYRON G. WELS
Assistant Editors: JAMES BIERY, KEVIN V. BROWN
ROBERT L. HERING, R. B. KIRKPATRICK
ARTHUR MIKESSELL, BIL TOMAN, RICHARD WILLIFORD
Assistant Editor, Makeup: JEAN KAVANAUGH

Art Director: HENRY M. NEHRBASS
Art Editor: RICHARD A. POTTS
Chief Photographer: FRANK P. FRITZ
Eastern Editor: RICHARD F. DEMPEWOLFF
959 Eighth Ave., New York 19, N. Y.
Western Editor: THOMAS E. STIMSON, JR.
Suite 1003, 3460 Wilshire Blvd., Los Angeles 5, Calif.
International Editor: HEINZ P. SCHLICHTING
Ritterstrasse 26, Karlsruhe/Bd., Germany
Advertising Manager: FRANK R. DUPUY
959 Eighth Ave., New York 19, N. Y.
Director, Bureau of Information: ALLAN CARPENTER

If you wish additional sources of information for the articles in this issue, or if you wish the name and address of the manufacturer of a particular product shown here, write to Bureau of Information, Popular Mechanics, 200 E. Ontario St., Chicago 11, Ill. Ask for the free "Where-to-Find-It-List" for this issue.

DANISH • SWEDISH • GERMAN • PORTUGUESE • DUTCH

Departments

Over the Editor's Desk - - -	8
Tune In on the Inventors - - -	14
Pentagon Sidelights - - - - -	16
Sidelights on Aviation - - - - -	20
Items From All Outdoors - - -	24
Science Bulletins - - - - -	32
On the Market - - - - -	53
Shopping for Tools - - - - -	76
Science Overseas - - - - -	98
What's New for Your Home - - -	146
Solving Home Problems - - - - -	188
Better Carkeeping - - - - -	194
Clinic for Homemakers - - - - -	216

Next Month . . .

Skill-thrills with the new sport of table-top racing . . . the three delivery secrets that will give you top bowling scores . . . the first road tests of the controversial new Wankel rotary combustion engine . . . a 3-in-1 family fun table for pool, table tennis or model railroad layouts . . . and an instant, vacuum-forming machine home craftsmen can build for less than \$5.

ADVERTISING OFFICES—Chicago: 200 E. Ontario St., Whitehall 4-0100; New York: 959 Eighth Ave., Columbus 5-7300; Detroit: General Motors Bldg., TRinity 5-8711; Cleveland: Hanna Bldg., 1422 Euclid Ave., PRospect 1-0456; Los Angeles: 3460 Wilshire Blvd., DUNKirk 2-8458; San Francisco: 111 Sutter St., YUKon 2-0823.

Published monthly by Popular Mechanics Company, 200 E. Ontario St., Chicago 11, Ill. Richard E. Berlin, President; Richard E. Deems, Executive Vice-President; Fred Lewis, Vice-President and General Manager; Robert F. MacLeod, Vice-President; John R. Miller, Vice-President; Joseph R. Buell, Jr., Vice-President; G. O. Markuson, Treasurer; R. F. McCauley, Secretary. Single copy in the United States and Canada, 35 cents; subscription rates in the United States and possessions, 1 year \$3.50; 2 years, \$6.00; 3 years, \$8.00. In Canada, add 50 cents per year. In countries of the Pan-American Postal Union, 1 year \$4.50; 2 years \$8.00; 3 years \$11.00. In all other countries 1 year \$5.50; 2 years \$10.00; 3 years \$14.00. If you plan to move, notify us at least 30 days in advance so you will not miss an issue. Give both your old and new addresses. Second-class postage paid at Chicago, Illinois, and at additional mailing offices. Authorized as second class mail. Post Office Department, Ottawa, Registered as Second Class Matter at the Post Office at Mexico, D.F., Mexico, June 20, 1950. © 1961 by Popular Mechanics Company. All rights reserved. Printed in the United States of America.



Pterodactyl Flex-Wing—page 85



Crowd Engineering—page 92



Fabulous Foremen—page 124

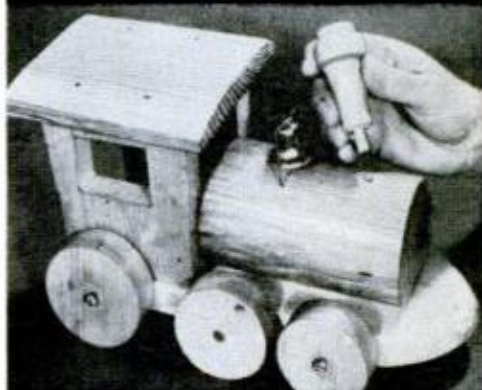

Christmas Choo-Choo—page 164

Car & Kid Washer—page 184



For '62 your Chevrolet dealer's



Impala Sport Coupe

'62 Chevrolet

*Built for people who want room,
refinement and riding comfort found in
much more expensive cars*



Chevy II 300 2-Door Sedan

the new Chevy II

Built for people who want modern basic transportation in the best Chevrolet tradition. Here they are—a totally new line of thrift cars from Chevrolet, encompassing a whole new concept of engineering simplicity to clamp down on service and maintenance cost. Bolt-on front fenders, roomy engine compartment and easy accessibility of adjustable components are just a few of the maintenance advantages of Chevy II's unique design. Thrifty 4-cylinder engine (also satin-smooth 6) wrings extra miles out of a gallon of regular. Unique Mono-Plate rear springs do away with the friction and harshness of old-style springs to give you a remarkably smooth ride. These and a host of other surprises in nine spanking new-sized models, including station wagons and the soon-to-come hardtop and convertible.



A New World of Worth from Chevrolet

got the car for car minded people



Impala Sport Sedan

Here's all the car you could reasonably want. Beauty *built to stay beautiful*, from long-lived deep-luster acrylic lacquer finish right down to new rust-resisting full front fender underskirts. A choice of six engines—ranging all the way up to a 409-cubic-inch powerhouse.* A Jet-smooth ride that rivals anything high-priced cars have to offer. (The reason, of course: Chevrolet's unsurpassed combination of Full Coil suspension and more than 700 noise and vibration filters.) Whatever else you have in mind for that next car of yours, you're almost sure to find Chevrolet has been thinking right along with you. See for yourself at your dealer's.

**Optional at extra cost*

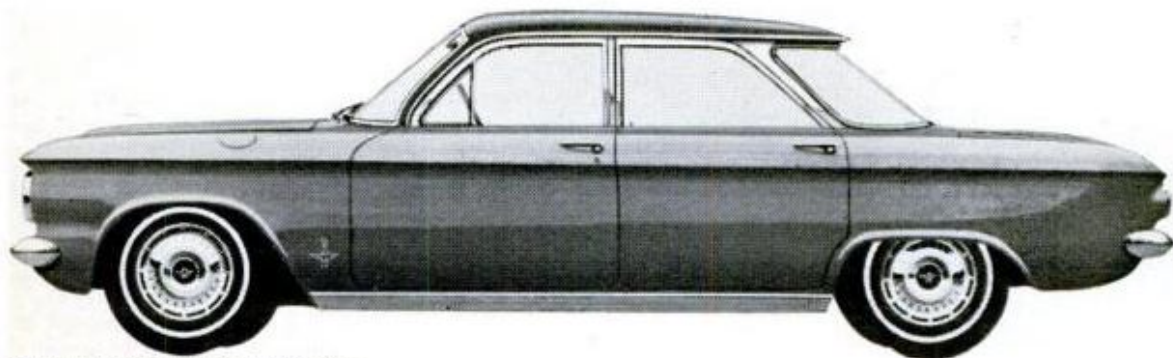

Corvair Monza 4-Door Sedan

'62 Corvair Monza

Built for people who go for sports car driving but don't go for sports car prices. Here's more that can't be copied—from the car that started the bucket seat* brigade. Bigger brakes combined with that special Corvair blend of rear-engined traction and precision steering give you an ever surer, more secure command of the road. There are saucy new styling accents and tasteful interior trim for '62. Yet—with all these refinements—the new Corvair is as sparing as ever on gas. Get on over to your dealer's and discover these and all the other delights that await you in this newest version of America's most renowned rally car. . . . Chevrolet Division of General Motors, Detroit 2, Michigan.

**Bucket front seats are standard on the Monza Club Coupe, optional at extra cost on the Monza 4-Door and Station Wagon.*

CHEVROLET • CHEVY II • CORVAIR • CORVETTE



OVER THE EDITOR'S DESK

Sorting Out Gee-Bees

On page 115 of the June PM, you picture a plane and label it the Gee-Bee. I always thought the Gee-Bee was Roscoe Turner's plane that is now at Weir Cook Field in Indianapolis.

Crookston, Minn.

BOB FLOODEEN

There was a series of Gee-Bee racers built by the Granville brothers (G-B) in the '30s. Jimmy Doolittle flew one to a speed record of 294.38 m.p.h. in winning the 1932 Thompson Trophy race. The Gee-Bee on page 115 has no connection—it was the one and only built by George Bogardus (G-B) and named by him.

Agribusiness?

On page 116 of your May issue, you claim Lancaster County, Pa. to be the richest agricultural county in America.

For the past 11 years, Fresno County, Cal. has been known as the World Capital of Agribusiness, leading the nation in the value of farm products sold.

Fresno, Cal.

ED SODERBERG

According to the Lancaster folks, Fresno cheats by irrigating. Seriously, though, irrigated Fresno certainly appears to be the richest agricultural county in the U.S. The Lancaster people still claim to be the number one nonirrigated county.

Three Wheeler

Being a regular PM reader for years, I have made quite a few of your handyman articles, the most recent being the pontoon boat and the family runabout *Swish*. For my two boys I made an electric car and tractor and this three-wheeler go cart. I am

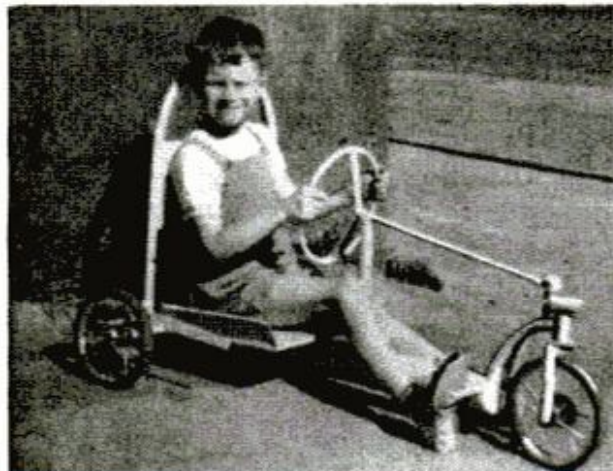

now making a 6 by 11-foot air boat using a 1929 Chevy engine.

Prospect, South Australia K. E. DUNNING

That energy of yours is a good example for us lazy galoots. The air boat might make a good magazine project, if enough PM readers are interested in it. How about a picture of it when you have her launched?

Hearing-Aid Radio Speaker

Could you please tell how to incorporate a built-in speaker into the *Hearing-Aid Radio* (June '61 PM)? Though not hard of hearing, I am going to incorporate the microphone; I have other uses for it.

At what spots in the schematic could I connect an outside antenna and ground to increase the range of the receiver?

Fairfield, Cal.

DAVID NORRIS

Using both a microphone and loud-speaker would give you a loud, squealing feedback, Dave. To increase the receiver's range, ground any of the ground points in the circuit, then tape a flat coil of insulated wire to the top of the antenna coil. Leave one end of the flat coil unconnected and connect the other end to your antenna.

Who's Knocking?

Re the September issue article, *How to Sell Your Own House*, since when did one American earn a writer's fee by knocking the legitimate profession of another? What has Paul L. Theurer got against a licensed real estate person earning a living? . . .

East Orange, N. J.

S. A. HART

Real Estate Broker

Author Theurer made no attempt to knock anyone's profession, Reader Hart. He simply reported the experiences some people have had of saving money by selling their own homes.

Survival at Home

Your article on wilderness survival, Aug. and Sept. PM, was an interesting experiment. Would an urban family be able to make such an exodus in time of actual nuclear attack?

First, roads would be impassably clogged with cars of other fleeing families. Second, supposing you reached your wilderness retreat, so would hundreds of other panicky people, many without resources, equipment or the knowledge or physical ability necessary for survival. Third, you presumed that the area chosen would be free of fallout, but defense against radiation would depend upon happy discovery of a cave—preferably one with a supply of luckless rabbits and a bubbling spring.

If you are in a primary target area, flight

(Continued to page 12)

THIS FREE SAMPLE LESSON

will prove that you can become an expert

ACCOUNTANT...AUDITOR

OR CPA



This well-paid LaSalle-trained Accountant's success could be yours.

FREE SAMPLE LESSON

We offer you this free sample lesson so that you can prove to yourself that you CAN master Accounting—quickly, thoroughly—in spare time at home.

You will see exactly how LaSalle's famous "Problem Method" works...how you are led step-by-step through actual accounting work—learning by doing and not by study of theory alone. First you tackle easy problems, then more difficult ones—until soon you master them all. And at every step you have the close personal guidance of LaSalle's large staff of expert accountants and CPA instructors.

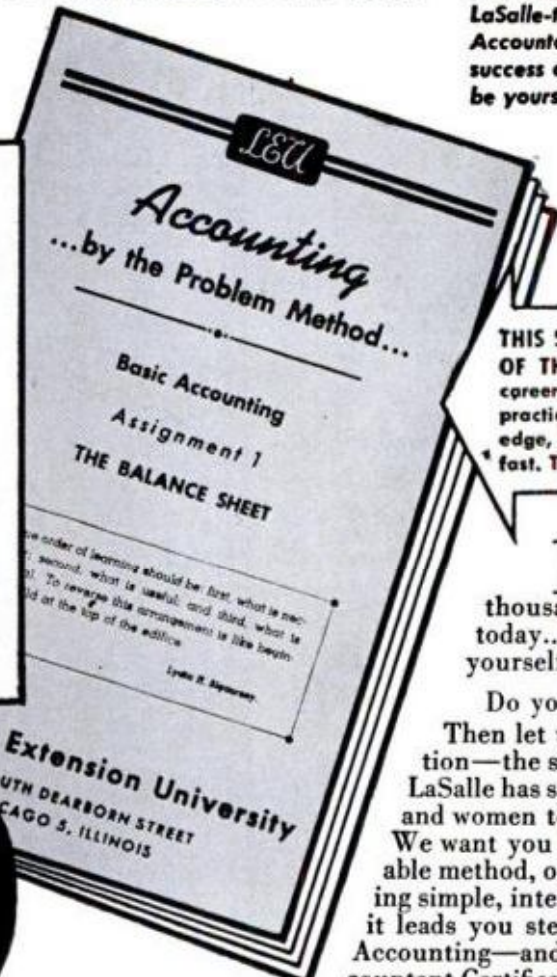

THIS SAME LESSON HAS STARTED HUNDREDS OF THOUSANDS toward well-paid accounting careers—in business, government, and public practice as CPAs. Even without previous knowledge, progress is rapid—earning power climbs fast. This sample lesson will show you why.

If you have been envying the high incomes and good jobs enjoyed by thousands of men and women Accountants today...why not launch such a career for yourself?

Do you doubt that you can?

Then let us send you—without cost or obligation—the same Lesson Number One with which LaSalle has started several hundred thousand men and women toward successful accounting careers. We want you to see for yourself how this remarkable method, originated by LaSalle, makes Accounting simple, interesting, practical, and certain...how it leads you step-by-step to a complete mastery of Accounting—and on up to the Certified Public Accountant Certificate if you so aspire. It doesn't matter

whether you've had previous bookkeeping experience, or whether you don't know a debit from a credit. Whether you wish to qualify as an expert accountant, advanced accountant, cost accountant, auditor, government accountant, income tax specialist, or public accountant...you'll find in LaSalle's Problem Method the exact plan to prepare you rapidly and inexpensively—in spare hours at home—without losing a day from your present job.

So right now, today...if you are an adult, employed, and earnestly ambitious for rapid advancement in one of the highest paying fields of business... send your name and address on the coupon below. We'll send you the free sample lesson—plus our illustrated book outlining today's career opportunities and how you can qualify for them. A coupon like this has started many thousands toward greater success. It can do the same for you. Mail it today!

Accredited Member, National Home Study Council

Clip Coupon... Mail TODAY!

LaSalle Extension University... A Correspondence Institution

Dept. 1164 H, 417 S. Dearborn Street, Chicago 5, Illinois

YES, I want to see how LaSalle's "Problem Method" works... Send me free sample lesson—also your book, "Opportunities in Accounting"... without cost or obligation.

Name.....Age.....

Street Address.....

City, Zone & State.....



One out of every 13 of all CPAs in the U.S. has been trained by the LaSalle Problem Method

GOOD-PAY JOBS IN MANY FIELDS

If you were an expert accountant right now, chances are you would find yourself in one of the best paid fields of business.

There are several big fields of opportunity open to men and women trained in accounting...opportunities that are wide open and highly inviting, offering maximum income and job security in good times or bad. And under LaSalle's "Problem Method" you can start earning while still learning—either in spare-time or full-time employment...or in business for yourself with no capital required.

Get the latest information by sending for our illustrated booklet, "Opportunities in Accounting"—plus free sample lesson. The coupon at right will bring both to you without cost or obligation. LaSalle Extension University, 417 S. Dearborn St., Chicago 5, Illinois.

I'M SICK AND TIRED OF WAITING!



1. **EVERYTHING** COMES TO HIM WHO WAITS? THAT'S A LAUGH. I WAITED FOR THE BREAK. WAITED 'TIL I WAS SICK OF IT. HOW LONG CAN A GUY WITH A WIFE AND 3 KIDS GO ON DREAMING?

HONEY, THERE'S NO OTHER WAY, I'VE JUST GOT TO GET MORE TRAINING. OTHERWISE, I'M STUCK

BUT JOHN, YOU CAN'T AFFORD TO STOP WORK AND GO TO COLLEGE NOW. THERE JUST HAS TO BE ANOTHER WAY



2. MY WIFE AND I THOUGHT ABOUT IT, TALKED ABOUT IT, WORRIED ABOUT IT. WE WERE STUMPED. WE THOUGHT WE HIT A DEAD END

THIS IS THE TRUE LIFE STORY OF JOHN W. HARVIN, JR. DAYTONA, FLORIDA. FROM OUR I.C.S. SUCCESS FILES

3. LOOK AT THIS: I.C.S. HAS A COURSE IN SURVEYING AND MAPPING. DO YOU SUPPOSE IT'S ANY GOOD?

WELL, JANE'S HUSBAND TOOK AN I.C.S. COURSE IN ACCOUNTING—AND SHE SAYS IT WAS THE SMARTEST THING HE EVER DID!



ONE DAY—MY LUCKY DAY—I TOOK A CLOSE LOOK AT THAT FAMOUS I.C.S. COUPON. I'D SEEN IT BEFORE A THOUSAND TIMES. BUT THIS TIME I REALLY LOOKED

I.C.S. IS THE OLDEST AND LARGEST CORRESPONDENCE SCHOOL IN THE WORLD. 256 PERSONALIZED-INSTRUCTION DIPLOMA COURSES

LOOK—IT SAYS THEY'LL SEND YOU A CAREER KIT FREE. THREE BIG SUCCESS BOOKS

I'M GOING TO SEND THAT COUPON. THIS MIGHT BE JUST WHAT WE'RE LOOKING FOR!



4. THAT SETTLED IT! I DECIDED TO FIND OUT WHAT I.C.S. WAS ALL ABOUT. AFTER ALL, WHAT DID I HAVE TO LOSE?

5. WHEN I SAW THE THREE FREE BOOKS, I KNEW I'D FOUND THE ANSWER. I ENROLLED —AND I WAS ON MY WAY!

THIS STUDYING AT HOME SURE IS SAVING ME TIME. LOOK HOW FAR I'VE GOTTEN ALREADY

FROM THE WAY THEY HELP WITH YOUR INSTRUCTIONS, YOU'D THINK YOU WERE I.C.S.'S ONLY STUDENT



6. JOHN HARVIN'S SUCCESS STORY CAN COME TRUE FOR YOU, TOO. HERE'S THE FAMOUS I.C.S. COUPON. LOOK IT OVER. CLIP IT. MAIL IT NOW!

THAT RAISE WAS JUST THE BEGINNING, IT'S SO GOOD TO LOOK AHEAD WITHOUT WORRYING. WE'RE ALL SO PROUD OF YOU, JOHN!

HONEY. THE BOSS TOLD ME I'VE GOT A REAL FUTURE NOW!



FREE!

I.C.S. CAREER KIT

Send coupon now . . . get all these:

- 1 "HOW TO SUCCEED"**
A 32-page gold mine of ideas
- 2 CAREER CATALOG**
Opportunities in the field that interests you most
- 3 SAMPLE LESSON (MATH)**
Shows the famous step-by-step I. C. S. teaching method

For Real Job Security—Get an I. C. S. Diploma! I. C. S., Scranton 15, Penna. Accredited Member, National Home Study Council

INTERNATIONAL CORRESPONDENCE SCHOOLS



BOX 69086L, SCRANTON 15, PENNA.

(In Hawaii, reply P.O. Box 418, Honolulu)

(Partial list of courses)

Without cost or obligation, send me "HOW TO SUCCEED" and the opportunity booklet about the field

BEFORE which I have marked X (plus sample lesson):

ARCHITECTURE and BUILDING CONSTRUCTION

- Air Conditioning
- Architecture
- Arch. Drawing and Designing
- Building Contractor
- Building Estimator
- Carpenter Builder
- Carpentry and Millwork
- Heating
- Painting Contractor
- Plumbing
- Reading Arch. Blueprints

ART

- Commercial Art
- Magazine Illus.
- Sign Painting and Design'g
- Sketching and Painting

AUTOMOTIVE

- Automobile
- Auto Body Rebuilding and Refinishing
- Auto Engine Tuneup
- Auto Electrical Technician
- Diesel Engines

AVIATION

- Aero-Engineering Technology
- Aviation Engine Mech.
- Reading Aircraft Blueprints

BUSINESS

- Accounting
- Advertising
- Bookkeeping and Cost
- Accounting
- Business Administration
- Business Management
- Clerk Typist
- Creative Salesmanship
- Managing a Small Business
- Professional Secretary
- Public Accounting
- Purchasing Agent
- Real Estate Salesmanship
- Salesmanship
- Salesmanship and Management
- Traffic Management

CHEMICAL

- Analytical Chemistry
- Chemical Engineering
- Chem. Lab. Technician
- General Chemistry

- Oil Field Technology
- Pulp and Paper Making

CIVIL ENGINEERING

- Civil Engineering
- Construction Engineering
- Highway Engineering
- Professional Engineer (Civil)
- Reading Struc. Blueprints
- Sanitary Engineer
- Sewage Plant Operator
- Structural Engineering
- Surveying and Mapping
- Water Works Operator

DRAFTING

- Aircraft Drafting
- Architectural Drafting
- Drafting & Machine Design
- Electrical Drafting
- Electrical Engineer Drafting
- Industrial Piping Drafting
- Mechanical Drafting
- Sheet Metal Drafting

ELECTRICAL

- Electrical Appliance Servicing
- Electrical Engineering

- Electric Motor Repairman
- Elec. Engr. Technician
- Elec. Light and Power
- Practical Electrician
- Practical Lineman
- Professional Engineer

HIGH SCHOOL

- Good English
- High School Diploma
- High School General
- H. S. College Prep.
- (Eng'r's & Science)
- High School Math
- High School Science
- Short Story Writing

LEADERSHIP

- Industrial Foremanship
- Industrial Supervision
- Personnel-Labor Relations
- Supervision

MECHANICAL and SHOP

- Diesel Engines
- Gas-Elec. Welding
- Heating and Air Conditioning
- Industrial Engineering
- Industrial Instrumentation

- Industrial Safety
- Machine Shop Practice
- Mechanical Engineering
- Plumbing and Heating
- Professional Engineer
- Quality Control
- Reading Shop Blueprints
- Refrigeration and Air Conditioning
- Tool Design
- Tool Making

RADIO, TELEVISION

- General Electronics Tech.
- Industrial Electronics
- Practical Radio-TV Eng'r's
- Radio-TV Servicing
- TV Technician

RAILROAD

- General Railroad

STEAM and DIESEL POWER

- Combustion Engineering
- Power Plant Engineer
- Stationary Diesel Engr.
- Stationary Steam Engines

TEXTILE

- General

Name _____ Age _____ Home Address _____
 City _____ Zone _____ State _____ Working Hours _____ A.M. to P.M. _____
 Occupation _____

Canadian residents send coupon to International Correspondence Schools, Canadian, Ltd., Montreal, Canada. . . . Special low monthly tuition rates to members of the U. S. Armed Forces.



Using too much gas?



Time to add GUMOUT..



and SAVE!

Here's a quick and easy way to fix many of the most common engine troubles. Troubles such as stalling, bucking, high gas consumption, hard starting.

Simply add GUMOUT to your gas tank and clean your carburetor while you drive. It's the best known, most reliable carburetor cleaner in America! Your car needs it.

Sold at most Service Stations, and Auto Supply Stores.



GUMOUT Cleveland 4, Ohio

(Continued from page 8)

would be the only solution—if no blast-proof shelter were available. Otherwise, the immediate construction of a fallout shelter would answer the problem of survival. Even a basement with provision for screening the door and any window against radiation would be preferable to taking to the highways. Our area had a small sample of panic a few weeks ago when we were menaced by a roaring forest fire. People were rushing about in all directions and the road was the most dangerous place to be. Oakhurst, Calif.

L. E. BEHNEY

Good points, Reader Behney, although most of us procrastinators don't have the home shelter or shielded basements.

Dreamboat Behavior

Built this 15-ft. *Swish* using your March '58 PM instructions, working week ends and after school during my spare time. When I first launched it, observers from shore told me it planed better than most



factory-made boats they had seen. Powered by a 35-horse outboard, it looks and behaves like a dreamboat.

Moodus, Conn. JOSEPH M. KOSTOSS

Any idea how fast the rig will go, Joe? Other readers might like to know.

Tipping the Hard Hats

Our hard hats are off to Ted Berland for his splendid article, *These Men Work the Superhot Lines* (July '61 PM). It was truly great, well-written and one of the few articles about linemen outside of the trade magazines or the obituary columns. Thank you.

I.E.L.P. Co.

L. L. HOLLAR

Guthrie Center, Iowa

When a "pro" tells us an article about his specialty is on target, we are the ones who should do the thanking, Reader Hollar.

The Editors

Great NEW Idea from CTI

...to help you get and hold a fine job
(or start a business of your own) in
Air Conditioning and Refrigeration!

"Practice" Your Way
to Bigger Pay!



Here Is Your
"Training Shop"

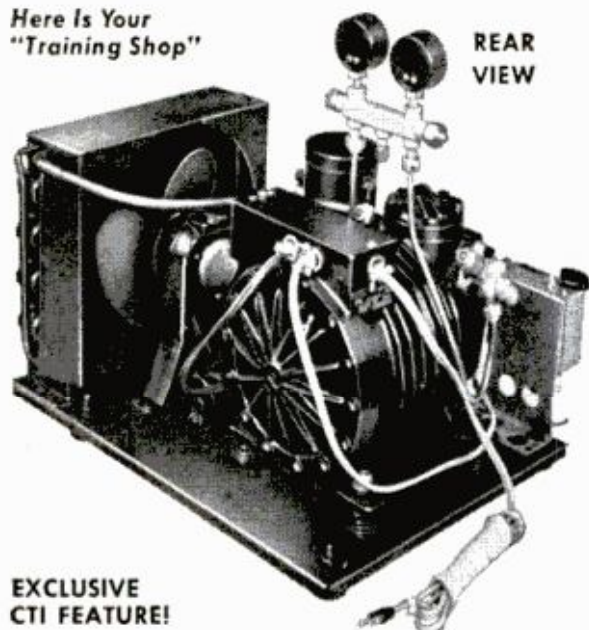

REAR
VIEW

EXCLUSIVE
CTI FEATURE!

25 KITS—20 SHOP PROJECTS

Illustrated above is a view of the new CTI condensing unit, fully assembled. This is a commercial-type, heavy-duty, 1/4 h.p. unit. You build it from 25 kits of parts (and with tools) that CTI sends without extra cost. In addition, CTI includes 20 Shop Projects, which simulate the kind of problems you are likely to encounter in the field. After assembling your condenser, you may then build an air conditioner, freezer, refrigerator or milk cooler.



Tools Are Included

You receive wrenches, tube flaring tools, hammer, tubing, fittings, gauges and many other items used by the experienced mechanic. Everything is of professional quality. Best of all, CTI trains you to use tools with speed and skill.

Move up to a better job, higher pay, steady work. Install and repair air conditioners and refrigerators in homes, office buildings, shopping centers, factories, autos. Air conditioning is one of America's two fastest-growing industries. Over 150 million units are in use, and nearly 8 million units more are produced annually. It's an uncrowded field for mechanics and technicians. There are more jobs and fewer qualified applicants. Industry leaders report that *20,000 men must be trained each year* to fill new job openings. Train yourself at home for higher income, more security. It's easy, it's fast when you enroll with CTI. For complete information, fill out and mail coupon below, for three valuable free booklets. No obligation.

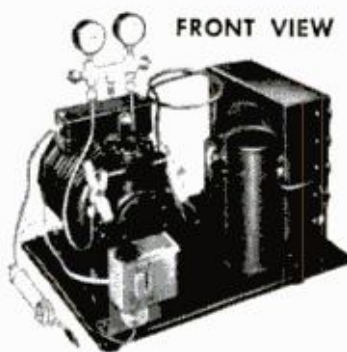

FRONT VIEW

You learn by practicing with operating equipment

Thousands once learned this rewarding craft just by completing home study lessons. But CTI goes a step farther—and an important step it is! CTI also sends you 25 kits of tools and parts. You build these parts into an operating unit. It's a practical method because *you get experience as you train.*

Go in Business



Because air conditioning and refrigeration is expanding so rapidly all over the nation, opportunities to go in business are plentiful. Many CTI graduates have accomplished this high aim. Start in a small way, from your own home, and gradually expand. In time you may wish to add a sales division. Manufacturers offer attractive franchises, including merchandising aids, to ambitious, qualified men.

Earn Cash in Spare Time

Soon after enrolling, many CTI students earn money in spare time. Some handle servicing on a monthly fee basis for food stores, restaurants, taverns and office buildings. Many work part time at local dealers. Quite a number of CTI students have a full-time business going by the time they graduate. CTI kit training gives you the practice and experience you need to step from lesson study to actual field work.

3 FREE BOOKLETS

Get complete information—read it—and then decide. The facts are free. Mail coupon for 3 opportunity booklets. Act today.



PROOF FROM GRADUATES

CTI has prepared a fascinating, new booklet called "Proof from Graduates." In their own words, CTI graduates tell you how training has helped them to better jobs, higher pay, or a business of their own. Send coupon for your copy.

COMMERCIAL TRADES INSTITUTE CHICAGO 26, ILLINOIS
A Non-Profit Organization • Accredited by National Home Study Council

MAIL
COUPON
TODAY

COMMERCIAL TRADES INSTITUTE

1400 GREENLEAF AVENUE
CHICAGO 26, ILLINOIS

DEPT. R-18

Send me your 3 free booklets: *Success in Air Conditioning & Refrigeration; Proof from Graduates; and Lesson Samples.*

NAME _____ AGE _____

ADDRESS _____

CITY _____ ZONE _____ STATE _____



TUNE IN ON THE INVENTORS

Sticky safety for drivers on slippery streets is promised by patent No. 2,971,793 granted Glen and Dale Peterson of Tulsa, Okla. It's an inexpensive gritty coating that can be applied to tire treads from a pressurized spray can. The grit, mixed with a glue, dries quickly to give traction, and lasts long enough for a short trip before it wears off, leaving the tire as it was before.



Another cold weather problem, certainly in the citrus-growing South, is the smoke, smog and soot caused by conventional smudgepots. Howard Martin, of Waterford, Calif., has been awarded patent No. 2,972,208 for a smudgeless smudgepot which uses a blower-driven burner to produce clean, hot air, then blows it toward the trees.



Freezing wouldn't bother your trees if you could move them indoors. That sounds ridiculous, but a full-grown tree can be transplanted safely with the invention that

won patent No. 2,977,716 for Lewis Pearce of Berea, Ohio. With his device, a deep trench is cut around the tree and a cable is dropped around the root system. The two cable ends are attached to a pulley system and are alternately tugged by motors to produce a cutting action which separates the tree core from the surrounding earth.



Growing things have always presented all sorts of problems. One of the oldest problems is birds—whether a flock of crows or neighbors' chickens—who would rather eat your newly-sown seed than scratch for their own. Morely R. Kare, of Ithaca, N. Y., has been granted patent No. 2,967,128 for a bird-repellent coating for food. The coating is completely distasteful to birds but harmless and even pleasant to humans, and the idea is to sprinkle some treated food, like corn, around the garden. After a sample or two of what they thought would be goodies, the birds decide that your garden isn't a cafeteria after all, and leave it—and your real seeds—alone.

Copies of the original patents may be ordered for 25 cents each from the Commissioner of Patents, Dept. of Commerce, Washington 25, D. C.

Quick starts in all kinds of weather . . . dependable operation at all speeds . . . with a Stewart-Warner Electric Fuel Pump. No more hot weather vapor lock or hard starting even when the temperature's way down.

The quality-engineered Model 240-A features an automatic pressure regulator. It automatically maintains desired pressure at carburetor from 1 psi to 8 psi, delivers up to 60 gallons per hour. A built-in fuel filter eliminates need for any other filter in the fuel system.

The popular Model 220 finds wide use where delivery requirements do not exceed 20 gallons per hour and pressure requirements are not critical. Efficient, trouble-free. Stewart-Warner Electric Fuel Pumps available in 6 and 12-volt types for any gasoline engine.

See your local Stewart-Warner dealer. He can recommend the correct Stewart-Warner Electric Fuel Pump for your needs.

Symbol of
SW
Excellence
INSTRUMENT DIVISION
STEWART-WARNER
CORPORATION

Dept. C-111, 1840 Diversey Parkway, Chicago 14, Ill.

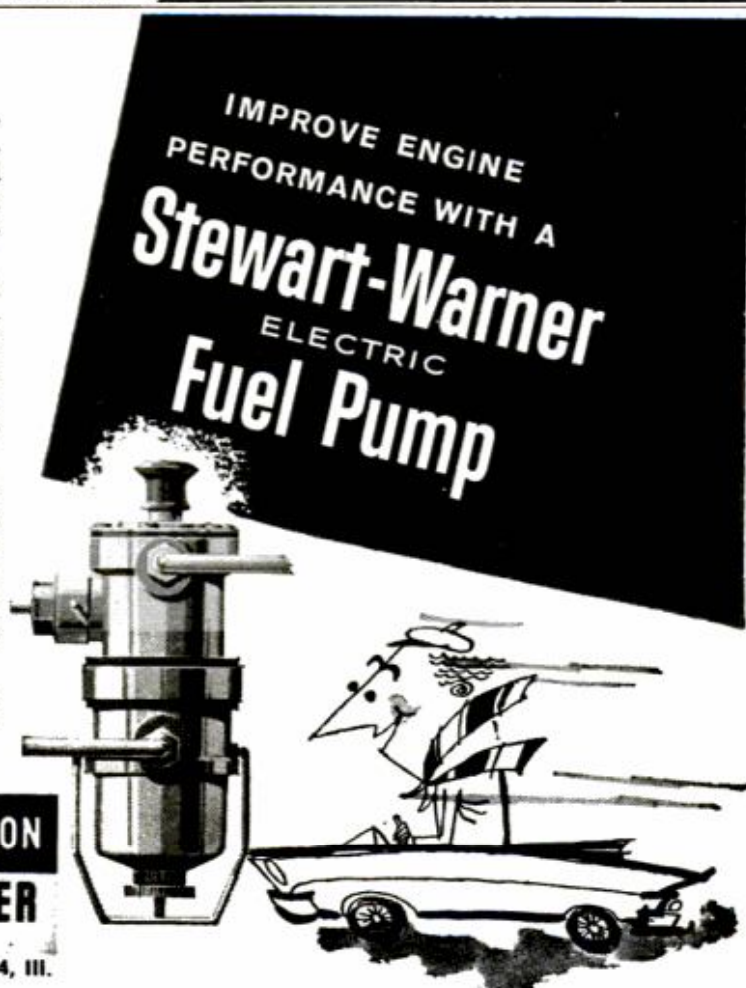

Learn Radio-Television Electronics

by Practicing at Home in Your Spare Time

WITHOUT EXTRA CHARGE NRI provides special kits that bring to life things you study. Makes learning easy, interesting, fast. All equipment yours to keep.

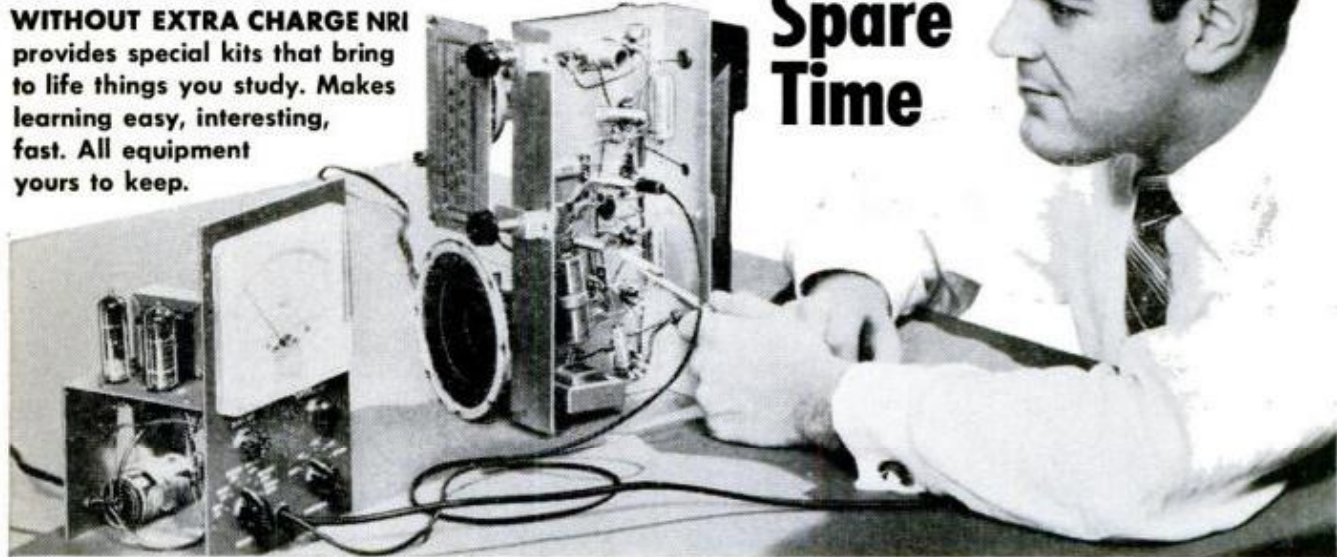

Fast Growth Offers You High Pay, Prestige, Bright Future



From Radio-TV Servicing and Broadcasting to missile launching sites like Cape Canaveral, NRI graduates share in the gigantic Electronics industry. Interesting jobs await you in studios, on ships and planes, in your own business. Mail coupon today for NRI catalog.

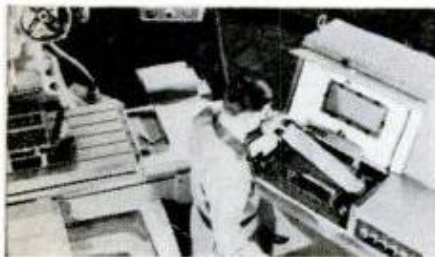

Many NRI graduates help build, install, operate and service automated electronic equipment for the new "Space Age" we live in—equipment used in offices, factories, the military. Others have important jobs as inspectors, laboratory technicians, etc., or hold essential civilian posts with the Government and Armed Forces.



J. M. SMITH
President

If you check the classified advertisements in your local newspaper, you will undoubtedly see more job opportunities available for men with Electronics training than for any other field. Hardly without exception, these are better than average jobs, with bright futures . . . jobs for which YOU could qualify through NRI training. Thousands of men like yourself—most of them without a high school diploma—have moved up to good pay and enjoy greater prestige in jobs with TV and Radio broadcasting stations, in industrial plants making Electronic equipment or in businesses of their own where they sell, install and service Radio and TV sets.

Train With The Leader

Join the many NRI graduates now taking advantage of career opportunities in this amazing Electronic Age. For 45 years, NRI has featured the best Radio-TV Electronics training for beginners—for men without previous experience. Throughout the U.S. and Canada, successful NRI graduates are proof that it's practical to train at home, in your spare time, at your own pace. Keep your present job while training. NRI supplies this training at low cost because it is

NRI Trained These Men



I was working in a textile factory trying to make ends meet. Now I own one of the most modern service shops in this section. **ARGIE C. TAYLOR**, Glasgow, Ky.

After graduating I was a shipboard radio operator. Now I am chief engineer at Station WARA.



NRI was a wonderful foundation. **RAYMOND D. ARNOLD**, Attleboro, Mass.

Thanks to NRI I am in a top position with the Federal Aviation Agency in the Navalds Electronic Section. **JOE DUCKWORTH**, Fort Worth, Texas.

Four months after starting your course I left my job in a hardware store to work at Raytheon Manufacturing. Now I am an engineering assistant in Microwave Power Tube Research and Development Laboratory. **LEONARD BLOOM**, Newton Centre, Mass.



the oldest and largest home-study Radio-TV Electronics school. In every respect, you will find the Electronics field a profitable one for the ambitious man. And the NRI "learn-by-doing" method is the most practical way for you to get into this exciting field quickly.

Soon after enrolling we show you how to earn \$10, \$15 and more a week extra fixing sets in your spare time. Mail coupon now. **National Radio Institute**, Washington 16, D. C.

Sample Lesson and 64-Page

Catalog FREE

MAIL THIS COUPON NOW

SAMPLE LESSON

The Amazing Field of Electronics



National Radio Institute

Washington 16, D. C.

1MA

Send me full information without cost or obligation. No representative will call. (Please print.)

Name _____ Age _____

Address _____

City _____ Zone _____ State _____

ACCREDITED MEMBER NATIONAL HOME STUDY COUNCIL

SIDELIGHTS FROM THE PENTAGON



By William R. Kreh

A 12-year-old girl with a flair for science put the White House and the Navy into a small flap recently. It seems she sent to the White House an elaborate plan, complete with drawings, for building a naval base under Antarctica. The White House bucked it over to the Navy to write the customary polite brush-off. But some wag with a sense of humor marked it: "Build it! J.F.K." and passed it on up the chain of command. It worked its way through channels until someone called the White House and said the Navy would build it, but where was the money coming from? The White House didn't take to the joke at all. In fact, naval intelligence and the Secret Service were ordered to investigate and try to find out who put the J.F.K. on the paper. No one's saying whether the wag was caught.



Frozen runways can be made stronger by combining glass fiber with seawater before freezing. This increases the structural strength of ice 10 times, the Air Force has found in its Arctic operations.



Combat appetites are under study by the Army. Does a soldier prefer ham and eggs or pancakes before entering battle? Would a paratrooper rather drink coffee or hot chocolate before leaping behind enemy lines? Do troops eat more or less when under stress?

Answers to these and other questions on the preference and eating behaviors of combat soldiers when they're in danger are being sought in a special study being made at Fort Bragg, N.C., where the stresses of going through paratrooper and ranger training are as near to actual combat as can be found in peacetime. Results of the experiment will be used to set up new guides for ration planning in combat.



Asthma sufferers in California have been finding relief in the Alameda Naval Air Station's pressure chamber recently. Groups of children and adult sufferers have been spending as much as five hours at a time in the low-pressure chamber at a simulated altitude of 8000 feet. It's part of a Stanford school of medicine project to see just how much the change of altitude relieves the asthma. If the experiments prove successful, doctors might call for such treatment for asthmatics during severe attacks.

It's a dog life for Air Force sentry dogs. The Air Force has started a new feeding program which changes the daily fare for the dogs from cooked meat to prepared dog food. Previously the dogs were given a ration of 1½ pounds of grade "A" beef a day; now they get an equal amount of dry ration. One canine was reported to have growled, "How do you get out of this chicken outfit?"



A general got dumped square on his . . . ah . . . khaki pants recently entering the Pentagon. Result: After 20 years they're putting windows in the doors. Ever since the building was erected the entrances have been guarded by heavy windowless doors. No one going out could see anyone coming in and vice-versa. As a result there were numerous collisions. But it had to happen to a general before the building engineers decided to put glass inserts in the doors.



A top-secret infrared device is being built for the Navy that is so sensitive it can measure the cooling of the moon during a total eclipse. The heat detector, which has surpassed all others for accuracy, operates at 452 degrees below zero. The Navy's not saying what it's going to be used for.



Weapons change but not the noise, and because of this a special Navy weather team at the Pacific Missile Range, Point Mugu, Calif., is constantly on the lookout for conditions which could make the sound of a missile firing become destructive.

When winds and temperatures are higher aloft than at launching pads, the ear-shattering noise can be turned into a window-shattering beam miles away. This is because these weather conditions can cause the circular sound waves to be bent back to Earth rather than going on out harmlessly into space. The special Navy team at Point Mugu uses weather balloons and computers to get a picture of conditions before a shoot. If the sound could return to Earth, the launching may be called off.



You think life's too short? Then pity the poor pion—one of the 30 known elementary particles that account for all forms of matter and energy in the Universe. Naval Research Laboratory scientists have just measured its lifetime as only 1/200,000,000,000,000 of a second. This is a million times briefer than any other natural process yet measured. Its time of existence was measured by the time it took to travel, at almost the velocity of light, 1/3,000,000 of an inch through a photographic emulsion. ★ ★ ★



Here are
3 good reasons

why I'm glad

I became a **DURACLEAN DEALER**

Raising a family takes a dependable, steady income. Too few jobs offer security and chance for advancement. That's why so many men are going into a business of their own. All around us are local merchants making a good living in respectable businesses where they hold a franchise. The big questions are "What is left to go into?—Which business is profitable?—Which requires only a modest investment?" Many have found the answers in DURACLEAN.

**EVERY TOWN NEEDS THIS AMAZING
BETTER HOME CLEANING SERVICE**

Duraclean is a scientific method of cleaning carpeting and upholstery in the home. This better process of cleaning by absorption virtually "lifts" the dirt from fabrics, leaves them bright and lively. Almost every home, hotel and many offices are potential customers who will call you again and again.

Check Experience of Other Dealers

There's no better way to learn of DURACLEAN profit opportunities than by checking with dealers already in business. If there's one near you, call him—or ask DURACLEAN whom to call.

M. LYONS: ILLINOIS

"Averaged over \$50,000 my first 3 yrs. Headquarters' help makes it possible".

E. BAILEY: ARKANSAS

"I know of no other business which can offer so much".

C. RANDALL: OHIO

"My 2nd year and business keeps growing. Have made as much as \$120 in one day".

L. LAWSON: NEW YORK

"National advertising creates leads. One month, jobs totaled \$1475".

**DURACLEAN PROVIDES EVERY
BUSINESS BUILDING NEED**

DURACLEAN headquarters supplies all equipment and chemicals to put you in business. Regularly held training sessions, cover techniques, methods and means of developing business. Local advertising helps and merchandising ideas are available; and an impressive national advertising program pre-sells customers on the gentle DURACLEAN cleaning process.

Start part time, full time or hire others. **NO SHOP NEEDED.** DURACLEAN service is rendered in the home or customer's place of business. Just 2 average jobs a day can net \$8,750.00 a year.

MORE WAYS TO MAKE MONEY

5 other DURACLEAN services multiply your profits. DURASHIELD soil retarding service, DURAPROOF mothproofing and DURAGUARD flame retarding are among the other services that mean more money for you. It takes less money to establish this prosperous business. No wonder so many men with vision are becoming DURACLEAN DEALERS. Why don't you? Write today for FREE booklets.

MAIL THIS "FUTURE SECURITY" COUPON

DURACLEAN COMPANY

1-16N Duraclean Bldg., Deerfield, Illinois.

Rush me all the facts about DURACLEAN PROCESS and what it takes to become a DURACLEAN DEALER.

NAME _____

ADDRESS _____

CITY _____ STATE _____

DURACLEAN COMPANY
1-16N DURACLEAN BLDG., DEERFIELD, ILLINOIS

DRAFTSMEN



ARE NEEDED!

LEARN AT HOME IN YOUR SPARE TIME

Check the want ads in any newspaper. See the big-pay opportunities open to you as a draftsman. What's more, you can learn this well-paid, prestige profession at home—quickly, easily! No special talent needed! Get complete, step-by-step Chicago Tech

lessons in the mail, spend a few pleasant hours studying each week. In a short time you'll be a well-trained draftsman, ready to take your pick of many good jobs. Decide now to get ahead. Mail coupon today!

SEND FOR FREE TRIAL LESSON TODAY!

Get **FREE TRIAL LESSON** plus information about C.T.C. practical training. Learn what successful Chicago Tech graduates say about high pay and opportunities in drafting. No charge, or obligation, it's yours free.

Est. 1904 • Accredited National Home Study Council

CHICAGO TECHNICAL COLLEGE

P-219 Tech. Bldg., 2000 So. Michigan Ave.
Chicago 16, Illinois

Mail me **FREE** Lesson with information about big opportunities in **DRAFTING**.

Name _____ Age _____

Address _____

City _____ Zone _____ State _____

C-14



COLORCRETE CAN BE YOUR OPPORTUNITY

All over the country, men are making money as applicators of Colorcrete—the beauty treatment for old, drab, time-worn masonry surfaces. Stucco, concrete and the like can be transformed in brief time and at relatively low cost into surfaces that gleam in colorful beauty. Colorcrete is good for homes, stores, schools, motels, garages, service stations and other public and commercial buildings. Range of 16 colors.

Every community can support a Colorcretor — and many territories are still available. Investment required is very moderate. Write at once for Opportunity Book.

COLORCRETE INDUSTRIES, INC.
570 Ottawa Avenue, Holland, Mich.



20

SIDELIGHTS ON AVIATION



A shrinking number of commercial flights is carrying an increasing number of passengers, cargo and mail.

The decline is directly attributable to the new jets which, because of their speed and load capacity, can carry more passengers and cargo farther and faster in fewer flights, and the trend seems to be continuing, especially on overseas routes.

According to the Federal Aviation Agency, the annual number of passengers boarding domestic flights passed the 50 million mark for the first time while the number of flights dropped nearly 100,000. On international carriers, the number of passengers increased an unprecedented 10 percent, cargo 5 percent and mail 16 percent.



The eyebrows of the officer in charge of such things shot up a few notches when he read a report that airmen assigned to a satellite tracking station were reading such books as "Caesar's Gallic Wars," "The Way of Chinese Art" and "The Complete Works of Francois Villon."

His eyebrows went back to normal when he read the terse explanation. The men are stationed on Kodiak Island in the Aleutians where reading material is limited and television reception is lousy.



Gold-filmed alumino-silicate glass, capable of withstanding temperatures up to 200 degrees C. and as low as 8 degrees below zero C., has been developed for British aircraft windshields.

Such glass, which contains a higher percentage of aluminum-oxide than normal aircraft glass, has not previously been made to optical standards nor in sizes as large as those required for aircraft.

The gold-filming will be used on some panels for demisting and de-icing by electrical transmission.



Best foreign customers for U.S. civil aircraft, according to Aerospace Industries Association, are Argentina and Canada.

In the first six months of 1961, Argentina purchased 100 aircraft valued at \$1,989,100, and Canada 124 valued at \$1,706,900.

Kevin W. Brown

POPULAR MECHANICS



6 REASONS WHY RCA TRAINING IN ELECTRONICS

can be the smartest investment
you'll make in your *entire lifetime!*

1. You get the finest training-at-home under the supervision of the RCA INSTITUTES, experts in technical training for over 50 years. The very name "RCA" means dependability, integrity, and scientific advance.

2. You get comprehensive training in your choice of many complete up-to-date Courses... including Radio and Electronic Fundamentals, TV Servicing, Color TV, Transistors, Automation.

3. You get Theory, Experiment, and Service Practice starting with the very first lesson... a complete training package throughout the course. No special technical background is required.

4. You get prime quality equipment as a regular part of your Course... equipment that you keep and use on the job. You never have to take apart one piece to build another.

5. Voluntary Tuition Payment Plan. You pay for each lesson only when you order it. If you interrupt your course *at any time, for any reason*, you owe nothing more unless you resume. You *never* have to pay for the whole course if you don't complete it.

6. You get top recognition — Graduates of RCA Institutes now work for leaders in the electronics field; many have their own businesses. This record is true tribute to the high quality of RCA Institutes training.

Send for this
64-page Home
Study Catalog
FREE!



RESIDENT SCHOOL Courses in New York City and Los Angeles offer comprehensive training in Television and Electronics. Day and Evening classes start four times each year. Detailed information on request.

RCA INSTITUTES, Inc. Home Study School

A Service of Radio Corporation of America Dept. PM-N1
350 West Fourth Street, New York 14, N. Y.

Please rush me your FREE illustrated 64-page book "Your Career in Electronics," describing your home training programs. No obligation. No salesman will call.

Name
please print

Address

City Zone State

Korean Vets! Enter discharge date

CANADIANS — Take advantage of these same RCA courses at no additional cost. No postage, no customs, no delay. Send coupon to: RCA Victor Company, Ltd., 5581 Royalmount Ave., Montreal 9, Quebec
To save time, paste coupon on postcard.

Make \$20 to \$30 a Week EXTRA MONEY!

With the high prices of food, clothing and everything else, just think what you could do with extra money every week! Turn your spare time into CASH—sharpening saws with a Foley Automatic



Saw Filer pays from \$3 to \$6 an hour. Start in your basement or garage—no experience necessary. "The first saw I sharpened with my Foley Filer came out 100%"—writes Clarence E. Parsons. No canvassing—"I advertised in our local paper and got in 93 saws—says M. L. Thompson. With a new model 200 Foley you can file all hand saws, also band and both combination and crosscut circular saws.

FREE BOOK Shows How to Start

It explains how you can get business from home owners, farmers, carpenters, schools, factories, etc. "I get work from 20 and 30 miles away"—says Charles H. Smith. Free Book, "Money Making Facts," tells how to start. Time Payment Plan. Send coupon today—no salesman will call.

Send Coupon for **FREE BOOK**

FOLEY MFG. CO.
1143-1 Foley Bldg., Minneapolis 18, Minn.

Send **FREE BOOK**—"Money Making Facts," and Time Payment Plan.

Name _____

Address _____



Color DIAL TELEPHONES \$1095⁰⁰

Factory rebuilt Western Electric in white, beige, ivory, pink, green or blue. If 4 prong plug is required add \$2.00. Fully guaranteed. Write for free list. All shipments FOB.

SURPLUS SAVING CENTER
Waymart Dept. 11B1 Penna.



INVESTIGATE ACCIDENTS

Train quickly in your own home for repeat income in the exciting, secure Claim Investigation and Claim Adjusting field. Our students and graduates are already earning \$4, \$5, \$6 an hour extra SPARE TIME — and up to \$10,000 a year Full Time. You need NO prior experience or higher education. Your age does NOT matter.

HERE IS YOUR CHANCE FOR ACTION AND REAL JOB SECURITY

As a trained Claim Investigator you will (1) INVESTIGATE FACTS and (2) DISTRIBUTE MONEY as the representative of wealthy organizations.

No other business offers you greater opportunities for success and security. Here's why: The huge, rapidly expanding Claim Investigation and Adjusting Profession right now distributes more money than any other service industry. And it's growing fast. Over 200 MILLION ACCIDENTS must be investigated this year for Insurance Companies, Airlines, Railroads, Steamship Lines, and Government Offices.

MAIL NOW for FREE BOOK →

SEND TODAY for Big, FREE, Illustrated Catalog. Learn the exciting facts about Universal Schools' low cost training. No obligation. No salesman will call. GI APPROVED.

double your income with degree

A college education is a splendid investment! Important firms like Tri-State graduates . . . visit campus to interview seniors. Qualify faster here. Bachelor of Science Degree in 27 Months in Electrical (Electronics or Power Major), Mechanical, Aeronautical, Chemical, Civil Engineering. IN 36 MONTHS a B.S. in Business Administration (General Business, Accounting, Motor Transport Management majors). For earnest, capable students. Small classes. More professional class hours. Modernized buildings, well-equipped labs, new dorms. Modest costs. Year-round operation. Enter January, March, June, September. Founded 1884. Write J. E. McCarthy, Director of Admissions for Catalog and "Your Career" Book.



TRI-STATE COLLEGE

4111 College Avenue Angola, Indiana



get into operating or repairing EARTH MOVING EQUIPMENT

Men needed now for good paying jobs in booming road and construction work. Learn operating or repair-rebuilding of heavy road machinery, cranes, bulldozers, earth carriers, etc. Actual "on the job" training. 5 to 13 1/2 week courses. Classes start every Monday. Reserve your space now. Complete catalog and reservation facts FREE. Approved for veterans. Write

Greer TECHNICAL INSTITUTE
Attn.: P. M. Hutch, Box 368, Braidwood, Ill.

Hotels, Motels Call for Trained Men

Record-breaking travel means nation-wide opportunities and a sound substantial future for trained men in the hotel, motel and hospitality field. Fascinating work; fine living; quick advancement. You can qualify at home or through resident classes in Washington. Previous experience proved unnecessary. Placement Service FREE. Write for FREE Book, "Your Golden Opportunity." Accredited by N.H.S.C.

Course Approved for ALL Veteran Training. 46th Year.
LEWIS HOTEL TRAINING SCHOOL, Rm. GS-312, Wash. 7, D.C.

Learn LANDSCAPE GARDENING

AND GROWING OF PLANTS. Latest information on propagation, soil-testing, plant growth regulators, garden design. Start a profitable business or wonderful hobby. Unique and modern home study course—accredited. Earn your certificate at home. May I send FREE, and without obligation, my informative Booklet? **NORM MORRIS NATIONAL LANDSCAPE INSTITUTE**
DEPT. M-111, 11826 SAN VICENTE BLVD., LOS ANGELES 49, CALIF.



UNIVERSAL SCHOOLS

6801 Hillcrest Ave.
Dept. PM-11, Dallas 5, Texas

Please rush me your FREE book on Claim Investigation. This does not obligate me and no salesman will call.

Name _____ Age _____

Address _____

City _____ Zone _____ State _____

Approved by Government for Korean Veterans

WHAT ALL AUTO MECHANICS WANT TO KNOW



This Big Practical Book gives full information, with working diagrams, covering the principles, construction, ignition, service and repair of modern cars, trucks and buses.

Air Conditioners, Hydramatic & Fluid Drives Fully Explained.

A complete guide of 1132 Pages with over 1000 Illustrations showing inside views of working parts, with instructions for service jobs. Completely up-to-the-minute! Priced at only \$6

CIRCLE No. 1 IN COUPON

HOW TO FIX HOME APPLIANCES

REFRIGERATORS TOASTERS IRONERS VACUUMS
WASHERS DRYERS RANGES FREEZERS

Handy other GAS AND ELECTRIC APPLIANCES Handy Reference for Electric & Gas Servicemen, Mechanics, Dealers and Homeowners Explains clearly and simply how to locate troubles, how to test, reassemble and connect Wiring diagrams 1000 Pages. Easy to read. Answers ALL your questions. 864 Pages Illustrated. Only \$6

CIRCLE No. 2 IN COUPON

TV TELLS HOW TO ANSWER RADIO TV QUESTIONS SERVICE LIBRARY

HERE IS LATE INFORMATION IN A MANDY FORM FOR RADIO AND TELEVISION REPAIRMEN, SERVICEMEN AND STUDENTS

TWO COMPLETE VOLUMES - 1568 Pages - 1085 Illustrations and Diagrams 1001 Important Facts and Figures on Modern T.V. Radio Electronic Devices, INCLUDES TRANSISTORS & Transistors Circuits, Rectifiers, Record Changers, 21 Systems Phonograph Pick-ups, F.M., Auto Radio, Short Wave,

Basic principles, Construction, Installation, Operation, Shooting, How to get Sharp, Clear TV Pictures, Install Aerials, How to Test, Explains COLOR SYSTEMS, Methods of Conversion, Terms, etc Includes Ultra High Frequency Quick-reference or use as a home study course Only \$8 for BOTH volumes

CIRCLE No. 3 IN COUPON

OIL BURNERS

New complete, explaining in detail both domestic and industrial oil burners. Includes electrical hook-ups and wiring diagrams. Fully covering the theory, construction, installation, operation, testing, servicing and repair of all equipment. Indexed for ready reference. Over 416 Pages. 320 Illustrations and Diagrams. Only \$2.50

CIRCLE No. 28 IN COUPON

ALL TYPES OF BLUEPRINT READING

How to read scales, the standard symbols, detail and assembly prints, working drawings, short cuts, hints, hints and suggestions THE MAN WHO CAN READ BLUEPRINTS IS IN LINE FOR A BETTER JOB. This book gives you the secret language, step by step in easy stages. 448 Pages. Very Fully Illustrated. Priced at \$3.

CIRCLE No. 25 IN COUPON

PLUMBERS AND STEAMFITTERS GUIDES

Practical Trade Assistant & Reference Set. Explains in plain language and by clear illustrations, diagrams, charts, graphs and pictures the principles of modern plumbing practice including Pipe Fitting and Air Conditioning. 4 Vols. - 2624 Pages - 3642 Diagrams & Illustrations. Only \$9 for the complete set of 4 vols. Sold individually \$2.50 each.

CIRCLE No. 6 IN COUPON

7-DAY FREE EXAMINATION

SEND NO MONEY - Pay the postman nothing! We are glad to send you any of the Audel Guides for absolutely FREE examination in your own home. We take all the risks and leave all the decisions up to YOU. There is no obligation! If you decide to keep the books of your choice you may pay for them under our astounding easy-pay plan of only \$2 a month.

HERE IS ALL YOU DO

IT'S EASY TO ORDER: In the No-Risk Mail Order Coupon at the right just draw a circle around the number of Audel Guides you want us to send you for FREE EXAMINATION. We will send them to you at once to help you build a brighter future by increasing your SKILL. If for any reason at all you are not COMPLETELY satisfied, return the books to us, and that will end the matter! NO STRINGS OR CATCHES TO THIS OFFER.

THEO. AUDEL & CO.
49 West 23rd Street, New York 10, N.Y.

CARPENTERS AND BUILDERS GUIDES



PRACTICAL STOREHOUSE OF MODERN CONSTRUCTION INFORMATION (4 vol. set) for carpenters and all woodworkers. Explains in easy language and by profuse illustration principles, advances, short cuts, trade secrets, all based on the NEWEST information.

Vol. 1 - Tools, steel square, saw filing, joinery, furniture, etc.; Vol. 2 - Builders' mathematics, drawing plans, specifications, estimates, etc.; Vol. 3 - House and roof framing, laying out, foundations, etc.; Vol. 4 - Doors, windows, stair building, millwork, painting, etc. 4 vols. 1904 Pages 3700 Illustrations. Whole set only \$9. CIRCLE No. 8 IN COUPON

PRACTICAL ELECTRICITY

A COMPLETE HANDBOOK - Quick, simplified, ready reference. Complete instruction and practical information on the rules and laws of electricity - Maintenance of Machinery - A.C. and D.C. Motors - Armatures - Wiring Diagrams - House Lighting - Power Wiring - Meters - Batteries - Transformers - etc. Simple to understand. 1052 Pages. 2600 Illustrations. Priced at \$5

DIESEL

ALL THERE IS TO KNOW ABOUT MODERN DIESEL ENGINES - Basic principles, starting valves, timing, fuel pumps, fuel injection compressor, air compressors, pistons, cylinders, lubrication cooling systems, etc. Answers on operation, calculations. 640 Pages. Fully Illustrated. Priced \$3.

MASONS & BUILDERS GUIDES

A PRACTICAL ILLUSTRATED 4 VOL SET - Explaining in clear, simple language and profuse illustration, principles, advances, short cuts, trade secrets, based on modern practice - including how to figure and calculate various jobs.

Vol. 1 - Brick work, bricklaying, bonding, designs. Vol. 2 - Brick foundations, arches, tile setting, estimating. Vol. 3 - Concrete masonry, placing forms, reinforced concrete. Vol. 4 - Plastering, stone masonry, steel construction, blueprints. 4 Vols. 1440 Pages. 2067 Illustrations. Complete Set only \$9

CIRCLE No. 26 IN COUPON Sold individually \$2.50 each

MATHEMATICS MADE EASY

A COMPLETE HOME STUDY COURSE - Starting with the first principles of arithmetic, advancing step by step through the various stages of mathematics, including the rules and calculations for mechanical and electrical problems. NEW EASY correct methods. Includes plane and solid geometry, trigonometry, algebra, calculus, etc. Practical tests, reference tables and data. How to use slide rule. 672 Pages. 550 Illustrations. Priced at only \$3.

CIRCLE No. 11 IN COUPON

NEW MACHINISTS AND TOOLMAKERS HANDBOOK

MODERN MACHINE SHOP PRACTICE. For every Machinist, Toolmaker, Draftsman or Student. Tells how to set up and operate lathes, screw and milling machines, shapers, drills and all other machine tools. A COMPLETE INSTRUCTOR AND REFERENCE BOOK 1250 Pages. Fully Illustrated. Priced at only \$6

CIRCLE No. 12 IN COUPON

ELECTRIC MOTORS

THIS GUIDE covers the construction, hook-ups, control, maintenance and trouble shooting of all types of motors. Includes armature winding. Explains entire subject in great detail in simple language. Over 1056 Pages of information. 617 Diagrams. All types of motors fully illustrated and indexed for ready reference. Priced at only \$5.

CIRCLE No. 27 IN COUPON

REFRIGERATION & AIR CONDITIONING

FOUR BOOKS IN ONE - basic principles, servicing, operation, repair of: 1. Household Refrigeration. 2. Special Refrigeration Units. 3. Commercial & Industrial Refrigeration. 4. Air Conditioning Systems. A GOLD MINE of essential information. Completely up-to-date. 1360 Pages. Fully Illustrated and Indexed. Priced at only \$6. CIRCLE No. 14 IN COUPON

New MECHANICAL DICTIONARY

THE AUTHORITATIVE WORD BOOK FOR MECHANICS TECHNICIANS AND STUDENTS

With the revolutionary progress being made today in all mechanical fields, new words and phrases come into use. Any mechanic who wants to be up to date must know this new trade language.

Audel's New Mechanical Dictionary gives you all these new words and also the old. Every mechanic will find his job made easier if he knows the exact meaning and use of technical words that come up every day at work. It is an engineer's shop companion and a student's guide.

PRACTICAL TABLES, FORMULAS, PROCESSES Constant use of Audel's New Mechanical Dictionary will increase your knowledge and skill in a matter of days without any conscious effort on your part. The right word at the right time is like the right tool - be sure you have it and use it! Defines 17,000 words - terms phrases - rules and formulas, 712 pages only \$6.95.

CIRCLE No. 44 IN COUPON

THE NEW ELECTRIC LIBRARY

A COMPLETE ENCYCLOPEDIA explaining in the simplest terms the fundamental principles, rules and applications of applied electricity.

A COMPLETE COLLEGE EDUCATION! Fully illustrated with diagrams and sketches, calculations and tables for ready reference. Questions and answers. Trial tests for practice study and review. All based on the most modern theory.

- Vol. 1 - Principles and rules of electricity, magnetism, armatures, repairs. No. 15
- Vol. 2 - Dynamos, DC Motors, construction, installation, maintenance, etc. No. 16
- Vol. 3 - Testing instruments and tests, storage battery constr. and repairs. No. 17
- Vol. 4 - Alternating current, power factor, alternators, transformers. No. 18
- Vol. 5 - A.C. Motors, winding, maintenance, converters, switches, fuses, etc. No. 19
- Vol. 6 - Relays, condensers, regulators, rectifiers, meters, switchboards, etc. No. 20
- Vol. 7 - Wiring, house light and power, circuits, high tension, plans, code, etc. No. 21
- Vol. 8 - Railways, signals, elevators, ignition, etc. No. 22
- Vol. 9 - Radio, telephone, telegraph, television, motion pictures. No. 23
- Vol. 10 - Refrigeration, illumination, welding, x-ray, electrical appliances, Index. No. 24

6,000 fully illustrated pages. Priced at only \$22.50 for the ENTIRE SET. Also sold individually for \$2.50 each

WELDERS GUIDE

Covers Electric, Oxy-acetylene, Thermit, Unionmet welding for sheet metal, spot and pipe welds, pressure vessels and aluminum, copper, brass, bronze and other metals. Airplane work, surface hardening, hard facing, cutting, brazing, etc. 608 Pages. Fully Illustrated. Only \$3.

CIRCLE No. 10 IN COUPON

ADDITIONAL IMPORTANT TITLES

The following Audel Guides are all the best in their fields, written in clear simple fashion, all lavishly illustrated. Circle the numbers wanted in the MAIL ORDER COUPON below. All books are sent for FREE EXAMINATION.

- No. 5 TRUCK & TRACTOR GUIDE 1376 Pages \$5.00
- No. 7 PAINTING & DECORATING MANUAL 417 Pages 3.00
- No. 13 WIRING DIAGRAMS Light & Power 304 Pages 2.50
- No. 29 SHEET METAL PATTERN LAYOUTS. 1152 Pages 7.50
- No. 30 SHEET METAL HANDY BOOK 448 pages 2.50
- No. 31 MECHANICAL DRAWING GUIDE 192 Pages 2.50
- No. 32 MECHANICAL DRAWING & DESIGN. 410 Pages 3.00
- No. 33 ELECTRONIC DEVICES 304 Pages 3.00
- No. 34 ELECTRICIANS EXAMINATIONS 272 Pages 2.50
- No. 35 ELECTRIC POWER CALCULATIONS. Page 485 3.00
- No. 36 ELECTRIC DICTIONARY 9000 Terms 3.00
- No. 37 POWER PLANT ENGINEERS GUIDE. 1568 Pages 5.00
- No. 38 ENGINEERS AND FIREMANS EXAMS. 544 Pages 2.50
- No. 39 OPERATING ENGINEERS LIBRARY 3 Book Set 12.00
- No. 40 PUMPS, HYDRAULICS AND AIR COMPRESSORS. 1760 Pages 6.00
- No. 41 HOUSE HEATING GUIDE 966 Pages 5.00
- No. 42 MILLWRIGHTS & MECHANICS GUIDE 1248 Pages 5.00
- No. 43 DO-IT-YOURSELF ENCYCLOPEDIA. 2 Book Set 8.95
- No. 45 MAGIC OF LANDSCAPING 128 Pages 1.49
- No. 46 WATER SUPPLY & SEWAGE DISPOSAL 436 Pages 4.00
- No. 47 GUIDE TO CREATIVE PHOTOGRAPHY 400 Pages 3.95

MAIL THIS NO-RISK COUPON TODAY!

THEO. AUDEL & CO. - Self Improvement Publishers Since 1879 - P11
49 W. 23rd Street, New York 10, N.Y.

Please mail me for 7 days' FREE EXAMINATION the books I have circled at right. I agree to mail \$2 in 7 days on each book or set ordered, and to further mail \$2 a month on each book or set ordered until I have paid the purchase price, plus shipping costs. If I am not completely satisfied with my Audel Guides I may return them.

NAME _____

ADDRESS _____

OCCUPATION _____

EMPLOYED BY _____

SAVE SHIPPING COSTS! Check here if you enclose complete payment with order. We pay postage charges. You have same return privilege.

1	2	3	4	5
6	7	8	9	10
11	12	13	14	15
16	17	18	19	20
21	22	23	24	25
26	27	28	29	30
31	32	33	34	35
36	37	38	39	40
41	42	43	44	45
46	47			

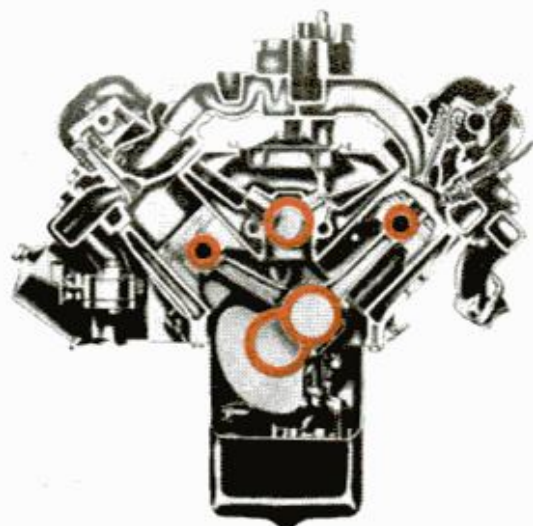

P*O*W*E*R

Built back in ailing engines

When a car engine gets tired, the symptoms are easy to spot. Performance is sluggish, gas mileage drops off . . . the engine begins to burn oil. The problem is wear. And the solution is having a skilled mechanic replace key parts.

Get a complete overhaul

New valves and rings are not enough. Why? Piston rings usually control oil from slipping into the combustion chamber, but even new rings can't control the more than 25 times normal amount of oil thrown off by worn bearings. This excess oil is forced into the combustion chamber where it burns to carbon and varnish. Deposits build up on valves, rings get clogged, and plugs become fouled.

• Federal-Mogul for like-new power

Precision engine bearings are vital to getting maximum efficiency from your engine. That's why Federal-Mogul bearings are made to tolerances that give exact oil clearances . . . tolerances as close as .00025". And that's why Fm replacement bearings are best for your car—American or import.

If your car has a "tired" engine, give it like-new power with an overhaul that includes Federal-Mogul engine bearings.



FEDERAL-MOGUL SERVICE



Division of Federal-Mogul-Bower Bearings, Inc. • Detroit 13, Michigan

ITEMS FROM ALL OUTDOORS



Survival is becoming more and more a topic of conversation these days—survival in the wilderness (PM, August and September '61); survival in fallout shelters; survival in any kind of unfavorable environment. If you've done any sort of survival planning, you know how important it is to have a ready supply of food and water in sealed, portable containers.

One easy way out is with a new "life pack" emergency food supply package, which holds enough food and water to support one person for eight days. Packed in an 11-pound corrugated carton, it contains:

1. Nine 10-2/3-ounce cans of sterile drinking water (they allow one can for washing). It'll stay good for 25 years.

2. Three 3½-ounce tins of pemmican—the old Indian staple survival food. It's a conserve of raisins, apples, dextrose, peanuts, shortening, soy oil, vanilla and salt. Sounds strange, but I understand that this government formula tastes pretty good, and it's loaded with food value.

3. Seven one-ounce bars of Hershey's tropical chocolate, which will store safely in temperatures up to 165 degrees.

4. Seven ounces of malted milk tablets, the Alpinist's energy staple, which can also be dissolved in water to make an emergency baby ration to replace milk or formula.

5. Seven ounces of C-ration crackers to be eaten with the pemmican. They're high in food value and also provide some bulk.

6. Two packages of dehydrated soup—sort of a bonus. The soups, which will stay good for at least 15 months, are the shortest lived of the food items. The others are good for about five years.

7. A can opener and a can of "canned heat." The food can will make into a stove, and the fuel will keep it going for an hour and a half to heat water for the soup.

The pack sounds like a good idea, not only for survival under an attack, but also for emergency food in a flood or storm, or for rations aboard a far-ranging cruiser or aircraft—even on a back-country hunting or fishing trip. It's packed by MacDonald-Bernier Co., 62 Long Wharf, Boston 10, Mass., and sells for \$8.95.

Dick Kiepatnik

POPULAR MECHANICS

**FLASH
NEWS!**

AUTO REPAIR Bulletin

**EXTRA!
★★★★★**

Published by the Automotive Experts of MOTOR's Manual

AMAZING FREE OFFER PROVES YOU CAN FIX ANY PART OF ANY CAR!

OVER 3½
MILLION COPIES
ALREADY SOLD!

**MOTOR'S
AUTO
REPAIR
MANUAL**

**MOTOR'S
AUTO REPAIR
MANUAL**

**MOTOR'S Manual Shows Green Beginner and Skilled Mechanic
Alike How To Do ANY Job Quick, Easy, Right the First Time!**

USE FAMOUS MOTOR's Manual for ten days at our expense. See how its giant "Trouble-Shooter" section pinpoints 2300 car troubles right away. Then see how it shows you *where* to start, *what* tools to use, *how* to use them.

If MOTOR's Manual doesn't make even the toughest jobs A-B-C Easy - if it doesn't pay for itself the first 2 times you use it - simply return it and pay absolutely nothing. That's how confident we are that THIS Manual really works! Beginners turn into skilled mechanics,

experts get many valuable time and money-saving tips. Crystal-clear directions and 2,850 big photos, diagrams, charts, etc. You CAN'T go wrong!

**The "Meat" of 176 Official
Shop Manuals**

You get a wealth of "Know-How" from 176 Official Shop Manuals and hundreds of Factory Bulletins, boiled down into one giant easy-to-use book. No more guesswork. You use same procedures as "pros" to do every job quick, easy, right the first time.

**Look At All
You Get:**

Over ELEVEN HUNDRED giant pages. 2,850 "this-is-how" pictures. 195 Quick-Check charts. 30,000 essential repair specs. Over 225,000 service and repair facts. PLUS adjustment tables, measurements and clearances, overhauling and replacement facts, *tune-up data for 40 foreign cars*, much more! Covers 2,219 popular make models since 1953 - including all 1961 compacts.

DO ANY CAR REPAIR JOB...



QUICK, EASY, RIGHT the first time!

Everything from tune-ups to transmission overhauls

Using new, revised MOTOR's Manual is like having factory experts themselves standing right beside you, guiding your hands through every job. You get big illustrated sections covering every one of 33 car makes - plus detailed chapters on transmis-

sions, rear ends, alternators, generators and regulators, fuel pumps, ignition systems, overdrives, automatic transmissions, engines, brakes, valves, rings, water pumps, distributors, dash gauges, power steering, power brakes, starting motors, etc.

"Inquiring Photographer"

**Q. What Do You Like About
MOTOR's Manual?**



HAS PAID FOR ITSELF TIME AND AGAIN. "It sure doesn't take schooling to read it. It's easy to see pictures of every part. Has paid for itself time and again."

-Paul Pemper, Wisconsin

SO COMPLETE AND EASY TO UNDERSTAND. "So complete, so easy to understand - I have done jobs with Manual that I would not have attempted without it."

-C. L. Vanerstrom, Michigan



AMAZED SELF AND FRIENDS. "I amazed myself and my friends, too. I now do auto repair jobs that stumped me before."

-Michael Baliczky, New Jersey

PAID FOR ITSELF ON FIRST 2 JOBS. "MOTOR's Manual paid for itself on the first 2 jobs and saved me valuable time by eliminating guesswork."

-W. Schrop, Ohio



Used by
U.S. Army & Navy
and Thousands of
Service Stations
and Repair
Shops

**USE MANUAL FREE
FOR 10 DAYS**

**FIX ANY PART OF ANY OF THESE MAKES
1953-1961 - including all new compacts!**

Buick
Buick
Special
Cadillac
Chevrolet
Chrysler
Comet
Continental
Corvair
Corvette
Dart
De Soto

Dodge
Edsel
Falcon
Ford
Hudson
Imperial
Jeep
Lancer
Lark
Lincoln
Mercury
Nash

Oldsmobile
Olds F-85
Plymouth
Pontiac
Pontiac
Tempest
Rambler
Rambler
American
Studebaker
Thunderbird
Valiant

FREE 10-DAY TRIAL OFFER

Just mail the coupon below. We'll rush Manual to your home or shop. Use it FREE for ten days! See if it doesn't help you whiz through even the toughest jobs. If Manual doesn't pay for itself in the first ten days, return it and pay nothing, owe nothing. So mail the No-Risk coupon AT ONCE to: MOTOR Book Dept., Desk 11X, 250 West 55th Street, New York 19, New York. (SCHOOLS, BOOKSTORES: Write for discounts.)

**MAIL COUPON NOW FOR 10-DAY FREE TRIAL
(Attach to Postcard for Fast Action)**

**MOTOR BOOK DEPT., Desk 11X,
250 W. 55th St., New York 19, N. Y.**

Rush to me at once the book(s) I have checked below:

MOTOR's New AUTO REPAIR MANUAL. If O.K., I will remit \$2 in 10 days, \$2 monthly for 2 months and a final payment of \$2.95 (plus 45¢ delivery charges and sales tax) one month after that. Otherwise I will return the book postpaid in 10 days.

MOTOR's New TRUCK REPAIR MANUAL. If O.K., I will remit \$3 in 10 days, \$3 a month later, then \$2 monthly for 2 months, plus 45¢ delivery charges and sales tax with final payment. Otherwise I will return book postpaid in 10 days.

Name.....Age.....
(Please Print)

Address.....

City.....Zone.....State.....

Check box and save 45¢ shipping charge by enclosing WITH coupon entire payment of \$8.95 for Auto Manual (or \$10 for Truck Manual) plus sales tax. Same 10-day return-refund privilege.

Same FREE Offer on MOTOR's New TRUCK REPAIR MANUAL



Covers 98% of all trucks, 1952-1961, including all new "Midsets." Over 2,000 illustrations; 300,000 facts. Easy to use. Covers all gasoline engines, plus Cummins, Mack, GM & Int'l Diesels. 822 pages. For 10-day FREE Trial, check box in coupon.



BE YOUR OWN MUSIC TEACHER

Send for Free Book Telling How Easily You Can Learn Piano, Guitar, Accordion, ANY Instrument This EASY A-B-C Way

NOW IT'S EASY to learn music at home. No tiresome "exercises." No teacher; just START RIGHT OUT playing simple little pieces. Thousands now play who never thought they could. Our pictured lessons make it easy as A-B-C to learn to play popular music, hymns, classical and any other music. Low cost. One million students all over the world. (Est. 1898.) Chartered by N. Y. State Education Dept.



Mail Coupon for FREE BOOK

Find out why our course can teach you quickly, easily, inexpensively. Write for FREE Book. No obligation. No salesman will call. Mention favorite instrument. Mail coupon today.

U. S. SCHOOL OF MUSIC
Studio A3011,
Port Washington, N. Y.



U. S. SCHOOL OF MUSIC, Studio A3011, Port Washington, N. Y. Please send me FREE 36-page Illustrated Book. I would like to play (Name instrument) _____.

Do you have instrument? Yes. No. Instruments, if needed, supplied at special reduced prices.

Name
Address
City Zone State

Get ahead faster in AUTO MECHANICS

Don't get caught in a layoff! Get into Auto Mechanics. Earn big pay or go in business. Over 100,000 mechanics and 25,000 shops are needed. **Learn by practicing.** Easy CTI course includes 30 Job Experience Projects. Tools, Tune-Up Kit and Volt-Ampere Tester sent. **Earn as you train.** Diesel or Body-Fender instruction provided. CTI is a non-profit organization. Course is accredited by National Home Study Council. Mail coupon for 3 free booklets.

COMMERCIAL TRADES INSTITUTE Dept. A-194
1400 GREENLEAF AVE. CHICAGO 26, ILLINOIS

Name Age
Address
City Zone State

WARN HUBS ON YOUR 4-WHEEL DRIVE

STOP FRONT END DRAG IN 2-WHEEL DRIVE!

Models for all 4-wheel drives

Most dependable, easiest to use hubs made for free-wheeling the front end in 2-wheel drive. Hundreds of thousands in use. Save gears, gas, tires; get more pep, speed, performance in 2-wheel drive with Warn Hubs, Locking or Lock-O-Matic. Guaranteed. See your dealer soon!

WARN MFG. CO. Riverton Box 6064-A, Seattle 88, Wash.

JEEP OWNERS

RE-POWER NOW WITH A V-8 OR 6 CYL. ENGINE — USE FORD—CHEV.—MERCURY—GMC—PONT—STUDE—DODGE OR PLYMOUTH

In Jeeps, Jeepsters, Sta-Wgn, trucks, Kaiser & H. J. cars. Conversion Kits \$45.35 to \$56.90. Want fast action? Give us full information, send \$15.00 Dep. and we will ship correct kit. Bal. COD. Send full amount for prepaid shipment. Wire, phone or write today. Details FREE.

HOOSIER MACHINE PRODUCTS CO.
312 S. E. 6th St. Phone CR 6-3442 Pendleton, Oregon

EASY AND QUICK FIX TV'S

LEARN IN ONE WEEK!

Most exciting development in history of TV repair—amazing short-cut training system that takes only few hours of study, helps you start your own business within a week! Instructions include "Magic Mail Plan" that may bring up to 200 or more customers without selling. Make as much as \$20 an hour, \$50 to \$75 a week in spare time. Later expand to full time business in multi-million \$\$\$ TV repair field. Send name & address for FREE facts "How to Learn TV Repair Fast"—FREE Sample Lesson—FREE booklet "How to Get 200 to 1000 Regular Customers Fast."

TV SERVICING SYSTEMS, DEPT. E-17B
1038 S. La Brea, Los Angeles 19, Calif.

SEND FOR THIS FREE!

Make money. Know how to break and train horses or ponies. Write today for this book FREE, together with special offer of a course in Animal Breeding. If you are interested in Galting and Riding the saddle horse, check here (). Do it today—now.

BEERY SCHOOL OF HORSEMANSHIP
Dept. 11011-D Pleasant Hill, Ohio

FREE GERMAN STEEL HUNTING KNIFE

4-INCH BLADE

We give you handiest hunting and fishing knife you've ever had! Has 4-INCH LONG highly tempered steel blade—VERY SHARP! Attractive handle. We send knife FREE to acquaint you with our below-wholesale bargains. Please send 25c for handling. NO LIMIT—but send 25c handling for each knife. Order TODAY! HUNTING KNIFE, Dept. K-621, Box 881, St. Louis, Mo.

PAY 2 or 3¢ on the DOLLAR

for 1000's of Useful Items of

U. S. GOV'T SURPLUS

LOOK

AT THE AMAZING PRICES PAID AT GOV'T SURPLUS SALES

Autos.....\$78	Tractors.....\$68
Trucks.....\$212	Motors.....99¢
Boats.....\$5.90	Typewriters..\$6.80
Compressors..\$9.69	Generators..\$8.78

You BUY DIRECT from U. S. Government at TREMENDOUS savings. Eliminate middlemen—Save BIG MONEY! Pay as LOW as 2¢ on the dollar. Our DIRECTORY Gov't Surplus Sales lists 100's Army, Navy, Air Force Surplus Depots all over the world. BUY JEEPS, sports equipment, hunting, fishing and photographic equipment and supplies, radio, electronic and electrical equipment, trucks, boats, airplanes. Plumbing, hardware, office equipment & supplies. Tools, machinery, furniture. This 1962 book tells how to buy Gov't Surplus DIRECT. No dealer profits to pay. Get on the gravy train NOW! Send \$1 TODAY for "Gov't Surplus DIRECTORY" to **AVIATION SURPLUS, Dept. PM11, Box 789, York, Pa.**

VERSA-MAGNET

45 lb. pull permanent Alnico V magnet equipped to hold lights where you want them — around the shop — on your car. Adjustable ball-swivel clamp fits trouble-light handle or standard light socket.



SEND **\$3.50**
CHECK OR MONEY ORDER each, postpaid

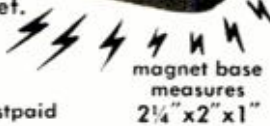

DeMAMBRO LABORATORIES, Inc. • Mayville, New York

NEW for INVENTORS

Now, deal direct and get a better deal! We follow through on your invention from start to finish: market research, manufacturing, distribution, advertising and sales. It's a new unique combination service that can do the most for you. Relax and enjoy the royalties we pay. Free market analysis to determine the potential of your invention. Patented or unpatented. No obligation. *Write:*

INTERNATIONAL PATENT AND DEVELOPMENT, INC.
603 Second Ave. S. Minneapolis 2, Minn.

BUILD FINE GRANDFATHER CLOCK NOW

The simple sensible **SPEEDE** Red-i-Kut way as thousands have — **FOR YOURSELF OR SELL AT A GOOD PROFIT. SAVE HUNDREDS OF DOLLARS. SHOP TEST-ED PLANS "SPIRIT OF THE CENTURY"** Narrow waist 53" tall or stately straight side **"SPIRIT OF AMERICA."** **EASY-TO-FOLLOW** photostatic **PLANS & LIFE SIZE PATTERNS** tell all—plus **MOVEMENT BROCHURE** \$40 up, of heavy brass weight (Kuempel original) Westminster, tube **BELL** chime, movements, *gorgeous* bronze-silver **MOVING MOON** dials. 3/4" solid-mahogany **Jiffy Joint-Kwik-Bilt** case kits. Send **\$1.00** today — Both plans **RUSH \$1.50** as folks have for over forty years.

Kuempel Chime Clock Works, 12 Kuempel Bldg., Minneapolis 16, Minn.

75 POWER TELESCOPE 25X-45X-75X \$398

NEW 3 in one telescopes, 3 variable 25X, 45X-75X magnification. Brass bound. 25 power for ultra bright images. 45 & 75 power for long range. Guaranteed to bring distant stars, moons, objects, sports 75 times closer.

Most powerful scope sold anywhere near this amazing low price. American made, 5 sections. Opens 36", closes 1 ft.; contains 4 ground & polished lenses. Can also be used as powerful compound microscope. Mass production enables us to offer telescope complete at \$3.98 postpaid. Money back guarantee.

CRITERION CO., Dept. PMB-99, 331 Church St., Hartford, Conn.

RUPTURED

BE FREE FROM TRUSS SLAVERY

Surely you want to **THROW AWAY TRUSSES FOREVER**, be rid of Rupture Worries. Then Why Do you put up with wearing a griping, chafing and unsanitary truss the balance of your life? If you do, it will **NOT** be through necessity but through choice on your part. Now there is a new modern **Non-Surgical** treatment that is designed to permanently correct rupture. These **Non-Surgical** treatments are so certain, that a Lifetime Certificate of Assurance is given. Write today for our New **FREE** Book that gives facts that may save you painful, expensive surgery. Tells how **non-surgically** you may again work, live, play, love and enjoy life in the manner you desire. There is no obligation.

Excelsior Medical Clinic, Dept. H6124, Excelsior Springs, Mo.

MY SPARE TIME HOBBY MAKES ME

\$5⁰⁰ an hour

CASH PROFIT

— Grover Squires

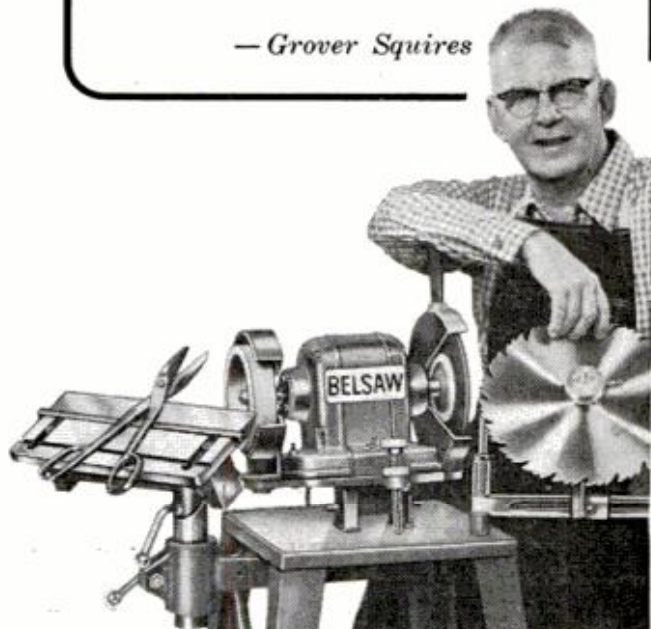

START YOUR OWN SPARE TIME BUSINESS



You can turn your spare time into Big Cash Profits with your own **COMPLETE SHARPENING SHOP**... Grind saws, knives, scissors, skates, lawn mower blades... all cutting edges. Your Own Cash Business with no inventory... right at home... no experience needed.

FREE BOOK tells how you can start your own spare time business while you are still working at your regular job. Low Cost—time payments only \$15.00 a month. **Send coupon today.**

FREE BOOK

BELSAW SHARP-ALL CO
712 Field Bldg.,
Kansas City 11, Mo.

Send Free Book "LIFETIME SECURITY". No obligation.

Name _____

Address _____

City _____ State _____

MAKE YOUR HOME WORKSHOP PAY OFF
in spare time or full time income
ELECTRICAL APPLIANCE REPAIR



Turn spare hours into cash profits. Millions of Home Appliances need fixing. Every home is your market for Full-Time Career or Spare Time "Second" Income.

Costs Less Than \$1.50 A Week. All you need is a workbench, spare time and N.T.S. Home-Training in Electrical Appliance Repair. You get a professional appliance tester, tools, and easy-to-learn, practical instructions, fully illustrated. Start earning early in course. Mail coupon now. No obligation. No salesman will call.

NATIONAL TECHNICAL SCHOOLS
WORLD-WIDE TRAINING SINCE 1905
4000 So. Figueroa Street
Los Angeles 37, Calif., U.S.A.

FREE BOOK and ACTUAL LESSON

NATIONAL TECHNICAL SCHOOLS
Los Angeles 37, California HB-111

Name _____ Age _____
Address _____
City _____ Zone _____ State _____

... TURN CONCRETE INTO GOLD!

MAKE UP TO \$75 A DAY IN YOUR OWN BUSINESS

If you want to have your own business — to start a business on your own — here's your big opportunity! New high speed, low cost General block machine produces up to 1,000 concrete blocks a day. Sell all you make to builders, supply houses, and others for homes, factories, buildings, garages. Cash in on the building boom! You can make profits of 100% to 150% — up to \$75. a day! General block machine equipped with 1/2 h.p. electric motor — or can be supplied with gasoline engine — works anywhere, in little space, indoors or out. Operates from ordinary house light socket. Simple, foolproof 3 step operation — so easy a child can do it. Makes superior 3 core blocks any size from 4" to 12". Also makes chimney, sash, corner and other types. Blocks meet any building code anywhere in the country. Materials — sand, water, cement, available anywhere. Simple illustrated operating instructions and mixing formulae for cement and cinder blocks supplied with each machine. Write for FREE folder with full information.

MOTOR DRIVEN

R. L. T. of New York City reports: "MY GENERAL BLOCK MACHINE PAID FOR ITSELF IN FIRST 2 WEEKS!"
Hundreds now in use the world over!
Write for FREE details today!

EXTRA Amazing illustrated book gives floor plans for 6 sensational concrete block bungalows. Tells how to lay blocks, lay out building lines, mix concrete, build steps, porch and concrete floors all at great savings. Written by experts. Can save many times the cost of the material! Get it now! No strings attached. Send \$1.

BOOK SENT FREE IF YOU BUY MACHINE.
\$1 REFUNDED IF YOU BUY LATER.

GENERAL ENGINES CO.
DEPT. PB-111, ROUTE 130, THOROFARE, N. J.

HOW TO BUILD YOUR OWN CONCRETE BLOCK HOME
Only \$1 Prepaid

ENJOY YOUR OWN BUSINESS
Start earning at once—No special experience required

STAND-ALL Model 7

A shop in itself—automatic, foolproof.

SHARPENS 10 types of saws, including rip and crosscut handsaws, hacksaws, bandsaws, circular saws.
RETOOTHs saws of 5 to 16 point size.
CROWNS—adjusts to any standard crown.
HOOKS from -5 to 21 degrees.
BEVELS from 0 to 30 degrees.

Down payment; Balance in low monthly payments from earnings.

SMITH-NIELSEN EQUIPMENT CO., Mfr. of Saw Grinders
902 N. NORMANDIE—SPOKANE, WASH.—FA 8-6680—Teletype SP13

REAL ESTATE BE A BROKER

FREE BOOK TELLS NOW

PAYS BIG! SEND FOR FREE, BIG, ILLUSTRATED CATALOG NOW! Graduates report making substantial incomes. Start and run your own business quickly. Men, women of all ages, learn easily. Course covers Sales, Property Management, Appraising, Loans, Mortgages, and related subjects. **STUDY AT HOME** or in classrooms in leading cities. Diploma awarded. Write TODAY for free booklet! No obligation. Approved for World War II and Korean Veterans

WEAVER SCHOOL OF REAL ESTATE (Est. 1936)
2020 Grand Avenue Kansas City, Mo.

BLUE BOOK OF CRIME FREE!

Given to men who want to get into CRIME DETECTION FINGER PRINT IDENTIFICATION

Train at home, spare time. Join hundreds of I. A. S. graduates now employed by police and identification bureaus in every state. Learn finger print identification, crime investigation, firearms identification, police photography, other subjects vital to qualifying for good paying, secure, interesting jobs. "Blue Book of Crime" and details Free. Must state age.

Institute of Applied Science, Dept. 1358,
A Correspondence School Founded in 1916
1920 Sunnyside Ave., Chicago 40, Ill.

Anyone for Pool? Table Tennis? Model Railroading?

There's a table that will accommodate all three of these fun-time activities. You'll find plans for it beginning in the

DECEMBER Popular Mechanics

POPULAR MECHANICS



FLY YOUR OWN HELICOPTER

The Commuter Jr. is a genuine helicopter — not a toy — that can be assembled in your home workshop. It is a practical, inexpensive and soundly engineered aircraft. All component parts and complete assembly drawings are now available!

Send \$2.00 for photo illustrated brochure, specifications and parts price list. Send an additional \$2.00 for our book "Basic Helicopter Aerodynamics" which will give you a basic understanding of the aerodynamic and physical principles in the building and flying of the Commuter Jr.

HELICOPTER RESEARCH CO.
Box 121 M • La Mirada, California



make your own Gems 3650 FOR

The Gem Maker comes complete with all necessary equipment, including a super-charged diamond blade for sawing, and all the wheels for grinding, shaping and polishing; also complete instructions. The complete equipment as shown, less motor and belt for only \$36.50. f.o.b., Burlington, Wisconsin. Write today for information and literature.

B&I MANUFACTURING CO.
Dept. P, Burlington, Wis.



MONEY in WORMS

Sell 20,000 fishworms per week @ \$4 per 1000 from a bed 3 feet wide and 8 feet long. We teach you how to raise and where to sell fishworms and crickets. Write for free literature.
CARTER WORM RANCH, PLAINS, GEORGIA
Read our success story in LIFE MAGAZINE, December 25, 1959 Issue

HYDRAULIC JACK REPAIRS



Earn While You Learn at Home

Millions of jacks in gas & auto-service stations, truckers, body-shops, riggers, factories, farms need servicing. We show you HOW—easy step by step directions—what tools to use. **EARN UP TO \$5 an hour, in spare time, in your own basement or garage. Start your own business NOW.**

Write for folder No. PM-11 & free bonus offer.

Institute of Hydraulic Jack Repair
P.O. Box 50, Bloomfield, N. J.

PRINT



ANYTHING YOU WANT IN SECONDS!
Business & Personal Use

Now print anything you wish quickly and easily with this sensational new printing outfit. "STA-TITE" set has complete alphabet of rubber letters and numerals which set FLAT and TIGHT in rubber tongue and groove holder to give clean, sharp impressions every time. Used by leading firms all over the country.

\$4.95
Postpaid
(No C.O.D.'s)

Introductory set contains all the following:

- More than 250 letters and numbers
- 4-line holder and FREE, one extra holder.
- Type tweezers
- Stamp pad

ORDER TODAY!

AMERICAN STAMP WORKS P. O. BOX 1300 PATERSON, N.J.

NOVEMBER 1961

IMPORT PAYS BIG!



GIGANTIC U. S. BOOM OFFERS BIG PROFIT OPPORTUNITY

Import Boom is bringing success to hundreds. You can get into this profit bonanza. I'll show you how to get bargains that "sell themselves." I'll show you simple, proved, big profit methods.

NEW HOME IMPORT BUSINESS

Get Imports at trifling cost abroad. Sell to friends, stores, mail order. Imagine *huge profit* on watch for only \$2.87—radio, \$3.02—recorder, Der-ringer. Mellinger shows how you order *direct*—how to make profit in advance—starts you full or spare time without capital or experience.



10,000 Products to Choose from

Mellinger's 53 foreign agents discover bargains for you. 10,000 imports are evaluated yearly in Mellinger's Home-Office of 22 specialists. The most profitable are granted Mellinger's Seal of Approval and reported to you.

YOU KEEP ALL THE PROFITS...

You deal direct with overseas sources. Mellinger shows you how you get FREE samples, how to get in on the beginning of the import boom that can pay you dividends for years. Rush coupon for FREE BOOK "How to Import & Export." No salesman will call. Airmail reaches us overnight.

Beginners following this plan report

"On my very first transaction I made \$904.00 for just 4 days work... My wife and I started this business together..." D.M.C. "With an initial investment of less than \$100, I have grossed a profit in the neighborhood of \$12,000..." D.L.S. "I was stumbling along on a time card job without much future. Now I can enjoy the freedom and security of a business of my own..." W.J.J. Many beginners start this way with little capital.



Plan shows where you get buys like these for big profit U. S. sales. Prices shown are direct from suppliers abroad.
DO NOT ORDER FROM US

MELLINGER CO.
Dept. T25B, 1717 Westwood, Los Angeles 24

Send for FREE BOOK!

MELLINGER CO., Dept. T25B
1717 Westwood Blvd., Los Angeles 24, Calif.

Show me how the big Import Boom can give me my own Home-Import Business. Rush FREE Book and details without obligation.

Name.....
Address.....
City & Zone..... State.....

Make UP TO \$1,000⁰⁰ IN A MONTH!

JUST LIGHTING THIS LIGHT!



Fits in palm of hand

Electronic Demonstrator Proves VX-6 Gives New Life to Old Car Batteries!

Join the men now making as much as \$265 monthly spare time, up to \$1,000 in a month full time, introducing sensational VX-6 Battery Additive. Just one application, costing only \$2.98, eliminates power-robbing sulphation for car and truck battery plates, makes old mechanically-sound batteries perform like new, protects new batteries for the life of the car. We supply portable Electronic Demonstrator to producers, prove in 30 seconds how VX-6 works. Put prongs in water and nothing happens . . . then add VX-6 to water and the bulb lights! When the bulb lights, the sale is made!



Tested and Approved by Famous Independent Research Laboratories



VX-6 has been tested and approved by these famous laboratories, and purchased by branches of the U.S. Government, branches of the Armed Forces, A&P, Canada Dry, Chrysler, and dozens of other leading corporations . . . plus OVER 3 MILLION MOTORISTS. Yet the market is scarcely scratched. There are still 64 million drivers who need VX-6, and thousands of fleet owners who buy in big quantities. You can tap this big market right away!



FREE! Big Illustrated Sales Kit, Lab Reports, Money-Making Plans

Rush name, address today for big Illustrated Sales Kit containing everything you need to start making big profits, full time or spare time. Everything FREE—no obligation! Write:



NATIONAL DYNAMICS CORP. (VX-6 Div.) Dept. D10C
224 East 23rd St., New York 10, N. Y.

LEARN TO MOUNT BIRDS



ANIMALS, FISH, PETS

Be a Taxidermist. Save your hunting TROPHIES. Have a fine home-museum. Hunters, save and MOUNT your beautiful DUCKS, QUAIL, DEER, TAN skins and FURS. Great Fun. Spare-time PROFITS.

FREE BOOK Tells ALL about it. 100 fine wild-game pictures. 48 pages.

Send TODAY, don't delay. Get this WONDERFUL FREE BOOK, MEN AND BOYS. Learn Taxidermy. Double your hunting pleasure. Rush letter or POSTAL today. STATE AGE. N.W. SCHOOL OF TAXIDERMY, Dept. 2511, Omaha, Neb.

STEP UP to BENJAMIN'S TRADITIONAL EXCELLENCE!

DISCOVER the BIG DIFFERENCE that EXPERT CRAFTSMANSHIP can Make in Your SHOOTING PERFORMANCE and FUN!

25 MODELS—SINGLE SHOT and REPEATERS—FIRST CHOICE of SHOOTERS who want SAFETY—CONVENIENCE—ECONOMY including HIGHEST QUALITY MATERIALS to Assure Them OUTSTANDING POWER—ACCURACY—DEPENDABILITY!



World Famous AIR GUNS and CO₂ GUNS

No. 3600 \$19.95

No. 3600 BENJAMIN Super 100 Shot BB Gas Rifle. Non-Toxic—Safe—Convenient—Uniform Hi-Velocity Power. →
No. 3620 BENJAMIN Super 85 Shot Cal. 22 Gas Rifle. . . . \$21.95
No. 3100 Super 100 Shot BB Air Rifle, Adj. Shooting Force \$24.95
No. 3120 BENJAMIN Super 85 Shot Cal. 22 Air Rifle. . . . \$26.95

FREE Catalog All Models Benjamin Single Shot & Repeater—Cal. BB or 177 or 22. Also, Special Hunting & Fishing Knife Offer.

BENJAMIN AIR RIFLE CO., 896 MARION ST., ST. LOUIS 4, MO.
You Can DEPEND on . . . BENJAMIN

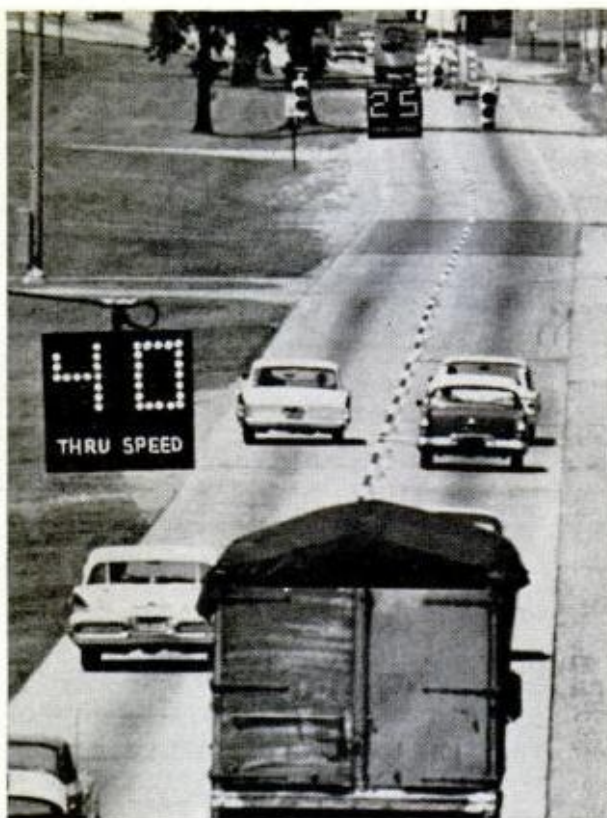

Signals Pace Traffic

Motorists along four miles of road in Warren, Mich., will always catch the green light at the intersection if they gear their driving to the speeds advised by overhead signs along that stretch.

The signs, 921 feet apart, advise drivers to vary their speeds from 25 to 40 miles an hour, informing them how fast to go to catch the green light. The pacing signals will be used for a two-year experiment.

START NOW - EARN TOP PAY!

Become a MASTER CRAFTSMAN—train in the LARGEST TRADE SCHOOL IN THE WORLD: AUTO MECHANICS □ TUNE-UP □ DIESEL □ BODY & FENDER □ AUTOMATIC TRANSMISSIONS □ WELDING □ REFRIGERATION □ AIR CONDITIONING □ MACHINIST □ TOOL & DIE □ DRAFTING □ FREE PLACEMENT SERVICE during and after training. CHECK COURSE INTEREST, TEAR OUT, AND MAIL TO BOX K

GREER SHOP TRAINING

2236 S. Michigan Ave., Chicago 16, Ill.

Another NEW Taft Kit!

HYDROFOIL BOAT KIT

"Fly" on water with less power—save on fuel!



COMPLETE—\$131²⁵ down \$20³⁷ per mo.
FREIGHT PAID
TAFT MARINE WOODCRAFT

FREE CATALOG OF MANY MODELS

Dept. PM1161, 636 39th Ave. N.E., Mpls. Minn.



BARBELLS

100 POUND SET \$14.80

140-Pound. CHROME DELUXE Barbell-Dumbbell set only \$22.80. This is our feature set and is the finest ever manufactured.

Training with adjustable weight is the BEST way to keep fit; the ONLY way to develop great strength and a perfect body. As the oldest and best equipped barbell company, BUR gives value and prices no one can equal.

SEND FOR FREE CATALOG
BUR BARBELL CO.
Lyndhurst 9, New Jersey

Extra Plates Only 14c Pound

POPULAR MECHANICS

"I UPPED MY EARNINGS \$200 A MONTH"



Says **TEDDY RYAN, Norfolk, Va.**
 "I have always liked working with my hands, and locksmithing seems to be what I've been looking for. I've increased my monthly earnings by \$200 just during my training period!"

Just a few of the many professional tools supplied FREE with course.

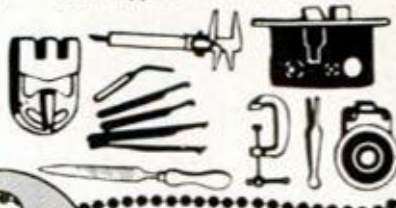

Be a LOCKSMITH

Train at HOME—Earn While You Learn
 Add 50%—100% to YOUR INCOME with easy spare time earnings. Cash in on the nation-wide shortage—trained locksmiths are in demand! Quickly step into a big pay opportunity job or start a high-profit shop of your own.

Earn Extra Money RIGHT AWAY! All Special Tools, Supplies Furnished FREE.

Age, education, minor physical handicaps don't matter in this growing trade. You can quickly qualify as a skilled locksmith. It's like a fascinating hobby. Study at home as little as one hour a week. Gain practical experience through well-illustrated lessons. Do real jobs on car locks, house locks, padlocks and safe locks, under the guidance of experts.

FREE illustrated book, write now.

LOCKSMITHING INSTITUTE, Dept. 111-1
 (Div. Tech. Home Study Schools)
 150 Park Avenue, E. Rutherford, N. J.

SEND FOR FREE BOOK!

PROFESSIONAL TOOLS SUPPLIED FREE FOR USE WITH COURSE

APPROVED FOR VETERANS

MAIL COUPON FOR FREE BOOK.

For a future as your own boss or in a high-pay job, write now for FREE illustrated book. Only school of its kind. Licensed by State of New Jersey.

Accredited,
 Nat'l Home Study Council

MAIL COUPON NOW!



LOCKSMITHING INSTITUTE, Dept. 111-1,
 150 Park Avenue, East Rutherford, N. J.

Please send without obligation the FREE illustrated book, "Your Opportunities in Locksmithing." I understand no salesman will call.

Name.....
 (Print Here)
 Address.....
 City..... Zone..... State.....

SEW LEATHER AND TOUGH MATERIALS EASILY COMPLETE, EASY-TO-USE, HEAVY DUTY STITCHER KIT IN ONE COMPACT TOOL

Not sold in stores

\$1.98
 Postpaid

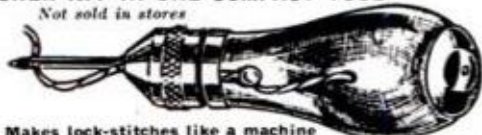

Makes lock-stitches like a machine

SAVE MONEY with HEAVY-DUTY STITCHER. It's easy to sew or repair anything made of Leather, Canvas, Nylon, Plastic, or other heavy materials. Quick "push-pull" action makes firm, even lock-stitches like a machine. Gets into hard-to-get-at places. Just the tool needed for repairing Luggage, Footwear, Convertible Tops, Awnings, Seat Covers, Sportsgear, Rugs, Saddlery, etc. Comes complete with 3 different needles (fine, heavy, curved) and bobbin of strong waxed thread (10 yds) all self-contained in HEAVY-DUTY STITCHER. Easy-to-follow directions included. Extra needles and thread always available. Send \$1.98 money order or check, and we pay postage. If C.O.D. \$1.98 plus postal charges. Money back Guarantee. Sportsman's Post, 366 Madison Ave., Dept. A-83, New York 17

Study programs in APPLIED SCIENCE and ENGINEERING

You can earn an Associate in Applied Science degree (2 years) in electronics communications, electrical power, computer, air conditioning, industrial, and metallurgical technology, or a Bachelor of Science degree (4 years) in electrical or mechanical engineering. A Pre-technology Program, scholarships, financial aids, and placement service also available. New classes start quarterly. Write today for free "YOUR CAREER" booklet. Dept. PM 11-61, 1025 North Milwaukee Street, Milwaukee 1, Wisconsin.

MILWAUKEE SCHOOL OF ENGINEERING

NOVEMBER 1961

Revolutionary Patents! Lifetime Engineered!

SAVE \$40

FULL 22" LONG, 4 1/2" AMT JOINTER-PLANER
NOW \$19.95

complete as shown

DOES WORK OF \$60 UNITS!

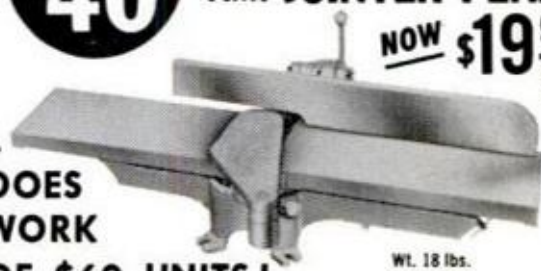

Wt. 18 lbs.
 Exp. Coll.

Now, at little more than a hand tool price a guaranteed professional quality precision machine which does same work as skilled hand planing... much faster, more accurately. Make accurate glue joints; rabbeting cuts for doors, window frames, table drawers; square taper cuts for chair legs; accurate beveling. Helps amateurs produce quality work—with the sweat eliminated.

TOP QUALITY FEATURES SPEAK FOR THEMSELVES

- Precision ground cast iron tables, adjustable for depth of cut
- Rigid cast iron base
- Rabbett depth 3/8"
- Hardened, ground high-speed steel knives
- Patent-pending fence adjustable to any position, any angle 0°-50°
- Patent-pending lift-off guard (nothing to loosen)
- Balanced steel cutter head

WHY THE LOW PRICE!

Special patents, streamlined design features cut material costs, reduce production time. Parts made, assembled, tested and packed in our own factories... shipped direct to you. No retail store handling or profits to add to your cost.

YOUR MONEY BACK IF NOT SATISFIED. Send check or money order for full amount. Or send \$4. deposit, balance C.O.D. 10-day money back guarantee. Return within 10 days for full refund. No questions asked.

UNCONDITIONAL 10-YEAR GUARANTEE!

ORDER TODAY!

AMERICAN MACHINE & TOOL CO. Dept. PM-111B, Royersford, Pa.

AMAZING SCIENCE BUYS

EXCELLENT XMAS GIFTS!

OVER 1000 ITEMS

WAR SURPLUS AMERICAN-MADE 7x50 BINOCULARS

Big savings! Brand new! Crystal clear viewing—7 power. Every optical element is coated. An excellent night glass—the size recommended for satellite viewing. Individual eye focus. Exit pupil! 7mm. Approx. field at 1,000 yds. is 376 ft. Carrying case included. American 7 x 50's normally cost \$274.50. Our war surplus price saves you real money.



Stock No. 1544-H only \$74.80 pstd. (Tax included)
6 x 30 Binoculars—similar to above and a terrific bargain.
Stock No. 963-H \$33.00 pos. pu. (Tax included)

New...PORTABLE ELECTRIC GREENHOUSE FOR YEAR-ROUND GARDENING MAGIC

Now you can practice gardening as a hobby 12 months a year! Grow endless varieties of plants to maturity summer and winter . . . experiment continuously with plant growth and development. Thermostatically controlled temperature and humidity for rapid germination of seed, rooting of cuttings, and maximum growth potential. Size 15" x 18", with styrofoam base, 25-watt heater and thermostat, 2 polystyrene planter trays, clear styrene lid. 2 sizes avail. ea. incl. bag of growing medium.



Stock No. 70,490-H Low-lidded model, 7" high. . . \$14.95 Pstd.
Stock No. 70,491-H High-lidded model, 15" high. . \$21.95 Pstd.

CIRCULAR DIFFRACTION GRATING JEWELRY A DAZZLING RAINBOW OF COLOR



Shimmering rainbows of gem-like color in jewelry of exquisite beauty—made with CIRCULAR DIFFRACTION GRATING REPLICA. Just as a prism breaks up light into its full range of individual colors, so does the Diffraction Grating.

Stock #30,349-H Earrings \$2.50 Ppd.
Stock #30,350-H Cuff Links \$2.50 Ppd.
Stock #30,372-H Pendant \$2.50 Ppd.
Stock #30,390-H Tie-Clasp \$2.50 Ppd.

WOODEN SOLID PUZZLES



12 Different puzzles that will stimulate your ability to think and reason. Here is a fascinating assortment of wood puzzles that will provide hours of pleasure. Twelve different puzzles, animals and geometric forms to take apart and reassemble, give a chance for all the family, young or old, to test skill, patience, and, best of all to stimulate ability to think and reason while having lots of fun. Order yours now.

Stock No. 70,205-H \$3.00 Postpaid



Remove Your Retaining Rings—
Disassemble Lenses, Cameras, etc.

ADJUSTABLE SPANNER WRENCH

Made for U.S. Air Force—available at a fraction of Government cost. A top grade, versatile tool that every instrument and camera repair man or just plain tinkerer should own. Adjustable for 1/2" to 12" diameter retaining rings. Complete with six different pairs of points to fit all types of slots and holes. 3", 6", and 12" main bars. All steel and nicely plated. The finest tool we have ever come across for this type of retaining ring work AND a real bargain at our low price.

Stock No. 70,355-H \$12.50 Postpaid

NOW . . . BE YOUR OWN WEATHERMAN!



WEATHER STATION MARK I performs all measurements and computations for professional weather forecasts. Rise and fall of fluid in Cape Cod Glass show changes in barometric pressure. Also compute wind speed and direction, measure rainfall, figure dew point, read wet-bulb temperature, etc. Weather manual included—clear instructions for calculating the Temperature-Humidity Index and relative humidity. Fully portable. Panels and packaging of heavy polystyrene.

Stock No. 70,488-H—15" x 6" x 8 1/4" \$9.95 Pstd.

DELUXE ADVANCED MODEL MARK II

Stock No. 70,489-H—15" x 6" x 11 1/2" \$19.95 Pstd.

Order by Stock No.—Send Check or M.O.—Money-Back Guarantee

Mail Coupon NOW On Facing Page
FOR FREE GIANT CATALOG "H"

160 Pages—Over 1000 Bargains

SCIENCE • MATH • OPTICS

ORDER BY STOCK NUMBER. SEND CHECK OR MONEY ORDER. SATISFACTION GUARANTEED.
EDMUND SCIENTIFIC CO., BARRINGTON, N. J.

BULLETINS FROM THE WORLD OF SCIENCE

The five Great Lakes were carved out of rock by ancient rivers and not by glaciers, as has been thought, according to geologists from the Universities of Michigan and Minnesota who drilled the bottom of Lake Superior this summer.

Cores from the lake bed indicate that glacial deposits were laid down in deep rocky valleys existing long before the last ice sheet retreated north 10,000 years ago.

Patients may get a shot of an old-new type of anesthetic for major operations, if a new technique further proves its value.

Dr. John C. Krantz, Jr., of the University of Maryland School of Medicine, and a team of co-workers have succeeded in putting one form of ether into a solution, making an emulsion that is compatible with elements in the blood, affects blood pressure only slightly, works quickly in small amounts, and lets the patient recover rapidly with very few side effects. This had been a goal of medical science for some years. Heretofore, the only anesthetics that could be injected were effective for only short periods of time.

Giant kelp from the ocean is literally being thrown into the fight against forest fires in the Northwest.

Air tankers dump water thickened with the kelp algin into fires. The solution evaporates slowly and when attacked by fire forms a scum on the exposed side, but remains wet underneath. After it has dried, a tough film something like polyethylene remains that seems to help prevent smoldering or rekindling of the fire.

Chew your gum on both sides of the mouth advises Dr. Robert D. Ralph of Washington, D.C. and you'll avoid "jaw joint syndrome." This is an earache that develops on the side opposite the one where the gum is maneuvered. The tenderness in the ear disappears quickly when patients start chewing on both sides.

Should you now have the syndrome, the doctor suggests aspirin.

James Biery

Sunspot Cycle Is Mirrored in Mud

Layers of sediment taken from 300-million-year-old lake beds around the world show 11- and 22-year variations caused by temperature and rainfall changes presumably induced by solar variations, says Dr. Roger U. Anderson of the University of New Mexico.

Other scientists at a New York Academy of Sciences conference on solar variation and Earth's climate further reported that sunspot numbers rise and fall in agreement with the same cycles.

This lends evidence to the long-held opinion that sunspots and related solar variations have a decisive influence on Earth's climate.

Gun "De-Spins" Space Vehicles

Called REPPAC, for repetitively pulsed plasma accelerator, a plasma-propulsion machine may keep future space vehicles on course by stopping unwanted spinning and tumbling motions.

Its advantage over conventional rockets and gas jets for this purpose is that it shoots off an energetic stream of material at extremely high speeds to obtain thrust, and a small amount of it goes a long way. Conventional methods require more fuel.

The plasma (a gas whose atoms have been broken up) reacts with a powerful magnetic field which accelerates the gas particles 50 times a second and discharges them at more than 22,000 miles per hour. The REPPAC is a T-shaped gun in which small amounts of gas are turned into the plasma and then propelled into a vacuum chamber.

Star Beams Radio Signals

Astronomers have tuned in the first true radio star, a station named 3C-48 that sends signals 10 million times stronger than the sun.

It was located by scientists at California Institute of Technology's radio observatory, Owens Valley, and lies in the constellation Triangulum, which is close in the sky to the Andromeda Nebula.

Spectrograms made at Mt. Palomar showed that the star, or its surrounding gaseous cloud, contains ionized calcium, ionized and neutral helium and possibly oxygen ionized many times. Its spectral lines do not show hydrogen, generally the main fuel in stars and almost always seen in stellar spectra.

EXCELLENT XMAS GIFTS!

AMAZING SCIENCE BUYS

See the Stars, Moon, Planets Close Up!

3" ASTRONOMICAL REFLECTING TELESCOPE

60 TO 180 POWER

Famous Mt. Palomar Type!
An Unusual Buy!

See the Rings of Saturn, the fascinating planet Mars, huge craters on the Moon. Equatorial Mount with lock on both axes. Aluminized and overcoated 3" diameter high-speed f/10 mirror. Telescope comes equipped with a 60X eyepiece and a mounted Barlow Lens. Optical Finder Telescope included. Hardwood, portable tripod. FREE with Scope: Valuable STAR CHART plus 272-page "HANDBOOK OF HEAVENS" plus "HOW TO USE YOUR TELESCOPE" BOOK.

Stock No. 85,050-H \$29.95 Postpaid

OVER 1000 ITEMS

MINIATURE WATER PUMP

Wonderful for experiments, miniature waterfalls, fountains, Christmas gardens, HO gage railroad backdrops, etc. Tiny (2 3/8" x 1 3/4") electric motor and pump ideal for hobbyists, labs, schools. Pumps continuous flow of water at rate of one pint per minute at a 12" head. With 2 D Batteries in series will pump to 24" high. Works in either direction. Stock No. 50,345-H \$2.25 Postpaid

OPAQUE PROJECTOR

Projects illustrations up to 3" by 3 1/2" and enlarges them to 35" x 30" if screen is 6 1/2 ft. from projector; larger pictures if screen is further away. No film or negatives needed. Projects charts, diagrams, pictures, photos, lettering in full color or black-and-white. Operates on 115 volt, A.C. current, 6-ft. extension cord and plug included. Operates on 60 watt bulb, not included. Size 12" x 8" x 4 1/2" wide. Weight 1 lb., 2 oz. Plastic case with built-in handle. Stock No. 70,199-H \$7.95 Postpaid

SCIENCE TREASURE CHESTS

Extra-powerful magnets, polarizing filters, compass, one-way-mirror film, prism, diffraction grating, and lots of other items for hundreds of thrilling experiments, plus a Ten-Lens Kit for making telescopes, microscopes, etc. Full instructions included. Stock No. 70,342-H \$5.00 Postpaid

Science Treasure Chest DeLuxe—Everything in Chest above plus exciting additional items for more advanced experiments including crystal-growing kit, electric motor, molecular models set, first-surface mirrors, and lots more. Stock No. 70,343-H \$10.00 Postpaid

NEW TAPE RECORDER AT AN AMAZING \$29.95

American Made—For Business, School or Hobby

Latest type, super-sensitive transistors in place of expensive bulky tubes is secret of low price. Excellent tone and quality. Real handy item for teachers, students, engineers, salesmen, etc. Single, foolproof control changes from rewind, off, play, record. All-transistor circuit sensitive crystal microphone, built-in Alnico V dynamic speaker for clear, loud amplification. Compact, lightweight. 8 1/2" x 9 1/4" x 3 1/8". Operates on 2 size D and one 9 V transistor battery (not included). Two 3" reels and 150 ft. magnetic tape, plus instructions (included). Stock No. 70,480-H \$29.95 Postpaid

BUILD A SOLAR ENERGY FURNACE

A fascinating new field. Build your own Solar Furnace for experimentation—many practical uses. Easy! Inexpensive! Use scrapwood! We furnish instructions. This sun powered furnace will generate terrific heat—2000° to 3000°. Fuses enamel to metal. Sets paper aflame in seconds. Use our Fresnel Lens—14" diameter . . . f.1. 14". Stock No. 70,130-H Fresnel Lens \$6.00 Postpaid.

Order by Stock No.—Send Check or M.O.—Money-Back Guarantee

EDMUND SCIENTIFIC CO., Barrington, New Jersey

MAIL COUPON for FREE CATALOG "H"

160 Pages! Over 1000 Bargains!

EDMUND SCIENTIFIC CO., Barrington, N. J.

Please rush Free Giant Catalog-H.

Name.....

Address.....

City.....Zone.....State.....

EARN \$125 A WEEK AND UP

BE AN AUTO DIESEL EXPERT - LEARN A TRADE YOU LIKE

You learn fast in our shops because you learn with tools on real equipment. Students short of money may earn most of their expenses by doing part-time work. Experienced instructors explain WHY and show you HOW, then you DO IT YOURSELF. Many of our graduates earn \$125 a week and up. Approved for veterans. Day and evening classes. Free bulletin-write today.

MAIL THIS COUPON TODAY!

NASHVILLE AUTO-DIESEL COLLEGE
226 7th Ave., No., Dept. 86, Nashville, Tenn.
Please send without obligation free catalog.

NAME _____
(please print or write plainly)

ADDRESS _____

CITY _____ STATE _____

BIG EARNINGS WAITING



FREE Use Of
Professional Tools
And Full-Sized
Typewriter
With Course



Be a TYPEWRITER REPAIRMAN

Earn while you train AT HOME

Here AT LAST your first opportunity to qualify quickly in your sparetime for phenomenal growth field—thousands more trained men needed than industry can supply.

NEVER BEFORE could you get industry-proved training at home. Now, for the first time, you can qualify quickly to repair, rebuild, recondition all makes, all models of manual and electric machines. Learn with a real typewriter plus sub-assemblies, all professional tools, and step-by-step illustrated lessons prepared by industry experts for home study.

SEND FOR FREE BOOKLET—Get vital government facts about urgent need for trained men. Free Booklet describes big, money-making opportunities. (Div. of Technical Home Study Schools.) Lic. by N. J. Dept. of Education.

—MAIL COUPON TODAY!

TYPEWRITER REPAIR SCHOOL, Dept. L-11, 150 Park Ave., E. Rutherford, N. J.
Please send FREE Booklet, without obligation.

Name _____
Address _____
City _____ Zone _____ State _____

6-IN-1 ONLY MACHINE OF ITS KIND! UNIMAT



Compact workshop for all metal, plastic, wood. Precision lathe, milling machine, drill press, surface grinder, polishing/grinding machine, portable drill. Complete basic unit, \$129.50. WRITE FOR FREE CATALOG.
AMERICAN EDELSTAAL, INC., DEPT. GK. 350 BROADWAY, N.Y. 13, N.Y.

NEW!

Just 5" HIGH



First Miniaturized TWO-WAY \$29⁹⁵ RADIO!

each postpaid
with batteries
Two for \$59.90

SPACEPHONE—FITS IN SHIRT POCKET! Two-way walkie-talkie sending and receiving set in the smallest case at the lowest price! Absolutely self-contained: microphone—loud-speaker, 9-volt transistor radio battery, transistorized transmitting and receiving sets with the latest miniaturized printed circuitry. U.S. designed and made. Volume control and tuning. Range 1/2 mile up.

Citizen's band—NO LICENSE, NO EXAMINATION—NO AGE LIMIT. For hunting, boating, fishing, hiking, all sporting uses, farms and ranches. Will operate between vehicles.

Electrosolids Corp. products are now in use on such projects as the Explorer VI Satellite. Spacephone replaces and does the same job as equipment costing from \$114 to \$300 per pair.

TO ORDER: Enclose check, cash or M.O. for postpaid shipment. \$5 deposit per unit for C.O.D. 10-day unconditional money-back guar. Dealers inquire. Calif. res. add 4% state tax.

Electrosolids Corp., 12740 San Fernando Rd. No., Sylmar 69, Calif.

SAVE MONEY! MAKE MONEY! WITH PORTABLE CEMENT MIXER!



It's easy, fast, fun to do your own work with the MIXAL Mixer. Build barbecues, patios, sidewalks for yourself, for others! Mixes 3' x 8' sidewalk every hour! Uses any 1/4 HP motor. Thousands used by contractors! Try it on MONEYBACK GUARANTEE! Send for FREE HOW-TO-DO-IT CEMENT MIXING BOOKLET. Dept. PM-1

\$29⁹⁵
pp
without
motor
(add \$3

KOL, INC., 2323 Ellis Ave., St. Paul, Minn. W. of Rockies)

EASY TO MAKE PRO GUITAR ONLY \$10 SAVE OVER 50% Regularly sells for \$22.00 in music stores everywhere

Complete Do-It-Yourself Kit... easy to assemble (simple instructions enclosed). Play this beautiful Spanish Guitar of ever-lasting hardwood, precision fit, finger board accurately scaled... ready for painting, staining and decorating. You'll be delighted with its excellent tonal quality.

It's fun to make... gives you a lifetime of musical pleasure.

FREE "short cut" playing instruction booklet with order. Send Check or Money Order. 10 Day Money Back Guarantee.
GOODY MUSIC CO., Dept. A, P. O. Box 2457, Grand Central Station, New York 17, N. Y.



Earn this high rate of dividend and get one of these valuable free gifts... from this modern 53 year old Association. Save by Mail... and we will handle all details for you.

Current Rate
4%
Per Annum

MONEY IN BY THE 15th EARNS FROM THE 1st!



POLAROID CAMERA KIT
Free with \$3,000 Account
G.E. CLOCK RADIO
Free with \$1,000 Account

G.E. ALARM CLOCK
Free when opening account for \$100 or more.



53 YEARS • 1908-1961
CITY SAVINGS ASSOCIATION



1656 W. Chicago Avenue • Chicago, Ill.
ASSETS OVER \$22,000,000.00

Not everyone does as well, but T. N. CODY, who started a business of his own, reports...

For 12 months I've averaged

\$800 PER MONTH INCOME

—most of it clear profit for me!

Many men have discovered how to be independent, to be free of layoffs and bosses. C. G. Naples grossed more than \$200 his first week. A father-son combination grossed \$44,000 their second year. H. Lemon says, "I netted \$133 in one 8-hour day."

How much you make depends largely on you. You need no special skill, no large investment. Start part time if you wish.

NO SHOP NECESSARY • Our Electric Deterger shampoos rugs, carpets right on floor—removes dirt and grime and helps to show their natural color and beauty. So efficient and safe it is used by largest railroads and hotels.

► **This is not a lease proposition. You own the machine, you work when and where you please and all the money you take in is your own. You take no risk. Machines fully guaranteed.**



MAIL COUPON TODAY FOR FREE BOOK

VON SCHRADER MFG. CO.
E10 "R" Pl., Racine, Wisconsin

Without obligation send me **FREE** booklet about your **RUG DETERGER** and tell me how I can start my own permanent, profitable business.

Name _____

Address _____

City _____ Zone _____ State _____

HEAD-QUARTERS FOR ALL SPORT CAR TIRE SIZES

TIRES!

ALL FAMOUS BRANDS!

FARM TRUCK AUTO

AT LESS THAN WHOLESALE

SAVINGS NEVER LESS THAN 50% up to 70% OFF REG. PRICE!

FREE - SEND FOR YOUR FREE CATALOG - FREE!

RELIABLE TIRE DIST., 730 Morgan Blvd., Camden 4, N.J.

GOVERNMENT OIL LEASES LOW AS \$1 PER ACRE

You do no drilling, pay no taxes, may realize a king-size profit without ever leaving home. Write for free map and literature.

AMERICAN OIL SCOUTS, Dept. PM
619 Cascade Bldg. Portland 4, Oregon



DIVE FOR EXTRA MONEY TRAIN AT HOME IN SPARE TIME

Send NOW for Amazing Free Booklet

Exciting, profitable, adventurous. Even if you've never tried, if you can swim, you can become a qualified diver under this complete training program prepared by E. R. Cross, world famous master diver. Hundreds of opportunities for big profit in free lance police and salvage diving. Get the facts on this comprehensive home study course today!

FOR FREE BOOKLET. Just SEND card or letter with your name, age, and address to

DIVEMASTER

Dept. PM-111, P.O. Box 3158, Madison 4, Wisconsin

LEARN MEAT CUTTING AT NATIONAL Pay After Graduation

The steady dependable trade of Meat Cutting taught easily in 8 short weeks. YOU LEARN BY DOING under actual meat market conditions in big modern school at Toledo.

For beginners or men with experience. Get a profitable store of your own. Remember, PEOPLE MUST EAT! Big pay jobs. Free employment help. Thousands of successful graduates.

Buying, cutting, percentage, pricing, advertising, selling, etc. A complete retail meat education. National School established 38 years. Get National training now. Pay your tuition in easy monthly payments after you graduate. Send coupon for FREE 40 page school catalog — TODAY. G.I. approved.

National School of Meat Cutting, Inc., Dept. 50-Y, Toledo 4, Ohio

Send me your FREE school catalog on National Training at Toledo in Meat Cutting, Meat Merchandising and Self-Serv-ice Meats. No obligation. No salesman will call.

Name _____ Age _____

Address _____

City _____ State _____

Approved for Veterans



Learn ELECTRIC APPLIANCE REPAIR! IN SPARE TIME AT HOME

START YOUR OWN BUSINESS
 New shop-method, home-training system gives you electrical know-how that used to take years to learn.

**100,000,000 CUSTOMERS
 YOUR POTENTIAL MARKET**

Learn at home by building valuable testing kits, repairing your own and neighbors' appliances. It is not unusual for appliance repairmen to charge on the basis of \$5.00 to \$6.00 an hour!

FREE ILLUSTRATED BOOK

Shows you how you can learn at home in your spare time and pay for your training from earnings made while learning! Send for your FREE book and Special Pay Later Form.

CHRISTY TRADES SCHOOL

3214 W. Lawrence Ave. Dept. A-1303, Chicago 25.

Learn PACKAGING

HERE'S PROOF
 that Packaging means
 Big Profits to you.

FREE "No Selling Plan"
 Reveals **BIG PROFIT**
HOME BUSINESS



Make to 2500% profits supplying our nationwide sales force. No selling—all you do is package in see-through bags. Thousands full, sparetime opportunities in self service packaging, contract packaging, gift wrapping, we guide you step-by-step. Everything furnished. Learn fantastic profits you can make right in your own home

Write today for FREE "10 STEP PACKAGING PLAN" and full details. No salesman will call.
HOME PACKAGING COMPANY Dept. R-252
 2212 E. Jesse St., Los Angeles 23, Calif.



Make profits like these... on over 100,000 products you can package right in your own home. We show you how.



ART—LEARN AT HOME Enjoy glamorous high-pay career or profitable hobby. Learn Commercial Art, Painting, Cartooning, Fashion Art, Lettering, TV, etc. We train you at home, in spare time. TWO 22-pp. art outlines (worth \$25) included, without charge. **LOW COST**—only 20¢ a day. Write for **FREE** Book describing easy course. No salesman will call. **Washington School of Art, Studio 1411, PORT WASHINGTON, N. Y.** (Estab. 1914). Tear this out.



DIVING High Paid Profession! Exciting Sport!

Find sunken treasures. Mine gold under water. Amazing earnings for underwater construction work, repairs, surveys. The **DIVERS TRAINING COURSE** by leading sport and commercial divers, prepares you at home for all branches of skin and lung diving. Step by step instruction safely trains you in this fast growing field. Low tuition cost with easy pay plan includes all textbooks, individual lessons, diving lung, mask, fins, etc.; everything you need! Don't miss out on this tremendous offer for excitement and high earnings. Free information, **RUSH** name, address, age to **DIVERS TRAINING COURSE, BOX 304-E NORTHBROOK, ILL.**

BEFORE YOU INVEST IN AN EXPENSIVE HOBBY READ THESE!

Five fact-filled manuals written from your (not the mfr.'s) point of view. Can save you hundreds of dollars. All brands covered impartially—no punches pulled. • Send \$1 for all five manuals to



- Get the facts on:
- H-O Trains
 - Electric Car Racing
 - Chemistry & Microscope
 - Miniature Figures
 - Radio Control Modeling

Lee's Hobby Supplies, 2072 Front St., E. Meadow, L.I., N.Y.

HAVE FUN! **BELT BUCKLE OPENS** • Beer • Bottles • Beans **BE PREPARED**

\$2.50... \$3.00 with black or white belt. No. c.o.d., please. Dealer inquiries invited. Buckle is solid brass. Made in U.S.A. Pat. 2,807,085. Satisfaction guaranteed. Canon Co., Dept. 51, Box 1173, Beverly Hills, Calif.

**After the city,
 Before the state
 The ZONE keeps your mail
 From being late**



The Post Office has divided 106 cities into postal delivery zones to speed mail delivery. Be sure to include zone number when writing to these cities; be sure to include *your* zone number in *your* return address — after the city, before the state.

PROFIT IN YOUR SPARE TIME



FIX Small Gasoline Engines
OUTBOARD • POWER MOWER • CHAIN SAW • TRACTOR



Harry F. Peters, Spokane, Wash., says
"... your Course led me into a very
profitable and enjoyable business."

Be a small engine expert... earn
EXTRA MONEY... own your own
business. Easy-to-learn LINCOLN
Home Study method qualifies you.
Write for full particulars.

LINCOLN TECHNICAL INSTITUTE
Suite 11-E, 472 Market St., Newark 5, New Jersey

SIGN PAINTING

Home-Study Course - Only \$5.95

Teaches you commercial sign painting
and sign building as it is being done
TODAY in leading shops all over the
country. Complete practical course for
self-instruction. Shows latest methods
of truck lettering office doors, wood letters, re-
flecting signs, plastics, sprayed signs, gold leaf, silk screen
process, up-to-date alphabets, money-making business information, etc.

SATISFACTION GUARANTEED OR REFUND!

Contains all the instruction of a high-priced correspondence course.
Full price, only \$5.95, postpaid. Or C.O.D. plus postage. No risk—
order today. Satisfaction or money back! Order "Sign Painting Course"
NELSON-HALL CO., 325 W. Jackson Blvd., Dept. 2LN-2, Chicago 6, Ill.



NO JOB WORRIES

PLASTEX INDUSTRY needs manufacturers on small
scale for big production of Lamps, Clock Stands, Art
Goods, Novelties in Plastic Marble imitation. No Ex-
perience necessary. Use material makes regular 10¢
store sellers. Moulds furnished for fast production.
Small investment brings good profit. Big wholesale
orders now being placed. Ambitious men have chance
for real prosperity and job security. Our NEW FREE
booklet will interest and benefit you.

PLASTEX INDUSTRIES, Dept. A
3400 Third Ave. New York 56, N.Y.



GIANT WOLF KILLER KNIFE

SHARP, RUGGED, IMPORTED BEAUTY
ACCLAIMED WORLD OVER FOR ITS EF-
FECTIVENESS IN ANY LIFE & DEATH
SPORTING EMERGENCY. Blade is of
fine carbon steel, guaranteed to stay
razor-sharp and open everytime.
Not a switch blade knife:
no buttons or springs
to fob with. Opens
lightning-fast.
Note: One Idaho
customer claims
it saved his life
when wolf at-
tacked him.

MERCHANTS INC., 1221 S. Grand Ave., Dept. PM-11, Los Angeles 15, Calif.



7
SIZES!
Overall
lengths:
3 1/2" - \$4.70;
6 1/2" - \$4.80;
7 1/2" - \$4.95;
8 1/2" - \$5.95;
9" - \$6.95;
11" - \$7.50;
13 1/2" - \$7.95. Special! Get both
5 1/2" and 13 1/2" knives (Reg. \$12.65) only
\$10.95. Immediate delivery. Send cash, check, or
M.O. Sorry, no C.O.D.'s. Calif. res. add 4% state
tax. 10-day money back guarantee.

New Table Top Invention Puts You In... PROFITABLE RUBBER STAMP BUSINESS

Home Operators now make
\$9.20 AN HOUR in Business
once monopolized by
a few big companies

Special rubber stamps bring high
prices—cost only pennies to make
on new, low-cost table top machine.
Take 27 cents worth of material,
make perfect stamps, the kind businesses
and offices now buy by the dozen at \$1.80 each. Make up to
\$9.20 an hour. Start in spare time in your own home. Run
machine on kitchen table using ordinary electrical outlet.
Make any kind of stamp. We'll send you free information
without obligation about this established, highly profitable
business. **We'll even help finance your start.** For free
information send name and address today on a postcard to:
Rubber Stamp Div., 1512 Jarvis Ave., Dept. R-2-M, Chicago 26



NOVEMBER 1961

FREE! NEW CATALOG Big Savings... FAMOUS MAKES! ACCORDIONS



**BUY DIRECT... at
Importer-to-You Prices**
...save middlemen's profits!
5 DAY FREE TRIAL!

E-Z TERMS

Low as
\$9.95 Down
Balance...
Just Pennies
a Day

**Over 30
Standard
or Electronic
Models**
for Students
Teachers or
Professional
Musicians

**TRADE-IN
Your Old Accordion
BIG ALLOWANCE!**

SAVE UP TO 1/2
**OFF RETAIL PRICES OF
Comparable Accordions**

WORLD'S LARGEST EXCLUSIVE ACCORDION
DEALER saves you more than you ever hoped possible on new
famous-make Italian Accordions of your dreams! Because you
buy DIRECT... Importer-to-You... save up to 50% OFF
retail prices of comparable accordions. Compare our low
prices... see and judge for yourself. Rush coupon for FREE
Color Catalogs and low Importer-to-You price list. See Amer-
ica's most exciting selection... **over 30 models.** Exclusive fea-
tures! Full range of Colors! Newest styling! Get FREE
5-DAY PLAYING TRIAL IN YOUR HOME. If you decide
to keep instrument, pay for it only pennies a day on E-Z terms.
100% Satisfaction Assured. Get FREE BONUS GIFTS for
promptness... Free Home Study Course. Trade-in allowance.

FREE BONUS GIFTS for promptness in ordering

- Year's Supply of Music
- Home Study Course
- Sturdy Music Stand
- Name in Chrome Letters
- Bellows Protector
- Music Portfolio

Let us prove how much more
you save—thanks to our money
saving Importer-to-You plan.
You pay NO Teacher's or Sale-
man's commissions. We buy for
less, save on high overhead...
and pass these savings on to you.
Mail coupon today for FREE
Color Catalogs and Importer-
to-You prices. No obligation.

ACCORDION CORPORATION OF AMERICA
Dept. R-111, 2003 West Chicago Ave., Chicago 22, Illinois

FREE
Color Catalogs
... Low Direct
Importer-to-You
Prices... Rush
Coupon Now!

Accordion Corporation of America, Dept. R-111
2003 W. Chicago Ave., Chicago 22, Ill.
Rush color catalog and "Importer-to-You" prices.

Name.....
Address.....
City & Zone..... State.....
 Check if you have instrument to trade in.

37

WANTED!

Mechanically Inclined
Men to Qualify for
BIG PAY JOBS
AND SPECIAL FACTORY
TRAINING IN DIESEL



"We need qualified repairmen, operators, mechanics NOW!" say Diesel Manufacturers, Highway Builders, Truck Line Operators in every corner of America. Can you qualify for these High Pay Jobs? We can help you! Interstate's General Course and Cummins-approved Diesel home-training courses are internationally recognized. Advisory placement service for trainees. Don't wait. Men are needed NOW!

Get the Facts Today!

WRITE INTERSTATE TRAINING SERVICE

Dept. A-3, Portland 12, Oregon

Rush information on I.T.S. Diesel Courses, Special Factory Training and Diesel Job Opportunities.

Name _____ Age _____
Address _____
City _____ Zone _____ State _____

FREE
EICO

CATALOG

Build Your Own
Hi-Fi, Radios,
Ham Gear, Test Inst., — Save 50%

Get started in ELECTRONICS the easy EICO way. No technical knowledge needed to build EICO kits. Simple, step-by-step "Beginner-Tested" pictorial instructions guide you all the way. LIFETIME service & calibration guarantee. Mail coupon now!



EICO, 33-00 Northern Blvd., L. I. C. 1, N. Y.
Please send FREE catalog & name of local dealer.

PM-11

Name _____
Address _____
City _____ Zone _____ State _____

WELD - BRAZE - SOLDER - CUT

REPAIR MOST EVERYTHING MADE OF METAL

Home Appliances, Auto parts, lawn chairs, tables, ornamental iron work, gates, wagons, etc.



Solder, heat, bend, and straighten, with terrific heat from arc torch. Cut and weld up to 1/2" steel plate. A million uses for Home, auto, farm, inventors, factories, etc. Works from any home 110 volt plug-in. Complete with dark welder's mask, arc torch, supply of carbon steel welding and brazing rods and complete Welding Instruction Book. 1 year guarantee. (cash, ck, mo.) and pay postman \$11.95 plus \$3 COD postage on arrival or send \$14.95 and we will send postpaid. Ideal gift for mechanically minded, relatives, friends. Order now. Available only from:

MIDWAY WELDER, Dept. DPM-11, Kearney, Neb.

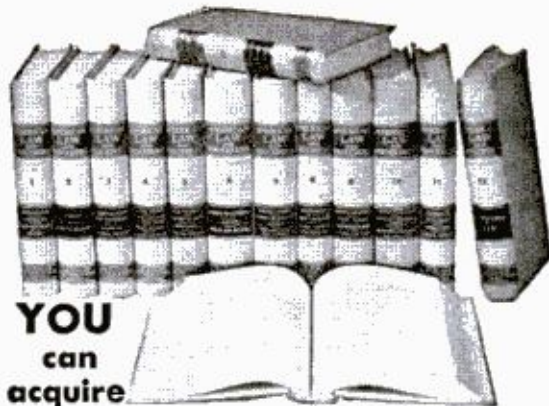

YOU
can
acquire

LAW AT HOME!
EARN LL.B. DEGREE

Legally trained men win higher positions and bigger success in business and public life. Greater opportunities now than ever before. We guide you step by step. You train in spare time. Degree of LL.B. We furnish all text material, including valuable 14-volume Law Library. Low cost, easy terms. Get full details. "Law Training for Leadership" and "Evidence" books FREE. Send NOW.

Accredited Member, National Home Study Council.
LASALLE EXTENSION UNIVERSITY, 417 South Dearborn Street
A Correspondence Institution Dept. 1164L Chicago 5, Ill.

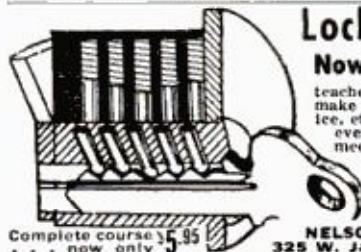

Locksmithing AND KEY MAKING

Now Made Easy! Practical up-to-date course

teaches you how to pick locks, de-code, make master keys, repair, install, service, etc. New self-instruction lessons for every handyman, homeowner, carpenter mechanic, service station operator, fix-it shop, hardware dealer, gunsmith. 53 easy illustrated lessons. Full price only \$5.95 postpaid; or C. O. D. plus postage. Satisfaction or refund guaranteed.

NELSON-HALL CO., DEPT. LN-2
325 W. Jackson Blvd. Chicago 6, Ill.

How Many Wear FALSE TEETH With Little Worry

Eat, talk, laugh or sneeze without fear of insecure false teeth dropping, slipping or wobbling. FASTEETH holds plates firmer and more comfortably. This pleasant powder has no gummy, gooey, pasty taste or feeling. Doesn't cause nausea. It's alkaline (non-acid). Checks "plate odor" (denture breath). Get FASTEETH at drug counters everywhere.



"Nothing over that way but a girls' camp, Ed."

Just a Few Months NEW and Already One of the **HOTTEST** Money-Makers for Men Everywhere—even Spare Time!

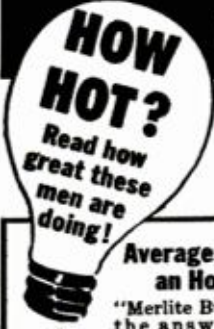

MERLITE Longer-Life Light Bulbs—the Only Bulbs in the World Backed by this SENSATIONAL GUARANTEE:

ONCE YOU BUY MERLITE LIGHT BULBS—YOU NEVER HAVE TO BUY BULBS AGAIN—NEVER!

Daring NO-TIME LIMIT FREE REPLACEMENT GUARANTEE
Does the selling **FOR YOU—MAKE** up to **\$1,000.00** in a **MONTH!**

It's fantastic—14 magic words (**ONCE YOU BUY MERLITE LIGHT BULBS—YOU NEVER HAVE TO BUY BULBS AGAIN—NEVER!**) are making it easy for men everywhere to make a "small fortune"—as much as \$1,000.00 and more in a month, spare time or full time! No demonstrations, no fast-talking sales pitch needed. Almost everyone jumps at the chance to buy Merlite Bulbs with the iron-

clad Guarantee (packed with each bulb) that unconditionally offers to replace **FREE** any burned-out Merlite Bulbs, no matter when they burn out—in 5 years, 10 years—**NO TIME LIMIT!** And the Guarantee applies to all Merlite Bulbs purchased or replaced! Every home needs 12 to 24 Merlite Bulbs to replace old-fashioned short-life non-guaranteed bulbs. Make up to 120% profit, easily make \$50 in few spare hours. Merlite men are doing this now!

Averages \$12 an Hour
"Merlite Bulbs are the answer to a salesman's prayers. They're fantastically easy to sell. Working only part time, I have averaged \$12.00 per hour."
Philip Smith, Maine

Sold 178 Bulbs First Afternoon
"The first afternoon I sold 178 bulbs. Am very pleased with reception we get from customers. Please ship my next order at once."
W. E. Foust, Arkansas

Makes \$8.20 an Hour in Just Spare Time
"These guaranteed Merlite Bulbs surely sell. I've averaged \$8.20 per hour for the time I've spent with them. That makes a nice income and wish I could give full time to the job."
L. C. Benedict, Virginia

FREE Money-Making Details
Amazing No-Risk Offer

Find out for yourself how much money you can make with the sensational Guaranteed Merlite Long-Life Light Bulb. We'll send you—**FREE** and without obligation—complete money-making Illustrated Sales Outfit and an astounding offer which helps you get started making money without risking a penny. Mail coupon **TODAY!**

Merlite Industries, Inc., Dept. C-15L
(Bulb Div.) 114 East 32nd Street, New York 16, N.Y.

Merlite Industries, Inc., (Bulb), Dept. C-15L
114 East 32nd Street, New York 16, N. Y.

Rush complete money-making illustrated Sales Outfit and No-Risk Starting Offer—**FREE** and without obligation.

Name _____

Address _____

City _____ Zone _____ State _____

In Canada: Mopa Co., Ltd., 371 Dowd St., Montreal 1, P.Q.

Wooded, High-ground
HOMESITE (70 x 150)
on **CAROLINA Coast!**

\$500 DOWN \$500 A MONTH

14,000 acres—50 freshwater lakes
... 40 miles of finished roads
... fishing, hunting, golf.

FREE LITERATURE!
BOILING SPRING LAKES, Southport 15, N. Car.

BRONZE FOUNDRY

Since 1935
Schools • Home Workshops • Inventors
Make your own castings of aluminum, copper, bronze, silver. Foundry sets are available in six sizes, capacity 1½ lb. to 48 lb. of red brass. 2400 Deg. F. blast furnace included with each. Write for Free Circular.

KANSAS CITY SPECIALTIES CO.
DEPT. P-11
N. ARYSVILLE, KAN.

PELLET FIRING LUGER AUTOMATIC

- MAGAZINE LOADING CLIP
- OVER 15 MOVING PARTS
- FULLY AUTOMATIC

ONLY \$198

Automatic full size model of a Luger Automatic pistol—contains over 15 moving parts. Loads 8 complete rounds which snap into the hard butt simulating a Luger. Fires 8 bullet shaped pellets. Has automatic slide action.

MOST AUTHENTIC MODEL GUN WE'VE EVER SEEN
Comes to you with working parts disassembled with cleverly engineered springs, full instructions, supply of pellets and specially designed belt holster. Full Money Back Guarantee. Simply send \$1.98 plus 27c shipping charge or order C.O.D. From:
HONOR HOUSE PROD. CORP., Dept. LL-68, Lynbrook, N. Y.

ELECTRONICS

Train in the new shop-labs of the world famous

COYNE ELECTRICAL SCHOOL
on a quarter of a million dollars worth of equipment or learn at home in your spare time with Coyne's modern television training.

Use this coupon to get our **FREE BOOK "GUIDE TO CAREERS"**

COYNE ELECTRICAL SCHOOL training at Coyne training at home
1501 W. Congress Pkwy. Dept. of Electronics 41-W Chicago 7, Ill.

NAME _____
ADDRESS _____
CITY _____ STATE _____

Unlike most other schools, we do not employ salesmen.

Accounting —

A STEPPING STONE TO TOP INDUSTRY POSITIONS

by B. Richard

Presidents of many of the largest corporations in the country have risen to their present responsible positions through the field of accounting.

More and more in evidence is industry's demand for highly trained accountants to help plan new record keeping systems and procedures for use with electronic data-processing equipment, which is coming into ever wider use. Companies all over the country are making greater use of accounting information in their business practices.

Complex tax systems and the growth in size and number of publicly held business corporations are contributing factors to the importance of accountants in today's business world.

With these factors in mind, it's easy to see how beginning accountants with the necessary training can progress to chief accountants, senior auditors, controllers, treasurers and, in many cases, corporation presidents.

Industry is not alone in offering opportunities for trained accountants. The government, for example, employs many accountants to work on financial records of government agencies or business firms subject to government regulation. Government accountants are also often assigned as internal revenue agents, investigators and bank examiners.

Public accounting also provides a wealth of opportunity to the trained accountant, and about one-third of all accountants are in this field. Public accountants or public accounting firms offer their services to individuals or companies on a fee basis. Beginning accountants in this field advance as their experience and ability grows in dealing with top executives in other companies.

Public accountants can become managers, supervisors or partners in the accounting firm for which they are working.

Accounting is the second largest field of professional employment for men. A 1958 survey revealed that there were almost 400,000 accountants and auditors working in this country. Of this total, about 60,000 were certified public accountants who had passed comprehensive examinations and met the educational and experience requirements of their states.

While there is a fine opportunity for men in all types of accounting, the untrained accountant is likely to be assigned a routine job with little chance for promotion. A college education is not a prerequisite for a successful accounting career and most states have no specific educational requirement even for CPA candidates, but a thorough education in accounting principles, methods and techniques is essential for rapid advancement.

For this reason, many accountants have found of particular value correspondence courses and part-time educational courses offered by private institutions. Correspondence courses and part-time classroom work have been responsible for the advancement of literally thousands of accountants throughout the country.

Even highly trained accounting specialists have found that educational courses offering training in new or different types of accounting are a big help in broadening advancement potential.

Correspondence training has been of special value in preparing skilled accountants for their CPA examinations. This examination, provided by the American Institute of Certified Public Accountants, is

used in all states and must be passed before accountants can call themselves "certified public accountants."

The advantage of correspondence training and part-time classroom work is that full-time jobs can be held while this extra education is in progress. In this way there is no interruption of earnings and family men can train to take advantage of the extra earnings that accounting offers.

Another advantage of accounting is that employment opportunities exist in all parts of the country. The greatest number of accountants are employed by private industry and wherever industry is located, accounting opportunities usually exist. In the past, public accounting was restricted primarily to major metropolitan areas. This is changing, both because accountants with public accounting firms are going into business for themselves in new areas, and because large companies continue to open branch offices in smaller communities.

Starting salaries for inexperienced accountants vary according to the training and preparation undertaken by the beginner. Recent surveys show that it is possible to start at \$450 per month and that salaries of accountants with five years of experience are about 50 percent higher than the starting rate. Able accountants usually advance rapidly, and there is no limit on their earning power as they progress into management positions.

For more information on accounting and other important fields of employment, write for Popular Mechanics career-guidance booklet **SKILLS for AMERICA**. Write to Popular Mechanics, Department SFA, 200 East Ontario Street, Chicago 11, Illinois.

MEN PAST 40

**Afflicted With Bladder Trouble,
Pains in Back, Hips, Legs,
Nervousness, Tiredness.**

If you have these troubles, particularly bladder trouble, then your condition may be traced to Glandular Inflammation . . . a constitutional disease. Neglect of this condition often leads to premature old age and sometimes incurable malignancy.

The Excelsior Medical Clinic has a **New Free Book** that tells how thousands of men have been successfully treated here at Excelsior Springs for Glandular Inflammation by **NON-SURGICAL Methods**. They found soothing relief and a new outlook in the future of life.

This **Free Book** may prove of utmost importance in your life. Write Today. There is no obligation. Excelsior Medical Clinic, Dept. B6129, Excelsior Spgs., Mo.

Schober
**captures
magnificent
pipe organ
tone
in a tiny
electronic
tube.**

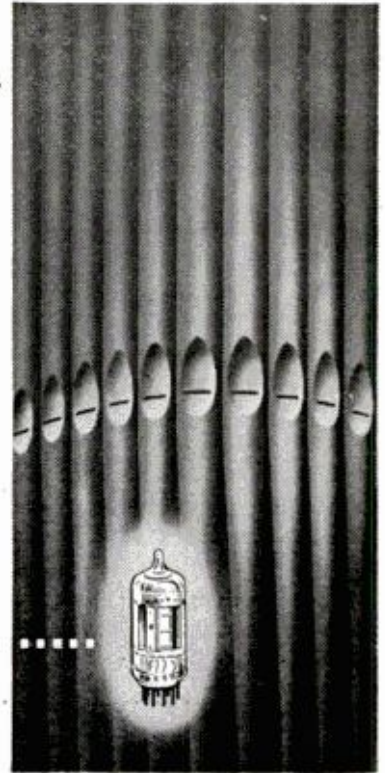

Here is magnificent Pipe Organ tone; tremendous tonal color range; two 61-note pipe-organ keyboards; hand-rubbed cabinetry in the finish of your choice. Taken together they comprise a superlative electronic instrument comparable to organs selling for \$2,500 to \$6,000.

Yet, when you assemble the Schober of your choice, you save more than half the normal cost and create a superb instrument to bring the delightful gift of music to your family.

Work requiring knowledge and experience is eliminated. All that remains is the pride and pleasure of watching a fine musical instrument take shape under your own hands. The Schober organ you assemble will equal or surpass any factory-built organ for quality, reliability and circuitry.

The coupon brings you full details on how you can start building the Schober of your choice with an investment of as little as \$18.95. In addition, you may have an exciting 10" LP record demonstrating Schober's full range of tones and voices. The \$2 charge for the record is refunded when you order your starting kit. No salesman will call.

THE SCHOBER ORGAN CORPORATION
Dept. PM-6, 43 West 61st St., N. Y. 23, N. Y.



The Schober Organ Corp.,
Dept. PM-6
43 West 61st St., N.Y. 23, N.Y.

Please send me FREE full-color booklet and other literature on the Schober organ.

Please send me the Hi-Fi demonstration record. I enclose \$2 which is refundable when I order my first kit.

name _____

address _____

city _____ zone _____ state _____

**ENGINEERING
SCIENCE
MATH**

**DEGREE IN
27 or 36 MOS.**



B.S. degree — 36 mos. • B.E. degree — 27 mos.

ACCELERATED YEAR-ROUND PROGRAM prepares for early employment in fields of SCIENCE AND ENGINEERING. Regular 4-year program for B.S. Degree completed in 36 months, special engineering degree program in 27. Classes start—January, March, June, July, Sept. QUALITY EDUCATION. Graduates employed from coast to coast. Government approved for veteran training. Students from 50 states, 40 countries, 20 buildings; dorms, gym, campus. SAVE TIME AND MONEY. EARN BOARD while studying. Write for catalog and complete information.

INDIANA TECHNICAL COLLEGE

5111 E. Washington Boulevard, Fort Wayne 2, Indiana

Please send me free information on Bachelor's Degree Programs in Engineering and Science as checked below:

- | | |
|---|--|
| <input type="checkbox"/> Aeronautical Engineering | <input type="checkbox"/> Mechanical Engineering |
| <input type="checkbox"/> Chemical Engineering | <input type="checkbox"/> Metallurgical Engineering |
| <input type="checkbox"/> Civil Engineering | <input type="checkbox"/> Physics |
| <input type="checkbox"/> Electrical Engineering | <input type="checkbox"/> Chemistry |
| <input type="checkbox"/> Electronic Engineering | <input type="checkbox"/> Mathematics |

Name.....

Address.....



FREE

**MUSCLE BUILDING
INFORMATION**

Sensational New Methods

Less Time—Less Effort—Better results

BODY-TONE, Box 638, North Miami 61, Fla.

**T-V[®] LAMP
CLOCK**

with FOCALIZED "STARE-BREAK" relieves
Eyestrain from constant TV stare and glare



**"TIME
AT A
GLANCE"**

**Model 710
WALNUT**

\$11⁹⁵

1 YEAR GUARANTEE

This T-V Lamp Clock is wholly new in concept! Fully automatic self starting electric clock . . . calculating and registering every second, minute, 10 minute and hour. Big, bold, easy-to-read "Time at a Glance" Colorama numerals. Glolite luminescent face GLOWS IN THE DARK. Has a comforting night light for bedroom or nursery controlled by independent switch. Plastic case. 5³/₈"H, 6"W, 3¹/₂"D. UL approved motor and cord. 110V, 60 cy., AC. Plus applicable tax. Dealer Inquiries Invited.

At Your Local Dealer or ORDER DIRECT from

PENNWOOD NUMECHRON CO.

7249 FRANKSTOWN AVE.

PITTSBURGH 8, PA.



No More Huff and Puff, Dad

Plugged into the cigarette lighter of a car with a 12-volt system, a lightweight air pump inflates beach toys, mattresses and other air-filled items. It's available for \$9.95 from Seven Hills Distributing Corp., 121 King St., San Francisco, Calif.

**Memory Molds and
Plastic Cocoons**

for baby shoes, Junior's first fish, carvings, tools, fishing reels—almost any small object you want to treasure or protect. You can make such molds easily with the unique vacuum forming machine—costing less than \$5—shown in the

**December
Popular Mechanics**

\$1 BRINGS YOU \$18

Discover Flok-Kraft and Earn \$\$\$\$\$ AT HOME

Earn up to \$15.00 per hour spare time. Amazing new Velvet-fiber spray instantly makes any object (Lamps, Radio & TV Cabinets, Figurines, Signs, Auto dash boards, toys, furniture, draperies — anything!) worth expensive \$\$\$\$\$ Prices . . . like magic, you can spray anything with this beautiful new suede-like finish that feels like rich Velvet.

EARN UP TO \$300.00 PER WEEK SPARE TIME

Imagine, materials cost only 3c per square foot. (Average TV or radio cabinet can be beautifully sprayed with this startling new 3-dimensional Velvet finish in 15 minutes at a cost of only 34c in materials. Your charge for this job is at least \$10.00.)

REPRESENTATIVES IN YOUR AREA URGENTLY NEEDED

Own your own business. Work at home in your spare time. Help fill the huge growing demand for this amazing new beautiful Velvet-fiber finish. Orders come from stores, offices, homes, architects, auto dealers, — everywhere. Possible \$20,000,000.00 worth of jobs to be done. Investigate today—be first in your area! Actual samples in 16 Radiant Colors, Booklet of 50 Home Business Opportunities and Confidential Details all sent free! Send No Money. Write: Coast Industries, Los Angeles 61, Calif., Dept. B-11.

● ● ANALYZE HANDWRITING

MORE INCOME . . . MORE PRESTIGE and Greater PERSONAL Success!

YOU CAN learn how to identify character and personality traits from ordinary handwriting. Fascinating home-study training. Many career opportunities for both men and women, full or spare-time. Just send your name, address for a FREE sample lesson and big illustrated catalog Free. No salesman will bother you. (State age).

INTERNATIONAL GRAPHO ANALYSIS SOCIETY, INC.
325 W. Jackson Blvd., Dept. LN-2, Chicago 6, Ill.



MECHANICAL DENTISTRY



Easy practical way to learn mechanical dentistry at home in spare time. FULL EQUIPMENT OF TOOLS AND MATERIALS INCLUDED WITH COURSE. Low tuition. Easy terms. Write for FREE BOOK about this money making profession that is not affected by machine age.

McCARRIE SCHOOL OF MECHANICAL DENTISTRY
207 N. Broad St., Dept. 117, Philadelphia 7, Pa.

Free!



BRAND NEW
**LAFAYETTE
ELECTRONICS**
1962
CATALOG 620

It's Bigger and Better Than Ever!

340 giant-sized page catalog from the world's leading supplier of electronics and stereo hi-fi equipment.

340 PAGES

It's a complete shopping center for audiophiles, technicians, engineers, students, hobbyists, servicemen and dealers. Thousands of items at lowest money-saving prices — featuring LAFAYETTE KITS . . . the best value for your money any day.

SPECIAL! NO MONEY DOWN

with Lafayette's NEW EASY-PAY PLAN.

MAIL THE COUPON TODAY FOR YOUR FREE CATALOG

LAFAYETTE LOCATIONS

JAMAICA • BRONX • NEW YORK CITY
NEWARK • PLAINFIELD • PARAMUS • BOSTON

Lafayette Electronics Dept. LK2-1
P.O. Box 190, Jamaica 31, N. Y.
Send me the FREE 340-pg. 1962 catalog 620.

Name _____
Address _____
City _____ Zone _____ State _____

The Construction Industry needs RUGGED MEN!

Earn HIGH WAGES as either

DIESEL HEAVY EQUIPMENT OPERATOR

High wages and future security are yours as a Heavy Equipment Operator. Learn to operate diesel bulldozers, scrapers, cranes, etc. Actual field training at National, the original school of heavy equipment operation teaches you how. VA approved. Budget terms available.



MEN AGES
17 to 56

DIESEL HEAVY EQUIPMENT MECHANIC

Put yourself in demand by today's booming construction industry! Highly-paid trained diesel mechanics are needed to keep equipment rolling. Learn to be a Heavy Equipment Mechanic at National, where field and shop training is on actual equipment under job conditions. Budget terms available.

No correspondence courses, no series of required home study lessons in advance of training.

Mail coupon NOW for
FREE Catalog
NO OBLIGATION . . . NO SALESMAN WILL CALL

Previous education no barrier

NOVEMBER 1961

NATIONAL SCHOOL OF HEAVY EQUIPMENT OPERATION

Dept D-22, P. O. Drawer 1686, Charlotte, N. C.

Please send me FREE, without obligation, illustrated school catalog and complete information about how I can become a

(please check which career) Heavy Equipment Operator

Heavy Equipment Mechanic

Name _____ Age _____

Address _____

City _____ Zone _____ State _____

ENGINEERING

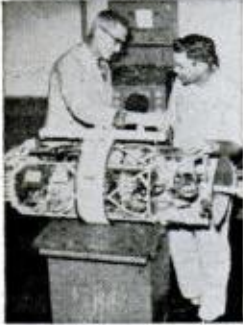

Heald's Micro-wave and Radar Laboratory Equipment.

ENROLL NOW FOR NEW TERM

HEALD Engineering College

Van Ness at Post, Dept. PM San Francisco, California

NAME _____
 STREET _____
 CITY _____ STATE _____

AMERICAN INDUSTRY NEEDS TRAINED ENGINEERS NOW
BACHELOR OF SCIENCE DEGREE, 30 MONTHS

SAVE 2 YEARS' TIME

B.S. Degree Courses:

- Electronic Engineering
- Mechanical Engineering
- Electrical Engineering
- Civil Engineering
- Architecture

Diploma Courses:

- Radio-Television Plus Color **TECHNICIAN**
- Architectural Drafting
- Electronic Technician
- Mechanical Drafting
- Structural Drafting

APPROVED FOR VETERANS

Send for **FREE** Information

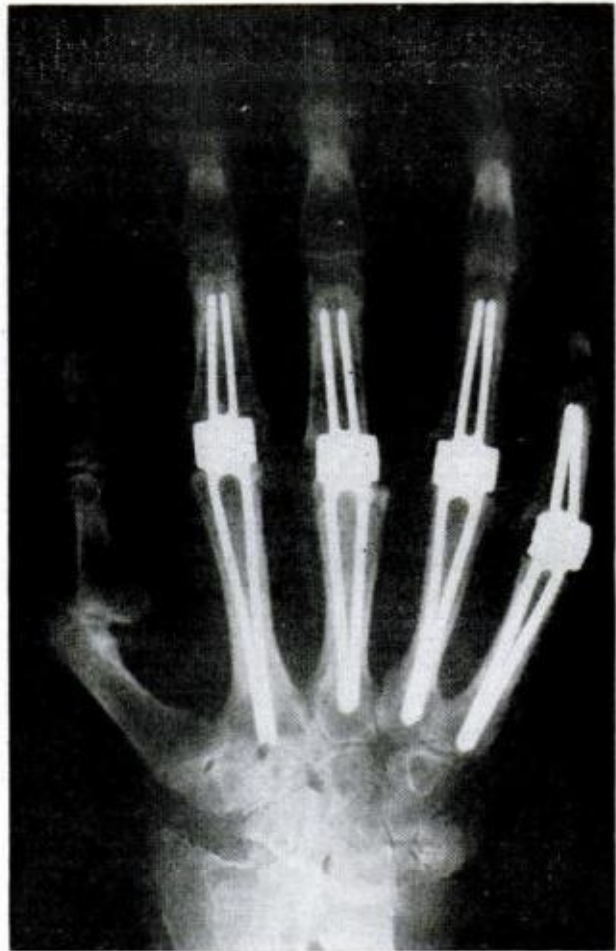

Stiff Fingers Get Steel Joints

Fingers of some arthritis sufferers have been restored to activity—even after being crippled for as long as 10 years—at University of Iowa Hospitals, Iowa City.

In an operation that is suitable for only a small percentage of persons crippled by rheumatoid arthritis, a surgeon substitutes joints of stainless steel for joints crippled by disease.

The experimental technique has been tried on 41 patients with some dramatic results. One woman who for 10 years could not so much as wring out a washcloth had five joints replaced. She now can crochet.

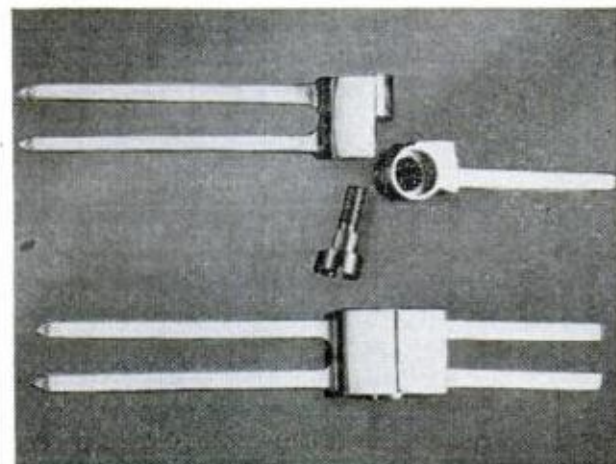

You can make money in

WATCH REPAIR

Learn at home the low cost Sweazey Way

Watch repairing pays up to \$6 an hour, part time watch makers report on survey. Unique and modern Sweazey home study System starts you making repairs right away on Swiss and American watches. Professionally prepared training. No previous experience needed. Special tools provided for practice. Tuition only \$5 a month. Diploma Awarded. Free sample lesson and opportunity book give all facts. Write today. No obligation.

CHICAGO SCHOOL OF WATCHMAKING
 2330 N. Milwaukee Avenue, Dept. 1111, Chicago 47, Illinois

FREE BOOK and SAMPLE LESSON

CHICAGO SCHOOL OF WATCHMAKING
 2330 N. Milwaukee Ave., Dept. 1111, Chicago 47, Illinois
 Please rush **FREE BOOK** and Sample Home Study Lesson.

Name _____ Age _____
 Address _____
 City _____ Zone _____ State _____

SAMURAI SUICIDE WARRIORS KARATE!
JUDO BOXING! MUSCLEBUILDING! YOGA!
STRONGMAN STUNTS! STRENGTH & ENDURANCE! HANDBALANCING! ETC.

YOU GET ALL THESE! *20 Illustrated KARATE FOR ONLY
 RATE blows *SAVATE foot fighting *Secret NERVE CENTER and ANATOMY charts *20 lethal JUDO throws *20 terrific STRONGMAN STUNTS *Complete MUSCLE-BUILDING program *Ancient YOGA secrets *HANDBALANCING stunts *Complete BOXING program Secrets of ENDURANCE *All picture packed. Super wall charts. (surplus 1960 printing). No C.O.D.'s. Canadian orders 50c.

35¢

K-MAN Huge KARATE PRACTICE DUMMY. Life like! Shows attack points, weak spots. **FREE** you get the lot!
 Oxford Studio, 44M Bromfield, Boston, Mass.

LEARN TO EARN



HIGH WAGES
AS A HEAVY EQUIPMENT
OPERATOR OR MECHANIC

- WORLD'S ONLY CONTRACTOR OWNED AND OPERATED SCHOOL
 - MODERN EQUIPMENT, HIGHLY QUALIFIED INSTRUCTORS
 - V.A. APPROVED FOR GI TRAINING

Learn to operate bulldozers, draglines, cranes, back hoes, scrapers and motor graders **ON ACTUAL CONSTRUCTION PROJECTS!**

Learn by doing . . . no impractical correspondence courses.

WESTERN SCHOOL OF HEAVY EQUIPMENT OPERATION

DEPT. B-16, BOX 510
WEISER, IDAHO
PHONE 910



WRITE TODAY FOR FREE SCHOOL CATALOG

Member American Road Builders Association
Associate Member Associated General Contractors

DRAINS cellars, cisterns, wash tubs; **\$7.95**
IRRIGATES - CIRCULATES - SPRAYS



1,001 uses. Stainless shaft. Won't rust or clog! Use 1/6 HP motor or larger . . . 3/4 HP for up to 2,400 GPH; 450 GPH 80" high; or 1800 GPH from 25' well. 1" inlet; 3/4" outlet. Coupling included free. **\$7.95.**
HEAVY DUTY BALL-BEARING PUMP. Up to 5,200 GPH; or 3,000 GPH from 25' well. 1 1/4" inlet; 1" outlet. **\$12.95**
Postpaid if cash with order. **MONEY BACK GUARANTEE**
Centrifugal and Gear Pumps in All Sizes
LABAWCO PUMPS, Belle Mead 7, New Jersey

Order your **FREE** copy of . . .
What You Should Know About Patents

Comprehensive information on patents and how to secure a patent. Write Popular Mechanics, Bureau of Information, 200 E. Ontario, Chicago 11, Ill.



RADIO SHACK ELECTRONIC CATALOG
Plus Every New Supplement For Next 12 Months!

- Giant book is 2/3 bigger than last year! Brims with values!
- Stereo, Hi-Fi, Ham Radio, Tapes, Records, Parts, 30 pages Kits.

MAIL COUPON TODAY

RADIO SHACK Corp.
730 Commonwealth Ave., Boston 17, Mass.

Send Radio Shack's famous electronics catalogs for one year—FREE and POST-PAID.

Your Name _____ 61L3B

Your Address _____

City and Zone _____ State _____

For a Friend _____

Address _____ 61L3B1

City and Zone _____ State _____

Free! Midget Racer



Nothing to buy. Nothing to sell. Nothing to pay. No obligation. No contest to enter. **YOU** can win this beautiful 1-passenger motor-driven Marx Racer complete with motor. Fun & Thrills riding around town!

Just send coupon. **Drawing Dec. 24, 1961** by reputable judge. Winner will be notified immediately and car will be shipped complete, prepaid, and announced in future issue.

You can win as easily as anyone else! **Only open to readers of this issue of Popular Mechanics.** One entry coupon per person.

Why We Make this Amazing Offer

We want **YOUR NAME** on our mailing list to receive special offers of unusual novelties, gadgets, jokes, tricks, timesavers, science, gifts, etc.



New 1962 Catalog of 2700 Novelties, Gadgets, Tricks, Etc. Now Available!

If you do not have our big catalog, check box on coupon and enclose 10c.

Mail Coupon Today To:

Johnson Smith Co., Dept. 148, Detroit 7, Mich.

Include my name in your mailing list to receive winner **ENTIRELY FREE!**

Name _____
Address _____

Check here & include 10c for New 1962 edition of World's Biggest Novelty Catalog.



ELECTRIC

APPLIANCES

PAYS \$3 TO \$5 AN HOUR
Spare Time, Full Time • Learn at Home

FREE BOOK offered below shows how **YOU** can now have a good-paying business of your own, right in your home. No experience needed, just simple tools. Learn to repair Electric Appliances. Pays \$3-\$5 an hour!

400 MILLION Appliances are in American homes right now. **76 Million MORE** bought each year. People need them fixed, good times or bad. **YOU** make good money doing it. In your base-

ment, garage, even on your kitchen table.

QUICK WAY TO GET STARTED
For less than 20¢ a day our easy, pictured instruction — backed by 45 years of success in home training — prepares you for top earnings in this booming field. Earl Reid of Thompson, Ohio says: "Made \$510 in one month spare time. NRI course is priceless." At no extra charge you even get all parts for your own Appliance Tester, too. Finds trouble-spots, speeds and checks your work.

Get your **FREE Book** and **FREE Sample Lesson!** Mail coupon below, letter or post-card, now.

FREE BOOK

FREE LESSON

NATIONAL RADIO INSTITUTE, Appliance Division
Dept. AM1, Washington 16, D.C.

Send **Free Book, Free Appliance Repair Course Lesson.** Am interested in:

Spare Time Earnings My Own Business
 Better Job

Name _____

Address _____

City _____ Zone _____ State _____

Accredited Member National Home Study Council



**I Thought I'd NEVER
Learn to Draw!**

**But it's EASY
NOW..**

with the
**FAMOUS SYSTEM OF
MANUAL TRAINING.**
E. G. N., L. A., Calif.

* Continental Schools trains you with a Completely New Concept in Art Instruction at Home. * Cartooning offers men and women a wide field rich in opportunities to make good money. * Advertising Agencies, Art Studios, T.V. and Movie Animators, Greeting Card Mfrs., Publishers, and thousands more... looking for new talent to fill the demand for cartoons needed in every field of visual communication. * There is nothing that man has ever conceived which was not drawn first. * No matter how difficult you have found drawing before, you will be amazed at the progress made with the FAMOUS SYSTEM OF MANUAL TRAINING. Enter this fascinating field... work at home like many top artists do... full or part time. Get out of life all the finer rewards reserved for the Cartoon Artist. * Investigate the opportunities in this lucrative and dynamic industry! Send for FREE information TODAY! No salesman will call, no obligation. **CONTINENTAL SCHOOLS, Inc.**
DEPT. E-56, 4201 S. BROADWAY, LOS ANGELES 37, CALIF.

Continental Schools, Inc., Dept. E-56
4201 S. Broadway, Los Angeles 37, Calif. | Please rush free information

NAME _____ AGE _____
ADDRESS _____
CITY _____ ZONE _____ STATE _____



AVIATION CAREER

SPECIALIZED EDUCATION / PROFESSIONAL TRAINING... only 16 months to 2 years

Top-pay prestige positions, bright future in aviation. Job opportunities waiting for you as soon as you're ready. Airframe and Powerplant Technician, Aeronautical Engineering 4-year course, Business or Executive, Pilot. Classes in Miami.

SEND FOR FREE 80-PAGE BOOK

Embry-Riddle Aeronautical Institute
Dept. B Miami, Florida (Founded 1926)

Name.....
Address.....
City.....Zone.....State.....

"\$7,108⁵⁰ NEW!"



**FIRST YEAR
Cleaning-
Repairing
RADIATORS."**

—Hank Konter, Newcastle, Wyo.
Make \$6,000-\$9,000 a year servicing auto-truck-tractor radiators with Inland's new 1-Piece Radiator Shop. Easy to do entire job—TEST, CLEAN and REPAIR radiators. Only 11' 7" long. Inland, world's largest radiator equipment manufacturer, trains you free. Small down payment starts you. Easy-pay plan lets you pay from profits. Proved merchandising assures volume. Profitable department for garage or service station. Many set up Radiator Shop in garage at home, make good money working evenings. Write.
INLAND MFG. CO., Dept. PM-11, 1108 Jackson St., Omaha 2, Nebr.

SAVE MONEY... EARN MONEY
with the **METL-FORMER**

ROLLS • FORMS • BENDS



Make screen door guards, wall hangings, plant shelves, room dividers... anything you want in light wrought metal and with a truly professional appearance. Form rod, tubing or flat metal.

\$34⁹⁵ PREPAID
including material

Write for information and free project folder.
SWAYNE, ROBINSON & CO.
Dept., A, 228 E. MAIN ST., RICHMOND, IND.



DAN LURIE
World's Most Famous Body-BUILDER, TV Strongman

**A BODY LIKE MINE
IN SHORT TIME with famous
DAN LURIE BARBELLS!**

SEND FOR NEW GIANT CATALOG

Factory Prices	Cast Iron	Semi-Steel	\$9.48 Plus Free \$10 Course
60 lb. Set.	..\$9.48.	..\$10.48	
100 lb. Set.	..15.98.	..18.98	
150 lb. Set.	..23.48.	..27.48	
Extra Wts. .16c lb.	..18c lb.		

MONEY BACK GUARANTEE—Send 50% in check or money order F.O.B. Plant Brooklyn, New York, Balance C.O.D.

DAN LURIE BARBELL CO. 1661-M11 Utica Ave., Dept. 59N, Brooklyn 34, N. Y.

Own Profitable Home Business in...

Mosaic TILE **FREE BOOKLET**

Free Brochure shows how to go into this year around business. Big profits making Sewing Trays, Jewel Boxes, Bric-a-Brac Shelves, Sewing Boxes, Table Pieces—customers come to you. Complete Business Outfit tells how to sell to Department Stores, Variety Stores, Gift Shops. Use in homes, for walls, table tops, floor patterns. Finest quality imported tile—Gold Fleck Patterns, Diagonal Square Designs, Block Random Patterns, Clover Leaf, Pebble Stones—also Trivets, Glue, Grout—all at Wholesale Prices. No previous experience necessary—with our visual aid training you learn to do professional looking work in 2 or 3 hours. Start earning right away. Get facts now—write today for full information. Stark's Distributing Corporation, 1601 So. Canal St., Dept. PM-111, Chicago 16, Ill.



"Who said your new saw wouldn't go through a nail?"

POPULAR SHOPPING

Popular Mechanics Product Shopping Guide

worth
writing
for...

Storage-battery care is covered thoroughly in a free 32-page booklet. General principles and specific how-to information on testing, charging, storing, and other areas are discussed in "Facts About Storage Batteries." Write Exide Sales, P.M. 61, The Electric Storage Battery Co., P.O. Box 6266, Cleveland 1, Ohio.

Cut razor blade costs
by two-thirds with
LEDUC Sharpener

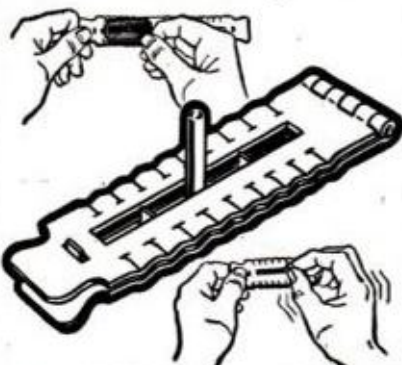

Now, even using the most inexpensive double edge razor blades, you can get the slickest, smoothest shaves ever! And get up to 20 or more extra shaves with each blade! LeDuc is the answer to shaving comfort and economy.

Simple to operate, LeDuc sharpeners also burnish—smooth out those invisible rough spots and coarse edges that burn and scrape the skin. LeDuc sharpeners pay for themselves over and over again—renew used blades in seconds. Last a lifetime. Chrome plated steel is indestructible and completely sanitary.

Only \$200 Postpaid

LeDuc, Incorporated
2531 Minnehaha Avenue
Minneapolis 4, Minnesota

Knot tying is the subject of a free 32-page booklet that can teach you what knot to use when, and how to tie it. Easy instructions on more than 20 knots plus other information about using rope. Ask for "Useful Knots and How to Tie Them" from James Bliss & Co., Inc., Wharf 51, 342 Atlantic Ave., Boston 10, Mass.

Refinishing furniture when it is marred makes the job more difficult than usual. A free pamphlet lists 11 steps that will

produce a like-new finish. Ask for "How to Refinish Marred Furniture" from Minnesota Mining and Manufacturing Co., Box NM 1600, 900 Bush Ave., St. Paul 6, Minn.

Files—the workshop variety—are discussed in the large, 64-page booklet "File Philosophy." It covers the steps in making a file, the various types and their applications, and how to use them properly. Available from Nicholson File Co., Box FFPM, Providence, R. I.

115 Volt, 60 Cy., Continuous Duty
SINGLE PHASE
A.C. GENERATORS
BRAND NEW SURPLUS, SAVE \$\$\$



750 WATT
Gov't Cost \$115.00
\$59.50
FOB

1000 WATT
Gov't Cost \$150.00
\$79.50
FOB

2500 WATT
Gov't Cost \$285.00
\$125.00
FOB

Fully Guaranteed

Permanent or stand-by unit for electricity IDENTICAL to house current. Perfect for farms, camps, aboard ship, oil fields, mines, etc. Easily handles lights, refrigerator, deep freeze, oil burner, radio; power for saws, floodlights, drills, pumps, etc.

All ball bearing. Operates at 3600 R.P.M. Drive with 2 HP to 3 1/2 HP or larger engine—or use power take-off. Voltage self regulating. Self excited! Standard base mounting. Two outlets. Tremendous overload capacity. Operates in either direction!

SUPPLY LIMITED! Order from this AD
Phone Taylor 9-1365

ROBERTS ELECTRIC CO., Dept. PM-209
849 W. GRAND AV., Chicago 22, Ill.

YOU CAN BE AN AUTHOR

Editors are searching for *fresh talent*. If you have good story or article *ideas* you can become a successful author. Earn good pay, prestige, the joy of self-expression—writing for magazines, newspapers, radio, TV, or as a free lance. We have trained thousands of successful writers since 1919. You learn to write by *writing*. Our home-study course gives you easy-to-follow assignments. Your personal instructor tells you where you are wrong, how to correct, how to bring out your best qualities. Short course, unbelievably low in price, on easy terms. If not satisfied, money returned for uncompleted lessons.

FREE BOOK. Send for Free Book with sample lesson. Write *today* to Writer's Digest, 22-1310 E. 12th St., Cincinnati 10, Ohio. No obligation; no salesman will call. Tear this out as reminder.

Now See This...
PROJECTS UNLIMITED
By
HELIJET CO. OF CALIFORNIA

A new concept of planning, layout and fabrication for the man with an idea. A boon to engineers, craftsmen, hobbyists.

You will be so pleased with results and so amazed at the possibilities with the inexpensive "easy to build" methods described in our illustrated booklet.

Build boats, campers, cabinets, cars, even airplanes and sail planes.

Own your own private submarine. From mock-up to product you will be thrilled with the ease, the simplicity, the economy of "Helijet Ideas" for "Projects Unlimited."

Send only \$1.00 for detailed, illustrated booklet and samples of construction materials.

Plans and Patterns Available for Projects to Build. Write for Details.

HELIJET CO.

Box 773 Azusa, California

Satisfaction Guaranteed or Money Refunded

U. S. Gov. Surplus
2 Terrific Buys!



PAINT SPRAY UNIT

Approximate cost \$225.

Our Low Price

\$44.50

Diaphragm compressor. Continuous operation, with 1/8 h.p. G.E. or W.H. motor, 110v. A.C. 1 qt. pressure type gun, round, fan and ceiling nozzles. Line filter, air dryer, air gauge, 10 ft. cord & plug, 20 ft. hose. Sprays paint, lacquer, enamel, insecticides, etc. Paint your auto, house, ANYTHING. Instructions furnished. Nothing else to buy. Wt. 66 lbs. Tire chuck FREE.



STAINLESS STEEL TANK—TYPE 304
J-1, 80 gal., 24" x 48", 400 PSI. For air, water, chemicals. Rust & corrosion proof, 1/4" pipe thread each end. Wt. 225 lbs. **\$99.50**
S-400 value **\$145.00**
F-1, 8 1/2" x 18" **\$14.50**

F.O.B. Chicago. Order from this ad. Money back guarantee. Send check or money order.
ILLINOIS MFG. & SUPPLY CO.
1829 S. State, Dept. PM, Chicago 16, Ill.

worth
writing
for...

Shotgun shells are discussed in a free little 32-page booklet, "Inside Facts on Shotgun Shells." Primers, powders, wadding, patterns and other topics are cov-



PAINT YOUR OWN WALL MURAL!
Enjoy the beauty, creative satisfaction of painting a lovely 5 to 14 ft. wide mural directly on your wall! New "paint-by-numbers" method is fun, incredibly easy. Takes just 3 to 5 hours. Artists charge up to \$350; wallpaper scenes cost \$100 and more. Our complete kits, \$12.95 up! Also fabulous "Black Light" mural kits. Many exquisite modern, provincial, oriental, etc. designs. A stunning prestige touch! Send for FREE Color Catalog. "How to" details (encl. 10¢ for postage handling). MURAL ART CENTER, Dept. E 17B, 1038 S. LaBrea, Los Angeles 19, Calif.



FREE!
100
WORLD-WIDE
STAMPS
...just
released!

HURRY! SEND TODAY for new, FREE collection of 100 Worldwide stamps. Get new issues of past 12 months—Pakistan Khyber Pass, Queensland "Victoria," Central African Butterfly, Argentina Llama, Mozambique Arms, many others. Wonderful additions to your collection. All different, all genuine, topical, pictorial, mint and used. Send today for this new, FREE collection, other offers for approval. Rush name, 10¢ for handling, postage. Garcelon Stamp Co., Dept. PMNX, Calais, Maine.

ered. Includes tips on storing shells and charts of average velocities. Write Federal Cartridge Corp., Dept. PM, 2700 Foshay Tower, Minneapolis 2, Minn.

Buying a home is probably the biggest investment most families ever make. A free 20-page booklet tells what to look for when you're in the market for a home. Ask for the "Home Buyer's Guide" from the Southern Pine Association, Dept. PM, P.O. Box 1170, New Orleans 4, La.

Telescopic sights are the subject of a 96-page manual filled with

data on their design and construction as well as instructions on how to buy and use them. "Facts About Telescopic Sights" costs 25c and is available from Bausch & Lomb, Inc., 1001 Lomb Park, Rochester 2, N. Y. for 25c.

First aid procedures should be learned now, before you are faced with a need to act swiftly and accurately. A simple, 12-page pamphlet explains six steps that will enable you to handle most emergencies. Includes list of first aid supplies, their use, and what quantities you need for a family of four. Send 5c

palley's gift imports

CORKSCREW and BOTTLE OPENER

Only **2.49 ea.** **brass**

The Key to fun and good fellowship. Of handsome gleaming Brass from India. Key head is made to open bottles or unscrew and behold a corkscrew. An unusual Gift. 7-1/2" long. Makes an excellent paper weight.

hand carved African
TRIBAL MASKS

Hand carved in Kenya by the finest native craftsmen... an authentic tribal mask to decorate your wall in den, rumpus room, etc. Carved from beautifully grained Walnut and polished to perfection. 10" to 12" long. **4.88 ea.**



SAVE IMPORTED POCKET SIZE
SLIDE RULE

4" SIZE - Non-warp with 2-color scales on white nitrate face. Has A, B, C1, C, D and K scales on face - S, L and T scales on reverse. One edge has a rule divided in 32nds... other edge has rule graduated in m/m to 10cm. Complete in leather case **A \$5.95 VALUE... 2.95**

10' LOG-LOG, DECIMAL TRIG Slide Rule - Scales are L, LL1, DF, CF, CIF, C1, C, D, LL3 and LL2 on face. Back has LLO, LLOO, A, B, K, C1, C, D, S, ST & T scales. With cursor and 16 page book. \$15.00 Value. **10.95** Ideal gift for advanced student.

WRITE FOR FREE 64 page IMPORT CATALOG

**NEW REMOTE CONTROLLED
JEEP WINCH**

16750
WITHOUT
CABLE



Engineered for YEARS of trouble-free service. Use for towing, dragging, lifting, dumping, etc. Made to mount behind the front bumper of any Jeep, Pick-up Truck, 4x4 or Gypsy. Operates on 6 or 12 volt current. Lifts 3500 lbs. with 12 volt current. Has ball-bearing motor. Write for list of OTHER MODELS!



1/4" CABLE
Preformed - 15¢
7 x 19 Steel. FT.

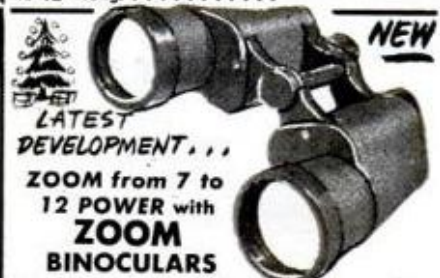

LATEST DEVELOPMENT...
ZOOM from 7 to 12 POWER with ZOOM BINOCULARS
Ideal for viewing football games or for spotting game... special focus lets you ZOOM right up to a close-up. Has 40mm objective lenses - center focus with power stops at 7, 8, 9, 10 and 12 power. Field of view of view is 270 ft. at 1000 yards. Air to glass surfaces fully coated. Chromium trimmed eyepieces. Comes with leather carrying case and socket in body to attach a tripod. NOW... **ONLY 39.95**

**JUST OFF
THE
PRESS!**

**WORLD'S MOST
AMAZING CATALOG**

196 PAGES of BARGAINS:
NATIONALLY ADVERTISED PRODUCTS •
NEW & USED GOVT. SURPLUS • FACTORY CLOSE-OUTS •
From EVERYWHERE Palley's bring you items of every description—at lower-than-wholesale 'DISCOUNT' Prices. Products include Hand & Power Tools, Sports & Outdoor Equip., Hobby Kits & "Gadgets," Aircraft Instruments and Hardware, Elect. Motors & Generators plus World's largest on-the-shelf stocks of Hydraulic Cylinders, Pumps, Valves, Motors, etc. Catalog supply LIMITED — Order your copy today!

Only 50c

Your 50c will be refunded with your first order of \$1.00 or more.

TO COVER HANDLING & MAILING

TO ORDER: Send check or M.O. 1/2 dep. with C.O.D.'s. All items sent freight or postage collect.

2263 E. VERNON AVE., Dept. PM-111
LOS ANGELES 58, CALIFORNIA

palley's

for "First Aid" to Superintendent of Documents, U.S. Government Printing Office, Washington 25, D.C.

Rockhounding, the collecting of rocks and minerals, is an exciting hobby for man and boy. An 18-page book for beginners, entitled "Let's Collect Rocks," explains the field and gives pointers for starting a collection. Single copies free from the Shell Oil Co., Dept. PM, 50 W. 50th St., New York 20, N. Y.

SAVE TO 30%
ON
HO TRACK AND TRAIN SETS

Write for **FREE** Catalogue

TOY WORLD
1 Fairview Terrace
Paramus 2, N. Y.



Stereo sound is explained briefly in a free pamphlet titled "Why Stereo?" It explains the principles through pictures and diagrams, also describes the vari-

MOTORIZED YOUR BICYCLE IN MINUTES!



SAVIDGE BIKE BOOSTER

- 15-20 MPH Speeds
- Bolt on in ten minutes
- 3/4 H.P. Air Cooled Engine
- Fits 16" to 26" and light-weights
- Total weight 9#

Send for free information today
Complete unit — ready to bolt on.

SAVIDGE SPECIALTIES • VENICE, CALIF.

ous kinds of stereo sources and tells how to convert monophonic systems to stereo. Write EICO, Dept. P.M.L., 3300 Northern Blvd., Long Island City 1, N. Y.

★ SURPLUS ★

Over 15,000 New FIRE EXTINGUISHERS

Dry Chemical & C.O.²
King Size 20 lb. each

★ Save Over 50% ★

Freight prepaid for 4 or more

Send for **FREE BROCHURE**

. . .

Fresno Hardware Co.
1776 H St. Fresno, Calif.



NEW FEATURES!

the new **POPULAR MECHANICS SHOP PROJECTS ANNUAL**

another big PM special-interest book

Staff-written and staff-researched by PM experts. Complete plans and how-to details on PM's new easy-to-build "Family Hobby Center." Tailor it to your family needs. Working area and storage space for mom's sewing, junior's models, or dad's hand tools.

ARTICLES ON:

- SABER SAWS
- RASPS
- WOOD CHISELS
- GLASS CUTTING
- TWIST DRILLS

PLANS FOR:

- BOBSLED
- UTENSIL RACK
- FIRE BELLOWS
- PICTURE FRAMES
- ROOM DIVIDERS

NOW AT YOUR NEWSSTAND

free

ALLIED

**MONEY-SAVING 1962
ELECTRONICS CATALOG**

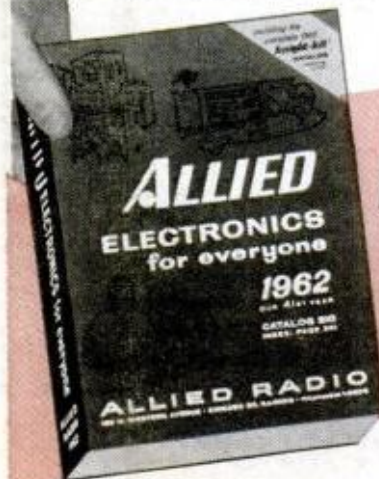

444 PAGES
WORLD'S BIGGEST
MOST COMPLETE

**NO MONEY
DOWN**
EASIEST TERMS

SAVE MOST ON

EVERYTHING IN ELECTRONICS

Send for this **FREE** catalog—it's the biggest—featuring everything in Electronics for modern living, including products and values available only from **ALLIED**. Whether you're a kit builder, experimenter, hi-fi fan, Amateur, serviceman or engineer, you'll save most on:

- **KNIGHT-KITS®**—Best in Build Your Own
- Everything in Stereo Hi-Fidelity
- New Multiplex Stereo FM
- New All-Transistor Stereo Hi-Fi
- **KNIGHT®** Super-Value Stereo Hi-Fi
- Tape Recorders & Phono Equipment
- Citizens Band 2-Way Radios
- TV Tubes, Antennas, Accessories
- Parts, Tubes, Transistors, Tools, Books
- Amateur Station Equipment
- Public Address & Intercom
- Latest Test & Lab Instruments



SAVE on everything in Electronics at **ALLIED**—get fastest service, expert personal help, easiest-pay terms, satisfaction guaranteed or your money back. Send coupon today for **FREE** 1962 **ALLIED** Catalog.

THE WORLD'S LARGEST ELECTRONIC SUPPLY HOUSE

free
CATALOG



ALLIED RADIO

ALLIED RADIO, Dept. 41-L1
100 N. Western Ave., Chicago 80, Ill.

Rush **FREE** 1962 **ALLIED** Catalog.

Name _____
PLEASE PRINT

Address _____

City _____ Zone _____ State _____



**New Car Assembles
In Five Minutes**

Looking for a lightweight runabout you can toss in your boat or car trunk? The Diehlmobile is a three-passenger, three-wheeler that's built with self-locking screws and quarter-turn aircraft fasteners. You can take it apart or put it together in less than five minutes and the only tool you need is a 50-cent coin.

Diehlmobile is powered by a 3-hp. one-cylinder engine with a top speed of 18 m.p.h. Its components are easily handled and stored in a boat bilge, car trunk or small plane cabin. The seat doubles for use in garden or boat.

Available in two models: Standard at \$299.50 or Deluxe \$379.50, from H. L. Diehl Co., South Willington, Conn.





ON THE MARKET

1. A SAFE, NONTOXIC SOLVENT does a selective job of cleaning model railroad, auto and airplane parts—even photographic film and paintings. Fluorinated solvent is fast-drying, nonflammable and does not harm insulation or plastic parts. Available in hobby shops at about \$1.70 per 8-oz. bottle. Kyle Products Co., 2207 Old Orchard Road, Wilmington 3, Del.

2. FLEXIBLE PATCHING MATERIAL which will expand and contract with atmospheric changes is available in kits, including roll of glass fabric and special applicator. The filler dries to a tough, pliable coat that is said to repair plaster cracks permanently. You no longer need to chip out the cracks to repair them. Tuff-Kote Company, Woodstock, Ill.

3. CONVERTIBLE LADDER becomes stepladder, regular wall ladder or scaffold—two-foot sections fold to 10x14x25 in. Made of extruded magnesium, the ladder is light and easily transported in the folded position; steel pins lock sections together. Basic 8-ft. ladder: \$39.95. Add-on section: \$9.95. Norseman, Inc., 2916 4th Ave. S., Minneapolis 8, Minn.

4. TRIM-TO-SIZE FILTER fits almost any model of air conditioner. Made of Scottfoam, the replacement filter can be trimmed with a pair of scissors—has a spongelike appearance. Filter may be removed and washed in clear water in a matter of minutes, then replaced. Measures $\frac{1}{4}$ x24 $\frac{3}{4}$ x11 $\frac{1}{4}$ in.; priced at 99c. General Electric Co., Schenectady 5, N. Y.

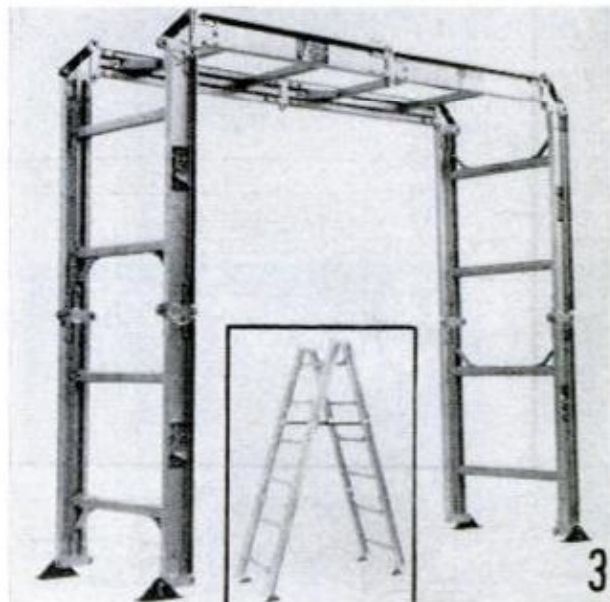

Superior's New Model 70 UTILITY TESTER®
FOR REPAIRING ALL ELECTRICAL APPLIANCES
MOTORS • AUTOMOBILES • TV TUBES

As an electrical trouble shooter the Model 70:



- Will test Toasters, Irons, Broilers, Heating Pads, Clocks, Fans, Vacuum Cleaners, Refrigerators, Lamps, Fluorescents, Switches, Thermostats, etc.
- Will test all TV tubes for open filaments, interelement shorts, burned out tubes, etc.
- Measures A.C. and D.C. Voltages, A.C. and D.C. Current, Resistances, Leakage, etc.
- Will measure current consumption while the appliance under test is in operation.
- Incorporates a sensitive direct-reading resistance range which will measure all resistances commonly used in electrical appliances, motors, etc.
- Leakage detecting circuit will indicate continuity from zero ohms to 5 megohms (5,000,000 ohms).

As an Automotive Tester the Model 70 will test:

- Both 6 Volt and 12 Volt Storage Batteries • Generators • Starters • Distributors • Ignition Coils • Regulators • Relays • Circuit Breakers • Cigarette Lighters • Stop Lights • Condensers • Directional Signal Systems • All Lamps and Bulbs • Fuses • Heating Systems • Horns • Also will locate poor grounds, breaks in wiring, poor connections, etc.

Model 70 comes complete including 64 page book, only **\$15.85**

SHIPPED ON APPROVAL
NO MONEY WITH ORDER — NO C. O. D.

Try it for 10 days before you buy. If completely satisfied then send \$9.85 and pay balance at rate of \$4.00 per month for 3 months — No Interest or Finance Charges Added! If not completely satisfied, return to us, no explanation necessary.

MOSS ELECTRONIC, INC., Dept. D-912
 3849 Tenth Ave., New York 34, N. Y.
 Please rush Model 70. If satisfactory, I will pay on terms specified. Otherwise I will return tester.

Name _____
 Address _____
 City _____ Zone _____ State _____
All prices incl. F.O.B. N. Y. C.

LEARN UPHOLSTERY

in your spare time
 run your own
 business
AT HOME

FREE BOOK with sample lessons

With Course You Make

SLIPPER CHAIR

CLUB CHAIR

OTTOMAN

PLUS SLIP COVERS Yours to Keep or Sell

BE YOUR OWN BOSS

Earn more from the start in spare time. STOP worrying about layoffs, enjoy a steady growing income and independence for life in the booming field of Custom Furniture Upholstery. Right off, you start upholstering with the tools, complete frames, fabrics and materials. Included FREE with N. Y. State-approved UTS Home Study Course. You learn skilled professional custom upholstery, reupholstery, furniture finishing, repairs, how to make beautiful slip covers, cushions and draperies. EARN WHILE YOU LEARN, in your spare time AT HOME . . . the UTS easy way.

FREE ILLUSTRATED BOOK—FREE SAMPLE LESSON Get ready for well-paid job and big profits, from steady work, as your own boss, running your own business. Mail coupon NOW for FREE BOOK! Training in N.Y. School also available. **VET APPV'D. ACCREDITED BY N.H.S.C.**

UPHOLSTERY TRADES SCHOOL
 Dept. PS-310, 721 E. 74th St., N. Y. 3, N. Y.

Please send me FREE book, "Your New Way to a Successful Career," and FREE sample lesson. No obligation—no salesman will call.

Home Study Training in N. Y. School

Name _____ (Please Print Plainly)
 Address _____
 City _____ Zone _____ State _____
 Check if Korean Veteran

GIANT 10 Ft.

Largest Distributors of U.S. Govt. Surplus Balloons in the USA. Inflate up to Giant 30 ft. diameter with air or gas. Fun at the Beach, Water Sports, etc., Flying Advt. visible for miles. Terrific for attracting crowds at Openings, Fairs, Roadside Stands, Gas Stations, Sports Events. Made of Durable Neoprene Rubber. New, never used. No C. O. D.'s.



2 ft. (Beach Ball Size).....	2 for 50c (5 for \$1.00)
6 ft. size	59c ea. (2 for \$1.00)
10 ft. size	\$1.00 ea. (6 for \$5.00)
30 ft. size	\$2.00 ea. plus 50c postage & handling
30 ft. size10 for \$20.00—Exp. collect

NOVEL MFG. CORP. 31 SECOND AVE., Dept. G-3692
 NEW YORK 3, NEW YORK

You Can Have a HE-MAN Voice



STRENGTHEN your voice this tested, scientific way. Yes—you may now be able to improve the POWER of your speaking and singing voice . . . in the privacy of your room! Self-training lessons, mostly silent. No music required.

FREE BOOKLET

Write today for Eugene Feuchtinger's great booklet "How to Develop a Successful Voice." It's absolutely FREE! You must state your age. Booklet mailed postpaid in plain sealed envelope. No salesman will bother you. Send your name and age RIGHT NOW!

PREFECT VOICE INSTITUTE, 325 W. Jackson Blvd., Studio LN-2, Chicago 6, Ill.



The Handy Weigh

Mounted on a wall, and looking like a clock, a household scale is ready for use when its plastic holding pan is folded down.

The scale automatically weighs goods up to 10 pounds. A built-in magnifying glass makes the dial easy to read. The pan is removable for cleaning. Scale and pan come in five colors of shockproof plastic.

The price is \$14.95 from Wagro Sales Co., Redwood City, Calif.



POUR PLASTER INTO 4 MOLDS



ADHERE BRICKS TO WALL



BEAUTIFUL BRICKWORK EFFECTS



Satisfaction Guaranteed

Decorate Your Home with **BRICK** at only **2¢** sq. ft.

for
**DRAMATICALLY
Beautiful
Interiors!**

BRIC-MOLD—amazing new plastic mold—turns inexpensive plaster into Roman or Decorator Brick . . . changes colorless walls and rooms into thrillingly dramatic interiors with decorative and realistic 3-dimensional brick facings—all for only \$3.00! You and your wife will gasp when you see the exquisitely beautiful change in the appearance of your home after you apply these fascinating brickwork facings to walls, room dividers and planters in basement, kitchen, dining room, dinette, laundry—anywhere! Overnight your home becomes a real show-place, changing drab, paint-peeled walls into thrilling decorative surfaces.

BRIC-MOLD is a plastic mold into which you pour inexpensive plaster of paris to form realistically textured bricks a full 1/4 inch thick. Use specially formulated **BRIC-MOLD** adhesive to adhere individual bricks to any wall or surface to form interesting effects. Apply **BRIC-MOLD** bricks over plaster, wood, plywood, concrete, cement, wallboard—**ANY** surface!

Each Kit processes 16 bricks at a time—so you can cover a 9x12' room in a few hours at a cost of only 2c per sq. ft. for plaster! You can apply white or colored paint to brickwork for added effect. Order **BRIC-MOLD** Kit today on money-back guarantee. Full instructions included.

Allow 3 weeks for delivery

BRIC-MOLD . . . Dept. PM-11, P.O. BOX 178, Allen Boulevard, Farmingdale, N.Y.
 Decorator Brick (2"x7 1/2") Roman Brick (1 1/2"x11")
 \$3.00 for complete Bric-Mold Kit of 16 molds to cast 16 bricks at time
 \$5.50 Two Kits (32 molds) \$8.00 Three Kits (48 molds)
 \$2.65 for 3 lb. can Bric-Mold Adhesive
 (Please add 25¢ for postage & handling on all orders.)

Name.....
 Address.....
 City..... Zone..... State.....

Magic Mail Plan—Make up to \$5 an Hour!



THIS MAN . . .
 . . . is taking out of the machine a Plastic Sealing Job—ordered by mail—only 11c in material cost brings back \$2.58 in cash by mail. Capacity of machine: **\$25.00 profit per hour of operation.**

Get **ORDERS** and **CASH** from your mailman—do work in **SPARE TIME** at home—or expand into **FULL TIME** business. Send coupon for Free facts about the newest and most fascinating of all home operated businesses. For the first time a simplified machine brings the fabulous profits of **Plastic Sealing** and **Plastic Laminating** within the reach of the small operator. Anyone can learn to operate the machine with a few minutes practice—then with our **Magic Mail Plan** can get mail orders pouring in daily with cash in every envelope. **No canvassing—no selling.** We even

Get into PLASTIC LAMINATING at home

WE'LL EVEN HELP FINANCE YOU supply the circulars you mail to bring back cash and orders, financing help, too. Rush name. We'll send you **FREE** and postpaid, pictures, prices, details, finance plan, all the facts you need. Mail coupon or send name on postcard. No charge. **Warner Electric Co., 1512 Jarvis Av., Dept. L-2-M, Chicago 26, Ill.**

Make Thousands of Beautiful Art Creations
COSTUME JEWELRY • CIGARETTE BOXES
TRAYS • CANDLESTICKS • COASTERS
LAMP BASES • BOOK ENDS...ALL IN
SPARKLING COLORED PLASTIC

WARNER ELECTRIC CO., 1512 Jarvis Av.
Dept. L-2-M, Chicago 26, Ill.
 At no cost to me, please rush full details and financing plan, postage prepaid. No obligation.

Name.....
 Address.....
 City..... Zone..... State.....

MEN—Immediate Training for HEAVY EQUIPMENT OPERATION
 We have now heavy equipment operators earning \$1.91 to \$4.21 per hour, who took our training as first step. Billions in nationwide construction projects need trained men. Home study—resident training. Get information about requirements which must be met. Write (give age)
HEAVY EQUIPMENT TRAINING, NORTHWEST SCHOOLS
 Dept. AA-11, 730 Third Ave., New York 17, N. Y.

Selsi YOUR BEST BUY Since 1854
 FINE OPTICAL GOODS AT BUDGET PRICES SEE YOUR DEALER
BINOCULARS MICROSCOPES TELESCOPES BAROMETERS

SELSI CO., Inc., 29 East 22nd St., New York 10, N. Y.

94.6% OF BAILEY GRADUATES ARE EMPLOYED AT TOP PAY IN THE FIELDS WHICH THEY WERE TRAINED!



DIESEL-AUTO MECHANICS DESPERATELY NEEDED!

We have a far greater demand for our students than we can fill!

We can show you an actual waiting list of leading companies throughout the world who have tried Bailey graduates — found them outstanding, and are coming back for more!

Bailey Graduates are Successful . . . RECEIVE BIG PAY — HAVE SECURE FUTURE!

The Famous Bailey Course prepares you for BOTH Diesel and Gasoline Mechanics.

This is a must—due to the advent of using Diesel principles, such as 'Fuel Injection' on passenger cars . . . use of gasoline engines for starting Diesel engines, etc. You learn all this at Bailey in the amount of time ordinarily required to learn just one of these subjects, **ALL FOR THE PRICE OF ONE.**

Don't be satisfied with a 'futureless', one-type job — learn how you can make big money now!

Write today for Free Booklet that takes you on a step-by-step camera tour through our spacious, modern shops — See Bailey students in action as they Learn-by-doing with the Famous Bailey Method of training!

We provide you with housing and part time jobs while in school, plus nation-wide placement service for graduates.

BAILEY Technical SCHOOLS

1634 S. GRAND ST. LOUIS 4, MO.

MAIL TODAY!

Please mail immediately this free booklet without obligation.

FREE BOOKLET



Name.....

Address.....

City..... State.....

APPROVED FOR VETERAN . . . NON-VETERAN

Choose "out of the ordinary"

Christmas Gifts from

Bean's Free Catalog



Hunters and campers will find many practical items in our 116 page fully illustrated Fall Catalog. Shows hunting footwear, clothing and 400 items of interest to both men and women. 135 items are of our own manufacture.

L. L. Bean, Inc., 379 Main Street, Freeport, Maine
Mfrs. Hunting and Camping Specialties

1000 TRICKS 10¢

AMAZE! ENTERTAIN! START NOW!

BIG EXCITING MAGIC & FUN CATALOG! 160 Pages! Tricks, Jokes, Magic, Illusions, Secrets! Puzzles, Stunts, etc.! Rush name, address and only 10¢.

FREE MAGIC TRICK GIVEN

House of 1000 Mysteries • Dept. PM11-61 • Trumbull, Conn.



GET INTO ELECTRONICS

V.T.I. training leads to success as technicians, field engineers, specialists in communications, guided missiles, computers, radar, automation. Basic & advanced courses in theory & laboratory. Assoc. degree in 29 mos. B.S. obtainable. ECFD accredited. G.I. approved. Graduates with major companies. Start Feb., Sept. Dorms, campus. H. S. graduate or equivalent. Catalog.

VALPARAISO TECHNICAL INSTITUTE
DEPT. D VALPARAISO, INDIANA

LAW FREE BOOK THE LAW TRAINED MAN

Write today for a FREE copy of illustrated law book, "THE LAW-TRAINED MAN," which shows how you can learn quickly at home the basic principles of all law topics through the famous Blackstone Law Course. All necessary books and lessons provided. Moderate cost; convenient monthly terms. Write for FREE law training book today.

Blackstone School of Law, 307 N. Michigan Ave.
Founded 1890 Dept. 58, Chicago 1, Illinois

NEW WESTERN HAIG

.12 CALIBER
SPECIAL FACTORY OFFER!



\$300
post-paid

USES POWDER CHARGE

This small bore gun shoots .12 cal. lead bullets fired by small 4.4 mg. powder charge. Not a CO₂ gun! You'll like the handsome lines, grip, and balance. Western in style, but patented ball and cap action allows this low price. 9 3/4" steel barrel cased in knurled styrene stock, overall 13 1/2". Develop pistol form, accuracy at a fraction of cost of large caliber pistols. Comes with 50 lead bullets. Satisfaction guaranteed. Send \$3 to: HAIG MFG. CO., P.O. Box K-4, Alhambra, Calif.



CLASSIFIED ADVERTISEMENTS



Advertisements in this section \$1.30 per word, each insertion, minimum 10 words, payable in advance. To be inserted under proper classification, copy must be in our office the 18th of the second month preceding date of issue
F. W. Johnson, Manager, Classified Advertising
Popular Mechanics, 200 East Ontario Street, Chicago 11, Illinois

YOU'LL PROFIT

By reading and answering the classified ads in this section. Hundreds of opportunities for you to make and save money

AUTOMOBILES, MIDGET CARS

CLYMER'S Volkswagen Owner's Handbook newly revised \$3.00. Porsche Owner's Handbook \$4.00. Simca Owner's Handbook \$4.00. British Ford Handbook all models \$3.00. Metropolitan Handbook \$3.00. Renault Dauphine Handbook \$3.00. Model A Ford Album, photographs, specifications every Model A ever manufactured \$3.00. Maserati Owner's Manual \$4.00. Ferrari Owner's Handbook all models \$4.00. New wonderful book 100 World's Finest Automobiles with specifications \$5.00. Modern Chassis \$2.00. Specials and Hot Rods of World \$1.50. Engine Swapping, tells all about exchanging engines all makes \$2.00. 1960 Indianapolis "500" Race Yearbook \$2.00. Souping the Volkswagen for more power speed acceleration \$3.00. Write free catalog. Clymer, Desk PM, Los Angeles 6, Calif.

AUTOMOBILE Catalogs, photos, manuals; hobby club, monthly bulletin. Free information. Auto Enthusiasts, Box 451H, Mount Clemens, Mich.

OWN A Volkswagen, Renault, Porsche, Simca, Metropolitan, British Ford, Ferrari, Maserati, Ford, Chevrolet, Plymouth? You need Clymer's owner handbooks. Write for free catalog 200 autobooks. Clymer, Desk PM, Los Angeles 6, Calif.

HOW To drive a Volkswagen. Factory manufacturing methods. How to take delivery overseas. Troubleshooting tips. Questions and answers. Clymer's road testing in Germany, includes proper handling technique rear engine cars, \$3.00. Clymer, Desk PM, Los Angeles 6, Calif.

HOTTSPARK: Starting, pep, mileage; varitypers, offsets, mimeographs, typewriters. EG, Elmsford, N. Y.

SWAPPING Engines newly revised. Tells how exchange all makes \$2.00. Clymer, Desk PM, Los Angeles 6, Calif.

AUTO SUPPLIES AND EQUIPMENT

TRANS-CHEK! Amazing new device. Gives timely warning to have your automatic transmission checked for proper adjustment, preventing costly repairs. Tells at a glance when trouble develops. 2-minute installation. Complete instructions. \$2.25 ppd. State year and make. Ranson Manufacturing Co., 318 Washington Avenue, Bay City, Michigan.

PARTS, Model "A." List 25¢. (Refundable) Matco, Box 135, San Pedro, Calif.

JEEP Parts! For military and civilian. At great savings. Largest inventory. Catalog for owners and dealers. Inquiries invited. American Auto Parts Co., 1830-PM Locust, Kansas City, Mo.

RING-Valve job while driving, \$6.00 postpaid. Guaranteed! Nothing like it! Lasts 100,000 miles! Motaloy, Grantham, Penna.

NEW And used parts at savings. Complete guaranteed parts service for all models cars and trucks. Largest in the West. Jeep and army parts specialists. Newest type shifting hubs for all jeep and all military and latest production front end drive vehicles. \$27.50 and up. Also, foreign car parts. Write, Pioneer Auto and Truck Parts Co., 734 W. 13th Avenue, Denver 17, Colo.

COPPER Tubing. For all purposes. 50 foot coils, 1/4", \$4.85; 5/16", \$5.99; 3/8", \$7.49. All other sizes in stock. Freight prepaid. B and H Metal Company, P.O. Box 615, Boston 2, Massachusetts.

1909-1934 FORD Parts illustrated catalogs 75¢. Mark Auto, Layton, N. J.

TRANSISTORIZED Electronic ignition systems. The greatest improvement since the original Kettering 1910 ignition invention. Can be used on all 6 and 12 volt automobiles, trucks, race cars, boats with negative ground. Dealers wanted. For low prices and literature write: Bill Slep Company, Drawer 178PM, Ellenton, Fla.

WILLYS Jeep tops, \$87.50. Mor-Nan, Box 141, Beverly, Mass.

PARTS And accessories catalog for Ford Model "A." Everything to renew, rebuild and renovate your '28-'31 Model "A" Ford. Send 10¢. J. C. Whitney, 1919 QM-11 Archer, Chicago 16, Ill.

ABOUT \$70.00 builds 1/2 ton dump trailer. Blueprint, material list \$1.00. Prints, Box 9, Avon, Conn.

AUTO Shop welding repair training in world's largest non-profit welding school. Low tuition. Free booklet. Hobart Welders, Box M-1111, Troy, Ohio.

SENSATIONAL! New coffee maker for cars. Works on 12 or 115-volt systems. Free literature. Available from Dobbs and Company, Vernal, Utah.

RADAR King plans \$1. Detects police radar. Wardell Smith, 65 Glenwood Road, Upper Montclair, New Jersey.

JEEP Owners—V8 conversions. Read Jeep Owners ad, page 26.

INCOMPARABLE "Voxon" theft-alarm. Proven, untouchable! Cameron, Box 2131, Cleveland 8, Ohio.

PATENTED Headlight reminder lights-up red lamp on instrument panel when car is parked with headlights left on or driven at night with headlights off. Prevent accidents, fines, dead battery. Easily installed. For 6 and 12 volt cars, \$4.00. Hollywood Hed-Lite Reminders, Box 4032, Inglewood, Calif.

AMAZING Alarm. Protect car and contents. Loran, 1536M Albany Ave., Brooklyn 10, N. Y.

SNOW Driving, traction units. Be the first to use this amazing new invention. Emergency type, fits all disc wheels. Price \$7.00 p.pd. Permanent type, keep on wheels all winter. Fits all General Motor, Ford and other flush axle cars and small trucks. Price \$18.00 p.pd. No c.o.d. Units fit under wheel covers, can't be seen. Amaze others driving through snow, etc. without chains. Works on new propulsion principle. Order now. Production limited. Give year, make, of car with order. Money back guarantee. Bateson Mfg. Co., 4402 Market St., Wilmington, Dela.

TUBELESS Tire repairs—on the wheel. Kit of ten with tool \$1.50. Twenty \$2.00. Woodmont, 123P Hampton, Winchester, Ky.

JUST Out! New 356 page, illustrated catalog offering savings up to 50% on over 100,000 auto parts and accessories, everything to renew, rebuild, renovate '28-'31 Model "A" Fords. All makes (1920 to 1961 models), trucks, foreign and sports cars. Hollywood accessories, custom styling, hi-speed equipment. Send 25¢ for postage, packing—refundable on first order. Whitney, 1919 PM-11, Archer, Chicago 16, Ill.

PROMOTE Patented automotive product nationally. Write: Box 1296, Denver 1, Colo.

AUTO TRAILERS

BUILD 5 Different camping travel trailers. Manual plans \$2.00. Circulars 30¢. Kamcraft, Box 1153, Milwaukee 1, Wis.

BUILD Expanding eight foot trailer. Accommodates five. Literature 10¢. Framar Company, Wilmington, Mass.

MOTORCYCLES, BICYCLES, MOTORSCOOTERS AND SUPPLIES

GO CART \$10. Servicycle \$5, midget car \$10, less engines. Engines \$7.50 up. 3 wheel Cushman \$40. (Mail order only). Send 25¢ (35¢ for First Class mailing) for directory - catalogue Number 104 listing these and hundreds of other bargains in go carts, motorscooters, homebuilders parts, plans, etc. Midget Motors Directory, Athens, Ohio.

BIKE Motors, fully automatic, \$69.95. Write: Go-Byk Industries, Rothsay, Minn.

BMW Motorcycles, shaftdrive. U. S. Distributor Butler & Smith, Inc., 160 West 83 St., New York 24, New York.

BE On top of a Petty Unicycle. Send for description and price. Petty Unicycle Co., 6822 Moore St., Arvada, Colorado.

MOTORCYCLE Parts. New, used. List 25¢. Ballak, 811 N. 9th, St. Louis 1, Mo.

HARLEY-Davidsons — Used bargains. New, used parts, accessories, all models. Bulletin 25¢. Knuth's (Factory Dealer), 1753 Muskego, Milwaukee, Wis.

RECONDITIONED Motorcycle motors. Chrome accessories. Complete stock Indian parts. Expert rebuilding. Fast service. Indian Motorcycle Sales, Kansas City 27, Missouri.

AVIATION

CATALOG Of scale model wheels and pilots 5¢. Williams Bros., Box 1254, Huntington Park, Calif.

\$6000 NEW McCulloch engine cheap. Karl Ort, PM, Thomasville, Penna.

HELICOPTER Rotor blades. HUP-H25 type, 13" chord 16 ft. long, stainless steel skin over steel spar. \$100 each. Prewitt Plastics Company, P.O. Box 147, Clifton Heights, Penna.

AIRPLANE New book Modern Flight. Four books in one, basic instrument, acrobatic, multi-engine flying \$3.00. Clymer, Desk PM, Los Angeles 6, Calif.

HOMEBUILT Helicopter handbook \$1.00. Directory \$1.00. Urshanair, 4332 N.P. Station, San Diego 4, California.

PROPELLERS. Plans, supplies for airboats, snowplanes. 125 h.p. Lycoming engines \$135.00. Prompt delivery. Catalog 25¢. Banks-Maxwell Propeller Co., Box 3301E, Ft. Worth 5, Texas.

AIRLINE Careers. Adventure! Prestige! Promotion! Four-week course. Free placement service with 35 airlines. G. I. approved. Free catalog B. McConnell Airline School, 1030 Nicollet, Minneapolis, Minnesota.

BATTERIES, GENERATORS

START Your own battery business. Manufacture, rebuild, repair. Easy with large 121-page manual. No job worries. Batteries, P.O. Box 341, New Castle, Penna.

A New development in battery chargers. Light, compact, waterproof, 12 volt. For boats, lawn mowers, etc. \$16.59. Agents wanted. Cad-E-Mobile Corp., 695 N. Miami Ave., Miami, Florida.

LEARN Battery repair! Complete manual \$3.00. Hydraulic jack repair manual \$3.00. C.O.D. accepted. Bayer Publications, L938 Betty Avenue, Neenah, Wis.

ELECTRICAL SUPPLIES

CONDUIT Bending attachable protractor. Easy instructions. \$2.50. Pal-Notes, Underwood, N. D.

BOOK 200 Electric stunts \$1.00. Kuttington, 875 Arastradero, Palo Alto, Calif.

ELECTRIC Motor winder's handbook. Pocket-sized. Over 200 most needed diagrams, tables, formulas. Single and three phase motors. \$1.50. Western, Box 1902, Phoenix 1, Arizona.

APPLIANCE. Lamp, range, vacuum parts wholesale. Illustrated catalogue 25¢. Seco, 112 South 20th Street, Birmingham 3, Alabama.

LAMP. Electrical parts, wholesale. Thousands of items for repairing, converting. Catalog 25¢. Brown Lamp, Box 305, Clayton 5, Mo.

LAMPS. 25¢ Brings parts catalog. Referred first order. Gyro, 5208P N.W. 35th Ave., Miami 42, Florida.

ELECTRO-SCRIBE! Engraves all metals. \$2.00. Beyer Mfg., 10511-H Springfield, Chicago 55.

WELDING, SOLDERING, PLATING

ACETYLENE Outfits \$59.50; arcwelders \$56.50. Eagle Welding, Dept. PM, 5085 Broadway, Chicago 40, Ill.

WELDERS. 110/220, \$39.50. Morris, 1070 Inner Drive, Schenectady 3, New York.

PLATING Equipment and supplies. Save 50% and more on new fiberglass tanks, DC power units. 50 amp, 6 volt DC power supply \$97.50; 100 amp, 6 volt \$145; other sizes from 5 amps to 250 amps. Easy terms. Mix your own solution and save. Newest formulas and operating data for all types of plating, equipment guide and catalog \$1.00. HBS Equipment Division, Dept. L5, 1624 E. First St., Los Angeles 33, Calif.

FREE Catalog, welders, kits. Build 350-ampere welder using aircraft generator, plans 25¢. Dunbar, Minneapolis 8, Minn.

MACHINERY, TOOLS, SUPPLIES

SPRINGS. Compression, extension. Write your needs. JM Springs, Box 52, Chesterfield, Indiana.

REGRINDING: Tapered, straight endmills. Free catalog of our new tapered endmills. Award Cutter Company, 1919 Sterling, Grand Rapids, Michigan.

MACHINE Shop bargains. Send 10 cents for 16 page catalog. Travers Tool Company, 10-23 Jackson Avenue, Long Island City 1, N. Y.

STRAIGHT Edge, accurate, extra hard, tool steel 30" long, \$3.00 p.p. Daco Mfg. Co., Woodsville, N. H.

SAW. Scissor supplies, free list. Overland's Saw Service, Independence, Iowa.

SURVEYING INSTRUMENTS

NEW And guaranteed factory rebuilt transits and levels, sale or rent, with purchase option. We will repair, trade or buy old instruments. Write for list M111. Warren-Knight Co. (Manufacturers of Surveying Instruments), 136 N. 12th St., Philadelphia 7, Penna.

ENGINES, MOTORS, DYNAMOS

NEW 10/15 horsepower aircooled Lawrence engines for racers, helicopters, welders, generators, only \$108.00. Ort, 8PM, Thomasville, Penna.

MOTORS: 1/4 H.P. General Electric \$7.50, 1/2 H.P. Wagner \$14.50. Send M.O. Rebuilt, sizes to 5 H.P. List 10¢. A.C. Motors, 3101 N. 32nd St., Philadelphia 32, Pennsylvania.

DIESEL Injector parts and fuel pumps wanted. GM51-71-110. Bares, 2093 East 19 Street, Cleveland 15, Ohio.

REWIND Motors yourself. Complete instructions, \$1.00. Lewis Manufacturing, Howell, Michigan.

WINDING Data. 275 motors, single and three phase \$1.10. Data Company, 512 Kensington, Kansas City 24, Mo.

GOVERNMENT SURPLUS

GOV'T Surplus. How and where to buy in your area. Send \$1.00. Surplus Information, PM, Headquarters Building, Washington 6, D. C.

WAR Surplus bargains! New government releases arrive constantly. Save up to 80%. Blankets, boots, coats, tents, wearing apparel, etc. Send for free war surplus catalog. Sioux Falls Surplus Store, Sioux Falls, South Dakota.

BUY War surplus direct from Government. Airplanes, boats, jeeps, trucks, tractors, helicopters, walkie-talkies, radar, misc. Send for Brody's "U.S. Depot Directory & Procedures" \$1.00. Box 425-PM, Nanuet, New York.

U.S. Government surplus—Jeeps, \$264.00; radios, \$2.53; guns; typewriters; cameras; tools; thousands of items. Fabulously low surplus prices. Complete information sent immediately. Send \$1.00 to: Surplus, Box 512-E, New Orleans 12, Louisiana.

P-47 TURBOSUPERCHARGER, \$225 shipped. Hammaren, 47 Edith Place, Kenil, N. J.

JEEPS \$278. Airplanes \$159, boats \$7.88, generators \$2.68, typewriters \$8.79 are typical government surplus sale prices. Buy 10,001 items wholesale, direct. Full details, 627 locations and procedure only \$1.00. Surplus, Box 789-C20, York, Penna.

GOVERNMENT Surplus, radios, jeeps, walkie talkies, boats, binoculars, etc. Buy direct. Satisfaction guaranteed. Send for "Depot Locations & Procedures" — 50¢. Delta, Box 2262-M, Dallas 21, Texas.

JEEPS \$223.83, cars \$38.53, boats \$7.58, radios \$2.45, tires \$1.33, typewriters \$7.15, televisions, guns, cameras, watches. Typical surplus prices. Buy direct. List of depots, procedure, full details only \$1.00. N.Y. Enterprises, International Airport, Box 402-X15, Jamaica 30, New York.

BOATS, OUTBOARD MOTORS

FIBERGLAS Your old wooden boat. Make it waterproof. Repaint over fiberglass, wood, or metal with new Poly-Aqua Epoxy paint. Free literature. Ajax Plastic Co., Dept. 6, P.O. Box 1323, Ft. Worth, Texas.

BOAT Plans, frame kits, full-size patterns prepared specially for amateurs. Send 50¢ for new 80-page catalog illustrating over 40 build-it-yourself power boats from 7' to 28'. "Inboard Motor Installations In Small Boats"—hardcover illustrative book on "how to" of inboard installations—\$6 ppd. Glen Designs, 9152 Rosecrans, Bellflower, Calif.

NEW. Used, rebuilt marine motors. Marine conversions, fittings. Free catalog. Stokes Marine Supply, Dept. 24, Coldwater, Michigan.

FULL Size, cut-to-shape boat patterns, blueprints, 7 1/2-38 feet. Big new 88-page illustrated "Build a Boat" catalog of naval architect-designed catamarans, cruisers, runabouts, skiffs, outboard boats, sailing, racing, houseboats, 50¢. "How to Build a Boat" booklet, \$2.50. Cleveland Boat Blueprint Co., Dept. A-66, Box 1651, Cleveland, Ohio.

BUILD Your own boat from our large-scale blueprints. Books of plans give how-to-build help. Hundreds of professional designs—motor, sail or auxiliary—for amateur builders. Free catalog. MoToR Boat-ing, 572A Madison Ave., New York 22, N. Y.

MARINE Conversions. Ford, Chevrolet, Jeep engines. Catalog 25¢. Lehman Manufacturing Company, 800 Elizabeth Avenue, Linden 4, N. J.

FIBERGLASS Materials. Guaranteed factory fresh & full strength. Wholesale prices! Hurricane Fiberglass, Recker Highway, Auburndale, Florida.

200 BOAT Plans, kits. Catalogs. Powerboat, \$1.00, sailboat, 25¢. Marinecraft, Box 161-M, Brighton, Mass.

AIRBOAT-Snowplane engines, propellers, supplies. 125 h.p. Lycoming engines \$135.00. Catalog 25¢. Banks-Maxwell, Box 3301F, Ft. Worth 5, Texas.

MARINE Conversions and gears for all popular automotive engines. Send 25¢ coin for complete catalogue. Barr Marine, 2706A Castor Ave., Philadelphia, Penna.

I want to send you proof of the wonderful pulling power of Popular Mechanics classified pages. What's your proposition? Write me today. Include literature if possible. F. W. Johnson Manager Classified Advertising, Popular Mechanics Magazine, 200 E. Ontario St., Chicago 11, Ill.

ATHLETIC EQUIPMENT, BODY BUILDING COURSES

OUTSTANDING Physical development! Any age. New guaranteed discovery uses only a rope! Strength, health, muscles. Gain—reduce. Free booklet. Roperice, 4834 Art. San Diego 15, California.

"GIANT Arms." Dr. Young's, D.C. revolutionary discovery. \$2. Satisfaction or refund. Gaucho, Box 9309-S7, Chicago 90.

BOOKS, Aikido, boxing, karate, judo, savate, stickfighting and wrestling. Price-list 15¢. Combat Sports Service, Box 482, Worcester 1, Mass.

PHYSICAL Perfection—reducing, gaining, big muscles and longevity. Agents wanted. Mail 25¢ for all 4 courses. Guaranteed. Sid's System, PMC-62, 8421-C Evergreen, Southgate, California.

PROF. Wong's Karate Kung-Fu. Break bricks bare-handed. \$9.95. Oriental Book Sales, 142 Waverly Place, San Francisco 8, Calif.

BARBELLS, Dumbbells, Courses, Booklet 10¢. Good Barbell Co., Siloam Springs, Arkansas.

GAIN Popularity, muscles and strength by doing hand balancing. Step by step instructions, complete with illustrations by state weight lifting champion. \$1. Box 911, Pompano Beach, Fla.

SPORTING GOODS, GUNS, FISHING, SKIN DIVING, ARCHERY

FREE Your hands while fishing. Rest-A-Rod holds your rod while you lite up, grab a snack, bait your hook, etc. Attach to your belt, tackle box or boat. 59¢ 2 for \$1.00. Jaco, 106 First Ave., Berea, Ohio.

SURPLUS Rifles \$7.95. Revolvers \$6.95. Bargain catalog 25¢. Arms Co., Box 286, PM-11, Santa Rosa, Calif.

FISHNETS Seines, gills, trammels, hoopnets, twines. Catalog. Nichols Nets, 500 Layton Road, East Saint Louis, Illinois.

FREE Catalog. Fine clothing and equipment specially designed for boat owners. Every item fully tested and guaranteed outstanding in quality and value. Captain Bill, Dept. A2, Longbranch, Washington.

SCUBA Equipment at 15-20% discount. Jabarb, Box 6844, Towson, Md.

ANIMAL And fish baits and lures. Guaranteed. Catalogs 20¢ Myers Lures, Marquand, Mo.

CRACK Shot? Learn secrets Kit Carson. Diagrams. \$1. Marksman, Box 2043, Topeka, Kansas.

NEW! Revolutionary! Lantern and rod holder designed for fishermen, campers, boatmen. Free illustrated circular from originator. Rekleo Manufacturing, Box 854M, Grand Prairie, Texas.

PLASTIC Lure bodies. World's famous flattish complete kit 25 for \$3.25. Spinning reels open and closed face \$3.25. Free circular. Quaker City Mfg., 3514-24 N. Lawrence, Philadelphia 40, Penna.

JAP Rifle altering to 30-06. \$6.00. Japshells, \$3.95. Catalog 10¢. T. P. Shop, West Branch 11, Mich.

MOLDS—For casting your own fishing sinkers. Free illustrated booklet. Reading Instrument Co., Box PM78, Reading, Penna.

FREE—Wholesale catalog. Beads. Spinners. Lure parts. Sinker molds. Jigs. Reels. Finnyports (ME). Toledo 14, Ohio.

BIG Money raising crickets and 12 inch African fishworms. Free literature. Carter Ranch, Plains, Georgia.

AMAZING Wholesale sporting catalog. Save 70%. Tremendous selections. Econ-O-Mart, Whippany 2, New Jersey.

MOLDS For fisherman's sinkers, jigs, squids, casting and spinning lures. Free catalog. Sweet's Molds, Tonawanda 1, New York.

NOBODY Undersells Kleins's! 144 page all-sports bargain catalog free. Kleins-PM, Chicago 24, Illinois.

HUNTING Guide free! Experts tell you how to be crack shot; dress game; care for weapons; camp cookery; and how to have convenient heat and light in the woods. Supply limited. Write A. W. Thacker Co., Dept. P, Clermont, Fla.

EYEGUARD Shooting glasses, amber, green, \$3.95. Bargain catalog, 5,000 guns, \$1.00. Agramonte's, 41 Riverdale, Yonkers, N. Y.

SUBSCRIBE To Government Surplus Weekly. Lists all sales. Buy jeeps, trucks, boats, tents, tires, etc., direct from government. Next 10 issues \$2. Government Surplus, Paxton 20, Ill.

CAMPING EQUIPMENT AND TENTS

CAMPING Equipment. Send 25¢, giant catalogue. Morsan, 10-21R 50th Avenue, Long Island City 1, New York.

BUILD Your pickup camper. Kits. Blueprints. Supplies. Literature 10¢. Comstock Trailers, Parsons, Kansas.

SAFETY Equipment with survival instructions. Keeps you calm when lost or detached from camp or companions! Kit fastens on belt—goes with you on all trips. Only \$3.00. Gemsco Corp., P. O. Box 297, Des Moines, Iowa.

PRIMUS And Therm'x stove and heater literature free. Davis Imports, Dept. G, Box 489, Edmonds, Washington.

EARTHWORMS, CRICKETS, FROGS

HYBRED Redworms 1000, \$3.00; 2000, \$5.00; 5000, \$8.00 postpaid with raising instructions. Brazos Bait Farm, 60 Lincoln, Waco, Texas.

BIG Money raising fishworms and crickets. We teach you: how to raise and where to sell. Free literature. Medium redworms, 3000, \$5.95; 10,000, \$16.95. Carter Redworms, Plains, Georgia.

FREE Picture folder, "How to Make \$3,000 Yearly, Sparetime, Backyard, Raising Earthworms!" Oakhaven-56, Cedar Hill, Texas.

MEN!—Women! Make money raising earthworms! Full, sparetime, at home. Easy—use backyard, garage, basement, spare room. Moneymaking details free! Red Wigglers, Warsaw 20, Indiana.

BINOCULARS, TELESCOPES, MICROSCOPES, MAGNIFIERS

REFLECTING Telescope, 60X, completely assembled. Guaranteed observatory clearness. Free information. Skyscope, P.O. Box 55, Brooklyn 28, N. Y.

SCIENCE Bargains! Lenses, telescopes, binoculars, microscopes, kits, parts, war surplus. Send \$1.00 for beginner's 10-lens kit with instruction booklet. Order Stock 2-CH. Request free 144-page Catalog CH. Edmund Scientific Co., Barrington, New Jersey.

DYNASCOPE—Amazing world-famous reflector telescope. Request free brochure. Criterion, Dept. DP-85, Hartford 1, Conn.

7-12 X 35 W/A ZOOM Binoculars \$49.99 plus 10% tax. Free catalog. Quality Optics, 13571 Kentucky, Detroit 38, Mich.

TELESCOPE Manufacturer's closeouts. Telescopes, lenses. Terrific bargains. Many giveaways. Write Hobbycraft Mfg., 1107-W 69th, Chicago 21.

BUILD Your own reflector telescopes. Complete kits: mirrors, eyepieces, tripods, all other accessories. Request free illustrated literature. Criterion Manufacturing, Dept. KPM-82, Hartford 1, Conn.

PLANTS, SEEDS, BULBS, NURSERY SUPPLIES

SEEDS From all over the world. Flowers, houseplants, shrubs, trees, evergreens and others. Send 25¢ for illustrated catalog plus free packet seeds. James & Co., P.O. Box 71 PM, Bedford, Ohio.

GROW Dwarf trees! Seeds and instructions. 35¢. Mail Order Specialties, 1439-C Sabraton Avenue, Morgantown, W. Va.

PETS—DOGS, BIRDS, HAMSTERS, ETC.

HAMSTERS—10 different colors. Free booklet. Pair, metal cage, \$4.00. Hamster House, Box 5185-PM, Augusta, Georgia.

BEAUTIFUL White band hamster and escape proof cage \$3.25. Engle's Hamstery, 2609 So. 11½ St., Terre Haute 12, Ind.

HAWKS, Reptiles, raccoons, skunks, squirrels. Catalogue 25¢. Trails End Zoo, St. Stephen, S. C.

MAKE Money raising chinchillas, mink, rabbits, cavies for us. Free catalog. Keeney Brothers, New Freedom 2, Penna.

PETS—Hamsters, mice, rabbits, squirrels, guinea pigs, chipmunks. Literature and pricelist dime. Moore's Hamster Ranch, Shepherdstown 25, West Virginia.

HAMSTERS—Ideal pets, \$2.95 pair. Free booklet. Jer-fre's Hamstery, 1447 Apple, Muskegon 13, Michigan.

RABBITS—FUR BEARING ANIMALS

RAISE Rabbits on \$500 month plan. Free details. White's Rabbitry, Mt. Vernon, Ohio.

MINK Raising information free. Complete. Lake Superior Mink Farm, Superior, EEL, Wisconsin.

RAISE Rabbits successfully by knowing facts. 48 page book. 38 illustrations describing 25 breeds. Housing, Breeding, Feeding, Markets and Marketing. Bulletin etc. 25 cents. American Rabbit Association, 36 ARBA Building, Pittsburgh, Penna.

FARMS, FARM LANDS, REAL ESTATE

KENTUCKY, Lakeshore homesites \$195.00, \$10.00 monthly. Free booklet. Write Col. Garland, Burnside, Ky.

NATURAL For sportsman. Yours for both pleasure and profit! 140-acre farm has 30-acre natural wild rice duck pond! Rice has been harvested one year! In addition to top duck hunting, there's excellent trapping, pheasant, grouse, squirrel, white-tail deer and coon to be found here. Land also suited for tree farming, raising hogs, pond and well-watered pasture. Electric-lighted 5-room 3-bedroom house, running water indoors. On all-weather road, 52 miles "Twin Cities." An interesting bargain offering several income potentials. \$6,500, only \$2,500 down. Big free illustrated Fall-Winter catalog, bargains coast to coast! United Farm Agency, 2825-PM Main St., Kansas City 41, Mo.

ARIZONA, Phoenix 2½ acres \$15.00 down. Box 6005, Kansas City 10.

CANADIAN Vacation lands: Full price \$385.00. 40 acres, \$10 month. Suitable cottage sites, hunting, fishing, investment. Free information. Land Corporation, 3768-C Bathurst, Downsview, Ontario, Canada.

FLORIDA Campsites—deep in the heart of the great Ocala National Forest. Abundance of game, best fishing. Warranty deed. Unrestricted—pitch tent, park trailer, build lodge. Free maps and photos. Howard Vernor, DeLand, Florida, AD60088(Q-O).

SILVER Springs area lots. \$195.00 full price—\$5.00 month. Free colored pictures. Write Lake Weir, Box 568V, Belleview, Florida.

CAROLINA Coast. \$5 down, \$5 monthly buys large homesite. 70x150, in beautiful Boiling Spring Lakes. Satisfaction guaranteed. 16,000 acres. 52 freshwater lakes. Excellent fishing, hunting. Free literature. Boiling Spring Lakes, Southport 1, North Carolina.

FREE Strout catalog! Farms, homes, businesses, resorts, retirement properties. Over 3000 values coast to coast. 61 years service. World's largest! Write Strout Realty, 7-CJ S. Dearborn, Chicago 3, Ill.

MONTANA—Fishing and hunting cabin and camp sites on the Kootenai River in the Montana Rockies \$595; \$10 down and \$10 per month. Mountain Empire Co., Box 203-P, Libby, Montana.

\$5 MONTHLY Buys 5 acres—near clear-water lake. Price \$125. Excellent fishing, good cabin sites. Free list. Box 425-P, Carthage, Mo.

WORLD'S Best! Low cost multipurpose lands. Booklet free. Armstrongs, Shook, Mo.

OPPORTUNITIES! Government land, U. S., Alaska, Canada. Sledge Surveys, Macon, Mississippi.

PROFITABLE OCCUPATIONS

INVESTIGATE Accidents. Earn \$750 to \$1,000 monthly. Men urgently needed. Car furnished; business expenses paid. No selling. No college education necessary. Pick own job location. Investigate full time. Or earn \$6.44 hour spare time. Write for free literature. No obligation. Universal, CPM-11, 6801 Hillcrest, Dallas 5, Texas.

PROFITABLE Career waiting. Free information. Davis Imports, Dept. C, Box 489, Edmonds, Washington.

START A magazine subscription business. Earn generous commissions on Popular Mechanics, Good Housekeeping and all others. Best commissions, bonus, all materials sent free. No experience needed. Write Popular Mechanics, Room 11-P, 250 West 55th St., New York 19, N. Y.

DEALERS Wanted for power house battery rejuvenator. Direct shipment. No investment. Sample \$2.75. Guaranteed. Bayer Co., 938 Betty Avenue, Neenah, Wisconsin.

AVERAGE Piano ability means dollars. Pre. info. \$2.00. Piano, 7103 Camelot Rd., Jacksonville, Fla.

PROFITS In manufacturing. Valuable information free. Colen, 7731-PM Yates, Chicago 49.

WHOLESALE Magazine subscriptions. Highest commissions. Bonus! Qualified Agencies, 451GA Kingston, Brooklyn 25, N. Y.

FREE: "How to Win Contests." Contestar, Box 51-PCC, Des Plaines, Illinois.

BUY Below wholesale! Thousands of nationally advertised products. Drugs, clothing, housewares, cameras, jewelry, hardware, sporting goods, etc. Postcard brings price list showing actual factory cost. Buy-Rite, 310 Main, Bennington 1, Vermont.

AUCTIONEERING—Home study course. Diploma granted. Auction School, Ft. Smith, Ark.

EARN \$240.00 A month at home, spare time, doing only two \$5.00 invisible mending jobs a day. Big money paid for service that makes cuts, tears disappear from fabrics. Steady demand. Details free. Fabricon, 6236 Broadway, Chicago 40, Ill.

VENDING Machines. No selling. Operate a route of coin machines and earn amazing profits. 32-page catalogue free. Parkway Machine Corporation, Dept. #25, 715 Ensor Street, Baltimore 2, Maryland.

SHARPEN Scissors, pinkers. Inexpensive machine. Clipper sharpener. Blackhaws, Sheldahl, Iowa.

BAKE New greaseless doughnuts in kitchen. Sell stores. Free recipes. Michael, 3605 South 15th, Minneapolis 7, Minn.

BIG Money raising fishworms and crickets. Free literature. Carter Wormery, Plains, Georgia.

BECOME Independent with your own franchise business. Thousands earning handsome incomes. Request interesting facts today. National Franchise Reports, PM-528, 333 North Michigan, Chicago 1.

WHOLESALE Magazine subscriptions. Highest commissions. Bonus! Qualified Agencies, 451FA Kingston, Brooklyn 25, N. Y.

FREE Book "711 Bizarre, Successful Ventures" How I retired. Work home. Hayling, Carlsbad, Calif.

FREE Report: "609 Unusual, Successful Businesses." Box 1001-PMK, Evanston, Illinois.

ATTENTION. Just out! Learn "The Secrets of Invisible French Weaving." This is the new, simplified, visual course which contains absolutely everything you need to know to establish your well-paying, invisible clothing repair business. Learn and earn at your convenience. For free literature write: Weaver's Workshop, 149-B No. Park Ave., Montebello, Calif.

BOOKS, PERIODICALS, PICTURES, POSTCARDS

OLD And rare books. Collectors items, etc. Catalogue 25¢. Antique Books, P.O. Box 12203, Houston 17, Texas.

BOOKS 50%-90% off! Catalog free. Werewolf Bookshop, Verona, Penna.

10,000 TRADE Secrets, processes and recipes for money-making formulas. Write: Patrick, 207 Wallis St., Tallahassee, Fla.

FIX-It book. 1000 subjects, 650 pages, 300 illustrations. \$3.95. Free circular. Daniel's Novelties, Box 61, Allen Park, Michigan.

FREE Catalog. Self-help books. Write Wilshire, 8721 Sunset, Los Angeles 46P.

BOOKFINDERS! All subjects. Send wants! Jaher Book Service, 183 Hazelwood Drive, Westbury, N. Y.

NATIONAL Geographic magazines, 1888-1960, any issue. Periodical Service, Box 465-PM, Wilmington, Delaware.

BOOKS Located fast. Out-of-print, scarce. Lowest prices without obligation. Book Mark, 51A Walnut, Mt. Clemens, Mich.

BOOKHUNTERS! Scarce, miscellaneous books supplied! Atlantic Book Service, Cedar Street, Charlestown 29, Mass.

OUT-Of-print books at lowest prices! You name it, we find it! Fast service. No obligation. International Bookfinders, Box 3003-PM, Beverly Hills, Calif.

BRITISH Book bargains—Any subject. Catalogues free. Transatbooks, Wantagh, N. Y.

BOOKLET Of 18 inspirational poems by A. W. Steen, Western philosopher and conservationist \$1.00 P.P. Frank E. Bostwick, Dist. 7055 No. Figueroa St., Los Angeles 42, Cal.

POSTCARDS One dozen different color postcards of scenic Washington, D.C. and vicinity. \$1.00. P.O. Box 7812, Benjamin Franklin Station, Washington, D. C.

FREE Literature. Self improvement books, hobbies, crafts. Martin's, Box 7142, Nashville 10, Tenn.

MAGIC TRICKS, PUZZLES, JOKER NOVELTIES

108 MAGIC Tricks explained, illustrated \$1.00. Mack the Magician, Box 1088, Albuquerque, New Mexico.

84 PAGES, Completely illustrated catalog, 25¢. Manhattan Magic, Box 334-P, New York City 11.

CATALOG, Free trick, 25¢ (1,500,399 tricks, jokes, novelties). Magico, #4037-P, San Antonio 7, Texas.

BE A magician! Large professional catalog of latest tricks, 35¢. Ireland, C-109 North Dearborn, Chicago 2, Illinois.

WORLD'S Finest professional magic, Joker novelties. Giant illustrated catalog 10¢. Top Hat, Evanston 12, Illinois.

INDIA Rope trick and magic catalog 25¢. Hocus Pocus, 209 West Capitol, Jackson, Mississippi.

500 TRICKS. Famous Douglas catalog of magicians' tricks and supplies now available just 10¢. Fastest service. Douglas Magician, Dept. 61, Dallas, Texas.

3000 TRICKS. Pocket, parlor, stage. World's finest magic catalog (408 pages), \$2.50. Kanter's, M-1311 Walnut, Philadelphia 7.

WORLD'S Most amazing magic & fun catalog! Bigger—better than ever! Brand new! Just off press! 160 illustrated pages! Jumbo international edition! Get yours today! Only 10¢. House of 1000 Mysteries, Dept. PM11-61C, Trumbull, Conn.

FLAME Thrower! 36" flashes at fingertips! \$1.00. Harmless! Arlane, Philadelphia 44.

CRAZY Stationery, 24 rib-ticking sheets, envelopes \$1.00, two \$1.50. Longhorn Card Co., Batesville, Ark.

TRICKS, Gags, jokes at wholesale. Sell to friends. Catalog free. 28 gag samples 25¢. Dohn-OX-Marks, Broadview, Illinois.

VENTRILLO Voice thrower 25¢ Ventriloquist's puppet 75¢. Box 971-PM, Philadelphia 5.

279 MAGIC Tricks only 15¢. Funmaster, 4629 So. 23rd East, Salt Lake City 6, Utah.

2700 NOVELTIES, Jokes, tricks, fun-makers, hobbies. World's biggest gadget catalog 10¢. Johnson-Smith, D-549, Detroit 7.

SMOKE Bombs 25¢ 7 for \$1.00. Terrific! 4463-PM Greene, Philadelphia 44.

COINS, TOKENS, CURRENCY

BEGINNER Collections: 20 different Buffalo nickels (1913-1938), \$3.50; 20 different Jefferson nickels (1938-1961) including 1939S, \$3.50. Both sets only \$6.75. In Whitman folders, postpaid. Earl's Coins, P.O. Box 305, Eureka, California.

SEVEN Different Indian cents with lists. \$1.00. Hutchinson's, Box 6256, Philadelphia, Penna.

LINCOLNS (Good) 1910S, 1913S, 1915S \$2.00; 1912S, 1914S, \$3.00; 1911S, 1924D \$5.00; 1921S, 1923S, 1924S, 60¢. Priced per coin. United, 348 Grotto, Providence, R.I.

BRILLIANT Proof sets, 1954, \$12.50; 1955, \$11.75; 1956, \$7.25; 1957, \$4.50; 1958, \$9.85; 1959, \$4.75; 1960, \$3.85, 1961, \$3.35. All eight sets \$53.00. President Kennedy official inaugural medal \$4.75. Retail guidebooks—U. S. \$1.75; Canada \$1.85; World coins \$4.25. Beebe's, 4514 North 30th, Omaha 11, Nebraska.

WE'LL Pay \$9,000.00 to \$18,000.00 for 1913 Liberty Head nickel. Certain dates—half cents, \$3,750.00; Large cents, \$5,500.00; Indian cents, \$1,750.00; Flying Eagle cents, \$650.00; Dimes before 1943, \$5,250.00; Quarters before 1934, \$5,250.00; Half dollars before 1940, \$7,500.00. Certain silver dollars \$15,000.00. We paid \$6,500.00 for one silver dollar. Thousands of others worth \$10.00 to \$3,000.00 each. Such as, certain dates—Lincoln cents before 1956, 2¢ pieces, 3¢ pieces, half dimes, shield nickels, Liberty Head nickels, Buffalo nickels, 20¢ pieces, commemorative coins, paper money, foreign coins, etc. Certain gold coins worth \$40,000.00. Whether your coin is worth \$10.00 or \$40,000.00, we'll pay the highest price of any dealer advertising a buying catalogue. We have been leaders of numismatic quotations for over twenty years and have purchased over \$250,000.00 worth of rare coins. Thousands of persons have sold us coins. For complete allcoin information, before sending coins, send \$1.00 for finest large illustrated complete guaranteed buying-selling catalogue. Catalogue dollar refundable. Worthycoin Corporation (K-508-C), Boston 8, Massachusetts.

WILL Pay \$15.00 for 1914D penny! 50¢ (refundable) brings big list. Cash Coin Company, P.O. Box 423, Bakersfield, Calif.

FIVE Genuine foreign bills sent free with our price catalogue of United States coins. 25¢ & 5¢ mailing. Choice approvals included with every order. Tatham Stamp and Coin, Springfield, Mass.

Send \$2.00 for 5 Indian cents, and 5 Liberty nickels, all different. 1961 proof set \$3.00. Price list included. Stroud's Coins, Kinston, N.C.

FASCINATING Collection: Introductory, five different marine military patches and catalog. 25¢. Hobbies, Box 71-M, Rockaway 94, New York.

UNCIRCULATED 1935 silver pony express commemorative medal \$1.00. Coin lists free. Sayers, 1000 Unaka, Johnson City, Tennessee.

SILVER Dollars: Send for free price list. I buy silver dollars 1794 thru 1935. Also Indian cents, gold. Pay top prices. T. Fitzpatrick, Box 177, Center Moriches, N. Y.

LINCOLN Investments, 15¢. Jones, Route 1, Box 383, Bartow, Fla.

KENNEDY And Lincoln presidential medals, bronze \$2.50; silver \$10.00 each. Hv Brown, P. O. Box 167, Painesville, Ohio.

CALIFORNIA Gold, souvenir tokens 5 different in plastic holder, \$4.10 postpaid! Dealers write. Sample \$1.00. France, P.O. Box 112-PM, Evansville, Indiana.

WANTED: Coins, Confederate money, relics. Heflin, 1501 Grandview, Nashville 12, Tennessee.

BERMUDA Silver dollar, \$3.00. Catalogue 25¢. Freddie Buza, Stevens Point, Wisconsin.

8 WORLDWIDE Bills—Yugoslavia, Japan, China—25¢. Jolie, Roslyn Heights, N. Y.

COIN'S Bargain list. Stamp please. Also buying Indian heads 15¢ each, none mutilated. Money immediately. Lightner, 1513 S. Marlan, Springfield, Mo.

LINCOLN Cents 1921-S, 1924-S, 1918-D-S, 1909-P, 1917-S-D, 1925-S-D, 1920-S-D, 1919-S-D, 1930-S-D, 1938-S-D, 1931-P, 1927-S-D, 1929-S-D, 1928-S-D, 1934-D, 1955-S. Complete lot \$4.00 good to fine rolls of 1955-S Lincoln cents good to A.U. \$5.00 roll. Berry, Box 306, Westminster, Calif.

LINCOLNS For sale 25¢ each: 1909, 1911-P-D, 1913-P-D, 1915-P-D, 1916-P-D-S, 1917-D-S, 1918-D-S, 1921-P-S, 1924-S, 1925-D-S, 1927-D-S, 1928-D-S, 1931-P, 1932-P-D, 1938-D-S, 1939-D-S, All 30 \$7.00. Al. Johnson, Box 35, Colorado Springs, Colo.

WONDERFUL Collection! 32 different foreign coins—scarce old issues included \$1.00. 20 different from Africa and Asia \$1.00. List free. Szego, Box 187, Jackson Heights 72, New York.

ALASKAN Statehood souvenir golden dollar, \$2.00. Oliver Merrell, Lake City, Minn.

LINCOLNS: 40 Different 1909VDB-1940 \$1.95. 25 different "S" \$1.50. Harris's, Box 611, Cupertino, California.

HIGHEST Prices paid for United States coins. Send 10¢ for our buying lists. Wilmot's, 1067-A Bridge, Grand Rapids 4, Michigan.

TWO Brilliant uncirculated Morelos-Mexicanos silver dollars, \$1.00 (refunded). Universal Services, Box 866, San Antonio 6-D11, Texas.

MEXICAN Silver dollars. Brilliant, uncirculated. Three for \$1.00. Ogden, Box 13404, Ft. Worth, Texas.

INDIAN Pennies, six different \$1.00. Also will buy Indians 10¢ each. Joseph Gaidar, 6615 South Ashland Avenue, Chicago 36.

MANY Coins worth more than face value, some 1909 pennies worth \$50.00, Indianheads up to \$100.00. Our buying lists tells all 25¢. Hyles Sales, Box 9566, Dallas 14, Tex.

"FABULOUS Treasure Hunt" particulars. Fred's Enterprises, 322 Pinnacle, Belleville, Ontario.

25 UNCIRCULATED Coins, 25 countries, \$1.00. Newcomers, Box 91, Atlantic 71, Mass.

GIANT Illustrated catalog listing hundreds of bargains in coins and supplies, only 25¢. Ben's Coin Shop, 31 North Clark, Chicago 2.

SPECIAL 60 Coins from 60 different countries \$5.00. Ace, 107 North Dearborn, Chicago 2.

COINS Wanted. List of prices paid—10¢. Wayne Coin, 1205 California Ave., Ft. Wayne, Indiana.

COINS, Supplies: Lists 20¢. Lund, 200 So. Sycamore, North Platte, Nebraska.

LARGEST Coin magazine, 288 pages, 50¢. Scrapbook, 7320-J Milwaukee, Chicago 31.

NUMISMATICS Largest newspaper. Semi-monthly. Sample 25¢. \$2.00 yearly. Numismatic News, Box 452, Iola, Wis.

TWENTY Page 1961 retail price list of USA and Canadian coins for 10¢. Our selling prices on thousands of coins and coin collectors supplies. Bryson Incorporated, 612A White, Toledo 5, Ohio.

NUMISMATISTS—Price list with valuable gift—40¢. Vanderman, Box 9161, Suitland, Maryland.

GIANT 100-Page coin catalog, listing coins and supplies for sale. Send 25¢. Ben's Coin Shop, 31 North Clark St., Chicago 2.

RARE 1878 CC mint dollar uncirculated \$5.00. 100pg. catalogue 50¢. Shultz, Salt Lake City 10, Utah.

BARGAIN List! U.S. coins, accessories. Stamp please. Hugh's, Hickory, N. C.

WORLD'S Greatest coin magazine and wooden nickel 10¢. Lawrence's, Anamosa, Iowa.

FREE Coin supplies! Giant coin list 10¢ (refundable). Economy Sales, Mansfield, Massachusetts.

40 PAGE Illustrated United States and Canadian coin list 10¢. Stoney, 260 Washington, Boston 8, Mass.

25 BEAUTIFUL Coins from 25 countries. Mostly uncirculated. Terrific assortment. \$1.00. Hindley, Box 708, Aurora, Illinois.

INDIAN Cents 7, \$1.00. Liberty nickels 6, \$1.00; 14, \$2.90. Doktor, P.O. Box 35151, Los Angeles 35, Calif.

CONFEDERATE Cent, half-dime, dime, quarter, half-dollar, uncirculated, \$2.95 boxed. Sample Confederate coin, and catalog 25¢. Collectors Club, Box 71-C, Rockaway 94, New York.

RARE Unc. 1899 Philadelphia silver dollar, \$5.00. Butts, Torrington, Wyo.

STAMP COLLECTING

FREE! 25 Egypt, 10¢ handling. Approvals. Bellet, Mapledale, Hazel Park, Michigan.

200 STAMPS, 25¢ With approvals. Smith, 508A Brooks, College Station, Texas.

10 CANAL Zone only 25¢. Merkel, 30 Grandview, South Hadley Falls, Mass.

FREE! Sports, animals, flowers. Approvals. Telico, Box 127, Long Island City 4, N. Y.

FREE U.S. mint price list. Mada, Box 22, Rosedale 22, N. Y.

25 ORIENT 5¢; Approvals extraordinary. Thiese, 9320-M San Juan, South Gate, California.

FREE! 25 Different New Zealand; colorful, inexpensive approvals. Elkhart, Box 33, Elkhart, Indiana.

700 COSMOPOLITAN For 25¢. Request approvals. Horace Gatewood, Winston-Salem, N. C.

U.S. Fully illustrated catalog 10¢ deductible. Simmy's, 45 Bromfield, Boston 8, Massachusetts.

GIANT Topical collection: Moon-rocket sets, satellites, atomic ship, Boy Scout issue, complete UN set, recent Olympics and sport issues from Togo, Mongolia, Paraguay, Germany, Romania, etc. Plus big stamp dictionary and approvals. Everything 10¢. Stampex, Box 47-CM, White Plains, N. Y.

INDONESIA, 50 Different for 25¢ with approvals. R. B. Griffiths, 29761 MacIntyre, Livonia, Michigan.

1,000 DIFFERENT Worldwide for approval buyers only. Jacobsen, Crompond, N. Y.

U.E. COMMEMORATIVES: 160 different \$1; 220 different \$2; 305 different \$5. Lists free. Moseley, 6 Hanley Downs, St. Louis 17, Missouri.

THREE Months trial subscription, 25¢. National Stamp News, Anderson, South Carolina.

TRADE Your duplicates toward our approvals! (Foreign only.) Complete information, 10¢. Variety Stamps, Box 98-P, Newton Highlands 61, Mass.

FREE! 222 worldwide 10¢ handling. Penny approvals. Jung, 1601 North Stanley, Los Angeles 46.

FREE. 250 peelable hinges and 20 different Brazil with approvals. Jaydee, 218 Dickinson S.W., Grand Rapids 7, Mich.

TERRIFIC Value. Eight complete mint sets 10¢ with approvals. Beatties, Box 4503, Fort Lauderdale, Florida.

BIG U.S. price list free! Bailey, 45-G Bromfield, Boston, Mass.

303 DIFFERENT Stamps 25¢ plus free gift with our low priced approval. Try us—you will be satisfied. Trust Stamp Co., P.O.B. 132/P, Jamaica 35, N. Y.

ENJOY Stamp collecting? Write for "penny-provals." Penny-Proval Service, New York Building, Saint Paul 1, Minn.

SPACEMAN Gagarin and ten complete sets, 10¢ with approvals. Stamp Imports, Peterborough, Canada.

21,000 ALL Different, only pennies a day using our systematic payment plan. Details free. Sjoquist, 1435 Cherrydale, San Jose 25, California.

PENNY Approvals. 1000 foreign stamps mounted in Scott order. No assorting! Send \$1.00 deposit deductible from first order. Bullof Approvals, 1359 Coney Is. Ave., Brooklyn 30, N. Y.

U.S., U.N., Confederate states catalog free. Stone, 260 Washington, Boston 8, Mass.

FREE! 25 different. Approvals. Ehrlich, 1012 Chiswell Lane, Silver Spring, Maryland.

U.S. Mint specials! Flag set, complete \$1.00; 1¢, 2¢, 3¢ famous Americans (21 different), \$1.00. Free list. Brooks, 2323 Avenue X, Brooklyn 35, New York.

GORGEOUS Miss Universe and mystery packet of complete sets, 10¢ with approvals. Kawartha Stamps, Box 513, Peterborough, Canada.

215 DIFFERENT Worldwide 25¢. Flume, Korea, Laos, Russia, Transvaal. Approvals. Bobb's, Box 3045, Saint Louis 30, Missouri.

HUMAN Rights set free with approvals. Collier, Box 265, Chamblee, Ga.

MILLION Foreign stamps! 2¢ each! Send for thrilling, giant approvals! ABC Stamps, Box 6000-HH, San Francisco 1, Calif.

SPUTNIKS, Rockets, space stamps free with sparkling approvals. Cambria Stamps, Box 2205, Anaheim, California.

ALBUMS! Hundreds of spaces! Only 25¢. Postpaid! Stampmart, Hartford 1, Conn.

TWO \$5.00 United States stamps, 20 others 10¢ with United States approvals. Irwin, Box 1105, Brooklyn 30, New York.

25 DIFFERENT Large American commemoratives, 10¢ with approvals. Linstamp, St. Catharines 101, Ontario.

80 DIFF. U. S. stamps includes 19th Century commemorative. High values. Plus 1943 flag stamp of occupied nations. All for only 25¢. Approvals included. Willett Co., Box 338-C, Yorktown Heights, N. Y.

107 DISTINCT British Colonial stamps, 10¢. Approvals. Linstamp, St. Catharines 401, Ontario.

25 DIFFERENT Commemoratives 1893 up 10¢. U. S. approvals. K & B, Box 70, Brooklyn 23, N. Y.

UNITED Nations 15th anniversary sheet with first day cancel, as commemorated by Russia. Free! While they last, with approvals. Philatelics, R-J, New Paltz, N. Y.

25 COLUMBIA 10¢. Approvals included. Reed, Box 980, Chicago 90, Illinois.

105 DISSIMILAR British Colony stamps, 10¢. Approvals. Crown Stamp Company, Virgil 601, Ontario.

INTRODUCING Our better United States approvals we offer 15 United States stamps including Columbian, Bi-Centennials, famous American, airs, others; only 10¢. Ocean Stamps, Box 64-PM, Brooklyn 29, New York.

PENNY Approvals. Thousands. Bargains for pennies. Gifts with purchases. Penny Stamps, Orange, California.

GIANT Approvals, thousands different, 1¢ and 2¢ each. Wahl's Stamp Exchange, 7008P Farragut, Chicago 31, Ill.

UNITED States commemorative collection containing 33 different—10¢. Approvals. White, 516-A Avenue L, Brooklyn 30, New York.

103 DIVERSIFIED British Empire stamps, 10¢. Approvals. Niagara Stamps, St. Catharines 501, Ontario.

SELL Your surplus good grade stamps. Write, describing fully what you have. Vanroy Shirk, Lebanon, Pennsylvania.

AMAZING OFFER! 200 United States stamps—including commemoratives, airmails, high denominations to \$1.00. Only 10¢ to approval applicants! Illustrated bargain lists free. Mystic Stamp Co., Dept. 80, Camden, New York.

100 OLD United States between 1861 and 1935. \$1.00. Roush Stamps, 51 Chestnut, Mansfield, Ohio.

UNITED States price list, 116 pages, price 25¢. Mark Hanna, 335 Fifth Ave., Pittsburgh 22, Penna.

SELL Stamps to our readers. Your ad in this space will be read by thousands of stamp buyers. I'll prove that to you. Write now for Folder "S." F. W. Johnson, Classified Advertising Manager, Popular Mechanics, 200 E. Ontario St., Chicago 11, Ill.

STAMP Jungle including Zabu, kookaburra, koalabear, kangaroo, rhinoceros, 10¢. Approvals. Crown Stamp Company, Virgil 301, Ontario.

14,000 DIFFERENT! Amazing new plan builds your collection systematically, country by country. Only 50¢ weekly. Free details. L. G. Ware, Monroe 75, Conn.

FREE Monaco nudes. Approvals. Stamp Ranch, 902 Addison, Chicago 13, Ill.

ECONOMICAL 1/2¢-3¢ Approvals, 39,000 varieties. Dresel, Box 128-N, West Englewood, New Jersey.

PENNY Approvals! Regardless catalogue! Kloster, 4164-52nd St., San Diego 5, Calif.

60 DIFFERENT U. S. (30 commemoratives) 25¢. No approvals. Seidenberg, Appleton, Wisconsin.

500 DIFFERENT. Includes pictorials. 35¢. Knopp, Box 1381, Bristol, Conn.

307 WORLDWIDE Different stamps only 25¢. Approvals. Niagara Stamps, St. Catharines 201, Ontario.

225 STAMPS For only 10¢! This mammoth value includes airmails, pictorials; stamps from strange countries cataloging up to 25¢ each! Also approvals. Mystic Stamp Company, Camden 90, New York.

DEFECTIVE Old U.S., 1/6 catalog. Approvals. K. Swartz, Malden Bridge, New York.

LOOK! Six Queen Elizabeth mint sets from Antigua, Caymans, Mauritius, Montserrat, Virgins, St. Kitts! 21 brilliant pictorials, 25¢. Attractive approvals! Gannon Stamps, Box 931, Canton 1, Ohio.

U.S. Stamps. Giant discount catalog—20¢. Raymax, 37-VZ Maiden Lane, New York City 38.

FREE 50 Worldwide, mailed with inexpensive approvals. University Stamps, P.O. Box 44-592, Miami 44, Florida.

FREE Mint set! Approvals accompany. Stampco, Box 737, Memphis 1, Tenn.

150 DIFFERENT U.S. 50¢, many older issues. Approvals. Winchester Stamps, 45 Winchester Rd., Mansfield, Ohio.

111 WORLDWIDE. Includes airs, midgets, triangles, 10¢. Approvals. Premiums. Faith, 20 1/2 Bushnell, Alhambra, Calif.

FREE—Airmails. Complete sets. Singles. Fifteen different countries. Handling 10¢. Approvals. Boger, Box 152, North Wales, Penna.

MORE Stamps for less money! Bargain lot: packets, sets, rare stamps \$1. Giant assortment \$5. High value packet \$3. Beginners album and credit coupon 20¢. Persile, 436 N. Y. Ave., Brooklyn 25, N. Y.

FREE: 30 Large U.S. Commemoratives Approval Applicants. Handling 10¢. Jack Clancy, Box 2187, Portland 14, Oregon.

WILL Send you Laos, Vietnam, Cambodia, new issues and obsolete. Deposit \$10.00. Phoalimkway, Box 6501, Kowloon, Hongkong. (Member ASDA.)

100 DIFFERENT United States commemoratives, 1/2¢ to 10¢ values—used \$1.00; Mint \$4.95. No approvals. Gil's, Box 12BA, Brooklyn 29, N. Y.

BRITISH Colonies. Three complete mint sets, 10¢ with world wide approvals. Peter R. Cope, 639 130th Avenue N.E., Bellevue, Washington.

SOUVENIR Sheets Czechoslovakia 1937 plus Japan 1947, 10¢ with approvals. Kingman, 30 Empire, Yonkers 4, N. Y.

WOW! 110 All different Germany 10¢! Zeppelins, semi-postals, airmails, high values, etc. Giant catalog, bargain lists included with beautiful approvals. Adults only! Jamestown Stamp, Dept. A111PM, Jamestown, N. Y.

100 DIFFERENT United States 10¢. Approvals. Gordon Davison, Henniker 8, N. H.

TERRIFIC Stamp bargain! Israel, Iceland, San Marino, plus triangle set, plus Antigua, Borneo, Virgin, Scots, Congo, Russia, plus large stamp book. All four offers free. Send 10¢ for mailing cost. Empire Stamp Corporation, Dept. PM, Toronto, Canada.

JAPAN Stamps & FDCs list. Postage 25¢. Maemura, Suzuka-shiroko, Mie, Japan.

FANTASTIC Fish triangles! Valuable "Ben Franklin" on Canal Zone! Flaming bi-colored volcano triangle! Lovely Olympics triangle! Plus icy Greenland, weird wild beast issue and others. 10¢ with approvals. Roseland Stamps, Spring Lake 2, Michigan.

SEND 25¢ for four beautiful sets! Evenden, Box 5001, Eugene, Oregon.

1065 DIFFERENT Stamps \$1.00 to approval applicants. Klondike, Harrisburg, Illinois.

TERRIFIC Beauties! 2¢-3¢ approvals. Marshall, Box 553-PG, Pacific Grove, Calif.

100 DIFFERENT Sweden, 25¢! Bargain approvals! Carling's, B-111, Howard City, Michigan.

50 PICTORIALS 10¢ with approvals. Anarden, 6041 Columbus, Minneapolis 17, Minnesota.

FREE—When you buy our foreign approvals, you receive absolutely free stamps equaling your purchases. Coast P.O. 2187, Santa Ana, California.

AMERICAN Historical collection! Enormous George Washington beauty, P. D. Roosevelt diamond, giant Abe Lincoln U.S.A. flag commemorative, plus midget soldier, Latin orchid issue, old IFNI overprint, etc. 10¢ with approvals. Roseland Stamps, Spring Lake 2A, Mich.

GOYA Nude (I) 10¢ approvals. Hannay's, 186 West Lawrence, Albany 3, N. Y.

FREE 60 Different stamps to collectors requesting approvals. Stanley Zajac, 159 Emerson Ave., Toronto, Canada.

PACIFIC Islands to Antarctica 50 different 25¢. Approvals. Peper, 506 East 120th St., New York 35, N. Y.

MALTA 50 Different \$1.00, 100 \$4.00. Magro, Zachary, Valletta, Malta.

100 STAMPS, 10¢ with approvals. Vickers, Box 134, Fort Worth 1, Texas.

200 DIFFERENT U.S. stamps \$1.00. Approvals included. Shelron, Box 907-J, New York 8, N. Y.

UNBEATABLE! 35 different sets, \$1.00. Pinkerton, Box 81-PM, Bethlehem, Pennsylvania.

EXOTIC Nepal 10¢ with approvals. Proctor, Box 46, Ferndale 20, Michigan.

CANADIAN Commemoratives. 50 different \$1.00. Broz, 168 4th Street, Medicine Hat, Alberta.

BARGAIN! 203 different 40¢. Three packets \$1.00. Howard Hance, 100 South Symington Avenue, Baltimore (28), Md.

DEALERS—Wholesale list. Postage 4¢. Frank, 5031 Queensberry, Baltimore 15, Maryland.

SPACE Album pages for stamps and covers. Artopages, Woodville, Ohio.

MONGOLIA Space traveler set 10¢. Praha, Box 68, New York 66, N. Y.

NO Gimicks. No gadgets. No giveaways. Just attractive approvals at attractive prices. Sunny Stamps, Apopka 2B, Florida.

50 DIFFERENT India—10 cents with approvals. Scheerer, Box 301, Pottsville, Penna.

1847, FIRST USA rarity! Goliath foreign beauty shows Ben Franklin in this outstanding issue! Plus Congo freedom stamp, unused 1/2 inch midget stamp freak, real cigar issue, icy Greenland, Free China Bomber airmail giant, etc. only 10¢ with approvals. Capital Stamp Co., Ferrysburg 2D, Mich.

508 DIFFERENT World-wide from Formosa, Morocco, Indonesia, etc., cataloging over \$15, only 35¢. Offer to adults only. Approvals. Littleton Stamp Co., Littleton Q1, N. H.

SPACEMEN. Rockets packet plus bathing beauty—10¢ with approvals. Nugget, Gillen, Racine, Wisconsin.

FREE! Giant bargain catalog—new edition listing thousands of bargains including U.S. and B.N.A. stamps, packets, mixtures, albums, accessories and supplies; sent with beautiful approvals. Adults only! Jamestown Stamp, Dept. E111PM, Jamestown, N. Y.

50 DIFFERENT Pictorials 10¢ with approvals. Lenn's, Box 2271, Miami 1, Fla.

MINT Sets 10¢ with approvals. Loughlin, 97 Williamson Avenue, Bloomfield, New Jersey.

NETHERLANDS Mint set seventeen. 10¢. Approvals. John Schuster, 301 Sandpiper, Playa Dell Rey, Calif.

MONACO Sports mint set cataloging over \$1.00, your price 50¢ with world wide sets on approval. Lido Stamps, 111 Via Yella, Newport Beach, Calif.

44 DIFFERENT Wild animal stamps. Good value. Mint, used. 59¢. Ruppel, 339 Pearl, Pittsburgh 24, Penna.

FREE! Giant Roosevelt diamond, 25 others with approvals. Myers, 17592 Ardmore, Detroit 35, Michigan.

200 COMMEMORATIVES \$2.00, 70% off approvals. Rosato, 1159 North, New York 66, N. Y.

BERLIN Russian bear occupation mint set 25¢. Approvals. J. W. Atnip, 49A Greenbrea Boardwalk, San Rafael, Calif.

FREE—Monaco antique auto set with approvals. Earn free albums and stamps with purchases. Student Stamp Company, Box 116M, Claremont, New Hampshire.

BEAUTIFUL—21 Wildlife stamps only 10¢ with approvals. Excellent service, plus terrific bonus plan. Mortons, Box 354A, Charlestown, New Hampshire.

500 U.S. Commemoratives, \$1 stamps, airmails, specials, postage, dues, etc. mixed. All for \$1 postpaid U.S.A. Wessbecher, 7116 Oakland, St Louis 17, Mo.

CANADA Mint postpaid stamp approvals. Adults only. Tremore, Ormiston, Saskatchewan.

OLD Scarce U.S. seconds on approvals. Slight imperfections, lowest prices. Hernefield, Clintonhill Sta., Newark 8, N. J.

HAITI: 50 Different—\$1.00. Approvals. Stamp Imports, Box 353, Port-au-Prince, Haiti.

FASCINATING European commemoratives. Airmailed approvals. Beverini, Via Manno 2/12, Ge-Sestri, Italy.

BUILD Large worldwide collection economically, 1000 stamps (mounted) at a time. 5000 different, \$4.00 per thousand, 10,000 different, \$6.00 per thousand, 20,000 different, \$9.00 per thousand, 30,000 different, \$15.00 per thousand. Order 1000 from collection desired. No further obligation. Satisfaction guaranteed. Holtzman, 95 Terrace Road, Levittown, Penna.

APPROVAL Buyers. Tremendous discount on approvals. Thousands must go. Gigi James, 3467 Dekalb Ave., Bronx 67, N. Y.

UNPRECEDENTED Opportunity! Worldwide, custommade collection, 141 different, over \$9.00 catalog, 25¢ with unique approvals of worthwhile stamps 1/2¢ up. Stamp Studio, Box 171M, New York 24, N. Y.

TREASURE Of stamps, catalog over \$10.00, all different, only \$1.00. Gaidar, 6615 South Ashland Avenue, Chicago 36, Ill.

100 FOREIGN Stamps only 10¢ with approvals. Rorry Stamps, 7521-A Mason, Canoga Park, California.

50 PAGE Album accessories catalog. Send 10¢ for postage, handling. Approvals. Robert J. Clark, P.O. Box 28-C, Wilmette, Illinois.

50 DIFFERENT, Triangle, diamond, topicals, U.S., 10¢ with approvals. Carpenter, Box 310, Claremont, Calif.

U.S. Commemoratives 100 Mixed 25¢. Rayworth, 321 So. Cicero, Chicago 44.

SAVE! Approvals at 1/2 catalog. Both singles and sets. Beautiful commemoratives and pictorials. Paul Terry, 1555 Inwood Ave., Bronx 52, N. Y.

GABON Three flowers, Poland five birds, Bulgaria three sea fauna all 10¢. Approvals. Berchtold, Troy, Ohio.

SAVE Money on approvals 1¢-3¢ each mounted in books. Harold Eppley, Bensenville, Ill.

THREE United Nations sets 10¢. Gorgeous colorful approvals. Muzsary, Box 543, Norwalk, Conn.

8 DIFFERENT U.S. airmails free! Approvals accompany. Dee, Box 1507, Ormond Beach, Fla.

VATICAN Mint, Scott 127, value \$1.50, yours 25¢, with first approvals. Bill Bavoso, 45 Gold Street, Valley Stream, N. Y.

POLAND. Gigantic bicolored "bird" collection—free! Approvals. William Deems, 226a Race, Ravenswood, West Virginia.

TREMENDOUS Accumulation. Collections, lots, miscellaneous. Closing out cheaply. Lists free. Alatelo, Maynard, Massachusetts.

BUILD Collection systematically—low-cost. G.f.s. Nations, Box 117-X, New York 51, N. Y.

CANADA Dollars, three different, \$1.00. Approvals. Box 832, Moncton, New Brunswick.

MULTICOLORED Set. Beautiful! 5¢. Approvals included. Lincar Stamp Co., 1531 29¹/₂ Street, Rock Island, Illinois.

AUSTRALIA, 25 Different, 10¢ handling. Approvals. Reinhardt's, Box 93MK, Troy, Michigan.

NOVEMBER Special. 1100 worldwide stamps \$1.00. 3,500, \$3.00. No approvals follow. Harrison's Stamps, 1435 1st Ave., Oakland 6, Calif.

1¢ **EACH** Over face. Mint commemoratives, 922 to date. United States catalog. 10¢ handling. Hille, 51 Lake, Arlington 74, Mass.

STAMP And Coin magazine with wooden nickel 10¢. Lawrences, Anamosa, Iowa.

APPROVALS. Penny bargains plus discount. Skytop, Box 1022PM, Binghamton, N. Y.

100 **WORLDWIDE** Stamps 10¢ with approvals. S. Storey, Wabamun, Alberta.

AFRICANS—65 Different. \$1.00. Dykhorst, Box 4081, San Francisco 1, Calif.

UNITED Nations. Five different 10¢. Approvals. Anderson, 1234 Delaware, Santa Cruz, California.

VATICAN Mint Lourdes, airmails, approvals. Snedco, Box 205, Waldwick, N. J.

PHILIPPINES. 15 Commemoratives 10¢. Approvals. Norton, Box 926, San Antonio 6, Texas.

PRICE List U.S. foreign. No approvals. Stamps, 5000 Miami, St. Louis 9, Mo.

ENVELOPE World stamps, mint set, stamp mail. 25¢. Stamp Service, 1438-MI, Huntsville, Ontario, Canada.

SPACE Man set complete 5¢! Approvals. Wagner, 547 Franklin, Buffalo 2, New York.

FREE! "Mystery" pictorial packet. Premiums. Approvals. Dancer, 75-P27, Mansfield, Ohio.

ROCKETS! Satellites! 10¢ with approvals. Schaefer, Californiastrasse 16, Wiesbaden, Germany.

50 **DIFF.** Foreign 10¢ with approvals. Blake, 1B Pendleton, Westover AFB, Mass.

STAMP Grab bag featuring exclusively animals, trains, flags, ships, triangles, maps, planes. Send dime. Stampliner, Route 3, North Bay, Ontario.

START Your own stamp business. Send for free circular. Donald Shepard, Box 1147-P, Chicago 90.

EXTRAORDINARY! Free! 20 different Finland to those requesting approvals. Rosenberg, Box 1303, Chicago 90.

LIST Of 100 mixtures, 10¢. Select Stamps, 737 Nottingham, Winnipeg 15, Canada.

INTRODUCTORY Offer, \$1.00 worth your choice of approvals free. 10¢ handling. Rainbow Stamp Co., Box 821, Dubuque, Iowa.

1000 **DIFFERENT** Worldwide stamps \$1.00. Valued over \$20.00. To adults only requesting our popular packet approvals. Universal, Box 6, Kenosha 5, Wisconsin.

12,000 **PENNY** Approvals waiting for you. Many from exotic countries, pictorials, airmails, new issues. Tilbury, Box 862, Newark 1, N. J.

ANTIQUES, RELICS, INDIAN GOODS, CURIOS

AUTHENTIC Russian bonds. Circa 1900. Re-live the noble splendor of Czarist Russia. Large, multi-colored, signed. Magnificent collectors item. Decorative on lampshades, coffee table tops, etc. \$2.00 each, 3 for \$5.00. Antique Specialties Co., 139 E. 33rd Street, New York 16, New York.

ANTIQUED Reproductions for framing! U. S. Constitution, Declaration of Independence, Gettysburg Address, Bill of Rights; set: \$1.00. Free catalog with order. Ameritage, Box 1377, Philadelphia 5, Penna.

SELLING 20,000 Ancient arrowheads, spearheads, etc. List free. Lear's, Glenwood, Arkansas.

10 **ANCIENT** Stone arrowheads, \$2.00. 10 birdpoints, \$2.00. List 10¢. Stan's, 1054 Lilley, Columbus 6, Ohio.

ILLINOIS: Gesundheit! Selling hundreds of historical, Confederate, Revolutionary, Civil War, Indian War muskets, carbines, revolvers, swords, bayonets, powderhorns, canteens, bullet molds, duelling pistols, holsters; 50,000 collector's cartridges; 110,000 Stoneage Indian relics, arrowheads, deerhorns, steerhorns, bowwood, military insignias, coins, mineral specimens, fossils, frontiers, Confederate money. Large listing, send 35¢ (refundable). Heike's Relics, Wenona, Illinois.

PRECIOUS STONES, MINERALS

ROCKHOUNDS—Gem cutters, jewelry makers. New free catalog—just off the press! Biggest supplier to hobbyists and craftsmen offers you tools, materials, equipment, introductory bargains and know-how. Free catalog. Write Grieger's, Dept. C-11, 1633 E. Walnut, Pasadena, California.

SEMI-Precious uncut gems. Ten different for \$1.00. Request list 28. Prospectors Shop, 201 San Francisco, Santa Fe, New Mexico.

FREE Bargain gem list. 1961 lapidary and silversmith tool catalog. 50¢. O'Brien's, 1116B Wilcox, Hollywood 38, Calif.

EARTH Science. Rockhound's National Magazine. Subscription \$2.50. Sample 35¢. Box 1357-PM, Chicago 90, Ill.

HOBBIES AND COLLECTIONS

CARTOONING—Good money in fields of television advertising, animation, movies, magazines. Famous system of manual training brings amazing new concept of art instruction at home. For profit or pleasure. Send for free details. Continental Schools, Dept. E-76, 4201 S. Broadway, Los Angeles 37, Calif.

COLLECT Timepieces? Free folder. Nawco, Box 8824, Pittsburgh 21, Penna.

AMERICAN Newspaper, complete, original, dated before 1860, \$1.50. 25¢ stamps brings catalogue. D. R. Spaight, Bookseller, Tall Timbers 1, Maryland.

COLLECTORS Matchbook covers. 100 different unused, \$1.00. Catalog 25¢. Album \$3.00. Charles Edelman, 1311-C East 84, Cleveland 3, Ohio.

PHOTOGRAPHY, CAMERAS, PHOTO SUPPLIES

DISCOUNTS On Kodak and Polaroid films. Free price list. Thrifty Camera Co., Box 1022E, Saginaw, Michigan.

\$99.50 **MOVIE** Camera \$29.95. Wholesale catalog "C" \$1.00. The PX, Vandalia, Ohio.

BARGAINS In photography, bulletin, 25¢ coin or stamps. Commercial, Dept. P.M., 727 N. 19th, Allentown, Penna.

PHOTO FINISHING

CUSTOM Professional enlarging. Commercial or portrait. 11x14 \$1.25, 3-8x10 \$1.75, 6-8x7 \$2.00, 12 wallet \$1.00. Postage 25¢. No c.o.d. Alpha, Box 6315, Dallas 22, Texas.

KODACHROME-Ektachrome guaranteed kodak processing. Prompt 8mm or 35mm 20 exp. \$1.40 Free list-mailers. Color Pix, Dept. P, CPO Box 30, Kingston, N. Y.

TWELVE Exposure rolls 59¢. Wallets 20 for \$1.00. Lincoln Studios, Dept. K, Box 13, Lincoln, Nebr.

FREE Roll of fresh Kodak film returned to you for each roll of black and white or Kodacolor sent in for developing and printing. Fast service, low prices, guaranteed quality. Send for free mailers. Economy Photo Service, Dept. PM, Box 1111, Albany 1, New York.

MOTION PICTURES AND SOUND EQUIPMENT

16MM **SOUND**—8mm films. New, used. Free list. Entertainment Films, 236 W. 55, N. Y. C.

5,000 8-16 MM. Movie films. Free catalogues. International Greenvale, N. Y.

8MM-16MM Color and B & W film and supplies. Save money. Free catalog. Superior, 448 N. Wells, Chicago 10.

MOVIE Camera film: 8mm. roll \$1.50. 16mm. 100' \$3.00. Free processing. Better Films, 742 New Lots, Brooklyn, N. Y.

MOVIE Film! Free catalog! ESO-R, 47th Holly, Kansas City 12, Missouri.

16MM. Sound, projectors, films. Sale, rental, exchange. Visit store or write for catalog. National Cinema, 71 Dey St., New York City.

BARGAINS In photography, bulletin, 25¢ coin or stamps. Commercial, Dept. P.M., 727 N. 19th, Allentown, Penna.

8MM., 16MM. Movie subjects. Silent, sound. New, used. 2"x2" color slides. Biggest selection anywhere! Free each month, big 24-page newspaper-size catalog Blackhawk Films, Davenport 14, Iowa.

8MM.-16MM. movies. Introductory offer 50' reel \$1.25 each. Comedies, cartoons, travel, fishing, hunting, adventure, thrills. Send \$5.00 for 5 subjects. Movieiland, Box 10, Van Nuys, Calif.

COLOR SLIDES

ALASKA Film, Box 5-621, Mt. View 8, Alaska. Movies, slide samples \$1.00.

TRANSPARENCIES Wanted. Up to \$500.00 each. For information write American Color, 1008 N. Stanley Ave., Hollywood 46, Calif.

LINCOLN Story in color slides. Catalogue and sample 40¢. Willems, Box 1515-A, Chicago 90.

BEAUTIFUL Western scenes. Nature subjects. Free slides with purchases. Write: Quality Approvals, 711 Columbia Road, Colorado Springs, Colo.

MUSIC & MUSICAL INSTRUMENTS

LEARN To play organ and piano chords the new easy code way. 7 codes teaches you 84 different chords, quick, simplified. \$2.00 prepaid. O. E. Mapel Co., Box 2115, Des Moines 10, Iowa.

ACCORDIONS—All sizes. Free home trial. Color catalog. Save 1/2. Terms. Accordion Import Center, 7120 Galli Dr., San Jose 29, Calif.

SWISS Musical movements. Mechanical—electrical. Spielman, 131 West 42nd, New York 36.

SONGPOEMS And songs wanted! Mail to: Tin Pan Alley, Inc., Box 405, Radio City Station, New York 19, N. Y.

POEMS Wanted for musical setting and recording. Send poems. Free examination. Crown Music Company, 49-C West 32 Street, New York 1.

POEMS Needed immediately for new songs and records. Free examination and appraisal. Send poems: Songcrafters, Acklen Station, Nashville, Tenn.

GUITAR Making books, plans, imported woods, tools. List 10¢. Satinwood, 510 East 11th Street, New York 9, N. Y.

ELECTRIC Guitars, amplifiers, wholesale. Free catalog. Carvin, P.M.M., Covina, Calif.

SONGS Wanted. Pays royalties. Enclose postage. Olenik Records, Mount Morris, Michigan.

SONGPOEMS Wanted! Collaborate with professional songwriters on equal basis. Share royalties. Songwriters Contact Co., 1619-D Broadway, New York 19.

WANTED: Songs, songpoems. Collaborate, publish. Submit: Co-Operative P.M., Capistrano Beach, Calif.

BEAUTIFUL Guitar with pure tone. Regular value \$29.95 now \$14.88. Electrified guitar \$59.00 now \$28.88. Free home study course. Deluxe McIntosh carrying bag \$2.75. Color catalog 10¢. Bonne Music, 1421 South Salina, Syracuse 5, N. Y.

SONGS. Poems, offer. Details. Newart Pubs., Box 693, Syracuse, N. Y.

VIOLINMAKERS, Repairers. Fine tone wood, and all violin supplies. Send for free wholesale new price list. International Violin Co., 414-MPM E. Baltimore Street, Baltimore 2, Maryland.

ACCORDIONS, Chord organs, guitars! Buy direct—save to 1/2. Famous makes. Free home trial. Easy terms. Trades. Free catalogs. Mention instrument. International Music Mart, Dept. R, 2003 Chicago Avenue, Chicago 22.

GET A Turn-A-Chord \$1.00 or literature free. Revelation in chord know how. Turn-A-Chord, 71 Somerton Ave., Kenmore 17, N. Y.

LYRICS Revised, prepared for publication, recording. Lee Ice, Marietta, Ohio.

"RECORDING Contracts Unlimited" \$3.00 for brochure. Tells how. Vulcan, P.O. Box 255, Wickliffe, Ohio.

PLAYER Piano actions rebuilt. Wallace Cheek, 4 Linden, Beverly, Mass.

SWISS Musical movements, \$1.90. Heiax, 218 W. 72nd St., New York City 23.

PLAY Guitar. Teach yourself method. \$1.00. Results guaranteed. Ernie Ball Guitars, Box 308PME, Tarzana, California.

VIOLIN Making supplies. Free catalog. Fred Artindale, 1243 Palm, San Luis Obispo, Calif.

BANJOS. All styles. Mercury, 263 E. Forhan, Long Beach 5, Calif.

ACCORDION Repair Guide \$3.00. How To Build Accordions \$5.00 Complete charts, parts. Satisfaction guaranteed. Fischer's, 1000 Jersey, Bellingham, Wash.

RADIO, TELEVISION AND ELECTRONICS

GOVERNMENT Surplus electronics by the pound: 100 lbs. \$8.00; 50 lbs. \$4.50; 10 lbs. \$1.00. Full payment with order, shipping charges collect. Send for free catalog of the world's finest government surplus electronic bargains. Fairradio Sales, Box 1105, Lima, Ohio.

"RADIO Explained" 64 page book—15¢. Bookmaster, 4629 So. 23rd East, Salt Lake City 5, Utah.

FONE-A-MILE Walkie Talkie. Keep in touch with your companions while hunting, fishing, boating and football games. Pocket-sized, transistorized. Only \$89.95 per pair. S. K. Tate, 98 Main St., Bradford, Penna.

COMPLETE Set tubes (excluding pic. tube) for your TV \$29.95. Brand new. Unconditionally guaranteed. Repair set in minutes. No delay. No service call. Tube checker free with order. \$3.95 value. Send make, and model number. National Tube Distributors, Room 822, Marshall Field Annex Building, 25 East Washington Street, Chicago 2, Illinois.

FREE! 1962 Heathkit catalog, world's biggest electronic kit catalog. 100 pages, over 250 kits we guarantee you can build regardless of experience. Save up to 50% on stereo/hi-fi, citizen's band, marine radio, portables, amateur radio, test equipment, educational kits; all illustrated, described, specified. Write: Heath Company, Benton Harbor 56, Michigan.

DON'T Buy hi-fi components, kits, tape, tape recorders until you get our low, low return mail quotes. "We guarantee not to be undersold." Wholesale catalog free. Easy time payment plan. 10% down—up to 24 months to pay. Hi-Fidelity Center, 220-M E. 23 St., New York 10, N. Y.

FREE! Giant wholesale catalog on electronics, hi-fi, transistor, scientific hobby, optics, photographic, housewares, jewelry, tools, novelties, toys. Write: Lektron, 241B Everett Ave., Chelsea 50, Mass.

RECORDERS, Hi-fi. Free wholesale catalogue. Carston, 125-Y East 88, N. Y. C. 28.

LEARN While asleep with amazing "Electronic Educator" endless tape recorder. Details free. Research Association, Box 24-N, Olympia, Washington.

GOVERNMENT Surplus radios, parts. Picture catalog 10¢. Meshna, Maiden 48, Mass.

RADIO And TV tubes at manufacturer's prices! 100% guaranteed! Brand new! No re-brands or pulls! United Radio, Box 1000-M, Newark, N. J.

FIX Your own TV. Save 80%! Send for free illustrated chart showing how! We'll include giant electronics catalog. Zalytron, 220-M West 42 St., New York City.

TAPE Recorders hi-fi components. Sleep learning equipment, tapes. Unusual values. Free catalog. Dressner, 1523M Jericho Tpke, New Hyde Park, N. Y.

CRYSTAL Radio kit \$1.00. Amplifier and speaker for same \$4.95. Catalogue. Clearco, Box 1638, Stuart, Florida.

FREE Confidential list of electronic supplies and equipment. Lowest prices anywhere. Knapp, 3174 1/2 8th Ave. SW., Largo, Florida.

HI-FI From Japan. Finest imported tuners, amplifiers, recorders, etc. Free catalog. KPJ Sales, Box 1252-P, Studio City, California.

RECORDING Tape. Stereophonic recordings. Bargain catalog available. Saxitone, 1776 Columbia Road, Washington 9, D. C.

BUSINESS OPPORTUNITIES

SKYROCKET Your income through business-building letters and win financial independence! Now you can sway people and write letters like the experts do. Noted writer-salesman specialist will coach you in "How To Write Letters That Sell" guide. Guaranteed. Postpaid \$6. Or request free literature. Helinger, 10, E. Syracuse, New York.

BOOKKEEPERS — Exclusive franchise operating bookkeeping service. Simplified system. Kern, 5633-A Cahuenga Blvd., North Hollywood, California.

OPERATE Profitable home mail order business. Write Allen's, Manchester, Wash.

OPERATE Profitable manufacturing business. Valuable information free. Colen, 7731-PM Yates, Chicago 49.

RAISE Rabbits on \$500 month plan. Free details. White's Rabbitry, Mt. Vernon, Ohio.

DRIED Mushrooms \$4.50 pound for large canning company. Receiving warehouse in United States. Growers wanted on contract, everything supplied. Mushroom Salt Co., No. 548, Calgary, Alberta, Canada.

OPERATE Profitable home business by mail. Write: American Distr., Box 409-P, Niles, Michigan.

FABULOUS President Kennedy portraits. Samples \$2.00 (refundable). Shermeta, Box 3620IC, Los Angeles 36, Calif.

FREE Report: "609 Unusual, Successful Businesses." Box 1001-PMJ, Evanston, Illinois.

EARN Money flocking Christmas trees. Send for "Spare Time Dollars." Free. Flocking, 1517 Log Cabin Ave., Rockford, Illinois.

\$70.00 WEEKLY — Home, spare time. Simplified mail bookkeeping. Immediate income—easy. Auditax, 34741A, Los Angeles 34.

JOIN Dollars Unlimited Club. Huge profits. Free details. Box 2766B, Kalamazoo, Mich.

BUY Direct from Japan! Cameras, binoculars, hi-fi, electronics, tools. Manufacturers' directory \$2.00. KPJ Sales, Box 1252-P, Studio City, Calif.

LIQUID Molding rubber, free sample. Shellcraft supplies. Chaney's, 1907-A East Road, Jacksonville 16, Fla.

EARN \$1200 Yearly. Washer-dryer repairing. Free information. Best Appliance Parts, 5127 Dempster, Skokie, Ill.

BUY Direct from factories. Appliances, cameras, watches! Free details! Cam Co., 436 P.M. Bloomfield Ave., Verona, N. J.

OWN Your own dry cleaning shop! With no investment, I'll show you how. Write Imperial School of Dry Cleaning, 1700 Touhy Avenue, Chicago 26, Illinois.

\$200.00 MONTHLY. Spare time. With tablesaw, bandsaw or jigsaw. Write. Holiday House, A3800 Harney, Vancouver, Washington.

SHARPEN Saws and lawnmowers the profitable way. Send for free literature. Max Manufacturing Company, 138 Stockton Avenue, San Jose 26, California.

CANDIED Popcorn and potato chip equipment. Eakins, Box 933-A1, Springfield, Ohio.

FRANCHISES Make profits! Operate your own exclusive franchised business. Write today for free interesting details. National Franchise Reports, W-528, 333 North Michigan, Chicago 1.

IMMEDIATE Profits with no capital or experience. Take orders for all magazine subscriptions. Friends and neighbors are your prospects. Write now for complete, free kit. McGregor Magazine Agency, Dept. 116B, Mount Morris, Illinois.

SELL Champion, AC, Autolite spark plugs. Reconditioned, electroplated, guaranteed 10,000 miles. 100% profit. Free sample. Lee Plugs, 1608-A Roberts, Houston 3, Texas.

WANT To make big money at home? \$10.00 profit in an hour possible with invisible mending. Make tears, holes disappear from clothing, fabrics. Steady year-round demand from cleaners, laundries, homes. Details free. Fabricon, 6234 Broadway, Chicago 40, Ill.

LEARN Sewing machine repairing. To \$125 weekly. Sparetime. Supplies. Add to present business. Write today! Taylor Service, Box 2126, San Bernardino, Calif.

FREE Picture folder, "How to Make \$3,000 Yearly, Sparetime, Backyard, Raising Earthworms!" Oakhaven-38, Cedar Hill, Texas.

VENDING Machines. No selling. Operate a route of coin machines and earn amazing profits. 32-page catalogue free. Parkway Machine Corporation, Dept. #27, 715 Ensor Street, Baltimore 2, Maryland.

BUSINESSES, Resorts, motels, investment property, ranches. Our special service dept. at your disposal. No obligation. World's largest. 58 years' service. Strout Realty, 7-MB S. Dearborn, Chicago 3, Ill.

BIG Money raising fishworms and crickets. Free literature. Carter Farms, Plains, Georgia.

TO \$100.00 Weekly. Sparetime, home operated mailorder business. Successful beginner's plan. Everything supplied. Lynn, 10420-M National, Los Angeles 34.

PIANO Tuning learned quickly at home. Tremendous field! Musical knowledge unnecessary. Information free. Empire School of Piano Tuning, Champaign, Ill. (Founded 1935).

I Want to send you proof of the wonderful pulling power of Popular Mechanics classified pages. What's your proposition? Write me today. Include literature if possible. F. W. Johnson, Manager Classified Advertising, Popular Mechanics Magazine, 200 E. Ontario St., Chicago 11, Ill.

COPUBLISH Mail Sale Advertiser, leading mail order paper. Details, latest copy, dime. Vanroy Shirk, Lebanon, Penna.

BRONZE Baby shoes: Instructions, equipment and mountings for genuine electroplating process. Largest supplier of all plating equipment, supplies. Free catalogue. Hollywood Bronze Supply, Dept. B-3, 1624 East First, Los Angeles 33, Calif.

OPERATE Profitable mail order business. Write Walter Service, 4159A East 112th, Cleveland 5, Ohio.

BAKE New greaseless doughnuts in kitchen. Sell stores. Free recipes. Montgomery, 3605 South 15th, Minneapolis 7, Minnesota.

\$3.00 HOUR—Home, sparetime, assembling pump lamps. Easy. Free details. Ougor, Caldwell, Arkansas.

OPERATE Home mailorder business. Vosacek Distributors, 4444A Ute, San Diego 17, Calif.

EXCEPTIONALLY Profitable opportunity in tape recording! Free information. Baron's, Lynden, Washington.

JAPAN Directory. 145 Japanese manufacturing exporters. Japan and Hong Kong trade journal information. Asia opportunities. Just \$1.00 today. Nippon Anna, Box 1150-P, Spokane 10, Wash.

COLORGLAZED Concrete pottery made without molds. Patented method. Cemetery products, novelties, tiles. Basement leak-sealing. Money-making projects. Booklet, details free. Men only. National Potteries Company, Grand Rapids, Minnesota.

MARKETS Everywhere. Make artistic concrete birdbaths, pottery. Best coloring. Home workshop. Hundred varieties. Free pictures. Hollywood Cementcraft, 8527-S Wonderland, Hollywood 46, California.

MAKE \$46 From square foot plywood: jigsaw necessary. Free details. Woodart, Bridgewater, Mass.

MAKE Money from old tires. Operators clearing \$400 weekly. Equipment costs \$800. Get facts. S & S Patents, Inc., 3511 N. Lincoln Ave., Chicago 13, Ill.

\$400.00 MONTHLY Raising giant fish-worms. Soilless method. Charlie Morgan, Bushnell, Florida.

HOW And where to obtain capital. Write: Reliable Service, Rome City, Ind.

"MAILORDER Laws and Regulations." Explains mailorder licenses and taxes. \$1.00. Neil H. Tasker, Shamokin, Pennsylvania.

EXPORT-Import business. Complete professional setup service. 20 lines delivered. Hermes, 152 West 42, New York City 36.

SELL Books by mail. 400% profit. Royal, Box 368-X, Cleveland 27, Ohio.

PLASTERCRAFT Molds, liquid rubber, plasters, floccs, candle supplies. Catalog and manual free. Blue Rapids Supply, Blue Rapids, Kansas.

MAILORDER To motels, churches, institutions. Complete set-up. Not just instructions. Hermes Advertising, 152 West 42, New York City 36.

WORLD'S Largest wholesale supply. Buy from 679 American, European, Japanese wholesalers. Tailormade suits from Hongkong. 123 dropship catalogs. Rock-bottom prices. Free details. International Buyers, 216-MM Jackson, Chicago 6, Ill.

INVISIBLE Reweaving: \$5-\$10 per job possible reweaving burns, tears, moth-holes. Spare-full time. Free details. Skill-Weave, Dept. RC-169, 335 W. Madison, Chicago 6, Illinois.

MAILORDER. America's most unique no cost beginner's plan. Armstrong's, 154-A Darrington S.W., Washington 24, D. C.

FREE Book "711 Bizarre, Successful Ventures." Retired at 47, simple home plan! Haylings, Carlsbad, Calif.

WANTED. Fishing tackle items for national distribution, exclusive manufacturing and sales. Our increasing sales force can handle 2 or 3 additional items for wholesale and retail distribution. Also want good mail-order items for established customers. Send full details and samples to: Axelson Fishing Tackle Mfg. Co., 1559G Placentia, Newport Beach, Calif.

\$600.00 PROFIT! Mailing catalogs. Sample instructions, 25¢. Home Business Digest, GPO Box 972, New York 1.

WANTED: Home producers, to be subcontractors. Cast plastic products for manufacturers in our clearing house service. Thousands of easily made items required. Cash in at home, without previous experience. Plastic Service Associates, Dept. 11-PM, East Boston 28, Massachusetts.

TERRIFIC Possibilities to road of independence. Exciting facts revealed. Mail order, real estate, etc. Booklet \$1.50. 100% satisfaction guaranteed. Natu-Rex, 12250 - 8th, Yucaipa 2, California.

CASH From sawdust, tin-cans, newspapers. Over 200 methods. Instructions \$1.00. Charles Company, 42-GPT, Norwood, Ohio.

JOKE Merchandise. Rack consignment deals. No selling. Rush \$1.00. Ten samples, profit plan. Robbins, 127-G West 17th Street, New York City 11.

MEN! Operate profitable construction equipment spare time. Nationwide. Box 7400-B, Washington 4, D.C.

EARN \$3 hourly, spare, full time, looking up information at your local library. Operate research bureau. Details free. Service, 81C Knickerbocker Station, New York.

RUN Your own business. Operate a United Rent-Alls store, the store that rents most everything. 300 home-owned stores coast to coast. Profitable business. Franchises available. \$7,000 cash required. Additional financing available. Write for free brochure to United Rent-Alls, Inc., Box M, 2627 North 27th Street, Lincoln, Nebraska.

PROFITABLE Catalog mailorder business: Vikari, 468PM Third Avenue, Salt Lake City 3, Utah.

A Mister Donut franchise. America's fastest growing chain of roadside donut shops has immediate franchise locations available in the U.S. and Canada. Cash in on one of North America's fastest growing industries. On yearly sales in major unit \$156,000, your profit \$31,000 net, junior unit \$78,000, your profit \$21,000 net. Benefit from big business practices such as volume buying, experienced supervision, merchandising, sales promotion, and national advertising. No experience necessary, we train you. Cash investment required from \$10,000 for junior unit to \$25,000 for major unit. For details write Mister Donut, Dept. PM2, 91 Providence Highway, Westwood, Mass.

BIG Money - Operate your own fix-it shop. Service all household appliances; irons, fans, refrigerators, automatic washer-dryers, etc. Do house wiring, commercial wiring. Rewind motors of all sizes. Sharpen mowers, skates, saws. Buy needed spare parts wholesale. Free book. Christy Trades School, A-1403, 3214 W. Lawrence, Chicago 25.

\$50.00 IN Your mailbox every day. Sensational home mailorder business. Cameras \$2.35; watches \$2.60; radios \$1.93. Hundreds of fabulous items. 500% profits. What, where, how to buy and sell. Thousands now doing it. 128 pages loaded with complete information sent immediately. Satisfaction absolutely guaranteed. Send \$2.00 to: Impex-E, 714 Howard Avenue, New Orleans 12, Louisiana.

AMAZING Profits in exterminating. Full time - part time. Free details. Baylab 21M, Cambridge, Maryland.

FREE Information about all kinds of business opportunities in all 50 States. No obligations. William Donoho, 493 8th St., Chico, California.

\$1.00 BRINGS You \$18.00 spare-full time home business opportunity! Amazing new velvet-spray transforms old cheap lamps, TV-radios, figurines, furniture, anything, into valuable products! Free samples. 50 business opportunities booklet. Send no money. Flok-Kraft, NR Los Angeles 61.

MAILORDER Home business. Get free copy, "Make Money in Mailorder." Mailco, 1554 South Sepulveda, Dept. T70B, Los Angeles 25, Calif.

IMPORT-Export opportunity, profitable, world-wide, mail-order business from home, without capital or travel abroad. Established world trader ships instructions for no-risk examination. Experience unnecessary. Free details. Mellinger, 1534 S. Sepulveda, Dept. T70B, Los Angeles 25, Calif.

LEARN Landscaping and the growing of plants. Start a profitable business part or full time. Free information without obligation. National Landscape Institute, Dept. MC-111, 11826 San Vicente Blvd., Los Angeles 49, Calif.

START Your own business on credit (U.S. and Canada). Your own boss. 1344 dealers sold \$5,000 to \$25,500 in 1960. We supply stock, equipment on credit. 200 home necessities. Sales experience unnecessary. Pleasant profitable business backed by world-wide industry. Write Rawleigh's, Dept. K-U-PPM, Freeport, Illinois.

\$250.00 WEEK Spare time profit possible. Earn at home with new fascinating printing method. \$5 starts you - send no money now. Free confidential facts and valuable sample. Screen-Print, NR, Los Angeles 61.

MOST Profitable aspect of mailorder is cheapest to try! Write: Simon, Box 87-PM5, Peiham, N. Y.

LEARN Professional TV servicing in one week! Fabulous new simplified system. No big expense. No studying. No tools or equipment. Spare, full time. Own your own big profit business! Save! Amazing but true! Free sample lesson, illustrated "How To" booklet. Write: TV Systems, Dept. EC-17B, 1038 So. LaBrea, Los Angeles 19, Calif.

BECOME Tax consultant. Graduates earn \$1,000-\$3,000 every tax season preparing returns evenings. State approved. Union Institute, Lakewood E-2, N. J.

MAKE Extra money - Big cash commission plus premiums for you and your customers. Sell advertising book matches. Sensational new tenorama, glamour girls, hillbillies; dozens others. All sizes. Quick daily sales; big repeat business. Free master kit makes selling easy. No experience necessary. Superior Match, Dept. MX 1161, 7530 Greenwood, Chicago 19.

WANT A raise? Better job? Promotion? Short-cut help, free. Webster House, 2038-5 Mockingbird Road, Columbia, South Carolina.

RETAIL Financial opportunity one hour a day. \$207 per month; two hours, \$496.80, etc. Dietary food supplement, T.V. advertising. Secure distributors, sell wholesale. Big volume, big profits. Free literature. Write Leroy Turner, 2834 Hilltop Rd., Concord, Calif.

YOUR Own wholesale business. No inventory. No investment. Thousands of nationally advertised brands direct from factories. Write: A. & H. Wholesalers, 97 Pulaski St., Brooklyn 6, N. Y.

900% PROFIT. Fast sellers by mail. Write DABL, 1218 16th, Golden, Colo.

EVERYBODY Likes candy and popcorn specialties. Learn to make professionally home. (Our 50th year.) Ragsdale Candies, B-107, East Orange, New Jersey.

PROFITABLE Career! Learn food cost control accountancy-management in 3-weeks. Tremendous demand: Restaurants, grocers, etc. Income guarantee over \$500.00 monthly. Write for: free literature-lesson. National Cost-trol Systems (PM-11), 101 Capri Lane-9, San Antonio 1, Texas.

NATURAL Molding rubber, extra thick. Free samples. W. Wooley, 2801-A Latrobe, Peoria, Illinois.

GET Samples, magazines, offers galore! Your name in 5000 mail directories 25¢. Results guaranteed. Muskoka Mailers, 1438-C4, Huntsville, Ontario, Canada.

MAILORDER. Profitable beginners information. John's, Box 943-PMN, Miami, Florida.

NEED Better job? Bigger earnings? Study secrets others use. "Finding and Changing Employment" tells how easily safely. Send \$2.98 or for information. Prompt orders receive bonus "Top Secret to Success in Your Job." Learn to Earn Co., 345 West Ave., Tallmadge, Ohio.

RE-CAST Junk batteries into new. Latest achievements. Battery Laboratories, Bayou LaBatre, Alabama.

MAKE \$20.00 per hour. Learn hand engraving. Engrave from glass to steel head of pin. Engrave for us. Send 25 cents. Engraver, 722 Market St., Victoria, B.C., Canada.

11,000 NEW Prospects daily. Baby record books, shoes, albums. Sell mailorder. Use our literature. Write: No-Co-Ro, Capitola, Calif.

OPERATE Profitable mail order business. Write Fred's Enterprises - Importers, 322 Pinnacle, Belleville, Ontario.

FREE: "How to Win Contests." Contestar, Box 51-PCB, Des Plaines, Illinois.

MAIL-ORDER Pays big. Complete home set-up - no inventory. Details free. National Mail Order Corp., Box 828, Dept. 1N, Wayne, N. J.

REPAIR Hydraulic jacks. Easy, profitable. Write: Hydraulics, Box 4104, El Paso, Texas.

YOUR Own baby shoe bronzing business. Instructions, equipment, supplies. Metalizing, glassing, Pearl-Kote. We finance. Free booklet. Dept. A, Box 5036, Inglewood, Calif.

HOW To sell books by mail. Box 51-BPMA, Des Plaines, Illinois.

EARN Good income sending us information. Weekly paycheck. Details 10¢. Thomas, Mount Wilson 8, California.

PACKAGE At home for profit! We supply everything. No selling. Free home business details. HPC, 2212BB Jesse Street, Los Angeles 23.

MONEYMAKING OPPORTUNITIES

NEW Automotive invention needed by every motorist. Big profits selling to service stations, garages, auto supply stores, hardware stores. Amazing rack deal. No risk introductory offer. Free details. Write: Safety Plug Lock Corp., Dept. P. 1270 B'way, N. Y. 1, N. Y.

FREE! Amazing new book of money making opportunities and mail order bargains. Write today! Dept. PM, P.O. Box 1123, Chicago 80, Illinois.

MANUFACTURE Beautiful, lightweight vases, patio stones, wall panels, artistic room dividers, etc., with new foam-crete plastic. Amazingly fast, easy, money-making system. Complete formulas and instructions only \$3.00. Or free details. Plasticon Company, Box 105, Grove City, Penna.

FREE. 200 Ways to make money by mail. Arch, 614 West Twelfth, Gastonia 1, N. C.

MEN — Women! Start money-making plastic laminating business at home in spare time. Material that costs 11¢ brings back \$2.58. No canvassing or selling but mail orders brings in \$20 a day. Write for full particulars free. Rush name on postcard to Warner, Room CL-2-L, 1512 Jarvis, Chicago 26, Ill.

MAKE Money sharpening saws, tools, knives, scissors, clippers, surgical instruments, etc. Grinding outfits low as \$34.95. Manual furnished. Write Treyco, N. Tonawanda, 15, N. J.

EASY To start rubber stamp business at home in spare time. Make up to \$9.80 an hour without experience. Facts free. Write Roberts, 1512 Jarvis, Room CR-2-L, Chicago 26.

MINK Raising information free. Complete. Lake Superior Mink Farm, Superior, EEL, Wisconsin.

VENDING Machines. No selling. Operate a route of coin machines and earn amazing profits. 32-page catalogue free. Parkway Machine Corporation, Dept. #26, 715 Ensor Street, Baltimore 2, Maryland.

EARN Money evenings copying and duplicating comic cartoons for advertisers. Adservice, Argyle 1, Wisconsin.

YOUR Own, easy-to-start, home mail-order business, sparetime. Fascinating; profitable! Information free. Alfano, 19-PM Pine, Closter, N. J.

BIG Money raising fishworms and crickets. Free literature. Carter Hatchery, Plains, Georgia.

READ "Progressive Mailtrade." The magazine that tells how to make money by mail. Quarter brings sample and special offer. Progressive Mailtrade, Box 357, Sheboygan, Wisconsin.

AMAZING Successes through franchises! Become exclusive franchise holder your territory. Information rushed. National Franchise Reports, MP-528, 333 North Michigan, Chicago 1.

LEARN The secrets of repairing junk batteries, generators, starters, profitable, easy, at home. Free particulars. Batteryman, 3465 Forrest, Santa Clara, Calif.

\$25-\$50 WEEKLY Possible, re-writing news items, jokes, poems, recipes, for publishers. Some worth \$10 each. Details free. Service, 81-D, Knickerbocker Station, N.Y.C.

LEARN Plastics fabrication for extra income. Low cost home training now available. Write for free booklet. Interstate Training Service, Dept. D-3, Portland 12, Oregon.

WIN Contest money. General Contest Bulletin gives hundreds of tips. Lists current contests, rules. Sample magazine 25¢. General Contests, 1609½ East 5th Duluth 12, Minnesota.

"HOW To Win Contests" manual may bring you riches! Contains successful formula professional winners use. Guaranteed. \$5 postpaid, or request free literature. Paragon Enterprises, 11 Mott St., DT-4P, New York 13, N. Y.

OFFICE Work—home, sparetime. Refundable moneymaking instructions 50¢. Interstate, 37-1 Besch, Albany 9, N. Y.

GETTING Dollars in your mail. Send 10¢ for eye opening literature. Donovan, 79-PM Greenbelt, Levittown, New York.

PUZZLE Contests! Cash prizes! Details free! Spence, Box 11569, St. Petersburg, Fla.

MAIL Catalogs! Highly profitable! Sample, instructions, 10¢. Lewis Bartlett, Richland, Georgia.

\$50 DAY Spare time live bait business. Send \$1.00, complete set up, details. D. C. Breeder Farms, R-39 Gladstone Ave., Toronto 3, Ont., Canada.

\$20 DAILY Spare time plating baby shoes, making exclusive jewelry, novelties. Ask about free examination offer. Jo-Ca, 468-D Northwest 79th Street, Miami 50, Florida.

AMATEUR Artists! Turn your art ability into money. Hamilton, Box 4-E, Astoria 5, N. Y.

RECEIVE Moneymaking offers galore. Name listed 6 months \$1.00. Satisfaction guaranteed. Homeworkers Guide, King, N. C.

SIMPLE, Pleasant mailorder can net \$12,000 year. Write: Simon, Box 87-PL2, Pelham, N. Y.

PRACTICAL Mail order. Start small. Moneymaker, 722-21 East Silver Spring, Milwaukee 17, Wisconsin.

MAILORDER Business learned easily. Write: Easco, Box 323, Grand Rapids 1, Michigan.

START A profitable subscription business in spare time! We need men and women (young and old) as representatives for all leading national magazines. Liberal commissions on all subscriptions. Supplies free. No experience needed. Send this ad with your name and address to: Popular Mechanics, Room 11-O, 250 W. 55th St., New York 10, N. Y.

"FORTUNES In Formulas." 10,000 trade secrets, 900 pages, \$3.95 (Free brochures). Berthoff's, 739 11-P Sylvania Avenue, Toledo 12, Ohio.

CHOICE Sparetime moneymakers. Literature 35¢. Harrison, 248 So. Hackett, So. Beloit, Illinois.

EXCEPTIONAL Opportunity. Earn lifetime income. \$1000 monthly possible. \$1.25 details. P.O. Box 1853, Tulsa, Okla.

MAKE Money with your power saw. Boyce, 3956PM West End, Chicago.

YOU Need only a mimeograph machine and a ruler to put yourself in a business that can make you financially independent. Details free. The Graphic Garret, Box 9312, Arlington 9, Virginia.

RAISE Crawlers, redworms. Odorless soilless method. Three Oaks Ranch, Dresden, Tenn.

FABULOUS Profits raising earthworms! Picture folder free. Excello, Kosciusko, Mississippi.

CARS. Buy-sell from backyard. People come to you. \$150.00 weekly easily. Start parttime with own car, grow Complete course, send \$2.00. Bud Arthur, 104 Susan, London, Ontario, Canada.

OPERATE Profitable manufacturing business. Valuable information free. Colen, 7731-PM Yates, Chicago 49.

\$480 MONTHLY! Taking four orders a day with fast selling art service. Write today! Portraits, 128 Roosevelt, Redwood City, California.

FIBER-GLO Gives beautiful, 3-D, textured effect to your own, and commercial greeting cards. Easy, colorful, profitable. Unlimited markets. Complete kit \$3.00. Reyncraft Industries Box 84, Northbrook, Ill.

\$35-\$65 WEEKLY Assembling our artificial lures for stores. Home. No charge for materials. Write: Lures, Lake Village 9, Arkansas.

\$16.00 PROFIT. Can be yours on a \$12.80 investment. Complete details 50¢. National, Box 168, Fairhaven, Mass.

EXPORT — IMPORT

100 NAMES Foreign suppliers plus free \$2.00 import. \$1.00. Drobnak's, 4518 West 226, Fairview Park 26, Ohio.

BEAUTIFUL Japanese paintings. Samples \$2.00. (Guaranteed). Sheremeta, Box 36201C, Los Angeles 36.

IMPORTERS Sale. Radios, recorders, binoculars, others. Free brochure! Importico, Enka, North Carolina.

JAPAN: Direct mail-order 26 page catalogue: dolls, novelties, business information, manufacturers' names, addresses, \$1.00; Japan's Trade Directory, 3000 companies, \$3.00. Send cash. Clarence Yamagata, 814 Toginbiru, Marunouchi, Tokyo.

SCIENCE & CHEMISTRY

SCIENCE Treasure chest. Do hundreds of experiments. Order No. 70.342-CZ—\$5.00 postpaid. Request free Catalog—CZ, Edmund Scientific Co., Barrington, New Jersey.

NEW Concept of atomic structure. Nuclear theory challenged. 30 pages, 25 cents ppd. C. F. Krafft, 4809 Columbia Road, Annandale, Virginia.

CHEMICALS And apparatus for industrial, analytical, and private laboratories. Catalog 25c. Dept. M-50, Biological Supply Co., 1176 Mt. Hope Ave., Rochester 20, N. Y.

ILLUSTRATED Catalog: Chemistry, mineralogy, biology 25¢. Tracey Laboratories, Evanston, Illinois.

UNUSUAL Chemistry books, courses, kits! Rare chemicals, cheap! Catalog 25¢. NSC, Box 11133, Palo Alto, Calif.

ROCKET Supplies, kits, parts, engines, chemicals. New illustrated catalog 25¢. Central Rocket Company, Box 89-P, Waupaca, Wis.

AMAZING New book of science experiments, formulas, and catalogue of laboratory supplies. Only 35¢. National Scientific Co., 13 S. Park Avenue, Dept. PM-11, Lombard, Illinois.

"EXPERIMENTER'S Booklet" and bigger catalogue—25¢. Hagenow Laboratories, Manitowoc, Wisconsin.

EXPERIMENTERS! Rocket kits, parts, chemicals. Catalog with samples 25¢. Rocket Model Research, Box 716, Newark 1, New Jersey.

ROCKET Test equipment for safe static firings. Catalog 25¢. Rocket Development Corporation, 445 East Second South, Salt Lake City, Utah.

NEW Chemistry catalog, 25¢. Laboratory Sales, Box 161-A, Brighton, Mass.

FORMULAS, PLANS, ETC.

ANTI-FREEZE, Waterless handsoap, re-silvering mirrors, all \$1.00. Nelko, Box 3462, Merchandise Mart, Chicago 54.

FORMULA Trade secrets. 10,000 to choose from. Information free. Norris Sales Co., Alpine 3, Tennessee.

FORMULAS For latest money-making discoveries. New! Good! Valuable literature free! Miller, Chemist, 1517-D, Tampa, Florida.

LATE, Modern manufacturing formulas. List free. Moon Chemical, Martville, New York

FORMULAS—All kinds. Amazing big catalog, 10¢. Kemixal, Park Ridge, Ill.

MODERN Formulas. Satisfaction guaranteed! Jack, Chemist, Box 25157, Los Angeles 25, California.

PLASTICS

BOXES, Plastic. 200 sizes. Free list. Althor, 170 Bay 23 Street, Brooklyn, N. Y.

NEW! Electric plastic laminating kit. Hobby. Easy. Profitable. Details. Burr, 330 East Center, Kalamazoo, Mich.

NEW Liquid casting plastic, clear, colors. Embed real flowers, butterflies, photos, coins. Send 25¢ for two handbooks "How to Cast Liquid Plastics" and "How to Make Extra Money at Home." Castolite, Dept. M-101, Woodstock, Illinois.

AMERICAN Plastic laminating press. Finest, fastest for exciting new business. Terrific demand. American Machine Manufacturing, Box 1246, Savannah, Ga.

CREATE Original artistic Christmas gifts. New instruction manual tells how to do plastic embedding and molding. Manual \$1.00. Catalog 25¢. Castcraft Corporation, Dept. M-1161, P.O. Box 555, Palo Alto, California.

CELLULOID Scrap assortment, \$6.00 postpaid. P.O. Box 333, Kearney, New Jersey.

AGENTS WANTED

RADAR Detector, sunvisor. Distributors, agents wanted. Sample \$39. Transmatic Co., Sedalia, Mo.

BIG Profits selling chamois to service stations, car lots. Steady repeat business. Free details. Inka Industries, 1606-H Roberts, Houston 3, Texas.

FREE Sample. Beautiful curios! Sell on sight! Apartado 9036, Mexico City.

START Your own business, selling the "World's Most Usable Bible." Sales quick, easy, and profitable. Extra bonuses; free insurance; other benefits. Write International Book Company, Department M, Box 118, Wichita 1, Kansas.

PRINTING. Advertising salesmen—Excellent moneymaking sideline selling decalcomania name plates, small quantities. Automobile initials, sign letters. Free samples. Ralco, XL, Boston 19, Mass.

YOUR Own business—Used suits \$1.50; overcoats 65¢; mackinaws 35¢; shoes 12½¢; ladies' coats 30¢; dresses 15¢. Enormous profits. Catalog free. Nathan Portnoy Associates, 2109-AA Roosevelt Road, Chicago 8, Ill.

MAKE Up to \$50.00 a day soliciting delinquent accounts. Terrific commissions. Write today. National Credit, 304Y Pickwick Bldg., Kansas City 6, Mo.

BIG Profits. Stamp social security plates, key protectors. Sample 50¢. Catalog free. General Products, 11 No. Pearl St., Albany 7, N. Y.

YOUR Ad in this space will get some good agents for you. Yes, I'll prove it. Write for Folder "A" right now. P. W. Johnson, Classified Advertising Manager, Popular Mechanics Magazine, 200 E. Ontario St., Chicago 11, Ill.

MAKE Profitable men's-women's wear. Sample free. Sunmade, Brockton 64, Mass.

SUPER-CHAM. Amazing new product wanted by millions everywhere. 101 uses—cleaning, drying, polishing. Sample \$2.00 postpaid. Information free. Good profit. Renlim Company, Box 143, Babson Park, Florida.

AUTOMATIC Bed warming sheet, you sleep on, not under. Outsell electric blankets 10 ways, costs less. Generous profits. Patented Products Corp., Dept. PM-111, Danville, Ohio.

PERFUMES. French type, imported essence. Saleable, 12 assorted sample bottles \$1.00. Catalogue. Parfums DiJon, 122 East 25 St., New York 10.

MAKE Most extra cash with world's biggest line Christmas cards, gifts. Introduce friends, neighbors to over 150 Christmas, everyday box assortments, 600 big money-makers. Pocket up to 50% profit plus big cash bonus. Free giant color catalog; samples on approval. Arrow Greetings, 513 Fourth Ave. S., Dept. 83-G, Minneapolis, Minn.

FOG-STOP Windshield cloth. Instantly removes blurry mist, frost, sleet, snow. Stops windshield fogging. Samples sent on trial. Kristee 87, Akron, Ohio.

DAMASCENE Earrings! Exotic Orientalism. Huge profit. OHGA, PM-303, Siganikusatu, Japan.

REAL Diamond rings. Nationally advertised. Sell direct. Make big middleman's profit. No investment. Experience unnecessary. Free catalog, details. Gleamlight, 111-B10 North Columbus, Mount Vernon, N. Y.

FREE Colored portrait sales kit. Portraits, 402-PM Hazlett, Baltimore 29, Maryland.

EARN Big money introducing amazing Color-V. Makes ordinary TV show in beautiful colors. Low \$2.98 price, sells like hotcakes. Free details. Excellent Buys, Dept. PMC-1, 34 E. 12th St., New York City 3.

CUDDLESOME Australian Koala bears, boomerangs, kangaroo purses and other irresistible, original Australian novelties. Terrific profits, easy selling. Webster's International Agencies, Melbourne S.2, Australia.

MEN, Women, teenagers. Hottest import yet. Territories going fast. Terrific door-opener. Magic pad container. Money back guarantee. Send dollar for sample, particulars. Facman, Box Nine, Sparta, New Jersey.

EARN Up to \$50.00 weekly spare time. Sell guaranteed Quick-John, exclusive enzyme formula for septic system troubles. High profit margin, excellent repeat orders. Ryter, Madelia 4, Minn.

BUY IT WHOLESALE

FURNACES, Gas water heaters, air conditioners, car parts, and awnings, 40% discount. Price books 50¢, refundable. Honey Heating, Box 168, Anna, Ill.

GENUINE Wholesale catalog. 50 cents, refundable. Gift. Cerny, 9700 West 56th Street, La Grange, Illinois.

JUST OUT! 356-page catalog—save to 50% on auto parts, accessories. All makes, models. Send 25¢—refundable on first order. Whitney, 1919 PA-11, Archer, Chicago 16.

ALUMINUM Combination storm doors, windows, awnings, folding doors, etc. Furniture, housewares, appliances, jewelry, tools, chain saws, mowers, etc. All items listed below wholesale. 125 page catalog. \$1.00 refundable first order. Wholesale Supply, 42 East Pembroke Rd., Danbury, Conn.

MILLIONS Of items wholesale. Details free. Write: BBBL, 1218 16th, Golden, Colo.

WHOLESALE: Name brands! Catalog \$1.00 (refundable), guaranteed. National Wholesalers, Tupper Lake, New York.

BUILD This exciting vacation cabin for \$200. Complete blueprints \$3.50. A. Beck, LeMars, Iowa.

LARGEST Wholesale supply source in U.S.! Furniture, clothing, appliances, housewares, automobiles and accessories, tools, sporting goods, hobby supplies, farm equipment, imports, new products, bargain merchandise. Free details. Associated Wholesalers, Box 108-DD, Lincoln 1, Nebr.

BARGAINS! Closeouts! Specials! Catalog 25¢. Reavis, Box 1134-PM, Lufkin, Texas.

DISCOUNT Catalog, general merchandise. 25¢, refundable. Chapman's Gifts, 1802 Barth, Flint, Michigan.

100,000 PRODUCTS Wholesale! Terrific bargains! United Wholesalers, 1265-M Broadway, New York 1, N. Y.

TEAR Gas pens \$3.75. Not sold to minors. Calumet Tear Gas, 8826 Commercial, Chicago 17.

TREMENDOUS Wholesale buys! Big catalog! Postcard! Spartan, 1236-M Winona, Chicago 40.

100 FREE Wholesale catalogs! Complete directory, \$1.00. (Refundable). Parmelee's Supply, Marshfield, Wisconsin.

FREE! Name brands catalog! Your own high profit business. Sell name brands, full or part time. No inventory, no investment. More than 2,000 name brand items; lowest wholesale prices. Watches, jewelry, cameras, hi-fi, stereo radios-phonos, appliances, housewares, hardware, power tools, luggage, musical instruments, garden equipment, sporting goods, toys, many others. 8 floors of name brands. Million dollar inventory. Orders shipped complete in 24 hours! Send for free, beautifully illustrated catalog now! Separate wholesale price list. H. B. Davis Corp., Dept. PM, 145 W. 15 St., New York 11, N. Y.

BUY Below wholesale! Thousands of nationally advertised products. Drugs, clothing, housewares, cameras, jewelry, hardware, sporting goods, etc. Postcard brings price list showing actual factory cost. Buy-Rite, 310 Main, Bennington 2, Vermont.

NEW Deluxe multicolor below wholesale catalog, automobile catalog, and others. Housewares, appliances, refrigerators, freezers, washers, dryers, television, radios, furniture, clothing, luggage, binoculars, phonographs, recorders, cameras, projectors, tools, typewriters, watches, jewelry. Name brands. Huge discounts to 70%. Postcard: Selbyco, Decatur 15, Ill.

WORLD'S Largest wholesale supply. Buy from 679 American, European, Japanese wholesalers. Tailormade suits from Hongkong. 123 dropship catalogs. Rockbottom prices. Free details. International Buyers, 216-M Jackson, Chicago 6, Illinois.

WHOLESALE: 850,000 Items. Supply source directory 25¢. Idealer, Park Ridge, Illinois.

USED And new watches \$2 up. Free list. Southern Watches, 5-PM So. Wabash, Chicago 3.

ELECTRIC Guitars, amplifiers, wholesale. Free catalog. Carvin PMW, Covina, Calif.

SALESMEN—DISTRIBUTORS

MAKE Extra money—Big cash commissions plus premium for you and your customers. Sell advertising book matches. Sensational new tenorama glamour girls, hillbillies; dozens others. All sizes. Quick daily sale; big repeat business. Free master kit makes selling easy. No experience necessary. Superior Match, Dept. M-1161 7530 Greenwood, Chicago 19.

MAKE Big money taking orders for Stark dwarf fruit trees. Everybody can now grow giant size apples, peaches, pears in their yards. Also shade trees, shrubs, vines, roses, etc. Outfit free. Stark Bros., Desk 30152, Louisiana, Mo.

CALENDARS, Novelties. Full or part time. Liberal commissions. Fleming, 6535-A Cottage Grove, Chicago 37.

SENSATIONAL New longer-burning light bulb. Amazing free replacement guarantee—never again buy light bulbs. No competition. Multi-million dollar market yours alone. Make small fortune even spare time. Incredibly quick sales. Free sales kit. Merlite (Bulb Div.), 114 E. 32nd, Dept. C-74L, New York 16.

WILL You wear new suits, sport coats without one penny cost and agree to show them to friends? You can make up to \$40.00 in a day even in spare time, without canvassing. Stone-Field, 532 South Throop St., Dept. F-926, Chicago 7, Illinois.

MEXICAN Leather hand stitched wallets \$3.00 value. Send \$1.00 for sample. Leather Company, Box 71-P, Nestor, California.

MILLIONS Sold—razor blade resharpeners. Retail \$3.98. Details. Sharpener, Box 66, Youngstown 1, Ohio.

MAKE Extra money selling advertising matchbooks. Free catalog and sales outfit. Matchcorp, Dept. PM-111, Chicago 32.

SEEKING New products? Get my outfit 47 money-making specialties. Latest conveniences for home, car. Send no money. Just your name. Kristee 50, Akron, Ohio.

SENSATIONAL Sideline retailer and jobber salesmen. Warson Mfg., Naperville, Ill.

SELL TV indoor antennas to stores. Packaged in plastic display rack bags. Sample cost 95¢, \$10.00 per dozen. Sell for \$5.95. Knox Electronic, Galesburg, Illinois.

TAKE Over your area—Agents, dealers, farmers make \$250 up weekly selling nationally advertised Campbell's Gro-Green concentrated plant food supplements, increase protein and mineral content of grains and forage. No investment. Credit given. Everything free. Ideal proposition for corn and feed men. Campbell Co. (Est. 1928), Rochelle 52, Illinois.

AMAZING. Folding, easy connecting, pickup tow-bar. Inexpensive. Guaranteed. Salesman making terrific profits. Literature free. Carson Industries, Faxon 1, Oklahoma.

TRANSISTOR Radios. Big profit. Florenz, 439 Race St., Cincinnati 2, Ohio.

EARN Big commission full or part time. Build profitable business of your own selling America's largest line low priced business printing. 360 page catalog samples hundreds of items used daily by business people. Imprinted ball pens low as \$8.95 for 100. Big full color catalog low priced advertising specialties included. Free sales kit. National Press, Dept. 8, North Chicago, Illinois.

MAKE Up to \$50.00 a day soliciting delinquent accounts. Terrific commissions. Write today. General Finance, 304V Pickwick Bldg., Kansas City 6, Mo.

IF You're interested in making money in selling, see the hundreds of exceptional opportunities in Salesmen's Opportunity Magazine. Send name for your copy, absolutely free. Tell us what you're selling now. Opportunity, 848 N. Dearborn, Dept. 17, Chicago 10, Illinois.

EMPLOYMENT INFORMATION

FOREIGN Employment information. Europe, Alaska, Africa, Asia, Canada. Travel, adventure. Up to \$1,600 monthly. Construction workers, truck drivers, clerks, teachers, professionals, etc. Sensational opportunities—most complete information, application form sent immediately by return mail. Send \$2.00 to: Jobs, Box 512-E, New Orleans 12, Louisiana.

CALIFORNIA Job opportunities are available. Why delay? Determine a happier future now. Employment experts analyze your job potential, list firms presently hiring. Write for free information and application. California Unlimited, 646 — 15 Ave., San Francisco 18. We deal with people; not statistics.

SELECT U.S. and overseas jobs. Firms, salaries, benefits, addresses, procedures supplied. Write for free information: International Occupations, N. Y. International Airport, P.O. Box 100-C1, New York City.

UNLIMITED Employment. U. S. A. & overseas. Top wages. Supervisory, clerical, construction, etc. Skilled, unskilled. Free transportation. Unusual opportunities. Complete information plus worldwide project listings. Only \$2.00 (\$2.25 airmailed). Satisfaction guaranteed. International Opportunities, Dept. B, 109 W. 42, New York 36, N. Y.

WANTED—Men, women. Civil Service job list for California, Nevada, and Hawaii. Send \$1.00 to Job Reports, P.O. Box 36532, Los Angeles 36, California.

CALIFORNIA Jobs, (guaranteed). \$2.00 (airmailed). Sheremeta, Box 36201C, Los Angeles 36, California.

CHOICE U.S. and overseas jobs. All trades. Firms, addresses, hiring, procedures, pay scales, benefits. For info, write: World Wide, Dept. B17, 155 N. Franklin St., Hempstead, N. Y.

"WANT To move to South Florida? Information on job openings, housing etc. \$2.00. Box 6021, West Palm Beach, Fla."

WORK. Construction jobs, all trades. Travel, cash big pay checks. Exclusive list firms hiring. Training on job. \$2.00 shows how. Results guaranteed. Construction Bulletin, Sharon 4, Massachusetts.

EXCELLENT Employment, California, Oregon opportunities. All occupations. Men, Women. Indicate area, occupation-employment preferred. Airmailed \$1.00. Employment Surveys, 2908 Gawthorne, Oroville, California.

FOREIGN Employment. Construction, other work projects. If interested in overseas work, good pay, extras, write: Foreign Service Bureau, Dept. PM, Bradenton Beach, Florida.

RESUMES Written. Send stamp. Jancek, 373 East 155th Street, New York 55, N. Y.

FOREIGN Employment. Now open. World wide. Four books in one, merchant marines, aviation, civil service, all this for only \$3.00 airmailed. Send money order to International Employment, P.O. Box 115, Boston 27, Mass.

FOREIGN Jobs—Latin America, Alaska, Canada, up to \$1500 monthly. Up-to-date 1961 foreign service directory gives complete information; hot list of firms hiring for military and civilian construction, aircraft, oil, exporters-importers, mining. How-when-where to apply. 13th successful year. \$1.00. Global Reports, Box 5201, Inglewood, Calif.

DIRECTORY Reports. Construction, aviation, shipping, oilfields, government, manufacturing, trucking, etc. Foreign-stateside. Helpful information plus job-getting tips on preparing application letters. Unconditional money-back guarantee of satisfaction. Act today. Only \$2.00 (\$2.25 airmail). (C.O.D.'s accepted). Research Services, Meramec Building, St. Louis 5-PM, Missouri.

HIGH Paying foreign employment now open. Construction, aviation, Civil Service, Merchant Marines, jobs on ships, thousands of jobs open right now. Travel to Far East, Europe, South America. This is your chance to earn big money. Do not delay. Write for free information to: International Employment Information Center, Boston 27, Mass.

MERCHANT Marine jobs. Men and women. Top wages. Travel. Captain, Box 501-P, Reading, Massachusetts.

SPECIAL SERVICES

WHAT'S Your problem? Financial, Business career matters solved confidentially by expert staff. Alliance, P. O. Box 1984, Trenton, N. J.

INFORMATION On anything. Ferguson Research Specialists, 59 Lent Ave., Hempstead, N. Y.

EDUCATIONAL AND INSTRUCTION

LINOTYPING Operating—Home study, resident. Includes instruction books, charts, lesson sheets. Linotype operators earn to \$12,000.00 year and more, work steady. Information free. Chicago Linotype School, 637 So. Dearborn, Dept. PM-111, Chicago 5, Ill.

BECOME A personal problem counselor. Enter dignified profession. Instructions \$1.00 refundable. Hermansen, Box 808, Grand Central Station, New York 17, N. Y.

LEARN By ear with Dormiphone. While you slumber, the amazing new scientific Dormiphone tools give you a shortcut to learning languages, correct speech; memorizing facts, figures; relaxation, habit training. Saves you time, effort. So simple to use, children benefit. Used by educators, psychologists. Write today for fascinating free book. No obligation. Modernophone, Inc., 320-111 Radio City, New York 20.

COMPLETE Your high school at home in spare time with 64-year-old school. Texts furnished. No classes. Diploma. Information booklet free. American School, Dept. X-845, Drexel at 58th, Chicago 37, Illinois.

GOOD Paying jobs open! Operate, repair heavy earth moving equipment! Learn "on the job" operating latest cranes, bulldozers, earth carriers! V.A. approved. Free catalog. Write T. M. Hutch, Greer Technical Institute, Braidwood, Illinois.

CIVIL Service. Training for U. S. tests. Get full information about this field, home study preparation for high rating. Free booklet. Private organization. No obligation. Franklin Institute, Dept. A 111, Rochester 4, N. Y.

CIVIL Service offers good pay, security. Special home-study course prepares you for passing high on examination. \$14.95 complete. Free information: American Tech, 661 Spring St., Atlanta 8, Georgia.

MASTER Watch making at home. Free sample lesson. Chicago School, 2328-YX Milwaukee, Chicago 47.

BRITISH College degrees through home study. Low cost. Payment plan. Registrar, 423 Wilson, New Westminster, Canada.

EARN Big money. Study negative retouching at home. Famous Photographers, Inc., 111B School Street, Concord, New Hampshire.

LEARN Civil and criminal investigation at home. Earn steady, good pay. State age. Institute Applied Science, 1920 Sunnyside, Department 168, Chicago 40, Illinois.

PENMANSHIP Corrector. Improve poor penmanship quickly. Details free. Oxment, Box 665-34, St. Louis 83, Mo.

EARN \$150 Weekly mechanical, electronics drafting. Send \$2 first lesson, \$25 complete home study course. Prior Inc., Dept. 121, 23-09 169 Street, Whitestone 57, New York.

EASY To have a powerful memory. Booklet \$1.50. Write: Melvin T. Tyler, Box 18297, Boston 18, Mass.

USED Correspondence courses, books. Satisfaction guaranteed. Catalog 10¢ refundable. Courses bought. Bayles, 78-B Courtright, Wilkes Barre, Penna.

EARN Extra money by clock and watch repairing. Learn at home. Kansas City School of Watchmaking, 1228PM Admiral, Kansas City 6, Missouri.

SPECIAL Books "How To Do It Yourself" kind. Many subjects. Also low-cost home-study Civil Service Guides. Free details. Write Harry's Book Shop, 4415-PA North 13th St., Tacoma 6, Wash

CIVIL Service opportunities—city, state, federal. Preparatory homestudy guides for higher rating. Free listings. Jorgensen, Box 5023-3111, Seattle 7, Washington.

"TRUTH About Correspondence Colleges." Recognized? State laws. Controversial! Details free. Aurean, Central Valley, New York.

PROFESSIONAL Investigators. Home study. Lapel pin, certificate, future. Box 41197-F, Los Angeles 41, California.

CRIMINOLOGY Certificate courses. Boston School Criminology, Box 5-M, Hanover, Massachusetts.

WOODWORKING And cabinetmaking course for beginning and advanced home craftsmen. Only complete low-cost home training program available. Write for free booklet. Interstate Training Service, Dept. G-3, Portland 12, Ore.

USED Correspondence courses and books sold and rented. Money back guarantee. Catalog free. (Courses bought.) Lee Mountain, Pisgah, Alabama.

BE A Real Estate Broker. Insure security for yourself and your family. Study at home. Prepare for state examination. GI approved. Write for free book today. Weaver School of Real Estate, 2018 P Grand, Kansas City, Missouri.

HIGH School diploma at home. Licensed teachers. Approved materials. Southern States Academy, Station E-16, Atlanta, Ga.

WANT A diesel job? Higher pay? Advancement? We can help you qualify! Complete diesel, tractor and heavy equipment and Cummins Diesel Engine Shop-method home-training courses available. Write today. Interstate Training Service, Dept. B-3, Portland 12, Ore.

DEVELOP Mind power, personality while asleep. Use your phonograph, recorder. Amazing psychological tapes, records now available. Details free. Sleep-Learning Association, Box 24-N, Olympia, Washington.

BOOKKEEPERS. Operate your own "Dollar-A-Week" system. Ellis, Box 200, Cedar Grove, North Carolina.

OWN Collection agency. Little "gold mine." Franklin Credit, Roanoke, Va.

LEARN Asleep or awake! Records, tapes, equipment! Free catalog! Drawer PM-697, Ruidoso, New Mexico.

MEN Wanted. Earn \$125 a week and up. Master a trade with a future. Learn auto diesel mechanics in our shops. You learn with tools on real equipment. Earn while you learn. Many of our graduates earn \$125 a week and up. Write for free bulletin: Dept. 256, Auto Diesel College, Nashville 3, Tenn.

STRENGTHEN Your voice — for more success in business, social life! Free booklet. Give age. PV Institute, 325 Jackson, Studio 2EN-2, Chicago 6.

ANALYZE Handwriting for profit, pleasure. Free sample lesson, catalog reveals plan. Write International, 325 Jackson, Dept. 2CN-2, Chicago 6.

SING. Speak with power. Self-training record. Amazing! \$9.95. Canfield, 2018-A Fifth Avenue South, Minneapolis 4, Minn.

PIANO Tuning pays. Learned easily at home. GI approved. 59th year. Free booklet. Niles Bryant School, Dept. P, 3731 Stockton, Sacramento 20, Calif.

OPERATE Restaurant or diner. Free booklet reveals plan. Write School of Restaurant Business, Dept. RMC-359, 335 W. Madison, Chicago 6, Illinois.

PIANO Tuning pays. Big money in spare time. Learn at home in 30 days. No musical knowledge necessary. Phonograph, records, tools and instructions furnished. Electronic tuning taught also. Free catalog. Capital Piano Tuning School, 3160 S.W. 16th Court, Fort Lauderdale, Fla.

SPEAK Spanish by comparing it with English. New booklet explains how. Prepaid 50¢. Spanish by Comparison, Box 5313, El Paso, Texas.

BOOKKEEPERS. Operate your own profitable bookkeeping service. Whiteley, 1645 Warwick Avenue, Warwick, Rhode Island.

SWEDISH Massage, physical culture and weight reduction pay big profits. Men and women. Learn at home. Diploma course. Free catalog. National Institute, Desk 4, 165 E. Ontario, Chicago 11, Illinois.

INVESTIGATORS Course. Credentials, diploma. Free information. Southwestern Institute Criminology, 510-A Iowa, Geronimo, Okla.

FINGERPRINTING And identification taught at home. Diploma. Details free. Alabama School of Fingerprinting, Fairfield, Alabama.

EARN More if you learn more! Write asking for training information for one of the following: Civil Service, high school diploma, art training. Write your preference to: N.T.S., Box 500-PM, Greenwich, Connecticut.

ELECTRICIANS Needed! Train at home in spare time. To get the facts, write M. G. Haugestuen, Electrical Inspector, Box 425, Cameron, Wisconsin.

LEARN Auctioneering. Free catalog. Missouri Auction School, 1330 Linwood, Kansas City 9-X3, Mo.

LEARN Ventriloquism. Amazing-entertaining! Easy! Details free. B. Davis, B-38, Safety Harbor, Florida.

SECRET Investigations. Experience unnecessary. Investigators particulars free. George Wagner, M125 West 86th, New York City 24.

BEGINNER'S Home training in drafting! Free information. Chickris Engineering, Liberty Building, Rock Island, Ill.

LEARN Real Estate business fast. Economical homestudy. Literature free. Howard Schools, Box 8394-A, Kansas City 5, Missouri.

PROFITABLE National Camera Repair School training at home! 174PM, Englewood, Colorado.

SWEDISH Massage. Home study. Diploma. Illinois Licensed School, 3809 Alta Vista, Chicago 13.

PLAYS, STORIES, MANUSCRIPTS

WANT Your book published? Learn how we publish, advertise, promote, distribute. Many successes. Free booklet PM. Vantage, 120 West 31, New York City. Or 6253 Hollywood Blvd., Hollywood 28, Calif.

AUTHORS! Free details "Selling your Manuscripts." Write Beth Kramer, Authors' Agent, Box 156, Tahlequah, Okla.

ADVERTISING AGENCIES, ADV. SERVICE, MAILING LISTS

"GOING Into business?" Be prepared. Have the correct and necessary personalized (your name) forms to operate properly. Write: Tymette, 4842 West Ainslie Street, Chicago 30, Ill.

FREE! Red-hot book, "More Profit From Your Advertising." Lists—best mail order magazine, newspapers. Adservice, 516 Cornelia, Chicago 13.

AMAZING New Book—"Profits From Classified Advertising." Tells how and what to advertise. Be sure to read this book before you invest one cent in advertising. Write for your copy now. F. W. Johnson, Classified Advertising Manager, 202-210 East Ontario Street, Chicago 11, Illinois.

NOW Ready: New, amazing Classified Advertising Record Book—prepared especially for classified advertisers. Here is a book that tells you instantly whether or not your advertising in any publication is paying you real results. You can tell immediately how many inquiries each publication produced—how much cash received from every ad. Spaces are provided for the name and address of the publication, date of issue, space used, rate, cost of ad, key number, etc. You have a complete record of each publication right before your eyes. Plenty of space to keep accurate record of 28 separate publications. You can have a copy by sending only 10¢ to cover postage and handling. Send for your copy now. W. F. Johnson, Classified Adv. Mgr., Popular Mechanics Magazine, 204 E. Ontario Street, Chicago 11, Illinois.

ADVERTISE: 24 Words. 75 Canadian newspapers, \$5.50. Lists free. Advertising Bureau, 10511-C Springfield, Chicago 55.

ADVERTISING Ratebook leading newspapers, magazines, free. Chicago Advertising Agency, 28-E Jackson, Chicago 4.

MAILING Lists most all kinds 1000 \$5.00. Free folder. Your circulars mailed \$4.00 1000. Dixie Mailers, King, N. C.

TYPEWRITERS, DUPLICATORS, OFFICE DEVICES

RECONDITIONED Typewriters, mimeograph, printing presses \$25.00 up. Write Dixiegraph, King, N. C.

RUBBER STAMPS AND OFFICE SUPPLIES

CHRISTMAS Special. Signature stamp and pad \$3.00. Star Stamp, 705 South Wells, Chicago, Ill.

RUBBER Stamps, 3 lines 75¢. 20 words \$1.25. Loadwick, 78 Alliston St., Cambridge, Mass.

3 LINE Pocket stamp \$1.00. To introduce our complete service. Signet Stamp Co., Box 694, Riverhead, L. I., N. Y.

HANDY Plastic pocket rubber stamp 3-lines \$1.00. Holland, C-633 Gifford Street, Syracuse, New York.

QUALITY Pocket (self-inking) 3-4 lines \$1.00; (metal) \$2.00. Adirondack Printers, Tupper Lake, New York.

STAMPS 3 lines \$1.00. 1000 labels \$1.00. Send stamp for catalog. Kantor Printing, 1391 Penna. Avenue, Bridgeville, Penna.

POCKET, 3 Lines \$1.00. Guaranteed. W. J. Specialty, 8464 Manhattan, Detroit 11, Michigan.

FREE 32-Page rubber stamp catalog. Stock stamps, racks, pads. Christmas stamps, signature stamps \$3.50. Youngers Stamp Shop, Princeton, Iowa.

FREE Catalog: Rubber stamps, printing. Martin, 1425 Major Drive, Jefferson City, Missouri.

QUALITY 3-Line rubber stamps, pocket or cushioned, \$1.00. Barney's, P.O. 278, Capitola, California.

CARTOONING, COMMERCIAL ART, SHOWCARD & SIGN PAINTING, TATTOOING

HARDBOARD. Plywood cut-out letters, patterns, custom designing, personalized rustic signs Paulow Signs, Crystal Falls, Michigan.

YOU Can entertain with chalk talks. Catalog 10¢. Balda the Cartoonist, Oshkosh, Wis.

LEARN Sign painting at home. Free talent test. Ben Kerns, Box 812-PM, Greenville, S.C.

LEARN Sign painting with fascinating system. Straley, 410 S. Western, Springfield, Ohio.

CARTOONING—Good money in fields of television advertising, animation, movies, magazines. Famous system of manual training brings amazing new concept of art instruction at home. For profit or pleasure. Send for free details. Continental Schools, Dept. E-72, 4201 S. Broadway, Los Angeles 37, Calif.

"HOW To Make Money With Simple Cartoons." A book everyone who likes to draw should have. It is free: no obligation. Simply address Cartoonists' Exchange, Dept. 911, Pleasant Hill, Ohio.

DRAW Cartoons in four minutes. Write: Cartoonist Cullen, Newtown, Conn.

PAINT Signs! Using patterns! Trial alphabet \$1.00. Harwell, PM-1161, Byrdstown, Tennessee.

\$10,000 YEARLY Drawing simple cartoons. Over 200 markets. Information free. Markets-11PM; 11620 Lansdowne, Detroit 24, Michigan.

PRINTING, MULTIGRAPHING, MIMEOGRAPHING, GUMMED LABELS

DISTINCTIVE Printing, proofs, cuts, mats, artwork. Writers', office supplies. Logan Enterprises, 6801-A Onyx, St. Petersburg 3, Florida.

MIMEOGRAPHING—Letters, pricelists, formulas, instructions. Lowest prices. Lem's Letter Shop, 5710 Stanton, Detroit 8.

ADS Running under this heading sell printing. Ask me for proof. I'll gladly send you amazing facts. Ask for Folder "P." F. W. Johnson, 200 E. Ontario St., Chicago 11, Ill.

FREE Catalogs postpaid printing. Rubber stamps. DM Press, Sebastopol, Calif.

SAVE 40% On quality offset printing. Free price list. Modern Engraving Co., 276 Friend St., Boston 14, Mass.

DISTINCTIVE Mimeographing. Lowest prices. Samples sent. Perkins Printing Service, Fremont, Nebraska.

1000 NAME-Address labels 88¢. Rubber pocket stamp 88¢. Printing, rubber stamp catalog. Jordan's, 552 West O'Connor, Lima, Ohio.

MIMEOGRAPHING—Offset printing. Lowest prices. Barskettis, 6752 So. Campbell, Chicago 29.

COLOR Letterheads. Free samples and prices. Bell Colorprint, Franklin, Tenn.

THERMO-GRAVED Two-color business cards 1000 \$4.50. Samples. Scholler, 1747 Seiby, St. Paul 4, Minnesota.

LETTERHEADS, Envelopes, statements, billheads—the works \$9.95 postpaid. Samples. Okayprinters, Martins Ferry, Ohio.

500 PRESTIGE Letterheads, 100% Rag Bond, 24 lb., 8¹/₂x11—\$7.95, 1000—\$12.95, printed, postpaid. Neal, 249 Sunrise, Nashville 11, Tennessee.

100 ENVELOPES Printed gold ink \$1.75. Edwards Printing, Bakersville 2, N. C.

FREE Samples, catalog, gift business cards \$3.00. Cerny, 56th Street, La-Grange, Illinois.

LETTERHEADS, 200 (8¹/₂x5¹/₂) 200 envelopes (6¹/₂), \$3.50. Ellis, Rt. 2 Box 97D, Richmond 29, Va.

250—8¹/₂x11 HAMMERMILL Letterheads \$2.75. 250 envelopes \$2.75 (samples). Patton, Box 248P, South Haven, Mich.

DELUXE Business cards 1000 \$3.95. Stationery, Valliant, Box 625, Tampa, Florida.

250 8¹/₂x11 HAMMERMILL Letterheads, \$2.95. 250 envelopes, \$2.95. (Samples.) Davis, 7609 Spruce Road, Baltimore 22, Maryland.

OFFSET Printing. Free samples, prices. Pennant Offset, 2441 North Halsted, Chicago 14.

DISTINCTIVE Letterheads, colors, embossing, golds, samples. Tuff, 4279-M Viola, Philadelphia 4, Penna.

DISTINGUISHED, Inexpensive business printing. Catalog. Print Shop, Box 576, Greenville, R.I.

ATTRACTIVE Stickers, labels, cards. Samples. Fame, 291 Ellis, San Francisco 2, Calif.

100 BOND Letterheads, envelopes \$2.95. Davies, 187 Austin, Old Bridge, N. J.

1000 GUMMED Labels printed with name and address \$1.00. H. Mull, 405 E. Chestnut, Wauseon, Ohio.

FREE—Quality case! 1,000 embossed business cards \$3.95. Two color \$4.95. The luxury look! Postpaid. Samples. Medallion, 356 E. Alondra, Gardena, Calif.

GET Our printing prices first. Crane, 3024 White, Kansas City 29, Missouri.

1000 BUSINESS Cards, raised letters. \$3.75 postpaid. Samples. Routh, PM-11, 2633 Randleman, Greensboro, N. C.

THERMOGRAVED Business cards. Low prices. Free samples. Craft's, Box 7142, Nashville, Tenn.

PRINTING OUTFITS AND SUPPLIES

NEW Printing supply and type catalogs. Two 9" x 12" books, 300 pages illustrating printing press, rubber stamp outfits, gold stamping presses, bookbinding equipment. Hundreds of type styles including brass type, steel type, wood type. Thousands of supply items from world's largest printers' supply house. Send \$1 to cover mailing. Refund with first order. American Printing Equipment & Supply Co., Dept. PM, 42-25 Ninth Street, Long Island City 1, N. Y.

RUBBER Stamp presses, hydraulic operated, electrically heated. Sizes 5"x8", 8"x12", 10"x15". Starting outfits, supplies. Printing presses. Custom Manufacturing, 1464-P East Commercial, Springfield, Missouri.

FOUNDRY Cast type and supplies for printers and rubber stamp makers. Satisfaction guaranteed. Send \$1.00 for big 96-page catalog and printers tweezers, deductible from first order. Acme Type, 633 Plymouth Court, Chicago 5, Ill.

MAKE Your own self-molding rubber stamps and printing cuts. Plexirubber. Argyle 1, Wisconsin.

DO Your own printing. Save money. Simple rules. We supply everything. Print for others; good profit. Raised printing like engraving too. Have home shop. Details free. Kelsey Presses, V-11, Meriden, Connecticut.

RUBBER Stamp outfits, supplies. Kiewiet, 2025 Barney Road, Kalamazoo, Mich.

PRINTING Presses, type, supplies. Lists 44. Turnbaugh Service, Mechanicsburg, Penna.

FOR INVENTORS

QUALITY Patent searches, \$6.00. Complete Patent Office report forwarded. Free "Protection Certificate." American Patent Search Co., 422 Washington Bldg., Washington 5, D. C.

PROFESSIONAL Searches of the Patent Office. Dependable—reliable \$6.00 including airmail report and related patents. For free protection forms and patent information write Trans-World Patent Service, 500 Walker Building, Washington 5, D. C.

PATENT Searches including full, airmail report and closest patent copies, \$6.00. Quality searches, expertly administered. Free protection forms and patent information. Write Professional Patent Office Search Bureau, 709 Albee Building, Washington 5, D. C.

INVENTORS! Outright cash sale or royalties for your inventions. Patented. Unpatented. Constant demand from our client manufacturers. Write: United States Invention Brokerage, 78 Wall Street, New York 5, N. Y.

INVENTORS! Consider our offer first before selling or licensing your invention on a cash or royalty basis. Patented. Unpatented. Write: Inventions on Demand, 79 Wall Street, New York 5, N. Y.

DON'T Pay high fees! Obtain U.S. patent yourself. It's easy with Professional Kit with fill-in forms. Free "Registration form." Patent Protection Institute, 15 Park Row, New York 38, N. Y.

INVENTIONS Wanted for immediate promotion—patented; unpatented! Outright cash; royalties! Casco, Mills Building, Washington 6, D. C.

PATENT Searches, including copies of nearest patents, \$6.00. Reports airmailed within 48 hours. More than 200 registered patent attorneys have used my service. For free invention protection forms, write Miss Ann Hastings, P. O. Box 176, Washington 4, D. C.

CASH Or royalties for inventions! Patented; unpatented. All types considered. International, 1170 Broadway, New York 1, N. Y.

WE Have the markets if you have the ideas. Harvey Engineers, Cambridge 1 Maryland.

INVENTORS: Test the commercial value of your patented or unpatented inventions, quickly and inexpensively. Write for free information. Institute of American Inventors, Dept. 40-E, 635-F St., N.W., Washington 4, D. C.

PATENT Searches, including complete copies of nearest patents, \$6.00. Inventors, attorneys, manufacturers use my original world-wide airmail service. "Proof of Invention" protection form and "Information Every Inventor Needs" sent free. Miss Jean Hayward, 1029 Vermont Avenue, N.W., Washington 5, D. C.

PROFESSIONAL Patent searches, \$6.00, complete with comprehensive report and official copies of related patents. Prompt, dependable airmail service. For free protective "Invention Record Folio" and "Information Every Inventor Should Have." Write: Congress Invention Institute, 210 B McKim Building, Washington 5, D. C.

INVENTORS! Searches of the Patent Office administered professionally, \$6.00 including airmailed comprehensive report and related patent copies. For free invention protection forms, dependable service, write Washington Patent Office Search Bureau, 1426 G Street N.W., Washington 5, D. C.

U.S. Patent office former examiner's inventors service. Patent office searches. Free commercial invention evaluation. Cash-royalties promotion. Patent engineering development. Free invention protection certificates. George Spector, Licensed Patent Engineer, Woolworth Building, New York.

U.S. Patent office searches—\$5.00. Free invention record. Patents engineered. Patent Office Searchers, 233 Broadway, Room 3615, New York.

INVENTORS! Sell your invention for cash or royalties! Our manufacturers constantly seeking new items. Patented. Unpatented. For free information write Gilbert Adams, Patent Broker, 80 Wall Street, Financial District, New York, N. Y.

PATENTS Skillfully prepared for maximum commercial value, with useful product development. High record of success in proving and claiming patentability. Valuable market service. Patent prepared for a fee as low as \$200.00. Send for self-protecting record of invention forms free. Patent search with valuable engineering report \$15.00. Foreign patents filed at low cost. Thirty years established. Joseph O'Brien, Patent and Development Engineer, 132 Nassau St., New York 38, N. Y.

SAVE High fees! Apply for your patent yourself. New do-it-yourself Patent Kit now makes it easy! Free "Registration Form." Miss Suzan Blaine, 306 Carry Building, Washington 5, D. C.

INVENTORS: Save time and money. Prepare and file your own patent application. Our complete "Patent Kit" makes it easy. Includes detailed instructions and all necessary material. Only \$8.95. Money back guarantee. Don't delay. Send check or money order today to National Inventors Service, Box 88, Benjamin Franklin Station, Washington, D.C.

INVENTIONS Needed immediately for manufacturers. For additional information write Kessler Corporation, C-511-FI, Fremont, Ohio.

FREE: The Seven Secrets for Invention profit. Product Research, Box 181, Arlington, Virginia.

PATENT Searches, \$6.00, complete with comprehensive report and official Patent Office copies of related patents. Certified, airmailed! For free "Invention Protection Form," and "Patent Information," write: United States Inventors Service, 1311 "G" Street, N.W., Washington 6, D. C.

WRITE For information about our new concept in developing and promoting ideas and inventions. Taylor-Garner Corp., 1113-B Healey Bldg., Atlanta 3, Georgia.

FAST Airmail service on all patent searches: \$6.00, including full report and copies of nearest U.S. patents. For free protection forms and vital information, write: Washington Inventors Service, 422 Washington Building, Washington 5, D. C.

PATENTS Professionally prepared for maximum commercial value. Patent searches including report \$6.00. Patents prepared as low as \$195.00. Valuable market service with cash or royalty sales. 10 years dependable service. For free self-protecting Record of Invention forms write: H. Lawrence Blasius, Patent and Development Engineer, 19 Park Row, New York 38, N. Y.

CASH Or Royalties for inventions! Consider our offer first before licensing or selling your patented or unpatented invention. Write Aladdin Industries, 80 Wall St., New York 5, N. Y.

QUALITY Patent searches \$15.00. Send disclosure. Development Research Service, Box 682, Washington 4, D. C.

INVENTIONS WANTED

INVENTIONS Wanted! Cash, royalty basis. Inventions International, 15 Park Row, New York City.

CASH Obtainable for good ideas, inventions. Ketchum's Advertising, Springfield, Illinois.

INVENTORS Profit from patent engineers. Reliable, complete service. Guide book tells what's needed, sell. Send \$1.00. Inventors Creative Service, PM 354 South Spring, Los Angeles 13, California.

CASH Or royalties for inventions! Patented; unpatented. All types considered. International, 1170 Broadway, New York 1, N. Y.

INVENTORS: Hundreds of manufacturers have requested our assistance in locating marketable new products. Complete information free. Institute of American Inventors, Dept. 40-D, 635-F St. N.W., Washington 4, D. C.

INVENTIONS Wanted. Patented; unpatented. Tremendous manufacturers lists. Global Marketing Service, 2420 77th, Oakland 5, California

ARE You interested in offers from reliable manufacturers for your invention? Patented, unpatented. Harvey Engineers, Cambridge, Maryland

INVENTIONS Wanted for immediate promotion—patented; unpatented! Outright cash; royalties! Casco, Mills Building, Washington 6, D. C.

INVENTORS! Outright cash sale or royalties for your inventions. Patented. Unpatented. Constant demand from our client manufacturers. Write: United States Invention Brokerage, 78 Wall Street, New York 5, N. Y.

INVENTORS! Consider our offer first before selling or licensing your invention on a cash or royalty basis. Patented. Unpatented. Write: Inventions on Demand, 79 Wall Street, New York 5, N. Y.

INVENTORS Needing help with any problem, financial, development, securing manufacturer, obtaining patent. Write the organization that delivers action and results—not promises. Pioneer Invention Institute, 150 Broadway, New York 38, N. Y.

INVENTORS! Sell your invention for cash or royalties! Our manufacturers constantly seeking new items. Patented. Unpatented. For free information write Gilbert Adams, Patent Broker, 80 Wall Street, Financial District, New York, N. Y.

INVENTIONS Promoted-for cash-royalty sales with manufacturer contacts. George Spector, Licensed Invention Engineer, Woolworth Building, New York.

INVENTORS: If you have an invention for sale, patented or unpatented, write for free brochure outlining manufacturers' requirements, royalty rates. Kessler Corporation, C-511-IW, Fremont, Ohio.

WANTED Inventions, patented or unpatented. Unusual services. Professional Engineer, Box 113-A, Hampton, N. H.

WANT To sell your patented, unpatented invention? Compare our offer! Write: Fidelity, 3 McDevitt Rd., Randolph, Mass.

NAMES Of manufacturers wanting inventions. Bizayde, Dept. 13K, Box 1682, Rapid City, South Dakota.

INVENTORS. Don't sell your invention, patented or unpatented, until you receive our offer. Write Universal Inventions, Marion, Ohio.

INVENTIONS Wanted for national promotion. Write: Prometheus, Box 1341, Akron 8, Ohio.

MODELS—SHIPS, TRAINS, PLANES, ETC.

LIVE Steam powered backyard railroads! All sizes. Complete "bolt-together-kits", and rough castings. Excellent drawings. 100 page catalog \$1.00. Little Engines, Lomita, Calif.

ROCKETS: New illustrated catalog 25¢. Kits, cones, tubes, engines, etc. Estes Industries, Penrose 2, Colorado.

SHIP Model kits and fittings: clippers, frigates, etc. Catalog paint-tool list, book list, 35¢. Model Shipways, Box 85, Bogota, N. J.

LIONEL Trains. Big discounts bulletin 10¢. Catalog 25¢. Mack-Bros., 2043P. Chicago Ave., Chicago 22.

SHIP Models. Most complete line in New England, kits, fittings, plans, books, tools, engines, motors. Illustrated catalog 35¢. James Bliss & Co., Inc., Dept. SM, 342 Atlantic Ave., Boston 10, Mass.

SHIP And yacht model fittings; blueprints. Send 40¢ for illustrated catalog listing hundreds of items. A. J. Fisher, Inc., 1002-1 Etowah Ave., Royal Oak, Mich.

"POWER Drives Handbook"—36 pages illustrating many types motor drives for model autos, boats, displays, turntables, etc. Mail 25 cents cash, returnable first order \$3.00 or more. Wilson's of Cleveland, Dept. PM, P.O. Box 8995, Ft. Lauderdale, Fla.

MINIATURE Gasoline or steam engines—easily machined using our castings and blueprints. Fascinating hobby. Illustrated catalog 25¢. Octura Models, 8148-PM Milwaukee, Niles 48, Ill.

CASTINGS And finished steam-gas engines from simple oscillating to triple expansion. Finest materials and fittings. Catalogue \$1.00. Denison Live Steam Models, 1606 Denison Ave., Cleveland 9, Ohio.

ROCKET Supplies 1961 Catalog now available 20¢. Sky Mfg. Co., Mineral Point, Penna.

STEAM Engines, tractors, boilers, castings, prints. Catalog \$1.00. Tiny Power, Junction City, Oregon.

SAVINGS To 50%. Lionel, Gilbert, Althearn, etc. New trains accessories. Hobby Surplus, P.O. Box 1106, New Britain, Connecticut.

POWER Models. Unusual steam, gasoline and traction engines, fittings, metals. Large selection of books! Comprehensive 100 page catalog = 18 \$1.00. Chas. Cole, Ventura, Calif.

ENGINEERING SERVICES

DEVELOPING. Designing, simple or complicated, gadgets, toys, machines, electrical devices. F. Ledermann, Prof. Engineer, 154 Nassau St., New York 38.

MANUFACTURING

MODEL Building. For inventors. Manufacturing. Any quantity. Research. William Parker, 32 Westminster, Worcester 5, Mass.

MODELS—Small lot manufacturing. Metals, plastics, etc. Milburn, Burlington, Kentucky.

HOME CRAFTSMEN

WOODWORKING Catalog and manual. Brand new 150th Anniversary edition! World's largest selection of domestic, imported woods—materials, tools, supplies, do-it-yourself plans, projects. 132 pages, many full color. More than 2,000 items. Send 25¢ for postage and packing. Act now! Constantine, 2050 Eastchester Road, Dept. S-101, New York 61, N. Y.

FREE! Leathercraft catalog. Hundreds of new items. Write MacPherson Bros. Leather Company, Dept. E. 730 Mission St., San Francisco 3, Calif.

POLYETHYLENE Glycol, new wood stabilizer. See "Work it Green" March Popular Mechanics. Also semifinished walnut carvings. Illustrated catalog 25¢. Crane Creek Company, Dept. A. Waseca, Minnesota.

101 PATTERNS Of smart gifts, novelties, shelves, action windmills plus "Make Money Jig Sawing". \$1.00. Mastercraft 115M, 7041 Olcott, Chicago 31.

BUY Picture frame moldings at wholesale. All styles and widths. Necessary tools, too. Free deliveries in U.S.A. Write for pricelists. Chesapeake Picture Frame Company, 414-A East Baltimore St., Baltimore 2, Md.

KNOCKDOWN Cedar chests and lumber. Catalog 25¢. Bedford Lumber Company, Shelbyville, Tennessee.

PICTURE Frames. Pre-mitred hardwoods. You assemble. Write for free details and prices. Frames, P.O. Box 7953, Kansas City, Mo.

SKIL-CRAFTS—All new '62-63 catalog. Largest and finest selection of leathercraft, artist and hobbycraft supplies in the world. Free goods gift with first order. 25¢ for latest catalog. Skil-Crafts, Box 167-P, Joplin, Mo.

PICTURE Frame moulding, squares and lumber. Kiln dried walnut, cherry, silver maple. Midland Lumber Company, Box 262, Savannah, Mo.

FREE, New catalog. 2447 plans, patterns. World's greatest selection things to do, make. Fun. Profit. Craftplans, 1322-A Wabash, Chicago 5.

LEATHERCRAFT. Send 10¢ for catalog. Saxcrafts, Inc., 1101 N. 3rd, Milwaukee, Wisconsin.

FREE Sample—Perma-Pelent, new one coat silicone formula. Corrects moisture problems on block, brick, stucco, stone, asbestos siding and all above grade masonry surfaces on your home. Less than one cent per square foot applied. Perma-Stone Co., Desk 17, Columbus 11, Ohio.

FREE "Do-it-yourself" leathercraft catalog. Tandy Leather Company, Box 791-V41, Fort Worth, Texas.

GRANDFATHER Clock movements, case plans, kits. Catalog 25¢. Mason-Sullivan, Noroton 7, Conn.

OUTDOOR Christmas displays brighten your yard. Easy building instructions in Booklet 202, only 25¢ from Popular Mechanics Service Bureau, Room 517H, 200 E. Ontario, Chicago 11, Ill.

DO IT YOURSELF

ONE Way glass installation for any type door. Easily installed in five minutes. Includes glass, frames, and installation tool. \$3.95. New dealerships open. One Way Glass, 610 S.W. 68 Terrace, Hollywood, Florida.

INSTANT Laminating: photos, cards. Self-adhesive plastic. Sample, details. Hughes Company, Middletown, Connecticut.

NEW Do-it-yourself ideas. Free handcrafts catalog. Larson, Dept. 1727, 820 S. Tripp, Chicago 24.

BUILD Excellent floor polisher attachment for electric drill. Buy materials anywhere. Tests show about easiest work drill can do. Plans \$2.00. R. E. Smith, Box 1259, Santa Monica, Calif.

CONCRETE Table and bench plans, easy to make 50¢. Plans. 4996 Nagle Rd., No. Ridgeville, Ohio.

WHIMSICAL Pendants, sample mold—25¢. Margy, P.O. Box 153, Albany 6, California.

FALLOUT Shelters. Do it yourself. Complete plans and material list \$1.50. Surface or underground type. Associated Drafting Service, P.O. Box 164, Claymont, Delaware. 10¢ for complete list of plans.

JARS And bottle tops can not stay tight when you use the Undershelf jar opener. This kitchen aide is always ready for use. Fasten under the cupboard or shelf. Postpaid \$1.00, 6 for \$5.00. Jo-Ed Enterprises, Dept. PM, Box 69, Glendale, California.

RESTYLE Your old piano to look like modern spinet. Manual tells how. \$2.98. Mayhew, 135 Elliott Street, Beverly, Mass.

STOP And think how much you can save and fun you can have by knowing how to do it yourself. Easy to learn from our new books. Free information. Write today. Johnny Russell & Company, Dept. B1Y11, P.O. Box 1997, San Antonio 6, Texas.

REFINISH Old furniture, save money, 17 operations fully described. 20 years experience in commercial refinishing. Send \$1.00. Kraft Finishers, 346 Keswick Ave., Glenside, Penna.

CHRISTMAS Cards. Make your own. Many methods described in Booklet 203, only 25¢ from Popular Mechanics Service Bureau, Room 517G, 200 E Ontario, Chicago 11, Ill.

ALUMINUM Storm windows, triple track \$12.50 each, carports \$141.36, awning \$10.00 up. Install your own. Details. Honey Heating, Box 168, Anna, Ill.

RESILVER Mirrors; plate. Literature catalog 25¢. Mirrocraft, 18518 Winthrop, Detroit 35.

FREE Check-list covering more than 500 classifications of projects, plans, instructions, service and repair information detailed in Popular Mechanics famous series of instructional booklets, books, patterns, and blueprints. List covers an extremely wide variety of do-it-yourself data on home remodeling, repair and improvement, hobbies, crafts, boating, games, lawn and garden, and hundreds of others. For your free copy of this helpful list, write: Service Bureau, Popular Mechanics, Room 520, 200 East Ontario, Chicago 11, Ill.

WATCHES, OLD GOLD, JEWELRY

SAVE Up to 50% on watch repairs. Write for details. Certified Watchmakers, 15029 East Cedarsprings Drive, Whittier, California.

LEARN Watch cleaning, repairing. Illustrated. Excellent earnings. Kester, Deckerville, Michigan.

HIGHEST Cash for old gold, jewelry, gold teeth, watches, diamonds, silverware, spectacles, platinum, mercury. Free information. Rose Refiners, Heyworth Building, Chicago 2.

HIGHEST Cash paid for old gold, jewelry, gold teeth, rings, diamonds, watches, silver, platinum. Mail articles today. Information free. Chicago Gold Co., 6 E. Monroe, Dept. 3458, Chicago 3.

SELL Them to us. Gold, silver and platinum articles. Send them to Electro Company, 1042 Highland Avenue, Buffalo 23, New York.

WATCH And clock repairing books. Free catalog. North American, 2320-AM Milwaukee, Chicago 47, Illinois.

WATCHMAKERS' Tools, materials, supplies, watches. Catalog, Gales, Box 1000, Chicago 90, Ill.

WATCHMAKERS' Jewelers', lapidaries' catalog 25¢. Bengal, 8910 Venice, Culver City, California.

PREHISTORIC Sharktooth necklace. Stunningly beautiful. \$6.95 each. Leffingwell, Surfside, S. C.

FREE Wholesale jewelry and Christmas gift catalog. Louis Perloff, 733 Walnut St., Philadelphia 6, Penna., Dept. P.M.

MEN, Women, children. Fine Swiss 17-jewel wrist watches. Only \$10. Money back guarantee. Send today. Merry Mart, 157 Federal Street, Boston 11, Mass.

OF INTEREST TO WOMEN

\$25.00 WEEKLY Making flowers. Discount catalog 10¢. Flocraft, Farrell, Penna.

RECEIVE interesting mail. Many unique offers. Your name listed only 25¢. Crafts, Box 63, New York 69, New York.

SELL Fine fabrics. Get yours wholesale. Box 363, Norwalk, Conn.

DRESSES 24¢. Shoes 39¢. Men's suits \$4.95. Trousers \$1.20. Better used clothing. Free catalog. Transworld, 164-G Christopher, Brooklyn 12, N. Y.

CANDLEMAKING & Decorating. Terrific hobby. Great business. Learn fascinating molding, dipping, creating & decorating candles for year-round demand—holidays, birthdays, weddings, anniversaries, all events. Spare time fun & extra income now, expand to colorful candle shop later. No age limit. Write for free facts on Home Instruction Method. Candle Institute, Dept. X-558, Fallbrook, Calif.

"8 MISTAKES Parents Make". Every parent should have this new book about child training. It is free; no obligation. Simply address Parents Association, Dept. 6711, Pleasant Hill, Ohio.

LEARN Expert cake decorating, candy making. Free details on Home Instruction Method. Candy & Cake, Dept. D-81, Fallbrook, Calif.

LADIES Bargain nylons. S-J Sales, 3329 Superior, Ashtabula, Ohio.

TYPEWRITER Owners. Make extra money. Successful plans, 25¢. Kenneth Wilson, Box 160, Mexico, Missouri.

BE Charming. Wear, present Saree. Beautiful Indian costume. \$15.00 up. Khalid Mian, Qasimjan Street, Delhi-6.

PERSONAL

BORROW \$100 To \$600 by mail. Quick, easy, private. No co-signers. Repay in 24 small monthly payments. For the amount you want write today to Dial Finance Co., 410 Kilpatrick Bldg., Dept. M-1, Omaha 2, Nebraska.

LOANS. Entirely by mail—\$600 or less. Repay 24 monthly payments. Write: Budget Finance Co., Dept. J-101, 114 S. 17, Omaha 2, Nebr.

NEED Spiritual help? Write to Helpful Tract Society. Helpful Tract Society, Corn, Oklahoma.

KNOW Yourself. Handwriting analysis \$2.00. Lewco, Box 26, Neillsville, Wis.

NEW! Borrow \$800. Anywhere. Increased loan limit. Air mail service. Postal Finance, 374 New Brotherhood Building, Dept. 17-B, Kansas City, Kans.

BIBLE Questions answered. Stamped envelope. Bylon, 17167 Bentler, Detroit 19, Michigan.

LOANS By mail, \$100-\$600. Anywhere. Confidential. Write Union Finance, Dept. PM, 323 E. Camelback, Phoenix, Arizona.

LOANS By Air Mail, \$100-\$600. Anywhere. Confidential. Easy payments. Write Security Finance Co., 898 Van Ness Ave., Dept. PM, San Francisco 9, Calif.

REMAILING SERVICE

LONDON, England, Airmails \$1. Toronto, Canada 25¢. Postcards available. Harley, Box 113, Scarborough, Ontario, Canada.

REMAIL-Forwarding service. Free details. Olson, Box 205, Tujunga, Calif.

YUKON Territory postcards, 4 for \$1.00. Write message and return to us for remailing. Monthly forwarding service \$3.00. Other remails, 25¢. Yarter, Box 177, Yukon Territory, Canada.

SWITZERLAND Remails \$1. Postcards 50¢. Parlat, 27 Riantmont, Lausanne, Switzerland.

CONFIDENTIAL Mail address, \$3.00 month, remails 25¢. Details free. Birnhan, 109 W. 42, New York City, 36.

LETTERS Retailed 25¢. Confidential. Robert Carter, Box 742, Los Angeles 53, Calif.

REMAIL 25¢. Davis Imports, Dept. 4, Box 489, Edmonds, Washington.

SECRET Mail address \$3.00 monthly. Reiss, Box 129, New York 18, N. Y.

INDIANAPOLIS Remails, 5 for \$1.00. Boone, P.O. Box 40,033, Indianapolis.

DALLAS Postcards, six for \$1.00, letters 25¢ remailed. Forward, 2706 Wilhurl, Dallas T16, Texas.

WORLDWIDE Postmarking. Details, 25¢. Via Associates, 422 Washington Bldg., Washington 5, D. C.

SECRET Mail address. Receiving and forwarding. Free information. Henry Labrie, 380 Elgin Street, Room 7, Ottawa 2, Ont., Canada.

SECRET Mail address, \$3 month. Hedgpeh, Box 830, Alhambra 23, Calif.

REMAILS. Receiving, forwarding, \$3.00 monthly, 25¢ single. 10437 Lanark Street, Sun Valley 3, California.

LETTERS Retailed from important, historic, Washington, D. C. 25¢ each. P.O. Box 7812, Benjamin Franklin Station, Washington, D. C.

SWITZERLAND. Letters airmailed \$1.00 each. Details free. Remailing Service, Brunnen, Switzerland.

HAWAII Remails 25¢. Information free. Coe, Box 984, Kailua, Hawaii.

HOLLYWOOD Remails 25¢. Monthly \$3.00. Sheremeta, Box 36201C, Hollywood 36, California.

TREASURE FINDERS

TREASURE! Handbook, map, 25¢. Locators. Howe, 811-P Kansas, Atchison, Kansas.

DISCOVER Buried loot, sunken treasure, gold, silver, coins; battlefield and ghost town relics, with powerful transistorized locators pioneered and perfected by Goldak. Low as \$79.50. Free, exciting information; literature on maps. The Goldak Co., 1541 West Glenoaks Boulevard, Glendale 1, California.

METAL Locator kits and assembled models from \$39.90. Terms. Transistorized and underwater models available. Free catalog. Electronic Applications, Dept. M, Box 8, Arlington 10, Virginia.

TREASURE. Gold, silver, relics. Find them with new super detectors, transistors. Free information. Detectron, North Hollywood, Calif.

TRANSISTOR M-Scope locates buried coins, gold, relics. From \$59.50; terms. Booklet, interesting customer comments free. Fisher Research, Dept. A-11, Palo Alto, Calif.

WANTED—MISCELLANEOUS

STAMP Collections, accumulations. Eagle Stamp Co., 2221 Romine, Pittsburgh 26, Penna.

QUICKSILVER. Platinum, silver, gold. Ores analyzed. Wholesale Terminal, Norwood, Mass.

FOR SALE—MISCELLANEOUS

FREE Money-saving catalog. Surplus and newly manufactured equipment and tools for workshop, home, boats, farm, factory. Write: Groban, 1139 South Wabash, Chicago 5, Illinois.

HEARING Aid batteries wholesale. Free list. Habs, Box 51, York, Penna.

JUST Out! 356-page catalog—save to 50% on auto parts, accessories. All makes, models. Send 25¢—refundable on first order. Whitney, 1919 AA-11, Archer, Chicago 16.

CIGAR Store Indian, antiques, investment property. Box 31, Sebastopol, Calif.

MISCELLANEOUS

NEW Hearing aids only \$29.95. Free trial, terms, agents. Inquire: Write Cary-B—Sales, Inverness, Fla.

SEPTIC Tanks, cesspools, clogged drains restored to newness by powerful crystal chemical. Details. Testimonials. Chemical Cesspool & Drain Cleaning Co., Allston 34, Mass.

SUPER Memory overnight! Success guaranteed! Bijou, Box 1727-M, Hollywood 28, California.

WANT Your name with 1000 mailers? 25¢ lists your name year with our mailings every month. Dixie Mailers, King, N. C.

100,000 PRODUCTS Wholesale—Free catalog! Send postcard: Econ-O-Mart, Whippany 15, New Jersey.

SEND Us wool for blankets. Free literature. West Texas Woolen Mills, 421 Main, Eldorado, Texas.

ELECTRONIC Bug killer \$5.95. Guaranteed 5 years. Ludwig, 7718 East Compton, Paramount, Calif.

FRATERNAL Jewelry, gifts, novelties. Free catalog. MacLeif, 105AW Canal, New York City 2.

"MEMORY-Lock." For self-advancement only. Inquire. Clarion, Box 9309-S7, Chicago 90.

PROFESSIONAL Compass adjuster secrets \$2.00. John Repp, 401 N. Riverside, Pompano Beach, Florida.

FLUORESCENT Tubes rejuvenated at no cost. Instructions \$1.00. Rejuvenators, 172 Bolton St., Portland, Maine.

FIFTEEN Feet 1/4" air or paint spray hose \$2.25 postpaid U.S. Additional foot 10¢. Specify male or female fittings. Ten day refund. Special hoses made. Rudow, 503 Kumquat, Sarasota, Florida.

HANDCARVED Wooden jewelry! Monogram keychains, pins, bookends! Special designs invited. Price list 10¢. Al Ball, 3905 Crest, Manhattan Beach, Calif.

SECRET Safety pocket. Detachable, no sewing. Send \$1.00. Cooper, Box 27, New York 1, N. Y.

CUCKOO Clocks. Widest selection. Buy from importer and save. Free catalog. Write: Simmons Bros., 10575 Robinson, Arlington, California.

READY Ruled 1" squares, 5 shts. 24"x38" \$1.00. U.S.A. only. Craig-Sullivan, 88 Broad, Boston, Mass.

INCORPORATE Yourself! How? Why? Free information. ERS, Washington Building, Washington 5, D. C.

ORCHIDS—Bromeliads. Richly illustrated catalogue \$1.00 airmailed. Orquideario Catarinense, Corupá, S.C., Brazil.

FOR Gifts of distinction consult R&G Products, 80-78 164th Street, Jamaica 32, N. Y.

FREE Fall and Christmas catalog. Discounts. Bob Henry, 1430 19th, Bessemer, Ala.

YOUR Prosperity, pertaining Scripture verses sent free. Box 251, Venice, Calif. (Print your name, address.)

SAVE 30% to 70% on Christmas gifts, housewares, appliances. Over 10,000 items. Free catalogue. K & S Specialties, GPO Box 2098, New York 1, N. Y.

POKER Players: Your name, as "Famous Expert" printed on booklet "Rules of Poker." \$1.25 postpaid. Wissings, 5851 16th Street North, St. Petersburg 3, Florida.

SEND \$1.25 for Scratch Covering furniture liquid for mahogany, Walnut or maple. Moezullo Furniture Finishes, 447 Sayles, Omeida, N. Y.



Rechargeable Flashlight Battery

Capable of being recharged 250 times, a D-size flashlight battery, little brother to the big industrial rechargeable battery, is now available to the consumer.

The nickel-cadmium battery can be recharged overnight from any 110-volt a.c. outlet. Each charge gives 50 percent more service than the ordinary D-cell battery.

A two-cell D-size flashlight cartridge retails at \$9.95. It is manufactured by Gould-National Batteries, Inc., Dept. PM, First National Banks, St. Paul 1, Minn.

SOURCES of further information on articles are listed in our free **WHERE-TO-FIND-IT** list. For your copy just write to the

SERVICE BUREAU
POPULAR MECHANICS
200 E. Ontario Street
Chicago 11, Illinois.



RUPTURE!

An amazing Air-Cushion Invention allows body freedom at work or play. Light, neat, cool, sanitary. Durable, cheap. Day and night protection helps Nature support weakened muscles gently but surely. No risk. Sent on Trial! Write NOW for free Booklet and Proof of Results. All correspondence confidential.

Brooks Company, 143-E State St., Marshall, Mich.



NEW BENSEN GYRO-COPTER

Plans and kits for one-man "Spirit of Kitty Hawk" now available. Easy to build and fly. 3-view drawings, specs, photo \$2 or simpler Copter Glider \$1. Order today!

BENSEN AIRCRAFT CORP., Dept. PM-111
Raleigh-Durham Airport, Raleigh, N. C.
NAME _____
ADDRESS _____



"TOOK IN \$217 FIRST 10 DAYS"

Some make more, some less...

We help you to start Your Own All-Year Business

Make Big Money! With our easily operated, highly efficient Wall Washer, Charles Stelle took in \$217 in first ten days. E. L. Goss took in more than \$10,000 in one year. G. H. Jones wrote, "I

made a net profit of \$1200 on one job." And no wonder—this machine washes walls 6 times faster and better than by hand and with no mess—no drop cloths needed.

Your Money Making Opportunity • We want more men to go into this profitable business for themselves and enjoy independence—freedom from layoffs and bosses. Customers everywhere—homes, offices, schools, churches, hotels, etc. How much you earn depends largely on you. What you take in is mostly profit. No need to rent shop or office; operate from home. Can start spare time until your full time is justified.

Lose No Time—Send Coupon Today for All the Facts



FREE BOOK! MAIL COUPON TODAY!

VON SCHRADER MFG. CO.
E10 "W" Pl., Racine, Wisconsin

Send at once (no obligation) your FREE booklet containing information about your WALL WASHING MACHINE and how I can start my own permanent, profitable business.

Name _____
Address _____
City _____ Zone _____ State _____

CHORD ORGANS SAVE UP TO 1/2

FREE Importer-to-You Prices

5 Day FREE Home Trial

Catalog and Discount Prices. Write

Startling value and performance! Buy direct from importer—amazing savings. Hand-crafted in Italy. Anyone can play, E-Z Terms, Bonus Gifts, Free Home Trial, Money Back Guarantee, Piano-keyboard models. New! Send for color catalogs, low discount prices.



Play at Sight—No Lessons Needed!

FREE Color Catalog Rush Coupon
PHILHARMONIC ORGAN CORP., Dept. R-111
2003 W. Chicago Ave., Chicago 22, Illinois
Rush color Catalogs and Discount Price List.
NAME _____
ADDRESS _____
CITY & ZONE _____ STATE _____

SAVE 80%
ON BRAND NEW

**Professional Quality
8" TILT ARBOR
POWER SAW**

**Guaranteed
TO DO WORK OF \$50 UNITS!**

NOT a toy or a gadget but a top quality full scale power tool of heavy duty cast iron and steel

**CROSS-CUTS, RIPS,
BEVELS, MITRES, DADOES,
CUTS COMPOUND ANGLES.**

Patented motor mount takes any standard 1/4 to 1/2 h.p. motor . . . keeps belt tight, assures perfect alignment at any angle, transmits full power. Table stays level—blade tilts, locks securely at any angle to 50°; raises, lowers 0"-2 1/4". Patented tilt mechanism has accurate etched scale. Takes standard blade, saw insert removes easily for insertion of any STANDARD dadoe heads, cutters, etc. Accessories, table extensions, when wanted, at factory prices. Versatile, rugged performance proved by almost a half-million users!

A very low price? Here's why!

Streamlined design features such as perforations on table top reduce weight, cut material costs, cut polishing and grinding time—reduce production costs. Special patents provide added efficiency, accuracy, savings. Parts made, assembled, tested and packed in our own factories . . . shipped direct to you. No retail store handling or profits to add to your cost.

ORDER TODAY!

AMERICAN MACHINE & TOOL CO.
Dept. PM-111A, Royersford, Pa.



Complete as shown, less blade. Incl. precision mitre gauge, ground cast iron table. If desired, RIP FENCE for easier work alignment, \$3.50 add'l. Wt.: 25 lbs. Exp. Coll.

**UNCONDITIONAL
10-YEAR GUARANTEE!**

**Your money back
if not satisfied!**

Send check or money order for full amount. Or send \$2. deposit, balance C.O.D. 10-day money back guarantee! Return within 10 days for full refund. No questions asked.

Processing of KODACHROME (Licensed by Eastman Kodak)

AT DISCOUNT PRICES

KODACHROME
I & II } \$1.00
8mm ROLL OR
35mm 20 EXP. MTD. }
8mm MAGAZINE75
35mm 36 EXP. MTD.1.75

SEND FOR FREE MAILERS and our big FREE CATALOG of Processing, Film and Equipment at DISCOUNT PRICES!



SOLAR CINE PRODUCTS 4247 S. Kedzie Dept. ME
Chicago 32, Ill.

**discounts by mail
up to 40%!**

Save on 1,001 famous U.S. products for workshop, garden, boat, paint jobs . . . Skil, Wen, Du Pont, Kide — dozens of name brands.

Satisfaction guaranteed. Send now for valuable, 68-page Catalog — free for limited time only (regular price, 50c).

GATES GENERAL CORPORATION
P.O. BOX 355 PM • FARMINGTON, CONNECTICUT

shaw

**shoes are designed for men whose feet
are part of their job!**

Here's a sturdy work oxford, with all the styling, fit and comfort of a dress oxford! Shaw's high value features include full cushion insole heel to toe with metatarsal pad and cushion side arch support . . . oil resistant Neoprene sole . . . steel arch . . . Nylon stitched . . . plus the finest leathers and craftsmanship, in black or Cordovan color. **AT STORES EVERYWHERE**, or write us for details.



IDEAL FOR

mechanics, filling station men, mailmen, factory workers—anyone who wants comfort and style in a work oxford! Also available as high shoe.



Today's
top values,
\$10.95 to \$14.95

M. T. SHAW, INC.
Coldwater, Michigan



"37 Years of Quality Shoemaking"



That's No Hot Rod--It's a Tractor!

Looking like a drag-strip racer that had made a wrong turn into a farm field, this experimental International Harvester gas-turbine tractor brings a flashy style, increased power, and a hydrostatic transmission to the job of tilling land.

The turbine engine, needing little servicing, allowed designers to slope the hood and enclose it so the operator has great visibility. The glass fiber skin is notched behind so the hitch is in easy view from the seat. The HT-340, as it is called, has rear-mounted fuel tank, front exhaust, and air intake on side.

POPULAR MECHANICS

Why all the cuts and colors?

REVELATION GIVES YOU
FIVE TOBACCOS IN ONE FINE MIXTURE

Look closely at Revelation and you'll see *five* fine tobaccos, ranging from bright yellow to a dark, rich brown. Each has a personality all its own, and here's how you can tell them apart:

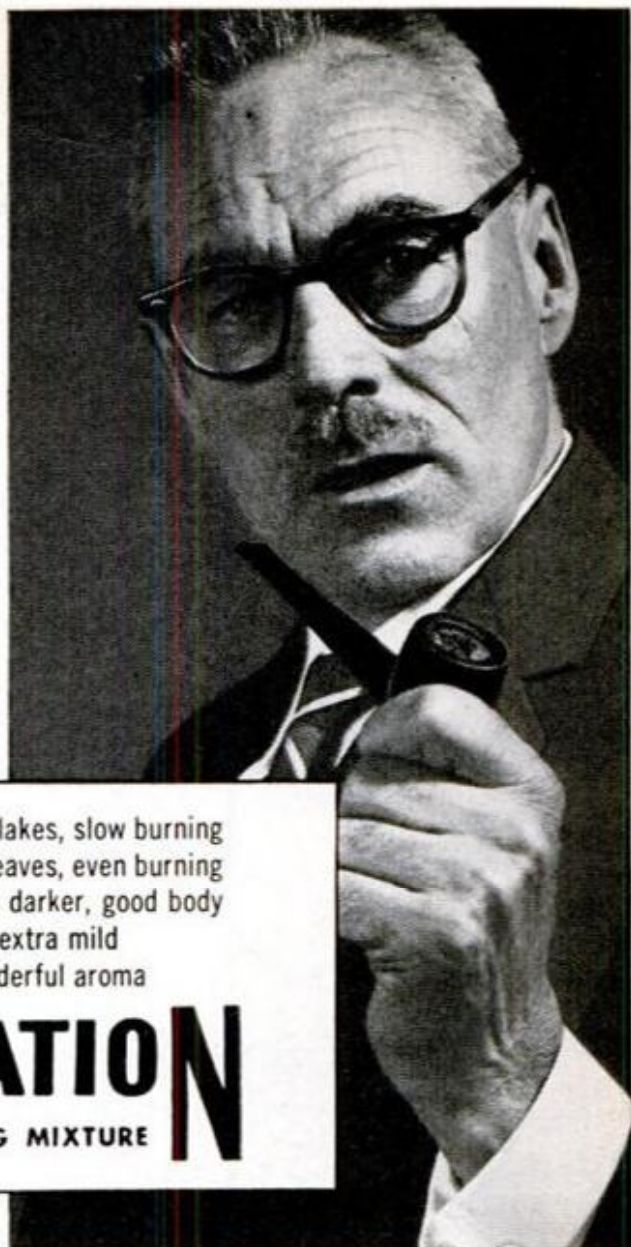

Kentucky Burley—dark flakes, slow burning
Virginia Bright—bright leaves, even burning
Old Belt Bright—slightly darker, good body
Latakia—deeper brown, extra mild
Perique—very dark, wonderful aroma

REVELATION

MILD SMOKING MIXTURE

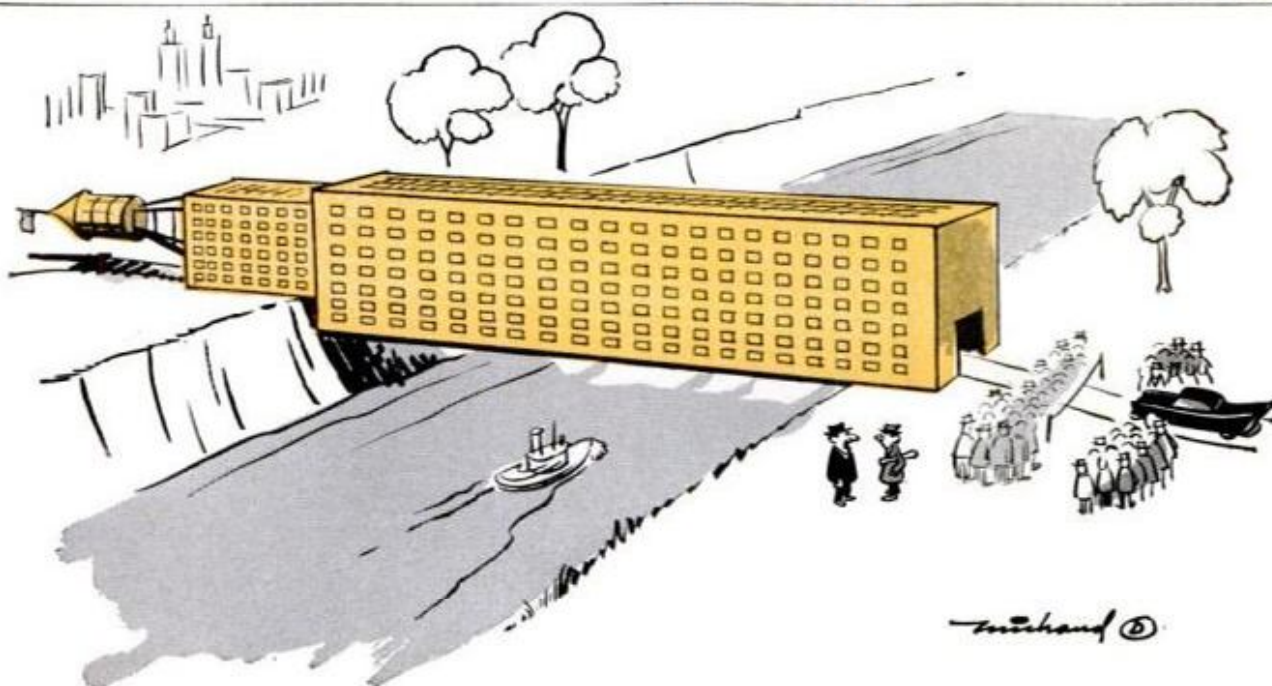

"What did you do before you built bridges?"

SHOPPING FOR TOOLS



2

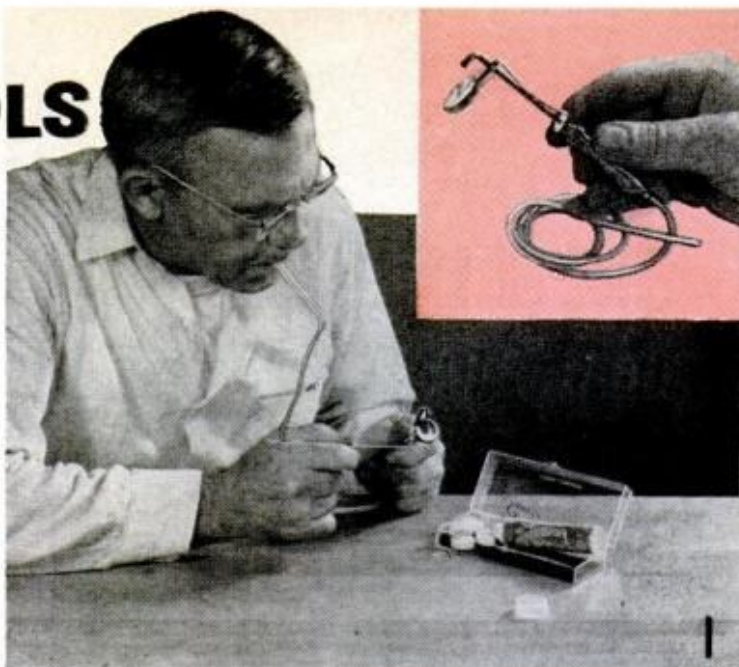

1

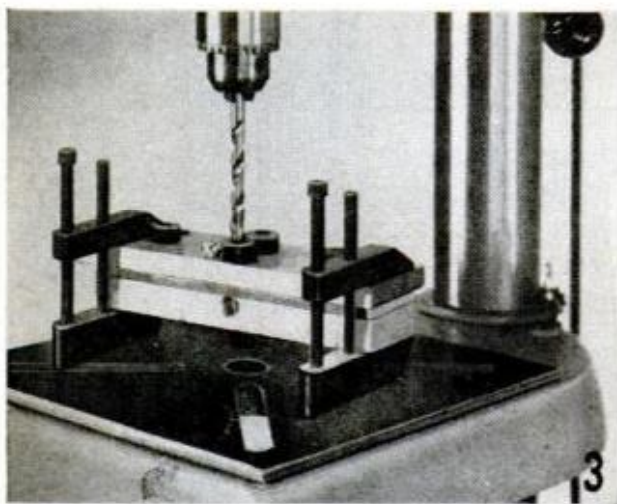

3

1. SOLID-FUEL BLOWTORCH uses fuel tablet that snaps in place. Torch may be lighted and used immediately without preheating. Developing more than 2000 deg. F., torch is used for silver soldering, brazing and annealing small parts. Priced at \$1.85; 12 refill tablets are 35 cents. Birk Mfg. Co., Niantic, Conn.

2. FOR THE BOY interested in woodworking, here's a good starter set of nine basic tools. You can give it as a Christmas gift to your son or an occasional tool user. Made of plastic, the fitted case may be hung on wall or closet door. Price: about \$15. Made by Stanley Works, 195 Lake St., New Britain, Conn.

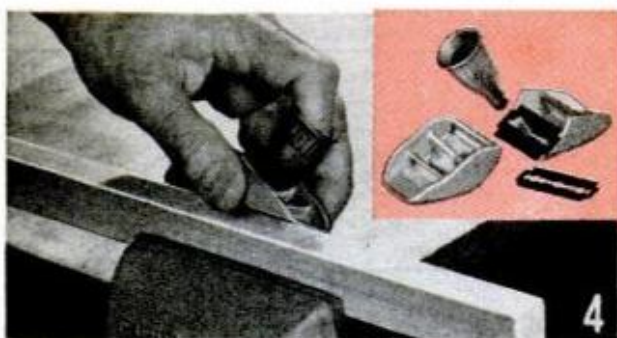

4

3. CLUBFOOT PARALLEL clamping system eliminates the screw obstruction of conventional parallel clamps. May be used for stack-sawing, drilling sheet metal, surface grinding of irregular parts and matched drilling operations. Per pair: \$9.95. Made by Baron Mfg. Co., 6090 Riverside Ave., Riverside, Calif.

*4139 MANCHESTER PL.
ARLINGTON, CALIF.*

4. MODELMAKERS PLANE uses any double-edged razor blade; converts into four different types of planes: short-nosed, curved, short-armed and regular. Tool is said to be more efficient and simpler to use for some types of work than larger planes. \$2. H & R Enterprizes, 18105 Landseer Rd., Cleveland 19, Ohio

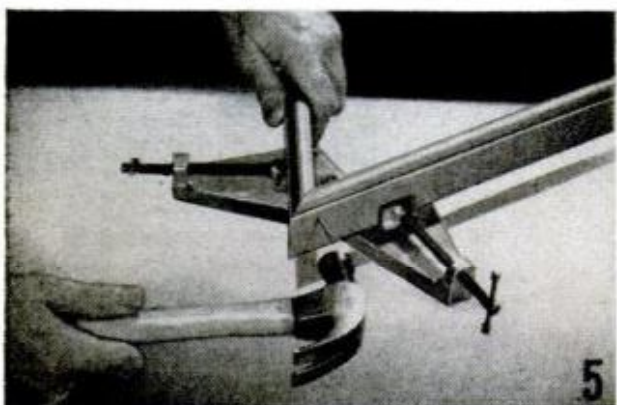

5

5. MITER CLAMP which has wide range of applications consists of two screw clamps with frames hinged together. Clamp adjustments may be made to any angle up to 180 deg. The pivotal dial is calibrated in 15-deg. units. Priced at \$5.95. Abernathy Vise and Tool Company, 132 W. Home Ave., Villa Park, Ill.

GET A BIG BOOST

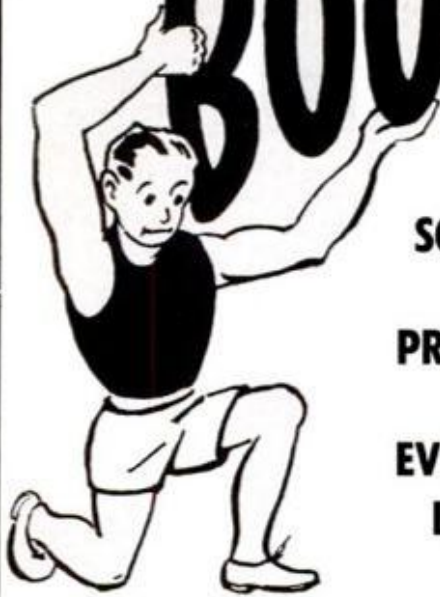

in
SOLVING
the
PROBLEMS
of
EVERYDAY
LIVING

Send for your FREE SERVICE FILE

This unique reference guide shows you where to find the answers to the problems of

- HOME REMODELING
- BOAT BUILDING
- FURNITURE FINISHING
- PAINTING
- LAWN PROJECTS
- OUTDOOR FIREPLACES
- PLUMBING REPAIRS
- UPHOLSTERING
- HOUSE WIRING
- SHOP PLANNING
- POWER TOOL TECHNIQUES
- MODELMAKING
- OUTDOOR LIGHTING
- LEAKY BASEMENTS

More than 500 subjects, covering almost every conceivable problem or project that ever faces a home handyman, are covered in this SERVICE FILE of Popular Mechanics' books, booklets, blueprints, and patterns. Send for one today and keep it handy as an invaluable reference guide.

POPULAR MECHANICS SERVICE BUREAU
Room 526, 200 E. Ontario, Chicago 11, Ill.

Please send me your FREE service file.

Name

Address

City..... Zone..... State.....

TRAIN AT HOME

in your Spare Time or in
Allied Resident School

1338-42 South Michigan Ave.
Chicago 5, Ill.

DRAFTING—All Branches
• Mech. • Structural • Aeronautical

ENGINEERING
• Industrial Engineering
• Tool Engineering & Design

TOOL & DIE MAKING

MACHINIST TRADE

AIR CONDITIONING
Refrigeration — Heating & Cooling

AUTO MECHANICS

SEND FOR
FREE
BOOKS

Choose the
Allied Way for Best Pay

Prepare for the best jobs in your spare time at home or at the ALLIED resident school. With ALLIED's practical training program you can progress so rapidly that big new opportunities will soon be open to you. Students planning a career in engineering can begin their training in short courses at Home or at Allied Institute and continue progressively toward an Engineering Degree in 31 months. Allied is approved by Industry, accredited by National Home Study Council, has approval of Department of Education, Office of Public Instruction, State of Illinois, U. S. Department of Justice.

ALLIED INSTITUTE OF TECHNOLOGY
1338-42 South Michigan Ave., Dept. PM-111, Chicago 5, Ill.

- Send me without obligation information on your courses:
- | | |
|---|--|
| <input type="checkbox"/> MECHANICAL DRAFTING | <input type="checkbox"/> AUTO MECHANICS |
| <input type="checkbox"/> STRUCTURAL DRAFTING | <input type="checkbox"/> MACHINIST TRADE |
| <input type="checkbox"/> ELECTRONIC DRAFTING | <input type="checkbox"/> AIR CONDITIONING |
| <input type="checkbox"/> TOOL ENGINEERING | <input type="checkbox"/> REFRIGERATION |
| <input type="checkbox"/> INDUSTRIAL ENGINEERING | <input type="checkbox"/> TOOL & DIE MAKING |
| <input type="checkbox"/> TOOL & DIE DESIGNING | |
| <input type="checkbox"/> HOME STUDY | <input type="checkbox"/> RESIDENT |

NAME AGE.....

ADDRESS

CITY..... COUNTY..... STATE.....

you can always
BE SURE OF A JOB

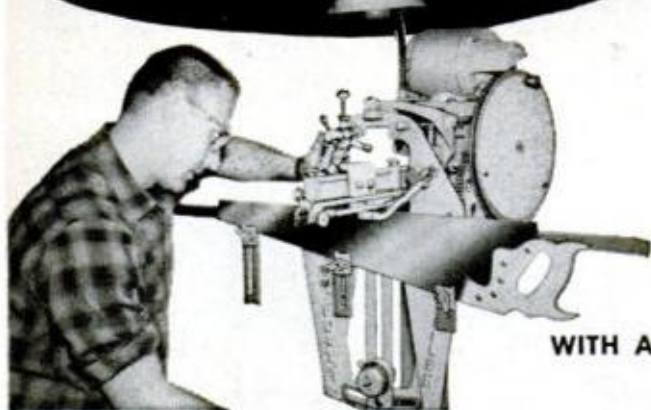

WITH A

FOLEY SAW FILER

Have you been laid off—or afraid you may be? If you want security, plus a bigger income too—don't look for a job—start your own spare time business. In his first 2 months J. P. Robitaille earned \$300 with his Foley Saw Filer. From his starting day H. T. Hart made \$600 in 4 months. Frank P. Layne wrote—"In our town of 2,800 instead of 200 to 300 saws I did over 1,500 the first year, averaging about \$1.50 each.

FREE booklet "MONEY MAKING FACTS" shows you how to get business. The new Foley "200" sharpens hand, band and both "combination" and crosscut circular saws. Use our Time Payment Plan—pay for the machine out of your CASH profits. Send coupon today—no obligation, and no salesman will call.

FOLEY MFG. CO., 1116-1 Foley Bldg., Minneapolis 18, Minn.
Send Free Booklet and Time Payment Plan on Foley Saw Filer.



Name _____

Address _____

City _____

State _____

FIX LEAKS YOURSELF!

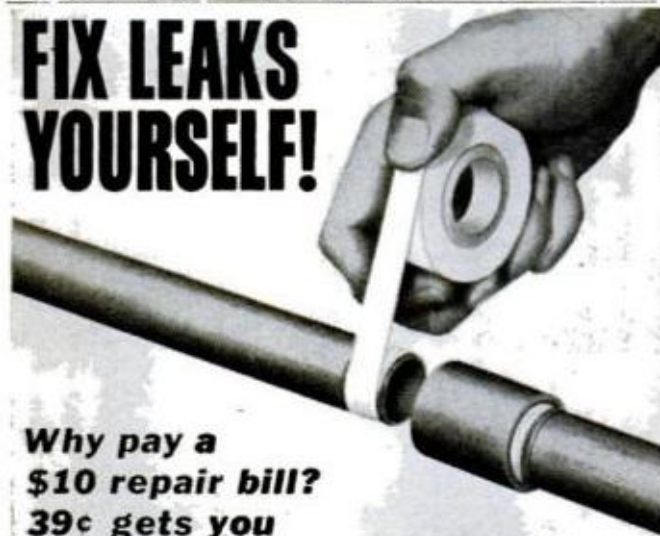

Why pay a
\$10 repair bill?
39¢ gets you

NEW HERCULES TAPE DOPE!

Stop leaks fast in shower heads, sink traps, radiators, valves, water lines, hose connections—any threaded joint—with cleaner, faster Hercules all-purpose Tape Dope, the modern pipe joint compound in easy to use tape form. Made of DuPont Teflon, Hercules Tape Dope eliminates old-fashioned messy pastes, gloppy brushes, soiled hands; it never runs or drips. Tape Dope permits easy assembly and disassembly and does a permanent leakproof job on all household plumbing connections. Only 39¢ for the 30" roll (seals 20—½" joints) at your hardware store or wherever plumbing supplies are sold. For free literature write to:

Hercules Chemical Co., Inc., 416 Broadway, New York 13



Withstands Heat Up to 6000° F.

Capable of withstanding temperatures up to 6000 degrees F., a protective coating called PyroShield can be applied to almost any surface and, once it has served its purpose, can be washed off again.

When intense heat or flame comes into contact with PyroShield-coated material, its components foam to form a thermally insulating shield which retard the transfer of heat to the material beneath it.

PyroShield withstands temperatures in excess of 2000 degrees for more than an hour, while the surface temperature remains under 350 degrees.

Shrinks Hemorrhoids New Way Without Surgery Stops Itch - Relieves Pain

For the first time science has found a new healing substance with the astonishing ability to shrink hemorrhoids and to relieve pain—without surgery.

In case after case, while gently relieving pain, actual reduction (shrinkage) took place.

Most amazing of all—results were so thorough that sufferers made astonishing statements like "Piles have ceased to be a problem!"

The secret is a new healing substance (Bio-Dyne®)—discovery of a world-famous research institute.

This substance is now available in *suppository* or *ointment form* under the name *Preparation H®*. Ask for it at all drug counters.

ALL-WEATHER CAPS

■ FOR SPORTSMEN; FOR
OUTDOOR WORKERS

■ OF WRINKLEPROOF
BRUSHED PIGSKIN

■ CHOICE OF
6 STYLES;
MANY COLORS

■ JUST BRUSH
OUT SOIL
AND SPOTS



BY WOLVERINE

THE BEST FROM 75 YEARS OF A GREAT MAGAZINE

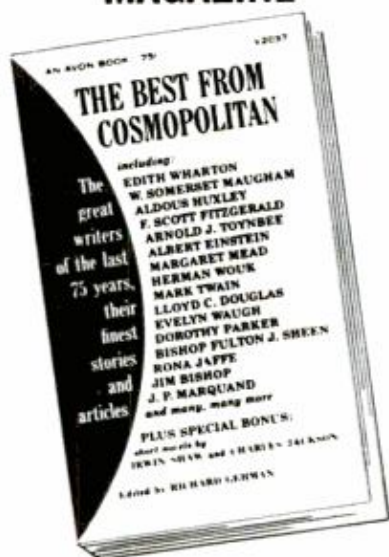

THE BEST FROM COSMOPOLITAN

Edited by Richard Gehman

An Avon Book **75c** V-2037

A superb collection of articles,
essays and short stories — plus
two short novels

Available at your local newsstand or
wherever paperback books are sold.
For a complete catalog of Avon Books
in print, write: Avon Book Division,
The Hearst Corporation, Dept. C, 250
West 55th Street, New York 19, N. Y.

NOVEMBER 1961

Dr. Grabow goes Continental

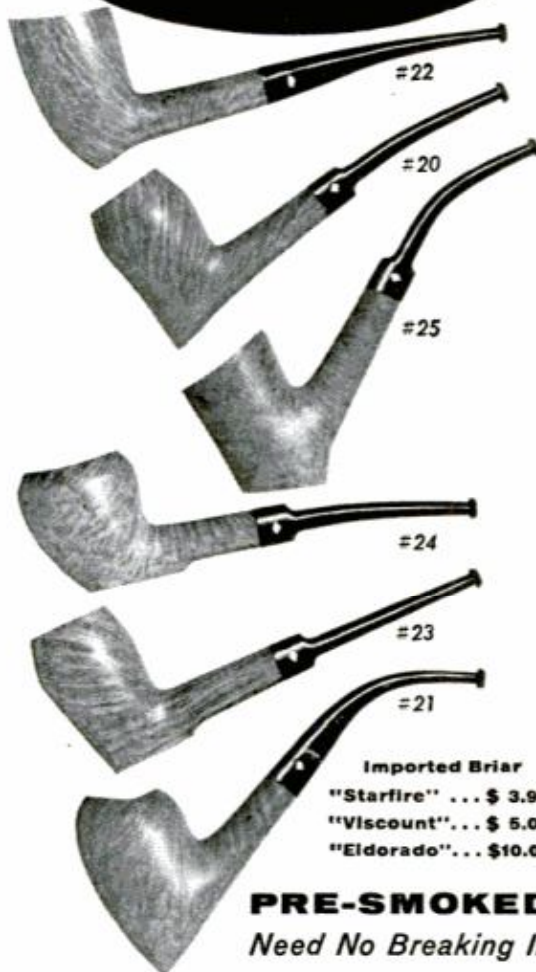

Imported Briar
"Starfire" ... \$ 3.95
"Viscount" ... \$ 5.00
"Eldorado" ... \$10.00

PRE-SMOKED
Need No Breaking In

New Continental shapes—strikingly handsome—
excitingly different—perfectly balanced—
moderately priced! Like all Dr. Grabows they're
mechanically pre-smoked with fine tobacco.
Never need breaking in—sweet, cool, satisfy-
ing from first puff. Write for FREE BOOKLET D

Dr. Grabow Pre-Smoked Pipes • Greensboro, N. C.

**FREE
TO YOU
and
your friends**

RADIO SHACK ELECTRONIC
CATALOG
Plus Every New Supplement
For Next 12 Months!

- Giant book is 2/3 bigger than last year! Brims with values!
- Stereo, Hi-Fi, Ham Radio, Tapes, Records, Parts, 30 pages Kits.

MAIL COUPON TODAY



RADIO SHACK Corp.
730 Commonwealth Ave., Boston 17, Mass.

Send Radio Shack's famous electronics
catalogs for one year—FREE and POST-
PAID.

Your Name _____ 61L3A

Your Address _____

City and Zone _____ State _____

For a Friend _____

Address _____ 61L3A1

City and Zone _____ State _____

NEW 22 cal. rim fire MAGNUM CARBINE

Look out varmints!
Here's another
Mossberg "Chuckster."

A sure-fire beauty—
only 38 $\frac{1}{4}$ " long,
wt. only 5 pounds.

And 22 cal.
Magnum ammo
costs less
than 6¢ each.

Model **642K**
5-shot, clip
carbine
\$3988

FREE:
Complete
catalog
on request.



Hinged
fore-end.
Carrying strap
on left of stock.

**OTHER
"CHUCKSTERS"**
640K, 5-shot
rifle.
640KS 5-shot,
deluxe,
golden
"Chuckster".
620K
top-loading
single
shot.

Don't fail
to see them
—at your dealer's.

Mossberg
for accuracy

O. F. MOSSBERG & SONS, INC.
19711 St. John St., New Haven 5, Conn.

**FREE
CATALOG!**

**TREMENDOUS SAVINGS ON
HUNDREDS OF SURPLUS AND
NEWLY MANUFACTURED ITEMS!**

New 1961 edition contains over 50 pages of
tools and equipment for farm, home, work-
shop, factory. Hydraulic equipment, pumps, mo-
tors, construction and diesel equipment and parts!
Write for your **FREE CATALOG** Today.

GROBAN SUPPLY COMPANY

1139 South Wabash Ave., Dept. 6-11 Chicago 5, Ill., WEster 9-3793



My Maid

AQUAMATIC BUILT-IN HOME CLEANER

"Down the Drain with
Household Dirt . . ."

featured page 194 Sept. issue
POPULAR MECHANICS

- **SPECIAL "do-it-yourself" DEAL**
for Popular Mechanics readers
— send for details.
- **DISTRIBUTORS:** Many fran-
chised territories still open;
contact Dept. PM.

MY MAID CORP., Ft. Atkinson, Wis.

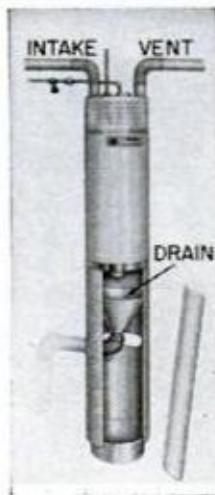

Toy Adding Machine

Labeled a toy—but useful in the office or
home—is a new adding machine. It adds,
subtracts and multiplies figures up to 99,-
999 and produces the answers to problems
at a touch of the total bar. Made of high-im-
pact plastic, it measures 10 by 5 $\frac{3}{4}$ by 2 $\frac{1}{2}$
inches and can be used in the home, school
or office. Manufacturer is Hassenfeld Bros.,
Inc., Pawtucket, R. I.; price is \$4.00.

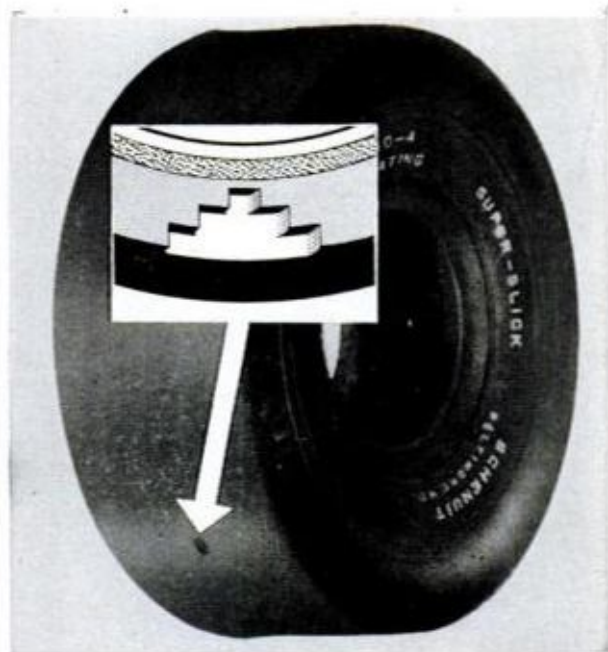

Hole in Tire Shows Tread Wear

Tread level indicators molded into the
face of a slick tire used in karting tell at a
glance how much tread is left. The indica-
tors are three half-inch-long depressions.
Each of three distinct steps down is equal
to one-third of tread thickness. The man-
ufacturer is Schenuit Rubber Co., Balti-
more, Md.

A number of one-man mail order enterprises are paying their owners an income of \$40,000 to \$50,000.

SPECIAL OPPORTUNITIES



Mail order is big business. Annual catalog sales volume of Sears, Roebuck and Co. is over 700 million dollars!

HOW TO START

Your Own Mail Order Business

You can make a fortune by mail. New firms will set you up in a fabulous mail order business of your own! They'll make up your catalogs, prepare your advertising, supply mailing lists and even ship your products for you!

By Robert Stephenson

When Anthony Sambati injured his back and was laid off from work he never dreamed it would be a blessing in disguise. Bedridden for weeks, he decided to start a small mail order business. This was something he could run right from his own home and required very little capital to begin. In fact, Sambati started with less than \$85.00.

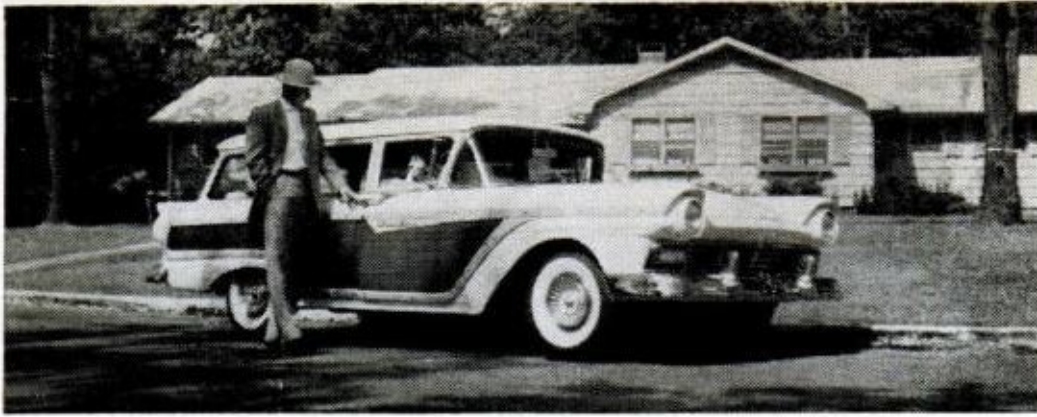

After a short time in mail order, Sambati soon had a beautiful home with all the luxuries of a successful businessman.

He figured that a small mail order business might provide a temporary income to support his family until he got back on his feet. His first step was to obtain a franchise from a large wholesale mail order firm which supplied him with all the necessary catalogs and mailing literature. It wasn't long until his spare-time venture blossomed into a booming enterprise. Drawing a small salary and pouring the rest of the profits back into the business, he soon had others working for him! Today he owns a large retail store, his own warehouse and a beautiful home with all the luxuries of a successful businessman.

Sambati's story is typical of a number of men and women who began a small mail order business with absolutely no previous experience, and made a huge success of it. These 'little' people are quietly pocketing big profits every day—many content to keep the business small . . . spending an hour or two each day in the privacy of their own home. No bosses, time clocks or small pay envelopes. No door to door selling, in fact, you never even meet your customers face to face.

Yes, a small one-man mail order business is ideal for anyone wanting a chance to gain financial security and independence. Yet thousands try mail order each year and fail, simply because they don't learn the few simple secrets of success early in the game.

Take the case of Bud Sheer who had been working for a theatre in a small New Jersey town. With only a few hours spare-time to spend each morning, he tried mail order to supplement his regular income. Like many beginners in this field, Sheer was faced with the problem of finding good mail order items which would have a high mark-up and repeat sales potential. But the biggest obstacle was the expense of printing a catalog.

Then he heard about the A. J. Statile Co. of Hillsdale, New Jersey — an organization set up to aid the small mail order beginner.

He wrote to A. J. Statile Co. for full information, sent in his application for a franchise and within a short time the cash began rolling in. Today Bud Sheer *owns* the theatre he once worked for. Sheer attributes his success in mail order to the A. J. Statile Co. Actually, the theatre he owns has become a side investment.

He still uses the beautiful 300 page mail order catalogs supplied by A. J. Statile Co.

How does the Statile Co. help the beginner get a sound start in mail order? Very simply. Just as Henry Ford made automobiles within the reach of the general public—by mass production and large volume.

Let's take a few specific examples:

(1) All franchised dealers of A. J. Statile are offered ready to mail catalogs and sales literature. Each mailing piece has the dealer's name and address printed right on it. By printing millions of catalogs, Statile is able to offer these at a fraction of their regular cost. The artwork and layout costs for these catalogs would run into thousands of dollars for the beginner if he were starting from 'scratch'.

(2) Since all mailing material and catalogs contain your name and address, all orders come directly to you. Yet you don't have to invest one penny in inventory. All merchandise is stocked for you. In fact Statile has over \$3 million dollars worth of mail order merchandise at your disposal.

(3) All packaging and shipping is done for you. You simply send a shipping label to Statile together with the wholesale cost of the items, and the merchandise is shipped directly to your customers under your own shipping label.

(4) A consultation service is provided to answer any questions you may have. You receive a secret list of over 100 national magazines which run free ads. You'll be shown how to obtain free publicity on your own mail order items. In addition, you obtain trade names and addresses of over 150 other mail order wholesalers who drop-ship top mail order items for you. You'll also be given all the government laws and regulations pertaining to a home operated mail order business. These laws are a 'must' for all beginners.

All this valuable information is covered in the Statile Mail Order Survey which every new franchised dealer receives from Statile before they begin. Formerly sold for \$25.00, this survey has become the 'bible' of the trade. Mr. J. M. of Baltimore, Md., writes, "To tell the truth, all the information in regard to obtaining free ads is alone worth the \$25.00 I paid you . . ." J. D. of Kalamazoo, Mich.,

states, "Just a personal note to say I am most satisfied with my \$25.00 investment. Your sales plan is simple and well organized . . ." These are only a few of the many testimonials received praising the Statile Mail Order Survey.

(5) The catalogs and mailing literature offered by Statile Co. cover every conceivable mail order item. You select the field you are interested in . . . BABY ITEMS, TOYS, APPLIANCES, VITAMINS, BOOKLETS AND



The thrill of receiving money in your morning mail is one you'll never tire of.

MAIL ORDER COURSES, you name it, Statile has the catalog or mailing piece. Select your market, order your mailing literature and you're in business.

(6) You'll be told how to compile your own mailing lists—and this is the most important part of your business. Many a beginner has fallen by the wayside simply because he mails his catalogs to a poor list of names. Suppose, for example, you offered a beautiful scale model of a 40' Chris-Craft cabin cruiser by mail. You would probably make your mailings to boating enthusiasts and the chances are that nine times out of ten your mailings would show a loss instead of a profit. How would Statile help you solve this particular mailing list problem? He would show you where to get the names and addresses of *actual owners* of 40 foot Chris-Craft cabin cruisers! Surely every owner would like to have a scale model of his own boat. Strange as it may seem, such a mailing list is available to anyone. The secret is where to find it. This is just one example of how an experienced mail order expert giving you personal advice, may mean the difference between success and failure!

This same method of obtaining selective specialized mailing lists may be applied to practically any market . . . selling baby items to new mothers, selling toys to young children, etc., etc.

So much for starting your own mail order business. Now, a word of caution. **OBTAIN YOUR MAIL ORDER FRANCHISE FROM A**

REPUTABLE MAIL ORDER FIRM. Unfortunately, during the past few years a number of ads have appeared in newspapers and magazines offering to start people in mail order. The ads are grossly misleading. Many imply that you can become a millionaire over night if you use their catalogs. Beware! Particularly if they operate their own mail order business direct to the consumer. These firms compete with their own franchised dealers! They could just as well mail all the catalogs themselves. They don't need you.

Other shady firms fail to drop-ship your orders promptly, thereby losing customers for you. In mail order, prompt shipment is an absolute requirement for a successful operation.

Deal only with firms whose business is preparing catalogs and shipping merchandise. They operate on a strict wholesale basis for franchised dealers exclusively. Such a firm is the A. J. Statile Co. Letters from successful franchised mail order dealers speak for themselves. A woman from Milwaukee writes, "It has been better than my expectations." A gentleman from California states "we are quite pleased with the response we are receiving." Another man from Wisconsin writes, "To say the least, I am more than satisfied."

Yes, a small mail order business offers you an opportunity to earn a second income, or—if you work at it in earnest, a chance to strike it rich. The young housewife in St. Louis may be content to make an extra \$20.00 a week . . . the office worker in Los Angeles may be aiming for \$150.00 weekly full time business . . . and the ambitious schoolteacher in Newark may reach \$20,000.00 a year. What is your objective? Set your own goal, pick your own hours, and the sky is the limit.

Even a government report stated that a number of the most successful one-man mail order enterprises make as high as \$40,000 to



Big firms will carry all stock for you. They ship orders direct to your customers using your own shipping labels.

Your Own Catalogs of Top Mail Order Items!



A. J. Statile Co. will prepare your catalogs, write your sales letters, supply mailing lists and even ship merchandise for you, using your own shipping labels!

\$50,000 a year! But frankly, this is the exception rather than the rule. Most mail order operators are content to earn a comfortable living doing little physical work, but enjoying their work thoroughly! We don't say you'll be a mail order millionaire or another Sears & Roebuck, but if you're looking for a business of your own with financial security, the answer is mail order. If you've already tried mail order with little or no success, don't give up! Try to analyze what went wrong. Success comes only to those who keep trying and learn from their own mistakes. Again we emphasize, deal only with a reputable firm.

The A. J. Statile Co. has been in business for over twelve years.

They gladly furnish bank or trade references upon request. They are probably one of the largest mail order wholesalers in the country. Whether it be toys, gifts, vitamins or appliances—they've got it ready to ship under your label WITHIN 24 HOURS!

Firmly convinced that no other business offers the tremendous opportunities of mail order, A. J. Statile, president of the firm, is an outspoken advocate of the man or woman who wants to start in business for himself. As Statile puts it, "by all means, start your own business and start NOW! If you want a chance at security and financial independence make your choice mail order. There's nothing like it. Absolutely nothing!"

FOR FREE DETAILS

Mail coupon below — no obligation

A. J. Statile Co., Dept. 16 • Statile Building • Hillsdale 16, N. J.

Dear Mr. Statile:

Please send me complete FREE details telling me how I may obtain a franchised mail order dealership with your firm. I understand I am under no obligation and no salesman will call on me.

NAME..... AGE..... SEX.....

ADDRESS

CITY..... ZONE..... STATE.....

PREVIOUS EXPERIENCE, IF ANY.....

(Advertisement)

POPULAR MECHANICS

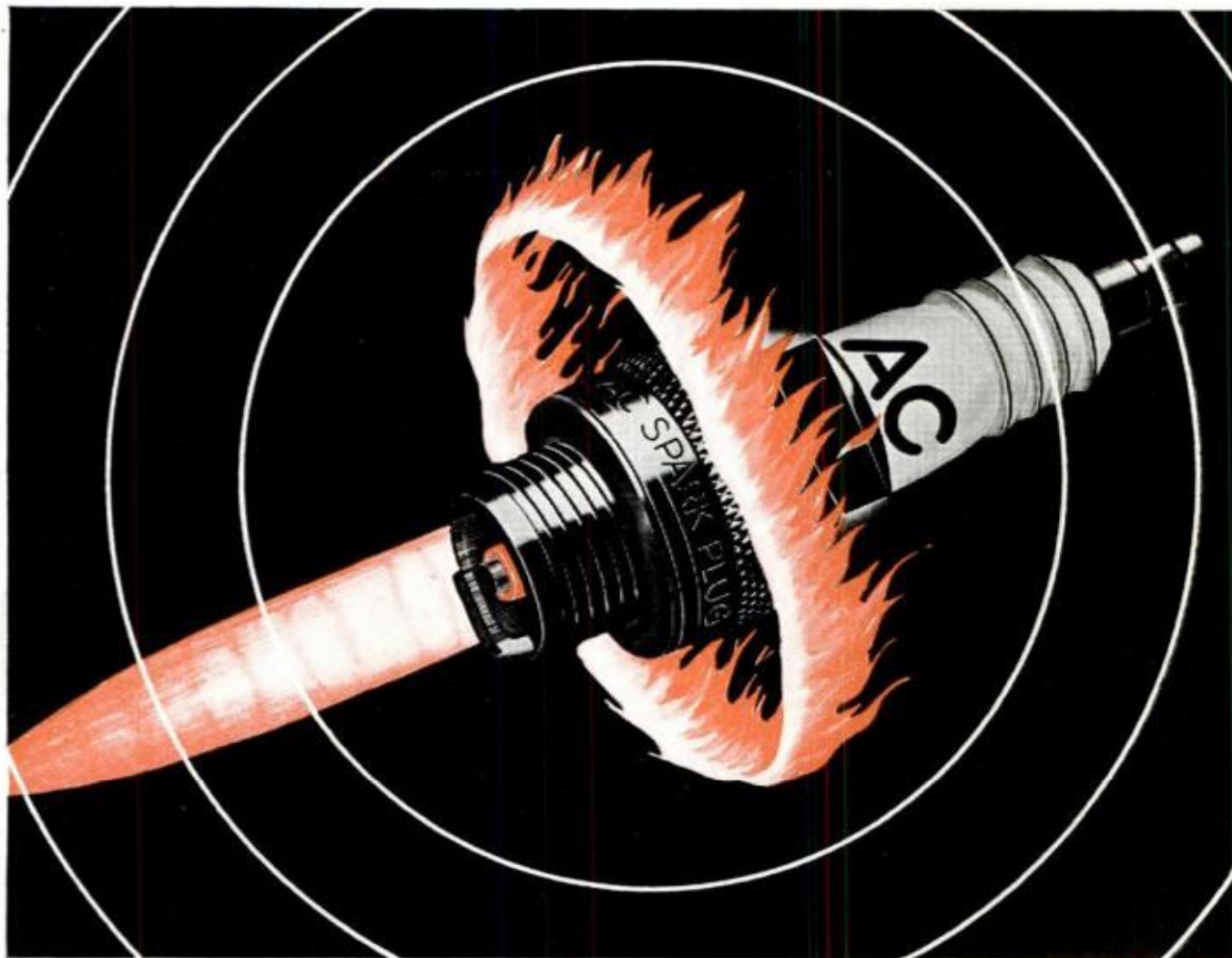

Get maximum A**CT**ion from today's high octane with AC Fire-Ring Spark Plugs

AC Fire-Ring Spark Plugs are designed and built for the fast power-producing action of today's high octane gasolines and high compression engines.

Your selection of ACs for your car provides you with spark plug construction made-to-order for the tremendous pressures and temperatures of modern engine combustion. AC Fire-Ring Spark Plugs feature heat bonded inner seals for positive protection against gas leakage and overheating—

massive chrome-nickel-barium electrodes for longer electrode life—and the exclusive Hot Tip that heats faster, cools faster for sustained smooth power performance.

At your next spark plug change, get the spark plug made for the explosive action of high octane gasoline—and remember, you get AC quality only under the AC name. Ask for A**CT**ion . . . ask for AC!

AC SPARK PLUG  THE ELECTRONICS DIVISION OF GENERAL MOTORS

powerful
you get **A**CT**ion** with



FIRE-RING SPARK PLUGS

You can light either end!

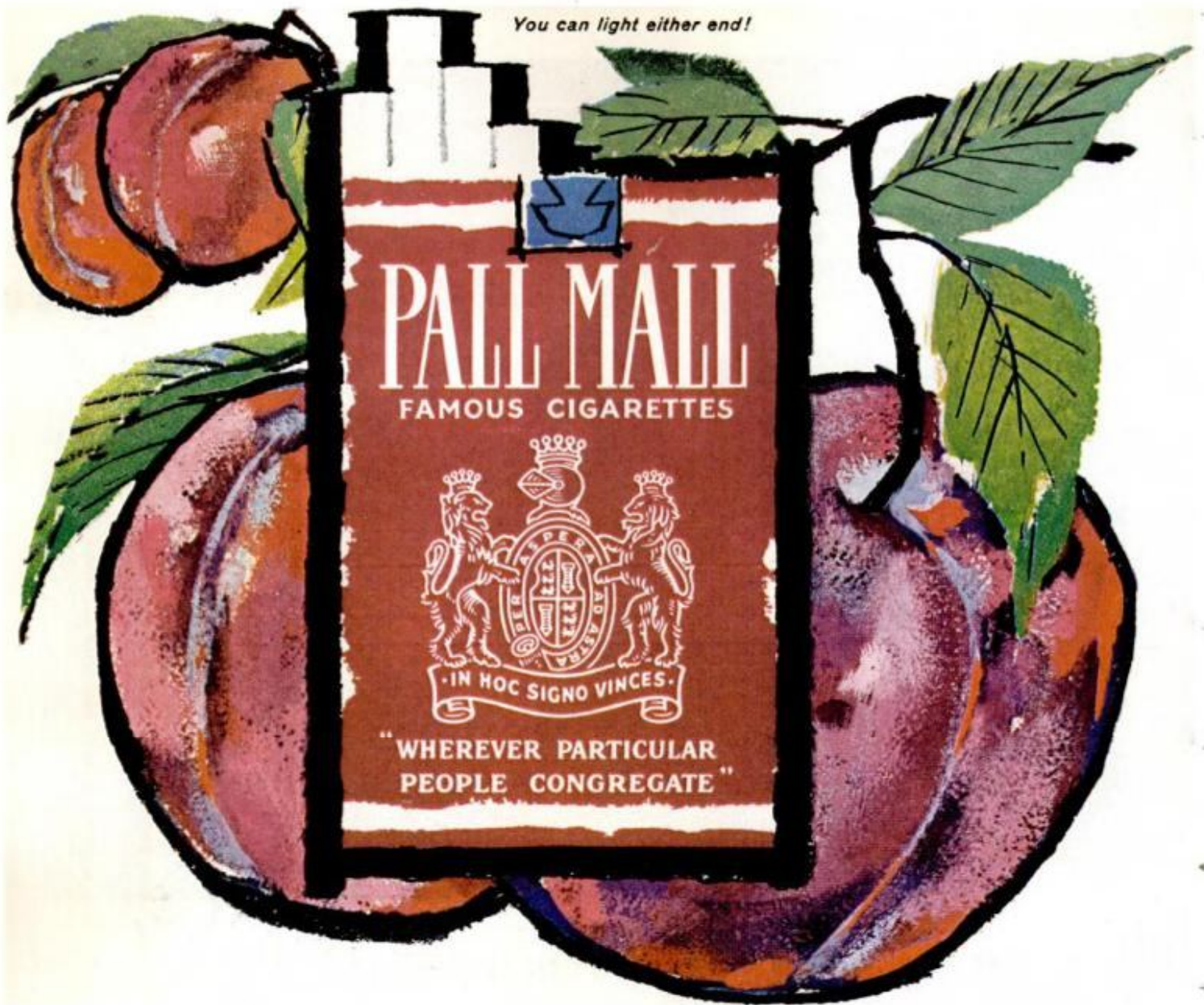

Pall Mall's natural mildness is so good to your taste!

So smooth, so satisfying, so downright smokeable!

See how Pall Mall's famous length of fine tobacco travels and gentles the smoke naturally — makes it mild — but does not filter out that satisfying flavor. Never too strong. Never too weak. Always just right! Enjoy satisfying flavor . . . so friendly to your taste.



Outstanding
...and they are **Mild!**

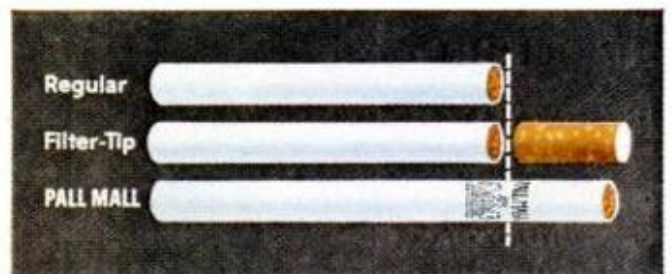

COMPARE ALL THREE! SMOKE "TRAVELED" THROUGH FINE TOBACCO TASTES BEST.

See the difference! With Pall Mall, you get that famous length of the finest tobaccos money can buy. Pall Mall's famous length travels and gentles the smoke naturally . . . over, under, around and through Pall Mall's fine, mellow tobaccos. Makes it mild . . . but does not filter out that satisfying flavor!

**EXCLUSIVE
FLIGHT TEST**



**By
Lou
Everett**

Test Pilot, Ryan Aeronautical Company

I Flew the

Pterodactyl Flex-Wing **Hottest Thing in Aviation**

NO ONE HAD EVER flown an aircraft like this before. It was a brand-new development of the Space Age. Yet at the same time it was a throwback to a flying machine in use millions of years ago.

The limp fabric of the arrow-shaped wing hung loosely from its supports. There were no control surfaces. The fuselage was an open platform on four wheels. In front, I was strapped to a seat from an old light plane and was holding the control wheel of a World War II bomber. Behind me the little 100-horsepower engine was warming up.

To a large extent the flexible wing was a nylon-and-aluminum copy of



MODEL GLIDER, left, and full-scale craft, below, show arrow-head shape of Flex Wing design



MAIN PARTS of craft are labeled at right. It's now being tested with 185-horsepower engine and rudder

the leathery membrane that the pterodactyls of the Jurassic Age used for gliding flight.

Would the odd craft fly smoothly, as we hoped? Would it snake violently from side to side or possibly pitch up out of control and crash? The first lift-off was going to answer these questions and a lot of others.

I advanced the throttle and the machine started down the runway. Overhead, the fabric ballooned up into its airfoil shape. At 30 miles per hour the machine was getting light and I eased back further on the control column. We were airborne!

My sensations were different from those experienced in any other aircraft. The platform remained level during the climb, and so the upward motion seemed like that of a helicopter. Now and then the platform rocked gently back and forth or from side to side in gusty air, yet the cloth wing remained completely stable.

I tried a turn, rolling the wheel to the left, and the plane began a slow left turn. The platform itself remained level; it was the wing that shifted and caused the turn. The airplane was performing beautifully.

As project engineer and test pilot for the Flex Wing at Ryan Aeronautical Company I was feeling out the characteristics of a "test bed" that may be the forerunner of many different kinds of vehicles.

The Flex Wing may be an answer to the

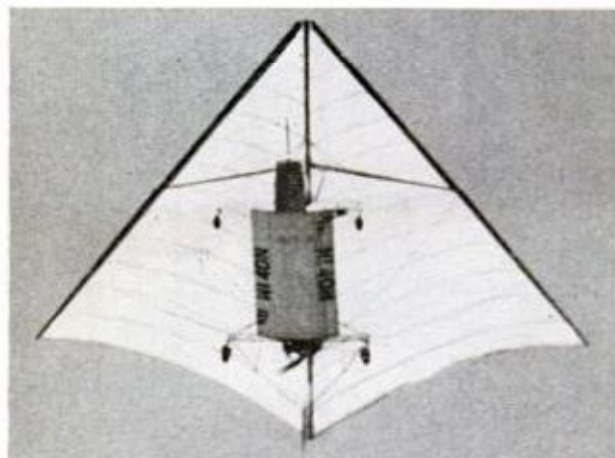

RADIO-CONTROLLED MODEL goes through taxi tests at Langley Research Center of National Aeronautic and Space Administration. The principle of the flexible wing originated with Francis M. Rogallo of the NASA



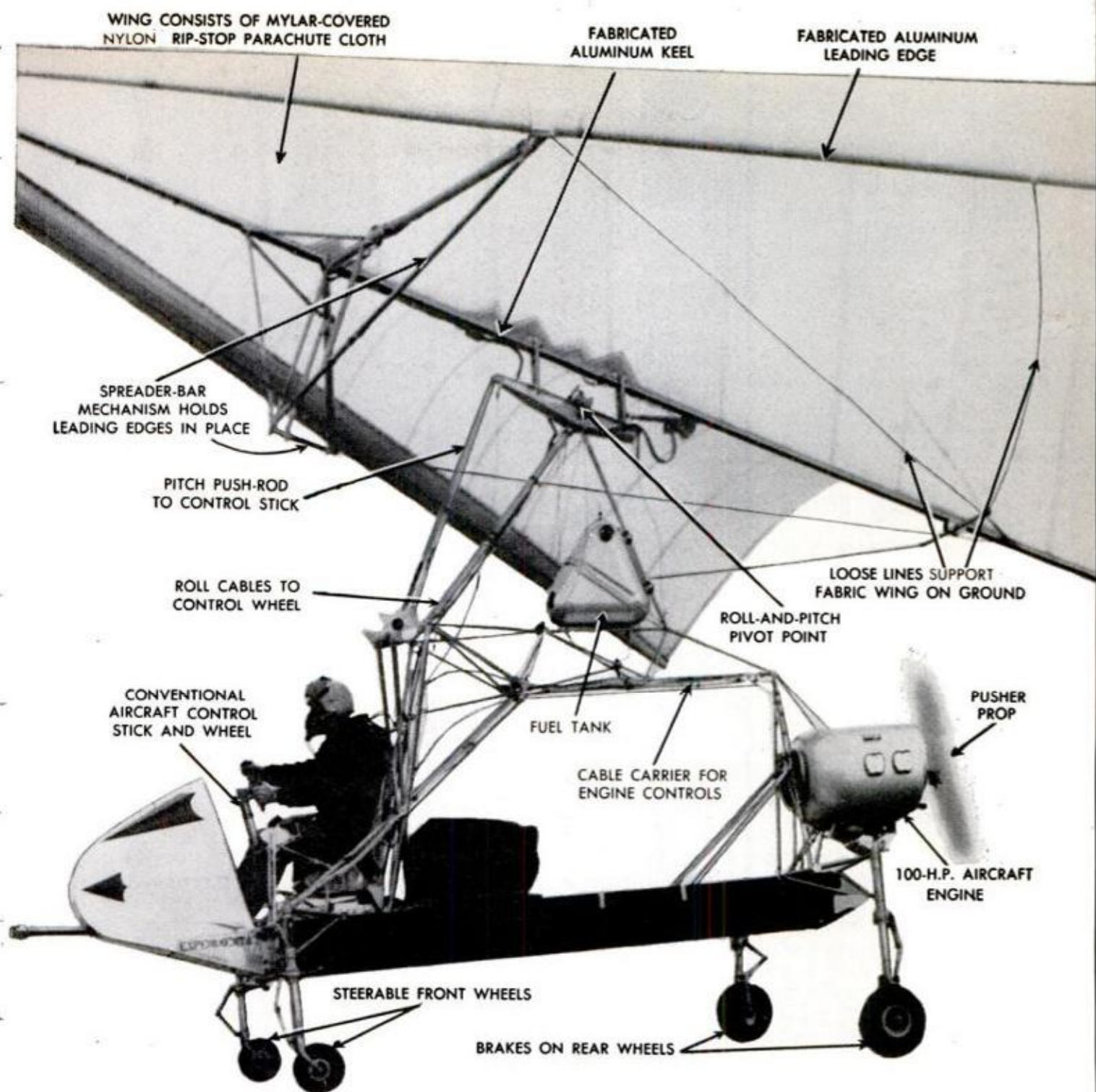

desire for a cheap and roadable personal aircraft. It could be the solution to the Army's need for an airplane that requires no more training than learning to drive a truck. It might be used for towing cargo behind a helicopter, increasing the helicopter's pay load up to sixfold.

As a temporary auxiliary lifting device, it could help get heavy transports up out of short fields. Used literally as an airbrake, the lifting surface could reduce the landing speed of a Mach 3 transport from 220 knots to no more than 69 knots.

As a small paraglider it could allow a paratrooper to spot-land just where he wished. Collapsed to minimum space on the jump plane, it would automatically spread its leading edges when released. The para-

trooper could steer in any direction and control his rate of descent to land where he wanted.

Larger paragliders steered by radio are being considered for lowering heavy rocket boosters and space craft back through the atmosphere. In fact the first dramatic use of the Flex Wing may be for returning a Mercury astronaut's capsule to a slow landing at an airport, avoiding the hazards of an ocean recovery.

Our test bed at Ryan is not a prototype for a production airplane. It is for research alone, hence all its cables and linkages are exposed. We can make adjustments without opening a lot of panels.

Supported above the fuselage at a single pivot point is a V-shaped frame that con-

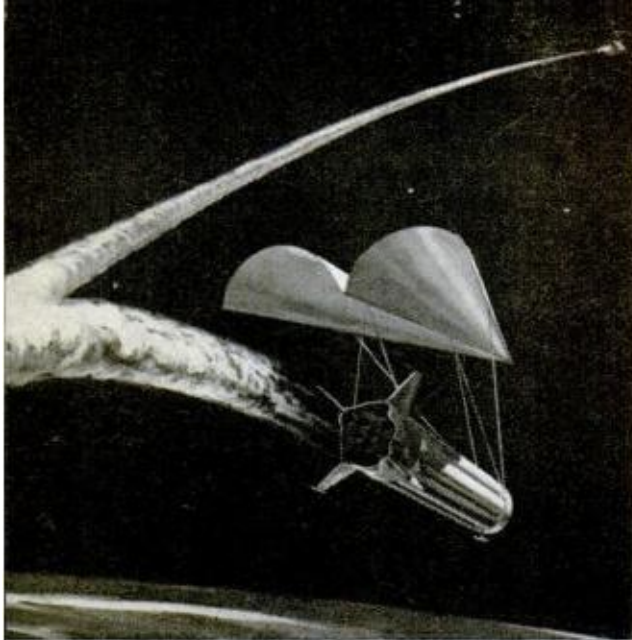

Wing will return rocket boosters, carry TV, tote cargo . . .

FLEX WING PARAGLIDER could bring burned-out Saturn booster back to earth

RADIO-CONTROLLED DRONE could be used for observation duties, relaying television pictures back to its launching site

sists of a central fore-and-aft aluminum tube called the keel and two side members or leading edges that sweep back from the nose of the keel to form an angle of 50 degrees. Spreader bars hold the two 28-foot side members in place.

Attached to this frame is the "rag" wing, 555 square feet of nonporous fabric. The original wing consisted of nylon sealed with Mylar but this has been replaced with Dacron cloth sealed with a resin as the Dacron is more durable in sunlight. The wing is simple, lightweight and inexpensive.

Control is by "C.G. shift" — that is, by shifting the plane's center of gravity in relation to the wing's center of pressure. The fuselage is literally hinged to the wing, so when the pilot pulls his control column back he actually moves the fuselage aft a

slight distance in relation to the wing itself. With the center of gravity moved aft, the wing automatically tilts to a climb attitude.

To descend, the pilot pushes the control column forward, moving the C.G. forward and causing the wing to reduce its angle of attack. To make a turn the pilot applies left or right wheel, shifting the C.G. so that the wing rolls in the desired direction.

A rudder was recently added to provide better control when taking off or landing in a side wind. The original engine has been replaced by a larger 185-horsepower engine to provide better climb characteristics. In a production aircraft a power-control system probably would be used, since it takes a heavy hand to maneuver the present machine. A simple power-control system can be designed. It would eliminate the rocking-chair effect created by air gusts.



DRONE for the Marines will resemble this prototype. It will be radio-controlled and can be used for such tasks as TV reconnaissance of the enemy

MOTIONLESS, the wing of the craft lies limp. The wing is composed of 555 square feet of Dacron cloth sealed with resin. It's a lightweight and relatively inexpensive wing

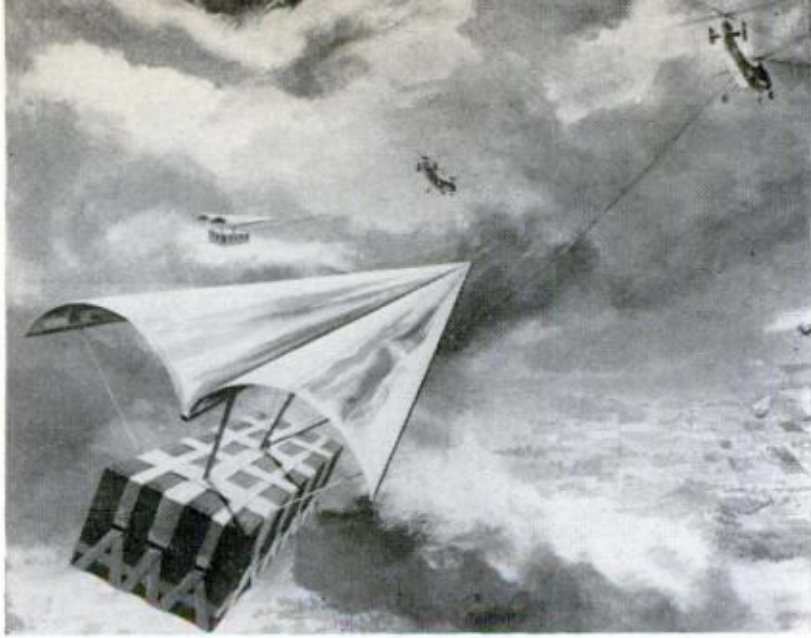

... and gently land paraglider troops

HELICOPTER may be able to increase payload as much as 400 percent by use of flexible-wing cargo carrier

Ryan has no plans at present for building a production Flex-Wing aircraft. The wing is not a high performance airfoil, though it is an efficient weight carrier. It could make a good slow-speed utility vehicle.

Cecil Craigo, program manager, suggests that a Flex Wing would make a very good flying pickup truck for, say, a rancher. It could be about the same size as the present test bed, trimmer in appearance with the control system enclosed in fairing. The present low platform would be retained for easy cargo handling and the landing wheels would be left exposed. Their drag is unimportant at low speeds.

With the pilot and enough fuel on board for an hour and a half of cruising, the craft would weigh 1000 pounds and could carry 1000 pounds of cargo. It would take off in

(Continued to page 260)

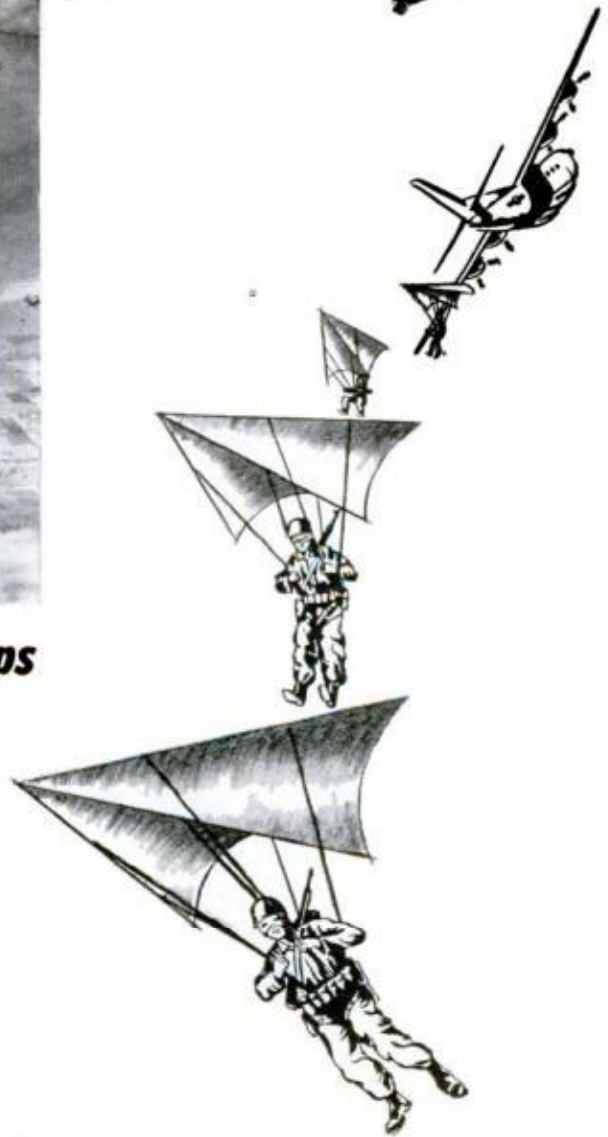

TROOPS could come down swiftly, yet land gently. Maneuverability of wing would let them pick dispersed landing spots

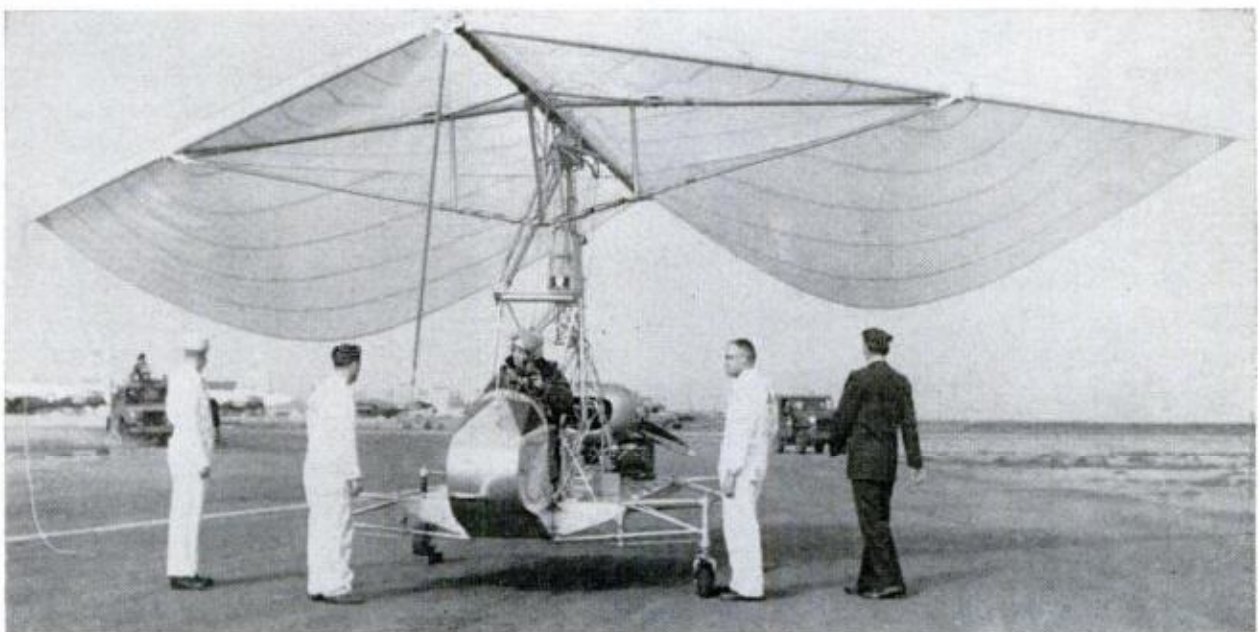

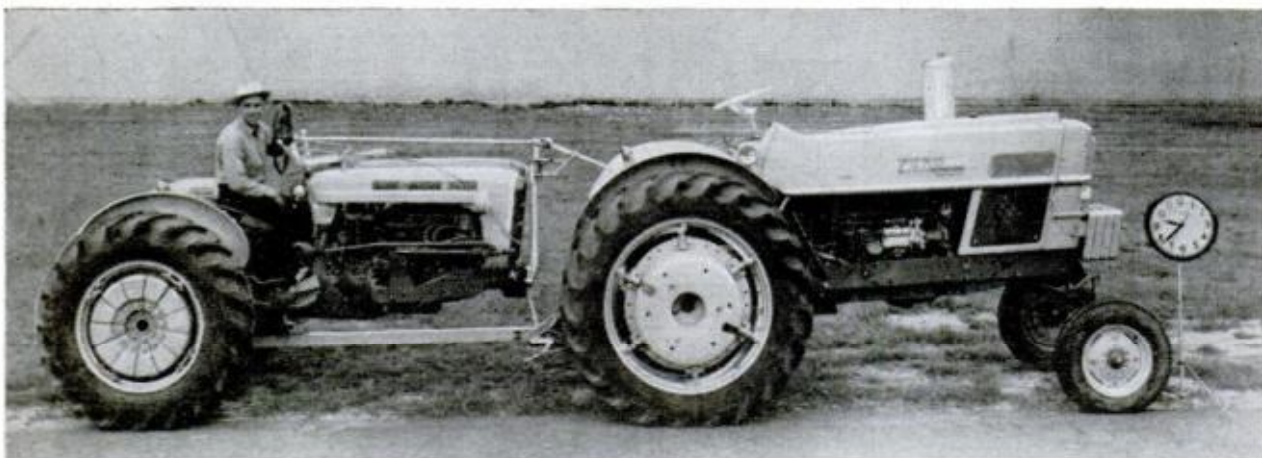
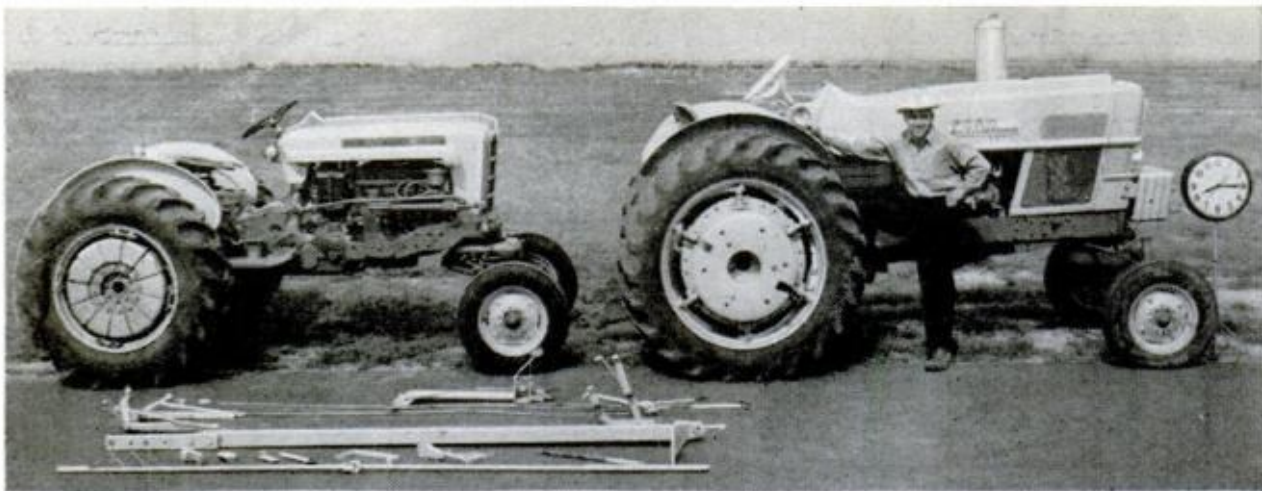

Tractors Can Pair Up in a Tandem Team

One man can team up two tractors, one behind the other, to get a four-wheel-drive tandem tractor producing over 100 horsepower and capable of pulling seven and eight-bottom plows.

Developed by Ford Motor Co., the coupling of a general-purpose tractor and a Ford 6000 tractor (which has power-shift transmission that can be remotely controlled) takes about an hour and a half.



Mini-Bike From a Kit

Do-it-yourself construction kits have appeared in the mini-bike field.

A St. Louis, Mo., firm has brought out three kits. One includes only castings and blueprints and sells for \$39.50; a second kit comes without engine, clutch, or gas tank and sells for \$119.50; the third, a \$149.50 kit, contains the complete works.

The last kit, with engine and all parts needed for a scooter, will make a buzz bike weighing 65 pounds. The two-cycle engine develops 2.5 horsepower.

Kits are available from O.K. Engineering Co., Box 2073, Benton Park Station, St. Louis 18.

So accurate is the bat's sonar equipment that it can dodge wires only slightly thicker than a human hair. The flying mammal can hear an echo from a target as tiny as a mosquito, compute its speed and direction, and swoop to attack in less than a second.

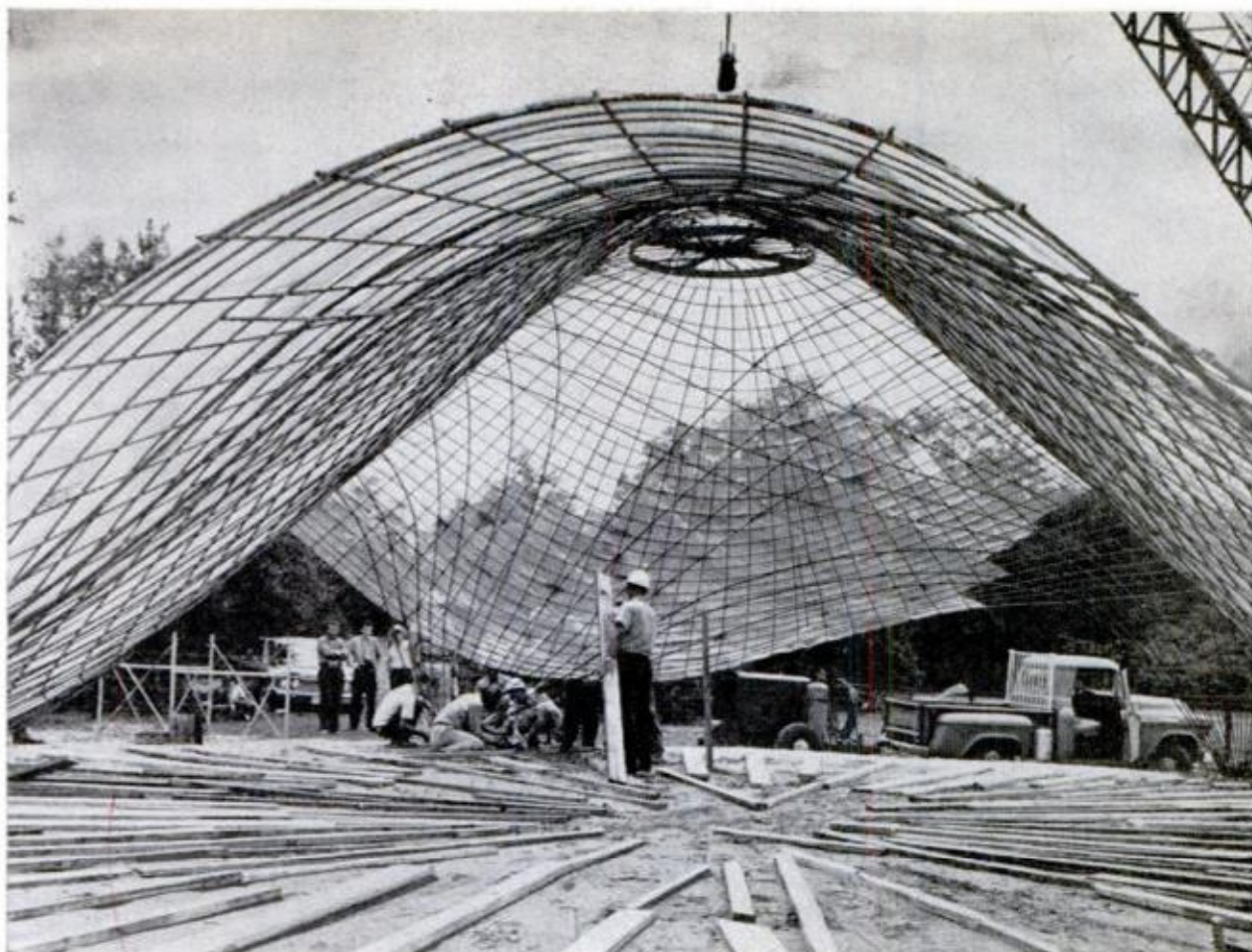

They're Raising the Roof—and Walls, Too

Builders are springing a new building into shape in College Station, Tex.

Metal lath and reinforcing rods are joined on the ground to form a flat shape. Then cranes lift the shape, and the legs of the

shell are drawn in, springing the building to proper form.

Concrete is sprayed on for body and structural support. The building was designed by Prof. James H. Marsh III.

Toothbrush Is Fountain

When the handle of a new toothbrush is placed against a faucet, the handle becomes a drinking fountain. It's always available to provide a rinsing swish after a person brushes his teeth.

The shape of the intake portion of the handle is such that it will fit all sizes and shapes of faucets says designer Harold Perry of Alexandria, Va. The stream of water may be directed to the distance most convenient for drinking purposes.

Children are encouraged to rinse bacteria from their mouth after brushing because they find the handle-fountain fun, says Perry. He designed the multipurpose brush to do away with the bathroom drinking glass, and as an aid for traveling men and service men.







THIS WAY, PLEASE!

By Richard Dunlop

EVERY YEAR Andy Frain's ushers show 30 million people to their seats. They shepherd crowds safely and comfortably not only into ball games, hockey matches, prize fights and national political conventions but to funerals, society weddings and store openings. All of this moved Chicago sports writer, John P. Carmichael to dub Andy "Head of the House of Usher."

"We handle 75 to 80 events a day," Andy calmly says, his blue eyes twinkling behind horn-rimmed glasses. "Given 48 hours notice, we can muster 20,000 ushers."

On a single night Frain, the world's foremost crowd engineer, will often have 7000 men on duty in 22 cities from coast to coast. They will take tickets, fend off gate-crashers and break up crowd bottlenecks. If need be, they will call a doctor, stop a riot or put out a fire. At Chicago's Marshall Field and Company Andy Frain ushers every day warn customers to watch their step on the escalators. They also handle the crowds at the Kentucky Derby. At a wedding they may park the cars, and at funerals they are often retained as professional mourners and pall bearers.

Months before a big public event a phone call comes into one of Andy Frain's regional offices or into his Chicago headquarters in a shabby building across West Madison Street from the Chicago Stadium. Andy likes to take these calls himself. As he listens, he doodles with a red pencil on a sheet of paper. He jots down the essentials.

"Thursday, 29, September, the President," he writes.

"Are you going to have seats in the foyer or the grand ballroom?" he demands. "What about the Secret Service? You'll have a lot of crashers—a lot of people who just want to see the President. First thing we'll have to do is to go down to the hotel and look it over."

Although Andy knows from experience every important public gathering place in



ANDY FRAIN, above with son Mike in uniform, eases a record crowd into Chicago's McCormick Place. Below, ushers march opening day crowd into Navy Pier

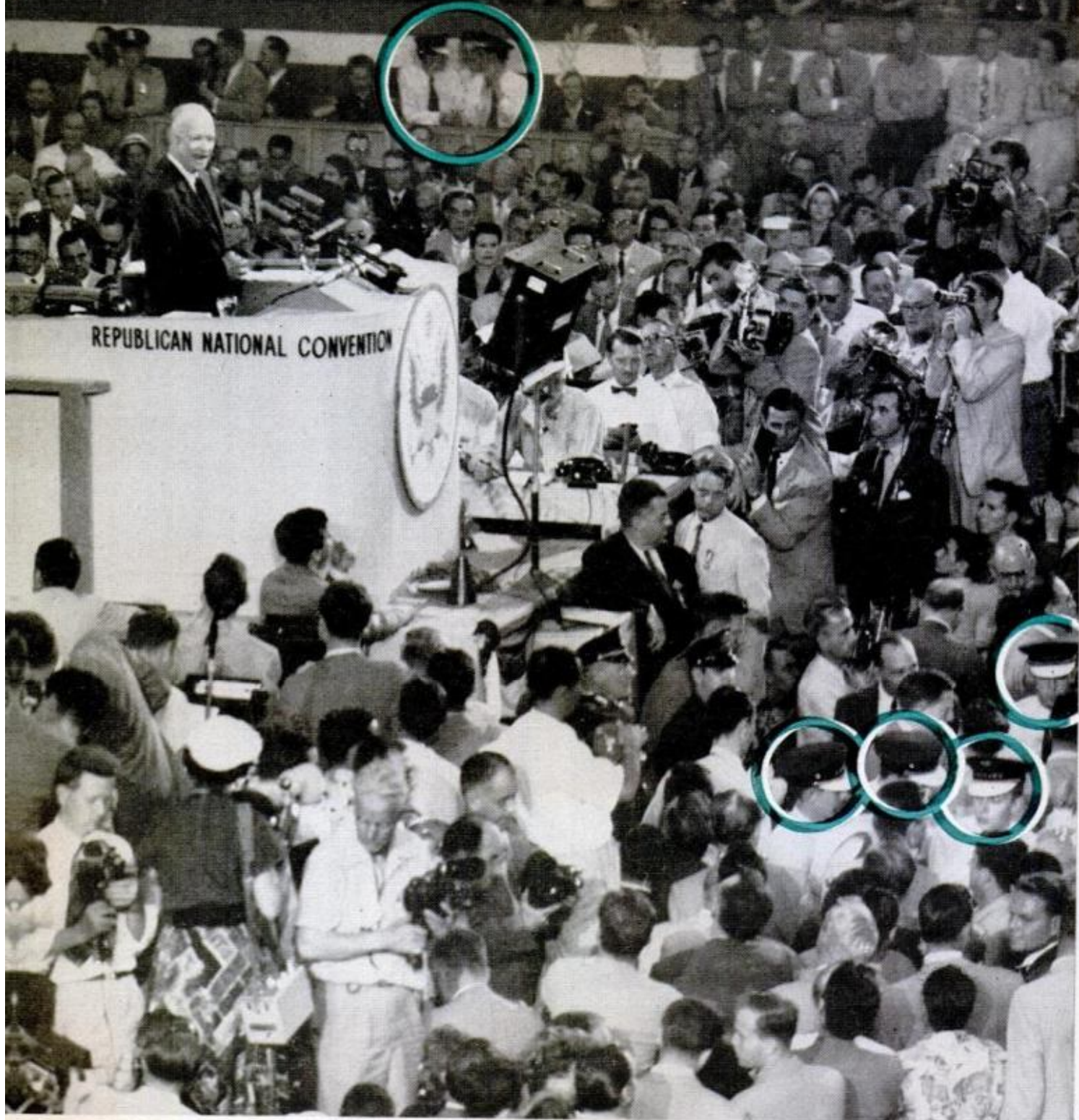

ONE PRESIDENT, seven Frainmen and a small section of a national political convention crowd—one of the toughest to handle. Big crowds, mob demonstrations and hundreds of gate crashers give the ushers a real workout

PLANNING convention strategy and tactics, Frain and usher supervisor use map of Chicago's International Amphitheatre to plan crowd flow, station ushers, and to anticipate traffic jams and potential trouble spots



TOTING giant balloons in a Christmas parade is all in a day's work—this group may be pallbearers tomorrow

the United States right down to such intimate details as the location of the wash rooms and the air-conditioning ducts, he always tries to start a new job with a visit to the premises. There he studies entrances, exits, seat locations and the degree of ramp rise. He locates aisles, gates and parking lots so that he will know where to post his ushers, doorkeepers, and ticket takers and where to base his trouble shooters. He plots crowd movements, overflows and bottlenecks with the skill of a materials handling expert laying out a modern factory. Rest rooms and refreshment stands are noted on the maps as he works up his grand strategy.

In one respect he is a stickler. He has a fireman's hatred for locked doors and absolutely refuses to take a job unless every exit door in the place will open easily. In the days before Frain the sergeants-at-arms at national political conventions kept all the building doors locked to keep out intruders. Andy would not agree. He finally compromised by sealing the unlocked doors with easily torn strips of red paper. To be sure that the doors would not be opened except in emergencies, he started a rumor that the sealing had been done by the U.S. Secret Service.

As Andy wanders about the cavernous

emptiness of the Miami Beach auditorium or huge new McCormick Place in Chicago he makes careful estimates of the number of people who can pass a given spot in a minute or in an hour. He compares crowd movements which his men, counters in hand, have tabulated in other places. For example, if he is called upon to take children through the toy department of a Denver department store to meet Santa Claus, he can study the figures he has compiled over the years conducting youngsters to Saint Nick's lap at Marshall Field's. He knows that he was able to move 257,456 visitors through the corridors of Chicago's Merchandise Mart to see the Brussels Fair exhibits on display there and that at nearby Medinah Temple for 29 days the crowd moved at the rate of 9195 people a day or 1150 per hour. Using these figures, he can estimate accurately crowd flows in similar circumstances elsewhere. His estimates are rarely off more than 50 individuals an hour.

"Crowd flow is one thing," admits Andy with a shake of his head, "but crowd behavior is another."

Andy knows, for example, that an afternoon crowd of ball fans is easy-going and sunny. They rarely drink more than a little beer and cause little trouble. The only rancor they feel is directed towards the umpire. Evening crowds are more difficult, tending to reflect the day's frustrations and fatigue. Football fans drink more than baseball fans and are quarrelsome, but the real troublemakers are fight fans.

"About the third or fourth round of a tough match, everybody's blood pressure is way up," explains Andy. "When the usher tells you not to smoke, you just punch him."



TOURING an empty auditorium before the crowd arrives, Frain and a chief make last-minute arrangements

Crowds differ around the country too. As might be expected, a Miami crowd takes an hour to enter a stadium while New Yorkers, keyed up to what Andy calls a "grab-a-sandwich-and-rush mentality," would take only half that time. Detroit and Chicago crowds hustle too, but folks in St. Louis, Louisville, Nashville and Knoxville or any

RESOURCEFUL FRAINMEN remove a hysterical Elvis Presley fan the hard way—over the heads of the crowd





BRITAIN'S QUEEN ELIZABETH visits Chicago, and Frain (right center) and his men worked with police for two wild days to control crowds of millions of curious, enthusiastic greeters who followed her everywhere

place in Texas are slow. Just to show that it is not entirely a matter of climate, Andy points out that Minneapolis crowds take their time too.

"You can seat more Southerners in a given amount of space than Northerners," observes Andy. "They are not only friendlier, but they don't wear the bulky overcoats that take up room in the North."

Stormy Tempers

Andy studies weather reports for the day of a big event. He has learned that if the weather is cool, a crowd will arrive briskly just before game time setting up a traffic of up to 2500 persons an hour through each turnstile in a big-league ball park. If the weather is warm, the crowd arrives early at a rate of about 1000 persons an hour through a turnstile. Rainy weather brings late crowds to an indoor event. Bright, clear weather often means there will be vacant seats. When the weather forecaster predicts thunderstorms, the people are in as threatening a mood as the weather, and he braces his men for the outburst of temperament that he knows will break with the arrival of the crowd.

Long before a major event the tickets are printed. Andy prefers to be in on the ticket planning. He then can see to it that the ducats are big, easy to read and imprinted

on a special cardboard which is difficult to counterfeit. Through an ingenious system of ticket colors and numbers he directs people to their proper gate. Ordinarily, the colors indicate the area, and the numbers the gate. If Andy's on-the-spot studies show that Gate One will take 3000 people an hour, Gate Two 2500 and Gate Three, 3500, he has the printer run off the right number of tickets to give each gate an efficient rate of flow.

Once Andy has determined his master strategy, he sets up his vaunted triple-defense system, which he first introduced to the 1932 Republican Convention in Chicago.

"The system we put in at that convention is still the one we use today," he says. "There was a front line of ticket checkers at the outer doors. They saw that the people had tickets. Then there was an inner line of ticket takers at the turnstiles. Backing them up at every gate was a roving trouble shooter."

At the World Series Frain ushers shout directions through megaphones directing knots of bewildered ticket holders to the right turnstiles. At most events ticket checkers are located at least six feet before the turnstiles to keep the crowd from mushrooming before the ticket takers. "A mush-

(Continued to page 248)



SCIENCE OVERSEAS

By William Kreh

The secret of a good golf swing? Six English scientists have begun a three-year project to try to find it.

"At present," says Sir Anynsley Bridgland, president of the Golf Society of Great Britain, "the ingredients that constitute the perfect stroke are not known. Many famous golfers have tried to explain the secrets of their performance, but when observed in action do not practice what they preach."

The researchers will examine the muscle action of a perfect golf swing, set up a formula for it, and then try to mass-produce the swing.

A super-bathyscaph has been launched by France for exploration of the greatest ocean depths. Named *Archimede*, this 61-ton underwater explorer will go into operation early next year with one of its first missions reported to be probing of the 34,000-foot-deep Kuriles Pit of northeast Japan.

The *Archimede* will be able to bore holes and take geological samples, and collect specimens of marine life. It will have a two-man crew.

When Israel shot off its first rocket recently, it was called Shavit II. Naturally, people wondered what had happened to Shavit I. The explanation: There wasn't one.

Calling the rocket Shavit I would have required using the Hebrew letter Aleph. This is the symbol of the political party Mapai, and possibly would have been regarded as electioneering for the campaign that was going on at the time of rocket's launch.

Women, have been fixing their faces for at least 1900 years. Archeologists excavating a 1900-year-old Roman cemetery in the Syrian city of Homs found one tomb containing a woman's skeleton which also held ivory boxes of white face powder, eye-shade sticks, tubes of perfume and ivory hairpins.

Russian "super race" experiments were revealed recently by Dr. R. A. McConnell of the University of Pittsburgh. According to Dr. McConnell, the Russian biological experiments indicate that scientists could "speed up the evolutionary process so that

perhaps 50,000 years of development will take place in the span of a lifetime." The purpose would be to quickly develop a race with high creative and intellectual ability.

Hawaiian Institute of Geophysics scientists are going to attach tide gauges to an abandoned communications cable running between Hawaii and the U.S. mainland. The pressure gauges will warn the islands when a tsunami wave is heading their way.

The 400-mile-long cable will be hoisted to the surface, pressure gauges added, then lowered in several hundred feet of water.

The gauges will measure the height of the wave by deep-sea changes in pressure. This information then will be sent back to the islands over the cable.

Rising at Parkes, Australia, is a radio telescope that will be able to track satellites better than any Russian or American equipment.

It will be 210 feet across, cover an area as big as a football field, and cost \$1,800,000. Scientists say it will be the most refined in the world and second in size only to the 250-foot dish at Jodrell Bank in England.

A team of Swedish doctors, in Uppsala, say they've found a new method to tell pregnancy within 90 minutes. The method, based on an analysis of the presence or absence of hormones in a test tube, is cheaper and more accurate than other biological tests, which may take weeks. Co-discoverers Prof. Carl Bemzell and Dr. Leif Wide have made more than 1200 tests, all of which provided accurate results.

Future ships may no longer knife through the waters with sharp-edged prows. Experiments by Prof. Takao Inui of Japan have shown that a bulbous bow can result in a large reduction of power requirements from a ship's engines.

The *Kurenai Maru*, a 3000-ton passenger vessel, was equipped with a whale-shaped bulbous bow, following recommendations of Professor Inui. Tests with the ship verified his findings with models that ships equipped with bow and stern bulbous fittings—rather than those that are knife-edged—need from 20 to 25 percent less power. ★ ★ ★



DESIGNED BY GHIA and built by Karmann, this sports coupe fits on 94.5-inch-wheelbase VW 1500 chassis

New VW 1500 Sports Specials

AFTER THE announcement of the new VW 1500 passenger sedan and station wagon by Volkswagen (PM, July 1961, p. 81) it was only a matter of time before the luxury versions of the new car would appear. There are three new models, all built by Karmann of Osnabruck, West Germany on stock VW 1500 chassis. First, there's a convertible with 4-5 passenger capacity which utilizes many of the VW 1500 sedan's body parts, much as the present

Volkswagen convertible utilizes such parts.

Next are the companion two-passenger models designed by Ghia of Italy and built entirely by Karmann on the VW 1500's platform chassis. There is a hardtop coupé and a convertible. All three new 1500s are powered by the new 53 horsepower air-cooled four-cylinder engine. The new Karmann VW 1500s are not expected to reach salesrooms before spring of 1962. Prices as yet are unannounced.

USING AS MUCH as possible of VW 1500 body sheet metal this convertible has two trunks, and seats four





PM EDITORS Dick Kirkpatrick (left) and Don Dinwiddie and research chemist Dr. Caroline Miller (center), study dissected baseballs and results of chemical analyses of their component materials as reported in October PM

FOR THE HOT-STOVE LEAGUE: More on Those Baseball Changes

AS THESE WORDS are being set in type, crews of researchers are still working on the tests we began in last month's issue. At Armour Research Foundation, a chemical analysis team is completing their qualitative and quantitative comparisons of the materials built into major league baseballs from several periods. Down the hall, a mechanical test crew is assembling a machine that may be the world's most complicated fungo bat. It will swat dozens of sample balls with an actual bat to measure their "liveliness." And down the street, on the campus of neighboring Illinois Institute of Technology, a wind tunnel expert is studying the aerodynamics of a batted base-

ball. As these crews add findings to a growing stack of reports and opinions, evidence is beginning to mount up. The 1961 big league baseball is not an exact duplicate of the ball that Babe Ruth put out of parks 60 times in 1927.

Chemical tests have shown that materials change from year to year. Rubber-and-cork core composition has definitely changed. The rubber layers around the cork core show some variations but a spectrographic examination of the rubber itself, shows that it has remained pretty much the same.

Thickness and weight of wool and cotton yarns used in the windings have varied. And because any changes in yarns may

require—or cause—changes in winding tension, and since winding tension affects the liveliness of the finished ball, we should get some interesting performance figures in that area.

Some Wind Tunnel Findings

The wind tunnel tests showed that several 1961 baseballs had higher, wider seams than a 1927, a 1929 and a 1931 ball tested. These create a rougher surface and a boundary layer of greater turbulence near the surface of the new balls, which helps insulate them from drag effect. As a result, the drag coefficient of the new balls tested was 10 to 20 percent lower than that of the old balls. This means it should be easier for the new balls to travel farther. Actual impact tests will help determine whether this could make the difference between a long fly ball and a home run.

In the meantime, if you have an old Major League ball handy and care to check it against "specs" of what it should have in it, here they are:

The modern cushion cork centered ball, being used from 1926 to the present, begins with a $\frac{1}{16}$ -inch ball of cork composition with a small percentage of rubber added. Twin black rubber shells $\frac{5}{32}$ -inch thick are fitted over the cork with a thin red rubber "washer" between the edges. Over the black rubber goes a red rubber shell $\frac{3}{32}$ -inch thick; the resultant rubber core is a ball $4\frac{1}{8}$ inches in circumference. The twin-shell technique ended an old problem; molding a single rubber layer around a cork core often squeezed the cork out of round.

Over the rubber core goes a winding of 121 yards of coarse four-ply Australian blue-grey wool yarn to make a $7\frac{3}{4}$ -inch ball, then 45 yards of three-ply white wool yarn to bring it to $8\frac{7}{16}$ inches in circumference. An outer layer of 53 yards of three-ply blue-grey wool yarn brings the size up to $8\frac{3}{4}$ inches. The final winding is 150 yards of fine cotton, which is coated with rubber cement to prevent unraveling. The cotton winding brings the size to $8\frac{7}{8}$ inches.

The cover is made of two identical "figure eights" of carefully-selected horsehide leather from .050 to .055 inches thick. Each is punched with 108 stitch holes around the outer edge. The cover halves are wet, then hand stitched into place with about 88 inches of five-strand thread, waxed to resist the tanning agents used on the horsehide.

Those are the basic specifications on the baseballs we are testing. And as soon as all of our returns are in, we'll give you what should be a conclusive report on whether a "rabbit ball" does or does not exist.

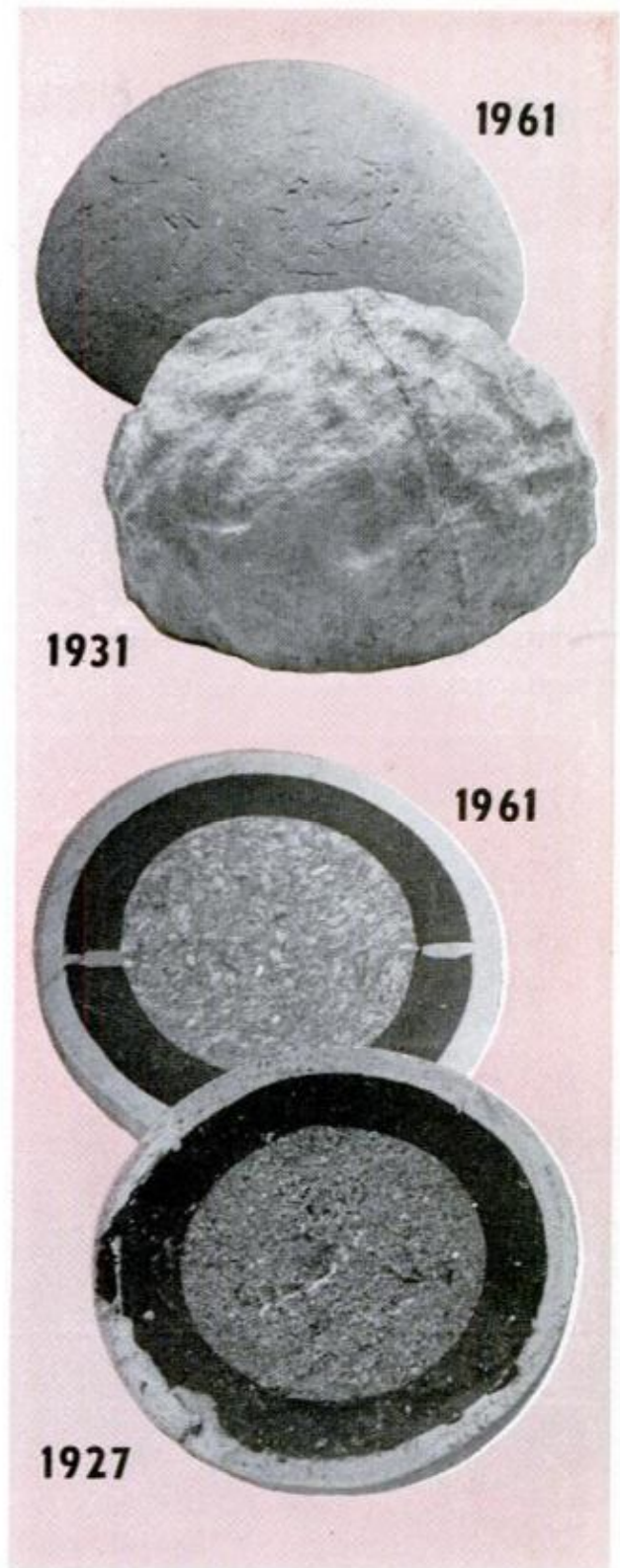

THE CORE of the problem? Outer rubber center of '31 ball, top, shows marks from yarn windings not evident on '61 counterpart. Softer rubber or tighter windings? Core cross section of '27 ball, bottom, shows almost same basic structure as '61 core, but seems to have been made by a different method, and composition cork is denser and almost 40 percent heavier. A heavier core requires less yarn to bring the ball up to weight. Do loose windings make a softer ball?

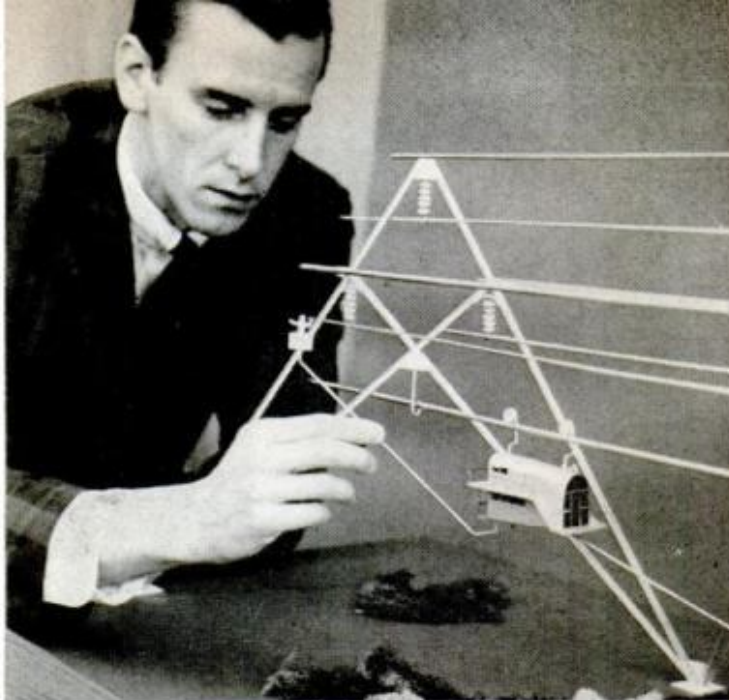

MULTI-SYSTEM'S monorail car can repair the utility structure

PORTA-DESK, less than twice as thick as portable typewriter case, holds typewriter, paper, folds to desk

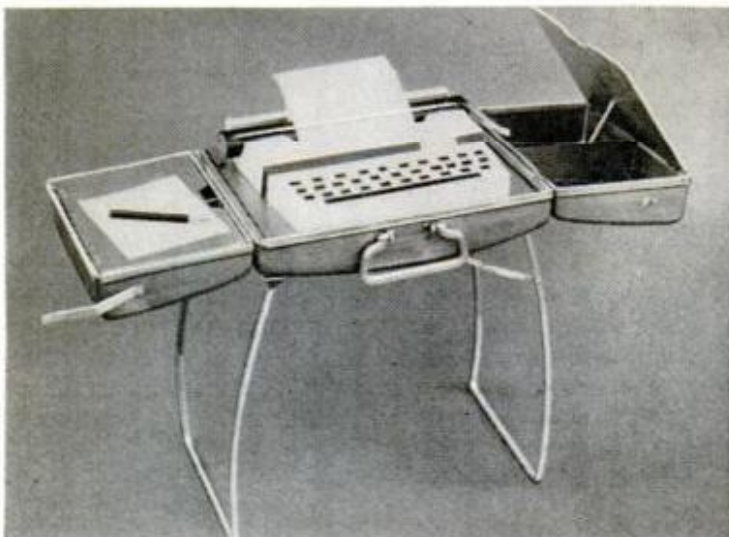

Ideas in Aluminum

Students in design schools, tackling an aluminum-design project, dreamed the metal into some exciting shapes.

They include an overhead system that supports electric transmission lines as well as a monorail transportation system. The Multi-System structure is braced by pipelines that carry oil and gas.

Another student designed an electric-powered runabout to retail under \$1000. Top speed is 30 miles per hour. It weighs 1000 pounds and ranges 60 miles on charge of six batteries.

These were among the projects shown by students in the 1961 Alcoa Student Design Merit Awards competition.

Restarts Hearts

Moving a rubber block up and down to compress and release a patient's chest once per second, a machine called the external artificial circulator mechanizes a new closed-chest heart resuscitation technique.

It consists mainly of an electric motor and gear box on a table that can be positioned above a supine patient. A plunger with a fist-sized rubber block is attached to the gear box through a hole.

Developed by two Oregon doctors, the machine was recently reported in "Medical News."





SKI TOTE weighs 10 ounces and holds skis and poles with pairs of pivoting clamps

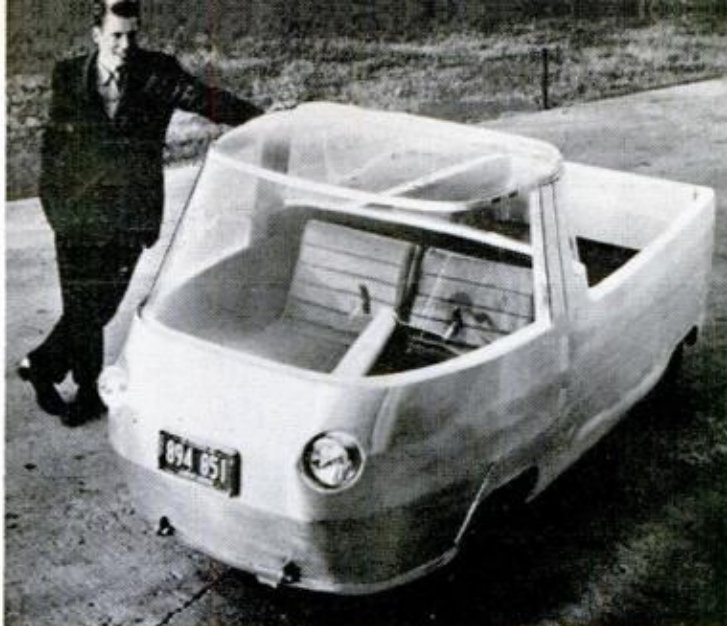

ELECTRIC CAR is 54 inches wide, 117 inches long, has tilt cab. Tuberosity chair supports all sizes with three rubber cups

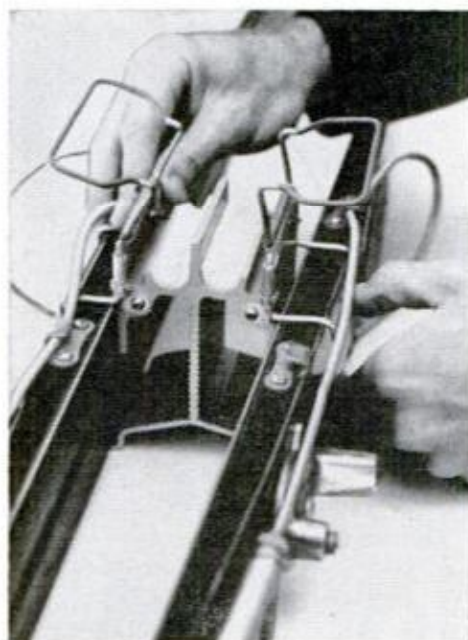

Sonar for Divers

Where are the fish? How deep is the lake? Is the car sunk over by the snag?

These questions are answered for divers by a handheld sonar system that operates at depths to 200 feet. It shows distance to large objects over 100 feet away by a light that flashes on a dial.

The unit is seven inches in diameter, eight inches long, weighs 11 pounds in air and is slightly buoyant in water. A battery powers it for 40 hours. Available at \$195 from Raymond Development Co., Watertown, Mass.



Performance Report on the New Ford Fairlane

By Jim Whipple



SOFTLY SPRUNG Fairlane sedan will lean a good deal in cornering but handles well, goes where you aim it

ALTHOUGH IT IS in fact a totally new car, Ford's 115.5-inch-wheelbase Fairlane represents the return engagement of an old favorite—the traditional “family sedan.”

And it might be added that Fairlane's appearance on the automotive scene is supposedly a result of “popular demand” for the size car represented by Fords, Chevies and Plymouths of 1949 through 1956. If you recall, those were the days before the “low-priced three” became (including Dodge and its protégé Lancer) “the widely-priced ten.”

A comparison of the Fairlane's basic specifications with an average of the corre-

sponding specifications of Ford, Chevy and Plymouth V8s of 1955 will prove how closely its dimensions mirror those of the popular-priced 1955 V8 four-door sedan:

	'55 Low-Priced Average	'62 Fairlane
Wheelbase	115.1	115.5
Length	199.3	197
Width	74	71
Height	61.0	55.5
Weight	3192	2921
Horsepower	163	143

The greatest differences are in weight, height and horsepower. And these differences themselves reflect not so much a change in character or capacity as the ad-

SQUARE TRUNK has 29 cubic feet of useful, accessible space. Filler for 16-gallon tank is in the center



HOODED DIALS make up instrument cluster of speedometer, fuel and temperature gauges, warning lights



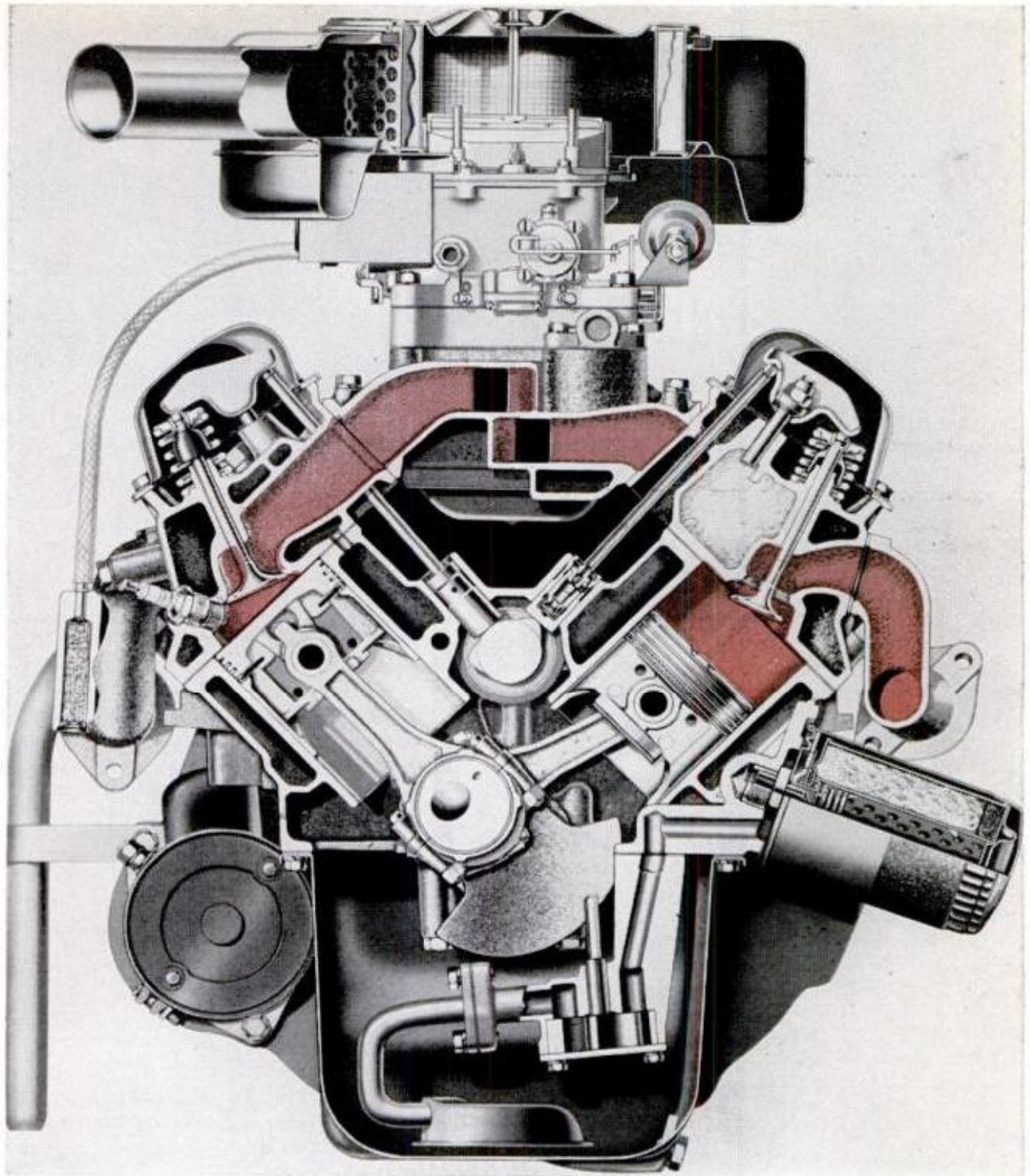

SHORT BLOCK, SHORT STROKE V8 is Fairlane's optional power plant. It develops 143 b.h.p. at 4500 r.p.m. Color shows path of fuel mixture from dual carburetor direct to intake valve, left. Short route for exhaust is shown at right. Note stud-mounted rocker arms of cast iron. They are lubed via hollow push rods

vances brought about by space and weight-saving unit construction that permits the same passenger and luggage space as in the heavier body and frame cars of the '50s.

What we have in Fairlane then, is not just another compact, but the logical development of the 1955 Ford, including all the advances in engineering, that might have taken place had Ford (along with its competition) not gone into making longer, lower, wider cars.

The '62 Fairlane offers just about the same array of power options as the typical

low-priced car of 1955. There's a choice of the new 221-cubic-inch V8 of 143 horsepower, or the 170-cubic-inch six-cylinder engine of 101 horsepower—the same one that's an option on Falcon and Comet.

With either engine you can get two-speed (plus torque converter) automatic transmission or three-speed manual synchromesh with column shift. As an economy plus for V8 buyers, overdrive is available with a gas-saving 3.50 axle ratio.

Other V8 axle ratios are 3.00 to 1 for automatic transmission and 3.25 to 1 when



SOLID, SENSIBLE and conventional lines with typical Thunderbird roof profile mark Fairlane 500 for as one of the Ford family. The wheels are 13-inches, tires 6.50, and brake drums are 10 inches in diameter

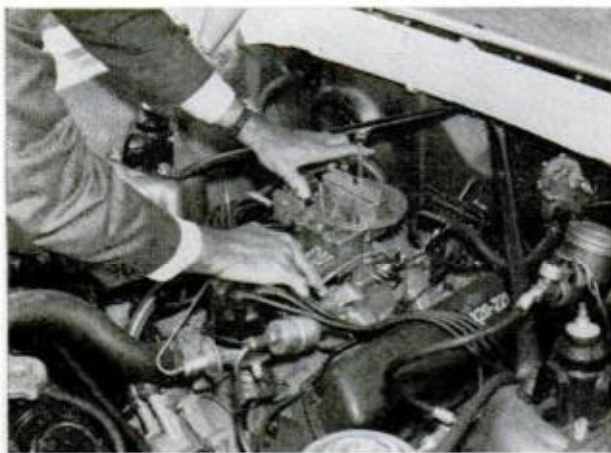

DISTRIBUTOR, CARBURETOR and other top-of-the-engine items are easily serviced. Plugs take reaching

car is equipped with manual transmission.

Sixes are equipped with 3.50 to 1 axles combined with manual transmissions and 3.20 to 1 when equipped with automatic. Power steering of the link-boost type is optional on all but manual-transmission sixes.

In performance the Fairlane V8 will equal or better the score of its 1955 Ford ancestor. PM was given an opportunity to test drive a Fairlane four-door sedan with V8 and automatic transmission for a day at Ford's mammoth Romeo, Mich. proving grounds. With two other men aboard we rolled up over 80 miles on winding black-top, gravel and on the five mile concrete oval and high-speed straightaway.

On the oval we hooked up PM's fuel meter and checked gasoline consumption at constant speeds.

FUEL CONSUMPTION—V8, Automatic Transmission
(Miles per gallon at constant speeds)

30 m.p.h.	26.5 miles per gallon
40 m.p.h.	23.7 miles per gallon
50 m.p.h.	20.8 miles per gallon
60 m.p.h.	19.7 miles per gallon
70 m.p.h.	16.5 miles per gallon

We found that the Fairlane compared favorably with other compact V8s in performance as well, using a stopwatch and corrected speedometer readings to check acceleration. The car's performance is a bit better than that of the similarly equipped 1955 Ford which was a larger and thirstier V8 of 272 cubic inches.

ACCELERATION PERFORMANCE—V8, Automatic Transmission

0 to 30 miles per hour	4.9 seconds
0 to 40 miles per hour	7.1 seconds
0 to 50 miles per hour	10.2 seconds
0 to 60 miles per hour	14.1 seconds
50 to 70 miles per hour	10.1 seconds
60 to 80 miles per hour	14.7 seconds

For those who are conscious of gallons per dollar as well as miles per gallon, Ford has kept the compression ratios of both Fairlane Six and V8 well within the limits of tolerance for regular grades of fuel; ratios are 8.7 to 1 for the Six, 8.5 to 1 for the V8.

Cast iron is used for both the block and cylinder head of the 211-cubic-inch V8 which weighs just 130 pounds more than the 170-cubic-inch Six. It is an over-square, short stroke design with a bore of 3.50 inches and stroke of 2.87 inches.

This engine is cast by new foundry techniques utilizing a combination of sand and plastic resin binder to form the cores around which the water jackets and cylinder bores are cast. These cores are packed under pressure permitting thinner engine walls of precise, uniform thickness resulting in greater strength and less weight.

A unique combination of exhaust crossover and an aluminum, water-heated "collar" between carburetor and manifold combine in helping keep fuel mixture at correct temperatures.

Fairlane's unit body, available only in two and four-door sedan models has bolt-on front fenders. ★ ★ ★



FACE OF A FORD on this Fairlane may be confused with other Ford products but few will tag it as a GM or Chrysler car. Note the solid, one-piece bumper that needs no guards, contains turn lamps

CLEAN-LINED rear end on Fairlane 500 has embryo fins, bulls-eye tail lamps, and etched trim panel like its big brother Ford Galaxie

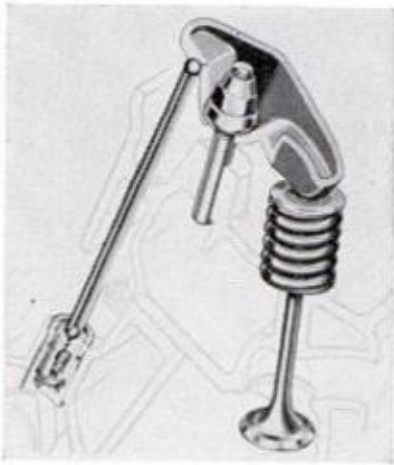

CAST IRON rocker arm of Fairlane valve gear pivots on a ball stud



UNIT BODY-FRAME has front and rear rails joined to sill side rails by "torque boxes" at cowl, kickup

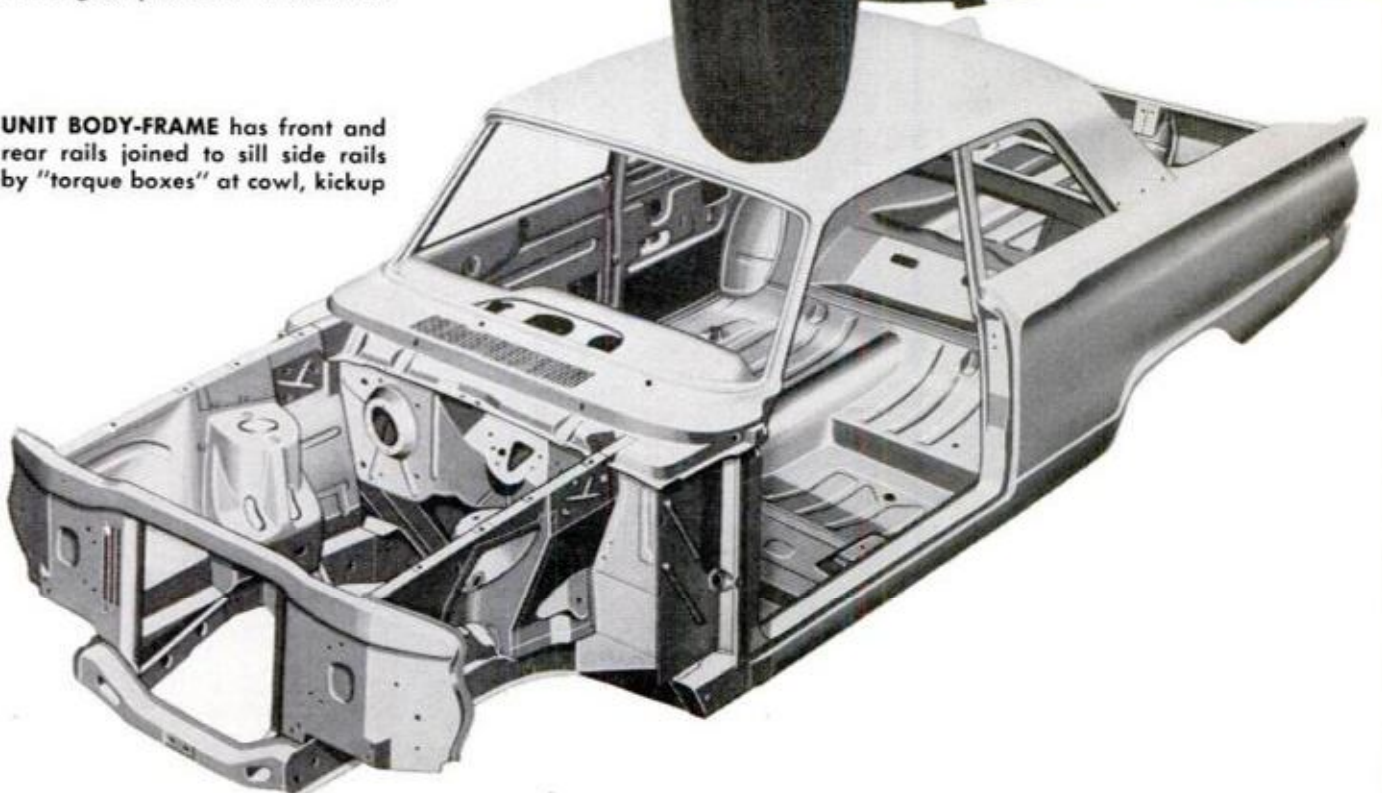

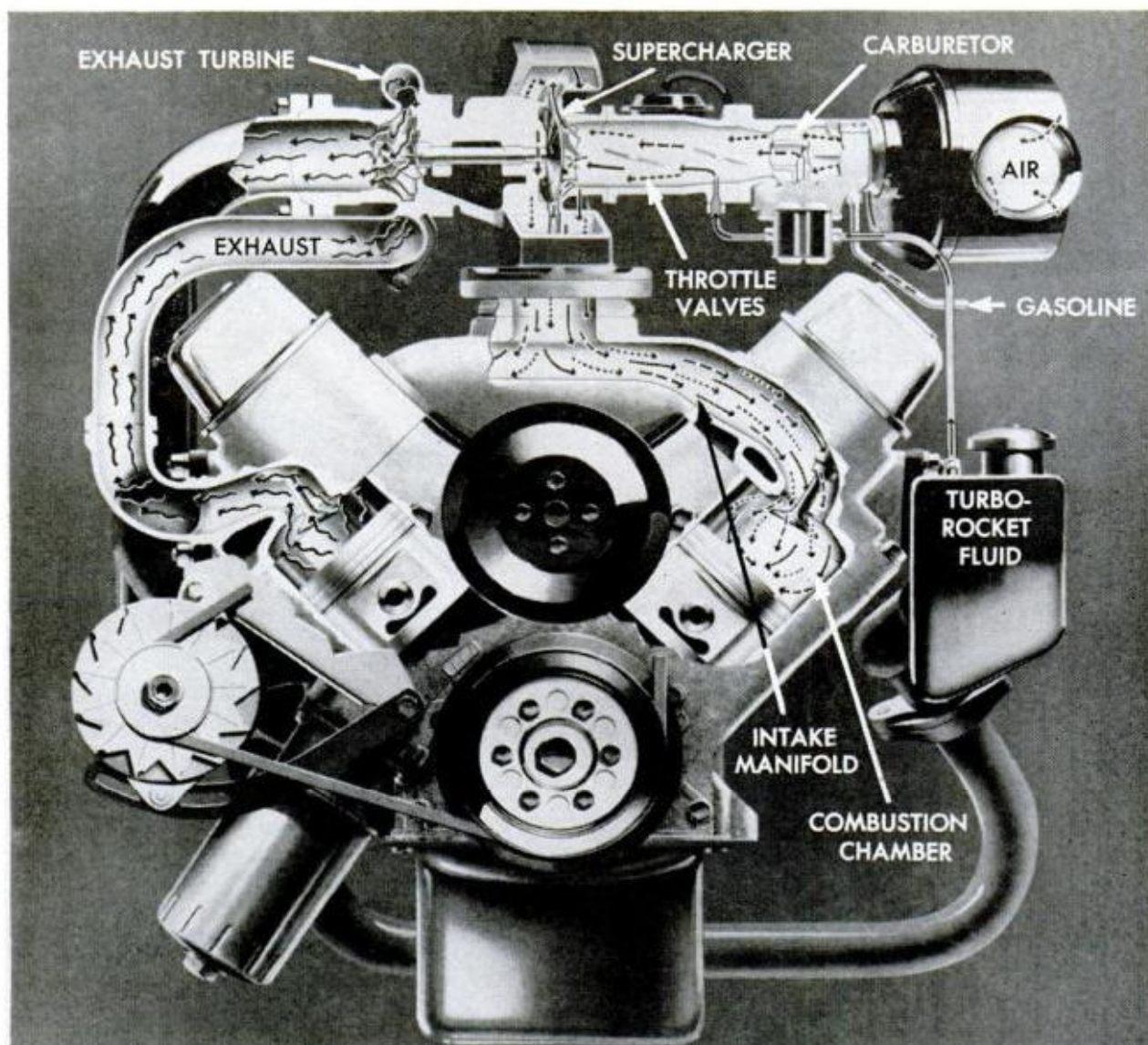

Aircraft-Type Supercharger for Sports Model F-85

A NEW, high-performance version of the 215-cubic-inch aluminum V8 engine will be introduced by Oldsmobile in a limited production sports-type model of the F-85 early this winter.

The "Turbo-Rocket" will feature the fuel induction technique of turbo-supercharging, pioneered by the aircraft industry on World War II fighter plane engines. It is the first application of a turbo-supercharger with fluid injection on a commercially produced automobile.

The turbo-supercharger increases power output by pumping more of the air-fuel mixture into the cylinders.

Through injection of a specially-formulated "Turbo-Rocket fluid," combustion is controlled by maintaining a more uniform burning rate during combustion to avoid detonation or "ping." Because of this, the turbo-charged engine operates at a highly efficient 10.25:1 compression ratio on readily available premium gasolines.

The turbo-charger system is driven by

the energy in the exhaust gas and not by gears, chains or belts like most superchargers which use direct engine power to run them even at speeds where supercharging is not required.

According to Oldsmobile, the Turbo-Rocket engine has the advantage of being able to deliver economy when it is wanted and also to supply plus performance when the driver demands it.

The Oldsmobile exclusive design incorporates in the Turbo-Rocket a turbo-charger manufactured by the Air Research Division of Garrett Corp., makers of turbo-chargers for the aircraft industry.

The Turbo-Rocket engine will put out approximately one horsepower for each of its 215 cubic inches and in so doing will approach a goal constantly sought by automotive engineers. The engine's power-to-weight ratio is extremely low at 1.88 lb. per horsepower. The lightness gained by the use of aluminum should reduce the operating costs of the car. ★ ★ ★

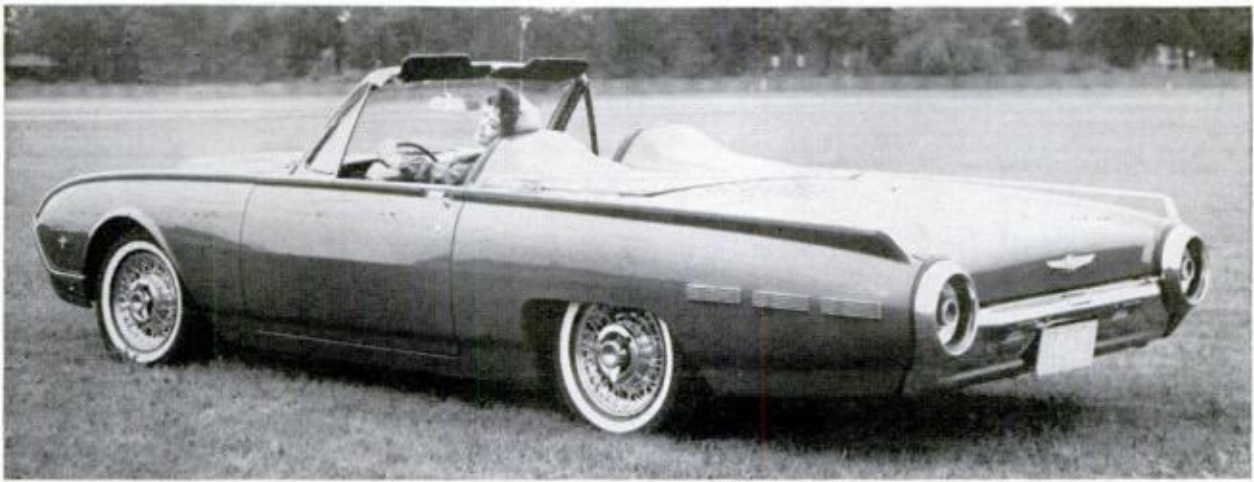

SPORTS ROADSTER with headrest tonneau cover and wire wheels



LANDAU COUPE' has upholstered vinyl top, chrome bars

T-Bird Sprouts More New Feathers

Two latecomers to the Thunderbird line for 1962 are the Sports Roadster and the Landau Coupe. These new models are in addition to the standard hardtop and convertible. The Sports Roadster is equipped with a racy package that includes real chrome wire wheels and a dashboard grab handle. It also features a fibreglas tonneau cover that seals off the rear seat compartment and incorporates two padded headrests for front seat passengers. This makes

the 'Bird temporarily a two-passenger car.

The tonneau cover matches the color of the car and the headrests are covered in the same material ordered for the car's upholstery—either leather or vinyl. The Roadster's convertible top and side windows can even be raised with the tonneau cover on.

The Landau Coupe' owes its elegant appearance to eye-catching chrome side bars and a distinctive top that sports a black or white-grained vinyl covering.

Model Reveals Inside Story of Famous Fighter

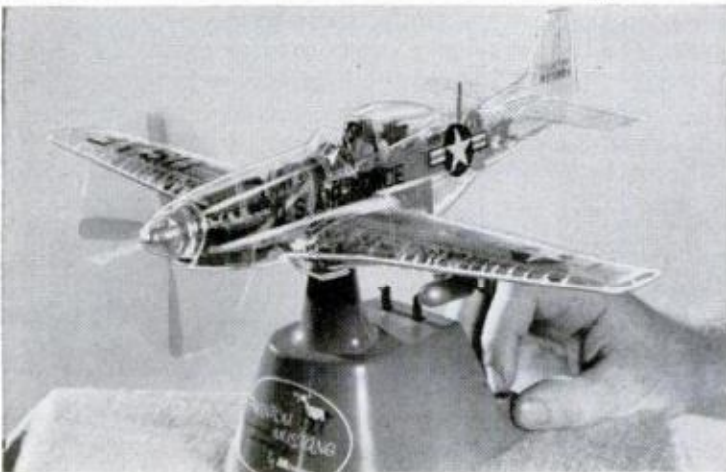

Buttons and levers in the base of a transparent model of the F-51 Mustang control the plane's landing gear, propeller and bomb-release mechanism.

Major parts of the plane—engine, controls, guns, etc.—are visible through the transparent skin. An electric motor inside the scale Rolls Royce/Packard Merlin engine spins the propeller; another in the plastic base actuates the landing gear.

The F-51 kit, by Monogram Models, Chicago 32, sells for \$4.98.



By Jim Whipple



That Bird You Saw Wasn't a Cardinal Quality Soars on Chrysler Corporation's '62 Cars

That painting of a new, small car seen on the cover of a recent issue of another science magazine wasn't the **Cardinal**, **Ford's** up-coming four-passenger compact. The artwork, and the article inside were a wide-screen symphony of guesswork. However, they are right on basics—the **Cardinal** is a front-drive car with a water-cooled V-type engine, as *PM* reported in August '61, p. 74.

But everyone, *PM* included, who guessed that the **Cardinal** is a look-alike with **Ford of Germany's Taunus** is wrong. It isn't. We've seen the prototype. And even this model will undergo sheet metal changes before it reaches the public.

A most interesting Question-and-Answer session took place recently when **Chrysler** Division's General Manager Ed Cole parried the thrusts of journalistic curiosity.

Asked if his new compact **Chevy II** might soon replace the standard-size **Chevrolet**, Cole replied, "No, but we are prepared to shift production from the (big) **Chevrolet** to **Chevy II** if the market shifts that way."

Now this doesn't mean that GM's biggest division is ready to scrap a car that sells over a million units each year, for just a few minutes later Mr. Cole remarked that **Chevrolet** engineers were "working on" a larger-than-**Chevy II** unitized-body car.

Chevrolet Division itself provides one of the best examples of the industry's new look of flexibility. It is obvious that **Chevy II** was waiting in the wings—well into prototype development stages—in the winter of 1960, as management waited to see which way the winds of public preference would blow.

When it became evident that the public desired a car of **Chevy II's** size—evidenced by zooming **Falcon** sales—**Chevrolet** had one ready to market in just 18 months. What a contrast to the slow reactions of just a short time ago when **Ford** made a wrong guess on **Edsel** three years before the car went on sale.

Turning from the immediate past to the immediate future—and the prospects for

an American-made **Volkswagen**-sized car, **Chevrolet's** Cole said that his division had this type of car under "study" (what a splendidly noncommittal word) but were waiting to see whether or not owners of less than 100-inch-wheelbase cars wouldn't upgrade to something a bit larger in the **Chevy II** or **Corvair** size brackets. Discretion in this case may very well be the better part of valor.

It's always a pleasure to report good news, especially when it follows a long siege of trouble. We were much impressed with the tremendous improvement in quality control shown in the finish and fit of trim on the first production runs of **Chrysler Corporation's '62** models.

Paint jobs on everything from **Valiant** to **Imperial** were excellent—better than anything we've seen on **Chrysler** products in recent years.

There's been an improvement in operation of controls too. Particularly outstanding is the smooth, precise working of the brand-new column shift on manual transmission **Dodges, Plymouths, Valiants** and **Lancers**.

Who or what is responsible? Answer: a lot of hardworking people in engineering production and inspection, not the least of whom is Harry Chesebrough, vice-president in charge of quality control. Harry attributes **Chrysler's** pulling up of socks to the Corporation's Clairpointe quality control pilot plant where initial samples from parts manufacturers are tested for perfect fit and where constant rechecking of all components takes place.

If **Chrysler** cars continue to be as well built as the early '62s, we will expect to see the Corporation increase its share of the market beyond the disappointing 9.2 percent of the current year.

Here's a piece of cake for the drag strip set—this one from Ed Cole himself. You will be able to put the basic **Chevrolet** 327-cubic-inch V8 engine into the **Chevy II**. It'll be a bolt-in swap available through dealers complete with beefed up front springs and four-speed stick. Go man, gone! ★ ★ ★



Rocket Retrievers

Collecting fragments of ill-fated rockets from the water off Cape Canaveral is the job of a highly specialized firm headed by Lou Berger, former Navy officer. Berger's skindivers work from boats offshore.

When a missile explodes shortly after leaving its pad, cause of the failure often isn't known until the fragments are recovered and studied by experts. Gathering of the fragments also keeps them from falling into unfriendly hands.



Viewer for Night Combat

Troops in the field can see in the dark with no more effort than using binoculars with a new infrared viewer now on order for the Army and Marines.

The transistorized unit combines optics, infrared image converter tube, 1.3-volt battery and infrared flashlight in one small package. The user sees as if he were using a flashlight and looking through a monocular. The Metascope is made by Varo, Inc., of Garland, Tex.

"Now Hear This"—and Listen to That

Converting easily from a "talker" to a "listener," a new all-electronic portable bull-horn amplifies the voice of the user, and (with the position of the horn reversed) enables the user to hear sounds

that are out of the normal hearing range.

The Rangerhorn uses six C flashlight batteries for power. The price is \$14.95, and the manufacturer is Electrosolids Corp., Van Nuys, Calif.



MUST APPLIANCE REPAIRS

Your complaints about the high cost of nursing ailing home appliances are finally getting through to the manufacturers. Here's what they are doing—and what you can do—to reduce those repair bills

By Ken Warner

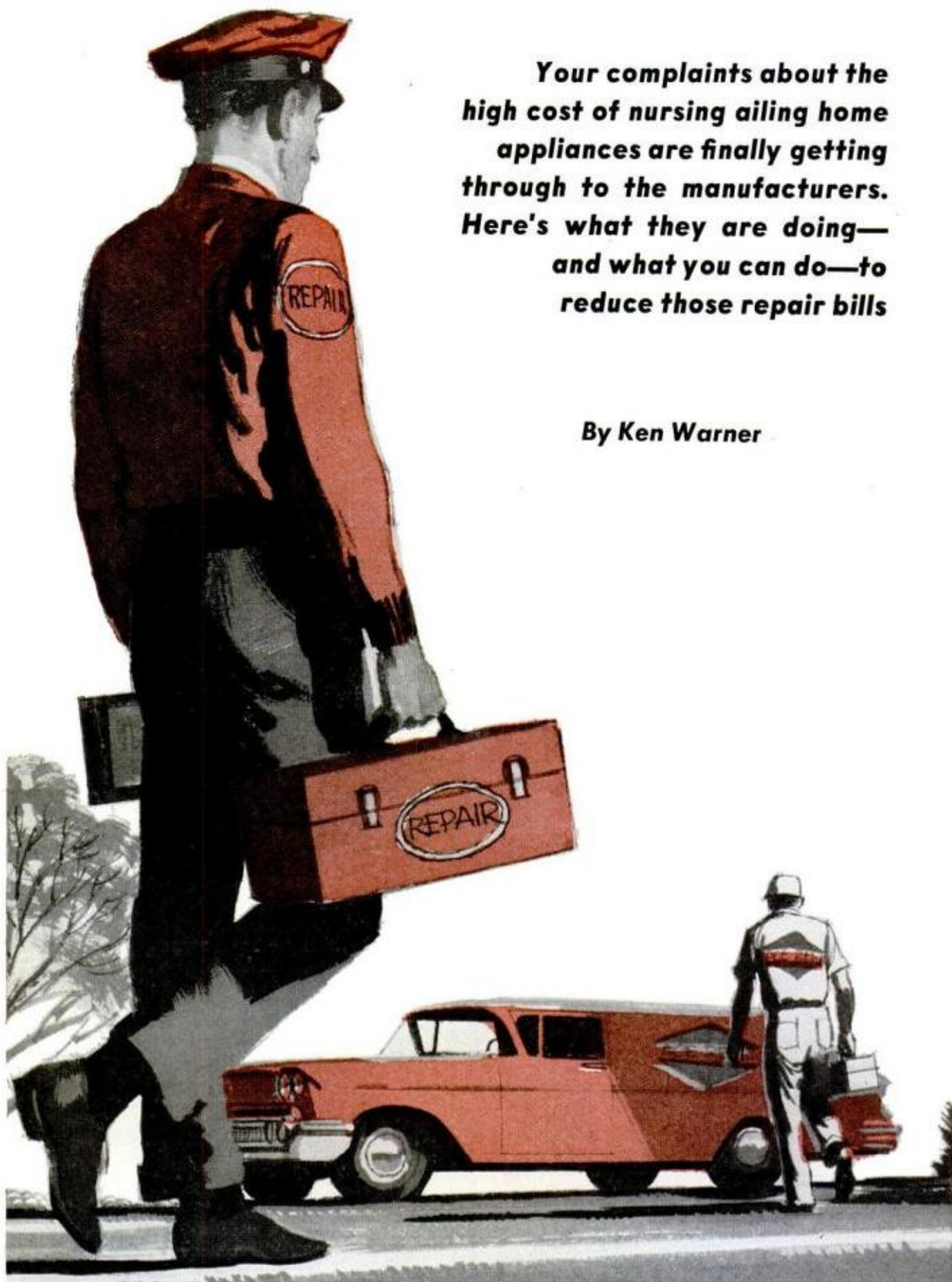

COST YOU SO MUCH?

IT COSTS \$2.85 in labor charges to replace a light switch in a refrigerator in Chicago. That's after you pay \$3.95 for getting the man there, and of course, you also pay for the light switch. In a Chicago suburb, the bill for installing a new pump, drive belt and filter seal in a washer recently came to \$17.29, for parts and taxes, plus \$7.20 in labor (including a \$5.95 minimum) for a total of \$24.49.

A big job, done in the suburban shop, looked like this: Replaced transmission, new belt, new pump, new leaf assembly: for parts and tax, bill of \$54.50, plus \$35 in labor. Total: \$89.50.

There are two basic reasons for today's service problems and those big bills: They just don't build appliances like they used to and they don't sell them like they used to, either. While there is some evidence that things may get better, there will still be some unnecessary difficulties for a few years yet.

One reason for this is that as late as 1956, appliance factories were still making service problems on the production line and, worse yet, were shipping them out to market. During 1959 and 1960, for example, one manufacturer spent an estimated \$5,000,000 making good on one defective 1954-1956 washer. There was a bad timer, a pump that regularly failed, and a bad transmission all in one model. It was cheaper to replace the machines than to send out "fix kits" for repairs, even for a year's production.

About the same time, another manufacturer picked up its own out-size repair bill by selling an ill-fated, poorly-tested washer. It added to its problem by taking the "dump" route to get rid of the nightmare; they sold the inventory at low prices, then furnished "fix kits" galore. Some dealers nearly went broke on this bargain."

Of course, it isn't only laundry appliances that make problems. The automatic-defrost refrigerators—a worthy development now

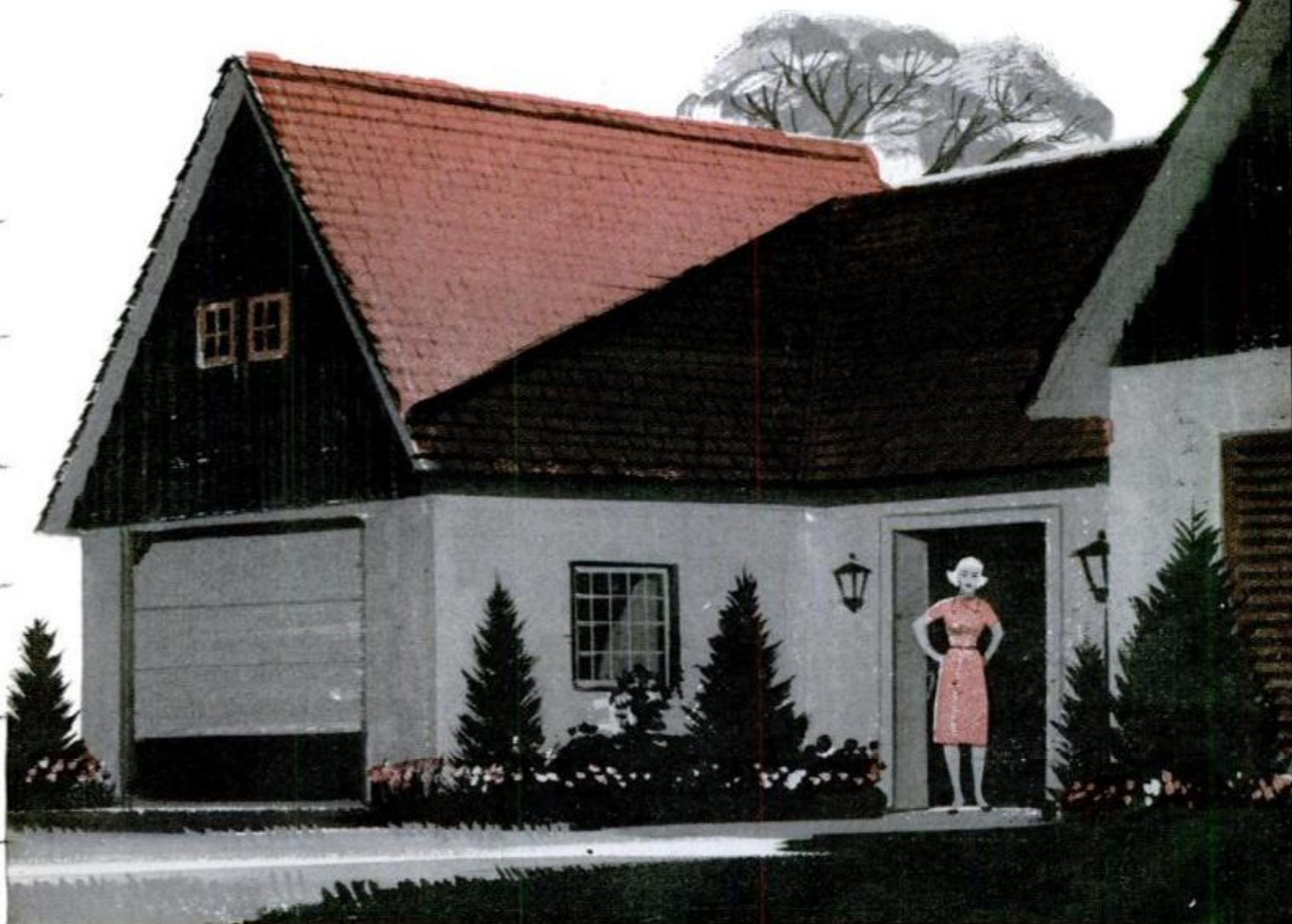

Manufacturers control quality

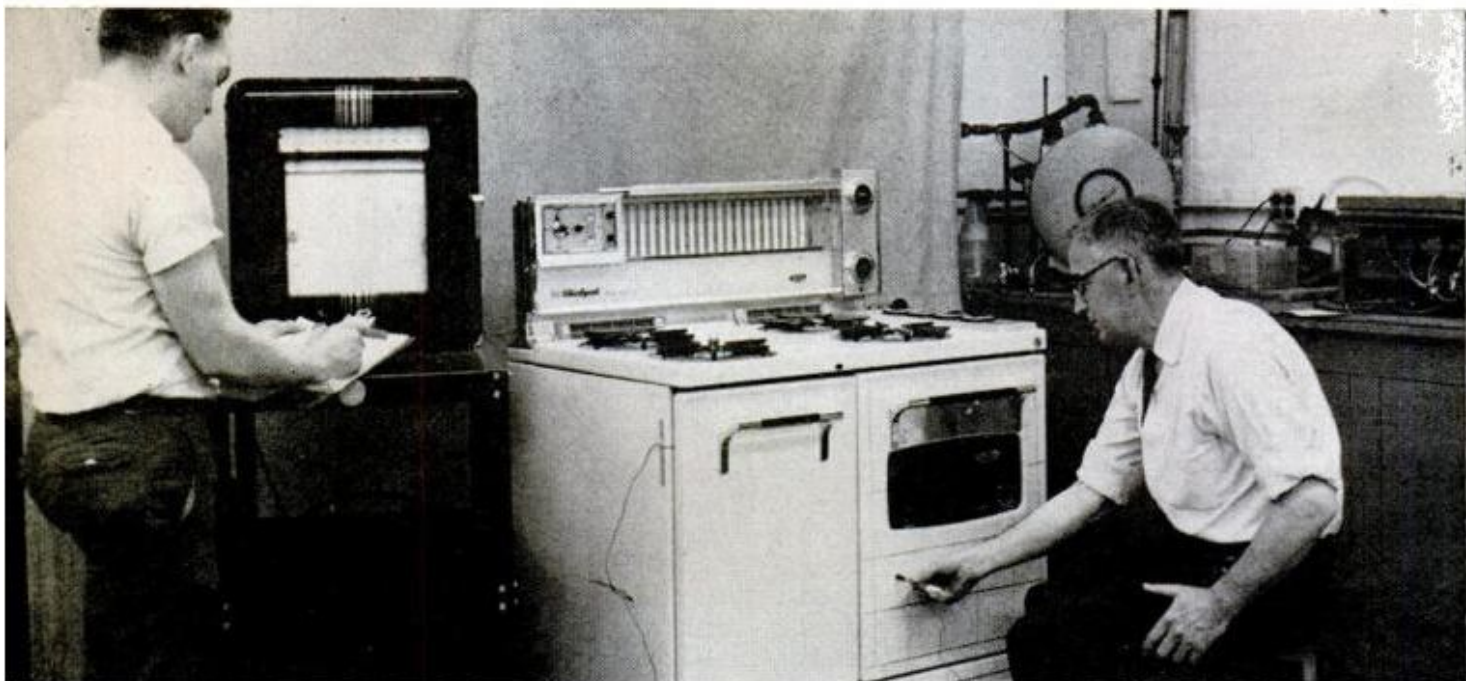

LABORATORIES of manufacturers now are not only testing products as they roll off assembly lines. These men are gauging how well a range holds its temperature. They also study reports of "in-use" trouble more than ever

TURNED UP HIGH, shaking on a floating stand, a new washer is studied to find possible vibration effects

CHEMIST works electrolytic water analyzer to make sure a refrigerator does not hold too much moisture

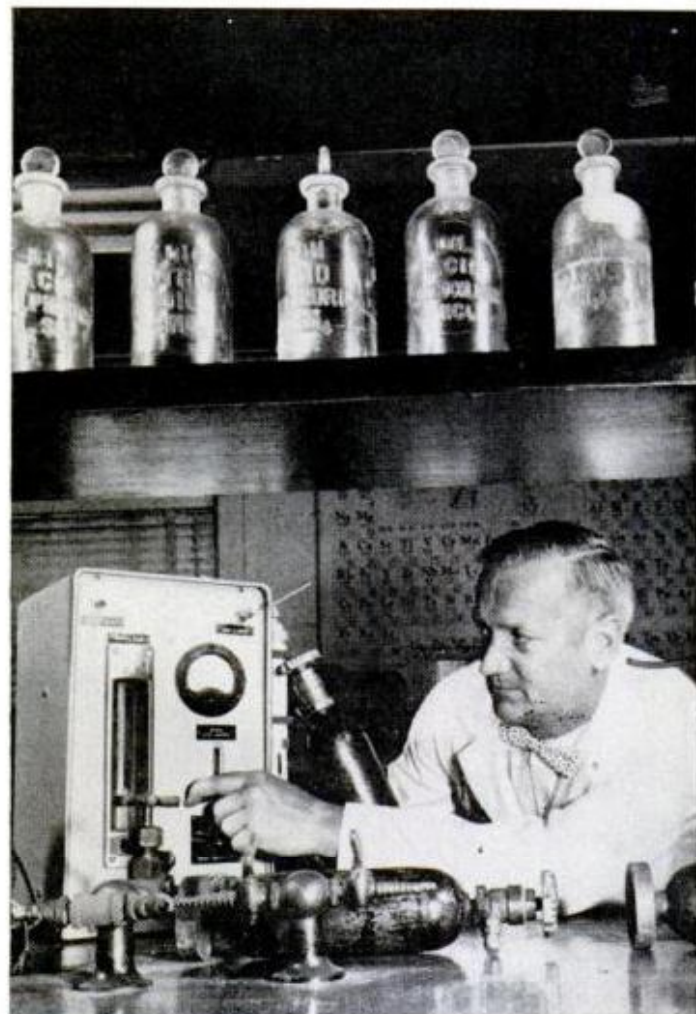

to some degree But . . .

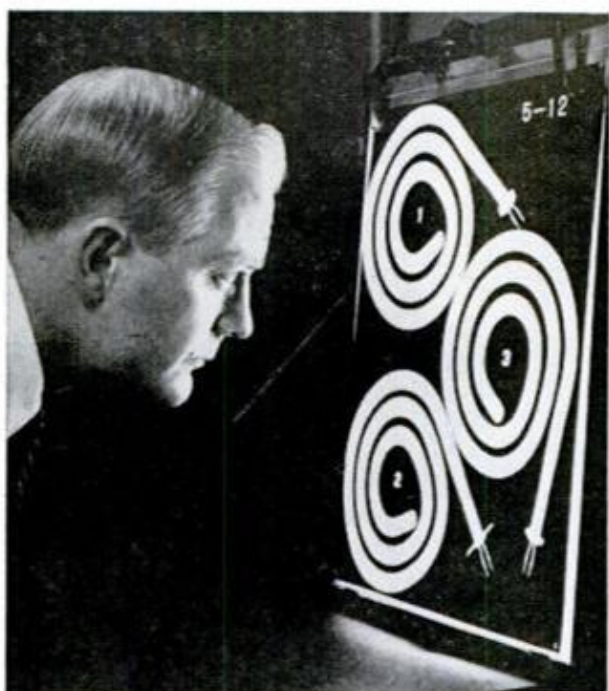

X RAY is a new check on quality control. Technician studies position of coils within sealed range units

VENTING a washer in installing it into an Indiana home. Everyone concerned hopes it's trouble-free

almost standard—had one manufacturer's dealers groggy with work for months on end in 1957, until they learned how to deal with a dime-sized lump of ice that persisted in clogging up the works.

Eighty Percent Disasters

The washer problems are examples of what appliance people call a "disaster," meaning high percentages of total production are affected—as high as 80 and 90 percent. Most common production problems that result in repairs for customers are little things—a batch of bad gaskets were installed, or there was an early run of loose tolerances in an accessory, and so on.

How do these repair-making problems develop in the million-dollar operations of manufacturers who have platoons of engineers, testers, survey teams, home economists, and production experts who rank among the nation's best?

Here are some explanations:

Competition tempts sales engineers and real engineers into rashness over materials, components, features. To get the price down, they sometimes take a chance, but the cheaper way is not always good for serviceability. For example, some plastic parts now used in impellers, pumps and

(Text continued on page 118)



*Once you own
the machine . . .
you own its
problems too*

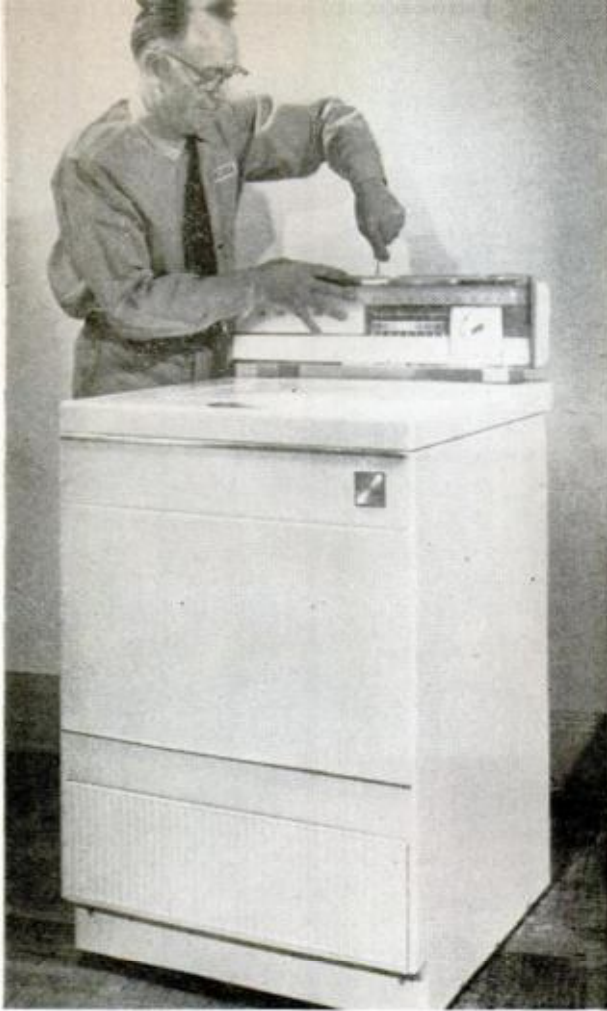

FOR EASIER REPAIRS, many appliances, such as this washer, are being built for servicing from the front, and in the home, which saves shop work. One manufacturer estimates this feature saves 33 percent in service time



CUSTOMERS FOR SERVICE are getting a chance to check up on the work and the costs. One manufacturer has its servicemen leave a postcard so the customer can write, evaluating repair work and the conduct of the "Red Carpet" serviceman. Other manufacturers have servicemen carry a flat-rate charge book (see below) which describes the job to be done and its cost

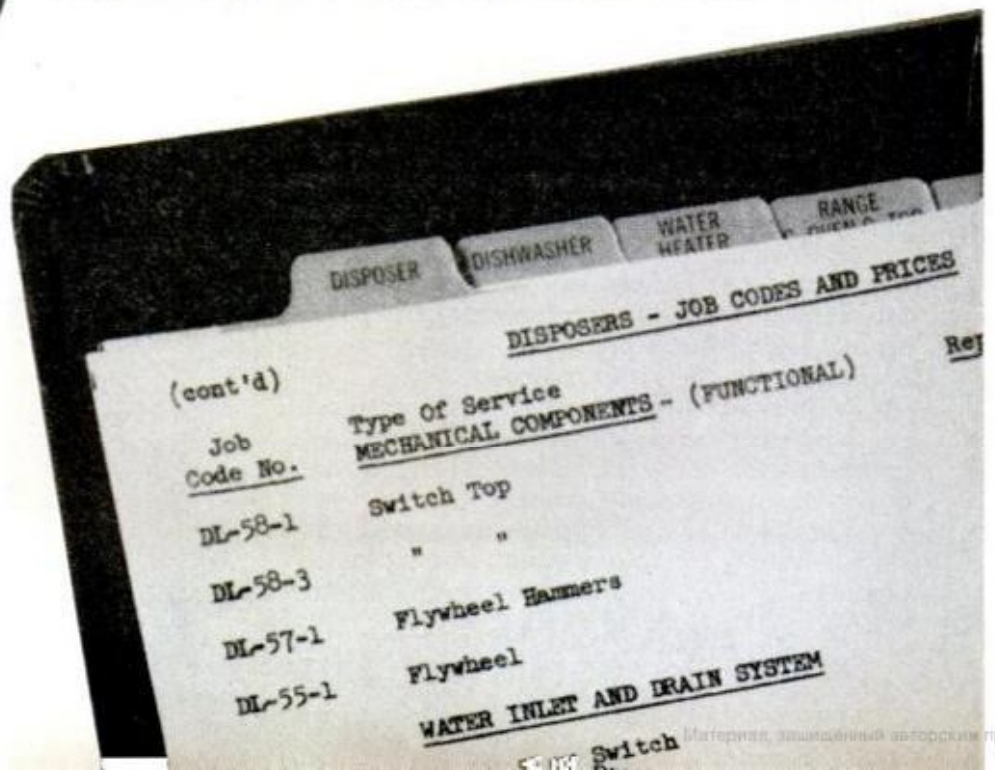

What you are entitled to . . .

Free service during the period of the warranty according to the terms of the sale. As a general rule, major appliances carry a full labor-and-service warranty for a year from the date of purchase or delivery (find out which). Small appliances carry similar warranties, though here they often call for return of the device to the factory and sometimes are replacement guarantees; and such items as TV, radio, stereo sets usually carry a parts-and-labor warranty for 90 days, a parts-only deal for a year. (The difference between the two words **warranty** and **guarantee** is practically nil, and the two are used synonymously. Therefore, you have to find the specific terms of the offer you are getting, no matter what it is called.) These warranties in any case apply only for defects in the machine present when you purchased it or developing during normal use. This means that the serviceman who finds a nail in the pump of your washer is entitled to charge for finding it. Make sure the bill-of-sale shows no notation that would change the maker's policy.

Fair service after the warranty period is past. However, for this you must pay at the going rate. In the event you are not satisfied, and can show why you are not, by all means complain, the squeaking wheel gets the grease. However, shouting won't get you any further than a nice quiet purposeful letter (don't threaten ever—just inform and say you expect action) and you can show the letter, with its dated complaint to other interested parties later, if you keep carbons and if you need to do so.

Satisfaction with the machine, the workmanship, the treatment you get from everyone concerned. When appliance people say they "guarantee" some device, they generally mean they will keep it running, not that it is perfect. When the amount of inconvenience reaches the ridiculous stage, it is time to talk about exchanging the device, getting a major shop job for free, or whatever other action will stop the problem. As complaints develop, it is smart business to keep a record of what you asked for and what you got, with dates. Since in-warranty service is free, you usually don't get receipts. If, in the end, neither the dealer nor the distributor satisfy you, and your com-

plaints are legitimate, write a careful letter, including dates and other pertinent facts, to the president of the manufacturing firm that made your appliance (your newspaper or library Thomas Register of Manufacturers on Standard Advertising Register will give you his name and address if you want it) and ask him to do something. Send it special delivery, but don't send it registered mail, as many firms have solid policies against accepting registered letters. (It's a favorite stunt of the amateur inventor and acceptance carries legal implications.) You will get action. Most such letters start a chain of events that wind up with the distributor having to report to the president just what action he has taken to satisfy you, the customer. It won't do any good to do this, however, before you have given the local people every opportunity to make things right.

There will be some service bills during the life of your appliance. A fair estimate for an automatic washer is \$20-\$30 a year after the warranty period. In other words, for a five-year life, you will spend perhaps \$80-\$100 over the price of the machine. If you are careful, it will be less. If you consistently overload the machine, it will be more. Service on such appliances as refrigerators, air conditioners, ordinary gas and electric ranges will cost less than this figure, of course. Dishwashers and dryers and elaborately automatic ranges will almost equal the washer. You might say that such complicated machines **automatically** have more problems.

There will be fewer big bills if you make a practice of getting your appliances checked out by a qualified man once or twice a year. You can do this at the minimum rate, and often can stop problems in advance. For example, a little rumble can be adjusted out of the drive and save bearings, a poorly-fitting door gasket puts a heavy extra strain on a refrigerator, certain clicks and buzzes and hesitations during a washer cycle can forecast timer trouble that can be saved with adjustment. It is like tuning the car: There's a lot of difference between \$7.50 to adjust the drive shaft end play (on a washer) and \$40-\$75 for an overhaul, yet the one may proceed directly from the other.

	CAUSE		CORRECTION
	25. Loose bolts or screws		Tighten foot bolts, support plate bolts, cylinder retaining bolts, frame and balance mech. screws Check by visual inspection and correct cause
	26. Interference between cylinder and tank		Check spring, replace if necessary
	27. Weak clamp spring in balance mechanism		Reinforce floor
	28. Weak floor		Adjust valve clearance to .061-.064
tor	29. Air bleed valve too close to bleed arm		Check for cabinet and tank interference or wear in motor to transmission coupling
ads	30. Not enough tank motion		Adjust for .002 to .010 clearance between lower jaw and leaf spring with shim in out position
defective			Check for air leak defective comp Free or replace
V & P	31. Stable frame positioned incorrectly		Replace leather
	32. Insufficient clutch torque		Replace spring
ns	33. Intake, exhaust, or relief valve on compressor stuck		Replace
akage	34. Piston leather in compressor defective		
	35. Broken piston return in compressor		

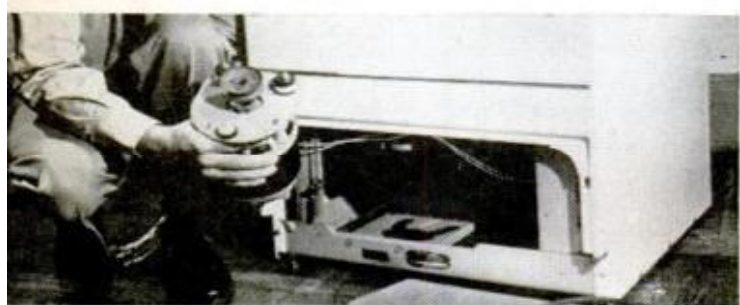
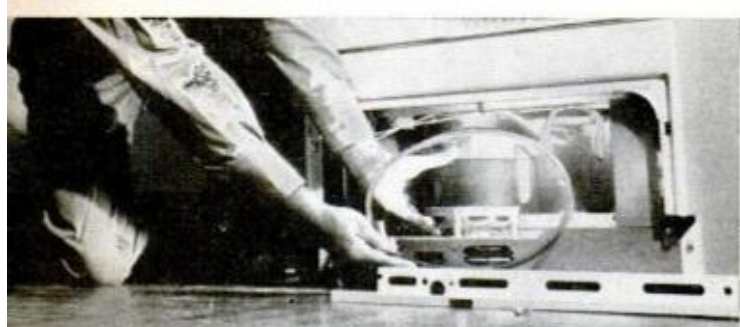
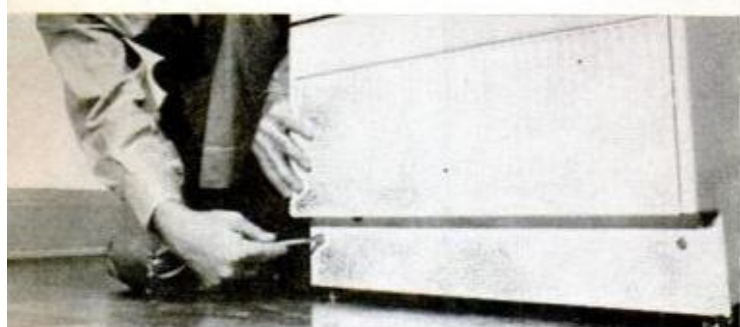

CONFIDENCE in repair work is being established by firms that supply repairmen with guides—which the customer may see—which shows symptoms of ailment, and directs repairman how to correct it. With new designs, troubles which in the past had to be taken to the repair shop, now can be corrected in your home

transmissions—where metal parts formerly were used—just do not stand up, servicemen say.

Too much speed-up brings service irritation. This gadget, or that widget, a sales manager screams, must be in the line and ready for the distributor showing in 60 days. Now it might take six months to test the new widget properly, but the engineer has to deliver. Sometimes it works, sometimes it doesn't.

The manufacturer buys some problems. Such items as valves, pumps, compressors, timers, and gaskets are vital, but most are furnished by outside suppliers. Many service calls can be traced to faulty parts not made by the company that puts its name on the machine. This of course should not release the manufacturer from responsibility of seeing that the parts function properly.

Housewife Testing

The manufacturer's laboratory cannot duplicate the actual use of thousands of machines in thousands of homes. The range

(Continued to page 234)

What you can do to save money . . .

When an appliance won't start. First, double-check the power supply. Plugs work out of the wall, or kids pull them out, fuses blow, occasionally the door safety switch may hang up, and, in the case of a washer, sometimes an overload will cause the overload switch to cut out the current.

Next, in the case of a washer, check the water supply. Make sure the faucets are on—you can usually feel the water pressure or hear it.

Now, if there's power and water, things should happen. Go over your starting procedures again, and make sure no selector buttons or switches are part-way down or stuck. Almost always, when an appliance worked fine the last time you used it, but now won't start, something has changed. Try to figure out or remember what it is—a different wall receptacle, kids fooling around, disconnected parts from cleaning (such as oven elements in an electric range).

If the trouble seems to be in the machine itself, try the time-honored methods of clicking the switches several times, cycling the control dial all the way around, slamming the door. Chances are, in the absence of loud noises or burning smells, the problem is minor when a machine won't start.

If all else fails, read the instructions.

If you do get it started, but don't know why, go ahead and use it, but get the serviceman over to check it before the next use. It's cheaper in the long run.

When an appliance quits. If it makes loud noises, bad smells, grinding sounds, anything alarming, just pull the plug out of the wall and call the serviceman.

If it just stops, quietly, stop and think before you fool with anything.

Chances are with a washer that either it is hung up on a sticking switch or it is not getting water. Note just where the machine is in its cycle so that, if necessary, you can give the serviceman some advance notice of the trouble.

Now, try and check the same things as when an appliance won't start. On a refrigerator, work the cold control back and forth and rock the unit gently. With a washer, make sure the load is balanced, then try the reset button if the unit has one; run the dial through the cycle again.

And double-check the instruction manual.

Again, if you do get the machine going, and are not sure that it is all right, the best bet is to get it checked by the serviceman.

When you have to call the serviceman. Have the model number (usually a short combination of letters and numbers) and

the serial number (less important, usually a 6-8 digit number plus one or two letters) written down to be sure to get them right—so the service truck will have the right parts on it. These numbers are to be found, if your instruction manual doesn't show them, on a brass or aluminum plate either on the back of the machine, or behind the front service panel on the bottom.

Be able to answer the question "What seems to be the trouble?" That is, know when it stopped, what sort of noises or smells (hot wires, for example) it made, that it isn't a lack of power or water.

Make sure your name, address and phone number get taken down clearly. If there is a genuine emergency, such as gas leaking, or food spoiling, make this plain. Don't expect a washer-load of clothes to be treated as an emergency, however, as almost every call they get involves some inconvenience to the customer. It is almost always a case of "first come, first served."

When the serviceman shows up, if he arrives in a private automobile, get some identification from him, unless you recognize him—and do it before he's in the house. If you've never dealt with the firm before, get as many of the financial details as possible in advance—that is, is there a service charge just to make the call, to what does this entitle you, will the serviceman accept a check, will he be sure to consult you before making extensive and expensive repairs?

Fortunately, there are few sharpies operating in the home-appliance service business, but there are some. In any event, a serviceman who is warned against spending any large amount of your money without checking with you, and who is not allowed to get the machine out of the house, has very little chance to pull an expensive fast shuffle. Almost every instance of shady operation reported in appliance repair is connected with a shop job. Usually, the sharpie diagnoses linkage trouble, for instance, as a need for a rebuilt transmission, and jerks the machine out of the house before anybody who knows machinery has a look at it. Don't let the machine go until you're sure—there are legitimate major repairs that have to be done in the shop, but not often.

Your best safeguard is to deal with the man who sold you the machine—he wants to sell you another. Next best is your neighbors' or friends' advice. And the factory outlet—listed directly under the brand-name in the classified directory—won't be a shady operation, though it will charge for every service performed.



Prefab "Apartment" Building

Latest idea in manufactured homes is a four-unit apartment building being added to the 1962 line of National Homes Corp., largest of the home manufacturers. The units, left to right, are two-bedroom single level, two-bedroom split-level, three-bedroom split-level, and a one-bedroom single-level studio unit. Features include ceiling-high kitchen cabinets, sliding glass doors to patios, and large utility-storage rooms.

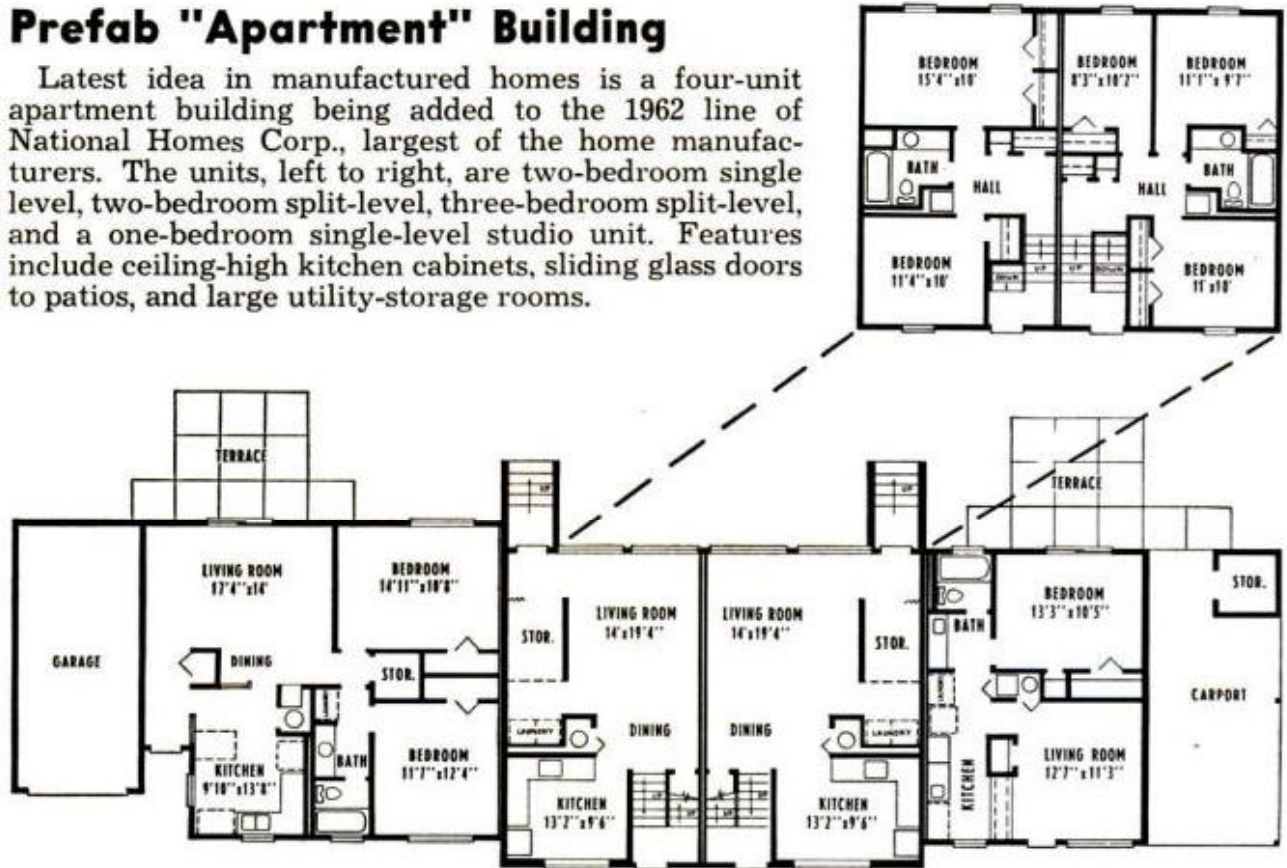

Printed-Circuit Prototype Kit for Engineers



Engineers can now produce printed circuit prototypes right at their desks. Kit contains perforated copper plated boards, acid resist tapes in strips and spots, and ballpoint tube of resist ink. Etchant provided in plastic bags, uses plastic container for etching bath. Takes approximately fifteen minutes from start of layout to finished board. Designed by Corning Glass, distributed \$8.95, Newark Electric, Chicago, Ill.

ADDRESSES of manufacturers and persons mentioned in this issue are published in the monthly Where-to-Find-It list, available free from Service Bureau, 200 E. Ontario St., Chicago 11, Ill. Send a stamped, self-addressed envelope.

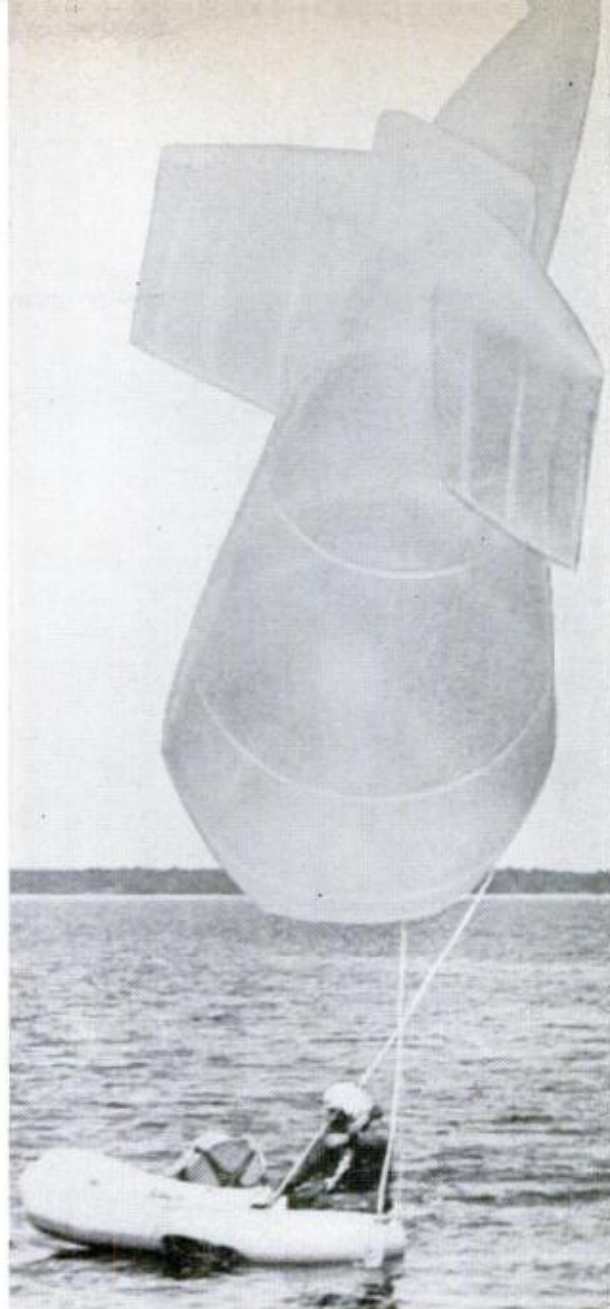
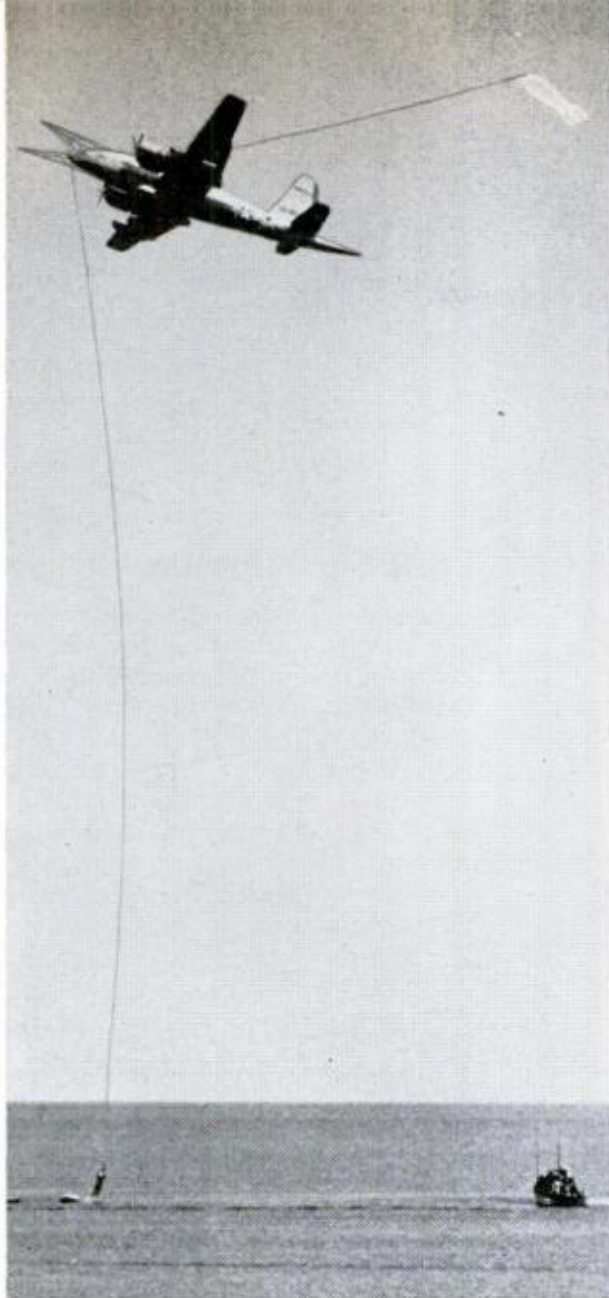

Skyhook Saves Stranded Sailors

CAPABLE OF rescuing persons shipwrecked at sea or stranded in remote land areas, a Navy skyhook system uses a long nylon line, an inflated balloon and a huge forklike yoke in the nose of the aircraft.

In rescue operations, a specially designed packet is dropped to the stranded sailor. It contains the 500-foot nylon line, the balloon envelope, a helium bottle and a harness that is donned like a pair of coveralls. The man dons the harness, inflates the balloon and releases it. The aircraft approaches the line just below the balloon and snags it at about 150 miles an hour.

The balloon breaks away and the line is automatically secured in the crotch of the yoke. It is then hooked through a bottom hatch onto a powered winch and the man is reeled into the plane.

The man experiences an initial stress roughly about one-third that experienced in a parachute jump. The whole operation lasts about seven minutes from initial snag.

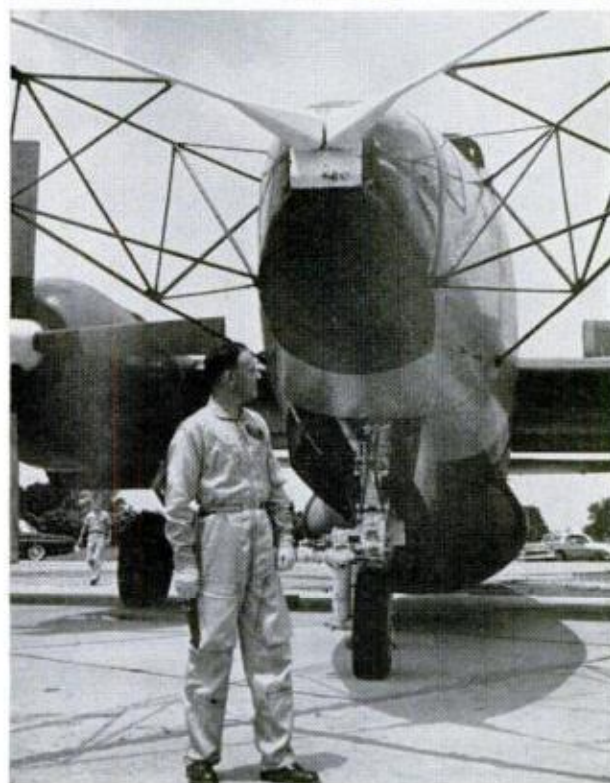



Mach-2 Training Target

Last month the first missile target with the speed and altitude capabilities of supersonic fighters became operational.

The XKD2B-1/A-12, a joint Air Force - Navy project, can fly at twice the speed of sound up to 70,000 feet. A self-contained guidance system takes it to its designated target area.



Portable Playpen

Ten feet in diameter, this playpen has smooth metal disks at the bottom of each post, allowing it to be slid from place to place along the lawn without damage.

Four feet high, it has all-steel construction, including 5-gauge 2 by 6-in. rustproof galvanized wire mesh with smooth tops.

Made by Walsh Manufacturing Corp., Charles City, Iowa.



DC-4 With a Bulgy Nose

Intended to ferry cars and passengers over the English channel, an old DC-4 had a new forward section attached to its old fuselage, making it 12 feet longer and allowing five cars to be driven into the fuselage beneath the flight deck which is now in the raised section of the bulge.

The new version of the old plane is called a Corvaire.

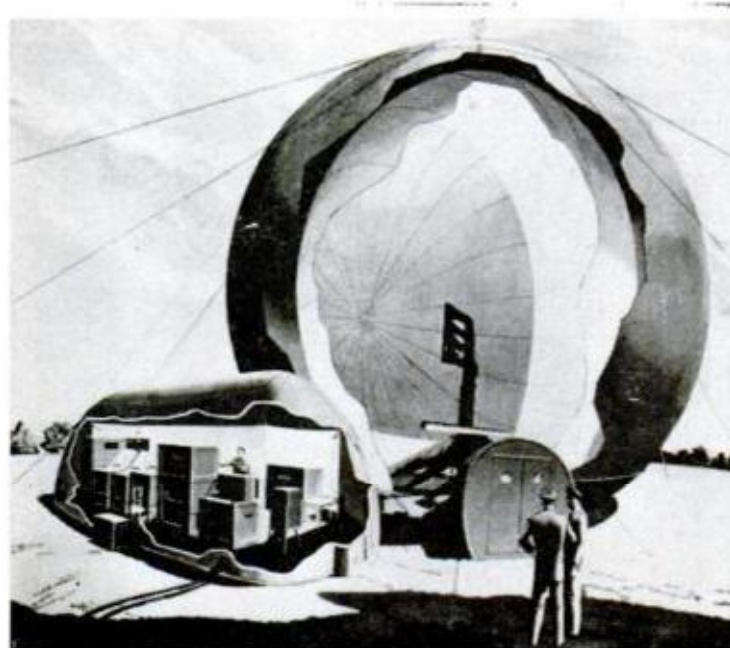

Cloth + Air = Radar

Made of fabric, and supported by air, an experimental radar set (65-foot radome, 35-foot antenna) may help the U.S. Air Force move around more quickly its Composite Air Strike Force—the unit sent to put out "brush fire" wars. At present the tactical unit must unbolt and bolt a metal antenna.

The antenna is made of woven glass fiber cloth coated with a vinyl formulation; an inner coat carries silver particles to give reflective properties. Put in a 200-pound package, the antenna could be used in space, it is thought, for communications, radar and solar power supplies. It would absorb sun energy to get power for radar.



Tetrapods Tame the Tides

Looking like children's game jacks that have been transformed to giants in a horror movie, 25-ton tetrapods guard the ocean entrance to Crescent City, Calif.

Some 1300 of the giant four-pronged tetrapods, cast in concrete, serve as the city's breakwater. Set in an interlocking configuration, they throw back the waves, and only dig deeper into the sand with each pounding blow from the sea.

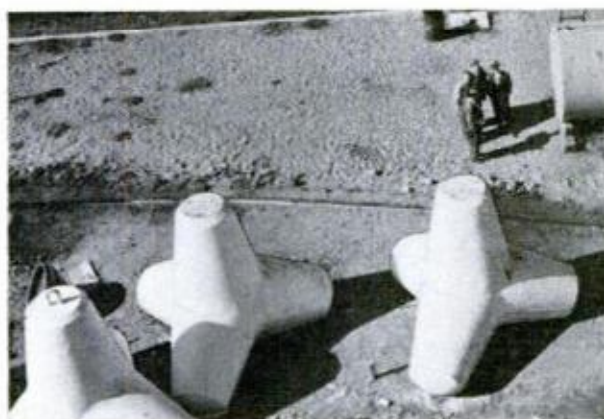

Recorder Gets an Earful

To keep tabs on the condition of patients after they have undergone operations, doctors are fastening on them such recording devices as one that fits to the ear to record diastolic and systolic blood pressures and pulse rates.

This recorder works by shining a light through the patient's ear and onto a photo-cell.

Part of a complete system called the Body Function Recorder, developed by the Minneapolis-Honeywell Corp., the ear attachment is plugged into a central control system, along with the recorders of some dozen or more patients. The whole system records body temperatures and respiration rate also.

An alarm is sounded automatically, summoning medical personnel to action, whenever a dangerous condition develops in a patient.



Football's Fabulous

Don't try to keep your eye on the ball to follow today's fast pro football game. Watch the man who handles it from center. He's running the show

EDITOR'S NOTE: Norm Van Brocklin, 35, head coach of the new Minnesota Vikings in the National Football League, is one of pro football's all-time great quarterbacks. A 12-year NFL veteran, he was last season's Player of the Year.

In 1950, 1952 and 1954 "The Dutchman" led the league in passing. Twice he was first in punting (1955, 1956). He has played in five championship games and on two world title teams, including the defending champion Philadelphia Eagles.

His all-time completion record is 53.6 percent, and he still holds the record for yards gained passing in a single game—554, set against the Giants in 1951. He is the author of Norm Van Brocklin's Football Book, published by The Ronald Press Co.

OF ALL TODAY'S spectator sports, professional football probably is the fastest-paced, most varied, and consistently thrilling. And of all players in the game, the quarterback is the focus of action. He's the field general, play-starter, passer, and sometimes punter and field-goal holder or kicker as well.

Yet few fans really understand how he works, why some plays click and others don't, and what to watch for during a game. Take what happens when the offensive team forms at the scrimmage line. After the huddle, when the players trot to their positions, many fans assume that's it—the play is set.

But not in pro football. This is the moment when some of the most important decisions in the game often are made. As the quarterback stands behind center, apparently ready to take the ball, you'll see him look over the defense before he starts shouting signals. He'll establish where every man is stationed. If anything isn't as expected, he may call a new play right at the line—what we call an "automatic" or "audible."

Why such last-minute changes? Pro football long ago ceased being a game of muscle alone. If you plan to send a fullback on an off-tackle smash, for example, but a linebacker is stationed right in that spot at the line-up, you change no matter how logical the play seemed before.

You may change for any number of other reasons. Sensing a special defensive stunt is one. A favorite surprise, for instance, is blitzing or "red-dogging" linebackers. Instead of covering their positions, they try surprising the quarterback by crashing through the line and upending him before he can hand off or pass. Teams with strong pass rushers, such as the Chicago Bears, New York Giants and Baltimore Colts, love to try this.



Foremen

By Norman Van Brocklin
As told to Alfred Balk

LIKE PUTTING THE MAIL on a passing fast freight, New York Giants' Charley Conerly hands off on a straight line buck—maybe. Maybe he's faking. If you were the opposing linebacker, what would you think?



Though pros are experts at hiding telltale mannerisms, if you're alert you can even detect some clues from the stands. A linebacker may "cheat up" to the line at the last minute, trying for a split-second head start in getting through. A tackle, knowing he'll have to protect territory vacated by a blitzing linebacker, may line up differently. Discovering these things is like finding gold.

The quarterback also must know exactly what defensive formation he's facing. While the offense is huddling, you'll see the de-

fensive captain, hands against chest, signaling the formation to his men. It may be a man-to-man or a zone, in various alignments: 4-3 (four linemen, four linebackers and three safety men), 4-4, 5-4, 6-1—all presenting different strength.

There are short cuts for spotting each. If it's a zone, for example, when an offensive man is sent out as a flanker, the corner defensive halfback will move up to cover him while the weak-side safety man moves toward the middle. Seeing this, if the quarterback has made a certain call, such as a



CHICAGO BEARS' quarterback Bill Wade comes up from center and hands off to—or does he? Maybe he'll fake to the first back and hand to the second. Trying to watch the ball may only get you fooled . . .



COWBOYS' QBs Meredith (17) and Heinrich watch play while keeping in touch with coach stationed upstairs

DALLAS COACH Tom Landry makes a point from sidelines for halfback Bercich while Meredith looks on. Players even study each other



long pass down the middle (which a zone is strongest against), he'll change instantly to a maneuver like flooding the secondary with pass receivers.

Do audibles or automatics occur often? Quarterback Johnny Unitas of the Baltimore Colts estimates he resorts to audibles more than two-thirds of the time in some games. Y. A. Tittle of the San Francisco 49ers says he changes half his plays. In my playing career with the Los Angeles Rams and Philadelphia Eagles, I depended on audibles about a fifth of the time.

Quarterbacks may appear busy on the field, but they're no less occupied before a game. We sift scouting reports, we run and rerun movies of our last game, and games of our opponent.

What do we look for? You can look for these points, too. They include a team's favorite defenses; their first, second and third-down probabilities; who calls their defensive signals and what his tendencies are; who is their best pass-rusher and whether he rushes hard on each play or only when signals call for it. Also, which



THERE. After a spin and a fake, Wade gives it to halfback Jim Dooley. Other options; the pitchout and the big gun, the forward pass. Below, Giants' Conerly, braced and calm amid a battle, stands and delivers





IN THE HUDDLE, Cowboys' Meredith, left, is boss, but he's helped by information from players, the coach, and grandstand spotters—even players on the other team

UP OVER THE CENTER, right, QB may continue with his huddle decision, but he may change at the last minute and use an "audible" to set up a new play

pass defenders cover their men loosely and which are so aggressive they can be fooled on certain maneuvers; which linemen can be "trapped" (let through, then blocked from the side); which ones are likely to make mental errors in certain situations.

Before last year's championship game, Eagle assistant coach Charley Gauer had noticed that the Packers' kick-off team had two fast men on the right side and a slower man on the left. Just for that game, we set

up a special blocking pattern designed to open up a long, wide alley for halfback Ted Dean. Late in the game this resulted in a 58-yard kick-off return to the Packer 39.

On the first series of downs in a game, sometimes you'll see a quarterback "going for broke" with a climax play or long pass. He uses that series to test the defense. If they've changed habits since the last game, he wants to know early in the game.

During the game you'll notice that



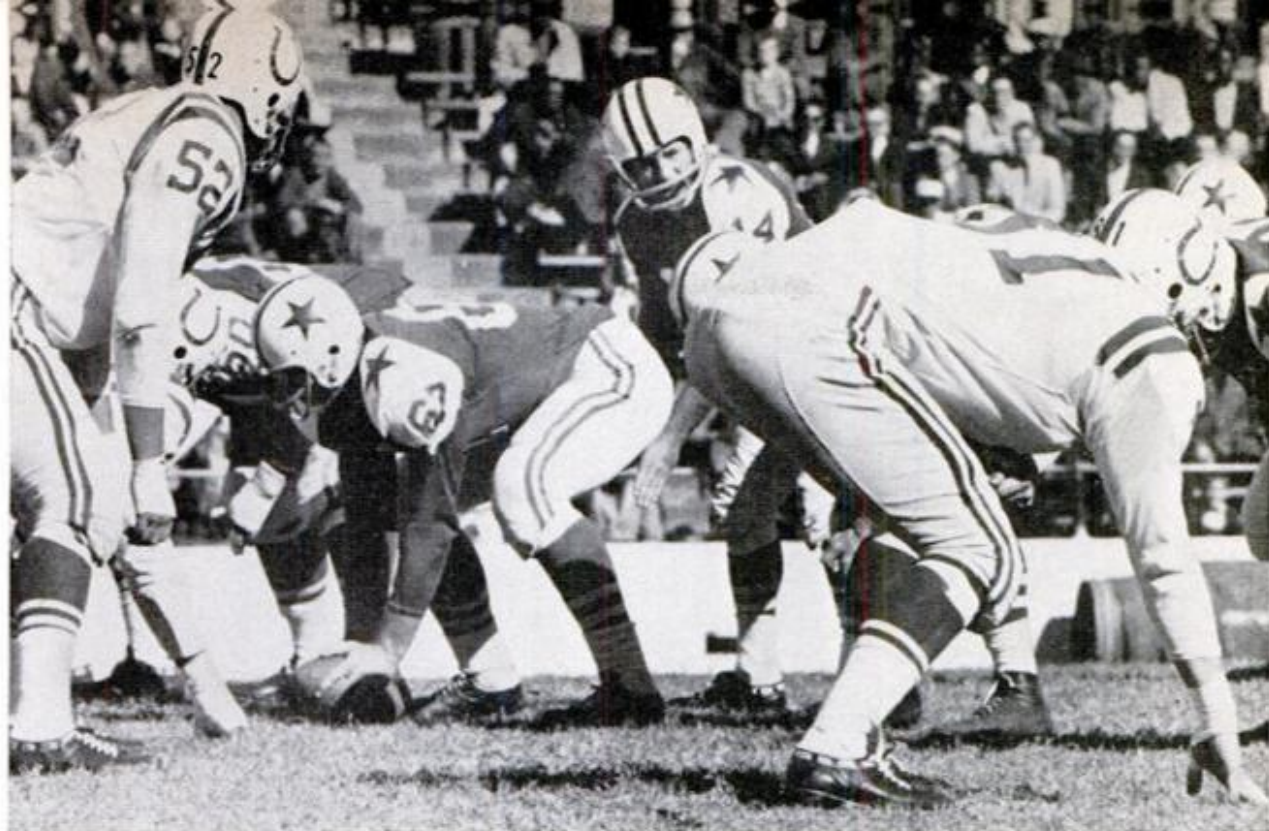

coaches and teammates talk with the quarterback more than any other player. Like the Central Intelligence Agency, he's collecting information. Coaches on the bench provide it; an assistant coach with a phone high in the stadium does also.

What goes on in the huddle? Because we approach the game seriously, there's no dawdling or horseplay. Once in the huddle, the QB has the next play selected—or, in the case of such teams as the Cleveland

Browns, because the coach calls the plays, it will have been sent in with a lineman. He calls it quickly.

"Four right, 25, full, trap, on 3." This tells every man all he needs to know.

"Four right" is the formation; "25" the ball carrier (the left halfback is designated "2") and the hole he'll go through ("5" means over right tackle); "full," the backfield style, in this case a fullback fake;

(Continued to page 230)

LOS ANGELES Rams' Frank Ryan runs one out, left. Pro quarterbacks seldom run; author Van Brocklin admits he ran with the ball "only out of sheer fright"

CONCEALING BALL behind his hip, Detroit quarterback goes wide on option play. He can pitch out, pass or run from there. Green Bay Packers photo



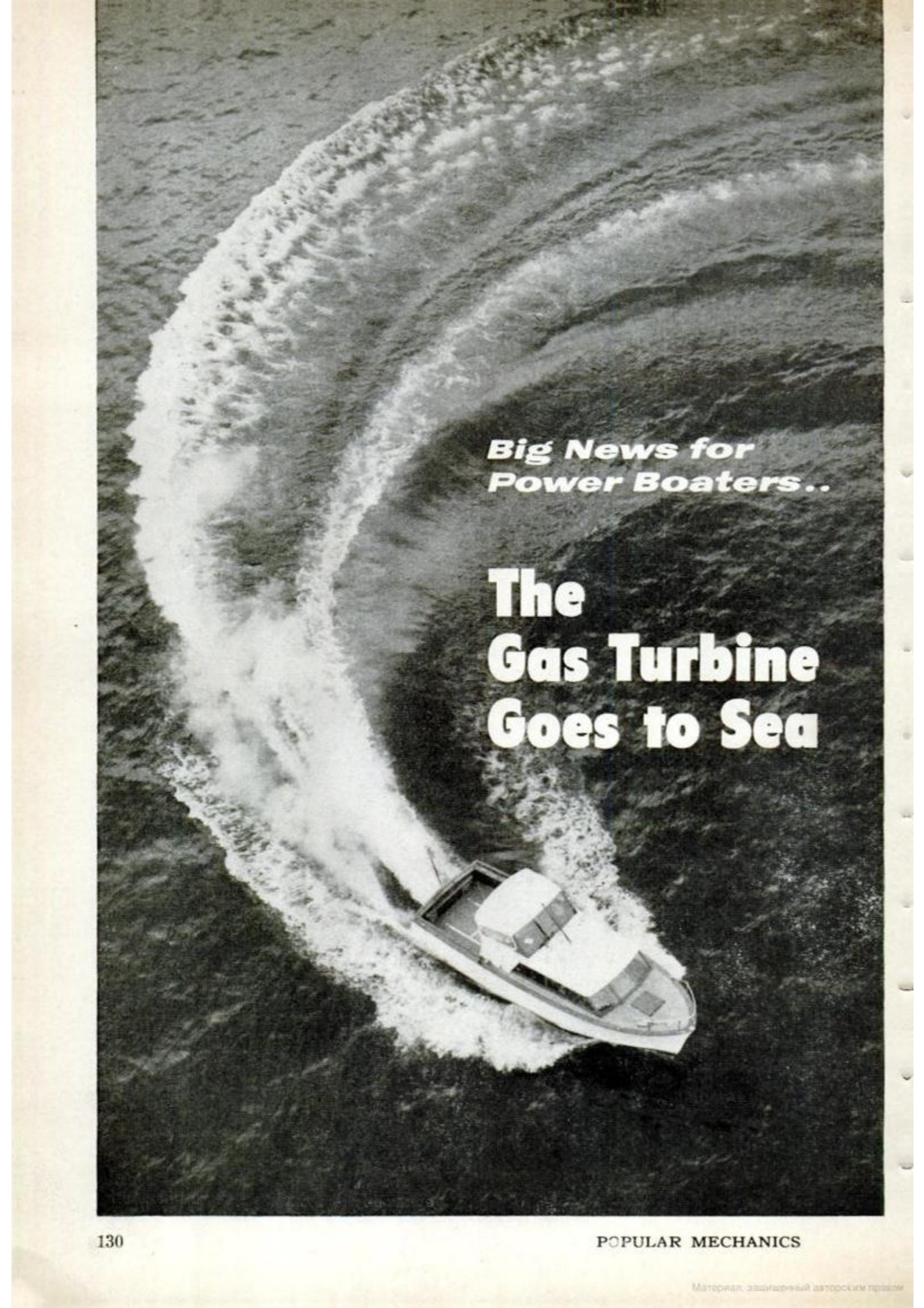

***Big News for
Power Boaters..***

**The
Gas Turbine
Goes to Sea**

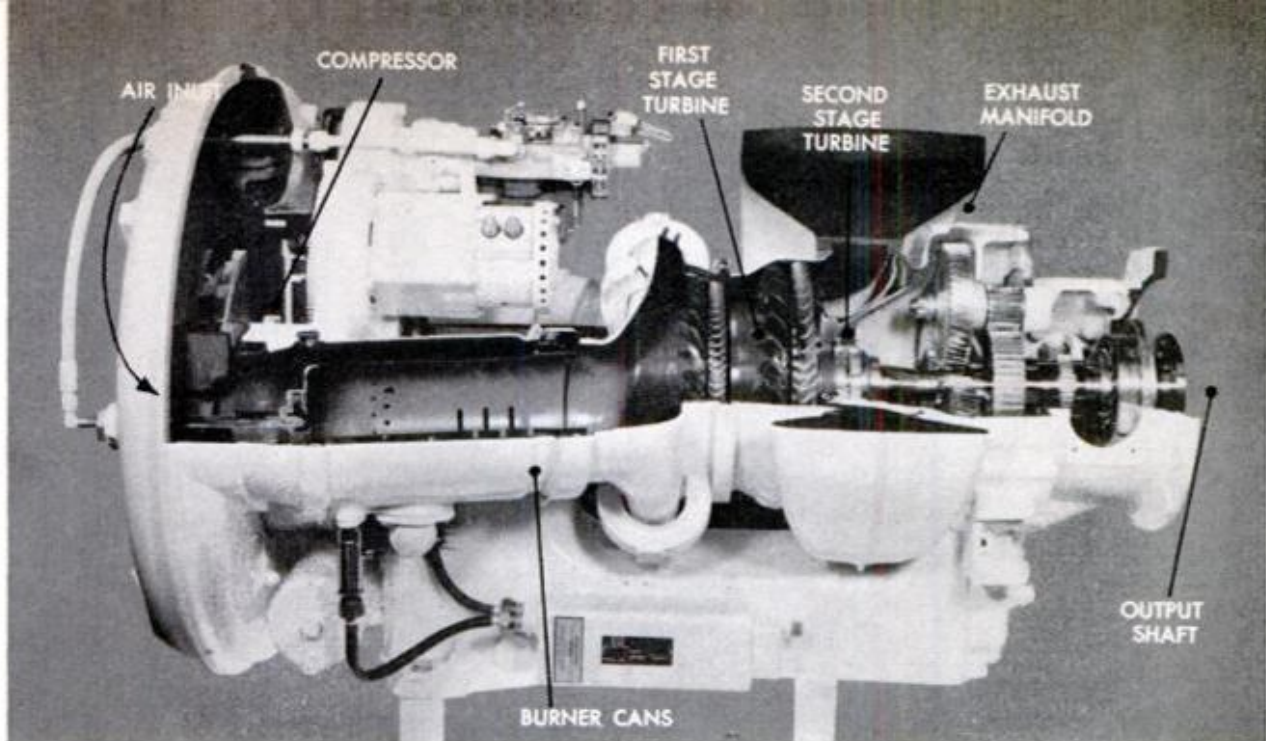

BOEING'S TURBO-MARINER—260 horses in a 625-pound package with gears, clutch, shift, starter and instruments included. Note lack of any connection between first and second stage turbines—a complete floating drive

By Chris Edwards

THE GAS TURBINE ENGINE—turbine for short—pushed pistons and props out of fighters and bombers because it delivered performance. Commercial airlines followed years later when turbines nearly doubled transport speeds, and for the same reason—they gave better performance.

Now, turbine power for boats offers a similar boost in performance.

Take one 26-foot cabin cruiser, for example. A 260-hp. gas or diesel piston engine churns out a top speed of 18 m.p.h. But with a gas turbine, top speed on this same cruiser jumps to 33 m.p.h. Two hundred and sixty turbine horsepower packed into only 625 pounds makes the difference.

Boeing's Turbo-Mariner, for example, weighs 400 to 500 pounds less than comparable 260-hp. piston engines. So, with the same horsepower at much less weight, you get performance from the turbine power plant that you can't buy with any other kind of power.

Packaged as a complete marine power plant, the Boeing Turbo-Mariner comes equipped with reduction gearing, clutch and reverse shift, push-button starter, instruments, and a simple one-knob control. The engine itself weighs only 335 pounds. Reduction gearing and accessories add the additional 290 pounds.

How about vibration? With no pistons pounding, turbine power is smooth and vibrationless. Except for a whirring purr you might think you are aboard a sailboat. Compare the ever present vibration aboard a propeller-driven airliner to the smooth flight of a 707 jetliner. You feel the same



PROPOSED TURBINE-POWERED hydrofoil cruiser, with turbine mounted in bow, will top 45 miles an hour

COMPACT TURBINE mounts flush under deck of 26-foot test boat shown at left. It's only two feet high

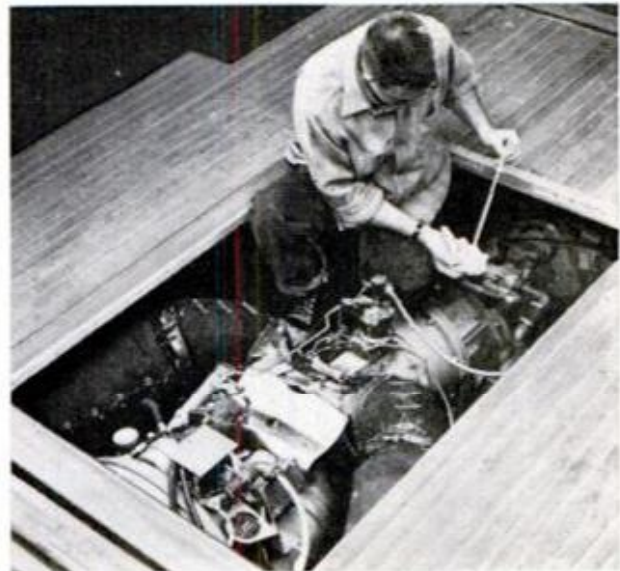

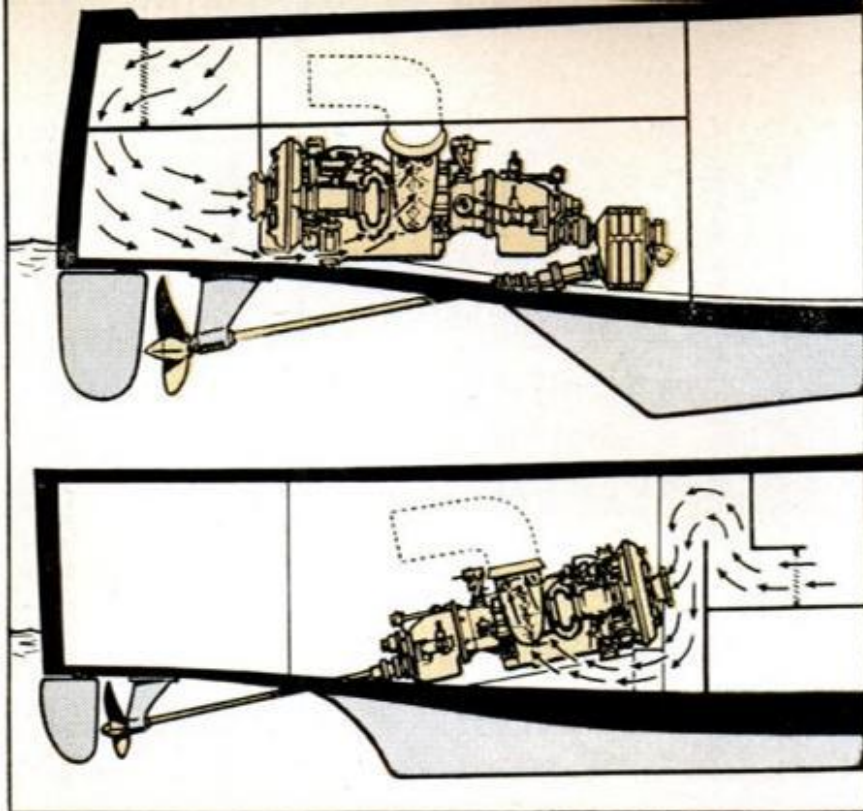

TWO TYPICAL INSTALLATIONS.
Top, V-drive to keep engine aft;
bottom, conventional mounting.
Arrows show intake air flow;
dotted lines show exhaust ducts

smooth power in the turbine-powered boat without any hull-thumping vibration.

Nor is the Turbo-Mariner's light weight and smooth power a sign of weakness. From a forward speed of 15 m.p.h. the 26-foot cabin cruiser can crash-stop in half its length by throwing the power plant into full reverse. Do the same thing at the 33-m.p.h. top speed and the cruiser stops in two lengths. During shake-out tests the Turbo-Mariner was cycled from full speed ahead to full reverse 200 times in quick succession. When the boat reached full speed in reverse, the engine and gearing were jammed forward again to full speed ahead. After this series of rugged reversing cycles, the turbine power package, protected by the engine's built-in torque-converter and free-floating turbine wheel design, showed no strain.

Like most turbines the Turbo-Mariner can thrive on a varied diet. Normal fuels are automotive or Navy diesel oil and ordinary home heating diesel-grade oil. By

making an adjustment to the governor and a change of fuel nozzles, the engine can burn white gasoline, kerosene, alcohol, or JP series jet fuels. In emergencies when nothing else is available, the turbine can operate up to five hours on automotive or aviation gasolines of any kind. Octane rating means nothing to the turbine.

Everyone knows a turbine is supposed to gulp fuel like a skid-row bum guzzles wine. For many early turbines this was true. Even today a gas turbine uses more fuel per hour—but you get farther in that hour if the gas turbine is in a boat. And the turbine fuel costs less. Let's get back to the 26-foot cruiser again. Operating at full speed (18 m.p.h.) during test runs, the piston engine burned about 18 gallons of gasoline per hour. At cruise (28 m.p.h., 5 m.p.h. below top speed), the turbine burned about 28 gallons of diesel oil per hour. The two power plants burned one gallon of fuel per mile. The difference in speed was

(Continued to page 242)

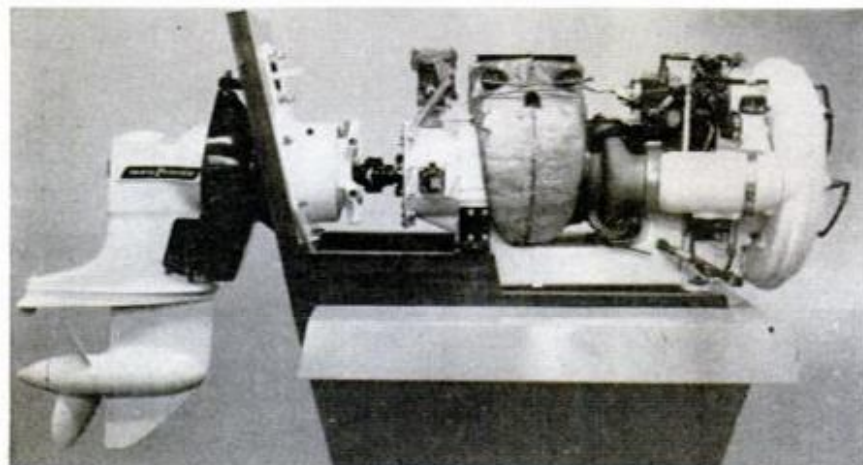

EXPERIMENTAL installation of turbine with MerCruiser stern drive unit would give turbine's high performance with flexibility and maneuverability of a conventional outboard engine



Helicopter Training on a Leash

Designed for self-training, a one-man helicopter makes all the usual maneuvers without ever rising more than a few feet. It can go up, down, tilt, change direction.

The Whirlymite, built by Del Mar Engineering Laboratories of Los Angeles, Calif., is mounted on a large flexible arm connected to a free-moving air-cushion platform.

Artificial Lake for Radioactive Water

More than 1,000,000 gallons of radioactive water from Canada's Chalk River atomic research center can be stored in an artificial lake which is lined with polythene.

The lake normally will be empty; it will store water that becomes contaminated

from circulating, as a coolant, around uranium fuel rods in a nuclear reactor to keep them from melting.

The lake measures 180 by 175 feet and is 18 feet deep in the center. A concrete lining would absorb radiation.



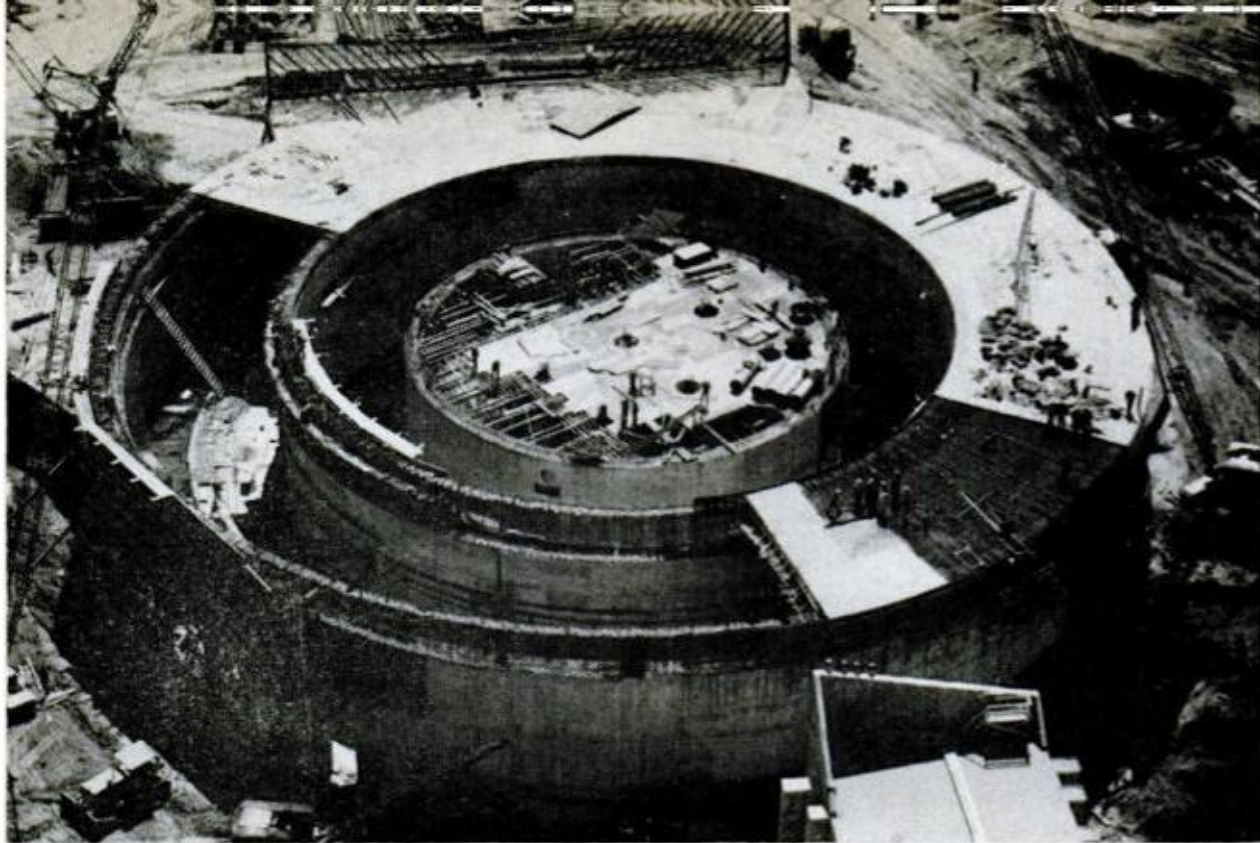

Doughnut Will Drive Protons to Pieces

Coiling around a field at Argonne National Laboratory, Lemont, Ill., is a doughnut-shaped building which will house a Zero Gradient Proton Synchrotron, a machine that shoots protons, small nuclear particles, with such energy—12½ billion

electron volts—that when they collide with protons at rest they will produce little-known pieces of matter (mesons, hyperons, antiprotons and antineutrons). The speeding protons will be kept on course by eight 600-ton magnets.

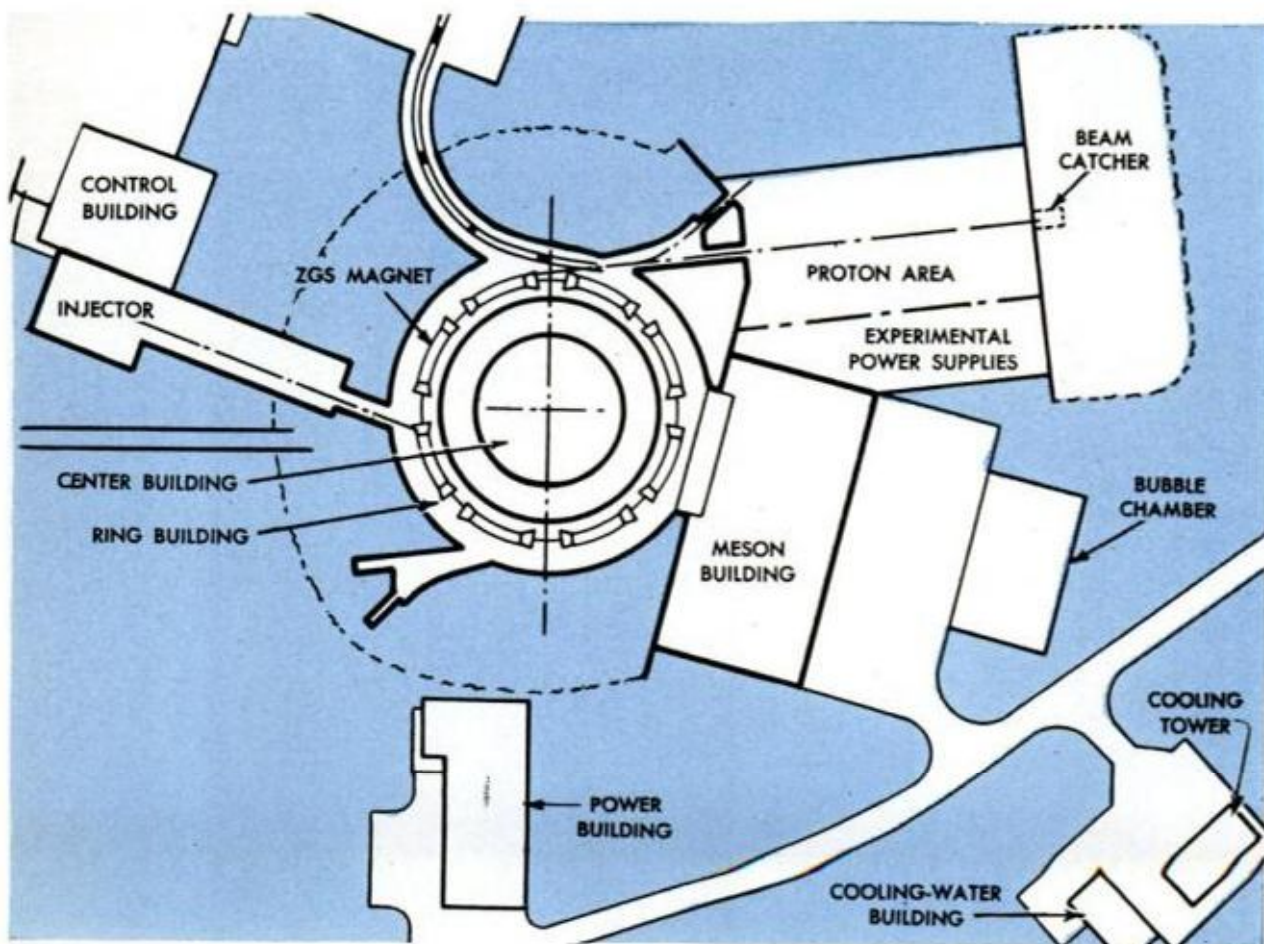

Igor Sikorsky, born in Russia in 1889, was designing and building flying machines before he was out of his teens. Since coming to the U.S. in 1919, he has developed transoceanic air clippers, helicopters, and organized an aircraft company for which he is still a consultant



My Most Exciting Moment

FROM THE EARLIEST DAYS of my aviation activities I had two long-range ambitions. One was to create a successful helicopter. The other was to design a large airplane with an enclosed cabin and several engines. Both ideas were considered impossible in the early days of aviation.

In September, 1912, I succeeded in persuading the management of the Russian Baltic Co., to authorize the construction of a large four-engined airplane. The ship was designed and constructed in spite of numerous difficulties, but it was generally predicted that it would never fly. I had confidence in it but I still waited with great interest for the tests of the new aircraft of which I was the designer and planned to be the test pilot.

The intensely interesting moment came when, on May 13, 1913, I had the *Grand*, as it was called, wheeled out and, for the first time, made an attempt to take off. I was sitting in the enclosed cabin fairly high above the ground. With no wind in my face I had the impression that the ship was accelerating very slowly yet the fact that the ailerons and elevators became active indicated that the ship was gaining speed. Finally all the shocks under the wheels ceased and I saw the Earth gradually moving away. The ship was airborne. It was flying!

The sensations of flight in a closed cabin with no wind and the beautiful view from the windows were novel and exceedingly pleasant. For a few moments there was an exciting and happy feeling of success, of the vindication of all the hard work, great expense and the confidence that had been placed in me. Then I had to focus my attention on becoming quickly familiarized with the responses to the aircraft controls which included several completely novel features such as its great size, its unprecedented heavy weight, the enclosed cabin, and the influences of four engines in line on the wing instead of one in the center.

In subsequent flights I was able to remain aloft up to one hour and 50 minutes and to establish several world records. The aircraft proved capable of flying under good control with any one of its four engines out of commission. The enclosed cabin offered greater comforts to the passengers and greater conveniences for the pilot and the navigator with his charts.

This confirmed in full our hopes and expectations for the success of this first four-engined airplane, which became the forerunner of the large transcontinental airliners that form the backbone of rapid transportation all over the globe.

A handwritten signature in cursive script, likely reading 'Igor Sikorsky'.

Guns for the Blue and Gray

—from modern Italy

Young American goes to Europe to build replicas of guns used during Civil War

By A. Delman

WHEN 30-YEAR-OLD Val Forgett of Ridgefield, N.J., decided to cash in on the current interest in Civil War firearms, he triggered an unusual success story. Today he is probably the world's only large-scale manufacturer of replicas of Civil War guns. All of the guns fire.

Among those made by his Navy Arms Co. are the .36-caliber 1851 Navy Colt and its two Confederate imitations; the Leech & Rigdon and Griswold & Grier .36-caliber percussion pistols; the

VAL FORGETT, who created firm that reproduces Civil War guns, examines one of its products, a Navy Colt



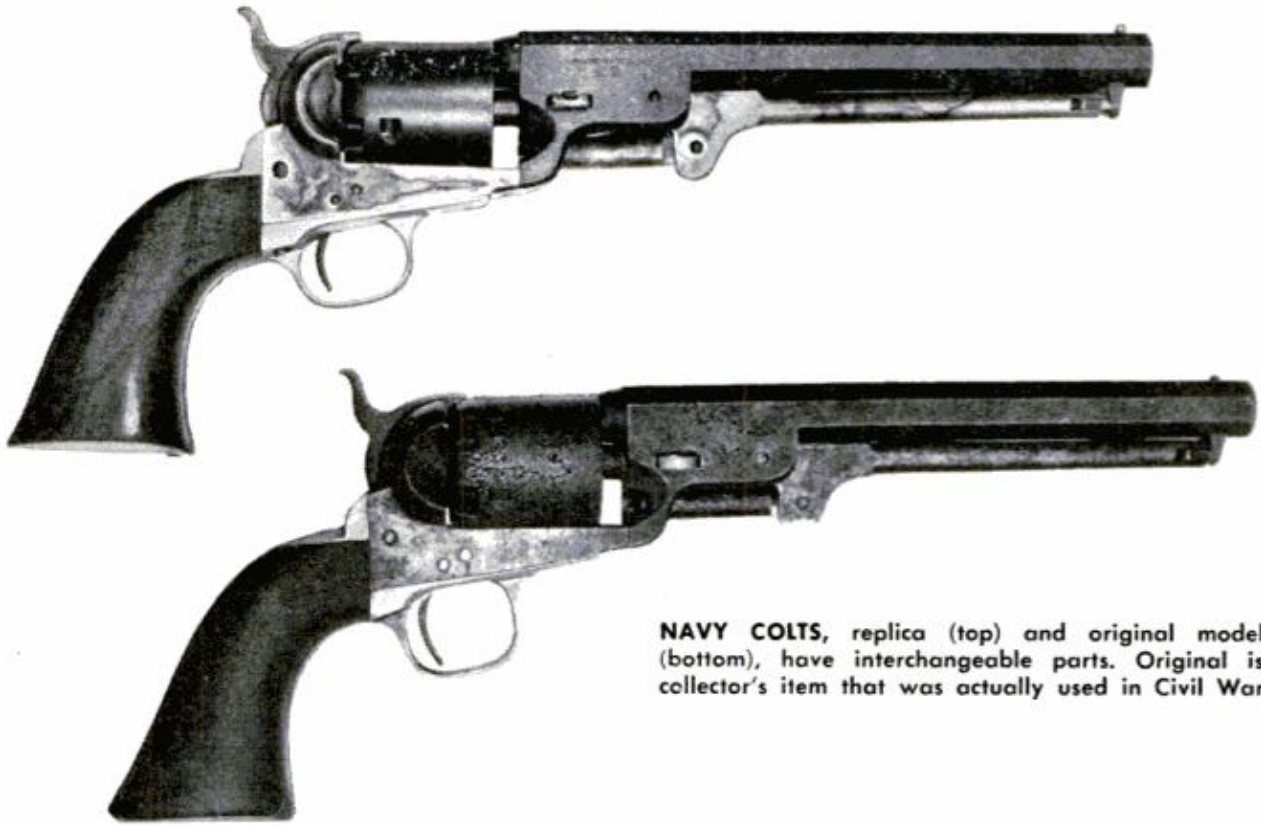

NAVY COLTS, replica (top) and original model (bottom), have interchangeable parts. Original is collector's item that was actually used in Civil War

.44-caliber Remington Army revolver; the .36-caliber Remington new-model belt revolver; the .36-caliber Sheriff's model Yank and Reb revolvers; the .58 Remington single-shot carbine; and the .44 Remington six-shot revolving carbine.

All the revolvers list at \$89.95 and the rifles at \$125.

Because these historic powder-burning muzzle-loading firearms demand greater shooting skill than the modern automatic, marksman find a more exciting challenge.

"Every gun shoots a little differently," Forgett says, "and each man has to learn his own gun."

Adding to the fun is the fact that these guns don't use standard ammunition. You buy percussion caps and cast your own lead ball. It's kind of do-it-yourself firearm.

A pleasure of another kind is that ammunition costs are only about one-fifth of that for contemporary handguns.

Forgett hit upon the idea of reproducing Civil War shooting irons because, as an avid gun collector and Civil War buff, he was keenly interested in these weapons and enjoyed shooting them himself. Sportsmen who shared his enthusiasm, he reasoned, would also get a charge out of this new adventure.

In addition, the coming Civil War centennial in 1961 made it a matter of timeliness to revive the guns which had helped decide the conflict.

Forgett chose the first model he reproduced on the basis of its popularity.

"The 1851 Navy Colt was one of the most widely used guns Colt ever made," he says. "It was the unofficial sidearm of the U. S. Navy and was also used by many Union Army officers during the Civil War.

Another advantage was one of economy.

With the same machinery which turned out the Colt, he could also produce the two other guns, since except for the shape of the barrel they were exact Confederate counterparts of the prized Navy pistol.

Forgett's reproductions are so close to the original models that the parts are interchangeable. He does not, however, give his guns a dull, "antique" finish.

"We're making reproductions," he says, "not fakes."

These military guns are accurate up to twenty-five yards and are as free of safety and jamming problems as the modern pistol.

They are not, however, useful for hunting because it takes too long to load them.

As the first step in his manufacturing venture, he trekked up to Colt's Patent Fire Arms Manufacturing Co. in Hartford, Conn., and maneuvered his way through old Sam Colt's original designs for the Navy 1851. Forgett was almost defeated in advance at the sight of the numerous manufacturing problems involved, then made up his mind to take the risk and go ahead.

A major difficulty was to adapt modern manufacturing techniques to the production of old guns. The use of Colt's mid-19th-century methods would have cost a fortune.

Since Forgett is an engineer, one of his



YUGOSLAVIAN WALNUT is seasoned in special sunlit room for later use as stocks of 1863 Remington rifles

ingenious solutions was to design special tooling machinery which increased efficiency and reduced expense. In another move to sidestep profit-destroying domestic production costs, he went abroad and persuaded a reluctant Italian arms manufacturer to start low-priced construction of the guns in the little valley town of Gardone, near Brescia, Italy.

This manufacturer was one of a number of skeptics who predicted that while Forgett might sell a few of his out-of-date weapons, he would never top the 1000 mark.

However, in the first year he sold almost 5000 Civil War guns.

Orders have flown in from all over the world, including Libya, Australia and Sweden, as well as the United States.

The next gun he put on the market was the .58-caliber Remington 1863 which he describes as the most accurate muzzle-loading military rifle of all time. A stumbling block in its manufacture was the scarcity of top quality walnut long enough for the full stock.

Forgett and his agents scoured Europe, almost despairing of unearthing the wood, when they finally tracked it down to an unsuspected hiding place—Yugoslavia.

Current plans are to bring out a new reproduction every few months.

"It's a good idea to give the customer something new a couple of times a year," Forgett philosophizes. "This keeps him from getting tired of your product, and keeps the business going . . . ah . . . great guns." ★ ★ ★

FINAL INSPECTION of pistols is made by Forgett's Italian agent. Guns are then dipped in tub of grease (left) to prevent rust

RIFLE LOCK on .58-caliber Remington is carefully checked before installation



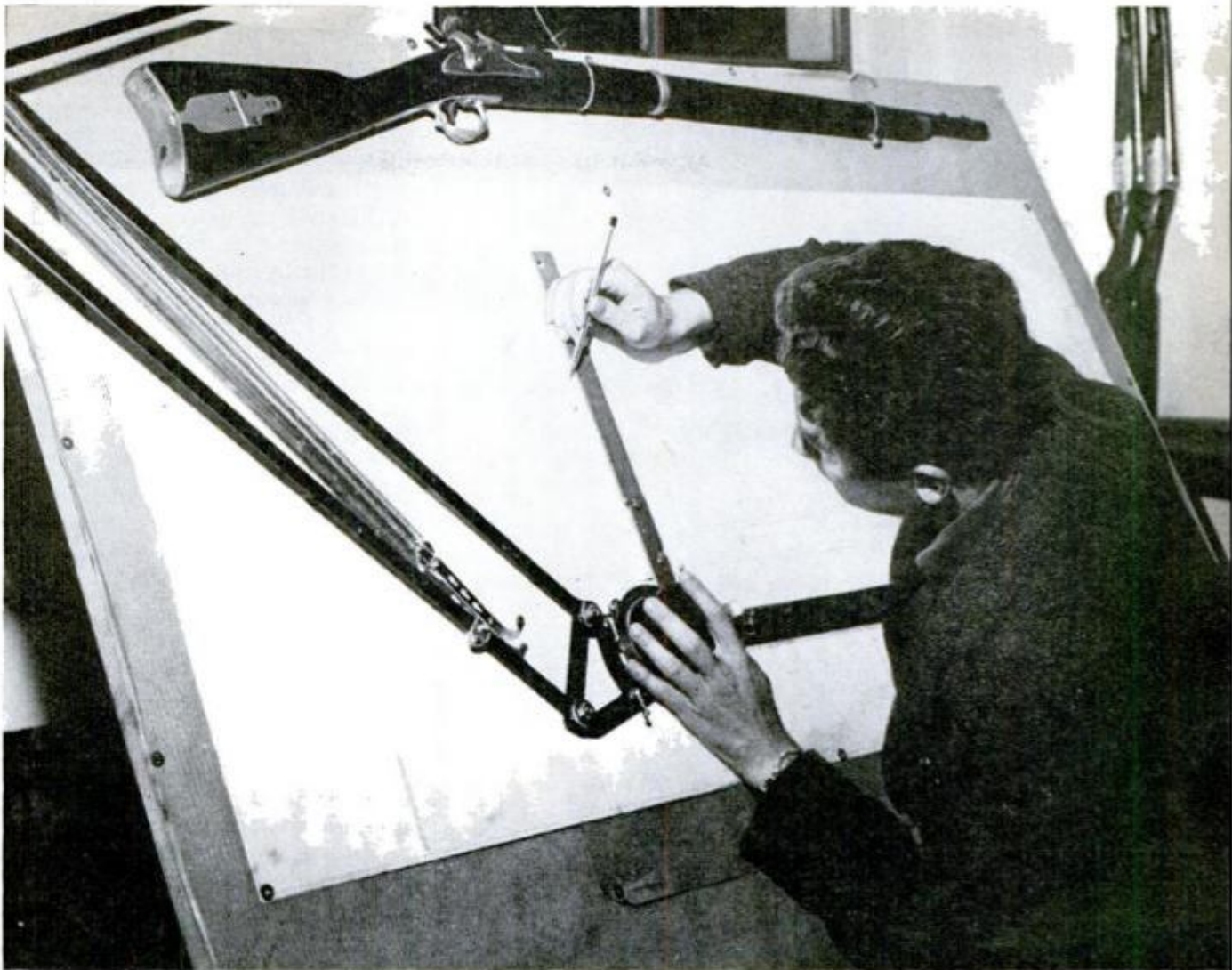

ITALIAN DRAFTSMAN draws the blueprint for a Remington replica, using an original 1863 rifle as his model

ITALIAN GUNSMITH files revolver frame. Forgett went to Europe to make replicas because of high labor costs in U.S.

ITALIAN MACHINIST straightens a rifle barrel after hole is drilled through center

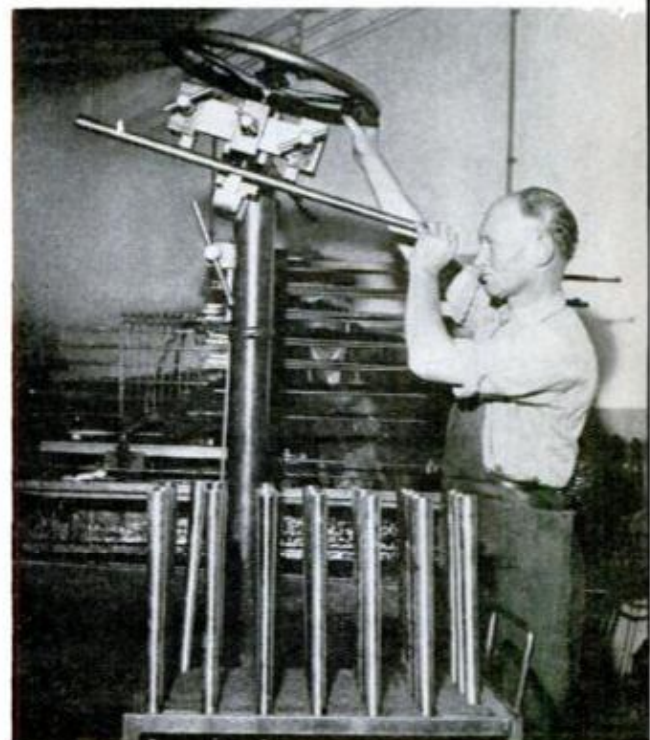



Kid-Sized Bulldozer

Junior-grade engineers now can get in all the practice they need for doing those big construction jobs.

A new pedal ride designed for children combines in one multi-control unit a bulldozer, a fork lift, a scoop, an earth mover and a front-loader cargo carrier.

Called the Lif-Tup, the toy ride has two controlling sticks which allow the pint-sized construction equipment operator to make quick turns and to engage in flashy zig-zag maneuvering.

The ride is made by the Universal Manufacturing Company, Inc., P. O. Box 5637, Bossier City, La.



Stretchers Float on Air

Demonstrating a new use for vehicles working on the ground-effect principle, British Royal Medical Corps personnel give two patients a bump-free ride on an air-cushion stretcher carrier. The vehicle, which works on the same principle as bigger ground-effect machines, balancing the load on a trapped "bubble" of air, is powered by two small industrial two-stroke engines operating fans at each end of the air chamber. A stretcher fits on each side of the engine compartment. It's made by Folland Aircraft.

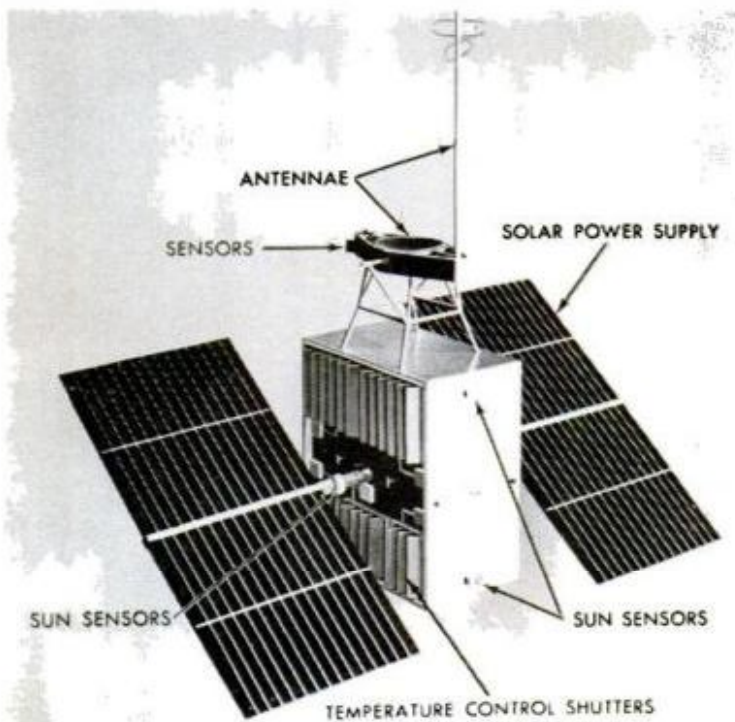

For Talk Around the World

To prove the feasibility of microwave satellite communications to beam signals around the world, the Army, Navy and Air Force have teamed to develop a relay system called Advent. It will require three satellites which will orbit Earth at 22,300 miles above the equator at a speed of 7000 miles per hour so that each satellite would stay in the same spot in relation to Earth.

High-speed radio teletype and voice broadcasts beamed to a satellite will be received, amplified and relayed to Earth.

The satellites each will consist of a vehicle body, two solar cell paddles and Earth-oriented antennas. Solar energy will be converted into electrical energy by photovoltaic cells.

By
Max Hunn

Wild Animals Pose Here



NATURAL SHOTS of wildlife are made by putting animals inside small corral and photographers outside fence

IN A WILD, rugged area in southwest Florida, photographers get natural, wild-animal pictures without blinds, stalking or creating fake backgrounds.

It's a unique photo corral developed by the Florida Game and Fresh Water Fish Commission, whose photographers produce pictures in authentic settings with a minimum of problems. East of Punta Gorda, three-and-a-half acres of typical Florida scrub palmetto, pines and underbrush have been enclosed with an eight-foot, hog-wire fence (the bottom foot underground), equipped with eight photographers' platforms and special releasing chutes, and converted into an unusual photographic set.

Each platform is four feet above the ground, outside the fence, and positioned so that no other photographer accidentally gets into the background. From the photo

corral have come a series of wildlife pictures — both stills and movies — which are being used in TV shorts, educational movies, publicity releases, and educational pamphlets by the commission.

To date, deer, bears, panthers, wildcats and alligators have been photographed. Completely wild animals would panic if trapped and placed in a corral. The solution was to borrow wild animals who were accustomed to cages. Such animals, while not domesticated, lose their fear of man, and learn not to injure themselves in their enclosures.

Fortunately, a source of such wild models is nearby at Bonita Springs, where the Piper brothers — Bill and Lester, famous wild-animal handlers — operate their Everglades Wonder Gardens, featuring every type of Florida wildlife. All the animal

Mama Bear Gets Careful Treatment . . .



actors are furnished by the Piper brothers.

Setting up for a photographic session has all the earmarks of a Hollywood production. The fence is carefully camouflaged with freshly cut, green palmetto fronds. No human tracks are made which might accidentally appear in the pictures. The underbrush is carefully trimmed permitting a clear camera view, yet not changing the wild appearance. Then the animals are brought to the corral in special cages and released into the photo area via special chutes.

Through experience, the camera crew has learned that the animals can be maneuvered into position by preparing special trails. Deer love tobacco and eagerly follow

a trail of cigarettes. While shooting a beehive sequence, a trail of cookies entices a bear on stage.

Probably the most disappointing actor was a female bear who refused to tear honey-laden bee hives apart. The stage was set, the honey-filled hives in place, and the bear coaxed on stage with cookies. Then the script went sour. As she opened the first hive, a bee stung her on the nose, and Mrs. Bruin abruptly departed and no amount of persuasion could coax her back.

During a shooting session (which usually lasts several days), every type of equipment is used, ranging from 35-mm. to 4 x 5-inch still cameras, and 16-mm. movie cameras. Both black-and-white and color film

Baby Bears Are More Congenial



are used, although the movies are predominantly shot in color.

Most of the photography is done in late spring and early fall when the vegetation is best. Also, the cooler weather is easier on the animals—and the mosquitos aren't as bad on the cameramen.

Getting animals into the corral is relatively simple, but retrieving them isn't. Panthers have to be roped by men on horseback. Deer usually can be led back to their cages with tobacco, except for the frisky ones. Several times it has been necessary for men on foot to tackle them, and don't think an adult deer is an armful of fluff. In the case of a seven-foot 'gator, it was necessary to rope and drag him from the spe-

cially made water hole. Bears can be equally difficult and usually are recaptured by trapping in huge drums. Wildcats are netted on foot.

Has the project paid off? Yes, the commission says.

"The first camera project repaid the cost of building the corral," declares Robert Dahne, chief of information-and-education for the commission. "We'd have to keep our cameramen in the woods for a year to duplicate the results we get in one hour in the photo corral."

P.S. The cameramen would rather work the corral, too. It has simplified many of their problems in wildlife photography.

And it's safer.

★ ★ ★



Bus-Boat Cruises Florida Waterways

Take one 36-foot surplus landing craft and one 30-foot passenger bus, saw off the bus below the window line, weld the two together, and you have a comfortable, seaworthy cruiser for something less than the

traditional thousand-dollar-a-foot cost. William O'Brien, of Miami, Fla., powers his craft with a 150-horsepower truck engine, gets 10 knots and a 300-mile range. He reports that "she handles like a baby carriage."

Champagne From Mink Slipper

Made of pink mink and gold snakeskin, this slipper has a champagne container in its heel with a small tap from which the champagne can be poured.

The slipper is made by L. & W. Theckston, Ltd., of England, and was displayed at a recent slipper fair in Blackpool.



Strip "Whites Out" Typing Errors

Typing mistakes can be undone easily by "whiting out" with a new treated paper slip. You place the strip over the mistake, repeat the error, and it disappears; the paper works like carbon paper but prints in white. It's made by Perry-Sherwood Corp., 255 Park Ave. South, New York 10.

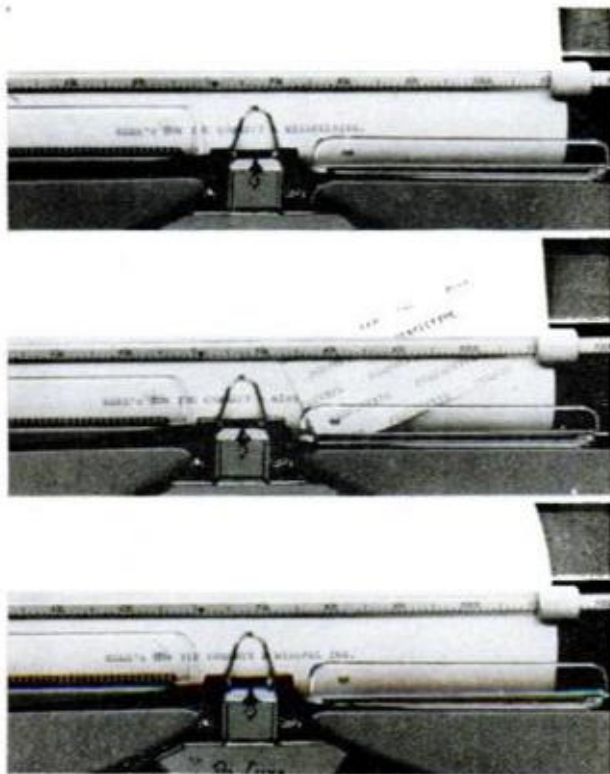

Samples Wheat 80 Feet Deep

Using a pointed nozzle with special slots and six-foot sections of a tube within a tube, a pneumatic wheat probe can suck up samples of stored grain from as deep as 80 feet or more.

The samples enter the slots in the nozzle and are air-lifted through the inner tube to a separator where they are held for inspection. Nozzles are available for either coarse or fine grain.

The unit is produced in two models, one for probes up to 30 feet and one for deeper probes.



"Pacemaker" Trains Runners

Like a greyhound chasing his mechanical rabbit, Japanese track star Saburo Yokomizo is paced in a workout by a remote-controlled pacemaker in Tokyo's National Stadium. Running just ahead of the runner on a track built parallel to the cinder track, the device helps perfect the exact lap timing required in modern track competition. In addition, it carries a radio "walkie-talkie" system that gives constant communication between runner and coach all the way around the track. The \$41,700 training aid will help train Japanese runners for the 1964 Olympics, scheduled to be held in Tokyo.



Cross-Spring Pivot for Space

Called "frictionless" by the manufacturer, a new flexural pivot bearing is intended to replace ball-bearing assemblies and jewels in similar installations requiring a rotational movement of 60 degrees or less. The bearing, which is an improvement of previous cross-spring flexures, has flat steel springs forming a web between two separated sections of a tubular bearing. It is the flexing of the cross springs that allows movement, but without rubbing of one part against another. The device, made by the Bendix Corp., is expected to have many applications in space, since it is not affected by radiation, high temperatures or vacuum, needs no lubrication, and has a long service life.



WHAT'S NEW FOR Your Home



ALUMINUM DRAPERIES consist of four-inch-wide S-shaped sections that interlock for complete light control. A cord-and-pulley system open and close draperies. Price varies with size. Made by Louver Products Company, 6611 Salt Lake Av., Bell, Calif.

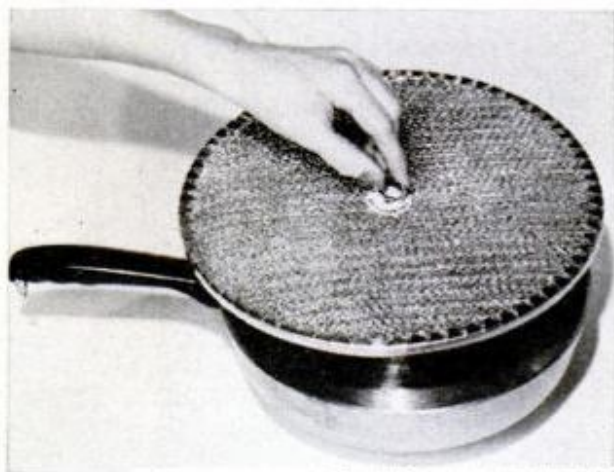

FRY-PAN FILTER keeps grease from spattering without making pan airtight. Steam escapes and foods are fried normally. Filter can be washed with dishes. Retail at \$1.19 for large size (11½-inch diameter). Made by Research Products Corporation, Madison, Wis.

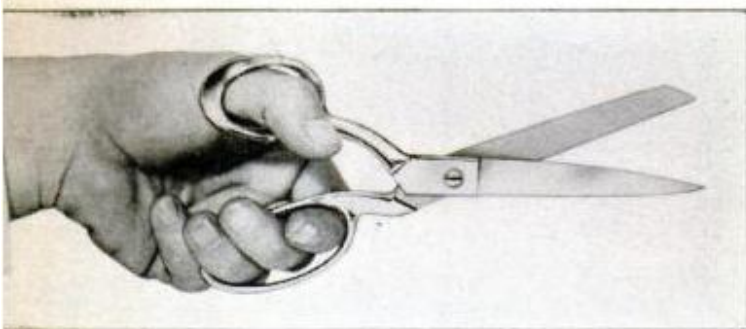

LEFT-HANDED TRIMMER designed for lefties who have trouble using right-handed tools, has been added to line of left-handed scissors made by Acme Shear Co. of Bridgeport, Conn. The eight-inch trimmer (\$3.50) can be used in home, school or factory

BABY CONVERTIBLE can be used as playpen, dressing table, bassinet or bed. It has telescoping legs, adjustable floor, roller wheels for moving from room to room and "wetproof" mattress. Also collapses for easy storage. Spring buttons and matching holes control length of legs. Bed bottom can be moved up to bassinet or dressing-table height by inserting wire hook at each corner into matching hole. Nylon net is washable. Frame is steel, and floor and shelf are hardboard. It is sold (\$33) by Tigrett Industries of Jackson, Tenn.





NESTLE NURSER, which holds baby bottle in place, can be hung around mother's neck, leaving her free to telephone, read, cook, etc., or can be hung from crib, play pen or car bed. Plastic, it is sold (\$1.98) by Underwood Products, Grand Prairie, Tex.



ELECTRIC RANGE with built-in look features two independent ovens at shoulder level, four cooking units on counter, each with variable speed control, and large cabinet underneath. Made by Thermador Electrical Manufacturing Co., Los Angeles, Calif.

TOOTHBRUSH IDENTIFICATIONS can be made with name plates that are attached to end of brush with three hooks. Price (75 cents each, four for \$2.95) includes name engraved in block letters in gold tone or silver. From K & F Distributors, Yonkers, N.Y.

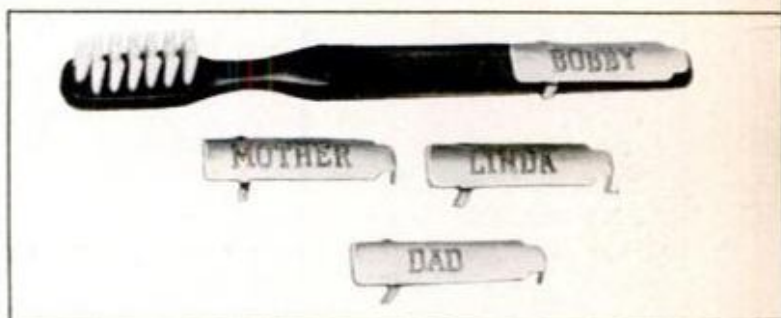

INSTANT SALAD, tossed thoroughly but neatly, is possible with special covered bowl that includes double twirler. Top and bottom of bowl interlock. Holds enough salad for six servings. Retail at \$2.98. Maker is Daco Products, White Plains, N.Y.



FERTILIZER STICKS, available in four balanced formulas for different trees or shrubs, can be inserted into ground for plant feeding. Ingredients are absorbed by roots. Gard-N-Sticks (12 sticks for 98 cents) and made by Gansco Products, Toronto, Ont.





DR. DONALDSON with "super salmon." Finger points to clipped adipose fin, breed's identifying mark



HOME TO SPAWN after three years of fattening in the ocean, salmon heads up Portage Bay fish ladder

They're Farming Super Salmon

By
Chris
Edwards

The Northwest's newest "crop" is one of its oldest products—salmon. A new method promises to double or triple the take, and might pay \$30,000 per acre of "farm" per year . . .

THE BEST ANSWER so far to the old problem of declining salmon runs is "fish farming"—a method that brings returns thirty times greater than the natural rate of one tenth of one percent survival from eggs to adult fish. Aiming at restoring, or even improving, the salmon runs in the Northwest, the state of Washington is expanding the number and size of fish farms in the state. At the same time Dr. Lauren Donaldson, at the University of Washington, has developed a breed of "super salmon," tailor-made for fish farmers through years of selective breeding.



REMOVING EGGS from spawning female. Since they die after spawning, they are killed before stripping

This fall (1961), about 5000 Chinooks will thread their way up Seattle's boat-busy ship canal, through the government locks into Lake Union's fresh water, onward into Portage Bay, and then make a sharp left turn directly toward the University's fish ladder. The incredible homing instinct of the salmon enables full-grown adults to find the exact spot where they were born after three or four years at sea. How a salmon can hit a target as small as a four-foot fish ladder after a period of several years and thousands of miles of swimming is still a baffling mystery, but a convenient phenomenon for fish farmers.

From the 5000 Chinooks Dr. Donaldson expects to harvest 12 million eggs. Out of these he will keep two million for continuing his project of further developing his "super salmon." Ten million of the eggs will be released to Washington's fish farms.

Operated scientifically, fresh water ponds

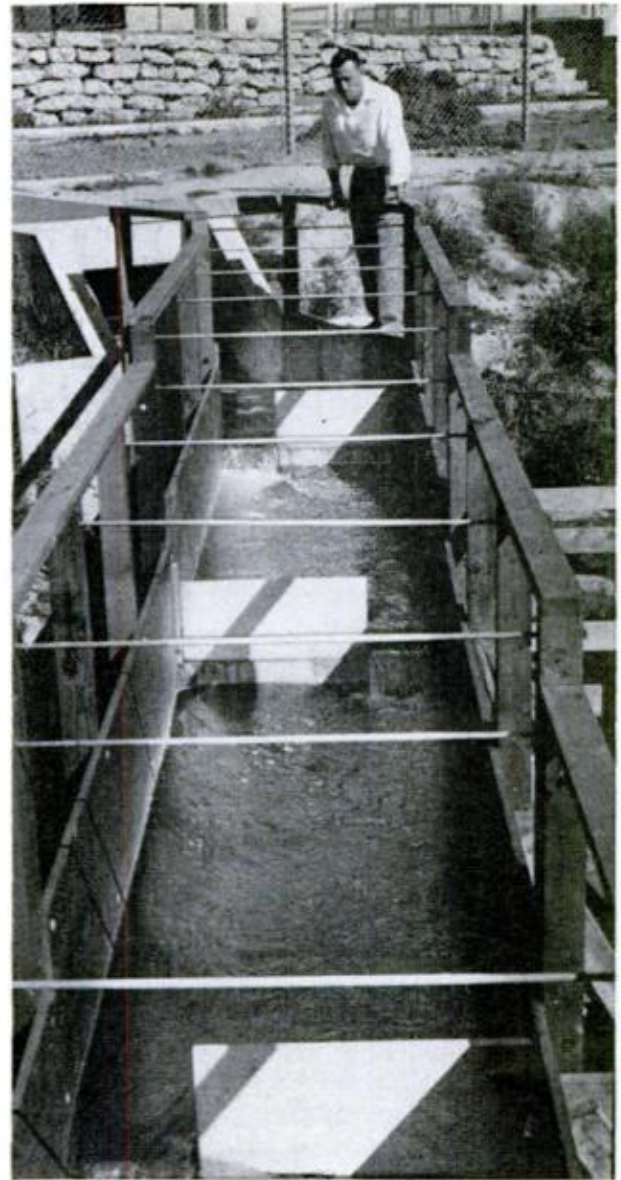

FOLLOWING their unerring homing instinct, salmon return up ladder to ponds where they were raised

can be stocked with 100,000 salmon fry per surface acre. During the time the tiny fish grow to fingerling size, that is about 3 to 6 inches long, about 40 percent of the fry will be lost. This means that out of the original 10 million eggs hatched and planted, six million salmon fingerlings will be released to find their way into the ocean. About 10 percent of the fingerlings released will survive in the ocean and return as adults.

Still, from six million fingerlings, 600,000 salmon will return for harvest by sport and commercial fishermen. Figuring each of the mature salmon at \$10 apiece for 15 to 30 pounds of fish, the salmon produced from 200 acres of farm ponds would be worth \$6,000,000 to fishermen. That's \$30,000 worth of fish for each acre of fish farm ponds if used only once. When in full production, the ponds will yield three crops per year. The figure of 600,000 fish is important because that is about double the number of

Chinook caught from the salmon produced by the whole Columbia River stream system.

Dr. Donaldson's salmon are not ordinary fish. They are the product of intensive selective breeding over a 12-year period. They are rightly termed "super salmon." Compared to a normal, wild Chinook salmon, Dr. Donaldson's salmon return in a three-year cycle rather than four. Yet they are, on the average, heavier than the four-year fish because they were selected for rapid growth. The super salmon also produce up to twice as many eggs per female compared to wild or stream-run salmon. Other factors considered in selection are: A high survival rate, resistance to harsh environments, such as higher than normal water temperatures or water polluted from industries, and higher commercial food value both in appearance and nutrition.

Eggs are kept in covered pans with fresh water flowing over them constantly until they hatch, about 60 days later. The tiny fry are fed 30 to 40 times a day at first. In the ponds the salmon grow to fingerling size in about three months. At the University of Washington, fingerlings released to Portage Bay down the fish ladder weigh about 100 to the pound. To be able to identify them later, one or more of their fins are clipped. While losing a fin for later identification might appear to handicap a fish in surviving the rigors of life in the ocean, studies show no apparent loss.

Survival of salmon at Dr. Donaldson's laboratory has averaged 3.3 percent from eggs collected to adult fish returning up the ladder. This compares with one tenth of one percent for wild salmon. In addition, records of catches of clipped-fin fish by

sport and commercial fishermen indicate 5.6 fish were caught in Washington waters for each fish returning up the ladder.

Ordinarily a female salmon spawning in the headwaters of a stream will lay an average of about 4000 eggs. From these 4000 eggs only 40 fingerlings will survive long enough to enter salt water. That's a 99 percent mortality before the salmon ever get out of fresh water. In the ocean and up to the time the adult salmon begin their return swim, 90 percent of the remaining salmon will have been eaten by seals or some other predators in the ocean. Out of the original 4000 eggs, only four salmon are left. That's "two for fishermen and two for the creek," as Dr. Donaldson puts it. The remaining pair can then start the cycle over again by laying and fertilizing 4000 eggs. When this percentage is disturbed, the fish population declines or increases. During the past several decades, salmon have been averaging fewer each year.

Since the greatest mortality rate occurs in fresh water, raising the fry in ponds greatly increases return of mature salmon. Instead of getting only four mature salmon back from an original hatch of 4000 eggs, more than 100 and possibly as many as 150 can be expected to return from fish farms.

"By cutting the loss of small salmon and keeping them in fish ponds until they are able to take care of themselves," Dr. Donaldson states, "we can build back the salmon runs—not only to their former heights but double or even triple those numbers. When this happens, fishermen can look forward to catching more of the fighting salmon. And there will be more salmon—canned, frozen, smoked, kippered, and fresh—for everyone." ★ ★ ★

RAISED IN TANKS, salmon "fry" are moved into tanks of increasing size. Right, careful fin clipping marks farm salmon for ready identification when they return. Loss of fin doesn't seem to bother them





PICKING SALMON for further breeding, University of Washington students harvest part of "crop." Spawning returnees, below right, gather in pens. Collected eggs, below left, are "checked in" at the salmon hatchery

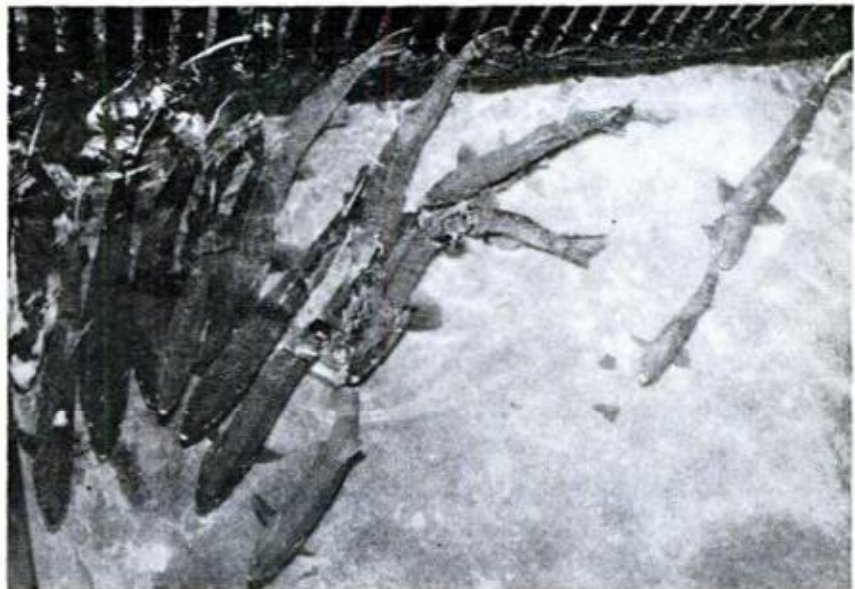



Instant Bicycle Folds Up for Easy Storage

It takes about 30 seconds to fold or unfold a bicycle that can be ridden in the conventional manner, then stored in a trailer, boat, tent, apartment, airplane or car trunk—or even carried on a bus or train. It's an answer, too, for those who don't have space for storage of a conventional bicycle.

The seat and handle bars can be adjusted to fit tall or short riders, and can "grow"

with children while they are growing up.

For storage, the seat comes down, the pedals fold up and the handle bars twist over the front wheel. Then the frame is unfolded back until the front and rear wheels are aligned.

Porta-Cycle is sold only by direct mail at \$69.50 by wico, P. O. Box 58405 PR, Los Angeles 58, Calif.



Lots of Muscle

Capable of spectacular lifts, a new cargo loader has a rated lifting capacity of 70,000 pounds. Its manufacturer claims it is the largest vehicle of its kind.

Its fork carriage can be rotated 12 degrees back and 90 degrees down from vertical. The lift height with forks level is 17 feet, 2 inches. The forward reach is 6 feet, 2 inches. When parked, the vehicle is 12 feet, 2 inches tall.

The first commercial version of the Super 70 is in service at Seward, Alaska, loading and unloading cargo from ships to storage and from storage to flat cars and trucks. Military versions are in use in Antarctica.

It is manufactured by Transitier Truck Co. of Portland, Ore.

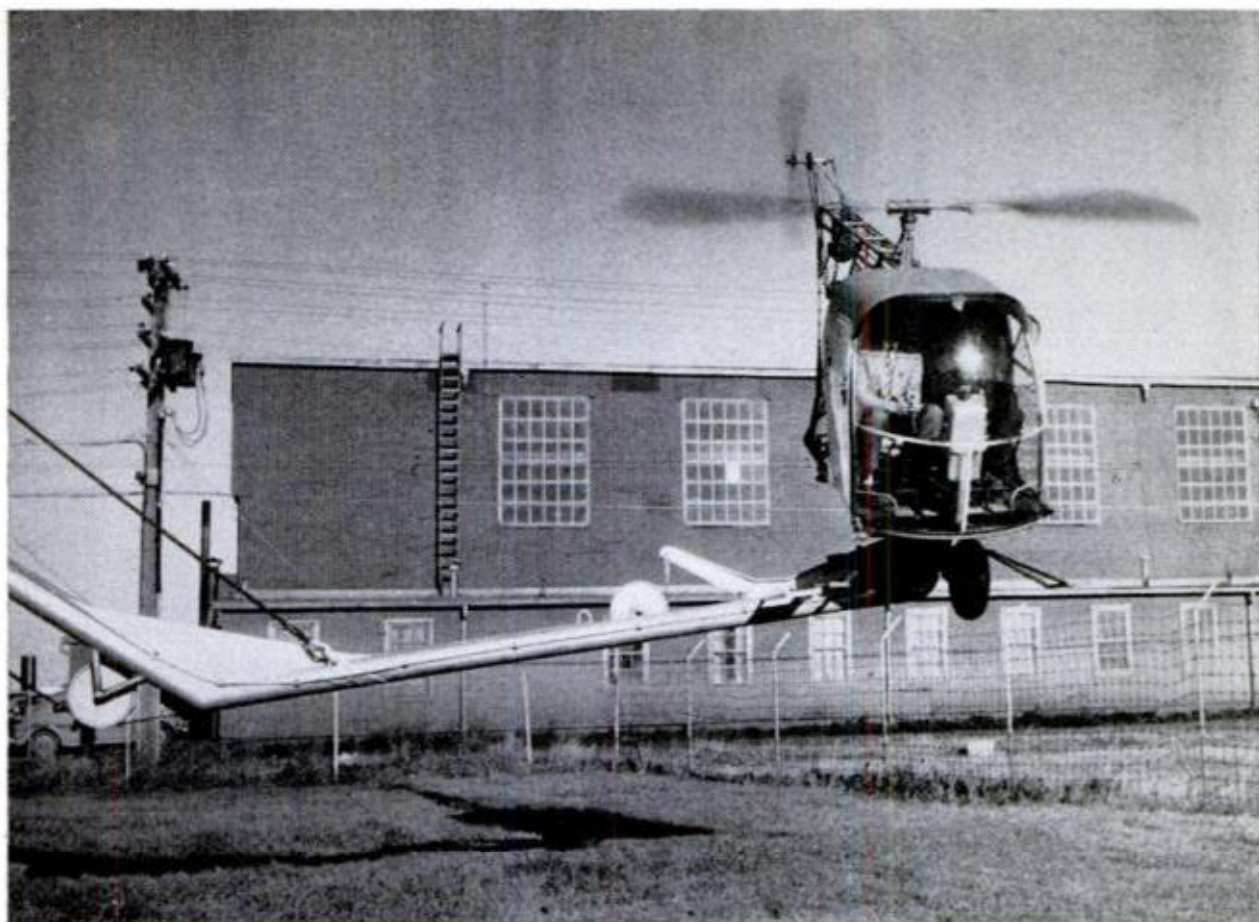

Like the Real Thing

Powered by electricity, a training device simulates the flight characteristics of a helicopter with realism and safety.

The fuselage is mounted on one end of a long arm and counterweights on the other end balance it during maneuvers. The cockpit has dual controls for instructor and student. The Jaycopter can reach a maximum height (right) of 76 feet.

Plastic Antenna for TV or FM

Made from flexible Koroseal, with a silver circuit printed on it to conduct the signals, a new indoor antenna for FM radio or television has been introduced by RF Industries of Summit, N. J.

The antenna is intended to be installed out of sight, behind draperies, on the back of furniture or even under the rug.

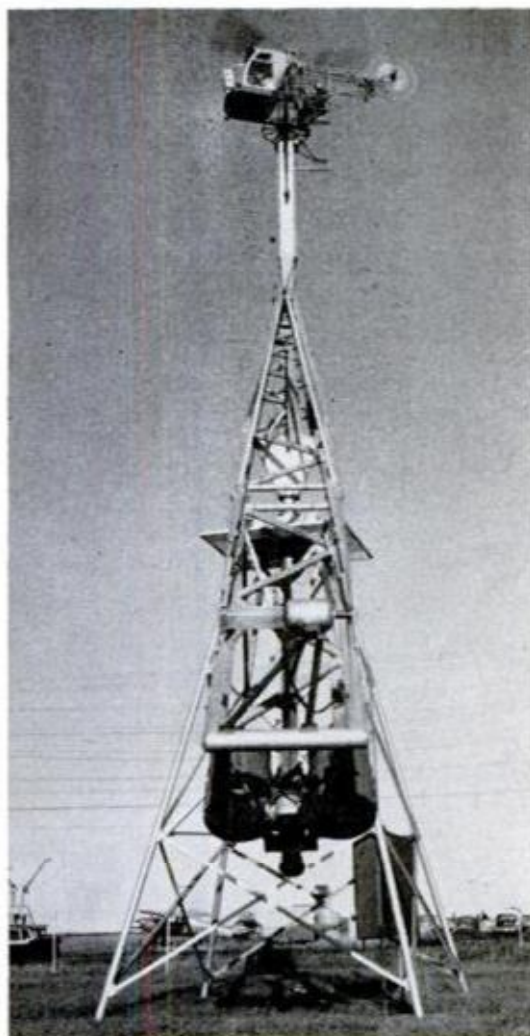



Merry Christmas

Dear Crafters:

Christmas comes but once a year and am I glad! Seems like the mad rush gets worse each year what with all the department stores to visit and letters to answer. Frankly, I could use some help and if you think you can make a few of the gifts and decorations suggested on the following 27 pages, I'd have no trouble in making it on the 25th, I'm sure.

Santa Claus

NATIVITY IN PAPER

THIS STYLIZED nativity group will make a handsome conversation piece for your mantel or table. Constructed entirely of paper, it can be stored easily and will give many years of enjoyment.

You'll need a number of different papers. The body cones are made from a light, flexible posterboard. For the heads, oak tagboard is used because its creamy color comes close to flesh tones. Fancy wrapping



VIRGIN'S HEAD is attached by putting a few drops of glue around the bottom edge and fitting it on the body

ARMS OF VIRGIN, though already curled, can be further shaped by drawing them between the thumb and forefinger until the desired curved shape is obtained

HANDS ARE GLUED together and the cape is attached to the shoulders. Be sure that the bottom edge of cape hangs away from body

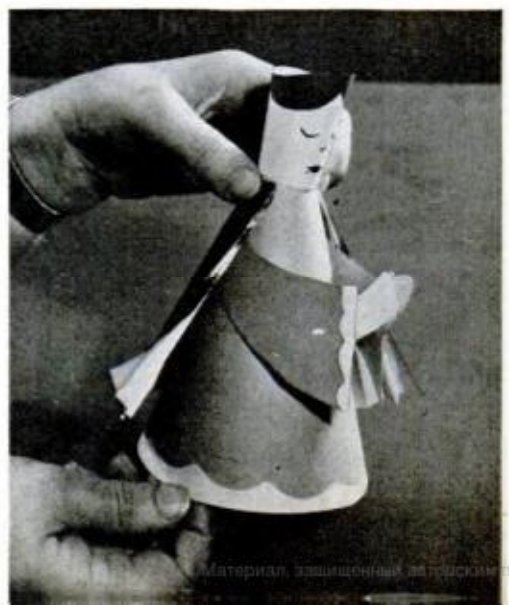
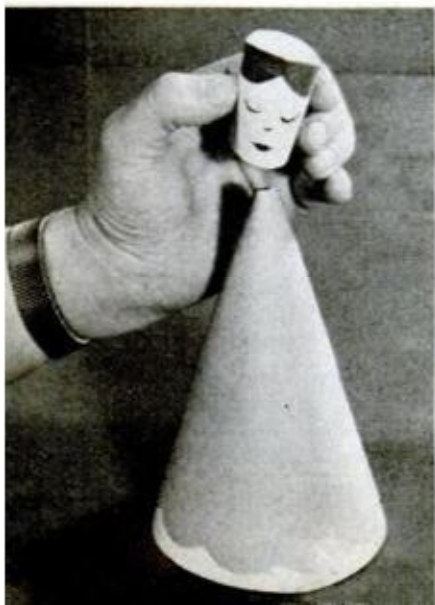

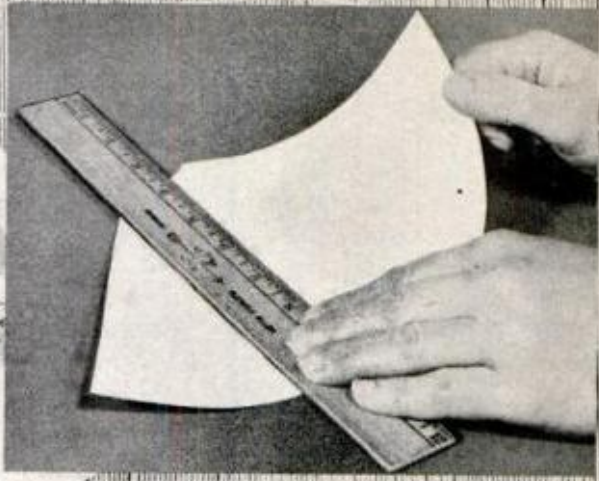

CONDITIONING PAPER by drawing it over edge of the ruler helps make it flexible

A HARMONIZING BACKDROP for this nativity scene can be made from a piece of unfinished matchstick drape

HEADRESS, pattern L, is folded into pleats before being mounted

JOSEPH'S BODY should be mounted on the base so that it leans slightly backward

HAIR IS CURLLED by rolling only one strand at a time

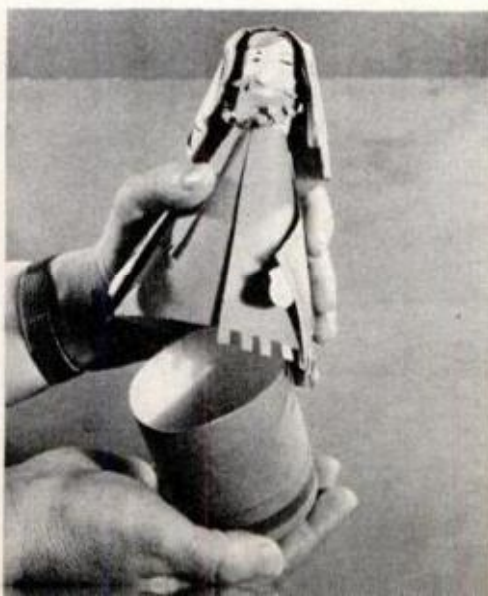



papers, especially the rich metallic types, are combined with other colored papers to make capes, borders and decorations. Gold and silver lace-paper doilies become haloes and decorations for the kings' robes. Water colors are used to add the faces.

If you can obtain the cardboard in a variety of colors, it can be used as is. However, if sheets of the right quality are available only in white, you can cover them with colored construction paper. When you purchase the paper, ask the clerk not to roll it for this makes it difficult to flatten again. Carry it home flat.

As each piece is cut to its proper shape, the paper should be flexed in order to condition it for rolling into a conical shape. To do this, draw it between a hard surface and a ruler or pull it down over the edge of a table. Be careful not to crack the paper in the process.

Pattern A is used to make the Virgin's body cone, pattern C for the head. Roll these cones, lap the edges and glue. Cut the hair from brown paper and glue it to the head before mounting the head on the body. The arms are made from pattern D and the sleeve sections covered with paper to match the body cone. After gluing the arms to the back of the body, cut the robe following pattern B. Curl back the front edges and glue it to the shoulders. Pattern

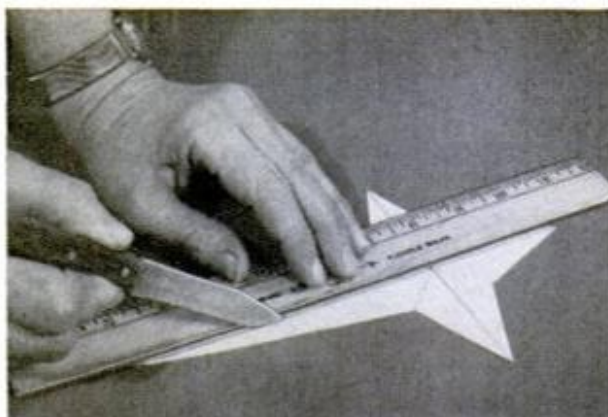

BEFORE BENDING STAR, score the solid lines on the upper side and the dotted lines on the lower side

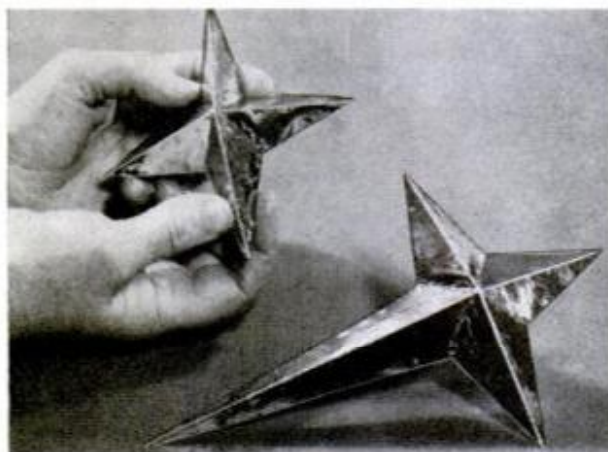

STARS ARE SHAPED immediately after being covered with metallic gold paper. If the glue is allowed to dry, the brittle paper will crack along the creases

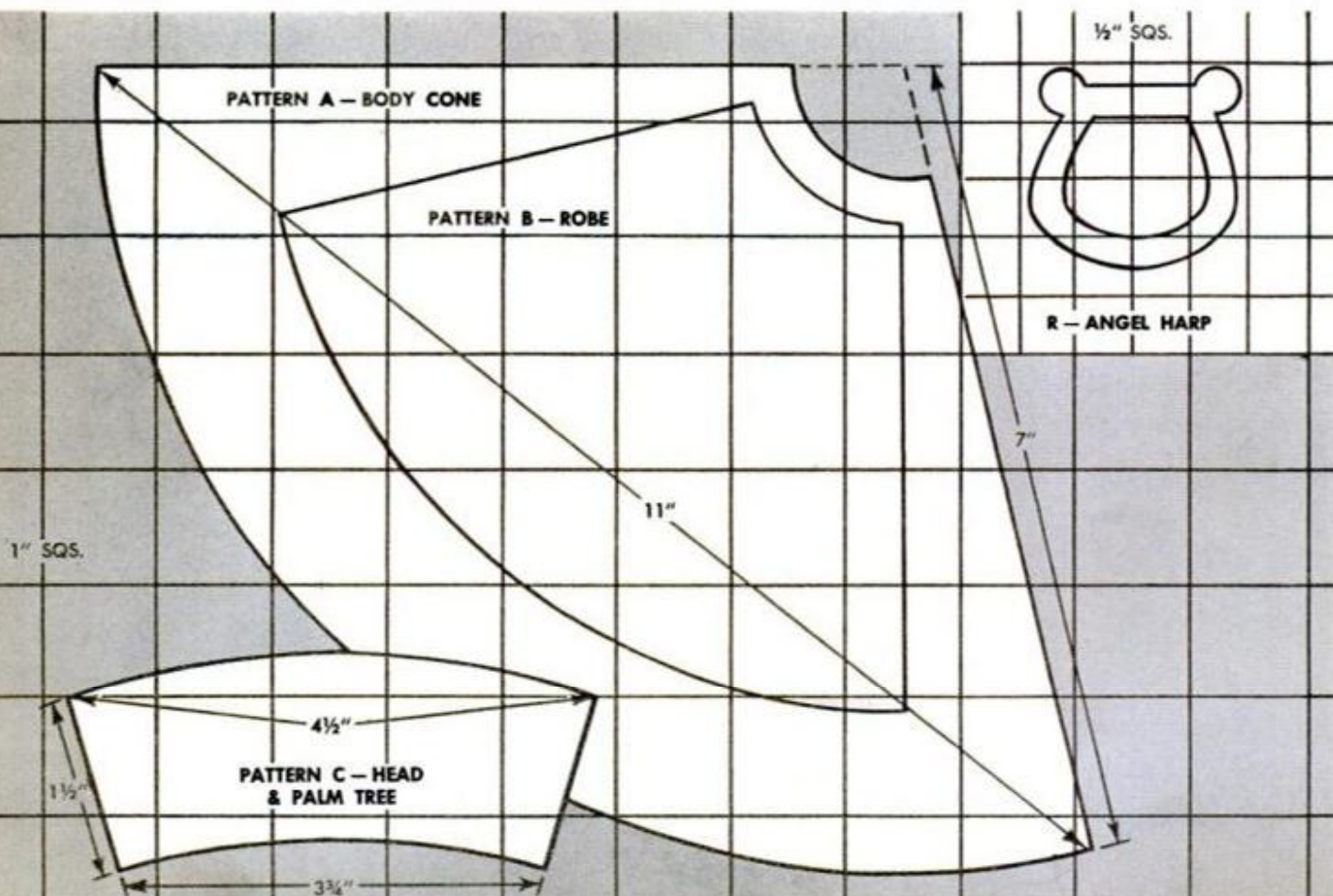

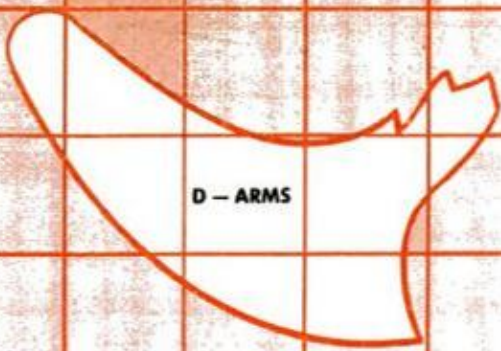

H - NOSE



G - SHAWL



F - HAIR



E - BEARD

1" SQS.

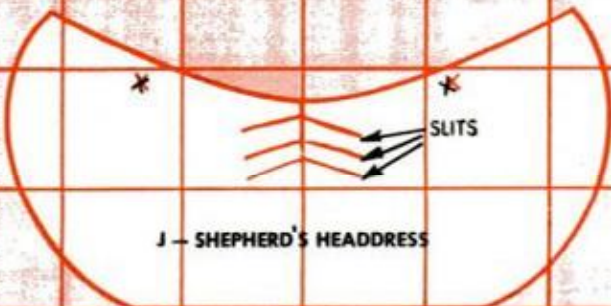

CREASED

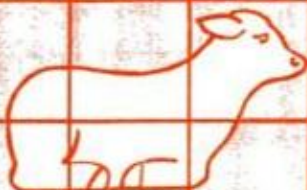
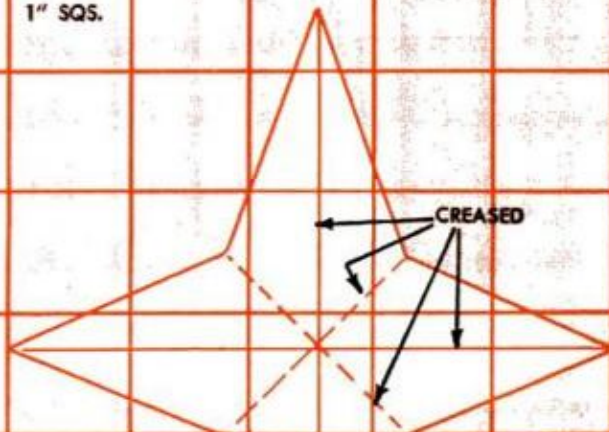

S - GUIDING STAR

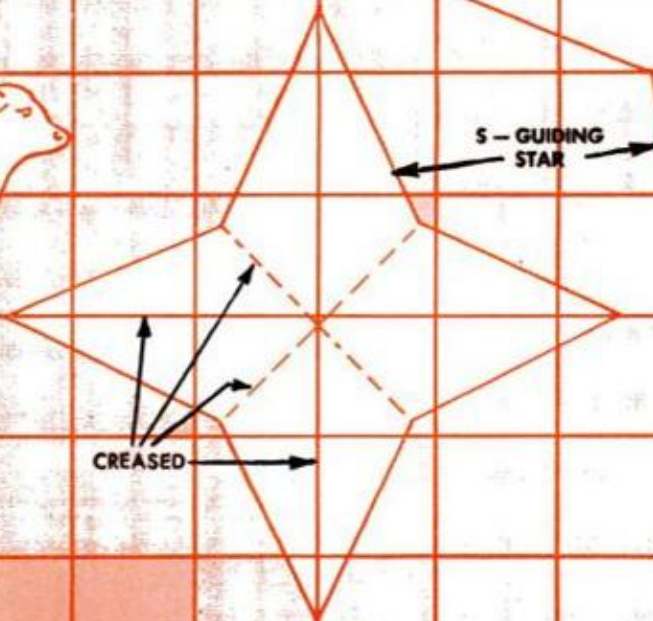

K - LAMB

CREASED

N - CRIB BOX

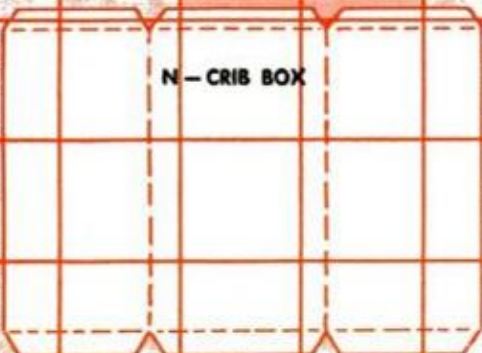

O - CRIB ENDS



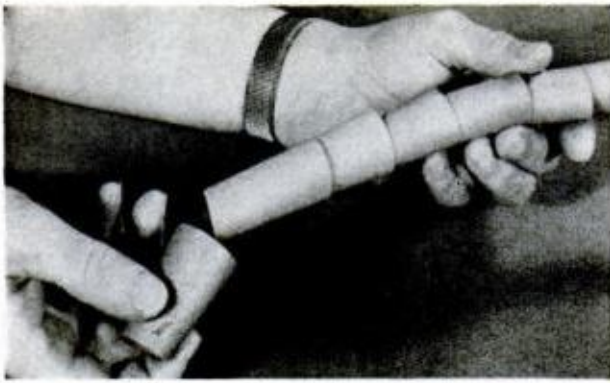

TRUNK OF PALM TREE is made in sections from the same pattern used to make the heads for the figures



PALM FRONDS, above, are glued to the top of the tree trunk. The trunk support, below, is made of two pieces of cardboard cut to follow the trunk's curve

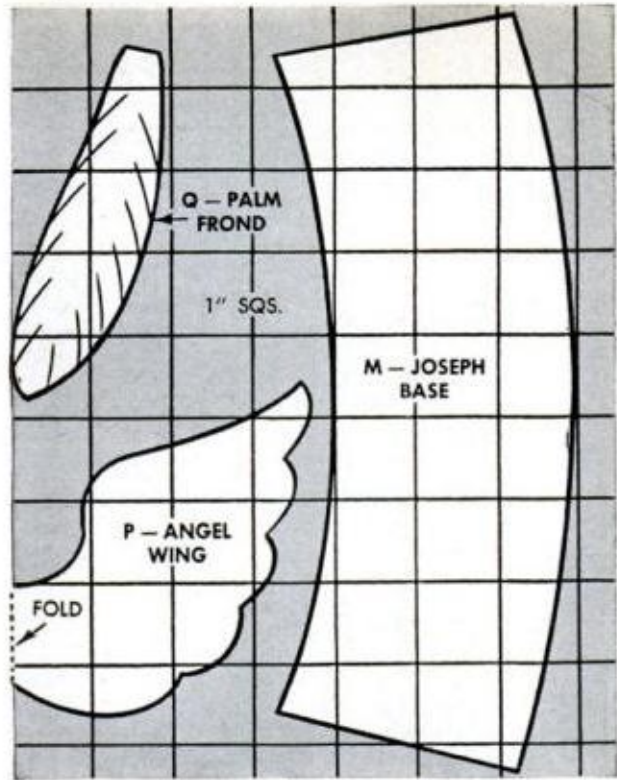
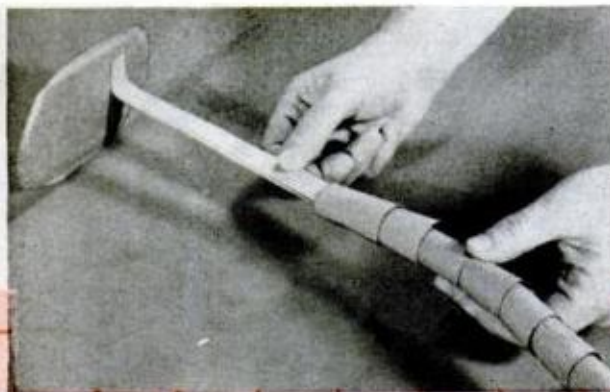

L is used for the headdress. Pleat it along the dotted lines and glue "x" edges together. Finally, glue the rounded tab edge down and attach the headdress to the head.

Joseph's head is prepared in the same way as that of the first figure. Cut the beard and hair from brown or black lightweight construction paper using patterns E and F. To curl the beard, roll individual strips of fringe around a toothpick. Shape the nose, pattern H, by creasing it along the center line and gluing the side tabs to the face so that the center is raised above the surface. Make Joseph's headdress from pattern L,

(Continued to page 222)

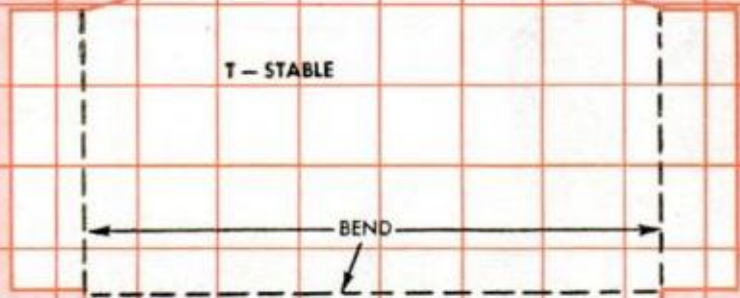
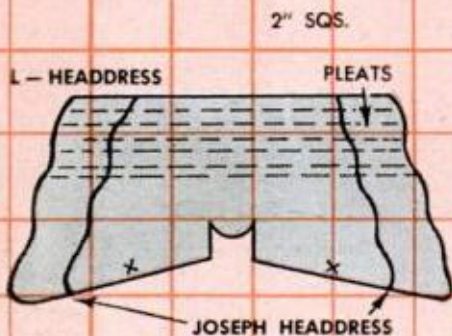



RIDE 'EM COWBOY



THANKS TO TV westerns, the old-fashioned rocking horse is still a popular Christmas toy and here's a palomino that will delight your little cowpuncher no end. Common 1 and 2-in. dimensional lumber is used throughout, the rockers being 1 x 4s, the legs 1 x 3s, the saddle and footrest 1 x 6s, etc. Most of the horse is simple enough to make with hand tools.

All the parts are glued, $\frac{1}{4}$ -in. carriage bolts being used to attach the rockers and #10 x $1\frac{1}{2}$ -in. wood screws for all the rest. Exposed screw heads should be set below the surface and puttied over before painting. Before drilling the holes for the carriage bolts, clamp the rockers to the legs and adjust them to make the horse rock evenly. You can either make the head from a built-up blank of 2-in. lumber as indicated or salvage the plastic head from a broomstick hobbyhorse. Paint the horse gray or tan and dapple it with spots of color from a can of spray paint.

—Robert Hoppough

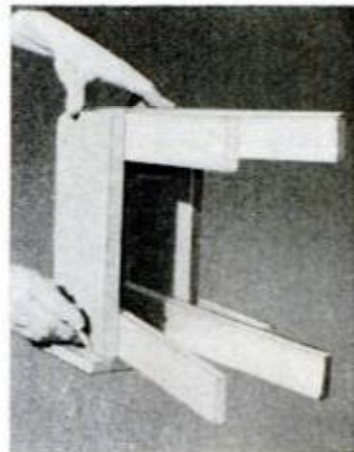
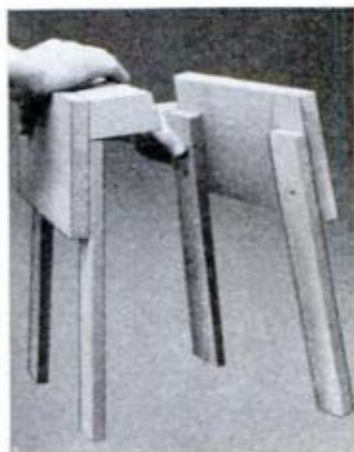

LEGS ARE ATTACHED from inside before body is completely assembled. Angle of end pieces is taken from work

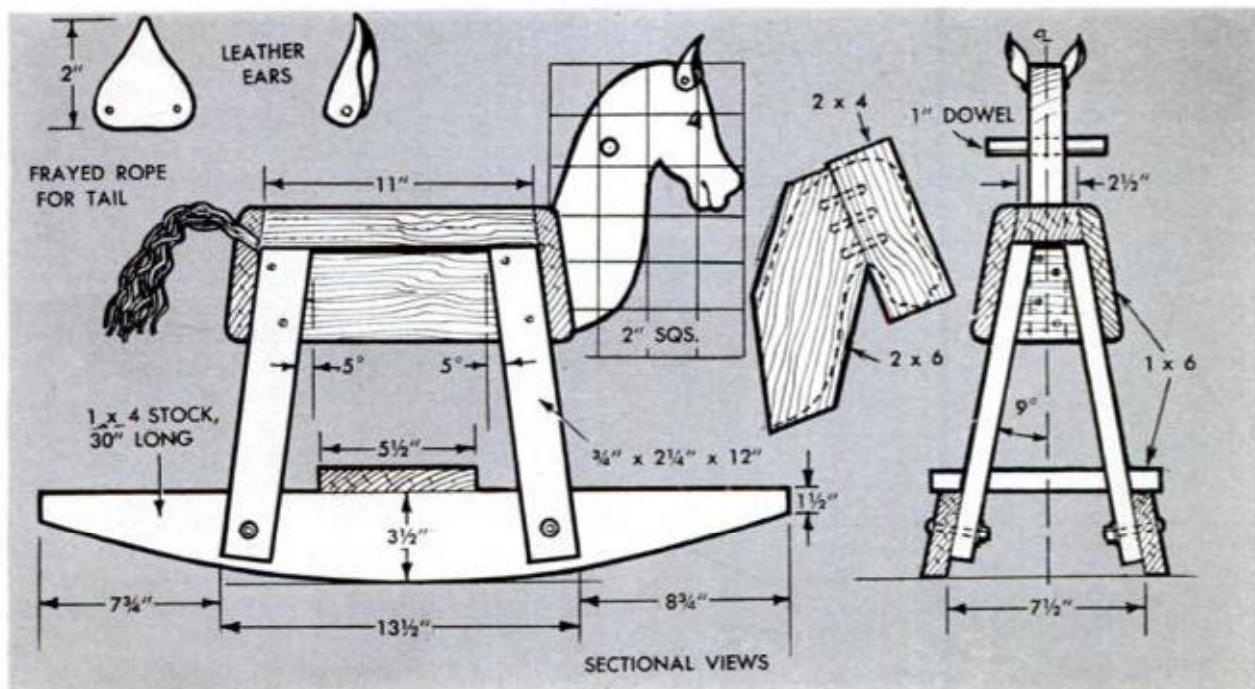

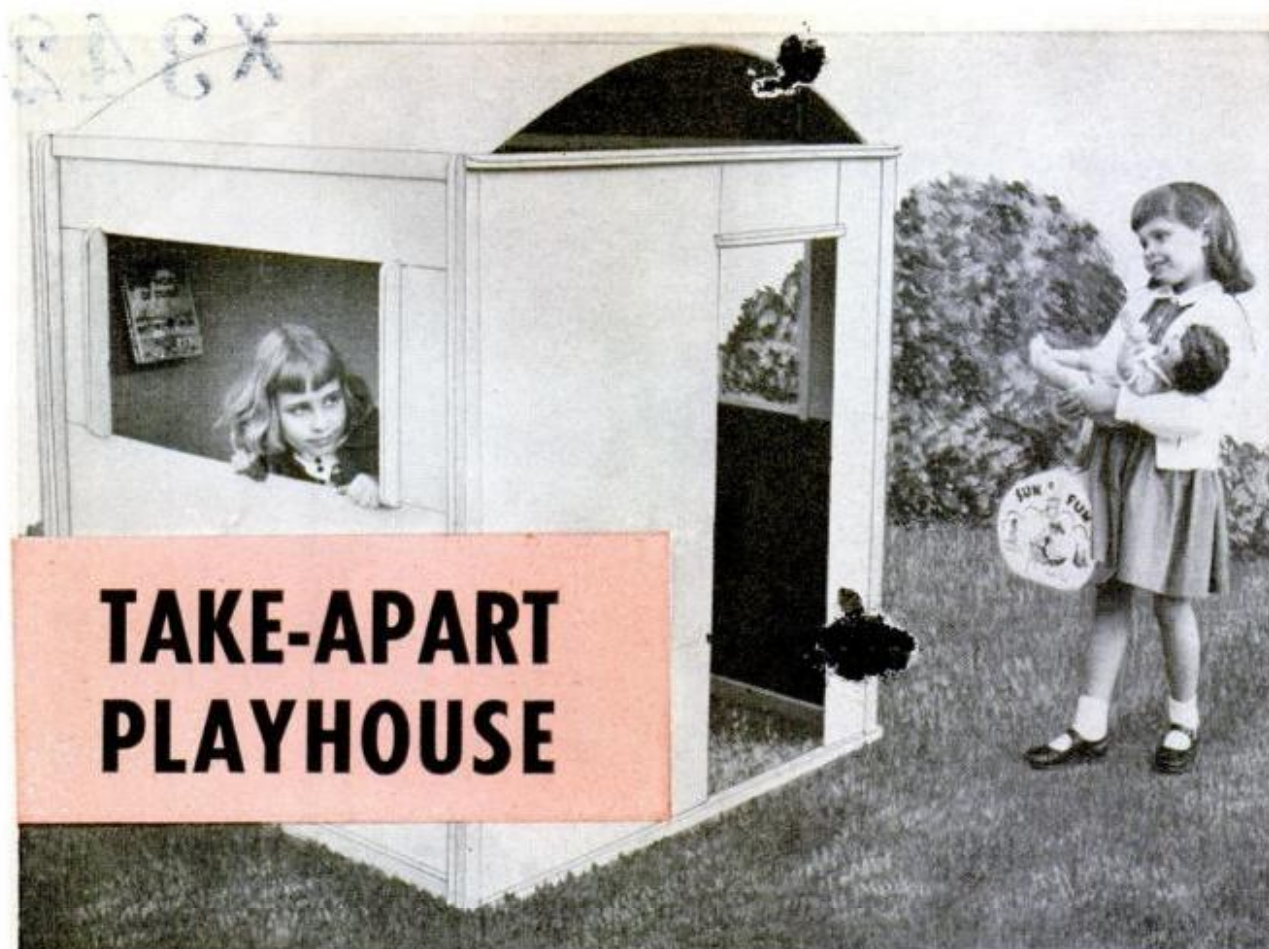

TAKE-APART PLAYHOUSE



WONDERING what to make the kids for Christmas? You can't go wrong with a playhouse, especially this one. They'll have fun with it the year 'round for it is small enough to set up indoors for winter play.

Measuring only 4 ft. square, it comes apart in five flat panels by removing just eight wood screws. Best of all, it's easy to build, especially if you have a circular saw to run the grooves in the frame members.

As for materials, you'll need two sheets of $\frac{1}{8}$ -in. tempered hardboard, eight 8-ft. and two 6-ft. lengths of 1 x 2, two dozen cadmium-plated #10 x $1\frac{1}{4}$ -in. wood screws and a $\frac{1}{4}$ -in. dowel 12 in. long. If you plan

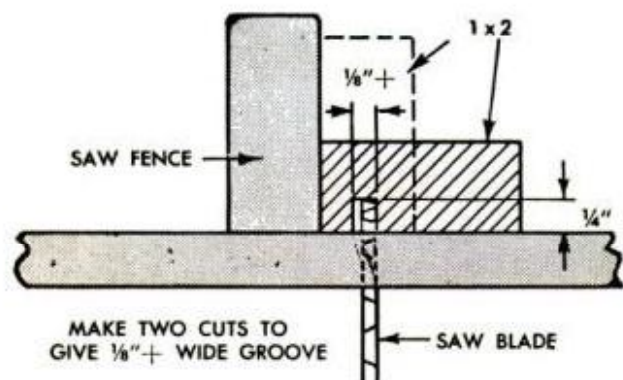

to have a perforated wall in the rear, as shown in the photo above, you'll need a 4 x 4-ft. panel of $\frac{1}{8}$ -in. perforated hardboard and a 4 x 6-ft. panel of tempered hardboard to replace one of the 4 x 8-ft. panels.

To groove the 1 x 2 frame pieces, set your circular saw to make a $\frac{1}{4}$ -in.-deep cut as shown in the detail at the left. You'll have to make two passes in order to make the grooves wide enough to accept the $\frac{1}{8}$ -in. hardboard. Groove eight 4-ft. lengths of 1 x 2 along the face and eight 4-ft. lengths along the edge. Round and notch the ends of the former, leave the others square.

Following the cutting diagrams, cut one of the 4 x 8-ft. panels into 24-in. (actually, $23\frac{7}{8}$ in.) widths. From the other panel cut the 4 x 4-ft. roof piece and the 6-in. strips to complete the doors and windows. Assemble each wall, using glue and one screw at each corner, and trim the hardboard where necessary to fit. If the perforated panel is used, trim it to size and fit the 1 x 2s around the edges as before.

The front and rear walls are joined to the side walls with screws only, two holes being drilled for them through each vertical member of the side walls. Also, $\frac{1}{4}$ -in. holes are drilled in the top framing of the side walls and short dowels are glued in them to hold the curved roof panel. The door and window fill-in panels are next.

Trim them to fit flush with the rest and glue them in the grooved members. Finally, strips of 1 x 2, grooved and slotted to fit over the edges of the fill-in pieces, are installed to add rigidity and trim to the openings. It will take at least two people to spring the roof in place between the dowels in the side walls.

When finishing, you may use one bright color throughout or paint the hardboard portions of the walls one color, the wood a second color and the roof a third. In any case, the easiest way to paint the walls completely is to take the house apart and paint each wall, plus the roof, separately. Whether you plan to use the playhouse outside or indoors, all parts should be painted on both sides. Also, be sure to paint the exposed edges of the hardboard itself. When the paint has dried, reassemble the playhouse and it's ready for play.

—Dave Swartout



1/8" x 4' x 8' TEMPERED HARDBOARD, 2 REQD.

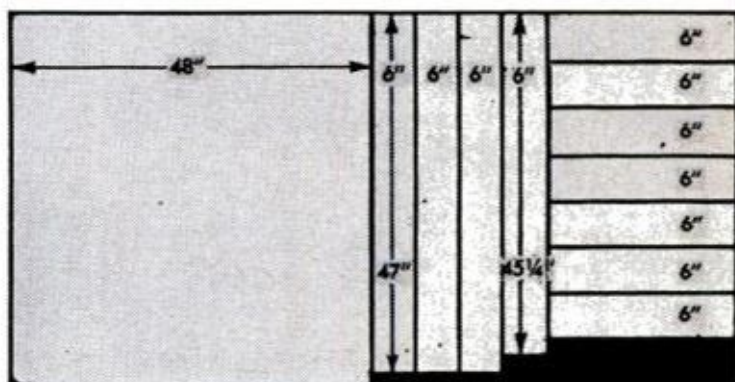

PANEL CUTTING DIAGRAM

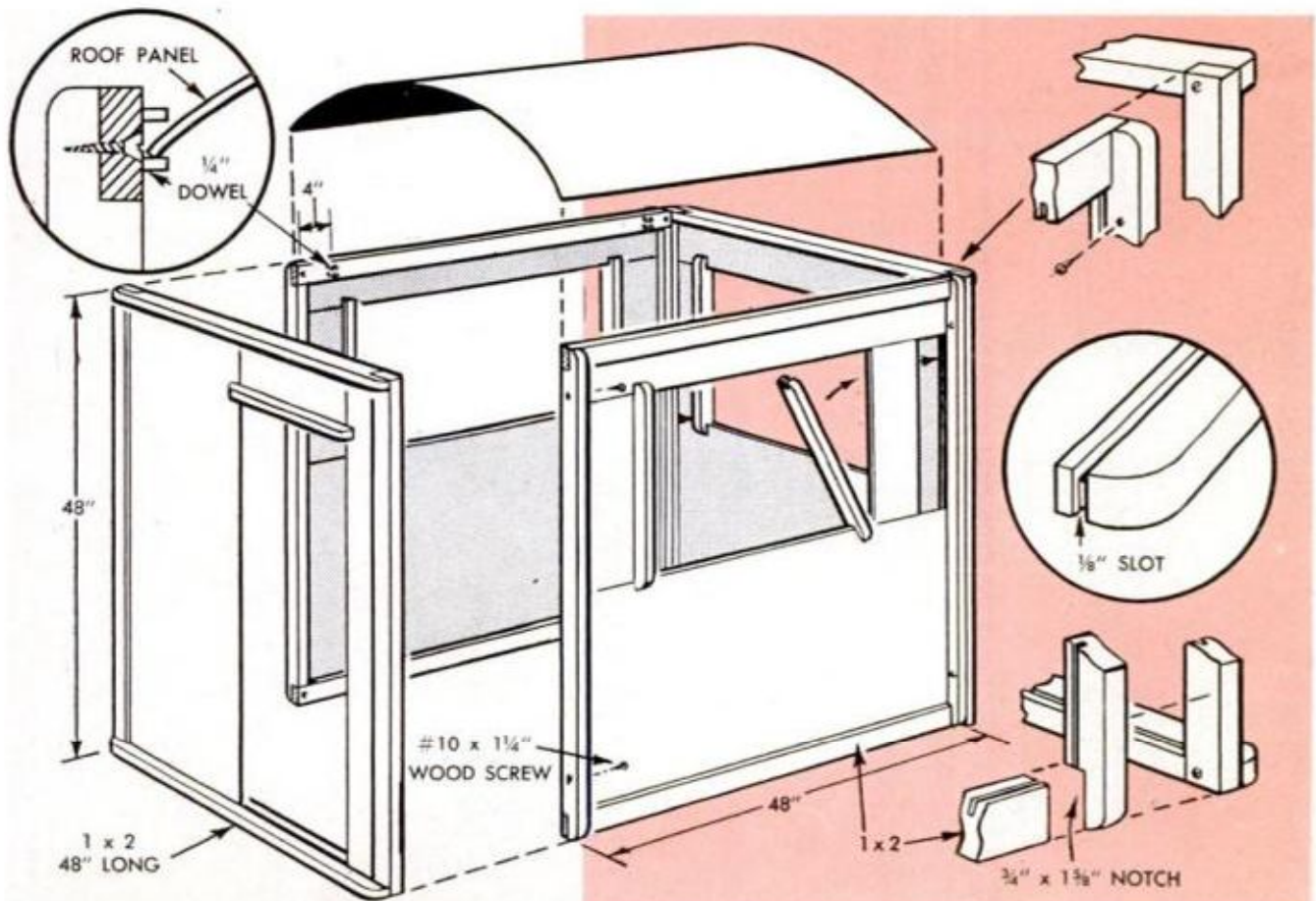
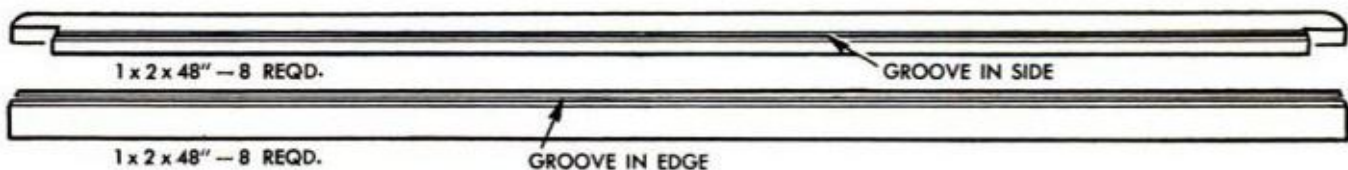

DANISH CANDLE

GIFTS that are unusual are always happy surprises and the simple elegance of this one will become more exciting when the candle is lighted. Known as a Danish candle, the flame burns in a recess, giving an iridescent, translucent glow which is even more striking when the candle is of colored wax.

The three-legged candle holder is formed from 8-in. lengths of $\frac{1}{4}$ -in. brass rod, each leg being formed to the shape indicated in a jig as pictured below. To bend each leg, clamp the jig to the bench top, remove the center stop and make the first or cup bend. Then replace the stop and make the second bend. The stops are $\frac{5}{16}$ -in. washers held with screws and positioned to coincide with the leg outline which is drawn full size on the jig. Place five or six washers on each screw.

The three legs are soldered together tripod-fashion, positioning them equidistantly and binding together temporarily with wire. The solder is flowed down from the top where it will be concealed by the candle. The latter is molded in a 3-in. hollow rubber ball, cut in half. Thread a length of string wick through a nail hole in one half and cut a $\frac{1}{2}$ -in. pouring hole in the other. Then tape the two halves together and fill with wax. When the wax hardens, the ball is peeled off, the wick is cut back and the outside of the finished candle is scraped smooth.—Robert Micals



PROP BALL in a tin can, left, and with a funnel made from aluminum foil fill with melted wax. As it cools, wax will shrink and a depression will form at center around the wick. Allow the wax to harden



AFTER WAX is hardened ball is peeled off, lower left, care being taken not to scratch or dent candle. Scrape candle with sharp knife to a uniformly smooth surface. Then buff to a high polish with a soft cloth

BENDING JIG, right, for making legs of tripod consists of 2 x 4, 10 in. long to which are attached a half disk of plywood having radius of $1\frac{3}{8}$ in. and three stops, each consisting of washers held by screws

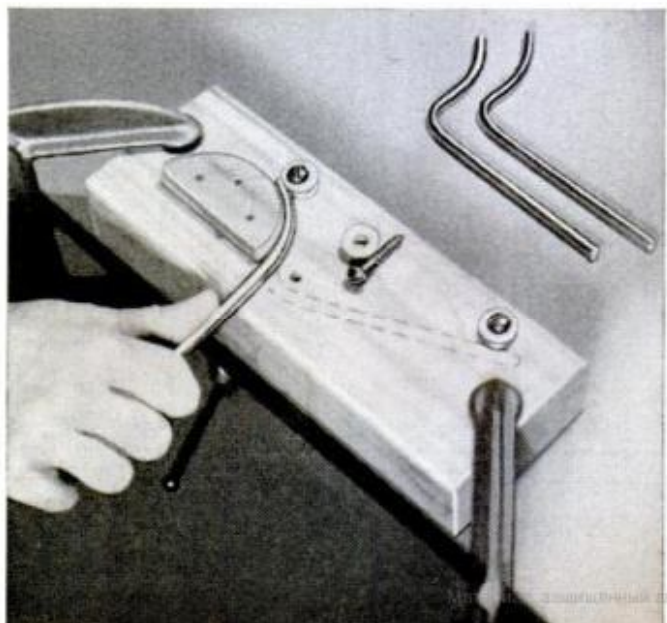
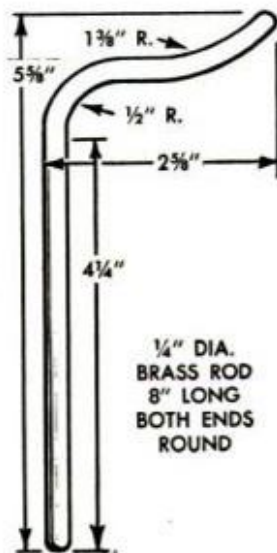



X733

ALL ABOARD!

Holiday special makes its first run on Christmas day



THIS ANIMATED pull-toy train will puff its way straight into the heart of any toddler lucky enough to get it for Christmas. As it is pulled along it puffs, or chuffs, realistically enough to please any junior railroad buff and all the time it's in motion the brakeman signals with his lantern from a window in the caboose.

Take the locomotive and caboose first so that you get these well along before the holidays. Then if you get pressed for time, you can complete the open car and the coal car, or tender, in an evening if necessary. Using Figs. 7 through 10 as the starting point, note closely in Fig. 10 the assembly of the mechanism that animates the brakeman. It's a simple parallelogram-type affair actuated by two pegs, or lugs, placed 180 degrees apart on the rear axle of the caboose. The axle is a $6\frac{3}{4}$ -in. length (cut it a trifle longer to begin with) of $\frac{3}{8}$ -in. dowel and the actuating lugs are $\frac{1}{2}$ -in. lengths of $\frac{1}{8}$ -in. dowel glued into the holes in the axle with the ends projecting about $\frac{1}{4}$ in. Note

in the sectional view, Fig. 10 that one arm of the parallelogram pivots on a screw while the other pivots on a dowel which passes through a clearance hole in the base of the caboose, the upper end being glued into a hole drilled into the body of the brakeman. The lower end of the pivot is a force fit in a hole centered through the arm.

Two pieces of coat-hanger wire with the ends bent at right angles and forced into holes in the wood arms, connect the ends of the parallel arms as you see in the bottom view of the assembly, Fig. 10. When bent, the U-shaped connectors must be exactly the same length.

The brakeman is turned from a $2\frac{1}{2}$ -in. length of 1-in. dowel, the arms and lantern from $\frac{1}{2}$ -in. dowel stock. Note in Fig. 10 that washers are placed between moving and stationary parts to provide smoother operation and offset any tendency of the parts



Fascination Board

Small youngsters will amuse themselves for hours with this playboard. They'll thread string through the holes, move any part that's movable and sometimes just pound on the whole thing to hear the rattles. To make it, select a smooth board and attach such common items as a hinge, hasp, toggle switch, door bolt and the like—as many as possible containing some moving part. Be sure to file down any rough metal edges and sand the board completely smooth.

—Alan W. Farrant

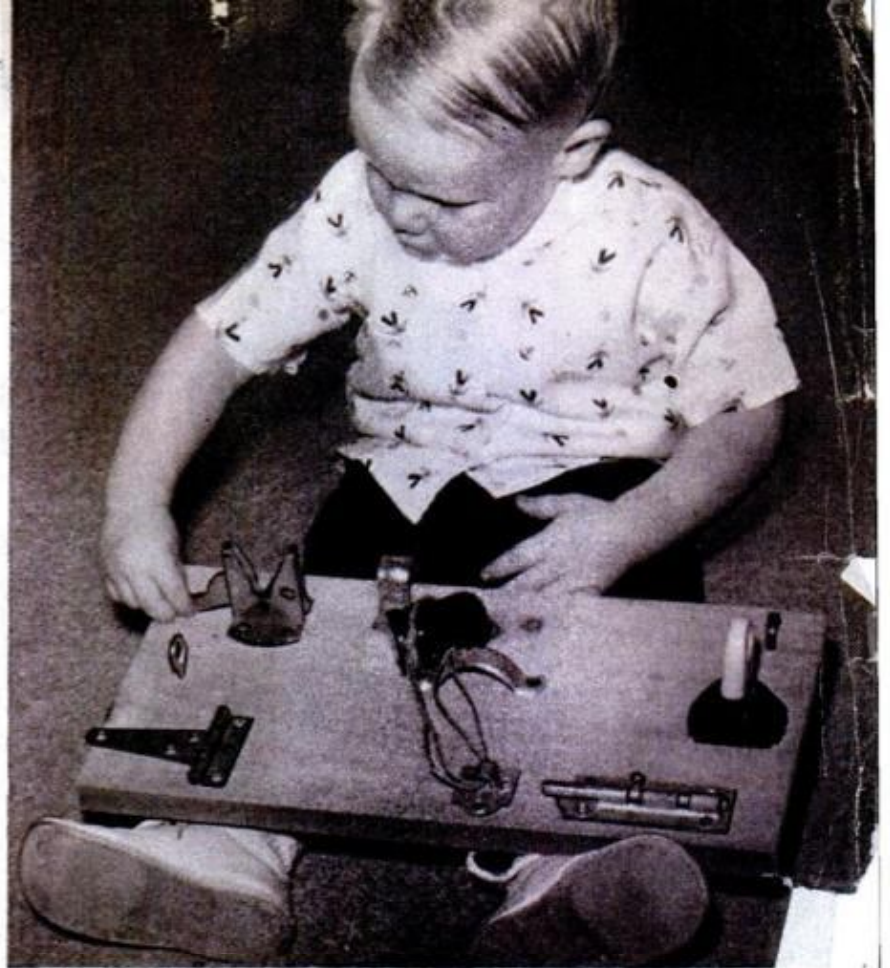

Susie Sew and Sew

Decorative and always handy, this pert manikin holds nine spools of thread, and an assortment of pins and needles in its cushion beret. All drilled holes should hold dowels securely yet permit them to be pulled out easily to remove spools. If the thumbscrew doesn't hold the legs tightly enough, slip a $\frac{1}{2} \times \frac{3}{4}$ -in. piece of tin between the screw and the legs. For an extra feminine touch, finish the body of the manikin with a coat of colored nail polish.—Robert Micals

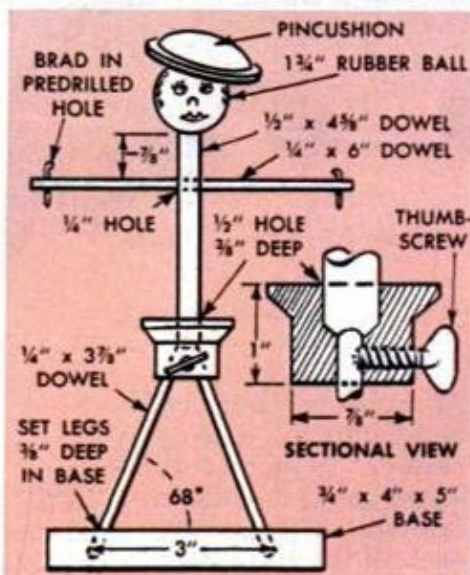

Tinkle Bells

You'd hardly recognize the toy at right as an empty No. 5 fruit-juice can, but that's just what it is. Punch center holes in both ends of the can and insert a heavy wire coat hanger for the axle. Bend the coat hanger as shown, twist the ends together and fit them tightly into the end of a café curtain rod. Punch a small hole in one end of the can and drop in several small bells. Finally, use bright-colored self-adhesive paper to cover this hole and decorate the toy.

—R. B. Joselyn

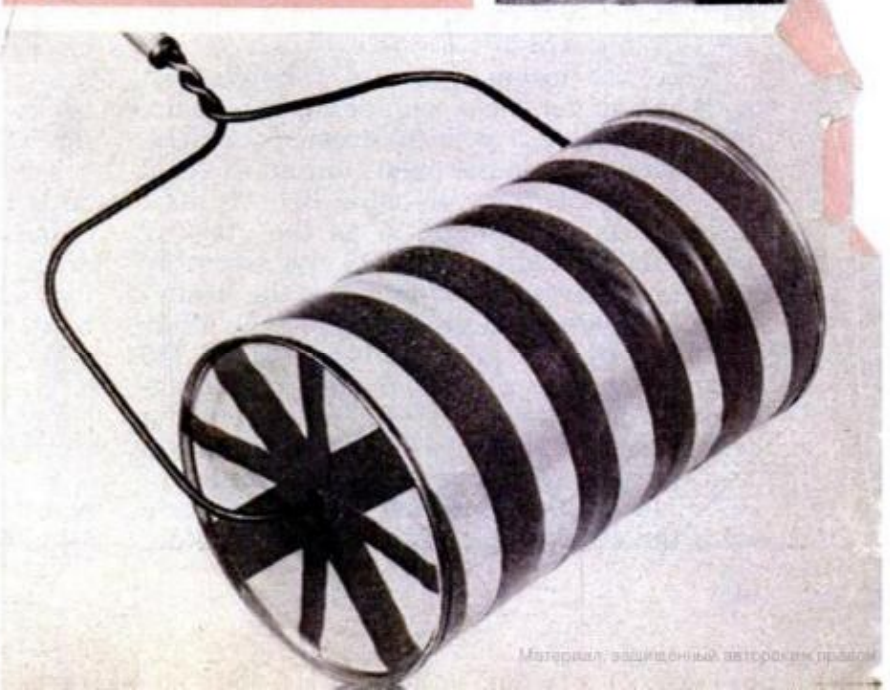

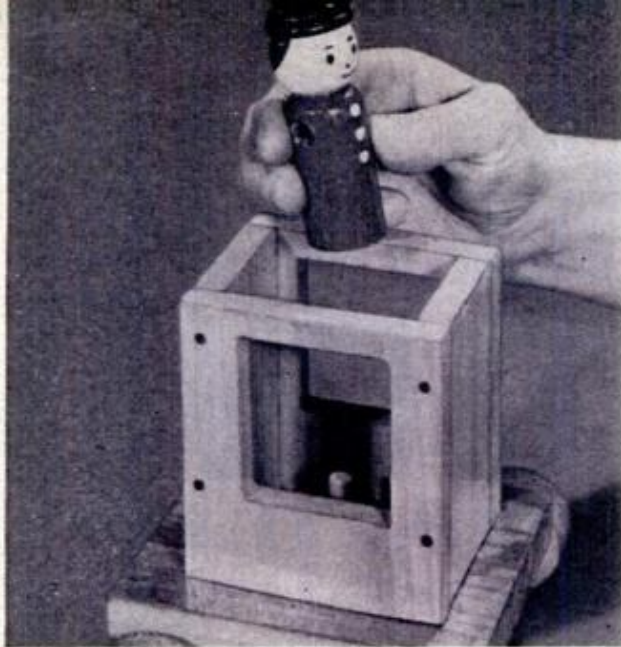

7. BRAKEMAN must be painted and mounted in his caboose before the roof of the car can be attached

8. LANTERN is attached to the brakeman's hand by means of a fine wire handle which allows it to swing

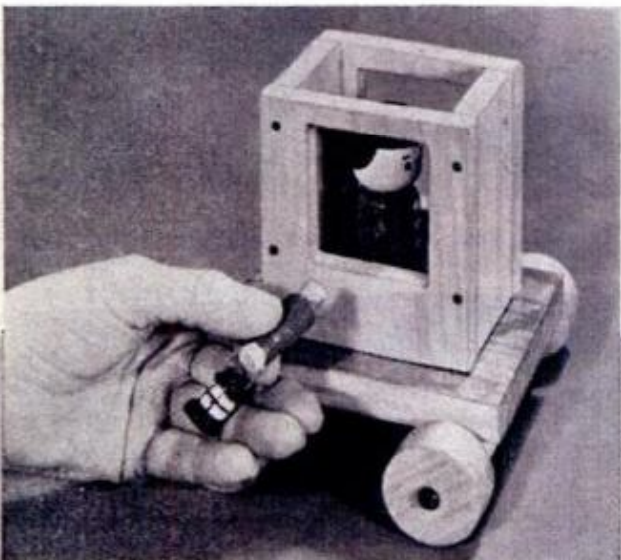

The center axle is a length of $\frac{3}{8}$ -in. dowel center-drilled for a short length of $\frac{3}{16}$ -in. dowel, the ends of which project equally when it is glued in place in the hole in the axle. These projections depress the end of the spring and release it, the action permitting the spring to snap back and strike the cardboard disk over the counterbore, which forms a resonance chamber.

The rest of the locomotive is simple box construction much like the car, tender and caboose. Note that the leading and trailing pairs of wheels on the locomotive, also those on the car and tender, turn on round-headed screws, which serve well as axles. Finish by first applying a sealer and then enamels in the colors that suit your fancy. Use only enamels that do not contain lead.

—Elma Waltner

9. DRIVE MECHANISM which controls the brakeman's movement is mounted on the bottom of the caboose

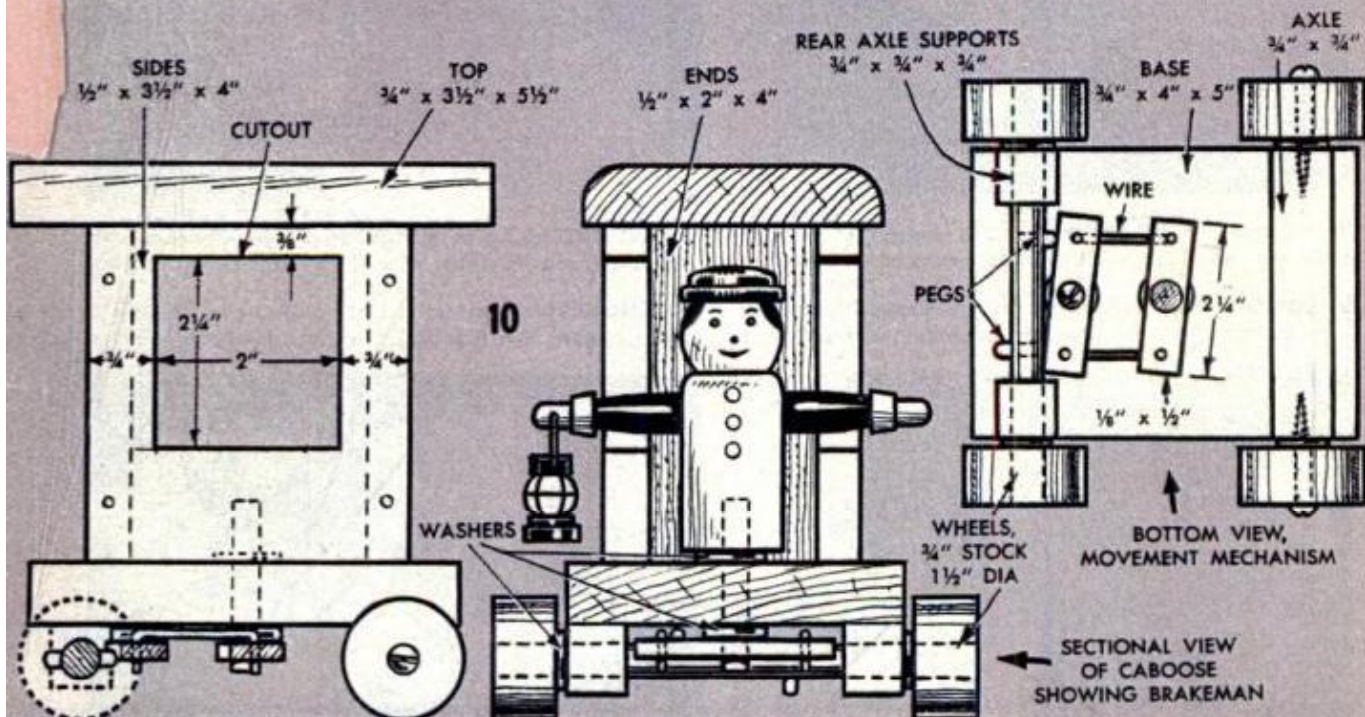
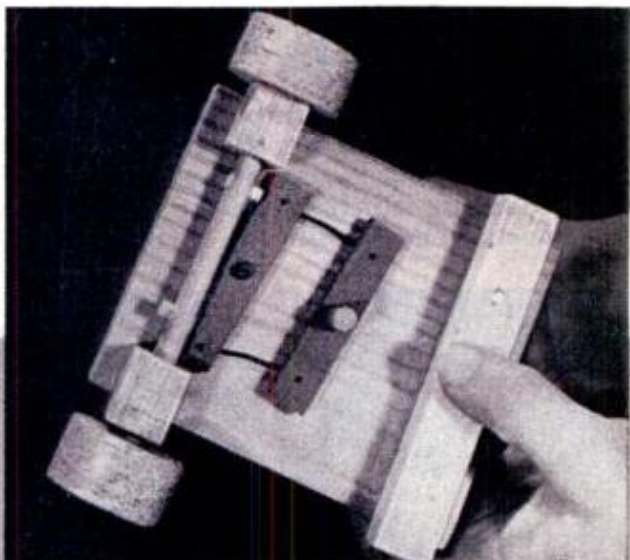

to bind. Balance of the caboose is easy box-like construction as you see in Figs. 7, 8 and 10. Wheels are cut to a width of $\frac{3}{4}$ in. from $1\frac{1}{2}$ -in. round stock. Two wheels are center drilled for round-headed screws which serve as axles. The rear wheels are center drilled $\frac{3}{8}$ in. and are glued to the axle.

Now the locomotive. Start by turning the boiler to a length of 5 in. and a diameter of 3 in. from a short length of 4 x 4. Plane a flat on the boiler $1\frac{3}{4}$ in. wide. Then counterbore one deep hole and bore one shallow hole centered along the flat as in Fig. 11 and also Figs. 1 through 6. The latter is a clearance hole for the axle lugs. The outside diameter of both holes should be 1 in., the smaller diameter of the counter bore $\frac{3}{4}$ in., as in Fig. 13 the upper right detail. Shape the base and cut the slot through as in Fig. 12. Now, you bend a short length of clock spring to the approximate shape shown in Figs. 11 and 13 and attach it to the forward end of the slot in the locomotive base with two screws and a hardwood clamping piece as in Fig. 12. Next, you cut a disk from thin cardboard or a postcard and glue it in the counterbore as in Figs. 3 and 13. As you will note, the axle carrying the center pair of locomotive wheels actuates the spring which strikes the cardboard disk twice at each revolution of the wheels.

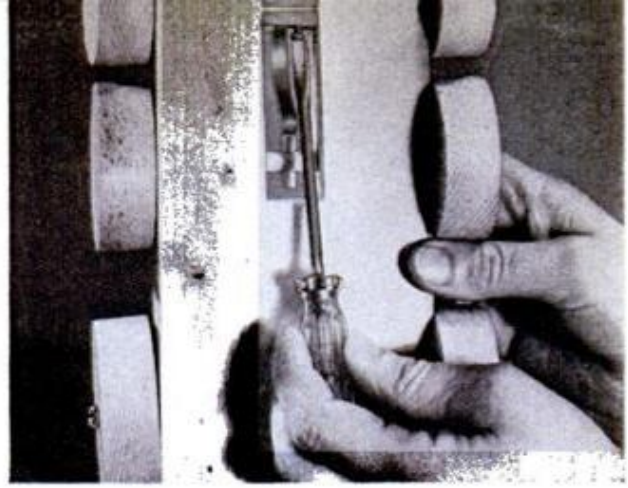

1. NOISEMAKER, a section of alarm-clock spring, is held in place with a small piece of hardboard

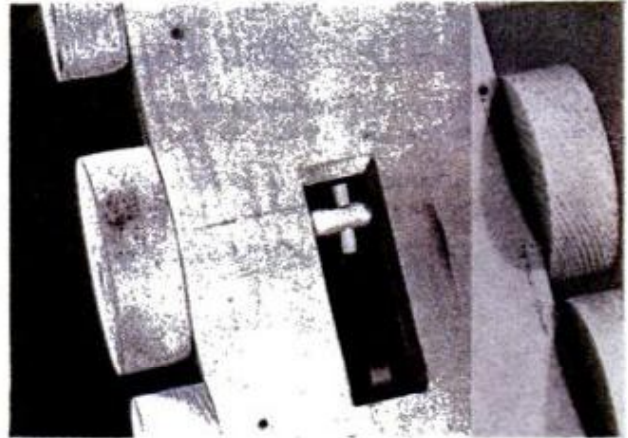

2. AXLE PEG engages the free end of the spring and snaps curved hump against the sounding board



3. SOUNDING BOARD about the weight of a postcard is glued flush with surface over sound chamber

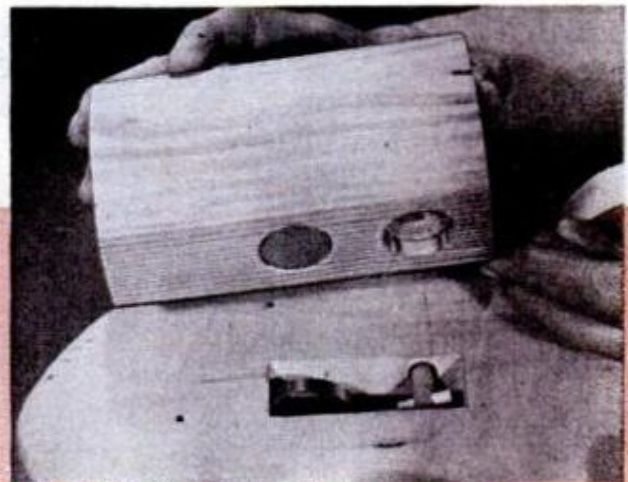

4. SECOND HOLE in the boiler allows clearance for the axle peg to turn when the wheels are turned

5. ENGINE BELL is mounted on a U-shaped length of wire whose legs are inserted in holes in the boiler

6. SMOKESTACK is turned to a diameter of $1\frac{1}{2}$ in. and pegged into the boiler ahead of the small bell

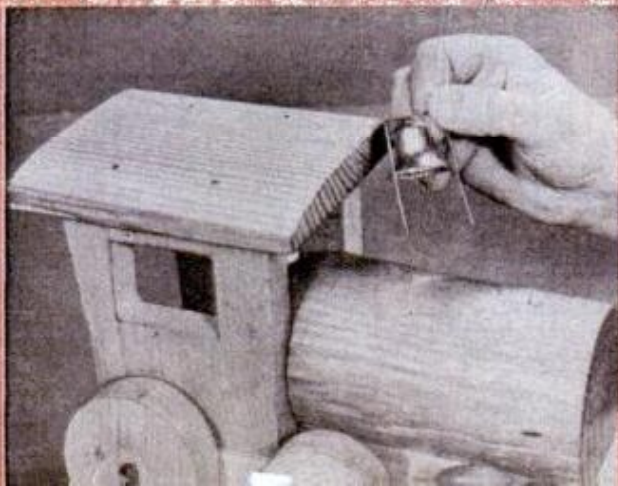

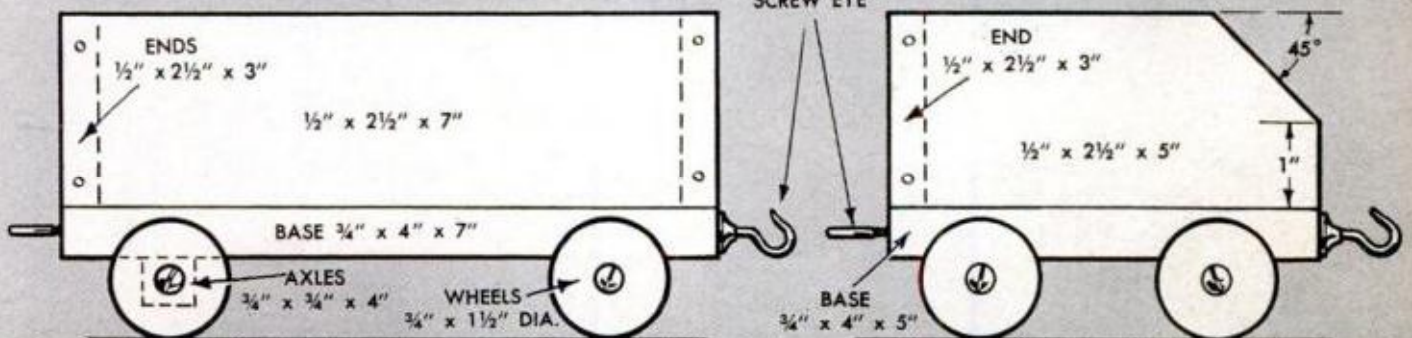
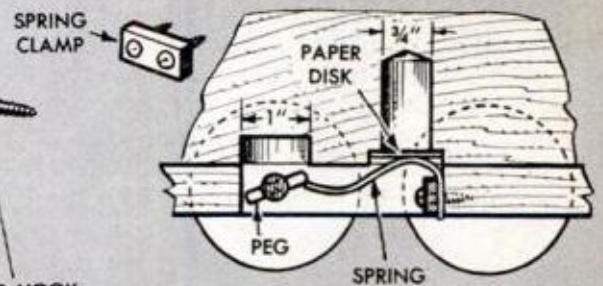
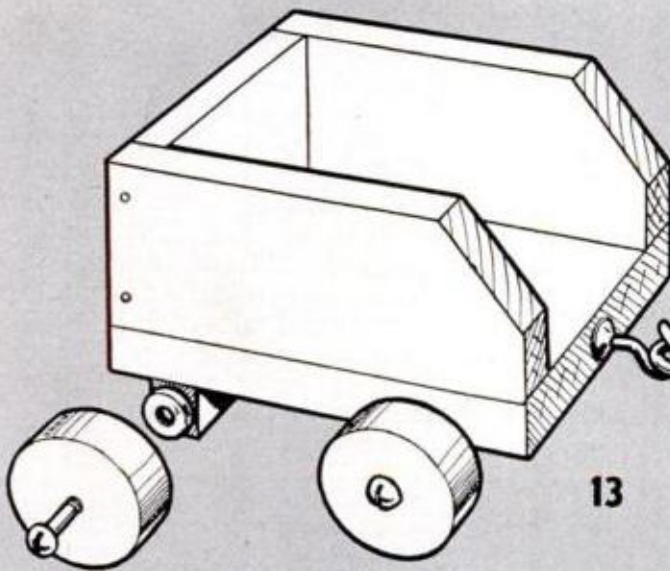
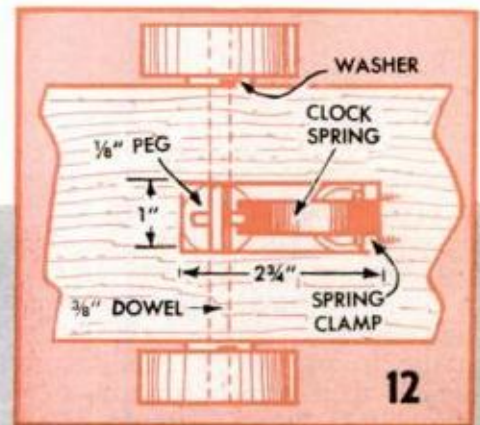
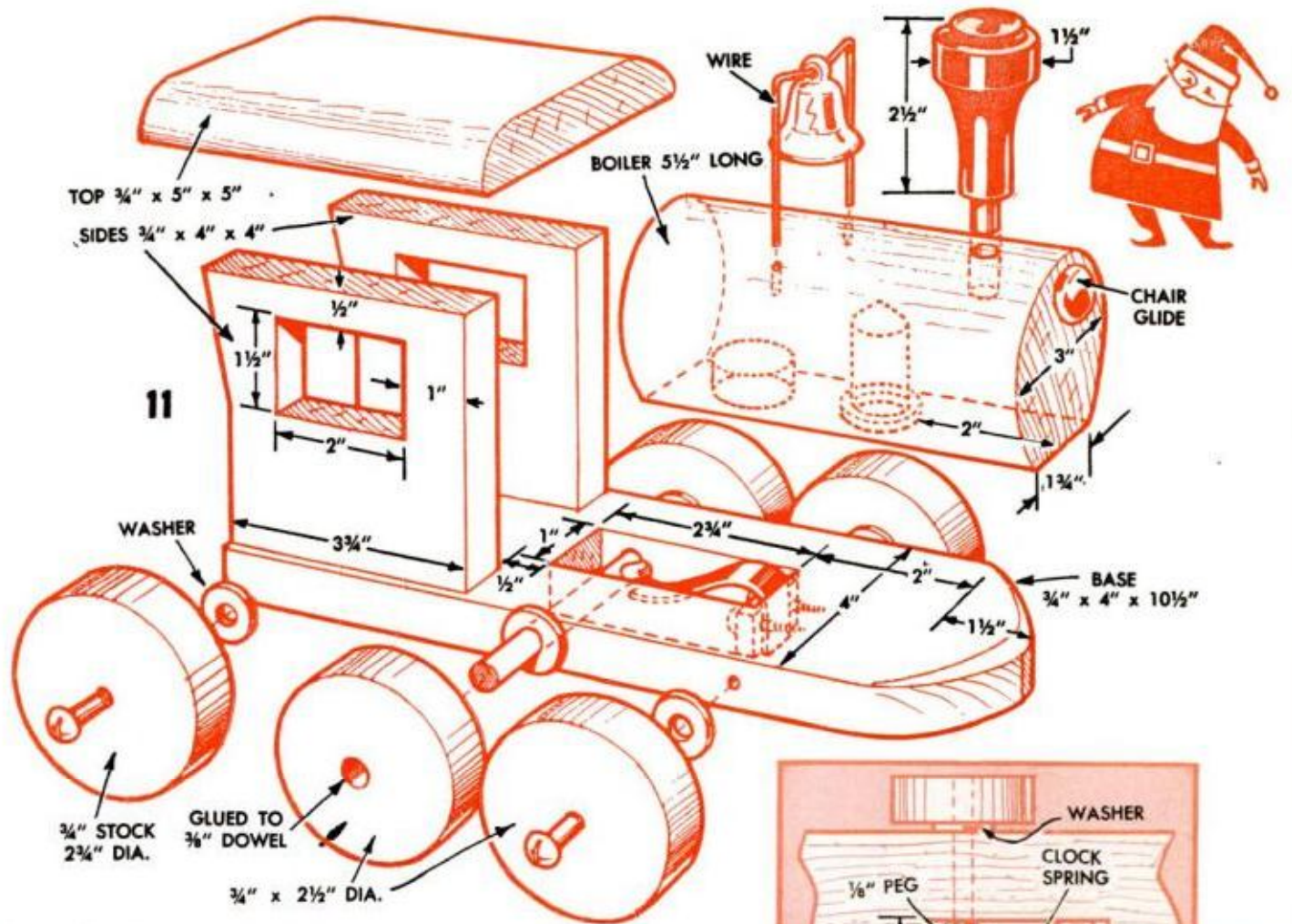

MOSAIC-TOP SEWING BOX



HANDSOME ENOUGH to be used anywhere, here's a gift that can be made to serve a number of uses. It can be fitted out as a sewing kit, it can be lined to serve as a trinket or jewelry box, it will store your bridge cards, keep track of gloves—you name it. Except for the top and bottom, which are cut from walnut-faced plywood, the whole thing is made of solid walnut stock, hand rubbed to a rich finish. The drawing shows clearly how the parts go together. Use glue and clamps in assembly. When assembling the lid, place the walnut-faced top piece face down and note that it

TILES ARE APPLIED individually to ruled-off surface, following color-keyed design worked out on paper

must rest $\frac{1}{4}$ in. below the rabbeted side members to form a recess for the mosaic tile overlay.

The mosaic design is first worked out on paper ruled off in $\frac{1}{2}$ -in. squares. It can be a monogram or other attractive design. The lid is likewise ruled off in $\frac{1}{2}$ -in. squares, then shellacked and $\frac{3}{8}$ -in. tiles are cemented to it, following the paper pattern. The tiles are applied individually by first soaking them off the paper backing on which they normally come. Finally, grouting is applied and the excess wiped off with a damp sponge.—*Elma Waltner*

JOINTS BETWEEN TILE are filled level by pouring grout over surface and removing excess with sponge

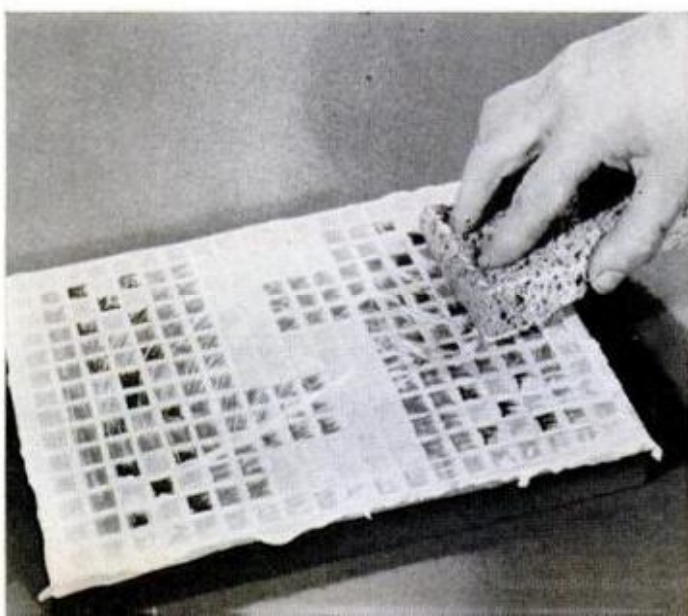

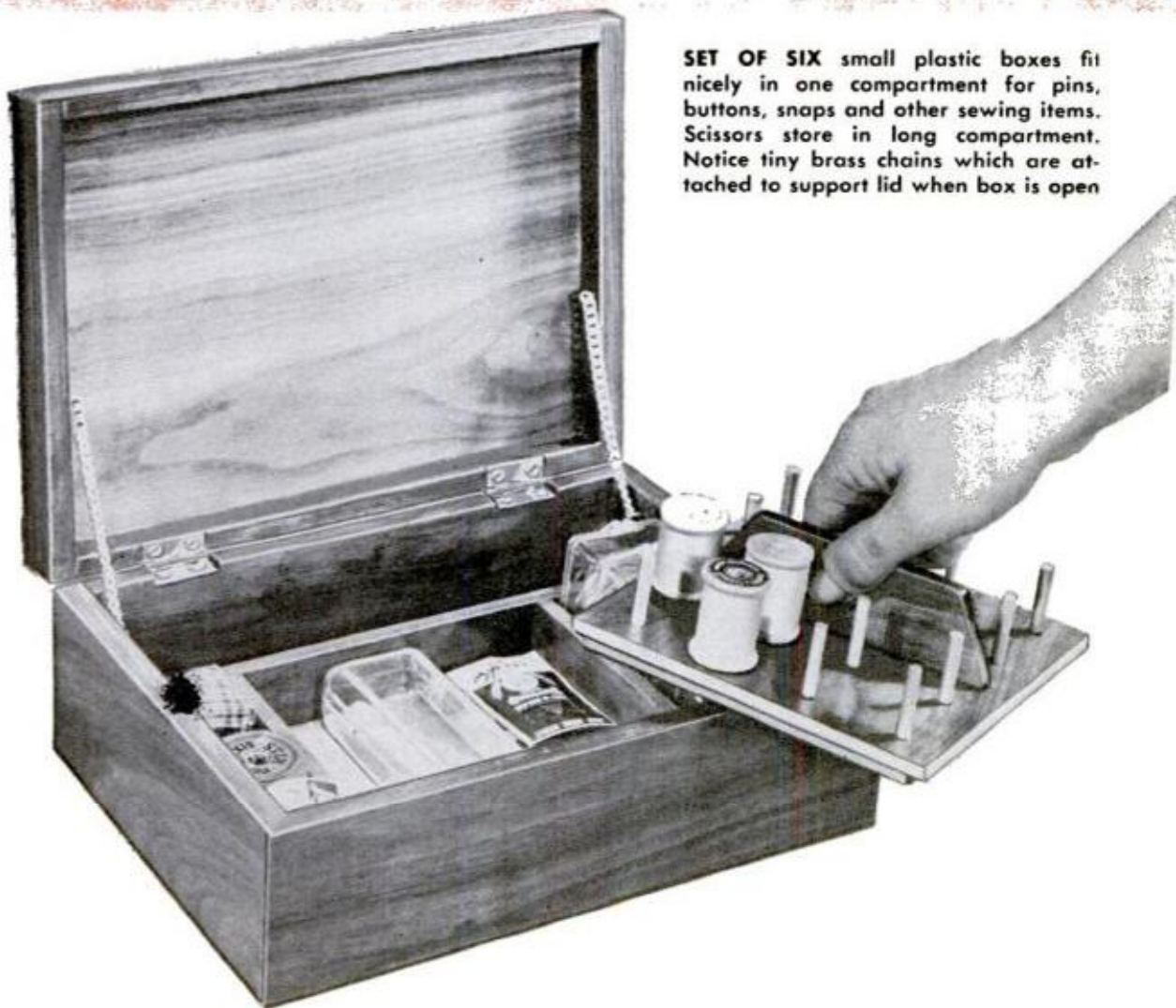
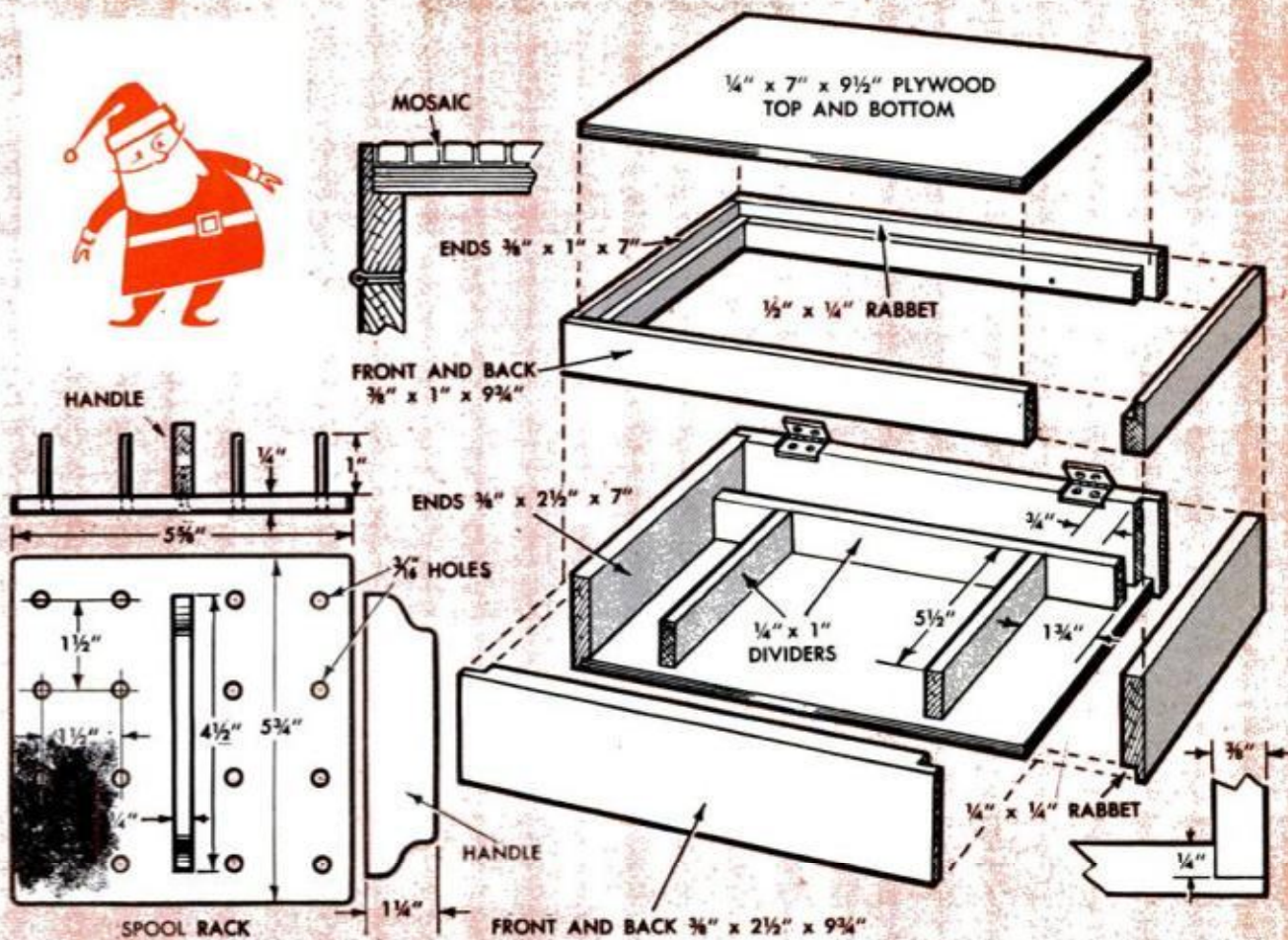

SET OF SIX small plastic boxes fit nicely in one compartment for pins, buttons, snaps and other sewing items. Scissors store in long compartment. Notice tiny brass chains which are attached to support lid when box is open



KIDDIE KITCHEN

ANY ONE OF these three pint-size appliances is bound to bring squeals of delight on Christmas morning, for what little girl hasn't dreamed of having her own stove, sink and refrigerator, just like Mommy's?

The stove is a simple box construction of $\frac{1}{2}$ -in. plywood with glue and nails used to fasten all joints. Switches on the front panel control the realistic burners and oven light which are powered by a 6-volt lantern battery mounted inside on the back of the stove. When a burner switch is turned on, it lights a small bulb mounted under red cellophane in the center of the circular burner cutout, causing the burner to glow red as if it were hot.

The drawing below details construction. When the stove is assembled, round off all exterior edges by sanding so that they resemble a real stove. Fill all cracks with wood putty and finish with white enamel.

The sink is constructed similarly, both glue and nails being used. Two rectangular polyethylene pans set in cutouts in the top serve as a double sink. The faucets, which are regular sink faucets, are attached to close nipples running through the splashboard and held in place by pipe caps. Trim is a matter of personal preference, but the sink can be



ELECTRIC STOVE

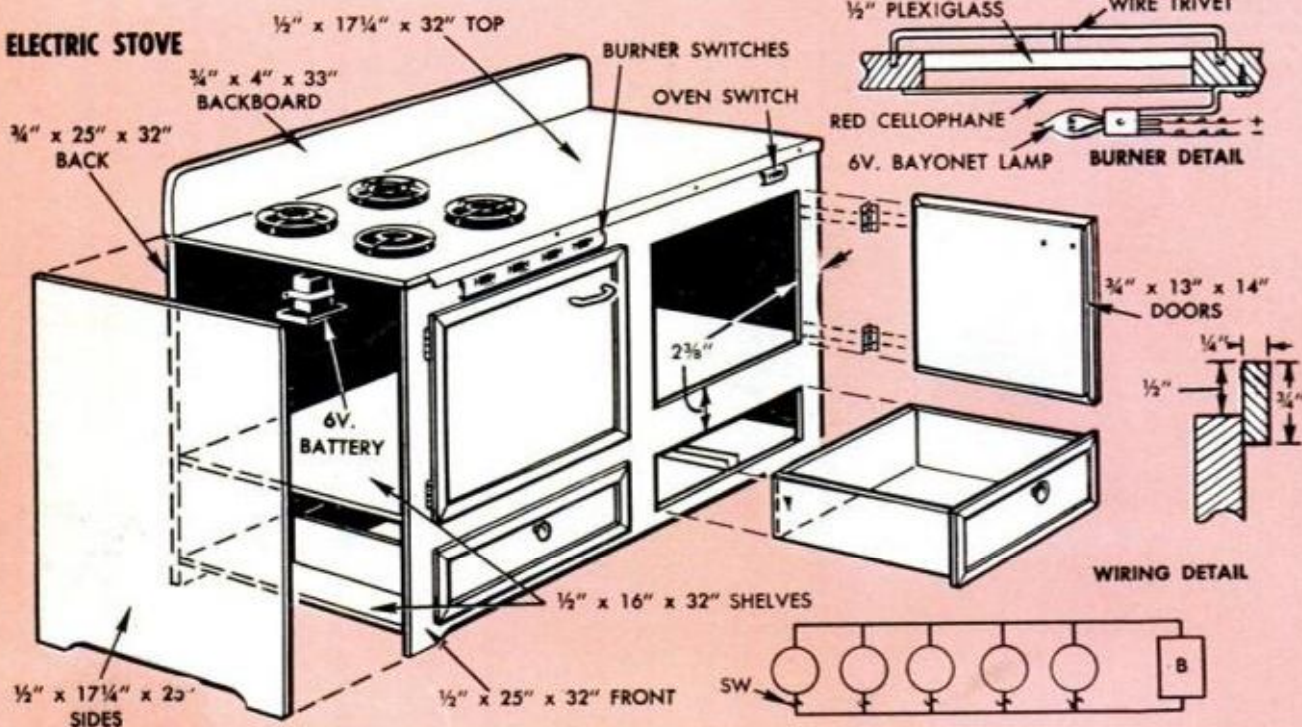



SINK

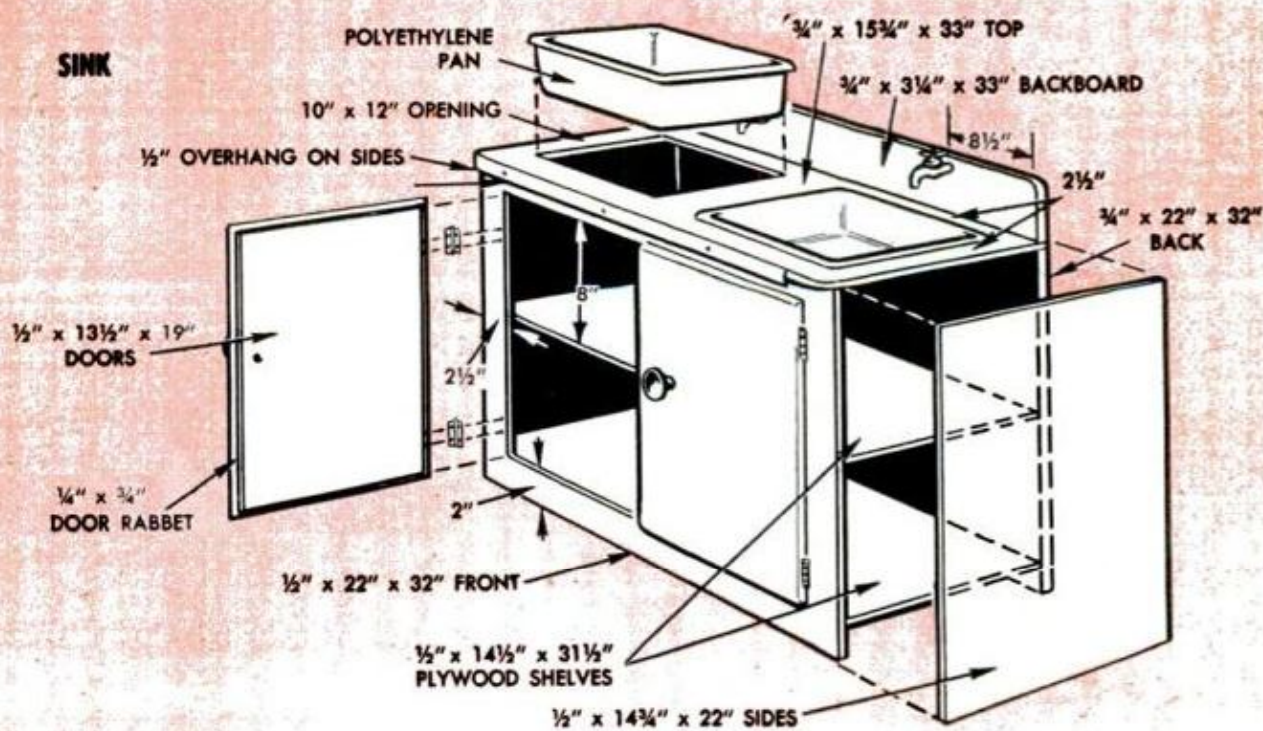



made more realistic by covering the top and splashboard with linoleum and metal edging.

While the refrigerator, with its light and all, is basically the same type of construction as the other two units, the top is assembled separately and mounted as a unit. First, nail the curved pieces to the plywood top and attach the filler strips. Then glue the hardboard top to the end pieces using an epoxy glue and C-clamps. Fill the gap between the edge of the hardboard and the filler strip with wood putty and mount the unit.

Finally, round the edges of the top with a belt sander or by hand. The shelves rest on wood cleats attached to the sides. If possible, salvage a couple of shelves from an old refrigerator. Otherwise, use any strong perforated material.

—D. A. Williamson

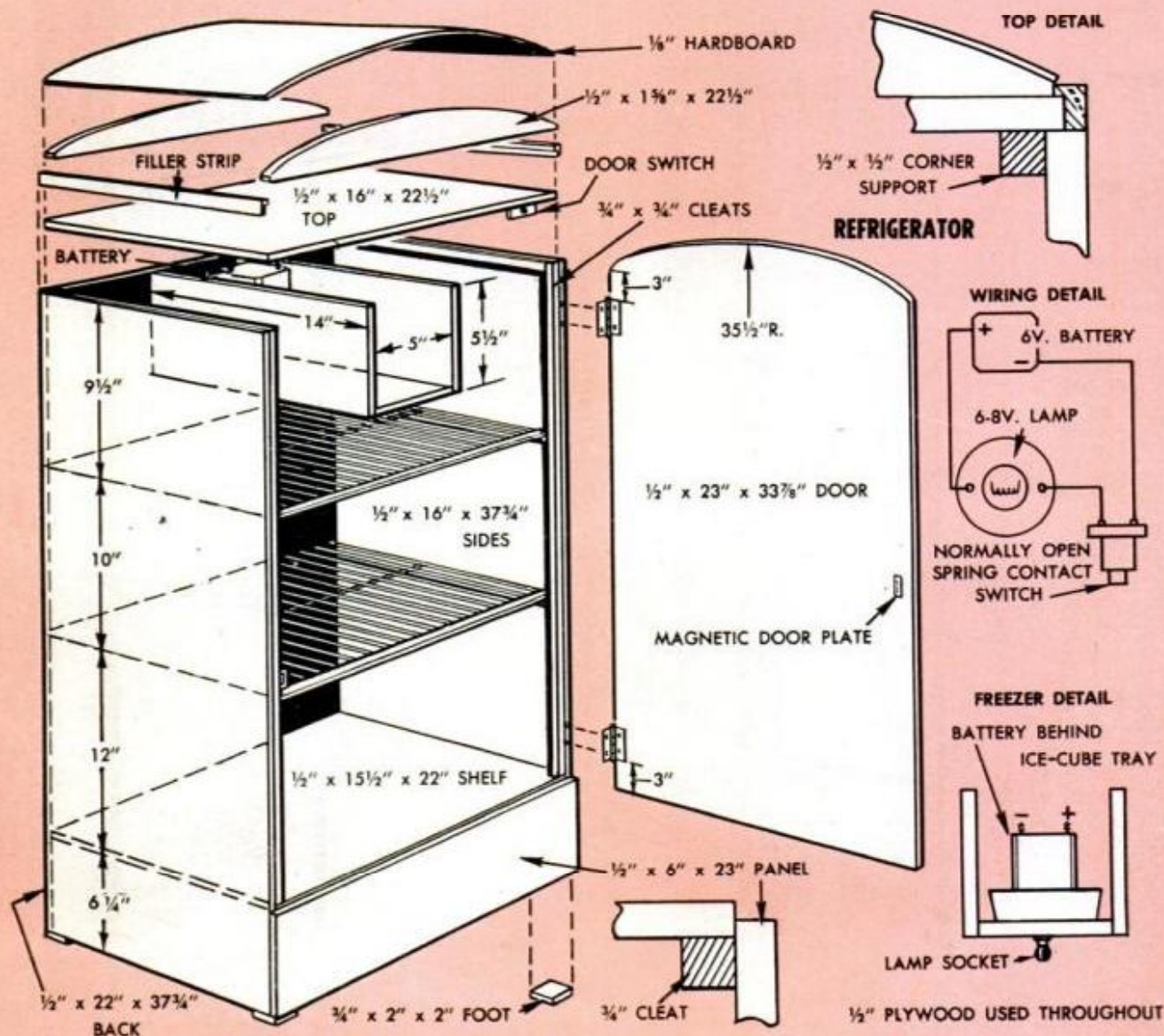



Ring Out The Old

From such common items as berry boxes and tree ornaments you can create unusual doorway decorations which will spread Christmas cheer throughout the house. The tower of bells (right) is made of seven green plastic berry boxes held together with fine wire. The bells, each of a different color, are suspended from the center of the inverted boxes. The mistletoe hanger (above) is made of two papier-maché berry boxes glued together, dusted with gold glitter and trimmed with green rick-rack and red sequins. Six plastic boxes are used to make the design shown below, all being wired together, sprayed bright gold and decorated with clusters of small balls

—Bob Joselyn

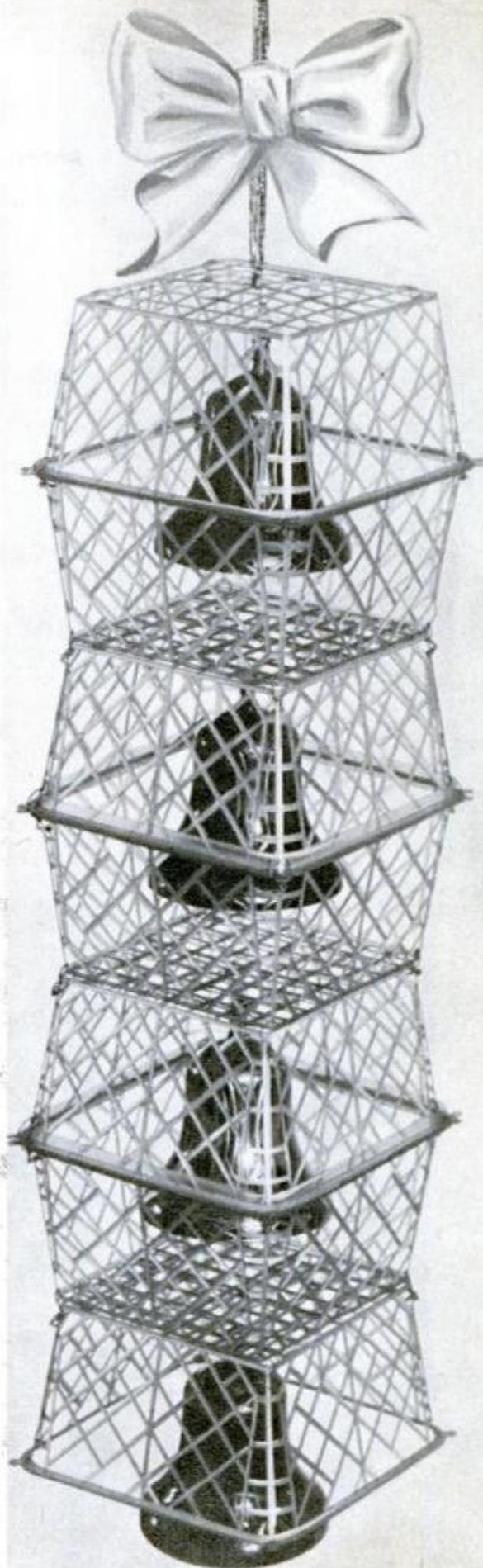
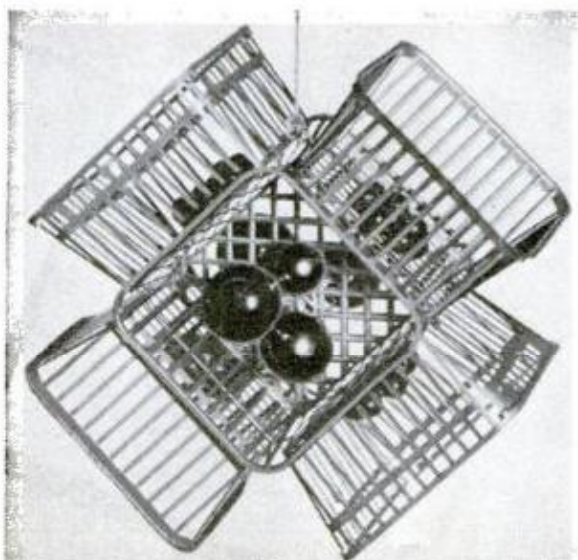

X618



Say It With Silk

Silk-Screen printing makes your greeting cards say "Merry Christmas" in a personal way





OF ALL THE millions of greeting cards that will be mailed this holiday season few will bring the Christmas message with quite the warmth and feeling of the card that has been handmade and printed by this photographic-silk-screen process. Your card made by this

method will be both personal and individual; there will be no duplicates.

Although the silk-screen process is in itself very old, in this procedure it is tied in with photography which greatly enlarges its scope. You create your very own greeting card design, using as subjects almost anything of your choice that expresses your thought for a relative, friend or acquaintance at Christmastime—yourself, your family, your house, your dog, your activities. The sample card used in outlining the process is a suggestion of how to proceed.

You'll need all the equipment and materials listed in the table. Silk-screen equipment can be purchased as a kit and you can add the other materials necessary, such as film or plates, card stock and envelopes, masking tape and artist's brushes.

The first step in the procedure is to determine the final trimmed size of your card to fit a stock-size envelope. A simple color sketch of the card is next made to determine the color combinations and, of course, the final appearance of the card. This should be worked three times the final size, Fig. 1. Having determined the design and made the rough layout, you make a black-and-white drawing three times the final size as in Fig. 2. This should be done on artist's illustration board in India ink. You can avoid much of the hand lettering by obtaining letters printed on clear acetate from art supply dealers. This product comes to you as a sheet, Fig. 3, and you simply cut out the letters you want and work them into your design. To do this, you make up each



CAMERA AND SILK SCREEN EQUIPMENT

1. Camera, 2 1/4 x 3 1/4 or larger ground glass back
2. Film holders
3. Enlarger, 2 1/4 x 3 1/4 or larger
4. Usual dark-room equipment, trays, thermometer, etc.
5. Light box with a diffused glass top for use in working on

negatives and positives

6. Silk-screen frame, minimum size 10 x 12-in.—16XX silk
7. Squeegee, 6 to 8 in., for use in screening
8. Base board for screening plus hinge clamps for screen
9. Dryer or fan which can be used for drying the screen

MATERIALS

1. Kodalith Ortho film or plates
2. D-11 or Kodalith A & B developer
3. Ektagraph film
4. Ektagraph activator
5. Ektagraph stripping solution
6. Water-soluble blockout (from a silk screen supplier)
7. Oil-base silk screen colors red, green, white, blue, yellow, gold, etc. (from silk screen supplier)

8. Solvent such as mineral spirits for washing out screen
9. Card stock
10. Envelopes
11. Masking tape, 1-in.
12. Large white, lintless blotters
13. Artist's brushes for hand touching and opaquing, No. 4 or 5, red sable



5

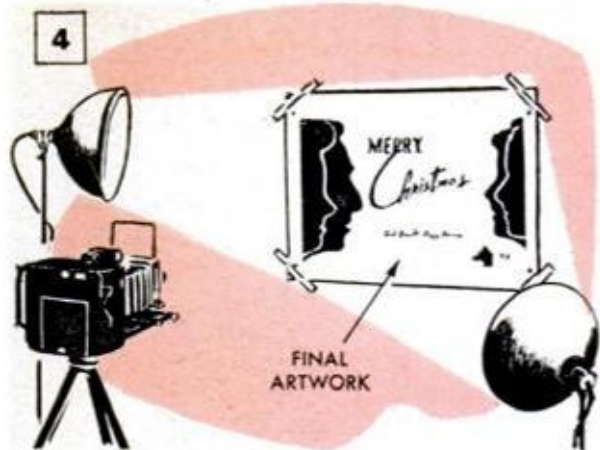

line of type needed, paste it on a separate sheet and photograph it to the exact size you want, using the high-contrast Ortho film listed in the materials list. From the negative you make a print on high-contrast paper, making sure the type is exactly the size you need. Then you paste this on the drawing you have made of the card.

Now clean up the drawing to remove all finger marks, smudges and pencil lines. White out any spots of ink with artist's white and be sure that all black areas are fully filled in, that is, are intense black throughout. If you're using more than one color, then color register marks are inked in just outside the working area. Now you're ready to shoot the copy to get an

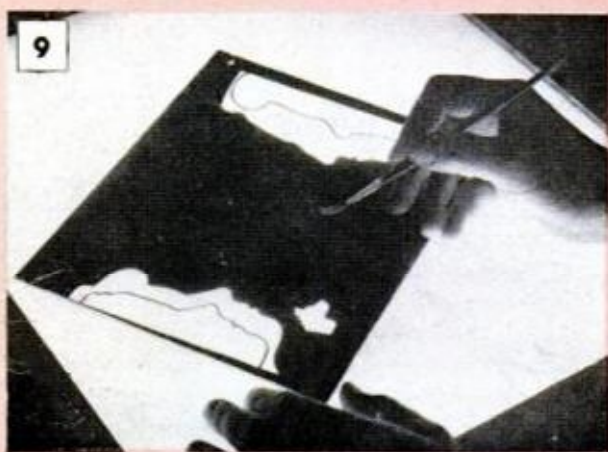

original negative. Use at least two No. 2 photofloods as a light source, setting up the work as in Fig. 4.

Using this negative you make a positive on Kodalith film, Fig. 5, using your enlarger and making the positive the same size as the finished card. If you are printing in a single color, this ends the photo process. But if you are printing in more than one color, say red, green and gold, you go farther and make a contact negative again in Kodalith film for each of the colors from your positive. Then on the red print, you opaque all of the image area except that which is to be red; on the green all the image area except that which is to be green; likewise on the gold. This procedure is pictured in Figs. 6 through 9. You now have three new contact positives from the negative. After these are made and developed in D-11 developer you are ready to contact the positives to the Ektagraph film. In using this film be sure to follow all instructions in detail. Fig. 12 shows in detail how to proceed. Start with a piece of $\frac{3}{4}$ -in. plywood a trifle larger than the silk-screen frame, placing the blotter first and then the Ektagraph film with the light side up. Then place the film positive with the emulsion side contacting the light side of the Ektagraph film. In this way you are exposing through the light side of the film. After exposing, Fig. 12, follow the developing in-

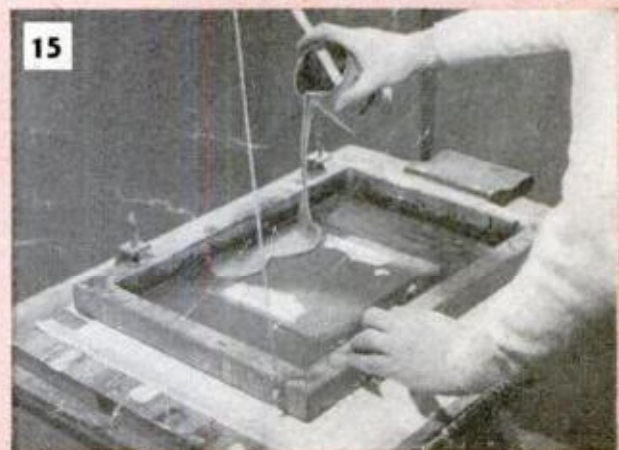
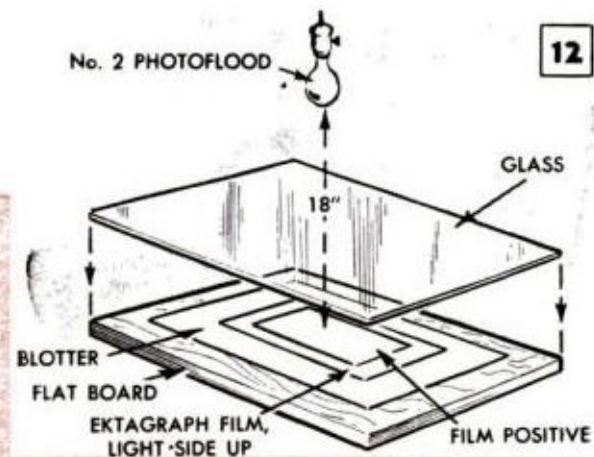
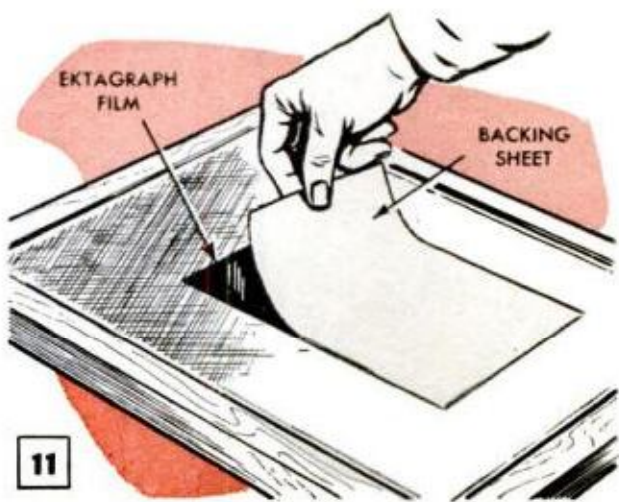
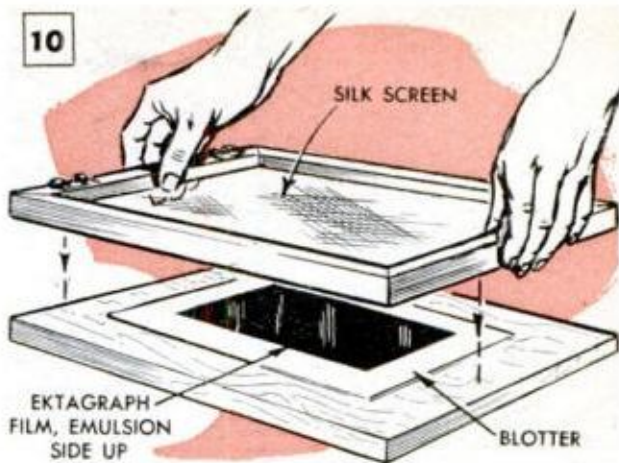

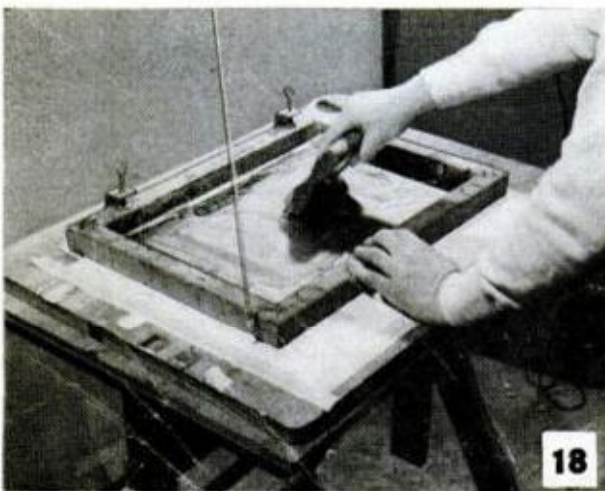
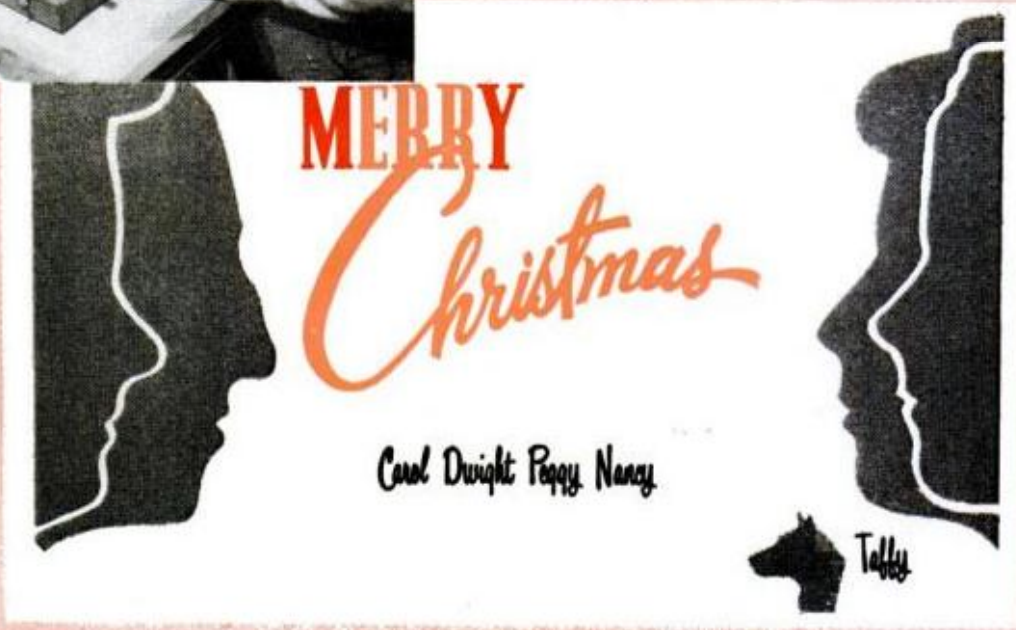
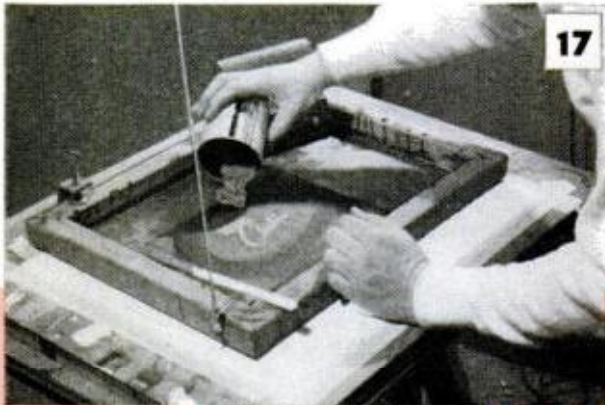

structions, using the Ektagraph activator and after the image is entirely black, keep it in the activator for about 25 seconds, then transfer to the acetic-acid bath.

Washout the Ektagraph film (which now is a stencil) with 95-degree water, making sure to remove all the milky emulsion on the black areas. Give special attention to the light areas as these are the areas through which the ink will be transferred. Now lay Ektagraph film, emulsion side up, on a blotter placed on the plywood base you have been using, so that as you look at the film it is reading positive. Fig. 10. Place the silk screen, with the silk still wet, over the film, lightly pressing the screen into the emulsion and using a blotter on the top side to remove excess water. Place the screen in a dryer or in front of a fan.

After the screen is thoroughly dry begin wetting the film on the bottom side of the screen with the Ektagraph stripping solution, using a piece of fine cheesecloth. Keep

(Continued to page 240)

LET THERE BE LIGHT

CHRISTMAS and candles go together like Eastertime and lilies. And now the soft glow of candlelight gets a new twist in these novel candelabras designed as centerpieces. One, pictured at the right, consists of eighteen tapers arranged in an ascending spiral, the other having the conventional seven tapers of graduated height.

Candles for both candelabras are molded in the cup shape you see by using a plastic refrigerator egg carton as the mold. Buy twelve-compartment cartons, use one as the mold and cut the cups from the others. In making the spiral candelabra attach the cups to the ends of $\frac{1}{4}$ -in. dowels with small screws. Note the lengths of the dowels in the detail. Glue the dowels into holes drilled in the circular base.

Melt old candles of varying colors in a double boiler and pour the wax into the egg cup molds. Just as the wax begins to harden place the wicks. When hardened remove the cup-shaped candles and place in the candelabra cups. Proceed in the same manner in making the seven-taper candelabra.

—Theodosia Carpenter

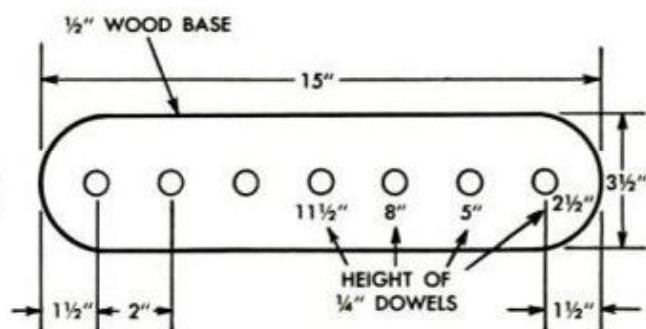
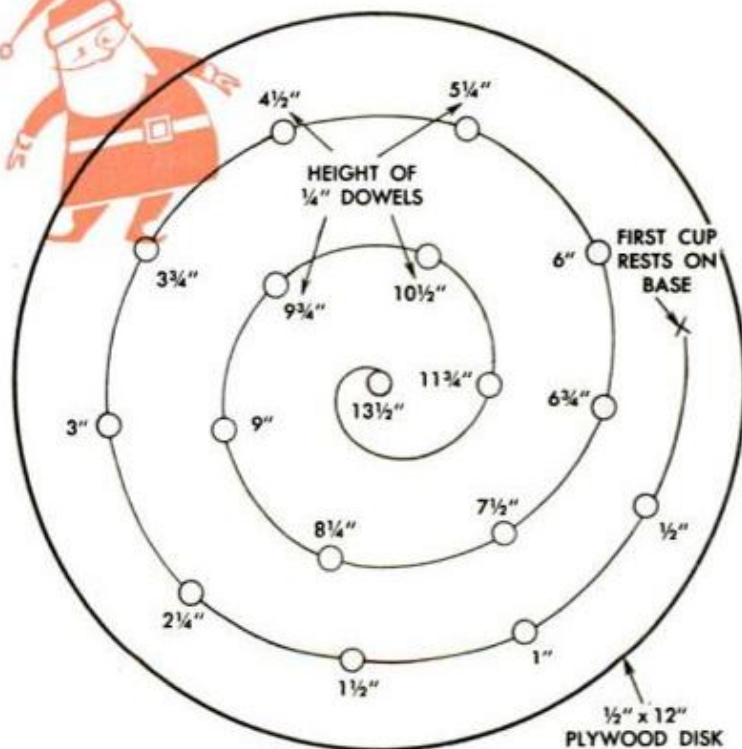
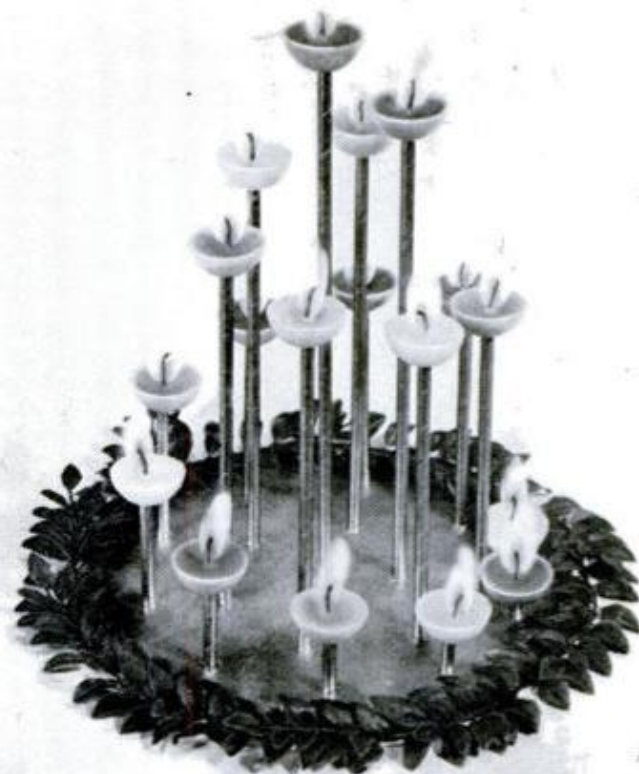

Grow a Yule Tree With Paper Towels

EVERYDAY MATERIALS, such as paper towels, 1-in.-mesh hardware cloth and a painted pole which serves as a trunk, are used to grow this one-of-a-kind Christmas tree. Cut hardware cloth to triangular shape according to half pattern, then curve it slightly across width. Trunk is a 1¼-in. wood pole about 48 in. long, tapered at one end and painted white. Attach hardware-cloth cutout to pole with staples and set lower end of pole in flower pot filled with sand. Locate lights, but before pushing sockets through mesh, tape all four wires of each mesh as in detail. This prevents possibility of electrical short. With light string in place finish tree by pressing individual paper towels through mesh. Cement a suitable ornament to top of trunk, attach ornaments to tree with pipe cleaners. You also can make a cone-shaped tree using same materials and methods.—Maurine Krohne

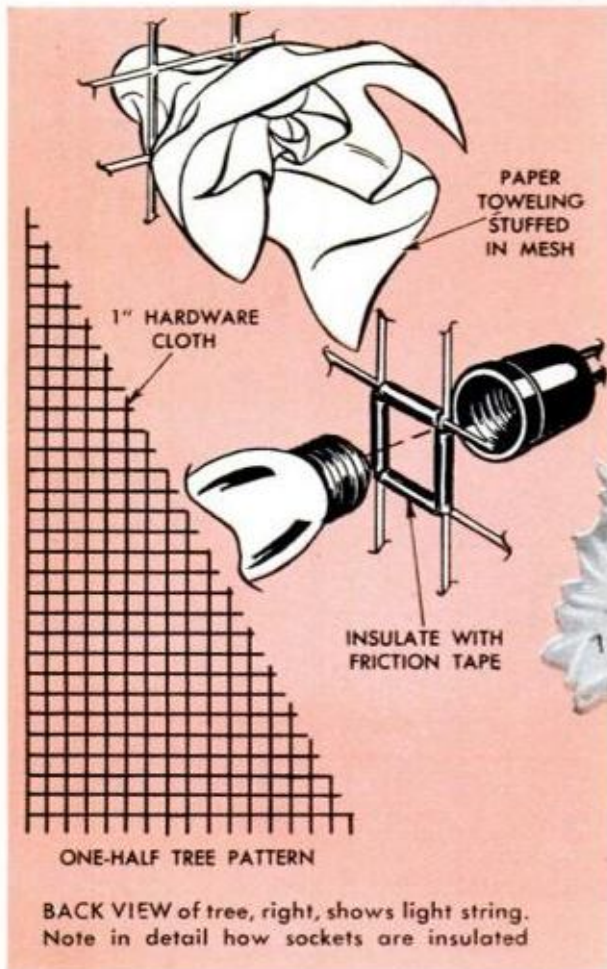

KEEP THESE IN MIND

All-Weather Bird Feeder

While bird feeders come in all shapes, sizes and price ranges, one of the most economical and practical of them all can be made from an old garbage can cover and the lid from a cheese box. You can obtain the cheese box lid from your local grocer. Drill four holes 90 deg. apart in both the cover and the lid. Then cut four 6-in. lengths of wire and bend both ends of each piece to form hooks. Hang the box lid from the cover, first drilling a few small holes in the bottom of the lid to allow any water which might accumulate to drain out. To hang the feeder, hook the end of a long piece of wire through the handle on the cover and wrap the other end around a tree limb. If desired, the feeder can be given a coat of paint to dress it up.—*Gene R. Griffin*



Ball Handles for Files

Discarded golf balls make excellent palm-fitting handles for files and other tanged tools such as carving chisels and gravers. Just drill a small hole through the center of the ball to take the tang in a snug fit. The resilient rubber core of the ball will grip the tang tightly. The ball provides an easy, comfortable grip that gives sure control of the tool.—*Bil Toman*



Scored Dowels Lock Joint

Don't use smooth dowels in edge-glued joints. Rather for maximum holding power, cut the dowels to required length and then score each one deeply along the entire length with the alligator teeth of your slip-joint pliers. The deep scores give the glue an extra bite in each dowel hole, greatly strengthening the joint.—*R. J. DeCristoforo*

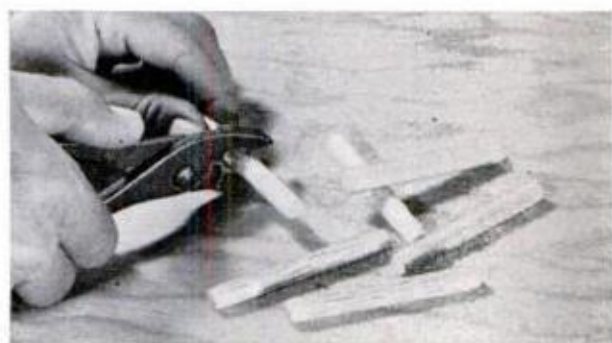

Models Fly in Formation

A small patented plastic clip makes it possible to lock three stick-model gliders together for formation flying. The clip, devised by North Pacific Products Co., Bend, Ore. as a wing mounting for their regular balsa models, simplifies both manufacture and assembly. It attaches to the top of the fuselage and sets the correct dihedral for the wings which are made in two pieces. An extra clip can be used on the underside of the fuselage to hold the wing tips of two other planes, thus permitting formation flying.

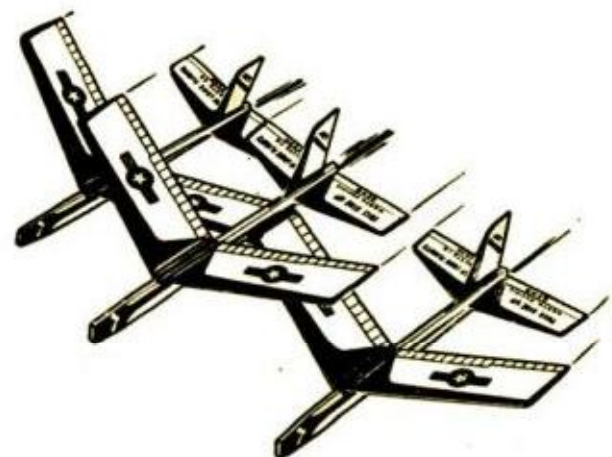

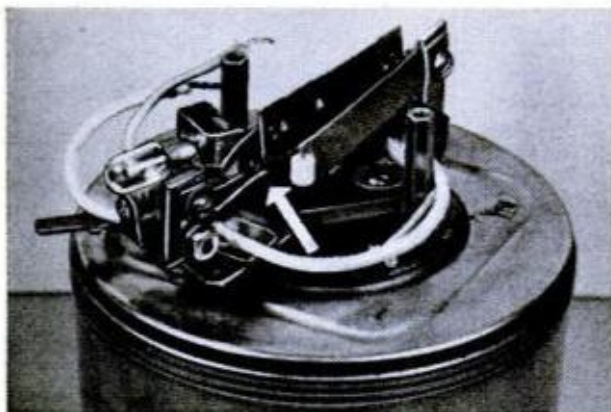
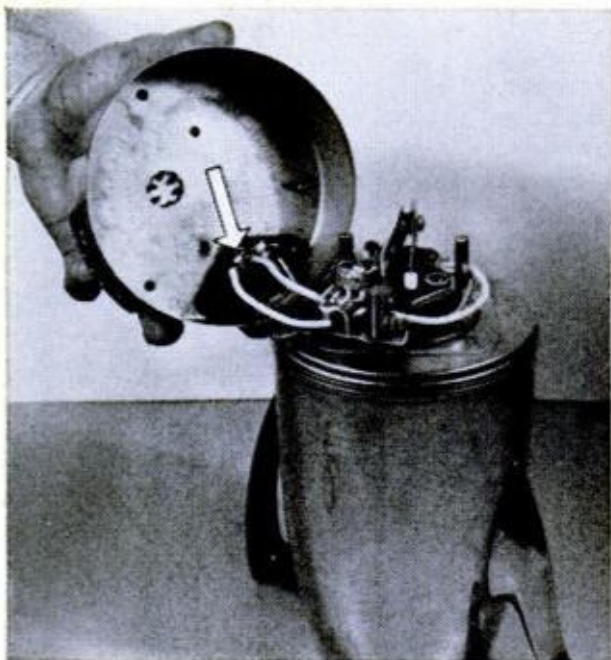

FEW HOME appliances get more hours of service in any given period of time than your electric coffeemaker. Not only hours of service, but it gets a lot of handling as well, for it must be cleaned regularly, wiped dry inside and out, placed in a cabinet or on a shelf between use periods, plugged in and unplugged at least once every day. Most good coffeemakers can take this for years but sooner or later wear will take its toll and some morning the maker will flatly refuse to work. It's then you can save a few dollars by fixing it yourself.

First, you clean the unit thoroughly and then remove the base. Generally you'll need a Phillips screwdriver for this job. Take it easy on any screws that seem to stick so that you don't damage the screws or parts.

With the base off, you'll probably see something like that pictured in the upper left-hand photo. Check the terminals, indicated by the arrow, carefully for looseness. Both the nut and the terminal post itself may be loose, a condition that can result in arcing. This can damage the terminal post or the terminal base, or both. In some instances it may be necessary to replace the terminal block.

In the center photo, the points and thermostat are indicated by the arrow. Often a tiny tip of carbon will form on one or both the points and prevent good contact. Usually it can be removed by passing a strip of cardboard between the points but you may have to use a strip of fine (8-0) sand-

Appliance Fix-It File

paper to clean the points thoroughly and remove any fine pits. Work carefully as otherwise you may damage the entire unit. If the points are badly pitted, then they should be replaced.

If all the parts you have examined so far appear to be in good order and the maker still fails to work properly, or not at all, then you should probe farther. Usually there are two tapped studs taking the screws which hold the base in place. Unscrewing these, lower photo, opposite page, allows you to lift off the control unit and have a look at the heating element, indicated by the arrow in the upper photo at the right. Check the element, which is of the plate type, for breaks and the lead-in wires for frayed or burned insulation. If you discover a break or if the wires are badly corroded, or if insulation is in doubtful condition, then replacements are advisable. You'll get more reliable service from the coffeemaker and save the bother and time of making the inevitable repair later on.

When you replace the control unit you will notice a small resistance winding, or coil, indicated by the arrow in the lower photo at the right. This serves as a warming element which keeps the coffee hot after the regular heating element shuts off. Examine this coil closely for breaks and worn insulation. It is easily replaced as a unit if defective.

Remember when dismantling any household electrical appliance to work carefully. Don't permit the wrench, screwdriver or pliers to slip and damage delicate parts.

—John Pennington

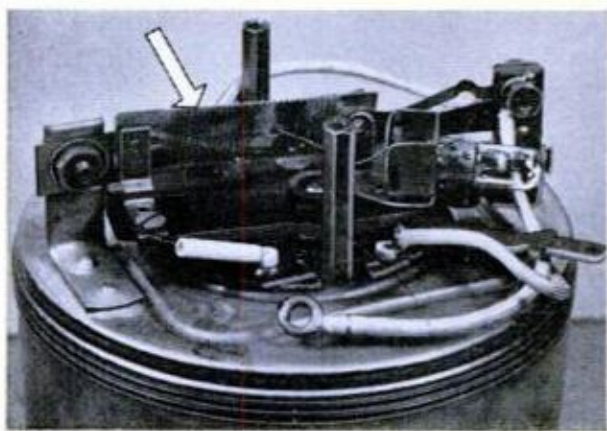
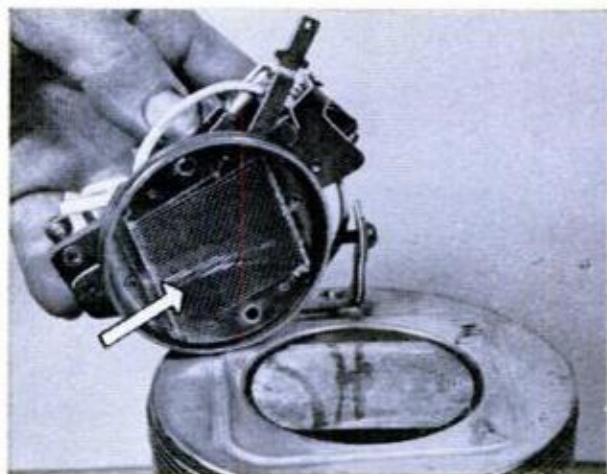





5-MINUTE CAR WASH

By Manly Banister

ENTERPRISING TEEN-AGERS who have outgrown the paper route, also the car owner who likes a quick wash to keep his car sparkling new will go for this speedy portable car washer. Its sprinkler heads, from a lawn sprinkler system, form a dirt-removing spray ring that hits every exposed inch of the car as it is driven slowly through the arch. The whole affair can be disassembled and bundled in minutes for moving to a new location or for storing.

To assemble this washer you'll need one 8-ft. and two 6-ft. lengths of 1 1/4-in. aluminum tubing, two aluminum elbows, two aluminum T-butt connectors, four end caps, one 8-ft. length of 1/4 x 1-in. bar aluminum, six 1/4 x 2-in. plated stove bolts with lock washers, two 1/4-in. wing nuts, 18 ft. of 3/4-in. plastic pipe, five 3/4-in. plastic-pipe tees with five 1/2-in. close nipples, five sprinkler heads, eight tool or broom clamps, a male hose coupling with cap and a female hose coupling for connecting a garden hose. You should be able to buy all the parts for about \$25.00. If you wish, you can salvage the soap dispenser from a car-washing brush and connect to the plastic hose just below the first sprinkler head.

The aluminum tubing and the fittings that go with it can be obtained at any hardware store selling Do-It-Yourself aluminum. You also can use pipe and slip-on fittings for the hose supporting framework, and it's possible to adapt the assembly to standard threaded pipe and fittings. The

STRONG JET SPRAY is provided by five sprinkler heads of the type used in underground lawn sprinkler system. Plastic pipe joins sprinkler heads

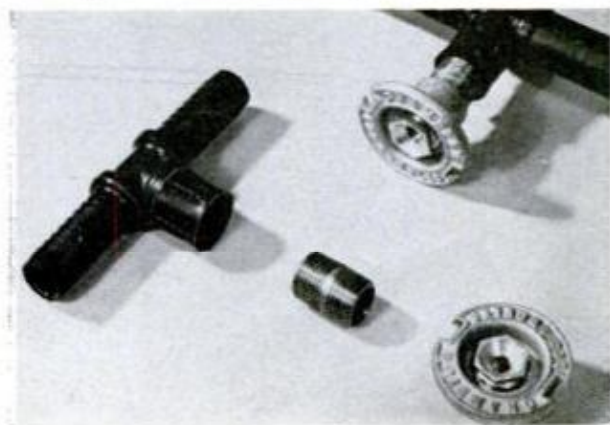

SHOP SHORT CUTS

Expanding Stock Sling

Rather than stand lengths of molding and other narrow strips of stock on end in a corner, store them on the shop wall in this expanding sling. It's made from two screw hooks, two screw eyes, two lengths of clothesline and a pair of sash weights. Turn the hooks into the wall at a convenient height, turn the screw eyes into the wall about a foot or so below the hooks. Tie the sash weights to the clotheslines, pass the free ends of the lines through the screw eyes and tie to the hooks. Then slide the lengths of stock back of the lines as pictured. The sling will hold one piece, a dozen or even more pieces securely, always out of the way, yet always visible and easily removed when needed.

—G. E. Hendrickson

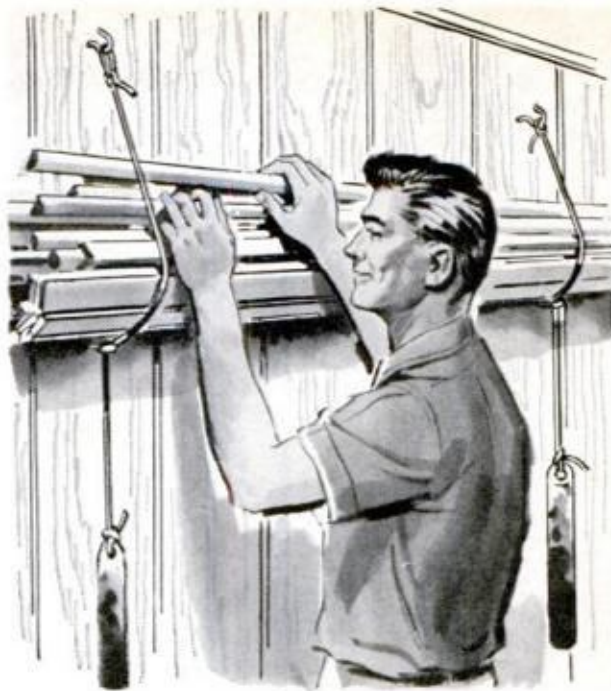

Improvised File Card

Everyone knows that a clean file will get the job done faster, and you can keep your files clean with an inexpensive file card made from a scrap of copper window screening about 3 in. wide. Simply roll the screening up tightly and either bind it with tape or insert it into a short section of bamboo. Since copper is a soft metal it won't harm the file, but it will be stiff enough to clean out any material which is clogging the teeth.—Bil Toman

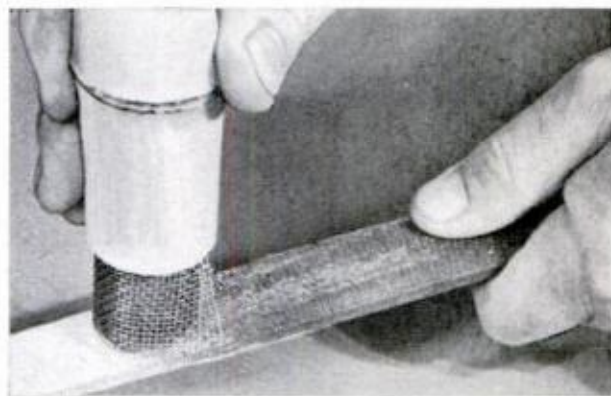

C-Clamp Deflector

Cutting a strip from heavy sheet metal with tin snips will be much easier if you use a small C-clamp as a deflector. Attached to the snips just back of the jaw the clamp turns the cut strip downward, making it easier to guide the snips straight in the cut and also opening the cut so that the snips slide forward to get a fresh bite without binding. This trick works equally well with the hawk's-bill snips pictured or with snips having straight cutters.—R. Hanscom

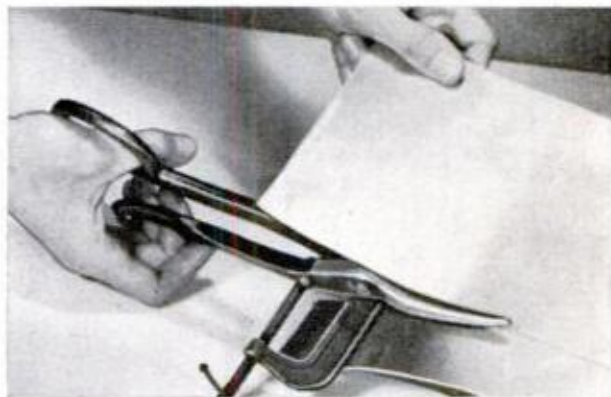

Circle Cutter Adapted for Glass

An ordinary circle cutter can easily be adapted to cut small glass disks. Cut off the handle of a regular glass cutter and square off the remaining portion of the handle to fit the hole for the regular cutter. Remove the pilot drill, substitute a short nail for it and stick a double patch of surgical tape to the glass to serve as a nonslip center or pivot point. Rotate the cutter by hand.

—O. A. Nelson

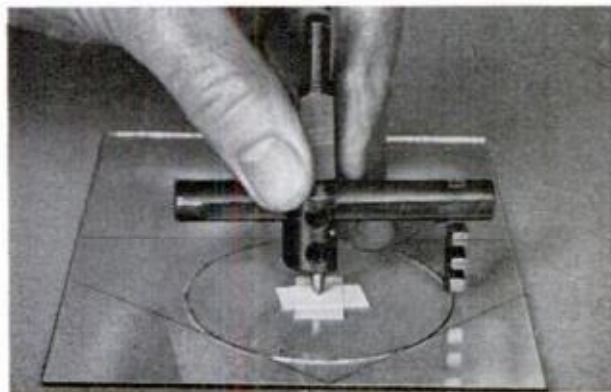

Solving HOME PROBLEMS

PLOW SNOW with a washtub? Try it. You'll be very much surprised at how efficient a snowplow the tub makes for clearing sidewalks. It will handle a new snowfall up to 4 or 5 in. Just tie a rope to one of the handles and weight the tub with a concrete block



USE OF ALUMINUM FOIL prevents rabbits and other rodents from damaging trees and shrubs during the winter. Simply wrap a piece of household aluminum foil around tree trunk at a height that will prevent the bunny from reaching the bark. He won't bother to chew through the aluminum barrier

DISCARDED CHILDREN'S sand box may be pressed into service as a mortar-mixing box. Later it can be cleaned out and returned to its original use. A bonus tip is shown in the illustration. The man is using a rake instead of a hoe for mixing the mortar. After a trial you may prefer this tool



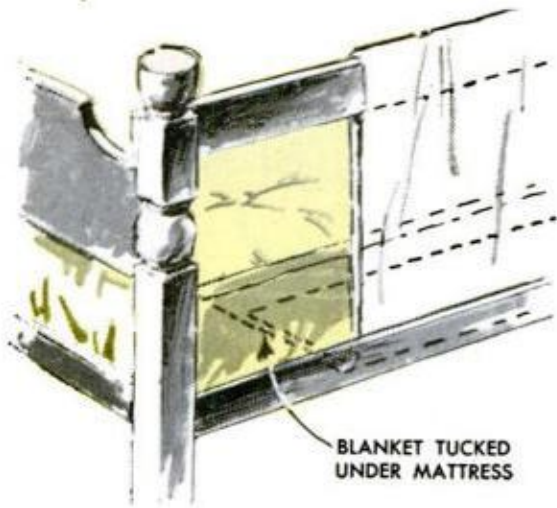

BLANKET TUCKED UNDER MATTRESS

TO PREVENT A SMALL CHILD from accidentally rolling out under the guard rail on the upper berth of a bunk bed, one mother "fenced in" the open rail with a blanket and tucked the ends under the mattress as shown

DISCARDED MAIL-ORDER CATALOG makes a high chair out of any ordinary chair for tykes or moppets who want to sit up to the table like grownup folks. Bind all the edges and the back of the catalog with strips of adhesive tape so that it won't come apart or twist out of shape



ADHESIVE TAPE BIND PAGES TOGETHER

COLORFUL LETTER OPENER can be made quickly from a toothbrush handle. Cut the bristle end from a discarded toothbrush, then file handle to a point. Sand filed section to an oval shape to produce two cutting edges, one on each side of the oval

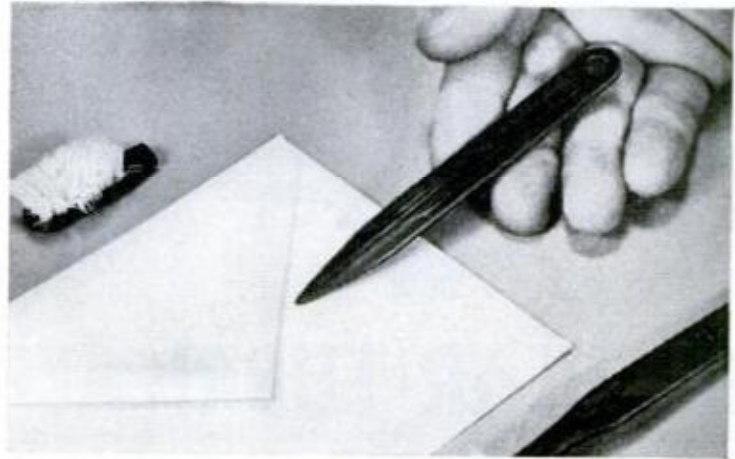

NEXT TIME YOU PAINT inside wear a pair of boot socks over your regular shoes. Then it's an easy matter to wipe up any spatters on the floor without stooping. Saves a lot of time and energy. You won't damage the socks as they are easily cleaned in a paint solvent for further use

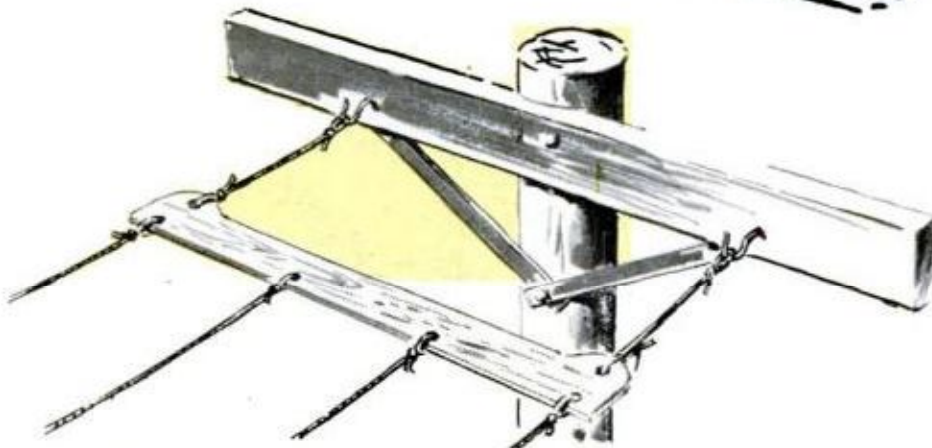

CLOTHESLINE stretchers, or gambrels, (left) are made of $\frac{1}{4}$ -in. plywood and drilled at 12-in. intervals to space the clotheslines. When not in use, the lines may be wound onto one stretcher and stored away



REGULAR LUBRICATION PAYS OFF

By Will Hector

LUBRICATING YOUR CAR periodically assures longer life for wear parts, smoother operation and measurable fuel economy. But miss one grease fitting, one oil cup, one oil change and you may reduce the life expectancy of at least one part and

possibly of the car itself. Unless, of course, you have a 1961 car with a sealed chassis which is lubricated for a guarantee period. Then you don't worry about grease jobs until you and the car are perhaps a year or two older.

1. AIR that circulates through crankcase and out discharge comes in through breather cap. Keep it clean

2. EQUIPMENT YOU NEED for a lube job is simple to use and inexpensive. Below are the essential items

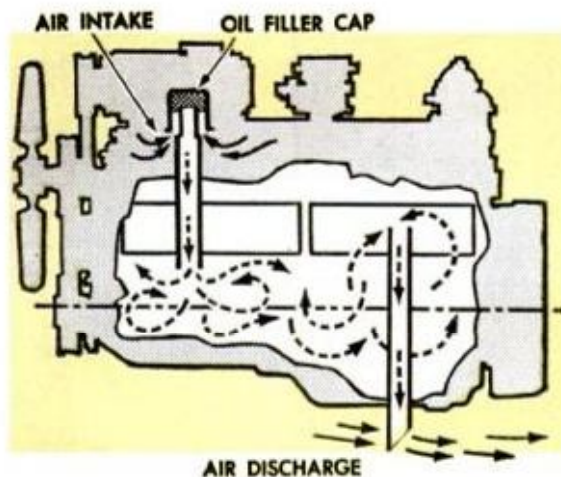

LUBRICATION CALENDAR

Every 1000 miles*

WHERE TO LUBRICATE	TYPE OF LUBRICANT	DATE	MILEAGE
Front suspension arms	All-purpose gun grease		
Steering linkage	All-purpose gun grease		
King pin	All-purpose gun grease		
Steering gear	SAE 90 oil to visibility		
Clutch release fittings	All-purpose gun grease		
Gearshift levers	All-purpose gun grease		
Transmission, clutch, and brake linkage	Dripless penetrating oil		
Rear axle	Multipurpose SAE 90		
Transmission, std. or OD	Multipurpose SAE 90		
Transmission, automatic	Special auto trans. fluid		
Deck lid, door, hood hinges	Dripless penetrating oil		
Door latches, striker plates	Wax stick		
Exhaust manifold valve	Liquid graphite		
Air cleaner (dry type)	Wash in solvent and dip in light engine oil		
Every 2000 miles*			
Breather cap	Wash in solvent, dry, dip in light engine oil		
Air cleaner (oil bath type)	Wash filter element in solvent, drain. Refill base with clean oil as recomm. Drain oil when hot. Refill with correct grade and type		
Crankcase			
Every 4000 miles*			
Oil filter	Replace cartridge and oil when oil is dirty		
Distributor	Oil rotor wick with light machine oil, also oil point on breaker plate, if any. Clean cam and grease lightly. Varies		
Generator	Add a few drops of engine oil. <i>Warning!</i> Don't over-lubricate		
Brake master cylinder	Add HD brake fluid to within 1/2" from top		
Convertibles, campers, etc.	Dripless penetrating oil to all moving metal parts		
Brake cables	Dripless penetrating oil or graphite liquid		
Parking brake handle	Lubriplate or dripless grease to shaft. Unscrew cable from rear of meter. Wipe clean. Then apply graphite lubrication or light grease from a point 6" from speedometer to end of cable.		
Speedometer cable			
Every 15,000 miles*			
Rear axle, transmission, standard and automatic transmission	Drain and refill with correct type and grade lube		
Front wheel bearings	Clean and repack with wheel bearing grease		
Every 25,000 miles*			
Universal joints	Clean, inspect. Repack with wheel bearing grease and replace grease seals at same time		

*At periodic lubrication all operations to that time must be done at the same time, i.e. at 4000 miles, operations for 1000 and 2000 must be performed as well as the 4000 mile operation.

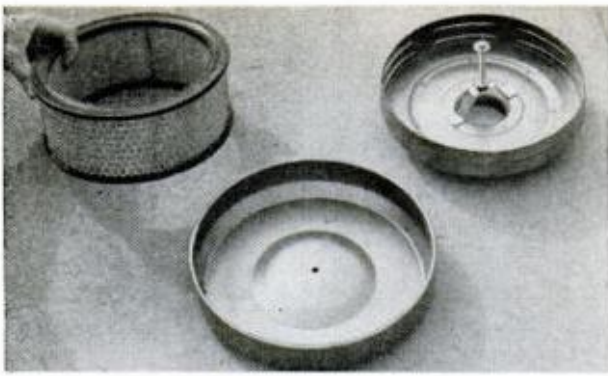

3. PAPER-FILTER AIR CLEANERS should be cleaned every 1000 miles or less under dusty conditions

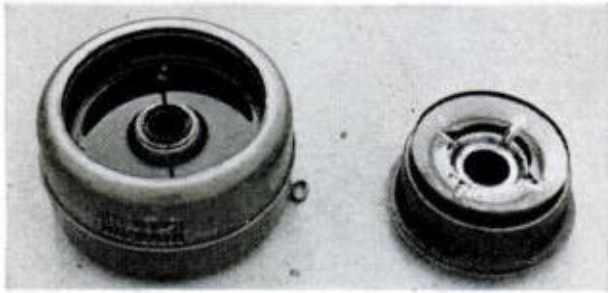

4. OIL-BATH CLEANERS should be serviced regularly. Follow instructions for your car when servicing



5. BREATHER CAPS get too little attention. They're really filters and should be serviced regularly. It takes a thorough cleaning to remove dust and sludge

6. HEAT VALVE on exhaust manifold is another lube point that is easily overlooked. It should get regular attention. Use special oil to withstand heat



7. DON'T WAIT for door hinges to squeak before oiling. Use pressure oil can and lubricate sparingly

Of course it's easier to take the car to your serviceman and leave oil changes and grease jobs to him. But if you'd like to give it a try just for kicks and the car know-how you can pick up, then here's how you go about it: You'll need the sludge pump, grease gun, pressure oil can and lubricants pictured in Fig. 2. These are the essentials. You'll also need to clip the lubrication calendar on the opposite page. It charts just about everything on the average car that needs oiling or greasing periodically and lists the type of lubricants to be used. You keep the dates and the mileage, of course, in the two righthand columns. It's a good idea to check the calendar with your mileage readings periodically. Obtain a chassis lubrication chart with diagram for your make of car.

If you're new at the greasing and oiling job, take the car to a service station and have the chassis steam-cleaned. This makes location of all lubrication points easier and more certain. Next, locate the car on the driveway or the garage approach—anywhere it's level and there is solid support for the stands. Then jack up the car and drop it on the stands. Make sure that the car cannot move once it is on the stands. Never get under a car until you are certain it is solidly supported.

Locate and hit all the pressure grease fittings first. Then do the oil holes, if any, and the oil cups. Note the warning in the 4000-mile division of the calendar in connection with lubrication of the generator bearings. The generator, distributor rotor and breaker plate are about the only points on a car where you can overlubricate and cause damage. Check each of the lubrication points off on the chart under the proper heading as you proceed.

Note in the 2000-mile division of the calendar that the breather cap, Fig. 3, is listed.



8. OPEN UNIVERSAL JOINTS on drive shaft need lubricating at 25,000 miles, or less. Before you loosen nuts have rubber bands at hand to hold parts in place. It's a good idea to have instruction sheet for your car

The diagram in Fig. 1 shows how important it is to keep it clean. It should be thoroughly cleaned at least every 2000 miles and every 1000 miles or less if your driving is in dusty conditions. The same is true of the air cleaners, the paper-filter type pictured in Fig. 3 and the oil-bath type in Fig. 4. Note that the paper-filter type cleaner is listed in the 1000-mile division of the calendar. This should be taken to mean "every 1000 miles or less," depending on driving conditions. When servicing both types of cleaners, always follow instructions given by the manufacturer.

Also in the 1000-mile division of the calendar you will note that the exhaust-manifold valve, or heat-riser valve, is listed. This valve, Fig. 6, is sometimes missed in lubrication schedules. If not properly lubricated at regular intervals, it may stick and
(Continued to page 218)

10. SLUDGE PUMP comes in handy when changing filter cartridge or relubricating rear end. It picks up the goo easily, keeping hands and clothing clean

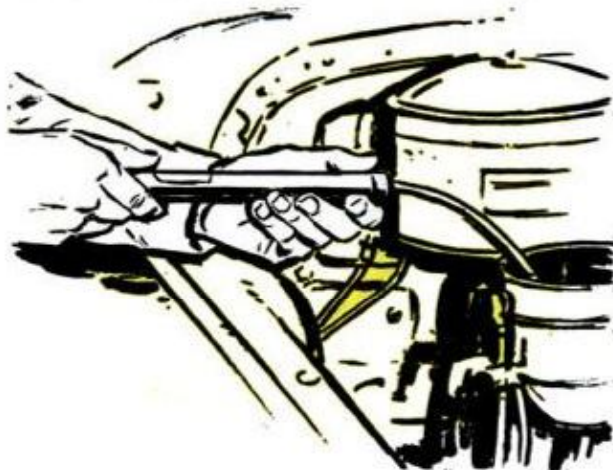

9. DRIVE UNIVERSAL JOINT apart with a short length of pipe. Take it easy with the hammer as otherwise you may damage parts. Note position of rubber bands that hold the bearing cages in place

11. FINAL STEP in removing bearing cages from universal is to lift the spider and slip small washers between spindle and bearing. Then tap bearing out

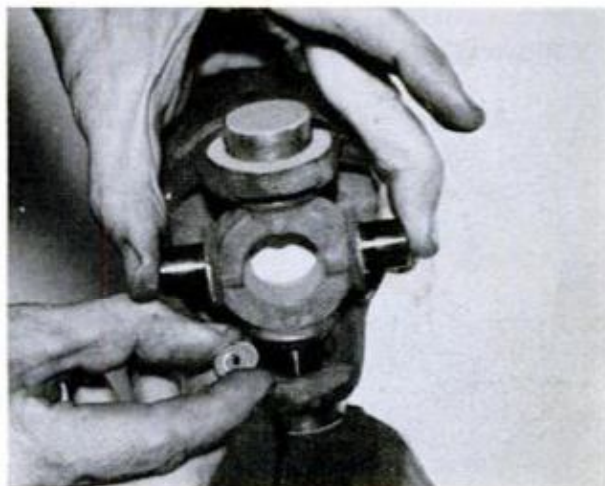

Better CARKEEPING



INFLATED TUBES are difficult to hold submerged in a testing tank while a close check is made to catch the telltale bubbles indicating a pinpoint leak. One way is to drill small holes through the tank near the top and insert a small-diameter rod after the tube is placed in the tank. The rod keeps the tube submerged, makes it easier to keep it under control

LOOSE SKID CHAINS can do a lot of damage to the under sides of fenders to say nothing of the distracting clatter. To quiet the chains, make two pairs of double hooks from heavy wire, bending them as in the inset detail. Then cut two 1-in.-wide rubber bands from an inner tube, insert a double hook at each and attach to the chains as in the photo

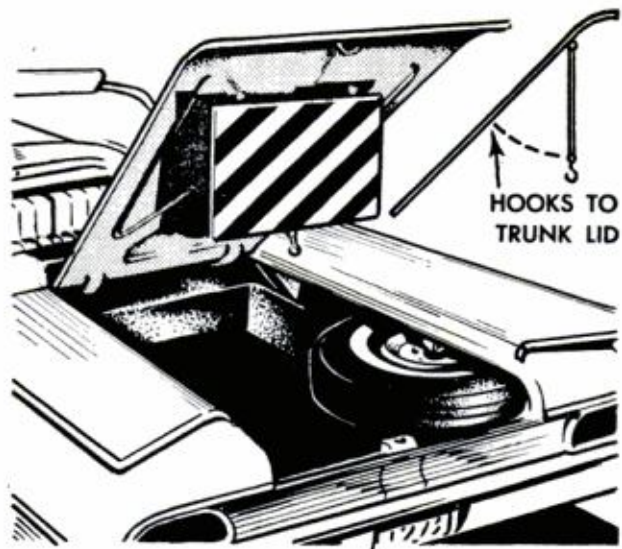
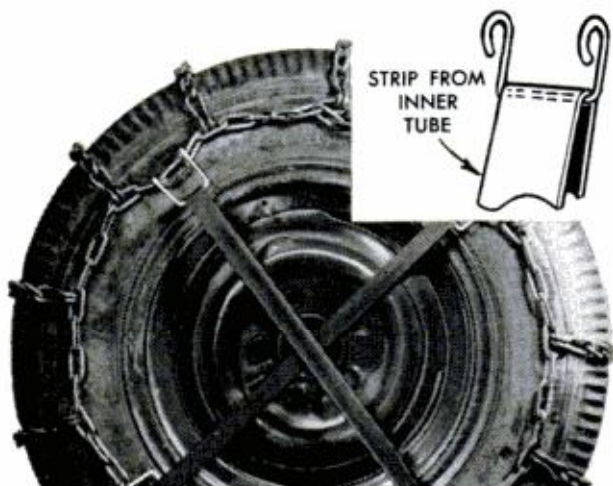

WHEN CHANGING A TIRE on a busy highway after dark with cars streaking past only a few feet away you'll feel easier if you install this warning reflector which shows when the trunk lid, or deck, is raised. Cut a piece of 1/4-in. hardboard about 12 x 16 in. and apply spaced strips of reflective tape to one face. Then hinge under lid, using rings of wire and a hook



GRIND A BEVEL on the end of your ignition-point file so that it will slip between the points without bending the arms or damaging the points. Don't grind to a sharp edge; leave a flat about 1/64 in. wide

EYE SHIELD that clips to the sun visor blocks out glare that gets past visor when driving directly into the sun. Glue a spring clothespin to a square of 1/8-in. hardboard or opaque plastic to make shield

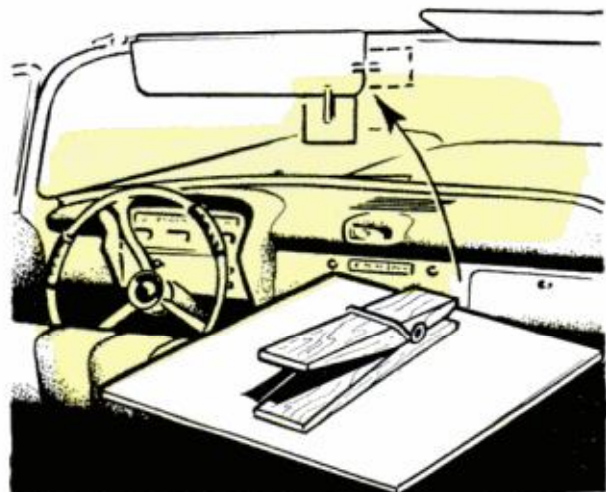

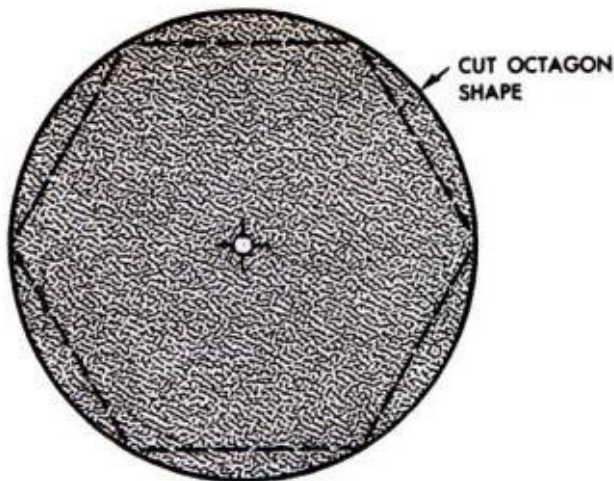

ABRASIVE DISKS used by auto-body repairmen won't leave scores in the metal surface if the disk is cut to an octagonal shape as indicated by the dotted lines in the detail. Octagonal disks cut more freely and work shallow reverse curves without digging in

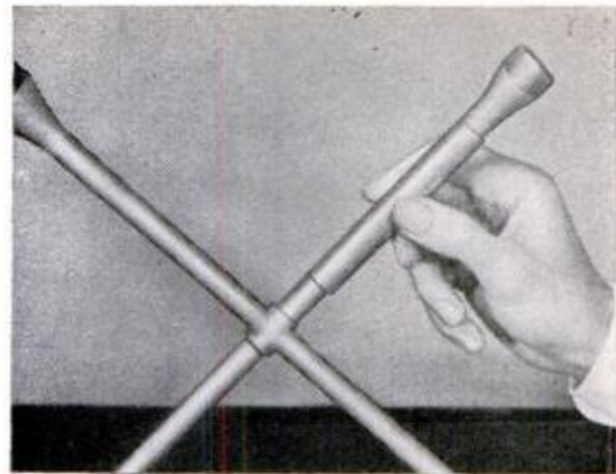

SPINNER HANDLE for a lug wrench eliminates that tiresome hand-over-hand job of tightening lug bolts. The job can be done a lot faster and with half the labor if you take time to fit one arm of the wrench with a sleeve which permits it to be used as a spinner. Simply form a sleeve of heavy sheet metal, using the wrench arm as a forming mandrel. Solder at the butted joint and then file off any burrs at ends of sleeve

PUNCTURES IN LARGE INNER TUBES usually are difficult to locate and more difficult to keep track of once they have been located, especially when there are several widely separated. If a round toothpick is inserted in each puncture as soon as it has been located in the testing tank you won't miss any when ready to make repairs. Care should be taken not to press the toothpicks in more than half their length

COMING UP NEXT...

3-in-1 Game Table. Like to play pool, table tennis or have fun with a train layout? Now you can enjoy all three pastimes on the same table. Turn the HO-gauge layout over and there's the tennis table; lift it off and there's a pool table, regulation size. Designed and built in PM's own shop. How-To begins next month.

Sugar-Plum House. Cardboard, candy and store cookies are the materials you use to build this novel Christmas centerpiece in Swiss chalet styling. You'll be surprised at its realism when you get it put together. Details and pictures in next month's PM show how it's made.

Vacuum Forming. Almost any small object, baby's shoes for example, can be enveloped in a plastic cocoon with this new kit. Suction from your vacuum cleaner causes a heated plastic sheet to snap down over the object, reproducing every detail of the surface. From this you can make a plaster cast, or use the vacuum-formed relief itself as a decoration. See next month's PM.

Spray With Air. You get a factory finish every time when you apply finishing materials with a spray gun or a pressurized spray container. Just aim the gun and pull the trigger, it's almost as simple as that. But there are tricks to know and that's what you'll find in an article on it next month.

MR. DO-IT AND BUNGLE



This month Bungle learns how to replace a broken window pane and plays a transparent trick on Mr. Do-It, his know-it-all neighbor

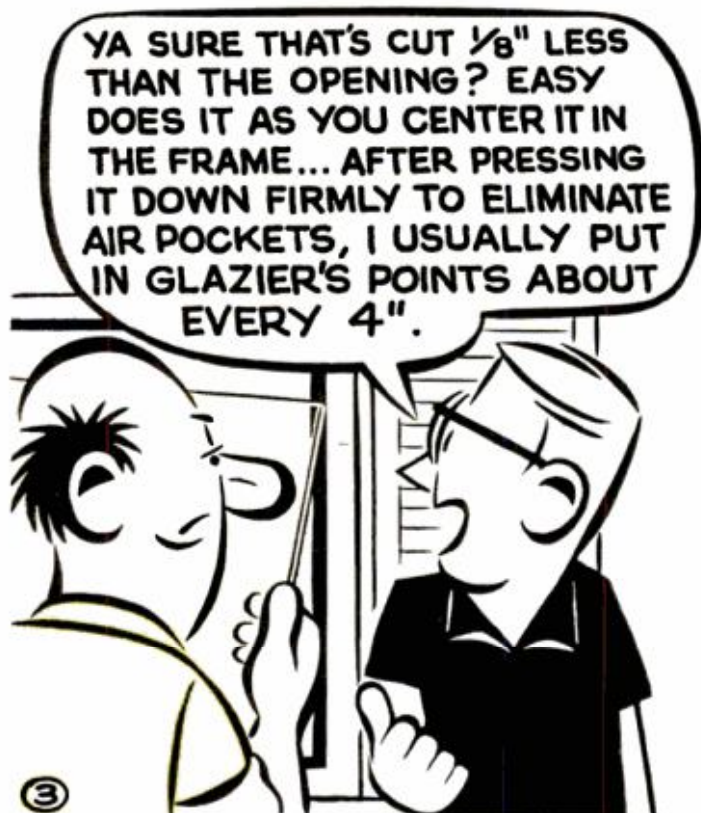

Toe-Touch Air System for Shop

By *Walter E. Burton*

YOU'LL WONDER how you ever got along without this foot-bellows air system in your shop. It can be used to blow out mortises and clear chips while routing to pattern lines as in the photo at the left, to provide an air supply for a small forge, a blow-pipe, Bunsen burner, or any other job where comparatively low air pressure is required.

The bellows unit, Figs. 1 and 2, consists of two plywood panels hinged together with the space between them enclosed by a diaphragm. A coil spring holds the panels apart until they are forced together. The inlet valve, Fig. 3, is located in the bottom panel and allows air to enter the bellows chamber. The compression stroke closes this valve, forcing air through the outlet valve, Fig. 4, and carrying it to the expansion air chamber, Fig. 11.

After cutting and drilling the $\frac{3}{8}$ -in. plywood bellows panels, Figs. 5 and 6, and attaching the end piece, stop blocks, base strips or runners, spring pocket (a fruit jar lid) and spring, Fig. 7, the hinge can be installed. Use a length of piano hinge with a thin leather gasket underneath to prevent leakage of air.

Cut the diaphragm from cloth-backed vinyl upholstery material or thin, pliable leather. It should enclose the bellows chamber completely with the spring slightly compressed, and is fastened in place with a double row of tacks and glue. Where there are



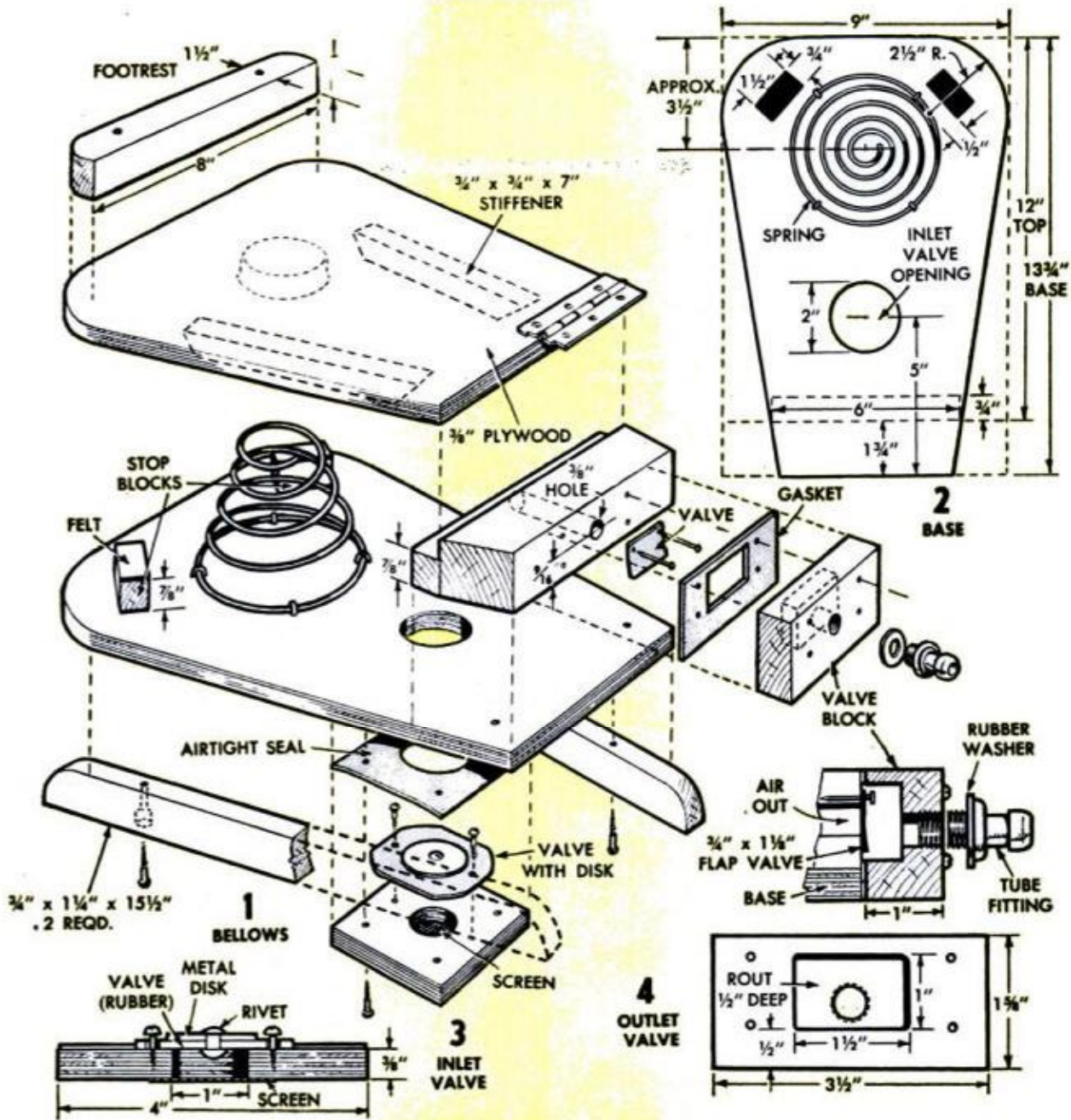

5. TOP AND BOTTOM panels are cut from $\frac{3}{8}$ -in. plywood with the top $1\frac{1}{4}$ in. shorter than the base

6. INLET VALVE OPENING drilled in bottom panel is only $\frac{1}{8}$ in. larger than the inlet valve itself

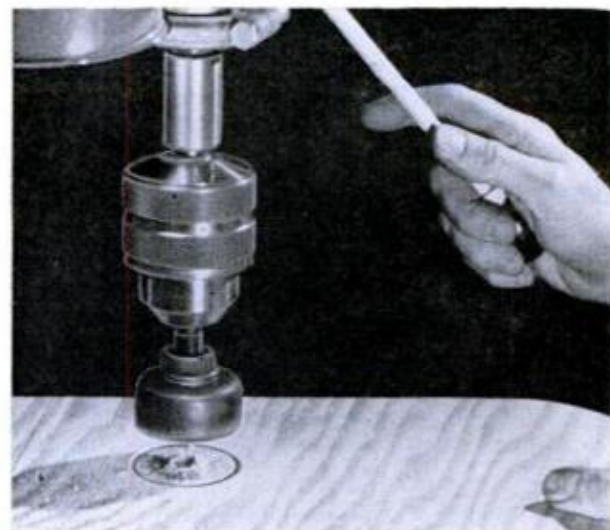
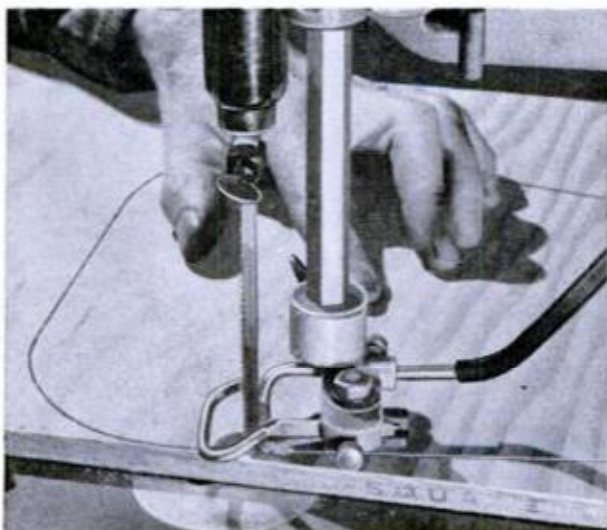

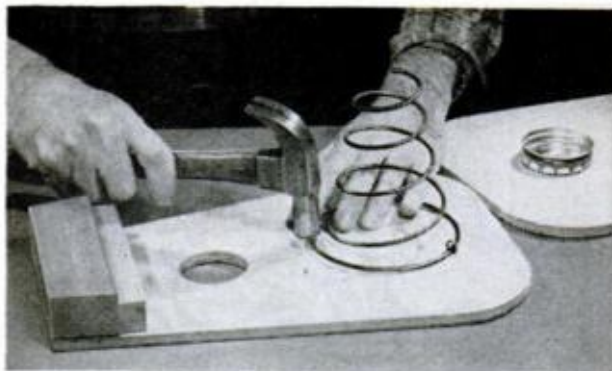

7. COIL SPRING which holds the two panels apart is fastened to the bottom panel with three staples. Jar lid at right serves as a pocket for this spring

8. INLET VALVE is mounted on a plywood block and can be removed. To make an airtight seal between the panel and valve block, a rubber gasket is used

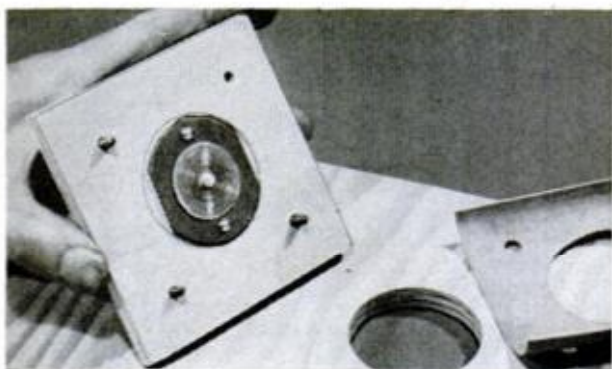

9. WIRE SCREEN over the inlet valve opening will catch small objects which might otherwise be sucked up through the valve and into the bellows chamber

10. TEE CONNECTOR on the rubber air chamber is made from a valve cap and a piece of copper tubing. Syringe tubing connects the chamber to the bellows



pleats at corners, split them and overlap.

The inlet valve is mounted on a 4 x 4-in. square plywood block, Figs. 8 and 9, so it can be removed if necessary. Cut a 1 7/8-in. disk from a leftover piece of inner tube. Punch two holes in this disk for 3/8-in. No. 4 round-headed wood screws, making the holes slightly oversize but smaller than the screw heads. Let the screw heads project about 1/16 in. above the rubber. Rivet an aluminum disk in the center to prevent the rubber piece from being forced into the valve opening.

The outlet valve is simply a flap of the same rubber fitted over the 3/8-in. hole in the end piece. Install a metal or plastic fitting for syringe tubing in the valve block, and attach the block to the end piece, using a rubber gasket.

The air chamber, Figs. 10 and 11, is made from a section of inner tube which is sound for about 15 in. each way from the valve, measured along the outer circumference. Seal the ends with the cement used in repairing inner tubes, position it with the valve uppermost on the inner edge and fold each end under twice so that the length at the outer edge is about 14 1/2 in. Cover with netting (that cut from an open-mesh sack will do) and clamp the chamber to the base board with two wooden strips. Netting should allow about 1/2 to 1 in. upward movement of the top of the tube with the chamber fully inflated.

To make the tee connector, cut the top off a tire-valve cap, file it concave to fit against a 5/16-in. brass or copper tube, drill a 3/16-in. hole in a 2-in. piece of this tube and solder the cap over the hole. ★ ★ ★

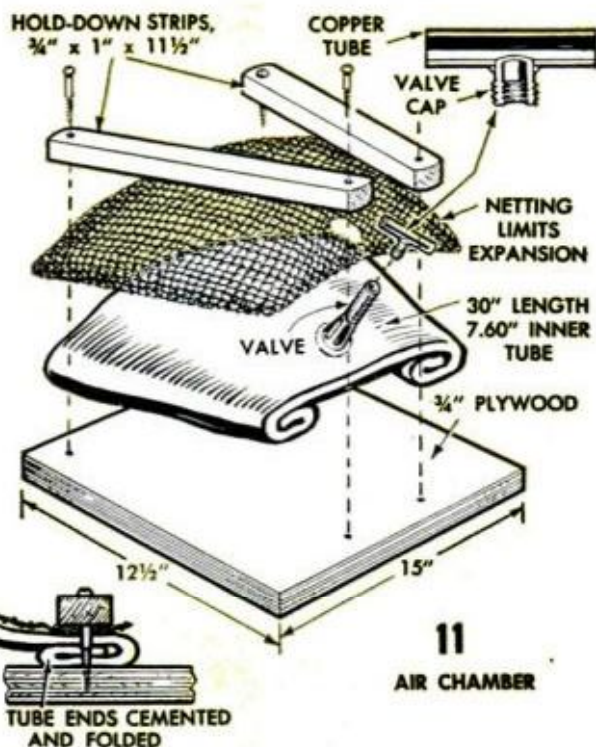



Roofed Bunks Shelter Feed and Livestock

Wide overhangs of this flat roof provide shelter for cattle and prevent feed losses during stormy weather. In summer the flat roof provides full shade and the open construction permits air circulation and admits a cooling breeze from any direction. The advantages of the flat-roofed structure are economy of construction over any conventional gable-roofed shelter, a new look in feedlot architecture and high wind resistance.

Notice that the feed bunks are integral with the structure itself, are not separate

units. The roof is supported solely by posts of uniform size which are set at an angle of about 15 degrees from the vertical. Each pair of posts supports a beam which carries the horizontal rafters. Stretchers carrying the feed bunks are attached to the posts near the lower ends. Additional bunk supports are spaced halfway between the posts. When available, used telephone poles are just the thing for the supporting posts. They are already pressure treated. Conventional materials are used for the balance of the construction.—C. F. Marley

Drawbar Stabilizer

This compression-spring stabilizer prevents springing a trailer drawbar when making a sharp turn; it also eases out the slack when starting heavily loaded trailers hooked in tandem. The drawbar is flamecut at the point indicated and two ½-in. steel plates are welded to the ends. The plates are then drilled near the corners for ½-in. bolts which join the plates and also serve as carriers for the heavy compression coil springs which take starting shocks and prevent springing of the drawbar.

—A. M. Wettach

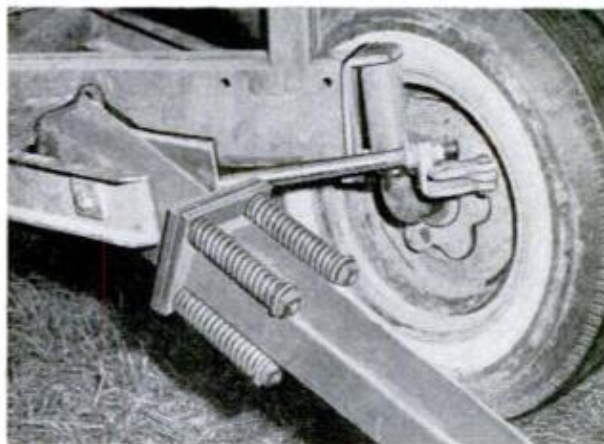

Self-Feeder Gets Lift

Conventional hog feeders can be utilized as cattle feeders for special rations and supplements by raising the feeder on an angle-steel stand as pictured. If it is necessary to move the feeder at any time during its period of service, then the stand should be fitted with hardwood skids. Steel feeders of the type pictured are waterproof, keep feeds and rations dry in all kinds of weather. Cattle quickly learn to lift the hinged lids.—Paul D. Andre



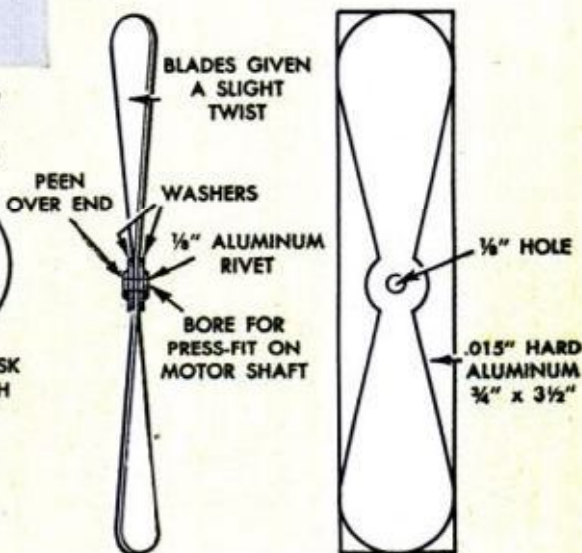
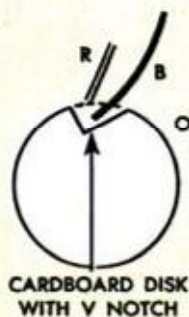
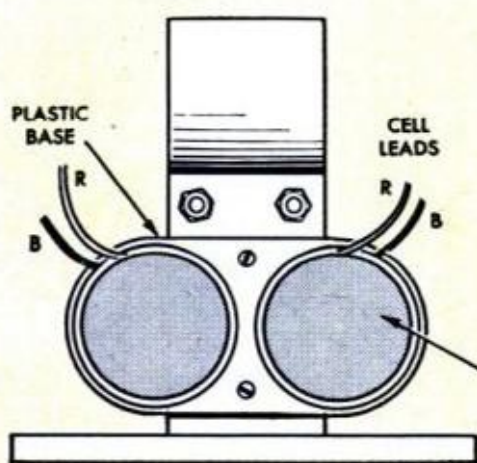
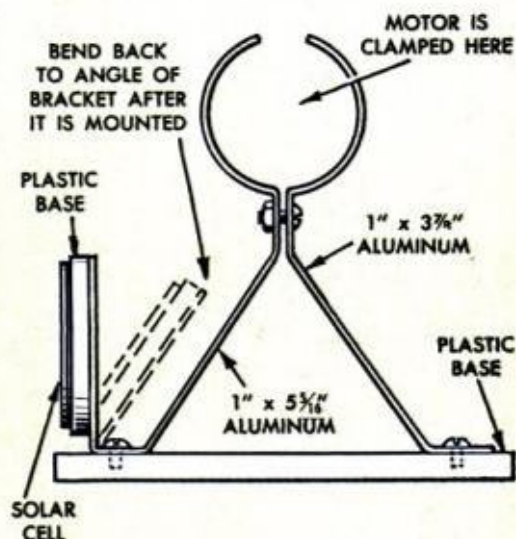
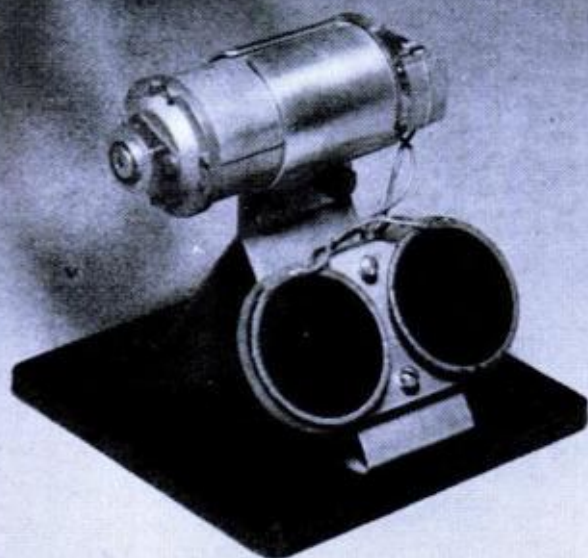

Light Powers This Electric Motor

By Harold P. Strand

JUST SET this tiny motor in direct sunlight or under your reading lamp and away it goes. Powered by two series-connected silicon solar cells as a light battery, the motor drives a propeller attached to its shaft at high speed when placed either in bright sunlight or artificial light. The solar battery which is the power source develops a maximum of about 1 volt and around 100 milliamperes. This is sufficient to operate the motor. Since the solar cells last indefinitely there is no power loss from continued use as there is with batteries. The motor is ball-bearing and is equipped with special low-resistance, low-friction brushes which are replaceable if required.

It can be built easily from a kit and will interest schools, teachers, students and

electrical experimenters since it teaches the principles of the direct conversion of light to electricity. When you experiment with this motor and kit, you will be working with the same type of solar energy that is used with our satellites to power their transmitters and other vital instruments. In addition to its educational value it makes a most interesting conversation piece on a desk where visitors are sure to marvel at the operating motor powered solely by light.

The base consists of a piece of black 3/16-in. plastic for good appearance, but, of course, a base of hard wood can be substituted if desired. Two aluminum bracket pieces are bent as detailed to form a support for the motor. An extended tab on one of the brackets supports the solar battery.

The latter consist of two No. 2-A Hoffman silicon cells mounted on a piece of $\frac{1}{8}$ -in. plastic as a base. The cells are connected in series or the black lead of one cell is connected to the red of the next one, see R and B leads in detail, the splice soldered and a small piece of spaghetti tubing slipped over the splice to insulate it. The base is attached to the support with two 2-56 screws. The remaining cell leads are then connected to the motor leads in a similar manner and the insulated splices turned down back of the cells. The notched disk detailed serves as a spacer for the back lead from each cell.

The motor is secured in the cradle type

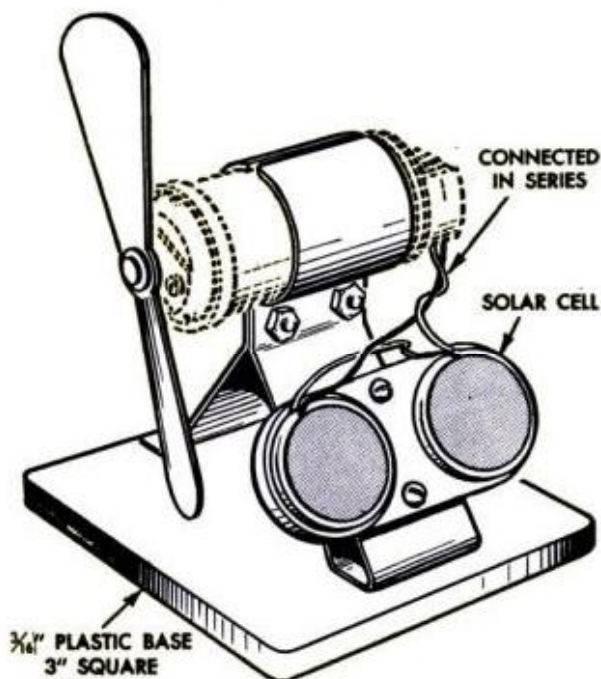

brackets with two 4-40 screws and nuts to hold it firmly in place, placing the motor in position so that the propeller will clear the cells when turning. The propeller is made from a piece of thin aluminum with a short aluminum rivet and two washers headed over in a center hole as a hub. A center hole is made in the hub to be a tight press fit on the motor shaft. Twist the blades slightly in opposite directions.

MATERIALS LIST

- 1 piece black Lucite plastic $\frac{3}{16}$ " x 3" x 3", (base)
- 1 piece half-hard sheet aluminum about .032"-.033" x 1" x $3\frac{3}{8}$ ", (bracket)
- 1 piece same stock 5-5/16" long, (bracket)
- 1 piece half hard or $\frac{3}{4}$ " hard sheet aluminum about .015"-.016" x $\frac{3}{4}$ " x $3\frac{1}{2}$ ", (fan)
- 1 aluminum low-head rivet $\frac{1}{8}$ " diameter, $\frac{1}{8}$ " long, (fan)
- 2 washers about $\frac{5}{16}$ " O.D., $\frac{1}{8}$ " hole, about .030"-.032" thick.
- 2 Hoffman 2-A silicon solar cells with attached leads.
- 1 piece Lucite clear plastic $\frac{1}{4}$ " x $1\text{-}5/32$ " x $2\text{-}5/16$ ", (cell base)
- 1 Aristo-Rev #2 ball bearing motor.
- 4 4-40 round head screws $\frac{3}{16}$ " long. 2 4-40 nuts.
- 2 2-56 round head screws $\frac{3}{16}$ " long.

Complete kit or parts can be purchased from Linwood Products Co., Pox 186, Wollaston 70, Mass. for \$27.50 postpaid.

SHOP SHORT CUTS



Low-Cost Pipe Centers

Small shops can save money by making this substitute for lathe pipe centers. Turn down a 60-degree center from cold-rolled steel then bore a 60-degree recess on the opposite face to take the point of the tailstock center in a snug fit.—Arthur Shults

Friction Ratchet for "Mike"

A sheet-metal collar with the ends forming a finger grip will give a delicate ratchet action to nonratchet mikes. Bend the strip around the knurled thimble. Bend the ends out to form a grip. In use, apply finger pressure until the collar slips.

—Richard Hanscom

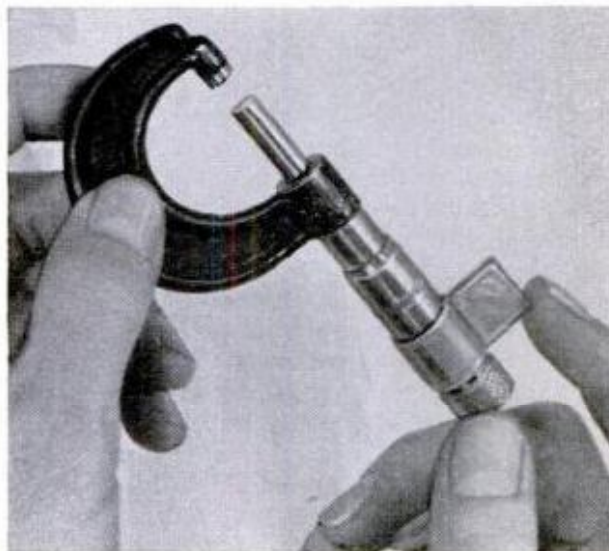

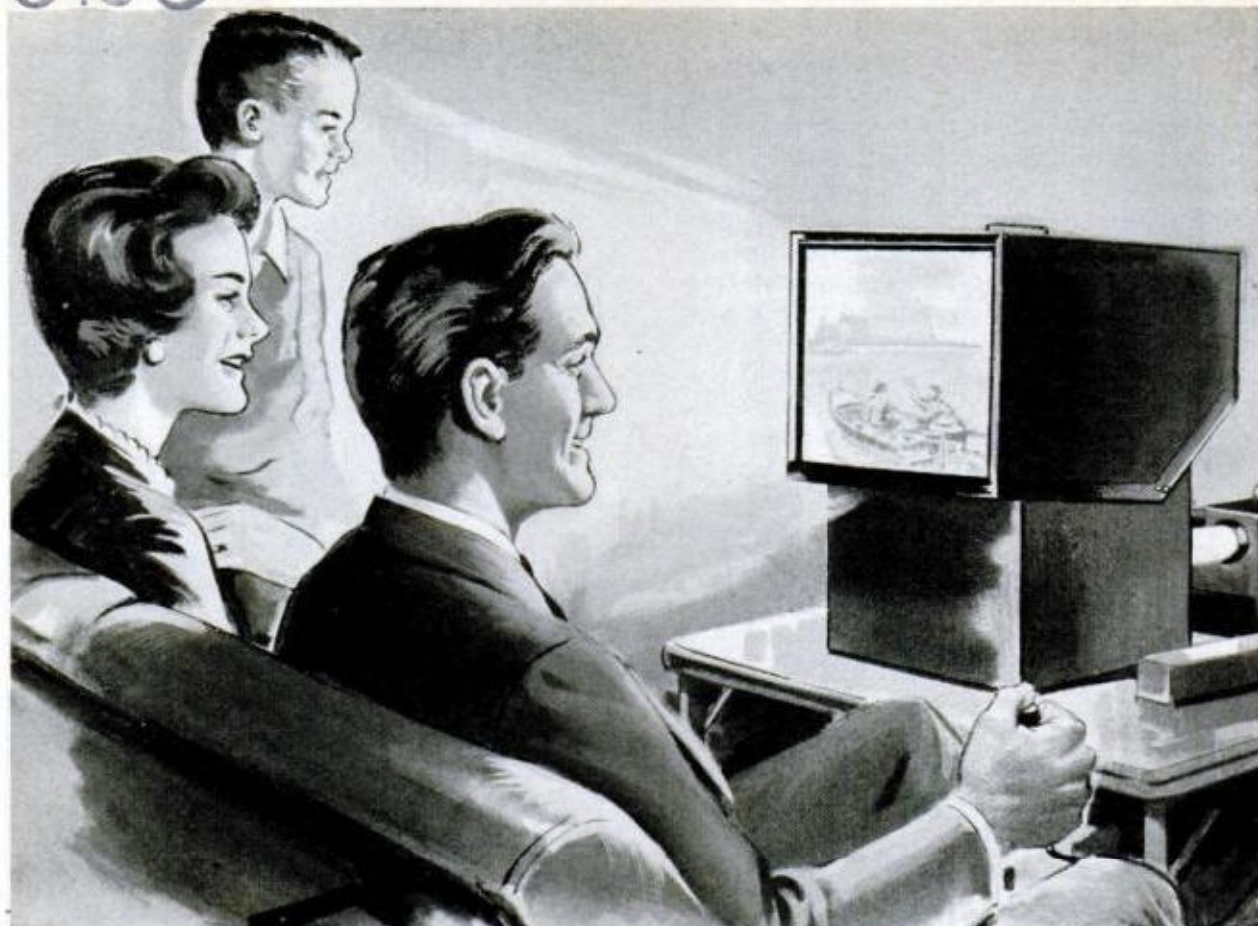
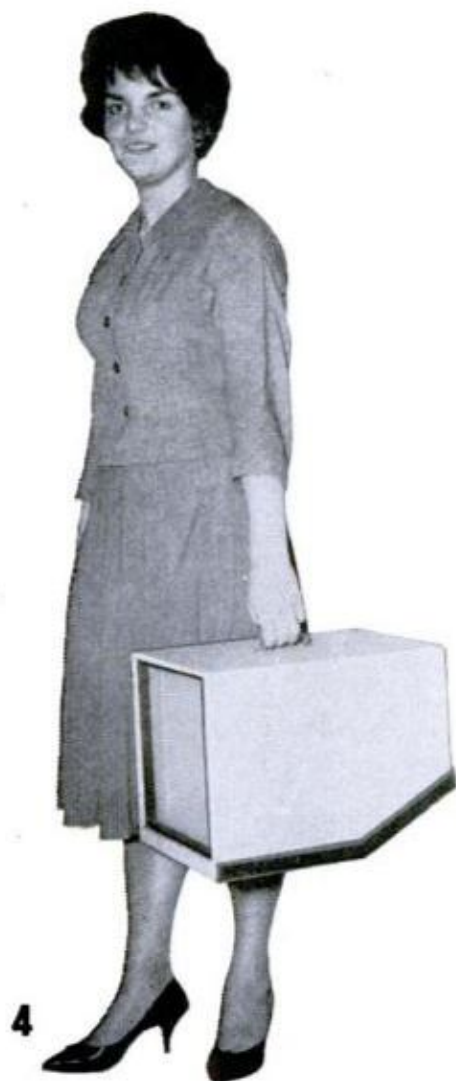
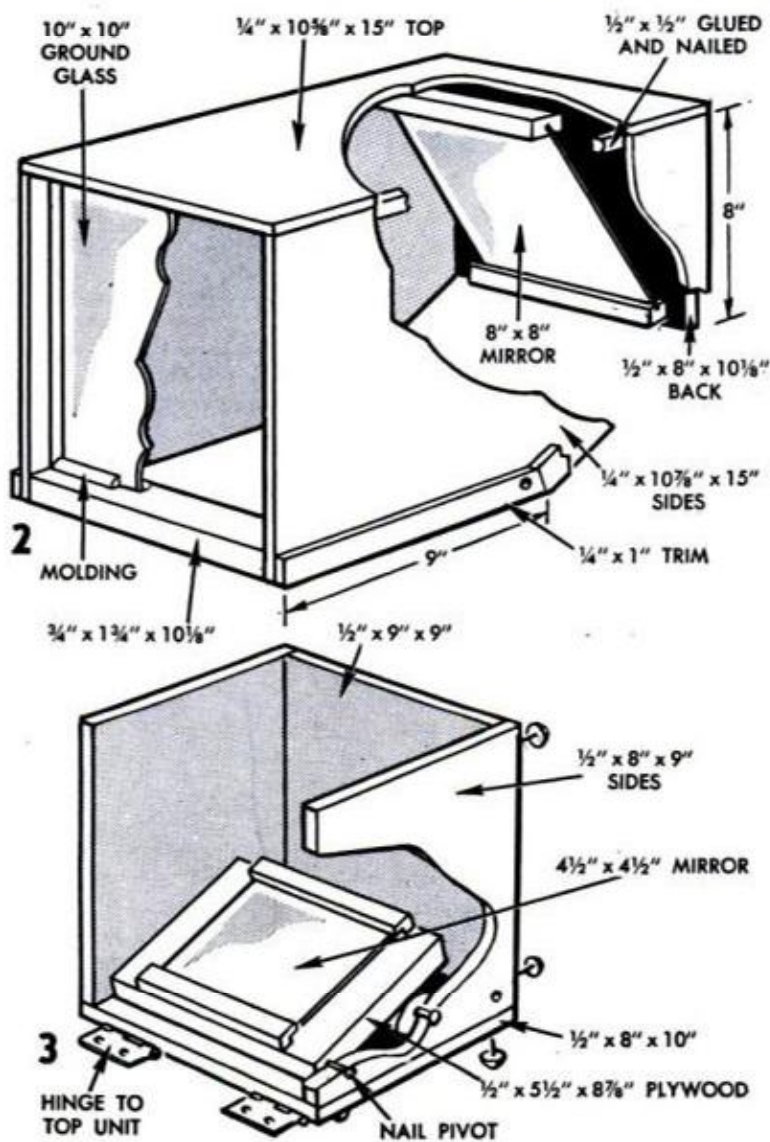
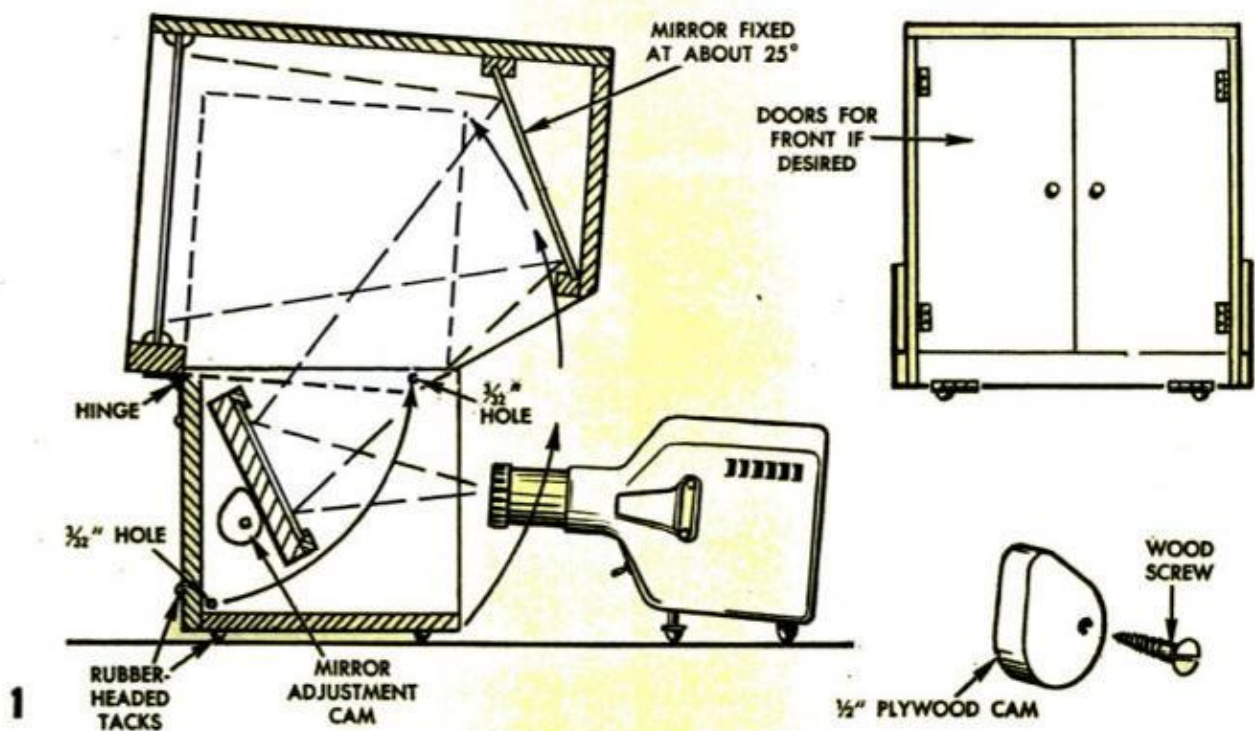

Table-Top Slide Viewer

WITH THIS VIEWER you watch slides projected on a screen which gives a TV-like image in daytime brightness without the bother of drawing the shades and setting up a conventional viewing screen. The viewer is a simple tote box with storage room for the projector. When the show is over, place the projector inside, fold the box and carry the whole thing just as you would a suitcase or a portable typewriter. The main reason for its compactness is that directional reflections of the image by mirrors reduces the distance between the projector lens and the screen to inches.

Top and sides of the upper section are made of plywood reinforced at the corners with $\frac{1}{2}$ -in. square strips. The mirror in this unit is fixed in grooved strips after the angle is determined through trial and error. Then the case is covered with a plastic material which is cemented on. Attach trim to the sides with cement and brads, clinching the points if they protrude. Screen can be opal or ground glass held in place matte side out with $\frac{1}{4}$ -in. molding on each side and placed 1 in. in from the front.

Lower box is all plywood construction with the mirror cleated to a tilting base which pivots on 1-in. brads through each side. A mirror-adjustment cam is screwed to one side. It also supports the mirror at the desired angle after the picture is located on the screen. The mirror is swung away from the cam when packing the projector, wire cord and slides for travel. The two boxes are hinged together with $1\frac{1}{2}$ -in. butt hinges and then placed on a table. Then, using a slide and projector, it's easy to determine the best angle for viewing the screen image. Drill a $\frac{3}{16}$ -in. hole through one side of both boxes about $\frac{3}{4}$ in. from the lower edge of the trim. You insert a snug-fitting nail in the hole to hold the viewer in the open position. Now close the viewer so the lower box is inside the upper one. Insert the drill through the same hole in the outer box and drill a new hole into the side of the inner one. By inserting the nail while in this position the viewer is held closed for carrying. Coat the inside of both boxes with flat-black paint, and attach a carrying handle.—*Ralph S. Wilkes*



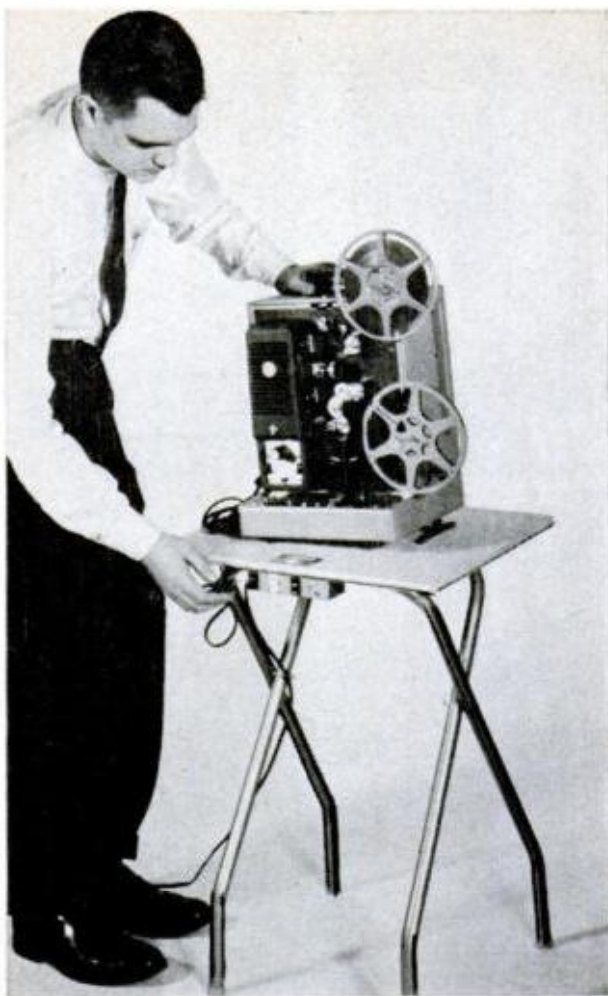

FOR SHUTTERBUGS

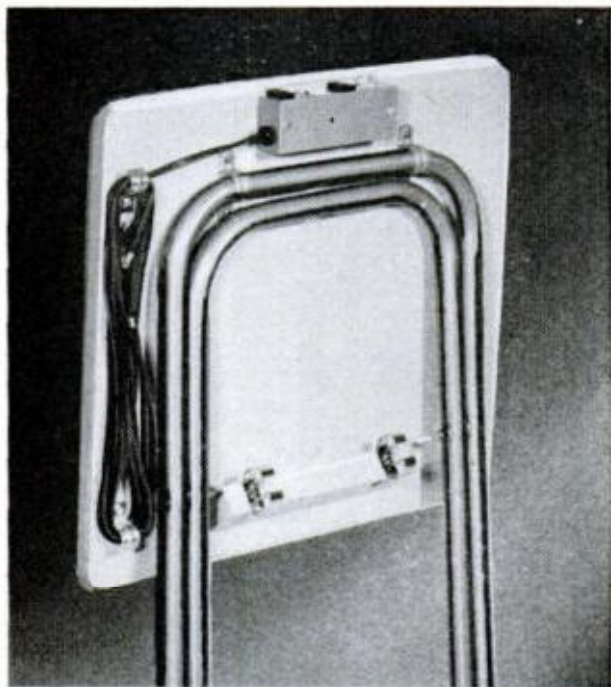

PREMIER FOLD-AWAY projection stand is easy to carry and stores compactly. Besides built-in outlet for projector, plus two additional switch-controlled outlets for room lights or accessories, there's a light for indentifying slides. Cord stores on underside as shown above. Legs come in gray enamel, chrome or brass finish, wood top has black-and-gray fleck finish. The projection table retails at \$21.50 from Premier Materials Co., 3717 N. Halsted St., Chicago 13



EXPOSURE METER package combines the Golden Crown meter, PR-3, with incident-type attachment. With attachment in place, meter gives incident light readings. Many photographers prefer reflected-light method for outdoor work and incident-light method for indoor work. This attachment gives them a choice. Made by General Electric Co., Schenectady 5, N.Y.



KODAK AUTOMATIC 8 movie camera is fully automatic in operation. Turn the cover latch to "open" and the cover pops up. When cover is locked, the footage indicator is reset. Light indicator, visible in viewfinder, tells when there's insufficient light for shooting. A built-in filter permits the rapid shifting from indoor to outdoor use; arrow in viewfinder indicates filter position. There's even a light-bar receptacle on top of the camera to hold floodlights. Camera is priced at less than \$50. Made by the Eastman Kodak Co., Rochester 4, N.Y.

Spares in Hand

Remember that time when a second flash exposure could have been the clincher but you weren't quite fast enough because there was no spare bulb handy? Next time, insert the bases of one or two extra midget bulbs between the fingers of your left hand when you're getting ready to shoot an action shot. Then you'll be ready for a quick second try just in case.—*H. J. Kennard*

Using a changing bag for reloading film holders is an awkward job, especially when it must be done on a car seat. You can make this a lot easier by inserting a long, narrow cardboard box with an open side in the bag. Have the opening facing the sleeves and it will serve as a form to give you an unobstructed working area.

Ribbed-Bottom Stand-Ins

When you're planning a temporary dark-room or when you need a quick replacement developing tray keep in mind that the ribbed-bottom glass trays supplied with refrigerators are a substitute for the regular thing. The deeply ribbed bottom is a definite advantage in uniform processing and more especially so when working with cut film or film packs.

Floating photo thermometer gives instant temperature readings. Use one of the glass-encased type and insert it through a snug-fitting hole of a cork fishing float available in bait shops. This is easily fitted by reaming the hole with a rat-tail file.

Reflector Protector

You've had it happen—a good reflector almost ruined by the scratches and scores on the polished surface that can result when reflectors are placed in the camera case along with other gear. Cut the top from a discarded man's stretchie sock, stitch across the cut end to close it, turn inside out and pull over the reflector.

—*Bil Toman*

Shock-absorbing pad for a tripod head made of $\frac{1}{8}$ -in. polyester urethane foam is not as likely to shred as foam rubber. Cut it to the pattern of the head and it will cushion vibration for sharper pictures. Available at most rubber product stores.

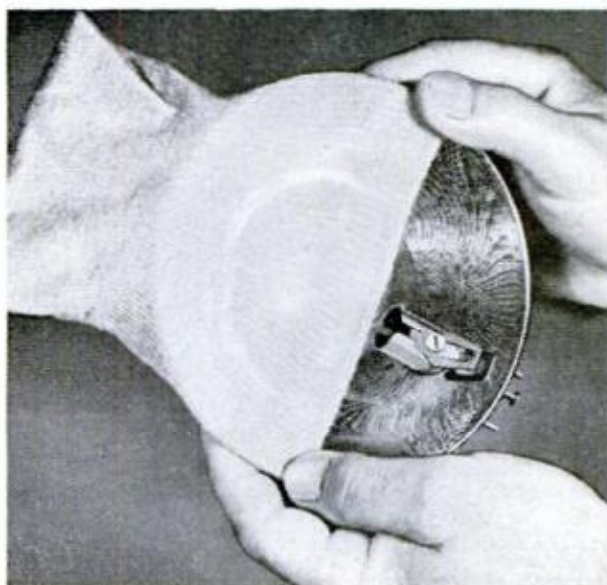

RADIO TV HI-FI

~~~~~ ELECTRONICS ~~~~~

## Stereo



## Super-Sorter

WHILE THE front switch on your amplifier is used to single out the various inputs, all inputs are either high level (tuner, ceramic, TV) or low level (mag. phono, tape, dynamic mike). The avid hi-fi fan soon finds all his jacks filled with plugs and the convenience outlet at the floor a rat's nest of a.c. wires.

To add new equipment, even temporarily, you must unplug something to plug in something else. With this super-sorter, however, you can effectively add six additional inputs to your amplifier and yet, much to the satisfaction of the vacuum cleaning hausfrau, only one wire—the one

from the sorter — connects to the outlet.

If, for example, you want the amplifier turned on, press the AMP button on the sorter. Power is delivered to the amplifier and a neon lamp on the front of the sorter confirms the fact. The FM tuner has its own switch and pilot lamp, as do the other major components of your system.

The Sorter provides stereo inputs for three more high-level and three low-level inputs, selected by the toggles on the sorter's panel. You can phase these to stereo, stereo reverse or mono. Another switch permits you to use reverb either for playback or for recording too!—Byron G. Wells

**PLUGS AND CABLES** appear at rear of unit. Jacks provide various inputs, cables high and low outputs



**POWER WIRING** is placed first, audio wiring added afterwards to avoid possible pickup of a.c. hum

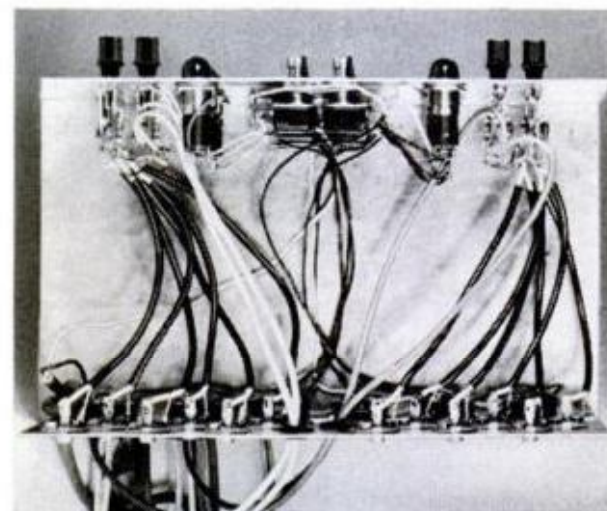



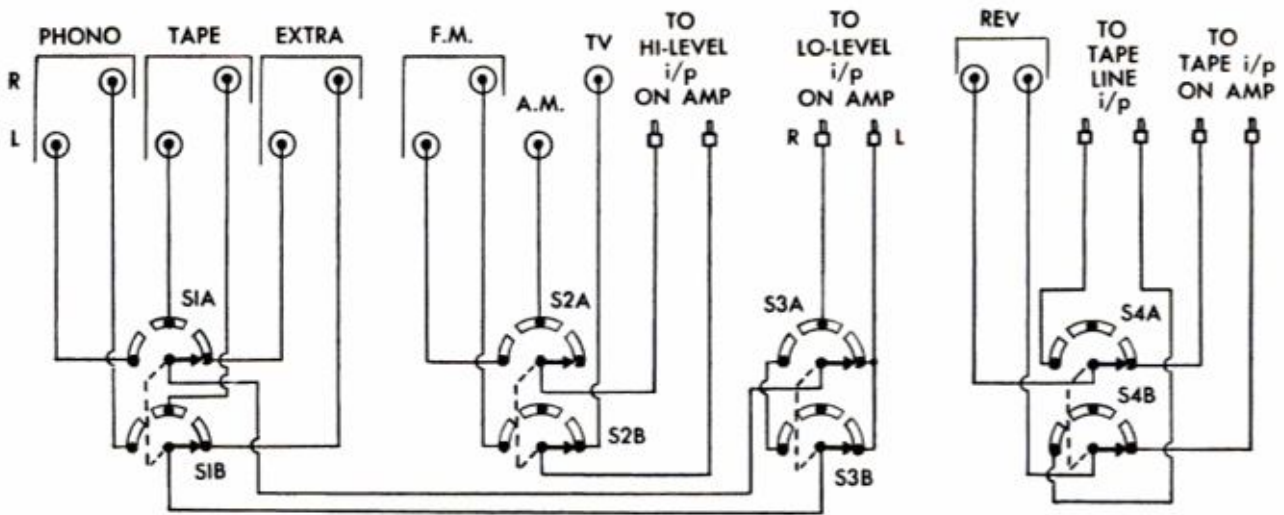

STEREO HI FI SUPER SORTER — SIGNAL WIRING SCHEMATIC

**SIGNAL WIRING DIAGRAM** is shown above. A group of 3 position lever switches are used on each side, one to select the desired input, another to provide single channel reverse or stereo outputs. The third switch selects one of three low level inputs and the last lever switch permits you to use reverberation either on record OR playback. System permits you to change components that require similar inputs with no connecting and disconnecting of rear plugs

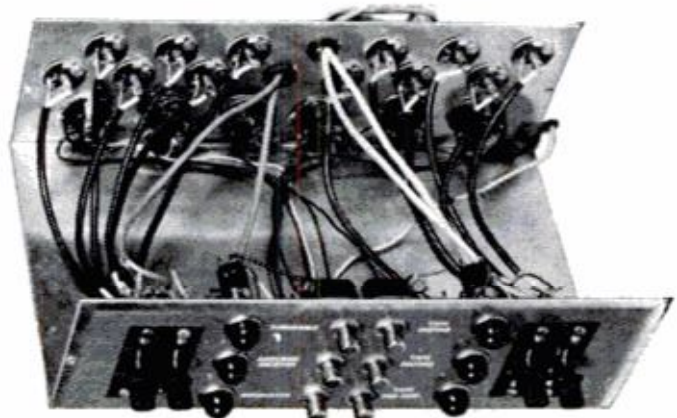

**POWER WIRING DIAGRAM** below illustrates the method for wiring the power circuits. Flush-mounted a.c. receptacles are connected to push-button switches on the front panel. These are also wired to NE-51-H neon lamps which indicate which outlets are activated. All component line cords can now be plugged into super-sorter and only one cord (from the sorter) goes to outlet. This eliminates the objectionable (and dangerous) rat's-nest/cube-tap mess

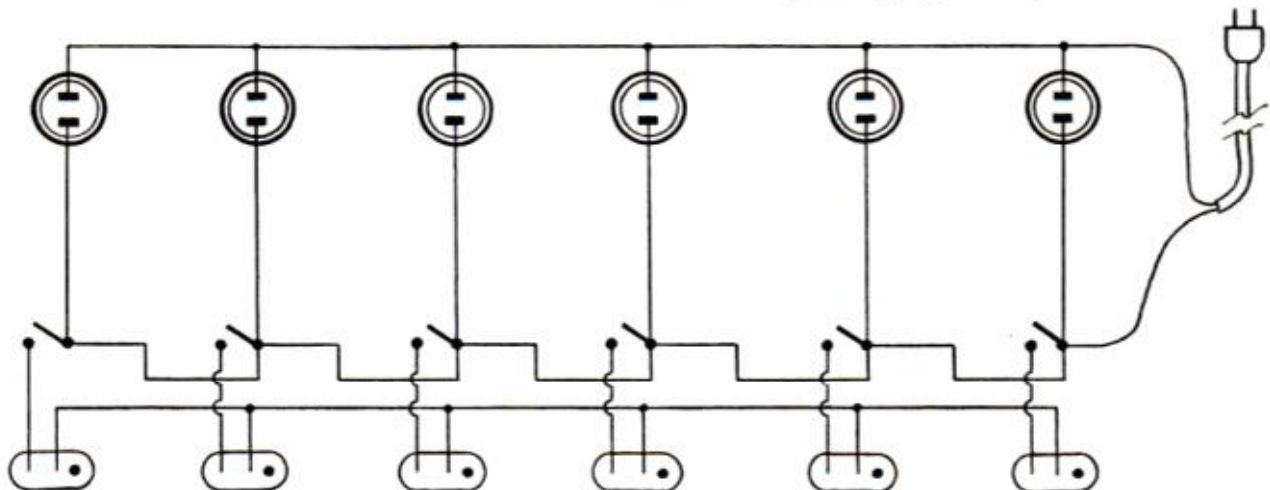
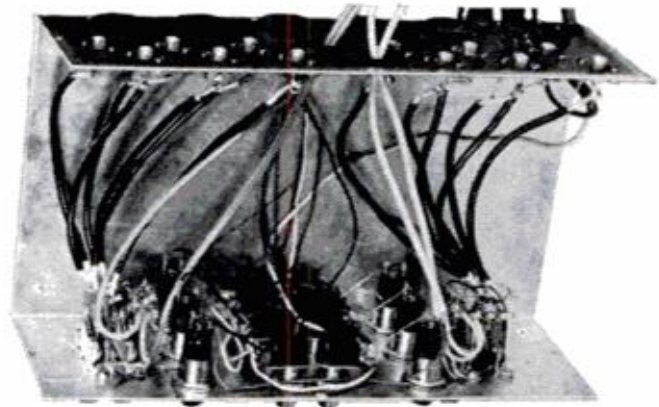

STEREO HI FI SUPER SORTER — A.C. SWITCHING



# For Better FM Reception

## Do You Need DSR?

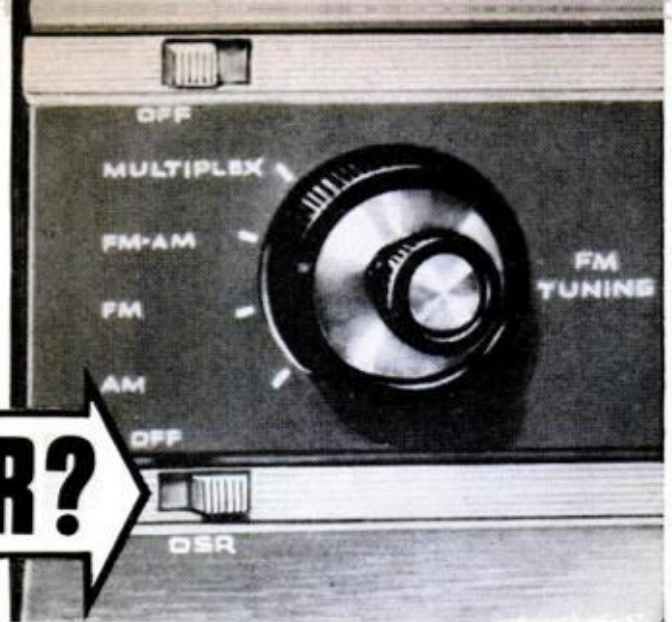

LET'S SAY you've been looking at FM tuners or receivers with an eye to buying one. On some, you see a switch marked DSR. Other units don't show this. What is the DSR switch for and how important is it to you as an FM listener? Also, does it make the tuner or receiver more costly?

DSR allows an FM receiver to compensate for that nemesis of studio engineers, called "overmodulation distortion." FM receivers have an intermediate frequency range of 150 kc. The transmitter is not supposed to pass a signal which spreads more than 150 kc. However, loud passages in transmitted music sometimes cause the signal to spread beyond the 150 kc. limit with the result that the receiver is unable to pass them and distortion results. To compensate for this, it would at first appear that the solution would lie in wider i.f. circuits for the receivers. However, this would create more problems than it solves, as such receivers are more costly to build, and a sacrifice of selectivity would also be made.

**STREAM OF WATER** pouring into neck of bottle simulates an FM signal in i.f. section. Increased pressure causes stream to widen, water splashes out of bottle and stream is distorted, like overmodulated signal "squeezing" through i.f. section of receiver



With the addition of DSR, the i.f. strip is made to "widen" only when overmodulated signals appear. This benefit is obtained with no appreciable cost increase, and no sacrifice of selectivity. A unit with DSR will cost no more than a unit without it.

Another problem that DSR helps to solve is the depreciation of fringe area reception. To combat this evil, many attempts have been made in the general direction of super fringe area antennas and electronic pre-amplifiers, called boosters.

By reducing the frequency shift of the station signal, the music is passed cleanly through the i.f. section of the receiver. DSR extends the useful range of the receiver as it "cleans up" many signals which would be too weak to hear without distortion.

While DSR is relatively new, there are several sets available on the market which do feature DSR. With the advent of multiplex, stability in FM receivers will be even more important, and DSR should provide all that is needed.—D. F. Harvey

**IMAGINARY FUNNEL** inserted into neck of bottle represents DSR action. When stream widens momentarily funnel expands to accommodate entire stream. Funnel returns to normal size when stream returns to normal. DSR expands i.f. section on wide signals





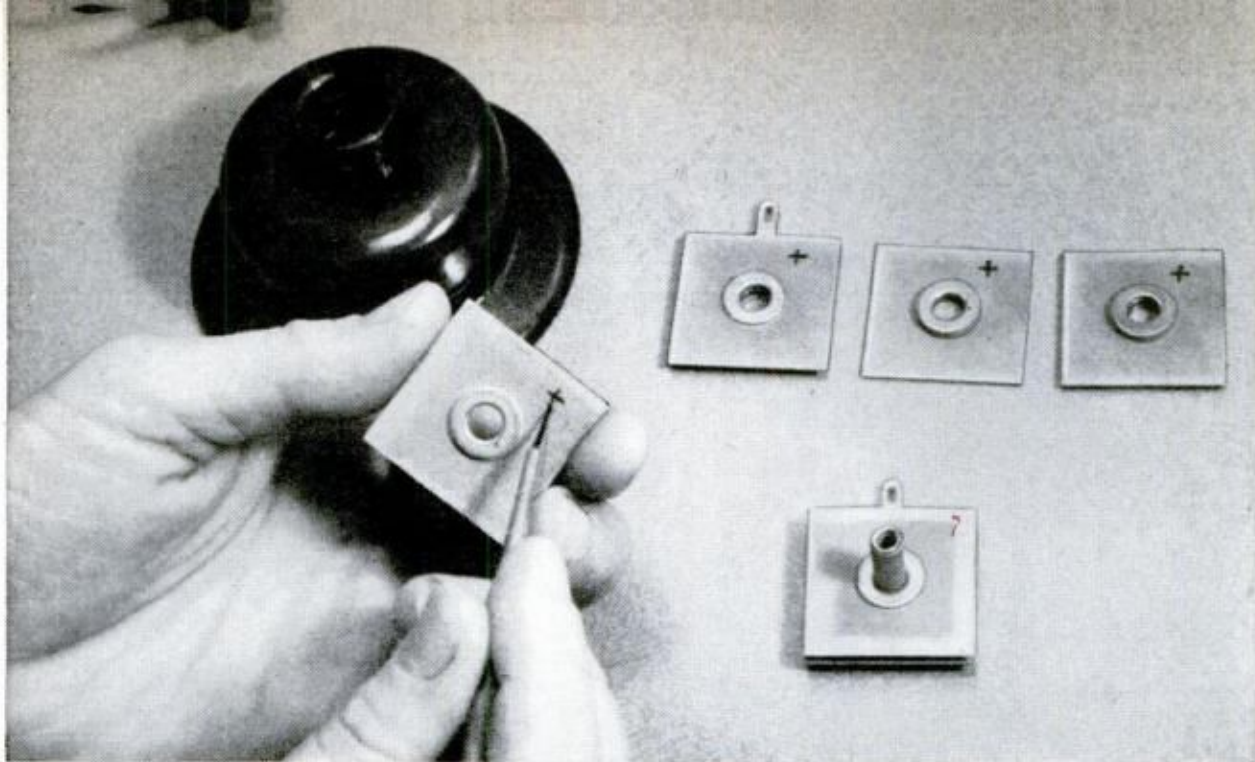

**WHEN DISASSEMBLING** rectifier plates first mark the positive side of each plate lightly with ink or paint so as to avoid error when reassembling. Be careful not to remove the washer attached to the positive

## Converting a Half-Wave Rectifier to Full-Wave

If you need a full-wave rectifier for an experimental circuit (say a battery charger or power pack) and have only half-wave units in the catch-all box, these can be converted to full-wave easily.

Remove the plates from the hollow brass rivet by drilling one end off the rivet. Avoid scratching the positive surfaces.

Insert a screw in the fiber tube on which the plates were mounted and reassemble the plates as in the diagram. Add three additional solder lugs between the plates ( $\frac{1}{4}$ -inch washer  $1\frac{1}{2}$ -inch tongue). Use a lock washer and nut on the screw after the plates are in place. You can double the current capacity by using two plates between taps.—*Robert Micals*

**ASSEMBLE ACCORDING TO DIAGRAM** (right). Be sure plates face right direction. New rectifier (below) shown on left. Note jumper soldered to two positives

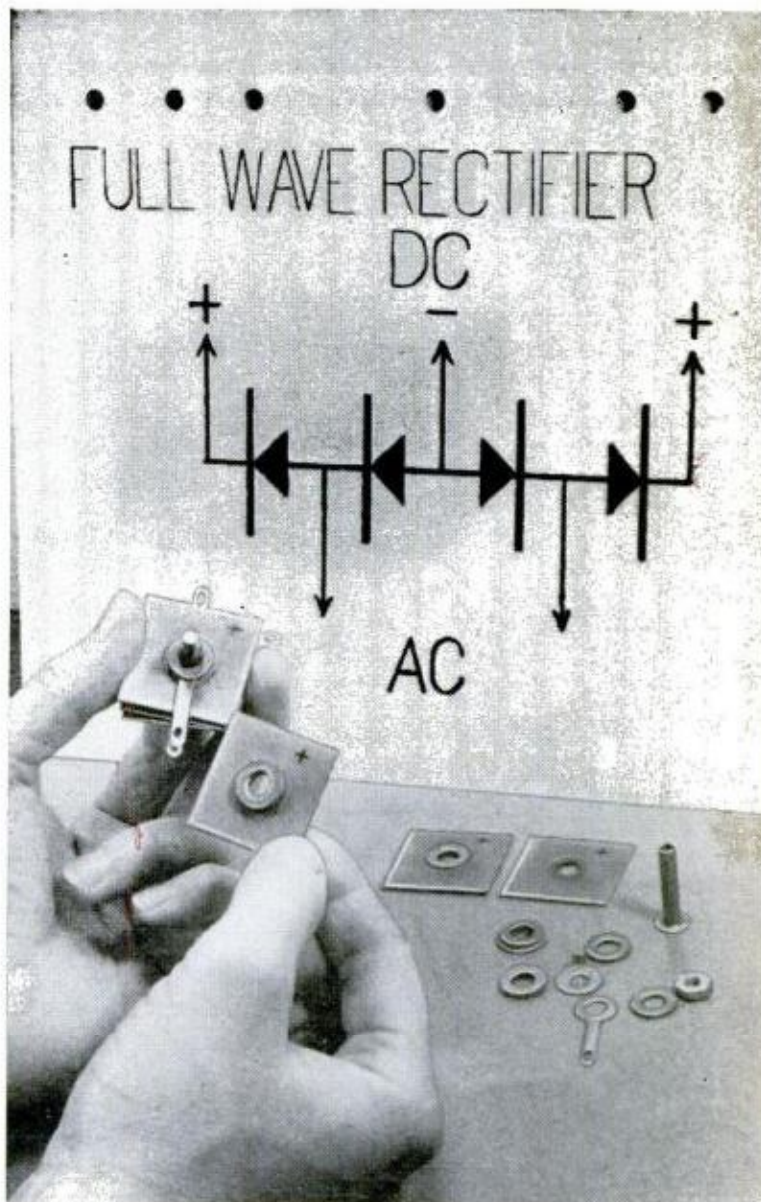
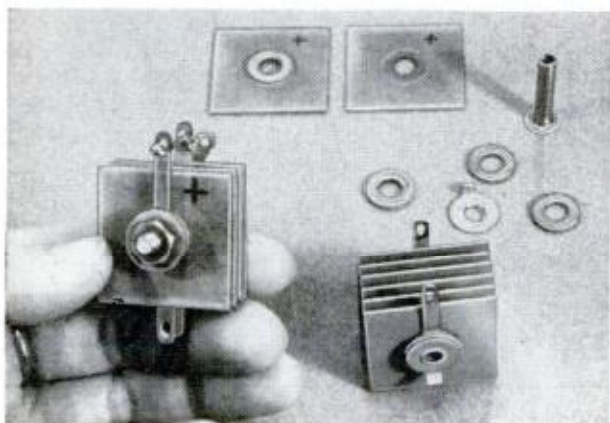





## Battery Charger-Eliminator

When the nine-volt battery in your transistor radio runs down, connect the battery to the matching terminals on this unit and plug the cord into a wall outlet. In a short time, the battery is recharged and ready for use again. If you prefer to do away with the bother of batteries, connect the terminals to the radio, and use the unit as a battery eliminator. \$4, P. A. Brown, 54 Ruxton Road, Great Neck, New York

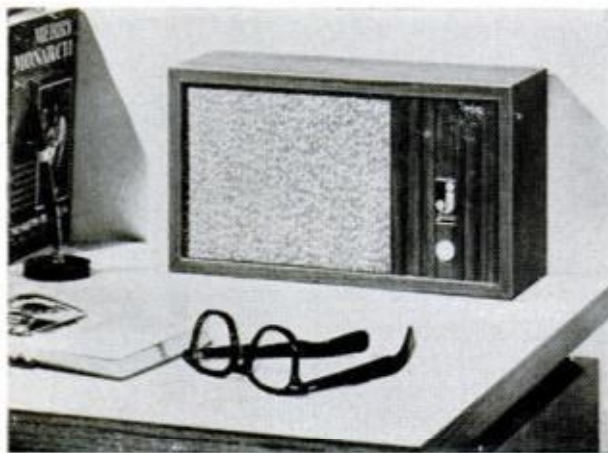

## Hi-Fi In Miniature

New ultra-compact two-way loudspeaker system boasts less than one-sixth the bulk of regular bookshelf speaker system. Utilizes miniature long-travel woofer, mass loaded and precisely matched to enclosure for improved bass response. Three-inch direct radiator tweeter provides excellent high-frequency response. Unit can be used as extension speakers through house, adjusting remote volume with small front panel volume control. System matches 4, 8 or 16-ohm amplifiers, provides six watts. Measures  $4\frac{5}{8} \times 7\frac{1}{4} \times 13$ . \$29.75, Jensen Mfg. Co., 6601 S. Laramie, Chicago.



## FM-AM Hi-Fi Portable

All-American manufactured transistor portable tunes both AM and FM bands. Unit has five-inch alnico speaker mounted with front-loaded bass port for good low-frequency reproduction. Has nine transistors plus five diodes, operates on six flashlight cells which provide over 300 hours of operation. Antenna collapses into case when not in use, extends a full 33 inches for reception of weak or distant stations. On-Off switch also selects either FM or AM, is independent of tone and volume controls, eliminating need to reset these each time set is turned on. \$79.95, Kinematix, Inc., 1616 N. Damen, Chicago, Ill.



## All-Band Receiver

Whether your taste runs to FM, AM or the novelty of short wave, this table-top receiver pulls the stations in and keeps the noise out. Built-in antennas, exact tuning indicators and "voice" or "music" switch to aid the tone control make for a versatile instrument. The versatility of this radio is increased by the rear panel jacks which allow for plugging in phono or tape. A front panel switch then allows you to select these accessories, eliminating the need for unplugging when they are not used. Short wave bands cover police, foreign and amateur as well. \$149.95, Majestic International, 743 N. LaSalle, Chicago, Ill.



*This Christmas ask her for  
one of these quality . . .*

# DISSTON TOOLS

*at special Christmas savings*



Make the most of your skill—with tools of Disston quality. Designed for easier handling, built to last. They have an edge on all others. Ask her for Tools by DISSTON—Master Toolmaker since 1840.

**"DISCUS" CIRCULAR SAW**  
Special Retail Price: **\$49.50**

Most powerful 6½" saw you can buy. Fast, effortless cutting—rated at 10 amps. Has 1½ hp motor. Diss-chrome blade makes 2⅜" cut at 90°; 1⅜" cut at 45°. Has "Life Saver" detachable plug.

**DISSTON D-23 HAND SAW**  
Special Retail Price: **\$8.95**

Finest hardened and tempered steel blade. Handle of cover-top hardwood, fully carved, weather-proofed. 26" long,—rip or crosscut points.

**"DAGGER" SABER SAW**  
Special Retail Price: **\$49.50**

Cuts straight, circles and bevels in wood, metal

and plastic. Handsaw-type handle, "Life Saver" detachable lock-in plug; "Orbite" blade action prevents drag and back-cut. 2.75 amps, 3600 strokes per minute. Depth of cut: 3".

**"SUPER CHIEF" TAPE RULE**  
Special Retail Price: **\$3.49**

16' long, stays rigid over entire length. Swing-tip end hook flips for easy, accurate inside and butt measurements. Graduated in 16ths, black on white. ¼" wide.

**DISSTON HACK FRAME**  
Special Retail Price: **\$3.20**

Sturdy, nickel-plated steel frame with steel handle faced with black plastic. Adjustable for 8, 10, 12-inch blades. 4 cutting positions.

*Available at leading hardware and department stores everywhere*

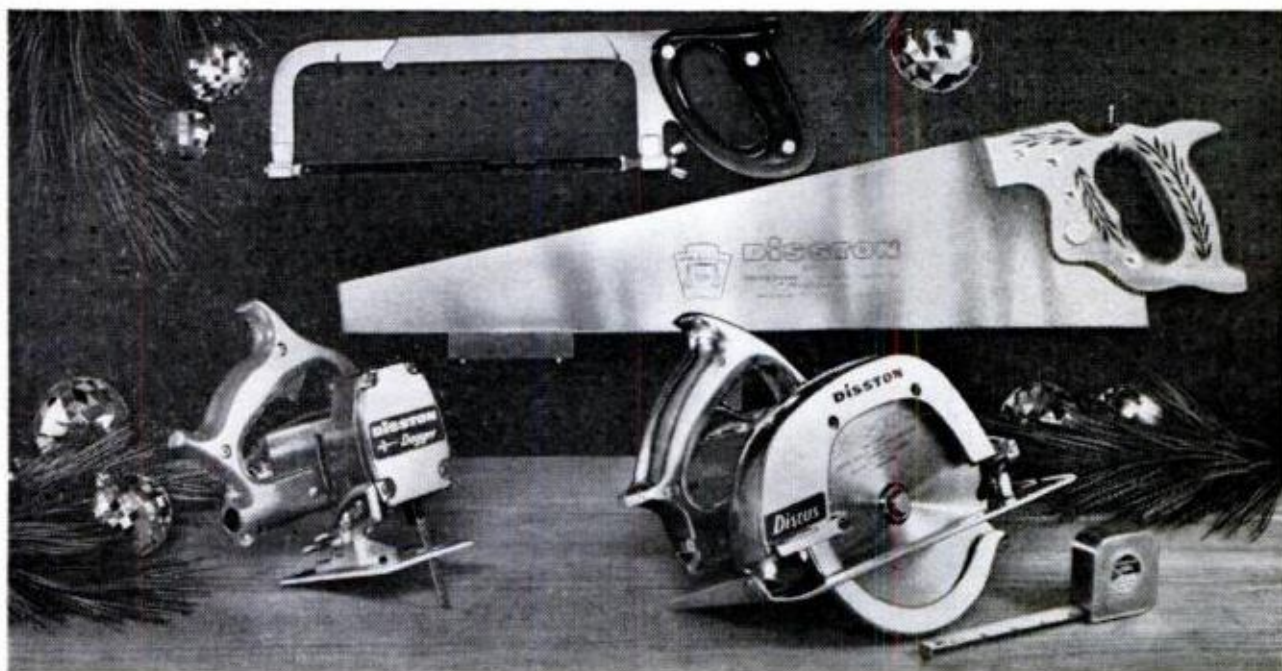

**PORTER**

**DISSTON DIVISION  
H. K. PORTER COMPANY, INC.**



**EXCLUSIVE ONE-PIECE CAB-BODY DESIGN** gives Ford Styleside pickups extra capacity, extra strength. Heavy duty in every way for heavy going all day. Car-like ride, too!



**THEY'RE HERE!**

## NEW '62 FORD TRUCKS

Get full-time economy that only starts with Ford's low price!

Meet the trucks that make saving money a full-time business — new Ford Trucks for '62!

In a selection of over 600 models there's a truck that's just right for your job, whatever your job . . . a truck that can

save you money, mile after mile, load after load, year after year!

You save on price. You save on gas and oil. You save on tires, on maintenance—wherever there's a way to save! The full record of Ford economy,

covering three years of independent tests, is in Ford's Certified Economy Reports. See your Ford dealer now. Check out the facts, work out a deal, and drive out a truck that saves money . . . full-time!

**FORD TRUCKS  
COST LESS**

SAVE NOW... SAVE FROM NOW ON

FORD  
TRUCK  
CERTIFIED  
ECONOMY  
REPORTS



**AMERICA'S MOST POPULAR VAN** — and small wonder! Econoline savings start with a price far under any conventional panel on the market! And they continue every day—certified tests have shown that in just 16,000 miles, savings in operating costs can top \$100! Big 4-ft. doors rear and curbside, 204 cu. ft. of loadspace!



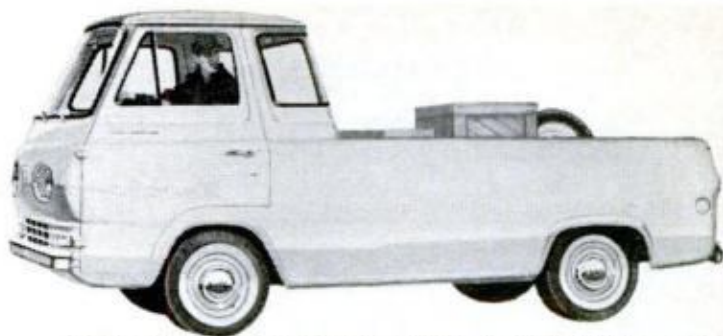

**ECONOLINE—ALL-AROUND ECONOMY LEADER**—can cut operating costs \$100 yearly! Carries  $\frac{3}{4}$  ton with up to 23% more loadspace than conventional 6½-footers. And the loadspace is all usable—the floor is flat, there's no rear-engine hump!

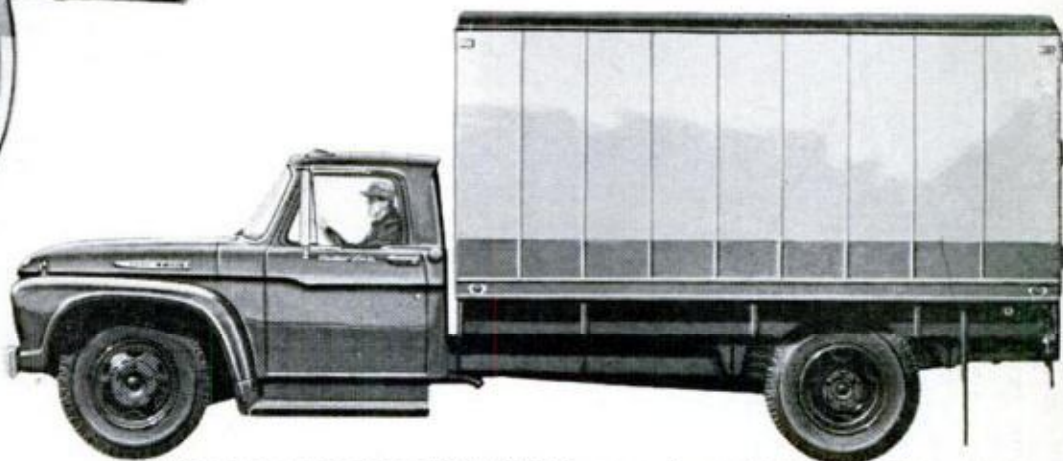

**NEW BIG SIX FOR FORD MEDIUMS** has more heavy-duty engine features than any other Six of its size! Never before such long-term reliability and economy!

**SUPER DUTY V-8 OR DIESEL** power gives Ford's new highway tractors superb performance. Optional sleeper cab adds only one inch to cab length, allows 40-foot trailers in 50-foot over-all length. GCW's up to 76,800 lbs.

PRODUCTS OF  MOTOR COMPANY





# CLINIC FOR HOMEMAKERS

As a service to our readers in solving the hundreds of problems pertaining to a home—inside or out—editors of Popular Mechanics invite you to present your problems to The Clinic Editor for help and advice. Address your questions to The Clinic Editor, Popular Mechanics Magazine, 200 East Ontario Street, Chicago 11, Ill.

## Poinsettias Fail to Bloom

*Q—I have been trying to raise poinsettias for the past two years. Plants leaf out, but I've never been able to get them to blossom. What am I doing wrong?* —H. K., Penn.

**A**—Poinsettias are native to the tropical regions of Central America, so in colder climates they require special attention. While blossoming, poinsettias should be in strong sunlight and given plenty of water. Temperatures should be 65 degrees or higher, with no rapid changes.

Once the leaves drop, plants become dormant and water should be withheld. Pots are then placed in basement where temperature should not drop below 50 degrees. Water is withheld unless stems shrivel.

In June, when outside temperatures are normal for that season, repot plants and sink in a sunny garden location. Cut them back to about six inches, leaving two or three shoots to develop. Water and feed them well.



Before cool weather, lift the pots and bring them inside. This is the critical period: Buds must set if plants are to bloom. They require short days and long nights for Christmas flowering. Poinsettias need about 13 hours of uninterrupted darkness every day during this period. Once buds are well developed you can leave plants in a sunny location.

## Orienting the House

*Q—We're planning on building a new house next spring, and I recall reading somewhere about the best direction to face a house on the lot. Now I can't remember just what the article said. Wish you'd tell us the advantages, if any, of facing a house in a particular direction.*—S. B., Ohio

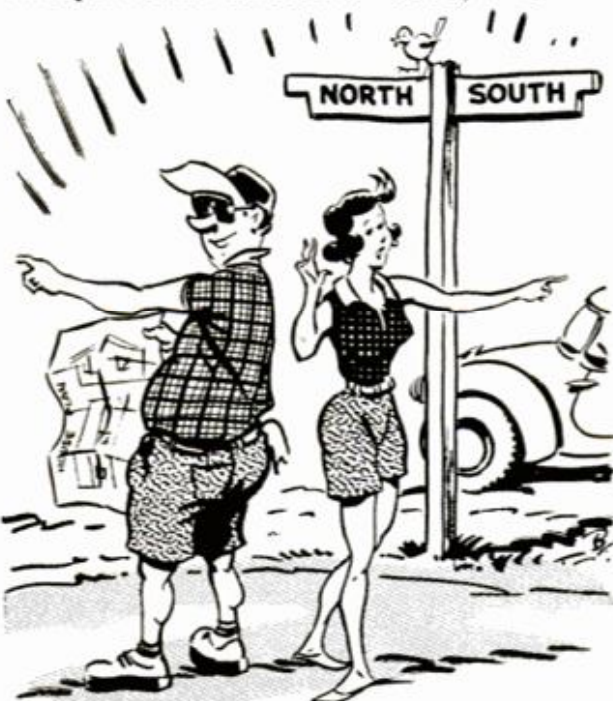

**A**—You don't say whether you own a lot on which you intend building or are planning to buy one. Property restrictions usually require setting house back a minimum distance from lot line, and may require locating house parallel with street.

In general it is best to orient rooms used most frequently during the day to take advantage of sunlight and summer breezes. Large glass areas, especially, should be located to receive sunlight, but they need shading from the outside by overhangs, trees and every practical means available to prevent heat radiating in towards you. If you value privacy most, living areas should face a garden view with a southern or southeastern exposure. Garage and service areas can be used to best advantage if they face the least desirable exposure, forming buffer zone (usually on west and north) against winter storms and late afternoon summer heat.



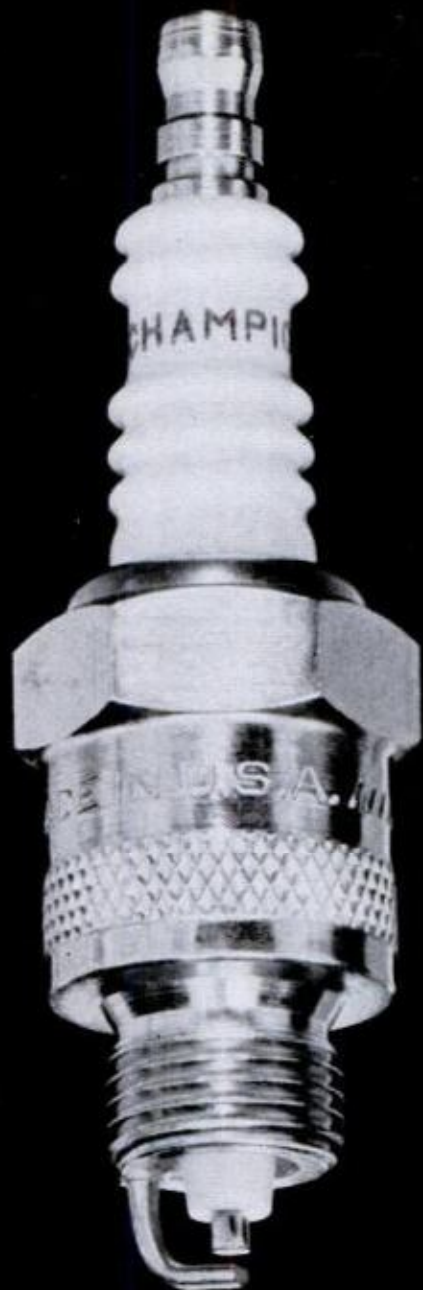

Twice as many car makers specify Champions, because Champions deliver the ultimate in performance and quality

Champion introduces a new silvery-plated spark plug, which has more than 10 times the resistance to rust! These silvery-plated plugs were first made for the world's finest aircraft and marine engines, and are now available for your car. They cost no more than ordinary plugs. Why settle for less?

**CHAMPION**



**There's a  
DIAMOND  
PLIER  
for every job**

*"There is  
nothing finer  
than a  
DIAMOND"*

**DIAMALLOY**®

All shapes, styles and sizes to the user's choice — all incorporating outstanding Diamond quality. Ask your favorite dealer for famous Diamond Tools.

Only manufactured by

**DIAMOND TOOL  
and Horseshoe Co.**

DULUTH, MINNESOTA  TORONTO, ONTARIO  
EST. 1908

For free tool booklet, write your name and address on margin below, clip ad and mail to manufacturer.

## Regular Lubrication Pays Off

(Continued from page 193)

cause lowered gas mileage, sluggish pickup, and even stalling. If you find it frozen, tap it lightly with a rubber mallet or a block of soft wood, then lubricate with a special heat-resistant lubricant containing graphite. And be sure not to forget it the next time around.

All other exposed metal-to-metal parts that move, such as the carburetor and accelerator linkages, the clutch and brake linkages, including the parking brake, should be lubricated regularly with a dripless penetrating oil. And while you're at this don't forget the door hinges, Fig. 7. Each hinge needs a few drops of dripless oil at regular intervals. This eliminates squeaks and keeps the doors from sagging due to excessive hinge wear. The same is true of door locks, luggage-compartment latch, front-seat shifting mechanism, the hood latch and hinges. Before you lubricate these points it's a good idea to consult the lubrication chart for your make of car and note the manufacturer's recommendations. Remember also that some recommendations for these and other lubrication points on your car may differ from those you see in the calendar on page 191. In such instances always follow the manufacturer's instructions in detail.

### 15,000 and 25,000-Mile Checks

Down near the end of the calendar there's a 15,000 and even a 25,000-mile-check listing several points that should never be neglected when that time comes around. Transmissions and rear ends seldom need lubricating under 15,000 miles unless there is a leak or an oil seal lets go. Even so, it's always a good idea to give these parts a close check while you're doing a general lube job. And, of course, the units should be drained, cleaned, and re-lubricated when (or even before) 15,000 miles have unrolled under the car. Some rear ends don't have a drain plug, so, to do a thorough job of removing the old lubricant you'll need the sludge pump shown at the left of the grease gun in the photo on page 190. The pump also may be used to force new lubricant into the rear-end housing and to clean an oil-filter housing as in Fig. 10. It pulls out all the heavy oils and sludges that tend to collect in such housings, keeps your hands and clothing clean, too.

Ordinarily, stick-shift transmissions and even the automatic transmissions should get the same servicing, but before you do this consult the manufacturer's manual

(Continued to page 220)



beautiful outdoor protection  
... colored aluminum roof coating  
made with pigments

from **ALCOA**



## Sipes Luma-Tint improved this fine suburban home

The attractive Gregg Mockenhaupt residence in suburban North Hills, Pittsburgh, is the envy of its neighborhood. One year ago, Mr. Mockenhaupt applied Sipes Luma-Tint, a colored aluminum roof coating made with Alcoa® Pigments by James B. Sipe & Co. There was nothing wrong with the roof. Mr. Mockenhaupt just wanted color—a soft green to blend with the landscape. All his neighbors admired the striking new appearance—and a Pittsburgh newspaper took photographs for its Roto section.

This improvement was more than visual. Colored aluminum coatings like Luma-Tint literally seal roofs, protect against surface deterioration, extend property life. Thousands of homeowners have discovered this easy, economical way to weatherproof (while beautifying) any building.

Ideal for composition, asphalt shingle, slate or tile roofs . . . brick, masonry, concrete or metal siding. Apply with ordinary roofing brush or stiff-bristle paint brush. Ask your dealer today for Luma-Tint or one of the other fine brands of roof coatings made with Alcoa Pigments.

Look for the Alcoa label when you buy.

**Alcoa does not make roof coatings**, but we will be happy to refer you to reputable manufacturers who do. Send coupon today for our informative booklets.



Entertainment at Its Best  
**ALCOA PREMIERE** with Fred Astaire as Host  
Tuesday Evenings, **ABC-TV**

Aluminum Company of America  
1758-L Alcoa Building, Pittsburgh 19, Pa.

Please send your free booklets:

- Painting with Aluminum In Color*  
 *Aluminum Roof Coatings Make Time Stand Still*

Name \_\_\_\_\_

Address \_\_\_\_\_

City \_\_\_\_\_ Zone \_\_\_\_\_ State \_\_\_\_\_





MR. FIX-IT  
THE  
**Turner**  
TORCH  
IS  
"YOUR TOOL"

This is the "Torch Tool" you'll use hundreds of times around your home and shop. With a Turner Torch you can solder, remove old putty, remove paint, light charcoal, soften asphalt tile, thaw pipes . . . you name it. Every "Mr. Fixit" needs a Turner Torch . . . and so do you.



**TURNER TORCHES HAVE FORGED BRASS VALVES FOR LONGER LIFE AND GREATER SAFETY**

**LP-99 MULTI-TORCH METAL CHEST KIT**

A complete kit in a sturdy metal case with pencil point burner assembly, giant sized fuel tank, heavy duty burner, soldering tip, flame spreader and spark lighter—all for only \$9.95 from your local hardware dealer.

**SPECIAL "FREE" OFFER**

This new booklet "How to Use Your Propane Torch" regularly sells for 35¢. We'll send you a copy, free, just write.



**Turner Corporation**

839 Park Ave., Sycamore, Ill.

which will describe in detail the recommended procedures. In any case, always use the lubricants called for by each part and be sure that these are of the viscosities recommended.

Universal joints on the drive shaft usually need cleaning and lubricating at 25,000 miles or less. Figs. 8, 9 and 11 show how to disassemble one type not provided with grease fittings. On others having grease fittings it may become necessary to disassemble the units in order to fit new grease seals. When you loosen the bolts in the joint have rubber bands handy to hold the bearing cages in place, Fig. 8. And to force the members apart cut a short length of pipe and use it as a driver as in Fig. 9, the joint being held in a vise. You'll need small washers to place under the spider spindles as in Fig. 11 in order to push the bearing cages all the way out. Be careful not to misplace any parts, clean the whole thing thoroughly and lubricate as recommended. Replace in the reverse order. ★ ★ ★

**WINTER'S ON THE WAY.** Prepare for bad weather now with Booklet 17, "How to Winterize Your Home." Only 25c from Popular Mechanics Service Bureau, Room 527, 200 E. Ontario, Chicago 11, Ill.

**Old-Timer Dated**

A newly developed potassium-argon dating method, which measures the radioactive decay of these materials in nature, shows that primitive man lived on Earth 1,750,000 years ago. Two University of California geologists—Drs. J. F. Evernden and Garniss H. Curtiss—found, by testing rock samples in which he was embedded, that this was the age of *Zinjanthropus boisei*, an early East African man found two years ago.

**Pianos on a New Scale—They've Gone Compact**

Pianos have joined the trend to compact styling. There's a new 73-note instrument that is just 50 inches long, 24 inches deep and 35 inches high.

Manufactured by the Wurlitzer Company, the compact piano has a grand piano type pin block to provide longer strings in the bass and middle registers than are available in pianos of comparable size. A pentagonal sounding board also provides more reverberation than standard design would allow in a piano of this size.

The piano is available in a number of hardwoods and styles. Prices start at \$595. for contemporary styling in mahogany.

POPULAR MECHANICS





## *Pontiac '62* *off the line with a* *contagious new "Cat"*

The '62 breed of 'Cat' is all you know Pontiac to be, and more. Pours it on with horsepower rated from 215 to 348. Transmissions include a 4-speed floor stick (option\*) and a heavy-duty 3-speed stick (floor conversion available from your dealer). Or, take it the easy way with Pontiac's Hydra-Matic\*. The Trophy V-8 A\* winds right up over 5000 r.p.m. There's nothing bogus about this 'Cat'. Clean, low and long. Take your choice of optional\* Tri-Power, Safe-T-Track rear end, aluminum wheels and Custom Ventura trim (full carpet, vinyl headliner and color-matched interior). Why follow the Wide-Tracks? Make your own in a '62 Catalina. Pontiac Motor Division • General Motors Corp.

\*Extra cost



# Test your automotive I.Q!

## QUICK QUIZ BY QUAKER STATE

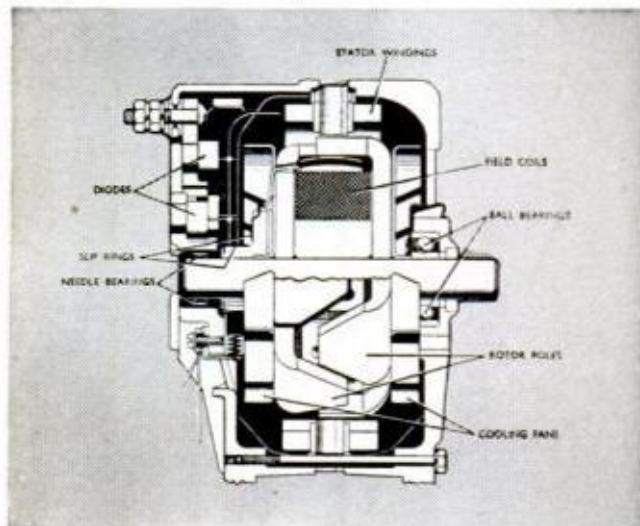

1. Can you name this successor to the generator?



2. What does this symbol stand for?

The symbol stands for Quaker State Motor Oil—world's best engine life preserver. Proved in labs and on the road to give peak protection for modern engines, Quaker State is refined from 100% pure Pennsylvania Grade Crude Oil. Insist on Quaker State—sold most everywhere. For your dealer's name, call Western Union Operator 25.

ANSWERS: 1. Alternator, now on all 1961 Chrysler Corp. cars.  
2. World's finest motor oil.



©QSORC, 1961

QUAKER STATE OIL REFINING CORP., OIL CITY, PA.

## Nativity in Paper

(Continued from page 158)

shortening as indicated. Cut two pieces for the shawl using pattern G, making one shorter than the other by removing about 1 in. at the top. The figure is mounted on a base, pattern M, made from the same paper as the body cone.

The kings' body cones, pattern A, should be deep rich colors—reds, purples or blues—trimmed with snips of gold or silver doily and gummed stars. Use pattern B to make the capes but round off the bottom front edges. Make their heads in the same way as you did Joseph's, remembering to use brown paper for one of them. Instead of headdresses, the kings wear crowns of gold lace-paper doily glued to construction paper. The gifts are small boxes and cylinders covered with colorful wrapping paper.

### To Make the Shepherds

When cutting the shepherds' body cones, pattern A, trim one cone about 1 in. shorter than the rest to make the shepherd boy. They wear shawls like Joseph's, pattern G, but the section on the right side is glued over the arm instead of under. When cutting arms for the shepherd boy, make them somewhat smaller than pattern D. The shepherds' headdresses, pattern J, are made by gluing the "x" edges together overlapping each other and then gluing the slashed portions in place to make the top. The shepherd boy is bareheaded, and his hair is curled under in a page-boy bob. The top of his head is covered with a paper disk cut to fit. The shepherds' crooks are made from soda straws with a short section of pipe cleaner slipped into the top end and bent into a crook. Posterboard is used to make the lamb carried by the shepherd boy, pattern K. Cover it with tiny balls of cotton and use snips of black felt to make the nose, eyes and hooves.

Infant Jesus consists of a tube of oak tag-board wrapped in white paper to simulate swaddling clothes. Individual curls of yellow construction paper are glued to the head, and the halo is made from the center of a gold lace-paper doily. His manger is a box made from patterns N and O filled with short strips of gold crepe paper for straw.

Like the other figures, the body, head and arms of the angel are from patterns A, C and D.

Make the stable from the side of a corrugated grocery carton using pattern T. For an interesting texture, cover the stable walls with gold crepe paper which has been crumpled and then flattened again. The roof is covered with overlapping strips of fringed gold crepe paper.—Elma Waltner



# World's First, Finest and Only Complete Line of FUN GUNS!

**SINGLE-Action  
SIX CO<sub>2</sub> Gas Pell-  
gun Revolver**

**"160"**  
CO<sub>2</sub> Gas Deluxe  
Pellgun Rifle



Today's  
deluxe marksmanship  
Pellgun rifle

**"140"**  
High Velocity  
Air Pellgun  
Pump Rifle



Real economy  
for every kind  
of fun shooting

**"V-350"**  
Slide Action  
BB Air Rifle



New high velocity—  
fastest, easiest barrel  
slide-action cocking

Fast draw  
with true western  
single action

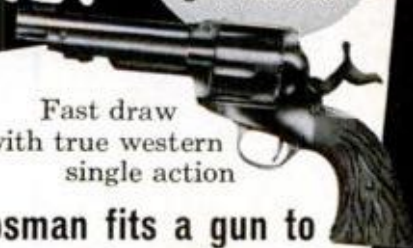

**Only Crosman fits a gun to  
every shooter from 8 to 80!**

You're sure to find your own favorite gun . . . for fun plinking, marksmanship, and gun training . . . among the twenty-two different models of Crosman CO<sub>2</sub> gas and high velocity air powered Pellguns® and BB guns. Priced from \$12.95. See them at your Crosman Select Dealers'.

**"600"**  
Pellgun Semi-  
Automatic  
Pistol

"10" shots in less  
than 3 seconds



*"Power without Powder"*  
**Crosman**  
High Velocity Air and CO<sub>2</sub> Gas

PELLGUNS

BB GUNS

WORLD'S LARGEST MANUFACTURERS OF CO<sub>2</sub> GAS-POWERED RIFLES AND PISTOLS

Information not listed on articles in this issue often is given in the WHERE-TO-FIND-IT list, available at no cost from the SERVICE BUREAU, POPULAR MECHANICS, 200 E. Ontario, Chicago 11, Ill.

## Just the ticket for SPEEDING

Strombecker Model Road Racing puts you in the driver's seat. With hand-held throttle, you control the speed of these remarkable little motor-powered cars every exciting mile of the way. And what speed! Built with authentic detail to 1/32 scale, they reach scale speeds exceeding 150 miles per hour. All the thrilling drama of the real thing is at your fingertips . . . spin-outs, spills, fish-tail action . . . crackups! Strombecker Model Road Racing is easy to assemble and costs only \$29.95. The Set includes everything you need to put the race on the road, including the world-famed D-Jaguar and Ferrari Testa Rosa racing cars. Enter the Grand Prix! See your Strombecker dealer soon.

**STROMBECKER**

*Sets the pace in road racing*

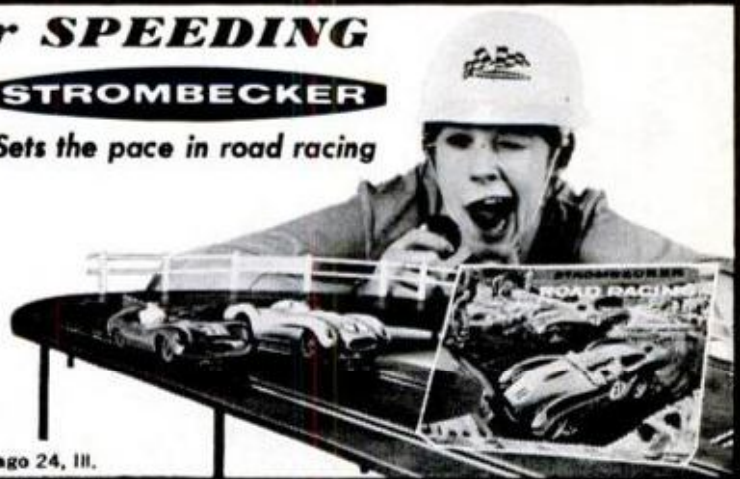

**STROMBECKER**

Send 10¢ for catalog. Dept. PM, 600 N. Pulaski, Chicago 24, Ill.



# Make Fall FIX-UP Time with STANLEY FALL SPECIALS



**MODEL H131, 1/4" Drill:** Built for all-round performance, easy handling. Geared chuck and key. Non-slip 3-position pistol grip. Perfect for drill attachments. Regular \$24.95  
**SPECIAL \$19.95**

## POWER TOOLS

by Stanley insure a lifetime of dependable, precision performance to help make your fall fix-up projects — and all your jobs — faster, easier and better!



**MODEL H264, 3/8 H.P. Router:** Heavy-duty, 23,000 rpm. "Spotlights" working area; brightness increases with work load. Micrometer depth adjustment. Full ball-bearing construction. Regular \$69.95  
**SPECIAL \$64.95**



**MODEL H75 Sabre Saw:** Heavy-duty, cuts 2" planking — ideal for scrolls, curves, valances, cabinets, plastics, veneers and other fine work. Complete with 3 blades for wood, metal and flush cutting; 19 other blade types available. Regular \$44.95

For even more power and speed, the **MODEL H267, 1 1/4 H.P. Router:** 27,000 rpm. Regular \$85.00  
**SPECIAL \$80.00**

**SPECIAL \$39.95**

*Prices slightly higher in Canada.*

BUY STANLEY HAND TOOLS • POWER TOOLS • HARDWARE

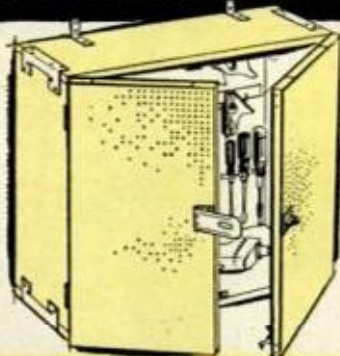

## IT'S FUN TO MAKE this all-purpose cabinet with STANLEY QUIK-KIT!

For utility room or basement use. Generous 32" x 32" size. Kit includes all necessary hardware. A \$3.50 value — now at special introductory price.  
**ONLY \$2.95**



**STANLEY**

REG. U. S. PAT. OFF.

AMERICA BUILDS BETTER AND LIVES BETTER WITH STANLEY

This famous trademark distinguishes over 20,000 quality products of The Stanley Works, New Britain, Conn.—hand tools • power tools • builders hardware • industrial hardware • drapery hardware • automatic door controls • aluminum windows • stampings • springs • coatings • strip steel • steel strapping—made in 24 plants in the United States, Canada, England and Germany.

CANADIAN PLANTS: HAMILTON, ONTARIO AND ROXTON POND, P.Q.



**STANLEY**

# Better Your Home On Your Own!

*and SAVE*

**MODEL ST1 1/2 "STEELMASTER" Hammer:** Finest ever made! Shaft and head are fine-grain, carbon steel, super heat treated. Perfect balance. Contoured, perforated non-slip grip. With **FREE** leather holster. Value \$5.65

**ONLY \$525**

**MODEL 296 "SURFORM" Plane:** Easy to use, saves time forming, trimming wood, aluminum, plastics. Ideal for trimming and fitting doors, windows, cabinets. With regular blade and **FREE** permanent sanding blade. Value \$4.68

**ONLY \$379**

## HAND TOOLS

form the base on which every well equipped home workshop is built . . . so get the finest. You'll do better work easier.

**STANLEY**

**MODEL MY10 10-FOOT "LIFE-GUARD" Rule:** Black on yellow background for fast, easy, accurate readings. Blade has unique coating;

outwears ordinary blades 3 to 10 times longer (U.S. Testing Company Test No. 81557B). Coupon for **FREE** copy of 35¢ book "How to Work with Tools and Wood." Value \$2.33

**ONLY \$198****ONLY 99¢**

**MODEL 299 Utility Knife:** Cuts wallboard, paper, cardboard, upholstery material, etc. With blade guard and 4 extra blades stored in handle. One of many Stanley Tools at only 99¢

**AT YOUR LOCAL HARDWARE STORE OR LUMBER YARD**

## FREE PLANS INCLUDED

Stanley QUIK-KIT includes: 2 pairs of hinges, 1 elbow catch, 1 magnetic catch, 1 Click-Lock hasp, 2 hanging brackets, **PLUS** 4 new Stanley exclusive brackets that make strong, square corners easily. Plan includes materials list and shows construction in 6 easy steps.



Scores of Home-Improvement **IDEAS** in this 20-page book . . . plus tips on tools and hardware. Ask your Stanley retailer or write, enclosing 25¢ in coin, to The Stanley Works, 6211 Elm St., New Britain, Connecticut.



# Soldering's a cinch...



## with a **Weller**® Dual Heat SOLDERING GUN KIT

Only Weller has Dual Heat! 2 trigger positions give low 90-watt and high 125-watt heat as your job requires. Tip heats instantly, has superior heat transfer and long reach. Spotlight eliminates shadows. Result... soldering is simple, sure and fast. Kit includes cleaning brush, soldering aid and solder.

Model 8200K **\$795**

You'll have many uses for this Weller Gun



APPLIANCE REPAIRS



HI-FI KIT ASSEMBLY



MENDING METAL



HOBBIES AND CRAFTS

Weller Dual and Single Heat Soldering Guns from 100 to 275 watts are available at your Hardware or Hobby Dealer.

WELLER ELECTRIC CORP., EASTON, PA.

## We'll Be in a Tight Squeeze On Friday, November 13, 2026

Three University of Illinois mathematicians calculate the human population will grow so large that—if conditions stay the same—it will squeeze itself to death on Friday, November 13, 2026.

Their calculations are based on paradise-like conditions; they considered no environmental hazards, no detrimental action between elements, and gave the expanding population an unlimited food supply. The date is accurate within 10 years, they believe.

The studies by Heinz von Foerster, Patricia M. Mora and Lawrence W. Amiot were partly supported by a grant from the National Institutes of Health, Bethesda, Md.

"Our great-great-grandchildren will not starve to death," they say. "They'll be squeezed."

## "Living Fossils" Aid Science

Man's oldest living relative, the goggle-eyed, big-eared little lemur, promises to be of help in the cause of science. Yale anthropologists have acquired several lemurs from the jungles of Madagascar and are studying them. The most important finding so far concerns the amazing speed with which the lemur's blood clots. There is hardly time to draw the blood off into a hypodermic needle before it coagulates. Researchers believe that whatever agent causes this extraordinary clotting action may be of value in fighting human circulatory and heart diseases. As one scientist put it, study of the lemur, a "living fossil," may well prove a boon to mankind.

## Men Go to Antarctic to Flee Women But Have Problems Just the Same

Half the men who go to the Antarctic do so to get away from women. Twenty percent know this, says Capt. E. E. Hedblom, the medical adviser to the Commander, Naval Support Force. The remaining 30 percent are motivated subconsciously.

"Too much of this much-touted togetherness gets sticky," he says, while agreeing that getting away from it all has penalties, too: Men serving on the ice have seven times more neuropsychiatric difficulties than other Navy men. Hazardous environment and isolation are the explanation, says Captain Hedblom.

The captain, incidentally, says there is a psychological advantage to be gained from occasional separation of the sexes, even among married couples.



## BUILT-IN IDEAS



# GET

THIS FREE BOOK-  
LET FROM YOUR  
LUMBER DEALER

# ADD

THAT NEEDED  
**STORAGE  
SPACE**  
YOURSELF!

■ This booklet contains a wide variety of practical ideas to help the home craftsman solve space and storage problems. Attractive shelves, drawers, cabinets adapt easily to the special needs of your home. Readily available Western Pine Region finish lumber provides beauty, ease of handling and finishing and outstanding workability . . . you'll appreciate its economy, too. ■ Consult your local lumber dealer for the materials and advice you need. If he is unable to supply this free booklet, write to: **Western Pine Association Dept. M-5, Yeon Building, Portland 4, Oregon**, giving us the name of your dealer. Enclose 10¢ for handling and mailing.



Quality Graded Lumber

## WESTERN PINE ASSOCIATION

- Idaho White Pine ■ Ponderosa Pine ■ Sugar Pine
- White Fir ■ Incense Cedar ■ Douglas Fir ■ Larch
- Red Cedar ■ Lodgepole Pine ■ Engelmann Spruce.





**NOW  
SAVE  
\$66<sup>45</sup>**

Limited time only at  
your DeWALT dealer's

Here's your chance to own

**DeWALT**

**33-PIECE**





the greatest "DOUBLE VALUE" ever offered!

# POWER SHOP plus CHEST FULL O' TOOLS



**1** DEWALT MODEL 925 DELUXE with all these exclusive features: (1) Wedge-line styling. (2) Eye-ease green color. Color-coded controls. (3) Totally-enclosed motor delivers over 2 H.P. Dual-arbor motor shaft permits use of low-cost right-hand tools. (4) Built-in motor brake stops saw instantly. (5) Safety key switch. (6) Drop-leaf safety table. (7) Cut-off scale on fence. (8) Big capacity—9" saw cuts 2½" deep, rips 48" panels in half. PLUS MANY OTHER BIG FEATURES.

**2** CUSTOM-MADE STEEL CHEST complete with select tools—33 pieces in all—and all are genuine

DEWALT brands that shopwise men use for quality work. Chest is also available with your purchase of other new 9" and 10" DeWalt models.

Buy this great combination—DEWALT plus CHEST FULL O' TOOLS and SAVE BIG \$66.45. Hurry to your DeWalt dealer and take home the biggest buy ever.

DEWALT, Inc., Dept. PM-1161  
A *Black & Decker* SUBSIDIARY  
Lancaster, Pa.

- Send me special Chest Full O' Tools information.  
 Send name of nearest dealer.

Name \_\_\_\_\_  
Address \_\_\_\_\_  
City \_\_\_\_\_ State \_\_\_\_\_



Just  
plug  
your  
TV set



into  
this NEW  
Winegard  
Booster-Pack



**your picture improves instantly!**

Now—get much more power into your TV set—get better pictures instantly with this wonder-working, transistor “Booster-Pack.” Reach out and get far-off stations—reduce picture “snow”—get sharper, snappier contrast. Channels too weak to enjoy will come in bright and clear, black and white or color.

Winegard “Booster-Pack” will power from one to six TV sets simultaneously—or, will allow you the convenience of TV-FM antenna plug-in outlets in every room. Costs less than 27c a year to operate. Installs in minutes. Your TV service dealer will deliver the Winegard “Booster-Pack” for only \$34.95. For free detailed brochure write today!



**Winegard**

3001-11 Kirkwood, Burlington, Iowa

## Football's Fabulous Foremen

(Continued from page 129)

“trap,” how the hole is to be blocked open; and “3” the snap count.

Now if all this begins to suggest that pro players, especially quarterbacks, must be fairly alert and intelligent, rest assured you are correct. The Minnesota Vikings have more than 200 separate plays in the play-book—only we call it a workbook.

Once a play begins, is there any sure way for spectators to follow the ball? It won't be easy, if the quarterback is doing his job. He'll fake handoffs, runs, passes, send decoys into and around the line, call trap plays and screen passes (letting the defense through, then lobbing the ball over their heads to a waiting back); even keep the ball and run himself now and then.

Despite all the deception, however, there are several indicators as to where a play is going. If the quarterback still has the ball as he clears the backfield while fading back, he probably will pass.

Pro quarterbacks seldom run. They're too slow, and their passing arm too valuable. As quarterback my motto was, “Run only out of sheer fright.”

Also, as the quarterback gets the ball, watch the action of the offensive guards. About half the time, if at least one pulls out of the line and moves in the same direction as one or more backs, this means a running play in that direction.

A backfield flanker (a man stationed wide to one side) or a split end also merits watching. He's often a decoy, but much of the time he's a key downfield blocker or a target for a quick pass.

When the quarterback plans to pass, he usually drifts straight back after fakes to the backs. Then, as a pocket of blockers forms, he steps into it for protection.

In high school or college, quarterbacks may rear back, cock an arm, follow a receiver with their eyes and head, and fire. Pro quarterbacks are more subtle. Before passing, they may fake throws in various directions—Unitas, for one, excels at this.

You'll also note that if a team has a dangerous passer (and all pro clubs do), linemen will put tremendous pressure on him. Keeping him off balance or unable to get the ball away is the best pass defense.

Watch rushers such as Andy Robustelli of the Giants, Gino Marchetti of the Colts, or Gene Brito of the Rams. When they are in overdrive, the quarterback is in for a rough afternoon. In the Colts-Giants championship game two years ago, Marchetti

(Continued to page 232)



HARLEY-DAVIDSON  
MOTORCYCLES AND MOTOR SCOOTERS

# HARLEY-DAVIDSON 1962 FUN-O-RAMA!

## 8 NEW EXCITING MODELS

I'M GETTING RID OF TRAFFIC AND SAVING MONEY, TOO WITH THIS ALL-NEW 80-MPG PACER!

TALK ABOUT A HOT CYCLE... THE NEW SPORTSTER 'H' HAS EVERYTHING FOR ALL-AROUND RIDING THRILLS!

COME RIGHT IN, FOLKS! WE'VE GOT MORE NEW MODELS FOR 1962 THAN WE'VE EVER OFFERED!

DON'T MIND TAKING A BACK SEAT ON THIS ONE!

TOLD YOU THE NEW SPRINT IS DIFFERENT!

BRING ON THE TROUT... I'M BLAZING NEW TRAILS WITH THIS NEW RANGER MODEL!

IT'S SPRY, SPIRITED... AND THE PRICE IS RIGHT FOR ME!

GO, GO, GO! I'LL LEAVE 'EM IN THE DUST WITH THIS NEW SPORTSTER 'CH'. ON OR OFF THE ROAD!

ON ANY ROUGH-AND-TUMBLE ACTION THAT SCAT'S A BEAUT!

JUST RIGHT FOR SCRAMBLES!

THAT GOES FOR BOTH OF US!

HONEY HOW ABOUT A DELUXE DUO-GLIDE FOR OUR NEXT VACATION TOUR?

MAN WHEN THEY SAY 'SCAT' THEY MEAN SCAT!

DAD, YOUR TOPPER 'H' IS AN EXTRA SET OF WHEELS THE WHOLE FAMILY CAN USE!

HARLEY-DAVIDSON  
MOTOR CO.

DEPT. P-11  
MILWAUKEE 1, WIS.

Send me the new literature on the 1962 Harley-Davidson motorcycle and motor scooter lines.

Name..... Age.....

Address.....

City..... Zone..... State.....

The scene? Your Harley-Davidson dealer. Stop in now for a look at the all-new line of Harley-Davidson motorcycles and motor scooters for '62. Take a test ride, too.



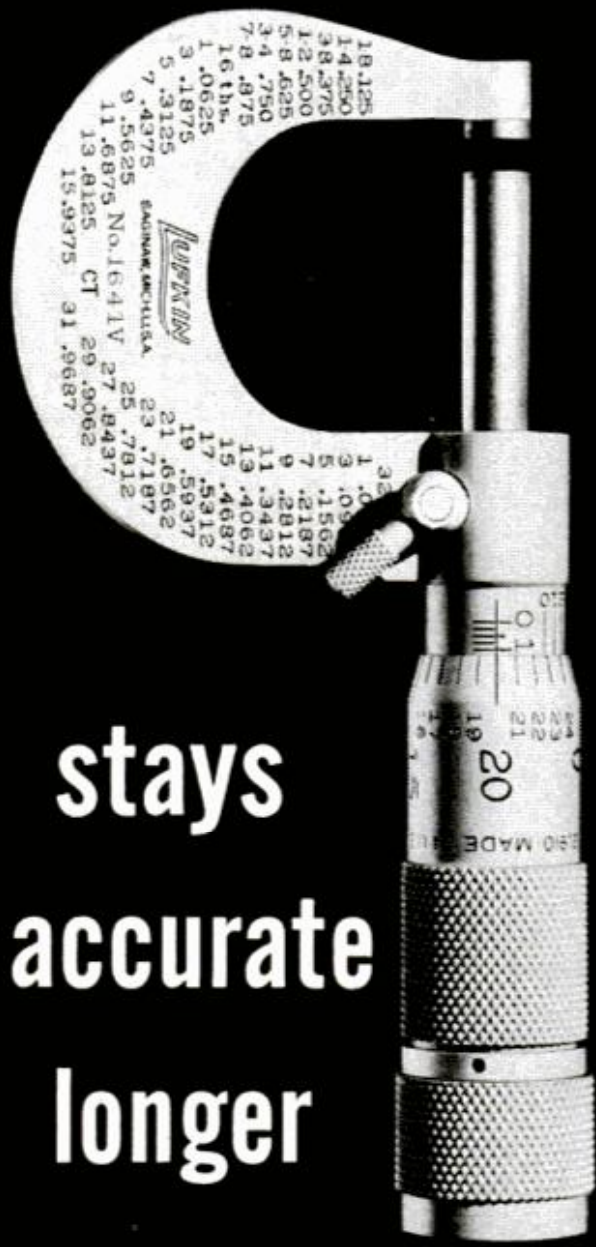

stays  
accurate  
longer

A LUFKIN EXCLUSIVE: 5 to 7 fewer parts than other micrometers . . . less to get out of adjustment! One-piece frame and hub simplifies wear adjustment, assures greater accuracy. Exclusive cam lock prevents reading errors. Ratchet stop top. Easy-to-read markings on nonglare *Chrome Clad*® finish.

Leading Industrial Distributors feature Lufkin — the new leader in precision tools.



**LUFKIN**  
SAGINAW, MICHIGAN

almost singlehandedly set up the Colts' romp—Conerly either was flat on his back, or so hurried and off-balance he was tagged with several costly interceptions.

Watch the line play and maneuvering of potential pass receivers. Both determine to a large degree how good the quarterback will look by sundown that day. Linemen may charge diagonally either right or left, or straight ahead. They may come in high or low. They may put everything into a charge, or hold and drift with a play to "read" how it develops. The quarterback will make a point of steering plays away from some individuals. Watch the Steelers' 288-pound Gene "Big Daddy" Lipscomb sort out opponents with his big hands sometime. You'll see why we must know what to expect at each point on the line, and why, when possible, we run plays away from such strongmen.

Follow an end or halfback as he breaks and tries to shake free to receive a quarterback's pass. There'll be head-bumping at the line as defensive men try to delay his getaway, more struggles in the secondary as linebackers also slow him down, then high-speed zigzagging, starts, stops, and head, shoulder, and body fakes in the deeper secondary as he tries to make his last break. On the Vikings we have 19 different patterns a receiver can run, from slants, arcs, buttonhooks, zigzags, sidelines, and stop-and-go maneuvers to running straight up the middle.

Because passes are dramatic, and remain in memory when they click, it may be easy to assume most pro plays will be passes. But, in recent years nearly 60 percent of all NFL plays each season have been rushes—only a little more than 40 percent have been passes. A good quarterback uses one to set up the other.

You can try to predict what play a quarterback will call. But don't be dismayed if you miss often. Unlike high school or college ball, there's no "automatic" passing or running down—in pro ball we'll pass on any down and for any yardage. We'll pass from our own goal line. We'll pass in any weather. Two years ago, when Pittsburgh's Bobby Layne set a league passing record against the Cardinals, it wasn't in the sunshine. It was in the mud.

Few games are as simple as they appear, and pro football is no exception. It's a magic show, a guessing game, an endurance test, and the department of higher athletic learning all rolled into one, with the quarterback right in the middle.

Try to understand his moves, and you'll be well repaid in thrills. ★ ★ ★



*a great new power mate for the Special's aluminum V-8*

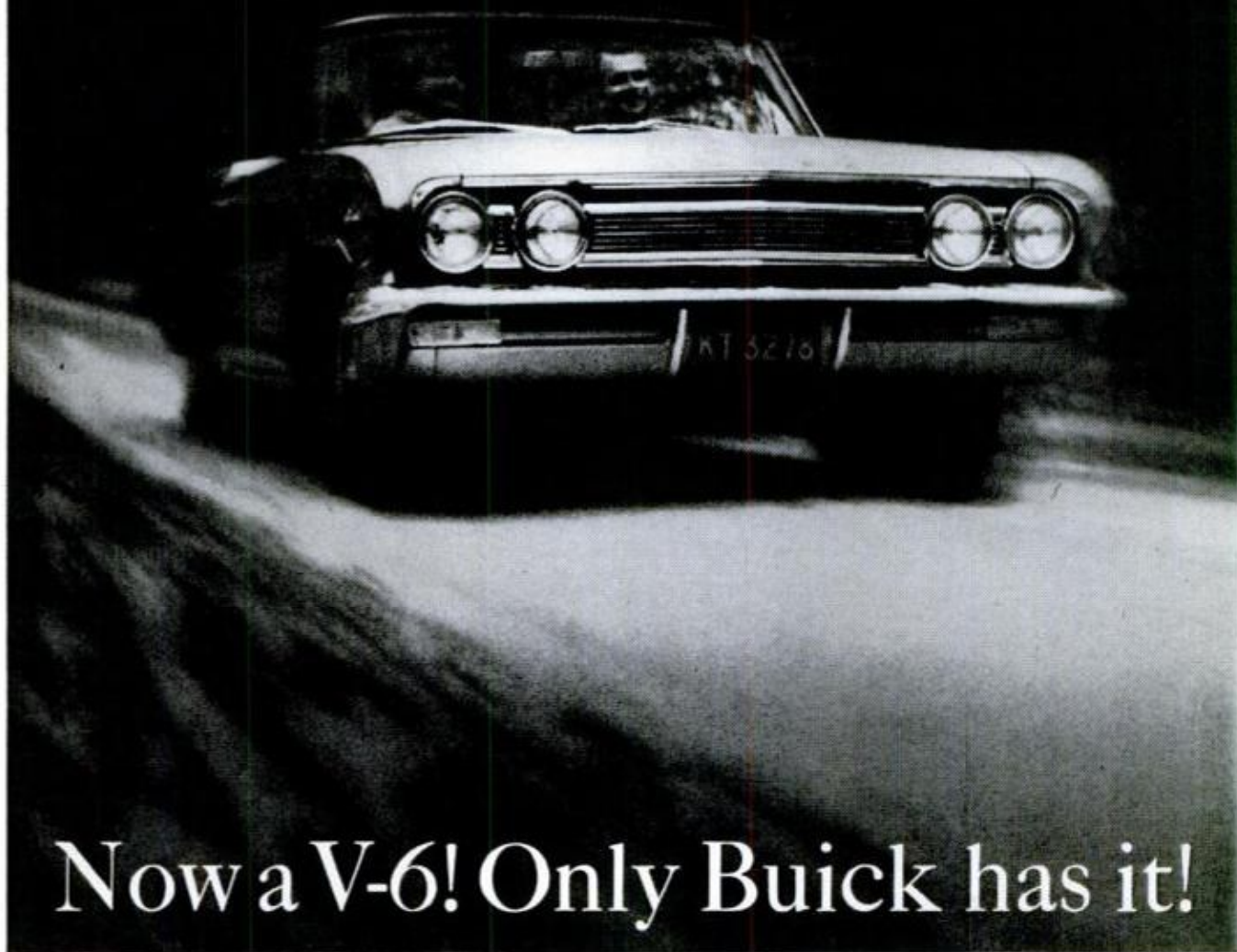

## Now a V-6! Only Buick has it!

Six for Savings—V for Voom. It was natural that it came from Buick. Natural that Buick developed the successor to the in-line six-cylinder engine...the V-6! A V-6 you can now get in the new 1962 Buick Special (in convertible, sedan or station wagon models). A V-6 that has 140 to 179 pounds less weight than in-line sixes of comparable power. A V-6 that gives you the V-smooth, V-lively *Voom* of big cars *plus* gas economy that challenges the compacts. A V-6 with the shortest, most rigid block and crankshaft in any American 6-cylinder car.

Why is it natural that this great engine should

come from Buick? Because it was Buick which also developed an *aluminum V-8* which you can also get in the Buick Special. This is the V-8 that gives you sizzling go, yet swept its class in 1961's Mobilgas Economy Run against the country's top drivers. It's natural that it should come from Buick, too, because so many other great automotive advances *have* . . . such as today's safe, simple directional signals . . . fin-cooled aluminum brakes . . . the first no-shift transmission . . . the first hardtop. So here again you have exciting proof that when better automobiles are built, Buick will build them. Buick Motor Division—General Motors Corporation.

'62 Buick Special   
*The happy-medium size*



space  
age  
hobby

**BUILD-YOUR-OWN  
ELECTRONICS  
FOR MODERN LIVING**

IT'S FUN...IT'S EASY WITH MONEY-SAVING

**knight-kits®**   
A PRODUCT OF ALLIED RADIO

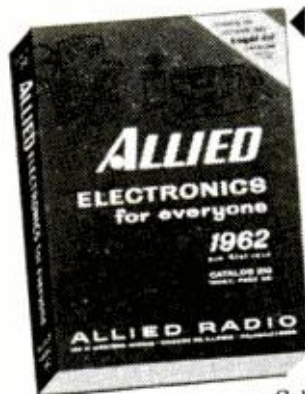

← featured in the 444 page

**1962 ALLIED  
ELECTRONICS  
CATALOG**

**free** send  
for it!



Dozens of new hobbyist kits, including amazing Electronic Science Lab—over 100 projects!

Select from more than 70 exciting Knight-Kits! See—Stereo hi-fi, including new Multiplex Stereo tuners and all-transistor amplifiers, short-wave radios, intercoms, Citizens Band radios, electronic science labs, test instruments—all easy to build and a pleasure to own! Send today for your FREE 1962 ALLIED Catalog!



Everything in Stereo hi-fi components; new Multiplex Stereo FM tuners



New—tachometer kit and outstanding test instruments



New all-transistor intercom; many other kits for modern living

**SAVE ON EVERYTHING  
IN ELECTRONICS**



Get the most for your money in: Stereo hi-fi systems and components • Recorders and tape • Citizens Band radios • Amateur station equipment • TV tubes, antennas, accessories • Electronic parts, tubes, transistors, tools, test instruments, books. Send today for your FREE 444-page 1962 ALLIED catalog!

**NO MONEY DOWN**  
Easiest Terms

**FREE  
CATALOG**



**ALLIED RADIO**

ALLIED RADIO, Dept. 24-L1  
100 N. Western Ave., Chicago 80, Ill.

Rush FREE 1962 ALLIED Catalog

Name \_\_\_\_\_  
PLEASE PRINT

Address \_\_\_\_\_

City \_\_\_\_\_ Zone \_\_\_\_\_ State \_\_\_\_\_

**WORLD'S  
BIGGEST**

**Must Appliance Repairs Cost  
You So Much?**

(Continued from page 118)

of problems uncovered by housewives goes from nails and coins in washer pumps to refrigerator door handles that automatically bump elbows, tricky shelves that dump loads, range controls that tear fingernails or the discovery by some women that too much detergent would thoroughly clog a certain washer's plumbing.

One at a time, as problems brought by these conditions have popped up, the manufacturer has had to deal with them. As you will see, there is hope that they will cope with some of them before they arrive in your home.

Which brings us to the other half of the situation: They don't sell them like they used to.

Time was you paid a dealer, say, \$200 for a washer. On that sale, he made about \$75 gross profit. Today, a \$200 washer gets the dealer maybe \$25-\$28. And for \$25, the dealer doesn't feel as responsible as he did for \$75. There has been a revolution in appliance selling, and it's called discounting, knocking off some of the dealer profit. The idea is to make money on the volume. The trouble is that volume means more units and more units automatically mean more service problems, but there isn't enough money in this new deal to continue servicing each unit at the old rate. Since it was discount and cut service, or die on the vine, most dealers went the discount route.

**Five-Year Confusion**

As a result there have been five years of confusion about who—dealer or manufacturer—was going to fill the service gap. But the customer, who was getting shuffled around while the wrangle raged, is finally getting some attention.

He got it the way everybody gets attention—he called for it loud, long and hard.

Here's what's happened since the screams of the consumers hit the factories where they hurt—the pocketbook:

First: Service was made a high-level responsibility. For example, one big manufacturer's service manager meets once a week with plant managers in their own plants; he also meets once a week with advance product engineers. He goes to these meetings armed with blue prints, with field reports, and other information that is not furnished by the product engineers.

Second: The factories took more of the service responsibility into their own hands—to the point where some factories figure

(Continued to page 236)





Take the "rub"  
out of refinishing  
peel paint off

WITH  
**KLEAN-STRIP  
PAINT REMOVER**

- Fast • Clean • Non-inflammable
- One application removes many coats

**THE KLEAN-STRIP CO., INC.**  
Memphis 6, Tenn.—Winnipeg, Man.

TOM MOORE TRACTOR, INC.

**FARM-ETTE**

MANTUA, OHIO  
U.S.A.

**TESTED • PROVED**  
Best in powered lawn  
and garden equipment

Write department 8 for catalog

Send for your free WHERE-TO-FIND-IT list  
giving sources of supply or further informa-  
tion on articles in this issue.



**G E A R S**

**In Stock — Immediate Delivery**

Gears, speed reducers, sprockets, thrust bearings, flexible couplings, pulleys, etc. A complete line is carried in our Chicago stock. Can also quote on special gears of any kind. Send in your blueprints and inquiries.

Send for Complete Catalog No. 10  
**CHICAGO GEAR WORKS**  
440-50 N. Oakley Blvd., CHICAGO 12, ILL.

**X-PANDOTITE<sup>®</sup> WHITE, MORTAR-LIKE**  
THE CEMENT THAT EXPANDS AS IT SETS

Perfect for repairs around bathtubs, toilets, urinals, shower stalls, tile, mosaics (resetting and grouting). Terrazzo, marble, etc. All joints. For anchoring bolts, screws, railings. For molding; electronic assemblies. Thousands of uses around the home. May be colored. Non-Toxic. No other cement does so much, so well.

At local stores. FREE leaflet available. Write — Dept. 10, X-Pando Corp., 43-15-36th St., Long Island City 1, N.Y.



**GENUINE ALNICO  
MAGNETS**

**AMAZING, PERMANENT, NON-ELECTRIC, HIGHLY PRACTICAL.** Conduct interesting experiments. Hundreds of uses. Retrieve valuable steel items such as guns, tackle from fresh or salt water; tools from tanks & drains. **GUARANTEED.** Try any magnet one week. Money back if you are not well-pleased.

- No. M-710 (Wt. 53 oz.) Has pull of 225 lbs. on steel block... \$18.00
- No. M-625 (Wt. 70 oz.) Has pull of 125 lbs. on steel block... \$10.00
- No. M-575 (Wt. 18 oz.) Has pull of 75 lbs. on steel block... \$ 7.00
- No. M-500 (Wt. 13 oz.) Has pull of 50 lbs. on steel block... \$ 5.00
- No. M-90 (Wt. 5 oz.) Has pull of 15 lbs. on steel block... \$ 3.50
- No. M-44 Rod Magnets for Electric Guitars, 1/4" Dia. x 1 1/4" 12 for \$4
- No. M-47 Hot Pad Magnets 10 for \$1.00 ..... 50 for \$ 4.87
- No. M-35 Science Experimenter Kit of 8 magnets..... \$ 2.00

Send M.O. or check. We pay postage. Sorry no C.O.D.'s.

MIAMI MAGNET COMPANY, 3240 N.W. 27th Ave., Miami 42, Fla.

NOVEMBER 1961

**Swings Easy**



**Balanced  
for  
Driving Power**

**F-57**  
Advised  
Consumer  
Price  
\$5.50

**NON-BREAKABLE  
Fiber-Glass**

**HANDLE**

*Stronger than Steel*

*Fiber-Glass HANDLE*

- light in weight
- will not collapse, bend or break
- will not rust, rot or corrode
- Guaranteed non-breakable in normal use

**NEOPRENE COVERED GRIP**

- keeps hand from slipping
- resists grease, oil and sweat

PERMABOND<sup>®</sup> assembly  
keeps handles tight

Fayette R. Plumb, Inc., Phila. 37, Pa.

Axes  
Files  
Hammers  
Hatchets





screens, upholstery, carpets...

hundreds of other uses.

You name 'em!

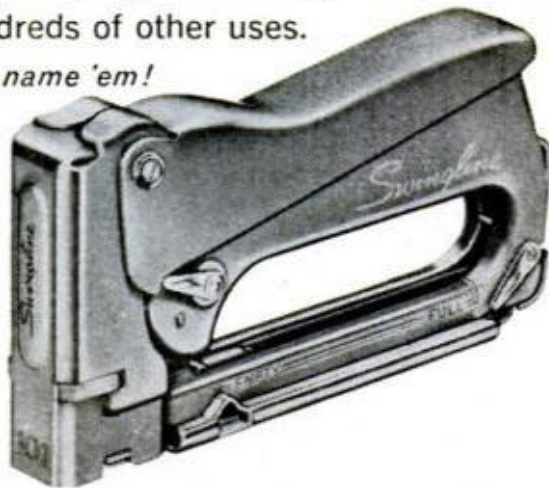

## Swingline 101 Staple Gun

Staples practically anything. Exclusive push-button loading and built-in staple extractor. At your stationery, department or hardware store.

only **4<sup>95</sup>**

**FREE!** New 8-page

SEND FOR YOURS TODAY!

**"TIPS FOR TACKING" Booklet**

... shows you how to save time, money and effort—  
with a SWINGLINE AUTOMATIC STAPLE GUN



**Swingline INC.**

38-00 Skillman Ave., Long Island City 1, New York

# STOP WATER DAMAGE...



Wood  
Plywood  
Shingles  
Asbestos siding  
Concrete blocks  
Concrete  
Mortar  
Stucco  
Plaster  
Brick  
Paint  
Wallboard  
Tile  
Canvas  
Leather  
Linoleum  
Fabrics

**Prevents warping, swelling, mildew, mold, water stains, seepage, dampness, rot.**

**Keeps moisture out 5 years and longer.**

Use on all woodworking jobs, boats, patio furniture, planter boxes, shutters, screen doors, window sash, shingle roofs. Stops seepage in basement walls, concrete silos, foundations. Waterproofs canvas, tarps, tents, awnings, leather boots, shoes, outdoor clothing. Won't harden or crack leather or fabrics. Perfect underseal for oil base or alkyd paints. Deep penetrating, colorless. Apply by brush, spray or roller. At paint or hardware stores or order direct. 1b oz. spray can \$1.89, Qt. \$1.75, Gal. \$5.35, 5 Gal. \$25.25, ppd., tax incl. Send check or money order to **E. A. Thompson Co 1355 Market St., San Francisco 3, Calif.** No COD's please. (Since 1929.) Dealer and jobber inquiries invited.

they handle the service on 80 percent of the units they sell.

Third: Service training was stepped up considerably, both at national and regional levels, to get more knowledgeable people in contact with the customer.

### Independent Control Wiring

Manufacturers have all taken certain steps with the appliances themselves. Control unit wiring is, for example, on its way toward independence from the rest of the machine, allowing quicker repair. Easily-accessible service "from the front" is beginning to be an important feature of all makes. And pretesting in the field and laboratory is increasing.

Such testing prevents "disasters" from being sold. As an example, one prominent company had a new washer design in the works. The new idea was a feature that would automatically feed the various detergents, fabric softeners, bleaches into the wash. This was done by running water through a series of bins at the right time.

Early test models drew bin water from the nearest inside pipe—which happened to be a cold-water line. As testing proceeded, an additive, supposed to be water-soluble, clogged things up by forming a hard insoluble mass inside the feed channels. It was then that testers found that this particular water-soluble material liked hot—not cold—water.

The solution was simple—pipe in the hot water instead of the cold. They did. However, without enough testing, or with testing with a compound that took longer to clog the works, the design might very well have gone on the market and become a disaster.

There has been a considerable trend toward simpler mechanical components, notably transmissions. One make of washer has an almost-never-failing transmission that has fewer working parts. It is simplicity itself. However, there is one possible problem that can be expensive in servicing it. Servicemen report that if the Neoprene seals fail, the whole machine has to be taken into the shop to be torn down.

Every advance apparently carries a penalty. The typical early automatic washer had 300-350 separate parts; the typical machine today has 450-500 parts. The price of automatic convenience automatically means more things to go wrong as well as easier washdays.

Service management is beginning to function better in many ways. And there have been basic improvements in the approach to the problem of satisfying the

(Continued to page 238)



## ADJUSTABLE MITER BOX & CORNER CLAMP



Adjusts to any angle!

2 TOOLS IN ONE

### No. 44—COMBINATION MITER BOX AND CORNER CLAMP

Holds the wood and holds your saw. Uses any handsaw for accurate cuts from 0° to 180°. Full 3" capacity. Sides of joints exposed for nailing, gluing.

\$2.75 PPD.

No. 33 Works the same as No. 44, but without saw guide attachment. \$1.75 ppd.

### SAW SHARPENING IS EASY

Super Filer No. 11 joints and sharpens hand and circular saws 6" to 10" with all teeth correct in height, depth, pitch, bevel. When file hits steel roller, teeth are finished. Saw runs true with no side pull. Includes 8" file.

\$9.95 PPD.



### "TRU-CIRCLE"

saw set automatically set-teeth at 10° or more.

\$2.95 PPD.



### SUPER DRILL GRINDER

Sharpens round shank drills like new, using hand or power grinders.

\$2.95 PPD.



MONEY BACK GUARANTEE

A. D. McBURNEY, 5908 Hollywood Blvd., Hollywood 28, Cal., Dept. A-111

## ECONOMY POWERFUL!

Thousands in Use! Since 1946

### UNEQUALLED LOW PRICE! TERRIFIC VALUE!

America's finest tractor. Ruggedly built. Easy to operate. 790 lbs. Borg-Warner clutch, trans. and diff. 140 to 1 reduction. 40% more drawbar pull than ordinary tractors. 9 H.P. engine. 20 quick change implements. HOOD-FENDERS.

Write for Catalog.

Engineering Products Co.  
1005 K-11 Anoka Avenue  
Waukesha, Wisconsin



## First Road Test of the Wankel Rotary Engine

How does it compare with conventional auto engines in performance and fuel mileage? The December issue of Popular Mechanics will bring you a full report



As versatile as they are powerful, Wiss Snips are an all-purpose cutting tool no home work bench should be without. Sizes from 7" to 17" in aviation, combination, solid steel and inlaid steel styles. At hardware and department stores.

### WISS SNIPS CUT EVERYTHING!



Cut Tile



Cut Leather



Cut Fish and Poultry



Cut Fencing and Screens

**J. WISS & SONS CO., NEWARK 7, N. J.**  
World's Largest Manufacturer of Shears, Scissors, Pinking Shears, Skalloping Shears, Metal Cutting Snips and Garden Shears



new  
Sony



for portable use\*

**STERECORDER 464-D**



for custom installation

only  
**\$199.50**

### **both stereo recording & stereo playback!**

An unprecedented price for the famed Sony quality! The long-awaited Sony Sterecorder 464-D—dual purpose, dual performance! Dual performance means both 4 track stereo **recording** and 4 track stereo **playback**. Dual purpose means custom component installation **and** portable use. Recording and playback pre-amps are **built-in**, and such features as sound on sound, language and music training, two speeds, push button track selection and Sony precision engineering make this the most outstanding tape recorder value at \$199.50. ■ **All Sony Sterecorders are Multiplex-ready!**

\*Carrying case optional

For literature or name of nearest dealer, write Superscope, Inc., Dept. 9, Sun Valley, California

**SUPERSCOPE**

The Tapeway to Stereo

housewife. For example, one thing about service that never fails to irritate is cost. Particularly the uncertainty of it all. Typically, the appliance man comes out to the house, makes some alarming noises for perhaps an hour, then says, "That will be \$36, ma'am. Had to put in a new frammis." That, at least, is how many housewives think of service calls.

#### **Flat-Rate Service Charges**

One way to get around this irritation is to get the bad news in advance. That's why some firms have set up flat-rate service charges. Armed with a book the housewife can look at, the serviceman can forecast precisely how much a job or combination of jobs will cost.

Other firms are jazzing up the service. A washer manufacturer has brought out what's called "Red Carpet Service," a tightly supervised repair program that requires its sellers to meet stiff requirements in performance with the privilege of advertising the service taken away if the service gets slipshod.

Still other manufacturers are taking steps to increase their responsibilities. Some are increasing the warranty period, making it include both parts and labor where, in some cases, it did not include both before.

All these efforts help, of course, but there is going to continue to be service expense connected with owning a new appliance. We are paying the price of convenience. In the old days, the wringer washer didn't cost much to buy and didn't need much servicing. But it didn't take care of all the hard labor the modern washer does.

#### **Housewives Don't Buy Simplicity**

Manufacturers still make the good old simple appliances. Every appliance store in the country carries the wringer washer, the simple small refrigerator—they are called "strippers"—and they are better than they used to be. But housewives don't buy many of them—wringer washer sales went down about 15 percent last year, 15 percent **more** than other appliances.

Since we've decided to buy more complex modern appliances, we're going to have to learn to live with them. Eventually, perhaps, we will learn that preventive maintenance, while an annual cost, will be cheaper than running the machine until something breaks and then fixing it. Here and there, appliance dealers are now advertising "Spring Tune-Ups," just like the automobile service stations.

And the records show that they pay in reducing major appliance repair costs. ★★★



# Why '62 Rambler stops when others can't



Ordinary car crashes barrier. '62 Rambler stops safely. A hydraulic line on each car was cut. Both started together, braked together. Rambler stopped, the other crashed through the barrier.

## NEW RAMBLER DOUBLE-SAFETY BRAKE SYSTEM STANDARD ON ALL MODELS

See '62's freshest new styling. Then see Rambler's "under-the-skin" improvements.

Biggest advance since hydraulic brakes is the new Double-Safety Brake System. Tandem master cylinders, one for front brakes, one for rear. If one system is damaged, the other still works. Self-adjusting brakes also standard.

New Road Command Suspension on Classic and Ambassador allows remarkable new precision control. New single lower control arm with outer ball joints. Newly calibrated Deep-Coil front springs. Widest track of any compact—new for '62.

Tires and wheels precision balanced at factory. Up to 27% more road clearance.

33,000-mile chassis lubrication, most models. Oil filters standard—normal oil

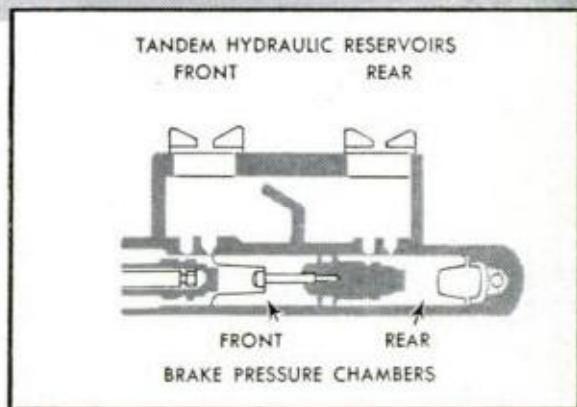

Simplified diagram of cross section of Rambler's new Double-Safety Brake System. Tandem master cylinder, separate systems.

change every 4,000 miles. Many components lubricated for life.

Now, besides Deep-Dip rustproofing of entire body up to roof, rocker panels are armor-plated with rustproof zinc.

Ambassador V-8 now has an even better power-to-weight ratio, best of any compact. 250 HP, standard, 270 HP, optional.

New E-Stick No-Clutch-Pedal Transmission optional on American. Most of the ease of automatic drive at about  $\frac{1}{3}$  the cost—with stick-shift economy.

Now, take a Discovery Drive at your Rambler dealer's and see how Rambler gives you more car value for your money.

**RAMBLER—WORLD STANDARD  
OF COMPACT CAR EXCELLENCE**



# Starrett TOOL CHESTS

for professional and amateur craftsmen



Designed for you by the

## "World's Greatest Toolmakers"

These professional quality tool chests are built to rigid Starrett specifications in hand-rubbed Honduras mahogany or rugged, wrinkled-finished steel. Available as chest only or with choice of three different assortments of Starrett tools to provide basic equipment for students, apprentices, home craftsmen, mechanics, machinists or tool and die makers.

**WOOD CHEST NO. 200 WC** (illustrated). Size 9½" x 20" x 13". Top storage and nine drawers with Starrett red lining plus outside panel to completely lock. Shown as furnished with 21 basic tools.

**METAL CHEST NO. 200 MC** (not shown). Size 8½" x 20" x 13¾". Top storage and seven drawers with Starrett red lining plus outside panel to completely lock — available with or without tools.

### BIG NEW CATALOG — FREE

Describes and illustrates over 3500 Starrett tools. Send the coupon.



STARRETT TOOLS are carried by leading Industrial Supply Distributors and Hardware Tool Stores.

THE L. S. STARRETT COMPANY 1161  
Dept. AP, Athol, Massachusetts, U. S. A.  
Please send complete information on Starrett Tool Chests and free copy of Starrett Catalog No. 27.

Name.....  
Occupation.....  
Address.....  
City..... Zone..... State.....

## Say It With Silk

(Continued from page 178)

wetting both the reverse and face sides in accordance with instruction with the film until some bubbling appears in the open areas of the film. At this point the backing sheet can be removed, Fig. 11. Continue wetting and at the same time lift one edge, stripping the backing off slowly. Then place in a dryer or before a fan and dry as before.

The final work on the screen is blocking all areas which are not to print. Apply the water-soluble blackout to all the screen areas where you do not want ink to transfer, (Fig. 13). Apply blackout to both sides of the screen with a brush, as shown, to eliminate any drops that would interfere with operation of the squeegee later on.

Now you place the screen back in the dryer again, or before the fan and allow it to dry. After drying thoroughly it's ready for use. To determine workability of the ink, make a trial impression as in Fig. 16. Silk-screen inks usually work well from the can, but they may require thinning slightly for best workability. Use only thinner recommended by the manufacturer of the ink and only in the amounts recommended should thinning be necessary. Set up as in Fig. 14 placing the screen frame in the clamps and line up the work for the first impression, using 1-in. masking tape as register points. Pour in your ink as in Fig. 15. When working with the squeegee in the actual printing, or screening, process, always use a firm, steady stroke all the way across the image area. Pressure should be uniform, Fig. 18, and ordinarily the squeegee is tilted at approximately the angle pictured throughout the stroke. The blade of a new squeegee is regularly square across the bottom. Don't use a squeegee with rounded edges for silk-screen printing.

After the work has been squeegeed properly, you have completed the first printing operation of the first color, which in the sample card, is gold. To print the second color (red), it is necessary that you clean up the excess ink in the frame and then wash all the ink out of the screen with the mineral spirits. Use water about as hot as it normally comes from the hot-water faucet to wash the Ektagraph-film emulsion and block-out dope from the screen. Also, in the Ektagraph instruction sheet you'll find a formula for bleaching out the stain in the screen. Then the steps from Fig. 9 on are repeated, using your second contact positive. Finally, after repeating these steps a third time (in a three-color card) you will complete the printing as in Fig. 19.

—D. A. Williamson



## All Chemical Elements Become Lighter

All of the 103 known chemical elements, the building blocks of the universe, will in the future weigh a tiny bit less.

After years of controversy, the Council of the International Union of Pure and Applied Chemistry decided that the new standard of weights should be figured from the carbon atom weight 12.

Oxygen atom 16 is dethroned as the standard. In fact, two oxygen standards are displaced. The chemists have, in the past, taken natural oxygen as 16 and the physi-

cists have taken the isotope of oxygen 16 as base. As there are three kinds of oxygen, isotopes 16, 17 and 18, in the natural oxygen in the air, there was a difference.

Oxygen, in the new system, is now 15 followed by decimal 9994 with plus or minus one in the fourth decimal place.

☪ Ocean waves have incredible power. They can hurl rocks weighing many tons onto the top of cliffs more than 100 feet high and wash out steel breakwaters.

*The proof is in the puffing!*

**PRINCE ALBERT** has the flavor  
most favored in the U.S.A.



- always tastes fresh
- mild, mellow flavor
- cool 'n' steady burning

**PRINCE ALBERT**

NOVEMBER 1961

R. J. Reynolds  
Tobacco Co.,  
Winston-Salem,  
N. C.

241



Any man will enjoy new

# AIRGRATE YELLO-BOLE

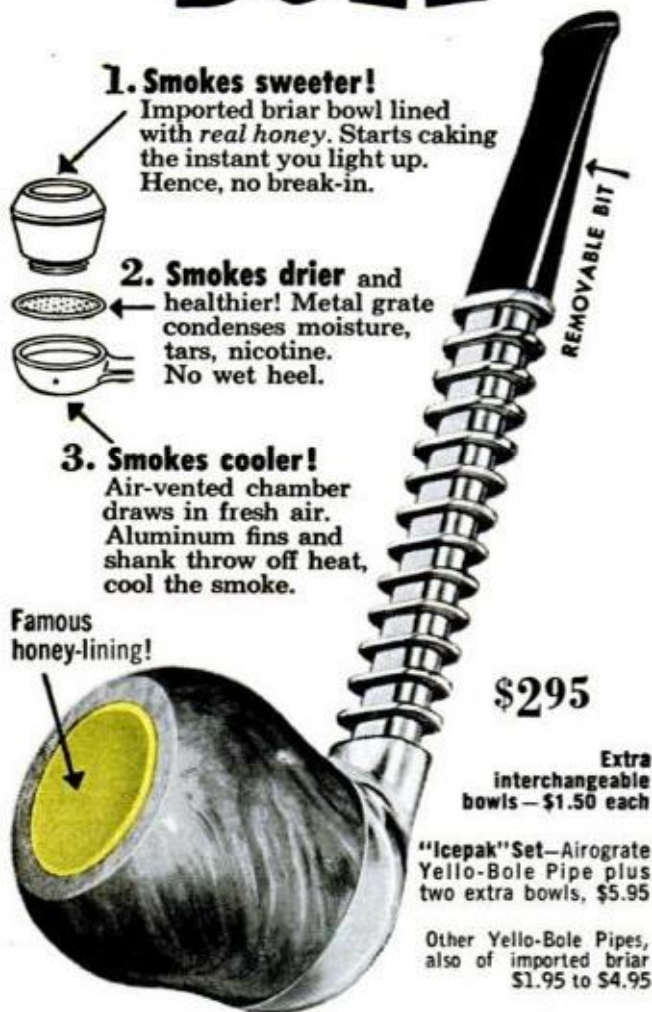

**1. Smokes sweeter!**  
Imported briar bowl lined with real honey. Starts caking the instant you light up. Hence, no break-in.

**2. Smokes drier and healthier!** Metal grate condenses moisture, tars, nicotine. No wet heel.

**3. Smokes cooler!**  
Air-vented chamber draws in fresh air. Aluminum fins and shank throw off heat, cool the smoke.

Famous honey-lining!

\$295

Extra interchangeable bowls—\$1.50 each

"Icepak" Set—Airograte Yello-Bole Pipe plus two extra bowls, \$5.95

Other Yello-Bole Pipes, also of imported briar \$1.95 to \$4.95

Send for FREE FOLDER, YELLO-BOLE PIPES, Inc., Dept. Y35, N.Y. 22

IDEAL CHRISTMAS GIFT FOR ANY MAN

**4-WAY WELDER \$14.95**  
WELD - BRAZE - SOLDER - CUT Complete

**NO OTHER WELDER AT THIS PRICE**  
Complete with SAFETY FOOT SWITCH, FULL FACE SHIELD, twin carbon arc torch, welding rod holder, clamp, carbons, welding & brazing rods, flux, fuses, instruction book. **FULL YEAR GUARANTEE.**

More than a quarter million in use in homes, garages, farms, shops, factories. NOW anyone can weld, braze, solder, cut, heat, without experience. Does 1001 jobs on all metals. Save & earn money. Make & repair auto bodies, parts, fenders, trailers, boats, metal furniture, fixtures, ornamental iron, farm equipment, garden tools, bicycles, toys, etc. Operate on any properly wired 110 V AC line. **SEND ONLY \$2.** Pay postman \$12.95 plus C.O.D. charges. Ideal lifetime gift for hobbyist, mechanic, hot rodder, homeowner. Order on 10-day money-back guarantee.

**FOUR WAY WELDER CO. DEPT. F2-M, 1810 S. FEDERAL ST. CHICAGO 16, ILL.**

## The Gas Turbine Goes to Sea

(Continued from page 132)

a bonus for the turbine drive. Costwise, on an hourly basis, gasoline figured \$4.50 per hour or 28 cents per mile vs. diesel oil at \$4.20 per hour or 15 cents per mile.

Comparative fuel costs can vary all over the map, of course. Other engine-boat combinations would undoubtedly show different results, but the fuel-consumption bogey has been pretty well licked for turbine boat power. During the past 12 years specific fuel consumption has dropped from 1.8 to .72 pounds per horsepower hour on Boeing gas turbines.

Gas turbine power opens up a whole new field for boat designers. Boeing used the 26-foot cruiser hull for tests because it was readily available—like other boats in its class, its hull was designed for use with a broad range of relatively heavy marine engines burning either gasoline or diesel oil. Hulls specially designed for the high horsepower and low weight of the gas turbine could increase both cruising and top speeds. With hulls of this class, fuel costs would decrease still further in gallons or dollars per mile.

### The Noise Problem

How about noise? Gas turbine engines are known for their noise level—just ask anyone living near an airport these days. But on a boat an inlet air silencer, insulated exhaust ducts and glass fiber matting around the gear box have reduced noise to levels below competitive gas or diesel engine installations. On the Turbo-Mariner, exhaust gas velocity draws cooling air over the engine to further reduce noise. Use of these exhaust eductors saves on the power normally extracted to drive a fan. Exhaust is vented through the side or stern of the boat and is scarcely noticed. Nozzles spray water into the exhaust outlets to protect dock areas and as a further noise depressant during cruise.

Early turbine engines, particularly those designed for aircraft, suffered the twin troubles of poor part-throttle performance and control difficulties. Need for precise balancing, short-life bearings, and lubrication problems also limited turbines to military uses where top performance was everything and the other problems secondary. Advancing technology has solved nearly all of these old problems. Turbojet airliners today have taken over nearly all routes. And despite their relatively high cost and fuel consumption, they are actually cheaper to operate per seat mile because their productivity is high. This same ad-

(Continued to page 244)



## Germ-Free Man on the Moon

Germ-free men may explore the moon.

Such sterile explorers, who would not contaminate extra-terrestrial areas, can be available in 25 years, according to Dr. Charles Phillips of the U.S. Army Chemical Corps Biological Laboratories, Ft. Detrick, Md.

"The same methods used to obtain sterile guinea pigs, chicken and rats, will produce a sterile man. All we have to do is keep him in a germ-free cabinet for some 25 years following birth, meanwhile teaching him how to fly spacecraft," says Dr. Phillips.

The airless, barren moon, believed to be the repository of dust and debris of outer space, holds important data that may tell scientists about the origin of the solar system. Contamination might obscure these data, resulting in loss of opportunity to get to the basis of life's origins.

## Intense Light Beam "Spot Welds" Eye Defect

Eye operations which once required hours of complicated surgery are now performed in minutes with a light coagulator. A coagulator at the University of Michigan produces a needle-sharp beam of xenon light several times greater in heat intensity than the light of the sun. The beam directed at a small hole in the retina, causes a light burn which forms scar tissue and, in effect, "spot welds" the hole. Left unattended, the hole could result in retinal separation and eventual blindness. The apparatus has also proven useful in removing small eye tumors and can be used to create a new pupil in cases where the eye opening has been closed through injury.

## Ultrasonic Agitation Aids Film Development

Vibrating liquid film developer with ultrasonic waves produces better negatives, a professional photographer claims. Martin P. Ostergaard Jr. of Woodbridge, N. J., agitates the developer (for five seconds during each minute the film is in the developing tank) with extremely fast vibrators. Most film-developer combinations require this periodic agitation, but it is usually done manually—either by agitating the whole tank or just the film. Ostergaard claims his method increases film speed up to 10 times its normal rating, reduces oxidation of the developer and, most important, provides uniform agitation of the developer over the film surface. Ostergaard obtained a patent for his process and assigned it to Gulton Industries, Inc., Metuchen, N. J.



U.S. Pat. No. 2,789,872

## THIS IS THE RING the experts pick to do a ring job right!

It's Sealed Power's KromeX ring set with the years-ahead Stainless Steel oil ring. This ring controls oil better and longer than any other, bar none. Here's why:

To start with, Stainless Steel is a superior metal. It doesn't corrode, it resists pitting and etching of gases caused by internal combustion. This means carbon doesn't cling, return oil vents don't plug, there's better lubrication with less friction and less wear. Rings last longer.

Stainless Steel retains its tension at operating temperatures, gives you lasting side-sealing, lasting oil control.

And Sealed Power's patented, proven end-abutment design always produces proper tension, regardless of contact with bottom of the groove. No groove depth problems. Chrome-plated side rails seat instantly.

Installation is simple as A-B-C. No gauges, no shims, no springs. No troubles. Period. Sealed Power Corporation, Muskegon, Michigan.



**Sealed Power** Stainless Steel  
oil rings stop oil pumping



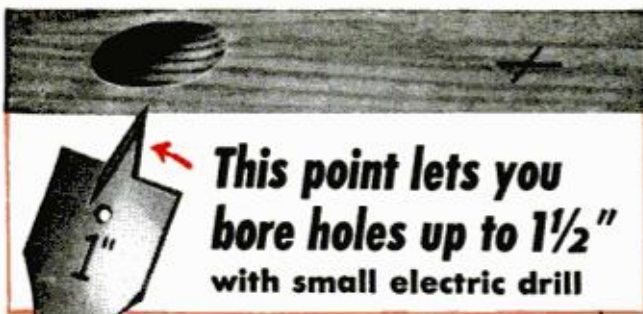

**This point lets you bore holes up to 1 1/2" with small electric drill**

**It's hollow ground to bore cleaner, faster at any angle**

**NOW YOU CAN** increase the boring range of your small electric drill or drill press. New Irwin Speedbor "88" bits bore faster, cleaner holes up to 1 1/2" in any wood. 1/4" shank chucks perfectly. No wobble, no run-out. Sharp cutting edges on Irwin exclusive hollow ground point start holes faster, permit spade-type cutters to bore up to 5 times faster. All Irwin Speedbor "88" wood bits are forged from single bar of special bit steel, tempered full length and machine-sharpened for extra accuracy, longest life. 17 sizes, 1/4" to 1 1/2". Buy individually or in sets from your Irwin hardware or building supply dealer.

**Only 75c each, sizes 1/4" to 1"**  
**Only \$1.25 each, sizes 1 1/8" to 1 1/2"**

**IRWIN SPEEDBOR "88" WOOD BITS**  
 at Wilmington, Ohio, since 1885

**There's a Delta Lantern RIGHT for You!**



**POWERlite** The all-time favorite! Modern new lens, rotary switch. Wide floodlight from top. Brilliant spotlight. . . . . **\$6.15**

**STARFIRE** Rotary switch operates powerful spot beam and flashing red light. Hang it or set on the handle—point the light where it's needed. . . . . **\$7.95**

**ASTROLite** Flashing red light pivots on arm. Piercing spotlight. Adjustable head. Dual fingertip switches. Mounts on twin-pack battery. From. . . . . **\$7.95**

Only Delta has sixteen beautiful electric lanterns—each with advantages for different uses. There's a lantern with features and design suited to your needs. Prices begin as low as \$1.79. See the Deltas at your dealer's, or write for literature and Free Fishin' Calendar.

*Prices list, less 6-volt batteries.*

**Delta LIGHTS THE WAY**

DELTA ELECTRIC COMPANY, 323 W. 33rd Street, Marion, Ind.

vancing technology makes the modern Turbo-Mariner drive for boats as totally different from early turbines as the Boeing 707 is from the DC-3.

The gas turbine engine is simplicity itself. It develops power in three steps: 1) Air is compressed. 2) Fuel is added to the compressed air and burned. 3) The resulting hot gases spin one or more turbine wheels. The Boeing Turbo-Mariner engine features two output turbines. The first turbine drives the compressor. The second turbine drives the output shaft through reduction gearing. Since the two turbine shafts are not connected, the engine operates much like an automatic torque-converter transmission. This free-turbine design turns a propeller at near constant speed under varying loads and prevents engine overspeeding if the propeller should spin free of the water. The engine also puts nearly full power on the prop over a wide range of prop speeds due to the free-turbine drive.

Control of speed is simple. By controlling fuel to the gas producer, that is, the compressor-burner section, and compressor turbine, the temperature and volume of gas available for driving the output turbine varies. One handle controls power output from idle to full speed. A secondary linkage automatically limits the speed of the output shaft to a preset maximum. Part-throttle fuel consumption varies roughly with output shaft speed. No warm-up is needed. Just press a button and the turbine starts in any temperature as long as fuel is not frozen. Twenty-five seconds after pushing the button, you're off.

The small size of the Turbo-Mariner package simplifies installation. Complete with reverse-reduction gear, the engine is 5 1/2 feet long, 2 feet high and 2 feet wide. Because its light weight affects balance and stability much less than heavier piston power plants, the turbine can be installed near the transom to leave a larger area of the cabin clear. The two profiles on page 132 show how it can be mounted with the output shaft forward or aft.

**Bearing Failures Licked**

Early turbines were troubled with bearing failures and vibration for a number of reasons. A change to floating sleeve-type bearings not only reduced bearing costs but increased their life and allowed a relaxation of rotating component balance requirements. Increased bearing clearances allow the turbine rotor assembly to seek its mass center and operate virtually free of vibration. Rotor assembly balance is no longer required, only component balance. Parts are interchangeable between engines, and

(Continued to page 246)





### Warning Buzzer Checks Speeding

Mounted on the dashboard, a buzzer alarm can be set at any speed and when that speed is exceeded the buzzer goes off.

The Speed-O-Minder is installed by a special bracket and is operated by a flexible cable joined to the original speedometer shaft. It fits any make car.

The warning speed can be the same as the speed limit or any speed selected by the driver or his passengers. It is listed at \$19.75 by the manufacturer, Engler Instrument Co., Jersey City, N.J.

### Exhaust From Spaceship Could Be Radio Antenna

Future spacemen may hold radio conversations by using exhaust gases from their rocket ships as antennas.

Ionized exhaust gases are good electrical conductors and could act as an antenna for communicating in lower frequency radio bands, says Barry Mindes of International Telephone and Telegraph Corp. These bands have not been used because they require a huge antenna.

**The 'All-Purpose' Oil  
For Home Workshops**  
Cleans • Lubricates • Prevents Rust  
**3-IN-ONE® OIL**  
REGULAR—OIL SPRAY—ELECTRIC MOTOR

NOVEMBER 1961

**FREE  
TO YOU  
and  
your friends**

**RADIO SHACK ELECTRONIC CATALOG**  
Plus **Every New Supplement  
For Next 12 Months!**

- Giant book is 2/3 bigger than last year! Brims with values!
- Stereo, Hi-Fi, Ham Radio, Tapes, Records, Parts, 30 pages Kits.

**MAIL COUPON TODAY**



**RADIO SHACK Corp.**  
730 Commonwealth Ave., Boston 17, Mass.

Send Radio Shack's famous electronics catalogs for one year—FREE and POST-PAID.

Your Name \_\_\_\_\_ 61L3C

Your Address \_\_\_\_\_

City and Zone \_\_\_\_\_ State \_\_\_\_\_

For a Friend \_\_\_\_\_ 61L3C1

Address \_\_\_\_\_

City and Zone \_\_\_\_\_ State \_\_\_\_\_

It's Sharp... keep it that way with the right sharpening stone by



**CARBORUNDUM®**

**P & C MIDGET PLIERS**  
for fast, easy accurate work

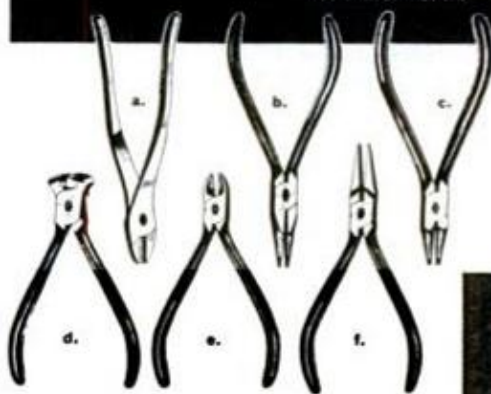

A complete family of precision midget pliers for telephone, electronic, radio, TV repair, assembly and every day use. Hand honed cutting edges, induction hardened. Approximately four inches total length.

- a. Straight Nose
- b. Chain Nose
- c. Round Nose
- d. End Cutting
- e. Diagonal Cutting
- f. Flat Nose



Look for the colorful P & C merchandisers in over 12,000 stores.

Send 10c for Tool Catalog.



**TOOL COMPANY**

Portland 22, Oregon subsidiary of Pendleton Tool Industries, Inc.

245



**GRAVELY  
MOVES  
SNOW  
FAST!**



## Conquer Snow With POWER!

Get out and go in spite of snow! Powerful 6.6 HP Gravelly Tractor and its big 26" Snowblower attachment clears your sidewalk and the drive in minutes. No need for hours of hard work—just guide the Gravelly and watch the snow go! All-gear Drive, Power Reverse, optional Electric Starter.

Snowblower, Snowplow two of 30 tools for year-round lawn and garden work.

**FREE** 24-Page POWER Vs. Drudgery Booklet tells all. Write Now!



**GRAVELLY TRACTORS**

DIVISION STUDEBAKER-PACKARD CORPORATION  
P. O. BOX 601-L DUNBAR, W. VA.

PERFORMANCE-PROVED SINCE 1922

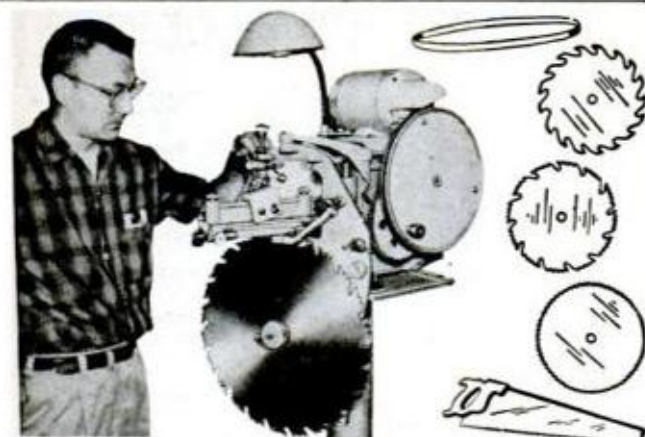

## CASH FILING SAWS

Here is a steady repeat CASH business you can start at home. No experience needed—no canvassing—every saw you sharpen will bring new customers. You can make up to \$3 or \$6 an hour—\$20 to \$30 a week in your spare time as a starter. "My spare time saw filing business has made me \$952 these first ten months," says R. T. Chapman.

The new model 200 Foley Saw Filer automatically sharpens combination (rip and crosscut) circular saws, hand saws, band saws and crosscut circular saws.

Free Book—"MONEY MAKING FACTS" shows you how to get into this CASH business. Time Payments if desired. Mail coupon now. No salesman will call.

FOLEY MFG. CO.  
1129-1 Foley Bldg., Minneapolis 18, Minn.

Send me free book "MONEY MAKING FACTS" and Time Payment Plan.

Name \_\_\_\_\_

Address \_\_\_\_\_

City \_\_\_\_\_ State \_\_\_\_\_



rotating components can be replaced or intermixed without the necessity for re-balancing the rotor assembly. Engine re-assembly requires only eight man-hours, with a complete overhaul requiring about 40 man-hours. Completion of tests now in progress is expected to increase time between overhaul to 2000 hours of engine operation. Mounted in the test 26-foot cruiser, that would total about 60,000 miles between overhaul. Normal maintenance between overhauls calls for a periodic burner inspection and filter element replacement.

The Boeing turbine is also being tested by Kiekhaefer Corp. with their MerCruiser inboard-outboard drive. Here again, because of its light weight, the turbine can be mounted in the aft section for direct connection to the outboard drive unit without seriously affecting fore-and-aft balance.

Inboard-outboard stern drives coupled with engines in the 150-hp. and up class offer many of the advantages of outboard engines but with more power. A Boeing turbine coupled to a stern drive offers an outboard's flexibility, propeller protection, maneuverability, and hydrodynamic efficiency along with two to four times the power normally available in an outboard drive. Compared to inboards, the stern drive permits operation in shallow water and steers positively by propeller thrust rather than by rudder.

So far the big reason more turbines haven't been used in boats is their first cost. Anyway you look at it, a Turbo-Mariner costing in the neighborhood of \$13,000 causes many boat owners to shy away despite its many other advantages. For years, high fuel consumption kept buyers away. Steady progress has eliminated this problem until today fuel costs *per mile* are definitely competitive. Similar progress is bringing the cost of the turbine power package down every year. In the past two years, turbine costs have dropped 20 percent, more than \$1000 per year. Nearly a thousand engines have been built and sold for use in a variety of powered equipment where light weight and performance offset the turbine's high initial cost. While costs will continue to drop as more engines are built, initial turbine costs will probably never reach the level of the ordinary gasoline and diesel engines. But for the boat owner who wants that extra 30 to 40 percent in performance not available from any other engine-boat combination, turbine power promises a major boost similar in many ways to the giant step forward that resulted when airlines switched from pistons to jets. ★★★



New standard for power and torque in a compact grinder!

**NEW DREMEL NO. 3  
INDUSTRIAL  
MOTO-TOOL**



This new industrial type grinder belongs on your work-bench! The No. 3 is a compact "powerhouse" developing 27,000 rpm — and sustains high torque under load. It's easy to handle (fits your hand), runs cool, lightweight. Weighs only 17 oz.! Just the ticket for precision grinding, polishing, drilling, sharpening, modelmaking — working in tight corners. Powerful 110 Volt AC or DC motor is housed in a heavy-duty, shockproof Bakelite case. Handy hanger hook keeps it within reach.

DREMEL MFG. CO., Dept. 111-K, Racine, Wisconsin

150



**No. 3 Moto-Tool** is complete with 1/8" and 3/32" collets, 3-wire grounding cord with 2-prong adapter, finger grip — in steel case. **Only \$29.95.**

**No. 2 Moto-Tool** — long time favorite with industry, craftsmen, model makers since 1936 —

**No. 2 Moto-Tool** with 3-wire grounding cord, \$19.95.

**No. 2 Moto-Tool** with 23 accessories in steel case, \$29.95.

See Your Dealer or Write for Complete Power Tool Catalog

**Keep Tools in  
Tip-Top Condition**  
Lubricate • Clean • Prevent Rust  
**3-IN-ONE® OIL**  
REGULAR—OIL SPRAY—ELECTRIC MOTOR

**\$47,983.06 ORDERS FROM 12 WORD  
CLASSIFIED AD.** Amazing — Startling — but TRUE. Terrific story sent free. Request must be made on business letterhead. F. W. Johnson, Classified Adv. Manager, 200 E. Ontario St., Chicago 11, Ill.



**Print Your Own**

Cards, Stationery, Advertising, Circulars, labels, photo and movie titles, church work, tags, etc. Save money. Sold direct from factory only. Raised printing like engraving, too.

**Own a Printing Business**

Print for Others, Good Profit. Have home shop. Junior press \$15; Senior \$35 up. We supply everything. Easy rules. Pays for itself in short time. Write now for free details. **KELSEY PRESSES, Z-37 Meriden, Conn.**



**The Modern PLASTIC  
for lasting Home Repairs**

PERMANENTLY mends cracks or holes in wood, tile, stone or plaster. Sticks and stays put — Does not chip, shrink or fall out. Easy to use. Economical. Mold it, chisel it, polish or paint it. The big 4-lb. can is obtainable from your lumber, paint or hardware dealer at \$1.40; or will be shipped direct postpaid (in U. S.) for \$1.75. Complete satisfaction guaranteed or your money refunded.

**DONALD DURHAM CO.**  
Box 805-T Des Moines, Iowa

**Exclusive Double-Bearing HEAVY-DUTY PUMPS**  
IRRIGATE • DRAIN • CIRCULATE • SPRAY  
Use 1/4 HP motor or larger . . . 1 HP for up to 5,200  
GPH: 1,000 GPH 60' high or 3,000 GPH from 25' well.  
1 1/2" inlet; 1" outlet. Stainless shaft.  
**TYPE X-2** oil-less bronze bearings. Won't rust. . . . **\$10.95**  
**TYPE XB**—Ball bearing model. . . . **\$12.95**  
Postpaid if cash with order. Rush your order today  
**MONEY BACK GUARANTEE**  
Centrifugal and Gear Pumps in All Sizes  
**LABAWCO PUMPS, Belle Mead 2, N. J.**

**Save Money on WOOD**  
**POWER TOOLS • HARDWARE • KITS  
WORKSHOP SUPPLIES • EQUIPMENT**  
**NEW LOW PRICES!**

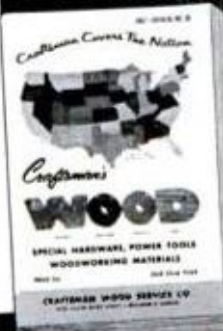

**Hardwoods, Veneers, Plywoods,  
Mouldings, Mosaic Tile, Tools,  
Lamp Parts, Upholstery Supplies**

Your complete wood and workshop buying guide — new 140 page edition now ready. Many pages in full color! Startling new savings on everything you need! Craftsman is your best and most complete source of the finest quality kiln-dried domestic and imported hardwoods. Beautiful wood inlays, bandings, matched plywoods, carved ornaments, modern & traditional furniture legs.

**NEW!  
140 PAGE  
CATALOG  
SEND FOR IT  
TODAY**

**Discounts on Stanley Power Tools**  
Craftsman offers startling savings on top name power tools, hard to find cabinet hardware, lamp and upholstery materials. More than 1,500 items. Packed with new patterns, projects. Enclose 25c to help pay mailing and handling costs.

**CRAFTSMAN WOOD SERVICE CO.**  
2729 S. Mary St., Dept. A-11, Chicago 8, Ill.

**CRAFTSMAN WOOD SERVICE CO., Dept. A-11**  
2729 South Mary St., Chicago 8, Illinois  
Rush giant new Craftsman WOOD Catalog. I enclose 25c to help cover mailing cost.

Name \_\_\_\_\_  
Address \_\_\_\_\_  
City \_\_\_\_\_ Zone \_\_\_\_\_ State \_\_\_\_\_



## DOT SPEEDY RIVETS

**JUST  
SWAT**  
with  
hammer



SPEEDY RIVETS are ideal where quick, sure riveting jobs are needed. Instant fastening for leather, cloth, paper, cardboard, light gauge metal and plastic... 1001 uses. No special tools required... works like a charm! Available in large or small size... nickle, gilt, black or brown at hardware dealers or send \$1.00 for special mail order package and name of nearest distributor. Specify size and color.

**COLUMBIA FASTENER CO.**

Dept. P.M. • 3229 S. Ashland Ave., Chicago 8, Illinois

### Carry your tools in safe HUOT HIP-ROOF TOOL BOXES

For men who treat their tools with pride! The models shown here are made with heavy gauge steel and full length piano hinges that never get out of line. Heavy duty hasps and latches, welded double corners. Bright blue hammerlin boxes, red tote trays. Many models—write for free bulletin. Treat your tools to a Huot!

At hardware stores —  
or order direct.

**HUOT MFG. CO.**  
545 N. Wheeler St. St. Paul 4, Minn.



"A hunter who fires too soon finds his efforts aimless."

## EMERSON ELECTRIC

### PORTABLE WELDER High Capacity... Low Price

Ideal for farm, home workshop. Cuts, brazes, solders, welds. One man can carry... only 68 lbs. 6 welding heats up to 180 amps... 3/32" to 3/16" rod sizes. Write today for prices and receive **FREE WELDING SELECTOR GUIDE**... gives working data you need in seconds!

DEPT. W-6



EMERSON ELECTRIC of St. Louis  
8100 Florissant • St. Louis 36, Mo.

## This Way, Please!

(Continued from page 97)

rooming crowd causes panic," Andy explains. He never fastens his turnstiles down. They can always be pulled aside at the first sign of trouble.

All Andy's planning in depth would come to nothing if it were not for the care with which he selects and trains the ushers who wear his blue and gold. At least in Chicago he personally picks the youths who work for him. They are mostly tall, well-built college boys, 18 or over, of above average intelligence. They must have good teeth, "not for biting but for smiling" and friendly personalities. They are the sort of young men who can get along well with a crowd and can command its attention in case of trouble.

Their training is intensive and continual. Andy and his lieutenants talk to them before each big event like football coaches. They try to anticipate what the crowd is likely to do, point out the weak spots in their positions. They lecture from charts and blueprints. Sometimes they show movies of crowd flows, pointing out the jams and the bottlenecks. The boys are schooled in how to give quiet commands and are drilled in marching.

### Mexican Firing Squad

The military polish of the ushers ordinarily makes a good impression, but once it almost put a group before a firing squad. En route to handle the crowds at the Agua Caliente races in Mexico, a bus load of ushers was taken for revolutionary troops. Mexican government soldiers threw them into prison until Andy could come to their rescue.

Usually Frain ushers have the muscle to meet any ugly situation that may develop. When the Chicago Blackhawks brawled during a Stanley Cup play-off, Andy's usher son Mike had two teeth knocked out and six stitches in one cheek, but he restored order. On April 1, 1960, Frain's boys rescued a fan who tried to throw a cup of beer at a Montreal Canadian player, splashed the spectators in the first row instead, and started a riot. At the Republican National Convention last summer 1000 Nixon demonstrators got out of hand and showed no intention of responding to the chairman's frantic gavel. Then a 16-year-old usher guided them through a doorway to where they thought they could get closer to their hero. Instead they found out too late that the door opened out onto Halsted Street.

A left-handed testimonial that Andy Frain's boys make up an effective force for order in public gatherings came from the

(Continued to page 250)



NEW EASY-TO-USE

# Mistral MINIATURE SPRAYER

PORTABLE!  
COMPRESSORLESS!

Dozens of Uses! → \$29.95 DELIVERED

NOW you can spray-paint to a professional finish on automobiles, refrigerators, all kinds of surfaces. Use Mistral Miniature to apply floor wax, fumigate, starch clothing, spray lawns or gardens, wash windows. Reach hard-to-get-to places easily! Dozens of home and industrial uses.

Mistral Miniature completely atomizes all fluids without an air compressor. Simply plug into 110V and it's ready for use.

German precision-built. Adjusts from narrow to full spray. Spray-coats up to two gallons per hour. Parts and workmanship warranty.

ORDER FROM:

**COMPRESSOR CORP. OF AMERICA**

Dept. 312, Box 1934 • Greenville, S. C., USA

Enclose check or m. o. • Dealer inquiries invited.



## What's New in High Fidelity

by Fred Honig

### High Fidelity Under The Stairs

Not the least of the advantages of component high fidelity is its flexibility of installation. Components let you place your high fidelity system out of the way, wherever there is some extra, unused space. Under the stairs, for example, is an excellent location for components. There—sitting on easily-built shelves and hidden from view by a hinged door—the amplifier, turntable, tuner and tape recorder give you a conveniently located control center that lets you play music throughout your home. Speakers, as many as you like, may be placed in the living room, bedroom, den, patio—in fact, wherever you wish. This flexibility is just one of the plus features of components. For further component high fidelity information send in the coupon below.



**Institute of High Fidelity Manufacturers, Inc.**  
Dept. J-31—516 Fifth Avenue, New York 36

Please send me the free booklet about  
High Fidelity Components.

NAME \_\_\_\_\_

ADDRESS \_\_\_\_\_

CITY \_\_\_\_\_ ZONE \_\_\_\_\_ STATE \_\_\_\_\_



"Look busy Al, here comes the boss."



# YOU need BALANCED RIDE CONTROL

for your car



Balanced Ride Control is the big motoring benefit you receive when you equip your car or truck with Air Lift Adjustable Air Springs. They are the only sure way to keep your car level at all times, regardless of road or load conditions.

Cornering is improved, side-sway greatly reduced, **A LEVEL CAR IS A SAFE CAR.**

Air Lift Adjustable Air Springs are unexcelled if you carry heavy loads or haul a trailer—just add a little AIR and you're on your way in 10 seconds with a LEVEL . . . SAFE car.

Air Lift Air Springs save money, too, by improving tire wear . . . keeping wheels in alignment and reducing vibration.

Available at leading garages and service stations or write to:



**AIR LIFT COMPANY**

LANSING 2, MICHIGAN

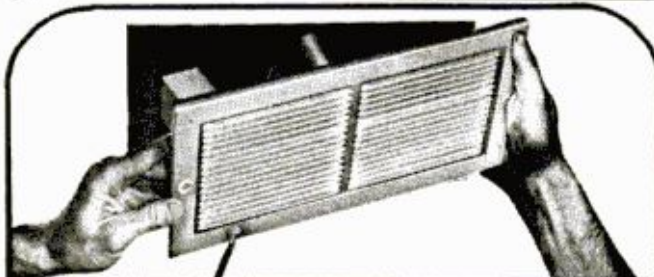

## AMAZING BOOSTAIR HOT-AIR-HEAT BOOSTER FOR COLD ROOMS

If you heat by warm air, amazing Boostair will raise the temperature of any cold room in the house up 10° . . . Not a heater . . . no expensive alterations to your heating system . . . Boostair replaces existing register grill . . . automatically draws warm air through the duct in those cold rooms starved for heat because of too long ducts or too many elbows. Fully automatic . . . adjustable thermostat turns Boostair on when furnace goes on . . . shuts it off when furnace goes off. When running takes less current than a 60-watt bulb. Do-it-yourself installation in minutes. Only two screws to remove and replace. Four sizes fit 95% of home warm air heating systems. Fully proven in over a year of field testing.

**\$29.95** complete, ready to plug in.  
Shipped prepaid.

**MONEY BACK SATISFACTION GUARANTEE—  
FULL YEAR WARRANTY**

Send duct size, register size and \$29.95 for each Boostair unit ordered to:

**MONITOR EQUIPMENT CORPORATION**  
640 West 249th Street, New York 71, N. Y.

football fan who admitted, "I feel a thrill when I knock over a set of goal posts, particularly in this challenging age when most goal posts are set in concrete and guarded by Andy Frain ushers."

How does a boy grow up to be a crowd engineer consulted by architects charged with planning new stadiums, the friend of world political figures whose persons he has safeguarded and head of a business with a million-dollar payroll every year? Andy Frain believes it helps to be one of 17 children as he was. He learned early how to move crowds by directing his brothers and sister into the family bathroom of their small Canaryville home in Chicago on busy school mornings. Today he has five bathrooms in his suburban mansion.

At 13, Andy was already supporting himself. He chased pigs in the nearby stockyards and sold seat cushions at ball games in Comiskey Park. Ushers were then paid as little as a dollar a game.

### Bribery Was Commonplace

"Anybody who offered those guys a bribe could get any seat in the house!" Andy remembers. "In a crowd of 33,000 you could be sure that 10,000 got the wrong seats."

He rounded up five other Canaryville boys and persuaded them to join him. They did not have enough money to buy caps or uniforms, but they purchased blue ties which they hoped would set them apart from the seedy ushers of the day. They shined their shoes and pressed their pants.

Major Frederick McLaughlin of the Chicago Blackhawks hockey team gave Frain his first chance. He had been troubled by mysterious shortages in the gate receipts.

The boys from Canaryville proved as honest as they were rugged. Politely and firmly they refused all bribes. The gate receipt shortages disappeared. P. K. Wrigley, owner of the Chicago Cubs, was also weary of dishonest ticket takers. He put Frain in charge of Wrigley Field's 250 ushers.

Within a week Andy had fired all but four men and replaced them with dependable youths. But he cleaned up Wrigley Field. Soon his ushers were protecting the public at World Series games, championship prize fights and horse races.

### Delivering a Baby

Young ushers grew accustomed to quick changes of pace which might find them at a horse race in the afternoon and an opera benefit in the evening. One medical student acted as a pallbearer one day. The next afternoon while he was ushering a ball game, he helped an expectant mother give birth to her baby in the stands. "From the

(Continued to page 252)



**A FINE CHRISTMAS GIFT FOR YEAR 'ROUND ENJOYMENT**



**WELD FOR PLEASURE OR PROFIT  
TRINDL INDUSTRIAL ARC WELDER**

Own a Trindl 125 Amp Industrial Welder at less than smaller machines. Welds metals to 1/2" thick. Operates off properly wired 110 or 220 volt line. 16 heat stages from 20 to 125 amps. Make, repair anything of metal in the home, garage, farm or shop. No experience or training needed. Full "do-it-yourself" instructions. Guaranteed 12 months in continuous operation. Complete only \$98.50 FOB or write for details on 125A and other Heavy Duty Trindl Welders. Dealer Inquiries Invited.



**EASY TERMS  
\$98.50 FOB**

Trindl Products, Ltd., Dept. T-2-M. 1007 S. Clark St., Chicago 16, Ill.

**LASTS 100% LONGER**

This super durable clear finish in GLOSS and SATIN outperforms all others on wood—interior, exterior, marine.



Write for free folder, name of dealer.  
**PRATT & LAMBERT-INC.**  
Dept. M11, 75 Tonawanda St., Buffalo 7, N. Y.

**ALL NEW!**

**150th Anniversary Issue!  
1962 Edition of Constantine's  
WOODWORKING  
CATALOG & MANUAL**



**WOODS, TOOLS, HARDWARE, ETC.**

Get the biggest Constantine Catalog & Manual—2,000 items! World's largest source since 1812 for rare imported and domestic woods in veneers, lumber, plywoods, bandings, inlays, mouldings, carvings... hard-to-find hardware, new solid brass hardware, wood finishing and upholstery supplies, patterns, tools, woodworking materials—at bargain prices! Also exclusive Inlaid-Wood-Picture Kits... Identification Chart of 60 rare woods in color... inspiring projects, plans, etc. For all-new 1962 Catalog & Manual, send 25c for postage and mailing. Write today!

**2,000 Items**  
Greatest selection, inspiring ideas, low prices. Write for your copy now!

**ALBERT CONSTANTINE AND SON, INC.**  
2050 Eastchester Rd., Dept. 5-5  
New York 61, N.Y.

**YOUR BEST BUY**



**FOR TOOL PROTECTION,** for lasting service, for complete satisfaction. Free catalog to tool-makers and machinists.

**GERSTNER TOOL CHESTS**  
461 Columbia St., Dayton 7, Ohio



Remember those in need across the world. Every \$1 sends one gift package thru the CARE Food Crusade, New York 16, N.Y.

**GUNK® removes grease like no detergent can!**



Cleans power mowers, engines, garage floors, kitchen walls, ovens, exhaust ducts, paint brushes, furnace filters, bar-b-q grills, machinery! At auto supply, farm, or hardware stores!

**GUNK CHICAGO CO.,** River Forest, Ill. serving the Midwest and Southwest  
**RADIATOR SPECIALTY CO.,** Charlotte, N.C. serving the East, Southeast and far West

**Planer·Molder·Saw!**

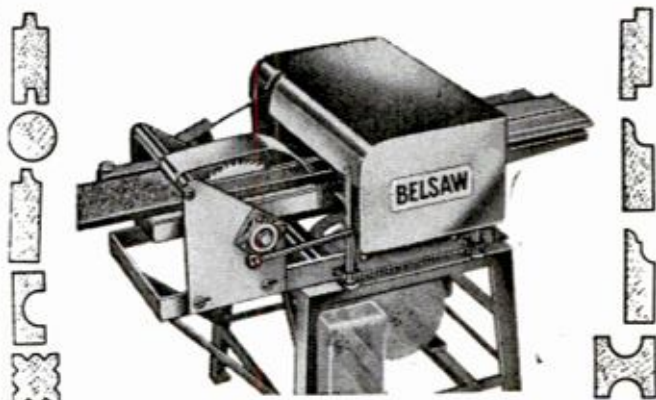

Now you can use this ONE power feed shop to turn rough lumber into high-value moldings, trim, flooring, furniture... ALL popular patterns.

**RIP...PLANE...MOLD...** separately or all at once by power feed... with a one horsepower motor. Use 3 to 5 HP for high speed commercial output.

**LOW COST...** You can own this MONEY MAKING POWER TOOL for only \$3000 down payment

Send coupon today

**BELSAW POWER TOOLS** 902 Field Bldg., Kansas City 11, Mo.  
Send me complete facts on the MULTI-DUTY Power Tool. No obligation.

Name \_\_\_\_\_  
Address \_\_\_\_\_  
City \_\_\_\_\_ State \_\_\_\_\_



cradle to the grave with Andy Frain," he quipped.

Whether at a national political convention or at a baseball game, the Frain ushers have most of their trouble with gate crashers. At last summer's Republican convention a hefty shirt-sleeved man strode in on the heels of Nelson Rockefeller.

"I'm going in with my buddy," he told the usher.

### Herbert Hoover's "Buddy"

The usher spun him around in a judo grip and propelled him out the door into the parking lot. In a moment he was marching in on the heels of another "buddy," Herbert Hoover. The usher had no sooner disposed of him for the second time than another gate-crashing artist approached. "Don't you know who I am?" he asked. "Why, I'm Andy Frain."

The usher pointed to Andy, Jr., who was the troubleshooter at the gate. "Mr. Frain," he said. "I'd like you to meet your son."

A Chicago restaurateur who makes gate crashing his hobby put a goat inside a suitcase marked ABC and got inside among the delegates. As red-faced ushers closed in on him, he called for recognition on the floor so that the goat could make a speech.

The all-time king of the art of slipping by Frain ushers was James "One-Eyed" Connelly. Once inside a place he would find Frain, wave jauntily and shout, "Look, Andy!" Then he would run out so he could have the pleasure of crashing the gates again on the same evening.

When the National Biscuit Company opened a new plant on Chicago's southwest side, the public was invited to an open house. Admission was free, and Frain's boys relaxed their defenses against "One-Eyed."

"There he was," remembers Andy, "selling peanuts to the visitors—peanuts that he had no right to sell."

### Connelly Versus Wrigley

Andy finally decided that only way to lick "One-Eyed" was to hire him. In 1944 Connelly put on the blue and gold to usher at Wrigley Field during the Cub-Tiger World Series. He stopped a ticketless man at the gate.

"I'm P. K. Wrigley, Jr., I own this ball park."

"That's for the birds," said "One-Eyed."

The man *was* Wrigley, and he was irate enough to demand that "One-Eyed" be fired. Connelly went back to crashing gates.

In December, 1953, Frain heard his nemesis was sick at an old people's home and went to see him. Soon afterwards "One-Eyed" died.

"He must have crashed the Pearly Gates," said Andy. "I'd like to see St. Peter keep him out."

Andy, who himself has been called a "St. Peter at the earthly gates," admits to a begrudging admiration for the gate-crashing prowess of old "One-Eyed," but for the most part he considers gate-crashers as an evil that besets the public, something to be lumped together with badly located washrooms, poor ventilation, hard seats, staircases where ramps should be and haphazard ticketing. Frain, who has made a science out of crowd engineering, points out that late crowds cause themselves inconvenience too.

"Come on time," is his advice to you whether you are going to a prize fight or a world series ball game. "Get to your seat a good half hour ahead of time. When you get near the stadium, look at the top of your ticket for your gate number. Use that gate and don't waste time trying to go in some other gate."

You'll enjoy the event more if you can minimize the struggle of getting to it. ★ ★ ★

---

## Latex Paints for Atom Subs

Water-thinned latex paints will be used for the interior of nuclear submarines because such paints are free of air pollutants that would seriously cut down the time a sub could spend underwater.

Comparable to enamel in gloss, resistance to dirt and ease of cleaning, they are superior in ease of application, drying in 20 minutes.

Conventional paints would release poisonous substances long after application.

## Stars Throw Off Tons of Gas

Red stars, the largest known, send as much as a trillion tons of gases into space each second.

Dr. Armin J. Deutsch of Palomar Observatory, Pasadena, Calif., first found the gases spewing from the giant Alpha Herculis, which is about 186 million miles in diameter. (The sun is 864,000 miles.)

Spectroscopic observation showed Herculis' gases are blowing about a hundred billion miles away from the star. Gas also streams from the sun, but as it is smaller and hotter, gases move from it at a lesser rate.

The red stars gradually shrivel up as they release matter into interstellar winds. But in so dying, says Dr. Deutsch, they probably supply half of the material used to form new stars.





1962 FORD FALCON

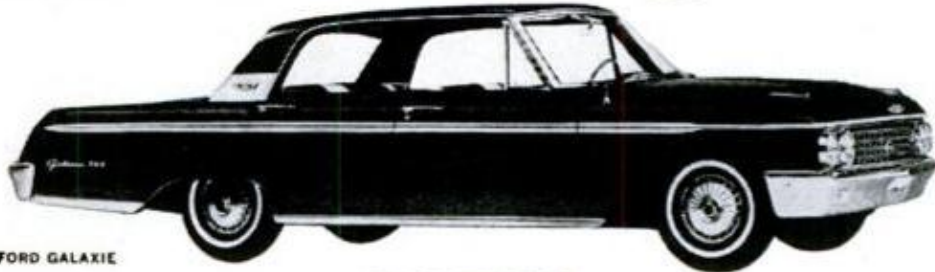

1962 FORD GALAXIE



1962 FORD THUNDERBIRD



1962 MERCURY COMET



1962 MERCURY MONTEREY



1962 LINCOLN  
CONTINENTAL

## **!NEWS! FORD MOTOR COMPANY SWITCHES TO AUTOLITE**

**Autolite spark plugs are now specified by Ford Motor Company engineers as original equipment on every Ford Falcon, Ford Galaxie, Ford Thunderbird, Mercury Comet, Mercury Monterey and Lincoln Continental they build. One reason why? Autolite Power Tip spark plugs actually clean themselves while you drive. They burn away fouling deposits to keep your engine's power and economy at their peak. No matter what make of car you drive, be sure you always replace with **AUTOLITE SPARK PLUGS****

*Clean themselves while you drive*





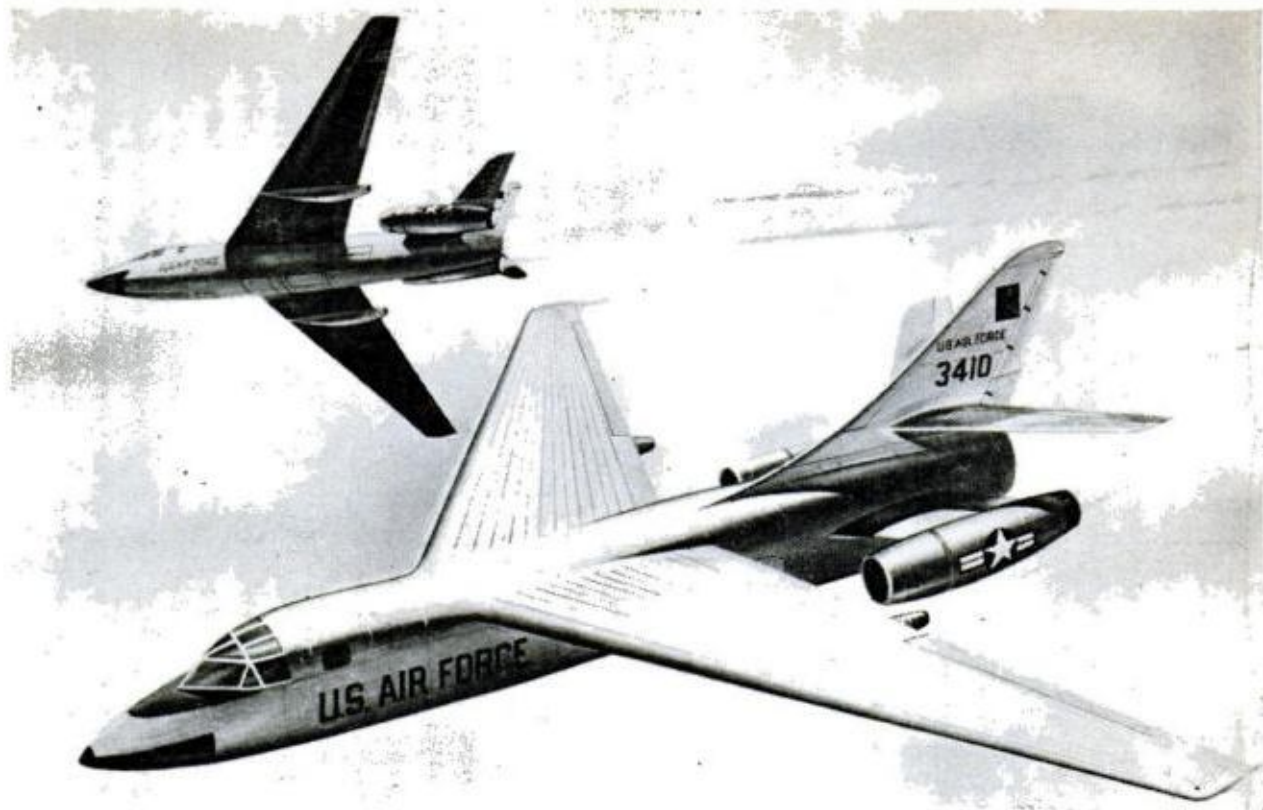

**AIR-INHALING WINGS**, part of revolutionary laminar-flow control system, may increase range, pay load and endurance of large aircraft. Artist's conception shows two aircraft designed by Northrop Corporation for U.S. Air Force with slots in wings and pods under wings. Compressors in pods suck air in through paper-thin slots, eliminating up to 80 percent of friction drag on wing surfaces. Slots are so fine, they cannot be seen from a distance of more than a few feet, and structural strength is not affected by new system

You have a use for  
**KRYLON** **SPRAY PAINT**  
 In Ready-to-Use Aerosol  
**IF YOU PRIZE IT...KRYLON-IZE IT!**

Works  
in  
seconds!



**Loosens Rusted Bolts  
nuts, screws, "frozen" parts!**  
**LIQUID  
WRENCH**  
 SUPER-PENETRANT

The super-penetrating rust solvent that quickly loosens rust and corrosion.

**AT ALL HARDWARE  
AND AUTO STORES**

**RADIATOR SPECIALTY COMPANY  
CHARLOTTE, N. C.**



**Patch that Crack  
with  
KEX  
VINYL LATEX  
PASTE SPACKLING**



Ready-mixed for filling holes in plaster, wallboard, wood, interior masonry. Dries hard. No water. No waste. Cans or handy tube.

**KEX**

is available in powder form in 1, 2½, 5, 25 lb. sizes. Easily mixed with water.



**RUTLAND FIRE CLAY CO. Rutland, Vt.**

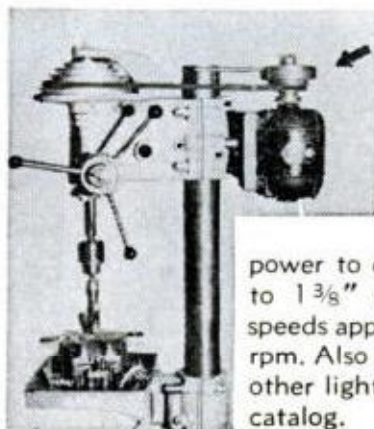

**DOUBLE  
DRILL PRESS  
CAPACITY**

Motor mounted speed reducer provides the correct speed and power to drill, ream, c'bore etc. to 1 3/8" dia. in steel. Spindle speeds approximately 45 to 3000 rpm. Also used on band saws and other light machinery. Write for catalog.

**PULL-GEAR CO.**

**13523 E. Eight Mile Rd.  
Warren, Michigan**



Weld. cable No. 1, 100' \$22.50, 50' \$10.95  
 G-1 150-250 amp. New \$19.50 Good \$12.95  
 R-1 300 amp G.E. Recond \$24.50 Good \$16.95

**Accessories Kit For Arc Welder** for above generators has helmet, gloves, elect. holder, volt reg. rheostat, volt-meter, Gr. Clamp, including switch & Tr. solenoid With G-1 generator **\$26.50**  
**Kit With G-1 160-250 Amp Gen. plus 30' cable & reactor coil \$36.45**

**Multi-Weld D.C. Arc Welding Kit** Complete with G.E. R-1, 300-350 amp gen. incl. accessories kit reactor coil w/ solenoid control & Cable **\$44.50**

**24-12V DC MOTORS**  
 (+ 15% P.P.) \*Reversible

| H.P.                 | Amp                            | RPM     | Reversible |
|----------------------|--------------------------------|---------|------------|
| Deleo 1/4            | 8.4                            | 2500    | \$5.95     |
| Deleo 1/8            | 6.5                            | 2500    | \$5.50     |
| Bendix 75-1BT        | 2A                             | 7       | \$7.50     |
| Bendix 1/4           | 8A                             | 4000    | \$6.45     |
| *Gear Red. Mtr 54: 1 | 1/20 HP                        | \$4.75  |            |
| *Pescoc 334HP        | 250A 2300RPM w/ 10:1 reduction | \$14.50 |            |

**400GPH Pump with Motor** 1/4HP 24-12VDC for hydraulic systems or fuel **\$7.95**

**Water or Fuel Pump & Mount** 400GPH w/ relief, adj. press & foot mount for driving with belt, gear, or pulley **\$10.95**. 400 GPH electric centrifugal pump with D.C. motor 1/8HP 8A, switch & rheostat **\$7.95**

**New HYDRAULIC CYLINDERS**  
 Hvy Duty 2000 P.S.I. air-oil special Discounts, Limited Time

| Bore   | Stroke  | D. Shaft | Long   | Dbl. Action |         |
|--------|---------|----------|--------|-------------|---------|
| 1"     | 1 1/8"  | 1 1/2"   | 6 1/2" | 1 1/4 lbs.  | \$ 2.95 |
| 1 1/2" | 4 1/2"  | 1 3/8"   | 10"    | 3 1/2 lbs.  | \$ 2.95 |
| 1 3/8" | 4"      | 3/4"     | 16"    | 4 lbs.      | \$ 2.95 |
| 1 3/8" | 2 1/2"  | 1"       | 38"    | 11 lbs.     | \$12.95 |
| 2 3/8" | 13-18"  | 1 1/4"   | 30"    | 11 lbs.     | \$14.50 |
| 1 1/2" | 8 1/2"  | 3/4"     | 13"    | 8 lbs.      | \$ 6.50 |
| 2 7/8" | 3 1/2"  | 2 1/4"   | 24"    | 10 1/2 lbs. | \$ 7.95 |
| 1 1/2" | 12 1/4" | 3/4"     | 24"    | 10 lbs.     | \$ 5.95 |
| 2 7/8" | 8 1/2"  | 7/8"     | 15"    | 16 1/4 lbs. | \$18.75 |
| 2 7/8" | 16"     | 1 3/4"   | 33"    | 12 lbs.     | \$ 8.50 |
| 2 3/4" | 9"      | 1 1/2"   | 19"    | 15 lbs.     | \$12.95 |
| 3 1/4" | 10 1/2" | 2 1/8"   | 23"    | 29 lbs.     | \$18.50 |
| 3 3/8" | 10"     | 1 1/4"   | 27"    | 22 lbs.     | \$15.50 |
| 4 7/8" | 8"      | 2"       | 22"    | 35 lbs.     | \$24.50 |
| 4"     | 18 1/2" | 1 3/8"   | 30"    | 30 lbs.     | \$24.75 |

**BUILD YOUR OWN HYDRAULIC PRESS**  
 9 Ton kit complete, consists of New Heavy Duty D.A. cylinder 3" bore x 10 1/4" stroke 2000 PSI, heavy duty Weaver hand pump, control valve, gauge reservoir, hose, fittings and 1 gal. oil, instructions incl. \$125.00 value, save \$67.50. Only **\$57.50**

**HYDRAULIC SNOW PLOW LIFT KIT**  
 Consists of 1 Stratopower hyd pump, .450 cu. in. 1400PSI drive from engine or power take off, 1 DA cyl. 2 3/8x9 1/4" control valve, tank, filter, 1 gal. oil, hose & fittings. **\$43.50**

**24-12V. D.C. Electric Hydraulic Lift Kit.** Ideal for operating light blades, plows, etc. for lifting, turning, push & pull. Has 24-12VDC, reversible motor, reversible electric pump, 1000PSI, 1 D.A. cylinder 2 3/8" bore x 7" stroke, 1" shaft, oil reservoir, reversing switch, Max. lift cap. 900 lbs. 3 Way solenoid valve, hose & fittings. Size 15"x 10"x10". Wt. 40 lbs. **\$49.50**

**New Big Vacuum Air & Compressor Kit.** Bendix rotary 4 vane, reversible 17 CFM at 2250 RPM, 7 1/2" suction, 18" G. pressure max, 2 gal tank, vacuum & pressure gauge hose & pump mount ready for driving with belt or pulley, requires 1 HP motor. Size 16"x12"x8". Wt. 30 lbs. O. C. \$135.00 kit price **\$47.50**

**NEW HYDRAULIC SYSTEM KIT**  
 +400 K heavy duty Power driven, rated 16,000 lbs. lift. Consists of 2 D.A. hyd cylinders 3 1/2" bore x 21 3/8" stroke ea. rated 8000 lbs. with 1000 PSI, 1 four way hyd control valve with built in relief - 821, 1 Vickers hyd pump 375 GPH 1000 PSI 3750 RPM, filter, gauge 2000 PSI hose & fittings. Va'uc 8'189.95 **\$79.95**

**GENERAL SALVAGE CO** Check or M.O.  
 2922 E. 27 St., Dept. 197, Kansas City 27, Mo.

**"POP" MECHANICS SAYS-**

"Many drivers with quick getaways have slow recoveries."

The thrill comes from the skill you apply to it, when you try the popular new sport of table-top racing. Learn how the experts play it, in PM's December issue.

**You can have CONFIDENCE in a growing America**



Today's record-breaking research will result in whole new industries, millions of new jobs . . . more opportunities for all. The long-range trend of the economy is UP!

Send for free booklet, "The Promise of America", Box 10, Midtown Station, N. Y.

Published as a public service in cooperation with The Advertising Council.

If it's worth painting it's worth sanding . . . with sandpaper by

**CARBORUNDUM®**

**CONCRETE BIRD BATHS AND OVER 250 OTHER MONEY MAKING ITEMS**



You've seen them all over the country . . . concrete bird baths, garden seats, flower boxes, appealing statuary, and many other items that add charm around the house and lawn. They're made by enterprising people, just like you, from our COPYRIGHTED ALUMINUM MOLDS. It's easy. It's fun. It's profitable.

Send \$2.00 today for this 82-page "How to" book, 20 pages of clear instructions. Valuable trade secrets. Over 250 items beautifully pictured (with description, dimensions, and prices of molds). Rushed to you by first class mail.

CONCRETE MACHINERY CO., INC. HICKORY 2, NORTH CAROLINA

Name \_\_\_\_\_  
 Address \_\_\_\_\_

**HOW TO TURN CONCRETE INTO GOLD**

**FREE TO YOU and your friends**

**RADIO SHACK ELECTRONIC CATALOG**  
 Plus Every New Supplement For Next 12 Months!

- Giant book is 2/3 bigger than last year! Brims with values!
- Stereo, Hi-Fi, Ham Radio, Tapes, Records, Parts, 30 pages Kits.

**MAIL COUPON TODAY**

RADIO SHACK Corp. 730 Commonwealth Ave., Boston 17, Mass.

Send Radio Shack's famous electronics catalogs for one year—FREE and POST-PAID.

Your Name \_\_\_\_\_ 61L3  
 Your Address \_\_\_\_\_  
 City and Zone \_\_\_\_\_ State \_\_\_\_\_  
 For a Friend  
 Address \_\_\_\_\_ 61L31  
 City and Zone \_\_\_\_\_ State \_\_\_\_\_



## HEAVY DUTY or LIGHT . .

### T-50 All-Purpose STAPLE GUN

For HEAVY DUTY  
Nailing Jobs!



\$1250

Powerful . . . jam-proof . . . with heavy all-steel construction. Perfect for insulation, ceiling tile, screening & 1001 other jobs. Uses 6 staple sizes up to 9/16" and CEILTILE.

## You're always RIGHT

with **ARROW**

### JT-21 Junior STAPLE GUN

For LIGHT DUTY  
Household Tacking!

Light . . . compact . . . easy to operate. Ideal for housewife for making valances, lining shelves and closets, tacking curtain tie-backs, etc. Uses 1/4" and 5/16" staples.

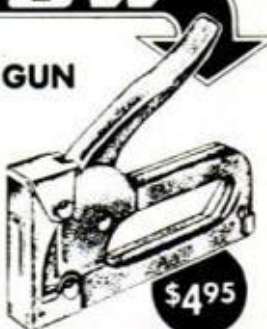

\$495

At Your Hardware, Lumber, Building Supply or Stationery Dealer

**ARROW FASTENER COMPANY, INC.**

ONE JUNIUS STREET • BROOKLYN 12, N. Y.



## Metal Band Cools Hot Heads

Headache? An aluminum band will provide cooling for as long as five hours when the strip of cellulose on its outside is dipped in water. Evaporation does it. Deer Hill Co., College Pt. 56, N.Y., sells the band for \$1.

INSTALL automatic night-lighting control for convenience and safety!

AUTOMATIC NIGHT-LIGHTING with Paragon's Time Control insures safety and convenience . . . prevents accidents and vandalism. Contact your local electrical distributor or contractor for Paragon all-purpose Time Controls.

List, from \$11.95 . . .



4000  
SERIES



**PARAGON ELECTRIC CO., INC.**

Subsidiary of American Machine & Foundry Company

DEPT. PM • TWO RIVERS, WISCONSIN



## One-Finger Chords

Even beginners can play chords "by the numbers" with the aid of a new accessory which is available on many pianos as a built-in extra.

Pianos thus equipped look and sound like standard instruments, except for a set of buttons at the left side of the keyboard. These buttons activate magnets which cause the conventional piano action to strike the proper chords. Factory-installed, the unit is \$325. Manufacturer is Wood and Brooks Co., Buffalo, N. Y.

## FREE *Kirsten* PIPE CATALOG

of lightweight, pocket size pipes featuring a new scientific approach to smoking pleasure. Patented Duraluminum stems clean, cool the smoke for real enjoyment.

Pipes \$3.95 to \$15. Cigarette, cigar holders also available.



*Kirsten*

PIPE CO.  
Seattle 7, Wash., Dep't A



FOR PANELING... BUILT-INS... CABINETS... FURNITURE

## The Complete Interior WOOD FINISH



in One Can

READY TO USE

A finer clear, semi-gloss for natural wood beauty. Non-darkening. ANYONE can use Deft... it's so easy.

Wherever paints are sold, or write Dept. SSPM  
Deft, 1526 W. 228th Torrance, Calif.

Free  
Shop  
Chart  
on  
Wood  
Finish-  
ing  
Write  
Dept.  
SSPM.

## ONE-WAY GLASS for Home • Office Store • Builders

FREE —  
Circular  
Saw. Fits  
any 1/4" drill.  
You would  
expect to pay  
\$1 or  
more for  
this tool  
alone.  
Cuts  
perfect  
circle for  
installing  
1-way  
glass.  
1000  
other  
uses.

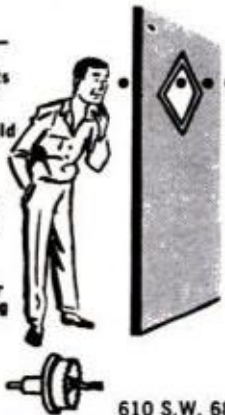

Now! You can see out, but peddlers, intruders, workers can't see you. Comes complete with 1-way glass, back plate, beautiful unfinished wood frame. Can be painted or stained any color. Fits and beautifies any wood door. Installed in 5 minutes. Guaranteed or money back. Send check or money order. **\$3.95**

Any size 1-way glass. Send exact measurement. 14c per sq. inch.

ONE-WAY GLASS CO.

610 S.W. 68th Terrace, West Hollywood, Fla.

## RETARDED CHILDREN CAN BE HELPED



SUPPORT YOUR LOCAL ASSOCIATION  
FOR RETARDED CHILDREN

LUBE  
anything  
for life!

...with sensational new  
**POXYLUBE**

Sprays on—  
stays on for keeps!

Speedway-tested, space-age POXYLUBE lubricates like magic. Dry film—applies like paint—use alone or as supplement to oil and grease. Lubricate moving parts: engines, gears, cams, levers, locks, springs, wheels, controls, etc. Excellent anti-gall, anti-seize; reduces wear. Order now!

• Used by leading auto and plane mfrs. to reduce friction by 20% or more.

POXYLUBE, Inc. Dept. MO-2  
541 S. Webster, Indianapolis 19, Ind.

FREE of extra cost: MICRO-JET NOZZLE  
POXYLUBE, INC. Dept. MO-2  
541 S. Webster, Indianapolis 19, Ind.

I enclose \$\_\_\_\_\_ (check or money order) for which please send \_\_\_\_\_ aerosol cans of POXYLUBE 330 and bonus of Micro-Jet Nozzle. If not pleased, I may return can for full refund of my money.

Name \_\_\_\_\_  
Address \_\_\_\_\_  
City \_\_\_\_\_ Zone \_\_\_\_\_ State \_\_\_\_\_  
Check here for  Dealer  Distributor

6-OZ.  
AEROSOL CAN  
with complete  
directions

covers  
**1,200**  
sq. in.

only  
**\$2.00**  
POSTPAID  
(no C.O.D.)  
MONEY-BACK  
Guarantee!



FOR  
HARD-TO-  
REACH  
AREAS

## EVERLITE\* World's THRIFTIEST Light Plants



1000 watt amazing new alternator. Most efficient trouble-free light plant ever made. Rugged new transistor circuit eliminates commutator and armature—all the old headaches of generators gone. Output is standard current — 115v., AC — operate oil burner, freezer, lights, TV, power tools or anything that requires up to 1200 watts. Powered by sturdy fast starting 2 1/2 hp Clinton engine guar. for 1 full year. Price is unbelievable, only \$159.50 F.O.B. factory for the finest 1000 w. plant made

\*Trade-Mark Registered  
Everlite 1200 watt, Item 869-10T Wt. 60 lbs. . . . . **\$159.50**  
Everlite 1500 watt, with 3 hp Briggs-Stratton engine . . . **\$209.50**

**HEATING AND VENTILATING FAN**  
(Item 10) Easily installed in furnace pipes. Forces even heat to all rooms. Over range removes kitchen smoke and odors. Powerful, continuous duty motor, 110-120 v. AC. Mount in wall or ceiling to ventilate any area. Quiet, super-efficient fan moves huge volume of air. (400 to 600 CFM).  
8" Pipe, wt. 5 lb. . . . . **\$6.85**  
9" Pipe, wt. 6 lb. . . . . **\$7.85**  
10" Pipe, wt. 7 lb. . . . . **\$8.85**  
12" Pipe, wt. 8 lb. . . . . **\$9.85**

**HEAVY DUTY FAN.** Semi-enclosed motor, suitable for spray booths, restaurant exhausts, poultry houses, etc.  
10" Fan, wt. 8 lbs. (Item 10E) . . . . . **\$11.95**  
12" Fan, wt. 10 lbs. (Item 10D) . . . . . **\$12.95**  
**HIGH SPEED BARN FAN** similar to above, but larger, high speed motor moves huge volume of air.  
12" Fan (Item 10f) . . . . . **\$14.95**  
14" Fan (Item 10g) . . . . . **\$17.95**

Send 10c for 100 page Catalog FREE with order. Prices f.a.b. factory—Send check or M.O.

**MASTER MECHANIC MFG. CO., Dept. A-111, Burlington, Wis.**  
Southern Customers Order from Dept. A-111, Box 65, Sarasota, Florida

## THAW FROZEN WATER PIPES FAST.



POSTA-THAW  
TH-3-10

Thaw pipe without digging or creating fire hazards. Just plug this low cost PORTA-THAW into a regular 110/220v AC power line. It's completely safe. Has no connection between power line and output terminals. Provides low, medium, high currents. Clears lines in 5 to 20 minutes. Complete with power cable, plug, receptacles, two thawing cables. Ask for data sheet TH-3-10.

HOBART BROTHERS COMPANY, BOX M-111, TROY, OHIO, PH. FE: 2-1223

## WELD • SOLDER • CUT METAL



Battery  
Charger  
Attachment  
Optional

Repair parts and equipment, build railings, furniture, trailers, hardsurface tools, braze, solder, cut, burn holes. Low cost 180 amp. "TROJAN" has 18 current control steps. Delivers top results in small repair, sheet metal, hobby, plumbing and heating shops, garages. Meets REA requirements. Accessories included. Ask for data sheet A-520-G.





## An Elmer's Glue for every job you do!

Elmer's new Wood-Gluing Handbook tells you all about them, gives hints, tips, and tells what to use where. Send stamped, self-addressed envelope for FREE copy. Elmer, The Borden Company, Dept. PM-111, 350 Madison Ave., N.Y. 17, N.Y. (Available in Canada.)



## KING MIDGET FOR 1961

WORLD'S  
MOST EXCITING  
LOWEST PRICED CAR

Drive it for 75c a week. Rider Agents Wanted. Send 25c for 32 page book, full details, dealer price. Or send \$1 (refunded first order) for this plus Service and Repair Manual and 16 5x7 photos of car and factory.

**MIDGET MOTORS CORPORATION, Athens 1, Ohio**

**HUNTING • CAMPING**

## HALTRAC HOISTS

take the lift out of lifting!

TOWING • RESCUE • FARMING

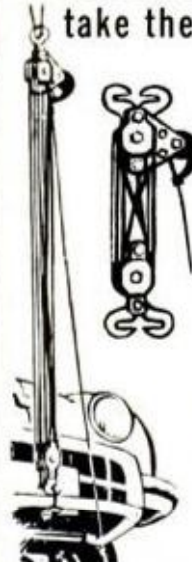

BOATING • CAR • TRAILERS

HALTRAC Autolock and Midget Hoists take the lift out of lifting — save your back from stress and strain.

HALTRAC Hoists are stress-tested to 1000 lbs. Will lift 9 ft. Weighs 1 lb. Exclusive AUTOLOCK feature locks loads in mid-air.

HALTRAC Hoists are ideal for camping, hunting, building, rescue work, boating, trailers, car accessory, portable winch and many more.

**Autolock Hoist \$12.95**  
**Midget Hoist \$9.95** (Without automatic holding device)  
**UNCONDITIONALLY GUARANTEED**

Save strain, buy HALTRAC now from your favorite dealer or write Department HP-11

**Engine Imports, Inc.**  
 Broadway Pier, San Diego 1, Calif.

**HOME • GARAGE**



## Puller Picks Up Posts

Resembling a horseshoe, a post puller made of cast iron or steel attached to an ordinary jack can pull posts with diameters to six inches. Price: \$12.95; Post Puller Co., Donahue, Iowa.



## Mixed Ancestry

Keeping track of the speeds of this home-made tractor (it has 19 forward, 6 reverse) is about as big a chore as maintaining the parts list. Its major parts came from at least seven different auto makes, plus many other sources. Crawler treads were made from the tires of a large tractor.

The 24-horsepower machine was built for less than \$100 by Wayne Disch, vocational agriculture instructor, Argyle, Wis.



# SURPLUS SALE

GOVT SURPLUS  
EXCESS INVENTORY  
BANKRUPT STOCK

## DIAL PHONE

• Item #716. W. E. phone, same type used in telephone offices. Use as extension or main line phone. Set up your own private system. Wt. 8 lbs. Black. . . . . \$7.95



Color (specify) Coral, Yellow, Lt. Green, Buff. . . . . \$11.95 FOB

## AIR COMPRESSOR BARGAINS

For painting, cleaning, tires, control terminals. Assemble your own outfit. Lowest prices in U.S.

• **DELUXE KIT.** Compressor, tank, gauge, regulator, paint gun, fittings. How to build instructions. List #52. . . . . \$49.50 FOB

• Compressor 1-cyl. \$21.50. 2-cyl. \$54.75. Govt. Air Tank. \$10.95. Regulators. \$3.95. Pop Off \$1.75. Pres. Gauge \$1.75. Finest paint gun, \$11.50. Auto switch. \$4.75 FOB.



## GAS ENGINE ELECTRIC STARTER

• Item #515. Genuine Fairbanks-Morse starter complete with 12-volt dry charged storage battery. Kit adapts unit to Clinton, Briggs Cushman, etc. engines up to 5 h.p.  
• Engine starts instantly, simply press button. Starter has 12 to 1 gear reduction.  
List over \$50.00. Wt. 25 lbs. \$17.95 FOB Sale



## ELECTRIC CAR MOTOR

• ITEM #576. Powerful gear motor. Hi torque. Build boy's car, golf cart, winch elevators, etc. Runs on 6 or 12-v battery. Reversible. Gear ratio 33 to 1. 100-150 rpm. Ball bearings. 15 1/2" x 4 1/4". Wt. 30 lbs. Govt. cost \$295. SALE. . . . . \$18.99 FOB  
Reversing switch for above motor—\$3.50 FOB



## ARMY AC GENERATOR

• Item #626. Brand new, original crate, all ball bearing DeLuxe heavy duty 115-v 3,000 to 4,000-w, 60-c generator. 1,200 rpm. With voltage control and voltmeter panel, etc.



• Drive with tractor, old auto engine, etc. Ready to use. Great emergency unit for farm, etc. Size 21" x 14" x 20". Wt. 200 lbs. Govt. cost over \$600. SALE. . . . . \$139.50 FOB

• A four star bus—141 units available.

## Govt. Surplus A-C POWER PLANT BUYS

• \$275 1-cyl. 1500-w 115-v Air/c. \$182.50  
• \$600 Onan 2-cyl. 3KW 115-v w/c. \$219.50  
• \$1150 4-cyl. 5KW 115/230-v w/c. \$449.50  
• 2250 4-cyl. 10KW 115/230-v w/c. \$599.50

## HYDRAULIC EQUIPMENT BARGAINS



Savings to 80%. Build loaders, diggers, presses, etc. All brand new.  
• Control Valve, 1 or 2 way. . . . . \$18.00 PPD  
• Tractor Pump 1000 psi. . . . . 49.75 PPD  
• 12-v Motor & Pump 1000 psi. . . . . 16.95 FOB  
• 2-Way cyl. 3" bore, 8" str. . . . . 19.70 FOB  
• Hyd. Press-gauge 1500 lb. . . . . 3.49 PPD

## MISC. ELECTRONIC BARGAINS

|                                             | FOB    |
|---------------------------------------------|--------|
| • \$6.50 Photo Electric Cell. . . . .       | \$1.29 |
| • \$7.25 Dual Thermister. . . . .           | 1.21   |
| • \$90 110-v A-C Selsyns. . . . . Pr.       | 6.95   |
| • \$6.95 Laboratory Solenoid. . . . .       | .79    |
| • \$5.50 110-v A-C Relay DPST. . . . .      | 1.49   |
| • \$15 Elec. Massage Vibrator-110v. . . . . | 7.69   |
| • \$10 Fish and Worm Shocker-110v. . . . .  | 3.49   |
| • \$90 Automatic Telephone Switch. . . . .  | 12.91  |
| • \$10 W.E. Telephone Handset. . . . .      | 3.35   |
| • \$50 Fire-Burglar Alarm System. . . . .   | 12.95  |
| • \$20 Electro-mag. Feeder Counter. . . . . | 4.67   |
| • \$135 Mobile 12v. P.A. Amplifier. . . . . | 9.79   |
| • \$125 Finest Wheatstone Bridge. . . . .   | 39.50  |
| • \$13.50 Hi-Voltage Vibrator Spark Coil    | 9.21   |

Hundreds electronic bargains in catalog.

## SPECIAL OF THE MONTH!

### ELECTRONIC EXPERIMENTAL KIT

• Fascinating gift for son or husband, consists of expensive Govt. electronic new surplus apparatus. Makes hundreds amazing instructive space age experiments in home laboratory.  
• Build alarm system, nuclear "fall out" detectors, extension telephones, eaves-dropping cct, remote control, electric theory cets, etc.  
• Kit contains marvelous asst. Geiger and radio tubes, bell, telephone set, mike, capacitors, relay, wire, resistors, etc. Three books on theory, Home Laboratory Test Bench and experiments furnished. Keep up with the Russians. Learn by doing.  
Wt. 11 lbs. Govt. cost over \$60.00. Sale. . . . . \$7.91 FOB



## STORAGE BATTERY WINCH

• Item #311. Powerful fully reversible, ball-bearing gear reduction winch. 1000-2000 lb. pull. Use on 6 or 12-v battery. Holds 40' of 1/4" cable. For trucks, docks, boats. Govt. cost \$280. . . . . \$49.95 FOB



## HYDRAULIC SPEED REDUCER

• Item #1304. 1 hp variable speed hydraulic transmission. Variable speed 0 to 350 rpm. Instantly reversible. Ideal for lathes, midget cars, etc. Roller bearings, and complete with 3-phase 220-v AC ball bearing motor. Size 21"x9"x20". Wt. 200 lbs. Shaft fitted with pulley (specify diameter desired). Govt. cost over \$900. SALE. . . . . \$89.50 FOB



1962  
CAT.  
ALOG

Electronics, Tools, Binoculars, Hydraulics, Plants, Compressors, etc. New 1962 cat. now ready (send dime or stamps).

**SURPLUS CENTER**  
LINCOLN, NEBR DEPT. 813

# Fill Cracks And Holes Better

Handles like putty. Hardens like wood.

# PLASTIC WOOD

The Genuine - Accept No Substitute.

## QUOTE:

"About 80 percent of [aircraft] accidents, many of which could be prevented by the installation of known and proven aids, occur at or near airports.

"In our opinion, no single category of preventable accidents has so . . . adversely affected the growth of the aviation industry as the continued lack of known and obtainable landing aids and airport safety standards.

"At 569 airports into which airline service has been certificated for 1961, only 249 instrument-landing systems and 174 approach-light systems have been authorized. Future and present planning indicates that by 1963 only 265 instrument-landing systems can be expected. This represents less than one-half of domestic airports served by air carriers."

C. N. SAYEN, President  
Air Line Pilots Association

NOVEMBER 1961

Free!



BRAND NEW  
LAFAYETTE  
ELECTRONICS

1962

CATALOG 620

It's Bigger and Better Than Ever!

340 giant-sized page catalog from the world's leading supplier of electronics and stereo hi-fi equipment.

## 340 PAGES

It's a complete shopping center for audiophiles, technicians, engineers, students, hobbyists, servicemen and dealers. Thousands of items at lowest money-saving prices — featuring LAFAYETTE KITS . . . the best value for your money any day.

## SPECIAL! NO MONEY DOWN

with Lafayette's NEW EASY-PAY PLAN.

## MAIL THE COUPON TODAY FOR YOUR FREE CATALOG

LAFAYETTE LOCATIONS

JAMAICA • BRONX • NEW YORK CITY  
NEWARK • PLAINFIELD • PARAMUS • BOSTON

Lafayette Electronics Dept. LK1-1  
P.O. Box 190, Jamaica 31, N. Y.  
Send me the FREE 340-pg. 1962 catalog 620.

Name \_\_\_\_\_  
Address \_\_\_\_\_  
City \_\_\_\_\_ Zone \_\_\_\_\_ State \_\_\_\_\_



## I Flew the Flex-Wing

(Continued from page 89)

300 feet fully loaded at around 30 miles per hour and cruise at about 75 miles per hour.

This machine could be converted into a road vehicle in a few minutes by unfastening the safety locks and folding the wing's leading edges back alongside its keel. Motive power would continue to be furnished by the propeller.

With a vehicle like this a rancher could do all sorts of odd jobs. He could inspect his fences from the air, carry supplies to water holes, transport machinery and laborers to distant points and do his own crop dusting. He could move calves or sheep from one range to another. With the wing folded back he could travel on the surface into hilly areas far from suitable landing places.

"If he wants to go to town," Craig says, "he could change his cloth wing for a smaller one in about half an hour. The small wing hasn't the carrying capacity of the larger one but it provides more speed. And the rancher could fold it back for street use in town."

What's the price? This hasn't been worked out but it's probable that a sturdy vehicle could sell for well under \$10,000 including the small speed wing for long trips. This craft would be almost foolproof and could be flown with minimum instruction.

### Don't Try a Build-It-Yourself

But don't try to design or build one yourself. Design factors are very precise and even a small change can make a tremendous difference in safety or handling. As an example, we recently scalloped the trailing edge of the wing to try to eliminate the slight flutter that occurs at the back of the cloth. It was a small change and yet it shifted the center of lift so far forward that the plane was too hazardous to fly until we repositioned the hinge point.

The principle of the Flex Wing originated with Francis M. Rogallo of the National Aeronautic and Space Administration who has since been in charge of Flex Wing research at NASA's wind tunnels at Langley Research Center. Models have been tested in free flight in wind tunnels and have been dropped, as gliders, from helicopters. Larger gliders with simulated pay loads have been released from rockets at altitudes of up to 200,000 feet. Powered models controlled by radio have been flown.

From this research several outstanding characteristics of the Flex Wing became apparent. It has twice the lifting capacity of a parachute per unit of surface. It is extremely stable and returns to its normal attitude after any kind of disturbance.

These features make it ideal for "unattended" applications and for use as a glider, either towed or free.

Ryan Aeronautical's interest in the flexible wing comes in part from a NASA contract to evaluate its use as a paraglider for returning Saturn boosters to safe landings. One glider that is being studied has rigid leading edges, another has leading edges that are inflated pneumatically into shape. Either would be folded and stored inside a fairing on the booster and would automatically deploy after burn-out to be steered by radio to a selected landing site. Landing speed would be about 70 miles per hour on extended skids or on a soft inflated runway. North American Aviation has a somewhat similar study contract.

Recovery of the booster would save some \$5,000,000 if it could be used again. Recovery would be even more important if the booster malfunctioned in flight. The physical evidence of what went wrong could then be studied in detail. And recovery of boosters points the way to the safe recovery of future space craft such as the return to Earth of Apollo capsules and their crews from the moon.

### Wing Built of Steel Mesh

We are peering only a little way into the future when we discuss that idea. A heavy space craft would start its plunge through the atmosphere at fairly high Mach numbers even after an initial braking by retro-rockets. The Flex Wing paraglider would then slow the craft so effectively that aerodynamic heating would be minimized. The wing could be built of stainless-steel mesh bonded with thin titanium sheet.

Many other kinds of chores have been suggested for the new wing. Small Flex Wing drones could perform photo or TV reconnaissance missions with less than the usual amount of radio control because of their inherent stability. Steered back to base, they could be landed at slow speed. Larger drones could be used in antisubmarine warfare to carry depth charges or homing torpedoes that would be dropped in the vicinity of hostile subsurface craft.

Under radio guidance, cargo Flex Wings could deliver supplies in ship-to-shore operations and return to the ship for more loads. A different application may be to use helicopters to tow Flex Wing gliders to the area of a drop site and then release them, after which the gliders could be steered to safe landings in response to radio commands.

Other jobs are being suggested all the time. The fact is that we don't yet realize all the possibilities of the brand-new and yet millions-of-years-old flexible wing. ★ ★ ★



What to do about high repair bills...

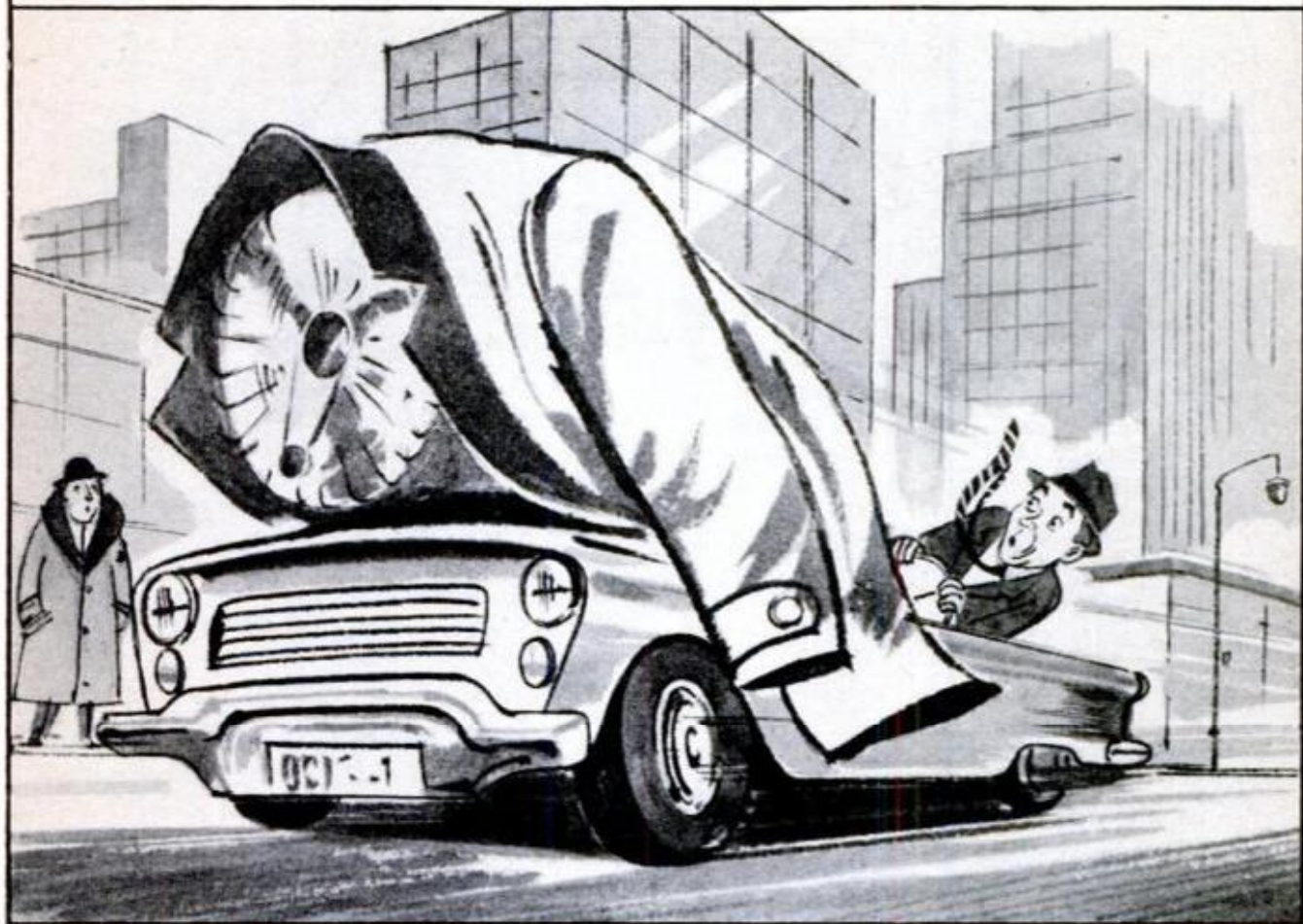

for about half your driving

## Your engine needs an overcoat

All but about 1/10 of your horsepower stays "under wraps", not being used, during most of your driving time. Result: incomplete burning of gas, carbon deposits, sludge build-up and excessive engine wear that lead to repair and replacement expense.

But Pennzoil Z-7 stops that. Gives your engine the *full-time* lubrication protection it needs. Stands up under the grind of low-speed traffic as well

as high speeds. And its power ingredient, Z-7, keeps engine parts *clean*, straight through to the next oil change.

So end unnecessary repairs. Get more miles per gallon and stepped-up all-around performance with Pennzoil. Ask for Pennzoil Z-7 by name at your service station, garage or car dealer. Always be sure that you remember to sound the "Z" that makes PENNSylvania OIL — PENNZOIL.



**PENNZOIL Z-7 — WORLD'S RICHEST, MOST COMPLETE MOTOR OIL**

*Member Penn. Grade Crude Oil Assn., Permit No. 2, Oil City, Pa.*



**POCKET SIZE**  
**4 inches long - 9<sup>7</sup>/<sub>10</sub> oz.**



**\$29<sup>95</sup>**

U. S. or  
CANADA  
with Fitted Case

**Remarkably accurate**  
**Amazingly powerful**  
**7 cartridges**  
**Unusual safety features**

**IDEAL PROTECTION FOR HOME AND CAMPING TRIPS**  
7<sup>3</sup>/<sub>4</sub> ounce Lightweight Model with Satin Chrome Finish, Pearl Grips, Gold Trigger: **'42<sup>50</sup>**. Nickel Plated, Luxuriously Hand-Engraved Model: **'75**.

Prices subject to change without notice

**BROWNING**

**.25 Caliber Automatic**

WRITE  
FOR  
CATALOG

SEE YOUR BROWNING DEALER

Browning Arms, Dept. S7, St. Louis 3, Mo.  
— in CANADA, Dept. S7, Box 991, Montreal 9, P. Q.

**Sugarplum Swiss** chalet is yours for the fun of building it, if you follow the simple plans in the December issue of PM.



### Cold-Morning Companion

This electronic auto brain will start a car's engine and heater automatically, hold the engine at a fast idle until warm, then slow it down. Engine and heater are shut off when inside temperature reaches a pre-set level, then start again when temperature drops 10 degrees.

When car won't start, the electro-mechanical unit—invented by Daniel J. Rutecki of Buffalo, N. Y.—waits and tries again. In case of engine failure, it will crank for about 10 seconds before shutting off completely. As a theftproof feature, if the emergency brake is released or car is put in gear, engine shuts off.

**"DON'T  
CALL  
IT  
CHARITY,  
GEORGE!"**

**"Contributions to the United Fund are really investments! Sure, charity takes the edge off hunger and misery. And that's necessary. But the agencies of the United Fund go way beyond that. They give the help that gets people back on their feet, makes them productive members of the community again. So it makes good sense to give the United Way—as an investment in a stronger, more prosperous community. Besides, that's the American way: to take care of our own, right at home. Our company makes a contribution, urges its employees to join in and makes it convenient through payroll payments. This once-a-year appeal cuts down the confusion of separate drives, too. It's more than a charity, George. It's an investment—and a duty—for your business and mine!"** **GIVE THE UNITED WAY**





### Filing Drawer Opens at Side

Opening on the long side, a new file has drawers that are like shelves, too. This feature allows contents of the drawer to be fully exposed when needed; two clerks may work the file at the same time. *Shelv-adrawer* is made by Wheeldex & Simpla-Products, Inc., Peekskill, N. Y.

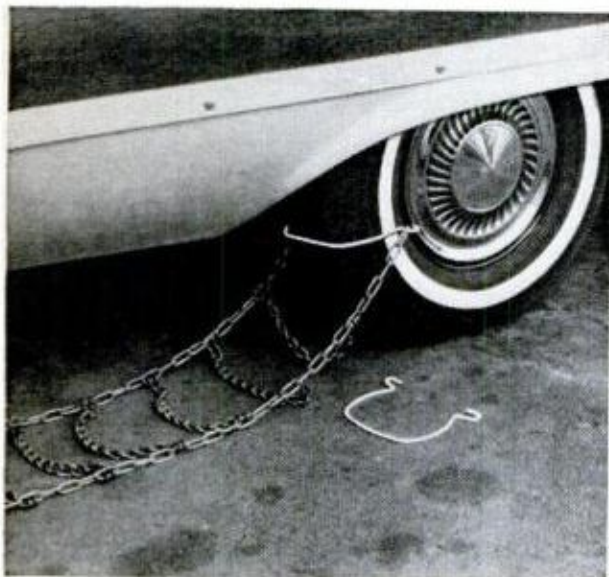

### It's a Snap

Tire chains go on easier with a new spring clip sold by Easy-On Chain Clips, 8640 W. Third St., Los Angeles 48, Calif. Chain is laid out behind tire and first links hooked into prongs on clip. When spread to surround tire, clip secures itself to wheel rim. Driving forward wraps chain around the tire. Clip is removed and chain is fastened in usual way. One size fits most cars and trucks. \$2 per pair.

NOVEMBER 1961

**NOW!**



Luxurious "HAND-RUBBED"  
**NATURAL  
WOOD FINISH**  
without the rubbing!

**WOOD LORE**

Amazingly easy to apply; "rubs itself as it dries" to the loveliest satin sheen ever seen. Use on any interior wood surface, bare wood or over old finishes.

At paint, hardware and lumber stores coast to coast.



**PIERCE & STEVENS CHEMICAL CORP.**

710 Ohio Street • Buffalo 3, N. Y.

In Canada: LE PAGE'S, Toronto 18, Ontario

**IT'S EASY TO MAKE YOUR OWN  
MINIATURE POWER TOOL**

**WITH YOUR  
OWN MOTOR**

- for grinding
- routing
- polishing
- drilling
- sawing
- cutting
- carving
- brushing
- buffing
- sanding
- engraving
- sharpening



with a wide  
selection of handpieces . . .

Turn any motor into the world's most versatile miniature power tool, ideal for every kind of model, craft, hobby and repair work. A real professional tool — not a toy — the slim handpiece is easy to hold, leaves one hand free to guide the work.

Complete flexible shaft with handpiece ready to attach to your motor priced from \$11.75. Many models available including complete machines. Satisfaction guaranteed. Write for illustrated bulletin #301.



**FOREDOM ELECTRIC COMPANY, INC.**  
Bethel, Connecticut

Manufacturers of Miniature Power Tools Since 1922



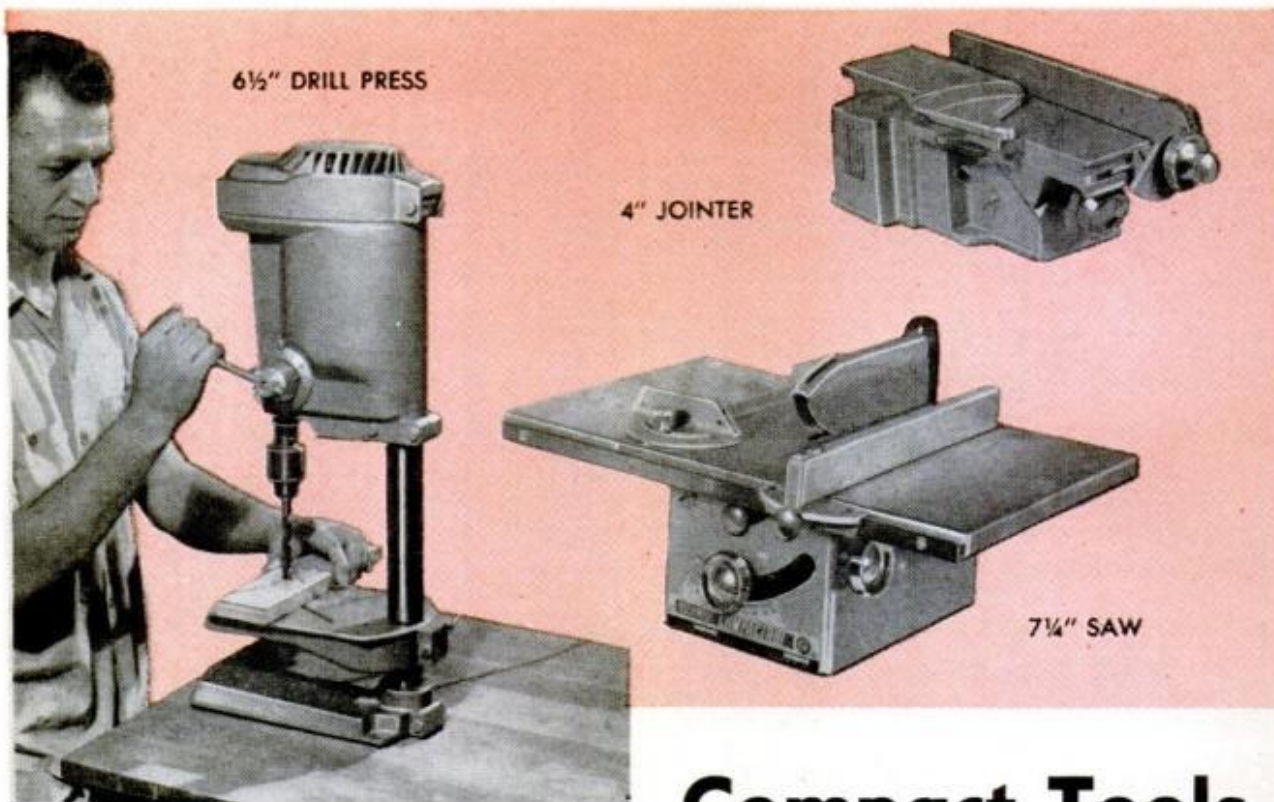

6 1/2" DRILL PRESS

4" JOINTER

7 1/4" SAW

**DRILL PRESS**, also jointer, are belt driven, have new Poly-V-Belt drives which are nonslip, easy to shift

## Compact Tools

These new tools come to you in a cardboard box, under-arm size. Unpack, place on the bench, plug in, flip the switch and they run. Motors and switches are built in. Table saw has 1/2-in. arbor taking 7 1/4-in. blade. Arbor tilts to 45 degrees; drive is direct. Table size is 14 x 24 in. with extensions, which are accessories. The 4-in. jointer has tables 19 1/2 in. overall with a fence that tilts 45 degrees right and left. Has 3-knife cutting head. Drill press has 7 3/4 x 11-in. table, spindle speeds 800, 1750, and 4000 r.p.m. and a drilling capacity in cast iron of 1/2 in. All three are made by Rockwell Mfg. Co., Delta Power Tool Div., 400 N. Lexington Ave., Pittsburgh 8, Pa., Price is \$79.99 each.

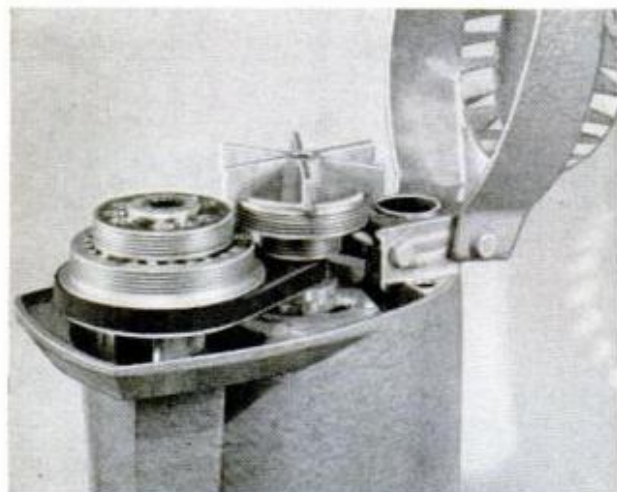

**JOINTER** has capacity of 4 in., makes any cut possible on a jointer. Main parts are aluminum for lightness

**SAW** makes compound angle cut on 2 x 4. Motor is direct drive. Motors have overload protection

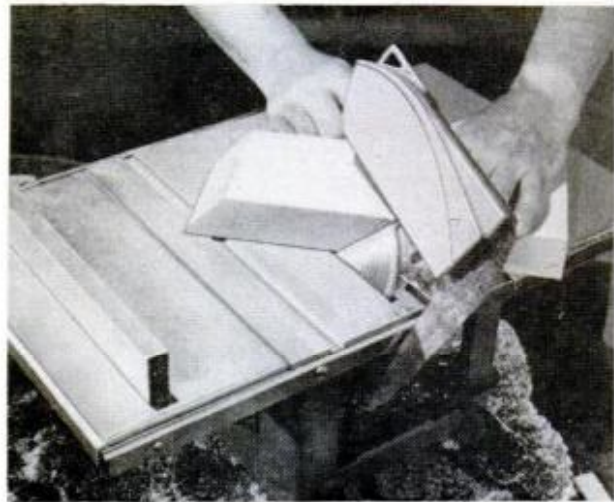
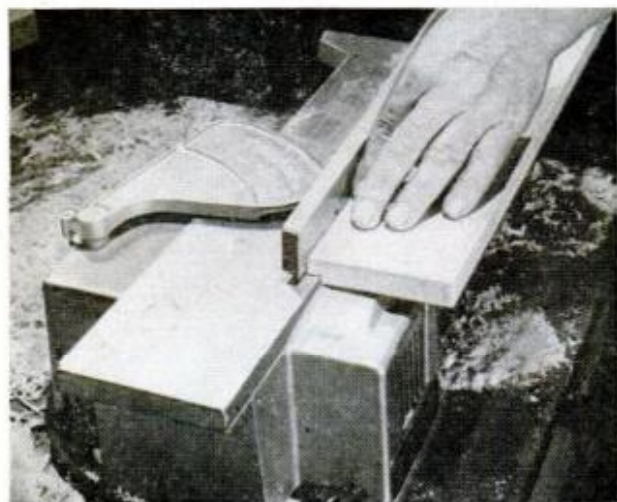



**WAR SURPLUS AND OTHER BARGAINS SAVE UP TO 90%**



**SOUTH WIND HEATER & ACCESSORIES**

Manufactured for govt. antarctic expeditions for jeeps and half-tracks. Heating unit puts out over 20,000 B.T.U.'s. Late recirculating type. Burns any type gas. 12 volt system. Fuel consumption extremely low. 1 gal. per 8 hrs. Terrific for trucks, etc. With service & installation manuals & many components. Approx. GOVT. COST \$550. Shpg. wt. 50 lbs. NEW. \$39.95. Limited quantity. Also available in 6 volts. \$39.95.



**ELECTRIC STORAGE BATTERY WINCH**

New, improved model contains heavy-duty, 2-way drum switch. Fully reversible heavy-duty, two-speed motor, 160 to 1 gear reduction. Ball bearing construction throughout. Drum will handle 70' of 1/4" cable. Can be used on 6, 12, 24 V. battery. Lift cap. 2000 lbs. plus. Ready to install & operate. 19" long x 9" wide x 8" high. For jeeps, trailers, boats, trucks, etc. Complete with mounting flange, safety load locking brake and leads. Shpg. Wt. 60 lbs. Approx. GOVT. COST \$400. NEW. Model E. \$49.50.

**DC JET GENERATOR ARC WELDING KIT** Complete with GE Type CM-77 Generator (30 volts D.C., 400 Amp., 3000 RPM up; rpm rating is for continuous duty, intermittent amperage is 500 to 600 amps.), also 2 rheostats, 1 voltage reg., 1 voltmeter, 1 electrode holder, 1 welder's mask, 1 toggle switch, 10 lb. vacuum packed 1/8 in. welding rods, pair welder's gloves & spline coupling. All units guaranteed pre-tested. Wt. 110 lbs. Approx. GOVT. COST \$700. All items, now only \$64.50.

\*G.E. Generator noted above can be purchased separately. Makes deluxe heavy-duty welder comparable to the finest commercial welders available. Wt. 90 lbs. Approx. GOVT. COST \$600. Gen. alone—\$49.50.



**DELUXE ELECTRIC STORAGE BATTERY WINCH**



Handles 250' of 1/4" steel cable. Operates on 6, 12, 24 V. battery. 160-1 gear reduction. Lift cap. 2500 lbs. Contains heavy-duty mounting base with outrigger bearing and spool support. Rugged construction. Heavy-duty dual speed motor with safety load-locking brake. Dim. 24" long x 9" wide x 8" high. Great for jeeps, trailers, boats, trucks & campers. Shpg. Wt. 80 lbs. Approx. GOVT. COST \$490. NEW. Model E-D. \$69.50.



**FRESH WATER SYSTEM PUMP**

For boats, campers & trailers. Output 10 to 200 gal. an hr. Variable rheostat controls output. 1/2" pipe thread into bronze impeller housing. 12 V.D.C. Radio noise filter. 5.2 amp. draw. Explosion-proof const. Shpg. wt. 11 lbs. Complete with mounting instructions & wiring diagram. Approx. GOVT. COST, \$200. NEW. \$10.95.

**225-1 REDUCTION GEAR** For beaching boats, winches, hoists. Ideal motor in golf or boy's electric car. DC motor and clutch. Easily reversible wiring diagram furnished. Hi torque, 105 RPM. Runs on 6-12 or 24-32 V. 65 lbs. gross. Approx. GOVT. COST \$300. \$13.50. Matched splined gear—\$3.00 ea.



**NEW 1962 CATALOG!**

Tremendous catalog — our biggest ever — fully illustrated — 1000's of bargains in war surplus & other items. Send for your free copy today. You're invited to visit our giant warehouse. Where ppd. indicated applies to U.S. only. Other prices F.O.B. Culver City Calif. Send cash, check, money order, 50% deposit for C.O.D.



**AIRBORNE SALES CO., INC DEPT. PM1161**  
8501 Stellar Drive, Culver City, Calif

End stalling forever!



**PERMA'S NEW START-O-MATIC KIT**  
Introductory price — only \$7.95

Install yourself! Easy.

Amaze your friends. Starts automatically whenever it stalls.

Developed by Perma's automotive engineers — this new device will revolutionize Americans' driving habits. Be the first in your neighborhood with Start-O-Matic. This amazing PERMA invention fits any car, domestic or foreign. Operates on manifold pressure drop. Restarts automatically when engine stalls, without driver attention. Added safety factor is car will not start in accelerator position. Works like automatic dimmers — only known device to prevent power brake and steering loss. Even if engine fails mechanically. Turns engine over, maintaining power control!

Send today for kit — can be installed in minutes. Complete instructions and wires color-coded. Send check or M. O., we ship prepaid. 10-day money-back guarantee.

**PERMA RESEARCH AND DEVELOPMENT CO.**  
345 E. Washington St., Route 1, No. Attleboro, Mass.



**MAGNET SALE!**

This small "Magnatron" pulls 150 lbs. Many practical uses for industry, shop, sportsmen, research. Retrieves valuable tools, motors, tackle, guns, etc. from fresh or salt water, tanks, shafts, etc. Permanent, non-electric, "Alnico V". (3 x 3 1/4 x 4 in./6 lbs.) Fraction of govt. cost. Formerly \$12.75. Sale price \$9.75 postpaid. No. S150.



**"R SERIES" ALNICO V RETRIEVER ASSEMBLY**  
R50 Pulls 50 lbs. (3 x 3 x 2 1/4 in./wt. 38 oz.).....\$3.95  
R75 Pulls 75 lbs. (3 x 3 x 1 3/4 in./wt. 42 oz.).....\$4.95  
R125 Pulls 125 lbs. (3 x 3 x 2 3/4 in./wt. 68 oz.).....\$6.95  
Sample pair (2) small magnets & sale catalog.....25c

**MONEY BACK GUARANTEE / WE PAY POSTAGE**  
MAGNA MAGNETICS, 7777 Sunset, Los Angeles 46, Calif. Dept. PM

**Fill Flaws In Plywood**  
Handles like putty. Hardens like wood.  
**PLASTIC WOOD®**  
The Genuine — Accept No Substitute.



**FREE GIANT B-A CATALOG**



SAVE UP TO 50% ON B-A SELECTED KITS

HI-FI AND STEREO SYSTEMS & COMPONENTS

TOP VALUES IN POWER AND HAND TOOLS

30 PAGES OF BARGAINS NOT IN ANY OTHER CATALOG

**BURSTEIN-APPLEBEE CO.**

Dept. PM, 1012 McGee St., Kansas City 6, Mo.

Rush me New 1962 B-A Catalog No. 621

Name.....

Address.....

City..... State.....

**SEND FOR IT TODAY**



Schupack's Amazing Tool Bargains! Save up to 100%!

**87 Mounted Wheels & Miniature Cutters.** Regular \$11.00 value  
**YU...T...P.P. \$6.95**  
For cutting and grinding on wood, metal or plastic. Includes 26 mtd. wheels and points on 3/32" shanks; 24 miniature cutters on 3/32" shanks; 25 short shank min. cutters. 12 Bristle Brushes on 3/32" shank. Will fit all electric drills and hand grinders.

**FLEXIBLE SHAFT—ONLY \$6.50 P.P.**

Fits all electric drills & hand power tools 35 3/4" long. Oilite bearings. Core of specially wound, high carbon steel wire in flexible steel casing. Will accommodate tool shafts up to 1/4" dia. For lathes, electric drills, etc.

**2 DRUM SANDERS**  
With 12 Bands in Assorted Grits, 1/2" dia. x 1" long on 1/8" arbor with 12 bands... **\$1.50 P.P.**  
One drum, 1" dia. x 1" long on 1/4" arbor with 6 extra sleeves **\$1.00 P.P.**

**12 Miniature Cutters.** For cutting wood, plastic or metal. Assorted shapes on 3/32" shank **\$1.50 P.P.**

**ELECTRIC HAND GRINDER**  
Fits in the palm of the hand and has an air-cooled motor that runs at 27,000 rpm AC or DC at 110 volts. Comes complete with both 3/32 and 1/8 inch Collets. **\$19.95 P.P. cord and plug.**

**10 Morse Taper Shank Drills** asstd. sizes up to 1". Brand new. **\$6.75 P.P.** (Add 50c postage.)  
**10 Straight Shank Drills** up to 1-7/32" asstd. sizes. Brand new. **\$7.25 P.P.** (Add 50c postage.)

SCHUPACK SUPPLY CO., 7331 COTTAGE GROVE AVE., DEPT. PM 25 CHICAGO 19, ILL.

**SPECIAL—101 PIECES for ELECTRIC GRINDERS**  
Grinding Wheels, Cut-off Wheels, Sanding Discs, Mounted Stones, Honing Stones, Rotary Cutting Burrs. **\$1.95 P.P.** Mandrels, other items.

**12 MOUNTED WHEELS and points on 1/4" Shank** **\$2.95**  
36 for 7.50 P.P.  
For grinding on plastic, wood, soft & hard metals. Regular Value \$8.40. **12 Mounted points on 3/32" shank \$2.50; 12 mtd. wheels on 1/4" shank \$4.75.**

**12 India Silicon Carbide and Arkansas Stones**—Squares, Rounds, Triangles. An assortment from 3 1/2" long to 6" long. Fine, medium and coarse. A real \$9.00 value. **\$4.25 P.P.** 12 for

**18 Rotary Cutters** **\$5.85 P.P.**  
**\$13.50 Value.** Assorted size cutters on 1/8" or 3/32" shank. Will fit all hand grinders. Ideal for cutting wood, metal or plastic.

**10 HIGH SPEED STEEL REAMERS**—Straight and Taper Shanks—all brand new and in excellent condition. Reg. \$25.00 value. **10 for \$4.50 P.P.**

**7 H.S. and carbon drills** from 6" to 12", in length. Assorted sizes up to 1/4" diam. for drilling in hard to reach places. A reg. \$10.00 val. for only **\$1.95 P.P.**

No C.O.D.'s. Catalog 10 cents

# AConomize on Gasoline

Get more miles per dollar—install an AC ACon-O-Mizer between your fuel pump and carburetor. Reduces flooding and stalling... tailors fuel pressure—precisely and instantly—to every driving condition from idle to full throttle. The best answer yet to real gasoline economy!



suggested retail price

**\$7.95**



At Your Nearby Service Station, garage or General Motors Dealer

**ACon-O-Mizer**

AC SPARK PLUG THE ELECTRONICS DIVISION OF GENERAL MOTORS

**AUTOMATIC**

MAKES NEW PROFITS

**RETOOTHER**

for HAND SAWS

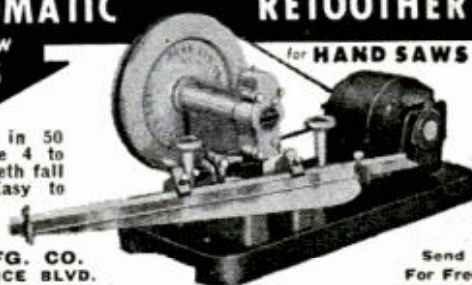

Cuts new teeth in 50 seconds—any size 4 to 16 points. Old teeth fall off as chips. Easy to operate. A perfect job.

**BURR MFG. CO.**  
8933-N VENICE BLVD.  
LOS ANGELES 34, CALIF.

Send For Free Literature

## OLD DOOR CLOSER ROUND-UP



Your old door closer is worth \$1.00 when you trade it in on a new "All Hydraulic" Illinois Glidraulic Storm & Screen Door Closer

Here's the all hydraulic closer that solves your storm and screen door closing problems. No more heel bumping, failure to latch or constant adjustments — when you have a Glidraulic.

- 15 Year Guarantee
- No Bounce
- Smooth, Even Closing
- Extra Latching Power
- More Power Against Wind
- Fluid Action, Needs no Adjusting

**WRITE TODAY**

See your Hardware Dealer

**FREE**

**\$1**

**CERTIFICATE**

If you don't have a closer to trade in. Just write and we'll send a certificate good for \$1.00 off at your dealer.

**THE ILLINOIS LOCK CO.**

309-5 W. Hintz Rd. • Wheeling, Ill.

HOME IMPROVEMENT



Better Your Living

COUNCIL

## NOW! A REAL 6/12 VOLT BATTERY BOOSTER

Now you can own a genuine SCHAUER 6 & 12 volt battery booster at a low, low price! The Model H612 is positively not just a battery "warmer", as are so many "economy" models on the market! It delivers a full 1 1/4 amps of power at BOTH voltages, that will charge car, boat, motorcycle and lawnmower batteries. Has full-wave Selenium rectifiers... automatic circuit breaker... 6 or 12 volt selector switch... rugged steel case with handsome red finish. Money-back guarantee. Buy yours now. If your dealer can't supply, send check or money order.

Automotive Division  
**SCHAUER MANUFACTURING CORP.**  
4532 Alpine Avenue, Cincinnati 42, Ohio

ONLY **\$9.95**

Postpaid Model H612





## Electronic Management System For Supersonic Aircraft

Airliners of the future will have an additional crewman—an electronic management system that will mechanize and automate routine tasks, freeing the flight crew for important tasks of decision making.

A five-year study proved the feasibility of using such systems in supersonic aircraft for preflight checkouts, takeoff monitor and control, flight profile control, propulsion and fuel-system management, navigation and communication, environmental control, minimum-weather landing system and data display systems.

## Volatile Liquid Rocket Fuel Easier to Handle Than Jelly

Experiments have turned highly volatile liquid fuel into easier-to-store, safer-to-handle jelly that can readily be liquefied again. The tests cost the Air Force Flight Test Center \$185, but may save thousands of dollars if put into effect.

Based on what scientists call the thixotropic principle, the jellied fuel lessens the danger of leaks and evaporation losses as well as making it safer to handle.

All equipment used in the experiments was improvised from used or surplus parts. In addition to "jelly-fying" the fuel, the equipment mixes it at the same time it feeds it into the storage tanks. Previously, the fuel had to be mixed elsewhere and hauled to the tanks.

## Gas Envelope Doubles Speed Of Underwater Missiles

Skin-friction drag of hydrodynamic bodies, such as underwater missiles (torpedoes), can be eliminated by enveloping them in a gaseous film.

The envelope has been created in the laboratories of the Convair Division of General Dynamics Corp., San Diego, Calif., by heating the hydrodynamic body as well as by using surfaces which react chemically with water. The effect is to move the missiles through gas instead of through water. The water does not cling to the body.

Convair engineers say the idea could be expanded to include manned underwater vehicles. Under optimum conditions, the skin friction can be reduced by as much as 95 percent, increasing the vehicle's range. And underwater missiles could be speeded up to the point where enemy submarines or surface vessels would be unable to take effective evasive action.

# EASY WAY TO MODERNIZE FURNITURE



TRADEMARK  
**Dexall**  
**WOOD BLEACH**

Apply... Let Dry... Sponge Off... Color's Gone

- modernize furniture, woodwork, floors
- works fast, easy... no sanding
- safe... will not harm wood or raise grain
- nonflammable

**Dexall** WOOD PATCH  
in paste form... ready to use

- fills holes, cracks, defects in furniture or woodwork
- actual wood... nonshrinking... can be nailed, sawed, sanded or planed
- six natural wood colors



**Dexall**  
HOLD-TITE  
GLUE



- High-strength, polyvinyl acetate glue for scores of workshop and household uses.
- Squeeze bottle eliminates waste... ends bottle dry-up.
- Dries clear, will not stain.

LOOK for the name

**Dexall**

at paint and hardware stores everywhere  
Deshler Products, Inc., Deshler, Ohio



**NEW FROM DIESEL TO DAZZLE!**

# JOB-MATCHED 1962 CHEVROLET TRUCKS

**New job-matched efficiency—more models to handle more kinds of work!**

■ There's a new world of worth in the Chevy truck line for '62—trucks powered and built to work more, save more, *earn* more! Power's *up* in every weight class; big High Torque 261-cubic-inch 6\* is new in light-duty models; new High Torque 327 V8\* powers middleweights; new 409 V8\* puts out more pull in the heavyweight trucks. And there's new medium-duty *diesel* power, too—a sure income booster on high mileage runs! A total of nine great High Torque engines enable you to match truck power to your job precisely for top performance and economy. *In every conventional model you get new Easy-View styling—a design that's as practical as it is good looking with a vision-sloped hood that enables the driver to see as much as 10½ feet more of the road ahead.* Every truck gives you the toughest of work-proved components . . . road-smoothing Independent Front Suspension on conventional models . . . easy-going Comfort-King cabs . . . scores of features that save you time, work or money every trip. If you've got a job for a truck—any kind of job—see your Chevrolet dealer about a 1962 Chevy *Jobmaster!*

## NEW HIGH TORQUE POWER IN EVERY WEIGHT CLASS!



**New wider choice of light-duty power**—Three work-proved Chevy engines for the light-duty line! Famous sure-saving High Torque 235 6 is standard. And, for '62, the rugged High Torque 261 6\* offers extra power plus dollar-saving durability to put you money ahead on tough hauls. And, for the extra punch of V8 power, you may specify Chevy's High Torque 283 V8\*.

**New 327-cubic-inch V8\***—Here's the biggest Chevy medium-duty engine yet, with 185 h.p. and 305 ft.-lbs. of torque to keep big loads moving at minimum cost. With long-lasting components and short-stroke design for efficient performance, it's provided optionally on Series 60 and 60-H models. Heavy-duty 261 6 is standard.



**New 409-cubic-inch V8\***—Gives you 409 cubic inches of high-performance, big-payload power designed to keep going when the going's hard and heavy. You get 252 h.p., a whopping 390 ft.-lbs. of torque, backed by a build that just won't quit. Available on Series 80.

## NEW DIESEL POWER FOR MIDDLEWEIGHTS



**Chevy-GM 4-53 Diesel**—New for '62, this work-proved engine brings diesel's special brand of fuel-saving, low-maintenance performance to Chevy's medium-duty truck line. Compact, rugged, high in torque, it's backed by years of GM Diesel experience. Here's a precision-built engine, designed to pay for itself many times over during its service life. It's tailor-made for 1962 Series D60 and D60-H models.

## NEW EASY-VIEW STYLING!

Practical new truck appearance eliminates front fender blind spots! Newly designed hood slopes neatly down at front and sides for maximum up-front visibility.



**Owner-Proved Corvair 95 efficiency**—Owners everywhere have profited from Corvair 95's kind of cost-cutting efficiency—from quality that's unique, in this truck class. Everything that adds up to stay-on-the-job sturdiness is right here—payload capacities up to 1,900 lbs. . . . short 95-inch wheelbase . . . economical air-cooled rear engine design . . . tough unitized body construction . . . smooth 4-wheel independent suspension.

\*Optional at extra cost.



HERE TO HOIST YOUR EARNING  
POWER TO NEW HIGHS!



---

**A NEW**  
**WORLD**  
— OF —  
**WORTH**  
**IN '62 CHEVROLET**  
**JOBMASTER TRUCKS**

---

New Chevies by the hundreds with  
new highs in hard-working power  
. . . new styling that does more for  
you . . . new *job-matched* models  
and components . . . a new world of  
worth that's out to do more work!



**ORVAIR 95 CORVAN**— Work-proved rear engine efficiency and *quality* construction. Easy handling, good looking, and remarkably roomy inside, the Corvan carries up to 1,700 lbs. of cargo astride an easy-handling 95-inch wheelbase. Low-loading heights, accessible load space ease deliveries.



**TEPSIDE PICKUPS**— These hard-working workhorses, with handy side running board, pave the way to extra earnings with smooth Independent front Suspension, High Torque 6 or V8 power and big payload capacities. Bodies up to 108 inches long provide ample room for bulky loads.



**CHEVROLET MOTOR DIVISION**  
**P. O. Box 7271**  
**Detroit 2, Michigan**

*Please send descriptive literature and specifications data on Chevrolet's 1962 truck line.*

Name

Address

City  Zone

County  State

**PM**





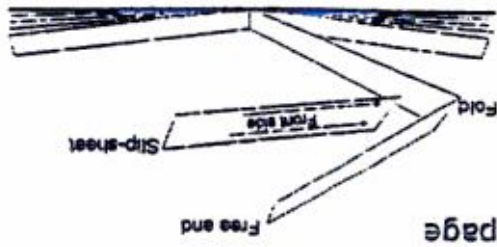

1. Open the foldout page
2. Insert this sheet with
  1. Front side touching the free page
  2. Arrow pointing to the fold
3. Slice the folded edge
4. Close the page and slip-sheet

Inverted Foldout slip-sheet



Folded edge of the page

Foldout slip-sheet

1. Open the foldout page
2. Insert this sheet with
  1. Front side touching the free page
  2. Arrow pointing to the fold
3. Slice the folded edge
4. Close the page and slip-sheet

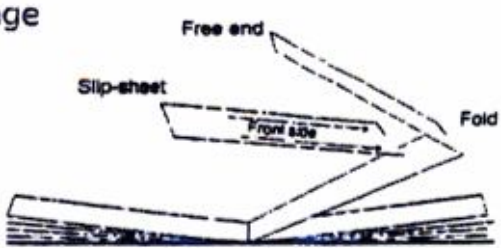



1. Follow instructions on the other side

Inverted Back

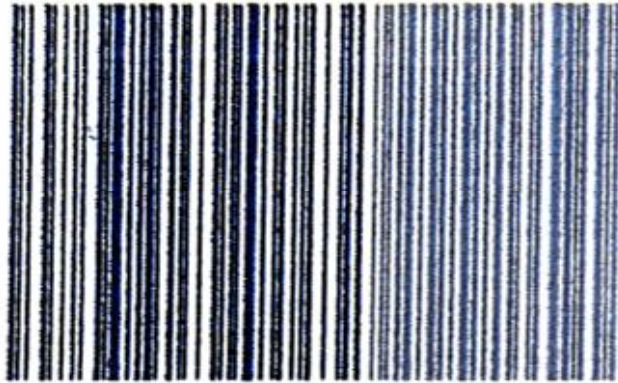

GbsSlipBack-001B

Back

1. Follow instructions on the other side





**FLEETSIDE PICKUPS:** 6 models; bodies in lengths of 78" or 98"; choice of 6-cylinder or V8 power. **FOUR-WHEEL-DRIVE PICKUPS:** Choice of Fleetside or Stepside Pickups; also Panels, Carryalls and Chassis-Cabs for go-anywhere hauling. **SERIES 80 TANDEMS:** 3 models with 30,000-lb. Eaton-

Hendrickson bogies, 5-speed Spicer transmission and V power standard. **SERIES 50 STAKES:** Select-wood bodies, or 12 ft. long; rugged chassis and driveline. **CORVAIR 95 RAMPSIDE:** Convenient side loading ramp, cost-saving air-cooled rear engine, 4-wheel independent suspension



**PANELS**—Newly styled, they haul big payloads (up to 3,000 lbs.) economically. GVW's up to 7,800 lbs. Smooth Independent Front Suspension. High Torque 6 or V8 engines for low-cost power aplenty.



**SUBURBAN CARRYALL**—Here's station wagon styling combined with truck utility; carries 8 passengers or up to 950 lbs. payload. Available also on go-anywhere 4-wheel-drive chassis.

*Yours for the asking:*

## **FREE INFORMATION**

*For details and specifications on the 1962 Chevrolet truck model that is right for your work, just fill out this coupon and mail to Chevrolet Division of General Motors, P.O. Box 7271, Detroit 2, Michigan. Do it today!*



Unlock a new world of fresh smoking pleasure



*Start fresh*

*Stay fresh with L&M*



© 1963 LIGGETT & MYERS TOBACCO COMPANY

**...Smoke after smoke, your taste stays fresh**

A difference  
you can taste—  
a difference  
you can feel!



**Moisturizing is the secret**

It seals in natural freshness and flavor. We call it Flavor-Seal—you'll call it *great!*

L&M's fine tobaccos are always fresher when you smoke them ■ Your *taste* stays fresher . . . L&M's are never drying to your taste ■ L&M's special *moisturizing* seals in the natural freshness and flavor of fine tobaccos ■ So start fresh with L&M today.

Get fresh-tasting best-tasting L&M...*pack or box*