

48 pages of **STIMULATING** home ideas...

POPULAR MECHANICS

SEPTEMBER, 1961

35 CENTS

PM'S HOUSE OF IMAGINATION
Brimful of New Products!

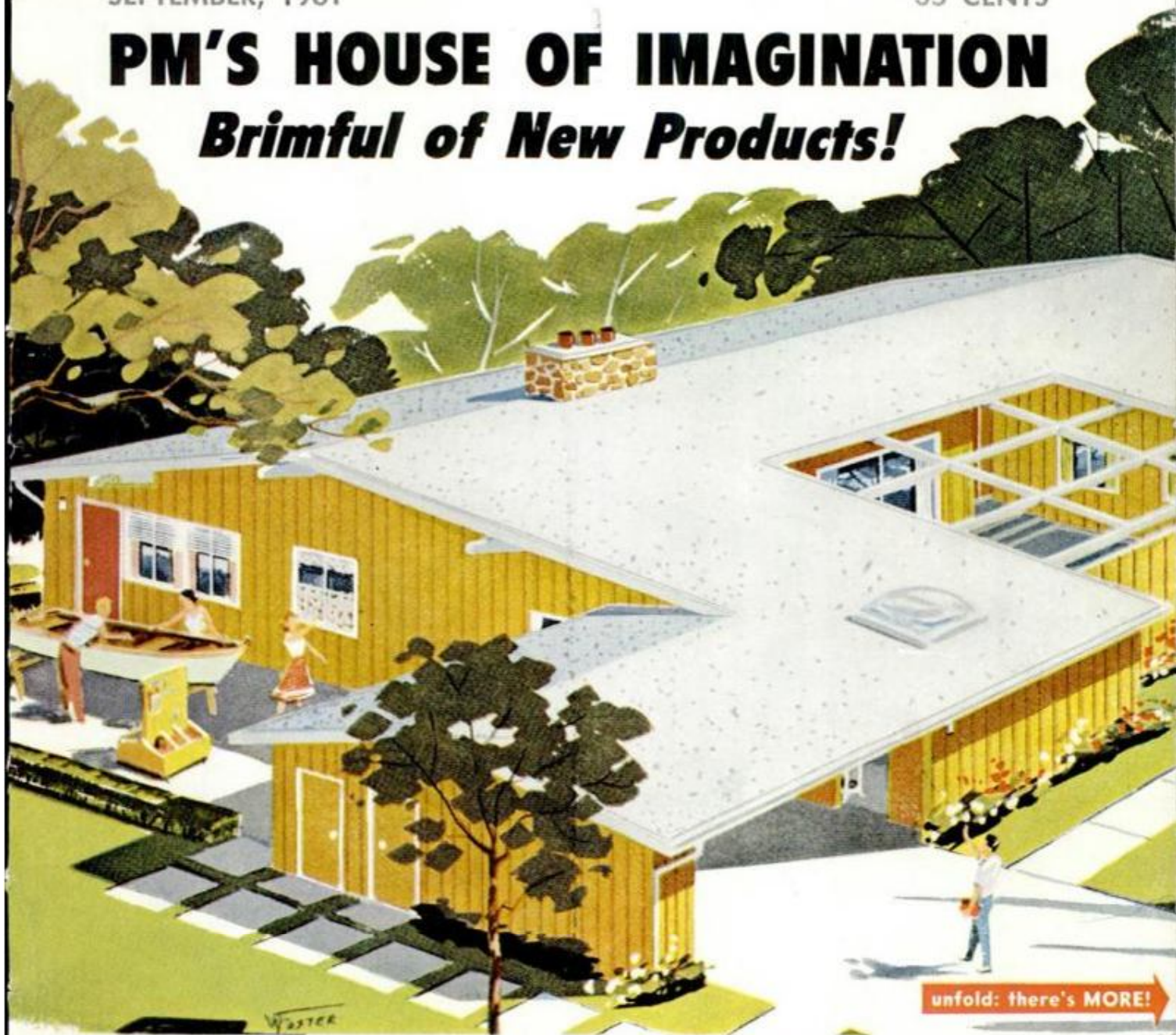

unfold: there's MORE! →

**You CAN detect a good used car
- a dealer's 19 secrets**

материал, защищенный авторским правом

TOOLS—BEST BUY FOR YOU!

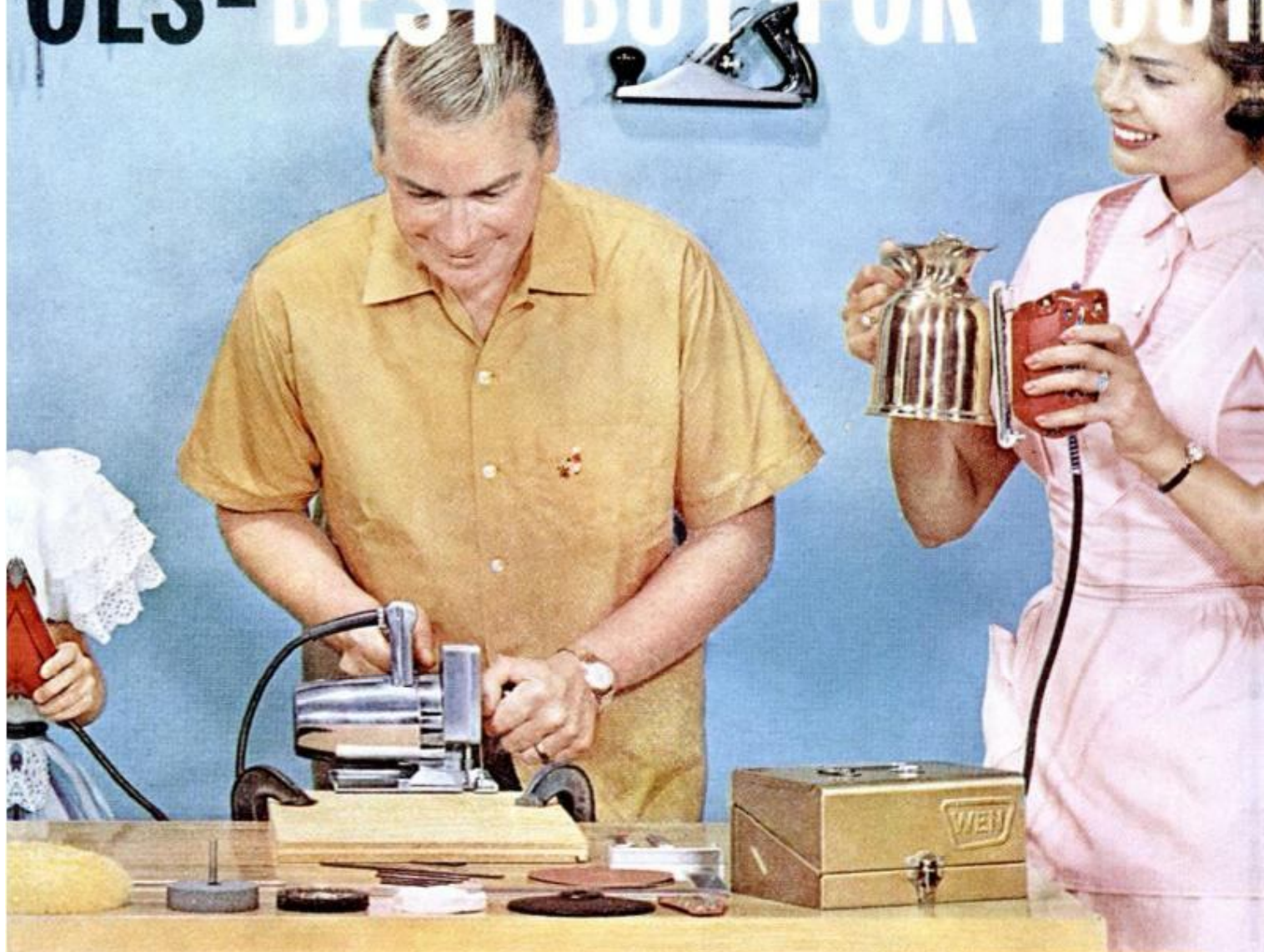

1000 Strokes
Per Minute



BEST QUALITY FINE FINISH SANDERS

Eight-line lightweight sanders essential in furniture finishing, or woodworking. Choose from two models—handy 14 sq. in. economy model at \$13.95, in a metal kit with extra paper at \$19.95, or heavy-duty model with big 20-inch sanding surface, metal kit with extra paper, at \$29.95. All have strong molded plastic housings with exclusive patented super-power magnetic motors driving 14,400 strokes per minute. Perfect for professional and amateur alike!



2 Professional
Speeds
3/8" Jacobs Chuck

DOUBLE-DUTY DRILL MOST VERSATILE TOOL IN YOUR WORKSHOP

No other drill like it! 3/8" Jacobs geared chuck handles big jobs easily, yet drill is lightweight—easy to handle. Change speed in a jiffy. 3000 RPM for drilling thin metal and wood... 1000 RPM for thick metal and wood, plaster and masonry. Handles every job at the correct speed—polish, sand, grind, wire brush, mix paint, drive screws—you name it. \$29.95



NEW...AND EXTRA SPECIAL!! WEN ROTARY SHAVER

A really BIG shaving head to cover large areas and provide a super-fast shave in addition to traditional rotary comfort. Domed shape fits the contour under the chin. Hollow-ground self-sharpening cutters working close to the outer edge make upper lip shaving a cinch. It's the fastest, smoothest, lightest, quietest shaver on the market. \$19.95

WEN

POWER TOOLS



**Quick to Heat
Easy to Use**

**WORLD'S BEST
SELLING
SOLDER GUNS**

Choose from 4 guns, 2 gun kits— from feather-light slim 100 watt model to heavy-duty 250 watt model standard among professionals. All guns are heated, ready to use in 2½ to 5 seconds . . . quick to cool. Built-in spotlights focus on work. Housings are shatterproof plastic. Long-reach, long life tips are replaceable and interchangeable with special purpose tips. \$5.95 to \$15.95

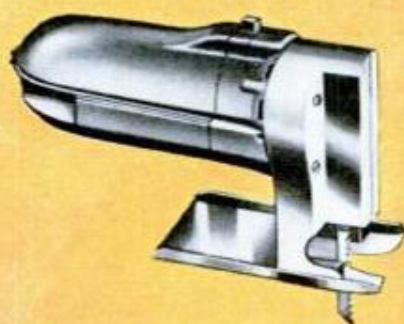

**2650 5/8" Strokes
Per Minute**

**14,
Per**

**LIGHTWEIGHT ALL-PURPOSE
SABRE SAW**

Extremely versatile and easy-to-handle, this fine saw is excellent for scrollwork and patterns. Slices through 2x4's in seconds. Cuts wood, metal, plastics, composition boards, hard rubber, leather. Air stream clears dust from work. You get a true cut every time. It's a must in your workshop . . . the finest of its kind. \$26.95

Stro
—e
fine
3 n
eco
mei
\$1.
wit
in n
\$11
pla
pac
moc
mini
and

... AS ADVERTISED IN LIFE, POST, NEWSWEEK, TIME, TRUE, SPORTS ILLUSTRATED

new concepts to improve your home RIGHT NOW

- All about new wall coverings
- Build in a central vacuum cleaner
- Shop caddy rolls tools to the job
- Built-in sorters save washday work

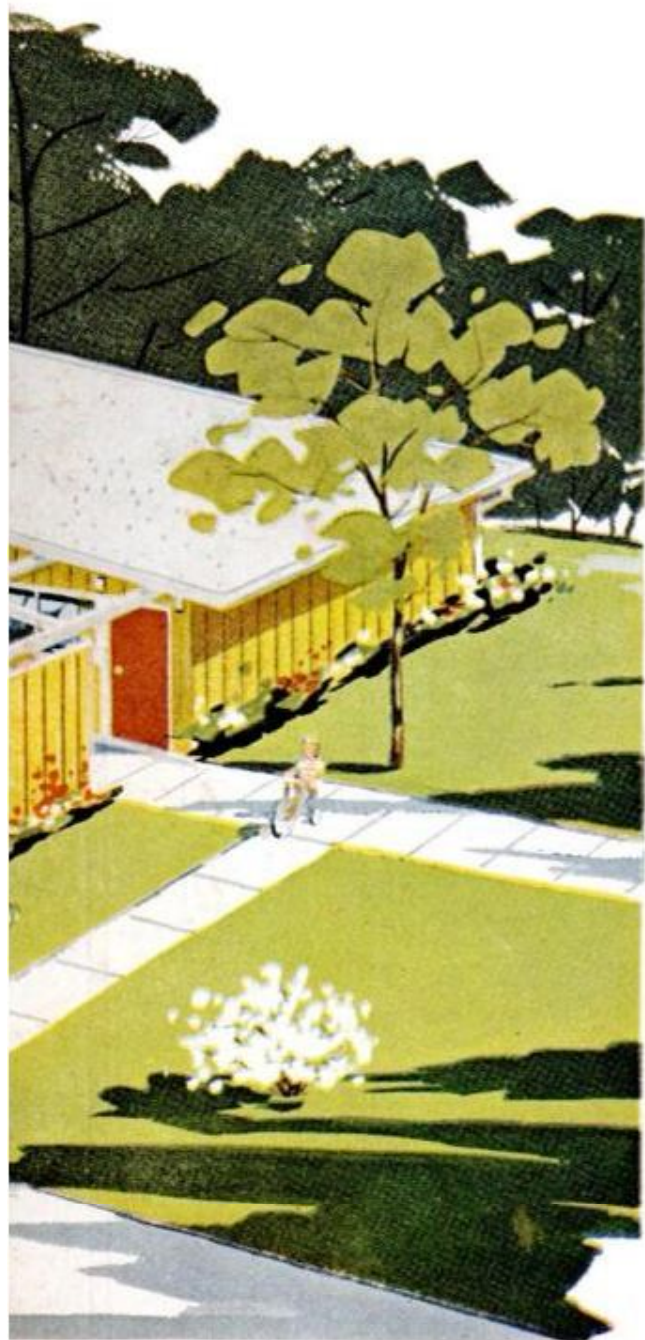

WARM AND FRIENDLY . . .



Floor-to-ceiling fireplace commands attention and subtly divides living room from dining space

ELBOWROOM . . .



Roll the tool caddy a few steps from the house, and the outdoor shop is ready for big projects

Save money! Sell your house yourself!

MONEY!

**NEW* EXTRA POWERFUL—
ALMOST DUSTLESS
NEW INDUSTRIALLY RATED
3" BELT SANDER AT
HOME WORKSHOP PRICE**

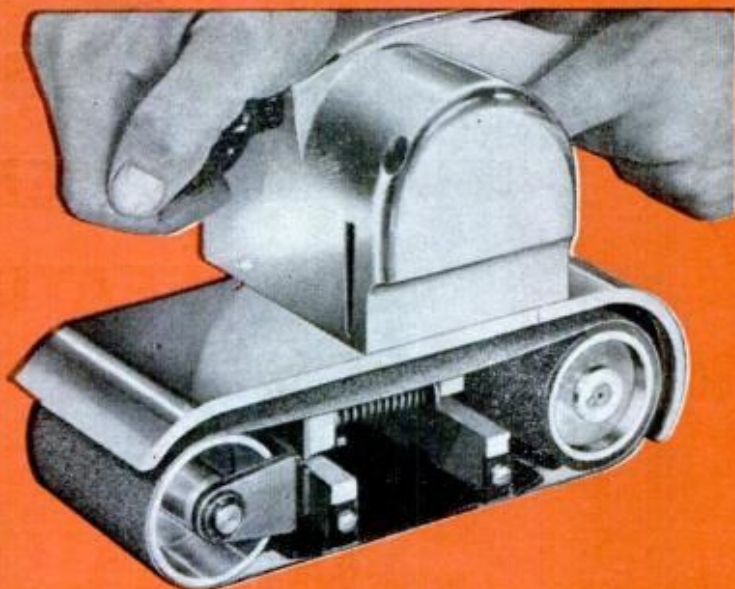

*This is brand new in the WEN line. If your dealer does not have it—ask him to order it. You'll be glad you waited—it's worth it!

Finally, the complete answer to home-workshop sanding . . . and finally at a sensible price. Exclusive casting design combines with forced air currents to cause dust to accumulate at rear—keeps work clean, easy to see. Cool-running 4¼ amp. motor turns belt at 850 surface ft. per min. Balanced weight—7 lbs—and contour grip handle minimize fatigue. Includes 3 belts: coarse, medium, fine. \$44.95.

WEN

PRODUCTS INC. 5810 NORTHWEST HIGHWAY CHICAGO 31, ILL.



**The Famous Industrially
Rated ALL-SAW
BEST SELLING SAW IN AMERICA—
CUTS A 6" LOG—FINE PATTERNS, TOO**

Powerful ½ HP motor—Industrially Rated—yet comfortable to hold . . . easy to use. Does everything a pattern saw will do . . . more than a circular saw . . . many things a band saw or nibbler will do . . . and much that until now only a chain saw could do. Cuts a 6" log—yet cuts delicate patterns in any material normally cut with saw or knife. Complete with 7 blades, rip guide, circle cutter. \$44.95

ARMSTRONG TIRES' PATENTED TREAD FEATURES CAN SAVE YOUR LIFE!

Read these 3 ways
Armstrong Tires add the grip
that stops deadly skids
as no other tires can!

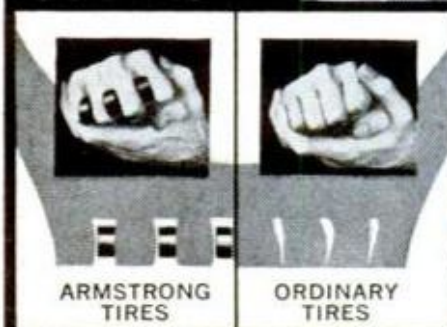

ARMSTRONG
TIRES

ORDINARY
TIRES

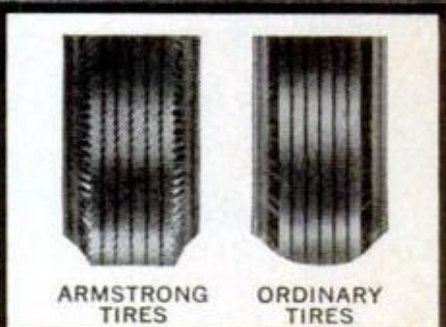
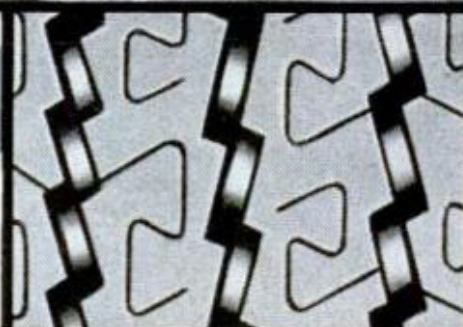

ARMSTRONG
TIRES

ORDINARY
TIRES

Famous "Ounce of Prevention" PATENTED SAFETY DISCS KEEP TIRE'S GRIPPING EDGES OPEN

Just as Safety Discs in fist (above left) keep fingers apart, so over 1000 Safety Discs in each Armstrong Tire keep tread's gripping edges apart, always ready to grip — no matter how hard you brake!

But fingers of fist *without* discs (above right) can squeeze shut. That's why ordinary tires, lacking Safety Discs, can squeeze smooth and slippery under braking pressure — and you skid.

Grip in all directions! PATENTED INTERLOCKING SIPES ADD OVER 2600 GRIPPING EDGES!

Sipes are slots put in tires to add gripping edges. Only Armstrong tires have S-shaped, *interlocking* sipes. They add over 2600 gripping edges, provide "bite" in ALL directions, sharply improve protection against forward and side skids.

In winter, interlocking sipes' "wiper" action keeps you safer on wet roads, gives you snow tire "go" on packed ice and snow.

Grip where it counts! UNI-CUSHION CONTOUR LAYS MORE LIVE RUBBER ON ROAD

Armstrong Tires, when inflated and rolling, put more tread — more gripping edges — on pavement. Greater stability at high speeds! Faster, surer stops when you brake!

Another extra: Armstrong's anti-vibration tread literally cancels noise! No hum, no whine, no drone: you ride on a whisper. Talk to your local Armstrong dealer — he's listed in the Yellow Pages.

GET EXTRA SAFETY AT NO EXTRA COST WITH

ARMSTRONG TIRES!

ARMSTRONG RUBBER COMPANY, Home Office, West Haven, Conn.

AS LOW AS
\$10⁹⁵
(6.70 x15)

plus tax and your
recappable tire



CLEAN YOUR HOUSE LIKE YOUR CAR? Sure — when it's an up-to-date mobile home. Today, many of the attractive new models, like the popular New Moon mobile home shown here, have exteriors of Care-free Alcoa * Tone-Cote. Available in many attractive colors, this covering of Alcoa Aluminum stays new-looking longer because it resists corrosion, fading and peeling. Occasional washing with water is all the care Alcoa Tone-Cote ever needs.

Mobile homes are just as Care-free inside. If you haven't seen one lately, you may be in for a big surprise—they're spacious! Ten feet wide by fifty feet long, and that's just an *average size*. Upkeep? Painting is not necessary, inside or out. Housework? Compactness of room arrangements, plenty of storage space and built-ins make mobile homes like this New Moon model a housewife's dream.

Your dream, too? Send the coupon below for more information on today's mobile home.

* Trademarks of Aluminum Company of America

a wonderful way of life's awaiting you in a new mobile home



Aluminum Company of America
886-J Alcoa Building, Pittsburgh 19, Pa.

YES, I'd like more information about New Moon mobile homes . . . and a copy of your free booklet, *Home Is Where You Take It.*

Name _____

Address _____

City _____ Zone _____ State _____

ALCOA ALUMINUM

ALUMINUM COMPANY OF AMERICA

For exciting drama watch "Alcoa Presents" every Tuesday evening—ABC-TV

SEPTEMBER 1961

3

POPULAR MECHANICS®

SEPTEMBER 1961
VOL: 116 NO. 3

INTERNATIONAL EDITIONS • SPANISH: Mexico-Caribbean, Southern Hemisphere • FRENCH •

Features of Special Interest

What We'll Learn From the Astronauts - - - - -	99
Owners Report on the Corvair Family - - - - -	106
Are You Taking Counterfeit Drugs? - - - - -	114
You CAN Detect a Good Used Car - - - - -	120
PM Tests Volkswagen's New 1500 - - - - -	128
Engine With Built-In Wings - - - - -	131
Plan for Peak-Action Pictures - - - - -	138
The Atom Taps the Forest's Secrets - - - - -	144
Adjusting Chrysler Brakes - - - - -	150
Ten Minutes to Survival (Part II) - - - - -	156
Inboard-Outboard Drives - - - - -	210

Your Home: Ideas, Projects, New Products!

PM's House of Imagination - - - - -	162
Home Products—New and Appealing - - - - -	170
Listen-Nook for Radio, TV, Record Players - - - - -	176
Rolling Toolbox - - - - -	178
How to Make Money Selling Your House Direct - - - - -	184
Built-In Convenience for Sorting Laundry - - - - -	188
"Snip-Off" House - - - - -	192
Down the Drain With Household Dirt - - - - -	194
Face-Lift Your Home With Luxury Walls - - - - -	200
Roll on a New Roof - - - - -	208

Address communications to: 200 E. Ontario St., Chicago 11, Illinois. **SUBSCRIPTION SERVICE:** Mail all subscription orders, changes of address, correspondence concerning subscriptions, and Postmaster notices of undeliverable copies to Popular Mechanics, 250 West 55th St., New York 19, N. Y.

Published by Popular Mechanics Company, RICHARD E. BERLIN, *President*

CLIFFORD B. HICKS
Editor

RICHARD E. DEEMS
Executive Vice-President

JOSEPH R. BUELL, JR.
Publisher

Managing Editor: DON DINWIDDIE
Assistant Managing Editor: JOHN A. LINKLETTER
Shop and Crafts Editor: WAYNE C. LECKEY
Automotive Editor: JAMES R. WHIPPLE
Associate Editors: W. CLYDE LAMMEY, WALLACE MYERS
Electronics Editor: BYRON G. WELS
Assistant Editors: GUERRINO F. AMATI, JAMES BIERY
KEVIN V. BROWN, ROBERT L. HERING
R. B. KIRKPATRICK, ARTHUR M. MIKESELL, BIL TOMAN
Assistant Editor, Mexico: JEAN KAVANAUGH

Art Director: HENRY M. NEHRBASS
Art Editor: RICHARD A. POTTS
Chief Photographer: FRANK P. FRITZ
Eastern Editor: RICHARD F. DEMPEWOLFF
959 Eighth Ave., New York 19, N. Y.
Western Editor: THOMAS E. STIMSON, JR.
Suite 1003, 3460 Wilshire Blvd., Los Angeles 5, Calif.
International Editor: HEINZ P. SCHLICHTING
Ritterstrasse 26, Karlsruhe/Bd., Germany
Advertising Manager: FRANK R. DUPUY
959 Eighth Ave., New York 19, N. Y.
Director, Bureau of Information: ALLAN CARPENTER

If you wish additional sources of information for the articles in this issue, or if you wish the name and address of the manufacturer of a particular product shown here, write to Bureau of Information, Popular Mechanics, 200 E. Ontario St., Chicago 11, Ill. Ask for the free "Where-to-Find-It-List" for this issue.

DANISH • SWEDISH • GERMAN • PORTUGUESE • DUTCH

Departments

Over the Editor's Desk - - - -	8
Pentagon Sidelights - - - -	16
Science Bulletins - - - -	18
Sidelights on Aviation - - - -	20
Tune In on the Inventors - - - -	24
Items From All Outdoors - - - -	28
Shopping for Tools - - - -	90
Spotlight: Austin Healey Sprite -	94
On the Market - - - -	98
Detroit Listening Post - - - -	110
Science Overseas - - - -	112
Solving Home Problems - - - -	218
Clinic for Homemakers - - - -	230

Next Month . . .

Your first colorful views and fact-filled news of the "Surprising '62 Cars." Don't miss the 1000-mile road test on America's first V6. Or the "X-ray" discussion on other all-new 4, 6 and V8 engines, styling and suspension innovations. In the same issue: "Adapting Your Stereo to Twin-Channel FM" and money-saving tips on "Repairing Home Appliances."

ADVERTISING OFFICES—Chicago: 200 E. Ontario St., Whitehall 4-0100; New York: 959 Eighth Ave., Columbus 5-7300; Detroit: General Motors Bldg., TRinity 5-8711; Cleveland: Hanna Bldg., 1422 Euclid Ave., PProspect 1-0456; Los Angeles: 3460 Wilshire Blvd., DUnkirk 2-8458; San Francisco: 111 Sutter St., YUkon 2-0823.

Published monthly by Popular Mechanics Company, 200 E. Ontario St., Chicago 11, Ill. Richard E. Berlin, President; Richard E. Deems, Executive Vice-President; Fred Lewis, Vice-President and General Manager; Robert F. MacLeod, Vice-President; John R. Miller, Vice-President; Joseph R. Buell, Jr., Vice-President; G. O. Markuson, Treasurer; R. F. McCauley, Secretary. Single copy in the United States and Canada, 35 cents; subscription rates in the United States and possessions and Canada, 1 year \$3.50; 2 years, \$6.00; 3 years, \$8.00. In countries of the Pan-American Postal Union, 1 year \$4.50; 2 years \$8.00; 3 years \$11.00. In all other countries 1 year \$5.50; 2 years \$10.00; 3 years \$14.00. If you plan to move, notify us at least 30 days in advance so you will not miss an issue. Give both your old and new addresses. Second-class postage paid at Chicago, Illinois, and at additional mailing offices. Entered as Second Class Matter at Post Office Dept., Canada. Registered as Second Class Matter at the Post Office at Mexico, D.F., Mexico, June 20, 1950. © 1961 by Popular Mechanics Company. All rights reserved. Printed in the United States of America.



What's Next in Space?—page 99



Tests for a Used Car—page 120



About Your House—page 162



No Noise Now—page 176

News in Paneling—page 200



This One



A965-TZS-PKZK



DIRTY SLUDGE DID THIS DIRTY WORK: Sludge clogged this oil intake, preventing oil from circulating. Result: engine wear, poor mileage, finally a major overhaul. That's why you . . .

ADD BARDAHL

Unburned carbon, varnish and dirt foul up oil and engine parts. BARDAHL, added to your oil, cleans out this power-robbing sludge. And BARDAHL lubricates like no other oil—won't burn off or squeeze out. Your car runs better . . . gives better mileage. Add BARDAHL every oil change.



WORLD'S NO. 1 SELLER AT STATIONS EVERYWHERE



YOU'RE OFF to a thrilling adventure in the wonderful world of **SUBMARINES!**

YOURS for only **10¢**
WITH TRIAL MEMBERSHIP

A Complete Sample Activity Kit to Acquaint You With
THE SCIENCE PROGRAM



Plus This Scale Model of the Famous
NUCLEAR-POWERED
Newest **POLARIS** Submarine

AN AUTHENTIC 18-INCH WORKING MODEL WITH
16 MISSILE TUBES AND POLARIS MISSILES THAT ACTUALLY FIRE!

Why this generous offer? Simply to introduce you to an exciting new way to understand and enjoy the scientific marvels all around us

PREPARE TO SUBMERGE! You're off on a great adventure through the underwater world of **SUBMARINES**.

You'll travel back to 1620 and board that first submarine, powered by . . . OARS! In a Confederate sub you'll ram a Union Ship. You'll cruise in the nuclear-powered *Nautilus*. A friendly expert will show you the atomic reactor, the radar and periscope in the Control and Attack Center. You will see why 7 million parts are needed for a single nuclear submarine.

AND FOR THE BIGGEST THRILL OF ALL, you'll fire practice shots from the newest and mightiest nuclear-powered missile-firing submarine! You'll stand breathless as the Skipper gives the command to launch the Polaris missile . . . cheer with the crew as the history-making shot lands on target *1,200 miles away!* These are just a few of the thrills that await you—in the new Science Program presentation of **SUBMARINES**. And it's yours for only 10¢ on this "get-acquainted" offer.

Enjoy Monthly Adventures Like These

Each month this new program will take you on a "guided tour" of a different field of science. One month a chemist will show you metal that burns and gas that pours. Another time a biologist will let you look through his microscope at a living cell. On other adventures your guides will be radio engineers . . . medical researchers . . . nuclear physicists.

Each month you receive sheets of full-color photographs—also an illustrated album, crammed with information, and with spaces for mounting the pictures. In addition, there will be many other interesting things-to-do.

What It Will Mean to Your Family

Think what these adventures will mean to your family—especially if you have children in school! It will help them participate in science projects, help prepare them for life in the space age—may even lead to a scientific career.

MAIL COUPON NOW with only 10¢ for the Introductory package. With it we will also send the current Activity Kit for which you will be billed only \$1, plus shipping. No further obligation. If you do not wish to continue, simply write us within ten days. Otherwise you pay only \$1 plus shipping for each month's scientific adventure. You may cancel at any time. Mail the coupon with only ten cents to: **SCIENCE PROGRAM, Dept. 1-PM-9, Garden City, N.Y.**

NEW INFORMATION OFFICIALLY RELEASED

Our first model (illustrated) had only 8 tubes. Now Navy has released more information. You get brand-new model with all 16 Polaris tubes.

- POLARIS missiles that FIRE •
- PERISCOPE slides UP and DOWN •
- RUDDER moves • PROPELLER rotates—half of hull snaps off revealing interior • 3 molded colors.

YOU GET THESE SIX EXCITING ITEMS for only 10¢

- 1 Authentic 18" WORKING model newest 16-tube Polaris Missile-Firing Sub *actually launches missile!*
- 2 Gummed full-color punch-outs and Wall Chart of the Ocean on which to mount them.
- 3 8,000-word illustrated album—crammed with information about Submarines, with spaces to mount the color prints.
- 4 Beautiful full-color prints of wonders of SUBMARINES.
- 5 A handsome pull-drawer library case to hold several albums.
- 6 Science Bulletin: Special monthly reports on the very newest scientific developments.



SCIENCE PROGRAM, Dept. 1-PM-9, Garden City, N. Y.

I enclose 10¢ to help cover shipping. Please rush me my introductory package described here. Also enroll me as a member of the Science Program and send the current Activity Kit with a bill for only \$1 plus shipping.

After examining this package, I may cancel membership simply by writing you within 10 days. In this case I may return everything and owe nothing. As a member I will receive a new Activity Kit every month for only \$1 each plus shipping. I do not have to take any minimum number of future Kits, and may resign any time I wish.

Name

(Please Print Plainly)

Address

City Zone State.....

(Same offer in Canada, 105 Bond St., Toronto 2.
Offer good only in U.S.A. and Canada)

27-SC17D



OVER THE EDITOR'S DESK

Kite Champ Reports



I'd be less than a proud father if I didn't think that Jane Yolen's story about my kite-flying adventures (June PM) was great. But she did overlook the smashing new Aero kite which is airborne the minute you blow it up. It can also rise like a rocket when handled by an expert, as witness the action in this photo.
New York, N.Y. WILL YOLEN

Seals and Coyotes

Being a control tower operator, I got a chuckle out of your June issue item on Lt. James Weeks' Antarctic flight problem: ("Will someone please chase that stupid seal off the runway?").

Out here at Rogers Dry Lake during the long, hot summer months, quite often you hear: "Edwards tower, will you please send someone out here to chase those shaggy coyotes off the runway." The job usually falls to our competent Air Policemen.

Sincerely enjoy your worth-its-weight-in-gold magazine.
Edwards AFB S/SGT. CHARLES A. BENT
California

Shaggy, Sarge? In summer?

Change the Family's Mind

Thank you for the May issue vacation articles, especially the one on Mexico.

I have wanted to travel to Mexico for some time now but haven't been able to sell the family on it. Your excellent article will change the family's mind, I'm sure. To be truthful, I've always been dubious in regard to some matters concerning Mexican travel until now.

Hats off to Jim Whipple for his Detroit Listening Post, also.
Wilmore, Kentucky GLEN POWELL

Senor Whipple sends you a buen viaje for those kind words, Glen.

Lost Reader

One little phrase has just lost you a reader. In the article, *The Town That Spends Its Summers Afloat*, you say: "Let a teenager go boat-rodding on the river . . ." I am a teen-ager and I believe that statement is a great injustice to our group.
Portsmouth, Va. DENNIS REGULA

We apologize, Dennis. Boat-rodders come in all ages, shapes and sizes, and are not typical of any group.

600 Nerve-Wracking Parts

Mr. Wadsworth stated that plastic kits should stay in the six to ten year age group. He apparently has never assembled any large plastic kit. They are anything but easy. As an example, the Revell Thermopylae took several weeks of tedious, nerve-wracking labor to assemble its over 600 parts, many of which had to be handled with tweezers.

I spend over two hours merely painting the average 98-cent plastic model, just to make it look like a model and not like a toy. It is not the kit, but how it is assembled. Oh yes, Mr. Wadsworth, I'm fourteen.
Fort Lauderdale, Fla. MICHAEL T. PARKER

. . . I agree with Reon Wadsworth. Plastic models should not be put in competition with homemade models in any age group. They show no ability on a person's part, while homemade models show the skill and time put into the models.
Kimball, Neb. BILL PTACEK, 13

Kit Versus Scratch-Built Again

In connection with the kit-versus-hand-crafted-models discussion (June PM), one group likes to build from scratch, purchasing only the parts they cannot construct themselves. A second believes in the lazy

(Continued to page 12)

Are You "STANDING STILL" on your job?

**SAME OLD
JOB . . .
SAME LOW
PAY . . . ?**

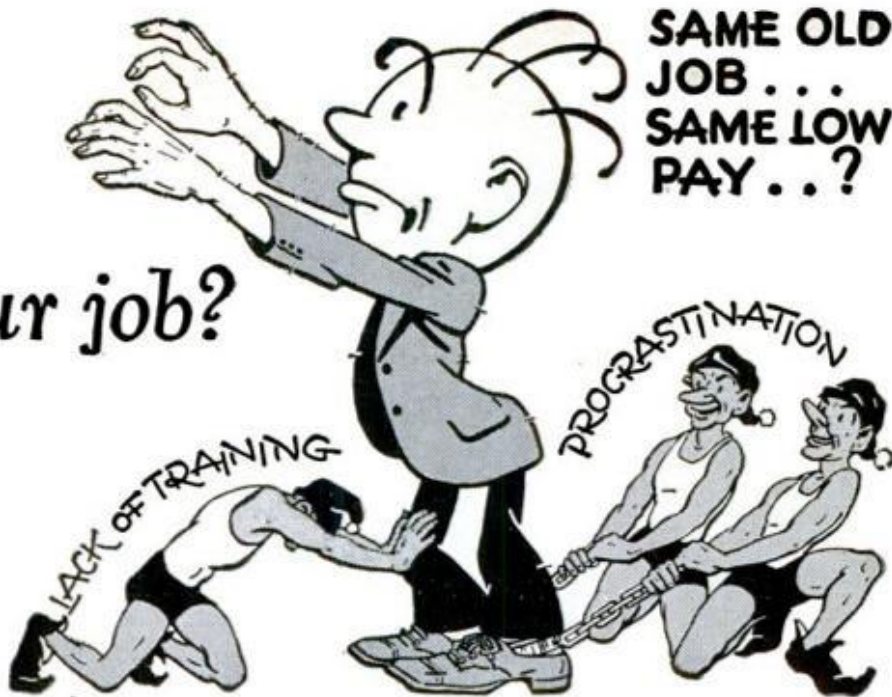

You can justify a real pay raise and a better position—by making one simple move—the move that opens the way to more earnings and promotions—*practical training.*

If YOU are "standing still" on your job—no promotions—only token increases in pay—then you had better do something about it. You know that if you are untrained, your chances of getting ahead are slim. **NOW IS THE TIME TO PREPARE.**

WILL RECOGNITION COME?

The only answer, as you know, is that success *does* come to the man or woman who is really *trained*. LaSalle has provided the "key to success" for many thousands of ambitious people who have sought our training for more than fifty years.

Get all the facts. Investigate the opportunities in your chosen field. It costs you nothing to learn about LaSalle's proven and tested accredited correspondence courses in the major fields of business as well as high school and technical courses. You can train in the

privacy of your own home, progressing at your own rate. You lose no time from work, and your instructors guide you every step along the way through our famous Practical Problem Method. Low cost—easy terms.

Don't let promotions pass you by—do something **TODAY** about your future.

The coupon below is for your convenience. Simply mark the program in which you are most interested, and mail at once. We'll send you, without obligation, free booklets describing that field together with the opportunities and what you must know to be a success.

ACCREDITED MEMBER, NATIONAL HOME STUDY COUNCIL

LaSalle Extension University, A Correspondence Institution, Dept. 964X, 417 S. Dearborn, Chicago 5, Ill.

Please send me, without cost or obligation, FREE catalog and full information on the field I have checked below:

ACCOUNTING

- Modern Bookkeeping
- Basic Accounting
- Practical Accounting
- Principles of Acctg.
- Cost Accounting
- Federal Income Tax
- Accounting Systems
- Business Law
- Auditing Procedure
- Controllship
- CPA Training
- Complete Accounting

TRAFFIC & TRANSPORTATION

- Organization & Mgt.
- Classifications, Rates & Tariffs
- Transportation Agency & Services

- Transportation Law & Regulation
- Rate Making & Rate Cases
- Complete Traffic & Transportation

LAW

- Law of Contracts
- Insurance Law
- Claim Adjusting Law
- Law for Trust Officers
- Business Law I
- Business Law II
- General Law
- First Year Law
- American Law and Procedure (LL.B. Degree)

BUSINESS MANAGEMENT

- Principles of Management
- Psychology in Business
- Selling & Sales Management
- Advertising & Marketing
- Production Problems
- Business Financing
- Credits & Collections
- Office Management
- Managing Men
- Accounting & Statistical Control
- Business Correspondence
- Organization & Reorganization
- Legal Problems
- Complete Business Management

MANAGEMENT COURSES

- Basic Management
- Production Management
- Sales Management
- Advertising & Sales Promotion
- Financial Management
- Personnel Management
- Sales & Executive Trng.
- LaSalle Sales Training
- Foremanship Training

HIGH SCHOOL

- High School Preparatory
- General Business Course
- High School Diploma
- Commercial Course
- Secretarial Course

- Stenotype (machine shorthand)
- Home Management Course
- General Culture Course
- Science Course
- Mechanical Course

DENTAL ASSISTANT

- Dental Assistant

TECHNICAL COURSES

- Auto Body Fender
- Refrigeration-Air Conditioning
- Diesel
- Drafting
- Welding
- Motor Tuneup

Name.....Age.....
Address.....
City, Zone, State.....

**CHECK THIS COUPON AND MAIL
TODAY...SURE!**

SKIPPED ME AGAIN!



I WAS DETERMINED TO MAKE GOOD IN MY JOB...BUT DETERMINATION, I FOUND, WAS NOT ENOUGH!

I HAD PLENTY OF EXPERIENCE. AND THE BOSS SEEMED TO LIKE ME. I LACKED JUST ONE THING—**TRAINING!**



I. C. S. IS THE OLDEST AND LARGEST CORRESPONDENCE SCHOOL IN THE WORLD. 256 COURSES. PERSONALIZED INSTRUCTION, CAREER GUIDANCE, EASY-PAY PLAN. DIPLOMA TO GRADUATES.

SIX MONTHS LATER... I.C.S. SENT MY BOSS REGULAR REPORTS OF MY PROGRESS. THEN ONE MORNING...

BURT, I'VE JUST MADE YOU THE ASSISTANT MANAGER OF YOUR DIVISION...AT \$15 MORE A WEEK. AND THE WAY YOU'RE GOING NOW, THIS IS JUST THE BEGINNING.



I GOT IT, HONEY! I GOT THE PROMOTION! OUR MONEY WORRIES ARE OVER! TODAY'S OUR LUCKY DAY!

TODAY AND THE DAY YOU MAILED THAT I.C.S. COUPON!



WHY NOT MAKE THIS YOUR LUCKY DAY? LET I.C.S. PUT YOU ON THE ROAD TO MORE PAY, RAPID ADVANCEMENT, REAL JOB SECURITY. HERE'S THE FAMOUS COUPON. MAIL IT NOW!

I WAS TIRED OF WAITING FOR "SOMEDAY." I MADE UP MY MIND TO ACT! I'D GET THE TRAINING I NEEDED...SOMEHOW!
JANE HAD A SUGGESTION...

I CAN'T QUIT MY JOB AND GO BACK TO SCHOOL! AND I SURE DON'T WANT THAT NIGHT CLASS ROUTINE IN THE CITY!

WHY NOT STUDY AT HOME?...THE WAY DAD DID... WITH I.C.S.



JANE SHOWED ME AN I.C.S. ADVERTISEMENT IN POPULAR MECHANICS. THERE WAS THE FAMOUS COUPON. AND THERE WAS EXACTLY THE COURSE I WANTED..

SAY, THEY'LL SEND ME A CAREER KIT FREE... THREE BIG SUCCESS BOOKS.

DAD SAYS HE NEVER WOULD HAVE BEEN MANAGER IF IT WEREN'T FOR I.C.S.



FREE!

I. C. S. CAREER KIT CONSISTING OF...

- 1 "HOW TO SUCCEED" 32-PAGE GOLD MINE
- 2 CAREER CATALOG ... OPPORTUNITIES IN YOUR FIELD.
- 3 SAMPLE LESSON (MATH) SHOWS I.C.S. METHOD.

For Real Job Security—Get an I. C. S. Diploma! I. C. S., Scranton 15, Penna.

Accredited Member, National Home Study Council

INTERNATIONAL CORRESPONDENCE SCHOOLS



BOX 90086J, SCRANTON 15, PENNA.

(In Hawaii, reply P.O. Box 418, Honolulu)

(Partial list of courses)

Without cost or obligation, send me "HOW TO SUCCEED" and the opportunity booklet about the field BEFORE which I have marked X (plus sample lesson):

ARCHITECTURE and BUILDING CONSTRUCTION

- Air Conditioning
- Architecture
- Arch. Drawing and Designing
- Building Contractor
- Building Estimator
- Carpenter Builder
- Carpentry and Millwork
- Heating
- Painting Contractor
- Plumbing
- Reading Arch. Blueprints

ART

- Commercial Art
- Magazine Illus.
- Sign Painting and Design's
- Sketching and Painting

AUTOMOTIVE

- Automobile
- Auto Body Rebuilding and Refinishing
- Auto Engine Tuneup
- Auto Electrical Technician
- Diesel Engines

AVIATION

- Aero-Engineering Technology
- Aviation Engine Mech.
- Reading Aircraft Blueprints

BUSINESS

- Accounting
- Advertising
- Bookkeeping and Cost
- Accounting
- Business Administration
- Business Management
- Clerk Typist
- Creative Salesmanship
- Managing a Small Business
- Professional Secretary
- Public Accounting
- Purchasing Agent
- Real Estate Salesmanship
- Salesmanship
- Salesmanship and Management
- Traffic Management

CHEMICAL

- Analytical Chemistry
- Chemical Engineering
- Chem. Lab. Technician
- General Chemistry

OIL Field Technology

- Pulp and Paper Making

CIVIL ENGINEERING

- Civil Engineering
- Construction Engineering
- Highway Engineering
- Professional Engineer (Civil)
- Reading Struc. Blueprints
- Sanitary Engineer
- Sewage Plant Operator
- Structural Engineering
- Surveying and Mapping
- Water Works Operator

DRAFTING

- Aircraft Drafting
- Architectural Drafting
- Drafting & Machine Design
- Electrical Drafting
- Electrical Engineer Drafting
- Industrial Piping Drafting
- Mechanical Drafting
- Sheet Metal Drafting

ELECTRICAL

- Electrical Appliance Servicing
- Electrical Engineering

Electric Motor Repairman

- Elec. Engr. Technician
- Elec. Light and Power
- Practical Electrician
- Practical Lineman
- Professional Engineer

HIGH SCHOOL

- Good English
- High School Diploma
- High School General
- H. S. College Prep. (Eng'r's & Science)
- High School Math
- High School Science
- Short Story Writing

LEADERSHIP

- Industrial Foremanship
- Industrial Supervision
- Personnel-Labor Relations
- Supervision

MECHANICAL and SHOP

- Diesel Engines
- Gas-Elec. Welding
- Heating and Air Conditioning
- Industrial Engineering
- Industrial Instrumentation

Industrial Safety

- Industrial Safety Practice
- Mechanical Engineering
- Plumbing and Heating
- Professional Engineer
- Quality Control
- Reading Shop Blueprints
- Refrigeration and Air Conditioning
- Tool Design Tool Making

RADIO, TELEVISION

- General Electronics Tech.
- Industrial Electronics
- Practical Radio-TV Eng'r's
- Radio-TV Servicing
- TV Technician

RAILROAD

- General Railroad

STEAM and DIESEL POWER

- Combustion Engineering
- Power Plant Engineer
- Stationary Diesel Engr.
- Stationary Steam Engines

TEXTILE

- General

Name _____ Age _____ Home Address _____
 City _____ Zone _____ State _____ Working Hours _____ A.M. to P.M. _____
 Occupation _____

Canadian residents send coupon to International Correspondence Schools, Canadian, Ltd., Montreal, Canada. . . . Special low monthly tuition rates to members of the U. S. Armed Forces.



Using too much gas?



Time to add GUMOUT..



and SAVE!

Here's a quick and easy way to fix many of the most common engine troubles. Troubles such as stalling, bucking, high gas consumption, hard starting.

Simply add GUMOUT to your gas tank and clean your carburetor while you drive. It's the best known, most reliable carburetor cleaner in America! Your car needs it.

Sold at most Service Stations, and Auto Supply Stores.



GUMOUT Cleveland 4, Ohio

(Continued from page 8)

way—they build kits and get their enjoyment out of viewing the finished product.

I belong to a third group who believes in scratch-and-kit building. I cut up model kits, such as my 1960 Ford F-100 which has had four scale feet chopped from the bed and eight scale inches from the top. This takes time and perfect matching is often harder than building from scratch.

I agree, though, that scratch-built models and kits should not be in the same classes for competition. Possibly there should be three groups, with scratch-builts and radically altered kits in a class together for final competition.

Richmond, B.C., Canada **MIKE TINDALL**

Lightening Lawn Chores

After reading John Linkletter's article on lawn chores (April PM), I decided he was still wasting time. Here's my little time-



saver, on which I mow and sweep at the same time. Why blow that extra 10 minutes?

I keep telling myself (and my wife) that I'm not lazy, just efficient!

Charlotte, N.C. **JOE DOYLE**

Lawn-shaver Linkletter sends congratulations, Joe. He also asks what job your wife thought up for you to do in that extra 10 minutes you saved.

Brooklyn Mayhem

Yes, please publish projects similar to Butch Biven's and George Godfrey's lightweight bicycle powered by a small gasoline engine (July PM, Editor's Desk column). Keep it simple and inexpensive—here in Brooklyn parking is a problem, insurance rates are exorbitant and traffic is mayhem . . .

Brooklyn, N.Y. **WILLIAM FLYNN**

A lot of enthusiastic readers second your motion, Bill, so you can expect to see projects along these lines in future issues of PM. Watch for them.

The Editors

How to build a big-pay future in the Air Conditioning and Refrigeration industry with CTI Home Training Kits

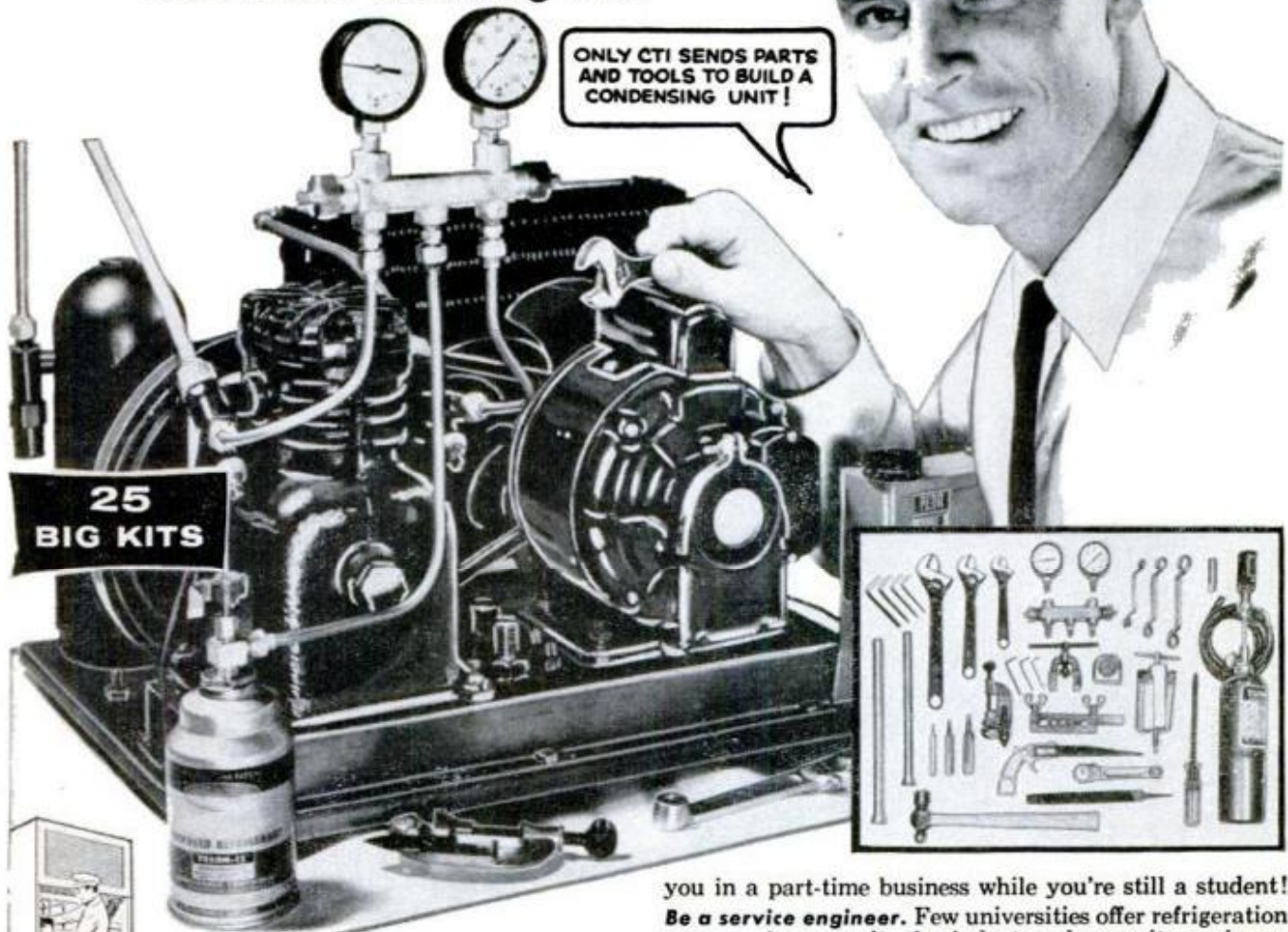

A better job or your own business

The news is spreading fast: America's finest opportunity field is now Air Conditioning and Refrigeration! Today there are over 150 million domestic and industrial units in use. Over 6 million new freezers, refrigerators and air conditioners are manufactured annually. So quickly is the industry expanding that 20,000 service technicians must be trained each year. Yes, air conditioning is a big, uncrowded field where the opportunities are as large as the paychecks!

Learn at home by practicing. It's easy to master this craft. CTI sends you 25 kits of parts and tools to build a heavy-duty, commercial-type, 1/4 h.p. condensing unit (illustrated above). You complete 20 work projects—do 10 trouble-shooting jobs. Then you build an air conditioner, freezer, refrigerator or milk cooler.

Make money as you train. So practical is CTI training that many students earn extra cash fixing and installing. Some make calls on their own; others work for local appliance dealers. CTI training pays its way—actually puts

you in a part-time business while you're still a student!

Be a service engineer. Few universities offer refrigeration courses. As a result, the industry chooses its engineers from technician ranks. If you have above-average ability, you too may get into planning and estimating—the engineering phase of a great business.

Go in business. This is one of the easiest of all fields in which to start small and grow big. You make friends as you make calls, and build a list of potential customers. You also can sign service contracts with food stores, taverns, motels, restaurants, etc. CTI has special information on how to get started.

Write for new catalog. Your opportunities in the air conditioning and refrigeration industry are thoroughly covered in our big new booklet. *Mail coupon for your free copy.* We'll also send a lesson sample so you can see for yourself how easy it is to learn this top-pay, secure craft. Be sure to mail coupon *today.*—Commercial Trades Institute, Chicago 26, Illinois. *A Non-Profit Organization*

FIRST GET THE FACTS—THEN DECIDE
Mail Coupon Today for 2 Free Booklets

COMMERCIAL TRADES INSTITUTE

1400 GREENLEAF AVENUE
CHICAGO 26, ILLINOIS

DEPT. R-983

Send catalog, *Success in Air Conditioning & Refrigeration*, and Lesson Sample. Both FREE.

Name _____ Age _____

Address _____

City _____ Zone _____ State _____

Accredited by National Home Study Council



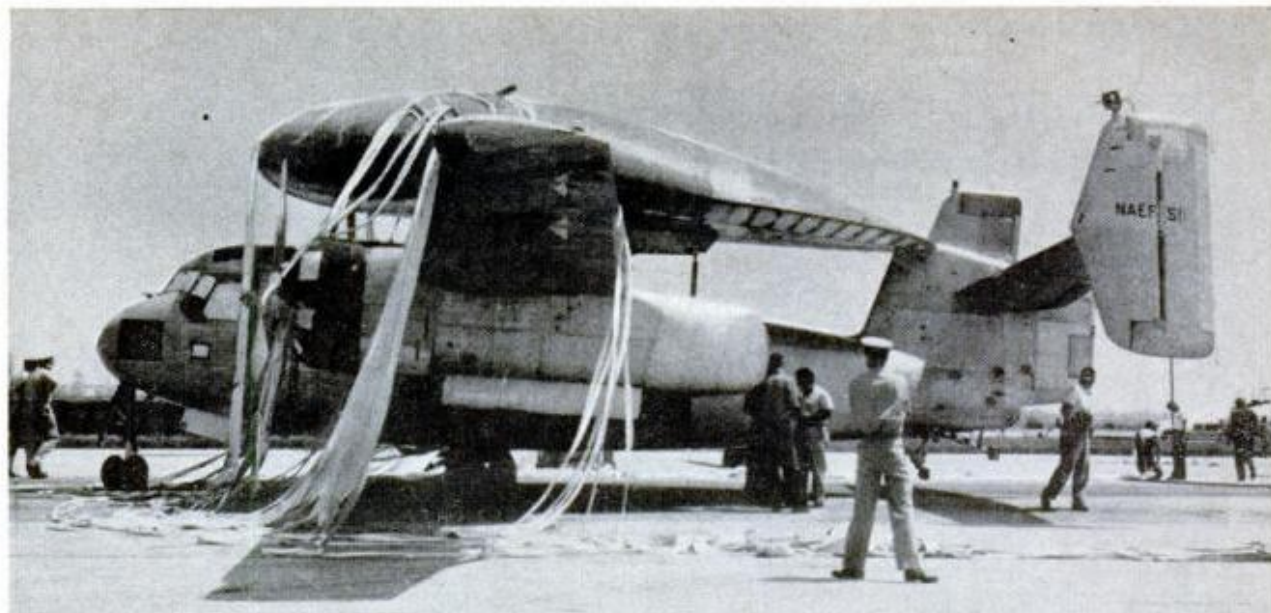

NYLON BARRICADE stops Grumman WF-2 Tracer in tests at Naval air-engineering facility. Purpose was to learn whether the plane, personnel or the radar equipment in the dome would be injured by such a barricade if plane were to land aboard ship. The only noticeable damage: slight dents to metal cowling



What's that in your pipe?

**ONE...TWO...THREE TOBACCOS?
REVELATION GIVES YOU FIVE**

That special flavor in Revelation comes from the harmony of 5 choice tobaccos—blended and processed according to a secret recipe in Richmond, Va. It tastes expensive but costs very little.



Kentucky Burley—dark flakes, slow burning
Virginia Bright—bright leaves, even burning
Old Belt Bright—slightly darker, good body
Latakia—deeper brown, extra mild
Perique—very dark, wonderful aroma

REVELATION

MILD SMOKING MIXTURE

Learn Radio-Television Electronics

by Practicing at Home in Your Spare Time

WITHOUT EXTRA CHARGE NRI provides special kits that bring to life things you study. Makes learning easy, interesting, fast. All equipment yours to keep.

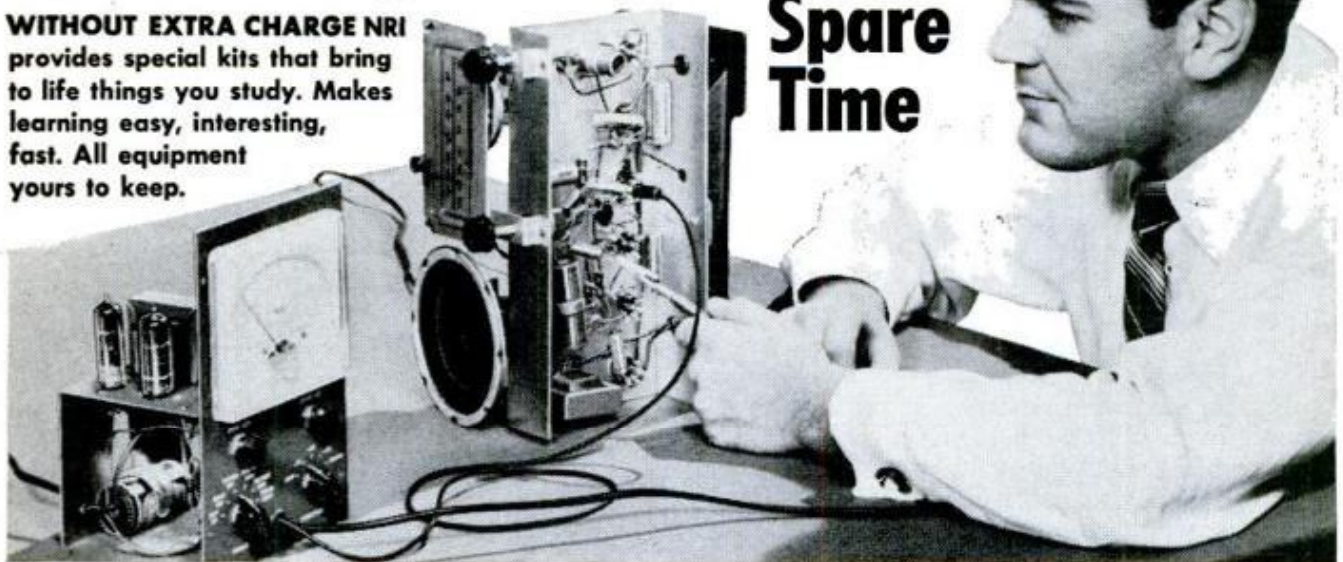

Fast Growth Offers You High Pay, Prestige, Bright Future



From Radio-TV Servicing and Broadcasting to missile launching sites like Cape Canaveral, NRI graduates share in the gigantic Electronics industry. Interesting jobs await you in studios, on ships and planes, in your own business. Mail coupon today for NRI catalog.



Many NRI graduates help build, install, operate and service automated electronic equipment for the new "Space Age" we live in—equipment used in offices, factories, the military. Others have important jobs as inspectors, laboratory technicians, etc., or hold essential civilian posts with the Government and Armed Forces.



J. M. SMITH
President

If you check the classified advertisements in your local newspaper, you will undoubtedly see more job opportunities available for men with Electronics training than for any other field. Hardly without exception, these are better than average jobs, with bright futures . . . jobs for which YOU could qualify through NRI training. Thousands of men like yourself—most of them without a high school diploma—have moved up to good pay and enjoy greater prestige in jobs with TV and Radio broadcasting stations, in industrial plants making Electronic equipment or in businesses of their own where they sell, install and service Radio and TV sets.

Train With The Leader

Join the many NRI graduates now taking advantage of career opportunities in this amazing Electronic Age. For 45 years, NRI has featured the best Radio-TV Electronics training for beginners— for men without previous experience. Throughout the U.S. and Canada, successful NRI graduates are proof that it's practical to train at home, in your spare time, at your own pace. Keep your present job while training. NRI supplies this training at low cost because it is

NRI Trained These Men



I was working in a textile factory trying to make ends meet. Now I own one of the most modern service shops in this section. **ARGIE C. TAYLOR**, Glasgow, Ky.

After graduating I was a shipboard radio operator. Now I am chief engineer at Station WARA.



NRI was a wonderful foundation. **RAYMOND D. ARNOLD**, Attleboro, Mass.

Thanks to NRI I am in a top position with the Federal Aviation Agency in the Navoids Electronic Section. **JOE DUCKWORTH**, Fort Worth, Texas.

Four months after starting your course I left my job in a hardware store to work at Raytheon Manufacturing. Now I am an engineering assistant in Microwave Power Tube Research and Development Laboratory. **LEONARD BLOOM**, Newton Centre, Mass.



the oldest and largest home-study Radio-TV Electronics school. In every respect, you will find the Electronics field a profitable one for the ambitious man. And the NRI "learn-by-doing" method is the most practical way for you to get into this exciting field quickly.

Soon after enrolling we show you how to earn \$10, \$15 and more a week extra fixing sets in your spare time. Mail coupon now. **National Radio Institute**, Washington 16, D. C.

Sample Lesson

and 64-Page

Catalog

FREE

MAIL THIS COUPON NOW



National Radio Institute
Washington 16, D.C. 1JA

Send me full information without cost or obligation. No representative will call. (Please print.)

Name.....Age.....

Address.....

City.....Zone.....State.....

ACCREDITED MEMBER NATIONAL HOME STUDY COUNCIL

SIDELIGHTS FROM THE PENTAGON



By William R. Kreh

Ice-resistant paint is being sought by the Navy. Ice is a hazard for Navy ships operating in Polar regions. It builds up on the superstructures, adding dangerous weight. So the Navy is carrying out extensive tests at the New York Shipyard searching for a substance that can be added to paint that will keep ice from sticking to surfaces it's used on.



A friendly land mine is being used by the Army during maneuvers. Instead of blowing off a tank's track when it's run over, the mine electronically slips the tank's gear into neutral to indicate gently that the driver has goofed.



Underwater radioactivity can be measured by a supersensitive instrument developed by the Navy. It's called DUNC, appropriately (for deep underwater nuclear counting). It's so sensitive that it will detect one lonesome atom of radium in a billion times a billion molecules of water.

Lowered from a ship, the three-foot-long tube sends electrical impulses back up the cable every time it is hit by a radioactive particle, thus instantly giving data that formerly could only be obtained by taking a water sample and analyzing it in a lab.

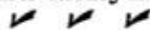

Jungle stripping is secretly being tested by the Army to rid dense forest areas of foliage to expose guerilla fighters or enemy installations. A chemical already has been developed that, when sprayed from the air, causes leaves to fall off plants and trees and denude a forest in less than three days. This isn't fast enough and Army experts are working full-speed to develop a quicker-acting chemical.



Like your eggs boiled *precisely* three minutes? Then you'll be glad to hear about the Naval Radio Station at Balboa, Canal Zone, which is now broadcasting time signals accurate to five parts in 100 billion. The accuracy is kept by comparing the signal with an atomic clock in the Naval Observatory in Washington, D.C. Balboa and another very-low-frequency station in Rugby, England, give the superaccurate time signals practically worldwide coverage.



A Rube Goldberg space capsule has been designed by the Navy. The capsule is to be used to recover small payloads from high

altitude probes and here's what happens when it re-enters the earth's atmosphere:

1) The heat of re-entry on the plastic skin closes a circuit and this blows off the back of the missile. 2) A projectile falls out into the ocean where it explodes to give sound-detection devices an idea of where the capsule is about to land. 3) A parachute pops out from the spot vacated by the projectile. 4) Tiny bits of foil are released with the chute to reflect radar beams. 5) An antenna is pulled out by the main chute and begins broadcasting signals good for as far as 150 miles. 6) When the capsule splashes, the water completes another circuit which causes cutters to close on the parachute lines and free the capsule. 7) The water also dissolves plastic material holding sea dye which spreads along the ocean surface so the capsule can be spotted from the air.

After all that, there's not much excuse for the Navy losing any capsules.



It takes 686 tons of sand to clean a Navy submarine. That's how much is needed to blast clean a typical hull before it can be repainted—and that's enough for a private beach 46 feet wide and 300 feet long.

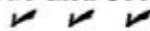

A flying missile launcher is under "serious study" by the Defense Department. The launcher could cruise the skies for two days or more without refueling.

The Pentagon calls the project "Dromedary" because the proposed aircraft could go a long time without a drink of fuel. One official described the concept as one "in which you have an aircraft that takes off, stays up a long time on patrol, on station, and is armed with missiles of the Skybolt or a more advanced type."

Such a plane would undoubtedly use the principle of "boundary layer control," a method of stabilizing air as it passed over the wing and tail surfaces of an aircraft. By controlling this boundary layer, drag would be reduced substantially, thus cutting fuel requirements.



Image intensification, a system for seeing in the dark, has been unveiled by the Army Corps of Engineers. In a night exercise recently at Fort Eustis, Va., observers were completely in the dark as hundreds of troops and scores of assault craft stormed the beaches right in front of them. With the flick of a switch, however, night was turned into day. Three special television cameras brought the entire scene into sharp focus.

The new TV cameras use ultrasensitive pickup tubes which amplify dim star light about 100,000 times. No infrared or other artificial light source is needed and because of this, the system cannot be detected.

PM REPORTS



DEATH ON BUGS

TIRED OF sharing your barbecue, patio, or outdoor play area with mosquitos, flies and sundry other bothersome insects? Then you will be happy that someone finally has gotten around to invent and market an inexpensive insecticide dispenser that is really effective. Called "Insect Fogger," the product shown is a compact electrically-driven unit that converts ordinary insecticide into thick clouds of fog which quickly envelope everything in a large area, killing most insects on contact. With the barrel removed, it can be used for applying water-base mothproofers, garden sprays, weed killers and similar liquids.

A self-priming motor-driven pump forces insecticide through an atomizing nozzle located in a heated, insulated chamber. Upon entering the latter, the atomized liquid vaporizes into a thick fog which shoots from the barrel as pictured above. Fogging is started and stopped by a trigger switch on the handle. A knob on the housing adjusts insecticide rate of flow. The unit becomes operational 6 min. after it is plugged into a 110-v. outlet. While sprayed areas may be occupied immediately, insect repelling effects remain for hours. The unit retails for about \$40 from Burgess Vibrocrafters, Inc., Grayslake, Ill.

SCIENCE BARGAINS

'FISH' WITH A MAGNET

Go Treasure Hunting On The Bottom

Great idea! Fascinating fun and sometimes tremendously profitable! Tie a line to our 5-lb. Magnet—drop it overboard in bay, river, lake or ocean. Troll it along the bottom—your "treasure" haul can be out-board motors, anchors, fishing tackle, all kinds of metal valuables. 5-lb. Magnet is war surplus—Alnico V Type—a terrific bargain. Lifts over 125 lbs. on land—much greater weights under water. Order now and try this new sport.



Stock No. 70,183-H. 5-lb. Magnet. \$9.95 Postpaid

MINIATURE WATER PUMP



Wonderful for experiments, miniature waterfalls, fountains, Christmas gardens, HO gage railroad backdrops, etc. Tiny (2 5/8" x 1 3/4") electric motor and pump ideal for hobbyists, labs, schools. Pumps continuous flow of water at rate of one pint per minute at a 12" head. With 2 D Batteries in series will pump to 24" high. Works in either direction. Stock No. 50,345-H. \$2.25 Postpaid

See the Stars, Moon, Planets Close Up!

3" ASTRONOMICAL REFLECTING TELESCOPE

60 to 180 Power—Famous Mt. Palomar Type! An Unusual Buy!



See the Rings of Saturn, the fascinating planet Mars, huge craters on the Moon. Equatorial Mount with lock on both axes. Aluminum and overcoated 3" diameter high-speed f/10 mirror. Telescope comes equipped with a 60X eyepiece and a mounted Barlow Lens. Optical Finder Telescope included. Hardwood, portable tripod. FREE with Scope: Valuable STAR CHART plus 272-page "HANDBOOK OF HEAVENS" plus "HOW TO USE YOUR TELESCOPE" BOOK.

Stock No. 85,050-H. \$29.95 Postpaid

WOODEN SOLID PUZZLES



12 Different puzzles that will stimulate your ability to think and reason. Here is a fascinating assortment of wood puzzles that will provide hours of pleasure. Twelve different puzzles, animals and geometric forms to take apart and reassemble, give a chance for all the family, young or old, to test skill, patience, and, best of all to stimulate ability to think and reason while having lots of fun. Order yours now.

Stock No. 70,205-H. \$3.00 Postpaid

War Surplus American-Made 7x50 Binoculars

Big savings! Brand new! Crystal clear viewing—7 power. Every optical element is coated. An excellent night glass—the size recommended for satellite viewing. Individual eye focus. Exit pupil 7mm. Approx. field at 1,000 yds. is 376 ft. Carrying case included. American 7 x 50's normally cost \$195. Our war surplus price saves you real money.



Stock No. 1533-H. only \$55.00 pstpd. (Tax included)

6 x 30 Binoculars—similar to above and a terrific bargain. Stock No. 963-H. \$33.00 pstpd. (Tax included)

OPAQUE PROJECTOR



Projects illustrations up to 3" x 3 1/2" and enlarges them to 35" x 30" if screen is 6 1/2 ft. from projector; larger pictures if screen is further away. No film or negatives needed. Projects charts, diagrams, pictures, photos, lettering in full color or black-and-white. Operates on 115 volt, A.C. current. 6-ft. extension cord and plug included. Operates on 60 watt bulb, not included. Size 12" x 8" x 4 1/2" wide. Weight 1 lb., 2 oz. Plastic case with built-in handle.

Stock No. 70,199-H. \$7.95 postpaid

BUILD A SOLAR ENERGY FURNACE



A fascinating new field. Build your own Solar Furnace for experimentation—many practical uses. Easy! Inexpensive! Use scrapwood! We furnish instructions. This sun powered furnace will generate terrific heat—2000° to 3000°. Fuses enamel to metal. Sets paper aflame in seconds. Use our Fresnel Lens—14" diameter . . . f.1. 14".

Stock No. 70,130-H. Fresnel Lens \$6.00 Postpd.

Order by Stock No.—Send Check or M.O.—Money-Back Guarantee
EDMUND SCIENTIFIC CO., Barrington, New Jersey

MAIL COUPON for FREE CATALOG "H"

144 Pages! Over 1000 Bargains!

EDMUND SCIENTIFIC CO., Barrington, N. J.

Please rush Free Giant Catalog-H.

Name.

Address.

City. Zone. State.



BULLETINS FROM THE WORLD OF SCIENCE

Disasterproof messages can be sent across the U.S. by a new underground communications system in the event of a war or the destruction of communication towers—as recently occurred in Nevada.

Under development, it calls for low-frequency radio signals to be shot through a dense rock mass underlying the nation. Signals would be picked up by mile-long antennas dropped into holes 50 miles apart. The overlying rocks prevent the messages from being intercepted or jammed.

Ocean levels have dropped 1500 feet in the last 20,000,000 years, and they are still dropping. The reason? According to Dr. John Weaver, of the University of Puerto Rico's Institute of Caribbean Studies, the Earth is continually expanding and rifts are opening in the ocean floors. Billions of gallons of water simply fall into these trenches.

While Weaver noted that a rift zone near Iceland is now widening about 20 feet a mile every 1000 years, he makes no prediction as to when it might be possible to hike—rather than to sail or fly—from New York to London.

Pink toothbrush is the coming thing for kids. Dr. Quinton Williams, U. of Texas, has started children to swishing a red dye (erythrosin) in their mouths before they brush their teeth. The dye turns red on spots where bacteria has collected. Using a mirror, the child sees where to brush, and just how effective are his up-and-down and side-to-side strokes.

You may soon be eating wood. The American Viscose Corp. has developed a filling food product from wood fibers. A purified form of cellulose, the product has no calories. It can be used to give body bulk, opacity, texture and palatability (so says the corporation) to many foods, particularly those for people who are dieting.

An official of the firm says they'll probably be using more wood for food than for rayon within the next few years. The U.S. Food and Drug Administration has already said it is safe for human consumption.

James Biery

SAVE AS MUCH AS 80% ON POWER TOOLS

GUARANTEED TO DO THE WORK OF \$40, \$60, \$80 UNITS

- SAVE! BUY DIRECT FROM FACTORY
- PROFESSIONAL QUALITY, LIFETIME ENGINEERED
- UNCONDITIONAL 10-YEAR GUARANTEE

REVOLUTIONARY PATENTS DECREASE COSTS, INCREASE EFFICIENCY. Top quality full scale power tools of heavy duty 100% cast iron and steel. Streamlined design features such as perforations on table tops reduce weight, cut material costs, cut polishing and grinding time—reduce production costs. Special patents provide added efficiency, accuracy, savings. Nothing left out but exp've gingerbread. Parts made, assembled, tested and packed in our own factories, shipped direct to you. No retail store handling or profits to add to your cost.

\$995

Wt. 25 lbs.
Exp. Coll.



**8" TILT
ARBOR
POWER
SAW**

Complete as shown, less blade. Incl. precision mitre gauge, ground cast iron table. If desired, RIP FENCE for easier work alignment, \$3.50 add'l.

DOES THE WORK OF \$50 BENCH SAWS!

CROSS-CUTS, RIPS, BEVELS, MITRES, DADOES, CUTS COMPOUND ANGLES. Patented motor mount takes any standard 1/4 to 1/2 h.p. motor... keeps belt tight, assures perfect alignment at any angle, transmits full power. Table stays level—blade tilts, locks securely at any angle to 50°, raises, lowers 0°-2 1/4". Patented tilt mechanism has accurate etched scale. Takes standard blade, saw insert removes easily for insertion of any STANDARD dadoe heads, cutters, etc. Accessories, table extensions, when wanted, at factory prices. Versatile, rugged performance proven by almost a half-million users.

UNCONDITIONAL 10 YEAR GUARANTEE

DOES THE WORK OF \$60 UNITS

Now, at little more than a hand tool price, a guaranteed professional quality precision machine which does same work as skilled hand planing... much faster, more accurately. Make accurate glue joints; rabbeting cuts for doors, window frames, table drawers; square taper cuts for chair legs; extremely accurate beveling. Helps amateurs produce quality work—with the sweat eliminated.

TOP QUALITY FEATURES SPEAK FOR THEMSELVES

- Precision ground cast iron tables, adjustable for depth of cut
- Rigid cast iron base
- New patent-pending design holds clearance between knives and tables at any depth
- Rabbet depth 3/8"
- Hardened, ground high speed steel knives
- Patent-pending fence adjustable to any position, any angle 0°-50°
- Patent pending lift-off guard (nothing to loosen!)
- Balanced steel cutter head. UNCONDITIONAL 10-YEAR GUARANTEE.



FULL 22" LONG, 4 1/8"
JOINTER-PLANER

NOW
\$1995

Complete as shown

100% precision ground cast iron and steel. Wt. 18 lbs. Exp. Coll

NEW! HIGH SPEED 5-IN-1 SAW

CUTS THRU 2 x 4's IN 5 SECONDS! New machine revolutionizing home workshop! Cuts circles, curves, straight lines, any angle 0°-45°. Tilt arbor bench, 5-IN-1 saw does most work of band saw, circular saw, jig saw and sabre saw... with all their desirable features, none of their shortcomings... and at less than half the price. There's nothing else like it! Comes with ground cast iron table top, HEAVY DUTY 6000 RPM UNIVERSAL MOTOR. Unique "hand saw" blade action clears teeth on each up-stroke, eliminates lift-up of work. UNCONDITIONAL GUARANTEE.

\$2995 MOTOR INCLUDED
Wt. 18 lbs. Exp. Coll.



**6" SWING
3-FT. LATHE**

\$985



DOES THE WORK OF \$40 UNITS—This sturdy all cast iron power tool will turn wood or plastics with the precision and speed of machines selling for 4 times as much. Has tubular steel bed, ball thrust cup center, spur center. T-Rest assembly, lever action tail stock. 2 speed pulley. Fits any motor. Perfect for the home or professional workshop, garage or farm. UNCONDITIONAL 10 YEAR GUARANTEE.

Complete as shown
Wt. 16 lbs. Exp. Coll.

BENCH DRILL PRESS

DRILLS TO CENTER OF 10" CIRCLE — Rugged, dependable... all cast iron and steel. Table to 1/2" handtight chuck; max. 1 1/2". Spindle has combination ball and bronze bearings. Adjustable stop for repetitive drilling. Precision ground cast iron table. Table assembly fully adjustable on column. UNCONDITIONAL 10 YEAR GUARANTEE.

\$1995 Less Belt
Wt. 32 lbs.
Exp. Coll.



MAIL COUPON TODAY!

American Machine & Tool Co., Dept. PM-91, Royersford, Pa. Send 8" Saw at \$9.95. Incl. Rip Fence at \$3.50 (both for \$13.45). Send Jointer-Planer at \$19.95. Send 5-IN-1 Saw at \$29.95. Send Lathe at \$9.85. Send Drill Press at \$19.95. Payment in full enclosed \$..... or \$3 dep. ea. item enclosed, balance C.O.D. I MUST BE FULLY SATISFIED OR WILL RETURN WITHIN 10 DAYS FOR FULL REFUND, no questions asked.

NAME.....

ADDRESS.....

CITY..... ZONE..... STATE.....

(please print)

10 DAY MONEY BACK GUARANTEE
You must be satisfied or money refunded, no questions asked.

AMERICAN MACHINE & TOOL COMPANY
Dept. PM-91, Royersford, Pa.

FREE!

TRIAL LESSON

Trial lesson in DRAFTING

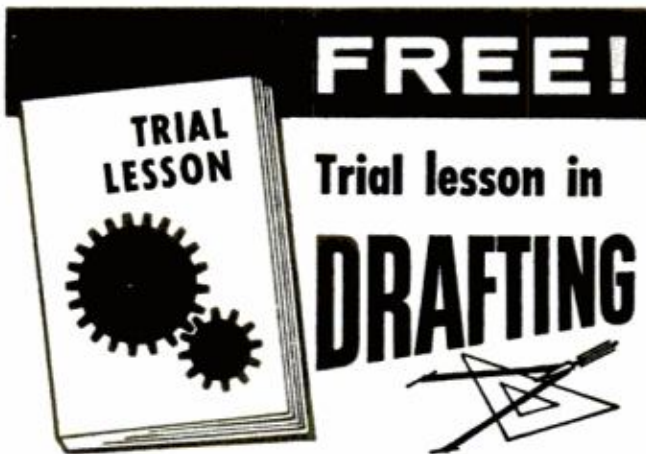

LEARN AT HOME IN SPARE TIME

Check the want ads in any newspaper — SEE the big-pay opportunities open to you as a draftsman. What's more, you can learn this well-paid, prestige profession at home — quickly, easily! No special talent needed! Get complete, step-by-step Chicago Tech lessons in the mail, spend a few pleasant hours studying each week. In a short time you'll be a well-trained draftsman, ready to take your pick of many good jobs. Act now!

FREE INFORMATION—MAIL COUPON TODAY!

Get **FREE TRIAL LESSON** plus information about C.T.C. practical training. Learn what successful Chicago Tech graduates say about high pay and opportunities in drafting. No charge, or obligation.

Accredited National Home Study Council

CHICAGO TECHNICAL COLLEGE

M-219 Tech. Bldg., 2000 So. Michigan Ave.
Chicago 16, Illinois

Mail me **FREE** Lesson with information about big opportunities in **DRAFTING**.

Name..... Age.....
Address.....
City..... Zone..... State.....

811

WANT TO BE A LOCAL Brikcrete* MANUFACTURER?

*Guaranteed to Contain No Clay

High income can be earned operating a Brikcrete plant, because Brikcrete — world's most modern masonry — gives more value for less cost to building owners without sacrifice of profits. Huge savings by local production makes possible low prices and high income potentials.

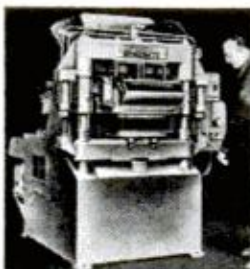

Choice Territories Open

Broad markets are waiting because Brikcrete is popular for every type of residential, commercial and industrial construction. Ultra modern in design, size, proportion. Cost less than lumber. Wide color range. Combines all the features that make for large consumer acceptance. More local plants are needed. Exclusive privileges in franchise-protected territories. Mark-up averages 100% on basic cost. Machine available on long-term payments. Write for Brikcrete Book No. 2 and tentative reservation of territory.

Brikcrete Associates, Inc., 402 W. 25th, Holland, Mich.

SIDELIGHTS ON AVIATION



Gooney Birds never die, and apparently they aren't about to fade away either.

The old DC-3, originally designed and built in 1935, is not only still flying but still outnumbers any other aircraft in the air. The International Civil Aviation Organization, an agency of the United Nations, announced there were 1926 Gooney Birds in service around the world, more than the total number of all the new turbojets and turboprops, plus a few piston-engines.

The figures justify the DC-3's selection as one of the 12 most significant aircraft of all time (PM, June, 1961).

All-time best sellers among aviation publications include three government booklets first put out about 15 years ago.

They are "Facts of Flight," on the fundamentals of aircraft operation (286,298 copies sold); "Path of Flight," on navigation (485,599 copies); and "Realm of Flight," on flying weather (455,096 copies).

Facts, which sells at 50 cents, Path, 65 cents, and Realm, 75 cents, are available from Superintendent of Documents, U.S. Government Printing Office, Washington 25, D.C.

Coast-to-coast flights in five hours are now routine. It was just 50 years ago this month that the first one began—and it was not completed until three months later.

Calbraith Perry Rodgers, flying a Wright Brother's pusher nicknamed the "Vin Fiz" (after a soft drink marketed by the sponsor of the flight), followed railroad tracks through most of his 4300-mile trail-blazer. In 1911 there were no air markers, no beacons, no radio beams, no weather forecasts, no airway maps, few highways and no airports. His only instrument was a piece of string fastened to a brace which told him whether the plane was climbing, diving or drifting. He landed where he could.

Rodgers made 69 landings, 15 of them severe crackups. The plane was repaired so often en route, the only original parts to survive were the rudder and one strut.

An engine cylinder exploded once embedding splinters of steel in his arm. In a crackup at Compton, Calif., his ankle was broken. When the plane was repaired, he hobbled to it on crutches and flew on to Long Beach on Dec. 10, taxiing into the surf to complete history's first coast-to-coast flight, an epic of perseverance.

Kevin V. Brown

POPULAR MECHANICS



LET RCA TRAIN YOU IN ELECTRONICS

RCA Institutes, one of the world's leading electronic technical schools, offers Home Study Courses in . . .

RADIO, TV, TRANSISTORS, AUTOMATION

. . . Now you have five comprehensive courses for your electronic training. Practical work with the very first lesson. With the new Voluntary Tuition Plan, you pay for each study group only when you order it. If you interrupt the course at any time, for any reason, you don't pay until you resume the course.

Even if you have not completed high school, you can begin your electronic career training at RCA Institutes. Choose from any of these courses. .

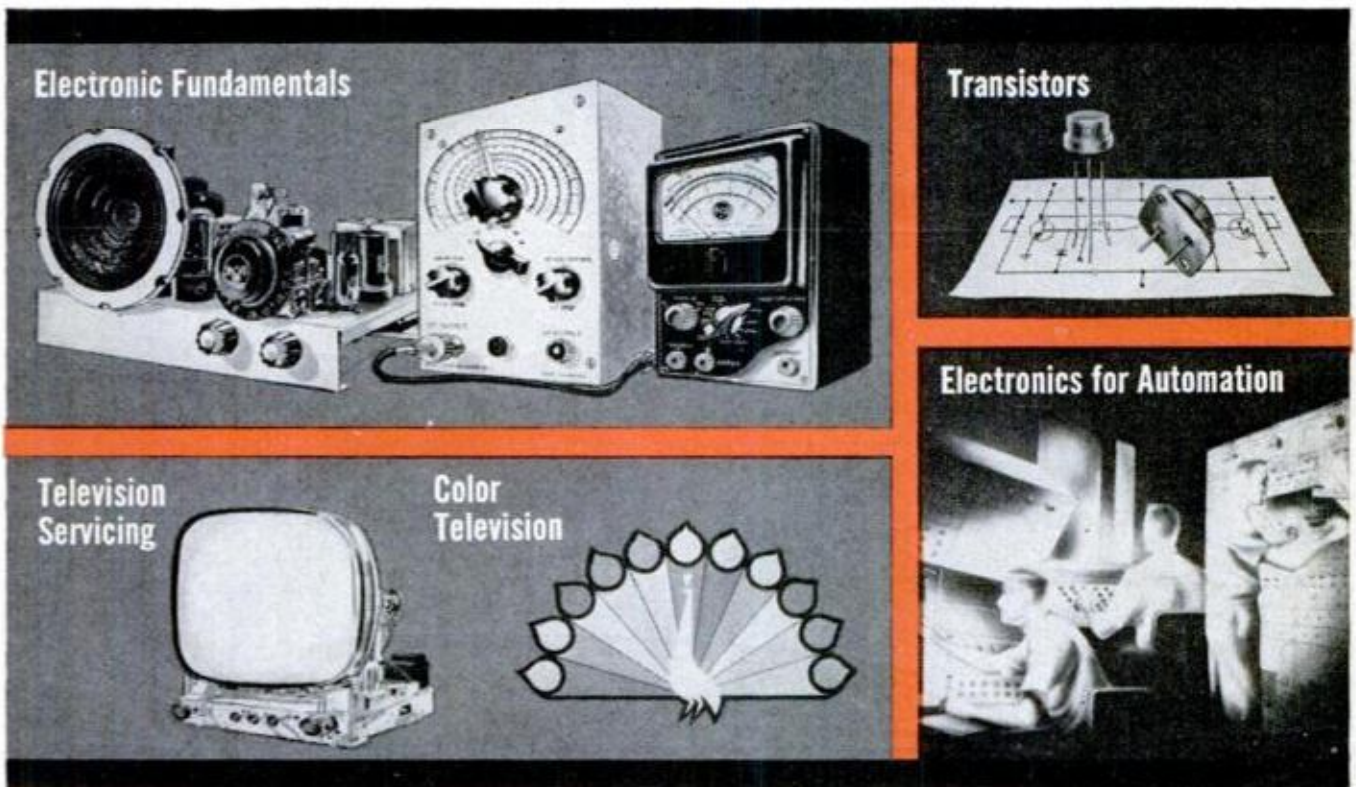

Send for our
64 page Home
Study Catalog

FREE!

RESIDENT SCHOOLS in New York City and Los Angeles offer Technical Institute and Vocational School Courses in Electronics. Day and Evening classes start 4 times each year. Resident School Catalog sent free on request.



RCA INSTITUTES, Inc. Home Study School, Dept. PM-91

A Service of Radio Corporation of America

350 West Fourth Street, New York 14, N. Y.

Please rush me your FREE illustrated 64-page book "Your Career in Electronics," describing your home training programs. No obligation. No salesman will call.

Name Age

Address

City Zone State

Veterans: Enter discharge date

CANADIANS — Take advantage of these same RCA courses at no additional cost. No postage, no customs, no delay. Send coupon to: RCA Victor Company, Ltd., 5581 Royalmount Ave., Montreal 9, Quebec. To save time, paste coupon on postcard.

Stewart-Warner Electric Tachometers *GIVE YOU BETTER ENGINE PROTECTION!*

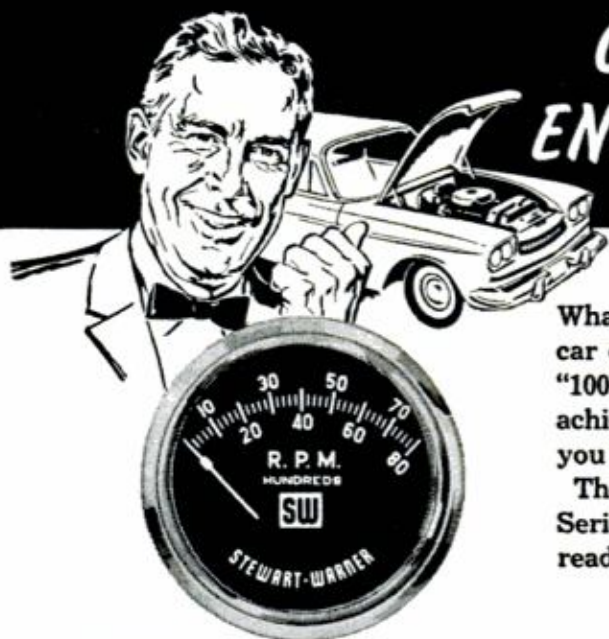

Whatever kind of car you drive—compact, sports car or even the family car—a Stewart-Warner “100” Series Electric Tachometer will help you achieve the engine protection and performance you should have for safe, economical driving.

The precision-engineered Stewart-Warner “100” Series Tachometers give accurate, flutter-free readings at every speed. Available for all distributor ignition engines of 4, 6 or 8 cylinders; 6 and 12 volt systems; and with dials to 5,000, 6,000 or 8,000 RPM. For top-of-dash, through-dash or steering-post mounting.



Dept. C-91, 1840 Diversey Parkway, Chicago 14, Ill.

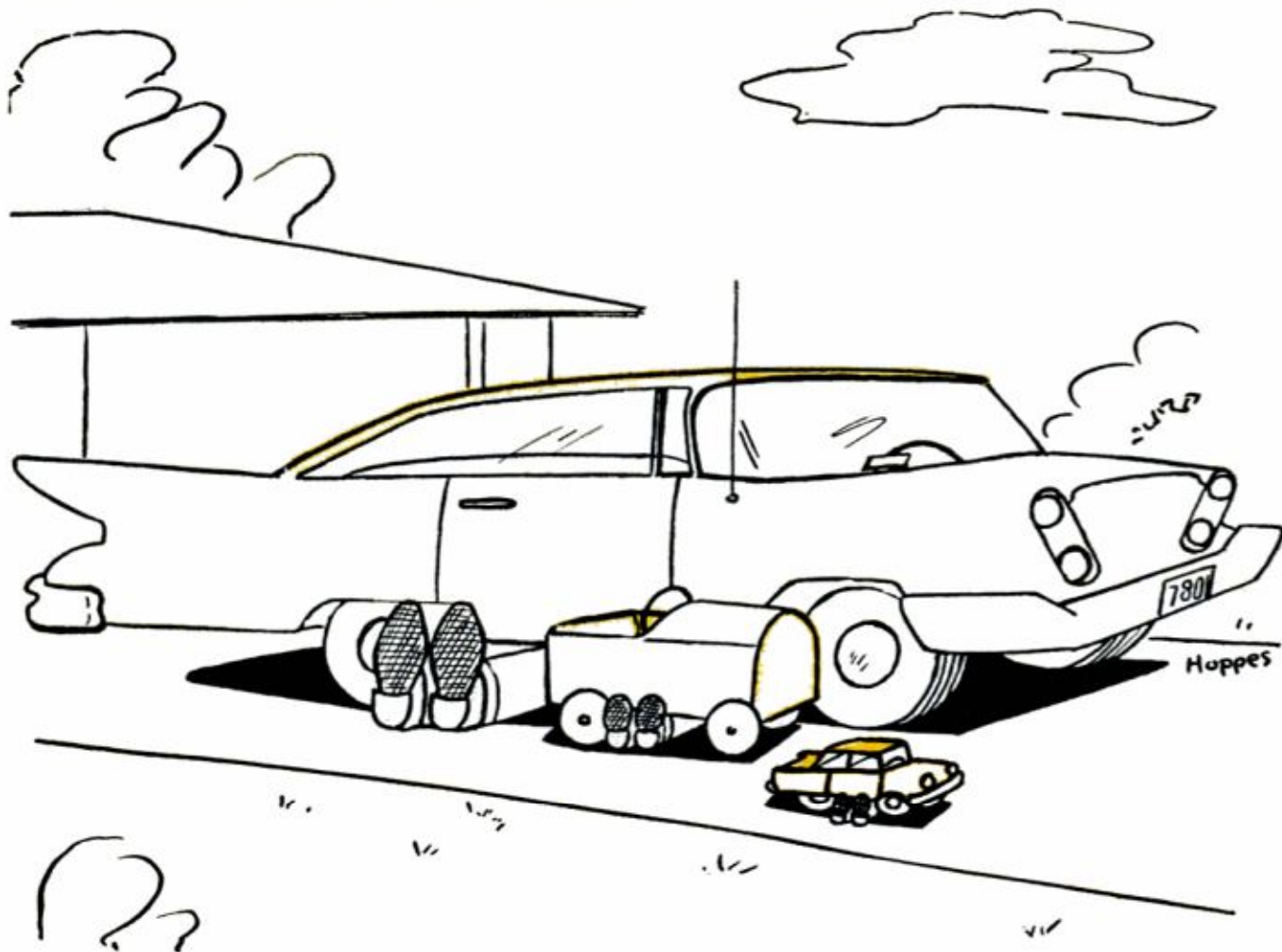

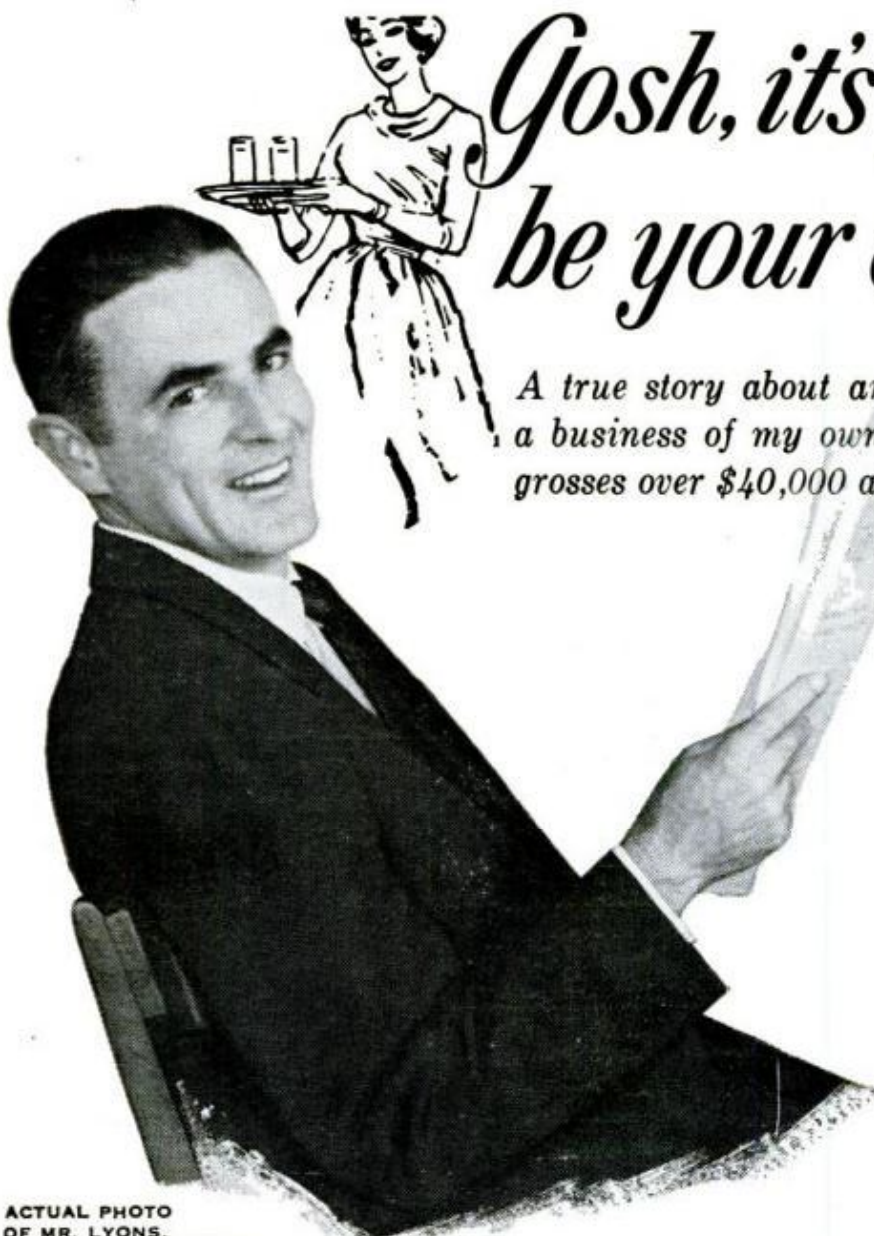

Gosh, it's good to be your own boss!

A true story about an ad that got me started in a business of my own three years ago—that now grosses over \$40,000 annually!

ACTUAL PHOTO OF MR. LYONS. ADDRESS ON REQUEST.

by Michael J. Lyons

It sure is a wonderful feeling to be your own boss and know the sky's the limit if you're willing to get in and pitch. I know, for I've been on both sides of the fence.

I'd been watching for just the right thing when I spotted an ad offering a Duraclean rug and upholstery cleaning dealership.

Now, just three years since I saw that ad, I have my own \$40,000-a-year business.

I investigated the company and found it to be a top level firm respected in the field since 1930.

Unlimited Market Potential

I found that the money-making pos-

sibilities in this field are endless. The Duraclean process itself—its safety and efficiency—told me that here was the right combination to make it BIG.

Easy to Start—Training Free

It's easy to get started with Duraclean. Everything is provided—and a complete training course helps you build your new business.

You don't need a shop since cleaning is done in the customer's home or place of business. And with wall-to-wall carpet so popular, "on location" cleaning is really a *must!*

Easy to Get and Keep Customers

Your success in this field is charted with a tested sales program set up by the company. First, it teaches you how to *get* customers. And when we get customers, we *keep* them because of Duraclean's fine advantages. Folks rave most over our no-scrubbing, no-soaking features which mean rapid drying and no-shrinking or texture distortion.

6 Ways to Make More Money

Money-making opportunities are not only in cleaning. You have 5 other services: soil retarding; moth-proofing; spot removal; minor carpet repair; flameproofing . . . and 15 home care products to sell, at a nice profit.

Security a Grand Feeling

As I start my fourth year as a Duraclean dealer, I have a profitable repeat business—satisfied customers who keep coming back for more!

If you're looking for this kind of opportunity, write Duraclean, as I did. They'll send you the facts free. No one will call on you until you *ask* for personal advice. Just fill in the coupon—this may be *your* big chance, too!

Backed by 3 famous awards

Mail coupon today for free booklets!

DURACLEAN COMPANY
 1-169 Duraclean Bldg., Deerfield, Ill.
 Please rush FREE booklets which detail how I may own my own business. I understand I am under no obligation and no salesman will call.

Name.....
 Address.....
 City.....State.....



**YOU
can
acquire**

**LAW AT HOME!
EARN LL. B. DEGREE**

LaSalle's famous Law Library—used as reference in many Law libraries and Law offices—has enabled thousands to master Law surprisingly fast, in spare hours at home, for business and professional advancement.

These 14 remarkable volumes, compiled by leading professors and lawyers, cover the whole basic field of Law in condensed, orderly, simplified manner.

You advance rapidly with this great library, plus special lectures furnished. We guide you step-by-step with personalized Problem Method of instruction...you learn by doing—handling legal problems—not by memorizing rules.

Send for two FREE booklets, "Law Training for Leadership," and "Evidence," answering questions about Law and its value to you. Mail coupon below. No obligation.

Accredited member, National Home Study Council

**LA SALLE EXTENSION UNIVERSITY
A Correspondence Institution**

417 S. Dearborn St. Dept. 964L Chicago 5, Ill.

Send me your two FREE booklets described above, without obligation.

Name Age
Street
City, Zone & State

**LEARN TO EARN
HIGH WAGES
AS A HEAVY EQUIPMENT
OPERATOR OR MECHANIC**



- **WORLD'S ONLY CONTRACTOR OWNED AND OPERATED SCHOOL**
 - **MODERN EQUIPMENT, HIGHLY QUALIFIED INSTRUCTORS**
 - **V.A. APPROVED FOR GI TRAINING**

Learn to operate bulldozers, draglines, cranes, back hoes, scrapers and motor graders
ON ACTUAL CONSTRUCTION PROJECTS!

Learn by doing . . . no impractical correspondence courses.

WESTERN SCHOOL OF HEAVY EQUIPMENT OPERATION

WRITE TODAY FOR FREE SCHOOL CATALOG



DEPT. B-15, BOX 510
WEISER, IDAHO
PHONE 910

Member American Road Builders Association
Associate Member Associated General Contractors

**TUNE IN ON
THE INVENTORS**



SEPTEMBER is housing month at PM, and here are a few recent patents awarded in that field:

A paint bucket for rollers which eliminates the roller pan won patent No. 2,988,767 for Arthur Tretwold and Willis Marshall, of Bellingham, Wash. Like so many good inventions, it's a simple improvement—an ordinary-looking paint bucket except that one side is flat and ribbed to make a rolling surface. You dip the roller in the paint in the bottom of the bucket, roll it out on the flat side, and you're ready to paint.

A home dry cleaning machine won patent No. 2,987,902 for Jack Mack, of Scottsbluff, Neb. The unit, which is an attachment for an electrically-controlled, automatic-cycling home washer, uses the washer's tub and control mechanism to supply dry cleaning fluid instead of water. It cleans, rinses and dries fabrics just like the big commercial automatic machines.

Combining an air supply and exhaust system with a fluorescent lighting fixture won patent No. 2,985,090 for Murray L. Quin, of Overland, Mo., for Day-Brite Lighting of St. Louis. Mr. Quin's system puts V-shaped, perforated ducts between the lights to circulate air through the home—or office. An air duct and exhaust system is connected to the fixtures; some feed fresh air while others exhaust stale air. As a bonus, the system maintains a constant temperature around the fluorescent lights for maximum lighting efficiency at all times.

The "scrubbing bar," a bar of soap with bristles embedded, won patent No. 2,979,748 for Guy Beatty, of Bakersfield, Calif. His soap bar contains bristles that are scored at short intervals. As the soap wears down, the bristles break off at the scored spots, maintaining a scrub-brush surface as long as the soap lasts.



It has nothing to do with housing, but the most interesting patent this month is No. 2,986,812, awarded to William Arter and Robert Clothier. They've designed a combination fishing lure and beverage can opener. It may be the ultimate in fishermen's conveniences.

Copies of the original patents may be ordered for 25 cents each from the Commissioner of Patents, Dept. of Commerce, Washington 25, D. C.

WHAT ALL AUTO MECHANICS WANT TO KNOW

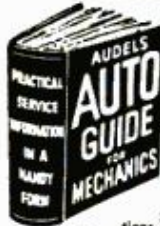

This Big Practical Book gives full information, with working diagrams, covering the principles, construction, ignition, service and repair of modern cars, trucks and buses.

Air Conditioners, Hydromatic & Fluid Drives Fully Explained.

A complete guide of 1132 Pages, with over 1000 Illustrations showing inside views of working parts, with instructions for service jobs. Completely up-to-the-minute! Priced at only \$6.

CIRCLE No. 1 IN COUPON

HOW TO FIX HOME APPLIANCES

REFRIGERATORS WASHERS TOASTERS DRYERS IRONERS RANGES VACUUMS FREEZERS

Masterly other GAS AND ELECTRIC APPLIANCES Handy Reference for Electric & Gas Servicemen, Mechanics, Dealers and Home-owners. Explains clearly and simply how to locate troubles, how to test, reassemble and connect Wiring diagrams. 1000 Facts. Easy to read. Answers ALL your questions. 864 Pages. Illustrated. Only \$6.

CIRCLE No. 2 IN COUPON



TV TELLS HOW TO ANSWER RADIO RADIO TV QUESTIONS SERVICE LIBRARY

HERE IS LATE INFORMATION IN A HANDY FORM FOR RADIO AND TELEVISION REPAIRMEN, SERVICEMEN AND STUDENTS

TWO COMPLETE VOLUMES - 1558 Pages - 1085 Illustrations and Diagrams. 1001 Important Facts and Figures on Modern T.V., Rad o. Electronic Devices. INCLUDES TRANSISTORS & Transistor Circuits, Rectifiers, Record Changers, P.A. Systems, Phonograph Pick-ups, F.M., Auto Radio, Short Wave.

Basic principles, Construction, Installation, Operation, Shooting. How to get Sharp, Clear T.V. Pictures, Install Aerials. How to Test, Explain, COLOR SYSTEMS, Methods of Conversion, Terms, etc. Includes Ultra High Frequency. Quick ready reference or use as a home study course. Only \$8 for BOTH volumes.

CIRCLE No. 3 IN COUPON

OIL BURNERS

New, complete, explaining in detail both domestic and industrial oil burners. Includes electrical hook-ups and wiring diagrams. Fully covering the theory, construction, installation, operation, testing, servicing and repair of all equipment. Indexed for ready reference. Over 416 Pages. 320 Illustrations and Diagrams. Only \$2.50

CIRCLE No. 28 IN COUPON

ALL TYPES OF BLUEPRINT READING

How to read scales, the standard symbols, detail and assembly prints, working drawings, short cuts, hints and suggestions. THE MAN WHO CAN READ BLUEPRINTS IS IN LINE FOR A BETTER JOB. This book gives you the secret language, step by step in easy stages. 448 Pages. Very Fully Illustrated. Priced at \$3.

CIRCLE No. 25 IN COUPON

PLUMBERS AND STEAMFITTERS GUIDES

Practical Trade Assistant & Reference Set. Explains in plain language and by clear illustrations, diagrams, charts, graphs and pictures the principles of modern plumbing practice including Pipe Fitting and Air Conditioning. 4 Vols. - 2624 Pages - 3642 Diagrams & Illustrations. Only \$9 for the complete set of 4 vols. Sold individually \$2.50 each.

CIRCLE No. 6 IN COUPON

7-DAY FREE EXAMINATION

SEND NO MONEY - Pay the postman nothing! We are glad to send you any of the Audel Guides for absolutely FREE examination in your own home. We take all the risks and leave all the decisions up to YOU. There is no obligation! If you decide to keep the books of your choice you may pay for them under our astounding easy-pay plan of only \$2 a month.

HERE IS ALL YOU DO

IT'S EASY TO ORDER: In the No-Risk Mail Order Coupon at the right just draw a circle around the number of Audel Guides you want us to send you for FREE EXAMINATION. We will send them to you at once to help you build a brighter future by increasing your SKILL. If for any reason at all you are not COMPLETELY satisfied, return the books to us, and that will end the matter! NO STRINGS OR CATCHES TO THIS OFFER.

THEO. AUDEL & CO.
49 West 23rd Street, New York 10, N.Y.

CARPENTERS AND BUILDERS GUIDES



PRACTICAL STOREHOUSE OF MODERN CONSTRUCTION INFORMATION (4 vol. set) for carpenters and all woodworkers. Explains in easy language and by profuse illustration principles, advances, short cuts, trade secrets, all based on the NEWEST information. Vol. 1-Tools, steel square, saw filing, joinery, furniture, etc.; Vol. 2-Builders' mathematics, drawing plans, specifications, estimates, etc.; Vol. 3-House and roof framing, laying out, foundations, etc.; Vol. 4-Doors, windows, stair building, millwork, painting, etc. 4 vols. 1904 Pages. 3700 Illustrations. Whole set only \$9. CIRCLE No. 8 IN COUPON

Sold individually \$2.50 each.

PRACTICAL ELECTRICITY

A COMPLETE HANDBOOK-Quick, simplified, ready reference. Complete instruction and practical information on the rules and laws of electricity-Maintenance of Machinery - A.C. and D.C. Motors - Armatures - Wiring Diagrams - House Lighting - Power Wiring - Meters - Batteries - Transformers - etc. Simple to understand. 1052 Pages. 2600 Illustrations. Priced at \$5. CIRCLE No. 4 IN COUPON

DIESEL

ALL THERE IS TO KNOW ABOUT MODERN DIESEL ENGINES-Basic principles, starting, valves, timing, fuel pumps, fuel injection compressor, air compressors, pistons, cylinders, lubrication, cooling systems, etc. Answers on operation, calculations. 640 Pages. Fully Illustrated. Priced \$3. CIRCLE No. 9 IN COUPON

MASONS & BUILDERS GUIDES

A PRACTICAL ILLUSTRATED 4 VOL. SET-Explaining in clear, simple language and profuse illustration, principles, advances, short cuts, trade secrets, based on modern practice-including how to figure and calculate various jobs. Vol. 1-Brick work, bricklaying, bonding, designs. Vol. 2-Brick foundations, arches, tile setting, estimating. Vol. 3-Concrete masonry, placing forms, reinforced stucco. Vol. 4-Plastering, stone masonry, steel construction. Blueprints. 4 V. Is. 1440 Pages. 2067 Illustrations. Complete Set only \$9. CIRCLE No. 26 IN COUPON Sold individually \$2.50 each

MATHEMATICS MADE EASY

A COMPLETE HOME STUDY COURSE-Starting with the first principles of arithmetic, advancing step by step through the various stages of mathematics, including the rules and calculations for mechanical and electrical problems. New EASY correct methods. Includes plane and solid geometry, trigonometry, algebra, calculus, etc. Practical tests, reference tables and data. How to use slide rule. 672 Pages. 550 Illustrations. Priced at only \$3. CIRCLE No. 11 IN COUPON

NEW MACHINISTS AND TOOLMAKERS HANDBOOK

MODERN MACHINE SHOP PRACTICE. For every Machinist, Toolmaker, Draftsman or Student. Tells how to set up and operate lathes, screw and milling machines, shapers, drill presses and all other machine tools. A COMPLETE INSTRUCTOR AND REFERENCE BOOK 1250 Pages. Fully Illustrated. Priced at only \$6. CIRCLE No. 12 IN COUPON

ELECTRIC MOTORS

THIS GUIDE covers the construction, hook-ups, control, maintenance and trouble shooting of all types of motors. Includes armature winding. Explains entire subject in great detail in simple language. Over 1056 Pages of information. 617 Diagrams. All types of motors fully illustrated and indexed for ready reference. Priced at only \$5. CIRCLE No. 27 IN COUPON

REFRIGERATION & AIR CONDITIONING

FOUR BOOKS IN ONE - basic principles, servicing, operation, repair of: 1. Household Refrigeration. 2. Special Refrigeration Units. 3. Commercial & Industrial Refrigeration. 4. Air Conditioning Systems. A GOLD MINE of essential information. Completely up-to-date. 1360 Pages. Fully Illustrated and Indexed. Priced at only \$6. CIRCLE No. 14 IN COUPON

New MECHANICAL DICTIONARY

THE AUTHORITATIVE WORD BOOK FOR MECHANICS TECHNICIANS AND STUDENTS

With the revolutionary progress being made today in all mechanical fields, new words and phrases come into use. Any mechanic who wants to be up to date must know this new trade language.

Audel's New Mechanical Dictionary gives you all these new words and also the old. Every mechanic will find his job made easier if he knows the exact meaning and use of technical words that come up every day at work. It is an engineer's shop companion and a student's guide.

PRACTICAL TABLES, FORMULAS, PROCESSES

Constant use of Audel's New Mechanical Dictionary will increase your knowledge and skill in a matter of days without any conscious effort on your part. The right word at the right time is like the right tool - be sure you have it and use it! Defines 17,000 words - terms phrases - rules and formulas, 712 pages only \$6.95.

CIRCLE No. 44 IN COUPON

THE NEW ELECTRIC LIBRARY

A COMPLETE ENCYCLOPEDIA explaining in the simplest terms the fundamental principles, rules and applications of applied electricity.

A COMPLETE COLLEGE EDUCATION! Fully illustrated with diagrams and sketches, calculations and tables for ready reference. Questions and answers. Trial tests for practice study and review. All based on the most modern theory.

- Vol. 1-Principles and rules of electricity, magnetism, armatures, repairs. No. 15
- Vol. 2-Dynamos, DC Motors, construction, installation, maintenance, etc. No. 16
- Vol. 3-Testing instruments and tests, storage battery, constr. and repair. No. 17
- Vol. 4-Alternating current, power factor, alternators, transformers, etc. No. 18
- Vol. 5-A.C. Motors, windings, maintenance, converters, switches, fuses, etc. No. 19
- Vol. 6-Relays, condensers, regulators, rectifiers, meters, switchboards, etc. No. 20
- Vol. 7-Wiring, house light and power, circuits, high tension, plans, code, etc. No. 21
- Vol. 8-Railways, signals, elevators, ignition, etc. No. 22
- Vol. 9-Radio, telephone, telegraph, television, motion pictures. No. 23
- Vol. 10-Refrigeration, illumination, welding, x-ray, electrical appliances, Index. No. 24

6,000 fully illustrated pages. Priced at only \$22.50 for the ENTIRE SET. Also sold individually for \$2.50 each.



WELDERS GUIDE

Covers Electric, Oxy-acetylene, Thermit, Unionmelt welding for sheet metal, spot and pipe welds, pressure vessels and aluminum, copper, brass, bronze and other metals. Airplane work, surface hardening, hard facing, cutting, brazing, etc. 608 Pages. Fully Illustrated. Only \$3. CIRCLE No. 10 IN COUPON

ADDITIONAL IMPORTANT TITLES

The following Audel Guides are all the best in their fields, written in clear simple fashion, all lavishly illustrated. Circle the numbers wanted in the MAIL ORDER COUPON below. All books are sent for FREE EXAMINATION.

- No. 5 TRUCK & TRACTOR GUIDE. 1376 Pages \$5.00
- No. 7 PAINTING & DECORATING MANUAL. 417 Pages 3.00
- No. 13 WIRING DIAGRAMS 'Light & Power' 304 Pages 2.50
- No. 29 SHEET METAL PATTERN LAYOUTS. 1152 Pages 7.50
- No. 30 SHEET METAL HANDY BOOK. 448 pages 2.50
- No. 31 MECHANICAL DRAWING GUIDE. 192 Pages 2.50
- No. 32 MECHANICAL DRAWING & DESIGN. 410 Pages 3.00
- No. 33 ELECTRONIC DEVICES. 304 Pages 3.00
- No. 34 ELECTRICIANS EXAMINATIONS. 272 Pages 2.50
- No. 35 ELECTRIC POWER CALCULATIONS. Page 489 3.00
- No. 36 ELECTRIC DICTIONARY. 9000 Terms 3.00
- No. 37 POWER PLANT ENGINEERS GUIDE. 1568 Pages 5.00
- No. 38 ENGINEERS AND FIREMANS EXAMS. 544 Pages 2.50
- No. 39 OPERATING ENGINEERS LIBRARY. 3 Book Set 12.00
- No. 40 PUMPS, HYDRAULICS AND AIR COMPRESSORS. 1760 Pages 6.00
- No. 41 HOUSE HEATING GUIDE. 966 Pages 5.00
- No. 42 MILLWRIGHTS & MECHANICS GUIDE. 1248 Pages 5.00
- No. 43 DO-IT-YOURSELF ENCYCLOPEDIA. 2 Book Set 8.95
- No. 45 MAGIC OF LANDSCAPING. 128 Pages 1.49
- No. 46 WATER SUPPLY & SEWAGE DISPOSAL. 436 Pages 4.00
- No. 47 GUIDE TO CREATIVE PHOTOGRAPHY. 400 Pages 3.95

MAIL THIS NO-RISK COUPON TODAY!

THEO. AUDEL & CO. - Self Improvement Publishers Since 1879 - P9

49 W. 23rd Street, New York 10, N.Y.

Please mail me for 7 days' FREE EXAMINATION the books I have circled at right. I agree to mail \$2 in 7 days on each book or set ordered, and to further mail \$2 a month on each book or set ordered until I have paid the purchase price, plus shipping costs. If I am not completely satisfied with my Audel Guides I may return them.

NAME _____

ADDRESS _____

OCCUPATION _____

EMPLOYED BY _____

SAVE SHIPPING COSTS! Check here if you enclose complete payment with order. We pay postage charges. You have same return privilege.

1	2	3	4	5
6	7	8	9	10
11	12	13	14	15
16	17	18	19	20
21	22	23	24	25
26	27	28	29	30
31	32	33	34	35
36	37	38	39	40
41	42	43	44	45
46	47			



BE YOUR OWN MUSIC TEACHER

Send for Free Book Telling How Easily You Can Learn Piano, Guitar, Accordion, ANY Instrument This EASY A-B-C Way



NOW IT'S EASY to learn music at home. No tiresome "exercises." No teacher; just **START RIGHT OUT** playing simple little pieces. Thousands now play who never thought they could. Our pictured lessons make it easy as A-B-C to learn to play popular music, hymns, classical and any other music. Low cost. One million students all over the world. (Est. 1898.) Licensed by N. Y. State Education Dept.

Mail Coupon for FREE BOOK

Find out why our course can teach you quickly, easily, inexpensively. Write for FREE Book. No obligation. No salesman will call. Mention favorite instrument. Mail coupon today.



U. S. SCHOOL OF MUSIC
Studio A309,
Port Washington, N. Y.



U. S. SCHOOL OF MUSIC, Studio A309, Port Washington, N. Y. Please send me FREE 36-page Illustrated Book. I would like to play (Name instrument):

Do you have instrument? Yes. No. Instruments, if needed, supplied at special reduced prices.

Name

(Please Print)

Address

City Zone State

6-IN-1 ONLY MACHINE OF ITS KIND! UNIMAT



Compact workshop for all metal, plastic, wood. Precision lathe, milling machine, drill press, surface grinder, polishing/grinding machine, portable drill. Choice of 3 models, from \$64.50. WRITE FOR FREE CATALOG AND BUDGET PLAN. AMERICAN EDELSTAAL, INC., DEPT. G1, 350 BROADWAY, N.Y. 13, N.Y.

\$6.44 AN HOUR IN YOUR OWN BUSINESS

STEP INTO THIS BOOMING \$19 BILLION A YEAR INDUSTRY



Hundreds of accidents and losses will happen this year in your community.

We'll show you how to investigate and adjust these losses for insurance companies, railroads, government offices. You buy NO tools or equipment. You do NO selling. You need NO prior experience or higher education. And you can operate out of your own home. Right now independent Accident Investigators average \$6.44 an hour. We'll train you quickly to do the same. Start part-time if now employed. Fill the need for an Accident Investigation specialist in your area. Colorful booklet explains everything. Absolutely no obligation on your part. No salesman will call. Write TODAY for FREE Booklet.

UNIVERSAL SCHOOLS, PM-9, 6801 Hillcrest, Dallas 5, Texas



Treated Twine Edges Lawn

By stretching a specially treated twine along the border of the lawn, then sprinkling, a gardner can keep grass from spreading into shrubbery, over sidewalks or under fences. The twine can also be tacked in place for curves.

The E-Z-Edge twine is manufactured by Farmer & Krueger, 1112 S. 10th St., Sunnyside, Wash. About two cents a foot.



Plastic Fibers Guard Fishhook

Eliminating an old fisherman's bogey—the wire weed guard that keeps a lure from being snagged but also keeps fish from being hooked—a new series of lead-headed lures uses a bunch of medium-soft plastic fibers in place of the wire. Hook protection is as good as before, but the plastic bends away when a fish strikes. Made as marabou-feather jigs or jig-and-worm combos by Bass-Buster Lures, Amsterdam, Mo.

Earn Extra Money Soon

... while training at home for high-pay career or business of your own!

AMAZING PLAN FOR YOUR SUCCESS IN RADIO-TV-APPLIANCES and ELECTRONICS

Central will show you how to start making money soon . . . servicing AM-FM radios and television sets . . . repairing electrical appliances . . . building and installing electronic equipment in homes, factories, and business offices. Step-by-step, you'll learn how to get started in spare time at minimum cost; how to prepare for a bright future in servicing, audio, communications, broadcasting, or the gigantic electronic industry. Complete FCC license preparation included. High income, prestige, security, prosperity . . . all can be yours!

NO EXPERIENCE NEEDED!

You don't need high school diploma or previous knowledge of electronics to get started. Quick, low-cost home training for young and old. New illustrated lessons make learning easy. We supply equipment and *know how* you need to start making money soon. You learn by *doing*. You assemble useful, practical electronic projects—no incomplete "student" radios and testers—our kits meet commercial standards. Also recommended for citizen band and amateur radio operators, hi-fi and stereo enthusiasts, hobbyists, etc. Your personal pleasure and the savings you can make on home installations and repairs alone, make this course a profitable adventure. Keep your present job—set your own pace—add to your income—and find out how much fun Electronics can be!

New Frontiers Need You!

Cash in on growing demand for technicians in hundreds of exciting space-age fields: guided missiles, rocketry, outer space research and development, automation, nuclear power, computers, microwaves, radar, communications, oil field exploration, air traffic control, civil service, armed forces, etc. *Start now*. Get facts—mail coupon today for two FREE books!

NEW KITS!



You will build and keep this handy "transistorized" electronic and appliance tester that you'll use soon to start earning spare-time money. Many other practical and profitable electronic projects to choose from: 4 transistor portable radio—code oscillator—solar cell switch—RF signal generator—CB converter—oscilloscope—others! Fully described in our FREE 64-page catalog.



Central grad GLEN LEIRER, shown here, earned an attractive income from part-time Radio-TV Servicing. Now he's employed as a Computer Technician for RCA Service Co., Camden, N. J.

Over 50,000 Successful Graduates Since 1931!



"I averaged between \$60 and \$70 a month servicing radios and TV's part-time while taking your home study course. Plan to open my own shop soon." Student THEODOR SCHMIDT, Peshastin, Wash.



Central grads HOWARD EDMONDS & FLOYD CONKRIGHT are joint owners of EDCO FACTORY TV SERVICE CO., K. C., Mo., and RANCH MART TV & STEREO, Leawood, Kansas, have three service trucks, seven full-time employees.

Grad FRANK LEENKNECHT works in missile field for Convair Astronautics, San Diego, Calif., and as Transmitter Engineer for Station KDEO as a sideline.



RESIDENT TRAINING—Central also offers a full-time ECPD-Accredited Technical Institute program at its resident school in Kansas City, Mo., for qualified high school graduates. Details in FREE catalog.

FREE

FCC PREP BOOK

Profits from Electronics

We'll mail you FREE FCC License Prep Handbook that prepares you to pass the 3rd Class FCC Radiotelephone examination, and to qualify to operate radiotelephone transmitting stations used by airlines, police, railroads, emergency services, etc. You get FREE FCC Prep Book plus FREE 64-page catalog with facts about Central's practical electronics home study course.

NO OBLIGATION



TRADE THIS COUPON FOR 2 FREE BOOKS!

Central Technical Institute
1644 Wyandotte, Dept. PM91A.
Kansas City 8, Mo.

(PLEASE PRINT)

NAME _____
ADDRESS _____
CITY _____
ZONE _____ STATE _____



Accredited Member
National Home Study Council

Central Technical Institute

What the "oil-burning" engine is telling you



No mechanical part will last forever. By the time you have driven your car 50,000 miles, the crankshaft in your engine will have made 150,000,000 revolutions. Piston rings will show signs of wear. Engine bearings will wear, too, and your engine may begin to burn increasing amounts of oil.

Worn bearings — sluggish performance

Main, connecting rod, and camshaft bearings control the oil flow inside your engine. As bearings wear, they leak excessive amounts of oil, and this oil—up to 25 times the normal amount—is thrown violently against the cylinder walls. It slips past piston rings into the combustion chamber where it burns to heavy carbon and varnish. Rings become clogged and deposits build up on valves. Your car burns oil, gas mileage drops, and performance becomes sluggish.

Fm bearings — 1st choice for cars

Your mechanic knows what to do. He'll probably recommend an overhaul . . . and new Federal-Mogul engine bearings. Fm bearings are used as original equipment by most American car and truck manufacturers.



Whether you drive an American car or an import, be completely satisfied—ask for Federal-Mogul bearings when you need an overhaul.

FEDERAL-MOGUL SERVICE



Division of Federal-Mogul-Bower Bearings, Inc. • Detroit 13, Michigan

ITEMS FROM ALL OUTDOORS



We're talking survival again this issue, with the second half of Russ Tinsley's test report on page 156. So it's fitting to pass the word on a new first-aid and survival kit designed for easy carrying by outdoor people—just in case. The kit is small enough to fit in a jacket pocket, tackle box or glove compartment, but contains a knife, compass, fishhooks, nylon leader, signal mirror, water-purification tablets, signal flag, pencil, candle, matches, burn ointment, ammonia inhalant, gauze bandage, adhesive tape, gauze pad, paper clip and an instruction booklet. It comes in a leather case for \$4.98 from Davenport and Walden, Box 692, Inglewood, Calif.

Outdoor activities far from power lines and modern conveniences have brought back many "old-time" appliances for campers, boaters and others. Now you can buy a wood or coal-burning cast-iron stove, just like Grandma used to use, only better. The compact little stove stands only 10 inches high, is 18 by 13 inches square and weighs 40 pounds. It'll burn any kind of fuel, from logs and coal to patent chemical fuels, and an optional attachment will rig it for oil. For boaters, it has a top railing to keep pots and pans from sliding off in rough seas. It's made by Washington Stove Works, Box 919, Everett, Wash.

Another convenience for outdoor living in a new compact form is the little 6 or 12-volt electrical water-pressure system being made by Grover Products Co., of 1233 South Hope St., Los Angeles 15, Calif. The motor and pump don't take up any more space than half a loaf of bread, but they'll put running water in a car or boat with instant, automatic pressure without a pressure tank, and will supply up to six faucets. The gadget will work as a bilge pump or bait-tank circulation system, too.

Fishermen and bird-watchers can learn to spot their quarry by sound with a new 12-inch long-playing record of fish and bird noises that comes with the book *Animal Sounds and Communication*, published by the American Institute of Biological Sciences, 2000 P. St. N.W., Washington 6, D.C.

Dick Kichpatnik

POPULAR MECHANICS

CHOOSE YOUR JOB TRAINING—THEN LEARN BY DOING!

Challenging work—if you can get it. To land a job as a Helicopter Mechanic, you need training. The kind of training you get through the Army Choose-it-Yourself System.

If you qualify (by passing aptitude and physical exams), this system lets you choose your job training before you enlist.

On-the-job or in school, Army training is practical. You learn by doing. The skills you absorb can pay off for the rest of your life.

You can choose from many different kinds of job training. Aircraft Maintenance is one possibility. There's also Data Processing, Missile Operations, Finance, Automotive Maintenance, Communications Center Operations—to name a few. Ask your Army recruiter to show you a complete list.

Can you qualify for the job training you want? It's easy enough to find out. Before enlistment. Without obligation.

CHOOSE-IT-YOURSELF



VOCATIONAL TRAINING SYSTEM

US ARMY



Any man will enjoy new

AIRGRATE YELLO-BOLE



1. Smokes sweeter!

Imported briar bowl lined with *real honey*. Starts caking the instant you light up. Hence, no break-in.



2. Smokes drier and healthier!

Metal grate condenses moisture, tars, nicotine. No wet heel.



3. Smokes cooler!

Air-vented chamber draws in fresh air. Aluminum fins and shank throw off heat, cool the smoke.

Famous honey-lining!

\$295

Extra interchangeable bowls—\$1.50 each

"Icepak" Set—Airograte Yello-Bole Pipe plus two extra bowls, \$5.95

Other Yello-Bole Pipes, also of imported briar \$1.95 to \$4.95

Send for FREE FOLDER, YELLO-BOLE PIPES, Inc., Dept. Y34, N.Y. 22

AUTO 100,000 Jobs Are Waiting in **MECHANICS** Train at Home

Earn big money. Work steady. Go in business. Over 100,000 mechanics are wanted to fill good jobs. Over 25,000 repair shops are needed. Train at home. Earn as you learn. CTI course provides 30 Job Experience Projects. This exclusive feature leads you from lessons to engine repair in easy steps. Tools, Tune-Up Kit and Viso-Analyzer sent. Diesel or Body-Fender Repair lessons included. Mail coupon for free booklet.



COMMERCIAL TRADES INSTITUTE A Non-Profit Organization
1400 GREENLEAF AVE. • CHICAGO 26, ILL. Dept. A-175

Name _____ Age _____
Address _____
City _____ Zone _____ State _____



Automatic Portable Pump

Convenient for boat owners and householders alike is an automatic, self-contained portable pump recently placed on the market. Powered by two two-volt rechargeable batteries, it can raise water over 35 feet and will run continuously for seven hours on one charge. The pump is manufactured by the Russell Harrington Co., Southbridge, Mass., and sells for \$69.50.

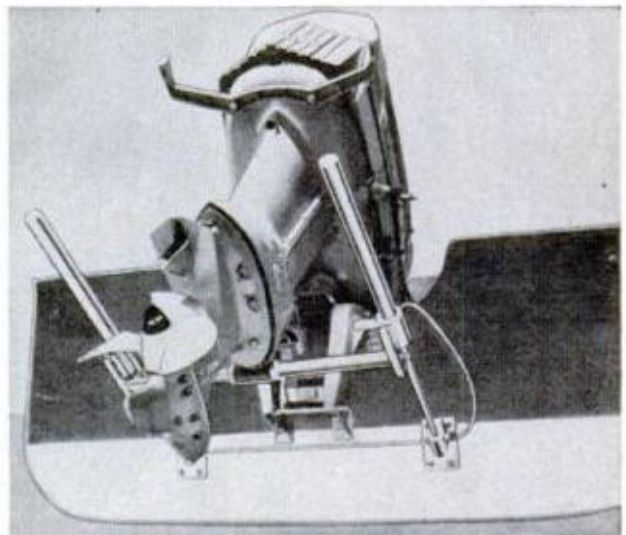

Push a Button, Up It Goes!

Tilting an outboard motor up on the transom has become a one-finger operation for the boater with the aid of a new boating accessory.

Powered by a cylinder of compressed carbon-dioxide gas, the lifting device is controlled by a push button mounted near the steering wheel. It will tilt the motor to any desired angle. Tilt-O-Matic is manufactured by the National Marine Corp., South Bend, Ind.

Just a Few Months NEW and Already One of the **HOTTEST** Money-Makers for Men Everywhere—even Spare Time!

HOW HOT?
Read how great these men are doing!

MERLITE Longer-Life Light Bulbs—the Only Bulbs in the World Backed by this SENSATIONAL GUARANTEE:

ONCE YOU BUY MERLITE LIGHT BULBS—YOU NEVER HAVE TO BUY BULBS AGAIN—NEVER!

Averages \$12 an Hour

"Merlite Bulbs are the answer to a salesman's prayers. They're fantastically easy to sell. Working only part time, I have averaged \$12.00 per hour."

Philip Smith, Maine

Sold 178 Bulbs First Afternoon

"The first afternoon I sold 178 bulbs. Am very pleased with reception we get from customers. Please ship my next order at once."



W. E. Foust, Arkansas

Makes \$8.20 an Hour in Just Spare Time

"These guaranteed Merlite Bulbs surely sell. I've averaged \$8.20 per hour for the time I've spent with them. That makes a nice income and wish I could give full time to the job."

L. C. Benedict, Virginia

Daring NO-TIME LIMIT FREE REPLACEMENT GUARANTEE Does the selling FOR YOU—MAKE up to \$1,000.00 in a MONTH!

It's fantastic—14 magic words (ONCE YOU BUY MERLITE LIGHT BULBS—YOU NEVER HAVE TO BUY BULBS AGAIN—NEVER!) are making it easy for men everywhere to make a "small fortune"—as much as \$1,000.00 and more in a month, spare time or full time! No demonstrations, no fast-talking sales pitch needed. Almost everyone jumps at the chance to buy Merlite Bulbs with the iron-

clad Guarantee (packed with each bulb) that unconditionally offers to replace FREE any burned-out Merlite Bulbs, no matter when they burn out—in 5 years, 10 years—NO TIME LIMIT! And the Guarantee applies to all Merlite Bulbs purchased or replaced! Every home needs 12 to 24 Merlite Bulbs to replace old-fashioned short-life non-guaranteed bulbs. Make up to 120% profit, easily make \$50 in few spare hours. Merlite men are doing this now!

FREE Money-Making Details Amazing No-Risk Offer

Find out for yourself how much money you can make with the sensational Guaranteed Merlite Long-Life Light Bulb. We'll send you—FREE and without obligation—complete money-making Illustrated Sales Outfit and an astounding offer which helps you get started making money without risking a penny. Mail coupon TODAY!

Merlite Industries, Inc., Dept. C-15J (Bulb Div.) 114 East 32nd Street, New York 16, N.Y.

Merlite Industries, Inc., (Bulb) Dept. C-15J
114 East 32nd Street, New York 16, N.Y.
Rush complete money-making illustrated Sales Outfit and No-Risk Starting Offer—FREE and without obligation.

Name _____
Address _____
City _____ Zone _____ State _____
In Canada: Mopa Co., Ltd., 371 Dowd St., Montreal 1, P.Q.

ELECTRIFY PLAYER PIANOS PUMP ORGANS

YOU CAN QUICKLY END TIRESOME FOOT-PUMPING
With a Compact Low-Cost Lee Silent Suction Unit

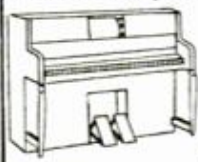

EASY TO INSTALL
FULLY GUARANTEED
1000'S IN USE

write to
LEE MUSIC MFG. CO.
Box 595, Tujunga, Calif.



JEEP OWNERS

RE-POWER NOW WITH A V-8 OR 6 CYL. ENGINE—USE FORD—CHEV.—MERCURY—GMC—PONT—STUDE—DODGE OR PLYMOUTH in Jeeps, Jeepsters, Sta-Wgn, trucks, Kaiser & H. J. cars. Conversion Kits \$45.35 to \$56.90. Want fast action? Give us full information, send \$15.00 Dep. and we will ship correct kit. Bal. COD. Send full amount for prepaid shipment. Wire, phone or write today. Details FREE.

HOOSIER MACHINE PRODUCTS CO.
312 S. E. 6th St. Phone CR 6-3442 Pendleton, Oregon

WARN HUBS ON YOUR 4-WHEEL DRIVE
STOP FRONT END DRAG IN 2-WHEEL DRIVE!

Models for all 4-wheel drives



Most dependable, easiest to use hubs made for free-wheeling the front end in 2-wheel drive. Hundreds of thousands in use. Save gears, gas, tires; get more pep, speed, performance in 2-wheel drive with Warn Hubs, Locking or Lock-O-Matic. Guaranteed. See your dealer soon!

WARN MFG. CO., Riverton Box 6064-A, Seattle 88, Wash.

... TURN CONCRETE INTO GOLD!
MAKE UP TO \$75 A DAY IN YOUR OWN BUSINESS

If you want to have your own business — to start a business on your own — here's your big opportunity! New high speed, low cost General block machine produces up to 1,000 concrete blocks a day. Sell all you make to builders, supply houses, and others for homes, factories, buildings, garages. Cash in on the building boom! You can make profits of 100% to 150% — up to \$75. a day! General block machine equipped with 1/2 h.p. electric motor — or can be supplied with gasoline engine — works anywhere, in little space, indoors or out. Operates from ordinary house light socket. Simple, foolproof 3 step operation — so easy a child can do it. Makes superior 3 core blocks any size from 4" to 12" Also makes chimney, sash, corner and other types. Blocks meet any building code anywhere in the country. Materials — sand, water, cement, available anywhere. Simple illustrated operating instructions and mixing formulae for cement and cinder blocks supplied with each machine. Write for FREE folder with full information.

MOTOR DRIVEN
R.L.T. of New York City reports: "MY GENERAL BLOCK MACHINE PAID FOR ITSELF IN FIRST 2 WEEKS!"
Hundreds now in use the world over!
Write for FREE details today!

EXTRA Amazing illustrated book gives floor plans for 6 sensational concrete block bungalows. Tells how to lay blocks, lay out building lines, mix concrete, build steps, porch and concrete floors all at great savings. Written by experts. Can save many times the cost of the machine! Get it now! No strings attached. Send \$1.

BOOK SENT FREE IF YOU BUY MACHINE.
\$1 REFUNDED IF YOU BUY LATER.

GENERAL ENGINES CO.
DEPT. M-91, ROUTE 130, THOROFARE, N. J.

HOW TO BUILD YOUR OWN CONCRETE BLOCK HOME
Only \$1 Prepaid

free

ALLIED

**MONEY-SAVING 1962
ELECTRONICS CATALOG**

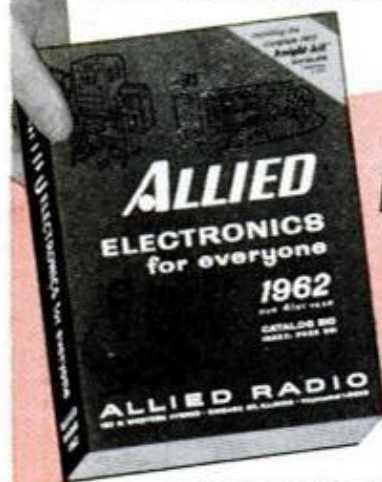

444 PAGES
WORLD'S BIGGEST
MOST COMPLETE

**NO MONEY
DOWN**
EASIEST TERMS

SAVE MOST ON

EVERYTHING IN ELECTRONICS

Send for this **FREE** catalog—it's the biggest—featuring everything in Electronics for modern living, including products and values available only from **ALLIED**. Whether you're a kit builder, experimenter, hi-fi fan, Amateur, serviceman or engineer, you'll save most on:

- **KNIGHT-KITS®**—Best in Build Your Own
- Everything in Stereo Hi-Fidelity
- New Multiplex Stereo FM
- New All-Transistor Stereo Hi-Fi
- **KNIGHT®** Super-Value Stereo Hi-Fi
- Tape Recorders & Phono Equipment
- Citizens Band 2-Way Radios
- TV Tubes, Antennas, Accessories
- Parts, Tubes, Transistors, Tools, Books
- Amateur Station Equipment
- Public Address & Intercom
- Latest Test & Lab Instruments



SAVE on everything in Electronics at **ALLIED**—get fastest service, expert personal help, easiest-pay terms, satisfaction guaranteed or your money back. Send coupon today for **FREE** 1962 **ALLIED** Catalog.

THE WORLD'S LARGEST ELECTRONIC SUPPLY HOUSE

free
CATALOG

ALLIED RADIO

ALLIED RADIO, Dept. 41-J1
100 N. Western Ave., Chicago 80, Ill.

Rush **FREE** 1962 **ALLIED** Catalog.

Name _____
PLEASE PRINT

Address _____

City _____ Zone _____ State _____

**Juice of Desert Snail
Makes Emergency Drink**

Flyers or other travelers who may get stranded in the Negev desert in southern Israel or in the scrub desert along the North African coast, need not fear they will die of thirst. They can drink the juice of a large white snail called *Ehrenbergi Roth* which abounds in those areas. Its shell contains as much as a half teaspoonful of body fluids. Flight Lt. John Billingham of the Royal Air Force Institute of Aviation Medicine at Farnborough, England, in a test lived for four days on the juice. Simulating conditions of a desert crash, he was shut in a chamber where the temperature sometimes soared to 118 degrees F.

"I was a bit weak at the end of the four days," he says. "But I was mentally alert and quite happy. It's pretty awful stuff, rather fishlike." He drank four pints a day. Two rats, fed the fluid, put on weight.

**Do-It-Yourself Spending
Was \$3 Billion in 1960**

American handymen spent \$3 billion to do it themselves in 1960, according to the Census Bureau's first survey of do-it-yourself spending. Of the total national outlay of \$9.5 billion for home upkeep and improvement, \$3 billion went for materials and equipment for home repair, alterations, or additions.

In one category, outdoor alterations, the amount spent for do-it-yourself operations exceeded the amount paid for hired work.

**How Much Acceleration
Can a Skeleton Stand?**

Most acceleration studies to date have concentrated on effects of G-forces on blood circulation, the nervous system and general human behavior. Anatomists and engineers at the University of Michigan and Wayne State University are now studying what these strenuous forces do to the human skeleton to find "the threshold for fractures"—the point at which bones begin to crack under intense acceleration. The test apparatus, built into an eight-story elevator shaft at Wayne's medical school, will create forces up to 50 times the weight of gravity (50 Gs). Specimens have been exposed in it to accelerations up to 14 Gs without causing fractures. Some of the findings concern the tensile and compressive strains measured along the spinal column during vertical acceleration, the effect of restraint by seat belt and shoulder harness and the inadequacy of seat cushions to absorb the shock of acceleration.

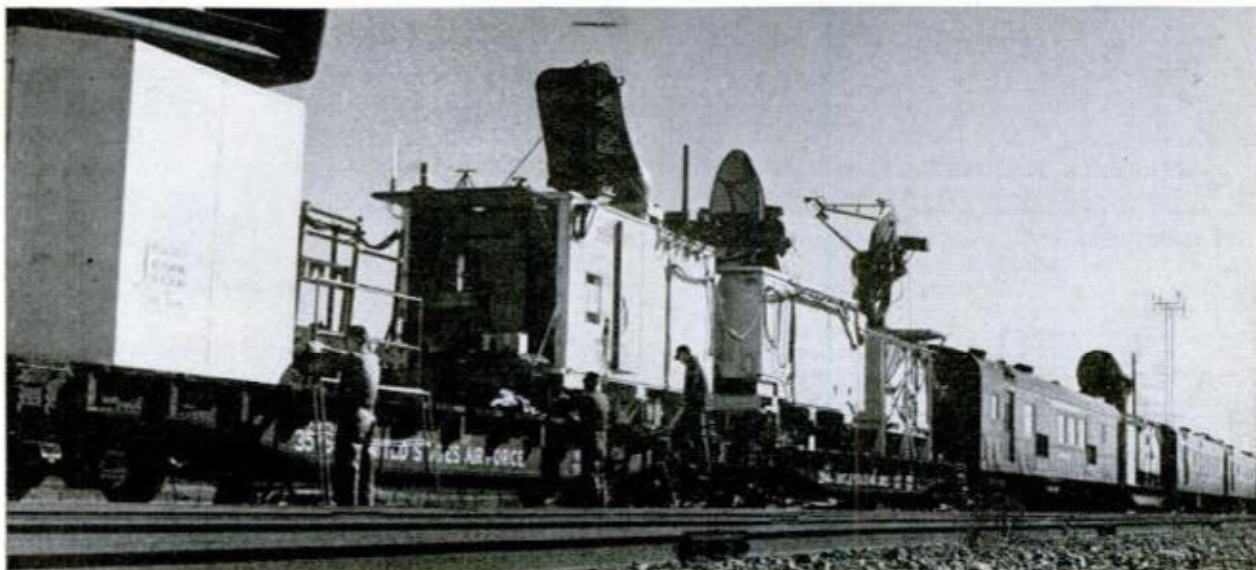

Radar on Rails Counts "Hits" by Air Force Bombers

In the early days, Air Force bombing crews practiced by dropping bags of flour at circles marked on the ground. Today they use radar that can pinpoint the accuracy of simulated raids from altitudes up to 45,000 feet. The "raids," incidentally, are on widely scattered towns and cities in the U.S. and are made almost daily.

The RBS units (for radar-bomb scoring) are set up in railroad cars—former hospital cars used by the Army in Korea—and moved about to give the bomber crews new targets to locate, unfamiliar routes to follow and a variety of terrain to fly over on each raid.

Here is how the system works:

The bomber, usually a B-52 of the Strategic Air Command, makes its practice bomb run on an assigned target city, keeping in constant contact with the RBS unit. The RBS radars "lock on" the oncoming bomber, tracking it automatically on a plotting board. Just before the simulated release of the bomb, the aircraft transmits a tone to the RBS site by radio. The moment of the simulated bomb release is indicated

by stopping the tone. Then the radar goes to work.

The target site and the radar site have already been precisely plotted. By using figures on distance and direction of the bomber from its target, the aircraft's ground speed, heading and altitude, wind conditions, bomb-fall characteristics and other data, RBS technicians can compute the accuracy of each mission. The computation allows them to tell exactly if the target was hit or, if not, by how far and in what direction it was missed.

The RBS train has enough power to serve a city of 2500, and its tanks carry 10,000 gallons of fuel—enough for 30 days' operation. Additional tanks carry more than 10,000 gallons of water. More than four miles of cable provide interconnecting communications and power outlets.

The whole train consists of the six converted hospital cars used for command, administration, maintenance, supply and power; three flatbed cars with vans housing the radar and electronic equipment; and one boxcar for storage.

Make Big Money LIGHTING MATCHES!



Fastest, Most Dramatic Demonstration Pulls in Fantastic Profits!

Imagine getting paid as much as \$1000 and more a month, just for lighting matches! It's entirely possible when you use matches to demonstrate sensational new MERLITE Fire Alarm. Takes only 5 seconds!

Owners of homes, stores, offices buy at once!

Just light a match, hold it below Merlite Fire Alarm. Almost at once heat from tiny flame automatically sets off Alarm's tremendous "HOWL"—audible 1/3 mile or more. Proves Merlite's so super-sensitive that in a fire, the "HOWL" will wake soundest sleeper, save lives. Entirely self-contained; needs no installation; hangs on wall like picture; "on duty" 24 hours a day. When folks see dramatic demonstration, hear astonishing low price (only \$4.95), they order 3 to 7 at a time and you make up to \$2.70 profit on each one. **FREE**—complete illustrated Sales Kit, with everything you need to start making fantastic profits right from start. Rush coupon with name, address TODAY!

MERLITE INDUSTRIES, INC.

Dept. F-15J (Alarm Div.) 114 E. 32nd St., New York 16, N. Y.

MERLITE INDUSTRIES, INC., Dept. F-15J (Alarm Div.)
114 E. 32nd St., New York 16, N. Y.

Rush big Sales Outfit showing how I can make big money with 5-second "lighted-match" demonstration of amazing Merlite Fire Alarm—everything FREE, no obligation.

Name _____

Address _____

City _____ Zone _____ State _____

IN CANADA: Mopa Co., Ltd., 371 Dowd St., Montreal 1, P.Q.

Exclusive Double-Bearing HEAVY-DUTY PUMPS
IRRIGATE • DRAIN • CIRCULATE • SPRAY
Use 1/2 HP motor or larger . . . 1 HP for up to 5,200 GPH; 1,000 GPH 60' high; or 3,000 GPH from 25' well. 1 1/4" inlet; 1" outlet. Stainless shaft.
TYPE X—2 oil-less bronze bearings. Won't rust. **\$10.95**
TYPE XB—Ball bearing model. **\$12.95**
Postpaid if cash with order. Rush your order today
MONEY BACK GUARANTEE
Centrifugal and Gear Pumps in All Sizes
LABAWCO PUMPS, Belle Mead 2, N. J.

ENGINEERING SCIENCE MATH **DEGREE IN 27 or 36 MOS.**

B.S. degree — 36 mos. • B.E. degree — 27 mos.

ACCELERATED YEAR-ROUND PROGRAM prepares for early employment in fields of SCIENCE AND ENGINEERING. Regular 4-year program for B.S. Degree completed in 36 months, special engineering degree program in 27. Classes start—Sept., January, March, June, July. QUALITY EDUCATION. Graduates employed from coast to coast. Government approved for veteran training. Students from 50 states, 40 countries. 20 buildings; dorms; gym. Campus. SAVE TIME AND MONEY. EARN BOARD while studying. Write for catalog and complete information.

INDIANA TECHNICAL COLLEGE

591 E. Washington Boulevard, Fort Wayne 2, Indiana

Please send me free information on Bachelor's Degree Programs in Engineering and Science as checked below:

- | | |
|---|--|
| <input type="checkbox"/> Aeronautical Engineering | <input type="checkbox"/> Mechanical Engineering |
| <input type="checkbox"/> Chemical Engineering | <input type="checkbox"/> Metallurgical Engineering |
| <input type="checkbox"/> Civil Engineering | <input type="checkbox"/> Physics |
| <input type="checkbox"/> Electrical Engineering | <input type="checkbox"/> Chemistry |
| <input type="checkbox"/> Electronic Engineering | <input type="checkbox"/> Mathematics |

Name _____

Address _____



Portable Shower's Secret Is All in the Footwork

Campers can now enjoy hot or cold showers no matter how far they stray from modern plumbing, thanks to an ingenious Austrian inventor who has come up with a completely portable shower.

Water is pumped from a bucket to the shower head by the bather who stands on the pumping apparatus and shifts his weight back and forth from right to left. The rustproof pump has no moving parts.



"If you're looking for economical transportation this is it . . . runs on carbon monoxide."

POPULAR MECHANICS



The Construction Industry **NEEDS YOU NOW!**



Earn **HIGH WAGES** as a **HEAVY EQUIPMENT OPERATOR**

**NATIONAL'S
ACTUAL
FIELD TRAINING
TEACHES YOU
HOW!**

**MEN
AGES
17 TO
56**

**TRAIN ON
SCHOOL-OWNED
DIESEL-ENGINED
MACHINES**

National, the original school of heavy equipment operation, offers full training courses at its huge proving ground in the beautiful Piedmont area of North Carolina.

High wages and years of future security are yours as a trained heavy equipment operator. The world's fast-growing multi-billion dollar construction industry needs men NOW for this work in this country and overseas — you can be one of them!

Amount of previous education is no barrier to your training. No correspondence courses, no series of required home-study lessons in advance of training. VA approved. Budget terms available.



Even if you are presently taking a course in heavy equipment operation, write for our catalog. Compare the training you are receiving with ours . . . there is no obligation.

**Mail coupon NOW for
FREE Catalog**
NO OBLIGATION . . . NO SALESMAN WILL CALL

APPROVED FOR VETERANS

NATIONAL SCHOOL OF HEAVY EQUIPMENT OPERATION
Dept. D-20
P. O. Drawer 1686, Charlotte, N. C.

Please send me FREE illustrated school catalog and complete information about how I can become an Operating Engineer. I understand no salesman will call on me.

Name _____ Age _____

Address _____

City _____ Zone _____ State _____



FLY YOUR OWN HELICOPTER

The Commuter Jr. is a genuine helicopter — not a toy — that can be assembled in your home workshop. It is a practical, inexpensive and soundly engineered aircraft. All component parts and complete assembly drawings are now available!

Send \$2.00 for photo illustrated brochure, specifications and parts price list. Send an additional \$2.00 for our book "Basic Helicopter Aerodynamics" which will give you a basic understanding of the aerodynamic and physical principles in the building and flying of the Commuter Jr.

HELICOPTER RESEARCH CO.
Box 121 M • La Mirada, California

NO-RISK 30 DAY OFFER PROVES YOU CAN MAKE HUGE PROFITS WITH NEW 5 YEAR LIGHT BULBS!



Part timers make \$100 a week. Full timers up to \$25,000 a year! Every home, store, office, factory a customer! Show how Sunmaster 5-Year Bulbs give better, softer, glare-free light. Guaranteed to outlast 10 to 13 ordinary bulbs. Customers save money — you make profits to 100% or more. Try our plan 30 days at our risk. Write for FREE Sales Kit.

Sunmaster Electric Products, Dept. PM-91
366 Fifth Ave., New York 1, N. Y.

Send FREE Sales Kit and No-Risk Profit Plan.

Name _____
Address _____
City _____ Zone _____ State _____
(In Canada, 539 King St. W., Toronto, Ont.)

STEP UP to BENJAMIN'S TRADITIONAL EXCELLENCE!

DISCOVER the BIG DIFFERENCE that EXPERT CRAFTSMANSHIP can Make in Your SHOOTING PERFORMANCE and FUN!

25 MODELS — SINGLE SHOT and REPEATERS — FIRST CHOICE of SHOOTERS who want SAFETY — CONVENIENCE — ECONOMY including HIGHEST QUALITY MATERIALS to Assure Them OUTSTANDING POWER — ACCURACY — DEPENDABILITY!

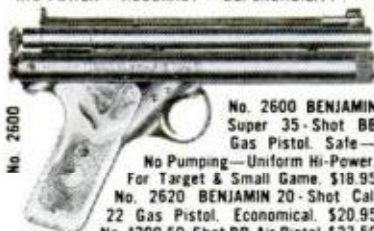

No. 2600 BENJAMIN Super 35-Shot BB Gas Pistol. Safe — No Pumping — Uniform Hi-Power. For Target & Small Game, \$18.95
No. 2620 BENJAMIN 20-Shot Cal. 22 Gas Pistol. Economical, \$20.95
No. 1300 50-Shot BB Air Pistol \$23.50
No. 1320 BENJAMIN 35-Shot Cal. 22 Air Pistol \$25.50

FREE Catalog All Models Benjamin Single Shot & Repeaters — Cal. BB or 177 or 22. Also, Special Hunting & Fishing Knife Offer.
BENJAMIN AIR RIFLE CO., 896 MARION ST., ST. LOUIS 4, MO.
You Can DEPEND on... BENJAMIN

World Famous AIR GUNS and CO₂ GUNS

No. 3600 BENJAMIN Super 100 Shot BB Gas Rifle. Non-Toxic — Safe — Convenient — Uniform Hi-Velocity Power. →
No. 3620 BENJAMIN Super 85 Shot Cal. 22 Gas Rifle \$21.95
No. 3100 Super 100 Shot BB Air Rifle. Adj. Shooting Force \$24.95
No. 3120 BENJAMIN Super 85 Shot Cal. 22 Air Rifle \$26.95



MAKE \$74⁰⁰ IN ONE CALL! Take Easy Orders for Smart BOWLING SHIRTS

Cash in fast on red hot business, showing Style Display of Topps Bowling Shirts, Slacks, for men, Blouses for women; to bowling teams and leagues, in factories, stores, offices, organizations, schools, and churches. Exclusive styling, custom embroidering, low prices win big orders, up to \$74.00 profit for you in one call. No inventory. Take orders, collect profit in advance. We do all the rest. Perfect business spare time or full time or as a sideline to your present line.

Make Even More Money with TOPPS ADVERTISING WORK UNIFORMS

Almost every business firm needs Topps Work Uniforms with company emblem embroidered on back. Take fast easy orders, make up to \$50 and more in a day. Rush name, address for free Bowling Apparel Sales Kit, and tell us if you also want money-making Work Uniform Style Display, FREE.

TOPPS GARMENT MFG. CO., Dept. B4-J, Rochester, Ind.



Finish HIGH SCHOOL AT HOME IN YOUR SPARE TIME
DIPLOMA AWARDED
Learn more! Earn more! Enter professional or technical schools. Advance socially. Live a happier, fuller life. Individual Courses or complete schedule. Write for School Bulletin.
ACADEMY FOR ADULTS
30 W. Washington, Dept. PM-91, Chicago, Ill.

GOVERNMENT OIL LEASES LOW AS \$1 PER ACRE

You do no drilling, pay no taxes, may realize a king-size profit without ever leaving home. Write for free map and literature.

AMERICAN OIL SCOUTS, Dept. PM
619 Cascade Bldg. Portland 4, Oregon

THE SURPRISING '62s

For an expert "scorecard" on the startling variety of new cars, new engines, new suspensions, styling innovations and fresh gadgetry, see the Special Section on '62 Cars in the upcoming

October Popular Mechanics

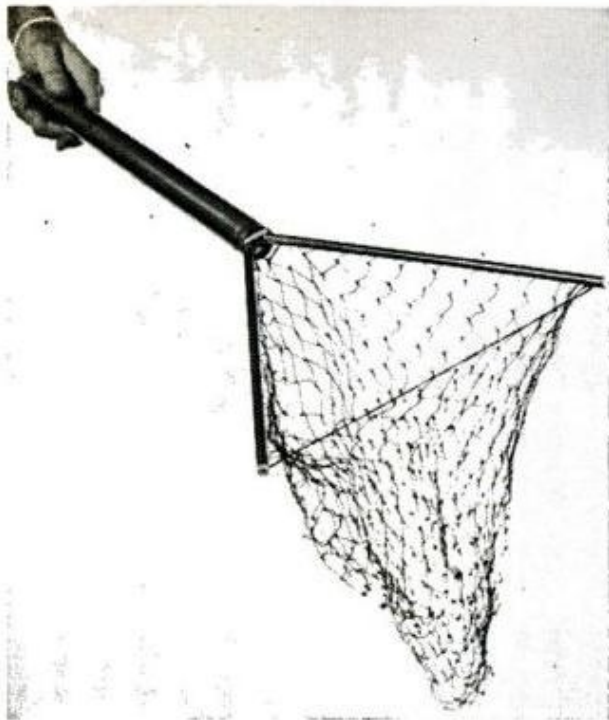

Instant Landing Net

Folded inside its tubular metal handle, a new spring-loaded fisherman's landing net stays out of the way when it's not in use. But a touch of a button on the handle snaps it out and open, ready for action.

Folded up, it's a lightweight tube with a wrist loop and a belt clip, and weighs less than a pound. The large size has a 24-inch tube with a 17-inch net triangle; the small size has 19-inch tube and 12-inch net triangle. Prices are \$7.95 and \$6.95, respectively, from Allagor Mfg. and Eng. Corp., 1552 Embassy St., Anaheim, Calif.



Soviet Rear-Engine Car

First small car with a rear-mounted, air-cooled engine to be made in the Soviet Union is the four-cylinder Zaporozhchec. The 23-horsepower car has four-wheel independent suspension and, according to the manufacturer, perfect stability at high speeds. Models of the car are shown at the Kommunar plant, Zaporozhe, U.S.S.R.

SEPTEMBER 1961

"I Made \$510⁰⁰



in One Month's Spare Time"
— says Earl Reid of Ohio

THE FREE BOOK offered below was a big first step ahead for men like Earl G. Reid of Thompson, Ohio, who says: "In one month I took in \$648, of which \$510 was clear. I work only part time — do a lot of service calls on ranges, dryers — also house wiring and electrical maintenance."

**YOU CAN "BEEF UP" YOUR INCOME,
SPARE TIME, OR FULL TIME,
WHEN YOU LEARN THIS WAY TO
Fix Electric Appliances**

Like Earl Reid, many others, YOU can now have a steady, good-paying "business of your own" right in your home. Spare-time at start, full-time later. No experience needed, no big investment. Learn how to Repair Electric Appliances. Many men now make \$3 to \$5 an hour!

FOUR HUNDRED MIL-
LION Electric Appliances

are in use right now in American homes. Seventy-six million MORE are bought each year. People need them fixed, good times or bad. YOU make good money doing it. Work in your own basement, garage, even on kitchen table. You need only few simple, basic tools. We train you, at home, to make steady money — earn while you learn.

Quick, Sure Way to Learn Everything You Need to Know

Our 24-page FREE Book tells how you can "cash in" on America's Electric Appliance Repair boom.

FREE Sample Lesson shows how our easy, clearly pictured instruction prepares you for top earnings and a profitable future in this big field. All for less than 20¢ a day.

At no extra charge we even provide all parts to assemble your own sturdy, portable Appliance Tester. It shows you where to repair, speeds your work,

makes sure each job is done right, ready to collect the cash coming to you.

Here's the big-demand business you've been looking for! — and the chance to train for it with methods proved successful for over 45 years. Get your Free Book, Free Lesson now. Mail coupon, letter, or postcard to: National Radio Institute, Appliance Division, Dept. AJ1, Washington 16, D.C. (No obligation, and no salesman will call on you.)



MAIL COUPON NOW

**NATIONAL RADIO INSTITUTE,
Appliance Division, Dept. AJ1,
Washington 16, D.C.**

Please send me Free Book about your Electric Appliance Repair Course and a Free Sample Lesson. I am particularly interested in:

- Spare Time Earnings Better Job
 Business of My Own

Name.....

Address.....

City..... Zone..... State.....

Accredited Member National Home Study Council



Sure Way to Pick Up Lots of Tomatoes

Harvesting up to six tons per hour, the first mechanical tomato harvester has been put to work in California. Developed by the University of California, the harvester moves forward, pushing a knife under the soil surface which cuts the vines. These are

then lifted from the ground, and rubber-covered "vine walkers" moving in opposite directions separate the vines from the tomatoes. The vines fall to the ground, and the tomatoes drop to conveyors, into a hopper and to further conveyors for sorting.

Study programs in APPLIED SCIENCE and ENGINEERING

You can earn an Associate in Applied Science degree (2 years) in electronics communications, electrical power, computer, air conditioning, industrial, and metallurgical technology, or a Bachelor of Science degree (4 years) in electrical or mechanical engineering. A Pre-technology Program, scholarships, financial aids, and placement service also available. New classes start quarterly. Write today for free "YOUR CAREER" booklet. Dept. PM-961, 1025 North Milwaukee Street, Milwaukee 1, Wisconsin.

MILWAUKEE SCHOOL OF ENGINEERING

BEAUTIFY YOUR HOME
with Pikes Peak Low Cost Quality Plantings
SEND TODAY FOR FALL PRICE LIST



PIKES PEAK
Nurseries

801 WATER STREET INDIANA 11, PA.

HYDRAULIC JACK REPAIRS



Earn While You Learn at Home

Millions of jacks in gas & auto-service stations, truckers, body-shops, riggers, factories, farms need servicing. We show you HOW—easy step by step directions—what tools to use. EARN UP TO \$5 an hour, in spare time, in your own basement or garage. Start your own business NOW. Write for folder No. PM-9 & free bonus offer.

Institute of Hydraulic Jack Repair
P.O. Box 50, Bloomfield, N. J.

© 1961
A.S.C.



LOOK

AT THE AMAZING PRICES

PAID AT GOV'T SURPLUS SALES

Autos.....\$78	Tractors.....\$68
Trucks.....\$212	Motors.....99¢
Boats.....\$5.90	Typewriters..\$6.80
Compressors..\$9.69	Generators..\$8.78

PAY 2 or 3¢ on the DOLLAR

for 1000's of Useful Items of

U.S. GOV'T SURPLUS

You BUY DIRECT from U. S. Government at TREMENDOUS savings. Eliminate middlemen—Save BIG MONEY! Pay as LOW as 2¢ on the dollar. Our DIRECTORY Gov't Surplus Sales lists 100's Army, Navy, Air Force Surplus Depots all over the world. BUY JEEPS, sports equipment, hunting, fishing and photographic equipment and supplies, radio, electronic and electrical equipment, trucks, boats, airplanes. Plumbing, hardware, office equipment & supplies. Tools, machinery, furniture. This 1961 book tells how to buy Gov't Surplus DIRECT. No dealer profits to pay. Get on the gravy train NOW! Send \$1 TODAY for "Gov't Surplus DIRECTORY" to **AVIATION SURPLUS, Dept. PM-9, Box 789, York, Pa.**

IMAGINE! The "Meat" of 176 Official Shop Manuals...in This One Giant Illustrated Repair Guide!



No wonder beginners and experts agree—
This is the Easy way to

FIX ANY PART OF ANY CAR

THERE'S one sure way to "lick" any auto repair job—and that's to get the advice of a real auto expert. That's why Motor's Auto Repair Manual is so widely used (over 3½ million copies sold!). It brings you the expert guidance of the engineers who make the cars and know them "inside out." Yes, packed into this giant volume is the "know how" from 176 OFFICIAL SHOP MANUALS, hundreds of factory bulletins, boiled down in easy-to-follow words and pictures.

Factory-tested procedures show how to fix any part of any popular make car — 1953 thru 1961. No guesswork! Manual "starts from scratch" — leads you through entire job with easy step-by-step directions, clear "how-to" pictures. You CANT go wrong.

OVER 1,000 BIG PAGES — 2,850 PICTURES

NEW, REVISED, ENLARGED Edition covers everything you need to know to repair over 1,967 different car models — including all the new compacts. Over 1,000 pages, 2,850 "This-Is-How" pictures, 195 "Quick-Check" charts — 30,000 essential repair specifications. Over 225,000 service and repair facts.

Not only do you get big separate illustrated sections covering every one of the 33 car makes—you also get detailed chapters on servicing car parts: Engines, Transmissions, Rear Ends, Generators and Alternators, Fuel Pumps, Ignition Systems, Overdrives, Auto-

matic Transmissions, Brakes, Valves, Pistons, Rings, Water Pumps, Distributors, Dash Gauges, Power Steering, Power Brakes, and more.

PLUS Factory Specifications and Adjustment Tables, Tune-Up Charts, etc. In addition, big TROUBLE-SHOOTING SECTION helps you spot any of 2,300 car troubles in a jiffy.

Try Book FREE 7 Days

SEND NO MONEY! Just mail coupon (paste it to postcard for faster action.) Use the Manual for a whole week, free. If you don't agree that it is the greatest time-saver and work-saver you've ever seen — return book in 7 days and pay nothing. Mail coupon today! Address: MOTOR Book Dept., Desk 119, 250 West 55th St., N. Y. 19, N. Y. (Schools, Bookstores: Write for discounts.)

FREE 7-DAY TRIAL

Return and Pay Nothing
If Not Delighted



Covers All These Models

Buick	Jeep
Buick Special	Lancer
Cadillac	Lincoln
Chevrolet	Mercury
Chrysler	Nash
Comet	Oldsmobile
Continental	Olds F-85
Corvair	Plymouth
Corvette	Pontiac
Dart	Tempest
De Soto	Rambler
Dodge	Rambler
Edsel	American
Falcon	Studebaker
Ford	Thunderbird
Hudson	Imperial

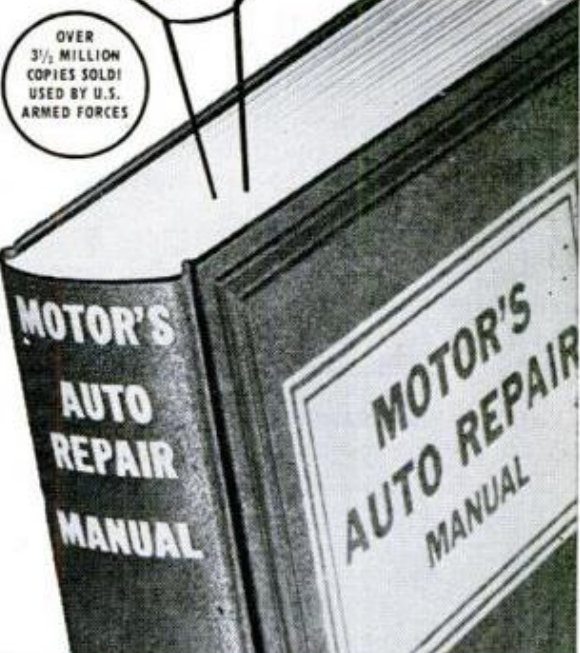

OVER 3½ MILLION COPIES SOLD! USED BY U.S. ARMED FORCES

Same FREE 7-Day Offer on MOTOR'S Brand-New TRUCK REPAIR MANUAL

Covers gasoline-powered trucks, 1952 thru 1961, including Chevy, Ford, & International "Midgets" — plus GM, Mack and Cummins Diesels. Over 2,000 illustrations; over 300,000 facts. Check box in coupon for FREE TRIAL

Amazed Self and Friends — "I amazed myself and my friends, too. Now do jobs that stumped me before." — Michael Baliczky, Newark, N. J.

So Complete and Easy to Understand — "So complete, easy to understand — have done jobs with Manual I would not have attempted without it." — C. L. Vanerstrom, Mich.

MAIL COUPON NOW FOR 7-DAY FREE TRIAL
(Attach to postcard if more convenient)

MOTOR BOOK DEPT.
Desk 119, 250 W. 55th St., New York 19, N. Y.

Rush to me at once (check box opposite book you want):

MOTOR'S New AUTO REPAIR MANUAL. If O.K., I will remit \$2 in 7 days, \$2 monthly for 2 months and a final payment of \$2.95 (plus 45¢ delivery charges) one month after that. Otherwise I will return the book postpaid in 7 days.

MOTOR'S New TRUCK REPAIR MANUAL. If O.K., I will remit \$3 in 7 days, \$3 a month later, then \$2 monthly for 2 months, plus 45¢ delivery charges with final payment. Otherwise I will return book postpaid in 7 days.

Print Name..... Age.....

Address.....

City..... Zone..... State.....

Check box and save 45¢ shipping charge by enclosing WITH coupon in envelope entire payment of \$5.95 for Auto Repair Manual for \$10 for Truck Repair Manual plus sales tax. Same 7-day return-refund privilege applies.



LARGER MODELS of prefab cottages include screened porch and can sleep up to eight persons comfortably

Do-It-Yourself Aluminum Cottage for Less Than \$1000

Six models of a compact vacation cottage made of special interlocking aluminum panels are being marketed beginning at less than \$1000 each. They can be erected by nonprofessionals.

Ranging in size from 125 to 645 square feet, the cottages are complete except for flooring, plumbing and electricity. Exterior and interior walls are available in a variety of colors. Jalousied doors and windows are

weather stripped and come with screens.

Basic unit of the cottages is a two-inch-thick panel, consisting of an insulating honeycomb core sandwiched between and permanently bonded to an aluminum skin. The panels are light enough to be handled by one workman and are interlocked for easy installation.

They are made by Panelfab Products, 2000 N.E. 146th St., North Miami, Fla.

INTERLOCKING PANELS make easy task of erecting cottages and also make them weatherproof. Aluminum walls eliminate maintenance; simple hosing down will wash exterior walls, soap and water the interior walls



Now...Painting is Easy!



ELECTRIC PAINT SPRAYER



\$12.95 complete

slightly higher on West Coast

powerful built-in 110 V. AC motor

Just plug in, pull trigger to spray paint, varnish, enamel, lacquer, mothproofers, garden sprays. 3 to 7 times faster than brush painting. Sapphire nozzle, instant heavy or light spray adjustment, 24 oz. graduated jar. Cleans easier than a brush. Fully guaranteed! At hardware, paint and department stores everywhere. New BVI Deluxe triple nozzle turret sprayer (not illus.) lets you dial 3 different spray patterns—fan, circular or fog. Only \$19.95. **BURGESS VIBROCRRAFTERS, INC.** • Grayslake, Illinois

Color DIAL TELEPHONES \$10.95 Complete.

Factory rebuilt Western Electric in white, beige, ivory, pink, green or blue. If 4 prong plug is required add \$2.00. Fully guaranteed. Write for free list. All shipments FOB.



SURPLUS SAVING CENTER
Waymart Dept. 9B1 Penna.

LAW FREE BOOK THE LAW TRAINED MAN

Write today for a FREE copy of illustrated law book, "THE LAW-TRAINED MAN," which shows how you can learn quickly at home the basic principles of all law topics through the famous Blackstone Law Course. All necessary books and lessons provided. Moderate cost; convenient monthly terms. Write for FREE law training book today.

Blackstone School of Law, 307 N. Michigan Ave.
Founded 1890 Dept. 56, Chicago 1, Illinois

LOANS BY MAIL

\$100-\$600 . . . to responsible borrowers anywhere. Confidential. Easy payments. Write

UNION FINANCE
Dept. PMD, 323 E. Camelback, Phoenix, Arizona



make your own Gems 36.50 FOB
The Gem Maker comes complete with all necessary equipment, including a super-charged diamond blade for sawing, and all the wheels for grinding, shaping and polishing; also complete instructions. The complete equipment as shown, less motor and belt for only \$36.50, f.o.b., Burlington, Wisconsin. Write today for information and literature.

B&I MANUFACTURING CO.
Dept. P, Burlington, Wis.



MEN PAST 40

Afflicted With Bladder Trouble, Pains in Back, Hips, Legs, Nervousness, Tiredness.

If you have these troubles, particularly bladder trouble, then your condition may be traced to Glandular Inflammation . . . a constitutional disease. Neglect of this condition often leads to premature old age and sometimes incurable malignancy.

The Excelsior Medical Clinic has a New Free Book that tells how thousands of men have been successfully treated here at Excelsior Springs for Glandular Inflammation by NON-SURGICAL Methods. They found soothing relief and a new outlook in the future of life.

This Free Book may prove of utmost importance in your life. Write Today. There is no obligation. **Excelsior Medical Clinic, Dept. B6129, Excelsior Spgs., Mo.**

94.6% OF BAILEY GRADUATES ARE EMPLOYED AT TOP PAY IN THE FIELDS WHICH THEY WERE TRAINED!



DIESEL-AUTO MECHANICS DESPERATELY NEEDED!

We have a far greater demand for our students than we can fill!

We can show you an actual waiting list of leading companies throughout the world who have tried Bailey graduates — found them outstanding, and are coming back for more!

Bailey Graduates are Successful . . . RECEIVE BIG PAY — HAVE SECURE FUTURE!

The Famous Bailey Course prepares you for BOTH Diesel and Gasoline Mechanics.

This is a must—due to the advent of using Diesel principles, such as 'Fuel Injection' on passenger cars . . . use of gasoline engines for starting Diesel engines, etc. You learn all this at Bailey in the amount of time ordinarily required to learn just one of these subjects, **ALL FOR THE PRICE OF ONE.**

Don't be satisfied with a 'futureless', one-type job — learn how you can make big money now! Write today for Free Booklet that takes you on a step-by-step camera tour through our spacious, modern shops — See Bailey students in action as they Learn-by-doing with the Famous Bailey Method of training!

We provide you with housing and part time jobs while in school, plus nation-wide placement service for graduates.

BAILEY Technical SCHOOLS

1634 S. GRAND ST. LOUIS 4, MO.

MAIL TODAY!

Please mail immediately this free booklet without obligation.

FREE BOOKLET















Name _____

Address _____

City _____ State _____

APPROVED FOR VETERAN . . . NON-VETERAN

IT'S EASY TO MAKE YOUR OWN MINIATURE POWER TOOL

- for grinding 
- routing 
- polishing 
- drilling 
- sawing 
- cutting 
- carving 
- brushing 
- buffing 
- sanding 
- engraving 
- sharpening 

WITH YOUR OWN MOTOR



with a wide selection of handpieces . . .

Turn any motor into the world's most versatile miniature power tool, ideal for every kind of model, craft, hobby and repair work. A real professional tool — not a toy — the slim handpiece is easy to hold, leaves one hand free to guide the work.

Complete flexible shaft with handpiece ready to attach to your motor priced from \$11.75. Many models available including complete machines. Satisfaction guaranteed. Write for illustrated bulletin #301.

F FOREDOM ELECTRIC COMPANY, INC.
Bethel, Connecticut

Manufacturers of Miniature Power Tools Since 1922

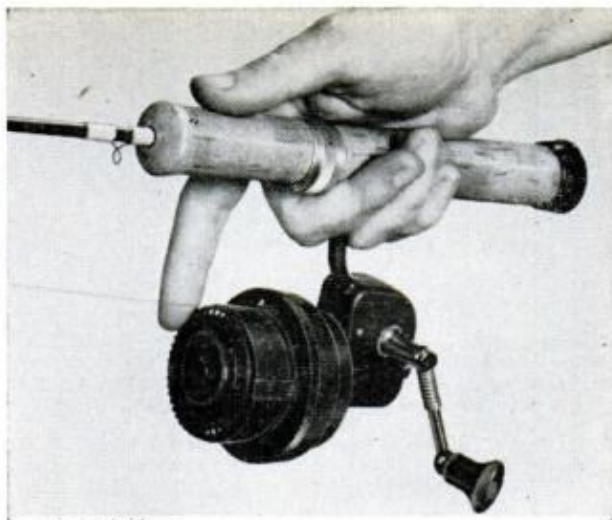

Reel Eliminates Line Handling

Completely internal, automatic line-handling — built into a flyer assembly mounted forward of the spool — gives a new spinning reel the ease of operation of a closed-face reel without sacrificing the casting efficiency of an open-faced reel. With no bail or pickup finger, the fisherman frees the line for casting by simply dropping his index finger onto a knurled ring at the front. The Taggart Model 10 reel sells for \$29.95, from Taggart Specialties, Indianapolis 24, Ind.

FIBERGLASS or PLYWOOD

\$41.95 Up: EASY TERMS
FREE CATALOG

Write Now

50 Models 8-22 ft.

Cruisers, houseboats, runabouts, convertibles, fishing, sailing. Pre-assembled, pre-formed units anyone easily assembles. Equal factory-built. Save 1/2 to 2/3. Free catalog has all details, color photos, paint, accessories, Fiberglass supplies, trailers. WRITE TODAY.



LUGER BOAT KITS

Dept. B-9, 9200 Access Road, Minneapolis 20, Minn.

Processing of **KODACHROME** (Licensed by Eastman Kodak)

AT DISCOUNT PRICES

KODACHROME
I & II

8mm ROLL OR
35mm 20 EXP. MTD.

\$1.00

8mm MAGAZINE75
35mm 36 EXP. MTD.1.75

SEND FOR FREE MAILERS and our big FREE CATALOG of Processing, Film and Equipment at DISCOUNT PRICES!



SOLAR CINE PRODUCTS 2427 S. Kedzie Dept. ME
Chicago 32, Ill.



Keeps Mower on Edge

Hardwood rollers attached to the front and rear of a power mower hold the mower level and prevent scalping of the grass when side wheels drop off the edge of a lawn or curb. The roller kit, by Protector, Inc., Rochester, N. Y., sells for \$13.

4 Current Rate **%** Per Annum

MONEY IN BY THE 15th EARNS FROM THE 1st!

Earn this high rate of dividend and get one of these valuable free gifts... from this modern 53 year old Association. Save by Mail... and we will handle all details for you.



POLAROID CAMERA KIT
Free with \$3,000 Account



G.E. CLOCK RADIO
Free with \$1,000 Account



G.E. ALARM CLOCK
Free when opening account for \$100 or more.

53 YEARS - 1908-1961
CITY SAVINGS ASSOCIATION



1656 W. Chicago Avenue • Chicago, Ill.
ASSETS OVER \$22,000,000.00

SHORTHAND IN

Famous **SPEEDWRITING** shorthand, 120 words per minute. No symbols; no machines; uses ABC's. Learn at home or through classroom instruction. Low cost. 500,000 graduates. For business and Civil Service. Typing available. 38th Year. Schools in over 400 cities. Write for **FREE** booklet.

Speedwriting
Dept. 1509-1
55 W. 42 St., N. Y. 36, N. Y.

6 WEEKS

get into operating or repairing EARTH MOVING EQUIPMENT

Men needed now for good paying jobs in booming road and construction work. Learn operating or repair-rebuilding of heavy road machinery, cranes, bulldozers, earth carriers, etc. Actual "on the job" training, 5 to 13 1/2 week courses. Classes start every Monday. Reserve your space now. Complete catalog and reservation facts **FREE**. Approved for veterans. Write

Greer TECHNICAL INSTITUTE
Attn.: P. K. Hutch, Box 368, Braidwood, Ill.

NO JOB WORRIES

PLASTEX INDUSTRY needs manufacturers on small scale for big production of Lamps, Clock Stands, Art Goods, Novelties in Plastic Marble imitation. No Experience necessary. The material makes regular 10¢ store sellers. Moulds furnished for fast production. Small investment brings good profit. Big wholesale orders now being placed. Ambitious men have chance for real prosperity and job security. Our **NEW FREE** booklet will interest and benefit you.

PLASTEX INDUSTRIES, Dept. A
3400 Third Ave. New York 56, N.Y.



ART—LEARN AT HOME Enjoy glamorous high-pay career or profitable hobby. Learn Commercial Art, Painting, Cartooning, Fashion Art, Lettering, TV, etc. We train you at home, in spare time. **TWO 22-pc. art outfits (worth \$25) included, without charge.** **LOW COST—only 20¢ a day.** Write for **FREE** Book describing easy course. No salesman will call. **Washington School of Art, Studio 149, PORT WASHINGTON, N. Y.** (Estab. 1914). Tear this out.

"MADE \$1200 ON ONE JOB"

Some make more, some less...

We help you start Your Own All-Year Business

Make BIG Money! With our easily operated, highly efficient wall washer, G. H. Jones made \$1200 on one school job. E. L. Goss took in more than \$10,000 in one year.



E. C. Taber wrote, "I made \$400 gross in two weeks." And no wonder... this machine washes walls 6 times faster and better than by hand—with no mess... no drop cloths.

Your Money-Making Opportunity • We want more men to go into this profitable business for themselves and enjoy independence—freedom from layoffs and bosses. Customers everywhere—homes, offices, schools, churches, hotels, etc. How much you earn depends largely on you. What you take in is mostly profit. No need to rent shop or office; operate from home. Start spare time until full time is justified.

Lose No Time — Send Coupon Today for All the Facts

FREE BOOK! MAIL COUPON TODAY!

VON SCHRADER MFG. CO.
910 "W" Pl., Racine, Wisconsin

Send at once (no obligation) your **FREE** booklet containing information about your **WALL WASHING MACHINE** and how I can start my own permanent, profitable business.

Name _____

Address _____

City _____ Zone _____ State _____

Save on Parts, Equipment!

Send for America's most complete, exciting Electronics Catalogs... Radio Shack's bigger, better-than-ever 336 page Buying Guide plus supplements for 12 months! See Stereo, Hi-Fi, Ham Radio, Tapes, Records, Kits. No money down credit terms. Satisfaction guaranteed.

RADIO SHACK Corp.
730 Commonwealth Ave. Boston, Mass.

FREE ELECTRONICS CATALOGS for 1 full year

MAIL Coupon TODAY

RADIO SHACK Corp. Dept. 61J3A
730 Commonwealth Ave., Boston 17, Mass.

Send me Radio Shack's famous electronics catalogs for 1 full year—all **FREE** and **POSTPAID**.

Name _____

Address _____

City _____ Zone _____ State _____

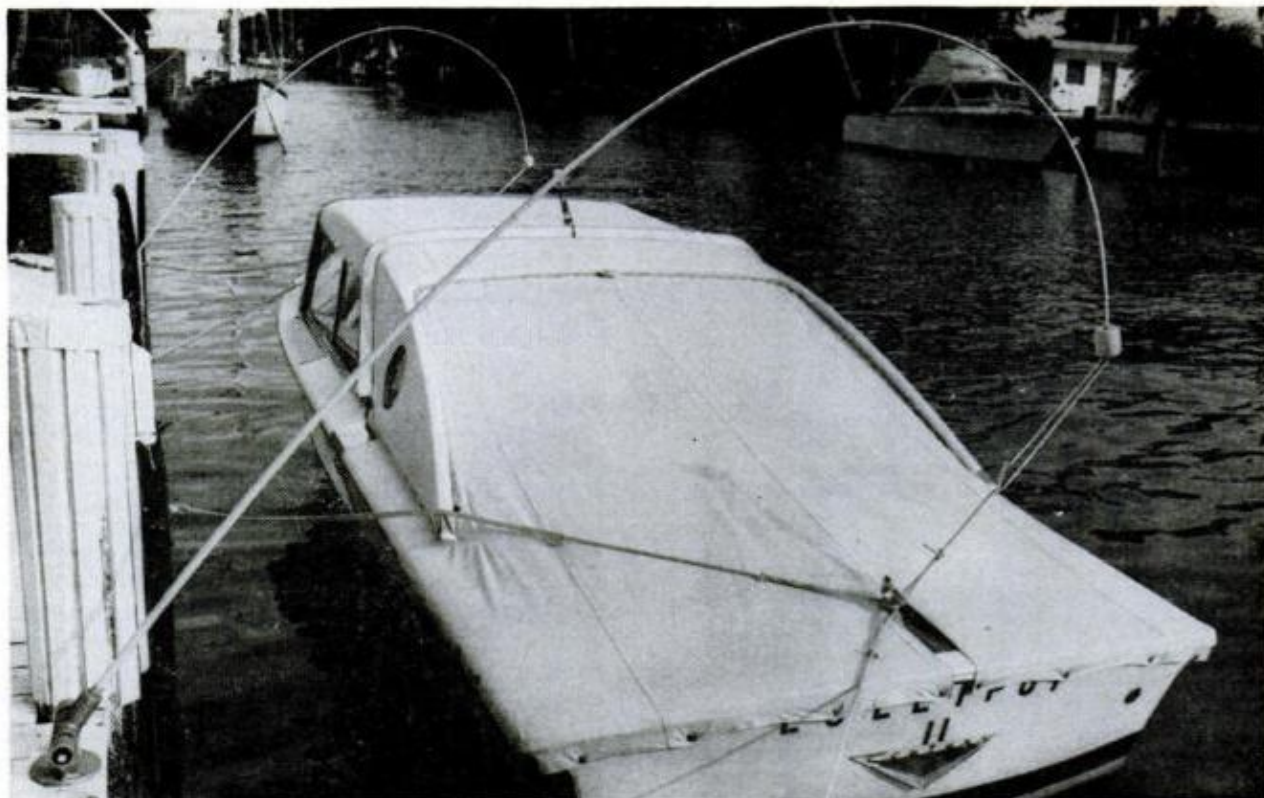

Mooring "Whips" Provide Safe and Flexible Boat Tie-up

Boats up to 40 feet can be spring-moored safely—and conveniently—against the roughest weather with a new fiberglass mooring whip that looks and acts like a big fishing rod. Mounted on aircraft-type tor-

sion bar mounts, the whips' lines slip easily over one cleat forward and one aft. Spring action holds it out, Y-lines hold it in. It's made by Marina Products, Inc., Fort Lauderdale, Fla.

Radio-Radar Telescope Will Listen to Stars and Map Moon

This fall a team of space scientists will turn on a giant radio-radar telescope nestled in a mountain valley near Arecibo, Puerto Rico, to investigate, among other things, the properties of the ionosphere.

It also will bombard the moon with radar signals; the echoes will produce a topographical map.

The \$6,000,000 'scope, a tool of the Defense Department, has a fixed reflector.

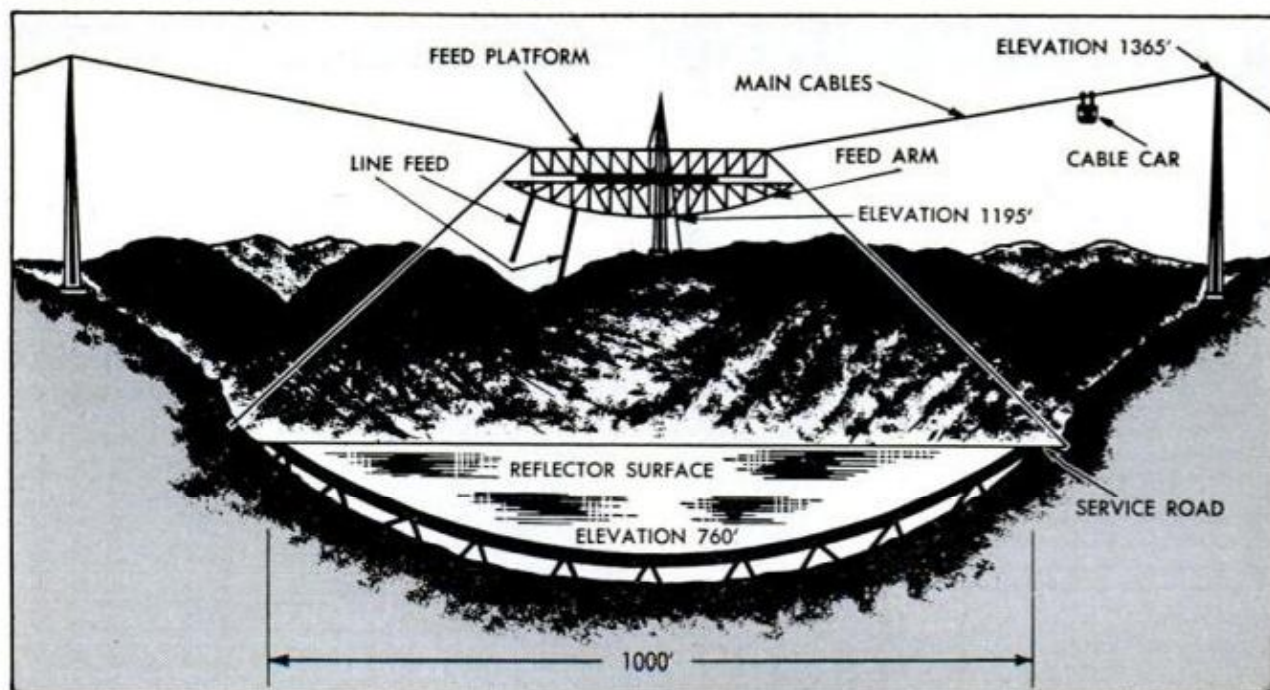

Magic Mail Plan—Make up to \$5 an Hour!



THIS MAN ... is taking out of the machine a Plastic Sealing Job — ordered by mail — only 11c in material cost brings back \$2.58 in cash by mail. Capacity of machine: **\$25.00 profit per hour of operation.**

Get **ORDERS** and **CASH** from your mailman—do work in **SPARE TIME** at home—or expand into **FULL TIME** business. Send coupon for Free facts about the newest and most fascinating of all home operated businesses. For the first time a simplified machine brings the fabulous profits of **Plastic Sealing and Plastic Laminating** within the reach of the small operator. Anyone can learn to operate the machine with a few minutes practice—then with our **Magic Mail Plan** can get mail orders pouring in daily with cash in every envelope. **No canvassing—no selling.** We even

Get into PLASTIC LAMINATING at home

WE'LL EVEN HELP FINANCE YOU supply the circulars you mail to bring back cash and orders, financing help, too. Rush name. We'll send you **FREE** and postpaid, pictures, prices, details, finance plan, all the facts you need. Mail coupon or send name on postcard. No charge. Warner Electric Co., 1512 Jarvis Av., Dept. L-2-K, Chicago 26, Ill.

Make Thousands of Beautiful Art Creations

COSTUME JEWELRY • CIGARETTE BOXES TRAYS • CANDLESTICKS • COASTERS LAMP BASES • BOOK ENDS...ALL IN SPARKLING COLORED PLASTIC



WARNER ELECTRIC CO., 1512 Jarvis Av. Dept. L-2-K, Chicago 26, Ill.

At no cost to me, please rush full details and financing plan, postage prepaid. No obligation.

Name _____
 Address _____
 City _____ Zone _____ State _____

"\$10,784 IN ONE YEAR"

SERVICING RADIATORS!"
 — Sidney Radiator Shop, Sidney, Mont. Make good money servicing auto-truck-tractor radiators with new Inland 1-Piece Radiator Shop. Easy to test, clean and repair radiators. Inland, world's largest radiator equip. mgr., trains you free. Small down payment starts you. "Pays-for-itself" Purchase Plan. Profitable dept. for garage or service station. Write for free information:



INLAND MFG. CO.
 Dept. PM-9
 1108 Jackson St.,
 Omaha 2, Nebr.

FREE
MUSCLE BUILDING INFORMATION
 Sensational New Methods
 Less Time—Less Effort—Better results
BODY-TONE, Box 638, North Miami 61, Fla.

Finish HIGH SCHOOL AT HOME IN YOUR SPARE TIME
DIPLOMA AWARDED
 Learn more! Earn more! Enter professional or technical schools. Advance socially. Live a happier, fuller life. Individual Courses or complete schedule. Write for *School Bulletin*.
ACADEMY FOR ADULTS
 30 W. Washington, Dept. PM-91, Chicago, Ill.

ELECTRONICS
 Train in the new shop-labs of the world famous
COYNE ELECTRICAL SCHOOL on a quarter of a million dollars worth of equipment or learn at home in your spare time with Coyne's modern television training.

INVENTORS NEEDED AT ONCE
 If you have an invention you wish to sell outright or license on royalty, write us at once. We are seeking inventions of household items, games, toys, sports items, tools, and mechanical and technical devices. Patented or unpatented. For further information and free brochure outlining manufacturers' requirements, royalty rates, send your name and address (no drawings, please) to us by letter or on postcard at once.
KESSLER CORPORATION, Dept. D-59, Fremont, Ohio

Use this coupon to get our free book **"GUIDE TO CAREERS"**
COYNE ELECTRICAL SCHOOL training at Coyne training at home
 1501 W. Congress Pkwy.
 Chicago 7, Ill., Dept. of Electronics 41-T
 NAME _____
 ADDRESS _____
 CITY _____ STATE _____
Unlike most other schools, we do not employ salesmen.

LEARN MEAT CUTTING AT NATIONAL Pay After Graduation

The steady dependable trade of Meat Cutting taught easily in 8 short weeks. **YOU LEARN BY DOING** under actual meat market conditions in big modern school at Toledo.

For beginners or men with experience. Get a profitable store of your own. Remember, **PEOPLE MUST EAT!** Big pay jobs. Free employment help. Thousands of successful graduates.

Buying, cutting, percentage, pricing, advertising, selling, etc. A complete retail meat education. National School established 38 years. Get National training now. Pay your tuition in easy monthly payments after you graduate. Send coupon for **FREE** 40 page school catalog — **TODAY** G.I. approved.

National School of Meat Cutting, Inc., Dept. 50-W, Toledo 4, Ohio
 Send me your **FREE** school catalog on National Training at Toledo in Meat Cutting. Meat Merchandising and Self-Service Meats. No obligation. No salesman will call.

Name _____ Age _____
 Address _____
 City _____ State _____
 Approved for Veterans

twenty to one dividend . . .

that's the reward you can receive from a college education in engineering or business. Employers like Tri-State graduates . . . interview seniors on campus. Qualify faster. Bachelor of Science Degree in 27 Months in Electrical (Electronics or Power major), Mechanical, Aeronautical, Chemical, Civil Engineering. IN 36 MONTHS a B. S. in Business Administration (General Business, Accounting, Motor Transport Management majors). For earnest, capable students. Small classes. More professional class hours. Modernized buildings, well-equipped labs, new dorms. Modest costs. Year-round operation. Enter January, March, June, September. Founded 1884. Write J. E. McCarthy, Director of Admissions for Catalog and "Your Career" Book.



TRI-STATE COLLEGE

491 College Avenue Angola, Indiana



DAN LURIE
World's Most
Famous
Body-
Builder,
TV Strongman

A BODY LIKE MINE IN SHORT TIME with famous DAN LURIE BARBELLS!

SEND FOR FREE GIANT CATALOG

Factory Prices	Cast Iron	Semi-Steel	\$9.48
50 lb. Set.	\$9.48	\$10.48	
100 lb. Set.	15.98	18.98	Plus Free
150 lb. Set.	23.48	27.48	
Extra Wts.	16c/lb.	38c/lb.	\$10 Course

MONEY BACK GUARANTEE—Send 50% in check or money order F.O.B. Plant Brooklyn, New York. Balance C.O.D.

DAN LURIE BARBELL CO. 1661-M9 Utica Ave., Dept. 59J, Brooklyn 34, N. Y.

Learn to MOUNT BIRDS



Tan SKINS, Make Up FURS

Be a Taxidermist. We teach you at Home. Mount Birds, Animals, Pets, Game Heads, Fish. Save your hunting trophies; decorate home and den. MAKE MONEY. Mount and R. from taxidermy for others. Big spare-time profits.

FREE BOOK 100 game pictures 48 pages - Hunters, get this wonderful book. It's Now Free. Send postcard TODAY. State AGE. NORTHWEST TAXIDERMIST SCHOOL Dept. 2509. Omaha, Nebraska

MECHANICAL DENTISTRY

To make Crowns, Plates, Bridgework, etc., for Dentists

Easy practical way to learn mechanical dentistry at home in spare time. FULL EQUIPMENT OF TOOLS AND MATERIALS INCLUDED WITH COURSE. Low tuition. Easy terms. Write for FREE BOOK about this money making profession that is not affected by machine age.

McCARRIE SCHOOL OF MECHANICAL DENTISTRY
207 N. Broad St., Dept. 116, Philadelphia 7, Pa.



You can make money in

WATCH REPAIR

Learn at home the low cost Sweazey Way

Watch repairing pays up to \$6 an hour, part time watch makers report on survey. Unique and modern Sweazey home study System starts you making repairs right away on Swiss and American watches. Professionally prepared training. No previous experience needed. Special tools provided for practice. Tuition only \$5 a month. Diploma Awarded. Free sample lesson and opportunity book give all facts. Write today. No obligation.

CHICAGO SCHOOL OF WATCHMAKING
2330 N. Milwaukee Avenue, Dept. 191, Chicago 47, Illinois

FREE OUTFIT STARTS YOU IN BIG MONEY SHOE BUSINESS!



Run your own profitable 'shoe store' business from home! Represent fast growing million dollar firm in spare or full time. We give you—FREE—complete Starting Outfit that makes you \$217.00 EXTRA each month for just 2 easy orders a day. You feature 195 fast-selling dress, sport, work shoe styles for men and women. Air-cushion shoes, many other special features! Sizes 2½-15—widths AAAA to EEEE. Draw on 200,000 pair stock. Also horsehide jackets. Start now selling to friends, folks where you work. Rush postcard for FREE Outfit!

MASON SHOE, Dept. G-981, CHIPPEWA FALLS, WIS.

MAKE BIG MONEY

MAKING COSTUME JEWELRY AT HOME!

Thrilling spare-time. MONEY-MAKING hobby! Make newest, beautiful jeweled earrings, necklaces, bracelets, pins, pendants, cuff links, tie clips! Quick, easy to make—easier to sell to friends, neighbors, stores, at big profit! Details FREE!

DON-BAR CO., Dept. K-191
2934 W. Fullerton Ave., Chicago 47, Ill.



LEARN CRIMINAL INVESTIGATION at home

Prepare for an exciting job, good pay, security! We teach you at home in spare time. Learn Finger Printing, Firearms Identification, Criminal Investigation, Police Photography. Low cost; easy terms. Over 800 Bureaus of Identification employ our graduates! Write for famous "Blue Book of Crime"—free! State age, please. (A Correspondence School Since 1918).

Institute of Applied Science
1920 SUNNYSIDE AVENUE - DEPT. 1356 - CHICAGO 40, ILLINOIS

Wooded, High-ground
HOMESITE (70 x 150)
on CAROLINA Coast!

→ \$500 DOWN \$500 A MONTH

14,000 acres—50 freshwater lakes
... 40 miles of finished roads ...
fishing, hunting, golf.

→ FREE LITERATURE!

BOILING SPRING LAKES, Southport 15, N. Car.

After the city,
Before the state
The ZONE keeps your mail
From being late



The Post Office has divided 106 cities into postal delivery zones to speed mail delivery. Be sure to include zone number when writing to these cities; be sure to include your zone number in your return address — after the city, before the state.

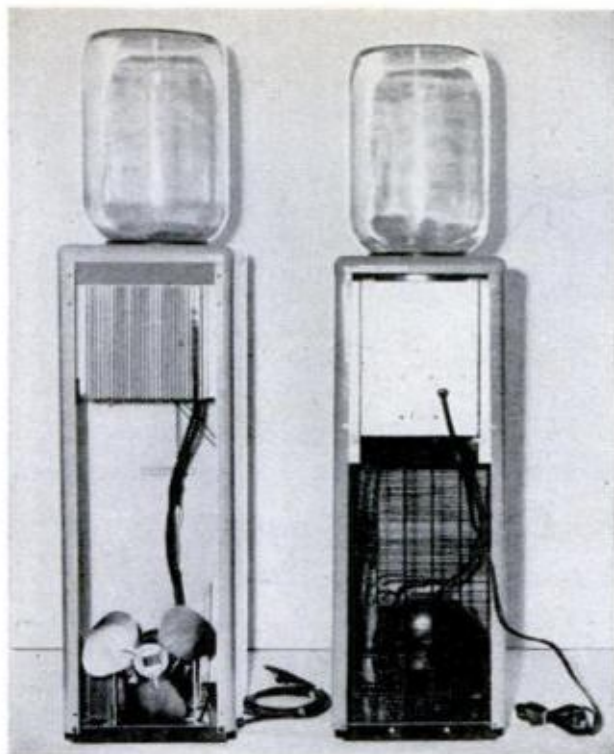

Electrically Cooled Water

A thermoelectric water cooler is believed to be the nation's first production-line appliance to make use of the principle that electricity passing through a junction of two dissimilar materials creates cold or heat.

The cooler's refrigeration system (left) is 25 percent smaller than a standard, compressor-operated unit (right) and has no moving parts except a fan to dissipate heat. The Westinghouse product is designed to retail for less than \$100.

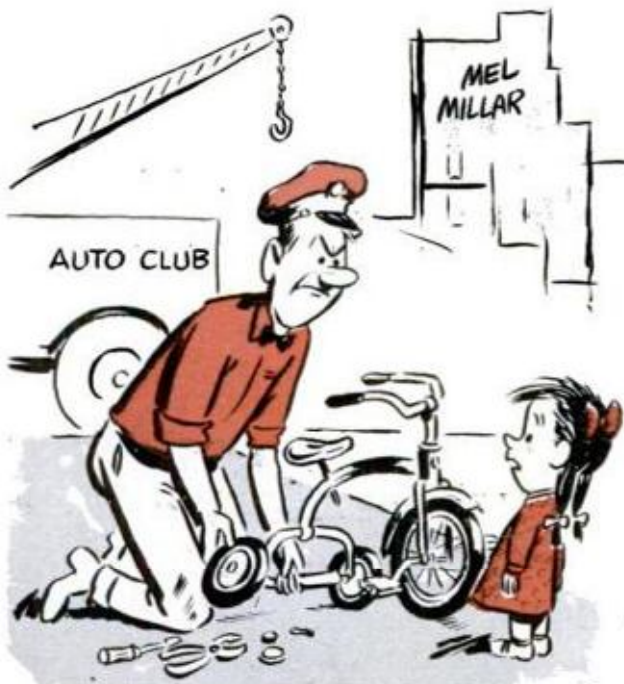

"Who else could I have called?"

SEPTEMBER 1961

BEL • SAW • SHARPNER

only \$39.50

Shipped Prepaid
Easy Payments



NOW YOU CAN BE AN EXPERT SAW SHARPENER . . .

Without previous experience you can sharpen all popular types and sizes of circular saws. Save money on your own sharpening, make money sharpening for others.

Bel • Saw • Sharpner quickly attaches to your bench grinder or any motor equipped for grinding wheel.

Compact, portable, mounts right or left of motor. Rounds saw to perfect circle, grinds tooth gullets to uniform depth, shapes and sharpens teeth. Tapered cone takes all popular saws. Gives correct hook angle. Scale for BEVEL grinding up to 30°

Order Today—Money-Back Guarantee

Use the **Bel • Saw • Sharpner** for 30 days . . . if not fully satisfied we refund your money. All parts guaranteed FIVE YEARS. Comes to you with saw grinding wheel, dressing brick, complete illustrated directions.

Shipped PREPAID \$39.50 or \$10 down, \$10 a month.

BELSAW ENGINEERING CO

412 Field Bldg., Kansas City 11, Mo.

\$149.50

COMPLETE

Your Best SCOOTER Buy!

Ready to ride, or put the "Little Gen" Scooter together yourself and save money. Send \$1.00 for plans, photos and material listings. Not a toy, 36" wheelbase—29" from ground to seat top. Easy to pack in auto or boat, as it disassembles. Fast, safe and most economical, up to 100 M.P.G. Years of satisfactory built-in service. Easy for youngsters to handle, yet strong enough for big grown-ups. Side car available. Before you buy a scooter, get the facts on "Little Gen" from



LITTLE GEN SCOOTER
Box 292 Fort Wayne, Indiana

MAKE YOUR
HOME WORKSHOP
PAY OFF
in spare time or
full time income

ELECTRICAL
APPLIANCE
REPAIR



Turn spare hours into cash profits. Millions of Home Appliances need fixing. Every home is your market for Full-Time Career or Spare Time "Second" Income.

Costs Less Than \$1.50 A Week. All you need is a workbench, spare time and N.T.S. Home-Training in Electrical Appliance Repair. You get a professional appliance tester, tools, and easy-to-learn, practical instructions, fully illustrated. Start earning early in course. Mail coupon now. No obligation. No salesman will call.

NATIONAL TECHNICAL SCHOOLS

WORLD-WIDE TRAINING SINCE 1905

4000 So. Figueroa Street
Los Angeles 37, Calif., U.S.A.

FREE BOOK
and
ACTUAL
LESSON

NATIONAL TECHNICAL SCHOOLS
Los Angeles 37, California

Dept. HB-91

Name _____ Age _____

Address _____

City _____ Zone _____ State _____

AVIATION CAREER

SPECIALIZED EDUCATION / PROFESSIONAL TRAINING... only 16 months to 2 years

Top-pay prestige positions, bright future in aviation. Job opportunities waiting for you as soon as you're ready. Air-frame and Powerplant Technician, Aeronautical Engineering 4-year course, Business or Executive, Pilot. Classes in Miami.

SEND FOR FREE 80-PAGE BOOK

Embry-Riddle Aeronautical Institute
Dept. B Miami, Florida (Founded 1926)

Name.....

Address.....

City.....Zone.....State.....

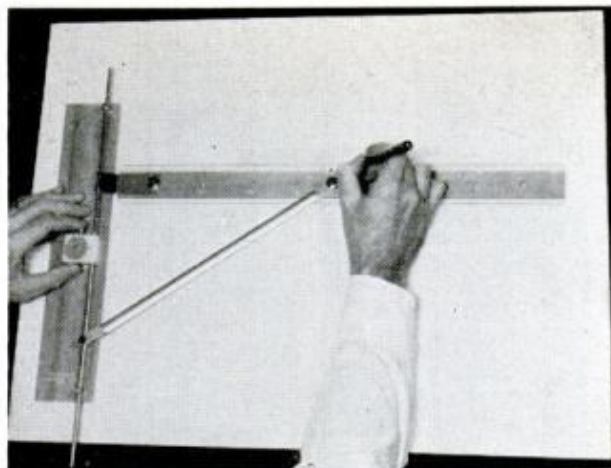

Push-Button T-Square Makes Parallel Lines

Each time a draftsman presses a button on the side of a new T-square, the ruler moves automatically to a new position for the inking of a parallel line.

The distance the ruler moves is predetermined by setting a dial that controls a gear mechanism.

For making parallel angled lines, there is an arm that swings into position on the ruler. This arm locks on at 15, 30 and 45 degrees. The parallel-line drawing apparatus is manufactured by Koh-I-Noor Pencil Co., Inc., Bloomsbury, N. J.



BARBELLS

140-Pound, **CHROME DELUXE** Barbell-Dumbbell set only **\$19.80**. This is our feature set and is the finest ever manufactured.

Training with adjustable weight is the **BEST** way to keep fit; the **ONLY** way to develop great strength and a perfect body. As the oldest and best equipped barbell company, BUR gives value and prices no one can equal.

SEND FOR FREE CATALOG

BUR BARBELL CO.
Lyndhurst 9, New Jersey

100 POUND SET \$12.80

Extra Plates Only 12c Pound

Learn LANDSCAPE GARDENING

AND GROWING OF PLANTS. Latest information on propagation, soil-testing, plant growth regulators, garden design. Start a profitable business or wonderful hobby. Unique and modern home study course—accredited. Earn your certificate at home. May I send FREE, and without obligation, my informative Booklet? **NORM MORRIS NATIONAL LANDSCAPE INSTITUTE** DEPT. M-91, 11826 SAN VICENTE BLVD., LOS ANGELES 49, CALIF.

High School at Home

MANY FINISH IN 2 YEARS

No classes. No time wasted going to and from school. Progress as fast as your time and abilities permit. Standard H.S. texts supplied. Thousands enroll each year in this 64-year-old school. Send for FREE descriptive booklet.

AMERICAN SCHOOL, Dept. H645

Drexel at 58th St., Chicago 37, Ill.

Without obligation, please send FREE descriptive booklet.

Name.....

Address.....

Accredited Member National Home Study Council

PROFIT IN YOUR SPARE TIME



FIX Small Gasoline Engines

OUTBOARD • POWER MOWER • CHAIN SAW • TRACTOR



Harry F. Peters, Spokane, Wash., says:
"... your Course led me into a very profitable and enjoyable business."

Be a small engine expert... earn **EXTRA MONEY**... own your own business. Easy-to-learn **LINCOLN** Home Study method qualifies you. Write for full particulars.

LINCOLN TECHNICAL INSTITUTE

Suite 9-E, 472 Market Street, Newark 5, New Jersey

Did He Goof?

Months ago, one of the country's leading weather forecasters made a prediction of what the weather would be like in *your* area at the time you would be reading his prediction in the October issue of *Popular Mechanics*. You'll have fun watching his predictions come true—or false.

Direct from England!

115 DIFFERENT BRITISH COLONIALS 24¢

Famous "Export Parcel" includes scarce old Classics, modern Pictorials, Regionals, Electronic issues! You get: Great Britain 1864 QUEEN VICTORIA; W. Australia 61 yr. old "SWAN"; 58 yr. old QUEENSLAND; unusual regionals for ULSTER, SCOTLAND; GHANA INDEPENDENCE; First 2 Electronic Stamps - with graphite on back; mint Queen & Sultan Issues from scarce colonies - KEDAH, GILBERTS, NAURU, TRISTAN, ASCENSION, MALACCA. Many others. Total 115 different. Regularly \$1.68 - bargain export price 24¢ to introduce overseas approvals.

IMPORT DIRECT - SAVE 20-60%. Buy direct - where dealers buy. Exciting offers, low prices, yours from London the easy 14 day approval way. Satisfaction Guaranteed. **SEND 24¢ IN UNUSED U.S. STAMPS (NO COINS).** Ask for Lot ZN-2.

BROADWAY APPROVALS LTD., 50 Denmark Hill, London S.E. 5, England



SIGN PAINTING

Home-Study Course - Only \$5.95

Teaches you commercial sign painting and sign building as it is being done TODAY in leading shops all over the country. Complete practical course for self-instruction. Shows latest methods of truck lettering office doors, wood letters, reflecting signs, plastics, sprayed signs, gold leaf, silk screen process, up-to-date alphabets, money-making business information, etc.

SATISFACTION GUARANTEED OR REFUND! Contains all the instruction of a high-priced correspondence course. Full price, only \$5.95, postpaid. Or C.O.D. plus postage. No risk—order today. Satisfaction or money back! Order "Sign Painting Course," NELSON-HALL CO., 325 W. Jackson Blvd., Dept. 2JN-2, Chicago 6, Ill.



"I'M MAKING \$1000 a Month MORE THAN

Haven't Touched Bottom Yet!" —reports Charles Kama, Texas, one of many who are "cleaning up" with orders for **PRESTO**. Science's New Miracle Fire Extinguisher. So can YOU! Amazing tiny new extinguisher ends fires fast as 2 seconds. Guaranteed 20 years! Sells for only \$4.95. Write for FREE Sales Kit. No obligation. **MERLITE INDUSTRIES, INC., Dept. P-15J, PRESTO DIV., 114 E. 32nd Street, New York 16, New York**

HEAD-QUARTERS FOR ALL SPORT-CAR TIRE SIZES

ALL FAMOUS BRANDS!

TIRES!

FARM TRUCK AUTO

AT LEAST THAN WHOLESALE

SAVINGS NEVER LESS THAN 50% up to 70% OFF REG. PRICE

FREE - SEND FOR YOUR FREE CATALOG - FREE!

RELIABLE TIRE DIST., 730 Morgan Blvd., Camden 4, N. J.

earn \$15 as TAX EXPERT

OUR STUDENTS EARN AS MUCH AS \$3,000 IN 3 SHORT MONTHS PREPARING INCOME TAX RETURNS IN SPARE TIME. ALSO OPERATE LUCRATIVE YEAR-ROUND BUSINESS TAX SERVICE, DIGNIFIED HOME-OFFICE BUSINESS. EXPERIENCE UNNECESSARY. WE TRAIN YOU; HELP YOU START. STATE APPROVED HOME TRAINING PROGRAM. WRITE TODAY FOR FREE PROSPECTUS.

UNION INSTITUTE, Lakewood C-20, N. J.

PELLET FIRING LUGER AUTOMATIC

- MAGAZINE LOADING CLIP
- OVER 15 MOVING PARTS
- FULLY AUTOMATIC

Automatic full size model of a Luger Automatic pistol—contains over 15 moving parts. Loads 8 complete rounds which snap into the hard butt simulating a Luger. Fires 8 bullet shaped pellets. Has automatic slide action.

ONLY \$198

MOST AUTHENTIC MODEL GUN WE'VE EVER SEEN

Comes to you with working parts disassembled with cleverly engineered springs, full instructions, supply of pellets and specially designed belt holster. **Full Money Back Guarantee.** Simply send \$1.98 plus 27¢ shipping charge or order C.O.D. From: **HONOR HOUSE PROD. CORP., Dept. LL-31, Lynbrook, N. Y.**

Superior's New Model 70 UTILITY TESTER® FOR REPAIRING ALL ELECTRICAL APPLIANCES MOTORS • AUTOMOBILES • TV TUBES

As an electrical trouble shooter the Model 70:



- Will test Toasters, Irons, Broilers, Heating Pads, Clocks, Fans, Vacuum Cleaners, Refrigerators, Lamps, Fluorescents, Switches, Thermostats, etc.
- Will test all TV tubes for open filaments, inter-element shorts, burned out tubes, etc.
- Measures A.C. and D.C. Voltages, A.C. and D.C. Current, Resistances, Leakage, etc.
- Will measure current consumption while the appliance under test is in operation.
- Incorporates a sensitive direct-reading resistance range which will measure all resistances commonly used in electrical appliances, motors, etc.
- Leakage detecting circuit will indicate continuity from zero ohms to 5 megohms (5,000,000 ohms).

As an Automotive Tester the Model 70 will test:

- Both 6 Volt and 12 Volt Storage Batteries • Generators • Starters • Distributors • Ignition Coils • Regulators • Relays • Circuit Breakers • Cigarette Lighters • Stop Lights • Condensers • Directional Signal Systems • All Lamps and Bulbs • Fuses • Heating Systems • Horns • Also will locate poor grounds, breaks in wiring, poor connections, etc.

Model 70 comes complete including 64 page book, only \$15 SHIPPED ON APPROVAL NO MONEY WITH ORDER - NO C. O. D.

Try it for 10 days before you buy. If completely satisfied then send \$3.85 and pay balance at rate of \$4.00 per month for 3 months — No Interest or Finance Charges Added! If not completely satisfied, return to us, no explanation necessary.

MOSS ELECTRONIC, INC., Dept. D-902
3849 Tenth Ave., New York 34, N. Y.

Please rush Model 70. If satisfactory, I will pay on terms specified. Otherwise I will return tester.

Name _____
Address _____
City _____ Zone _____ State _____
All prices net, F.O.B. N. Y. C.

LEARN UPHOLSTERY

in your spare time run your own business AT HOME

FREE BOOK with sample lessons

With Course You Make

- SLIPPER CHAIR
- CLUB CHAIR
- OTTOMAN

PLUS SLIP COVERS Yours to Keep or Sell

BE YOUR OWN BOSS

Earn more from the start in spare time. STOP worrying about layoffs, enjoy a steady growing income and independence for life in the booming field of Custom Furniture Upholstery. Right off, you start upholstering with the tools, complete frames, fabrics and materials. Included FREE with N. Y. State-approved UTS Home Study Course. You learn skilled professional custom upholstery, reupholstery, furniture finishing, repairs, how to make beautiful slip covers, cushions and draperies. **EARN WHILE YOU LEARN**, in your spare time AT HOME . . . the UTS easy way.

FREE ILLUSTRATED BOOK—FREE SAMPLE LESSON

Get ready for well-paid job and big profits, from steady work, as your own boss, running your own business. Mail coupon NOW for FREE BOOK! Training in N.Y. School also available. **VET APPY'D. ACCREDITED BY N.H.S.C.**

UPHOLSTERY TRADES SCHOOL
Dept. PO-310, 721 B'way, N. Y. 3, N. Y.

Please send me FREE book, "Your New Way to a Successful Career," and FREE sample lesson. No obligation—no salesman will call.

Home Study Training in N. Y. School

Name _____ (Please Print Plainly)
Address _____
City _____ Zone _____ State _____
 Check if Korean Veteran



COMPLETE KIT



LEAD COIL

EDGER



ZIGZAG RIBBON OF CEMENT IS SPREAD WITH BRUSH

A

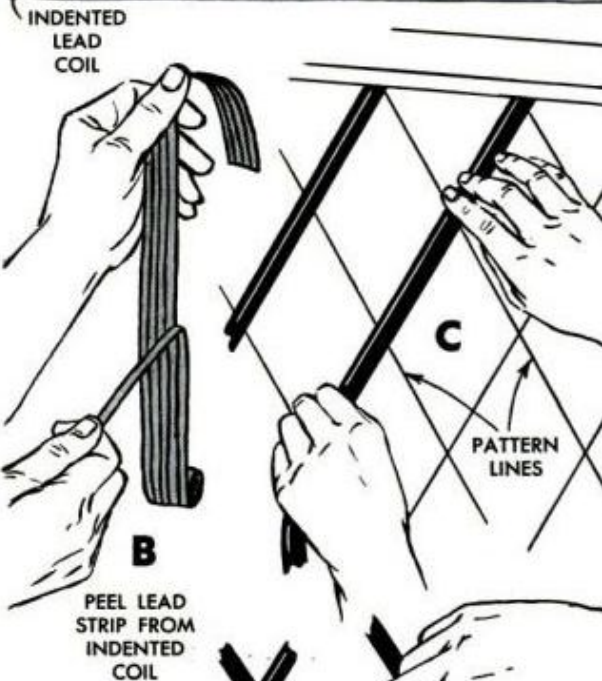

INDENTED LEAD COIL

B

PEEL LEAD STRIP FROM INDENTED COIL

C

PATTERN LINES



D

FIRST STEP WITH EDGER

Leaded Windows In a Kit

ALL THE CHARM and authenticity of old leaded-glass windows can be yours with these new Decra-Led kits which enable you to lead any suitable window pane without altering the existing sash frame. According to Craftwood Corp., P.O. Box 187, Oconomowoc, Wis., suppliers of the kits, you first measure the exact size of the glass pane inside the frame and draw the outline on a sheet of paper. Divide into uniform rectangles and then draw heavy pencil lines through the rectangles diagonally both ways. This gives you the pattern lines. Tape the sheet to the glass with the lines showing through.

A typical kit is pictured above with the tube of special cement, brush and smoothing peg. With these items at hand and the paper pattern taped on the glass pane, you proceed through the steps A, B, C and D. The lead strips come to you as an indented coil and after unrolling and spreading the cement and allowing to set to the tacky stage, detail A, you peel a single strip from the lead as in detail B and place along the pattern line as in detail C. Then you use the smoothing peg, or edger, as in detail D to press the strip firmly into contact with the glass. Decra-Led is available in $\frac{1}{8}$, $\frac{1}{4}$, $\frac{3}{8}$ and $\frac{1}{2}$ -in. widths. The No. 1 kit will lead three 18 x 30-in. panes, costs \$6.95 with detailed instructions.

POPULAR MECHANICS



Coming Next Month...

BOOKLETS • INSTRUCTIONS
PLANS • NEW PRODUCTS
... you can get lots of
HELPFUL INFORMATION
through the mail!

Starting next month, Popular Mechanics will offer its readers another great buy-it-yourself service. A new money saving—

POPULAR SHOPPING SECTION

that will include the latest on manufacturers' booklets, plans and mail-order products. Many will be free for the asking; others will be nominally priced. Interesting reading, worthwhile reading. Another great service from Popular Mechanics.

**Beginning in Oct.—Look for
— POPULAR SHOPPING —
in
Each Month's Issue of PM**



DEMPSEY

By the man himself, as told to
Bob Considine and Bill Slocum

An Avon Book **50c**

Jack Dempsey recounts his classic fights against Carpentier, Firpo and Gene Tunney, and the unforgettable years as Heavyweight Champion of the World.

For a complete catalog of Avon Books in print, write: Avon Book Division, The Hearst Corporation, Dept. C, 250 West 55th Street, New York 19, N. Y.

**discounts by mail
up to 40%!**

Save on 1,001 famous U.S. products for workshop, garden, boat, paint jobs... Skil, Wen, Du Pont, Kidde — dozens of name brands.

Satisfaction guaranteed. Send now for valuable, 68-page Catalog — free for limited time only (regular price, 50¢).

GATES GENERAL CORPORATION
P.O. BOX 355 PM • FARMINGTON, CONNECTICUT

You Can Have a HE-MAN Voice

STRENGTHEN your voice this tested, scientific way. Yes—you may now be able to improve the POWER of your speaking and singing voice... in the privacy of your room! Self-training lessons, mostly silent. No music required.

FREE BOOKLET

Write today for Eugene Feuchtinger's great booklet "How to Develop a Successful Voice." It's absolutely FREE! You must state your age. Booklet mailed postpaid in plain sealed envelope. No salesman will bother you. Send your name and age RIGHT NOW!

PREFECT VOICE INSTITUTE, 325 W. Jackson Blvd., Studio JN-2, Chicago 6, Ill.



"I Earned \$400 While Learning"

Says John Brankis, Burlington, Ontario, Canada

"I earned \$400 during my training period. And it was fun! The course was so easy, the instructors so helpful, that I think anyone can master locksmithing, as I did."

Be a LOCKSMITH

Add 50%-100% to YOUR INCOME with easy spare time earnings. Cash in on nationwide shortage — trained locksmiths in demand! Quickly step into a big-pay opportunity job — high-profit shop of your own.

Earn Extra Money RIGHT AWAY! All Special Tools, Supplies Furnished FREE.

Age, education, minor physical handicaps don't matter in this growing trade. You can quickly qualify as a skilled locksmith. Study at home as little as one hour a week. Gain practical experience through well-illustrated lessons. Do real jobs on car locks, house locks, padlocks and safe locks, under the guidance of experts.

MAIL COUPON FOR FREE BOOK

For a future as your own boss or in a high-pay job, write now for FREE illustrated book! Only school of its kind. Lic. State of N.J., Accredited NHSC. Locksmithing Institute, (Div. Tech. Home Study Schools) Dept. 109-1 150 Park Ave., E. Rutherford, N.J.

MAIL COUPON NOW!

LOCKSMITHING INSTITUTE, Dept. 109-1
150 Park Avenue, E. Rutherford, N.J.

Please send Free Illustrated Book without obligation.

Name _____ (Print here)

Address _____

City _____ Zone _____ State _____

Check if Veteran (No Salesman will call.)

Diesel Mechanics —

DIESEL POWER INCREASING IN IMPORTANCE--MECHANICS NEEDED

by B. Richard

The list of uses of diesel power in American industry is a long one.

Trucks, buses, ships, locomotives, farm machinery, construction equipment, and stationary power equipment such as electric generators and drilling equipment all make use of diesel power.

The list of applications of diesel power has grown steadily in recent years and growth is expected to continue in years to come. This has brought about increasing job opportunities for trained diesel mechanics, and industries that depend on diesel engines as a primary power source are expected to expand considerably during the 1960's.

The number of diesel-powered trucks and buses in this country almost doubled between the years 1953 and 1957, and diesels are by far the most-used power source in today's railroads. In fact, the advantages of diesel power are so well known that one of the world's leading car manufacturers offers a diesel-powered passenger car.

An important consideration in the increased use of diesels in industry and in the increase in job opportunities for diesel mechanics is the fact that most industries using diesels in large numbers are expected to expand their activities considerably in the coming decade.

Great numbers of diesel-powered bulldozers, cranes and other earth-moving equipment will be manufactured and sold because of the government's multibillion dollar highway expansion program. Farm mechanization has been steadily increasing for a long time and this trend will continue at an accelerated pace in years to come. This has opened up a gigantic market for diesel-powered harvesters, tractors and other farm equipment.

The expanding petroleum industry will be ordering great numbers of diesel engines to run generators which supply power for drilling and pumping equipment.

Diesel equipment is used in ventilating, drilling, pumping and hauling in modern

mining operations. It is expected that the use of diesel equipment in mining will be expanded to an even greater extent in coming years.

An advantage of the diesel engine is that it operates relatively inexpensively. Not only is diesel fuel cheaper than gasoline, but the engine itself burns fuel more efficiently, uses less fuel for a given amount of work and delivers more miles per gallon for moving equipment.

American industry will be putting diesels to ever greater use wherever dependable and economical power is needed and wherever it is possible to apply diesel engines to the job.

Because of this increased use of diesel power, many mechanics with years of experience on standard gasoline engines are taking educational courses in diesel mechanics so they can capitalize on these new opportunities. The similarity of the basic parts of diesel and gasoline engines (although fuel feeding and firing systems differ) makes gasoline engine experience a valuable asset for a diesel mechanic.

Many young men have found it helpful to take correspondence or resident-training courses in the theory and practice of diesel mechanics while they are working full-time on standard gas engines. In this way it is possible to broaden employment potentials and build a good base for the increased income opportunities available to qualified diesel specialists.

Some correspondence schools offer by mail detailed courses in diesel engine repair and maintenance. These courses are often tailored so that they are of value not only to beginning mechanics with limited job experience, but also to experienced gas-engine mechanics who want to broaden their knowledge to include diesels.

Excellent resident-training courses are also available to beginners and experienced mechanics. These courses have the advantage of offering actual classroom instruction and practical training with valves,

cooling systems, starting systems, bearings, injection systems and other important diesel-engine parts.

Correspondence training lets students undertake their courses of instruction without interrupting their present jobs. Students can set their own "classroom" hours for minimum interruption with other demands on their time.

Although it is necessary for students to be present for classes in resident-training schools, evening courses are often offered, and many such schools help their students find part-time work to assist in defraying expenses. This lets students hold jobs at the same time they are learning new techniques.

Throughout the country there are opportunities for qualified diesel mechanics because diesel power is used in so many different industries. Among the important sources of employment are bus lines, trucking companies, shipping lines, railroads, electric power plants, logging camps, marine-engine repair shops and firms that service diesel farm tractors and construction equipment.

The earning power of a diesel mechanic depends on his experience, training and knowledge. Obviously, the more a man applies himself to increasing his knowledge of the theory and practice of diesel mechanics, the greater his opportunity to take over a well-paid supervisory position with a bus or truck line or in a repair shop.

Figures show that in 1958 most qualified and experienced diesel mechanics earned upwards of \$2.50 an hour and this wage has risen since that time. Although no national data are available on the incomes of diesel mechanics, it is reported that many earn over \$120 a week, and salaries offered in supervisory positions are considerably more substantial.

If you are now an auto mechanic and want to broaden your employment outlook with diesel training, you will want to check into correspondence and resident-training schools for the detailed instruction they make available.

If you are considering making diesel mechanics a career or are a beginning gas-engine mechanic, you will find educational courses in diesel mechanics can be your stepping stone to a higher-paying job in this expanding field.

For information on diesel mechanics and other career opportunities, write for Popular Mechanics career-guidance book, "SKILLS for AMERICA." Write to Popular Mechanics, Dept. SFA 80, 200 East Ontario St., Chicago 11, Illinois.

Free!



**BRAND NEW
LAFAYETTE
ELECTRONICS
1962
CATALOG 620**

It's Bigger and Better Than Ever!

340 giant-sized page catalog from the world's leading supplier of electronics and stereo hi-fi equipment.

340 PAGES

It's a complete shopping center for audiophiles, technicians, engineers, students, hobbyists, servicemen and dealers. Thousands of items at lowest money-saving prices — featuring LAFAYETTE KITS . . . the best value for your money any day.

SPECIAL! NO MONEY DOWN
with Lafayette's **NEW EASY-PAY PLAN.**

MAIL THE COUPON TODAY FOR YOUR FREE CATALOG

LAFAYETTE LOCATIONS

JAMAICA • BRONX • NEW YORK CITY
NEWARK • PLAINFIELD • PARAMUS • BOSTON

Lafayette Electronics Dept. LI-1
P.O. Box 190, Jamaica 31, N. Y.
Send me the FREE 340-pg. 1961 catalog 620.

Name.....
Address.....
City..... Zone..... State.....

**MY SPARE TIME HOBBY MAKES ME
\$5⁰⁰ an hour
CASH PROFIT**

—Grover Squires



START YOUR OWN SPARE TIME BUSINESS
You can turn your spare time into Big Cash Profits with your own **COMPLETE SHARPENING SHOP**... Grind saws, knives, scissors, skates, lawn mower blades... all cutting edges. Your Own Cash Business with no inventory right at home... no experience needed. **FREE BOOK** tells how you can start your own spare time business while you are still working at your regular job. Low Cost—time payments only \$15.00 a month. Send postcard today.

BELSAW SHARP-ALL CO., 712 Field Bldg., Kansas City 11, Mo.

**CONCRETE BIRD BATHS
AND OVER 250 OTHER MONEY MAKING ITEMS**



You've seen them all over the country . . . concrete bird baths, garden seats, flower boxes, appealing statuary, and many other items that add charm around the house and lawn. They're made by enterprising people, just like you, from our **COPYRIGHTED ALUMINUM MOLDS**. It's easy. It's fun. It's profitable.

Send \$2.00 today for this 82-page "How to" book. 20 pages of clear instructions. Valuable trade secrets. Over 250 items beautifully pictured (with description, dimensions, and prices of molds). Rushed to you by first class mail.
CONCRETE MACHINERY CO., INC.
HICKORY 2, NORTH CAROLINA

Name.....
Address.....

**HOW TO
TURN
CONCRETE
INTO
GOLD**

ALL-WEATHER CAPS

■ FOR SPORTSMEN; FOR
OUTDOOR WORKERS

■ OF WRINKLEPROOF
BRUSHED PIGSKIN

■ CHOICE OF
6 STYLES;
MANY COLORS

■ JUST BRUSH
OUT SOIL
AND SPOTS



BY **WOLVERINE**

SAMURAI
SUICIDE
WARRIORS

KARATE!



JUDO BOXING! MUSCLEBUILDING! YOGA!
STRONGMAN STUNTS! STRENGTH &
ENDURANCE! HANDBALANCING! etc.

YOU GET ALL THESE! *20 illustrated FOR ONLY
KARATE blows *SAVATE foot fighting
*Secret NERVE CENTER and ANATOMY
charts *20 lethal JUDO throws *20 terrific
STRONGMAN STUNTS *Complete MUSCLE-
BUILDING program *All-In WRESTLING
*Ancient YOGA secrets *HANDBALANC-
ING stunts *Complete BOXING program
*Secrets of ENDURANCE *WEIGHTLIFTING
schedule! *All picture packed. Super wall
charts, (surplus 1960 printing). No C.O.D.'s.
Canadian orders 50c. Satisfaction Guar-
anteed or Refund.

35¢
you get the lot!

Oxford Studio, 44K Bromfield, Boston, Mass.

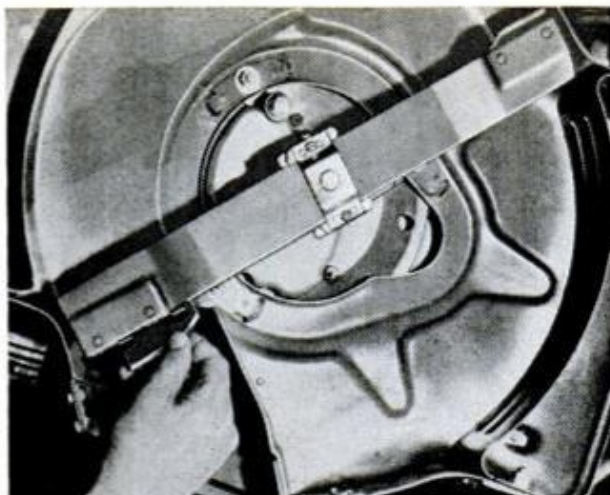

Throwaway Mower Blades

Putting a fresh edge on a rotary mower is as easy as changing the blade in your safety razor with a new cutter bar which uses inexpensive, replaceable blades.

Available in 18, 19, 20, 21 and 24-inch lengths, the bar is similar in shape to conventional bars but has holders at each end for the 1 by 2½-inch cutting blades. The bar sells for \$4.98 with four blades and three bushings to reduce shaft size. Four extra blades cost \$1.25. It's made by Green Colonial, Inc., Des Moines, Iowa.

\$1 BRINGS YOU \$18

Discover Flok-Kraft and Earn \$\$\$\$\$ AT HOME

Earn up to \$15.00 per hour spare time. Amazing new Velvet-fiber spray instantly makes any object (Lamps, Radio & TV Cabinets, Figurines, Signs, Auto dash boards, toys, furniture, draperies — anything) worth expensive \$\$\$\$\$ Prices . . . like magic, you can spray anything with this beautiful new suede-like finish that feels like rich Velvet.

EARN UP TO \$300.00 PER WEEK SPARE TIME

Imagine, materials cost only 3c per square foot. (Average TV or radio cabinet can be beautifully sprayed with this startling new 3-dimensional Velvet finish in 15 minutes at a cost of only 34c in materials. Your charge for this job is at least \$10.00.)

REPRESENTATIVES IN YOUR AREA URGENTLY NEEDED

Own your own business. Work at home in your spare time. Help fill the huge growing demand for this amazing new beautiful Velvet-fiber finish. Orders come from stores, offices, homes, architects, auto dealers, — everywhere. Possible \$20,000,000.00 worth of jobs to be done. Investigate today—be first in your area! Actual samples in 16 Radiant Colors, Booklet of 50 Home Business Opportunities and Confidential Details all sent free! Send No Money. Write: Coast Industries, Los Angeles 61, Calif., Dept. B-9.



FOR BIG OR TALL MEN ONLY!

We specialize in Large Sizes Only! Sizes 10 to 16; Widths AAA to EEE. Dress, sport, casual, golf shoes, insulated boots, sox, slippers, jackets. Also dress and sport shirts with bodies cut full 4" longer than usual. Slacks, rain-coats and sweaters, too! Sold by mail only; Satisfaction Guaranteed! Write for Free Style Book today! King-Size, Inc., 4571 Forest St., Brockton 64, Mass.



NORDBERG-

"First findum long, straight, supple
piece of fiberglass!"

POPULAR MECHANICS

New Table Top Invention Puts You In...
PROFITABLE RUBBER STAMP BUSINESS

Home Operators now make **\$9.20 AN HOUR** in Business once monopolized by a few big companies

Special rubber stamps bring high prices—cost only pennies to make on new, low-cost table top machine. Take 27 cents worth of material, make perfect stamps, the kind businesses and offices now buy by the dozen at \$1.80 each. Make up to \$9.20 an hour. Start in spare time in your own home. Run machine on kitchen table using ordinary electrical outlet. Make any kind of stamp. We'll send you free information without obligation about this established, highly profitable business. **We'll even help finance your start.** For free information send name and address today on a postcard to: Rubber Stamp Div., 1512 Jarvis Ave., Dept. R-2-K, Chicago 26



GET INTO ELECTRONICS

V.T.I. training leads to success as technicians, field engineers, specialists in communications, guided missiles, computers, radar, automation. Basic & advanced courses in theory & laboratory. Assoc. degree in 20 mos. B.S. obtainable. ECFD accredited. G.I. approved. Graduates with major companies. Start Sept., Feb. Dorms, campus. H. S. graduate or equivalent. Catalog.

VALPARAISO TECHNICAL INSTITUTE
 DEPT. D VALPARAISO, INDIANA



Up to 200% PROFIT in CANDLE MAKING-DECORATING

Investigate exciting money making opportunities being your own manufacturer-distributor-dealer in fastest growing fun and profit craft. Enormous year around demand. Start at home in spare time. No artistic skills needed. No age or educational limits. Send for free facts.

CANDLE INSTITUTE, Dept. X-496 Fallbrook, Calif.

FREE GERMAN STEEL HUNTING KNIFE



4-INCH BLADE

We give you handiest hunting and fishing knife you've ever had! Has 4-INCH LONG highly tempered steel blade—VERY SHARP! Attractive handle. We send knife FREE to acquaint you with our below-wholesale bargains. Please send 25c for handling. NO LIMIT—but send 25c handling for each knife. Order TODAY! HUNTING KNIFE, Dept. Z-602, Box 881, St. Louis, Mo.

REAL ESTATE BE A BROKER

PAYS BIG! SEND FOR FREE, BIG, ILLUSTRATED CATALOG NOW! Graduates report making substantial incomes. Start and run your own business quickly. Men, women of all ages, learn easily. Course covers Sales, Property Management, Appraising, Loans, Mortgages, and related subjects. **STUDY AT HOME** or in classrooms in leading cities. Diploma awarded. Write TODAY for free booklet! No obligation. Approved for World War II and Korean Veterans
WEAVER SCHOOL OF REAL ESTATE (Est. 1936)
 2020R Grand Avenue Kansas City, Mo.



RUPTURED

BE FREE FROM TRUSS SLAVERY

Surely you want to **THROW AWAY TRUSSES FOREVER**, be rid of Rupture Worries. Then Why Do you put up with wearing a gripping, chafing and unsanitary truss the balance of your life? If you do, it will NOT be through necessity but through choice on your part. Now there is a new modern **Non-Surgical** treatment that is designed to permanently correct rupture. These **Non-Surgical** treatments are so certain, that a Lifetime Certificate of Assurance is given. Write today for our New **FREE** Book that gives facts that may save you painful, expensive surgery. Tells how non-surgically you may again work, live, play, love and enjoy life in the manner you desire. There is no obligation. **Excelsior Medical Clinic, Dept. H6124, Excelsior Springs, Mo.**

Not everyone does as well, but **T. N. CODY**, who started a business of his own, reports...

For 12 months I've averaged

\$800

per month income

— most of it clear profit for me!



Many men have discovered how to be independent, to be free of layoffs and bosses. C. G. Naples grossed more than \$200 his first week. A father-son combination grossed \$44,000 their second year. H. Lemon says, "I netted \$133 in one 8-hour day."

How much you make depends largely on you. You need no special skill, no large investment. Start part time if you wish.

NO SHOP NECESSARY • Our Electric Deterger shampoos rugs, carpets right on floor—removes dirt and grime and helps to show their natural color and beauty. So efficient and safe it is used by largest railroads and hotels.

This is not a lease proposition.

You own the machine, you work when and where you please and all the money you take in is your own. No risk. Machines fully guaranteed.

Mail Coupon Today for FREE Book

VON SCHRADER MFG. CO.,
 910 "R" Pl., Racine, Wis.

Without obligation send me **FREE** booklet about your RUG DETERGER and tell me how I can start my own permanent, profitable business.

Name _____
 Address _____
 City _____ Zone _____ State _____

WANTED!

Mechanically Inclined Men to Qualify for **BIG PAY JOBS** AND SPECIAL FACTORY TRAINING IN DIESEL



"We need qualified repairmen, operators, mechanics NOW!", say Diesel Manufacturers, Highway Builders, Truck Line Operators in every corner of America. Can you qualify for these High Pay Jobs? We can help you! Interstate's General Course and Cummins-approved Diesel home-training courses are internationally recognized. Advisory placement service for trainees. Don't wait. Men are needed NOW!

Get the Facts Today!

WRITE INTERSTATE TRAINING SERVICE
 Dept. A-3, Portland 12, Oregon
 Rush information on I.T.S. Diesel Courses, Special Factory Training and Diesel Job Opportunities.

Name _____
 Address _____
 City _____ Zone _____ State _____

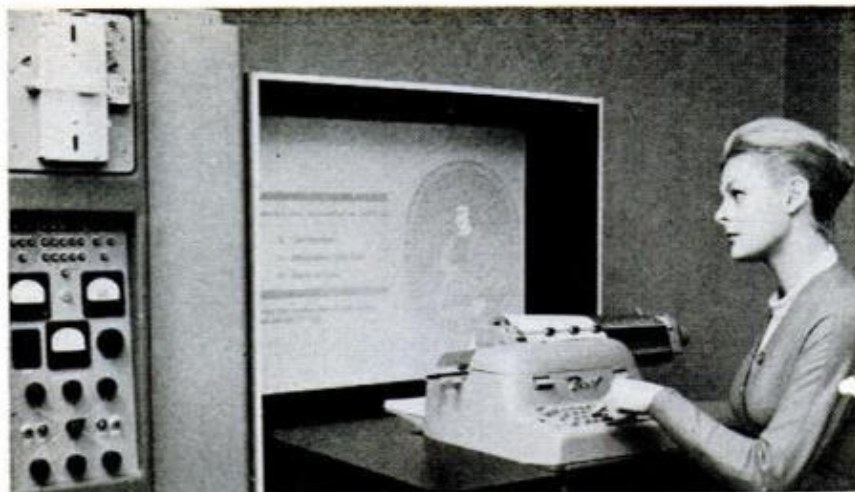

Computer System Guides Student

A computer-operated teaching system is programmed to "sense" a student's needs and to guide him to building his knowledge.

In reply to multiple-choice questions produced on a screen before him, the student punches answer keys on an electric typewriter. The unit either acknowledges the answer as right, or, if wrong, detours him to remedial questions.

According to Dr. John Coulton, director of the manufacturer's automated teaching project, the computer unit may well prove to be "one of the country's best hopes in the face of a teacher shortage."

The unit is made by System Development Corp., Santa Monica, Calif.

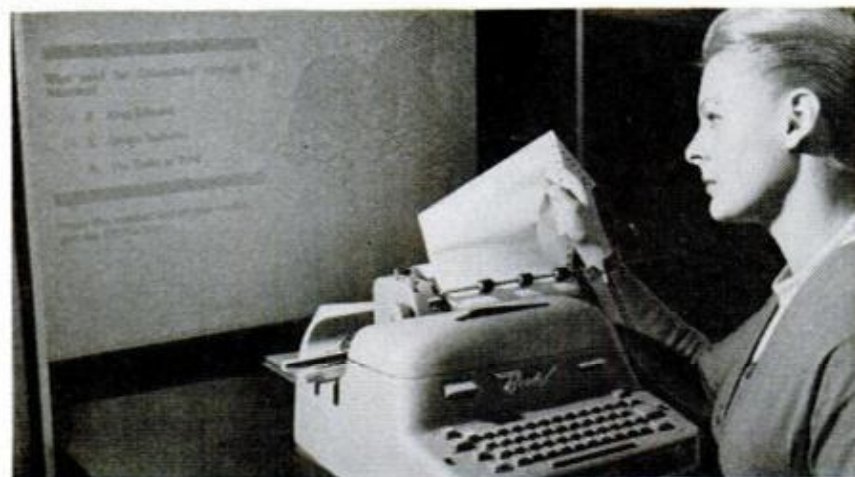

How to Hurdle Your HOW-TO-DO-IT



Send for your
FREE
SERVICE FILE!

GET THE JUMP ON PROBLEMS OF HOME REPAIR AND MAINTENANCE as well as do-it-yourself information on hobbies, crafts, remodeling, boats, lawn and gardens, workshops, hi-fi, etc. This tremendous file lists sources of more than 500 subjects covered in Popular Mechanics' famous books, booklets, plans, and patterns. Send for yours today.

POPULAR MECHANICS SERVICE BUREAU, Room 525, 200 E. Ontario, Chicago 11, Ill.
Please send me your FREE service file.

Name.....
Address.....
City..... Zone..... State.....

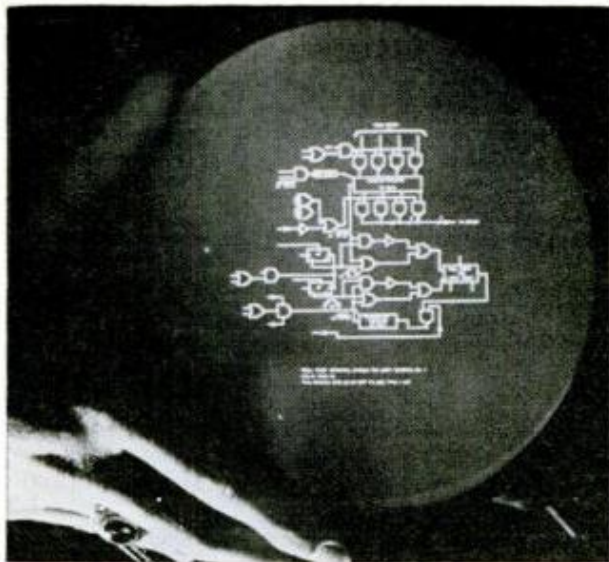

Goodbye T-Square

Engineering drawings are being whipped up by an electronic computer and produced by electron beams in less than half a second.

The new technique, developed by the Stromberg-Carlson Co., calls for the computer to be programmed with contours and specifications of the part to be designed. The information is transferred to a micro-film recorder which makes the multiview mechanical drawings.

You can have CONFIDENCE

in a growing America



Today's record-breaking research will result in whole new industries, millions of new jobs . . . more opportunities for all. The long-range trend of the economy is UP!

Send for free booklet, "The Promise of America", Box 10, Midtown Station, N. Y.

Published as a public service in cooperation with The Advertising Council.

SEPTEMBER 1961

ENGINEERING



Heald's Micro-wave and Radar Laboratory Equipment

ENROLL NOW FOR NEW TERM

AMERICAN INDUSTRY NEEDS TRAINED ENGINEERS NOW

BACHELOR OF SCIENCE DEGREE, 30 MONTHS

SAVE 2 YEARS' TIME

B.S. Degree Courses:

- Electronic Engineering
- Electrical Engineering
- Mechanical Engineering
- Civil Engineering
- Architecture

Diploma Courses:

- Radio-Television Plus Color TECHNICIAN
- Electronic Technician
- Architectural Drafting
- Mechanical Drafting
- Structural Drafting

APPROVED FOR VETERANS

Send for FREE Information

HEALD Engineering College

Van Ness at Post, Dept. PM

San Francisco, California

NAME _____

STREET _____

CITY _____

STATE _____



CARTOONING IS EASY NOW

Famous System of Manual Training brings a complete new conception in Art Instruction at home. . . Cartooning is a wonderful profession that offers Men and Women a wide field rich in unequalled opportunities to make good money. It is worth while to get the facts. Ask for free information today.

Continental Schools, Inc.

DEPT. E-2 4201 S. BROADWAY, LOS ANGELES 37, CALIF.

Learn BAKING At Home



Baking is one of America's high industries in wages. Nearly depression-proof. Thorough basic home course lays sound foundation. If you have aptitude, write for FREE BOOKLET, "Opportunities in Commercial Baking." National Baking School, 835 Diversey Pkwy., Dept. 1356, Chicago 14, Illinois

FREE Catalog and Discount Prices. Write

CHORD ORGANS. SAVE UP TO 1/2

IMPORTER-TO-YOU PRICES

Play at Sight—No lessons needed

Buy Direct—Save 1/2. Own the finest. Italian hand-crafted! 5-Day

Free Home Trial. E-Z Terms!

Money-back guarantee. Free Catalogs. Discount Prices. Write—

Philharmonic Organ Corp.

2003 W. Chicago Ave., Dept. R-91, Chicago 22



H. L. Mellinger, Jr.
Director



Transistor Radio with battery \$3.92



Derringer Pistol \$5.74



17-Jewel Watch \$2.87

MEN! WOMEN! IMPORT PAYS BIG!

Make big profits. Buy dazzling bargains like these abroad. Sell to friends, stores, mail order. New Drop Ship Plan puts you in direct contact with overseas sources—starts you full or spare time, without product investment or previous experience. FREE details! Airmail reaches us overnight.

MELLINGER CO., Dept. T259

1717 Westwood, Los Angeles 24, Calif.

Plan shows where you get bargains like these for big profit sales.

DO NOT ORDER FROM US

59

**EARN \$125
A WEEK AND UP**

**BE AN AUTO DIESEL
EXPERT — LEARN
A TRADE YOU LIKE**

You learn fast in our shops because you learn with tools on real equipment. Students short of money may earn most of their expenses by doing part-time work. Experienced instructors explain WHY and show you HOW, then you DO IT YOURSELF. Many of our graduates earn \$125 a week and up. Approved for veterans. Day and evening classes. Free bulletin-write today.

MAIL THIS COUPON TODAY!

NASHVILLE AUTO-DIESEL COLLEGE
226 7th Ave., No., Dept. 86, Nashville, Tenn.
Please send without obligation free catalog.

NAME _____
(please print or write plainly)
ADDRESS _____
CITY _____ STATE _____



Mower Bumper Protects Feet

A back bumper for rotary lawn mowers keeps the operator's feet at a safe distance from the rotating blades. It is available at \$3.49 from Thomas Products Co., Inc., 8500 E. 21st St., Indianapolis 19, Ind.

Catalog of 2900 Novelties 10c

Send 10c for amazing catalog of novelties, live animals, scientific supplies, hobbies, funmakers, planes & boats, looms, magic tricks, joke articles, unusual seeds, gadget timesavers, cameras, optical goods, projectors, movies, lucky jewelry, religious novelties, disguises, musical instruments, stamps, coins, puzzles, fortune tellers, radios, auto & bike accessories, telescopes, magnifiers, compasses, banks, smokers' gadgets, artists' supplies, printing sets, engines, motors, shockers, knives, billfolds, guns, rifles, sports, books, games, plants etc. Send 10c.

JOHNSON SMITH COMPANY Dept. 504 Detroit 7, Michigan

**FREE
EICO®**

CATALOG

**Build Your Own
Hi-Fi, Radios,
Ham Gear, Test Inst., — Save 50%**

Get started in ELECTRONICS the easy EICO way. No technical knowledge needed to build EICO kits. Simple, step-by-step "Beginner-Tested" pictorial instructions guide you all the way. LIFETIME service & calibration guarantee. Mail coupon now!



EICO, 33-00 Northern Blvd., L. I. C. 1, N.Y.
Please send FREE catalog & name of local dealer. PM-9

Name _____
Address _____
City _____ Zone _____ State _____

CLIP AND SAVE

each article in a new series on repairing home appliances. You'll have a handy reference file to check when your toaster, coffee maker or waffle grill goes on the fritz. Watch for this new fix-it file beginning in the

OCTOBER ISSUE

**WORLD'S
BEST
WANT-AD
MEDIUM**

CLASSIFIED ADVERTISEMENTS



Advertisements in this section \$1.30 per word, each insertion, minimum 10 words, payable in advance.

To be inserted under proper classification, copy must be in our office the

18th of the second month preceding date of issue

F. W. Johnson, Manager, Classified Advertising

Popular Mechanics, 200 East Ontario Street, Chicago 11, Illinois

YOU'LL PROFIT

By reading and answering the classified ads in this section. Hundreds of opportunities for you to make and save money

AUTOMOBILES, MIDGET CARS

MONEY In used cars. Big list of wholesale auto auctions. Latest wholesale prices. Send \$1.00 today. Pruitt, Box 4536, Charleston Heights, So. Car.

CATALOGS: Photos, manuals, antique through modern; monthly bulletin. Hobby Club: free information. Auto Enthusiasts, Box 451H, Mount Clemens, Mich.

AUTO SUPPLIES AND EQUIPMENT

FREE Information. New, patented, easy connecting, folding towing bar for pickups. Dealers attractive commission, sales guaranteed. Carson Industries, Faxon, Oklahoma.

PARTS. Model "A." List 25¢. (Refundable) Matco, Box 135, San Pedro, Calif.

JEEP Parts! For military and civilian. At great savings. Largest inventory. Catalog for owners and dealers. Inquiries invited. American Auto Parts Co., 1830-PM Locust, Kansas City, Mo.

RING-Valve job while driving, \$6.00 postpaid. Guaranteed! Nothing like it! Lasts 100,000 miles! Motaloy, Grantham, Penna.

FREE! New catalog. Speed, power, mileage increasing equipment. Discounts! Almqvist Engineering, Milford PM5, Penna.

NEW And used parts at savings. Complete guaranteed parts service for all models cars and trucks. Largest in the West. Jeep and army parts specialists. Newest type shifting hubs for all jeep and all military and latest production front end drive vehicles. \$27.50 and up. Also, foreign car parts. Write, Pioneer Auto and Truck Parts Co., 734 W. 13th Avenue, Denver 17, Colo.

JUST Out! New 356 page, illustrated catalog offering savings up to 50% on over 100,000 auto parts and accessories, everything to renew, rebuild, renovate '28-'31 Model "A" Fords. All makes (1920 to 1961 models), trucks, foreign and sports cars. Hollywood accessories, custom styling, hi-speed equipment. Send 25¢ for postage, packing—refundable on first order. Whitney, 1919 PM-9, Archer, Chicago 16, Ill.

COPPER Tubing. For all purposes. 50 foot coils. 1/4", \$4.85; 5/16", \$5.99; 3/8", \$7.49. All other sizes in stock. Freight prepaid. B and H Metal Company, P.O. Box 615, Boston 2, Massachusetts.

"HOW To keep your cooling system in perfect condition." Free. Aqua-Jets Company, Florence, Kentucky.

CONVERT Column shift transmission to lightning-fast, straight-line floor shift with top quality, easy-to-install conversion kit. Complete, only \$25.70. Includes bent, straight lever (specify), knob, boot, instructions. Specify make, year, model, type of transmission. Enclose 25¢ for c.o.d. orders. Whitney, 1919-LM-9 Archer, Chicago 16.

AUTO Shop welding repair training in world's largest non-profit welding school. Low tuition. Free booklet. Hobart Welders, Box M-911, Troy, Ohio.

VOLKSWAGEN Owners! Latest accessories—lowest prices. Brochure free. Wagen-Ware, Box 297-A, So. Orange, N. J.

CRANKSHAFT Grinder. Hand operated. Makes bearings fit without taking engine apart. \$4.00. Literature. L. D. McGee, 719 Cascade St., Wenatchee, Wash.

1909-1934 FORD Parts illustrated catalogs 75¢. Mark Auto, Layton, N. J.

REPAIR And inflate tires instantly. Details 25¢ refundable. R&G Products, 80-78 164th Street, Jamaica 32, N. Y.

SAVE On spark plugs. Nationally advertised re-manufactured and unconditionally guaranteed for 10,000 miles. Special \$3.00 per set postpaid. State make and model of car. Ashcroft Sales Company, 1818 Ridgewick Road, Glen Burnie, Maryland.

DETECT Police radar traps before they detect you. Build Radar King. Plans \$1. Wardell Smith, Electronic Designs, 65 Glenwood Road, Upper Montclair, New Jersey.

AVOID Speed traps! Home built device warns of police radar. Plans, instructions \$1.00, refundable. Radar, House Springs, Missouri.

JEEP Owners—V8 conversions. Read Jeep Owners ad, page 31.

ANTIQUE. Classic car magazine. Sample 25¢. The Helper, Box 315, Florissant 11, Mo.

TRANSISTORIZED Electronic ignition systems. The greatest improvement since the original Kettering 1910 ignition invention. Can be used on all 6 and 12 volt automobiles, trucks, race cars, boats with negative ground. Dealers wanted. For low prices and literature write: Bill Slep Company, Drawer 178PM, Ellenton, Fla.

PARTS And accessories catalog for Ford Model "A." Everything to renew, rebuild and renovate your '28-'31 Model "A" Ford. Send 10¢. J. C. Whitney, 1919 QM-9 Archer, Chicago 16, Ill.

AUTO TRAILERS

PICKUP Camper kits, blueprints, supplies. Literature 10¢. Custom Products, 10917-28th S.W., Seattle 66, Washington.

BUILD Expanding eight foot trailer. Accommodates five. Literature 10¢. Framar Company, Wilmington, Mass.

MOTORCYCLES, BICYCLES, MOTORSCOOTERS AND SUPPLIES

GO Cart \$30, Motorscooter \$20, motorbike \$20, less engines. Engines \$2 up. Minibike \$25, doodlebug \$35, Flat chassis \$75. (Mail order only). Send 25¢. (35¢ for First Class mailing) for 32-page Directory-Catalogue Number 103 listing these and hundreds of other bargains in go carts, motorscooters, war surplus, home-builders plans, parts, etc. Midget Motors Directory, Athens, Ohio.

MOTORCYCLE Parts. New, used. List 25¢. Ballak, 811 N. 9th, St. Louis 1, Mo.

HARLEY-Davidsons—Used bargains. New, used parts, accessories, all models. Bulletin 25¢. Knuth's (Factory Dealer), 1753 Muskego, Milwaukee, Wis.

RECONDITIONED Motorcycle motors. Chrome accessories. Complete stock Indian parts. Expert rebuilding. Fast service. Indian Motorcycle Sales, Kansas City 27 Missouri

BUILD It yourself. Motorized two-seater sidewalk car for youngsters 8 to 15. Easy, inexpensive. Free brochure. Fincraft, Dept. B, Box 7031, Hudson City, Jersey City 7, New Jersey.

SCARCE Bicycle parts-tires. We have them. Northern Wheel Goods, Box 3100, Madison, Wisconsin.

BE On top, of a Petty Unicycle. Send for description and price. Petty Unicycle Co., 6822 Moore St., Arvada, Colorado.

AVIATION

CUSTOM Machine parts manufacturing. Harold Boyd Barber, 403 South 1st, Missoula, Montana.

PROPELLERS. Plans, supplies for airboats, snowplanes. 125 h.p. Lycoming engines \$135.00. Prompt delivery. Catalog 25¢. Banks-Maxwell Propeller Co., Box 3301E, Ft. Worth 5, Texas.

BATTERIES, GENERATORS

BATTERIES—Large 120 page manual shows how. New, rebuild, repair. Illustrated. Get the best. Literature 25¢. Refundable. Batteries, P.O. Box 341, New Castle, Penna.

LEARN Battery repair! Manual \$3.00. C.O.D. accepted. Bayer Publications, H938 Betty Avenue, Neenah, Wisconsin.

ELECTRICAL SUPPLIES

ELECTRICIANS! Bend conduit easily, correctly. Amazing simplified system. Manual \$3.00. William Goforth, Buellton, Calif.

FREE Fluorescent catalog. Includes midjet fluorescent fixtures, fixture kit bargains, parts. Shoplite, 650M Franklin, Nutley 10, New Jersey.

LAMPS. 25¢ Brings parts catalog. Re-fund first order. Gyro, 5208P N.W. 35th Ave., Miami 42, Florida.

ELECTRONIC Bug killer \$5.95. Guaranteed 5 years. Ludwig, 7718 East Comp-ton, Paramount, Calif.

CONDUIT Bending. Attachable pro-tractor. Easy instructions. \$2.50. Pal-Notes, Underwood, N. D.

APPLIANCE. Lamp, vacuum, range parts wholesale. Catalogue 25¢. Seco, 26 South 20th Street, Birmingham 3, Ala.

WELDING, SOLDERING, PLATING

GOLD Silver, copper, plating supplies, instructions. Free price circular. Crows Craft Studio, Box 597, Rockaway, Oregon.

ACETYLENE Outfits \$59.50; Arcwelders \$56.50. Eagle Welding, Dept. PM, 5085 Broadway, Chicago 40, Ill.

WELDERS. 110/220, \$39.50. Morris, 1070 Inner Drive, Schenectady 3, New York.

PLATING Equipment, supplies. Complete line of anodes, solutions. Home work-shops, industrial sizes. Hollywood Bronze Supply, Dept. C, 1624 East First, Los Angeles 33, California.

MACHINERY, TOOLS, SUPPLIES

SAW. Scissor supplies, free list. Over-land's Saw Service, Independence, Iowa.

HANDY Sharpener—Combination, glass cutter, knife, scissors, lawn mower, and shear sharpener. \$2.00 each. No c.o.d. please. George Nicholaisen, P.O. Box 4527, Chicago 7, Illinois.

FREE Brochure. New, patented, spring action 3 x 8 belt sanding block with tapered ends, for wood or metal. Turn your do-it-yourself sanding projects into interesting hobby or business. M. L. Mendelsohn, Dept. MLM, 53 Selwyn Rd., Newton Highlands, Mass.

PROFESSIONAL Eleven piece drafting set: plain dividers, bow dividers, ruling pens, pencil, accessories, velvet lined case, \$4.99. Moss Machinery, 5323 Venice Blvd., Los Angeles 19, Calif.

NEW 100 Page #108 catalogue, wood-working tools, saws, knives, bits, cutters, woodworking machinery and equipment, 25¢ postpaid. Woodworkers' Tool Works, 222 Jefferson St. South, Chicago 6, Illinois.

BEARINGS Any manufacturer's list price—60% delivered any size and quantity. Satisfaction guaranteed. Moba, Box 281, Arvada, Colorado.

12 POUND Heavy duty power saws. 7" blade. Retail price \$62.00. My price \$34.75. Walter B. Leavens, 916 West 9th Street, Los Angeles 15, California.

PRECISION Hole and slot gages. Camp-bell Tools, 1424 Barclay, Springfield, Ohio.

ENGINES, MOTORS, DYNAMOS

AIRBOAT—Snowplane engines, propellers, supplies. 125 h.p. Lycoming engines \$135.00. Catalog 25¢. Banks-Maxwell, Box 3301F, Ft. Worth 5, Texas.

GEAR Motors. New and used. 90 to 1,000 r.p.m. Reduced prices. Davison, 742 E. Street, San Diego, Calif.

1 AND 2 Cylinder gasoline motors for sale, shipped prepaid to your door. New engines: 6.3 hp. Kohler, \$77.00; 14 hp. Wisconsin with centrifugal clutch, \$197.00; 18 hp. Wisconsin with centrifugal clutch, \$276.00; Wisconsin motors less clutch subtract \$45.00. Used engines: Guaranteed like new: 6.3 hp. Kohler, \$63.00; 14 hp. Wisconsin with centrifugal clutch, \$142.00; 18 hp. Wisconsin with centrifugal clutch, \$224.00. Finco, Inc., Attn. John Dabney, 525 Rathbone Avenue, Aurora, Illinois.

DIESEL Injector parts and fuel pumps wanted. GM51-53-71-110. Bares, 7120 Carnegie, Cleveland 3, Ohio.

62 POPULAR MECHANICS

REWIND Motors yourself. Complete in-structions, \$1.00. Lewis Manufacturing, Howell, Michigan.

WINDING Data. 275 motors, single and three phase \$1.10. Data Company, 512 Kensington, Kansas City 24, Mo.

GOVERNMENT SURPLUS

JEEPS \$223.83, Radios \$2.47, boats \$6.18, tires \$1.74, generators \$1.38, typewriters \$6.48, guns, cameras, binoculars. Typical surplus prices. Buy directly from govern-ment. List of depots, procedure, full de-tails only \$1.00. N.Y. Enterprises, Inter-national Airport, Box 402-X13, Jamaica 30, New York.

GOVERNMENT Surplus, radios, Jeeps, walkie-talkies, boats, telescopes, etc. Send for "Depot Locations and Procedures" 50¢. Delta, Box 2262-PM, Dallas 21, Texas.

ARMY Surplus equipment, heavy outer-wear, etc. Catalog free. Princeton, 300V Northern Blvd., Greatneck, N. Y.

GOVERNMENT Surplus. Jeeps, \$264.00; radios \$2.53; boats, \$36.00; guns; airplanes; walkie talkies; typewriters; cameras; tools; thousands of items. Buy direct from govern-ment at ridiculously low surplus prices. Full details and procedure all yours com-plete by return mail, only \$1.00. Surplus Bargains, Dept. PM, P.O. Box 512, New Orleans, La.

GOV'T Surplus. How and where to buy in your area. Send \$1.00. Surplus In-formation, PM, Headquarters Building, Washington 6, D. C.

PAINT Sprayers. Cost \$275. Our price \$44.50. Tents, 5 man size. Cost \$140. Our price \$39.50. Free folder. Illinois Mfg. & Supply, 1829 S. State, Chicago 16, Ill.

JEEPS \$278. Airplanes \$159, boats \$7.88, generators \$2.68, typewriters \$8.79 are typical government surplus sale prices. Buy 10,001 items wholesale direct. Full details, 627 locations and procedure only \$1.00. Surplus, Box 789-C5, York, Penna.

BOATS, OUTBOARD MOTORS

FIBERGLAS Your old wooden boat. Make it waterproof. Repaint over fiber-glas, wood, or metal with new Poly-Aqua Epoxy paint. Free literature. Ajax Plastic Co., Dept. 6, P.O. Box 1323, Ft. Worth, Texas.

BOAT Plans, frame kits, full-size pat-terns prepared specially for amateurs. Send 50¢ for new 80-page catalog illustrat-ing over 40 build-it-yourself power boats from 7' to 28'. "Inboard Motor Installa-tions In Small Boats"—hardcover illustra-tive book on "how to" of inboard installa-tions—\$6 ppd. Glen Designs, 9152 Rose-crans, Bellflower, Calif.

NEW. Used, rebuilt marine motors. Ma-rine conversions, fittings. Free catalog. Stokes Marine Supply, Dept. 24, Coldwa-ter, Michigan.

FULL Size, cut-to-shape boat patterns, blueprints, 7 1/2-38 feet. Big new 88-page illustrated "Build a Boat" catalog of na-val architect-designed catamarans, cruis-ers, runabouts, skiffs, outboard boats, sailing, racing, houseboats, 50¢. "How to Build a Boat" booklet, \$2.50. Cleveland Boat Blueprint Co., Dept. A-66, Box 1651, Cleveland, Ohio.

BUILD Your own boat from our large-scale blueprints. Books of plans give how-to-build help. Hundreds of professional designs—motor, sail or auxiliary—for am-ateur builders. Free catalog. MoToR Boat-ing, 572A Madison Ave., New York 22, N. Y.

MARINE Conversions. Ford, Chevrolet, Jeep engines. Catalog 25¢. Lehman Manu-facturing Company, 800 Elizabeth Avenue, Linden 4, N. J.

MARINE Conversions and gears for all popular automotive engines. Send 25¢ coin for complete catalogue. Barr Marine, 2706A Castor Ave., Philadelphia, Penna.

FIBERGLASS Cloth, yard \$1.00. Resin, gallon \$5.70. Free catalog. Seiffert's, Box 1206-M, Green Bay, Wis.

I want to send you proof of the wonder-ful pulling power of Popular Mechanics classified pages. What's your proposition? Write me today. Include literature if pos-sible. F. W. Johnson Manager Classified Advertising, Popular Mechanics Magazine, 200 E. Ontario St., Chicago 11, Ill.

ATHLETIC EQUIPMENT, BODY BUILDING COURSES

OUTSTANDING Physical development! Any age. New guaranteed discovery uses only a rope! Strength, health, muscles. Gain—reduce. Free booklet. Ropercise, 4834 Art, San Diego 15, California.

"**GIANT** Arms." Dr. Young's, D.C. revolutionary discovery. \$2. Satisfaction or refund. Gaucho, Box 9309-S7, Chicago 90.

BIG Deal. 12 large advanced muscle courses. Health wisdom courses. Valuable information. Over 50,000 words. Com-plete. Guaranteed. Special only \$3.00. Sid's System, PM-C6, 8421-C Evergreen, Southgate, California.

BOOKS. Aikido, boxing, karate, judo, savate, stickfighting and wrestling. List 15¢. Combat Sports Service, Box 482, Worcester 1, Mass.

PROF. Wong's "Karate Kung-fu." Break bricks bare-handed. \$9.95. Oriental Book Sales, 142 Waverly Place, San Fran-cisco 8, Calif.

BARBELLS. Dumbbells, Courses, Book-let 10¢. Good Barbell Co., Siloam Springs, Arkansas.

JIU JITSU Ten official police holds. Overpower biggest bullies easily. 33 pho-tographic illustrations. 35 cent postpaid. Jorgensen, Box 5023-391, Seattle 7, Wash.

BECOME Taller. New scientific method will add inches to your present height even after maturity. Visible results in weeks. Send for free information and trial offer. Height Increase Institute, Dept. PM-1, GPO Box 1902, New York 1, N. Y.

SPORTING GOODS, GUNS, FISHING, SKIN DIVING, ARCHERY

BUY Hunting and fishing equipment direct and save. Weaver Scopes K 2.5 or K 3 Retail \$37.50, Special \$23.95; K 4 Retail \$45.00, Special \$28.75; Vari Power V 8 with mount, Retail \$79.50, Special \$52.95; Redding Powder Scale, Retail \$14.00, Special \$10.95; Redding Press, Retail \$16.00, Special \$11.95; Lyman 310 Tool with Dies, Retail \$16.50, Special \$13.20; Ruger Deerstalker Carbine, Retail \$108.00, Special \$91.75. Free giant fully illustrated catalogues featuring world's finest hunt-ing and fishing equipment at lowest dis-count prices. (Specify hunting, fishing or both.) No money down. Up to 10 months to pay. International charge credit cards honored on all purchases—any amount. (Add postage all items—20% deposit on all c.o.d.'s.) Parker Distributors, (Dept. PM-961), 3516 White Plains Road, New York 67, New York. TULIP 1-1900.

JAP Rifle altering to 30-06. \$6.00. Jap-shells, \$3.95. Catalog 10¢. T. P. Shop, West Branch 11, Mich.

MOLDS—For casting your own fishing sinkers. Free illustrated booklet. Reading Instrument Co., Box PM78, Reading, Penna.

FREE—Wholesale catalog. Beads. Spin-ners. Lure parts. Sinkers molds. Jigs. Reels. Finnyports (ME). Toledo 14, Ohio.

BIG Money raising crickets and 12 inch African fishworms. Free literature. Car-ter Ranch, Plains, Georgia.

AMAZING Wholesale sporting catalog. Save 70%. Tremendous selections. Econ-O-Mart, Whippany 2, New Jersey.

MOLDS For fisherman's sinkers, jigs, squids, casting and spinning lures. Free catalog. Sweet's Molds, Tonawanda 1, New York.

WAR Surplus guns, ammo, accessories, relics. 24-page catalog describing 450 items. 25¢. Martin B. Retting, Inc., 11029 Washington, Culver City 4, California.

NOBODY Undersells Kleins's! 144 page all-sports bargain catalog free. Kleins-PM, Chicago 24, Illinois.

GUNS. All kinds under \$20.00. Bargain list 25¢. Armsco, Box 286, Santa Rosa, Calif.

FRONTIER Colts, Bisleys, Cap & Balls, Rem, S&W, Win. All models and many others. Walnut stocks, belts, holsters, parts. Long list. Write. Laredo Gun Shop, 3710 San Bernardo Ave., Laredo, Texas.

HUNTING Guide free! Experts tell you how to be crack shot; dress game; care for weapons; camp cookery; and how to have convenient heat and light in the woods. Supply limited. Write A. W. Thacker Co., Dept. P, Clermont, Fla.

10,000 GUNS, Antiques, moderns, swords, armour. Every description. Giant catalog \$1.00. Agramonte's, Yonkers 2 G, N. Y.

CAMPING EQUIPMENT AND TENTS

CAMPING Equipment. Send 25¢, giant catalogue. Morsan, 10-21R 50th Avenue, Long Island City 1, New York.

PRIMUS And Therm'x stove and heater literature free. Davis Imports, Dept. E, Box 489, Edmonds, Washington.

BUILD Your pickup camper. Kits. Blueprints. Supplies. Literature 10¢. Comstock Trailers, Parsons, Kansas.

CAMPER For auto. Also camping kitchen. Kits or easy to follow plans. Free information. Smiths, 2254 Cynthia, Pomona 4, Calif.

EARTHWORMS, CRICKETS, FROGS

HYBRED Redworms 1000, \$3.00; 2000, \$5.00; 5000, \$8.00 postpaid with raising instructions. Brazos Bait Farm, 60 Lincoln, Waco, Texas.

BIG Money raising fishworms and crickets. We teach you how to raise and where to sell. Free literature. Medium redworms, 3000, \$5.95; 10,000, \$16.95. Carter Redworms, Plains, Georgia.

FREE Picture folder, "How to Make \$3,000 Yearly, Sparetime, Backyard, Raising Earthworms!" Oakhaven-56, Cedar Hill, Texas.

RAISE Fishworms and rabbits on \$500 month plan. Free details. White's Rabbitry, Mt. Vernon, Ohio.

DEALERS! Fishermen! Growers! Before buying fishworms, write for low, job-lot prices, free raising instructions! "Fishworms-F," Cedar Hill, Texas.

LARGE African nightcrawlers! 100—\$2.00, 500—\$7.00, 1000—\$12.50, postpaid. (Dealers wanted). Ozark Worm Farm-J, Willow Springs, Missouri.

PROFIT! Raise hybrid red wigglers. 500 breeders \$2.50. Instructions free. Stoney Point Worm Ranch (B), RD#1, Kintnersville, Penna.

BINOCULARS, TELESCOPES, MICROSCOPES, MAGNIFIERS

BUILD Your own reflector telescopes. Complete kits: mirrors, eyepieces, tripods, all other accessories. Request free illustrated literature. Criterion Manufacturing, Dept. KPM-80, Hartford 1, Conn.

BARGAINS! Binoculars, telescopes, microscopes, riflescopes. Catalog free. Adventure Sales, Box 2133, San Diego 12, California.

TELESCOPE Kits—Direct from manufacturer. Other optical hobby kits. Large selection. Free booklet. Esco Products, Oakridge, N. J.

DYNASCOPE. Amazing world-famous reflector telescope. Request free brochure. Criterion, Dept. DP-83, Hartford 1, Conn.

REFLECTING Telescope, 60X, completely assembled. Guaranteed observatory clearness. Free information. Skyscope, P.O. Box 55, Brooklyn 28, N. Y.

SCIENCE Bargains! Lenses, telescopes, binoculars, microscopes, kits, parts, war surplus. Send \$1.00 for beginner's 10-lens kit with instruction booklet. Order Stock 2-CH. Request free 144-page Catalog CH. Edmund Scientific Co., Barrington, New Jersey.

TELESCOPES And telescope makers supplies. Free catalog. Suffolk Science, Mattituck, New York.

PLANTS, SEEDS, BULBS, NURSERY SUPPLIES

GINSENG. Big money crop. Reliable, authentic information. Val Hardacre, Wadsworth, Ohio. Route 1.

GINSENG Bringing \$14 pound. Free seeds, plants, Goldenseal. Full information. K. Collins, Viola, Iowa.

PETS—DOGS, BIRDS, HAMSTERS, ETC.

MAKE Money raising chinchillas, mink, rabbits, cavies for us. Free catalog. Keeney Brothers, New Freedom 2, Penna.

PETS—Hamsters, mice, rabbits, squirrels, guinea pigs, chipmunks. Literature and pricelist dime. Moore's Hamster Ranch, Shepherdstown 25, West Virginia.

HAMSTERS—Ideal pets, \$2.95 pair. Free booklet. Jer-fre's Hamstery, 1447 Apple, Muskegon 13, Michigan.

LIVE Seahorses mated pair direct to your door for \$3.50 check or c.o.d. Food, instructions included. Animated Shoppers, Opa Locka, Fla.

FOODLE Puppies—pets, profits. A.K.C. registered. \$75.00 up. Thelma Hayse, Sunny Valley, Oregon.

RABBITS—FUR BEARING ANIMALS

MINK Raising information free. Complete. Lake Superior Mink Farm, Superior, EE1, Wisconsin.

RAISE Rabbits successfully by knowing facts. 48 page book. 38 illustrations describing 25 breeds. Housing. Breeding. Feeding. Markets and Marketing. Bulletin etc. 25 cents. American Rabbit Association, 36 ARBA Building, Pittsburgh, Penna.

EARN \$10,000 Yearly raising Angora rabbit wool for us. Information 25¢ coin. American Angora Company, Malta 12, Montana.

RAISE Rabbits and fishworms on \$500 month plan. Free details. White's Rabbitry, Mt. Vernon, Ohio.

RABBIT Raising details free. Rabbit Enterprises, 548 River Road, Ludlow, Ky.

FARMS, FARM LANDS, REAL ESTATE

CAROLINA Coast. \$5 down, \$5 monthly buys large homesite. 70x150, in beautiful Boiling Spring Lakes. Satisfaction guaranteed. 16,000 acres. 52 freshwater lakes. Excellent fishing, hunting. Free literature. Boiling Spring Lakes, Southport 1, North Carolina.

FREE Strout catalog! Farms, homes, businesses, resorts, retirement properties. Over 3000 values coast to coast. 61 years service. World's largest! Write Strout Realty, 7-CJ S. Dearborn, Chicago 3, Ill.

MONTANA—Fishing and hunting cabin and camp sites on the Kootenai River in the Montana Rockies \$595; \$10 down and \$10 per month. Mountain Empire Co., Box 203-P, Libby, Montana.

CANADIAN Tax sale lands. Our 44th annual series of lists, just begun, describe farms, timber lots, hunting and fishing camps. Average price five dollars an acre; small monthly payments, guaranteed titles. Write today for free sixteen page booklet containing full information. Tax Sale Service, Room 411-D, 1173 Bay Street, Toronto 5, Canada.

\$5 MONTHLY Buys 5 acres—near clear-water lake. Price \$125. Excellent fishing, good cabin sites. Free list. Box 425-P, Carthage, Mo.

FLORIDA—Silver Springs area. 1/4 acres waterfront homesites, improved streets. \$595.00. \$10.00 month. Free color photos. Write Silver Springs, 4601V Grand Central, Tampa, Florida.

U.S. Residents eligible now. Amazing profits from recorded timber leases. Low cost, terms. Free information. Zelsman, 130K Shaftesbury, Downsview, Ontario, Canada.

WORLD'S Best! Low cost multipurpose lands. Booklet free. Armstrongs, Shook, Mo.

CANADIAN Vacation lands: Large acreages, low prices, \$10 month. Suitable cottage sites, hunting, fishing, investment. Free information. Land Corporation, 3768-C Bathurst, Downsview, Ontario, Canada.

GOV'T. Tax lands. U.S. Alaska. Bargain prices. Maps, lists available. Free information. Box 1632-JB, Richmond, California.

EQUIPT! Modern! Easy terms! Only \$1,950 down gets 160-acre Southwest Missouri beef setup with tractor and equipment included! 105 acres pasture handles 35 to 40 head. Good deep well under pressure. Unique 4-room modern stone home. Barn, garage, machine shed, old house. Family orchard with about 100 plum trees. All pick-up routes, 3 1/2 miles town. Out-of-state owner says sell for \$9,800, only \$1,950 down! New Fall-Winter catalog, beautifully illustrated throughout, bargains coast to coast! United Farm Agency, 2825-PM Main St., Kansas City 41, Mo.

BEST Values Arkansas Ozarks retirement homes, town and country homes, farm lands. Stand strictest investigation. Free listings. Rogers Land Co., Dept. 201, Rogers, Ark.

FLORIDA. 2 1/4 Acres, Gulf Coast area: 50 ft. elevation; \$795.00; \$15.00 down and month. Russell Hancock, Realtor, Brooksville, Fla.

OPPORTUNITIES! Government land, U. S., Alaska, Canada. Sledge Surveys, Macon, Mississippi.

PROFITABLE OCCUPATIONS

INVESTIGATE Accidents. Earn \$750 to \$1,000 monthly. Men urgently needed. Car furnished; business expenses paid. No selling. No college education necessary. Pick own job location. Investigate full time. Or earn \$6.44 spare time. Write for free book. No obligation. Universal Schools, CPM-9, 6801 Hillcrest, Dallas 5, Texas.

BUY Below wholesale! Thousands of nationally advertised products. Drugs, clothing, housewares, cameras, jewelry, hardware, sporting goods, etc. Postcard brings price list showing actual factory cost. Buy-Rite, 310 Main, Bennington 1, Vermont.

INVESTIGATE Auto accidents. Earn \$750 to \$1,000 monthly. More investigators urgently needed. Car furnished; business expenses paid. No college education necessary. No selling of any kind. Pick your own job locality. Meet interesting, important people. We train you at home in spare time. You keep present job until ready to switch. Write for free booklet. No obligation. Liberty School, Dept. C-98, Libertyville, Illinois.

WHOLESALE Magazine subscriptions. Highest commissions. Bonus! Qualified Agencies, 451EA Kingston, Brooklyn 25, N. Y.

AUCTIONEERING—Home study course. Diploma granted. Auction School, Ft. Smith, Ark.

EARN \$240.00 A month at home, spare time, doing only two \$5.00 invisible mending jobs a day. Big money paid for service that makes cuts, tears disappear from fabrics. Steady demand. Details free. Fabricon, 6236 Broadway, Chicago 40, Ill.

VENDING Machines. No selling. Operate a route of coin machines and earn amazing profits. 32-page catalogue free. Parkway Machine Corporation, Dept. #25, 715 Ensor Street, Baltimore 2, Maryland.

SHARPEN Scissors, pinkers. Inexpensive machine. Clipper sharpener. Black-hawks, Sheldahl, Iowa.

GROW Mushrooms. Cellar, shed and outdoors. Spare, full time, year round. We pay \$4.50 lb. dried. We have 29,000 customers. Free book. Mushrooms, Dept. 99, 2954 Admiral Way, Seattle, Wash.

BAKE New greaseless doughnuts in kitchen. Sell stores. Free recipes. Michael, 3605 South 15th, Minneapolis 7, Minn.

BIG Money raising fishworms and crickets. Free literature. Carter Wormery, Plains, Georgia.

BECOME Independent with your own franchise business. Thousands earning handsome incomes. Request interesting facts today. National Franchise Reports, PM-528, 333 North Michigan, Chicago 1.

FREE Book "990 Successful, Little-Known Businesses." Work home! Plymouth-47R, Brooklyn 4, New York.

LEARN Expert cake decorating, candy making. Free details on home instruction method. Candy & Cake, Dept. D-19, Fallbrook, Calif.

PROFITABLE Career waiting. Free information. Davis Imports, Dept. A, Box 489, Edmonds, Washington.

RAISE Nightcrawlers, redworms. Easy new soilless method. Three Oaks Ranch, Dresden, Tenn.

BOOKS, PERIODICALS, PICTURES, POSTCARDS

FREE Catalog. Self-help books. Write Wilshire, 8721 Sunset, Los Angeles 46P.

BOOKFINDERS! All subjects. Send wants! Jaher Book Service, 183 Hazelwood Drive, Westbury, N. Y.

NATIONAL Geographic magazines, 1888-1960, any issue. Periodical Service, Box 465-PM, Wilmington, Delaware.

BOOKS Located fast. Out-of-print, scarce. Lowest prices without obligation. Book Mark, 51A Walnut, Mt. Clemens, Mich.

BOOKHUNTERS! Scarce, miscellaneous books supplied! Atlantic Book Service, Cedar Street, Charlestown 29, Mass.

OUT-Of-print books at lowest prices! You name it, we find it! Fast service. No obligation. International Bookfinders, Box 3003-PM, Beverly Hills, Calif.

BRITISH Book bargains—Any subject. Catalogues free. Transatbooks, Wantagh, N. Y.

WANTED: Old Physics books before 1890. Thos. Staley, 1436, Eagle Point, Oregon.

"PANNING Gold for Beginners," \$1.00; "Gold in Placer," \$3.00; "Gold in Lode," \$3.00. Frank Harnagy, 701 1/2-M East Edgeware Road, Los Angeles 26, Calif.

MAGIC TRICKS, PUZZLES, JOKER NOVELTIES

MAGIC! Fantastic hobby! Mystifies, entertains! Details free! Mounier's, 209 Armand, Ville Platte, Louisiana.

CATALOG. Free trick, 25¢ (1,500,399 tricks, jokes, novelties). Magico, #4037-P, San Antonio 7, Texas.

GET Your tricks, gags wholesale. Sell to friends. Free catalog. 28 gag samples 25¢. Dohn-OV-Marks, Broadview, Illinois.

FLAME Thrower! 36" flashes at fingertips! \$1.00. Harmless! Arlane, Philadelphia 44.

BE A magician! Large professional catalog of latest tricks, 35¢. Ireland, C-109 North Dearborn, Chicago 2, Illinois.

WORLD'S Finest professional magic. Joker novelties. Giant illustrated catalog 10¢. Top Hat, Evanston 12, Illinois.

SMOKE Bombs 25¢. 7 for \$1.00. Terrific! 4463-PM Greene, Philadelphia 44.

INDIA Rope trick and magic catalog 25¢. Hocus Pocus, 209 West Capitol, Jackson, Mississippi.

500 TRICKS. Famous Douglas catalog of magicians' tricks and supplies now available just 10¢. Fastest service. Douglas Magicland, Dept. 61, Dallas, Texas.

VENTRILLO Voice thrower 25¢. Ventriloquist's puppet 75¢. Box 971-PM, Philadelphia 5.

VENTRILLOQUISM. In Spanish and English. Details free. Smith, 2125 N. Bigelow, Peoria, Ill.

MAKE Money with magic, full or part time! Age no barrier! Amazing plan! Anchor, P.O. Box 974, Tahoe Valley, Calif.

3000 TRICKS. Pocket, parlor, stage. World's finest magic catalog (408 pages), \$2.50. Kanter's, M-1311 Walnut, Philadelphia 7.

2700 NOVELTIES, Jokes, tricks, fun-makers, hobbies. World's biggest gadget catalog 10¢. Johnson-Smith, D-549, Detroit 7.

COINS, TOKENS, CURRENCY

LARGEST Coin magazine. 288 pages, 50¢. Scrapbook, 7320-J Milwaukee, Chicago 31.

NUMISMATICS Largest newspaper. Semi-monthly. Sample 25¢. \$2.00 yearly. Numismatic News, Box 452, Iola, Wis.

TWENTY Page 1961 retail price list of USA and Canadian coins for 10¢. Our selling prices on thousands of coins and coin collectors supplies. Bryson Incorporated, 612A White, Toledo 5, Ohio.

NUMISMATISTS—Price list with valuable gift—40¢. Vanderman, Box 9161, Suitland, Maryland.

GIANT 100-Page coin catalog, listing coins and supplies for sale. Send 25¢. Ben's Coin Shop, 31 North Clark St., Chicago 2.

RARE 1878 CC mint dollar uncirculated \$5.00. 100pg. catalogue 50¢. Shultz, Salt Lake City 10, Utah.

BARGAIN List! U. S. coins, accessories. Stamp please. Hugh's, Hickory, N. C.

RARE Unc. 1899 Philadelphia silver dollar, \$5.00. Price lists 25¢. Butts, Torrington, Wyo.

NEW 1961 Giant U. S. Coin Catalogue 25¢. Ace, 107 N. Dearborn, Chicago 2.

INDIAN Heads, buffaloes before 1936, eleven cents each. None mutilated. Money immediately. Robert Reeder, Box 1702, Brownsville, Texas.

WORLD'S Greatest coin magazine and wooden nickel 10¢. Lawrence, Anamosa, Iowa.

SIX Different Indians \$1.00. Free discount list. Michael's, New Hope, Penna.

FREE Coin supplies! Giant coin list 10¢ (refundable). Economy Sales, Mansfield, Massachusetts.

COIN Press Magazine 35¢. 24 issues \$3.00 year. East Orange, N. J.

LINCOLNS: 40 Different 1909-40 plus 1960D small date \$1.95. 25 different "S" including rare 1955S \$1.50. Harris's, Box 6193, San Francisco, California.

40 PAGE Illustrated United States and Canadian coin list 10¢. Stoney, 260 Washington, Boston 8, Mass.

68 DIFFERENT Lincolns, \$2.25 postpaid. Howard Melton, Box 483, Portales, New Mexico.

25 BEAUTIFUL Coins from 25 countries. Mostly uncirculated. Terrific assortment. \$1.00. Hindley, Box 708, Aurora, Illinois.

INDIAN Head cents, two different only 25¢. Approvals. Littleton Coin Co., Littleton R1, N. H.

TRUNKFULL 30,000 Liberty-Buffalo nickels. Will pack "grab-bag" style 300 mixed, \$50; sample bag of 10, \$2. Money back guar. Mrs. Fischer, Dept. FF, 3 Centre St., Hempstead, N. Y.

SIX Different Indian cents with lists. \$1.00. Hutchinson's, Box 6256, Philadelphia, Penna.

BRILLIANT Proof sets—1955 \$11.75; 1956 \$7.75; 1957 \$4.95; 1958 \$9.75; 1959 \$5.25; 1960 \$3.85; 1961 \$3.50; all seven \$42.50. Beautiful lucite cube paper-weight with encased 1961 proof set \$10.50. Gigantic bargain catalogue \$1.00 (free with \$10.00 order). Bebee's, 4514 North 30th, Omaha 11, Nebraska.

LINCOLN Cents: 1921-S, 1924-S, 1918-S-D, 1917-S-D, 1925-S-D, 1920-S-D, 1919-S-D, 1930-S-D, 1938-S-D, 1931-P, 1927-S-D, 1929-S-D, 1928-S-D, 1934-D. Complete lot \$3.95 good to fine. Rolls of 1955-S Lincoln cents fine to A.V. \$5.00 roll. Berry, Box 306, Westminster, Calif.

THIRTEEN Different nice Liberty nickels \$2.39. 100 mixed dates \$15.00. Pratali, 165 Aster Dr., New Hyde Park, N. Y.

LINCOLN Head cents. 1909-VDB, 1916-DS, 1917-DS, 1918-DS, 1919-DS, 1920-DS, 1921-S, 1923-S, 1924-S, 1924-DS, 1927-DS, 1928-DS, 1929-DS, 1930-DS, 1931-P, 1932-P, 1933-P, 1934-D, 1938-DS, 1939-PDS, 1955-S. Good to Fine, all for \$4.95, postpaid. Guaranteed. 4 Indianhead cents \$1.00. Hyles Sales, Box 9566, Dallas 14, Texas.

CALIFORNIA Gold souvenir pieces. Quarter, half dollar sizes, \$1.35 each. Collection of 9 different, dates before 1856, \$10.00. Steve Ruddel, Box 61, Arlington, Virginia.

DEMONETIZED English farthings: 15 different dates \$1.00; 25, \$2.00; 40, \$5.00. Coin Center, Box 298, Station H, Montreal 25, Canada.

INDIAN Cents 7. \$1.00. Liberty nickels 6, \$1.00; 14, \$2.90. Doktor, P.O. Box 35151, Los Angeles 35, Calif.

LINCOLNS: Fine: 1916S; 17S; 18S; 19S; 20S; 24S; 40S through 49S; \$5.00. O'Rux, Davenport, Washington.

THREE Sample medals \$1.00. Information free. Medal-of-the-Month, Dept. P, Sioux Falls, South Dakota.

INTRODUCTORY: Free Confederate dime. Foreign coin and medal catalog. Send 25¢ for postage, etc. Hobbies, Box 71-C, Rockaway 94, N. Y.

FIVE Genuine foreign bills sent free with our price catalogue of United States coins. 25¢ + 5¢ mailing. Tatham Stamp and Coin, Springfield, Mass.

STAMP COLLECTING

21,000 ALL Different, only pennies a day using our systematic payment plan. Details free. Sjoquist, 1435 Cherrydale, San Jose 25, California.

1000 DENNISON Hinges free with approvals. Send 10¢ for postage, handling. Robert J. Clark, P.O. Box 28-B, Wilmette, Illinois.

FREE 50 Different stamps with approvals. Beacon Stamps, Box 218-D, Pompano Beach, Florida.

1001 COSMOPOLITAN—50¢. Contains U.S.A., Russia, First U.N., Summit Conference, olympics, space satellite—hundreds more! Approval request, references required. Horace Gatewood, Winston-Salem, North Carolina.

FIVE Diamond Olympic airmails 5¢! Approvals. Wagner, 547 Franklin, Buffalo 2, New York.

PENNY Approvals. 1000 foreign stamps mounted in Scott order. No assorting! Send \$1.00 deposit deductible from first order. Bullot Approvals, 1359 Coney Is. Ave., Brooklyn 30, N. Y.

U.S., U.N., Confederate states catalog free. Stone, 260 Washington, Boston 8, Mass.

U.S. Mint specials! Flag set, complete \$1.00; 1¢, 2¢, 3¢ famous Americans (21 different), \$1.00. Free list. Brooks, 2323 Avenue X, Brooklyn 35, New York.

215 DIFFERENT Worldwide 25¢. Fiume, Korea, Laos, Russia, Transvaal. Approvals. Bobb's, Box 3045, Saint Louis 30, Missouri.

HUMAN Rights set free with approvals. Collier, Box 265, Chamblee, Ga.

TERRIFIC Latin commemoratives \$1.00 bankcheck. Triple selection \$2.50. Jekker, CP 721, Vitoria, Brazil.

WORLDWIDE Large pictorials commemoratives 100 to 1000 diff. penny each. 100 diff. foreign airmail large, or 75 large foreign from 75 countries \$1.00. Philatelic supplies, albums, catalogs, supplements, coin folders, etc. 20% discounts. Rudin, Box 325, Amityville, N. Y.

MILLION Foreign stamps! 2¢ each! Send for thrilling, giant approvals! ABC Stamps, Box 6000-HH, San Francisco 1, Calif.

SPUTNIKS. Rockets, space stamps free with sparkling approvals. Cambria Stamps, Box 2205, Anaheim, California.

ALBUMS! Hundreds of spaces! Only 25¢. Postpaid! Stampmart, Hartford 1, Conn.

TWO \$5.00 United States stamps, 20 others 10¢ with United States approvals. Irwin, Box 1105, Brooklyn 30, New York.

25 DIFFERENT Large American commemoratives. 10¢ with approvals. Linstamp, St. Catharines 101, Ontario.

80 DIFF. U. S. stamps includes 19th Century commemorative. High values. Plus 1943 flag stamp of occupied nations. All for only 25¢. Approvals included. Willett Co., Box 338-C, Yorktown Heights, N. Y.

107 DISTINCT British Colonial stamps, 10¢. Approvals. Linstamp, St. Catharines 401, Ontario.

25 DIFFERENT Commemoratives 1893 up 10¢. U. S. approvals. K & B, Box 70, Brooklyn 23, N. Y.

UNITED Nations 15th anniversary sheet with first day cancel, as commemorated by Russia. Free! While they last, with approvals, Philatelics, R-J, New Paltz, N. Y.

25 COLUMBIA 10¢. Approvals included. Reed, Box 980, Chicago 90, Illinois.

105 DISSIMILAR British Colony stamps, 10¢. Approvals. Crown Stamp Company, Virgil 601, Ontario.

INTRODUCING Our better United States approvals we offer 15 United States stamps including Columbian, Bi-Centennials, famous American, ahrs, others; only 10¢. Ocean Stamps, Box 64-PM, Brooklyn 29, New York.

PENNY Approvals. Thousands. Bargains for pennies. Gifts with purchases. Penny Stamps, Orange, California.

GIANT Approvals, thousands different, 1¢ and 2¢ each. Wahl's Stamp Exchange, 7008P Farragut, Chicago 31, Ill.

UNITED States commemorative collection containing 33 different—10¢. Approvals. White, 516-A Avenue L, Brooklyn 30, New York.

103 DIVERSIFIED British Empire stamps, 10¢. Approvals. Niagara Stamps, St. Catharines 501, Ontario.

SELL Your surplus good grade stamps. Write, describing fully what you have. Vanrov Shirik, Lebanon, Pennsylvania.

AMAZING OFFER! 200 United States stamps — including commemoratives, airmails, high denominations to \$1.00. Only 10¢ to approval applicants! Illustrated bargain lists free. Mystic Stamp Co., Dept. 80, Camden, New York.

100 STAMPS, 10¢ With approvals. Smith, 508A Brooks, College Station, Texas.

100 OLD United States between 1861 and 1935, \$1.00. Roush Stamps, 51 Chestnut, Mansfield, Ohio.

UNITED States price list, 116 pages, price 25¢. Mark Hanna, 335 Fifth Ave., Pittsburgh 22, Penna.

SELL Stamps to our readers. Your ad in this space will be read by thousands of stamp buyers. I'll prove that to you. Write now for Folder "S." F. W. Johnson, Classified Advertising Manager, Popular Mechanics, 200 E. Ontario St., Chicago 11, Ill.

STAMP Jungle including Zabu, kookaburra, koalabear, kangaroo, rhinoceros, 10¢. Approvals. Crown Stamp Company, Virgil 301, Ontario.

1,000 DIFFERENT Worldwide stamps \$1.00. Valued over \$20.00. To introduce our unique services. Universal, Box 6, Kenosha 5, Wisconsin.

14,000 DIFFERENT! Amazing new plan builds your collection systematically, country by country. Only 50¢ weekly. Free details. L. G. Ware, Monroe 75, Conn.

1002 DIFFERENT Worldwide for approval buyers only. Jacobsen, Crompond, N. Y.

FREE Monaco nudes, Approvals, Stamp Ranch, 902 Addison, Chicago 13, Ill.

ECONOMICAL 1½¢-3¢ Approvals, 39,000 varieties. Dresel, Box 128-N, West Englewood, New Jersey.

PENNY Approvals! Regardless catalogue! Kloster, 4164—52nd St., San Diego 5, Calif.

60 DIFFERENT U. S. (30 commemoratives) 25¢. No approvals. Seidenberg, Appleton, Wisconsin.

500 DIFFERENT. Includes pictorials, 35¢. Knopp, Box 1381, Bristol, Conn.

307 WORLDWIDE Different stamps only 25¢. Approvals. Niagara Stamps, St. Catharines 201, Ontario.

225 STAMPS For only 10¢! This mammoth value includes airmails, pictorials; stamps from strange countries cataloging up to 25¢ each! Also approvals. Mystic Stamp Company, Camden 80, New York.

DEFECTIVE Old U.S., 1/6 catalog. Approvals. K. Swartz, Maiden Bridge, New York.

LOOK! Six Queen Elizabeth mint sets from Antigua, Caymans, Mauritius, Montserrat, Virgins, St. Kitts! 21 brilliant pictorials, 25¢. Attractive approvals! Gannon Stamps, Box 931, Canton 1, Ohio.

THIS Is different! Our system brings you hundreds of stamps, each and every week. Gives your duplicates real value. Obtains stamps otherwise hard to find. Complete details and one year's membership, \$1.00. Kinnear, 558 Oakley Blvd., Las Vegas 6, Nevada.

FREE! World's largest! Strange, valuable 7 x 14½" beauty. Send 15¢ handling now! Norrisco, Milwaukee 7, Wis.

GLOBAL Foreign approvals mint-used. Enclose 10¢. Peterson, Box 31, St. Paul 2, Minnesota.

60 DIFFERENT, British Colonies, foreign, U.S.A. free to collectors requesting approvals. Stanley Zajac, 159 Emerson Ave., Toronto, Canada.

STAMP Grab bag featuring exclusively animals, trains, flags, ships, triangles, maps, planes. Send dime. Stampliner, Route 3, North Bay, Ontario.

FREE 400 Genuine postage stamps! Worth \$10.00 at catalogue prices. Africa, British Empire, Asia, Europe incl. bonus, Russia honoring "Man in Space" Yuri Gagarin, beautiful stamps with tab signed by Krushev—a fascinating valuable mixture from foreign convents, banks, etc. Who knows what you will find. Also free valuable booklet. Adults only. Approvals enclosed. Frasek Co., PM9, White Plains, N. Y.

WEIRD Diamond shape coffee stamps. Lively flower triangle! First American big commemorative. Greenland, Idol Dancer, etc. 10¢ with approvals. Capital Stamp Co., Ferrysburg 2, Michigan.

TERRIFIC Stamp bargain! Israel, Iceland, San Marino, plus triangle set, plus Antigua, Borneo, Virgin, Scouts, Congo, Russia, plus large stamp book. All four offers free. Send 10¢ for mailing cost. Empire Stamp Corporation, Dept. PM, Toronto, Canada.

FREE! Giant bargain catalog. New edition listing thousands of bargains including U.S. and B.N.A. stamps, packets, mixtures, albums, accessories and supplies; sent with beautiful approvals. Adults only! Jamestown Stamp, Dept. E91PM, Jamestown, N. Y.

508 DIFFERENT World-wide from Formosa, Morocco, Indonesia, etc., cataloging over \$15, only 35¢. Offer to adults only. Approvals. Littleton Stamp Co., Littleton Q1, N. H.

AMERICAN Historical collection! Enormous George Washington beauty, F. D. Roosevelt diamond, giant Abe Lincoln U.S.A. flag commemorative, plus midget soldier, Latin orchid issue, old IFNI overprint, etc. 10¢ with approvals. Roseland Stamps, Spring Lake 2A, Mich.

FREE! Exotic mint Polynesian hula girl stamps! Giant bargain lists included with approvals. Aloha Stamps, 1019-PM Tarryall Drive, Dallas 24, Texas.

"OLD Glory" in flaming colors! U.S.A. flag giant beauty from Honduras. Enormous United Nations Mexican stamp. Plus strange gorilla issue. Duke of Windsor, Morocco, lovely Macao flowers, wild buffalo stamp and others, 10¢ with approvals. Sunny Stamp, Apopka 2, Fla.

FREE — Malgache butterflies with approvals. Bacon, 405 Main, Rolla, Missouri.

DEALERS—Wholesale list. Postage 4¢. Frank, 5031 Queensberry, Baltimore 15, Maryland.

200 DIFFERENT U.S. stamps \$1.00. Approvals included. Shelton, Box 907-J, New York 8, N. Y.

TOPICALS, 8 Sets 15¢. Approvals. Miller, Box 548, Levittown, New Jersey.

RUSSIA, 28 Mint, 15¢ to approval applicants. Linear Stamp Co., 1331 29½ Street, Rock Island, Illinois.

FANTASTIC Fish triangles! Valuable "Ben Franklin" on Canal Zone! Flaming bi-colored volcano triangle! Lovely Olympics triangle! Plus icy Greenland, weird wild beast issue and others. 10¢ with approvals. Roseland Stamps, Spring Lake 2, Michigan.

HAITI: 50 Different—\$1.00, with approvals. Haiti-Herald, Port-au-Prince, Haiti.

ARCTIC Birds, penguins sets, 5¢ with approvals. Peterson, Box 3651, Lincoln 6, Nebr.

FREE! Triangles, pictorials, others. 55 different. Colorful, unusual approvals. L. Baird, PM-2, Box 8128, Portland 7, Oregon.

FREE Packet Australian animals with \$1.00 world wide packet order. James F. Coleman, 1433 Tunnel ill, Charlestown, Indiana.

PACKETS! Largest packet catalogue in the world! Low prices. Send 4¢ stamp. Hyatt Stamps, Box 366, Danville, Illinois.

SURPRISE Collection! Exotic mint British Colonials absolutely free with approvals. Viking, Great Neck 8, N. Y.

U.S. Stamps. Giant discount catalog—20¢. Raymax, 37-VZ Maiden Lane, New York City 38.

DISCONTINUING Stamp business. Tremendous values! \$2.00. Conglomeration includes mixtures, packets, sheets. Norge, Ho-Ho-Kus, N. J.

WOW! 110 All different Germany 10¢! Zeppelins, semi-postals, airmails, high values, etc. Giant catalog, bargain lists included with beautiful approvals. Adults only! Jamestown Stamp, Dept. A91PM, Jamestown, N. Y.

50 FREE With attractive approvals. Patton's, 660 Cal., Boulder City, Nev.

100 DIFFERENT United States commemoratives, 1½¢ to 10¢ values, \$1.00. Adults may request approvals. Gil, Box 12B, Brooklyn 29, N. Y.

QUALITY Packet 10¢. Worldwide approvals. Avery, Box 8261, Honolulu 15, Hawaii.

VATICAN Set of 5 values, catalog \$1.92. 20¢ with unique approvals 1½¢ up. Stamp Studio, Box 171M, New York 24, N. Y.

SEVENTY Different United States. Obsolete and current. 25¢. Ed. Keller, Library, Penna.

UNITED States and foreign approvals. Kenn, 3640 Howard, Windsor, Ont., Canada.

UNBEATABLE Value 50 different worldwide only 10¢. Includes airmails, flowers, animals, sports, other fine stamps with approvals. Return postage paid. Len's Stamp Mart, Box 2271, Miami 1, Fla.

OLD Scarce U.S. seconds on approvals. Slight imperfections, lowest prices. Hernefield, Clintonhill Sta., Newark 8, N. J.

TERRIFIC Beauties! 2¢-3¢ approvals. Marshall, Box 553-PD, Pacific Grove, Calif.

SPACE Pictorials, 10¢ with approvals. Schaefer, Californiastrasse 16, Wiesbaden, Germany.

FREE 50 Worldwide, mailed with inexpensive approvals. University Stamps, P.O. Box 44-592, Miami 44, Florida.

EXTRA Quality world wide selection including pictorials, commemoratives, 116 different 25¢ to adult approval applicants. James Hobden, Carmel 93, Maine.

WHOLESALE! Stock liquidation. U.S., airmails, covers. Trial lot, lists \$1.00. Stamparee, Sierra Madre, Calif.

PORTUGUESE Empire, 50 including Angola, Mozambique 10¢ with approvals. Elkhart, Box 33, Elkhart, Indiana.

FREE Magnifying glass with order for 40 U.S. postage 15¢. Manning, 21 Lakeview, Freeport, N. Y.

FREE Mint set! Approvals accompany. Stampco, Box 737, Memphis 1, Tenn.

153 DIFFERENT U.S. commemoratives \$1.00. Approvals. Carstamps, 739 Ordway, Freeport, Illinois.

50 DIFFERENT 10¢ With approvals, includes mint topicals, U.S. Comm., others. Carpenter, Box 310, Claremont, Calif.

FREE—21 Beautiful sport, wildlife, flower stamps with approvals. Earn free albums and stamps with purchases. Student Stamp Company, Box 116, Claremont, New Hampshire.

BRAZIL 35 Mint different commemoratives \$1.00. Nelson Angelino, Joinville, St. Catarina, Brazil.

FIRST Day covers, specimen and details quarter. Mueller's, Arpin, Wisconsin.

FREE Bargain United States lists. Approvals. Dolin, 31 Parkrow, New York City 38.

FREE! "Mystery" stamp packet. Approvals. Premiums. Dancer, 75-P25, Mansfield, Ohio.

BIRDS, Five of New Poland set, plus 100 different 10¢. Approvals. Berchtold, Troy, Ohio.

150 DIFFERENT U.S. 50¢, many older issues. Approvals. Winchester Stamps, 45 Winchester Rd., Mansfield, Ohio.

111 WORLDWIDE. Includes airm, mid-gets, triangles, 10¢. Approvals. Premiums. Faith, 20½ Bushnell, Alhambra, Calif.

LIQUIDATION Bulletin #13, U.S.-foreign, free on request. Taaffe, P.O. Box 226, Los Angeles 53, Calif.

FREE—Airmails. Complete sets. Singles. Fifteen different countries. Handling 10¢. Approvals. Boger, Box 152, North Wales, Penna.

SUPERB Material—\$1.00. Vergil Nelson, 2204 Division St., Manitowoc Wisconsin.

50 DIFFERENT U.S. 10¢ with U.S. approvals. Desert Company, Box 1026, Scottsdale, Arizona.

SEPTEMBER Special. 1100 worldwide stamps \$1.00, 3,500, \$3.00. No approvals follow. Harrison's Stamps, 1435 1st Ave., Oakland 6, Calif.

60 DIFFERENT Australia 25¢. 100 different French Colonies 45¢. Approvals, lists. CBR, 6931 South Merrill, Chicago 49, Ill.

FREE. 33 Greenland, Congo, Ruanda, others. Approvals. Keating, 2520-P Boulevard, Jersey City 4, New Jersey.

PHILIPPINES. 15 Commemoratives 10¢. Approvals. Norton, Box 926, San Antonio 6, Texas.

HAWAIIAN First day surprise, plus accumulation. Clearance good catalogue value for \$1.00. No approval follow up. Menehune Stamp Co., Box 7033, Honolulu, Hawaii.

TRADES. 100—25¢. Send addressed envelope. Chas. Bryant, Emporia, Va.

U.S. Collection 125 different 50¢. Rayworth, 321 South Cicero, Chicago 44.

1065 DIFFERENT \$1.00 With approvals. Klondike, 682 Jefferson, Elgin, Illinois.

MINT U.S. at face! Older commemoratives only. Send 25¢ for all different packet. Limit one with request for mint U.S. Approvals. Western, Box 1689P, Salinas, California.

100 DIFFERENT Sweden. 25¢! Bargain approvals! Carling's, B-901, Howard City, Michigan.

COLORFUL Triangle collection. 22 different, 10¢. Approvals. Valley's, Box 414-PM, Spring Valley 9, California.

SCREWBALL Fish in natural colors; Pan, the Goat Man; Egypt, Mother's Day; Crawley Bugs set; jets; Somaliland flower garden; French model; U.S. Revolutionary War, others free when purchasing approvals. Stamp Farm, MS-38, Oxford, Wisconsin.

50 DIFFERENT Large U.S. commemoratives 10¢ with approvals. Jack Clancy, Box 2187, Portland 14, Oregon.

20,000 DIFFERENT 1¢ And 2¢ each. Howard G. Davison, Suncook, N. H.

U.S. For pennies. Sherman, 6728 N. Talman, Chicago 45, Ill.

ENJOY Stamp collecting? Write for "penny-provals." Penny-Proval Service, New York Building, Saint Paul 1, Minn.

ANTIQUES, RELICS, INDIAN GOODS, CURIOS

3 WAR Arrowheads, scalping knife, thunderbird \$4.00. List. Arrowhead, Glenwood, Arkansas.

SELLING 20,000 Ancient arrowheads, spearheads, etc. List free. Lear's, Glenwood, Arkansas.

COINS, Weapons, antiquities, antiques. Six illustrated catalogues one dollar bill. M. Hope, 4 Myrtle Ave., Sherwood Rise, Nottingham, England.

10 ANCIENT Stone arrowheads. \$2.00. 10 birdpoints, \$2.00. List 10¢. Stan's, 1054 Lilley, Columbus 6, Ohio.

GIANT Photo-illustrated Indian relic catalog 25¢. (Refundable!) Indian Gallery, 8 Helene Avenue, Merrick 5, New York.

SOUVENIRS, Folklore, gaucho motifs, etc. from Argentina, superb artists. We mail 70 decalcomanias for \$2.00 or equivalent. Arte Practico, Guatemala 5200, Buenos Aires, Argentina.

PRECIOUS STONES, MINERALS

ROCKHOUNDS—Gem cutters, jewelry makers. New free catalog—just off the press! Biggest supplier to hobbyists and craftsmen offers you tools, materials, equipment, introductory bargains and know-how. Free catalog. Write Grieger's, Dept. C-11, 1633 E. Walnut, Pasadena, California.

20 ASSORTED Polished gem stones \$1.00. Eberle's, 2727 West Slauson, Los Angeles 43, Calif.

SUPER Brilliant blue white gems. Swiss made, German cut, diamond faceted. \$3.00 carat. Sell \$24.00. Phillips Gem Co., Brady Lake, Ohio.

SEMI-Precious uncut gems. Ten different for \$1.00. Request list 28. Prospectors Shop, 201 San Francisco, Santa Fe, New Mexico.

FREE Bargain gem list. 1961 lapidary and silversmith tool catalog, 50¢. O'Brien's, 1116B Wilcox, Hollywood 38, Calif.

EARTH Science. Rockhound's National Magazine. Subscription \$2.50. Sample 35¢. Box 1357-PM, Chicago 90, Ill.

ALASKA Minerals. 10 different \$2.00 postpaid. Aspco, Box 914-M, Ketchikan, Alaska.

HOBBIES AND COLLECTIONS

50 JUNGLE Butterflies; 50 oriental seashells; 25 gemstones, each \$2.00. Free collector lists. State interest. P. Haas, 57-34 256 St., Little Neck, N. Y.

ORIGINAL Antique advertising broadsides—circus, Uncle Tom's Cabin, melodramas, minstrels, \$2.00. Assortment 10, \$18.50. McClintock Collection, Franklin, Penna.

AMERICAN Newspaper, complete, original, dated before 1860, \$1.50. 25¢ stamps brings catalogue. D. R. Spaight, Bookseller, Tall Timbers 1, Maryland.

COLLECT Timepieces? Free folder. Nawco, Box 33, Columbia, Penna.

EUROPEAN Military curios and Nazi relics. Authentic and reasonably priced. Colonel John Stoddard, 5110 North 61 Ave., Glendale, Ariz.

PHOTOGRAPHY, CAMERAS, PHOTO SUPPLIES

BARGAINS In photography, bulletin, 25¢ coin or stamps. Commercial, Dept. P.M., 727 N. 19th, Allentown, Penna.

164 PAGE Photographic bargain catalog. listing thousands of photographic bargains. Send 10¢ for your copy, receive 25¢ credit on first order Dept. 1-E9, Central Camera Company, 230 So. Wabash Ave., Chicago 4, Illinois.

PHOTOGRAPHY For pleasure or profit. Learn at home. Practical basic training. Long established school. Free booklet. American School of Photography, 835 Diversey Parkway, Dept. 343C, Chicago 14.

DISCOUNTS On Kodak and Polaroid films. Free price list. Thrifty Camera Co., Box 1022E, Saginaw, Michigan.

PHOTO FINISHING

TWELVE Exposure rolls 59¢. Wallets 20 for \$1.00. Lincoln Studios, Dept. K, Box 13, Lincoln, Nebr.

FREE Roll of fresh Kodak film returned to you for each roll of black and white or Kodacolor sent in for developing and printing. Fast service, low prices, guaranteed quality. Send for free mailers. Economy Photo Service, Dept. PM, Box 1111, Albany 1, New York.

SAVE! Fifty wallet photos. \$1.25. Feathers, 1790 Third Street, Atwater, California.

12 EXPOSURE Roll 49¢. Prints 5¢. Able Studios, Box 707, Lowell, Mass.

TWO Beautiful prints from each picture on roll 8 exposures 45¢; 12 exposures—60¢. Forty years of satisfied customers. Quick service. Lens Photos, Dept. J4, Janesville, Wis.

MOTION PICTURES AND SOUND EQUIPMENT

16MM SOUND—8mm films. New, used. Free list. Entertainment Films, 236 W. 55, N. Y. C.

5,000 8-16 MM. Movie films. Free catalogues. International, Greenvale, N. Y.

8MM-16MM Color and B & W film and supplies. Save money. Free catalog. Superior, 448 N. Wells, Chicago 10.

MOVIE Camera film: 8mm. roll \$1.50. 16mm. 100' \$3.00. Free processing. Better Films, 742 New Lots, Brooklyn, N. Y.

MOVIE Film: Free catalog! ESO-R, 47th Holly, Kansas City 12, Missouri.

16MM. Sound, projectors, films. Sale, rental, exchange. Visit store or write for catalog. National Cinema, 71 Dey St., New York City.

8MM Home movies. Free catalog. Midwest Enterprises, P. O. Box 2062, Milwaukee, Wisconsin.

BIG Money! Making short, simple, 8mm movies. Free details. Lagene's, Pocasset, Mass.

BARGAINS In photography, bulletin, 25¢ coin or stamps. Commercial, Dept. P.M., 727 N. 19th, Allentown, Penna.

8MM, 16MM. Movie subjects. Silent, sound. New, used. 2"x2" color slides. Biggest selection anywhere! Free each month, big 24-page newspaper-size catalog. Blackhawk Films, Davenport 14, Iowa.

THIRD Dimension movies with any projector! \$4.95. Lists, information free. Spl. Box 1155, Sherman Oaks, Calif.

FREE! "16MM. Sound Film Fan Monthly." Burr Films, 210 Durham, New Westminster, B. C.

16MM. Sound—8MM. Giant bargain lists. Gaines, Box 32430, Van Nuys, Calif.

8MM.-16MM. Antique airplane movies. Send \$2.00 for "Special Film" and catalogue. Movieland, Box 10-M, Van Nuys, Calif.

COLOR SLIDES

ALASKA Film, Box 5-621, Mt. View 8, Alaska. Movies, slide samples \$1.00.

ALASKA Color slides. Wildlife (moose, caribou, sheep, etc.) scenic native life, etc. Send \$1.00 for 3 sample slides and catalog. Co-Op Photo Shop, Dept. PM, Fairbanks, Alaska.

TRANSPARENCIES Wanted. Up to \$500.00 each. For information write American Color, 1008 N. Stanley Ave., Hollywood 46, Calif.

LINCOLN Story in color slides. Catalogue and sample 40¢. Willems, Box 1515-A, Chicago 90.

MUSIC & MUSICAL INSTRUMENTS

GRAB-BAG! Three LP records \$2.00 postpaid! Towers, Box 3095, Philadelphia 50.

POEMS Wanted. Free examination. Best recorded free. 7-piece orchestra. Melodies written. Free sample record. Send poems. Songmakers, 1472-M Broadway, New York 36.

SONGPOEMS And songs wanted! Mail to: Tin Pan Alley, Inc., Box 405, Radio City Station, New York 19, N. Y.

POEMS Wanted for musical setting and recording. Send poems. Free examination. Crown Music Company, 49-C West 32 Street, New York 1.

POEMS Needed immediately for new songs and records. Free examination and appraisal. Send poems: Songcrafters, Acklen Station, Nashville, Tenn.

GUITAR Making books, plans, imported woods, tools. List 10¢. Satinwood, 510 East 11th Street, New York 9, N. Y.

ELECTRIC Guitars, amplifiers, wholesale. Free catalog. Carvin, PMM, Covina, Calif.

SONGS And songpoems wanted for our summer and fall program. Sincere writers only. Colonna Enterprises, Box 888M, Burbank, Calif.

PIANO Tuning. Home study course. Diploma granted. American School of Tuning, Box 707, Gilroy, Calif.

VIOLINMAKERS. Repairers. Fine tone wood, and all violin supplies. Send for free wholesale new price list. International Violin Co., 414-MPM E. Baltimore Street, Baltimore 2, Maryland.

ACCORDIONS. Chord organs, guitars! Buy direct — save to 1/2. Famous makes. Free home trial. Easy terms. Trades. Free catalogs. Mention instrument. International Music Mart, Dept. R, 2003 Chicago Avenue, Chicago 22.

SONGWRITERS! Collaborate with professional songwriters on equal basis. Share royalties. Songwriters Contact Co., 1619-PM Broadway, New York 19.

CANADIAN Songwriters. Assistance in submitting songs for publication. Arranging Service, 495 Hounslow Avenue, Willowdale, Ontario.

VIOLIN Makers supplies. Free catalog. 423 S. Hill, Los Angeles 13.

POEMS Wanted by America's largest song and recording studio. Free examination. Five Star Music Masters, 630 Beacon Bldg., Boston.

PLAY Guitar like Chet Atkins. Teach yourself. \$3.00. Ernie Ball Guitars, Box 308PMM, Tarzana, California.

WOULD You like to give top performance in singing or speaking? My book contains practical new ideas on voice development, inspiring an audience, group practice, etc. Price \$2.00. V. E. Doane, R4, Fredonia, Kansas.

SONGS Wanted. Pays royalties. Enclose postage. Olenik Records, Mount Morris, Michigan.

PLAY Guitar. Teach yourself method. \$1.00. Results guaranteed. Ernie Ball Guitars, Box 308PMM, Tarzana, Calif.

MERCURY, Venus banjos. Write particulars. 263 E. Forhan, Long Beach 5, California.

ACCORDION-O-RAMA. 874 Broadway, N. Y. 3, N. Y. Tremendous discounts. Top brands. Free brochure.

LEARN To sing beautifully. Unlimited opportunities. Inexpensive course. Sunland, 3362 Romero Rd., Tucson, Arizona.

RADIO, TELEVISION AND ELECTRONICS

DON'T Buy hi-fi components, kits, tape, tape recorders until you get our low, low return mail quotes. "We guarantee not to be undersold." Wholesale catalog free. Easy time payment plan. 10% down — up to 24 months to pay. Hi-Fidelity Center, 220-M E. 23 St., New York 10, N. Y.

JUMPER Leads, assorted, 10 for \$2.50. U.S.A. made. Kurtston, 702 Bay, Staten Island 4, N. Y.

CAN'T Be done, electrically, electronically? I'll do it. \$350 per day. Farris, Williamsburg, New Mexico.

RADIO Course only \$15.95. Includes all tubes, parts, tools, instructions. Write for full information. Progressive "Edu-Kits" Inc., Dept. 569B, Hewlett, N. Y.

DETECT Police radar traps. Build Radar King. Refer Auto Supplies, Wardell Smith.

FREE! Giant wholesale catalog on electronics, hi-fi, transistor, scientific hobby, optics, photographic, housewares, jewelry, tools, novelties, toys. Write: Lektron, 241B Everett Ave., Chelsea 50, Mass.

RECORDERS. Hi-fi. Free wholesale catalogue. Carston, 125-Y East 88, N. Y. C. 28.

LEARN Write asleep with amazing "Electronic Educator" endless tape recorder. Details free. Research Association, Box 24-N, Olympia, Washington.

GOVERNMENT Surplus radios, parts. Picture catalog 10¢. Meshna, Malden 48, Mass.

RADIO And TV tubes at manufacturer's prices! 100% guaranteed! Brand new! No re-brands or pulls! United Radio, Box 1000-M, Newark, N. J.

FIX Your own TV. Save 80%! Send for free illustrated chart showing how! We'll include giant electronics catalog. Zalytron, 220-M West 42 St., New York City.

TAPE Recorders hi-fi components. Sleep learning equipment, tapes. Unusual values. Free catalog. Dressner, 1523M Jericho Tpke, New Hyde Park, N. Y.

STEREOPHONIC Tape recorders. Bargains. Free catalog. Towers, Box 3022, Philadelphia 50.

FOR Sale: Series 2000 Micromax temperature controller. Series 50 amplifier. Equipment, P.O. Box 5104, Pensacola, Fla.

CRYSTAL Radio kit \$1.00. Amplifier and speaker for same \$4.95. Catalogue. Clearco, Box 1638, Stuart, Florida.

TERRIFIC Bargains. Electronic components, books, records. Free list. ST Labs., 438 Third Ave., Newark 7, N. J.

BUSINESS OPPORTUNITIES

BUY Direct from factories. Appliances, cameras, watches! Free details! Cam Co., 436 P.M. Bloomfield Ave., Verona, N. J.

RAISE Rabbits and fishworms on \$500 month plan. Free details. White's Rabbitry, Mt. Vernon, Ohio.

OWN Your own dry cleaning shop! With no investment, I'll show you how. Write Imperial School of Dry Cleaning, 1700 Touhy Avenue, Chicago 26, Illinois.

U.S. Residents eligible now. Amazing profits from recorded timber leases. No selling, spare time, easy. Oldest, largest international corporation. Low investment. Free information. Zelsman, 130-D Shaftesbury, Downsview, Ontario, Canada.

\$200.00 MONTHLY. Spare time. With table saw, bandsaw or jigsaw. Write, Holiday House, A3800 Harney, Vancouver, Washington.

SHARPEN Saws and lawnmowers the profitable way. Send for free literature. Max Manufacturing Company, 138 Stockton Avenue, San Jose 26, California.

CANDIED Popcorn and potato chip equipment. Eakins, Box 933-A1, Springfield, Ohio.

LIQUID Molding rubber, free sample. Shellcraft supplies. Chaney's, 1907-A East Road, Jacksonville 16, Fla.

FREE Report: "609 Unusual, Successful Businesses." Box 1001-PMH, Evanston, Illinois.

FRANCHISES Make profits! Operate your own exclusive franchised business. Write today for free interesting details. National Franchise Reports, W-528, 333 North Michigan, Chicago 1.

IMMEDIATE Profits with no capital or experience. Take orders for all magazine subscriptions. Friends and neighbors are your prospects. Write now for complete, free kit. McGregor Magazine Agency, Dept. 116B, Mount Morris, Illinois.

SELL Champion, AC, Autolite spark plugs. Reconditioned, electroplated, guaranteed 10,000 miles. 100% profit. Free sample. Lee Plugs, 1608-A Roberts, Houston 3, Texas.

WANT To make big money at home? \$10.00 profit in an hour possible with invisible mending. Make tears, holes disappear from clothing, fabrics. Steady year-round demand from cleaners, laundries, homes. Details free. Fabricon, 6234 Broadway, Chicago 40, Ill.

LEARN Sewing machine repairing. To \$125 weekly. Sparetime. Supplies. Add to present business. Write today! Taylor Service, Box 2126, San Bernardino, Calif.

FREE Picture folder. "How to Make \$3,000 Yearly. Sparetime. Backyard. Raising Earthworms!" Oakhaven-38, Cedar Hill, Texas.

VENDING Machines. No selling. Operate a route of coin machines and earn amazing profits. 32-page catalogue free. Parkway Machine Corporation, Dept. #27, 715 Ensor Street, Baltimore 2, Maryland.

BUSINESSES. Resorts, motels. Investment property, ranches. Our special service dept. at your disposal. No obligation. World's largest, 58 years' service. Strout Realty, 7-MB S. Dearborn, Chicago 3, Ill.

BIG Money raising fishworms and crickets. Free literature. Carter Farms, Plains, Georgia.

TO \$100.00 Weekly. Sparetime, home operated mailorder business. Successful beginner's plan. Everything supplied. Lynn, 10420-M National, Los Angeles 34.

PIANO Tuning learned quickly at home. Tremendous field! Musical knowledge unnecessary. Information free. Empire School of Piano Tuning, Champaign, Ill. (Founded 1935).

I want to send you proof of the wonderful pulling power of Popular Mechanics classified pages. What's your proposition? Write me today. Include literature if possible. F. W. Johnson, Manager Classified Advertising, Popular Mechanics Magazine, 200 E. Ontario St., Chicago 11, Ill.

COPUBLISH Mail Sale Advertiser, leading mail order paper. Details, latest copy, dime. Vanroy Shirk, Lebanon, Penna.

BRONZE Baby shoes: Instructions, equipment and mountings for genuine electroplating process. Largest supplier of all plating equipment, supplies. Free catalog. Hollywood Bronze Supply, Dept. B-3, 1624 East First, Los Angeles 33, Calif.

OPERATE Profitable mail order business. Write Walter Service, 4159A East 112th, Cleveland 5, Ohio.

BAKE New greaseless doughnuts in kitchen. Sell stores. Free recipes. Montgomery, 3605 South 15th, Minneapolis 7, Minnesota.

\$3.00 HOUR—Home, sparetime, assembling pump lamps. Easy. Free details. Osgor, Caldwell, Arkansas.

OPERATE Home mailorder business. Vosacek Distributors, 4444A1 Ute, San Diego 17, Calif.

EXCEPTIONALLY Profitable opportunity in tape recording! Free information. Baron's, Lynden, Washington.

JAPAN Directory. 145 Japanese manufacturing exporters. Japan and Hong Kong trade journal information. Asia opportunities. Just \$1.00 today. Nippon Annal, Box 1150-P, Spokane 10, Wash.

COLORGLAZED Concrete pottery made without molds. Patented method. Cemetery products, novelties, tiles. Basement leak-sealing. Money-making projects. Booklet, details free. Men only, National Potteries Company, Grand Rapids, Minnesota.

MARKETS Everywhere. Make artistic concrete birdbaths, pottery. Best coloring. Home workshop. Hundred varieties. Free pictures. Hollywood Cementcraft, 8527-S Wonderland, Hollywood 46, California.

MAKE \$46 From square foot plywood: jigsaw necessary. Free details. Woodart, Bridgewater, Mass.

MAKE Money from old tires. Operators clearing \$400 weekly. Equipment costs \$800. Get facts. S & S Patents, Inc., 3511 N. Lincoln Ave., Chicago 13, Ill.

FREE Book "990 Successful, Little-Known Businesses." Work home! Plymouth-472R Brooklyn 4, New York.

NEW Snow cone machines. All prices. Box 7803, Dallas, Texas.

EARN \$3 Hourly, spare, full time, looking up information at your local library. Details free. Service, 81C, Knickerbocker Station, N.Y.C.

\$400.00 MONTHLY Raising giant fishworms. Soilless method. Charlie Morgan, Bushnell, Florida.

DRIED Mushrooms \$4.50 pound for large canning company. Receiving warehouse in United States. Growers wanted on contract, everything supplied. Mushroom Salt Co., No. 651, Calgary, Alberta, Canada.

EVERYBODY Likes candy and popcorn specialties. Learn to make professionally home. (Our 50th year.) Ragsdale Candies, B-107, East Orange, New Jersey.

HOW And where to obtain capital. Write: Reliable Service, Rome City, Ind.

"MAILORDER Laws and Regulations." Explains mailorder licenses and taxes \$1.00. Neil H. Tasker, Shamokin, Pennsylvania.

CAN'T Fail. Latest booklet. "Seven Steps Start to Success in Mail Order." Send 25¢. P. M. Russell Enterprises, 694 Kerr, Columbus, Ohio.

EXPORT-Import business. Complete professional setup service. 20 lines delivered. Hermes, 152 West 42, New York City 36.

SELL Books by mail. 400% profit. Royal, Box 368-X, Cleveland 27, Ohio.

PLASTERCRAFT Molds, liquid rubber, plasters, flocks, candle supplies. Catalog and manual free. Blue Rapids Supply, Blue Rapids, Kansas.

SELL Low-priced plastic laminating machines and supplies. Sipco, 4469M East Olympic, Los Angeles 23, Calif.

MAIL Order. Earn extra money, part or full time. Lowest priced wholesale catalog in U.S.A. Holliday, 914 Burnside Rd., Sharon Hill, Penna.

START Home business in spare time. Make extra income. Revealing literature free. Joel Wix, Route 2, Villa Rica, Georgia.

IMPORT. Represent manufacturers. Details free. Benko, Box 188-A, New York 21, N. Y.

REPAIR Sewing machines, vacuum cleaners. Excellent field. Gardner, 401 Johnson, Jenkintown, Penna.

DO It with "Floating-Henryburgers" 35 million sold. Box 936, Wichita, Kansas.

MAILORDER To motels, churches, institutions. Complete set-up. Not just instructions. Hermes Advertising, 152 West 42, New York City 36.

START Now earning mail order profits. Write Allen's, Manchester, Wash.

LEARN Expert cake decorating, candy making. Free details on home instruction method. Candy & Cake, Dept. D-20, Fallbrook, Calif.

I Want a man who wants a business of his own. I will train you, supply the equipment, help finance you, start you rolling. This is not a risky get-rich-quick scheme. It is a legitimate business, a selected franchise, proved successful by hundreds throughout the country. An investment of \$995 is required. Send name, address and phone number to Marion Wade, 2117 North Wayne, Dept. 476M, Chicago 14, Illinois.

NATURAL Molding rubber, extra thick. Free samples. W. Wooley, 2801-A Latrobe, Peoria, Illinois.

CASH From sawdust, tin-cans, newspapers. Over 200 methods. Instructions \$1.00. Charles Company, 42-GPM, Norwood, Ohio.

WORLD'S Largest wholesale supply. Buy from 679 American, European, Japanese wholesalers. Tailormade suits from Hongkong. 123 dropship catalogs. Rock-bottom prices. Free details. International Buyers, 216-MM Jackson, Chicago 6, Ill.

INVISIBLE Reweaving: \$5-\$10 per job possible reweaving burns, tears, moth-holes. Spare-full time. Free details. Skill-Weave, Dept. RC-169, 335 W. Madison, Chicago 6, Illinois.

YOUR Own baby shoe bronzing business. Instructions, equipment, supplies. Metalizing, glassing, pearlizing. Free booklet. Dept. A, Box 5036, Inglewood, Calif.

BIG Money—Operate your own fix-it shop. Service all household appliances: irons, fans, refrigerators, automatic washer-dryers, etc. Do house wiring, commercial wiring. Rewind motors of all sizes. Sharpen mowers, skates, saws. Buy needed spare parts wholesale. Free book. Christy Trades School, A-1103, 3214 W. Lawrence, Chicago 25.

START Your own business on credit (U.S. and Canada). Your own boss. 1344 dealers sold \$5,000 to \$25,500 in 1960. We supply stock, equipment on credit. 200 home necessities. Sales experience unnecessary. Pleasant profitable business backed by world-wide industry. Write Rawleigh's, Dept. I-U-PPM, Freeport, Illinois.

BECOME Tax consultant. Graduates earn \$1,000-\$3,000 every tax season preparing returns evenings. State approved. Union Institute, Lakewood C-2, N. J.

MAKE Extra money—Big cash commission plus premiums for you and your customers. Sell advertising book matches. Sensational new tenorrama glamour girls, hillbillies; dozens others. All sizes. Quick daily sales; big repeat business. Free master kit makes selling easy. No experience necessary. Superior Match, Dept. MX-961, 7530 Greenwood, Chicago 19.

MONEY In your mailbox every day. Fabulous home mail order business. Import from all over the world at ridiculously low foreign prices. Cameras, \$4.24; watches, \$2.40; radios, \$2.67; gift items, jewelry, novelties, etc. Sell to eager U.S. buyers at profits up to 500%. Thousands now doing it. Where to buy, how to buy, where to sell, etc. Everything complete by return mail. Satisfaction guaranteed beyond your expectations. Send \$2.00 to: Impex, Dept. PM, 714 Howard, New Orleans 12, La.

MAKE Most extra cash with world's biggest line Christmas cards, gifts. Introduce friends, neighbors to over 150 Christmas, everyday box assortments, 600 big money-makers. Pocket up to 50% profit plus big cash bonus. Free giant color catalog; samples on approval. Style-Line, 421 Fifth Ave., S., Dept. 83-E, Minneapolis, Minn.

MAKE Money with Lechler, dropship beauty cosmetics. Free art, copy, layout-circulars available. Wholesale prices. Lechler Laboratories, 560-G Broadway, New York.

INCREDIBLE New "table-top" machine manufactures over 15,000 saleable products. Also laminates, encases, moulds and plates in bronze, chrome, or copper in 30 seconds. 20¢ materials produce \$3.00 products. Free confidential details and home-business plan. Plasti-Form, Dept. PM-9, Gardena, Calif.

\$250.00 WEEK Spare time profit possible. Earn at home with new fascinating printing method. \$5 starts you—send no money now. Free confidential facts and valuable sample. Screen-Print, SR, Los Angeles 61.

IMPORT-Export opportunity, profitable, world-wide, mail-order business from home, without capital or travel abroad. Established world trader ships instructions for no-risk examination. Experience unnecessary. Free details. Mellinger, T709, Los Angeles 24.

LEARN Landscaping and the growing of plants. Start a profitable business part or full time. Free information without obligation. National Landscape Institute, Dept. MC-91, 11826 San Vicente Blvd., Los Angeles 49, Calif.

DOLLS! Dolls! Dolls! We teach you to repair, make, sell all kinds of dolls and accessories including clothing. Study at home. Earn while you learn. Free booklet. Doll Hospital School, Studio MC-91, 11826 San Vicente Blvd., Los Angeles 49, Calif.

\$1.00 BRINGS You \$18.00 spare-full time home business opportunity! Amazing new velvet-spray transforms old cheap lamps, TV-radios, figurines, furniture, anything, into valuable products! Free samples, 50 business opportunities booklet. Send no money. Flok-Kraft S.R., Los Angeles 61.

MAKE Money mimeographing! "There's Gold in Your Mimeograph"—concise illustrated course, 25¢. Mozella Mimeo Service, Bonham, Texas.

MAILORDER. America's most unique no cost beginner's plan. Armstrong's, 154-A Darrington S.W., Washington 24, D. C.

SELL Greatest profit makers—by mail! Details free! American Distr., Box 409, Niles, Michigan.

MAIL-ORDER Home business. Get free copy. "Make Money in Mail-Order." Mail-co, 1717 Westwood Blvd., Dept. T709, Los Angeles 24.

MAKE Durable building plastic easily. Waterproof, fireproof, economical. Bays Laboratory, Chinle, Arizona.

PROFIT With Popular Mechanics' subscription plan. No investment, no experience needed. Earnings begin immediately when you obtain subscriptions for Popular Mechanics, Good Housekeeping and others. High commissions, bonus. No experience needed. Deal directly with the publisher. Write Popular Mechanics, Room 9B, 250 West 55th St., New York 19, N. Y.

MAKE \$20.00 Per hour. Learn professional skill hand engraving. Engrave glass to steel and head of a pin. Engrave for us. 722 Market St., Victoria B.C., Canada.

GOOD Earnings showing, installing intercommunication systems for businesses, homes. Hold private inter-departmental, house to garage, etc. phone conversations. Requires only household tools. Telephone Repairs, 1760-A Lunt, Chicago 26.

BROKERS, Agents and part time salesmen. National Patent Brokers, 6757 Jerles Drive, Milford, Ohio.

START Amazingly profitable mail order. Literature free! Hillman, Mullica Hill 1, New Jersey.

MANUSCRIPT—"Mail Advertising Ideas, Slogans Phrases," increases business knowledge for beginners, merchants in mail-order. \$2.00 guaranteed. ReGal Crafts, 904-M North Labrea, Inglewood, Calif.

CARTOONING. Good money in fields of television, advertising, animation, movies, magazines. Famous system of manual training brings amazing new concept of art instruction at home. For profit or pleasure. Send for free details. Continental Schools, Dept. E-17, 4201 S. Broadway, Los Angeles 37, Calif.

SYLVANIA Light bulbs. Earn money, respect, selling nationally advertised repeat order products. Free details. Light Corp. of America, Bureau 4, Mt. Vernon, N. Y.

UNUSUAL (Wholesale) import catalog, plus directory listing hundreds foreign suppliers. Both \$1.00. Gem Imports, P.O. Box 3022, Denver 18, Colo.

\$34.70 TWO Hours manufacturing concrete products. No selling. Castings =3, P.O. Box 1721, Rapid City, South Dakota.

MONEYMAKING "Mail Gazette." Sample, 25¢. Bestmart, Box 12-303, Cincinnati 12, Ohio.

MOLD Statuary, pottery, tiles, novelties. 5¢ materials makes dollar sellers. Particulars free. Marbleizing Service, Edwardsville, Illinois.

MAILORDER. Profitable beginners information. John's, Box 943-PMS, Miami, Florida.

FREE Book "711 Bizarre, Successful Ventures." Retired at 47, simple home plan! Haylings, Carlsbad, Calif.

RADIO Promotion! List of 50 radio stations who will sell merchandise on a commission basis. No air-time charge! List only \$5. Beneficial Research Service, Box 41A, Barrington, N. J.

MAKE Money assembling modern wall plaques without tools. Send \$1.00 for two basic kits plus guaranteed instructions. Sauer, 1225-PB North 31st, Milwaukee 8.

CARAMEL Corn recipe with extra ingredient. Delicious. Wolz, 3201 S. Wayne, Wayne, Michigan.

WANTED. Fishing tackle items for national distribution, exclusive manufacturing and sales. Our increasing sales force can handle 2 or 3 additional items for wholesale and retail distribution. Also want good mail-order items for established customers. Send full details and samples to: Axelson Fishing Tackle Mfg. Co., 1559G Placencia, Newport Beach, Calif.

DRIVING Schools needed. National automobile driving school owners association desires to encourage development of badly needed driving schools. Will help, advise and instruct men of good character to start their own businesses in most states. National Professional Driver Education Association, 4935 W. Foster, Chicago 30, Ill.

OVER \$1,000 for you on exclusive ad-game deal. Send \$1 (refundable) for details and wonder games. Seibel, 555, Stanhope, N. J.

\$600.00 PROFIT! Mailing catalogs. Sample instructions, 25¢. Home Business Digest, GPO Box 972, New York 1.

DOLLARS Daily by mail. Guaranteed! Jess Mack, Cincinnati 26-A, Ohio.

COMPLETE Home set-up—no inventory. Details free. National Mail Order, Box 828, Dept. IL, Wayne, N. J.

WORK Like a millionaire. \$400-\$1000 monthly plus apartment, managing a motel. Learn at home. Free booklet. Motel Managers Training School, PM-H, 612 S. Serrano, Los Angeles 5.

MAIL-ORDER Pays big. Complete home set-up—no inventory. Details free. National Mail Order Corp., Box 828, Dept. 1H, Wayne, N. J.

ADVERTISERS In this column. We will buy your inquiry letters. Write. Give quantities by year. We will pay \$15.00 per thousand promptly. Active Mail Order Lists, 241-F Lafayette St., New York, New York.

NO Capital required. Sell your product or service without cash commitment. For information write Postal Sales Company, Inc., 4348 Avondale, Dallas, Texas.

AMAZING Book, "From Nothing To Independence," 50 mail order and local tested money-making plans. \$1.95 postpaid. Satisfaction guaranteed. Mail dealers send \$1.00 for sample copy, details. Lind Publishing, Box 89-F, Glendale 5, California.

HOME Business. Excellent income. New. Walp, 1454 Polaris, Mobile, Alabama.

MAILORDER Drop Ship Brochure. Contains 72 luxury gifts that may be drop-shipped under your label. Same method used by Jack and Mary Leslie since 1954 in building their own successful mail order business. Send for details and free sample brochure. Mail Order Methods, (Division of Leslie Creations) Lafayette Hill 15, Pa.

MONEYMAKING OPPORTUNITIES

MANUFACTURE Beautiful, lightweight vases, patio stones, wall panels, artistic room dividers, etc., with new foam-crete plastic. Amazingly fast, easy, money-making system. Complete formulas and instructions only \$2.00. Or free details. Plasticon Company, Box 105, Grove City, Penna.

CIGARETTES—Make 20 plain or filter-tip for 9¢. Facts free. Moberly, Box 4012, Owensboro, Kentucky.

MINK Raising information free. Complete. Lake Superior Mink Farm, Superior, WI. Wisconsin.

VENDING Machines. No selling. Operate a route of coin machines and earn amazing profits. 32-page catalogue free. Parkway Machine Corporation, Dept. #26, 715 Ensor Street, Baltimore 2, Maryland.

GROW Mushrooms. Cellar, shed and outdoors. Spare, full time, year round. We pay \$4.50 lb. dried. We have 29,000 customers. Free book. Mushrooms Dept.: 173, 2954 Admiral Way, Seattle, Wash.

EARN Money evenings copying and duplicating comic cartoons for advertisers. Adservice, Argyle 1, Wisconsin.

YOUR Own, easy-to-start, home mail-order business, sparetime. Fascinating; profitable! Information free. Alfano, 19-PM Pine, Closter, N. J.

BIG Money raising fishworms and crickets. Free literature. Carter Hatchery, Plains, Georgia.

READ "Progressive Mailtrade," the magazine that tells how to make money by mail. Quarter brings sample and special offer. Progressive Mailtrade, Box 357, Sheboygan, Wisconsin.

AMAZING Successes through franchises! Become exclusive franchise holder your territory. Information rushed. National Franchise Reports, MP-528, 333 North Michigan, Chicago 1.

LEARN The secrets of repairing junk batteries, generators, starters, profitable, easy, at home. Free particulars. Batteryman, 3465 Forrest, Santa Clara, Calif.

\$25-\$50 WEEKLY Possible, re-writing news items, jokes, poems, recipes, for publishers. Some worth \$10 each. Details free. Service, 81-D, Knickerbocker Station, N.Y.C.

PROFITABLE Mailorder business started easily. Our easy to understand, instructive manuscripts teach how. Details free. Easco, Box 323-A, Grand Rapids 1, Mich.

EASY To start rubber stamp business at home in spare time. Make up to \$9.80 an hour without experience. Facts free. Write Roberts, 1512 Jarvis, Room CR-2H, Chicago 26.

LEARN Plastics fabrication for extra income. Low cost home training now available. Write for free booklet. Interstate Training Service, Dept. D-3, Portland 12, Oregon.

MEN—Women! Start money-making plastic laminating business at home in spare time. Material that costs 11¢ brings back \$2.58. No canvassing or selling but mail orders bring in \$20 a day. Write for full particulars free. Rush name on postcard to Warner, Room CL-2-H, 1512 Jarvis, Chicago 26, Ill.

FABULOUS Profits raising earthworms! Picture folder free. Excello, Kosciusko, Mississippi.

UNUSUAL Moneymaking opportunity. Free details. Surway, 714 W. Mulberry, Springfield, Ohio.

MAKE Big easy profits creating costume jewelry at home in spare time! Quick, easy to make easier to sell! Details free! Don-Bar, 2934 W. Fullerton, Dept. K-201, Chicago 47, Illinois.

TEAR Out this ad, and mail with name, address for big box of home needs and cosmetics for free trial, to test in your home. Tell your friends, make money. Rush name. Blair, Dept. 31ES, Lynchburg, Va.

WIN Contest money. General Contest Bulletin gives hundreds of tips. Lists current contests, rules. Sample magazine 25¢. General Contests, 1609 1/2 East 5th Duluth 12, Minnesota.

125,000 **BARGAINS**. Exotic gifts, television, advertising specialties, newest products in direct single item importing. 475 worldwide firms, classified—\$1.00. Henderson, 2620 Rio Vista, Tampa 3, Florida.

MOST Profitable aspect of mailorder is cheapest to try! Write: Simon, Box 87-PM-2, Pelham, N. Y.

"**HOW** To Win Contests" manual may bring you riches! Contains successful formula professional winners use. Guaranteed. \$5 postpaid, or request free literature. Paragon Enterprises, 11 Mott St., DT-4P, New York 13, N. Y.

OFFICE Work—home, sparetime. Re-fundable moneymaking instructions 50¢. Interstate. 37-1 Besch, Albany 9, N. Y.

GETTING Dollars in your mail. Send 10¢ for eye opening literature. Donovan, 79-PM Greenbelt, Levittown, New York.

GET Free money making offers, samples, opportunities! Your name "listed for life" for 25¢! Hamilton's, 1374, Las Cruces, New Mexico.

EXTRA Dollars for you with "Information Research." Copyrighted manual \$2. Guaranteed. Free details. MacKenzie's, 3240 Southport, Dept. 17, Chicago 13, Ill.

AMATEUR Artists! Turn your art ability into money. Hamilton, Box 4-C, Astoria 5, N. Y.

PUZZLE Contests! Cash prizes! Details free! Spence, Box 11569, St. Petersburg, Fla.

10,000 **FORMULAS**. 900 Pages, \$3.95. Circular free. Bertholf's, 739 Sylvania Avenue, P-Toledo 12, Ohio.

"**MAIL** Order Tips". Information galore. 25¢. Mampa, 557 Surf, Chicago 14.

MEN—Women! Make money raising earthworms! Full, sparetime, at home. Easy—use backyard, garage, basement, spare room. Moneymaking details free! Red Wigglers, Warsaw 20, Indiana.

SHARPEN Saws, tools, knives, scissors, clippers, twist drills, surgical instruments, etc. Manual furnished. Treycos, N. Tonawanda 15, N. Y.

QUICKEST Money for part-time writers. Send \$1.00 for selling hints, free list 20 good humor markets for quips, jokes, sketches. Writer's Service (M), P.O. Box 2366, Victoria, Texas.

CHRISTMAS Money! Sell beautiful Vancouver Island holly. Information. Sun-Pocket Holly Farm, Route 2, Qualicum Beach, British Columbia.

MAKE \$200.00 Monthly spare time with jigsaw. Free details. Elkman, 346 N. Summit, Sioux Falls, So. Dak.

MAIL Catalogs! Highly profitable! Sample, instructions, 10¢. Lewis Bartlett, Richland, Georgia.

EARN Extra cash! Men and women. 21 proven ways to earn money in your spare time. Thousands satisfied. Send \$1 (refundable). Taylor Surveys, Lake Ave., Lake George 2, N. Y.

STOP Throwing money away. Nearly everyone does. Turn into cash. No experience or money needed. No interference regular duties. Nothing to sell. I buy. Send \$1.00 for information. (Refundable). Dryz, 3015 — 21st Ave., S., St. Petersburg 12, Fla.

MONEYMAKING During home hours! 25¢. Commercial, Box 663, Kansas City, Missouri.

EXPORT — IMPORT

AFRAID To make \$50.00 daily? Sell Japanese art service. David Teel International, Dept. PM-3, 217 Christopher, Clovis, N. M.

INTERNATIONAL Trade advertiser. Huge world-wide circulation. World trade offers and inquiries. Send 40¢ (coins) for sample copy to ITA, 27, Maldon Road, Colchester, Essex, England.

RECEIVE Catalogs, offers from 100 foreign exporters without contacting them. Importico, Enka, North Carolina.

JAPAN: Direct mail-order 26 page catalogue: dolls, novelties, business information, manufacturers' names, addresses, \$1.00; Japan's Trade Directory, 3000 companies, \$3.00. Send cash. Clarence Yamagata, 814 Toginbiru, Marunouchi, Tokyo.

SAVE And earn substantial income. Write for free catalogs on fine imported Swiss watches and beautiful hand-tooled leather purses, etc. from Mexico. Wholesale Supplies, P.O. Box 1892, Idaho Falls, Idaho.

BEAUTIFUL Hand painted oil portraits. Imports, 128 Roosevelt, Redwood City, Calif.

SCIENCE & CHEMISTRY

SCIENCE Treasure chest. Do hundreds of experiments. Order No. 70,342-CZ—\$5.00 postpaid. Request free Catalog—CZ. Edmund Scientific Co., Barrington, New Jersey.

NEW Concept of atomic structure. Nuclear theory challenged. 30 pages, 25 cents ppd. C. F. Kraft, 4809 Columbia Road, Annandale, Virginia.

CHEMICALS And apparatus for industrial, analytical, and private laboratories. Catalog 25¢. Dept. M-50, Biological Supply Co., 1176 Mt. Hope Ave., Rochester 20, N. Y.

ILLUSTRATED Catalog: Chemistry, mineralogy, biology 25¢. Tracey Laboratories, Evanston, Illinois.

UNUSUAL Chemistry books, courses, kits! Rare chemicals, cheap! Catalog 25¢. NSC, Box 11133, Palo Alto, Calif.

EXCITING Experiments booklet and catalogue. 25¢. Hagenow Laboratories, Manitowoc, Wisconsin.

AMAZING New book of science experiments, formulas, and catalogue of laboratory supplies. Only 35¢. National Scientific Co., 13 S. Park Avenue, Dept. PM-9, Lombard, Illinois.

ROCKET Test equipment for safe static firings. Catalog 25¢. Rocket Development Corporation (formerly C-W Products), 445 East Second South, Salt Lake City, Utah.

ROCKET Supplies, kits, parts, engines, chemicals. New illustrated catalog 25¢. Central Rocket Company, Box 89-P, Waupaca, Wis.

FREE! Write for new catalog, soon available. Unusual bargains in science fair materials. Frey Scientific, 273 Orange, Mansfield 2, Ohio.

SCIENTIFIC Space information available. Send \$1.00. E. E. Wixcel, Delhi, California.

FORMULAS, PLANS, ETC.

FORMULA Trade secrets, 10,000 to choose from. Information free. Norris Sales Co., Alpine 3, Tennessee.

FORMULAS—All kinds. Amazing big catalog, 10¢. Kemixal, Park Ridge, Ill.

FORMULAS For latest money-making discoveries. New! Good! Valuable literature free! Miller, Chemist, 1517-D, Tampa, Florida.

ANY Formula. Satisfaction guaranteed! Jack, Chemist, P.O. Box 25157, Los Angeles 25, California.

FASTEST Sellers, easily home mixed. Specialties House, Cincinnati 26-T, Ohio.

LATE. Modern manufacturing formulas. List free. Moon Chemical, Martville, New York.

PLASTICS

BOXES, Plastic. 200 sizes. Free list. Author, 170 Bay 23 Street, Brooklyn, N. Y.

NEW Liquid casting plastic, clear, colors. Embed real flowers, butterflies, photos, coins. Send 25¢ for two handbooks "How to Cast Liquid Plastics" and "How to Make Extra Money at Home." Castolite, Dept. K-101, Woodstock, Illinois.

NOW! Electric plastic laminating kit. Hobby. Easy. Profitable. Details. Burr, 330 East Center, Kalamazoo, Michigan.

SEND Only \$1.00 for new "Castcraft Instruction Manual" on plastics for casting, embedding, molding and jewelry or 25¢ for catalog only. Castcraft Corporation, Dept. M-961, P.O. Box 555, Palo Alto, California.

AGENTS WANTED

CHRISTMAS Cards—the easy way to that extra income you need. Personal and business designs, with customer's name imprinted, all in one album. These deluxe cards pay deluxe commissions. Earn \$300 to \$500 (plus bonuses) easily this season, even in spare time. Sales experience unnecessary. Free sales kit includes our outstanding 40th Anniversary sample album and easy-to-follow selling instructions. Send for kit now; pocket profits next week! Write Process Corp., Dept. D-3, 3450 S. 54th Ave., Chicago 50, Ill.

IF You sell Christmas cards, make most extra cash with lines of all leading companies from one firm. World's biggest line. Over 150 Christmas, everyday box assortments, 600 big money-makers. Make up to 50% profit plus big cash bonus. Free giant color catalog of all lines; samples on approval. Arrow Greetings, 513 Fourth Ave., S. Dept. 83-E, Minneapolis, Minn.

AMAZING Christmas card profits! Make 75¢, not 50¢, on fast-selling \$1.25 assortment! \$75.00 on 100. Gift bonuses. 250 best sellers—assortments, candy, novelties. 52 personalized samples free; assortments on approval. Free gift offer. Creative, 4401 Cermak, Dept. 507-A, Chicago 23.

WANTED Part-time fire extinguisher salesman. Out-O-Matic, 1737C East 31st, Denver 5, Colorado.

BIG Money making opportunity. Exclusive line uniforms, jackets, pants, shirts, coveralls, sportswear. Advertising embroidered. Every business prospect. Get selling outfit free! Topps, Dept. 106-J, Rochester, Indiana.

\$480 MONTHLY Commission on 4 easy orders a day, selling nationally advertised line comfort shoes, warm jackets. 230 styles. No investment—postcard brings free outfit. Mason, Chippewa Falls K-377, Wis.

MAKE \$50 - \$75 - \$100 extra money. Run Greeting Card, Gift Shop at home, visit friends. Show thrilling Evans Christmas card assortments, gifts, exclusive 25 for \$1.50 personals. Experience unnecessary. Write for sample boxes on approval, free imprint albums, surprise gift offers. New England Art Publishers, North Abington 90, Mass.

SELL Greeting cards. Make extra money. Christmas, all occasion assortments, stationery, jewelry, gifts, name imprinted Christmas cards. Experience unnecessary. Write for salable samples on approval, details. Hedenkamp, 361 Broadway, Dept. PM-69, New York.

AUTOMATIC Bed warming sheet, you sleep on, not under. Outsells electric blankets 10 ways, costs less. Generous profits. Patented Products Corp., Dept. PM-91, Danville, Ohio.

WANT To make \$25.00 or more in a day for part or full time route work? Man or woman. Write McNess Co., Freeport 24W, Ill.

NEW Bathroom deodorizer. Hangs on wall. Banishes odors bathroom, kitchen. Lightning seller. Samples sent on trial. Kristee 84, Akron, Ohio.

BEAUTIFUL Feather pictures! Free details, sample 20¢ stamps. Apartado 9036, Mexico 1, D.F.

FREE Sample. Beautiful curios! Sell on sight! Apartado 9036, Mexico City.

START Your own business, selling the "World's Most Usable Bible." Sales quick, easy, and profitable. Extra bonuses; free insurance; other benefits. Write International Book Company, Department M, Box 118, Wichita 1, Kansas.

EARN Good weekly profits. Clip news items for plastic laminating. Details free. Plastiperm, Dept. 2, 156 Elm St., No. Cambridge 40, Mass.

FABULOUS Profits in transistor radios. Write Flor'enz, 439 Race St., Cincinnati 2, Ohio.

WORLDWIDE Opportunity. High continuous earnings. William Cole, Mahwah, New Jersey, U.S.A.

AMERICA'S Newest fragrance combination spillproof Flacon Cologne for purse plus 1/2 oz. bottle attractively packaged. Retail \$1. Nelson, 153 E. Tremont Ave., New York 53.

MAKE Terrific money during spare time! Take orders with colorfully illustrated catalog of toys, jewelry, all-occasion cards, collector's items and household gadgets. Work your own hours. No experience necessary. Excellent for direct selling or parties. For free money-making catalog, write: North Star, Dept. 1-722, 251 East Fifth Street, St. Paul 1, Minn.

NEW, Exclusive, toilet repair. Fifty million prospects. Repeat, top profit. F. C. Johnson Inc., 2827 Lawndale, Rockford, Illinois.

PRINTING, Advertising salesmen—Excellent moneymaking sideline selling decalcomania name plates, small quantities. Automobile initials, sign letters. Free samples. Ralco, XL, Boston 19, Mass.

YOUR Own business—Used suits \$1.50; overcoats 65¢; mackinaws 35¢; shoes 12 1/2¢; ladies' coats 30¢; dresses 15¢. Enormous profits. Catalog free. Nathan Portnoy Associates, 2109-AA Roosevelt Road, Chicago 8, Ill.

MAKE Up to \$50.00 a day soliciting delinquent accounts. Terrific commissions. Write today. National Credit, 304Y Pickwick Bldg., Kansas City 6, Mo.

FREE Offers of \$1.25 Christmas card assortment, \$5 in gifts introduce sensational, new spare-time money-makers. Over 300 fast-sellers at \$1 up. Many exclusives. Free personal album. Request samples on approval and free offers. Cardinal, 1400 State, Dept. 31-K, Cincinnati 14.

RUN A spare-time greeting card and gift shop at home. Show friends samples of our new 1961 Christmas and all occasion greeting cards and gifts. Take their orders and earn to 100% profit. No experience necessary. Costs nothing to try. Write today for samples on approval. Regal Greetings, Dept. 5, Ferndale, Mich.

BIG Profits. Stamp social security plates, key protectors. Sample 50¢. Catalog free. General Products, 11 No. Pearl St., Albany 7, N. Y.

YOUR Ad in this space will get some good agents for you. Yes, I'll prove it. Write for Folder "A" right now. F. W. Johnson, Classified Advertising Manager, Popular Mechanics Magazine, 200 E. Ontario St., Chicago 11, Ill.

MAKE Profitable men's-women's wear. Sample free. Sunmade, Brockton 64, Mass.

OUR First man made \$250 weekly selling lumber, hardware, garage, filling station and tire dealers. Exclusive territory. Commissions on repeats. Hiram Barber Co., Crete, Nebraska.

BUY IT WHOLESALE

100 FREE Wholesale catalogs! Complete directory, \$1.00. (Refundable). Parmelee's Supply, Marshfield, Wisconsin.

JUST Out! 356-page catalog—save to 50% on auto parts, accessories. All makes, models. Send 25¢—refundable on first order. Whitney, 1919 PA-9, Archer, Chicago 16.

LARGEST Wholesale supply source in U.S.! Furniture, clothing, appliances, housewares, automobiles and accessories, tools, sporting goods, hobby supplies, farm equipment, imports, new products, bargain merchandise. Free details. Associated Wholesalers, Box 108-DD, Lincoln, Nebr.

FREE! Name brands catalog! Your own high profit business. Sell name brands, full or part time. No inventory, no investment. More than 2,000 name brand items; lowest wholesale prices. Watches, jewelry, cameras, hi-fi, stereo radios-phonos, appliances, housewares, hardware, power tools, luggage, musical instruments, garden equipment, sporting goods, toys, many others. 8 floors of name brands. Million dollar inventory. Orders shipped complete in 24 hours! Send for free, beautifully illustrated catalog now! Separate wholesale price list. H. B. Davis Corp., Dept. PM, 145 W. 15 St., New York 11, N. Y.

2,000 PAGES Wholesale catalogs! Write: Mosaser, Box 47-B, Newark, Ohio.

BUY Below wholesale! Thousands of nationally advertised products. Drugs, clothing, housewares, cameras, jewelry, hardware, sporting goods, etc. Postcard brings price list showing actual factory cost. Buy-Rite, 310 Main, Bennington 2, Vermont.

SAVE! Name brands at special discounts—free catalog. Unlimited Sales Co., Box 9250, Chicago 90, Illinois.

97 PAGE Wholesale import catalog. Order by dozen. Sell to neighbors. \$1.00, refunded first order. Ben-Jean Importers, 2631 Raymell, San Diego 11, California.

NEW Deluxe multicolor below wholesale catalog, automobile catalog, and others. Housewares, appliances, refrigerators, freezers, washers, dryers, television, radios, furniture, clothing, luggage, binoculars, phonographs, recorders, cameras, projectors, tools, typewriters, watches, jewelry. Name brands. Huge discounts to 70%. Postcard: Selbyco, Decatur 15, Ill.

WORLD'S Largest wholesale supply. Buy from 679 American, European, Japanese wholesalers. Tailormade suits from Hongkong. 123 dropship catalogs. Rockbottom prices. Free details. International Buyers, 216-M Jackson, Chicago 6, Illinois.

WHOLESALE: 850,000 Items. Supply source directory 25¢. Idealer, Park Ridge, Illinois.

USED And new watches \$2 up. Free list. Southern Watches, 5-PM So. Wabash, Chicago 3.

ELECTRIC Guitars, amplifiers, wholesale. Free catalog. Carvin PMW, Covina, Calif.

BIG Discount family catalog! \$1.00, refundable: Feathers, 1790 Third Street, Atwater, California.

100,000 PRODUCTS Wholesale! Terrific bargains available! United Wholesalers, 1265-M Broadway, New York 1, N. Y.

NAME Brands from Benrus through Webcor. Wholesale catalog \$1.00 refundable. Zietz Enterprise, White Temple Rd., Vandavia, Mich.

WHOLESALE Catalogue! Housewares, appliances, watches, tools, \$1.00, refundable. Andrews Distributors, Box 631, Graham, N. C.

USED And new watches \$2 up. Free catalogue. Southern Watches, 5-PM So. Wabash, Chicago 3.

SOURCE List. Over 200 manufacturers and wholesalers \$2.00. Buyers Source, Dept. 3PW, 3702 Aurora, Indianapolis 27, Indiana.

SALESMEN—DISTRIBUTORS

GET New shirt outfit free! Make \$90 weekly on 5 average orders a day. Famous quality made-to-measure dress and sport shirts, \$4.50 up, sell fast to all men. No experience needed. Full or part time. Write: Packard Shirt Co., Dept. 425, Terre Haute, Ind.

SENSATIONAL New zipout shrimp tool—the hottest item in years. Sells on sight, big volume, terrific profits through super markets and houseware stores. Fully patented, a must for every home and restaurant. Write today. Send \$1.00 for demonstration sample. Zipout, Inc., Dept. PM, 4905 North Second, Rockford, Illinois.

STEP Up to effortless merchandising! Selling is old-fashioned! Revealing booklet shows how you can parlay modest sum into profitable lifetime business without pounding pavements. Rush name for free book. Indiana Laboratories, 315 W. Franklin, Dept. J-68, Elkhart, Ind.

AMAZING Opportunity. New low priced fire alarm protects homes, farms, offices, factories, etc. No wiring—hangs like picture. Pays up to \$1,100 a month. Free kit. Merlite (Alarm Div.), 114 E. 32nd St., Dept. F-66J, New York 16, N. Y.

SELL Bowling shirts with players' names, team emblems colorfully embroidered. For men, women. Entire teams, leagues buy at low prices. Make \$500 monthly extra. Sales kit free. Topps, Dept. B106-J, Rochester, Indiana.

WILL You wear new suits, sports coats without one penny cost and agree to show them to friends? You can make up to \$40.00 in a day even in spare time, without canvassing. J. C. Field & Son, Inc., Dept. C-1826, Harrison & Throop Sts., Chicago 7, Ill.

ANYONE Can sell famous Hoover uniforms for beauty shops, waitresses, nurses, doctors, others. Miracle fabrics—nylon, dacron, wash 'n wear cottons. Exclusive styles, top quality. Big income, real future. Equipment free. Hoover, Dept. L-100, New York 11, N. Y.

CALENDARS, Novelties. Full or part time. Liberal commissions. Fleming, 6535-A Cottage Grove, Chicago 37.

MAKE Big money taking orders for Stark dwarf fruit trees. Everybody can now grow giant size apples, peaches, pears in their yards. Also shade trees, shrubs, vines, roses, etc. Outfit free. Stark Bros., Desk 30192, Louisiana, Mo.

MAKE Extra money—Big cash commissions plus premium for you and your customers. Sell advertising book matches. Sensational new tenor glamour girls, hillbillies; dozens others. All sizes. Quick daily sales; big repeat business. Free master kit makes selling easy. No experience necessary. Superior Match, Dept. M-961, 7530 Greenwood, Chicago 19.

SHINE Shoes without polish. New invention. Lightning seller. Shoes gleam like mirror. Samples sent on trial. Kristee 48, Akron, Ohio.

MAKE Extra money selling advertising matchbooks. Free catalog and sales outfit. Matchcorp, Dept. PM-91, Chicago 32.

EARN Big commission full or part time. Build profitable business of your own selling America's largest line low priced business printing. 360 page catalog samples hundreds of items used daily by business people. Imprinted ball pens low as \$8.95 for 100. Big full color catalog low priced advertising specialties included. Free sales kit. National Press, Dept. 8, North Chicago, Illinois.

BIBLE Profit 130% — why make less? Literature free. Bible, 4813A Hurford, Chester, Penna.

MAKE Up to \$50.00 a day soliciting delinquent accounts. Terrific commissions. Write today. General Finance, 304V Pickwick Bldg., Kansas City 6, Mo.

IF You're interested in making money in selling, see the hundreds of exceptional opportunities in Salesmen's Opportunity Magazine. Send name for your copy, absolutely free. Tell us what you're selling now. Opportunity, 848 N. Dearborn, Dept. 17, Chicago 10, Illinois.

OUTDOOR Advertising pennants, spinners, etc. 100% distributors profit. High salesmen's commission. Write: Radder Products, Box 31, Colvin Station, Syracuse 5, New York.

\$1,000.00 A Month for making dramatic 3-second demonstration of amazing lightweight Presto fire extinguisher. New chemical used by airforce snuffs out fires instantly. Only \$4.95. Terrific commissions. Millions want it. Free kit. Merlite, 114 E. 32nd, Dept. P-66J, New York 16.

MAKE Big money selling industrial brush line to gas stations, stores, factories. 6 orders daily pay you \$100 weekly. Protected territory, full commissions on repeat orders. No experience needed. Sample offer. Sales guaranteed. Write Harper Brush, 3109 State, Fairfield, Iowa.

EARN To \$3000 by Christmas. Sell "New Instant Snow-Thaw" (Chemical ice and snow de-icer). Sells in large quantities. Every business a prospect. No investment. Liberal weekly commissions. Full or part time. Snow-Thaw, Box 8505, Nashville 11, Tennessee.

SENSATIONAL New longer-burning light bulb. Amazing free replacement guarantee—never again buy light bulbs. No competition. Multi-million dollar market yours alone. Make small fortune even spare time. Incredibly quick sales. Free sales kit. Merlite (Bulb Div.), 114 E. 32nd, Dept. C-74J, New York 16.

MOST Restaurants buy our action sign. Swiveletter Co., Hammond, Indiana.

MAKE More money in business for yourself as a distributor or direct dealer for Success Motivation Institute! No company offers a more complete program of recorded inspirational, motivational and sales training material. Write today for information on SMI distributorships and direct dealerships. Success Motivation Institute, Inc., Box 7614, Waco, Texas.

EARN \$12,000 Yearly. Sell only two drums daily. Let repeat commissions double income. Revolutionary, fireproof, degreaser-cleaner replaces dangerous solvents in industry. For free easy profit story, write Elgene, Mt. Vernon, N. Y.

FAST-Selling, new and attractive "Sale" signs and promotional material for retail stores can earn you an average of \$20.00 per day. Free catalog and information. Write today. Red Wing Products, New Hyde Park 2, New York.

EMPLOYMENT INFORMATION

U. S. A. Worldwide jobs, up to \$1600.00 monthly. Construction, clerical, supervisory, etc. Skilled, unskilled. Free transportation. Unusual opportunities. Complete information plus worldwide project listings. Only \$2.00 (\$2.25 airmail). Satisfaction guaranteed. International Opportunities, Dept. 111, 109 W. 42, New York 36, N. Y.

FREE Information — U.S.A. overseas jobs, high pay. Transportation. Futures, Dept. M, 215 West 34th Street, New York City 1.

FOREIGN Employment. If interested in good paying overseas work with travel expenses, write Foreign Service Bureau, Dept. PM, Bradenton Beach, Florida.

WORK In Arizona. Information, job listings, \$1.00. Thompson Enterprises, Box 6561, Phoenix 5, Ariz.

THOUSANDS Of job openings. All trades. Top wages. Benefits. Travel expenses paid. Nationwide-worldwide, Box 12, Detroit 13, Mich.

MERCHANT Marine jobs. Men and women. Top wages. Travel. Captain, Box 501-P, Reading, Massachusetts.

FOREIGN Employment information. Work overseas. Travel, adventure. Europe, Africa, Asia, Canada, Alaska. Earn as much as \$1,600 monthly. Construction men, truck drivers, clerks, teachers, professionals, etc. Fabulous opportunities. Most complete information, application blanks, etc. Sent by return mail same day received. Send \$2.00 to Dept. PM, Foreign Bureau, P.O. Box 512, New Orleans, Louisiana.

FOREIGN Jobs—Latin America, Alaska, Canada, up to \$1500 monthly. Up-to-date 1961 foreign service directory gives complete information; hot list of firms hiring for military and civilian construction, aircraft, oil, exporters-importers, mining. How-when-where to apply. 13th successful year. \$1.00. Global Reports, Box 5201, Inglewood, Calif.

DIRECTORY Reports. Construction, aviation, shipping, oilfields, government, manufacturing, trucking, etc. Foreign-stateside. Helpful information plus job-getting tips on preparing application letters. Unconditional money-back guarantee of satisfaction. Act today. Only \$2.00 (\$2.25 airmail). (C.O.D.'s accepted). Research Services, Meramec Building, St. Louis 5-PM, Missouri.

HIGH Paying foreign employment now open. Construction, aviation, Civil Service, Merchant Marines, jobs on ships, thousands of jobs open right now. Travel to Far East, Europe, South America. This is your chance to earn big money. Do not delay. Write for free information to: International Employment Information Center, Boston 27, Mass.

MEN Free to travel merchant marine jobs, ships, yachts. No experience necessary. Send for application. Captain Wohlenberg, 192 Bowling Green Station, New York.

CHOICE U.S. and overseas jobs. All trades. Firms, addresses, hiring, procedures, pay scales, benefits. For info, write: World Wide, Dept. B15, 155 N. Franklin St., Hempstead, N. Y.

EXCELLENT Employment. California, Oregon, Washington, Nevada, Arizona, Alaska, Hawaii. All occupations needed immediately. Men. Women. Free details. Employment Surveys-18, 2908 Gawthorn, Oroville, California.

GOOD Resumes help land best jobs. Complete instruction \$2.00. Planatrol, P.O. Box 353, Ft. Wayne, Indiana.

FOREIGN Employment! High paying, tax exempt jobs of all types in all corners of the Free World are in our current listing. Send \$2.00 to Capital Services (PS), Box 5609, Colonial Station, Sacramento, Calif.

SPECIAL SERVICES

FAMILY Income tax deduction kit. Small businesses simplified bookkeeping kit, \$3.00 each. Norman, Box 147, Hancock, Michigan.

INFORMATION On anything. Ferguson Research Specialists, 59 Lent Ave., Hempstead, N. Y.

BOOKFINDING Our specialty. Try us. Babcock, 412 Lulu, Wichita 11, Kansas.

INFORMATION Research. Worldwide Information Services, 221 Butler Avenue, Waterloo, Iowa.

OPERATE Own collection agency. Spare time extra cash: Satellites, Box 172, Manhattanville Station, New York 27, N. Y.

TRADERS-Swappers. Anything traded with anyone throughout U.S.A. For nation-wide contact with interested swappers send \$1.00. Box 7204, Camden Station, Minneapolis 12, Minnesota.

LETTER-Circular remailing. Date reminders. Gift shopping. Family budgeting. Norman, Box 147, Hancock, Michigan.

EDUCATIONAL AND INSTRUCTION

DRAFTING Pays big money. Leads to to position in automotive, aeronautical, construction, mechanical fields. Learn at home in spare time. All equipment supplied. Pay later plan. Free book. Christy Trades School, CD-5203, 3214 Lawrence, Chicago 25.

COMPLETE Your high school at home in spare time with 64-year-old school. Texts furnished. No classes. Diploma. Information booklet free. American School, Dept. X645, Drexel at 58th, Chicago 37, Illinois.

OIL Coloring photographs. A fascinating hobby or profitable sideline for those with artistic talent. Learn at home. Easy simplified method. Free booklet. National Photo Coloring School, 835 Diversey Parkway, Dept. 3436, Chicago 14, Ill.

MASTER Watch making at home. Free sample lesson. Chicago School, 2328-YV Milwaukee, Chicago 47.

BE A locksmith! Earn while you learn at home. Big opportunities await you in this fascinating, profitable trade in good times or bad. Earn quickly—step into a wellpaid job or start a business of your own, full or parttime. All materials and special tools supplied. Write for free book today! Locksmithing Institute, Dept. 6709-1, 150 Park Avenue, East Rutherford, New Jersey.

GOOD Paying jobs open! Operate, repair heavy earth moving equipment! Learn "on the job" operating latest cranes, bulldozers, earth carriers! V.A. approved. Free catalog. Write, T. K. Hutch, Greer Technical Institute, Braidwood, Illinois.

LEARN Civil and criminal investigation at home. Earn steady, good pay. State age. Institute Applied Science, 1920 Sunnyside, Department 166, Chicago 40, Illinois.

"HOW To Train Horses"—A book everyone who likes horses or ponies should have. Free. No obligation. Simply address Beery School, Dept. 1109, Pleasant Hill, Ohio.

BECOME A telephoneman, experience unnecessary, details free. Occupations Unlimited, 1100 Reeve, Santa Clara, Calif.

ENGINEERING And Art degrees earned through home study. Electronics, electrical, mechanical, civil, physics, liberal arts. When writing, specify course desired. Pacific International College of Arts & Sciences, primarily a correspondence school. Resident classes also available. 5719-A Santa Monica Boulevard, Hollywood 38, California.

WOODWORKING And cabinetmaking course for beginning and advanced home craftsmen. Only complete low-cost home training program available. Write for free booklet. Interstate Training Service, Dept. G-3, Portland 12, Ore.

BULLDOZER Operation! Learn how your area. Nationwide Training, Box 7400-A, Washington 4, D. C.

EARN Extra money by clock and watch repairing. Learn at home. Kansas City School of Watchmaking, 1228PM Admiral, Kansas City 6, Missouri.

BECOME A personal problem counselor. Enter dignified profession. Instructions \$1.00. Hermansen, Box 808, Grand Central Station, New York 17, N. Y.

USED Correspondence courses and books sold and rented. Money back guarantee. Catalog free. (Courses bought.) Lee Mountain, Pisgah, Alabama.

LEARN Auctioneering. Free catalog. Missouri Auction School, Box 9252X3, Kansas City, Missouri.

BE A Real Estate Broker. Insure security for yourself and your family. Study at home. Prepare for state examination. GI approved. Write for free book today. Weaver School of Real Estate, 2018 P Grand, Kansas City, Missouri.

HIGH School diploma at home. Licensed teachers. Approved materials. Southern States Academy, Station E-16, Atlanta, Ga.

WANT A diesel job? Higher pay? Advancement? We can help you qualify! Complete diesel, tractor and heavy equipment and Cummins Diesel Engine Shop-method home-training courses available. Write today. Interstate Training Service, Dept. B-3, Portland 12, Ore.

DEVELOP Mind power, personality while asleep. Use your phonograph, recorder. Amazing psychological tapes, records now available. Details free. Sleep-Learning Association, Box 24-N, Olympia, Washington.

BOOKS, Free general catalog, 100 pages. Text, vocational, educational, instructional subjects. Millions of volumes, new and used. Bargain prices. Books bought. Est. 1902. Long's College Book Co., Dept. PM, Columbus 1, Ohio.

BOOKKEEPERS. Operate your own "Dollar-A-Week" system. Ellis, Box 200, Cedar Grove, North Carolina.

OWN Collection agency. Little "gold mine." Franklin Credit, Roanoke, Va.

LEARN Asleep or awake! Records, tapes, equipment! Free catalog! Drawer PM-697, Ruidoso, New Mexico.

MATHEMATICS Made easy by new step-by-step home study method. Courses from elementary to advanced level. Fees as low as \$10. Diploma awarded. Free booklet by Prof. Allcut, P. Eng., gives complete detail. Write today to Canadian Institute of Science & Technology Ltd., 412-5th St. N. W., Washington, D. C.

MEN Wanted. Earn \$125 a week and up. Master a trade with a future. Learn auto diesel mechanics in our shops. You learn with tools on real equipment. Earn while you learn. Many of our graduates earn \$125 a week and up. Write for free bulletin: Dept. 256, Auto Diesel College, Nashville 3, Tenn.

LEARN Mechanical Dentistry in your spare time. Send for specific instructions in the "Art of Setting Teeth." Free. No obligation. Simply write Grant Dental Laboratory, Haas Bldg., Los Angeles 14, Calif.

INTERLANGUAGE Approved by UNESCO. Teach each other kit. 25¢. Esperanto, Middleton, Wis.

STRENGTHEN Your voice—for more success in business, social life! Free booklet. Give age. PV Institute, 325 Jackson, Studio 2EN-2, Chicago 6.

ANALYZE Handwriting for profit, pleasure. Free sample lesson, catalog reveals plan. Write International, 325 Jackson, Dept. 2CN-2, Chicago 6.

"EASY To have a powerful memory" Booklet \$1.50. Write: Melvin T. Tyler, Box 16297, Boston 18, Mass.

LEARN Candle making—decorating at home. Send for free facts on famous home study course. Candle, Dept. X-502, Fallbrook, Calif.

"HOW To Analyze Handwriting." Book \$1.50. Grapho-Analyst, 640 Sonoma, Santa Rosa, Calif.

PENMANSHIP Corrector. Improve poor penmanship quickly. Details free. Ozment, Box 665-34, St. Louis 88, Mo.

BEGINNER'S Home training course in drafting. Free information. Chickris Engineering, Liberty Building, Rock Island, Illinois.

NEED Better job, bigger earnings? Study secrets others use to change employment, to win better earnings. Send for information to secure free copy "Top Secrets to Success in Your Job." Learn to Earn Co., Box 8043, Akron 20, Ohio.

SING. Speak with power. Self-training record. Amazing! \$9.95. Canfield, 2018-A Fifth Avenue South, Minneapolis 4, Minn.

LEARN Expert cake decorating, candy making. Free details on home instruction method. Candy & Cake, Dept. D-21, Fallbrook, Calif.

PIANO Tuning pays. Learned easily at home. GI approved, 59th year. Free booklet. Niles Bryant School, Dept. P, 3731 Stockton, Sacramento 20, Calif.

OPERATE Restaurant or diner. Free booklet reveals plan. Write School of Restaurant Business, Dept. RMC-359, 335 W. Madison, Chicago 6, Illinois.

EARN As you learn writing, practical self-help text. \$2 postpaid. Creative Press, Claremont, California.

EARN \$150 Weekly mechanical, electronics drafting. Send \$25 complete home study course. Prior, Inc., Dept. 121, 23-09 169 Street, Whitestone 57, New York.

PLAY Guitar. Teach yourself method. \$1.00. Results guaranteed. Ernie Ball Guitars, Box 308PME, Tarzana, California.

USED Correspondence courses, books bought, sold, rented. Catalog free. Vernon, Summerville, Ga.

BECOME Finance specialist. Handsome profits. Tucker Associates, 3633 Warder St., Northwest, Washington 10, D. C.

VENTRILOQUISM. Throw your voice. Details free! B. Davis, 38, Safety Harbor, Florida.

LEARN House designing. Brochure. Write! Wat, Box 1, Brecksville 41, Ohio.

TRAIN In spare time for a profitable business of your own in pest control. Costs little more than a daily pack of cigarettes. 20 complete lesson course. Insect specimens, chemical samples, magnifying glass, business forms all furnished. Licensed by the State of Illinois. Write for free brochure. Elston School of Pest Control, 4674 Elston Avenue, Chicago 30, Illinois.

USED Correspondence courses, books. Satisfaction guaranteed. Catalog 10¢ refundable. Courses bought. Bayles, 78-B Courtright, Wilkes Barre, Penna.

PLAYS, STORIES, MANUSCRIPTS

WANT Your book published? Learn how we publish, advertise, promote, distribute. Many successes. Free booklet PM. Vantage, 120 West 31, New York City. Or 6253 Hollywood Blvd., Hollywood 28, Calif.

ADVERTISING AGENCIES, ADV. SERVICE, MAILING LISTS

ADVERTISING Ratebook leading newspapers, magazines, free. Chicago Advertising Agency, 28-E Jackson, Chicago 4.

MAILING Lists most all kinds 1000 \$5.00. Free folder. Your circulars mailed \$4.00 1000. Dixie Mailers, King, N. C.

100 ADDRESSES Of foreign exporters, \$2. Delmar R. Lipelt, Box 76, Yankton, S. Dak.

FREE! Red-hot book, "More Profit From Your Advertising." Lists—best mail order magazine, newspapers. Adservice, 516 Cornelia, Chicago 13.

AVERS Mailing lists. Small accounts invited. 331 N. Austin, Chicago 44, Ill.

AMAZING New Book—"Profits From Classified Advertising." Tells how and what to advertise. Be sure to read this book before you invest one cent in advertising. Write for your copy now. F. W. Johnson, Classified Advertising Manager, 202-210 East Ontario Street, Chicago 11, Illinois.

NOW Ready: New, amazing Classified Advertising Record Book—prepared especially for classified advertisers. Here is a book that tells you instantly whether or not your advertising in any publication is paying you real results. You can tell immediately how many inquiries each publication produced—how much cash received from every ad. Spaces are provided for the name and address of the publication, date of issue, space used, rate, cost of ad, key number, etc. You have a complete record of each publication right before your eyes. Plenty of space to keep accurate record of 28 separate publications. You can have a copy by sending only 10¢ to cover postage and handling. Send for your copy now. W. F. Johnson, Classified Adv. Mgr., Popular Mechanics Magazine, 204 E. Ontario Street, Chicago 11, Illinois.

TYPEWRITERS, DUPLICATORS, OFFICE DEVICES

NEW Duplicators from \$16.95, free particulars. Premium Products, 4103 Barrington, Baltimore 7, Maryland.

RECONDITIONED Typewriters, mimeograph, printing presses \$25.00 up. Write Dixiegraph, King, N. C.

RUBBER STAMPS AND OFFICE SUPPLIES

RUBBER Stamp given first order. Free catalog. Fisherprint, Hartland, Maine.

FREE Rubber stamp catalog. Stock stamps, pads, racks, signature stamps \$3.50. Free printing catalog. Youngers Stamp Shop, Princeton, Iowa.

QUALITY. Pocket (self-inking) 3 or 4 lines \$1.00; deluxe (metal) \$2.00. Free literature. Adirondack Printers, Tupper Lake 11, New York.

POCKET, 3 Lines \$1.00. Guaranteed. W. J. Specialty, 8464 Manhattan, Detroit 11, Michigan.

FREE Catalog: Rubber stamps, business cards, printing. Martin, 1425 Major Drive, Jefferson City, Missouri.

FREE Rubber stamp and printing catalog. Stamps 3 lines \$1.00 postpaid. Guaranteed. Kantor Printing Co., 1391 Pennsylvania Ave., Bridgeville, Pennsylvania.

NAME And address, indexed, cushioned. 3 lines \$1.00. Literature free. Sharrer, Parkhill, Penna.

DELUXE Three line pocket stamp \$1.50. Catalog 10¢. J. E. Maki, P.O. Box 71, Holden, Mass.

CARTOONING, COMMERCIAL ART, SHOWCARD & SIGN PAINTING, TATTOOING

LEARN Sign painting at home. Free talent test. Ben Kerns, Box 812-PM, Greenville, S.C.

LEARN Sign painting with fascinating system. Straley, 410 S. Western, Springfield, Ohio.

WANTED—Cartoonists. Amateurs, professionals. Over 200 markets. Information free. Cartoon Markets, 11620 Lansdowne, Detroit 24, Michigan.

"HOW To Make Money With Simple Cartoons." A book everyone who likes to draw should have. It is free; no obligation. Simply address Cartoonists' Exchange, Dept. 99, Pleasant Hill, Ohio.

CARTOONING. Good money in fields of television, advertising, animation, movies, magazines. Famous system of manual training brings amazing new concept of art instruction at home. For profit or pleasure. Send for free details. Continental Schools, Dept. E-12, 4201 S. Broadway, Los Angeles 37, Calif.

CARTOONERAMA Teaches you cartooning in a new 24 lesson course. Free brochure. CFA, Box 263-C1, Branford, Conn.

COMPACT Cartoon course. \$3.00 complete. M. Ronnel, 463 S. Bixel St., Los Angeles, Calif.

PAINT Signs! Using patterns! 6-inch alphabet \$2.00. Harwell, PM-961, Byrdstown, Tennessee.

PRINTING, MULTIGRAPHING, MIMEOGRAPHING, GUMMED LABELS

MIMEOGRAPHING — Offset printing. Lowest prices. Barskett's, 6752 So. Campbell, Chicago 29, Illinois.

1,000 BUSINESS Cards. Raised letters \$3.95. Samples. Pioneer, PM-9, Island Park, N. Y.

250 8 1/2 x 11 HAMMERMILL Letterheads \$2.95. 250 envelopes \$2.95. 1,000 5 1/2 x 8 1/2 business forms \$9.95. Postpaid. Samples. Davis, 7609 Spruce Road, Baltimore 22, Maryland.

GUMMED Address labels. Free samples on request. Charles Diamond, 55 Larkspur Ave., Merrick, N. Y.

100 SHEETS Note bond. Three printed lines. \$2.65 plus 55¢ handling. Dept. PM, 1139 McCormick, North Hollywood, Calif.

350 PAGE Printing catalog available. 50% commission. Beaver Printing, Box 40-M9, Babylon, New York.

ENVELOPES, all kinds. Small quantities wholesale. Write: Lewis, 624 Hinton, Petersburg, Va.

1000 EMBOSSED Business cards \$3.75. 100 miniature photographs from any photo, negative \$2.00. Samples. Kormoczy, 230 Broadway E., Seattle 2, Wash.

1000 BUSINESS Cards, raised letters. \$3.75 postpaid. Samples. Routh, PM-9, 2633 Randleman, Greensboro, N. C.

ATTRACTIVE Stickers, labels. Samples free. Fame, 291 Ellis, San Francisco 2, Calif.

1,000 BUSINESS Cards (raised) \$3.75 3 line stamp \$1.00. Adcock, Box 1265, San Antonio 6, Texas.

HIGH Quality printing. Lowest prices. Free samples. Tuff, 4279-M, Viola, Philadelphia 4, Penna.

COMPLETE Printing catalog and \$1.00 gift. Steinbergen, 1274CM Stebbins, New York City 59.

1000 EMBOSSED Business cards \$3.50 postpaid. Agents discount. Samples. Northgate Printing, 5210 Cornell, El Paso, Texas.

1,000 EMBOSSED Cards \$3.50 postpaid. Samples. Buserco, 1555M Saint Marks, Brooklyn 33.

DISTINCTIVE Printing, proofs, cuts, mats, artwork. Writers', office supplies. Logan Enterprises, 6801-A Onyx, St. Petersburg 3, Florida.

MIMEOGRAPHING—Letters, pricelists, formulas, instructions. Lowest prices. Lem's Letter Shop, 5710 Stanton, Detroit 8.

ADS Running under this heading sell printing. Ask me for proof. I'll gladly send you amazing facts. Ask for Folder "P." F. W. Johnson, 200 E. Ontario St., Chicago 11, Ill.

FREE Catalogs postpaid printing. Rubber stamps. DM Press, Sebastopol, Calif.

SAVE 40% On quality offset printing. Free price list. Modern Engraving Co., 276 Friend St., Boston 14, Mass.

500 BUSINESS Cards \$1.75. 300 piece stationery package \$2.00. Soutar, 1191 Merrick, Detroit 2, Michigan.

TWO-Color letterheads. Free samples. Prices other printing. Bell Colorprint, Franklin, Tenn.

1000 NAME-Address labels 88¢. Rubber pocket stamp 88¢. Printing, rubber stamp catalog. Jordan's, 552 West O'Connor, Lima, Ohio.

PRINTING OUTFITS AND SUPPLIES

FOUNDRY Cast type and supplies for printers and rubber stamp makers. Satisfaction guaranteed. Send \$1.00 for big 96-page catalog and printers tweezers, deductible from first order. Acme Type, 633 Plymouth Court, Chicago 5, Ill.

MAKE Your own self-molding rubber stamps and printing cuts. Plexirubber, Argyle 1, Wisconsin.

DO Your own printing. Save money. Simple rules. We supply everything. Print for others; good profit. Raised printing like engraving too. Have home shop. Details free. Kelsey Presses, V-11, Meriden, Connecticut.

TYPE Case catalog. Manufacturer. King McKay Company, 23179 Telegraph, Southfield, Michigan.

RUBBER Stamp outfits, supplies. Kiewiet, 2025 Barney Road, Kalamazoo, Mich.

RUBBER Stamp presses, hydraulic operated, electrically heated. Sizes 5"x8", 8"x12", 10"x15". Starting outfits, supplies. Printing presses. Custom Manufacturing, 507-P N. Jefferson, Springfield, Missouri.

PRINTING Presses, type, supplies. Lists 4¢. Turnbaugh Service, Mechanicsburg, Penna.

FOR INVENTORS

INVENTORS: Save time and money. Prepare and file your own patent application. Our complete "Patent Kit" makes it easy. Includes detailed instructions and all necessary material. Only \$8.95. Money back guarantee. Don't delay. Send check or money order today to National Inventors Service, Box 88, Benjamin Franklin Station, Washington, D. C.

INVENTORS! Outright cash sale or royalties for your inventions. Patented. Unpatented. Constant demand from our client manufacturers. Write: United States Invention Brokerage, 78 Wall Street, New York 5, N. Y.

PATENTS Professionally prepared for maximum commercial value. Patent searches including report \$6.00. Patents prepared as low as \$195.00. Valuable market service with cash or royalty sales. 10 years dependable service. For free self-protecting Record of Invention forms write: H. Lawrence Blasius, Patent and Development Engineer, 15 Park Row, New York 38, N. Y.

INVENTORS! Consider our offer first before selling or licensing your invention on a cash or royalty basis. Patented. Unpatented. Write: Inventions on Demand, 79 Wall Street, New York 5, N. Y.

DON'T Pay high fees! Obtain U.S. patent yourself. It's easy with Professional Kit with fill-in forms. Free "Registration form." Patent Protection Institute, 15 Park Row, New York 38, N. Y.

INVENTIONS Wanted for immediate promotion — patented; unpatented! Outright cash; royalties! Casco, Mills Building, Washington 6, D. C.

PATENT Searches, including copies of nearest patents, \$6.00. Reports airmailed within 48 hours. More than 200 registered patent attorneys have used my service. For free invention protection forms, write Miss Ann Hastings, P. O. Box 176, Washington 4, D. C.

CASH Or royalties for inventions! Patented; unpatented. All types considered. International, 1170 Broadway, New York 1, N. Y.

WE Have the markets if you have the ideas. Harvey Engineers, Cambridge 1 Maryland.

INVENTORS: Test the commercial value of your patented or unpatented inventions, quickly and inexpensively. Write for free information. Institute of American Inventors, Dept. 40-B, 635-F St., N.W., Washington 4, D. C.

PATENT Searches, including complete copies of nearest patents, \$6.00. Inventors, attorneys, manufacturers use my original world-wide airmail service. "Proof of Invention" protection form and "Information Every Inventor Needs" sent free. Miss Jean Hayward, 1029 Vermont Avenue, N.W., Washington 5, D. C.

PROFESSIONAL Patent searches, \$6.00, complete with comprehensive report and official copies of related patents. Prompt, dependable airmail service. For free protective "Invention Record Folio" and "Information Every Inventor Should Have." Write: Congress Invention Institute, 210 B McKim Building, Washington 5, D. C.

PATENT Searches including full airmail report and closest patent copies, \$6.00. Quality searches, expertly administered. Free protection forms. Write Professional Patent Office Search Bureau, 709 Albee Building, Washington 5, D. C.

INVENTORS! Searches of the Patent Office administered professionally. \$6.00 including airmailed comprehensive report and related patent copies. For free invention protection forms, dependable service, write Washington Patent Office Search Bureau, 1426 G Street N.W., Washington 5, D. C.

U.S. Patent office former examiner's inventors service. Patent office searches. Free commercial invention evaluation. Cash-royalties promotion. Patent engineering development. Free invention protection certificates. George Spector, Licensed Patent Engineer, Woolworth Building, New York.

U.S. Patent office searches—\$5.00. Free invention record. Patents engineered. Patent Office Searchers, 233 Broadway, Room 3615, New York.

INVENTORS! Sell your invention for cash or royalties! Our manufacturers constantly seeking new items. Patented. Unpatented. For free information write Gilbert Adams, Patent Broker, 80 Wall Street, Financial District, New York, N. Y.

PROFESSIONAL Searches of the Patent Office. Dependable—reliable. \$6.00 including airmail report and related patents. For free protection forms write Trans-World Patent Service, 500 Walker Building, Washington 5, D. C.

PATENTS Skillfully prepared for maximum commercial value, with useful product development. High record of success in proving and claiming patentability. Valuable market service. Patent prepared for a fee as low as \$200.00. Send for self-protecting record of invention forms free. Patent search with valuable engineering report \$15.00. Foreign patents filed at low cost. Thirty years established. Joseph O'Brien, Patent and Development Engineer, 132 Nassau St., New York 38, N. Y.

SAVE High fees! Apply for your patent yourself. New do-it-yourself Patent Kit now makes it easy! Free "Registration Form." Miss Suzan Blaine, 306 Carry Building, Washington 5, D. C.

INVENTIONS Needed immediately for manufacturers. For additional information write Kessler Corporation, C-59-FI, Fremont, Ohio.

INVENTIONS Bought and sold. No listing fees. National Patent Brokers, 6757 JerLes Drive, Milford, Ohio.

PATENTS prepared professionally. Quality work at lowest prices. Established 1939. Adams, 15 Park Row, New York City.

INVENTIONS WANTED

INVENTORS: Profit from patent engineers. Reliable, complete service. Guide book tells what's needed, sell. Send \$1.00. Inventors Creative Service, PM 354 South Spring, Los Angeles 13, California.

INVENTORS: Want to sell your invention for cash or royalty? Write Allen, Department C, 3100 So. Buckner, Dallas 27, Texas.

INVENTIONS Wanted: Patented-patent pending. 30 years experience promoting inventions. National Service Bureau, 3120 Meramec, St. Louis 18, Mo.

CASH Or royalties for inventions! Patented; unpatented. All types considered. International, 1170 Broadway, New York 1, N. Y.

INVENTORS: Hundreds of manufacturers have requested our assistance in locating marketable new products. Complete information free. Institute of American Inventors, Dept. 40-D, 635-F St. N.W., Washington 4, D. C.

INVENTIONS Wanted. Patented; unpatented. Tremendous manufacturers lists. Global Marketing Service, 2420 77th, Oakland 5 California.

ARE You interested in offers from reliable manufacturers for your invention? Patented, unpatented. Harvey Engineers, Cambridge, Maryland.

INVENTIONS Wanted for immediate promotion—patented; unpatented! Outright cash; royalties! Casco, Mills Building, Washington 6, D. C.

INVENTORS! Outright cash sale or royalties for your inventions. Patented. Unpatented. Constant demand from our client manufacturers. Write: United States Invention Brokerage, 78 Wall Street, New York 5, N. Y.

INVENTORS! Consider our offer first before selling or licensing your invention on a cash or royalty basis. Patented. Unpatented. Write: Inventions on Demand, 79 Wall Street, New York 5, N. Y.

INVENTORS Needing help with any problem, financial, development, securing manufacturer, obtaining patent. Write the organization that delivers action and results—not promises. Pioneer Invention Institute, 150 Broadway, New York 38, N. Y.

INVENTORS! Sell your invention for cash or royalties! Our manufacturers constantly seeking new items. Patented. Unpatented. For free information write Gilbert Adams, Patent Broker, 80 Wall Street, Financial District, New York, N. Y.

INVENTIONS Promoted—for cash-royalty sales with manufacturer contacts. George Spector, Licensed Invention Engineer, Woolworth Building, New York.

INVENTIONS Wanted immediately for promoting on cash or royalty. Patented, unpatented. Free booklet outlines royalty rates, requirements. Write Kessler Corporation, C-59-IW, Fremont, Ohio.

NAMES Of manufacturers wanting inventions. Bizayde, Dept. 13T, Box 1682, Rapid City, South Dakota.

INVENTIONS Wanted! Cash, royalty paid. Inventions International, 15 Park Row, New York City.

Cash Or Royalties for inventions! Consider our offer first before licensing or selling your patented or unpatented invention. Write Aladdin Industries, 80 Wall St., New York 5, N. Y.

WANTED Inventions all kinds, patented or unpatented. Engineer, Box 113, Hampton, N. H.

PATENTS FOR SALE

MEASURING Rule with built in light. Enon Products Inc., Box 173, Enon, Ohio.

KICKING Man toy 2,506,260. M. Yaggy, 1209 Bishop, Waterloo, Iowa.

MODELS—SHIPS, TRAINS, PLANES, ETC.

POWER Models. Unusual steam, gasoline and traction engines, fittings, metals. 33 years—model business! Reason? Satisfied customers. Comprehensive 100 page catalog \$1.00. Chas. Cole, Ventura, Calif.

SHIP Model kits and fittings: clippers, frigates, etc. Catalog paint-tool list, book list, 35¢. Model Shipways, Box 85, Bogota, N. J.

LIONEL Trains. Big discounts bulletin 10¢. Catalog 25¢. Mack-Bros., 2043P, Chicago Ave., Chicago 22.

SHIP Models. Most complete line in New England, kits, fittings, plans, books, tools, engines, motors. Illustrated catalog 35¢. James Bliss & Co., Inc., Dept. SM, 342 Atlantic Ave., Boston 10, Mass.

SHIP And yacht model fittings; blueprints. Send 40¢ for illustrated catalog listing hundreds of items. A. J. Fisher, Inc., 1002-1 Etowah Ave., Royal Oak, Mich.

"POWER Drives Handbook"—36 pages illustrating many types motor drives for model autos, boats, displays, turntables, etc. Mail 25 cents cash, returnable first order \$3.00 or more. Wilson's of Cleveland, Dept. PM, P.O. Box 8995, Ft. Lauderdale, Fla.

ROCKETS: New illustrated catalog 25¢. Kits, cones, tubes, engines, etc. Estes Industries, Penrose 2, Colorado.

MINIATURE Gasoline or steam engines—easily machined using our castings and blueprints. Fascinating hobby. Illustrated catalog 25¢. Octura Models, 8148-PM Milwaukee, Niles 48, Ill.

CASTINGS And finished steam-gas engines from simple oscillating to triple expansion. Finest materials and fittings. Catalogue \$1.00. Denison Live Steam Models, 1606 Denison Ave., Cleveland 9, Ohio.

ROCKET Supplies 1961 Catalog now available 20¢. Sky Mfg. Co., Mineral Point, Penna.

ENGINEERING SERVICES

INVENTION Development. Industrial research. Submit technical problems in confidence for no-cost survey. Todd Consulting Engineers, 430 West 119th, New York 27.

MANUFACTURING

MODELS—Small lot manufacturing. Metals, plastics, etc. Milburn, Burlington, Kentucky.

MODEL Building. For inventors. Manufacturing. Any quantity. Research. William Parker, 32 Westminster, Worcester 5, Mass.

HOME CRAFTSMEN

KNOCKDOWN Cedar chests and lumber. Catalog 25¢. Bedford Lumber Company, Shelbyville, Tennessee.

FREE, New catalog. 2447 plans, patterns. World's greatest selection things to do, make. Fun. Profit. Craftplans, 1322-A Wabash, Chicago 5.

LEATHERCRAFT. Send 10¢ for catalog. Saxcrafts, Inc., 1101 N. 3rd, Milwaukee, Wisconsin.

PICTURE Frame moulding, squares and lumber. Kiln dried walnut, cherry, silver maple. Midland Lumber Company, Box 262, Savannah, Mo.

FREE Sample—Perma-Pelent, new one coat silicone formula. Corrects moisture problems on block, brick, stucco, stone, asbestos siding and all above grade masonry surfaces on your home. Less than one cent per square foot applied. Perma-Stone Co., Desk 17, Columbus 11, Ohio.

FREE "Do-it-yourself" leathercraft catalog. Tandy Leather Company, Box 791-V41, Fort Worth, Texas.

BUY Picture frame moldings at wholesale. All styles and widths. Necessary tools, too. Free deliveries in U.S.A. Write for pricelists. Chesapeake Picture Frame Company, 414-A East Baltimore St., Baltimore 2, Md.

FOUNDRYETTE, 2400°F., 1½ to 48 lb. capacity. Free circular. Kansas City Specialties Co., Dept. P-9, Wymore, Neb.

WOODWORKING Catalog and manual. Brand new 150th Anniversary edition! World's largest selection of domestic, imported woods—materials, tools, supplies, do-it-yourself plans, projects. 132 pages, many full color. More than 2,000 items. Send 25¢ for postage and packing. Act now! Constantine, 2050 Eastchester Road, Dept. M-101, New York 61, N. Y.

GRANDFATHER Clock movements, case plans, kits. Catalog 25¢. Mason-Sullivan, Noroton 7, Conn.

101 PATTERNS Of smart gifts, novelties, shelves, action windmills plus "Make Money Jig Sawing." \$1.00. Mastercraft, 95M, 7041 Olcott, Chicago 31.

FREE! Leathercraft catalog. Hundreds of new items. Write MacPherson Bros. Leather Company, Dept. E, 730 Mission St., San Francisco 3, Calif.

OUTDOOR Christmas displays brighten your yard. Easy building instructions in Booklet 202, only 25¢ from Popular Mechanics Service Bureau, Room 517H, 200 E. Ontario, Chicago 11, Ill.

SKIL-CRAFTS—All new '62-'63 catalog. Largest and finest selection of leathercraft, artist and hobbycraft supplies in the world. Free goods gift with first order. 25¢ for latest catalog. Skil-Crafts, Box 167-P, Joplin, Mo.

DO IT YOURSELF

MOTORS Can be salvaged from discarded electrical appliances and re-used with unique base-clamp motor holder. 5 minutes to install. Only \$1.75, 2 for \$3.35. Heavy gauge rustproof steel base 4½" x 6½" with corner holes for mounting. Holds motors from 6-1/16" to 6-11/16" dia., and 1/6-1/4-1/3 h.p. Drumcliff Co., Dept. 701, Towson 4, Md.

CONCRETE Table and bench plans, easy to make 50¢. Plans, 4990 Nagle Road, No. Ridgeville, Ohio.

WATER Conditioners. Assemble your own. Save on tanks, zeolite, solo valves, etc. McCarthy Co., 7136 W. State Street, Milwaukee 13, Wis.

SAVE \$20. Recover your kitchen and dinette chairs to look like new. Step by step instruction \$1.00. Satisfaction guaranteed. E-Z Manuals Co., P.O. Box 47, Carnarie Station, Brooklyn 36, N. Y.

OPERATE Own investigation agency. Make extra cash. Satellites, Box 172, Manhattanville Station, New York 27, N. Y.

BUILD It yourself plans. The world's best suction dredge. Alligator gold grabber attachment. B.C. Prospectors & Surface Miners, 125 W. Broadway, Vancouver 10, B.C., Canada.

CHRISTMAS Cards. Make your own. Many methods described in Booklet 203, only 25¢ from Popular Mechanics Service Bureau, Room 517G, 200 E Ontario, Chicago 11, Ill.

FREE Check-list covering more than 500 classifications of projects, plans, instructions, service and repair information detailed in Popular Mechanics famous series of instructional booklets, books, patterns, and blueprints. List covers an extremely wide variety of do-it-yourself data on home remodeling, repair and improvement, hobbies, crafts, boating, games, lawn and garden, and hundreds of others. For your free copy of this helpful list, write: Service Bureau, Popular Mechanics, Room 520, 200 East Ontario, Chicago 11, Ill.

WATCHES, OLD GOLD, JEWELRY

COSTUME Jewelry supplies, settings, rhinestones, etc. 88 page illustrated catalog. 30¢. Milady, Box 1328, G.P.O., New York City.

WATCH And clock repairing books. Free catalog. North American, 2320-AK Milwaukee, Chicago 47, Illinois.

LEARN Watch cleaning, repairing. Illustrated. Excellent earnings. Kester, Deckerville, Michigan.

WANTED, Gold, silver, platinum, scrap (any form), coins. Information free. Wilmot's, 1067-PM Bridge St., Grand Rapids 4, Michigan.

HIGHEST Cash for old gold, jewelry, gold teeth, watches, diamonds, silverware, spectacles, platinum, mercury. Free information. Rose Refiners, Heyworth Building, Chicago 2.

WANTED—Old gold, silver, spectacles, watches, teeth, jewelry, platinum, mercury for cash. Electro Company, 1042 Highland Avenue, Buffalo 23, New York.

WATCHMAKERS' Tools, materials, supplies, watches. Catalog, Gales, Box 1000, Chicago 90, Ill.

JEWELRY, Goldplated findings, rhinestones. Free catalog. Reduced prices. Sexton's, 416 Potomac, Buffalo 13, N. Y.

WATCHMAKERS', Jewelers', lapidaries' catalog 25¢. Bengal, 8910 Venice, Culver City, California.

OF INTEREST TO WOMEN

LEARN Candle making—decorating at home. Send for free facts on famous home study course. Candle, Dept. X-509, Fallbrook, Calif.

SELL Fine fabrics. Get yours wholesale. Box 863, Norwalk, Conn.

DRESSES 24¢. Shoes 39¢. Men's suits \$4.95. Trousers \$1.20. Better used clothing. Free catalog. Transworld, 164-G Christopher, Brooklyn 12, N. Y.

HOUSEWIVES, Teachers, students, office workers, if you need extra cash each week but household or other duties prevent you from taking a part-time job, learn how you can earn by accepting orders to Popular Mechanics, Good Housekeeping and all other magazines. No experience needed. Write Popular Mechanics, Room 9W, 250 West 55th St., New York 19, New York.

SPARETIME Profits for women. Karla, 129 So. 2nd., Corvallis, Oregon.

LEARN Expert cake decorating, candy making. Free details on home instruction method. Candy & Cake, Dept. D-22, Fallbrook, Calif.

PERSONAL

BORROW \$100 To \$600 by mail. Quick, easy, private. No co-signers. Repay in 24 small monthly payments. For the amount you want write today to Dial Finance Co., 410 Kilpatrick Bldg., Dept. J-1, Omaha 2, Nebraska.

NEW! Borrow \$800. Anywhere. Increased loan limit. Air mail service. Postal Finance, 374 New Brotherhood Building, Dept. 17-B, Kansas City, Kans.

LOANS Entirely by mail—\$600 or less. Repay in 24 monthly payments. Write: Budget Finance Co., Dept. J-81, 114 S. 17, Omaha 2, Nebr.

BIBLE Questions answered. Stamped envelope. Bylon, 17167 Bentler, Detroit 19, Michigan.

ANY Handwriting analyzed. Scientific. Confidential. \$2.00. D. R. Ballard, CGA, 640 Sonoma, Santa Rosa, Calif.

WIN Success, 5 booklets \$1.00. Sample 10¢. Ben Arid, Hermosa Beach, California.

LOANS By mail, \$100-\$600. Anywhere. Confidential. Write Union Finance, Dept. PM, 323 E. Camelback, Phoenix, Arizona.

LOANS By Air Mail, \$100-\$600. Anywhere. Confidential. Easy payments. Write Security Finance Co., 898 Van Ness Ave., Dept. PM, San Francisco 9, Calif.

REMAILING SERVICE

PHILADELPHIA Postcards, six for \$1.00. You write message, stamp, return for remailing. Other confidential remails 25¢. Bertman, P.O. Box 8615, Philadelphia 1, Penna.

FLORIDA, Winter Haven or Cypress Gardens. Details free. Boydent, 580-A Fifth Street, S.W., Winter Haven, Fla.

SECRET Mail address. \$3 month. Hedgpath, Box 830, Alhambra 23, Calif.

WASHINGTON, D. C. Address, \$3.00 monthly, remails 25¢. Studios, Box 8993, Washington 20, D. C.

LETTERS Remailed from Switzerland. Airmailed \$1.00 each. Remailing Service, Brunnen, Switzerland.

CONFIDENTIAL Mail address \$3.00 month. Remails 25¢. Birnhan, 109 W. 42, New York City 36.

FABULOUS San Diego remails. 25¢ letter, \$3.00 month. De Graff, 8765 Innsdale, Spring Valley, California.

FAST Confidential mail service. 25¢. 10 for \$1.00. Harrington, 60 West Rutgers, Pontiac 17, Michigan.

CHICAGO Remails 25¢. Five \$1.00. M. Lyons, 2240 Wilson, Chicago 25.

CONFIDENTIAL Address \$2.50 month. Remails 25¢. Galvin, 2900 North Andrews, Ft. Lauderdale, Florida.

REMAIL 25¢ Davis Imports, Dept. 1, Box 489, Edmonds, Washington.

REMAILS, Receiving, forwarding, \$3.00 monthly, 25¢ single. 10437 Lanark Street, Sun Valley 3, California.

GLOBAL Viewcard selection; worldwide remailing \$1.00. Travelpost Hdq., Tombstone, Arizona.

BOSTON, Portland, Providence remails 25¢. Confidential mailing, receiving, forwarding address. \$3.00 monthly Box 1225, Boston 4.

LETTERS Remailed from important, historic, Washington, D. C. 25¢ each. P.O. Box 7812, Benjamin Franklin Station, Washington, D. C.

NEW York City confidential remails, 25¢. Receiving, forwarding, \$3.00 monthly. Reiss, P.O. Box 129-D, New York 18, N. Y.

C. Nunnally's, Box 775, Sarasota, Florida. Single 25¢. Monthly \$3.00.

CHICAGO Remailing. Single 25¢. monthly \$2.50. Joybil, Box 44, Chicago 90.

CALIFORNIA 25¢ Remails. Bulk rates, \$3.00 monthly. Confidential, personal attention. Box AA, Carmel Valley, Calif.

SECRET Mail address. \$3.00 month. Hawkes, 861 Lothrop, Detroit, Mich.

TREASURE FINDERS

DR-299 NUCLIONETER Uranium detector. Reasonable. F. Hamann, 146 Hilton, Pacifica, Calif.

TRANSISTOR M-Scope locates buried coins, gold, relics. From \$59.50; terms. Booklet, interesting customer comments free. Fisher Research, Dept. A-9, Palo Alto, Calif.

TREASURE, Gold, silver, relics. Find them with new super detectors, transistors. Free information. Detetron, North Hollywood, Calif.

TREASURE Hunter's manual. 200,000 words, 384 pages, illustrated. \$5.00 postpaid. Karl von Mueller, Box 649, Grand Prairie, Texas.

TREASURE! Handbook, map, 25¢. Locators. Howe, 811-F Kansas, Atchison, Kansas.

DISCOVER Buried loot, sunken treasure, gold, silver, coins; battlefield and ghost town relics, with powerful transistorized locators pioneered and perfected by Goldak. Low as \$79.50. Free exciting information; literature on maps. The Goldak Co., 1541 West Glenoaks Boulevard, Glendale 1, California.

METAL Locator kits and assembled models from \$39.90. Terms. Transistorized and underwater models available. Free catalog. Electronic Applications, Dept. M, Box 8, Arlington 10, Virginia.

WANTED—MISCELLANEOUS

STAMP Collections, accumulations. Eagle Stamp Co., 2221 Romine, Pittsburgh 26, Penna.

QUICKSILVER, Platinum, silver, gold. Ores analyzed. Wholesale Terminal, Norwood, Mass.

OLD Automobile catalogues—manuals. Pierce, 3517 Dollar Dr., Akron 19, Ohio.

FOR SALE—MISCELLANEOUS

FREE Money-saving catalog, Surplus and newly manufactured equipment and tools for workshop, home, boats, farm, factory. Write. Groban, 1139 South Wabash, Chicago 5, Illinois.

HEARING Aid batteries, wholesale. Free list. Habs, Box 51, York, Penna.

JUST Out! 356-page catalog—save to 50% on auto parts, accessories. All makes, models. Send 25¢—refundable on first order. Whitney, 1919 AA-9, Archer, Chicago 16.

HEAVY Cotton 50 star flags, embroidered stars, colorfast \$3.95 ppd. All sizes available, free list. Elmore, 6120 Transit, Depew, N. Y.

FLORAL Lights. Details. Lazaro Cabrera, 90 Wadsworth Ave., New York 33, N. Y.

BALL Gum. Factory prices. Free list. Vending, Coldspring Street, Norwalk, Conn.

MISCELLANEOUS

SUPER Memory overnight! Success guaranteed! Bijou, Box 1727-M, Hollywood 28, California.

WANT Your name with 1000 mailers? 25¢ lists your name year with our mailings every month Dixie Mailers, King, N. C.

100,000 PRODUCTS Wholesale—Free catalog! Send postcard: Econ-O-Mart, Whippany 15, New Jersey.

SEND Us wool for blankets. Free literature. West Texas Woolen Mills, 421 Main, Eldorado, Texas.

STOP Leaky faucets \$1. Details free! River Sales, Box 201, Hatboro, Penna.

COPPER Candy dish 8½", brass legs, from Netherland \$2.29 postpaid. Clell Potter, 5408 3rd St., Lowell, Washington.

AT Last hearing aids only \$34.95. Free trial, and credit. Also other bargains. Cary Sales-B, Inverness, Fla.

BIG Savings on merchandise which people need. Send 10¢ coin or 12¢ stamps for catalog listing hundreds of bargains. Linberr Sales, Box 89-A, Glendale, California.

GAS Furnaces, 100,000 B.T.U. \$160.00. Honey Heating, Box 168, Anna, Ill.

NEW Control makes refrigerators automatic—simply plug in. Clearance bargain \$6.00 postpaid. Finelli Electric, Bangor, Pennsylvania.

BOOKS On antiques and their prices. Free circular! P. Warman Publishers, Uniontown, Penna.

PARACHUTES, Pilot chutes, factory surplus—use to open larger equipment drop chutes, loads of uses and fun. \$1 each. BISC, Box 1023, Albuquerque, New Mexico.

"AMAZING New Book"—"Profits From Classified Advertising." Tells how and what to advertise. Be sure to read this book before you invest one cent in advertising. Write for your copy now. Just send 10¢ for postage and handling. F. W. Johnson, Classified Advertising Manager, 202-210 East Ontario Street, Chicago 11, Illinois.

MIRA-CLEAR, World's finest glass cleaner. Eliminates dirt, bugs, grime, grease in seconds. One vial \$1.95 makes 5 gals. cleaner. Mira-Clear Corporation, Box 26, Valparaiso, Indiana.

INSTANTLY Cure leaking faucets. 5 guaranteed brass seals \$1.00 refundable R&G Products, 80-78 164th Street, Jamaica 32, N. Y.

CIGARETTES—Make 20 plain or filter-tips for 9¢ Facts free. Moberly, Box 785, Owensboro, Kentucky.

YOUR Prosperity, pertaining Scripture verses sent free. Box 251, Venice, Calif. (Print your name-address)

YOU Are the power. I teach the formula for success in career, business, finances, life problems. Minimum fee, \$10. Author of "Seed Money," \$1. "Your Genie," \$1.50. John Hoshor, 507 Fifth Ave., N. Y. 17.

CESSPOOLS, Septic tanks, clogged drains cleaned, deodorized without pumping. Sursolvent reduces solids in cesspools, etc. Opens clogged drains and overflows. Reclaims systems to a condition approaching newness. Protect your family's health. Free descriptive literature. Electric Sewer Cleaning Co., Allston 34, Mass.

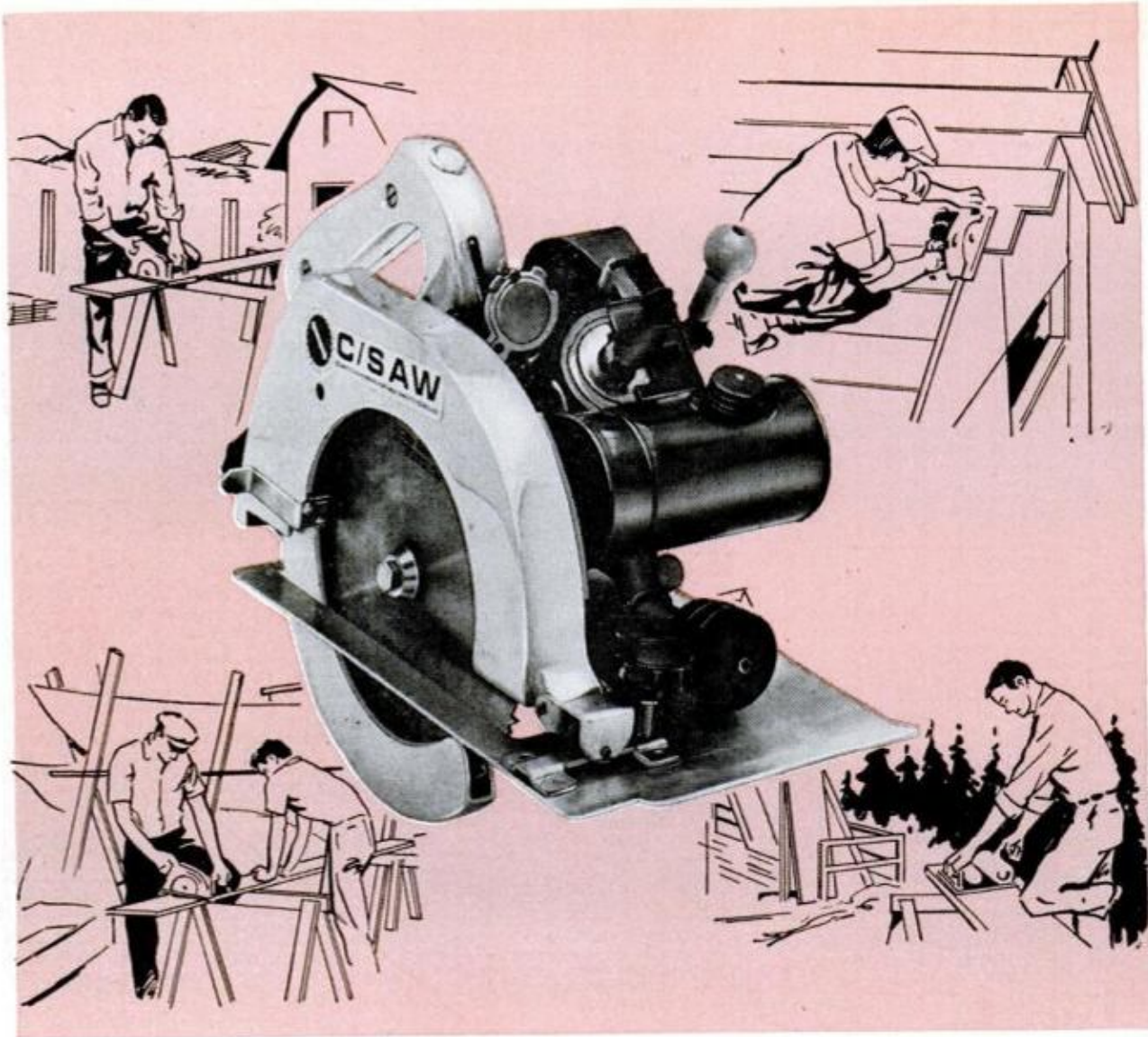

Forget About the Power Cord

COMES TO YOU NOW a portable saw that runs without the power cord dragging along the length of the stock, entangled in your legs or draped over your shoulder and always catching on something behind you. This unit is just about the size and heft of the electric portable saw you've been used to, but it's driven by a tiny, $\frac{3}{4}$ -hp. gasoline-powered engine that gives the same spitfire performance as a model airplane engine, only it's much, much more powerful.

What can you do with it? According to the manufacturers, Comet Manufacturing Div., of the Siegler Corp., P. O. Box 2098-D, Pasadena, Calif., it will handle any job that can be done with the old standbys, the portable electric saws. To a builder this means no waiting for a power line to be brought in to the building site. He takes his C/saw out of the case, pulls the starting cord and in seconds he's cutting lumber to dimensions. He can make 90-degree cuts to $2\frac{5}{8}$ in.; 45-degree cuts to $1\frac{7}{8}$ -in. depth with the

8-in. blade which is regular equipment.

To a farmer C/Saw is portable power sawing anywhere on the farm, miles from a high line, if the job to be done is that far from electricity. No need to bring the job to the saw; he takes the saw to the job, no matter where. C/Saw takes only a pint of fuel per hour.

C/Saw means much the same thing to a boat builder. He has no need to select the building site with a power source always in mind. Building boards, frames, planking and decking can be cut to size anywhere.

And then there's the fellow set on building his own cabin on some remote lake. With C/Saw in his pack he can be cutting joists, studs and rafters in minutes after the lumber is delivered to his clearing. C/Saw weighs only 11 lb.

What's the price of C/Saw? It sells for \$119.95 and for that money it's a lot of machinery in a very small package — no electric cord included, of course.

NEW CHEMICAL MIRACLE

TAKE-OFF

— REMOVES —

PAINT — LACQUER — VARNISH
EPOXIES — URETHANES
BAKED ENAMEL

FROM ANY
SURFACE

Spray On
Water Wash
NON
FLAMMABLE

AT
LEADING
HARDWARE • PAINT
& MARINE
DEALERS \$1.98



ALLIED AEROSOL • Bklyn N. Y.

Shop PM Ads for Exciting
Direct-Mail Offers

FREE GUIDE Reveals 200 Ways to Make Extra Money

YOU can turn your spare hours into cash (\$25 to \$100 a week) by selling products and services to friends and others. Famous *Salesman's Opportunity Magazine* shows you how. Contains hints, plans, hundreds of offers. No matter what your age, experience or occupation—write TODAY for next 5 issues—absolutely FREE. Send no money just name. OPPORTUNITY, 850 N. Dearborn, Dept. 330, Chicago 10, Ill.

NEED HELP WITH YOUR HOME?

Send for your copy
of our FREE FOLDER

TIPS FOR HOMEOWNERS

Loads of helpful suggestions and ideas on improving, repairing, and maintaining your home inside and out. Folder contains sources of further information to help you make your home look better and have greater value.

SERVICE BUREAU, POPULAR MECHANICS,
200 E. Ontario, Chicago 11, Illinois

Please send me my free copy of your TIPS for HOME-OWNERS folder.

Name.....

Street.....

City..... Zone... State.....

101 HOME & SHOP LIQUID TRANSFER USES!

Just Squeeze!
Pumps or Syphons
Gallons in Minutes!

NEW *Miracle* HAND PUMP



EMPTY CLOGGED DRAINS, sinks, appliances. Just squeeze ball for jet flow pumping action. *Miracle Hand Pump* is 6½' long. Tubing 9/16" O.D. Resists gasoline, alkali, acids. It's handy, rugged. American-made of finest virgin vinyls. (*Pat. No. 2,954,048)



IDEAL emergency gas pump for car. Use to fuel-up power mower from car. Avoids spilling. A must for dark rooms, do-it-yourself plumbers, mechanics! Solves liquid transfer problems for beauticians, chemists, printers, farmers. Use, too, to blow out clogged lines. GUARANTEED satisfaction or full refund within 30 days. Now available by mail order only.



\$3.49 per unit, postage prepaid.

Mail check or money-order today. No C.O.D.'s. Please print your name and address, specify quantity — and send to: Mate Research Lab (Dept. M)
P. O. Box 22610
Fort Lauderdale, Florida

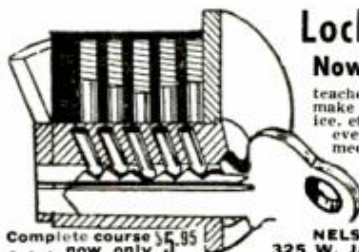

Locksmithing AND KEY MAKING

Now Made Easy! Practical up-to-date course

teaches you how to pick locks, de-code, make master keys, repair, install, service, etc. New self-instruction lessons for every handyman, homeowner, carpenter mechanic, service station operator, fix-it shop, hardware dealer, gunsmith, 53 easy illustrated lessons. Full price only \$5.96 postpaid; or C. O. D. plus postage. Satisfaction or refund guaranteed.

Complete course \$5.95
... now only \$3.95

NELSON-HALL CO., DEPT. JN-2
325 W. Jackson Blvd. Chicago 6, Ill.

Shrinks Hemorrhoids New Way Without Surgery Stops Itch — Relieves Pain

For the first time science has found a new healing substance with the astonishing ability to shrink hemorrhoids and to relieve pain — without surgery.

In case after case, while gently relieving pain, actual reduction (shrinkage) took place.

Most amazing of all — results were so thorough that sufferers made astonishing statements like "Piles have ceased to be a problem!"

The secret is a new healing substance (Bio-Dyne®)—discovery of a world-famous research institute.

This substance is now available in suppository or ointment form under the name *Preparation H*®. Ask for it at all drug counters.



Ferris Wheel—for Eggs

Poultry farmers have modernized everything but the hen in recent years, and this one, Clayton Hirniesen of Denver, Pa., has put his egg-gathering baskets in a six-basket ferris-wheel frame to speed egg pickups in his laying shed. Built of scrap metal and mounted on three industrial casters, the cart can be pushed with a waist-high yoke to leave his hands free. It rotates to keep an empty basket at hand.

Self-Cleaning Rake

Self-cleaning tines on this garden rake eliminate the need for periodic removal of debris by hand. The operator simply presses down and forward. This action "folds" and cleans the tines. Jerco Machine & Steel Co., 2020 N. Washington Ave., Minneapolis, Minn., it costs \$3.65.



No Discords Here

With an aluminum strip, plywood, a plastic cylinder and a broom handle, William Strong of New South Wales, Australia, devised the Strongo, an instrument for folks who have lost the use of their fingers. The strings are plucked with a special plectrum while a metal bar is drawn over the instrument's neck. Strong says it sounds like a guitar and that it is almost impossible to produce a discord on it.

Bicycle Power Attachment

With a 2½-horsepower do-it-yourself attachment, any bicycle can be motorized. The unit has one moving part—its clutch-pulley combination. Its friction drive eliminates the need for chains and sprockets. Manufactured by Go-Byk Industries of Rothsay, Minn., it costs \$69.95.



Thousand-Mile Road Test on America's First V6 Engine



How did it hold up? What kind of performance did it deliver? What was the fuel mileage? Read this exclusive report in the October
Popular Mechanics

START NOW-EARN TOP PAY!

Become a MASTER CRAFTSMAN—train in the LARGEST TRADE SCHOOL IN THE WORLD: AUTO MECHANICS TUNE-UP DIESEL BODY & FENDER AUTOMATIC TRANSMISSIONS WELDING REFRIGERATION AIR CONDITIONING MACHINIST TOOL & DIE DRAFTING FREE PLACEMENT SERVICE during and after training. CHECK COURSE INTEREST, TEAR OUT, AND MAIL TO BOX 1

GREER SHOP TRAINING
2236 S. Michigan Ave., Chicago 16, Ill.

Send for your free WHERE-TO-FIND-IT list giving sources of supply or further information on articles in this issue.



ACCORDIONS UP TO 1/2 OFF

Save up to 1/2 off retail prices of comparable accordions
5-DAY FREE TRIAL
Buy DIRECT from world's Largest Exclusive Dealer! Compare our Importer-to-You prices! See how you save! Over 30 models—finest genuine Italian makes! New, easier terms! 5-Day Free Home Playing Trial with satisfaction 100% assured. Bonus Gifts Free. Rush name and address for FREE Color Catalogs and direct Importer-to-You prices—FREE. Write TODAY!
Accordion Corporation of America
2003 W. Chicago Av., Dept. R-91, Chicago 22

BUILD, FLY YOUR OWN COPTER!



Easy to build, inexpensive, simple to fly. Order 3-view drawings, specs, photo of Glider \$1 or motor powered Gyrocopter \$2. Factory kits available.

BENSEN AIRCRAFT CORP., Dept. PM-91
Raleigh-Durham Airport, Raleigh, N. C.
NAME _____
ADDRESS _____

LEARN YOGA SECRETS



Gain better health, more reserve vitality and a sharper, keener mind. Use YOGA, the science of body and mind control.

NEW POWER for SUCCESS!

From the first lesson you'll see improvements in yourself. *Insight School's Course* is simple, stimulating, effective! Results are startling, immediate!

No fads, fests, diets, drugs. No expensive equipment to buy. All you do is study and practice a few minutes daily. YOGA training builds an enormous reservoir of will power and concentration... a new inner strength.

Prove it to yourself! Mail coupon for FREE trial Lesson I. Absolutely no obligation. No salesman will call. Just fill in and mail coupon TODAY!

**Start Your
All-Around
Improvement
TODAY!**

SEND COUPON

YOGA

INSIGHT SCHOOL Dept. A291, 845 Chicago Ave. Evanston, Ill.

Please send me YOGA Lesson No. 1 (No obligation.) I enclose 25c for handling and mailing costs.

Name.....

Address.....

City..... Zone..... State.....



DELIVERY • SERVICE

2-WAY RADIO

from \$13495

• Anyone can operate—
license issued on request!

Used by thousands of businessmen, salesmen, farmers, doctors, construction crews and sportsmen! Finest Citizens' Transceiver available—excellent range. Covers 23 channels. Maximum legal power—dozens of features—easy to install anywhere!



Delivery or servicing



Building or contracting



Boat-to-boat or ship-to-shore



Car-to-office or home



SEND FOR FREE COLOR BROCHURE!

Send full details on the "Messenger"

NAME _____

ADDRESS _____

CITY _____ STATE _____

VIKING
Messenger



E. F. JOHNSON CO.
1403 10 Av. SW, Waseca, Minn.



Italian-Styled TR-3 Rated at 118 M.P.H.

Combining a rugged TR-3 chassis and engine with plush body work by Italy's Michelotti, the Italia 2000 is designed for dependability plus smooth, good looks. The TR-3A mill puts out a maximum of 100 horsepower at 5000 r.p.m. and makers claim it has a top speed of 118 miles per hour. Among optional items are overdrive, leather upholstery, wire wheels and whitewalls

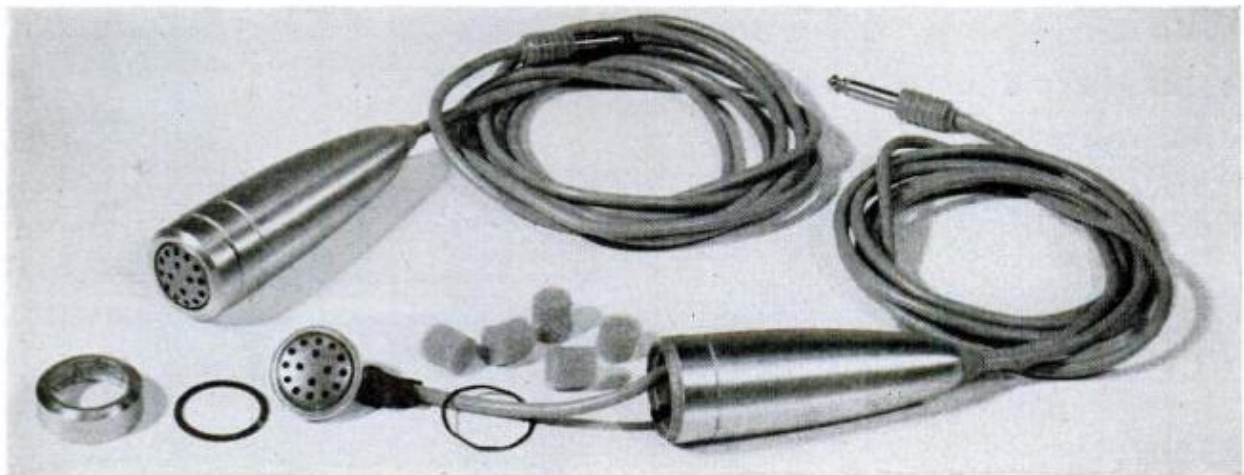

New Mike for Electronic Customizers

New microphone in kit form permits the builder to choose his own variables in frequency response. To increase bass response, eliminate the polyfoam bits and drill a small hole in the case. Small screw in hole will restore high response. \$7.50, CBS Electronics, Danvers, Mass.

Spring-Loaded Tools Have Safety Grips

Tools in a wide assortment of types feature plastic hand grips which not only provide added safety factor, but make working easier on the hands. Most types feature small spring between grips under the joint, to permit ease of opening. Diamond Tool Co., Duluth, Minn.

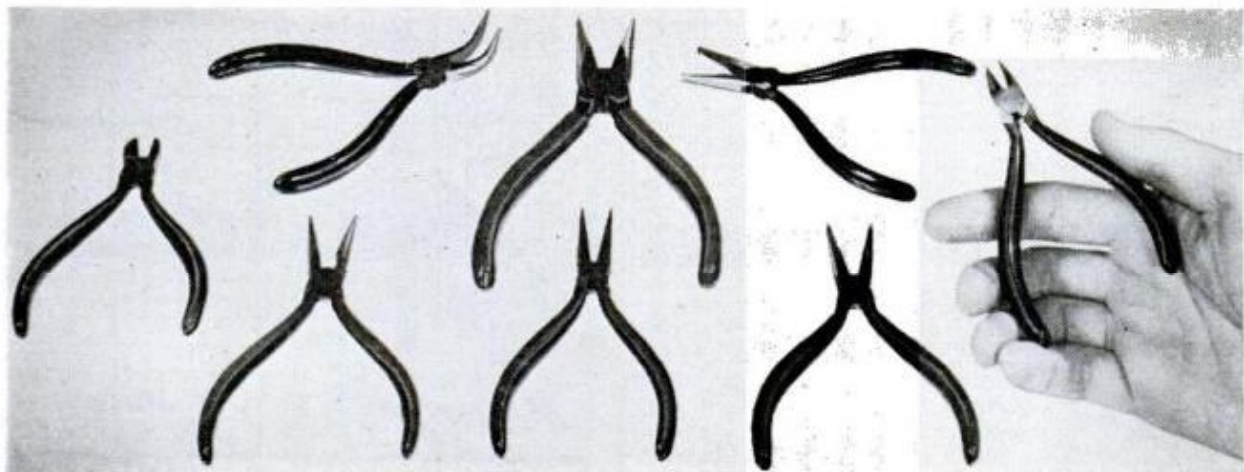

VISIT THESE POPULAR MECHANICS-RECOMMENDED HOME REMODELING AND MODERNIZATION HEADQUARTERS

NOW FOR YOUR FREE COPY
OF THE NEW PRODUCTS
HOUSE IDEA BOOKLET!



THESE STORES CAN PROVIDE YOU WITH COMPLETE COST AND PRODUCT
INFORMATION ON THE IDEAS YOU'VE SEEN IN THIS ISSUE.

ALABAMA

Jasper
North Alabama
Lumber Co.
Second Ave. and
22nd Street

ARIZONA

Phoenix
Ray Lumber Co.
4450 West Camelback Rd.

Tucson
Midway Lumber Inc.
4155 East Speedway Blvd.

ARKANSAS

Decatur
Bill Copeland Lumber
North Main St.

Eldorado
Eldorado Lumber Co.
700 South Washington St.

Fayetteville

Dyke Lumber Co.
309 St. Charles St.

Little Rock
J. C. Tucker & Sons
Floor Service
1113 Battery St.

Malvern

R. E. Norwood Lumber &
Supply Inc.
1105 West Moline

Star City

Builders Supply Co.

CALIFORNIA

Anaheim
Linbrook Hardware
2144 West Lincoln
Standard Brands
Paint Store

Anderson
Diamond National Corp.
2796 West Center St.

Arbuckle

Diamond National Corp.
99 W and Eddy St.

Atwater
Diamond National Corp.
Hiway 99 at Schaffer Rd.

Auburn

Diamond National Corp.
316 Lincoln Way

Azuma
Angels Supply
777 West Pothill

Bakersfield

Standard Brand
Paint Store

Biggs
Diamond National Corp.
California & Tehama

Buena Park

Buena Park Lumber Co.
6586 Beach

Burbank
Standard Brands
Paint Store

Chico

Diamond National Corp.
4th & Cherry Sts.
C. Meek Lumber Co.

Colusa
Diamond National Corp.
15 Fifth Street

Concord

Diamond National Corp.
Willow Pass
Extension Rd.

Corning
Diamond National Corp.
1102 South Street

Cotati

Diamond National Corp.
7740 Redwood Highway

Downey

All American
Home Center
8351 East Firestone
Imperial Home Supply
7908 East
Imperial Highway
Standard Brands
Paint Store
Woodruff Plywood
& Lumber
1212 Woodruff

Dunsmuir

Diamond National Corp.
104 South Highway

Esparto
Diamond National Corp.
Yolo Street

Fairfield

Diamond National Corp.
340 West Travis Road
Foster Lumber Co.

Fair Oaks
Diamond National Corp.
Fair Oaks Blvd.

Fresno

Diamond National Corp.
2244 Railroad Ave.
Standard Brands
Paint Store

Fullerton

Saveway Lumber Co.
204 South Eichman

Gait
Diamond National Corp.
164-4th Street

Grass Valley

Diamond National Corp.
205 East Main St.

Hanford
Diamond National Corp.
426 Lacey Street

Hawthorne

Standard Brands
Paint Store

Lakeport
Diamond National Corp.
175 South Main

Lakewood

Build 'N Save
4007 Paramount

La Mesa
Standard Brands
Paint Store

Lincoln

Diamond National Corp.
604 "G" Street

Live Oak
Diamond National Corp.
19th Street

Livermore

Diamond National Corp.
19 South "L" Street

Lodi
Diamond National Corp.
224 North Main St.

Long Beach

Standard Brands
Paint Store
Sun Lumber Co.
1532 West Anaheim

Los Angeles
The American
1240 South Broadway
Eagle Rock Lumber Co.
2214 Fairpark Ave.
(Eagle Rock)
Galleher Hardwood Co.
6430 Avalon
Hackers
1000 Broadway Place
Sam Slater Lumber
5850 West Washington
Standard Brands
Paint Store

Willis Cashway
Lumber Co.
4425 East Olympic

Los Molinos
Diamond National Corp.
Highway 99E

Manteca
Diamond National Corp.
151 South Main St.

Martinez

Diamond National Corp.
535 Escobar St.

Marysville
Diamond National Corp.
601-5th Street
Spekett Bulding
Supply, Inc.

Mill Valley

Goodman Lumber Co.
775 Redwood Highway

Modesto
Diamond National Corp.
McHenry &
Orangeburg Ave.
Plypack
1507 9th Street

Montclair

Standard Brands
Paint Store

Montebello
Willis Cashway
Lumber Co.
1919 Whittier Blvd.

Monterey

Bay Hardware
442 Alvorado St.

Oakdale
Diamond National Corp.
347 East H Street
Sierra Lumber Co.

Oakland

CBS Plywood Co.
24th & Cypress
Pacific Floor Supply
2791 Wood Street

Orange
Orange County Lumber
324 W. Chapman

Oroville

Diamond National Corp.
1630 Myers Street

Palo Alto
Kline Flooring & Supply
215 Demeter

Paradise

Diamond National Corp.
6308 Skyway

Paramount
Wenholz Lumber Co.
Compton & Garfield

Pasadena

Standard Brands
Paint Store

Petaluma
Diamond National Corp.
101 East Washington

Placerville

Diamond National Corp.
598 Main St.

Pt. Reyes Station
Diamond National Corp.
Highway 1 & B St.

Red Bluff

Diamond National Corp.
401 Sycamore St.

Redding
Diamond National Corp.
1155 Court St.
C. Meek Lumber Co.

Redondo Beach

Linoleum Oogies
813 Guadalupe

Redwood City
Progress Lumber Co.
2425 El Camino Real

Roseville
Diamond National Corp.
210 Tahoe Ave.

Sacramento
Barkwood Lumber Co.
4525 Arbor Blvd.
Diamond National Corp.
2826 "Q" St.
Joe Morse Lumber
& Plywood
6007 Folsom Blvd.
Richmond Floor
210 13th St.

Salinas

Alisal Paint &
Hardware Co.
108 Williams Road
Hamilton Paint &
Hardware Co.
11 Williams Road

San Bernardino
Gibson Lumber Co.
596 Waterman Ave.
Kaufmans Floor
Coverings
699 Third
Standard Brands
Paint Store

San Diego

Standard Brands
Paint Store

San Francisco
Goodman Lumber Co.
445 Bayshore

San Jose

American Plywood
500 Phelan Way
Wilmars, Inc.
1260 E. Santa Clara St.

San Leandro
CBS Plywood Co.
150th & E. 14th

San Rafael

Goodman Lumber Co.
269 Third St.

Santa Cruz
Santa Cruz Lumber Co.
235 River St.

Santa Monica

Fisher Lumber Co.
1601 14th St.
Standard Brands
Paint Store

Santa Rosa
Diamond National Corp.
375 Sebastopol Rd.

Seaside

Del Ray Plumbing
& Hardware
568 Charles Ave.

Sebastopol
Diamond National Corp.
6828 Depot Street

Selma

Citizens Lumber Co.
2135 McCall

Solana Beach
Lumber & Builders
Supply Co.

Stockton

Diamond National Corp.
848 West Fremont St.

Sutter
Frank Close & Son

Tahoe Valley

C. Meek Lumber Co.

Torrance
Standard Brands
Paint Store
4300 West 190th St.

Torrance

Standard Brands
Paint Store
4300 West 190th St.

Torrance

Standard Brands
Paint Store
4300 West 190th St.

Torrance

Standard Brands
Paint Store
4300 West 190th St.

Torrance

Standard Brands
Paint Store
4300 West 190th St.

Torrance

Standard Brands
Paint Store
4300 West 190th St.

Torrance

Standard Brands
Paint Store
4300 West 190th St.

Torrance

Standard Brands
Paint Store
4300 West 190th St.



Model Fuel Cell Drives a Motor

Chemical energy is turned into electrical energy by a model fuel cell that drives a motor and propeller.

Available in kit form, the fuel cell uses easily obtainable chemical ingredients, an electrolyte of potassium or sodium hydroxide, an alcohol fuel and hydrogen peroxide. Combined ingredients react with a catalyzed electrode surface to produce current. Made by Allis-Chalmers Mfg. Co., the kit costs \$9.75.

ANALYZE HANDWRITING

MORE INCOME... MORE PRESTIGE and Greater PERSONAL Success!

YOU CAN learn how to identify character and personality traits from ordinary handwriting. Fascinating home-study training. Many career opportunities for both men and women, full or spare-time. Just send your name, address for a FREE sample lesson and big illustrated catalog Free. No salesman will bother you. (State age).

INTERNATIONAL GRAPHO ANALYSIS SOCIETY, INC.
325 W. Jackson Blvd., Dept. JN-2, Chicago 6, Ill.



YOU NEED MOTION

Protects by displacing moisture, sealing surfaces with complete molecular film that lubricates, stops rust! Frees "frozen" parts. Stops squeaks in hinges, locks, all moving parts. Protects electrical gear and motors, instruments, tools. FREE extension spray tip. 2 oz. Aerosol can at dealers or postpaid \$1 (Jobbers, Dealers, WANTED!)

PRODUCT RESEARCH & DEVELOPMENT CORP.
DEPT. PM, BLUE BELL, PENNA.



More New Product Information Centers:

- Turlock**
Diamond National Corp.
301 West Olive St.
- Ukiah**
Diamond National Corp.
235 East Perkins St.
- Vacaville**
Diamond National Corp.
918 Callen St.
- Vallejo**
Poster Lumber Co.
- Van Nuys**
Standard Brands
Paint Store
- Walnut Creek**
Diamond National Corp.
1701 Locust St.
- Whittier**
Glick Brothers
Lumber Co.
13555 Telegraph
Sackett & Peters
15020 East Whittier Blvd.
- Williams**
Diamond National
Sixth Street
- Winters**
Diamond National
7 East Edwards St.
- Woodland**
Diamond National Corp.
East & Main Streets
- Yuba City**
C. Meeks Lumber Co.
- COLORADO**
- Arvada**
American Lumber Co.
5920 Lamar
- Denver**
R. E. Spencer Lumber Co.
4000 York St.
- Sterling**
Broadway Lumber Co.
101 Broadway
Sterling Lumber Co.
412 Main St.
- CONNECTICUT**
- Darien**
Rings End Fuel Co.
- Hamden**
Centerville Lumber Inc.
2308 Whitney Ave.
- Manchester**
W. G. Glenney Co.
336 North Main St.
- West Hartford**
M. A. Peterson, Inc.
607A New Park Ave.
- FLORIDA**
- Clearwater**
Floor Master's, Inc.
103 North Greenwood Ave.
- Cocoa**
Home Builders
Supply, Inc.
3 Miles South on U.S. 1
- Fort Lauderdale**
Causeway Lumber Co.
2627 South Andrews Ave.
- Hallandale**
Bunny's Millwork
and Supply
520 South Dixie Highway
- Jacksonville**
Home Builders
Supply, Inc.
150 South Edgewood Ave.
- Lakeland**
Home Builders
Supply, Inc.
1508 Highway 92 West
- Leesburg**
Home Builders
Supply, Inc.
Highway 27 North
- Miami**
Rowell Southern
Flooring Co.
2723 N.W. 17th Ave.
- Orlando**
Home Builders
Supply, Inc.
63 West Amelia
- St. Petersburg**
Home Builders
Supply, Inc.
2491 22nd Ave., N.
- Sarasota**
Home Builders
Supply, Inc.
325 School Ave.
- GEORGIA**
- Cordele**
Cordele Sash, Door &
Lumber Co.
- Thomaston**
Frank Binford Supply Co.
North Center St.
- ILLINOIS**
- Bloomington**
Baumgart Lumber &
Coal Co.
1001 W. Market St.
- Cambridge**
Clifford & Clifford
Lumber and Building
Materials
- Caseyville**
Steck Lumber Co.
10505 Lincoln Trail
(Route 50)
- Chicago**
Gee Lumber and
Hardware
2600 West 79th St.
- Danville**
Vermillion Lumber Co.
615 North Jackson St.
- Dixon**
North Side Lumber Co.
725 North Galena Ave.
- East Moline**
East Moline Lumber Store
1301 13th Street
- Effingham**
Effingham Builders
Supply Co.
South Second and
National Sts.
- Fairbury**
Steffen & Son
Lumber Co., Inc.
309-315 East Locust St.
- Garden Plain**
Brinkman and Pessman
Lumber Co.
- Glen Ellyn**
M. C. Stephens
Lumber Co.
462 Park Blvd.
- Harrisburg**
Barnes Lumber Co.
318 West Lincoln St.
- Joliet**
I. N. R. Beatty Lumber Co.
North Broadway
and Chaney
- Kankakee**
H. H. Troup and Co.
111 E. Oak St.
- Kings**
White Rock Elevator
Lumber Co.
910 Seventeenth St.
- Lincoln**
Mitchell-Newhouse
Lumber Co.
910 Seventeenth St.
- Litchfield**
Litchfield Lumber Co.
- Marseilles**
I. N. R. Beatty
Lumber Co.
322 Main Street
- Mattoon**
Construction
Materials Co.
312 South 21st St.
- Mendota**
Mendota Farmers
Co-op Supply Co.
- Milledgeville**
Litwiler Lumber &
Grain Co.
- Moline**
Moline Building Center
4101 23rd Ave.
- Morris**
I. N. R. Beatty
Lumber Co.
824 Liberty St.
- Oak Lawn**
I. N. R. Beatty
Lumber Co.
9537 South 52nd Ave.
- Orland Park**
I. N. R. Beatty
Lumber Co.
9730 West 143 St.
- Peoria**
Carver Lumber Co.
603 East War
Memorial Drive
Carver Lumber Co.
205 North Western Ave.
- Pontiac**
I. N. R. Beatty
Lumber Co.
703 East Howard St.
- Port Byron**
Brinkman & Pessman
Lumber Co.
- Quincy**
Middendorf's
Incorporated
Third and Delaware
- Ridgway**
Ridgway Lumber Co.
- Rock Island**
Rock Island Lumber Co.
2701 Fifth Avenue

More New Product Information Centers:

Round Lake
 Trio Lumber Co.
 340 West Railroad Ave.

St. Charles
 St. Charles Lumber &
 Fuel Co.
 123 South First St.

Tinley Park
 I. N. R. Beatty
 Lumber Co.
 6721 North Street

Tuscola
 F. H. Jones Lumber Co.
 100 North Parke

Ursa
 Middendorf and Son
 Building Materials

Walnut
 Gonigam Bass Hill Inc.

West Salem
 Southern Illinois
 Lumber Co.

Wilmington
 I. N. R. Beatty
 Lumber Co.
 Kankakee Street

IDAHO

Blackfoot
 Rockford Lumber
 and Hardware
 Route 2

Idaho Falls
 Bonneville Lumber Co.
 170 North Yellowstone
 John J. Poltevin
 Lumber Co.
 525 West Thirteenth St.

INDIANA

Angola
 Daniel Shank
 Lumber Co., Inc.
 609 West Maumee St.

Berne
 Gilliom Lumber Co., Inc.
 518 East Main

Bremen
 Bremen Lumber &
 Coal Co.
 401 North Marshall St.

Columbus
 Wendel's, Inc.
 1416 Sycamore St.

Connersville
 Connersville Lumber Co.
 121-129 West Sixth St

Decatur
 Arnold Lumber Co., Inc.
 425 Winchester St.

East Chicago
 Indiana Harbor Lumber
 & Coal Co., Inc.
 3440 Watling St.

Elwood
 Home Lumber Company
 of Elwood, Inc.
 1911 South B St.

Evansville
 Grimm Lumber, Inc.
 1009 E. Virginia St.

Fort Wayne
 South Side Lumber Co.
 4928 South Hanna St.

Frankfort
 Kramer Brothers
 Lumber Co.
 608 West Washington St.

Franklin
 Central L. & M Supply
 Co., Inc.

Gary
 Tri State Supply
 219 Virginia St.

Huntington
 Home Lumber Co.
 317 East State St.

La Porte
 Moore & Richter
 Lumber Co.
 607 Jackson St.
 Wilson Lumber, Inc.
 Washington &
 Madison Sts.

Morgantown
 Stockton Co., Inc.
 Building Supplies

Richmond
 Richmond Lumber
 Co., Inc.
 Northwest Second & E St.

St. John
 Standard Lumber Co. of
 St. John, Inc.
 Route 41

Salem
 Curtis Miller
 West Market St.
 at Bridge

Seymour
 Central Lumber & Supply
 Co., Inc.
 Eighth & Pershing St.

Valparaiso
 Smith-Nuppau
 Company
 360 Indiana Ave.

Whiteland
 Home Fair, Inc.

IOWA

Algona
 Kelley Lumber Co.
 821 North Main

Davenport
 White Lumber Store
 909 East River Drive

Hawarden
 Schoeneman Bros. Co.
 901 Ave. E

KANSAS

Arkansas City
 Woods Lumber Co.

Bern
 Bern Lumber Co.

Kansas City
 Logan Moore Lumber Co.
 47th & Mission Rd.
 Midwest Floors
 4660 Parallel Lane
 Roddis Lumber &
 Veneer Co.
 1016 Southwest Blvd.

La Harpe
 Diebolt Lumber
 and Supply

Newton
 Houston-Doughty
 Lumber Co.
 200 East Sixth

Waterville
 Waterville Lumber &
 Coal Co.

Wichita
 Houston Doughty Lumber
 Co. Big Six Yard
 6601 East Kellogg
 Rock Island
 Lumber Company
 302 South Emporia Ave.

KENTUCKY

Louisville
 Roy B. Thompson
 Lumber Co.
 3200 Preston
 T. W. Yunt Lumber Co.
 2915 Preston

LOUISIANA

New Orleans
 Simon Streiffer Co.
 Home Supply Center
 2026 Metairie Road

MASSACHUSETTS

Chicopee
 J. G. Roy Lumber Co.
 861 Meadow St.

Fall River
 Schwartz Lumber
 664 Broadway

MICHIGAN

Auburn Heights
 Grace Harbor Lumber Co.
 70 South Squirrel Road

Charlevoix
 Kit Carson Lumber Co.

Detroit
 Eastern Cabinet Works
 6615 E. Jefferson

Escanaba
 Stegaths
 1812-20 Ludington St.

Galesburg
 Taylor Lumber Co., Inc.
 89 East Battle Creek St.

Gladstone
 Sterling Building
 Supplies
 1122 Delta Ave.

Iron River
 Proksch Lumber Co.
 132 Third St.

L'Anse
 Lake View Lumber &
 Hardware Co.

Owosso
 Sturtevant & Blood
 Lumber Co.
 301 South
 Washington St.

Wyandotte
 Williamson Lumber Co.
 657 Vinewood

MINNESOTA

Maple Plain
 Lundsten Lumber Co.

Montrose
 Lundsten Lumber Co.
 (Continued to page 84)

BROWNING®
9mm HI-POWER AUTOMATIC

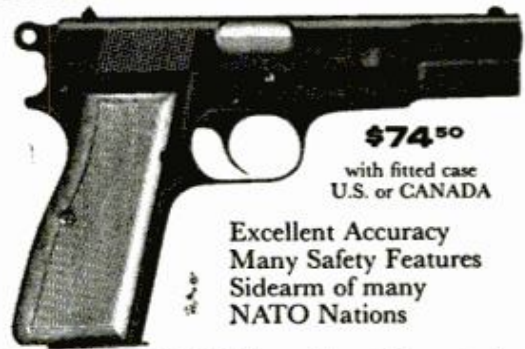

\$74.50
 with fitted case
 U.S. or CANADA

Excellent Accuracy
 Many Safety Features
 Sidearm of many
 NATO Nations

GREATER FIRE POWER — 14 cartridge capacity against 6 in center-fire revolvers and the usual 7 to 9 in other semi-automatics. Rugged, dependable, compact and richly hand-polished and finished. So safely designed the severest blow on the hammer cannot cause accidental discharge. Weight — 2 lbs., over-all length — 7¾", ammunition — 9mm Parabellum or Luger.

Handsome Renaissance presentation model — Hand-engraved, pearl grips, gold plated trigger



Prices subject to change without notice

WRITE
 FOR
 CATALOG

SEE YOUR BROWNING DEALER

Browning Arms, Dept. P1, St. Louis 3, Mo.
 — in CANADA, Dept. P1, Box 991, Montreal 9, P. Q.

YOU need
BALANCED RIDE CONTROL

for your car



Balanced Ride Control is the big motoring benefit you receive when you equip your car or truck with Air Lift Adjustable Air Springs. They are the only sure way to keep your car level at all times, regardless of road or load conditions.

Cornering is improved, side-sway greatly reduced, **A LEVEL CAR IS A SAFE CAR.**

Air Lift Adjustable Air Springs are unexcelled if you carry heavy loads or haul a trailer—just add a little AIR and you're on your way in 10 seconds with a LEVEL . . . SAFE car.

Air Lift Air Springs save money, too, by improving tire wear . . . keeping wheels in alignment and reducing vibration.

Available at leading garages and service stations or write to:



AIR LIFT COMPANY

LANSING 2, MICHIGAN

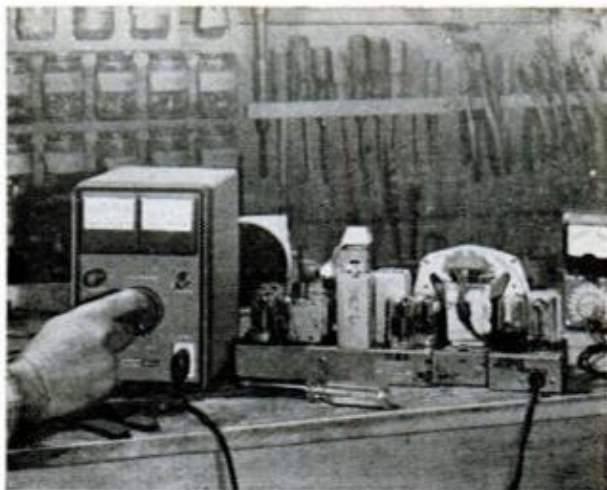

Variable Power Supply In Economy-Kit Form

This compact piece of test equipment provides continuously variable a.c. at the test bench. Two meters provide monitoring of current to three amperes, voltage from zero to 140 volts. Both sides of line are fused for added safety. Balky radios frequently respond to cure-or-kill treatment. Plug radio into variable supply, run primary voltage up to 140. Leaky or marginal components will burn open, are then easy to identify. EICO, Long Island City, N. Y.

THE ORIGINAL PACKAGED

KITS

World's Largest Line—New Fiberglass Hulls. Over 200 styles Boats—Kits, Formed-Hulls, Semi & Custom finished. All types: Prams, Cruisers, Racers, Inboards, Outboards. Easy to build. Professional results. Dealers—Agents Inquire. **Send 35¢ for Colored Catalog** 52 pg. Kit Catalog plus 20 pg. Hardware and 8 pg. Armor Glass books. (SPECIAL OFFER) Colored CATALOG plus "Boating Handbook"...all for \$1.



BOAT PLANS PATTERNS FRAME PACS

Over 400 Plans—Patterns, Frame Pak Kits, Prams, Kayaks, Racers, Runabouts, Catamarans, Cruisers—In-Outboards (6 to 40) Wood, Plywood and Steel. **Send 35¢ for 120 pg. Plan Catalog.** Catalog plus "Boat Building Handbook"... Send \$1.00.

CUSTOM • CRAFT

Buffalo 7L, N. Y.

MONEY in WORMS

Sell 20,000 fishworms per week @ \$4 per 1000 from a bed 3 feet wide and 8 feet long. We teach you how to raise and where to sell fishworms and crickets. Write for free literature. **CARTER WORM RANCH, PLAINS, GEORGIA**

Read our success story in LIFE MAGAZINE, December 25, 1959 Issue



The Modern PLASTIC for lasting Home Repairs

PERMANENTLY mends cracks or holes in wood, tile, stone or plaster. Sticks and stays put—Does not chip, shrink or fall out. Easy to use. Economical. Mold it, chisel it, polish or paint it. The big 4-lb. can is obtainable from your lumber, paint or hardware dealer at \$1.40; or will be shipped direct postpaid (in U. S.) for \$1.75. Complete satisfaction guaranteed or your money refunded.

DONALD DURHAM CO.
Box 805-T Des Moines, Iowa

More New Product Information Centers:

- MISSISSIPPI**
Belzoni Y-D Lumber Co., Inc.
Jackson Trenton Lumber Co. 321 East Pearl St.
Yazoo City Gilbert Lumber & Supply Co. North Main and Canal Sts.
- MISSOURI**
Burlington Junction B. J. Lumber Co.
Kansas City Marzoff Hardwood Floors, Inc. 1617 West 39th
St. Genevieve Ste. Genevieve Lumber & Realty Co.
St. Louis Sloan-Seidel 2239 South Vandeventer
Slater Sailor Lumber Co. 164 West Front St.
- MONTANA**
Lewistown Montana Lumber & Hardware Co. 403 First Ave. South
Missoula Wright Lumber Co.
- NEBRASKA**
Brady Farmers Lumber & Coal Co.
Elwood Elwood Lumber Co.
Grand Island Johnson Cashway Lumber Co. 716 South Elm
Lincoln Johnson Cashway Lumber Co. 1820 R St.
Pauley Lumber Co. 945 South 27th St.
Millard Millard Lumber & Grain Co. 305 South Fifth
North Platte Field-Birge Co. 101 West Front St.
Oakland Holmquist Grain & Lumber Company
Ogallala S. E. Martin Lumber Co. East Highway 30
Plainview Great Plains Supply Co.
- NEW JERSEY**
Belford Bay City Lumber Co. 230 Main St.
Denville Metalcraft Center Route 46
Fanwood Fanwood Lumber & Supply Co. 246 South Ave.
Flemington L. Tereshko Lumber Co., Inc.
Lake Hopatcong Jefferson Lumber
Madison Unkel Plywood & Lumber Co., Inc. 313 Main St.
Neptune Channel Lumber Co. Standard Supply Co., Inc. Rt. 33 at Garden State Parkway
Neshanic Station J. S. Amerman & Co.
Newark Channel Lumber Co.
Parlin Channel Lumber Co.
Secaucus U. S. Timber Lumbermart 143 County Ave.
Springfield Channel Lumber Co.
Wayne Circle Building
- NEW MEXICO**
Albuquerque Seymour Lumber Co. 3101 Fourth St., N.W.
- Artesia City Builders Supply, Inc. 1801 West Main
Hobbs Hobbs Lumber & Supply Co., Inc. 706 West Marland
Moriarity Moriarity Trading Co.
- NEW YORK**
Baldwinsville Tappan Lumber Corp. East Genesee St.
Batavia Genesee Lumber & Coal Co. 76 Franklin St.
Brooklyn Fox Lumber Co. Windsor Lumber Co.
Buffalo Frontier Lumber Co. 1941 Elmwood Ave. Frontier Lumber Co. 1670 Genesee St.
Coldwater Coldwater Lumber Co. 149 Cherry Road at NYC
Depew 6161 Transit Road
Fairport Dudley Lumber Co., Inc. 23 South Main St.
Flushing Sugar Lumber Co.
Hamburg Draudt Bros. Lumber-teria, Inc.
Haverstraw Allison & VerValen Co., Inc. 9 W & Westside Ave.
Jamaica Sutphin Builders
Leroy Joseph Lapp Lumber Co. 43 Mill St.
Long Island Macrose Lumber Co.
Mottydale Sposata Linoleum Co. Brewerston Road
North Syracuse Beauty Craft Floors, Inc. 456 South Main St.
North Tanawanda Esco Lumber Co. Main & Thompson Sts.
Rochester Atlantic Millwork, Inc. 2715 West Henrietta Road
Genesee Reserve Supply Co.
Giordano Lumber Co., Inc. 200 Clifford Ave.
Fred R. Large Lumber Co. 36 Harrison St.
Mathews & Fields Lumber Co. 120 Stonewood Ave.
Spencerport Spencerport Lumber Co. 36 Slayton Ave.
Syracuse E. W. Edwards Co. South Salina St. Minfelt Wholesale Co. 1850 Lemoyne Ave.
Watertown Minfelt Wholesale, Inc. 434 Eastern Blvd.
Webster Webster Lumber Co. 799 Holt Road
Williamson Williamson Lumber Co. 9 Railroad Ave.
- NORTH CAROLINA**
Canton Powell Lumber Co. 30 Clyde St.
Carrboro Fitch Lumber Co., Inc. Chapel Hill
Fitch Lumber Co., Inc.
Charlotte Cathey Lumber Co. 4115 Monroe Road
Dunn Nu-Home Wholesale Builders Supply 1212 North Ellis Ave.
Gastonia Seth Lumber Co.
Greensboro New Home Building Supply Co. 625 South Mendenhall St.
(Continued to page 86)



Hand-Powered Dry Shaver

Taking its power from a spring-loaded key which is depressed with the thumb, a dry shaver from West Germany features gyroscope drive. Power is transmitted through a lever and clutch to accelerate a flywheel. The shaver operates at a speed of 10,000 revolutions per minute and will run for one minute after the key is depressed a few times. It is available for \$14.95 from Hertvy Co., Box 57, Rego Park 74, N. Y.

Magnetic Wave Guides in Space May Aid Radio Communication

It may be possible to beam high-frequency radio waves from Northern to Southern Hemispheres through naturally existing magnetic channels that carry the radio waves at almost full strength. Prof. Henry Booker, director of the school of electrical engineering at Cornell University, Ithaca, N. Y., has been investigating the possibility of such a system under a grant from the National Science Foundation. He concludes that it is feasible. Basis for such a system lies in the fact that earth's magnetic field controls the motions of the outer atmosphere so as to filament the plasma into millions of magneto-ionic ducts. These wave guides extend from the ionosphere in the Northern Hemisphere to the ionosphere of the Southern Hemisphere via the part of space known as the magnetosphere. The ducts may well be more than 10,000 miles in length, says Professor Booker, who suggests these channels will permit scientific investigations of outer space with a detail hitherto unavailable to scientists.

SEPTEMBER 1961



TAKE IT OFF - PUT IT ON PAINT TOOLS

A. HYDElectric Paint Remover — \$12.95. B. KWIK SKRAPE Window Scraper — \$.98. C. Best Quality Putty Knives and Wall Scrapers. D. Paint and Wood Scrapers with double edge steel blades, all sizes. E. Double Header Putty Knife Tool to apply putty. F. Heavy Duty Paint Removing Scraper. G. Hyde Spray Painter sprays all paints right from manufacturer's quart can. Fastens to exhaust outlet of canister or tank-type vacuum cleaners — \$12.95. H. Complete, Low Pressure Spray System in steel carrying case with Hyde Spray Painter, HYDElectric Air Blower — \$73.40. Buy Hyde Tools in hardware, paint, building supply and lumber yard stores. Write Department "C" for Free Pocket Catalog and How-To Book.

HYDE TOOLS

Southbridge, Mass.



Although only 3" in diameter this internal expanding centrifugal clutch will transmit up to 7 hp. easily. Built to stand hard use, it contains heavy duty oven bonded friction linings, flanged drum to maintain concentricity, precision calibrated springs for control of engagement speeds, and comes to fit any size shaft. The Comet clutch is used on more racing karts than any other, as well as lawn mowers, pumps, compressors and other power equipment. When ordering give shaft diameter and engagement speed desired. See your dealer for further information or write to

COMET INDUSTRIES,
842 ELM PLACE, RICHMOND, IND.

85



Foldaway Automobile Desk

Salesmen can fill out call reports immediately after making each call, using a traveling desk which folds out of the way when not in use.

The pressed-wood unit includes a clip to hold papers in place and pockets in the vinyl back to carry cigarettes, sunglasses, maps and other small items.

The accessory is made by the Car-Jot Co., Box 144, Deerfield, Ill., and sells for \$6.95.

Save! You must be satisfied with **JOHNSON SUPER ADHESIVE** or double-your-money-back!

Send \$1.98 PPD.

JOHNSON SUPER ADHESIVE
TOUGH AS A BULLDOG

Joins where other materials fail to make bond. Bonds any and all materials. Joins, insulates, seals, fills; can be drilled, tapped, sanded. In simple-to-use tubes—useful as any tool in your kit. You'll save its cost many times over! Secret formula, tested for years, results guaranteed. Send check or money order to:

JOHNSON LABORATORIES, 907 W. Madison, HASTINGS, MICH.

8-in-1 SWIVEL SOCKET WRENCH
Chrome vanadium steel, 7/16 to 7/8 and metric sizes. GUARANTEED! Only \$3.95 Postpaid. Send check or M.O. to:

METALWARE
Box 148 • Fairfield, Conn.

SAVE MONEY...EARN MONEY
with the **METL-FORMER**

ROLLS • FORMS • BENDS

Make screen door guards, wall hangings, plant shelves, room dividers... anything you want in light wrought metal and with a truly professional appearance. Form rod, tubing or flat metal.

\$34.95 PREPAID including material

Write for information and free project folder.

SWAYNE, ROBINSON & CO.
Dept., A, 228 E. MAIN ST., RICHMOND, IND.

More New Product Information Centers:

- Kingston**
Grady's Building Supply & Hardware, Inc.
512-514 East Vernon Ave.
- Lincolnton**
Cronland Warp Roll Co., Inc.
Building Material Department
Seth Lumber Co., Inc.
- Mt. Holly**
Seth Builders Supply Co., Inc.
- Rose Hill**
Herring Supply Co.
304 South Sycamore St.
- Thomasville**
Reed Supply Co.
100 National Highway
- OHIO**
- Akron**
Brown-Graves Lumber Co.
191 East Miller Ave.
- Canton**
The DeVille Lumber Co.
1225 Gross Ave., N. E.
- Cleveland**
Rock Island Lumber Co.
14550 Lorain Ave.
Weiler-Wilhelm Lumber Co.
1087 West 11th St.
- Coshocton**
Muskingum Valley Lumber Co.
1247 East Main St.
- Maumee**
Maumee Lumber & Supply Co.
707-717 Conant St.
- North Olmsted**
North Olmsted Lumber Co.
27375 Lorraine Road
- Warren**
McAllister & Morgan, Inc.
5400 Oakhill Drive, N.W.
- OKLAHOMA**
- Anadarko**
Antrim Lumber Co.
207 East Main
- Boise City**
The Star Lumber Co.
South Cimarron Ave.
- Chickasha**
Stone Lumber Co.
320 South Third St.
- Oklahoma City**
Caston Lumber Co.
4416 North Western
Temple-Johnson Floor Co.
1211 North Pennsylvania
- Ponca City**
Rock Island Lumber Co.
208 South First Street
- Stillwater**
Grimsley Flooring Co.
200 North Main
Roy T. Hoke Lumber Co.
218 West Ninth St.
Kermit W. Ingham Lumber Co.
7 West Eighth
- Tulsa**
Dale Carter's Building Center
4459 South Sheridan Road
Hanna Lumber Co.
Plywood Tulsa, Inc.
4205 Southwest Blvd.
- Watonga**
Davidson & Case Lumber Co.
- OREGON**
- Albany**
Brad's Floor Covering
Edwards Albany Planing Mill
- Astoria**
Brookfield Co.
- Baker**
Builders Supply Co.
- Gresham**
Gresham Linoleum Co.
- Medford**
Big Pines Lumber Co.
32 West Sixth
- Milwaukie**
Casey's Linoleum
- Portland**
Acme Hardwood Floors
1708 S.E. 122nd Ave.
J.W. Copeland Yards
Don Town, U.S.A.
8950 S.E. McLoughlin Blvd.
House of Linoleum
3739 S.E. Hawthorne
- Linoleum Looe**
2815 S.W. Barbur Blvd.
Mt. Hood Supply Co.
8300 S.E. Division
Spear Floor Covering
1201 S.W. Jefferson
Stewart Griffith Co.
Strom Floors
10320 N.E. Halsey
Sunset Floors
6913 S.E. Foster
Westside Floor Covering
2432 N.E. 26th Ave.
- Prineville**
Healy's Prineville Furniture Co.
- Rhododendrum**
Mt. Hood Linoleum
- The Dalles**
The Dalles Linoleum Co.
- PENNSYLVANIA**
- Bellafonte**
M. L. Claster & Son, Inc.
- Blairsville**
Andre Lumber & Supply Co.
164 Davis Way
- Cochran**
Crum Brothers Lumber Co.
152 South Franklin St.
- Greensburg**
Cook Lumber Co.
249 West Otterman St.
- Saint Clair**
Integrity Building Supply, Inc.
59 North Second St.
- St. Marys**
Elk Building Materials, Inc.
Trout Run Road
- Sharon**
Johnson-Sizer Co.
369 South Dock St.
- Union City**
Mullens' Coal & Supply
5 Market St.
- SOUTH CAROLINA**
- Gaffney**
Gaffney Lumber Co.
North Johnson St.
- Lake City**
F. H. Sullivan & Co.
- SOUTH DAKOTA**
- Sioux Falls**
Schoenemans Home Improvement Center
305 East Eighth St.
- TENNESSEE**
- Memphis**
Hill Flooring Co.
110 Neil St.
- TEXAS**
- Amarillo**
Lumber & Supply Co.
2601 East Third
Witt Builders Supply
2306 West Seventh
- Borger**
Knight Lumber Co.
306 North Weatherly
- Bridge City**
Fields Lumber Company
355 West Round Bunch Road
- Clarksville**
Allen Lumber Co.
Temple Lumber Co.
201 South Walnut
- Dallas**
Don Cameron Lumber Co., Inc.
711 South Ewing
Trinity Floor Co.
127 Oregon
- El Paso**
Peterson Lumber Company
1630 Texas Ave.
- Freeport**
Haynes Lumber Company
304 North Gulf Blvd.
Simmons Building Supply Co.
Fourth Street at Park Ave.
- Houston**
Gateway Lumber Co.
6801 Telephone Road
Maynor Lumber Co.
6316 Mykawa Road
Roddis Lumber & Veneer Co.
2403 Sabine St.

More New Product Information Centers:

Laredo
Laredo Lumber & Supply Co.
220 Market Street

Mercedes
Farris Lumber & Supply Co.
202 Second Street

Orange
Temple Lumber Co.
1111 Park Ave.
West End Lumber Co.
Mac Arthur Drive

Port Arthur
Wyde Lumber Corp.
1205 Ft. Worth Ave.
Wyde Lumber Corp.
3333 25th St.

Richmond
Wessendorff Lumber Co.
109 North 8th St.

San Antonio
Billbrey Lumber Co.
2030 Pleasanton Rd.
Roddis Lumber & Veneer Co.
727 North Cherry St.

San Marcos
Tuttle Lumber Co.

Texarkana
Alamo Supply & Lumber Co.
727 West Third Street

UTAH

Orem
Central Builders Supply Inc.
673 North State

VIRGINIA

Ashland
Ashland Lumber Co., Inc.
Ashcake Road

Virginia Beach
Bill Macdonald's Virginia Beach Lumber and Supply Co.
Birdneck Road

WASHINGTON

Kennewick
Diamond National
P. O. Box 457

Newport
Diamond National

Spokane
Diamond National

Vancouver
Art Pugsley Floor Covering

WEST VIRGINIA

Charleston
Wright-Bachman Lumber Co.
701 West Washington St.

WISCONSIN

Athens
Braun Brothers & Co.

Beaver Dam
Luken Lumber Company
Roedl-Jacobs Lumber Co.
114 East Third Street

Boulder Junction
Ashtons

Eden
Community Lumber & Supply, Inc.

Gillett
Gillett Building Supply Co.

Green Bay
Green Bay Planing Mill
Willow and Elizabeth

Hudson
Consolidated Lumber Co.
701 Second Street

Kenosha
Andrews Lumber Co., Inc.
4800 75th Street

Madison
Findorff Lumber & Supply
601 West Wilson Street

Marathon
Menzner Lumber & Supply Co.

Niagara
J. H. Zawada Supply & Lumber Co.
1009 Main Street

Sister Bay
Berns Brothers Lumber Co.

South Milwaukee
Bliffert Lumber & Fuel Co.
6826 South 13th Street

Sturgeon Bay
Berns Brothers Lumber Co.

Wabeno
Twin City Lumber & Fuel Co.

Wales
Allen Lumber & Fuel
124 South Main

Wausau
City Lumber & Supply Co.
710 South Tenth Ave.
Mortenson & Stone Lumber Co.
First Avenue North at Bridge Street

West Allis
Wilbur Lumber Co.
7919 West National Ave.

West De Pere
Rupiper Lumber Co.
315 South Sixth St.

Wisconsin Dells
Dells Lumber Co., Inc.
931 Michigan Ave.

Wisconsin Rapids
Peters Lumber, Inc.
Kellner Yard
Route #1

WYOMING

Basin
Thompson Lumber and Hardware Co.

Casper
Casper Lumber Inc.
404 East Railroad

Rawlins
H. Larsen Inc.
218 West Cedar

Sheridan
Vickere Lumber Company
135 North Gould

CANADA

BRITISH COLUMBIA

New Westminster
Valley Lumber Yards Limited

ONTARIO

London
Copp Builders Supply Co., Ltd.
York Street at Ridout

IF THERE IS NO DEALER IN YOUR AREA, CONTACT YOUR NEAREST JOBBER, LISTED BELOW, FOR INFORMATION ON THE NEW PRODUCTS . . . PLUS A FREE COPY OF THE FULL-COLOR IDEA BOOKLET.

ALABAMA

Montgomery
H. L. Booth Company
1119 Bell Street

ARKANSAS

Little Rock
Arkansas Foundry Company
1423 East Sixth Street

ARIZONA

Tucson
Hardware and Metal Specialties
3840 E. 37th Street

CALIFORNIA

Bakersfield
Griffin Steel & Supply Company
625 Williams Street

LOS ANGELES
Ducommun Metals & Supply Company
4890 South Alameda St.

Oakland
Welsh & Bresee Co.
311 — 2nd Street

San Bernardino
Ford Wholesale Company
271 South "Z" Street

San Francisco
Northern California Hardware & Steel Co.
209 Mississippi Street

Santa Clara
Panal Plastics and Aluminum Inc.
750 Walsh Avenue
(Continued to page 88)

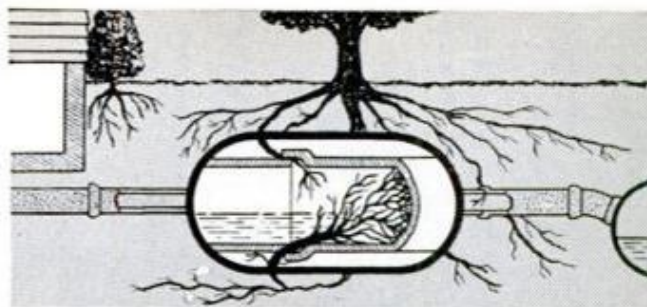

END SEWER-LINE ROOT MESS, SAVE ON COSTLY REPAIRS!

Roots are just naturally thirsty. They force their way through joints in your sewer line, eventually clog it. Toilets and sinks "back up", soon overflow. Now you can avoid costly digging or mechanical cleaning this easy, permanent way.



Pour one box of revolutionary Hercules R-D into toilet bowl. R-D kills and decomposes roots permanently, often overnight. To keep sewer lines root free, apply R-D twice a year. Safe to handle. Safe in septic tanks. Don't wait for trouble. Get R-D now from your plumbing or hardware dealer. It works, or your money back. Only \$3.95 for 2 lb. box. Send for literature.

HERCULES CHEMICAL CO., INC.
416 Broadway, New York 13, N.Y.



Bigger than ever..
better than ever

FREE ELECTRONICS CATALOGS for 1 full year

from Radio Shack
Boom-center of Electronics

Mail coupon! See the greatest line of electronics for "pro," amateur, music lover! Receive 1961-62 Buying Guide of 336 pages, 2/3 larger than last year, PLUS exciting supplements for 1 full year! Hundreds of famous brands and our private label Stereo, Hi-Fi, Ham Radio, Tapes, Records, Parts, 30 pgs. of Kits. New No Money Down credit terms. Satisfaction guaranteed.

RADIO SHACK CORP.
730 Commonwealth Ave., Boston, Mass.

MAIL
Coupon
TODAY

RADIO SHACK Corp. Dept. 61J3
730 Commonwealth Ave., Boston 17, Mass.
Send me Radio Shack's famous electronics catalogs for 1 full year—FREE, POSTPAID.

Name _____
Address _____
City _____ Zone _____ State _____

TAPE-SEAL®

STOPS LEAKS
in pipe, tube, hose joints

Use it on — household plumbing, out-board motors, power mowers, garden hose connections, hydraulic lines, refrigerators, sump pumps, heaters, oil lines, dehumidifiers . . . hundreds of other uses.

It's fast, neat . . . no sticky mess. Just wrap Tape-Seal around joint, tear off, that's all! Tape-Seal never hardens . . . lubricates as it seals. Prevents thread binding even on stainless or plastic. Unaffected by high temperature, gasoline, oil, acids, etc.

Get new home "handy-pack" at leading hardware stores or write Friesland Plastics Co., Friesland, Wisconsin.



Only
39¢
full 32"
(When writing add 6¢ for handling.)

F-12



CUT HEAT BILLS UP TO 37%

If your attic insulation is less than 4" thick, up to 37% of your fuel dollars are being wasted every year. The easiest, most inexpensive way to bring your attic insulation up to the 4" level is with Zonolite Attic Insulation.



Pour Zonolite right over your present insulation. It's fire-proof. Verminproof. Permanent. Won't rot or pack. At your lumber and building supply dealer.

FREE! NEW ILLUSTRATED BOOKLET SHOWS
14 WAYS TO CUT HEATING COSTS. WRITE:

ZONOLITE

ZONOLITE COMPANY • DEPT. PM-91
135 S. LASALLE ST. • CHICAGO 3, ILLINOIS

More New Product Information Centers:

- Van Nuys**
Glesby Building Materials Co.
14421 Aetna St.
- COLORADO**
Denver
Barter Machinery & Supply Co.
230 South Santa Fe Drive
- FLORIDA**
Jacksonville
Carolina Lumber Co.
575 Phelps St.
- Tampa**
Eagle Roofing & Art Metals Works
Florida Steel Buildings
- GEORGIA**
Atlanta
Carolina Lumber & Supply Co.
2135 Plaster Bridge Road
- ILLINOIS**
Elgin
George W. Hitzeman & Son
42 Kimball Street
- Peoria**
Lumber Yard Supply Co., Inc.
105 Hancock St.
- Springfield**
Springfield Builders Supply Corp.
1900 E. Mason St.
- INDIANA**
Evansville
Lensing Wholesale, Inc.
600 North Sixth Ave.
- IOWA**
Early
Iowa Lumber & Supply Company
- Dubuque**
Service Wholesale Company
540 East 9th Street
- Waterloo**
The Wood Products Company
127 Utica Street
- West Des Moines**
Wheeler Lumber Bridge & Supply Company
110 Hoak Drive
- KENTUCKY**
Russellville
Bilt-Rite Products
- LOUISIANA**
New Orleans
Metal Building Products Co., Inc.
- Shreveport**
Ideal Building Materials, Inc.
1730 Claiborne Avenue
- MAINE**
Lewiston
De-Lar, Inc.
35 Willow Street
- MARYLAND**
Baltimore
Central Building Supply, Inc.
210 E. Monument Street
- MASSACHUSETTS**
Cambridge
Sondik & Co. of Mass., Inc.
733 Concord Avenue
- Springfield**
Valley Wholesale Building Products Company
232 Albany Street
- West Springfield**
Eastern States Farmers Exchange, Inc.
26 Central Street
- Worcester**
General Building Products Co. of Mass.
112 Grove Street
- MICHIGAN**
Livonia
Lightmetals Construction Products Company
27805 Schoolcraft Road
- MINNESOTA**
St. Paul
Farwell Ozmun Kirk & Company
Reserve Supply Company
2570 Ellis Avenue
- MISSOURI**
Joplin
C. Clark Supply
321 W. 13th Street
- NEW HAMPSHIRE**
Nashua
Edgcomb Steel of New England, Inc.
West Hollis Street
- NEW JERSEY**
Newark
Bayonne Steel Products Company
258 Jelliff Avenue
- NEW YORK**
Depew
Duo-Temp Corporation
786 Terrace Blvd.
Eric County
- Ithaca**
Co-operative G.L.F. Exchange, Inc.
- Richmond Hill**
Long Island Tinsmith Supply Corporation
111-112 Jamaica Avenue
- NORTH CAROLINA**
Albemarle
Lowder Hardware Company
- Greensboro**
Hodgin Roofing & Supply Company
923 West Lee Street
- North Wilkesboro**
Buchan Supply Company
- OHIO**
Alliance
United Co-Operatives, Inc.
111 Glamorgan Street
- Cincinnati**
Oldfield Equipment Company
430 West Seymour Ave.
- Columbus**
Farm Bureau Co-Operative Assoc., Inc.
245 North High Street
- Dayton**
Aluminum Materials, Inc.
2663 Dixie Avenue
- Toledo**
Oneida Supply Company
728 George Street
- OREGON**
Portland
Lumber Products Company
2116 N.W. 20th Street
Pacific Metal Company
303 N.W. Park Avenue
- PENNSYLVANIA**
Bethlehem
Bethlehem Aluminum Inc.
920 Cherokee Street
- Philadelphia**
Aluminum Supply Corporation
967-973 N. Ninth Street
Counties Supply Company
2nd & Berks Streets
- Pittsburgh**
Williams and Company, Inc.
910 Pennsylvania Avenue
- Scranton**
Albert Nivert Steel and Aluminum Co.
551 Front Street
- Verona**
Stirling Lumber Company, Inc.
10 Allegheny River Blvd.
- York**
Union Roofing & Paper Co., Inc.
2200 Monroe Street
- RHODE ISLAND**
Providence
Kenney Products Company

More New Product Information Centers:

TENNESSEE

Knoxville
C. M. McClung & Co.,
Inc.
501 West Jackson Avenue

TEXAS

Dallas
Dallas Iron Works, Inc.
6025 Denton Drive
Lubbock
Forrest Lumber Company

VIRGINIA

Alexandria
Metal Distributors of
Alexandria, Inc.
Calvert Avenue
Norfolk
Metal Distributors of
Norfolk, Inc.
2602 Hampton Boulevard

Richmond

Southern States Co-Oper-
ative
627 E. Main Street

WASHINGTON

Seattle
Berkheimer's, Inc.
701 Northlake Way

WISCONSIN

Milwaukee
Wisconsin Bridge & Iron
Company
5023 North 35th Street
Waterloo
The John C. Cooley
Company
268 S. Jackson Street

FREE AMAZING NEW BOOK
"HOW TO ANSWER ADS"



Never before have you seen anything like this. Tells you in simple language the correct way to answer ads. Gets you quicker replies—better results, and greater satisfaction. Will save you time and money and it's ABSOLUTELY FREE. No obligation whatever. Every reader of advertising should have this booklet. Send a postcard for your copy NOW. F. W. JOHNSON, Popular Mechanics Magazine, Room 600-A, 204 East Ontario Street, Chicago 11, Ill.



Everything But the Wings

Years ago an Air Force mechanic bought a 1941 Chevrolet sedan for \$25 and began installing different pieces of aircraft equipment in it.

Today, the car has four aircraft seats, each equipped with shoulder harness and seat belts; a control stick which works the throttle and can be used for steering; and a battery of 33 aircraft instruments which even includes an airspeed indicator.

Builder and owner of the machine is A1C John R. Collins, an engine mechanic at Tinker AFB, Okla.

RIGHT CHOKE
MEANS
MORE GAME

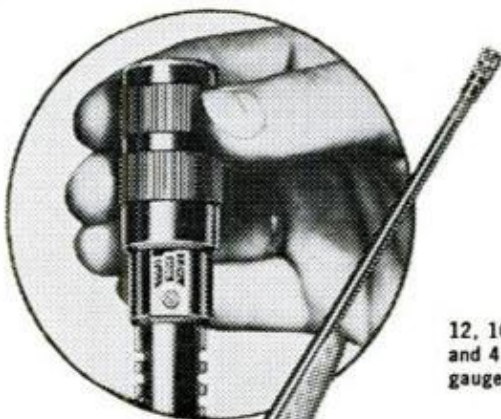

12, 16, 20
and 410
gauges

"K" Models
from
\$39.95

C-LECT-CHOKE

Standard on all Mossberg "K" Model 3-shot shotguns—this finest, finger-operated choke. A typical Mossberg value. Settings are positive and clearly visible.

For FREE catalog—address O. F. Mossberg & Sons, Inc., 19709 St. John St., New Haven 5, Conn.



75 POWER TELESCOPE \$3.98
25X-45X-75X

NEW 3 in one telescopes, 3 variable 25X-45X-75X magnification. Brass bound, 25 power for ultra bright images 45 & 75 power for long range. Guaranteed to bring distant stars, moons, objects, sports 75 times closer.

Most powerful scope sold anywhere near this amazing low price. American made, 5 sections. Opens 36", closes 1 ft.; contains 4 ground & polished lenses. Can also be used as powerful compound microscope. Mass production enables us to offer telescope complete at \$3.98 postpaid. Money back guarantee. CRITERION CO., Dept. PMB-97, 331 Church St., Hartford, Conn.

GUNK® removes grease like no detergent can!



Cleans power mowers, engines, garage floors, kitchen walls, ovens, exhaust ducts, paint brushes, furnace filters, bar-b-q grills, machinery! At auto supply, farm, or hardware stores!

GUNK CHICAGO CO., River Forest, Ill. serving the Midwest and Southwest
RADIATOR SPECIALTY CO., Charlotte, N.C. serving the East, Southeast and far West

SHOPPING FOR TOOLS

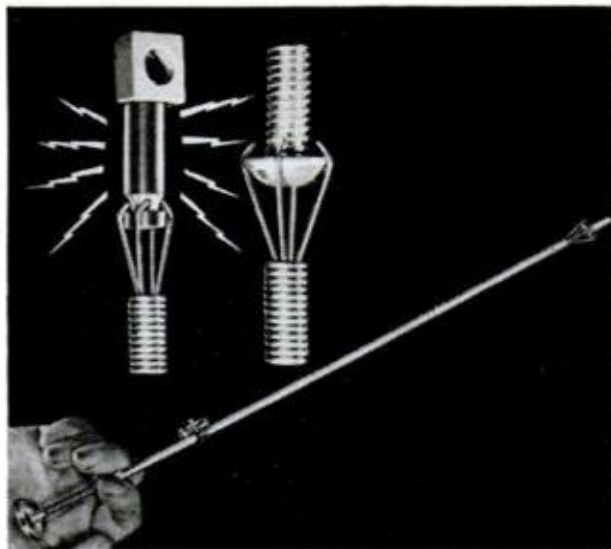
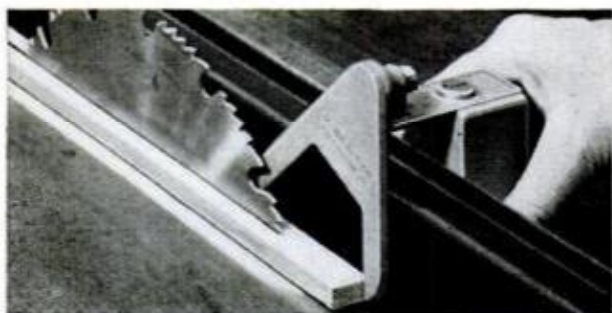
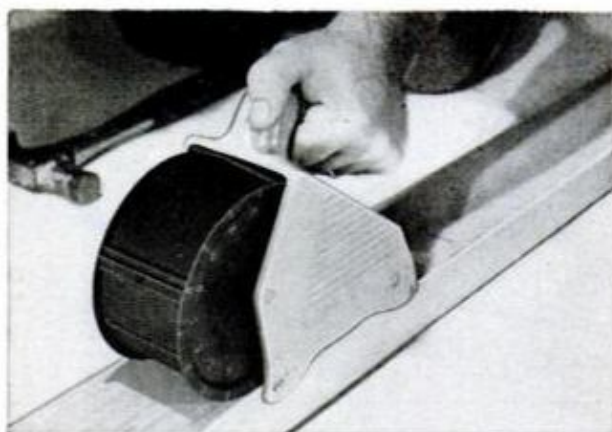

PAD SANDER, above left, with housing and plate of plastic, sands with the grain in a straight-line action. The reciprocating motor operates at 14,400 short strokes per minute. A removable knob adapts sander for right or left-hand operation and gives free access to corners. The rubber bearings reduce lubrication problems. It's priced at \$19.95 by the Weller Electric Corp., 601 Stone's Crossing, Easton, Pa.

RETRIEVER, above, is used to pick up articles such as small tools, screws and nails dropped in hard-to-get-at places. A retracting plunger closes four steel claws around object to be retrieved. A permanent magnet is included with kit. It may be seized in mechanical fingers and used to pick up metal objects. Retail at \$2.95. Available from Borroughs Tool & Equipment Corp., 2429 Burdick St., Kalamazoo, Mich.

HOLE SAW, above left, is adjustable for cutting holes from 1½ to 2½ in. Saw is designed for use in a portable drill with a ¼-in. chuck. Hole size may be adjusted rapidly by simply rotating the plate until blades are at desired diameter and then tightening lock nut. An extra set of blades for cutting metal are included with the drill. Made by Zoron, Inc., 612 W. Monroe St., Chicago, Ill.

LAYOUT MARKING TOOL automatically prints 8, 12, 16 and 24-in. spacings for studs or other modular building materials. The tool eliminates the time-consuming job of laying out stud positions by hand. Markings show equally well on steel or concrete. Tool will print cross marks as fast as it is rolled along work surface. Body is aluminum. Price \$19.95. Pearson Products, 127 Kipling St., Elyria, Ohio

SAFETY PUSHER makes it possible for an operator to keep his hands at a safe distance from the blade of the table saw while ripping narrow strips. Made of aluminum, the pusher adjusts to most thicknesses of lumber, doing the work of both push stick and hold-down. Besides being safer, pusher helps to assure cutting accuracy. Guide retails at \$3.98. Alson Mfg. Co., 937 N. Evans St., Pottstown, Pa.

THE '61 FORD

beautifully built to be more service-free...inside and out!

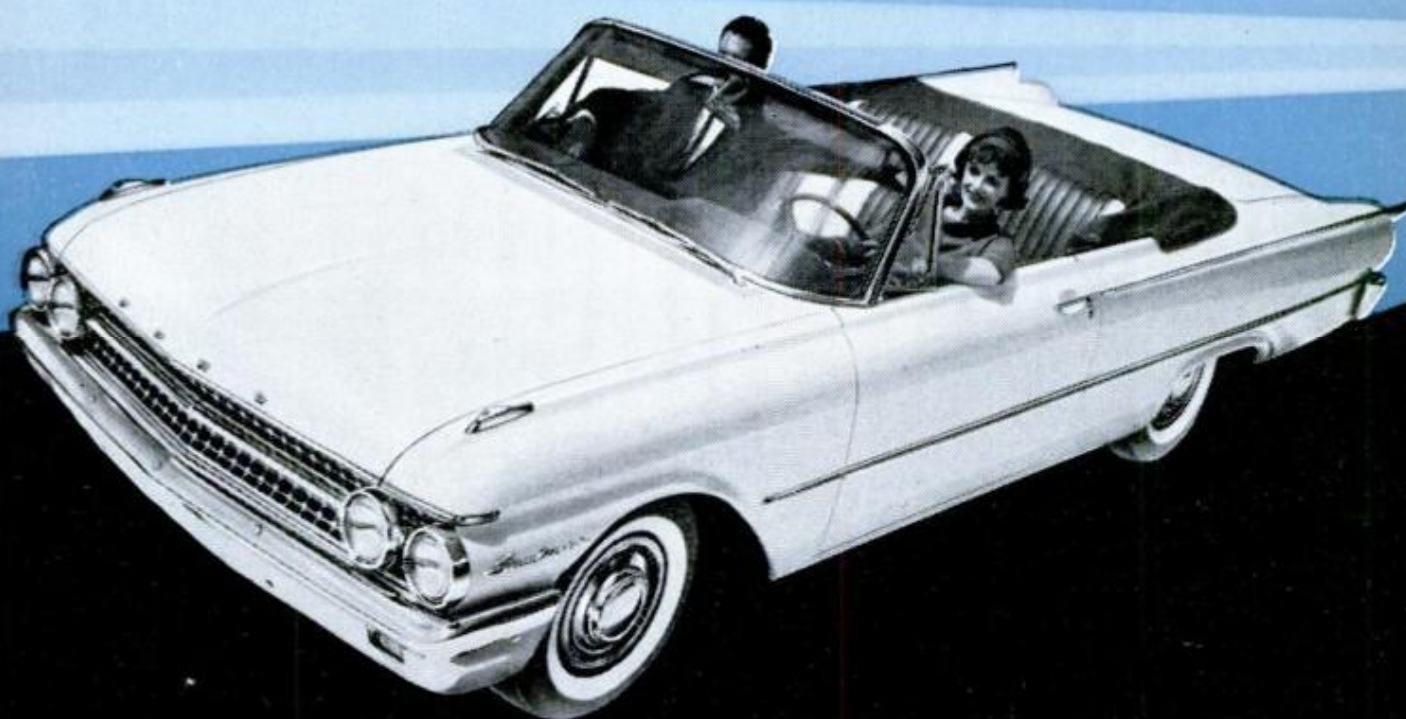

■ **Bold, imaginative engineering produces many new minimum-service features for the Ford Fine Car Family.**

Inside and out, the Ford Family of Fine Cars is designed to require less servicing than ever, with fewer oil changes, less frequent chassis lubrication, self-adjusting brakes and triple-life mufflers.

And inside each engine, too, Ford adheres to traditional high standards of quality by specifying Perfect Circle piston rings for original equipment use. Falcon, Comet, Ford, Mercury, Thunderbird and Lincoln Continental engines utilize the performance advantages of PC ring sets, custom-engineered to each engine's specific requirements.



PERFECT CIRCLE *The Rings the "Pros" Prefer!*

PISTON RINGS • PRECISION CASTINGS • SPEEDOSTAT • ELECTRONIC PROGRAMING EQUIPMENT
Hagerstown, Indiana Don Mills, Ontario, Canada



RESEARCH MAKES THE DIFFERENCE*

SONY®



NEW STEREO TAPE DECK

Now, for less than the cost of a good record changer, you can add a versatile new dimension to your hi fi system. ■ The Sony 262-D tape deck has a 4 track stereo erase head and 4 track stereo record/playback head. Heads are wired to six output and input facilities for connection of external electronics to play and record four track stereo. This is the same quality mechanism used in the most expensive Sony Superscope tape recorders.

\$89⁵⁰

NOW AVAILABLE!

Complete your 262-D stereo system: the long-awaited Sony SRA-2 stereo recording amplifier provides instant connection to the Sony 262-D stereo tape deck for complete 4-track stereophonic and monophonic recording. Two V.U. meters, track selector switch, record safety interlock, microphone and radio inputs. No modifications necessary. \$89.50.

■ For literature or nearest dealer, write: Superscope, Inc., Dept. 9, Sun Valley, Calif.

*TM

SUPERSCOPE

Tapeway to Stereo



First-Aid Kit on Visor

Always within easy reach for emergency use, a new first-aid kit mounts on the visor of any car or truck. Contained in the plastic package are an assortment of bandages, antiseptic and burn compounds. The kit is a product of Medical Supply Co., 1027 West State St., Rockford, Ill.

Chemical Prevents Tooth Decay

Tooth decay can be prevented and early decay healed by a chemical that rehardens tooth enamel, according to test-tube experiments conducted by biochemists at the University of Alabama Medical Center.

Researchers softened some 300 teeth in an acetate buffer solution, then exposed them to rehardening chemicals such as secondary calcium phosphate dihydrate and synthetic hydroxyapatite. The former returned teeth to original hardness in eight days; the latter took four hours.

Once rehardened, the teeth resisted softening solutions more vigorously than they had previously, said Drs. Theodore Koulourides, Heriberto Cueto and Ward Pigman.

Why a good tune-up includes Spark Plugs

Some people do engine "tune-ups" and never look at the spark plugs; others service or replace spark plugs, and that's all. Either of these operations can give a temporary lift to engine performance—but it's only temporary, you can be sure. A good tune-up *starts* with spark plugs, then checks all the things that affect their operation—compression, battery, coil,

distributor, timing and carburetor. In a good tune-up, the prime concern is the proper functioning of the spark plugs, for only when spark plugs are right and everything that works with them is right, is your engine conditioned for long-lasting top performance. So, for the very best results, make sure your spark plugs are checked when your engine is tuned.

Why the best tune-up includes AC Fire-Ring Spark Plugs

Your engine will perform better—longer—if the tune-up it gets includes new AC Fire-Ring Spark Plugs. AC Fire-Rings have a host of superior performance and reliability features. ACs give you the exclusive Hot Tip that provides self-cleaning action as you drive. ACs are built with heat-bonded internal seals and pressure-

formed external seals for positive prevention of gas leakage, overheating and pre-ignition. ACs have exclusive Buttress Top insulator for greater strength and better wet-weather firing. In every area, ACs offer the most advanced design. For the best tune-up, make sure your spark plugs are ACs.

AC SPARK PLUG  THE ELECTRONICS DIVISION OF GENERAL MOTORS



BUILT BEST FOR EVERYTHING YOU OWN THAT RUNS ON GASOLINE

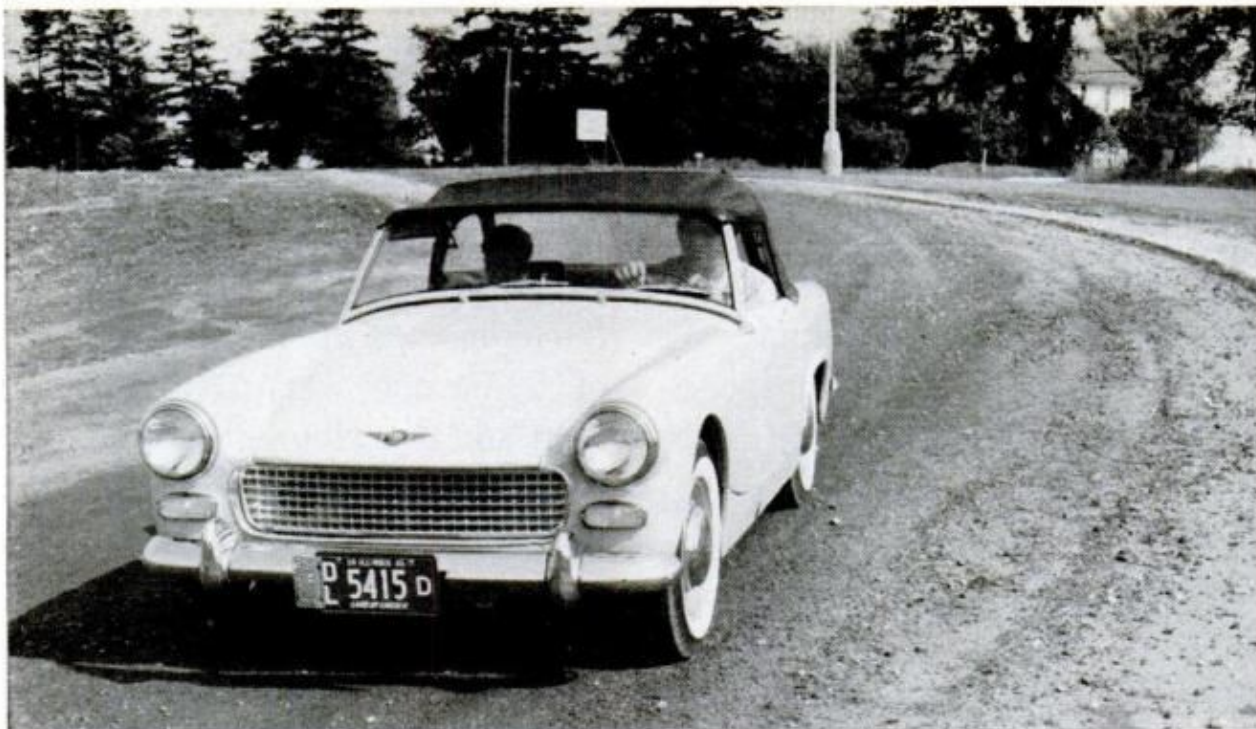

RESTYLED FRONT END (no more frog eyes) and added horses under the hood make new Sprite a prize to own



Spotlight on the New Mark II **SPRITE**

By *Jim Whipple*

WHEN British Motors Corporation first launched their Sprite three years ago, nobody believed that a bona fide sports car could be manufactured, shipped to the U.S. and sold for under \$1800. At that time (1958), Triumphs and MG's delivered for around \$2500 and all the other true sports cars commanded lots more money.

But, after five minutes at the wheel the skeptics became enthusiasts and the Sprite established itself as Junior-Grade version of the big Austin Healey six-cylinder "3000" Sports car.

In its original version the Sprite handled beautifully, but its 45 horsepower made it something less than a real competitor in stock form.

However, its potential was a real challenge to the sports-car racing crowd, especially the limited-budget boys. They reasoned that if it handled that well at 70 it might do just as well at 95. They felt if they could lay on more power for go and more brakes for stop, they might well have a promising class H winner. (That's 750 to 1000 cubic centimeters displacement, or 45 to 60 cubic inches.)

Before too long highly-modified Sprites

were turning up class victories just about everywhere this side of the Iron Curtain, and the Sprite won at such big international events as the Sebring (Florida) Grand Prix and THE big race at Le Mans, France.

Of course the racers had such things as beefed-up brakes and clutches, racing wheels and tires, stiffer shocks, and engines modified with higher compression ratios, bigger carbs and manifolds, "hot" valve timing, tuned exhausts and high-speed ignition systems.

Yet, basically, these racing Sprites were the same cars that were buzzing around suburban streets in the U.S.

However, even as they drove their new Sprites happily out of showrooms, thousands of owners had ideas for improvements. Most owners wished for: more power, better luggage space, a more usable interior and, perhaps most fervently, improved styling.

Owners could struggle with the murky, lidless, unlined luggage "compartment" that, in effect, was the entire rear end of the car aft of the folding bucket seats. They

(Continued to page 96)

STADRI

The YEAR 'ROUND
OUTDOOR BOOT

100% WATERPROOF
WELDED SOLE

At better dealers;
write for catalog!

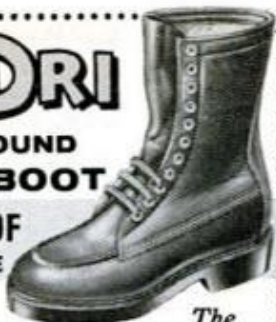

The
Standard of Quality

STA DRI BOOT CO.

SUBSIDIARY



DAISY MANUFACTURING COMPANY
Dept. P-91, Rogers, Arkansas, U.S.A.
75 YEARS OF QUALITY PRODUCTS!

EMERSON ELECTRIC

PORTABLE WELDER High Capacity ... Low Price

Ideal for farm, home workshop. Cuts, brazes, solders, welds. One man can carry... only 68 lbs. 6 welding heats up to 180 amps... $\frac{3}{32}$ " to $\frac{3}{16}$ " rod sizes. Write today for prices and receive **FREE WELDING SELECTOR GUIDE**... gives working data you need in seconds!



DEPT. W-6

EMERSON ELECTRIC of St. Louis
8100 Florissant • St. Louis 36, Mo.

Look for This New FIX-IT-CENTER in Your Favorite Store

See Actual Demonstrations of These
Fine Products in Use:

- Thriftee-Fix
- Pal Liquid Rubber
- Thriftee Liquid Wood
- Thriftee Steel
- Nifty Fabric Mender
- Thriftee Kalk

... AND BUY THEM TODAY!

INDIANA LABORATORIES, ELKHART, IND.



BEST

rol-O-valve TOILET TANK BALL

THE ONLY ACTION THAT COUNTS!

A vinyl plastic device **GUARANTEED** to
**STOP TOILET TANK
LEAKS!**

- Seats in different position each time.
- No tools required.
- Self threading.
- Acid resistant.
- 5 yr. guaranty.

It's new—it's different—it works.
AT YOUR HARDWARE STORE
or postpaid anywhere in the
U.S. for \$1.00.

ROL-O-VALVE—Dept. PM
Box 197—Americus, Georgia

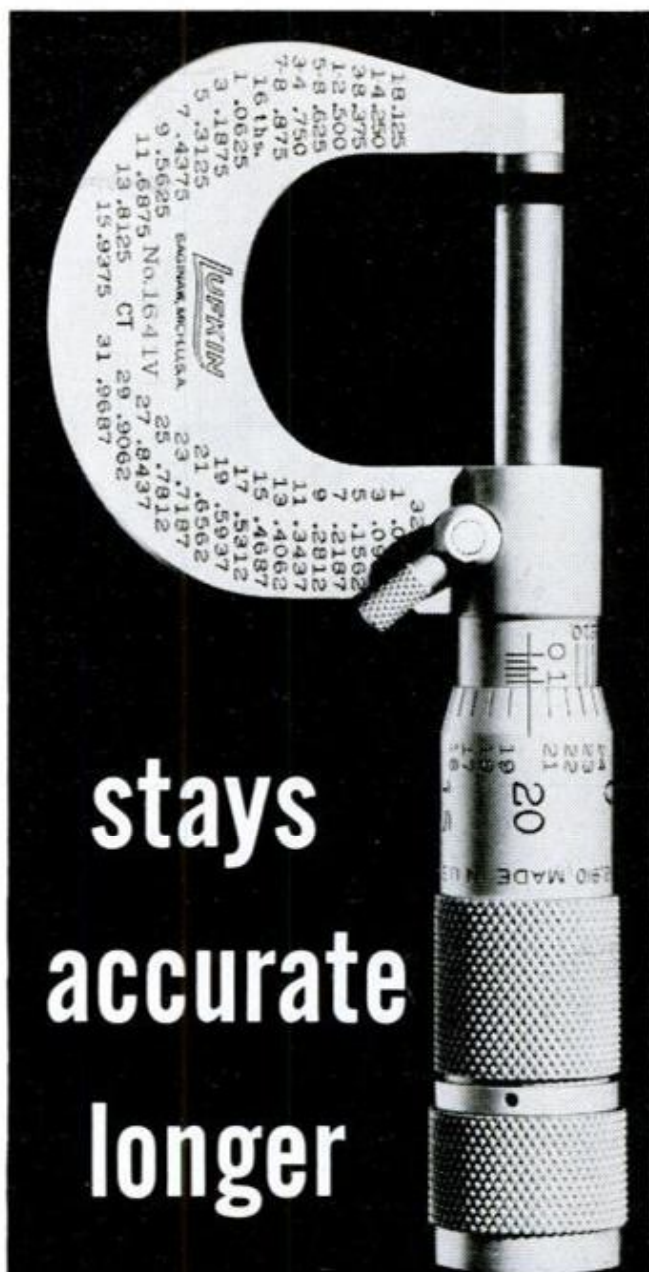

stays accurate longer

A LUFKIN EXCLUSIVE: 5 to 7 fewer parts than other micrometers... less to get out of adjustment! One-piece frame and hub simplifies wear adjustment, assures greater accuracy. Exclusive cam lock prevents reading errors. Ratchet stop top. Easy-to-read markings on nonglare *Chrome Clad*® finish.

Leading Industrial Distributors feature Lufkin — the new leader in precision tools.



LUFKIN

SAGINAW, MICHIGAN



TOP'S A SNAP to snap once you've fitted tubular frame in place. Small boy sits snug behind seats



LUGGAGE COMPARTMENT has 11½ cubic feet, is moderately capacious by two-seater sports car standards

didn't mind losing stop-light drag races to elderly Nashes. But that buglike front end had to go.

The factory was not unaware of these opinions. They took significant steps.

The fruits of their labors, the "new" or Mark II Sprite recently appeared and PM hastened to borrow one for a test.

Pepper Pot Altered?

Those familiar with the old, "first" Sprite, will be happy to know that their little pepper pot has lost none of its terrific roadability. No one has messed around with that suspension. The rack and pinion steering gear is still as light and quick as ever. The taut feel of the coil-spring independent front suspension and the solid tracking of the rear axle, located by its quarter elliptic springs and torque rods is the usual delight.

The action of the hydraulically operated clutch is smooth and the four-speed transmission works crisply and quickly.

But we hadn't driven the Sprite 20 feet before the area of change in performance made itself felt. An increase of five horsepower would seem pretty small to a Detroit engineer and invisible to an advertising agency. But, in the 1525-pound (dry weight) Sprite, the extra 10 percent puts added snap in each gear. You can reach 60 miles per hour in 20.6 seconds — slowish compared to a U.S. V8 but enough to give some compacts a real tussle at traffic lights. Of course, on a winding country lane you can keep ahead of most passenger cars, thanks to the low center of gravity.

Top speed is well over 80 and the little car cruises happily in the lower 70s, although the wind scream around the vinyl top and detachable side screens could be

annoying on those long high-speed trips.

The side screens—British for side curtains—really keep water out. Sliding plexiglass panels make it easy to ventilate the car in bad weather, as you can get fresh air through the heater for cooling your feet or defogging the windshield, once the hot water tap under the hood is turned off for the season.

Sprite devotees will love the new rear which has been squared off for a crisper appearance. While some space is lost to the spare, jack, tools and, when it's down, the top and its braces, the Sprite's new, lockable luggage compartment compares favorably with those of two-seater sports cars costing three times as much.

Just aft of the bucket seat backs there's a carpet-lined room for coats, extra luggage or two quite-small boys.

Frog Eyes Gone

The new front end is probably one of the greatest changes ever made for the better. The old Sprite's frog eyes have gone the way of all tortured sheet metal and the tilt-up hood assembly has been replaced with a sleek pair of fixed fenders and a conventionally hinged hood panel.

Summing up the Sprite is fairly easy. Here we have the lowest-priced genuine sports car available in the U.S. at the price of the lowest of the compact coupes. For long trips the car needs only a better soundproofing and a bit more power to insure a slower-running quieter engine. For short around-town hops or cruising on pretzel-like mountain roads, it's well nigh perfect.

And beneath it all is the intriguing possibility of converting it to a class H race car!

★ ★ ★

beautiful outdoor protection
 ... colored aluminum roof coating
 made with pigments *from* **ALCOA**

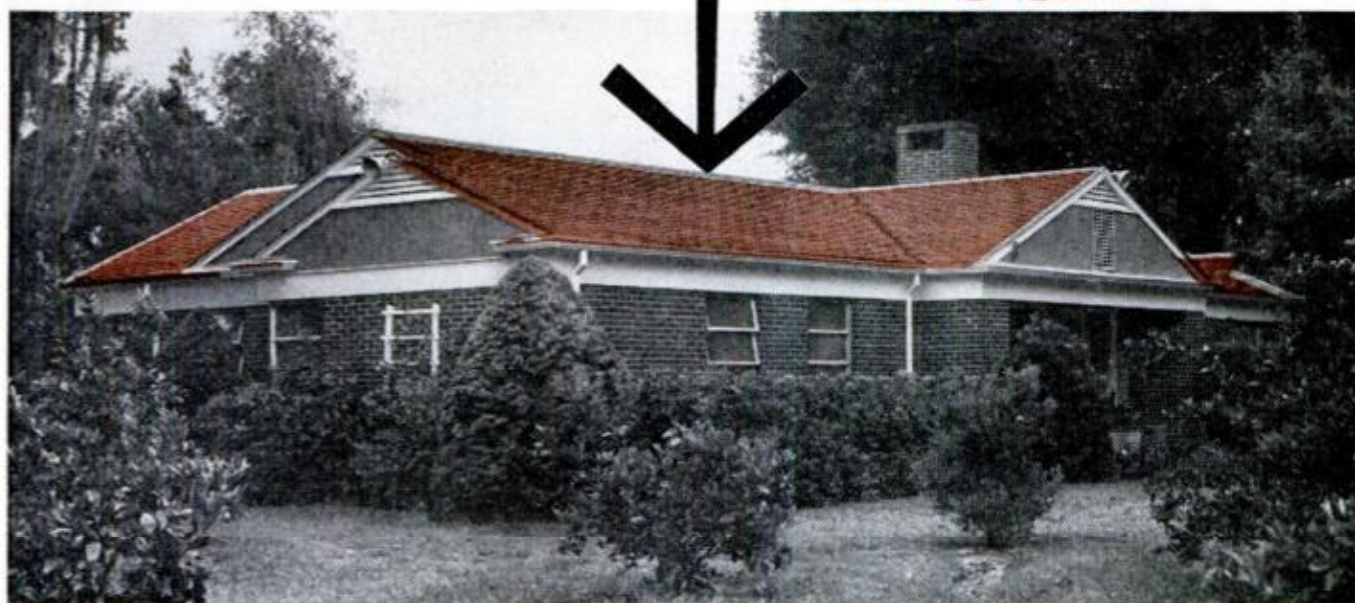

Sheriff Hall restores defective roof with Masticote

Sheriff J. P. Hall, Green Cove Springs, Fla., says he added many years to the life of his roof—with a paintbrush. Sheriff Hall applied Masticote, a fibrated colored aluminum coating made with Alcoa® Pigments by Madison Paint Co., Cleveland, Ohio. Mrs. Hall (who wanted a new roof) was completely sold after seeing the finished job.

The Hall roof was seven years old. Hard years of exposure to Florida's semitropical climate had caused wear and deterioration. The granules had washed and worn off; the shingles had faded and were beginning to curl. Sheriff Hall reports that Masticote sealed down the shingles and waterproofed the entire surface.

Aluminum coatings like Masticote protect in any climate—stay firm on top, pliant underneath; will not run or crack. And the reflective aluminum pigments turn back the sun's

heat, help keep interiors cooler in summer.

Available in a choice of harmonizing, attractive colors, these coatings are ideal for composition, asphalt shingle, slate, tile, tar paper roofs . . . brick, masonry, concrete or metal siding. Apply with ordinary roofing brush or stiff-bristle paintbrush. Ask your dealer today for Masticote or one of the other fine brands made with Alcoa Pigments.

Alcoa does not make roof coatings, but we will be happy to refer you to reputable manufacturers who do. Send coupon today for our informative booklets.

For exciting drama watch "Alcoa Presents" every Tuesday evening—ABC-TV

Aluminum Company of America
 1758-J Alcoa Building, Pittsburgh 19, Pa.
 Please send your free booklets:
 Painting With Aluminum In Color
 Aluminum Roof Coatings Make Time Stand Still

Name _____

Address _____

City _____ Zone _____ State _____



ON THE MARKET



1. BAKER VISUAL STAIRULE is versatile computer that solves problems in stair planning. By setting the known distance for stair rise, user can directly read dimensions of risers as well as other usable combinations. Answers most stair questions. Price \$3.95. Emmert Products Co., Box 221, Sycamore, Ill.



2. HUNDREDS OF SIZES of precision compression and extension springs are now available as stock items. These new springs are made with music wire for standard use and stainless steel for high-temperature use. Stock springs are economical for small-quantity users. Made by Associated Spring Corp., Bristol, Conn.



3. A COMPLETE LINE of cut nails is now available. Their sharp edges are said to have up to 75 percent more holding power than ordinary nails, and they penetrate hard woods without splitting, enter concrete readily where round, smooth nails do not. Hillwood Mfg. Co., 21700 St. Clair, Cleveland 17, Ohio



4. PLASTIC FILLER now available makes it easy to repair unsightly holes and dents in the family car. Also, you save dollars and increase the car's trade-in value. After sanding the patch, prime and paint area to make an invisible repair. Made by Webb Products Co., G & Columbia, San Bernardino, Calif.

DAP INC., BOX 999, DAYTON, OHIO

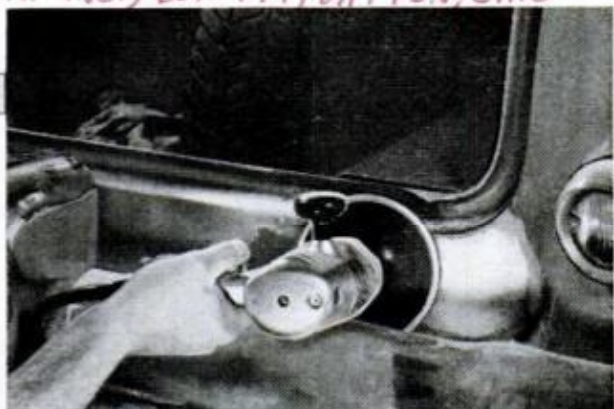

AMAZING 5-IN-1 POWER TOOL!

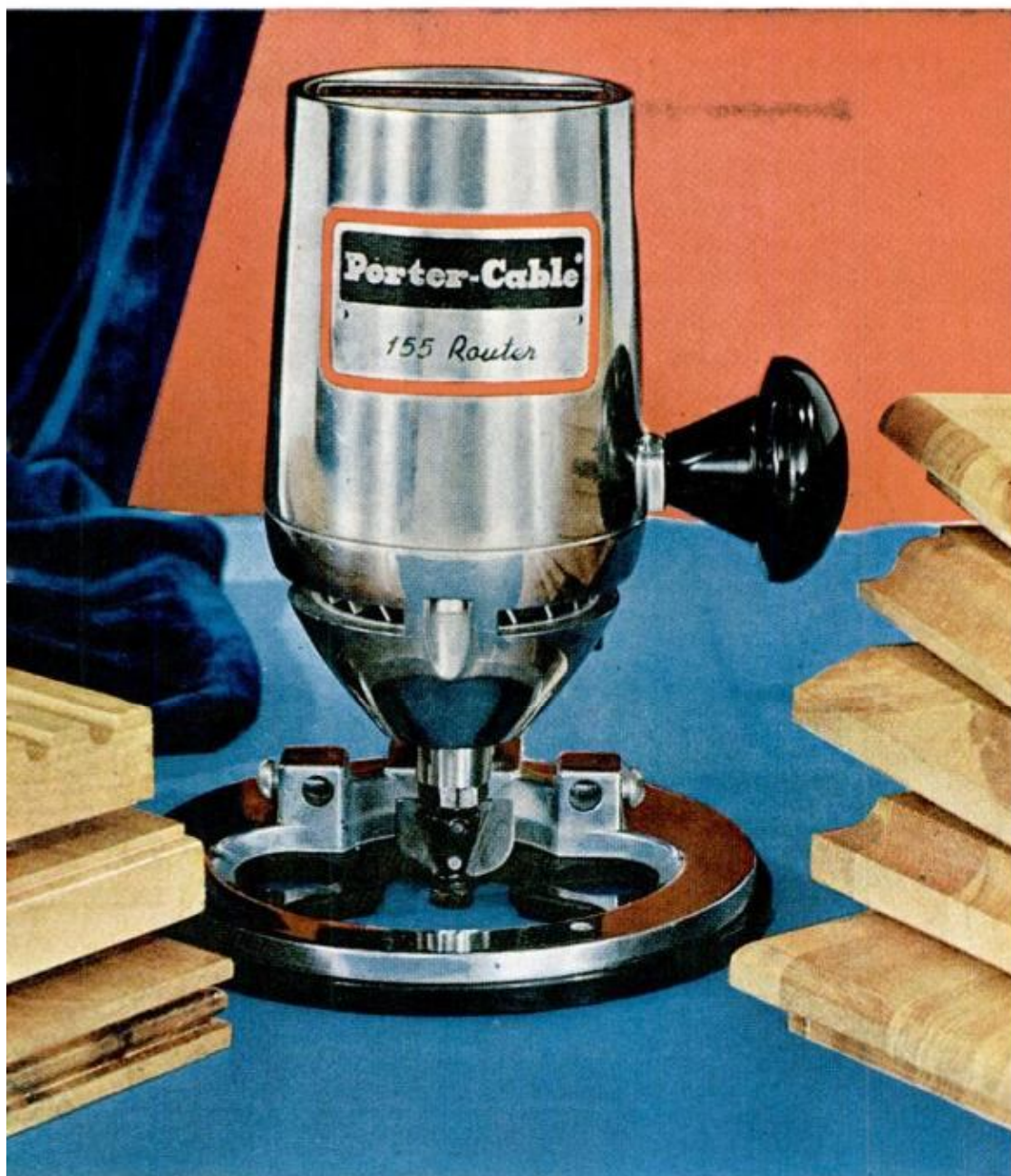

SCROLL SAW



SANDER



SHAPER



POWER PLANE

Porter-Cable Model 155 Router

A heavy-duty job, too! Rugged 4-amp., ball-bearing 23,000-RPM power pack specifically designed to power this unit as a Router, Power Plane, Shaper, Scroll Saw, or Finishing Sander. You change from one tool to another in just **seconds** . . . and **save** the cost of 4 complete motor units! Why it's practically a whole toolshop. Get an exciting demonstration of what **you** can do with it today. Your Porter-Cable dealer will give you a free 10-day home trial!

FREE CATALOG shows the complete line of Porter-Cable tools and accessories. Write: Rockwell Manufacturing Company, Porter-Cable Division, N. Lexington Ave., Pittsburgh 8, Pa.

PORTER-CABLE MACHINE COMPANY

Subsidiary of Rockwell Manufacturing Company
Pittsburgh 8, Pennsylvania

In Canada: Porter Cable Ltd., Box 817, Kingston, Ont. Canadian prices slightly higher.

LIMITED OFFER!

\$8.95 SCROLL SAW **FREE**

Yes, until Dec. 24, 1961, your dealer will give you **FREE** a Porter-Cable Scroll Saw attachment (\$8.95 value) with your purchase of an amazing Model 155 Router unit. Does inside, outside curves, cuts openings without a starter hole, contour curves of every kind!

Porter-Cable

another fine product by

ROCKWELL



Материал, защищенный авторскими правами

FRIGIDAIRE adds beauty, convenience to your kitchen, value to your home

Only from Frigidaire can you expect the beauty, convenience, and features you get in these easy-to-install, work-saving appliances. See your Frigidaire Dealer for models, colors, sizes, and prices. Frigidaire Factory-Trained Dealer Service available everywhere. Frigidaire Division of General Motors, Dayton 1, Ohio.

Put a Flair in Your Kitchen — the fascinating Flair Wall Oven with the exclusive Glide-Up Glass Door . . . never in your way in cooking or cleaning. Fits standard 33" cabinets. Choice of models with such features as Automatic Cook-Master Control, Meat Tender, and Spatter-Free Broiler Grill.

Wall Ovens to Fit 24" Cabinets, too! . . . French Door or Drop-Leaf Door, single or double oven models with easy-cooking, easy-cleaning features! *Cooking Tops* to match or blend with Wall Ovens . . . Fold-Back Surface Units also available!



The glamor of Frigidaire Flair also available in free-standing Ranges!



Model FPI-15B-61

Frost-Proof Foodkeeping—Frost never forms in either the refrigerator or freezer sections! Easy-access Roll-To-You Shelves. Many models, sizes, and colors to fit your kitchen and your budget!

only from



Models WI-62, DI-62

Extra-Care Laundering, Flowing Heat Drying—Bathe deep dirt out with exclusive "Three-Ring Agitator" Washing Action. Conventional and No-Vent matching Dryers to fit every budget.

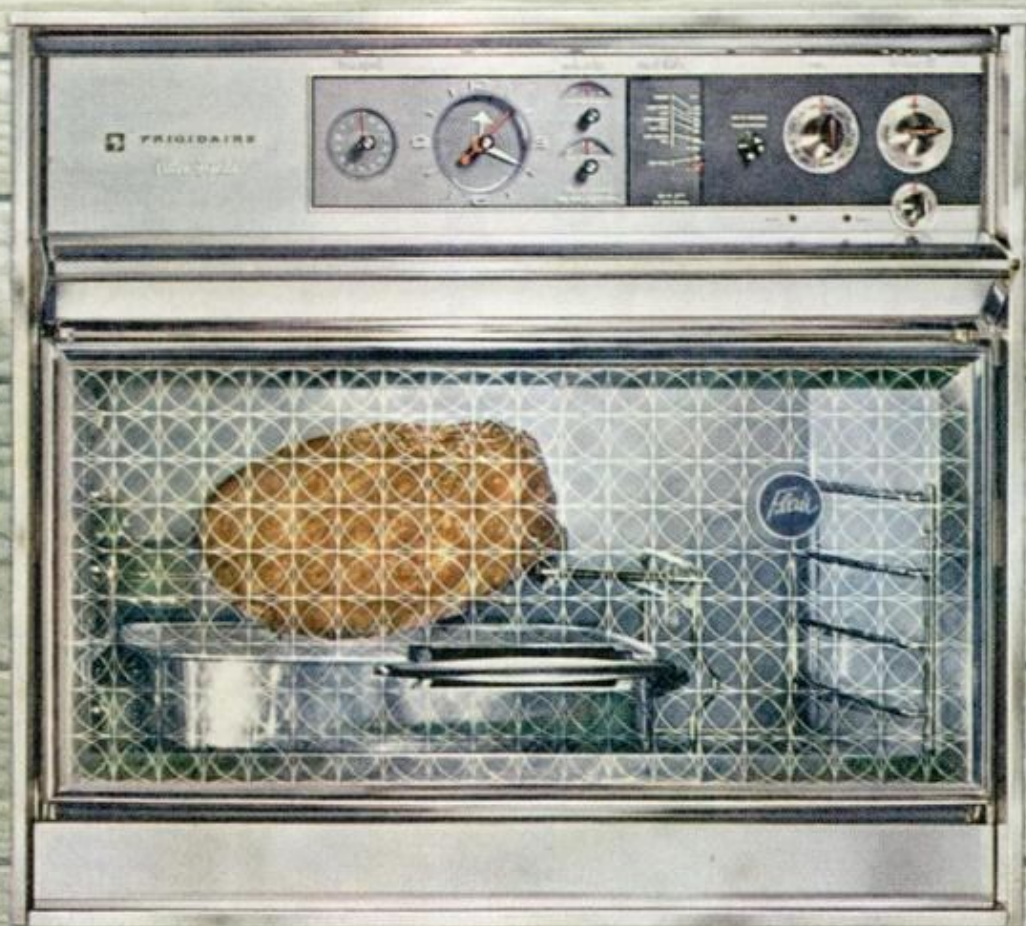

Model RBGB-335

FRIGIDAIRE...

That Frigidaire Touch!



Model DW-IUB

Sparkle-Clean Dishwashing —
Big capacity for once-a-day use.
Roll-To-You Racks glide out for
easiest loading ever! 4-cycle Dial.
Exclusive Swirling Water Action.
Quiet *Frigidaire Disposer*.



a touch you love in features
a touch you see in styling
a touch you feel in craftsmanship
a touch you trust in engineering
... a touch you'll find only in
products bearing this symbol



98C

You can light either end!

Taste PALL MALL...
so GOOD!
GOOD!
GOOD!



Good-looking, Good-tasting, Good-smoking Pall Mall!



Why does Pall Mall taste so good, good, good? Because Pall Mall's famous length of fine, good-tasting tobacco travels and gentles the smoke naturally—makes it mild—but does not filter out that satisfying flavor. That's why Pall Mall tastes so good! good! Never too strong. Never too weak. Always just right!



HERE'S WHY SMOKE "TRAVELED" THROUGH FINE TOBACCO TASTES BEST

- 1 You get Pall Mall's famous length of the finest quality tobaccos money can buy.
- 2 Pall Mall's famous length travels and gentles the smoke naturally. Travels it...
- 3 Over, under, around and through Pall Mall's fine, good-tasting tobaccos—and makes it mild!

Outstanding...and they are Mild!

Enjoy satisfying flavor...so friendly to your taste!

© A.T. Co. Product of The American Tobacco Company—Tobacco is our middle name™

POPULAR MECHANICS

Материал, защищенный авторским правом

What We'll Learn From the Astronauts

**POPULAR
MECHANICS**

SEPTEMBER

1961

By
Edwin Diamond

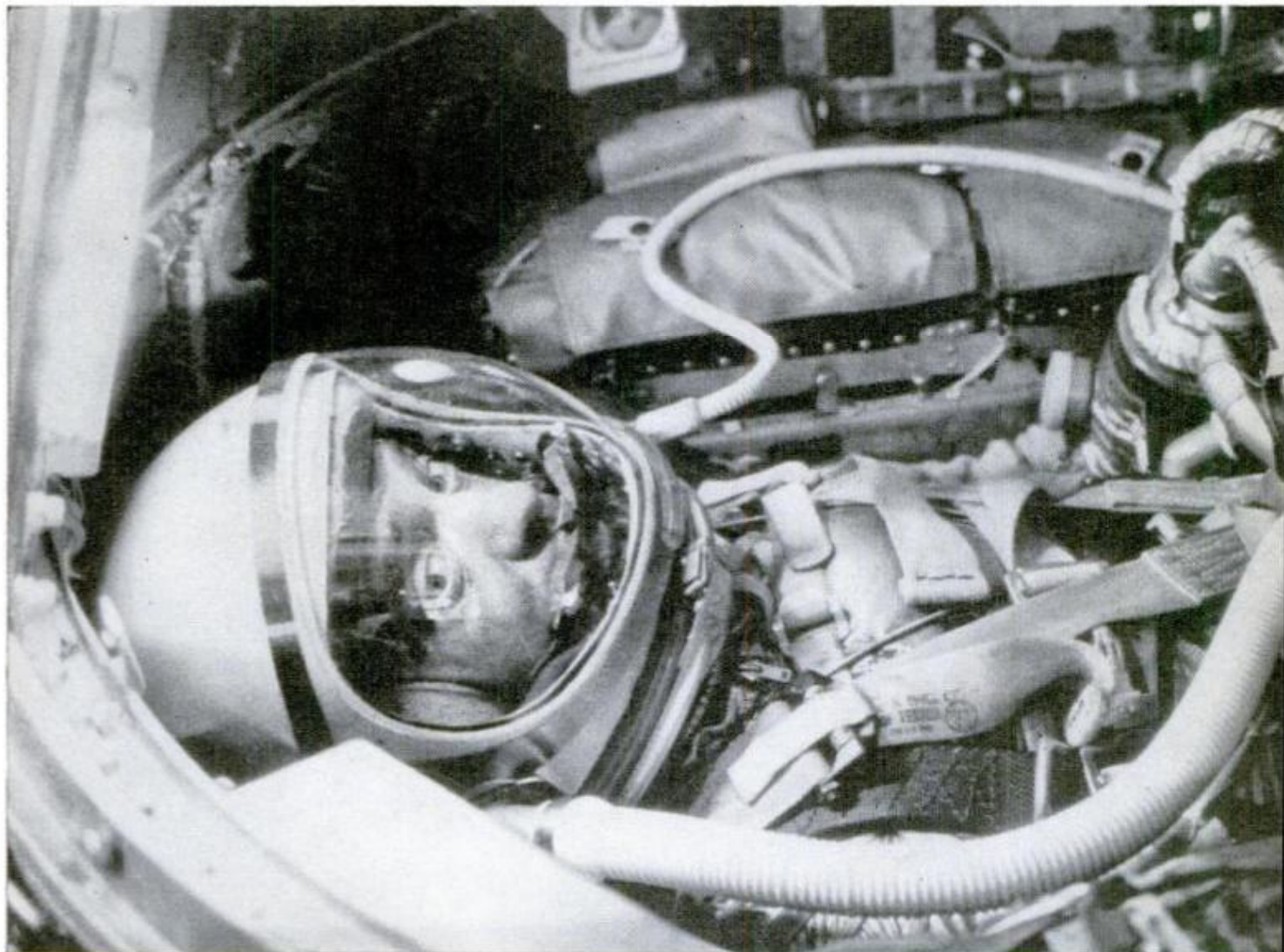

FIRST VOYAGER into space from the U.S., Alan Shepard, suggested important changes in space flight procedure

ONE MORNING LATE THIS FALL, shortly after dawn, millions of Americans will watch a seemingly familiar drama on their television screens. One of the seven astronauts, clad in a silvery space suit with white plastic helmet attached at the neck ring, will ease himself into the Mercury space capsule. The hatch will be closed. The gantry tower will rumble back, and a huge white rocket will stand solitary on the concrete launching pad.

At this point, however, the drama will deviate from other space spectacles, the first of which Americans watched on May 5, 1961.



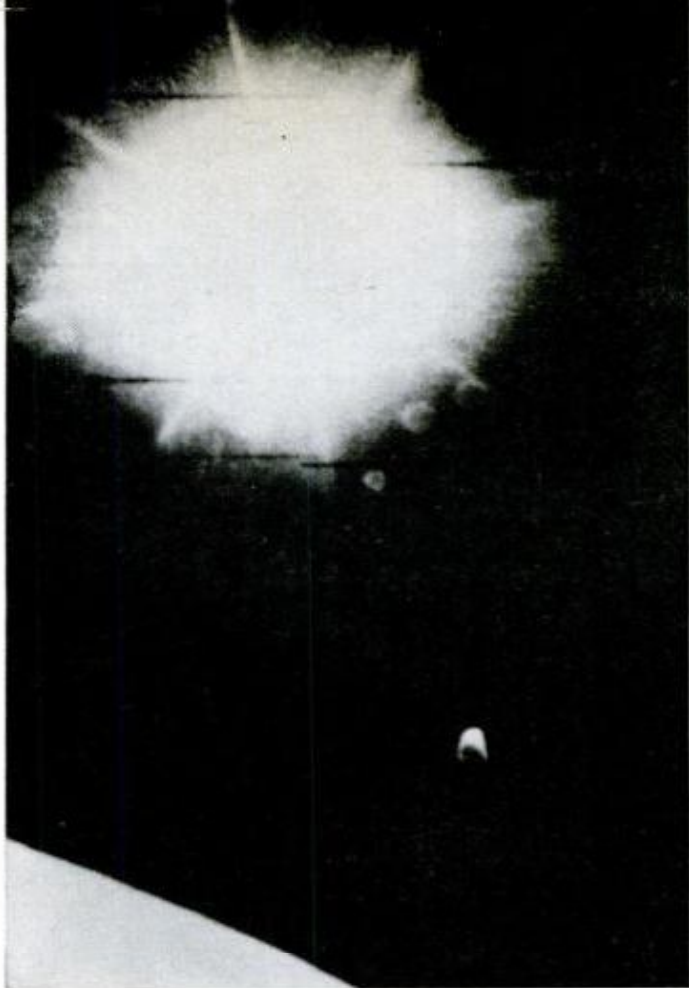

SUN and Earth are seen together in this photograph: it will be a sight, too, for the eyes of astronaut



EARTH drops away in this picture from Thor nosecone. Cape Canaveral is below; U.S. East Coast curves north

This rocket will be broader, taller and more powerful than the Redstones that lifted Alan B. Shepard, Jr. and "Gus" Grissom into space for their brief, pioneering rides.

This booster is the Atlas ICBM, most powerful carrier available to the American space effort. At the command "lift off," three Rocketdyne engines, capable of generating 360,000 pounds thrust, will flame to life. In four furious minutes of flight, the Atlas will carry the first American into orbit. He will circle Earth at 17,500 m.p.h.

in "true" space flight. From a vantage point 120 miles high, he will survey an exhilarating domain. His periscope eye—a precise optical system that provides a 175-degree view of Earth through a "picture window" porthole twice the size of the one in the first capsule—will take in 1600-mile-long vistas.

Three times around Earth the astronaut will circle. On the first orbit, the Canary Islands, the Sahara, Lake Victoria in Tanganyika, the Indian Ocean, southern Australia, and Mexico will all flash by under-

← **RECOVERY** techniques, and recovery areas for orbital shots have been worked out from experiences gained during suborbital flights. After Shepard's 302-mile flight, for instance, explosive bolts installed to quickly open capsule hatch worked too well on Grissom's flight when his capsule flooded and sank

MOON may have smaller moons 60° before and behind itself. Orbiting astronaut may verify report

SKY holds possible danger of meteorite collision. Capsule will pass shower from Orion constellation

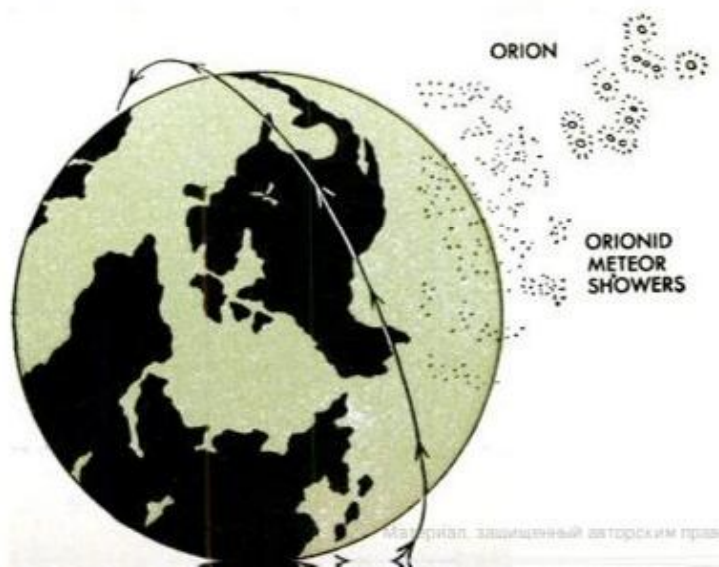
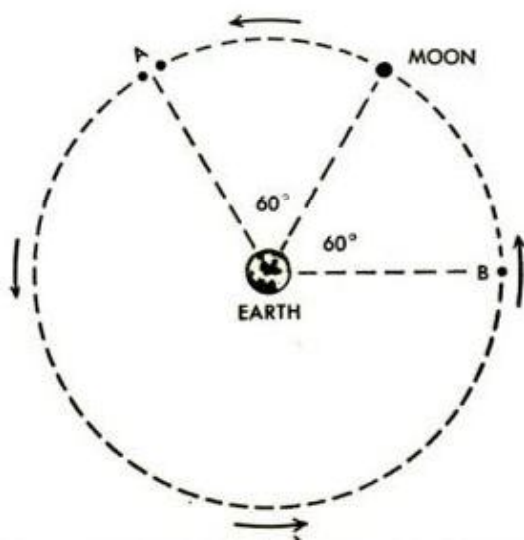



SHEPARD FLIGHT experience caused gauge on spacesuit arm to be moved, a new microphone in the helmet, and a raft trackable by radar for capsule

neath in less than 90 minutes. To a network of stations below (see map), the astronaut will call out the shape and distribution of cloud formations, demonstrating the potential weather-watching capabilities of manned satellites. Near the end of the second orbit, the capsule will pass over the United States for the first time at a point near San Diego. On the third orbit, it will pass over the Hawaiian Islands before beginning the critical descent from orbit.

If all goes as planned, this epochal flight will last four hours and 30 minutes. Its relatively Earth-hugging path (120 miles altitude) will keep the astronaut well under the Van Allen radiation belts, which begin to reach lethal intensities at approximately 200 miles altitude above the equator.

But the flight path will be lofty enough to give the space rider a view of the starry universe free of the atmospheric veil that distorts celestial objects for Earthbound observers. On his agenda are several astronomical observations. Recent color movies, recovered from a 500-mile-high nose cone, showed the stars as distant orbs in a rainbow assortment of their true radiation spec-

trum colors—brilliant red, yellow, white and blue. Will human eyes pick up the same radiation spectrum differences? They should. If the orbiting astronaut can see the colors, the night sky will look as though someone had spangled a black velvet carpet with thousands of glowing colored sequins. Earth itself, will be a greenish-orange ball suffused with the bluish glow of its atmospheric blanket—fading into deep blue where day meets night. The sun will be a glaring white disc, observable only through special tinted glass, in the black infinity of space.

Recently, a Polish astronomer, Dr. K. Kordylewski of Cracow Observatory, reported the existence of two faint, cloudlike objects circling Earth on the moon's orbit—60° ahead of it. Astronomers believe these cosmic "clouds" may be natural satellites of meteoric material, trapped between Earth's and the big moon's gravitational fields. There is another such point 60° behind the moon. From his vantage point in space, the Mercury astronaut, trained in astronomy, may well be able to see and identify other mysterious celestial



ORBITING FLYER will see daylight fade into night as shown in first photograph ever taken of Earth partly in daylight, partly in night. Hazy band along rim is thin layer of atmosphere. Will astronaut see color?

bodies, which have appeared in some nose-cone movies but don't show on sky maps. The astronaut is also certain to test out some important changes incorporated in his space vehicle as a result of Shepard's and Grissom's experiences. Though it isn't generally known, at 9:35.10 eastern standard time of the morning of May 5, 1961, Comdr. Shepard made a momentous decision.

His brief flight was only one minute and ten seconds old. From his Mercury capsule "Freedom Seven," he had just radioed back to Cape Canaveral: "Fuel is go. 2.5g. Cabin 5.5 Oxygen is go . . ." Then, nine miles high, his slim Redstone rocket passed from subsonic to supersonic speed. The capsule was subjected to maximum aerodynamic pressure—the forces of air density and speed combined at their peaks. The entire ship vibrated; there was heavy buffeting. For several seconds, Shepard had difficulty reading the cabin pressure dials.

Shepard *had* to make a decision. If he reported the buffeting, he might be ordered to terminate or abort the mission. He had made up his mind, he later recalled, "to handle things alone if I could and call for

help only if I couldn't." After 15 seconds, the vibration stopped. Shepard and the capsule were through in one piece. "Okay. It is a lot smoother now," he radioed back, "a lot smoother . . ."

And suddenly, the way was also a lot smoother for the entire U.S. space effort. Only a few weeks before Shepard's flight, President Kennedy had seriously considered proposals to postpone the mission. Our-toe-hold in space had been truly precarious. If Shepard had aborted, the U.S. manned space flight program would have slipped months behind while technicians worked over the autopilot records, replayed the mission, and subjected wind-tunnel models to stress tests. NASA officials would have spent weeks before Congressional investigating committees. The Mercury-Atlas manned orbital flights set for late this fall would have been endlessly postponed. And, finally, the U.S. might never be committed today to the next logical step—the Apollo program for the conquest of the moon by Americans in 1967.

(Continued to page 282)



You Take the High Road

Not a circus act, but a military exercise — a British Army Land-Rover crosses a defile on twin tightropes that eliminate the need for a bridge for wheeled vehicles.

A set of specially-designed outer wheels, flanged to fit a pair of cables, support the 3600-pound vehicle over a 110-foot span. Once on the cables, the crossing is under power with the driver controlling the operation. The technique was developed by the Australian Army Engineers.



Study Liquids in Space

How do liquids which will be used to fuel spaceships behave in a condition of weightlessness—part of the environment of space?

To find out, engineers at Northrop Corp. have devised a zero-gravity capsule, a mockup of which is shown at the left.

Air is evacuated from it to form a vacuum. The capsule is then dropped inside an 87-foot tower. As the capsule falls, a hinged shelf (5) releases the test container which then falls within the falling capsule.

An automatic camera (1) records the behavior of liquid in the specimen cup (2) which is lighted from beneath by miniature lamps (3) powered by batteries (4).

Dr. Elliot T. Benedikt, who heads Norair's zero-gravity research, is shown with the mockup capsule.

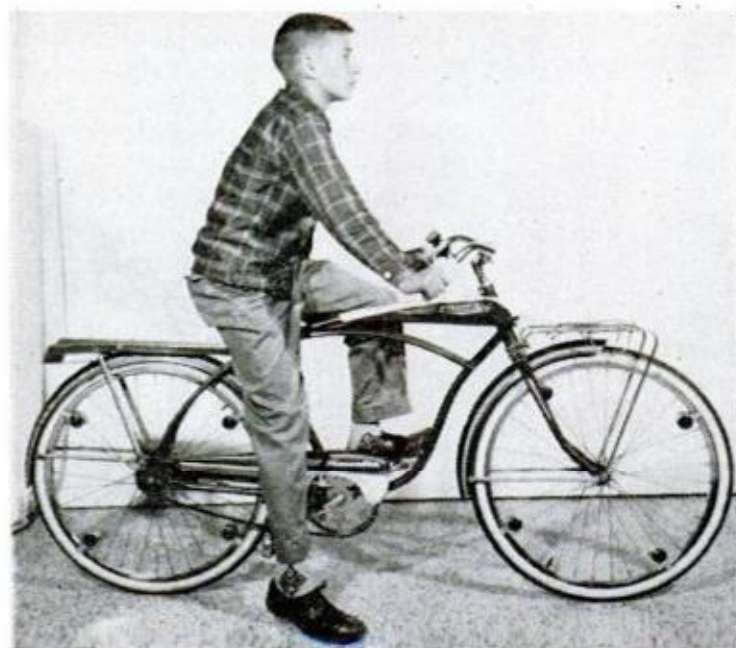

Spokes-man for Safety

Bicycles can be decorated with safety reflectors that are mounted on the front and rear wheel rims between the spokes.

Called Rim Gems, the reflectors are attached by hooking one side of a clamp under the rim and pushing until the other side snaps on. Made of lightweight aluminum, the lights get their brilliance from two red plastic reflectors which shine when automobile lights hit them. They are intended primarily for safety when crossing intersections.

Rim Gems are sold four for \$1.50 or eight for \$2.95 by Deans, Dept. PM, 504 8th St., Rockwell City, Iowa.

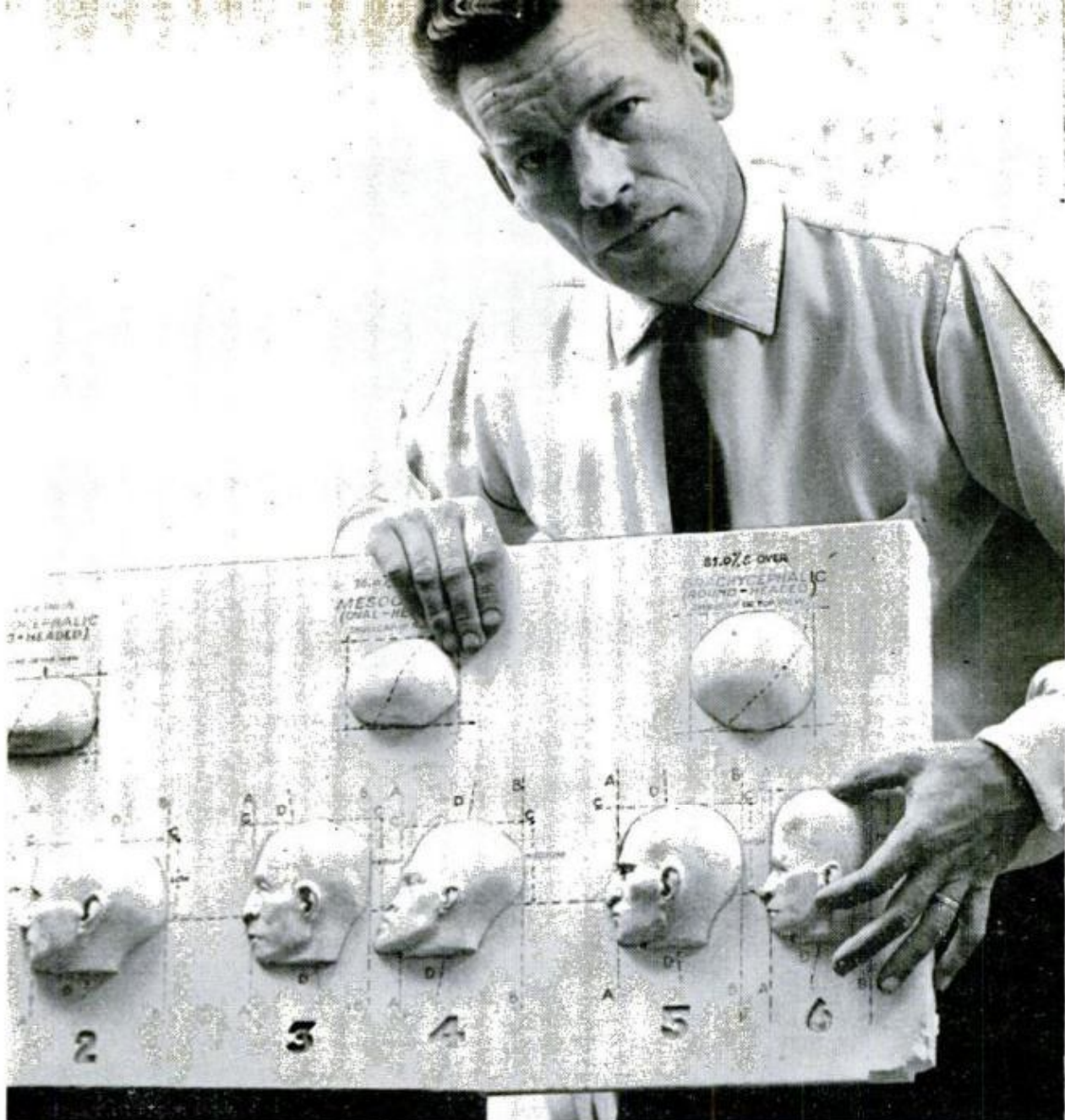

SYSTEM OF IDENTIFICATION, using basic head and facial types, has taken John Abbott years to develop

Plaster Masks Give Police 3-D Views of Wanted Criminals

Carved by a retired 20-year veteran of the Royal Canadian Mounted Police, life-like plaster masks of wanted criminals are giving California police a third dimension in identification. From eyewitness accounts of crimes, recorded on a 115-item questionnaire, John Abbott is able to produce

masks which police claim are superior to the composite, two dimensional drawings in common use.

Abbott uses a set of masks representing basic facial types when questioning witnesses, gradually working up the wanted man's final appearance.

QUESTIONING WITNESSES is important part of system. Detailed answers give clues to exact measurements



POPULAR MECHANICS



A NATIONWIDE SURVEY

PM photos by Don Honick

BASED ON 1,895,100 OWNER-DRIVEN MILES

Marginal and boldface comments by Jim Whipple, PM's Auto Editor

Owners Find Nimble, Sporty Corvair

Sales for the first six months of 1961 were 171,459 compared to 114,207 for similar period in 1960 →

Lowness, the very quality that makes Corvair coupes so appealing to sporty types, is a major objection of family users →

IN MARCH 1960, PM published an Owners Report on the 1960 Corvair. At that time, the car was brand-new. In fact, it was something of a nine-day wonder. You couldn't pull into a filling station in one without attracting the attention of curious onlookers who wanted to see "that engine in the trunk."

Now, seventeen months later, Corvair is an accepted part of the automotive scene, and we've polled another group of brand-new owners of a growing family of Corvairs.

Mind you, this Corvair they are rating is basically the same vehicle as the subject of the March 1960 report. Changes have been relatively few. Free hot air has replaced gasoline as a heating agent. The basic sedan of early 1960 production has been supplemented with coupe, station-wagon and camper-wagon models. A Super Deluxe Monza series, in coupe and sedan models, has been added, and there's now an optional 98-horsepower engine and four-speed synchronized manual transmission. And the spare tire has moved to the engine compartment.

When Corvair first appeared, many in the industry assumed that it would take its place alongside the Rambler, Lark, Falcon and Valiant and appeal to buyers interested

WHEN YOU SAY CORVAIR today, you may be talking about a roomy, nine-passenger camper-type wagon (right), a sporty sedan (center) or a compact six-passenger wagon, (at far right)





HANDLING EASE, the number one item on Corvair owners' list of best-liked features, is demonstrated as PM's test Monza swings over a rail crossing with perfect control, thanks to unique suspension

a "Fun Car" With a Few Rough Edges

in an economy compact for a one-car family. But America and Chevy's General Manager, Ed Cole, had other ideas.

After a slow start in '60, due to public hesitancy in accepting Corvair's radical innovations, the car caught on, but not so much as a bread-and-butter family sedan. The largest single group of owners, 40 percent of all reporting on the '61 model, own sporty Monzas, and most of these are probably bucket-seat coupes.

Fewer than 10 percent chose the austere (rubber windshield molding) "500" series. Some 35 percent chose the middle-of-the line "700" series which includes the Lakewood station wagon. And about 12 percent were owners of the Greenbrier camper wagon.

Culling through the reports revealed a strong "personal car" pattern, with many owners using Monza coupes for business as well as pleasure transportation.

The most striking contrast between this and the March '60 report deals with the business of fuel economy. Lack of this attribute was the number-one complaint last year, with 25.6 percent of all reports listing it. Some 45.4 percent of the owners of automatic transmission models said they were not satisfied with mileage.

The Monza was the first really new sports coupe since Studebaker's Loewy-designed job of 1953. ← No wonder it became the car with the built-in waiting list

Air-cooled rear-engined cars have a reputation as great gas savers, ← thanks to a well-known German import; thus the great expectations for Corvair economy



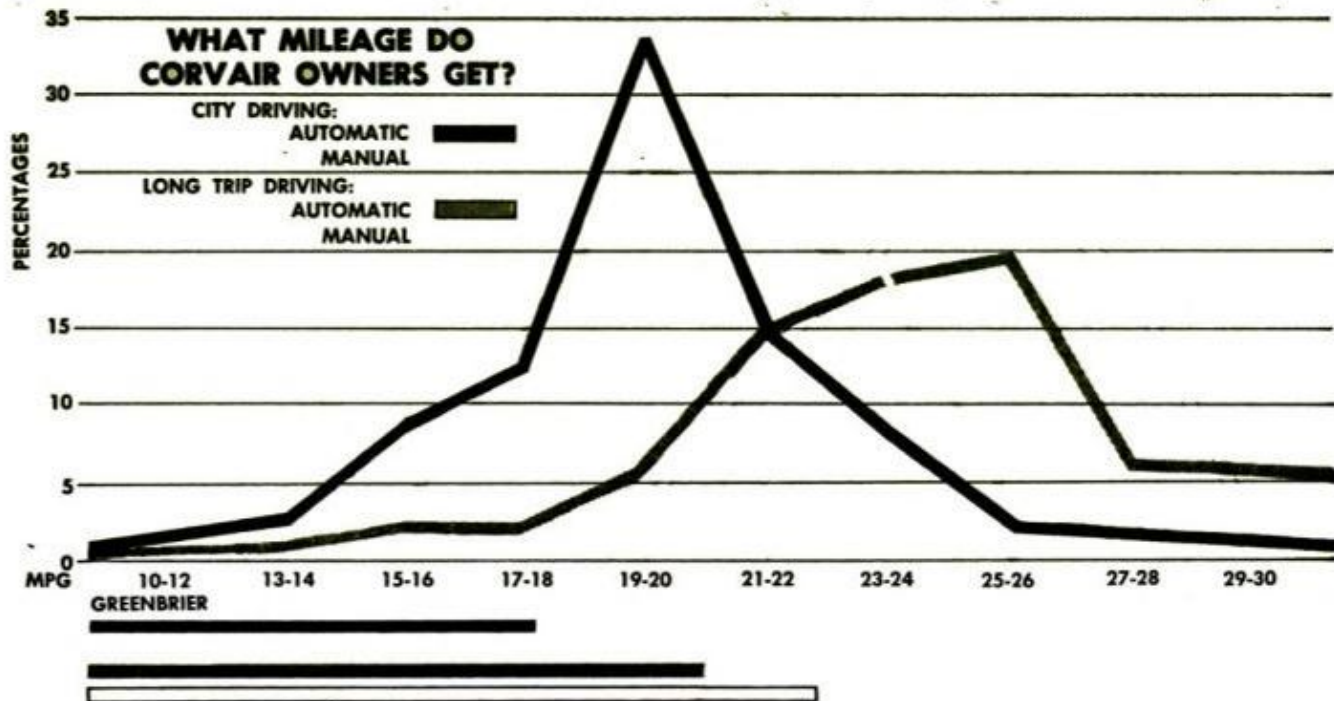

GRAPH OF CORVAIR FUEL CONSUMPTION shows that the difference between city and long trip driving is greater than the difference between manual and automatic transmission in determining gas mileage

There was no black magic here, Chevy engineers merely needed more time to perfect Corvair's dual carburetion →

In about a year and a half, matters have changed. Poor fuel economy has dropped right out of the top complaint hit parade and only 30 percent of automatic transmission owners were dissatisfied with their '61 Corvair's gas appetite.

Among the "best-liked" features, handling ease, riding comfort remain first, second and third respectively, but good fuel economy has moved into fourth place edging out traction in ice and snow.

PM's own constant-speed fuel meter tests and over-all mileage pointed up the fact that Corvair economy is up for '61. The test car was a Monza four-door sedan with 80 horsepower engine and automatic transmission. Here are the results:

Lower-than-average air resistance of small Corvair is one reason for good mileage at high speeds; light weight is another →

- 34.8 miles per gallon at 30 m.p.h.
- 31.32 miles per gallon at 40 m.p.h.
- 30.5 miles per gallon at 50 m.p.h.
- 27.5 miles per gallon at 60 m.p.h.
- 22.1 miles per gallon at 70 m.p.h.

Over-all mileage for city, expressway and country driving was 22.2 miles per gallon.

In what may be a measure of changing public opinion, the matter of insufficient head and legroom showed up in

THREE SMALLISH SUITCASES and a camera bag fill trunk of Corvair, below, with little space left

THE SAME ITEMS stow easily in Lakewood wagon, below, with leftover space plus unfilled front trunk





A BIG PROBLEM for many owners is that of low headroom and entry or exit through Corvair's low doors



ONE JACK RAISES A FULL HOUSE, or at least a full Greenbrier wagon; so that both wheels are off ground

second place on the list of specific complaints in 1961. In the 1960 Corvair report it did not appear among the first half-dozen complaints listed most frequently. Yet no change has been made in size of door openings, seat heights or interior dimensions.

When it came to making an over-all judgment of the '61 Corvair, the balloting came out strangely close to the division of opinion recorded by the '60 owner group.

In 1960 71.2 percent of all owners rated their Corvairs "Excellent." For the '61 owner group the "Excellent" ratings dropped a hair to 70.0 percent. Of the 1960 owners 23.4 percent rated their Corvairs "Average" compared to 25.4 percent for the owners currently reporting. Those who placed their Corvair in the "Poor" category have decreased in number from 5.4 percent in 1960 to 4.6 percent today.

Now, let's lend an ear to the owners' opinions of their new Corvairs. Here, in the order of frequency of mention, are the first six best-liked features.

"I like its handling ease, especially on corners. It rides well."—California airline employee.

"My Corvair is small and easy to manage in traffic, perfect for town driving. Besides, it's a mighty cute little car."—Mississippi school teacher.

"This car is fun to drive."—California draftsman.

"This car is easy handling under all conditions, very responsive in all gears and in the steering. Balances well on all road conditions, including up and down on hills and

(Continued to page 274)

People have had a chance to take some long second looks at all compacts—the novelty and "gee-whiz" attitude has been replaced by more realistic evaluation



This lack of an increase in the "Excellent" rating by owners of a second-year car is disappointing.



It seems there are still puzzling lapses in quality control

This Dixie pedagogue is so right—Corvair gets an A-plus as the nimblest car in town—it steers quicker than a kid's tricycle

THE ACID TEST of a wagon for do-it-yourselfers is passed as Lakewood swallows 4 x 8 plywood sheet



WHERE'S THE SPARE? Answer—in engine compartment of sedan, left, or in front trunk of wagon, right





By Jim Whipple



True quality control rears its lovely head. Who will win 1962's guessing game?

Before we get too deep in the details of the new model year there's something that happened in '61 which merits mention — **Buick's** achievement of a remarkably trouble-free new car, the **Special**. This new design, assembled from thousands of completely new parts, gave a large portion of its owners no reason to go back to the dealer other than for the routine warranty checkups. In PM's Owners Report, (March 1961, p. 81) the **Special** received the unusually high Excellent rating of 85.4 percent from a wide sampling of owners. Everybody in Flint from General Manager Ed Rollert down to power wrench operators on the line deserves a hearty "well done!"

They have done much to restore quality control to the status of a strong promise, rather than a weak joke.

1962 may go down in history as the year Detroit outguessed the public. Compact, subcompact "family-sized car" or full-sized car, there's going to be a size, if not a price, to suit everyone. Just look at the list.

There will be the subcompact four-passenger **Cardinal** by **Ford**; there will be a new Falcon-sized compact, the **Chevy II** which will have interior dimensions similar to **Rambler**, **Lark**, **Valiant-Lancer** and **Comet**. It will be larger than **Corvair** which would seem to put that sporty job into a separate category all by itself.

Then there are the **Buick**, **Olds**, **Pontiac** compacts with their 112-inch wheelbases. Somewhere slightly above the BOP's in size but not in price, will be the new "family-sized" **Ford Fairlane** and **Mercury Meteor** with 115½ and 116½-inch wheelbases and over-all lengths of around 200 inches. A little larger, heavier and lots more powerful, in their V8 versions, are the new **Plymouth** and **Dodge Dart** which have wheelbases similar to the slightly lighter **Fairlane** and **Meteor**. Then finally we have the "full-sized" **Ford** and **Chevrolet** of 119-inch wheelbases and around 210 inches in over-all length.

This could also be the year in which Detroit outguessed itself. It's just possible that a thoroughly bewildered public will stick to established buying patterns, choosing either **Rambler-Falcon-Lark-Valiant**-sized cars or the traditionally larger **Ford** or

Chevy. This would leave several of the newcomers to slip between the chairs.

Hard to guess which way the trends will swing, isn't it? But save a little sympathy for the dealer. He's going to have to stock three different varieties of **Fords**, **Chevies** and **Mercurys**. (**Comets** will be registered under the **Mercury** nameplate in '62.)

And if model choices aren't enough just consider the engine and transmission combinations not to mention the optional axle ratios. (**Buick Special** and **Olds F-85** will have limited-slip differentials too!)

What's behind it all? The industry's desire to make sure there's a car for every potential buyer, that no contracts will go unsigned for lack of suitable merchandise.

There's one bright spot, however. There will be few if any leftover '61 models around to complicate matters. If you were thinking of picking up an end-of-the-year bargain in your favorite color and optional equipment combination, forget it. Your neighbor has beaten you to it. This fact will put the industry hip deep in the new model shakeout — i.e. which models will sell and which won't by Thanksgiving.

Amidst all the new-size car hoopla, one fact should be noted. The compacts — **Falcon**, **Valiant**, **Rambler American**, **Lark** and **Corvair** — have received very minor face-lift changes for '62 and wear the same basic sheet metal that they did back in 1959.

This can only be good news for the buyer as model stability decreases mechanical "bugs," reduces depreciation rates and helps the manufacturer hold the price line in the face of increased labor and material costs. This is good anti-inflation insurance.

How long will this state of affairs last? Which of the five manufacturers will be the first to "chicken" out and spend the big money for the big styling changes? The answer is, whichever one thinks that the styling of his current compact is hurting sales. Then, if he has the money to spend, comes the major body change. And, like dominoes, most of his competitors will follow. One thing's sure, the decision has already been made, thanks to the industry's long lead time. The '63s are already basically locked up and major decisions on '64 models have probably been made. ★ ★ ★



All the Earmarks of a Cyclist

English motorcyclist John Gillson at first glance appears to have an uncommonly large pair of ears. But they're really indicators that make it safer to turn.

"When I want to turn left or right," he says, "I merely flick a switch on the handle bar, the signal on my helmet lights. My hands are then free to grip when a sure grip is most needed—that is, when turning a corner."



Thermoelectric Refrigerator

Previously used primarily in research and armed-forces applications, the principle of thermoelectric refrigeration has now been adapted by Norge for commercial units.

Five hundred thermoelectric refrigerators, which need no compressor or refrigerant fluid, have been purchased by the Sheraton hotel chain. Home refrigerators of this type are expected within five years.

Big-Scale Number Painting Produces Mural

Painting "by the numbers" works as well on walls as it does on the coded canvas that comes with kids' paint sets. The C. J. Nast family of Cornwallis, Nova Scotia, transferred a kit painting to a basement wall by ruling the original, small, numbered canvas into half-inch squares, then transferring the

design onto six-inch squares on the wall. They matched the original oil-paint colors with latex wall paint—over a neutral base of concrete wall paint—and came out after a week of evening work with a 5-by-11-foot mural. The original is a 5-by-11-inch child's painting kit.

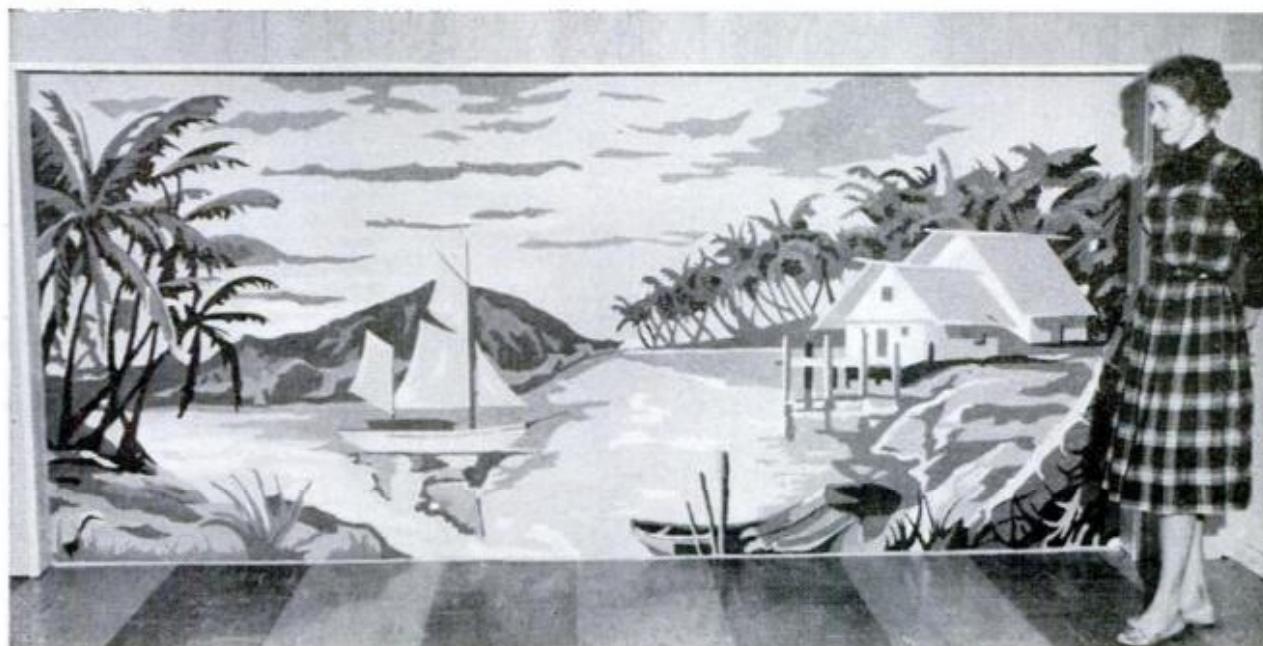



SCIENCE OVERSEAS

By William Kreh

It's a pity, but nurses no longer make the rounds to take temperatures at the Royal Infirmary, Edinburgh, Scotland. A new electronic machine takes and records temperatures of all patients at the same time.

An electrode, taped to the patient's shoulder, is wired to a central recording machine. By turning the dial to a patient's name, the nurse reads his temperature.

With a little luck, scientists will have a photographic record of the next eruption of New Zealand's Ngauruhoe volcano. They've embedded a remote-control camera, along with a seismometer, in concrete on the rim of the active volcano. Operated from a laboratory five miles away, it will take about 300 pictures before a scientist need venture out to reload it.

Regardez the white square! With these words, or words more definitely French, parents send their kids skedaddling from the TV sets in France. The square, put on the screen by an engineer's pushbutton, signals that something not for children is going to appear. Presumably little Jacques runs the risk of a paddling should papa walk into the room and find him watching the set after the square warning.

The British Naval Air Force trains helicopter pilots to land on the bouncing deck of a ship without ever going to sea.

They've built a rolling platform upon which helicopters can land while it simulates the motion of a frigate's deck. A system of cams and gears make the platform pitch and yaw at varying angles and degrees.

Nerves of iron are being given dogs by Soviet scientists. Pieces of a dog's nerve as long as two inches were removed and replaced by metal electrodes.

"Scalpel! Sutures! Barometer!" This bit of operating-room dialogue is not too far-fetched. German surgeons now get special weather forecasts before scheduling operations.

The theory is that extreme pressure changes, abrupt temperature changes, humidity and rainfall all play a role in human health. This role becomes especially important for people about to undergo critical

operations, for the body under surgery is more vulnerable to atmospheric change.

Skiing on air is the latest fad for winter sportsmen in France. Air cushion skis, conceived by Swiss engineer Gaston Halde-man produced in France, are popular at French ski resorts.

They are made of glass fiber, impregnated with synthetic resin, and wrapped around a hollow plastic tube that's filled with compressed air. By varying the air pressure, skis can be made to vary in hardness, making them suitable for different snow conditions.

A new life raft, made of nonporous, self-sealing foam rubber, is being manufactured in Norway. The floating igloo looks like a big cheese topped by a dome-shaped tent.

Transported halfway across the world in the body of a rabbit, a flock of sheep has arrived in South Africa.

Lionel Rowson of the animal research station, Cambridge University, reports that purebred English lambs whose parents never left their native pastures have been born to a foster mother of a different breed 6000 miles away in South Africa.

In the experiment, fertilized ova were removed from a ewe of the English Border Leicester breed. The eight ova were planted in the body of a rabbit for incubation on the flight. They were then transferred to ewes of an African native breed, which subsequently gave them birth.

"Using this method a small flock of breeding animals can be sent thousands of miles in a rabbit at the cost of only a few pounds," Rawson says. "To send the same number of grown animals by air over the same distance would cost thousands."

Object of the experiment is to develop a method of transplanting ova from beef cattle to dairy cows. Farmers would then be able to get high-class beef animals from lightly-built dairy cows acting as foster mothers.

The complete skeleton of an anchilosaur—a giant lizard 30 feet long—has been uncovered by Chinese and Russian scientists in the heart of the Gobi desert. It is about three times the length of the previous largest skeleton of this species. ★ ★ ★



Disappearing Act for Mooring Line

Bow lines on boats with foredecks are automatically stored out of sight under the deck on the spring-rewind reel built into a new piece of boat hardware.

The line runs through a drilled cleat onto the rewind reel beneath. Up to 14 feet of line can be pulled out, tied to the dock and then secured to the cleat with a half hitch. When untied, the line slides automatically back through the cleat and onto the reel.

Manufactured by Puritan Cordage, the reel is being built into boats by Cruisers, Inc., Oconto, Wis., and is also being distributed by Cruisers dealers.

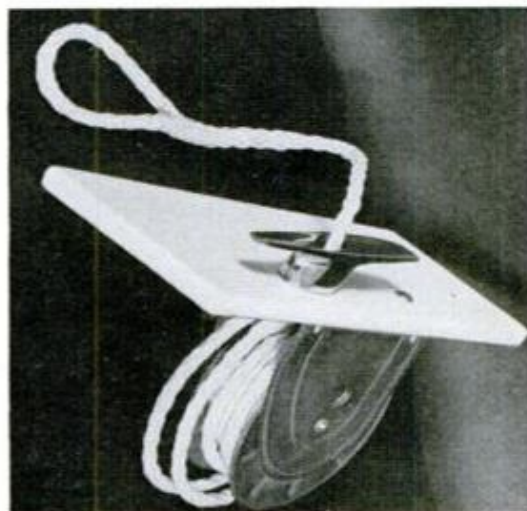

Regular Meals at the Aquarium

Solving the problem of how to insure regular feeding for a tankful of fish when nobody's home, a new self-timing automatic feeder mounts on the edge of the tank and drops 14 feedings in the water at preset intervals.

It will handle any type of food in almost any desired amount, and can be set for 14 single feedings—twice-a-day feeding for seven days, or three-times-a-day feeding for five days. It mounts with rubber-footed screws and runs on a clock-type electric motor. Two rubber "legs" hold a feeding ring. It's made by Double A Brand, 1703 West Wellington, Chicago 13, Ill.



Are You Taking Counterfeit Drugs?

Scientific detectives of the Food and Drug Administration have launched a nationwide drive against traffic in bogus medicine

By James Nevin Miller

ONE JULY AFTERNOON in 1960 an inspector for the Food and Drug Administration performed a routine chore in a Washington, D.C., drugstore. He handed the druggist a doctor's prescription for 24 tablets of Diuril, a high-potency drug for treating high blood pressure, and paid for his purchase.

The inspector drove to his office and gave the tablets to an FDA micro-analyst for the customary examination for authenticity in accordance with the Food and Drug Act.

Next day the micro-analyst telephoned the inspector and announced, "We've spotted a phony. The analysis shows the drug tablets weren't made by the legitimate manufacturer and the chemist has verified the findings. Our microscopic tests show the tablets are just a bit different along the edges from ground bevel marks made by the genuine manufacturer's die on the authentic tablets. Also, the chemical analysis proves there is an obvious difference in the identity of the fillers used to carry the drug ingredients in the tablets."

Two days later another inspector visited the same drugstore and this time had a prescription filled for another drug called Hydrodiuril. This purchase also turned up

a phony drug, instead of the genuine product called for by the prescription.

These findings touched off a nationwide drive against traffic in counterfeit drugs, the first really big campaign in history. Today, after more than a year of undercover investigations, the FDA has moved to bring criminal charges against several alleged makers and sellers of bogus products.

As of July 1, 1961, almost a dozen criminal informations had been filed in the East, Midwest, South and Southwest. Many other prosecutions are expected after sufficient evidence is gathered.

- Two companies and eight individuals in New York and New Jersey were among the first to be charged with counterfeiting and distributing a variety of drugs, including two well-known tranquilizers.

- Another case was filed in Boston against an individual in Roxbury, Mass.

- Another criminal action involving counterfeit Hydrodiuril was filed in Chicago against a wholesale distributor and one of his salesmen for delivering counterfeit drugs to two retail drug stores in Chicago.

- Also, the FDA announced the seizure of more than 6000 tablets described as counterfeits of well-known drugs from



GEORGE P. LARRICK

Commissioner of the U.S. Food and Drug Administration

"Since the purpose of counterfeiting is to conceal the identity of the true manufacturer, there can be no assurance that counterfeit drugs actually contain the kind or amount of the drug supposed to be present.

"Manufacturing, sanitation and laboratory controls are likely to be absent, and the drugs, most of which are potent new drugs, do not pass through the safety clearance required under the federal Food, Drug, and Cosmetics Act.

"Thus, even though the particular batch of a counterfeit drug may have the same strength and purity of the drug it counterfeits, the counterfeiting of drugs is contrary to the public interest and is in violation of federal laws.

"This reprehensible practice poses a serious threat to the public health since it could undermine the fundamental control over the safety and efficacy of drugs."

PRESCRIPTION



FDA INSPECTORS, in the first step of a local drive, spot-check drugstores for possible counterfeit drugs

firms in Chicago, Georgia and California.

Meanwhile, the Senate antitrust monopoly committee, headed by Senator Estes Kefauver of Tennessee, is expected to start an investigation of this and other troublesome problems in the drug trade.

FDA Commissioner George P. Larrick has said, "This is a bootleg operation easily detected by the retail pharmacist. The racket could not exist without the cooperation of unethical druggists."

In view of this, what has the drug industry itself been doing to combat the blot on its good name and on that of legitimate druggists?

Officially, the pharmaceutical companies have hired detectives to track down those suspected of being active in the illicit drug traffic. Besides the public, who unknowingly purchase the counterfeit drugs, the legitimate drug manufacturers stand to lose the most. One major drug manufacturer has estimated its own loss in sales to the bootleg trade at about \$1,000,000 in one year. Throughout the trade, the estimate runs to \$50,000,000.

Semi-officially, the industry's trade journals have been publishing editorials pinpointing the gravity and nationwide spread of the menace, and urging the pharmaceu-

FDA laboratories test suspect and genuine drugs,



MICROSCOPIC TESTS of drug tablets help identify filler material used to bind actual drug ingredients



COUNTERFEIT DRUGS (left row) duplicate originals, even to brand marks, but blowups show differences

SIX MOST COMMON counterfeited drugs. All are provided in tablet form and require prescription



find telltale differences . . .



CHEMICAL TESTS reveal amount of drug used in tablets. Ground up and dissolved in solution, tablets are placed in machine which records contents. Results are then compared to samples of genuine drugs

➔
MICROMETER TESTS measure thickness of suspect drug. Ballistic method is similar to that used by police to study bullet characteristics. Size and shape of tablets, plus other telltale marks, are checked

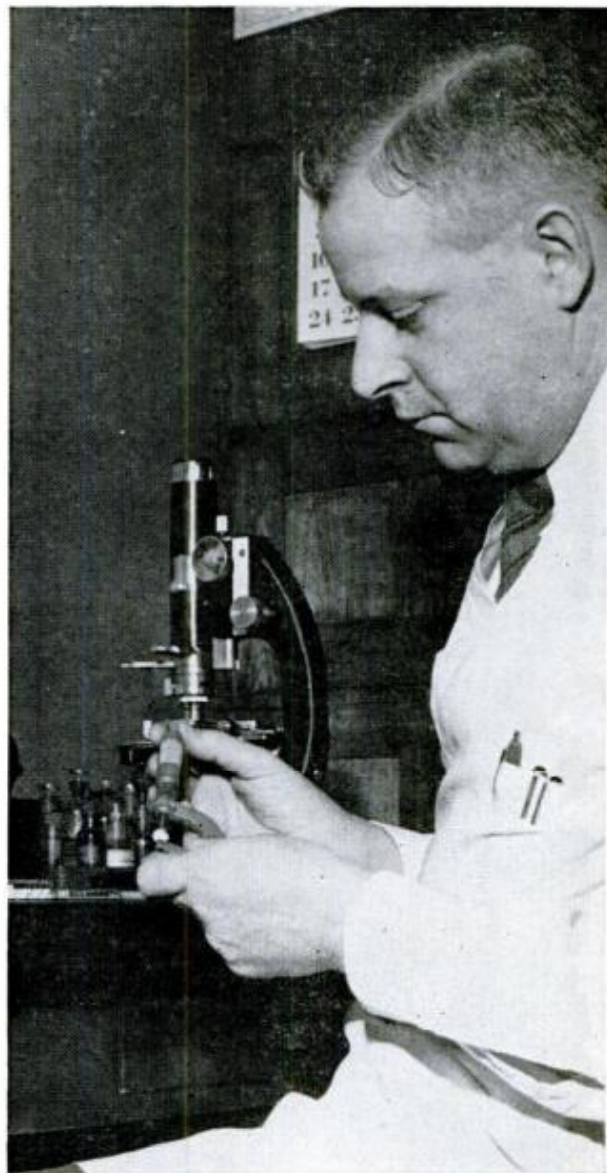

tical firms and pharmacies to combine forces to defeat the cheap criminals responsible for the situation.

One trade journal commented: "As far as the pharmacist is concerned, he can protect himself by being sure of his source of supply. In fact, we suggest that he take extraordinary precautions to guarantee that those who provide him with his prescription-department stock have outstanding reputations."

Counterfeit drugs are made in precise simulation of well-known trademarked, and usually patented prescription items currently in great demand. The simulation extends even to the use of the same monograms appearing on the genuine item and is so close that differences are discernible only by microscopic, chemical and other highly technical examinations. Counterfeits are generally sold unlabeled, often in paper or pliofilm bags or in partially filled

bottles. The distribution is always surreptitious.

Counterfeiters produce these phonies in their own shops, which often are in basements or garages, free of any control of purity or potency of the ingredients used. They use forged dies bearing the trademarks or other distinctive symbols of reputable manufacturers to stamp the drugs, which usually are in tablet form.

Wholesalers and jobbers in the racket usually buy these goods in bulk lots from shady manufacturers, and in turn will sell them in smaller quantities to retail druggists. So far, according to FDA sources, there is little evidence that box and bottle labels also have been counterfeited, the spurious tablets being dispensed to the customer in the druggist's own containers.

As suggested earlier, the racket is nationwide with especially heavy concentrations along the Eastern Seaboard, Midwest,



SORDID SANITARY conditions of storage room for raw ingredients in plant of company named in federal charges for counterfeiting and distributing drugs. Manufacturers of counterfeit drugs bypass federal inspection

Midsouth and Texas. The states in which counterfeit drugs have been found include New York, Massachusetts, New Jersey, District of Columbia, Virginia, North Carolina, Georgia, Florida Alabama, Mississippi, Louisiana, Kentucky, Texas, Indiana, Illinois, Kansas, Oklahoma, Nebraska, Colorado and California. Some industry sources have estimated that as many as five percent of all prescriptions contain some counterfeit material.

In the FDA's nationwide investigation, samples of eight different drugs were collected from 900 drugstores selected at random between January 1 and March 30, 1961. The drugs surveyed by FDA, known from previous experience to have been counterfeited, were: Merck's Diuril and Hydrodiuril, both sold to relieve high blood pressure and hypertension; Wyeth's Equanil and Wallace's Miltown, both tranquilizers; Schering's Meticorten, for rheuma-

tism and arthritis sufferers; Ciba's Serpasil and Esidrex for hypertension; and Chilcott's Tedral, for bronchitis, asthma and hay fever.

All these drugs have a lot in common. They're much in demand, are usually put up in tablet form and require a prescription for purchase. The most widely counterfeited tablet of Diuril is the 500-milligram strength which retails for about \$5.80 a bottle of 50 tablets. Hydrodiuril of 50-milligram strength is also widely counterfeited and retails for about \$5.75 a bottle.

Equanil and Miltown come in a 400-milligram strength, which retails for about \$5.85 a bottle of 50 tablets. Meticorten retails for about \$15.50 for 50 tablets of 5-milligram strength. These tablets are widely simulated. The Serpasil strength that has been found to be counterfeited is the .25-milligram which sells for about \$8 for 50 tablets.

(Continued to page 270)

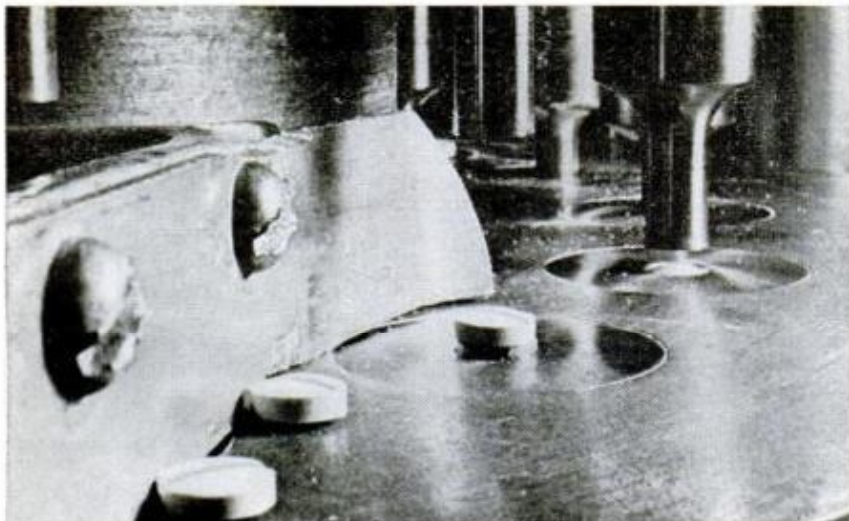

DRUG-MAKING MACHINE, in closeup view, shows punches which form each tablet. Counterfeiters duplicate punches which bear trademarks of legitimate manufacturers and turn out tablets in unsupervised conditions

Dr. Paul Siple first went to Antarctica as the Boy Scout's representative on the 1928 Byrd expedition. He has returned five times since, spending, all told, more than four years in South Polar exploration. He is scientific advisor to the Chief of Research and Development, the U.S. Army general staff.



My Most Exciting Moment

I HAVE FOUND ALL OF LIFE so exciting that to single out a moment of greatest exuberance is almost like selecting the most perfect blade of grass in a meadow. For an explorer or scientist each new discovery is exciting. Yet one moment about 27 years ago remains indelibly engraved in my memory.

While being the leader and navigator (as well as cook) of the Marie Byrd Land sledging party, three companions and I had sledged with 27 dogs some 300 miles eastward from Little America. We were, at this point, further into unexplored territory than anyone had ever been. A few days earlier I had lugged a small surveyor's transit to the summit of Mt. Grace McKinley where our supporting party had left our last depot of provisions. From a narrow footing above a sheer drop of about 2000 feet I had run a set of angles on the new mountain peaks that lay ahead. Gusts of bitterly cold wind at about -30 degrees F. jarred my instrument and made my eyes water. Still I could glimpse more peaks ahead of us than my companions could possibly see from our camp position lower down the mountain slope.

The urge to reach these new nunataks was a strong enough motivation to endure the next two weeks of travel. There was a heartsick day when after an exhausting 12 hours we had only advanced a mile. By lightening our loads and relays we made as much as 15 miles on good days. There were pauses for surveys and geological studies among the red, brown, gray, and black outcrops of granite and ancient metamorphosed sedimentary rocks. At last we reached the foot of a giant mountain which barred our view. A glacier saddle formed a pass between portions of the lofty wall. From this saddle we might see a promised land beyond.

Steve Corey and I could not wait another day. While Al Wade and Olin Stancliff made observations on the rocks at hand. Steve and I started our climb in beautiful calm weather, lit by a low midnight sun. As the ascent became steeper we abandoned skis and walked. This was dangerous on the glacier. Our way was barred by great sagging 50 to 100-foot-wide crevasse bridges, but we ran across them. They held or else they would have been our icy tombs for eternity. We reached the crest of the saddle. There, seeming close at hand on the other side of the mountain, were 50 or so bare rugged peaks, black and bold against the white continental glacier. Our excited expressions of awe were absorbed by a stillness that had never before been broken by the sound of a human voice.

We knew that ours were the first eyes to see the looming central peaks of the Edsel Ford Range—a major discovery that suddenly made the years of preparation, work, hardships and discomfort fully worthwhile.

Paul A. Siple

You CAN Detect a Good

-a dealer's 19 secrets

By Charles McMurdo

As told to Watson Fenimore

THERE WAS LITTLE DOUBT in my mind as to the outcome. The young lady couldn't take her eyes off the shiny, green and white hardtop on the used-car lot which I manage.

Traded in on a new car weeks before, the hardtop had come to us in bad condition, but it had been given the standard "cosmetic" treatment from bumper to bumper—a complete repaint, new floor mats, foot pedals, upholstery. It looked as good as new.

Standing next to it was another car of identical year, make and model—in good operating condition but with its original paint and equipment attesting to its years. The second car looked drab in comparison with the refurbished hardtop.

From years of experience, though, I knew that the second car was a better buy. And, since both had been tagged with the same price, I tried to steer the young lady to the second car. But the hardtop's glamour was too much. Against my advice, she bought it.

In a week she was back. The car was hard to start, had little pickup and its exhaust emitted blue smoke. It needed a complete engine overhaul.

My customer was lucky. We did the job free for her, but it cost us \$150. In some other dealerships she might not have been so lucky.

This incident illustrates why many used-car buyers do not get a good buy. They let



the car's looks catch their fancy, a weakness that makes them easy victims for unscrupulous used-car peddlers whose jaloopies ought to be headed for the junk yard.

Knowing the car-buyer's weakness for appearance, the first thing a dealer does on taking a car in trade is to give it a quick, superficial "beauty" treatment. This costs the dealer about \$20, and nets him at least an added \$50 in profit.

Weathered paint is rubbed down with an abrasive and the remaining finish buffed to a high shine. Rusted chrome is sanded

VETERAN USED-CAR APPRAISER Charles McMurdo turns steering wheel in check action for roughness

Used Car Bargain



SHE LOOKS GOOD FROM THE OUTSIDE, but what's under the paint and chrome? Springs and shocks may be in fine shape and a bit of jumping on bumpers will tell. If car returns to original level when you've jumped off, shocks are fine. Continued bouncing after you've quit is sure sign the shocks are ailing

and given a chrome refinish base coat, then dusted with powdered-metal chrome finish and buffed until it, too, shines. The car's interior is washed and sometimes dye-sprayed, and worn floor mats and pedal covers are replaced.

Worn tires may be replaced with recaps, cheap third line or so-called "high-tread" tires, or tires from wrecks. Or tires may simply be repainted or (in a practice which should be outlawed) regrooved and then painted.

Dirty motors are steam-cleaned and then may be painted to cover up water and oil leak marks. And all of these chores the dealer may either do himself or have done on his lot by professional car cleaners who may charge him as little as \$8 labor per car.

The shining result is, of course, what traps the unwary. Yet there's no need to be stuck on the purchase of any used car, if the buyer will only follow a few simple rules—such as those I have learned from years of appraising trade-ins.



1 OIL PRESSURE DIVES as water temperature hits normal, look for bad oil pump or rings

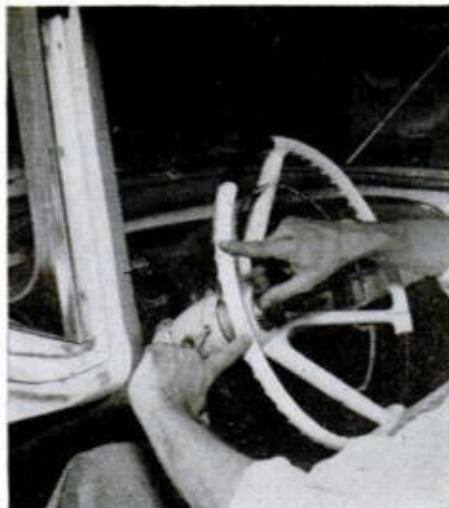

2 MORE THAN TWO INCHES of free play in steering wheel is sign steering gear is worn



3 REPAINTING BATTERED BODY may leave paint flecks on sills, seats and weather stripping



7 VIBRATIONS IN SHIFT LEVER may only mean loose linkage—or transmission's death rattle



8 RUST ON ROCKER PANEL may not be serious; on doors and main panels, it spells repairs



9 POCK-MARKED CHROME is normal. Slightly duller clean finish may be "reconditioned"

My job, in fact, has depended on my ability to tell the true condition of a car without actually taking it apart. Usually I have to do this in a hurry while the customer and the dealer await my verdict. In this sense, I am in the same position as the man who is trying to decide whether to buy a car he sees on the used-car lot. But there is an important difference. I have a boss who expects me to be right!

To make sure I am, I use a number of quick check points which any buyer can follow. Add to these a few he can pursue at more leisure than I usually have, and there's no reason why he shouldn't come up with a good buy.

First of all, inspect the paint job. If its texture differs noticeably from that on other cars in the lot, or you find paint flecks on weather stripping, upholstery or door hardware, or see body-repair ripples under the finish, the car has probably had to be re-

painted because of hard usage, bad care or an accident. Don't buy it. Also make sure the doors, hood and trunk lid fit correctly. They may not if the car has been in a wreck.

Recently, a trade-in customer insisted that the 40,000 miles on the odometer was correct, but the repainted steering wheel told me the car had at least 70,000 miles on it. He finally admitted I was right. Painted instrument panels, new floor mats, new pedal covers, arm rests, seat covers, upholstery—all are signs of hard wear.

A close look at the tires may reveal adhesion ridges along the tread rims, a sign of recapping. While recapping may be safe for normal driving, recaps are not the new tires they appear to be. Watch for freshly-cut treads on tires that are scuffed and worn on the sidewalls. Such regrooving may leave the core nearly bare between the treads and this spells danger.

Check the tire pressures. Low-pressure



4 SCREWDRIER TEST gives idea of tread depth. Close look may reveal regrooving job



5 TELLTALE OIL DRIP? It may be just a bad pan gasket or a main bearing may be gone



6 WHAT'S UP THE PIPE? If carbon deposits are oily, it may mean engine is an oil pumper



10 WHEELS OUT OF BALANCE or out of line show up in uneven tread wear, bald spots



11 GLEAMING HUB CAPS may hide grease or fluid from leaking seal or wheel cylinder



12 TIRE PRESSURE MAY BE right or pumped higher for a snappy demonstration ride

jobs requiring 25 pounds or so can be pumped to 30 pounds or more. The hard tires can make a sluggish engine seem to have more pep since there is less tire drag on the road. Your demonstration ride on the smooth macadam, minus bumps and ruts, won't be likely to show up such "high pressure" tactics.

Uneven tire wear confined to one side of the tire points to bad wheel alignment. A bald spot indicates an out-of-balance wheel. Worn ball joints or worn king pins and bushings may show up in a road test as wobbles and vibrations transmitted through the steering wheel, or sloppy, uneven cornering characteristics.

If the steering wheel binds on the turns during your test run, chances are that steering mechanism has been over-tightened to conceal wear. Also check it with the car at rest for any roughness in turning and excessive free play (over two inches) before

the car's front wheels begin to turn.

With the car in motion and "pulling a load," listen for rattles or heavy thuds from the engine. They may mean anything from bad valves to loose rods or piston slap. A complaining drive-line will sound off with whines, hums and grinding sounds from a bad differential or transmission, or thumps during the shifting of gears from worn universal joints. Of course, the car should have a reasonable amount of pep and pulling power.

What about brakes? Do they hold and does the pedal resist firmly when not more than halfway to the floor? If not, the car may need nothing more than a simple brake adjustment—or it may need new linings or repairs in a leaky hydraulic system. When you get back to the lot, remember to check by turning the wheels as far in one direction as they will go, and then inspecting the back sides of the wheel drums for signs of



13 LEAKY CARBURETOR GASKETS allow fuel to wash down and leave "varnish" deposits on float bowl—bespeak lack of basic maintenance

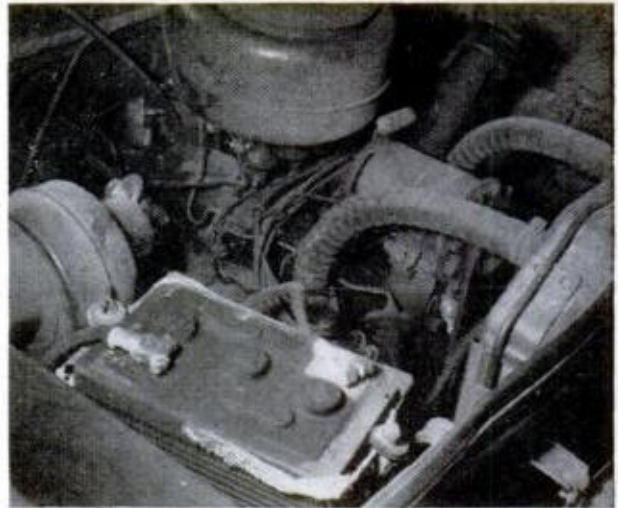

14 OWNER CARELESSNESS shows up in "boiled-over" battery covered with white acid deposits—probable result of faulty voltage regulator

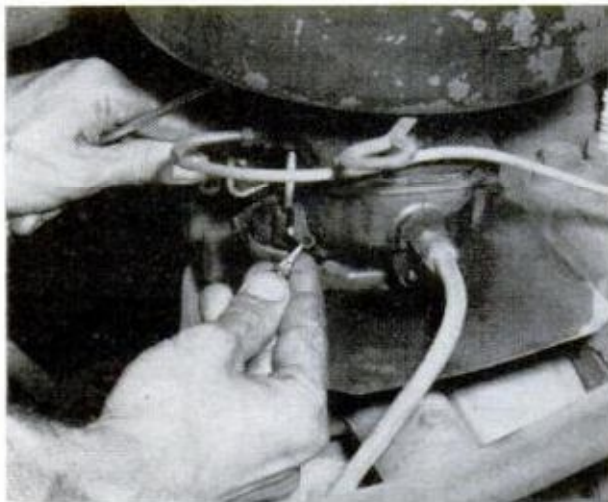

16 PROPERLY TAKEN CARE OF, oil-bath air cleaner does important job. Neglected, it lets dirt into carb, makes for worn, dirty idler valve

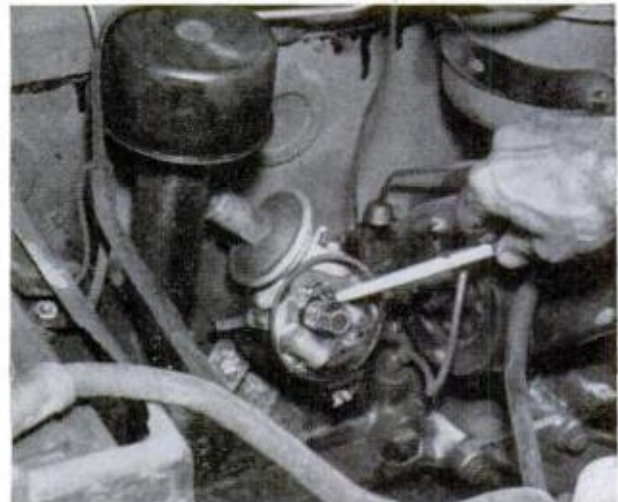

17 WHAT'S THE DISTRIBUTOR LIKE? Good care will have left grease in cup and wick, no burning of contact points or cracks in tower terminals

a leak. (This may also reveal frayed or leaking wheel lines.)

Also try driving the car at slow speed and applying the brakes while holding the wheel lightly. A pull to the right or left indicates the need for adjustment or repairs.

On standard-shift models, pressure on the clutch should meet with resistance in an inch or so of travel. If it doesn't, the clutch needs either adjustment or replacement. The odds favor replacement on older models. On cars with automatic transmissions, shifting should be relatively quiet and smooth through all speeds.

With the engine warmed up after a test run, if the oil pressure drops when the water temperature reaches normal, the oil pump is ailing and the bearings may have been running dry to the point where an expensive repair job is due. If, in addition, blue smoke is coming from the exhaust, you know the engine is burning oil and

needs an overhaul. (Unfortunately, on cars with warning indicator lights, the oil pressure light doesn't come on until pressure is down to about seven pounds. If normal pressure is 15 pounds the car may have been running at eight pounds or close-to-critical low pressure for some time.)

If gray-black (not blue) smoke keeps coming from the exhaust, an engine flush and tuneup are probably needed. Spitting or sputtering sounds from the exhaust can mean burned valves in need of repair.

If you're used-car shopping in old clothes (and you should be), a quick crawl underneath the car may reveal broken spring leaves or shackles, or a loose or rusted-through muffler or exhaust pipe.

Having tested and discounted several cars as potential trouble, let's assume you have found one that stands up fairly well to inspection. Try looking at things under the hood. You might begin with the distrib-

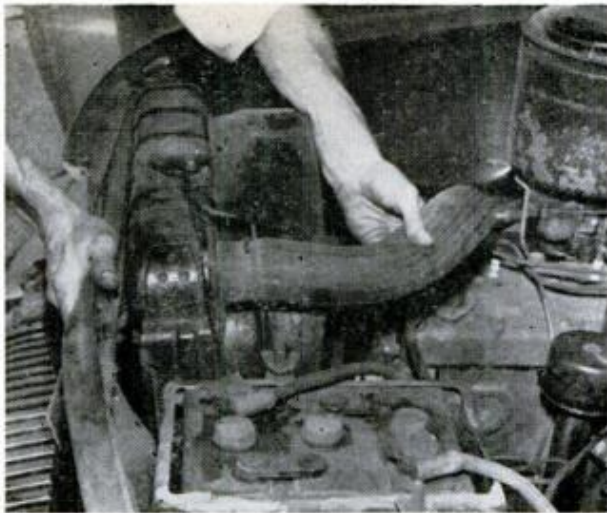

15 SPONGY HOSES NEED REPLACING. Wetness on supporting crossmember, white lime or signs of sealing compound on core mean bad radiator

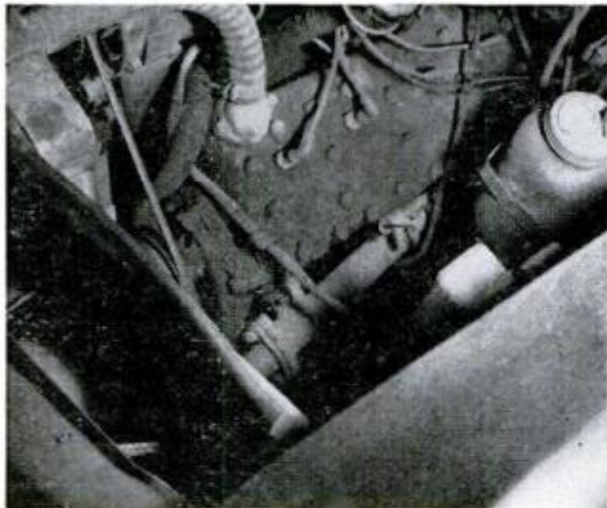

18 WIND-SPRAYED OIL LEAK mixed with dirt coats engine, holds moisture, shorts out wiring and makes for engine which runs as bad as it looks

utor. If possible, pull the coil lead out from both its coil and distributor ends (it's easily reinserted) and check the brass tips for blue-green corrosion. Do the same with the spark-plug wire ends. Such corrosion bespeaks a lack of simple maintenance and, though it may not have a serious effect in dry weather, unless remedied, it will make starting difficult when things turn wet. Burned, cracked terminal towers are a sign of a bad coil and/or condenser.

By this time you have pretty well added up the score for better or worse. Even if the car exhibits only a few of these more minor weaknesses, your discoveries will supply you with a bargaining point with which to secure needed repairs or pull down the quoted price of the car.

From experience, I would advise you to expect to encounter the following problems. On cars up to three years old, a tune-

(Continued to page 288)



19 DON'T BE AFRAID TO YANK PLUGS. They are as good a barometer of engine's running condition as anything you'll find. Top plug covered with reddish-brown deposits points to good rings, combustion. Bottom plug, from an oil burner, is covered with black, greasy carbon and oil



Police Get Evidence by "Shooting" Speeders

Yielding "the best possible evidence," a squad-car camera system automatically takes pictures of speeders and other traffic violators. It produces negatives that show the time, date, license plate, speed and situation, without the driver taking his eyes

from the road. Two 35-mm. rapid-sequence cameras, one with a normal lens and the other a telephoto, are operated by a button on the dash. A powerful 500-watt-second electronic flash, mounted on the roof, is synchronized for night photography.

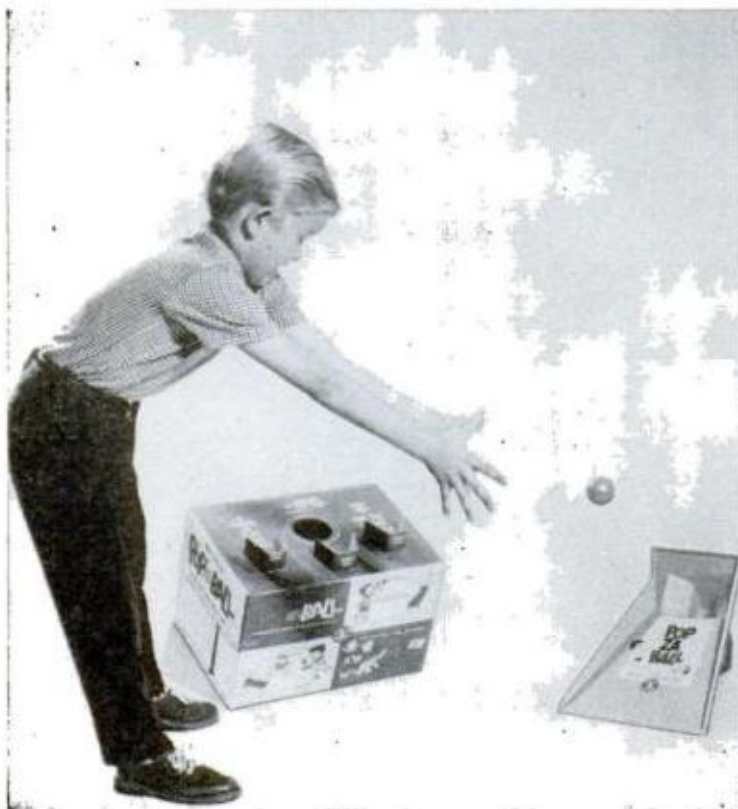

Dad-Saving Spring Toy Plays Catch With Junior

When a plastic ball (furnished) is rolled into a new toy, it is thrown right back by a spring mechanism which has settings for both long and short throws.

The Popzaball (manufactured by Mattel, Inc., 5150 Rosecrans, Hawthorne, Calif.) is expected to be as popular with sore-armed fathers as with their tireless youngsters.

The kit includes a target (shown) which can be used to play a variety of games. List is \$7.

☐ The smallest atoms that have been measured are less than four billionths of an inch across.

☐ Though a porcupine moves slowly by nature, it can run as fast as a man for short distances.

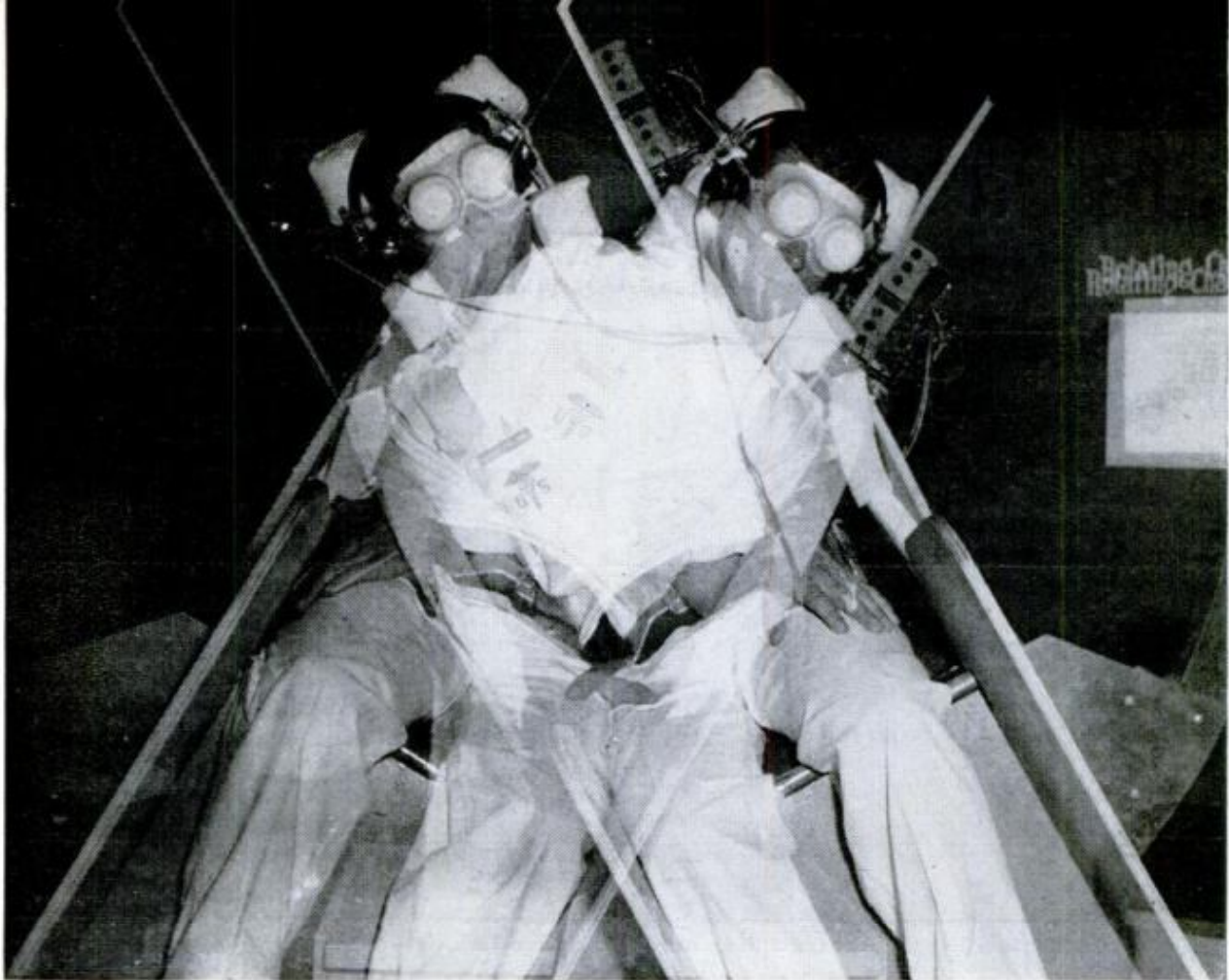

Here's the Air Force Version of Rock 'n' Roll

This double-exposure picture shows a blindfolded Air Force test subject being tilted in two directions while revolving in a special chair at the School of Aviation Medicine at Brooks Air Force Base, Tex.

The apparatus is used to study man's reactions to spatial disorientation. The chair rotates at 18 revolutions per minute and can be tilted electrically to 30 degrees from the vertical at the same time.

Concrete Sculpture Forms Roof of Air Terminal

While an observer from the air might mistake the new TWA terminal at Idlewild Airport for a gigantic airplane ready to take off, the knowledgeable visitor will see a flowing design that makes spectacular use

of new techniques in concrete construction.

The New York terminal has a concrete roof ranging in thickness from eight inches at the edges to 44 inches at centerplate. The shell is supported by four buttresses.

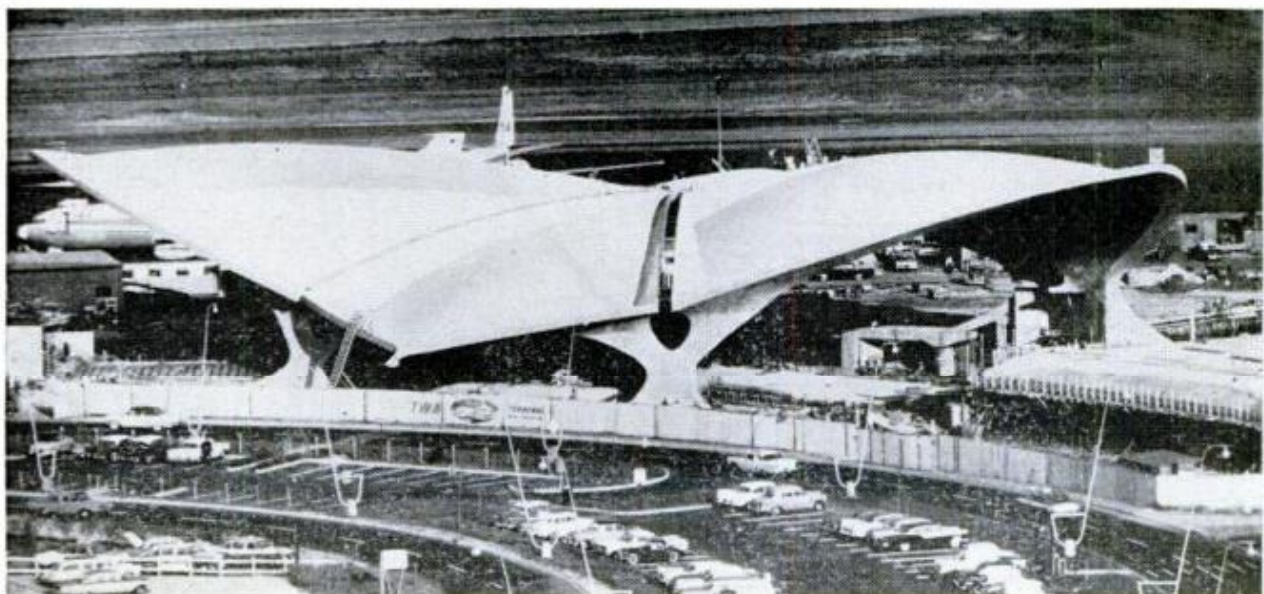

PM Tests Volkswagen's



WHEELING THE VW 1500 through this tight curve at 30 miles per hour produced moderate body lean and considerable tire scrub, but car had absolutely no inclination to break loose in dangerous oversteer

NOW THERE ARE TWO. After 23 years of development, production and refinement of one basic model, Volkswagen has brought out a second series, (PM, July '61, p. 81) to be known as the VW 1500.

This new car will go on sale in Germany this autumn, initially in two-door sedan and two-door wagon models. A convertible is set to follow.

Let's hasten to add that there is no thought on Volkswagen's part of abandoning the world-renowned "beetle" (No. 113) which the company likes to call "The Volkswagen" to set it apart from the new "VW 1500." As a matter of fact, there are no announced plans for bringing the VW 1500 into the North American market.

The new model is intended primarily to provide a "step-up" car for motorists in newly prosperous European nations who can afford a bit more car than the current model.

Up 'til now Volkswagen owners who wanted more performance, more elbow room or more luxury, have had to turn to

OPTIONAL SUN-ROOF on VW 1500 glides back into its hiding place smoothly and easily at turn of crank

an Opal, a Taunus or another competitor.

The VW 1500 should suit these people perfectly. In many ways it's a good deal more car than the current classic (dare we say it?) model. But it is not a better car in the sense that it provides any more-efficient transportation than the beloved "beetle."

In appearance, of course, there is a startling difference. Those who expected the new car's styling to mirror the present VW's Gothic slopes were disappointed.

Except for the familiar interlocking VW letter insignia on hood and hub caps, there's little clue as to the family relationship. The 1500 might very well have been styled in Stockholm, Turin, Coventry or even Detroit.

The 1500 is neither sleek nor exciting—these qualities have been saved for a new Karmann Ghia. There's nothing of Jaguar or Lancia in the VW 1500, but it grows on you.

The more we looked at it the more we liked it. The VW 1500 has the simple elegance of Danish modern furniture.

CROSSED TORSION BARS act through lower trailing arms of front suspension. Antiroll bar is on upper arms

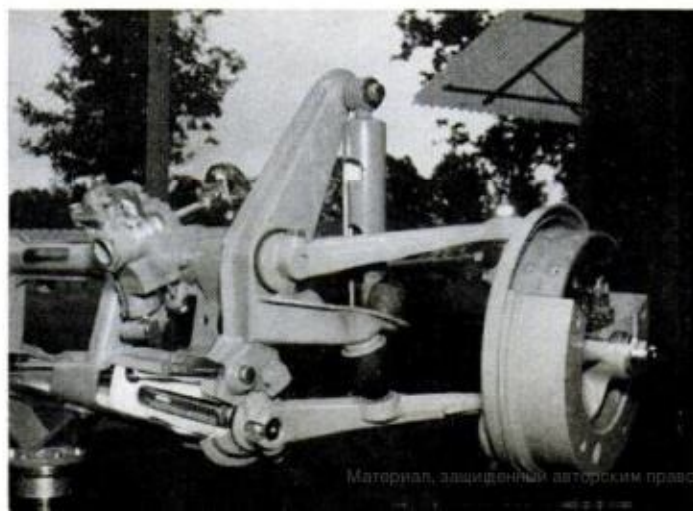

New 1500

By Jim Whipple

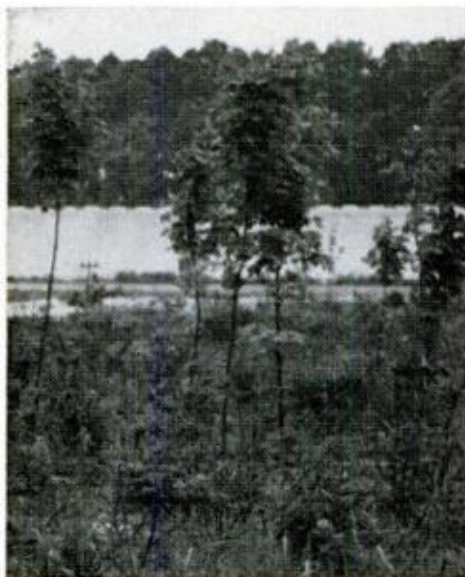

THERE'VE BEEN SOME CHANGES MADE in the world's most famous automotive shape. The "beetle," left, poses with its new running mate the VW 1500

Or course, the car could have been made to look sleeker at the cost of comfortable seat height and headroom, or more imposing by adding extra sheet metal fore and aft. But this sort of nonfunctional "stylishness" is as foreign to VW thinking as a hula hoop in church.

The most obvious change, of course, is the full-width body which provides 50-inch shoulderroom front and rear and 53 inches of hiproom in the rear seat.

The rear seat incidentally, is contoured to position two passengers on either side of the folding center armrest. With the armrest up, three 180-lb. men can sit back there and still have plenty of room for their legs—making this a snug but workable five-passenger car.

Up front there are two individual chair (not true bucket) seats, also contoured to position driver and passenger. Both front seats are adjustable on a four-inch fore-and-aft travel and both have backrests that have knob-controlled variable tilt.

Front seats are a comfortable 12½ inches

off the floor with a generous 44 inches of legroom. Front headroom is 35½ inches which is ample for over six footers. Rear headroom is two inches less—a hats-off situation for tall men.

The plastic upholstery is pleasantly firm, and the critical front-to-rear cushion measure equals that of the BOP compacts.

This generously-sized passenger compartment goes on the same 94.5-inch wheelbase of the current model. However, the VW 1500 is 6 inches longer and 2½ inches wider than the No. 113. At 1896 lb. it weighs 265 pounds more. The weight is distributed 43 percent on the front wheels and 57 percent on the rear.

One problem that has always plagued VW owners has been the lack of enough luggage space. Many people have made their living producing roof-top racks for the current car.

With the VW 1500, however, the luggage problem may be solved for many by the two luggage compartments. The one in front, larger than on the No. 113, is over the gas

SUITCASE ENGINE of the VW 1500 is a marvel of space-saving engineering. Top view, left, shows how air cleaner sits beside the horizontal carburetor. Cutaway, right, shows crankshaft-driven blower, generator drive

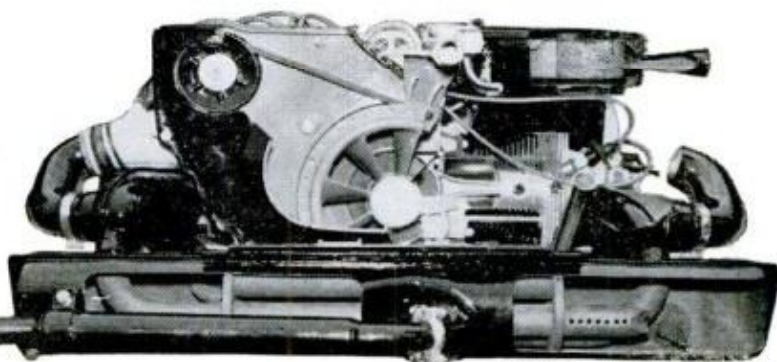
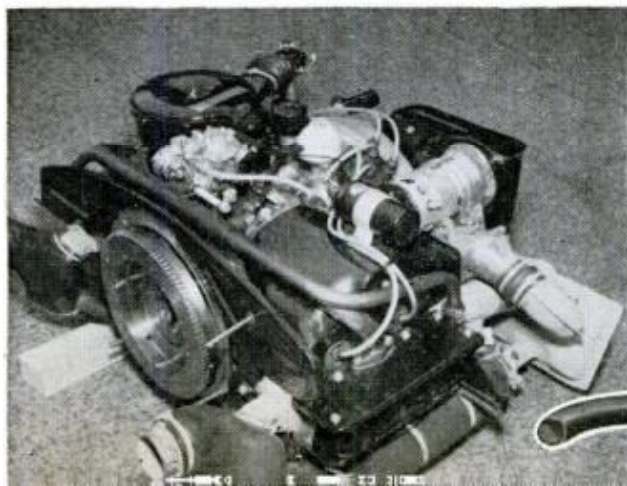



FRONT TRUNK of VW 1500 measures 27 inches long by 41 inches wide at the rear, is 11 inches deep at rear. Cowl air intake can be seen at upper edge of trunk



REAR TRUNK is 9½ inches deep, runs back 41½ inches under rear deck and window, is 36 inches wide. Oil dipstick and filler is located on trunk's rear rim



DOOR TRIPS LATCH (when closed) which works through cable to lock front seat-back upright for safety. Handwheel, at left, adjusts seat-back rake

tank, and there's another in the rear, above the "suitcase" engine (see photos). Both trunks are neatly lined to make luggage scratchproof.

The engine compartment is covered with a latched, insulated hatchway that's gasket-sealed. Engine cooling air comes around from slots at the base of the back window past the sides of the metal luggage bin down through an air duct below sill of trunk door, and through a rubber "boot" into the fan housing and hence through the blower into the ductwork and over the top of the engine. A new blower mounts on the end of the crankshaft. It forces air around the oil cooler, which is flat-mounted, and down over the engine and out through ducts beneath.

There is no thermostat to shut down the flow of air. VW engineers say that the ther-

(Continued to page 286)

AT LAST a wagon for folks who like Volkswagens. It's an alternate body style to VW 1500 sedan. It has one-piece, top-hinged tailgate, and side windows that swing out like the sedan's for rear-seat ventilation

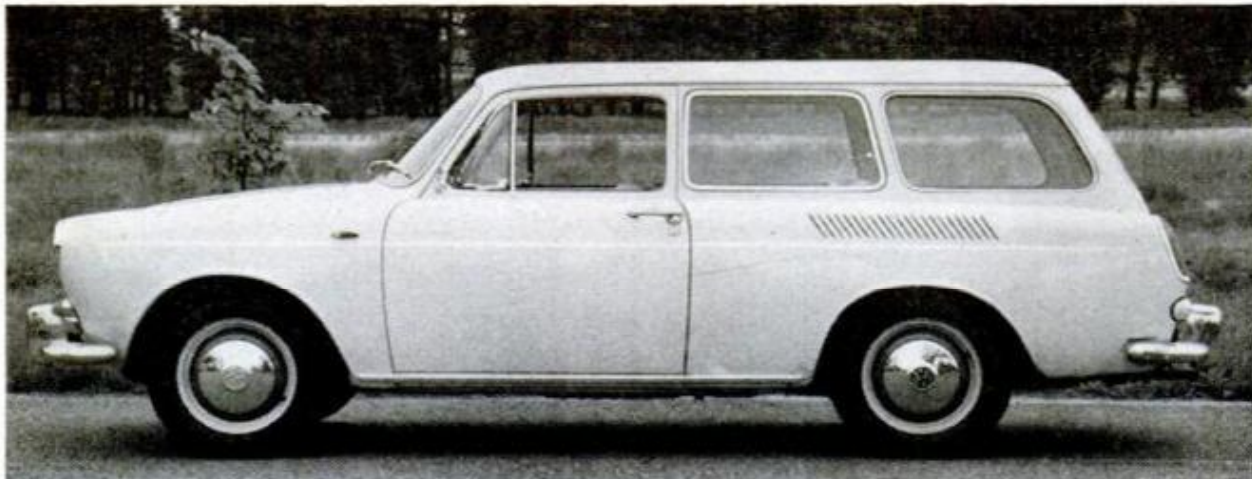

Engine With Built-In Wings

*It can thrust itself, and heavy loads,
in any direction — including straight up!*

By Richard F. Dempewolff



NORMAN L. DEAN unlocked a heavy door in his Victorian house, in Washington, D. C., and led the way into a barren room. A workbench stretched along one wall.

"This is my laboratory," he explained, "and there is the newest prototype of the Space Drive System."

Three brass chains, hanging from the ceiling in the center of the room, held a V-shaped structure of clear Plexiglas a few inches above the floor. It was framed in polished aluminum; the broad end contained motors,

PROPELLED by Norman Dean's "rotating mass" engine, a truck could deliver goods to any floor of a building. Inventor, left, demonstrates a model engine that has lifted itself so paper can be slid under it

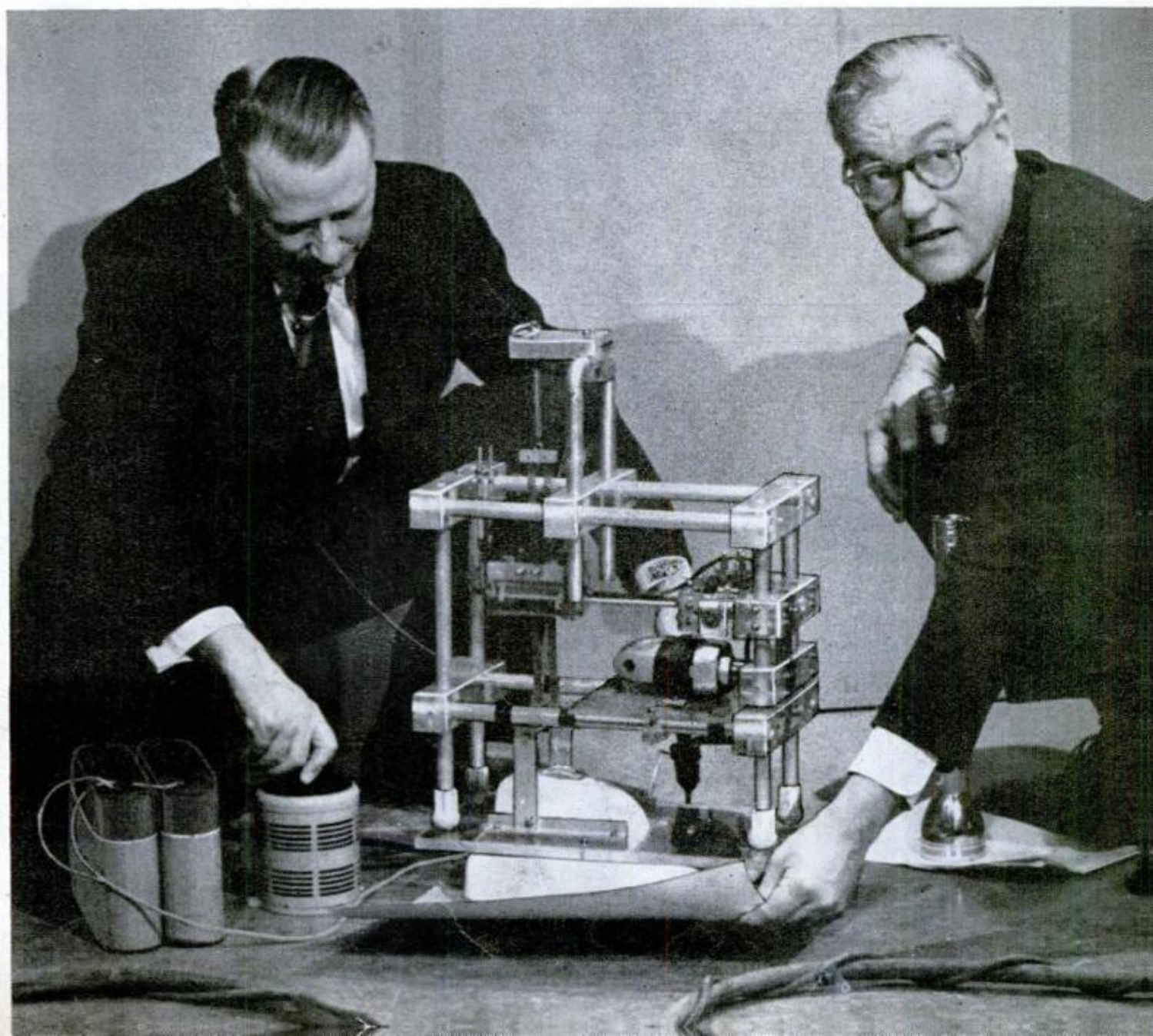

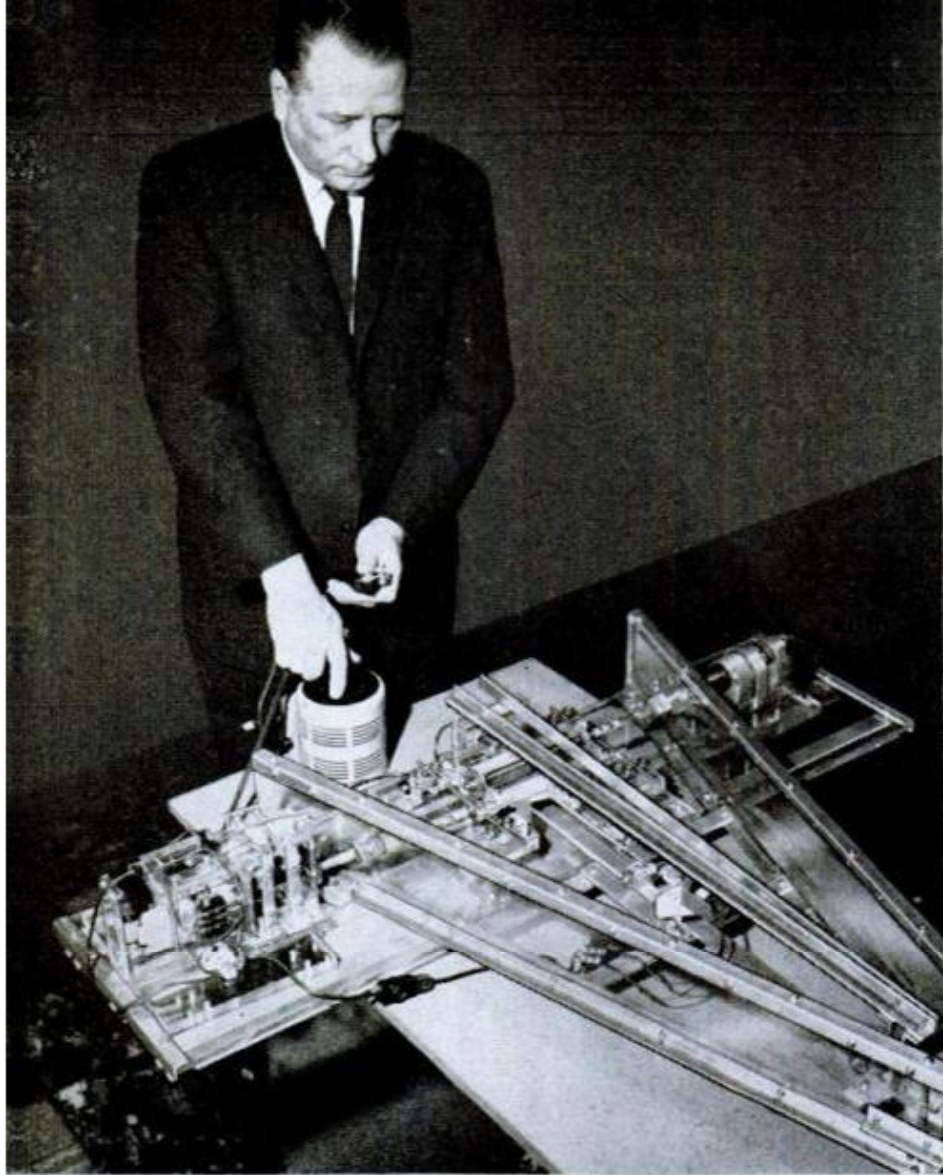

ANCHORLESS WINCH will not only move in any direction in which it is pointed, it also will remain still while pulling loads to it.

ONE PAIR of counter-rotating weights suspended in the framework at right provides enough thrust to move the entire engine along the top of a table—and to pull a weighted 25-pound load, left, along with it.



FUTURE APPLICATIONS: The propulsion system would let a truck move over a swamp; its force could be used to push down walls quickly, easily.

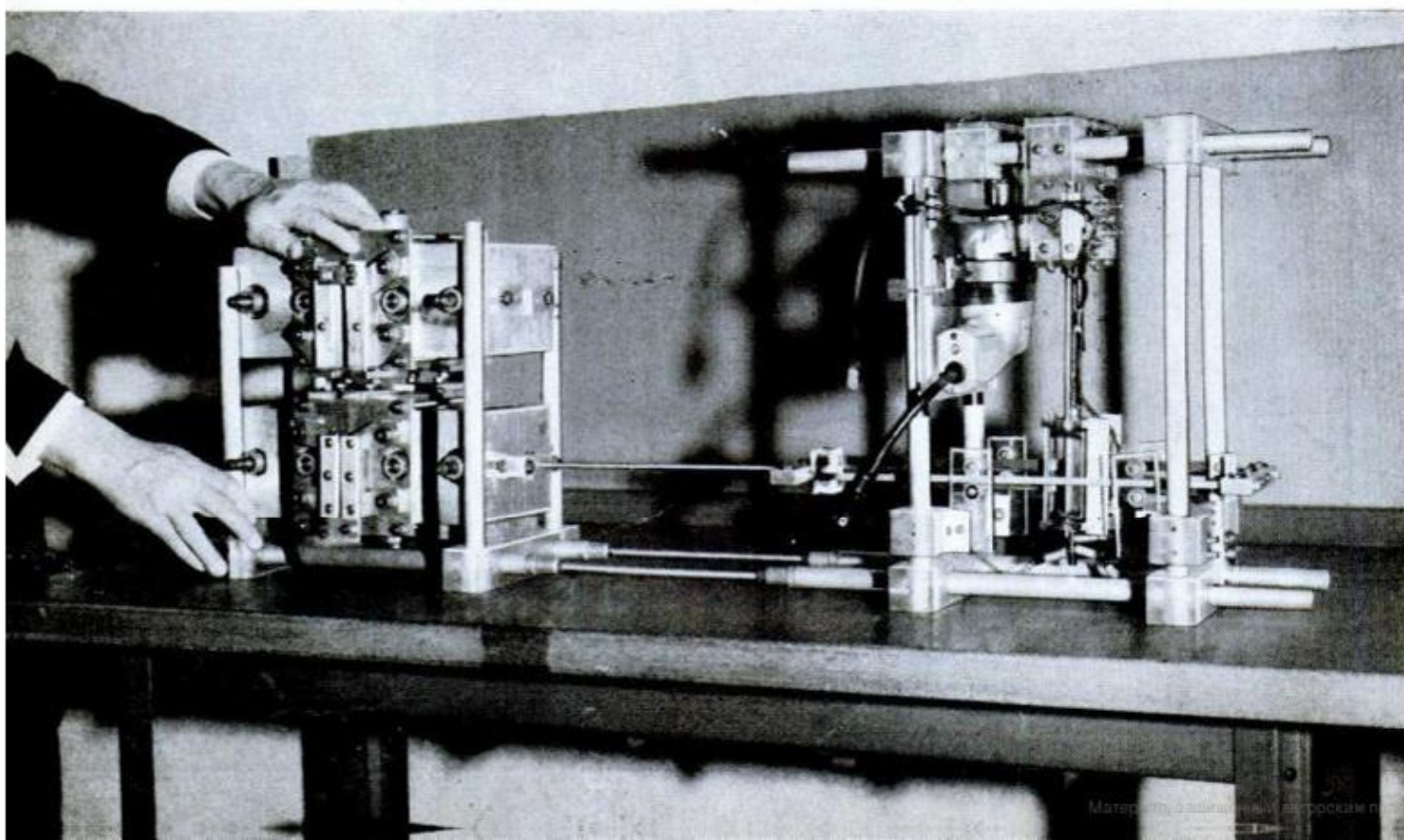

machined brass, steel and aluminum, and a maze of wiring.

I was gazing at what may be the most revolutionary concept in propulsion systems ever devised. The principle employed in the V-shaped framework would enable it to move itself and formidable loads forward, backward, sideways, straight up, or you name it and that's where it will go.

"This model is a version of a commercial anchorless winch," Dean said. "It was built spread out behind windows so engineers can see what goes on inside, and why. It demonstrates the basic principle of the system: *Rotating masses, which are the heart of the mechanism, can be made to exert a force in one direction only.* It also demonstrates a number of things that can be done with this force, as do the other versions of the system you see on the workbench."

Dean's models not only show a net output of one-directional force on instruments—much to the consternation of some engineers who have refused to believe the mathematics of his system—but they also work in actuality. Not long ago, one multiple unit lifted its own weight right off the floor and stayed relatively weightless while the masses inside rotated. Others, not designed to do anything but exert a suggestion of one-directional thrust for measurement by instruments, have brought their weight to zero. Any one of them could, and some did, creep across the lab floor pushing or dragging loads.

While I watched, Dean attached an 18-pound load of boards to a set of skids on the floor. He fastened the skids to the V-shaped machine with a rod. Another rod, on the load of wood, held an index pointer that was lined up with a plumb bob hanging from the top of the framework. A second plumb bob was lined up with the two back chains.

"We'll run it slowly so you can see what happens," Dean said. He closed two switches, turned up a rheostat, and everything came alive inside the unit. Eccentric rotors began to spin and oscillate. Solenoids snapped. The load of boards began to move across the floor.

Incredibly, though it still hung suspended like a pendulum from those three chains, the V-shaped unit remained still. The chains stayed in alignment with the plumb bob.

"The forces generated in the machine are exerted on the load in one direction," explained Dean, "but you can see there is no reaction on the machine. The reaction is being taken up by the system itself.

THIS DIAGRAM shows, in plan view, how the system functions during four basic steps in a single cycle

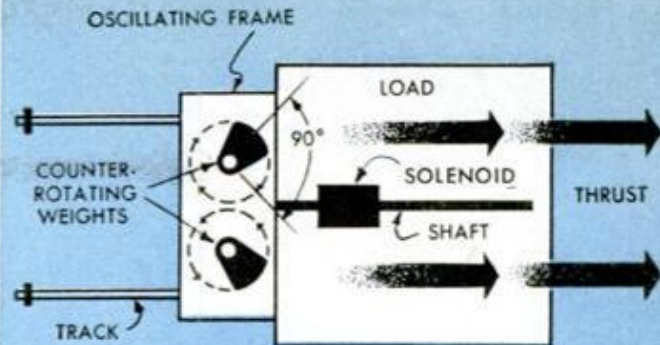

THROUGH 90° OF FORWARD SWING ROTORS THRUST AGAINST LOAD AND MOVE IT FORWARD

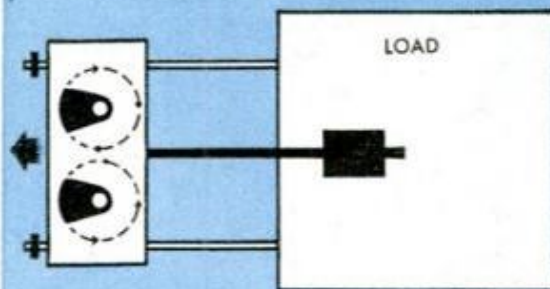

ON BACK SWING ROTORS THRUST OSCILLATING FRAME BACK ON TRACKS

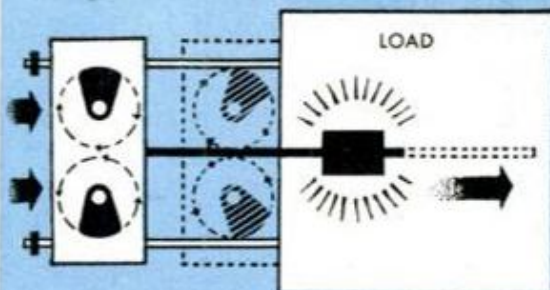

AT START OF NEXT REVOLUTION, ACTIVATED SOLENOID PULLS FRAME AGAINST LOAD SO THAT CENTRIFUGAL FORCE CAN AGAIN THRUST LOAD FORWARD

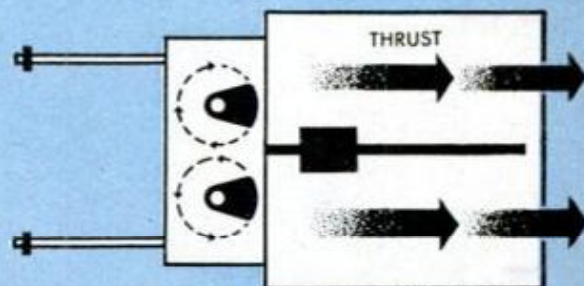

FOR 90° OF FORWARD SWING, ENTIRE ASSEMBLY MOVES FORWARD AGAIN

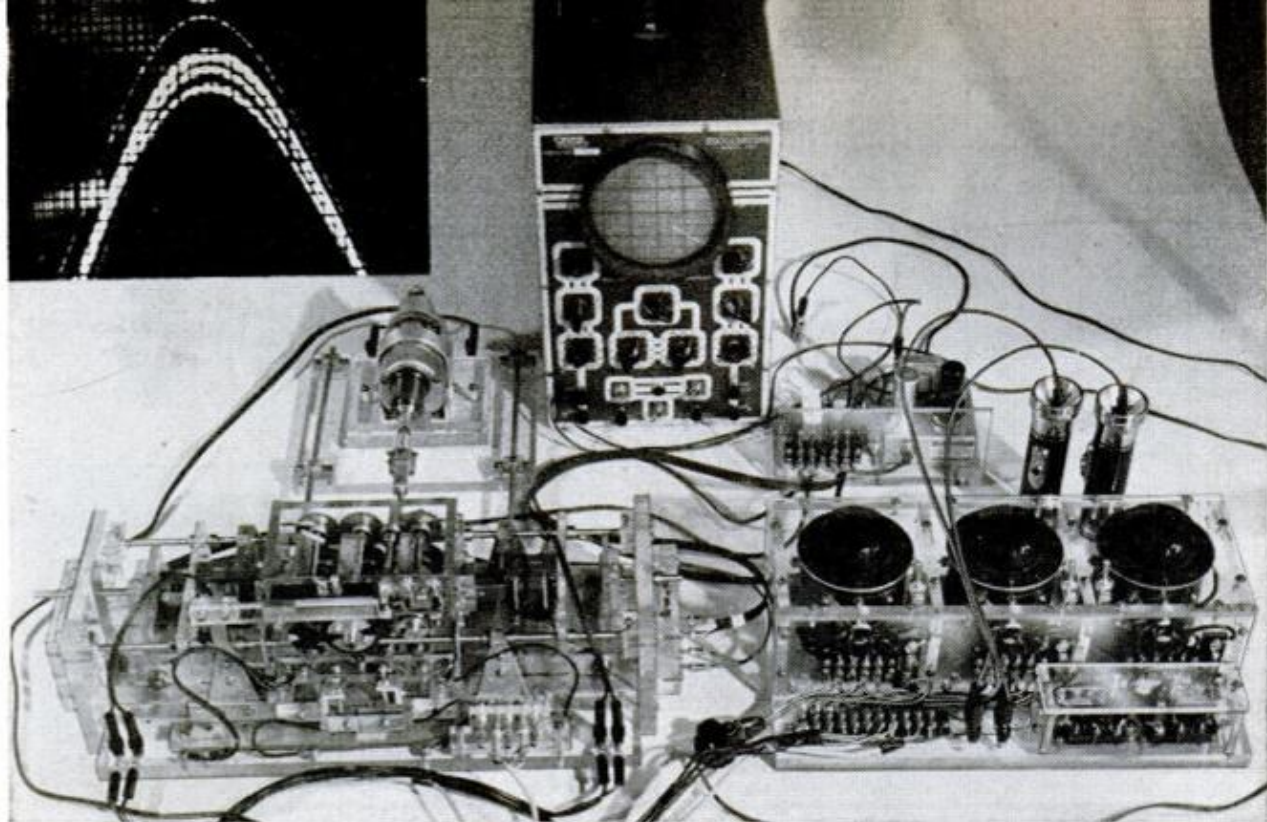

DEAN'S PROTOTYPES have been built for testing with instruments. The oscillograph, top left, which shows a net output of directional force, was obtained by this complex setup. Engine is left, control equipment right

If it weren't, the machine and load would have to move toward each other. Instead, the load moves toward the free-hanging machine."

An anchorless winch, using this system, could pull down a tree without exerting force on the man who held it, Dean pointed out.

"Now watch," he said, fastening two

COUNTER-ROTATING masses are enclosed within frame at the bottom of the vertical driveshaft. Wedge-shaped eccentrics rotate in a vertical plane

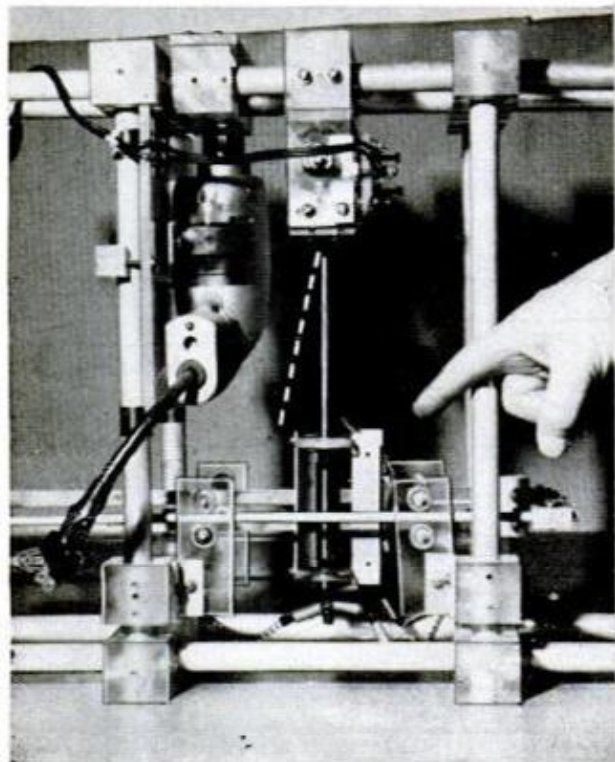

metal rods to the load so that their ends just touched the machine—like a pair of prods. "This time, when the load moves forward, the machine will have to move, too."

He flipped the control switches and turned up the rheostat. The load moved forward, its chain supports describing an angle against the plumb bob. "The machine itself, while operating, has become part of the load," Dean explained. "It will work the same way whether it is at the bottom of the ocean, on the face of the moon, or in interstellar space. All it needs is an energy source.

"Imagine a truck using this kind of drive," he said. "No power transmission to the wheels would be needed. You could drive anywhere on any surface. Turn the force direction upward, and you'd lift the vehicle as high as you wanted, then let it down fast or gently. Your foot on the accelerator would control speed in any direction."

Dean is a precisely groomed gentleman who looks like anything but an inventor. In fact, in his workaday capacity, he is a real estate mortgage expert, and Assistant Chief Appraiser for the Federal Housing Administration. For some time though he has spent his spare hours in testing ideas resulting from his interest in the relationships of physical laws. The concept for the space drive was born some 13 years ago as he grew curious about the dynamics of rotating masses. The result of his curiosity is a set of patents on "A System for Con-

(Continued to page 264)

Trailer Totes Chambermaid

For those whose idea of "roughing it" includes the addition of an upstairs maid, the French have designed a trailer with an upstairs room. Called the Digue, it is furnished in the latest deluxe fashion and affords complete separation of living and servant's quarters. For those without a maid, it might do very well as a place in which to sleep an overflow of youngsters.



Lunar-Landing Cushion

To provide spaceships with a soft landing on the moon and other spatial ports of call, the Goodyear Aircraft Corporation proposes that a special shock-absorbing cushion be used—presumably on the ship's tail end. Already subjected to extensive torture tests, the inflatable doughnut-shaped fabric decelerator consists of a series of separate compartments, each inflatable independently of the others. Sections absorbing the main weight of the vehicle and the greatest percentage of shock, would "give" by partial deflation, minimizing bounce and chances of upset.



Cam-Dwell Indicator

Service mechanics and Saturday tune-up experts may be interested in a pocket-sized cam-dwell indicator which allows dwell adjustments to be made without removal of the distributor from its mounting. With an indicator arm fitted onto the shaft and a protractor set on the housing, the housing is loosened and rotated until the distributor breaker points are closed and the unit's bulb lights up. Continued rotation will move the rubbing block flush with a lobe, forcing the points open again. By moving the pointer to one of the zero markings on the protractor and continuing rotation through one complete cam dwell, the degrees of dwell will be indicated by the sweep of the arm across the protractor. Point adjustments can then be made to compensate for worn lobes. Manufacturer—Arnold Manufacturing Co., 610 E. North Ave., Westfield, New Jersey.

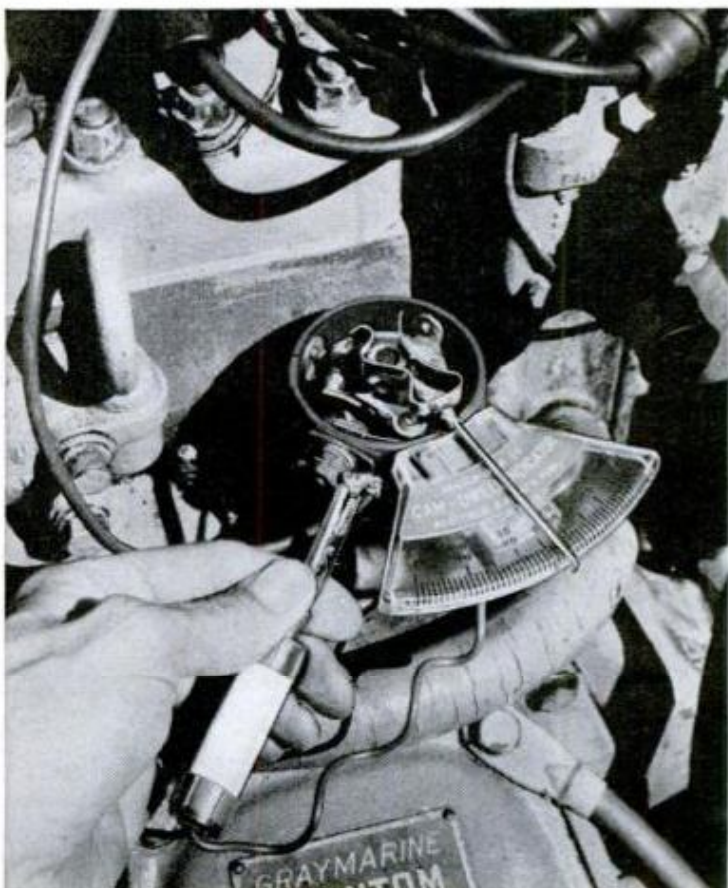

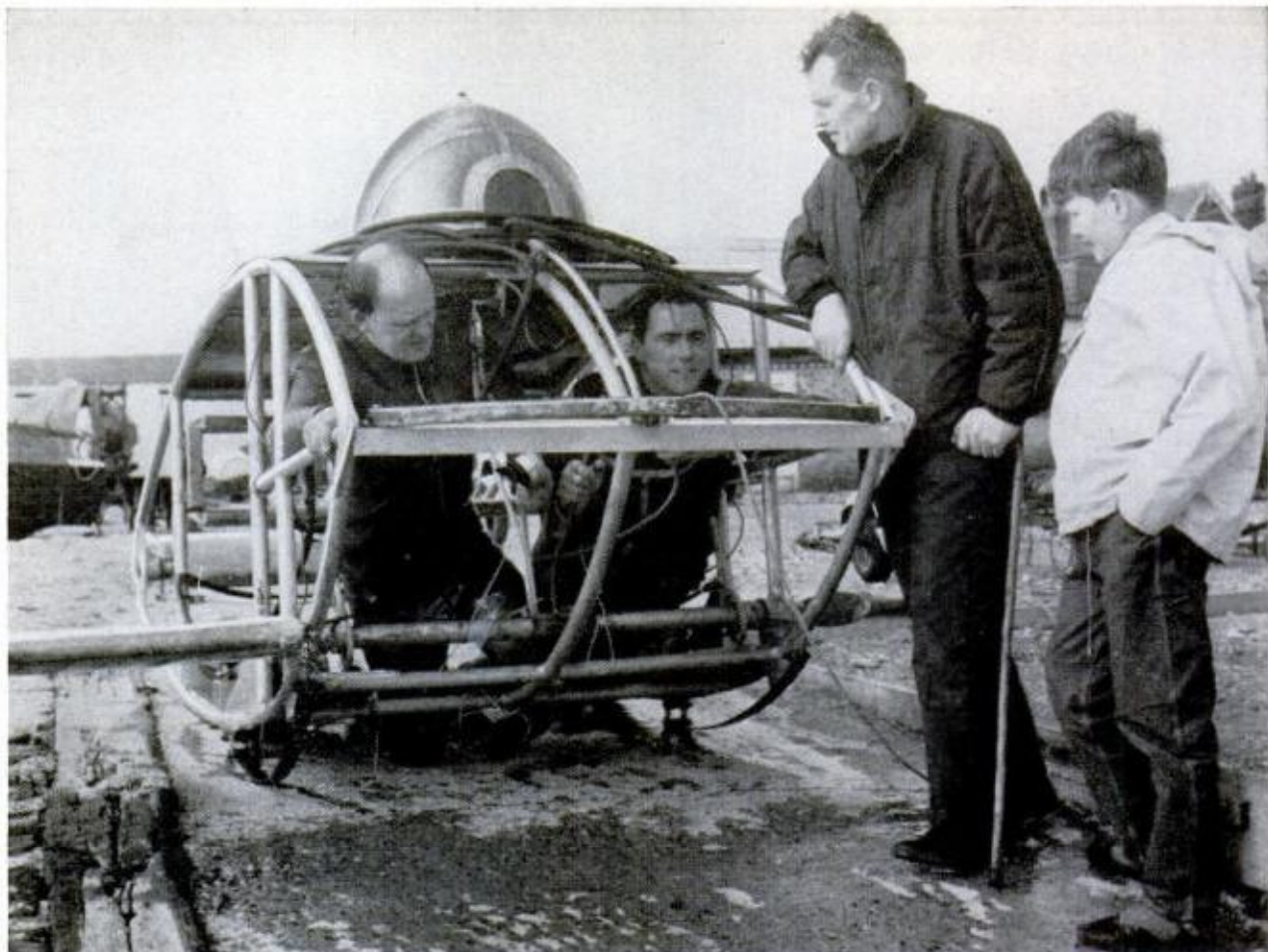

COMMANDER BROOKS (with cane, above) supervises sea trials of his "mobell." The crippled British Navy veteran, who was a submarine crew member in World War II, hopes to have his craft manufactured in the U.S.

Mobile Diving Bell Carries Two Skindivers

Designed by British naval veteran Joe Brooks as a vehicle for underwater salvage and sea-bed farming operations, a new mobile diving bell tours the undersea world with the flexibility of a helicopter. Driven by an electric motor and trimmed and

steered by hydroplanes, the craft's buoyancy is controlled by the amount of air released from tanks into the flotation dome at the top. It carries two men in scuba diving gear. Production models will have a metal skin.

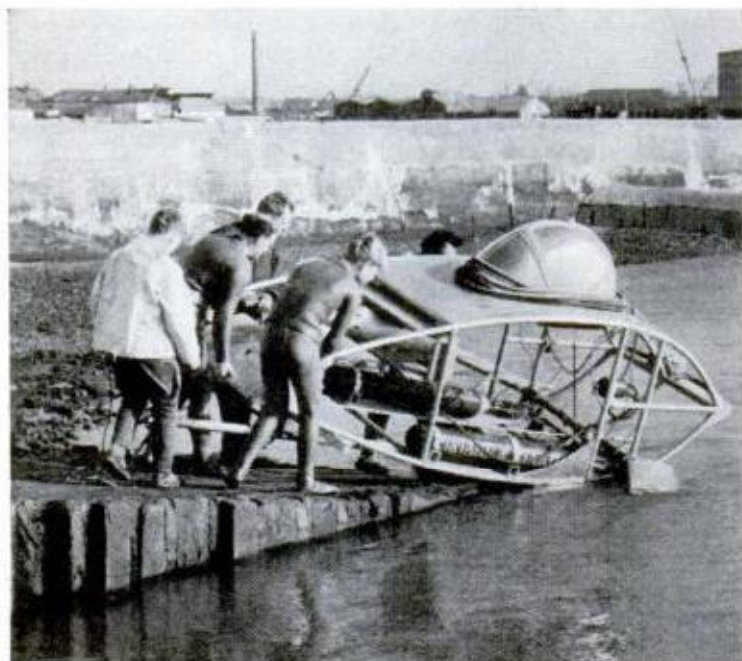



ICBM Container-Erector

Minuteman ICBMs can be transported to their underground silo sites, erected to an upright position and lowered into the silo with a 63-foot long container.

At the site, the container is raised by two erector-actuators operated from a control panel (top, foreground). When upright, a hydraulically powered hoist, capable of handling 50 tons, lowers the missile into its underground launch site.



Pen Gun Fires Distress Flares

Based on the familiar pen-sized tear-gas gun, a new flare launcher uses rifle flares to fire a 5000-candlepower distress signal 150 feet in the air. It'll shoot gas cartridges, too. Costs \$8.95 with two rounds, from Penguin Associates, Devon A1, Penn.

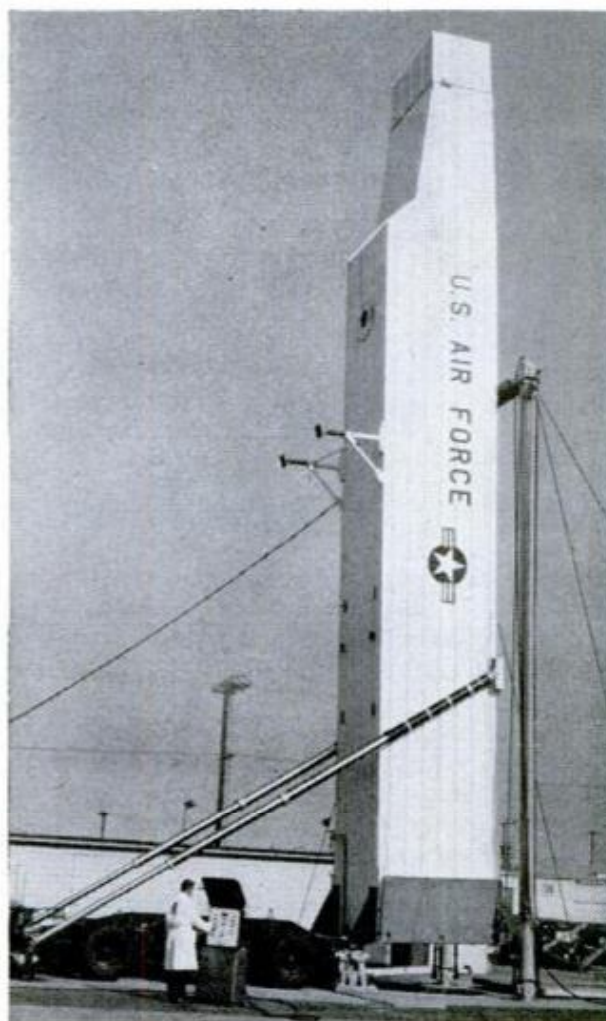

Plan for Peak-

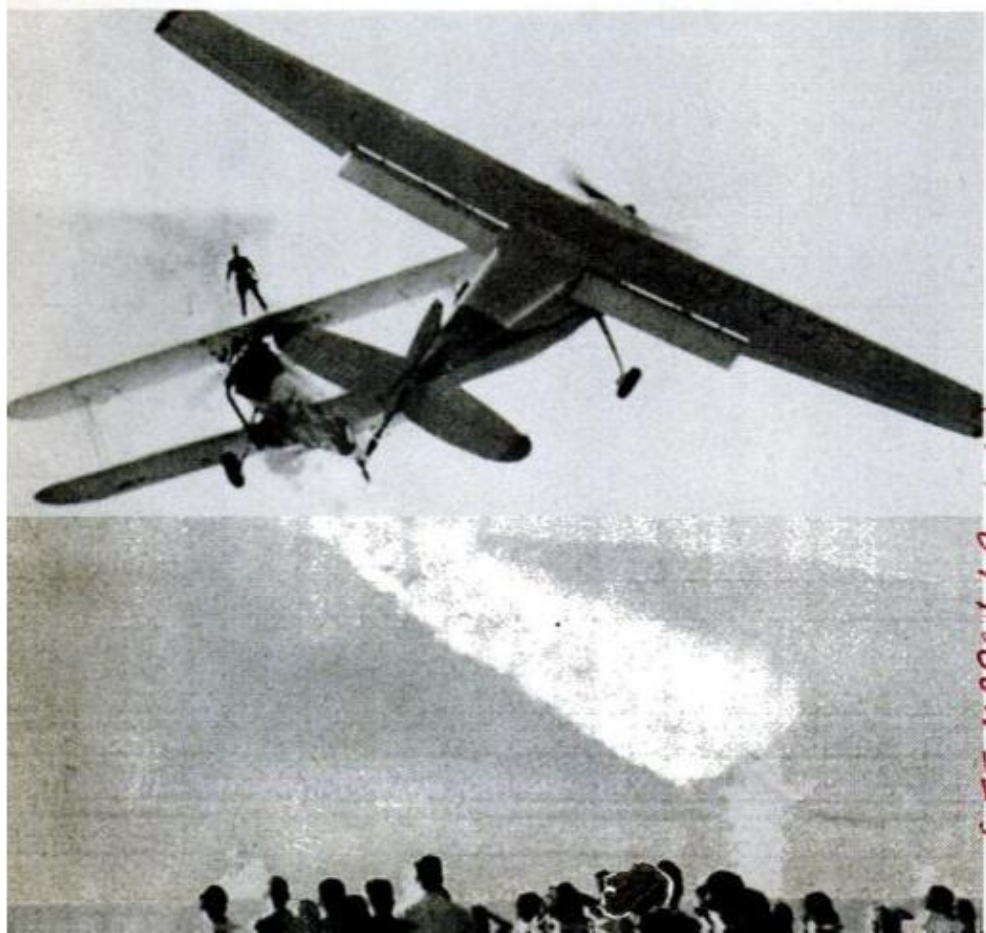
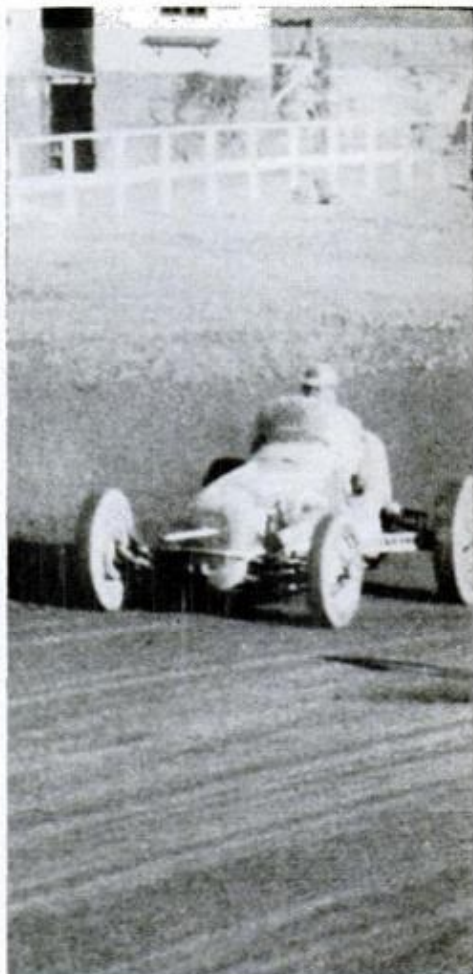

PULITZER PRIZE was awarded Japanese photographer who took dramatic picture of assassination of Socialist leader, Inejiro Asanuma, by fanatic student. If photographer had shot fraction of section before or after, he'd have missed peak action

PUBLIC EVENTS are fair game for amateur photographers who have as good a chance as pros at action. This one, however, was snapped by newspaper photographer who picked peak moment as two planes, one with woman doing wing stand, nearly collided

(SEE MARCH 6 & 7, p. 10)

Action Pictures

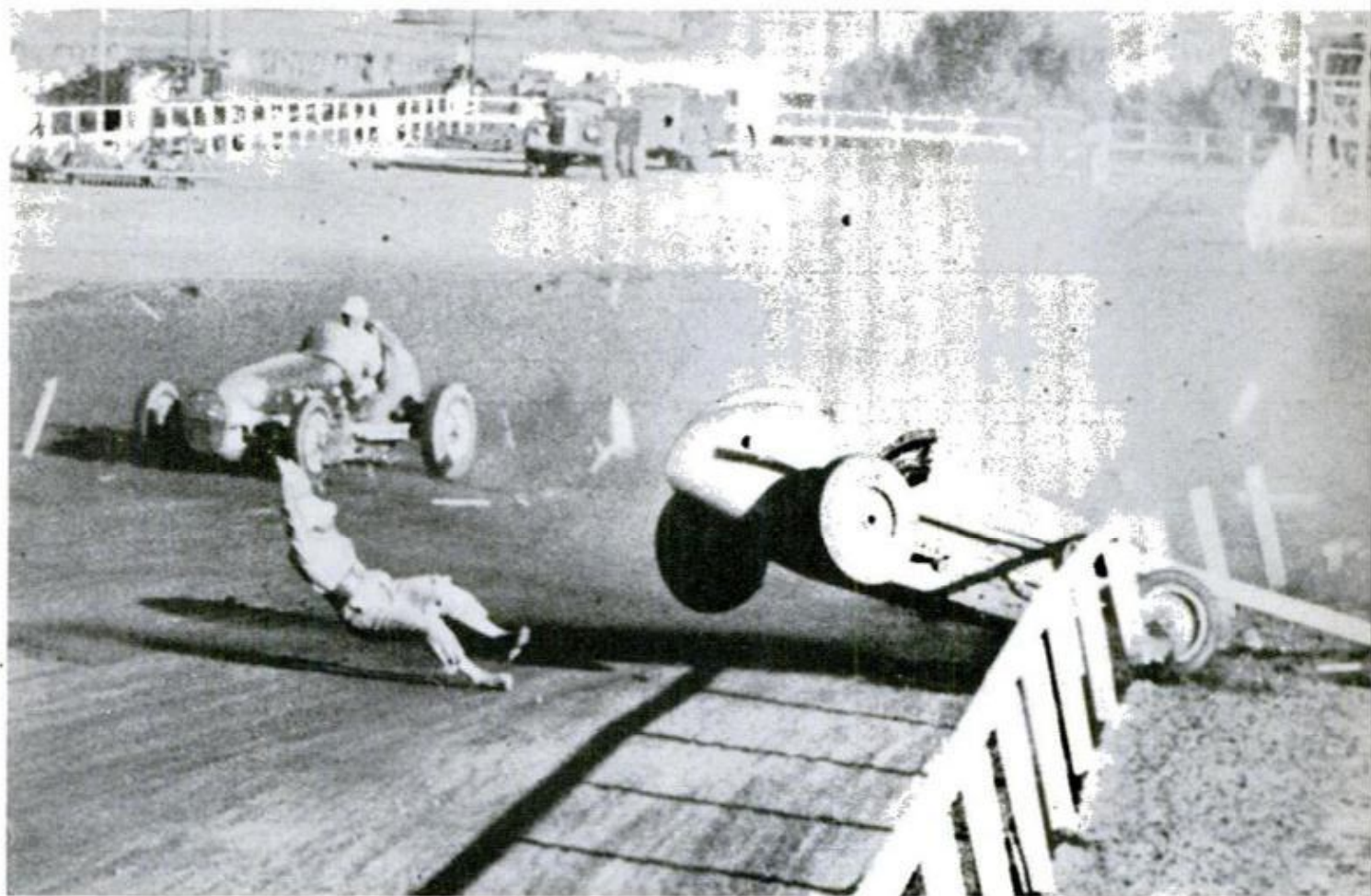

SPECTACULAR CRASHES go to photographer who is in right position and ready to shoot. News photographer recorded death of racer Rex Mays by being prefocused on start of backstretch where cars begin straightening out after turn. Amateurs have good chance to get crash pictures at county fairs and stock-car races

ONCE-IN-A-LIFETIME pictures can be taken by anyone with a camera. Some of the all-time classics were shot by amateurs.

Remember the sinking of the SS *Vestris* and the picture of the struggling crew on the tilted deck, the look of fear on one man's face and, in the background, another man with his arms folded in prayer? It was taken by a seaman with an \$8.50 folding Kodak.

Most of the great ones, however, were shot by professionals. The only reason they didn't get all of them is that they weren't there when all of them happened. An amateur was. Luck is the great leveler among photographers. But if luck shines equally on the amateur and the pro, the pro will probably get the better picture.

Why? Because the professional plans his luck.

So can you. You can study your equipment and develop your technique to handle all of the important pictures that luck is likely to bring you—with, perhaps, one exception. Some pictures take courage, and no man can give it to you. What photographer would stand still and take a picture of a man who was trying to kill him? Howard

By
Tom Shafer

30-YEAR veteran of United Press-International, who has photographed some of the world's greats like Gen. Douglas MacArthur, author Tom Shafer offers tips to amateurs



It Sometimes Takes Guts to



OIL-TANK EXPLOSION sent some photographers scurrying for safety, but *Chicago Tribune's* John Austad stood his ground and shot with this spectacular result. Debris in foreground is from earlier explosion in costly refinery fire at Whiting, Ind.



CHIMNEY COLLAPSE caught workman unaware. As he raced for his life, photographer captured scene. Note in this picture and one at left, if photographers had missed the figures they would have killed the impact. Cover figures up, and see the difference

DALLAS TORNADO (right) became one of best photographed in history because, when it whirled into city and residents fled to cellars, photographers raced to roof tops to record it on film. In this shot, tornado is less than a mile away. Nature's rampages are available to all photographers who have guts to face them

Jones of the *Knoxville Journal* did—and got the picture (see page 142).

But courage aside, three elements will prepare you for capturing the peak moment of most situations—studying your equipment, practicing technique, and planning.

There is no excuse for not knowing your equipment, and the only explanation is laziness. Equipment varies too much to go into detail here, but I can offer you this tip: Use only one film and learn basic settings.

Ideally, each picture should be focused

and exposed individually, but often the action happens too fast. Using one “bread and butter” film, you’ll get to know instinctively what exposure it requires under all lighting conditions. All that’s left is focus.

In action photography most pros will pre-focus their cameras by the footage scale at 10, 15, 25, 35 or 50 feet, then wait until the action moves into range or move where the action is. With practice you’ll find that a few *basic* settings will cover all situations.

Stand There and Shoot...



When that happens you're ready for technique, and technique really needs practice.

Let's face it, the pros get more practice than you do, but it's the *kind* of practice you get that will teach you how to take pictures at the very peak of the action.

Try a simple picture of a friend talking. Real nothing, isn't it? Ah, but wait until he points his finger or raises an eyebrow. This is what will lift it out of the ordinary, and this is what the pros aim at.

Catch on? Routine actions will only make

routine pictures unless you catch them at a peak moment. Try a baseball game, even a Little League game. Don't just shoot haphazardly and, like most amateurs, "hope they turn out." Shoot at something definite, like the moment the ball leaves the pitcher's hand or the exact instant it hits the bat. See how close you come. If you're way off, keep practicing until you get it.

This is the essence of peak-action photography—knowing what you want and getting it on film.



Copyright by Knoxville Journal

PEAK-ACTION PHOTOGRAPHY reached its peak in this shocker (left) of an attempted murder. Staring down barrel of gun, newspaper photographer Howard Jones fired back with his camera. His assailant, en route to court to answer charges of drunken driving, objected to being photographed and fired four times. Jones (above) poses alongside marks indicating where two of the shots hit—and, fortunately, missed

To do this consistently, you've got to plan your luck. You've got to anticipate the action. You've got to think!

In predictable situations, it's relatively easy. In a scoring situation in baseball, focus on home plate. In a passing situation in football, get off the scrimmage line and move downfield. If a child drops her ice-cream cone, wait for the tears.

In unpredictable situations, it's much harder but much more rewarding. These situations produce most of the great pictures, and they happen only once.

Japanese photographer Yasushi Nagao had just one sheet of film left when a stu-

dent dashed on stage and stabbed the speaker at a political rally. With just seconds to make up his mind, Nagao waited until the assassin withdrew the sword and prepared to plunge it in again. It was a perfect picture.

Freddie Tschantre saw racer Rex Mays' car skidding, but waited until Mays was thrown from the car before shooting.

These guys were pros, but they applied the same principles that are available to you. If Lady Luck offers you that one big picture, you won't be ready for it unless you've studied your equipment and done some practicing on smaller things. ★ ★ ★



AUTHOR SHAFER, along with other photographers, was blocked by police from covering nursing-home fire. Shafer kept his eye on fellow photographer Steve Lasker, an aggressive type. Moments later, in "discussion" with police, Lasker got the old "heave-ho" and Shafer got his picture — by planning his luck

Jules Verne Airship Model

Described by Jules Verne more than 100 years ago in his novel, "Master of the World," the airship *Albatross* has been produced in a detailed working model for a movie film.

The model is lighted and has tiny electric motors to drive each of its 39 propellers, 37 of which are mounted vertically (for lift according to Verne), and one fore and another aft for propulsion "up to 200 miles per hour."

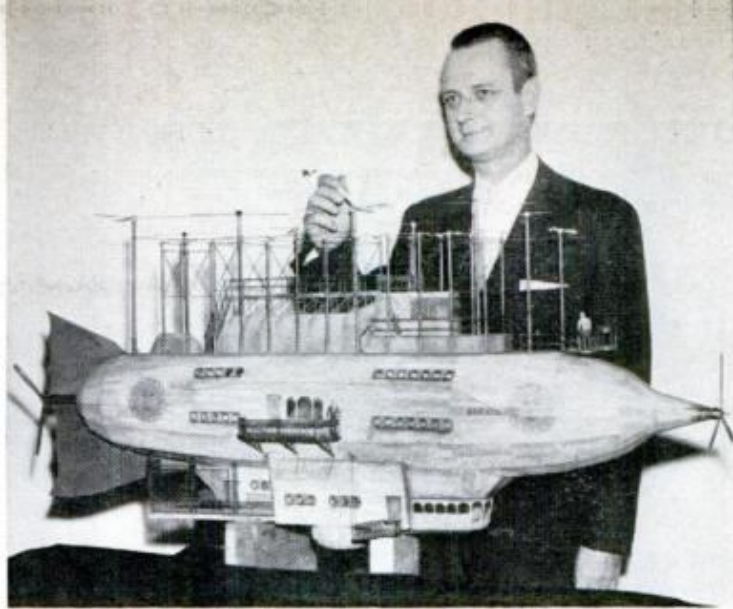

Twin Bunks Fold Into Wall

Hinged to the wall, twin bunk beds can be folded up during the day and hidden behind sliding doors in an alcove.

The beds can also be taken off their hinges and used side by side on the bedroom floor as conventional twin beds.

Available with or without the sliding-door compartment, the beds feature twin-size springs, square metal-tubing frames and plastic head and foot boards. A metal ladder (not shown) is used to reach the top bunk.

The beds are manufactured by Furniture Dynamics, Inc., P. O. 54114, Los Angeles 54, Calif.

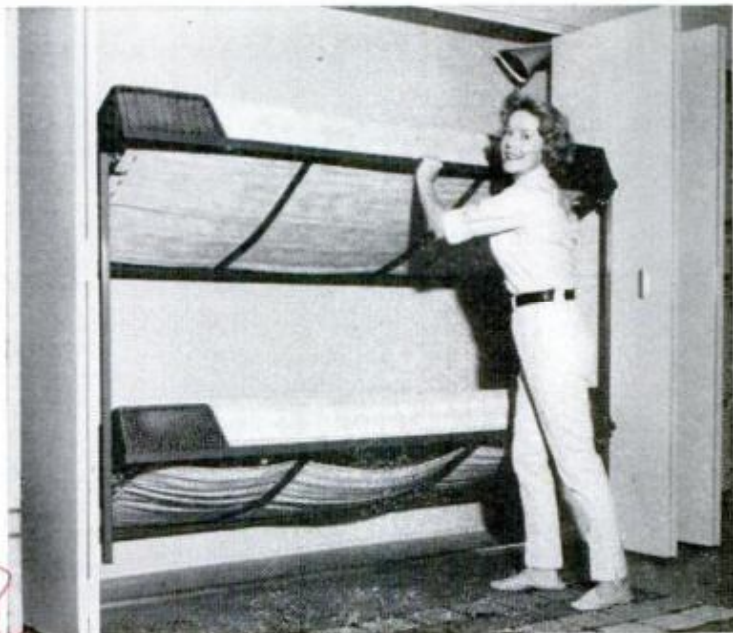

out of business

Electromagnetic Brake

With a new electromagnetic retarder, extra braking action for trucks and buses is supplied independently of the vehicle's air or hydraulic system.

The retarder consists of a coupling of two finned rotors run by the drive shaft, and an electromagnetic stator. For added or emergency braking power, battery current is switched in by the driver and eddy currents are created between the stator and rotors. With the stator locked to the vehicle frame, the eddy currents' retarding action is directed back to the drive shaft and thence to the wheels. This retards forward motion and, incidentally, contributes to reduced brake lining wear.

The unit is manufactured by Lear Industrial Products of Grand Rapids, Mich., under license to Compagnie Telma of Paris, France.

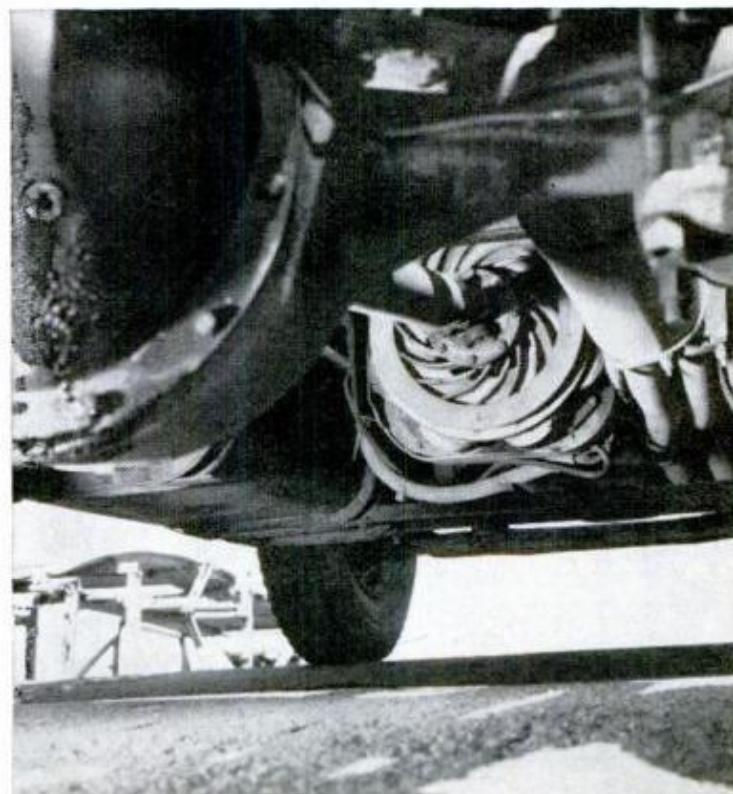

THE ATOM TAPS THE FOREST'S SECRETS

By James Nevin Miller

ATOMIC ENERGY, with its terrible implications of death and destruction, offers no nightmarish headaches to John Rediske, young scientist working at a forest research center in Centralia, Wash.

This is true despite the fact that he spends eight hours every day conducting important experiments with the aid of nuclear radiation. The "Caution! Radiation!" signs, prominently displayed on trees and laboratory walls throughout the timber-thick center, don't bother Rediske. The killing aspects of radioactive isotopes are taking a back seat to peaceful uses in his daily work, which aims to improve the lumber-producing qualities of trees.

Just the same, as an entirely new breed of scientist, a combination of atomic researcher and tree physiologist, John Rediske has a tough job. He must ferret out the innermost secrets of a growing tree. And in this connection he must answer four major questions. How may certain chemical compounds be used most effectively to stimulate tree growth? How may other chemicals be used to kill weed species without damaging the valuable timber? Can chemicals be introduced in growing lumber crops to prevent damage by insect, disease and animal pests? Can they improve germination and genetic makeup?

To help him find the answers, young Rediske has many tiny "atomic assistants" to send inside the test trees for a scientific look. They're called "identifiable radioactive tracers," and they're placed into the complex system of a tree to enable the scientist to follow their paths and evaluate their behavior.

In many cases this novel searching system provides the only practical approach to the solution of vital problems of tree nutri-



Fighting insect enemies

ATOMIC ENERGY is giving scientists new insight into trees, helping them develop chemical sprays that may kill harmful insects without damaging the forest

Mapping root systems

CUTAWAY SKETCH illustrates new technique of mapping tree's root system with atomic radiation. Picture at right shows technique in actual operation



POPULAR MECHANICS



with radioactive materials . . .

PILL BOXES, filled with bark beetles and dosed with radioactive strontium, are attached to tree barks. Beetles' activities can then be carefully traced

FOREST SCIENTISTS' work is divided between outdoor and indoor laboratories. Research center is in heart of timberland rich in pine and fir trees

with the aid of a Geiger counter . . .

GRID SYSTEM is set up around irradiated tree. As radioactive material—injected into sap stream—circulates through root system, its course is charted with special Geiger counter called a scintillator. Pattern of roots is important to planning the spacing of trees on commercial farms and to developing fertilization systems



Producing better seeds . . .

NUTRIENT TESTS supplement work of studying trees' enemies by studying ways of first producing healthier seeds. Scientists here examine young tree grown from seed produced on soil-nutrient test plot. Experiments have increased diameter of some trees as much as 50 percent

GROWING SEEDLINGS in radioactive solutions in laboratory (far right), scientists are able to learn structural facts about trees—with help of radiation counter—that will enable them to find better ways to treat diseases, combat tree enemies and produce better trees

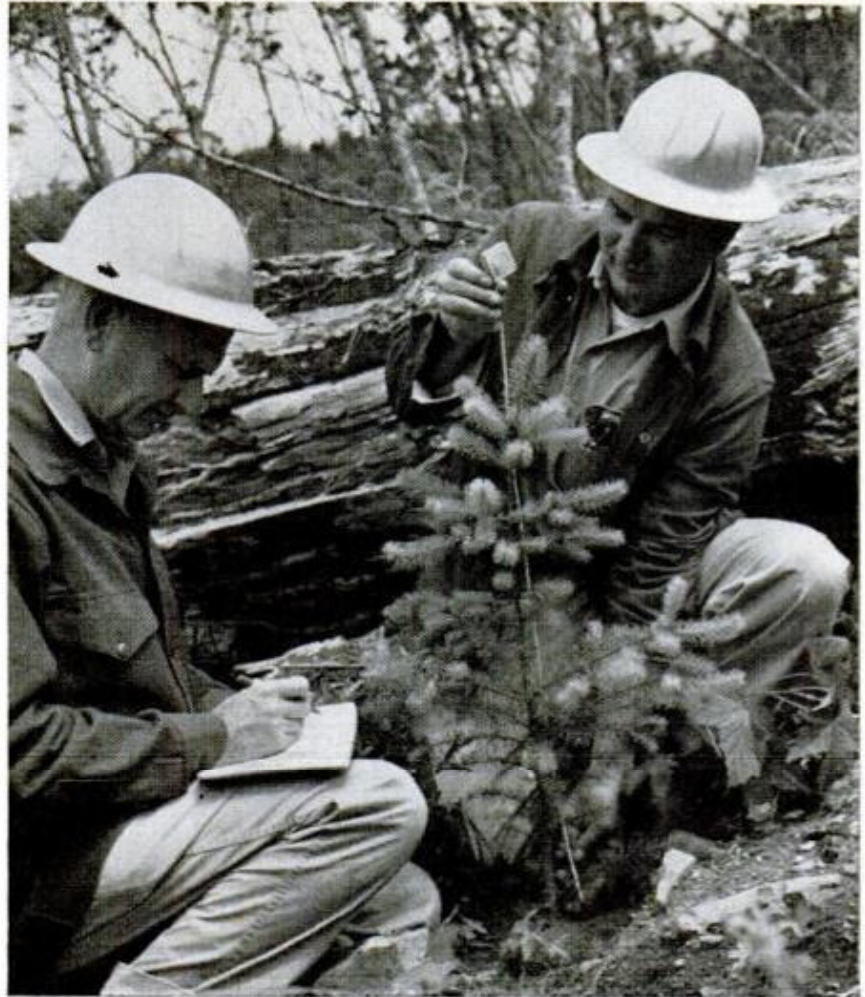

tion, pest and disease relationships, and genetic influences.

Science's use of atomic tracers in forestry research, which promises to be virtually a science in itself, provides a novel tool for gaining clear insight into the basic biological processes. This technique provides such information rapidly and effectively. In some instances, it is nearly impossible to obtain such information in any other way.

Rediske, one of a half-dozen scientists using the technique at the center, operated by the Weyerhaeuser Company, finds that radioisotopes offer a means of understanding more completely the growing processes and photosynthesis, Nature's means by which green plants use carbon dioxide in the air, water, soil nutrients, and the sun's radiant energy to form the compounds essential to life. With this improved understanding, methods are being investigated to increase the efficiency of timber growth, and thereby, the amount of top quality wood harvested.

Sometimes Rediske wishes he had the ability of the author of Aesop's Fables. Aesop endowed animals with the sense and reasoning of human beings. Foresters often

wish they could reason with deer and elk to keep them from eating valuable tree seedlings as fast as they grow.

Since this is asking for the impossible, Rediske and his associate researchers are using radioactive materials to aid in the development of deer and elk repellents for Douglas fir seedlings. For example, selenium, a nonmetallic, sulfurlike element, when present in small amounts in plants, seems to make them distasteful to animals. If present experiments at the center reach their expected promise, then chemically treated seedlings will be left untouched to grow into trees for timber and pulp.

In this general connection a current problem of the researchers is to develop more effective repellents to keep timber bears from destroying immature trees. Surveys show that 200,000 acres of valuable timberland suffered serious bear damage in the state of Washington during the past two years.

Already the scientists have made marked progress on this assignment. A number of their new bear-repellents are now being tested on company tree farms and seem to be serving their purpose very well indeed.

Growing trees in the laboratory . . .

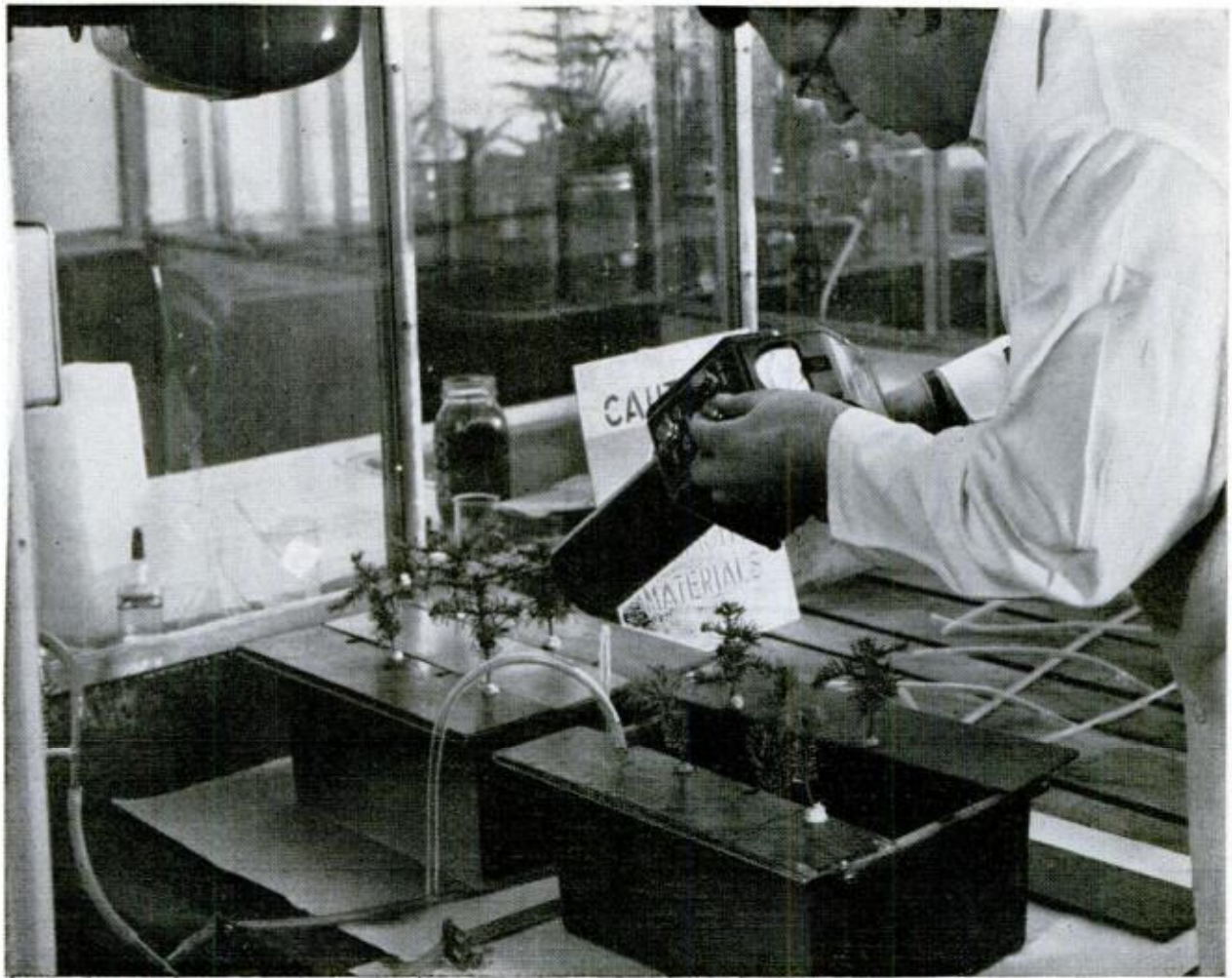

In no instance do the chemical compounds injure the animals. However, their unsavory smell and taste have persuaded the hungry bears to seek their food among other kinds of growing plants.

Another present project is aimed at reducing damage to tree seedlings by rabbits, mice and other rodents. It uses isotopes in the development of repellents to divert the rodents to native vegetation. The experiments made thus far indicate that rodents' eating habits can be changed so that the 15,000 to 20,000 pounds of tree seed planted each year by the company will survive the hungry rodents, and will be allowed to germinate and produce top-grade lumber trees.

Norman Johnson, a young entomologist, has the job of "packing pill boxes." This is involved in a new method he has devised for making tree-killing insects radioactive so he can detect their day-to-day movements as they burrow through bark and into log sections brought into his laboratory.

First Johnson fastens tiny pill boxes to the log sections of Douglas fir trees and fills the boxes with live bark beetles. Next he places radioactive strontium in each box

with the beetles. The radioactive material clings to the insects as they dig through the bark and into the log sections.

Johnson then uses a scintillator (a form of Geiger counter) that is sensitive to gamma rays emitted by the radioactive strontium to track the beetles as they chew their way, out of sight of normal vision, in the test log sections. Every movement of the tiny tree destroyers is visible to the scientist with the scintillator, regardless of where their hungry journey takes them through the wood.

Facts of life habits of these destructive insects, learned in this new type of forest research, enable the scientist to devise methods of combatting them effectively in the forests where they wreak havoc with valuable commercial trees.

George Staebler, a silviculturist, is working on a new and fascinating chore. His problem is to pinpoint or "map" the complicated contours of a Douglas fir's root system. This type of original research is extremely important. The new knowledge it reveals of the extent, depth and density of the root system will enable forest scientists

(Continued to page 260)



Bull's-Eye by Missile

Demonstrating its accuracy, the Air Force's Falcon air-to-air missile was fired at 36-inch targets from F-106 jets more than a mile away. The targets were heated to simulate a jet's exhaust to give the heat-seeking missile something to home in on. A pilot shows a hole it made.



Warm Buddies

In laboratory tests, the British are attempting to find whether soldiers can be acclimatized by artificial means to tropical climates before being assigned there. Volunteers are dressed in inflatable plastic suits to undergo periods of duty while temperatures are raised as high as 101 degrees F.



Boaters' "Personal Windshield"

High-speed sports, from boating through motorcycling, present wind-in-your-eye problems, and it's no fun to con your cruiser through a tricky channel while squinting through tears.

One answer is a new "personal windshield"—a lightweight, ventilated plastic goggle which keeps out the wind and dust without restricting vision. It's called Aye-Eye, and is available in clear or tinted models for \$3.50 from the Alfson Co., 143 East State St., Trenton, N. J.



Converts Heat to Power

Using radioactive isotopes as a heat source, a 40-pound nuclear generator undergoing tests for the Air Force produces 150 watts of electrical power for one year of continuous operation.

It was developed to provide a reliable, long-life power source for unmanned radio beacons and weather stations.

The decaying isotopes heat 144 small semiconductive elements to about 1000 degrees F. Heat exchangers keep ends farthest from the heat at 300 degrees. Heat difference produces electrical current.



They Play Hockey the Hard Way — No Ice

Proving that you don't really need ice for a game of hockey, a group of scuba divers play their version of the game at the bottom

of a swimming pool in Miami Beach, Fla. They report that it's a slower version, but just as rough as it is on ice.

Do-It-Yourself World

Do-it-yourself world-makers can have a field day with a 42-piece plastic construction kit that makes a 12-inch globe with 24 snap-on land masses in bas relief. Countries — and changes — can be painted on as needed, or as the changes occur. Comes with a geological and geographical booklet for \$11.95 from Eldon Industries, Inc., Hawthorne, Calif.



Indicator Guards Frozen Foods

Temperature history of a shipment of frozen foods can be kept without complicated instruments by a cigarette-sized "yardstick" developed by Minneapolis-Honeywell. The device works on a predictable electromechanical reaction, and records temperature changes for as long as a year to guard against accidental, often undetectable, cold losses.

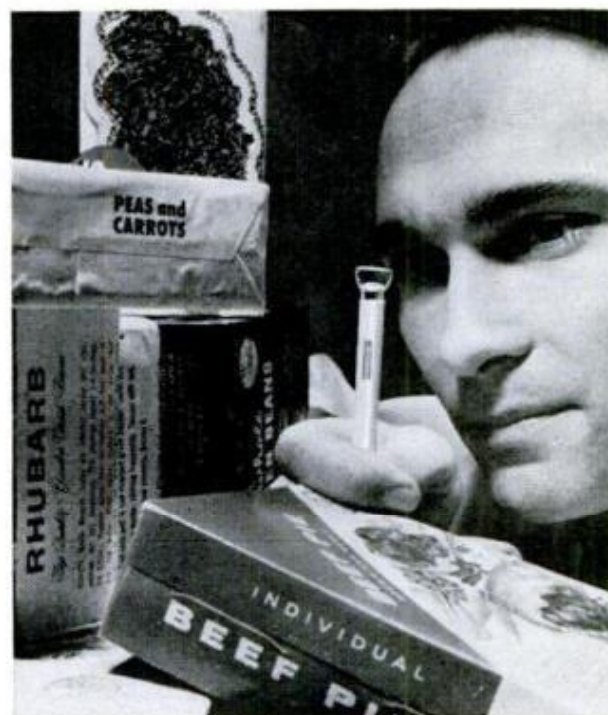

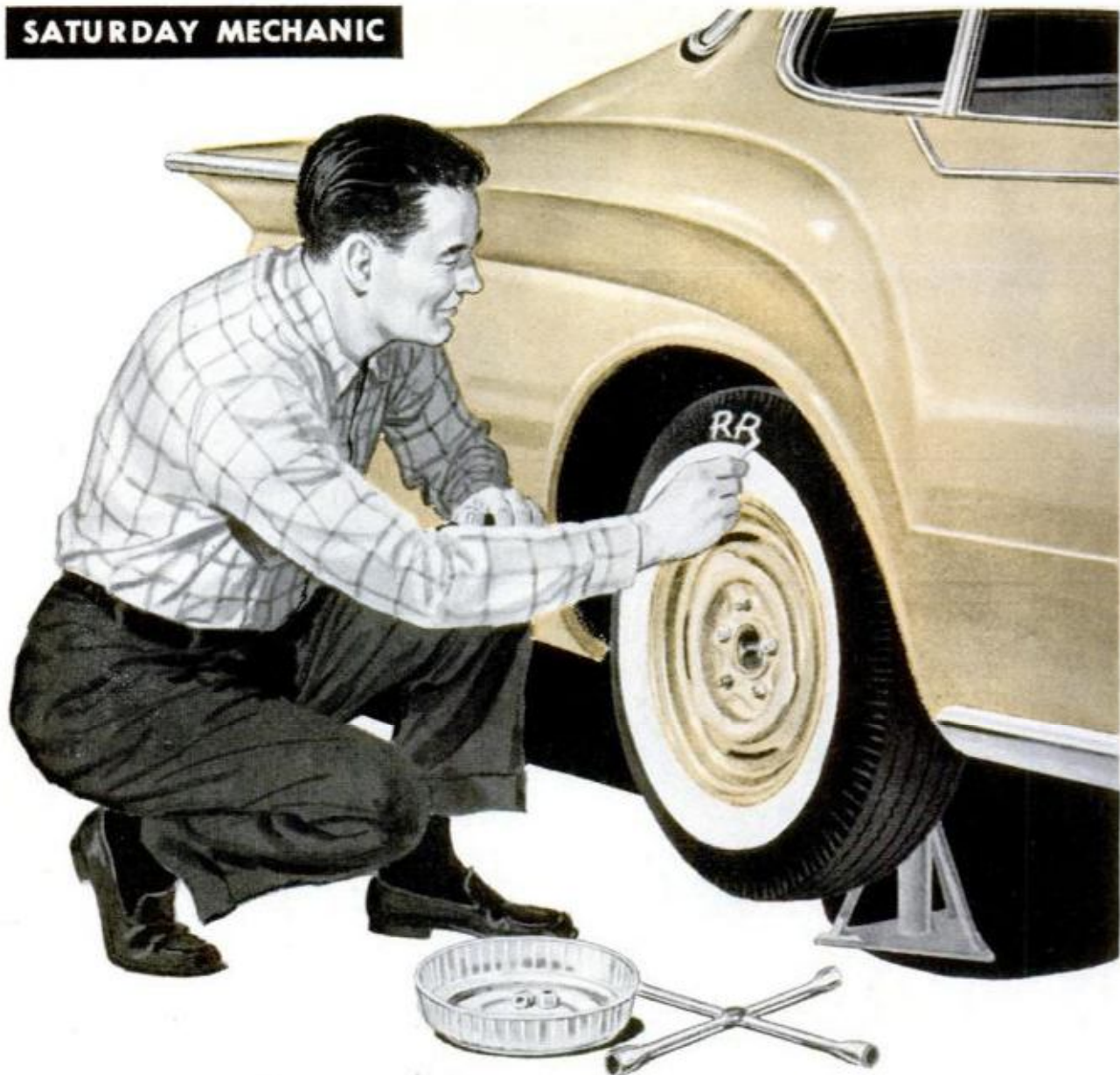

ADJUSTING CHRYSLER BRAKES

By William Hector



BRAKES ON Chrysler cars have certain mechanical features that differ from Bendix brakes and it is well to be acquainted with these variations before you try adjusting the brakes on your Chrysler, De Soto, Dodge or Plymouth car. As an example, you'll find the brakes on 1956 and earlier Chrysler cars fitted with separate adjustable anchor pins and also there will be a hydraulic cylinder for each brake shoe on the front wheels. Rear wheels will have only one brake cylinder but you'll find separate anchor pins. After 1956 Chrysler brake units were fitted with floating anchors which do not require adjustment.

1. CAR STAND is a good investment if you do your own work. Don't rely on jack if you must "get under"

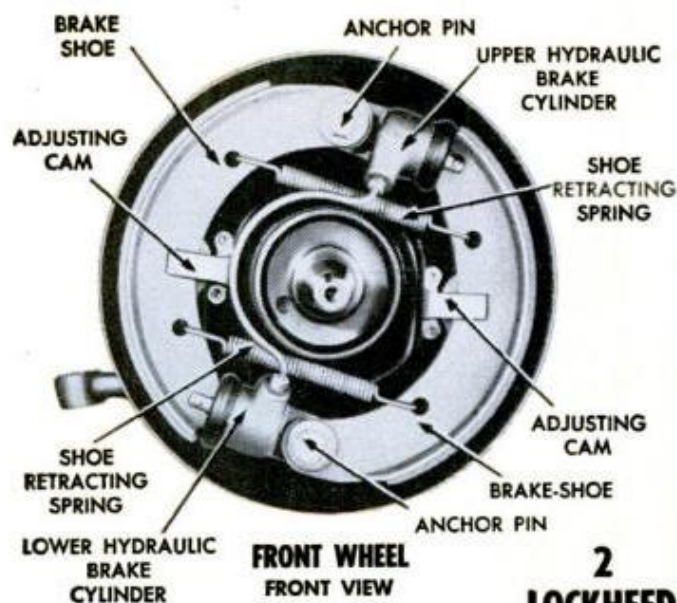

**FRONT WHEEL
FRONT VIEW**



**REAR WHEEL
REAR VIEW**

**2
LOCKHEED
HYDRAULIC
BRAKES**

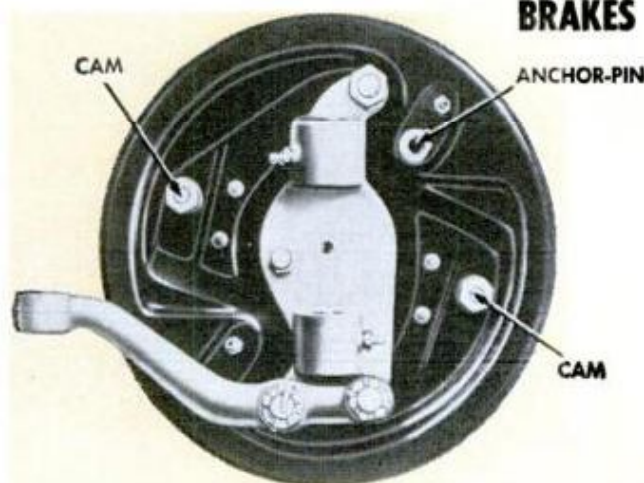

**FRONT WHEEL
REAR VIEW**

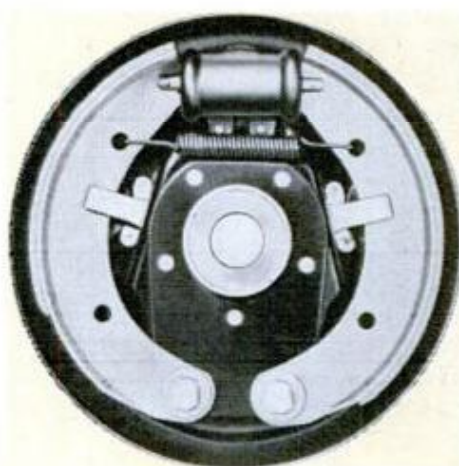

**REAR WHEEL
FRONT VIEW**

If you plan to do the job over a weekend, you'll save a lot of time and possible grief by having everything in order before you pull off wheels and drums and disassemble bearings. See that your car jack is in working order and it's a good idea to have a car-stand handy, Fig. 1, even if you have to borrow one. Never fully trust a bumper jack, especially when some unlooked-for condition or defect makes it necessary to disassemble brakes and possibly get part of yourself under the car. If you're working in a carport or on the garage ramp, clean up the area around the car. Any wisp of gritty dust stirred up by the wind is sure to land on the bearing assemblies you may have removed. Have cloth wipers at hand.

If you've already made the Saturday-morning run to the shopping center, with a lot of stop-and-go, let the brakes cool down

to normal nonoperating temperature before you begin work. And remember that in warm weather this takes time. Before you pull off a wheel chalk the tire so you're sure to get the wheel back in the right axle. Then turn to Fig. 3. You're looking at what you'll see when the wheel and drum come off if your car is 1956 or later. Compare with Fig. 2.

To carry out an inspection it usually is permissible to examine the brakes on only one wheel, the condition of this brake being indicative of the general condition of the other three, assuming, of course, that there is no pulling to one side and no apparent drag or other brake defect. So, you jack up the wheel, drop the axle on a stand, remove the hub cap or wheel disk and then the wheel. Clean the hub cap and use it as a container for the bearings. Wipe off any

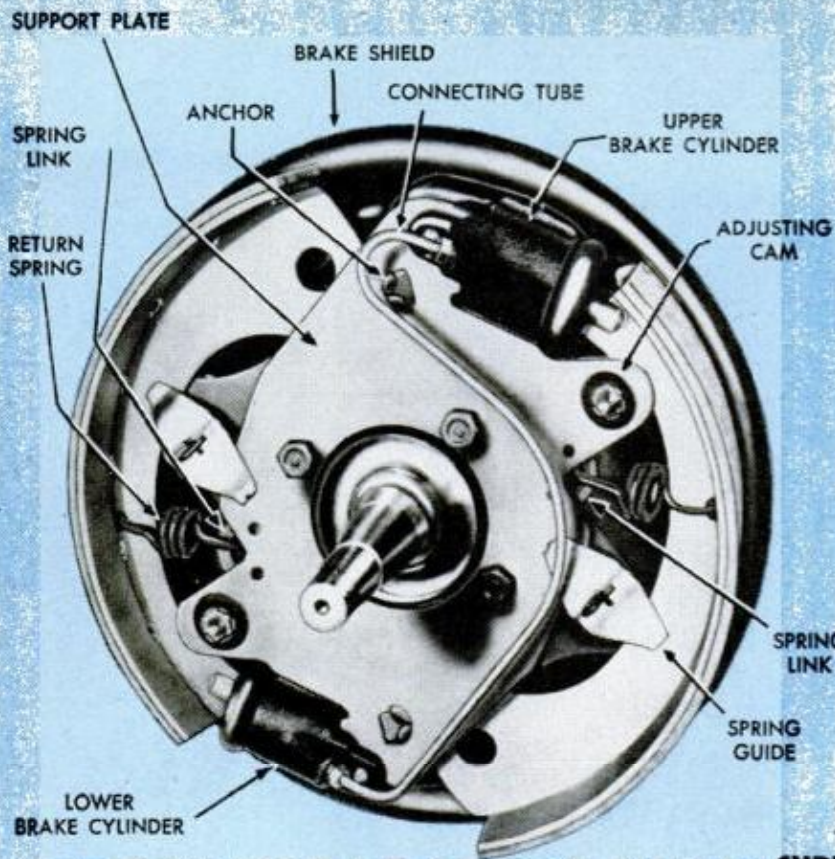

FRONT WHEEL

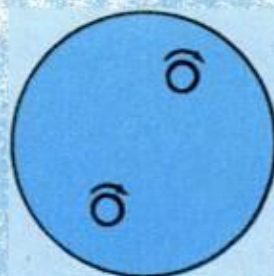

LEFT FRONT

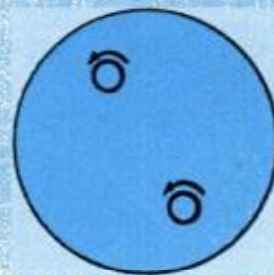

RIGHT FRONT

3

**CHRYSLER
CENTER-PLANE
BRAKES**

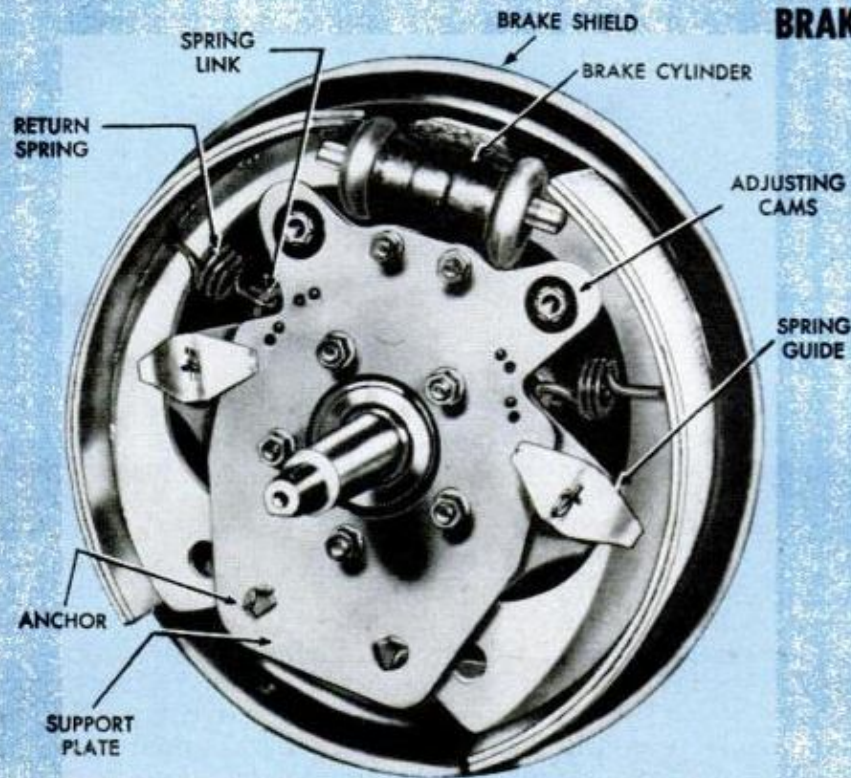

REAR WHEEL



LEFT REAR



RIGHT REAR

**ADJUSTING CAMS
(NO ANCHOR-PIN
ADJUSTMENTS)**

LATE MODEL Chrysler brakes, after 1956, have floating anchors that do not require adjustment. Only cams are adjusted. In details at right arrows show direction in which cams should be turned

grease smears which may be on the brake plate or spindle. Dust the drum or clean with sponge and solvent, Fig. 5. Remove and replace oil seals as in Fig. 4.

Now give both linings and drums a critical inch-by-inch inspection to discover any possible defects that may be developing, such as uneven wear on the linings, also loose linings, or threadlike scores on the shoe track inside the drum. If no defects show up, then lubricate the brake-shoe ledges, or platforms, using only the approved lubricant and that sparingly. Remove the bearings in the hub portion nearest the brake plate, or dust plate. Clean and lubricate all bearings and replace in the order in which they were removed. Then, before you replace the drum and wheel, dust the parts thoroughly and re-examine all parts for stray traces of lubricant. Often it is helpful to sand the faces of the linings, Fig. 6, to remove any imbedded dirt. Edges of the linings can be rounded slightly. Finally, replace the drum and wheel, remembering the chalk mark on the tire, and make sure that all nuts are tightened.

To make a minor brake adjustment, rotate the wheel slowly and turn the adjusting cam until the wheel drags, then release the cam until the wheel turns freely. Do this twice on each wheel.

A major adjustment must be made when the shoes are relined, or replaced. With the brakes completely assembled apply pedal pressure to center the shoes. Then adjust each shoe separately. On 1956 and earlier cars, back off adjusting cams and anchor pins until the wheel turns. Then, with the wheel rotating slowly, turn the adjusting cam until the lining contacts the drum. Now, back off slowly on the anchor pin until the wheel turns. Repeat these two steps until anchor-pin adjustment will not free the wheel. Finally, back off on the ad-



4. MAILING TUBE makes a good driver for removing and replacing oil seals in brake drums. Tap lightly

justing cam until the wheel turns freely.

On later Chryslers the brakes have the floating anchors and only the cams are adjusted. Note especially in Fig. 3, the right-hand details, the direction of the arrows on the cams on the front and rear brakes. When adjusting these later brakes it is the general practice to turn the adjusting cam in the direction of forward wheel rotation until the shoe lining is solid against the drum and the wheel is locked. Then turn the cam in the opposite direction until no drag is felt. Repeat the operation on the other cam. ★ ★ ★

5. CLEAN BRAKE DRUM with detergent and hot water or with a solvent. Make sure it is thoroughly cleaned



6. IT'S PERMISSIBLE to clean linings with medium sandpaper. The latter will remove any embedded dirt

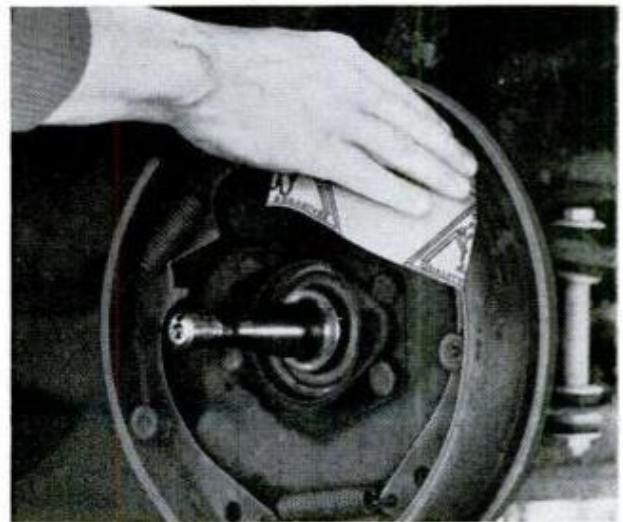



Amphibious Army Carryall

Capable of floating without preparation, the Army Muskrat will cross waterways under full load at about three miles per hour.

On land, its 127-horsepower engine will power it over any kind of terrain, including grades up to 60 percent, and in excess of 60 m.p.h. on the highway. It will carry 1500-pound cargoes or seven passengers with field equipment.

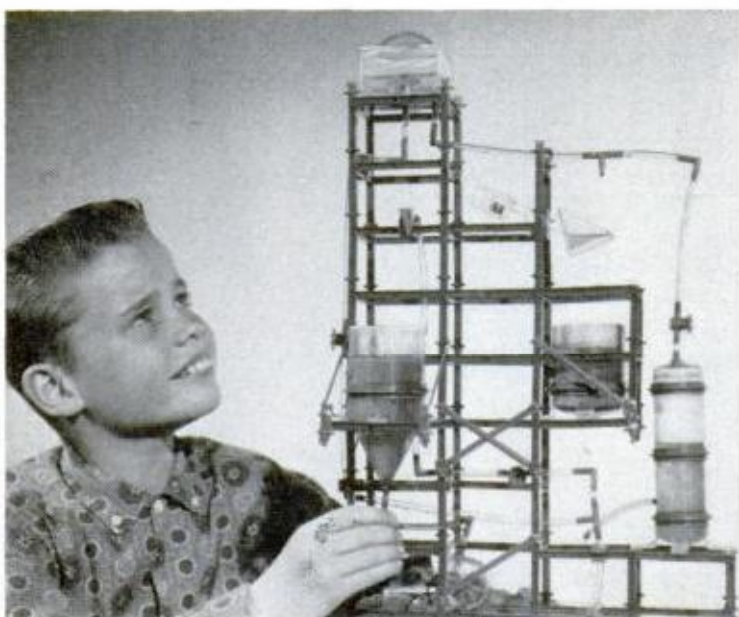

Hydraulic Toy Kit

Youngsters can build and operate model oil refineries, distillation plants and other industrial installations, and learn principles of hydraulics, with a new kit.

Each set, priced from \$12.95 to \$19.95, includes plastic girders, panels and braces, plus a battery-operated centrifugal pump, siphons, level gauges, float valves, elbows, reservoirs, tanks and clear plastic piping.

Colored water is forced through the systems, giving a visual picture of the device in operation.

The kits are manufactured by Kenner Products Co., 912 Sycamore, Cincinnati, Ohio.



World Full of Gas

A 60-foot storage tank for natural gas near Savannah, Ga., has become something of a tourist attraction due to the colorful scale map of the world painted on its surface.

Specially designed for the Savannah Gas Co., the globe contains a reserve supply of natural gas for Georgia's largest port city.

Some idea of the scale used on this gigantic map can be obtained by noting the group of Girl Scouts standing at the base of the ladder, lower left.

☐ The so-called "rare earths" are not particularly rare. Most of these chemical elements are more common than gold or silver. Some, like lanthanum, cerium and neodymium, are more abundant than lead.

☐ The Great Wall of China is thought to be the only work of man that would be visible to the human eye from the moon. The wall stretches 2000 miles.



Long to Be a Gypsy?

TOURISTS are leading the gypsy life in Ireland these days. Seated on caravans, reins loose in their hands, they roam the green countryside, moseying along at their horse's clippity-clop pace.

This gypsy freedom, however, is not free from costs. Con Murphy, a Cork businessman, rents out the four-berth caravans complete with ware, bedding, propane-gas stove, and horse for \$37 a week. Food and fodder for the horse is extra. Grazing a horse overnight may cost nothing or up to \$1.50.

Mr. Murphy's fleet of caravans has grown from one (in 1946) to 14. Sometimes half a dozen are booked as a tour party—with a cook and guide furnished. Usually, though, each caravan is hired individually for trips that may take a traveler—at far from hectic speeds—over byways that pass men cutting turf, blacksmiths at work, or down to the coast where a lighthouse keeper may find time for a mid-day chat.

It seems, by the way, that the romantic open road appeals not so much to adventurous young men but to English nurses.





"We were tired, dirty, sore and hungry. . . ashes and dirt found their way into our food . . . tables and seats built of stone and logs helped immeasurably. . ."

10 Minutes to Survival

PART II
By
Russell Tinsley

Photos by Author

*P.O. Box 3013
Austin 13, Texas*

Could your family leave home on 10 minutes' notice, move into the wilderness and start a new life without outside help? The Tinsleys did, on a surprise assignment from PM. Here's the second half of their report . . .

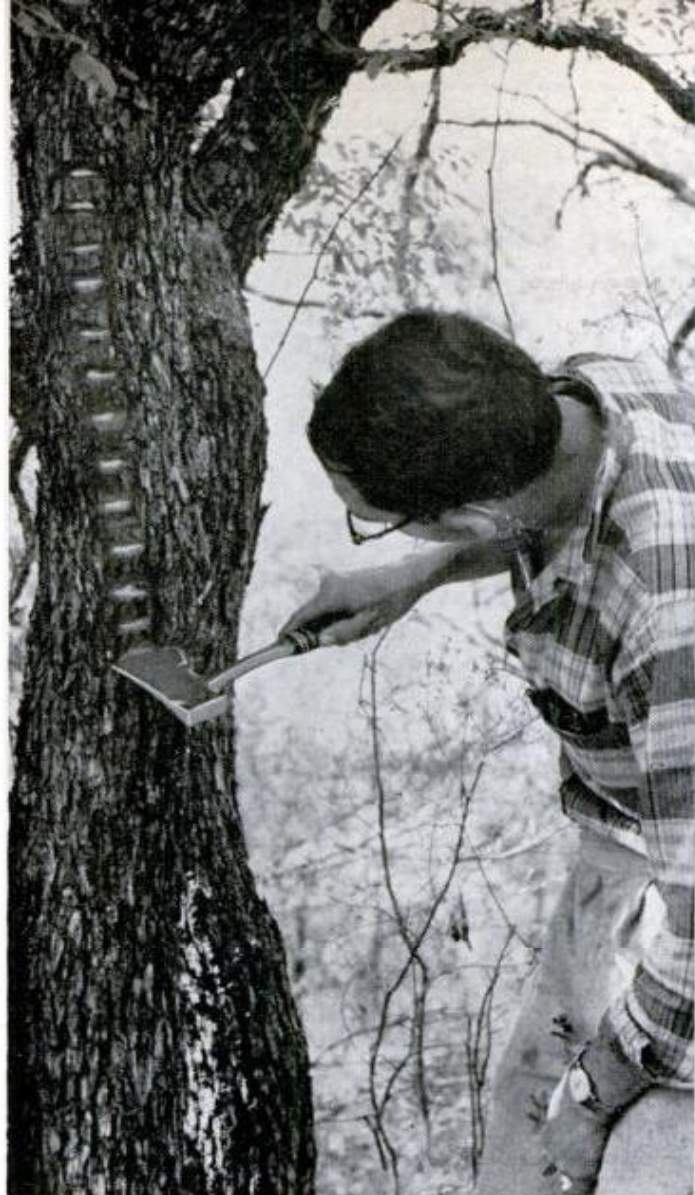

“An important daily ritual . . . marking off the day with a blaze on a tree.”



“Sanitation was a worry . . . we were constantly searching for ticks.”

SPRING SUNSHINE filtered through budding oaks into our campsite, promising shirt-sleeve weather. The only sounds were the gurgling of our spring-fed creek mixed with spring bird songs. It was a setting suitable for a fine family camping jaunt, and should have been a happy one for our outdoors-loving family. But it wasn't.

Settling into the routine of our survival camp, we were tired, dirty, sore, hungry, and still a little scared. The woods around us were more than a setting—they were our home, neighborhood, shopping center and worst enemy as we tried to scratch a living out of them.

Imagine yourself in our position—living in the wilds with only what food and equipment we had been able to gather in a frantic 10-minute rush to evacuate our home and city to escape a “disaster.” The test assignment from *Popular Mechanics* was dropped in our laps without warning. We went out under the most realistic survival conditions possible with the job of setting up a new home for an indefinite period, then reporting our success—and failures.

Perhaps most important (and something overlooked in so-called survival tests) we had the car. It proved to be a lot more than simple transportation, for the uses of an automobile are endless; it's a

“March 19: We feel like the last family left in Texas—or on Earth . . .”



“What little was left from one meal was carefully hung in storage for the next. Wild water cress, a treat to some people, became a standard vegetable at every meal.”



wonderful tool for survival. Once out of gas it is worthless as a vehicle, but it has a myriad of other uses. The ignition wires can bind things, firewood and belongings can be stored in the trunk, the tire tools are good for digging, floor mats make table cloths, tires can be cut into containers, metal can be hacked from the sides, and the body is always a reliable shelter, from bad weather.

“March 20: Tonight, a treat—soft-shelled turtle on a spit. The white meat tasted like pork; our best meal so far. . . .”

One of the handiest uses of the automobile is for making a fire if no matches are available. Although the time-honored flint-and-steel method is good (knocked together to place a spark in a roll of tinder, in our case, dried cedar bark), a

still better method is to remove the two battery cables where they are attached to the auto engine and rub them together to throw bold sparks. Even when the battery is too weak to serve any other purpose it still will provide a spark for setting a fire. A bit of gasoline captured from the carburetor and dripped on the tinder quickly draws a flame from the spark.

“March 21: Coffee from re-boiled grounds isn’t something I’d serve my friends, but at least it’s hot and satisfying. . . .”

The car seats can be removed to use around camp. The fabric of the seatcovers always is a reliable standby. A pair of pliers, a stock item in our glove compartment, did many jobs around camp; the most important was handling hot pots to and from the fire. The radio, until the battery is exhausted, provides some contact with the outside world, important in the time of disaster. Even an old hunting cap in the trunk proved useful—Marjorie wore it to keep the sun from her face.

A lot of unlikely items proved useful. While gathering her belongings Marjorie, in a rare stroke of luck, came up with three sealed jars. They just happened to be in a cardboard carton she grabbed to



“Eventually we’d have to think about tanning our own furs for clothing . . . Big carp promised a feast, but we prepared it wrong; it made us sick. . . .”



pack the other things in but they were welcome additions. One made a minnow trap, baited and sunk in the creek with a small hole in the lid. Another stored goods from one meal to the next, and the third made a dry container for the two pounds of sugar we had along. A spoonful of sugar is a wonderful energy booster.

Every can, once emptied, was religiously saved. They were used for everything from eating utensils to cups. We had only one eating utensil, a large service spoon, so we had to improvise others by bending tops of tin cans into makeshift spoons. Our one serving pan was drafted into service as a heating container for canned goods, for making coffee and for boiling bath water.

Tools, in any form or fashion, are vital for self-reliant existence. I had an ordinary camping hatchet. It wasn't adequate. A lightweight double-blade ax would have been more practical. A small shovel like the entrenching tools used by our armed forces earns its way

“March 23: What we wouldn't give for a big-big container . . . a toothbrush . . . some soap . . . a tall, cold drink and a cigarette . . . and a mattress.”

The author's "survival kit" of things you might forget:

Heavy knife and small file	Waterproof matches	Roll of stout nylon cord
Fishhooks and fishing line	Coil of wire (for snares)	Garden vegetable seeds

Adding these items would make it a real survival kit:

.22 rifle, 'scope sight	First-aid kit	Pliers
500 rounds .22 ammunition	Aspirin and dysentery medicine	Flashlight with extra batteries
Light double-bitted ax	Several bars of soap	12-foot square of waterproof canvas
Small shovel	Canteen and cooking kit	
Heavy-duty waterproof boots		

NOTE: These items are only basics which can be kept in the car or house to supplement food, clothing and equipment in the event of an emergency evacuation.



“A windfall of pecans was the first fatty food in days—Reed stuffed.”



“Cleanliness became essential . . . ‘dishes’ were scrubbed and scalded.”

in any camp, survival or otherwise. We didn't have one. For digging we loosened dirt with a tire tool and removed it with a tin can.

Fishhooks can be fashioned from almost anything which will sharpen and hold its shape under pressure. One of the best substitutes I've discovered is the strong tin overlap where a can is sealed. This can be cut loose from the can with a knife, bent into the proper shape and honed sharp, either with a file or on a rock. Wire, even fence wire, also makes good hooks. Or they can be made from bone, complete with barb, if a person has the patience to file a bone into the proper shape, or carve it with a knife.

If we should ever face a showdown where survival becomes necessary I believe the sportsman stands the best chance of staying alive. He knows how to fish and hunt. Of the two, I'd pick fishing as more important. A gun with ammunition is a soul-satisfying tool of

(Turn to page 234)

“Abby has been great for Reed . . . He doesn't seem to mind discomforts. . . .”

“Tools are vital to self-reliance . . . but a handy man could improvise. . . .”



Rings Don't Mean a Thing

There are coffee tables, and then there are coffee tables made from a chunk of solid black granite.

One such table, weighing 2400 pounds and costing \$600 was cut from the stone by the DoAll Co., a manufacturer of tools in Des Plaines, Ill., and installed in the firm's lobby.

Because of its hardness and fine grain, the table defies scratches, cigaret burns, ring marks from glasses and never needs polishing.



Any Truck a Swamp Buggy

Swamps, bogs and generally inaccessible terrain which once presented formidable barriers to oil exploration, are no longer serious obstacles. A new, extra-wide, low-pressure tire developed by Goodyear Tire and Rubber Co., allows conventional vehicles to carry crews and equipment into the worst marshland without bogging down.

Operating on four to ten pounds pressure, the tires are quickly replaced with conventional tires for road use, thus eliminating the need for separate road and field-vehicle fleets.



First All-Cargo Jet

In a joint program, the Federal Aviation Agency and the U.S. Air Force are developing the first jet transport to be used exclusively for cargo by commercial airlines and for cargo and paratroopers by the Air Force.

Specifications include a cargo capacity of 70,000 pounds and a capability of taking off fully loaded from a 6000-foot runway. It will be powered by turbofan engines and features truck-bed-height loading.



Hot Storage Iron

When finished with this new soldering iron, simply unscrew the handle and screw it over the business end. The iron can then be safely placed in your tool kit without waiting for a cooling-off period. Open end allows heat to escape safely. L.I. Electro-Labs Inc., Hewlett, N.Y.

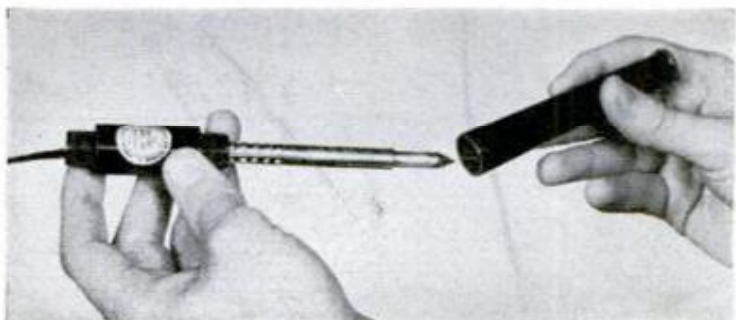

PM's House of Imagination



*Build it from our
plans . . . page 169*

*Add the rolling
toolbox to your
own shop . . . page 178*

*Preview tomorrow's
TV intercom in the
PM house . . . page 182*

*H*ERE'S A HOME that gives you lots of choices—chances to use your imagination—before and after it's built.

- Do you prefer the low sloped roof (above) or the more conservative New England country style (facing page)? The same plan builds both.
- Do you like a sloped suburban lot? This two-level house is designed just for that lot—but it can also be built on one level from the same plan.
- Are your workshop projects indoor or outdoor type? You can have both—in the shop next to the garage or the project area behind the garage.
- What about noisy vs. quiet family pursuits? This house is zoned so that both can be carried on without disturbance.

PM's House of Imagination is a home for *you*. You'll be inspired to add your own ideas as you imagine yourself living in this home of exciting architectural features.

(Continued to page 268)

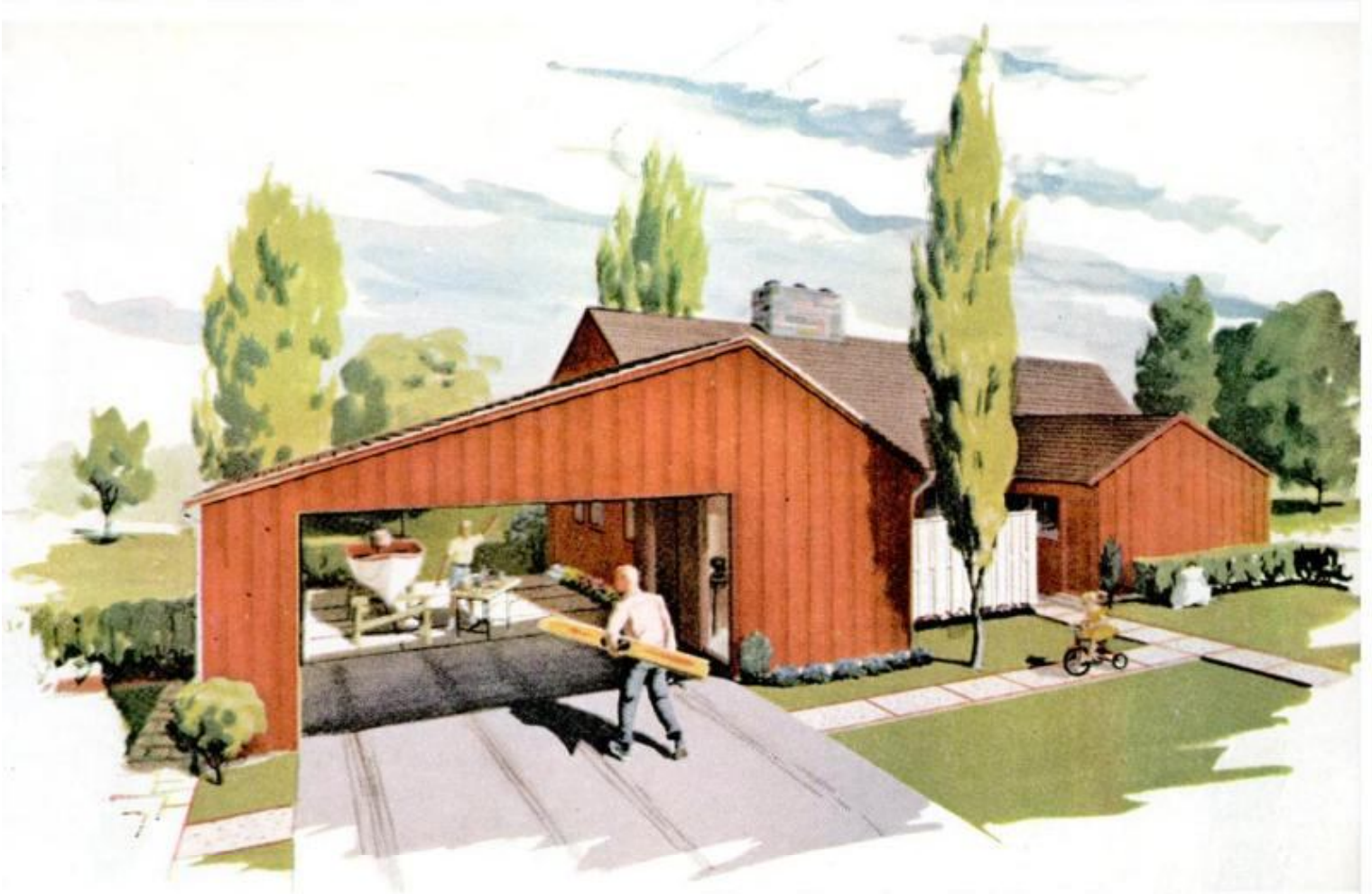

New England Country Style

ROOF STYLE, with gabled faces of wings toward the street, and vertical siding give this version a traditional appearance. Floor plan is same as that of house shown on the cover. Overhead doors at front and rear of garage open up project area to street and to shop (inside the garage)

STEPS from family room to kitchen also form a base for permanently mounted stools. The family room (like the two front bedrooms in the opposite wing) is 16 inches lower than main portion of house. Sliding glass doors allow this "farm kitchen" to open onto the court

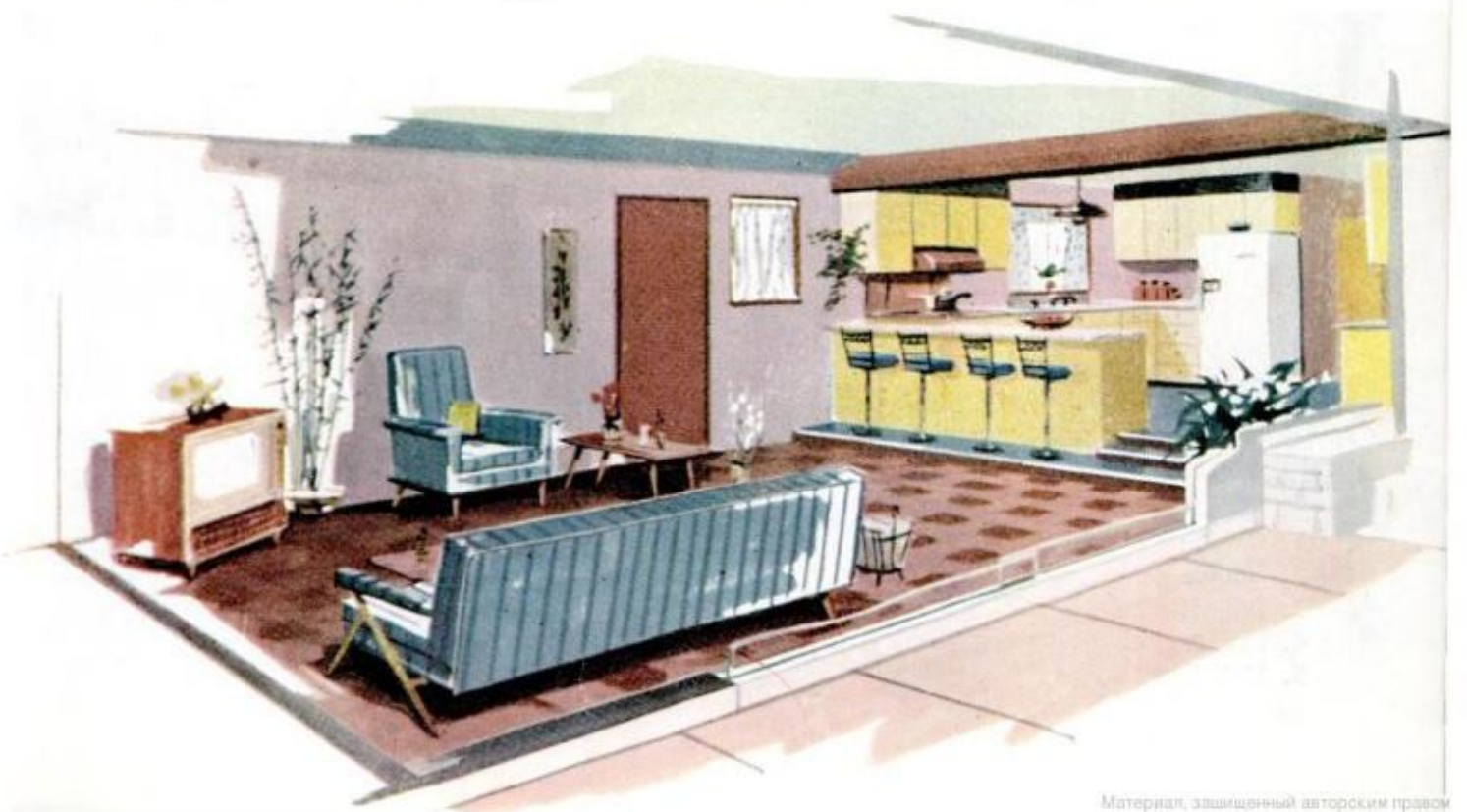



1. Garden and tool storage, 2 x 20
2. Double garage, 20 x 20
3. Project area, 16½ x 26
4. Laundry-sewing-ironing room, 8 x 12
5. Half bath, 3½ x 5½

6. Heating plant and water heater
7. Kitchen, 12 x 12
8. Family room, 12 x 15½
9. Workshop, 8 x 12
10. Family entry court, 20 x 20

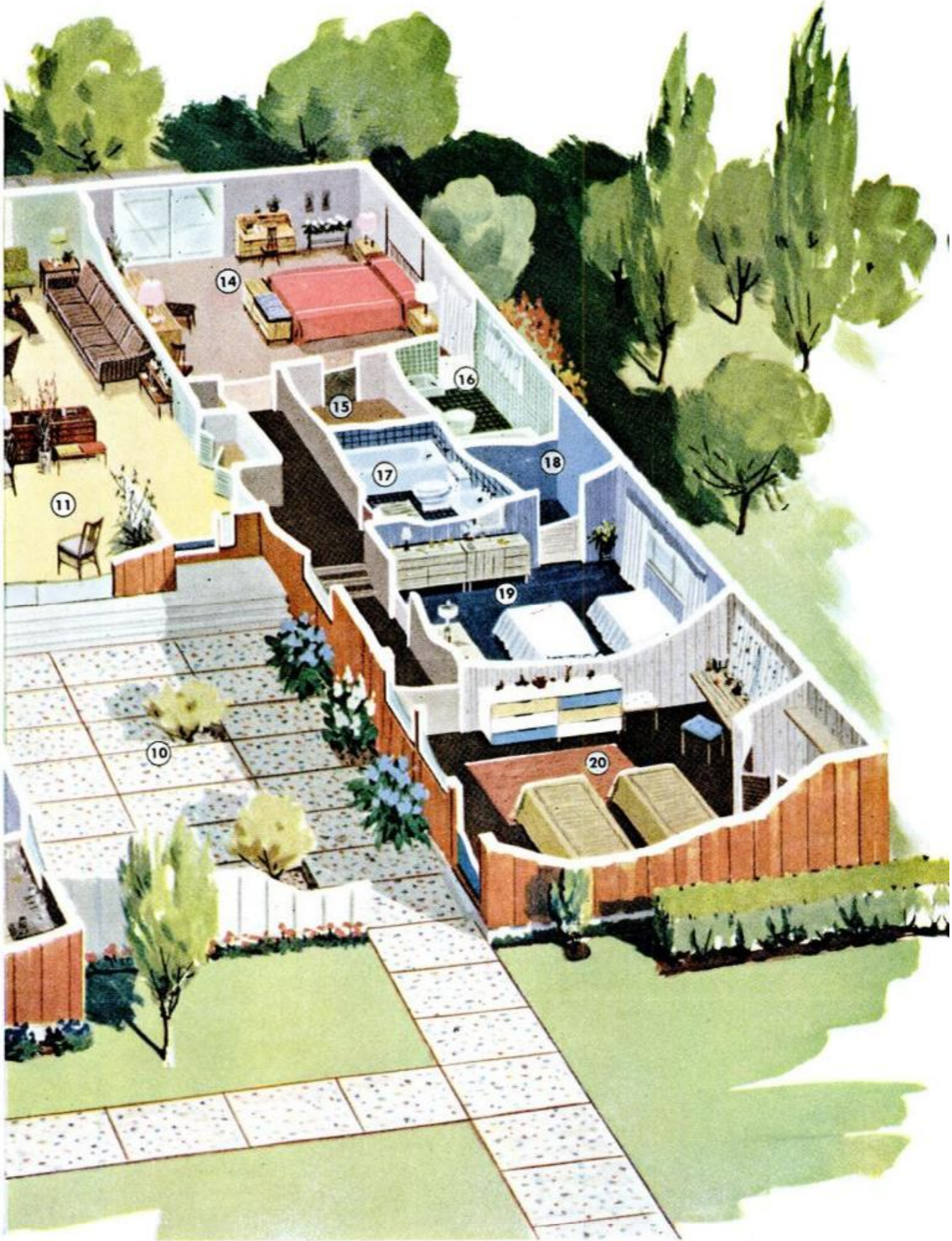

- 11. Dining room and entry, 12 x 20
- 12. Living room, 12 x 20
- 13. Patio, 9 x 22
- 14. Master bedroom, 12 x 16
- 15. Walk-in closet, 4 x 6

- 16. Bath, 4½ x 7
- 17. Bath, 5½ x 7
- 18. Walk-in closet, 4 x 5
- 19. Bedroom, 10 x 12½
- 20. Bedroom, 10 x 16

SEPTEMBER 1961



LIVING ROOM is divided from dining room by a striking fireplace that reaches to the highest point of the ceiling. Front door of home can be seen beyond the low cabinets that house high-fidelity equipment



PASS-THROUGH frames the dining table in this view from the kitchen. Beyond the table can be seen the doorway that leads to the bedroom hallway and the main bath



SHOP has door that opens into the garage, making it handy for materials to be brought in and easy for tools to be carried in or out. On the far shelf is an ultrasonic cleaner that keeps hand tools as shiny as new



SUNNY COURT at the entry of the house is a pleasant "greeting" for visitors. It's also an ideal family gathering place, since a privacy fence hides the area from the street. The sliding glass doors at left open into the "farm kitchen" and those at the right lead into the dining room. Trellis overhead, casting shadow into court, is a feature of low-roofed version of house

FAMILY ROOM is a spot for activities. View from kitchen shows entertainment wall at far end. Door at right leads to shop; curtains at left cover sliding doors to the entry court. Besides the two sliding doors to the front court (the second is in the dining room), there are two others—in the living room and master bedroom—opening onto patio at rear of house





BUILT-IN OVEN and rotisserie are a housewife's delight in the kitchen of the PM House of Imagination. They and other new products appear throughout the house in a display of exciting modern conveniences. Ultrasonic cleaner in shop (page 175) also cleans pots and pans

TV INTERCOM carries voice and picture. Camera is incorporated in cabinet of new Motorola system. More on page 182

FRESH COFFEE in 12 seconds is a quick boost in the morning. The built-in, by Havajava, Glendale, Calif., draws water, brews coffee



All were built except The Chicago one

Where to find the PM house

Watch for local announcement of opening dates

You can visit the PM House of Imagination in your area. Here's a list of the local sites and the names of the builders.

ATLANTA, GEORGIA

3643 Winview Court
Winding Woods Subdivision, Decatur
Built by F. Coin Campbell, Jr.

BATON ROUGE, LOUISIANA

11525 Parkwood Drive
Sherwood Forest Subdivision
Built by Maher and Sharkey, Inc.
Furnished by Kornmeyer's Furniture Co.

CHICAGO, ILLINOIS

12240 Surrey Hill Road
Country Squire Estates (122 St. South and
76th Ave. West)
Built by Country Gentlemen Homes

DENVER, COLORADO

66 South Clarkson Street
Built by Cosman Construction Co.
(see local announcement for opening date)

FORT WORTH, TEXAS

4100 and 4101 Big Bend Trail (twin models)
Built by Art Endres

HOUSTON, TEXAS

107 St. Marks
Venetian Estates
Built by Leo E. O'Neal

LOS ANGELES, CALIFORNIA

4030 Crenshaw Boulevard
Built by Construction Management, Inc.
Decorated by Jeanette Coppes, NSID, and
Associates
Furnished by Angelus Furniture Mfg. Co.

MILWAUKEE, WISCONSIN

7460 North Longview Avenue, Glendale
Built by MGM Builders, Inc.

SEATTLE, WASHINGTON

2011 123rd Street, S.E.
Woodridge Addition, Bellevue
Built by Modern Home Builders, Inc.
Decorated by Swigart's of Seattle and
Bellevue

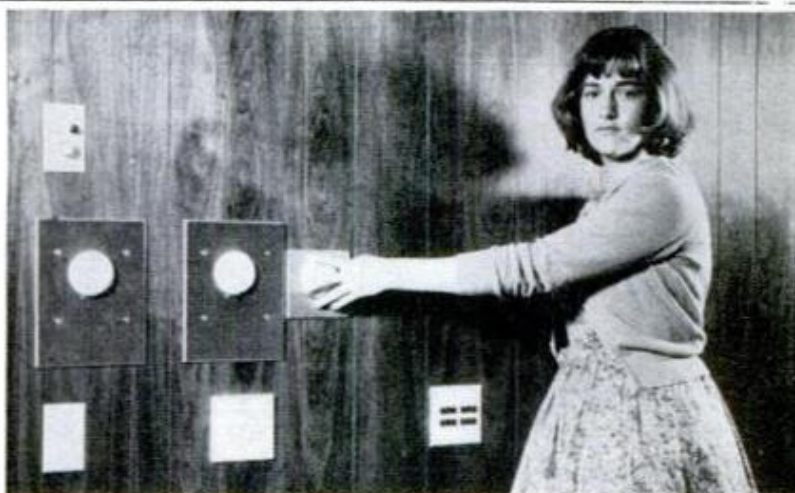

WEATHER STATION-THERMOSTAT, a product of Minneapolis-Honeywell, and radio-phono intercom by Step-Saver, Culver City, Calif., are built-in conveniences at left. At right, lights are dimmed with a Luxtrol control

**PM's
House
of
Imagination**

Architect: Grosvenor Chapman, 1640 Wisconsin Avenue, N.W.,
Washington 7, D.C.

Builder of Pilot Model (shown in this section): Construction Management,
Inc., 343 Screenland Drive, Burbank, California

Decorator: Jeanette Coppes, NSID, and Associates

Furnishings: Angelus Furniture Manufacturing Company

Photography: Ralph Morris and Associates

**FOR
PLANS**

Complete plans including specifications for the PM House of Imagination are available. Each set of plans contains all variations of the house: Contemporary with low-pitched roof; Conservative New England country style with gabled roof; two-level; single-level, and the expanded version. The cost of each set of plans is \$35.00 in the U.S.; elsewhere in the Western Hemisphere, \$40.00; all other areas of the world, \$45.00. Order from Plans Department, Popular Mechanics, ~~200 East Ontario Street, Chicago 11, Illinois.~~

SEPTEMBER 1961

575 Lexington Ave. 169
New York, N.Y. 10022



HEATING AND COOLING an entire house with a unit small enough to be hidden away in a closet is possible with Delco's 365 series furnace and air-conditioning systems. The cooling section includes a weatherproof condensing unit mounted outside house

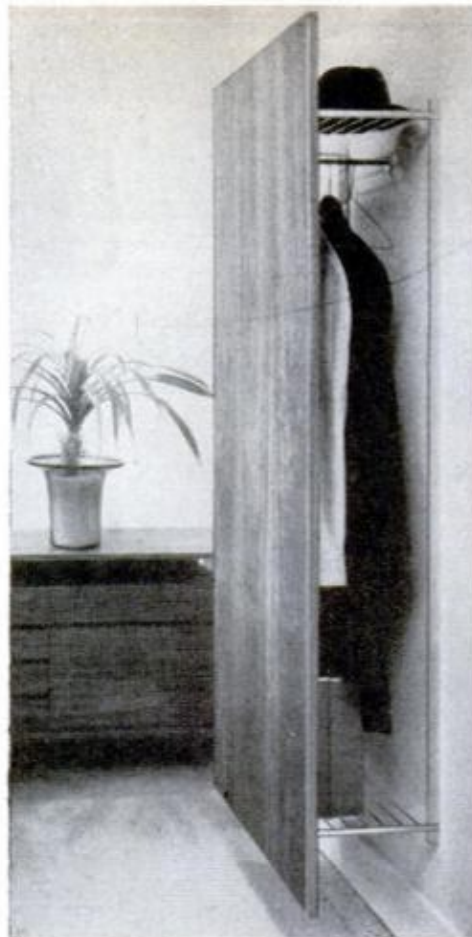

WALL-MOUNTED WARDROBE which includes a chrome-finished luggage shelf below and a hat rack above is by Hugh Acton, 588 Brockside, Birmingham, Mich.

Home Products--New and Appealing

ELECTRONIC AIR CLEANER which can be installed easily in any type of forced-air heating system is produced by Minneapolis-Honeywell. The small control panel, below left, can be mounted anywhere in the home. Safety switches automatically shut off power when the access door is removed to service the three-inch cleaning cell, below right. The cost of the unit, including installation, is about \$350 in a new home, \$400 in an existing home





HOME INTERCOM which works through extension telephones is being offered on a rental basis by Bell. Each station consists of a phone and a speaker, while a combination speaker-microphone is used at the door

ADJUSTABLE BED with two motors which elevate the head or foot section at the touch of a switch is being manufactured by the Sleeper Lounge Co., 3279 Wilshire Blvd., Los Angeles 5, Calif. With mattress, \$349.50

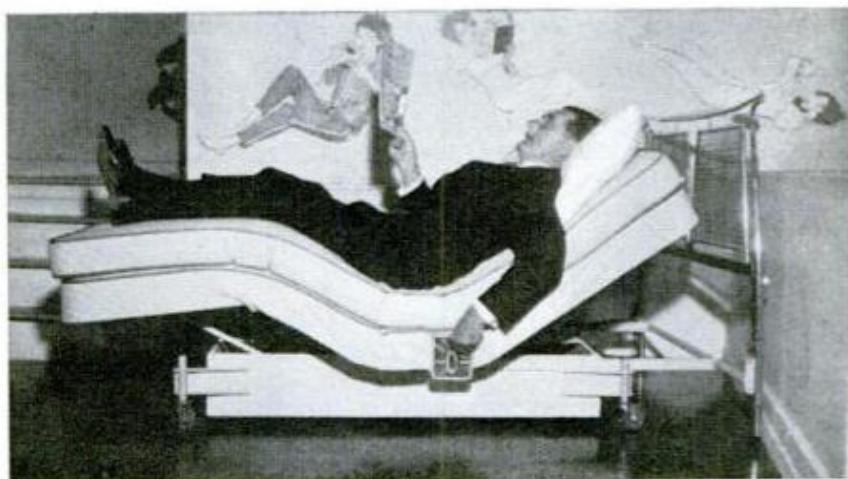

PULL-DOWN SCREEN which covers garage door opening operates like a window shade. Made of fibreglas, it zips up the sides for full protection. A screen to fit the opening of a single-car garage sells for under \$50

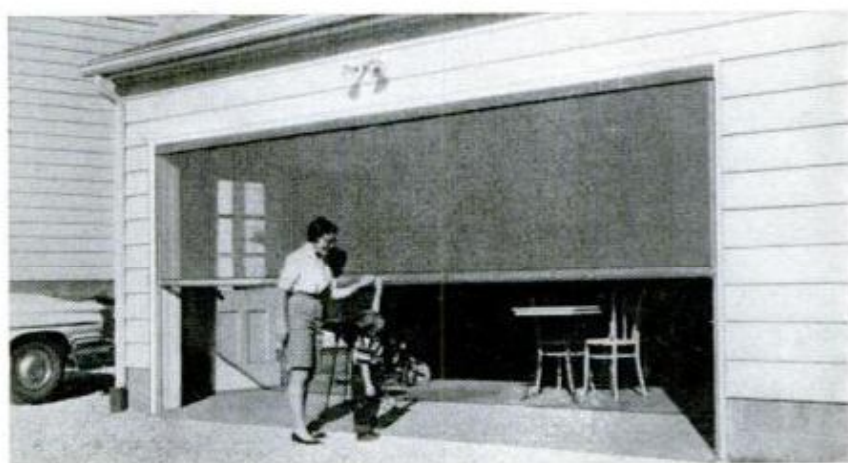

More New Products



PHONOGRAPH RECORD ALBUMS stored on a new pole-type unit are held in hangers which pivot 90 degrees so that the record can be removed without taking down the jacket. It's made by Record Tree, Inc., 214 S. 12th St., Philadelphia, Pa., and sells for \$24.95



MODERN FIREPLACE HOOD is available in copper, brass, "Skonsmetal" (a pewter-type metal) or iron with a wide choice of light or dark colors and dull or bright finishes. It's manufactured by Scandinavian Art Metal, 1599 E. Walnut St., Pasadena, Calif.

SOFFIT, FASCIA AND GUTTER SYSTEM combined into one easy-to-install unit uses interlocking components made of .032-inch aluminum finished in baked white enamel. Soffit sections are made with fluted ribs and have a continuous breather vent panel extending the length of each section. Fascia plates are available in heights from 6 to 10 inches, and the V-shaped gutter, which extends 14 inches back from the fascia, meets all FHA requirements for rain-carrying equipment. It's made by Gary Steel Products Corp., Gary, Ind.

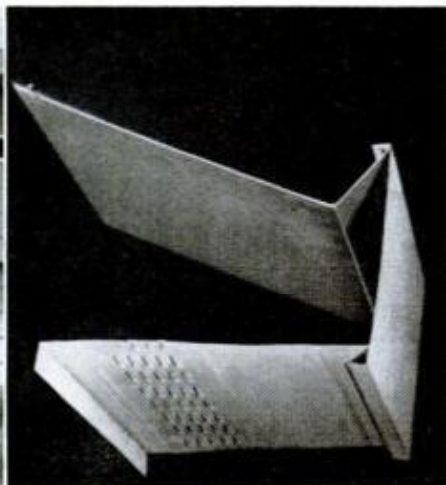
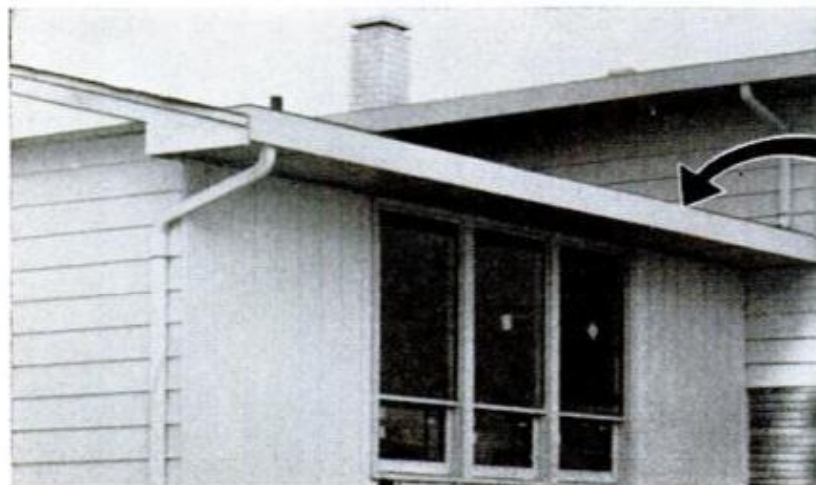



DECORATIVE DOOR MOLDINGS for use with flush doors come in many styles and periods and are available in stock door sizes. They are manufactured by Decorator Door Co., 425 Austin Place, Bronx, N.Y.



BUILT-IN CLOTHES HAMPER of heavy-gauge metal has baked enamel interior. Exterior is primed, ready for finish coat. Retailing for \$14.95, it's made by Quality Line, 5973 Venice Blvd., Los Angeles, Calif.

ELECTRICALLY OPERATED GARAGE DOOR raises like a Venetian blind without the use of any counterweights or overhead tracks. The steel panels stack into a compact unit only 10 inches deep. All surfaces are primed and ready for a finish coat with any exterior paint. An 8 by 7-foot door retails for \$159.50, and installation costs about \$15. It's made by Panel-Lift Door Corp., 1724 Chestnut St., Philadelphia, Pa.

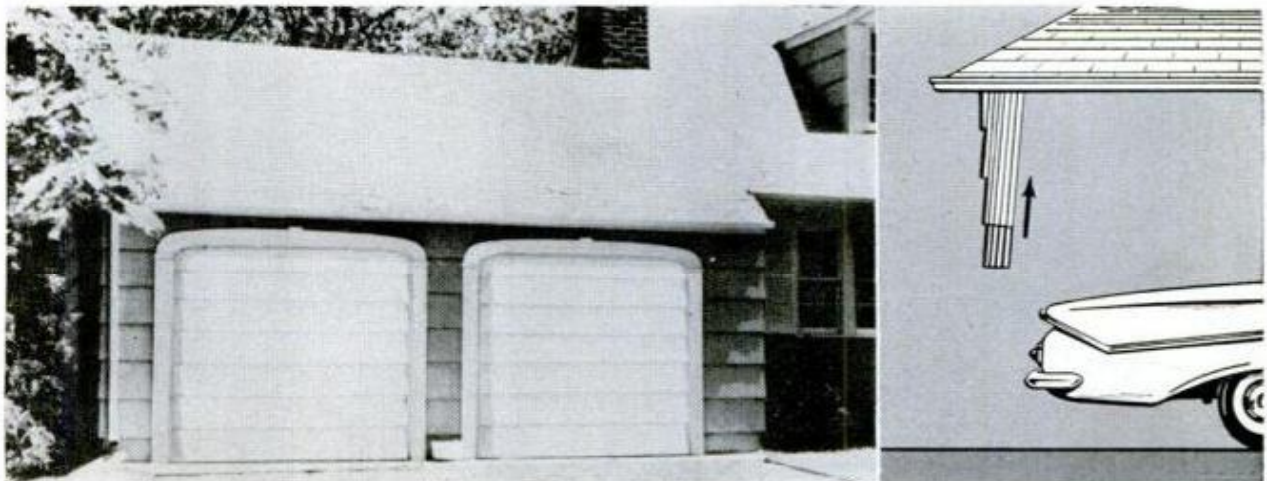

More New Products



TRaversing SCREEN of polystyrene plastic which blocks out 86 percent of the sun's infrared rays while remaining cool to the touch can be ordered from Jaylis Sales Corp., 514 W. Olympic Blvd., Los Angeles, Calif.

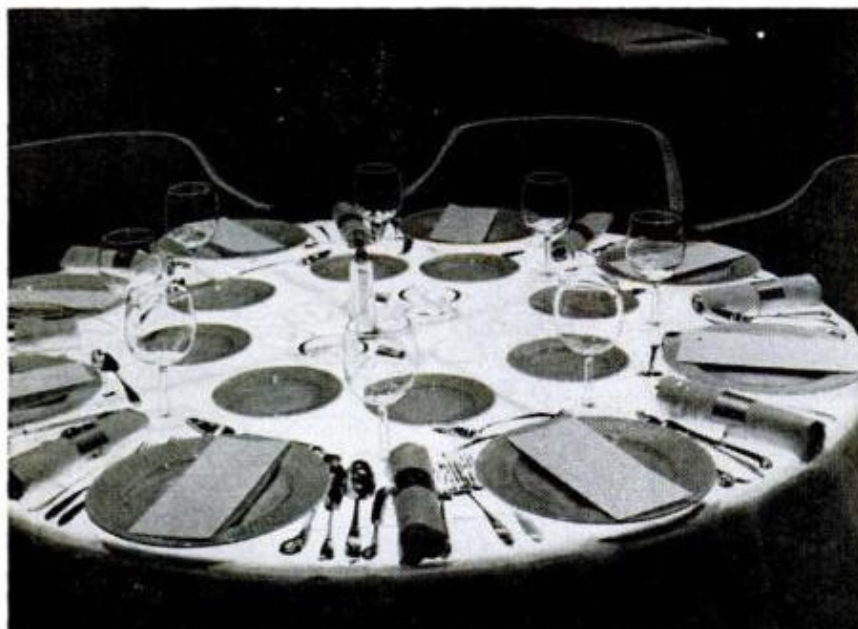

ELECTROLUMINESCENT PANELS in a number of colors and sizes are now being sold by Westinghouse. They are glass panels coated with a conductive film, can even be used as table tops



COMPACT DISHWASHER suitable for built-in or countertop installation washes and steams dishes in 25 minutes. Priced from \$199.95 to \$279.95, it's made by Ling-Temco Electronics, Dallas

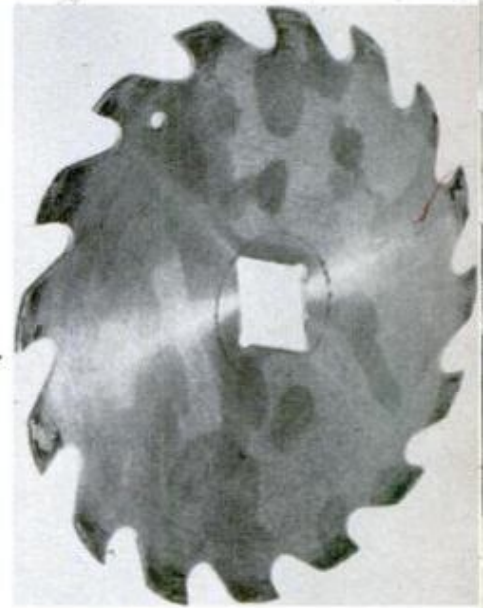
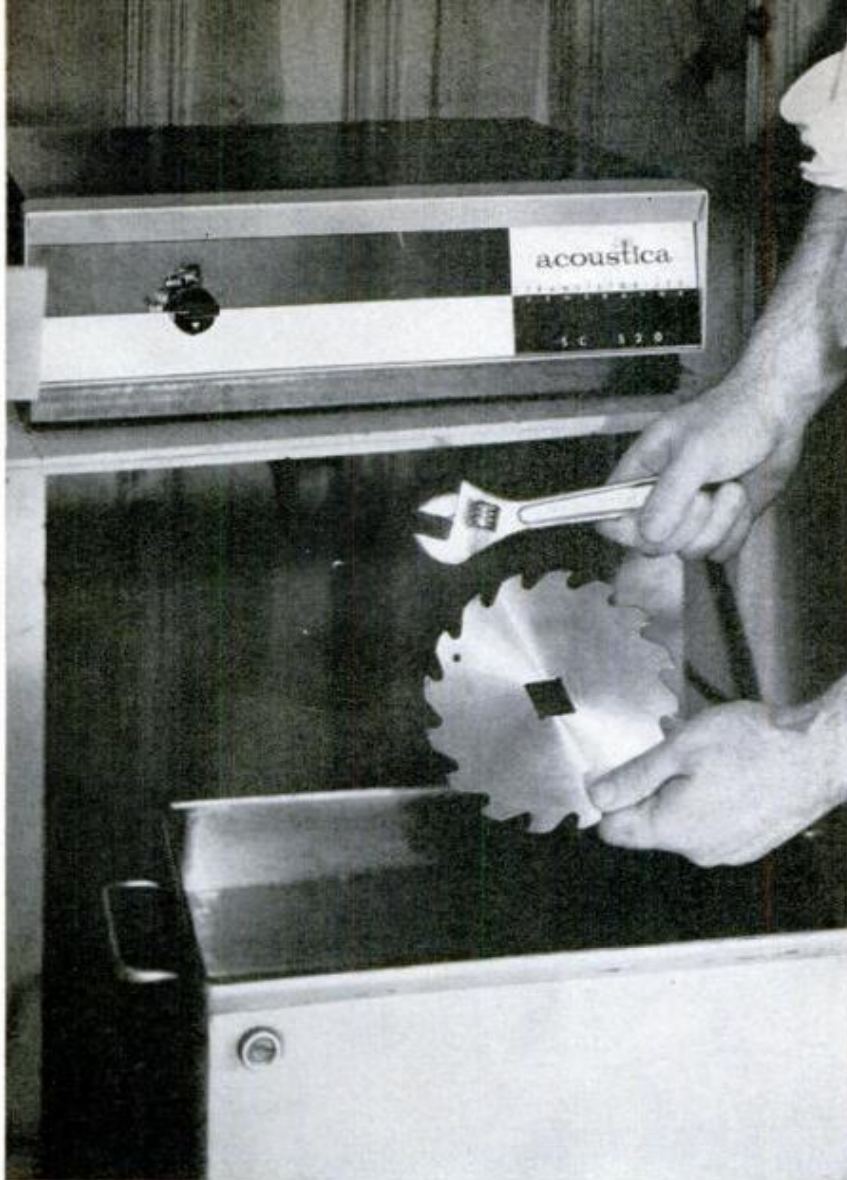

UNRETOUCHED PHOTOS of wrench and saw blade shown before and after a less-than-five-minute cleaning in the ultrasonic washer. Wrench was covered with grease and penetrating oil stain; saw teeth with dirt and gum

Workshop Ultrasonic Cleaner

MR. CLEAN will have nothing on the Dad who sports one of these ultrasonic washers in his workshop. Dirt, surface rust, grease, slime — just about anything that can be scrubbed with a wire brush — will come out of this ultrasonic bath clean in a few minutes.

In fact, if Dad doesn't watch it, Mom will be slipping a skillet with burned-on grease into his washer for a cleaning.

Custom-designed installations of the Acoustica ultrasonic cleaners were made both at *PM's* new product-filled House of Imagination in Los Angeles, and *PM's* workshop laboratory in Chicago. These installations consisted of a tank fitted with a transducer and connected to the generating unit by coaxial cable. The generator operates on standard house current. Water is added to the tank with detergent, and high frequency sound then does the dirty work.

At this writing, such ultrasonic cleaners are relatively expensive installations. As they become more popular, though, the cost will come down.

One manufacturer, in fact, is working on a commercially-feasible ultrasonic dishwasher. *PM* hopes to bring you a report on its operation and effectiveness in the near future.

CLOUDS OF GRIME billow from machine part. Clear tank is demonstrator

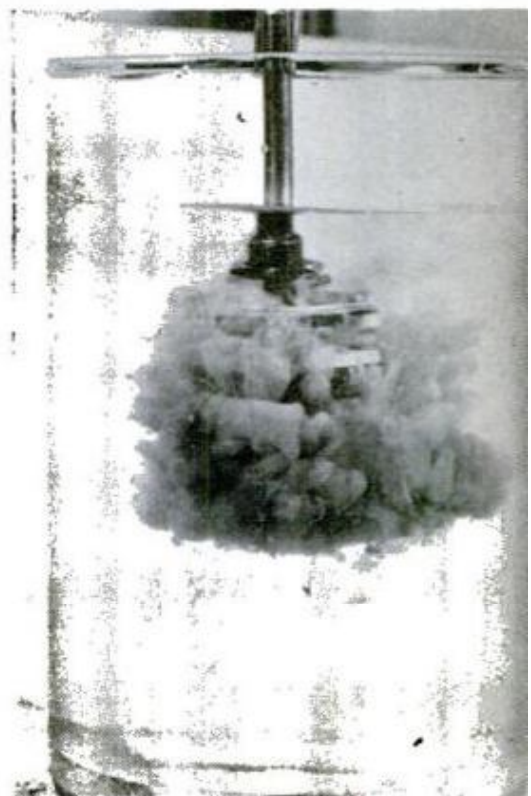

Listen-Nook for Radio-TV Record Players...



... and Other Noisemakers

TAKE UP TO FOUR KIDS, give each his choice of turning on TV, the record player, the radio or a tape recorder—all at the same time. The noise should start you reaching for some super tranquilizers.

With this appliance sorter-pacifier, however, all is *silence!* There'll be few squabbles over what to listen to, for each child can select his favorite, be it a record, TV program, or radio. Or all four can listen to the same entertainment, while you enjoy peace and quiet in the same room.

Each appliance is slightly modified with a closed-circuit jack. The jack is wired by breaking one of the two loudspeaker wires and connecting each end to a lug of the jack. Then mount the jack to any convenient place on the appliance cabinet. When nothing is plugged into the jack, the appliance operates just as it did before.

The Listen-Nook is a simple, nonelec-

tronic switching circuit. The reels (Wm. H. Ransome, 400 W. Madison, Chicago) insure that earphones will be properly put away, as they are retracted when not in use. Each child selects his program source and sets his own volume level. As six-ohm earphones are used, mismatch is of no consequence.

After punching the required cabinet holes, mount the parts and follow the wiring diagram. Use shielded audio cable for internal wiring to reduce the possibility of cross-talk. No shielding is needed on the reels for the earphones.

The total cost for the entire system built of all-new parts is about \$30. If you use fewer stations or junk-box parts, the total cost will be reduced.

(Why do you look so surprised, Yogi? After all, our readers are smarter than the av-er-age bear!)—Byron G. Wels

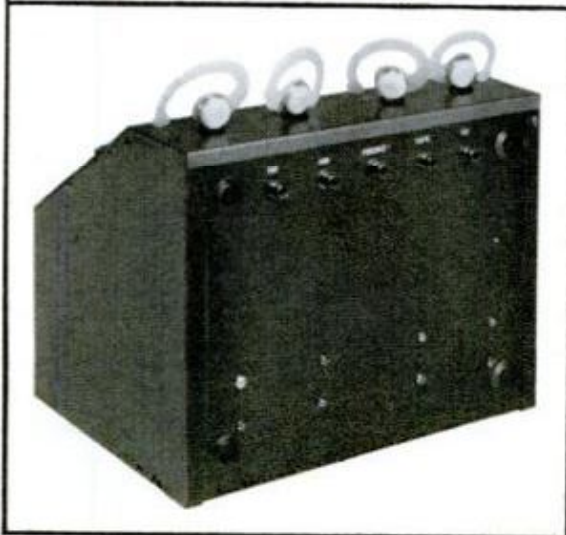
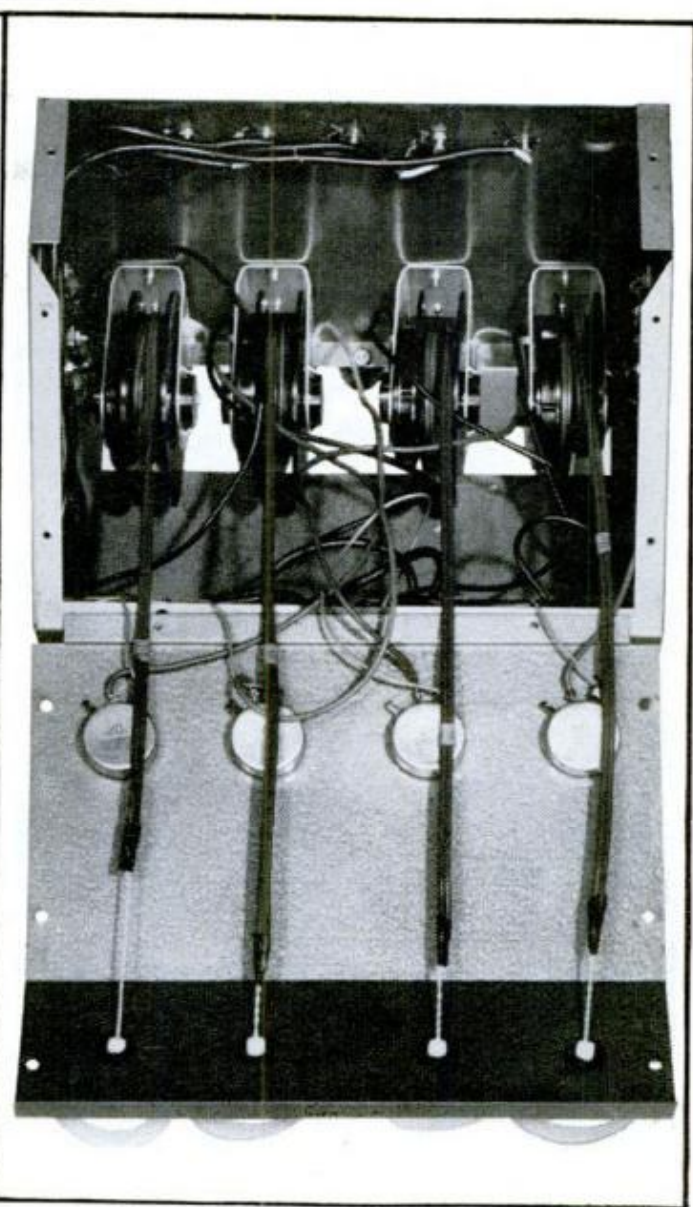
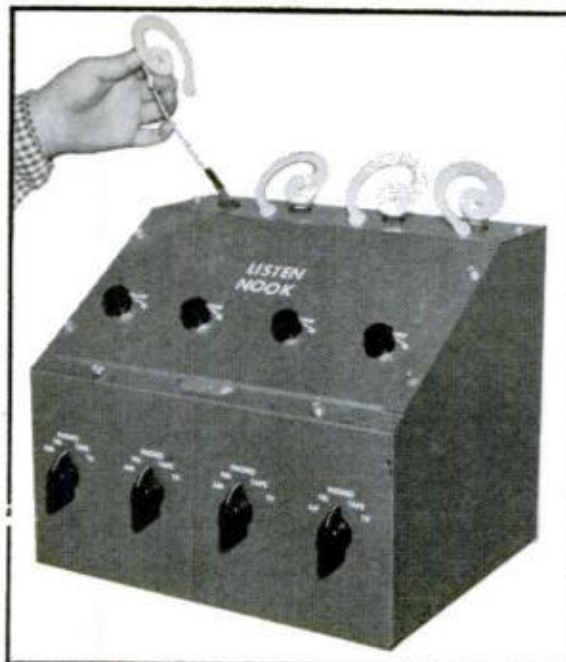

STANDARD HI-FI PHONO JACKS are used to bring the signal into the Listen Nook. Each station selects the desired signal using five-position switches. Volume level is set by the potentiometer. Add stations as needed

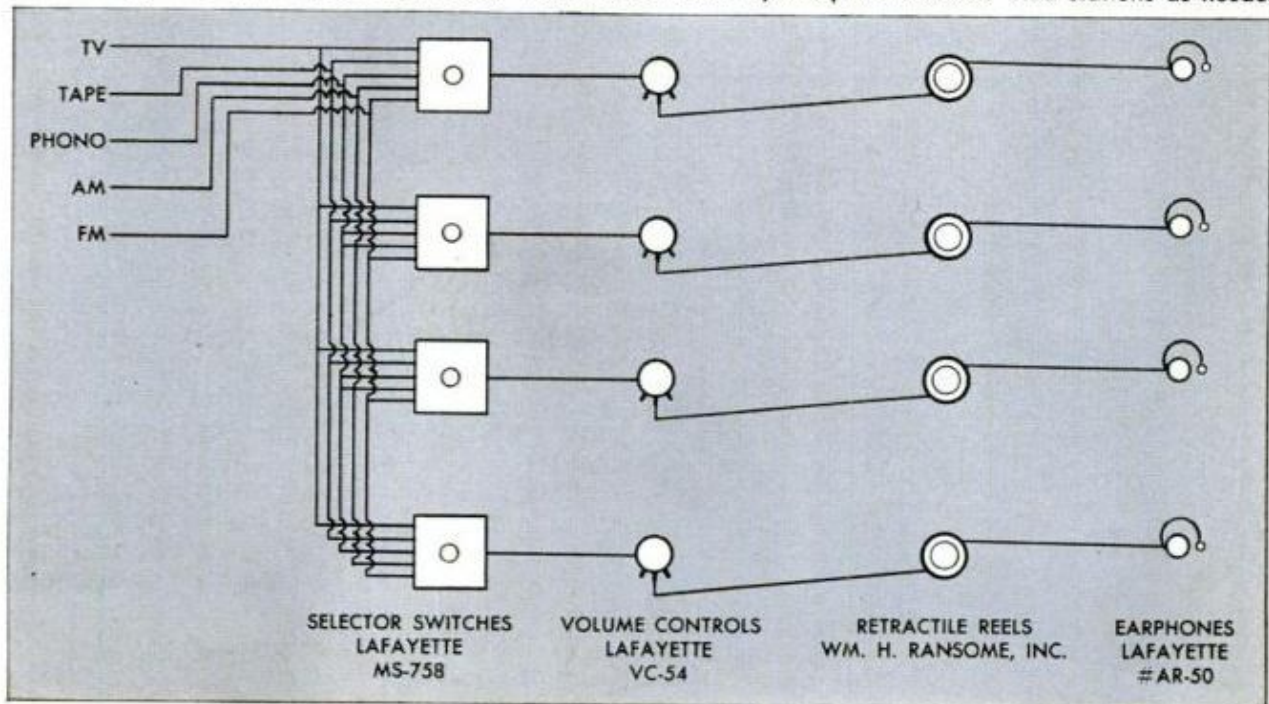

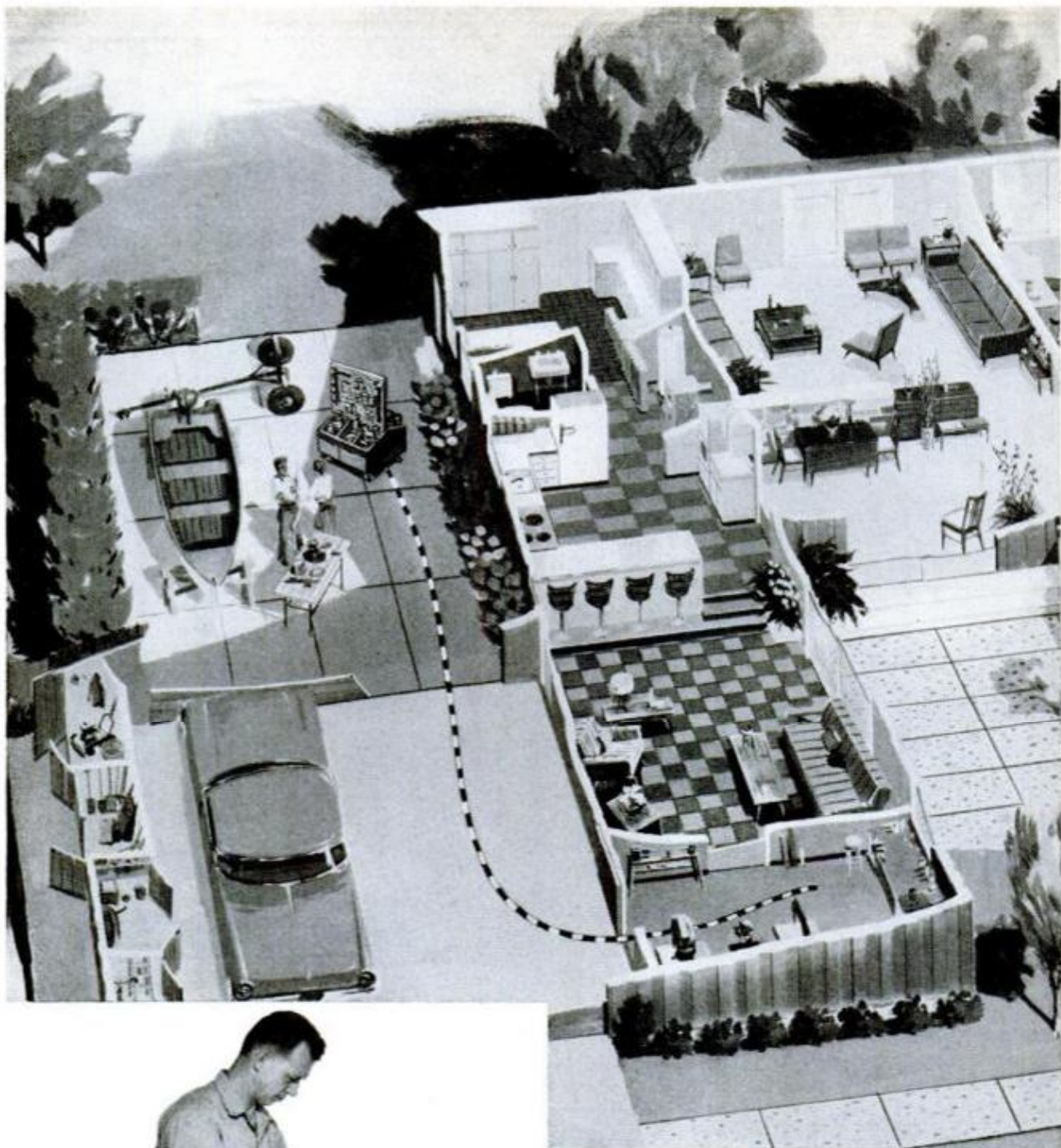

ROLLING

THAT DOTTED LINE you see on the birds-eye plan of the PM New Products House above shows how this rolling toolbox, or caddy, moves from the workshop right out to the project area, carrying a full kit of tools in one trip. And after one look at the original caddy pictured on the opposite page you won't be long figuring out how you, too, can use it.

Study the details and see what you get—six handy open bins, four deep storage drawers for portable power tools and a two-sided tool panel of perforated hardboard, the whole thing requiring a floor space of only 30 x 40 in. That 30-in. width means that the caddy will go through a standard

In the PM New Products House a complete kit of tools is moved from the workshop to the project area in this caddy. Plans on the next page show you how to build one like it

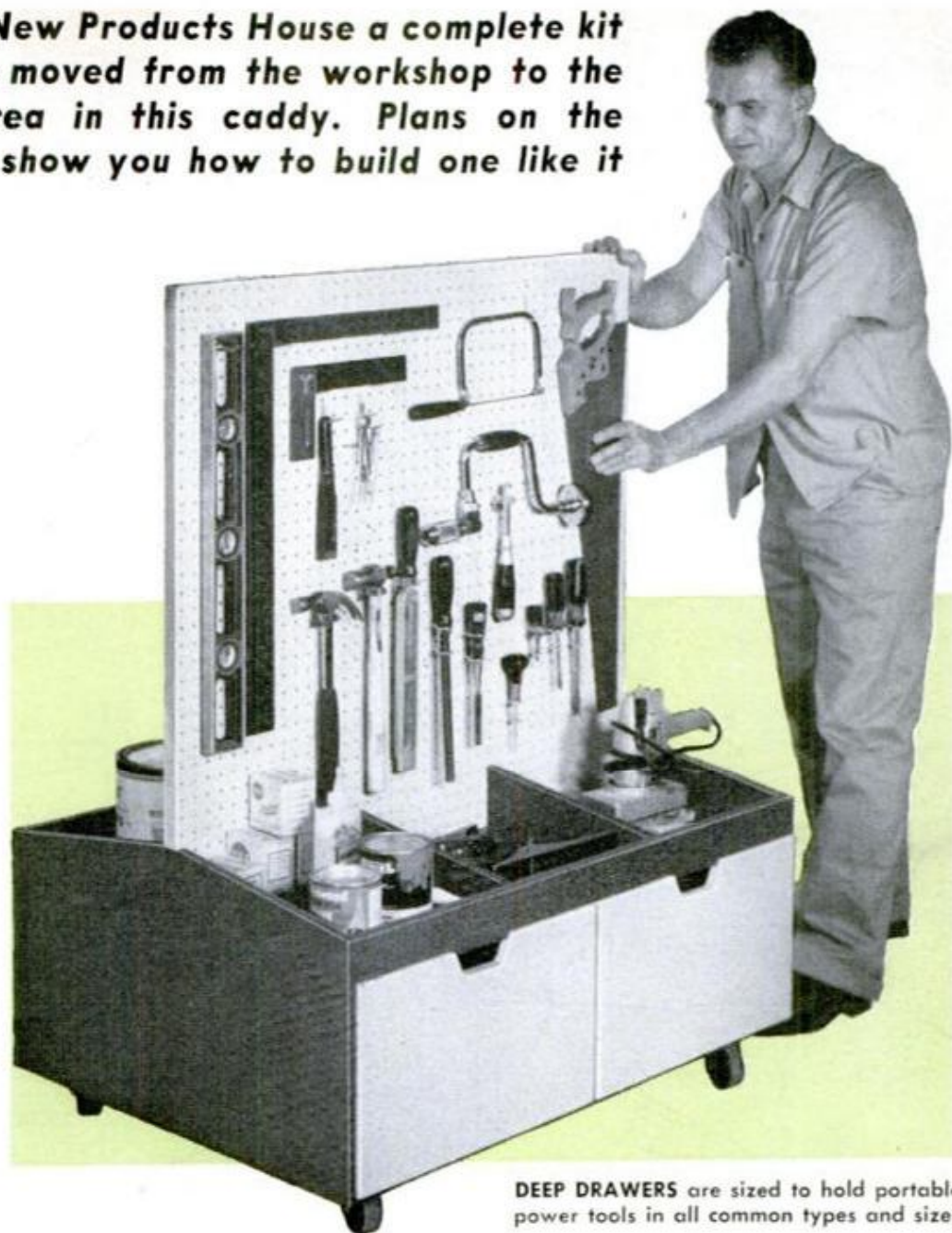

DEEP DRAWERS are sized to hold portable power tools in all common types and sizes

TOOLBOX

door, into or out of the garage or from the utility room onto a patio or porch, carrying its full complement of tools. This means that any open space you have available, inside or out, becomes a project area when you have this tool caddy to keep tools in order and out of the way until they are needed.

From the construction details you will see that the tool panel consists of two 40 x 48-in. pieces of $\frac{1}{8}$ -in. hardboard attached to the two sides of a frame of 1 x 2s of the same over-all size. The 1 x 2s are joined with corrugated fasteners and the hardboard panels are attached with short flat-headed screws and glue. Note that two





DRAWER BACK is notched to permit grooved slide to engage guide strip. Notch is same size as groove

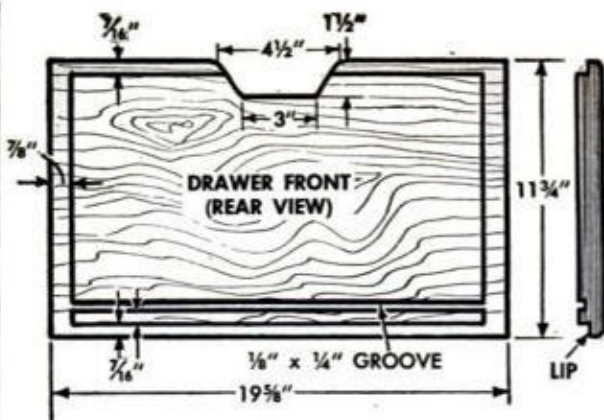

edges of this assembly are notched 15 3/4 in. up from the lower corners and 3/4 in. deep to take the end panels in a flush fit. The assembly is attached to the base by driving screws up from the underside. End panels are glued and screwed in the notches.

Next, you install the drawer dividers and drawer guide strips. Then follow with the

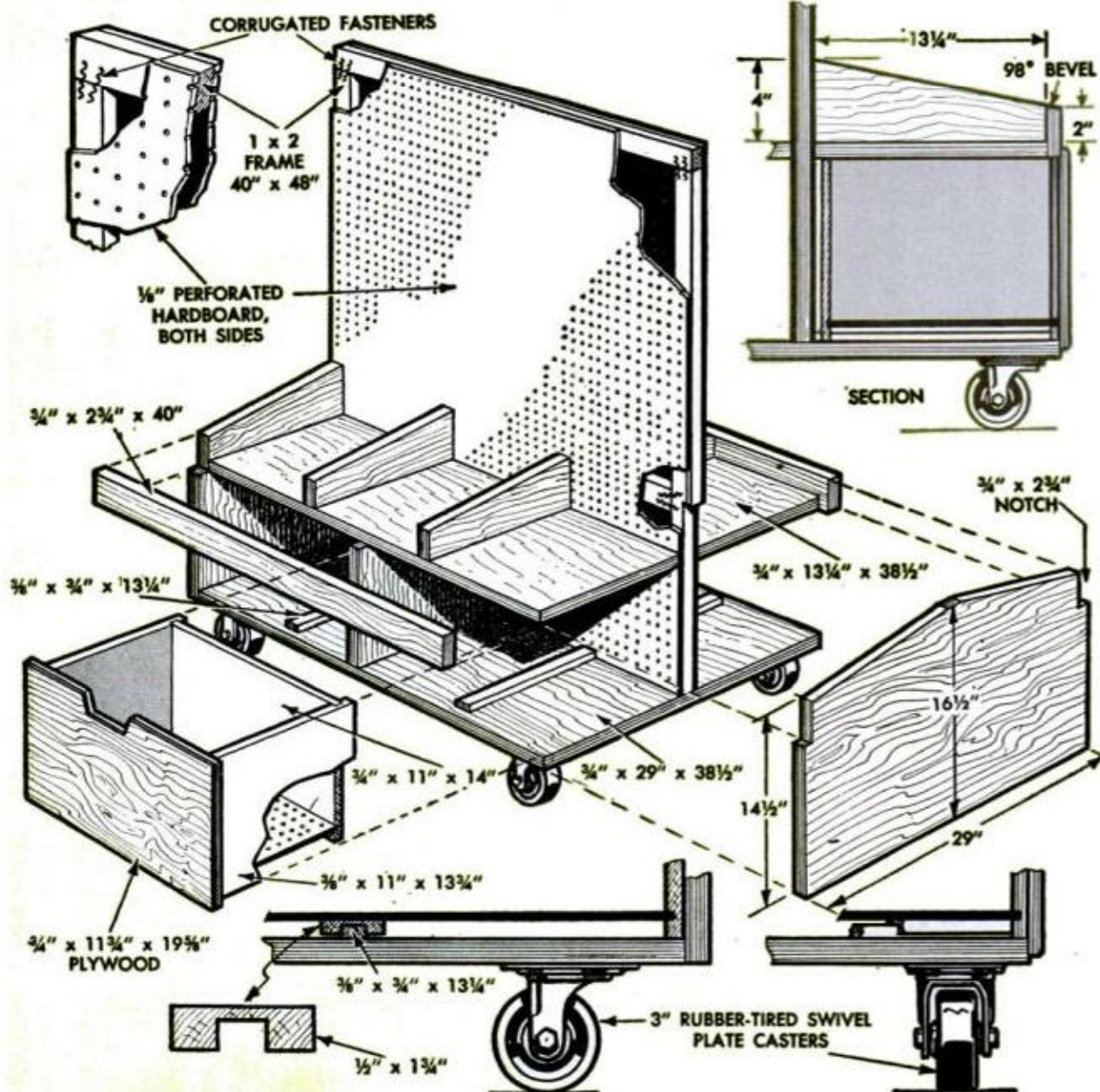

bottoms of the bins, each with the two dividers attached before assembly. Screws driven through the end pieces hold the bottoms in place, glue being used in the joints for added strength. Finish the bins by attaching the closure strips which, it will be noted, lap the end pieces flush in notches and are attached with screws and glue.

One detail shows a drawer front from the back, or rear, side and indicates the locations of rabbets, hand openings and the groove taking the bottom panel. In the original caddy the drawer bottoms were of 1/8-in. perforated hardboard but you can use 1/8-in. solid tempered hardboard if you prefer. The four drawers are duplicates and each is fitted with a grooved guide which slides on the strip attached to the bottom of each drawer compartment. Attaching the casters finishes the construction.

As all exposed parts are of plywood you'll need to do sanding only with fine sandpaper to get a good surface for finishing. First, apply a sealer and then follow with one or two coats of multicolor spatter finish in the color, or colors, of your choice. These new finishes are very durable, perfect for covering plywood and especially attractive.

★ ★ ★



TOOLBOX rolls easily on rubber-tired swiveling casters. Caster plates are attached to bottom with screws

HAND OPENING in each drawer front eliminates pulls, allows caddy to pass through standard door

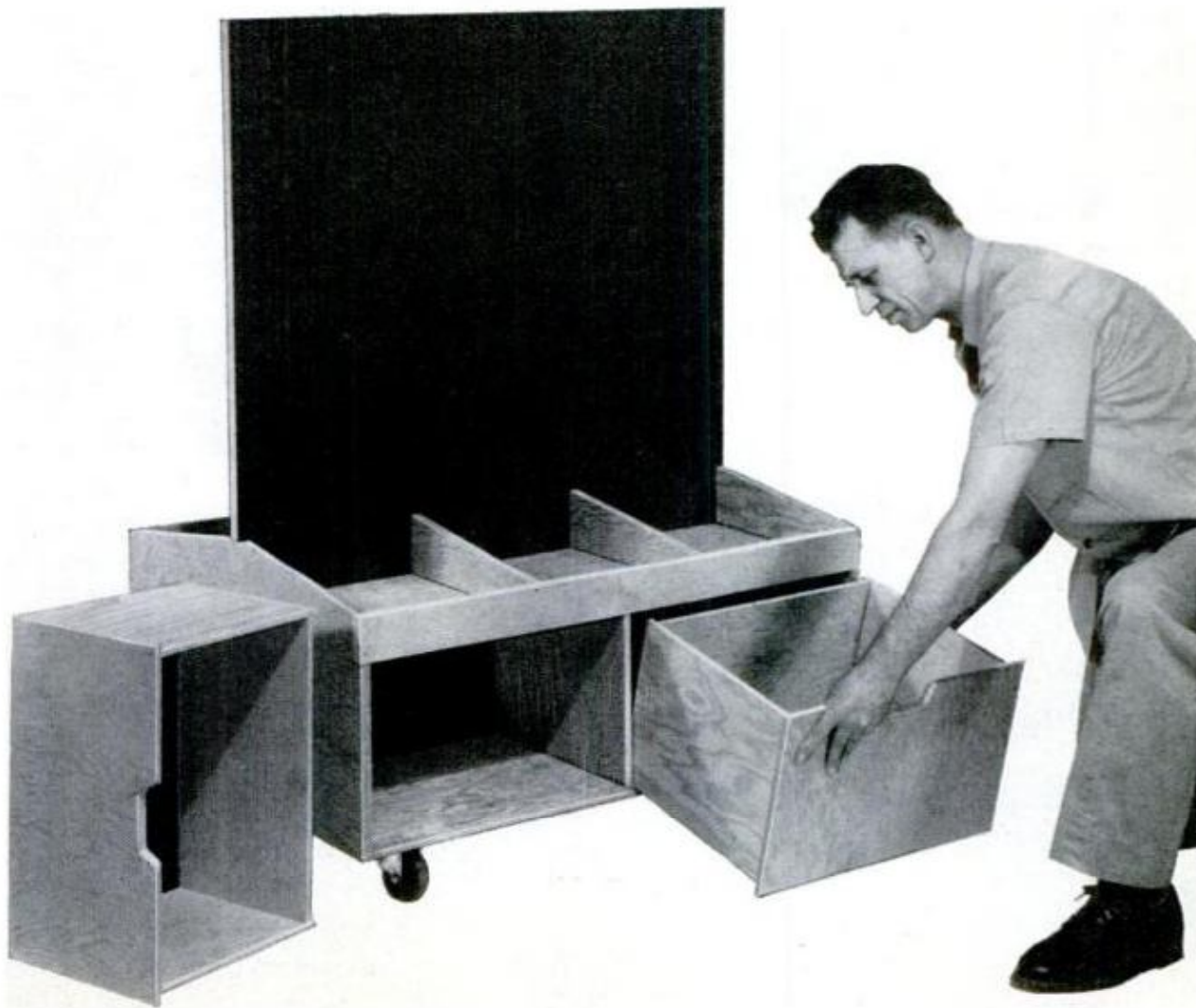

Television Interwatcher

"WHAT ARE you kids doing in there?"

"Nothing Mom."

"Well, I can see you, so stop it!"

With this TV intercom, not only can Mom see the kids, but the kids can see Mom, and you can bet that the horseplay will come to a halt.

This is one of the unique new home products installed in the *Popular Mechanics* House of Imagination shown elsewhere in this issue.

Each 7 x 8 x 12-inch unit of the system weighs 18 pounds and consists of an eight-inch TV receiver, a TV camera tube, the necessary audio circuits, a 3½-inch speaker, and brightness and contrast controls. Power consumption is 30 watts per unit.

The system is fully transistorized for rugged compactness and is capable of sending the combined audio-visual signal a distance of up to 300 feet along an easily installed ¼ x 1-inch flat line cable. The cable can provide outlets in each room, permitting the user to carry the set from room to room, plug into a wall convenience outlet and the circuit outlet, and be ready to use.

Until recently, TV intercoms were somewhat impractical because of the need for excessively-high light levels. Now however, ambient light is sufficient to provide a clear, sharp picture on the TV screen.

While the system is flexible and can find numerous applications in the home, imagine the convenience when Junior holds a book up and asks, "Is this the one you wanted Mom?"

While plans for commercial distribution of this new Motorola TV intercom have not been completed, such installations of them as the one in the *PM* House of Imagination displayed at the Los Angeles home show will sample public response to such products. If enough interest is shown, you may find TV Interwatchers available for your home soon.



"WE AREN'T FIGHTING MOMMY!" Anybody who has children knows this refrain. Mommy can stop the fray before harm is done

"MOMMY CAN SEE YOU!" The psychological effect of observation seems to add a quiet note to children's noisy play periods



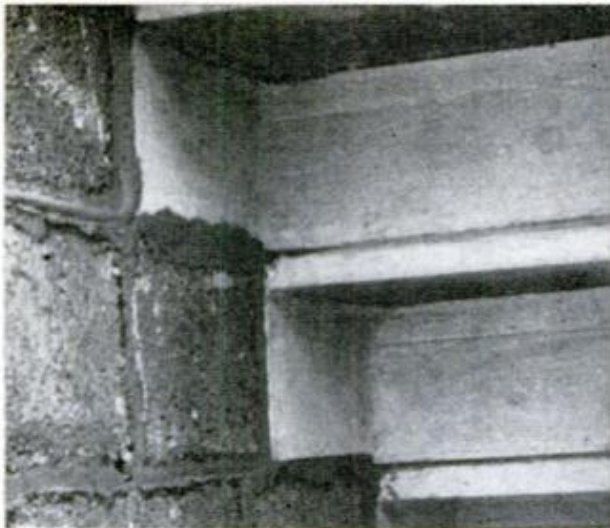

PRECAST STEPS are available with end members that permit them to be mortared into concrete-block walls

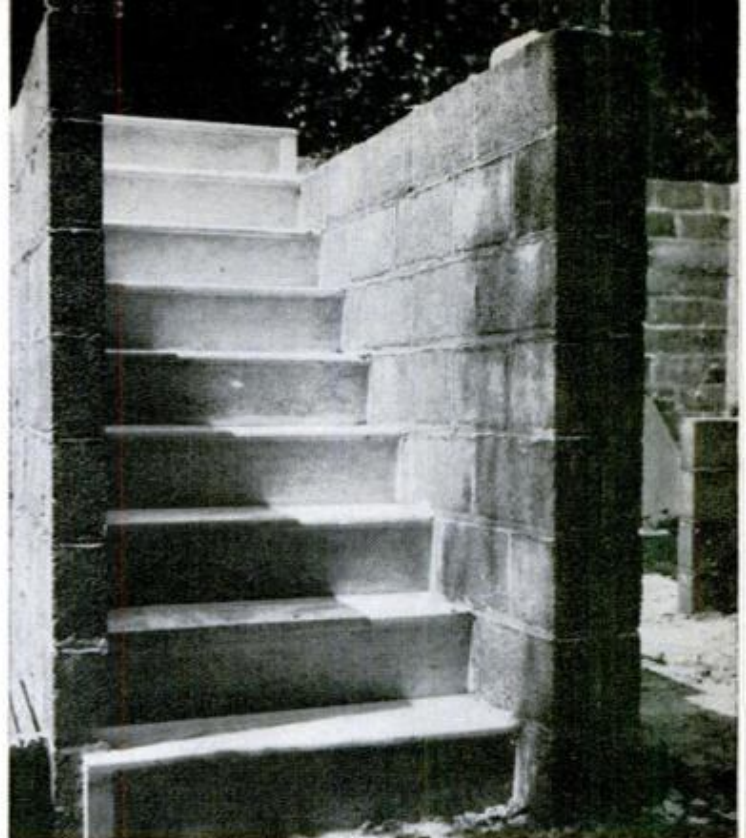

GOING-UP VIEW, right, of basement stairway made with precast steps. Not a single form board is required

STEP UP—TO PRECAST CONCRETE STEPS

PACKAGED concrete steps can save you hours of time building forms, mixing, pouring, troweling and curing with the usual cement-sand-gravel-water procedure of regular concrete work. Not only precast, reinforced steps and risers are available, but a stoop complete with iron railing can be yours for the ordering and setting up.

Just be sure to order the size you need including the steel-reinforced landing slab, reinforced steps with precast risers and the flanged abutments with cast-in stringers as in the detail below.

Pour a base slab on a gravel fill, set the abutments in mortar, then mortar the

stringer, set the steps and landing slab in place and there you are. If you ordered the iron railing to fit, just bolt it in place; the necessary bolts are cast in place.

Or, if you're building an inside or outside basement stairway there are steps precast for mortaring right into the concrete-block walls as you see in the photos above. The steps come with nonslip or smooth treads. They are set in place without use of forms.—James A. Lockhart - *Box 128, Bryan, Ohio*

FLANGED, PRECAST ABUTMENTS are mortared to slab poured over gravel fill. Note flanges and cast-in stringers which take steps in made-to-measure fit

PRECAST STEPS consisting of step-and-riser units designed to fit cast-in stringers on precast abutments

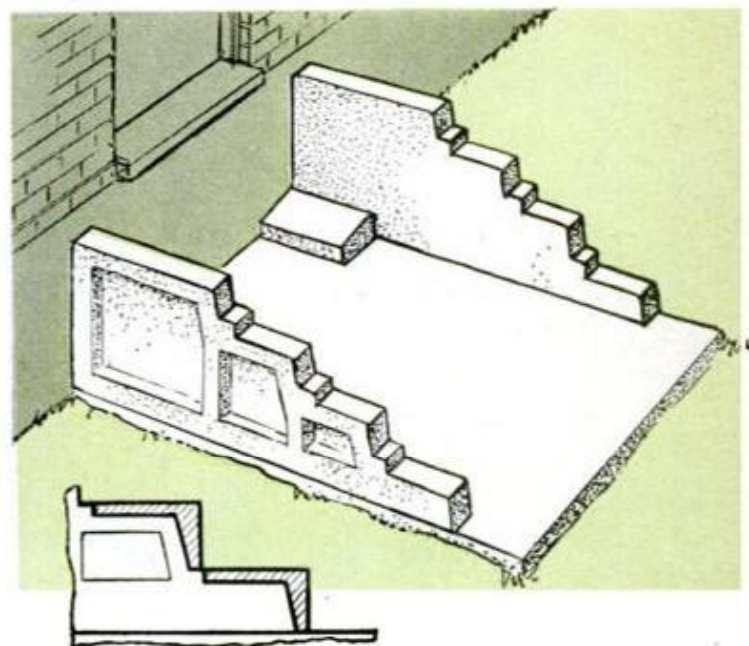



THIS OLDER HOUSE, which needed painting, was sold by owner directly to buyer for \$21,000—or \$900 less than the “dickering price” first quoted. By selling direct, though, the owner pocketed over \$1200 he would have had to pay to a real estate agent. The ad which sold this house is the one labeled B on page 186

How to Make Money Selling Your House Direct

With the right improvements and a good sales campaign, you can sell it yourself — and “earn” the commission

By Paul L. Theurer

HOW MUCH YOU SAVE IF YOU SELL YOUR HOUSE YOURSELF





DO put out a FOR SALE sign to attract potential buyers cruising the neighborhood. **DON'T** use a crudely lettered homemade sign such as the one shown here. A professionally made sign will inspire more buyer confidence

"I MADE \$900 yesterday," my neighbor told me smugly.

With visions of fantastic stock deals, poker games, or horse racing, I swallowed the bait and asked how.

His answer, "Selling my house."

No, the house didn't sell for \$900. It sold for \$15,000. The \$900 was extra income, realized because smug neighbor handled the sale himself and saved the six-percent commission he would have had to pay to a realtor.

An extra \$900 on a \$15,000 house could mean a plush vacation, a new hi-fi and TV, or just getting a couple of bill collectors off your neck. Some cities still have only a five-percent commission on real-estate sales (like Birmingham, Bridgeport, Tampa and Indianapolis). But most have adopted the six-percent rate which realtors expect to be the national standard by 1962. And if you happen to be in one of the holdout cities where the five-percent figure is still in effect, the saving on selling a \$15,000 home yourself would still be a very acceptable \$750.

The average American family owns at least three homes in a lifetime, so the opportunity to act as your own salesman and realize that five-percent or six-percent saving may arrive sooner than you think.

Don't expect to just tack up a FOR SALE

sign, and then choose from among the eager buyers, all waving sheafs of greenbacks. Selling your home requires preparation.

Before you place your home on the market, check the want ads for homes similar to yours in size and in a comparable neighborhood. See what their asking price is. Balance the going market value with the price you paid, adding the value of any improvements and subtracting the value of some of the living you got out of the house. The result should be a reasonable price. Remember, when comparing your house with others on the market that most asking prices are set high to leave room for dickering.

In my neighborhood one family advertised its house for sale in a newspaper want ad, sold it to the third couple that called. Inspired by this example, another family brushed off the real estate agents and tried handling their own house sale, too. After two months of open houses, ads and frustration, they gave up and turned the house over to a realtor. His luck was no better. In desperation, they sought the counsel of their banker. His advice was concise. "Lower your price \$1000."

With the price \$1000 lower, the home sold in less than three weeks. The couple handled it themselves, and still realized almost as much from its sale at the lower figure as

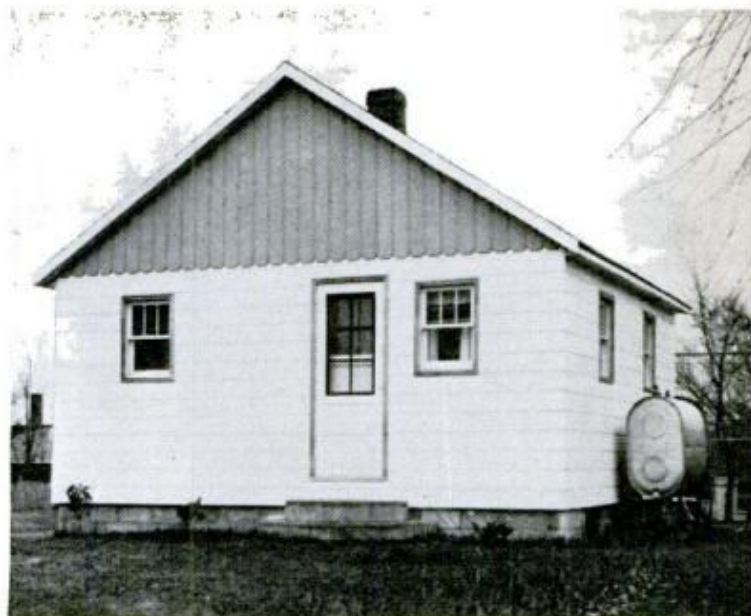

DRAMATIC EXAMPLE of how the same type of house—no matter how simple and plain it is in appearance—can be made more salable with some fixing up, and without major remodeling or altering of the structure

they would from the higher figure working through a realtor.

The moral is clear: An over-priced house will not sell.

After you have decided the price, put the home on the market, if possible in the spring or fall, the best periods for selling real estate. Usual practice is to place a want ad in the local paper and put a sign on the lawn.

Before you prepare your ad, make a list of all the attractions your house might have to a buyer. Select those you feel would most appeal to some family looking for a home in your neighborhood, and then write up the advertisement using some "friendly" words and a little originality. Instead of "Stucco 4 br, 20x14 lr, hot water ht, 2 baths," a Kansas City man ran this ad: "Comfortable older home, sprinting distance Hale school, lots of room for kids and dogs." The phone started ringing at six in the morning, and didn't stop until it was taken off the hook. The house was sold by noon.

Don't stop your promoting with a want ad. There are plenty of opportunities for free listings. Big corporations are constantly shifting personnel, and to make the moves more painless, actually solicit listings for the convenience of the employees. Supermarkets and drugstores often have free bulletin boards where you can post a notice. Your church secretary will probably be glad to put an announcement in the church bulletin.

And for heaven's sake don't take a pencil stub and scrawl "For Sale by Owner" on an old piece of cardboard, and expect it to attract passersby. Many prospective home-

owners cruise the neighborhood where they would like to live, keeping on the lookout for likely looking homes for sale. A sloppy sign would be no inducement to stop. It only costs a few dollars for a neat-looking professional sign.

Desperate to make a big impression, some people will actually redecorate their whole house before putting it up for sale. This is a waste of time and money. Experts recommend keeping the interior decoration to a minimum since most homeowners prefer to do their own refurbishing, selecting the colors and styles they prefer. However, you should definitely repair cracks and clean or repaint marred or dirty walls, using a neutral color like beige, white or gray.

Unless you absolutely have to move, stay put until you have made the sale. A furnished house sells 10 times easier than an unfurnished one, a bank mortgage officer tells me, and he has scores of examples to prove his point. Rooms look more appealing with furniture in them. But clean out the attic and basement so they don't look cluttered. Convenient storage space, which looks bigger when neatly arranged, is a major selling point.

Greeting Your Maiden Aunt

If the exterior looks unkempt and the lawn scrubby, you may not even entice some prospects in the door. Clean up the yard as if your rich maiden aunt, who's also president of her garden club, were coming for a visit.

Should you paint the exterior? Sometimes it pays. "One coat of paint can in-

(Continued to page 246)

Built-in Convenience

By David M. Swartwout

JUST THINK OF the time and steps that would be saved by presorting a whole week's laundry before washday. Think, too, of the convenience of table space in the laundry where the ironing can be organized and carried out without a wasted minute or extra step. If wishes were facts . . . you say. But why not?

It's simple. You do the sorting as you gather the soiled laundry by dropping the items into compartmented, built-in hamper and you end washday with stacks of ironing neatly arranged on an in-the-corner or around-the-corner table having—of all things!—a built-in, sorting Susan. Begin with Fig. 1 and go right on through Fig. 10 and you'll see how it can be done in your own home.

Look first at Figs. 1, 2, and 3 and also Figs. 9 and 10. These are just different versions of much the same type of hamper installation, especially those detailed in Figs. 1, 3 and 10. Fig. 1 shows you a simple four-compartment unit, ceiling and wall supported above the washer-dryer. Then

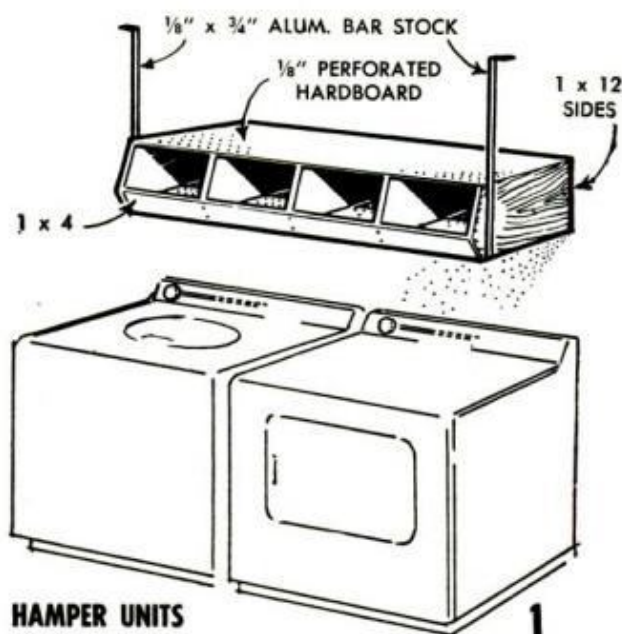

HAMPER UNITS

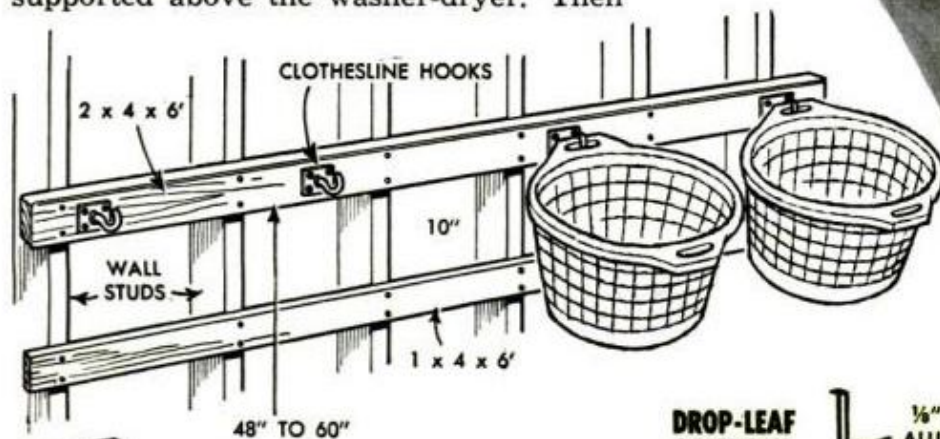
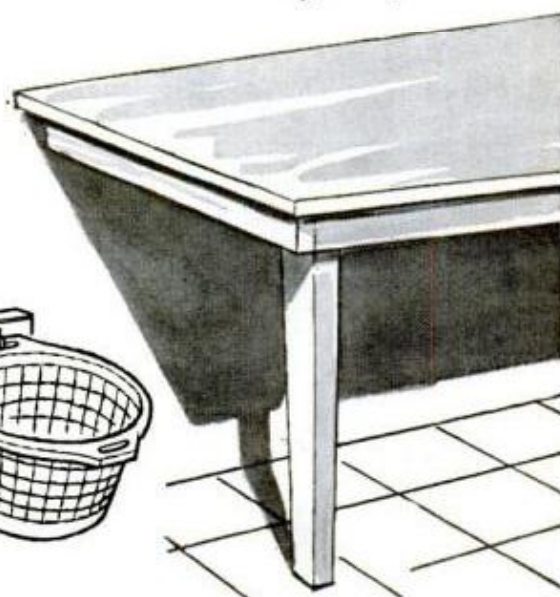

BASKET
HAMPER
2

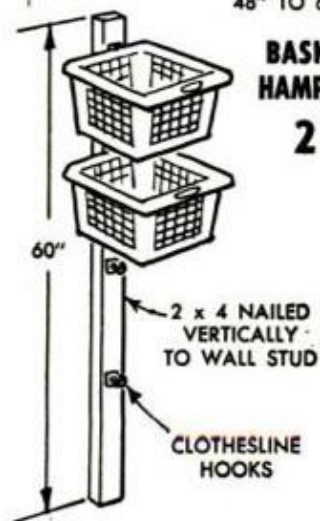

STACKED HAMPER with four compartments is convenient for sorting before washing. Leg-supported drop leaves are added convenience

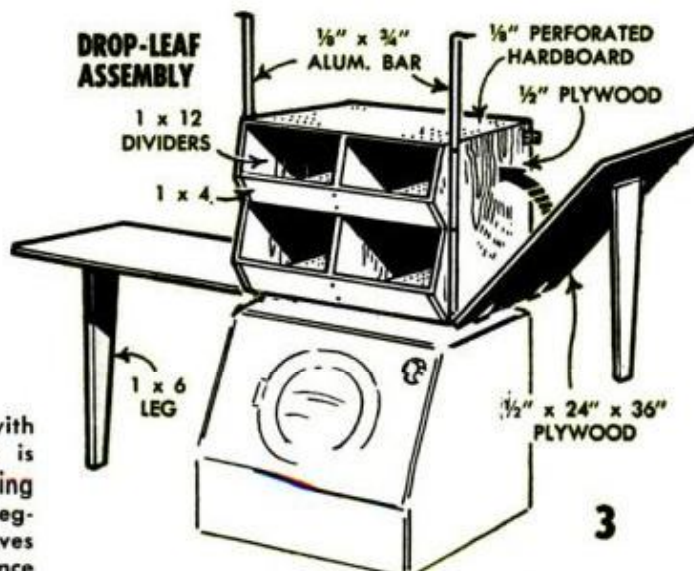

POPULAR MECHANICS

for *Sorting Laundry*

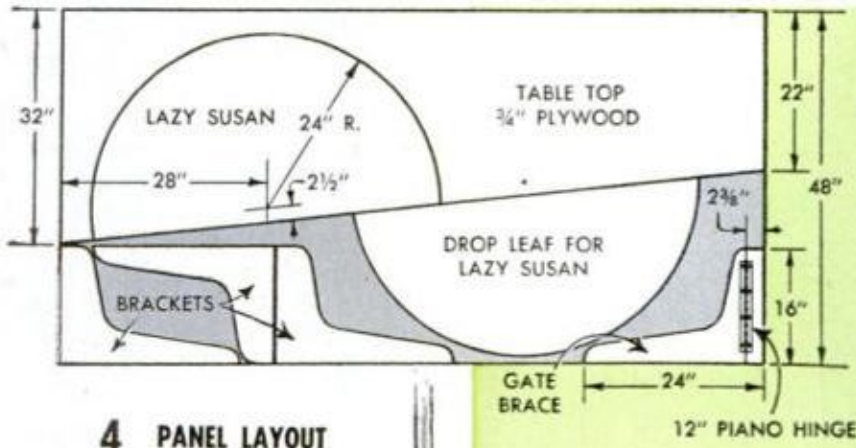

4 PANEL LAYOUT



PLYWOOD PANEL is first cut diagonally as indicated in detail. Then pieces are moved past each other and Lazy-Susan top is laid out with yardstick trammel. Parts are then edge-glued

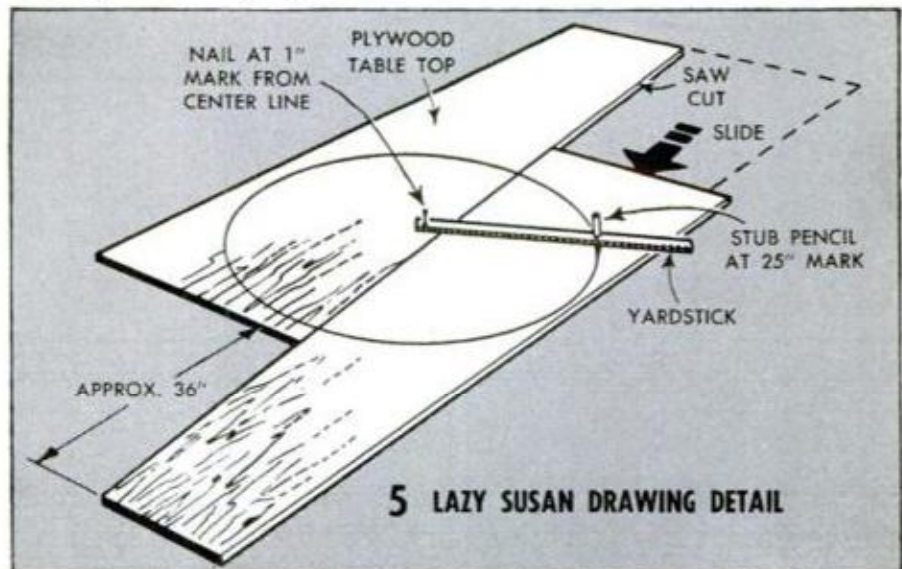

5 LAZY SUSAN DRAWING DETAIL

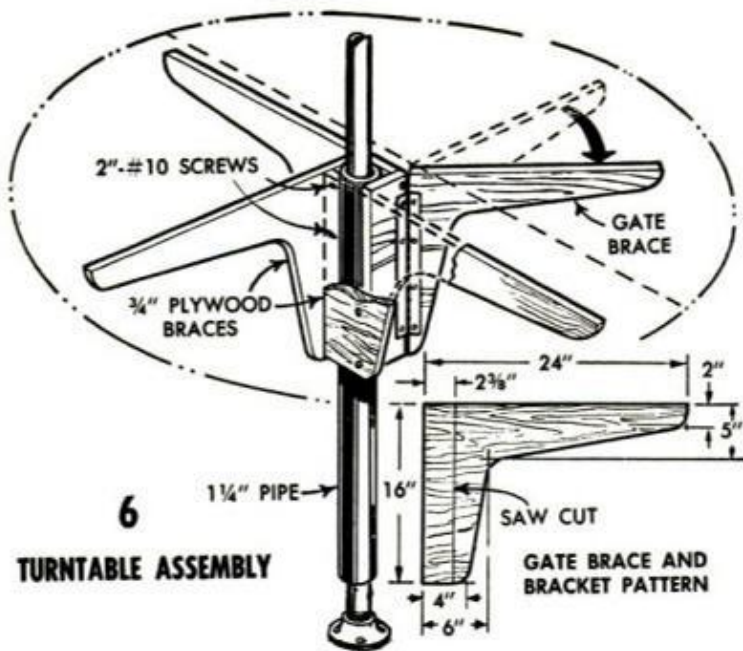

6
TURNTABLE ASSEMBLY

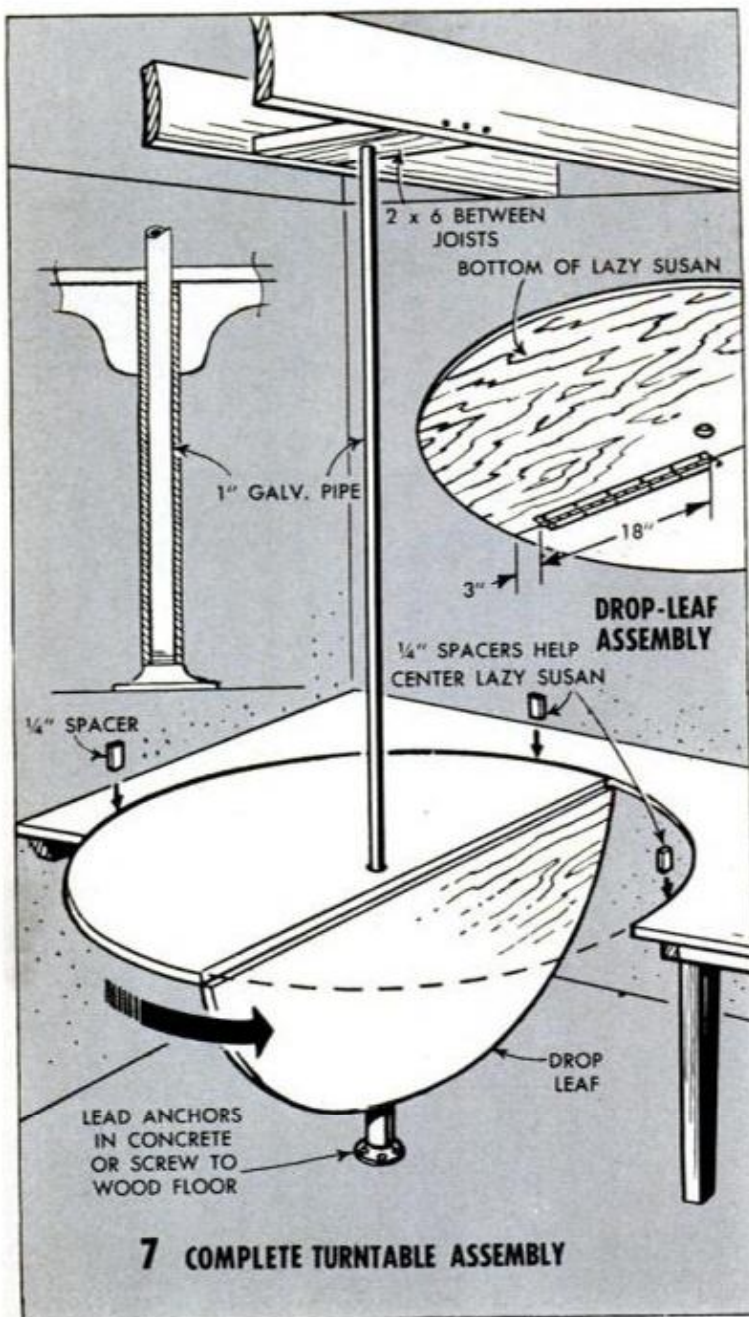

7 **COMPLETE TURNTABLE ASSEMBLY**

there's the four-compartment hamper detailed in Fig. 3, having the added convenience of leg-supported drop leaves on both sides of the combination washer-dryer. Over-all dimensions given for the in-line and stacked types of hamper are only suggestions. You can make four-compartment units like those shown or any number of compartments up to a dozen, using the same materials and methods.

The tilting hampers, made as in Fig. 9 and mounted along the basement stairway as in Fig. 10, are a step-saving convenience. The hampers pivot on lengths of 3/8-in. pipe assembled with elbows, nipples and flanges as in Fig. 10. Each hamper is held in a vertical position by screen-door hooks and tilts down to a horizontal position.

A simple convenience is the basket-hamper arrangement in Fig. 2, common plastic baskets being placed side by side or one above the other as detailed. A 10-lb. load of white goods, colored fabrics and other sortings can be placed in each basket ready for the washer.

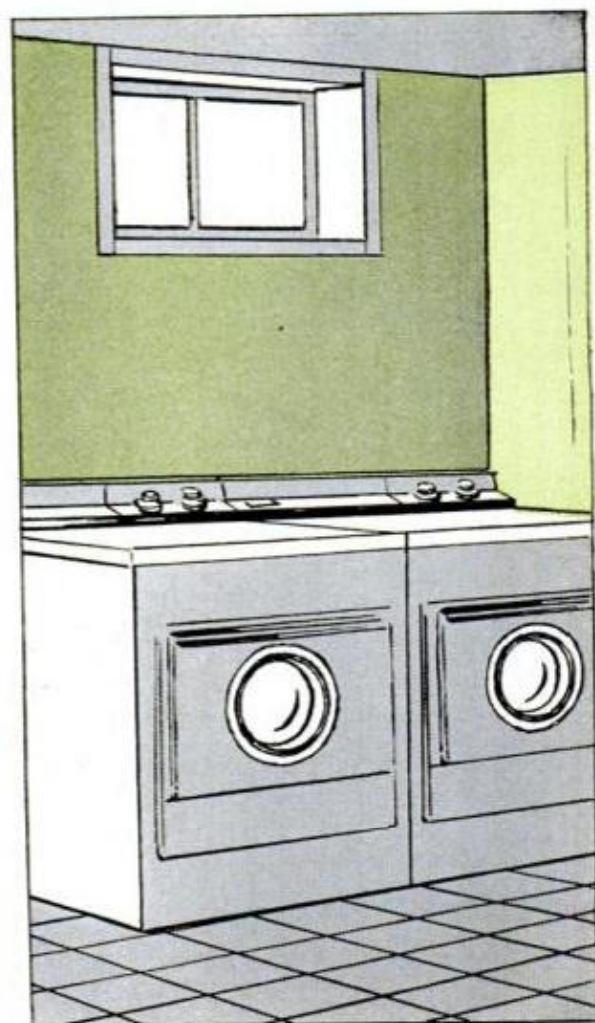

POPULAR MECHANICS

Saving the best for the last, study the details of the sorting Susans in Figs. 4 through 8. Note especially that one Susan has a drop leaf and is designed for the in-a-corner table, Figs. 7 and 8. Otherwise the assemblies are the same with the single exception that one arm of the turntable assembly, or spider, Fig. 6, is hinged to permit the hinged leaf to drop as in Fig. 7. The regular Susan is designed for the around-a-corner table illustrated in Fig. 4. The purpose of the drop leaf, of course, is to gain additional space by dropping the leaf when the Susan is not in use. This is done by swinging the Susan so that the drop-leaf joint lines up with the edge of the table, then swinging the gate brace, Fig. 6, inward to permit the hinged leaf to drop to the down position.

Finish? Plywood table tops and perforated hardboard can be finished by using a priming coat of shellac enamel and two finishing coats in whatever color suits your fancy or the decor of the room. ★★★

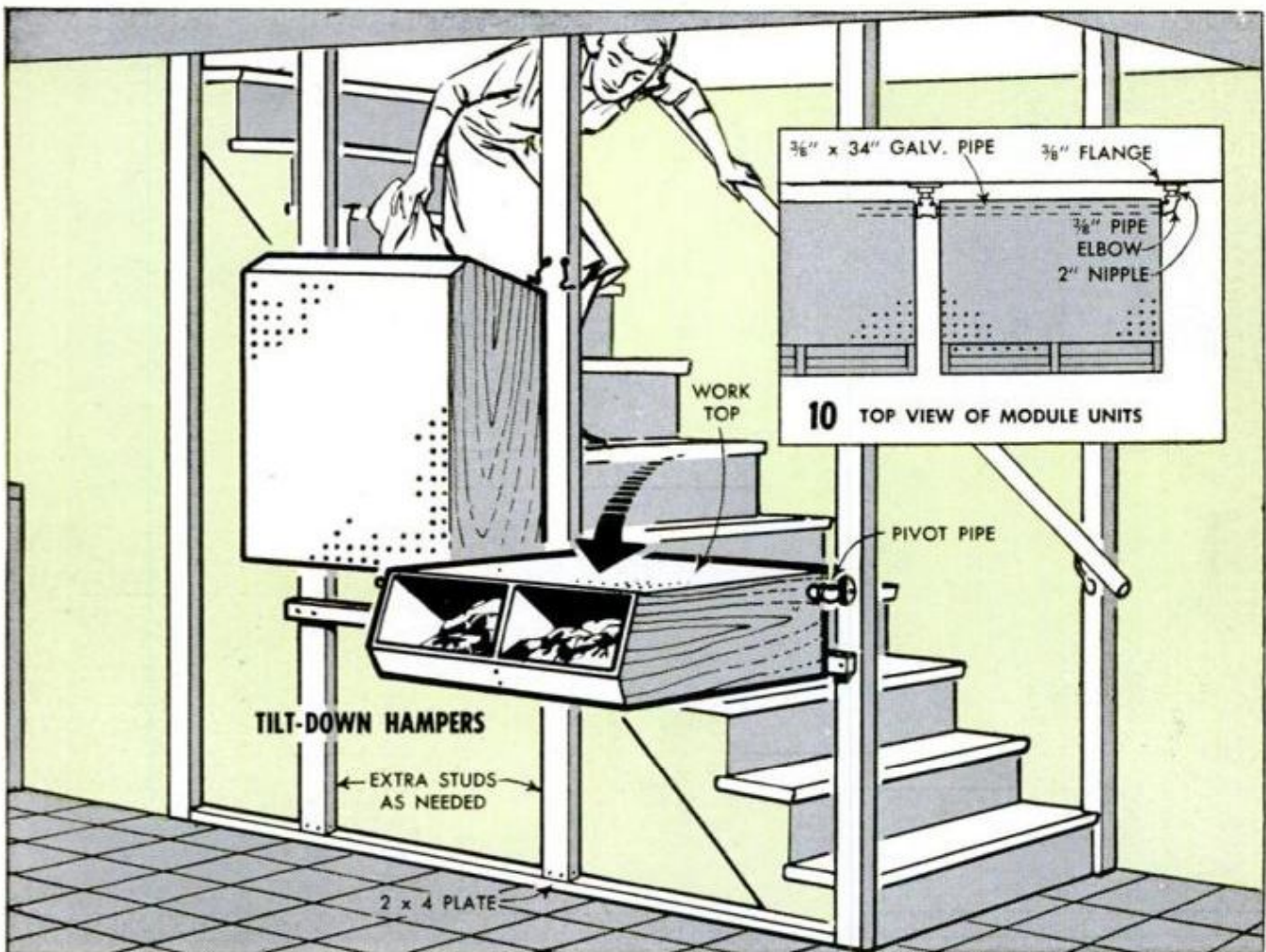
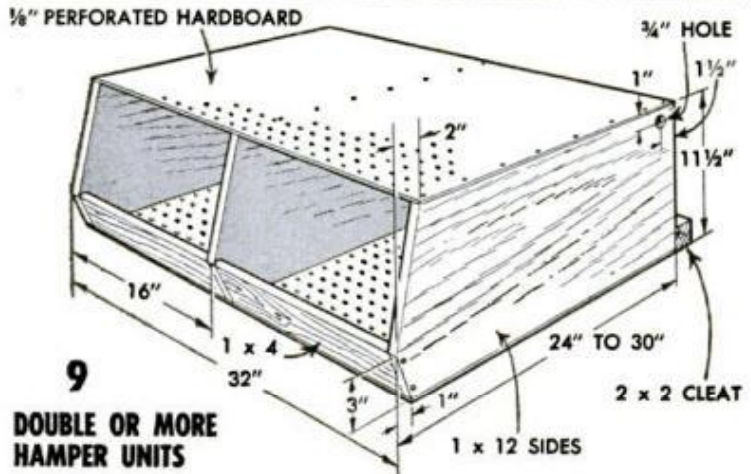
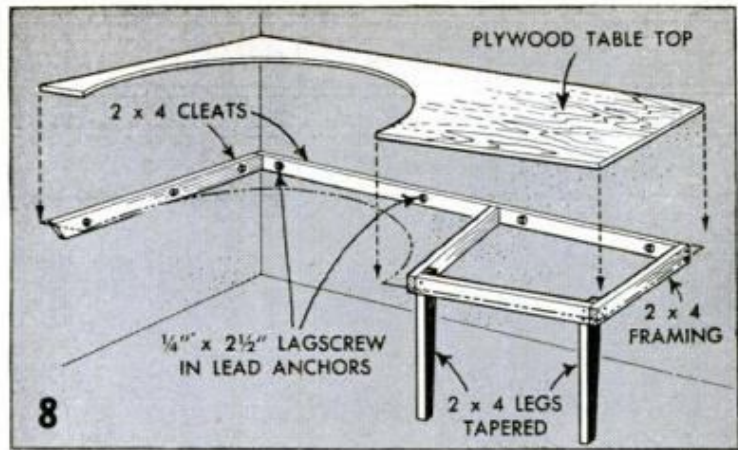

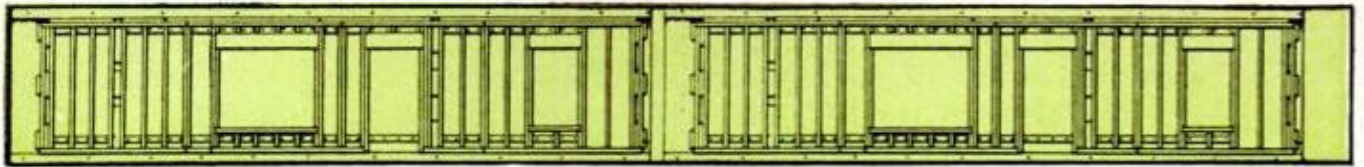

"Snip-Off" House

Assembled as a unit on a table, this wall structure is cut in sections to go to the site

PLYWOOD PATTERN STRIPS are placed in narrow grooves on either side of the 175-foot assembly table

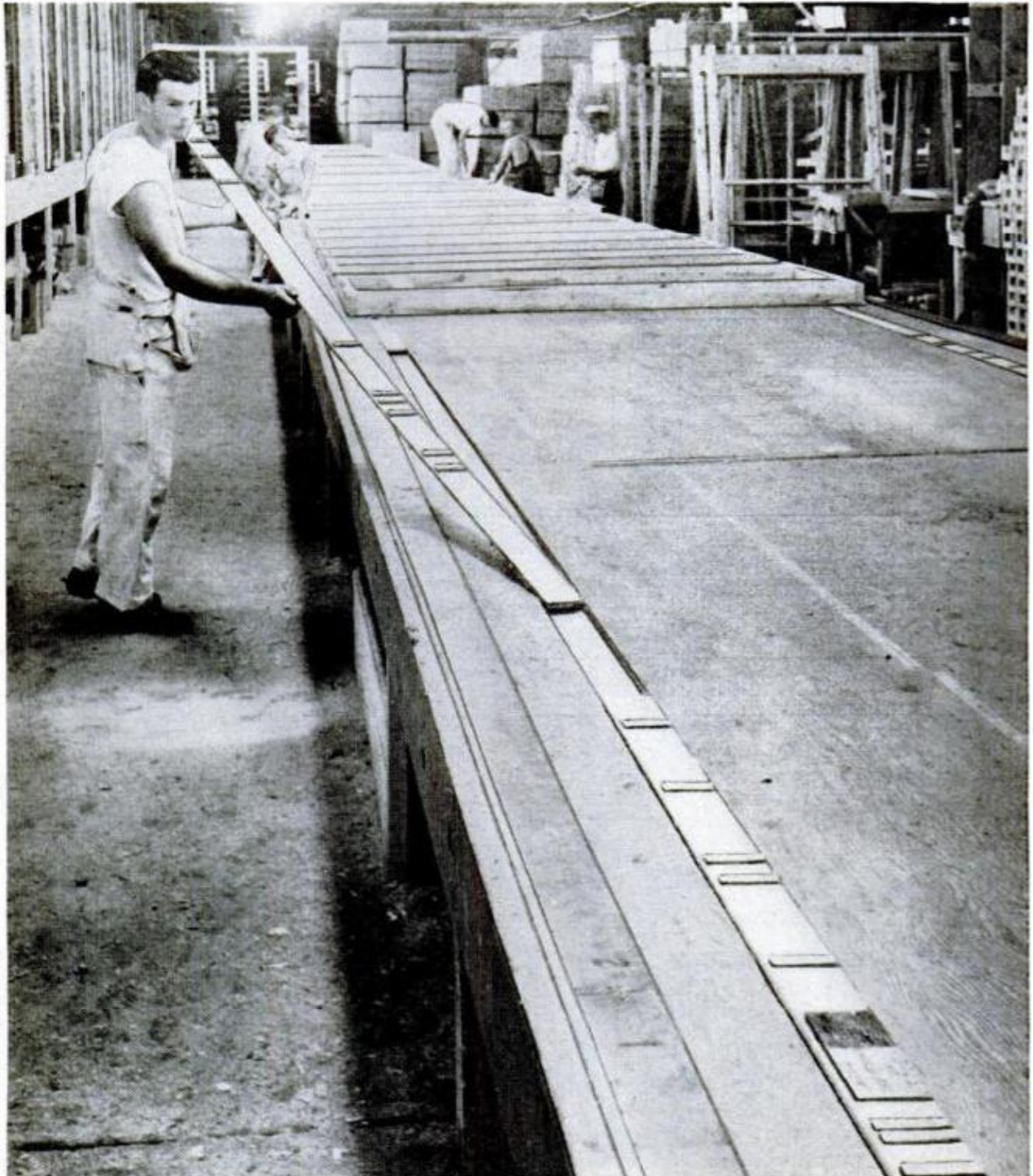

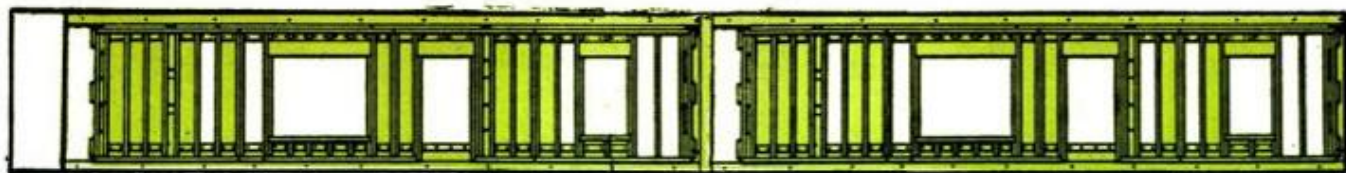

Slotted plywood pattern strips in grooves on a 175-foot table are guides for assembling wall sections from precut pieces in an unusual method of prefabricating houses. All interior and exterior walls are made as a unit, then cut into convenient sections for transportation to the home site.

Builder John M. Kemp, Jr., Chattanooga, Tenn., who developed the method, says that pattern strips can be made from blueprints of any style house. Inside and outside walls for a 1500-square-foot house can be erected by four men in two hours on the site, he adds. He is licensing lumber dealers to use the system.

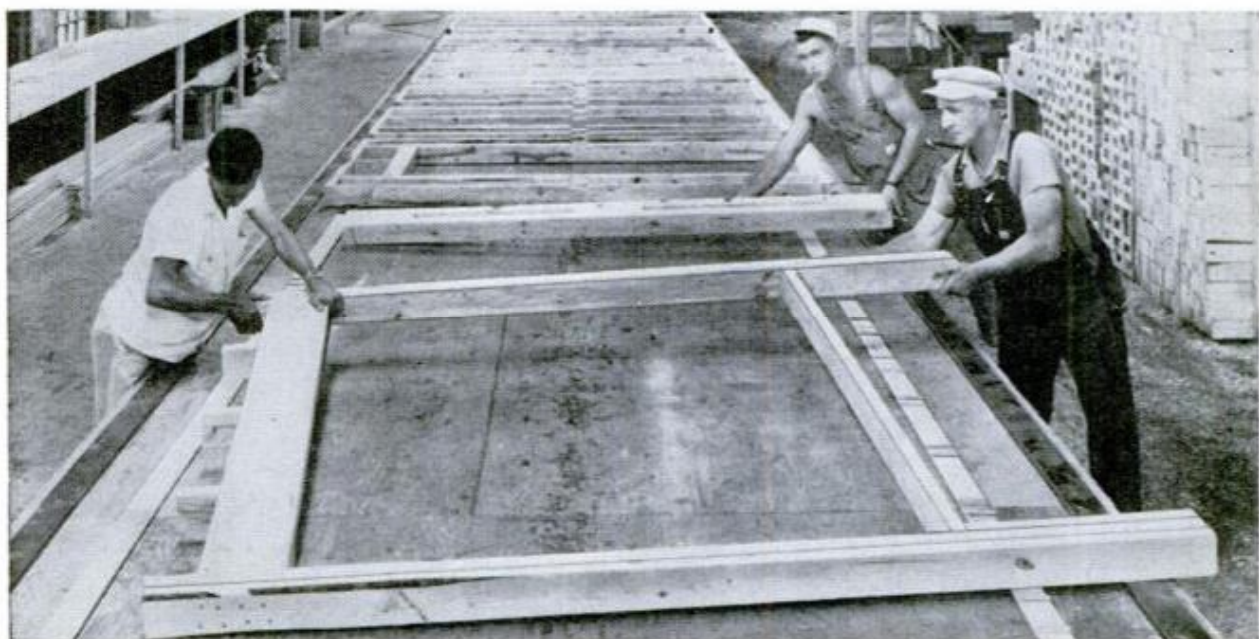

PRECUT LUMBER is positioned in the slots, and the whole assembly is nailed to form one long wall section

PATTERN MAKER converting blueprint into slotted plywood pattern strips is first step in prefabing

WALL SECTIONS are fitted together again at the building site after being cut apart at the plant

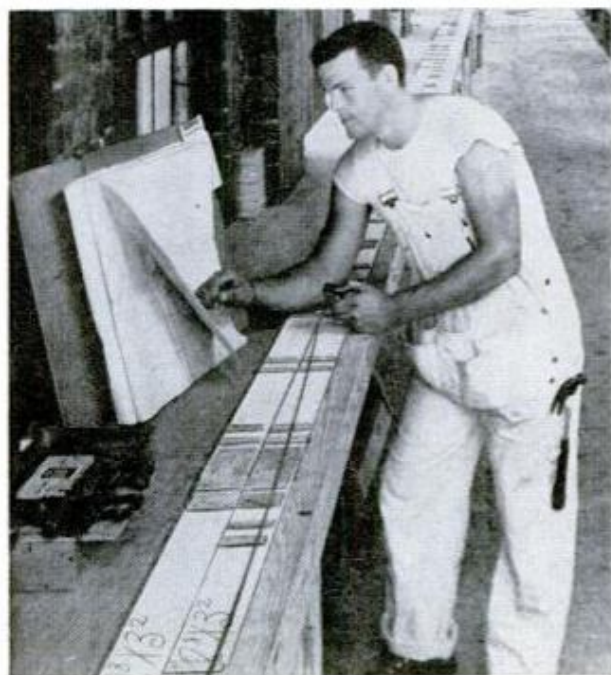

DOWN THE DRAIN WITH

Built-in disposal system sucks up both dust and scrub water and flushes it down the drain automatically. Offers many advantages over portable cleaners



HOUSEHOLD DIRT

1. THIS IS THE TIMER which when set from 1 to 30 min., automatically starts the motor and the flow of water in the tank of power unit

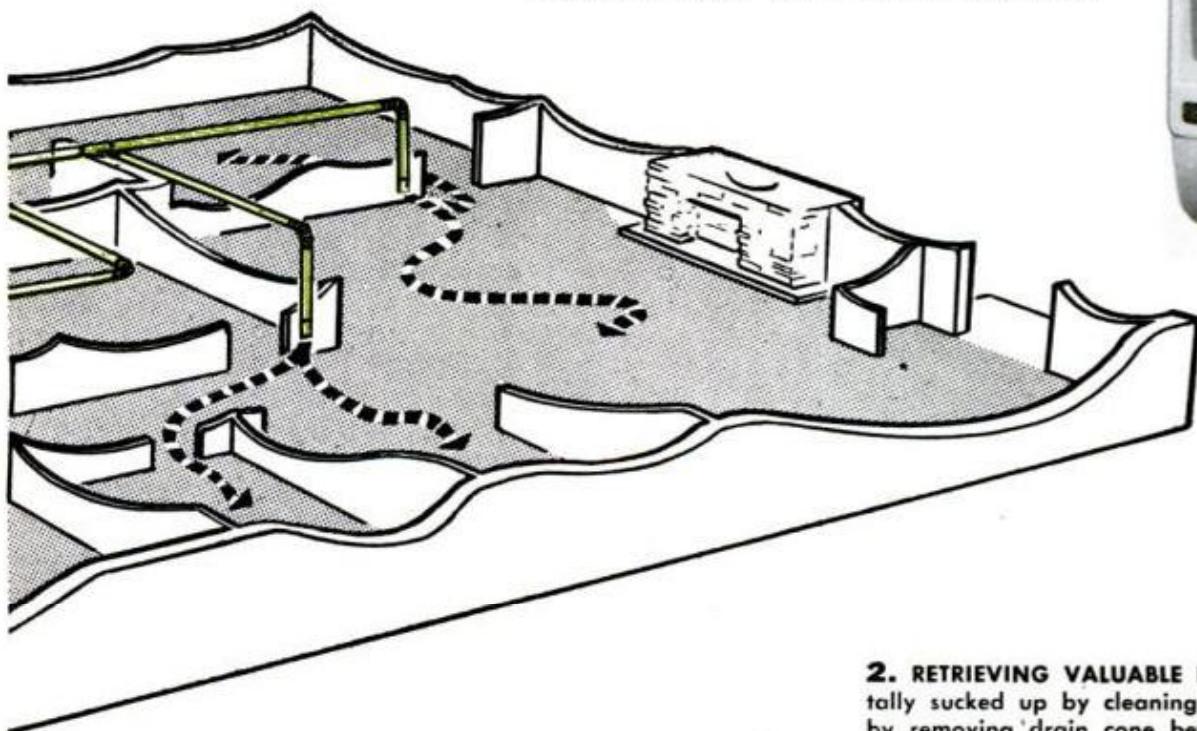

2. RETRIEVING VALUABLE ITEM accidentally sucked up by cleaning tool is done by removing drain cone before motor is turned off and holding it as shown below to divert the flow of drain water into a pail

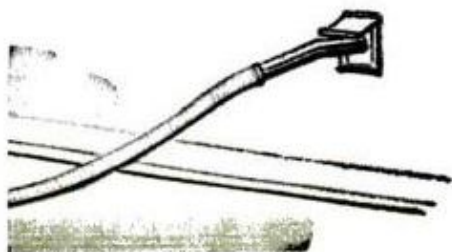

LUGGING AND TUGGING a noisy, cumbersome vacuum cleaner around your home is the old-fashioned way of cleaning. The modern housewife has only to plug the cleaning tool into handy wall inlets and the dust and dirt are whisked away through a built-in cleaning system which disposes of it down the drain and out of the house for good.

With the system being vented outdoors, there is no recirculation of germladen air or need to redust as with conventional portable units. With the dirt flushed away, there are no bags or filters to clean or empty. The power





WALL MOUNTING BRACKET



3. POWER UNIT hangs on wall by this steel mounting bracket which is positioned from the floor the exact distance indicated in detail above

4. HOLE SAW is used to bore hole through house to vent exhaust line outdoors. Vent should be protected with hood of some kind such as vent-pipe elbow

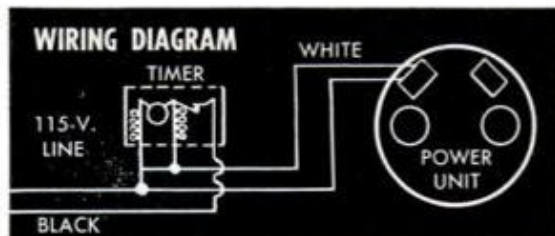
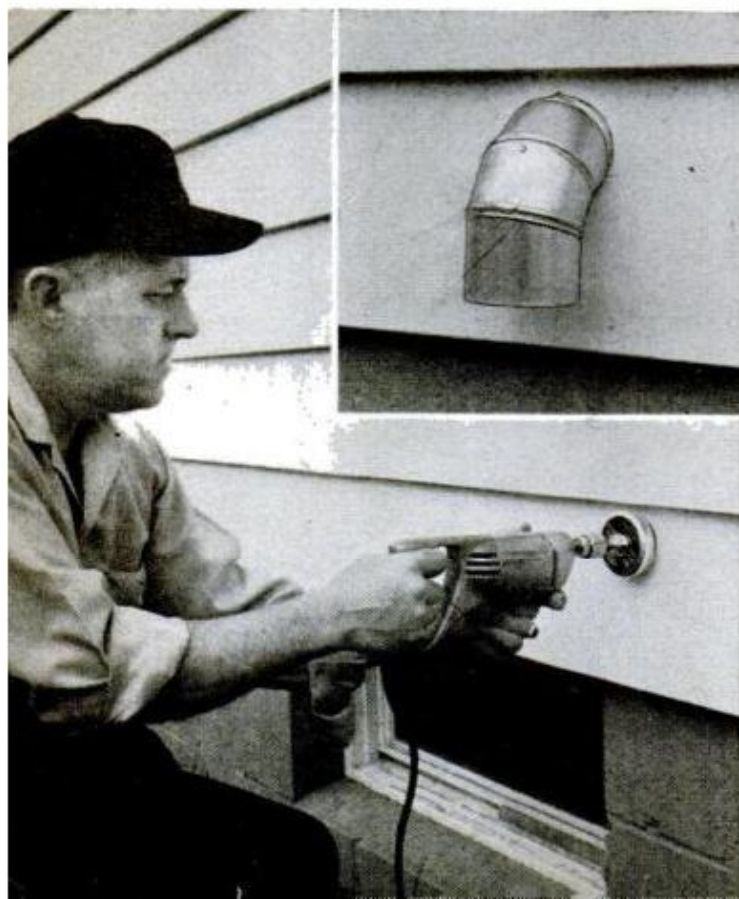

THREE-WIRE CONDUCTOR from junction box to timer is required, two-wire from 115-v. line to power unit

unit is located in an out-of-the-way spot away from the living area, so there is no noise to interrupt phone calls, radio or TV programs, or disturb sleeping or sick rooms. With nothing but a cleaning tool in hand, there is no machine to topple down stairs or tangled cord to trip over. And with a squeegee accessory which wipes dry as it sucks up scrub water, cleaning the kitchen floor is no longer a messy mop-wringing job.

Basically, the built-in system consists of a powerful centrally located suction unit (usually located in the basement or utility room) from which airtight ducts in the form of tubing run to wall inlet valves strategically located throughout the house. The various branch valves join to create one central suction system that will serve the entire house.

Called the Aquamatic, here's how this unique "down-the-drain" system works: The motor is turned on by a wall-mounted cycling timer, Fig. 1, which is conveniently located where the cleaning tools and hose are stored. The timer is set manually for any preselected cleaning period up to 30 min. As soon as the motor is turned on a measured amount of water (about 2 1/4 gal.) enters the tank of the power unit during a 45 sec. interval. A 25-ft. length of flexible cleaning hose is plugged into an inlet valve and dirt sucked through the ducts accumulates in the water in the tank. When the preselected cleaning period has elapsed, the timer turns off the motor automatically, opens a drain valve in the bottom of the tank and the dirt flushes down the drain along with the water. During the cleaning operation the hose can be transferred from one valve to another without turning off the power unit, and the timer can be reset while in operation to extend the cleaning period. When finished, the cleaning hose is merely unplugged from the wall inlet and put away. The cycling timer will even turn the system off automatically if the housewife doesn't want to bother doing it manually. This eliminates any chance of the system being left in operation for a long period if she is suddenly called away from her cleaning.

(Continued to page 252)

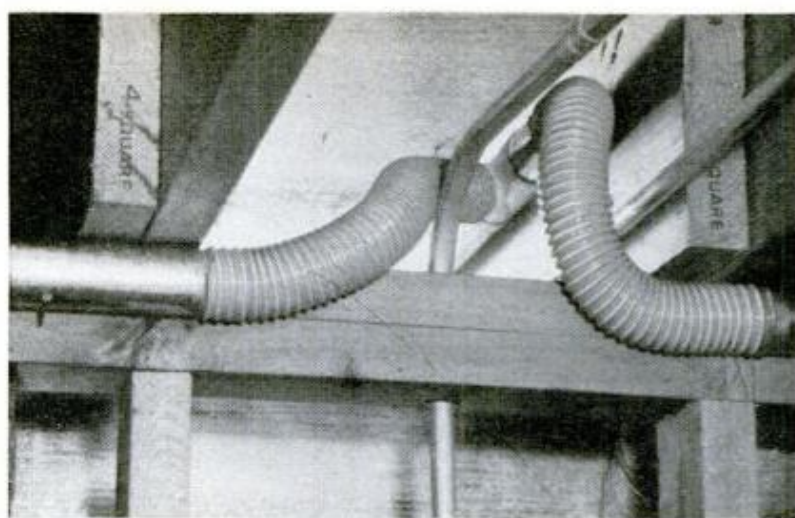
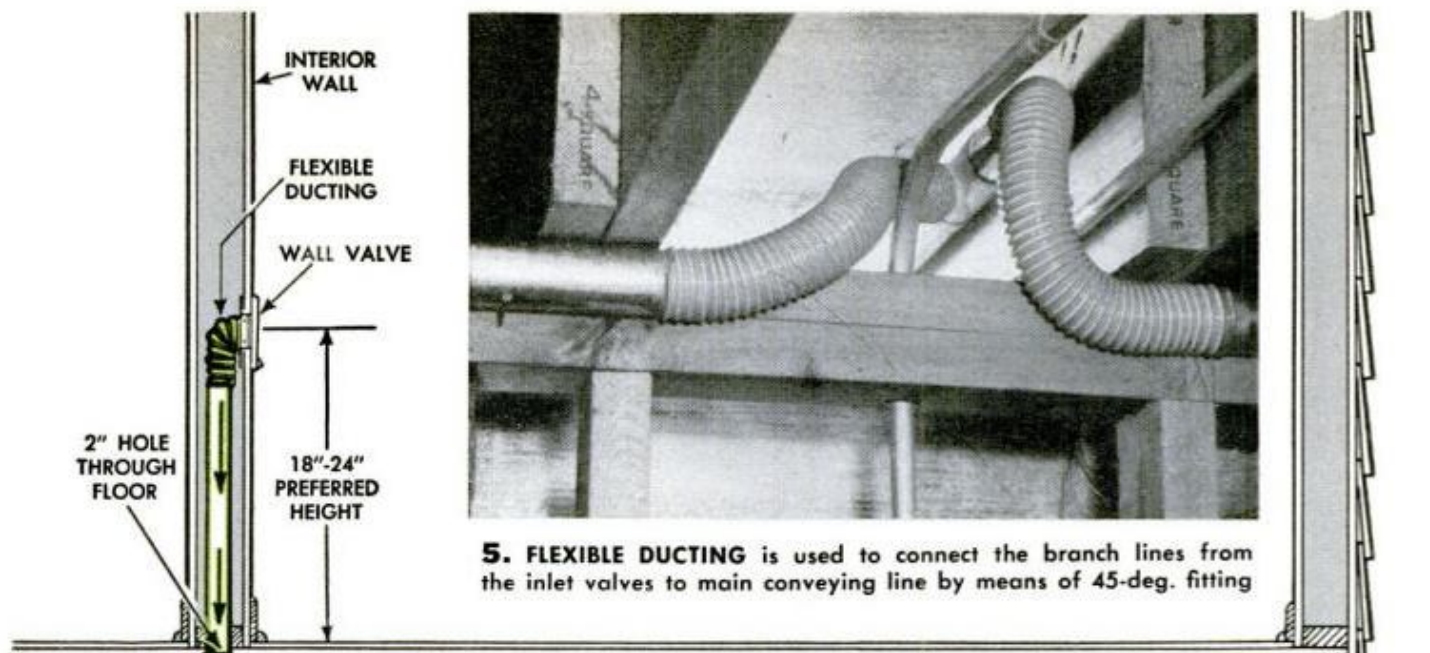

5. FLEXIBLE DUCTING is used to connect the branch lines from the inlet valves to main conveying line by means of 45-deg. fitting

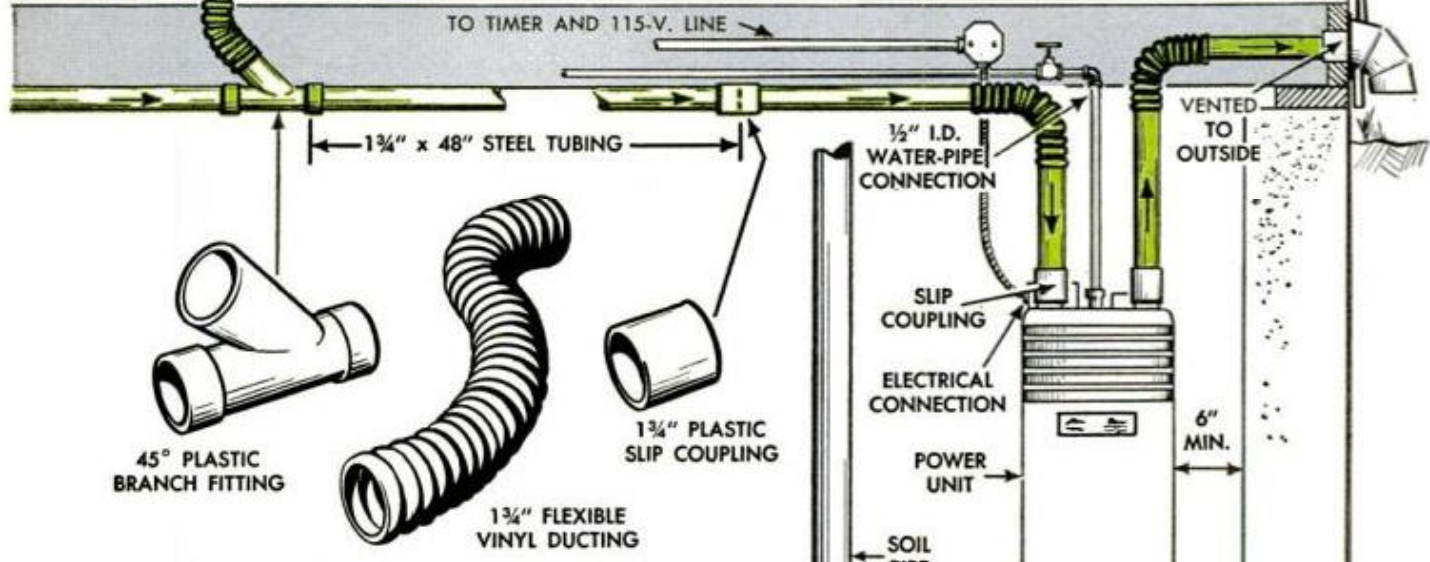

45° PLASTIC BRANCH FITTING

1 3/4" FLEXIBLE VINYL DUCTING

1 3/4" PLASTIC SLIP COUPLING

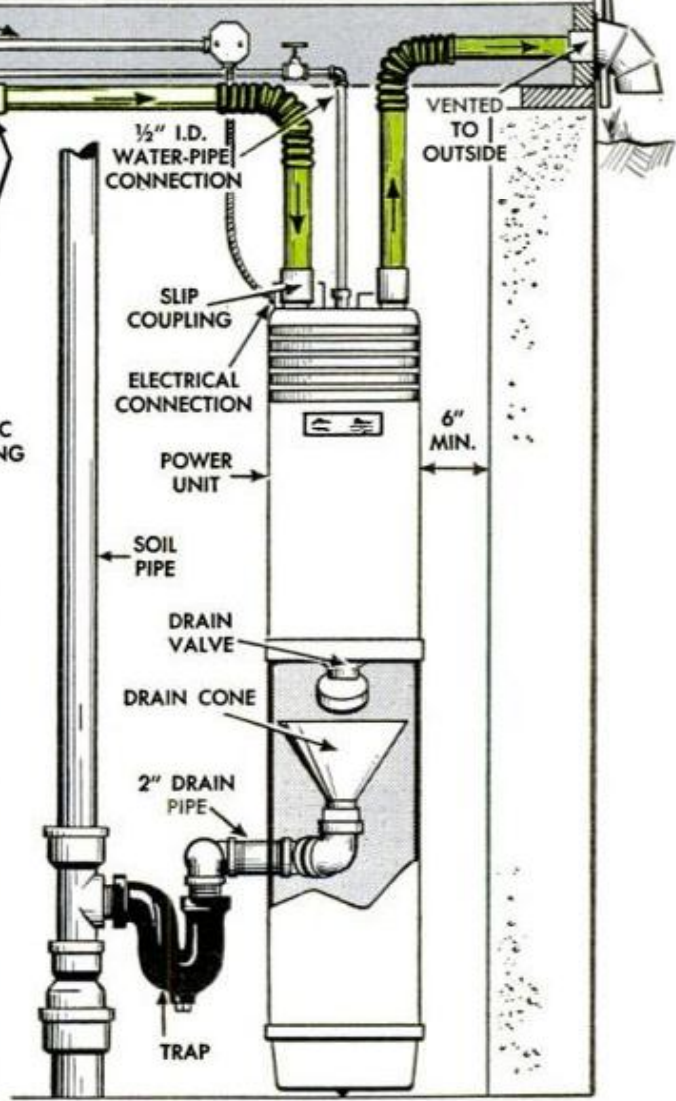
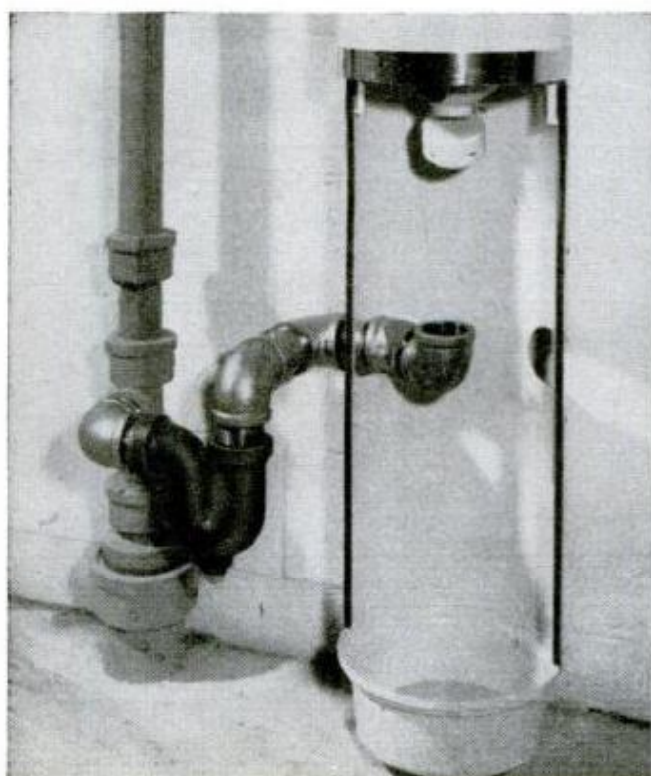

TYPICAL BASEMENT INSTALLATION

6. PIPING ARRANGEMENT of drain connection will vary with each installation. Photo at left shows how original installation was made. In every case, trap must be installed in drainage line. Special nipple screws in 90-deg. elbow for supporting removable drain cone directly below drain valve in bottom of tank

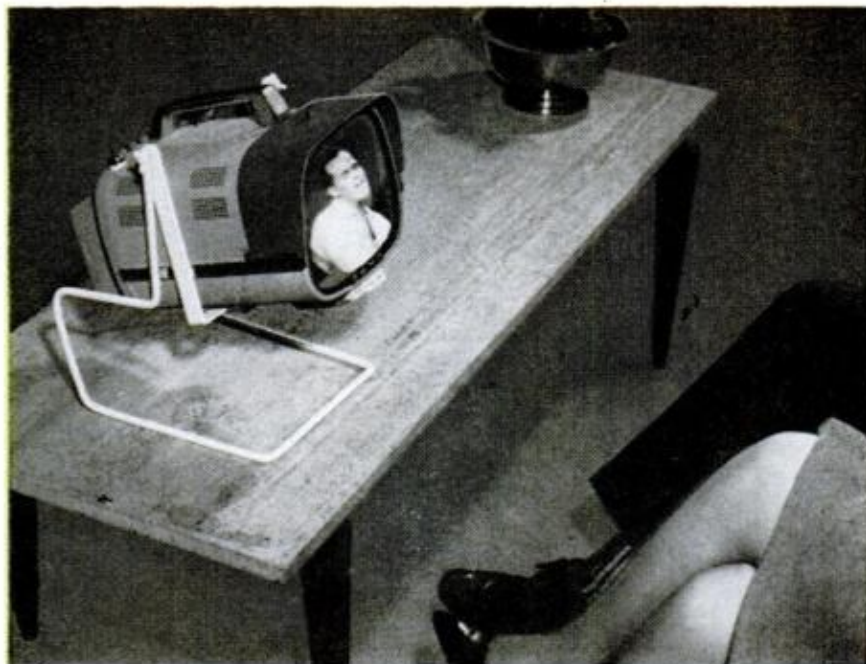

THIS SWIVEL-MOUNTED BASE was designed by the PM staff for the new eight-and-one-half-inch screen portable television set. Affording easy viewing in any position, it makes television a part of many activities

COMPANION TV

**Hang it in the car. Tote it anywhere you want it.
This small TV is made for your convenience**

THE DAYS OF the stationary one-eyed monster staring at you from across the room may be numbered.

Lightweight, portable sets such as this 13-pound Sony with its four-pound attach-on power pack, are proving to be more adaptable companions for modern-day living.

They have another advantage too. When TV first came in, a scan rate of 520 lines was developed. With an average tube size of only seven inches, these 520 lines gave a picture that was sharp, crisp and clear.

Then the bigger-is-always-better design kick set in. Plastic lenses filled with mineral oil were suspended in front of the TV screen to magnify the image. Bigger and bigger tubes were built until the 27 inch rectangular tube was reached. But the 520-line scan rate, now a standard, could not change, so that as the screen sizes grew, the pictures became fuzzier.

Smaller screens with their sharper picture give excellent viewing if you select the right distance. For example, try holding a ruler at arm's length, and sight alongside the ruler on the wall across the room. Using a door jamb as a reference point, find the place on the wall where the eight-inch mark on the ruler would fall. If your room has any depth, you can see that an eight-

inch TV screen at arm's length is far bigger than a 27 inch screen across the room.

The Sony Corp. set shown is a transistorized unit (tougher than a tube-type) which can operate on standard house current. Or, with an accessory power pack, you can use it at the beach, on picnics or even at ball games. If the unit is used in the home, the power pack recharges. In a car, the set can plug into the cigarette lighter receptacle, using a special cord and plug, or be used on its own power pack.

A hood, mounted on a locking slide, can be moved forward to shield the eight-and-one-half-inch screen. All tuning and volume controls are mounted at the top of the set, including those for the fully transistorized 12-channel tuner. The antenna is a collapsible telescoping unipole, which disappears into the set when not in use.

While the set is easily carried from living room to bedroom, the stand that came with it did not lend itself well to "all-angle" viewing. So *PM's* editors designed the all-purpose support shown in the drawing, which you can also adapt to other small TV sets. *PM's* stand uses the same mounting holes the original stand did, and can easily be swiveled to any position.

The stand also conveniently clamps to

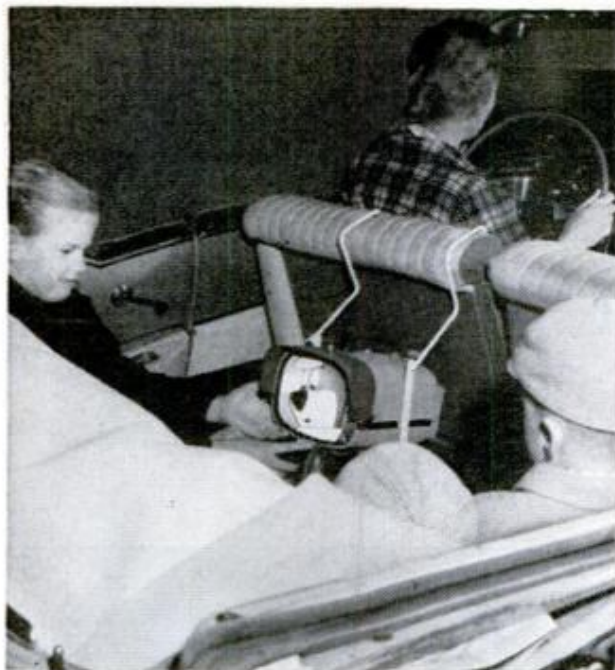

TV IN THE CAR with the PM base does not distract the driver. It distracts the kids, though, pleasantly

the back of the front seat of a car. While you may get some flutter from the motion of the car, reception should be adequate as long as the car remains within fringe limits.

To make the bracket, impress heavy-gauge wire or several strands of wire solder around the bottom of the set to obtain the proper contour. Transfer this shape to a piece of paper and bend a piece of 1x $\frac{1}{8}$ -inch



REAR-MOUNTED POWER PACK permits viewing anywhere. It goes to picnics, the beach or the family car

aluminum ($\frac{1}{4}$ inch for a heavier set) to match the contours.

Construct the base platform as shown in the drawing. We used $\frac{1}{4}$ -inch steel rod for our model; a larger set will require heavier diameter rod.

To help the wing nuts hold the set in any position, use a pair of toothed washers supplemented with split lockwashers.

Stylus Aligner

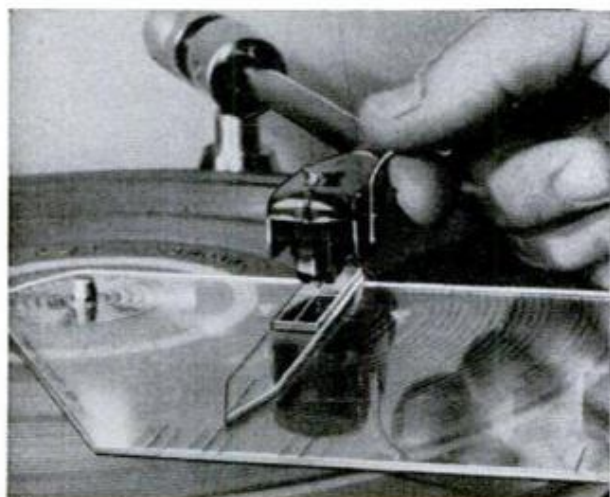

Place the hole of this new aligner over your spindle, set the pointer with its mirrored reference in the proper point, and lower your cartridge over the cross lines. By observing the alignment of the stylus-cartridge-arm in the mirror, you can exactly line up these components for maximum tracking efficiency and less one-side groove wear. \$5.25, Prestige Products, 13647 Burbank Blvd., Van Nuys, Cal.

SEPTEMBER 1961

Radio Pen Set



Transistor radio in a desk set uses six transistors in a full superheterodyne circuit. Operates with four penlight cells, features Alnico permanent magnetic speaker, ferrite antenna, slide-rule dial and fingertip tuning. Earphone jack on side provides quiet listening when desired. The Shaeffer Skripriter ball point pen is set in an all-angle swivel socket. \$54.95, Gulf Coast Distributors, 1907 West Bell, Houston, Tex.

199

X773



Face-Lift Your Home with LUXURY WALLS

By E. R. Haan



1. AN ARM'S LENGTH away Royalcote looks like natural wood. Panels are attached with special clips

NOWADAYS you can be your own interior decorator, using wall coverings that come prefinished, unfinished, primed and also in a variety of textures, colors and wood graining to fit any decorative scheme in old and new homes. Along with the wall coverings you buy fast, easy application and you get durability equaling that of the house itself. And you do the work with common household tools.

Special hard coatings of many of the wall coverings defy ordinary

2. SEADRIFT TEXTURED AND PRIMED hardboard panels take a tone-on-tone finish, using the priming coat as the predominant color. Just apply latex or acrylic-base paint to a small area and wipe the surface with grain using a damp sponge as below. Depth of tone easily controlled





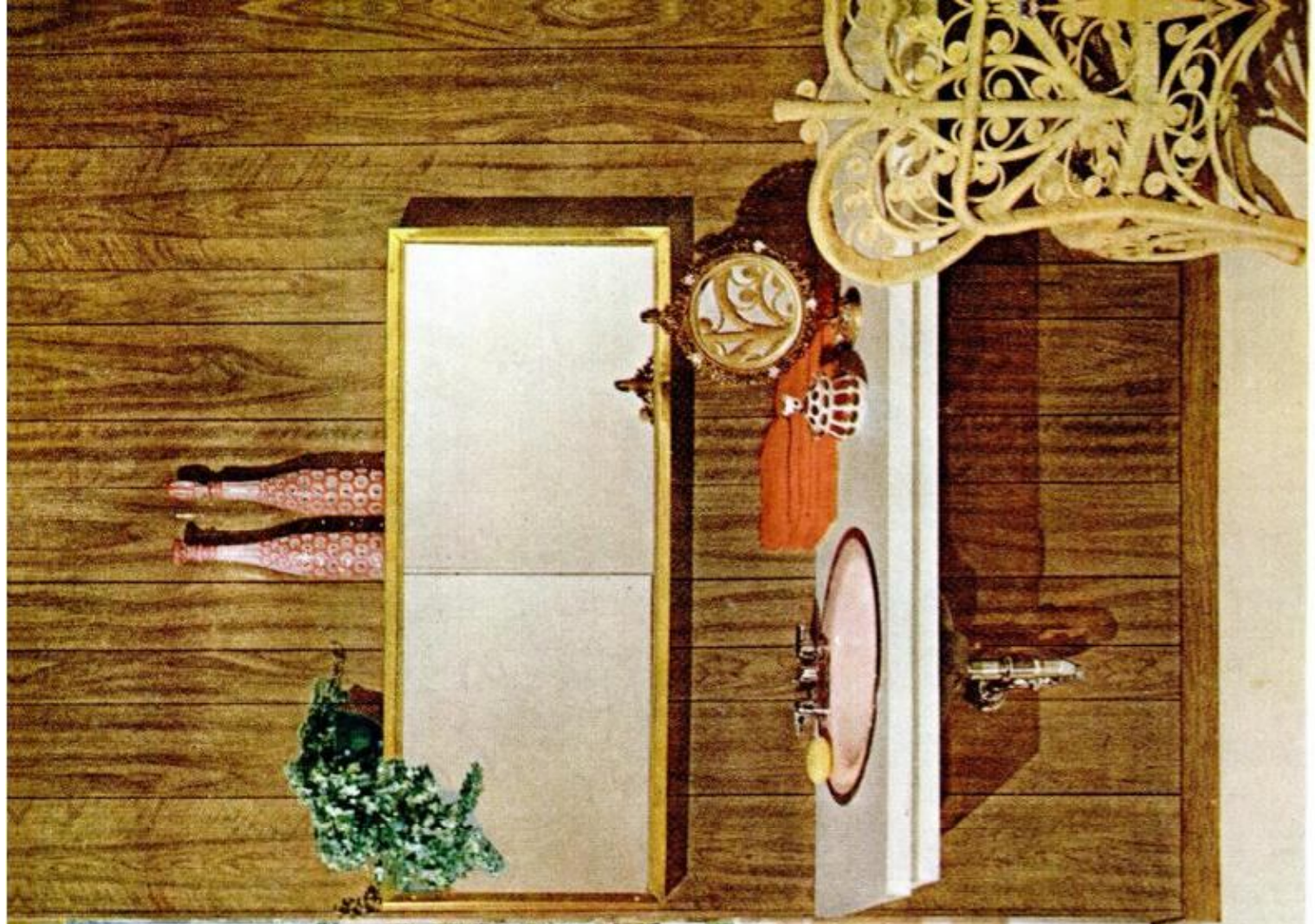

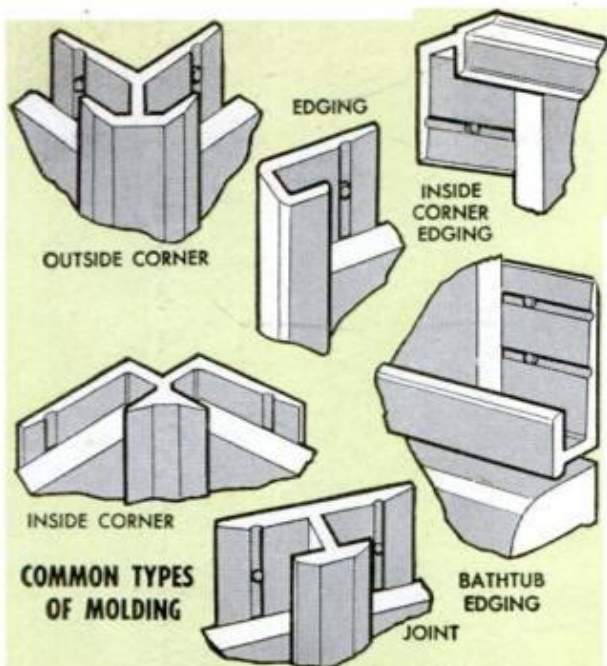

FURNISHED PLAIN OR WITH EXPOSED PARTS VENEERED TO MATCH PANELING

3. EXTRUDED METAL moldings make it easy to fit hardboard wall coverings around bathtubs, around inside and outside corners, conceal exposed edges

wear, resist dents and scratches. Smudges, fingermarks and food stains wipe off without a trace. Dust won't stick to the smooth surfaces; panels don't shrink or check and the colors don't fade. Rigid wall coverings come as 4 x 8-ft. sheets and in planking 6 to 16 in. wide and 8 ft. or more in length. Other types of coverings, some flexible, come as panels in various sizes. These are coverings such as those shown in Figs. 4, 8, 10, 11, 12 and the nonceramic bricks pictured in Fig. 14.

Fastenings. Many of the rigid wall panels can be applied directly to studding in new work, to horizontal wood furring strips, or to plastered walls in old work after wall-paper and loose paint have been removed. Old plastered walls that are uneven or rather badly cracked often require that furring strips be shimmed to give a level nailing or cementing surface. Corners and exposed edges of panels usually are finished with special metal moldings, Fig. 3. Nails, staples, clips, Fig. 1 and locking strips, Fig. 8, and several types of adhesives are common fasteners now recommended by manufacturers of panels. Adhesives are coming into widespread use. Tile and linoleum cements sometimes are used as in Fig. 4, detail A, on plastered walls. Contact adhesives can be applied directly to studs as



4. EXTERNAWALL is a vinyl-surfaced gypsum board that resists scuffs and stains. Details A, B, C, below show how adhesives are used as fasteners for panels

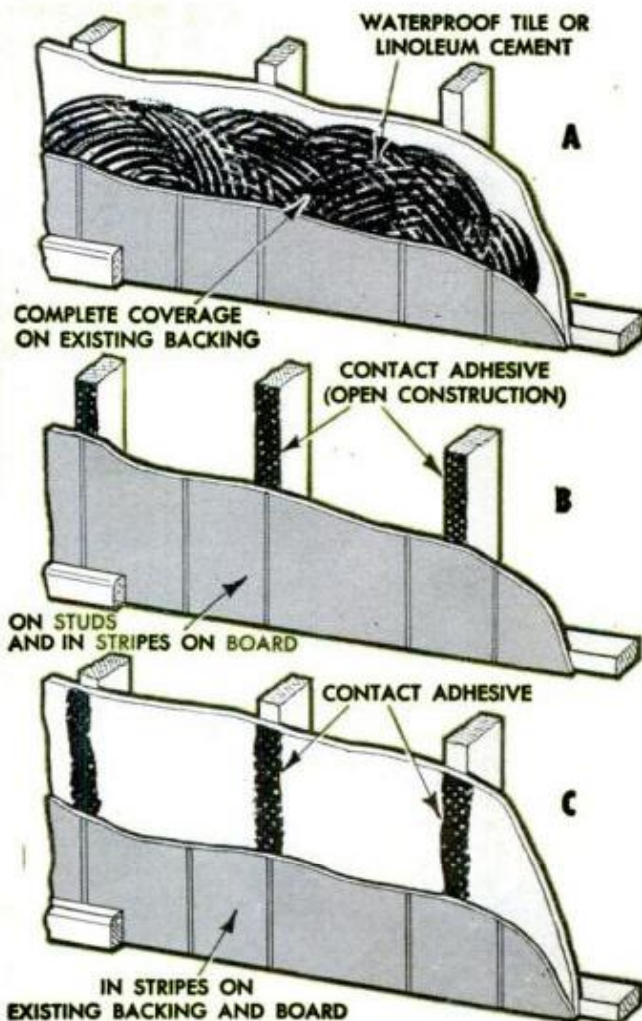

5. A PLASTIC-SURFACED HARDBOARD, Trendwood lends beauty of real wood to walls. Note grain direction in accent panel



6. PREFINISHED PERFORATED hardboard is not only attractive; it's a place to hang almost anything decorative

in Fig. 4, detail B, or in spaced stripes over the studding on old or new plastered walls as in Fig. 4, detail C. When applying panels with any type of fastener, follow manufacturer's instructions in all details.

Hardboard and plywood. Available in

thicknesses from $\frac{1}{8}$ to $\frac{3}{4}$ in., hardboards and plywoods have face surfaces which may be smooth, striated, wood-faced, wood-grained or otherwise textured. These come prefinished, unfinished and primed. The white primed, textured hardboard shown

7. PERFORATED HARDBOARD with square holes, also others known as Shadobord, Weavbord, Louverbord, Starpoint and Shadobox are available. Boards find application as room-divider panels, cabinet fronts, etc.

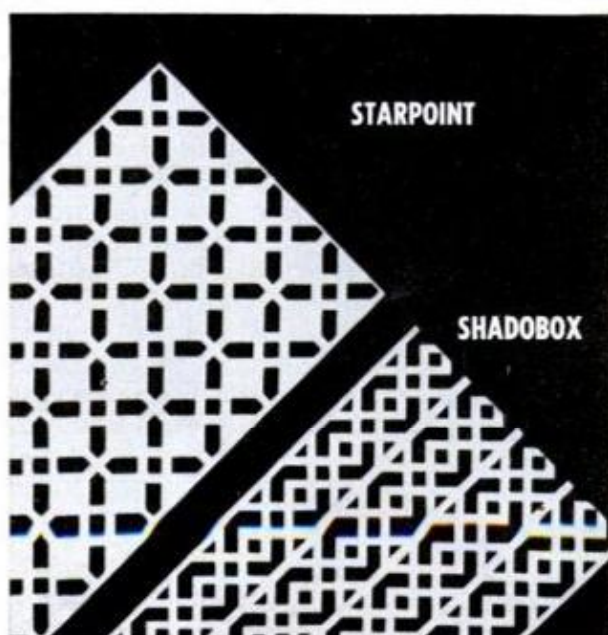
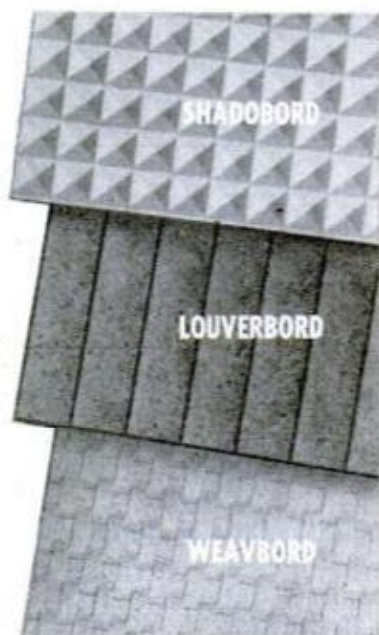
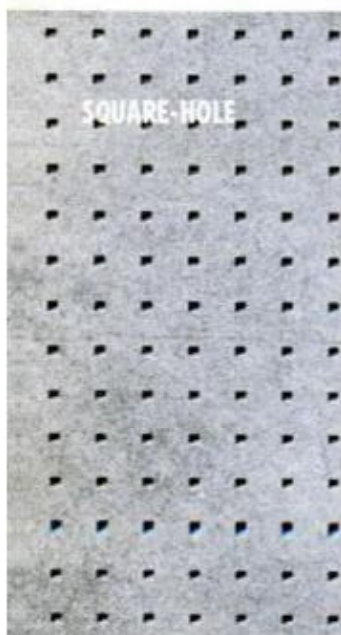

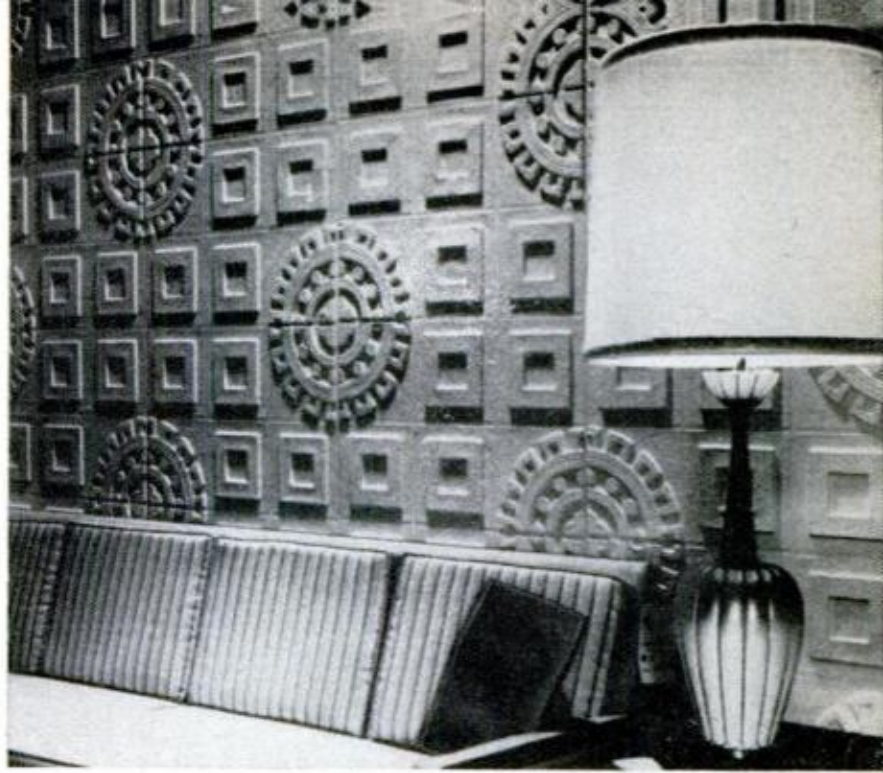

8. WALL EXPANSES are no problem when you use this decorator pattern in Peruvian stone. Easily and quickly applied to the wall with a special cement the keyed panels assemble into realistic pattern pictured at right

in Fig. 2 and pictured in color on the opposite page is an example. This you can finish in your own choice of color simply by applying a coat of latex or acrylic-base paint and wiping with a damp sponge to give the tone-on-tone desired. Some pre-finished surfaces are coated with a solid-color, baked enamel, others are plastic finished. Some wood-grained surfaces are produced by bonding a plastic laminae to a hardboard backing, the room finished with wood-grained planking, Fig. 5, being an example of this type of material.

Then there are the perforated and textured hardboards, examples and applications being pictured in Figs. 6 and 7. The perforated boards permit any arrangement of wall hangings without use of nails. Perforated hardboard panels can be attached to plastered walls by backing with 1 x 2 wood strips so that there is space between the board and the wall for inserting the various wire hangers through the holes. Also, hardboard panels in wood-grained or textured types can be attached to walls with lock-strip fasteners of the type shown in Fig. 9. The strips serve as joint fasteners for the panels and also as supports for adjustable metal shelf brackets. The exposed portions of the metal strips are colored to match the panels.

Textured wall decorators. Fig. 8 is an example of the several textured wall decorators now available. The material comes in keyed panels which are cemented to the wall to give the interesting Peruvian-stone pattern pictured. The plastic material is light, easily handled and remarkably real-

9. PANELOK WALL SYSTEM consists of a U-shaped metal locking strip which joins panels and provides slotted bar for attachment of adjustable shelf brackets

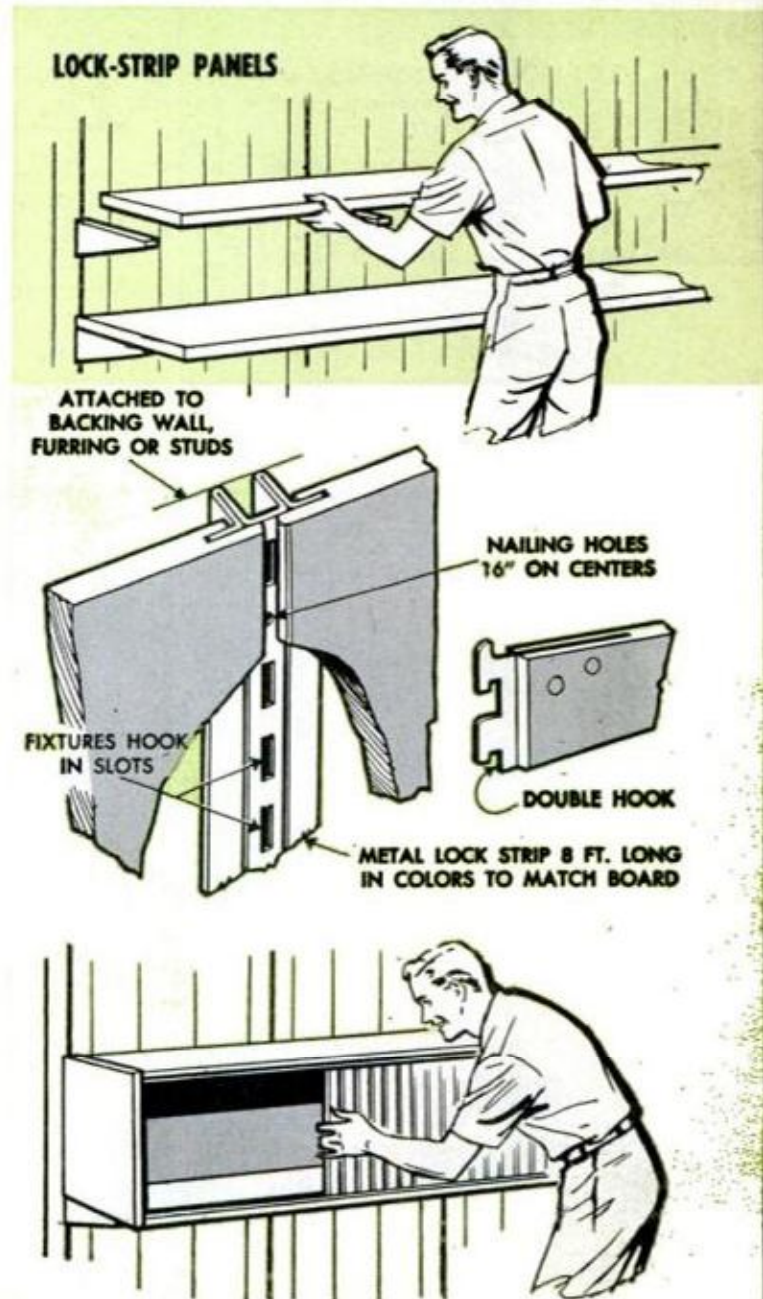

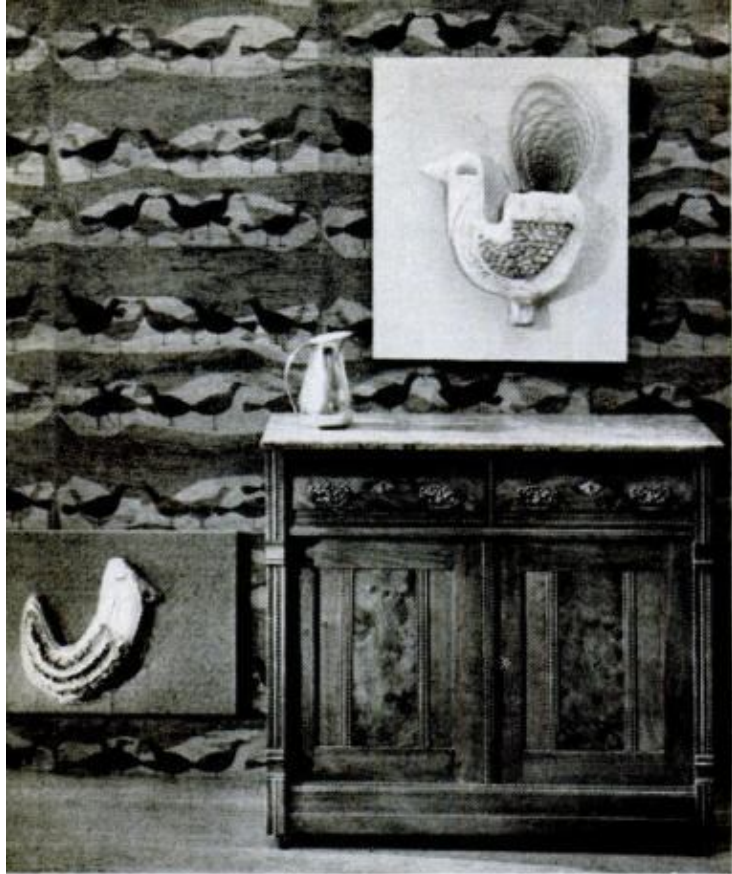

10. SILK-SCREENED designs on paper, canvas, Shiki silk and vinyl emphasize a movement away from conventional wall coverings. Above are types of applied decorations in color for use in both new and old rooms

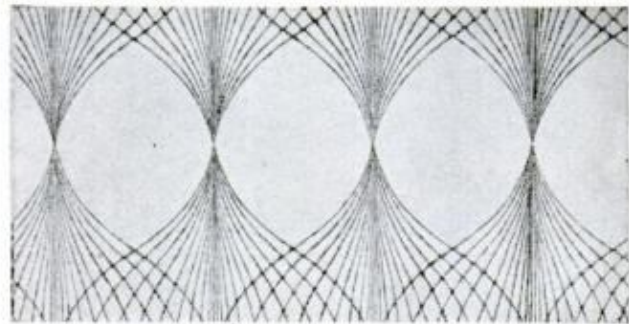
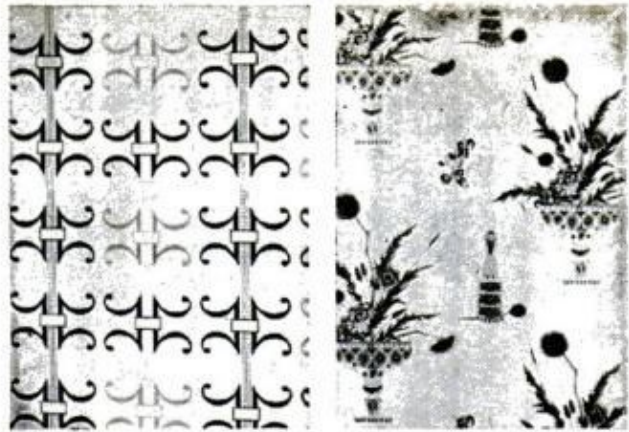

istic in final appearance. For accent walls and entire walls in some rooms you may prefer real wood panels grooved to form squares of uniform size, Fig. 12. Such a material is especially effective as an accent in a large room.

Printed wall coverings. Real luxury coverings having colored designs printed on paper, Shiki silk, canvas, and vinyl, are available to fill just about any need in modern wall decor. Several examples of these

11. IMBEDDED DESIGNS in fibreglas panels make up into attractive room dividers, partitions, screens



ultra wall coverings are pictured in Fig. 10. A wide choice in design and color combinations is available to home decorators.

Fibreglas panels. Room dividers, partitions, folding screens can be made with fibreglas panels in which are imbedded colored designs such as you see in Fig. 11. The material comes in panels 36 x 72 and 36 x 96 in. in light (nonstructural) and heavy (structural) weight, the latter about $\frac{3}{32}$ in. in thickness and suitable for wall paneling.

12. ACCENT WALLS, or entire walls in Gruvwood are tasteful selection in decoration for new and old homes

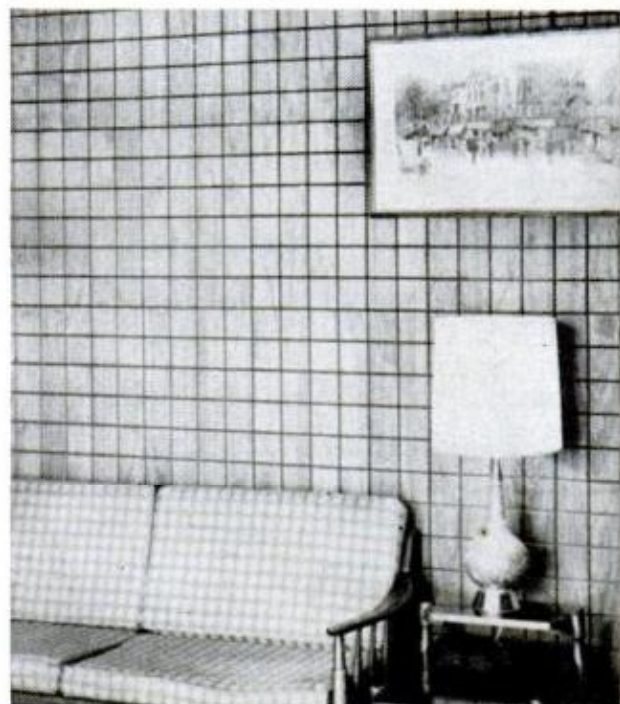

13. DURASAN WALL PANELS are of gypsum with a hard, "cloth"-texture surface. Smudges, fingerprints sponge off. Panels are attached with colored nails

In addition to the three designs illustrated in Fig. 11 the materials come in imbedded colored woven cane, random assorted leaves and butterflies, stained glass, gold thread and street scenes of old buildings.

Vinyl-faced gypsum panels. Representative examples of vinyl-faced gypsum paneling are pictured in Figs. 4 and 13. These materials usually come as 4 x 8-ft. sheets with a durable facing in both cloth and wood-grain texture that cleans with a damp cloth or sponge as in Fig. 13. Large panels go up fast with special colored nails.

Nonceramic brick. A typical interior application of nonceramic brick (vermiculite) is pictured in Fig. 14. Bricks come in four decorator colors and are applied directly to the wall with a special adhesive. ★ ★ ★

14. NONCERAMIC Z-BRICK find a place in wall decoration in homes of any age. Especially effective as accents in kitchens. Bricks are available in 4 colors

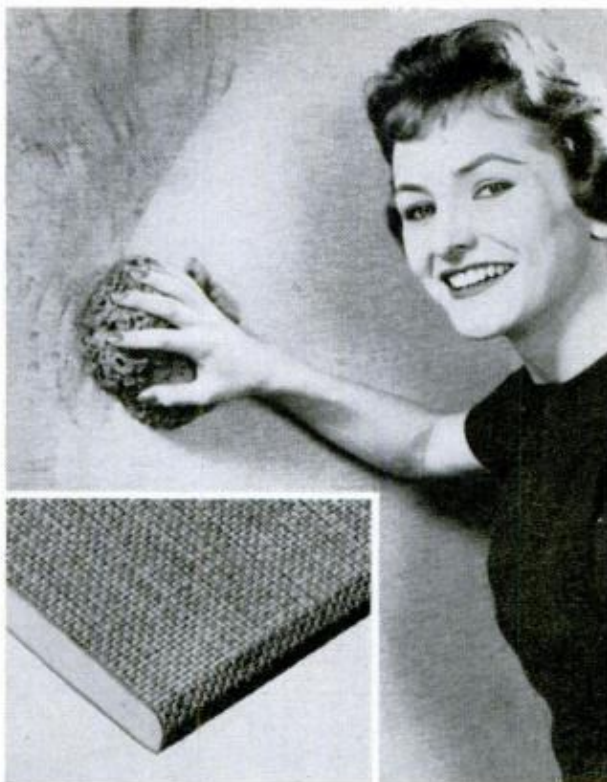

X542

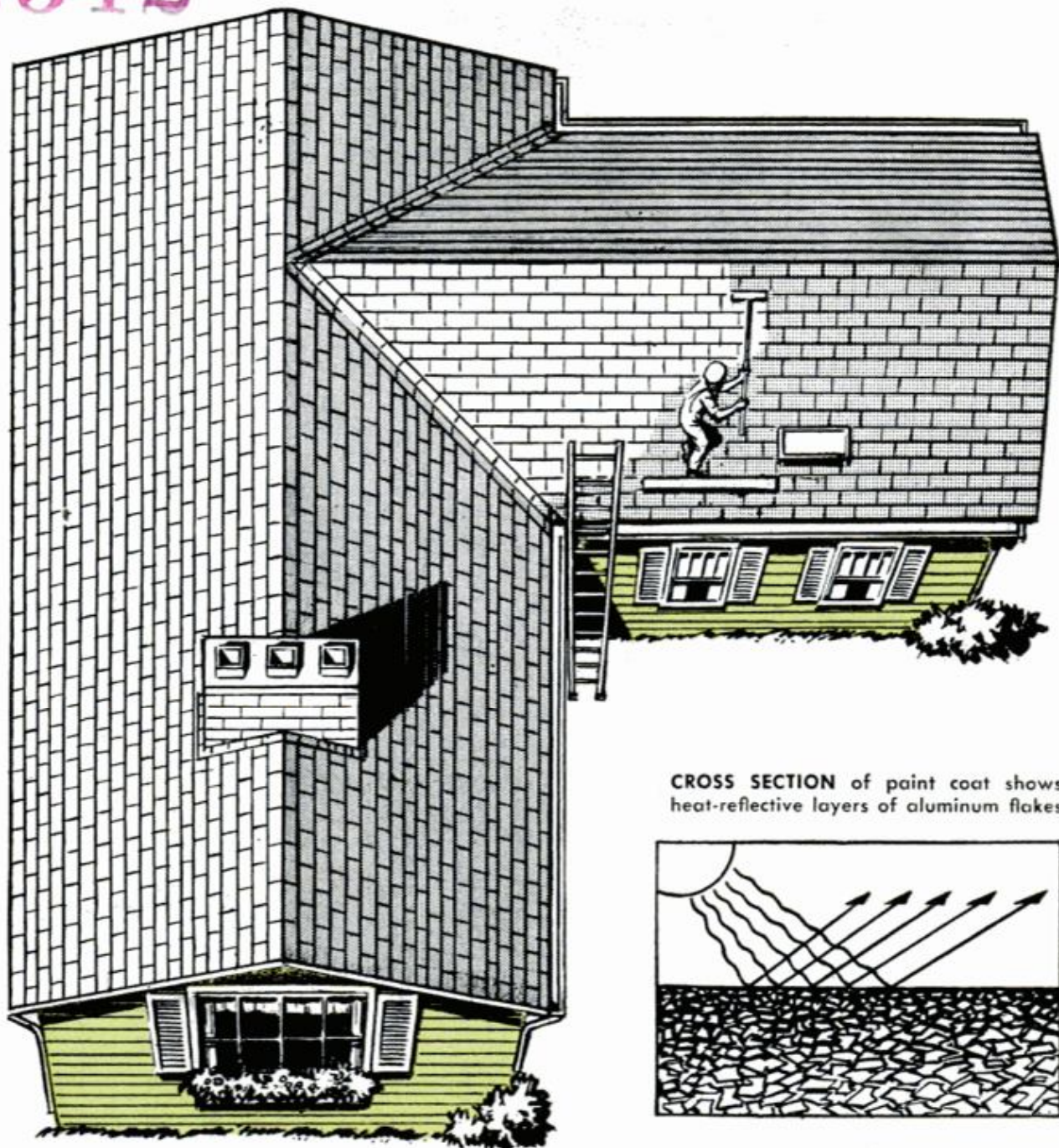

CROSS SECTION of paint coat shows heat-reflective layers of aluminum flakes

Roll on a New Roof

Long-oil aluminum paints rolled, brushed or sprayed on can add years of useful life to aging wood-shingle roofs

IS YOUR cedar shingled roof showing its age? While the appearance of many and persistent leaks indicates an urgent need for replacement, less advanced stages of deterioration can be arrested by application of an oil-base aluminum paint made especially for this purpose. Such paints are available in colors and in natural aluminum. Composed of a high percentage of linseed or

alkyd oil (40% or more), minute aluminum particles in flake form and a color pigment (if colored), the paint may be applied with a roller, sprayer or brush as pictured.

Normal life of a cedar shingle roof is 20 to 25 years, depending upon the quality of shingles used and the exposure. Application of aluminum roof paint can add another 5 to 10 years of useful life to such a

roof if it is done before deterioration becomes too advanced. Applied in one heavy coat or two light ones, the paint will last about 10 years before recoating becomes necessary. Cost per gallon is somewhat higher than shingle stain. In addition to extending the life of a roof, the aluminum paint improves its appearance and reflects the sun's heat. This means a cooler house and lower air conditioning costs in summer.

When selecting a paint for this purpose be sure to get one with a high linseed oil or alkyd content, referred to sometimes as "long-in-oil." About 1½ lb. of aluminum flake per gallon of paint is considered a good formulation. The oil serves as a bonding agent and preservative for the shingles, requiring from 2 to 5 days to dry. Do not use a varnish or asphalt-base aluminum paint, as neither is recommended for exterior application on wood surfaces.

Shingles Must Be Dry

Preparation of the roof prior to painting is simple. It should be clean and dry. If you paint after a rain, allow ample time for the shingles to dry, about a week in hot weather, a little longer when it is cool.

Application with a roller is easiest. Spraying should be done only on a calm day. Brushing is tedious and time-consuming but produces a good job. For brush applications, use a 4 to 6-in. nylon-bristle wall brush. Start painting at the top of the roof, and with a full brush apply the paint across the shingles. This will allow it to run into the gaps between shingles. Runs on unpainted shingles are covered later.

Roof Tray From Cake Tin

Rolling equipment needed includes a 9 or 12-in. roller, lambskin cover, tray and a holder for the latter to keep it level while on the roof. The roller shown is a commercial model adjustable to take roller covers up to 14 in. A long handle saves stooping and kneeling. The tray is an inexpensive 14-in.-square cake tin which is placed on a wooden holder to suit the pitch of the roof. The drainboard is a piece of ¼-in. plywood to which retaining strips are nailed at the sides and one end. It is slightly lower at the open end, which overhangs the tray. A strip of sponge rubber tacked to the bottom of each leg prevents the holder from sliding when placed on a fairly steep roof.

For roofs that are too steep to stand on safely, it will be necessary to use a ladder secured to the roof, or perhaps roof scaffolding. When painting with a roller, first roll across the shingles, then up and down. Avoid rolling over edges of painted areas. This will prevent unsightly laps.

—F. C. Stebbins



SECTION ROOF with chalk lines. Then stop spray pattern at lines and you won't end up with laps that show when paint dries. Adjust nozzle to round spray

PAINT must be stirred frequently to keep aluminum pigment well distributed in vehicle. For brush application, 4 to 6-in.-wide nylon brush is used



TRAY FOR 12-in. roller is cake tin mounted on holder having wooden drain board and sponge-rubber covered legs cut at an angle equal to pitch of roof

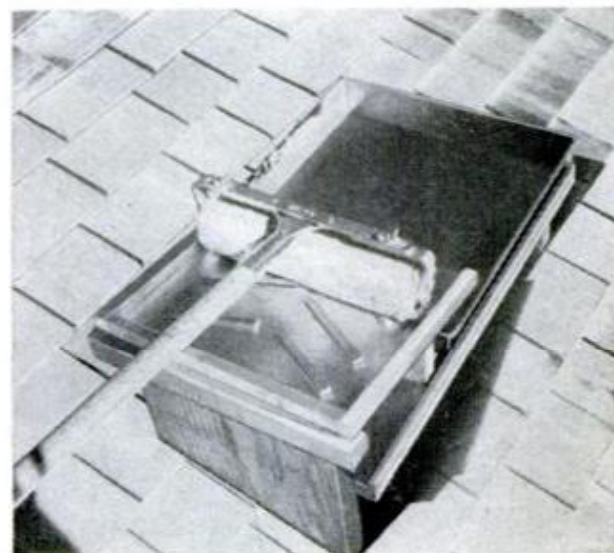

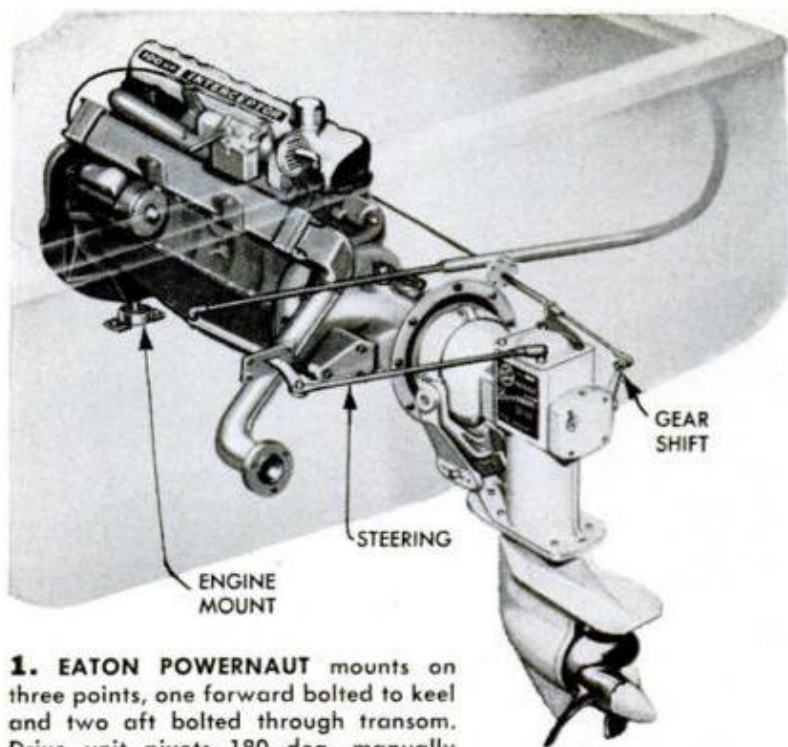

1. EATON POWERNAUT mounts on three points, one forward bolted to keel and two aft bolted through transom. Drive unit pivots 180 deg. manually



2. SEA POWER drive unit is secured to transom by means of hinge pin and locking lever. Entire lower gear case rotates, permitting 360-deg. steering

INBOARD-OUTBOARD DRIVES

A roundup of models available, comparison with inboard and outboard motors, and step-by-step installation photos

By Earl Wobeck

BEFORE RINGING THE "engine room" for full speed ahead on inboard-outboard drives, it is appropriate to review the good and bad features of other principal forms of marine propulsion and compare them with in-outs (inboard-outboard drive). Only then can you choose wisely between outboard motor, in-

3. MERCUISER has flexible, rubber-cushioned drive line from engine to stern unit, eliminating alignment problems. Control linkages on production models are neatly concealed in through-transom drive housing

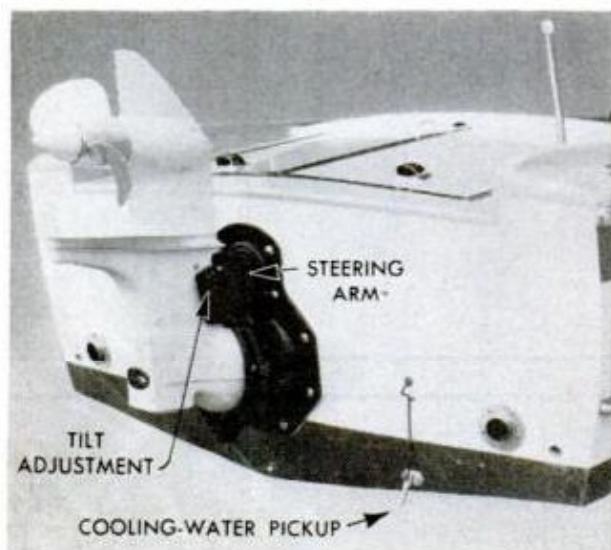

4. DRIVE UNIT of Mercruiser can be hand cranked 180-deg. into raised position for easy prop changing. OMC (Outboard Marine Corp.) unit may be tilted up like outboard, except that it is power operated





board-outboard drive and inboard for a new boat, or when repowering your present craft.

Most in-out units now on the market are pictured in this story, with important design features labeled. The smallest is rated at 35 hp., while the largest is designed for a power range of 125 to 200 hp. While all models are basically similar, there are some important differences. The models shown in Figs. 3 and 6 have a trim tab that counteracts propeller torque, making steering easier. A hand crank is used for elevating the drive unit from within the boat in Fig. 4. The lower half of the drive unit shown in Fig. 2 in color can be rotated 360 deg., giving it a high degree of maneuverability. Most units tilt up outboard fashion, al-

though some can be raised much higher, Figs. 3, 12 and 13. Most units have the steering arm attached to the head of the drive unit as in Fig. 14.

While some models of inboard-outboard drives are sold as a complete power package installed, a few are sold separately for owner installation. Of the latter group, which includes Volvo - Aquamatic, Sea Power, Brennan Imp, Sea Hawk and Muncie Flexidrive, several are available only as a combination power-and-drive package, although only the drive unit may be purchased in one or two cases.

Inboard-Outboard Drives

In an inboard-outboard installation the engine, which may be a converted car en-

5. OMC's INBOARD-OUTBOARD power package weighing 285 lb., is lightest of all such power combinations available, has basic 75-hp. outboard motor powerhead that mounts snugly in stern of boat. Although 2 cycle, engine has special lubricating oil injection system which is supplied from 2-gal. tank located in cockpit

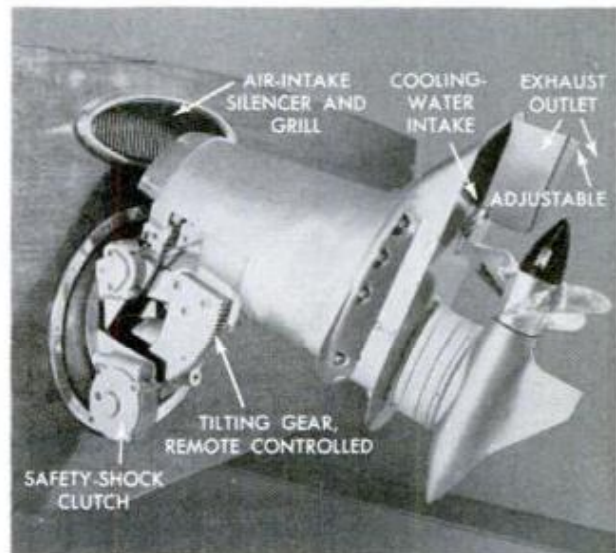
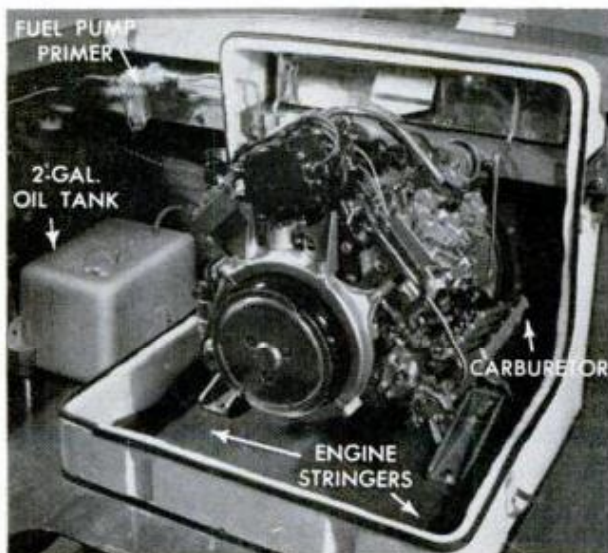

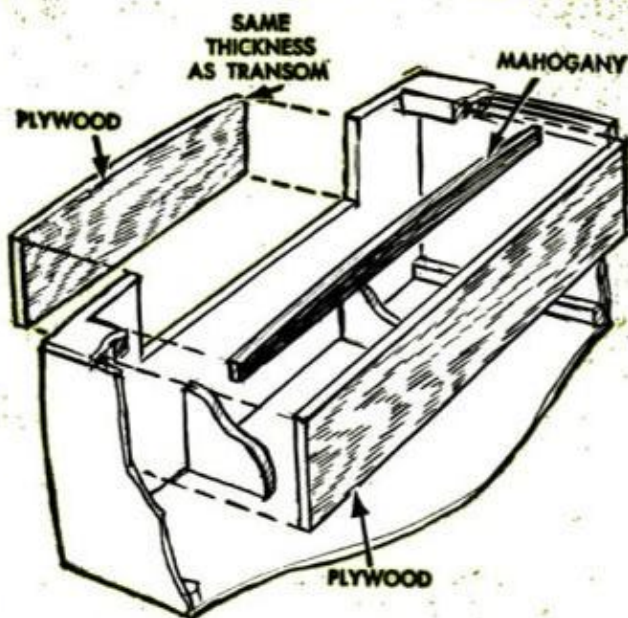

6. CONVERSION OF OUTBOARD BOAT for in-out (inboard-outboard) installation starts with removal of motor well. Cutout then is closed with plywood laminated to same thickness as transom and a trim piece of solid mahogany glued and screwed flush with the upper edge as in the drawing. Some hulls also require engine stringers

or a marine engine without a gear train (bobtailed), is mounted next to the transom as in Fig. 1. The drive shaft passes through a hole in the transom and is connected to an outboard-type gear case and drive unit which is bolted to the transom in line with the drive shaft. On most models the engine is mounted on stringers at the forward end and attached to the transom at the after end, while on one model it is supported entirely by the transom.

Uses recommended for this type of propulsion include pleasure and commercial craft 17 to 30 ft. in length, or craft requiring more than 80 hp. in a single engine, less than 400 hp. in twins. The largest in-out

drive unit available is engineered for a 125 to 200 hp. power range.

Advantages over outboards: Lubricating oil is not mixed with the fuel, eliminating a nuisance and additional operating cost common to outboard-motor fueling. In-outs give single engine power options beyond that offered by outboards. Better protection from swamping is provided by a higher, full transom and fully enclosed engine installation.

Advantages over inboards: Installation is much easier, with no long shaft hole to be drilled through the boat bottom for the propeller shaft. Also, no stuffing boxes, separate skeg, shafting or rudder are re-

7. SERIES OF PHOTOS at bottom of this page and next show installation of Volvo "Aquatic" engine and drive combination. First, transom template is centered vertically over keel, after which holes for mounting bolts, exhaust port and tiller arm are marked for drilling. Outside mounting plate then is bolted in place

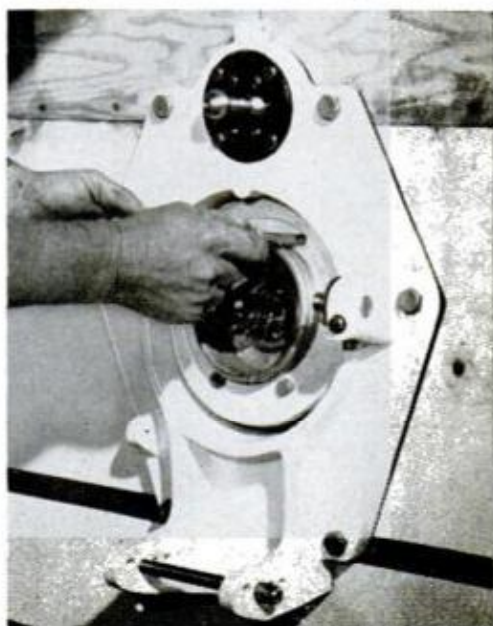
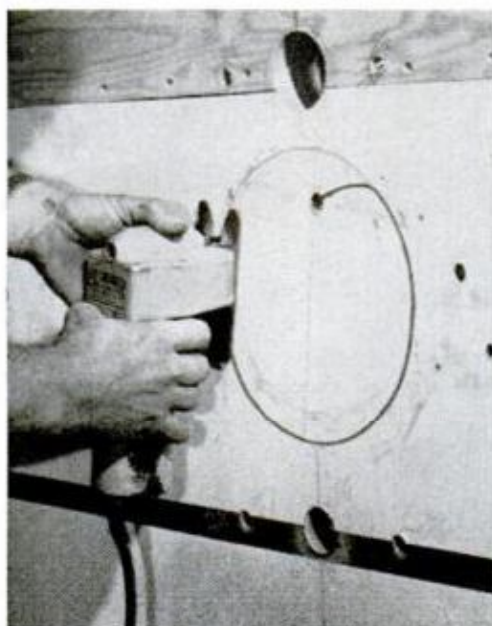

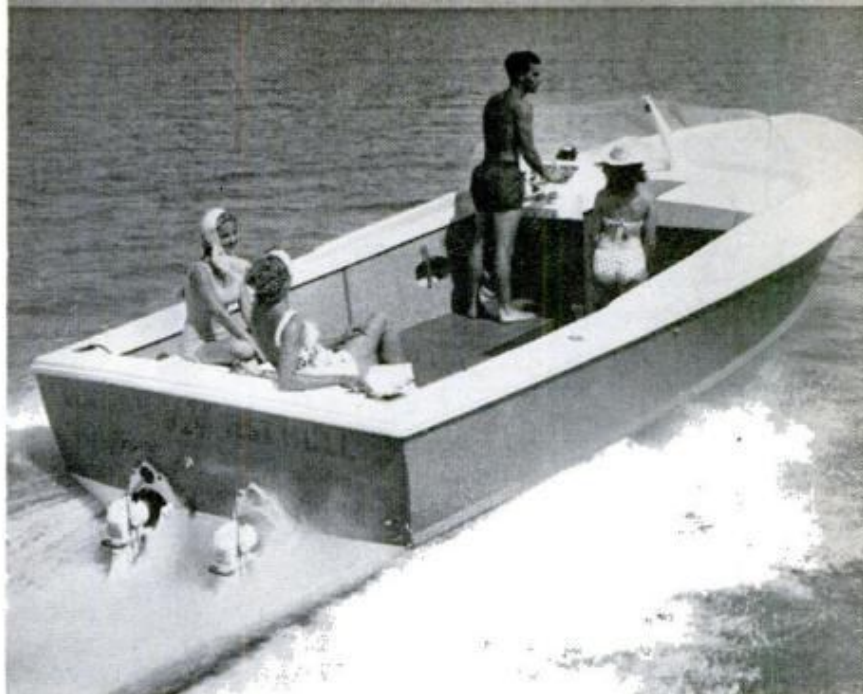
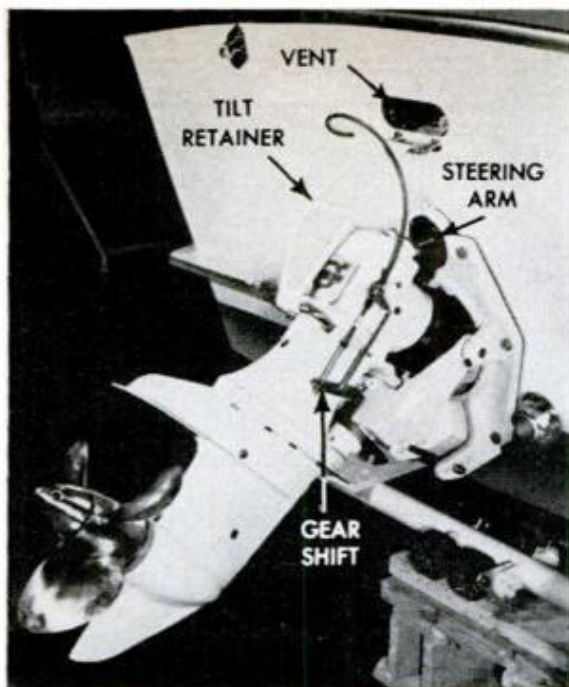

8. CONTROL LINKAGES on Aquamatic drive unit, left, are mounted externally, as is the case with all other models except Mercruiser. Latter's control linkages are concealed in drive-shaft housing. Right, 24-ft. inboard which placed first in 1961 Miami-Nassau race, demonstrates capabilities of twin in-out installation

quired. In-out drive units kick up automatically when an obstruction is hit in a similar manner to outboard motors, avoiding damage to underwater drive parts. Steering is much more efficient, being accomplished by rotation of part or all of the outboard-drive unit, similar to outboards. This gives a single-prop boat almost pivot-type turning capabilities which is far better than even twin-screw (prop) inboards.

The drive unit includes reduction and reverse gearing at little more cost than conventional marine reduction gears. Also, the tilt-up feature permits trailer launching and retrieving, and the boat can be beached with impunity. With the lower

unit raised out of the water when moored, electrolysis is less of a problem and fouling of the prop and associated underwater parts by marine growth is eliminated. Further, the entire drive unit may be uncoupled easily for servicing or any other reason, a much-appreciated convenience.

Hydrodynamically, an in-out drive unit is more efficient than an inboard since it has less underwater surface area. This means faster speeds and better fuel economy for the same power input. A further gain in efficiency is achieved through positioning of the prop shaft on a horizontal plane, making maximum use of prop thrust. The angled prop shaft of an inboard oper-

9. BELL HOUSING, left, is bolted to inside of transom, after which engine is lowered into cockpit and bolted to bell housing, center. Right, drive unit is fitted to shaft and locked in place with pins, completing installation except for connecting remote controls, fuel lines, electrical and cooling systems

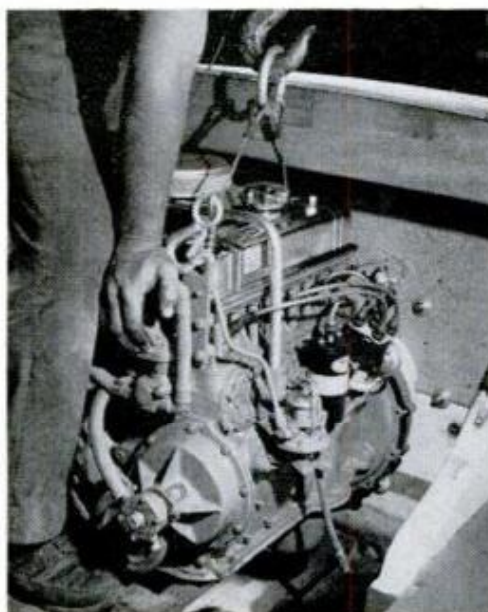
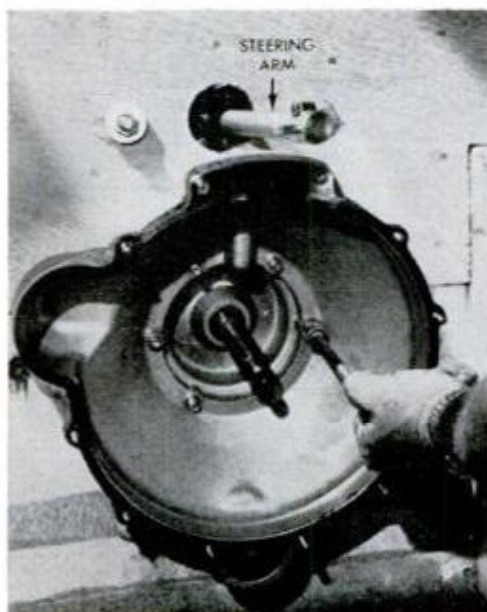

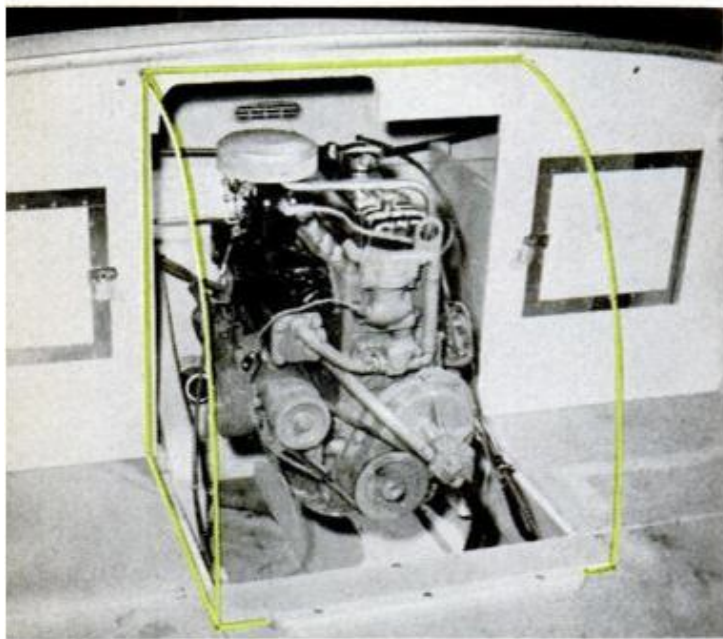

10. ENGINE COVER indicated above may be made of plywood lined with nonflammable sound-deadening material. Note storage compartments port and starb'd and external breather grille at top of transom

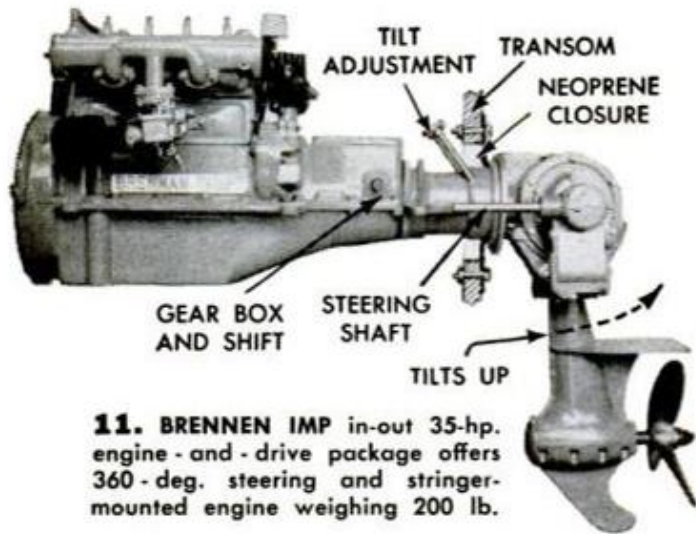

11. BRENNEN IMP in-out 35-hp. engine - and - drive package offers 360 - deg. steering and stringer-mounted engine weighing 200 lb.

12. SEA HAWK outboard drive can be used with engines of 50 to 300 hp., weighs only 60 lb. and can be rotated upward 180 deg. to clear water or road hazards. Tilt angle can be adjusted from seat

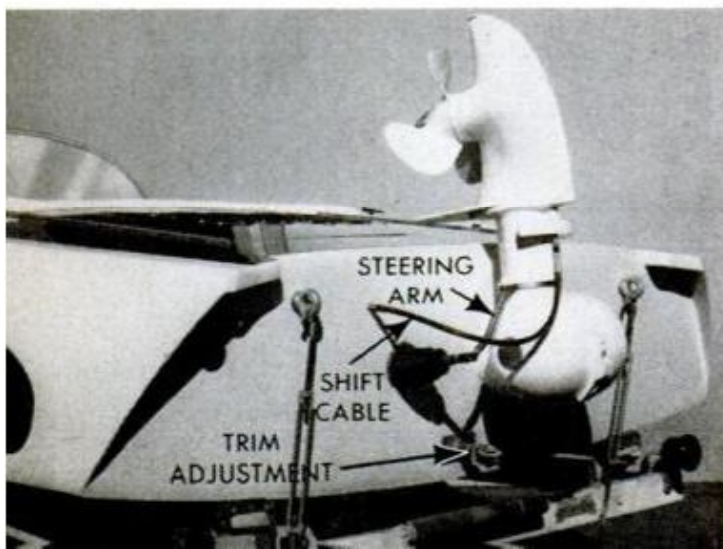

ates at a disadvantage proportional to the amount of angle from the horizontal at which the shaft is installed.

Outboard Motors

The best uses for outboard motors are, pleasure and commercial craft up to 20 ft. in length, or boats requiring a maximum of 80 hp., the largest outboard motor available. When a twin outboard installation is necessary to meet power requirements, most of the weight advantage over inboards is lost and cost becomes equal or greater. However, a twin motor installation offers a hedge against power failure and should not be overlooked as a safety factor, especially if offshore boating or cruising remote areas are frequent fare.

Advantages of outboards; Light weight per cu. in. cylinder displacement (in-outs and inboards weigh about twice that of an outboard of the same size). This makes outboard-powered craft easier to trail, launch and store. Outboard motors are the easiest to install or remove of all propulsion systems, requiring no through-hull fittings for water cooling and exhaust as is the case with in-outs and inboards. The compact powerhead and over-all design takes the least amount of hull space of any propulsion system. Motors are easily removed from one boat and installed in another, giving this type of power greater versatility than others. Outboards are lower in total cost installed, the amount depending upon the size of engine. The same type of remote steering, throttle and shift controls can be used for in-outs as for outboards. The big outboard companies offer a well established, proven product and have a well developed network of repair facilities in the United States and some foreign countries, as a final point in its favor.

(Continued to page 232)

13. MUNCIE FLEXIDRIVE is available as complete power package, or drive unit only for attaching to any marine or converted car engine within its horsepower range of 15 to 160 hp. Unit weighs 86 lb.

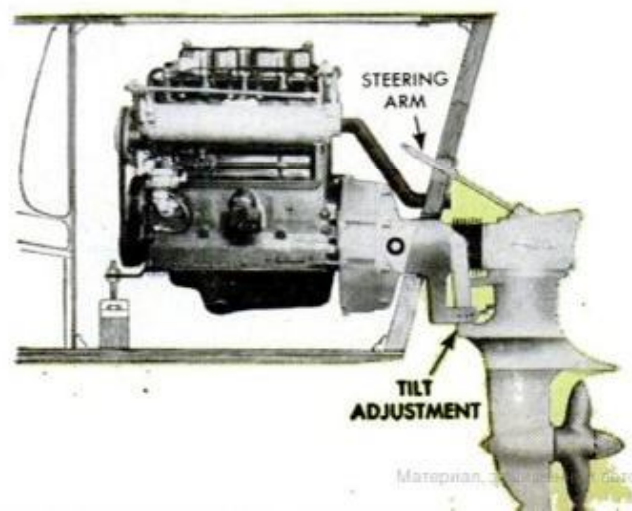

QUICK AND EASY

Trapping Hose Dust

When using a vacuum-cleaner sprayer attachment for painting, dust from the hose sometimes becomes dislodged and gets in the paint, or it may even clog the sprayer nozzle. This can be easily prevented by wrapping a wad of steel wool in a piece of cloth, tying both ends and inserting in the hose coupling at the top of the sprayer as shown. The tied end of the filter projects slightly for easy removal.



Cards Kept in Order

For anyone who keeps an index card file on appliance servicing and other items requiring a continuing service record, here is a tip on keeping multiple cards on each item in better order. Place the first two cards of a series back-to-back with the upper one facing down, bottom one up. Then, cut a hinge from adhesive or masking tape and apply it across the joint at the outer edges as detailed at right. Additional cards are bound into the series in the same manner, by flipping the last card face down, butting the new one against it and applying the hinges.—L. Kasper

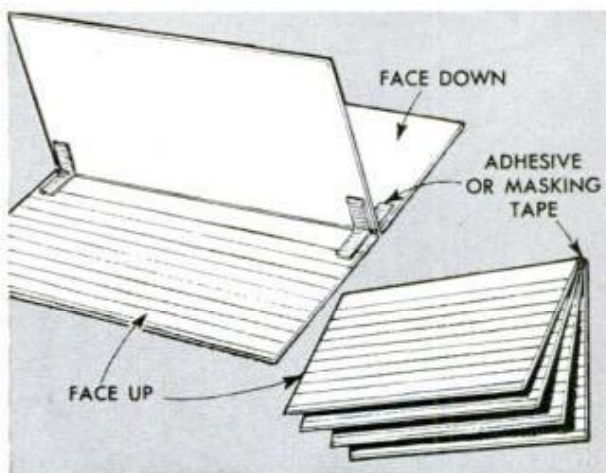

Right End at a Glance

Small rubber collars cut from an inner tube and slipped on double-end wrenches as pictured, quickly identify the end being used. This saves time and eliminates the annoyance of having frequently to try both ends before finding the right one, especially when a wrench is laid down often while making an adjustment. The collars, which also keep the wrenches propped up slightly for easy pickup with a gloved hand, should be large enough for easy grasping when sliding them to the end of the wrench being used.



Pockets Hold Paper

When drafting or drawing paper is fastened to a board and you do not want to pierce the corners with thumbtacks, or risk tearing the paper as sometimes happens if masking tape is used, try this method of mounting the paper. Simply cut four corners from used stationary envelopes, slip them on the corners of the drafting paper and then tape the corner mounts to the board in the desired position. Since the mounts are easily removed, they can be relocated anywhere on the board to accommodate any size of drafting paper.

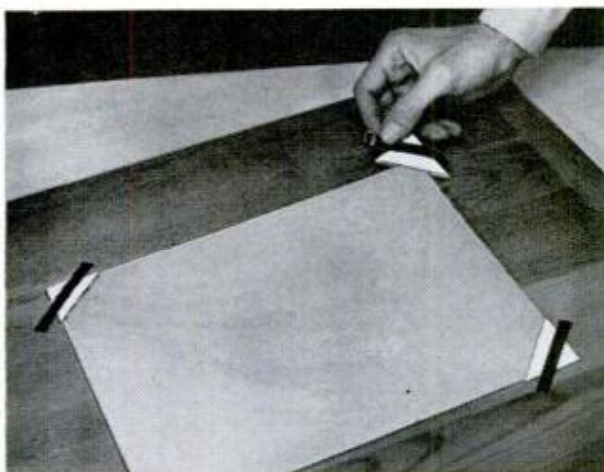

—R. Hanscom

MR. DO-IT AND BUNGLE

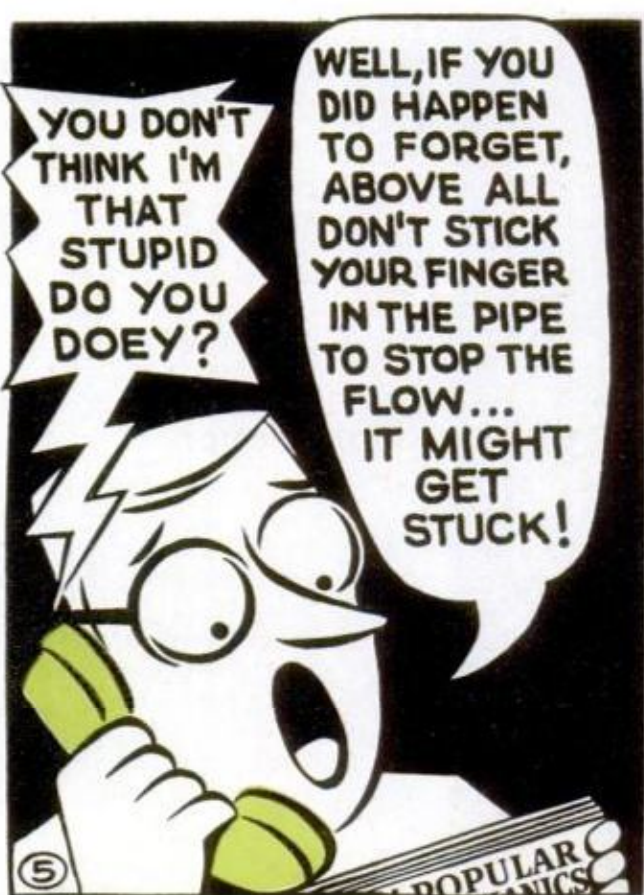
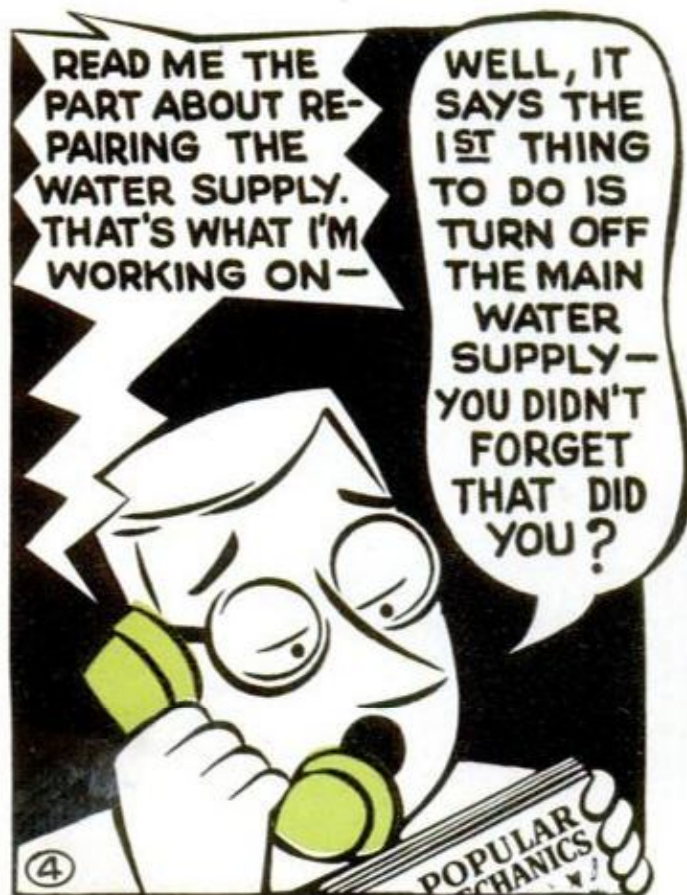
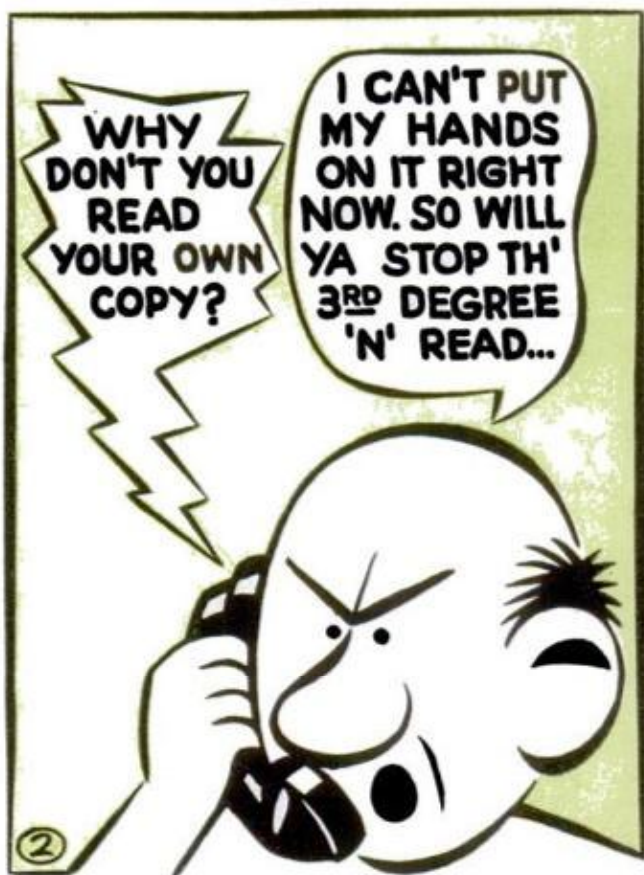

Not really the drip he appears to be, Bungle finds out last what you should do first when replacing a worn faucet washer—TURN THE WATER OFF!

O.K. O.K. IT STARTS OUT "CONTINUED DRIPPING AFTER A FAUCET HAS BEEN CLOSED USUALLY MEANS A WORN WASHER ..."

FAUCET PARTS

PACKING
CAP NUT
SPINDLE
WASHER
GROUND SEAT
LOCK NUT

TO REPLACE WASHER

- 1 Turn off water at meter.
- 2 Wrap cap nut with adhesive tape to protect finish.
- 3 Loosen cap nut with flat-jaw wrench.
- 4 Remove brass screw holding worn washer.
- 5 Measure for new washer.
- 6 Replace with one of the new press-fit swivel washers.
- 7 Screw stem back in place, turning it counterclockwise.
- 8 Replace cap nut.

REALLY, DOEY, YOU DON'T GIVE ME CREDIT FOR ANY BRAINS! NOW, I ASK YOU, COULD I HAVE DIALED YOUR NUMBER IF I HAD MY FINGER STUCK IN A PIPE?

WELL, I GUESS NOT

YA SEE THAT PROVES I'M NOT AS DUMB AS YOU THINK I AM —



Solving HOME PROBLEMS

1. WHEN THE LIGHTS go out during a nighttime thunderstorm, or on a cold winter night, the first thing you think of is a candle. You'll probably find the candle readily enough but where's the candlestick? Don't bother. Just grab a can of peaches, hold the candle against the side of can, snap a rubber band around both and you have a safe, nontipping candlestick

2. TIGHT BOTTLE CAPS that won't let go usually can be loosened easily with the aid of a strip of sandpaper. Fold strip the long way with abrasive side out and wrap it around cap. Then grip wrapping with one hand and hold bottle with the other. Abrasive on one side of fold will cut into metal of bottle cap. The other surface will prevent your hand from slipping

3. DON'T DISCARD or destroy an old wooden chair or stool. It's still worth something other than kindling wood. For example, it's a hose rack as you see pictured. And what can you find, other than a boughten hose reel, that will serve the purpose better? Such a rack, made by cutting back off an old chair and screwing to wall, holds 50 to 100 ft. of hose without kinks

4. MODERN GLUES will set quickly in the tip of the plastic bottle unless you replace the cap immediately after each period of use. Once the glue sets in the small opening in the tip it is difficult to remove. This trouble can be prevented simply by pressing the point of a thumbtack through the center of the cap as detailed. Point of tack keeps hole in bottle tip open

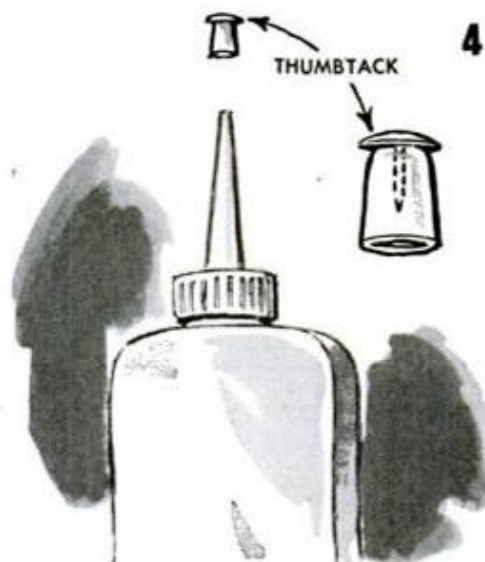
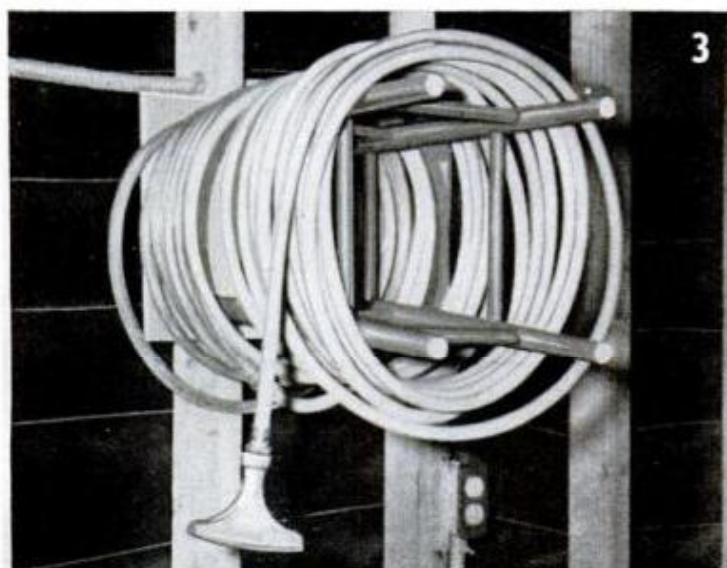



5. CONVENIENT CLIP accessory can be added to your pen-holder base with an inverted paper clamp. It will serve to hold important notes for quick reference or copy for typing at a comfortable angle. Bend one of the finger grips outward about 90 deg. just below the hole. Remove the pen holder from the base and hold the bent grip under it as you screw it back

6. FRUIT PIES often overflow and oven heat fuses sirupy drippings onto wire shelves and oven bottom, making drippings difficult to remove. Before you prepare pie and place in oven, shape aluminum foil over bottom of tin, then when ready to bake, place pie tin in shaped foil dish and expand sides slightly. Foil dish will catch drippings, save a tedious job of cleaning

7. KEEP GARDEN SPRAYS AND DUSTS out of reach of tots and tykes by placing them in empty 1-gal. paint cans with the friction covers closed tightly. Such covers can't be removed without skilful prying, something kids are not likely to try, even if they should reach cans. Sprays and dusts in small bags or cans may be hidden without removing from original containers

8. CHARCOAL added to the water in a vase of cut flowers makes them last much longer but charcoal gives the water a cloudy appearance which may be objectionable in a clear-glass vase. This can be overcome by placing bits of charcoal in a metal tea ball and suspending ball below water level and at the same time locating so that it is concealed by stems

9. DOUBLE CLOTHES TREE CAPACITY by placing four additional hooks at a point about halfway between base and top. Then you'll have a place for umbrellas and the youngsters can hang coats and snow suits on hooks they can easily reach. Use hooks that match the originals as nearly as possible, vary the height as indicated and attach to the column with small screws

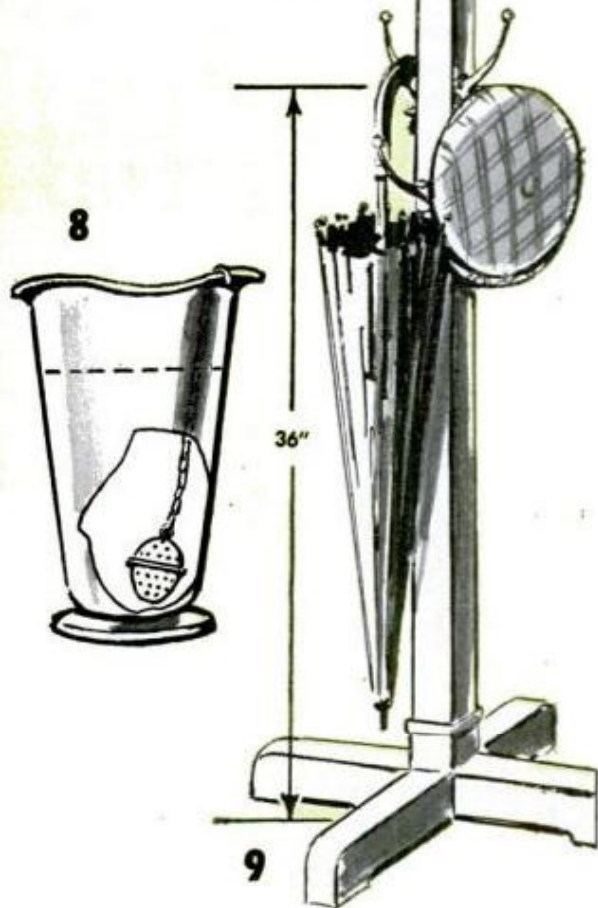



TRIPPING the shutter by foot through the use of a long cable release has a distinct advantage over a self-timer when taking your own picture—there's no waiting with mounting tension for the shutter to click. You simply shoot the instant you're ready. The foot tripper, of course, frees the hands when using a long cable release alone and allows shots to be self-posed where both hands are involved in the picture.

The drawing shows how this foot-operated tripper works. The finger grips on the release engage blind holes in the side brackets to hold it secure and pressure on the pivoted foot pedal operates the thumb plunger which in turn works the shutter. The foot pedal automatically returns to the ready position by means of the spring in the cable release.—*Manly Banister*

PHOTOS BY THE FOOT

OPERATING THE SHUTTER REMOTELY with the foot will bring much better results with subjects that are likely to freeze or become self-conscious and you will get your picture with less effort. Removable side permits detaching cable release for hand control

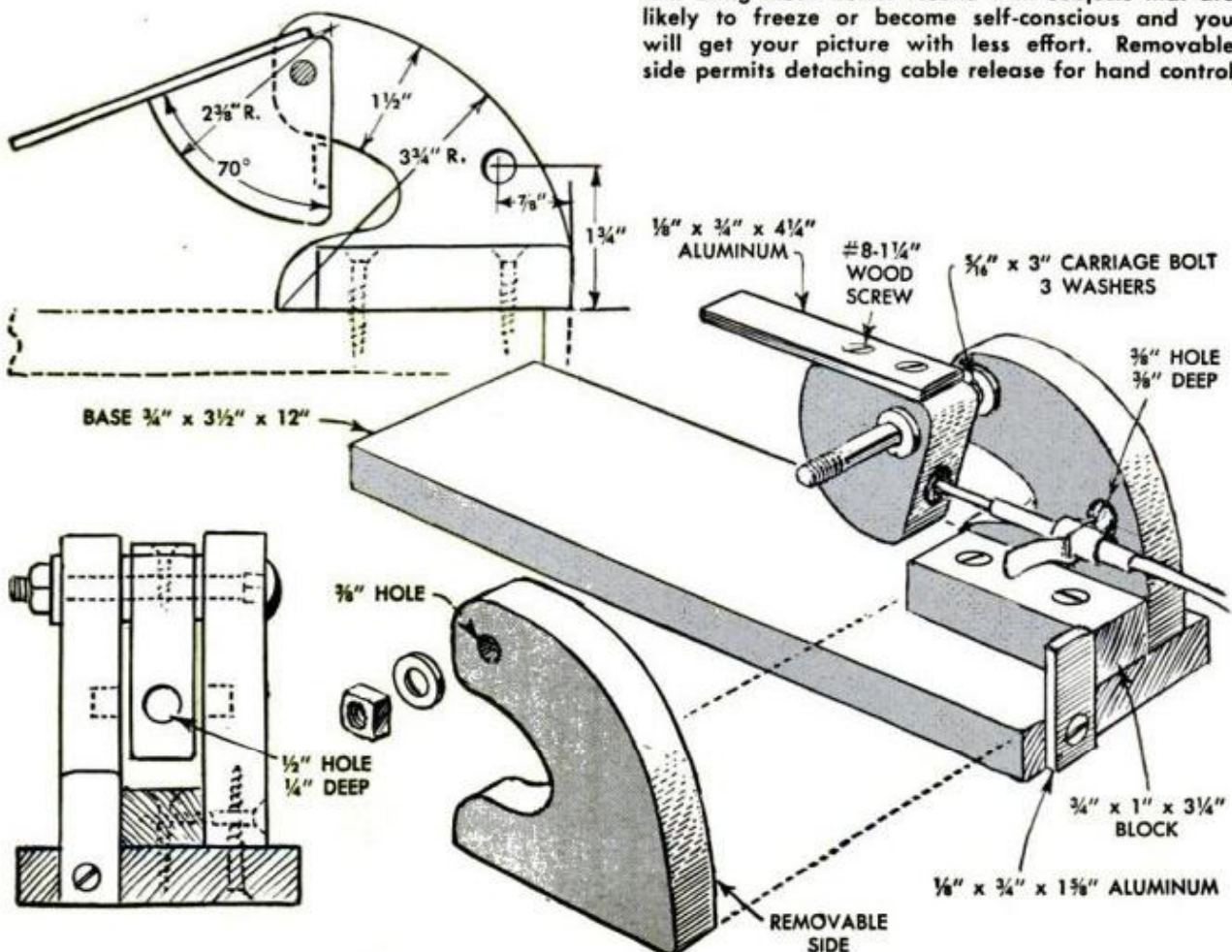

FOR SHUTTERBUGS

1. MAGNETIC RECORDER-REPRODUCER unit makes a perfectly synchronized sound camera out of most 16-mm. movie cameras. Light in weight for fast hand-held shooting and recording. Twin tracks record lip-sync sound and dubbed background effects. Fully transistorized with remote hand mixer. Magnasync Corp., 5546 Satsuma Ave., N. Hollywood, Calif.

2. SLIDE VIEWER for 16 mm. lets you see your sub-miniature transparencies as big, brilliant, lifelike images. Two penlight batteries provide bright, even illumination and the focusing optical eyepiece gives a sharp, clear picture. A strip-film carrier for unmounted slides is included. Priced at \$5.95. The FR Corp., 951 Brook Ave., New York 51, N. Y.

3. COMPACT ELECTRONIC FLASH units with transistor-controlled circuits and exclusive sunlight converters are available in either one or two-piece units. The latter also can be mounted on the camera as a single unit with a special cord reel in the power pack to retract the cord. Each unit sells for \$69.95. Burleigh Brooks Inc., 420 Grand Ave., Englewood, N. J.

4. PHOTOCELL PRINT TIMER measures and controls exposures by automatically turning off the enlarger light when correct exposure time has been reached. Interchangeable optical system permits control from smaller areas of the negative. Foot-switch outlets allow control when focusing or timing. Fotomatic Corp., 2603 Kessler Blvd., N. Dr., Indianapolis 22, Ind.

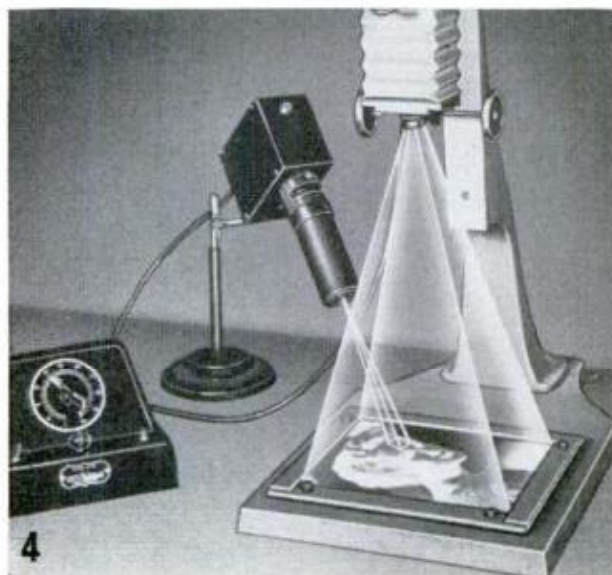
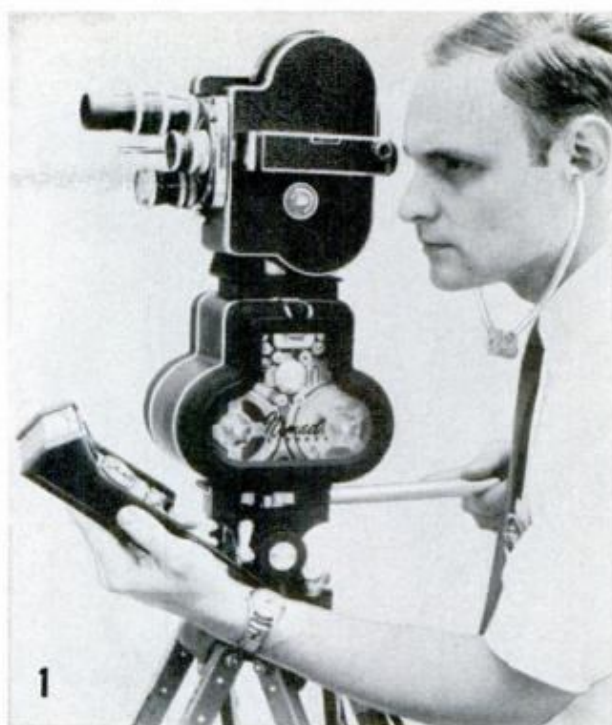

3

4



KEEP THESE IN MIND

Scooter-Board Fun

Riding this sidewalk scooter board is as tricky as riding the surf—it requires balance and then some, which comes only with considerable practice. It makes use of the front and rear parts of a single roller skate, which are separated and securely fastened to the bottom of a 1 x 6 board about 24 in. long. Extra blocks of wood provide clearance for the heel and toe clamps when attaching the skate wheels to the board. In this way, the skate is not altered in any way and can be reassembled and used for skating. The board can be covered with a rubber stair tread.—*Robert B. Ryan*

When drawing or tracing a pattern on aluminum foil you'll find that a ball-point pen makes a good substitute for a stylus. The ball point won't tear the foil yet will make a crease which is easily seen.

Saw Fills in as Grinder

If your shop isn't equipped with a regular bench grinder, your table saw can pinch hit by simply removing the blade and mounting a grinding wheel on the saw arbor. A block of wood, serving as a tool rest, permits the tool to be held at the proper angle and a neat way of temporarily fastening it to the saw table is to attach it to strips of wood positioned to engage the miter gauge grooves in the table. When grinding, dip the tool in water frequently to prevent overheating and drawing the temper, or use a vitreous grinding wheel.—*Harry S. Scholl*



COMING UP NEXT...

Colonial settle. In early American homes the settle was a mainstay of the furnishings. The high back fended off cold drafts, there was a drop shelf for a candle, a handy storage space under the hinged seat. Now once again the settle finds a place in modern homes. See October *PM* for construction details.

How to fix it. How do I fix a balky iron, a toaster that doesn't work, a vacuum cleaner that doesn't clean or a coffee pot that refuses to perk? You've asked the questions and now *PM* comes up with the answers in the "Fix-It File," a new series starting in the October issue. Don't miss the first one.

Uses for propane torch. A propane torch is hot, 2300 degrees of it! It's a portable, pencil-size, furnace-hot flame that you light with a match and take wherever it's needed. After you've read about propane torches in October *PM* you'll agree that here's about the nearest thing to an all-around tool.

Time to weather strip. Weather stripping can stand between you and a cold winter, can reduce fuel bills and induce draftless comfort from October to June. And there's a form of weather stripping for every window, every door, every crack. Next month's issue covers all kinds and tells how to install them.

SPICE CHEST

By Jackson Hand

Here's a faithful copy of a spice cabinet in which great-grandmother stored sage, pepper, cinnamon, and other spices

WALL-HUNG spice cabinets probably were favorite do-it-yourself projects of early American craftsmen, for they not only served a very useful purpose but were easy to make with hand tools. The cabinet illustrated is a copy of an authentic antique and is here reproduced in complete detail for easy construction. While you can make it entirely with hand tools, a table saw and a jigsaw will speed the work.

White pine in $\frac{1}{2}$ -in. solid stock is used for all parts, except the $\frac{1}{4}$ -in. plywood drawer bottoms and sides which in the



1. AFTER OUTLINING back, drawer dividers and rails on pine stock, back is cut to shape on jigsaw

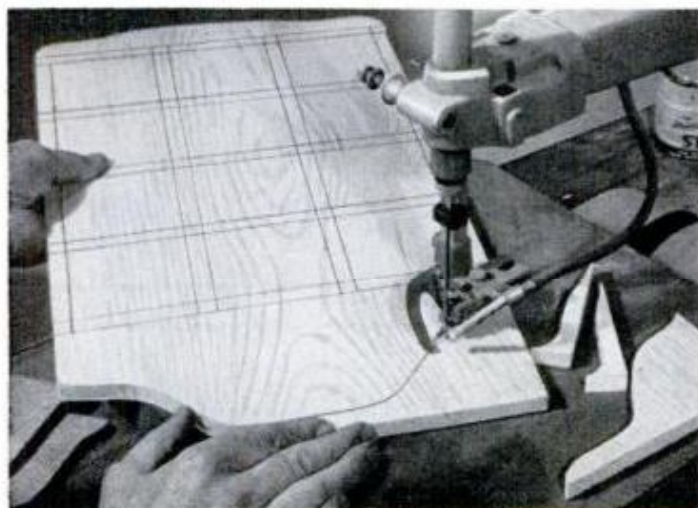

2. DRAWER dividers and rails are cut to uniform length with aid of stop block clamped to rip fence

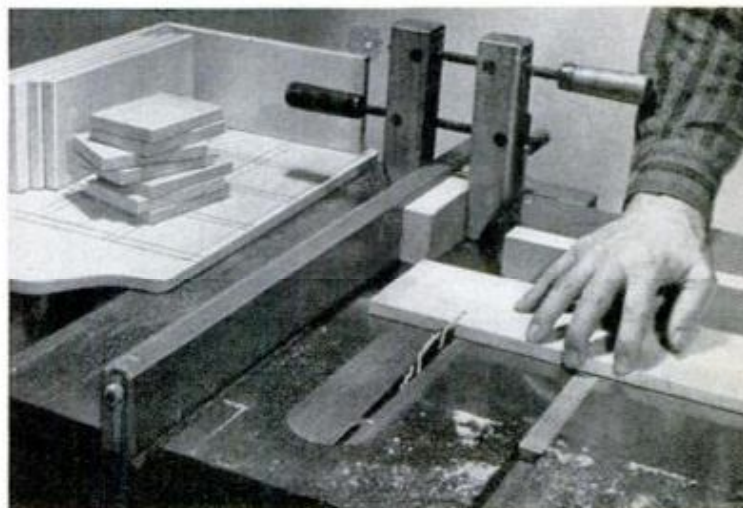

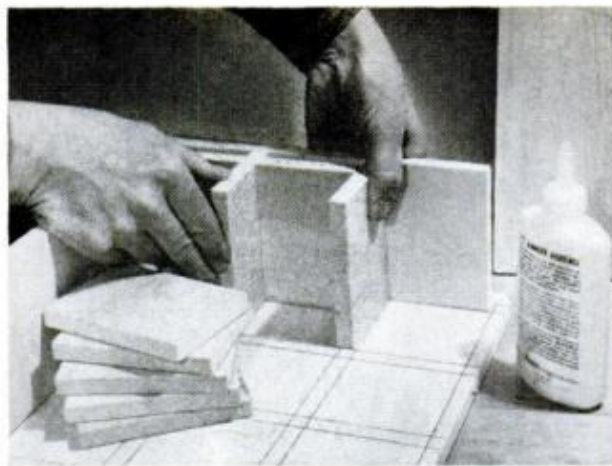
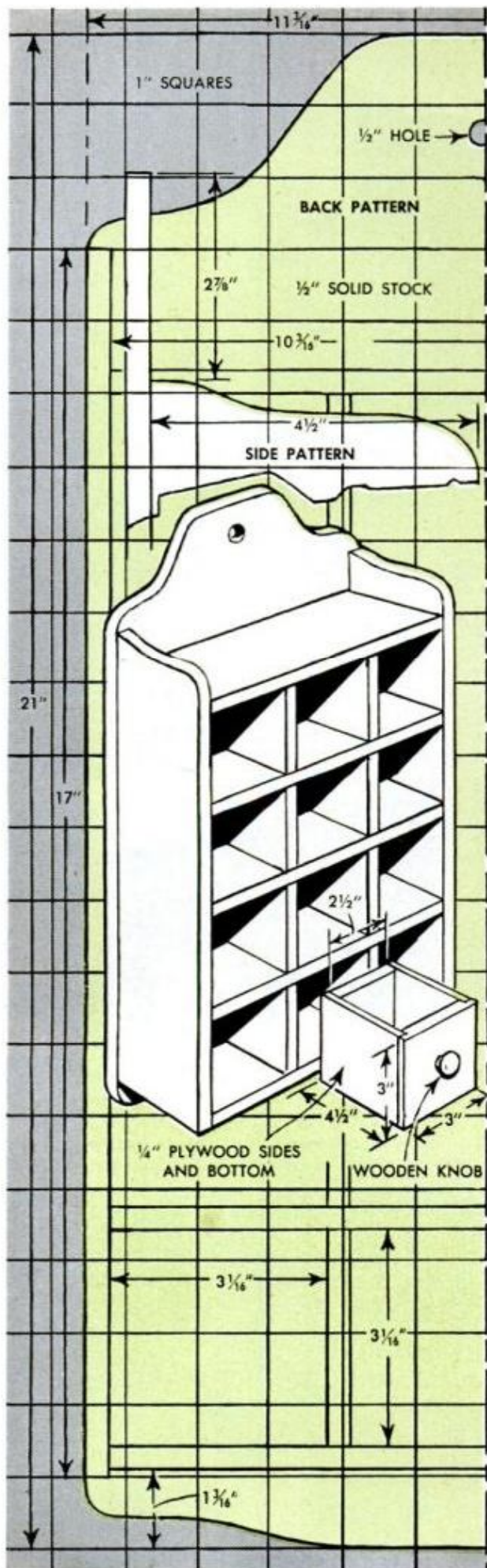

3. BACK IS first nailed and glued to one side and bottom. Dividers go on next, then rail and so on

original were of 1/4-in. solid stock. All joints are glued and nailed. The exterior surfaces are stained a medium brown color, using a wiping stain especially developed for use on pine. All inside surfaces, except insides of drawers, are enameled in turquoise.

The main steps in the assembly sequence are shown in Figs. 1, 2, 3, and 4. Holes for the knobs should be drilled before putting the drawers together. The squared drawing at the left gives the patterns for the back and sides. Locations of the drawer dividers and rails are laid out directly on the cabinet back. All exposed edges of the completed cabinet are rounded off with sandpaper, unevenly in some places to simulate wear. ★ ★ ★

4. CABINET BACK is clamped in bench vise for easy nailing of drawer rails. The left side goes on last

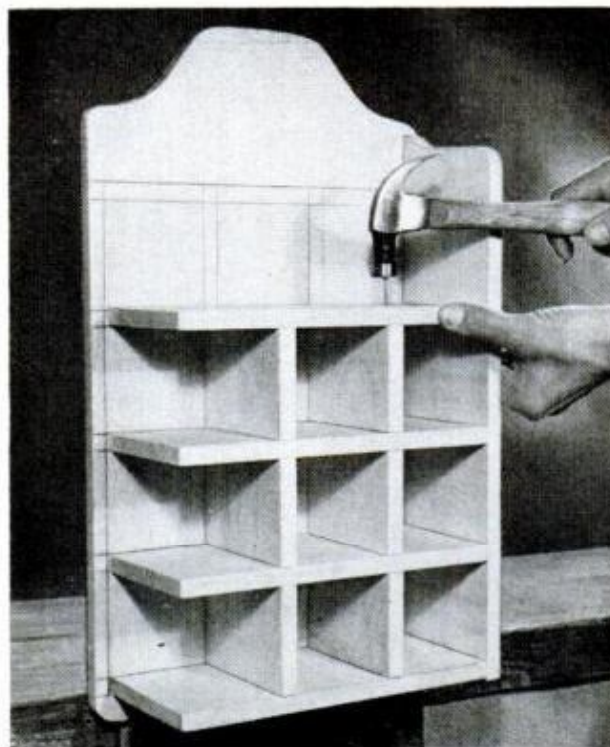

FOR THE MOTORIST

Hook Seizes Springs

Replacing sealed-beam headlights in some cars requires removing and replacing the springs that hold them in place. Set back in the recess as they are, there are few tools that can reach these springs through the narrow opening. A handy tool for this purpose is a small steel hook to which you weld or solder a short steel bar across the end, forming a T shape. With this tool you can unhook and replace the spring easily.
—Phil Lance

Removing metal particles from crankcase oil is easily done with a magnetized dipstick. Wrap it with about 10 to 15 turns of 20-ga. insulated wire with about 1 in. skinned off each end. Touch the bared end to the battery terminals for a few seconds then remove the coiled wire from the dipstick which is now magnetized.

Ring Short Burns Finger

Man, watch yourself! Before reaching down among battery or starter terminals remove any rings you have on your fingers and your wristwatch. Any metal object can cause a short circuit and a ring or watch would be most likely to invite a short, with painful results. A ring will become red hot almost instantly and severely burn your finger.—Charles H. Hardy

Removing stubborn screws can be done much easier and quicker by dipping the screwdriver tip into coarse valve-grinding compound. This abrasive coating will provide extra bite to prevent the blade from slipping out of the slot and burring it.

Foil Stubborn Spots

Spots on automotive chrome and stainless steel that are too tough for ordinary cleaners usually yield to a hard rubbing with aluminum foil. Save the used foil you usually throw away because, though crumpled, it is still a good polisher for chrome plating. Form it into a wad and use as a scouring pad, rubbing with a firm pressure to remove tarnish and other discolorations and restore the luster.—Alan Linn

When parked in a position where booster battery cables will not reach, simply ease the bumper of one car against the other. Connect the two cables to make one long one and clamp each end to the positive battery post of each car, making a circuit.

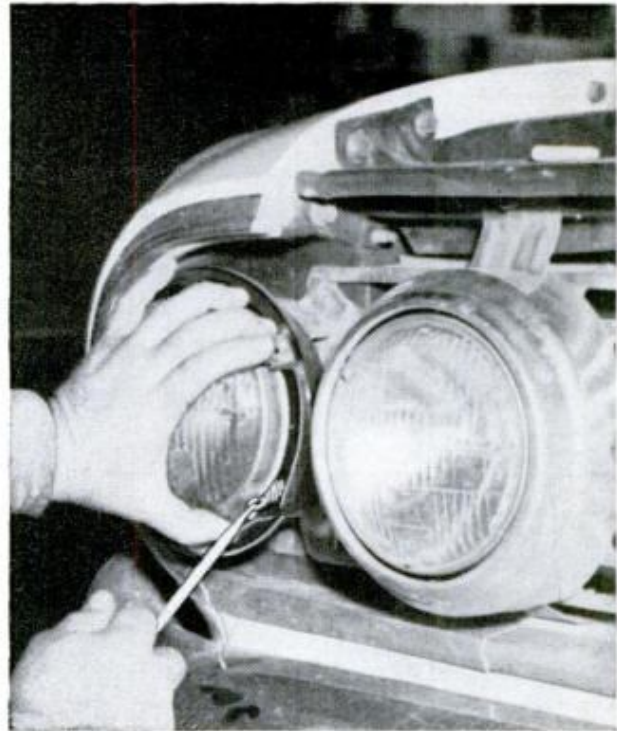



FARM TIMESAVERS

Guard That Tumbling Rod!

Serious and even fatal accidents have been caused by unguarded tumbling rods. A dangling coat or shirt sleeve or a loose trouser leg can catch and wind on the rod in an instant, resulting in a broken arm or leg, or worse. A long rod, such as that pictured, can be safely guarded with a length or two of downspout which, when slipped over the rod, will turn independent of it and thus offer sure protection to those who must work nearby when the equipment is operating. Downspout must cover the entire length of the rod to be effective.

—A. M. Wettach

A discarded tub from a wringer-type washer is easily converted to use as a rock-salt container or supplement feeder for cattle on pasture. Such tubs usually are porcelain enameled and quite durable. Rain water drains away through openings in the bottom.

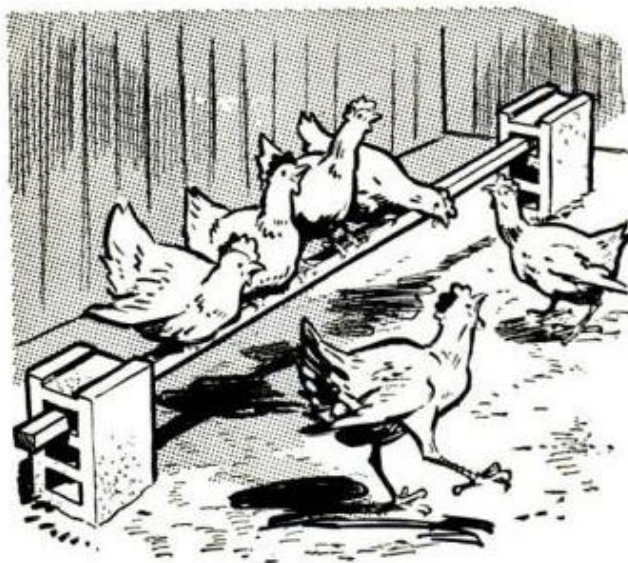

Roosts Grow Up With Chicks

Young chicks learn to roost early when you provide them with these adjustable perches. To start the training period, place two concrete blocks on end and slip the ends of the perch through the lower openings in the blocks. Then, as the chicks grow in size, simply raise the perch, first to the second, and then to the third hole in each block. Use 2 x 2s for perches.

—Ann Zawistowski

When making feeders for chicks fit end pieces 6 to 8 in. high and drill a hole for a 3/4-in. dowel near the top of each. Cut bottoms out of tin cans, slip the cans over the dowel and pass ends of the dowel through the holes. A spinner made in this way prevents chicks from roosting on top of the feeder.



Sunshades Follow Turkeys

Range turkeys are always provided with shelter and shade with these light, portable sunshades, each of which will accommodate about 200 birds. The frame is assembled from 2 x 4s and covered with 2 x 8 sheets of corrugated roofing. Each T-shaped sill forms a runner and is made by laying one 2 x 4 flat and spiking another to it on edge. The rafters, each about 10 ft. long, are nailed to these sills. Purlins between the rafters provide nailing strips for the corrugated roofing. The structure is braced diagonally as indicated.



Jaguar's new XK-E convertible

Jaguar engineers specify
Champion spark plugs
because they demand the utmost
in quality and performance.
Why settle for less in your car?



CHAMPION

New Ideas in Photography

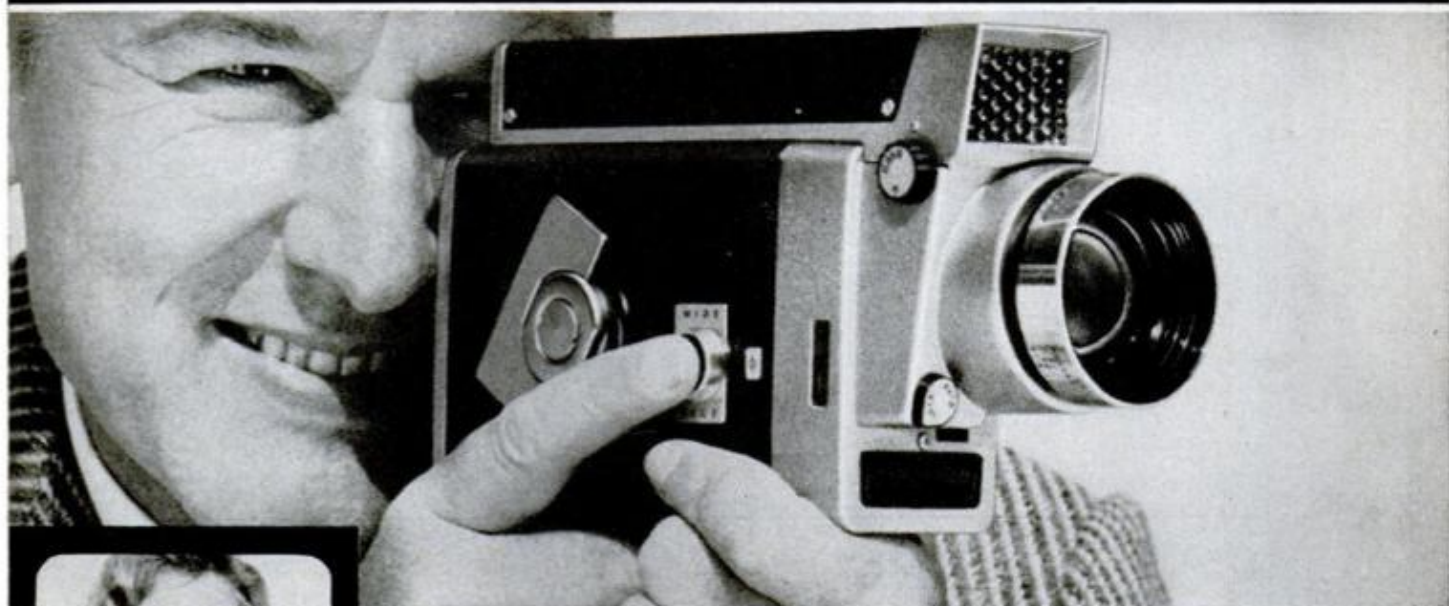

ZOOM LENS is controlled by the same button and the same motor that operate the camera. Push up for wide-angle, down for telephoto—or stop anywhere between or zoom manually for special effects.

Dramatic movie zoom close-ups made easy by new Reflex Camera

Dramatic ultra-close zoom shots are easy with a Kodak Zoom 8 Reflex Camera—because you do your viewing right through the taking lens! There's no framing error—even at close range!

With this movie camera, you can show a face—then safely zoom in for expressive eyes . . . or for a youngster's missing front tooth . . . or for an identifying badge on a cap. You know the framing will be

exactly right! You can picture a flower bed—then zoom in confidently for the center beauty. Or show a single bloom, then zoom in for the butterfly on it!

The camera's motor-driven lens lets you zoom in and out with professional smoothness. Electric eye adjusts exposure automatically. A meter lock lets you switch from automatic to manual exposure control whenever you choose.

Kodak Zoom 8 Reflex Camera is less than \$200. Other Kodak movie cameras from less than \$27.

BEAM-SPLITTER lets you see in viewfinder the exact picture going to the film. It is an angled glass disc with a small translucent mirror spot in the center. Part of the light hitting the spot is reflected to the eyepiece—to produce a sharp, clear image.



EXTREME CLOSE-UP MOVIE ZOOM is simple with Kodak Zoom 8 Reflex Camera. Through-the-lens viewing lets you compose your picture precisely. Low-cost Kodak Portra Lenses, attached to camera lens, let you come as close as 16 inches to your subject.

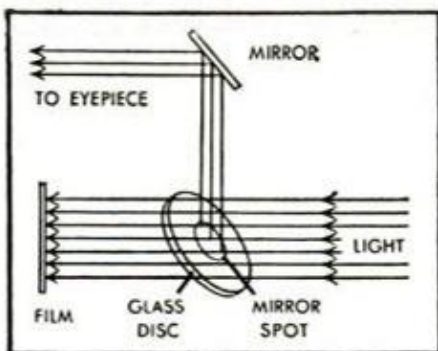

from Kodak

New automatic cameras solve old problems of outdoor action

Two Kodak automatic 35mm cameras are bringing new freedom to outdoor picture-taking—where action is fast and conditions change quickly.

The Kodak Motormatic 35 Camera and Kodak Retina Automatic III Camera not only set the exposure for you automatically—they also let you select fast shutter speeds to handle fast action. And the Motormatic 35 Camera even advances the film for you—keeps you always ready for the next shot!

Fast action is only one outdoor problem—when picturing sports or frolicking kids, for example. Variable light is another—as when clouds are passing across the sun. And going from sun into shade is a third.

Fast shutters . . . electric eyes

The Kodak Motormatic 35 and Retina Automatic III Cameras handle all these situations easily. On the Kodak Motormatic 35 Camera, you can set the shutter up to 1/250—on the Kodak Retina Automatic III Camera, all the way to 1/500 second.

And each camera has an electric eye which reads the light continuously. When you press the shutter release, your lens instantly sets to the right opening.

Manual setting, too

If you wish, you can set either camera manually. The Kodak Retina Automatic III Camera also has a precision lens-coupled rangefinder for measuring distance. And the Kodak Motormatic 35 Camera has a special linkage for flash shots—as you change focus, the lens opening automatically adjusts for correct flash exposure.

Examine these remarkable ultra-modern cameras. One is just right for *your* kind of outdoor picture-taking.

See your dealer for exact retail prices. Many dealers offer terms as low as 10% down.

EASTMAN KODAK COMPANY, Rochester 4, N.Y.

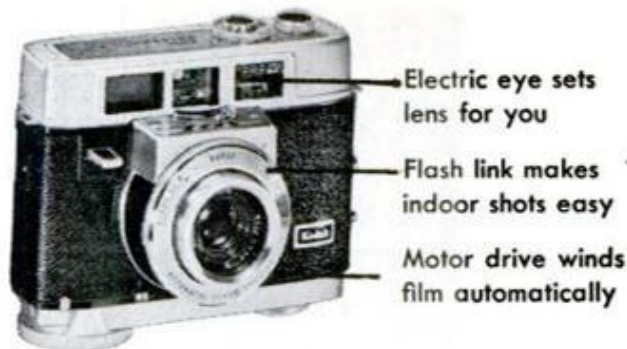

KODAK MOTORMATIC 35 CAMERA can take 10 shots in 10 seconds! After each shot, a tiny spring motor swiftly advances the film, cocks the shutter. Fast $f/2.8$ lens. Fully automatic lens setting. Full manual control. With this camera, you can keep your eye glued on the action, ready for the best shots, no matter how fast they come. For flash pictures 5 to 25 feet from subject, setting focus automatically sets correct lens opening. Less than \$110.

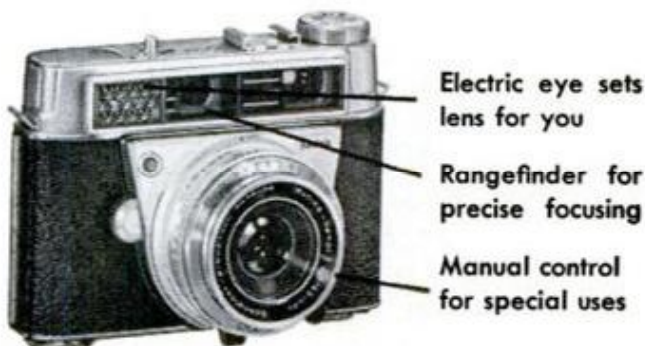

KODAK RETINA AUTOMATIC III CAMERA has superb Retina Xenar $f/2.8$ Lens. Fully automatic exposure setting, with override for manual control. Fast single-stroke film wind. Coupled rangefinder. Depth-of-field scale. ASA film settings from 10 to 1250. Shutter release locks if light is too dim or too bright. Less than \$130.

Now—snap fast action in color!

This weekend, start exploring the new picture possibilities opened by Kodak's ultra-fast 35 mm color film, *Kodak High-Speed Ektachrome*. With a sizzling daylight index of 160, it lets you take action shots in color that once were out of the question. Lets you get greater depth of field. Permits many indoor available-light shots with the camera *handheld*. Try it!

Prices subject to change without notice.

Kodak
TRADEMARK

CLINIC FOR HOMEMAKERS

As a service to our readers in solving the hundreds of problems pertaining to a home—inside or out—editors of Popular Mechanics invite you to present your problems to The Clinic Editor for help and advice. Address your questions to The Clinic Editor, Popular Mechanics Magazine, 200 East Ontario Street, Chicago 11, Ill.

Laying Floor Tile

Q—I have taken up the old linoleum in my kitchen and I want to lay rubber or vinyl tile. The present floor consists of a tongued-and-grooved subfloor and a top floor of the same material. The subfloor is laid diagonally and the top floor boards straight, that is, at right angles to two walls. The top floor boards are warped, or cupped rather badly, so much so that the ridges showed in the old linoleum. Both the subfloor and top-floor boards appear to be loose from the joists. How should I proceed to lay a permanent, faultless tile floor in my kitchen?—O.M., Mass.

A—We wouldn't know about a "permanent, faultless" floor but we can go so far as to say that a good, sound tile floor can be laid over the present rough floor in your kitchen if you take the time and expend the effort necessary to prepare the surface properly, and lay the tile according to accepted practice. We will offer suggestions, but what we have to say should not in any way supersede what the manufacturer of the tile gives as the proper procedure. As a first step the old floor should be renailed, using nails that are long enough to go through the top floor, the subfloor and well into the joists. Two nails through each board at each joist should do it. Set the heads of both the new and original nails well below the surface. Next, use a hand

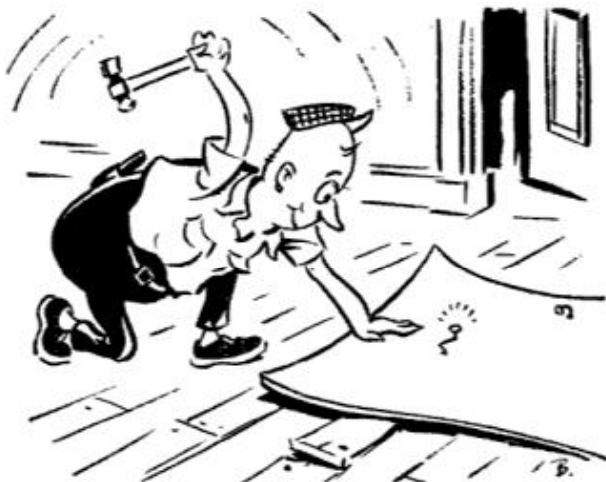

plane to level the cupped top boards. This is tedious work but it will pay well to take time to do a thorough job. Follow with an underlayment of tempered hardboard. Although 1/8-in. hardboard is often used over floors in good condition, we think it advisable to use 1/4-in. hardboard as underlayment over your floor, even though the cost will be somewhat higher. Then you're ready to spread cement and lay your tile and here's where you follow the tile manufacturer's instructions in every detail.

Water Hammer?

Q—When I open the cold-water faucet in my bathroom lavatory I get a rapid hammering sound which is most annoying if not damaging. Certainly there is a lot of vibration in the water pipes. I knew of another similar instance where just such a noise



was produced in the home plumbing. This was referred to as "water hammer" and as a remedy the plumber installed what he called an air chamber on one of the water pipes. That's what I directed my plumber to do, but he says that an air chamber, or whatever it is, is not necessary. He says that the threads on the faucet stem are loose and that this looseness is causing the noise. He says he will replace the faucet or fix it, whichever I say. Sounds ridiculous to me. Can he be right?—M.V., Ind.

A—He is right. And we would suggest you have him replace the old faucet with a new one. It will be cheaper and more satisfactory in the end, as the old faucet threads are badly worn. It would take considerable time to effect even a temporary cure of the trouble, using the old faucet, as the threads would have to be upset with rows of punch or chisel marks in order to tighten them sufficiently to prevent vibration of the faucet stem when opened. Sometimes this fault can be corrected temporarily by replacing the seat washer and repacking the gland, but in sections where the water is very hard such a repair cannot be relied on. ★ ★ ★

Lay your hammer in the Rocket's shadow and compare them point by point. You'll find out why the True Temper Rocket is a better way to drive a nail. Then go to your hardware store and heft a Rocket. It's the greatest feeling in hammering

No. A16

\$5.49

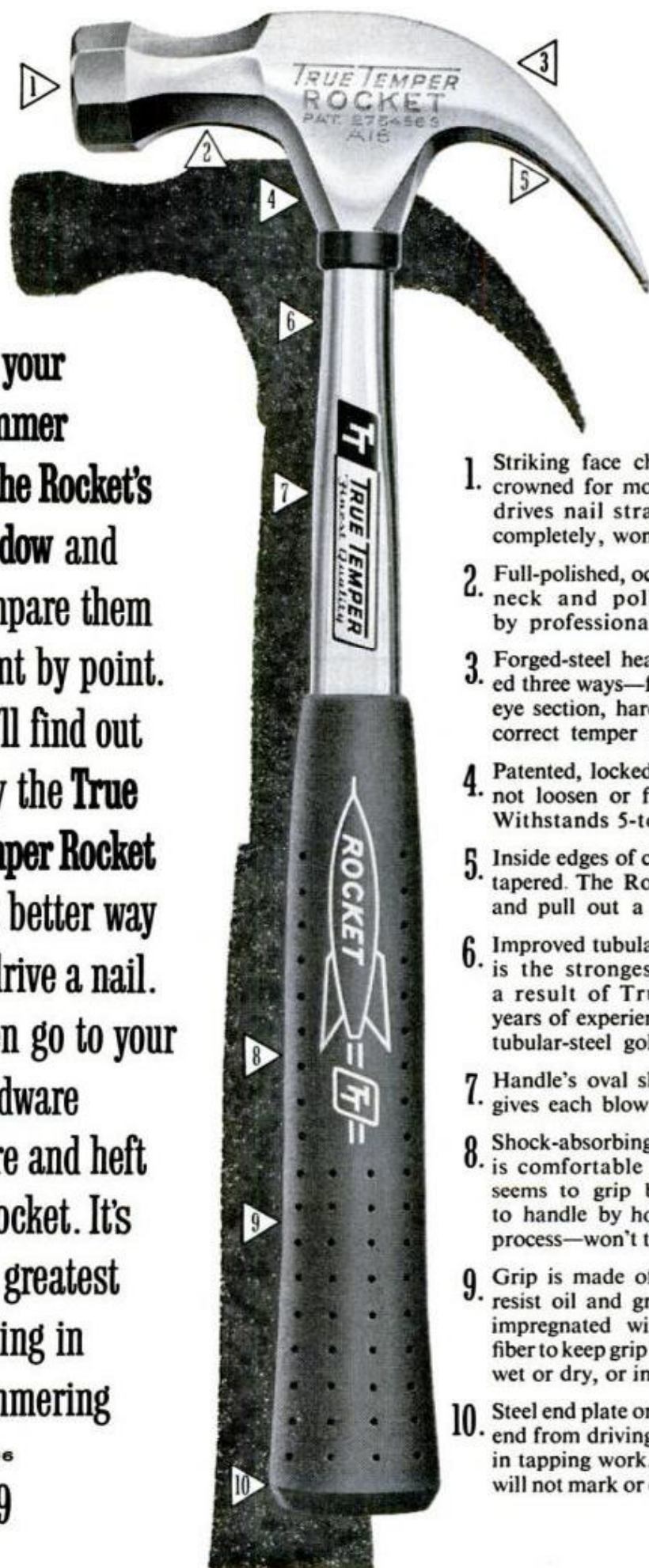

1. Striking face chamfered and crowned for more durability; drives nail straighter, more completely, won't mar wood.
2. Full-polished, octagon-pattern neck and poll—preferred by professional carpenters.
3. Forged-steel head, heat-treated three ways—for strength at eye section, hardness of face, correct temper in the claws.
4. Patented, locked-on head will not loosen or fly off in use. Withstands 5-ton pull tests.
5. Inside edges of claws precisely tapered. The Rocket will bite and pull out a *headless nail*.
6. Improved tubular-steel handle is the strongest made. It's a result of True Temper's years of experience in making tubular-steel golf-club shafts.
7. Handle's oval shape actually gives each blow more power.
8. Shock-absorbing cushion grip is comfortable and lively—seems to grip back. Bonded to handle by hot vulcanizing process—won't turn or loosen.
9. Grip is made of neoprene to resist oil and grease, and it's impregnated with pulverized fiber to keep grip from slipping, wet or dry, or in gloved hand.
10. Steel end plate on handle keeps end from driving through grip in tapping work. Cushion end will not mark or damage work.

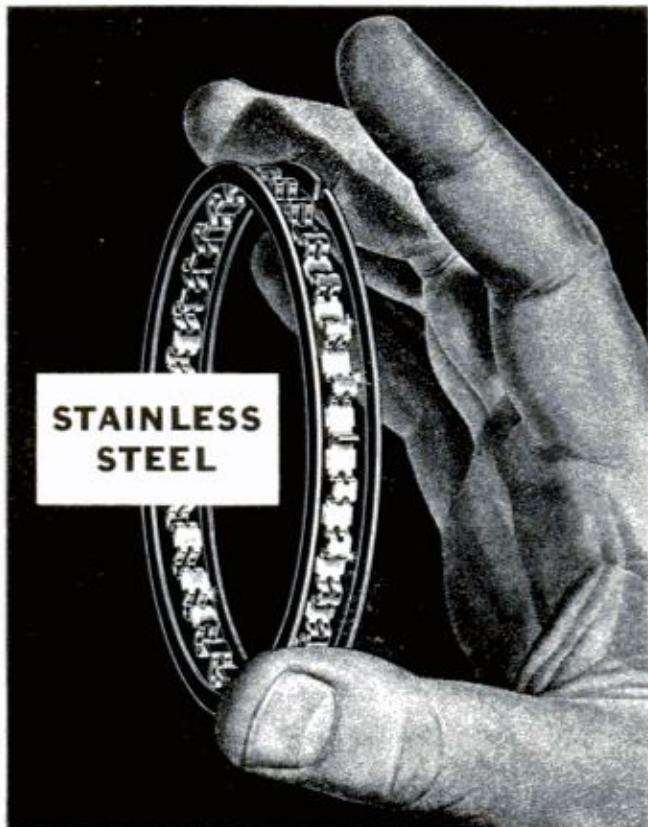

U.S. Pat. No. 2,789,872

WHY DO SEALED POWER STAINLESS STEEL OIL RINGS GIVE BETTER OIL CONTROL?

It's as simple as this: Sealed Power oil rings control oil better (and longer) because they are of Stainless Steel—the finest metal yet developed for an oil ring.

Stainless Steel won't rust and it resists pitting and etching effects of gases. The oil ring surface stays bright and clean, there is nothing for carbon to cling to. Return oil vents remain open so that oil flows freely back to the crankcase.

Stainless Steel retains its tension at operating temperatures far better than carbon steel. And Sealed Power's patented end-abutment design produces proper ring tension independently of contact with bottom of piston groove. Result? No groove depth problems. Chrome-plated side rails seat instantly, of course. Sealed Power Corporation, Muskegon, Michigan.

Sealed Power Stainless Steel
oil rings stop oil pumping

Inboard-Outboard Drives

(Continued from page 214)

Recommended uses for inboard engines are for main or auxiliary power for boats requiring more than 200 hp. and applications for which an outboard motor or in-out power is not suited. The latter category would include sailing auxiliaries over 30 ft. in length and situations for which the additional cost of the outboard drive cannot be justified.

Advantages of conventional inboard: Considerably less expensive than an in-out, when no reduction gear is required for an installation. Inboards do not have their transoms cluttered with propulsion machinery and therefore, are best when considered strictly from an aesthetic viewpoint. With the propeller located further forward and lower in the water than is normal for most stern-mounted drive units, there is less chance of cavitation (power loss from the prop turning in an air or air-water medium) when operating in rough water, a fine point of performance.

Installation of an in-out unit and engine is easy as shown in Figs. 6, 7, 8, 10 and 11. The captions explain the important steps, from converting an outboard transom to take the installation, to providing a housing for the engine. As mentioned previously, there are no complicated alignment problems, or of drilling a long shallow-angled hole through the boat bottom to take the prop shaft. The latter must be done very precisely to avoid binding, vibration and leaks, which rob the engine of power. The most important step in any installation is locating the transom hole through which the drive shaft passes and over which the drive unit is mounted. A single-unit installation should have the anticavitation plate slightly below the bottom of the boat (at the transom) on the centerline, although this will vary slightly depending upon the size of boat. Such specific instruction usually is provided in the installation manual, as well as all necessary templates for layout of holes to be drilled or cut. Units that depend upon the transom for primary support, should have that part of the boat beefed up as indicated in Fig. 7. If most of the weight of the engine is to be borne by the boat bottom, husky engine stringers should be installed to distribute the load evenly. All of this comment applies primarily to boats designed for outboard power, as an inboard hull presumably would incorporate the required design features for installation of an inboard engine. If in doubt, the engine manufacturer is your best source of information, next to a marine architect. ★ ★ ★

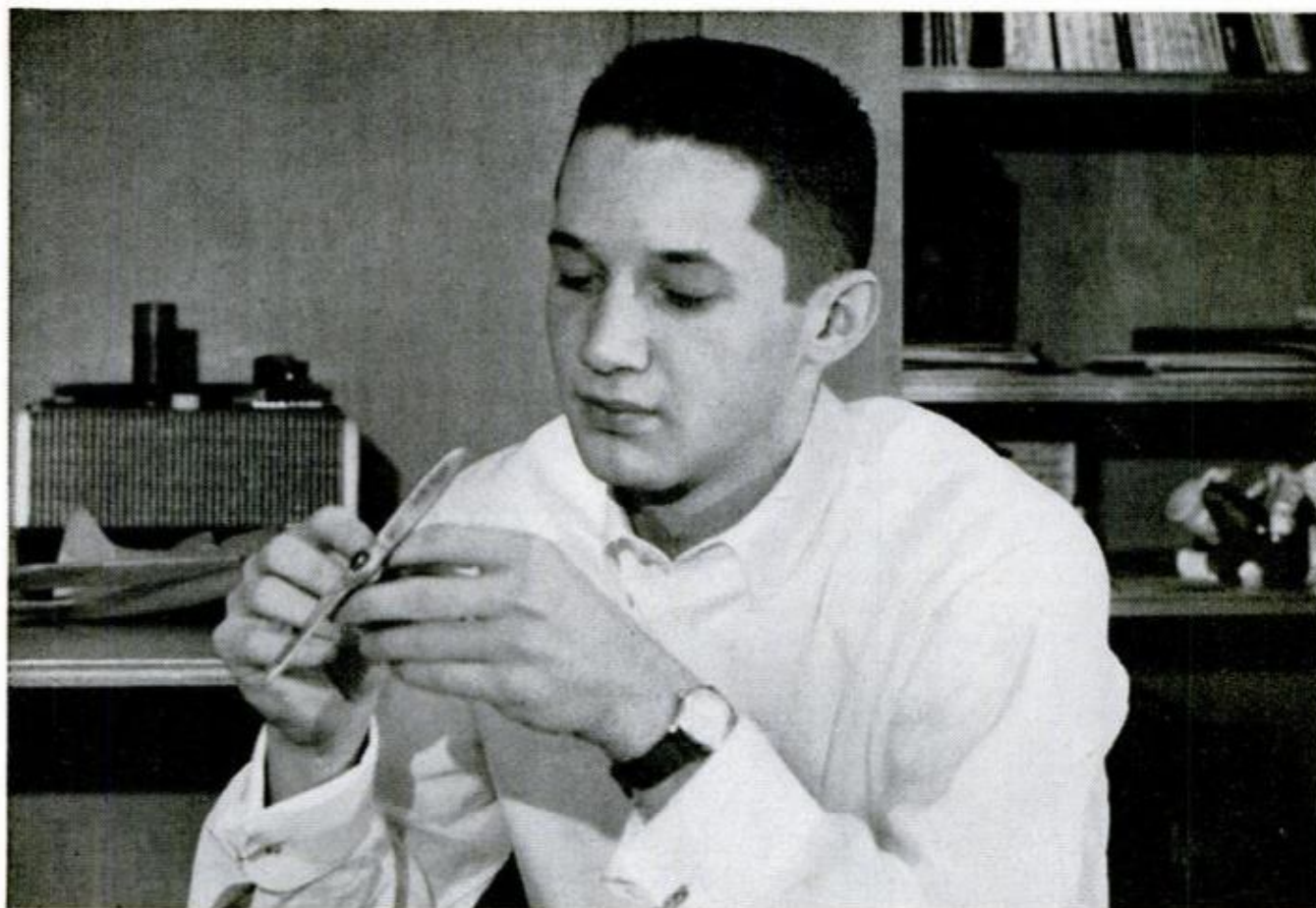

Career-minded Jay C. Douglass of Elizabethtown, Pa., asked...

“How should I get started?”

This year some 100,000 ambitious young people will answer this question the same way Jay Douglass did—they will become members of the Air Force. The road they will start upon leads straight into the Aerospace Age. And the organization of which they will become a part is the most important one in our world. For it is our country's first line of defense.

In time to come many of these young men will advance to the role of skilled technicians in such fields as airplane and missile maintenance, communications

equipment, computers, radar. A number of these young men will enter the vital support specialties—administration, supply, air police...to name a few. Any one of these career fields holds the promise of a bright and rewarding future—a future *you* should know about in detail right now.

Getting started in the right job, is important to any young man...or any young woman. To find out if your start might best be made in Air Force blue, clip and mail this coupon.

U. S. Air Force



Airman 2C Douglass is presently working as an electronics specialist at Duluth Air Base, Minnesota. As Air Force aptitude tests indicated, he finds he can handle his job well. He feels he has made a good start.



Career Information

Dept. MM19, Box 7608
Washington 4, D. C.

I am a citizen (or resident) of the U.S.A. Please send me your illustrated booklet.

Name _____ Age _____

Address _____

City _____ County _____ State _____

10 Minutes to Survival

(Continued from page 160)

survival, but once the ammunition is gone the weapon becomes worthless. Good fishing gear is not likely to deteriorate; with care it can be used indefinitely. There's no time for sport fishing, but a reel can be stripped of line to be cut into pieces and used for a series of bank lines. Hooks can be removed from an artificial lure and used on the lines with natural baits.

After several days of poor fishing, we finally caught a 20-pound carp. At last, we thought, we would get our fill of fish. We sliced off thick steaks along the carp's sides and roasted them over a bed of coals. But the flesh, particularly the dark streak along the side which we should have removed, was repulsive and the odor which remained on our hands was sickening. It nauseated us.

Which Gun for Survival?

Any gun would do for a survival weapon, but there are some guns which are better than others. During our 10-minute alert, I had a choice of four weapons—12-gauge shotgun, .22 rim-fire rifle, .22 rim-fire magnum rifle, and .22 rim-fire handgun—and about 300 rounds of ammunition.

I weighed the factors fast. A shotgun is good on running game but it has its drawbacks. Range is one, bulkiness of ammunition another. Still another is muzzle blast. Yes, in a real survival situation a person would wish to be left alone. People will be roaming through the woods, hunger overpowering any habits of decency. They'd stop at nothing to get something to eat, not even killing or stealing from others. So isolation is important.

The .22 magnum was discarded as impractical. So I had it condensed to two weapons, both .22 caliber, the scope-sighted automatic rifle and the revolver.

It wasn't a difficult choice. Except for close-range self defense, portability and concealment, the handgun isn't in the class with the rifle. Certainly not in the hunting woods where accuracy outweighs the other factors mentioned. A scope-sighted .22 rifle hunter can place his shots, ruining little meat. He can easily kill small game up to 50 yards, and farther if he is a marksman. A well-placed head, neck, or heart shot will kill a deer or a cow—and a man, if necessary.

One of the nicest things of all about the .22 rifle, however, is that the ammunition is light, compact and cheap. A person can keep an adequate supply on hand. Five hundred rounds, eight or nine dollar's worth, will keep for years and keep the average hunter in meat for six months or

longer. The trick is being a deliberate, thorough hunter. This means hunting when wildlife is most active and unsuspecting—from daybreak to sunup and again from sundown to dusk—and working quietly and slowly for close-range, standing shots.

I had two boxes of .22 long rifle ammunition, 100 rounds. I used about 38 cartridges, and kept meat on the table through most of our stay.

Game meat became our one staple food, but cooking game presented problems. Generally the flesh of wild animals is dry, with little fat. In nature's scheme of things, where animals prey on each other, food is scarce and animals are gaunt, lean and muscular. The few exceptions are the animals which have porklike flesh, creatures such as opossums and armadillos.

All of our meat either was cooked on a spit over a bed of coals or boiled in a stew. Another possibility is baking by burying fish or game wrapped in leaves or mud in a hole filled with hot stones, then building another fire over the spot where the food is buried. We never had time.

We built a fireplace of stones carried from the creek bed. We built a fire near the mouth of the fireplace, and pushed the coals to the rear where our roasting spit was located. This way we always had a fire for warmth and light, and also an adequate supply of red-hot coals.

Wilderness Diet

A typical meal consisted of one can of vegetables (our supply was predominantly canned peas and beans), and either fish or wild game, supplemented by wild onions and water cress. We used a ration of about one-and-one-half cans of food daily. What little was left from one meal was carefully hung in storage for the next. Abby ate almost every scrap except the onions.

Here are a few of our typical meals:

Cottontail rabbit roasted on a spit; a can of peas; wild onions and water cress; coffee made from reboiled grounds, and one-fourth slice of bread per person. (The bread lasted just about a week with careful rationing.)

Squirrel stew (ingredients: chunks of squirrel, wild onions, salt); small can of fruit cocktail, and water cress.

Fish baked on a hot rock, wild onions and a can of string beans.

Squirrel roasted on a spit, boiled dandelions, wild onions and water cress.

One day we found some pecan nuts down along the creek. It was the first fatty food we'd had in days. Reed stuffed himself. To think that water cress is a treat to some people! It and wild onions became our standard vegetables for every meal.

Sanitation was another worry. Because

of our close proximity to the ground, and consequently filth and insects, there was the omnipresent danger of disease and infection. My hands, after days of immersion in cold water, cracked in several places. One raw ugly sore opened across my right thumb, hindering me considerably.

We were constantly searching our bodies for ticks. Dirt found its way into our food, ashes scattered by the wind ended up in our vegetables and coffee. Tables built of stone, although elevated only about six inches off the ground, helped immeasurably. We also made seats from rocks and improvised shelves in the trees to hang our food, getting it away from insects on the ground. One of these so-called shelves was made by placing a hub cap from the car on two clothes hangers suspended from a limb.

Salt Becomes Important

To brush our teeth we used salt on our fingers. Salt around camp was a prized item, both in cooking and for sanitary purposes. As it turned out we had enough for our two-week stay, but if our supply had run short I would have hunted a livestock supply. Wherever there is livestock you can assume there are salt blocks somewhere nearby. Also natural salt deposits can be located with some exploring.

A latrine ditch equipped with long grass took care of one disposal problem, while any garbage that the dog didn't eat, like fish bones and onion tops, was burned. Although we saw numerous flies in the air, we had no trouble with them whatsoever.

Most of the things we brought along were pressed into duty one way or another. We had a surplus of clothing, but over a longer period the extra garments would have been important, either as wearing apparel or as rags for use around camp. There were several items we overlooked which would have made our task easier. Kitchenware, for example. Or a larger stewing pan. Cooking grease. A sharpening stone.

Our legs were scratched by briars and, particularly during the first few days, our hands were scarred by the rough cedar. The bottle of alcohol and the bed sheet Marjorie thought of were a great help. We used the disinfectant on the scratches and on the bites of ticks, and the bed sheet for bandages (it came in handy in dressing a blister I got on my foot).

In my tackle box I had a tiny bottle of tincture of Merthiolate and a small tin of aspirin. When they were gone we'd have been on our own.

Regularly we boiled water and washed our faces and hands. Cuts and scratches were treated. Our bedding was removed

from the lean-to each morning and allowed to sun all day. Dishes were scrubbed with sand and scalded with boiling water. Preventive medicine becomes terribly important when no aid is available, or when a lost day means a hungry family.

On the chance that one day *your* family may have just a few minutes to abandon home and civilization and "head for the hills," it might be a good idea to have some kind of plan for getting clear. It would have helped us greatly.

I have listed a few basic and essential items as a "survival kit" on the grounds that those few things can make the difference between success and failure. Beyond that list, you'll have to depend on what's at hand. Not one person in a thousand would pack a complete kit and keep it handy—though *he'd* be the one certain to be really ready. This kit can be easily assembled and kept handy to supplement the items you can pick up in a hurry.

Fishing, Hunting Gear First

Probably the most important thing around the house is your fishing and hunting gear. Most households have something along that line, and it should come first; it'll feed you anywhere.

Next comes clothing. Easiest way to get it out is simply to strip the closet, taking everything. This is easy if your hangers are all turned to face the same way (that's the easy way to manage a closet, anyway). The same method works for drawers—take the whole lot and sort it later. Basic, warm, waterproof clothing is, of course, most important.

For bedding, the easy way again is to simply strip the beds, taking sheets, blankets and all except pillows. The material not needed for bedding can serve dozens of other purposes, from bandages to building materials.

Food, of course, is important, even though what you can carry will only serve for a short time. Preserved items like canned, dried and packaged foods are best; salt, sugar and other staples are both important and good to have. In the kitchen, a few basic cooking utensils and eating tools should go, too, and any kind of sealable containers.

In any survival or emergency situation, drugs and medicines can mean the difference between life and death. Almost anything found in a medicine chest will prove valuable; take it all. As a result of our experience we plan to keep all our drugs in a small box inside the medicine cabinet. It would take only a second to grab the entire collection, from aspirin to antibiotics.

(Continued to page 244)

space
age
hobby

**BUILD-YOUR-OWN
ELECTRONICS
FOR MODERN LIVING**

IT'S FUN...IT'S EASY WITH MONEY-SAVING

knight-kits® 

A PRODUCT OF ALLIED RADIO



← featured in the 444 page

**1962 ALLIED
ELECTRONICS
CATALOG**

free send
for it!



Dozens of new hobbyist kits, including amazing Electronic Science Lab—over 100 projects!

Select from more than 70 exciting Knight-Kits! See—Stereo hi-fi, including new Multiplex Stereo tuners and all-transistor amplifiers, short-wave radios, intercoms, Citizens Band radios, electronic science labs, test instruments—all easy to build and a pleasure to own! Send today for your FREE 1962 ALLIED Catalog!



Everything in Stereo hi-fi components; new Multiplex Stereo FM tuners



New—tachometer kit and outstanding test instruments



New all-transistor intercom; many other kits for modern living

**SAVE ON EVERYTHING
IN ELECTRONICS**



Get the most for your money in: Stereo hi-fi systems and components • Recorders and tape • Citizens Band radios • Amateur station equipment • TV tubes, antennas, accessories • Electronic parts, tubes, transistors, tools, test instruments, books. Send today for your FREE 444-page 1962 ALLIED catalog!

NO MONEY DOWN
Easiest Terms

**FREE
CATALOG**

ALLIED RADIO

ALLIED RADIO, Dept. 24-J1
100 N. Western Ave., Chicago 80, Ill.

Rush FREE 1962 ALLIED Catalog

Name _____

PLEASE PRINT

Address _____

City _____ Zone _____ State _____

**WORLD'S
BIGGEST**

In such a situation, a family should plan to work as a team, each member knowing what to get and where to go. The father can concentrate on tools and equipment, mother on food and clothing—even the children can get their own clothing to the car. You can strip a house of essentials in a matter of minutes with teamwork, and so equipped could spend a considerable time in the most hostile environment without danger of going hungry or unsheltered. It might be a good idea, while you're thinking about it, to decide on a spot or area which you can reach but which is off the beaten path and clear of traffic patterns and fall-out paths.

We came out after two weeks in the woods, feeling that we had done well. While we were never very comfortable, we had enough food, water, and shelter—our site served us well.

Our feelings after the test were mixed. We were awfully happy we didn't have to stay indefinitely, but we think we could have if it became necessary. Like a lot of experiences, it was something we were glad to have behind us, but we wouldn't want to do it again.

Let's hope we never need to. ★ ★ ★

Will teaching machines cheat your child? Or improve his education? The October **PM** will tell you what the experts think about mechanical instructors.

Radiation From Solar Flares Is a Hazard to Space Travel

If men are to travel through space and survive, some way must be devised to protect them from lethal doses of radiation released by giant solar flares.

The flares, from which jets of very high-energy radiation are sprayed into the solar system, cause radiation levels from four to nine times the present annual recommended occupational doses.

Besides the giant flares, Dr. Cornelius Tobias, of the University of California, and Dr. Roger Wallace of the Lawrence Radiation Laboratory, Berkeley, have found that the sun's monthly activity would expose men in space to highly dangerous radiation doses—from five to 100 times present permissible occupational exposures.

Dr. Tobias suggests the problem perhaps can be solved by a combination of a short trip, some shielding (enough would be impractical), prophylactic measures with regard to radiation sickness and traveling at a period of minimum solar activity.

What **STANLEY** means on screw drivers

Stanley is a name you know. It means delivery of everything a tool should deliver to a tool user. Take Stanley screw drivers—

Is there a difference in screw drivers? You bet a blistered palm there is! The strong, durable plastic handle is made to give a man a comfortable grip on a driving tool that is designed to *drive* screws accurately and easily. The crossground non-slip tip *fits* screw slots . . . doesn't just slide by on its way to gouge your work.

This is one of the Stanley "1000 Line" of screw drivers . . . the finest made. Available in a variety of styles and sizes. Prices start at \$1.05.

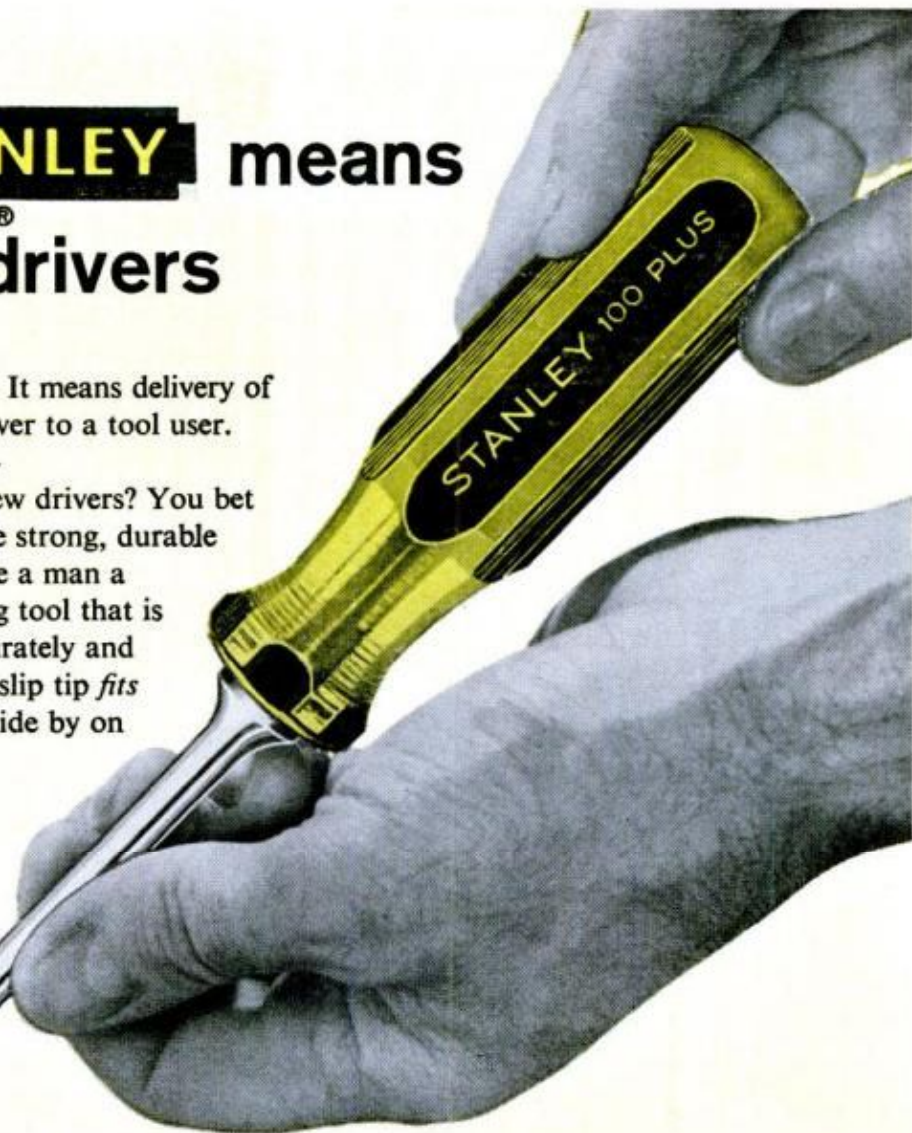

OTHER DEPENDABLE SCREW DRIVERS FROM THE TOOL BOX OF THE WORLD



No. 233H

Famous Yankee-Handyman spiral ratchet screw driver. Drives and draws screws. Drills pilot holes, too! Magazine handle contains two screw driver bits and three drill points—\$4.98 each.



No. 3006

Stanley Handyman screw driver has red "Cushion-Core" plug that adds extra resistance to pounding on the handle. It shouldn't be done but everyone does it. Prices start at 55¢ each.



No. 2702

Popular wood-handled drivers for Phillips Head screws. Available in four sizes to fit the entire range of Phillips-type screws and bolts. Prices start at 55¢ each.

You get what you pay for in tools! If you lose tools, are careless with them or with your work—get cheap ones. If you value good help for your hands . . . if you are proud of your work—buy Stanley Tools.

Stanley Tools • A Division of The Stanley Works • New Britain, Conn.

SEPTEMBER 1961

STANLEY
®

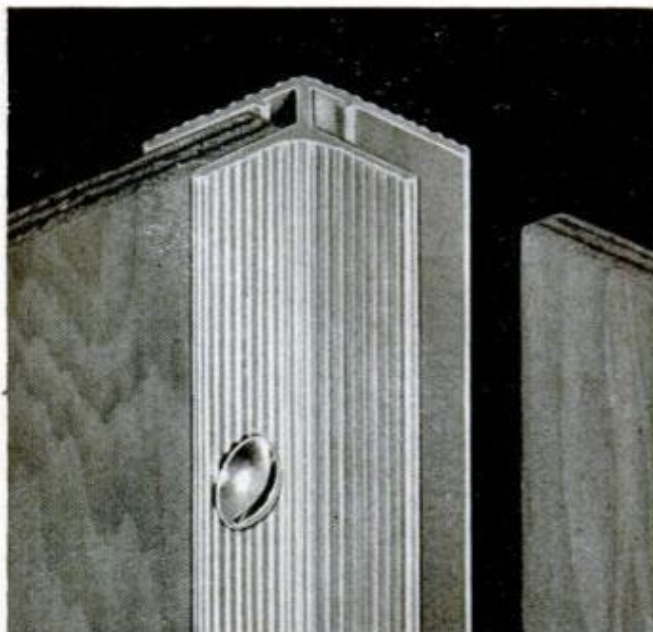

New from Reynolds!

Aluminum Corner Posts

Reynolds Aluminum Corner Posts are the easy way out of any cornering problems.

- No butting of joints
- No exacting angle measurements
- No elaborate corner finishing

And they're easy to use! Just slip the material into the open slots on either side and screw or glue into place. That's all there is to it. Corner posts may also be extended to form legs or supports on chests, cabinets or desks. Storage chests, paneled walls, furniture . . . all take on a real professional look. Available in 8 ft. sections to match any cuts, without waste, made from standard 4 x 8 ft. panels; for $\frac{1}{4}$ ", $\frac{1}{2}$ " or $\frac{3}{4}$ " thick materials. Reynolds Aluminum Corner Posts are now available at your hardware or building supply dealer; see them soon!

Watch Reynolds TV show, "Harrigan & Son," Fridays, ABC-TV



REYNOLDS METALS COMPANY
Richmond 18, Virginia

Selling Your House Direct

(Continued from page 187)

crease the sale price of a modest home by as much as \$1000," says an FHA appraiser. "In general, a good exterior can add 10 percent to 20 percent to the price," he adds.

A St. Paul realtor points to identical homes side by side in a multihouse development. One owner had added shutters, shrubs, two small trees, and a fresh paint job, while the second contented himself with merely keeping the yard and house clean. Within a month, the house with the extra exterior features sold for \$13,800 to \$12,500 for the unimproved home. Yet both were identical in construction.

Don't fall into that trap of showing a prospect through the house, and confining yourself to merely identifying the rooms. Most people can tell the kitchen from the living room. Instead, remember the checklist of "plus" features you made up for your ad, and emphasize the strong points on the list. Perhaps the kitchen has eating room for six, or washable walls. Or the walls are plaster rather than plasterboard. Or the insulation is double, or the floors hardwood, or the heating costs low. Every house has its strong points. Know them and talk about them.

Be able to discuss knowledgeably the construction of your house, the heating system, electrical outlets, utility costs, and the neighborhood (churches, schools, shopping areas).

Taking the Mystery Out of Financing

Financing can be one of the strong points of your sales story. Have the home-loan officer at the bank or savings and loan association where you have your mortgage tell you how the new owner can go about taking over your mortgage, or getting a new one.

Ask two or three lending institutions to make an FHA mortgage commitment (how much money they will lend) on your house. Their appraisers will look the house over—at no cost to you—and the loan officer will then tell you: "The appraised value of your house is so much. To a qualified buyer we will lend 70 percent (or anywhere from 50 to 90 percent) of that value over 15 years (or 10, 20 or even 25 years)."

Not only do you have an independent appraisal of your house's value, but you now have another sales advantage—you can tell the prospect exactly what his monthly payments and down payment will have to be. And \$1500 down and \$74 a month sounds a lot easier than \$16,000.

There are three types of home loans:

(Continued to page 248)

FREE!



LIFETIME SHARPENING

WHEN YOU BUY YOUR **COMET QUICK-SET DADO...**



during this special offer, you will receive free sharpening by factory experts for the lifetime of the blades! You will receive a Lifetime Sharpening Certificate with your purchase of any Comet 6" or 9" Quick-Set Dado. This Certificate (plus \$1 for insurance, postage and handling) is all you need to save an average of \$4.5 each time the blades need sharpening.

Only Comet Can Make Such An Offer:

1. Because only Comet Quick-Set Dados have high speed, tool-steel blades — stay sharp 5 times longer!
2. Because only Comet Quick-Set Dados are perfectly balanced to cut clean, to eliminate the chewing/chipping at the wood that causes dulling in conventional leaf and wobble-type dados.

Take Your Choice of a Comet 6" or 9" Quick-Set Dado. Both are available with either tool-steel or carbide-tipped blades. Both are adaptable for right or left-hand rotation

for any table or radial arm saw and fit a wide variety of shafts. And—with a Comet Quick-Set Dado, you can dial the width of cut with the Dado on the arbor!

SPECIAL, LIMITED OFFER EXPIRES MID-NIGHT, OCTOBER 5. SEE YOUR LOCAL COMET DEALER RIGHT NOW ... OR WRITE NOW FOR ONE NEAREST YOU

Hurry! Send me the name of my nearest Comet Dealer:

Name:

Address:

City..... State.....

COMET MANUFACTURING COMPANY

875 Arroyo Parkway

Pasadena, California



© Comet—1961 M

Offer good in U.S. only.

ONLY ONE PLIER GIVES YOU BOTH

1. Reinforcing Rib
for **ADDED STRENGTH**
WHERE YOU NEED IT!

2. Machined Undercut
Channels... **SMOOTH-
WORKING, CAN'T SLIP**
UNDER ANY LOAD!

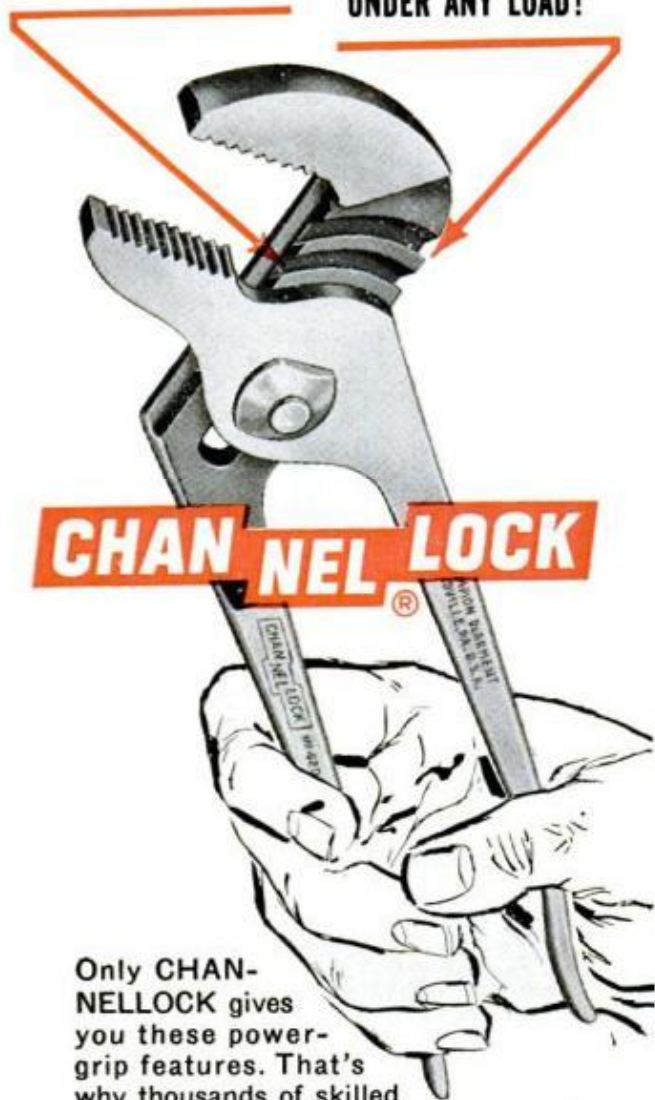

Only **CHAN-
NELLOCK** gives
you these power-
grip features. That's
why thousands of skilled
mechanics—year in, year out—buy
CHANNELLOCK in preference to any
other plier. They prefer its terrific grip-
ping power, its all 'round usefulness.
And you will, too! Available in three jaw
capacities: $\frac{7}{8}$ " , $1\frac{1}{2}$ " and 2". Ask your tool
supplier for a genuine **CHANNELLOCK**
Plier. If he's out of them, ask him to
order one for you.

Write for Catalog of Complete Line of Pliers

CHAMPION DEARMENT TOOL COMPANY

MEADVILLE 1, PENNSYLVANIA

conventional, VA, and FHA. Chances are that your buyer's best bet will be an FHA loan, both from the standpoint of value and availability. A GI loan would be cheaper, but they are hard to get. But the FHA loan can cost you, the seller, some money. Because most lending institutions can get better interest on their money elsewhere, they must often be coaxed into making FHA mortgage loans.

This coaxing takes the form of cash—a fee for handling the loan. Since the government says they can charge the person borrowing the money only one percent of the loan as fee, they turn to the seller of the property involved. The government says nothing about him, so the lending institutions turn to him for more money. This additional charge may run from another one percent of the loan in the East to as high as three percent in the West. So figure this in your asking price.

Whether the buyer is buying through you or through a real estate firm, he must meet the lender's requirements for credit rating and income. There's nothing you can do about that.

Follow Up Can Swing a Sale

When you do get an interested buyer don't be afraid to follow him up. A Dayton, Ohio, man found one couple who "just loved the house." The size was right, the price reasonable, the neighborhood just what they were looking for. Yet after three visits they abruptly cut off negotiations. While extremely skilled in his own field (as a tool and die maker) the owner was no salesman, and was reluctant to attempt to reopen talks. Finally, urged (or perhaps nagged) by his wife, he called the prospects, found them still friendly but firm. At an impasse, he blurted, "Well, what don't you like about the house?"

The prospects told him. Their three young daughters would have to cross a much-traveled main city street to get to school, and the rush of traffic had the parents concerned. The homeowner had the answer. A policeman appeared daily to shepherd the youngsters through the traffic. Thus reassured, the prospects reopened negotiations, bought the house a week later.

Some objections can't be overcome as easily as this, although in many cases a follow-up phone call can clear up an objection or misunderstanding, and renew a prospect's interest.

One of the cardinal rules of salesmanship is "ask for the sale." So ask each prospect at the end of your tour to make you an offer. Many will.

That's where an earnest money contract

(Continued to page 250)

use these new PANELING IDEAS



This booklet of design and color ideas
free at your lumber dealer's

Get this free booklet on wonderful new ideas in solid lumber paneling. See how *only* solid lumber paneling lets you obtain striking uses of color on wood . . . offers dozens of variations in pattern, design and texture. And how easy and economical it is to install. There are ten different Western Pine Region woods and numerous interesting interior textures and finishes to give your home the beauty and warmth that only genuine lumber can provide.

Your local lumber dealer will help you select the right materials and methods. See him for your free paneling booklet. If he is unable to supply you, write to Western Pine Association, Dept. M-4, Yeon Bldg., Portland, Oregon, giving us the name of your dealer. Please enclose 10c for handling and mailing.

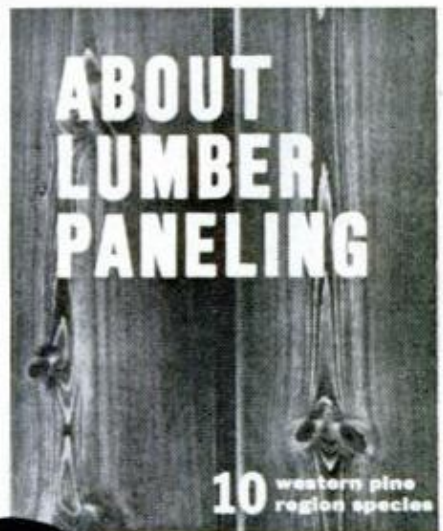

WESTERN PINE ASSOCIATION Quality Graded Lumber

IDAHO WHITE PINE • PONDEROSA PINE • SUGAR PINE
WHITE FIR • LODGEPOLE PINE • DOUGLAS FIR • LARCH
ENGELMANN SPRUCE • INCENSE CEDAR • RED CEDAR



SEPTEMBER 1961

219

Test your automotive I.Q!

QUICK QUIZ BY QUAKER STATE

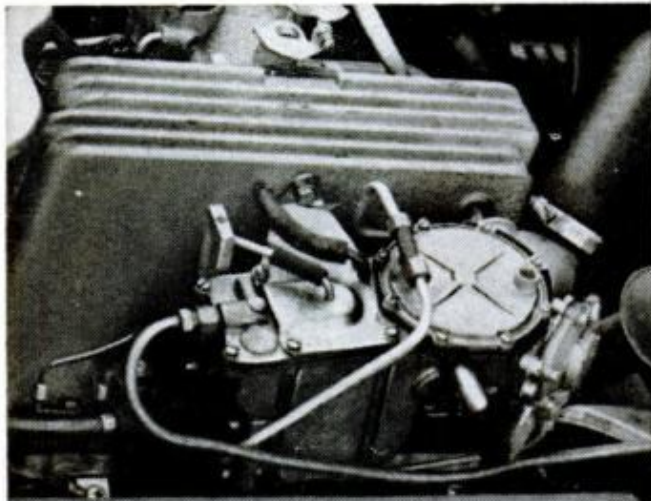

1. *What is the purpose of this alternative to the conventional carburetor?*



2. *What does this symbol stand for?*

The symbol stands for your car's best engine life preserver—Quaker State Motor Oil. Super-refined from 100% pure Pennsylvania Grade Crude Oil, Quaker State keeps your car on the road, out of the repair shop—saves you money! Insist on Quaker State. Available most everywhere. For your dealer's name, call Western Union Operator 25.

ANSWERS: 1. *Fuel injection system, for efficient fuel consumption.*
2. *World's finest motor oil.*



©QSORC, 1961

QUAKER STATE OIL REFINING CORP., OIL CITY, PA.

comes in. It's really a contract to buy the house for an agreed-upon amount, and lists pertinent information such as who's going to pay the taxes, when the buyer can move in, and what furnishings are included in the sale. If the prospect is serious, he signs this contract and posts money (usually \$50) to guarantee that he's serious. The earnest money contract is a stock form, available at most office supply stores.

It's up to the buyer then to retain a lawyer to investigate the mortgage, the deed and liens on the property. As the seller, you don't need an attorney at all, except perhaps to check the final transaction to see that all is in order. If the buyer's lawyer finds everything in order, you merely sign the deed over and take your money.

The only trouble is that, after beautifying your yard, repainting the outside, repairing the cracks and peeling wallpaper, and checking over all the good features of the house, you may decide to turn down all offers. The house will be too good to leave.

★ ★ ★

Russians Dry and Color Trees While Trees Are Standing

Trees may be dried, colored, preserved like stone, made fire-resistant or made limber enough to bow to the ground by the use of a new Russian treatment.

Wood dried while still in tree form loses about half its weight, with no warping or cracking, and dries in three to four summer months compared to about a year for felled logs, according to P. S. Zakharov, who developed the technique with the Soviet Ministry of Forest Production.

A ring of bark is removed from the tree's butt part. Then, canals are drilled along this girdle to stop assimilation of water from roots, and a network of metal tubes is inserted.

Chemical solutions are fed into the tubes from a bag hung on the tree. Main component of the drying solution, says Zakharov, is powdered sodium fluoride dissolved in pure, filtered water.

Other chemicals give special properties to the wood. Sodium dinitrophenolate is a preservative, but makes wood more combustible. Antipyrene makes it fire-resistant. Silica salts will harden a tree so it cannot be chopped or sawed.

Acetic acid gives an orange coloring to birches and beeches. Treatment with dicyanodiamide and urea made a birch so flexible in one experiment, says Zakharov, that "after long treatment... (it) was bent in an arc with the green crown touching its own root."

Remarkable new PPG LATEX House Paint guards against ugly blistering and peeling!

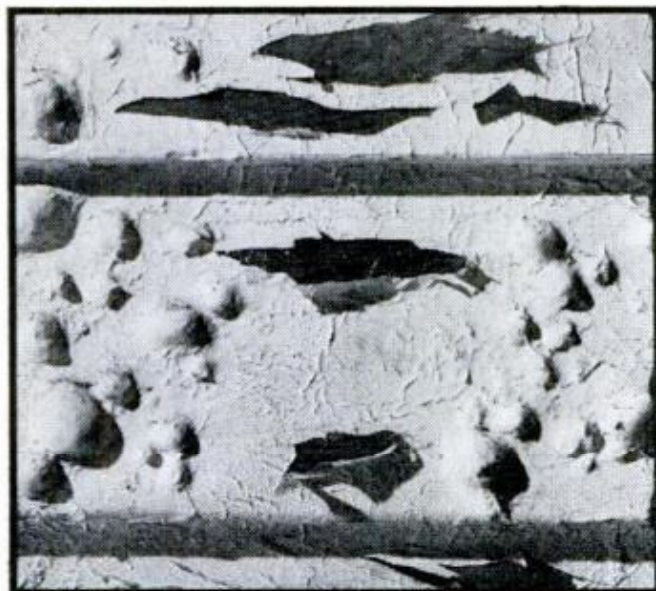

Left: Moisture escaping from inside the house causes some house paints used on wood siding to blister and peel.

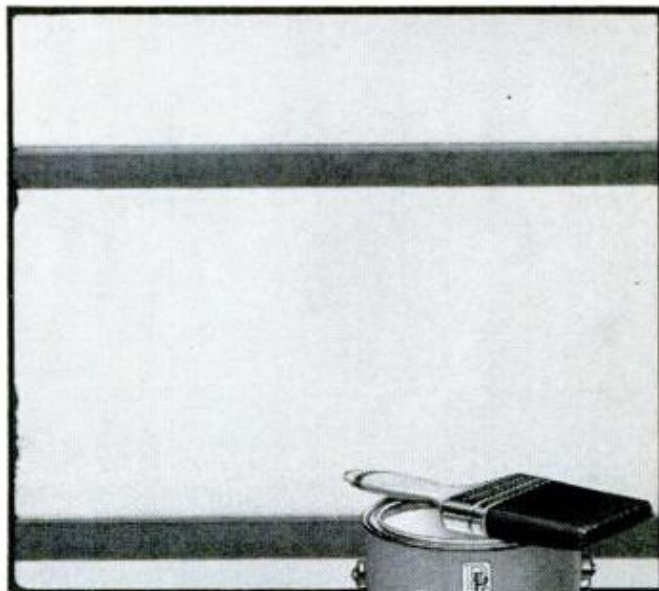

Right: New PPG LATEX protects siding against such damage, lets trapped moisture out without harm to paint film.

Lasts years longer . . . goes on faster, smoother . . . can be applied even over damp surfaces . . . dries in just 30 minutes . . . brush or roller wash clean in soapy water!

• Thorough testing . . . in various climates . . . has proved sensational new Pittsburgh LATEX House Paint superior in many ways.

• Far easier to apply, it "wraps" your home in an amazingly tough, flexible film that prevents unsightly blistering and peeling *years longer*.

• Thanks to new miracle resins, white stays whiter, and colors stay brighter—on any type of construction!

• PPG LATEX goes on right over damp surfaces . . . dries dust- and bug-free in ½ hour. Wash up with soapy water!

• For the best paint job ever, just use new PPG LATEX and follow directions.

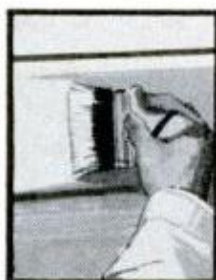

• Saves time and work, because PPG LATEX goes on faster, smoother—without brush drag, or lap marks.



• No rain worries, no wasted week ends! Soon as the rain stops, you can start right in painting again!



• Dries bug-free and dust-free in ½ hour. You can apply second coat without even moving your ladder!



• Easy cleanup! Just wash brush, roller or spray in soapy water—wipe up spatters with damp cloth.



PITTSBURGH® PAINTS

PAINTS • GLASS • CHEMICALS • BRUSHES • PLASTICS • FIBER GLASS

PITTSBURGH PLATE GLASS COMPANY

IN CANADA: CANADIAN PITTSBURGH INDUSTRIES LIMITED



• For America's finest oil-base house paint, ask your Pittsburgh Paint dealer for Sun-Proof—famous for quality since 1892.

Down the Drain

(Continued from page 197)



7. FLEXIBLE DUCTING is forced over stud on back of inlet valve to make airtight connection in line

Any handy homeowner can install the system easily enough in an existing home. Naturally, it is easier in new construction. Some help may be needed in connecting the unit to the home drainage system and in wiring the timer and motor to a 115-volt line. Otherwise it is mainly a job of running the ducts up (or down) through the walls and connecting them to the power unit and the inlet valves. This of course, is less of a problem in a ranch-type home than a two

8. HOLE SAW in portable electric drill is used to bore holes up through floor for passage of suction ducts



WALL-VALVE INSTALLATION

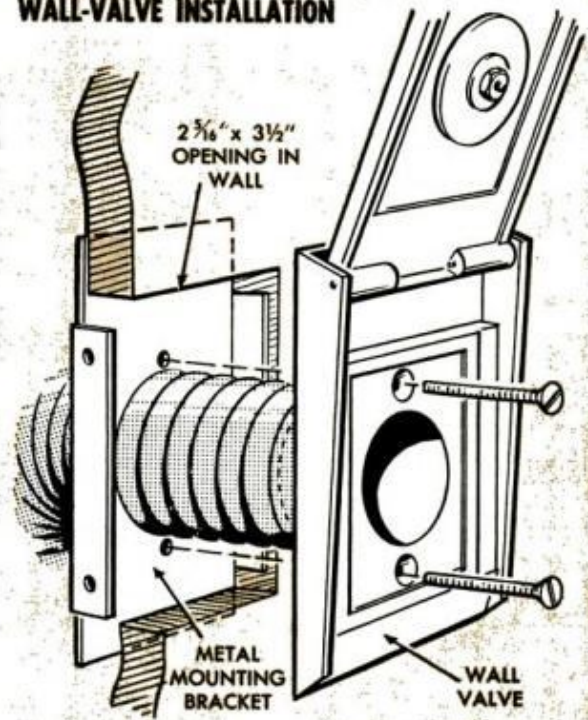

story dwelling but usually in the latter the ducts can be brought up through closets, clothes chutes and alongside cold-air returns. Where there is no basement the ducts are run overhead and connected to the inlet valves by bringing them down through the walls from the attic.

The number of inlet valves and the lineal feet of ducting required will vary with each particular installation. With a standard 25-ft. cleaning hose you'll find that as few as three valves will service the average-size home. The installation pictured here was made in a split-level home and required only two inlet valves to reach all rooms. Four valves are included with each kit (one being a utility valve), plus fourteen 4-ft. lengths of steel tubing, 12 slip-on couplings, 3 branch fittings and a 12-ft. length of flexible vinyl ducting which is used to make all turns in the system. The latter is forced over the tubing and is cut as needed with wire cutters and a knife.

Locating Power Unit

Location of the power unit is an individual problem. Whether in the basement or utility room it naturally should be located as close to a soil or waste pipe as possible so a minimum of pipe will be needed to make the drain connection. Accessibility to water and outside venting also must be considered. The power unit is hung on the wall by a sheet-metal bracket. This is mounted 42¹³/₁₆ in. up from the floor as

(Continued to page 254)

NEW STORAGE PANEL!!!

WITH THE WAINSCOT RIGHT ON IT,
SUITS ROOMS ALL OVER THE HOUSE

In children's rooms, utility rooms, workshops, G-P's new Garage Liner looks handsome, works hard, wears well. A heavy-duty hardboard, it provides storage for tools, toys, paraphernalia... makes a perfect set-up for shelves. With the wainscot right on the panel, you just add a molding and the job's done. Factory-finished, it needs no paint... costs about 22¢ a sq. ft. at your lumber dealer's. 1/4" V-groove 4' x 8' panels, perforated to wainscot.



GEORGIA-PACIFIC

Plywood • Lumber • Redwood • Hardboard • Pulp • Paper • Chemicals

Free "how-to" booklet! Ways to work with hardboard. Write: Georgia-Pacific, Dept. PM961H, Equitable Bldg., Portland 4, Ore.

name _____
address _____ city _____
county _____ state _____

shown in Fig. 3 and fastened securely. If it is a poured wall, use lead anchors in holes drilled with a star or carbide drill. If you have a block wall, use toggle bolts. If it is a frame wall, use wood screws and drive them in a stud.

The lower section of the power unit is fitted with a shroud which has openings cut in each side to admit the drain pipe. The front of the shroud is removable to gain access to a drain cone, Fig. 2, and to permit making the drain connection. While the number of 2-in. elbows and nipples needed will vary, a 45-deg. elbow is required inside the shroud to center a 90-deg. elbow under the tank drain valve. This is clearly shown in the photo in Fig. 5. The code requires that a trap with a clean-out plug be installed in the drain.

Where to Put Inlets

Existing obstructions such as cold-air returns, heating ducts, water pipes, etc., will have a bearing on where the wall inlets can be located. Aside from this, the best way to determine where the inlets should be located insofar as reaching the far corners of each room with the cleaning hose is to use the hose itself or a 25-ft. length of cord. Fig. 6 shows what the inlet valves look like and how they lock in place in the wall by a metal bracket or backing plate. From a convenience point of view, the preferred height for the valves is 18 to 24 in. from the floor. This saves stooping to plug in the cleaning hose. However, if you prefer, you can line them up with the convenience receptacles. An important point in plotting the openings for the valves is to make sure you miss wall studs. The best position is midway between wall studs to provide ample clearance for the flexible ducting and to avoid trouble in boring holes up through the floor for the ducting. A trick found helpful in plotting the position of the holes through the floor so you won't miscue in coming up inside the wall is to run a small twist drill through the floor next to the shoe mold at the baseboard and at a point directly below the plotted position of the wall inlet valve. Then from the basement it is easy enough to observe the drill bit extending through the floor and to measure over roughly $3\frac{3}{4}$ in. to spot the hole and to note if it is feasible, spacewise, to bore a hole at that point. If not, perhaps you can shift the location of the hole one way or the other to a better place and then shift the plotted position of the inlet valve accordingly so it is directly above.

Each inlet valve requires an opening $2\frac{5}{16} \times 3\frac{1}{2}$ in. which can be cut out neatly in either plaster or drywall by drilling a hole in opposite corners of the penciled

outline and sawing through with a keyhole saw or a hacksaw blade.

The routing of the ductwork from the power unit to the inlet valves should be as direct as possible. In all cases, it is advisable to plan a main conveying line from the power unit and then branch off from it with the 45-deg. fittings provided. Here it is important that the branch leg of the fitting be positioned to direct the flow from the inlet valve to the power unit, and also that it be placed horizontally in installations where the fitting is located below the main conveying line. This is to avoid a straight drop into the perpendicular line rising from the inlet valve. The lines may be installed under or between floor joists and should be anchored securely with bands of perforated pipe strapping.

Hole Saw Is Best

A hole saw chucked into a portable electric drill makes quick work of boring the 2-in. holes up through the floor for the ducting. Where the saw will not pass completely through both the subfloor and the wall plate, you can continue with a sharp chisel, chipping away the wood until you break through.

If your inlet valves are positioned low on the wall there is no need to run steel ducting up inside the wall. Being so short a distance, the flexible ducting itself can be fished up through the wall and out through the wall opening. Where the inlet valves are mounted high on the wall, steel ducting is used inside the wall as shown in Fig. 5, to conserve on the flexible ducting which is to be used primarily as elbows in making right-angle turns in the ducting. A supply of a dozen plastic slip couplings are included for joining the straight lengths of steel ducting. A regular tubing cutter is recommended for cutting the steel tubing, although a hacksaw can be used. Here a miter box is essential to make a square cut, and in using either method it is important to remove any burr on the inside.

Must Be Airtight

All joints and connections in the ducting system must be carefully sealed to prevent air leaks and consequent loss of suction power. This step is most important. A quick-setting and pliable adhesive with a brush applicator is provided. To use it, first apply a thin coat to both male and female surfaces and let dry. Then apply a second coat and let it become tacky-dry before joining the parts. You'll find that the cement will also serve as a lubricant in forcing the tight fitting flexible ducting over the ends of the steel ducting, and if the

(Continued to page 256)

Do dozens of home, hobby and shop jobs with

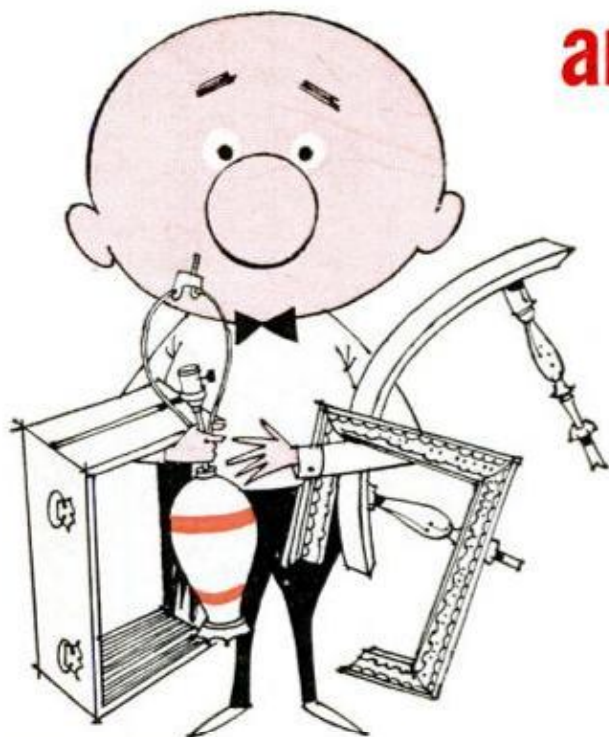

Easiest and best products to use for mending wood or metal, repairing and refinishing marred wood surfaces, filling and refinishing unsightly holes or cracks in wood, plaster, drywall, stucco — and more.

If it's worth fixing — it's worth fixing right . . . with Duratite! Professionals have used Duratite since 1923. Now you can, too, and get better results on home fix-up, hobby and do-it-yourself projects. See your hardware, paint or building supply dealer for Duratite wood and metal fillers, glues and adhesives.



DURATITE WHITE GLUE makes a joint stronger than the wood itself. For general purpose use, bonding wood, paper, fabrics, leather, china, tile, other materials.



DURATITE WOOD DOUGH. For filling-in deep holes or gouges in wood. Takes stain, paint and lacquer finishes. Choice of 9 popular wood-finish colors.



DURATITE SURFACING PUTTY. Best and fastest for refinishing scratches and mars in wood, metal or canvas surfaces. Dries fast, sands easy. 9 wood-finish colors.



DURATITE WATER PUTTY. For filling cracks and holes in woodwork, plaster, drywall, exterior or interior stucco. Packed dry for long storage life. Easily mixed with water.



DURATITE HOUSEHOLD CEMENT. Perfect for countless glueing jobs around the home. Permanently waterproof and heatproof. Dries extra fast. Colorless.



DURATITE AUTO-MARINE PLASTIC FILLER. Repairs dents, mars; fills holes caused by rust in automobiles and boats. A polyester resin. Can be filed, or ground smooth with power tools.

DAP®

Special Duratite Products for tough fix-up jobs

LIQUID SOLDER

Welds metal without heat.

AUTO-BODY FILLER

For auto body refinishing.

PORCELAIN GLAZE

Repairs chipped porcelain, sinks, etc.

TUB-N-TILE CEMENT

Seals leaky tub, sink joints.

CONTACT CEMENT

Bonds hard-to-mend surfaces.

DAP inc., Duratite Division, General Offices: Dayton 31, Ohio

Now! It's easy to have Beautiful Oak Floors



PRE-finished Bruce Crestwood Flooring

Now you can have beautiful new oak floors in less than a day. Crestwood is a modern pre-finished flooring in a special size (2" wide by only $\frac{3}{8}$ " thick) designed to be laid over your old wood floor or subfloor. It's packaged in handy cartons complete with nails.

Completely finished—even waxed—at the factory, Crestwood requires no sanding or finishing. It's ready for use as soon as laid! Strips have tongues and grooves for blind nailing as shown in the photo above.

A new Bruce Crestwood Floor will cost you less than a good rug or carpet . . . and will last the life of your home. Sold by leading lumber dealers. Mail coupon for colorful literature.

SEND FOR COLOR FOLDER



E. L. BRUCE CO.
Box 397-BB, Memphis 1, Tenn.
Send literature on Bruce Crestwood
Floors to:

Name _____

Address _____

BRUCE CRESTWOOD FLOOR

Product of world's largest hardwood flooring maker

branch fittings seem too snug to force over the steel ducting, the tightness can be relieved by scraping the fittings a little with a knife blade. The steel ducting should enter the full depth of the fittings and the flexible ducting should lap the steel ducting a minimum of 1½ in.

To connect the flexible ducting to an inlet valve first slip the metal backing plate over the ducting. Then after cementing the ducting to the valve stub insert the plate inside the opening so it bears against the inside face of the wall. After this turn in the two screws provided. Holding both the backing plate and the valve in position while turning the screws that clamp both together is a bit of a job but it can be done if the top screw is turned partway in first so as to hold the plate temporarily and keep it from falling down inside the wall. The cover of each inlet valve has a rubber gasket which seals the valve shut when any one particular valve is not being used.

Other than making the proper water and electrical connections, a final step in the installation is venting the exhaust line outdoors. Here the hole saw is used again to bore a suitable hole through the house siding and joist boxing. An extra slip coupling makes a neat through-the-wall fitting in which to insert and cement the steel ducting. A hood of some kind should be placed over the vent as in Fig. 4.

An important point to remember in operating the power unit is that you should not operate it **without water** in the tank. If you do, the motor impeller will quickly become clogged with dust and lint, resulting in a loss of suction power and a tricky dismantling job to clean it. ★ ★ ★

QUOTE:

"We need science education to produce scientists, but we need it equally to create literacy in the public. Man has a fundamental urge to comprehend the world about him, and science gives today the only world picture which we can consider as valid. It gives an understanding of the inside of the atom and of the whole universe, of the peculiar properties of the chemical substances and of the manner in which genes duplicate in biology. An educated layman can, of course, not contribute to science, but can enjoy and participate in many scientific discoveries which are constantly made. Such participation was quite common in the 19th century, but has unhappily declined. Literacy in science will enrich a person's life."

—DR. HANS A. BETHE,
Professor of Physics,
Cornell University

HARLEY-DAVIDSON
MOTORCYCLES AND MOTOR SCOOTERS

HARLEY-DAVIDSON 1962 FUN-O-RAMA!

8 NEW EXCITING MODELS

I'M GETTING RID OF TRAFFIC AND SAVING MONEY, TOO WITH THIS ALL-NEW 80-MPG PACER!

TALK ABOUT A HOT CYCLE... THE NEW SPORTSTER 'H' HAS EVERYTHING FOR ALL-AROUND RIDING THRILLS!

COME RIGHT IN, FOLKS! WE'VE GOT MORE NEW MODELS FOR 1962 THAN WE'VE EVER OFFERED!

DON'T MIND TAKING A BACK SEAT ON THIS ONE!

TOLD YOU THE NEW SPRINT IS DIFFERENT!

BRING ON THE TROUT... I'M BLAZING NEW TRAILS WITH THIS NEW RANGER MODEL!

IT'S SPRY, SPIRITED... AND THE PRICE IS RIGHT FOR ME!

GO, GO, GO! I'LL LEAVE 'EM IN THE DUST WITH THIS NEW SPORTSTER 'CH'... ON OR OFF THE ROAD!

ON ANY ROUGH-AND-TUMBLE ACTION THAT SCAT'S A BEAUT!

JUST RIGHT FOR SCRAMBLES!

THAT GOES FOR BOTH OF US!

DAD, YOUR TOPPER 'H' IS AN EXTRA SET OF WHEELS THE WHOLE FAMILY CAN USE!

HONEY HOW ABOUT A DELUXE DUO-GLIDE FOR OUR NEXT VACATION TOUR?

MAN WHEN THEY SAY 'SCAT' THEY MEAN SCAT!

HARLEY-DAVIDSON
MOTOR CO.

DEPT. P-9
MILWAUKEE 1, WIS.

Send me the new literature on the 1962 Harley-Davidson motorcycle and motor scooter lines.

Name.....Age.....

Address.....

City.....Zone.....State.....

The scene? Your Harley-Davidson dealer. Stop in now for a look at the all-new line of Harley-Davidson motorcycles and motor scooters for '62. Take a test ride, too.



**1961
WINNER
OF PRODUCT ENGINEERING'S
MASTER DESIGN
AWARD**

POWER POWER POWER

DISSTON'S NEW 1/4" DIRK DRILL breezes through concrete block, too!

The new Disston 1/4" Dirk gives you exceptional power for the toughest jobs because it has a full 3-amp, 1800-rpm motor with Spiroid® gearing. With the new Disston Dirk you can drill closer to corners than with any other drill in its class. Dirk's offset motor and recessed Jacobs chuck give it the slimmest profile available. You are able to work between joists, in corners, closer to floors and ceilings than ever before.

Here's what a popular handy-man's magazine says about the new Disston Dirk, "The unusual design makes sense (we recently won Product Engineering's 1961 Master Design Award). With your hand directly behind the bit, you can drill straighter, apply more muscle on tough boring jobs and eliminate the wobble that breaks bits and gives you oval holes."

The new Disston Dirk is the only drill with a "stand-up base." It's easier for you to change drill bits and they won't snap or bend when you set the unit aside.

See the Disston Dirk 1/4" drill now on display in your local hardware store for \$30.00 (only a nickel more than the next best drill). Once you try it, you'll want to buy it. The Dirk, made in Danville, Virginia, is another fine product from Disston, master toolmaker since 1840.



The Disston Dirk

Other Disston Products you'll want to try and buy!

D600 Circular Saw

D20 Sabre Saw

Electric Hedge Trimmers

PORTER

DISSTON DIVISION
H. K. PORTER COMPANY, INC.

Atom Taps the Forest's Secrets

(Continued from page 147)

to plan better spacing of trees on industrial tree farms and to develop improved fertilization formulas.

Staebler constructs a grid system around an experimental tree. He injects radioactive ribidium into the tree's sap stream and, as it circulates throughout the complex root system, he charts its course, and the pattern the roots follow underground, with the aid of the scintillator.

The tree scientists are using atomic energy in another novel way. A big killer of ponderosa pine is dwarf-mistletoe, a parasite which drains the life from the pine trees. Using photographs of gamma and beta particle radiation, called autoradiograms, Rediske and his associates are investigating the introduction of chemical elements into the trees that are toxic to the parasite, but not to the ponderosa pine.

Branch Is X-Rayed

An autoradiogram is used to assist the forest scientists in determining the relationship between a ponderosa pine branch and a piece of parasitic dwarf-mistletoe attached to the branch. The branch, with the parasite attached, is injected with a radioisotope of phosphorus. The branch is then dried, pressed flat, and finally laid on a piece of X-ray film. Gamma rays from the radioisotope register on the film, the branch is removed and the film developed, and an autoradiogram is the result. The autoradiogram shows that there is a direct connection between the dwarf-mistletoe and the pine branch because the radioactive substance was able to travel freely from branch to parasite.

Thus far, thanks in great measure to the pioneer work of the "atomic scientists," in cooperation with other researchers at the center, many remarkable results have been achieved. Soil nutrient experiments, for example, have been successful in recent months in increasing seed cone production five-fold, and they also have increased tree diameter 40 percent on the company's tree farms.

Expressed in another way: The nuclear researchers are helping achieve the forest geneticist's major goal, better seed. He is looking for methods to grow top-quality trees that will grow rapidly, resist insects and diseases and above all, produce good seed in generous quantities.

Douglas fir, prime species on Pacific Northwest timberland, normally produces a good seed crop on an average of only three years out of every ten. Because of this unique cycle nature fails to do a fast enough job of stimulating new forest

growth. In order to cut the time lag between timber harvest and the start of a new forest growth, the forest scientists knew they would require a continuing source of seed. The problem then became one of finding new methods of increasing seed production.

Today, as a direct result of their test program, using radioisotopes, plus the use of nitrogen and phosphorus, in varying rates of application to determine better methods of cone production, there is definite hope that in the very near future the foresters will be collecting abundant seed crops from cone production each year, instead of only three years in ten.

Already the Johnson "pill-box" study has thrown important new light on how Douglas-fir bark beetles attack and kill trees. It is now known that the adult beetle bores through the bark and constructs long egg galleries in the inner bark. The larvae on hatching from the egg radiate outward, destroying the inner bark. All this is vital information for designing new and more effective control measures against both adult and larvae beetles.

New Insecticides

Insect destruction has long been a major problem in the forests of Washington, especially in the exceptionally poor seed year of 1958. Studies on control of the cone and seed insects in the past three years have resulted in the development of 10 promising new insecticides for use in cone production areas alone.

A current project in cooperation with the U. S. Forest Service seeks to determine whether old growth or young growth trees, or whether shaded trees or trees exposed to the direct rays of the sun produce the greatest number of bark beetles. Already the scientists, following a special study in western Washington, have made important progress. Their research indicates that young growth exposed to sunshine tends to have fewer beetle attacks than the shaded and thicker-barked old growth.

A multimillion dollar bill for damages has been run up by the balsam wooly aphid in its attacks on a half-billion feet of timber in the Pacific Northwest. Canadian and United States government entomologists have imported natural enemies of the dangerous aphids. Weyerhaeuser researchers have been helping in the colonization of these predators in infested stands of timber. Their new atomic tools of research will help these scientists to pinpoint how the aphids perform their destructive work, and will also help them determine to exactly what extent the aphids' natural enemies are able to destroy the timber-killing pests.

(Continued to page 262)



BEAUTIFUL MARLITE PANELING

wash-and-wear walls you can install yourself

You can finish a room with Marlite this weekend—and eliminate redecorating for good! Marlite's melamine plastic finish is *baked on*, so it's smooth and durable as the surface of a refrigerator. It takes abuse that would spoil other finishes, then wipes clean with a damp cloth. And Marlite's simple to install in new rooms or old. Choose from a handsome array of Trendwood® reproductions, beautiful patterns and decorator colors—in large sheets or easy-to-handle Plank and Block. See your building materials dealer.



Tongued-and-grooved Marlite Random Plank (16" x 8" x 1/4") goes up fast over furring strips or solid backing with no waste, muss or fuss.

Marlite®
plastic-finished paneling

Marlite Division of Masonite Corporation
Dept. 942, Dover, Ohio

Please send full-color building and remodeling folder on Marlite Paneling.

Name _____

Address _____

City _____ Zone _____ State _____



ANOTHER QUALITY PRODUCT OF MASONITE® RESEARCH

DON'T SPOIL YOUR NEXT PAINT JOB BEFORE YOU BEGIN

Paint better and easier with any kind of paint on any surface with brushes of 100% Du Pont tapered TYNEX®



When picking a paintbrush from the vast variety on display at your dealer's, remember: A poorly made brush can spoil your job before you begin. To be safe, buy the brush with the red quality seal . . . your guarantee that the brush is made 100% with Du Pont tapered TYNEX nylon filament. Then check for full stock, mixed lengths, properly processed tips. Results? You can paint better and easier on any surface, with any paint. Look for the red quality seal at stores where quality paint is sold!

E. I. du Pont de Nemours & Co. (Inc.),
Polychemicals Dept., Wilmington 98, Delaware



BETTER THINGS FOR BETTER LIVING . . . THROUGH CHEMISTRY

Atomic research in the forest is enabling the timber scientists to grow more trees in needed areas, larger or smaller trees as the occasion demands; in general to regulate the growth of trees as desired; and to help thicken or thin a stand of trees as the specific needs of a tree farm demands.

These profound changes in timber growth are achieved by altering the heredity characteristics of trees through mutations brought about by placing radiation in their germ cells, a new peacetime science in itself. Already in the 10-year-old field of atomic agricultural science, radiation treatments have succeeded in changing a freestone peach into a clingstone variety, to name but one of hundreds of genetic achievements. In the brand-new field of atomic-forestry science, equally spectacular results can be expected.

As physiologist John Rediske reports: "Nuclear research will play an ever-increasing role in forestry studies. Peaceful uses of atomic energy are working every day to produce higher quality forest products at a faster rate for use both today and tomorrow." ★ ★ ★

His neck is way out. Months ago, an expert weather forecaster predicted what the weather would be in **your** area in October. Find out how right or wrong he was by checking his predictions in the October issue of **PM**.

QUOTE:

"I believe as a matter of faith that the extension of space travel to the limits of the solar system will probably be accomplished in several decades, perhaps before the end of the century. Pluto is about 4000 million miles from the sun. The required minimum launching velocity is about 10 miles per second and the transit time is 46 years. Thus we would have to make the velocity considerably higher to make the trip interesting to man. Travel to the stars is dependent on radically new discoveries in science and technology. The nearest star is 25 million million miles away and requires a travel time of more than four years at the speed of light. Prof. Dr. Ing. E. Sanger has speculated that velocities comparable with the speed of light might be attained in the next century, but such an extrapolation of current technology is probably not very reliable."

—HUGH L. DRYDEN,
Deputy Administrator,
National Aeronautics and
Space Administration

POPULAR MECHANICS

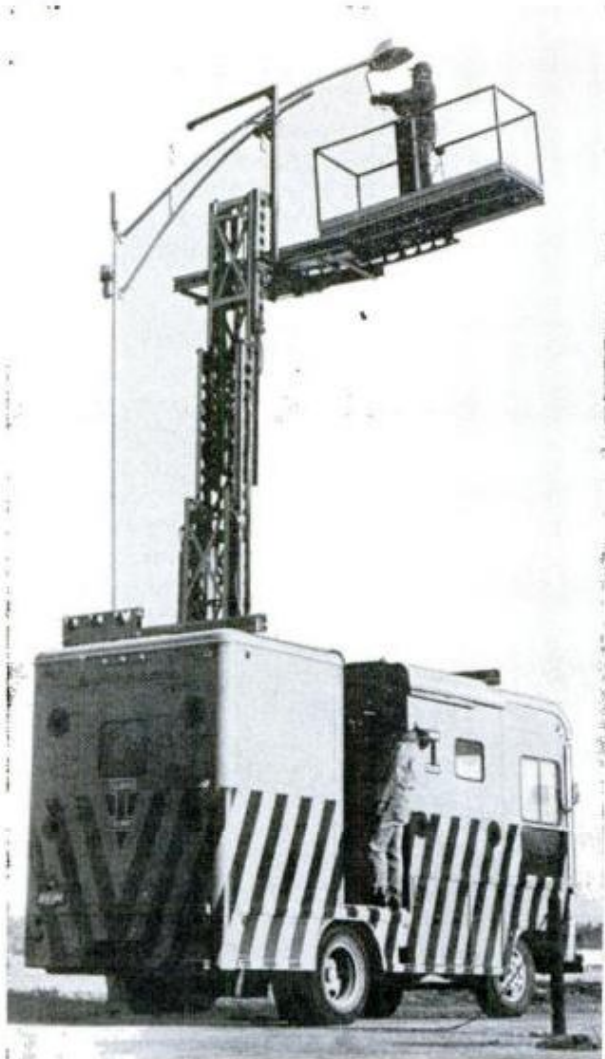

Tollway Lights Stay Bright

Prowling the 187 miles of the Illinois Tollway that borders Chicago and extends from the Indiana to the Wisconsin line, is a traveling "dishwasher." It lifts workmen aloft to change any of the tollway's 3900 lights and washes and dries their glass coverings in its kitchenlike interior.

The lift raises 33 feet above the pavement and is often used by such other workmen as welders and painters. Inside the van are three tubs and a hot-air dryer.



As versatile as they are powerful, Wiss Snips are an all-purpose cutting tool no home work bench should be without. Sizes from 7" to 17" in aviation, combination, solid steel and inlaid steel styles. At hardware and department stores.

WISS SNIPS CUT EVERYTHING!



Cut Tile



Cut Leather



Cut Fish and Poultry



Cut Fencing and Screens

J. WISS & SONS CO., NEWARK 7, N. J.

World's Largest Manufacturer of Shears, Scissors, Pinking Shears, Skalloping Shears, Metal Cutting Snips and Garden Shears

Engine With Built-In Wings

(Continued from page 134)

verting Rotary Motion Into Unidirectional Motion."

What this means might best be explained with an illustration. When you whirl a stone on the end of a string, you generate a tremendous amount of centrifugal force with very little expenditure of energy. The trouble is you can't do much with it; as long as the stone keeps whirling in a circle, the big forces cancel themselves out with each revolution. But if you could extract just some of that tremendous force and make it go in one direction for an instant. . . . Well, look what David did to Goliath with a slingshot.

Dean's Space Drive does just that. Its basic component, a pair of eccentric masses, counter-rotate in a frame mounted on a sliding track. Spun by a motor, the eccentrics cause the frame to slide back and forth in the track. This unit, for all practical purposes, is a simple oscillator. Dean has made an arrangement of solenoid-operated clutches to grab and release the sliding frame in a precisely phased rhythm. Thus, part of the force of the spinning masses is transmitted to a one-directional force.

Wheels Aren't Needed

What is one-directional force? "Let's take a car, for instance," Dean explains. "The engine in an ordinary car turns the wheels and the car moves forward because the turning wheels move against the ground. That's two-directional force. With one-directional force, the engine has no connection with the wheels. Instead, it produces thrust **inside** the car. Wheels simply give the car something to roll on."

The usable force from a single pair of spinning rotors can't exceed 180 degrees in any cycle, Dean says. Instruments showed him further that peak thrust fell within a 90 degree arc in the forward swing. "It's usually advisable," he says, "to use only the peak of the wave that falls within an arc of 60, 70 or 90 degrees." Harnessing the centrifugal force of even these short arcs in the orbit of the counter-rotating masses, Dean discovered he could develop tremendous one-directional thrust.

"A single pair of brass eccentrics three inches long, with a radius of $\frac{3}{4}$ of an inch each, will, when spinning at 1200 r.p.m., lift a weight of 25 pounds $\frac{1}{64}$ of an inch each cycle in a frictionless atmosphere," he says. "At the same speed, the unit will pull itself, and a 25-pound load, across the floor."

One unit produces thrust for only a fraction of each 360 degrees that its rotors spin. To get continuous thrust, you'd need a machine with multiple rotor units, synchronized so that one followed another. "The one-unit machine I'm using here," said Dean, "would certainly not take off, anymore than a one-legged cat could climb a tree." However, he has built a six-unit model that actually lifted itself from the floor.

The potential of the space drive becomes apparent as Dean projects data he has gathered over the past five years. "A six-unit engine with three-inch rotors," he says, "could be put in a tube the size of a jackhammer. It would weigh less than 40 pounds. But it would knock over the brick wall of a building by sheer push."

The bigger the rotors, the larger the thrust. According to Dean, a six-unit machine using five-pound rotors would fit in a box measuring about one by one by three feet. It would weigh about 110 pounds. "With only 23 horsepower spinning the rotors at 2800 r.p.m. in a frictionless atmosphere—or add 25 percent if you want to include a broad margin for friction—" he says, "a device using this propulsion system could put a 3000-pound Jeep into a condition of zero gravity. If you increased the rotation by a single increment, you'd begin to lift the Jeep. As you increase the rotation of the shaft, the lift increment increases in geometric progression.

"This darn thing is basically a truck. It will lift or pull anything. Its most logical use will be to perform the world's heavy work. It could be used effectively in heavy truck transmissions. Instead of grinding wheels on the ground, you'd be pulling the whole works with a directional force—almost as though the truck had an invisible propeller up front."

Space, and Space Drive

Though he doesn't stress it, Dean is aware of what his system can mean in air and space travel. "It is a self-contained unit capable of moving itself in any direction," he points out. "With it, you could stack traffic in cities. Trucks could unload at any given floor of a skyscraper simply by hovering in space, if that seems practical. Newton's law says that objects in motion tend to move outward in a straight line if gravitational effects are nullified. So here's an interesting thought to contemplate: Give one of these engines zero gravity. It has the velocity of Earth because it is on Earth's surface. As the rotating surface of Earth turns away under it, would our engine move off into space at 700 miles

(Continued to page 266)

LASTS 100% LONGER

This super durable clear finish in GLOSS and SATIN outperforms all others on wood — interior, exterior, marine.



Write for free folder, name of dealer.
PRATT & LAMBERT-INC.
 Dept. M-9, 75 Tonawanda St., Buffalo 7, N. Y.

SAVE MONEY ON POWER TOOLS WORKSHOP SUPPLIES **WOOD**



World's Largest Selection, Rare, Fancy and Imported Woods, Mosaic Tile, Lamp and Upholstery Supplies, Tools and Hardware! All at Money Saving Prices!

Send for this complete new wood buying guide and project book. Craftsman is your best, most complete source of finest kiln-dried domestic and rare imported woods, beautiful wood inlays, colorful bandings, matched plywoods, furniture legs, embossed mouldings, carved ornaments, newest wood-working tools, "hard to find" cabinet hardware and fittings... most over 1,500 items! Packed with new patterns, project ideas and money making plans. Enclose 25¢ to help pay mailing and handling cost. Write:

NEW 140 PAGE CATALOG
Send Today!

CRAFTSMAN WOOD SERVICE CO.
 2729 S. Mary St., Dept. A-9, Chicago 8, Ill.

FREE CATALOG!

TREMENDOUS SAVINGS ON HUNDREDS OF SURPLUS AND NEWLY MANUFACTURED ITEMS!

New 1961 edition contains over 50 pages of tools and equipment for farm, home, workshop, factory. Hydraulic equipment, pumps, motors, construction and diesel equipment and parts! Write for your FREE CATALOG Today.

GROBAN SUPPLY COMPANY

1139 South Wabash Ave., Dept. G-9 Chicago 5, Ill., WEbster 9-3793

SPARE-TIME MONEymaking OPPORTUNITIES

READ OUR CLASSIFIED ADS

HUNDREDS OF BARGAINS AMAZING OFFERS

WELD - BRAZE - SOLDER - CUT

REPAIR MOST EVERYTHING MADE OF METAL



Home Appliances, Auto parts, Make and repair lawn chairs, tables, ornamental iron work, gates, wagons, etc. Solder, heat, bend, and straighten, with terrific heat from arc torch. Cut and weld up to 1/4" steel plate. A million uses for Home, auto, farm, inventors, factories, etc. Works from any home 110 volt plug-in. Complete with dark welder's mask, arc torch, supply of carbon steel welding and brazing rods and complete Welding Instruction Book. 1 year guarantee. **SEND ONLY \$3** (cash, ck. mo.) and pay postman \$11.95 plus COD postage on arrival or send \$14.95 and we will send postpaid. Ideal gift for mechanically minded, relatives, friends. Order now. Available only from: **MIDWAY WELDER, Dept. DPM-9, Kearney, Nebraska**

Spray 'em on!

JUST PRESS THE BUTTON!

- Clear Plastic Lacquer • Slide Lubricant
- Degreaser and Cleaner • Rust Penetrator
- Anti-Rust Oil • Spray Adhesive
- Brush Softener and Protector

These 7 new Stanley Chemical Tools are quick-easy-clean . . . help you do dozens of jobs faster and better . . . offer push-button ease when working with wood, metal, paper, rubber, leather, etc. For descriptive folder, write: Stanley Tools, 6209 Elm St., New Britain, Conn.

100% inspected and spray tested

7 NEW CHEMICAL TOOLS
 from

STANLEY

THE TOOL BOX OF THE WORLD

YOUR CHOICE...
 ONLY
\$1.39
 EACH



NOW ON SALE AT YOUR HARDWARE DEALER'S



CLIK-STOP Adjustable Wrench

**AUTOMATICALLY
LOCKS AT
EVERY SETTING**

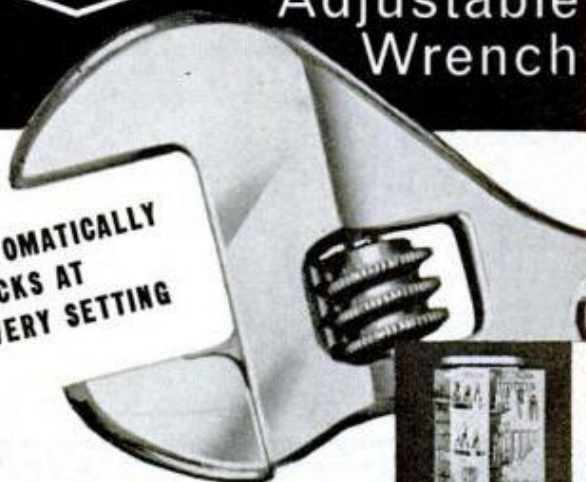

No levers . . . no gadgets . . . it won't slip or work loose . . . ever! You can yank it, bang it, even on the toughest jobs the jaws will never work loose. Available in both chrome or industrial-black finish in sizes from 4" to 20".

Send 10c for descriptive P&C Tool Catalog.



Look for the colorful P&C Merchandisers in over 12,000 stores.

P & C TOOL COMPANY

Portland 22, Oregon • subsidiary of Pendleton Tool Industries, Inc.



Has the face of our house changed!



We used to have this old basement door.



Till we heard about all-steel Bilco.



And replaced our old door.

Spring balanced Bilco Doors open at a touch . . . lock securely . . . are weathertight, cost so little! The door used on thousands of new homes!

The Bilco Co., Dept. R99
New Haven 5, Conn.
Please send me your fully illustrated folder and name of local dealer.

Name _____
Address _____
City _____
Zone _____ State _____

Bilco

AMERICAS FINEST
BASEMENT DOOR

an hour? Allowing for atmospheric friction, it should, theoretically."

Just why and how Dean's space drive system works gets complicated fast. But, in simple terms, by use of his oscillating mechanism, he has managed to polarize centrifugal force in two alternate horizontal directions. Then, by means of his solenoid-activated clutch, he has managed to grab the tail of the sliding oscillator, during one direction phase, and extract a burst of horizontal thrust in that direction.

"The important thing to remember," says Dean, "is that centrifugal force of the spinning rotors on their axis in the oscillator (not the oscillator itself) is really doing the work.

"Think of force in terms of electricity. An alternating current moves in two alternate directions. Then you rectify that alternating current to get direct current. We do much the same thing."

Action and Reaction

The idea of one-directional thrust produced from an alternating force is what causes consternation among some engineers. Action and reaction, they point out, are equal and in opposite directions, according to Newton. Dean agrees thoroughly. "But the effects of action and reaction aren't necessarily simultaneous," he says. "They can be sequential. The second point has to do with Niels Bohr's established physical law: When an orbit is shortened, it releases energy; when lengthened, it demands energy.

"Here, the load to be moved is part of the system. In operation, it moves during a phase when the rotors describe a shorter arc through space. The negative phase is completely unopposed and is longer in distance than the positive phase. The rotors would like to take more time traveling that distance. But since both orbits during both phases are required to be of exactly the same time duration, the orbit which tends to lengthen draws the same amount of energy from the motor that was realized during the positive phase. In this way, there is a cyclical demand and release of energy.

"What the system does," Dean sums up, "is to combine Newton's law of action and reaction with an additional effect—which is not simultaneous."

Not everyone is sure just what that means. But one thing is certain. Whether or not the time-honored laws permit it, Norman Dean's Space Drive system moves. If he is right in his theoretical assumptions, it may some day be moving a lot of things for a lot of people in a lot of places—including outer space. ★ ★ ★

Radioactive Iodine Helps Heart

Some heart diseases respond to treatment with radioactive iodine.

Patients with severe pains (angina pectoris), congestive heart failure and irregular heart rhythms are given small, harmless doses of the iodine. It is taken up by the thyroid gland, which influences the body's metabolic rate. The radiation reduces thyroid activity, metabolism is slowed and the heart's work load is decreased.

Of 202 patients treated in a study sponsored by UCLA and the University of Southern California medical schools, 167 showed marked improvement.

B-36 Engine Helps Railroaders

By aiming the powerful exhaust of a surplus B-36 jet engine, New York Central Railroad crews blow snow from the tracks, minimizing frozen switches and delayed trains.

Mounted on a caboose, the engine blasts a path free of snow and ice for a distance of about 100 feet. It has been modified to operate on regular diesel fuel, which is less costly than jet fuel. A nozzle on the engine can be swung up and down and sideways.

Sound baffles control the noise and safety devices automatically shut it off if it is operated improperly.

The proof is in the puffing!

PRINCE ALBERT has the flavor
most favored in the U.S.A.



- always tastes fresh
- mild, mellow flavor
- cool 'n' steady burning

PRINCE ALBERT

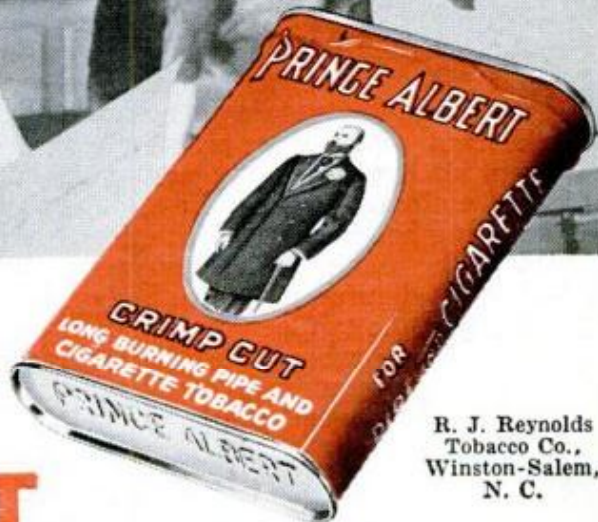

R. J. Reynolds
Tobacco Co.,
Winston-Salem,
N. C.

SEPTEMBER 1961

67

PM's House of Imagination

(Continued from page 162)

We approached the prominent East Coast architect, Grosvenor Chapman of Washington, D.C., with these requirements:

Our 1961 house must make the best use of new building and household products . . . it must appeal to the active type of person who reads *PM* . . . and it must be a good example of contemporary planning—yet appealing both to those who like long, low modern styling and those who prefer a more traditional appearance.

Let's look at the house he designed.

How about the use of new products?

A glance at the color photographs on pages 163 through 168 is convincing evidence that the House of Imagination is "made for" new products. From the sliding glass doors (an architectural feature) to a remote-indicating weather station (owner's option), it's an imaginative showcase of modern building materials and conveniences.

Does it appeal to people who have lots to do—like our readers?

Well, it's hard to imagine anything you'd want to build that couldn't be built in the shop and its "annexes."

The shop itself has plenty of space for small jobs. If you want more roofed-over space, just move the project and tools (see page 178 for a rolling toolbox) through the door into the garage. For a really big one—like a boat—simply move into the project area at the rear of the garage. (The garage has overhead doors front and rear, so there's no problem in getting back to the project space.)

There's lots of storage along the outer wall of the garage for garden tools, bicycles and other possessions of an active family. (Note that the garden storage space opens *outward* so that lawn mowers don't have to travel through the garage.)

For other hobbies, informal entertaining and television, there's a large family room next to the workshop. The family area and kitchen combine into a warm and friendly gathering place appropriately called the "farm kitchen" by architect Chapman. Located well away from the quieter living room and bedroom wing, the farm kitchen can be the scene of boisterous teen parties that don't disturb others in the house.

Mother, too, will enjoy her own corner of the house where the laundry, sewing and ironing equipment are conveniently grouped. One particularly appealing feature for a much-interrupted mother is the folding door that quickly hides sewing-room litter. The laundry-sewing-ironing room is just a few steps from the kitchen.

Now, what about the design and plan of the 1961 house? Does it really make everybody happy?

There are several options that give you a chance to "design" the house the way you want it. Initial choice is between the long, low roof (cover) or the more traditional one (page 163) for the 1833-square-foot home. (The garage is an additional 468 feet.)

The latter is Chapman's original concept of the house; he calls it New England country style. There's a reserved air about it, though the warmth of board-and-batten siding eliminates any feeling of austerity.

For our pilot model, which was displayed at the Los Angeles Home Show in the spring, we went to the low-roofed version because of the regional preference. Designated a Gold Medallion home by the Los Angeles Department of Water and Power it was visited by thousands during the show.

The House of Imagination is designed for a suburban lot that slopes gently toward the street (as many do). The main portion of the house is 16 inches higher than the level of the wings. The two-level design keeps the profile of the house low, and, more important, creates some truly striking interior scenes. The most charming is the view from the family area up toward the kitchen (see page 163).

There is an alternate version of the plan for a one-level house and another for adding four feet to the width of the main section. All versions are included in the single seven-sheet plan.

As for the over-all plan (page 164), you'll see its many good points as you imagine yourself touring the house.

Note the view a visitor has as he enters the court at the front of the house. And imagine the striking view he has of the interior when he goes in the front door and sees the dining and living rooms—with the cathedral-type ceiling sweeping up to the peak of the roof. A further dramatic element is the tall fireplace that divides the two rooms. Note, too, how handily the kitchen serves the dining room (via a pass-through) and the family room.

In the bedroom wing are two baths (a third is next to the kitchen). Large walk-in closets serve both the master and middle bedrooms. There's even an outside door to the front bedroom—a feature boys will like.

That's the 1961 *PM* home. Because of the versatility and flexibility of design, as well as its striking architectural features, we think you'll agree with the name we've given it—the *PM* House of Imagination. ★★

Further information on the Popular Mechanics House of Imagination is available from the lumber dealers listed on page 81.

FOR PANELING... BUILT-INS... CABINETS... FURNITURE

The Complete Interior WOOD FINISH



in One Can

READY TO USE

A finer clear, semi-gloss for natural wood beauty. Non-darkening. ANYONE can use Deft... it's so easy.

Wherever paints are sold, or write Dept. SSPM
Deft, 1526 W. 228th Torrance, Calif.

Free
Shop
Chart
on
Wood
Finish-
ing

Write
Dept.
SSPM.



A BRICK FIREPLACE, PLANTER, KITCHEN OR ACCENT WALL IS SO EASY WITH Z-BRICK

Z-Brick (in your choice of 4 decorator colors) comes in handy cartons with complete instructions, suggested patterns and enough lightweight Z-Brick to cover 7½ sq. feet. Applied to any wall without additional foundation or mortar. Special adhesive is stronger than mortar. Shaped with common hacksaw and round wood rasp. If you can stack blocks you can apply Z-Brick. Elegant in any room, non-ceramic Z-Brick is true unit masonry (not a plastic imitation or panel), fireproof, easy to clean, fadeproof and sound-absorbing. Z-Brick is available through your building supply store. Or write for Free Brochure, complete details and name of nearest Z-Brick supplier.

JOINT AND SHARPEN ALL SAWS



SUPER FILER NO. 11 joints and sharpens hand and circular saws 6" to 10" with all teeth correct in height, depth, pitch, bevel. When file hits steel roller, teeth are finished. Saw runs true with no side pull. Includes 8" file... **\$9.95 PPD**

"TRU-CIRCLE" saw set automatically sets teeth at 10° or more... **\$2.95 PPD**

PAINT BRUSH HOLDER and Wiping Bar. Pin holds brush securely. Fits any bucket or roll... **\$1.00 PPD**



SUPER DRILL GRINDER Sharpens round shank drills like new, using hand or power grinders... **\$2.95 PPD**

Send for free catalog.

Calif. Residents add 4% Sales Tax

A. D. McBurney, 5908 Hollywood Blvd., Hollywood 28, Cal., Dept. A-91

KING MIDGET FOR 1961

WORLD'S
MOST EXCITING
LOWEST PRICED CAR



Drive it for 75¢ a week. Rider Agents Wanted. Send 25¢ for 32 page book, full details, dealer price. Or send \$1 (refunded first order) for this plus Service and Repair Manual and 16 5x7 photos of car and factory.

MIDGET MOTORS CORPORATION, Athens 1, Ohio

(Item 24)



World's THRIFTIEST Light Plants

700 Watts, push button start, 115 v. 60 cyc. AC. 2.2 HP, easy starting Briggs eng. No wiring necessary; just plug in and operate. Plenty of current for any oil burner, freezer, brooder, emergency lights, etc. which require up to 700 watts. Ideal for television and radios. Complete with voltmeter and built-in winding to charge auto batteries. (Item 24) Wt. 75 lbs. Easily fits in car trunk. Be prepared if storm knocks out power lines. Reg. \$275... **\$149.50**

1500 Watt Plant (Item 45) same as Item 24 but larger generator and engine with 50% greater output... **\$199.50**

ELECTRONIC BRAIN IDLER Now Available On All Our Plants—Write
MASTER MECHANIC MFG. CO., Dept. A-961, Burlington, Wis.

Southern Customers Order from Dept. A-961, Box 65, Sarasota, Fla.

HANDLE LOOSE?
fix it quick with



PLASTIC WOOD
Handles like putty-hardens like wood!

Vermiculite Mfg. Co., Dept. A-4, 2107 N. 34th;
Seattle 3, Wash.

Gentlemen: Please send me, without obligation, your brochure and information for a Z-Brick: Fireplace Planter

Kitchen Accent Wall Other _____

NAME _____

ADDRESS _____

CITY _____ ZONE _____ STATE _____



55
Years

FOR 55 YEARS GERSTNER CHESTS have provided top quality tool care to the toolmakers and machinists of America. Free catalog.

GERSTNER TOOL CHESTS
461 Columbia St. Dayton 7, Ohio



Save on Parts, Equipment!

Send for America's most complete, exciting Electronics Catalogs... Radio Shack's bigger, better-than-ever 336 page Buying Guide plus supplements for 12 months! See Stereo, Hi-Fi, Ham Radio, Tapes, Records, Kits. No money down credit terms. Satisfaction guaranteed.

**FREE
ELECTRONICS
CATALOGS
for 1 full year**

RADIO SHACK Corp.
730 Commonwealth Ave.
Boston, Mass.

MAIL
Coupon
TODAY

RADIO SHACK Corp. Dept. 61J3B
730 Commonwealth Ave., Boston 17, Mass.

Send me Radio Shack's famous electronics catalogs for 1 full year—all FREE and POSTPAID.

Name _____

Address _____

City _____ Zone _____ State _____

Are You Taking Counterfeit Drugs?

(Continued from page 118)

Nevis E. Cook, director of FDA's Boston district office, explains that a counterfeit drug is "a drug which is manufactured for the specific purpose of being passed to-and-by the retailer when filling prescriptions as the product of another manufacturer."

The great danger to the general public from the counterfeits, he says, "is that critically important medications do not pass through the safety clearance or manufacturing-control procedures necessary to assure compliance with the Federal Food, Drug and Cosmetics Act. Therefore there can be no assurance that they contain the proper potency and purity of the drug alleged to be present."

Shipped as "Machine Tools"

Some counterfeits have been shipped via air freight to distributors under such false billings as "machine tools," "ceramics," "water softener" and "glass beads" and are frequently delivered to the local pharmacists by personal automobile. Sales to the retailer are usually made on a cash basis without invoicing or other billing.

How are the FDA chemists and other laboratory specialists able to identify counterfeit drugs? As explained by John L.

Harvey, FDA deputy commissioner: "We use a 'ballistic' method not unlike the one used by big-city policemen to pinpoint a particular gun that fired a certain bullet. It includes a systematic comparison of unknown tablets with authentic samples from the known manufacturing sources."

Genuine Tablets

This is how genuine tablets are made by ethical manufacturers:

After compounding and mixing, the tablets are formed by presses which operate at pressures up to three tons per square inch between two punches in a die. Simplest type of press is the single-plate machine which has only one pair of punches. The granulation (drug and filler mixture) is fed into the die and compressed as the upper and lower punches come together. Any deviation of the punch faces from a smooth, flat surface is shown in reverse on the tablets' surfaces. Most manufacturers use rotary presses, requiring 16 pairs of punches, each pair operating like a single-plate machine.

Many kinds of punches are used. Their outline may be round, rectangular or heart-shaped. The faces of the punches may be flat, concave or convex; they may be un-scored, single-scored, double-scored, or no

(Continued to page 272)

PARAGON *Automatic* TIME CONTROLS

Electric servants that never forget... work for pennies a day



- 1 MODEL APT1-0 is a portable 24-hr. automatic appliance Time Control. It's ideal for automatic control for decorative and protective lighting, radios, coffee makers and other household appliances.
- 2 Automatic night-lighting with Paragon's 4000 Series Time Control insures safety and convenience... prevents accidents and vandalism. Ideal for control of post lights, flood lights, patio and driveway lighting.
- 3 MODEL PF31-0 is a Time Control that automatically turns OFF ventilating fans at any pre-selected time up to 24 hrs. Simply plug TIMER cord into outlet... fan cord into TIMER.
- 4 MODEL FA51 is a flush-mounted, interval TIMER that fits into a single, gang-switch receptacle or handy box. It is ideal for automatic time control of kitchen and

attic exhaust fans, yard lights, built-in heaters, and other interval timing applications.

- 5 MODEL AT3160-0 is a compact, attractive interval TIMER with 0-60 minute range with one-minute dial graduations. It controls the time for sun lamps, vibrators, heating pads, sterilizers, and other appliances.
- 6 MODEL AC1 is a 24-hr. automatic, air-conditioner Time Control that assures cool comfort when desired... and reduces maintenance costs due to needless overwork. It comes complete with a 3-wire cord set to meet code regulations, 3-wire grounded receptacle, rubber feet, and back plate for easy mounting. Available 120 or 240V, up to 1-hp full-rated load.

See your Electrical Appliance Dealer or Contractor.

Time is money... control it with Paragon



PARAGON ELECTRIC COMPANY, INC., Dept. PM, Two Rivers, Wisconsin
Subsidiary of American Machine & Foundry Company

NEW BELSAW MULTI-DUTY POWER TOOL SAWS—PLANES—MOLDS

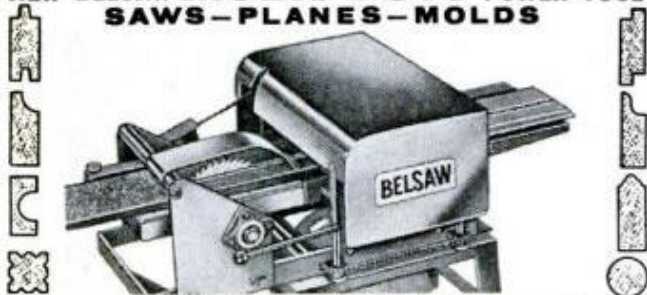

Now you can use this ONE power-feed shop to turn rough lumber into moldings, trim, flooring, furniture... ALL popular patterns. RIP... PLANE... MOLD... separately or all at once with a one HP motor. Use 3 to 5 HP for high speed output. Low Cost... You can own this power tool for only \$30.00 down payment.

Send postcard today for complete facts.

BELSAW POWER TOOLS, 902 Field Bldg., Kansas City 11, Missouri

TOM MOORE TRACTOR, INC.

FARM-ETTE

MANTUA, OHIO
U.S.A.

TESTED • PROVED
Best in powered lawn
and garden equipment
Write department 8 for catalog

FREE power tool catalog

Get the right tool for the job! Write:



Black & Decker®

WORLD'S FIRST CORDLESS ELECTRIC DRILL
...WORLD'S LARGEST MAKER OF POWER TOOLS
Dept. D-091, Towson 4, Md.

X-PANDOTITE® WHITE, MORTAR-LIKE THE CEMENT THAT EXPANDS AS IT SETS

Perfect for repairs around bathtubs, toilets, urinals, shower stalls, tile, mosaics (resetting and grouting). Terrazzo, marble, etc. All joints. For anchoring bolts, screws, railings. For molding; electronic assemblies. Thousands of uses around the home. May be colored. Non-Toxic. No other cement does so much, so well.

At local stores. FREE leaflet available. Write — Dept. 10, X-Pando Corp., 43-15—36th St., Long Island City 1, N.Y.

Constantine's Catalog & Manual for WOODWORKERS

ALL-NEW! 1961 Edition. More than a catalog—a manual, too! 130 pages—exciting new items! Since 1812, world's most complete source for rare imported & domestic woods at rock-bottom prices. Inlays, bandings, carvings, hard-to-find hardware, inlaid wood picture kits, new brass hardware, etc. Plus tools, plans, projects. Enclose 25¢ (refunded on 1st order). Get FREE "Chips & Chats" too. Write NOW!

ALBERT CONSTANTINE AND SON, INC.
2050 Eastchester Rd., Dept. M-5, New York 61, N. Y.

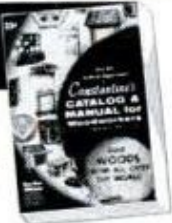

The 'All-Purpose' Oil For Home Workshops

Cleans • Lubricates • Prevents Rust

3-IN-ONE® OIL

REGULAR—OIL SPRAY—ELECTRIC MOTOR

SEPTEMBER 1961



MR. FIX-IT

THE
Turner
TORCH
IS
"YOUR TOOL"

This is the "Torch Tool" you'll use hundreds of times around your home and shop. With a Turner Torch you can solder, remove old putty, remove paint, light charcoal, soften asphalt tile, thaw pipes... you name it. Every "Mr. Fixit" needs a Turner Torch... and so do you.



TURNER
TORCHES HAVE
FORGED BRASS
VALVES FOR
LONGER LIFE AND
GREATER SAFETY

LP-99 MULTI-TORCH METAL CHEST KIT

A complete kit in a sturdy metal case with pencil point burner assembly, giant sized fuel tank, heavy duty burner, soldering tip, flame spreader and spark lighter—all for only \$9.95 from your local hardware dealer.

SPECIAL "FREE" OFFER

This new booklet "How to Use Your Propane Torch" regularly sells for 35¢. We'll send you a copy, free, just write.



Turner Corporation

839 Park Ave., Sycamore, Ill.

271

bevel at all. Each type includes variations, such as the degree of curvature or convex faces, bevel angle, groove or score angle, width and depth of groove. Also, upper and lower punches may be combined.

The first step in tablet identification is the examination of the tablets for these "gross punch marks," and it usually doesn't require magnification. Punches, even when new, show various characteristic microscopic marks that can be used to differentiate them. As the punches are used they develop other characteristic shapes, marks or imperfections that are impressed into the tablets and positively identify the tablet with a given manufacturer's punch, just as fingerprints identify a human being.

Rough handling of the punches may cause characteristic scratches, pits and ridges on the punches, which are matched in reverse on the tablets. Sometimes the upper and lower punches hit together with no granulation between them; this damages the punches, usually by flattening the score marks of the upper punches and correspondingly denting or scoring the lower punches. This may happen to only one of the punches of the set, or to all of them. The extent and character of these imperfections depend on what types of punches are used, how much of the punch surfaces hit together, whether the punches rotate before hitting again, or other factors.

Telltale Ridges

If the punches fit loosely into the die, some of the granulation is squeezed into the gap between the punch and die as the material is compressed, and a ridge forms at the tablet edges. Sometimes punches are not highly polished when they are made or when they are reworked, and the marks of the grinding wheel or file show up on the tablets as curved striations.

By mounting a tablet so that a silhouette of the tablet is projected, or by mounting the tablet with the groove vertical, the width and depth of the groove and the groove angle can be measured.

The punch marks detected and measured on the tablets suspected of being counterfeit can then be compared with the punch marks of tablets of legitimate manufacture.

The final step in tablet identification is determination of the ingredients and study of their microscopic habit by the optical-crystallographic method. Each crystalline compound has its own set of peculiar and specific optical properties that serve to identify and differentiate it from all other compounds. These properties include refractive index, extinction angle, sign of elongation, optic sign and axial angle. Each

may be pinpointed for each crystalline substance present by mounting a portion of the crushed tablet in a liquid of suitable refractive index and examining it under a polarizing microscope with polarized light. The results of this analysis are then compared with the results of a similar microscopic analysis of tablets of known manufacture, and to the manufacturer's formula.

Summing up, by making these comparisons of gross and microscopic punch marks and identity and microscopic habits of ingredients of the suspect tablet with those of tablets of known manufacture, the manufacturer of tablets of unknown origin can be determined.

Deputy Commissioner Harvey says there are not nearly so many counterfeits of capsule drugs as of the tablet varieties. However, capsule identification proceeds in somewhat the same way. It is more difficult than tablet identification because there are fewer external characteristics that can be used, and capsules usually contain fewer ingredients. The capsule size, shape, color and weight are determined, and any characteristic markings are observed. Some manufacturers use special shapes, others have monograms molded into the capsule. Still others print a name or monogram on their capsules.

In the case of time-disintegration capsules, the external characteristics of the pellets are determined, such as glossiness, colors, size, shape, mottling of color pattern and lumpiness of surface. All of these characteristics, as well as microscopic habit and identity of ingredients, are utilized in the identification of drug capsules.

FDA chemists and other laboratory specialists have been successful in determining by these methods the manufacturing source of many counterfeit drugs. Some particular lots have resisted identification for a while, but eventually a telltale mark or ingredient will furnish the clue needed.

How to Be Safe

Can the consumer tell if he is buying bootleg drugs? Not always, according to FDA officials. However, in most cases he can "play it safe" while making his prescription purchase, granted that his physician has made out the prescription for a well-known branded drug. The consumer can follow these simple safety rules: First, be sure you're dealing with a known drug-gist. Next, when you hand your pharmacist your prescription, ask him if he will show you the sealed, clearly branded container while he is measuring out the tablet amount of your purchase. Thus you can be virtually certain that you are getting the genuine drug. ★ ★ ★



WELD FOR PLEASURE OR PROFIT TRINDL INDUSTRIAL ARC WELDER

Own a Trindl 125 Amp Industrial Welder at less than smaller machines. Welds metals to 1/2" thick. Operates off properly wired 110 or 220 volt line. 16 heat stages from 20 to 125 amps. Make, repair anything of metal in the home, garage, farm or shop. No experience or training needed. Full "do-it-yourself" instructions. Guaranteed 12 months in continuous operation. Complete only \$98.50 FOB or write for details on 125A and other Heavy Duty Trindl Welders. Dealer Inquiries Invited.



EASY TERMS
\$98.50 FOB

BUILD YOUR WORKSHOP LIBRARY

Seven handsome hard cover books, 120 pages each, tell and show you with photos and drawings how to get the most out of your: CIRCULAR SAW & JOINTER, DRILL PRESS, LATHE, ABRASIVE TOOLS, BAND SAW AND SCROLL SAW, SHAPER and RADIAL SAW. Your choice—\$1.00 each. Mail check or money order to Deltacraft Books, Rockwell Manufacturing Company, 502J N. Lexington Ave., Pittsburgh 8, Pa.



GENUINE ALNICO MAGNETS

AMAZING, PERMANENT, NON-ELECTRIC, HIGHLY PRACTICAL. Conduct interesting experiments. Hundreds of uses. Retrieve valuable steel items such as guns, tackle from fresh or salt water; tools from tanks & drains. **GUARANTEED.** Try any magnet one week. Money back if you are not well-pleased.

No. M-710 (Wt. 53 oz.) Has pull of 225 lbs. on steel block . . .	\$18.00
No. M-625 (Wt. 70 oz.) Has pull of 125 lbs. on steel block . . .	\$10.00
No. M-575 (Wt. 18 oz.) Has pull of 75 lbs. on steel block . . .	7.00
No. M-500 (Wt. 13 oz.) Has pull of 50 lbs. on steel block . . .	5.00
No. M-90 (Wt. 5 oz.) Has pull of 15 lbs. on steel block . . .	3.50
No. M-47 Hot Pad Magnets, 10 for \$1.00 . . .	50 for \$ 4.87
No. M-35 Hobbyist assortment of 8 magnets . . .	2.00

Send M.O. or check. We pay postage. Sorry no C.O.D.'s.
MIAMI MAGNET COMPANY, 3240 N.W. 27th Ave., Miami 42, Fla.



FIX IT FOR KEEPS

DU PONT **DUCO**® HOUSEHOLD CEMENT
ALSO MENDS CHINA METAL PAPER GLASS LEATHER

HERE'S A MONEYMAKER FOR YOU!

make from \$3 to \$6 an hour
with the **FOLEY SAW FILER**

Ask yourself these three questions: 1. Do I really want to get ahead *faster*? 2. How can I do it? 3. Am I willing to use my spare time? If you answer "Yes" to questions 1 and 3—then we have a positive answer for you on No. 2. Men make from \$3 to \$6 an hour sharpening hand, band and circular saws with Foley Saw Filers. No experience needed, to turn out sharp, smooth-cutting saws with this automatic machine. Start in spare time—no canvassing.

HERE'S THE WAY TO START

Read "Money Making Facts"—shows you how others have added hundreds or thousands of dollars to their incomes in this steady, repeat, CASH business. Start your *own* business in your basement or garage, no overhead, small investment. With *Time Payment Plan* the Foley can more than pay for itself out of profits. Send for "Money Making Facts"—mail coupon now. No salesman will call.

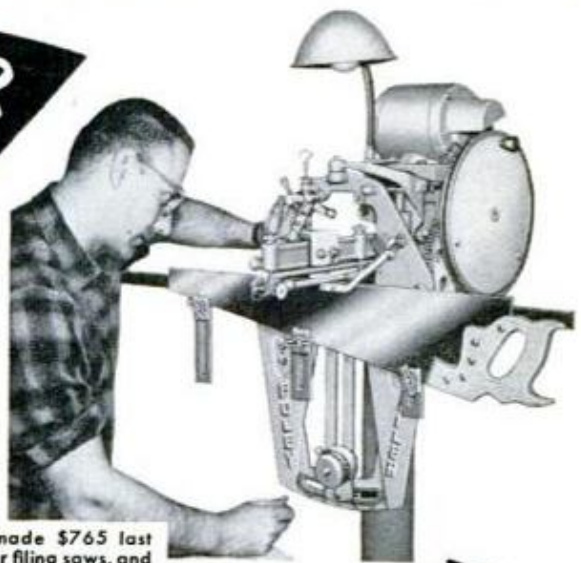

HERE'S PROOF

"When Mr. Patrick got his Foley Saw Filer in March 1946 he made a good and wonderful investment. He has done so well that we bought a house and paid for it; bought a new car, built an addition to our house. Nicest of all, it's all paid for."
Mrs. Leslie Patrick.

"I made \$765 last year filing saws, and it sure comes in handy. I do this work in my spare time."
—James B. Williams

"Last year's profit amounted to \$3,000. Not so bad for a one-man outfit."
—Charles C. Hough.

"I have done 4 or 5 thousand saws in my spare time in the 4 1/2 years since I got the outfit, and they are all coming back with repeat orders."
—Len Crego.



FOLEY MFG. CO., 916-1 Foley Bldg., Minneapolis 18, Minn.
Send me free book "MONEY MAKING FACTS" and Time Payment Plan.

NAME _____
ADDRESS _____

Report on the Corvair Family

(Continued from page 109)

SUMMARY OF OWNERS REPORT:

EXCELLENT 70.0%  AVERAGE 25.4%  POOR 4.6% 



Satisfied with automatic economy?	Best-liked exterior features	Is Corvair only car in family?
Yes, satisfied.....69.6%	Low, clean, trim lines.....26.7%	Yes, it is.....53.2%
No, not satisfied.....30.4	Sensible trim, no fins.....10.0	No, it is not.....46.8
Satisfied with manual economy?	Sports-car look.....4.6	Make of other car?
Yes, satisfied.....74.4	Front end.....3.8	Chevrolet.....15.6
No, not satisfied.....25.6	Side view.....3.0	Other G.M. make.....16.9
Best-liked features	Least-liked exterior features	Ford.....5.9
Handling ease.....65.6	Front end.....3.5	Other Ford Co. make.....3.5
Riding comfort.....32.3	Trunk space.....3.5	Chrysler Corp. make.....5.4
Styling.....26.1	Rear end.....3.0	Other U.S. make.....2.4
Economy.....19.4	Bumpers.....2.4	Decision to buy Corvair based on:
Traction on snow, ice, mud.....17.5	13-inch wheels.....2.2	Economy.....61.7
Roominess.....16.7	Best-liked interior styling	Style.....54.9
Parking ease.....14.3	Bucket seats.....29.1	Size.....45.4
Most-frequent complaints	Flat floor, no hump.....12.9	Rear, air-cooled engine.....9.2
Poor workmanship, paint, rattles.....19.9	Fold-down rear seat.....12.4	How is dealer service?
Insufficient leg, headroom.....8.9	Instrument panel.....10.8	Excellent.....45.5
Difficult entry, exit.....7.0	Least-liked interior features	Average.....37.5
Sluggish engine.....6.7	Seats too small.....9.1	Poor.....17.0
Heater operation.....6.5	Windshield, dash-panel glare.....5.4	Make of car traded in
Noisy engine.....5.9	Gearshift, selector lever.....2.7	Chevrolet.....33.9
Had mechanical trouble?	Lack of gauges.....2.2	Corvair.....3.5
No trouble.....44.4	Did consider another compact? 55.6	Other G.M. make.....12.4
Some trouble.....47.0	What make?	Ford.....12.4
Considerable trouble.....8.6	Falcon.....43.5	Other Ford Co. make.....3.5
What was trouble?	Valiant.....12.6	Chrysler Corp. make.....5.1
Carburetor.....8.9	Volkswagen.....12.6	Other U.S. make.....4.3
Oil leaks.....8.1	Rambler.....7.7	Would buy another Corvair?
Fuel pump.....7.5	Comet.....6.3	Yes, would buy.....71.5
Valve lifters.....7.3	Tempest.....6.3	No, would not buy.....17.2
Manual transmission.....6.7	Lark.....3.4	Undecided, don't know.....11.3

also on curves."—New Jersey salesman.

"I like the ride. I average over 100 miles per day while working at my sales job, and every day is just as enjoyable as the preceding day." New York salesman.

"My Corvair may be small but it rides like a big car."—Michigan machinist.

Independent suspension all-around and low center of gravity are big factors in Corvair's smooth road personality.

"I'm quite happy with its nice, clean design."—Illinois architect.

"I like its sporty appearance."—New York hairdresser.

"The car has a nice, rakish appearance."—Michigan attorney.

"On my first tank of regular gas I got 21.6 m.p.g. Now I burn ethyl gasoline, drive about 1000 miles per week in and about Los Angeles, and get 23.5 to 24.5 m.p.g."—California editor.

He isn't saving any more money buying the more expensive premium, but he's got two or three more miles per gallon to talk about.

"My Corvair Monza has given me many miles of comfortable, economical transportation. To date, I have had not one single mechanical difficulty although I have driven an average of over 1500 miles per month."—California attorney.

"My mileage is 20.8 m.p.g. over-all, based

on an accurate record of gasoline purchased. My total transportation expense has been reduced by over 25 percent compared with the '59 Chevy Six I formerly owned."—New York mechanic.

"This Corvair is wonderful in winter. It will take slippery hills that other cars cannot negotiate, and without chains.—Connecticut architect.

"In last year's heavy snowfall, I did not have to use chains or snow tires once."—New York secretary.

We have never seen a Corvair with chains on.

"I like its roominess, interior space and trunk space."—Wisconsin insurance agent.

And now for complaints, here are the first six; again, in the order of frequency of mention.

"I'm six-feet, two-inches tall and the front wheel well cramps my left foot."—Michigan physician.

Move over Doc, we're 6' 2½" and have the same problem! Say, have you tried riding with your left foot in depression beneath clutch pedal?

"Larger persons are likely to be slightly cramped if they're driving."—New York mechanic.

"I was unable to drive comfortably until

(Continued to page 276)

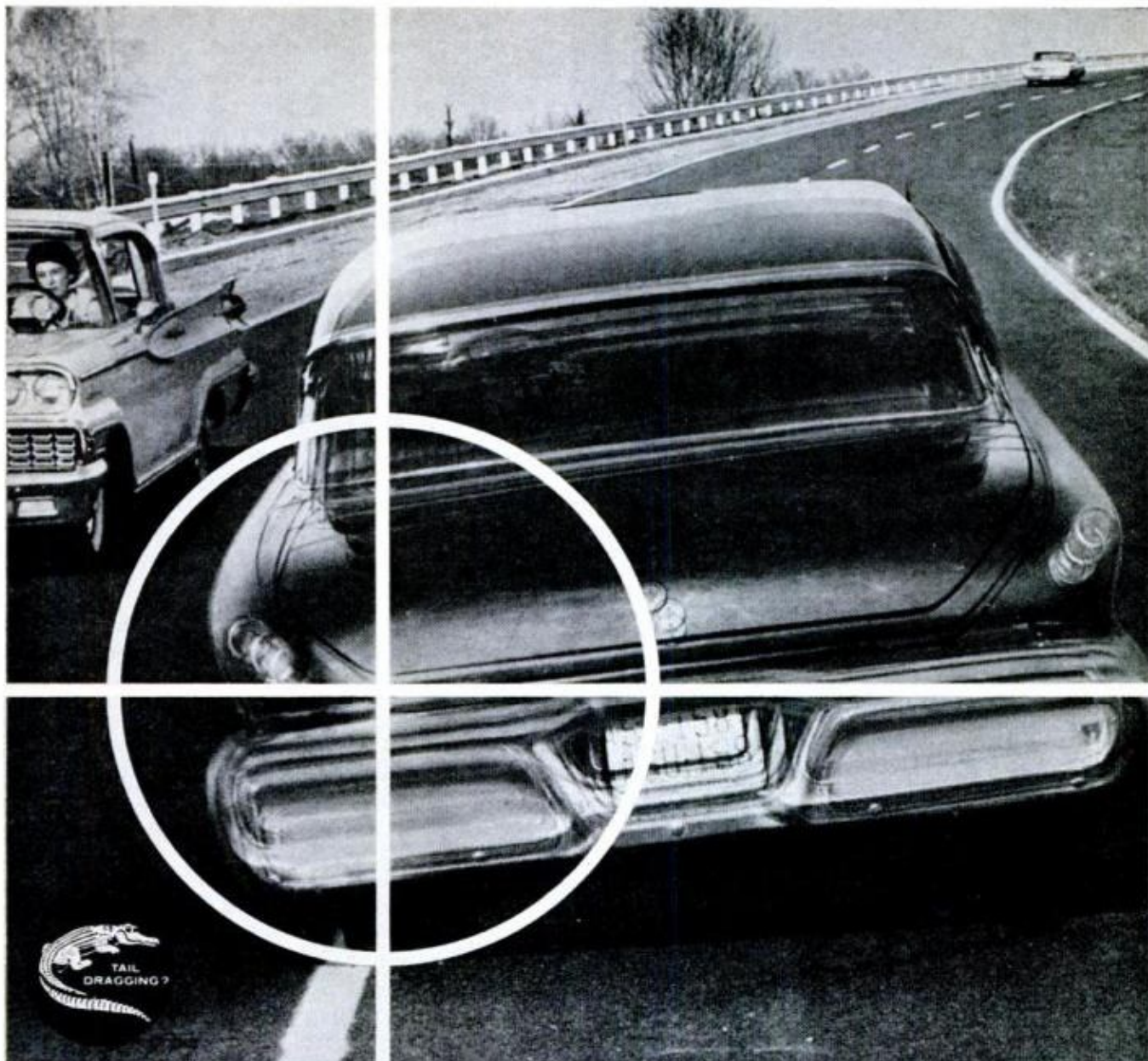

This car needs Load-Levelers®. Does yours?

STABILIZING UNITS

Does your car sway dangerously around curves? Does it "bottom" on the frame when you hit a bump or rut? Does "tail drag" cause your rear bumper or tailpipe to scrape on driveways? Your car needs Super Load-Leveler® stabilizing units to compensate for the added weight of passengers and luggage, to keep your car riding its level best under all road and load conditions. And, in keeping your car level, they hold your headlight beams on the road, out of the eyes of oncoming motorists. Have a set of Super Load-Levelers installed today wherever you have your car serviced. *Monroe's 60-day free ride plan guarantees you complete satisfaction.*

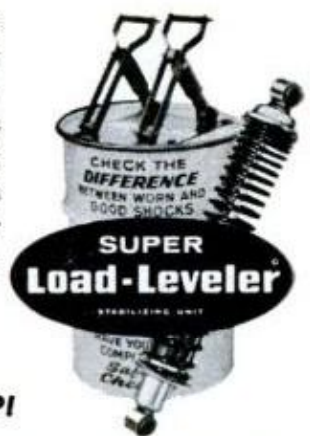

LOOK FOR THE YELLOW AND BLUE SAFETY BARREL WITH THE SHOCKS ON TOP!

MONROE

MONROE AUTO EQUIPMENT COMPANY • MONROE, MICHIGAN • In Canada, MONROE-ACME LTD., Toronto, Ontario
 In Mexico, MEX-PAR, Box 28154, Mexico City • World's Largest Maker of Ride Control Products, Including MONRO-MATIC® Shock Absorbers



Doubles Traction—Assures Stability
Uses Same Tires and Wheels
Adds to Appearance—Easy to Install
Loads or Towing Trailers Made 100% Safer
Satisfaction Guaranteed or Money Refunded
\$49.95 for 1/2 Ton—\$59.95 for 3/4 & 1 Ton

Also Manufacturers of World's Most Complete Line of "Selective Drive" Hubs



FOR ALL 4-WHEEL DRIVE TRUCKS

Available for Willys, Ford, Chevrolet,....
 Dodge, GMC, IHC, Scout, All Army Units
 and many others.

Fleet cost, \$47.50 for Willys and Scout. Available at
 over 5,000 jobbers. Warehoused in 100 principal cities.
 Write for free literature.

DUALMATIC

P.O. BOX 419 LONGMONT, COLORADO

**FREE CARBURETOR
 TUNE-UP KIT
 WITH THE NEW PACCO
 INSTRUCTION HANDBOOK**

★ _____ ★

ONLY \$2.25 POSTPAID

Order your new PACCO Handbook with
 goof-proof instructions for carburetor
 tune-ups today, and we'll send you free
 a \$2.25 (List Price) Pacco Tune-Up Kit
 for 1950-56 6-cyl. Chevrolets (for
 Rochester applications). Offer good
 while supply lasts, so hurry.

MAIL THIS COUPON NOW

Enclosed is \$2.25 (check or money order).
 Send my Handbook and free Tune-Up
 Kit.

Name.....

Address.....

City..... State.....



PRECISION AUTOMOTIVE COMPONENTS CO.
 Manchester, Missouri

I installed brackets to move the front seat
 farther back—but this makes rear-seat leg-
 room practically nonexistent." Virginia ra-
 dar technician.

**Let's face it, the Corvair is just a bit too
 small for us six-foot-and-over guys. More's the
 pity, too!**

"Very poor quality control on the assem-
 bly line."—Massachusetts teacher.

"Within the first week, I had to have a
 new fuel pump installed."—Florida house-
 wife.

"Almost every bolt and screw was loose
 when I took possession of the car."—Mon-
 tana salesman.

"Getting in and out of this car is difficult
 and the step-down design makes it even
 more so, especially for the ladies."—Ohio
 physician.

"It is difficult for normal-sized men and
 for older people to get in and out without
 hitting their heads on the door frame."—
 California secretary.

**Corvair is America's lowest car, actually
 half an inch lower than Chevy's Corvette, an
 out and out sports car! For many people it's
 too low.**

"Slow response when trying to accelerate
 engine after idling. This often causes slow
 start-up after change at stop light."—Flor-
 ida engineer.

"Not enough passing power at speeds
 from 40 to 65 m.p.h."—N. Carolina trucker.

"Car heater continues to throw heat in
 summer even with all the switches turned
 off."—Pennsylvania housewife.

**This is an almost universal complaint with
 the new heater. Many dealer service depart-
 ments seem unable to lick it either.**

"Heater gives off heat even with the vent
 closed."—Ohio administrator.

"The heat regulating cable seems to be
 subject to kinking and breakage."—Penn-
 sylvania pressman.

"This car has one of the worst paint jobs
 I have ever had on a new car, and the Chev-
 rolet people didn't seem to care whether it
 was taken care of or not."—Ohio parts man-
 ager.

"I would like to see them produce a bet-
 ter paint job as this one has quite a few bad
 spots."—California serviceman.

**Back to the brighter side of the picture,
 here are the features most approved, rank-
 ing seven through twelve.**

"I like the beautiful way it handles—you
 can turn corners or parallel park with hard-
 ly any effort."—New York housewife.

"Tremendous parking ease."—Illinois
 nurse.

"Our Lakewood station wagon is small
 enough for city driving, yet large enough

for a family of six (four small children). We all like its added trunk space which most wagons lack."—California plant manager.

Lakewood is probably best Corvair for family use. Its roof is higher than the sedans, giving higher seating and better headroom.

"I do not feel dwarfed by the other cars on the road, yet this is a small car, attractively designed and with plenty of room inside."—New Jersey finance manager.

"Being a small person, I always had trouble seeing over the steering wheel and out of all the windows. In my Corvair I have no trouble seeing in all directions."—Illinois office manager.

"This Monza is real fast—1st, 45 m.p.h., 2nd, 75 and 3rd, 87 with a high of 104 m.p.h."—California educator.

Bet you he doesn't teach Driver Education!

"With the 98 hp. engine and the four-speed transmission, there is plenty of go. Yet I still have a small and economical car."—Missouri mechanic.

Yep, this Ozark monkey-wrench commando is right. The hot engine and four-speed box makes Corvair the poor man's Jaguar.

"I have worked around electric welders driven by air-cooled gasoline engines, and they worked so faithfully I figured Corvair would be the same."—Pennsylvania retiree.

"I knew that this type of engine was used in light aircraft . . . this type of engine is pretty efficient and I was influenced considerably by this fact."—Illinois technician.

The air cooled flat-type engine has also made quite a name for itself in light automobiles!

"It is very easy to handle at normal road speeds and holds the road well on curves."—New York engineer.

"Better handling all around, especially in sharp turns at higher speeds, than any car I have ever had."—Michigan designer.

And, as the other side of the coin turns up again—here are complaints numbering seven through thirteen in their order of mention.

"Too much engine noise in this particular model—the Lakewood station wagon."—California builder.

Sad, but true. Lakewood wagon's design closets engine and passengers. Try covering engine hatch with a couple of layers of rug cushion material.

"Too many rattles coming from the dash."—California maintenance engineer.

"The gas mileage is a disappointment. They said I'd get 28 m.p.g. with the four-speed transmission."—Iowa farmer.

(Continued to page 278)

Professional Paint Spray Outfit \$29.50*

Outfit No. 680
Fits any 1/4 hp motor
*less motor

Prices slightly higher—West Coast

Speedy Sprayer

Do it yourself and pay for a Speedy Sprayer from the savings on the first paint job! Sprays fences, screens, shutters, furniture rough walls, floors, big jobs in minutes instead of hours. Finish is smooth, flawless. A real professional tool proved by 40 year's use. Get a Speedy Sprayer!

W. R. BROWN CORP.
Our 40th Year of Portable Paint Sprayers
2635 N. Normandy Ave., Chicago 35, Ill.

FREE! Write for "How to Spray" and catalog.

STOP WATER DAMAGE...

Wood
Plywood
Shingles
Asbestos siding
Concrete blocks
Concrete
Mortar
Stucco
Plaster
Brick
Paint
Wallboard
Tile
Canvas
Leather
Linoleum
Fabrics

Prevents warping, swelling, mildew, mold, water stains, seepage, dampness, rot.

Keeps moisture out 5 years and longer.

Use on all woodworking jobs, boats, patio furniture, planter boxes, shutters, screen doors, window sash, shingle roofs. Stops seepage in basement walls, concrete silos, foundations. Waterproofs canvas, tarps, tents, awnings, leather boots, shoes, outdoor clothing. Won't harden or crack leather or fabrics. Perfect underseal for oil base or alkyd paints. Deep penetrating, colorless. Apply by brush, spray or roller. At paint or hardware stores or order direct. 16 oz. spray can \$1.89, Qt. \$1.75, Gal. \$5.35, 5 Gal. \$25.25, ppd., tax incl. Send check or money order to **E. A. Thompson Co.** 1355 Market St., San Francisco 3, Calif. No COD's please. (Since 1929.) Dealer and jobber inquiries invited.

HEAVY DUTY or LIGHT...



T-50 All-Purpose STAPLE GUN

For HEAVY DUTY
Nailing Jobs!

Powerful . . . jam-proof . . . with heavy all-steel construction. Perfect for insulation, ceiling tile, screening & 1001 other jobs. Uses 6 staple sizes up to 9/16" and CEILTILE.

\$1250

You're always RIGHT

with **ARROW**

JT-21 Junior STAPLE GUN

For LIGHT DUTY
Household Tackling!

Light . . . compact . . . easy to operate. Ideal for housewife for making valances, lining shelves and closets, tacking curtain tie-backs, etc. Uses 1/4" and 5/16" staples.



\$495

At Your Hardware, Lumber, Building Supply or Stationery Dealer

ARROW FASTENER COMPANY, INC.

ONE JUNIUS STREET • BROOKLYN 12, N. Y.



Pella

WOOD FOLDING DOORS

ASH • BIRCH • OAK • PINE • PHILIPPINE MAHOGANY • AMERICAN WALNUT

HERE'S AN IDEA—Use PELLA WOOD FOLDING DOORS with their natural beauty of wood as room dividers, closures for closets, utilities, storage areas. Save floor and wall space. Easily installed. Order unfinished and save. Distributors in U. S. and Canada.

CLIP AND MAIL TODAY!

ROLSCREEN COMPANY, Dept. MC-57, Pella, Iowa

Please send free 6-page Folder on PELLA WOOD FOLDING DOORS.

NAME _____

ADDRESS _____

CITY & ZONE _____

STATE _____

"My gas mileage—18 to 21 m.p.g.—isn't as good as I thought it would be."—California engineer.

"They should either use a bigger heater blower, or find a way to put more air through the defrosters."—Colorado ambulance driver.

"The choke control binds and is hard to work."—Ohio accountant.

"I've had trouble with the choke and with carburetor flooding."—Florida minister.

"My Corvair is overly wind sensitive."—Illinois accountant.

"The steering ratio is too slow. They should decrease the steering ratio or provide an optional ratio as they do for the rear end."—Ohio foreman.

"Because of the light front end, the steering traction is slow to respond in mud and snow at speeds above 30 m.p.h."—Ohio draftsman.

There are some people who think that you shouldn't go over 30 m.p.h. in mud or snow. Black rocks lurk under that white stuff.

"The shifting linkage was fouled up. It kept jamming in reverse gear."—California draftsman.

"I think the gear-shift lever should be two or three inches longer."—California TV engineer.

Back to the plaudits and the compliments. Here are the best-liked features ranking fourteen through nineteen.

"Corvair's oversteering has been effectively controlled and is no problem in normal driving."—Utah engineer.

We couldn't have phrased it any better ourselves.

"This car has beautifully detailed appointments."—Maryland engineer.

"Among several things I go for is the aluminum engine in the rear."—Florida store manager.

"The Monza-bucket seats are the most comfortable I have sat in to date."—Ohio salesman.

"I like the comfortable bucket seats."—Virginia electrician.

"Having owned foreign jobs with four-speed boxes, I can truthfully say the four-speed Corvair transmission is comparable to anything the foreign cars have to offer."—California retiree.

"I like the fact that the back seat tips forward to make additional room."—Michigan trucker.

You need that extra room for luggage on long trips. This seat would be a useful option on other makes too.

"This car has a roomy trunk for a compact."—Massachusetts secretary.

(Continued to page 280)

Weld. cable No. 0, 100' \$24.50, 50' \$12.95
 G-1 150-250 amp Record \$19.50 Good \$12.95
 R-1 300 amp G.E. Record \$24.50 Good \$16.95

Accessories Kit For Arc Welder for above generators has helmet, gloves, elect. holder, volt reg, rheostat, volt-meter, Gr. Clamp, including switch & R. C. relay With G-1 generator **\$26.50**
 Kit With G-1 160-250 Amp Gen. plus 30' cable & reactor coil **\$36.45**

Multi-Weld[®] D.C. Arc Welding Kit Complete with G.E. R-1, 300-350 amp gen, incl. accessory kit reactor coil w/ solenoid control **\$47.50**

24-12V DC MOTORS
 *Reversible
 H.P. Amp. R.P.M.
 Delco 1/4 8.4 2500 **\$5.95**
 Bendix 75-1bT 2A 7 **\$7.50**
 Bendix 1/4 8 4000 **\$6.50**
 With 10-1 gear red. **\$12.95***
 Dumore 1/20 5 200 **\$4.75***
 with 54-1 gear red.
 Rotator Mtr. 1.5A 1 1/2 RPM 75 lb Torque, 12V.D.C. instr. incl. **\$7.50**

New Linear Actuators with 24 V DC motors, runs on 12 to 32V adj. travel & reversible

HP watts	RPM	Amps.	Travel	Tens-Comp	Price
1/8 HP	7500	9	5 1/4"	2800 lbs	\$7.50
1/15	7500	8	4 1/2"	750 lb	\$6.95
.04 HP	10,000	3	3 1/2"	350 T	\$4.95
1/4 HP	1800	17	7"	1800 lbs	\$ 9.95
1 HP	7500	75	8"	7500 lbs	\$17.50

HYDRAULIC CYLINDERS
 Hvy Duty 2000 P.S.I. air-oil
 * with tie rod construction

Bore	Stroke	D. Shaft	Long	Double Action	Price
1 1/2"	4 1/2"	1 1/8"	10"	3 1/2 lbs.	\$ 3.75
1 3/8"	4 1/2"	1 1/8"	13"	5 lbs.	\$ 3.95
1 5/8"	2 5/8"	1"	38"	11 lbs.	\$12.95
2 3/8"	13-18"	1 1/4"	30"	11 lbs.	\$14.50
1 1/2"	8 1/2"	3/4"	13"	8 lbs.	\$ 7.50
2 7/8"	35 3/8"	2 1/4"	13"	10 1/2 lbs.	\$ 7.95
2"	24"	3/4"	24"	6 lbs.	\$10.50
2 1/2"	4"	1 1/4"	13"	6 lbs.	\$ 4.95
*2 1/2"	3 1/2"	3/4"	12"	5 lbs.	\$ 7.50
2 7/8"	16"	1 3/4"	33"	16 1/4 lbs.	\$18.75
*3"	10 1/2"	1 1/4"	19"	13 lbs.	\$14.50
*3"	10 1/2"	1 1/4"	19"	10 lbs.	\$17.50
3 1/4"	10 1/2"	2 1/8"	23"	29 lbs.	\$18.50
3 1/2"	2 1/8"	1 3/8"	31"	15 lbs.	\$24.50
4 7/8"	8"	2"	22"	35 lbs.	\$29.50
4"	18 1/2"	1 5/8"	30"	30 lbs.	\$29.75

BUILD YOUR OWN HYDRAULIC PRESS
 Complete kit consists of New Heavy Duty D.A. cylinder 3" bore x 10 1/4" stroke 3000 PSI, heavy duty Weaver hand pump, control valve, gauge reservoir, hose, fittings and 1 gal. oil. Rated output 9 tons. Instructions incl. \$125.00 value, save \$67.50. Only **\$57.50**

HYDRAULIC PUMP BARGAINS 1500 P.S.I.

Type	RPM	GPH	*Reversible	Price
*Pesco Gear	4500	270		\$ 9.95
*Vickers 410	3750	375		\$17.50
*Stratopower PD	4500	375		\$15.50

Hyd. hand pump 1.5 cu. in. p-stroke **\$6.75**

NEW HYDRAULIC SYSTEM KIT
 #400 K heavy duty power driven, rated 16,000 lbs. lift. Consists of 2 D.A. hyd cylinders 3 1/2" bore x 2 1/8" stroke ea. rated 8000 lbs. with 1000 PSI, 1 four way hyd control valve with built in relief = 821, 1 Vickers hyd pump 375 GPH 1000 PSI 3750 RPM filter, gauge 2000 PSI hose & fittings. Value \$169.95 save \$90.00 **\$79.95** Same kit with two D.A. cylinders 3 bore x 10 1/4" stroke **\$69.95**

12 1/2 TON NEW HYDRAULIC POWER KIT
 Consists of 2 DA cylinders 4" bore x 5" stroke each rated 12500 lbs. with 1000P.S.I. working independently. 1 four way Hyd c. valve with press relief 1 stratopower hyd pump 375GPH 1400PSI 1 accumulator 3000 PSI press gauge, filter, tank, unloading valve, unloads pump at predetermined press setting. Hose and fittings \$248.10 value. Save **\$148.00**. Kit price **\$94.10**

Water pump & 1/8 motor runs on 12-24 VDC adj. press 400GPH **\$12.95**
 1 700GPH & 1/4 mtr. **\$14.95**

GENERAL SALVAGE CO Check or M. O.
 2922 E. 27 St., Dept. 196, Kansas City 27, Mo.

Works in seconds!



Loosens Rusted Bolts nuts, screws, "frozen" parts!

LIQUID WRENCH[®]
 SUPER-PENETRANT

The super-penetrating rust solvent that quickly loosens rust and corrosion.

AT ALL HARDWARE AND AUTO STORES

RADIATOR SPECIALTY COMPANY
 CHARLOTTE, N. C.

Painting?

DO A BETTER JOB FASTER
 Prepare surfaces with Wil-Bond

This unique liquid, applied with a rag, removes all dirt and grease. Also dulls glossy, varnished or enamelled surfaces. Paint or enamel goes on smoothly and bonds tightly — no unsightly streaks.

At paint and hardware stores.
 Send 25¢ for illustrated Refinishing Manual
 Write for free Wil-Bond folder
 Wilson-Imperial Co., 118 Chestnut St., Newark 5, N. J.

WIL-BOND

It's Sharp... keep it that way with the right sharpening stone by



CARBORUNDUM[®]

FREE from **RADIO SHACK**

America's most complete, exciting **ELECTRONICS CATALOG**

PLUS all other issues for a full year!
 Latest giant book is 3/4 bigger! 336 pages! Stereo, Hi-Fi, Ham Radio, Tapes, Records, Parts, 30 pgs. of Kits! No Money Down credit terms. Satisfaction guaranteed.

RADIO SHACK Corp. Dept. 61J3C
 730 Commonwealth Ave., Boston 17, Mass.

Send me Radio Shack's famous electronics catalogs for 1 full year—FREE, POSTPAID.

Name _____
 Address _____
 City _____ Zone _____ State _____

MAIL Coupon TODAY



Brighten and protect your home with

SUPERPLY
APPLY IT YOURSELF

the high gloss enamel that's so easy to apply!

This alkyd enamel is ideal for kitchens, bathrooms, woodwork and furniture. Keeps its brilliant porcelain-like finish after repeated scrubbing. So durable, people even paint boats with it!

ONLY
\$1.79
qt.

SUPERPLY SATIN, 100% Latex Paint

for walls, ceilings, woodwork
Just brush or roll it on... no laps or brushmarks, no trace of touch-ups. Dries in 20 minutes... no unpleasant odor.

RECOMMENDED BY A DIVISION OF
Guaranteed by
Good Housekeeping
* NOT AN ADVERTISED PRODUCT

COMMENDED
BY THE
PARENTS'
MAGAZINE

ON SALE AT

WOOLWORTH'S and NEISNER'S

A. WILHELM CO. • READING, PA.

STATION WAGON OWNERS!

Jet Stream AIR DEFLECTORS

- Keeps exhaust fumes out!
- Keeps rear window clean!
- Handsome chrome finish
- Installs in minutes
- Fits all makes & models

\$9.95 pair
At your auto parts store.

Also Shock Springs and Helper Springs

Superior Industries
7260 Atoll Ave., No. Hollywood, Calif.

DOT SPEEDY RIVETS

**JUST
SWAT
with
hammer**



SPEEDY RIVETS are ideal where quick, sure riveting jobs are needed. Instant fastening for leather, cloth, paper, cardboard, light gauge metal and plastic... 1001 uses. No special tools required... works like a charm! Available in large or small size... nickel, gilt, black or brown at hardware dealers or send \$1.00 for special mail order package and name of nearest distributor. Specify size and color.

COLUMBIA FASTENER CO.

Dept. P.M. • 3229 S. Ashland Ave., Chicago 8, Illinois

"I also like the extra storage room that is provided when the rear seat is folded down."—California realtor.

Rounding off the owners' commentary, here are the last of the complaints, numbering fourteen through sixteen.

"My Corvair doesn't start very well."—Maryland assemblyman.

"It seems to be a bit sluggish about cranking and I have to use the hand choke each time in starting."—Florida forester.

"The shift throw from 1st to 2nd is too far when shifting up. When shifting down it isn't so noticeable because I'm usually leaning forward a bit."—New Hampshire salesman.

"Dealer service may be good elsewhere, but it's Ali Baba and the Forty Thieves here in the Bay area."—California shipping clerk.

"I've been in and out of the dealer's for service and it's nothing doing. Their comment: 'We are learning along with the customer the various problems with this car'."—Pennsylvania office manager.

Where, Oh where did those "factory-trained mechanics" go to?

"It seems to me that once again the buyer has been taken advantage of through poor engineering. I am referring to the inability of this car to perform on regular gas."—Florida air-traffic controller.

"Apparently the dealer's service managers haven't heard that the Corvair was designed to run on regular gas. Or was it?"—California salesman.

Well, that wraps it up, the pros and cons of the 1961 Corvair as frankly expressed by a cross section of owners from all over the U.S.

Earth Has a Dusty Halo

Nosing 102 miles into the sky above White Sands, N.M., a rocket has located a dense band of micrometeorites that seems to encircle Earth.

The nose cone of an Air Force rocket was built to open during the four minute rise and fall between 65 miles and 102 miles altitude. During this time, dust particles struck each square centimeter of the opened cone at the rate of 10 each second, then the cone closed.

The dust particles bored through various plastic layers in the nose cone, and pitted one layer of plexiglas. A few of the dust particles were collected, but most vaporized on contact with the nose-cone layers.

Analysis of trapped particles from the halo of dust will take a number of years.

WAR SURPLUS AS GOOD AS **SAVE UP TO 90%**



FRESH WATER SYSTEM PUMP — For boats, campers & trailers. Output 10 to 200 gal. an hr. Variable rheostat controls output. 1/2" pipe thread into bronze impeller housing. 12 V.D.C. Radio noise filter. 5.2 amp. draw. Explosion-proof const. Shpg. wt. 11 lbs. Complete with mounting instructions & wiring diagram. Approx. GOVT. COST, \$200. NEW, \$10.95.



BUILD YOUR OWN ARC WELDER, LIGHT PLANT OR BATTERY CHARGER \$37.50
Kit incl. 1 Navy NEA-5 Gen. combination AC-DC type. AC 115 V, DC 24 V., 200-300 Amps. 2 complete generators in 1, yet no larger than reg. gen. Ideal for home, shop and farm lighting plants. Delivers 1200 Watts AC, DC side for charging batteries, welding and operating war surplus motors. Also in kit: 1 DC Voltage Reg., Reverse Current Relay, 30' New Welding Cable, Rheostat, Electrode Holder, Toggle Switch, Welder's Shield, Wiring Diagram for kit. Wt. under 100 lbs. Approx. GOVT. COST \$650. KIT—\$37.50. Navy NEA-5 Gen. as above, purchased separately, \$23.50.

225-1 REDUCTION GEAR For beaching boats, winches, hoists. Ideal motor in golf or boy's electric car. DC motor and clutch. Easily reversible wiring diagram furnished. Hi torque, 105 RPM. Runs on 6-12 or 24-32 V. 65 lbs. gross. Approx. GOVT. COST \$300. \$13.50. Matched splined gear—\$3.00 ea. *140-1 Reduction Gear—\$12.00.

Hundreds and thousands of switches, all types, prices on request.



ELECTRIC STORAGE BATTERY WINCH

Fully reversible with heavy-duty, 2-way drum switch. Heavy-duty motor, 150 to 1 reduction. Drum will handle 60 ft. of 1/4" cable. Can be operated manually by hand crank. Use on 6, 12, 24, 32 V. battery. Lift cap. 2000 lbs. plus. Ready to install & operate. Dim: 17" long x 9" wide x 7" high. For jeeps, trailers, boats, trucks, etc. Approx. GOVT. COST \$400. NEW, \$46.50

DC JET GENERATOR ARC WELDING KIT Complete with GE Type CM-77 Generator (30 volts D.C., 400 Amp., 3000 RPM up: ampere rating is for continuous duty, intermittent amperage is 500 to 600 amps.), also 2 rheostats, 1 voltage regulator, 1 voltmeter, 1 electrode holder, 2 ea. 25 ft. lengths No. 0 welding cable, 1 welder's mask, 1 toggle switch, 10 lb. vacuum packed 1/4 in. welding rods, pair welder's gloves & spline coupling. All units guaranteed pre-tested. Wt. 110 lbs. Approx. GOVT. COST \$700. All items, now only \$64.50.

*G.E. Generator noted above can be purchased separately. Makes deluxe heavy-duty welder comparable to the finest commercial welders available. Wt. 90 lbs. Approximate GOVT. COST \$600. Gen. alone—\$49.50.



NEW 1961 CATALOG!

Tremendous catalog—our biggest ever—fully illustrated—1000s of bargains in war surplus & other items. Send 25c in coin for your copy today or free copy with order. Where ppd. indicated applies to US only. Other prices FOB Culver City, Calif. Send cash, check, money order. 50% deposit for COD.



AIRBORNE SALES CO., INC. DEPT. PM961
8501 Stellar Drive, Culver City, Calif

SAVE MONEY! MAKE MONEY!
WITH PORTABLE CEMENT MIXER!

It's easy, fast, fun to do your own work with the MIXAL Mixer. Build barbecues, patios, sidewalks for yourself, for others! Mixes 3' x 8' sidewalk every hour! Uses any 1/4 HP motor. Thousands used by contractors! Try it on MONEYBACK GUARANTEE! Send for FREE HOW-TO-DO-IT CEMENT MIXING BOOKLET. Dept. PM-9
KOL, INC., 2323 Ellis Ave., St. Paul, Minn.



WOOD ROTTING?
fix it quick with



PLASTIC WOOD
Handles like putty-hardens like wood!



CHOICE OF



PROFESSIONAL MECHANICS

SK/Lectrolite tools are preferred by men who make their living with tools



A COMPLETE SELECTION OF SOCKETS, HANDLES AND WRENCHES



A tool for every need... with quality you can actually feel.

CHICAGO 32, ILLINOIS / DEFIANCE, OHIO

We'll Learn From the Astronauts

(Continued from page 103)

This is the one that will make Mercury look like the Wright Brothers at Kitty Hawk.

Shepard's Suggestions

Shepard made four recommendations for improvements. First, he suggested the astronaut enter his space capsule much later during the countdown to reduce waiting time—he waited 4 hours and 14 minutes; Grissom waited 3 hours and 32 minutes. Second Shepard suggested the number of monitoring tasks and switch flippings be reduced to give the astronaut more time for observation. In the first 2 minutes and 22 seconds of his powered flight, he observed the cabin pressure gauge 12 different times and glanced at the clock timer, position and speed indicators, oxygen supply gauge, acceleration meter, and the peroxide fuel supply gauge each at least five times. Third, Shepard suggested moving the space suit gauge from the left forearm of his suit to a more readily visible place. To lessen vibration, he also suggested more foam rubber padding be put under the spacemen's helmets for head support. On a more personal note, Shepard also expressed the hope that the space medics would spare the needles and take less body fluid samples before and after future flights.

In addition to these minor changes, NASA and the McDonnell Aircraft Corp. engineers have incorporated a "picture window" porthole with double the viewing area of the eight-inch portholes in Freedom Seven, and with lines inscribed which permit astronaut to match capsule's attitude with the horizon. Unfortunately, on Grissom's flight, extensive cloud cover prevented a real evaluation of this improvement. For the orbital flights, too, the beryllium heat shield used in the up-and-down ballistic flights will be replaced by a resin-and-glass fiber shield able to withstand the friction-red heat of re-entry from orbit.

The entire orbital flight will be a far more

severe test of both man and machine. For two minutes after blastoff, Shepard and the capsule were subjected to up to 6.2-Gs, which means that crushing acceleration forces made his weight, in effect, six times normal. In the Atlas orbital flight, the acceleration forces during launching will be the same, but will last two minutes longer. In their flights, Shepard and Grissom were weightless about 5 minutes. Top speeds were 5,180 and 5,310 m.p.h. The orbital flight calls for three turns around Earth at 17,500 m.p.h., or over four hours of weightlessness. The astronaut will be expected to eat and drink and perform certain regular tasks in orbit. Although Yuri Gagarin's flight has already indicated that such tasks can be carried out, NASA scientists want to observe for themselves the effects of prolonged weightlessness and the transition from high launch-Gs to zero-G and then to re-entry-Gs.

When Shepard returned to Earth, his flight path was essentially fixed and predetermined; the temperature on the heat shield rose only 30 degrees F. from normal. But, when the orbiting vehicle makes its re-entry, the angle of attack must be precisely determined to insure return along the narrow "safety" corridor. The heat will reach as high as 200 degrees F. as the shield glows an incandescent orange-white during the atmospheric plunge.

Earth is the Lab

Where Freedom Seven's flight was confined to a strip of space from Canaveral out 302 miles in the south Atlantic, the orbital flight will turn the whole globe into a test laboratory. A single communications belt will link 20 ground monitoring stations on a 30,000-mile circle spanning North America, Africa, Australia, Hawaii, the Atlantic, Pacific and Indian Oceans. Radio and radar, telemetry, telephone and teletype, leased land lines and overseas radio and cable facilities will keep the Goddard Space Flight Center in Greenbelt, Md., informed of the

(Continued to page 284)

BOOKLETS • INSTRUCTIONS • PLANS • NEW PRODUCTS

... you can get lots of helpful information through the mail!

Starting next month, **Popular Mechanics** will offer its readers even more of its famous do-it-yourself help. We're starting a new **SERVICE AND INFORMATION CENTER** that will tell you how to get the newest and latest

manufacturers' booklets, instructions, plans and mail-order products.

Many will be free for the asking; others will be nominally priced. We will also list outstanding new hard-cover books.

Look for WORTH WRITING FOR and POPULAR SHOPPING
Starting in the October issue of PM

PEELS PAINT OFF furniture boats floors woodwork

Makes ANY refinishing job easier

FAST - CLEAN

Non-Inflammable - Needs No Neutralizing



KLEAN-STRIP

PAINT REMOVER

The Klean-Strip Co., Inc.

Memphis 6, Tenn., Winnipeg, Man.

PROTECTS TOOLS, SORTS THEM NEATLY

HUOT TOOL CHEST

Keeps tools organized. 4 sliding drawers, rugged steel Professional Style cabinet—blue or red—26" x 12 1/4" x 12 1/4". Write for FREE BULLETIN on this and 15 other models.

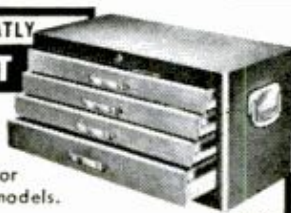

HUOT MFG. CO. 505 N. WHEELER ST., ST. PAUL 4, MINNESOTA MODEL 107

DYNAMIC INDUSTRIAL TYPE TRANSFORMER WELDER

WELD-CUT-BRAZE-SOLDER-HEAT
IRON-STEEL-BRONZE-BRASS
ALUMINUM AND OTHER METALS



Professional Electric Arc Welder. Ideal for Home, Shop, Farm or Industrial use. The handiest tool in your workshop. Weld, Braze, Solder, Cut, Bend all metals. Do expert work on your first job. Build or repair Boats, Trailers, Auto Bodies, parts, fenders, metal and ornamental iron furniture, fixtures, farm equipment, garden tools, bicycles, toys, etc. Operates on any properly wired 110 V. A.C. line. Complete with helmet, arc torch, electrode holders, flux, rods, cables, instruction book. FULL YEAR GUARANTEE. 10 day money back trial. ONLY \$38.50 f.o.b.

Only \$38.50 f.o.b. Send only \$6.00 check or m.o. Pay postman balance plus charges. EASY PAY PLAN. Low down payment. Pay as you weld.

DYNAMIC WELDER CO. 1808 SOUTH FEDERAL STREET Dept. D2-J, CHICAGO 16, ILL.

Another NEW Taft Kit! "2 SEASON" AIR BOAT & Snow Sled KIT (not shown)

with surplus aircraft engine
\$223⁷⁵ Down \$38⁰⁴ Per Mo.

FREE Catalog of many models

TAFT MARINE WOODCRAFT
Dept. PM-961, 636 39th Ave. N.E. Minneapolis 21, Minnesota

DRAINS cellars, cisterns, wash tubs; \$7.95
IRRIGATES - CIRCULATES - SPRAYS

1,001 uses. Stainless shaft. Won't rust or clog! Use 1/8 HP motor or larger. 3/4 HP for up to 2,400 GPH; 450 GPH 80' high; or 1800 GPH from 25' well. 1" inlet; 3/4" outlet. Coupling included free. \$7.95. HEAVY DUTY BALL-BEARING PUMP. Up to 5,200 GPH; or 3,000 GPH from 25' well. 1 1/4" inlet; 1" outlet. \$12.95. Postpaid if cash with order. MONEY BACK GUARANTEE. Centrifugal and Gear Pumps in All Sizes. LABAWCO PUMPS, Belle Mead 7, New Jersey

Print Your Own

Cards, stationery, circulars, etc. Save money. Print for Others, Good Profit; easy rules sent. Raised Printing like engraving, too. Junior press \$15; Senior \$35 up. Sold direct from factory only. We furnish everything. Write for free details. KELSEY PRESSES, Y-37 Meriden, Connecticut

ALVA ALLEN Heavy Duty PUNCH PRESSES

1 to 25 Ton Capacity Punch Presses—in hundreds of different model combinations

Moderate in Price Fully Guaranteed

Write for Free literature giving complete information and prices on Alva Allen Heavy Duty Presses.

Alva Allen Industries, Dept. PM, Clinton, Mo.

Keep Tools in Tip-Top Condition

Lubricate · Clean · Prevent Rust

3-IN-ONE® OIL

REGULAR—OIL SPRAY—ELECTRIC MOTOR

HANG FIXTURES SECURELY...



USE **MOLLY**®
SCREW ANCHORS and JACK NUTS®

BETTER THAN NAILS & SCREWS—Molly lets you put fixtures where you want . . . not just where studs are. Spider backing reinforces area in which used, won't pull through. BETTER THAN TOGGLE BOLTS—Easy to install, needs much smaller hole, fixtures can be removed and replaced in same anchor! Inexpensive, guaranteed. Ask your hardware dealer for genuine Molly . . . the name is stamped on the cap.

JACK NUTS GRIP ANY MATERIAL, WORK IN NARROW SPACE

Jack Nuts need only 3/8" expansion space . . . now you can fasten fixtures to flush doors! Grip any material up to 3/4" . . . perfect for use in thin materials where wood or sheet metal screws won't hold!

SEND \$1.00 FOR SAMPLE BOX OF 12

EXPANDS BEHIND WALL
MOLLY® Corp., 200 N. 5th St., Reading, Pa.

Enclosed is \$1.00 for sample box of (check one) Mollys Jack Nuts

NAME

ADDRESS

CITY

ZONE

STATE

screens, upholstery, carpets...

hundreds of other uses.

You name 'em!



Swingline 101 Staple Gun

Staples practically anything. Exclusive push-button loading and built-in staple extractor. At your stationery, department or hardware store.

only **4⁹⁵**

FREE! New 8-page

SEND FOR YOURS TODAY!

"TIPS FOR TACKING" Booklet . . . shows you how to save time, money and effort — with a SWINGLINE AUTOMATIC STAPLE GUN



Swingline INC.

38-00 Skillman Ave., Long Island City 1, New York

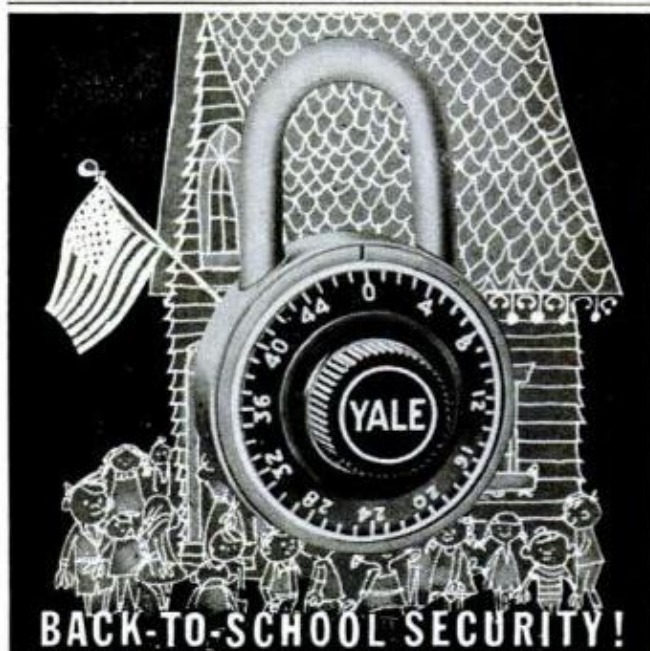

BACK-TO-SCHOOL SECURITY!

YALE® COMBINATION PADLOCKS

Books, clothing, personal belongings — all are safe when a student's locker is protected by a dependable Yale combination padlock. 3-number dialing . . . 10,000 possible combinations. Available wherever better locks are sold. Product of The Yale & Towne Mfg. Co., Yale Lock & Hardware Division, White Plains, New York.

YALE—REG. U. S. PAT. OFF.

YALE & TOWNE

capsule position at all times. The stations are so placed that at least one can always communicate with the capsule. A medical doctor at each monitoring station will listen in on the telemetered record of the astronaut's heart beat, respiration, and body temperature. He will share a position at the console with the technicians monitoring the flight's engineering phases. Thus, both man and machine are under constant surveillance during the entire mission.

Following the 4-hour and 30-minute orbital mission, later Mercury-Atlas missions will take astronauts on a 24-hour Earth-circling mission sometime in 1963. By then, the three-man Apollo program will begin to take over as Mercury is phased out. Riding atop an eight-engined Saturn rocket with a thrust some four times greater than that of the Atlas, the crew of Apollo "A" will go on leisurely week-long Earth orbits in 1964. Apollo "B" and its crew will make flights around the moon in 1966, picking out, among other things, a likely landing site for the Apollo "C" crew. The seven astronauts, wise old birds all in their forties, will, in all likelihood, stay on in the Apollo program as senior instructors to a new breed of true "space cadets."

Lengthy Apollo

Where Shepard's Mercury capsule weighed hardly more than a ton (exclusive of fuel) and measured nine feet high and six feet wide at its broadest, the Apollo will be 40-feet long and 12-feet wide. Its landing rockets will add another 60 feet in length, and the total weight will be 150,000 pounds. Three men will be able to live, work and sleep aboard it for three weeks.

The towerlike escape rocket used on Mercury, which wrenches the capsule away from the booster rocket in the event of failure may also be adapted to Apollo. Apollo may also return to Earth blunt end forward in the same manner as the Mercury ship. And the Mercury-type contour couch will be used to seat the Apollo's spacemen. Suit design, environment control, reaction jets for steering in space, and other Mercury features may also be used in Apollo.

Not all flights in our step-by-step journey into space will succeed as well as the Shepard and Grissom trips. There may well be failures — aborts on the pad, incorrect trajectories, re-entry disasters. "This is a risk we have to take," says Trevor Gardner, Chairman of the Air Force Space Study Committee. "It's like testing high-speed aircraft in which men have died. The risks are there, and they have to be faced."

They do, indeed, if we are ever going to achieve and maintain an equal footing in space with the Soviets. ★ ★ ★

SURPLUS SALE

GOVT. SURPLUS
EXCESS INVENTORY
BANKRUPT STOCK

AC-DC ELECTRIC GENERATOR

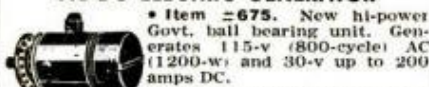

• Item #675. New hi-power Govt. ball bearing unit. Generates 115-v (800-cycle) AC (1200-w) and 30-v up to 200 amps DC.

• Very versatile. Use for 115-v AC lights or stove or for DC 200-amp welder. Drive with tractor, engine, etc. Size 14"x8"x6". Wt. 55 lbs. Govt. cost over \$250. **SALE... \$15.85 FOB**

SELF PRIMING WATER PUMP



• Item #204. New Govt. units. Fine for boat pumping, sump pump, etc. Timken bearings, 1 1/2" intake and discharge ports, 3/4" shaft. Size 12"x10"x18". Wt. 32 lbs. Cost \$97.50. **SALE... \$19.49 FOB**

STORAGE BATTERY WINCH



• Item #311. Powerful fully reversible, ball-bearing gear reduction winch. 1000-2000 lb. pull. Use on 6 or 12-v battery. Holds 40' of 1/4" cable. For trucks, docks, boats. Govt. cost \$280. **SALE... \$49.95 FOB**

DIAL PHONE

• Item #716. W. E. phone, same type used in telephone offices. Use as extension or main line phone. Set up your own private system. Wt. 8 lbs. Black. **SALE... \$7.95**



Color (specify) Coral, Yellow, Lt. Green, Buff. **SALE... \$11.95 FOB**

GOVT. GEARED BATTERY MOTOR



• Item #569. Powerful geared-down motor. Runs on 6 or 12-v. Use for golf cart, boat, farm winch, etc. Reversible. Speed 25-85 rpm. Wt. 35 lbs. Govt. cost \$250. **SALE... \$21.79 FOB**

• Our most popular item.

POWER PLANTS

• Item #607. Super Special!



Finest Deluxe 10,000-w, 115-230-v, 60-c, water cooled 4-cyl. engine. Full instrumentation. Many features. New condition. Ideal for emergency or full time use. Be prepared for war or peacetime power failures. Size 68"x39"x28". Wt. 1495 lbs. Govt. cost over \$2,000. **SALE... \$649 FOB**

• Many other buys down to \$69. See catalog.

HYDRAULIC SPEED REDUCER

• Item #1304. 1 hp variable speed hydraulic transmission. Variable speed 0 to 350 rpm. Instantly reversible. Ideal for lathes, midget cars, etc. Roller bearings, and complete with 3-phase 220-v AC ball bearing motor. Size 21"x9"x20". Wt. 200 lbs. Shaft fitted with pulley (specify diameter desired). Govt. cost over \$900. **SALE... \$89.50 FOB**



BATTERY REMOTE CONTROL WINCH

• Item #322. Powerful Govt. DC hoist with "up-down-off" push-button control switch, 20' cable. • 35' 4000-lb. hi-strength super-flexible steel cable on self leveling pre-grooved high-strength 5"x6" drum. Winch rating 1000-lbs. on 12-v, 1500 lbs. on 24-v. Fine for boats, loading docks, trucks, jeeps, garages, farms, etc. Easy to install. Electric automatic locking brake. Works off any car-truck 12-v battery. Wt. 90 lbs. Size 12"x14"x8". **SALE... \$58.25 FOB**



FLEXIBLE POWER CABLE



• Item #1105. Finest War Surplus 3-conductor super flexible No. 8-ga. heavy duty power cord. Ideal for contractors, builders, factories, farmers, etc. • Use for motors, large power tools, air conditioners, etc. Fine flexible stranding long life neoprene cover. 100 ft. coil—Wt. 38 lbs. 225 ft. coil—Wt. 85 lbs. Std. price—90¢ ft. **SALE—100 ft. \$19.90—225 ft. \$44.50 FOB**

SPECIAL OF THE MONTH!

ARMY AC GENERATOR



• Item #626. Brand new, original crate, all ball bearing Deluxe heavy duty 115-v 3,000 to 4,000-w, 60-c generator. 1,200 rpm. With voltage control and voltmeter panel, etc. • Drive with tractor, old auto engine, etc. Ready to use. Great emergency unit for farm, etc. Size 21"x14"x20". Wt. 260 lbs. Govt. cost over \$600. **SALE... \$139.50 FOB**

• A four star buy—171 units available.

HYDRAULIC EQUIPMENT BARGAINS



Savings to 80%. Build loaders, diggers, presses, etc. All brand new. • Control Valve, 1 or 2 way... **\$18.00 PPD** • Tractor Pump 1000 psi... **49.75 PPD** • 12-v Motor & Pump 1000 psi... **16.95 FOB** • 2-Way cyl. 3" bore, 8" str... **19.70 FOB** • Hyd. Press-gauge 1500 lb... **3.49 PPD**

AIR COMPRESSOR BARGAINS

For painting, cleaning, tires, control termites. Assemble your own outfit. Lowest prices in U.S.

• DELUXE KIT. Compressor, tank, gauge, regulator, paint gun, fittings. How to build instructions. List \$52. **SALE... \$49.50 FOB**

• Compressor 1-cyl. **\$21.50**. 2-cyl. **\$54.75**. Govt. Air Tank, **\$10.95**. Regulators, **\$3.95**. Pop Off **\$1.75**. Pres. Gauge, **\$1.75**. Finest paint gun, **\$11.50**. Auto switch, **\$4.75 FOB**.



FREE CATALOG Electronics, Tools, Binoculars, Hydraulics, Plants, Compressors, etc. New 1962 cat. now ready (send dime or stamps).

SURPLUS CENTER
LINCOLN, NEBR. DEPT. 811



Life Jackets for Space

Scale models of foamed plastic "space life jackets" have been made under simulated space conditions to demonstrate how an astronaut could build his own protective shield after bailing out of a space vehicle for a quick emergency return to Earth.

In use, the plastic foam would fill an envelope pre-cut to re-entry vehicle shape, enclosing the astronaut and protecting him from the severe heat and shock of re-entry.

If it's worth painting
it's worth sanding...
with sandpaper by



CARBORUNDUM

The astronaut would bail out of his orbiting vehicle wearing everything necessary for his safe return to Earth including, in addition to the life-jacket material, his pressurized space suit, oxygen supply, location and recovery aids, survival gear, and retro-rocket package. The plastic envelope, when it is formed, would enclose everything except the retro-rockets.

After placing himself in a re-entry trajectory with the rockets, the astronaut activates the foaming-plastic system.

ARC WELDING PAYS BIG MONEY

NEW AC SHOP TYPE WELDER, the 180 amp. "Hustler" welds, cuts, burns holes, hard surfaces and heats metal for bending and forming. Comes complete with accessories. Meets REA requirements.

If It's Metal
WELD IT!
WITH EITHER OF
THESE TWO LOW
COST HOBART UNITS

NEW WELDER/POWER COMBINATION, the 200 amp. "Power/Weld" furnishes DC current for welding and 110/220 volts AC power for running lights, tools, etc. Can be invaluable in a power failure emergency.

HOBART BROTHERS COMPANY, BOX M-91, TROY, OHIO, Ph. FE 2-1223



FREE "HOW-TO" HANDBOOK ON GLUING

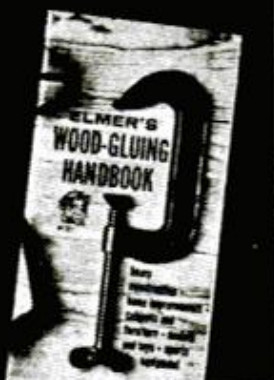

NEW 12-page Elmer's Wood-Gluing handbook gives you details on gluing for heavy construction, home improvements, cabinets and furniture, models and toys, sports equipment. Contains hints, tips, and shortcuts. Includes drawings, as well. Tells you what glue to use indoors and out. Send stamped, self-addressed envelope for your free copy. Elmer, The Borden Company, Dept. PM-91, 350 Madison Ave., New York 17, N. Y. (Available in Canada.)

Remove Paint in one easy scraping - NOT COAT BY COAT

You'll save yourself time and work with famous Wonder-Paste. This deep-penetrating remover softens up the toughest paint or other finishes. Makes them come off clean. Stays moist and active indoors or out. And it does not run on upright surfaces.

At paint and hardware stores.

- Send 25¢ for Refinishing Manual
- Write for free Wonder-Paste folder
WILSON-IMPERIAL CO.
118 Chestnut St., Newark 5, N. J.



DRAFTY?



CAULK with RUTLAND

Seal cracks in concrete, masonry, around doors, windows. KLIP-TIP* gives 3 sizes from one spout.
*Reg. & Pat. Pend.

other quality
RUTLAND PRODUCTS
Glazing Compound
KEX Spackling
Patching Plaster
Concrete Patcher

RUTLAND FIRE CLAY CO., Rutland, Vt.



PM Tests Volkswagen's 1500

(Continued from page 130)

mostat on the oil cooler and the thermostat on the intake manifold heat pipe crossover will do the job and the engine won't overcool in winter. They should know.

The engine has four cylinders in opposed pairs mounted horizontally and air cooled. Larger in displacement, it produces 53 horsepower compared to the current model's 40.

The engine was "flattened" to provide space for the luggage compartment by mounting the cooling blower on the end of the crankshaft and providing for a side draft carburetor and horizontally-mounted oil cooler.

Acceleration Brisker

Acceleration is very good through gears. It gets to 50 m.p.h. in about 13 seconds. The car will peak out comfortably at 70 m.p.h. (120 k.p.h.) in third gear. The 0-60 m.p.h. time is about 21.5 seconds with two 190-lb. men aboard.

Top speed worked out to an honest 80 on the VW test oval. That speed can be held indefinitely as the engine is understressed like the Model 113 and has low piston speeds and, accordingly, lower inertial forces.

We were unable to test fuel economy in the short time at the Wolfsburg proving ground but Volkswagen engineers told us that the current 1961 regular VW will make about 30.03 m.p.g. and that the new VW 1500 will make about 24 m.p.g. for the same distance.

As any Volkswagen owner can tell you these are very conservative figures; most '61 VW's deliver around 33 m.p.g. in average use.

Riding qualities are better in the VW 1500. The car has a typical firm but not harsh VW ride, yet there is less pogo-stick bounce on the really rough, uneven pavement. The newly-designed suspension has crisscross torsion bars fastened to the lower control arms and cased in the steel tubing of the axle housing.

The upper control arms are attached to the antiroll bar, also enclosed in housing, so that the entire front axle assembly, including steering gear and shock absorbers, is an integral, aligned unit bolted to the spine frame of the body platform.

Rear tread is 3-inches wider than the current car's for greater stability. The car is thoroughly pleasant to drive. Shifting down to 3rd or 2nd is, if possible, softer and easier than with the Model 113. Noise at 80 m.p.h. on the prototypes was a bit noticeable, but at 50 to 60 m.p.h. the car whispers.

There were no rattles, and no wind noises from the sun-roof.

The steering wheel is the same as the regular VW's, set at the same approximate angle, too.

The gearshift lever is shorter and its action firmer, with less throw and little of the wobbly feel of the older model. It's much more sporting in action. It has a thicker shaft and bigger knob. Clutch and brake pedals are the same. Brakes are the same diameter, but have larger lining area due to increased lining width.

Handling is excellent. Oversteer has been almost completely eliminated. You can "bend" the car until tire scrub commences yet there's actually a feeling of understeer until finally the rear end does break loose. The current Model 113 has been vastly improved in this respect, but the VW 1500 is still better.

The VW 1500 has an excellent array of accessories and interior comforts. The forced-air heating system has a vent in the back seat as well as on front door stills (as in the regular model). Heating is still controlled by a handwheel on the tunnel, but there are interior vents beneath the panel and a de-mister on the windshield with two sets of controls for left and right vents so that you can spray warm and/or cool air on the inside of the windshield all at the same time.

The windshield itself has a gentle curvature and vision forward is great due to the down-sloped hood between fenders. Wiper coverage is good, too. The instrument panel consists of three dials: speedometer, fuel gauge, and clock, with lights for generator charge, oil pressure and turn signals.

Roomy New Wagon

For those who travel as most of us do, with more luggage than they need, the VW 1500 station wagon may be a practical answer. With rear seat folded forward there is a flat load area 67 inches long, 30 inches high and 48 inches wide. Between the wheel wells the load bed narrows to 36 inches. With the rear seat occupied you still have about 40 inches of load space. And, of course, there's the front trunk to add to the wagon's capacity.

To sum it up, the VW 1500 is larger and more impressive than its famous older sister, but every extra pound and every extra inch provides a genuine increase in comfort, convenience, and usefulness.

At an increase of 30 percent over the price of the Volkswagen Model 113 (now approximately \$1175 in Germany), the VW 1500 should find a warm welcome in European countries. If and when it reaches the U.S., the welcome may be warmer. ★ ★ ★



PORTABLE CORNELIUS AIR COMPRESSOR AND MOTOR ASSEMBLY

Ideal for filling Diving Tanks or wherever high pressure air is needed. Each unit consists of a surplus Cornelius Compressor combined with a NEW Gasoline or Electric Motor... compact and easily portable. Designed to displace 0.6 cu. ft./min. Operates at 2250 PSI continuous and tested to 3000 PSI.

Compressor Assem. No. HPC-GE
With 2½ HP Clinton Gas Engine as illustrated.

Compressor Assem. No. HPC-115
With 1/2 HP, 115/230 V., 60 cycle AC electric motor.

SAVE 99.50 EA.

HIGH PRESSURE AIR PURIFIER ASSEMBLY

A complete 3-tank filter unit for use with the above compressors. Has a 3000 PSI gauge and a safety valve set at 2250 PSI. **32.50**

AIR TANK FILLER ASSEMBLY

A 3000 PSI Hose and Fitting for filling ALL tanks that have J, K, R or S type valves. NOW ONLY **12.50**

BUILD YOUR OWN DIVING LUNG - SAVE 50%



ONE TANK SKIN DIVING KIT

Has 38 cu. ft. tested and dated Air Tank... allows approx. 45 minutes diving time. Comes with shut-off valve, surplus dilutor-demand regulator, connector assembly, air hoses, mouth piece, web cradle and harness, weight belt, etc. No. PSD-11 **39.95**

SPECIAL TWO TANK DIVING KITS

This diving kit allows approximately 1 hour diving time. Has two 22 cu. ft. tested and dated tanks, shut-off valves, air hoses, surplus dilutor demand regulator, plus harness, safety belt and weight belt. **45.95**

JUNIOR SWIMMING and DIVING TRAINING UNIT - 6.88

A "snorkle" type swimmer - portable and compact. Perfect to instill confidence in the child learning to swim. Child can swim along surface or release float pantoon and enjoy submarine swimming to depths of 2½ to 4½ feet. Complete with face mask, hoses, snorkle air valve, floating "tanks," carrying bag and instructions.

PORTABLE ARMY ICE PAC

Of extra heavy Neoprene rubber with an insulated inner liner. Keeps food or liquid cold all day. Ideal for packing and icing-down small game and fish. Waterproof and salt resistant. Two sizes.

SAVE
Approx. 16" x 13" x 8" Shpg. Wt. 10 lbs. **1.99**

Approx. 21" x 16" x 12" Shpg. Wt. 20 lbs. **2.99**

STAINLESS STEEL MESS TRAYS

One-piece stainless steel. Has 6 compartments & rolled edges. Easy to stock and clean. No. CMT1 **1.59 each**

NAVY HAND MICROPHONE

Has bakelite case with push-to-talk button control. With 4 ft. rubber covered cord and jack. No. EL-HMRS38A **1.88**

SPECIAL GOV'T SURPLUS BARGAINS





A - British combination PICK-HOE tool - \$1.29 ea. 2 for **\$2.29**
 B - Army BAYONET with scabbard. Has 14" blade. **\$2.98**
 C - Army MACHETE w/Vanadium steel 27" blade & sheath. **\$1.98**
 D - Special Swedish folding BAYONET. 7" blade. **\$1.98**
 E - Officer's LENSATIC POCKET COMPASS - Ideal for Hunter, Camper, Boy Scout, etc. A \$5.95 Value **3.49**

4-WAY HYDRAULIC VALVE

No. H-V7A-1 **3.95**
 A spring loaded, poppet type valve. Pressure balanced. Off in neutral. Has ½" tube parts. Cost Gov't approx. \$30

SAVE

1500 PSI - Double Action CYLINDER

Bore 2-3/8", Stroke adjustable from 7-3/8" to 9-5/8", Shaft 7/8", eye-to-eye length is 20".
 No. H-17USU - Used **7.88**
 No. H-17NSU - New **14.88**

COMING! NEW 192 PG. CATALOG

WORLD'S MOST SOUGHT AFTER CATALOG!
 192 Pages of Bargains! Packed with NEW and SURPLUS Machinery, Hydraulic Equip., Tools, Aircraft Hardware & Instruments, Hobby Motors & Tools, etc. Catalog Available in October - Quantity LIMITED, reserve yours NOW. Send 50c for Handling and Mailing costs.

TO ORDER - Send Check or Money Order, 1/2 deposit with C.O.D.s. All items sent. freight or postage collect. P.O.s accepted from D&B firms.

palleys

2263 EAST VERNON AVE., DEPT. PM-91
 LOS ANGELES 58, CALIFORNIA

You CAN Detect a Good Used Car

(Continued from page 125)

up with replacement of plugs, coils and points is usually needed. New front-end bearings and bushings or ball joints may be needed. Generator and starter may need overhaul. Brakes may need relining.

Cars four to six years old are subject to the same potential ailments listed for the younger cars, plus some additional woes. Fuel and water pumps may be shot. Valves may need regrinding. Universal joints, transmission and rear end may need repair.

Cars seven to ten years old are usually junk, and these are the ones that may be gimmicked up to keep them running. Heavy grease is still shot into rear ends of older cars to quiet unwanted noises and into steering wheels to take up slack in worn steering columns. Heavy oil is still put into motors to keep an oil-burning engine from smoking temporarily.

The Canned Milk Cap

Where canned milk, which congeals under heat, used to be used to seal radiator core holes; liquid solder is used today. It works for minor leaks, but is not adequate where major repairs are needed.

Now and then I have a customer ask me for the name of the car's former owner. I always supply this, but this is not always an infallible check on a car's condition. Many a used-car salesman has friends who obligingly pose as former owners, and give a glowing account of the car's virtues when the unsuspecting customer telephones them.

Does the dealer make repairs on the used cars he offers? Well, he frequently gives the customer a 30-day, 50-50 guarantee. This means the dealer agrees to pay half the cost of parts and labor if anything goes wrong with the car in the 30-day period. If the customer does come back with a complaint, the dealer makes the repairs and recovers his costs from the "half" the customer pays him. So the dealer loses nothing in the transaction. Of course, he hopes that no repairs will be needed, and the fact that so many customers do not return is more of a tribute to the stamina of the modern American automobile than to anything else.

The truth is that, under the pressure of competitive selling, dealers simply cannot afford to make repairs without some method of getting their money back.

I know of a way, however, by which dealers could make needed repairs without going broke and thus would be able to guarantee customers that the cars were in sound mechanical condition.

This would involve bringing repairs—

and defects—out into the open, making them an integral part of the whole used-car deal. Repairs would be made on all late-model used cars and a sticker listing repairs and costs would be placed in the car window—just as price stickers are now posted in new cars.

The repairs would be made by the dealer at rock-bottom prices and the total added to the car's asking price.

The Truth at a Glance

The prospective buyer would then know at a glance what had been wrong with the car and that the defects had been remedied. He would be paying wholesale prices for the repairs in exchange for the peace of mind that would come from knowing the car was in sound condition.

As things stand now, he is going to pay in any event—either under the so-called 50-50 guarantee, or after the 30-day period is over. Add to this the fact that the dealer would benefit from word-of-mouth advertising by satisfied customers and everybody would benefit—customer, dealer and the automotive business in general.

Since this is as yet only a desirable prospect, how does today's used-car shopper minimize the risk of being cheated? He can go only to long-established dealers with good reputations in a community. And he can keep his eyes and ears open as he inspects a used car, and not be shy about checking out the points I have mentioned.

Above all, he can ignore the glitter and the shine. ★ ★ ★



Emergency Stethoscope

When a seaman on the USN's *Kimbro* was injured during a recent storm, medics discovered that there was no stethoscope aboard. Equal to the emergency, Chief Engineer Norman A. Roman made one on the spot from rubber hose, copper tubing, tube fittings, a plastic funnel and some tape.

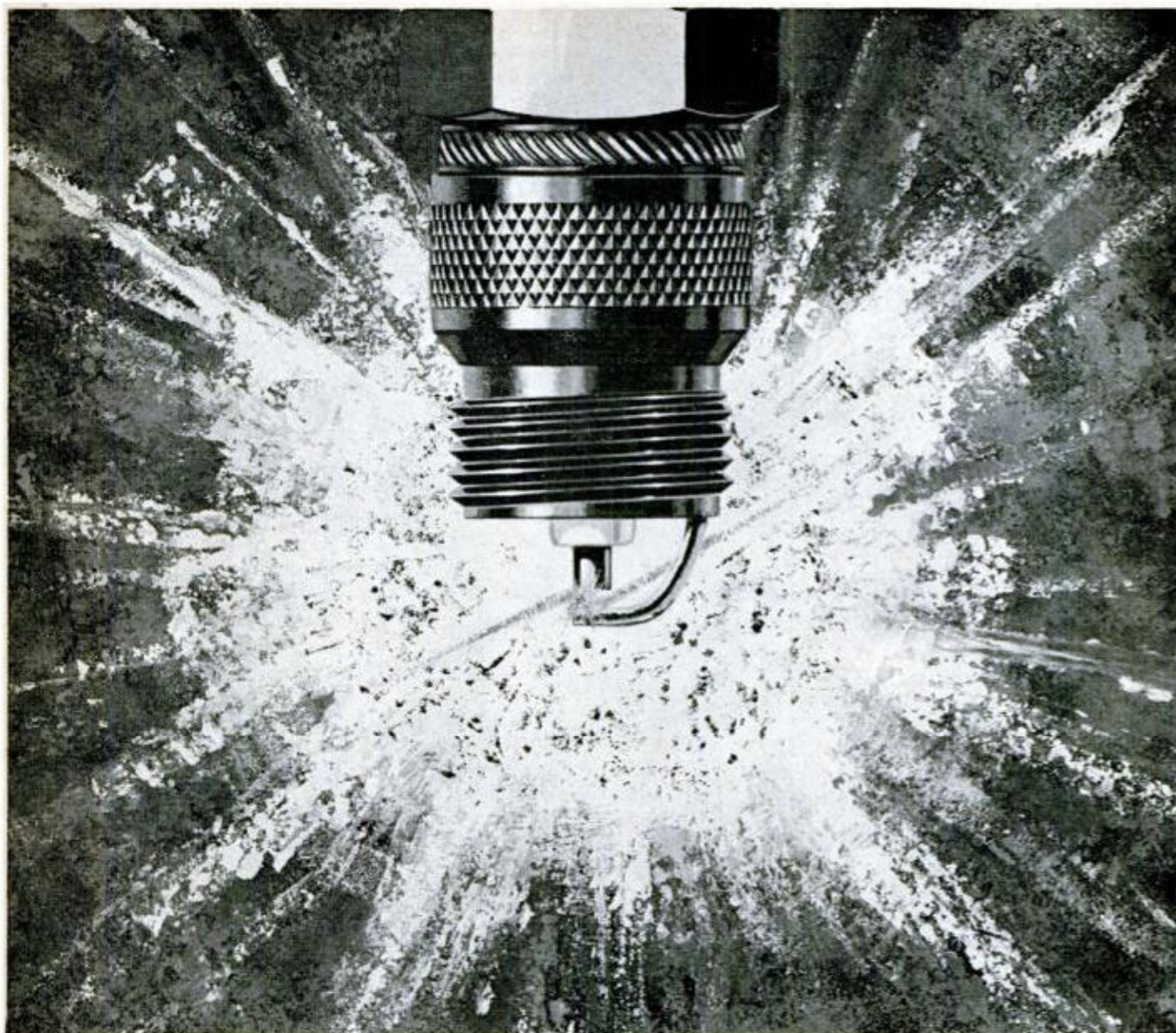

*Autolite, the sparkplug that cleans itself
while you drive,
is now standard equipment on the Ford Family of Fine Cars.*

This unique performance and economy feature is one of the reasons why Ford Motor Company, and several other car makers, specify Autolite Spark Plugs as standard equipment on every car they build.

The Autolite Power Tip is longer than the tip of ordinary plugs. It extends much deeper into your engine. Deposits are literally burned off by the exploding gasoline.

If your present plugs are killing the pep and mileage in your car, try Autolite, the spark plug that cleans itself while you drive.

AUTOLITE  **SPARK PLUGS**

Now standard equipment on the Ford Family of Fine Cars.

FOR REAL JOB SECURITY —GET AN I.C.S. DIPLOMA



"You can stop worrying, Jane. My job's secure now! And here's the insurance policy to prove it—my I.C.S. diploma!"

This feeling of security is probably typical of every I.C.S. graduate. Because—as the job situation gets tighter, the man with I.C.S. training has the advantage.

Why? Your I.C.S. diploma tells your present employer three important things: (1) You want to make the most of your present job.

(2). You have the training you need for advancement. (3) You look for better ways of doing things on your own.

What you do about your future is up to you. Do nothing and stay at your present job at the same old pay. Or earn an I.C.S. diploma in your spare time for security, promotions, more pay! Your first step is to mark the course that interests you in the coupon below, and mail it to us.

Three Free Booklets

We'll send you three interesting booklets: (1) "How to Succeed" is a career guide of helpful tips that point out many small things in your personality and behavior that can make the difference between success and failure; (2) A booklet telling you about the opportunities in the field of your choice; (3) Sample I.C.S. lesson.

Small investment now means big gains later

Many an I.C.S. student has reported a substantial increase in pay after only a few months of training. By studying at home in your spare time and applying what you learn on the job, you pay yourself many times an hour more than you're now making.

The security of your present job—or the success in finding the new job you've always wanted—is in your hands. Move ahead with I.C.S. training while others stay behind on the routine, small-pay jobs. Remember, your first step to security and success is to mail this coupon. Take a few minutes and do it now. Putting it off will put you further behind in the race for higher pay and real job security.

For Real Job Security—Get an I. C. S. Diploma! I. C. S., Scranton 15, Penna.

Accredited Member,
National Home Study Council

INTERNATIONAL CORRESPONDENCE SCHOOLS



BOX 81086J, SCRANTON 15, PENNA.

In Hawaii reply P. O. Box 418, Honolulu

(Partial list of courses)

Without cost or obligation, send me "HOW TO SUCCEED" and the opportunity booklet about the field BEFORE which I have marked X (plus sample lesson):

- ARCHITECTURE and BUILDING CONSTRUCTION**
- Air Conditioning
 - Architecture
 - Arch. Drawing and Designing
 - Building Contractor
 - Building Estimator
 - Carpenter Builder
 - Carpentry and Millwork
 - Carpenter Foreman
 - Heating
 - Painting Contractor
 - Plumbing
 - Reading Arch. Blueprints
- ART**
- Commercial Art
 - Magazine Illus.
 - Show Card and Sign Lettering
 - Sketching and Painting
- AUTOMOTIVE**
- Automobile
 - Auto Body Rebuilding and Refinishing
 - Auto Engine Tuneup
 - Auto Technician

- AVIATION**
- Aero-Engineering Technology
 - Aircraft & Engine Mechanic
- BUSINESS**
- Accounting
 - Advertising
 - Business Administration
 - Business Management
 - Cost Accounting
 - Creative Salesmanship
 - Managing a Small Business
 - Professional Secretary
 - Public Accounting
 - Purchasing Agent
 - Salesmanship and Management
 - Traffic Management
- CHEMICAL**
- Analytical Chemistry
 - Chemical Engineering
 - Chem. Lab. Technician
 - Elements of Nuclear Energy
 - General Chemistry
 - Natural Gas Prod. and Trans.
 - Petroleum Prod. and Engr.
 - Professional Engineer (Chem)
 - Pulp and Paper Making

- CIVIL ENGINEERING**
- Civil Engineering
 - Construction Engineering
 - Highway Engineering
 - Professional Engineer (Civil)
 - Reading Struc. Blueprints
 - Sanitary Engineer
 - Structural Engineering
 - Surveying and Mapping
- DRAFTING**
- Aircraft Drafting
 - Architectural Drafting
 - Drafting & Machine Design
 - Electrical Drafting
 - Mechanical Drafting
 - Sheet Metal Drafting
 - Structural Drafting
- ELECTRICAL**
- Electrical Engineering
 - Elec. Engr. Technician
 - Elec. Light and Power
 - Practical Electrician
 - Practical Lineman
 - Professional Engineer (Elec)
- HIGH SCHOOL**
- High School Diploma

- Good English
 - High School Mathematics
 - High School Science
 - Short Story Writing
- LEADERSHIP**
- Industrial Foremanship
 - Industrial Supervision
 - Personnel-Labor Relations
 - Supervision
- MECHANICAL and SHOP**
- Diesel Engines
 - Gas-Elec. Welding
 - Industrial Engineering
 - Industrial Instrumentation
 - Industrial Metallurgy
 - Industrial Safety
 - Machine Shop Practice
 - Mechanical Engineering
 - Professional Engineer (Mech)
 - Quality Control
 - Reading Shop Blueprints
 - Refrigeration and Air Conditioning
 - Tool Design
 - Tool Making
- RADIO, TELEVISION**
- General Electronics Tech.

- Industrial Electronics
 - Practical Radio-TV Eng'g
 - Practical Telephony
 - Radio-TV Servicing
- RAILROAD**
- Car Inspector and Air Brake
 - Diesel Electrician
 - Diesel Engr. and Fireman
 - Diesel Locomotive
- STEAM and DIESEL POWER**
- Combustion Engineering
 - Power Plant Engineer
 - Stationary Diesel Engr.
 - Stationary Fireman
- TEXTILE**
- Carding and Spinning
 - Cotton Manufacture
 - Cotton Warming and Weaving
 - Loom Fixing Technician
 - Textile Designing
 - Textile Finishing & Dyeing
 - Throwing
 - Warping and Weaving
 - Worsted Manufacturing

Name _____ Age _____ Home Address _____
 City _____ Zone _____ State _____ Working Hours _____ A.M. to P.M. _____
 Occupation _____

Canadian residents send coupon to International Correspondence Schools, Canadian, Ltd., Montreal, Canada. . . . Special low monthly tuition rates to members of the U. S. Armed Forces.

NOW HOME MODERNIZATION
MADE EASY WITH

Par-TILE

the low cost wood block flooring that **YOU CAN INSTALL**

Add the warmth, beauty and elegance of *real wood* flooring to every room in your home with Par-TILE. YOU can easily install Par-TILE just like other tile flooring . . . and for the same economical cost. Par-TILE can be installed over your old floors and over concrete.

With its exclusive flexo-grid back Par-TILE is soft and quiet to walk on.

Par-TILE will last longer . . . its durable, prefinished surface will not dent or mar and it is easy to keep clean.

Buy Par-TILE Today at your nearest building supply dealer.

- 9" x 9" x $\frac{3}{8}$ " tongue and grooved blocks—one carton of 54 Par-TILE blocks covers 30.3 sq. ft.
- Available in Natural and Walnut wood tones.

**WRITE FOR FLOOR IDEAS
BOOKLET**

Par-TILE can be installed in an unlimited number of floor designs. Send for our colorful FLOOR IDEAS booklet by clipping this portion of our ad and sending it with 10 cents and your name and address to Par-TILE • FOREST INDUSTRIES, INC. P. O. Box 78 • Dillard, Ore.

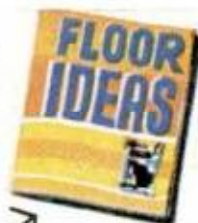

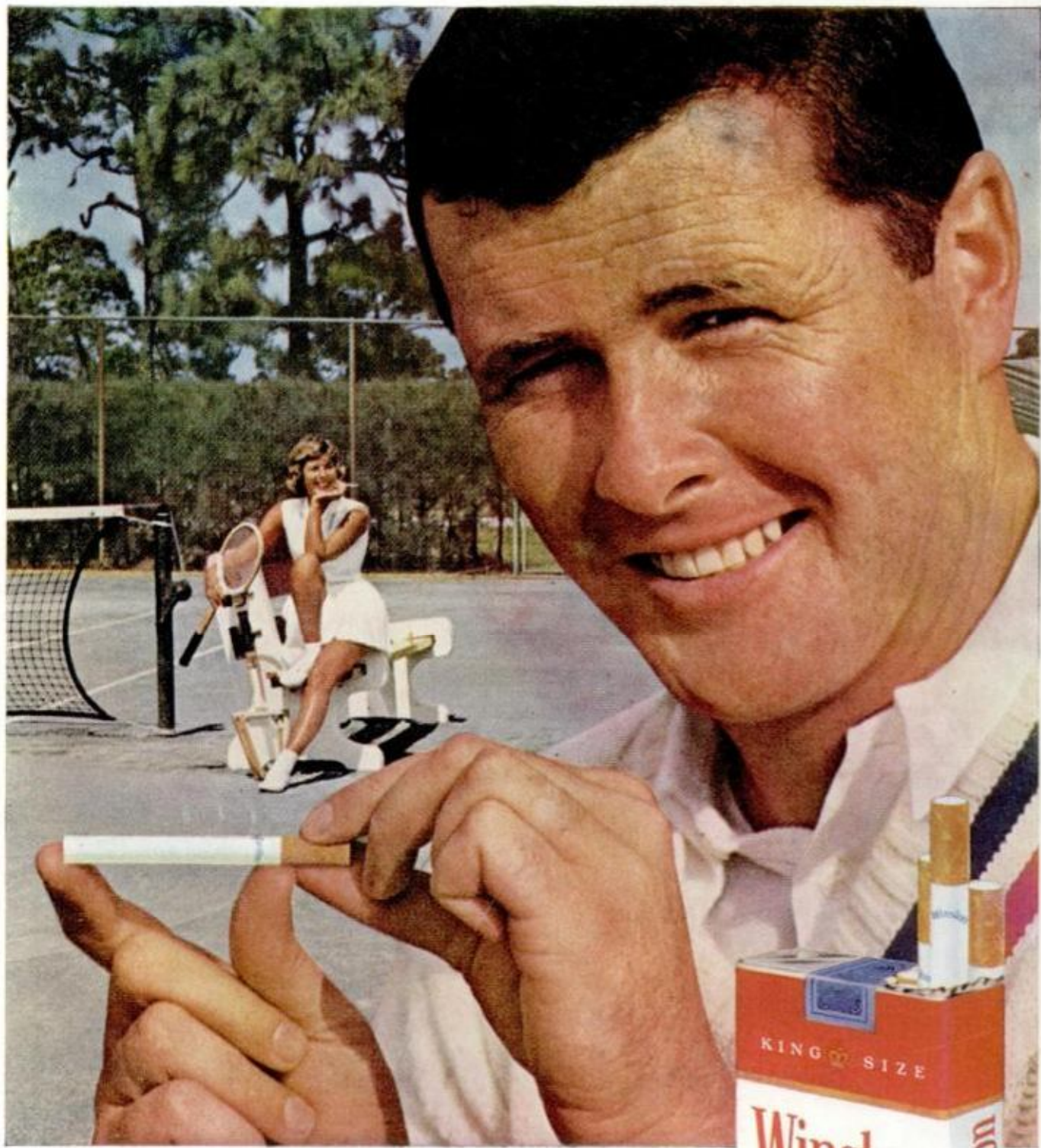

It's what's up front that counts

FILTER-BLEND up front, *ahead* of Winston's pure white filter, makes the big taste difference. Get this Winston exclusive—flavorful mild tobaccos specially selected and specially processed for good filter smoking. Next time you buy cigarettes, ask for Winston.

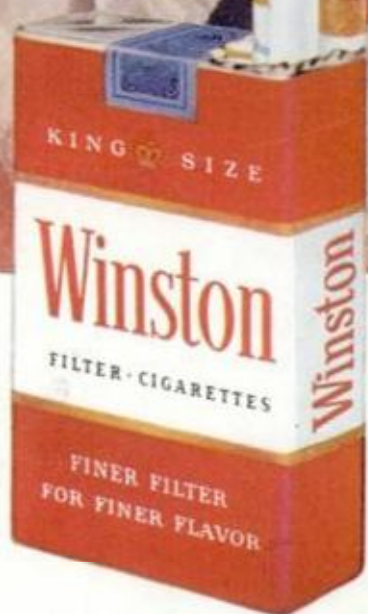

R. J. REYNOLDS TOBACCO CO., WINSTON-SALEM, N. C.

WINSTON TASTES GOOD *like a cigarette should!*