

ALL THE '61 CARS IN COLOR

POPULAR MECHANICS

NOVEMBER, 1960
35 CENTS

CORVAIR REAR-ENGINE WAGON



- **SPECIAL—SIXTEEN CHRISTMAS GIFT IDEAS**
- **ROCKETS FOR CIVILIANS**

**RAMBLER AMERICAN
CONVERTIBLE**





**NOW, YOU IN YOUR OWN HOME WORKSHOP
CAN TURN OUT MAGNIFICENTLY FITTED FURNITURE WITH THE
SAME EASE AS PROFESSIONAL WOODWORKERS!**

New from Comet! The 6" Dial-A-Cut Quick-Set Dado. The biggest boon to home woodworkers since the invention of the radial arm. Now, you can have the tightest-fitting shelves and joints, turn out stronger furniture, easier and faster than you ever dreamed possible.

You add no leaflets...you remove no leaflets. The Comet Quick-Set Dado has done away with leaflets. You simply dial the width you want...anywhere from 1/4" to 13/16". Best of all, you do it without ever removing the Dado from the arbor!

Get perfect dado grooves, sides and bottoms in seconds and at speeds up to 7,000 rpm...with no annoying wobble, vibration, chatter, burning or chewing. What's more, your Comet Quick-Set Dado's eight Silvanite cutting teeth are tough, silver-brazed and air-cooled. Stay sharp five times longer than leaf-type dados! Your Comet Dado will pay for itself six times over in the money you save on resharpening costs.

SEND FOR YOUR QUICK-SET DADO TODAY.

It fits any shaft... 3/4", 5/8" or 1/2"

**NEVER BEFORE
A DADO SO EASY TO USE
OR SO ACCURATE!**



- * **GET PERFECT DADO CUTS, GROOVES,** rabbets, panels, bevels, ploughs and miters every time!
- * **DIAL INSTANTLY ANY CUT YOU WANT!** The actual width you want is marked right on the dial...from 1/4" to 13/16" or any hairbreadth in between. Gives you depths up to 3/4"...all without removing it from the arbor.
- * **USE IT ON ANY TABLE OR RADIAL ARM SAW** Fits 3/4", 5/8" and 1/2" shafts.



- * **ADAPTABLE FOR EITHER RIGHT- OR LEFT
HAND ROTATION!**
- * **AMAZING ACCURACY AT SPEEDS UP TO
7000 RPM!** Perfectly balanced. Runs true, smooth, with no wobble, vibration, burning or chewing.
- * **STAYS SHARP 5 TIMES LONGER THAN
OTHERS!** The Comet Dado's eight Silvanite tough, high-speed, tool-steel blades are self-cooling.
- * **PAYS FOR ITSELF 6 TIMES OVER** in the money you save on resharpening costs!

COMET



COMET MANUFACTURING COMPANY
875 So. Arroyo Parkway, Pasadena, California
A Division of The Siegler Corporation

Announcing

THE FINEST ROI-TAN EVER MADE!



Firmer—Finer—Fresher...

And you enjoy the smooth flavor and mildness of Roi-Tan's finer quality tobaccos *all the way*. For every puff comes through the remarkable new STA-FIRM HEAD free and easy—right to the end! Have a fresh new Roi-Tan today—there's a size for every taste.

MAN TO MAN...SMOKE ^{new}

ROI-TAN

AMERICA'S LARGEST-SELLING CIGAR—AT 10¢

Product of The American Tobacco Company—Tobacco is our middle name

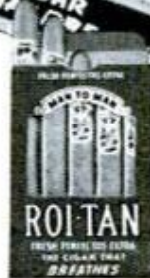

IN BOXES
OF 50
AND HANDY
5-PACKS.

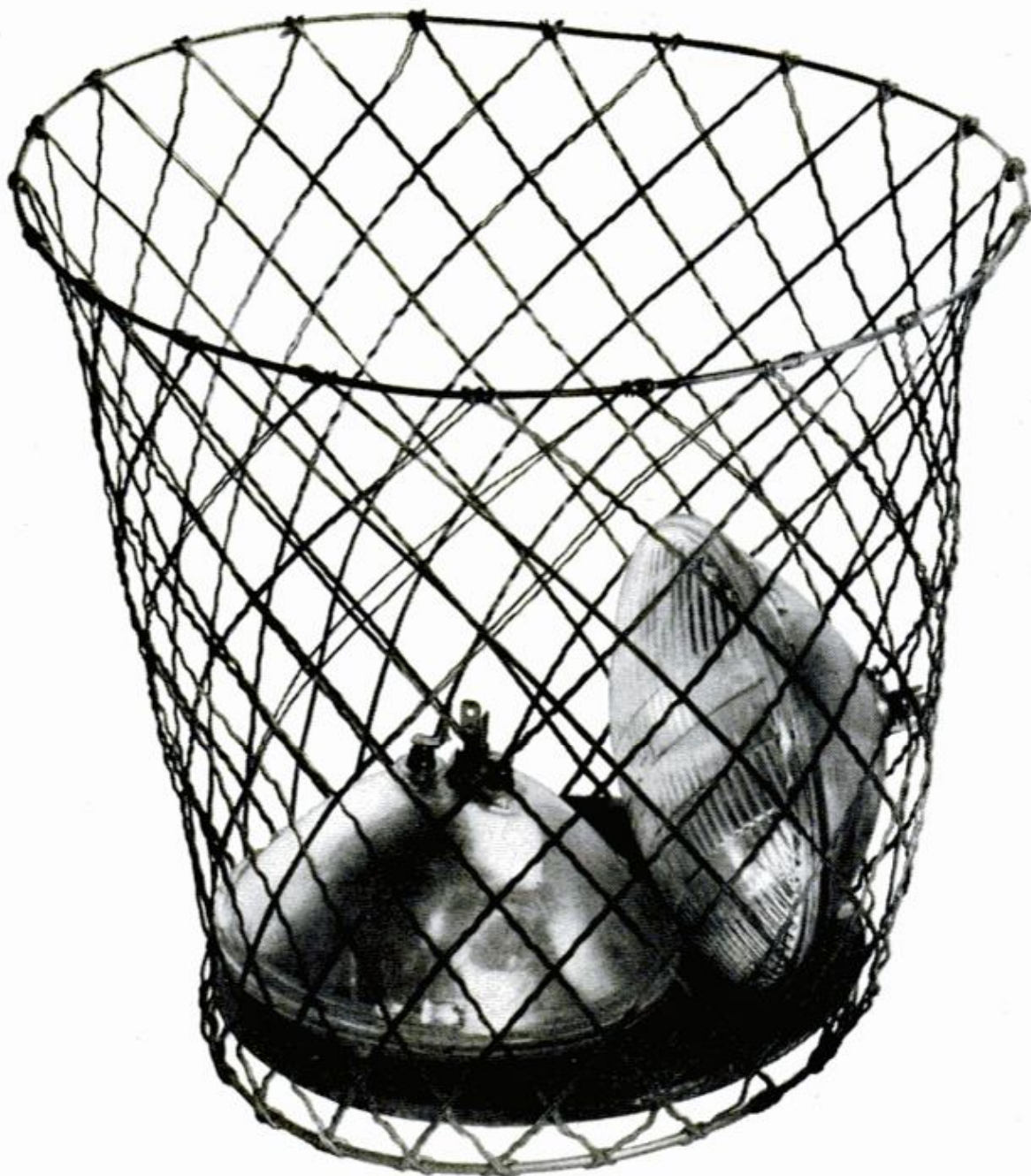

Why are people throwing away both headlamps when one still lights?

Because a pair of G-E SUBURBAN Headlamps gives their 2-headlamp cars twice as much light where it's needed! It's almost like driving a new 4-headlamp car when you switch on the low beam of your new General Electric SUBURBAN Headlamps! Only G-E SUBURBAN Headlamps, among all the brands made for two-headlamp cars, have the low beam filament on focus to give you a "spotlight effect". This gives you twice as much light where you need it . . . down the right side of the road. So you see better in spite of the other car's lights . . . even if he fails to "dim" for you!

If you have a two-headlamp car, don't even wait for *one* headlamp to burn out. Have a pair of new General Electric SUBURBAN Headlamps installed and aimed today! See how much easier and more relaxing night driving can be. General Electric Company, Miniature Lamp Dept. M-024, Nela Park, Cleveland 12, Ohio.

Progress Is Our Most Important Product

GENERAL  ELECTRIC

POPULAR MECHANICS®

Address communications to: 200 E. Ontario St., Chicago 11, Illinois. **SUBSCRIPTION SERVICE:** Mail all subscription orders, changes of address, correspondence concerning subscriptions, and Postmaster notices of undeliverable copies to Popular Mechanics, 250 West 55th St., New York 19, N. Y.

Editor

RODERICK M. GRANT

Executive Vice-President

RICHARD E. DEEMS

Publisher

JOSEPH R. BUELL, JR.

Managing Editor

CLIFFORD B. HICKS

Shop Notes and Crafts Editor

WAYNE C. LECKEY

Associate Editor, General Features

JOHN A. LINKLETTER

Associate Editor, Automotive

JAMES R. WHIPPLE

Associate Editors, Shop Notes and Crafts

W. CLYDE LAMMEY, EARL WOBECK

Radio-Television, Electronics Editor

BYRON G. WELS

Assistant Editors, General Features

JAMES BIERY, KEVIN V. BROWN

R. B. KIRKPATRICK

Assistant Editors, Shop Notes and Crafts

GUERRINO F. AMATI, ROBERT L. HERING

Assistant Editors, Makeup

WALLACE MYERS, JEAN KAVANAUGH

Art Staff

FRANK BEATTY, Director

HENRY NEHRBASS, Assistant Director

RICHARD A. POTTS, Art Editor

Eastern Editor

RICHARD F. DEMPEWOLFF

959 Eighth Ave., New York 19, N. Y.

Western Editor

THOMAS E. STIMSON, JR.

Suite 1003, 3460 Wilshire Blvd.
Los Angeles 5, Calif.

Advertising Manager

FRANK R. DUPUY

959 Eighth Ave., New York 19, N.Y.

Director, Bureau of Information

ALLAN CARPENTER

Advertising Offices

Chicago: 200 E. Ontario St., Whitehall 4-0100;
New York: 959 Eighth Ave., Columbus 5-7300;
Detroit: General Motors Bldg., TRinity 5-8711;
Cleveland: Hanna Bldg., 1422 Euclid Ave.,
PRospect 1-0456; Los Angeles: 3460 Wilshire,
DUNKirk 2-8458; San Francisco: Russ Bldg.,
235 Montgomery St., YUKon 2-0823.

Published monthly by Popular Mechanics Company, 200 E. Ontario St., Chicago 11, Ill. Richard E. Berlin, President; Richard E. Deems, Executive Vice-President; Fred Lewis, Vice-President and General Manager; Robert F. MacLeod, Vice-President; John R. Miller, Vice-President; G. Harry Chamberlaine, Vice-President; G. O. Markson, Treasurer; R. F. McCauley, Secretary. Single copy in the United States and Canada, 35 cents; subscription rates in the United States and possessions and Canada, 1 year \$3.50; 2 years, \$6.00; 3 years, \$8.00. In countries of the Pan-American Postal Union, 1 year \$4.50; 2 years \$8.00; 3 years \$11.00. In all other countries 1 year \$5.50; 2 years \$10.00; 3 years \$14.00. If you plan to move, notify us at least 30 days in advance so you will not miss an issue. Give both your old and new addresses. Second-class postage paid at Chicago, Illinois, and at additional mailing offices. Entered as Second Class Matter at Post Office Dept., Canada. Registered as Second Class Matter at the Post Office at Mexico, D.F., Mexico, June 20, 1950. ©1960 by Popular Mechanics Company. All rights reserved. Printed in the United States of America.

INTERNATIONAL EDITIONS

SPANISH: Mexico-Caribbean, Southern Hemisphere

FRENCH, DANISH, SWEDISH, GERMAN, PORTUGUESE, DUTCH

Volume 114

NOVEMBER 1960

Number 5

In This Issue...

All the 1961 Cars in Full Color - - - - -	81
More Details on the New Cars - - - - -	89
Kid-Size Rodeo - - - - -	98
Worldwide Adventure—Person to Person - -	105
Let's Bring Our Planes Down Safely - - -	109
What to Look for in a New Gun - - - - -	117
Christmas Gift Ideas - - - - -	130
Rockets for Civilians - - - - -	138
Let a Robot Drive the Plow - - - - -	145
Rubber Geese - - - - -	154

For the Craftsman...

Grow Yourself a Fence - - - - -	170
It's Outboard Layup Time - - - - -	172
Hanging Decorator Clocks - - - - -	178
Button Up Your House for Winter - - - -	188
Build Your Own Quick-Charger - - - - -	192
Portable Drill Powers Wood Lathe - - - -	196
Entertainment Wall for House of Built-Ins -	202
Radio, TV and Electronics - - - - -	76 and 212

Regular Departments...

GUIDE TO THIS ISSUE - - - 6

Items From All Outdoors - - - 17	What's Up in the Air - - - 42
Know This Old-Timer! - - - 18	Detroit Listening Post - - - 106
Pentagon Sidelights - - - 20	An Eye on Space - - - 116
Pioneer in Science - - - 24	Solving Home Problems - - - 166
Keeping Up With the Atom - - - 26	Clinic for Homemakers - - - 232
Science Bulletins - - - 30	On the Market - - - 268
Tune In on the Inventors - - - 36	Shopping for Tools - - - 276

Turn to detailed index on page 6. Sources of additional information on items in this issue are shown on the Where-to-Find-It List, available without charge by writing the Bureau of Information, Popular Mechanics, 200 E. Ontario St., Chicago 11, Ill.

Next Month...

WHAT'S THE NATION'S number one hobby? Stamp collecting was the champ until recently, when model building took over undisputed first place. Within the short span of two years the sale of model kits has more than doubled. Learn what put "Model-makers in a Tizzy" in December. . . . Also, there's a big 17-page section of Christmas gifts and decorations you can make yourself



What's so special about the Buick Special?

The answer? Everything! Smaller than big, yet bigger than small, this all-new Buick Special gives you the room, ride, go and pride of the costliest cars with the savings and ease of the small. Here's how Buick achieved this engineering miracle:

ENGINE: Revolutionary. The Fireball Aluminum V-8 is a water-cooled engine made almost entirely of aluminum. Its .487 horsepower per pound gives you the industry's highest horsepower to weight ratio. Performance? You can go from a standstill to expressway speed as safe and sprightly as in many a full-size car. Economy? With all its go, the Special is right up there with the compacts for gas savings.

TRANSMISSION: Exceptionally lightweight, automatic transmission* with aluminum housing and many aluminum parts. It works on a "dual path" principle. When cruising, about 70 per cent of the driving forces go through a turbine torque converter and 30 per cent through a planetary gear set. This way you get the go and gas savings of geared transmission with the smoothness of turbine drive. And for stick-shift levers there's an action-packed Synchronesh transmission that's as delightful for gas savings as it is for git.

PROPELLER SHAFT: The Special's new Hide-Away drive shaft lowers the hump, gives more flat floor space, greater foot room and softer seating for the "man in the middle." A special "constant velocity" universal joint keeps driving power flowing to the differential with perfect smoothness.

SUSPENSION: Here's a real luxury feature in new-size cars — full-coil suspension — the same type used on the full-size '61 Buicks. Front stabilizer bar and a new link-type rear mounting stabilize the ride perfectly, giving flatter cornering and a smooth "all-day" ride. The Special also uses the same hydraulic shock absorbers, front and rear, as the larger Buicks.

BODY: Full, unitized construction. It's tight and snug. Absence of heavy frame cuts dead weight for extra gas savings.

MODELS: A handsome four-door sedan and an amazingly roomy four-door station wagon with convenient full-height liftgate.

SEE FOR YOURSELF how beautifully and skillfully Buick engineers have combined the best of two automotive worlds — the big and the small. See your Buick *Special* dealer this week. **Optional at extra cost.*

BUICK MOTOR DIVISION — GENERAL MOTORS CORPORATION

BLOW-TORCH TEST SHOWS ADVANTAGE OF FAMOUS AC "HOT TIP"

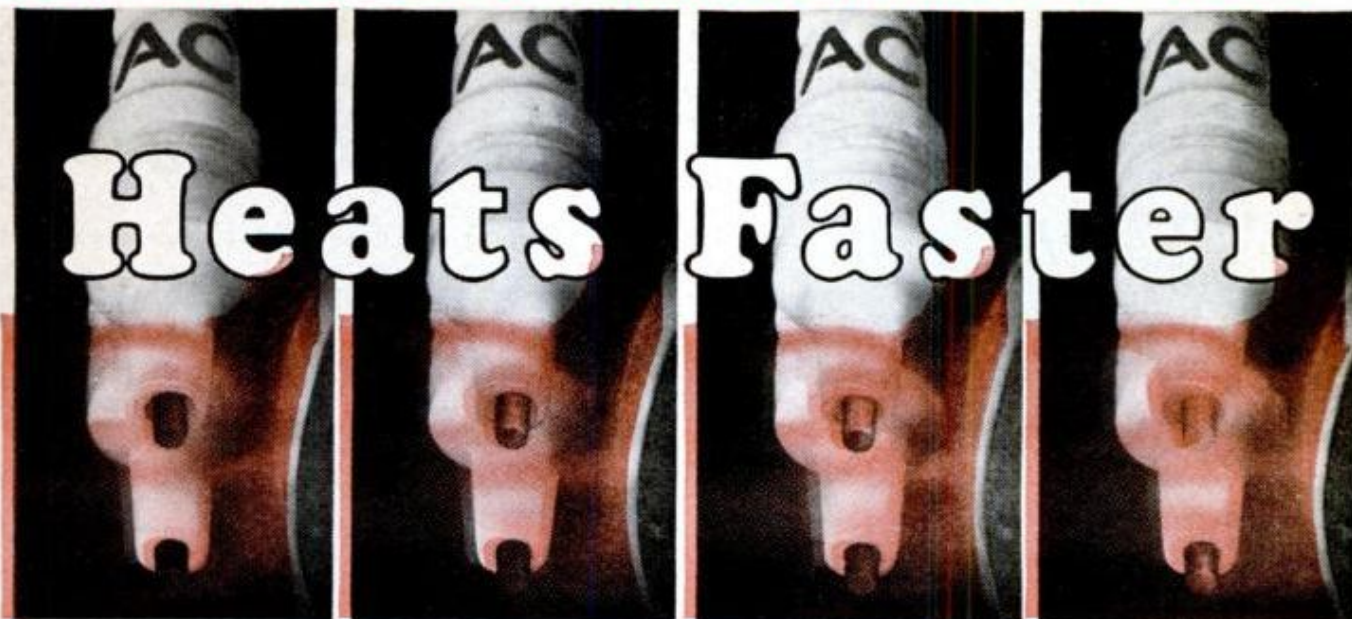

Hot Tip (at top)

Heats Rapidly

Gets Hotter

Still Hotter

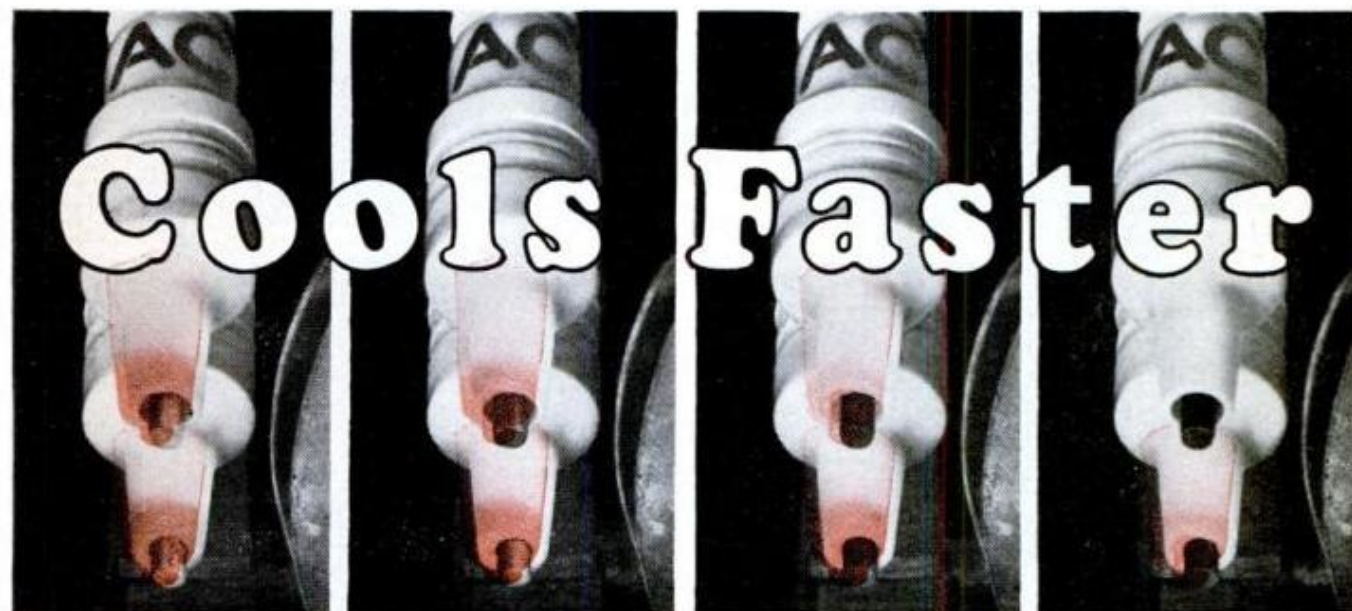

Flame Removed

Tip Cools Rapidly

Gets Cooler

Still Cooler

ACs stay clean longer!

The searing 2000-degree heat of a blow-torch can tell you plenty about spark plug performance. AC's exclusive long, thin, "Hot Tip" insulator heats more rapidly in the flame, cools more rapidly when the flame is removed.

The faster heating action burns off combustion deposits . . . the faster cooling prevents engine-damaging pre-ignition . . . the long, thin, deeply recessed insulator design provides maximum clearance for "scrubbing action" by combustion gases to destroy accumulations as they form.

AC's "Hot Tip" means more miles of sure-firing operation and economy, with less cleaning and servicing. Next time you need spark plugs, ask for AC Fire-Ring Spark Plugs with the famous "Hot Tip."

AC SPARK PLUG  THE ELECTRONICS DIVISION OF GENERAL MOTORS

AC Fire-Ring Spark Plugs

THEY MUST BE THE BEST'



This One

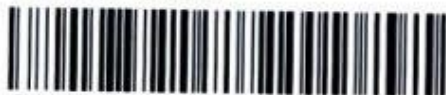

C1LS-2DH-T9ZA

NOVEMBER 1960

Знак, защищенный авторским правом

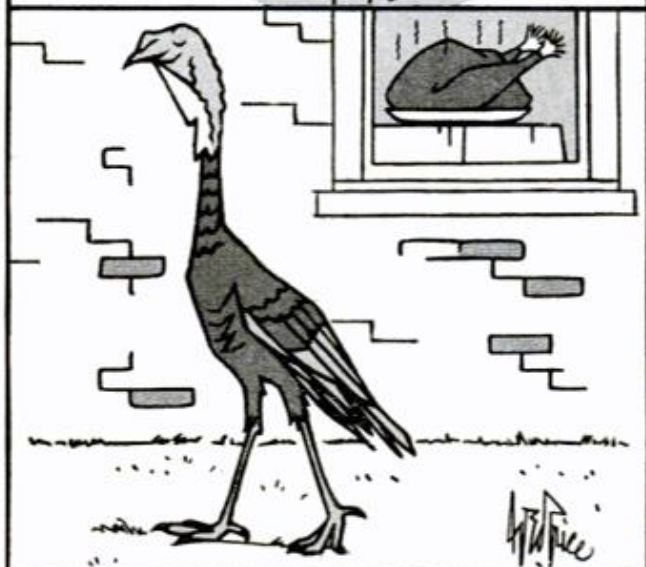
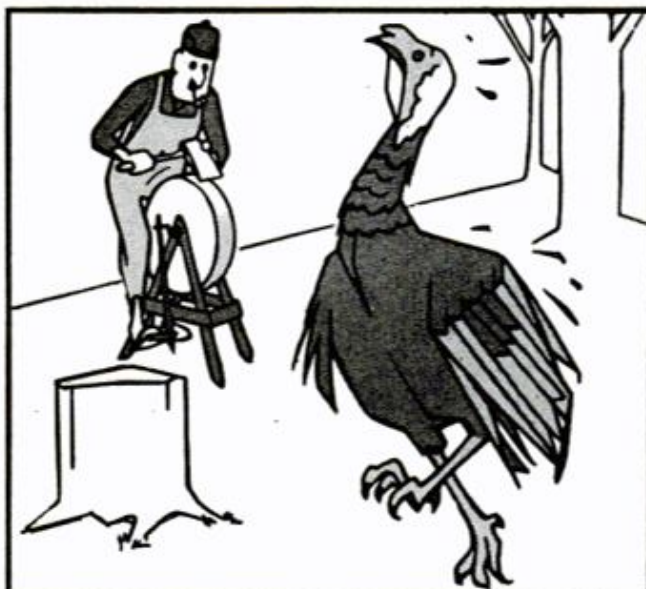

poultry, novelties, souvenirs,
plumbers, books, boats, gears
whatever you need—



Advertisers displaying this emblem make your shopping easy.

GUIDE TO THIS ISSUE

With Sources of New Products

Drive-in post office	103
Deluxe golf cart is air-conditioned (Henry F. Unger, 805 N. 3rd Ave., Phoenix, Ariz.)	103
Uranium ball for reactor (Hydromatics, Inc., 70 Okner Pkwy., Livingston, N.J.)	103
Flying torpedo	104
Swedish locomotive's six motors deliver 7500 horsepower	107
Tank crews get infrared binoculars for seeing at night	107
Pint-sized cot keeps baby happy (Barker & Lovering Ltd., Waterloo Wharf, Transporter Bridge, Newport, Monmouth, Wales)	108
Punched tape instructs machine (Lucas Machine Div., New Britain Machine Co., 12300 Kirby Ave., Cleveland, Ohio)	108
Greenhouse for skiers	115
Pressure-balancing hose (Apparatefabrik Alsfeld Eng., Guenther Uhlmann, Alsfeld-Liedebach/Oberhessen, West Germany)	115
Electronic sight for subs	121
Man bikes dog	121
Supersonic cockpit becomes space capsule (Lockheed Aircraft Corp., Burbank, Calif.)	121
Does foam really help in belly landings?	122
World's biggest yo-yo	123
Columbium toughens steel pipe	123
"Piggyback" wrecker (Transportation Equipment Development Corp., 1625 I St., NW, Washington 6, D.C.)	123
Glowing Tabletop	123
This man's home really is his castle	124
My most exciting moment	125
Practicing fire at sea	126
Pickup camper goes amphibious	128
Infrared viewer keeps night watch	129
Solar boiler on Okinawa	129
Arc-jet engine for satellites (Arco Corp., 201 Lowell St., Wilmington, Mass.)	129
Christmas gift ideas	130
Army moon simulator	136
Punch-card data by phone (IBM Corp., Data Processing Div., 112 E. Post Rd., White Plains, N.Y.)	136
First turboprop jetliner ready for service (Boeing Airplane Co., Seattle 24, Wash.)	137
Portable boat unfolds from "suitcase" (John Thomson, 271 Main, Glen Ellyn, Ill.)	137
Model builder—historian	143
Electron tube amplifies light	144
Four-place helicopter for businessmen (Hiller Aircraft Corp., Palo Alto, Calif.)	144
Space-travel hazards simulated in chamber	144
Bowling by braille (The Indikon Co., Watertown, Mass.)	148
Microwaves speed paychecks (IBM Corp., Data Processing Div., 112 E. Post Rd., White Plains, N.Y.)	148
Pipe-organ guitar produces novel tone (Arnold Hoyer, Tennenlohe, Bavaria, W. Germany)	148
Wild horses are vanishing	148
Electronic "side man" (The Wurlitzer Co., De Kalb, Ill.)	149
Compact home gymnasium (Marcy Gymnasium Equipment Co., 1398 Sunset Blvd., Los Angeles 26, Calif.)	149
Lightweight gas turbine powers fire truck (Boeing Airplane Co., Seattle 24, Wash.)	149
Airborne pinball machine	150
Fiberglass foxholes	152
Quicker by the dozen	152
Space-medicine instruments (Boeing Airplane Co., Seattle 24, Wash.)	152
Antenna chamber (Republic Aviation Co., Research & Development Center, Farmingdale, Long Island, N.Y.)	153
Machine prints music	153
Radio tracks grouse (Minneapolis-Honeywell Regulator Co., 2747 Fourth Ave., S., Minneapolis 8, Minn.)	153
Mercury astronauts test space capsule for water landing	157
"Roundhouse" in hangar rotates airplane	157
Clothespin is marking gauge for fitting new linoleum	160
Filing system for duplicates keeps track of keys in use	160
Removable typewriter shelf fits over desk drawer	160
Stable soldering-iron stand made from empty coffee can	160
Uni-sled for more winter fun	161
Ice dams along gutters can cause roof leaks	161
Sponge-backed sandpaper fits curved surface	161
Water heater supplies radiant heating system	165
Roll key for the toothpaste tube	166
Hinges for the valance	166
Discarded nylon stocking makes fine polishing cloth	166
Wild paintbrush bristles	166

(Continued to page 8)

Are You "STANDING STILL" on your job?

**SAME OLD
JOB . . .
SAME LOW
PAY . . . ?**

You can justify a real pay raise and a better position—by making one simple move—the move that opens the way to more earnings and promotions—*practical training.*

If YOU are "standing still" on your job—no promotions—only token increases in pay—then you had better do something about it. You know that if you are untrained, your chances of getting ahead are slim. **NOW IS THE TIME TO PREPARE.**

WILL RECOGNITION COME?

The only answer, as you know, is that success *does* come to the man or woman who is really *trained*. LaSalle has provided the "key to success" for many thousands of ambitious people who have sought our training for more than fifty years.

Get all the facts. Investigate the opportunities in your chosen field. It costs you nothing to learn about LaSalle's proven and tested accredited correspondence courses in the major fields of business as well as high school and technical courses. You can train in the

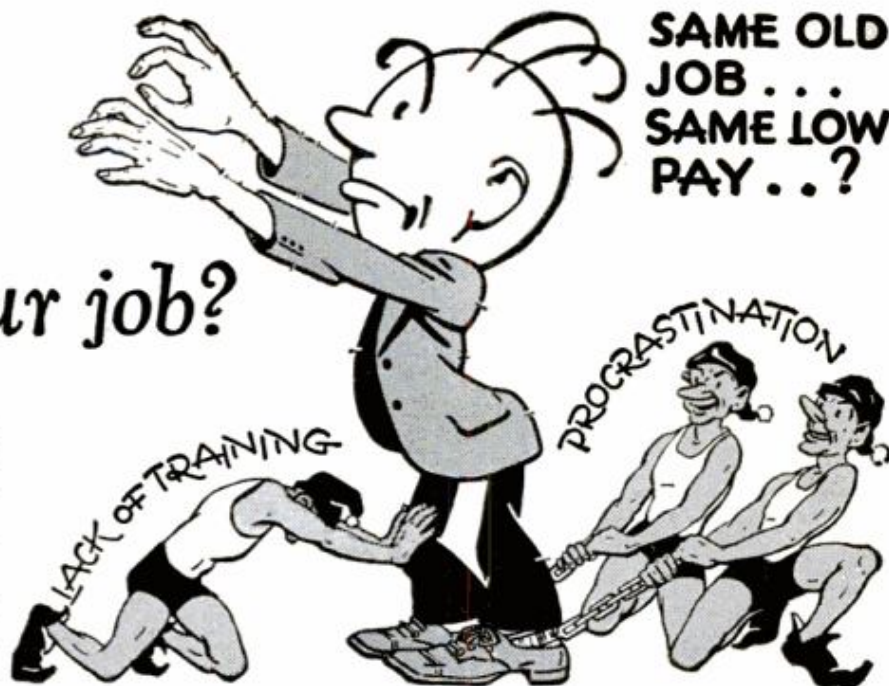

privacy of your own home, progressing at your own rate. You lose no time from work, and your instructors guide you every step along the way through our famous Practical Problem Method. Low cost—easy terms.

Don't let promotions pass you by—do something **TODAY** about your future.

The coupon below is for your convenience. Simply mark the program in which you are most interested, and mail at once. We'll send you, without obligation, free booklets describing that field together with the opportunities and what you must know to be a success.

ACCREDITED MEMBER, NATIONAL HOME STUDY COUNCIL

LaSalle Extension University, A Correspondence Institution, Dept. 1164X. 417 S. Dearborn, Chicago 5, Ill.

Please send me, without cost or obligation, **FREE** catalog and full information on the field I have checked below:

ACCOUNTING

- Modern Bookkeeping
- Basic Accounting
- Practical Accounting
- Principles of Acctg.
- Cost Accounting
- Federal Income Tax
- Accounting Systems
- Business Law
- Auditing Procedure
- Controlling Procedure
- CPA Training
- Complete Accounting

TRAFFIC & TRANSPORTATION

- Organization & Mgt.
- Classifications, Rates & Tariffs
- Transportation Agency & Services

- Transportation Law & Regulation
- Rate Making & Rate Cases
- Complete Traffic & Transportation

LAW

- Law of Contracts
- Insurance Law
- Claim Adjusting Law
- Law for Trust Officers
- Business Law I
- Business Law II
- General Law
- First Year Law
- American Law and Procedure (LL.B. Degree)

BUSINESS MANAGEMENT

- Principles of Management
- Psychology in Business
- Selling & Sales Management
- Advertising & Marketing
- Production Problems
- Business Financing
- Credits & Collections
- Office Management
- Managing Men
- Accounting & Statistical Control
- Business Correspondence
- Organization & Reorganization
- Legal Problems
- Complete Business Management

MANAGEMENT COURSES

- Basic Management
- Production Management
- Sales Management
- Advertising & Sales Promotion
- Financial Management
- Personnel Management
- Sales & Executive Trng.
- LaSalle Sales Training
- Foremanship Training

HIGH SCHOOL

- High School Preparatory
- General Business Course
- High School Diploma
- Commercial Course
- Secretarial Course

- Stenotype (machine shorthand)
- Home Management Course
- General Culture Course
- Science Course
- Mechanical Course

DENTAL ASSISTANT

- Dental Assistant

TECHNICAL COURSES

- Auto Body Fender
- Refrigeration-Air Conditioning
- Diesel
- Drafting
- Welding
- Motor Tuneup

Name.....Age.....
Address.....
City, Zone, State.....

**CHECK THIS COUPON AND MAIL
TODAY... SURE!**

South Bend

10" LATHES

with new
welded steel
floor legs

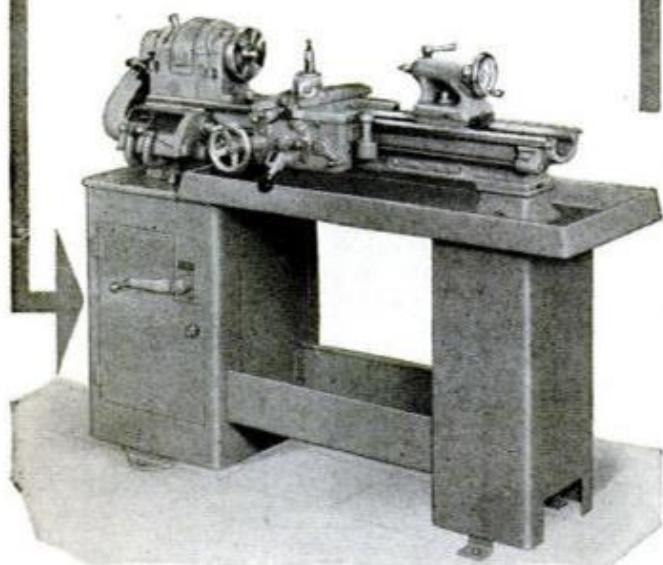

- New, trim floor legs . . . reinforced construction of welded, heavy gauge steel . . . maximum rigidity with minimum weight . . . no increase in price!
- Famous South Bend dependability.
- Superfinished spindles and bearings for uniform accuracy and fine finishes.
- 70 screw threads (4 to 480 per in.) . . . 70 longitudinal feeds . . . 70 cross feeds.
- Tool room and Engine Lathe models . . . prices start at \$1346 f.o.b. factory.

WRITE FOR CATALOG

*of South Bend Lathes, Milling Machines,
Shapers, Drill Presses and Pedestal Grinders*

SOUTH BEND LATHE, INC.

South Bend 22, Indiana

Building Better Tools Since 1906

Only 3¼% interest per year
on unpaid balance
up to 36 months to pay



Paint bucket for small home jobs	166
Appliance cord	167
Rubber mullage applicator kept from drying shut	167
Clothes hamper	167
Displaying chinaware	167
Clogged ball point pen can be made to write	167
Drawing board hints	168
Template and rubber cement speed snapshot mounting	184
Rubber tips on print tongs insure against scratched prints	184
Rolled newspaper or magazine takes curl out of old prints	184
Colored edges on slides help spot choice shots	184
Open flash "synchronizer"	185
Model outboard motor mixes photo chemicals	185
Drop-top enlarging table	186
Dash meters are back again	191
Build your own quick-charger	192
Jackshaft for your Shopsmith	198
Sockets held on wrench handle	199
Fitting protects grease-gun tip	199
Where's that chuck key?	199
Tool guard prevents hand injury	199
Color keys socket screws and wrenches	200
Wire coat hooks make storage racks for dowels	200
Cutting large holes with a coping saw	200
Eyebolt chuck for special job	208
Longer handle for Allen wrench	208
Drill sizes taped on screw tape	208
Cardboard disks protect blades	208
Square cuts with portable saw	208
Steel-wool finishing pad backed with emery cloth	210
Chip guard on tool post protects lathe operator	210
Witness mark "remembers" settings on lathe crossfeed dial	210
Tap wrench is ideal holder for grinding lathe tools	210
Hardening steel	211
Dictating machine from tape recorder	212
"Tomorrow's TV set today"	214

NOTICE—It is the intention of this magazine to provide its readers with information regarding the latest developments in the mechanical arts. Except where otherwise indicated, this magazine has no information as to any unexpired patents in respect of the developments reported herein. In the event that commercial use is to be made of any of the developments reported herein, it is suggested that legal counsel be consulted to avoid liability for patent infringement. It is not the purpose of this magazine to encourage patent infringement but, as indicated, it is the intention of this magazine to report on the latest developments in the mechanical arts.

X Rays of Hand and Wrist Can Identify Person

X rays of human wrists and hands can provide conclusive proof of a person's identity, reports a Stanford University scientist. Individual bones of the hand and wrist differ enough from one person to another so that if fingerprints or dental work are not available, the person can be identified. The scientist, Dr. William Walter Greulich, said that identification is based on the pattern of some 27 complete bones and parts of two others, the radius and ulna of the arm.

Brain's Mineral Regulator

Researchers for the U. S. Air Force have discovered that the pineal gland in the brain is part of a region controlling the amounts of minerals present in human bodies. The pineal region—once thought to be a remnant of a sense organ used by prehistoric man—helps control the output of a body chemical called aldosterone which, in turn, helps control the mineral balance in the body, say scientists who are performing research at Western Reserve University under contract to the Air Research and Development Command.

Learn Radio-Television Electronics

by Practicing at Home in Your Spare Time

WITHOUT EXTRA CHARGE YOU GET special NRI kits developed to give you actual practice with Radio-TV receiver or broadcasting circuits and equipment. All equipment is yours to keep.

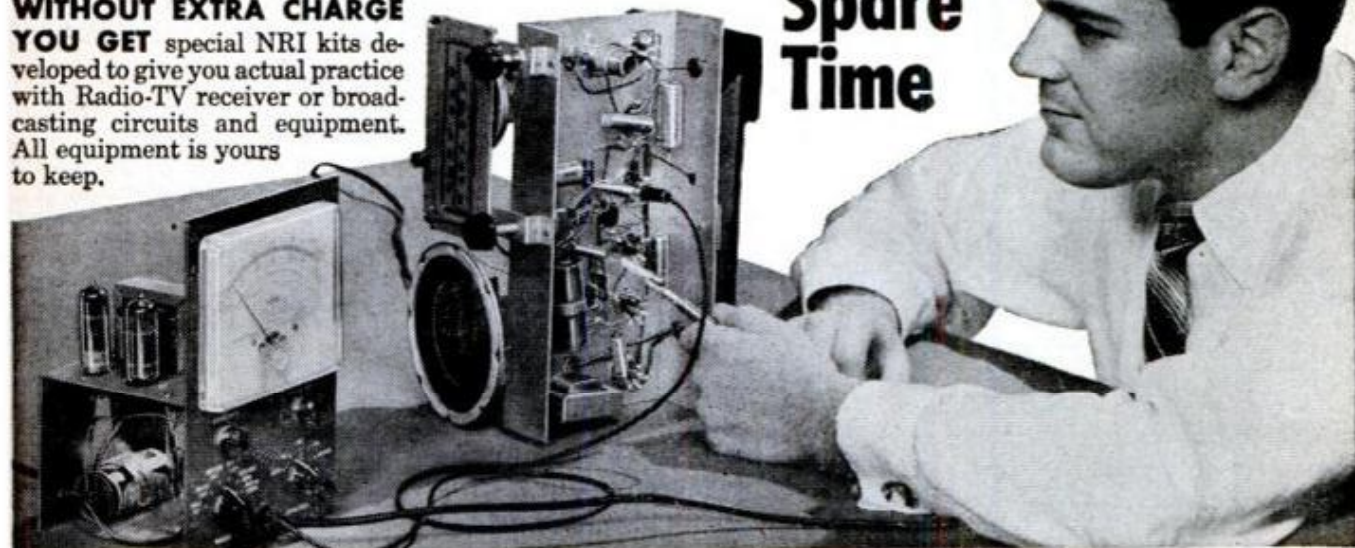

RADIO-TV BROADCASTING (see above) offers important positions as Operators and Technicians. **RADIO-TV SERVICING Technicians** (see below) needed in every community. Their services are respected, their skill appreciated.



Fast Growing Field Offers You Good Pay, Success, Bright Future



J. E. SMITH
founder

Bigger than ever and still growing fast. That's why Radio-TV has special appeal to ambitious men not satisfied with their job and earnings. Training PLUS opportunity is the ideal combination for success. The technical man is looked up to. He does important work, gets good pay for it. NRI can supply training quickly. Keep your job while training. You learn at home in your spare time.

Added Income Soon—\$10, \$15 a Week in Spare Time

Soon after enrolling, many NRI students start to earn \$10, \$15 a week in spare time fixing sets. Some pay for their training and enjoy extra pleasures this way. Some who start in spare time build their own full time Radio-TV servicing business. NRI training is practical—gets quick results. Easy to understand, well illustrated lessons teach you basic principles.

And you **LEARN-BY-DOING** by practicing with kits of equipment NRI furnishes. NRI methods are tested, proven. NRI has trained thousands for successful careers in Radio-TV.

Find Out What NRI Offers

Mail coupon now. *Actual lesson free.* Also 64 page catalog that shows opportunities in Radio-TV, things you learn, equipment you get. Cost of NRI courses low. Easy terms. **NATIONAL RADIO INSTITUTE, Dept. OMA, Washington 16, D.C.**

**No Stamp?
USE THIS**

**PASTE OR
SCOTCH TAPE ON
ENVELOPE**

BUSINESS REPLY MAIL

NO POSTAGE STAMP NECESSARY IF MAILED IN U.S.A.

FIRST CLASS

PERMIT NO. 209

WASHINGTON, D.C.

POSTAGE WILL BE PAID BY

NATIONAL RADIO INSTITUTE

WASHINGTON 16, D.C.

N.R.I. TRAINED THESE MEN FOR SUCCESS



"I was repairing Radios by 10th lesson. Now have good TV job." **M. R. LINDEMUTH, Fort Wayne, Ind.**



"Doing spare time repairs on Radio and TV. Soon servicing full time." **CLYDE HIGGINS, Waltham, Mass.**

"I had a successful Radio repair shop. Now I'm Engineer for WHPE." **V.W. WORKMAN, High Point, N.C.**



"There are a number of NRI graduates here. I can thank NRI for this job." **JACK WAGNER, Lexington, N. C.**



VETERANS Approved Under G. I. Bills

SEND FOR BOTH FREE

National Radio Institute
Dept. OMA, Washington 16, D.C.

Mail me Sample Lesson and 64-Page Catalog FREE. (No salesman will call. Please write plainly.)

Name _____ Age _____

Address _____

City _____ Zone _____ State _____

Accredited Member National Home Study Council



HOW A FEW LOW-COST PARTS CAN GIVE YOUR CAR THOUSANDS OF EXTRA MILES!

Which parts to replace is as important as when to replace

Nobody wants to put out good money for an engine overhaul if there's no real need for one. But when key parts such as bearings are too far gone, your car engine can no longer operate efficiently.



WHEN TO GET AN OVERHAUL

Know the signs, and you'll know the time. You'll probably notice that your engine has lost much of its original pep. Gas mileage drops off, oil consumption begins to get out of hand . . . and your engine may knock or misfire. Your car isn't ready to be retired yet. Do as fleet owners do. Treat your engine to a *complete* overhaul. Your car will purr like new again.

WHICH PARTS NEED REPLACING

Get a first class mechanic, and *don't compromise on parts*. Parts represent the smallest portion of the cost. You'll probably need new main, connecting rod, and camshaft bearings. These bearings control the amount of oil that lubricates vital parts in your motor. And for bearings to give proper oil clearances, they must be manufactured to tolerances as small as .00025".

FEDERAL-MOGUL MEANS LONG SERVICE

Your car engine is a precision mechanism, and bearings—main, connecting rod and camshaft—are the very heart of it. Yet it costs no more to use the best—Federal-Mogul. Ask any mechanic. *There's a Federal-Mogul engine bearing to fit every domestic and leading imported make of car.*



FEDERAL-MOGUL SERVICE



Division of Federal-Mogul-Bower Bearings, Inc. • Detroit 13, Michigan

Over the Editor's Desk



My Eye Was on Space

Popular Mechanics' readers are always alert and eager to clobber a scientist who slips up on his figures. This time I got it. I had given the distance to Pluto as 3,600,000 miles in my September article, and righteous wrath has descended upon me. The error was corrected in most issues, but a few sharp-eyed astronauts pointed out that Pluto is still 3,600,000,000 miles out there, and in no mood to approach Earth any closer. I'm not sure that we can blame it. Blame me.

Humbly, sheepishly,
Dan Q. Posin

☆☆☆

To the Editor:

I got a charge out of your article "20 Ways to 'Kidproof' Your Home," in the August 1960 issue. Wouldn't it be better for parents to discipline their children instead of spoiling them? Also it would be quite a bit cheaper.

Robert P. Graham
Holmes, New York

☆☆☆

We're Sorry

When I was reading your August issue I couldn't help wondering, when I saw the insect picture on page 68, who makes your identifications. You claim the insect is a wasp, when in fact it is a cicada. I am not enough of a taxonomic entomologist to determine from the picture whether or not this is the annual cicada, sometimes referred to as the dog day cicada or harvest fly, or the periodical cicada.

W. K. Delaplane, Jr.
General Manager
Illini Pest Control and Service, Inc.
Champaign, Ill.

Calling your attention to the photograph labeled "wasp's wings stand still" . . . As the nature counselor at this camp, I have one question: Isn't the organism a cicada (locust) rather than a wasp?

Bruce R. Bender
Crystal Lake Camp
Roscoe, N. Y.

A lot of PM's readers spotted the error. The studio that provided picture and caption made a bad guess.

(Continued to page 12)

THIS is how you train at home to become a **SERVICE ENGINEER** in the **Air Conditioning and Refrigeration industry...**



An old industry offers bright new opportunities

Almost any industry has jobs for men with special skills. In many cases, good pay and steady work are the rule. Yet—would you be happy in being a repairman all your life? Wouldn't you rather have a job that presents a *challenge*—still *bigger money*—an opportunity to *grow*?

Listen, if you are ambitious to *keep climbing*: The air conditioning and refrigeration industry is growing so fast that 20,000 newly-trained technicians are needed each year. They can come only from the technical schools. Because installation and repair work is important, graduates may expect high pay and security right from the start. That's not all. *A well-trained technician has a great opportunity to develop into a Service Engineer.* As a matter of fact, 90 percent of all refrigeration engineers are former repairmen!

If you seek a *career*, not just a job, get into air conditioning and refrigeration. Your first step is to gain skill and knowledge. Learn at home by practicing with 25 big kits that CTI sends. Acquire experience as you train.

CTI ships you all parts and tools—with shop-proved instruction—to build a heavy-duty, commercial-type, ¼ h.p. condensing unit (illustrated above.) You complete 23 field-type projects—do 10 trouble-shooting jobs. You make home a training center!

So practical is CTI training that many students earn extra cash in spare time soon after they start. They make calls on their own, or get part-time jobs with local appliance dealers or air conditioning contractors.

But read the complete story. It is told in a new CTI catalog. *Just fill out and mail coupon below for your copy.* Sample lesson included. No cost nor obligation—Commercial Trades Institute, Chicago 26, Ill.

COMMERCIAL TRADES INSTITUTE

1400 GREENLEAF AVENUE
CHICAGO 26, ILLINOIS

DEPT. R-804

Send catalog, *Success in Air Conditioning & Refrigeration*, and Lesson Sample. Both FREE.

Name _____ Age _____

Address _____

City _____ Zone _____ State _____



To the Editor:



Have you noticed how much the Uher recorder on page 191 (PM, Aug. 1960) resembles a fellow that has gotten his eye blackened for talking out of turn?

John A. Marotta
Euclid 23, Ohio

☆☆☆

To the Editor:

Volkswagen, with an excellent rating of 95.8 percent, average rating 4.2 percent and poor rating of 0 still isn't the highest in PM history. The Mercedes-Benz 300SL in the January 1956 issue racked up an excellent rating of 99 percent, average of 1 percent and poor rating of 0 percent. I believe this rating is the best ever achieved.

David L. Hunt
Newport News, Va.

We stand corrected.

☆☆☆

To the Editor:

With reference to the article entitled "The Man Who Owns a Tank Corps," published in the June 1960 issue of *Popular Mechanics*, I wish to advise you that this story has aroused tremendous interest. I have received letters from South America, Southwest Africa, France, and many, many telephone calls from interested people in the United States.

I never realized that your magazine had such tremendous readership, and I think that the author of this article, Mr. Alfred Balk, should be commended very highly.

Walter Ising, President
Laube Steel Co., Chicago

"EARNED OVER \$2,000.00 IN TEN WEEKS"



You can investigate full time for one company — or earn \$3 to \$10 an hour in *your own business*. No prior experience or higher education needed. And age is no barrier. Here is a field wide open to men 18 to 60.

INVESTIGATE ACCIDENTS. We train you. Then we assist you to step into an excellent position — or to develop your own lifetime business.

A. J. Allen earned over \$2,000 in ten weeks. Gary Williams doubled his former salary. Jessie Hill says "Had I not learned of Universal Schools' Accident Investigator Course I would still be just another time card puncher; but today I have a wonderful position, and I receive \$3.00 an hour plus an expense allowance."

RIGHT NOW the Accident Investigation and Adjusting Field offers you a tremendous future. Here's why: *This vital business distributes more money than any other service industry.* Last year alone over 200 MILLION ACCIDENTS had to be investigated for Insurance Companies, Airlines, Railroads, Steamship Lines, and Government Offices — and the need for trained men is booming!

NOW! FREE Book Gives You All the Facts

Send TODAY for new, illustrated Book mailed FREE. Learn how you can prepare at home in just a few weeks for excellent full time or spare time income. See for yourself how others have doubled and even tripled their earnings. Let us show you how Universal Schools has trained hundreds of men in their own homes spare time — and then helped them add thousands of dollars to their incomes. Absolutely no obligation on your part. No salesman will call. Write at once to me, M. O. Wilson, Universal Schools, 6801 Hillcrest Ave., Dallas 5, Texas.

Mr. M. O. Wilson, Dept. PM-11
Universal Schools, 6801 Hillcrest Ave.,
Dallas 5, Texas

Send me free book on Big Money in Accident Investigating & Adjusting Field. No salesman will call.

Name..... Age.....
Address.....
City..... Zone..... State.....



In Spare Time at Home—Prepare for a Better Job—or
Your Own Business in One of the Many Branches of

ELECTRONICS

RADIO - TELEVISION - RADAR

If you are seeking a better job or a business of your own, the appealing field of Television-Radio-Electronics offers **REAL PROMISE!**

In this fast-growing field, trained Electronic technicians find many good-paying, interesting jobs in manufacturing, installing, operating, servicing. Equally important is the fact that these are **GOOD JOBS**—offering the kind of a future that an untrained man often dreams about.

No previous technical experience or advanced education needed. Prepare for this profitable field in your spare time at home, or in our modern Chicago or Toronto Laboratories. Nothing else like it! Send for **FREE** details.

EARN WHILE YOU LEARN
After you get part of DeVry Tech's training with equipment at home, you may then in your spare time, begin to earn real money servicing Radio and Television sets.

You build and keep this valuable Vacuum Tube **VOLTMETER**

You build and keep this 5-inch **COLOR OSCILLOSCOPE**—almost a "must" for TV servicing.



HOME MOVIES . . .

. . . make important points crystal clear. Speeds your learning. It's almost like having an instructor at your side!

MILITARY SERVICE

If you are subject to military service, the information we have should prove very helpful. Mail coupon to-day.



21 INCH

Build and keep this **BIG DeVry Engineered TV set**—easily converted to U.H.F. (DeVry offers another home training, but without the TV set.)

COLOR TV

DeVry Tech's program also includes training in Color Television

Your GUIDE

to Profitable Job Opportunities

TV-Radio Broadcast Technician
Color Television Specialist
Radar Operator • Laboratory Technician
Airline Radio Man • Computer Specialist
Quality Control Manager
Your Own Sales & Service Shop
. . . **PLUS MANY OTHERS**

YOU GET THE SAME EMPLOYMENT SERVICE

that has helped thousands of our graduates toward fine careers in Electronics.



Send for FREE BOOKLET TODAY!

Accredited Member of National Home Study Council

"One of North America's
Foremost Electronics
Training Centers"



DeVRY TECHNICAL INSTITUTE

CHICAGO 41, ILLINOIS



You work over
300
Learn-By-Doing
projects

Build over 300 practical projects from many shipments of Radio-Electronic parts. You build and operate TV-Radio circuits . . . wireless microphone . . . and many other major projects—all designed to provide outstanding practical experience at home.

ACT NOW! Get information-packed publication **FREE!** Mail coupon today.

DeVRY TECHNICAL INSTITUTE

4141 Belmont Ave., Chicago 41, Ill., Dept. PM-11-Q

Please give me your **FREE** booklet, "Electronics in Space Travel," and tell me how I may prepare to enter one or more branches of Electronics.

Name _____ Age _____

PLEASE PRINT

Street _____ Apt. _____

City _____ Zone _____ State _____

2044 Canadian residents address: DeVry Tech of Canada, Ltd.
970 Lawrence Avenue West, Toronto, Ontario



Powerful GERMAN BINOCULARS

... NOW HALF PRICE ...

**NEW
ZOOM
MODEL
\$4.94**

AMAZING BARGAIN from America's greatest importer of German binoculars—regular price \$9.98—now given away for half price—only \$4.94 complete. This high power German binocular is not a cheap imitation but the real thing—big, sturdy, with true crystal lenses, same type as used in \$100.00 instruments! **ZOOM** model—you enjoy sharp views even in moonlight. No fuzziness. No distortion. No eyestrain.

Super Features for Lifetime Fun!

1961 **ZOOM** model gives you quick focusing, extra sharp view. Aluminum bridge and draw tubes. Folds to any eye width. Handsome heavy duty case with straps included free. A wonderful gift sure to please anyone. No. 67—new 1961 German Binoculars \$4.94

SPECIAL DELUXE MODEL only \$2.00 more

No. 67-D—This hi-power model has interior coated objective lenses, cast metal body with genuine pebble-grain covering and deluxe case with straps. Now only \$6.94. Please specify model desired when ordering.

NEW ZOOM

DACRON INSULATED SWEATER

—warmer than heavy wool!

\$4.98



Featherweight!—only 8 ounces—yet this amazing Dacron insulated vest keeps you warmer than 5 sweaters! No bulk! No tight feeling! Wonderful health protection for farmers, hunters, ice fishermen, construction engineers, postmen, police, etc.

Miracle Insulation! Nylon Shell!

Handsome tailoring. Rugged, lasts years. Extra large zipper can't freeze. 2 big pockets! Inside elastic shell loops. Machine washable. Dries fast, shrinkproof, mothproof, always keeps shape. 4 sizes: small (36-38) medium (40-42) large (44-46) extra large (48-50). Smoked Ivory color. Order now! No 53 Insulated Vest . . .

\$4.98. **DELUXE Triple Gard** Orlon Model, No. 53-D only \$1.00 more. Total \$5.98

Insulated Booties Keep Feet Warm as Toast!

DACRON insulated booties keep your feet warm as toast in bitter, below zero weather. Wear inside shoes with insulated undersuit or alone. Completely machine washable. Comfortable! State shoe size. No. 546—only—\$1.98.



PLASTIC STORM WINDOWS

See-thru like glass, yet can't break! Non-porous. Seals out wind & cold. Install in minutes. No nails or screws. Press on with special tape from inside. That's all! Shipped flat in rolls 36"x 43 1/2"—only \$1.98 for 10 windows. Add 22¢ shipping. No. 74—complete kit with tape. Postpaid—\$2.20.

19 1/2¢

LESS THAN HALF PRICE!

FAMOUS

ICE KING DACRON INSULATED 2 PIECE UNDERSUIT

Reg. \$19.95

8.99

Feel Warm at 70° below zero!

Enjoy cozy comfort all winter in freezing weather! Wear genuine **ICE KING** insulated underwear—yet save over half! Why spend \$19.95 for an ordinary undersuit when you can get the best—**ICE KING**—world's fastest selling brand, for only \$8.99 plus postage. Insulated with genuine **DACRON**—Dupont's miracle fibre—now used on icy minesweepers and by arctic explorers and surveyors. It's the brand chosen by daring explorers searching for the "Abominable Snowman"—half human, half beast (?) roaming the eternally frozen peaks of the Himalaya Mountains. Used by more salesmen, firemen, rural residents than any other brand, because it gives superior insulation, greater comfort, longer wear.

Different From Other Underwear

ICE KING gives you unbelievable warmth even at 70° below freezing. No bulk. No weight. No clammy feel. You feel free as a bird. Never hems you in. Wear indoors without sweating. It insulates—doesn't smother.

LOOK . . . Big Super Features! Full cut! Triple long life stitching. Tight-seal snaps. Knit collar and cuffs. Fully machine washable. Never shrinks. Dries fast. Never mats or bunches. Genuine Nylon shell in smoked ivory.

Wear 30 Days Without Risk 100% satisfaction guaranteed or money back! State your size—Small (36), Med. (38-40), Large (42-44), Extra Large (46-48). Model A-33 now only \$8.99 plus 74¢ mailing cost. Total \$9.83

TRIPLE-GARD Extra-Insulation Model This deluxe model gives you 66% more insulation. Same sizes. Worth dollars more but it's yours for only \$1 extra. Order by no. TG-33. Total postpaid, only \$10.83

SPECIAL SAVINGS OFFER

Order 2 Triple-Gard suits and save! Both for only \$19.50 postpaid. You save \$2.16.



➔ SEND ALL ORDERS TO



All items sold on 10 day money-back guarantee. Over 6,000,000 satisfied customers. Send check, cash or money order for prompt delivery. COD's cost 50c extra.

THORESEN, INC.

DEPT. 6-M, 585 WATER STREET
NEW YORK 2, N. Y.

WHAT ALL AUTO MECHANICS WANT TO KNOW

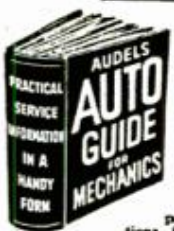

This Big Practical Book gives full information, with working diagrams, covering the principles, construction, ignition, service and repair of modern cars, trucks and buses.

Air Conditioners, Hydromatic & Fluid Drives Fully Explained.

A complete guide of 1132 Pages, with over 1000 illustrations showing inside views of working parts, with instructions for service jobs. Completely up-to-the-minute! Priced at only \$6.

CIRCLE No. 1 IN COUPON

HOW TO FIX HOME APPLIANCES

REFRIGERATORS TOASTERS IRONERS VACUUMS
WASHERS DRYERS RANGES FREEZERS

Many other GAS AND ELECTRIC APPLIANCES

Handy Reference for Electric & Gas Servicemen, Mechanics, Dealers and Homeowners. Explains clearly and simply how to locate troubles, how to test, reassemble and connect. Wiring diagrams. 1000 Facts. Easy to read. Answers ALL your questions. 864 Pages. Illustrated. Only \$6.

CIRCLE No. 2 IN COUPON



TV TELLS HOW TO ANSWER RADIO T.V. QUESTIONS SERVICE LIBRARY

HERE IS LATE INFORMATION IN A HANDY FORM FOR RADIO AND TELEVISION REPAIRMEN, SERVICEMEN AND STUDENTS

TWO COMPLETE VOLUMES—1568 Pages—1085 Illustrations and Diagrams. 1001 Important Facts and Figures on Modern T.V., Radio, Electronic Devices. INCLUDES TRANSISTORS & Transistor Circuits, Rectifiers, Record Changers, P.A. Systems, Phonograph Pick-ups, F.M., Auto Radio, Short Wave.

Basic principles, Construction, Installation, Operation.

tion, Repairs, Trouble Shooting. How to get Sharp, Clear T.V. Pictures. Install Aerials. How to Test. Explains COLOR SYSTEMS, Methods of Conversion, Terms, etc. Includes Ultra High Frequency. Quick ready reference or use as a home study course. Only \$8 for BOTH volumes.

CIRCLE No. 3 IN COUPON

OIL BURNERS

New, complete, explaining in detail both domestic and industrial oil burners. Includes electrical hook-ups and wiring diagrams. Fully covering the theory, construction, installation, operation, testing, servicing and repair of all equipment. Indexed for ready reference. Over 416 Pages. 320 Illustrations and Diagrams. Only \$2.

CIRCLE No. 28 IN COUPON

ALL TYPES OF BLUEPRINT READING

How to read scales, the standard symbols, detail and assembly prints, working drawings, short cuts, helps, hints and suggestions. THE MAN WHO CAN READ BLUEPRINTS IS IN LINE FOR A BETTER JOB. This book gives you the secret language, step by step in easy stages. 448 Pages, Very Fully Illustrated. Priced at \$3.

CIRCLE No. 25 IN COUPON

PLUMBERS AND STEAMFITTERS GUIDES



Practical Trade Assistant & Reference Set. Explains in plain language and by clear illustrations, diagrams, charts, graphs and pictures the principles of modern plumbing practice including Pipe Fitting and Air Conditioning. 4 Vols.—2624 Pages—3642 Diagrams & Illustrations. Only \$8 for the complete set of 4 vols.

CIRCLE No. 6 IN COUPON

7-DAY FREE EXAMINATION

SEND NO MONEY—Pay the postman nothing! We are glad to send you any of the Audel Guides for absolutely FREE examination in your own home. We take all the risks and leave all the decision up to YOU. There is no obligation! If you decide to keep the books of your choice you may pay for them under our astounding easy-pay plan of only \$2 a month.

HERE IS ALL YOU DO

IT'S EASY TO ORDER: In the No-Risk Mail Order Coupon at the right just draw a circle around the number of Audel Guides you want us to send you for FREE EXAMINATION. We will send them to you at once to help you build a brighter future by increasing your SKILL. If for any reason at all you are not COMPLETELY satisfied, return the books to us, and that will end the matter! NO STRINGS OR CATCHES TO THIS OFFER.

THEO. AUDEL & CO.
49 West 23rd Street, New York 10, N.Y.

NOVEMBER 1960

CARPENTERS AND BUILDERS GUIDES



Practical STOREHOUSE OF MODERN CONSTRUCTION INFORMATION (4 vol. set) for carpenters and all woodworkers. Explains in easy language and by profuse illustration principles, advances, short cuts, trade secrets, all based on the NEWEST information. Vol. 1—Tools, steel square, saw filing, joinery, furniture, etc.; Vol. 2—Builders' mathematics, drawing plans, specifications, estimates, etc.; Vol. 3—House and roof framing, laying out, foundations, etc.; Vol. 4—Doors, windows, stair building, millwork, painting, etc. 4 vols. 1904 Pages. 3700 Illustrations. Whole set only \$8. CIRCLE No. 8 IN COUPON

PRACTICAL ELECTRICITY

A COMPLETE HANDBOOK—Quick, simplified, ready reference. Complete instruction and practical information on the rules and laws of electricity—Maintenance of Machinery—A.C. and D.C. Motors—Armatures—Wiring Diagrams—House Lighting—Power Wiring—Motors—Batteries—Transformers—etc. Simple to understand. 1052 Pages. 2600 Illustrations. Priced at \$5. CIRCLE No. 4 IN COUPON

DIESEL

ALL THERE IS TO KNOW ABOUT MODERN DIESEL ENGINES—Basic principles, starting valves, timing, fuel pumps, fuel injection compressor, air compressors, pistons, cylinders, lubrication, cooling systems, etc. Answers on operation, calculations. 640 Pages. Fully Illustrated. Priced \$3.

CIRCLE No. 9 IN COUPON

MASONS & BUILDERS GUIDES

A PRACTICAL ILLUSTRATED 4 VOL. SET—Explaining in clear, simple language and profuse illustration, principles, advances, short cuts, trade secrets, based on modern practice— including how to figure and calculate various jobs. Vol. 1—Brick work, bricklaying, bonding, design. Vol. 2—Brick foundations, arches, tile setting, estimating. Vol. 3—Concrete mixing, placing forms, reinforced stucco. Vol. 4—Plastering, stone masonry, steel construction, blueprints. 4 Vols. 1440 Pages. 2067 Illustrations. Complete Set only \$8.

CIRCLE No. 26 IN COUPON

MATHEMATICS MADE EASY

A COMPLETE HOME STUDY COURSE—Starting with the first principles of arithmetic, advancing step by step through the various stages of mathematics, including the rules and calculations for mechanical and electrical problems. New EASY correct methods. Includes plane and solid geometry, trigonometry, algebra, calculus, etc. Practical tests, reference tables and data. How to use slide rule. 672 Pages. 550 Illustrations. Priced at only \$3.

CIRCLE No. 11 IN COUPON

NEW MACHINISTS AND TOOLMAKERS HANDBOOK

MODERN MACHINE SHOP PRACTICE—For every Machinist, Toolmaker, Draftsman or Student. Tells how to set up and operate lathes, screw and milling machines, shapers, drill presses and all other machine tools. A COMPLETE INSTRUCTOR AND REFERENCE BOOK. 1250 Pages. Fully Illustrated. Priced at only \$6.

CIRCLE No. 12 IN COUPON

ELECTRIC MOTORS

THIS GUIDE covers the construction, hook-ups, control, maintenance and trouble shooting of all types of motors. Includes armature winding. Explains entire subject in great detail in simple language. Over 1056 Pages of information. 617 Diagrams. All types of motors fully illustrated and indexed for ready reference. Priced at only \$5.

CIRCLE No. 27 IN COUPON

REFRIGERATION & AIR CONDITIONING

FOUR BOOKS IN ONE—basic principles, servicing, operation, repair of: 1. Household Refrigeration. 2. Special Refrigeration Units. 3. Commercial & Industrial Refrigeration. 4. Air Conditioning Systems. A GOLD MINE of essential information. Completely up-to-date. 1360 Pages. Fully illustrated and indexed. Priced at only \$6. CIRCLE No. 14 IN COUPON

New MECHANICAL DICTIONARY

THE AUTHORITATIVE WORD BOOK FOR MECHANICS TECHNICIANS AND STUDENTS

With the revolutionary progress being made today in all mechanical fields, new words and phrases come into use. Any mechanic who wants to be up to date must know this new trade language.

Audel's New Mechanical Dictionary gives you all these new words and also the old. Every mechanic will find his job made easier if he knows the exact meaning and use of technical words that come up every day at work. It is an engineer's shop companion and a student's guide.

TABLES, FORMULAS, PROCESSES AND PRACTICAL SUGGESTIONS

Constant use of Audel's New Mechanical Dictionary will increase your knowledge and skill in a matter of days without any conscious effort on your part. The right word at the right time is like the right tool—be sure you have it and use it! Defines 17,000 words—terms phrases—rules and formulas, 712 pages only \$6.95.

CIRCLE No. 44 IN COUPON

THE NEW ELECTRIC LIBRARY

A COMPLETE ENCYCLOPEDIA explaining in the simplest terms the fundamental principles, rules and applications of applied electricity.

A COMPLETE COLLEGE EDUCATION!

Fully illustrated with diagrams and lectures, calculations and tables for ready reference. Questions and answers. Trial tests for practice study and review. All based on the most modern theory.

- Vol. 1—Principles and rules of electricity, magnetism, armatures, repairs. No. 15
- Vol. 2—Dynamoes, DC Motors, construction, installation, maintenance, etc. No. 16
- Vol. 3—Testing instruments and tests, storage battery constr. and repairs. No. 17
- Vol. 4—Alternating current, power factor, alternators, transformers. No. 18
- Vol. 5—A.C. Motors, windings, maintenance, converters, switches, fuses, etc. No. 19
- Vol. 6—Relays, condensers, regulators, rectifiers, meters, switchboards, etc. No. 20
- Vol. 7—Wiring, house light and power, circuits, high

tenion, plans, code, etc. No. 21

- Vol. 8—Railways, signals, elevators, ignition, etc. No. 22
- Vol. 9—Radio, telephone, telegraph, television, motion pictures. No. 23
- Vol. 10—Refrigeration, illumination, welding, X-ray, electrical appliances, Index. No. 24

6,000 fully illustrated pages. Priced at only \$30 for the ENTIRE SET. Also sold individually for \$2 each.



WELDERS GUIDE

Covers Electric, Oxy-acetylene, Thermit, Union-bolt welding for sheet metal, spot and pipe welds, pressure vessels and aluminum, copper, brass, bronze and other metals. Airplane work, surface hardening, hard facing, cutting, brazing, etc. 608 Pages. Fully Illustrated. Only \$3.

CIRCLE No. 10 IN COUPON

ADDITIONAL IMPORTANT TITLES

The following Audel Guides are all the best in their fields, written in clear simple fashion, and all lavishly illustrated. Circle the numbers wanted in the MAIL ORDER COUPON below. All books are sent for FREE EXAMINATION.

- No. 5 TRUCK & TRACTOR GUIDE. 1376 Pages \$5.00
- No. 7 PAINTING & DECORATING MANUAL. 417 Pages 3.00
- No. 13 WIRING DIAGRAMS (Light & Power). 304 Pages 2.00
- No. 29 SHEET METAL PATTERN LAYOUTS. 1152 Pages 7.50
- No. 30 SHEET METAL WORKERS HANDY BOOK. 448 pages 2.00
- No. 31 MECHANICAL DRAWING GUIDE. 192 Pages 2.00
- No. 32 MECHANICAL DRAWING AND DESIGN. 410 Pages 3.00
- No. 33 ELECTRONIC DEVICES. 304 Pages 3.00
- No. 34 ELECTRICIANS EXAMINATIONS. 272 Pages 2.00
- No. 35 ELECTRIC POWER CALCULATIONS. Page 480 3.00
- No. 36 ELECTRIC DICTIONARY. 9000 Terms 3.00
- No. 37 POWER PLANT ENGINEERS GUIDE. 1568 Pages 5.00
- No. 38 ENGINEERS AND FIREMANS EXAMS. 544 Pages 2.00
- No. 39 OPERATING ENGINEERS LIBRARY. 3 Book Set 12.00
- No. 40 PUMPS, HYDRAULICS AND AIR COMPRESSORS. 1760 Pages 6.00
- No. 41 HOUSE HEATING GUIDE. 966 Pages 5.00
- No. 42 MILLWRIGHTS & MECHANICS GUIDE. 1248 Pages 5.00
- No. 43 DO-IT-YOURSELF ENCYCLOPEDIA. 2 Book Set 8.95

MAIL THIS NO-RISK COUPON TODAY!

THEO. AUDEL & CO.—Self Improvement Publishers Since 1879— P11 1 2 3 4 5 6
49 W. 23rd Street, New York 10, N.Y.

Please mail me for 7 days' FREE EXAMINATION the books I have circled at right. I agree to mail \$2 in 7 days on each book or set ordered, and to further mail \$2 a month on each book or set ordered until I have paid the purchase price, plus shipping costs. If I am not completely satisfied with my Audel Guides I may return them.

7	8	9	10	11					
12	13	14	15	16					
17	18	19	20	21					
22	23	24	25	26					
27	28	29	30	31					
32	33	34	35	36					
37	38	39	40	41					
42	43	44							

NAME _____

ADDRESS _____

OCCUPATION _____

EMPLOYED BY _____

SAVE SHIPPING COSTS! Check here if you enclose complete payment with order. We pay postage charges. You have same return privilege.

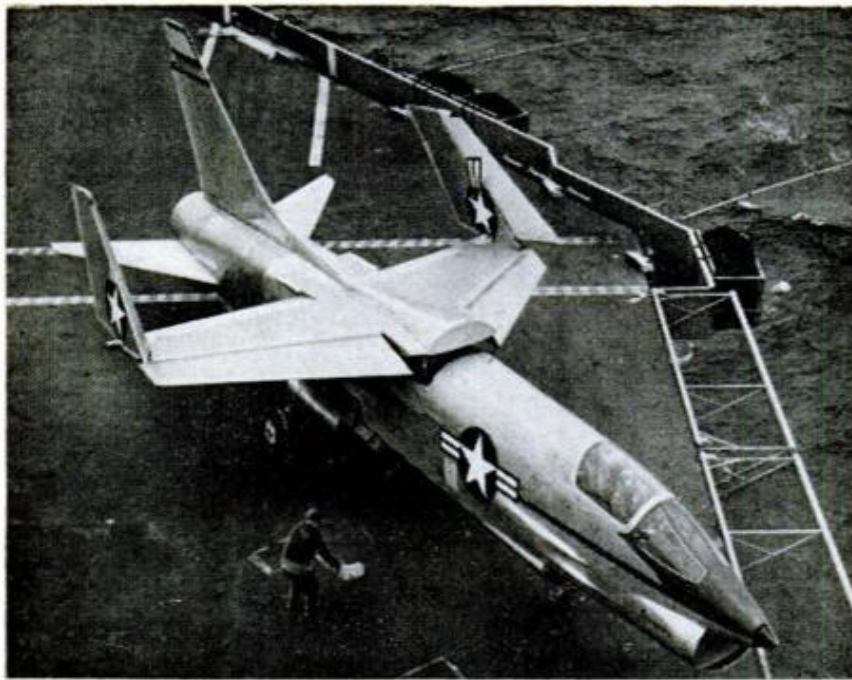

Perched on a carrier's deck with its wing tips folded upward is an F8U Crusader. It was in this wings-up attitude that a Crusader took off from an Italian air field and amazingly stayed aloft for 24 minutes before landing without difficulty at Naples

WHO SAYS YOU NEED WINGS TO FLY?

WHEN A NAVY pilot took off from a Naples air field the other day and found himself flying with his fighter plane's wings still folded, he was, to put it mildly, startled. So was the rest of the world, which read in newspapers everywhere of the amazing achievement.

It wasn't the first time. But it was the first time a carrier plane had done it and come back in one piece.

Popular Mechanics reported a similar occurrence back in May of 1952, in an article relating weird incidents in the Korean war. The plane taking off with its wings still folded was pictured on the magazine cover.

The account of that unhappy incident read: "Everybody knows an airplane has to have wings to fly. Navy fighters and dive bombers, because they operate from the cramped flight decks of aircraft carriers, have wings that fold upward or backward like a bird's. One Navy pilot tried to take off from the runway of an air station with the wings of his

dive bomber folded upward. He not only tried to, he did! The powerful engine succeeded in getting the 20,000-pound plane 250 feet into the air before it went into a spin and crashed. The half wing extending from the fuselage to where the outer wing folded up apparently offered enough lifting surface to get the plane off the runway. Any aviator will still argue it can't be done."

The American pilot who duplicated the takeoff at Naples recently was luckier. Airborne in his F8U Crusader, he discovered the wing tips were vertical when he noticed that control required an excessive amount of forward stick. Then he kept climbing to 5000 feet, remained aloft 24 minutes while testing the plane's aerodynamic characteristics with "parked" wingtips (the folded tips are each six feet seven inches long), then dumped his fuel for safety and flew back for an uneventful landing.

The Crusader was the first aircraft to span the United States faster than the speed of sound and was first to set an official national speed record above 1,000 miles per hour. But it used its wingtips normally on those occasions.



ITEMS FROM ALL OUTDOORS

By Dick Kirkpatrick

DUCK HUNTERS can be pretty philosophical about this year's waterfowl census by the Fish and Wildlife Service. The flying biologists predict that the flights will be about like last year along the Central, Mississippi and Eastern Flyways but the number of ducks along the Pacific Flyway will be down for the second year in a row. The waterfowl population did not show the upward trend this year that many conservationists had hoped for, but on the other hand, it's holding its own. The experts did hold out some hope for 1961—improving nesting conditions should produce an increase for next year.

If you're looking for a new shotgun for the 1960 campaign, you have a chance to try something really new in Winchester's Model 59 Automatic with the Win-Lite glass-fiber barrel. It's not all glass fiber, of course, but is a .02-inch-thin steel liner wrapped with 500 miles of glass fibers bonded with chemical resins. Big advantage is its light weight—only 6½ pounds for the Model 59, a pound or so under the average autoloader. Other advantages are great durability and resistance to weather, doubled bursting strength, and cooler shooting but warmer handling; it won't stick to skin in the cold.

If you get very far off the beaten path in your hunting, and especially if you go 'way back into the big woods, there's always a chance of getting lost or of being injured and needing help. Next best thing to a radio is an aerial flare, and the March Coulter Co. of Fraser, Mich., is marketing a hunter's distress flare to fit your shotgun or rifle and fire like regular ammunition. Fired into the air, it explodes at 500 feet into a 2000-candlepower red ball that's 15 times brighter than a railroad flare, and visible for miles. The flare drifts down slowly, then burns out at about 100 feet.

If you do start a fire (a campfire, that is) you might as well make coffee. And it's available in a handy new form for the outdoorsman. Coffee Clubs, Inc., of Chicago, is packing coffee, sugar, instant cream and several soups in one-shot containers. Available in many stores. ★★ ★

UNUSUAL BARGAINS

EXCELLENT
XMAS
GIFTS!

See the Stars, Moon, Planets Close Up! 3" ASTRONOMICAL REFLECTING TELESCOPE

60 to 180 Power — Famous Mt. Palomar Type! An Unusual Buy!



Assembled—Ready to use! You'll see the Rings of Saturn, the fascinating planet Mars, huge craters on the Moon, Star Clusters, Moons of Jupiter in detail. Galaxies! Equatorial mount with lock on both axes. Aluminized and overcoated 3" diameter high-speed f/10 mirror. Telescope comes equipped with a GOX eyepiece and a mounted Barlow Lens, giving you 60 to 180 power. Low-cost accessory eyepiece available for higher powers. An Optical Finder Telescope, always so essential, is also included. Sturdy, hardwood, portable tripod. FREE

with Scope:—Valuable STAR CHART plus 272 page "H.A.N.D. BOOK OF HEAVENS" plus "HOW TO USE YOUR TELESCOPE" BOOK.

Stock No. 85.050-H \$29.95 postpaid

4¼" Astronomical Reflector Telescope! Up to 255 Power. New Vibration-Free Metal Pedestal Mount.

Stock No. 85.105-H \$79.50 F.O.B.

SCIENCE TREASURE CHESTS



Extra-powerful magnets, polarizing filters, compass, one-way-mirror film, prism, diffraction grating, and lots of other items for hundreds of thrilling experiments, plus a Ten-Lens Kit for making telescopes, microscopes, etc. Full instructions included.

Stock No. 70.342-H \$5.00 Postpaid

Science Treasure Chest DeLuxe—Everything in Chest above plus exciting additional items for more advanced experiments including crystal-growing kit, electric motor, molecular models set, first-surface mirrors, and lots more.

Stock No. 70.343-H \$10.00 Postpaid

War Surplus American-Made 7x50 Binoculars

Big savings! Brand new! Crystal clear lensing — 7 power. Every optical element is coated. An excellent night glass — the size recommended for satellite viewing. Individual eye focus. Exit pupil 7mm. Approx. field at 1,000 yds. is 376 ft. Carrying case included. American 7 x 50's normally cost \$195. Our war surplus price saves you real money.

Stock No. 1533-H only \$55.00 pstpd. (Tax included)



Terrific Buy! American Made!

OPAQUE PROJECTOR

Projects illustrations up to 3" x 3½" and enlarges them. No film or negatives needed. Projects charts, diagrams, pictures, photos, lettering in full color or black-and-white. Operates on 115 volt, A.C. current. 6-ft. extension cord and plug included, operates on 60 watt bulb, not included. Size 12" x 8" x 4½" wide. Weight 1 lb., 2 oz. Plastic case with built-in handle.

Stock No. 70.199-H \$7.95 Postpaid



ANALOG COMPUTER KIT

Demonstrates basic analog computing principles—can be used for multiplication, division, powers, roots, log operations, trig problems, physics formulae, electricity and magnetism problems. Easily assembled with screwdriver and pliers. Operates on 2 flashlight batteries. Electric meter and 3 potentiometers are mounted on die-cut box. Answer is indicated on dial. Computer is 20" long, 9" wide, 2" deep.

Stock No. 70.341-H \$14.95 Postpaid



CIRCULAR DIFFRACTION GRATING JEWELRY

A DAZZLING RAINBOW OF COLOR

Shimmering rainbows of gem-like color in jewelry of exquisite beauty—made with CIRCULAR DIFFRACTION GRATING REPLICA. Just as a prism breaks up light into its full range of individual colors, so does the Diffraction Grating.

Stock # 30.349-H Earrings \$2.75 Ppd.
Stock # 30.350-H Cuff Links \$2.75 Ppd.
Stock # 30.372-H Pendant \$2.75 Ppd.
Stock # 30.300-H Tie-Clasp \$2.75 Ppd.

Order by Stock No.—Send Check or M.O.—Money-Back Guarantee
EDMUND SCIENTIFIC CO., Barrington, New Jersey

MAIL COUPON for FREE CATALOG "H"

144 Pages! Over 1000 Bargains!

EDMUND SCIENTIFIC CO., Barrington, N. J.
Please rush Free Giant Catalog-H.

Name

Address

City Zone State





Do You Know This Old-Timer?

This one is really old, as you can tell by the right-hand drive; standard, left-hand drive for American cars was settled well before World War I. Although it resembles the early Ford Model-T in some ways, it is a different breed entirely.

Like the Model T, this old-timer was the product of one of the automobile industry's pioneers, one of the do-it-yourself auto tycoons who did everything from design the crankshaft to preside over the board of directors meetings.

Although its hood looks massive and the fin-and-tube radiator is impressive in size there is only one cylinder under the hood. Well, it was enough for the performance needs of the day. Seat in rear is draped with what might well be a blanket for the horse that inevitably came along in time of trouble.

REVOLUTIONARY NEW DESIGN SAVES YOU \$20 TO \$40

4 1/8" JOINTER PLANER

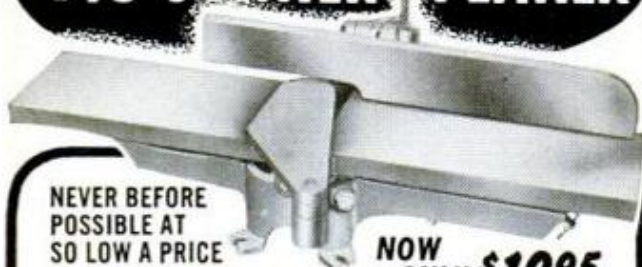

NEVER BEFORE POSSIBLE AT SO LOW A PRICE

NOW ONLY \$19.95

(shipped complete as shown)

SOLD DIRECT FROM FACTORY

Patents pending on revolutionary new engineering developments make this bargain possible. This is a power plane with all the features of machine tools costing 3 times OUR PRICE. It planes, rabbets, bevels, aids beveling and glueing joints; is so rugged and durable we guarantee it unconditionally for ten years.

SEE THESE QUALITY FEATURES

All cast iron and steel construction • Balanced steel cutter head • Hardened and ground knives • Precision ground cast iron tables • Rugged cast iron base • Table depth adjustable 0" to 3/8" • Cast fence with single action cam lock • Pat. lift-off aluminum guard • Big, full size—22" long • Shp. wt. 25 lbs. Order By Mail — Sold Direct From Factory to You

OUR 30TH YEAR SEND \$19.95 CHECK OR M.O. SENT C.O.D. WITH \$3.00 DEPOSIT

(If not completely satisfied after ten days return for full refund.) Shipped express collect.

AMERICAN MACHINE & TOOL CO., INC.
ROYERSFORD 88, PENNSYLVANIA

LEARN TO MOUNT BIRDS

ANIMALS, FISH, PETS
Be a Taxidermist. Save your hunting TROPHIES. Have a fine home-museum. Hunters, save and MOUNT your beautiful DUCKS, QUAIL, DEER, TAN skins and FURS. Great Fun. Spare-time PROFITS.
FREE BOOK Tells ALL about it. 100 fine wild-game pictures. 48 pages. Send TODAY, don't delay. Get this WONDERFUL FREE BOOK, MEN AND BOYS. Learn Taxidermy. Double your hunting pleasure. Rush letter or POSTAL today. STATE AGE. N.W. SCHOOL OF TAXIDERMISTRY, Dept. 2511 Omaha, Neb.

Learn LANDSCAPE GARDENING

AND GROWING OF PLANTS. Latest information on propagation, soil-testing, plant growth regulators, garden design. Start a profitable business or wonderful hobby. Unique and modern home study course—accredited. Earn your certificate at home. May I send FREE, and without obligation, my Informative Booklet?
NORM MORRIS NATIONAL LANDSCAPE INSTITUTE
DEPT. M-110, 11826 SAN VICENTE BLVD., LOS ANGELES 49, CALIF.

Model K312

CHARGES 12-VOLT CAR BATTERY OVERNIGHT

ONLY \$14.95 POSTPAID

Avoid run-down battery troubles—own this high-grade SCHAUER Charger. Has automatic circuit breaker. Pays for itself many times over in longer battery life; sure, quick starts. Get yours now. If your dealer can't supply, send check or money order. Money-back guarantee. The best made, most beautiful charger you can own is a SCHAUER. Other 6 and 12 volt models available. Send for free catalog.

SCHAUER MFG. CORP. 4532 Alpine Avenue Cincinnati 42, Ohio



**Courses in Radio and
Electronic Fundamentals—
TV Servicing—Color TV—
Electronics for
Automation—
Transistors**



RCA Institutes, one of the leading technical institutes in the United States devoted exclusively to electronics, offers the finest training-at-home. The very name "RCA" means dependability, integrity, and scientific advance. Practical work with your very first lesson. Pay as you learn. *No monthly installment payments.* You pay for your next study group only when you order it. Remember, in electronics, the more you know the higher you go! Licensed by the New York State Education Dept.



RCA INSTITUTES, INC.,
A Service of Radio Corporation of America
350 West Fourth Street, New York 14, N. Y.

The Most Trusted Name
in Electronics

SEND FOR THIS FREE 64-PAGE BOOK TODAY!

RCA INSTITUTES, INC., Home Study School Dept. PM-NO
350 West Fourth Street, New York 14, N. Y.

Please rush me your FREE illustrated 64-page book describing your electronic training programs. No obligation. No salesman will call.

Name _____ Age _____

Address _____ (please print)

City _____ Zone _____ State _____

Korean Vets: Enter discharge date _____

Canadians—Take advantage of these same RCA Institutes courses at no additional cost. No postage, no customs, no delay. Send coupon to: RCA Victor Company, Ltd., 5581 Royalmount Ave., Montreal 9, Quebec

Resident School Courses in Los Angeles and New York City offer comprehensive training in Television and Electronics. Day and Evening classes. Free Placement Service. Catalog free on request.

FREE!

TRIAL LESSON

Trial lesson in DRAFTING

LEARN AT HOME IN SPARE TIME

Check the want ads in any newspaper — SEE the big-pay opportunities open to you as a draftsman. What's more, you can learn this well-paid, prestige profession at home—quickly, easily! No special talent needed! Get complete, step-by-step Chicago Tech lessons in the mail, spend a few pleasant hours studying each week. In a short time you'll be a well-trained draftsman, ready to take your pick of many good jobs. Act now!

FREE INFORMATION—MAIL COUPON TODAY!

Get **FREE TRIAL LESSON** plus information about C.T.C. practical training. Learn what successful Chicago Tech graduates say about high pay and opportunities in drafting. No charge, or obligation.

Accredited National Home Study Council

CHICAGO TECHNICAL COLLEGE

P-218 Tech Bldg., 2000 So. Michigan Ave.
Chicago 16, Illinois

Mail me **FREE Lesson** with information about big opportunities in **DRAFTING**.

Name..... Age.....

Address

City..... Zone..... State.....

MAKE MONEY

Repair HYDRAULIC JACKS

EARN UP TO \$5 AN HOUR IN YOUR OWN BUSINESS

Start your own profitable business in the competition-free field of Hydraulic Jack Repair. **EARN WHILE YOU LEARN!** Work full or part-time from your own basement or garage. Millions of jacks in gas and auto service stations, body shops, truckers, riggers, factories, farms, need servicing.

We show you **HOW**, Start **NOW!**

THESE BASIC MANUALS CAN BE YOUR KEY TO SUCCESS!

All you need to know to start right in repairing jacks. Easy, step-by-step directions, what tools to use, how to start your own business.

WRITE FOR FOLDER NO. PM-11 AND FREE BONUS OFFER

INSTITUTE OF HYDRAULIC JACK REPAIR

P.O. BOX 50 • BLOOMFIELD, N. J.

A Correspondence School Licensed by N. J. Board of Education

Sidelights from the PENTAGON

By **William R. Kreh**

AT LAST! A real panic button!

The Coast Guard is developing one for mariners to hit when they're in trouble at sea. The button will trigger a device that will automatically screech for help, knifing through any traffic on the marine voice-radio distress frequency.

The unit, enclosed in a little black box, is designed to plug into marine radio-telephones. It became necessary because the traditional "May Day" distress call is often lost in static or drowned out by other voices using the distress band. The frequency is used, not only by vessels in distress, but by ships wanting to contact the Coast Guard for other emergencies.

The new electronic instrument will wail into this frequency in two alternating tones, a shrill 1300 cycles per second and an even shriller 2200 cycles per second, at quarter-second intervals. It will continue wailing as long as the ship's radio works, even after the ship is abandoned, to give rescuers a longer time to get a "fix" on it.

The Army is experimenting with break-away fuel tanks for its helicopters.

Research has shown that in 'copter crashes some crews survive only to be fatally burned by fire after impact, and fuel is the greatest cause of fire.

The tanks under test are made of strong, heat-resistant Fiberglas. They're attached to the helicopter by two straps fastened by a single turnbuckle. The turnbuckle is designed to break upon impact of more than five G's when coming straight down, or at 35 miles an hour if it hits something head-on.

When it breaks, the straps release the tanks and they fall down and away from the 'copter. They're equipped with quick disconnect fittings which stop fuel flow in

(Continued to page 22)



I'd like to give this to my fellow men... while I am still able to help!

I was young once, as you may be—today I am older. Not too old to enjoy the fruits of my work, but older in the sense of being wiser. And once I was poor, desperately poor. Today almost any man can stretch his income to make ends meet. Today, there are few who hunger for bread and shelter. But in my youth I knew the pinch of poverty; the emptiness of hunger; the cold stare of the creditor who would not take excuses for money. Today, all that is past. And behind my city house, my

summer home, my Cadillacs, my Winter-long vacations and my sense of independence—behind all the wealth of cash and deep inner satisfaction that I enjoy—there is one simple secret. It is this secret that I would like to impart to you. If you are satisfied with a humdrum life of service to another master, turn this page now—read no more. If you are interested in a fuller life, free from bosses, free from worries, free from fears, read further. This message may be meant for you.

By Victor B. Mason

I am printing my message in a magazine. It may come to the attention of thousands of eyes. But of all those thousands, only a few will have the vision to understand. Many may read; but of a thousand only you may have the intuition, the sensitivity, to understand that what I am writing may be intended for you—may be the tide that shapes your destiny, which, taken at the crest, carries you to levels of independence beyond the dreams of avarice.

Don't misunderstand me. There is no mysticism in this. I am not speaking of occult things; of innumerable laws of nature that will sweep you to success without effort on your part. That sort of talk is *rubbish!* And anyone who tries to tell you that you can *think* your way to riches without effort is a false friend. I am too much of a realist for that. And I hope you are.

I hope you are the kind of man—if you have read this far—who knows that anything worthwhile has to be *earned!* I hope you have learned that there is no reward without effort. If you have learned this, then you may be ready to take the next step in the development of your karma—you may be ready to learn and use the secret I have to impart.

I Have All The Money I Need

In my own life I have gone beyond the need of money. I have it. I have gone beyond the need of gain. I have two businesses that pay me an income well above any amount I have need for. And, in addition, I have the satisfaction—the deep satisfaction—of knowing that I have put more than three hundred other men in businesses of their own. Since I have no need for money, the greatest satisfaction I get from life, is sharing my secret of personal independence with others—seeing them achieve the same heights of happiness that have come into my own life.

Please don't misunderstand this statement. I am not a philanthropist. I believe that charity is something that no proud man will accept. I have never seen a man who was worth his salt who would accept

something for nothing. I have never met a highly successful man whom the world respected who did not sacrifice something to gain his position. And, unless you are willing to make at least half the effort, I'm not interested in giving you a "leg up" to the achievement of your goal. Frankly, I'm going to charge you something for the secret I give you. Not a lot—but enough to make me believe that you are a little above the fellows who merely "wish" for success and are not willing to sacrifice something to get it.

A Fascinating and Peculiar Business

I have a business that is peculiar—one of my businesses. The unusual thing about it is that it is needed in every little community throughout this country. But it is a business that will never be invaded by the "big fellows". It has to be handled on a local basis. No giant octopus can ever gobble up the whole thing. No big combine is ever going to destroy it. It is essentially a "one man" business that can be operated without outside help. It is a business that is good summer and winter. It is a business that is growing each year. And, it is a business that can be started on an investment so small that it is within the reach of anyone who has a television set. But it has nothing to do with television.

This business has another peculiarity. It can be started at home in spare time. No risk to present job. No risk to present income. And no need to let anyone else know you are "on your own". It can be run as a spare time business for extra money. Or, as it grows to the point where it is paying more than your present salary, it can be expanded into a full time business—overnight. It can give you a sense of personal independence that will free you forever from the fear of lay-off, loss of job, depressions, or economic reverses.

Are You Mechanically Inclined?

While the operation of this business is partly automatic, it won't run itself. If you are to use it as a stepping stone to independence, you must be able to work with your hands, use such tools as hammer and screw driver, and enjoy getting into a pair of blue jeans and rolling up your sleeves. But two hours a day of manual work will keep your "factory" running 24 hours turn-

ing out a product that has a steady and ready sale in every community. A half dollar spent for raw materials can bring you six dollars in cash—six times a day.

In this message I'm not going to try to tell you the entire story. There is not enough space on this page. And, I am not going to ask you to spend a penny now to learn the secret. I'll send you all the information, free. If you are interested in becoming independent, in becoming your own boss, in knowing the sweet fruits of success as I know them, send me your name. That's all. Just your name. I won't ask you for a penny. I'll send you all the information about one of the most fascinating businesses you can imagine. With these facts, you will make your own investigation. You will check up on conditions in your neighborhood. You will weigh and analyze the whole proposition. Then, and then only, if you decide to take the next step, I'll allow you to invest \$15.00. And even then, if you decide that your fifteen dollars has been badly invested I'll return it to you. Don't hesitate to send your name. I have no salesmen. I will merely write you a long letter and send you complete facts about the business I have found to be so successful. After that, you make the decisions.

Does Happiness Hang on Your Decision?

Don't put this off. It may be a coincidence that you are reading these words right now. Or, it may be a matter that is more deeply connected with your destiny than either of us can say. There is only one thing certain: If you have read this far you are interested in the kind of independence I enjoy. And if that is true, then you must take the next step. No coupon on this advertisement. If you don't think enough of your future happiness and prosperity to write your name on a postcard and mail it to me, forget the whole thing. But if you think there is a destiny that shapes men's lives, send your name now. What I send you may convince you of the truth of this proverb. And what I send you will not cost a penny, now or at any other time.

VICTOR B. MASON
1512 Jarvis Ave., Suite M-2-M
CHICAGO 26, ILLINOIS

"TOOK IN \$217 FIRST 10 DAYS"

Some make more, some less...

We help you to start Your Own All-Year Business

Make Big Money! With our easily operated, highly efficient Wall Washer, Charles Stelle took in \$217 in first ten days. E. L. Goss took in more than \$10,000 in one year. G. H. Jones wrote, "I made a net profit of \$1200 on one job." And no wonder—this machine washes walls 6 times faster and better than by hand and with no mess—no drop cloths needed.



Your Money Making Opportunity • We want more men to go into this profitable business for themselves and enjoy independence—freedom from layoffs and bosses. Customers everywhere—homes, offices, schools, churches, hotels, etc. How much you earn depends largely on you. What you take in is mostly profit. No need to rent shop or office; operate from home. Can start spare time until your full time is justified.

Lose No Time—Send Coupon Today for All the Facts

FREE BOOK! MAIL COUPON TODAY!

VON SCHRADER MFG. CO.
E10 "W" Pl., Racine, Wisconsin

Send at once (no obligation) your FREE booklet containing information about your WALL WASHING MACHINE and how I can start my own permanent, profitable business.

Name _____
Address _____
City _____ Zone _____ State _____

AUTO MECHANICS

Train at home for Big Money in

Experts say that "America needs 100,000 auto mechanics and 25,000 repair shops." Good jobs everywhere. Steady work. High pay plus opportunity to go in business. Train at home. Earn money spare time as you learn. Mechanic's tools and test instruments sent. Diesel or Body Rebuilding lessons included. Facts are free. Be sure to mail coupon today.

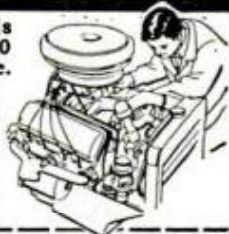

COMMERCIAL TRADES INSTITUTE
1400 GREENLEAF AVE. • CHICAGO 26, ILL.

A-71

Name _____ Age _____
Address _____
City _____ Zone _____ State _____

the lines to the engine as the tanks fall away. Being oval, they roll away.

The Navy is teaching its men how to deal with radioactivity without using any atomic materials.

It's done with a practice phosphor called "Poppup" which can be used as a solid, liquid or powder—all typical forms in which actual radioactive materials might appear. And it can be washed away, or removed like actual atomic material.

The phosphor gives off light when exposed to ultraviolet rays. After it's scattered about, the Navy trainee enters the contaminated area with an invisible ultraviolet light. When it excites the phosphor, a photo-multiplier tube picks up the light and changes it into "clicks," just like a geiger counter. The number of clicks gives the amount of "radioactivity."

The Marine Corps has reorganized the bucket brigade.

When it was learned that many recruits weren't developing certain muscles that had not been used enough in civilian life, the Marines turned to weight-lifting. Calisthenics, the obstacle course and other forms of exercise weren't enough. The biceps and triceps—important muscles in rifle firing—were being neglected.



It was too expensive to issue each recruit a set of barbells, but there were lots of buckets and lots of sand. The buckets were carefully calibrated and, as the exercises progressed, more sand was added until a maximum of 60 pounds was reached.

Results showed the recruits scored an average of 20 points per man more in their physical-fitness tests than previously, and showed a gain of more than 38 percent in rifle-range tests. ★ ★ ★

LEARN KARATE AT HOME faster this easy picture way!



Over 200 pictures show you how!

Fear no man!

Big Bonus Section Included

Karate Course for WOMEN!
Yours at NO Extra Cost!

FREE

Karate "Fortifier"

Strengthens Hands, Wrists, Forearms. Sells separately for \$2.00—but it's yours FREE just for reading the big new book, "Super Karate Made Easy." Made of high tension spring steel—lasts for years and years. Use it only a few minutes a day—that's all! Soon you'll have that "Grip of Steel." The Karate "Fortifier" is offered only by us, only by mail. It's yours to keep FREE even if you should return the big book. Supply limited. Rush coupon today!



BETTER... FASTER THAN JUDO

Turns Hands, Elbows and Feet Into Deadly Weapons!

Now you can learn KARATE fast—right in your own home! You can learn SUPER KARATE—the deadliest art of self defense known to mankind—in just weeks. A big illustrated book, just published, makes it simpler than ever before—so plain that even a girl or schoolboy can learn Karate quick. This new book is called, "SUPER KARATE MADE EASY." Over 200 actual fighting pictures and diagrams show you how to use Karate to K.O. any enemy—even when armed—just with your bare hands! Even a 100 pound weakling can overpower and paralyze a 200 pound brute with lightning speed—simply by using his pressure points and other weak spots.

Super Karate is more positive than boxing. It's faster, more powerful and much easier to learn than Judo. All you need is your hands and feet and a reasonably limber body—no strenuous exercises...no barbells or weights...no bulging muscles. Size and weight mean practically nothing in Karate. The bigger your adversary is, the easier it is to topple him. You actually use his weight, his own strength to floor him. That's why even the best Judo experts are afraid to tangle with a Karate Man. Now Karate is easier than ever to learn with this simplified picture method. Send for "SUPER KARATE MADE EASY" on two weeks FREE TRIAL without risking one penny. See for yourself how easy it is. You actually begin learning the very first day—there's nothing complicated about it. Try it out! In just one or two weeks—surprise your friends with your newly acquired skills!

**KEPT SECRET FOR CENTURIES
NOW REVEALED TO YOU**

The principles of Karate are extremely simple. Yet most people were kept in the dark for centuries. It's secrets were revealed only to a select few, like the special guards of the Emperor of Japan. Eventually it was taught to special Japanese troops in World War II. Any friend with Pacific combat experience can tell you how deadly Karate could be—even when used by a puny little Japanese Soldier. Now these secrets are revealed to you for you to use in any emergency. Learning Karate will give you new confidence in yourself, a new sense of power and courage.

WIN NEW RESPECT—FEAR NO MAN

After you've learned Super Karate you will fear no man—no mugger—no insulting street corner gang. Women will admire you, men will respect you. Karate is a powerful weapon nobody can ever snatch from you. That's why it's being taught to marines, paratroopers, and police officers. This new simplified book makes it easier than ever to learn. It does away with the mumbo-jumbo. It teaches you in plain easy-to-understand English. Over 200 pictures, diagrams, anatomical charts show you the weak pressure points—how to use the nervous system for mild, serious or fatal blows. You'll never be humiliated again. You'll feel more manly, more healthy, more self reliant.

**FREE 2 WEEK TRIAL
NO RISK... NO OBLIGATION!**

Order this big, illustrated book NOW on 2 week FREE TRIAL. Read and learn. Then try it out, being careful to use only mild blows! Use the giant 6 foot "dummy" for practicing on. Also use the reg. \$2.00 Karate Hand and Wrist Fortifier given FREE to you. Then if you are not satisfied with the wonderful results...if you are not thrilled with the quick progress you've made...return the book alone and get money back! Act now! The regular publisher's price for "SUPER KARATE MADE EASY" is 4.98. Special price while this edition lasts—only 2.98. Send the free trial coupon TODAY—avoid disappointment.

**THORESEN INC., Dept. 6-M-931
585 Water St., New York 2, N. Y.**

NOTICE: Not sold to minors under 18 without parents written consent.



**14 DAY
FREE
TRIAL**

**THORESEN INC., Dept. 6-M-931
585 Water Street, New York 2, N. Y.**

RUSH the all new book, "SUPER KARATE MADE EASY" on 14 day free trial. Also send FREE the special Karate "Fortifier" and Giant Practice Dummy. I must be satisfied with the progress I make in only 2 weeks or will return book alone for my money back quick.

2.98 enclosed. Rush postpaid
 Send COD plus postage and COD costs

Name _____

Address _____

Town _____ Zone _____ State _____

NOTE: Minors under 18 years must have signed consent of father or guardian.
Canadians: 439 King Street West, Toronto 28, Ont.

FREE

GIANT 6 FOOT PRACTICE "DUMMY"



Life size and true to life in every detail. Suitable for mounting on wall or door. Big numbers show you exact location of pressure points and weak spots. Just what you need to practice and learn faster. One side shows nude body. The other side shows the same man—in the exact same 6 foot size fully dressed. Both sides numbered with pressure points. Hand-somely lithographed on high grade bond stock. Folds for easy carrying anywhere. This Karate Practice Dummy is included FREE with "Super Karate Made Easy." NOT offered by any other publisher. Learn Karate easier and faster with this new amazing book, send coupon now!



**YOU
can
acquire**

**LAW AT HOME!
EARN LL. B. DEGREE**

LaSalle's famous Law Library—used as reference in many Law libraries and Law offices—has enabled thousands to master Law surprisingly fast, in spare hours at home, for business and professional advancement.

These 14 remarkable volumes, compiled by leading professors and lawyers, cover the whole basic field of Law in condensed, orderly, simplified manner.

You advance rapidly with this great library, plus special lectures furnished. We guide you step-by-step with personalized Problem Method of instruction...you *learn by doing*—handling legal problems—not by memorizing rules.

Send for two FREE booklets, "Law Training for Leadership," and "Evidence," answering questions about Law and its value to you. Mail coupon below. No obligation.

Accredited member, National Home Study Council

**LA SALLE EXTENSION UNIVERSITY
A Correspondence Institution**

417 S. Dearborn St. Dept. 1164 L Chicago 5, Ill.

Send me your two FREE booklets described above, without obligation.

Name Age

Street

City, Zone & State

**You Can Make a BIG LINE
of Concrete Products
on a SMALL INVESTMENT**

Brick . . . patio stones . . . screen block . . . flagstones, slump brick and many other items can be made on the low-cost, easy-to-operate Gardencrete Machine. \$1.00 worth of material can be turned into \$5.00 to \$8.00 worth of products to build patios, planters, walks, barbecues, walls, terraces, etc. A cash-and-carry business with large, waiting market. Every home can use Gardencrete.

As Little as \$810.10 Cash

Can procure you a Gardencrete Machine, with up to three years to pay the balance. Easy to set up in shed or garage. Gives opportunity to turn idle hours into profit and build a spare-time activity into a full time enterprise. Full information in 4-color brochure — free. Write today.



COLORCRETE INDUSTRIES, INC.
704 Ottawa • Holland, Mich.

GARDENCRETE



G-6

**Great Pioneers in Science
Do You Know Them?**

—By James S. Thistle—

IN 1632 THERE APPEARED a great masterpiece known as *A Dialogue on the Two Principal Systems of the World*. These two systems were the Copernican theory that the earth moves around the sun and the Ptolemaic theory that the earth is the center of the universe. For advocating the Copernican theory, our Pioneer, the author of this great writing, was ordered to stand trial before the Holy Inquisition. He was given a prison sentence and forced to abandon his belief in what is, of course, our present concept of the solar system.

This early scientist also perfected a special telescope by which he became the first man to see the true face of the moon, the first to observe multitudes of stars beyond the sight of the naked eye and the first to discover four of the twelve satellites of Jupiter. He also demonstrated that gravity pulls all falling bodies to the earth at the same rate, regardless of their weight.

*These letters, unscrambled,
spell the name of this
month's Great Pioneer
in Science:*

ILLAGOGLIEAILE

(First and Last Names)

Write the correct name here:

Now turn to page 250 for the answer.

POPULAR MECHANICS

**AT
LAST!**

RADIO-TV and ELECTRONICS TRAINING

**.... AT A PRICE
YOU CAN AFFORD!**



***21 INCH**
Receiver Kit included

Yes, this great course costs far less than any training of its kind given by other major schools! Radio-Television Training School will train you for a good job in Television or Industrial Electronics — **AT HOME IN YOUR SPARE TIME.**

Think of it—a complete training program including over 120 lessons, Fourteen Big Radio-Television Kits, Complete Color-TV Instruction, Unlimited Consultation Service . . . **ALL at a really big saving to you.** How can we do this? Write to us today . . . and find out!

And what's more — you can (if you wish)
**OPEN YOUR OWN RTS-APPROVED AND
FINANCED RADIO-TV SERVICE SHOP**

We Want Many More Shops This Year

This 38 year old training organization — called RTS, that's Radio-Television Training School — wants to establish a string of Radio-TV Repair Shops in principal cities throughout the U. S. So far, a great many such shops are **NOW IN BUSINESS AND PROSPERING.** We are helping and training ambitious men to become future owners and operators of these shops in all areas.

**FOR UNSKILLED
INEXPERIENCED MEN ONLY —
WE TRAIN YOU OUR WAY!**

We must insist that the men we sign up be trained in Radio-TV Repair, Merchandising and Sales by our training methods—because **WE KNOW** the requirements of the industry. Therefore, we will **TRAIN YOU . . .** we will show you how to earn **EXTRA CASH**, during the first month or two of your training period. **YOU KEEP YOUR PRESENT JOB. TRAINING TAKES PLACE IN YOUR OWN HOME, IN YOUR SPARE TIME!**

**COMPLETE
COLOR TV
INSTRUCTION
INCLUDED**

*you build these
and other units*



**RADIO-TELEVISION
TRAINING SCHOOL**

815 EAST ROSECRANS AVENUE
LOS ANGELES 59 CALIFORNIA

Est. 1922

**RTS
APPROVED
SERVICE
SHOP**

Get your free book on the
FAMOUS RTS BUSINESS PLAN
find out how you can open
A REPAIR SHOP OF YOUR OWN

We supply and finance your equipment

When you are ready and qualified to operate one of our RTS-Approved TV Repair Shops **WE WILL SUPPLY AND FINANCE EVERY BIT OF EQUIPMENT YOU NEED TO GET STARTED** plus an inventory of parts and supplies. In other words we will stake you . . . **AN OFFER NEVER MADE BEFORE BY ANY TRAINING ORGANIZATION.** Under the RTS Business Plan you receive:

1. An electric sign for the shop front.
2. Complete laboratory of test equipment.
3. Letterheads, calling cards, repair tickets, etc.
4. Basic inventory of tubes, parts, supplies.
5. Complete advertising and promotional material.
6. Plans for shop arrangement.
7. Instructions on how to go into business.
8. Continuous consultation and help.
9. The right to use RTS Seal of Approval, and the RTS Credo.
10. The right to use the Famous Trade Mark.

**ACT
NOW!**

CUT OUT AND MAIL — TODAY!

RADIO-TELEVISION TRAINING SCHOOL

815 EAST ROSECRANS AVE Dept. PM-110
LOS ANGELES 59 CALIFORNIA

SEND ME FREE — all of these big opportunity books — "Good Jobs in TV-Electronics," "A Repair Shop of Your Own" and "Sample Lesson." I am interested in:

- Radio-Television Industrial Electronics (Automation)

Name _____ Age _____

Address _____

City & State _____

304

Mail This Coupon Now — No Salesman Will Call

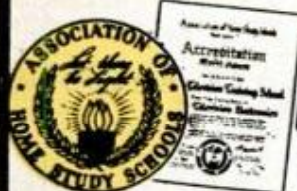

RTS' Membership in The Association of Home Study Schools is your assurance of Reliability, Integrity, and Quality of Training.

**ALL
THESE
FREE!**



**MY SPARE TIME HOBBY
MAKES ME
\$5⁰⁰ an hour
CASH PROFIT**

— Grover Squires

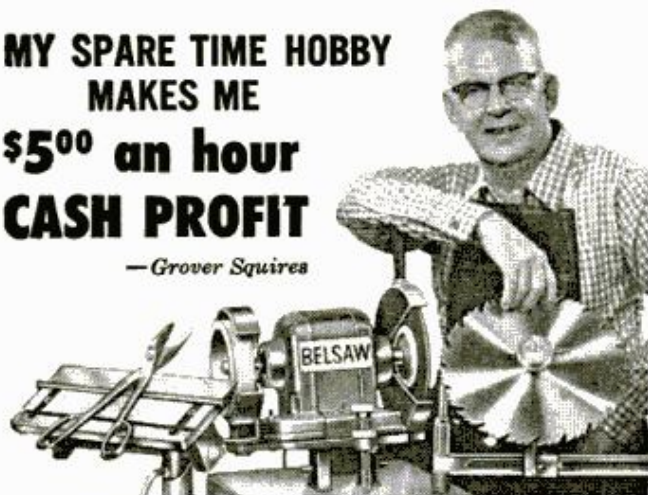

START YOUR OWN SPARE TIME BUSINESS

You can turn your spare time into Big Cash Profits with your own **COMPLETE SHARPENING SHOP . . .** Grind saws, knives, scissors, skates, lawn mower blades . . . all cutting edges. Your Own Cash Business with no inventory . . . right at home . . . no experience needed.

FREE BOOK tells how you can start your own spare time business while you are still working at your regular job. Low Cost — time payments only \$15.00 a month. Send coupon today.

FREE BOOK

BELSAW SHARP-ALL CO, 711 Field Bldg., Kansas City 11, Mo.
Send Free Book "LIFETIME SECURITY". No obligation.

Name _____

Address _____

City _____ State _____

HEAD-QUARTERS FOR ALL SPORT CAR TIRE SIZES

ALL FAMOUS BRANDS!

FARM TRUCK AUTO

AT LESS THAN WHOLESALE

SAVINGS NEVER LESS THAN 50% up to 70% OFF REG. PRICE.

FREE - SEND FOR YOUR FREE CATALOG - FREE!

RELIABLE TIRE DIST., 730 Morgan Blvd., Camden 4, N. J.

ENJOY YOUR OWN 2-WAY RADIO

COMMUNICATIONS with **TEICO®**

CITIZEN BAND TRANSCEIVERS

KIT from \$59.95 **WIRED** from \$89.95

Send and receive up to 20 miles from home, office, car, boat, etc. No exams or skills needed. A rugged, powerful, reliable instrument easy to build from kit. Write for free catalog of over 70 electronics kits for stereo hi-fi, "ham" gear, test instruments, transistor radios and nearest dealer. Add 5% in the West.

EICO, Dept. PM-11, 3300 N. Blvd., L.I.C. 1, N. Y.

**Keeping up
with the
ATOM**

By James Biery

THE STAGE HAS BEEN SET for the atom to go to work in the Arctic and Antarctic, and for the building of giant atom smashers that would dwarf those in existence today:

Dr. John Wolfe, a U.S. Atomic Energy Commission scientist, says a 15-month study costing \$2,000,000 disclosed that a proposed nuclear blast on the Alaskan coast 35 miles south of Point Hope would be safe from a biological standpoint. This Arctic phase of Operation Plowshare, the program dealing with peaceful uses of atomic energy, calls for an underground experimental explosion designed to demonstrate the feasibility of digging harbors and canals with nuclear energy. One 200-kiloton and four 20-kiloton devices would be detonated at the same time from depths of 400 and 800 feet. (Twenty-kiloton bombs were exploded over Hiroshima and Nagasaki in World War II.) It is estimated the detonation would blow up 30 million yards of material, some of it as high as 30,000 feet. But the report concludes that it is doubtful that "a single fish or other sea organism would be killed by radiation." Nor, it added, would there be deaths from this factor on land.

This month, the first boatloads of men and supplies will leave U.S. ports for McMurdo, principal base for American operations in Antarctica, where work will start this year on an atomic power station to provide electricity for the permanent scientific exploration of the South Polar continent. The reactor, scheduled for completion in 1962, will replace oil furnaces now used in the development of electricity.

Atomic scientists attending the 10th International Conference on High Energy Physics, at the University of Rochester, N.Y., have called for the building of high-energy atom smashers having as much as 300-billion electron volts. Such a machine, which would accelerate beams of sub-atomic particles (such as electrons) to high energies and hurl them into the nucleus of atoms to break them apart, would be 100 times more powerful than any now in existence and would cost some \$300,000,000.

SOMETHING TELLS ME!



Develop Your Intuition...

The Unlearned Knowledge

Whence come the whisperings of self—the still small voice within? Who has not experienced that certain impelling impression that suddenly flashes into consciousness? It conveys that undeniable conviction of truth that neither reason nor persuasion can set aside. The *intuition* is a source of unlearned knowledge—a reservoir of superior judgment that lies enshrined in the subconscious. It strives to guide and advise you—even against the dictates of will.

There is nothing supernatural or uncanny about intuition. Beneath your surface consciousness exists *another mind*. It can be a source of inspiration, of new and startling ideas. Intuition is the fountainhead of creative ability. Every person's life can be fuller, richer in achievement, if he learns to awaken and direct intuition. Don't wait for enlightenment. *Call it forth.*

Accept this FREE BOOK

There is nothing of greater satisfaction nor of more practical *advantage* than the full employment of your personal powers. Let the Rosicrucians, a world-wide brotherhood of learning (not a religion), send you a free copy of the book, THE MASTERY OF LIFE. It will tell you about this useful knowledge. Use the coupon for your *free* copy or write Scribe A.K.F.

Scribe A.K.F.
Rosicrucian Order, (AMORC)
Rosicrucian Park, San Jose, California, U.S.A.

Gentlemen:

Kindly send me a free copy of THE MASTERY OF LIFE. I am sincerely interested in the mysteries of self and of the Cosmic.

NAME _____

ADDRESS _____

CITY _____ STATE _____

The ROSICRUCIANS (AMORC) • SAN JOSE, CALIFORNIA

**EARN \$125
A WEEK AND UP**

**BE AN AUTO DIESEL
EXPERT — LEARN
A TRADE YOU LIKE**

You learn fast in our shops because you learn with tools on real equipment. Students short of money may earn most of their expenses by doing part-time work. Experienced instructors explain WHY and show you HOW, then you DO IT YOURSELF. Many of our graduates earn \$125 a week and up. Approved for veterans. Day and evening classes. Free bulletin-write today.

MAIL THIS COUPON TODAY!

NASHVILLE AUTO-DIESEL COLLEGE
226 7th Ave., No., Dept. 86, Nashville, Tenn.
Please send without obligation free catalog.

NAME _____
(please print or write plainly)

ADDRESS _____

CITY _____ STATE _____

**BEST SPORTS CAR
YOU CAN OWN!**

**A 4-WHEEL DRIVE
WITH WARN HUBS**

Hi-ball on the highway in free-wheeling 2 w.d. with Warn Hubs on your 4 w.d.—no front end drag or whine, better gas mileage, easier steering. Save money, save road time. Switch in seconds into 4 w.d. when the going gets rough! Change to 2 or 4 w.d. automatically with Warn Lock-O-Matics, manually with Warn Locking Hubs. Guaranteed. Models for all makes 4 w.d.s to 1 1/2 tons. At your dealer's or write:

WARN MFG. CO., Riverton Bx 6064-A,
Seattle 88, Wash.



**WARN
Selective Drive
HUBS**

JEEP OWNERS

**RE-POWER NOW WITH A V-8 OR 6 CYL. ENGINE — USE
FORD—CHEV—MERCURY—GMC—PONT—STUDE—DODGE OR PLYMOUTH**

In Jeeps, Jeepsters, Sta-Wgn, trucks, Kaiser & H. J. cars.
Conversion Kits \$45.35 to \$56.90. Want fast action? Give us full
information, send \$15.00 Dep. and we will ship correct kit. Bal.
COD. Send full amount for prepaid shipment. Wire, phone or write
today. Details FREE

HOOSIER MACHINE PRODUCTS CO.
312 S. E. 6th St. Phone CR 6-3442 Pendleton, Oregon

**'How to Make Money with
Simple Cartoons'**



A book everyone who likes to draw
should have. It is free; no
obligation. Simply address

**FREE
BOOK**

CARTOONISTS' EXCHANGE
Dept. 911-D Pleasant Hill, Ohio



"Wouldn't it have been easier to fix the roof?"

Save hundreds of dollars on car repairs

NEW EDITION OF MONEY-SAVING "Fix-it-Fast" MANUAL

SHOWS HOW TO...

FIX ANY PART OF ANY CAR

... without wasting time, breaking your back, or guesswork!

It's like having factory experts show you the how-what-where of practically every car repair job — from tune-ups to a complete engine overhaul!

Now you can save real money; avoid wasted time, elbow grease, and grief — by letting MOTOR's New AUTO REPAIR MANUAL help you "wrap up" just about ANY repair job on any car listed below—1953 thru 1960.

You "Knock Off Toughies" in 1-2-3 Fashion!

Beginner or veteran mechanic, you'll "knock off" the most complicated jobs in 1-2-3 fashion — "toughies" that stump other men! For MOTOR's AUTO REPAIR MANUAL won't let you just guess at how to do a job. Its easy-to-use "Trouble-Shooter" Section first spots any one of 2,300 car troubles in a jiffy.

Then, with step-by-step instructions and large crystal-clear photos and diagrams, MOTOR's Manual shows you exactly where to start, what tools to use, how to go about it like a "pro," without a waste motion. While the other guys are cussing and sweating, you "breeze" right through the entire operation! With MOTOR's it's almost impossible to make a mistake!

The "Guts" of 176 Official Shop Manuals

Why is working with MOTOR's so foolproof, so easy, so time-saving? It gives you the "meat" of 176 Official Factory Manuals and hundreds of service manuals — all the procedures only the men who build the cars know about. You can almost feel these experts guiding your hands through every repair—from adjusting a carburetor, fixing automatic transmissions, tearing down a motor, to spotting ignition failures, and fixing power brakes, steering, etc.

A Huge Picture Book — With Everything Right at Your Fingertips

What a storehouse of money-saving information! Covers every car listed—

all models, 1953 through 1960. Over 1,000 double-size pages... 2,850 this-is-how pictures... 30,000 essential specifications... 195 quick-check charts... 225,000 service and repair facts... complete information on 1,967 car models... tune-up data for over 42 different foreign car makes... plus much more.

MOTOR's Manual must be good. The Armed Forces use it. Schools teach from it. Over 3,000,000 copies have been sold and are making money for users. P. Pemper of Wisconsin says, "it sure doesn't take schooling to read it... has paid for itself time and again." H. Hartman of Baltimore writes, "MOTOR's has saved us a lot of time and money... cannot do without it."

Try MOTOR's Manual for a Whole Week FREE!

Talk won't convince you that MOTOR's can save you hundreds of dollars on car repairs. Only a trial will. So we'll send you a copy of the new edition for a FREE 7-day examination. If it doesn't pay for itself on the very first job, return it and owe nothing. You don't risk a penny. So rush coupon today to MOTOR Book Dept., Desk 01X, 250 W. 55th St., New York 19, N. Y. (Schools, Bookstores: write for discounts.)

"Instructions so clear, I have no trouble learning anything about any car."



—Sam Ordonez, Calif.

OVER 3 MILLION COPIES SOLD!

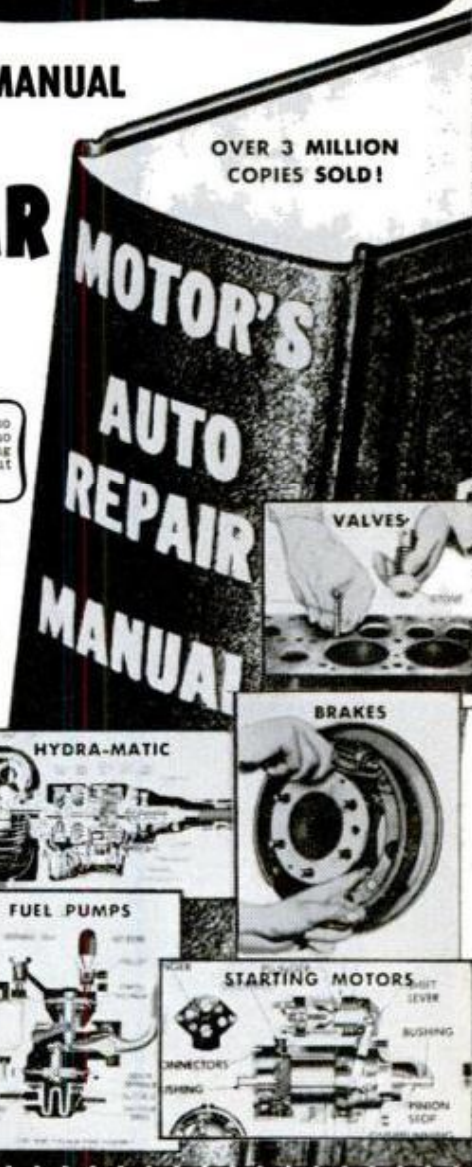

FREE 7 DAY TRIAL
Return and Pay Nothing if Not Satisfied

MAIL COUPON NOW FOR 7-DAY FREE TRIAL
(Attach to postcard for faster action)

MOTOR BOOK DEPT.
Desk 01X, 250 W. 55th St., New York 19, N. Y.

Rush to me at once (check box opposite book you want):

MOTOR's New AUTO REPAIR MANUAL. If O.K., I will remit \$2 in 7 days, \$2 monthly for 2 months and a final payment of \$1.95 (plus 45¢ delivery charges) one month after that. Otherwise I will return the book postpaid in 7 days. (Foreign price, remit \$10 cash with order.)

MOTOR's New TRUCK REPAIR MANUAL. If O.K., I will remit \$2 in 7 days and \$2 monthly for 2 months, plus 45¢ delivery charges with final payment. Otherwise I will return book postpaid in 7 days. (Foreign price, remit \$11 cash with order.)

Print Name.....
Address.....
City..... Zone..... State.....

Check box and save 45¢ shipping charge by enclosing WITH coupon in envelope entire payment of \$7.95 for Auto Repair Manual (or \$9 for Truck Repair Manual) plus sales tax. Same 7-day return refund privilege applies.

Same FREE 7-Day Trial on TRUCK REPAIR MANUAL

Covers every job on every popular make truck from 1952 thru 1960, including GM, Mack and Cummins Diesels. For FREE TRIAL check box in coupon.

COVERS ALL THESE MAKES—1953 Thru 1960

Buick	Dodge	Nash '55-'57
Cadillac	Edsel	Oldsmobile
Chevrolet	Falcon	Plymouth
Chrysler	Ford	Pontiac
Continental	Hudson '55-'57	Rambler
Corvair	Imperial	Studebaker
Corvette	Jeep	Thunderbird
Dart	Lincoln	Valiant
De Soto	Mercury	

engineering degree in only 27 months

Realize your dream of becoming a graduate engineer. Then promotion will not pass you by. Share rewards awaiting college men . . . higher income . . . rapid advancement. Important firms visit Tri-State campus to interview seniors. Founded 1884. *Bachelor of Science Degree in 27 months* in Electrical Engineering (Electronics or Power major), Mechanical, Civil, Aeronautical, Chemical Engineering. *In 36 Months* a B.S. in Business Administration (General Business, Accounting, Motor Transport Management majors). For earnest, capable students. Small classes. More professional class hours. Well-equipped, new and modernized buildings, labs, dorms. *Modest costs.* Year-round operation. Enter Jan., Mar., July, Sept.

Write J. E. McCarthy, Director of Admissions, for Catalog and Career Book.

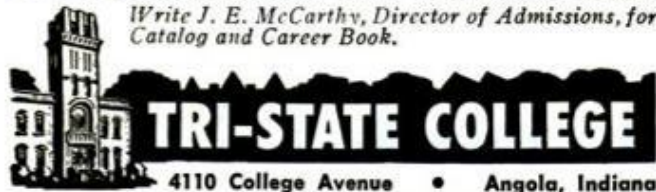

4110 College Avenue • Angola, Indiana

27 YEARS IN BUSINESS AT THE SAME ADDRESS.

Beat the high cost of new tires.

EXTRA MILEAGE TOP GRADE Tires,
ANNIVERSARY SPECIAL. SEND AD

WHY PAY MORE?

UP TO
15,000 MI.

Our entire stock of good used tires.

ALL SIZES IN STOCK. White Walls \$1.00 extra	
600-16 \$4.72	670-15 \$4.72
600-16(6) 7.92	710-15 4.72
650-16(6) 8.82	760-15 4.72
750-14 4.72	800-15 4.72
800-14 4.72	820-15 4.72
750-16(6) 10.02	700-16(6) 10.02
	700-15(6) \$10.92
	750-16(8) 11.02
	825-20 19.92
	900-20 18.92
	1000-20 19.92
	1100-20 19.92
	1000-20 20.92

SNOW TIRES \$7.82 AND \$6.00 ANY SIZE

BLACK WALL PASS.

SUBURBANITE OR TOWN & COUNTRY TREAD

Thousands of tires shipped all over the U.S.A. All tires shipped F.O.B. Phila. Send Check or M.O. with this ad. Dept. 2 No C.O.D.

STANDARD 834 N. Broad St., Philadelphia 30, Pa.

PROFESSIONAL DEVICE AVAILABLE



DOT TEENUTS

Use this flush mounted, "can't slip" nut that needs no washer! . . . get the strength of steel threads in wood. Fast, easy, sure. The professional fastener!



Now specified in
EASI-BILD PATTERNS

Get them both at Hardware, Variety and Lumber Stores:

Ask for TEENUTS!

COLUMBIA FASTENER COMPANY
Chicago 8, Illinois



BULLETINS from the world of **SCIENCE**

By James Biery

WHERE DO COSMIC RAYS come from? Contrary to some theories, say two Massachusetts Institute of Technology scientists, some may originate from outside the Milky Way, the galaxy that includes the solar system. Drs. John Linsely and Livio Scarsi reached this tentative conclusion after studying data gathered during possibly the largest and most powerful shower of rays to be detected bombarding Earth. Such showers are caused by subatomic particles that plunge into the upper atmosphere at nearly the speed of light and smash into atoms, causing a chain reaction that produces a rain of atomic debris. The two scientists say some 10 billion particles rained down in a period of 10 one-millionths of a second during December 3, 1959. The shower was detected by 20 fluorescent counters spread out in a six-sided pattern over an area of 600 acres at the Institute's research center near Albuquerque, N.M.

Research at a New Mexico station operated by Harvard University has tended to validate the theory that meteors—or "shooting stars"—are simply debris of comets. Using an array of camera telescopes, scientists at the station photographed some 750 meteors, gathering in this manner data on their paths, speeds, weights so their origin could be determined. It appears the meteors, as suspected, came from points in the sky lying on orbits of the major comets. Surprisingly enough, though, the Harvard researchers put the size of most meteors as being no larger than a grapefruit and their composition so fragile that most vanish at almost the instant they touch the atmosphere.

The half-way point has been reached in a census of the stars, undertaken by a dozen or so observatories located throughout the world under the auspices of the International Astronomical Union. The project began in 1955 and, when completed in the last half of this decade, it may open the way for a new understanding of the universe. The goal is a catalogue of 30,000 stars uniformly distributed over the sky. Several hundred distant galaxies have been selected as reference points so future movements of stars can be determined with accuracy. ★★★

Choose "out of the ordinary" Christmas Gifts from



Bean's Free Catalog

Hunters and campers will find many practical items in our 108 page fully illustrated Fall Catalog. Shows hunting footwear, clothing and 375 items of interest to both men and women. 130 items are of our own manufacture.

L. L. Bean, Inc., 379 Main St., Freeport, Me.
Mfrs. Hunting and Camping Specialties

- • **Finish HIGH SCHOOL at Home** • •
- *in spare time. Progress at your own speed.* •
- Many finish in 2 years. Equivalent to resident school—prepare for college entrance exams. Standard H.S. texts furnished. •
- Credit for subjects already completed. Single subjects if desired. Diploma awarded. •
- *Write today for Free Bulletin!* •
- **AMERICAN SCHOOL, Dept. H845, Drexel at 58th, Chicago 37** •

MAKE YOUR FORTUNE



Sell famous Spring-Step Cushion Shoes for all the family—men, women, children and babies! Earn big money daily plus Cash Bonus and Retirement Income with amazing 2-minute demonstration that sells on sight. Big repeat business. Full or spare time. America's Biggest Selection of Shoes for all the family. Free outfit given. No investment ever. Write today.

ORTHO-VENT Shoe Co., Inc.
11011 Brand Road Salem, Virginia

GOVERNMENT OIL LEASES LOW AS \$1 PER ACRE

You do no drilling, pay no taxes, may realize a king-size profit without ever leaving home. Write for free map and literature.

AMERICAN OIL SCOUTS, Dept. PM
8350 Santa Monica Blvd. Los Angeles 46, Calif.

RUPTURED

BE FREE FROM TRUSS SLAVERY

Surely you want to THROW AWAY TRUSSES FOREVER, be rid of Rupture Worries. Then Why Do you put up with wearing a griping, chafing and unsanitary truss the balance of your life? If you do, it will NOT be through necessity but through choice on your part.

Now there is a new modern Non-Surgical treatment that is designed to permanently correct rupture. These Non-Surgical treatments are so certain, that a Lifetime Certificate of Assurance is given. Write today for our FREE Book that gives facts that may save you painful, expensive surgery. Tells how non-surgically you may again work, live, play, love and enjoy life in the manner you desire. There is no obligation. Excelsior Medical Clinic, Dept. H6124, Excelsior Springs, Mo.

Learn at Home *in your spare time* to Fix Electric Appliances



Better Pay—More Opportunities

Get into a field where there is important work and opportunity for the trained man. Millions of electric appliances are sold every year. Every wired home now has an average of 8. Many of them need service and repair. Owners pay well to have them fixed quickly, properly. This is your opportunity for a better job, your own part time or full time business. NRI can give you the training you need, at home, in your spare time.

Spare Time Earnings Start Soon

Soon after starting you will be able to earn extra cash fixing toasters, clocks, fans, vacuum cleaners, etc., for neighbors and friends. Keep your job while learning and earning. Put spare time to work for you. Work in your basement, garage, spare room. You'll be amazed how easily, quickly you, too, can start earning many extra dollars. NRI shows you how. Even before you finish training your spare time earnings may pay for the course and equipment.

NRI Sends Tester to Learn and Earn

You need proper equipment to service today's automatic appliances. With this course you get parts to build professional type, multi-use Appliance Tester. You learn to use it. Takes guess work out of servicing. Mail coupon for FREE book and Sample Lesson. See how easy it is to learn. Find out about NRI—a school that for more than 40 years has been training men, through home study, for success, good pay jobs. Our reputation, record, experience back up this course. Address: **NATIONAL RADIO INSTITUTE, Dept. AMO, Washington 16, D.C.**



FREE Lesson and Book
Mail this NOW!

NATIONAL RADIO INSTITUTE

DEPT. AMO, WASHINGTON 16, D. C.

Send me Lesson and Book Free. No Salesman will call.

Name..... Age.....

Address.....

City..... Zone..... State.....

ACCREDITED MEMBER NATIONAL HOME STUDY COUNCIL

Not everyone does as well, but T. N. CODY, who started a business of his own, reports...

For 12 months I've averaged

\$800

per month income

— most of it clear profit for me!

Many men have discovered how to be independent, to be free of layoffs and bosses. C. G. Naples grossed more than \$200 his first week. A father-son combination grossed \$44,000 their second year. H. Lemon says, "I netted \$133 in one 8-hour day."

How much you make depends largely on you. You need no special skill, no large investment. Start part time if you wish.

NO SHOP NECESSARY • Our Electric Deterger shampoos rugs, carpets right on floor—removes dirt and grime and helps to show their natural color and beauty. So efficient and safe it is used by largest railroads and hotels.

This is not a lease proposition.

You own the machine, you work when and where you please and all the money you take in is your own. No risk. Machines fully guaranteed.

Mail
Coupon
Today
for
FREE
Book

VON SCHRADER MFG. CO.,
E10 "R" Pl., Racine, Wis.

Without obligation send me **FREE** booklet about your RUG DETERGER and tell me how I can start my own permanent, profitable business.

Name _____

Address _____

City _____ Zone _____ State _____



**Colorcretors
are Needed
Everywhere**

C-9



More Colorcretors are needed to supply growing demand for the enduring, colorful beauty possible only from Colorcrete. Time-worn concrete, stucco and other old or new masonry walls are quickly transformed into clean freshness from a selection of 30 tints, tones and shades. Cementitious base—tough, tenacious, enduring. Colorcrete is applied under pneumatic air pressure by authorized Colorcretors. Machine is easy to operate and readily mobile. Opens up opportunities for men of modest capital. Broad markets with high income potentials. Write for Opportunity Book.

COLORCRETE

COLORCRETE INDUSTRIES, INC.
570 Ottawa Ave., Holland, Mich.

YOU CAN BE A REAL HE-MAN!



CHARLES
ATLAS

DON'T let anybody tell you that you're just "naturally" skinny . . . flabby . . . soft. I'll show how you can have the handsome muscle-mighty HE-MAN BODY that Nature meant you to have! In just 15 minutes a day I can make you a NEW MAN! I'll build smooth, powerful layers of muscle wherever you want 'em—arms, chest, stomach, back, legs, etc.—send wonderful new pep and energy surging through your whole body! **WRITE FOR FREE BOOK.** Tells about famous "Dynamic Tension," the NATURAL way I built my own famous body. How I've built up other fellows. What I can do for YOU! Address: **CHARLES ATLAS, Dept. 811, 115 E. 23rd St., New York 10, N. Y.** In England: Chitty St., London, WI

Send for
FREE
BOOK



KILLS MOSQUITOS / MOTHS / MILLERS / FLIES / GNATS / FISH FLIES / ETC.

USES NO CHEMICALS, GASES, ETC.

No insect recovery. Harmless. Guaranteed. Built to last 25 years. Beautiful outdoor lighting. Plug into any 110 volt socket. Very reasonably priced...

NO AREA CONTAMINATION

Uses up to 200 watt bulb. Grid costs 10¢ per month. Complete with fly attractor. Dead insect catcher, write to **SING SING BUG CHAIR, INC., BOX P 3708 / OAK PARK 37, MICH.**



OVER
ACRE

BOX SIZE 5x15x19
WEIGHT: 2 LBS.

DRAINS cellars, cisterns, wash tubs; \$7.95 IRRIGATES - CIRCULATES - SPRAYS



1,001 uses. Stainless shaft. Won't rust or clog! Use 1/8 HP motor or larger. 3/4 HP for up to 2,400 GPH; 450 GPH 80' high; or 1800 GPH from 25' well. 1" inlet; 3/4" outlet. Coupling included free. **\$7.95.** **HEAVY DUTY BALL-BEARING PUMP.** Up to 5,200 GPH; or 3,000 GPH from 25' well. 1 1/4" inlet; 1" outlet. **\$12.95** Postpaid if cash with order. **MONEY BACK GUARANTEE** Centrifugal and Gear Pumps in All Sizes **LABAWCO PUMPS, Belle Mead 7, New Jersey**



BEFORE



AFTER

Polo Products, 1048 Franklin St., S.E., Grand Rapids 7, Mich.

Pop-Up Signal for Mailboxes

One glance at a rural mailbox equipped with a new, simple signal mechanism discloses whether the mailman left any mail. The signal is an eye-catching orange color and is made of aluminum. It is easy to install, as there are no springs involved in the action. The pop-up signal is mounted on the box with two screws. The orange flag is set by pushing it flat against the top of the box. In this position, a curved arm extends over the box lid. When the lid is opened, it slides under the arm, causing the arm to move up, popping the orange flag into a vertical position.

MAKE EXTRA CASH

SHARPENING LAWN MOWERS THE MODERN WAY

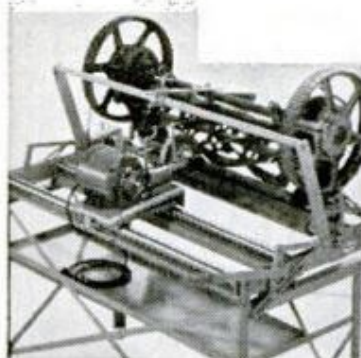

Start your own shop! Full or spare time. Earn many dollars in a short time... average \$5.00 per hour. Many mowers need sharpening. With MODERN'S Extra Heavy Duty LAWN MOWER SHARPENER AND BED KNIFE GRINDER you have 6 machines in one. All operations are done quickly and easily. You make money from the start. Write for free details.

MODERN MFG. CO.
160 N. Fair Oaks Ave. Dept.
Pasadena, California 10-10

75 POWER TELESCOPE

\$6.00



A must in a missile or bomb attack.

Space conquest—very powerful scope. Sells several times as much as this scope—manufactured in America. It has polished lenses—75 Power for Long Range—30 Power for Bright Images. Brings the distant moon and stars much closer. Large production enables us to offer this scope at \$6.00 postpaid. Guaranteed.

DRISCOLL SALES & SERVICE, 536 — 12th Street, Denver, Colorado

Hotels Call for Trained Men

Record-breaking travel means nation-wide opportunities and a sound substantial future for trained men in the hotel, motel and hospitality field. Fascinating work; fine living; quick advancement. You can qualify at home or through resident classes in Washington. Previous experience proved unnecessary. Placement Service FREE. Write for FREE Book, "Your Golden Opportunity." Accredited by N.H.S.C.

Course Approved for ALL Veteran Training. 45th Year.
LEWIS HOTEL TRAINING SCHOOL, Rm. FS-312, Wash. 7, D.C.

FREE AMAZING NEW BOOK "HOW TO ANSWER ADS"



Never before have you seen anything like this. Tells you in simple language the correct way to answer ads. Gets you quicker replies—better results, and greater satisfaction. Will save you time and money and it's ABSOLUTELY FREE. No obligation whatever. Every reader of advertising should have this booklet. Send a postcard for your copy NOW. F. W. JOHNSON, Popular Mechanics Magazine, Room 600-A, 204 East Ontario Street, Chicago 11, Ill.

MAKE BIG MONEY in MAIL ORDER!

It's easy to start and operate a mail order business of your own. You need little or no capital and you work in your spare time. Mail Order Business Magazine is written by experts who tell you everything there is to know about the mail order business. Ideas, methods, new products, free publicity, etc. For FREE Details, rush postcard with your name and address today to—

MAIL ORDER BUSINESS MAGAZINE
550 Fifth Avenue, Dept. M-4 New York 36, N. Y.

Now Many Wear FALSE TEETH With Little Worry

Eat, talk, laugh or sneeze without fear of insecure false teeth dropping, slipping or wobbling. FASTEETH holds plates firmer and more comfortably. This pleasant powder has no gummy, gooey, pasty taste or feeling. Doesn't cause nausea. It's alkaline (non-acid). Checks "plate odor" (denture breath). Get FASTEETH at drug counters everywhere.

NOVEMBER 1960

FREE CAREER BOOKLET

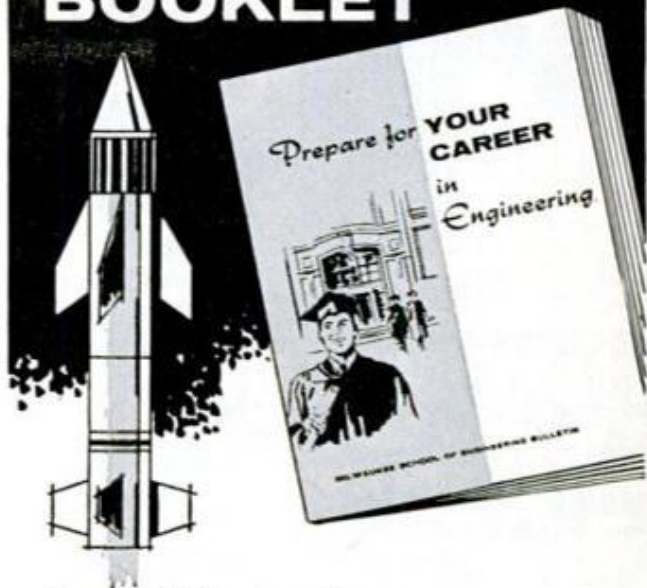

To guide you to a successful future in

METALLURGY MECHANICAL ENGINEERING AIR CONDITIONING INDUSTRIAL TECHNOLOGY

This interesting pictorial booklet tells you how you can prepare for a dynamic career as a Mechanical Engineer or Engineering Technician in such rewarding fields as:

**DEVELOPMENT • RESEARCH • SELLING
PRODUCT DESIGN • PURCHASING
QUALITY CONTROL • TIME STUDY**

Get all the facts about job opportunities, length of study, courses offered, degrees you can earn, scholarships, part-time work — as well as pictures of the Milwaukee School of Engineering's educational and recreational facilities. No obligation — it's yours free.

MILWAUKEE SCHOOL OF ENGINEERING

MAIL COUPON TODAY!

Milwaukee School of Engineering
Dept. PM-1160, 1025 N. Milwaukee St., Milwaukee, Wis.

Please send FREE "Your Career" booklet
I'm interested in Metallurgy Air Conditioning
 Industrial Engineering Mechanical Engineering
 Electrical Engineering.

Name _____ Age _____
PLEASE PRINT

Address _____

City _____ Zone _____ State _____

I'm eligible for veterans education benefits.

Discharge date _____ MS-118

Don't be half-trained... CHOOSE YOUR CAREER IN



Train at home...
in spare time...
in one of America's
Big 3 industries!!!

MAKE MORE MONEY... A Successful Career... Security... Are Yours NOW in Modern Industry!

Every one of the "Big 3" industries...TV-RADIO-ELECTRONICS...AUTO MECHANICS AND DIESEL...AIR CONDITIONING-REFRIGERATION-ELECTRICAL APPLIANCES... each is growing at a tremendous pace.

Right now is the best time for you to get into the industry of your choice! You can be a part of its growth...you can increase your earning power... you can really build a Successful, Secure Future, filled with all the good things life has to offer!!! Send for information NOW...TODAY. We'll give you all the facts by mail. There is no obligation on your part...nor will you be inconvenienced...as NO SALESMAN WILL CALL ON YOU!!!

N. T. S. TRAINS YOU RIGHT, FAST AND EASY!

Incomplete "short-cut" training limits your earning power, even disqualifies you for top-pay jobs. N. T. S. gives you training in All Phases...to qualify you for any job in your field...for greater profits all year 'round!

YOUR N. T. S. TRAINING IS BETTER, MORE COMPLETE, LOWER COST!

BETTER...proved and tested in N. T. S. Resident School Shops and Laboratories, by the OLDEST and LARGEST School of its kind in the world. Established in 1905.

MORE COMPLETE...you learn ALL Phases, and you receive EVERYTHING YOU NEED—Lessons, Manuals, Diagrams, many big Professional Kits with parts, tools, instruments for your experimental, repair, service, and trouble-shooting projects. You also receive many valuable training "Extras" to assure your success.

LOWER COST...other schools make several courses out of the material in each one of our MASTER COURSES...and charge you more for less training than you get in any one of our "Big 3" at ONE LOW TUITION.

EARN AS YOU LEARN

We'll show you how you can earn money right from the start. Many students pay for their courses—and earn much more—while studying. So can you!

RESIDENT TRAINING AT LOS ANGELES
If you wish to take your training in our Resident School at Los Angeles, start NOW in our big, modern Shops and Labs. Here you work with latest equipment, professionally installed... finest most complete facilities offered by any school. Expert, friendly instructors. Personal attention. Graduate Advisory Service. Help in finding home near school... and part time job while you learn. Check box in coupon for full information.



NATIONAL TECHNICAL SCHOOLS
WORLD-WIDE TRAINING SINCE 1905
4000 SO. FIGUEROA ST.,
LOS ANGELES 37, CALIF., U. S. A.

TELEVISION RADIO-ELECTRONICS

SEND FOR YOUR
FREE
OPPORTUNITY BOOK
AND ACTUAL LESSON
NOW!!!



YOU ARE NEEDED in All Phases of TELEVISION-RADIO-ELECTRONICS... Servicing, Communications, Broadcasting, Manufacturing, Automation, Radar and Micro Waves, Missile and Rocket Projects, plus all the other high-pay branches of this vigorous industry. N. T. S. Shop Tested Home Training gives you ONE MASTER COURSE... at ONE LOW TUITION... to train you for these unlimited opportunities, including many technical jobs leading to supervisory positions.

YOU BUILD MANY EXPERIMENTAL AND TEST UNITS WITH KITS AND PARTS WE SEND YOU... you advance step by step, perform more than 100 experiments, and you build a complete, modern circuit TV set from the ground up! The set is yours to keep, including the big new TV picture tube we send you at no extra charge. You also build and keep a Short Wave-Long Wave Superhet Receiver. In addition, you receive a valuable Multitester for your repair, service, and trouble-shooting job projects. **UP-TO-DATE, PRACTICAL LESSONS AND INSTRUCTION MATERIAL**... you'll find that every N. T. S. Shop Tested Home Training lesson and manual is easy to understand with many numerous illustrations and diagrams. See for yourself. Check the Actual Lesson you receive FREE along with our Opportunity Book. Clip and mail coupon NOW!

NATIONAL TECHNICAL SCHOOLS

WORLD-WIDE TRAINING SINCE 1905

MAIL NOW TO

National Technical Schools, Dept. B-110
4000 S. Figueroa St., Los Angeles 37, Calif.

Please rush FREE Book and Actual Lesson checked below. No obligation. No salesman will call.

(CHECK ONE ONLY)

- "My Future in TV-Radio-Electronics" Book
 "My Future in Auto-Mechanics & Diesel" Book
 "My Future in Air Conditioning, Refrigeration & Electrical Appliance" Book

Name _____ Age _____
Address _____
City _____ Zone _____ State _____

Check here if interested ONLY in Resident Training at Los Angeles.
VETERANS: Give date of discharge _____

be a MASTER TECHNICIAN

ONE OF THESE 3 BIG PAY INDUSTRIES

AUTO-MECHANICS & DIESEL

SEND FOR YOUR
FREE
OPPORTUNITY BOOK
AND ACTUAL LESSON
NOW!!!



TAKE YOUR CHOICE... be a successful all-around car, truck and heavy-engine Mechanic. Or specialize in your favorite field...Tune-Up, Automatic Transmissions, Farm Mechanics, Trucks and Buses, Stationary Installations, Foreign Cars, or get into Auto Air Conditioning, Engine Rebuilding, Diesel, and all the other high-pay fields too numerous to mention here. Or go into business for yourself. Remember...a qualified ALL AROUND MECHANIC always has a good job!

EVERY PHASE SHOP TESTED...our streamlined lessons, manuals and other training materials are easy to understand, completely practical and right up-to-date. YOU ALSO GET AND KEEP VALUABLE PROFESSIONAL EQUIPMENT. We send you a complete set of Mechanic's tools...an All-Metal Tool Box...a Motor Analyzing Set containing three valuable instruments in a sturdy carrying case... plus a Top Quality Socket Wrench Set with Fittings.

PROVE IT TO YOURSELF...N.T.S. gives you everything you need to make more money in today's big, opportunity filled Auto Mechanics and Diesel Industry. Send coupon!

AIR CONDITIONING REFRIGERATION & ELECTRICAL APPLIANCES

SEND FOR YOUR
FREE
OPPORTUNITY BOOK
AND ACTUAL LESSON
NOW!!!



FUTURE BRIGHT FOR TRAINED MASTER TECHNICIANS...over 30,000 new Technicians must be trained annually. You are needed to help service and repair the 50 million air conditioners, refrigerators and electrical appliances that will need fixing this year alone. No wonder the Master Technician has steady work, at high pay, year after year. You can go places in your own business or with a manufacturer, dealer, distributor or department store. With All-Phase training, your earning power is unlimited!

JOB TRAINING AT HOME...you get Professional Technician's Tools, Precision Instruments, PLUS a factory-made APPLIANCE TESTER...a full set of PRACTICAL, professional equipment! You use them to conduct over 100 experiments...in your Spare Time Work while in training...and in your service, repair, and trouble-shooting work later on. It is all yours to keep!

DON'T LOSE OUT—FIND OUT...we'll rush you our big, illustrated OPPORTUNITY BOOK AND ACTUAL LESSON. No-obligation. It costs nothing to find out. Mail coupon...DO IT NOW!

SEND ONE OF THE 3 COUPONS TODAY! ASK ONE OR TWO FRIENDS TO DO THE SAME. IT'S FUN TO STUDY TOGETHER.

NATIONAL TECHNICAL SCHOOLS

WORLD-WIDE TRAINING SINCE 1905

MAIL NOW TO

National Technical Schools, Dept. B-110
4000 S. Figueroa St., Los Angeles 37, Calif.

Please rush FREE Book and Actual Lesson checked below. No obligation. No salesman will call.

(CHECK ONE ONLY)

- "My Future in Auto-Mechanics & Diesel" Book
 "My Future in TV-Radio-Electronics" Book
 "My Future in Air Conditioning, Refrigeration & Electrical Appliance" Book

Name _____ Age _____

Address _____

City _____ Zone _____ State _____

Check here if interested ONLY in Resident Training at Los Angeles.

VETERANS: Give date of discharge _____

NATIONAL TECHNICAL SCHOOLS

WORLD-WIDE TRAINING SINCE 1905

MAIL NOW TO

National Technical Schools, Dept. B-110
4000 S. Figueroa St., Los Angeles 37, Calif.

Please rush FREE Book and Actual Lesson checked below. No obligation. No salesman will call.

(CHECK ONE ONLY)

- "My Future in Air Conditioning, Refrigeration & Electrical Appliance" Book
 "My Future in TV-Radio-Electronics" Book
 "My Future in Auto-Mechanics & Diesel" Book

Name _____ Age _____

Address _____

City _____ Zone _____ State _____

Check here if interested ONLY in Resident Training at Los Angeles.

VETERANS: Give date of discharge _____

WANTED!

Mechanically Inclined
Men to Qualify for
BIG PAY JOBS
AND SPECIAL FACTORY
TRAINING IN DIESEL



"We need qualified repairmen, operators, mechanics NOW!" say Diesel Manufacturers, Highway Builders, Truck Line Operators in every corner of America. Can you qualify for these High Pay Jobs? We can help you! Interstate's General Course and Cummins-approved Diesel home-training courses are internationally recognized. Advisory placement service for trainees. Don't wait. Men are needed NOW!

Get the Facts Today!

WRITE INTERSTATE TRAINING SERVICE

Dept. A-3, Portland 12, Oregon

Rush information on I.T.S. Diesel Courses, Special Factory Training and Diesel Job Opportunities.

Name _____

Address _____

City _____ Zone _____ State _____

GET INTO ELECTRONICS

V.T.I. training leads to success as technicians, field engineers, specialists in communications, guided missiles, computers, radar, automation. Basic & advanced courses in theory & laboratory. Assoc. degree in 2 1/2 mos. B.S. obtainable. ECPD accredited, G.I. approved. Graduates with major companies. Start Feb., Sept. Dorms, campus. H. S. graduate or equivalent. Catalog.

VALPARAISO TECHNICAL INSTITUTE
DEPT. D VALPARAISO, INDIANA

... TURN CONCRETE INTO GOLD!



**MAKE UP TO \$75 A DAY
IN YOUR OWN BUSINESS**

If you want to have your own business — to start a business on your own — here's your big opportunity! New high speed, low cost General block machine produces up to 1,000 concrete blocks a day. Sell all you make to builders, supply houses, and others for homes, factories, buildings, garages. Cash in on the building boom! You can make profits of 100% to 150% — up to \$75 a day! General block machine equipped with 1/2 h.p. electric motor — or can be supplied with gasoline engine — works anywhere, in little space, indoors or out. Operates from ordinary house light socket. Simple, foolproof 3 step operation — so easy a child can do it. Makes superior 3 core blocks any size from 4" to 12". Also makes chimney, sash, corner and other types. Blocks meet any building code anywhere in the country. Materials — sand, water, cement, available anywhere. Simple illustrated operating instructions and mixing formulae for cement and cinder blocks supplied with each machine. Write for FREE folder with full information.

MOTOR DRIVEN

R.L.T. of New York City reports: "MY GENERAL BLOCK MACHINE PAID FOR ITSELF IN FIRST 2 WEEKS!" Hundreds now in use the world over! Write for FREE details today!

EXTRA

book gives floor plans for 6 sensational concrete block bungalows. Tells how to lay blocks, lay out building lines, mix concrete, build steps, porch and concrete floors all at great savings. Written by experts. Can save many times the cost of the machine! Get it now! No strings attached. Send \$1.

BOOK SENT FREE IF YOU BUY MACHINE.
\$1 REFUNDED IF YOU BUY LATER.

GENERAL ENGINES CO.

DEPT. M-110, ROUTE 130, THOROFARE, N. J.



Only \$1 Prepaid



TUNE IN ON THE INVENTORS

By John Linkletter

PULSATING BRAKES that go on and off rapidly have been designed to combat the tendency of auto wheels to slide sideways when brakes are applied on slippery surfaces. Inventor of the braking system is Burton S. Aikman of St. Petersburg, Fla. The pulsating effect is obtained by subjecting a piston to a pulsating oil pressure. The device may be connected or disconnected at will in response to road conditions. Patent number is 2,949,740.

A light-sensitive device will let you know how you're progressing with your sun tan (or burn) by popping out such warnings as "light," "medium," or "dark." It's essentially an exposure meter which has a number of areas sensitized with photographic emulsion. These areas are of different sensitivities so that they darken in the sun at different periods, allowing the words of warning (printed in reducing agent) to become visible. Invented by Stephen Fromer of Staten Island, N.Y., the meter won patent No. 2,949,880.

Automation has come to snowball fighting! R. D. Smith of Iroquois, Ont., has come up with a toy that makes and launches snowballs. Snow placed in the barrel of the gunlike launcher is packed by two cup-shaped pieces. One cup swings out of the way when the gun is cocked, and a trigger then releases a spring mechanism. Smith received patent No. 2,948,275.

An entire evening of television viewing can be programmed on a channel selector that will automatically switch the set from station to station at the right time. The selector consists of an electric clock incorporating a contact which is coupled with the hour hand and a ring of conducting rods around the rim of the clock face. Inventor is Arnold M. Steffan of Woodland Hills, Calif., and patent is No. 2,951,918.

When it's not drying the wash, Dellis Forbush's rotating clothesline can be fixed up with swing seats and turned into a merry-go-round. An electric fan acts as a propeller to turn it. Forbush, of Sandy, Utah, won patent No. 2,950,109. ★ ★ ★

Learn DRAFTING

For Top Pay—Unlimited Opportunities

Train in spare time at home for the excellent rewards which can be yours through Drafting. All manufactured products start at the drafting board.

This can spell real opportunity for you if you are trained in this interesting and profitable field. Don't be satisfied with a future-less career—get all the facts. Send today for Free Book "Careers in Drafting."

Accredited Member, National Home Study Council

UTILITIES ENGINEERING INSTITUTE

419 So. Dearborn, Dept. 1159 DR, Chicago 5, Ill.

make your own Gems 36⁵⁰

The Gem Maker comes complete with all necessary equipment, including a super-charged diamond blade for sawing, and all the wheels for grinding, shaping and polishing; also complete instructions. The complete equipment as shown, less motor and belt for only \$36.50, f.o.b., Burlington, Wisconsin. Write today for information and literature.

B&I MANUFACTURING CO.
Dept. P Burlington, Wis.



Learn MECHANICAL DENTISTRY

To make Crowns, Plates, Bridgework, etc., for Dentists. Easy practical way to learn mechanical dentistry at home in spare time. FULL EQUIPMENT OF TOOLS AND MATERIALS INCLUDED WITH COURSE. Low tuition. Easy terms. Write for FREE BOOK about this money making profession that is not affected by machine age.

McCARRIE SCHOOL OF MECHANICAL DENTISTRY
207 N. Broad St., Dept. 106, Philadelphia 7, Pa.

FREE!

100
WORLDWIDE
STAMPS..
just
released!



RUSH REPLY for your new, FREE collection of 100 all-different World-Wide stamps. Newest issues of the year — pictorials, commemoratives — bi-colors, mint and used. Get Togo "Summit Meeting" stamp, Netherlands KLM, South African Antarctic, colorful mask stamp of new Upper Volta Republic, many more. Many of these are in limited circulation, so you'll have them first. Supply limited, only one to a collector. Send for this valuable free collection and other stamp offers for approval, today. Rush reply, 10c for handling to GARCELON STAMP CO., Dept. NPMX, Calais, Maine.

GARCELON STAMP CO., Dept. NPMX,
Calais, Maine. Rush FREE 100 Different Stamps, other offers. Enclosed 10c for handling. (PLEASE PRINT).



"I Earn Two Incomes Now!"

Says JOHN BENNIE, Pittsburgh, Pennsylvania

"Thanks to your wonderful training, I have been able to earn \$20 to \$25 extra each and every week doing little locksmith jobs at home and after work at my regular job. This is the best trade a man can take up."

THESE PROFESSIONAL TOOLS SUPPLIED FREE!

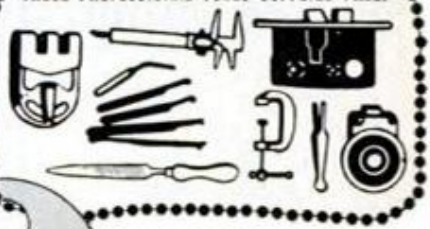

Be a LOCKSMITH

Train at HOME—Earn While You Learn

Add 50%—100% to YOUR INCOME with easy spare time earnings. Cash in on the nation-wide shortage—trained locksmiths are in demand! Quickly step into a big pay opportunity job or start a high-profit shop of your own.

Earn Extra Money RIGHT AWAY! All Special Tools, Supplies Furnished FREE.

Age, education, minor physical handicaps don't matter in this growing trade. You can quickly qualify as a skilled locksmith. It's like a fascinating hobby. Study at home as little as one hour a week. Gain practical experience through well-illustrated lessons. Do real jobs on car locks, house locks, padlocks and safe locks, under the guidance of experts.

FREE illustrated book will bring you interesting details about big money opportunities in locksmithing. Write for it today—no obligation—no salesman will call.

LOCKSMITHING INSTITUTE, Dept. 111
(Div. Tech. Home Study Schools)
150 Park Avenue, E. Rutherford, N. J.

SEND FOR
FREE BOOK!

PROFESSIONAL TOOLS
FREE
WITH COURSE.

APPROVED FOR
VETERANS

MAIL COUPON FOR FREE BOOK.

For a future as your own boss or in a high-pay job, write now for FREE illustrated book. Only school of its kind. Licensed by State of New Jersey.

Accredited,
Nat'l Home
Study Council

MAIL COUPON NOW!

LOCKSMITHING INSTITUTE, Dept. 111
150 Park Avenue, East Rutherford, N. J.

Please send without obligation the FREE illustrated book, "Your Opportunities in Locksmithing." I understand no salesman will call.

Check if Veteran

Name.....

(Print Here)

Address.....

City.....Zone.....State.....



AUTOMATIC-EXPOSURE CAMERA HAS POWER-DRIVEN FILM ADVANCE

Eastman Kodak Co., Rochester 4, New York

"Most automatic of the automatic cameras," the Kodak Motormatic 35 features fully automatic exposure control and an automatic flash calculator, with a new power-driven film advance that lets you shoot 10 exposures in seven seconds. The automatic features can be bypassed, however, for special effects. Other features: 44-mm. f/2.8 lens with click-stop zone focusing; projected frame viewfinder; click-stop shutter control.

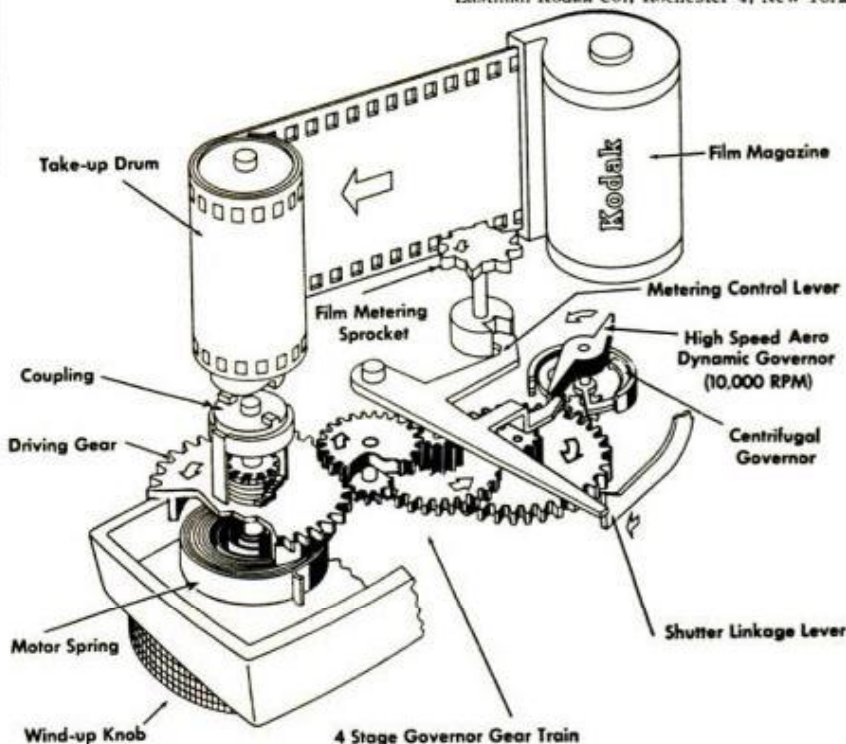

Excitement! Security! Good Pay! **CRIME DETECTION**

LEARN AT HOME IN SPARE TIME—START NOW!
Crime everywhere is on the rise! Learn now, in your own home, the profitable profession that enables you to track down criminals and bring them to justice! Hundreds of Identification Bureaus employ I. A. S. graduates... trained in finger printing, police photography, handwriting identification, firearms and investigation. Our 44th year! FREE "Blue Book of Crime"... packed with crime facts and the full story of famous I. A. S. training. State exact age. No salesman will call. Rush Coupon!
A Correspondence School Founded in 1916.

FREE

Blue Book of Crime

MAIL COUPON

INSTITUTE OF APPLIED SCIENCE, Dept. 1358
1920 Sunnyside Avenue, Chicago 40, Ill.

Rush Blue Book of Crime... FREE!

NAME.....Age.....
ADDRESS.....
TOWN.....STATE.....

TELEPHONES



MODERN CRADLE STYLE

\$3.00

2 for \$5.00

Genuine telephone company phones, reconditioned. Ideal for Inter-House, House-to-Barn, Office to Shipping Room, etc. Battery operated. Guaranteed. Also, Magneto Telephones for Farms, Camps and Mines. Telephone Materials and Supplies of all kinds.

TELEPHONE DEPT. PM-132, 1760 Lunt Avenue, Chicago 26
"America's Largest Independent Telephone Repair Shop"

MONEY in WORMS

Sell 20,000 fishworms per week @ \$4 per 1000 from a bed 3 feet wide and 8 feet long. We teach you how to raise and where to sell fishworms and crickets. Write for free literature.

CARTER WORM RANCH, PLAINS, GEORGIA

Read our success story in LIFE MAGAZINE, December 28, 1959 Issue



LOOK

AT THE AMAZING PRICES

PAID AT GOV'T SURPLUS SALES

Autos.....\$78	Tractors.....\$68
Trucks.....\$212	Motors.....99¢
Boats.....\$5.90	Typewriters..\$6.80
Compressors..\$9.69	Generators..\$8.78

PAY 2 or 3¢ on the DOLLAR for 1000's of Useful Items of U.S. GOV'T SURPLUS

You BUY DIRECT from U. S. Government at TREMENDOUS savings. Eliminate middlemen—Save BIG MONEY! Pay as LOW as 2¢ on the dollar. Our DIRECTORY Gov't Surplus Sales lists 100's Army, Navy, Air Force Surplus Depots all over the world. BUY JEEPS, sports equipment, hunting, fishing and photographic equipment and supplies, radio, electronic and electrical equipment, trucks, boats, airplanes, Plumbing, hardware, office equipment & supplies. Tools, machinery, furniture. This 1960 book tells how to buy Gov't Surplus DIRECT. No dealer profits to pay. Get on the gravy train NOW! Send \$1 TODAY for "Gov't Surplus DIRECTORY" to **AVIATION SURPLUS, Dept. PM-11, Box 789, York, Pa.**

ADVERTISED IN LIFE

**make \$10 an hour—
\$300 a week**

HELP US
SUPPLY THE OVERWHELMING DEMAND
FOR OUR NEW, REVOLUTIONARY

sunmaster "Multi Million-Prism"

5 YEAR BULBS

Wonderfully soft, flattering, eye-comfort light unconditionally guaranteed for 5 years. (Outlasts 13 ordinary bulbs.) Unlimited earning possibilities! **ONE-TIME-ONLY OFFER** — Send \$1.98 for six sample bulbs worth \$4.69. Sell them or return for full refund.

Silicate-treated to assure positive overall light for 5 years

Write for free Dynamic Sales Kit.
SUNMASTER ELECTRIC PRODUCTS, INC.
Dept. PM11, 366 Fifth Ave., New York 1, N. Y.
In Canada: Dept. PM11, 539 King Street West, Toronto, Ont.

High School at Home

No classes...interesting spare-time home study; standard texts; credit for previous schooling; diploma awarded. Equivalent to resident school work. If you've completed 8th grade and are over 17, write for free catalog and Sample Assignment in English Review.

Accredited Member, National Home Study Council

Wayne School of La Salle Extension University
A Correspondence Institution

419 So. Dearborn St., Dept. 1159W, Chicago 5, Ill.

TRAINED AND SKILLED MEN IN CLOCK AND WATCH REPAIR

Are Needed in Watchmaking, Electronics, Defense, Aviation, and other technical and precision instrument fields. NOW IS THE TIME TO LEARN THIS VALUABLE TRADE. But, Before You Enroll in Any HOME STUDY Course in Watchmaking, Write for Your Copy of "LEARN THE FACTS." **KANSAS CITY SCHOOL OF WATCHMAKING**
1226 Admiral Blvd. Kansas City 6, Missouri

REAL ESTATE BE A BROKER

PAYS BIG! SEND FOR FREE, BIG, ILLUSTRATED CATALOG NOW! Graduates report making substantial incomes. Start and run your own business quickly. Men, women of all ages, learn easily. Course covers Sales, Property Management, Appraising, Loans, Mortgages, and related subjects. **STUDY AT HOME** or in classrooms in leading cities. Diploma awarded. Write TODAY for free booklet! No obligation.

Approved for World War II and Korean Veterans
WEAVER SCHOOL OF REAL ESTATE (Est. 1936)
2020R Grand Avenue Kansas City, Mo.

FREE BOOK TELLS HOW

MEN PAST 40

Afflicted With Bladder Trouble,
Pains in Back, Hips, Legs,
Nervousness, Tiredness.

If you have these troubles, particularly bladder trouble, then your condition may be traced to Glandular Inflammation . . . a constitutional disease. Neglect of this condition often leads to premature old age and sometimes incurable malignancy.

The Excelsior Medical Clinic has a New Free Book that tells how thousands of men have been successfully treated here at Excelsior Springs for Glandular Inflammation by NON-SURGICAL Methods. They found soothing relief and a new outlook in the future of life.

This Free Book may prove of utmost importance in your life. Write Today. There is no obligation.
Excelsior Medical Clinic, Dept. B6129, Excelsior Spgs., Mo.

Learn Now at Home to Make BIG MONEY in ELECTRICITY!



New Course is Really 3 in 1 — Shows You How To MAKE MORE MONEY IN YOUR SPARE TIME

Make a lot more money this time next year! Get into Electrical work, the growing field of Opportunity. Demand for trained men at all time high. Easy to learn. Your income can start upward within surprisingly short time. Go as far as YOU like—a highly respected, highly paid career can be yours upon completion of training.

Most courses in Electrical work teach you to repair appliances (which can be very profitable) and stop right there. But I.T.I.'s Electrical course is really 3 courses at the price of one! First you learn, at home, in spare time, to fix fans, motors, vacuum cleaners, toasters, all appliances and wiring found in the home today. This can pay off for you immediately in the form of sideline neighborhood electrical repair work at \$5 to \$8 an hour!

—Or Enjoy Profitable Business of Your Own

Most Electrical Courses stop here, but not I.T.I. You'll be receiving training that will enable you, upon completion, to go into business for yourself—make good money (as much as \$110 to \$175 weekly, depending on kind of work you choose) as Electrician, Electrical Contractor, Shop Manager. You'll know your business, too—you'll learn by doing, and you receive as part of your I.T.I. course Kits to construct valuable Testing Equipment you'll use to good advantage later—Equipment that would cost you hundreds of dollars if you bought it, pre-assembled, through regular Electrical Supply sources.

—OR GO ON TO A TOP PAY CAREER

You will be ready, if you choose, to take your place among top-pay Electrical men with most any company, just about anywhere in the U.S. you want to live and work—as fully qualified Plant Electrician, Maintenance Man, or Electrical Foreman. Advancement is usually accelerated because I.T.I. training, though deceptively easy, is also thorough—you'll know your business and your employers will know you know it, too. In fact, I.T.I. has successfully trained over 400,000 men since 1916—proof that, regardless of age, education, past experience, YOU can learn profitable Electrical Work too! See for yourself—rush Coupon for FREE SAMPLE LESSON and complete details right now!

INDUSTRIAL TRAINING INSTITUTE, Dept. 11
2150 Lawrence Avenue, Chicago 25, Illinois.

Industrial Training Institute, Dept. 11
2150 Lawrence Avenue, Chicago 25, Illinois
Please rush FREE SAMPLE LESSON, details of the exciting Opportunities for me in Appliance Repairs, a business of my own, or a top-pay Career in Electrical work.

Name _____

Address _____

Town _____

State _____

Age _____

Occupation _____

.308 WINCHESTER CALIBER SPORTING RIFLE

\$24.95
with adjustable open sights

\$29.95
mounted with 4X fully adjustable scope



NEW NATO HIGH VELOCITY CALIBER

.308 Winchester is the new official NATO caliber, sporting and target ammo available at all sporting goods stores. This is a lightning fast bolt action rifle, 5-shot detachable box magazine, 22" barrel with sharp accurate bores, precision machined, all milled parts. \$75 value. Add \$5 for select collector's grade exterior.

BRITISH Custom SPORTER FIRES WINCHESTER .303 AMMO

Powerful .303 British caliber ammo is made in the U.S. by Winchester, Remington, Peters, etc. Available at all sporting goods stores. Our superb .303 sporter conversions are created from selected late model Lee-Enfield Mark 4 10-shot bolt actions, sharp, clean bores. Pistol grip contoured sporter stock. Add \$5 for select exterior.

GUNSMITHING: These are fine sporter conversions with prime hardwood stocks shaped to sporter contours. We lighten, round forestocks, install swivels, headspace, testfire and guarantee. **SURPLUS SCOPE** purchase allows us to make this fantastic offer! We have picked up just a few hundred of these 4X color corrected scopes (adj. for windage, elevation) at inventory clearance. We mount and bore-sight at our cost with purchase of rifle. **ACCESSORIES & AMMO:** .308 or .303 half-price ammo special: 20 rds. softpoint, \$2.95. Leather sling, \$2. Cleaning rod, \$1. Gun case, heavy duty, \$2. cleaning kit (patches, bore cleaner, gun oil, brushes) \$1. **TO ORDER:** Enclose check, cash or money order. \$10 deposit for C.O.D. Shipped F.O.B. Culver City, 10-day free trial period with money back guarantee. Calif. res. add 4% state tax.

\$24.95
mounted with 4X fully adjustable scope

\$19.95
with original peep sights



Target Ammo. for .303 only, 100 rds. \$7.50

MARTIN B. RETTING, INC. 11029 Washington Blvd., Culver City 71, Calif.

Millions have done it so can YOU!



Stop being **SKINNY** like I was
Quickly **GAIN 25 LBS.** of
HANDSOME, POWER-PACKED MUSCLES like I did



Send for these 5 **AMAZING PICTURE COURSES**
All **5 FREE** before \$1 price goes back

1. How to **GAIN MIGHTY ARMS**
2. How to **GAIN A BIG CHEST**
3. How to **GAIN A MIGHTY BACK**
4. How to **GAIN POWERFUL LEGS**
5. How to **GAIN A GRIP OF STEEL**

Send 10¢ for postage for all 6 items.

Also **FREE Photo Book of Strong Men**

Jowett Institute, Dept. PM-011, 220 Fifth Avenue, N. Y. 1, N. Y.

LEARN WHILE YOU SLEEP!



Hypnotize self, others while asleep with amazing hypnotic phonograph records, tapes. Free catalog lists 200 unusual records, tapes & equipment for sleep-learning & hypnosis experimenters. Sleep-Learning Research Ass'n., Box 24-D, Olympia, Washington.



Army Truck Takes to the Water

When a five-ton, eight-wheel-drive truck, newly developed to carry men and cargo for the U. S. Army, is equipped with a kit that includes a rudder and propeller, it can cruise through inland water at six miles an hour. Then, bulling its way onto dry

land, it can roll down the highway at 50 miles an hour. An important feature of the truck is its ability to carry and tow a combined load of almost twice its weight of 12,020 pounds. It can carry a load of 10,000 pounds and tow an additional 11,000 pounds.

POPULAR MECHANICS

cabana marrone



PLAN YOUR FUTURE NOW... have a business of your own

Luxurious, high-fashion fur now being ranch-raised in U.S.A. and Canada. All select, pedigreed, registered stock. Easy and economical to raise in any climate. One pair should produce 10 to 15 young per year. Warranty assures life and production. You may qualify for membership in CNBA (Cabana Nutria Breeders Association), the largest and strongest Nutria association. Free ranch training program, Cabana Marrone Nutria garments nationally advertised.

Cabana Marrone available only through authorized distributors. Write for complete information. Distributor inquiries invited.



CABANA NUTRIA INC.
Dept. 71 636 West Lemon Arcadia, Calif.

"MINIATURE MACHINE SHOP

No Bigger Than A Typewriter, Outperforms Machines Many Times Its Size!

That's what a popular publication says about UNIMAT in their 3 page feature story in the May issue. If you want a reprint of this story plus complete information about this amazing 10 in 1 combination precision tool write to:

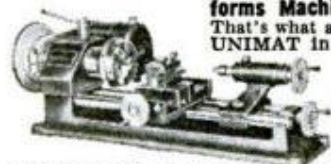

AMERICAN EDELSTAAL, Inc.

UNIMAT DIV., DEPT. GK, 350 BROADWAY, NEW YORK 13

Secrets of VENTRILOQUISM Now Revealed!



Easy to learn in 60 to 90 days with our Home Study Course. **RESULTS GUARANTEED.** Make Money! Be Popular! Have Fun! Big Opportunity! Radio, Television, Stage Appearances! For FREE Information regarding price and terms WRITE. You must state your age. Dummy Catalog 25c.

MAHER HOME COURSE OF VENTRILOQUISM
Box 36, Studio PM-11, Kensington Station
Detroit 24, Michigan



SEND FOR THIS FREE!

Make money. Know how to break and train horses or ponies. Write today for this book **FREE**, together with special offer of a course in Animal Breeding. If you are interested in Gaiting and Riding the saddle horse, check here (). Do it today—now.

BEERY SCHOOL OF HORSEMANSHIP
Dept. 11011 Pleasant Hill, Ohio

FREE CATALOG



The WORLD'S FINEST ELECTRONIC GOV'T SURPLUS BARGAINS:

Transmitters, Receivers, Meters, Microphones, Headsets, Amplifiers, Motors, Generators, Gyros, Automatic Pilots, Test Equipment, Telephone Equipment, Etc.—Etc. Send for your FREE Catalog today! Address Dept. PM-11

FAIR RADIO SALES • P.O. Box 1105 • LIMA, OHIO

I'll Send You This Handsome SAMPLE CASE—FREE



and Show You How to Make
Up to \$30.00 in a Day

WRITE for this FREE Tailoring Sample Case packed with 100 beautiful, big-value suit and overcoat fabrics. Take orders from friends, fellow-workers, others, for fine quality, made-to-measure clothes. Pocket big cash profits in advance. Because wearing our suits and overcoats brings more orders, we make it easy for you to get your own clothes without its cost. No experience is needed. **SATISFACTION GUARANTEED.** SEND NO MONEY. Rush your name, address, and age—today!
J. C. FIELD & SON, INC., Harrison & Throop Sts.
DEPT. N-1716 CHICAGO 7, ILLINOIS

TRAIN AT HOME

in Your Spare Time or in the Great Allied School

1338-42 South Michigan Ave.
Chicago 5, Ill.

DRAFTING—All Branches
• Mech. • Structural • Aeronautical

ENGINEERING
• Industrial Engineering
• Tool Engin. & Designing

ELECTRONICS

AUTO MECHANICS

AIR CONDITIONING
Refrigeration — Heating & Cooling

TOOL & DIE MAKING
Machinist Trade

Now you can
attend Allied under the
Education Fund Plan. Get Details.

PREPARE for the best jobs in your spare time at home. With ALLIED'S practical home study program you can progress so rapidly that big new opportunities will soon be open to you. Students planning a career in engineering can begin their training in short courses at Home or at Allied Institute and continue progressively toward an Engineering Degree in 31 months. Enjoy benefits of Allied's Education Fund Plan and Industrial Coop Plan. Pay almost all your tuitions from earnings. Allied is approved by Industry, National Home Study Council, Department of Education, Office of Public Instruction, State of Illinois, U. S. Department of Justice.

ALLIED INSTITUTE OF TECHNOLOGY,
1338-42 South Michigan Ave., Dept. PM-110, Chicago 5, Ill.

Send me without obligation information on your courses:

- | | |
|---|--|
| <input type="checkbox"/> MECHANICAL DRAFTING | <input type="checkbox"/> AUTO MECHANICS |
| <input type="checkbox"/> STRUCTURAL DRAFTING | <input type="checkbox"/> ELECTRONICS |
| <input type="checkbox"/> ELECTRONIC DRAFTING | <input type="checkbox"/> AIR CONDITIONING |
| <input type="checkbox"/> AERONAUTICAL DRAFTING | <input type="checkbox"/> REFRIGERATION |
| <input type="checkbox"/> INDUSTRIAL ENGINEERING | <input type="checkbox"/> TOOL & DIE MAKING |
| <input type="checkbox"/> TOOL & DIE DESIGNING | |
| <input type="checkbox"/> HOME STUDY | <input type="checkbox"/> RESIDENT |
| | <input type="checkbox"/> EDUCATION FUND |
| | <input type="checkbox"/> VETERAN |

NAME AGE.....

ADDRESS

CITY..... COUNTY..... STATE.....



REMOVE that GAG from Your VOICE

Don't you often dream of being able to command immediate attention when you speak? Wouldn't it be wonderful to have a voice that RINGS WITH AUTHORITY AND ASSURANCE . . . instead of feeling that your voice is bottled up inside you? Science has demonstrated that VOICE is one of the real secrets of PERSONALITY.

Eugene Feuchtinger has the amazing method for removing that gag from your voice . . . releasing powerful tones that will astonish you and everyone who hears you.

A SCIENTIFIC PROGRAM

Now you can learn how your voice can be made excitingly forceful for both speaking and singing. The success-winning tones you have admired can be yours! Why be handicapped in business and social life? Read Eugene Feuchtinger's new book "Voice Power and Personal Power." It may be the key to your future success. Mail coupon below TODAY!

FREE BOOK ON VOICE DEVELOPMENT



PREFECT VOICE INSTITUTE, Studio LP-2
210 S. Clinton St., Chicago 6, Ill.
Please send me, absolutely free, Eugene Feuchtinger's new book "VOICE POWER and PERSONAL POWER." I understand there is no cost or obligation. No salesman will call.

Name.....
Address.....
City..... State..... Age.....

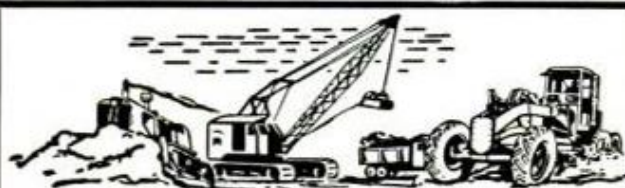

HIGH WAGES!

High wages can be yours as an Operating Engineer of heavy construction equipment! Learn NOW to operate our diesel engined bulldozers, draglines, cranes, back hoes, rubber-tired scrapers and motorgraders! Machines of major manufacturers are used in our training program. Contractors are on our advisory staff. Full courses of 220 hours for bulldozers, scrapers, motorgraders; 440 hours for cranes. National is the ORIGINAL construction equipment operators training school. COMPARE our training with any other school, anywhere!

We are NOT a correspondence school, but a fully equipped educational institution in the beautiful Piedmont area of North Carolina where you will live while you learn. Budget plan available. VETERANS: Ask about G. I. Benefits. Booking NOW for November and December classes.

Write TODAY for FREE School Catalog,
no obligation, to

NATIONAL SCHOOL of HEAVY EQUIPMENT OPERATION

Dept. D-11, P.O. Drawer 8415, Charlotte, N. C.
Western Office: 730 S. Western Ave., Los Angeles 5, Cal.

WHAT'S UP IN THE AIR



By Kevin V. Brown

AIRPORT runways may soon be sending out their own signals to lure planes down safely during poor weather conditions.

A new glide-path system, mounted flush in the concrete at the end of the runway, is being studied by the Federal Aviation Agency. Conventional systems use 25-foot antenna towers near the runways and are accurate only to within 30 feet of the point of touchdown. The flush-mounted system, besides eliminating the hazard of towers, brings the plane directly down the flight path all the way to touchdown point which is, in fact, the exact spot where the equipment is buried. Current regulations forbid descents closer than 200 feet above the runway unless it is clearly in sight, but the new system, developed by an Ohio State University team, could conceivably be used for landings without any visual contact.

Future aircraft may all be "bugged" to assure accurate navigation.

Transparent slide maps are slid into place on a new pictorial navigational device that projects a luminescent "bug." The center of the map represents the ground-station transmitting distance and bearing information, and the "bug" represents the location of the plane. Movement is synchronized electronically to duplicate movement of the plane. By watching the reticle the pilot can pursue off-course flying or maintain holding patterns over any point with complete accuracy.



HOME IMPORT BUSINESS

MEN... WOMEN... MAKE BIG PROFITS... Buy dazzling bargains abroad. Sell to friends, stores or mail order. New Drop Ship Plan puts you in *direct contact with overseas sources*—starts you full or spare time, without product investment or previous experience. Complete details **FREE**. Write *today!*

MELLINGER CO., Dept. C25B
1717 Westwood, Los Angeles 24, Calif.



... Plan shows where you get bargains like these for big profit sales. **DO NOT ORDER FROM US**



ART—LEARN AT HOME Enjoy glamorous high-pay career or profitable hobby. Learn Commercial Art, Painting, Cartooning, Fashion Art, Lettering, TV, etc. We train you at home, in spare time. **TWO 22-pc. art outfits** included free of extra charge. **LOW COST—only 20c a day.** Write for **FREE** Book describing easy method. No salesman will call. **Washington School of Art, Studio 1411, Port Washington, N. Y. (Estab. 1914)** Tear this out as a reminder.

ADDING MACHINE

\$1.98 ea. or 2 \$3.69 for

+ ADD — SUBTR. — MULT. — DIVIDE

Does all 4 operations. Handles 9 columns of numbers. Settle for no less. Leatherette case. Lowest price adder made in America. Beware of cheapened foreign imitations. Money back guarantee. Agents wanted. \$1.98 add 4% tax in Pa.

TOM THUMB P.O. Box 5066, Dept. N-10, Philadelphia 11, Pa.



RUPTURE!

An amazing Air-Cushion Invention allows body freedom at work or play. Light, neat, cool, sanitary. Durable, cheap. Day and night protection helps Nature support weakened muscles gently but surely. No risk. **Sent on Trial!** Write **NOW** for free Booklet and **Proof of Results**. All correspondence confidential.

Brooks Company, 143 D State St., Marshall, Mich.



OWN a BUSINESS

Be a Specialist in Booming Industry



Get in on the ground floor of a booming \$750 million a year industry. Fill the need in your area for safe, effective "on location" cleaning of carpets and upholstery. Every home houses a customer! We'll train and establish you in **YOUR OWN** lifetime business! Start part-time if employed. You'll be trained by a nearby dealer and at 50-hr. school to get you quickly established. You provide 6 services to multiply profits. No shop needed. Just 2 jobs a day nets \$8,750.00 first year. We back you with 27 services: counseling, nat'l advg... McCall's, Parents, etc., conventions, advg. kits, others. Booklets explain everything—no obligation, no salesman will call. Send for **Free Booklets**. **DURACLEAN COMPANY** 0-16N Duraclean Bldg., Deerfield, Ill.

FREE! NEW CATALOG Big Savings... FAMOUS MAKES! ACCORDIONS



BUY DIRECT... at Importer-to-You Prices
... save middlemen's profits!
5 DAY FREE TRIAL!

E-Z TERMS

Low as **\$9.95** Down
Balance...
Just Pennies a Day

Over 30 Standard or Electronic Models

for Students Teachers or Professional Musicians

TRADE-IN
Your Old Accordion
BIG ALLOWANCE!

SAVE UP TO 1/2

OFF RETAIL PRICES of Comparable Accordions

WORLD'S LARGEST EXCLUSIVE ACCORDION DEALER saves you more than you ever hoped possible on new famous-make Italian Accordions of your dreams! Because you buy **DIRECT... Importer-to-You... save up to 50% OFF** retail prices of comparable accordions. Compare our low prices... see and judge for yourself. Rush coupon for **FREE Color Catalogs** and low **Importer-to-You** price list. See America's most exciting selection... **over 30 models**. Exclusive features! Full range of Colors! Newest styling! Get **FREE 5-DAY PLAYING TRIAL IN YOUR HOME**. If you decide to keep instrument, pay for it only pennies a day on **E-Z terms**. 100% Satisfaction Assured. Get **FREE BONUS GIFTS** for promptness... Free Home Study Course. Trade-in allowance.

FREE BONUS GIFTS

for promptness in ordering

- Year's Supply of Music
- Home Study Course
- Sturdy Music Stand
- Name in Chrome Letters
- Bellows Protector
- Music Portfolio

Let us prove how much more you save—thanks to our money saving **Importer-to-You** plan. You pay **NO** Teacher's or Salesman's commissions. We buy for less, save on high overhead... and pass these savings on to you. Mail coupon today for **FREE Color Catalogs** and **Importer-to-You** prices. No obligation.

ACCORDION CORPORATION OF AMERICA
Dept. R-110 2003 West Chicago Ave., Chicago 22, Illinois

FREE

Color Catalogs
... Low Direct
Importer-to-You
Prices... Rush
Coupon Now!

Accordion Corporation of America, Dept. R-110
2003 W. Chicago Ave., Chicago 22, Ill.
Rush color catalog and "Importer-to-You" prices.

Name.....

Address.....

City & Zone..... State.....

Check if you have instrument to trade in.



BE YOUR OWN MUSIC TEACHER

Send for Free Book Telling How Easily You Can Learn Piano, Guitar, Accordion, ANY Instrument This EASY A-B-C Way



NOW IT'S EASY to learn music at home. No tiresome "exercises." No teacher; just START RIGHT OUT playing simple pieces. Thousands now play who never thought they could. Our pictured lessons make it easy as A-B-C to learn to play popular music, hymns, classical and any other music. Low cost. One million students including TV Star Lawrence Welk. (Est. 1898.)

Mail Coupon for FREE BOOK

Find out why our course can teach you quickly, easily, inexpensively. Write for FREE Book. No obligation. No salesman will call. Mention favorite instrument. Mail coupon today.

U. S. SCHOOL OF MUSIC

Studio 3011,
Port Washington, N. Y.



U. S. SCHOOL OF MUSIC, Studio 3011, Port Washington, N. Y.

Please send me FREE 36-page Illustrated Book. I would like to play (Name instrument):

Instruments, if needed, supplied to our students at special reduced prices.

Name (Please Print)

Address

City Zone State

FOR INDUSTRY OR HOMECRAFT 8" TILT ARBOR SAW BUY DIRECT FROM FACTORY

BLADE TILTS • TABLE
REMAINS LEVEL



Heavy duty all cast iron and steel construction. Precision ground cast iron table. Price includes massive cast iron mitre gauge and patented motor drive that fits any motor. Does everything same as saws costing five times as much—cross cuts, rips, bevels, mitres, dadoes, cuts compound angles. Adjustable depth of cut; 0" to 2 1/4".

Complete
as shown
less blade

NOW
\$9.95
FACTORY
PRICE

SPECIAL BARGAIN—This saw is our 1960 model. Brand new—sent to you in factory sealed cartons. Sold and guaranteed direct from factory to you at a fantastic bargain. This machine has features of machines costing many times more. 480,000 now out working—winning praise everywhere.

MONEY-BACK GUARANTEE

Try this famous saw 10 days. If not completely delighted—FOR ANY REASON—return for immediate refund.

SENT EXPRESS COLLECT Send check or M.O. \$2.00 deposits on C.O.D.'s. We reserve right to refund money if stock is exhausted. Avoid disappointment. Order right now!

AMERICAN MACHINE & TOOL CO.

ROYERSFORD 88, PA.



Beryllium Detector

Prospectors for beryllium, the rare element being used in space satellites because of its heat-resisting quality, can carry on their search with a new detector. Portable enough for field work, it does away with the need for time-consuming chemical analysis. In use, the detection machine captures neutrons emitted by beryllium ore as a result of its gamma irradiation. These neutrons are counted by the instrument circuitry, and either a direct reading counter or head phone is used. Comparison of sample counts against known standards is used to indicate the presence of beryllium. As the instrument contains a radioactive source, the Atomic Energy Commission requires the prospector using it to meet certain qualifications.

Electronic Sprinkler System Waters Lawn Automatically

Automatic control of the water supply to your lawn, garden, trees or even farms and orchards is possible with a new electronic control that measures the water content in the soil, then "orders" an automatic sprinkler system to add just enough water to bring the supply up to normal. Called Rain-brain, the control system is regulated by a "feeler" sphere which is buried in the ground and connected to a master controller at the water source. When the system is installed and set for the desired amount of water in the soil, it adds water until that level is reached, then adds more daily to maintain that level, but only if it's needed.

FORTUNES IN DIVING

Train at Home in Spare Time
Mail Coupon Today for Amazing Free Booklets



Here is one of the greatest opportunities of our time. Make big money fast in Skin and Lung Diving. Trained divers needed in hundreds of industries and by the government. Build a successful business of your own. Hourly rates among highest paid in any field. Training program by E. R. Cross, world famous master diver.

A Job Waiting for You Just as Soon as You Start Your Training

You can have a job in the big, profitable field of Skin and Lung Diving just as soon as you start our training — a job offering really big pay opportunities. You have a chance to immediately add to your income with good part time earnings — and build up into a full time big money position.

Divemaster—Authoritative Home Training Program

You get thorough, comprehensive training by a man many consider the greatest living authority on Diving. The Divemaster training program is illustrated by hundreds of diagrams, charts, drawings, photographs. Send the coupon for the booklets — see the facts about this program for yourself.

MAPS OF SUNKEN TREASURE

Included in the program are maps of sunken, lost, buried treasure. These large, full size maps in color show location of buried treasure in both hemispheres.

DIPLOMA AWARDED—CERTIFIED MEMBERSHIP CARD

Upon enrolling you receive your card showing you are a Certified Member and are participating in the Divemaster Skin and Lung home training program. Upon graduating you receive a large, beautiful diploma designed in deep blue against a rich gold background.

Free Booklets—Mail Coupon

Big illustrated FREE Booklets have detailed information about everything used in Skin and Lung Diving. Get the Facts—Mail Coupon Now! **DIVEMASTER, Dept. 109, 5637 W. 63rd Place, Chicago 38, Ill.**

DIVEMASTER

5637 W. 63rd Place, Dept. PM 110, Chicago 38, Ill.

Send me Free Booklets and Information about Diving.

Name Age.....

Address

City State.....



get into operating or repairing EARTH MOVING EQUIPMENT

Men needed now for good paying jobs in booming road and construction work. Learn operating or repair-rebuilding of heavy road machinery, cranes, bulldozers, earth carriers, etc. Actual "on the job" training. 5 to 13 1/2 week courses. Classes start every Monday. Reserve your space now. Complete catalog and reservation facts FREE. Approved for veterans. Write

Greer TECHNICAL INSTITUTE
Attn.: P. N. Hutch, Box 368, Braidwood, Ill.

\$6.00 OR 2 FOR \$11.00!

With 40 ft. of wire. Additional wire 3c ft. **TESTED AND GUARANTEED.** Write for free list of all types of telephones. Shipments FOB Simpson, Pa.

TELEPHONE ENGINEERING CO., Dept. 1180, Simpson, Pa.

Would YOU Like to Make \$1 000 A MONTH?



That's What Stanley Hyman Made Selling **PRESTO**

Amazing Midget Fire Extinguisher

Sensational! Presto does job of bulky extinguishers costing 4 times as much. Ends fires fast as 2 seconds; fits palm of hand. Never corrodes; guaranteed 20 years! Sells for only \$4.95. Show it to owners of homes, cars, boats, farms, etc., and to stores for re-sale — make good income. Write for FREE Sales Kit.



Stanley Hyman

MERLITE INDUSTRIES, Presto Div.

114 East 32nd St. Dept. P-15X New York 16, N. Y.
In Canada: Mopa Co., Ltd., 372 Dowd St., Montreal 1, P. Q.

LEARN UPHOLSTERY

in your spare time
run your own business
AT HOME



FREE BOOK
with
sample
lessons

BE YOUR OWN BOSS

Earn more from the start! Set up your own profitable business, in your own home, enjoy steady income, independence for life. You're in demand in the booming field of Custom Furniture Upholstery.

Right off, you start upholstery with the tools, complete frames, fabrics and materials, included **FREE** with N.Y. State-approved UTS Home Study Course. You learn skilled professional custom upholstery, reupholstery, furniture finishing, repairs, how to make beautiful slip covers, cushions and draperies. **EARN WHILE YOU LEARN**, in your spare time **AT HOME** . . . the UTS easy way. **FREE ILLUSTRATED BOOK—FREE SAMPLE LESSON** Get ready for well-paid job and big profits, from steady work, as your own boss, running your own business. Mail coupon **NOW** for **FREE BOOK!** Training in N. Y. School also available. **VET APP'VD. ACCREDITED BY N.H.S.C.**

With Course You Make:

SLIPPER CHAIR

CLUB CHAIR

OTTOMAN

PLUS SLIP COVERS
Yours to Keep or Sell

UPHOLSTERY TRADES SCHOOL
Dept. MS-310, 721 B'way, N. Y. 3, N. Y.
Please send me **FREE** book, "Your New Way to a Successful Career," and **FREE** sample lesson. No obligation—no salesman will call.
 Home Study Training in N. Y. School

Name _____

Address _____ Please Print Plainly

City _____ Zone _____ State _____

Check if Korean Veteran

LEARN MEAT CUTTING AT NATIONAL

Pay After Graduation

National School of Meat Cutting, Inc., Dept. 50-L, Toledo 4, Ohio

Send me your FREE school catalog on National Training at Toledo in Meat Cutting, Meat Merchandising and Self-Service Meats. No obligation. No salesman will call.

Name _____ Age _____

Address _____

City _____ State _____

Approved for Veterans

The steady dependable trade of Meat Cutting taught easily in 8 short weeks. **YOU LEARN BY DOING** under actual meat market conditions in big modern school at Toledo.

For beginners or men with experience. Get a profitable store of your own. Remember, **PEOPLE MUST EAT!** Big pay jobs. Free employment help. Thousands of successful graduates.

Buying, cutting, percentage, pricing, advertising, selling, etc. A complete retail meat education. National School established 37 years. Get National training NOW. Pay your tuition in easy monthly payments after you graduate. Send coupon for FREE 40 page school catalog — TODAY. G.I. approved.

**ENGINEERING
SCIENCE
MATH**

**DEGREE IN
27 or 36 MOS.**



ACCELERATED YEAR-ROUND PROGRAM prepares for early employment in fields of SCIENCE AND ENGINEERING. Regular 4-year program for B.S. Degree completed in 36 months, special engineering degree program in 27. Classes start — January, March, June, July, Sept. QUALITY EDUCATION. Graduates employed from coast to coast. Government approved for veteran training. Students from 50 states, 40 countries. 20 buildings; dorms, gym. Campus. SAVE TIME AND MONEY. EARN BOARD while studying. Write for catalog and complete information.

INDIANA TECHNICAL COLLEGE

5110 East Washington Boulevard, Fort Wayne 2, Indiana

Please send me free information on Bachelor's Degree Programs in Engineering and Science as checked below:

- | | |
|---|--|
| <input type="checkbox"/> Aeronautical Engineering | <input type="checkbox"/> Mechanical Engineering |
| <input type="checkbox"/> Chemical Engineering | <input type="checkbox"/> Metallurgical Engineering |
| <input type="checkbox"/> Civil Engineering | <input type="checkbox"/> Physics |
| <input type="checkbox"/> Electrical Engineering | <input type="checkbox"/> Chemistry |
| <input type="checkbox"/> Electronic Engineering | <input type="checkbox"/> Mathematics |

Name _____

Address _____

FREE SALES OUTFIT THAT STARTS BIG SHOE BUSINESS FOR YOU

Rush Postcard Today



Get in highly profitable, repeat-order shoe business! Sell amazing line of Air Cushion Innersole comfort shoes to friends, neighbors, fellow workers. Dress, sport, work, safety shoes for men, women. Make \$10 to \$75, as much as \$200 monthly just in spare time. No investment. Send card today for FREE SELLING OUTFIT.

Mason Shoe, Dept. G-713 Chippewa Fall, Wis.

RUPTURED?

Something different. Light and cool. No leg straps, elastic belt or cruel springs. No pressure on hips or spine. Inexpensive. Guaranteed. Write to

HAND-LOCK PRODUCTS

Est. 1893. DEPT. P.M., PRESTON, ONTARIO, CAN.



Moto-Mower, Inc., 625 South G St., Richmond, Ind.

Snow-Blower Clears Walks

Matching, in smaller scale, the snow-moving ability of the big railroad rotary plows, a new 15-inch snow-thrower for homeowners eats up drifts and throws the snow up to 16 feet to either side. It's powered by a 3.25-horsepower four-cycle engine which drives the snow impeller through a slip-clutch. The snow-throwing assembly is mounted forward on sled runners which are adjustable vertically to control the plowing depth.

KEEP YOUR...  on

BENJAMIN 

Largest Selection in the World
Single Shot & Repeaters
for Every Shooter's Needs! • 25 MODELS

**HI-COMP
AIR GUNS
AND
POWERFUL
CO₂ GUNS**

No. 3600 \$19.95

You Can **DEPEND** on BENJAMIN . . . for
Safety — Power — Accuracy — Convenience — Economy

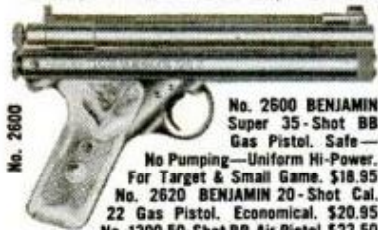

No. 2600

No. 2600 BENJAMIN
Super 35-Shot BB
Gas Pistol. Safe—

No Pumping—Uniform Hi-Power.

For Target & Small Game. \$18.95

No. 2620 BENJAMIN 20-Shot Cal.

22 Gas Pistol. Economical. \$20.95

No. 1300 50-Shot BB Air Pistol \$23.50

No. 1320 BENJAMIN 35-Shot Cal. 22 Air Pistol \$25.50

No. 3600 BENJAMIN
Super 100 Shot BB Gas
Rifle. Non-Toxic—Safe

—Convenient—Uniform

Hi-Velocity Power. →

No. 3620 BENJAMIN

Super 85 Shot Cal. 22

Gas Rifle . . . \$21.95

No. 3100 Super 100

Shot BB Air Rifle. Adj.

Shooting Force \$24.95

No. 3120 BENJAMIN

Super 85 Shot Cal. 22

Air Rifle . . . \$26.95

FREE Catalog All Models Benjamin Single Shot & Repeaters—Cal. BB or 177 or 22. Also, Special Hunting & Fishing Knife Offer.

BENJAMIN AIR RIFLE CO., 896 MARION ST., ST. LOUIS 4, MO.

If you take

Color Pix

8mm - 16mm - 35mm 127 • 120 • 620

You must get our MONEY SAVING

Free Catalog

Listing all popular KODAK and ANSCO Film Type and Sizes . . . WRITE TODAY!

SOLAR CINE PRODUCTS, Inc.

"Direct-by-Mail" Film and Processing Specialists for almost a quarter century" Dept. ME
2427 S. Kedzie Chicago 32,

BIGGER MUSCLES

YOU can become one of the most muscular men in the world! Become better developed than you ever thought possible! Be LOOKED UP TO—ADMIRER—RESPECTED! Get BIGGER, BULGING, IMPRESSIVE, POWERFUL muscles! MUCH BETTER results! FASTER results! GUARANTEED results! Write for free further information to:



JOHN SAMSON Dept. PM-1

P. O. Box 43, Tremont Station, New York 57, N. Y.

SIGN PAINTING

Home-Study Course — Only \$5.95

Teaches you commercial sign painting and sign building as it is being done TODAY in leading shops all over the country. Complete practical course for self-instruction. Shows latest methods of truck lettering, office doors, wood letters, reflecting signs, plastics, sprayed signs, gold leaf, silkscreen process, up-to-date alphabets, money-making business information, etc.



SATISFACTION GUARANTEED OR REFUND!

Contains all the instruction of a high-priced correspondence course. Full price, only \$5.95, postpaid. Or C.O.D. plus postage. No risk—order today. Satisfaction or money back! Order "Sign Painting Course," NELSON-HALL CO., 210 S. Clinton St., Dept. 2LP-2, Chicago 6, Ill.

"\$10,784 IN ONE YEAR" NEW!

SERVICING RADIATORS!

— Sidney Radiator Shop, Sidney, Mont.
Make good money servicing auto-truck-tractor radiators with new Inland 1-Piece Radiator Shop. Easy to test, clean and repair radiators. Inland, world's largest radiator equip. mfr., trains you free. Small down payment starts you. "Pays-for-itself" Purchase Plan. Profitable dept. for garage or service station. Write for free information:



INLAND MFG. CO.
Dept. PM-11
1108 Jackson St., Omaha 2, Nebr.

*After the city,
Before the state
The ZONE keeps your mail
From being late*



The Post Office has divided 106 cities into postal delivery zones to speed mail delivery. Be sure to include zone number when writing to these cities; be sure to include *your* zone number in *your* return address — after the city, before the state.

NOVEMBER 1960

BIG EARNINGS WAITING

Be a TYPEWRITER REPAIRMAN



Earn while you train at home to take your place in the booming field of typewriter repair. Skilled men are in demand. America needs thousands more trained men for this multi-million dollar field.

You can quickly step into a big-pay job or business of your own, full or part time. Learn easily to repair ALL makes of typewriters under expert guidance with clearly illustrated lessons and sub-assemblies. You work on a real typewriter, with professional tools, gain practical experience.

FREE BOOK SHOWS HOW YOU CAN ENTER THIS BIG OPPORTUNITY FIELD

Send for the FREE book that gives you vital government facts about the urgent need for trained typewriter repair men and describes the vast opportunities waiting for you.

SEND COUPON NOW!

TYPEWRITER REPAIR SCHOOL, INC.
Dir. Technical Home Study Schools
Dept. L-10, 150 Park Avenue
East Rutherford, New Jersey
Licensed by New Jersey Dept. of Education

FREE PROFESSIONAL TOOLS, TYPEWRITER SUPPLIED WITH COURSE



TYPEWRITER REPAIR SCHOOL, Dept. L-10
150 Park Avenue, E. Rutherford, N. J.

Please send Free Book "Opportunities Unlimited," at no obligation to me. (No salesman will call.)

Name.....
Address.....
City.....Zone.....State.....

AVIATION CAREER

SPECIALIZED EDUCATION / PROFESSIONAL TRAINING... only 16 months to 2 years

Top-pay prestige positions, bright future in aviation. Job opportunities waiting for you as soon as you're ready. Airframe and Powerplant Technician, Aeronautical Engineering Technologist, Business or Executive Pilot. Classes in Miami.

SEND FOR FREE 80-PAGE BOOK

Embry-Riddle Aeronautical Institute
Dept. B Miami, Florida (Founded 1926)

Name.....
Address.....
City.....Zone.....State.....

ELECTRONICS

Train in the new shop-labs of the world famous **COYNE ELECTRICAL SCHOOL** on a quarter of a million dollars worth of equipment or learn at home in your spare time with Coyne's modern television training.

Use this coupon to get our free book "GUIDE TO CAREERS"

COYNE ELECTRICAL SCHOOL
1501 W. Congress Pkwy. Chicago 7, Ill., Dept. of Electronics 2D training at Coyne training at home
NAME.....
ADDRESS.....
CITY.....STATE.....

Unlike most other schools, we do not employ salesmen.

MACHINING WORKERS

**Highly specialized skills
make these craftsmen
vitaly important to our
nation's industry**

by B. Richard

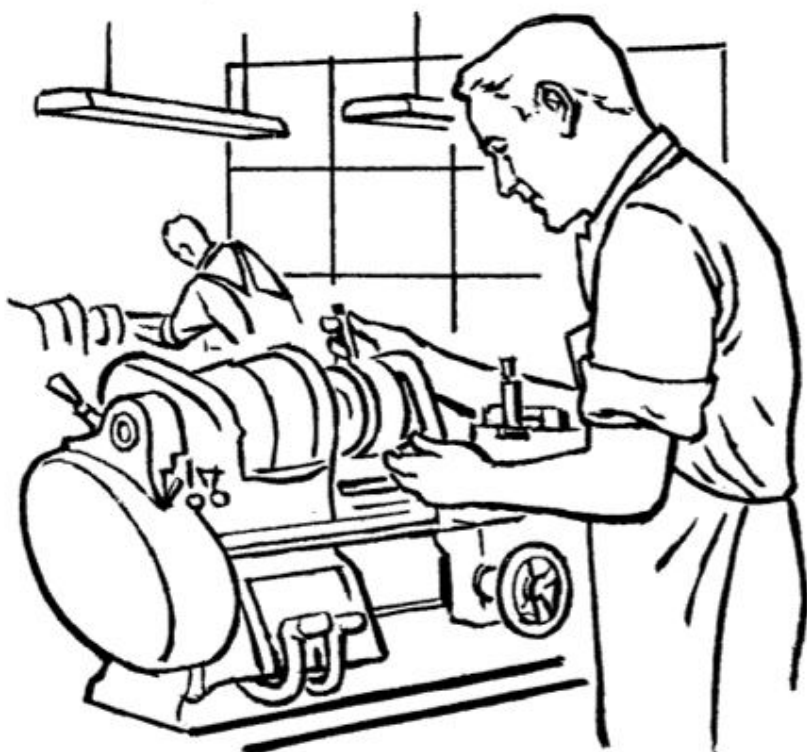

Without machining workers, American industry would come to a virtual standstill. Machining workers make most of the metal parts contained in manufactured products; and, even more important, they make the metal parts for the machines on our modern production lines.

Machine tool operators, tool and die makers and all-round machinists shape metal parts with precision accuracy, sometimes allowing for tolerances of only one ten-thousandth of an inch, and these parts are so important to industry that machining workers have been termed the "anchor men" of America's industrial team by the National Association of Manufacturers.

In 1958, over one million workers were employed in skilled or semi-skilled machining occupations, and the United States Department of Labor predicts that there will be thousands of opportunities for new workers during the 1960's.

Our growing population is expected to bring about a continuing increase in demand for metal consumer products such as cars, refrigerators, washing machines, heating equipment, stoves, freezers, etc. In addition, American industry is expected to increase its expenditures for new equipment, new plants and industrial machinery.

All of these products contain the results of the skilled machinist's labors; and, as the demand for these products grows, the demand for machinists, the highly-trained "anchormen" of industry, will also grow.

Of the utmost importance to the strength of America is the contribution made by skilled machining workers to our national defense projects. The great use of metal in virtually all of our defensive weapons and the fact that this country will most likely be forced to expand the defense program, will increase even further employment opportunities in machining.

It is the job of a machinist to operate power-driven equipment which either cuts, shaves, grinds, or drills metal. The most common types of machine tools are lathes, grinding machines, boring mills, drilling machines, milling and broaching machines, shapers and planers.

As an example, a machine operator preparing a metal part for an automobile engine must be so accurate in his work that the parts he makes are interchangeable for fast, easy mass production. This makes the margin for error in his work very small, and he must be experienced in the use of such measuring instruments as the micrometer.

An all-round machinist is experienced in operating many different types of machine tools and is expected to plan and execute all operations required in turning out a machined product or part. A thorough knowledge of the strength and machining characteristics of metals and a complete background in the mathematics used in planning his work are required.

(Continued to page 50)

New Table Top Invention Puts You In... **PROFITABLE RUBBER STAMP BUSINESS**

Home Operators now make
\$9.20 AN HOUR in business
once monopolized by
a few big companies

Special rubber stamps bring high prices—cost only pennies to make on new, low-cost table top machine. Take 27 cents worth of material, make perfect stamps, the kind businesses and offices now buy by the dozen at \$1.80 each. Make up to \$9.20 an hour. Start in spare time in your own home. Run machine on kitchen table using ordinary electrical outlet. Make any kind of stamp. We'll send you free information without obligation about this established, highly profitable business, now open to individuals for the first time. For free information send name today on a post card to
Rubber Stamp Div., 1512 Jarvis, Dept. R-2-M, Chicago 26, Ill.

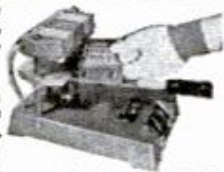

GIANT PLASTIC TARP **45**

Formerly 1.25 NOW ONLY

Huge 9 x 12 size. Covers and protects cars, furniture, carpets, etc. Or make into tablecloths, appliance covers, auto seat covers, etc. Waterproof, durable, transparent. No seams. Minimum order 2 tarps at 45c each. Add 25c postage. Total \$1.15

MONEY-BACK GUARANTEE.

BARCLAY DISTRIBUTORS,
Dept. 59-M, 170-30 Jamaica Ave., Jamaica, N. Y.

SHORTHAND IN **6** WEEKS

Famous **SPEEDWRITING** shorthand. 120 words per minute. No symbols; no machines; uses ABC's. Learn at home or through classroom instruction. Low cost. 500,000 graduates. For business and Civil Service. Typing available. 38th Year. Schools in over 400 cities. Write for **FREE** booklet.

Speedwriting
Dept. 1511
55 W. 42 St., N.Y. 36, N.Y.

PROFIT IN YOUR SPARE TIME

FIX SMALL GASOLINE ENGINES
Outboard • Powermower • Chain Saw • Tractor
MAKE EXTRA MONEY—or, repair your engines and **SAVE**. Illustrated, easy-to-understand, Home Study Course. **FREE** information. Write **TODAY!**

LINCOLN TECHNICAL INSTITUTE
Suite 11-E, 472 Market Street, Newark 5, New Jersey

PELLET FIRING LUGER AUTOMATIC

- MAGAZINE LOADING CLIP
- OVER 15 MOVING PARTS
- FULLY AUTOMATIC

Automatic full size model of a Luger Automatic pistol—contains over 15 moving parts. Loads 8 complete rounds which snap into the hard butt simulating a Luger. Fires 8 bullet shaped pellets. Has automatic slide action.

ONLY \$198

MOST AUTHENTIC MODEL GUN WE'VE EVER SEEN

Comes to you with working parts disassembled with cleverly engineered springs, full instructions, supply of pellets and specially designed belt holster. **Full Money Back Guarantee.** Simply send \$1.98 plus 27c shipping charge or order C.O.D. From:
HONOR HOUSE PROD. CORP., Dept. LL-100, Lynbrook, N. Y.

ENGINEERING



U.S. AIR FORCE Photo. Missile headed for outer space. Courtesy of Space Technology Laboratories, Inc.

ENROLL NOW FOR NEW TERM
Heald College Ranks **FIRST** West of the Mississippi in "Who's Who in America"

AMERICAN INDUSTRY NEEDS TRAINED ENGINEERS NOW

BACHELOR OF SCIENCE DEGREE, 30 MONTHS

SAVE 2 YEAR'S TIME

B.S. Degree Courses:

- | | |
|---|---|
| <input type="checkbox"/> Electronic Engineering | <input type="checkbox"/> Mechanical Engineering |
| <input type="checkbox"/> Electrical Engineering | <input type="checkbox"/> Civil Engineering |
| <input type="checkbox"/> Architectural Drafting | <input type="checkbox"/> Architecture |

Diploma Courses:

- | | |
|--|---|
| <input type="checkbox"/> Radio-Television Plus Color TECHNICIAN | <input type="checkbox"/> Architectural Drafting |
| <input type="checkbox"/> Electronic Technician | <input type="checkbox"/> Mechanical Drafting |
| <input type="checkbox"/> Structural Drafting | |

APPROVED FOR VETERANS

Send for **FREE** Information

HEALD Engineering College

Van Ness at Post, Dept. PM San Francisco, California

NAME _____

STREET _____

CITY _____ STATE _____

TURN YOUR HANDS, FEET, FINGERS INTO SUPER WEAPONS

Learn KARATE Quicker, Better than Judo!
Amazing Deadly Defense.

Fully illustrated book shows many defense and attack methods. How to temporarily paralyze your opponent, how to subdue an enemy who may come unexpectedly out of the dark. **FEAR NO MAN!** Profusely illustrated with actual combat photos. Learn quickly by yourself, at home, in weeks. Learn just where the **KARATE** striking points and nerve centers are. Send \$2.98. Cash, Check or M. O. to Best Values Co., Dept. W-192, 403 Market St., Newark, N. J.



Draw **CARTOONS**



Learn at Home in Spare Time...

EARN BIG MONEY

You don't need previous training or art ability with the "Famous System of Manual Training!" With this modern streamlined method, you learn rapidly, easily... start to cartoon immediately, without tedious study or exercises.

WIDE DEMAND FOR CARTOONISTS
... **EARN WHILE YOU LEARN**
... Magazines, newspapers, movies, television, ad agencies—all are searching for new cartoon ideas and talent. As a successful, Continental-trained Cartoonist, your earnings are not limited. Many of our students start earning after first few lessons. A wonderful pastime, too.

WE SUPPLY EVERYTHING... As our student, you receive **FREE** of extra cost a big 15-piece Professional Kit with all equipment and materials you need, and valuable Articulated Model to help you draw any human pose.

GET ALL THE FACTS FREE... Big, colorful Free Catalog gives all details, plus pages of useful information. Use coupon now.

Continental Schools, Inc.
DEPT. A-11, 4201 S. BROADWAY, LOS ANGELES 37, CALIF.

Continental Schools, Inc.
Dept. A-11, 4201 S. Broadway, Los Angeles 37, Calif.
Please rush me your Free Catalog and other information by return mail. No charge or obligation, no salesman will call.

NAME _____
ADDRESS _____
CITY _____ ZONE _____ STATE _____

SEND COUPON FOR FREE BOOK

95% PROFITS YEAR 'ROUND

Be your own boss, Operate a SIMPLEX lawn-mower sharpening service in your community. One compact machine grinds all mowers, sharpens cutlery. Low investment, 95% profit. Pays for itself in average month.

SIMPLEX

—4 Machines in One!

Reel Grinder—sharpens any mower reel in or out of mower.
Bed Knife Grinder—grinds with either round or cup wheel.



Rotary Blade Grinder—hollow grinds any rotary mower blade.
Cutlery Knife Grinder—sharpens cutlery, tools, scissors.

Send for free, money-making details!

The FATE-ROOT-HEATH Company • Dept. PM-11, Plymouth, Ohio



BARBELLS

140-Pound. CHROME DELUXE Barbell-Dumbbell set only \$19.80.
This is our feature set and is the finest ever manufactured.

Training with adjustable weight is the BEST way to keep fit; the ONLY way to develop great strength and a perfect body. As the oldest and best equipped barbell company, BUY gives value and prices no one can equal.

SEND FOR FREE CATALOG
BUR BARBELL CO.
Lyndhurst 9, New Jersey

100 POUND SET \$12.80

Extra Plates Only 12c Pound

TECHNICAL ILLUSTRATORS

AT LAST . . . complete home training in this highly profitable and exciting field.

Also a real asset to Engineers and Draftsmen

Learn to do all types of perspective drawings, work from prints or observation of the object . . . exploded views or cut-a-ways, layouts & rendering and the latest industrial art aids.

COURSE COMPLETE WITH DRAWING BOARD AND EQUIPMENT

WRITE FOR DETAILS

SHERIDAN SCHOOL OF INDUSTRIAL ART
DEPT. 9-10 BOX C, ADMIRAL STA. TULSA, OKLA.

Without obligation, please send FREE descriptive booklet.

Name

Address



You can make money in

WATCH REPAIR

Learn at home the low cost Sweazey Way

Watch repairing pays up to \$6 an hour, part time watch makers report on survey. Unique and modern Sweazey home study System starts you making repairs right away on Swiss and American watches. Professionally prepared training. No previous experience needed. Special tools provided for practice. Tuition only \$5 a month. Diploma Awarded. Free sample lesson and opportunity book give all facts. Write today. No obligation.

CHICAGO SCHOOL OF WATCHMAKING
2330 N. Milwaukee Avenue. Dept. 1110, Chicago 47, Illinois

Even more specialized and skillful are the tool and die makers who produce the jigs and fixtures needed to hold a piece of work for machining and the metal forms used in shaping metal by the stamping, forging or punching methods. Not only is it essential that these craftsmen be top machinists, but it is also necessary that they have a sound knowledge of mathematics, basic science, electronics and hydraulics to help them in their work.

As is the case in many skilled occupations, the machining trades require a certain formal, supervised period of training. This involves an apprenticeship during which the worker learns all the aspects of his trade while he is on the job.

Most employers prefer to select men with trade school training for their apprenticeship programs. Resident or home-study trade school courses in metal working are highly recommended for those who wish to enter into apprenticeship for the machining field.

Most experienced all-round machinists and tool and die makers have started as machinists working with only one or two metal-forming tools. Experience and know-how picked up on the job have qualified these men for their present highly skilled positions. Many have helped themselves qualify for higher-paying jobs by taking correspondence or trade school courses in blueprint reading and mathematics.

Skilled machining workers have many possibilities for advancement. Some become foremen and others become tool designers or advance to other more highly technical jobs. Many skilled machining workers have found it profitable to open their own tool and die or machine shops, and in this way these workers capitalize on the knowledge and experience they have gained through the years with larger industrial concerns.

If you like mechanical work, like to use tools, take pride in craftsmanship and want to get into a creative occupation with good pay and excellent future opportunity, you should consider the machining trades.

Machinists make an important contribution to our national economy and are needed to help keep America strong. They work in every state and in almost every city in the country.

For information on correspondence and resident training courses in the machining trade and other important occupations, write for your free SKILLS for AMERICA booklet. Write Popular Mechanics Magazine, Dept. SFA, 200 East Ontario Street, Chicago 11, Illinois.

Magic Mail Plan—Make up to \$5 an Hour!



THIS MAN . . .

... is taking out of the machine a Plastic Sealing Job—ordered by mail—only 11c in material cost brings back \$2.58 in cash by mail. Capacity of machine: \$25.00 profit per hour of operation.

Get **ORDERS** and **CASH** from your mailman—do work in **SPARE TIME** at home—or expand into **FULL TIME** business. Send coupon for **Free** facts about the newest and most fascinating of all home operated businesses. For the first time a simplified machine brings the fabulous profits of **Plastic Sealing** and **Plastic Laminating** within the reach of the small operator. Anyone can learn to operate the machine with a few minutes practice—then with our **Magic Mail Plan** can get mail orders pouring in daily with cash in every envelope. **No canvassing—no selling.** We even

Get into PLASTIC LAMINATING at home

supply the circulars you mail to bring back cash and orders. Don't waste a minute. Rush your name. We'll send you **FREE** and postpaid, pictures, prices, details, and all the facts you need to start. Mail coupon or send name on postcard. No charge. Warner Electric Co., 1512 Jarvis Av., Dept. L-2-M, Chicago 26, Ill.

Make Thousands of Beautiful Art Creations

COSTUME JEWELRY • CIGARETTE BOXES TRAYS • CANDLESTICKS • COASTERS LAMP BASES • BOOK ENDS...ALL IN SPARKLING COLORED PLASTIC



WARNER ELECTRIC CO., 1512 Jarvis Av. Dept. L-2-M, Chicago 26, Ill.

At no cost to me, please rush complete details postage prepaid. I am under no obligation.

Name _____

Address _____

City _____ Zone _____ State _____

New Jet Engine Burns Gasoline



Powerful continual thrust for models: boats, cars, planes. No moving parts. Easy to start, runs on regular gas. 8-in. long. Complete, Only **\$1.49**

JOHNSON SMITH COMPANY, Dept. 924, Detroit 7, Mich. Catalog of 2900 Novelties, Tricks, Jokes, Gadgets 10c

SCIENCE ENGINEERING

Bachelor's degree in 27 or 36 months Accelerated year-round program: Aero., Chem., Civil, Elec., Mech., Metal.; Math., Chemistry, Physics. Modest rate. Earn board. New classes Jan., March, June, July, Sept. Catalog. 1611 East Washington Blvd., Fort Wayne 2, Indiana

INDIANA TECHNICAL COLLEGE

WHAM-O BLOWGUN SET for target and hunting

This amazing gun has accuracy like a rifle. Compression of breath in barrel gives terrific air power. You won't believe your eyes!

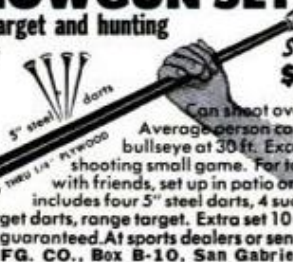

SPECIAL \$1.98 postpaid

Can shoot over 150 ft. Average person can hit a 2" bullseye at 30 ft. Excellent for shooting small game. For target fun with friends, set up in patio or den. Set includes four 5" steel darts, 4 suction-cup target darts, range target. Extra set 10 darts \$4. Satisfaction guaranteed. At sports dealers or send 1.98 to: **WHAM-O MFG. CO., Box B-10, San Gabriel, Calif.**

FREE DETAILS Reveal New Franchise Opportunity... start your own HOME-IMPORT MAIL ORDER BUSINESS Overnight!

Make profits up to five times the original cost on hundreds of exotic "below wholesale" imports! No experience necessary. No investment in merchandise. No face-to-face selling. Exclusive franchise if you act now! Complete details by return mail.

Write: **MAIL ORDER DISTRIBUTORS, DEPT. B5B, 15201 SO. BROADWAY, LOS ANGELES 54, CALIF.**



BIG MONEY OR EXTRA INCOME Home Appliance Repair

LEARN TO EARN MORE... QUICKLY AND EASILY!

Wide-open field for men of all ages. Millions of Home Appliances need fixing . . . Every home is your market for Full-Time Career or Spare-Time "Second Income" opportunities. Save on your own repairs. N.T.S. Shop-Tested HOME TRAINING is streamlined, modern, low-cost, practical. Qualifies you fully and you start earning early in your course. Includes Tools and Appliance Tester. Send for **FREE** Opportunity Book and actual lesson. No Obligation. No Salesman Will Call!

NATIONAL TECHNICAL SCHOOLS Dept. HB-110 Los Angeles 37, California

Name _____ Age _____

Address _____

City _____ Zone _____ State _____

FREE BOOK

SAVE 1/2 ON FINE ITALIAN CHORD ORGANS

BUY DIRECT FROM IMPORTER! BIG DISCOUNTS!

5 DAY FREE HOME TRIAL



PLAY AT SIGHT! NO LESSONS NEEDED!

Now everyone can play and enjoy this new musical sensation. Buy direct from importer . . . **SAVE up to 1/2 off mfr's list prices.** Hand-crafted in Italy . . . finest Swedish Steel Reeds, plus many other exclusive features. Has famous easy-play DA-MAR Music System. **E-Z Terms**—Small down payment. Free Bonus Gifts. 24 models including piano-keyboard models. Money back guarantee. Rush coupon for **FREE** Color Catalogs and Low Discount Prices.

PHILHARMONIC ORGAN CORPORATION - DEPT. R-110 2003 West Chicago Avenue, Chicago 22, Ill.

Rush Color Catalogs and Lowest Discount Prices.

Name _____

Address _____

City _____ Zone _____ State _____

**94.6% OF BAILEY
GRADUATES ARE EMPLOYED
AT TOP PAY IN THE FIELDS
WHICH THEY WERE TRAINED!**



**DIESEL-AUTO MECHANICS
DESPERATELY NEEDED!**

We have a far greater demand for our students than we can fill!

We can show you an actual waiting list of leading companies throughout the world who have tried Bailey graduates — found them outstanding, and are coming back for more!

**Bailey Graduates are Successful . . . RECEIVE
BIG PAY — HAVE SECURE FUTURE!**

**The Famous Bailey Course prepares you
for BOTH Diesel and Gasoline Mechanics.**

This is a must—due to the advent of using Diesel principles, such as 'Fuel Injection' on passenger cars . . . use of gasoline engines for starting Diesel engines, etc. You learn all this at Bailey in the amount of time ordinarily required to learn just one of these subjects, **ALL FOR THE PRICE OF ONE.**

Don't be satisfied with a 'futureless', one-type job — learn how you can make **big money** now! Write today for Free Booklet that takes you on a step-by-step camera tour through our spacious, modern shops — See Bailey students in action as they Learn-by-doing with the Famous Bailey Method of training!

We provide you with housing and part time jobs while in school, plus nation-wide placement service for graduates.

BAILEY Technical SCHOOLS

1634 S. GRAND ST. LOUIS 4, MO.

MAIL TODAY!

Please mail immediately this free booklet without obligation.

FREE BOOKLET



Name.....

Address.....

City..... State.....

APPROVED FOR VETERAN...NON-VETERAN

**THE ALL NEW
MARKSMAN
BB REPEATER
AIR PISTOL**

6
7 5 4 2
12 8 7 3
14 10 9
19 18 16 17

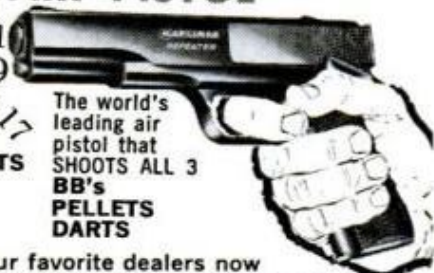

The world's leading air pistol that SHOOTS ALL 3 BB's PELLETS DARTS

20 SHOTS

\$8.95

At your favorite dealers now

MARKSMAN PRODUCTS
Division of Morton H. Harris, Inc.,
Los Angeles 25, Calif.

75 POWER TELESCOPE \$3.98
25X-45X-75X

NEW 3 in one telescopes, 3 variable 25X 45X-75X magnification. Brass bound, 25 power for ultra bright images 45 & 75 power for long range. Guaranteed to bring distant stars, moons, objects, sports 75 times closer.

Most powerful scope sold anywhere near this amazing low price. American made, 5 sections. Opens 36", closes 1 ft.; contains 4 ground & polished lenses. Can also be used as powerful compound microscope. Mass production enables us to offer telescope complete at \$3.98 postpaid. Money back guarantee.

CRITERION CO., Dept. PMB-87, 331 Church St., Hartford, Conn.

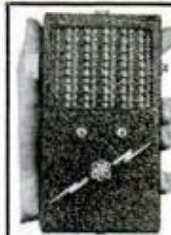

AMAZING MINIATURE TRANSMITTER

Broadcast on to any radio or car radio. Use as fun maker, P.A., Walkie Talkie. Portable (5 3/8 x 3 1/8 x 1 5/8) with self contained batteries and antenna. No wires or hookup! Works up to one block or more. No license needed. Transmits through walls! Simply push button to talk. Built-in selector lets you tune station desired. 3 Models: M27—\$10.95, Hi-power M37—\$11.95, Super Power de luxe M47—\$12.95 post paid or send \$1.00 and pay postman balance. Batteries \$2.50 extra. Kits all models, \$2.00 less than above. Write for free info.

MALCO ELECTRONICS, DEPT. L
9211 Venice Blvd., L. A. 34, Calif.



to WEEKEND WORK

Tells 200 Ways You Can Earn \$5.00-\$50.00 in Spare Time

Rush your name and address for a FREE subscription to Opportunity Magazine — learn how you, like other men and women everywhere, can turn your extra time into extra cash! Age, education, experience unimportant. Get 5 FREE issues packed with offers, information, plans — today. **OPPORTUNITY, 850 N. Dearborn, Dept. 171, Chicago 10, Ill.**



**BETTER THAN YOUR OWN
SHOE STORE AT HOME!**

Earn \$10.00 to \$50.00 weekly extra cash, with great Kushiontred Shoes! No experience or investment! Spare time only! Write for big FREE outfit!

TANNERS SHOE CO. • 750 Brockton, Mass.

**INVENTIONS WANTED!
FREE PATENTS!**

Get full information on SHAW'S PATENT PROMOTION PACKAGE . . . Your invention fully protected while we run down patent, manufacture, merchandising, sales . . . **YOU RAKE IN PROFITS** . . . small registration fee covers everything!

Write today.

SHAW ENTERPRISES

— Inventors' Agents —

Dept. PM-11, 908 N.W. 79th St., Miami 50, Florida
Plaza 8-2645 • Member, Miami-Dade Co. Chamber of Commerce



CLASSIFIED ADVERTISEMENTS



Advertisements in this section \$1.30 per word, each insertion, minimum 10 words, payable in advance. To be inserted under proper classification, copy must be in our office the 18th of the second month preceding date of issue
 F. W. Johnson, Manager, Classified Advertising
 Popular Mechanics, 200 East Ontario Street, Chicago 11, Illinois

YOU'LL PROFIT

By reading and answering the classified ads in this section. Hundreds of opportunities for you to make and save money

AUTOMOBILES, MIDGET CARS

JEEP Headquarters. New and used jeeps, parts, plows, winches. Every type of special equipment. Franklin-Weber Pontiac, 6101 N. Clark, Chicago 26, Illinois.

CHANGE Oil! When? Time or mileage basis? No! Simple procedure \$1.00. Brown's Automotive, 2407 34th St. N.E., Canton 5, Ohio.

BATTERY-Powered electric cart plans, \$1.00. Magnuson Co., Box 15003, San Diego 15, Calif.

HISTORICAL Record of 1960 U.S. and foreign cars, fully illustrated. Detailed specifications on all models. 160-page "Car Facts Book, 1960." \$1.00. Service Bureau, Room 517C, Popular Mechanics, 200 E. Ontario, Chicago 11, Ill.

CATALOGS-Automobile, old, modern, foreign; dealer books, service manuals, glossy photographs; motor magazines. Non-profit organization. Write for free information. Auto Maniacs C, Box 451, Mt. Clemens, Michigan.

HOT Rod racing book reports 1959 races, trials, drags. Expert advice on hopping up engines, tuning the stock Corvette, supercharger selection. Send 75¢ (85¢ in Canada) to Service Bureau, Room 517D, Popular Mechanics, 200 E. Ontario, Chicago 11, Ill.

AUTO SUPPLIES AND EQUIPMENT

VOLKSWAGEN Fuel gage system \$8.95. Longmire, Box 97, Goleta, Calif.

PARTS, Model "A." List 25¢. (Refundable) Matco, Box 135, San Pedro, Calif.

FREE! New catalog. Speed, power, mileage increasing equipment. Discounts! Almqvist Engineering, Milford PM5, Penna.

JEEP Parts! For military and civilian. At great savings. Largest inventory. Catalog for owners and dealers. Inquiries invited. American Auto Parts Co., 1830-PM Locust, Kansas City, Mo.

RING-Valve job while driving, \$6.00 postpaid. Guaranteed! Nothing like it! Lasts 100,000 miles! Motaloy, Grantham, Penna.

SILENCE Hydraulic valves \$3.00 postpaid. Free literature. Micro-Moly Products, Garrison 1, Kentucky.

NEW Magnetized warning signal reflector. Warns and slows down all traffic making it safe for you in any emergency when stopping on any dark highway. No bulbs or batteries needed. As shown Page 81, May 1960, Popular Mechanics. Only \$2.50 postpaid. A. Scarpello, Box 1031, Secaucus, New Jersey.

TUCKER Automobile literature. Pictures, \$1.00. Jerry Moore, P.O. Box 657, Grand Rapids, Mich.

MONA-TONE Guttled mufflers for car owners, hot-rod fans. More power! More mileage! Rich, mellow tone! Fits all cars. \$5.95 plus COD and postage. Give year, make, model. Universal, Box 7823M, Nashville 9, Tennessee.

AUTO Shop welding repair training in world's largest non-profit welding school. Low tuition. Free booklet. Hobart Welders, Box M-1101, Troy, Ohio.

SPARK Plugs. Factory reconditioned, 10,000 mile guarantee, new seals, plated. Box of 8 prepaid in U.S.A. \$2.95. Include make and model. Craft Tool, 1573 Boy Scout Rd., Caro, Michigan.

GREATEST Auto parts catalog. Thousands racing and restyling accessories for all cars. Only 25¢ (refundable). Newhouse Automotive Industries, 5805-PM11, Beverly, Los Angeles 22, Calif.

HOT Rodders can get a fantastic, almost unbelievable bonus for buying major brand power and speed equipment. We tell you how, what, and where Ledbetter Enterprises, 1015 17th, Texarkana 4, Texas.

CORROSION Resistant plated brass license plate bolts. Set \$1.00. Raydie, 248 Interstate, Addison, Illinois.

JEEPS—\$223.00. Trucks—\$212.00, tractors—\$68.00, tools, guns. Typical government surplus prices. Buy direct. List of depots, procedure, full details only \$1.00. New York Enterprises, Wall Street, 402-X2, New York 5.

FOREIGN Car accessories— Windwings MGA, Sprite, TR2&3 \$14.45. Great new catalog 25¢ (refundable) first order. European Accessories Ltd., P.O. 784, Joplin, Missouri.

NEW And used parts at savings. Complete guaranteed parts service for all models cars and trucks. Largest in the West. Jeep and army parts specialists. Newest type shifting hubs for all jeep and all military and latest production front end drive vehicles. \$27.50 and up. Also, foreign car parts. Write. Pioneer Auto and Truck Parts Co., 734 W. 13th Avenue, Denver 17, Colo.

MODEL T Ford parts. 25¢ brings 36 page catalogue. Amato Ridgewood, Middletown, Conn.

JUST Out: New 404-page, illustrated catalog offering savings up to 50% on over 100,000 auto parts and accessories, many hard-to-get. All makes (1920 to 1960 models), trucks, foreign and sports cars. Also Hollywood accessories, custom styling, hi-speed equipment. Send 25¢ for postage, packing—refundable on first order. Whitney, 1919 PM-11 Archer, Chicago 16, Ill.

MILLION Miles (plus). Attainable by new principle of lubrication. \$3.00 postpaid. Bailey's Staylube, 814 Lyngrove Drive, Houston, Texas.

JEEP Tops. Free catalog. Mor-Nan, Box 141, Beverly, Mass.

NEW Auto alarm. Stops car looters! Easily installed, it guards against theft of car or contents by protecting all doors. Horn blasts continuously if thief tries to enter. Only \$7.95 postpaid. 16 page gift catalogue 25c. Hehman Sales Company, 312 Bausman St., Dept. PM, Pittsburgh 10, Pennsylvania.

JEEP Owners—V8 conversions. Read Jeep Owners ad, page 28.

AUTO TRAILERS

BUILD Expanding eight foot trailer. Accommodates five. Literature 10¢. Framar Company, Wilmington, Mass.

PICKUP Coach blueprints. Supplies. Literature 10¢. Comstock Trailers, Parsons, Kansas.

MOTORCYCLES, BICYCLES, MOTORSCOOTERS AND SUPPLIES

GO Cart \$50. Childs car \$25. Whizzer motor \$12. Cushman motorscooter \$40. (Mallorder only). Send 25¢, (35¢ for first class mailing) for 32 page Directory-Catalogue Number 98 listing these and hundreds of other bargains in go carts, motor-scooters, homebuilders parts, plans, etc. Midget Motors Directory, Athens, Ohio.

BICYCLE Supplies, Goodyear tires. Free delivery. Attleboro Cycle, County Street, Attleboro, Massachusetts.

BMW Motorcycles, shaftdrive. U.S. distributor. Butler & Smith, Inc., 160 West 83 St., New York 24, N. Y.

MOTORSCOOTER Kit. Large frame, 16" wheels, fenders, fork, \$49.50. Other assemblies available. Send \$1.00 for 3 view drawing, parts list, pictures, information. Scooter, Box 6384, Minneapolis 23, Minn.

MOTORCYCLE Parts. New, used. List 25¢. Ballak, 811 N. 9th, St. Louis 1, Mo.

RECONDITIONED Motorcycle motors. Chrome accessories. Complete stock Indian parts. Expert rebuilding. Fast service. Indian Motorcycle Sales, Kansas City 27, Missouri.

HARLEY-Davidsons— Used bargains. New, used parts, accessories, all models. Bulletin 25¢. Knuth's (Factory Dealer), 1753 Muskego, Milwaukee, Wis.

AVIATION

BUY Govt. surplus: Aircrafts; helicopters; boats; jeeps; tractors; misc. Individuals can buy direct now from govt. Send for "U.S. Depot Directory & Procedures," \$1.25. Brody, Box 425-PM, Nanuet, New York.

PROPELLERS, Plans, supplies for aircrafts and snowplanes. Latest designs, prompt delivery. Catalog 25¢. Banks-Maxwell, Box 3301E, Ft. Worth 5, Texas.

AVIATION Surplus bargain catalogue. One dime. Box 22PM, Thomasville, Penna.

AIRLINE Careers. Adventure! Prestige! Promotion! Four-week course. Free placement service with 35 airlines. G. I. approved. Free catalog B. McConnell Airline School, 1030 Nicollet, Minneapolis, Minnesota.

HELICOPTER—Completely engineered, assembly drawings and parts available. Send \$2.00 for photo, 3 view drawings, specifications and design information. Send additional \$2.00 for book "Basic Helicopter Aerodynamics" uses our helicopter as example problem for performance calculations. Helicopter Research Co., Box 121, La Mirada, Calif.

HELICOPTERS Are our business, not our sideline. A-W, originators of home-built helicopters (not autogyros) sells more kits, plans than all others combined. Learn why! Booklet with 3-view drawings, complete prices, regulations, specifications, photos sent postpaid, 25¢. Adams-Wilson Helicopters, Lakewood 14, Calif.

BATTERIES, GENERATORS

BATTERY Repair manual \$3.00. Bayer Publications, 9385 Betty Avenue, Neenah, Wisconsin.

ELECTRICAL SUPPLIES

LAMP, Electrical parts, wholesale. Thousands of items for repairing, converting. Catalog 25¢. Brown Lamp, Box 305, Clayton 5, Mo.

SIMPLIFIED Conduit bending guide and protractor. \$1.90. Pal-Notes, Underwood, N. D.

LAMPS, 25¢ Brings parts catalog. Refunded first order. Gyro, 5208P N.W. 35th Ave., Miami 42, Florida.

ELECTRO-Scribe! Engraves all metals, \$2.00. Beyer Mfg., 10511-H Springfield, Chicago 55.

LAMP—Appliance parts wholesale. Giant fully illustrated catalogue 25¢. Seco, 26 South 20th Street, Birmingham 3, Alabama.

HOME Fire protection. Early warning thermostat, detects heat raise. Gives time to extinguish or escape fire, use battery or transformer. Free folder. Signal Specialties, South Acton, Mass.

WELDING, SOLDERING, PLATING

WELDERS, 110/220, \$39.50. Morris, 1070 Inner Drive, Schenectady 3, New York.

PLATING Equipment, supplies. Complete line of anodes, solutions. Home workshops, industrial sizes. Hollywood Bronze Supply, Dept. C, 1624 East First, Los Angeles 33, California.

WELD, Solder, cut, braze. $\frac{1}{8}$ " welder complete \$8.95. Flame torch, \$3.95. Postage 50¢. 75 ampere transformer welder $\frac{1}{2}$ " , \$24.95 complete. F.O.B. Essay Mfg. Co., Quincy 69, Mass.

NEW! Electric solder gun with internal solder feed. Leaves one hand free to manipulate work. Free literature. Arnie's Electronics, McNeal, Arizona.

ACETYLENE Welding outfits—arcwelders. Dealership open. Eagle Welding, Dept. PM, 5085 Broadway, Chicago 40, Ill.

SURVEYING INSTRUMENTS

NEW And guaranteed factory rebuilt transits and levels, sale or rent, with purchase option. We will repair, trade or buy old instruments. Write for list M-110. Warren-Knight Co. (Manufacturers of Surveying Instruments), 136 N. 12th St., Philadelphia 7, Penna.

MACHINERY, TOOLS, SUPPLIES

FREE New catalog showing only complete line of work holding tools available anywhere. Drill press vises, angle and swivel machine vises, rotary tables, production and heavy duty angle vises. 68 different models, fully described with prices. Palmgren Products Co., 8365 South Chicago Ave., Chicago 17, Illinois.

SHEET Metal brakes: 36", \$37.00. Larger sizes. Benders, folders, shears. Free catalog. Vyke Co., P4158 Jason, Denver 11, Colo.

ENGINES, MOTORS, DYNAMOS

REWIND Motors yourself. Complete instructions, \$1.00. Lewis Manufacturing, Howell, Michigan.

WINDING Data. 275 motors, single and three phase \$1.10. Data Company, 512 Kensington, Kansas City 24, Mo.

DIESEL Injector parts and fuel pumps wanted. GM51-53-71-110. Bares, 7120 Carnegie, Cleveland 3, Ohio.

MOTOR Rewinders data manual and parts catalog \$1.00. Modern, Box 8715, Kansas City 14, Mo.

BOATS, OUTBOARD MOTORS

FRAME Kits, plans or full-size patterns for 35 inboards and outboards. Prepared for amateur builders. New 80 page illustrative catalog, 50¢. Glen Designs, 9152 Rosecrans, Bellflower, Calif.

BUILD Your own boat from our large-scale blueprints. Books of plans give how-to-build help. Hundreds of professional designs—motor, sail or auxiliary—for amateur builders. Free catalog. MoToR Boat-ing, 572A Madison Ave., New York 22, N. Y.

MARINE Conversions. Ford, Chevrolet, Jeep engines. Catalog 25¢. Lehman Manufacturing Company, 800 Elizabeth Avenue, Linden 4, N. J.

NEW, Used, rebuilt marine motors. Marine conversions, fittings. Free catalog. Stokes Marine Supply, Dept. 24, Coldwater, Michigan.

FULL Size, cut-to-shape boat patterns, blueprints, 7 $\frac{1}{2}$ -38 feet. Big new 88 pg. illustrated "Build a Boat" catalog of naval architect-designed Catamarans, cruisers, runabouts, skiffs, outboard boats, sailing, racing, houseboats, 50¢. "How to Build a Boat" booklet \$2.50. Cleveland Boat Blueprint Co., Dept. A-66, Box 1651, Cleveland, Ohio.

FISHERMAN'S Jet Boat Inc. has the he-man gift for yourself, or buddy. Complete do-it-yourself plans, layout, instructions, photos for converting fishing boat to Jet! Go anyplace, nothing below hull. Send \$10 direct or request free details. 704-P, Inland Bldg., Indianapolis, Ind.

I want to send you proof of the wonderful pulling power of Popular Mechanics classified pages. What's your proposition? Write me today. Include literature if possible. F. W. Johnson, Manager Classified Advertising, Popular Mechanics Magazine, 200 E. Ontario St., Chicago 11, Ill.

FAST Planing sailboats. 12' scows \$495. 14' surfboards \$295. Dacron sails included. Brochure free. Laurents, Route 1, Largo, Florida.

300 BOAT Plans, many kits. Catalogs: Powerboat \$1.00. Sailboat 25¢. Marine-craft, Box 161-M, Brighton, Mass.

FIBER Glass cloth. White 50" wide. Sample yard \$1.00. 20 yds. 80¢ yd. ppd. 200 yds. 55¢ yd. Miami. Catalog 25¢. Check with order. Nation Wide Supplies, Inc., 3421 N.W. 48th Street, Miami, Fla.

PROPELLERS, Plans, supplies for aircrafts, snowplanes. Catalog 25¢. Banks-Maxwell, Box 3301F, Ft. Worth 5, Texas.

ATHLETIC EQUIPMENT, BODY BUILDING COURSES

FREE Muscle building information. Body-Tone, Box 638B, North Miami, Florida.

BARBELLS, Dumbbells, Courses. Booklet 10¢. Good Barbell Co., Siloam Springs, Arkansas.

KARATE! Judo! Yoga! Muscles! Boxing! Stunts! 125 individual, illustrated lessons. All for \$1.00. Scientific instructions, deadly secrets. Charts! Diagrams! Sanson Institute, 44N Bromfield, Boston 8, Mass.

MUSCLES By mail. Free brochure on the latest, fast body building methods. Write Milo Institute, P.O. Box 1060, Johannesburg, South Africa.

4 MUSCLE Courses 25¢. 12 large courses \$2.00. Big deal \$3.00 (guaranteed). Agents wanted. Sid's System, PMC4, 8421-C Evergreen, Southgate, California.

DEADLIEST "Fighting Arts Orient." Elemental Karate, Kung-Fu manual. 336 illustrations. Break planks bare-handed using breath, sand, straw, \$3.98. Positively no minors. Oriental Book Sales, P.O. Box 1183, Oakland 4, Calif.

OUTSTANDING Physical development! Any age. New guaranteed discovery uses only a rope! Strength, health, muscles. Gain—reduce. Free booklet. Roperice, 4834 Art, San Diego 15, California.

"**BIG** Muscles. The Quick Way." Dr. Young's revolutionary discovery. Free information. Gaucho, Box 9309-S7, Chicago 90.

SPORTING GOODS, GUNS, FISHING, SKIN DIVING, ARCHERY

FREE Brochure on the most useful outdoorsman's aid ever devised. B&W, Delaware City 1, Del.

MOLDS For fisherman's sinkers, jigs, squids, casting and spinning lures. Free catalog. Sweet's Molds, Tonawanda 1, New York.

MOLDS—For casting your own fishing sinkers. Free illustrated booklet. Reading Instrument Co., Box PM78, Reading, Penna.

BIG Money raising crickets and 12 inch African fishworms. Free literature. Carter Ranch, Plains, Georgia.

FREE—Wholesale catalog. Beads. Spinners. Lure parts. Sinker molds. Jigs. Reels. Finnysports (ME), Toledo 6, Ohio.

AMAZING Wholesale sporting catalog. Save 70%. Tremendous selections. Econ-O-Mart, Whippany 2, New Jersey.

KILL Submersed water weeds which foul up motor propellers, tangle fishing gear, with R-H Weed Rhap-20, Granular 2,4-D. Inexpensive, easy to use, sure results. For free information write Reesor-Hill Corporation, Box 36PM, Jacksonville, Arkansas.

JAP Rifle altering to 30-06, \$6.00. Japshells, \$3.95. Catalog 10¢. T. P. Shop, West Branch 11, Mich.

10,000 GUNS. Antiques, moderns, swords, armour. Every description. Giant catalog \$1.00. Agramonte's, Yonkers 2 G, N. Y.

GUNS. All kinds. None over \$20.00. Bargain list 25¢. Millers-PM, 5201 Gordon Drive, Sacramento, Calif.

CAMPING EQUIPMENT AND TENTS

CAMPING Equipment, tents, world's largest selection. Send 25c for new 160 page catalogue—handbook—camp site directory. (Print name, address). Morsan Tents, 10-21R 50th Ave., Long Island City 1, New York.

EARTHWORMS, CRICKETS, FROGS

BIG Money raising fishworms and crickets. We teach you how to raise and where to sell. Free literature. Medium redworms, 3000, \$5.95; 10,000, \$16.95. Carter Redworms, Plains, Georgia.

FREE Picture folder, "How to Make \$3,000 Yearly, Sparetime, Backyard, Raising Earthworms!" Oakhaven-56, Cedar Hill, Texas.

RAISE Fishworms and rabbits on \$500 month plan. Free details. White's Rabbitry, Mt. Vernon, Ohio.

GOLDEN Meal worms, (grubs). Tops for fall, and winter fishing. 300—\$1.00, 1000—\$3.00. Postpaid. Agents wanted. Central Bait Distributors, 801 West New York, Indianapolis 2-P, Ind.

FROG Raising for pleasure and profit. We ship "Nufond" giants. Broel-A, Box 506, New Orleans 1, Louisiana.

BINOCULARS, TELESCOPES, MICROSCOPES, MAGNIFIERS

SATELLITES Seen easily. Imported telescopes, binoculars, microscopes. Free lists. Butts, Torrington, Wyo.

BUILD Your own reflector telescopes. Complete kits: Mirrors, eyepieces, tripods, all other accessories. Request free illustrated literature. Criterion Manufacturing, Dept. DPM-70, Hartford 1, Conn.

20 x 50 BINOCULARS. New war surplus at a fraction of the original cost. Post paid, \$8.00. Guaranteed. Driscoll Sales Service, 536—12th Street, Denver 4, Colorado.

DYNASCOPE — Amazing world-famous reflector telescope. Request free brochure. Criterion, Dept. DP-73, Hartford 1, Conn.

SWIFT Binoculars. Big discount. C. Phillips, 132 Lincoln Avenue, Syracuse 4, New York.

TELESCOPES, Binoculars, all sizes. Complete telescope makers supplies. Free catalog. Suffolk Science, Mattituck, New York.

BINOCULARS, Telescopes, microscopes. Terrific values—\$3.98 up! Request free money-saving catalogue. Criterion, Dept. P-96, Hartford 1, Conn.

TELESCOPE Kits—Direct from manufacturer. Other optical hobby kits. Large selection. Free booklet. Esco Products, Oakridge, N. J.

REFLECTING Telescope, 60X, completely assembled. Guaranteed observatory clearness. Free information. Skyscope, P.O. Box 55, Brooklyn 28, N. Y.

WAR Surplus bargains: Millions of lenses, instruments, telescopes, binoculars, components and complete line of astronomical telescope items. World's greatest optical market-place! Send only \$1.00 for beginner's 10-lens kit and big instruction booklet Stock 2-CH. Write for Catalog CH free! Edmund Scientific Co., Barrington, New Jersey.

BARGAINS, Binoculars, telescopes, microscopes. Free catalog. Adventure Sales, Box 2133, San Diego 12, California.

BARGAIN Telescope, microscope catalog 25¢. Winn Chemicals, 124 West 23 Street, New York 11, New York.

AMAZING Prices precision binoculars. Folder "Binocular Selecting," catalog free. Prentiss Importers, Mercury Bldg., West Los Angeles 25, Calif.

PLANTS, SEEDS, BULBS, NURSERY SUPPLIES

GINSENG Bringing \$14 pound. Have seeds, plants. Goldenseal. Full information. K. Collins, Viola, Iowa.

GROW Ming trees! Instruction and seeds, 35¢. Mail Order Specialties, 1439-L Sabraton Avenue, Morgantown, W. Va.

GREENHOUSE For your own home. Low as \$186. Send for free literature. Metropolitan Greenhouse Mfg. Corp., 1875 Flushing Ave., Brooklyn 37, N. Y.

PETS—DOGS, BIRDS, RABBITS, HAMSTERS, ETC.

HAMSTER And cage unit \$4.95. Winch's Hamstery, Box 582, Fort Wayne 6, Indiana.

HUNTING Hounds: Cheap. Trial. Literature free. Dixie Kennels, D35, Herrick, Ill.

ANGORA Rabbit magazine. Carpenter's, Piqua, Ohio. Year \$1.00. Sample 15¢.

EARN \$10,000 Yearly raising Angora rabbit wool for us. Information 25¢ coin. American Angora Company, Malta 12, Montana.

GOLDEN Hamsters—Pedigreed breeders \$3.85 pair. Albinos Whitebands. Literature. Moore's Hamster Ranch, Shepherdstown 25, West Virginia.

MAKE Money raising chinchillas, mink, rabbits, cavies for us. Free catalog. Keeney Brothers, New Freedom 2, Penna.

RAISE Rabbits on \$500 month plan. Free details. White's Rabbitry, Mt. Vernon, Ohio.

HAMSTERS—Ideal pets, \$2.95 pair. Free booklet. Jer-fre's Hamstery, 1447 Apple, Muskegon 13, Michigan.

SKUNKS, Reptiles, hawks, raccoons. Illustrated catalogue, 25¢. Trails End Co., St. Stephen, S. C.

RAISE Rabbits successfully by knowing facts. 48 page illustrated book describing 25 breeds. Housing, feeding, breeding, marketing, etc. Pius bulletin, 25 cents. American Rabbit Association, 36 Arba Building, Pittsburgh, Penna.

FUR BEARING ANIMALS

MINK Raising information free. Complete. Lake Superior Mink Farm, Superior, EE1, Wisconsin.

FARMS, FARM LANDS, REAL ESTATE

WOULD You like to have your own private hunting domain? Deer, ducks, geese, upland birds, pickerel, moose. Modern home, 3000 acre ranch. Write Frank Erickson, Pebble Beach, Manitoaba, Canada.

EQUIPT! Easy terms. Only \$2,000 down buys productive 280 Missouri acres ready for profitable farming with tractor and machinery! 150 acres tillable, 75-head carrying capacity, 2 springs, 5 ponds. Good family orchard. See picture in catalog—modern 4-room bungalow, gas heat, screened porch, oak shade. Barn, poultry house, 2 brooders, granary. On state highway, 2½ miles village. Genuine bargain at \$13,000 complete. Only \$2,000 down! Free Fall-Winter catalog, the nation's biggest, 184 pages, 1,250 photos, bargains coast to coast! United Farm Agency, 2825-PM Main St., Kansas City 41, Mo.

\$5 MONTHLY Buys 5 acres—near clear-water lake. Price \$125. Excellent fishing, good cabin sites. Free list. Box 425-P, Carthage, Mo.

FLORIDA Homesites (high and dry) near national forest \$345 at \$10 monthly. Folder free. Howard Vernor, DeLand, Florida.

FREE Strout catalog! Farms, homes, businesses, resorts, retirement properties. Over 3000 values in 36 states. 60 years service. World's largest! Write Strout Realty, 7-CJ S. Dearborn, Chicago 3, Ill.

CANADIAN Vacation lands: Full price \$285.00. 40 acres, \$10.00 month. Suitable cottage sites, hunting, fishing, investment. Free information. Land Corporation, 3768-C Bathurst, Downsview, Ontario, Canada.

ARMSTRONG'S, Shook, Missouri. Sell Ozark lands. Write them. Listings mailed free, quarterly.

FLORIDA—Silver Springs area. ¼ acre waterview homesites. \$795.00, \$10.00 month. Free color photos. Write: Smith Lake Estates, Box 5681, Belleview, Florida.

OPPORTUNITIES! Government land, U. S., Alaska, Canada. Sledge Surveys, Macon, Mississippi.

FLORIDA 5 Acres full price \$695—\$10 month no interest. Send \$1 for contract and full information on this amazing tropical Collier County land offer. You must be convinced this best land bargain in Florida or deposit promptly refunded. Webb Realty Corporation, 11575 N.W. 7th Ave., Miami 50, Florida. AD59021(c)(7).

FLORIDA 2½ Acres. Full price \$395.00, \$5.00 monthly. O. Olson, 903 Central, Ft. Dodge, Iowa.

ERECT An Adcor prefab cabin, home, hangar. Erection manual \$2.50 pp. Free price list. Adcor, 7035 N.E. Hassalo, Portland 13, Oregon.

KENTUCKY: Lakeshore homesites \$195.00, pay \$10.00 monthly. Free booklet. Edgar Garland, Burnside, Ky.

FREE Literature. Most desirable retirement, recreation development in South. Twenty square miles with fifty beautiful fresh-water lakes. Near Carolina coast. Best fishing, boating, hunting. Golf course, country club, ocean beach club and yacht basin planned. \$4 down, \$4.40 monthly buys large, beautiful, shady homesite priced \$395. Offer limited. Write Boling Spring Lakes, Southport 1, N. C.

NOW You can own your own camp or cabin site on the beautiful Kootenai River in the Montana Rockies for \$10 down and \$10 per month. Mountain Empire Co., Box 203P, Libby, Montana.

HOME Buyers & Sellers Guide. Special \$1.00. Counsel Publications, Box 206, Carmichael, Calif.

FLORIDA Lot bargain! Three lots only \$195 each. No money down—pay \$5 per lot per month. Subdivision on 4 lane U.S. Hwy. 441-27 between Ocala and Orlando. Exceptionally high and dry. Lots face newly graded roadway. Electricity, phones, schools, churches. 1400 fishing lakes within 45 miles. Write for Free photos and plat. Al Clotfelter, Reg. Fla. Broker, Box 1222, Leesburg, Florida.

FARM MACHINERY AND SUPPLIES

ELECTRIC Welders. New, heavy-duty, 180 amp. Free trial. Dealerships open. 20 year warranty. 8139 South Pleasant Department A1, Minneapolis 20, Minn.

PROFITABLE OCCUPATIONS

INVESTIGATE Accidents. Earn \$750 to \$1,000 monthly. Thousands of airlines, insurance companies, steamship lines urgently need accident investigators. Make excellent full time or spare time income. Free book! No obligation. GI approved. Write: Universal Schools, CPM-11, Box 8227, Dallas 5, Texas.

FACTORY Prices! Thousands nationally advertised products. Typewriters, housewares, jewelry, watches, appliances, television, cameras, etc. New factory buying plan saves up to 40% below wholesale. Details free. Factory Supply Company, Bloomfield 1, New Jersey.

BAKE New greaseless doughnuts in kitchen. Sell stores. Free recipes. Michael, 3605 South 15th, Minneapolis 7, Minn.

BIG Money raising fishworms and crickets. Free literature. Carter Wormery, Plains, Georgia.

VENDING Machines. No selling. Operate a route of coin machines and earn amazing profits. 32-page catalogue free. Parkway Machine Corporation, Dept. #25, 715 Ensor Street, Baltimore 2, Maryland.

GROW Mushrooms. Cellar, shed and outdoors. Spare, full time, year round. We pay \$4.50 lb. dried. We have 29,000 customers. Free book. Mushrooms, Dept. 99, 2954 Admiral Way, Seattle, Wash.

SHARPEN Scissors, pinkers. Inexpensive machine. Clipper sharpener. Black-hawks, Sheldahl, Iowa.

REDUCING Equipment rentals, sales, booming business! Moon Co., 120 E. College, Covina, Calif.

START A magazine subscription business. Earn generous commissions on Popular Mechanics. Good Housekeeping and all others. Best commissions, bonus, all materials sent free. No experience needed. Write Popular Mechanics, Room 11-P, 250 West 55th St., New York 19, N. Y.

FREE Book "990 Successful, Little-Known Businesses." Work home! Plymouth-7N, Brooklyn 4, New York.

WHOLESALE Magazine subscriptions. Highest commissions. Bonus! Qualified Agencies, 451SA Kingston, Brooklyn 25, N. Y.

BETTER Memory means bigger income. "Your Memory." Hardbound. Autographed 16,000 sold. \$2.95. William Hayes, Temple, Tex.

MASK Making, fascinating, profitable. Workbook, patterns, \$2.00. Masketeers, R. D. #2, Burlington, N. J.

BECOME independent with your own franchise business. Thousands earning handsome incomes. Request interesting facts today. National Franchise Reports, PM-528, 333 North Michigan, Chicago 1.

NOT 900, not 99. Just "23 Spare Time Jobs." Good ones. New. No investment, no experience. Details, tips, leads. \$1. Cambridge Services, Box 252, Hartsdale, N. Y.

BOOKS, PERIODICALS, PICTURES, POSTCARDS

BOOKS, All popular titles. Dime for catalog. Deductible first order. Myers Book Service, Marquand, Mo.

BOOKS Located fast. Out-of-print, scarce. Lowest prices without obligation. Book Mark, Box 68A, Mt. Clemens, Mich.

OUT-Of-print books at lowest prices! You name it, we find it! Fast service. No obligation. International Bookfinders, Box 3003-PM, Beverly Hills, Calif.

BRITISH Book bargains—Any subject. Catalogues free. Transatbooks, Wantagh, N. Y.

FREE Catalog. Self-help books. Write Wilshire, 8721 Sunset, Los Angeles 46P.

BOOKFINDERS! All subjects. Send wants! Jaher Book Service, 183 Hazelwood Drive, Westbury, N. Y.

SCIENCE-Fiction book bargains. List free. Werewolf Bookshop, Verona, Penna.

NATIONAL Geographic magazines, 1888-1960, any issue. Periodical Service, Box 465-PM, Wilmington, Delaware.

LOCATE Any book. No obligation. Aardvarks, Box 734, La Mesa, Calif.

SPARETIME Repeat profits taking magazine subscriptions. Special offers. Cassell Agency, Boynton Beach, Florida.

BEAUTIFUL 16x20" Full color art reproductions, 3 for \$1.50. Free list of 50 subjects. Adams, p405, Martinez, Calif.

BIBLES, Books, magazines bound. Price list free. Norris Bookbinders, Greenwood, Miss.

BIBLES, Books, bargains. Free catalog. Price, 4813 Hurford, Chester, Penna.

3 NOVELS, 20¢. Thrills, action. Marino, 415 W. 44, New York 36.

GAMES, TOYS, NOVELTIES

FUN Gifts and jokes galore. Catalog 10¢. Greenland Studios, Miami 47, Florida.

MAGIC TRICKS, PUZZLES, JOKER NOVELTIES

FREE—Big amusement catalog free. Tricks, stage goods, Houdini handcuff escapes. I teach you. Heaney the Magician, Oshkosh, Wisconsin.

FREE Trick and magic catalog 25¢. Castle Magic, Box 92-PM, Jamaica 35, New York.

3000 TRICKS, Pocket, parlor, stage. World's finest magic catalog (408 pages), \$2.50. Kanter's, M-1311 Walnut, Philadelphia 7.

BE A magician! Large professional catalog of latest tricks, 35¢. Ireland, C-100 North Dearborn, Chicago 2, Illinois.

WORLD'S Finest professional magic. Joker novelties. Giant illustrated catalog 10¢. Top Hat, Evanston 12, Illinois.

CATALOG, Free trick, 25¢. (1,500,399 tricks, jokes). Magico, Box 4373-P, San Antonio 7, Texas.

500 TRICKS, Famous Douglas 120 page catalog number 33 now available. Complete catalog-magic tricks-equipment just 10¢. World's fastest service. Magicland, Dept. 14, Box 274, Dallas, Texas.

3100 NOVELTIES, Jokes, tricks, gadgets, funmakers, hobbies. Big catalog 10¢. Johnson-Smith, D-494, Detroit 7.

WORLD'S Best professional magic, tricks, illusions, jokes! 1000 selections! Giant 160 page catalog with free trick. Special offer! Now 10¢. House of 1000 Mysteries, Dept. PM11C, Trumbull, Conn.

PROFESSIONAL Catalog, 175 pages, 25¢. Williams, 900 Plymouth, Ellwood City, Penna.

25,000 PROFESSIONAL Comedy lines. Catalog 10¢. Orben Publications, Hewlett, N. Y.

COINS, TOKENS, CURRENCY

LINCOLNS 1922D, 1926S, 1931D \$1.00 each. 1910S, 1913S, 1915S \$1.50 each. 1912S, 1914S \$2.00 each. United, 348 Grotto, Providence, R. I.

BRILLIANT Uncirculated 1950D Jefferson \$5.00. United, 348 Grotto, Providence, R. I.

WE'LL Pay \$9,000.00 to \$18,000.00 for 1913 Liberty Head nickel. Certain dates: Large cents before 1858 up to \$5,500.00; Indian cents \$1,750.00; Lincoln cents before 1956, \$225.00; Dimes before 1943, \$5,250.00; Quarters before 1934, \$5,250.00; Half dollars before 1940, \$7,500.00. Certain Silver dollars \$15,000.00. We paid \$6,500.00 for one dollar. Whether your coin is worth \$10.00 or \$50,000.00, we'll pay the highest prices of any dealer advertising a Buying Catalogue. We have checked every advertised Guaranteed Buying Catalogue. We have been leaders of numismatic quotations for over twenty years, have paid out thousands of dollars for rare coins dated before 1956. Our catalogue is used by practically every coin dealer as a buying and selling guide. Know their true value. Before sending coins, send \$1 for finest illustrated complete guaranteed Buying-Selling Catalogue of United States coins, paper money, foreign coins, etc. Catalogue dollar refundable. Worthycoin Corporation (K-340-C), Boston 8, Massachusetts.

DIFFERENT Liberty nickels 15, \$3.00; 11, \$2.00; 6, \$1.00. I. Doktor, P.O. Box 35151, Los Angeles 35, Calif.

RARE Unc. 1899-P silver dollar, each \$5.00. Free price lists. Butts, Torrington, Wyo.

GET Profit and pleasure in collecting old coins. Send 25¢ for 68-page illustrated coin catalog. You'll be delighted with it. Send for it now. B. Max Mehl, Box 750-B, Costa Mesa, Calif. Oldest rare coin establishment in U.S. Established 59 years.

NEW 1961 Giant U. S. coin catalogue 25¢. Ace, 107 N. Dearborn, Chicago 2.

SIX Different Indian cents \$1.00. Free list Collector's Bargains, New Hope, Penna.

32 PAGE U.S. coin list 10¢. Contains almost 100 illustrations; over 5,000 delightful bargains. Stoney, 260 Washington, Boston 8, Mass.

FREE List! U. S. coins. Lowest prices! Hugh's Coins, Hickory, N. C.

OLD Money wanted. Will pay \$5,000.00 for nickel of 1913 with Liberty head (not buffalo). We pay cash premiums for all rare coins. Send 5¢ for large coin folder. May mean much profit to you. Numismatic Co., Box 750-A, Costa Mesa, Calif.

FREE Bonus offer! U. S. bargain list, 10¢ (refundable). Economy Sales Company, Mansfield, Massachusetts.

LARGEST Coin magazine, 200 pages, 50¢. Scrapbook, 7320-J Milwaukee, Chicago 31.

NUMISMATICS Largest newspaper. Semi-monthly. Sample 25¢. \$2.00 yearly. Numismatic News, Box 452, Iola, Wis.

RAREST CC mint dollar, 1885. Uncirculated, \$10.00. 100pg. coin catalogue, 50¢. Shultz, Salt Lake City 10, Utah.

COINS: Price lists 10¢. Lund, 200 So. Sycamore, No. Platte, Nebraska.

LINCOLN Cents: 1923-S; 1921-S; 1924-S; 1916-S-D; 1927-S-D; 1928-S-D; 1920-S-D; 1909-P; 1925-S-D; 1938-S-D; 1930-S-D; 1955-S; 1917-S-D; 1918-S-D; 1919-S-D; 1920-S-D; 1934-D; 1931-P. Good to fine. Complete lot \$3.95. Berry, Box 306, Westminster, Calif.

INDIAN Cent, foreign coin, plus bargain lists 10¢. Hutchinson's, Box 4747, Philadelphia 34, Penna.

WE Sell pennies, nickels, dimes. Bargain prices. Free list. Send self-addressed stamped envelope. Ben's Coins, 31 North Clark, Chicago 2.

CALIFORNIA 24K Plated souvenir gold pieces, 1/4, 1/2 octagon, round; also \$1.00 size, \$1.50 each. Five dates before 1860, \$7.00. Brewer, 641 Saint Paul, Los Angeles 17, Calif.

STARTER Collections. 15 Indian cents, \$2.50. 12 Liberty nickels \$2.50, 23 Mercury dimes, \$5.00, 15 Barbour quarters \$8.00, 15 Barbour halves, \$15.00. In folders. All different postpaid. Prager, 470 27th Avenue, San Francisco, Calif.

LINCOLNS: 1915P, 16S, 21s, 31P, 32P, 33P, 38S, 39D, 55S. \$2.85. Coinwallace, Hayden Lake, Idaho.

EIGHT Indianhead pennies \$1.00. 7 large Canadian cents \$1.00. Frank Herget, 2884 Bailey, Buffalo 15, N. Y.

SIX Scarce uncirculated 5¢ Jeffersons. Philadelphia mint 1955 through 1960. Catalogues \$2.70. Special \$2.00. Same Denver set \$1.00. Southern Coin Exchange, Covington, Georgia.

RARE Small dates 1960 Lincoln cents both Philadelphia and Denver mints uncirculated while they last only \$6.00. Special starter set of Lincoln cents all dates and mints from 1941 including 1960 condition good to uncirculated in coin folder 55 coins in all only \$3.85. New cleaning cloths for coins \$1.00. Meyer Company, Box 868, Galesburg, Illinois.

UNCIRCULATED Coins, discounts! Samples. Pricelist, 25¢. Alamo Coins, Box 5273, San Antonio 1, Texas.

U.S. Large cent and 2¢ piece, only \$1.95. Bargain list included. Vacoins, Box 10, Richmond 1, Va.

GENUINE Ancient bronze—Constantine the Great 60¢. Jolie, Roslyn Heights, New York.

LINCOLNS, 25 Different, 1909-1934 in folder, \$2.00. DeWolf, 508 South Hill, Oceanside, California.

NEW Coin book. Gives value and numbers made of all U. S. coins since 1793. Free supply folder included. Send 75¢ for illustrated book. Des Moines Coin Co., Box 1064, Des Moines, Iowa.

BEAUTIFUL Brilliant uncirculated sets. In deluxe albums. Commemorative half dollars \$965.00; Franklin half dollars \$69.75; Roosevelt dimes \$43.50; Jefferson nickels \$110.00. 1959 proof set \$5.95, or set encased in glittering lucite cube "paper-weight" \$10.75. Bebee's, 4514 North 30th, Omaha 11, Nebraska.

TWENTY Page 1961 retail price list of USA and Canadian coins for 10¢. Our selling prices on thousands of coins and coin collectors supplies. Bryson Incorporated, 612A White, Toledo 5, Ohio.

GOLD, Uncirculated: \$20, \$42.50; \$10, \$23.95. Cook, Box 181, Jackson 5, Miss.

TOP Prices paid for old money. Up to \$35,000.00 each paid for certain rare dates of United States coins. An estimated \$500,000,000.00 worth of rare coins are in circulation or in attics, drawers, etc. just waiting for discovery. Certain dates are worth: Penny before 1932 \$5,000.00; Nickel before 1942 \$15,100.00; Dime before 1943 \$5,100.00; Quarter before 1940 \$5,100.00; Half dollar before 1943 \$4,250.00; Silver dollars before 1936 \$12,500.00; Half cents, Indian pennies, 2¢, 3¢, Liberty head coins, gold coins worth up to \$35,000.00 each. Get our buying prices for your share of profit in old coins. Send only one dollar for Endwell's large, illustrated complete guide to rare coins giving buying prices (we have never failed to honor our listed buying prices) as well as many extra features such as information concerning Confederate money, paper money, Canadian coins and paper money, etc. The dozens of clear actual-size illustrations make it easy for you to identify the coin types. Thousands of copies of our fine catalog are in use in every state and many foreign countries. Many have called the Endwell guide "the finest rare coin guide available." We invite you to compare the Endwell guide with any other coin guide. Our reputation is proven by our thousands of satisfied customers and the many people who have sold us rare coins. We are proud of our reputation for fairness. Get your share of the \$500,000,000.00. Sell your coins to one of America's largest coin dealers. Send your dollar today. Your dollar will be refunded as soon as you sell us rare coins. Reliability absolutely guaranteed. Endwell-Union Company, Inc., Kirkwood H13A, New York.

LINCOLNS: 25 Different 1909-1930 \$1.45. 40 different 1909-1940 \$1.85. 25 different "S" \$1.50. Pricelist 10¢ (free with order). Buying list 25¢ (refunded). Harris, 1457 Moreno, Oceanside, California.

TWENTY Different early Lincoln cents \$1.00. Catalogue, 25¢. Freddie Buza, Stevens Point, Wisconsin.

25 DIFFERENT Coins from 25 foreign countries. \$1.00. Bargain. Hindley, Box 808, Mt. Vernon, Ohio.

INDIAN Head cents, two different only 20¢. Approvals. Littleton Coin Co., Littleton R1, New Hampshire.

LINCOLNS: 50 Different dates 1909-1940, including 1909VDB in folder. Only \$2.50 plus 35¢ postage. Earl Kammerzell, 207 Cleveland, Pullman, Washington.

HAWAII, Alaska statehood medals 95¢ each. Both in plastic holder \$3.95. Lincolns: 20 different before 1929 \$1.25. 1960-D small date uncirculated 75¢, closed "6," filled "B," filled "R" \$1.50 each. G Distributors, Box 35123, Los Angeles 35, California.

LINCOLNS — 1909-1938-18 Different — \$1.00. Box 85, N.E. Station, Livonia, Mich.

MEXICAN Silver dollars. Brilliant, uncirculated. Three for \$1.00. Ogden, Box 13404, Ft. Worth, Texas.

RARE Small dates. 1960-P \$3.80. 1960-D 30¢. 1960 proof set \$28.50. Gabsa, 4565 W. 170th, Lawndale, Calif.

SPECIAL 5 Different Liberty head nickels, album, 28 page Canada American catalogue \$1.00. Hobby Sales, Box 4054, St. Paul 16, Minn.

TRUNKFULL 25,000 Indian-Lincoln cents mixed (from the 1920's & older). Will pack "Grab-Bag" style 800 mixed—\$50; sample bag of 22—\$2. Mrs. Fischer, 5 Centre St., Hempstead 62, N.Y.

STAMP COLLECTING

1000 DIFFERENT, \$1.00 With approvals. Louis Golden, 6721 Eastwood, Philadelphia 49, Pennsylvania.

BERLIN Baers free with approvals. Heitmueller, Box 322, Asbury Park, N. J.

SOUVENIR Sheets Czechoslovakia 1937 plus Japan 1947, 10¢ with approvals. Kingman, 30 Empire, Yonkers 4, N. Y.

PORTUGUESE! 40 different free. Approvals. Elkhart, Box 33, Elkhart, Ind.

STAMP Collecting outfit, includes packet worldwide stamps, package hinges, watermark detector, millimeter gauge. Everything 10¢ with approvals. Loraine Brown, Marion, Michigan.

OLYMPIC Sets 3 complete 25¢, approvals. Snedco, Box 205E, Waldwick, N. J.

25 TURKISH Stamps—10¢ with approvals. Broadmoor Stamp Company, Mt. Vernon, Ohio.

TRADE Your duplicates toward our approvals! (Foreign only.) Complete information, 10¢. Variety Stamps, Box 98-P, Newton Highlands 61, Mass.

1075 DIFFERENT \$1.00 With approvals. Klondike, 682 Jefferson, Elgin, Illinois.

MEXICO 25 Beautiful 10¢; approvals. Salsman, Box 702, Berkeley, Calif.

15,000 DIFFERENT. Astounding new offer. Build your collection systematically as low as 50¢ monthly. Free gifts. Also a plan to earn money. Details free. Write to: Antioch Stamp Co., Akron, Indiana.

DEFECTIVE Old U.S., 1/6 catalog. Adults. K. Swartz, Malden Bridge, N. Y.

500 DIFFERENT, Includes pictorials, 35¢. Knopp, Box 1381, Bristol, Conn.

FREE—Italy. Collection of beautiful stamps, including 80 year old stamp. Free with approvals. De Respini, G.P.O., Box 771, New York City.

2000 U.S. Mission mixture \$1.00; 13,000, \$5.00. Wes Rood, Box 285, Cedar Rapids, Iowa.

AFRICAN Stamps. Send \$1.00 bill for 250 stamps. Africstamps, P.O. Box 9367, Johannesburg, S. Africa.

GAMBLER'S Packets, unsurpassed values. 50¢. No approvals. Weyer, Layton, N. J.

U.S. Plate blocks, singles. Price list free. Carlos Elbert, Box 222, Mt. Clemens, Michigan.

500 WORLDWIDE For 25¢! Contains U.S.A., Russia, first U. N., Summit Conference, Olympics, space satellite—hundreds more! Approvals, illustrated offers included. Horace Gatewood, Winston-Salem, North Carolina.

FREE! Surprise packet with approvals. Chamberlin, Box 113, Hesperia, California.

HUNDREDS Of stamps on paper. Unpicked from missions all over the world. With approvals. Quarter pound \$1.00, trial lot 25¢. Laurentian, 5600 Beurling, Montreal 19, Canada.

80 DIFFERENT U.S. stamps. Includes 19th century commemoratives. High values. Plus 1943 Flag stamp of occupied nations. All for only 25¢. Approvals included. Willett Co., Box 338-C Yorktown Heights, N. Y.

1000 DIFFERENT Worldwide stamps \$1.00. Valued over \$20.00. Universal, Box 6, Kenosha 5, Wisconsin.

21,000 ALL Different stamps, yours for only pennies a day on our systematic payment plan. Details free. Sjoquist, 1435 Cherrydale, San Jose 25, California.

FREE 50 Worldwide, mailed with inexpensive approvals. University Stamps, P.O. Box 95, Tamiami Station, Miami 44, Florida.

ALBUM! Hundreds of spaces! Only 10¢. Postpaid! Stampmart, Hartford 1, Conn.

FREE! \$1.00 Worth, your choice, from first selection. No strings! Adults only. Rush request now. Philatelics, Dept. RP, New Paltz, N. Y.

INTRODUCING Our better United States approvals we offer 15 United States stamps including Columbian, Bi-Centennials, famous American, airs, others; only 10¢. Ocean Stamps, Box 64-PM, Brooklyn 29, New York.

PENNY Approvals. Thousands. Bargains for pennies. Gifts with purchases. Penny Stamps, Orange, California.

UNITED Nations. Five different 10¢. Approvals. Anderson, 1112 Harrison, San Francisco 3, Calif.

25 DIFFERENT Commemoratives 1893 up 10¢. U. S. approvals. K&B, Box 70, Brooklyn 23, N. Y.

307 WORLDWIDE Different stamps only 25¢. Approvals. Niagastamp, St. Catharines 671, Ontario.

MINT U.S. at face! Older commemoratives only. Send 25¢ for all different packet with first selection mint U.S. approvals. Western, Box 1689P, Salinas, California.

GIANT Approvals, thousands different, 1¢ and 2¢ each. Wahl's Stamp Exchange, 7008P Farragut, Chicago 31, Ill.

UNITED States commemorative collection containing 33 different—10¢. Approvals. White, 516-A Avenue L, Brooklyn 30, New York.

SELL Your surplus good grade stamps. Write, describing fully what you have. Vanroy Shirk, Lebanon, Pennsylvania.

AMAZING OFFER! 200 United States stamps — including commemoratives, airmails, high denominations to \$1.00. Only 10¢ to approval applicants! Illustrated bargain lists free. Mystic Stamp Co., Dept. 80, Camden, New York.

100 STAMPS, 10¢ With approvals. Smith, 508A Brooks, College Station, Texas.

OLD Scarce U.S. seconds on approvals. Slight imperfections, lowest prices. Hernefield, Clintonhill Sta., Newark 8, N. J.

100 OLD United States between 1861 and 1935, \$1.00. Roush Stamps, 51 Chestnut, Mansfield, Ohio.

225 STAMPS For only 10¢! This mammoth value includes airmails, pictorials; stamps from strange countries cataloging up to 25¢ each! Also approvals. Mystic Stamp Company, Camden 80, New York.

UNITED States price list, 116 pages, price 25¢. Mark Hanna, 335 Fifth Ave., Pittsburgh 22, Penna.

SELL Stamps to our readers. Your ad in this space will be read by thousands of stamp buyers. I'll prove that to you. Write now for Folder "S." P. W. Johnson, Classified Advertising Manager, Popular Mechanics, 200 E. Ontario St., Chicago 11, Ill.

14,000 DIFFERENT! Amazing new plan builds your collection systematically, country by country. Only 50¢ weekly. Free details. L. G. Ware, Stepney 75, Conn.

U. S. Mint flag set, complete, \$1.00. Free list. Brooks, 2323 Avenue X, Brooklyn 35, New York.

103 DIVERSIFIED British colony stamps only 10¢. Approvals. Niagastamp, St. Catharines 671-A, Ontario.

50 DIFFERENT British colonials 10¢. Approvals. Robert Searjeant, Mendon, N. Y.

102 DIVERSIFIED Worldwide stamps 10¢. Approvals. Linstamp, St. Catharines 618, Ontario.

105 BRITISH Colony stamps, all different 10¢. Approvals. Crown Stamp Company, 901, Virgil, Ontario.

508 DIFFERENT World-wide from Formosa, Morocco, Indonesia, etc., cataloging over \$15.00, only 35¢. Offer to adults only. Approvals. Littleton Stamp Company, Littleton Q1, New Hampshire.

INTERESTING Worldwide animal stamp collection 10¢. With approvals. Niagastamp, St. Catharines 671-B, Ontario.

FREE! World's largest! Strange, valuable 7 x 14 1/2" beauty. Send 10¢ handling now! Norrisco, Milwaukee 7, Wis.

FREE Packet! Five different foreign countries. Request fascinating approvals. Coral, Box 55, Valle Crucis, N. C.

BIG U.S. price list free! Bailey, 45-G Bromfield, Boston, Mass.

25 DIFFERENT Large American commemoratives 10¢. With approvals. Linstamp, St. Catharines 618-A, Ontario.

1002 DIFFERENT Worldwide for approval buyers only. Jacobsen, Crompond, N. Y.

FREE Monaco nudes. Approvals. Stamp Ranch, 902 Addison, Chicago 13, Ill.

FREE. 250 Peelable hinges and 20 different Brazil with approvals. Jaydee, 218 Dickinson S.W., Grand Rapids 7, Mich.

FOREIGN F.D.C.'s mailed direct. 20 years experience. Contacts in every quarter of the world. Brumsey, 2418 First, Ft. Myers, Fla.

FREE! U.S. Roosevelt set with approvals. Philpot, 1902 Losey, La Crosse, Wis.

U.S. Stamps. Giant discount catalog 20¢. Raymax, 37VZ Malden Lane, New York City 38.

LOOK! Six Queen Elizabeth mint sets from Singapore, Malta, Virgins, Mauritius, Montserrat, St. Kitts! 21 brilliant pictorials, 25¢. Attractive approvals! Cannon Stamps, Box 931, Canton 1, Ohio.

ECONOMICAL 1/2¢-3¢ Approvals, 39,000 varieties. Dresel, Box 128-N, West Englewood, New Jersey.

STAMP Grab bag featuring exclusively animals, trains, flags, ships, triangles, maps, planes. Send dime. Stampliner, Route 3, North Bay, Ontario.

BULLFIGHTERS And five complete sets, 10¢ with interesting approvals. Kawartha Stamps, Box 513, Peterborough, Canada.

VOLCANO Triangle, Mexico's largest stamp, Ghana Lincoln statue, animal set, many others, all large pictorials. 10¢ with approvals. Nomad Stamp Co., Box 117, Shalimar, Florida.

GENERAL Foreign grab bag lot \$1.00. Try one and you will order more. Stroskey, 223 Market St., Perth Amboy, N. J.

500 FINE Mixed U. S. 15¢. Wright, 201M Mealey, Hagerstown, Maryland.

FREE! 25 Egypt, 5¢ handling. Approvals. Belleit, Mapledale, Hazel Park, Mich.

NEW Issues of the world each month on approval. Marson Stamp Company, 3922 S.E. 37th, Portland 2, Oregon.

30 LARGE U.S. commemoratives free approval applicants. Handling 10¢. Jack Clancy, Box 2187, Portland 14, Oregon.

FREE 400 Genuine postage stamps! Worth \$10.00 at catalogue prices. Africa, Europe, Asia, British Emp. A fascinating, valuable mixture from foreign convents, banks, etc. Who knows what you will find. Also free helpful collectors handbooks. Adults only. Fine approvals enclosed. Frasek Co., PM, White Plains, N. Y.

SPACE Pictorials. 10¢ with approvals. Schaefer, Californiastrasse 16, Wiesbaden, Germany.

LATIN America—50 different only 10¢ with our fine approvals. Hawkeye Stamps, R. 1, Highway 30 West, Cedar Rapids, Iowa.

DEALERS—Wholesale list. Postage 4¢. Frank, 5031 Queensberry, Baltimore 15, Maryland.

GREATEST Premium! World-wide collection! Over 1000 different stamps from Angola, Nigeria, Ecuador, Macao, other exotic lands. Includes triangles, airmails, sport, animal, ship, map stamps. Catalog value over \$25.00. This exciting collection given to qualified customers. Request approvals, details today. Odd Stamps Co., Dept. A10, Box 31, Redondo Beach, Calif.

ILLUSTRATED Monthly stamp news! Free, no approvals. Pictures galore, bargains in stamps. Darby Co., Milford Center, Ohio.

1¢ EACH Over face United States mint, commemoratives, 907 to date. Hille, 51 Lake, Arlington, Mass.

10 DIFFERENT Sets. Worth \$1.00. 25¢ with approvals. Bob's Stamps, Box 3045, Saint Louis 30, Missouri.

TOGO, Olympics. Seven values complete. 35¢ with approvals of world-wide complete sets. Le Roy Stamps, 645 W. 2nd, Winston-Salem, N. C.

NETHERLANDS Mint set seventeen only 10¢ to introduce my approvals. J. Schuster, 301 Sandpiper, Playa Del Rey, Calif.

FREE U.S. price list. Haverhill Stamp, Box 586, Haverhill, Mass.

FREE—25 Beautiful sport stamps in sets. Earn free albums with approval purchases. 10¢ handling please. Student Stamp Company, Box 116M, Claremont, New Hampshire.

1961 U.S. Price list 30¢. Lee's, Box 796, Rockford, Illinois.

MYSTERY Bag stamp collection, only 10¢. Hill Company, Defiance, Ohio.

100 STAMPS Plus 192 page, illustrated collector's handbook. \$2.00. Swiss Hill, 1114 White, Beloit, Wisconsin.

WORLD Unpicked! Mission bags \$1.00 each. Exceptional value, guarantee. Elroy Pick, R3, Manitowoc, Wis.

QUEEN Elizabeth on stamps. A beautiful collection of 50 different stamps from 22 countries, all bearing the portrait of the Queen of England. 10¢ with approvals. Capital Stamp Co., Ferrysburg 2A, Mich.

ESPECIALLY Beautiful commemorative; 50 diff. 25¢; 200 diff. \$1. E. M. Remley, Mount Dora, Florida.

TOGO, Mozambique, Maldives mint sets 10¢. Approvals. Jean's Stamp Den, Whitmeadow, Rockaway, New Jersey.

TERRIFIC Stamp bargain! Israel, Iceland. Vatican assortment—Plus exotic triangle set. Also fabulous British Colonial accumulation. Plus large stamp book. All four offers free. Send 10¢ to cover postage. Empire Stamp Corp., Dept. PM, Toronto, Canada.

FANTASTIC Fish triangles! Valuable "Ben Franklin" on Canal Zone! Flaming bi-colored volcano triangle! Lovely Olympics triangle! Plus icy Greenland, weird wild beast issue and others. 10¢ with approvals. Ozark Stamps, Spring Lake 2, Michigan.

NO Gimmicks. No gadgets. No give aways. Just attractive approvals at attractive prices. Sunny Stamps, Apopka 2B, Florida.

FREE! Giant bargain catalog. New edition listing thousands of bargains including U.S. and B.N.A. stamps, packets, mixtures, albums, accessories and supplies; sent with beautiful approvals. Jamestown Stamp, Dept. E110PM, Jamestown, N. Y.

FABULOUS Germany set collection: Giant ship set, moonrocket giant, sports and flowers sets, high mark value cpl. sets, scarce Se-tenant, ancient art treasures, concentration camp, error, sport races plus dozens of other tropical issues. This entire collection together with a 48-page stamp dictionary is yours for only 25¢! Bargain approval offers included. Stampex Co., Box 47BM, White Plains, N. Y.

NOVEMBER Special. 1000 worldwide stamps, \$1.00, 3.500, \$3.00. Guaranteed value. Harrison's Stamps, 1435 First Ave., Oakland 6, Calif.

FREE! Hyderabad, Afghanistan, Trengganu, Bahawalpur, Tanganyika. Inexpensive approvals accompany. Nade's, 116 Thomas, Wilmington 6, Delaware.

50 DIFFERENT Latin America, 10¢ with approvals. Quynn's, Scotland 2, Penna.

INDIA, 50 Different 10¢. Approvals. Hildebrand, Box 332, Oakland 4, California.

UNITED Nations—New souvenir sheet. 25¢ with approvals. Ftacek, Box 169-P, Ottawa, Illinois.

SPAIN'S Goya Nudes stamp 25¢. Approvals. Royal Stamp Company, Tamaqua, Penna.

COMMEMORATIVES! All different! Hungary 100—\$1.00. Free list. Wagner, 110 Calloidine, Buffalo 26, New York.

SWEDEN—100 Different, 25¢! Bargain approvals! Carling's, B-110, Howard City, Michigan.

TRY These! Low priced bulk approvals. Learned, 738 E. 18th, Denver 3, Colo.

FREE Sample! Interesting. Informative. Illustrated. National Stamp News, Anderson, South Carolina.

U.S. Commemoratives: 150 different \$1; 210 different \$2. Moseley, 6 Hanley Downs, St. Louis 17, Missouri.

U.S. Commemorative set 10¢ to approval applicants. Lippert, 16958 East Warren, Detroit 24, Mich.

SPACEOPHOBIA? Monaco nudes 10¢ to approval applicants. BKJ, Astor, Boston 23, Mass.

WOW! 110 All different Germany 10¢! Zeppelins, semi-postals, airmails, high values, etc. Giant catalog, bargain lists included with beautiful approvals. Jamestown Stamp, Dept. A110PM, Jamestown, New York.

MINT Set triangles, 200 different, 25¢. Approvals. Abbott, Box 245B, Jamaica 31, New York.

FREE—Any volume Scott's International albums, Scott's 1961 catalogues, even Master Global albums free, when you buy our sensational foreign approvals. Topval, Redlands 2, Calif.

TRIANGLES, Diamonds, Monaco plus beautiful San Marino, birds 10¢. Approvals. Berchtold, R.F.D. #1, Troy, Ohio.

PICTURESQUE Mint set free. Introducing outstanding approvals. Philapost, Pennington, New Jersey.

DEUTSCHE Democratic Republic, 50 different, \$1.00; 200 different Czechoslovakia, \$1.00; 50 Belgium Congo, \$1.00. Adams, p405, Martinez, Calif.

SAN Marino triangles 10¢. Approvals. Bates, 612 3rd, Red Oak, Iowa.

SOUTH American airmail set, surprise set, 100 worldwide different. 10¢. Approvals. Newman, Box 176, Penticton 37, B. C., Canada.

PICTORIAL Collection of ten nudes. Two dimes. Approvals. Stamp Farm, M2-28, Oxford, Wis.

FREE—World packet, including triangles. Approvals accompany. Skwarstamp, 730 Strawberry, Trenton 8, N. J.

RUSSIA! 28 Different, 15¢ with approvals. Bednar, 3455 Dayton Avenue, Lorain, Ohio.

MYSTERY Set! Long, complete, pictorial. Cataloging over \$1.00. Absolutely free with fine approvals. Stamp Imports, Peterborough, Canada.

TRIANGLES! 10 Different 10¢. World-wide approvals. Douglas Stamp, 3763 N. Y. Ave., Seaford, N. Y.

GERMANY Commemoratives, plus small catalogue \$1. Anton Langheinrich, München 23, Sturystr. 4.

FREE Stamp wallet perforation gauge with approvals. Robert J. Clark, P.O. Box 28-P, Wilmette, Illinois.

28 **CZARIST**, Early Soviet mint stamps, 15¢. Fine approvals. Edgington, Mountain Ranch, California.

FREE! Five different packets. Adult approval applicants. Norge, Ho-Ho-Kus, N. J.

FREE U.S.—50 different with fine U.S. approvals. Handling charge 10¢. Stamps, Kennebunk, Maine.

PREMIUMS! With penny approval purchases. Ross, Box 341, Yonkers, New York.

12,000 **PENNY** Approvals waiting for you! Many from exotic countries, pictorials, airmails, new issues. Tilbury, Box 862, Newark 1, N. J.

200 **DIFF.** Stamps 25¢. Approvals. Shirleys, 394 Silver St., Greenfield, Mass.

GERMANY 50 Different 10¢. Request approvals. Dancer, 75-P15, Mansfield, Ohio.

BEAUTIFUL 3¢ approvals. Thousands varieties! Marshall, Box 553-PB, Pacific Grove, Calif.

6 **BEAUTIFUL** Sets. French Colonies 10¢ with approvals. Bennett Candor 3, N. Y.

BEAUTIES! Pictorials from Sudan, Hong Kong, Iceland, Somali Coast, New Caledonia, San Marino, Singapore, etc. Only 10¢. Approvals. Champlain, Isle La Motte, Vermont.

19 **U.S.** Over 50 years old 30¢. Rayworth, 321 So. Cicero, Chicago 44.

U.S. Mixture, ten ounces, \$1.00 postpaid. Kirtland Philatelic, Willoughby, Ohio.

100 **DIFFERENT** U.S. 35¢. Joseph Myers, Route 5, Coldwater, Michigan.

10 **YEARS** Offer always available. Amazing bargain lots, hundreds stamps, packets. Sets \$1. Giant assortments \$5. High value packet \$3. Catalog. Samples, 31¢. Persile, 436 N. Y. Ave., Brooklyn 25, N. Y.

FREE! 33 Greenland! Congo! Ruanda! others. Approvals. Keating, 2520-P Boulevard, Jersey City 4, New Jersey.

FOR Older type stamps and covers contact Frank Peters, 77 Military Road, St. John's, Newfoundland.

TERRIFIC Value. Eight complete mint sets 10¢ with approvals. Beatties, 58 Glensagar Islington, Ont., Canada.

ENJOY Stamp collecting! Write for "Penny-provals." Penny-proval Service, New York Building, Saint Paul 1, Minn.

40,000 **VARIETIES** Available on approvals. 1¢ upwards. Keigwin, Box 933B, Daytona, Florida.

ANTIQUES, RELICS, INDIAN GOODS, CURIOS

BEAUTIFUL Oregon obsidian arrowheads. Introductory offer 3 perfect bird-points \$1.00. Strobeck, 724 Willamette, Eugene, Oregon.

10 **ANCIENT** Stone arrowheads, \$2.00. List 10¢. Stan's, 1054 Lilley, Columbus 6, Ohio.

SELLING Ancient Indian relics. Catalog free. Richard Kotil, 7500-M S.W. 16th St., Miami, Fla.

SELLING 20,000 Ancient arrowheads, spearheads, etc. List free. Lear's, Glenwood, Arkansas.

4 **ARROWHEADS** \$1.00. List. Smith, 841 N. Tacoma, Indianapolis 1, Indiana.

PRECIOUS STONES, MINERALS

GET Free catalog no serious rockhound, gem cutter, jewelry maker, hobbyist or craftsman can be without. Full of bargains, exclusive items, low prices from largest suppliers and authorities in the field. Free, new catalog just off the press, yours for the asking! Write Grieger's, Dept. C-11, 1633 E. Walnut, Pasadena, California.

PROSPECTORS! Learn from experienced geologists how to locate and identify rocks and minerals. A comprehensive home study course designed for anyone interested in exploring for valuable ore deposits. Write now for free literature. Pacific School of Mines, Dept. B11, Box 2538, Palm Springs, California.

FIND Jade! Thousands of American discoveries. Recognize valuable jades in stream gravels, quarries, fields. Ten different jade identification specimens \$5.00. Catalogue. Wilderness Originals, Canyon, California.

SEMI-Precious uncut gems. Ten different for \$1.00. Request list 26. Prospectors Shop, 201 San Francisco, Santa Fe, New Mexico.

FREE Bargain gem list. Lapidary and silversmith catalog, 56 pages, 25¢. O'Brien's, 1116M Wilcox, Hollywood 38, Calif.

EARTH Science. Rockhound's National Magazine. Subscription \$2.50. Sample 35¢. Box 1357-PM, Chicago 90, Ill.

QUALITY Sterling silver and gold filled mountings. Catalog free. Rockhound, Dept. P-M, Box 307, Onida, S. D.

HOBBIES AND COLLECTIONS

50 CHOICE Oriental seashells, identified \$2.00. 50 jungle butterflies \$2.00. Gem stone collection, 20 classified \$2.00. Free collector lists. P. Haas, 57-34 256th St., Little Neck, N. Y.

AMERICAN Newspaper, complete, original, dated in 1790's, \$1.50. 15¢ stamps brings catalogue. D. R. Spaight, Bookseller, Tall Timbers 1, Maryland.

COLLECT Medals, American, French, German: Three different regulation size; send \$2.00, get five foreign emblems free. Catalog 25¢. Insignia Club, 550-B, Fifth Ave., New York City.

COLLECTORS Matchbook covers. 100 different unused, \$1.00. Catalog 25¢. Album \$3.00. Charles Edelman, 1311-C East 84, Cleveland 3, Ohio.

PHOTOGRAPHY, CAMERAS, PHOTO SUPPLIES

164 PAGE Photographic bargain catalog, listing thousands of photographic bargains. Send 25¢ for your copy, credited on first order. Dept. 1-C11, Central Camera Company, 230 So. Wabash Ave., Chicago 4, Illinois.

PHOTOGRAPHIC Equipment. Free wholesale catalog. RNG Sales, PM, Willdorm, California.

PHOTO FINISHING

EIGHT Black and white 50¢. Reprints 5¢. Spade, 806 Market, Emporia, Kansas.

2x2-35MM. — Black and white slides mounted from any photo 35¢, or from any size b&w negative 15¢. B. J. Anderson, P.O. Box 26072, Indianapolis 26, Indiana.

INTRODUCTORY Special. Processing Kodachrome 8mm movie or 35mm 20 exp. \$1.00. Kodacolor 8 exp. complete \$2.00; 12 exp. \$3.00. Black and white 8 jumbos 40¢. Jumbo reprints 5¢. Quality guaranteed. Prompt service. Write for free mailers. Fast-X-Photo, Dept. PM-11, Box 7A, Jersey City, N. J.

8 x 10 BLACK And white photo enlargement of any snapshot only \$1.00. No negative needed! Photo Enlargements, Dept. P, 417 N. State St., Chicago 10, Ill.

ENLARGEMENTS, Heavyweight, six 5x7's or three 8x10's \$1.00. Jack Koons, Huntington Mills, Penna.

A Triple value. Quality, price, service. Color or black and white, 12 exp. (black and white) 59¢. 20 gift photos \$1.00. Holiday Photos, Dept. 16, Box 666, Denver, Colo.

A 3-In-1 value. Price, quality, service. 20 gift photos, \$1.00. 12 exposure rolls (black and white), 59¢. Color or black and white. Interstate Photos, Dept. 11, Box 15, Aurora, Ill.

TWELVE Exposure rolls 49¢. Wallets 20 for \$1.00. Lincoln Studios, Dept. K, Box 13, Lincoln, Nebr.

KODACHROME-Ektachrome guaranteed kodak processing. Prompt 8mm or 35mm 20 exp. \$1.40. Free list-mailers. Color Pix, Dept. P, CPO Box 30, Kingston, N. Y.

MOTION PICTURES AND SOUND EQUIPMENT

14 PAGES 16mm. sound films. 8mm. Carlsbad Caverns 50 color \$2.95. Gaines, Box 32430, Van Nuys, Calif.

WORLD'S Largest selection of 8mm. silent and sound films at discount prices. New and used—features and shorts from Castle, Official, AAP, NTA, etc., including "Old Time Movies," "Collectors Items." New 8mm. magnetic sound films available. Free Bargain Bulletin (specify size). Write to Peerless Camera Stores, 415 Lexington Ave., New York. Dept. M18.

16MM. SOUND Films, clearance. Free list. Cinemart Films, Box 75695, Los Angeles 5, Calif.

8MM Movies, 50', comedies, cartoons, travel, airplanes, hunting, fishing. Limited offer. Send \$1.00 each. MovieLand, Box 10-M, Van Nuys, Calif.

16MM SOUND—8mm films. New, used. Free list. Entertainment films, 236 W. 55, N. Y. C.

SPECIAL Entertainment—8 mm. b&w, 50 feet \$12.00. 16 mm., b&w. 100 feet \$20.00. Paré, Box 368, Terminal A, Toronto, Canada.

16MM. Sound feature films \$20.00. Bedner, 5300 So. Talman, Chicago 32.

16MM. Sound Shorts. Tremendous assortment features. \$16.50 up. Used 16mm. sound projectors, \$79.50 up. Catalog. Abbe Films, 417 West 44th Street, New York 36, N. Y. PLaza 7-2219.

5,000 8-16 MM. Movie films. Free catalogues. International, Greenvale, N. Y.

8MM-16MM Color and B & W film and supplies. Save money. Free catalog. Superior, 448 N. Wells, Chicago 10.

FREE Every month. Blackhawk's newspaper-size catalog 8mm., 16mm. movies, 2"x2" color slides. Biggest selection in USA. Bargains in used 16mm. sound films, projectors. Blackhawk Films, Davenport 14, Iowa.

MOVIE Camera film: 8mm. roll \$1.50. 16mm. 100' \$3.00. Free processing. Better Films, 742 New Lots, Brooklyn, N. Y.

16MM. Sound films. Bargain bulletin. Duquette, 97-T Snow, Fitchburg, Mass.

MOVIE Film! Free catalog! ESO-R, 47th Holly, Kansas City 12, Missouri.

16MM. Sound, projectors, films. Sale, rental, exchange. Visit store or write for catalog. National Cinema, 71 Dey St., New York City.

COLOR SLIDES

TITLES, Travel and wildflower slides. 8mm. titles. Free catalog. Title-Color, Box 35521T, Dallas 35, Texas.

BEAUTIFUL Color slides, glossy prints, movies. Landscapes, town photos and models. Samples and prospects U.S. \$1.00. Atlantic, Versand, P. Box 301, Kiel (Germany).

SOUTHSEAS—Hawaii, Samoa, Fiji, Tahiti, New Zealand, Australia. Six color slides for \$1.00. Catalogue, sample, 20¢. Avery, Box 8261, Honolulu 15, Hawaii.

AVIATION, Space Age wonders. 3 color slides, \$1.00. Coventry, 10989 Roebling, Los Angeles 24, California.

ALASKA Wildlife in color. Slides, 8mm., 16mm. movies. 3 sample slides \$1.00. Alaska Film, Box 5-821, Mt. View, Alaska.

LINCOLN Story, complete in 500 color slides. Catalogue and sample, 35¢. Willems, Box 1515-A, Chicago 90.

TRANSPARENCIES Wanted. Up to \$500.00 each. For information write: American Color, 1008 N. Stanley Ave., Hollywood 46, Calif.

MUSIC & MUSICAL INSTRUMENTS

CHORD Organs. Save ½. Italian craftsmanship. Play without lessons! Terms. Free trial! Free catalogs. Philharmonic Importers, Department R, 2003 Chicago, Chicago 22.

LEARN Piano in 6 weeks. Free information. Pennyfield's, P. O. Box 413, Chicago 90, Ill.

WANTED Poems. Music furnished free. Recordings, Box 6565, Shreveport, La.

VIOLINMAKERS, Repairers. Fine tone wood, and all violin supplies. Send for free wholesale new price list. International Violin Co., 414-MPM E. Baltimore St., Baltimore 2, Maryland.

SWISS Musical movements \$2.50. Electrical \$6.50. Spielman, 131 West 42nd, New York City 36.

SONGPOEMS And songs wanted! Mail to: Tin Pan Alley, Inc., Box 405, Radio City Station, New York 19, N. Y.

ACCORDIONS—Organs! From importer. Save ½. Free trial. Terms. Trades welcome. Free catalog. Dept. PM-11. Accordion Import Center, 7120 Galli Drive, San Jose, Calif.

RECORDING Contracts are unlimited for yourself, or group. \$3.00 for my brochure. Tells how to get on any label. J. A. Emmert, P.O. Box 101, Willoughby, Ohio.

SONGWRITERS—Outstanding, ethical offer. Hibbler, C-5, 6808 Oleander, Chicago 31, Illinois.

EXCITING News for musicians! Sunny-side Co., 8B Harwick Rd., Westbury, N. Y.

POEMS Wanted for musical setting and recording by America's largest song studio. Send poems. Free examination. Five Star Music Masters, 630 Beacon Building, Boston.

POEMS Wanted for musical setting and recording. Send poems. Free examination. Crown Music Company, 49-C West 32 Street, New York 1.

POEMS Needed immediately for new songs and records. Free examination and appraisal. Send poems: Songcrafters, Acklen Station, Nashville, Tenn.

GUITAR Making books, plans, imported woods, tools. List 10¢. Satinwood, 510 East 11th Street, New York 9, N. Y.

ELECTRIC Guitars, amplifiers, wholesale. Free catalog. Carvin, PMM, Covina, Calif.

SONGWRITERS! Money waiting for your poems! Information free! Successful Songs, Box 608, Danbury, Conn.

ACCORDIONS! Direct from importer—savings to 50%. Free home trial. Trades accepted. Easiest terms. Famous makes. Free 1961 catalog. Accordion Corporation, Dept. R, 2003 Chicago, Chicago 22.

POEMS Wanted! Best songs recorded free with 7-piece orchestra. Melodies written. Send poems, free examination. Songmakers, 1472-M Broadway, New York 36.

PIANO Tuning. Home study course. Diploma granted. American School of Tuning, Box 707, Gilroy, Calif.

RADIO, TELEVISION AND ELECTRONICS

HERE It is! A personal radio for \$4.49 complete. No tubes, transistors, batteries, or electricity needed. Lasts indefinitely. Complete with antenna, earphone, case. Send money order or check. No c.o.d. Bargains Unlimited, P.O. Box #62, Sault Ste. Marie, Michigan.

FREE 444-Page 1961 Allied Electronics Catalog! See products and values available only from Allied. See everything in stereo hi-fi systems and components; latest money-saving build-your-own Knight-kits; tape recorders; TV accessories; public address systems; world's largest stocks of parts, tubes, transistors, test instruments, tools, books. Only \$2 down on orders up to \$50. Write for value-packed free catalog! Allied Radio, 100 N. Western Ave., Dept. 96-L, Chicago 80, Ill.

4-TRANSISTOR Radios \$12.50. 3-transistor \$9.95. Details free. Elmer Block, Sarcoxie, Mo.

GET "Skip-It." From your chair, turn off or on, all sound on T.V. or radio. Send \$5.00 to Clark Enterprises, 6101 S.W. 11th cor. 61st Ave., West Hollywood, Fla. Mailed post-paid insured.

FREE! 1961 Catalogs for newest, best electronic bargains available. Stereo, hi-fi, ham radio, 1000 other items. Alco Electronics, Lawrence 2, Mass.

MYSTIC Antenna reveals secrets of nature's electronics! Locate hidden springs, water, gas, sewer lines, buried treasure! Works indoors; outdoors. Saves work, money! Easy to use. Fun for experiments! Details free. Stillwater, Box 317-M, Morris Plains, New Jersey.

REPAIR TV'S. Complete course \$10.00. Certificate. Guaranteed. Bacon, Portageville, Missouri.

FREE! Giant wholesale catalog on electronics, hi-fi, transistor, scientific, hobby, optics, photographic, housewares, jewelry, tools, novelties, toys. Write: Lektron, 131M Everet Ave., Chelsea 50, Mass.

GOVERNMENT Surplus radios, parts. Picture catalog 10¢. Meshna, Malden 48, Mass.

TAPE Recorders, Hi-Fi components, sleep learning equipment, tapes. Unusual values. Free catalog. Dressner, 69-02M, 174 St., Flushing 65, N. Y.

LEARN While asleep with amazing "Electronic Educator" endless tape recorder. Details free. Research Association, Box 24-N, Olympia, Washington.

ELECTRIC Guitars, amplifiers, wholesale. Free catalog. Carvin, PMR, Covina, Calif.

RADIO And TV tubes at manufacturer's prices! 100% guaranteed! Brand new! No re-brands or pulls! United Radio, Box 1000-M, Newark, N. J.

HI-FI Components, recorders. Free wholesale catalogue. Carston, 125-Y East 88, N. Y. C. 28.

FIX Your own TV. Save 80%! Send for free illustrated chart showing how! We'll include giant electronics catalog. Zalytron, 220-M West 42 St., New York City.

LOW Quotes. Hi-Fi equipment. Stereo tapes. Catalog. Hi-Fi, Roslyn 6, Penna.

STEREOPHONIC Phonographs, radios, recorders. Wholesale catalog free! Towers, Box 3022, Philadelphia 50.

CRYSTAL Radio kit \$1.00. Amplifier and speaker for same \$6.95. Catalogue. Clearco Crystal Company, 2966 No. 4th, Milwaukee 12, Wisconsin.

BUSINESS OPPORTUNITIES

IMPORT-Export opportunity, profitable, world-wide, mail-order business from home, without capital; or travel abroad. Established world trader ships instructions for no-risk examination. Experience unnecessary. Free details. Mellinger, C70B, Los Angeles 24.

INCREDIBLE New "table-top" machine manufactures over 15,000 saleable products. Also laminates, encases, moulds and plates in bronze, chrome, or copper. 20¢ materials produce \$10.00 products. Free confidential details and home-business plan. Plasti-Form, Dept. PM-11, Gardena, Calif.

PACKAGE At home! Items costing 2¢ in bulk sell for 40¢ on self-service racks. We show you how. Free home business details. HPC, 2212BM Jesse Street, Los Angeles 23.

MAIL Order franchise. No experience needed. Spencer Gifts, a well-established and successful mail order firm, starts you in business. Supplies catalogs with your own name imprinted. No investment in stock. No shipping merchandise. Catalog items pre-tested for salability. Initial investment of less than \$50 can get you started. Write for free information kit. Spencer Gifts, EZ-53 Spencer Building, Atlantic City, N. J.

MAKE Extra money—Big cash commissions plus premiums for you and your customers Sell advertising book matches. Sensational new tenor, glamour girls, hillbillies; dozens others. All sizes. Quick daily sales; big repeat business. Free master kit makes selling easy. No experience necessary. Superior Match, Dept. MX-1160, 7530 Greenwood, Chicago 19.

14 PROFESSIONAL Invisible mending needles with new book "Textile Repairing" covering all phases of reweaving including rugs and upholstery \$13.75. \$3.00 with order, balance c.o.d. Redden's, Box 98, Shingle Springs, California.

EXCEPTIONAL Mailorder opportunity! Write—George Lenhoff, Box 201-M, Lincoln 1, Nebraska.

BECOME Refrigeration serviceman. Complete instructions \$3.00. Details free. Lincoln, Box 52R, Hempstead, N. Y.

BIG Money—Operate own fix-it shop. Service household appliances, motors, mowers, saws, skates, etc. Free book. Christy Trades School, A-9603, 3214 Lawrence, Chicago 25.

INVISIBLE Reweaving: \$5-\$10 per job possible reweaving burns, tears, moth-holes. Spare-full time. Free details. Skil-Weave, Dept. RC-1612, 335 W. Madison, Chicago 6, Illinois.

EARN \$100.00 Week upholstering dinette chairs. Instructions 50¢. Simplcraft, 2338 Elston, Chicago 14.

MAILORDER — 750,000 items. Free wholesale lists. Dean Products, Box 40-PM, Elberton, Georgia.

BIG Income! Start a mimeographed advertising bulletin. Details \$1.00. Local Bulletin, Box 193, Feeding Hills, Mass.

NAMES. New mothers. Freshest. Unique service. Veatch, 972 Second, Beaver, Penna.

WANTED: Home producers, to be subcontractors. Cast plastic products for manufacturers in our clearing house service. Thousands of easily made items required. Cash in at home, without previous experience. Plastic Service Associates, Dept. 11-PM, East Boston 28, Massachusetts.

"HOW To Write Letters That Sell." Compact manual by expert brings you powerful weapon for success in any field. Only \$2.95 postpaid, money back guaranteed. Literature free. Helinger, East Syracuse 10, N. Y.

EXCLUSIVE Business opportunity. \$400 investment necessary. Details free! Box 3097, New York City 17.

MAIL Order! Imports! Details on free advertising, catalogs, directories. Kolsar, 611 Naysmith, McKeesport, Penna.

TERRITORIES Open for "Auto-Moly" Lubricant (doubles engine life). Small investment, build future state franchise. Pacific Lubricants, 5808-PM11 Beverly, Los Angeles 22, Calif.

\$1.00 BRINGS You \$18.00 spare-full time home business opportunity! Amazing new velvet-spray transforms old cheap lamps, TV-radios, figurines, furniture, anything, into valuable products! Free samples, 50 business opportunities booklet. Send no money. Flok-Kraft NR, Los Angeles 61.

LEARN Landscaping and the growing of plants. Start a profitable business part or full time. Free information without obligation. National Landscape Institute, Dept. MC-110, 11826 San Vicente Blvd., Los Angeles 19, Calif.

NEW Home-import mail order profitably! Your mailbox stuffed with money! No selling. No experience. No investment. We supply everything. Free details. Mail Order Distributors (Import Division) Dept. B5BC, 15201 South Broadway, Los Angeles, Calif.

BECOME Tax consultant. Graduates earn \$1,000-\$3,000 every tax season preparing returns evenings. State approved. Union Institute, Lakewood 2S, N. J.

START Your own business on credit (U.S. and Canada). Your own boss. 1396 dealers sold \$5,000 to \$25,500 in 1959. We supply stocks, equipment on credit. 200 home necessities. Sales experience unnecessary. Pleasant profitable business backed by world-wide industry. Write Rawleigh's, Dept. K-U-PPM, Freeport, Ill.

START Successful mailorder business without inventory, packaging, delivery headaches. Dropship Buyers' Guide reveals how. Send for free details. Rutward, 116 Bryant Ave., Columbia Station, Ohio.

\$250.00 WEEK Spare time profit possible. Earn at home with new fascinating printing method. \$5 starts you—send no money now. Free confidential facts and valuable sample. Screen-Print, NR, Los Angeles 61.

EXPORT-Import business made easy. Individual setup service. Not just instructions. Hermes, 152 West 42, New York City 36.

CASH From sawdust, tin-cans, newspapers. Over 200 methods. Instructions \$1.00. Charles Company, 42-GPT, Norwood, Ohio.

FREE Book "990 Successful, Little-Known Businesses." Work home! Plymouth-72N, Brooklyn 4, New York.

NATURAL Molding rubber, extra thick. Free samples. W. Wooley, 2801-A Latrobe, Peoria, Illinois.

MONEY Daily—Selling by mail. Everything furnished. Irvin, Box 1052, Oklahoma City 1.

REPAIR Hydraulic jacks. Easy and profitable. Write: Hydraulics, Box 4104, El Paso, Texas.

UNIQUELY Different magazine. \$4,500 profit possible! Dignified business. Operate from home! Sample, complete instructions \$1.00. Free details. HBD, GPO, Box 972-PM, New York 1.

FLORIDA—25 Different profitable businesses. Self operated, low investments, big profits. Florida Business Guide \$1.00. Research, Box 1891, Jacksonville, Florida.

MAKE Money at home! Respectable field. Experience unnecessary. No public contact. Nothing to grow or make. Excellent profit potentials! Free expert guidance helps you achieve success. Complete plan, details, \$1.00 (refundable). Columbia, 45-09-PY Broadway, Long Island City 3, New York.

CHROME Plating kit for automobiles. Penn Products, 1616 Wm. Penn, Conemaugh, Penna.

MAILORDER To motels, churches, institutions. Complete individual setup, not just instructions. Hermes Advertising, 152 West 42, New York City 36.

OPERATE Profitable mail order business. Free details. JEX, Box 411M Oklahoma City, Oklahoma.

EARN \$200.00 Monthly. With table saw or jigsaw. Sparetime. Mac-Dan, Box 457, Stanton Calif.

ANSWER Ads effortlessly. Use personalized "Jiffy" postcards. Sample free. Rafter, North Boston 11, N. Y.

BE Independent, be secure, have your own big money mail order business. Earn \$10,000 and up annually. Start from home. Start small and grow big. We set you up, show you how, guarantee results. You never invest one cent in inventory. All orders shipped for you. Collect cash in advance. Exciting details free. National Mail Order Corp., Dept. 1A, P.O. Box 828, Wayne, N. J.

FREE Catalog. Fast selling jewelry. Jacobie, 1715 East Mercer, Seattle 2, Wash.

FREE! "How to manufacture concrete drain tile." Easy. Profitable. Ceeten Products, Cornelia, Ga.

FRANCHISES Make profits! Operate your own exclusive franchised business. Write today for free interesting details. National Franchise Reports, W-528, 333 North Michigan, Chicago 1.

TRAVEL The world! Be a travel agent! Free travel. Unlimited income. Details. U.S. Travel Research, 708 Lucerne, Lake Worth, Florida.

SUCCESSFUL Tax deductible, home business plan. Only \$1.00. Incoplan, 1087 Yorktown, Sunnyvale, Calif.

SPARETIME Home moneymaking business—Easy! Trotta, Pka-2036—66th, Brooklyn 4, New York.

FREE! Name brands catalog! Your own high profit business. Sell name brands, full or part time. No inventory, no investment. More than 2,000 name brand items; lowest wholesale prices. Watches, jewelry, cameras, hi-fi, stereo radios-phonos, appliances, housewares, hardware, power tools, luggage, musical instruments, garden equipment, sporting goods, toys, many others. 8 floors of name brands. Million dollar inventory. Orders shipped complete in 24 hours! Send for free, beautifully illustrated catalog now! Separate wholesale price list. H. B. Davis Corp., Dept. 11, 145 W. 15 St., New York 11, N. Y.

FREE! Beautiful Mexican curios! Rush 30¢ stamps mailing. Sylviako, Apartado 9036, Mexico City.

DISTRIBUTE Lowest priced wholesale catalog. Felix, 160-04-16th, Whitestone 57, N. Y.

WANT To make big money at home? \$10.00 profit in an hour possible with invisible mending. Make tears, holes disappear from clothing, fabrics. Steady year-round demand from cleaners, laundries, homes. Details free. Fabricon, 6234 Broadway, Chicago 40, Ill.

MARKETS Everywhere. Make artistic concrete birdbaths, pottery. Best coloring. Home workshop. Hundred varieties. Hollywood Cementcraft, 8527-S Wonderland, Hollywood 46, California.

LEARN Sewing machine repairing. To \$125 weekly. Sparetime. Supplies. Add to present business. Write today! Taylor Service, Box 2126, San Bernardino, Calif.

IMMEDIATE Profits with no capital or experience. Take orders for all magazine subscriptions. Friends and neighbors are your prospects. Write now for complete, free kit. McGregor Magazine Agency, Dept. 6B, Mount Morris, Illinois.

FREE Picture folder, "How to Make \$3,000 Yearly, Sparetime, Backyard, Raising Earthworms!" Oakhaven-38, Cedar Hill, Texas.

VENDING Machines. No selling. Operate a route of coin machines and earn amazing profits. 32-page catalogue free. Parkway Machine Corporation, Dept. #27, 715 Ensor Street, Baltimore 2, Maryland.

BIG Money raising fishworms and crickets. Free literature. Carter Farms, Plains, Georgia.

BUSINESSES, Resorts, motels, investment property, ranches. Our special service dept. at your disposal. No obligation. World's largest. 58 years' service. Strout Realty, 7-MB S. Dearborn, Chicago 3, Ill.

TO \$100.00 Weekly, Sparetime, home operated mailorder business. Successful beginner's plan. Everything supplied. Lynn, 10420-M National, Los Angeles 34.

PIANO Tuning learned quickly at home. Tremendous field! Musical knowledge unnecessary. Information free. Empire School of Piano Tuning, Champaign, Ill. (Founded 1935).

I want to send you proof of the wonderful pulling power of Popular Mechanics classified pages. What's your proposition? Write me today. Include literature if possible. F. W. Johnson, Manager Classified Advertising, Popular Mechanics Magazine, 200 E. Ontario St., Chicago 11, Ill.

COPUBLISH Mail Sale Advertiser, leading mail order paper. Details, latest copy, dime. Vanroy Shirk, Lebanon, Penna.

11,000 NEW Prospects daily. Baby record books, shoes, albums. Sell mailorder. Use our literature. Write: No-Co-Ro, Capitola, California.

BRONZE Baby shoes: Instructions, equipment and mountings for genuine electroplating process. Largest supplier of all plating equipment, supplies. Free catalogue. Hollywood Bronze Supply, Dept. B-3, 1624 East First, Los Angeles 33, Calif.

OPERATE Profitable mail order business. Write Walter Service, 4159A East 112th, Cleveland 5, Ohio.

EARN Good money sharpening chain saws, scissors, cutters, knives. Free manual. Treyco, North Tonawanda, N. Y.

BAKE New greaseless doughnuts in kitchen. Sell stores. Free recipes. Montgomery, 3605 South 15th, Minneapolis 7, Minnesota.

IF You like motorcycles and money then send for Harley-Davidson dealership book on how to become a dealer of motorcycles and a new line of motorcooters. Here's a chance to own your own business with a very modest investment. The youth market is beginning to explode and the next few years promise a chance to cash in on it. Write for free illustrated dealership book today. Harley-Davidson Motor Company, Dept. P, Milwaukee 1, Wisconsin.

\$3.00 HOUR—Home, sparetime, assembling pump lamps. Easy. Free details. Ougor, Caldwell, Arkansas.

RAISE Rabbits on \$500 month plan. Free details. White's Rabbitry, Mt. Vernon, Ohio.

\$400.00 MONTHLY Raising giant worms. Odorless soilless method. Charlie Morgan, Bushnell, Florida.

LIQUID Molding rubber, free sample. Shellcraft supplies. Chaney's, 1907-A East Road, Jacksonville 11, Fla.

VENDING Machine catalog. Rakes, 609P Spring Garden, Philadelphia 23, Penna.

PLATE Baby shoes, jewelry, gifts, bronze and colored pearl. We finance. Free booklet. Platex, 11029 South Vermont, Los Angeles 44

MAKE Fabulous weekly profits clipping newspaper items for publishers. Some clippings worth \$5.00 each. Particulars free. National, 81-PM, Knickerbocker Station, New York City.

RECAST Junk batteries into new. Latest achievements. Battery Laboratories, Bayou LaBatre, Alabama.

\$34.70 TWO Hours. Manufacturing concrete products. No selling. Castings #3, 2907 Dundee, Rapid City, South Dakota.

CANDIED Popcorn and potato chip equipment. Eakins, Box 933-AO, Springfield, Ohio.

BUY Direct from factories. Appliances, cameras, watches! Free details! Cam Co., 6810PM-20th Ave., Brooklyn 4, N. Y.

PROSPER By selling "The World's Most Usable Bible." Sales quick, easy and highly profitable. To start earning a better living, write today. International Book Company, Department M., Box 118, Wichita 1, Kansas.

MAIL Order, home workers, dealers, hobbyists opportunities. Part time or full. Earn extra income. Details. Sterling, Box 626-PM, Dania, Florida.

MAILORDER Beginners no cost plan. Armstrong's, 154 Darrington S.W., Washington 24, D. C.

PLASTERCRAFT Molds, liquid rubber, plasters, flocks, candle supplies. Catalog and manual free. Blue Rapids Supply, Blue Rapids, Kansas.

SELL Books by mail. 400% profit. Royal, Box 368-X, Cleveland 27, Ohio.

EARN \$10,000 Yearly raising Angora rabbit wool for us. Information 25¢ coin. American Angora Company, Malta 77, Montana.

\$70 WEEKLY—Home, spare time. Simplified mail bookkeeping. Immediate income—easy! Auditax, 34757A, Los Angeles 34.

COLLECT Names for us, \$1.00 each. Instructions 25¢. Wilson's Specialties, Box 61-M, Mt. Pleasant, Michigan.

EVERYBODY Likes candy and popcorn specialties. Learn to make professionally home. (Our 50th year.) Ragsdale Candies, B-107, East Orange, New Jersey.

OPERATE Home mailorder business. Vosacek Distributors, 4444A Ute, San Diego 17, Calif.

EXCEPTIONALLY Profitable opportunity in tape recording! Free information. Baron's, Lynden, Washington.

MAKE Money from old tires. Operators clearing \$400 weekly. Equipment costs \$640. Get facts. S & S Patents, Inc., 1307 N. Clark, Chicago 10.

"**HOW** To make money by mail." Write: American Distributors, Box 409-P, Niles, Michigan.

MOLD Statuary, pottery, tiles, novelties. 5¢ materials makes dollar sellers! Particulars free. Marbleizing Service, Edwardsville, Illinois.

VALUABLE "Mailorder Business Franchise" absolutely free. Neil H. Tasker, Shamokin, Penna.

48 OPPORTUNITIES To make money in Florida. Copyright book \$1.00. Xotic's, Box 471, Largo, Florida.

OPPORTUNITY Of lifetime. More money Quicker advancement. Amazing information. Free. Fred Morris, 719 Mangum, Durham, N. C.

MAKE \$46 From square foot plywood; jigsaw necessary. Free details. Woodarts, Bridgewater, Mass.

MONEYMAKING OPPORTUNITIES

IN 1952 I was unemployed, broke. Today own \$18,000 home, drive Cadillac, have bank account. Anyone can do this. Write Norris Cole, 217 West 49th, Bradenton, Florida.

WIN Contest money. General Contest Bulletin gives hundreds of tips. Lists current contests, rules. Sample magazine 25¢. General Contests, 1609½ East 5th, Duluth 12, Minnesota

MAKE Fabulous weekly profits clipping newspaper items for publishers. Some clippings worth \$5.00 each. Particulars free. National, 81-PM, Knickerbocker Station, New York City.

EASY To earn extra money! Free 100 page catalog. Tandy Leather Company, Box 791-T37, Fort Worth, Texas.

100% PROFIT. No investment. Stamp brings samples, details. Miller, Box 584, Brooklyn 1, New York.

MINK Raising information free. Complete. Lake Superior Mink Farm, Superior, EEl, Wisconsin.

VENDING Machines. No selling. Operate a route of coin machines and earn amazing profits. 32-page catalogue free. Parkway Machine Corporation, Dept. #26, 715 Ensor Street, Baltimore 2, Maryland.

GROW Mushrooms. Cellar, shed and outdoors. Spare, full time, year round. We pay \$4.50 lb. dried. We have 29,000 customers. Free book. Mushrooms Dept.: 173, 2954 Admiral Way, Seattle, Wash.

CIGARETTES: Make 20 plain or filter-tips for 9¢. Facts free. Moberly, Box 821, Owensboro, Kentucky.

EARN Money evenings copying and duplicating comic cartoons for advertisers. Adservice, Argyle 1, Wisconsin.

YOUR Own, easy-to-start, home mail-order business, sparetime. Fascinating; profitable! Information free. Alfano, 19-PM Pine, Closter, N. J.

BIG Money raising fishworms and crickets. Free literature. Carter Hatchery, Plains, Georgia.

READ "Progressive Mailtrade." the magazine that tells how to make money by mail. Quarter brings sample and special offer. Progressive Mailtrade, Box 357, Sheboygan, Wisconsin.

MAKE Big money with fast-selling line self-help manuscripts, many titles! Imprints available; drop shipments if desired! Complete details to established mailorder dealers only! Economy, Box 2580-PM, Greensboro, North Carolina.

12 SURE-FIRE Mail order business plans plus 30 fast-selling products to manufacture in your basement. Complete \$1.00. Leko Enterprises, 2968B Wilson, Campbell, Ohio.

BOOKS: Terrific profits! No investment. Lindstroms, 48 Boylston, Cambridge, Mass.

SPARETIME Homework. Typewriter required. Money-making instructions 50¢, refundable. Interstate, 37 Besch, Albany 9, N. Y.

MEN—Women! Start money-making plastic laminating business at home in spare time. Material that costs 11¢ brings back \$2.58. No canvassing or selling but mail orders bring in \$20 a day. Write for full particulars free. Rush name on postcard to Warner, Room CL-2-L, 1512 Jarvis, Chicago 26, Ill.

EASY To start rubber stamp business at home in spare time. Make up to \$9.80 an hour without experience. Facts free. Write Roberts, 1512 Jarvis, Room CR-2-L, Chicago 26.

SIZEABLE Profits, buying, selling antique items locally. Information free. O'Rourke, 201B Arlington, Jersey City 5, New Jersey.

WANT A second income? Write: Wagner, 110 Callodine, Buffalo 26, New York.

SHELLCRAFT Supplies. Highest quality. Lowest prices. Large Catalogue 25¢. Pace's, Cortez, Florida.

TERRIFIC Profits. Easy. Assemble and sell waitress name plates. All businesses. Free details. Box 182P, Maywood, Calif.

UNUSUAL Profits in pocket change. Giant, illustrated guide of wanted coins, plus amazing free offer, only 25¢. Albetco, Box 843, Union, New Jersey.

DYNAMIC Mail order plans. Everything furnished. Details 25¢. Donovan, 79-PM Greenbelt, Levittown, New York.

MONTHLY Puzzle contests. Cash prizes! Spence, Box 11569, St. Petersburg, Fla.

CASH From discarded tires, valuable information, \$1.00. Woodson & Shay, 128½ Woodland Road, Asheville, N. Car.

FREE: 40 Wholesale catalogs to 900 pages. Sources \$1.00. Dalelum, 721 Solano Ave., Los Angeles 12, Calif.

SELL Perfume. Wholesale list, sample. Geller, 2089P Matthews, New York 62, New York.

START Big-pay business at home in spare time. No experience needed to operate little table-top machine for bronzing baby shoes. Make \$5.46 profit on every pair. Full particulars free. Send postcard to Mason, 1512 Jarvis, Room CM-2-L, Chicago 26, Ill.

MAIL Order success secrets revealed by new magazine. Free details. Mail Order Business, Dept. M-102, 550 Fifth Ave., New York 36.

KEY To success in mail order. North Star Products, Box 112-P2, Cedar Grove, New Jersey.

1 PAIRS—5 Pairs \$1.00. Make 100% profit. Tested Products, Box 393, Radio City Station, New York 19.

HUSBANDS And housewives wanted! Big money. Spare or full time cake decorating and candy making. Turn your kitchen into a gold mine. No age, education limits. Complete instruction, learn and earn at home. Write for free facts: Candy and Cake, Dept. 768, Fallbrook, California.

START A profitable subscription business in spare time! We need men and women (young and old) as representatives for all leading national magazines. Liberal commissions on all subscriptions. Supplies free. No experience needed. Send this ad with your name and address to: Popular Mechanics, Room 11-O, 250 W. 55th St., New York 10, N. Y.

JUST Out! R. C. Sellon's new manual "Poor Man's Way to Riches in Real Estate." Amazing method. Details from Author's Press, Box 265, Alameda, N. Mex.

FREE Folio! "The Facts About Plastic Laminating Business." Keller, Box 3097, New York City 17.

MEN, Women. Make money spare time and earn new car as bonus for encouragement. Amazing hosiery guaranteed to wear without holes, snags and runs, or replaced free. For example, lovely 60 gauge nylons guaranteed for as long as 1½ years, or replaced free. Write: Wilkmit, 17010 Washington, Greenfield, Ohio.

\$50 WEEKLY—Spare time, home operated. Sharpening all types scissors and pinking shears. Details free. Serr-Edge, 4469 West 160 Street, Cleveland 35, Ohio.

LEARN The secrets of repairing junk batteries, profitable, easy, at home. Free particulars. Batteryman, 3465 Forrest, Santa Clara, California.

\$600.00 PROFIT! Mailing catalogs! Sample, instructions 25¢. GPO, Box 972, New York 1.

WANT To make \$5,000 yearly or more in respectable, easily learned and operated mailorder business? Experience unnecessary. Valuable help given. Rush \$1.00 (refundable) for complete plan, details. Columbia, 45-09-PX Broadway, Long Island City 3, New York.

RAISE Nightcrawlers, redworms. Easy soilless method. Three Oaks Ranch, Dresden, Tenn.

GET Listed for life! Receive hundreds free magazines, samples, special offers. Rush 25¢, stamped, addressed envelope. Columbia, 45-09-MH Broadway, Long Island City 3, New York.

TERRIFIC Profits. Easy. Assemble and sell waitress name plates. All businesses. Free details. Ace, Box 182P, Maywood, Calif.

\$200.00 MONTHLY. Spare time. With tablesaw, bandsaw or jigsaw. Write. Holiday House, Box 1825 A, Vancouver, Washington.

ANSWER Ads effortlessly. Use personalized "Jiffy" postcards. Sample free. Rafter's, North Boston 11, N. Y.

MAKE Money in your spare time, or even go into business for yourself. Write today for free details. Zephyr Enterprises, Box 1484-D, Hartford 1, Connecticut.

MAKE \$200.00 Monthly spare time with jigsaw. Free details. Elkman, 346 N. Summit, Sioux Falls, So. Dak.

YOUR Jigsaw, bandsaw, lathe, can earn profits. Details. Majot, Michigan City, Indiana.

SEVENTEEN Dollars from square foot Balsawood. Machinery unnecessary. Instructions, sample \$1.00. Northern Crafters, PM-1, Bradford, Maine.

HOSIERY Salesmen. No canvassing. Details. George, Box 1224-p, Clarksburg, W. Va.

AMAZING Successes through franchises! Become exclusive franchise holder your territory. Information rushed. National Franchise Reports, MP-528, 333 North Michigan, Chicago 1.

EXPORT — IMPORT

ADDRESSES, 100 Foreign firms, \$1.00. Reid, Box 481, Clinton, N. C.

FOREIGN Import Directory \$1.00. Lists 400 exporters. Tech Publications, Box 821, Logan, W. Va.

RARE, Decorative, useful imports. Free catalog! Labranche, 308 Gagne, Rouyn, Quebec, Canada.

RECEIVE Gifts from foreign countries. Catalog 15¢. Veach, 716 W. 7th, Littlefield, Texas.

IMPORT Bargains. Free gifts, catalog 25¢. Carle Distributors, 2 Empire Street, Buffalo 12, New York.

JAPAN: Direct mail-order. 26 page catalogue, kimonos, dolls, novelties, gifts, business information, manufacturers' names, addresses. Send \$1.00. Clarence Yamagata, 814 Toginbiru, Marunouchi, Tokyo.

SCIENCE & CHEMISTRY

40 MISSILES! Identify your missiles. Send 50¢ for 11x17 informative, artist's renderings, suitable for framing. Durk Advertising, 654 Sheridan, Escondido, Calif.

AMAZING New book of science experiments, formulas, and catalogue of laboratory supplies. Only 35¢. National Scientific Co., 13 S. Park Avenue, Dept. PM-11, Lombard, Illinois.

ROCKETS Model kits, parts, chemicals. Catalog, plans, instructions 25¢. Central Rocket Company, Waupaca, Wis.

CHEMISTRY Catalog, 25¢. Expendibles kit free with \$15.00 order. Laboratory Sales, Box 161-A, Brighton, Mass.

232 PAGE Catalog \$2.00. Laboratory Materials, 7319 Vincennes, Chicago, Ill.

BARGAIN! Twelve Chemistry-Science booklets, \$1.00. Franks, 3121 South Racine, Chicago 8.

MICROSCOPE Slides, anatomical. Free list. Bay, 409 Roosevelt, San Francisco 14, California.

NEW Chemistry catalog 25¢. Winn Chemicals, 124 West 23 Street, New York 11, New York.

CHEMICALS, Apparatus, glassware. Illustrated catalog 25¢. Bio Chemical Products, Somerset, Belmont 78, Massachusetts.

CHEMICALS And apparatus for industrial, analytical, and private laboratories. Catalog 25¢. Dept. M-50. Biological Supply Co., 1176 Mt. Hope Ave., Rochester 20, N. Y.

ILLUSTRATED Catalog: Chemistry, mineralogy, biology 25¢. Tracey Laboratories, Evanston, Illinois.

ROCKET Supplies for amateur rocketry. Catalog 25¢. Mervin Hill Company, R.D. #1, Seward, Penna.

POPULAR Mechanics book, "Science Year," illustrated survey of last year's developments in science. Covers rockets, medicine, astronomy, electronics, etc. Send \$1 to Service Bureau, Room 517E, Popular Mechanics, 200 E. Ontario, Chicago 11, Illinois.

UNUSUAL Chemistry books, courses, kits! Rare chemicals, cheap! Catalog 25¢. NSC, Box 11133, Palo Alto, Calif.

EXPERIMENTERS: New! Bigger catalog and "Experiments Booklet." Only 25¢. Hagenow Laboratories, Manitowoc, Wis.

FORMULAS, PLANS, ETC.

RESILVER Mirrors—make one-way mirrors. Both \$1.00. Kem-Mir, Park Ridge, Illinois.

LATE, Modern manufacturing formulas. List free. Moon Chemical, Martville, New York.

FORMULAS: All kinds, moneymakers. Three catalogs, dime. Kemixal, Park Ridge, Ill.

FORMULAS For latest money-making discoveries. New! Good! Valuable literature free! Miller, Chemist, 1517-D, Tampa, Florida.

PLASTICS

PLASTIC. Vinylite, laminating supplies, machines. Solomonson, 4 Beacham, Everett 49, Mass.

PLASTIC Vacuum-forming machine. Hobby. Easy. Profitable. Details. Burr, 330 East Center, Kalamazoo, Michigan.

PLASTIC And supplies for laminating. Colamco, 12 Center, New Haven, Conn.

BOXES, Plastic. 200 sizes. Free list. Althor, 170 Bay 23 Street, Brooklyn, N. Y.

NEW Liquid casting plastic, clear, colors. Embed real flowers, butterflies, photos, coins. Send 25¢ for two handbooks "How to Cast Liquid Plastics" and "How to Make Extra Money at Home." Castolite, Dept. M-101, Woodstock, Illinois.

SEALED In plastic service. Cards, etc. Burr Laminating, 330 East Center, Kalamazoo, Mich.

PLASTICS And accessories for casting, molding, embedding and jewelry. Make unique Christmas gifts for pleasure or profit. Send 25¢ for 64 page catalog. Castacraft Corp., Dept. M-11, P.O. Box 555, Palo Alto, Calif.

AGENTS WANTED

"FOG-STOP" Windshield cloth. Instantly removes blurry mist, frost, sleet, snow. Stops windshield fogging. Samples sent on trial. Kristee 75, Akron, Ohio.

FAST-Selling specialties—Jewel Cleaner, Bouquet-Magic, many others. Excellent profits. Free catalog, special offer. Shaklee Products, 300 12th St., Oakland 7, Calif.

YOUR Own business—Used suits \$1.50; overcoats 65¢; mackinaws 35¢; shoes 12½¢; ladies' coats 30¢; dresses 15¢. Enormous profits. Catalog free. Nathan Portnoy Associates, 2109-AA Roosevelt Road, Chicago 8, Ill.

BE The Popular Mechanics representative in your neighborhood and earn big profits in your spare time. Write Popular Mechanics, Room 10-A, 250 West 55th St., New York 19, N. Y.

PRINTING. Advertising salesmen—Excellent moneymaking sideline selling decalcomania name plates, small quantities. Automobile initials, sign letters. Free samples. **Ralco, XL, Boston 19, Mass.**

SELL Champion, AC, Autolite spark plugs. Reconditioned, electroplated, guaranteed 10,000 miles, 100% profit. Free sample. **Lee Plugs, 1608-E Roberts, Houston 3, Texas.**

START Making money now. Earn top commissions taking orders for all magazine subscriptions. Friends and neighbors are your prospects. No experience needed. Write for free money-making kit. **McGregor Magazine Agency, Dept. 5A, Mount Morris, Illinois.**

MAKE Up to \$50.00 a day soliciting delinquent accounts. Terrific commissions. Write today. **National Credit, 304Y Pickwick Bldg., Kansas City 6, Mo.**

BIG Profits. Stamp social security plates, key protectors. Sample 50¢. Catalog free. **General Products, 11 No. Pearl St., Albany 7, N. Y.**

FREE! Beautiful Mexican curios! Rush 30¢ stamps mailing. **Sylvlak, Apartado 9036, Mexico City.**

MAKE Profitable men's-women's wear. Sample free. **Sunmade, Brockton 64, Mass.**

SELL Amazing glow-in-dark pictures. Big profits. Samples free. **Madison Mills, 303 Fourth Ave., New York 10, N. Y.**

YOUR Ad in this space will get some good agents for you. Yes, I'll prove it. Write for Folder "A" right now. **P. W. Johnson, Classified Advertising Manager, Popular Mechanics Magazine, 200 E. Ontario St., Chicago 11, Ill.**

WILL You test new items in your home? Surprisingly big pay. Latest conveniences for home, car. Send no money. Just your name. **Kristee 77, Akron, Ohio.**

MAKE Big money selling famous Swami polishing cloths, treated with General Electric Silicone oil. Over one million sold. Write **Swami Kloth, Box 155, Great Neck, N. Y.**

QUICK-Change magnetic letter signboards sell themselves! Order-getting sample, details, \$1.00. **Specialties House, Cincinnati 43B, Ohio.**

MEN! Women! 60% profit on cosmetics. Famous nationally advertised Hollywood cosmetics pay 60%. Make \$25 day up. Hire others. For free samples, details, write **Studio Girl, Glendale, California, Dept. 12011J.**

DAMASCENE Earrings! Exotic orientalism. Huge profit. Ohga, PM-210, Sigakenkusatu, Japan.

TIES On consignment. \$1.00 sellers, 40¢ profit. Rush for starting assortment. **Campus Cravats, 93 South Orange Avenue, Newark 2, N. J.**

MAKE \$10-\$100 A day! Sell new 5 year light bulbs. Guaranteed. Send for sample 6 pak \$1.98. Sells for \$4.69. Free details. **Sunmaster, 366 Fifth Ave., Dept. 11PMC, New York City.**

\$3.95 AUTOMATIC Fire extinguisher. Details free. **Aut-O-Matic, 1737G East 31st Ave., Denver 5, Colorado.**

NEW Sleeping comfort means generous profits with Electro-Warmth. Beat electric blankets 10 ways, costs less. Adds no top covering you sleep on it. Best season starting. **Patented Products Corp., Dept. PM-1160, Danville, Ohio.**

NEW Product. Sells on sight. Every home prospect. Sample \$1.00 or write for free information. **Bath Aid Mfg. Co., Box 484, Mitchell, So. Dak.**

MAKE Up to 150% selling quality French perfume types at 1/2 retail! Free sales kit. Exclusive territory. **Jule, Suite 810, 530 Arlington, Chicago 14.**

REAL Diamond rings. Nationally advertised. Sell direct. Make big middleman's profit. No investment. Experience unnecessary. Free catalog, details. **Gleam-light, 111-B9 North Columbus, Mount Vernon, N. Y.**

ANSWER Ads effortlessly. Use personalized "Jiffy" postcards. Sample free. **Rafters, North Boston 11, N. Y.**

AGENTS—Dealers—Farmers—up to \$250 weekly. Represent highly rated, well established firm your area. Products nationally advertised, needed by every farmer. Proven sales plan. No investment. Free sample. Ideal proposition for seed corn and feed men. **Farm Products, 248 No. Main, Rochelle, Ill.**

BUY IT WHOLESALE

FREE! Wholesale toy catalog! Big savings on hundreds of nationally advertised toys for Christmas. **Housewares Distributors, 1216-AB West 79th St., Chicago 20, Illinois.**

NOW! Gigantic wholesale catalog \$1.00 (deductible). **Earl Johnson, Hudson, Ind.**

BOOTS. Handmade western styles. Free catalog. **Austin Boot Co., Box 5303-J, El Paso, Texas.**

FREE Catalog! General merchandise; bargains, amazing! **Cole, P. O. 793-P, Pine Bluff, Arkansas.**

WHOLESALE Catalog. You profit. Free details. **Loeber, 224-F Wyatt, Lincoln, Ill.**

7/16" RAISED. Metal letters, numerals. Black; white; gold. 150, \$3.95. **RNG Sales, Wildomar, California.**

NAME Brands at discount prices. Toys, appliances, jewelry. Catalog 25¢. (Refundable first order). Lifetime, 211 Genesee. **Auburn, New York.**

JOIN Now and save 20% to 50% on nationally advertised appliances, furniture, carpeting, photo equipment and other famous brand merchandise. Limited exclusive membership. Write for free brochure to **Mutual Buyers Club, Inc., Dept. PM-3, 1000 W. Roosevelt Road, Chicago 8, Ill.**

BARGAIN Catalog. Discounts on appliances, housewares, tools, toys. 32674 **Merritt, Garden City, Michigan.**

BULOVA. Benrus watches like new \$5.95 up. Illustrated catalog with hundreds of bargains, free. **Cosmos, New York 35, N. Y. Dept. 617.**

WORLD'S Largest wholesale supply. Buy from 679 American, European, Japanese wholesalers. Tailormade suits from Hongkong. 123 dropship catalogs. Rockbottom prices. Free details. **International Buyers, 216-M Jackson, Chicago 6, Illinois.**

TYPEWRITERS. Cameras, watches, outboard motors, blades shavers exerciser-reducers, guitars, gold coins. **Simms, Warwick, N. Y.**

POWER Tool catalog 25¢. **B. L. Roberson, 14A Brooks Drive, Austell, Georgia.**

CAMERAS Wholesale. Catalog free. Photo Distributors, Box 4203, San Diego 4, California.

EVERYTHING In name brands merchandise sold wholesale to individual consumers. No quantity purchases necessary. Send 50¢ for large beautifully illustrated catalog. Refunded with first order. **Gary Gifts, Dept. 12-B, 672 South Alvarado Street, Los Angeles 57, California.**

ELECTRIC Guitars, amplifiers, wholesale. Free catalog. **Carvin, PMW, Covina, Calif.**

WHOLESALE: 850,000 Items. Supply source directory 25¢. **Idealer, Park Ridge, Illinois.**

LARGEST Wholesale supply source in U.S.! Furniture, clothing, appliances, housewares, automobiles and accessories, tools, sporting goods, hobby supplies, farm equipment, imports, new products, bargain merchandise. Free details. **Associated Wholesalers, Box 2068-DD, Sioux City 4, Iowa.**

USED And new watches \$2 up. Free list. **Southern Watches, 5-PM So. Wabash, Chicago 3.**

100,000 PRODUCTS Wholesale! Terrific bargains! **United Wholesalers, 1265-M Broadway, New York 1, N. Y.**

NEWLY Namebrand merchandise and toy catalog. \$1.00 for both plus postage. **Strom Sale Service, Box 141, Templeton, Mass.**

BELOW Wholesale. Clothing, appliances, etc. Catalog 10¢. **Wambaugh, 7316 Lawndale, Philadelphia 11, Penna.**

FACTORY Prices! Thousands nationally advertised products. Typewriters, housewares, jewelry, watches, appliances, television, cameras, etc. New factory buying plan saves up to 40% below wholesale. Details free. **Factory Supply Company, Bloomfield 2, New Jersey.**

BUY Direct from factories. Appliances, cameras, watches! Free details! **Cam, 116 Malden Street, Worcester, Mass.**

NEW DeLuxe Multicolor wholesale catalog, automobile catalog, and others. Nationally advertised merchandise. Housewares, appliances, refrigerators, freezers, washers, dryers, television, radios, rugs, furniture, sewing machines, clothing, luggage, binoculars, phonographs, musical instruments, recorders, cameras, projectors, typewriters, power tools, toys, notions, sporting goods, watches, jewelry, novelties, vitamins, drug sundries, cosmetics, books, school supplies, practically everything. Famous brands. Huge discounts up to 40 to 70%. Postcard: **Seibco, Decatur 5, Illinois.**

BELOW Wholesale most merchandise. Write: **Factory Buyer, 446, Jacksonville, Illinois.**

SALESMEN—DISTRIBUTORS

WILL You wear new suits and topcoats without one penny cost and agree to show them to friends? You can make up to \$30.00 in a day even in spare time, without canvassing. **Stone-Field, 532 South Throop St., Dept. N-926, Chicago 7, Ill.**

SEEKING New products? Get my outfit 47 money-making specialties. Latest conveniences for home, car. Send no money. Just your name. **Kristee 103, Akron, Ohio.**

\$1,000.00 A Month for making dramatic 3-second demonstration of amazing lightweight Presto Fire Extinguisher. New chemical used by Airforce snuffs out fires instantly. Only \$4.95. Terrific commissions. Millions want it. Free kit. **Merlite, 114 E. 32nd, Dept. P-66X, New York 16.**

MAKE Extra money—Big cash commissions plus premium for you and your customers. Sell advertising book matches. Sensational new tenoramas, glamour girls, hillbillies; dozens others. All sizes. **Quick daily sales; big repeat business. Free master kit makes selling easy. No experience necessary. Superior Match, Dept. M-1160, 7530 Greenwood, Chicago 19.**

CALENDARS. Advertising novelties, matches. All styles, including religious, varnished, 12 sheet, girls. Hundreds of advertising novelties, book matches, etc. **Fleming Calendar Co., Sales Division, 6539 Cottage Grove, Chicago 37, Ill.**

SEPTIC Tank, cesspool trouble, and expense of cleaning prevented by using nationally advertised Septo-Bac. Guaranteed. Harmless to plumbing. Flush down toilet. Send for free descriptive literature, plus details to **W. B. McGay Company, Owosso, Michigan.**

MAKE Extra money selling advertising matchbooks. Free catalog and sales outfit. **Matchcorp, Dept. PM-110, Chicago 32.**

MONEY-Making opportunity! Take big profit orders for world famous patented varieties fruit trees. Also flowering shrubs, roses, vines. Big sales outfit free. **Stark Bro's, Desk 30151, Louisiana, Missouri.**

STEADY Profits. Made - to - measure shirts. Free sales kit. **Dept. PM-11, Henlein, Cincinnati 2, Ohio.**

SALESMEN To sell transparent mirrors and novelties made on Catalina Island. **Ye Olde L.A. Press Club, 9026 So. Orchard Avenue, Los Angeles 44, Calif.**

AMAZING "Show and Sell" earns you top commission. Businesses need signs and advertising materials. **Advance Press, Addison, Ill.**

BIG Money. New sensational plan. Fleets and farmers buy huge quantities. Free details. **Conklin, Inc., 5626 Nokomis Station, Minneapolis 17, Minn.**

SENSATIONAL new longer-burning light bulb. Amazing Free replacement guarantee—never again buy light bulbs. No competition. Multi-million dollar market yours alone. Make small fortune even spare time. Incredibly quick sales. Free sales kit. **Merlite (Bulb Div.), 114 E. 32nd, Dept. C-74X, New York City 16.**

OFFPRICE Merchandise Bulletin 10¢. Liquidations, overstocks, bargains. "Close-outs." 3931 Washington, Boston 31, Mass.

GROUND Floor opportunity. Sell stores or direct. New ice grippers. Quick on and off. Fits men's, boy's shoes. Patent pending. Sample pair \$1. **Albert Bailey, Box 35, Cabanne Station, St. Louis, Mo.**

RARE Opportunity to become an exclusive dealer for America's largest producers of aluminum home and commercial additions with Honeycomb insulation. Requires \$3390 for inventory. Write or wire including phone to National Sales Division, Power-Matics, Inc., 1572 Stillwell Ave., Bronx, N. Y., TYRone 2-4400.

NEW Polish discovery. "Alumakleen" cleans, polishes, protects. Aluminum, copper, brass, chrome, stainless steel. Write Nycopro Products Co., 1803 S. Jefferson St., Chicago 16, Ill.

BIG Profits selling homes, factories 6-in-1 pocket workshop. Sample \$1.00. Gam Corporation, Lancaster, Penna.

MAKE Up to \$50.00 a day soliciting delinquent accounts. Terrific commissions. Write today. General Finance, 304V Pickwick Bldg., Kansas City 6, Mo.

IF You're interested in making money in selling, see the hundreds of exceptional opportunities in Salesmen's Opportunity Magazine. Send name for your copy, absolutely free. Tell us what you're selling now. Opportunity, 848 N. Dearborn, Dept. 17, Chicago 10, Illinois.

MONEYMAKING Opportunity in fast growing market selling attractive outdoor advertising pennants. Write: Radder Products, Box 31, Colvin Station, Syracuse 5, New York.

VITAMINS! Private labels! Exclusive sales! We furnish product, plan, literature. You provide management, employ salesmen. Terrific profits. Repeats! Sample and details free. VimVite, 2908-E Beverly Boulevard, Los Angeles 57.

EMPLOYMENT INFORMATION

LIST Of names—addresses. 100 American contractors with large overseas projects. Only \$1.00. Contractor Services, Meramec Building, St. Louis 5, Missouri.

MERCHANT Marine jobs. Men and women. Top wages. Travel. Captain, Box 501-P, Reading, Massachusetts.

HIGH Paying jobs. World wide, Alaska, Japan, South America, Europe. Skilled and unskilled. Thousands of positions open, and jobs on ships. For free information, write to International Employment, P.O. 115, Boston 27, Mass.

U.S.A. Foreign jobs, up to \$1600.00 monthly. Construction, clerical, supervisory, etc. Skilled, unskilled. Free transportation. Unusual opportunities. Complete information plus worldwide project listings. Only \$2.00 (\$2.25 airmail). Satisfaction guaranteed. International Reports, Dept. Q, 109 West 42, New York 36, N. Y.

VIRGIN Island employment information send \$1.00. Domini Hus (1), St. Thomas V. I.

HIGH Pay overseas domestic jobs. Men, women. Generous benefits. Companies pay transportation. For information write: World Wide, Dept. B5, 149 N. Franklin St., Hempstead, N. Y.

APPRENTICESHIPS And jobs available Germany, Great Britain, Sweden, Switzerland. Learn new skills. Travel. Complete particulars \$2.00. Erikson, 6857 Franklin Avenue, Los Angeles 28.

JOBS: High pay. Foreign countries, U.S.A. All trades. Write Dept. 55C, National Employment Information, 1020 Broad, Newark, N. J.

LATEST Foreign jobs! Highest wages. Unlimited opportunities. Laborers, clerical, construction, electronics, oil fields, civil service. \$2.00 (c.o.d.'s accepted). America's leading overseas employment researcher. Plus newest South American, Alaskan, Venezuelan listings. Universal Research, Box 4912, Baltimore 20, Md.

GOOD Salaries—Petroleum, construction, manufacturing, teaching, etc. Technical, professional personnel. Travel paid, living allowances, bonuses, U.S. tax exempt. Information \$2.25 air mailed. Colombian Opportunities, Apartado Aereo 14448, Bogota, Colombia.

100s GOVERNMENT Jobs. Civil Service security. Overseas, in States. West Point-Annapolis entrance. Learn how to come out high in exams. \$1 starts you. Tole House, Box 2521M, Hollywood 28, Calif.

FOREIGN Employment information. Work overseas. Travel, adventure. Europe, Africa, Asia, Canada, Alaska. Earn as much as \$1,600 monthly. Construction men, truck drivers, clerks, teachers, professionals, etc. Fabulous opportunities. Most complete information, application blanks, etc. Sent by return mail same day received. Send \$2.00 to Dept. PM, Foreign Bureau, P.O. Box 512, New Orleans, Louisiana.

FREE Information—U.S.A., overseas jobs. High pay, transportation. Futures. Dept. M, 215 West 34th Street, New York City 1.

JOBS On ships. \$100 weekly, beginners. Travel, adventure. Write: Seamans Service, Box 17-M, Brooklyn 8, N. Y.

FOREIGN Jobs—Latin America, Alaska, Canada, up to \$1500 monthly. Up-to-date 1960 foreign service directory gives complete information; hot list of firms hiring for military and civilian construction, aircraft, oil, exporters-importers, mining. How-when-where to apply. 12th successful year. \$1.00. Global Reports, Box 8873-S, Los Angeles 8, Calif.

PLENTY Jobs. Stateside-worldwide. High pay. Elsing, Box 12, Detroit 13, Michigan.

DIRECTORY Reports. Construction, aviation, shipping, oilfields, government, manufacturing, trucking, etc. Foreign-stateside. Helpful information plus job-getting tips on preparing application letters. Unconditional money-back guarantee of satisfaction. Act today. Only \$2.00 (\$2.25 airmail). (C.O.D.'s accepted). Research Services, Meramec Building, St. Louis 5-PM, Missouri.

SPECIAL SERVICES

\$2.00 BRINGS List of manufacturer's for anything. Air mailed same day. National Listing Systems, Box 5173, Amarillo, Texas.

INFORMATION On anything. Ferguson Research Specialists, 43-11 64 St., Woodside 77, N. Y.

EDUCATIONAL AND INSTRUCTION

LEARN Civil and criminal investigation at home. Earn steady, good pay. State age. Institute Applied Science, 1920 Sunnyside, Department 168, Chicago 40, Ill.

INVESTIGATORS Course. Credentials, diploma. Free information. Southwestern Institute Criminology, A-510 Iowa, Geronimo, Oklahoma.

BLUEPRINT Reading. Learn to read blueprints with confidence in 10 easy lessons. Write: Belton, 1059C North Lawndale, Chicago 51.

AMAZING New dental laboratory manual. Constructive, authentic, illustrated. Free millimeter rule. Write Grant Laboratory, Haas Bldg., Los Angeles 14, Calif.

MASTER Watchmaking at home. Free sample lesson. Chicago School, 2328-YL, Milwaukee, Chicago 47.

STUDY At home for personal advancement and spiritual unfoldment. Systematic study of Metaphysics or Metaphysical Psychology may help solve mental worries. Correspondence only. Free booklet. College of Universal Truth, 23 East Jackson, Dept. 3, Chicago 4, Ill.

FINISH High school at home. No classes. Texts furnished. Diploma awarded. If 17 or over and left school, write for free assignment and catalog. Wayne School of LaSalle Extension University, A Correspondence Institution, Dept. 1159 WC, 419 S. Dearborn, Chicago 5, Ill.

BE A locksmith! Earn while you learn. Big opportunities await you in this fascinating, profitable trade. Earn quickly—step into a wellpaid job or start a business of your own, full or parttime. Learn easily at home, all materials and special tools supplied. Write for free book today! Locksmithing Institute, Dept. 6711, 150 Park Avenue, East Rutherford, New Jersey.

COMPLETE Your high school at home in spare time with 63-year-old school. Texts furnished. No classes. Diploma. Information booklet free. American School, Dept. X845, Drexel at 58th, Chicago 37, Illinois.

LEARN By ear with Dormiphone. While you slumber, the amazing new scientific Dormiphone tools give you a shortcut to learning languages, correct speech; memorizing facts, figures; relaxation, habit training. Saves you time, effort. So simple to use, children benefit. Used by educators, psychologists. Write today for fascinating free book. No obligation. Modernophone, Inc., 320-110 Radio City, New York 20.

"HOW To Train Horses"—A book everyone who likes horses or ponies should have. Free. No obligation. Simply address Beery School, Dept. 11011-C, Pleasant Hill, Ohio.

CIVIL Service. Learn about this field of work and how you can prepare yourself by home study for a high entrance mark. Private organization. Free booklet. No obligation. Franklin Institute, Dept. W40, Rochester 4, N. Y.

GAME Warden, government hunter, forestry, park and wildlife service announce job openings regularly. Enjoy outdoor work, good pay real security. Complete information free! Write North American School of Conservation, Dept. 17BB, 810 Dodsworth, Covina, Calif.

FREE Book "990 Successful, Little-Known Businesses." Work home! Plymouth 71N, Brooklyn 4, New York.

PLAY Organ like professional. New. Free details. Afsco, 414 E. Valley, San Gabriel, California.

USED Correspondence courses, books. Satisfaction guaranteed. Catalog 10¢ refundable. Courses bought. Bayles, 78-B Courtright, Wilkes Barre, Penna.

BECOME A personal problem counselor. Enter dignified profession. Instructions \$1.00. Hermansen, Box 808, Grand Central Station, New York 17, N. Y.

REAL Estate course. Economical home-study. Prospects free. Howard Schools, 320 Glover Building, Kansas City 5, Missouri.

PIANO Tuning pays. Big money in spare time. Learn at home in 30 days. No musical knowledge necessary. Phonograph, records, tools and instructions furnished. Electronic tuning taught also. Free catalog. Capital Piano Tuning School, 3160 S.W. 16th Court, Fort Lauderdale, Fla.

MATHEMATICS. Algebra, Trigonometry, Geometry. In your spare time you can learn at your own pace from qualified instructors to master mathematics. We guarantee proficiency or money refunded. Send for Catalog T. Mathematics Institute, Dept. 12-L, 2 Wash. Sq. Vill., New York 12, N. Y.

DEVELOP Powerful mind. Details free. Troy's Record Service, 173 W. San Fernando, San Jose 13, Calif.

EARN Degree from institutes abroad, taking tests or courses. No traveling. Aureab, Central Valley, New York.

USED Correspondence courses, books bought, sold, rented. Catalog free. Vernon's Summerville, Ga.

SEND And receive Morse Code in 30 minutes! Complete code kit \$1.00. Money-back guarantee. Mail to Code, Box 666-H, Whittier, California.

SLIDE Rule. Simplified method. Learn to read, multiply, divide. \$2.00. Slide Rule Institute, 3808 Cornelia, Chicago 18.

ENGINEERING And art degrees earned through home study. Electronics, electrical, mechanical, civil, physics, liberal arts. When writing, specify course desired. Pacific International College of Arts & Sciences, primarily a correspondence school. Resident classes also carried. 5719-B Santa Monica Boulevard, Hollywood 38, Calif.

POPULARITY Through music! Make new friends. Earn extra money. Learn accordion, guitar. Easy lessons. Instrument furnished. Satisfaction guaranteed. Free information. National Conservatory of Music, P.O. Box 1938, New Haven, Connecticut.

INVESTIGATOR Training—Free booklet covering approved home-study plan. Write National Detective Academy, Dept. E, 722 West Chapman Avenue, Orange, Calif.

BILLION Dollar technical industry needs qualified men! Our unique combination home training assures high earnings. Free placements. Vital information furnished. Northeast Schools, New Haven 9, Conn.

BE A Real Estate Broker. Insure security for yourself and your family. Study at home. Prepare for state examination. GI approved. Write for free book today. Weaver School of Real Estate, 2018 P Grand, Kansas City, Missouri.

LEARN Auctioneering. Free catalog. Missouri Auction School, Box 9252X3, Kansas City, Missouri.

LEARN World interlanguage approved by UNESCO. Textbook 25¢. Esperanto, Middleton, Wis.

LEARN Asleep or awake. Self-help books, tapes, recordings. Free catalog. Drawer PM-697, Ruidoso, New Mexico.

HIGH School diploma at home. Licensed teachers. Approved materials. Southern States Academy, Station E-16, Atlanta, Ga.

WANT A diesel job? Higher pay? Advancement? We can help you qualify! Complete diesel, tractor and heavy equipment and Cummins Diesel Engine Shop-method home-training courses available. Write today. Interstate Training Service, Dept. B-3, Portland 12, Ore.

DEVELOP Mind power, personality while asleep. Use your phonograph, recorder. Amazing psychological tapes, records now available. Details free. Sleep-Learning Association, Box 24-N, Olympia, Washington.

EARN While you learn. Auto and diesel mechanics master this top paying trade. Many graduates earn \$100 a week and up. Approved for Korean veterans. For free information write Dept. No. 256, Nashville Auto-Diesel College, Nashville 3, Tenn.

PHYSICAL Therapy and massage. Home training. Practice privately or work with doctors and hospitals. Free catalogue. National Institute, Desk 4, 159 E. Ontario, Chicago, Ill.

BOOKS, Free general catalog, 100 pages. Text, vocational, educational, instructional subjects. Millions of volumes, new and used. Bargain prices. Books bought. Fst. 1902. Long's College Book Co., Dept. PM, Columbus 1, Ohio.

STRENGTHEN Your voice—for more success in business, social life! Free booklet. (Give age.) PV Institute, Studio EP-2, 210 South Clinton, Chicago 6.

INVESTIGATOR Training—Robert B. Phillips Sr., Founder, former U.S. Government Special Agent. Write to 1917-K North Kenneth, Chicago 39, Ill.

USED Correspondence courses and books sold and rented. Money back guarantee. Catalog free. (Courses bought.) Lee Mountain, Pisgah, Alabama.

BOOKKEEPERS. Operate your own "Dollar-A-Week" system. Ellis, Box 200, Cedar Grove, North Carolina.

ANALYZE Handwriting for profit, pleasure. Free sample lesson, catalog reveals plan. Write IGAS, Inc., Dept. 2, Springfield 4, Missouri.

OWN Collection agency. Little "gold mine." Franklin Credit, Roanoke, Va.

PIANO Tuning pays. Learned easily at home. GI approved. 59th year. Free booklet. Niles Bryant School, Dept. P, 3731 Stockton, Sacramento 20, Calif.

PROFESSIONAL Investigators. Home study. Lapel pin, certificate, future. Box 41197-F, Los Angeles 41, California.

SWEDISH Massage. Home study. Diploma. Illinois Licensed School, 3809 Alta Vista, Chicago 13.

BIBLE Lessons, orthodox, evangelical, interdenominational. Home Bible Studies, Box 316, Elkhart, Indiana.

ELECTRONICS. Learn at home. Training equipment furnished. Catalog free. National Radio Institute, Dept. OKAA, Washington 16, D. C.

FREE L.P. record and book gives instructive facts about sleep-education and the Audio Educator, the short cut method to learning and self-development. No obligation. SDRF, Dept. P-11, 104 East 40th Street, New York 16, N. Y.

DANCE! Free lesson proves you can! Castle, 507 Fifth Avenue, New York 17.

NEW Amazing sub-conscious method for effective speaking, improved singing, master salesmanship, dynamic concentration, and powerful memory, along with 20 other revolutionary courses. Works wonders. Easy, pleasant. Guaranteed. Write: Alpha Distributing Co., Box 765, Chicago 90, Ill.

SECRET Investigations. Experience unnecessary. Investigators particulars free. George Wagner, M125 West 86th, New York City 24.

PLAYS, STORIES, MANUSCRIPTS

WRITERS: Send 10¢ for copy of "Writers' Bulletin," Box 156, Tahlequah, Okla.

PUBLISH Your book! Join our successful authors: Publicity, advertising promotion, beautiful books. All subjects invited. Send for free manuscript report and our detailed booklet. Carlton Press, Dept. MP11, 84 Fifth Avenue, New York City 11.

WANT Your book published? Learn how we publish, advertise, promote, distribute. Many successes. Free booklet PM. Vantage, 120 West 31, New York City. Or 6253 Hollywood Blvd., Hollywood 28, Calif.

ATTENTION All writers! Authorship means prestige! Your short stories, articles, books, plays, will receive our prompt sales handling! Write immediately for free literature! Literary Agent Mead, 915 Broadway, New York City 10.

ADVERTISING AGENCIES, LETTER WRITERS, FOR ADVERTISERS

FREE! Red-hot book, "More Profit From Your Advertising." Lists—best mail order magazine, newspapers. Adservice, 516 Cornelia, Chicago 13.

ADVERTISE: 24 Words, 100 Canadian newspapers, \$5.50. Lists free. Advertising Bureau, 10511-C Springfield, Chicago 55.

"AMAZING New Book"—"Profits From Classified Advertising." Tells how and what to advertise. Be sure to read this book before you invest one cent in advertising. Write for your copy now. Just send 10¢ for postage and handling. W. Johnson, Classified Advertising Manager, 202 East Ontario Street, Chicago 11, Illinois.

MAILING Lists most any classification \$5.00 1000. Your circulars mailed with ours \$4.00 1000. Write for our literature. Dixie Mailers, King, N. C.

CREATIVE Advertising. Magnetic copy. Dramatic layouts. Moran Agency, Shoenakersville, Pennsylvania.

ADVERTISING Ratebook leading newspapers, magazines, free. Chicago Advertising Agency, 28-E Jackson, Chicago 4.

SAVE! Circulars, brochures, folders, catalogs designed and printed. Samples! Flair, 8 West 45th, New York City 36.

NOW Ready: New, amazing Classified Advertising Record Book—prepared especially for classified advertisers. Here is a book that tells you instantly whether or not your advertising in any publication is paying you real results. You can tell immediately how many inquiries each publication produced—how much cash received from every ad. Spaces are provided for the name and address of the publication, date of issue, space used, rate, cost of ad, key number, etc. You have a complete record of each publication right before your eyes. Plenty of space to keep accurate record of 28 separate publications. You can have a copy by sending only 10¢ to cover postage and handling. Send for your copy now. W. F. Johnson, Classified Adv. Mgr., Popular Mechanics Magazine, 204 E. Ontario Street, Chicago 11, Illinois.

CARTOONING, COMMERCIAL ART, SHOWCARD & SIGN PAINTING, TATTOOING

PAINT Signs! Using patterns! Trial alphabet \$1.00. Harwell, PM-1160, Byrdstown, Tenn.

LEARN To draw simple cartoons that sell. Puckett, Marengo 5, Indiana

CARTOONERAMA Teaches you cartooning in a new 24 lesson course. Free brochure. CFA, Box 263K, Branford, Connecticut.

"HOW To Make Money With Simple Cartoons"—A book everyone who likes to draw should have. It is free! No obligation. Simply address Cartoonists' Exchange, Dept. 911-C, Pleasant Hill, Ohio.

LEARN Art and cartooning. Guaranteed portfolio of 24 proven lessons only \$4.95. Southgate Press, 711 Empire Building, Birmingham, Alabama.

LEARN Sign painting at home. Free talent test. Ben Kerns, Box 812-PM, Greenville, S.C.

LEARN Profitable, fascinating tattooing. Illustrated information \$1. Zeis, 728-C Leslie, Rockford, Illinois.

LEARN Sign painting with fascinating system. Straley, 410 S. Western, Springfield, Ohio.

TYPEWRITERS, DUPLICATORS, OFFICE DEVICES

MIMEOGRAPH! 3500 Copies hourly—in colors! Details. Schetz's, Sellersville, Penna.

RECONDITIONED Typewriters, duplicating, printing devices. \$25.00 up. Supplies. Appliances. DixieGraph, King, N. C.

RUBBER STAMPS AND OFFICE SUPPLIES

SPECIAL Introductory offer. 3 line pocket stamp 59¢. Junior, Box 227, Valparaiso, Ind.

FREE Type styles sheet. Free stock stamp literature. Free printing catalog. Pads, racks, Xmas stamps. Youngers Stamp Shop, Princeton, Iowa.

FREE—Rubber stamp catalog. Martin, 1425 Major Drive, Jefferson City, Missouri.

3 LINES. Rubber stamp \$1.00. 25 cents each additional line. Whitney's Rubber Stamp Shop, 18 Washington Ave., Chatham, N. Y.

50¢, 3 LINES—Cushioned. Guaranteed. Verilla, Box 1282, Paterson 3, N. J.

RUBBER Stamps 1x2" \$1.00; up to 3" \$2.00. Adirondack Printers, Saranac Lake, New York.

PRINTING, MULTIGRAPHING, MIMEOGRAPHING, GUMMED LABELS

EMBOSSSED Business cards. Rulon, Box 575, Station A., Richmond, California.

BUSINESS Cards with your glossy photo reproduced on back, 1,000 \$8.40. Les Barker, 1011 North Dixie, West Palm Beach, Florida.

1000 QUALITY Business cards, \$3.00. Embossed \$3.75. 2-color \$5.50. Samples. S. Wasserman Printing, 1276 East 84th St., Brooklyn 36, N. Y.

ADVERTISING Flyers, Newspaper style. 500 to 5000 copies. Times, Pandora, Ohio.

FREE Catalog, postpaid printing. Miller, Box 859, North Miami, Florida.

1,000 BUSINESS Cards. Raised letters \$3.95. Samples. Pioneer, PM-11, Island Park, N. Y.

250 8½x11 HAMMERMILL Business letterheads \$2.95. 250 envelopes \$2.95. Samples. Davis, 7609 Spruce Rd., Baltimore 22, Maryland.

ENVELOPES Printed. 1000 prepaid \$6.95. Samples free. Lido, 414 32nd, Newport Beach, Calif.

UNPRINTED Envelopes: 500 # 10—\$3.95, 500 #6¼—\$2.95. Postpaid. Wholesale prices, sample book, \$1.00. Universal-Colorprint, Box 2525, Grand Central, New York 17, New York.

1000 SIMULATED Engraved business cards, \$4.95. Post paid. Samples 10¢. Martin, P.O. 8653, Dallas 16, Texas.

MIMEOGRAPHING—Illustrations, hand lettering. Samples free. Stadler, 1733 North Ohio, Roswell, New Mexico.

SILK Screen printing, photo stencils, art service. Investigate. Boettger 961, Dorothy, N. J.

BUSINESS Cards—1000, \$2.95. Rubber stamps. Weiss, Box 8304, Kansas City, Mo.

PHOTO-Offset, samples, prices free. Litho, 53 Laurie, Fort Walton Beach, Fla.

OFFSET Printing, 1000 8½x11, \$5.50. Alpine, Box 676-EA, Cupertino, Calif.

LETTERHEADS: 500—\$4.50. Free sample. Carlayne, 1803 Fremont, Rapid City, South Dakota.

MIMEOGRAPHING—Letters, pricelists, formulas, instructions. Lowest prices. Lem's Letter Shop, 5710 Stanton, Detroit 8.

ADS Running under this heading sell printing. Ask me for proof. I'll gladly send you amazing facts. Ask for Folder "P." F. W. Johnson, 200 E. Ontario St., Chicago 11, Ill.

FREE Catalogs postpaid printing. Rubber stamps. DM Press, Sebastopol, Calif.

1,000 BUSINESS Cards. Raised printing. \$3.75. Agents wanted. Elco, 5909 Highlandview, Sylvania, Ohio.

MIMEOGRAPHING Service U.S.A. Swanson, 834 (X) Harvey Road, Toms River, New Jersey.

COLORED Or white 8½x11 offset. \$6.50—1,000; \$18—5,000. Fast! Flair, 10 West 45th, New York City 36.

ECONOMY Business printing. Rubber stamps. Free samples. Rayborg, 810 West 18th, Erie, Penna.

PRINTING OUTFITS AND SUPPLIES

ENVELOPES—Paper Wholesale only. Sample books, prices, \$1.00. United States Color Corporation, Box 2650, Grand Central, New York 17, New York.

TYPE For printers and rubber stamp makers. Complete home printing outfits. Send 25¢ for big new 96 page catalog. Largest selection in U. S. Acme Type, 633 Plymouth Court, Chicago 5, Ill.

HARD Type for rubber stamp making, printing. Introductory offer, 10 or 12pt. 20th Cent. or Stylic medium. Caps \$2.00. L.C. \$2.00. Catalog. Barco Type, 64 Wagner, Northlake, Ill.

RUBBER Stamp presses, hydraulic operated, electrically heated. Sizes 5"x8", 8"x12", 10"x15". Starting outfits, supplies. Printing presses. Custom Manufacturing, 507-P N. Jefferson, Springfield, Missouri.

PRINTING Presses, type, supplies. Lists 4¢. Turnbaugh Service, Mechanicsburg, Penna.

RUBBER Stamp presses, supplies. Kiewit, 2025 Barney Road, Kalamazoo, Mich.

MAKE Your own self-molding rubber stamps and printing cuts. Plexirubber, Argyle 1, Wisconsin.

DO Your own printing. Save money. Simple rules. We supply everything. Print for others; good profit. Raised printing like engraving too. Have home shop. Details free. Kelsey Presses, V-11, Meriden, Connecticut.

FOR INVENTORS

PATENT Drawings your inventions made by experts. Accurate and complete. Patent Service Associates, Haverhill, New Hampshire.

INVENTIONS Needed immediately for manufacturers. For additional information write Kessler Corporation, C-511-FI, Fremont, Ohio.

PATENT Drawings your invention made by our experts. Reasonable cost. Patent Service Associates, Haverhill, New Hampshire.

INVENTIONS Wanted for immediate promotion—patented; unpatented! Outright cash; royalties! Casco, Mills Building, Washington 6, D. C.

OPINIONS Furnished regarding necessity further development and marketability ideas, inventions, patents. Send papers, patents and \$50.00 for services. Umatilla Patent Development Company, Box 54, Hermiston, Oregon.

PATENT Drawings skillfully prepared, reasonable. Metzler, 130 West 42nd, New York City.

PROFESSIONAL Searches of the Patent Office Records. Dependable. Reliable. \$6.00—For free protective forms write Trans-World Patent Service, 500 Walker Bldg., Washington 5, D. C.

INVENTORS! Consider our offer first before selling or licensing your invention on a cash or royalty basis. Patented. Unpatented. Inventions on Demand Associates, 79 Wall Street, New York 5, N. Y.

YOU Can easily apply for patents. Save with complete professional kit, featuring "Exclusive Demonstrator Method" and fill-in forms. Free registration certificate. Patent Associates, 1214 Commonwealth Building, Philadelphia 7, Pennsylvania.

SAVE! New Inventor's Patent Kit makes it easy to apply for patents yourself. Free "Registration Form." Miss Suzan Blaine, 306 Carry Building, Washington 5, D. C.

DON'T Pay high fees! Obtain U.S. patent yourself. It's easy with Professional Kit with fill-in forms. Free "Registration Form." Patent Protection Institute, 2000 P Street, N.W., Washington 5, D. C.

INVENTORS' Complete service. Cash-royalties sales. Inventions researched. Patent development engineering. Free invention certificate. George Spector, Licensed Invention Engineer, 3615 Woolworth Building, New York.

INVENTIONS Wanted now by my manufacturer clients. Patented. Unpatented. Write Gilbert Adams, Patent Broker, 80 Wall St., Financial District, New York City.

PATENT Searches, including copies of nearest patents, \$6.00. Reports airmailed within 48 hours. More than 200 registered patent attorneys have used my service. For free invention protection forms, write Miss Ann Hastings, P. O. Box 176, Washington 4, D. C.

WE Have the markets if you have the ideas. Harvey Engineers, Cambridge 1, Maryland.

INVENTORS: Test the commercial value of your patented or unpatented inventions, quickly and inexpensively. Write for free information. Institute of American Inventors, Dept. 40-B, 635-F St., N.W., Washington 4, D. C.

PATENT Searches, including complete copies of nearest patents, \$6.00. Inventors, attorneys, manufacturers use my original world-wide airmail service. "Proof of Invention" protection form and "Information Every Inventor Needs" sent free. Miss Jean Hayward, 1029 Vermont Avenue, NW, Washington 5, D. C.

INVENTORS! Determine patentability of your invention. Searches of the Patent Office Records administered professionally—\$6.00. For free invention protection forms, dependable service write Washington Patent Office Search Bureau, 1426 G Street, N. W., Washington 5, D. C.

PATENTS Skillfully prepared for maximum commercial value, with useful product development. High record of success in proving and claiming patentability. Valuable market service. Patent prepared for a fee as low as \$200.00. Send for self-protecting record of invention forms free. Patent search with valuable engineering report \$15.00. Foreign patents filed at low cost. Thirty years established. Joseph O'Brien, Patent and Development Engineer, 132 Nassau St., New York 38, N. Y.

INVENTORS! Outright cash sale or royalties for your inventions. Patented. Unpatented. Constant demand from our client manufacturers. Write: United States Invention Brokerage, 78 Wall Street, New York 5, N. Y.

NEW Toy ideas wanted. We have markets for good new toys. Outright purchase or royalty. Will be an Art Linkletter product. Link Research Corp., 9460 Wilshire Boulevard, Beverly Hills, California.

INVENTIONS Sold: patented and patent pending. Write: Kenwal Enterprises, Box 584, Watertown, South Dakota.

INVENTORS: Join Inventors Associates, 1 Beekman St., New York 38, New York. Details free.

INVENTORS: Save time and money. Our complete "Patent Kit" makes it easy to prepare and file your own patent application. Free "Registration Certificate." National Inventors Service, Box 88, Benjamin Franklin Station, Washington, D. C.

PATENT Searches, \$6.00, complete with comprehensive report and official Patent Office copies of related patents. Certified, airmailed. For free "Invention Protection Form" and "Patent Information," write: U.S. Inventors Service Bureau, Headquarters Building, Washington 6, D. C.

PROFESSIONAL Patent searches, \$5.00, complete with report and related patent copies. Complete patent and trademark services. Free forms; write: Congress Invention Institute, 210B, McKim Building, Washington 5, D. C.

PATENT Searches including copies of closest patents \$6.00. Quality searches expertly administered. Free protection forms. Write Professional Patent Office Search Bureau, 412 Abee Building, Washington 5, D. C.

INVENTIONS WANTED

PLAYGROUND Equipment manufacturer wants inventions for institutional-type items. Kelso Engineering, 112-42nd Street, Des Moines, Iowa.

MANUFACTURER Seeks new items for medical, surgical, hospital field. Write: Suite 618, 565 Fifth Avenue, New York 17, N. Y.

INVENTIONS Wanted immediately for promoting on cash or royalty. Patents, unpatented. Free booklet outlines royalty rates, requirements. Write Kessler Corporation, C-511-IW, Fremont, Ohio.

INVENTORS! Consider our offer first before selling or licensing your invention on a cash or royalty basis. Patented. Unpatented. Inventions on Demand Associates, 79 Wall Street, New York 5, N. Y.

INVENTORS Needing help with any problem, financial, development, securing manufacturer, obtaining patent. Write the organization that delivers action and results—not promises. Pioneer Inventions, 150 Broadway, New York 38, New York.

INVENTORS! Outright cash sale or royalties for your inventions. Patented. Unpatented. Constant demand from our client manufacturers. Write: United States Invention Brokerage, 78 Wall Street, New York 5, N. Y.

INVENTORS' Complete service. Cash-royalties sales. Inventions researched. Patent development engineering. Free invention certificate. George Spector, Licensed Invention Engineer, 3615 Woolworth Building, New York.

INVENTIONS Wanted: patented, patent pending. 29 years experience promoting inventions. National Service Bureau, 3120 Meramec, St. Louis 18, Mo.

INVENTIONS Wanted now by my manufacturer clients. Patented. Unpatented. Write Gilbert Adams, Patent Broker, 80 Wall St., Financial District, New York City.

INVENTORS: Hundreds of manufacturers have requested our assistance in locating marketable new products. Complete information free. Institute of American Inventors, Dept. 40-D, 635-F St. N.W., Washington 4, D. C.

INVENTIONS Wanted. Patented; unpatented. Tremendous manufacturers lists. Global Marketing Service, 2420 77th, Oakland 5, California.

ARE You interested in offers from reliable manufacturers for your invention? Patented, unpatented. Harvey Engineers, Cambridge, Maryland.

INVENTORS! Don't sell your invention, patented or unpatented, until you receive our offer. Write Universal Inventions, Box 298, Marion, Ohio.

INVENTIONS Wanted for immediate promotion—patented; unpatented! Outright cash; royalties! Casco, Mills Building, Washington 6, D. C.

MANUFACTURING

MODELS—Small lot manufacturing. Metals, plastics, etc. Milburn, Burlington, Kentucky.

PATENTS FOR SALE

LIFE-Saving vehicle door bolt lock. Charles Burke, Veterans Hospital, St. John, N.B., Canada.

SAFETY Device for cranes. Outright. Royalty. Manufacturers moneymaking opportunity. James Auld, 2908 Seminole, Miami 33, Florida.

MODELS, MODEL SUPPLIES

LIONEL Trains. Big discounts bulletin 10¢. Catalog 25¢. Mack-Bros., 2043P. Chicago Ave., Chicago 22.

ROCKET: New model. Positive performance-recovery! Plans 10¢. Complete kit prefabricated parts, two "high-thrust" motors, parachute, \$2.00. Central Rocket Company, Waupaca, Wis.

POWER Models. Unusual steam, gasoline and traction engines, fittings, metals. Iron cylinder and flywheel castings. New comprehensive 100-page catalog \$1.00. Chas. Cole, Ventura, Calif.

ROCKETS—Supplies lists 10¢. Hand booklet with 3 model rocket plans 25¢. Two sample 1.1 pound NAR approved rocket motors 75¢. All three \$1.00. Estes Industries, 5505 Tejon, Denver, Colorado.

SHIP Models and yacht supplies complete. Large 68 page catalogue 50¢. Bill Wild's, 510 East 11 St., New York City 9.

SAVINGS To 50%. Lionel, Gilbert, Athearn, etc. New trains accessories. Hobby Surplus, P.O. Box 1106, New Britain, Conn.

ROCKET Blueprints. Easy instructions. Plus fuels, instrumentation, ignition, parachute, 2-stage \$1.00. Rocketry, Box 4122, Washington 15, D. C.

MODEL Cars, electrified roadways. Electromat Company, Box 13742, Dallas, Texas.

SCALE Model materials for building model homes and architectural buildings of any type. 1/4" and 1/8" scale. Send 50¢ for catalog. A & B Model Builders, 454-H Donovan Road, Kansas City, Kansas.

SHIP Models. Most complete line in New England, kits, fittings, plans, books, tools, engines, motors. Illustrated catalog 35¢. James Bliss & Co., Inc., Dept. SM, 342 Atlantic Ave., Boston 10, Mass.

ROCKET Supplies—Nozzles, cones, tubes. Specials also made. Catalog 10¢. Sky Mfg., Mineral Point, Penna.

SHIP And yacht model fittings; blueprints. Send 40¢ for illustrated catalog listing hundreds of items. A. J. Fisher, Inc., 1002-1 Etowah Ave., Royal Oak, Mich.

SHIP Model kits and fittings: clippers, frigates, etc. Catalog, paint-tool list, book list, 25¢. Model Shipways, Box 85, Bogota, N. J.

"POWER Drives Handbook"—36 pages illustrating many types motor drives for model autos, boats, displays, turntables, etc. Mail 25 cents cash, returnable first order \$3.00 or more. Wilson's of Cleveland, Dept. PM, P.O. Box 8995, Ft. Lauderdale, Fla.

HOME CRAFTSMEN

KNOCKDOWN Cedar chests and lumber. Catalog 25¢. Bedford Lumber Company, Shelbyville, Tennessee.

130 FULL Size toy-novelty-lawn patterns, \$1.00. Lynds, Medway 3, Mass.

101 PATTERNS Of smart Gifts, Novelties, Shelves, Action windmills plus "Make Money Jig Sawing." \$1.00. Mastercraft, 115M, 7041 Olcott, Chicago 31.

WOODWORKING Catalog and manual. Brand new 1961 edition! World's largest selection of domestic, imported woods—materials, tools, supplies, do-it-yourself plans, projects. 130 pages, many full color. Send 25¢ (refunded first order). Year's subscription to "Chips and Chats" included free. Constantine, 2050 Eastchester Road, Dept. S-101, New York 61, N. Y.

TOOL Buying service. Write for low price quotation. Give manufacturers name, model number and size. Grand Central Tool Supply, 507 Fifth Ave., New York 17, N. Y.

VALUES In leathercraft. Latest ideas. Catalog, 10¢. Larson, Dept. 1227, 820 S. Tripp, Chicago 24.

GENUINE Rawhide bundles—direct from leather tannery. Assorted lengths, widths. 1000 uses. Handy for hangers, binders, laces. Tough. Strong. Dandy for quick repairs around home, farm, or shop. Send \$1.00 plus name and address. You'll be delighted with your bargain—or money back! Shingle Co., 1302 Walnut Street, Camden, N. J.

FREE Sample—Perma-Pelent, new one coat silicone formula. Corrects moisture problems on block, brick, stucco, stone, asbestos siding and all above grade masonry surfaces on your home. Less than one cent per square foot applied. Perma-Stone Co., Desk 17, Columbus 11, Ohio.

FREE Leathercraft catalog. Quality kits, leather, tools. Handicrafters, Montrose, Calif.

GRANDFATHER Clock movements, case plans, kits. Wholesale catalog 25¢. Mason-Sullivan, Noroton 7, Conn.

FREE, New catalog. 2447 plans, patterns. World's greatest selection things to do, make. Fun. Profit. Craftplans, 1322-A Wabash, Chicago 5.

SKIL-CRAFTS—World's finest and largest selection of leathercraft, hobby craft, art & craft supplies. Free billfold or leathercraft kit with first purchase. Send 25¢ latest catalog. Skil-Crafts, Box 167-P-Joplin, Missouri.

NON-CORROSIVE Wood screws. More than 50 assorted screws in reusable plastic box. Flat head. Aluminum \$1.25. Stainless steel \$1.75. Postpaid. Joart Specialty, Box 3007, Elmira, N. Y.

LEATHERCRAFT. Send 10¢ for catalog. Saxcrafts, Inc., 1101 N. 3rd, Milwaukee, Wisconsin.

FREE! Leathercraft catalog. Hundreds of new items. Write MacPherson Bros. Leather Company, Dept. E, 730 Mission St., San Francisco 3, Calif.

LEARN Jewelry making at home. Inexpensive art metalcraft course teaches how to make all types cuff links, earrings, tableware, etc. of silver, gold, copper. Send postcard for free booklet. Interstate Training Service, Dept. L-3, Portland 12, Oregon.

WALNUT, Cherry, silver maple, kiln dried lumber, squares, blocks and picture frame moulding. Midland Lumber Company, Box 262, Savannah, Mo.

FREE "Do-It-Yourself" leathercraft catalog. Tandy Leather Company, Box 791-Q36, Fort Worth, Texas.

KNOCKDOWN Cedar chests, also over fifty kits. Catalog 25¢. Giles Kendall Co., Huntsville 2, Alabama.

DO IT YOURSELF

UPHOLSTERING—Have you a chair or sofa with sagging springs? Repair it yourself with our New-Seat Kit. Complete with webbing, twine, tacks, cambric, tools and simple step-by-step instructions. Chair \$4.75, sofa \$8.50. Also upholstering fabrics, supplies and tools available. P. O. Box 134 A, Newfield, N. Y.

UPHOLSTER Without experience. Instructions, catalog, swatches 35¢. Hart Company, Payne 14, Ohio.

HOW To make fireplace logs from newspapers. \$1.00. Satisfaction. Profit opportunities. Twinair, Box 1245-P, Mountain View, Calif.

ASSEMBLE Your own 3 track tilt storm window. All aluminum parts only \$8.95 postpaid, most sizes. Send for instructions, order blank. U-Do-It, Box 576, St. Cloud, Minn.

MOSAICS—Free catalog and instruction folder. Fantastic selection. Reasonable prices. House Of Mosaics, 2012 Chapala Street, Santa Barbara, Calif.

LACQUER Letters for house signs, mailboxes. Weatherproof, apply any surface, no paint. 2 alphabets—numbers, 2" black, \$1.00. Pioneer Products, Waterford, Va.

FREE Check-list covering more than 500 classifications of projects, plans, instructions, service and repair information detailed in Popular Mechanics famous series of instructional booklets, books, patterns, and blueprints. List covers an extremely wide variety of do-it-yourself data on home remodeling, repair and improvement, hobbies, crafts, boating, games, lawn and garden, and hundreds of others. For your free copy of this helpful list, write: Service Bureau, Popular Mechanics, Room 520, 200 East Ontario, Chicago 11, Ill.

WATCHES, OLD GOLD, JEWELRY

WATCHMAKERS' Jewelers', lapidaries' catalog 25¢. Bengal, 8910 Venice, Culver City, California.

WATCHMAKERS' Tools, materials, supplies, watches. Catalog. Gales, Box 1000, Chicago 90, Ill.

HIGHEST Cash paid for old gold, jewelry, gold teeth, diamonds, watches, silver. Mail articles today. Information free. Chicago Gold & Precious Metals, 6 E. Monroe, Dept. 2558, Chicago 3.

WANTED—Old silver, gold, jewelry, teeth, watches, spectacles, mercury, platinum for cash. Electro Company, Refining Dept., 1042 Highland Ave., Buffalo 23, N. Y.

EASY To make costume jewelry. Catalog 10¢. Introductory kit including catalog \$1.00. J & M Novelties, Dept. CM-3, Box 173, Broadview, Ill.

WATCH And clock repairing books. Free catalog. North American, 2320-AY Milwaukee, Chicago 47, Illinois.

COSTUME Jewelry supplies, settings, rhinestones, etc. 88 page illustrated catalog. 30¢. Milady, Box 1328, G.P.O., New York City.

FREE Illustrated catalog. Jewelry parts, supplies, rhinestones. Reasonable prices. Unique merchandise. Fast service. Folsom's, Box 52, Medford 55, Massachusetts.

HIGHEST Cash for old gold, jewelry, gold teeth, watches, diamonds, silverware, spectacles, platinum, mercury. Free information. Rose Refiners, Heyworth Building, Chicago 2.

GOLD, Silver, platinum, discarded jewelry, watches, spectacles, gold teeth, gold coins. Highest prices paid immediately. Information free. Wilmot's, 1067PM Bridge, Grand Rapids 4, Mich.

POCKET Watches. 16s railroad models. Prices to suit you. W. E. Russell, 704 Skyview Dr., Nashville 6, Tenn.

WHOLESALE Quality jewelry findings, chains, charms. Fraternal, religious emblems. 100% satisfaction guaranteed. Catalog 10¢, refundable. PM-11-60, Caraday, Box 22, West Hempstead, New York.

OF INTEREST TO WOMEN

LADIES—Nylons with one year replacement guarantee. Try before buying. Kendex, Box 95C, Pasadena, California.

"8 MISTAKES Parents Make." Every parent should have this new book about child training. It is free; no obligation. Simply address Parents Association, Dept. 6711, Pleasant Hill, Ohio.

FREE Brochure picturing personalized gift items. Miles, Box 63, New York 69.

DRESSES 29¢; Shoes 59¢; men's suits \$5.98; trousers \$1.38. Better used clothing. Free catalog. Transworld, 164-G, Christopher, Brooklyn 12, N. Y.

WEDDING Invitations. Lowest prices. Free samples. Publications, 5431 Euclid, Kansas City 30, Missouri.

CHRISTMAS Candlemaking kit \$2.98 complete! Holiday Kits, Box 39844C, Los Angeles 39.

DISPOSABLE Plastic gloves. 1001 uses. 12 pairs, \$1.00. Postpaid. Fox, 2602 Messanie, St. Joseph, Mo.

POISON Antidote calculator. Twist dial. Shows immediately symptoms—antidotes for most household poisons. \$1.00. Will-O-Matic, 550 Lakeshore, Nice, Calif.

MAKE Money weaving rugs at home for neighbors on \$89.50 Union Loom. Thousands doing it. Booklet free. Union Loom Works, Dept. 3, Boonville, N. Y.

SELL Fine fabrics. Get yours wholesale. Box 863, Norwalk, Conn.

TURN Your kitchen into money. Everybody eats what you make. Free details. James, 6926 Greenvale Parkway, Hyattsville, Maryland.

FREE Literature. New magic wand "spotone" massager. Secors, Bradenton Beach, Florida.

PERSONAL

LOANS By mail. \$50 to \$600 for any purpose. Confidential. 2 years to repay. Write for free loan application. American Loan Plan, City National Bldg., Dept. PM-11010, Omaha 2, Nebraska.

BORROW \$100 to \$600 by mail. Quick, easy, private. No co-signers. Repay in 24 small monthly payments. For the amount you want write today to Dial Finance Co., 410 Kilpatrick Bldg., Dept. M-1, Omaha 2, Nebraska.

NEED Worlds of help? Borrow up to \$600 for any purpose entirely by mail. Repay in 24 monthly payments. Write for free loan application: World Finance Co., 620 Symes Bldg., Dept. 100-H, Denver 2, Colo.

CUTS Income taxes. New system. Details 10¢. Edgemont Tax Service, Whitesboro, New York.

LOVERS: Plexiglas double-heart pins. With "his-hers" first names (or initials) \$1.10. Tax included. Higgins Products, 1015 So. Presa, San Antonio (3), Texas.

HUNDREDS Of overseas manufacturers want distributors. Thousands of items. European list \$1.50, Asian \$1.50. Both lists \$2.00. Trader, Savage, Minnesota.

BORROW By mail. \$100-\$600. Anywhere. Air mail service. Postal Finance, 200 Keeline Building, Department 17, Omaha 2, Nebraska.

BIBLE Questions answered. Stamped envelope. Bylon, 17167 Bentler, Detroit 19, Michigan.

ADVENTUROUS? Details for dime. Fred Woodgate, Tamworth, NSW, Australia.

NEGOTIATE Your injury settlement with wrongdoer's adjuster. Candid specific instructions. Sensational booklet! November special \$1.00. Wilkes Enterprises, Box 4103, Mobile, Alabama.

REMAILING SERVICE

MAILING, Receiving, forwarding, \$3.00 month. "A-1," 170 Fifth Ave., New York 10.

RENT Confidential remailing-receiving address. Agents since 1950. William McLaughlin, 800 Stewart, Columbus 6, Ohio.

REMAILS, 25¢ Each. \$8.00 quarterly. 8912 Gayle Avenue, Tacoma 99, Wash.

REMAILS 30¢. Confidential. Duke City Mail Service, Box 752, Albuquerque, New Mexico.

REMAILS From seaway port. 25¢. Hobbies, 17167 Bentler, Detroit 19, Mich.

NATIONWIDE Arrangements! Forty-eight states! Postmarks! 45¢. Interpost, 5321 Hackberry, Sacramento 21, Calif.

LETTERS Retailed 25¢. 5 post cards scenic New York \$1.00 retailed free. Jonfield, Box 192, Jackson Heights 72, New York, N. Y.

PARAMOUNT, 140 West 42nd Street, New York City 36. \$3 monthly. Remails 25¢.

SWEDEN Remail 50¢ each. Secret address \$3.00 monthly. Arbin, Box 839, Solna 8, Sweden.

MEXICO Confidential. Dependable. Four for dollar bill. Webb, Box 418, Guadalajara, Jalisco.

MEXICO Re-airmails: Dollar bill. Replies free. Apartado 2042, Guadalajara, Mexico.

ABSOLUTELY Confidential, 50-State & international re-mailers. Free dollar coupon. Via Associates, Box 2434, Washington (13) D. C.

FREE \$1 coupon! Confidential! Worldwide Service, Box 51, Oakford, Penna.

CHICAGO, Ill. Remails, 25¢. Forwarding. Confidential. Avers, 33' North Austin.

HONGKONG, Remails. 1 or six for \$5. In authentic Suzie Worz envelope \$2 or six for \$10. Cash only. ran Box, P.O. Box 6213, Kowloon, Hongkong.

HOLLYWOOD Confidential mailing service 25¢. Tole House, Box 2521M, Hollywood 28, California.

REMAILS 25¢ each. \$3.00 monthly. Sedgwick, 1114 30th St., Newport News, Virginia.

PARIS. Hotel stationery, postcards free. Each airmailed to and from Paris \$1.00. Bonded service. Central Secretariat, 70 State Street, Boston 9, Mass.

NOTRE Dame—South Bend remails 25¢. Specify. Vlock, Box 486, South Bend, Indiana.

SECRET Mail address. \$3 month. Hedgpeh, Box 830, Alhambra 23, Calif.

WASHINGTON, D. C. remails, confidential 25¢. Studios, Box 6993, Washington 20, D. C.

TREASURE FINDERS

GOLD—Silver detectors. Latest types. Five models including transistors. Violites for tungsten, etc. Geiger counters. No finer instruments anywhere. Free information. Detectron, Dept. 22, Sylmar, California.

SEARCHING For treasure? Transistorized electronic M-Scope locates it. Lightweight. Guaranteed. From \$59.50, easy terms. Free catalog. Fisher Research, Dept. C-1, Palo Alto, Calif.

TREASURE Hunter's manual. Authoritative, comprehensive, adventuresome! America's Premier Buried Treasure Hunter tells how! Buy from local bookstore; write for nearest dealers name. Karl von Mueller, 649 Mechanicsburg, Grand Prairie, Texas.

METAL Locator kits and assembled models from \$39.90. Transistorized and underwater models available. Free catalog. Electronic Applications, Dept. M, Box 8, Arlington 10, Virginia.

TREASURE! Map, handbook, 25¢. Locators. Howe, 811 Kansas, Atchison, Kansas.

DISCOVER Buried loot, sunken treasure, gold, silver, coins; battlefield and ghost town relics, with powerful transistorized locators pioneered and perfected by Goldak. Low as \$79.50. Free, exciting information; literature on maps. The Goldak Co., 1541 West Glenoaks Boulevard, Glendale 1, California.

FOR SALE—MISCELLANEOUS

HEARING Aid batteries, wholesale. Free list. Habs, Box 51, York, Penna.

FREE Money-saving catalog. Surplus and newly manufactured equipment and tools for workshop, home, boats, farm, factory. Write: Groban, 1139 South Wabash, Chicago 5, Illinois.

50,000 **BOARD** Feet random lengths, thicknesses and grades of walnut, cherry, maple, cedar and oak lumber in furniture stock; one 4-inch Xel moulder; one 30-inch single surfacer; one 7-inch jointer with 8-foot bed. Need storage space, will sacrifice for \$5000.00 f.o.b. Elkins Corporation, Harrison, Arkansas.

\$2.00 (REFUNDABLE) Buys Mr. Thrifty's own giant catalog and free closeout sheet. Box 26, Prince St. Station, New York 12, N. Y.

WANTED—MISCELLANEOUS

OLD Automobile manuals-catalogues. Pierce, 3517 Dollar Dr., Akron 19, Ohio.

FREE Xmas catalog. Shop at home. Dependable Gifts, Box 736, National City, California.

QUICKSILVER, Platinum, silver, gold. Ores analyzed. Wholesale Terminal, Norwood, Mass.

MISCELLANEOUS

STOP Buying vitamins until you compare prices and formulas of all leading brands in our new catalogue. Save 50%. Mention vitamins now using for free sample. Vitamin Specialties, Box 4435-B, Philadelphia 40, Penna.

IF You have a severe or slight hearing loss, whether you wear a hearing aid or not, write for new booklet "7 Steps To Better Hearing." It's free! Write Maico, Room 145M, 21 N. 3 St., Minneapolis, Minn.

AMAZING New checkwriter, lasts a lifetime, does the work of machines costing up to \$500.00, yet weighs just ten ounces. Only \$9.95. Send check or money order to John T. Benjamin, Box 75637, Sanford Station, Los Angeles 5, California.

LOANS Entirely by mail—\$600 or less. Strictly confidential. Repay in 24 monthly payments. Write: Budget Finance Co., Dept. J-100, 114 S. 17, Omaha 2, Nebr.

CUSTOM Fitted corsets! Photo catalog, \$1.00. Finecraft, Box 442-R, Hollywood 28, Calif.

LIFETIME Listing. Receive valuable free samples. Interesting educational books. Moneymaking mailorder opportunities. 25¢. Ply-O-Film, Box 30G11, Berea, Ohio.

PIGEON Trouble? Trap the pests. Free information. Johnson's, Waverly, Kentucky.

STOP Throwing away soiled leather jackets, gloves, etc. "Drexeen" cleans, renews all soiled leather goods in a jiffy. New, amazing formula! Restores original luster. Try it! Only \$1.00 postpaid. Moneyback guarantee. Order now. Merryman Distributors, Formosa, Arkansas. (Agents inquire.)

LIKE To get lots of mail? 25¢ brings it forever. Or send \$1.00 and receive 3 useful items. Bargains, P.O. Box 471P, Ora, Indiana.

75 FREE Items! List of sources 30¢. Martinelli, Box 82, Brooklyn 29, N. Y.

GET Samples, magazines, offers galore! Your name in 5000 mail directories 25¢. Double refund coupon. Results guaranteed. Muskoka Mailers, 1438-C2, Huntsville, Ontario, Canada.

PERSONALIZED Matches. 25 books with your initials embossed in gold \$1.50 postpaid. Three initials. No c.o.d.'s. Brewster House, Box 203, Dearborn, Michigan.

BOOKS On antiques and their prices. Free circular! P. Warman Publishers, Uniontown, Penna.

YOUR Name wanted. We'll send 1000 publishers, mailers, wholesalers your name, on our list one year 25¢. Dixie Mailers, King, N. C.

CIGARETTES: Make 20 plain or filter-tips for 9¢. Facts free. Moberly, Box 915, Owensboro, Kentucky.

100,000 PRODUCTS Wholesale—Free catalog! Send postcard: Econ-O-Mart, Whippany 15, New Jersey.

SEND Us wool for blankets. Free literature. West Texas Woolen Mills, 421 Main, Eldorado, Texas.

SUPER Memory overnight! Success guaranteed! Bijou, Box 1727-M, Hollywood 28, California.

CESSPOOLS, Septic tanks, outhouses cleaned, deodorized. No pumping necessary. Free details. Electric Sewer Cleaning Co., Allston 34, Mass.

ORNAMENTAL Iron designs. Book of 1600 beautiful, practical designs for railings, columns, etc. Free literature. Cunningham, 3881 South 3200 West, Salt Lake City 4, Utah.

HOW To make a will: simply written. \$1.00. Weyer, Layton, N. J.

LET Us tell you how to turn the reading habits of your friends into profit for you. \$10.00, \$25.00 or \$50.00 can easily and quickly be made under our Popular Mechanics subscription plan. No experience needed. Write Popular Mechanics, Room 10M, 250 West 55th St., New York 19, N. Y.

**FOR SALE: 1/4 ACRE
HOMESITE
IN FLORIDA**

**PRIVATE LAKE WITH
COUNTRY CLUB PRIVILEGES**

\$595 complete

only \$10 down & \$10 a month

Guaranteed high dry 1/4 acre homesite in this private resort development set in the Central Ridge among the highest, driest elevations in Florida! Ideal location on U.S. 41; only 2 1/2 miles from Rainbow Springs, only 6 miles to Dunnellon, "Home of World's Best Bass Fishing"; schools, churches, shopping, etc. Only 20 miles from Gulf. Features twin mile-wide deep-water fishing lakes right at the property, free membership in private country club; lovely homes, HARD-PAVED roads under construction. All for amazing low \$595 price per 1/4 acre site in one of Florida's largest homesite developments. For low cost living, retirement, investment, write for free color brochure plus 24-page booklet of facts, maps, photos; no obligation. Send now to beat coming price rise. AD 59072(2)

RAINBOW LAKES ESTATES, Dept. MP44

819 Silver Springs Blvd., Ocala, Florida



**Finish HIGH SCHOOL AT HOME
IN YOUR SPARE TIME**

DIPLOMA AWARDED

Learn more! Earn more! Enter professional or technical schools. Advance socially. Live a happier, fuller life. Individual Courses or complete schedule. Write for School Bulletin.

ACADEMY FOR ADULTS
30 W. Washington, Dept. PM-1160, Chicago, Ill.



Ritter Co., Inc., 1954 Ritter Park, Rochester, N. Y.

Painless Dentistry?

Actually, it's more like self-hypnosis. Developed by a dentist in cooperation with an audio research firm, a machine produces sounds that soothe the patient and mask discomfort and awareness. One knob controls the volume of stereophonic taped music, and the other brings in a special masking sound similar to the roar of falls.

FREE!

**1961 LAFAYETTE
ELECTRONICS CATALOG 610**

From the world's leading supplier of electronics and stereo hi-fi equipment.

OUR 40TH YEAR

The biggest and best catalog in our history, featuring the latest equipment from all major manufacturers at prices that can't be beat anywhere.

**HUNDREDS OF EXCLUSIVE
LAFAYETTE FINE-QUALITY ITEMS
AVAILABLE IN THIS CATALOG ONLY**

The "complete shopping center" for the audiophile, hobbyist, technician, student, engineer, serviceman and dealer. Mail the coupon today for your free copy.

LAFAYETTE LOCATIONS
JAMAICA • BRONX • NEW YORK CITY
NEWARK • PLAINFIELD • PARAMUS • BOSTON

Lafayette Electronics
P.O. Box 190 Dept. LK-6
Jamaica 31, N. Y.
Send me the **FREE** 324-pg. 1961 catalog 610.

Name.....
Address.....
City..... Zone..... State.....

**JUDO KARATE *STRONGMAN STUNTS
MUSCLES *HANDBALANCING *YOGA *ETC!**

YOU GET ALL THESE COURSES! * 20 Smashing KARATE lessons * Secret NERVE CENTER & PRESSURE POINT Charts * 20 lethal JUDO lessons * Terrific STRONGMAN stunts * Complete MUSCLE course * Ancient YOGA secrets * HANDBALANCING stunts * 10 prize-ring PUNCHES * Secrets of ENDURANCE! All picture packed. Charts, diagrams etc. (surplus 1959 printing).

FOR ONLY 35¢ you get the lot!

Oxford Studio, 44B Bromfield, Boston, Mass
Name.....
Address.....
City..... State.....

SAVE ON NEW FAMOUS BRAND GUITARS

Direct from Wholesaler-to-You ... Low Discount Prices!

5-DAY FREE TRIAL
Easy Terms!

OVER 100 Models for students and professionals ... yours at **BIG DISCOUNTS!** All nationally advertised makes ... finest quality. Regular or Electric! E-Z Terms. Spanish, Hawaiian and Cutaway models. Low as \$19.95 up to \$249 for glorious professional models. Try before you buy on No-Risk 5-Day Free Trial Plan. Terms low as \$5 down; balance now low as \$1 per week!

FREE Home Study Lesson Course
Get our low discount prices before you buy! Extra discounts on mandolins, ukes and banjos; amplifiers and pick ups. **Money back guarantee.** Rush coupon today!

FREE BONUS GIFTS

GUITAR WORLD, Dept. R-110
2003 W. Chicago Ave., Chicago 22, Ill.
Rush free Color Catalog and Discount Prices.

Free Color Catalog - Discount Prices
Name.....
Address.....
City..... Zone..... State.....

Superior's New Model 70 UTILITY TESTER®
FOR REPAIRING ALL ELECTRICAL APPLIANCES
MOTORS • AUTOMOBILES • TV TUBES

As an electrical trouble shooter the Model 70:



- Will test Toasters, Irons, Broilers, Heating Pads, Clocks, Fans, Vacuum Cleaners, Refrigerators, Lamps, Fluorescents, Switches, Thermostats, etc.
- Will test all TV tubes for open filaments, inter-alemant shorts, burned out tubes, etc.
- Measures A.C. and D.C. Voltages, A.C. and D.C. Current, Resistances, Leakage, etc.
- Will measure current consumption while the appliance under test is in operation.
- Incorporates a sensitive direct-reading resistance range which will measure all resistances commonly used in electrical appliances, motors, etc.
- Leakage detecting circuit will indicate continuity from zero ohms to 5 megohms (5,000,000 ohms).

As an Automotive Tester the Model 70 will test:

- Both 6 Volt and 12 Volt Storage Batteries • Generators • Starters • Distributors • Ignition Coils • Regulators • Relays • Circuit Breakers • Cigarette Lighters • Stop Lights • Condensers • Directional Signal Systems • All Lamps and Bulbs • Fuses • Heating Systems • Horns • Also will locate poor grounds, breaks in wiring, poor connections, etc.

Model 70 comes complete including 64 page book, only... **\$15.85**

SHIPPED ON APPROVAL
NO MONEY WITH ORDER — NO C. O. D.

Try it for 10 days before you buy. If completely satisfied then send \$3.95 and pay balance at rate of \$4.00 per month for 3 months — No Interest or Finance Charges Added! If not completely satisfied, return to us, no explanation necessary.

MOSS ELECTRONIC, INC., Dept. D-818
 3849 Tenth Ave., New York 34, N.Y.
 Please rush Model 70. If satisfactory, I will pay on terms specified. Otherwise I will return tester.

Name _____
 Address _____
 City _____ Zone _____ State _____
 All prices net, F.O.B. N. Y. C.

SUB-MACHINE GUN

.30 CALIBER

- Magazine loading clip.
- 15 moving parts.
- Fires 10 rounds automatically.

\$6.95

Freight prepaid
 Not available to residents of New Jersey



full size model
 pellet firing automatic

Automatic full size model of famous sub-machine gun. Beautiful gun with complete take-down action. A real collectors piece. Crafted in styrene like famous guns used by troops, law enforcement agencies. Over 28 inches in length. Fires as fast as you can pull the trigger. Loads 10 complete rounds in magazine clip which snaps into frame. Comes with complete instructions on operation and maintenance plus full supply of .30 caliber plastic pellets. Satisfaction guaranteed. Send to: **WHOLESALE IMPORT CO.** Box R-20, San Gabriel, Calif.

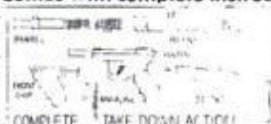

Take Correspondence Courses
 For a Better Education

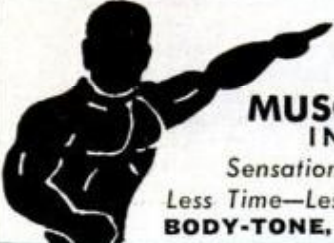

FREE

MUSCLE BUILDING INFORMATION

Sensational New Methods
 Less Time—Less Effort—Better results
BODY-TONE, Box 638, North Miami 61, Fla.



Tirfor, Ltd., 27 Broomgrove Road, Sheffield 10, England

Two Winches Pull Overturned Bus Upright

Demonstrating the power of new British winches, a three-man team returns an overturned double-deck bus to its wheels. Using two of the winches, anchored on opposite sides, they attached the first to an outrigger bolted to the undercarriage, and

the other to a frame member on the superstructure. The first pulled the bus up to its point of balance, then the other lowered it gently onto its wheels. The odd man alternated between winches. They righted the 7½-ton bus in a half hour.

MAKE BIG MONEY with the **Only Light Bulb**
backed by This Sensational "No-Time-Limit"
FREE REPLACEMENT GUARANTEE:

Once You Buy Merlite Light Bulbs . . . You
Never Have to Buy Bulbs Again—NEVER!
Have Owners Buy 12 to 24 and More at a Time!
You Make up to \$50.00 and More in a Few Hours!

Everybody who hears fabulous No-time Limit Free Replacement Guarantee is immediate customer for you! Sell 12 to 24 Merlite Light Bulbs per home at 89c each, make up to 120% PROFIT ON COST, spare time. Merlite Bulbs burn so much longer, we can afford to make this daring guarantee . . . and you can make fantastic profits just telling friends, neighbors, others about this Free Replacement Guarantee!

FREE! Rush name, address today for complete details of biggest money-making opportunity in years . . . all FREE, no obligation. Write: **Merlite Industries, Inc., Bulb Div., 114 E. 32nd St., Dept. C-15X, New York 16, N.Y.**

NO JOB WORRIES

PLASTEX INDUSTRY needs manufacturers on small scale for big production of Lamps, Clock Stands, Art Goods, Novelties in Plastic Marble imitation. No Experience necessary. 1/2c material makes regular 10c store sellers. Moulds furnished for fast production. Small investment brings good profit. Big wholesale orders now being placed. Ambitious men have chance for real prosperity and job security. Our NEW FREE booklet will interest and benefit you.

PLASTEX INDUSTRIES, Dept. A
3400 Third Ave. New York 56, N.Y.

RUPTURED

Totally New
Comfort

for reducible
hernia. See the
differences in
our patented
materials & design.
Exclusive FITTED-
TO-ORDER Method.

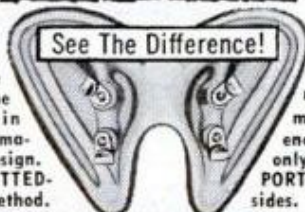

Single or
Double . . .
direct or indi-
rect hernia,
makes no differ-
ence. We design
only BALANCE SUP-
PORT to hold both
sides.

Free

Facts in Plain Wrapper
DEPT. 1-R FRED B. MILLER
HAGERSTOWN, MARYLAND

**Tiny Gas Cartridge
Operates Landing Gear**

About the size of a flashlight battery a liquid propellant gas cartridge is powerful enough to start a faulty landing gear on a jetliner toward the down and locked position. The liquid is a mono-propellant containing its own oxydizer, With it,



the cartridge produces high pneumatic pressures in a fraction of a second, and can be adapted to operate nearly any pneumatic power-actuated device. Its primary purpose, however, is to nudge a landing gear loose from its "up" position.

NOVEMBER



for only \$695

\$1

DOWN

\$10

PER MONTH

- NO TAXES TILL PAID
- NO CLOSING COSTS
- NO INTEREST

Collier County lies directly in the path of Florida's Fabulous Growth . . . already the third fastest growing county in all of Florida! Respected Investors who have noted past land profit trends predict that conditions in Collier County are now highly favorable for speculative investments. Even today Collier County boasts farming, timber, cattle raising and light industry. You can be part of Collier County's fabulous Tomorrows if you act Today! \$1. down reserves your stake in the land of sunshine and opportunities, Florida!

TROPICAL FLORIDA ACRES, INC.
420 Lincoln Road
Miami Beach, Florida

Yes! I want to own a share of Fabulous Florida! Enclosed find \$1. to reserve my 5 acres. Please forward your sales contract and brochure. I understand that my money will be refunded within 30 days if I am not completely satisfied with my purchase.

NAME.....

ADDRESS.....

CITY.....STATE.....

PM-11

**30-DAY
MONEY-BACK
GUARANTEE...
MAIL COUPON
TODAY!**

AD 60023(C)(1)



For instant 2-way Wireless Communication with car, home, boat, office, factory or farm

now—a low cost **WALKIE-TALKIE** for everyone, everywhere

- Talk & listen to persons up to a mile away
- As easy to use as a telephone—just push a button
- Completely portable hold it in the palm of your hand
- No tests, licenses, or age limits
- Handsome in aluminum and black simulated leather
- Buy it in easy-to-build kit form or factory assembled

Kit Only **\$32.95** each
 \$64.95 pair
 Factory Assembled \$50.95 ea. \$99.95 pr.

HEATHKIT DAYSTROM

Mail coupon today for complete information and

Free Heathkit Catalog

HEATH COMPANY
 Benton Harbor 17, Michigan

NAME _____
 ADDRESS _____
 CITY _____ ZONE _____ STATE _____

NOW YOU CAN GET MORE THAN HALF OF YOUR VITAMINS AT NO COST

YOU CAN NOW SAVE $\frac{2}{3}$ TO $\frac{3}{4}$ ON YOUR FAMILY VITAMINS. And HOW? Simply buy KOR-VAL vitamins. That's All. Not merely low, low prices, but **LOWEST** low prices.

TYPICAL VALUES:	KOR-VAL PRICE	COMPARABLE NATLY. ADV.
IMPROVED THERAPEUTIC FORMULA & B12 (100 caps.)	\$3.25	\$9.45
VITAMIN A — 25,000 UNITS (100 caps.)	75c	\$4.09

And there are dozens more values like that listed in Kor-Val's new exciting catalog. And you can be SURE you're getting the best your money can buy. Because...the government sets the standards for vitamins...for your protection. We set the price for your benefit. Kor-Val gives you everything you want in vitamin value...the utmost in quality any manufacturer can guarantee under strict government regulation. So SEND TODAY...now! for Kor-Val's FREE 32-page catalog. The values you can get only through E. J. Korvette, one of the NATION'S LARGEST CHAIN OF DEPARTMENT STORES. Send postcard with name and address NOW.

E. J. KORVETTE, 12 EAST 46 STREET, Dept. #90, NEW YORK 17, N. Y.

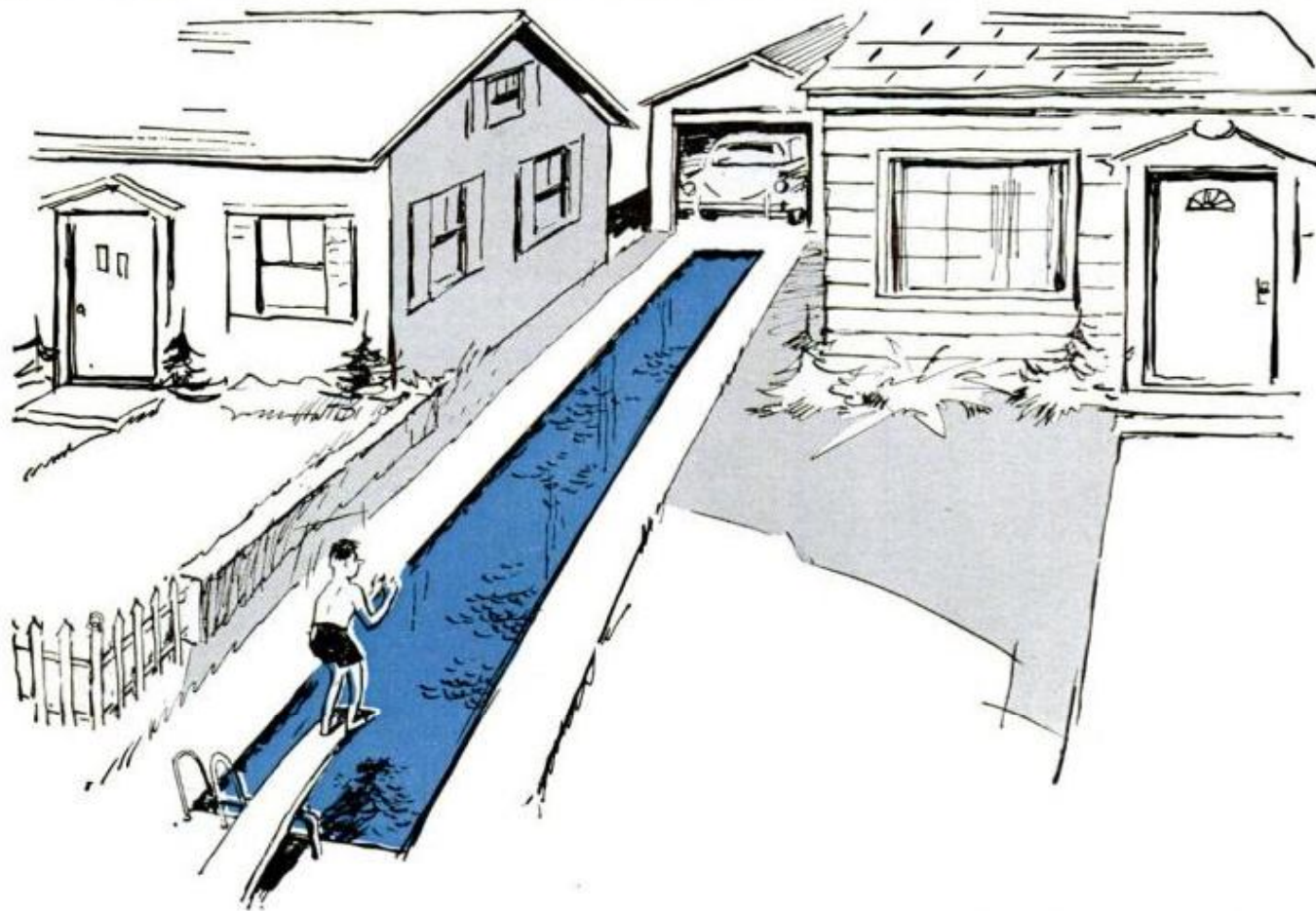

NEW WESTERN HAIG

**.12 CALIBER
SPECIAL FACTORY
OFFER!**



\$3.00
post-paid

USES POWDER CHARGE

This small bore gun shoots .12 cal lead bullets fired by small 4.4 mg. powder charge. Not a CO₂ gun! You'll like the handsome lines, grip, and balance. Western in style, but patented ball and cap action allows this low price. 9 3/4" steel barrel cased in knurled styrene stock, overall 13 1/2". Develop pistol form, accuracy at a fraction of cost of large caliber pistols. Comes with 50 lead bullets. Satisfaction guaranteed. Send \$3 to: HAIG MFG. CO., Box G-30, San Gabriel, Calif.

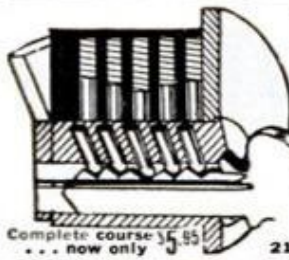

Locksmithing AND KEY MAKING

Now Made Easy! Practical up-to-date course

teaches you how to pick locks, de-code, make master keys, repair, install, service, etc. New self-instruction lessons for every handyman, homeowner, carpenter, mechanic, service station operator, fix-it shop, hardware dealer, gunsmith. 53 easy illustrated lessons. Full price only \$5.95 postpaid; or C. O. D. plus postage. Satisfaction or refund guaranteed.

NELSON-HALL CO., DEPT. LP-2
210 S. Clinton Chicago 6, Ill.

Complete course \$5.95
... now only \$3.95



**FIGHT
TB
WITH
CHRISTMAS
SEALS**

ANSWER YOUR CHRISTMAS
SEAL LETTER TODAY



Here's one more proof...

PLIOBOND is the one adhesive
that does the work of many



- Brick
- Plastic sheeting
- Aluminum
- Synthetic Rubber
- Hardboard
- Fabric
- Glass
- Leather
- Steel plate

EASY—PLIOBOND needs no mixing, no involved surface preparation, just brushes on.

FAST—PLIOBOND dries in minutes, even faster with the application of heat.

STRONG—PLIOBOND provides bonds up to 1600 lbs./sq. in. in shear tests.

LASTING—PLIOBOND resists heat, cold, water, most chemicals, oil—and age.

Goodyear, Chemical Division
W-9459, Akron 16, Ohio



Pliobond
BY
GOOD YEAR

CHEMICAL DIVISION

Pliobond—T. M. The Goodyear Tire & Rubber Company, Akron, Ohio

NOVEMBER 1960

73

AMAZING 6-SECOND **HERCULES**
SWIF SOLDER

REAL SOLDER (NOT A GLUE). JUST SQUEEZE ON AND HEAT...42% FASTER THAN WIRE SOLDER*

Squeeze on Hercules SWIF Solder and heat . . . even a match will work when you solder wires with SWIF SWIF solders copper, brass, iron, steel, silver, zinc, tin, etc. Plumbers, electricians and electronics men choose SWIF because it gives them a real 50/50 tin-lead solder in time-saving easy-to-use paste form. One tube of SWIF does the work of 3 to 4 times as much ordinary solder. Each tube comes with a free Do-it-Yourself Solder Leaflet that shows how to use SWIF for so many jobs.

*Test report available on request

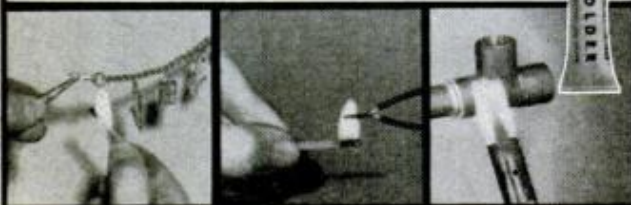

Hobbies & Crafts Electrical Wiring Plumbing & Repairs

ONE HANDY TUBE MAKES HUNDREDS OF CONNECTIONS. ONLY **69c**



Also available with acid flux in 4 oz., ½ lb., 1 lb. and 3 lb. containers
HERCULES CHEMICAL CO., INC., 416 Broadway, New York 13, N.Y.



Bomard Industries, Inc., Grand Haven, Mich.

Bicycle Has Glass-Fiber Frame

One manufacturer is peddling bicycles distinguished by their colorful glass-fiber frames. Designed by an industrial designer, the new bicycle combines a streamlined effect with the protective enclosure of mechanical parts, such as gears and chains. Accessories such as horn and light are concealed in the sweep of the frame. The color is designed into the glass fiber.

AMERICAN ACADEMY OF

yoga



W does YOGA offer the GREATEST
H return in physical and mental
Y health and development for the
 LEAST investment of time, effort
 and money— **?**

Find out in the FREE 5,000 word introductory lesson in authentic Physical-Mental YOGA without obligation.

AMERICAN ACADEMY OF YOGA, INC.—CORRESPONDENCE COURSE
 DIVISION • P. O. BOX 1305P • CORAL GABLES 34, FLORIDA

84 GREAT CARD TRICKS

PLUS BIG 160 PAGE MAGIC CATALOG
 OF OVER 1000 TRICKS NOW BOTH FOR **50¢**
 A fabulous collection of Card Tricks you can do! Book contains latest & best tricks used by magicians. The exciting big catalog lists 1000 tricks with balls, coins, flowers, cigarettes, rope, etc. Here's your chance to entertain & astonish others with exciting feats of magic. Rush name, address, & only 50¢ for everything!
 HOUSE OF 1000 MYSTERIES • Dept. PM11, Trumbull, Conn.

BUILD, FLY ONE-MAN COPTER!



Fun to build, inexpensive, easy to fly. Factory kits available. Order 3-view drawings, specs, photo of Gyro-Copter \$2 or simpler copter Glider \$1. Send now to:

BENSEN AIRCRAFT CORP., Dept. PM-110
 Raleigh-Durham Airport, Raleigh, N. C.

NAME _____
 ADDRESS _____

The World's Great
ATOM GUN
Blasts Off—

Read This Exciting
 Story in the

DECEMBER

**POPULAR
 MECHANICS**

NEW HO COLLECTORS ITEM!

NEVER BEFORE AVAILABLE!

B & O

"TEAKETTLE"

OLD TIME LOCO

\$7.95

ONLY \$7.95 P.P. A beauty to display . . . a dependable performer that hauls long loads effortlessly. Colorful, authentic . . . a real value! R.T.R. Order today!



Send For:

Giant RR Catalog—Lionel-A.F.-Hobbies . . . only 25c **FREE** WITH EVERY ORDER!

GAMERMAN'S

Dept. R 3615 Bank Street
Baltimore 24, Maryland

FAMILY RADIATION FALLOUT SHELTER

Provide complete radiation fallout protection for your family. Greatest home improvement need of the 1960's. Complete plans and specifications \$3.00.

GENERAL SHELTER CORPORATION • ROCKLEDGE, FLORIDA
(Florida residents add 3% sales tax)

DOG, PET OWNERS, SPORT & FISHERMEN

ATTENTION!

FIELD TESTED & PROVEN
AUTO TRUNK "VENT" & "LOCK"

CONVERTS TRUNK TO TRAVEL-SAFE ROOM!



GUARANTEED & Precision Built to Fit most cars 1950-1961 . . . from \$3.65

VENT-LOK SALES COMPANY
Dept. P.M., 9224 VAN DYKE, DETROIT 13, MICHIGAN

AMAZING BRAKE EQUALIZER



Gives shorter, more reliable, straighter stops. DO-MOR Brake Equalizer eliminates "surge" in brake lines, increases brake efficiency, life of tires, brake linings and drums. Reduces costly brake repairs. Simple to install. Free brochure **Only \$995** Ppd. —Money-back guarantee.

DO-MOR BRAKE ENGINEERING CO.
Box 266 Orange 22, California

**Shrinks Hemorrhoids
New Way Without Surgery
Stops Itch—Relieves Pain**

For the first time science has found a new healing substance with the astonishing ability to shrink hemorrhoids and to relieve pain — without surgery.

In case after case, while gently relieving pain, actual reduction (shrinkage) took place.

Most amazing of all — results were so thorough that sufferers made astonishing statements like "Piles have ceased to be a problem!"

The secret is a new healing substance (Bio-Dyne*) — discovery of a world-famous research institute.

This substance is now available in suppository or ointment form under the name Preparation H.* Ask for it at all drug counters—money back guarantee. *Reg. U.S. Pat. Off

NOVEMBER 1960

FREE!

**ALLIED
MONEY-SAVING 1961
ELECTRONICS CATALOG**

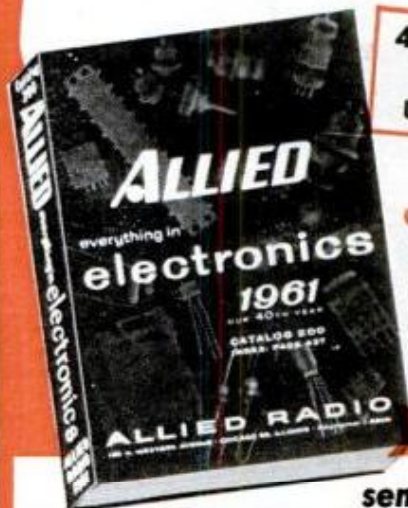

**444-PAGES
COMPLETE
UP-TO-DATE**

ONLY \$2 DOWN
on orders up to \$50; only \$5 down up to \$200; \$10 down over \$200

send for it today!

Largest Selection—Lowest Prices

Send for the leading buying guide to everything in Electronics, including products available only from ALLIED. Builders, experimenters, hi-fi fans, Amateurs, servicemen, engineers—save most on:

- KNIGHT-KITS®—Best in Build-Your-Own
- Everything in Stereo High-Fidelity
- KNIGHT® Super-Value Stereo Hi-Fi
- Tape Recorders & Phono Equipment
- TV Tubes, Antennas, Accessories
- Parts, Tubes, Transistors
- Everything in Tools & Technical Books
- Amateur Station Equipment
- Citizen's Band 2-Way Radio
- Public Address & Paging Systems
- Latest Test & Lab Instruments



SAVE on everything in Electronics at ALLIED. Get every buying advantage: fastest shipment, expert personal help, easiest-pay terms, satisfaction guaranteed or your money back. Send today for your value-packed, **FREE 1961 ALLIED Catalog.**

YOU CAN DEPEND ON THE WORLD'S **40th**
LARGEST ELECTRONIC SUPPLY HOUSE **year**

ALLIED RADIO

**SEND FOR
FREE
CATALOG**

**ALLIED RADIO, Dept. 5-L
100 N. Western Ave., Chicago 80, Ill.**

Rush **FREE** 1961 ALLIED Catalog

Name _____

Address _____

City _____ Zone _____ State _____

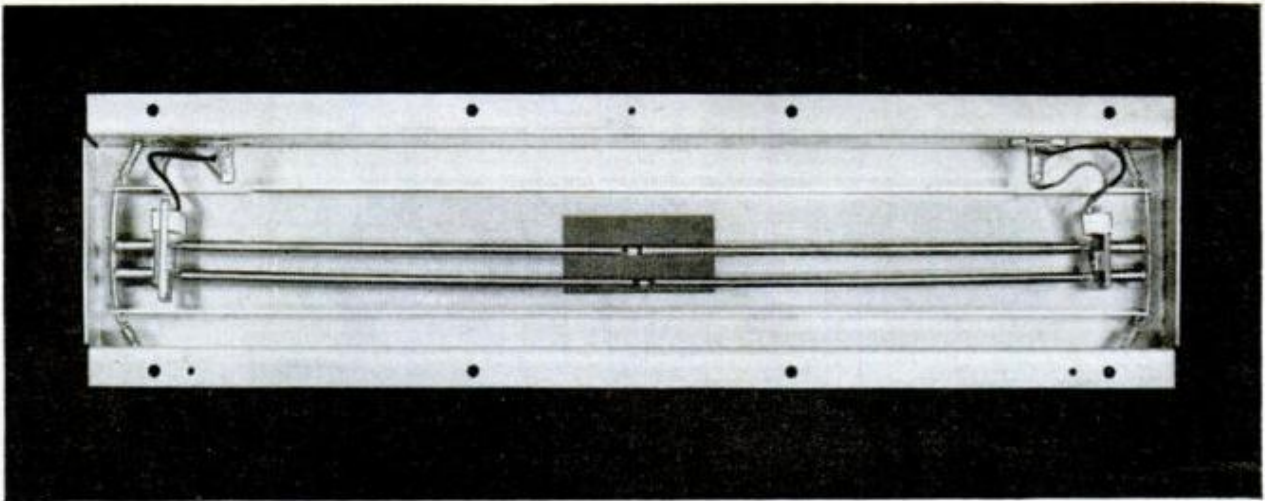

NOW ADD REVERBERATION TO YOUR STEREO SYSTEM

By Otto Fried

ACOUSTIC RESEARCHERS, musicians and many audio engineers appreciated the value of short echoes introduced into music recordings for many years. If we listen to an orchestra in an auditorium, our ears are subjected not only to the sounds propagated directly by the instruments, but also to the complex wave forms produced by the acoustics of the hall. The mathematical treatment of these phenomena is very difficult, and in many cases it

offers solutions that are only approximate.

We are going to concern ourselves with one important parameter of acoustics, and that is the short echo referred to as reverberation. Reverberation time is defined as that length of time required for a sound to decay 60 db. This definition can be found in any textbook dealing with the subject of acoustics, but it does not explain the effect on the listener. There is no doubt

(Continued to page 78)

Schematic of amplifier system for reverberation unit. Above, reverberator used in many commercial systems

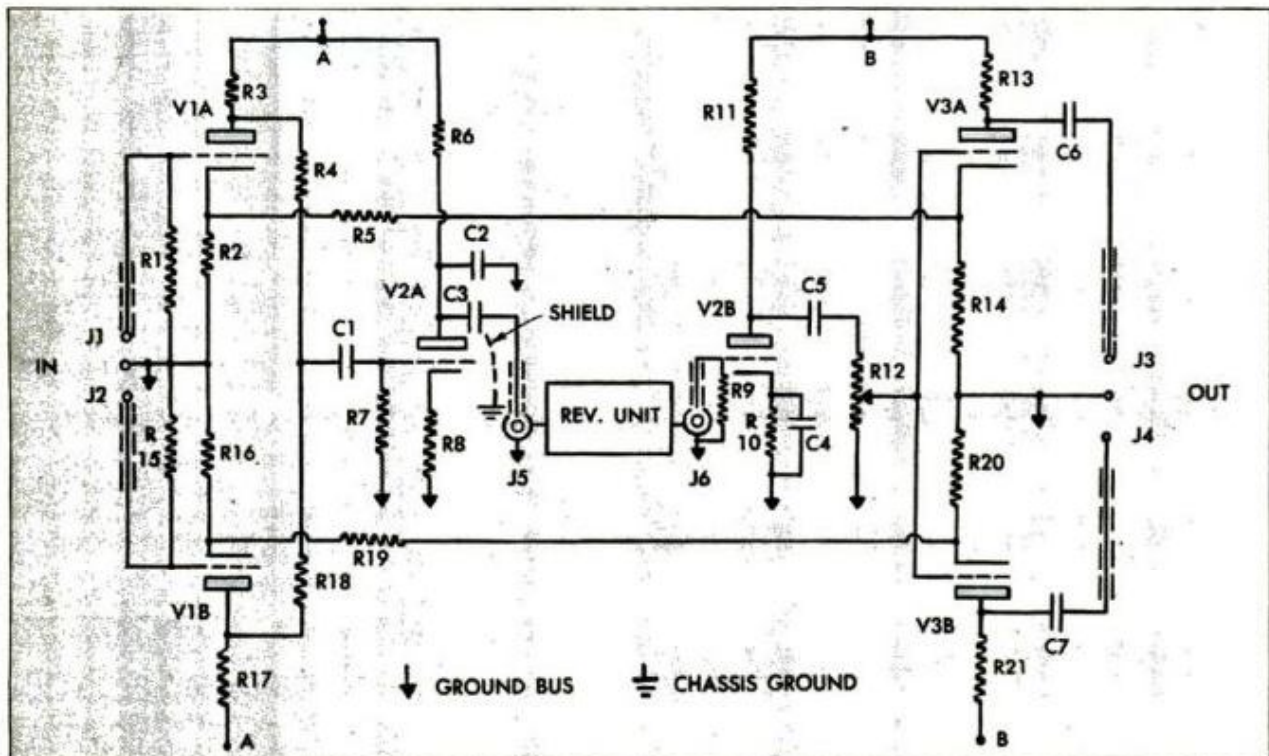

want training in Photography? Mechanics? Electronics?

choose-it-yourself

before
enlistment

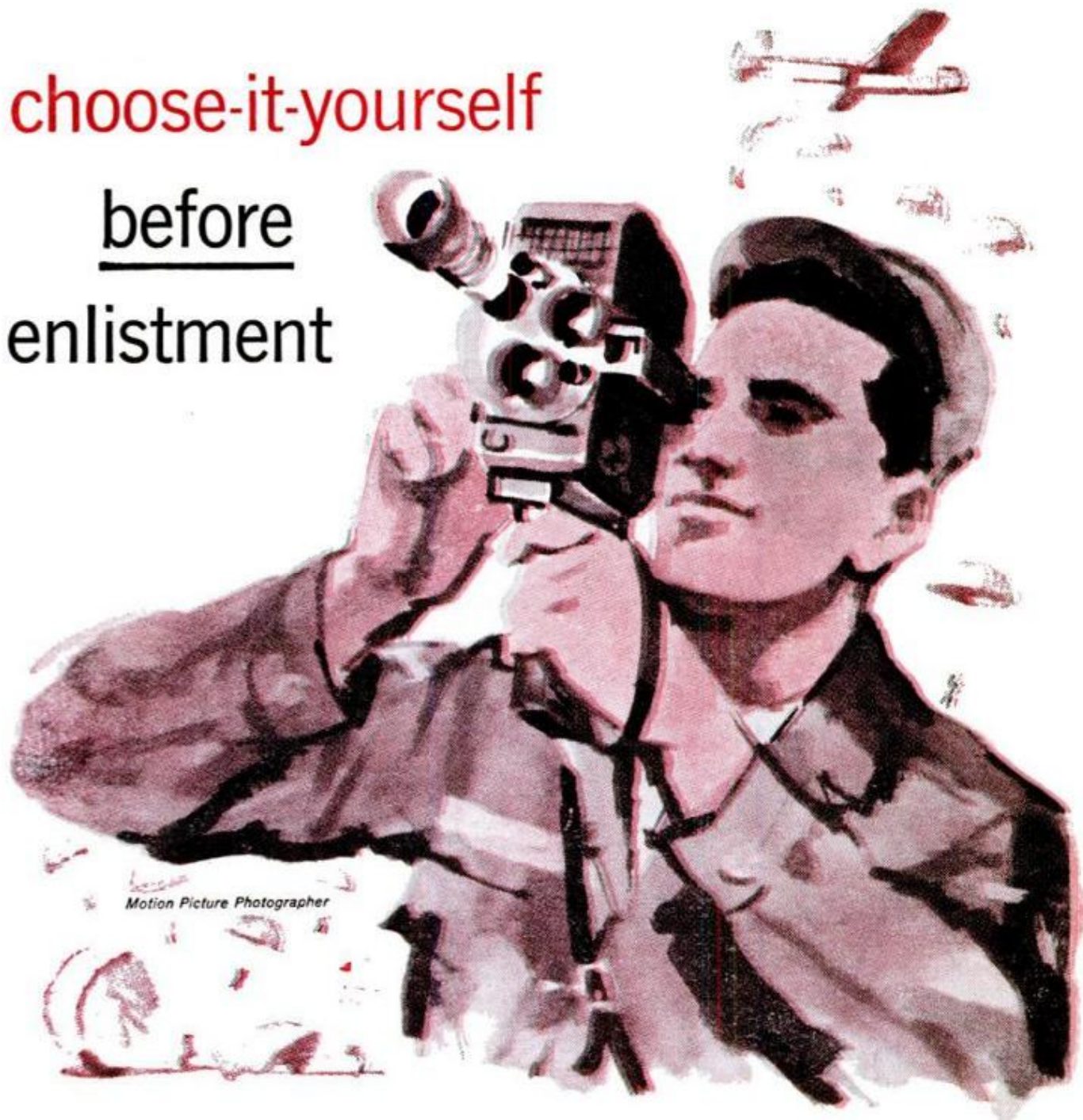

Motion Picture Photographer

It's up to you! The Army's new "Choose-it-Yourself" System lets you choose valuable training before you enlist. Here's how it works: **1. Choose** before enlistment. Choose your training from fields like Photography, Missiles, Communications, Construction, Automotives—and many more. **2. Qualify** before enlistment. Take aptitude and physical exams to qualify for the training you've chosen. **3. Know** before enlistment. If you qualify, you know you'll get the training you want. Your choice is written into your future Army record—guaranteed before you enlist. **Choose, qualify, know — this week!** Ask your Army recruiter to show you his complete list of available training fields.

CHOOSE IT  YOURSELF VOCATIONAL TRAINING SYSTEM
US ARMY



Remove most of cone to modify speaker. Springs finish unit

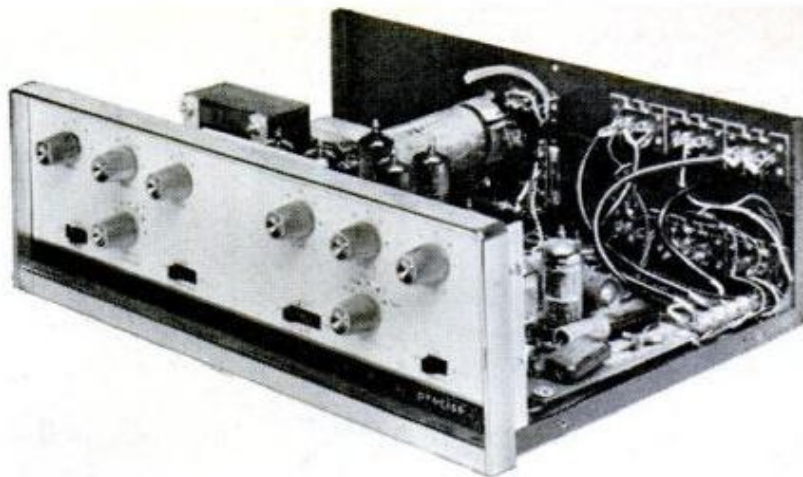

Utilize unused input and output connectors on amplifier to install wiring for reverberation. Below, two possible means of installing system

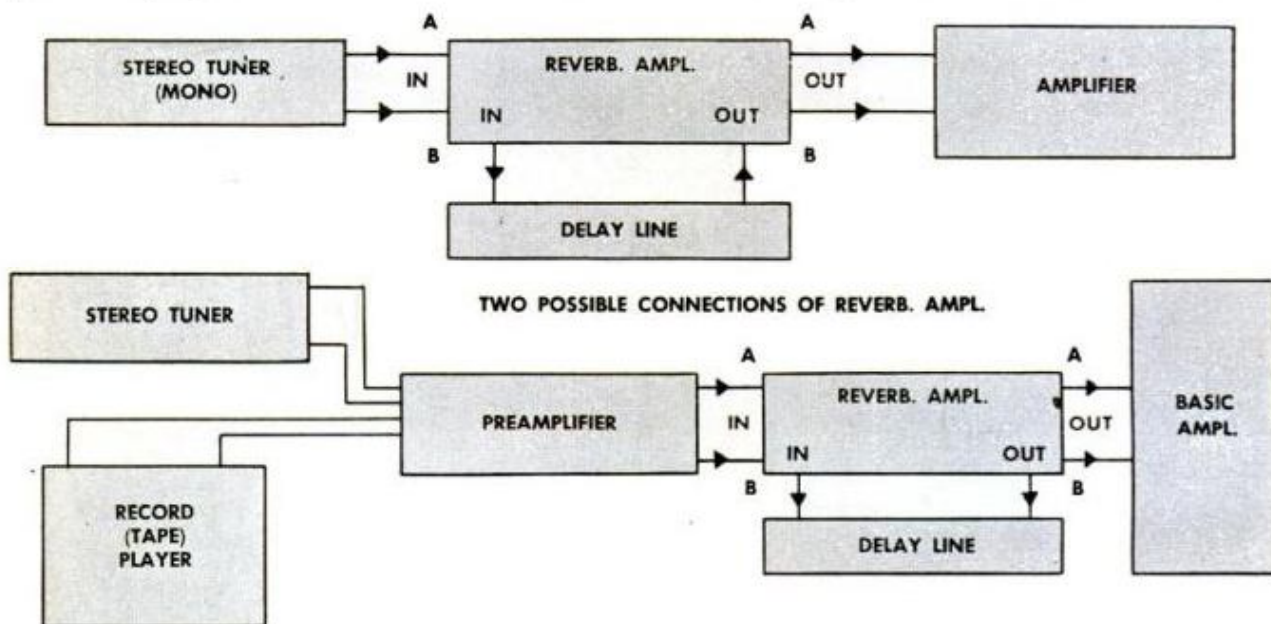

that reverberation, when properly applied to your system (monophonic or stereo) will produce such realism, that many listeners will prefer the electronic reproduction to the "live" orchestra in an auditorium. Recording companies employ many different techniques to offset the effect of a "dead" studio, and there are many professional types of reverberating machines on the market. A simple method to introduce reverberation in your home recordings is to use two microphones. One of them picks up the source directly, and the other one is placed in such a way that it picks up the echoes produced by the room. Outputs of both mikes have to be properly mixed, in order to achieve the desired effect.

However, most of us depend on broadcasting stations or commercial recordings for a source of music enjoyment, and the following describes reverberation generators, which can be added to any hi-fi system. The first one consists of two 3-inch or 5-inch PM speakers, several ordinary springs and a small a.c.-d.c. amplifier. The

speakers with 3.2-ohm voice coils have to be modified in order to provide anchors for the springs.

Carefully cut out the cone around the speaker frame, leaving only a narrow strip of paper around the voice coil. This strip should not exceed 2 inches in length and 1 inch in width. Be sure that you do not damage the voice coil; we have found the razor blade to be an excellent tool for this operation. The next step is to prepare a small phenolic board about 1½ inches long, ¾ inch wide and 1/16 inch thick. Drill three holes along the center line, and insert #20 wire into each of them, forming a small loop on one side and flattening the loose ends of wire on the other side. The board is then glued carefully to the cone strip left around the voice coil. Be sure that none of the glue seeps between the voice coil and the magnet. The wire loops are on top of the board—the side with the loose ends is glued to the cone. Both speakers are mounted on a small metal L-shaped

(Continued to page 80)

Gift idea from Texaco—for now, for Christmas!

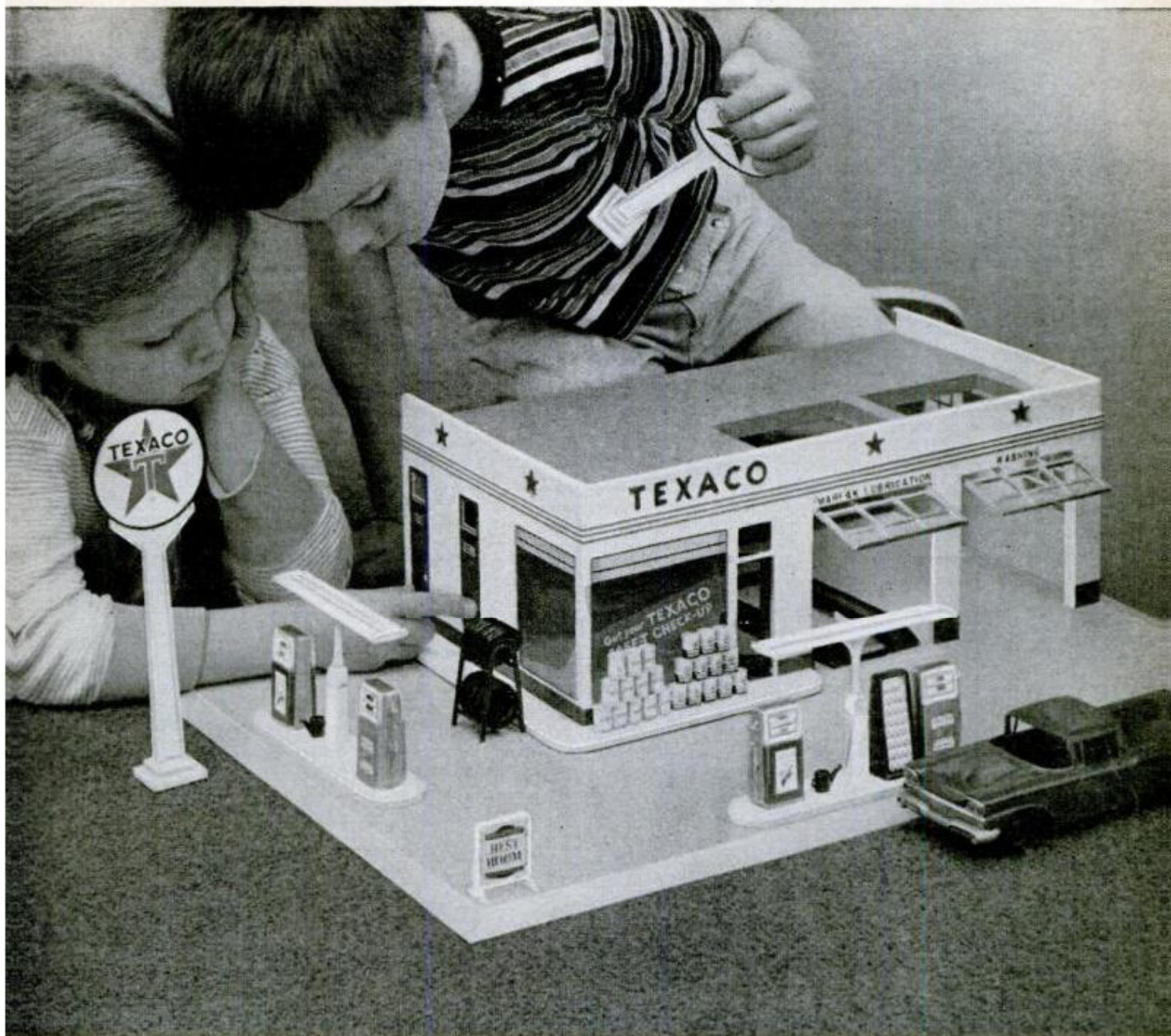

Big, authentic scale-model service station!

Special Price \$3.50

- Made of rugged plastic, with 18"x24" metal base
- model car • overhead lube bay doors open and close
- car lift raises and lowers
- 2 pump islands with light poles
- 2 Texaco signs
- oil display cabinet
- Havoline and PT Anti-Freeze display cans
- tire rack with miniature tires
- other station equipment

A delight for any youngster! Order now. Lay it away for Christmas. This toy Texaco Service Station is custom-made by "Buddy-L"—makers of the famous toy Texaco Tank Truck. It will be delivered to your door for the special price of \$3.50. Here's all you do: just drive in to your nearby Texaco Dealer. *Ask him for a free coupon.* Fill it out and mail it with your check or money order. It's that easy to get this exclusive Texaco Dealer offer—good only in the U.S.A. *Is your car ready for safer, surer, colder-weather driving? When you come in for your coupon, get a Texaco Fall Safe-T check-up.*

Order now...lay away for Christmas. See your Texaco Dealer.

Материал, защищенный авторским правом

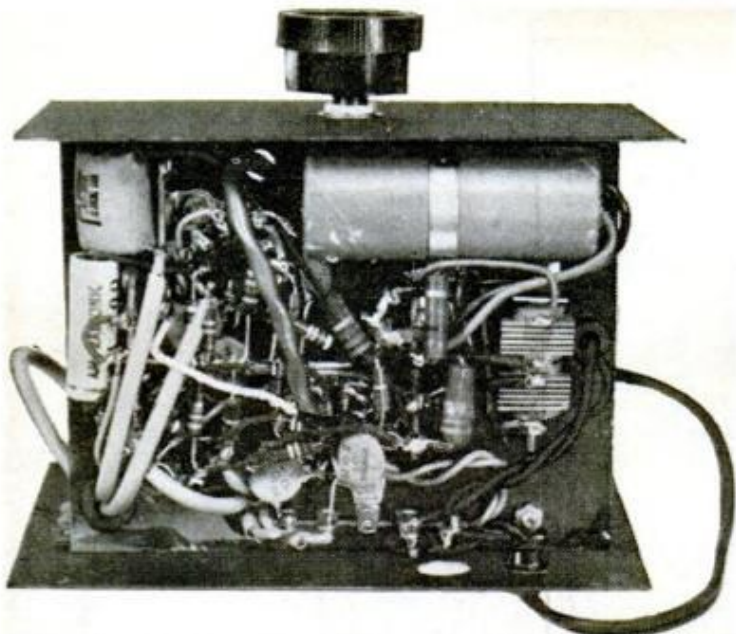

Under chassis view of amplifier unit. This will operate as well with either commercial or homemade reverberation units

PARTS LIST

R1, R15, R4, R18	1 Meg., 1/2 W
R2, R16, R10	3.3 K., 1/2 W
R3, R17, R13, R21	100K., 1/2 W
R5, R19	22K., 1/2 W
R6	6.8K., 1W
R7	82K., 1/2 W
R8	100 ohms., 1/2 W
R9	15K., 1/2 W
R11	47K., 1/2 W
R12	.5 Meg. Pot. linear taper
R14, R20	2.2K., 1/2 W
R22	100 ohms Pot. linear taper
R23	100 ohms, 1W
R24	3.3K., 2W
R25	33K., 1W
C1, C2, C5, C6, C7	.01 Mfd. disc
C3	.47 Mfd., 200V
C4	.068 Mfd., 10V or higher
C8	Electrolytic—40-20-20 mfd. at 250 V., d.c.
V1, V3	12AX7
V2	6CG7
T1	Power transformer, Stancor 8416
CR1, CR2	Selenium rectifier, 50MA.
S1	SPST switch on pot (R12) (optional—see text)
F1	Fuse, Slo-Blo, .25 amps. (optional—see text)
Chassis	Fuse, Slo-Blo, .25 amps. (optional—see text)
J1—J6	See text
Hardware, wire, etc.	Phono plug—see text

Recommended power supply diagram for reverberation amplifier. Switch S1 may be mounted on R12 or omitted entirely if unit is connected to switched convenience outlet on back of amplifier. R22 controls hum

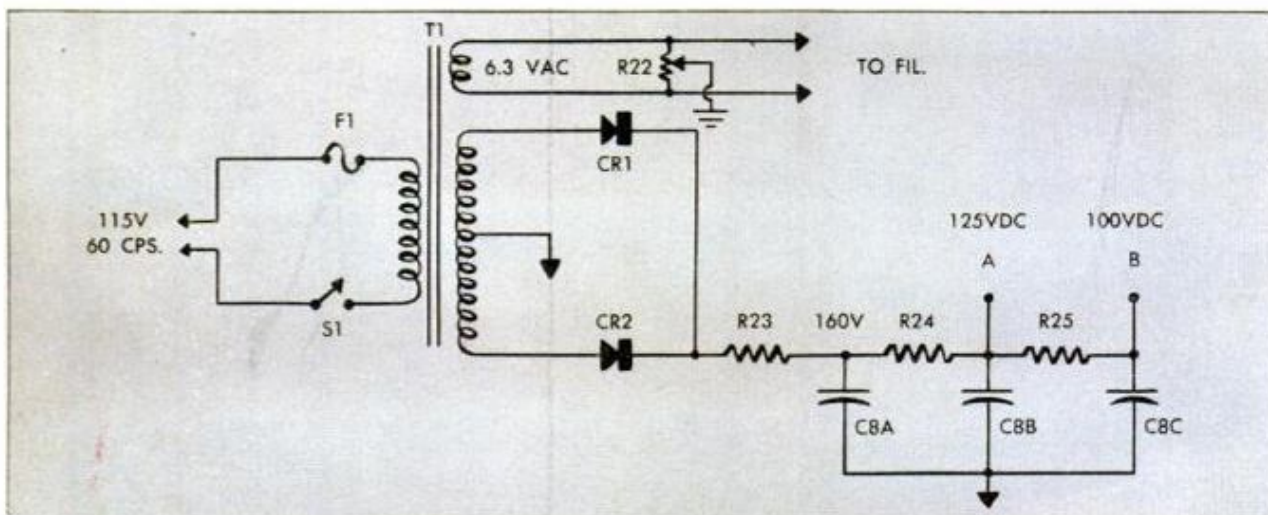

One of many commercial reverberation devices available to add to your presently existing equipment. This unit can be connected between preamplifier and amplifier, providing complete reverberation in your home



(Continued to page 272)



PRUNES TREES



CUTS FIREWOOD



CLEARs BRUSH AND WEEDS

ONE McCULLOCH ENGINE



DIGS HOLES



CUTS PULPWOOD

DOES MANY JOBS

Tough cutting jobs come easy, go fast with a lightweight McCulloch chain saw—the powerful tool of many uses. Cut firewood to use or sell for profit, clear ski trails and campsites, whisk away brush and weeds, trim orchards and hedgerows, dig holes for fenceposts, cut lumber for construction . . . build things, do things faster and easier than ever before. Your McCulloch chain saw is quick to start, economical to operate and always dependable. Thrifty to buy, too. Mail this handy coupon for more information.

ONE/41 Direct-Drive

This easy handling chain saw with its powerful 2-cycle gasoline engine cuts through a 9" tree in just 5 seconds . . . cuts that tree into logs just as fast. Takes Brushcutter, Weedcutter, Earth Drill and Paddle Bow attachments; straight bars up to 24". Weighs only 17 lb.

Professional Quality,
Economy Price

ONLY \$149⁹⁵

5-0102 with full 16" bar



McCULLOCH CORPORATION

6101 W. Century Blvd.
Los Angeles 45, California
Dept. PM-1



Please send me free your illustrated color booklet showing the many ways a McCulloch chain saw can help me do more work faster—easier.

Name _____

Address _____

City _____ State _____

McCulloch Corporation, Los Angeles • Marine Products Division (Scott Outboards), Minneapolis • McCulloch of Canada, Ltd., Toronto • McCulloch International Inc., Los Angeles

Remember how great cigarettes used to taste?
LUCKIES STILL DO



CHANGE TO LUCKIES

and get some taste for a change!

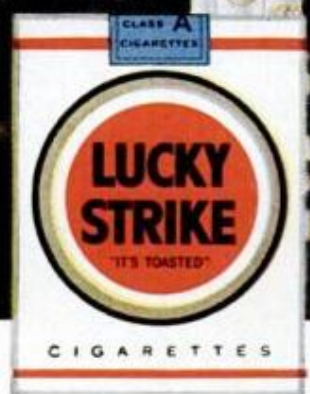

TOBACCO AND TASTE
TOO FINE TO FILTER

© A. T. Co.

Product of *The American Tobacco Company* - "Tobacco is our middle name"

80B

POPULAR MECHANICS

Материал, защищенный авторским правом

Four New "Medium Compacts" Join '61 Car Lineup

Aluminum engines, unit bodies, new suspensions and automatic transmissions are top new features for '61.



BUICK SPECIAL

Buick's new Special, like the other two new GM compacts, is based on the same 112-inch-wheelbase unit-construction body. Models are four-door sedan and four-door wagon. The Special is powered by a light, efficient all-aluminum V-8 of 155 horsepower, has new automatic transmission of unique "split-torque" design. Manual transmission is standard equipment.

PONTIAC TEMPEST

Beneath its crisp, conservative styling Pontiac's new compact Tempest crams the most imaginative engineering of 1961. There's the big, 130-horsepower slanted four-cylinder engine, a curved torsion bar drive shaft leading aft to independent rear suspension transaxle. A 155 horsepower aluminum V-8 is optional. Three-speed floor-shift transmission is standard.





Buick's big Le Sabre, Invicta and Electra have undergone a complete styling change as a result of a brand new body with improved seating positions, legroom and vision. Suspension is still by coil springs all around, but the torque tube has been replaced by a two-section drive shaft with four universal joints. Engines and Dynaflo are unchanged. Buick continues with its aluminum brakes.

BUICK



DODGE DART

A very thorough restyling job is the big news for 1961 from Dodge's popular Dart series. The wheelbase remains 118 inches, while width, length and height are virtually unchanged. Grille, hood, fenders, rear deck and all trim are new. Only the roof, glass area and basic Unibody and frame remain as in 1960. Basic engines are 135-horsepower slant Six and 361-cubic-inch V-8. Dart has joined other Chrysler Corporation cars in switching from generator to alternator.

Oldsmobile's version of the handsome new GM medium-priced compact, the F-85 shares its body in sedan and four-door station wagon styles with Pontiac Tempest and Buick Special. However, its 215-cubic-inch aluminum V-8 has Oldsmobile's own cylinder heads, pistons, carburetion and intake manifold as well as a light-weight version of the newly-redesigned Hydra-Matic transmission. The car is smaller than "full-sized" Olds but has room for six.

OLDSMOBILE F-85





LINCOLN- CONTINENTAL

Lincoln Division has put all its chips on just one series and two models for 1961, the Lincoln Continental four-door sedan and four-door convertible. With 123-inch wheelbase and 212-inch over-all length, (that's one inch shorter than the 1960 Ford), the Lincoln Continental is the first entry in what might grow into a "compact luxury" field. Car's performance is very high.

PLYMOUTH

Plymouth has dropped the familiar fin with a vengeance for 1961. On, and around, the unchanged shell of its unit-construction body, all-new sheet metal has given Plymouth a lower, wider look. Passenger compartment, engines and chassis are little changed. Flatter rear deck lid has permitted an enlarged trunk compartment. The standard V-8 engine has displacement of 318 cubic inches, is rated at 230 horsepower. The Six has 145 horsepower.



An all-new T-Bird, still a four-passenger two-door body in hard-top and convertible models, has been built around the big 430-cubic-inch V-8 engine of 350 horsepower. Fordomatic dual-range automatic transmission is standard. Body is now sleek, torpedolike. Windshield no longer wraps into front door opening. Front springs are mounted high in the unitized body. Steering column swings to right when car is stopped for easy exit.

THUNDERBIRD





OLDSMOBILE

Except for its big, 394-cubic-inch engine and the rear axle, the 1961 Oldsmobile is virtually a new car with a wider, box-type frame, brand new bodies and a redesigned, lighter version of Hydra-Matic transmission. Horsepower is up slightly from 240 to 250 on the Dynamic 88 and from 315 to 325 on the Super 88 and 98 models. Interiors have more room.

DODGE LANCER

Lancer is Dodge's lively and attractive new compact based on the successful unit body and chassis of Valiant. Basic engine is 101-horsepower slant six of 170-cubic-inch displacement. A 225-cubic-inch engine of 135 horsepower is optional. Two-door sedan and hardtop are available as well as four-door sedans and wagons. Buyer gets his choice of manual or automatic transmission.



PLYMOUTH VALIANT

Plymouth's Valiant has been changed slightly in appearance—just enough to let you know it's a '61. A two-door sedan and hardtop have been added to the four-door sedan and wagons. An extra-cost, high-performance version of the 170-cubic-inch slant six engine will be available. All models except the hardtop are available in "standard" or "deluxe" trim. Power steering and air conditioning are available at extra cost.

FALCON

In response to demand Falcon has been given a useful power boost for 1961 in the form of an optional 170-cubic-inch version of its current 144-cubic-inch six cylinder engine. Horsepower rating is 90 for the smaller engine, 112 for the extra-power job. Body and chassis are otherwise little changed, except for a neat new grille.





MERCURY

Mercury shares basic body and chassis with Ford for 1961 as well as its 292 and 352-cubic-inch V-8 engines, and, for the first time in Mercury's 21-year history, a six-cylinder engine. A unique variation of the coil-and-leaf-spring suspension system, exclusive with Mercury, uses movable rubber-bushed shackles to absorb ride harshness of rough roads.

PONTIAC

The senior Pontiacs for 1961 now have wider frames to match their wide tracks and mount their all-new bodies upon. As a result of this new, box-type frame, legroom is exceptionally good in both front and rear compartments. Wheelbases are now 119 and 123 inches. Seating positions, vision, entrance and exit have all been improved for 1961. The basic engine remains Pontiac's big 389-cubic-inch displacement V-8 of 215 horsepower.



LARK

There are more changes than meet the eye in the 1961 Larks. Hood and cowl have been lowered and flattened for improved driver vision. Dual headlamps are now on the Regal models. Rear quarter panels, rear deck, "C" posts and back lights have all been changed. Underneath the hood is an all-new overhead-valve six of 170-cubic-inch displacement and 112 horsepower. The 180 horsepower, 259-cubic-inch V-8 is, of course, still an option on all models.

RAMBLER

Most exciting change in the improved and facelifted 108-inch-wheelbase Rambler is the die-cast aluminum cylinder block on the 127-horsepower overhead-valve six-cylinder engine. Use of aluminum cuts 80 lb. from the engine's weight. Over-all appearance is improved by new grille, one-piece bumpers and new front-end sheet metal.





CHRYSLER

Chrysler retains the familiar fins of the Forward Look styling but takes on a different personality due to restyling of the front end including canted pairs of headlamps and a new grille. Added to the New Yorker and Windsor lines is a new, lower-priced Chrysler, the Newport, on 122-inch wheelbase with 361-cubic-inch V-8.



CORVAIR

Corvair has added a new four-door station wagon called the Lakewood to its coupe and four door sedan models. Also there's a new camper wagon, the Greenbrier, (see cover photo) and commercial vans and pickups on an entirely new 95-inch wheelbase chassis. The air-cooled rear engine is used on all models. Sedan and coupe luggage space has been greatly increased by moving spare tire to the engine compartment. Heating is by hot air.



COMET

A longer stroke, 170-cubic-inch version of the current Comet six-cylinder engine adds 20 needed horsepower to the 1961 Comet as an option for those willing to make a slight sacrifice in economy for the sake of livelier performance. This new engine should be especially welcome to station-wagon buyers. A new grille with horizontal bars and some changes in name plates and trim mark the only visible differences. Two-speed automatic transmission optional.



CHEVROLET

Bigger and better bodies with slightly smaller exterior dimensions are the big news for 1961 Chevrolets. Styling retains the "gull-wing" theme on the rear trunk area, but increases trunk's useful capacity very greatly. Frame, suspension and three basic engines; the six and 283 and 348-cubic-inch V-8s, are unchanged.

DODGE

The "big" Dodge for 1961 is one series, the 122-inch-wheelbase Polara, with five models; a four-door sedan, two and four-door hardtops, a convertible and four-door hardtop station wagon. Basic dimensions of interior and exterior of the Dodge unit construction body are unchanged. Restyling has changed the car's entire appearance making it look more compact.



RAMBLER AMERICAN

Seldom has a car been as completely restyled as the 1961 Rambler and yet retain its same engine, drive line and suspension on the same unit body and frame chassis. In addition to its two- and four-door sedans and wagons, the 100-inch-wheelbase American will offer a convertible around the first of the year. The new American is 5.2 inches shorter and three inches narrower.



FORD

The thoroughly restyled 1961 Fords are nearly four inches shorter and two inches narrower—good news for city drivers. Wheelbase remains 119 inches as do the basic dimensions of the passenger compartments. Ford has made a number of real improvements designed to ease maintenance and increase reliability. For example, chassis lubrication is needed only at 30,000-mile intervals. Brakes are self-adjusting, and lower body panels are galvanized steel.



AMBASSADOR

American Motor's Ambassador shows a considerably changed face with smaller grille and down-curved hood for 1961. Wheelbase remains at 117 inches and body shell is unchanged underneath the new front sheet metal. Powerplant is the 327-cubic-inch-displacement V-8 which develops 250 horsepower on regular grade gasoline.





CADILLAC

Cadillac has undergone a complete restyling for 1961 yet it manages to retain its typically restrained air of evolutionary change. The rear fender fins are much the same as on the 1960 models, yet the side panels from head to tail lamps have been completely changed, as has the grille. The limited-production El Dorado Brougham has been dropped, but the Sixty Special for 1961 has a "formal" rear quarter and smaller rear window. Roof lines for '61 have a new "knife-edge," somewhat continental appearance.



IMPERIAL

There are three model series of Imperials for 1961; Custom, Crown and LeBaron. The four-door hardtop is available in all three series; a two-door hardtop is offered in Custom or Crown and a convertible in Crown series. All models are powered by the 413-cubic-inch-displacement V-8 which develops 350 horsepower. Biggest change is in the styling of the front end with the chrome-plated, free-standing headlamps and new grille.

DESOTO

The 1961 DeSoto comes in two models, a two- and four-door hardtop, both on a 122-inch-wheelbase unit-construction body. The engine (and only one is offered) is a 361-cubic-inch V-8 with two-barrel carburetion. This engine has had its compression ratio lowered to 9.1 so that it may be operated on regular grade gasoline. Transmission is Chrysler Corporation's TorqueFlite automatic. Power brakes and power steering are optional extras.



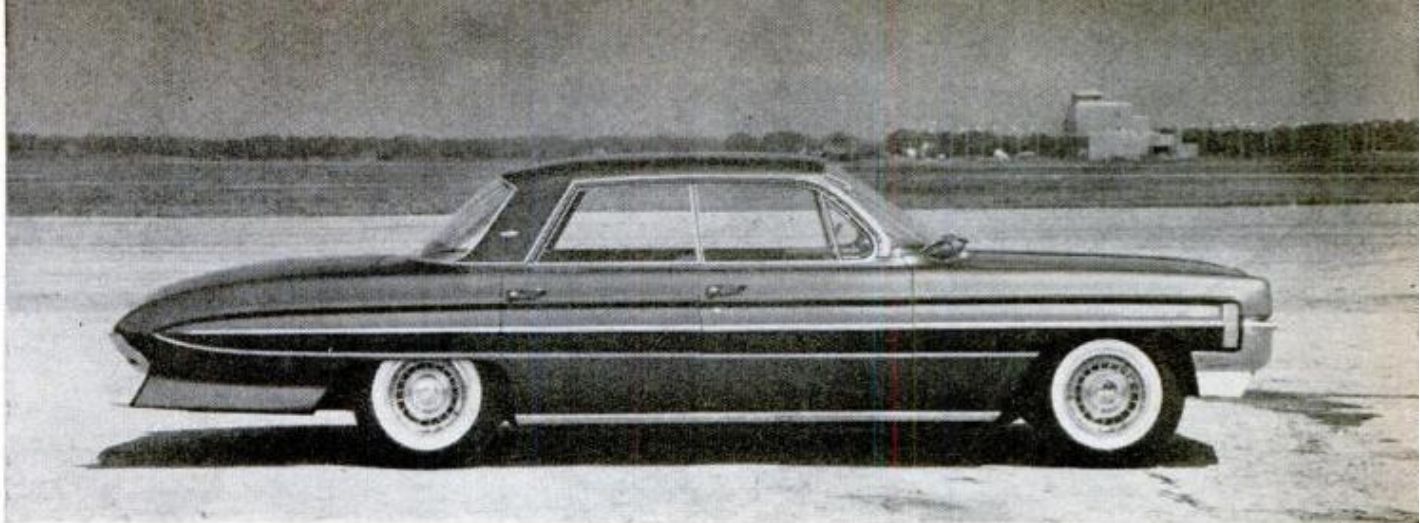

Side view of Olds 98 four-door hardtop, above, shows entirely new lines. Note elimination of fins, wrap-around windshield and new roof and rear quarter treatment. Grille, below, is uncomplicated and attractive

New Looks for Olds in 1961

As in previous years Oldsmobile offers its three series; the Dynamic 88, Super 88 and the 98. The first two series are on 123-inch-wheelbase chassis with over-all lengths of 212 inches. Major differences between these two are interior trim and engine output. The Dynamic 88 has a 250-horsepower version of the 394-cubic-inch engine, while the Super 88 version is rated at 325 b.h.p., thanks to higher compression ratio and a four-barrel carburetor. Synchromesh manual transmission is available as an option to Hydra-Matic on the 88's. The 98, which shares the Super 88's engine is available only with automatic transmission. The 98 has a wheelbase of 126 inches and is six inches longer over-all, than the 88s. Most of this extra length has gone into the passenger compartment. All models are 3½ inches narrower than the 1960 Pontiacs and range from 3 to 5½ inches shorter over-all. At the same time interior dimensions relating to passenger comfort have been increased. Seats are higher. The tunnel is lower, headroom has been increased and the cars are much easier to enter or leave. Suspension is still by four coil springs, but linkages have been changed.



Rear treatment, above, shows down-curve of wide trunk lid on '61 Olds. Trunk has much more usable space than in previous models. Four-door station wagon, below, can be had with two or three seats





1961 Rambler Classic station wagon shows off the principal area of restyling, the front end. There's a new hood, new front fenders, newly sculptured door panels, side trim and new one-piece bumpers

No changes have been made in the window and roof area of the '61 Rambler Classic, right, yet it has a much different appearance. No change made in dimensions



Restyled Rambler Gets Aluminum Six

Biggest single change on the 1961 Rambler, now dubbed the Classic series, is its new aluminum six-cylinder engine of 195-cubic-inch displacement. This engine has the same basic design as the overhead-valve, cast-iron six that it succeeds.

The cylinder block is die cast with iron "sleeves" or cylinder liners. The cylinder head is a cast-iron alloy. Weight saving over the all cast-iron engine of 1960 is 80 pounds. Horsepower of the six remains unchanged at 127. The 200-horsepower V-8 is optional.

Ambassador V-8 Has Changed Appearance

The 117-inch-wheelbase Ambassador for 1961 continues with much the same unit construction body and chassis as used in 1960. Engine is the same 250-horsepower V-8 of 327-cubic-inch displacement. This powerplant has a compression ratio of 8.7 to 1 and is equipped with a two-barrel carburetor and single exhaust. Optional equip-

ment is a four-barrel carburetor, 9.7 to 1 compression and a dual exhaust system. With the optional "power pack" the engine develops 270 horsepower. Ambassador is equipped, as are all other American Motors cars, with new ceramic-coated mufflers that are guaranteed for the life of the car. Synchronmesh transmission is standard.



A new down-curved hood and new, forward-thrusting fenders frame the smallish grille of '61 Ambassador



Rambler American four-door station wagon, a new body type for 1961, packs a lot of space on its 100-inch-wheelbase chassis. Area of glass and size of rear opening have been much increased for '61



Five-passenger convertible, left, is brand new body for Rambler, has power-operated top, choice of 90 or 172-horsepower engines. Legroom in sedan, right, is adequate for six-footers with front seat fully back

Rambler American: After 10 Years, a New Shape

American Motors' chief Stylist has done one of the great glamorizing jobs of all time on the friendly, familiar roly-poly shape of Rambler's compact American.

The basic underframe of the unit body, those structural members that comprise the "chassis," are unchanged as are the engine, suspension and driveline parts. However, every inch of the exterior from bumper to roof pan is totally new, as is the instrument

panel on the inside. Among the improvements resulting from the new body design are a larger windshield giving much better vision over the flat hood, full width rear window in the sedans and a larger rear opening on the station wagon. The trunk, too, is larger and more accessible as a result of the redesigned rear end. Two new models, a four-door station wagon and a convertible have been added to the line.

American's trunk, below left, is larger, and much easier to load due to larger lid. New instrument panel, below right, is topped by deeper windshield, which gives much improved forward vision over hood

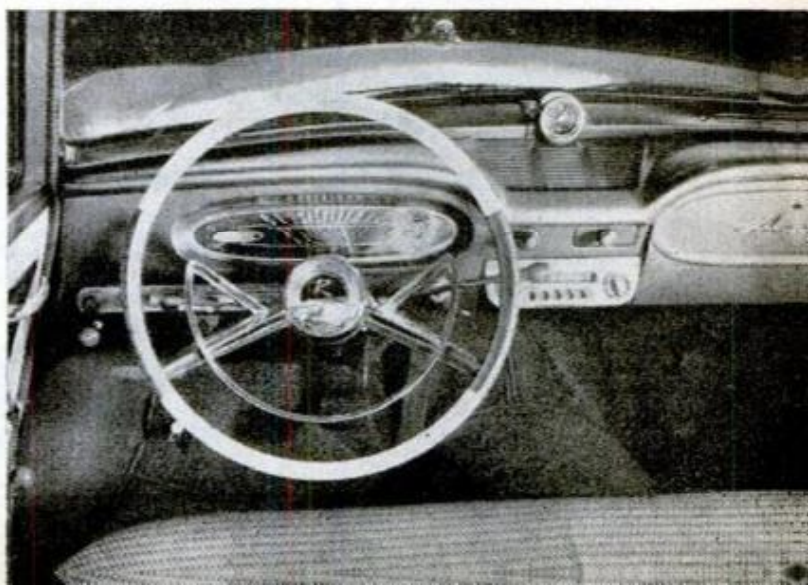

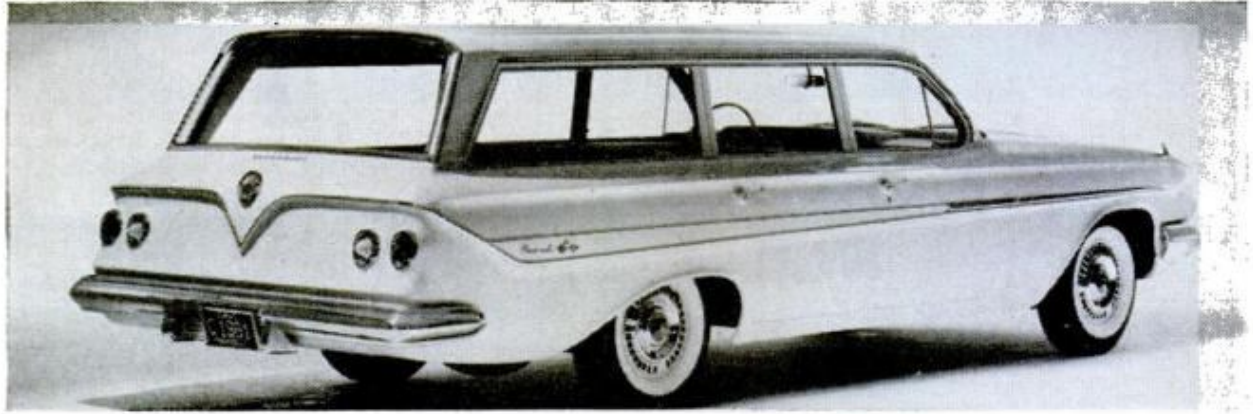

Impala Sport sedan, top, has newly contoured roof line. Nomad wagon, above, has rearward-facing third seat

Chevrolet Gets All-New Bodies

The 1961 Chevy has entirely new bodies on its chassis which is refined but basically unchanged from the 1960 model. The new bodies are smaller on the outside yet have approximately the same room on the inside with some gains in headroom, ease of entrance and vision.



Restyled Rear End for Corvette

Maintaining the same basic chassis used on the 1960 model, Corvette has a newly styled rear quarter and deck area. Rear deck contour has been raised to increase luggage room. Mechanically, the car remains unchanged with the 283-cubic-inch V-8 engine coupled with three or four-speed manual or automatic transmission.



The '61 Corvette, below, retains familiar front end with grille changes. Rear end, right, is higher, more integrated





Relocating tire in engine compartment was made possible by eliminating large, central air cleaner



With tire removed and gas tank reshaped, Corvair's front trunk becomes much larger and more usable

Refined Corvair

The rear-engined Corvair has received some important improvements as well as two new station wagon models. Luggage compartment on sedans and coupes has been much enlarged by moving front panel forward, changing shape of the gas tank and moving spare tire to engine compartment in the rear. To make this possible the tall, single air cleaner in center has been replaced with two lower ones. Gasoline heater has been replaced by a built-in, forced hot-air system with booster blower. Engine warmup is much improved due to new recirculation of air in engine compartment. The Lakewood, four-door station wagon has engine beneath rear cargo deck.



Corvair's new wagons, six-passenger Lakewood, top, and nine-passenger Greenbrier, above and below, are powered by space-saving rear engines



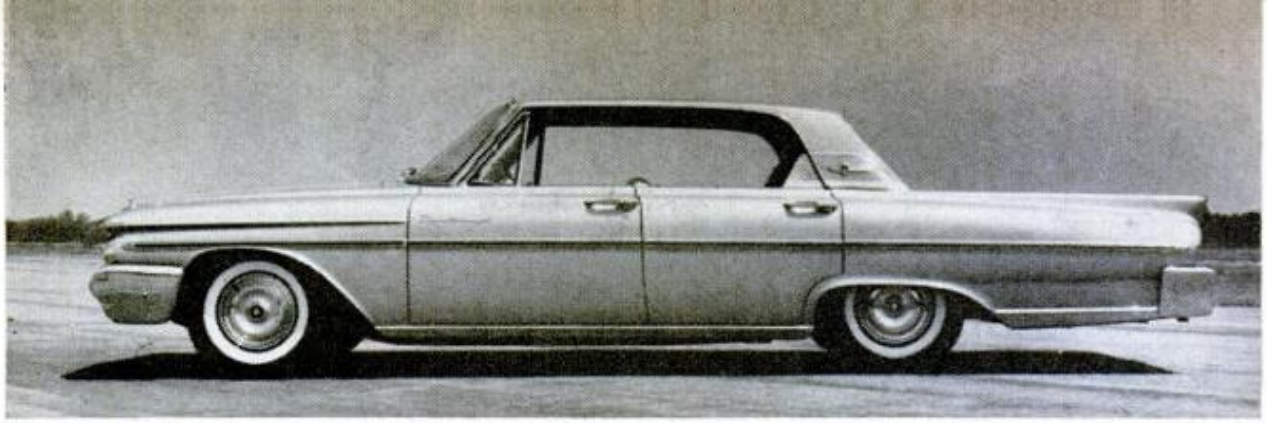

Mercury four-door hardtop, above, has cleaner lines than '60 model plus Ford "trade mark" roof line. Four-door wagon, below, can be ordered with optional third seat. Wagons can be had with six or V-8 engines

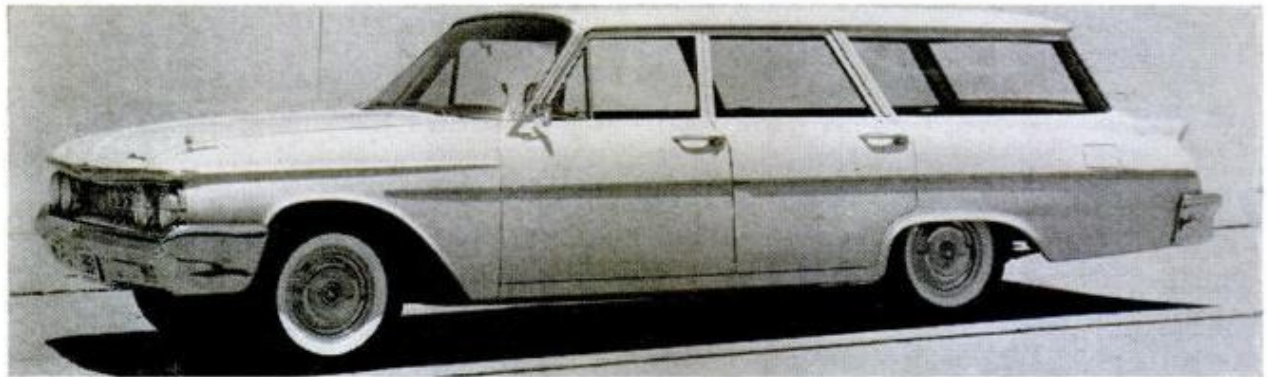

Smaller Mercury Has New Bodies, Many Improvements

Although its wheelbase has been reduced from 126 inches to 120 inches and over-all length from 219 to 214, the '61 Mercury has as much or more room inside than its predecessor. Entrance and exit are much improved too, due to the fact that rear door openings on four door models are wider and the new windshield no longer wraps back into the front door opening. For the first time this year Mercury will be avail-

able with a six-cylinder engine, the same 223-cubic-inch, 145-horsepower unit used by Ford. Other engines will be the standard V-8 of 292-cubic-inch displacement, the 352-cubic-inch V-8 and a special option of a 390-cubic-inch engine. The '61 Mercury's ride is improved by means of unique "cushion links" at front pivot of lower front suspension control arm and at the front of the rear springs.

Roomier, More Comfortable Bodies for Cadillac

As a result of completely new bodies for 1961, Cadillac offers easier entrance and exit and greater comfort. Wheelbase at 129½ inches is half an inch shorter, while over-all length is three inches less at 222 inches. Tops of door openings are higher, sills are narrower and "dogleg" corner of windshield has been eliminated. Rear doors are six inches wider and swing open seven inches further than on 1960 models. Head-room in the four-window sedan and the

coupe has been increased by two inches. Tunnels in front and rear compartments of all models are lower due to changes in position of engine and transmission. The Sixty Special four-door hardtop sedan is now the top of the line as the Eldorado Brougham has been dropped. Seating comfort has been improved by lowering of the front floor, giving greater "chair height." Chassis lubrication has been eliminated for 1961. Engine remains the same.

Cadillac Sixty Special, below, is leader of the '61 line, has special "formal" roof all its own





Profile of the '61 Lincoln Continental, above, shows its long hood, and deck contrasted to short roof area or "greenhouse." Rear view, below, left, has T-Bird look. Instrument panel, glove box, right, are wood



Lincoln Unwraps Compact Luxury Car

The 1961 Lincoln Continental may be the leader in a new trend toward expensive, top-quality luxury cars that are not the largest passenger cars on the highways. The new Lincoln Continental at 212 inches over-all, is 15 inches shorter than the '60 Lincoln. Wheelbase is down from 131

inches to 123. Height is down from 56 to 53 inches and width from 80 to 78 inches. In spite of these reductions which make the Lincoln actually smaller than 1960 Fords, the interior dimensions are almost unchanged. Models are four-door sedan and four-door convertible.

All-New Body for Thunderbird

The '61 Thunderbird is virtually a new car except for its 390-cubic-inch displacement V-8 engine and Cruise-O-Matic automatic transmission. Exterior dimensions of 205-inch length, 52½-inch height are unchanged, as is the 113-inch wheelbase. The new body has a rounded, "torpedo" look and is roomier inside, although the seating capacity remains limited to four adult passengers.

Thunderbird convertible, below, is smoother-lined, looks lower. Steering wheel, right, pivots for easy exit





The new Lark two-door wagon, above, is one-inch lower, looks longer due to raised side trim. Regal hard-top, below, in profile shows new, flatter hood and rear deck. Cutaway, right, shows Lark's new OHV Six



Restyled Lark Has New Engine

At first glance the familiar lines of the '61 Lark might lead one to think that it was little changed from the '60. Closer inspection reveals a new hood, flatter cowl, larger windshield, lower (by one inch) over-all height, dual headlamps (on Regal models), restyled side trim, changed rear quarter of roof, new, more attractive backlight glass and a new rear decklid. Under the hood is a brand new Six.

Bucket Seats, Floor Shift for Hawk

Studebaker's perennial favorite, the Hawk sports coupe, remains basically unchanged on its 120-inch-wheelbase chassis. Engine is Studebaker's 289-cubic-inch V-8 rated at 210 horsepower (225 with four-

barrel carburetor and dual exhaust). New for '61 is an excellent four-speed, synchromesh transmission nicely matched to the engine's power. New also, are deeply upholstered bucket-type front seats.





Pontiac's Tempest has clean, uncluttered sculptured lines, differs from other GM compacts in that it has 15-inch wheels instead of the 13-inch wheels used by Olds and Buick. Car has typical divided Pontiac grille

Tempest: Pontiac's Stylish Four-Cylinder Compact

Based on a new unit body-chassis of 112-inch wheelbase shared with GM's other new compacts, the Tempest breaks with engineering tradition with its four-cylinder engine, curved, torsion bar driveshaft and independent rear suspension-differential-transmission combination known as trans-axle. Vibration, the past enemy of four-

cylinder engine smoothness, is kept to a minimum by the extra-sturdy block and crankcase of the big four, and is isolated from the body by widely separated rubber mountings; two at the engine and two back at the transmission. The new engine develops 110 horsepower with manual transmission, 130 with automatic.

New Shape for the '61 Pontiac

The "senior" Pontiacs have new and completely restyled bodies yet manage to keep a distinctly "Pontiac" flavor to their looks. All models are four inches shorter and 2½ inches narrower. Wheelbases are 119 inches (down from 122) on Catalina and Ventura series; Star Chiefs and Bonneville are 123, (down from 124 inches). Wider frame provides lower floors for better seat height and two inches more headroom. A two-section driveshaft with double center universal joint has reduced tunnel height considerably. Front suspension is newly designed as is rear coil spring suspension with four, rubber-bushed links.



Grille on larger Pontiacs is two-section style with recessed, shadow-box grillework, above. New roof line on Bonneville, below, is crisp, knife-edged



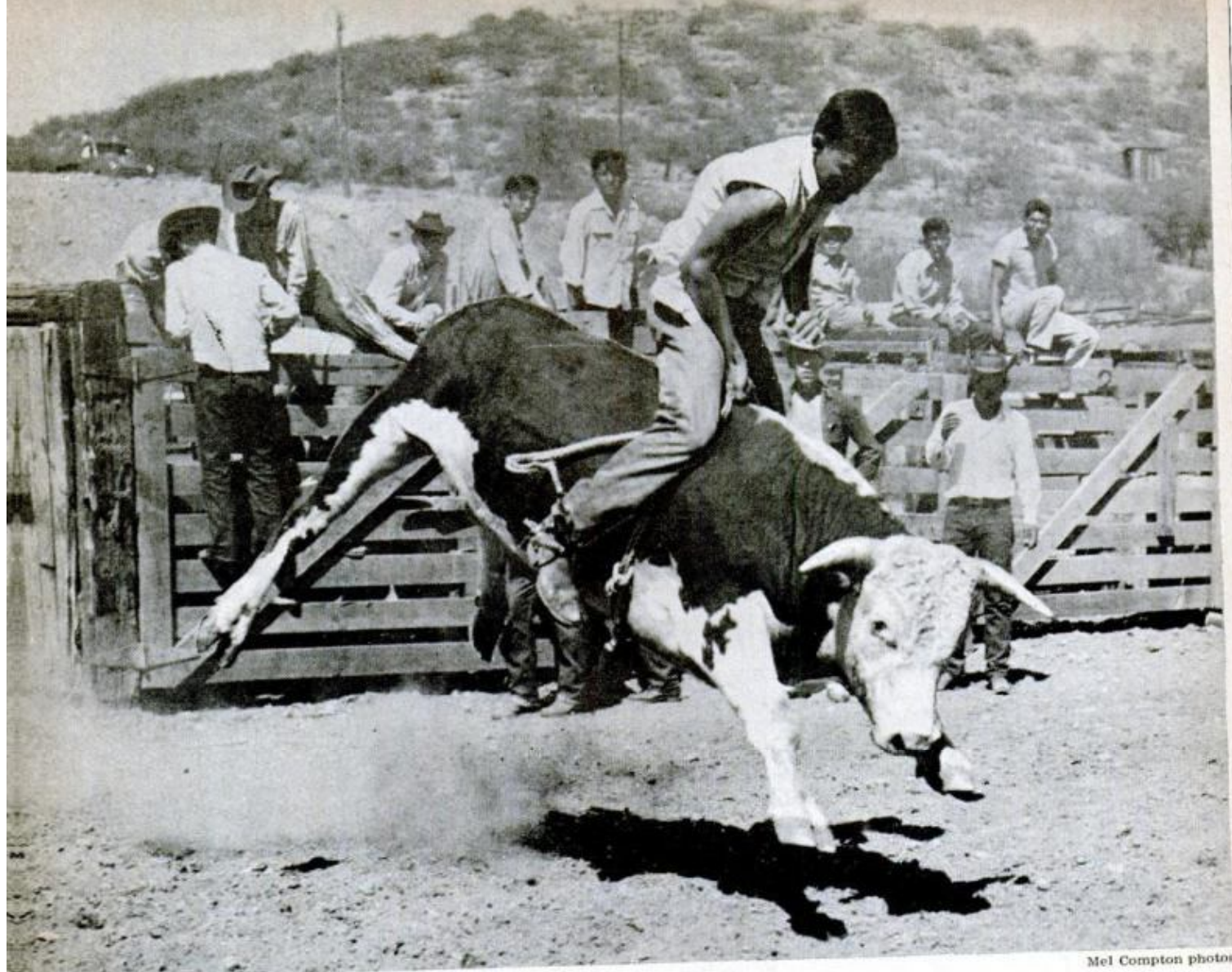

Mel Compton photos

Kid-Size Rodeo

Grand entry parade at one of Arizona's junior rodeos—many horses come from rodeo-riding parents



STANLEY ROSSON



By Thomas E. Stimson, Jr.

Kids in the 13-17-year-old class ride full-sized steers, above left. Five-year-old's mount, above, is to scale

PROFESSIONAL COWBOY rules don't apply at scores of rodeos in the West these days, for kids (from five years up) are the contestants while their friends and relatives fill the seats in the grandstands.

When a seven or eight-year-old comes charging out of the chute on a white-face calf or a wild colt, with his face in a scowl and both hands clutching the surcingle strap, he's on top of the world—but the chances are he won't stay there long. In the next few seconds he's apt to be thrown or, more likely, ignominiously lose his balance and fall off. If he sticks it out for eight seconds he wins this go-round and gets to do it all over again the next day. If he's thrown and plows up dirt he'll need a bath and that's about all. The ground in the arena is soft.

Junior rodeos got their start in 1932 when Charles A. Whitlow, Sr., Arizona cattle rancher, staged a competition for his son and several dozen school mates. The PTA milk fund in the town of Florence was running low and the rodeo was to raise money

Just like dad, a small rider spurs his steer for a better ride



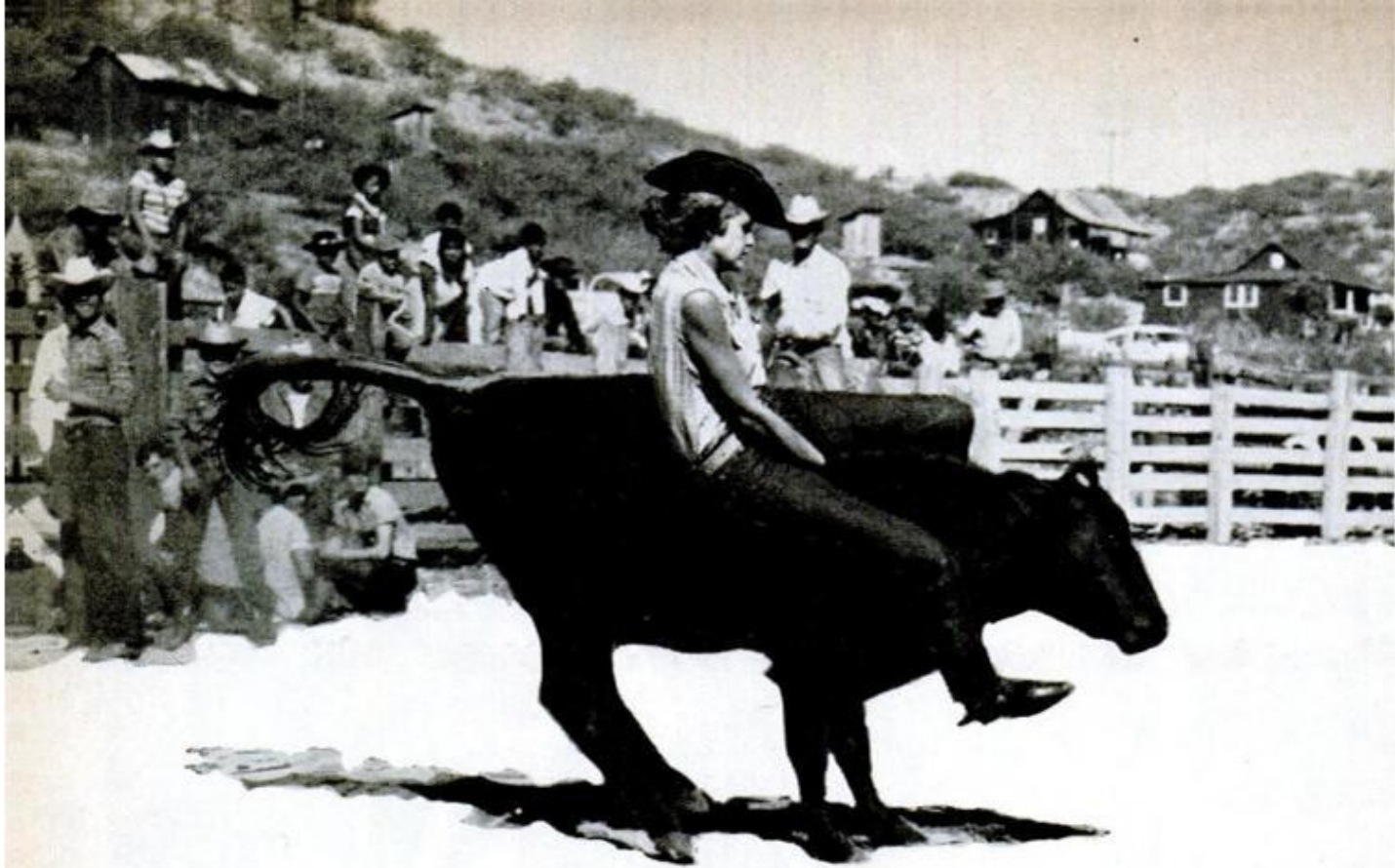

Caught by a fast camera, girl steer rider comes off sideways at the end of a violent buck. Of those who manage to stay aboard for eight seconds, the rider who got the most spirited ride is selected the winner

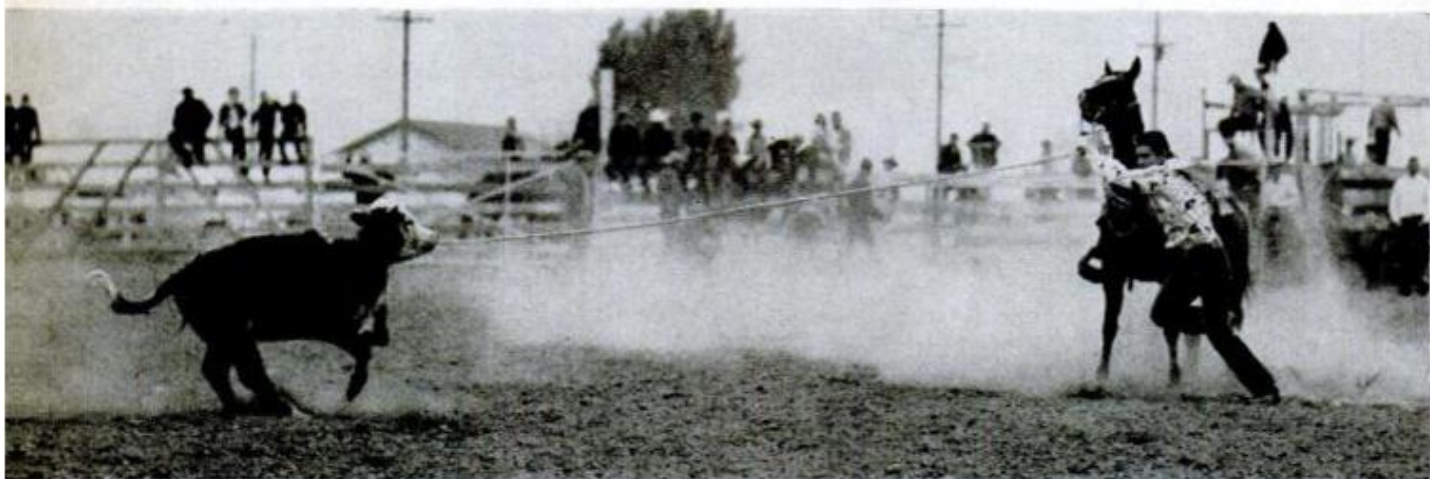

Calf roping (above) tests boy and horse alike, for the roping horse must hold a tight rope on the calf until the boy throws him. Below, barrel racing tests the ability of horse and rider to pivot and run—fast





for it. The show was a big success and since then the Florence "Junior Parada" has been a big annual two-day event held during "Parada Weekend," the weekend after Thanksgiving Day. Charley Whitlow still acts as managing director, with the Pinal County Sheriff's Posse running the event. This year's show will be held November 26 and 27.

Ranchers and professional cowboys serve as officials. Gene Autry, the cowboy movie star, usually is on hand to award his "all around championship" belt to the junior cowpoke who wins that title. Other prizes are donated by local business men. There's a pre-rodeo parade downtown, a grand entrance into the arena, and printed programs listing the competitors and events. Two school bands and the band from the local prison keep spectators entertained between events.

Of the more than 150 contestants the majority are youngsters who live in Florence and the surrounding area. Possibly a third of them come from farm and ranching families. There's apt to be a handful of hard-riding youngsters from out of state and a scattering of tourist children. About the only formalities are the filling in of an entry blank ahead of time and possibly paying a dollar entry fee that goes for renting the rodeo stock.

Rules for junior rodeos vary in the different areas but in general there are two divisions: from 5 years through 12 years

Where'd that horse's head go? An older junior dismounts against his wishes in the bareback bronc riding event. Flanking strap, cinched around the horse just ahead of his hind legs, makes him buck

Another older junior gets a good ride coming out of the chute on a wild colt. Fresh from the range, the colt has never been ridden, and needs no flanking strap to make him want to get rid of the rider





Out of the chute on a wild brahma steer, above, youngster sticks tight. Below, rider loses a stirrup but stays aboard



and from 13 years through 16. Today there's a move to break the "junior juniors" into two classifications, from 5 to 8 and from 9 to 13, just to give the youngest kids a better break. Prizes are awarded liberally with a championship in each event.

Ranch youngsters have the edge in the roping events because they have had the most practice and because they usually can borrow a trained roping horse from a parent. Sometimes the same horse is used by several contestants in the same event. A roping horse is trained to charge after a running calf, then set all four feet and slide to a stop as soon as his rider ropes the calf. The horse then backs off to hold the rope tight while the rider dismounts and runs to the calf, throwing it and tying three legs with the pigging string he carries in his mouth. A good junior roper completes the job in 15 to 18 seconds, just about as fast as a professional.

Team roping often is performed by a father and son. Both contestants spur after a running steer and the header throws his loop over over the animal's head. The heeler ropes the steer's hind legs and then both horses separate to

(Continued to page 244)



Landing on the plowed arena floor isn't as bad as it looks — injuries are rare

Deluxe Golf Cart Is Air Conditioned

Probably the ultimate in golf-cart design, the Brannon Brrr-Buggy built by Joe Brannon, of Phoenix, Ariz., features a three-horsepower automobile air conditioning unit. The engine, transmission, and rear axle are from a Renault automobile. The cart will run Brannon to the links at 60 miles an hour, but gears down to a quiet 17 on fairway straightaways.



Drive-In Post Office

You can transact your post-office business in Luton, England, almost as fast as you can say "sports car." The first of a number of self-service, drive-in post-offices has been opened alongside a road there, attracting customers who like to do things in a hurry. Coin-operated, the machine that comprises the wayside office provides stamps, post cards and stamped envelopes. The letter box has an opening large enough to catch letters tossed toward it by drivers who are getting ready to roll.



Uranium Ball For Reactor

Dressed in flame-protective caps and gowns, and wearing respirators, a team of machinists worked six days to machine a 500-pound uranium ball into a valve. The ball has a 10-inch bore to admit contaminated uranium fuel-rods from the core of a new reactor. When the rods are in the bore, the ball will be flipped over, dumping them into a wheeled cart. The ball then becomes a radiation shield. Machining was tricky as uranium has a low ignition point.

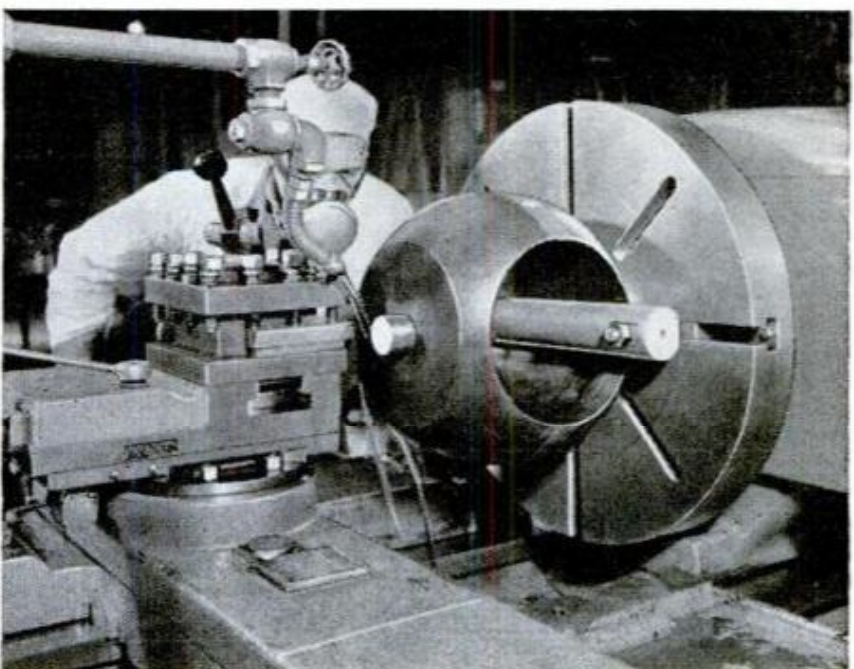

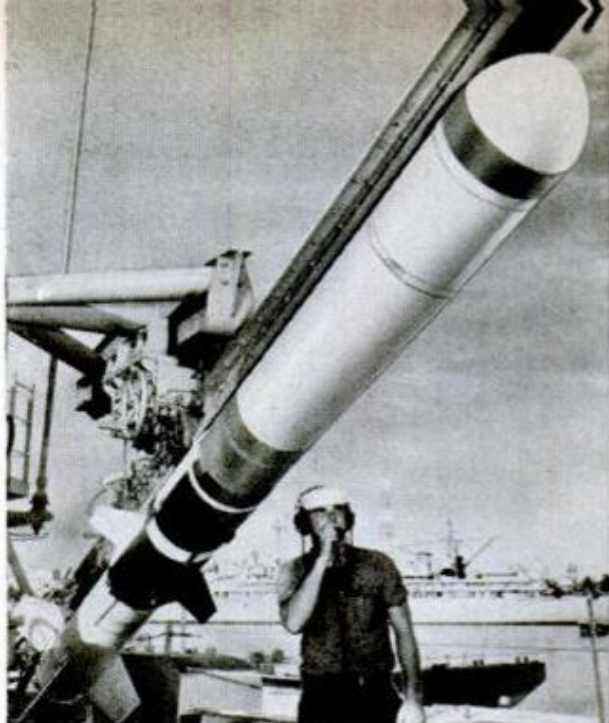

Fifteen-foot ASROC, with torpedo payload, is ready for loading into launcher aboard sub-chaser (left). At right, combination missile-torpedo is fired in tests off Florida Keys. Missile weighs 1000 pounds

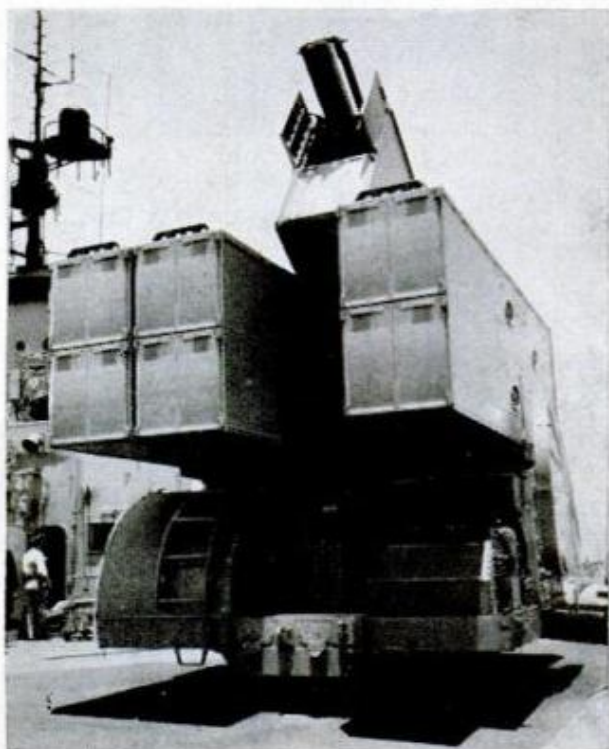

Flying Torpedo

Named ASROC (for antisubmarine rocket), the Navy's newest weapon is a combination missile and torpedo or depth charge. An enemy sub is first tracked by sonar; a computer charts its course, range and speed and aims the launcher. The missile is then fired in the usual manner, following a ballistic trajectory to the target area. During flight, the rocket motor and airframe drop off. If the payload is a torpedo, it is eased into the water by parachute and locates its target with an acoustical homing device. If the payload is a depth charge, it sinks into the water and detonates at a predetermined depth. The missiles are loaded on launchers that can handle eight at a time, thus allowing combinations of torpedo and depth-charge payloads. The missiles can be launched in any direction without the ship changing course.

Launcher (left) holds eight missiles in separate compartments, fires in salvos. Chart shows sequence

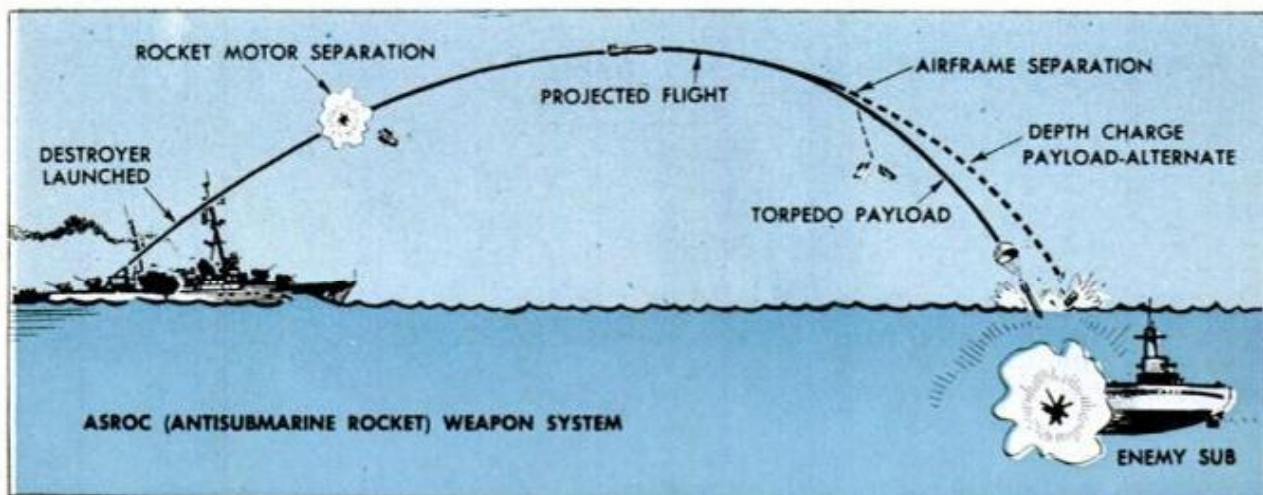

Worldwide Adventure— Person to Person

By Edwin L. Chinnock

Staff Member at the Holmdel Research Laboratories of Bell Telephone Co.



ON A sweltering evening last July, in the hinterland of the new and still savage Congo Republic, a heavy-set Belgian sat down before a curious, homemade device and clamped on a pair of earphones. Pausing for a moment to wipe the perspiration from his brow, he noted that the native drums had increased their tempo. His anxiety aroused afresh, he began tapping nervously on the telegrapher's key in front of him: "This is OQ4XX. This is OQ4XX, calling someone—anyone! We are desperately in need of help. All official communication has been disrupted. We have here five women, eight children and four men, and we have been cut off for days. The situation is now critical. Two of the women have been raped and need immediate medical attention." After giving his location and signing off, the Belgian in that faraway country could only hope that his message had been heard.

It had—in Leopoldville. Within hours, Belgian paratroopers arrived at the isolated farmhouse, and two days later the anxious father was informed by other "telegraphers" in Belgium that the women and children were now home, safe and among friends!

Just six months earlier, when Fidel Castro was ranting about "perfidious American leadership," a call for help was picked up by 17-year-old Walt Murray of Long Beach, Calif. A young girl in a remote section of Cuba had been stricken with an acute case of hydrocephalus, or "water on the brain." What was needed and quickly was a special valve that could drain the excess fluid from the brain.

Walt immediately interrupted a big traffic network and passed on the emergency message. It was relayed to West Hartford, Conn., then to a Boston firm which dispatched the necessary equipment. So, at a time when Cuban-American relations were at a new low, there was at least one Cuban who felt nothing but affection for the "Yanquis."

Walt Murray and the Belgian in distress are not isolated examples. They belong to

a band of people who each day and night live the greatest person-to-person adventure in the world. They are the amateur radio operators, the dedicated "hams"—an imaginative band of 300,000 men, women and children, scattered over the globe. At the touch of a key or with a soft word spoken into a microphone these businessmen, scientists, students and housewives reach around the world, ignoring the age-old barriers of race, language and distance.

Amateur radio is the only hobby provided for by national regulations and international treaty. And few hobbies offer such a chance for adventure, for becoming a full-scale hero—and a way to help in bringing the peoples of the world a little closer together.

Anyone can become a "ham" radio operator.* A basic "rig"—receiver, transmitter and antenna—sells from \$50 in do-it-yourself kits all the way up to \$50,000. The average "rig" usually runs about \$150 in second-hand gear purchased from a mail-order house or a local radio shop. If you want to send by voice (about 50 percent of the hams do) it will cost more—\$250 is average.

To get a license, every U.S. ham must pass FCC tests. Several grades of licenses exist, each requiring a knowledge of the regulations and the ability to send and receive international Morse code. The simplest license—the novice class—requires only a five-words-per-minute code test, while the extra-class license test is so difficult that some commercial radio operators have failed it.

Whatever your proficiency, there is usually little difficulty in making yourself understood. The international "Q" signals cover a multitude of questions and answers: anything from "QTR" which in any language means "What is the correct time?" to "QTH" (What is your address?) and "QSG" (Have you a doctor on board or nearby?). In addition, hams have, over the

(Continued to page 286)

*For information on How to Become a Radio Amateur, write to the American Radio Relay League, West Hartford, Conn.



By Jim Whipple



Rambler's die-cast aluminum engine block shows the way to higher production rates, lower costs

One "wave of the future" in automotive engineering lies under the hood of the 1961 six-cylinder **Rambler Classic**. This is the die-cast aluminum engine block which weighs only 59 lb. Almost all of the rest of the engine remains unchanged from 1960, with cylinder head of cast iron alloy and other iron and steel parts.

The engine's displacement and horsepower remain the same, so why, you ask did **American Motors** go to die casting for a total weight saving of only 80 lb.? (Die casting is the method of fabrication where molten aluminum, or a similar alloy, is forced into water-cooled steel molds almost instantaneously under terrific pressures.)

With this method of production, a complete block can be cast from molten metal in mere seconds with no time out for core making or removal of casting sand. Here lies the real reason for aluminum engines; cost saving, far more important than weight saving to the manufacturer.

American Motors still uses the cast iron cylinder head and many other iron and steel parts, because the cost of tooling up for the die casting process is extreme.

Thanks to the compatibility of the aluminum block and the cast iron cylinder head **American Motors** is able to move into die-casting gradually and spread the cost of tooling over several years' production.

Newly-designed rear axles are next on the list of engineering changes to appear on Detroit cars. In search of an even better ride and surer handling, at least one of **GM's** divisions is road testing a prototype independent rear suspension in a conventional "big car," front-engined chassis. Between the differential and the engine this car uses what seems to be **GM's** solution to the drive-line problem; a two-piece drive-shaft with double universal joint in the middle.

This prototype independent rear suspension is of the coil-spring and swing-axle type similar to that used on the **Corvair** and **Pontiac Tempest**. However, there is one important difference, the big-car prototype has inboard drum brakes mounted right at the differential.

This makes for even lower unsprung

weight at the rear in proportion to total chassis weight than **Corvair** or **Tempest**, so that even less mass will be displaced by bumps, hence less thrust against the springs to compress them and, in turn, less rebound energy to toss the body. We might well see this highly sophisticated new axle in 1962.

Look for **Chrysler Corporation** to ride along with its present suspension system of torsion-bar independent up front and semi-elliptic leaf springs at the rear. This setup is still competitive in ride and handling characteristics to the new "swing-axle" cars such as **Corvair**. Compare any independent rear suspension car with a **Valiant** and you'll get the idea. There's a great deal of brilliant engineering in **Torsion Aire** suspension that isn't revealed by its conventional layout.

The excellent designs of such compacts as the highly roadable **Corvair** and the new **Pontiac Tempest** with its lively four-cylinder engine seem to beg for sports or semi-sports-car versions. **Corvair**, of course, already has one in its '61 **Monza** coupe with fully-synchronized, four-speed manual transmission and 95-horsepower engine.

It's hard to see how performance-minded **S. E. Knudsen**, **Pontiac's** General Manager, can resist putting the high-performance version of the **Tempest's** engine into a bucket-seated sports car, possibly a coupe like the **Corvair**. Rumor has it that one of these is in the works for late spring '61.

The future of U.S.-built four-passenger cars, that might be called "ultra-compacts," will depend on how competitive in cost they can be with established economy import leaders such as **Volkswagen** and **Renault**. **Ford** will be first with its four-passenger, four-cylinder economy car the **Cardinal**.

Ford plans to keep the cost of this job within limits by supplying major mechanical components such as engine transmission and drive line (front wheel drive) parts from its subsidiary, **Ford of Germany's** Cologne plant. In this way much of the expensive tooling and manufacture would be performed by German labor at lower total cost. Further cost reduction will be the result of sharing these components with the German-built **Ford Taunus**. ★ ★ ★



Tank Crews Get Infrared Binoculars for Seeing at Night

Searchlights, periscopes and binoculars which will enable tank operators to observe a possible enemy at night with either visible or infrared light are under development by the U.S. Army Engineers at Fort

Belvoir, Va. The searchlight operates in unison with the tank gun; the periscope emerges from the tank hatch, to probe the night with infrared light. The infrared binoculars allow open-hatch viewing.

Swedish Locomotive's Six Motors Deliver 7500 Horsepower

Three permanently coupled sections make up a new electric locomotive owned by the Swedish State Railways, and thought to be the longest and most powerful in the world. Each section has two traction motors

and four driving axles; the motors will deliver a total of 7500 horsepower. The locomotive, which will be able to pull a train with a weight of 4900 metric tons is 35 meters long and weighs 260 metric tons.

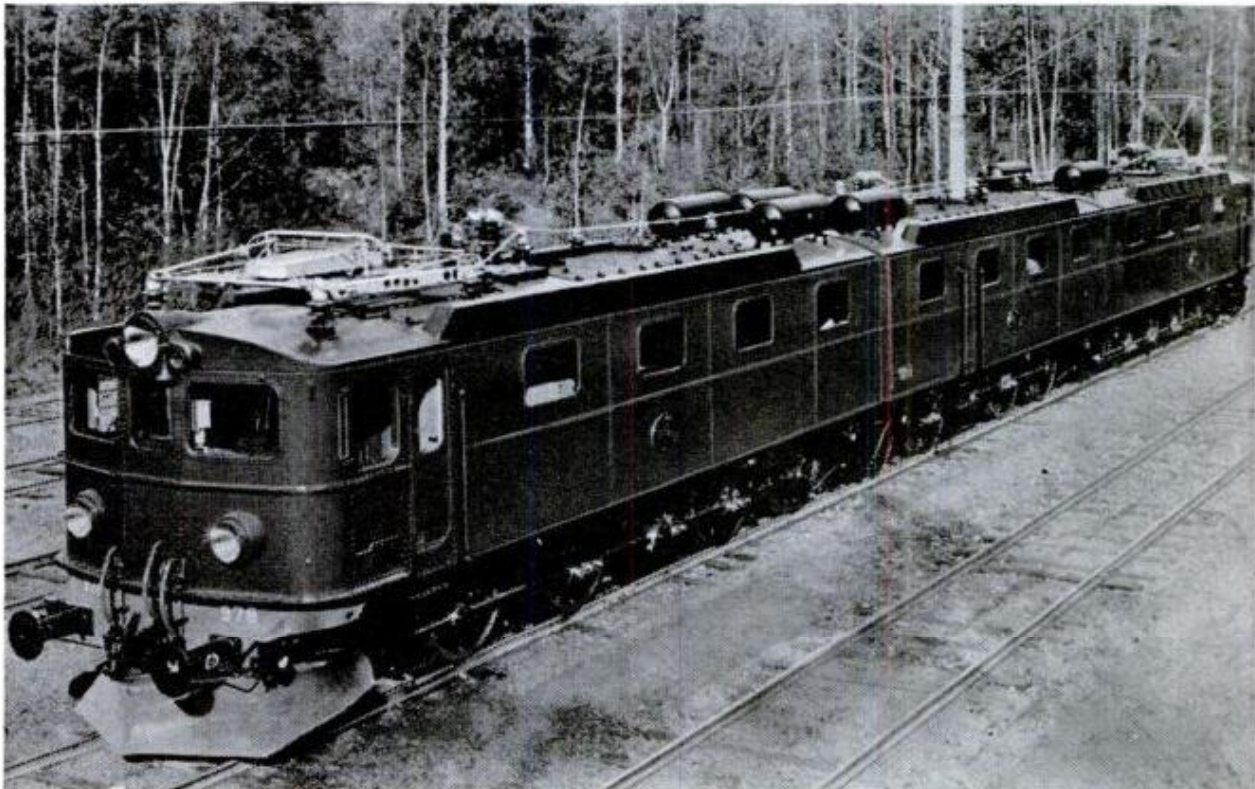

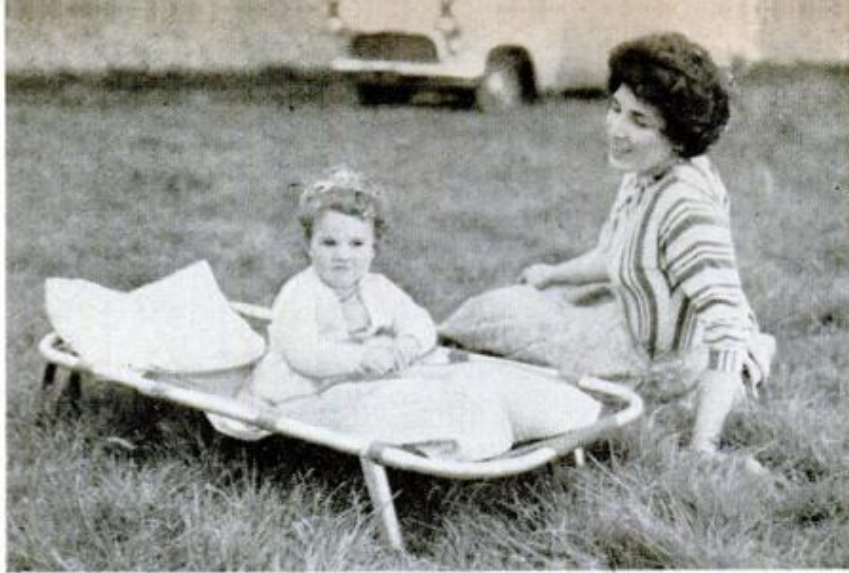

Pint-Sized Cot Keeps Baby Happy

Built to provide baby with a safe, comfortable and familiar bunk anywhere the family goes, the new British "Autocot" fits snugly between the front seat and the rear deck in any car; won't slip during turns or sudden stops. The canvas hammock is slung from an aluminum frame which expands from 40 to 48 inches in two-inch steps to adjust to cars of any length. Outside the car, aluminum legs fold down to make a bed or seat for the yard, beach, or hotel rooms. The whole cot weighs only four pounds, and collapses for carrying and storage into a flat 24-inch package. Thus a bed familiar to the baby can be carried anywhere.



Punched Tape Instructs Machine

More than 80 percent of all machine-shop metal-working can be handled on a single automated machine that takes its instructions from a one-inch-wide strip of punched paper tape. It selects its own tools—up to 84 of them, from quarter-inch drills up to face-milling cutters 14 inches in diameter. It can hold and work on metal castings almost as big as a compact car—five feet high, six-and-a-half feet wide, and eleven feet long. Operations include drilling and boring, tapping holes and milling metal surfaces. It works to repeatable accuracies of plus or minus two ten-thousandths (.0002) of an inch, and can be operated manually from pendant station or automatically from a console (shown at left side of picture).

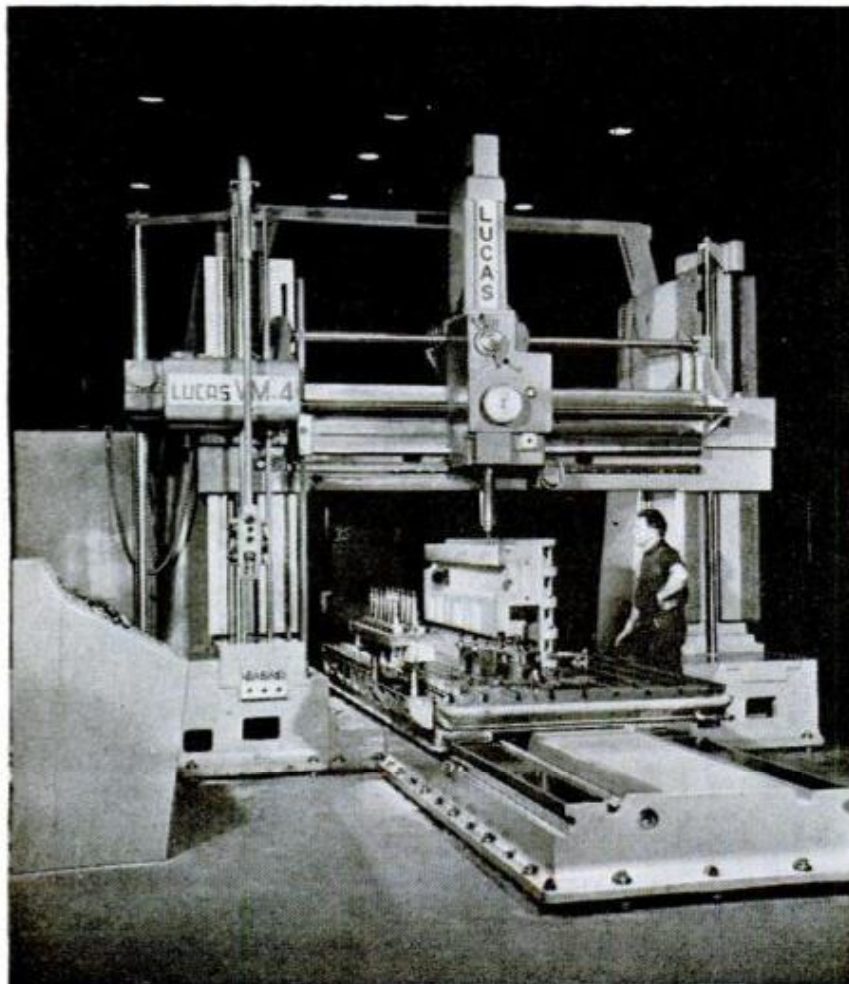

LET'S BRING OUR PLANES DOWN SAFELY

By Capt. Frank A. Tinker

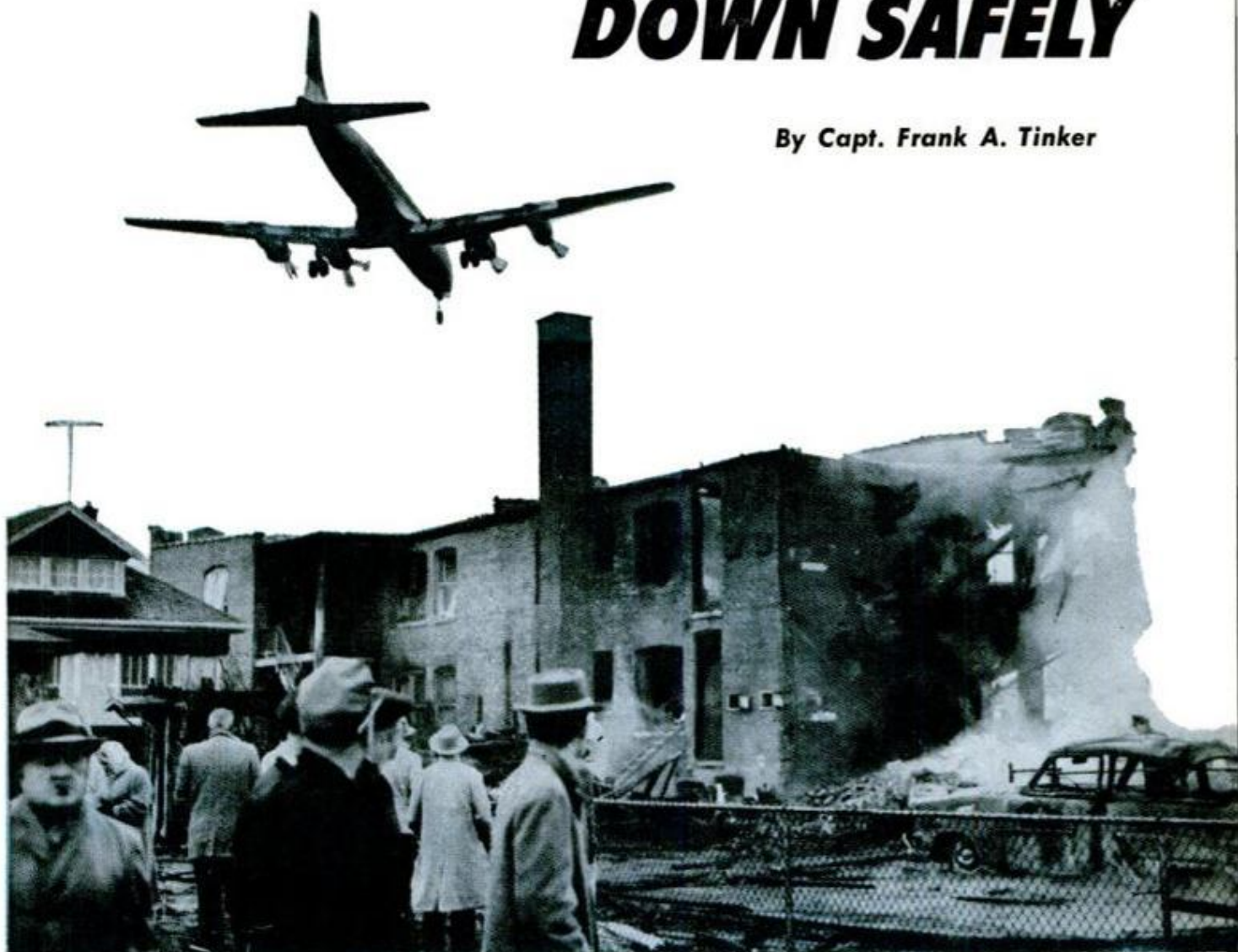

Traffic can't pause for tragedy at Midway. A DC-6 makes approach as spectators gawk at the wreckage of an airliner that crashed moments before

Frank Tinker (left), a veteran airline pilot, blasts today's air terminals that are endangering safety by trying to handle too many aircraft with too few facilities. He cites the world's busiest, Chicago's Midway, as the ugliest example of all.

THIS FLIGHT into Chicago-Midway had been fairly typical, both of that airport and too many others in our over-populated air traffic centers. Since cranking up the C-46 at New York three hours before, we had made and received fifty-odd transmissions with control agencies. Most of these calls had necessitated tuning and locating at least two other radio facilities, either VOR (very-high-frequency omnidirectional range) or low frequency. We had entered each pertinent call in the log, one every four minutes on the average, consulted the charts, watched our fuel consumption, kept the ice from building too deeply on wings, props, and windshield, and wondered how thick the stacks of

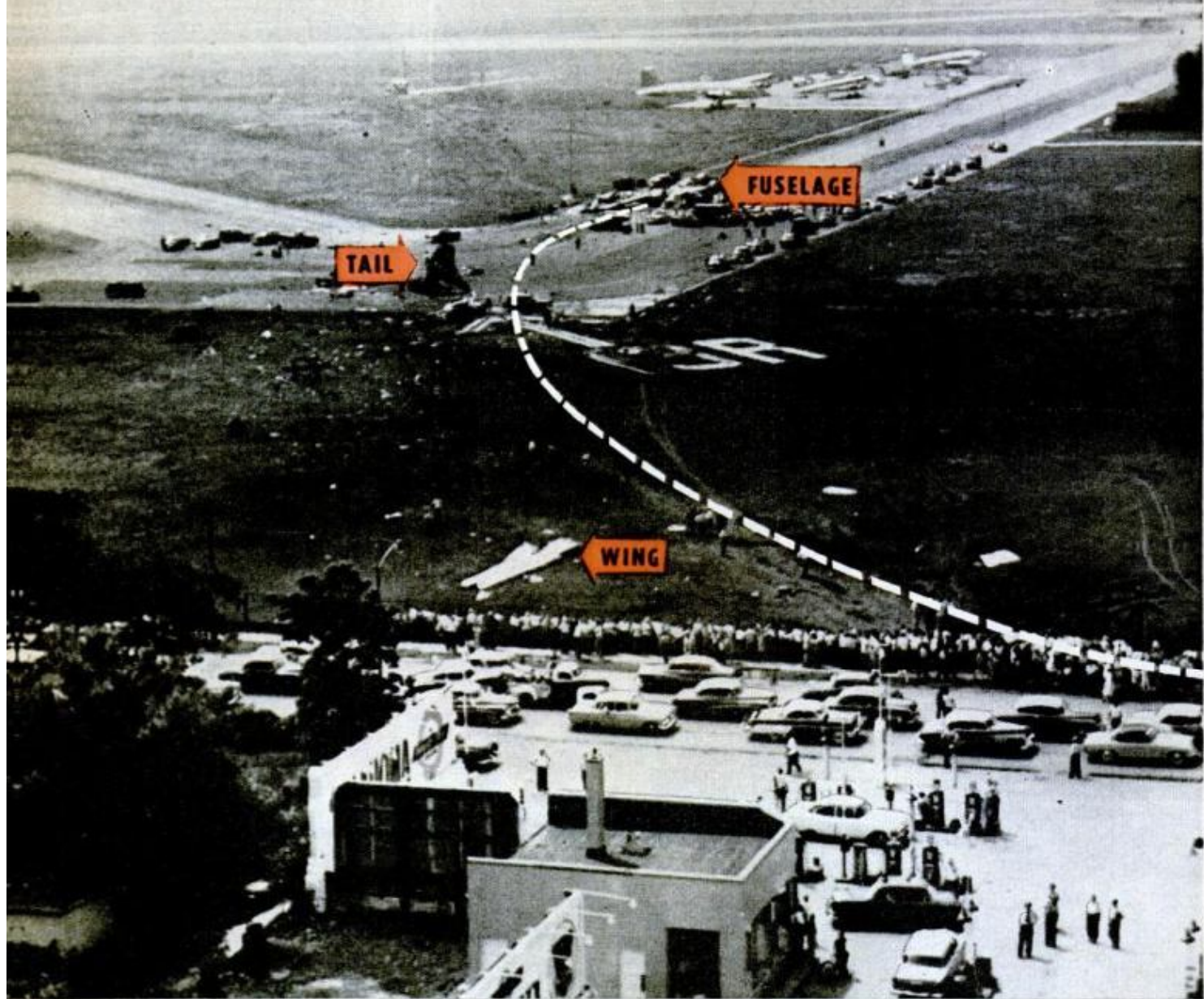

Twenty died in spectacular crash when incoming plane hit sign across street from Midway on foggy day, spewed wreckage along dotted line, finally coming to rest about a block away. And airport traffic went on



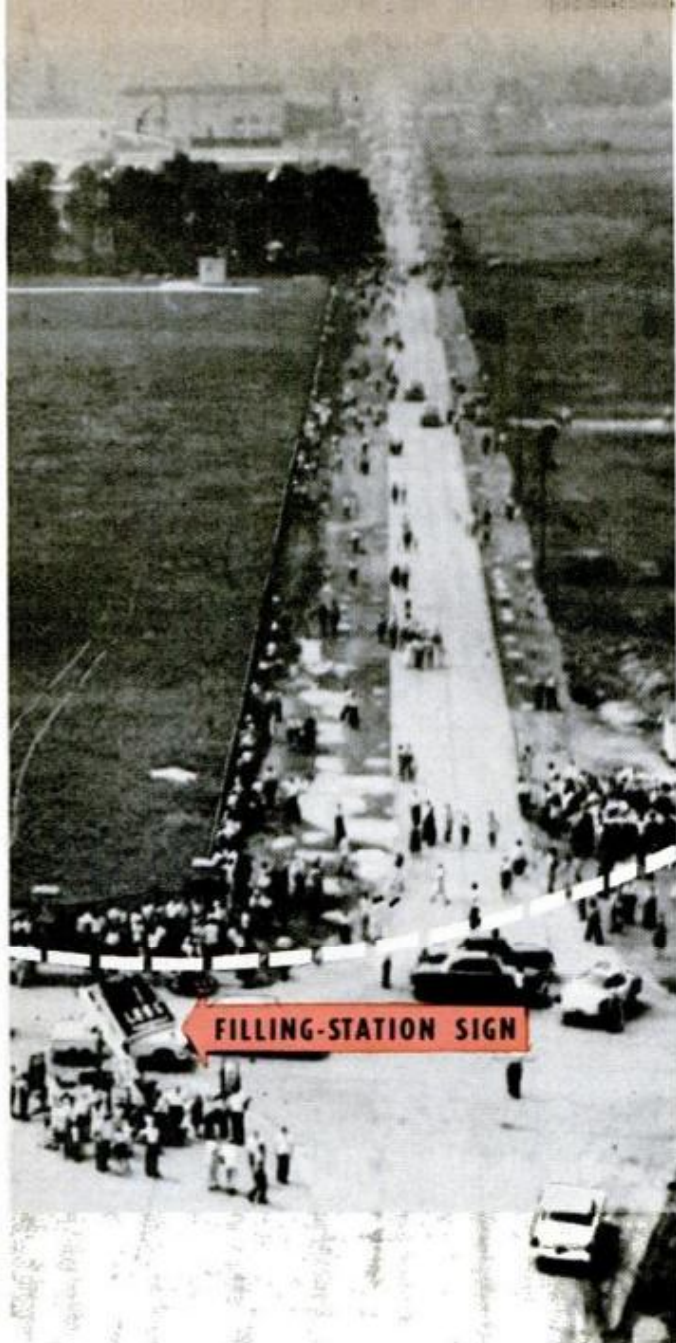

FILLING-STATION SIGN

As many as 100 aircraft are in traffic patterns at Chicago area's airports during peak periods. Getting them down safely demands perfection from everyone

holding planes were over Midway Airport.

Chicago was reporting 300-foot ceiling and one-mile visibility, wind from the north. This meant that we would probably have to use the back door of the single instrument-landing runway, which has no glide slope to indicate how high you may be above the tenements and factories crowding in on every side of your approach. It was here that a TWA freighter crashed into the buildings while making an apparently routine three-engined return to Midway last winter. And it was while trying to approach a similarly half-equipped runway that an Electra crashed in New York only a few months before.

As we entered the area we were switched from Center to Approach Control—unfortunately to a frequency which our airline company, despite the pleas of the pilots, had not seen fit to install in this aircraft. It was embarrassing and provoking, but legal. We finally managed to break through the constant stream of chatter and obtain another frequency, one which we had aboard.

“Dig me out the approach charts for Midway,” I told the doubtful young man in the right seat. “We’re cleared to Chicago Heights.”

A few minutes and several transmissions later—during which I gave and verified our estimated time of arrival over the Chicago Heights VOR, descended a thousand feet twice, and made a rapid calculation of how long I could hold over this facility at reduced power yet still make it to Milwaukee, our alternate, with a legal 45 minutes of fuel remaining—we arrived at the assigned fix.

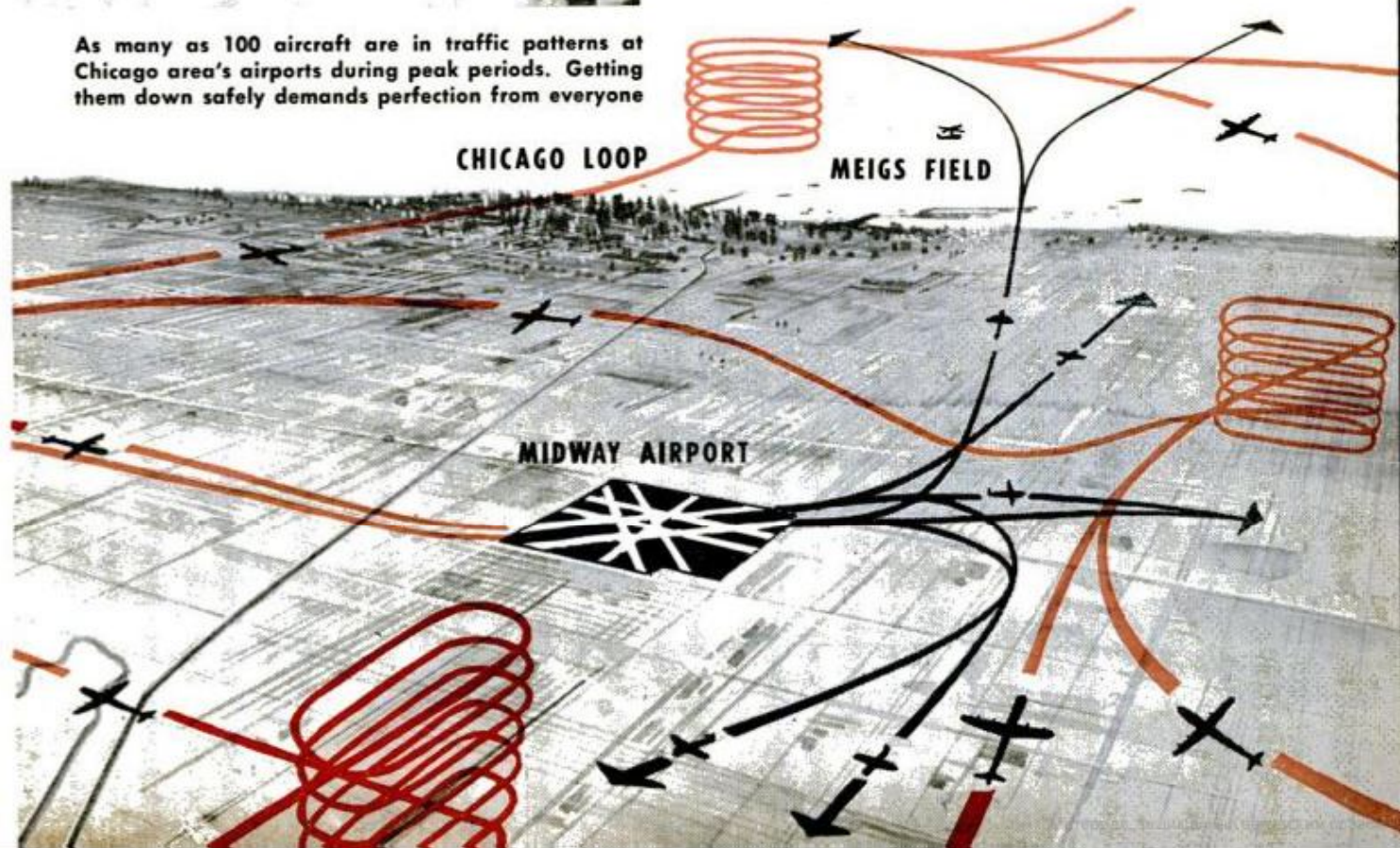



Midway's short runways force pilots to make perilously low approaches past signs, homes and smokestacks

From the chatter on the single approach frequency (several are used here to avoid jamming the air completely) I estimated there were the usual 30 or 40 aircraft milling through the freezing mist and snow over Midway. We might not have to wait more than an hour for our turn. That is, if the fuel and the anti-ice alcohol lasted.

"TWO-FOUR-METRO," Approach Control rattled, "EXPECT APPROACH AT

ZERO-FOUR-ONE-FIVE." Since Two Four Metro was our bird I would have acknowledged, but there was no time to do so between this message and the next—or the next half dozen. Having visited the Midway tower I knew that they would see whether or not I had received my instructions by following on their radar scope the little blip our ship made. This may seem rather risky but, in aviation, people still

Different receptions await pilots at night at different airports. Some runways are merely outlined



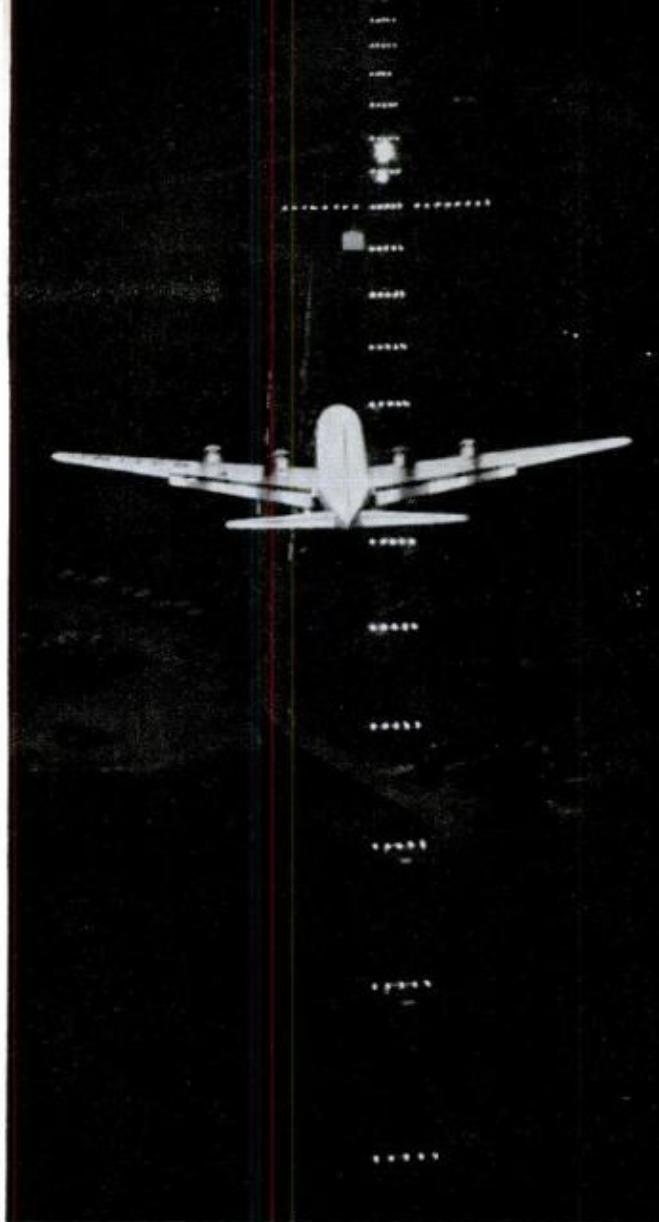
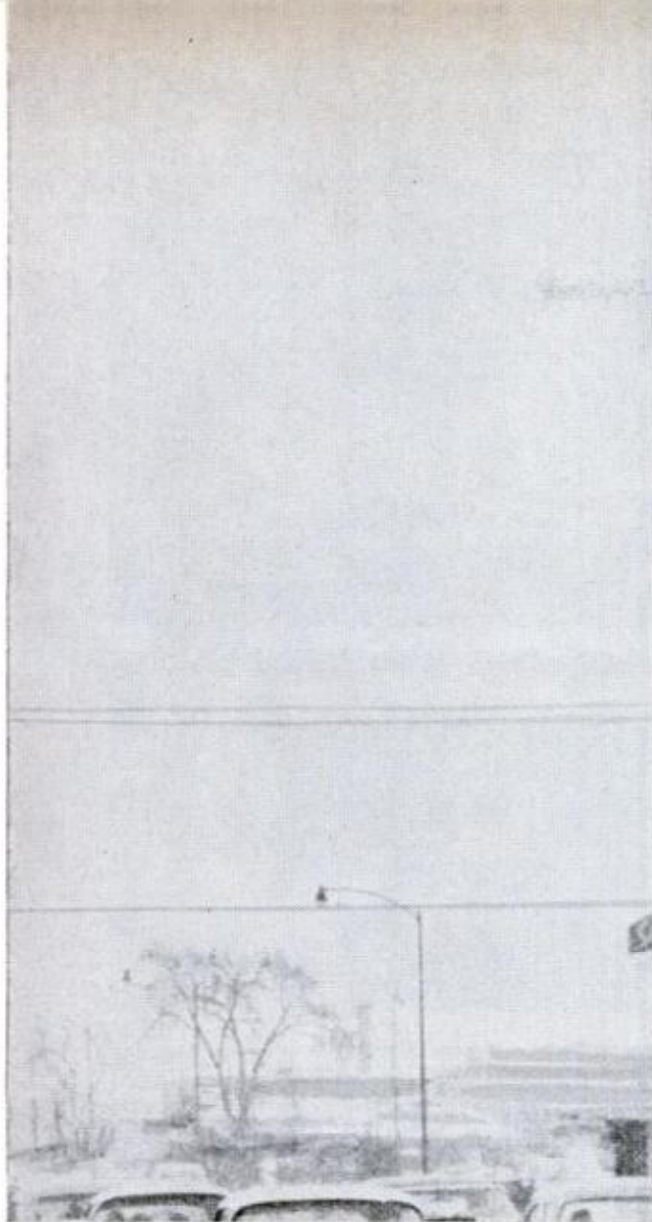

Center-line light system, like this one at another airport, shows pilot path to runway on night landings

operate under the refreshing, old-fashioned idea that the other person is not a moron.

"Let's see," I thought, while toggling alcohol into the carburetors and starting my turn into a holding pattern and pulling props and throttles back to holding power, "Zero-four-one-five in Greenwich, England, means that my approach time will be quarter after ten in the evening here, an hour and a half away. However, they are

usually pessimistic about it so I'll cut that down to an even hour. I think we can make it."

And I went back to making the turn, adjusted power because we could not hold our altitude at the settings advised for holding, studied the Jeppesen Approach Chart, asked the copilot to get on airways frequency with the other VHF (very high frequency) set and obtain the Milwaukee

Modern lighting system, installed at Washington National, gives incoming pilot well-illuminated target



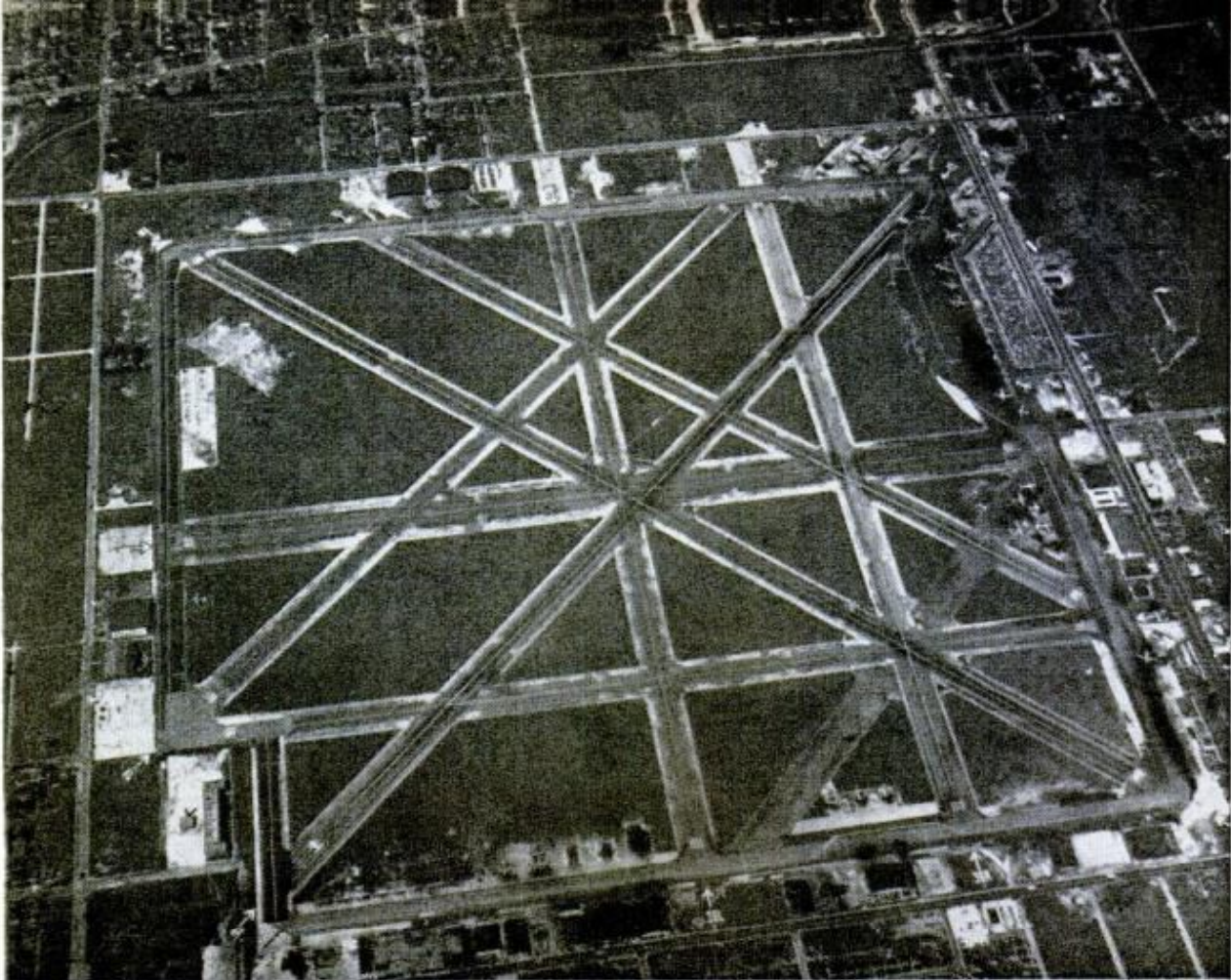

Once a dream airport, because of its near-perfect symmetry, Midway is now a nightmare, giving headaches to harried traffic controllers (left) and ulcers to intrepid pilots (below) on those low, low approaches

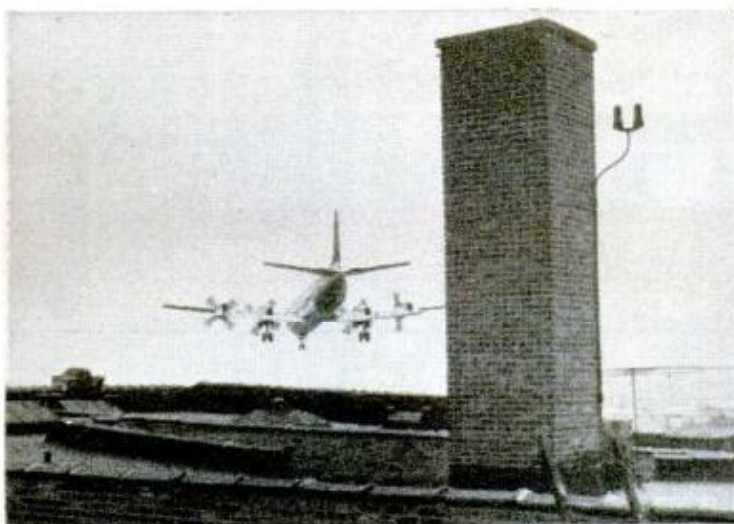

forecast, and listened to the other member of this team down in Approach Control trying to sort out his brains. After a few hours at his job, this must have been difficult.

Just consider: This airport reached its peak capacity in 1952, which means that it handled all it theoretically could, with safety. Since that time it has increased its traffic every year, although the theoretical capacity remained the same. Some authorities maintained that the airborne traffic over Chicago had saturated the available space and facilities shortly after World War II. But then the traffic tripled and nothing more was heard about it.

Last year, as in every year of the past decade, this ridiculously small, poorly-placed conglomeration of obscure runways led the nation's airports in almost every category of civil air operation—the most landings and takeoffs, the most passengers, the most revenue. In 1959 it handled nearly twice the

(Continued to page 242)



Greenhouse for Skiers

Skiers at Jiminy Peak, near Hancock, Mass., can eat, rest, or warm up without losing sight of the runs in a new indoor-outdoor base lodge built from modular sections designed for greenhouse construction. In cold weather, skiers can still sit in the sun; on warm days, the lower row of glass frames and one top row can be opened. The "greenhouse," above, is supplemented by an adjacent wooden building about the same size, which houses the kitchen, ski shop, offices, and other service facilities. Inside, skiers and visitors sit at picnic tables under the flags of the major skiing nations of the world. The glass part of the structure was erected by the ski area staff.

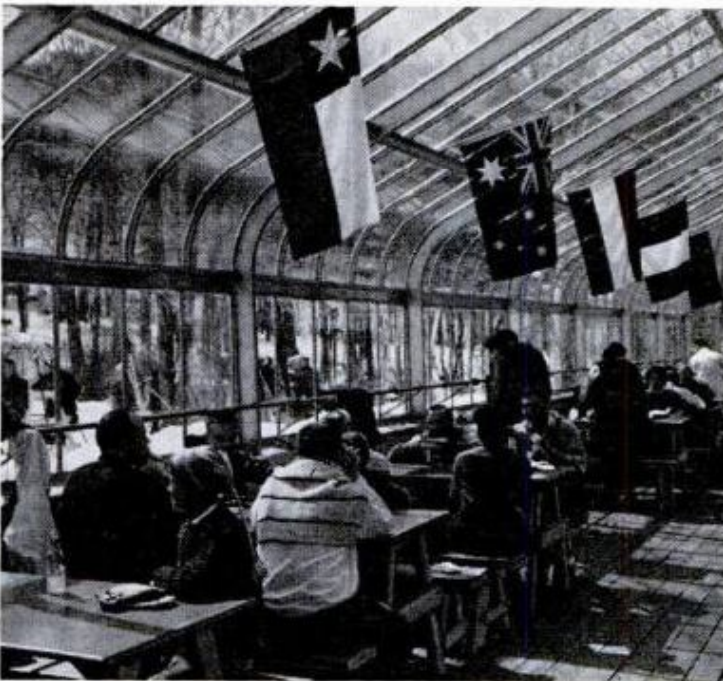

Pressure-Balancing Hose

Drivers who try to maintain equal pressure in both front and both rear tires will like a new German device which connects to two tires at once, equalizing their pressures and filling them to exactly the same pressure. The uniform tire pressure gives better control and cuts uneven tire wear. The simple attachment consists of a T fitting on the end of the usual air hose, with a pressure valve fitting on each end of the two branch hoses. The model shown is for service-station use, but another model has been designed for the car owner.

AN EYE ON SPACE

By Dr. Dan Q. Posin

PROFESSOR OF PHYSICS, DE PAUL UNIVERSITY
SCIENTIFIC CONSULTANT AND ADVISOR, COLUMBIA BROADCASTING SYSTEM

THE NIGHTMARE of any one of the first few men into space—into orbit—is that he may not be able to *come out of orbit*. After all, this event befell the Russian Sputnik that carried a dummy astronaut. Ground control sent a radio signal to have the Sputnik fire retro-rockets with the exhaust pointing in the direction of travel so that the recoil would *slow* the rocket, make it arch downward, and eventually come to Earth. However, the Sputnik happened to have turned over and was pointing the other way, so that the so-called braking rockets actually gave the Sputnik more speed, and it went into a larger orbit, never again to return to Earth.

In the shot with the dogs Belka and Strelka, however, the braking rockets operated properly. That is, the spaceship was pointing the right way when the radio signal was sent to fire the fuel for the braking shot.

What is more heartening, of course, is that one can expect a live man in orbit to see to it that the retro-rockets fire at the right time. That is to say, the orbiting spaceman himself will decide when to press the out-of-orbit button. Nevertheless, the possibility exists that the spaceman may not be competent at the right moment. Of course, in the two-way radio communication between ground and the spaceship it will become clear whether or not the spaceman is in possession of his faculties and can run the show. If not, ground will take over and fire the retro-rockets for him via radio command. And if this contact fails, a later automatic preset firing will take place. So, all together, there can be three controls to bring the spaceship out of orbit. Any cause for nightmares, then, is not evident.

There are other possible nightmares due to "minor" causes, however. "Supposing I succeed in getting out of orbit," the spaceman may say, "Is it all smooth sailing for the rest of the way?"

The question now raised is this: What kind of a system are we talking about? Is this the Mercury Project or a more advanced operation?

In the Mercury Project, after coming out of orbit, we have the pilot coming down in a capsule which, upon entering the atmosphere, is lowered "gently" by parachutes. The probable outcome is that the capsule lands safely in water, that it floats, is found and then is rescued by ships and aircraft at sea. Despite successful recoveries of satellites in the air, Mercury will still end up in the water—intentionally.

A certain amount of troubled sleep, naturally, is associated with this operation—insofar as the astronaut is concerned—even though all phases of this post-orbit activity have been well rehearsed. There are *several* parachutes, including those opening in emergency; the capsule is constructed to float, and *will* float (if it does not break); and it sends out radio signals and emits flickering lights to pinpoint its position for recovery.

What else might cause insomnia and bad dreams for an astronaut and his relatives? Well, we have skipped something: What about a misfire on the way up to orbit? That problem has been worked on. The capsule has an emergency rocket attached to it, and if there is trouble with the booster rockets or an explosion, the emergency rocket fires, and lifts the capsule containing the astronaut clear of the shambles to a considerable altitude

(Continued to page 254)

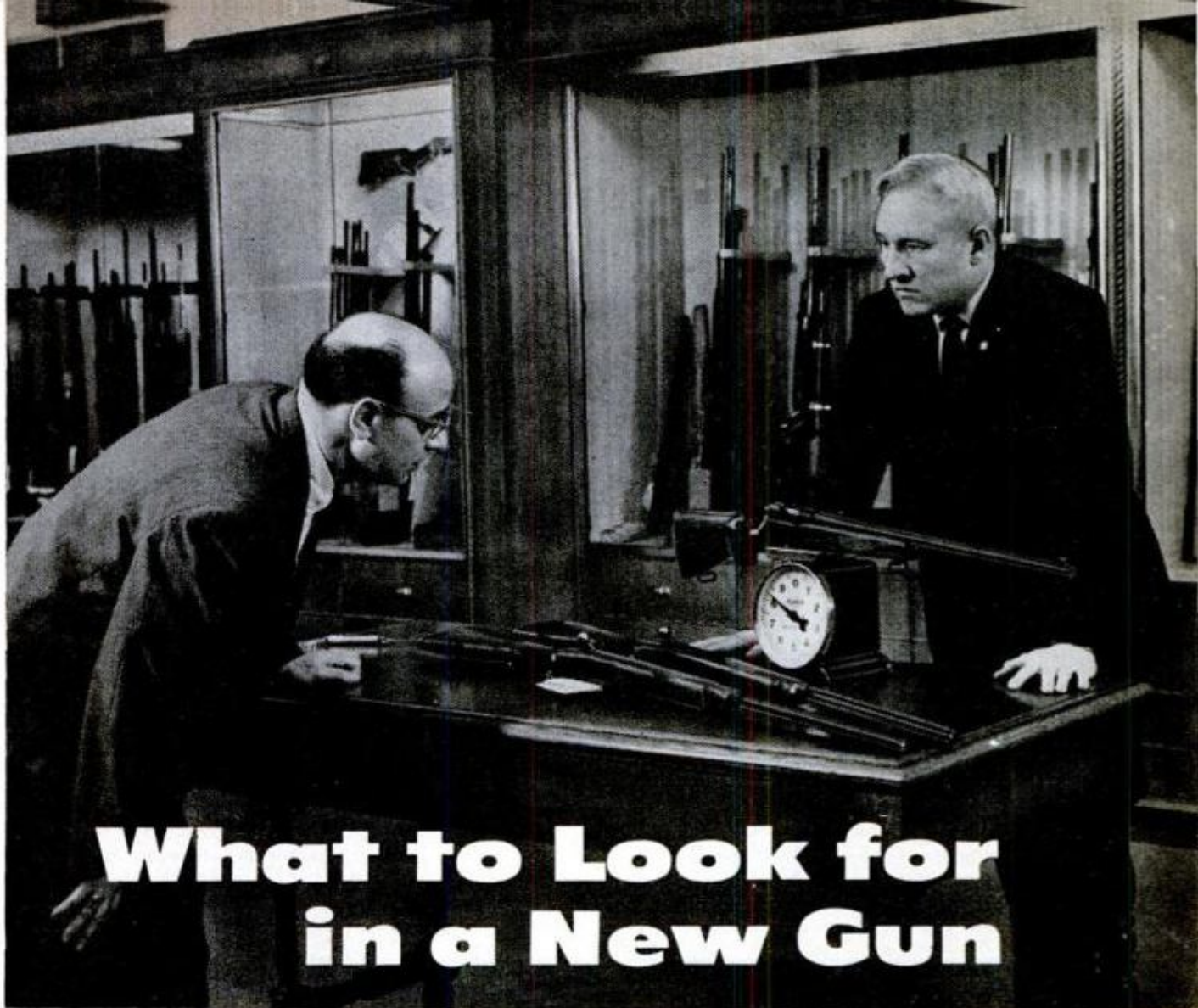

What to Look for in a New Gun

By Ken Warner

American-made guns, for the most part, are excellent production-line items. You might say they are all equal, but some are more equal than others.

MOST GUN BUYERS know what they want. When it comes to caliber, type of action, price and brand name, the usual shooter has his mind made up before he walks into the store. But even when he gets exactly what he wants, he can miss out on a good thing by not inspecting his choice.

Dollar for dollar—or maybe even two for one—standard American factory-made firearms are a solid value from buttplate to muzzle. They are capable of accuracy and operating efficiency better than all but a handful of shooters can use to full advantage, and even the most complicated mechanisms are almost completely reliable. But they do come off production lines, and are almost completely machine-made. Machines need tolerances, tolerances make differences, and differences can make one gun better than its apparent twin.

It is possible, of course, to buy a malfunctioning gun. It doesn't happen very

often, and no factory wants it to happen, but occasionally it does. More likely, one gun of a group of identical weapons will be a little bit better than the others. You'll get your money's worth if you buy the minimum that's passed by the inspectors, but why not check a few points and get their best?

For example, you can walk into any sporting goods store and find surprising differences between three identical factory models. They can vary as much as half a pound in weight, and three or four pounds in trigger-pull weight. Stock wood that looked fine at the factory, allowed to dry for a few months more on a dealer's rack, can undergo minor-looking changes that could seriously affect accuracy and grouping in an otherwise fine rifle.

In most cases, a little tinkering will fix things, but the time to find them is before you take the gun home.

Photographed for POPULAR MECHANICS in the Gun Room of VL&A—Abercrombie and Fitch, Chicago, Ill.



YOU WOULDN'T BE a normal gun buyer if you didn't throw the gun to your shoulder "to see how it feels." While you're at it, though, check to see if you can get the balance between your hands, and if the gun throws nicely to your shoulder and swings easily for you. Some will, some won't; here's where you decide on the size and weight you can handle best. If you hunt in a coat, bring it along or borrow one and try the gun with the coat on; it can make a big difference



NOW YOU start looking. Take a good long look at everything (being careful with the dealer's gun, of course). First thing to do is work the action. While the slide is sliding or the lever is moving, ask yourself, "Is it cramping? Can I work the action with gloves on? How long will it take the stiff new action to limber up? How does it sound? Is everything getting into place and out again every time?" Load and eject a dummy round of ammunition if one is available



MEASURE THE weight of trigger pull with a scale, if only to demonstrate to the salesman that you're serious. If he doesn't have a scale, his fishing-tackle department does. Besides an ideal pull weight—usually three to five pounds, but whatever you prefer—the trigger mechanism should feel sharp and clean. It shouldn't "travel" much while you pull it off. If it's adjustable, find out where and how. Remember that you may want to get at it with gloves on some day



CHECK THE SAFETY. Cock the gun, put the safety in the ON position, and try to pull the trigger. It won't bend. Then release the safety and pull the trigger, feeling for differences from your trigger pull test. Do it a couple of times. While you're at it, imagine yourself in the field and see how easy (or hard) it is to get the safety off while throwing the gun to your shoulder for a fast shot. You should be able to feel whether it's on or off without stopping to look and think

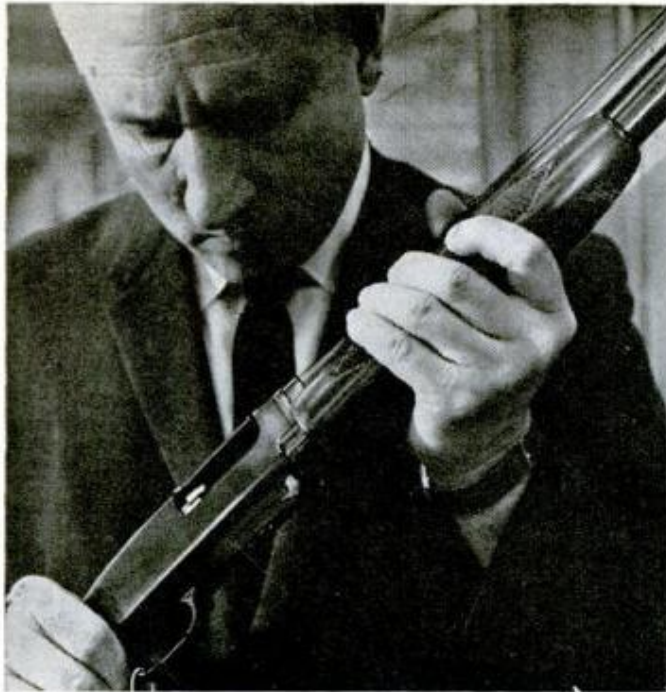

NOW TAKE A LOOK INSIDE, and make it a good one. There will be bright spots and dull ones, rough spots and smooth ones. Make sure they're all where you expect them. Check the extractor and ejector, see that the firing-pin hole isn't burred, the bolt face isn't rough, and the milled parts are clean. Even on a brand-new gun there can be small faults, and you might as well avoid them or get them fixed now. If your dealer has a repair shop, small changes can be done in minutes

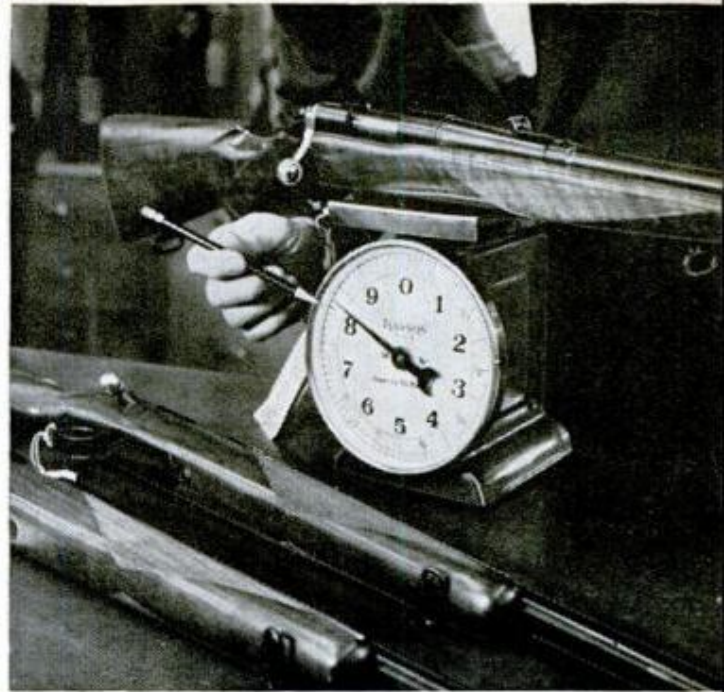

WEIGH YOUR CHOICE, especially for a field gun that you'll be carrying all day or toting with a pack. There was $\frac{5}{8}$ ths of a pound difference in the weights of these three identical rifles. The heaviest, shown on the scale, was the prettiest—but a mountain-climbing deer hunter would fail to see anything pretty about that extra weight. On the other hand, the heavier wood is denser, and denser wood is usually stronger if you're likely to give your gun any hard knocks



CHECK THE WOOD GRAIN in the stock, especially around the pistol grip and especially on guns with one-piece stocks. The grain should run straight, but down a little for maximum strength, as in this fine Mannlicher-Schoenauer rifle. Bad grain at this point, which is necessarily the thinnest on the stock, could produce a weakness and a nice, Z-shaped break from a good blow. Checkered surfaces should be clean-cut, with sharp points. It's more than a decoration



MAKE SURE the gun is solid. One easy way to check is to hold the piece at the balance point and slap the buttstock hard. Any vibrations? If you feel anything loose, find out what it is and get it fixed. Chances are it's only a loose bolt somewhere, but once in a blue moon it's something seriously wrong. On rifles with two-piece stocks, be sure the buttstock through-bolt is tight, and on one-piece stocks always be sure the guard screw is tight, but not too tight



SIZE IS A fairly standard thing in American factory guns, but the buttstock length may vary a bit even between twins. The traditional test, with the buttplate in the elbow, is still good (trigger should hit the first joint of your index finger), if an experienced salesman checks you out. It works fine for most shooters unless they're short and stout (under 5½ feet) or long and lanky (over six feet). This stock is just right; the relaxed hand falls on the grip, finger on the trigger

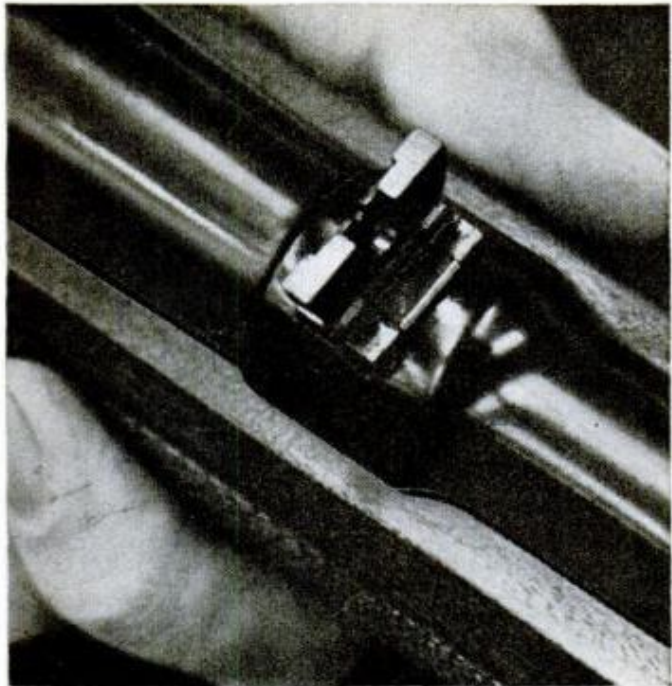

TAKE SPECIAL CARE looking at the inletting. Despite the importance of a good fit between wood and metal, factory prices and tolerances don't allow careful hand fitting of barrel and action, and changes sometimes occur in the wood after leaving the humidity-controlled factory. You don't want the inaccuracy that can result from one-sided pressure or strain. This gun was well fitted, but too tight on one side, near the rear sight. A few minutes with the store's gunsmith fixed it

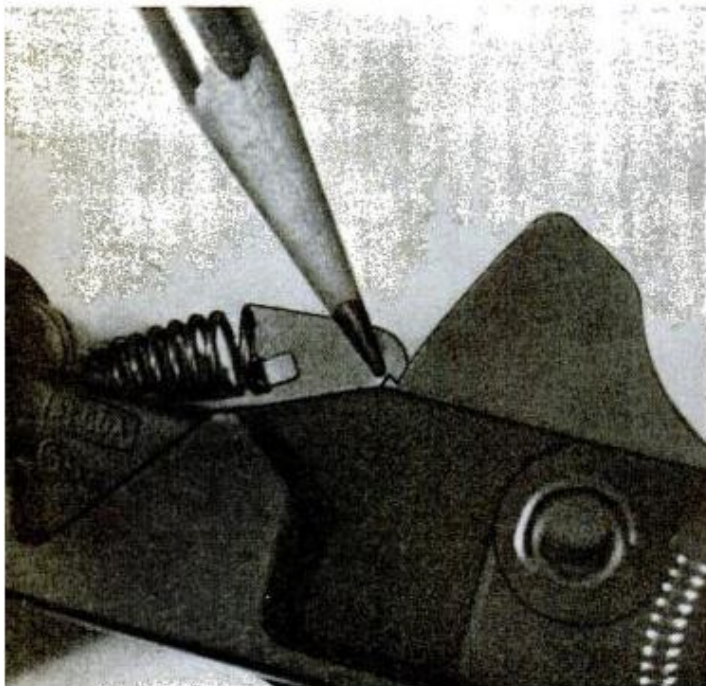

INSIDE SURFACES on any factory gun are going to be rough. In most cases, it doesn't matter, but a rough metal-to-metal surface can produce difficult and erratic performance until it's smoothed down by wear. You can do the smoothing yourself with fine emery stones or crocus cloth, or you can have it done by a gunsmith. But a good look inside several guns will show you that the job can be a real chore on one but a pretty simple operation on another

120



SCRATCHES, or rough spots, under the bluing, as on the side of this lever, are to be expected on production-line guns in some places, but overall, you're entitled to a fair polish and a good bluing job over the action and barrel. The unavoidable rough spots will turn up in the same places on every gun of a given type, but they'll be less noticeable on some. Avoid rough spots or scratches—they'll annoy you every time you clean your gun if you didn't put them there

POPULAR MECHANICS

Supersonic Cockpit Becomes Space Capsule

At Mach-4 speeds, ordinary ejection methods would kill a pilot if his plane became disabled. Tomorrow's safety device, according to Lockheed, may be a detachable forward section which would parachute safely to Earth, and even float on water. An emergency radio, parkas, fishhooks and other survival items are stored in the capsule. For escape up to 100,000 feet, the pilot presses a button. Three wedge-shaped stabilizers extend for drag; a small rocket thrusts the capsule away from the fuselage; at 15,000 feet the parachute opens.

Man Bikes Dog

Gary Helmerick didn't build his three-wheel tandem bicycle just to take his dog Queenie for a ride, but it works nicely for that, too. The 14-year-old Cleveland newsboy taught the dog to ride along behind him on his old two-wheeler on his newspaper route, so she goes along now on the back seat when it isn't occupied by a companion. Gary built the three-wheeler by simply attaching the frame and rear wheel from one bike to the rear axle of another.

☐ The National Science Foundation estimates that total funds for the performance of basic research in the United States reached a level of \$1 billion in the last year.

Electronic Sight for Subs

Commanders of future atomic submarines will see through the murky world around them by gazing at "electronic portholes." One result could be that far fewer men will be needed to man new subs. The U. S. Navy is developing, for first installation in 1964, a control system that uses electronic sensing and data-processing equipment. Information about the sub's course, its position in relation to the ocean's surface and the depth at which it can safely operate will be shown on televisionlike screens. One screen, for example, will show various ocean depths. The course at which the sub is set to operate will stretch straight out. If the sub goes off course, the path's position will change.

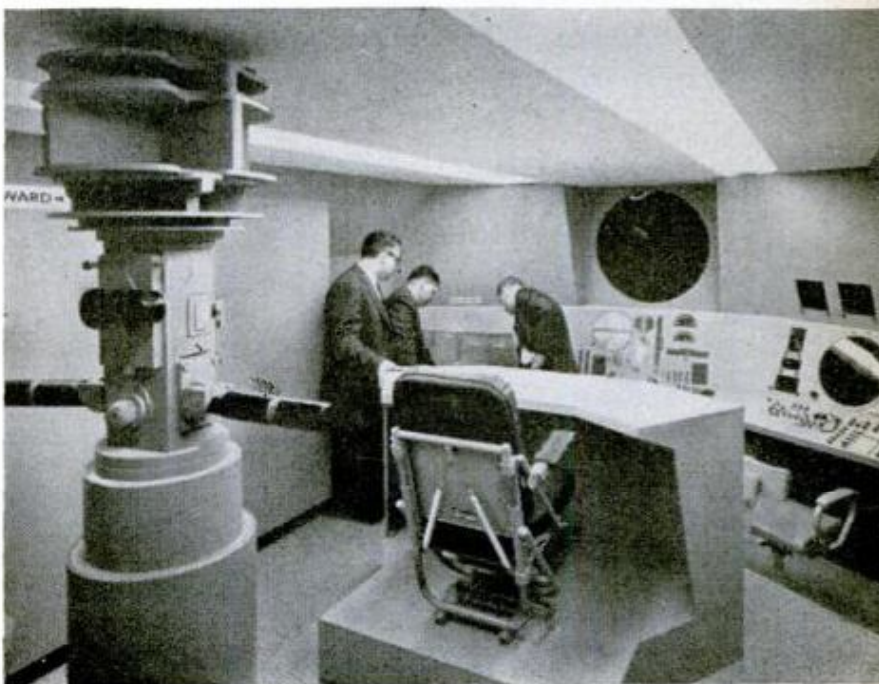
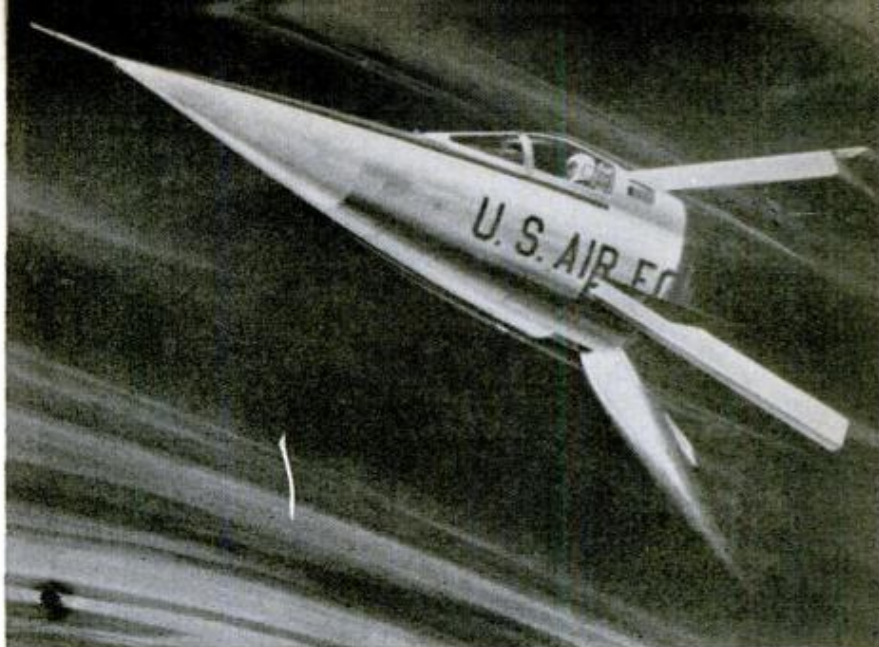

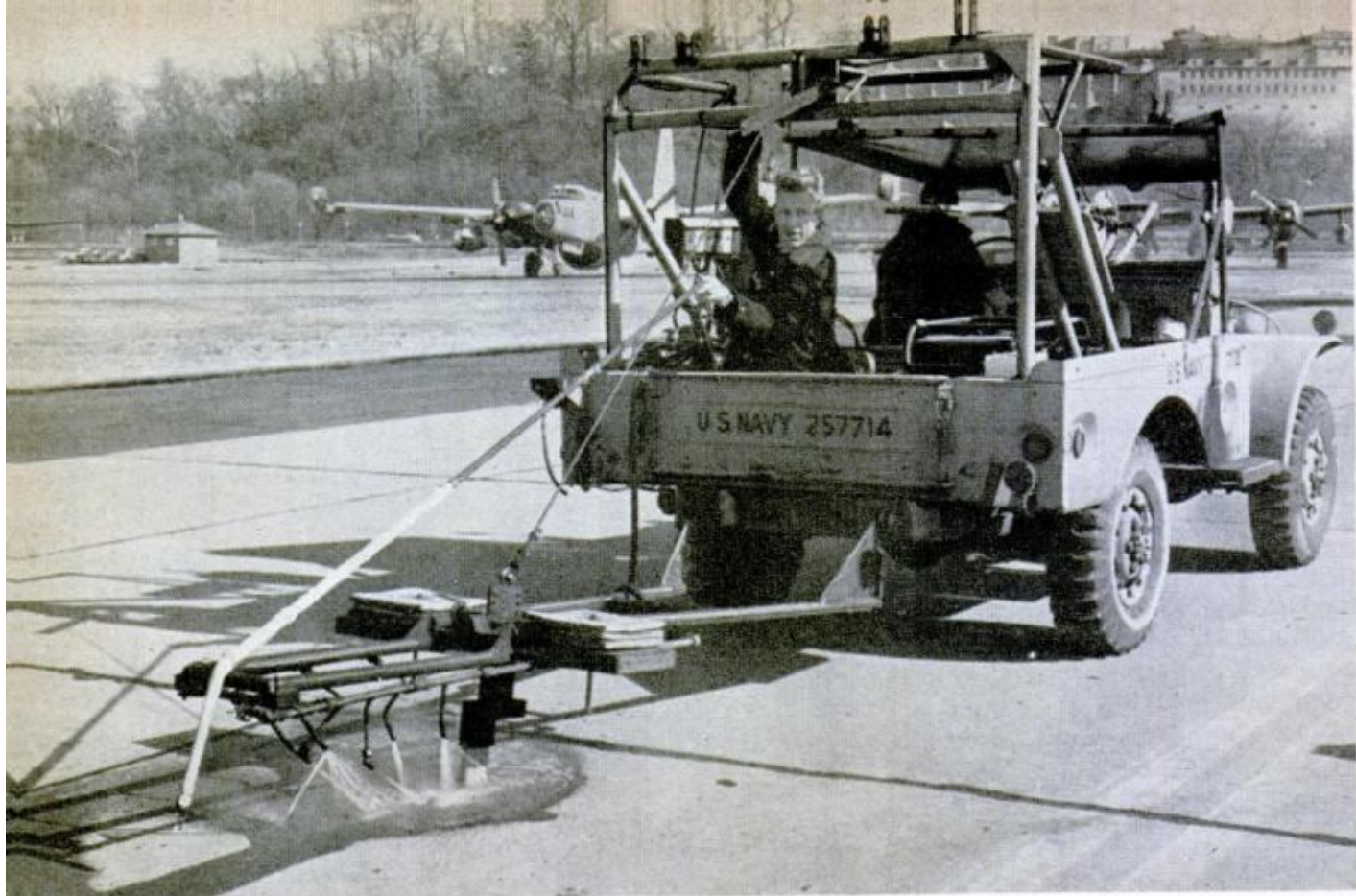

Does Foam Really Help in Belly Landings?



To test the efficiency of "greasing" airfield runways before a plane makes a wheels-up landing, the Naval Research Laboratory fitted a truck with a device (above) which dragged metal "shoes" over test runways through a spray of gasoline. A foam truck (left) prepared the runway with coatings of several depths, and the foam was allowed to "age" for varying periods. Later, the truck pulled wrecked aircraft bodies through the foam to test its lubricating qualities (below). The results were surprising—properly aged foam (10-15 minutes old) prevented fire 90 percent of the time, but the lubricating effect was almost negligible—less than five percent.

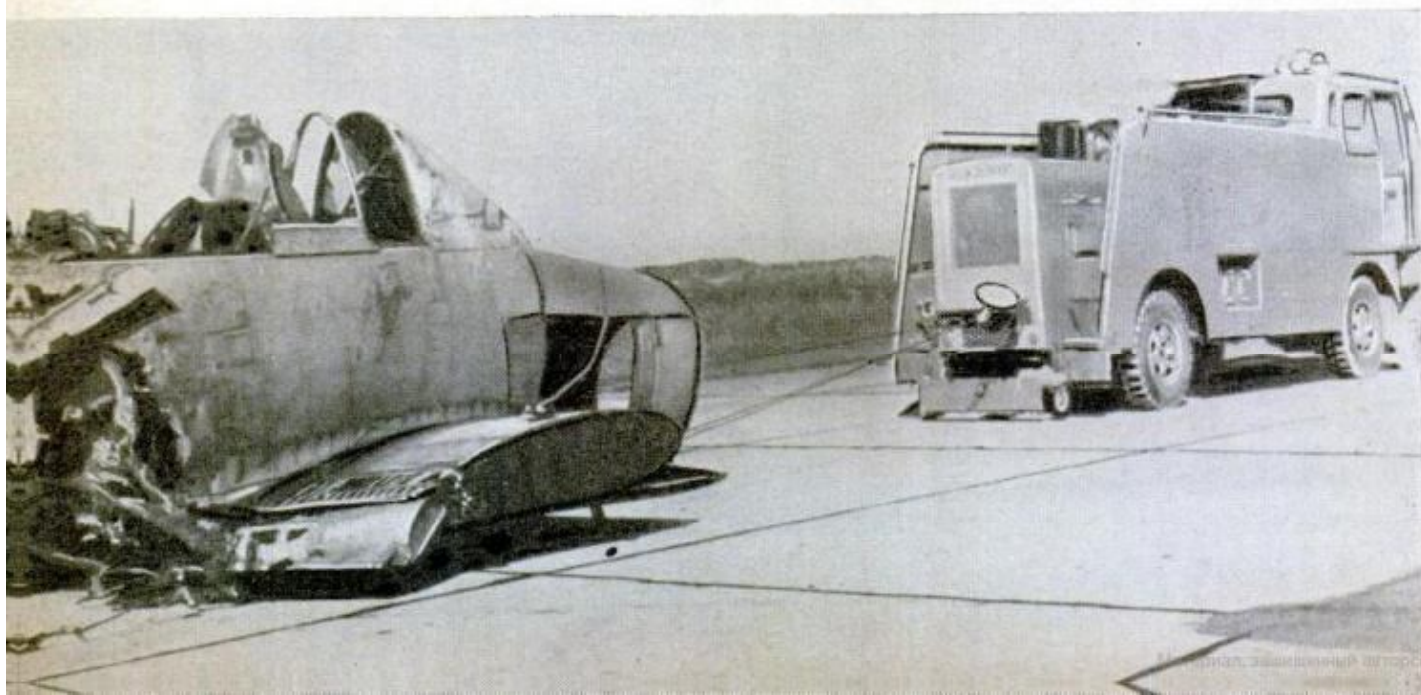

World's Biggest Yo-Yo!

Army Lt. Gene Pedrick plays with the biggest yo-yo in the world. He's a member of an Army helicopter team that travels around putting on shows to demonstrate the versatility of "choppers." As "Bozo the Clown," Pedrick hangs the 70-pound yo-yo from a landing skid and, with perfectly timed altitude changes, makes the yo-yo run up and down the giant rope.

Columbium Toughens Steel Pipe

Small amounts of columbium, a metallic element, are being added to steel for gas pipelines, to add strength and make welding easier. High-carbon steels formerly used in long-distance high-pressure pipelines tend to be brittle and present welding difficulties, especially at low temperatures, but the new columbium steel has solved the problem. The steel is now being tested for possible use in truck frames, highway lamp posts and railroad equipment.

"Piggyback" Wrecker

Garage owner Joe Klosek, of Utica, N. Y., solved a lot of the problems of towing in wrecked cars when he invented a "piggyback" retrieving truck. The truck is backed to within eight feet of a wrecked car, then the flatbed platform tilts 12 degrees and slides back to the ground. A powerful hydraulic winch pulls the wreck aboard, and the platform levels itself for the trip home. The entire operation takes one man less than one minute.

Glowing Tabletop

Now the soft glow of candlelight for dinner illumination has been replaced by the soft glow of the table itself. Italian architect Giuseppe Scagliotti has designed a table with a glowing top. The light is soft enough that it does not dazzle the eyes of the diners. One interesting and strange effect is a "white shadow" that appears under each item placed on the tabletop.

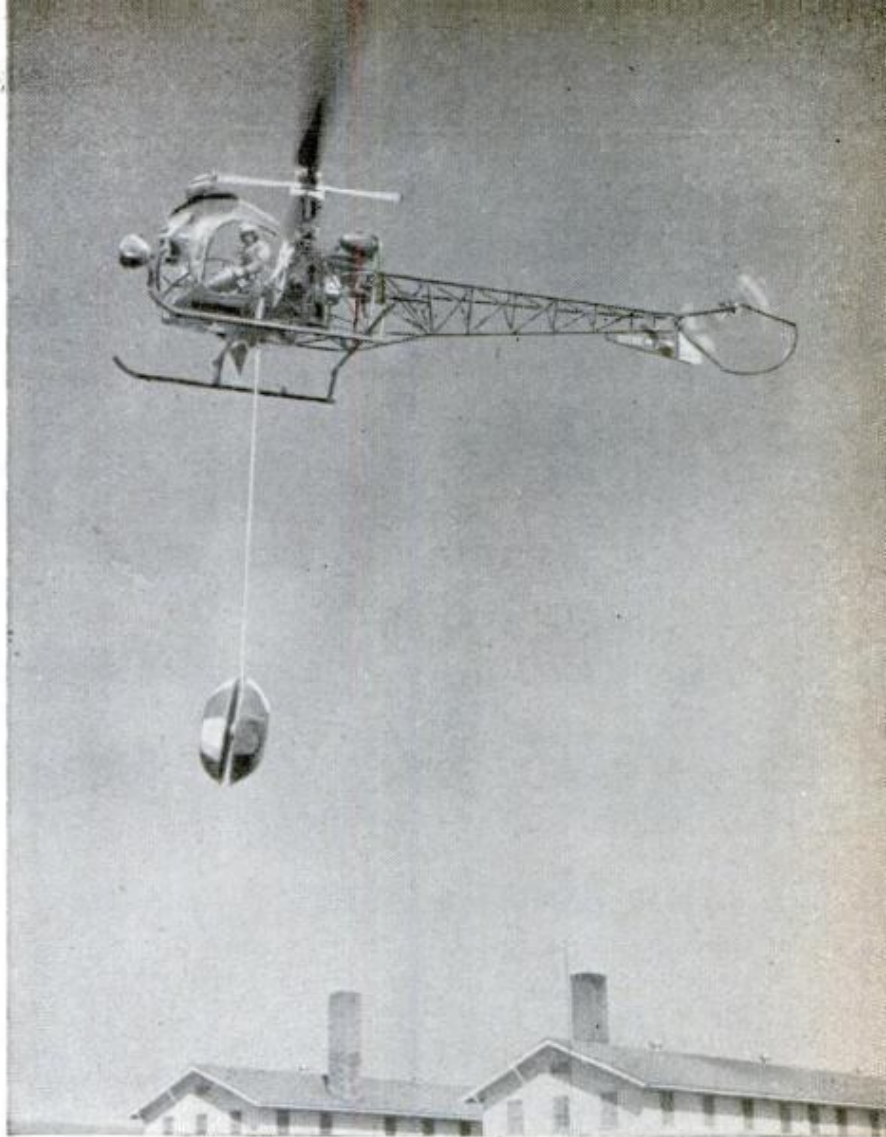

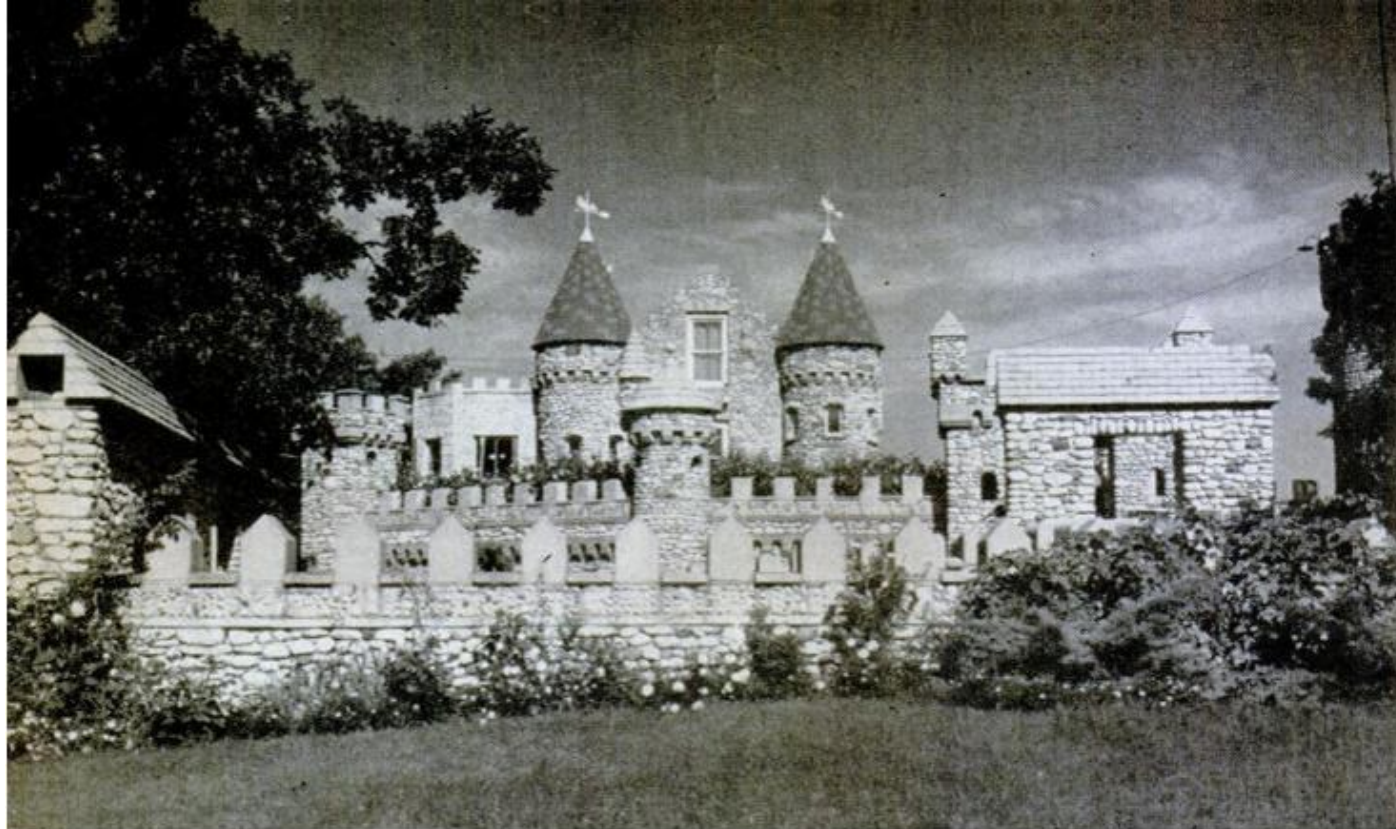

This Man's Home Really Is His Castle

When Ted Bettendorff started putting a stone veneer over his three-room home 30 years ago, he soon realized that the beginnings of a castle were taking shape under his hands. His land, in Fox River Grove, Ill., abounds in stones and he knows how to work with them, so it was no trick to throw up four turrets to hold closets, a shower-room, washroom and stairway to the basement and attic. Liking the effect, he decided to go ahead and build a scaled-down version of Vianden Castle, a famous building in the Luxembourg town where he lived as a boy.

The reproduction of Vianden, which he

has been constructing alone over the years, today spreads its walls, guard towers, terraces, walks, moat and drawbridge across a tree-shaded section of his property. It is a favorite playground for neighborhood children who whoop along its walls in make-believe Robin Hood fashion. Its acceptance by children delights Bettendorff, a bachelor, who hopes the town eventually will take over the property for use as a park.

Now 71, Bettendorff has more plans for building and is at work on a new wing for his castle which, he says, "won't be finished as long as I can lay stone."

Using stones from his own property, Ted Bettendorff, 71, fills in a wall between two turrets in a new wing he is adding to his castle. The drawbridge tower, right, conceals a bridge-raising winch and chains

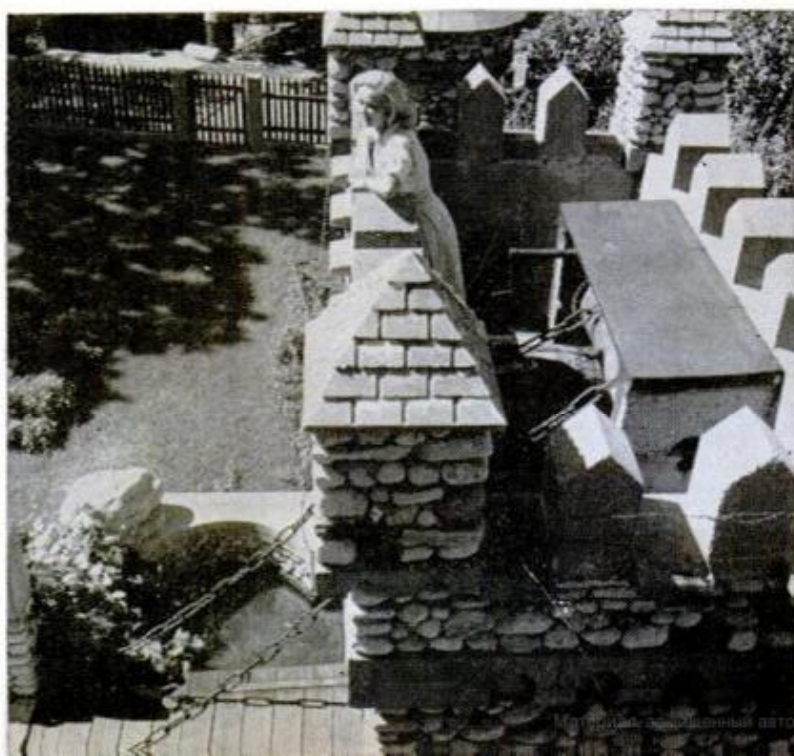

Astronomer Harlow Shapley, through his study of variable stars, revolutionized thinking about the structure of the universe. He demonstrated, among other things, that our galactic system, the Milky Way, is some 1000 times larger than had been supposed. Formerly director of the Harvard College Observatory, he is engaged in research and teaching



Harlow Shapley

By Harlow Shapley

ALL OF MY waking moments are exciting, and even some of the dream-laden hours of sleep. It is exciting when I awake to see that the Earth has turned on its tireless axis and has again produced a warming sunrise. It is exciting to feel a slight hunger and realize that as I slept the remarkable metabolic process of this animal's body has used up yesterday's fuel. And this magic has been accomplished without my direct supervision. It is exciting to contemplate that the same mechanisms that put me in motion activate the song sparrow in the maple tree, and in fact similarly operate the tree. It is made of the same elements as the bird and I, principally of nitrogen, oxygen, hydrogen and carbon. Thus in a way I am brother of the birds, cousin of the maples, and more distant kin to the hillside rocks and the atmosphere.

To be a part of a world that contains such magnificent objects as mountains, oceans, photons, stars and gravitation is a continuous excitement. The elation is reinforced when I grasp the rich idea that in the midst of the diversity there is a unifying thread that keeps me akin to atoms, stars, plants and animals; and that thread is the struggle to evolve, to participate in universal evolution. For not only do the primitives of the animal and vegetable kingdoms grow and evolve into complexity, but the atoms of which they are composed have mutated from simple hydrogen into the heavier elements, and further into molecules, and molecular aggregates of wonderful potentialities, including life.

But perhaps the most exciting moments in a world of amazement are those in which I find that I can think and write about my continuously exciting moments, and can pass on to others a taste of my elation.

Harlow Shapley



Duplicating the conditions around a burning tanker, personnel of the British Navy Damage Control School pour kerosene into the test tank. The volatile fuel produces a towering inferno below, a real trial by fire



Practicing Fire at Sea

FOR CREWMEN on an oil tanker, fire at sea is a killer that all the ocean's water can't quench. Burning oil, floating around the stricken ship, encircles the survivors in a flaming death trap. To find a way out of that trap, the British Admiralty and Ministry of Transport build man-made infernos to test lifeboats and canopies, looking for a combination that can carry crewmen through the flames to safety.

The researchers conduct their spectacular tests in a small tank at Portsmouth, England. The boat to be tested is filled with instruments to record conditions inside during the fire, then the tank is primed with a layer of kerosene and touched off. Results of the tests are being forwarded to lifeboat manufacturers with recommendations for solving the problem.



Barely visible through the smoke and flame, this aluminum lifeboat and its wet canvas cover withstood four minutes of terrible heat and emerged intact and floating with the only damage a hole in the bow





DEMONSTRATING a new "fireman's carry" technique for bringing unconscious fire victims down a ladder, a Cincinnati fireman eases a limp "victim" out of a practice tower, above left, then down the long ladder, right. The old method hung the body around the fireman's neck like a millstone, but the new way distributes the weight across the fireman's arms and shoulders, and keeps arms and legs out of the ladder rungs



Pickup Camper Goes Amphibious

Perhaps the ultimate in pick-up-truck camping bodies, a new amphibious model works like the others ashore, but also floats nicely on built-on pontoons. To launch, you simply back the truck hubcap-deep into the water, pivot the floats around until they're afloat, and push the unit off. It becomes a trim little houseboat 10 feet long and 80 inches wide, with an 11-foot beam across the pontoons, which are 12 feet long. Inside, it sleeps two, and has a portable toilet, a stove and an icebox. With a 40-horsepower outboard motor, it will top out at around 30 miles an hour, but can be powered easily with a smaller motor. It is made of marine mahogany plywood; the pontoons are built to aircraft specifications.

Infrared Viewer Keeps Night Watch

Cover of darkness is no protection from troops equipped with the Army's new Thermograph T-2 surveillance instrument. The portable scanning apparatus picks up heat radiated by men, vehicles and equipment, even at great distances, and gives the operator an accurate image of the object. It will even spot a mouse in the dark. The jeep-mounted model shown here records the infrared surveillance data on Polaroid film.



Solar Boiler On Okinawa

Latest of the instruments that soak up energy from the sun and put it to use is a "solar-heat" boiler designed to be sold at low cost to Okinawan householders. Its operation is simple. Masao Ikema, the electrical engineer who devised the boiler, set five zinc pipes in a glass-covered box. He says water placed in the pipes — they hold 12 gallons — will heat to 160 degrees F. on a sunny day. Selling price on Okinawa is \$15.



Arc-Jet Engine For Satellites

No bigger than a milk bottle, a 3½-pound, arc-jet engine has been developed by Avco Corporation to push Earth-satellites around the skies. In a two-day test, the engine produced ¾ pound of thrust which was developed by passing helium through an electric arc; the heated gas expanded supersonically through a nozzle. Such a tiny engine could provide the small amount of power needed to change the orbit of a satellite in outer space.

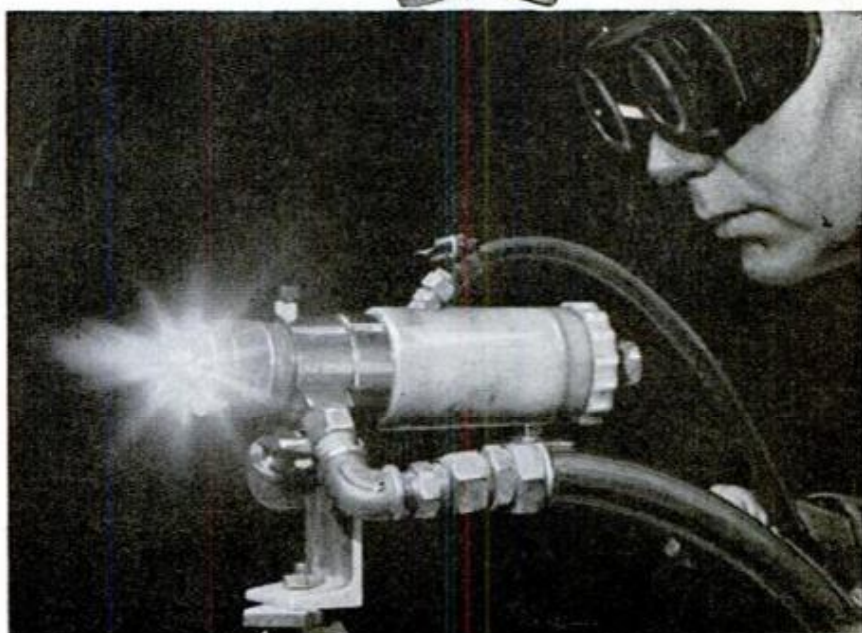

CONTOUR LOUNGE designed for use in the office has a hand switch which allows the person catching his "40 winks" to raise and lower head and feet independently. It comes in a variety of upholstery styles
Dura Corp., 21800 Greenfield Rd., Oak Park 37, Mich.



Christmas



STAMPING TOY is equipped with 12 different dies so children may stamp out such things as simulated concrete blocks and noodles from modeling material
Rainbow Crafts Co., Cincinnati, Ohio



FRINGE-TOPPED SURREY holds up to 200 pounds and trundles along at five miles an hour on battery power. It has a low center of gravity, hardboard body
 Donnan Mfg. Co., 1335 Airway, Glendale 1, Calif.



Gift Ideas

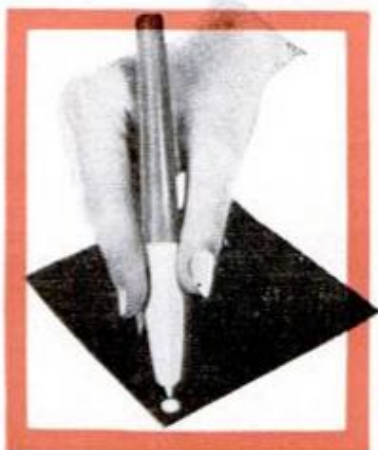

GLUE PEN holds 5000 dots of glue, fits in pocket. Three dots from the pen are said to provide enough bonding strength to support the largest telephone directory. A dot does most jobs
 Twining Mfg. Co., Ann Arbor, Mich.



AIR CAR rides a fraction of an inch over any surface, including water. Made of plastic, it has a 48-inch control line and is powered by batteries
 Edmund Scientific Co., 101 E. Gloucester Pike, Barrington, N.J.





PICNIC BOX converts to a four-place dining table. Each side of the box becomes a plate setting for one person; the bottom functions as the table center. Panels are of wood. Steel legs are 14 inches high.
 Re-Ly-On Metal Products Inc., 230 Eagle St., Brooklyn 22, N.Y.



Christmas

FLUID DYNAMICS laboratory set uses water to demonstrate effects of diffusion, air pressure, water pressure, and to power many other experiments
 A. C. Gilbert Co.





DASH LIGHT plugs into lighter socket. It has a built-in magnet to hold it securely in place on any steel surface and has a one-piece plastic hood and body

Auto Lamp Mfg. Co.,
2909 S. Indiana Ave., Chicago 16

MOTOR SCOOTER has a top speed of 35 miles an hour. It features an automatic centrifugal clutch which lets the rider stop while the engine is running

The 500 Industries, Inc., Fremont, Neb.



Gift Ideas

VEGETABLE PEELER attaches to kitchen disposer. Consisting of a hopper with an abrasive disk on a driveshaft and a rubber cup on bottom, the new peeler takes power from the disposer

Manesco, Inc., 605 Plandome Rd.,
Manhasset, N.Y.





TOY TAPE RECORDER, operating on transistors, measures 8½ by 5½ by 2½ inches. The unit includes microphone, earphone, magnetic tape, has simple controls

Damar Co., 768 Damar Building, Elizabeth, N.J.

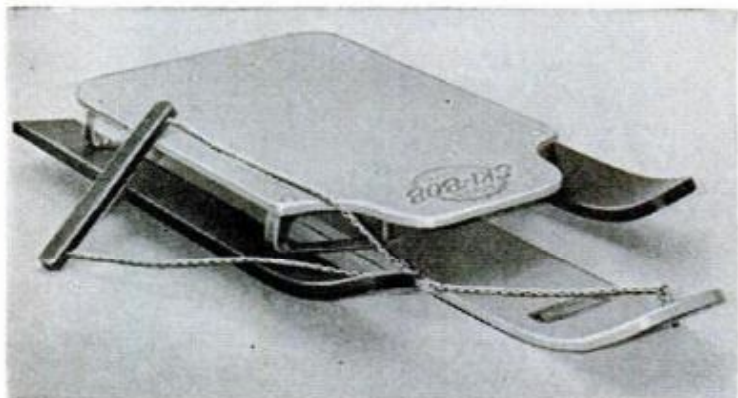

SKI-SLED can be used in water or on snow. Essentially a sled with skilike runners, it offers good balance for children when towed by motor boat. Suitable for adults

Mid-West Mfg. Co., Middlebury, Ind.



Christmas

TELESCOPE-KALEIDOSCOPE gives a new look to familiar scenes. It magnifies a view, repeating it eight times

Edmund Scientific Co., 101 E. Gloucester Pike, Barrington, N.J.

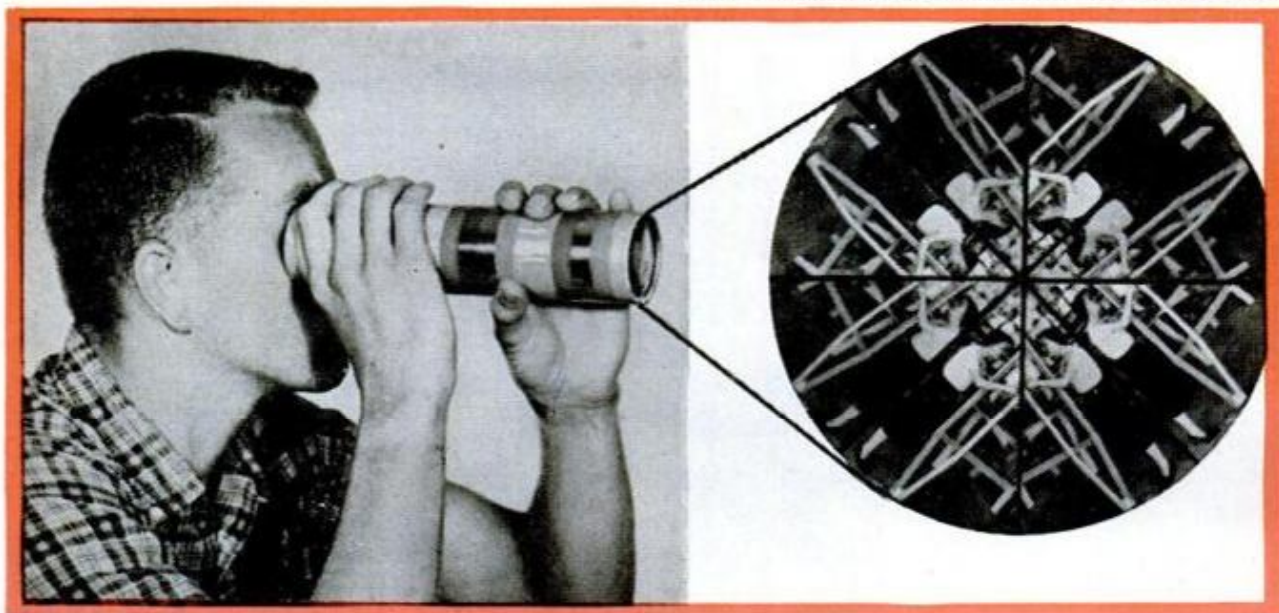



RABBIT RACK serves as a catch-all for toys, a rack for clothes, or as a toy. The frame is tubular steel, the face is plastic. It comes in two different sizes.
Hamden Specialty Products Corp.,
Eastampton, Mass.



Gift Ideas



ELECTRIC SHAVER using three blades has a device for trimming sideburns, opens easily for cleaning
Sunbeam Corp., 5600 Roosevelt Bld., Chicago 50

KNIFE SHARPENER is hand held and electrically operated. It hones blades with 7200 strokes a minute
Burgess Vibrocrafters, Inc., Graylake, Ill.

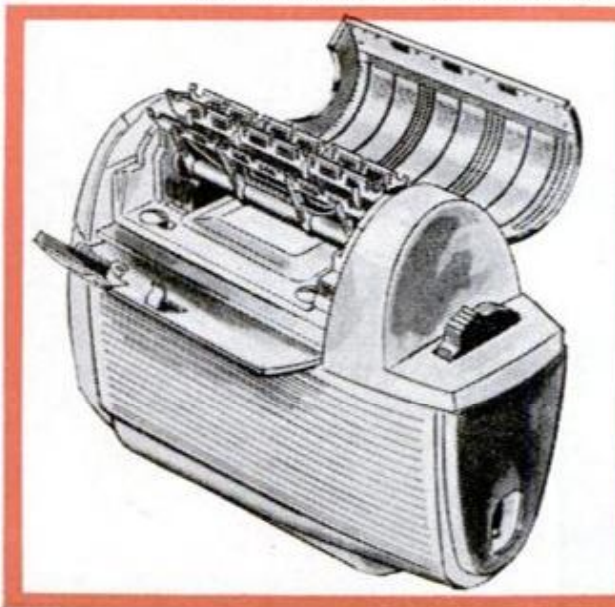

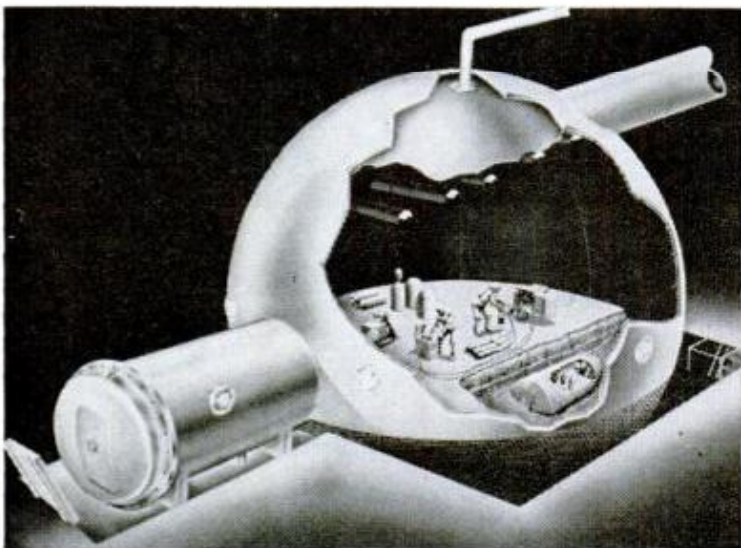
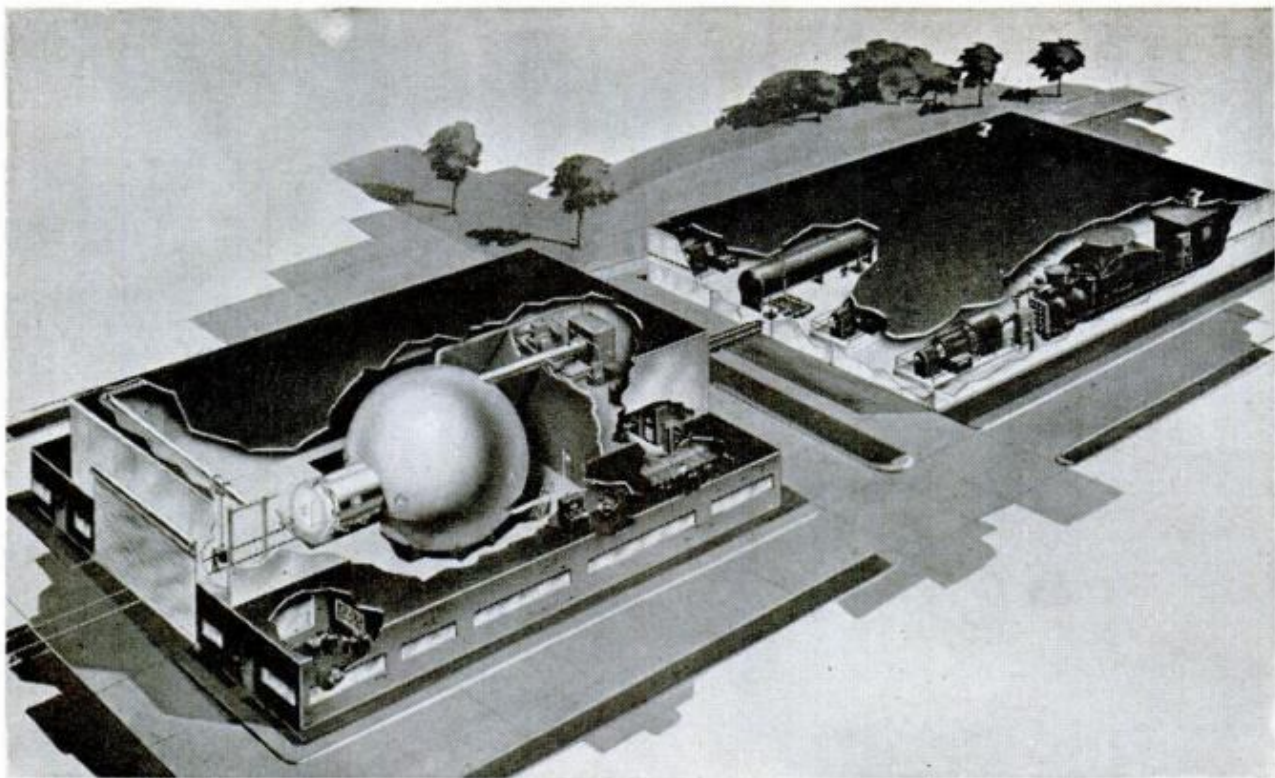

Army Moon Simulator

U.S. Army engineers have designed a laboratory to simulate conditions believed to exist on the moon. Sketches of the simulator were shown congressmen by Lt. Gen. Emerson C. Itchner, Chief of Army Engineers, who said a device of this type is "a prerequisite tool for acquiring the knowledge to survive on the moon." The device would use a liquid-nitrogen refrigeration system and heat lamps to create temperatures ranging from nearly 212 degrees F. to -270 degrees F.—the range of moon temperatures.



Punchcard Data by Phone

Data processing is transmitted over telephone lines with a new IBM system that links one or more sending stations to a central receiving station by regular dial telephone. Under the system, companies of any size can transmit data from branches to one machine center, where the data is automatically punched in cards for high-speed processing by an accounting machine or computer. The operator dials the main station, then sends the keypunch information with a manual keyboard. The system also allows routine information to be transmitted automatically from prepunched data cards.



First Turbofan Jetliner Ready for Service

Reportedly 35 miles an hour faster than the 707, the new Boeing 707-120B features four turbofan engines. It is expected to replace many of the 707s now in service. The turbofan differs from regular turbojets in that it has a large fan, powered by

the jet engine, at the front of the engine cell. The fan, like a large many-bladed propeller, pushes air back past the engine as well as through it. The 707-120B will also feature more sweep-back to the wings than previous models.

Portable Boat Unfolds From "Suitcase"

One solution to the mooring and dock-space shortage is to fold up your boat and take it home with you. John Thomson, a senior industrial design student at the University of Illinois, manages that easily with his folding aluminum boat. It collapses—

seat, backrest, oars and all—into a neat 30-pound package no bigger than a suitcase. The hull is made of sheet-aluminum sections, with the joints hinged, then taped with flexible, waterproof plastic. The boat was Thomson's entry in a class project.

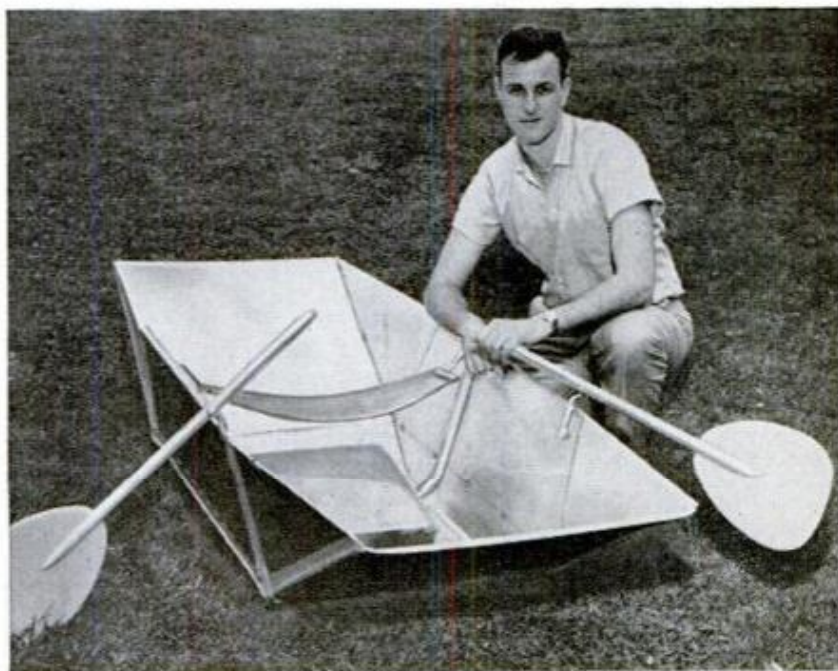



Atlantic Research Corporation builds the Arcas, a solid-propellant rocket, for low-cost experimental work

Rockets for Civilians

By S. David Pursglove

WHEN PEOPLE TODAY think about rockets, they think of military weapons and vehicles for expensive government space research. However, civilians are rapidly taking over large areas of rocketry.

Many defense missile contractors look forward to important civilian markets for their rockets in the very near future. The widely discussed probabilities of mail and cargo rockets and reliable overseas communication via satellites have prompted many rocket company officials to gear up for new civilian markets. However, there are many companies that already make rockets especially for civilian uses. They sell their products off the shelf to industry, universities and private research organizations.

Several laboratory rockets are sold to provide the heat needed to test new materials. Industry has developed a wide variety of rockets to start engines, drill

wells and hammer rivets. Rockets are even replacing wind tunnels in testing scale models of new airplanes and of other rockets. Several fire-fighting rockets already have been made and used. A close cousin of the rocket engine, the military pulse jet, operates a unique posthole digger, defrosts sidewalks and protects orchards against sudden temperature drops.

Ships and transoceanic aircraft will soon navigate by artificial "North Stars"—accurately positioned satellites. Other satellites study weather, and the Weather Bureau is gaining experience with weather rockets by observing Navy and Air Force meteorology projects. Some research institutions and universities are using rockets in weather studies and to gather information that will improve communications.

Universities are starting to follow the lead set by Prof. S. Fred Singer and his graduate students in physics at the University of Maryland. Long before anybody



In Buck Rogers fashion, man makes a vertical jump with Thiokol's rocket-powered Jump Belt. At right, an Arcas rocket — capable of reaching a 40-mile height — leaves its unusual closed breech launcher

heard of Sputnik, Professor Singer's students built their own research rockets, using commercial solid-propellant motors, and launched them from Wallops Island, Va. Many universities have government contracts to make studies that call for rockets. Other universities are planning to expand graduate curricula to include more chemistry and physics of the upper atmosphere and other studies that require rockets.

The National Aeronautics and Space Administration (NASA), when it was the National Advisory Committee for Aeronautics, routinely cooperated with aircraft manufacturers in making wind tunnels, laboratories and launching sites available for design testing. These facilities are now available to universities. The university builds the experiment and packs it into an approved rocket. NASA launch teams, working closely with the university, fire the rockets whenever government schedules permit and help collect the data.

Many companies make small, inexpen-

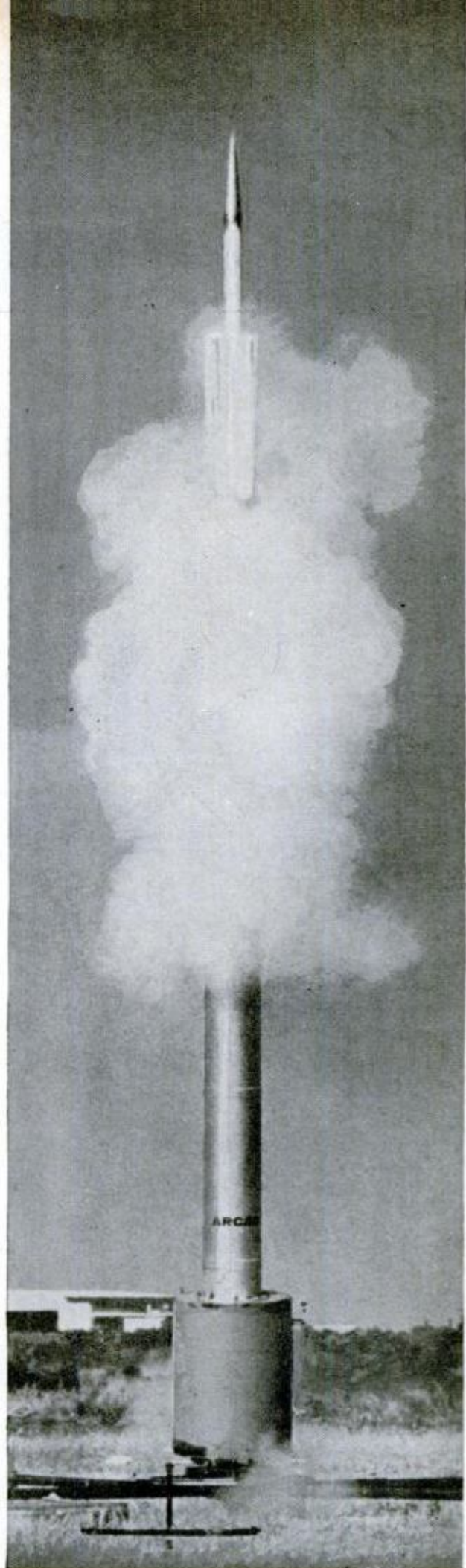



Two Aerojet Junior JATO units, in nacelles of Beechcraft Super 18 executive plane, yield 200 horsepower for 15 seconds

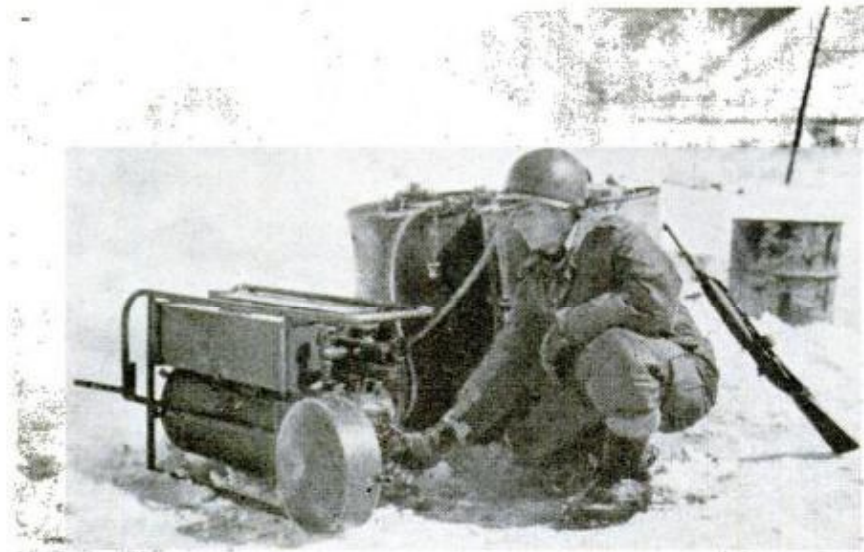

Navy's version of this Army Chemical Corps pulse-jet fog generator digs postholes, de-ices streets, protects orchards

U. S. Army photo



Two solid-propellant JATO units assist takeoff of company plane. These standby engines have wide military use also

Poised for Mach 5 rocket flight is an NASA model with nose cone similar to those planned for hypersonic manned gliders

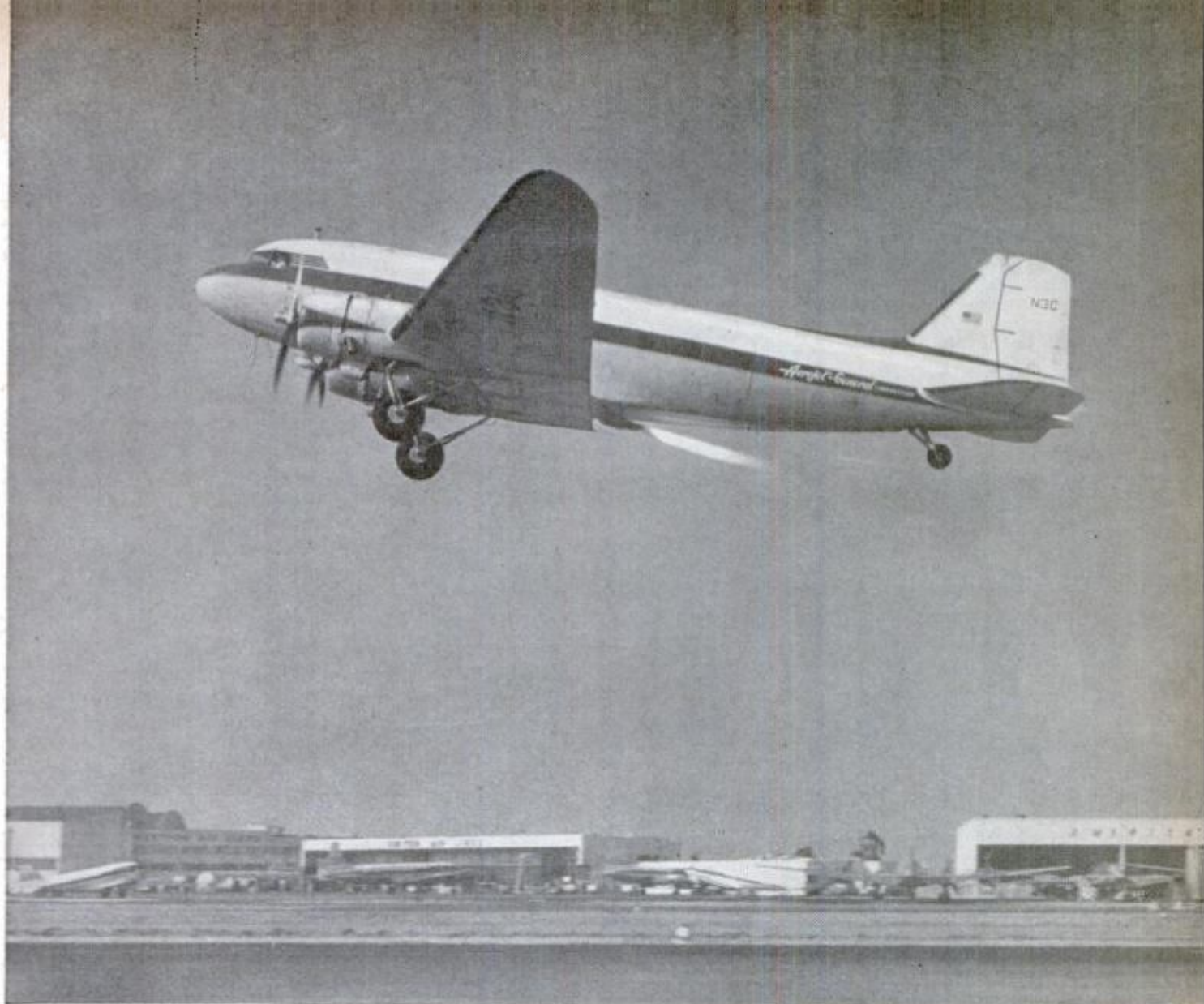

sive rockets ideally suited to this work. Aerojet-General Corp., Atlantic Research Corp., Douglas Aircraft Co., and Thiokol Chemical Corp. are among them. Atlantic Research builds a 4½-inch diameter solid-propellant rocket, the *Arcas*, designed especially for low-cost experiments. The company makes around 100 per month at approximately \$1500 each. The price will drop considerably, company officials say, when the demand that appears to be developing justifies quantity production.

The *Arcas* will carry a five to 15-pound pay load to a 40-mile altitude. The eight-foot, 65-pound rocket develops a 350-pound thrust for 28 seconds. These are the specifications that most university experiments need. And the price is within the range of departmental budgets.

The well-known *Aerobee*, built by Aerojet-General, is a larger, more expensive rocket, but still meets the specifications and budgets of many university experiments. The company sells *Aerobees* for \$20,000 to \$30,000, depending on the modifications made especially for the buyer. The company will sell the rocket to anybody who wants it. However, the *Aerobee* booster

and the *Arcas* motor are classified confidential. The user must have a military clearance, which is very easy for a university to obtain on a legitimate experiment at such a low security classification. Otherwise, the user can buy several other propellants and small solid rocket motors from other firms.

Major electronic firms are using these rockets, often launched in cooperation with the government, to test radio and radar developments, and to calibrate radar. Sometimes the rocket releases metal chaff at peak altitude, and signals reflect from the falling pieces. Other times, radar is calibrated and radio devices are tested directly against the speeding rocket moving at a known velocity. The drift of falling chaff, followed by radar, is also useful in weather and geophysical studies. It describes wind direction, velocity and air density.

Atlantic Research and other companies that make small, low-cost rockets sell them to the Air Force and Navy as well as to non-federal organizations for weather studies. The U.S. Weather Bureau follows the projects closely and has participated in one series of rocket studies by providing



Rocketdyne photo

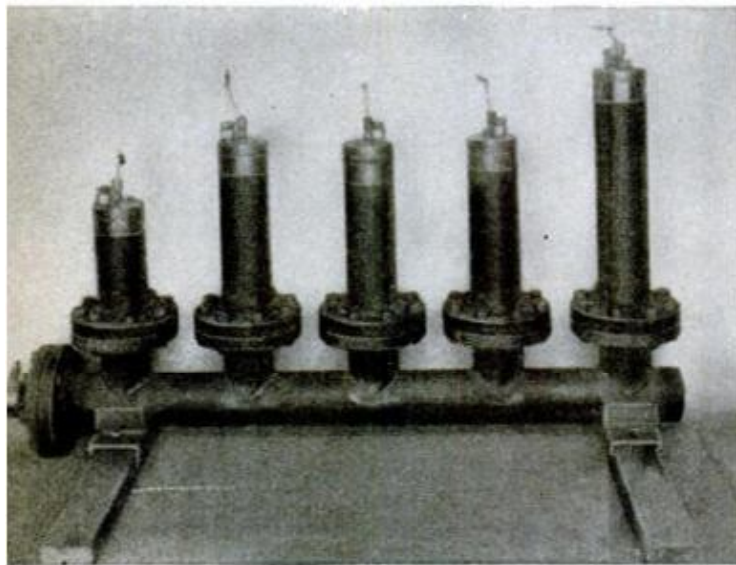

U. S. Navy photo



funds to join its National Hurricane Research Project to a military rocketry photography study. Now the Weather Bureau is weighing the advisability of instituting its own rocket program. Bureau officials are strongly impressed with the possibility of buying an adequate rocket—designed for the Bureau's purposes—at a low price. So far, most weather experiments have been hitchhikers in rockets much larger and more expensive than needed by meteorologists.

A typical weather experiment uses a balloon to carry aloft instruments that measure conditions and radio data to a weather station as the instrument package returns to earth by parachute. A rocket gets the instruments to a higher altitude, much faster, than a balloon. A rocket places the instruments precisely where they are needed; a balloon places them only approximately.

Some problems still face the Weather Bureau. People in New York and Chicago rarely are interested in weather conditions over White Sands, N.M., and off the Maryland-Virginia coast where most rocket weather information is taken. They want details about their own localities. However, short-range rockets are dangerous over cities. The firms that make the small rockets now are working on cases that will detonate at peak altitudes so they will not fall back onto populated areas.

Another use for rockets that is related to weather is cloud seeding. Most rocket firms have built rockets designed to seed sodium iodide crystals into clouds to cause rain. These often have been the same rockets they sell for weather studies or university experiments. They will sell them to reputable organizations for cloud-seeding work, but the firms do not go out of their way to encourage these sales. Although there is a definite use for cloud-seeding rockets over drouth and fire areas, many legal problems crop up. The courts must determine the rights to cause precipitation, the responsibility for causing unwanted rain, and the possible liability for damages to a person deprived of rain because a cloud was seeded early in its journey. Until these questions are solved, the rocket companies believe the market for cloud-seeding rockets will be limited to a few official government experiments.

There is another delay. Scientists must agree on whether cloud seeding really is effective. There is some doubt. On the

(Continued to page 256)

Top: Final assembly of Rocketdyne auxiliary power rocket similar to those being developed to start prop-jet engines. **Center:** Solid-propellant rockets supply pressure to operate Navy fire extinguisher. **Bottom:** Solid-propellant canisters can be fired by soldier wearing Thiokol rocket-powered Jump Belt

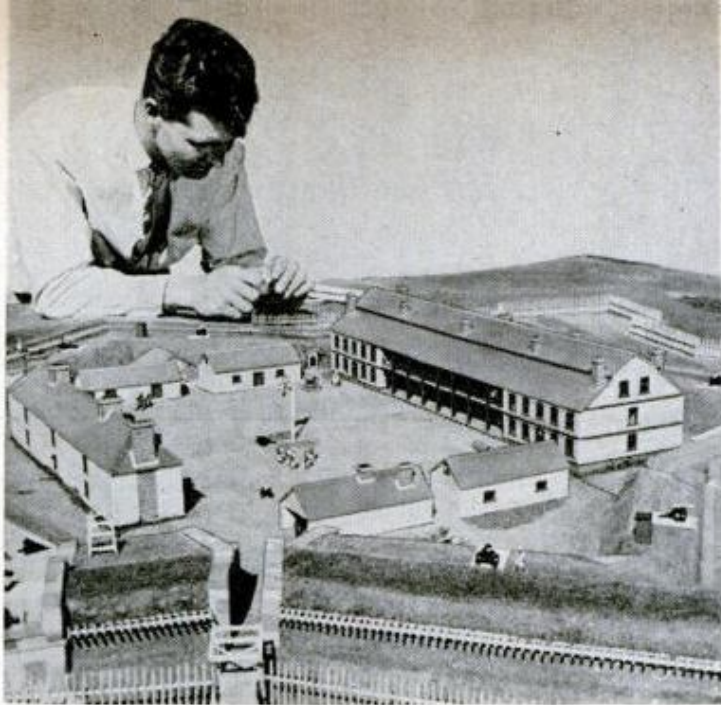

Model Builder—Historian

SINCE HIS ARRIVAL in St. John's, Newfoundland, from his native England, in 1955, David Webber has studied the history of his adopted country and has worked to reconstruct—in miniature—the forts that played such a big part in the history of Britain's first colony in the new world.

Working with his wife, Jennifer, he studies old maps and documents, then works by hand to duplicate the forts, buildings, earthworks, and the soldiers. Shown here are his models of The Battery, or Queen's Own Fort, above and right, Fort Townshend, below left, and Fort Frederick, below right. The Government of Newfoundland has awarded several commissions to Webber for construction of his miniatures.

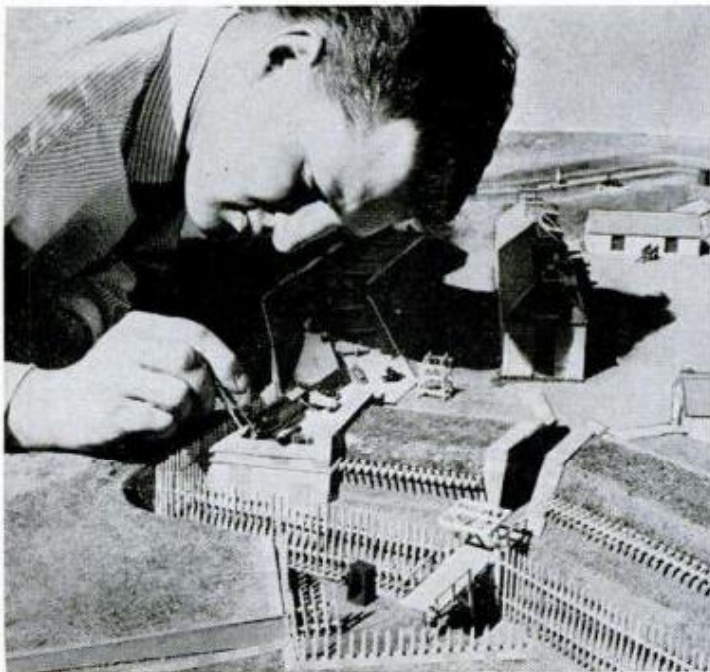



Four-Place Helicopter For Businessmen

Called a "station wagon of the sky," a low-cost, four-place helicopter has been placed on the market to appeal to the business-executive field. The craft, which is nearly 30 feet long, can carry nearly 1000 pounds. It cruises at up to 96 miles per hour, and has a range of 225 miles and a ceiling of 14,600 feet.

Electron Tube Amplifies Light

Making big telescopes out of little ones — and bigger telescopes out of big ones—is the job of Westinghouse Electric Corporation's new Astracon electron tube, which is so sensitive that it makes visible to the eye every individual elementary particle of light that triggers its input. It can increase the effective size, or light-gathering ability, of even the largest telescopes many times over, enabling astronomers to get photographs of the heavens never before possible.

Space-Travel Hazards Simulated in Chamber

Six hazards of space travel can be simulated in a "multistress" chamber at Boeing Aircraft Company, Seattle, Wash. Scientists seeking to learn how to condition and protect a man working in a hostile environment will be able to expose test subjects simultaneously to these conditions of space flight: noise, intense light, vibration, variations of barometric pressure, temperature and compositions of various gases.

Subjects sitting in an airtight chamber inside a larger chamber will perform such tasks as identifying targets on a radar screen and aligning rotating dials on an instrument panel while scientists alter the environment. For example, air is purified by circulating it through chemicals which remove carbon dioxide and odors. A heat exchanger condenses moisture from the pilot's breath and maintains relative humidity at the desired level. Walls of the chamber can be heated to 400 degrees F. to simulate high temperatures which might be encountered by a space vehicle re-entering Earth's atmosphere.

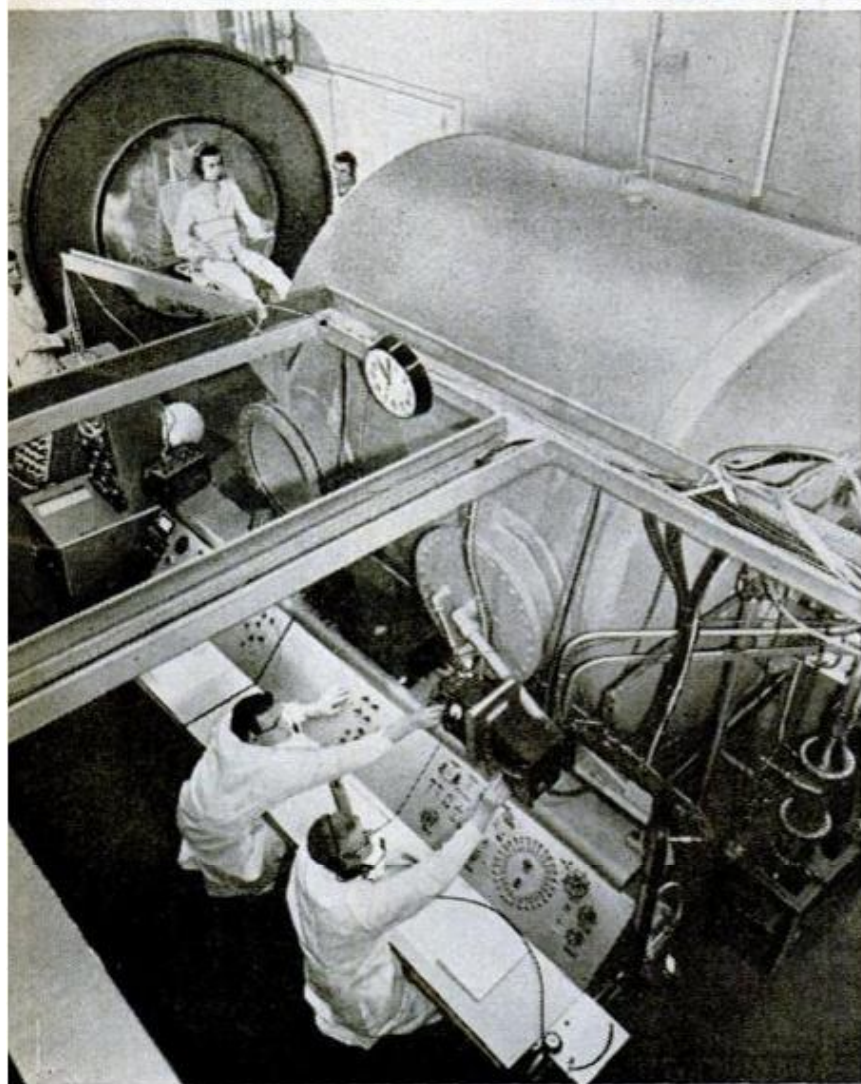

Let a Robot Drive the Plow



Guide disks follow furrow; if they leave furrow, an automatic ignition cutoff switch will stop tractor

By Roger Francis

DRIVING ON U.S. HIGHWAY 78, an insurance salesman saw a large farm tractor plowing with no one on it. He drove frantically to a nearby filling station to report the "accident" and find someone to stop the tractor.

"That tractor has been running two days and nights without anyone on it," calmly explained the filling-station operator. "You're the second person to tell us." It also happened that the farmer who owned the vehicle was at the station—and he invited the salesman to take a closer look.

In the field, the salesman saw two guide disks and a pivot wheel being pushed ahead of the tractor. These parts of the robot ran in the furrow and steered the tractor by a linkage to the front wheels.

This was the basis of the system that let the farmer do his plowing without a driver on the tractor, the salesman learned. And he was told that the robot he was looking

at was similar to the many others now in use.

The guide disks are mounted on an axle with each end angled about five degrees forward, and they are adjusted to push against each other. Pushing the disks, a piece of round shafting hinged from a vertical shaft permits adjustment between this horizontal shafting and the disk's axle by use of setscrew clamps.

The vertical shaft carries the pusher pipe from the tractor mounting and is supported by the pivot wheel. This pusher pipe—an old car or truck drive shaft may be used—is about six feet long. A universal joint on its mounting end permits the pipe to move up or down and crosswise. An adjustable coupling link between the pipe and the tie rod (or a guide bar on row-crop tractors) completes the basic elements.

A homemade furrow guide and purchased accessories cost from \$60 to \$125,

depending on materials used and whether it is built in the farm shop or a machine shop. Using good hubs with tapered roller or ball bearings, the guide will give excellent service for several thousands of acres without repairs.

Robot guides require several safety factors for proper self-control.

A small rope from the plow to the tractor's hand clutch, distributor coil wire, or a wire installed in the ignition circuit with clamps or pull-out couplings, stops the tractor should it become unhitched from the plow. This prevents the guide and tractor from continuing around the furrow until they run into the back of the plow.

Another safety device is an ignition switch, which is automatically turned off if the guide disks get out of the furrow. Also, a mechanical yoke across the pivot shaft uses a cord to pull the coil wire from the spark distributor or coil to stop the tractor when the guide disks are turned sharply by leaving the furrow.

If these two safety devices fail, a third is the mechanical construction which allows the guide disks to swing around only about 150 degrees on the pivot shaft until one disk hits the pusher pipe. This position of the guide disks turns the tractor in a tight circle to keep it from leaving the field.

Before the yoke and cord were routinely added on the guide, a tractor might leave the furrow and run in a tight circle for some time. Other cases of tractors leaving their guiding furrows have been more dramatic.

West of Plainview, Tex., a big tractor left the field pulling a disk-breaking plow. It plowed across a paved farm-to-market road twice before running into a concrete irrigation-well spillway pit. Here the tractor's differential ran on high center and the tires caught fire by continuing to rotate against the concrete.

To stop the tractors for servicing, many farmers mount their tractors from the plow side. However, this is dangerous should a man stumble. A better way is to pull the cord on the guide to remove the spark distributor wire or to throw the switch on the pivot shaft. In the latter cases, the farmer does not get in front of his tractor or plow.

For night operations, lights on the tractor add safety and convenience. Farmers watch the lights to see if their tractors are running at night. Also, the tractors are easy to locate for servicing during the hours of darkness.

"By running my furrow-guided tractor 24 hours a day, I plowed my land in half as many days as if I had driven my tractor,"

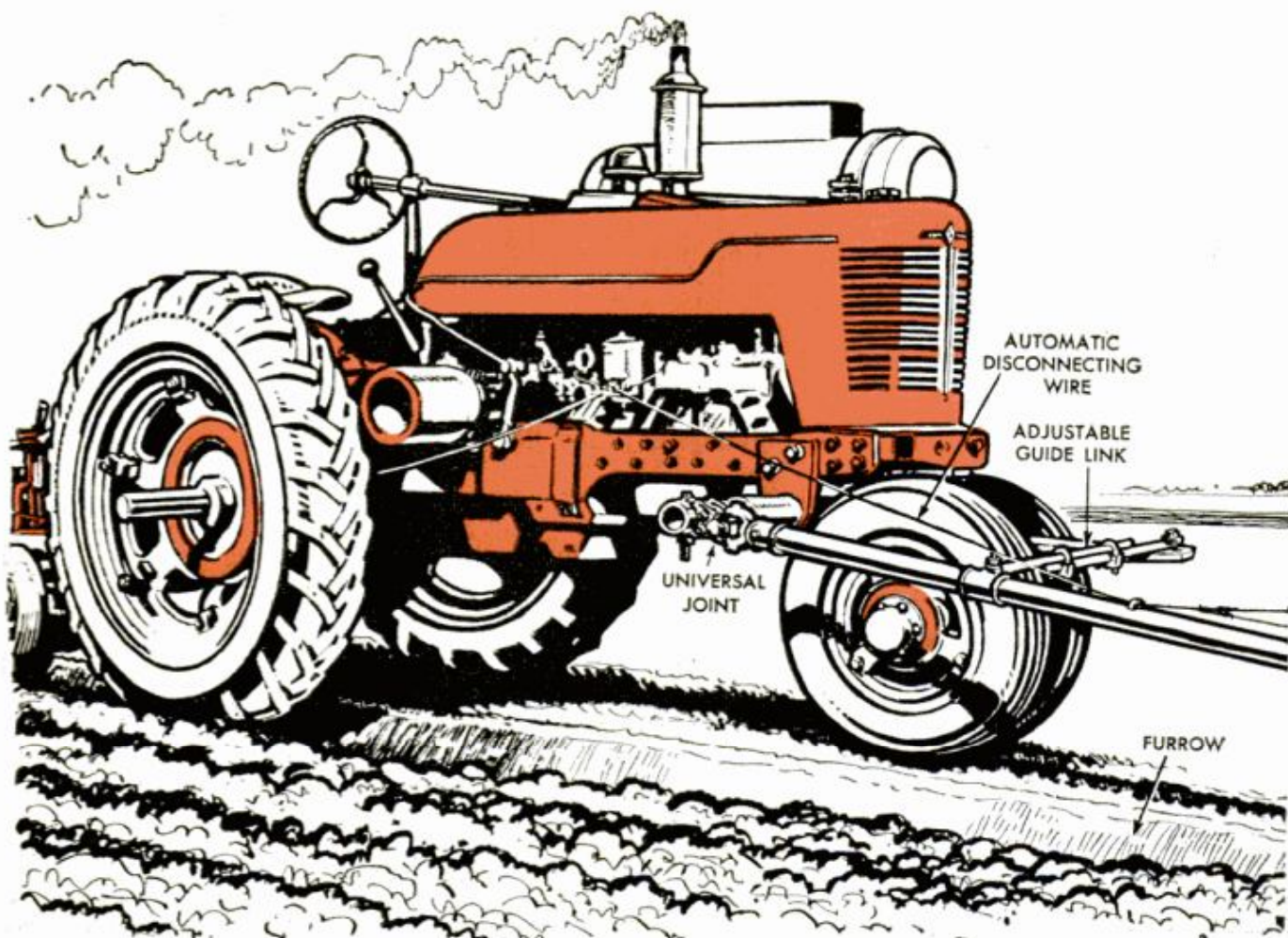

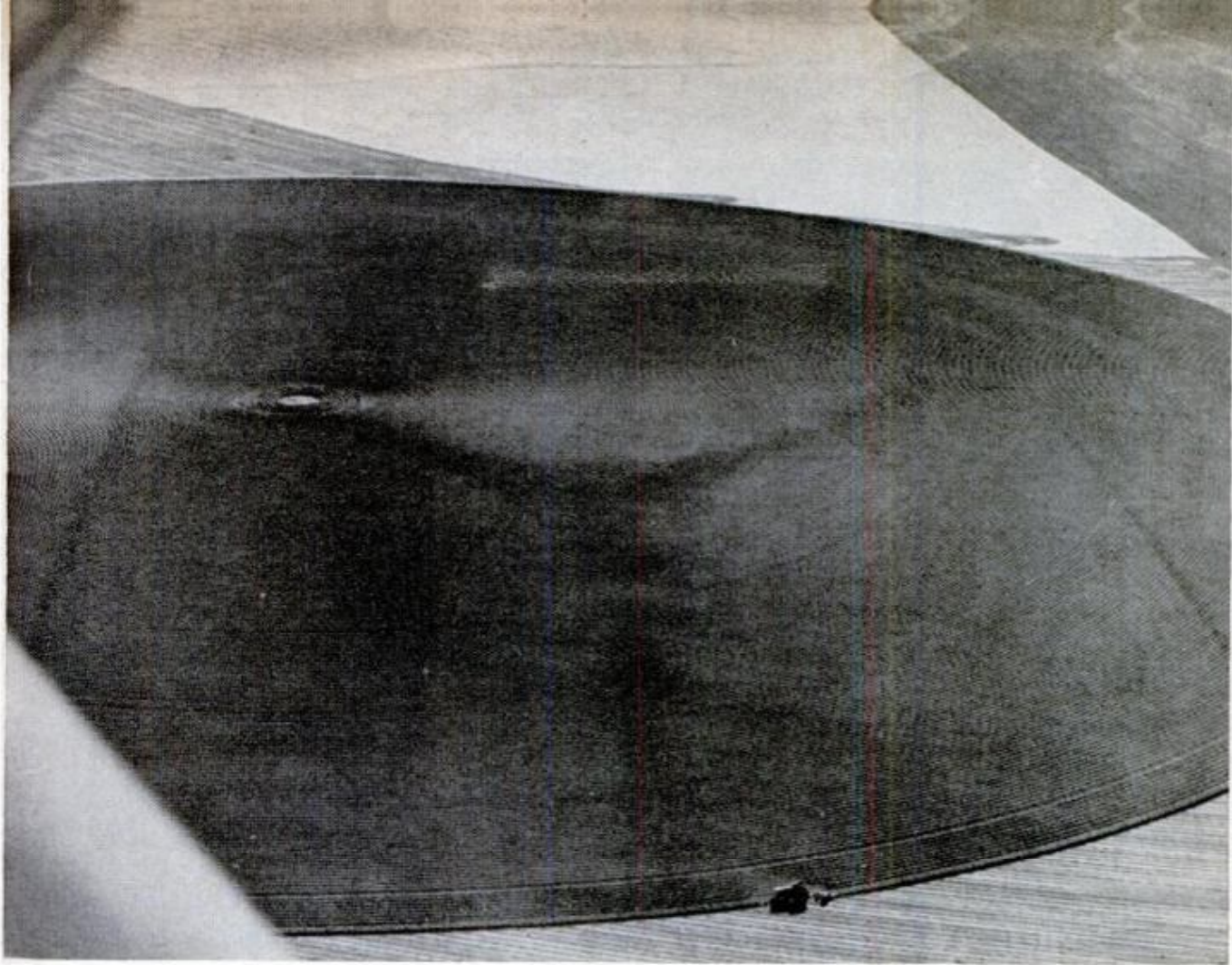

Robot-guided tractor makes field look like giant phonograph record as it pulls plow in ever-widening circle

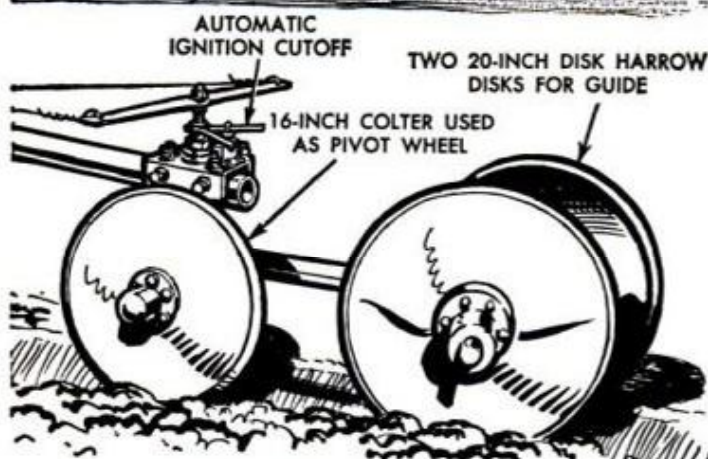
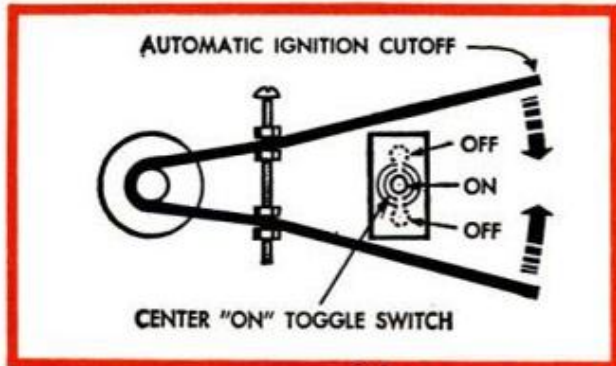

said a farmer living south of Dimmit, Tex.

Labor time saved by the robot amounts to about 11 out of 12 hours for conventional tractors and plows requiring service every six to eight hours. Some farmers who live in towns have extra fuel tanks on their tractors so that the furrow guide may operate their tractors for 12-hour periods without servicing.

"My guide gives me more time for tending to the business end of farming. This is important with rising cost," said one farmer. In Swisher County, Tex., a cotton and grain farmer credited his robot for helping him get his grain-sorghum ground plowed while he was still harvesting cotton.

"I can usually attend a special church meeting and visit my neighbors more while the guide is running," said a faithful church worker. A money-minded man claimed, "In plowing 600 acres 10 inches deep, the guide saved me \$400 on labor."

Fields are usually plowed from the outside to the inside using the robot guide. With a disk-breaking plow, the front disk may run in the furrow without cutting the new ground. This extra disk will pull into

(Continued to page 240)

Robot guides are made of new and scrap parts. Inset: Cutoff that's actuated when guide disks leave furrow



Bowling by Braille

Blind persons can enjoy bowling without assistance, both for recreation and exercise, with an electronic pin-reporting system which enables them to "see" which pins are down. The system was developed by Leon M. Bablouzian, above, of Arthur D. Little, Inc., Cambridge, Mass., who produced it as a public service. In use, pegs on the top of the reporting box retract as the pins fall. The bowler delivers the ball from a foot-orienting rubber mat, then touches the box to check the results.



Microwaves Speed Paychecks

Electronic computers located 30 miles apart "talk" to each other via a microwave relay that, among other things, speeds along payroll information. The computers are located at North American Aviation installations at Canoga Park and Los Angeles, Calif. Computer information is microwaved between the plants at a rate 500 times faster than that of human speech. Payroll data received in Los Angeles is processed automatically by a printer that stamps out 400 paychecks a minute.



Pipe-Organ Guitar Produces Novel Tone

Using principles of the organ, a Bavarian guitar designer has built a guitar with pipes. Arranged in assorted sizes, like a church organ, the pipes produce a distinct, resonant tone that is especially effective in solos. The pipe-guitar has been put into production, costing about 40 percent more than an ordinary high-quality guitar. It is made of maple and pinewood.

Wild Horses Are Vanishing

Vast herds of wild horses no longer roam the West's rangelands—their numbers have been reduced to a comparative handful, according to Dr. Tom L. McKnight of the University of California. The total population is down to about 17,000 head, 5000 of which are in Nevada. All of the animals are feral; that is, descendants of animals that escaped domestication; none are native.



Electronic "Side Man"

Members of a band or combo who accompany a soloist are called "side men." Now even that job is being taken over by electronic substitutes. The new Wurlitzer "Side Man" produces the effects of a rhythm section automatically, creating the sounds of 10 percussion instruments in any combination in 85 different beat patterns and at any speed from 36 to 195 beats per minute. The accompaniment is preprogrammed for automatic operation, but the "Side Man" can be "played" to produce many special effects.

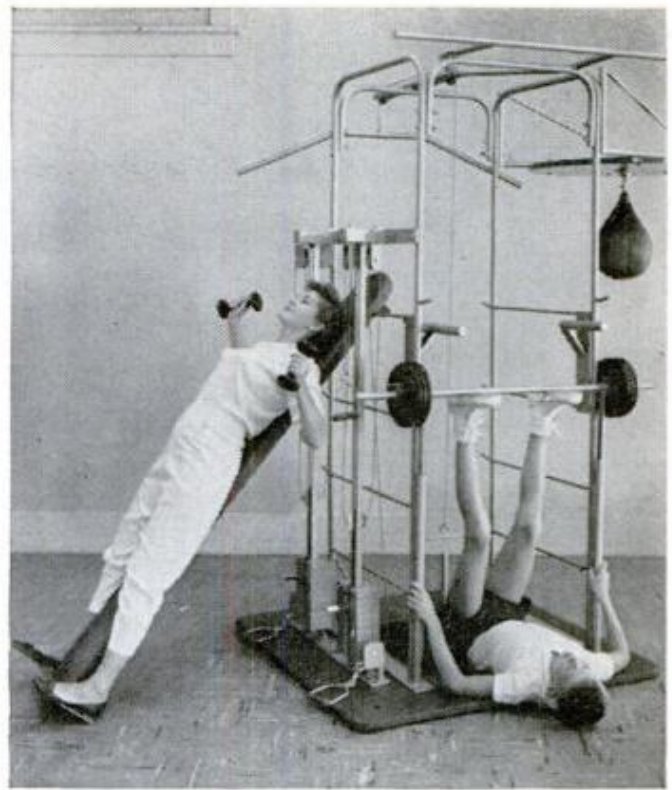

Compact Home Gymnasium

Thirteen pieces of gymnasium equipment fit on a four by four-foot platform in a new "gym," offering at least 57 different exercise combinations for home or office reducing or body-building. Besides the usual lifting and pulling exercises, it includes a punching bag, chinning bar, inclined bench, sit-up and relaxing board and a low exercise bench. To complete the set, the company offers a matching belt vibrator and exercise bicycle. The whole family gymnasium will fit nicely into 120 square feet.

Lightweight Gas Turbine Powers Fire Truck

Gas-turbine fire trucks—believed to be the world's first—have been ordered for the San Francisco and Seattle fire departments. Powered by Boeing 325-horsepower aircraft turbines, the trucks will require no warmup, can accelerate to 55 miles an hour in 34 seconds, and can perform better on hills (a problem in both cities) and in traffic

than conventionally powered trucks. The turbine engine, which uses a conventional transmission, weighs only 325 pounds, compared to 3500 pounds for a comparable piston engine, and will amount to only one percent of the total weight of the trucks. Another advantage is low maintenance—the engine can be overhauled in one day.

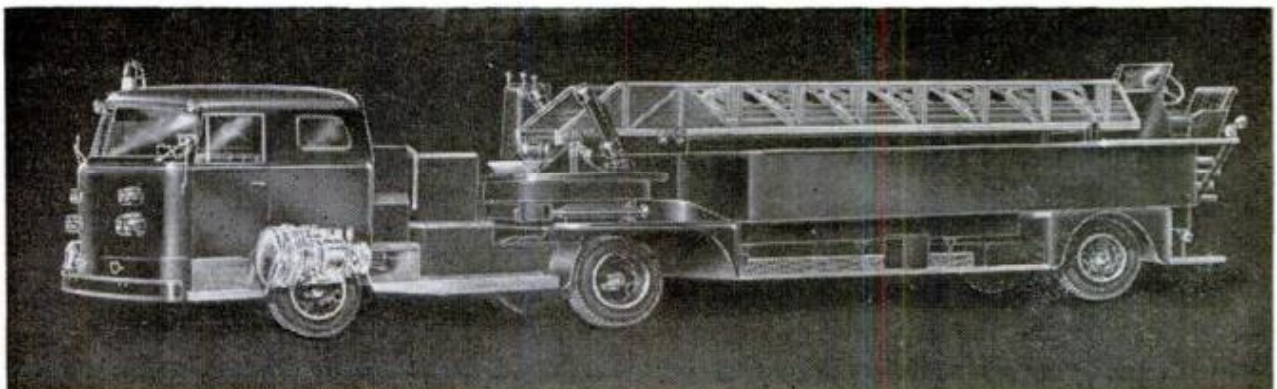

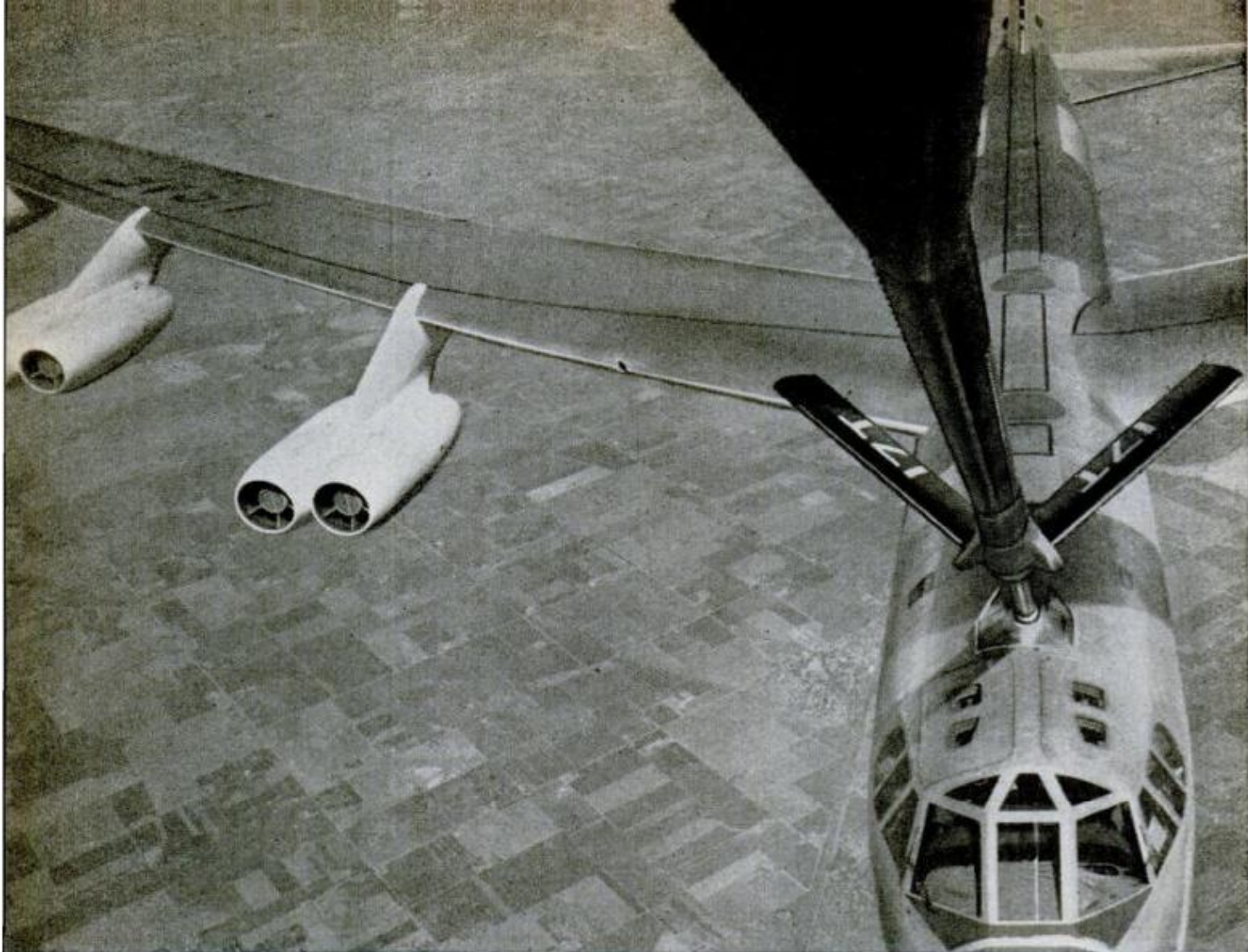

Refueling boom stays snugly in place if bomber pilot obeys light signals to nurse his big jet along

AIRBORNE PINBALL MACHINE GUIDES REFUELING

By Tom Sherman

THE PILOT of a jet bomber hanging on a tanker's refueling boom has his work cut out for him. His biggest problem is holding his plane in position to stay hooked up. The tanker's director lights help him solve this problem.

When the bomber is hooked up, the telescoping refueling boom is free to follow it within the area of contact, or "envelope," as it is called. If the bomber slips past the limits of the envelope, the boom will automatically disconnect to keep from getting damaged.

The pilot would be hard pressed to keep the bomber in the envelope without the director light. Ordinary formation techniques aren't precise enough, because there are only a few feet of leeway. The envelope is about 12 feet long, 14 feet high and 21 feet wide. At refueling speeds of 500 miles per hour and better, it doesn't take long to get out of position.

There are two rows of lights on the tanker's underside, just forward of the wing. The left row tells the pilot to go up or down a graduated amount, and the right row tells him to go forward or aft. The center, or safe, position on both rows is shown by green lights.

If the bomber runs too far forward, it telescopes the boom on itself. This telescoping actuates a set of electrical contacts tied into the right row of lights. Depending on how far forward the bomber is, the lights direct different amounts of correction on the "A" end of the row. The green bar plus the center green means "come back a little," the green bar alone means "come back a little more," and so forth. The red bar alone means "any further, and the boom will disconnect."

If the bomber drops behind the center position, the boom extends. This closes other contacts, which light appropriate



Lights are located on underside of tanker behind nosewheel. In good weather, pilot can get instructions from boom operator by radio, but in bad weather, at night or during radio silence, lights are invaluable

lights on the "F" end, telling the pilot to come forward.

The left row of lights works the same way, except that it's controlled by the angle that the boom makes below the tanker. For example, as the bomber falls below the center position, the "U" lights will light, with a green or a red arrow. Again the red means, "Go no further or the boom will disconnect."

Let's say that you're already hooked up. Maybe you're a little too high, so the left row shows a green arrow on the "D" end. Now you're drifting still higher, see, now it's a red arrow—you'd better ease the nose down or the boom will disconnect. Good, you're back in the green. Now you're sliding back too far, see that red bar on the "F" end of the right row? That's it, add some throttle and pull forward.

As you can see, air refueling isn't easy. When it gets turbulent, the lights sometimes flash back and forth like a pinball machine. It takes tremendous flying skill to make the bomber follow the lights. But without them, refueling would be a lot tougher. ★ ★ ★

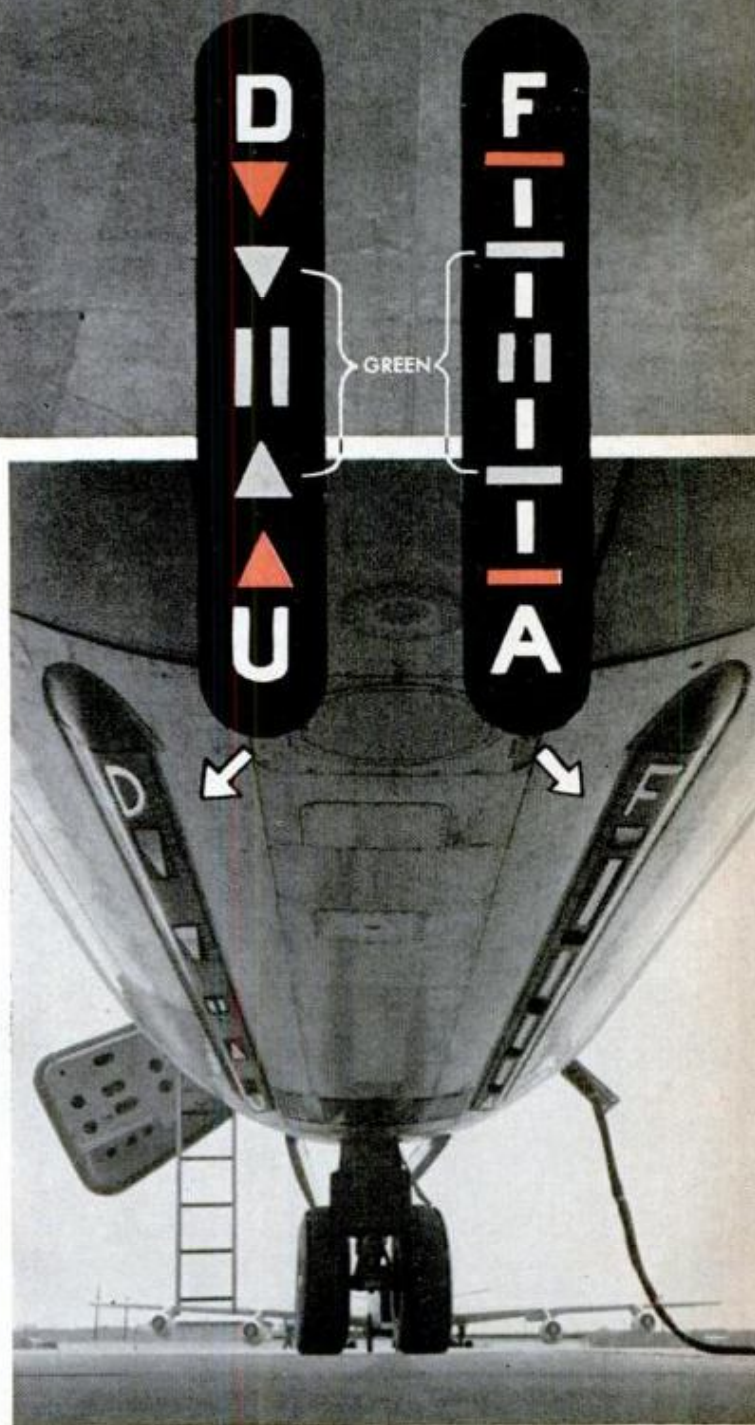



Space-Medicine Instruments

Miniature electronic instruments, about the size of a pack of cigarettes, are being used to record in-flight physiological data in space-medicine research. The small size makes the instruments especially valuable, since the subjects of experiments are less restricted in their activities and movements than with larger standard equipment. They are worn on a belt around the waist with a miniature battery box, providing an integrated system. Included are miniature electrocardiographs, phonocardiographs, respirometers, electroencephalographs and equipment for measuring body temperature.



Quicker by the Dozen

Edwin Gangwer invented a stainless-steel "multi-egg fryer" that can cook 12 orders of eggs at once. It consists of 12 rings mounted in a frame, with a cup set over each ring. Eggs are broken into the cups and a lever tilts the cups, emptying the eggs into the rings and onto the grill. When the eggs are done, the multi-fryer is lifted and quickly reloaded. Using 16 of them, Gangwer fries 2304 eggs in 23 minutes each morning. Now, why would anyone want to fry 2304 eggs every morning? Well, Gangwer is food-service manager in the kitchen of the Virginia State Penitentiary.



Fiberglas Foxholes

Atomic-age soldiers now have plastic-age foxholes to help protect them from nuclear blasts and fallouts. They dig their foxholes in the usual way, then wedge a Fiberglas cover on top of it. Atop the cover they throw about 18 inches of dirt.

☐ Making electricity from noise, a phono-power element can use automobile noises to supply all of a car's electric power except for starting, according to its originator, Electronic Development Company of Tampa, Fla.



Machine Prints Music

Descended from a typewriter-like machine that prints music symbols instead of the usual characters, an "electronic punched-tape musicwriter" simultaneously prints the music and punches computer tape which can later be used to turn out additional exact copies without any further manual operation. Its inventors, two college professors, also hope the tape can be fed into a computer which will extract individual instrument parts from an orchestral score. Other uses may be transposing music to another key, transcribing old music into modern, etc.



Minneapolis-Honeywell Regulator Co. photo

Radio Tracks Grouse

Six ruffed grouse are going about their daily lives in the northern Minnesota brush, unaware that they're taking part in a wildlife survey for the University of Minnesota. Each grouse carries an ultraminiaturized radio transmitter fastened to its back by a plastic harness. Movements of the grouse are being carefully tracked by two directional receiving antennas spaced a mile and a half apart on either side of the home territory. The transmitters weigh less than an ounce apiece, are powered by a tiny battery that will produce a nine-volt signal for 1000 hours.

Antenna Chamber

Odd in shape, but for a purpose, an unusual anechoic room has been built into Republic Aviation's new Farmingdale research center. To study the performance of radio antennas on space vehicles and advanced aircraft, models of the craft and their antennas are remotely turned in the 40-foot room while radio signals are beamed at them and an antenna-pattern measuring system records the results. The walls are lined with radio-wave-absorbing materials, and curved to cut reflections.

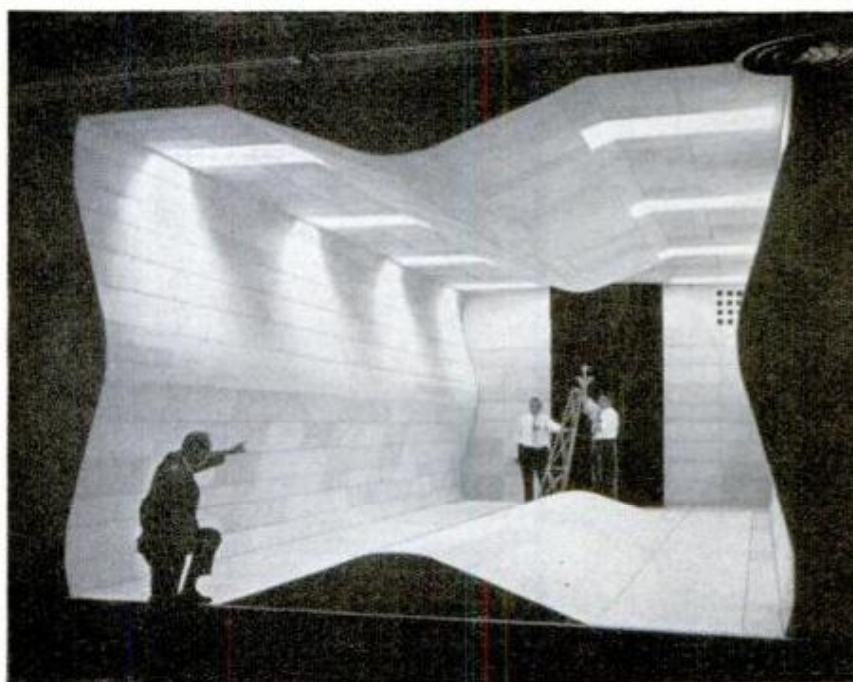

Rubber



By Dan Brogan

J. C. SCHULTZ, of Aberdeen, So. Dak., tried a dozen types of field decoys for goose hunting without finding one he liked. They were either too heavy or too bulky—he couldn't carry enough decoys when he took along a carload of friends—or they weren't natural enough to fool the real geese. So like a lot of do-it-yourselfers faced with an unsatisfactory product, he decided to try making his own.

The ideal material seemed to be rubber—inflatable decoys are light, easy to carry and handle, and don't take up much room when they aren't in use. Schultz bought some new raw rubber and started to experiment, but the price of the material made the decoys impractically expensive, so he tried using cast-off inner tubes, which he could pick up free at any service station or garage. Even new tubes, condemned because of a flaw, were available at little or no cost.

To get a pattern, he laid a freshly-killed Canadian goose on a piece of paper and outlined a two-piece pattern, but when he put the two halves together, the outline wasn't right—it bulged where it should have been flat and was flat where it should have bulged. Finally he skinned his "model," tanned the skin, and laid it out, cutting off sections and laying them out until he had a nine-piece pattern. In later experiments with mallard duck decoys, he worked out an eight-piece pattern for that size.

The first decoys, assembled with a cold-patch method and painted with decoy paint, were not a success. The seams wilted in the sun, pulling the body out of shape, and the paint, intended for wood or plastic, reflected so brightly that it frightened the geese. But vulcanized seams and rubber-base paint solved those problems, and his current decoys are so lifelike that they have been endorsed by Ducks Unlimited, a

Geese



waterfowl hunters' conservation group.

To make a decoy, Schultz first slits the tube down the center, lays it open on a flat surface, and cuts out the sections with a sharp scalpel. Then he joins the sections by vulcanizing a quarter-inch strip of raw rubber over the seams. When the decoy is assembled with the seam strips inside, the joints are all but invisible.

When all the seams are sealed, he inserts an inch-long piece of soft rubber tubing at the bottom, through which the decoy can be inflated by mouth. A cork is used to close the tube. On each side of the body he vulcanizes a one-inch length of stiff rubber tubing under a square of heavy sheet rubber, so it's open through the center. These fittings allow the decoys to be set up on shore or in shallow water by inserting foot-long sections of quarter-inch steel rod as legs, then planting the legs in the ground.

To get the different head and neck positions—feeding, resting and watching—nec-



Step one—cutting the pattern for half the neck and head section from an old rubber inner tube



Step two—seam edges are buffed and spread with solvent, then vulcanized with thin raw rubber strips

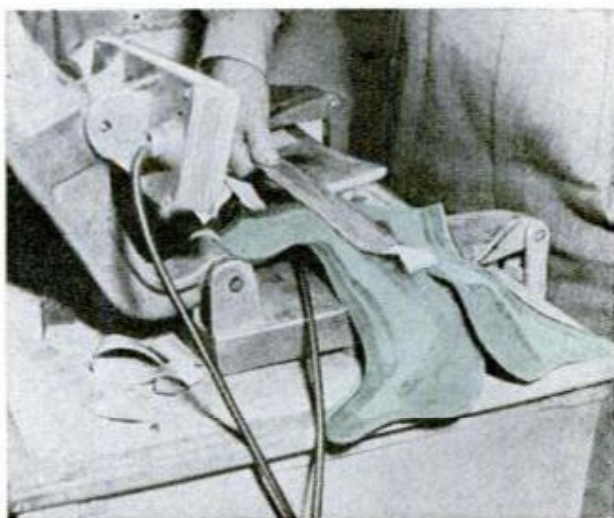

Rubber seam strips control the shape of the seam—if it's stretched before vulcanizing in place, it pulls the seam, and the rubber, into the desired curve



Vulcanizing takes about 15 minutes, and welds the nine cut-out sections into airtight shape. A short piece of quarter-inch tubing forms a simple valve

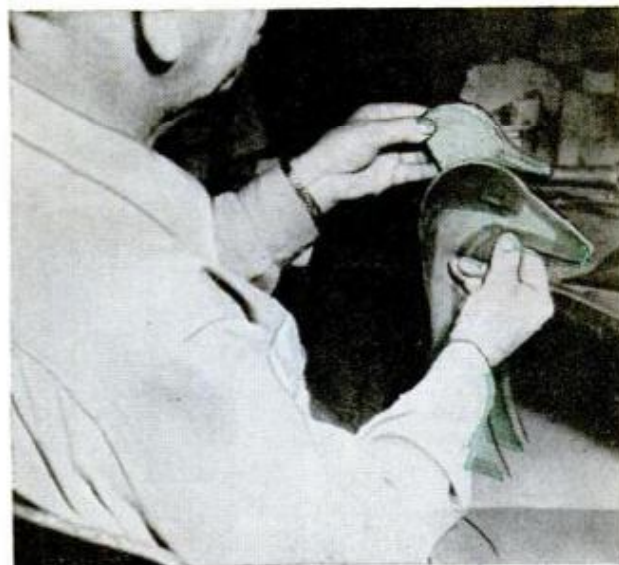

Mallard duck head presents a forming problem, so it must be carefully vulcanized over a wooden form

Painting in the feather pattern, Schultz finishes a goose that's hard to tell from the real thing



essary for goose decoys, he uses a slightly different pattern and forms them as needed while vulcanizing the neck seams.

To get lifelike eyes, Schultz uses a pot-metal eye mold which he built for the job. He places a quarter-inch square of raw rubber in each of the 12 sections in the mold, then turns on the heat and melts the squares into the mold. The perfect eyes are then vulcanized into place on the decoy's head.

One molding problem, in making duck decoys, was to duplicate the rounded bill and flat head of a mallard drake. To match that difficult shape, Schultz assembles the mallard head and neck section over a wooden form and vulcanizes the head over the form. When cooled, it pulls off like a rubber glove.

Once assembled and tested, the rubber decoy is ready for painting. He uses ordinary black and white rubber-base tire paint, with pigments added to produce the right colors. The biggest trick is to match the purple-blue-green iridescent color of a mallard drake's head and neck, but he finally worked out a formula that produces the difficult color every time.

The Canadian goose decoys are comparatively easy, since they're all grey, black and white. He paints the body first, mixing paint as he works from the light grey body toward the darker grey and black at the tail. Then he traces in the feather pattern on the breast, back and wings with white paint, then paints the molded eyes.

The "rubber geese" proved very successful, and also very popular with Schultz' friends and other hunters, and a market was created. Before he realized it, he was making decoys as a business. Until his recent retirement, he worked his hobby interest into a business with all the orders he could handle. ★ ★ ★

Inflated, they're full-sized model game birds, but deflated, these four would fit inside a shoe box





Mercury Astronauts Test Space Capsule for Water Landing

Lt. Comdr. Walter M. Schirra, one of the Project Mercury Astronauts, climbs out of a working model of the Mercury space capsule in the Gulf of Mexico during a recent

practice for water landings. Wearing his full-pressure space suit, Schirra is assisted by Astronauts Allen Sheppard, Virgil Grissom and a Navy frogman.

"Roundhouse" in Hangar Rotates Airplane

Unlike automobiles, a small airplane can be driven in only one direction—forward. It has no reverse gear, so parking is a problem. If it's taxied into a hangar, it must be hauled out tail first. A homemade "roundtable" solved this problem for three Kansas pilots. It looks like a grease rack, but

works automatically. When the nose wheel of the plane passes over a lever, it releases a spring catch, allowing the turntable to swing free. The force of the propwash on the rudder swings the plane around. Automatic catches stop the turntable after a 180-degree turn.



Shop Projects 1961

SHOP NOTES AND CRAFTS



Have Fun CREATING NEW ART FORMS

By Frank Tehan

ALL YOU NEED are a few pieces of colorful fabric, polyester resin and imagination to fashion art forms having a refreshing newness and a flair that holds the eye. Personalized gifts you can't buy anywhere, that drape-matching lampshade you've always wanted, a planter that compliments a special floral arrangement—these creations and many others are right at your fingertips with this simple process.

Polyester resin is usually sold for use

with Fiberglas cloth. But it's practical to combine this easy-to-work plastic resin with almost any type of cloth. Basically the resin is applied to cloth and allowed to harden. After that the cloth and resin hold their shape and retain the color and pattern of the cloth. Hardened resin is transparent and water and weatherproof.

The cloth may be scraps of clothing such as old sweaters, skirts, coats, even drapes. And by adding pigment to the resin you

MELTED PARAFFIN is brushed on all surfaces of the form which contact the resin-impregnated cloth. On this form the edges and the dowel ends are coated

POLYESTER RESIN is brushed on the cloth after it has been stretched tightly and taped to the underside of the form. Apply resin rapidly in an even coat

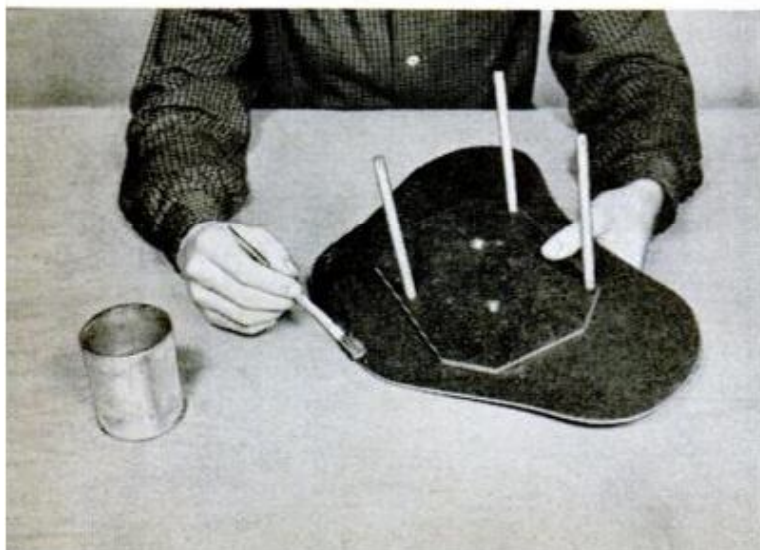

can change the color of the finished product. An addition of a small amount of pigment adds an interesting overtone.

The basic form is made of 1/8-in. hardboard and cut to the shape needed for a base. To this base, a slightly smaller piece of 1/4-in. perforated hardboard is bolted. The perforated hardboard makes an adjustable form in which one or more 1/4-in. dowel rods set. This completed form is reusable, and additional forms may be added to create unlimited variations.

Melted paraffin is brushed on the forms wherever resin might stick to them. On the form shown in the photo below the edges of the hardboard base and the ends of the dowels, which touch the cloth, are coated with wax. The cloth stretches over the pegs and under the edges of the hardboard to which it is taped.

Just before applying the resin, a catalyst is mixed with it in the proportion of 1/4 teaspoon of catalyst to 1/4 cup of resin. The mixing is done in a clean, disposable container that later may be thrown away. Resin should be brushed on the cloth soon after mixing. And after using the brush, rinse it immediately in acetone. Then allow the piece to harden for about thirty minutes. Once it is hard, the base is removed and all excess cloth trimmed off with a pair of scissors. Rough edges and other rough areas are sanded lightly to smooth them, and then the entire surface is wiped clean with acetone. An additional coat of resin may be applied to add more strength.

The bowl at the top of facing page is made in two sections, the form for both sections being circular and fitted with a single dowel. Cloth in the top section is black and white striped denim. For the bottom, a scrap of black wool jersey contrasts with the striped top. The two sections are held together by a wooden dowel, and resin is poured around the dowel. The simulated planter and lamp, shown at the right, is made from two forms, both using circular hardboard bases. ★ ★ ★

TRIM OFF the excess cloth after removing the form. The trimming should be done carefully, using a pair of ordinary scissors to form a smooth, even edge



WHITE PIGMENT is added to the resin before coating the cloth to make this three-legged, oval planter



THIS ATTRACTIVE PLANTER (below) is made by stretching black and white striped cotton jersey over a free form oblong base and three dowel rods

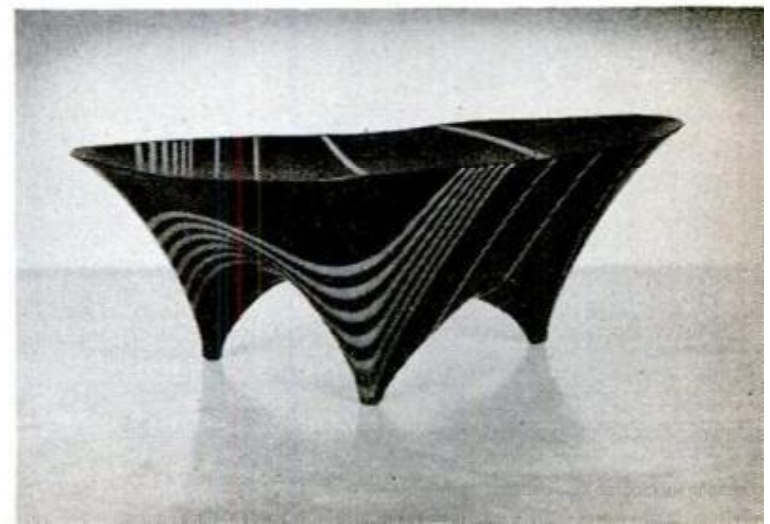



Removable Typewriter Shelf Fits Over Desk Drawer

My desk wasn't equipped with a pull-out shelf for a typewriter, so I cut a piece of $\frac{1}{2}$ -in. plywood to the width of the center drawer and wide enough to support my portable typewriter. Then I cut three 4-in. lengths of flat steel, bent one end of each up slightly, and attached them along the rear edge of the plywood shelf as in the detail. To use this improvised shelf I pull the center drawer of the desk out about halfway and place the shelf upon it with the projecting flat-steel lugs hooked under the rail.—Bob McPhail



Filing System for Duplicates Keeps Track of Keys in Use

Some folks have more key troubles than others, especially when it comes to keeping track of a good number of them. A good idea is to check them all over, making sure there is a duplicate for each. Now, put an identifying tag on each key and place them all on a ring in some safe place. If you hang a list of the keys you actually carry on this same ring, in the event you lose them you've only to check the list and select the corresponding duplicates.



Clothespin Is Marking Gauge For Fitting New Linoleum

When laying a new piece of linoleum flush against one already in place you can solve the problem of an accurate fit by using a wooden clothespin as a marking gauge. Cut a shouldered flat on one prong, and drive a brad just through the other prong, the projecting point aligning with the shoulder. Cut the new piece of linoleum slightly oversize and slip the pin over the edge. Then slide the shoulder of the pin along the edge of the old linoleum. The brad point will score a registering line on the new piece.—Burton L. Wollenzien



Stable Soldering-Iron Stand Made From Empty Coffee Can

No doubt it has happened to you at one time or another. You're intent on the soldering job at hand and in setting the iron down you either miss the rest or tip it over and end up with a scorched bench top. But, if it has happened once it need not happen again. Just take an ordinary coffee can and bend the sides in. You'll find that the can is big enough to spot out of the corner of your eye and is almost impossible to tip over.

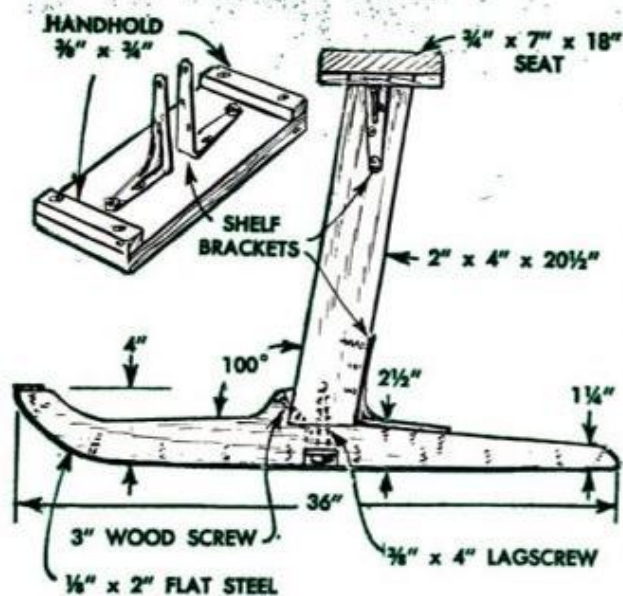

UNI-SLED FOR MORE WINTER FUN

If you like your snow-sledding rough, tough and fast as the wind then this jumper offers thrills that nothing else on runners can equal. The sled is designed for an adult or a teenager, but the height of the post should be cut so that the rider's feet rest on the ground when he is sitting upright.

Draw a full-size pattern of the runner

Ice Dams Along Gutters Can Cause Roof Leaks

Winter build-up of snow and ice often causes roof leaks. Ice dams form along gutters backing up trapped water which runs under shingles and drips into attic. Since the damage is caused by heat escaping through a gap in the attic insulation and melting trapped ice and snow, a thick

layer of insulation should be placed between roof rafters. By installing flashing along the eaves most of the water will run off. When leaks develop, cut channels in ice so trapped water can escape. Gutters can be cleared of ice by installing lengths of inexpensive heating cable.

*435 N. South Ave.
Elmira, N.Y.*

Sponge-Backed Sandpaper Fits Curved Surfaces

Contour sanding blocks make it easy to sand curved surfaces quickly and evenly. But lacking blocks that fit the curves you can always improvise by wrapping a piece of sandpaper around a common cellulose sponge. Mold the sponge in the hand to distribute pressure evenly over the curved surface. Bil Toman

¶ **Amusing toy** is improvised from transparent plastic typewriter ribbon box. Place four gummed reinforcements in empty box and replace cover. Holding box by edges, run finger rapidly around top a few seconds and then around bottom. Static electricity causes reinforcements to move and jump around.

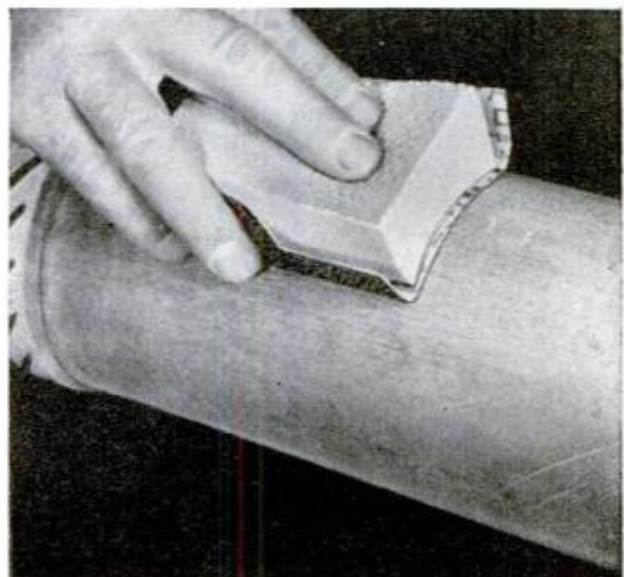

CONCRETE TIPS FOR



Early and Late Troweling

Strength, durability and surface-wearing qualities of concrete floors are determined when the floor is laid. It's important that the dry materials be correctly proportioned and that the specified amount of water be used in every batch of concrete. The mix must have just the right amount of coarse aggregate for maximum strength. A topping mix of cement and sand trowels easily to a very smooth finish but it does not wear well. Early troweling of any poured concrete mix brings the "fines" (fine sand particles and cement) to the surface along with a portion of the water content. This will result in dusting of the cured floor. Steel troweling should never begin until water sheen has disappeared entirely from the surface. Late troweling produces an impervious and highly wear-resistant floor that will withstand hard usage.

Waterproofing Block Walls

Waterproof masonry coatings, or paints, are widely used for the dual purpose of preventing seepage through concrete blocks and poured walls and also to serve as an attractive finish on the room side of the wall. When properly applied the waterproofing qualities of such coatings are unquestioned, but it is important that instructions for application be followed in all details. Nearly all instructions call for a thorough cleaning of the walls, especially old walls, before application. As a rule you also will be directed to wet the walls before applying the coating and there will be explicit directions for mixing the dry waterproofing materials. Of course, any cracks must be filled with a mastic filler made especially for the purpose of patching concrete walls.



Cleaning Concrete Surfaces

Cleaning is important in extending the useful life of any concrete surface, particularly floors. Periodic cleaning of floors subjected to hard usage removes not only the accumulation of dirt, but also picks up the grit which acts as an abrasive to accelerate wear. As a rule warm water and soap are best for a reasonably thorough job of cleaning. After washing, the floor should be rinsed off with clean water to remove all soap residues. Always sweep the floor before washing to get up the dust and any coarse grit. A floor-sweeping compound will control dust in basements and garages while sweeping, but don't allow the compound to stand for any length of time on the floor as the oil it contains may be absorbed by the concrete. Oil and grease stains on the garage floor usually can be removed by covering the spot with dry cement or hydrated lime, which will absorb most of the oil.

CONCRETE CARE

Hardener Prevents Dusting

One fairly common defect of concrete floors is continual dusting, which usually is caused by too early troweling. In this condition fine particles continually loosen from bond and appear on the surface as a fine dust. The use of a chemical hardener offers a fairly reliable remedy for this condition. The hardener consists of materials in solution which react chemically with the lime in the concrete to form a seal and to harden the surface. After cleaning the floor the hardener is applied by flooding the surface and spreading and respreading with a broom until the concrete has absorbed all of the liquid that it will. Whenever the liquid tends to collect in puddles, it is continuously respread with the broom for a period of an hour or more. Then any excess is mopped up and the floor permitted to dry for 24 hours. The application is repeated in the same manner.



Roll on the Paint

Painting makes a more attractive floor as concrete floor paints are available in a variety of colors. But it should be kept in mind that any paint will show wear much sooner than will the bare floor. Only in a recreation room or a game area, where appearance is important, is painting worth the extra effort required to apply it properly. Concrete floors should be etched before painting. This is done by applying a 10-percent solution of muriatic acid and allowing this to stand until etching action is complete. Then the residue is rinsed off thoroughly and the floor allowed to dry. Nearly all concrete floor paints can be effectively applied with an ordinary paint roller. It's much faster and far easier than applying with a brush and you get a much better job with no wearisome knee work if you use a handled roller.



Tiles Are for Plush Finish

Floor tiles can be worked into any decorative scheme as they are available in a great variety of patterns and materials. If you plan on tiling the concrete floor in the recreation room in your new home or you are pouring a new floor over old, be sure to tell your contractor what you plan to do. Perhaps he can save you some money as concrete floors which are to be tiled do not require the time and care in finishing. Concrete floors can be covered with asphalt, rubber, vinyl or linoleum tile but the floor must be dry and it must be of a construction that will remain dry. And be sure that you follow the manufacturer's instructions for laying tile below grade. You can get these very complete details on procedure direct from the manufacturer of the tile or from your local dealer in floor coverings. Tile can be used to solve a floor-dusting problem.



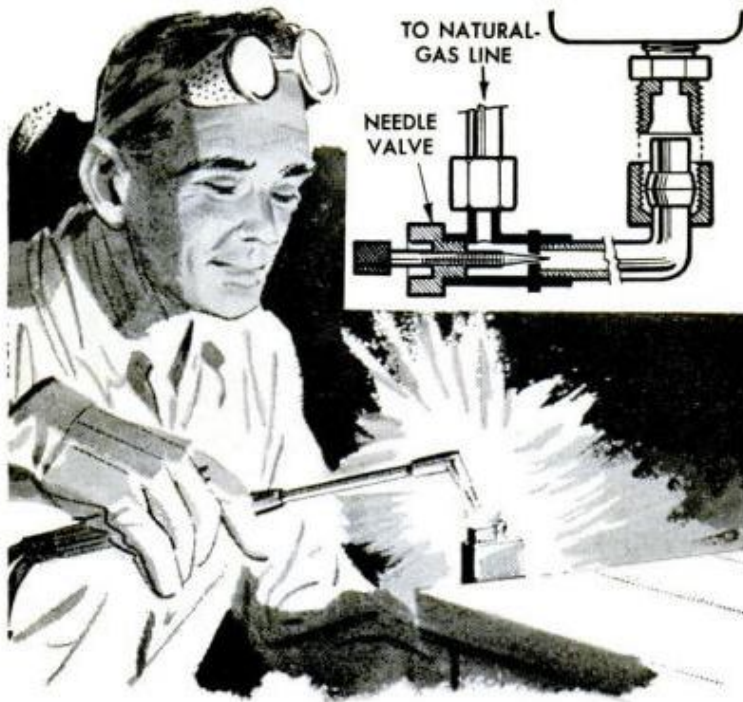

Gas-Fed Cigarette Lighter Reignites Solder Torch

Auto-repair shops specializing in radiator repair find that very often sweating parts together with a gas-oxygen torch will generate enough steam to extinguish the flame. Relighting it with matches takes time and patience especially if the repairman's hands are wet. To avoid this nuisance one shop owner fitted an outlet tube to the natural-gas line. One end of the tube is fitted with a needle valve. A cigarette lighter, minus wick and cotton, is secured to the other end with a compression fitting. When the flame-out occurs, a twist of the valve and a flick of the lighter and the torch is relit.

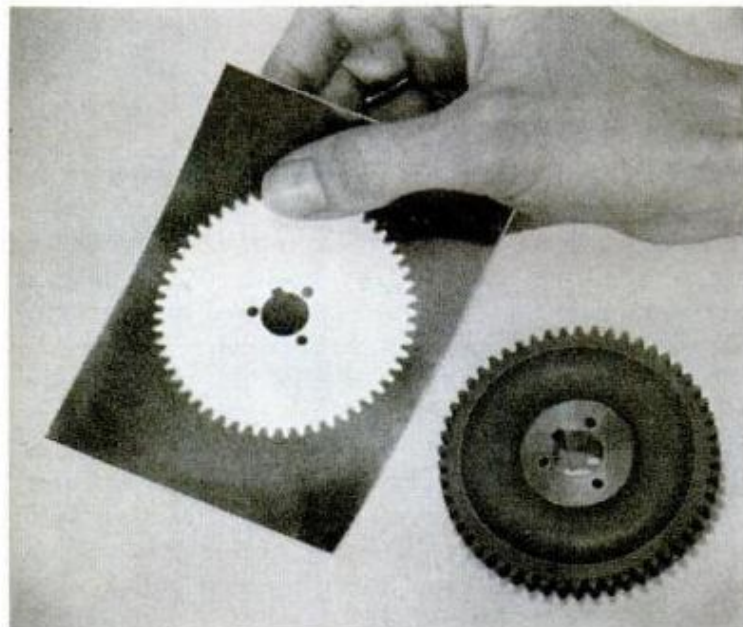

Red Photoproof Paper Prints Outline of Parts

Duplicating or matching the outlines of intricate machine parts is easy to do if you use a sheet of photographic red-proof paper to do the work for you. Place the part to be copied on the paper and expose it to sunlight until the exposed part darkens. The light should be direct and contact of part to paper must be good. The resulting "print" can then be cut out and pasted to the blank to be cut. Of course, you can use regular black-and-white contact paper for the same purpose, but it will have to be fixed and developed in the usual manner.—H. Hanscom

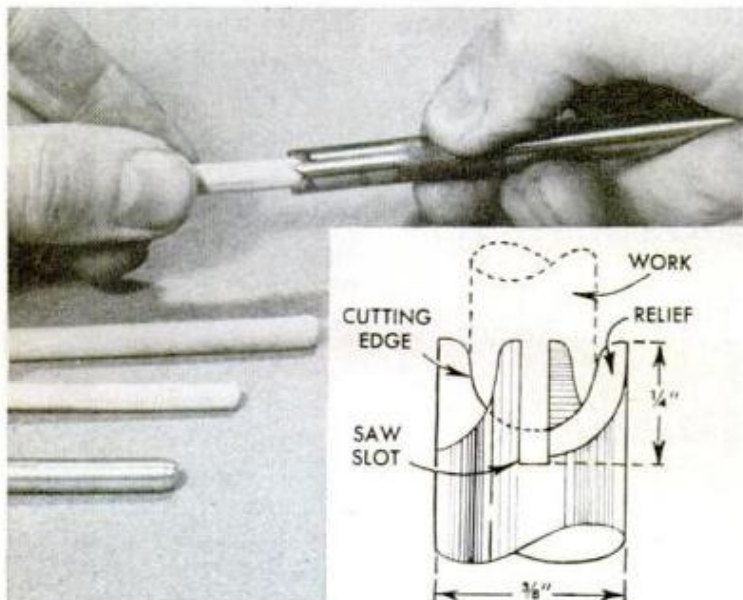

Small Hollow Milling Center Rounds Ends of Dowels

Essentially a hollow milling center with a semi-spherical cavity, this special tool can be used as a hand tool or chucked in a lathe or drill press to round off the ends of dowels or soft metal rods. A reamer to form the concavity is first cut from tool steel and is shaped exactly like the cavity to be made in the center. Flutes are cut in it and relief is ground on each edge. The center is then cut from a length of drillrod, the cavity is reamed out and two saw cuts are made across it at right angles. The rim is then filed to form the four cutting edges.

—H. Emerson Anderson

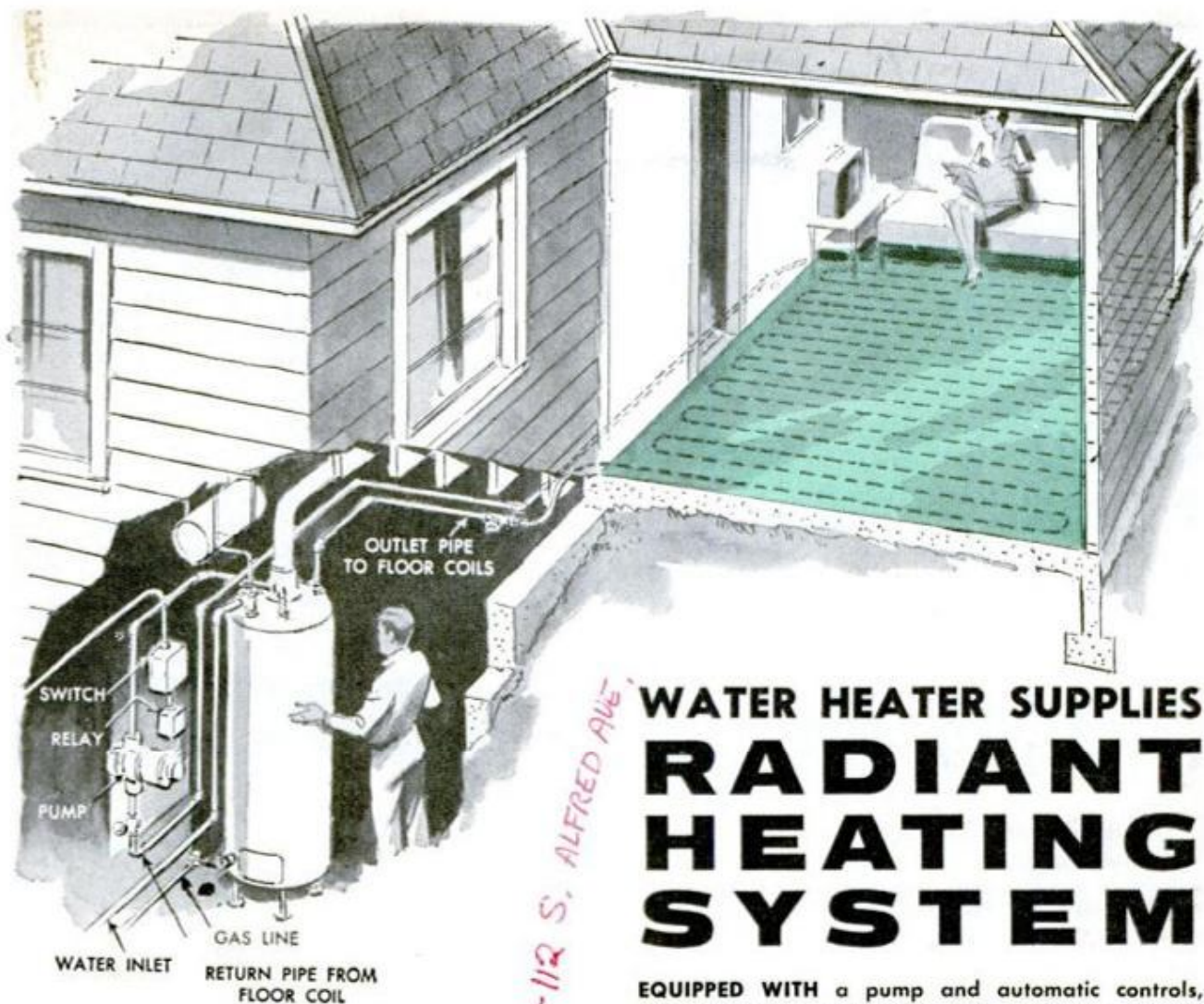

WATER HEATER SUPPLIES RADIANT HEATING SYSTEM

EQUIPPED WITH a pump and automatic controls, the system is practically self sufficient, providing inexpensive heat with a minimum of attention

IF YOU'RE PLANNING the addition of an average size room to your home and you're confronted with the problem of heating it, it might be worthwhile for you to consider how Jack Hintt of Elgin, Illinois, solved this problem when he found that his heating system wouldn't handle the additional load. The radiant heating system pictured and diagrammed was the solution. It's simply a radiant hot-water system in which a 40-gallon gas-fired water heater is used as a boiler. The radiant coil, or field, is made up of loops of $\frac{1}{2}$ -in. copper tubing with the runs spaced 12 in. apart. The system is completed with the installation of an expansion tank and a booster pump as you will note in the diagram. Operation of both the heater and pump is automatically controlled.

Of course, complete installation data cannot be included as there are variable factors to be considered and these will vary with each installation. In a colder climate such an installation as that described might not prove adequate in severe weather, especially if the exposure of the room is direct. But in a milder climate in a well constructed, well-insulated, one-room addition, it should give clean, uniform heating throughout the entire season.

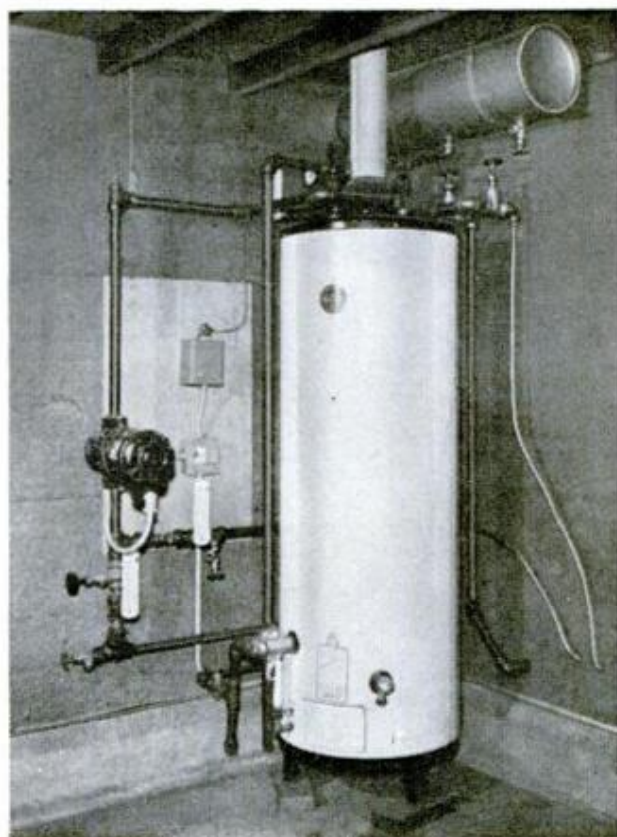



ROLL KEY FOR THE TOOTHPASTE TUBE will discourage those family members who insist on squeezing the tube in the middle. Make a saw cut in a length of 1/4-in. dowel, as shown, slip it over the bottom edge of the tube and roll up as toothpaste is needed

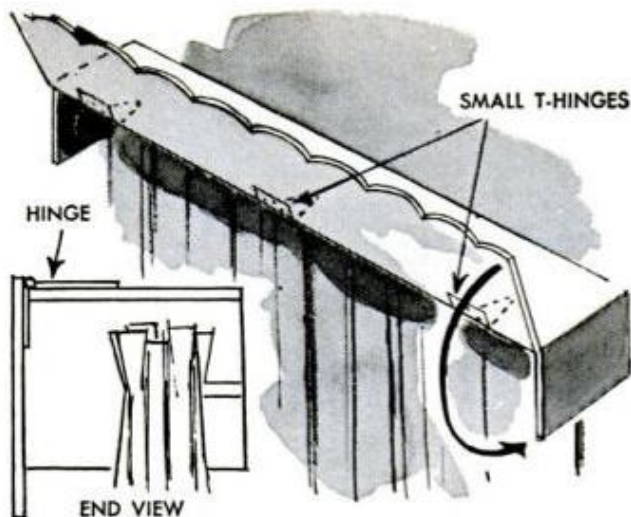

HINGES ON THE VALENCE will be a big help to the lady of the house when it's time to remove and rehang the drapes. Three small T-hinges at the top edge of the front panel will allow it to swing up to make it easier to hook the drapes in the rod

SOLVING HOME PROBLEMS

GOT A RUN IN YOUR NYLONS? Don't throw them away. A nylon stocking makes a fine polishing cloth for mirrors and windows. Unlike most cloth, nylon is lint free and won't leave particles clinging to the glass. Just dampen it, rub briskly, and watch the window or mirror come up to a high shine



RUBBER BAND

WILD PAINTBRUSH BRISTLES can be tamed if you take this little precaution. After cleaning the brush, slip a rubber band loosely over the bristles while they dry

DANDY PAINT BUCKET CAN BE MADE for small home jobs from a 2 lb. coffee can. Run the wire handle through the can so that it serves as wiper and rest for the brush

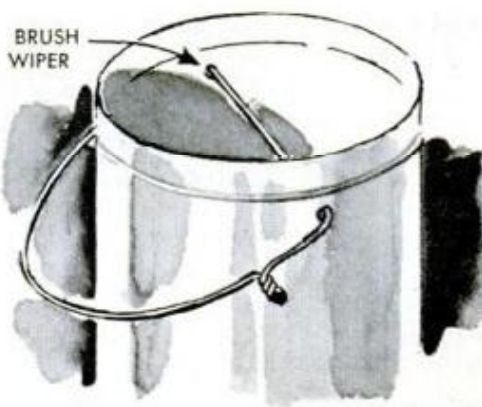

BRUSH WIPER

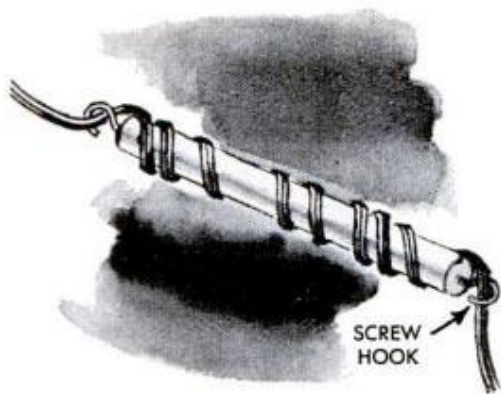

SLACK IN APPLIANCE CORD is taken up by using a section of $\frac{1}{2}$ -in. dowel and two screweyes. Wrap cord around dowel and slip it out through the screweyes on the ends

AVOID GETTING STICKY FINGERS prying open the slit of a rubber mucilage applicator. Next time you use it, slip a paper clip into the slit to keep it from drying shut



NEED A GOOD SIZED CLOTHES HAMPER? Then fetch that old radio-phonograph from the attic, remove the works and close back and bottom of cabinet. Front is dolled up by backing speaker grille with flowered wallpaper, a few holes in back will vent hamper

DISPLAYING MOTHER'S BEST CHINA needn't involve cutting a groove in a shelf. Rip a section from the grooved edge of a tongue-and-groove board and brad or screw it to the shelf as indicated

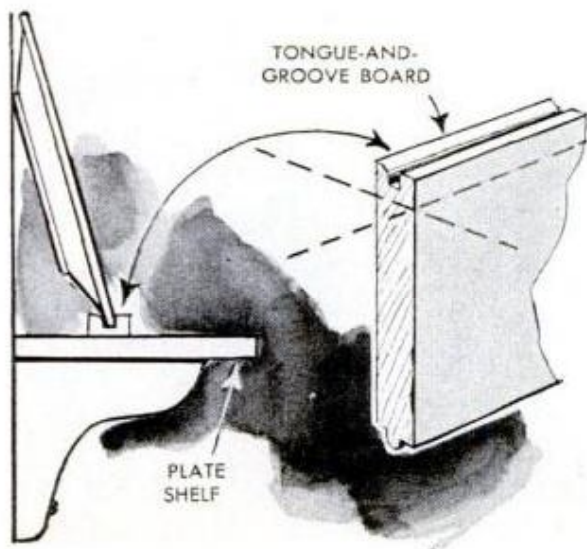

DON'T GET YOUR DANDER UP over a temperamental ball-point pen. If it refuses to write, run the tip of the cartridge through the flame of a cigarette lighter two or three times. Heat loosens caked ink, permitting the ball to roll and the pen to write again

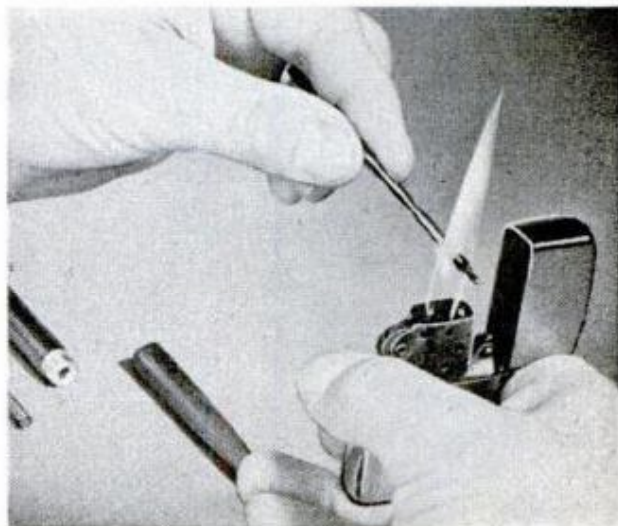

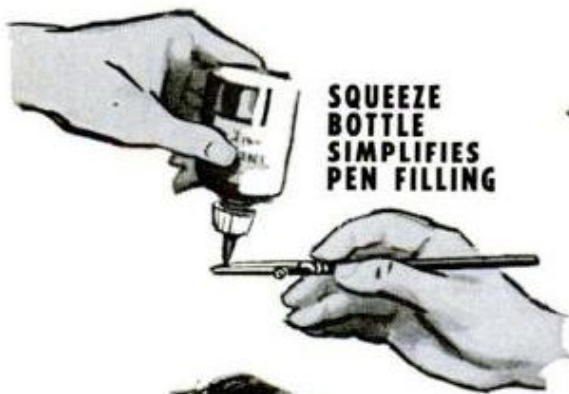
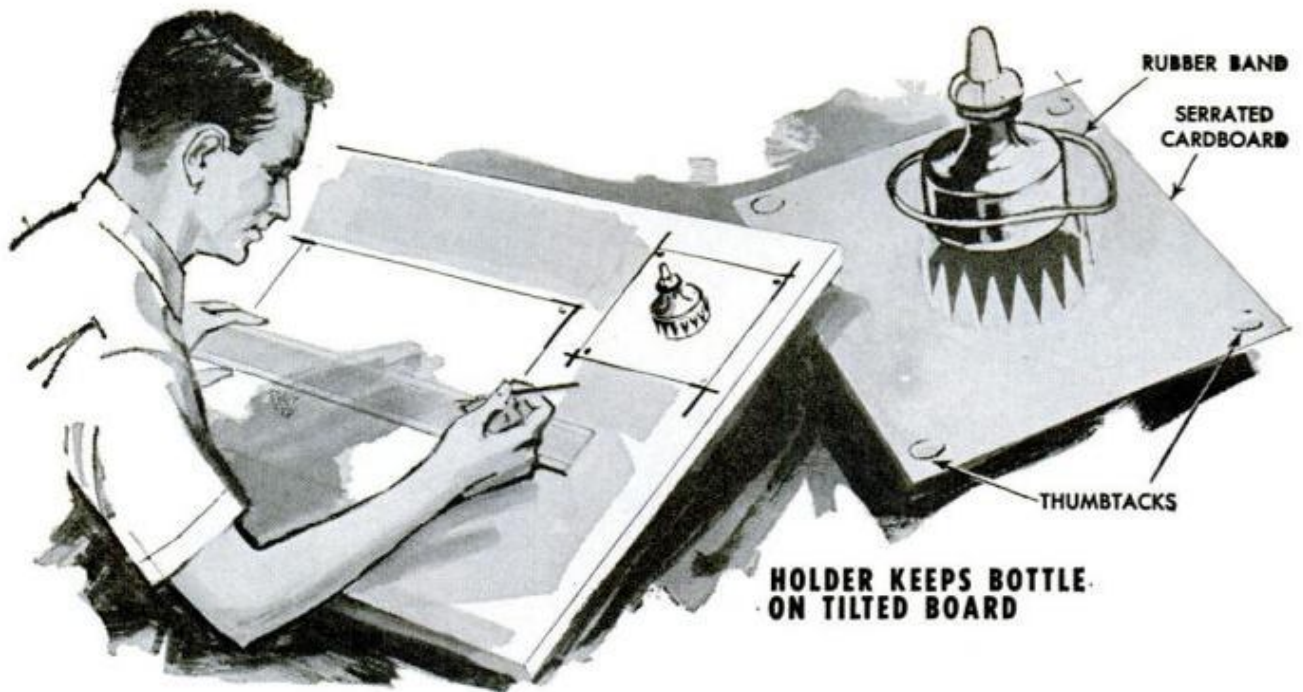

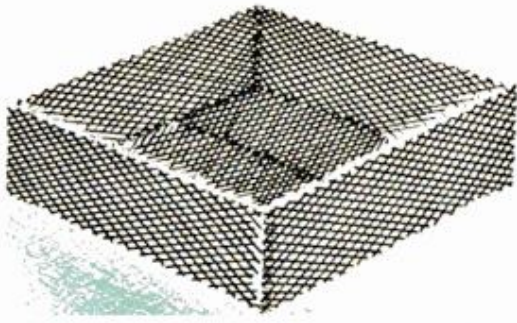

Wading Pool



Metal Lath Mfrs. Association

EXPANDED USES FOR EXPANDED LATH

METAL LATH just for plaster? You're in for a surprise. This lowly material, long used as a quality base for plastered walls, has shaken its original shackles and taken on a more versatile existence. For example, you can use it to fabricate a form for a plastered wading pool or sandbox. Expanded metal makes smart decorator mats for frameless pictures. It makes a dandy see-through floor for the garage attic which won't collect dust when the loft is used for storage. You'll find it useful as a tool panel over a workbench. Available in both rib and diamond types, metal lath comes pre-dipped with a protective paint coating, is readily shaped, formed and cut. ★★★

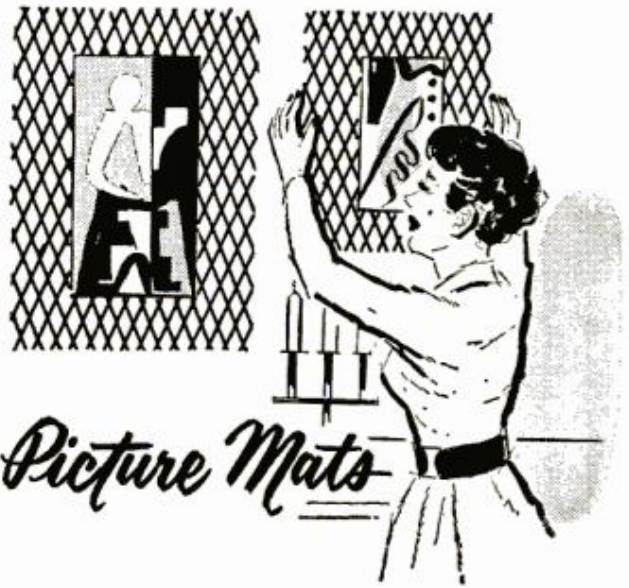

Picture Mats

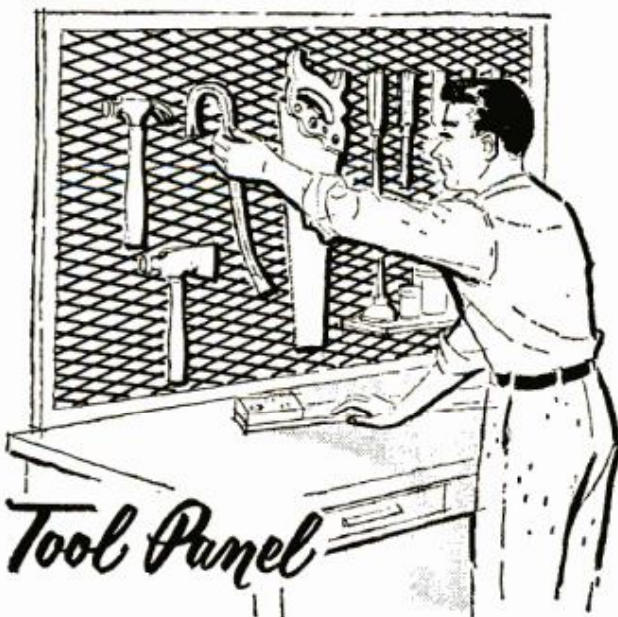

Tool Panel

Overhead Storage

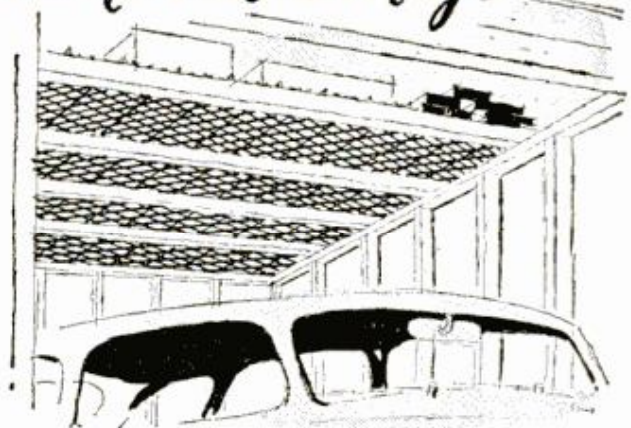



BY SELECTIVELY PRUNING a neighbor's hedge, you'll do him a favor in improving the hedge's growth and at the same time provide yourself with plenty of spring planting stock. Clippings should be taken from vigorous new shoots about as thick as a pencil and long enough to be cut into 5 or 6 sections of the proper size. These are then stored for the winter

GROW YOURSELF A

FOR THE HOMEOWNER interested in growing a fence as a part of a landscaping plan, here's a method of propagating from any existing hedge that costs next to nothing. Select one of the fast growing varieties and then, just before cold weather sets in, take cuttings from new growth on a well developed hedge. The cuttings should be about 7 to 9 in. long and $\frac{1}{4}$ in. in diameter, each shoot providing 4 or 6 cuttings. All you need now is a large bucket or tub of moist sand. Tie the planting stock in bundles, 4 to 6 in. each bundle, and bury in the sand in a horizontal position throughout the winter. Be sure the sand is kept moist

and at a temperature of between 33 and 55 deg. During this winter storage the cuttings will form "calluses" at the butt ends. Come spring, spade the hedge site to a depth of 7 to 8 in. and a width of 12 in. Use a large screwdriver to make holes for the cuttings about 12 in. apart. Be sure to plant the cuttings butt end down, leaving about 1 in. of the tip end exposed above ground. Tamp the soil firmly and keep it moist until growth starts. Waist high within two seasons, the privet grows at a tremendous rate and in 5 or 6 years will reach 12 to 15 feet, tall enough to give privacy plus.

—B. A. Roth

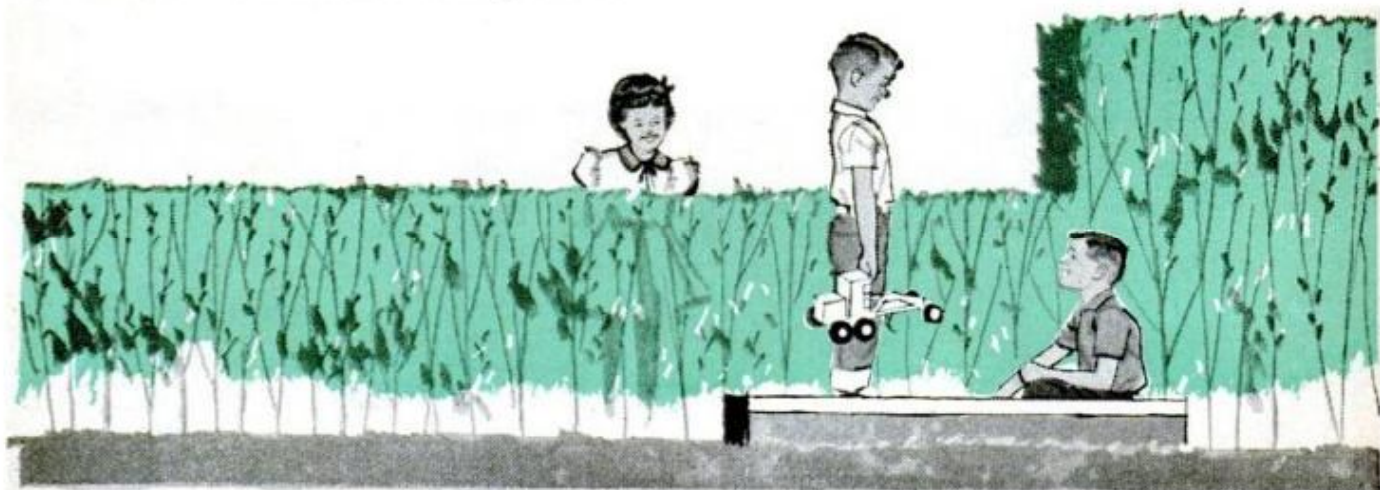

USUAL METHOD OF STORAGE is to tie the bundles of cuttings with the "butt" or rootward ends all facing one way and to place them in a tub of moist sand. Over the long winter months the ends will callous and the cuttings will be ready for planting. Be sure to keep a constant eye on the temperature to see that the dormant shoots don't freeze and die



FENCE

IN DECIDING HOW MANY shoots you'll need to clip and cut, figure on about one cutting per linear foot of hedge, and you might throw in a few extra for good measure in case some of them don't "take." Within a few seasons your "living" fence should be fairly thick and approximately waist high—ready for trimming as suits your particular needs and desires

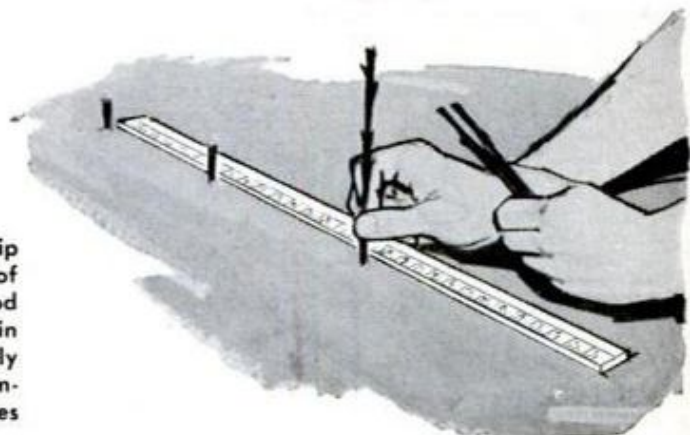

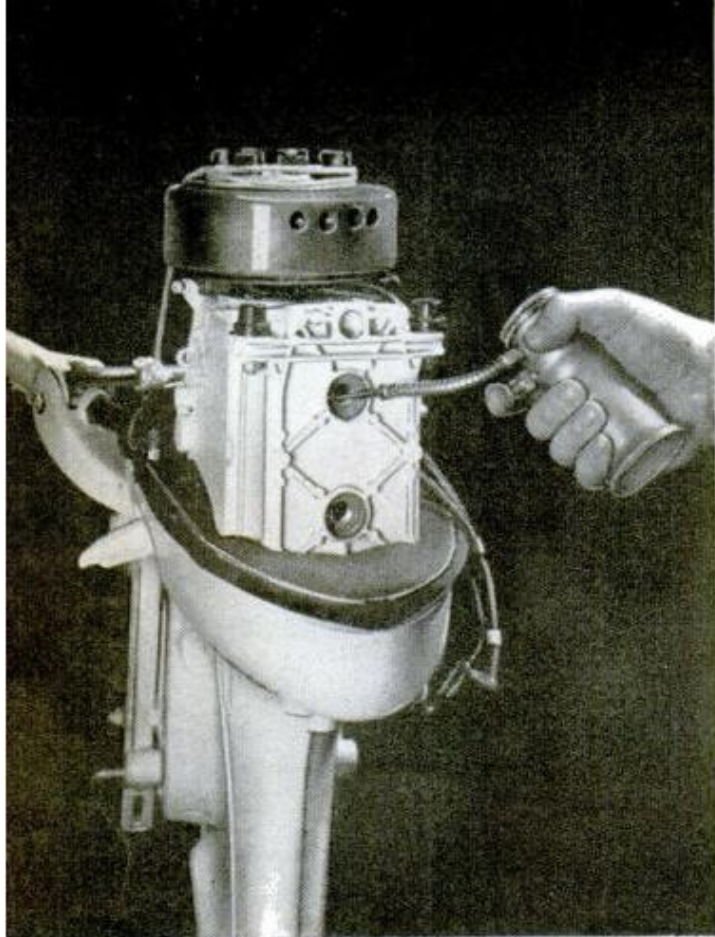

Mercury Outboard Motors photos

1. OIL SQUIRTED ONTO CYLINDERS through plug holes prevents rust formation on vital internal parts

JUST ONE HOUR of servicing at layup time will keep your outboard motor in the "pink" of condition, until warm spring breezes call you and your motor back into action again. Using the handy check list provided at the end of this story as a guide, there will be no slip-ups on important servicing and the work will be done before you know it. Clip the story and mount the list on a piece of hardboard for convenient check-off of items serviced.

2. CLEAN SEDIMENT BOWL and filter element assures constant delivery of clean fuel to carburetor

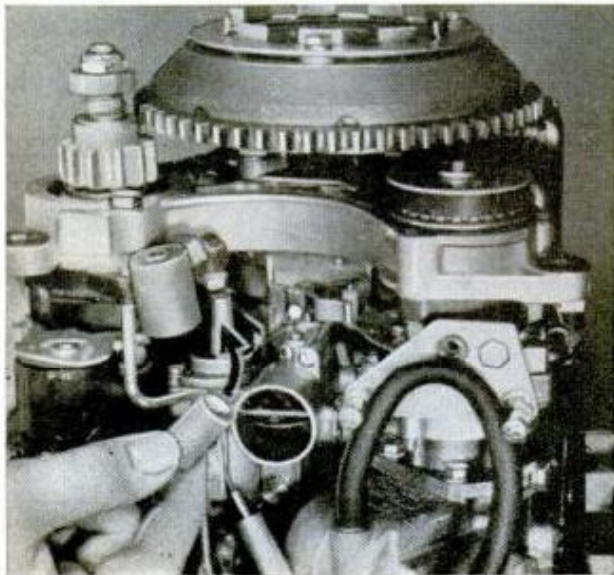

172

IT'S OUTBOARD LAYUP TIME

By Earl Wobeck

Boating Annual, 1961

Fuel that is allowed to remain in the motor forms harmful gum deposits, so this is the first item to be attended to. Disconnect the fuel line from the motor and run it while still in the water until all fuel is exhausted. Otherwise, lines and carburetor must be drained individually, entailing extra work in disconnecting them, and running the motor without coolant may overheat it. Next, flush the cooling system with clean water. Many motors of recent manu-

3. AFTER REMOVING GRIME and solidified grease from gearshift cam, lubricant is applied to joints

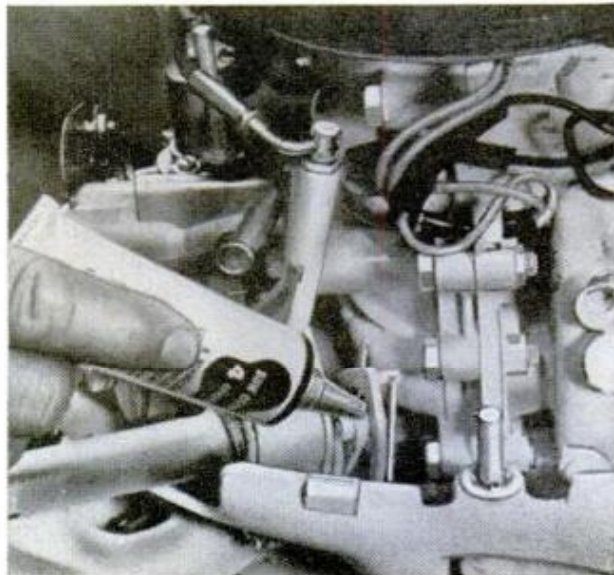

POPULAR MECHANICS

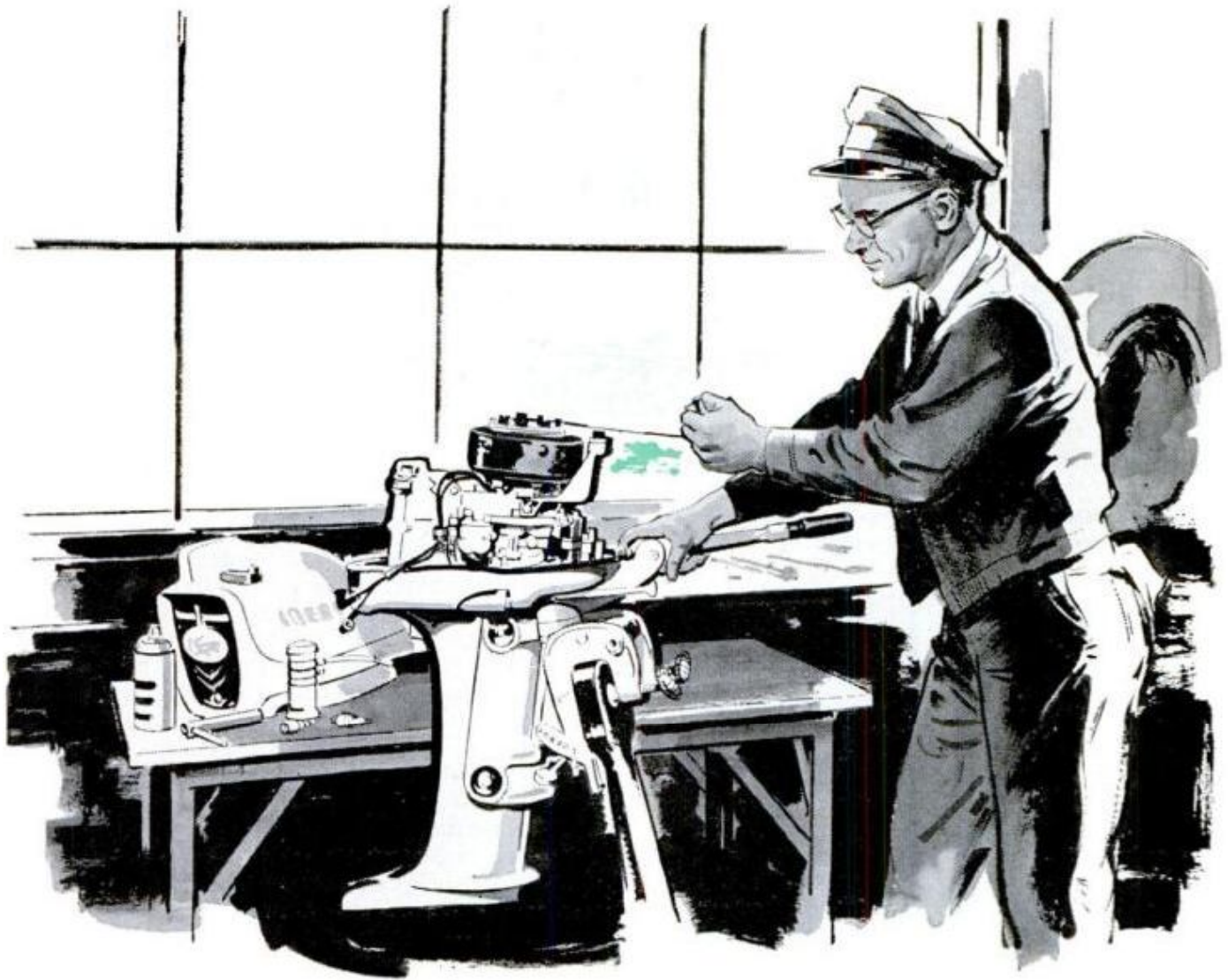

facture have a hole in the upper pump body marked, "water flush," for insertion of a hose nozzle. If your motor has no flush hole, the easiest way to do this is to tilt the lower unit into a clean garbage can filled with water, and while the motor is

4. CONTROL LINKAGES get protective coat of lubricant, after brushing them clean with gasoline

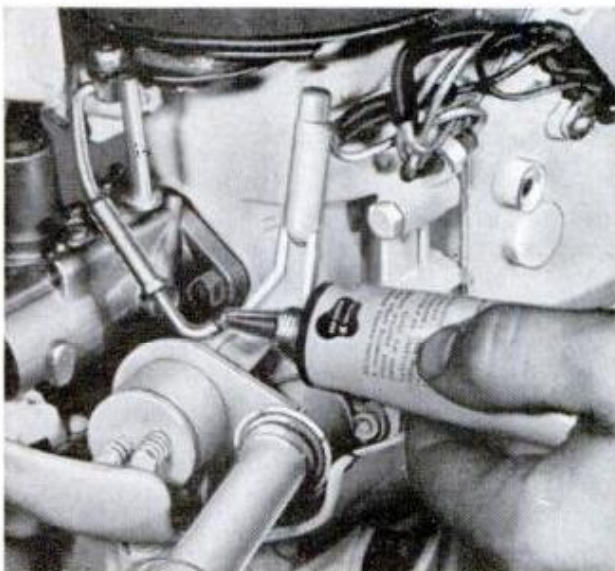

NOVEMBER 1960

still on the boat, run it for a few minutes. If the latter is done, it affords a good opportunity to exhaust the fuel supply in the motor at the same time, completing two servicing items at one time. After the motor has stopped, the water remaining in

5. LOWER UNIT OF MOTOR should be drained completely, then refilled with outboard gear oil

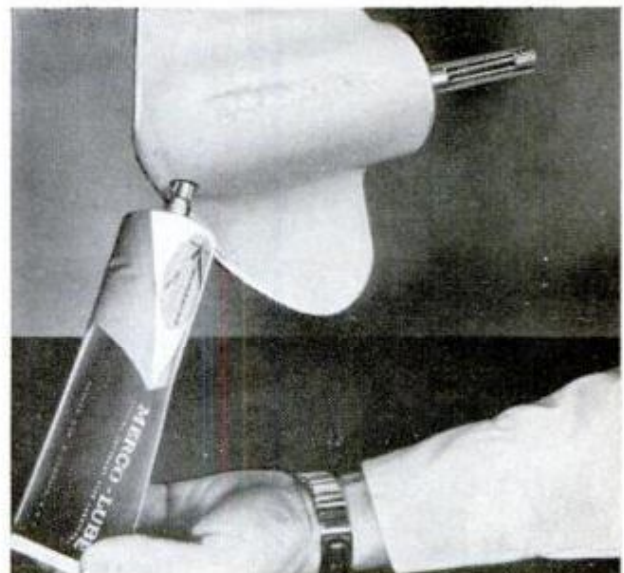

173

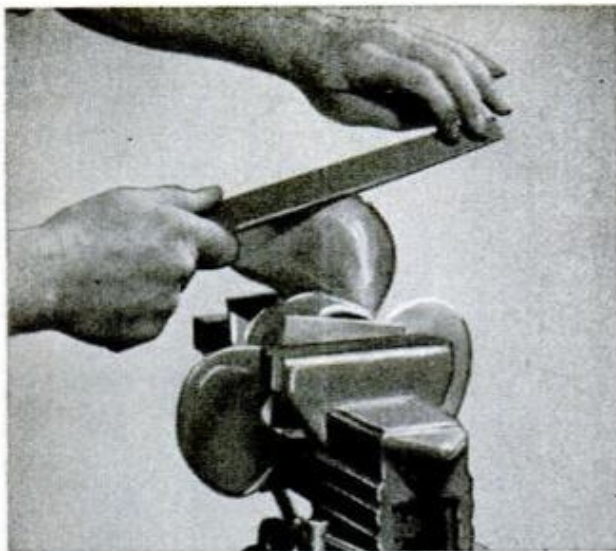

6. SMALL NICKS AND BURRS on propeller blades may be dressed down by outboarder, using metal file

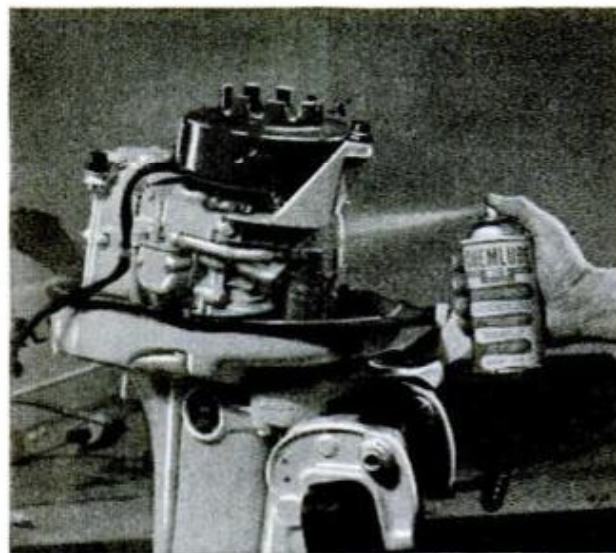

7. SPRAY COAT OF SILICONE LUBRICANT on external parts shields them from moisture in atmosphere

8. WORN GASKET ON FUEL-TANK CAP lets in dirt and unwanted air, should be replaced when compacted

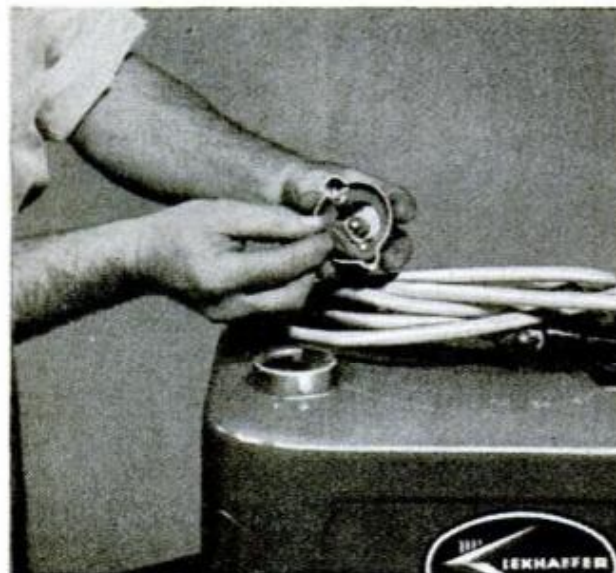

it is expelled by rotating the flywheel manually, with the motor in an upright position. This is an important step, as water left in the powerhead and water pump will corrode these important parts and cause irreparable damage if exposed to freezing temperatures.

The next step is to remove the motor cover, brush and wipe accessible parts clean with a solvent. Gasoline is ideal for this, as it leaves an oily film to protect the parts from rust. Apply thin grease to remote-control linkage joints, levers, bushings and other exposed moving parts as in Figs. 3 and 4. Some motors have pressure fittings, so don't overlook this part of the grease job. Check for loose-fitting joints and bent levers, which should be replaced if they cannot be made to operate properly.

Propellers seldom get through a season's use without running afoul of some sort of underwater obstruction, resulting in nicked or bent blades. Small nicks and burrs may be dressed down with a metal file by the outboarder, Fig. 6, but the repair of bent blades and other more extensive damage should be left to the professional repairman.

It's a good idea to remove grime and hardened grease from the propeller shaft before replacing the propeller to prevent it from becoming "frozen" on the shaft. Simply rub the metal to a bright finish and apply waterproof grease as in Fig. 9. Then you'll have no trouble removing the prop when the need to do so arises.

To complete servicing of the lower unit, drain and refill it with fresh gear lubricant, Fig. 5. When doing this be sure to remove the air-vent screw located above the filler plug to prevent entrapment of air. Grease must be forced into the gear housing until it starts to flow from the vent hole, indicating the cavity is filled. Before replacing the vent screw and filler plug, make sure the gasket under each is in place, otherwise water may leak past the threads into the gear housing.

Servicing the main, upper portion of the motor is next. While this sequence need not be followed, it is arranged to expedite the work with a minimum of backtracking. The spark plugs should be removed first, cleaned and regapped if they still are in good condition. If bad, tag for replacement next spring. If the motor has performed unsatisfactorily previously and the plugs and carburetor adjustment are in order, take it to your dealer for a compression test, magneto inspection, breaker-point adjustment and possible carburetor cleaning. The trouble also may be in damaged or worn internal parts, the diagnosis of which can best be done by a factory trained mechanic having adequate equipment and facilities at his disposal. Consider money spent for

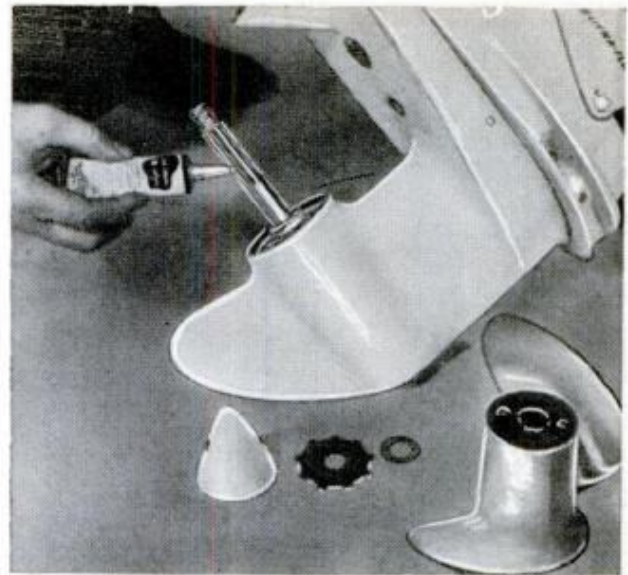
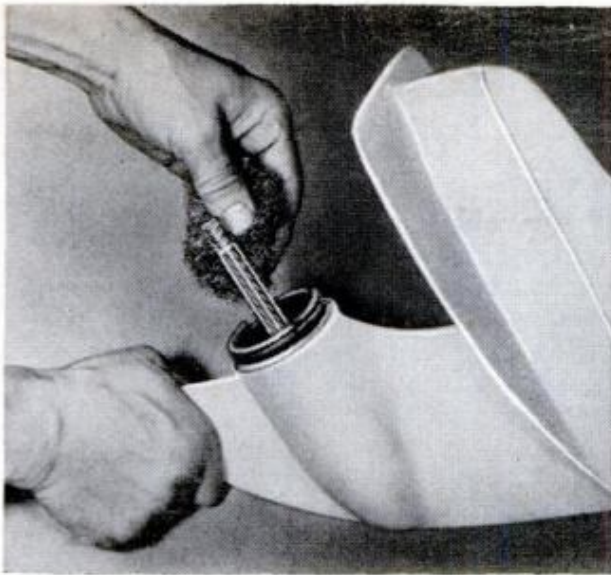

9. AFTER GRIME IS REMOVED from propeller shaft with steel wool, it is given a protective coat of water-resistant grease, making it easy to slide the propeller off the shaft the next time it must be removed

such service well worth the hours of trouble-free boating you will have next season.

With the spark plugs removed, squirt several drops of lubricating oil into the cylinders through the plug holes as in Fig. 1. At the same time, inject oil directly into the carburetor through the air silencer. Then rotate the flywheel to distribute the oil over these vital internal parts. Use #10 oil for this purpose. Next, remove the carburetor sediment bowl and wipe it clean. Agitate the filter element, Fig. 2, in a can of clean benzine and reassemble it on the carburetor.

Most motors are operated with remote fuel tanks, which also require periodic inspection. The tank should be checked for loose fittings, damaged or missing parts and worn filler-cap gasket, Fig. 8. The latter, if badly compacted, will let in dirt and allow the fuel to evaporate which causes formation of gum deposits that clog car-

buretor jets and coat the combustion chamber.

Scratches in the motor and fuel tank's finish invite rust and make them appear shabby, reducing the value of the equipment in the event resale is contemplated. Paint touch-up is an easy job if it is done at least once a year. Feather out deep scratches with fine-grit sandpaper and re-touch the finish with matching paint applied from a spray can. After the paint dries, spray all exposed surfaces of the motor with a silicone lubricant as in Fig. 7 and cover it. The motor should be clamped to a rack in a dry dust-free area.

If your motor is equipped with an electric starter, test each cell of the battery and keep it on trickle charge during the winter months. Your outboard dealer will do this for you at small cost if you don't have a charger. Having put your motor to bed well cared for you can relax and look forward to another happy boating season. ★ ★ ★

PM'S OUTBOARD MOTOR LAYUP CHECK LIST

1. () Remove fuel from tank and start motor to use all fuel in carburetor and lines.
2. () Give cooling system good flushing. Expel all remaining water from cooling system by rotating flywheel manually.
3. () Remove motor cover and clean accessible parts.
4. () Apply grease to remote control linkage joints, levers, bushings and other exposed moving parts. Check for loose-fitting joints and adjust, if possible. Replace worn parts.
5. () Remove propeller, clean and coat shaft with waterproof grease.
6. () Dress down nicks and burrs on propeller with file. If badly damaged, tag and send out for repair.
7. () Drain lower unit and refill with fresh gear lubricant.
8. () Remove plugs, clean and regap. If bad, tag for replacement next spring.

9. () If motor has given poor performance previous to layup and plugs are good, take it to dealer for carburetor cleaning, magneto inspection and breaker-point adjustment.
10. () With plugs removed, squirt several drops of oil into cylinders, also directly into carburetor through air silencer. Then rotate the flywheel to distribute the oil.
11. () Remove carburetor sediment bowl and wipe clean. Flush fuel filter element in clean benzine.
12. () Inspect remote fuel tanks for leaky gaskets, worn fittings, damaged hose.
13. () Clean all painted surfaces and re-touch scratches and nicks with matching paint from spray can.
14. () Cover motor and store it clamped to rack in area free of dust and moisture.
15. () Test battery and keep on trickle charge during layup period.

WRAP-AROUND

By Albert E. Helland

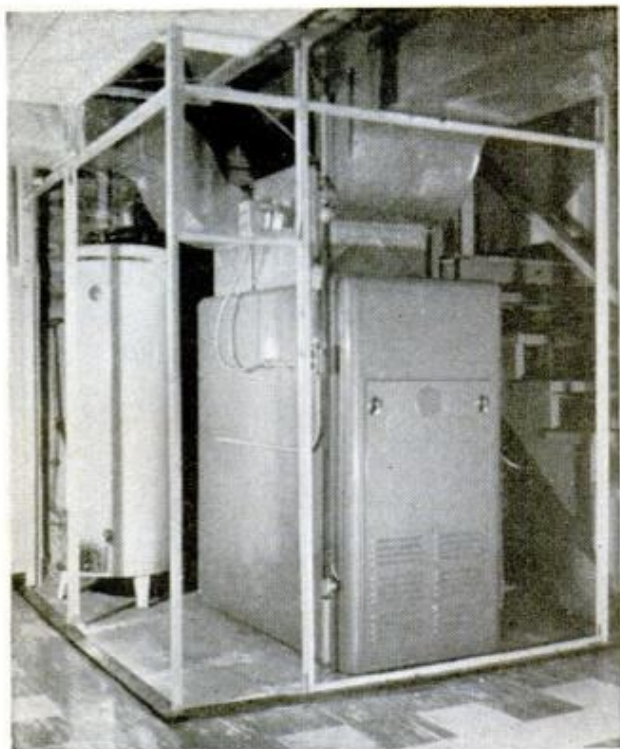

LIGHT FRAMEWORK of 2x2s is all that is needed to support the stone-covered panels of the fireplace wall

THERE'S ALWAYS the problem in an open basement of hiding the furnace and water heater from view when one section is used as a recreation room. The usual solution is to build a separate utility room enclosed by permanent walls. But one family solved the problem by building a false fireplace wall around the furnace and water heater which not only concealed the equipment, but added a conversation piece.

To begin a 1 x 3 or 2 x 4 sole plate is anchored to the floor. If the plate is rabbeted to hold the panels, the groove should be cut first. Otherwise quarter-round molding is nailed to the plate to form a groove. The plate can be nailed to the concrete floor with nails made especially for the purpose. If needed, a top plate should be fastened to the ceiling joists, and studs are spaced to support the edges of the panels on centers. Although the framing

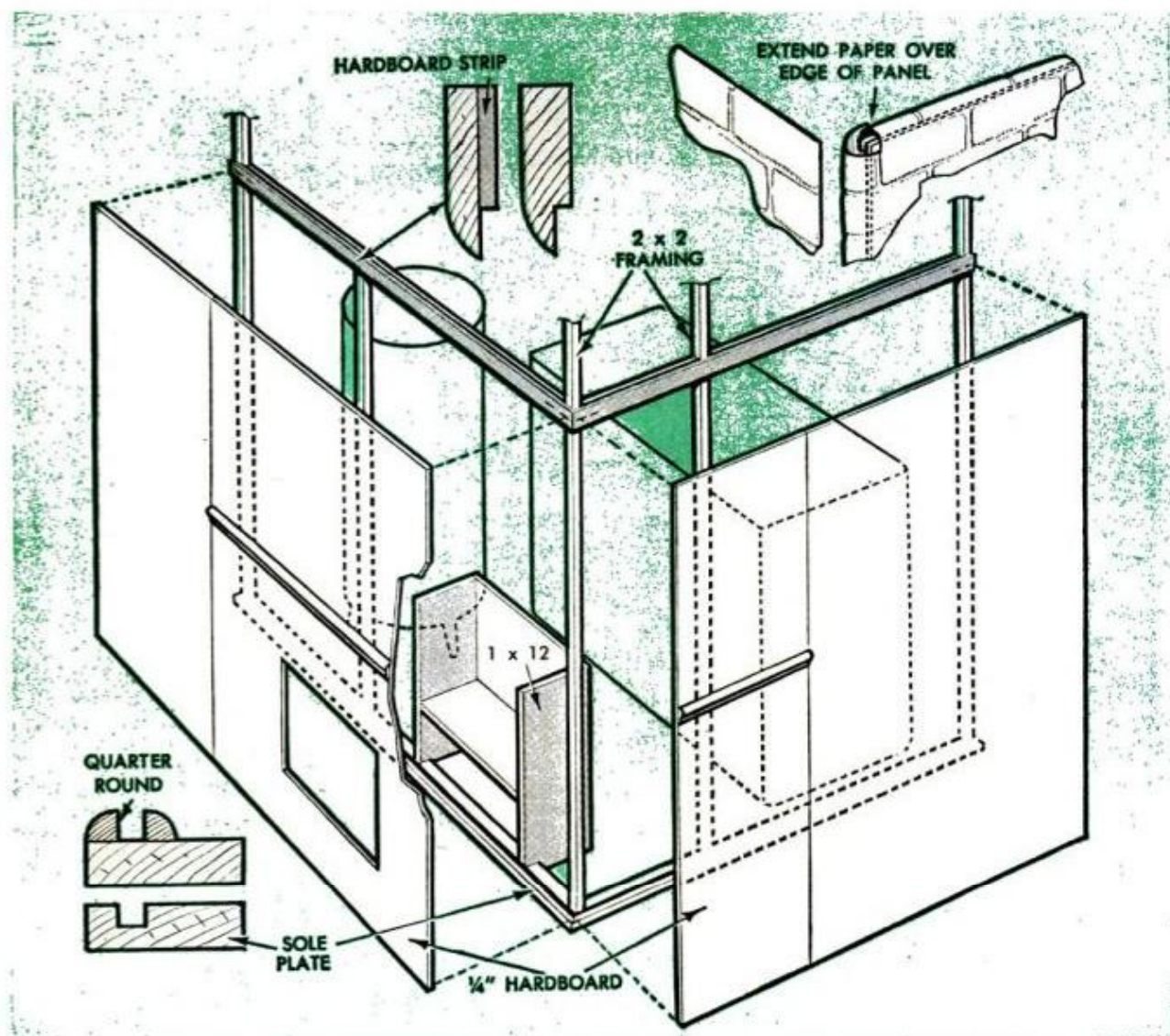

WALL HIDES FURNACE IN RUMPUS ROOM



FIREPLACE WALL hides the utilities that otherwise would be an eyesore in the basement recreation room

studs can be toenailed to the plates, metal angle brackets and screws were used to hold 2 x 2 studs in the original installation, making it easy to dismantle the enclosure at some later date should the furnace or water heater need replacing or extensive repairs. For the periodic job of changing furnace filters and draining the water heater, only a single panel need be removed.

At the top, a wide molding holds the panels in place. Here you can either cut a 1/2-in. rabbet in the molding or use hardboard backing strips to form the rabbet as detailed. The molding is nailed to the top plate at the ceiling line.

Hardboard or plywood panels are cut to the correct size to form the walls. To install, the panels are inserted into the 1/2-in. groove, the molding at the top, and are then dropped into the 1/4-in. groove in the sole plate. Finger holes are drilled in the bottom of each panel to make it easy to lift it out. The fireplace opening is a rectangular opening cut in the paneling, and behind this opening is a boxed-in area forming a raised hearth. The box is open at the top to represent a fireplace flue and to supply combus-

tion air for both the furnace and heater.

The wall panels and the fireplace pit were finished with a self-adhesive paper in a stone design. The paper wraps around the edges of the individual panels and the latter merely butt at the corners. A covering of a different color was used to set off the fireplace. Molding, nailed to the panels, suggests a fireplace mantel. An electrically lighted log sits in the fireplace to add a bit of realism. Then when a "fire" is desired the light is plugged into an outlet.

For a more realistic looking masonry wall, a brick or stonelike covering is available which is embossed to give an authentic three-dimensional appearance. Made of plastic, it is cemented in place on the panels and is exceptionally durable. It comes in different colors and in stone and brick patterns and is available in panels of about seven square feet. A special adhesive in tube form is run along the back of all simulated mortar joints, after which the plastic sheet is pressed against the wall and the mortar joints rubbed with a blunt tool to insure proper contact. The plastic is easily cut with scissors. ★ ★ ★

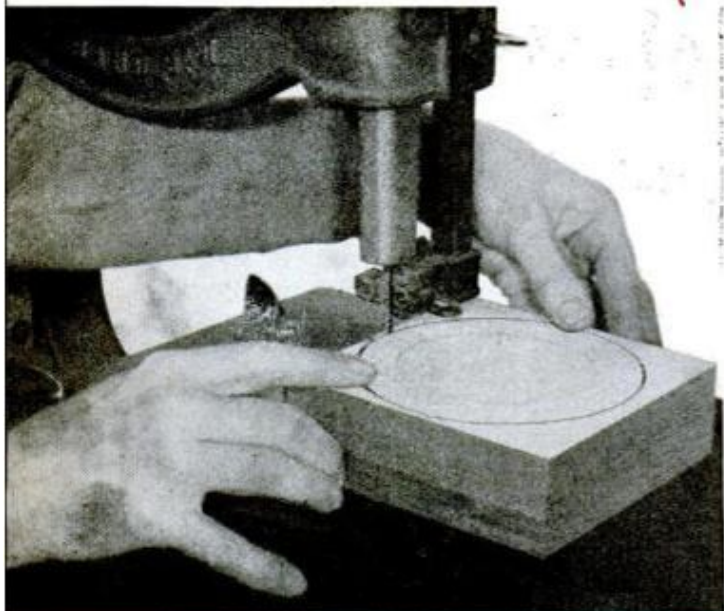

HOUSING FOR MOVEMENT is a glued-up plywood sandwich which is bandsawed round with circle jig

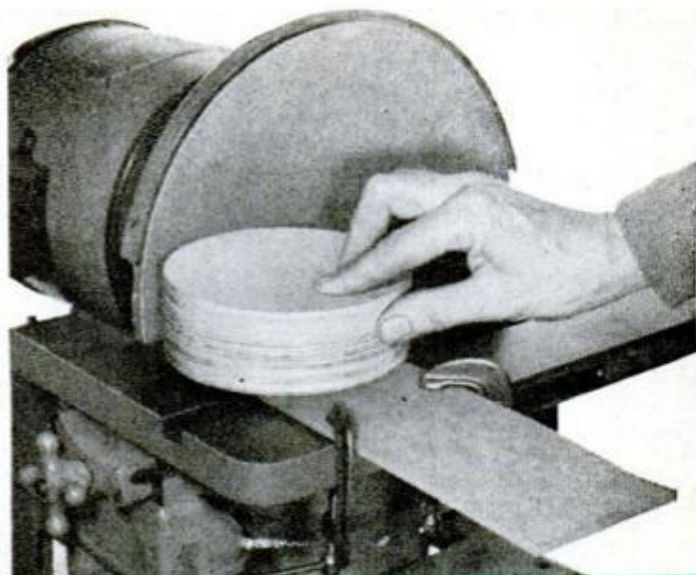

SAME IMPROVED JIG is used to sand bandsawed blank round. Nail point in hole in hardboard forms jig

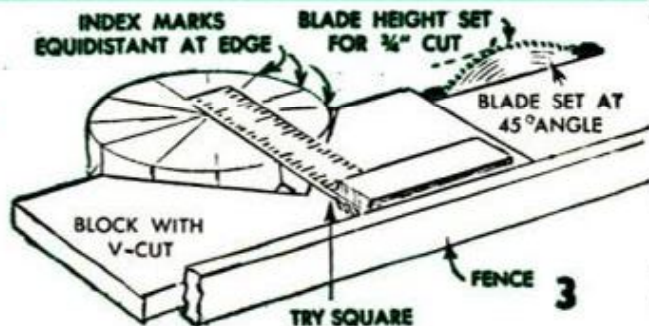
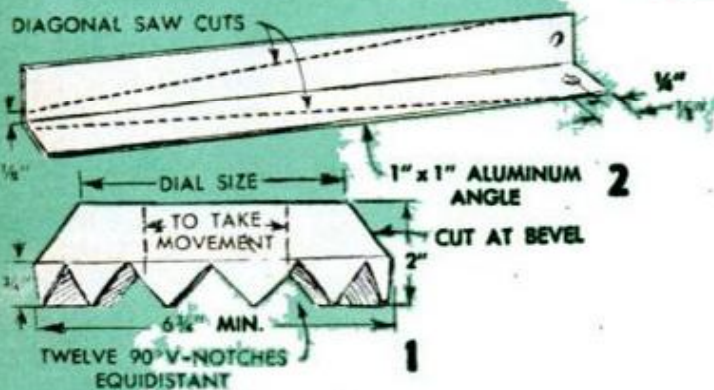

HANGING DECORATOR

By E. R. Haan

THERE'S NO limit to the design possibilities of fascinating wall clocks that you can make at a fraction of the cost of comparable ones on the market. They can house either electric or spring-wound movements which you may have salvaged from broken or obsolete cases.

As most clock-case designs of the kind shown are circular, they are built on a plywood core or housing which encloses the movement. The size of the housing varies with the size of the movement and the kind of ornamental work to be added. The method of holding the movement in the housing also varies. These details should be worked out first. Many movements will require a housing about 2 in. thick, which can be built up by gluing together pieces of plywood. The outside circular cut of a housing can be bandsawed and the inner one scrollsawed.

Typical procedure in making a housing is as follows: First scribe both circles, prickpunch the center and drill a small hole here to take the cut-off end of a nail. The latter should project about 1/8 in. and serves as a pivot for sawing and sanding. The pivot engages a hole drilled in a piece of hardboard which you clamp to the table of the machine. The pivot hole should be on a line at right angles to the cutting blade and flush with the tooth tips. After bandsawing the outside circle, the cut edge is sanded smooth on a disk or belt sander, again using the pivot to rotate the work. The scrollsawing of the inside circle is always done last.

About the simplest novelty case to make is the spoke-and-sphere type, Fig. 6, which is especially suitable for kitchens, dens, playrooms, and children's rooms. Assembly details are given in Fig. 4. If the clock is

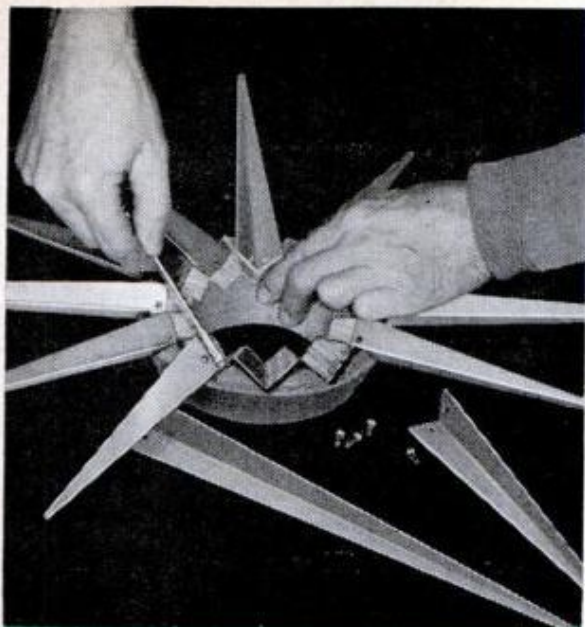

RUBBER TAPE placed around outer edge of V-cuts provides shim to tip the spokes upward

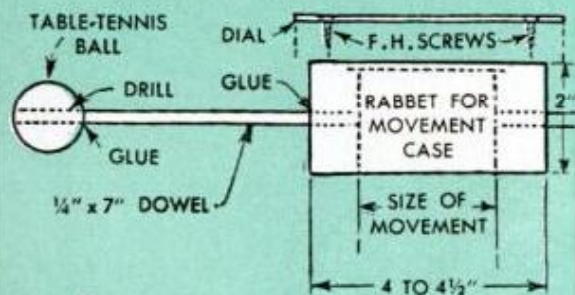

CLOCKS

used over a sunken wall outlet to dispense with a long cord, the housing should be large enough to conceal the outlet. Table-tennis balls are fitted over and glued to dowels extending from the side of the housing. Drilling one hole in each ball is done with a sharpened brass tube chucked in a drillpress, the balls being held in a blind hole almost their diameter, which permits adjusting them so that the lap at the center is parallel to the surface of the block. Markings on the balls can be eliminated with a wad of cloth moistened with lacquer thinner. Before attaching the balls, the housing, dial and dowels are painted flat black, avoiding paint on the dowel ends. Cement is applied to the dowel ends, then the balls are slipped in place. The hands should be white to match the "numerals."

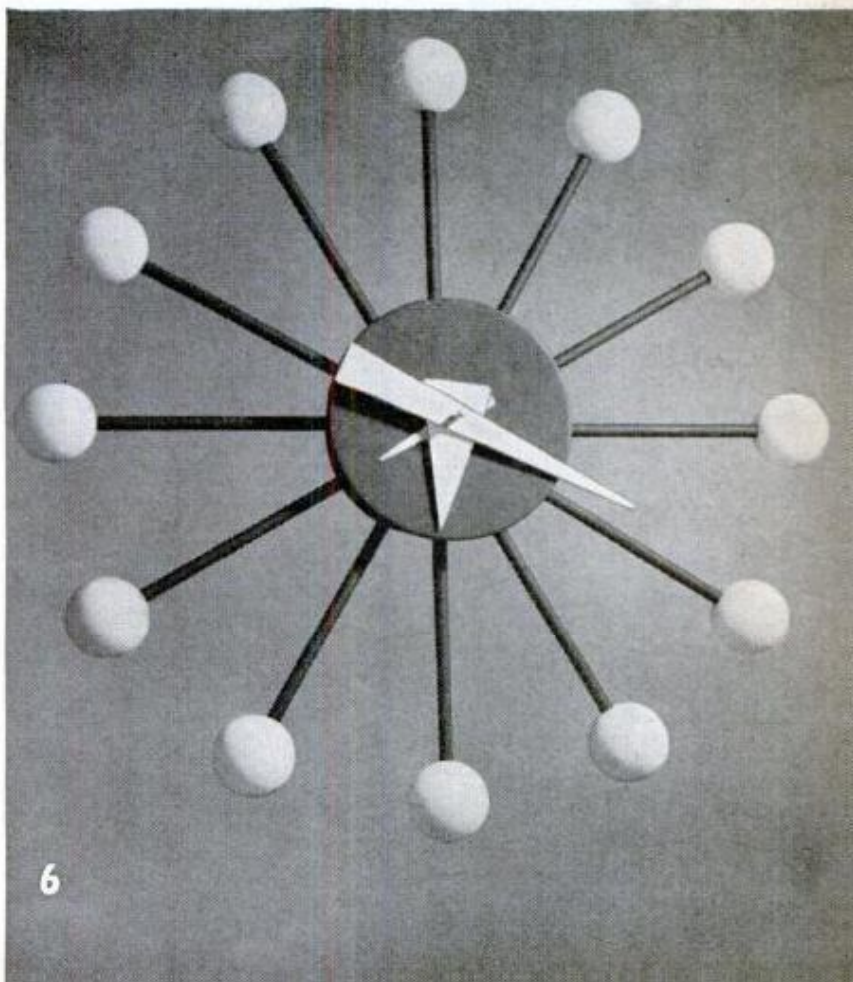

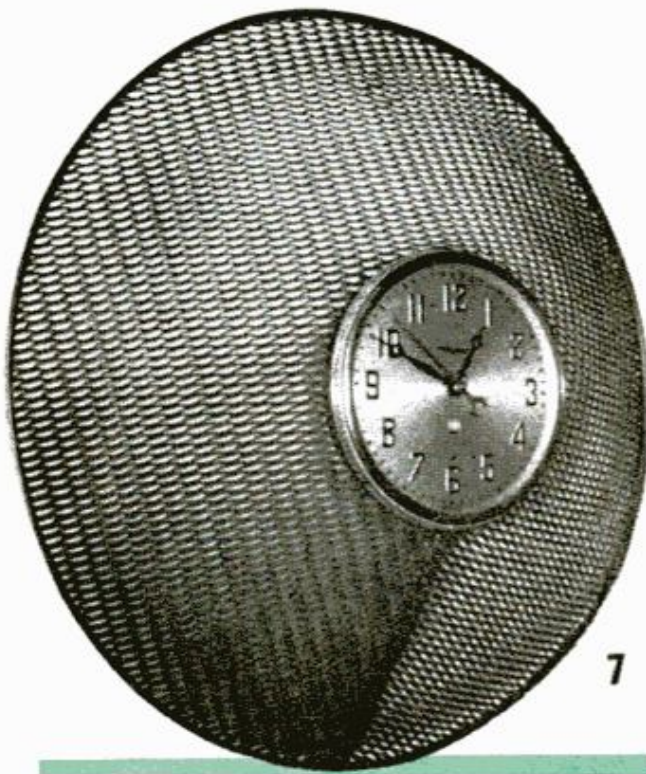

7

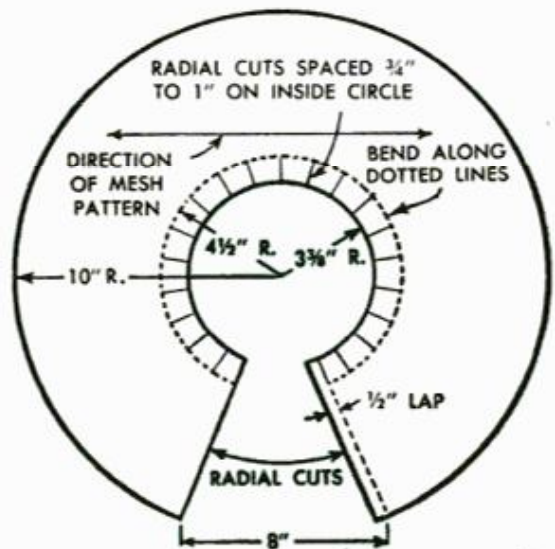
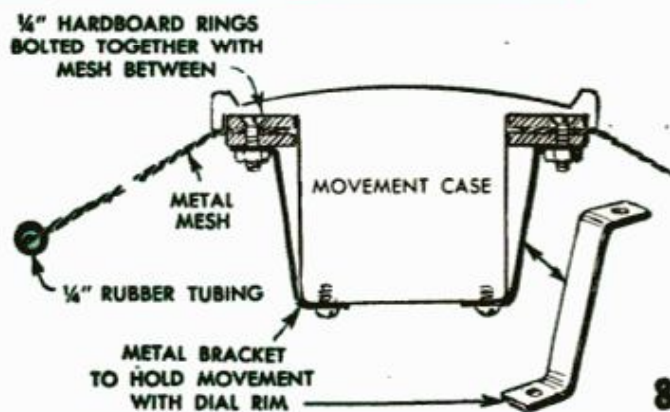

8

Twelve slender tapered points produce the classic saber-type case shown in Fig. 5. The housing is bandsawed first to a diameter not less than $6\frac{3}{4}$ in. To hold the points to it, 90-deg. V-notches are cut in the back of the housing on a circular saw, Fig. 1. To do this you mark the edge of the housing at twelve equidistant points and carry these marks over the front of the block, crossing each other at the center. Next, set the saw to 45 deg. with the table and adjust for a cut $\frac{3}{4}$ in. deep. Adjust the fence so that when the work is resting firmly in a V-block slid along the fence, the cut to be made will reach an index mark at a point exactly $\frac{3}{4}$ in. from the bottom of the housing. When a try square is set against the fence so that its edge coincides with an index mark across the face, as shown in Fig. 3, the work is in position for a correct cut. The work must be held firmly in the V-block without shifting while sawing. All the notches are so cut.

After cutting the notches the bevel cut on the housing is made on a bandsaw, and the outside is sanded—both the straight and beveled portions. Following this the inside circle is cut on a scrollsaw. The housing is finished before attaching the points. The one shown was finished natural, using wood filler, then sanding and finally waxing.

The points are cut from 1 by 1-in. angle aluminum as indicated in Fig. 2. Four points representing the hour numerals 12, 3, 6 and 9, are 12 in. long and the others are 8 in. long. Cutting is done quickly on a bandsaw provided with a metal-cutting blade. To prevent scratching the aluminum on the bandsaw table, use a backing piece of hardboard. After sawing, the edges are filed smooth and the burr removed. The points extend into the housing about $\frac{3}{4}$ in., and are screwed in place with $\frac{1}{2}$ -in. f.h. screws.

Just before attaching the points, they are

given a satin finish with fine steel wool, the surface then cleaned and coated with clear lacquer. Rubber tape, $\frac{1}{4}$ in. wide, is cemented in the V-grooves beforehand. The tape compensates for the taper of the points and makes them fit against the wall. Otherwise, they will lean outward.

Perforated or expanded-metal mesh was used to make the shallow conical case in Fig. 7, following the pattern in Fig. 8. The base of the resulting cone will be $17\frac{3}{4}$ in. in diameter and its height about $3\frac{3}{4}$ in. To produce a 3-in. hole for the movement to fit, the inner circle of the pattern is cut $3\frac{3}{8}$ in. in diameter. For other size holes on cones of this angle, the circle on the pattern should be $\frac{1}{8}$ larger in diameter than the intended opening.

Radial cuts from the center circle permit flattening the segments so formed to fit between two rings of hardboard. The rings are bolted together with 6-32 flat-headed machine screws and nuts. The lap at one

of the straight edges is cut out of the waste portion, it being parallel to the edge. The edges are fastened with fine wire or rivets. Windshield-wiper tubing was slit lengthwise and cemented over the base edge. A wire loop tied to the mesh from the inside provides a means of hanging the case on a hook or nail.

Ordinary cove molding was used to make the case shown in Fig. 9. The pieces were mitered first, then rabbeted on a circular saw set at a 45-deg. angle. The dial was opal glass, 12 by 12 in., on which lustrous brass buttons, filed smooth on the back, were cemented. Two 7-watt lamps, wired in series to reduce their brilliancy, were positioned behind a 6-in. sheet-metal disk placed against the dial. The

SOCKETS, plus turn-type fixture switch (below), are held by brackets screwed to case

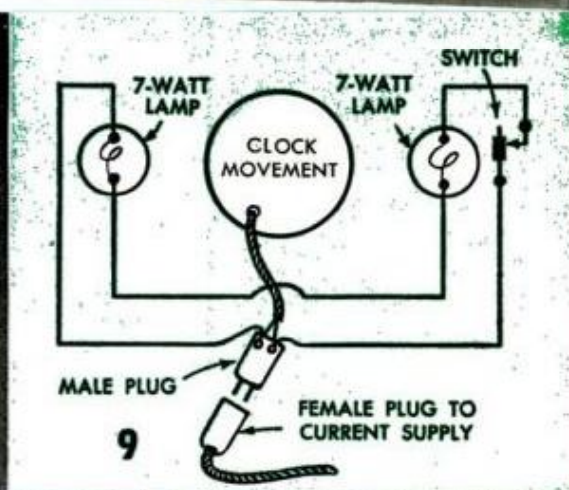
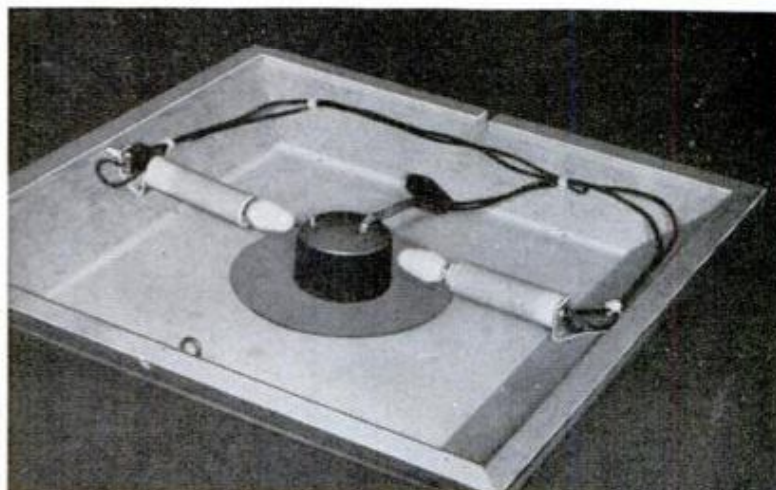
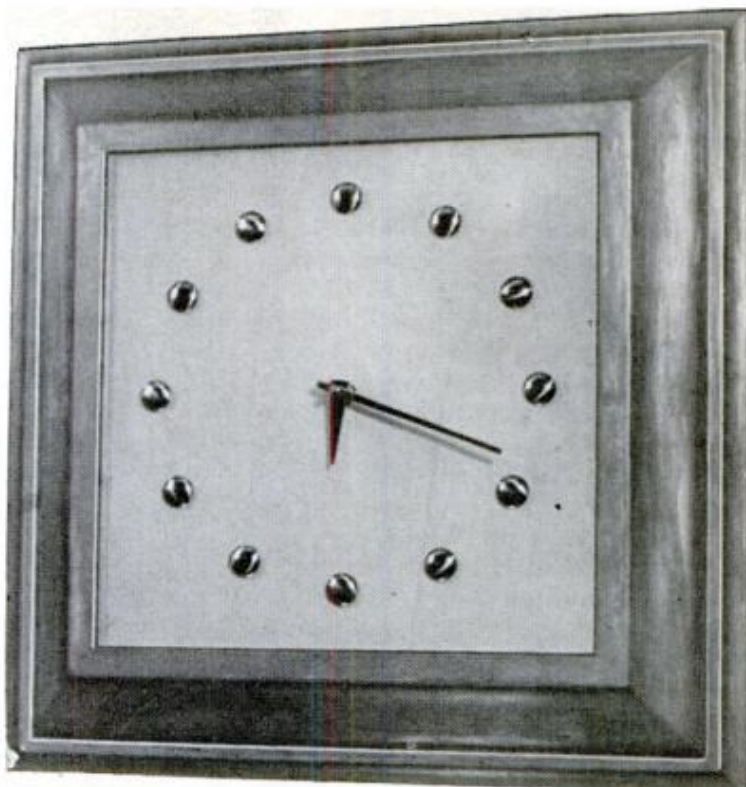

sockets and a small turn-type fixture switch are held by metal brackets screwed to the case. The switch is provided with an extension tube to operate it from the outside. The cord passes through a notch in the frame so that the latter rests snugly against the wall. In the case illustrated the center of the dial was drilled for the threaded sleeve of a metal housing by which it was fastened to the dial. The frame was first painted gold and later toned with flat green partly rubbed off.

Twenty - four sheet - aluminum fins, bent to identical shape and fitted into equidistant saw kerfs in the housing, comprise the intriguing case shown in Fig. 13. Outside diameter of the housing, Fig. 14, should not be less than 5¾ in.,

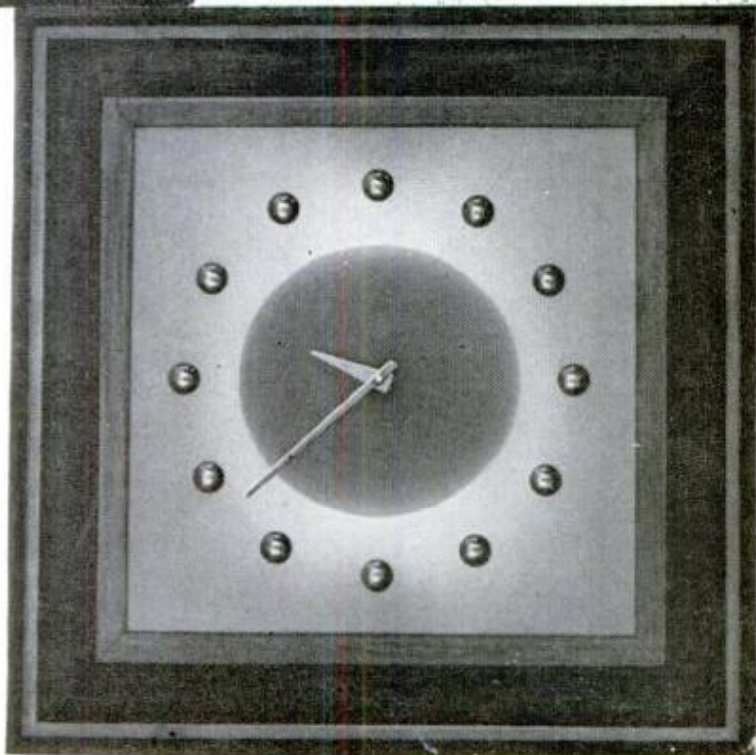

but may be larger. The cuts must be made to width accurately so that the two free ends of a fin will fit snugly. An individual fin, completely bent and drilled, is shown in Fig. 12. The fins are made from 2 by 18-in. strips of No. 24 gauge sheet aluminum available at many hardware stores. It can be bandsawed to size, which should be done on a hardboard backing to avoid scratching it on the bandsaw table. After sawing the strips their edges are filed smooth and the burr removed.

Jig No. 1, Fig. 10 is used first. Its curvature is shown full size for direct tracing. You clamp one end of a strip at the point indicated, using a wooden "pad" to avoid clamp marks on the aluminum. First form the small curve and then do the rest, feeding the stock into the jig from the free end to prevent distortion of the smaller curve. Then unclamp the strip, turn it end for end, clamp the other end and repeat the operation, but this time you bring the metal sharply around the metal corner piece. The bend so made should come at the center of the strip if bending was done properly.

After removing the strip from jig No. 1, pinch the doubled end together carefully to permit placing it into jig No. 2, detailed in Fig. 14. The two free ends slip into the slot of the fixed end block. Then the sliding piece is pushed over the doubled end of the fin to compress it symmetrically, taking care not to scratch it with the metal drill guide. The curve of the sliding piece is shown full size in Fig. 11. A dowel is pegged into the hole

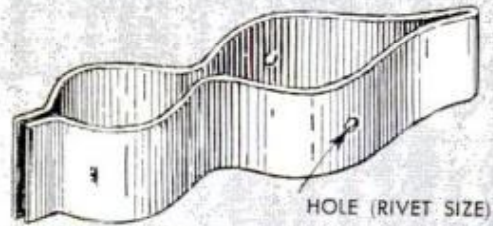
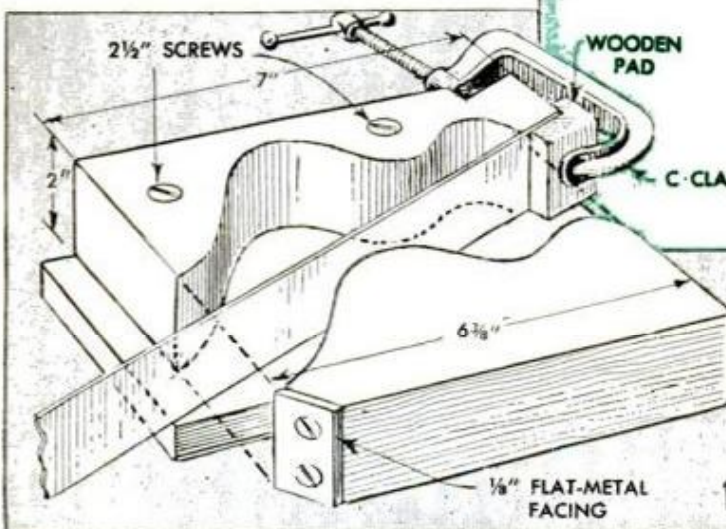
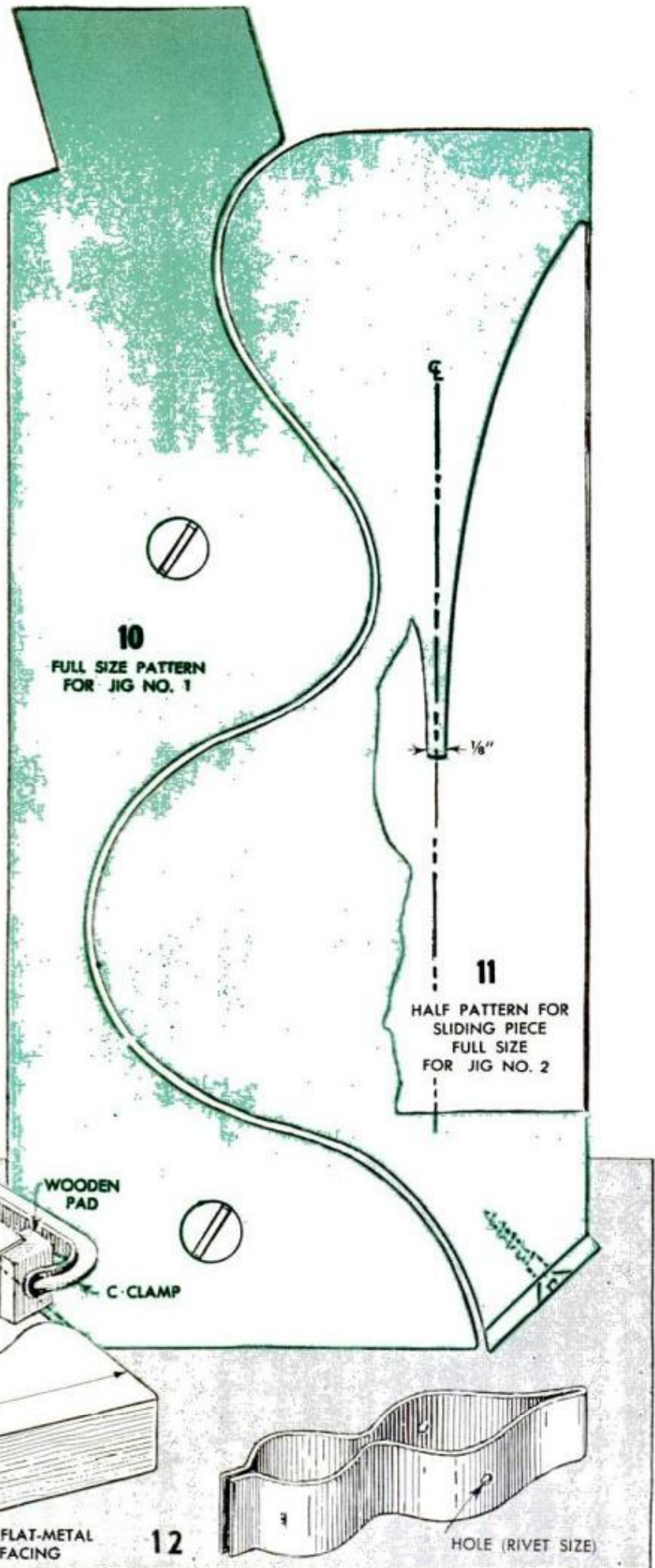

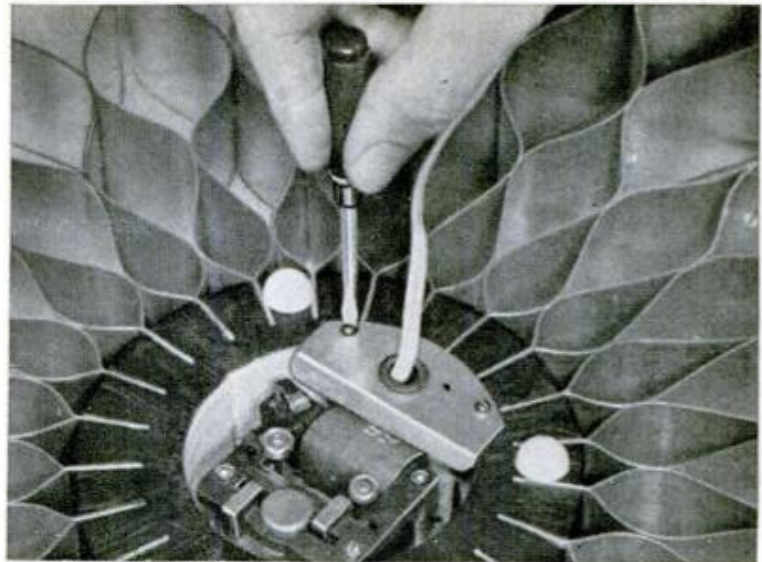
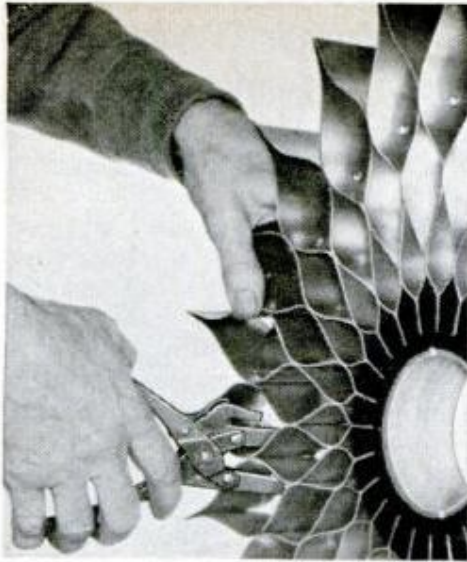

AFTER JOINING FINS to housing, fins are riveted together with hand setting tool, above. Above right, metal shield screwed to housing insulates the wiring terminals

in the base to hold the sliding piece in position while drilling the rivet holes. This is done on a drill press, the jig resting with its side on the table. After drilling one side of a fin, it is reversed in the jig and the other side is drilled. This procedure assures identical locations of the rivet holes. After joining the fins to the housing, the fins are riveted together with a hand setting tool. The housing is painted before the fins are attached, being careful not to get paint in the saw kerfs. A metal shield was screwed to the housing to prevent accidental touching of the 115-volt clock terminals when setting the hands. This should be done on any electrical movement not already safely enclosed in a case.

Old conventional hands seldom
(Continued to page 282)

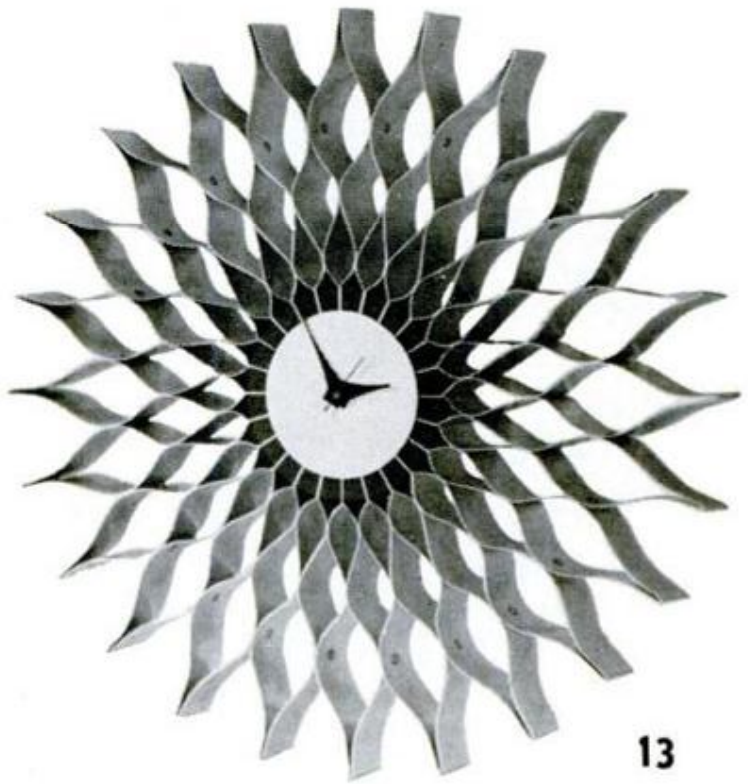

13

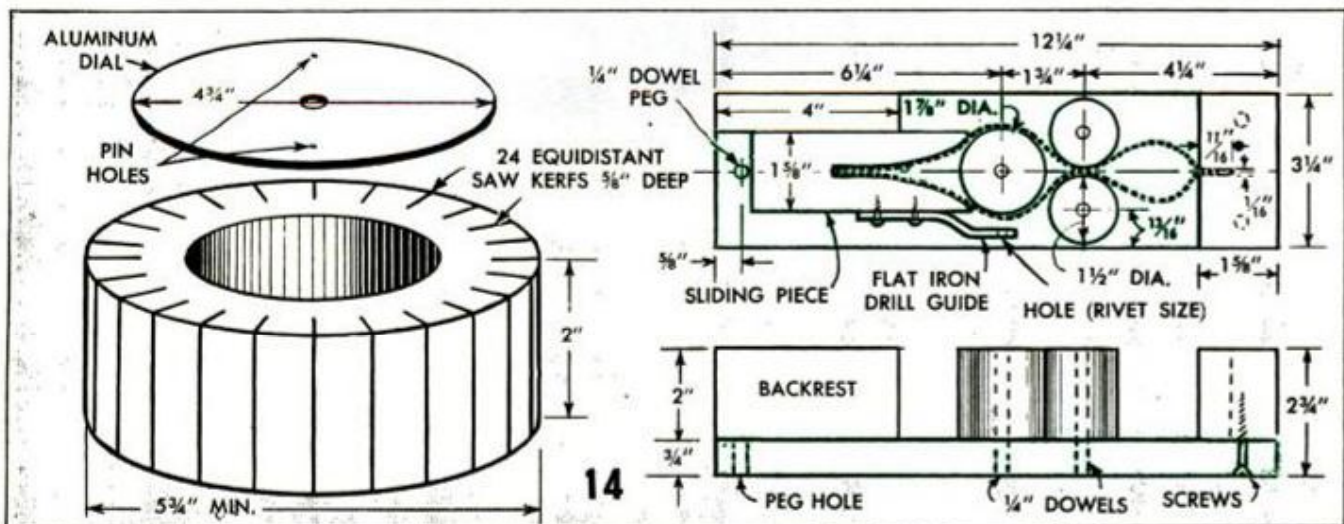

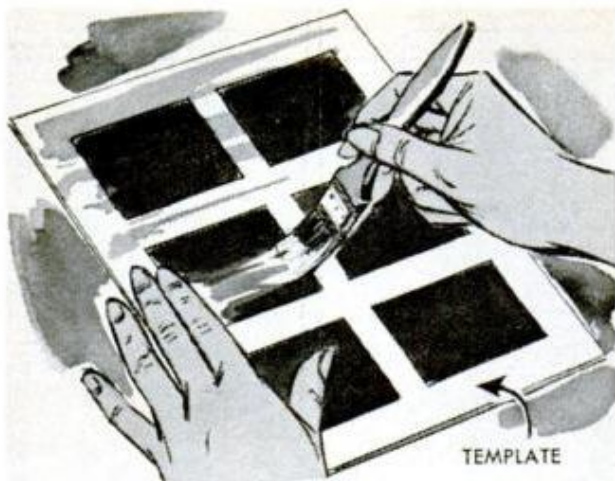

TEMPLATE

Template and Rubber Cement Speed Snapshot Mounting

Next time you mount a batch of snapshots in an album, you'll find you can do a faster, neater job and avoid a sticky mess by using a template and rubber cement. Cut the template from heavy show-card stock to album-page size with cut outs $\frac{1}{8}$ in. smaller than the size of the photos. Place the template over the album page and brush the cement within the cutouts. Remove the template and press the photos firmly in place.—P. Buzzel

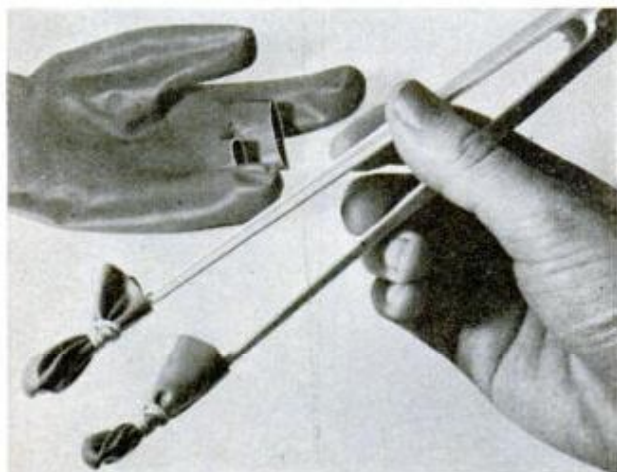

Rubber Tips on Print Tongs Insure Against Scratched Prints

It's a real shame to find that all the pains you've gone through to produce a fine photo print have come to nothing because your tongs have scratched it. This is especially true with some printing paper emulsions that require more handling care than others. However, if it's happened once don't let it happen again. Cover the tips of the tongs with the finger tips from an old pair of rubber gloves. The tips, which can be held in place with rubber bands, will also insure a better grip on the prints.



RUBBER BANDS

Rolled Newspaper or Magazine Takes Curl Out of Old Prints

Photo prints that have been stored for a considerable time have a way of curling up and will often refuse to lie flat for mounting. One way to take the curl out of them is to place them between the pages of a newspaper or magazine. Roll the paper or magazine up tightly against the direction of the curl and set aside for a few hours. The ends of the roll may be secured with rubber bands. In a few hours you'll find that the prints will lie flat enough to be mounted with little trouble.



Colored Edges on Slides Help Spot Choice Shots

If like some folks you are an avid collector and displayer of color slides, you most probably have several which you consider your best. Rather than sort through dozens of slides to find them try coating the top edges with nail polish to make the slides easy to spot. If there's no nail polish handy, it is also a simple matter to draw the top edge of the slides across the surface of an ink pad of the kind used with a rubber stamp. In each case, be sure to mark the "top edge."—Wayne Floyd

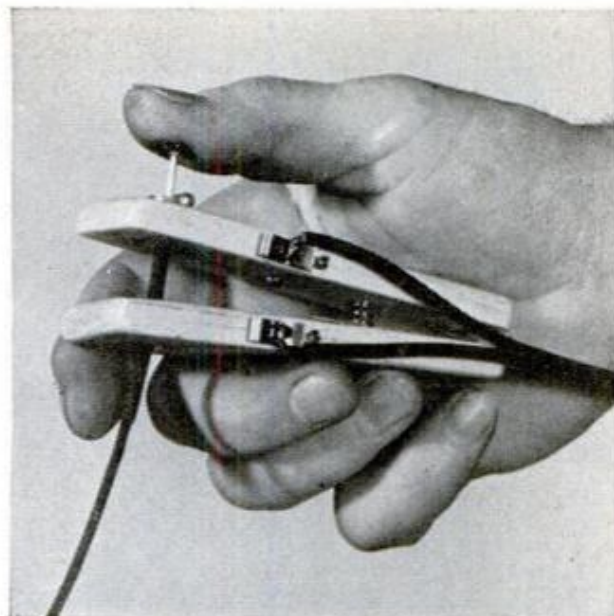
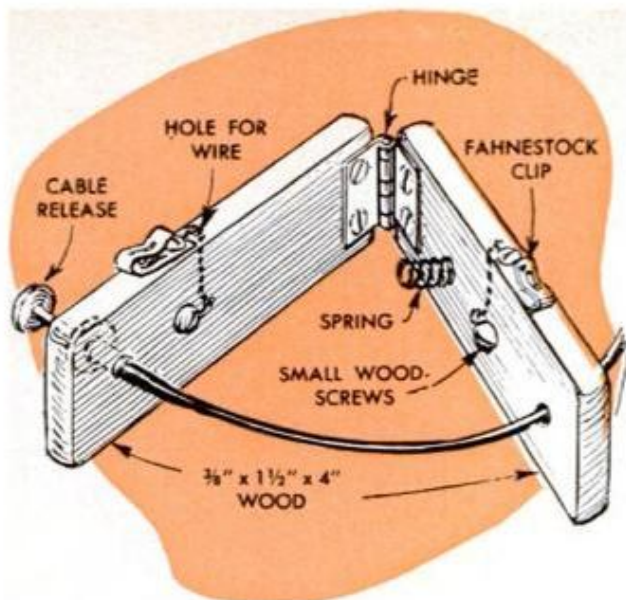

Open Flash Synchronizer

Operating this flash synchronizer simplifies open-flash photography for use with any shutter accepting a cable release. Two blocks of wood approximately $1\frac{1}{2} \times 4$ in. are hinged together at one end. One end of a coil spring about $\frac{3}{4}$ in. long fits tightly into a $\frac{1}{4}$ -in. blind hole drilled in one of the blocks.

Two round-headed screws form contact points. These are positioned, one in each block, so that they contact when the blocks are pressed together. Terminal clips on the edges of the blocks connect with the contact points, and wires from the flashgun attach to the clips. The circuit is closed when the two contact points touch. Holes

through the blocks accept the cable release.

The open-flash synchronizer operates by pushing down on the cable-release plunger with the thumb. The spring between the blocks holds the contacts apart until the shutter—set on bulb—opens. Then, when the plunger is depressed, a further squeeze on the blocks compresses the spring until the contacts close and fire the bulb. After the bulb fires, pressure is released on the plunger, automatically breaking the circuit and closing the shutter. The whole operation—open, fire, close—should take no longer than a second and provide foolproof control of open-flash photography.

—David D. Rudd

Model Outboard Motor Mixes Photo Chemicals

When Phil Slattery of the Denver Post decided he had enough of mixing photo solutions by hand he came up with a most novel power mixer. He clamps a model outboard motor to the side of his 1-gal. tank, turns it on and forgets it. Powered by two D-size cells, the little outboard churns away and does a most efficient job of mixing which sure beats stirring.

—Bernard Kelly

The wide mouth of a 1-qt. milk bottle makes it a favorite storage container for the amateur darkroom dweller. It's easy to fill and the fact that it holds 1 qt. by measure makes it doubly handy when preparing small amounts of stock developer. If you haven't thought of it, the bottles also are perfect for storing photo solutions. All you have to do to make them lightproof is to paint them black on the outside.

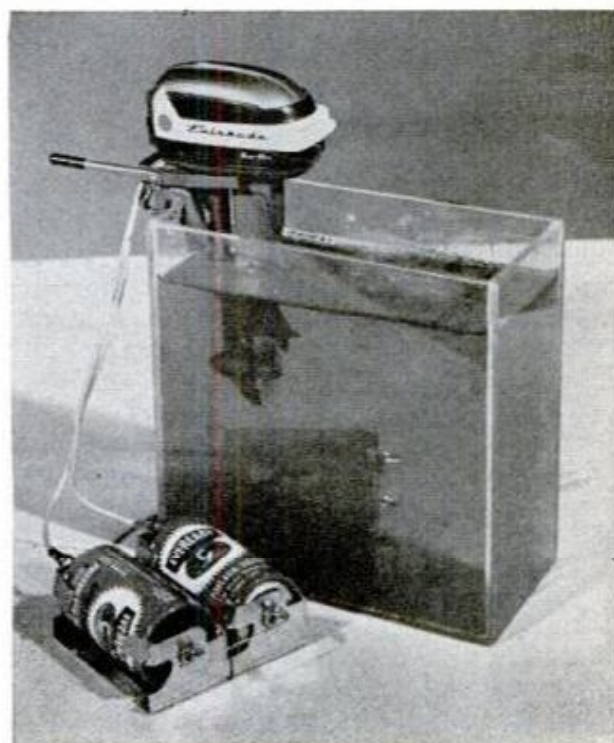

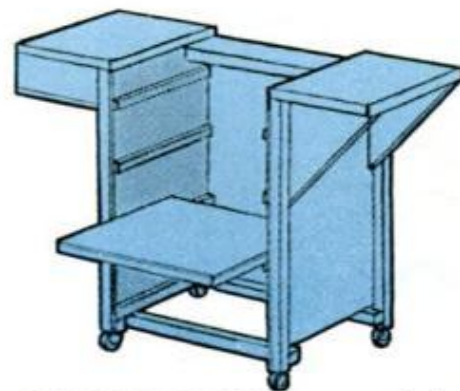
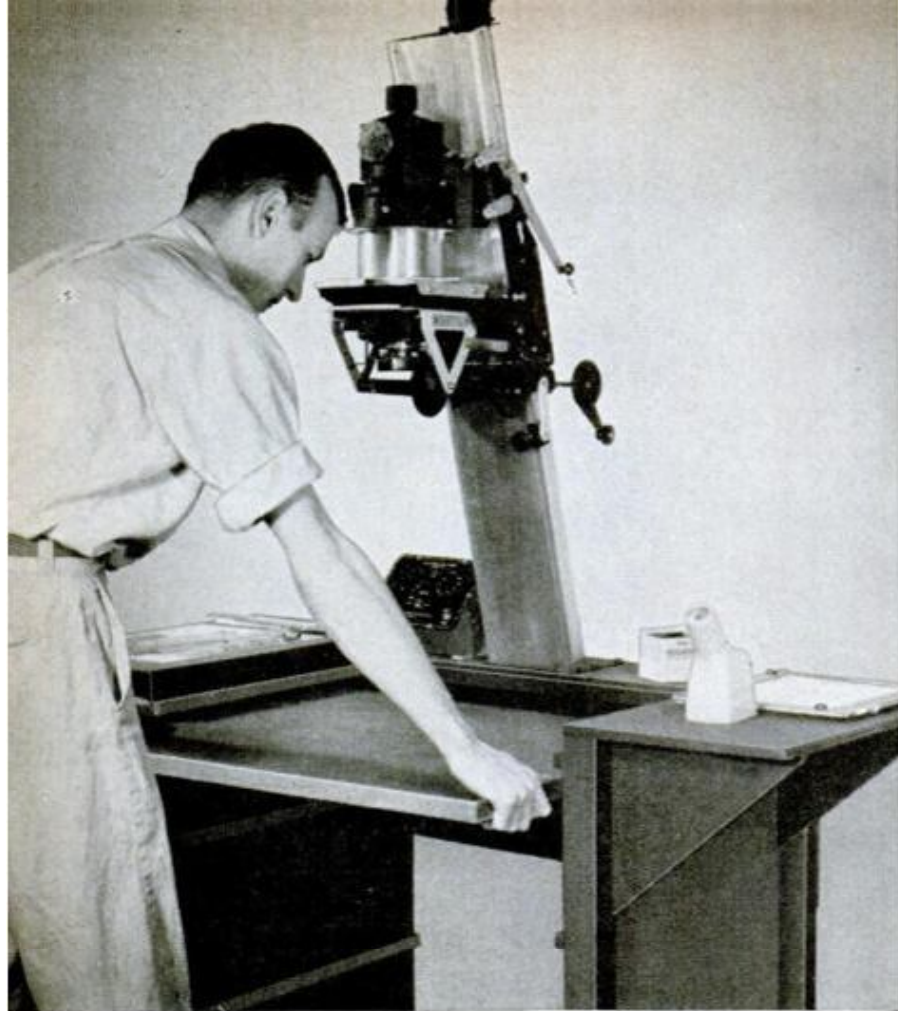

ENLARGING TABLE is compact unit that easily can be rolled into a closet or corner of basement when not in use. Adjustable easel may be set to height needed by merely pulling out shelf

DROP-TOP ENLARGING TABLE

EVER WISH you had more room to raise the head of your enlarger for making large blowups? Most likely you have if you work in an average basement with a low ceiling that limits making those high-ratio enlargements in the usual way. Normally there's a choice of either tilting the enlarger head 90 deg. to make a horizontal projection or swinging the head outboard and projecting the image on the floor. Both methods are time consuming and usually a nuisance.

A more satisfactory solution is to build a drop-top enlarging table, similar to those used in some of the top professional magazine and newspaper darkrooms. The adjustable shelf-like top replaces the fixed work surface with one which is easily raised or lowered. In addition, the table has a built-in viewing box.

The first step is to build two U-shaped frames of 2x2 stock, cut to dimensions shown in the detail. Drill holes for carriage bolts and casters and bolt the frames together. Cut two side panels from 1/4-in. plywood. The easel rails must be accurately located and aligned. Nail and glue the rails to each panel and check to make sure each pair align. Side panels are set flush with the edges of the uprights and glued in place. The 2-in. member to which the enlarger is anchored fits flush with the top of the

panels. Next, the back panel is attached to complete the basic table.

The easel may be built with a framework of 1x2s as shown in the detail, and covered with a hardboard panel glued to the frame, or, a 3/4-plywood panel may be substituted. The shelf on the right-hand side of the cabinet rests on two triangular supports.

The light box should be completed and then attached to the table. Top of the box is cut from single piece of 3/4-in. plywood. Small wood strips nailed to the inside edges of the opening to support a sheet of milk glass, which rests flush with the face of the light box. If you wish, the edge of the panel may be rabbeted to support the glass. Sides and bottom are cut as detailed.

Four receptacle sockets are spaced for even light distribution, on the base of the box. Screw the receptacles in place and wire them in parallel through a small toggle switch set in one end of the box. Assemble the box and nail it to the left-hand side of the table.

Table and light box, especially the top of the easel and the inside surfaces of the cabinet, are finished with one or two coats of flat black or dark gray paint to reduce the reflected light that may otherwise degrade the highlights of the prints. Inside surfaces of light box are white. ★ ★ ★

Shop Projects 1961

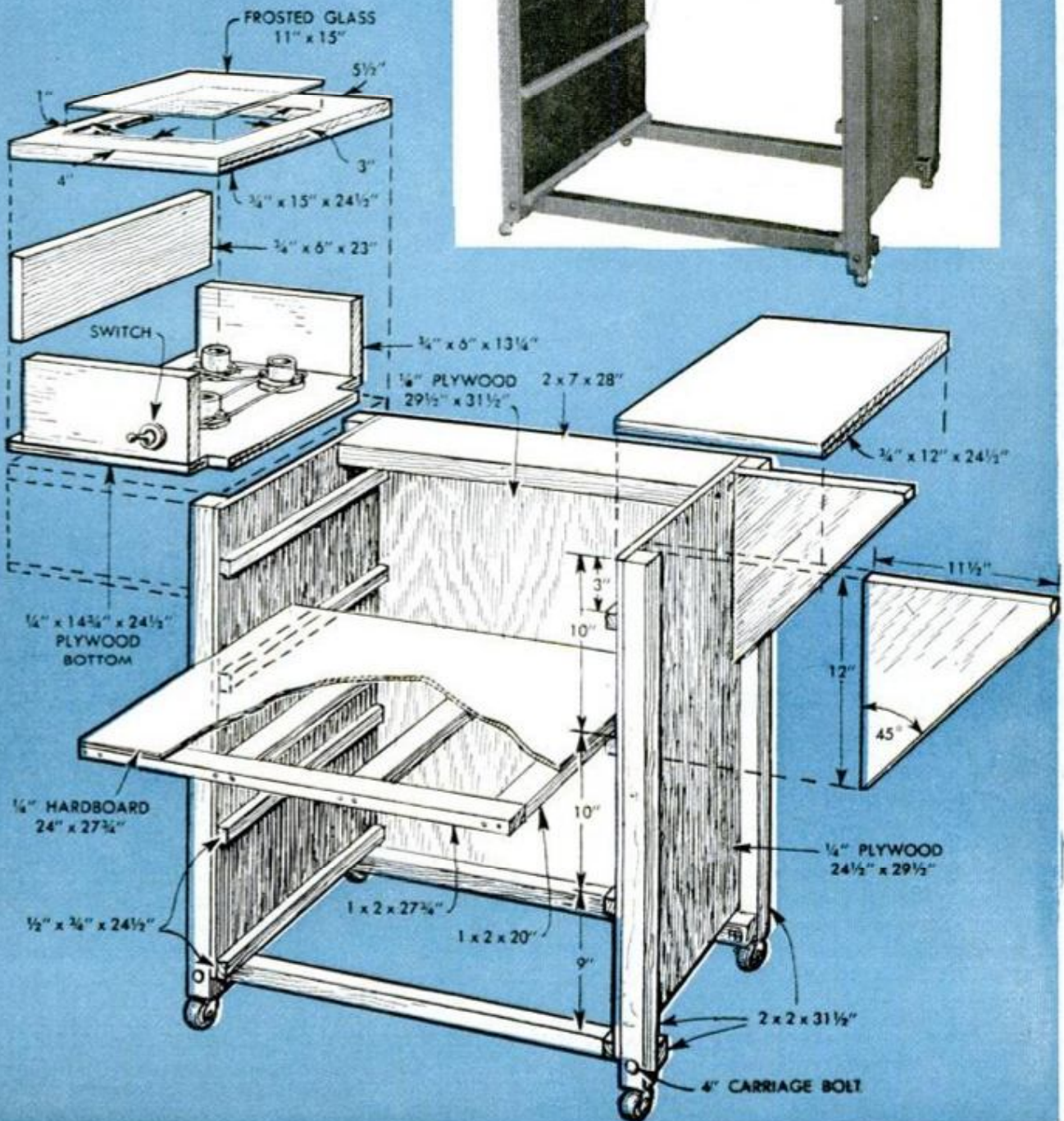
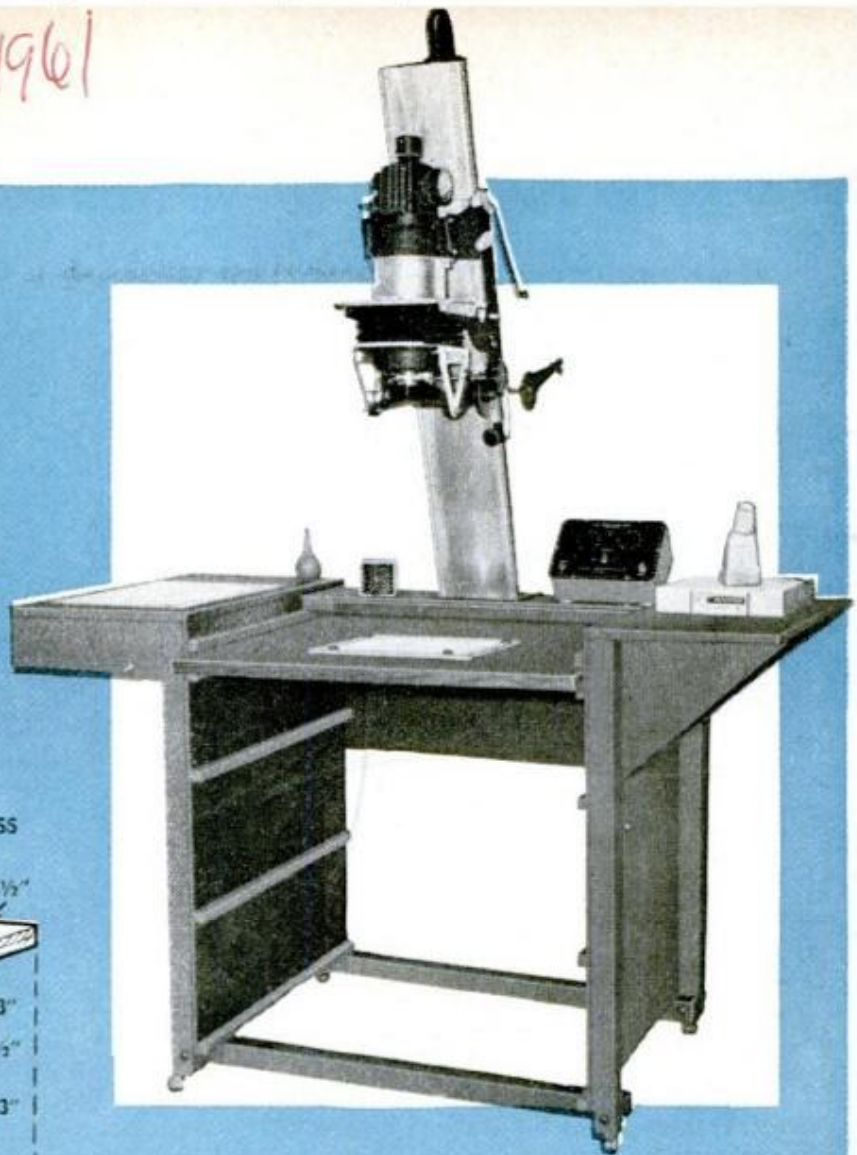

BUTTON UP YOUR HOUSE FOR WINTER



By M. Robert Beasley

AN INCREASING NUMBER of homeowners realize the dollar and sense value of buttoning up their homes for winter. In fact, homeowners reportedly buy between 40 and 50 million cartridges of caulking compound annually.

For an investment of just a few dollars and a few hours work there can be great savings by preventing moisture penetration, heat loss and peeling paint. Caulking compounds adhere to any surface that

paint does, and a professional looking job is obtained by using good material, applying it properly and then protecting oil-base compounds with paint. A good caulking material remains pliable for years. Though it may harden somewhat on the surface, the bond will remain flexible and provide an airtight, watertight seal for 10 years or more.

Just as with paint, the surface must be properly prepared. With a good base a



OPENINGS AROUND SILL COCKS, lead-in wires and clothes dryer vents need calking to keep out moisture

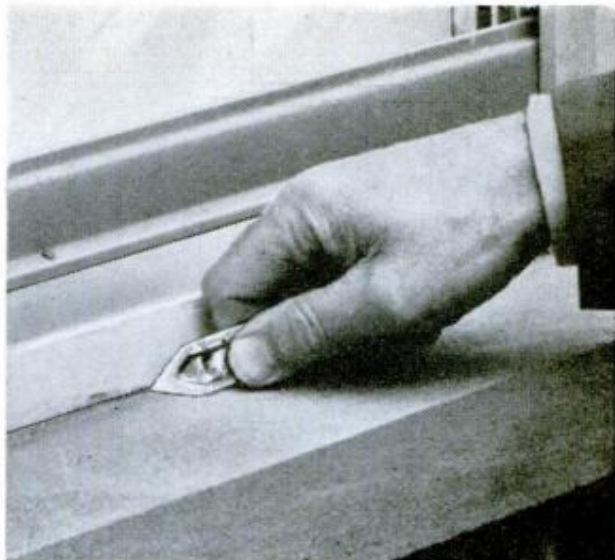

REMOVE LOOSE PAINT, other debris that prevents adhesion with V-shaped can opener and putty knife



ROUGHEN SURFACES with coarse sandpaper or coarse steel wool. Rough surface promotes adhesion of calk

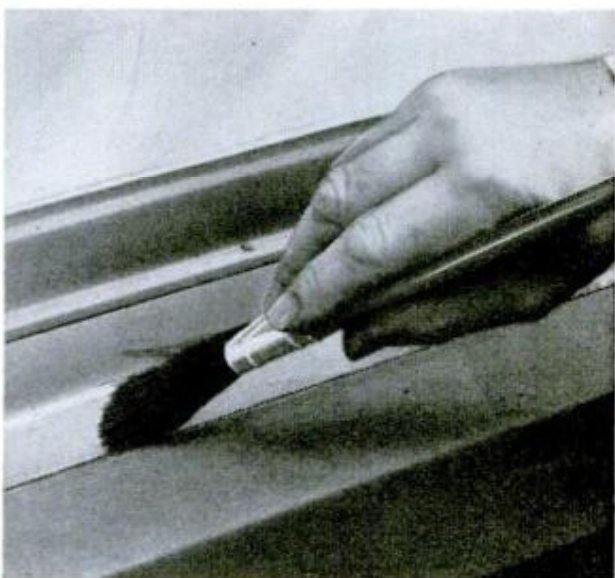

PRIME DRY WOOD with commercial primer or linseed oil. Then allow to dry 24 hours before applying calk

APPLICATION. Slant gun for equal distribution on both sides of crack and force compound into cracks

PAY PARTICULAR ATTENTION to metal casements, such as basement windows, where moisture is found

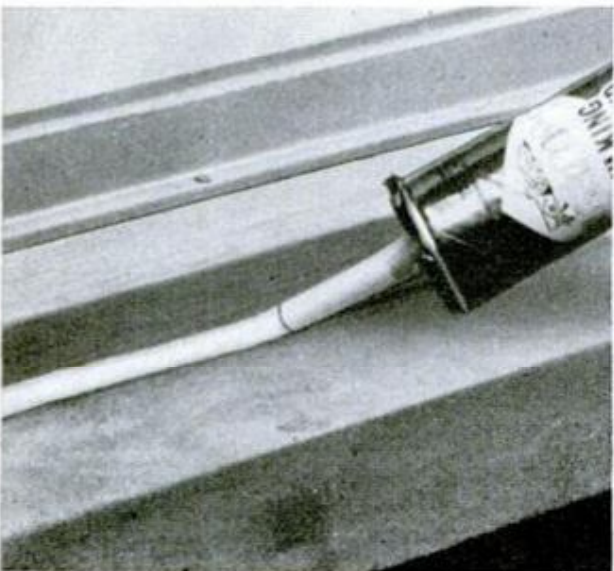



DON'T FORGET TO CALK where siding joins masonry foundation. Generally, calk wherever wood meets masonry. Otherwise moisture penetrates up under the siding, causing the deterioration of the wall structure

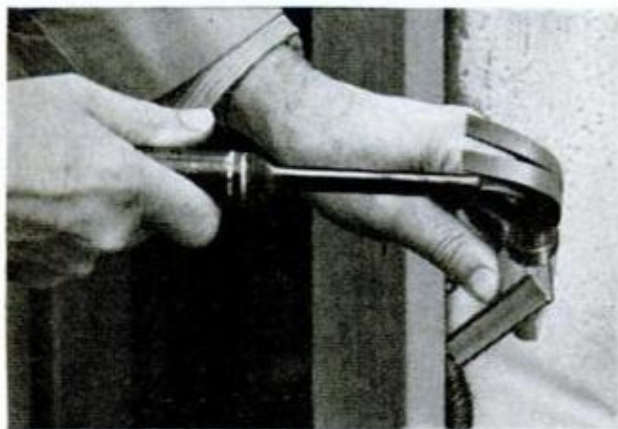

FOR LARGE CRACKS tap in oakum or mineral wool with piece of wood and hammer to provide calk base

PROFESSIONAL BEAD is produced by even pressure on the trigger and an uninterrupted motion of the gun



quality compound sticks to most surfaces, such as metal-to-masonry, wood-to-concrete or whatever combinations you might encounter. Though calking does not develop galvanic action between different types of metals, galvanized surfaces should first be roughened with vinegar or solvent for maximum adhesion.

A film will form over the calk a day or two after application and it is then ready for painting. While compounds are waterproof, they require the protection of paint to give them long life and continued resilience for which they are designed. The primary purpose of calking is to seal openings. It doesn't hurt the compound to be exposed for several months, but it should be painted before freezing weather arrives. Emulsion paints require primer, but oil or elastic-base paints are applied directly over the calk. The exceptions are the black asphaltum-base compounds—these will bleed through most paints, and they should not be painted. Asphalt compounds are designed for use on roofs and gutters.

Should the material smear, just use a dry, clean rag for removing it. Solvents are not advised at this point because a dry rag is more efficient for removing the smeared compound. After the job is finished, use a paint thinner to remove miscellaneous spots and to clean gun. ★ ★ ★

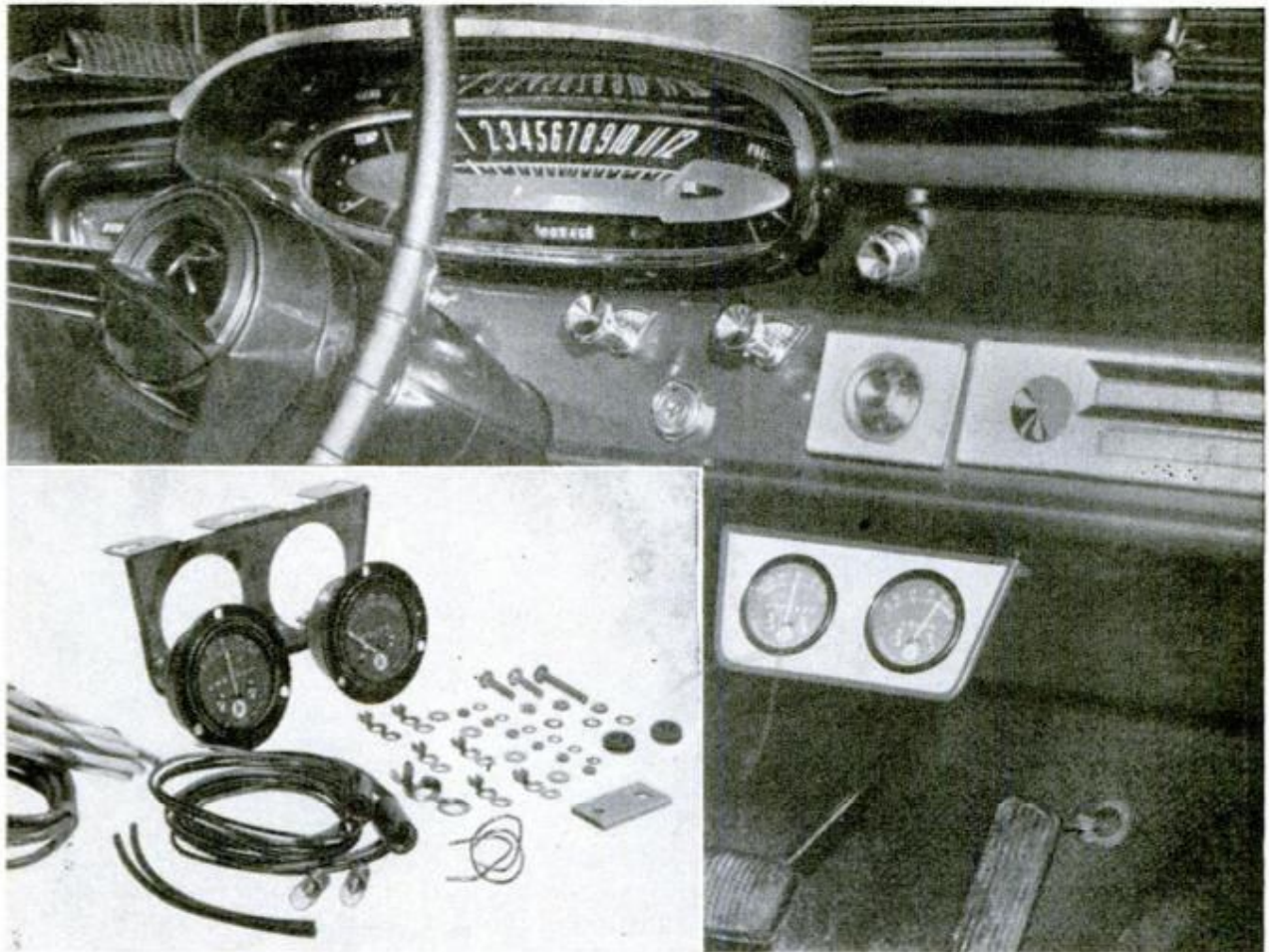

Dash Meters Are Back Again

FOR THE OWNER of a late-model car equipped with "charge" and "discharge" panel lights a kit is now available consisting of a voltmeter and ammeter which enable a driver to keep close check on the precise voltage charge of his battery and to detect any excessive drain of power, as through a short. The voltmeter is especially useful in cold weather when the capacity of a battery decreases with a drop in temperature and gives ample advance warning of impending battery failure. Wiring hookups will differ, of course, depend-

ing on whether a car has a positive or a negative ground system. Illustrations for both the positive and the negative systems are shown below at the right and left respectively, and full instructions are included with the kit. Once the kit is installed and ignition and accessories are turned off, the voltmeter should read about 12.6 volts for a fully charged 12-volt battery, and the ammeter should read zero. One word of caution: Be sure to avoid shorts and shocks by disconnecting the positive cable from the car battery.

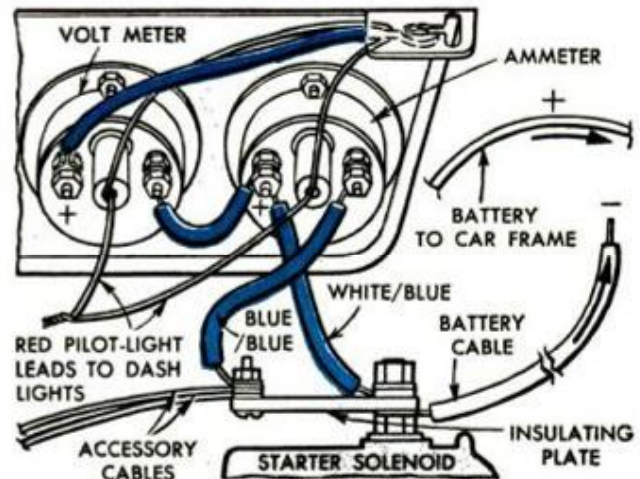
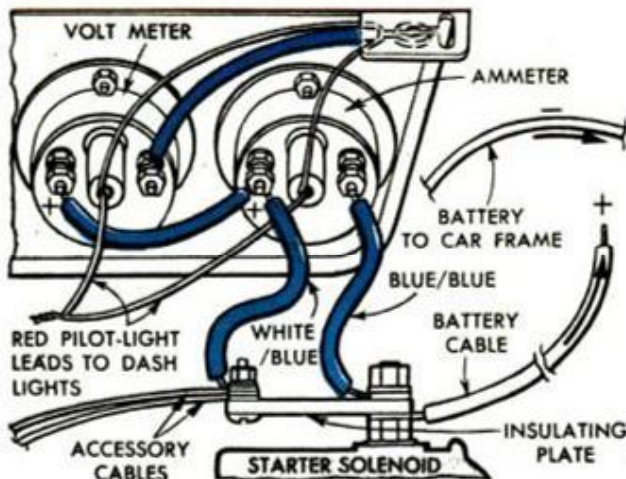



DON'T BE CAUGHT WITH A DEAD BATTERY

BUILD YOUR OWN QUICK-CHARGER

By Patrick K. Snook *2202 Catherine St
Northbrook, Ill*

FEW MOTORISTS are able to put back what they take out of a battery during winter driving. The extra drain of cold-morning starts, increased use of lights and added heater consumption takes its toll and unless you do lots of highway driving, you can't hope to keep the battery up to par by mere driving alone. The in-town driver, particularly, will do well to have his own quick-charger which he can use on occasion to keep up with the increased battery drain that comes with winter driving.

A simple quick-charger can be put together at little cost from odd parts that can be found in almost any junk yard. If possible, select a generator and voltage regulator from the same car—the generator being of the same voltage as that in your own car. You'd also better see if you can't buy, beg, or borrow the proper wiring diagram as the wiring set up is sure to vary with the type generator and regulator. The only other major items you'll need will be a 1/4-hp. motor and an ammeter and these, too, can be obtained used or rebuilt. Once

you've cleaned the generator thoroughly, make sure that the pulleys on both the generator and the motor are equal in size.

The carriage, or dolly, which makes the charger portable, consists of a 3/4-in. board measuring approximately 12 x 27 in. which is mounted on an axle and two 8-in. wheels and provided with a handle. Mount the motor on blocks of 2 x 4 cut to conform and bolt this assembly to the dolly. To find the proper position for the generator, bolt it to its single mounting block, slip the 3/8 x 36-in. V-belt over the pulleys and move the generator assembly back until the belt is snug when the generator inclines about 15 deg. toward the motor. This will enable you to mark the assembly's exact position. The generator then may be removed from its mounting block and the block bolted permanently to the dolly. At this point the box housing the ammeter may be assembled and mounted on the dolly. Leave the ammeter panel off until after wiring. The voltage regulator may be screwed to the opposite corner of the dolly. Aside from

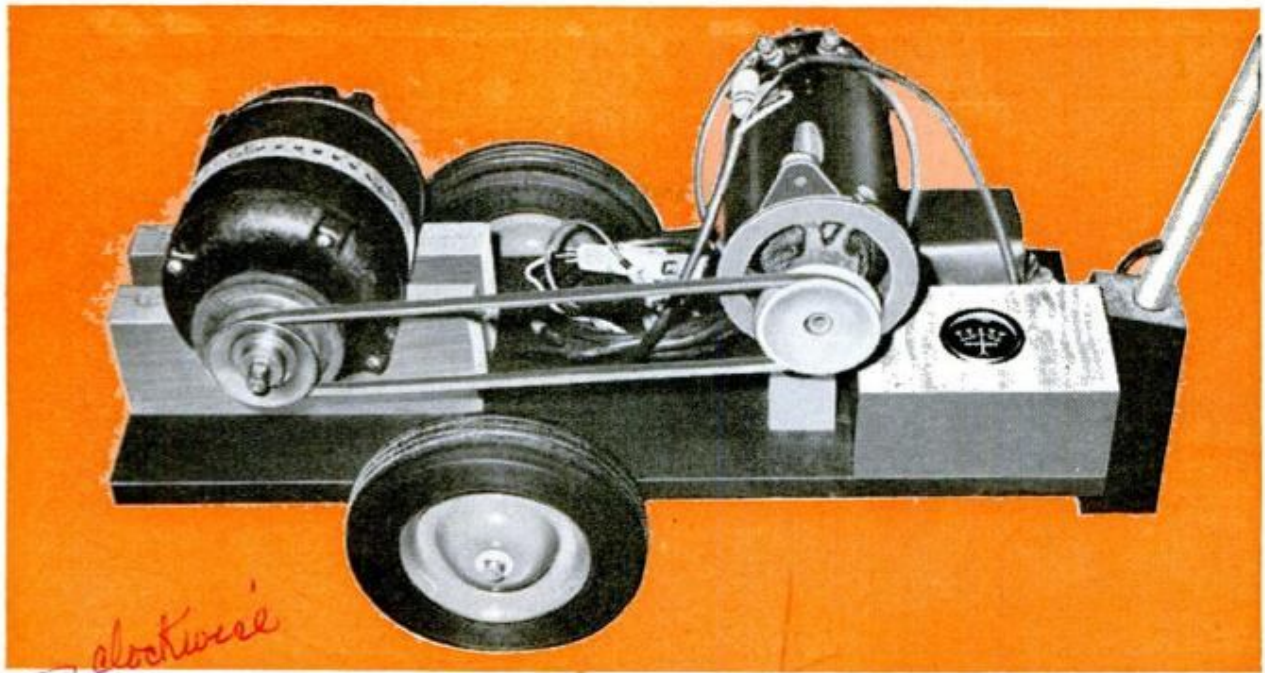

the wiring, all that remains to be done now is to fit the foot block and handle. The heavy-duty, two-wire power cable (No. 12 ga.) runs through the conduit and out of a hole drilled near the base, then under the dolly and up through a hole near the motor to which it is connected. Since most 1/4-hp. motors can be reversed make sure to connect the wiring so that the motor runs counterclockwise, viewing it from the shaft end.

There are probably half a dozen different generator-regulator wiring set ups depending on the make and vintage of the car.

One possible set up is shown in the diagram below. The generator terminals as well as those on the regulator are letter coded so that there should be no problems involved. One word of caution: On some models the field terminal is grounded by way of a resistor to the generator shell. In this case, mount the negative lead of the battery power cable to the screw that anchors the resistor, *not to the field terminal*. The direct lead from the field terminal should be attached to the F-post of the voltage regulator. ★ ★ ★

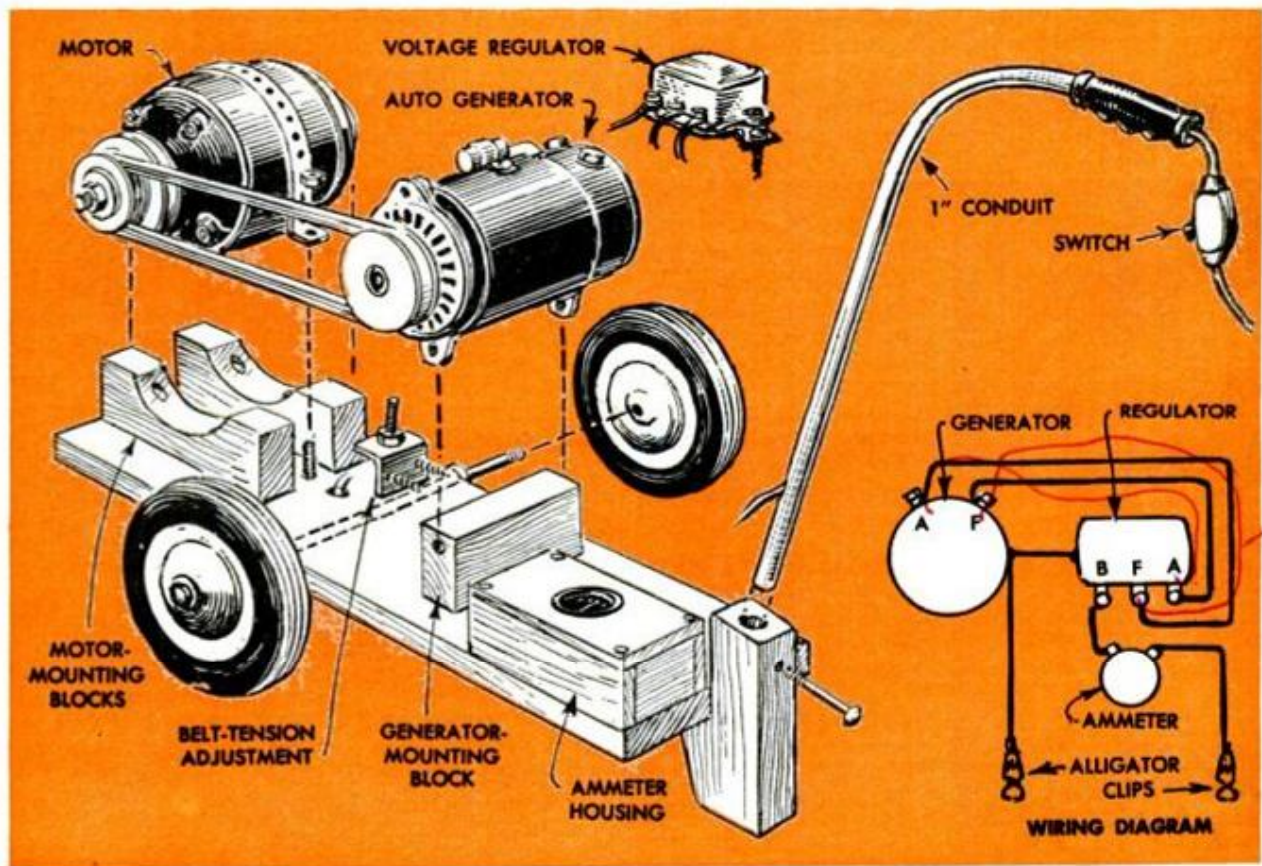

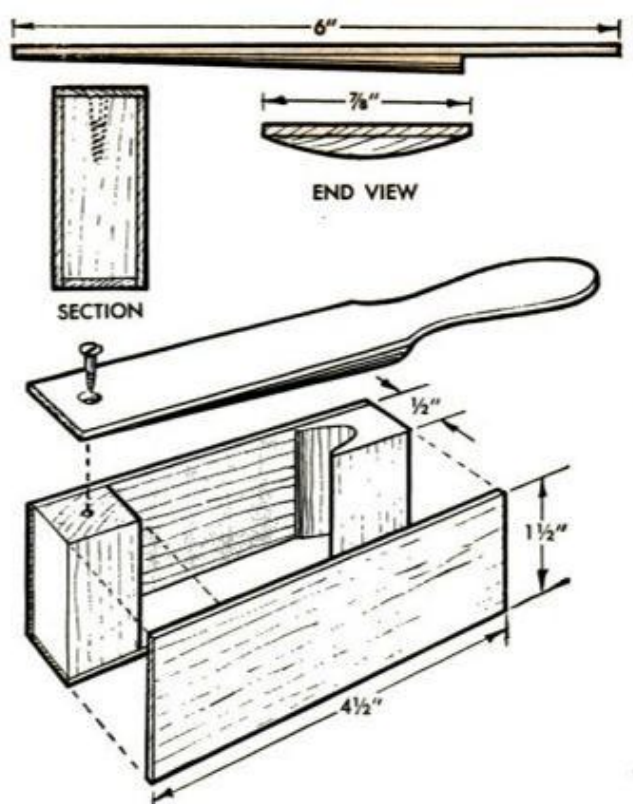

THIS BOX TALKS TURKEY

HUNTERS RATE the wild turkey as the shyest and wariest of all the game birds. Getting in shooting range of a wild turkey by any ordinary stalking method is sheer luck, they say, even when the stalker is favored by the best of cover. This is largely because the turkey relies on an incredibly sharp eye for security and also because the birds usually frequent open-timber areas where danger can be sighted at a distance.

But if you can bring yourself to sit rock-still in suitable cover in an area turkeys are known to frequent and then use a caller, or yelper, your chances of bagging a gobbler should be reasonably good. There

are many different types of callers, only two of which are pictured in use on the opposite page. The caller shown in the upper photo, opposite page, is perhaps the most popular of all the turkey callers largely because it is easily carried in a pocket and is somewhat more easily manipulated in the field. The detail above shows how it is made. Selected red cedar is used for all the parts. Note especially how the pivoted tongue is made. It consists of two pieces glued together, the top piece extending beyond the end of the box and forming a handle. The lower of the two pieces is shorter and is both rounded and

Coming
Next
Month

Take Over From Santa. Coming a month before the holidays are 17 pages packed with suggestions for Christmas gifts for your family and friends, also novel and original Christmas decorations for the home. You don't buy these anywhere. You make them.

Decor in Metal. A refreshingly new idea in hanging wall pieces, a tree branch in full autumn color. So real is the piece that you'll look at it very closely before you're fully convinced it's fashioned entirely from metal.

How to Install Drywall. Details clearly the correct methods of installation outlined by manufacturers. Tells how to nail gypsum wall board, how to score it, how to cement and tape joints and how to lay out and cut to fit without waste.

Cutting Glass Is a Snap. That's right! Just a quick, scoring stroke with the glass cutter, a snap, and you have two pieces of glass from one, with the edges line-straight. The trick is in knowing how. This article tells you in words and pictures.

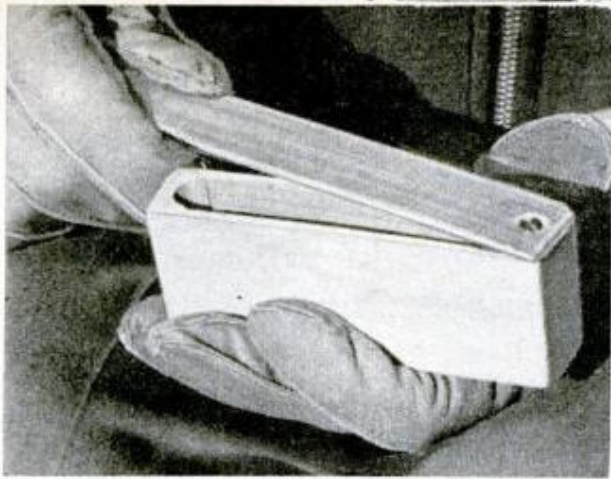

tapered as indicated in the drawings. A hole is drilled near the end opposite the handle to take a flatheaded screw in a loose fit. The sides and bottom of the box are of $\frac{1}{8}$ -in. stock. Sand all surfaces smooth but do not apply any type of finishing material, inside or out.

In use, the box call just described is held in the left hand as in the photo above while the right hand moves the tongue, which has been coated with chalk, across the edges of the box in a rolling motion. No one can tell you just how to use a turkey call. You have to get the call in your hands and learn for yourself. It takes some practice to acquire the knack, but once you do learn how you can fool the wariest wild gobbler.

Another type of call which is popular in many localities where turkeys are hunted is pictured in use in the lower photo. This call consists of the top third of a coconut shell, a 2-in. length of hardwood (a $\frac{3}{8}$ -in. maple dowel often is used) and a small square of slate. The piece of hardwood, or the dowel if used, is forced into the "eye" of the coconut shell and the outer end is beveled to form a flat point. In use the flat point is rubbed across the surface of the slate, which has been coated with chalk.

When learning to use the callers, it will



help you to listen carefully to the calls of domestic turkeys and also try out the caller on them. When you can attract tame turkeys you can feel fairly sure of success in calling up the wild birds. Also, to hunt turkeys successfully you must know something of their food habits. Acorns usually are first choice, but wild grapes, wild cherries, sumac berries and beechnuts are favored foods. Wherever these are found in abundance, there you are likely to find turkeys.—Don Shiner ★ ★ ★

Shop Projects 1961

PORTABLE DRILL Powers Wood Lathe

*A Handy, Efficient Lathe for Making
Small Between-Centers Turnings*

YOU HAVE a portable drill. A shop project calls for several turnings, but you don't have a wood lathe. So, what to do? There's no need to buy a wood lathe for those occasional turning jobs; make one, utilizing your portable drill as the headstock. All you need are two lengths of steel angle to make the lathe bed, an accessory stand to fit your drill (some manufacturers refer to this item as a bench stand) and a few odds and ends from which to put together a suitable tool rest and a tailstock with movable center. The details on the opposite page show you how to go about assembling the bed, tool rest and tailstock.

The first thing to do is lock the drill in its stand, place it on the level bench top and measure the distance from the surface of the bench top to the center of the chuck. This will give you the necessary height of the tailstock center above the bed. Assemble the bed as in the detail using $\frac{1}{8}$ x $1\frac{1}{2}$ x $1\frac{1}{2}$ -in. steel angles throughout. Note that in the detail the spacers give a 1-in. spacing between the bed angles. You may have to alter this spacing to properly accommodate your drill stand. The built-up tailstock base was made from a short length of channel from an auto frame, the webs being notched at a 90-degree angle. The channel was then bent at right angles and joined by means of $\frac{1}{16}$ -in. steel gussets. These can be welded on or joined by means of stove bolts as indicated. Then a $\frac{1}{2}$ -in. steel plate was joined to the vertical member and center-drilled and tapped for the dead-center screw pictured at the left.

The original tool rest was made from a 6-in. length of square tubing, but if this is not available then use a $\frac{1}{2}$ -in. square of steel as detailed. Note that both the tool rest and the tailstock are fitted with guides and clamping strips. The live center, upper left-hand detail on the opposite page, is made by center-drilling and tapping a 1-in. length of steel rod for a threaded rod with a sharp point which forms a center point. The opposite end of the rod forms a spindle which is gripped by the drill chuck. Although the photo at the center, left, shows four spurs, two are sufficient as shown in the detail.

—W. Herdman Schwatka

POPULAR MECHANICS

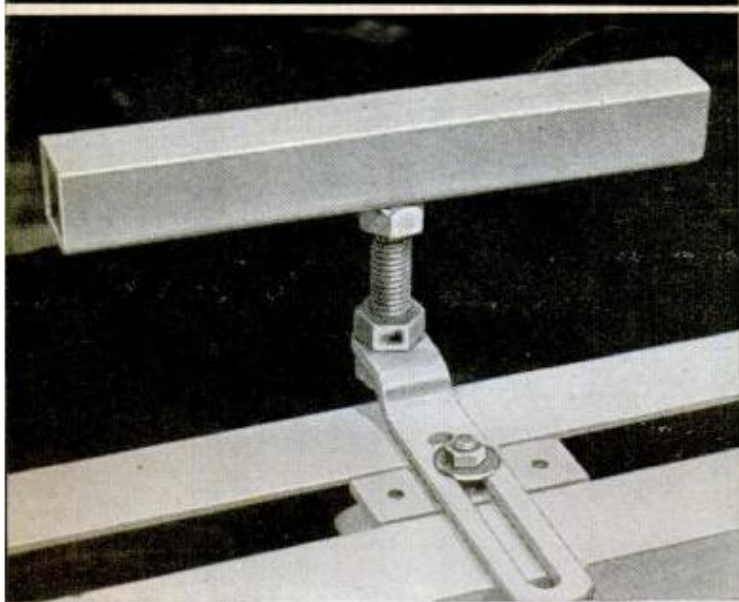

ORIGINAL TOOL REST was made from a 6-in. length of 1-in. square tubing. You also can make a suitable tool rest from $\frac{1}{2}$ -in. square steel as indicated in detail

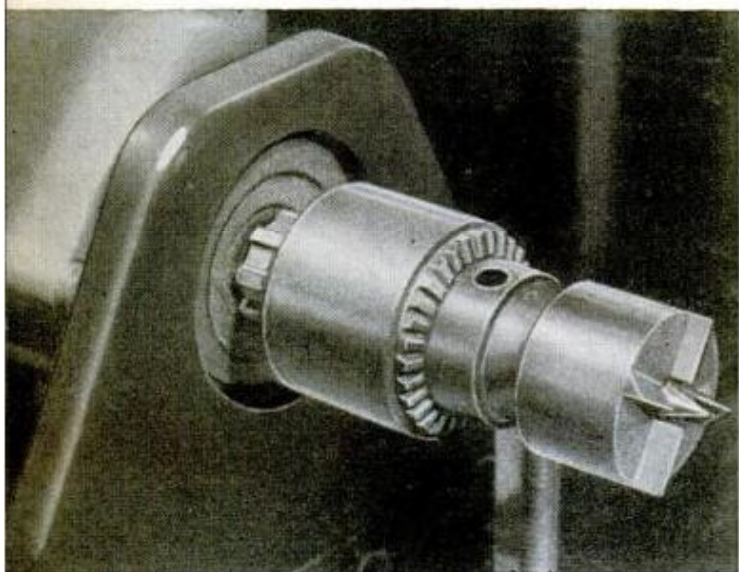

SPUR CENTER, or live center, which drives the material being turned can be made with four spurs as shown or with two. Two spurs are easier to form by filing

TAIL CENTER is adjusted to the length of the stock to be turned and then is held in position by tightening the jam nut. End should be ground to sharp point

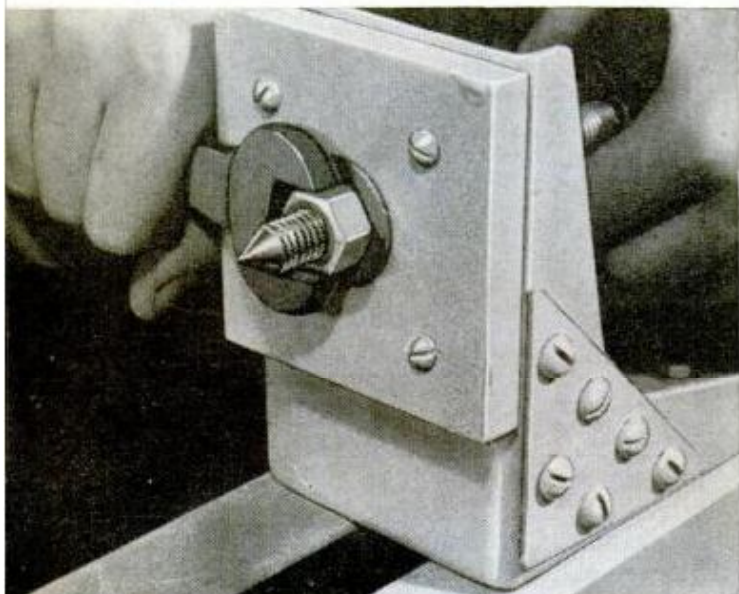

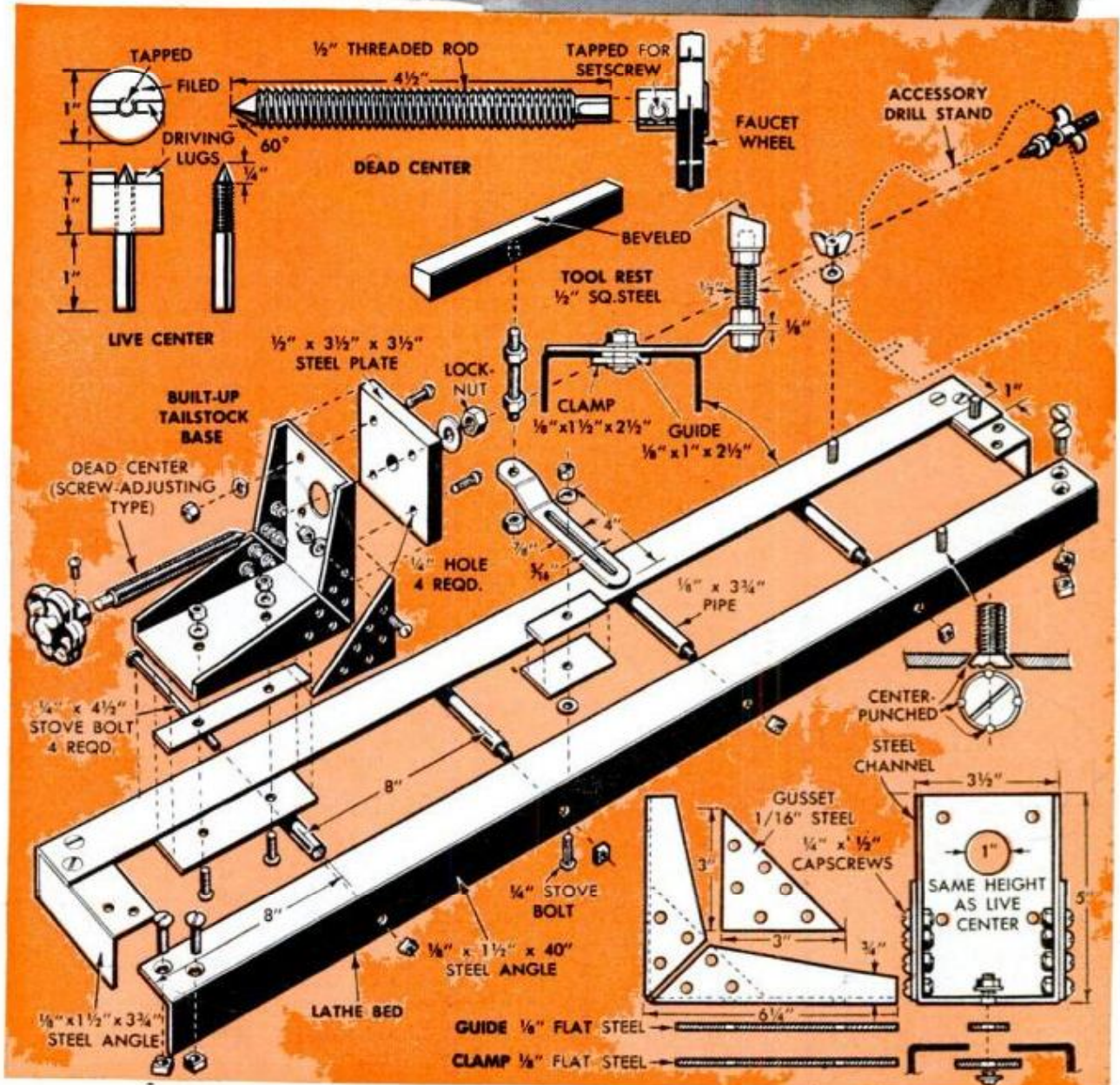
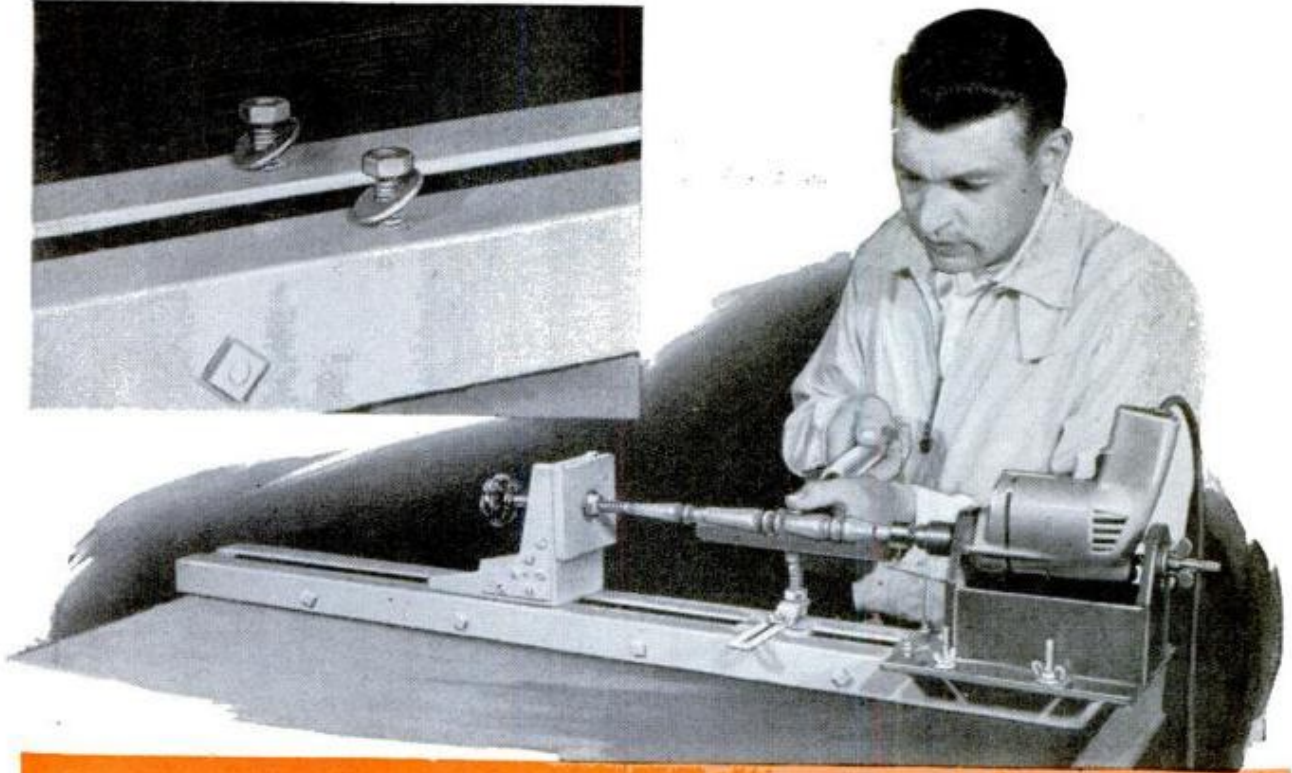
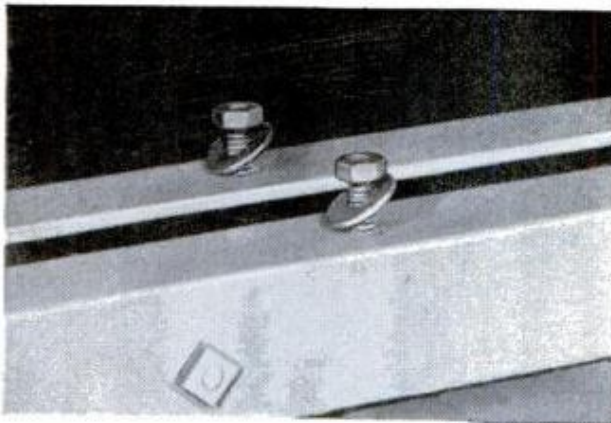

JACKSHAFT

FOR YOUR SHOPSMITH

Reduces speed of accessory bandsaw
for cutting metals and plastic

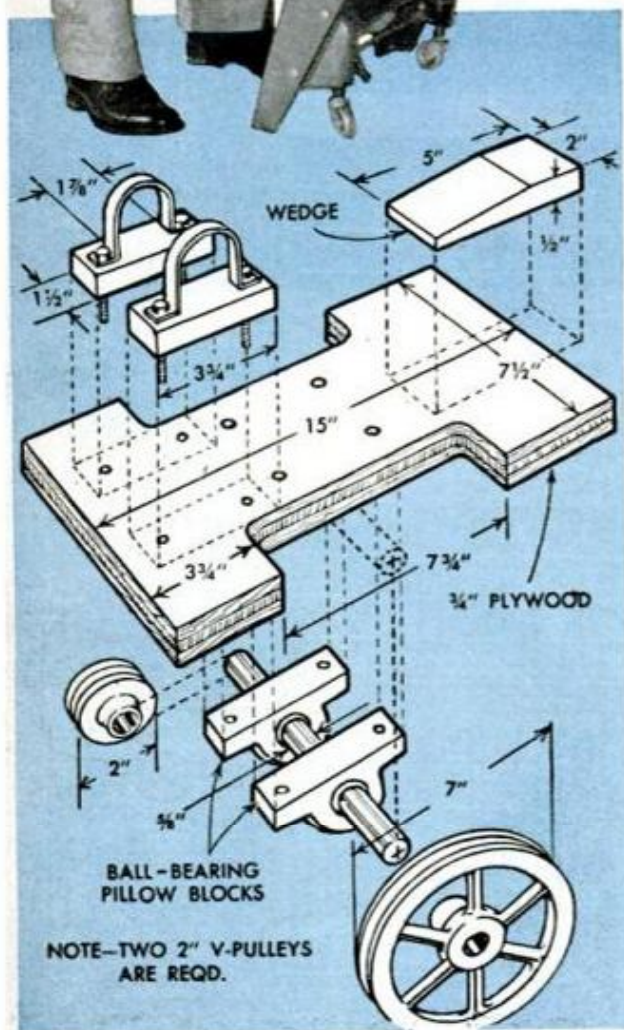
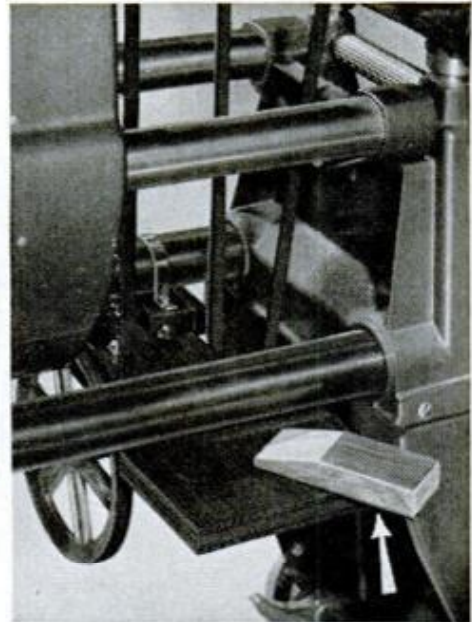

MY COMBINATION machine is of the type designed only for woodworking, but I wanted to reduce the speed of the accessory bandsaw for cutting metal. So I made a jackshaft that gave me a double reduction, machine spindle to jackshaft, jackshaft to bandsaw, which did the job very nicely. It's a simple affair consisting of a piece of plywood for a base, four V-pulleys, two pillow-block bearings, a length of shafting and a wooden wedge. These parts are assembled as in the detail at the left and attached to the tubular machine bed as in the photos above. The band clamps tighten over one of the tubular frame members as in the left-hand photo and permit the assembly to pivot for removal and replacement of the V-belts. The wooden wedge you see in the photo above keeps the belts at the correct tension. When locating the pillow blocks be sure that they are in line so that the shaft does not bind and waste power. Use a metal-cutting blade with fine teeth for sawing metals, turn the speed-selector on the machine to the lowest speed and tighten the belts with the wedge. Then make sure that the saw blade is correctly aligned on the band wheels and is properly tensioned. Adjust the blade guides to support the blade both above and below the bandsaw table. Use a light, steady feed with just sufficient pressure on the work to keep the blade cutting. Forcing the work will cause heating.—Al. G. Haerberle

Sockets Held on Wrench Handle

When you're in a hurry nothing is more exasperating than to find the wrench, or driver, and every one of the sockets—except the one you need. That's the one usually missing from any wrench kit stored loosely in a drawer or tool chest. After an experience of this sort one mechanic cut a strip from inner tube, then made X-cuts near the ends and slipped the strip over the handle of the socket driver as pictured. When he finishes using the wrench the sockets of the kit are stored piggy-back on the handle of the driver.

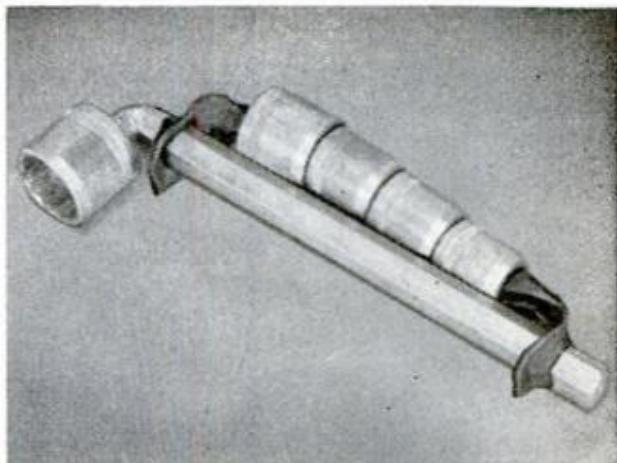

Fitting Protects Grease-Gun Tip

Hand-operated grease guns carried in tool boxes on farm machinery and also on excavating machinery generally are subjected to rough use and often the tips are damaged. One sure way to protect the tips is to use a standard grease fitting with the threaded end turned into a hole in a small, square block of hardwood. Just drill an undersized hole in the center of the block and turn the fitting into the hole, forcing it to cut its own threads. Then snap the protector onto the tip of the gun before placing in the toolbox.—R. Hanscom

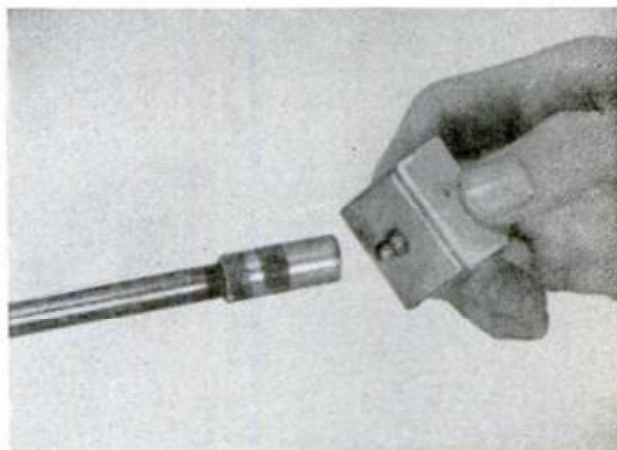

Where's That Chuck Key?

Of course, you've lost the chuck key for your portable electric drill. You were lucky if you found it again as the smaller keys are easy to lose and hard to find. I had this experience several times. Finally I went to my service station, got an old inner tube and cut a strip from it with round ends as you see in the photo. I cut a slot in the center of one of the round ends and punched a small hole in the other. I looped this flexible holder on the cord and then forced the key through the hole in the free end.

Bil Toman



Tool Guard Prevents Hand Injury

When you're setting up work on a faceplate or in a chuck you can get a rather painful hand injury from the sharp lathe tool, even though you ran the carriage back beforehand. To offset this possibility and assure complete safety when reaching across the lathe, slip a short length of small-diameter tubing over the edge of the tool. Or, if no suitable length of tubing is at hand, simply wrap several layers of tape around the tool and pinch the open end tightly together to protect your hand from the sharp cutting edge.

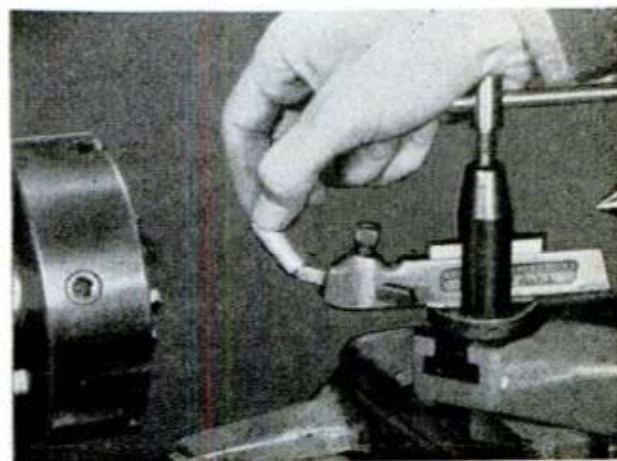

Color Keys Socket Screws and Wrenches

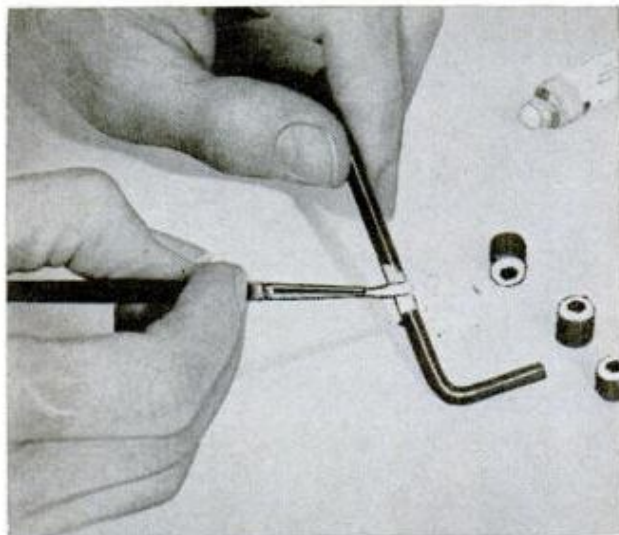

Various sizes of socket screws and wrenches are difficult to match unless provided with a quick method of identification. This can be done by painting matching screws and wrench a single color. Just paint the end of each screw and brush a band of the same color around the wrench. The same idea can be applied to nuts and end wrenches.—R. Hanscom

Save those old typewriter erasers! They're just the thing to keep in the tool box for cleaning small files and brushing metal particles from taps and dies. If a small screw is used to mount the ferrule on a wooden handle, the brush can be used for spreading glue.—Ken Murray



Wire Coat Hooks Make Storage Racks for Dowels

Need a good storage rack for dowels? Attach wire coat hooks to the wall of your workshop by screwing a couple into the studs or into a board nailed on the wall. The very ends of the hooks are bent upward to keep the dowels from rolling off. Several sets of hooks can provide storage space for various sizes of dowels.

To disguise a small burned spot in a carpet use a knife to scrape out the discolored pile. Then snip pile from a hidden section of the same rug. Spread the pile in the palm of one hand and dab glue over the top. Then press the pile in place in the damaged spot. Later brush the pile to make the repair unnoticeable.

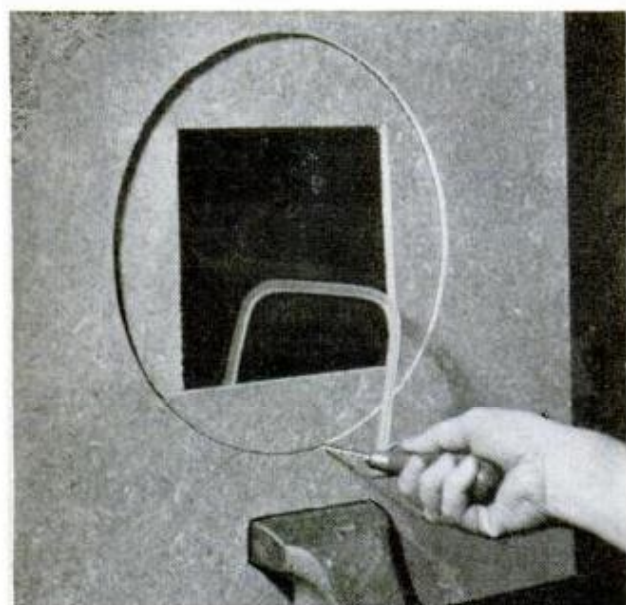

Cutting Large Holes With a Coping Saw

Cutting large circular openings is easy enough with a jigsaw. But what if you have to do it by hand with a coping saw? There's a stunt that makes the job ridiculously simple and in one respect a better way than a jigsaw in that there is almost no limit to the size of the hole that can be cut. The secret is to first cut a square hole in the center of the circular opening to be cut. This provides the necessary clearance for the frame of the coping saw. Sawing the square hole can be done quickly by bringing the blade of your bench saw up through the work. In using the coping saw, the blade, of course, must be removed to insert the frame in the opening.

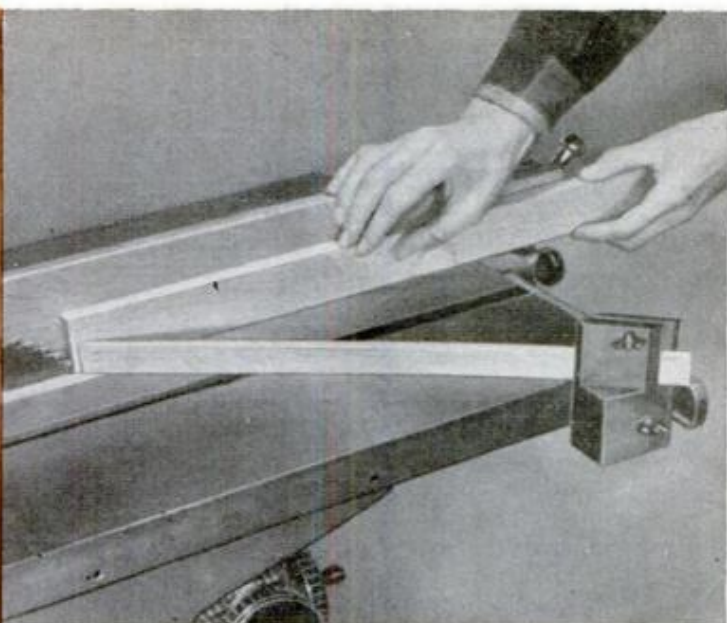
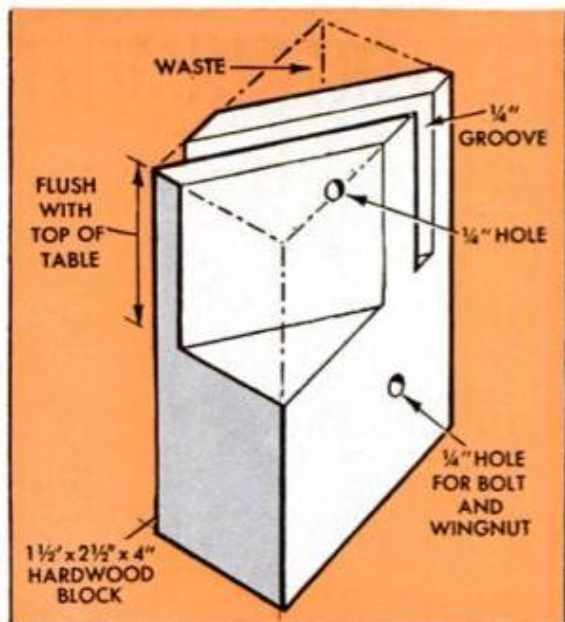

Hold That Board in Line—Safely

Resawing stock on edge to obtain a number of thin strips of a given length can be a tricky operation on a circular saw. The problem, of course, is to hold the stock firmly against the ripping fence as the cut is being made. This can be done in a number of ways, but without a push stick and a spring-type hold-in you risk getting a finger nipped by the blade. To make the whole operation safe and to assure accuracy take the time to make the hold-in pictured.

It consists of a holder of hardwood cut in the fashion detailed and attached to the edge of the saw table with a bolt and wing nut. The spring strip also is of hardwood and it must have lots of spring to be effective. If you can locate a piece of straight-grained hickory, that's the wood to use. Straight-grained white oak is next best for the purpose. Rip the strip to $\frac{1}{4}$ in. in

thickness and sand it smooth. Then bevel the end that is to bear against the stock. Coat the strip on both sides with paste wax and rub to a polish. Drill a $\frac{1}{4}$ -in. hole through the saw-table flange at the left-hand front corner to take the bolt which attaches the hardwood holder to the table. Be sure to drill this hole exactly at right angles to the outer face of the flange.

In use, the hold-in strip must be accurately set for different widths and thicknesses of stock to be worked. When resawing thin stock like that pictured, the end of the spring strip should be set to work as closely as possible to the blade, but be sure that when the stock is passed through, the end of the spring strip will clear the blade. In the photo a push stick has been omitted for reasons of clarity. Always use a push stick when ripping thin stock.

—R. Hanscom

On Center With a Locator

Quite often it happens that holes drilled in metal, especially those of the smaller diameters, turn up offcenter simply because the operator does not take the time to center the work under the drill chuck. Unless this is done the drill bit may be forced out of line and the result will be an oversized hole, or worse, an elongated hole and possibly a broken drill bit. To make a locator, also a prick punch suitable for center-punching soft metals, grind a sharp point on a short length of drill rod, lock this in the chuck and use as a locator in the manner pictured. Non-ferrous metals should be center punched first then centered under the chuck with the locator.

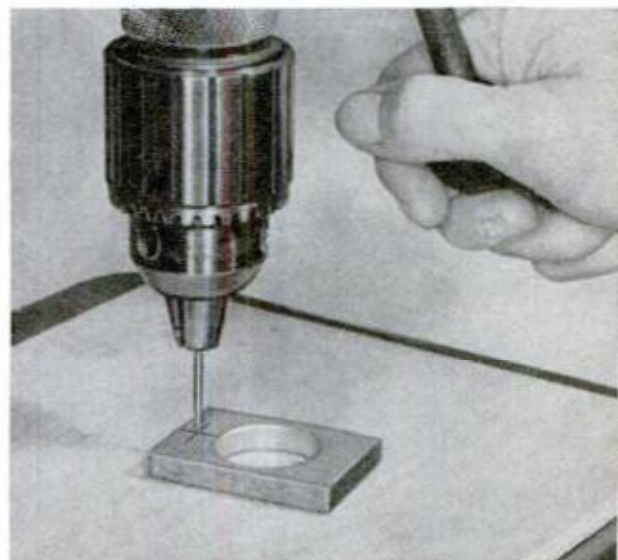

HOW TO BUILD THE ENTERTAINMENT

HERE'S PLENTY of well-organized storage space right where it is needed. This entertainment wall separates the living room from the family room in the PM House of Built-Ins, featured in the October, 1960, issue of POPULAR MECHANICS. The wall increases living space by providing compact storage and it doubles as a dividing wall. Architect Milton Schwartz designed the wall so that it integrates completely with the house.

The wall has adequate storage space for books, records, a TV set and other electronic equipment, plus a place for games, writing supplies and displays of bric-a-brac. In addition, the entertainment wall is a work saver, eliminating much of the dust problem by the use of closed storage units.

Building the wall is not confined to new houses. You'll find all the ideas shown here, suitable for remodeling a present home. Instead of using the idea dividing wall, a similar built-in could fit against one wall of a family room, and by using only a narrow slice from the room provide the compact storage space needed for the activities of a modern family. This method of construction is economical, too, since it utilizes the walls of the house for the back and ends of the storage unit.

In older houses the traditional basement and attic provide enough storage room, but these usually end up as catchalls where it is inconvenient and sometimes impossible to locate things when they are needed. By adding built-ins you can keep articles near the activities they serve. And built-in storage units conserve space by replacing dressers, tables and similar pieces of furniture that often take up too much of the available floor space.

In planning your own storage space, use cabinet depths which are as shallow as practical. Then you can reach an item without disturbing all the other articles, and less storage space will be needed.

The cutaway detail on pages 206-207 shows the general construction of the entertainment wall in enough detail to supply many new ideas for your own built-ins.

The wall features a TV section that is open to both sides, and the set can be turned about for viewing from either the family room or the living room. On the living-room side, a drop panel closes off the view of the set. All the wiring for the TV is hidden inside the cabinets. The wiring is easier to install at the time framing is put up rather than waiting until the wall has been completed.

The end of the wall facing the kitchen

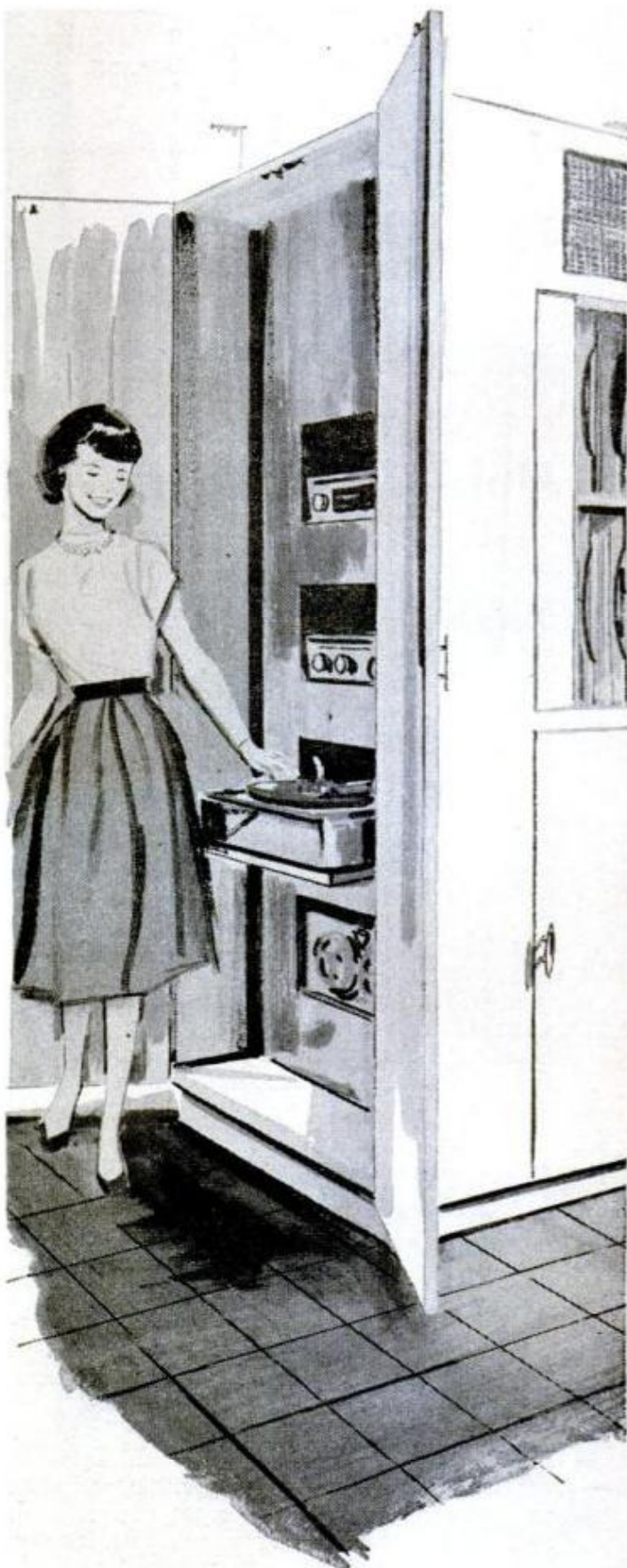

WALL IN THE HOUSE OF BUILT-INS

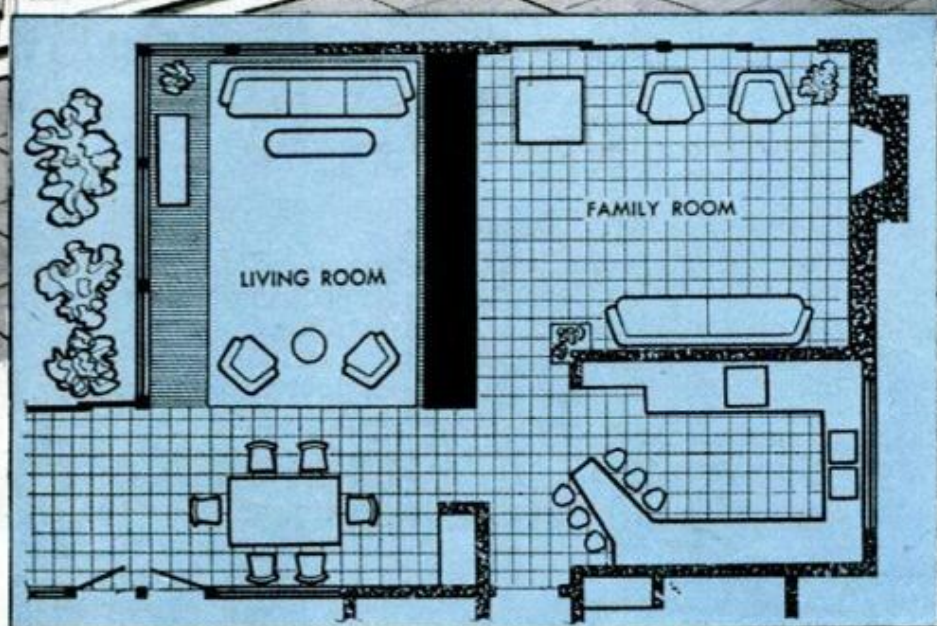

ENTERTAINMENT WALL is center of family life, dividing the two living areas and easily accessible from both kitchen and dining areas. There's a desk for writing letters and plenty of storage for books, records and all the items a family needs for entertaining



and dining areas is the center of the built-in electronics equipment. This section includes a hi-fi radio, record turntable, tape recorder and an intercom system. The two stereo speakers are built in near the top of the wall, and face towards the family room. Wiring for the system extends up from the base of the wall to the equipment mounted in the face of the recessed panel. The space required for this equipment varies, so openings should be cut for the individual units being installed. The full-length doors that enclose the electronic section may be omitted, to make the controls handier.

Next to the sound equipment is a record compartment, set into the wall facing the

family room. This section should be large enough to hold all the records the family owns and provide enough extra space to take care of several future acquisitions.

The book sections have adjustable shelves that can be rearranged quickly to accept different sizes of books and display items. Both sides of the wall include book shelves, so reference books and favorite reading material may be kept accessible for immediate use.

On the family room side there is a handy fold-down writing shelf near one end of the wall. It's a convenient place for writing letters and doing the family book work. Any clutter is quickly hidden in the wall

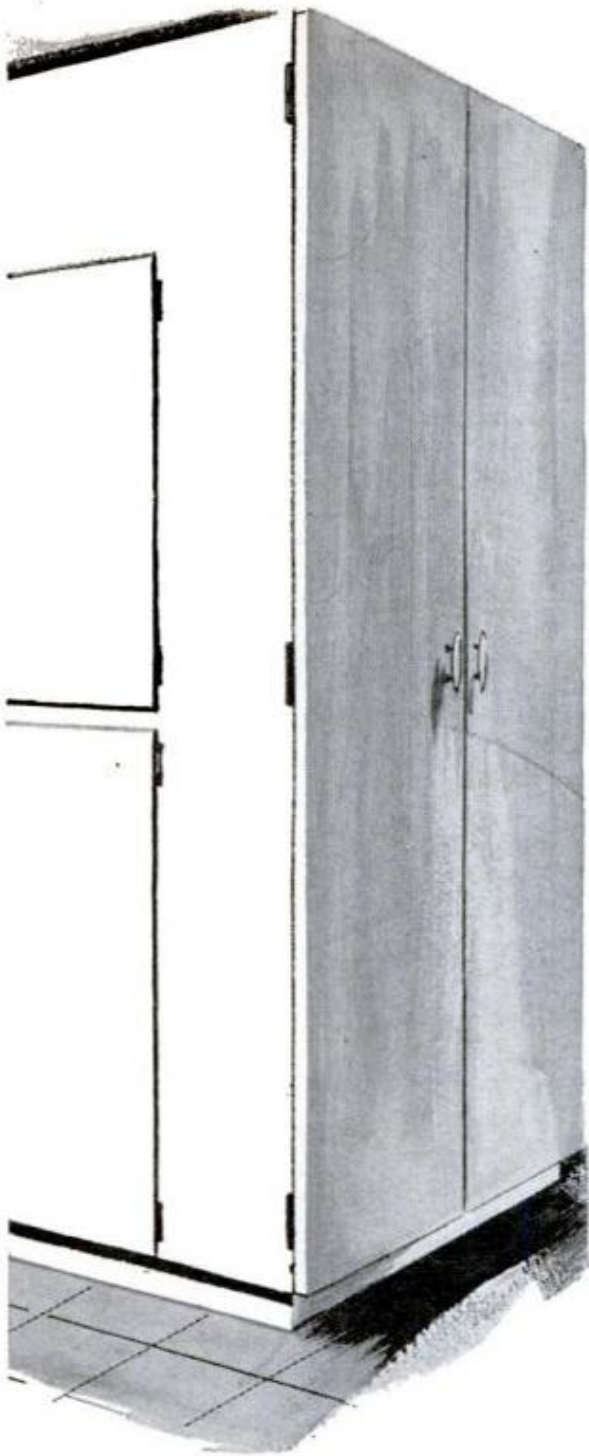

whenever unexpected guests arrive — simply by raising the drop-down shelf of the desk. The two drawers above the desk provide space for all of those small items that get misplaced so easily.

For the bridge-playing family who would like to store folding tables and chairs in the wall, a narrow section may be designed especially for these items. Possibly the family has an interest in home movies, or perhaps color slides are frequently shown to guests. If so, a screen can be hidden in the upper section of one cabinet and permanently mounted. Then, when movies or slides are to be shown, the screen is quickly lowered. And don't forget to include a

storage slot for those TV trays. They are always in demand at snack time.

Built-ins should be designed to insure sufficient flexibility in meeting the changing needs of the family. And it should be kept in mind that these needs are never static. The sizes and quantities of the articles stored are always changing, and space is needed that will meet these future requirements. Even an individual's own ideas about where articles are needed change from time to time. One of the best methods for achieving flexibility in the storage areas is to use adjustable shelves which can be set at any height in the cabinets to store articles of various sizes.

Building the Wall

Every large built-in installation is bound to vary according to the individual needs of the family. The entertainment wall, as shown here, is made in two 8-ft. sections, with 1x2 battens to hide the joint of the abutting sections. Once a satisfactory plan has been drawn up, start by sawing out the basic framing members. The 1x4 base provides 3 in. of toe room around the bottom of the wall. Nail the base together first and then set the floor of the cabinet on the base. Check the spacing and nail the floor and base together.

Before setting the vertical panels, mark the locations for the adjustable metal shelf strips and cut dadoes in the panels to provide recesses for the strips. The metal strips should sit flush with the surface of the panels. Also, if the sizes of the openings in the electronics section are known, cut out these openings before assembling the wall.

By laying the base on its side it is easier to nail the top and ends in place. Then the center dividing panel is added. As you proceed, make sure the pieces are square and level—check verticals and horizontals with a level. The dividing center panels, which form the back of the bookcases and cabinets, are made of 1/4-in. plywood.

Continue by fitting the rest of the shelves, backs and vertical panels into place. Some of the permanent shelves must be toenailed into the framing when it is impossible to nail straight through the vertical panel into the shelf end.

Facing strips of 1x2 lumber cover the vertical panels to form edges to which the doors are hinged. The 3/8-in. rabbets in the edges of the doors fit against the 1x2 facing strips as shown in the detail of the lipped door on page 206. All the doors have magnetic catches, though other types of catches are usable. Where doors do not close against 1x2 facing strips, the rabbeted edges are omitted.

To cover the edges of the plywood shelves, thin strips of matching solid wood are glued and nailed to the exposed edges. These strips fill the $\frac{3}{8}$ -in. space between the edge of the shelf and the lip of the door.

On the living room side of the wall the drop panel closes off the view of the TV set. Two spring-type sash balances facilitate raising the drop-panel in tracks formed between 1x2 facing strips and 1x1 strips added to the sides of the cabinet.

Except for the 1x4 base, 1x2 facing strips and a few other small pieces of 1-in. stock, plus hardboard spacers in the record cabinet, the wall is made of $\frac{3}{4}$ -in. and $\frac{1}{4}$ -in. interior plywood. If a natural finish is used,

all surfaces that can be seen when the cabinet doors are closed should be made of a wood having an attractive grain pattern, such as the birch built-ins featured in the PM House of Built-Ins.

The electronics end of the wall is custom built to accept whatever individual units are used. If holes are not cut before the end panel is nailed into place, they can be sawed out later with a portable electric saber saw or a keyhole saw.

The fold-down writing desk on the family-room side of the wall requires sturdy hardware to hold it in place. A continuous hinge extends the full length of the desk, and two lid-type hinges support the shelf

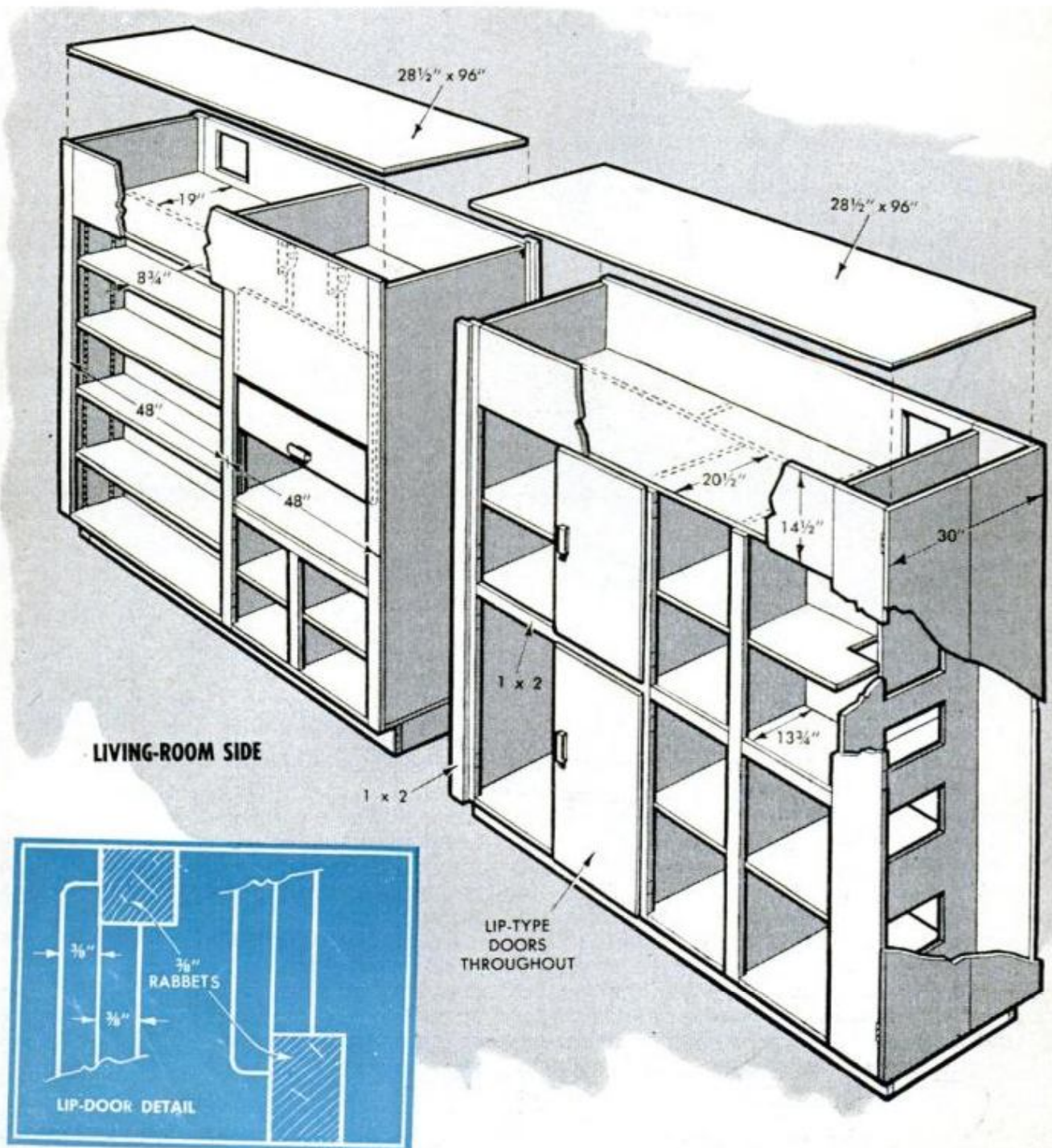

section when it is in the writing position. A magnetic catch holds the desk closed. The two 3-in. drawers above the desk are made according to standard drawer construction. The bottom rests in dados cut into the sides, front and back of the drawer. The back dados to the sides, and the two sides fit rabbets in the front of the drawer. Drawers overlap the 1x2 facing strips.

The record compartment is divided by 1/4-in. plywood panels, cut as shown in the record compartment detail on page 207. Strips of hardboard form grooves for the plywood divider panels which may be pulled out to rearrange the space.

Finishing built-ins is a matter of individ-

ual preference. The modern trend is towards soft, satiny finishes, both for built-ins and furniture. Most built-ins are not subjected to rough handling, so one of the penetrating resin finishes is a good choice. If you wish to retain the natural color of the wood, apply one of the water-clear finishes.

To change the color of the wood, choose from the wide selection of prepared stains or colored sealers that are available. For an important finishing job, test the combination you plan to apply by first finishing a scrap of wood or running the test in a corner of the work that will not be seen.

★ ★ ★

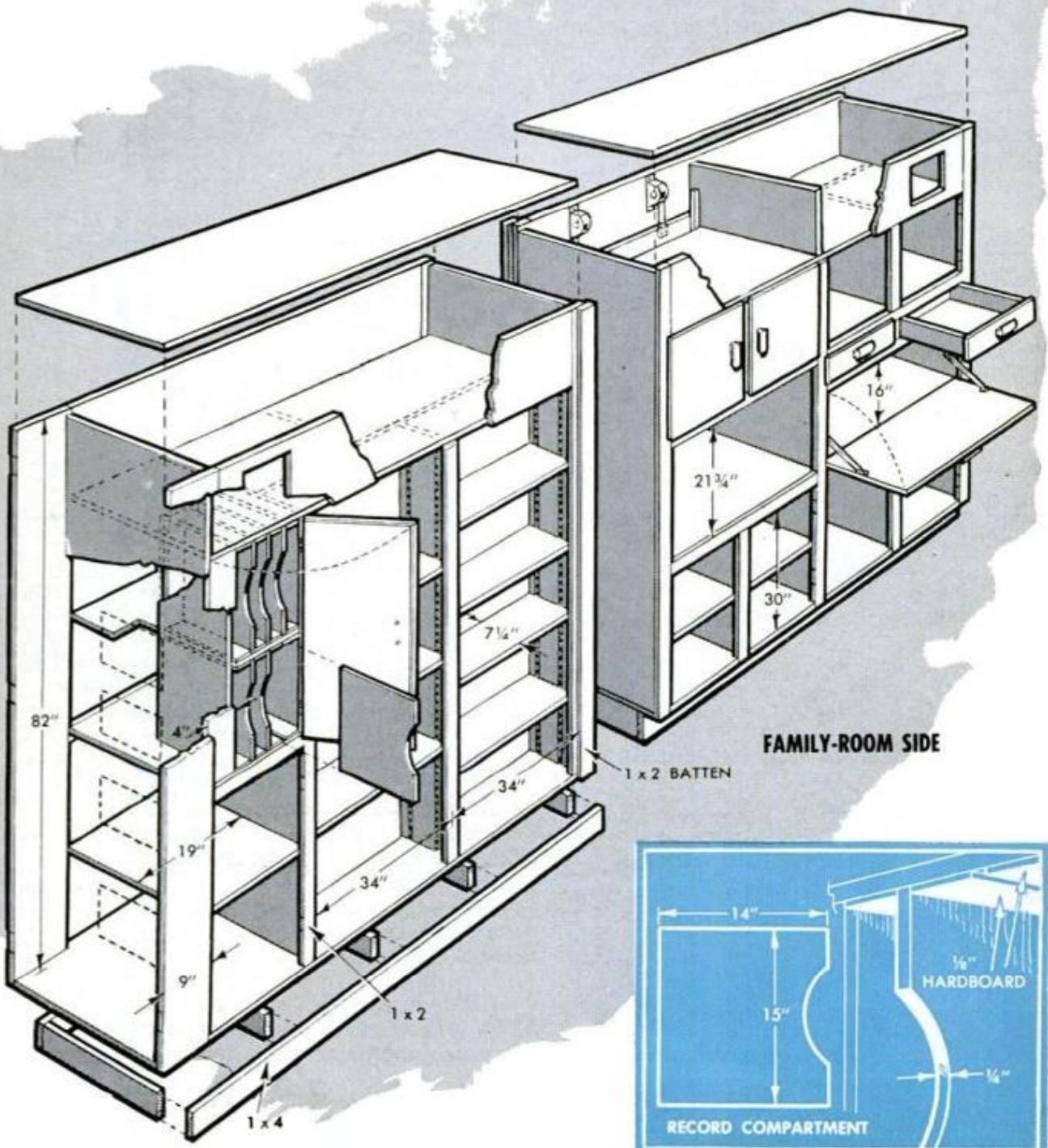

Eyebolt Chuck for Special Job

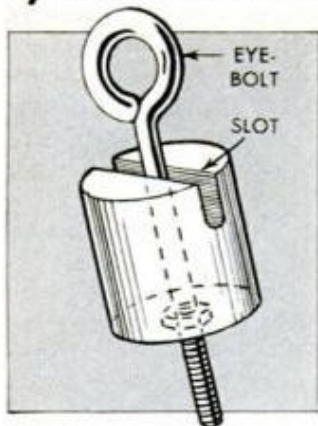

This eyebolt chuck solved a problem for one machinist. The job called for machining a shoulder on the threaded ends of a number of heavy eyebolts. The chuck is made by slotting and drilling a steel round as indicated.

Longer Handle for Allen Wrench

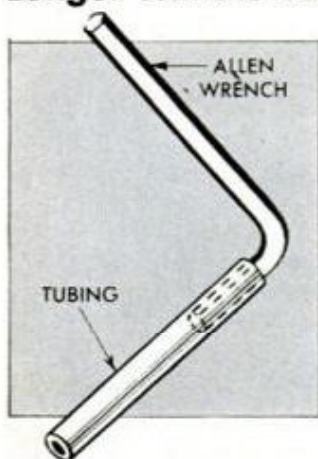

Often you need extra leverage on the short leg of an Allen wrench in order to work in a hard-to-reach location. Keep a piece of tubing handy for this purpose. Inside diameter of the tubing should be such that it will slip over end of wrench.

Drill Sizes Taped on Screw Taps

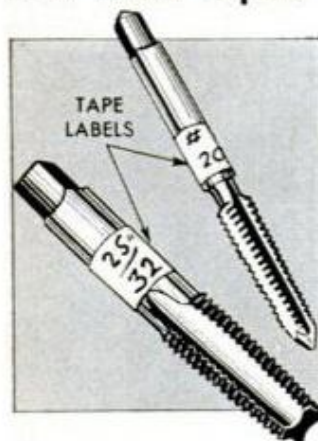

By marking the tap and body-drill sizes on screw taps the proper drills can be selected without the need for checking a chart just to make sure. Mark the sizes on tape with India ink and attach to the shank of the tap.

Cardboard Disks Protect Blades



Hang one saw blade over another on a nail or peg and you'll discover what has happened to the cutting edges of the teeth only after you put the blades back in service. To prevent dulling, cut cardboard disks and place between the blades.

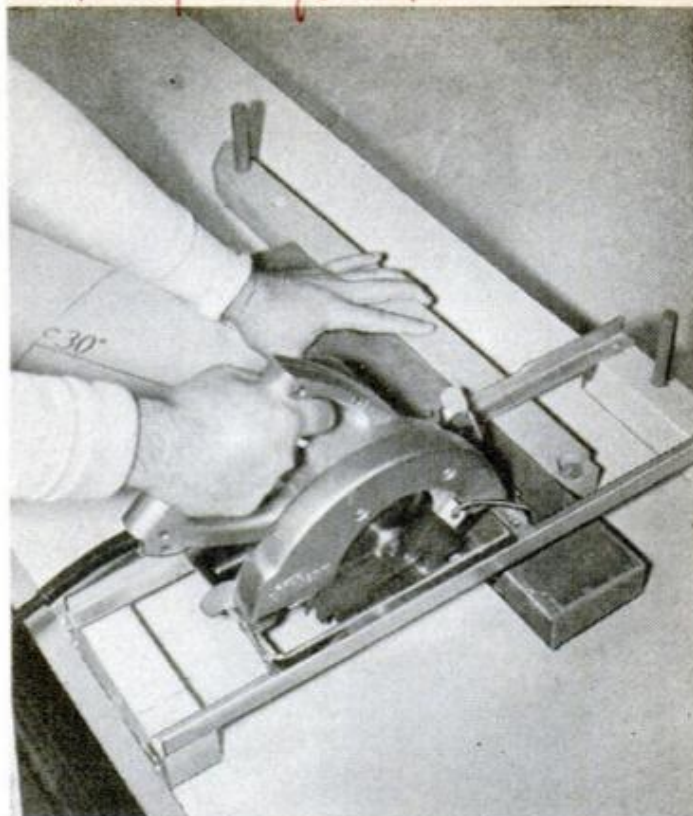

THIS PORTABLE saw guide is easy to make and can be mounted on a 24 x 48-in. plywood panel or bench top

SQUARE CUTS With Portable Saw

WITH A little practice you can do very accurate work freehand with your portable electric saw. But when the job calls for miter-box accuracy, then this simple guide, or jig, really pays off. A plywood panel forms the base of the unit, or a bench top can serve as the base. Then all you need to make are the swinging arm and the guide for the saw, and attach these directly to the bench top. First, make the guide for the saw. Note from the details on the opposite page that the aluminum angles which form the guide are mounted on two hardwood blocks. The length and height of the blocks suit the portable saw pictured but the dimensions may not be correct for your saw. Check the size of the sole plate of your saw before you cut stock. When you drill holes for the screws holding the guide angles, make sure that they are correctly spaced to permit the saw to slide easily throughout the length, but without any side play. Note in the detail that the angle stop has two positions. The second position makes it possible to cut a compound angle at 45 degrees. Mark 90, 15, 30 and 45-degree positions on the table. Drill holes at these positions to take the anchoring pin.—Gathel B. Weston.

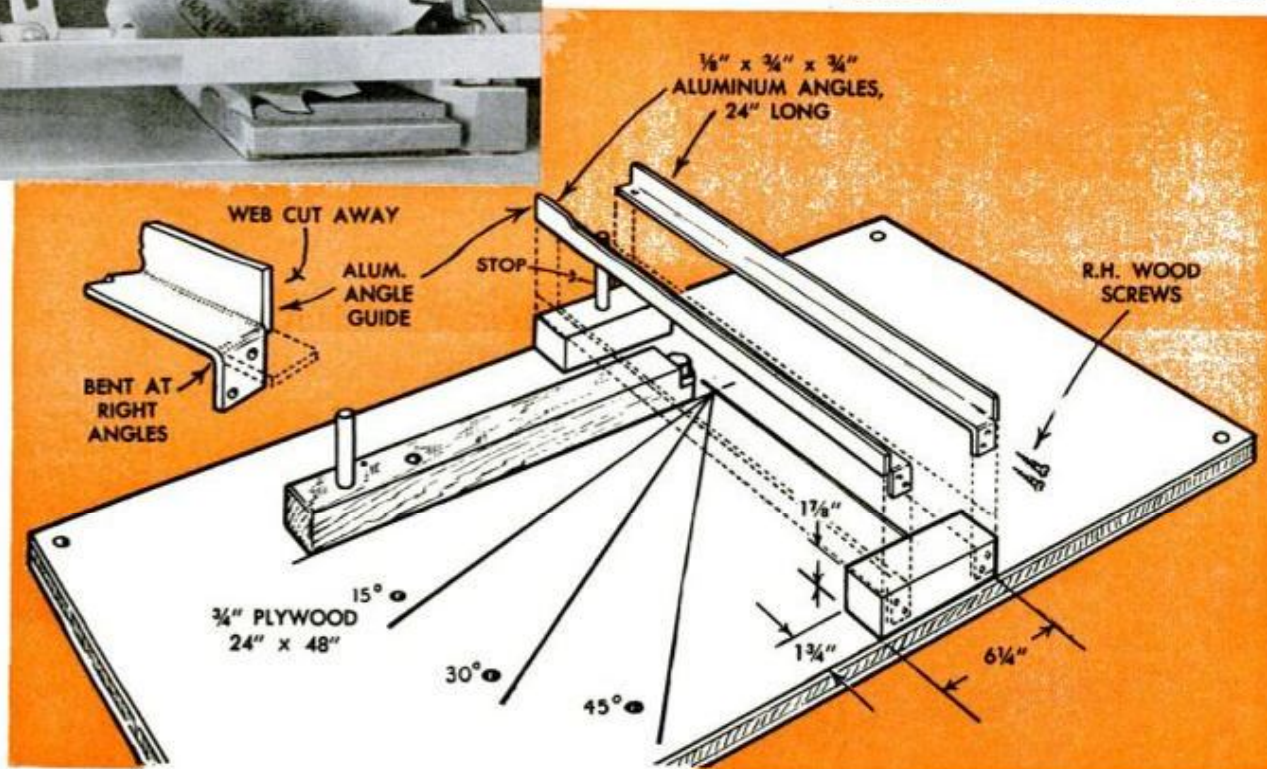
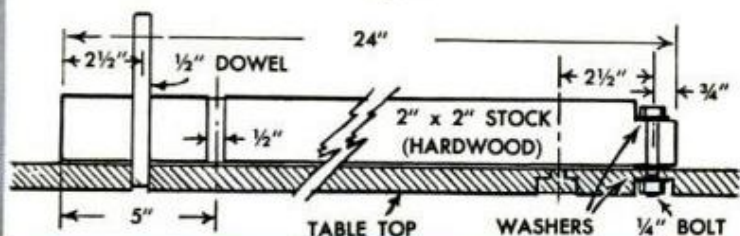
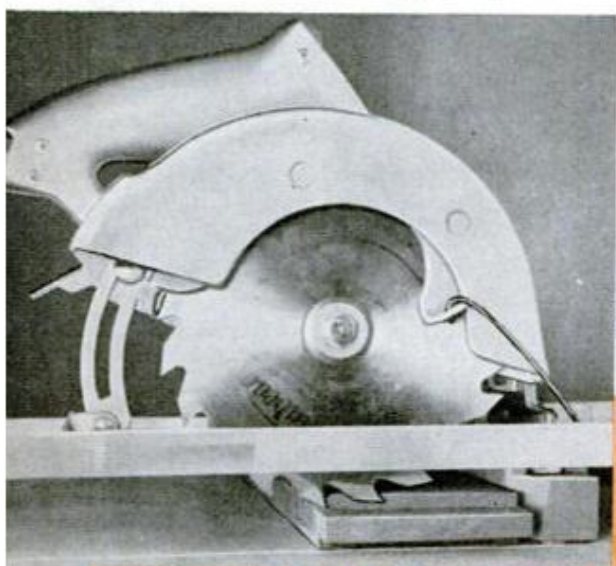
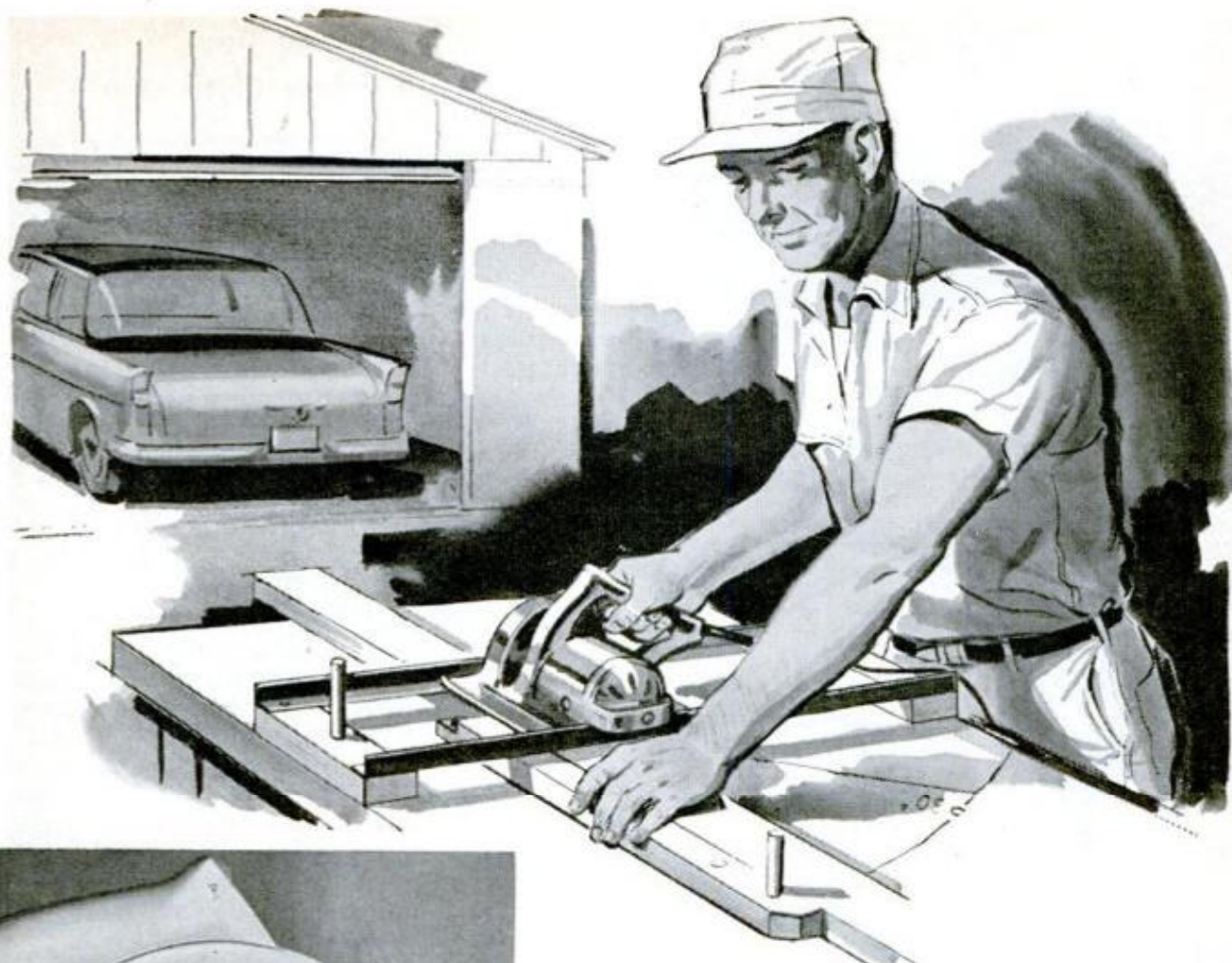

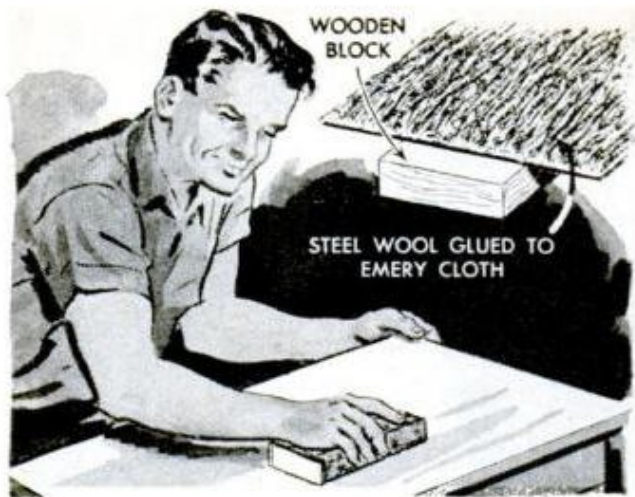

Steel-Wool Finishing Pad Backed With Emery Cloth

Next time you have occasion to use steel wool in the pad form, especially fine wool, try this stunt: Unroll a pad of the wool and glue it to a piece of fine emery cloth or any stiff, heavy fabric. When the glue has dried fold the finishing pad thus made around a wooden block or use loosely to polish metals or for rubbing down a fine cabinet finish. You'll be surprised at the increased efficiency of steel wool backed in this manner.—Sam Fleischman

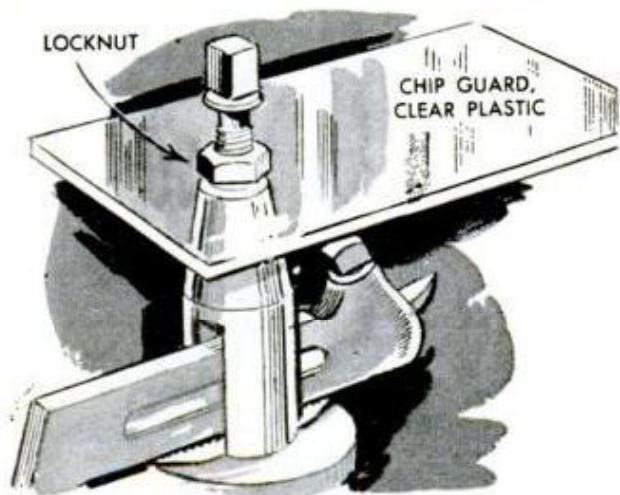

Chip Guard on Tool Post Protects Lathe Operator

When metals such as gray iron and certain non-ferrous metals are machined dry chips are sometimes thrown upward with considerable force. Rather than wear a face shield constantly, one machinist installs a chip guard, or deflector, on the top end of the toolpost. This is made from clear plastic and is attached by means of the toolpost screw and a locknut as in the detail. Use of transparent plastic permits a clear view of the work.—Joseph Federico

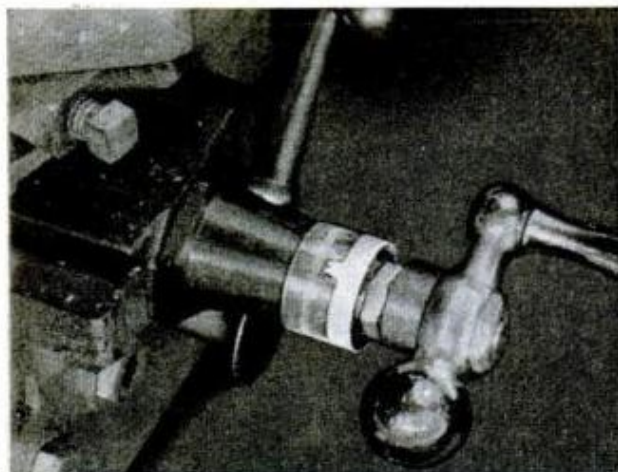

Witness Mark "Remembers" Settings On Lathe Crossfeed Dial

Often the nature of the work requires that the crossfeed be moved and then returned to the same setting. To avoid the necessity of jotting down the original setting and not trusting to memory, one machinist made this indicator from light spring steel. It's a strip about 1/4 in. wide with a projection at one point on which a witness mark is made. Clipped to the dial and moved to the desired position it indicates the original setting clearly.

—R. Hanscom



Tap Wrench Is Ideal Holder For Grinding Lathe Tools

It's difficult to grind a lathe tool accurately without a holder, especially one that has been worn down to a short length. But if you have a tap wrench handy this problem is quickly solved for the wrench is a perfect holder for freehand grinding. You remove the sliding handle, of course, and the wrench chuck is readymade for the job as it takes the square shank of taps in a range of sizes. Just tighten the tool in the wrench chuck and you're in business.

Hardening Steel

CRAFTSMEN, hobbyists and students in school shops who like to make tools need to know methods of hardening and tempering tool steels. In general, there are three steps in the process. The first is annealing to improve the physical condition of the steel and relieve stresses that may have been locked in the metal by rolling and forging processes. This usually is done by heating the metal to a dull red color and then permitting it to cool gradually. The next step is heating the steel to temperatures within the critical range where changes occur in the carbon it contains. Note from the table at the right that these temperatures vary with the carbon content of the metal. Note also the relation of temperature to color as expressed in the center table. Where a pyrometer-equipped furnace is not available one must rely on interpretation of the color of the metal to determine when to quench it in the hardening bath, which usually is cold water or oil, depending on the degree of hardness desired and other factors. The final step is tempering the steel to the desired hardness and toughness for the job it is to do. This is often referred to as drawing, and is done by reheating and quenching in oil or water by the color method.—Frank L. Rush



CARBON PERCENT	CRITICAL RANGE D.F.
.10 or less	1,290 to 1,600
.30	1,290 to 1,520
.45	1,290 to 1,430
.60	1,290 to 1,400
.90 and over	1,290 to 1,330

COLOR	TEMP.	COLOR	TEMP.
Faint Red	900 F.	Salmon	1,650 F.
Blood Red	1,050 F.	Orange	1,725 F.
Dark Cherry	1,175 F.	Lemon	1,825 F.
Medium Cherry	1,250 F.	Light Yellow	1,975 F.
Cherry or Full Red	1,375 F.	White	2,200 F.
Bright Red	1,550 F.		

COLOR	TEMP.	TYPE OF TOOL
Very Pale Yellow	430 F.	Scrapers, light-turning tools
Pale Yellow	450 F.	Razors, surgical instruments
Medium Yellow, or Light Straw	460 F.	Lathe tools, milling cutters
Full Yellow, or Straw	470 F.	Penknives, drills for iron and steel
Brown	490 F.	Taps, reamers, die for screw cutting, shears, flat drills
Brown with Purple Spots	510 F.	Axes, planes pocket knives, wood chisels
Purple	530 F.	Twist drills, cold chisels for light work, table knives
Dark Blue	550 F.	Wood saws, hammers
Full Blue	560 F.	Stone-cutting chisels, fine saws
Medium Blue	580 F.	Carving knives
Light Blue	600 F.	Drills for wood, cold chisels

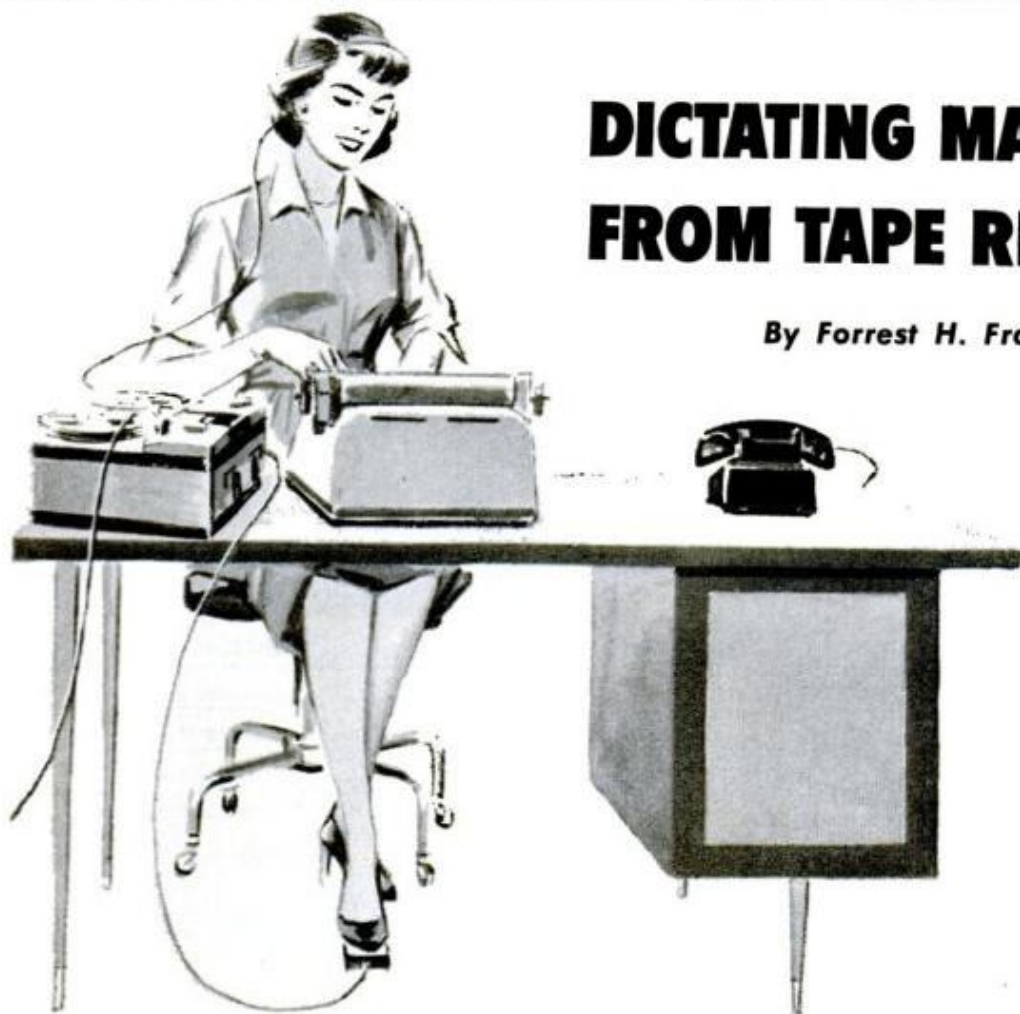

DICTATING MACHINE FROM TAPE RECORDER

By Forrest H. Frantz, Sr.

PRICES for most dictating machines start at \$200 or more and dictating machines are limited to this one specific function. Tape recorders can be modified to function as a dictating machine for a few dollars. Furthermore, the tape is reusable and the entertainment value of the recorder is retained.

Dictating machines have features that are not incorporated in tape recorders. These are stop-start transport action and earphone playback for privacy. These features may be added to a tape recorder with very few parts. To provide easy stop-start operation, a foot switch is desirable. Typists can transcribe easily if their hands are not required to operate the machine. The switch is handy during recording when interruptions occur. A connector permits the use of the recorder without the switch. An earphone jack switches the speaker on for playback when the earphone plug is removed.

The switch is a Grayhill 2202 normally on, momentary contact switch. This switch

(connected in series with the recorder motor) allows the motor to run when in the normal position. The person recording or transcribing stops the motor by depressing the switch. To resume use, release pressure on the switch.

The switch is mounted on a rubber door wedge. Drill a $\frac{1}{2}$ -in. hole for the switch and two $\frac{1}{8}$ -in. holes for the mounting screws.

The wedge then mounts on a plastic case which accommodates the portion of the switch protruding from the rear of the wedge. The plastic box protects the user from the connections and provides a base for the switch. The case is $4\frac{5}{8} \times 2\frac{1}{4} \times \frac{3}{4}$ -in. (Lafayette MS-160.) The case walls flex slightly, so there's little chance of cracking. Cut a 1-in. hole with center 1-in. from an end of the larger piece of the case and on the centerline, with a heated ice pick. Place the wedge on the case. Centering the wedge, pass a heated pick held perpendicular to the top of the wedge through the mounting holes to mark them on the case.

Enlarge the case holes by passing the heated pick through. Make a 1/4-in. hole in the end of the case nearest to the switch for the cord. Start this hole with a hot pick and ream to size.

Cut out a wood block 2 1/4 x 3/4 x 3/4-in. and apply casein glue to a side. Place the block in the case near the mounting hole adjacent to the switch and fasten the wedge with a 3/4-in. screw. Fasten the slim end of the wedge with a 6-32 nut and 1/2-in. machine screw. Connect 5-ft. of lamp cord to the switch. Fasten the male plug (Amphenol 91-MPM3L) to the end of the cord.

Run a bead of casein cement around the inside of the lid and spread some glue on the back of the block. Fasten the pieces together and allow to dry.

The switch is in series with one side of the motor line. A length of lamp cord to extend outside the recorder after reassembly is provided. This connects to the center and to one of the outer terminals of a SPDT switch (Carling S60B). A socket (Amphenol 91-MPF3L) connects across the outer switch terminals for the foot switch plug. The socket is mounted on the board with the shell retaining screw and a wire. The wires are bent over on the board bottom.

The recorder mechanism is removed from the case to make connections. The method of attachment varies with individual recorders. Place the mechanism in a position which makes the wiring accessible. Locating the motor leads, disconnect one. Turn the recorder on and check that the disconnected lead stops the motor. Usually motors have three leads (third lead grounds frame). In some recorders the motor is also the power transformer and more leads are involved, such as the Telectro 1960 in the photos. The motor lead attached to the AC switch is disconnected. Connect one lamp cord lead to the disconnected motor lead and tape. Connect the other lead to where the motor lead was disconnected.

The phone jack is connected into the loudspeaker transformer. The jack is sub-miniature (Lafayette MS-282). The loudspeaker operates as prior to modification unless the headphone plug is inserted. When the plug is inserted, the speaker is silenced due to resistance of the earphone. To connect the jack, disconnect one loudspeaker terminal. Trace the wiring back. Be sure the lead which you disconnect is ungrounded. Fasten the three jack leads to the speaker terminals and the disconnected lead. Use different wire colors to make connection easy. Replace the deck in the case, and connect the jack. Cut a mounting

(Continued to page 238)

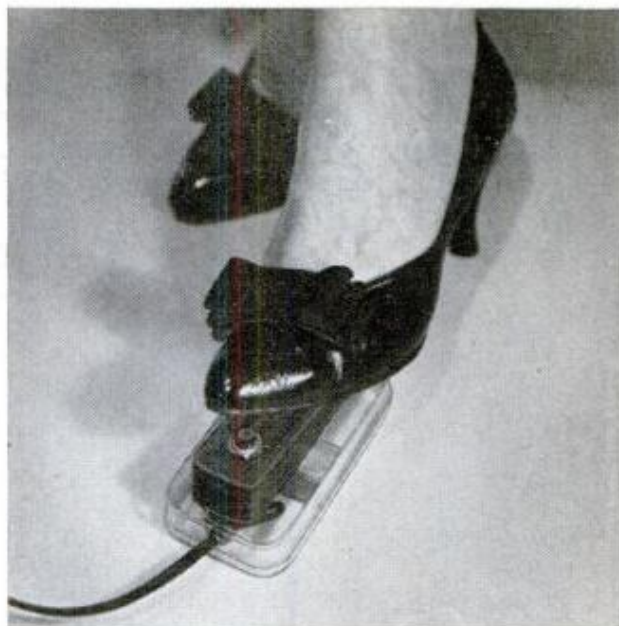

Foot switch, mounted on door wedge, turns the tape recorder on and off so that typist can "catch up"

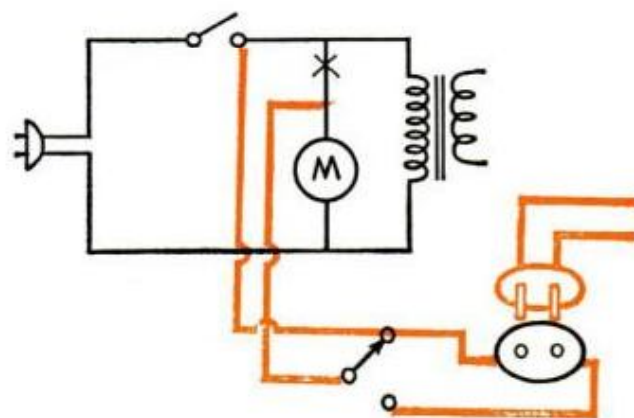

Red lines indicate new wiring for the foot switch. Break connection at "X," add the switch and plug

New control board is mounted to the top of tape recorder. Controls are accessible but out of the way



"Tomorrow's TV Set Today"

IT'S BEEN a long road to haul, and a tough one—but TV is finally going the transistor route and television fans the world over stand to benefit by the transition.

Transistors, of course, are no longer strangers to the electronics field. They've taken over the portable-radio field where they've virtually edged out their vacuum-tube predecessors. As a result, portable radios are now smaller, lighter and less expensive to operate. They've launched a full-scale invasion of the military and industrial electronics fields; and the resulting equipment is more reliable and infinitely more efficient. Now they've mounted a multi-pronged attack on modern, large-screen television with the promise of bringing all of their advantages to bear in this far-reaching area.

Of course, even in television, transistors are not entirely new. As far back as 1957, fully transistorized, experimental models were displayed. None of these, it was pointed out, was commercially practical at the time—owing to the high cost of prevailing transistors and a general lack of engineering background and experience with transistor circuitry.

In '59 the first commercial versions of all-transistor sets appeared on dealers' display racks. But all of these were small-screen receivers. Evidently, the problems of marrying transistors to today's large-screen picture tubes had not yet been solved.

Then came the unit shown on these pages and, with it the last obstacle to full-scale transistorization has apparently been hurdled.

Incorporating 23 transistors and 12 diodes, it drives a full-sized, 19-inch picture tube with a 114° deflection angle which presents about the severest challenge that television has to offer. With the experience gained in its design, and with very similar circuitry, engineers triumphantly claim to be able to drive even larger tubes—21s and 23s—to the full limit of their capabilities. It has been predicted that: "the next four or five years will see an almost complete transition from tubes to transistors, in the television industry."

Why all the excitement over transistorized television? Perhaps the biggest single reason is the added reliability which

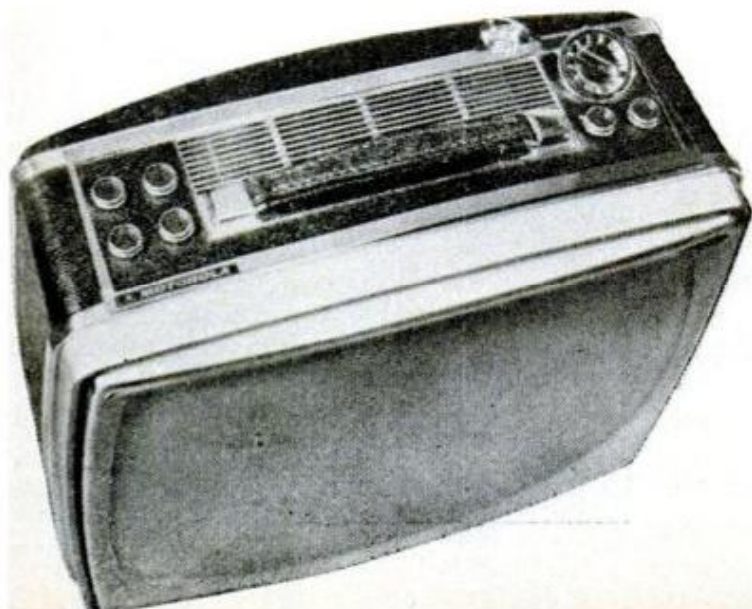

No line cord to plug in makes this portable, the ideal picnic companion. Monopole antenna collapses entirely into top

Block diagram shows how the unique power supply system operates. Energy cell recharges when set is used on house current

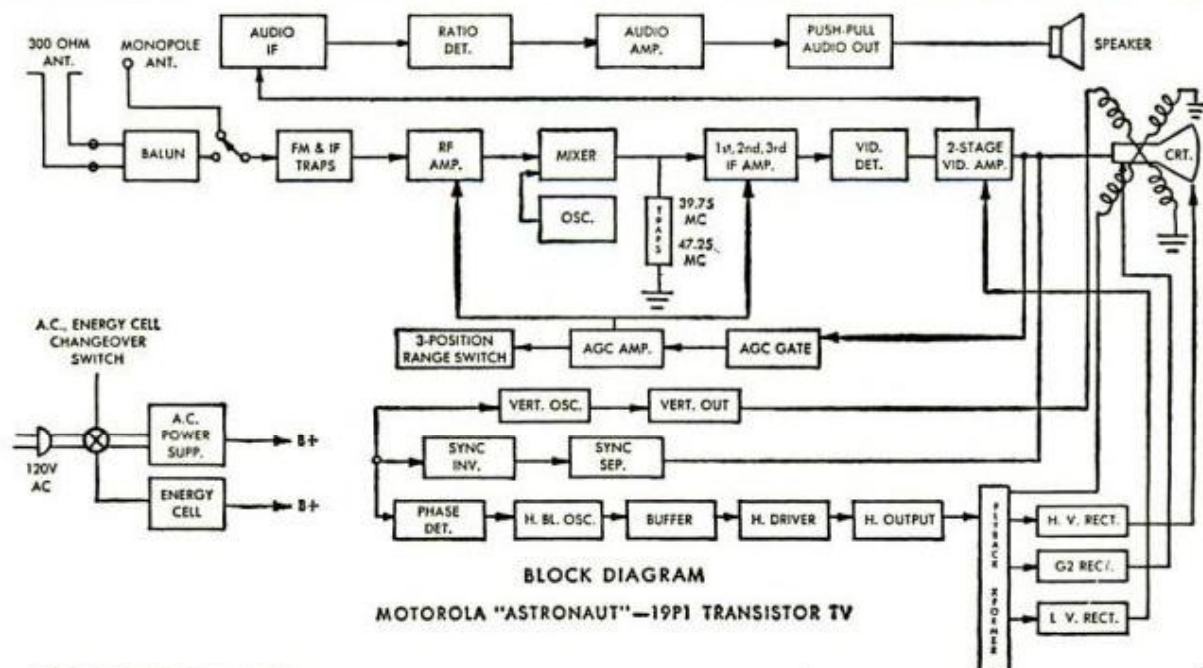
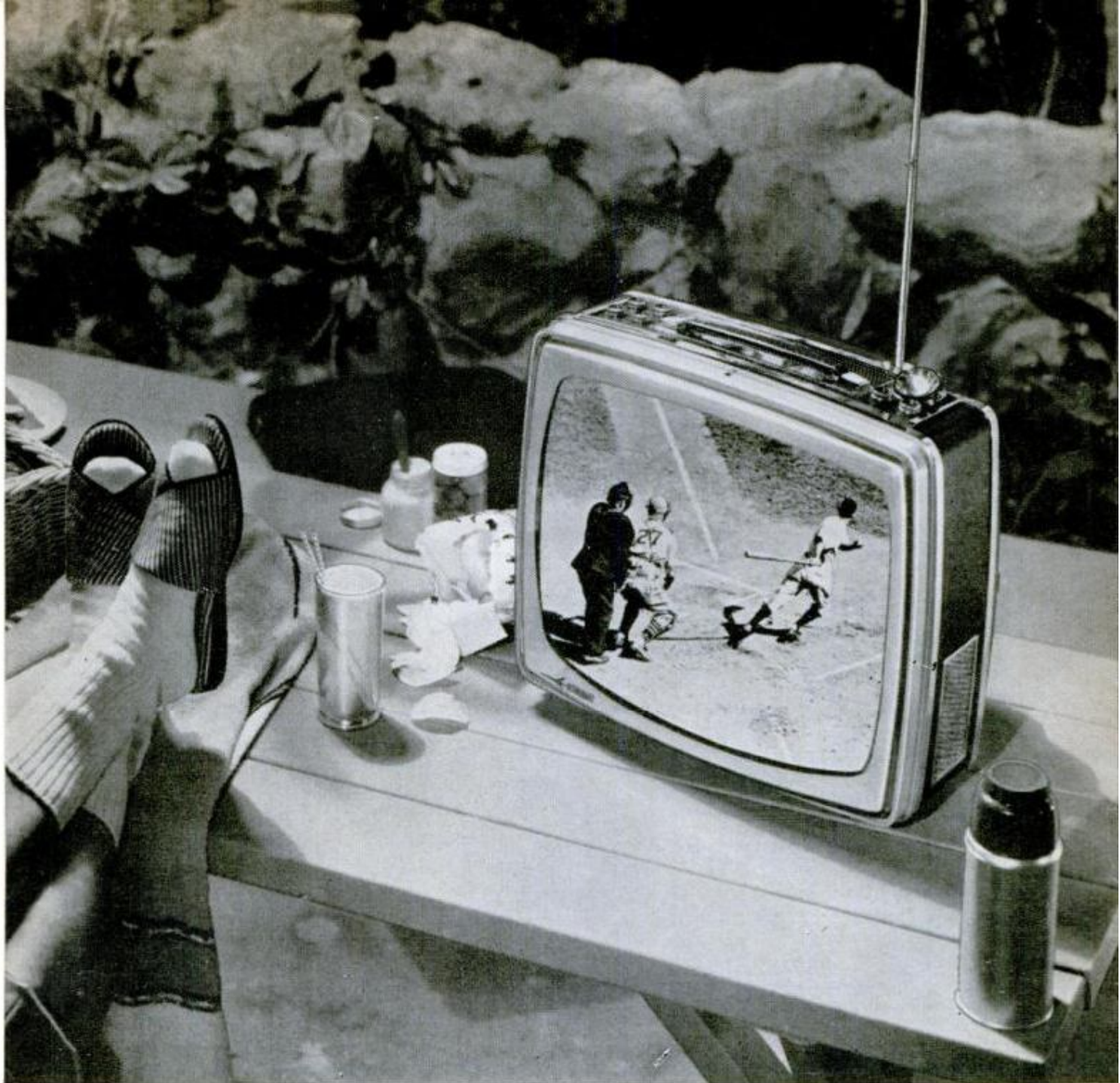

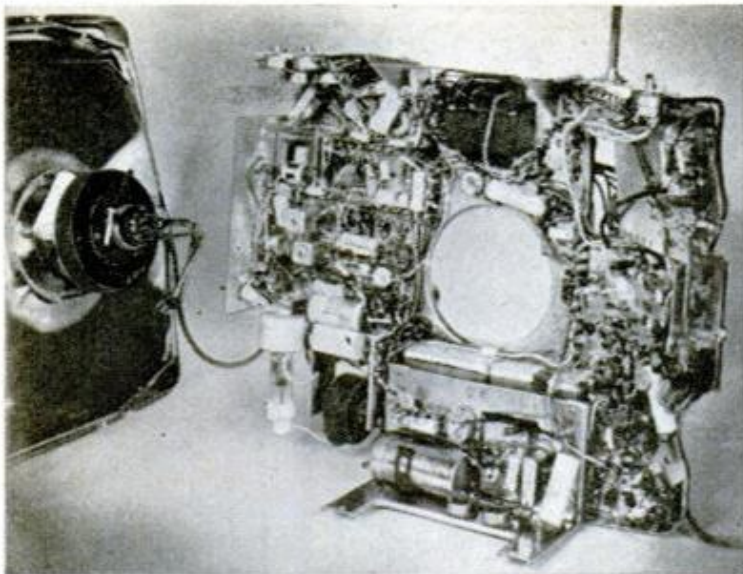

Chassis fits over neck of picture tube, keeping the size of the set to a minimum. All the wiring is easily accessible



The transistors and diodes combined use less space than the only tube in the set

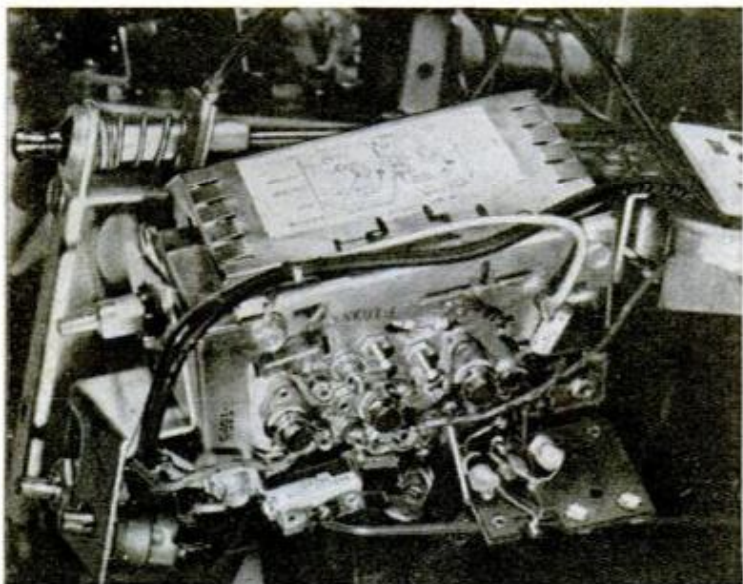

Transistorized front end (above) shows compact construction. With chassis removed from cabinet (below) energy cell can be seen under yoke assembly. Transistors can be easily replaced

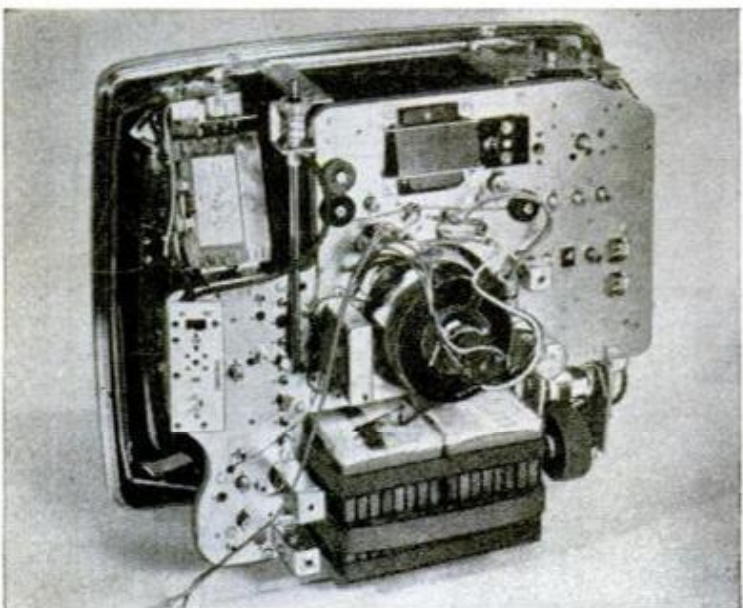

these amazing electronic midgets impart to the equipment in which they are used. With no filaments to burn out or deteriorate they are expected to outlast even such relatively troublefree parts as resistors and capacitors. And, because transistors produce very little heat—the arch enemy of electronic components—the life of all other parts is expected to be considerably prolonged.

The goal, apparently, is to put television on a reliability par with refrigerators, freezers and similar appliances which operate for years without any attention.

There are other advantages, however, which are no less significant. Because transistors require very little driving power, compared to vacuum tubes, they are admirably suited for battery operation. This model, in fact, performs just as well outdoors, operating from an internal energy cell, as it does indoors from the standard 120 volt a.c. power line.

In the home, only 40 watts are drawn from the power line—less than $\frac{1}{4}$ the power requirements and operating costs of an average vacuum-tube model. This model equals or betters the performance of conventional sets in every respect. This, of course, is essential in a unit costing \$275, plus an additional \$88 for the optional energy cell which permits its use outdoors where a convenient source of line power is not available.

(Continued to page 238)

There's a Weldwood Adhesive for just about every gluing job



QUICK, CLEAN Presto-Set® Glue, the all-purpose glue, bonds paper, wood, cloth, china. Dries fast, won't stain. Handy new bellows-action squeeze bottles with spreader tops. From 39¢.



EASY-TO-USE Weldwood Contact Cement bonds leather, wood, plastic instantly, permanently, on contact. Needs no clamping; water-resistant, stays flexible when set. From 29¢.



STRONGEST of them all is Weldwood Plastic Resin Glue. Nothing like it for heavy-duty jobs. Makes joints even stronger than the wood itself. Mixes instantly, is water-resistant. From 40¢.



WATERPROOF and best for lawn furniture, boats, Weldwood Waterproof Resorcinol Glue makes a powerful bond on most porous materials. Resists rot, fungus, heat, cold. From \$1.15.

Each Weldwood® Adhesive has an important place in every home. In your kitchen, workshop, garage, family activities room, wherever repairs or projects go on in your house, one or more of these Weldwood work savers belong—there when you need it. Your hardware, lumber, and paint dealers stock all four—pick up your supply soon.

NOVEMBER 1960

WELDWOOD
ADHESIVES

Products of United States Plywood

229

New Ideas in Photography

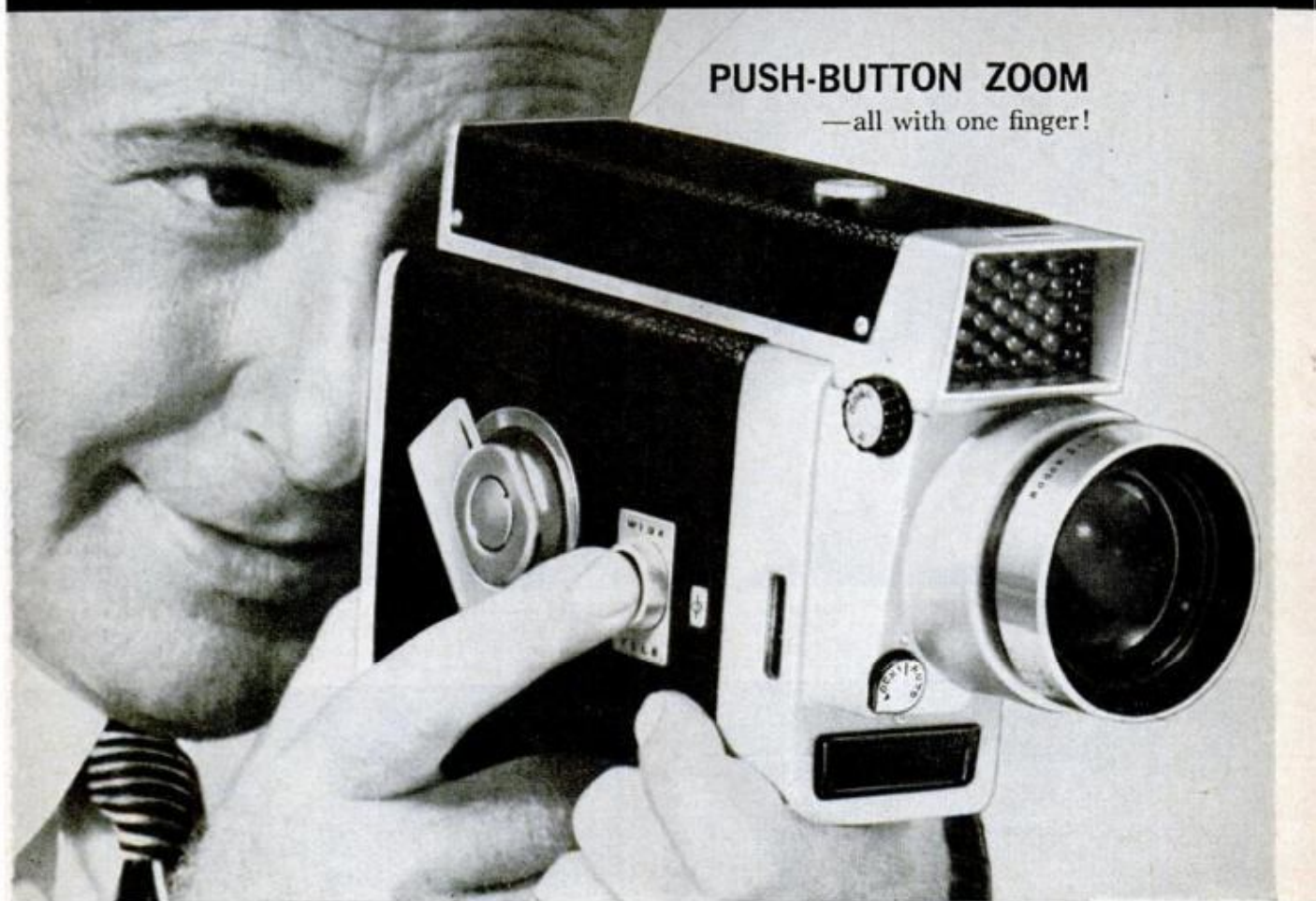

PUSH-BUTTON ZOOM

—all with one finger!

Look! A single button operates the camera and zooms your movies, too!

Z-O-O-O-M! Push button zooms your movies, electric eye sets the lens—new Kodak Zoom 8 Reflex Camera

Now! A push button brings you the most marvelous thing that's ever happened to movies—the zoom! You look through the finder and before your eyes people and objects suddenly swoop close and fill the scene. Or, starting with a close-up, the scene suddenly widens like opening the curtain on a gigantic stage.

Since you view through the lens of this new Kodak Zoom Camera, you see exactly what will appear in full, brilliant color on your screen at home—a wholly new and dramatic experience in movies you make yourself.

You can also zoom manually with this 8mm camera, or set the lens in advance at any position from wide-angle view to telephoto close-up, without taking a step. And the camera's electric eye makes all the exposure settings for you . . . automatically.

Inspect this remarkable new movie camera. You'll find it at your photo dealer's now. Price: less than \$190, or as little as \$19 down. See your dealer for exact retail price. Many dealers will take your old camera in trade.

Prices are subject to change without notice.

PICTURE IT NOW . . . SEE IT AGAIN AND AGAIN!

from Kodak

POWER FILM WIND

—10 color shots in
10 seconds!



Listen! You can hear the film advancing automatically for the next shot!

BZZ-Z-Z-T! Power drive winds the film, electric eye sets the lens—new Kodak Motormatic 35 Camera

If ever a camera wouldn't let you miss a picture this is it!

The new Kodak Motormatic 35 Camera power-winds the film automatically—quick as a wink. It's ready for the next picture instantly. Now you can click off sequence shots that tell the whole story. Catch that fleeting expression that so often happens just after you press the button.

The electric eye adjusts the lens automatically for picture-perfect exposure—dawn to

sundown, summer or winter, in bright sunlight or shade. You get a good shot every shot.

And imagine—automatic flash setting! Just set the distance, and the lens opening automatically adjusts for correct flash exposure!

This is the most automatic, fastest-operating 35mm camera Kodak ever made. Costs less than \$110, or as little as \$11 down. See your dealer.

EASTMAN KODAK COMPANY, Rochester 4, N.Y.

SEE KODAK'S "THE ED SULLIVAN SHOW" AND "THE ADVENTURES OF OZZIE AND HARRIET"

Kodak
TRADEMARK



**for furnaces and
air conditioners**

- * REMOVES DUST, DIRT, POLLEN
- * REMOVES ODORS
- * KILLS BACTERIA
- * ALUMINUM
- * CONVENIENT
- * WASHABLE
- * LONG LASTING
- * EFFICIENT

Send for **FREE Booklet**
Complete information on what
to look for in an air filter

There is a
difference
in **AIR
FILTERS** 

See Your Dealer or Write
RESEARCH PRODUCTS Corporation

Dept. 2109, Madison 1, Wisconsin

IN CANADA: HICKS-BAKER LTD., WINNIPEG • SPALL-BOWMAN LTD., GUELPH

Clinic for Homemakers

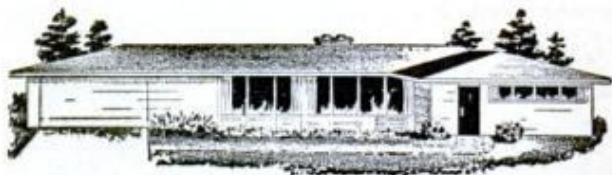

As a service to our readers in solving the hundreds of problems pertaining to a home—inside or out—the editors of *Popular Mechanics* invite you to present your problems to The Clinic Editor for help and advice. Address your questions to The Clinic Editor, *Popular Mechanics Magazine*, 200 East Ontario Street, Chicago 11, Ill.

Moisture Condensation on Walls

Q—I live in an older home which I purchased two years ago. It is built of brick, with solid brick walls and I think the plaster is put on over the brick. The house is very old. I installed a modern heating system and papered the rooms upstairs. The walls sweat in winter in the upstairs rooms, so much so that the paper has been ruined in two rooms in the north end of the house. I'm at a loss as to what to do. Why do the walls sweat like this?—W. H., Vt.



A—The walls sweat, as you say, simply because they are colder than the air in the rooms. Notice the beads of moisture that form immediately on a glass tumbler full of cold water on a warm summer day and you are looking at essentially the same thing. The surface of the glass is colder than the air which contacts it. This causes the moisture in the air to condense on the cold surface. In your upstairs rooms the exposed walls (outside walls) are relatively cold. The air in the rooms is heated to a temperature of, say, 70 degrees and contains moisture in the form of vapor. The variation in temperature causes condensation of this moisture on the relatively cold walls. When brick walls are used as a plaster base, there is no "air blanket", or dead-air space, interposed between the two extremes of temperature. This

(Continued to page 234)

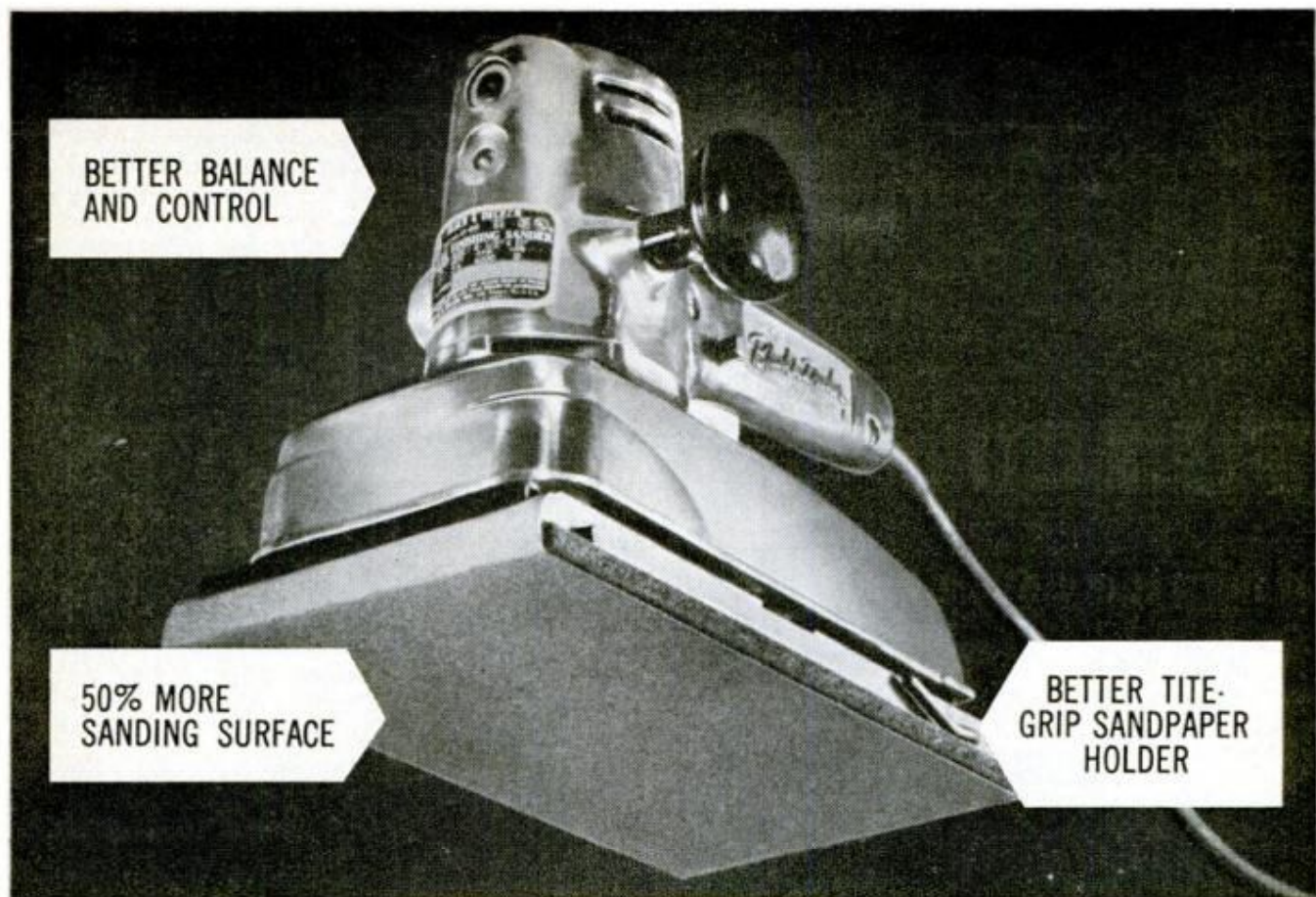

BETTER BALANCE
AND CONTROL

50% MORE
SANDING SURFACE

BETTER TITE-
GRIP SANDPAPER
HOLDER

New B&D Finishing Sander cuts sanding hours to minutes

Black & Decker's NEW action-packed U-66 Finishing Sander has a 50% larger sanding area for faster sanding and refinishing. Professional type king-size platen, feather light control and broad-shouldered B&D power make it a natural choice for jobs rough or fine . . . for heavy-duty removal or fast refinishing.

You get easier handling from natural grip handles positioned over the work for accurate control. You get positive paper clamp which locks and *stays* locked. You get instant release trigger switch—with locking pin—and 3-conductor cable and plug. You get one of the lightest, most compact units on the market—and famous B&D power, dependability and durability.

Black & Decker offers the widest selection of sanders and features on the market. Prices start at only \$29.95. For free catalog, write: THE BLACK & DECKER MFG. Co., Dept. D-110, Towson 4, Md.



B&D U-440 Utility Sander. Power-sanding economy in initial cost, in hard work, in time savings.



Dust-Less Attachment. Dust-Less Attachment equips any B&D Finishing Sander for clean, dust-free operation.



Black & Decker®

WORLD'S LARGEST MAKER
OF POWER TOOLS



for Christmas Giving

THERE'S NO FINER GIFT THAN

Starrett TOOLS

Give a gift he'll treasure and use — on the job or in his hobby. Always appreciated by the man or boy who loves fine tools. Choose from more than 3,000 Starrett tools — at hardware tool stores or industrial distributors.

FOR HANDYMEN



Drive Pin Punches No. 565. Set of 8 in wood box



Jewelers' Screw Drivers No. 555. Set of 6 in plastic case

FOR HOBBYISTS



Combination Set No. 9. Eight handy tools in one



Toolmaker's Hammer No. 815. With built-in magnifying glass

FOR PROFESSIONALS



1" Micrometer No. 230RL. With no-glare Satin Chrome Finish

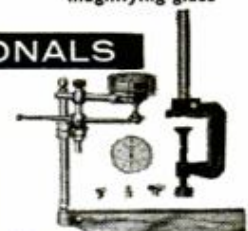

Universal Dial Test Indicator No. 196 With attachments

FOR STUDENTS



The Starrett Book for Student Machinists. Only \$1.60 per copy

Kit of Tools No. 902. Basic measuring equipment



3,000 GIFT IDEAS

Ask your Starrett distributor to show you the many gift-worthy items in the complete line of Starrett tools — or write for free Catalog No. 27. Use the coupon.

STARRETT TOOLS are carried by leading Industrial Supply Distributors and Hardware Tool Stores.

THE L. S. STARRETT COMPANY
Dept. AP, Athol, Massachusetts

Please send my free copy of Catalog No. 27 describing over 3,000 Starrett tools for professional and amateur craftsmen.

Name.....

Occupation.....

Address.....

City.....Zone.....State.....

air space tends to equalize the temperatures before the dewpoint is reached, at which point the moisture (vapor) condenses. Unfortunately, the remedy is not simple or inexpensive in homes already built. The only remedial measure that can be considered permanent is to furr the walls with wood strips, apply an insulating blanket faced with a metallic vapor barrier and cover with plasterboard finished with taped and puttied joints. Or, if you prefer, you can cover the furring strips with a plaster base and finish with conventional wet plaster. You also should ventilate the attic and insulate the attic floor with foil-faced insulating bats or with a glass-wool blanket. Also, anything you can do to reduce the moisture content of the air in the rooms will help. A humidifier on a warm-air furnace, an unvented electric or gas-fired clothes drier, the daily preparation of food, all these are sources of gallons of moisture. We hesitate to recommend that you purchase and operate an electric dehumidifier during the winter months when the trouble is likely to persist, but this might be better than going to the expense of making a permanent correction of the trouble which would involve furring and plastering the walls.

Finishing Cherry

Q—Sometime ago I completed a rather simple shop project, using cherry wood. I finished this in the natural color, that is, I used a sealer and varnish, no stain. Now I notice that the wood is turning gradually to a darker shade with some of the pieces much darker than others. When newly finished the wood was a very light brownish tan, or perhaps a sand color and the grain was quite pronounced. Now in the darker pieces the grain has almost disappeared. What does one do to make the cherry wood age more uniformly?—M. M., Ky.



A—Black cherry, from which nearly all furniture is made, has a tendency to darken with age as you describe it. In an assembly consisting of a number of exposed pieces it is difficult even for the experts to tell definitely which will darken and which will remain fairly light when finished natural. This is one reason why manufacturers of furniture in cherry usually

(Continued to page 236)

when your engine's

SICK!



rely on the man back of this sign
... he delivers

TESTWORK
not
GUESSWORK

patronize him
for satisfaction guaranteed
tune up and engine repair work!

Next time you're in trouble... or in need of a tune up... see the repairman who uses Sun Testing Equipment! The man who displays this sign can guarantee his work because he is Sun trained and Sun equipped to do the job right. He tests with the most modern, scientific engine testing instruments. He saves your time... your money... avoids needless repair. He is a man you can depend on. For an interesting FREE BOOKLET ON "TESTWORK NOT GUESSWORK! the only way to get your money's worth" write SUN ELECTRIC CORPORATION, 6302 Avondale Ave., Chicago 31, Illinois.

easy, inexpensive PICTURE FRAMING

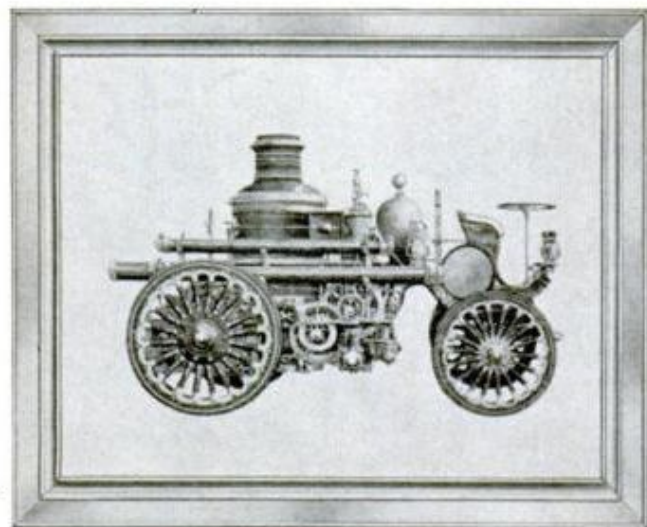

with Reynolds Do-It-Yourself Aluminum

Now in one evening you can make frames for those family photos or favorite prints easily, inexpensively. Saw, screwdriver, adjustable T-square and free plans (see coupon) are all the tools you need to make a professional-looking frame. Aluminum picture frame sections take a variety of finishes. Ideal for Christmas gifts.



Look for this
Do-It-Yourself rack
at hardware and
building supply stores.
Over 90 items—plus
plans and dealer advice
for making frames.

Reynolds Metals Co. • Richmond 18, Va.
Please send Do-It-Yourself Aluminum How-
To booklet with FREE Picture Frame plans.

Name

Address

City Zone State

Dept. PM

stain the wood to a uniform color in the finishing process. Of course, it should be remembered that all furniture woods darken with age, some more uniformly than others. You can verify this by examining old pieces made of cherry and other cabinet woods. Also, there are two varieties of cherry used in cabinet work, known as the northern and the southern varieties, or types, and there is some difference in the texture of the two. Ordinarily it is best to stain the wood to a uniform color, as the stain will tend to modify the natural changes in color as the wood ages. Some manufacturers of finishing materials make stains which are especially compounded for use on cherry. We suggest that you use one of these, following the instructions for application in all details.

House Plants in Winter

Q—What kinds or varieties of plants do best in the house during the winter months? We have just moved into a new home and have a bay window in our dining room, the room being on the north side of the house. We'd like to keep plants in this window all winter long, not necessarily blooming plants but something that will stay green during the winter. Can you tell us how?—W. L., Pa.



A—Only a few plants can be expected to thrive with the proper care during winter and especially in a north window. Assuming that the window sashes are reasonably tight fitting or are weatherstripped or fitted with storm sashes it is possible to grow some types of ferns, ivies and variegated foliage plants. There are others, of course, but these seem to be the most successful. The plants should be started in large pots containing enriched soil, with a mixture of gravel and sand in the bottom of each pot to provide aeration and drainage. On severely cold nights the plants should be protected from drafts either by moving them away from the windows or by covering the lower half of each sash with cardboard held in place with tape. On bright, sunny days when the temperature is more moderate, the plants can be moved close to the window.

SAVE \$

DELTA HOME WORKSHOP SALE

on two of the most useful power tools you can own



Cat. No. 34-005
Delta Homecraft 9"
Tilting Arbor Circular
Saw equipped
with Extension Wings
and Steel Stand.

Starting (or improving) your workshop? This 9" Circular Saw is the tool you'll use most often—gives you fast, easy, accurate cuts on plain or fancy jobs. Why put off pleasure—start enjoying this saw now at a big \$22.05 savings.*



Cat. No. 49-576 Delta Dust
Collector complete with
motor and hose.

*Prices and savings slightly higher in the West

Want more convenience in your shop? You can't beat this new, improved Delta Dust Collector for sheer versatility! Use it with your other wood-working power tools, for general attic-to-basement cleaning, for paint spraying or in a dozen more ways. It's practical, it's portable and it's yours for a savings of \$10.00.*

HURRY-OFFER LIMITED!

See your Delta Dealer (listed under "TOOLS" in the Yellow Pages) or visit leading Department, Hardware or Building Supply Stores. Rockwell Manufacturing Company, Delta Power Tool Division, 502L N. Lexington Ave., Pittsburgh 8, Pa.

DELTA POWER TOOLS

another fine product by

ROCKWELL



The Christmas Gift
that does what
warning lights will
never do!



Stewart-Warner
DELUXE

"twin-gauge" panel

Warning lights never tell you the full story of your car's electrical system. With only warning lights you never know *how much* oil pressure you have. Stewart-Warner's "Twin Gauge" Panel is the answer to both of these problems!

The ammeter tells actual *rate* of current flow. Indicates when current flow exceeds generator output, or when there is danger of burning out the generator or battery due to overcharging. The oil pressure gauge tells exact oil pressure, helps assure safe engine operation.

Instruments have Black and White and Twin-Blue face dials. Panels are available in choice of black enameled steel, chrome plated steel, or deluxe panel of Colonial White grain finish Royalite.

Ask your nearby service station, garage, or automotive parts store for a Stewart-Warner "Twin Gauge" Panel!



Dept. AM-110, 1840 Diversey Pky., Chgo. 14, Ill.

Dictating Machine from Tape Recorder

(Continued from page 213)

board to convenient size from a piece of 1/16-in. thick Bakelite. (Lafayette MS-305). Drill a 1/4-in. hole for the jack and mounting holes as required. The board is held in place by a recorder plate screw here. The earphone is Lafayette MS-368, and includes the jack.

Tubes will stay hot when the footswitch is off in most recorders. In recorders like the Telectro 1960 which utilize a motor winding for a transformer, heater voltage is disconnected when the switch is off. Since off periods are short, warm-ups are quick.

When recording, watch for the machine to start. A typist will operate the recorder after a sentence. A pause allowed for starting prevents loss of information.

The SPDT switch allows the recorder to be used for normal or foot operation. When in the "normal" position, the foot switch is ineffective. When in the "dictation" position, the foot controls tape operation.

★ ★ ★

"Tomorrow's TV Set Today"

(Continued from page 216)

Much of the additional cost of the transistorized set (it costs about \$75 more than an equivalent tube-type receiver) is in the transistors themselves. At the moment, these cost roughly three times as much as an equivalent tube complement. The costs are almost certain to come tumbling down as more manufacturers join the switch to transistors and these units become more prevalent. When transistor receivers become the standard, rather than the exception, it is predicted that they will cost no more than the present day vacuum-tube models, while retaining all their inherent advantages. In the meantime, thanks to the engineering advances encompassed in this unit, TV fans can look forward to an even brighter future for their favorite hobby.

★ ★ ★

QUOTE:

"If a space traveler could get safely to the nearest star, record necessary information, and return for a ticker-tape reception, he might find himself 50 years older, the world three million years older and, instead of being a hero, he might end up in the zoo."

—DR. EDWARD TELLER
Physicist
"Father of the H-Bomb"

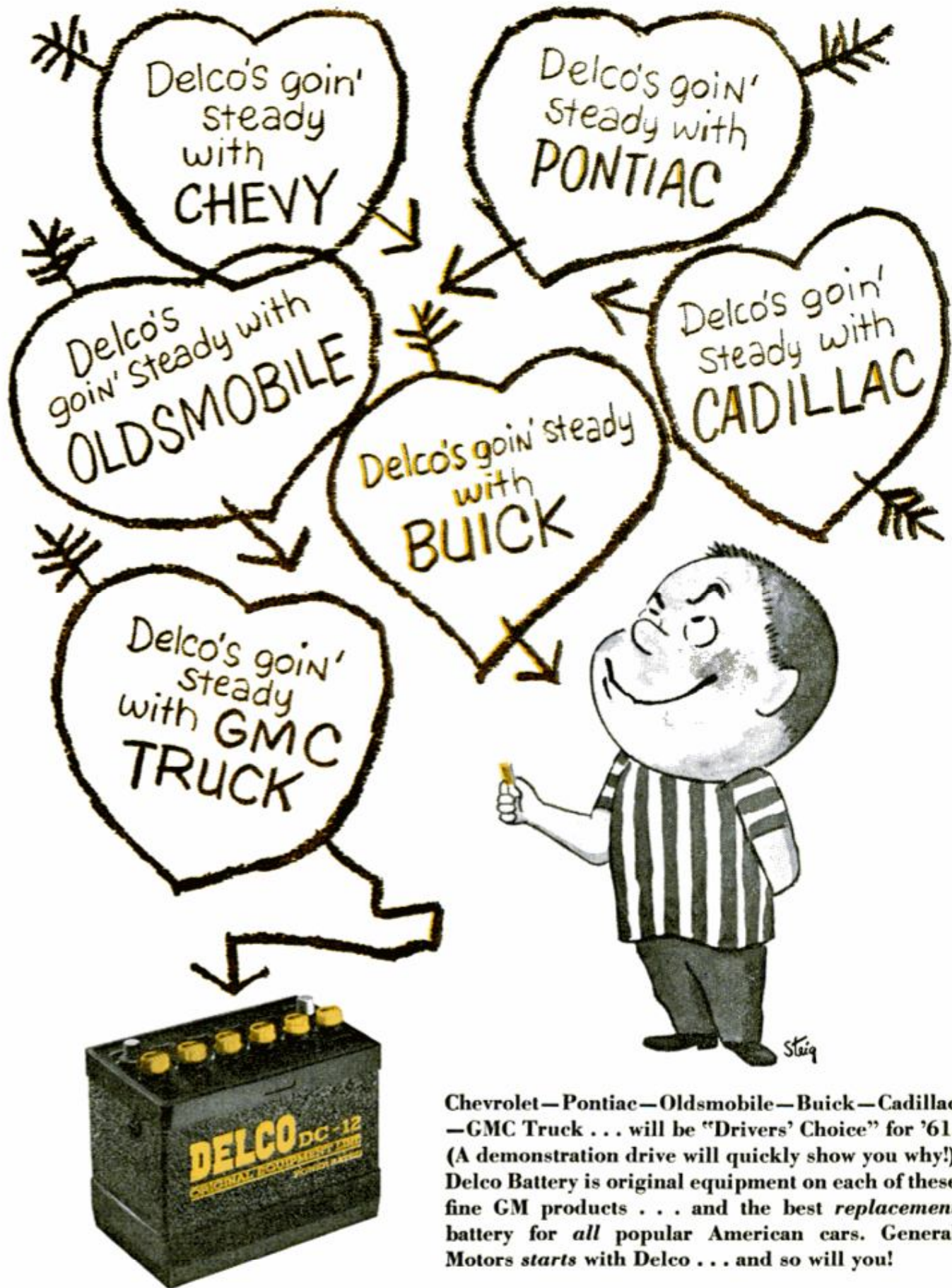

Chevrolet—Pontiac—Oldsmobile—Buick—Cadillac—GMC Truck . . . will be "Drivers' Choice" for '61. (A demonstration drive will quickly show you why!) Delco Battery is original equipment on each of these fine GM products . . . and the best *replacement* battery for *all* popular American cars. General Motors *starts* with Delco . . . and so will you!

Delco Battery . . . best to START with . . . best to STAY with. /

Another reliable
General Motors product,
distributed nationally through



SEE TWO NEW TV SHOWS FOR DELCO—"Stagecoach West" and "The Islanders" on ABC-TV.

THE EASIEST WAY IN THE WORLD TO DRIVE AND REMOVE SCREWS

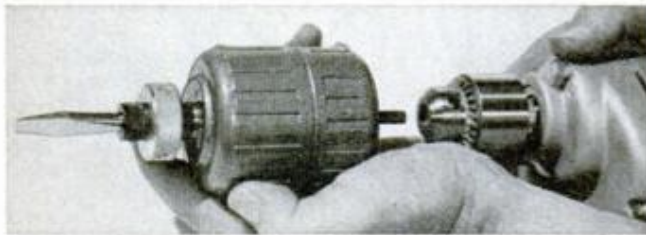

1. After drilling pilot holes simply attach a Versamatic to electric drill. Fits any make.

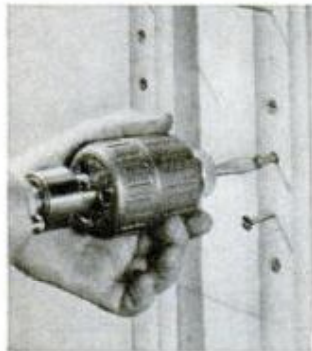

2. Place screw in hole; drive it easily with slight forward pressure . . . hold housing in fingertips.



3. Your fingers act as a clutch . . . starting, stopping action instantly. Simple and safe . . . no blisters.

Versamatic puts your power drill into low gear . . .

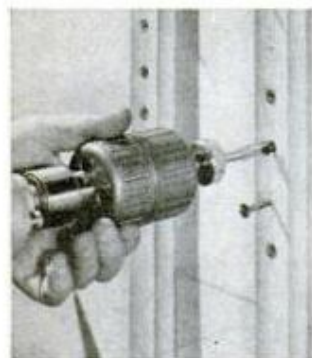

4. Versamatic runs in reverse for removing screws. You won't believe how easy it is until you try it.

by means of 7 to 1 speed reduction. Gives your drill 7 times more power.

Supreme Versamatic

MADE BY THE MAKERS OF SUPREME BRAND CHUCKS

SUPREME PRODUCTS CORPORATION

2222 S. CALUMET, CHICAGO

Sold by leading tool dealers...\$14.95 list

PRECISION  PRODUCTS

Let a Robot Drive the Plow

(Continued from page 147)

the land on 90-degree corners and plow them out completely. The disadvantage is the deep dead furrow in the middle of the field, which must be filled with the land leveler or by back plowing.

Plowing from the inside to the outside is also possible. Often an old dead furrow may be filled by this method and high fence rows turned back into the field.

A beginning plot is made in the middle of the field by plowing on each side of the center of the land before circling the corners and starting the guide. The plot plowed should be slightly longer than is proportional to the field's shape; therefore it is longer than the old dead furrow.

A furrow robot drives the tractor more accurately than a man. Once the guide is set to run in a particular place in the furrow and to steer the tractor in relation to the furrow, it will drive the tractor within an inch of this chosen position. This certainty of position aids in setting the plow to do a level and uniform job of plowing.

Accidents from these robots have been very few, considering the number of hours of work they have done.

Robot plowing shows the abilities of American farmers to meet varying needs in their ever-changing and revolutionary operations. Likely, robot plowing will spread to other areas of large obstruction-free fields. ★ ★ ★

QUOTE:

"The average consumer in the 1960's will be progressively better educated, more sophisticated and more discriminatory. He knows what he wants in a car and he will expect value for his purchase. His choice of places to spend his extra dollars has never been greater, and it will take a much better job of salesmanship to win his monetary favor. Let's face it. The customer is in the driver's seat and is likely to be there a long time. . . . The theme of the 1960's will be functionalism with thrift. Styling will be simple and unadorned. Annual model changes will not involve massive and exotic changes, but will consist generally of refinements to improve the products and give the customer greater dollar value. Cars will probably get shorter, maybe a little higher, and much lighter through use of several lightweight metals. They will be easier to get into and out of—and will have more room for passenger comfort and trunk space.

—EDWARD N. COLE
Gen. Mgr., Chevrolet Div.
General Motors

POPULAR MECHANICS

New Kind of Model Kit for Hobbyists, Experimenters, Home Shop Fans!

Customizing ★ AUTO ENGINE

WITH 135 INTERCHANGEABLE PARTS



- 1/Makes Dozens of Different Engine Combinations
- 2/All Models With Exciting Working Action
- 3/Models Can be Motorized for Electric Power

The most amazing hobby-model kit of all time. Makes not one, but dozens of authentic, all plastic engine models—hot rod, drag strip, racing, stock, street and show—and other engines. Each model (one-eighth actual size) has six or more working parts and can be electric powered with optional (98c) motorizing kit. Assemble models over and over.

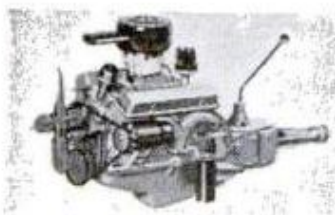

Chevrolet Stock Engine

Famous Chevy "283" stock engine. Many parts in gleaming chrome plate.

Drag Strip Engine

With supercharger, tuned exhausts, Scintilla magneto and four-barrel carburetor, etc.

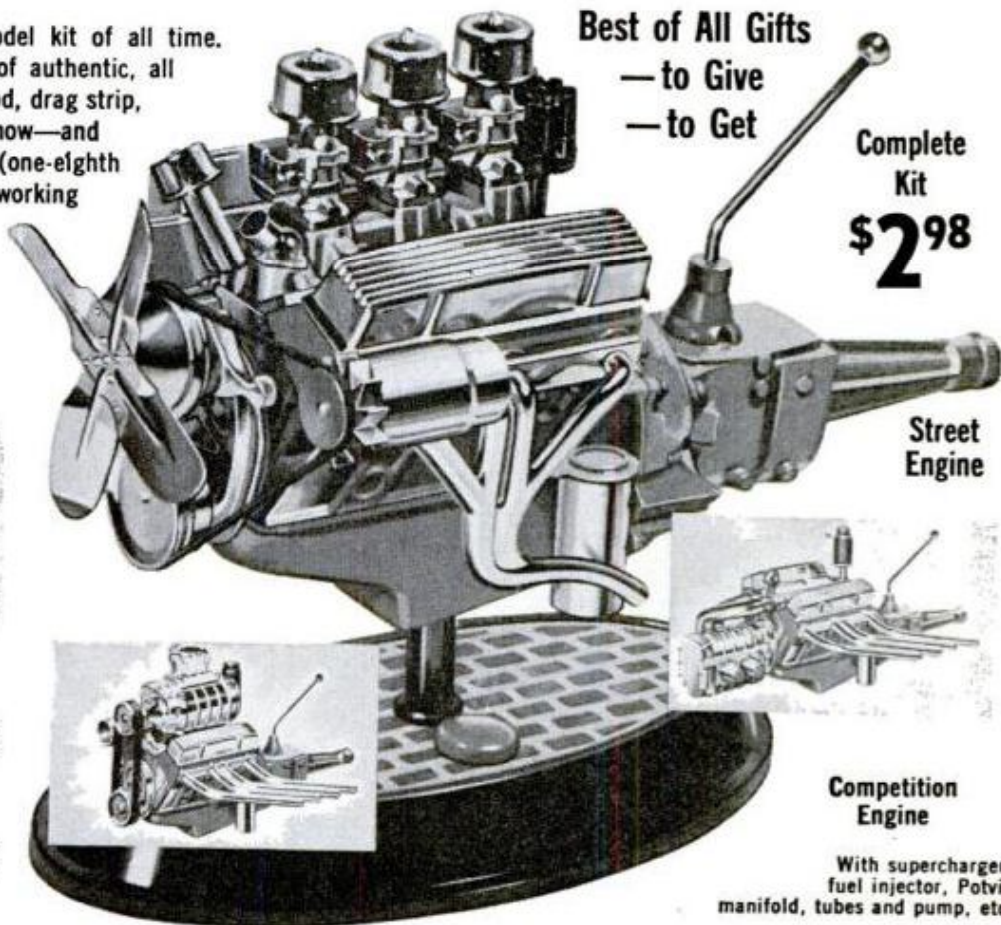

Best of All Gifts

— to Give
— to Get

Complete Kit
\$2⁹⁸

Street Engine

Competition Engine

With supercharger, fuel injector, Potvin manifold, tubes and pump, etc.

Fun and Challenge for Youngsters, Adults and Entire Family

Want fun? Want an exciting challenge? Want to learn how engines are customized for more power; more speed; faster acceleration? Get the Customizing Auto Engine kit today for realistic customizing in miniature. Contains Chevrolet V-8 283 engine model and the newest components and customizing accessories. Includes supercharger, tuned exhausts, 7 carburetors, 6 intake mani-

folds—135 parts in all—in four colors and real chrome plate. No painting is required.

Display stand as pictured and 16 page illustrated book included. Book describes engine operation, customizing and how to do it. Get the Customizing Auto Engine kit today. Wherever hobby kits are sold. Only \$2.98.



MONOGRAM MODELS, INC.
CHICAGO 32

NOVEMBER 1960

241

Let's Bring Our Planes Down Safely

(Continued from page 114)

traffic of New York's Idlewild, which was recently touted as the world's busiest by a travel magazine whose editors are not pilots. During that year more than 430 thousand separate aircraft landings or takeoffs were directed by Midway's controllers, not even counting 103 daily scheduled helicopter flights. And it has increased since.

In order to space this traffic perfectly, these controllers would have to get an aircraft up or down every minute and fifteen seconds through the year. Sometimes, however, the field is closed because of weather, and rush hours occur in air travel as in any other transportation, so the traffic could not possibly be evenly spaced. The uninitiated might immediately ask the obvious—doesn't this resultant crush during peak periods exceed the capacity of the airport?

The question has long been outdated; rather, now it is simply—doesn't such traffic surpass the safe limits of pilots and controllers? For years it has far exceeded the capacity of the mechanical facilities.

This is something which a gadget-minded, somewhat propagandized public has not fully appreciated. At present and for many years to come modern aircraft must be directed by voice between individuals. Yet this voice is often received at a level of clarity well below that obtained on a ten-dollar transistor set sold at the corner drugstore, which indicates a similar lack of appreciation by aviation engineers. No gadget now operative or on the drawing boards will replace this communication method; even the most advanced of these will merely assist.

This means that the poor controller down there in his luxuriously padded cell, for whom every pilot has an abiding respect and affection, must far surpass the designed capacity of both his gadget and the regulations which cover its use. If these main terminus controllers followed strict procedures in their transmissions, using approved terms and methods and waiting for an acknowledgement of each, they would not get a third of their traffic moving.

At Midway the tower operator's duties during peak periods is so demanding on his voice and general equilibrium that his tours of duty on that microphone are limited to one hour or less. Understandably, not everyone can handle the job, nor do many operators want it. Despite the fact that this is a top-rated post in the Federal Aviation Agency setup, the experience

level is kept fairly mediocre among the personnel by the frequent turnover of controllers bidding out to less ulcerous jobs.

By using abrupt, informal commands and not bothering with acknowledgements and by putting a flattering faith in every pilot this wild-haired operator is supposed to be able to handle approximately 100 movements an hour *under perfect conditions*. One of these conditions is that the aircraft alternate evenly on the two sets of parallel runways. But most of the four-engined and turbo-prop craft *must* demand the longer runways for the little safety margin they provide. Many of these planes are overweight for a landing on the short runways if they have not burned sufficient fuel in flight. Several have suffered brake trouble and have wound up mingling with the startled commuters along adjoining streets.

With such a demand for a particular runway, the ideal maximums even with good weather prevailing are reduced to 80 movements an hour. When the ceiling lowers or the smoke and city haze can no longer be ignored, the capacity of the field drops again, to 45 aircraft an hour, which is close to the year-long actual average of flights. And this drops still further—catastrophically—when one of the many electronic aids such as a radio frequency or a radar set fails.

Then what happens to the schedules, which have supposedly been based on the reasonable capacity of the airport and the traffic control agencies? Remember that in addition to the actual takeoffs and landings, all these departing and incoming aircraft must be directed around Two-Four-Metro and the score of other waiting planes and dovetailed into the constant stream of traffic overflying the Midwest. At some periods, this instrument capacity had recently dropped to a bare 58 percent of the *scheduled* movements out of Chicago, without regard to the normal 10 transients an hour.

At times, this becomes downright ridiculous. On a Tuesday afternoon at five o'clock, as many as seven aircraft are scheduled to depart Midway simultaneously! In addition, two or three are supposed to be landing at the same instant. One might think a passenger depending on such schedules would become a little disturbed at the swindle such schedules represent. But when authorities tried to divert traffic to the new spacious O'Hare airport only 20 miles northwest, few persons would take the trouble to drive that far.

Altogether, between 4 and 6 p.m. on a typical weekday, a casual count shows 135 airline trips due in or out, which is more

(Continued to page 246)

EPOXY-ADHESIVE

WORKS LIKE PUTTY
SETS HARD LIKE METAL

Repairs
FENDERS • MUFFLERS
RADIATORS • BOATS
MACHINERY

IT'S EASY TO USE!
THRIFTY KIT .98c ppd.

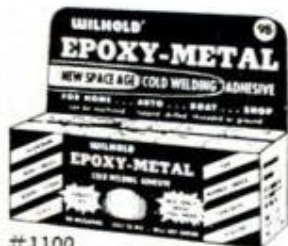

WILHOLD GLUES, INC. • CHICAGO 12 • LOS ANGELES 31

NEVER BEFORE SO MANY
FEATURES . . . SO MANY "EXTRAS"!

sensational **NEW** *Evans* WOOD FOLDING RULES

Evans "GOLD TIP"
6 ft. EXTENSION RULE

1. **FREE!** Rule holster with belt clip.
2. **EASY TO READ!** Marked in inches, plus feet-and-inches. Stud marks every 16". "Flags" every foot.
3. **BUILT-IN GRADUATED BRASS TIPS** at both ends.
4. **BRASS EXTENSION**, graduated for inside measurement. (Models X40 and X40F only).
5. **MANUFACTURER'S REPLACEMENT AND REPAIR SERVICE!**

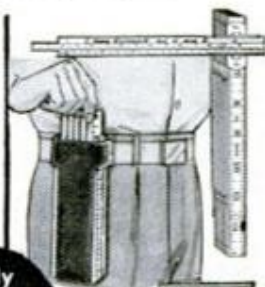

Only
\$249

FREE

BRASS NAMEPLATE
plus set of "A to Z"
metalized initials with
all rules.

Also available: STANDARD
"SILVER TIP" Rule, \$1.79

Evans RULE CO.

Factories at: Elizabeth, N. J.
& Montreal, Quebec

FIBERGLASS or PLYWOOD

\$41.95 Up: EASY TERMS
FREE CATALOG

50 Models 8-22 ft.

Cruisers, houseboats, runabouts, convertibles, fishing, sailing. Pre-assembled, pre-formed units anyone easily assembles. Equal factory-built. Save 1/2 to 2/3. Free catalog has all details, color photos, paint, accessories, Fiberglass supplies, trailers. WRITE TODAY.

LUGER BOAT KITS

Dept. B-11, 9200 Access Road, Minneapolis 20, Minn.

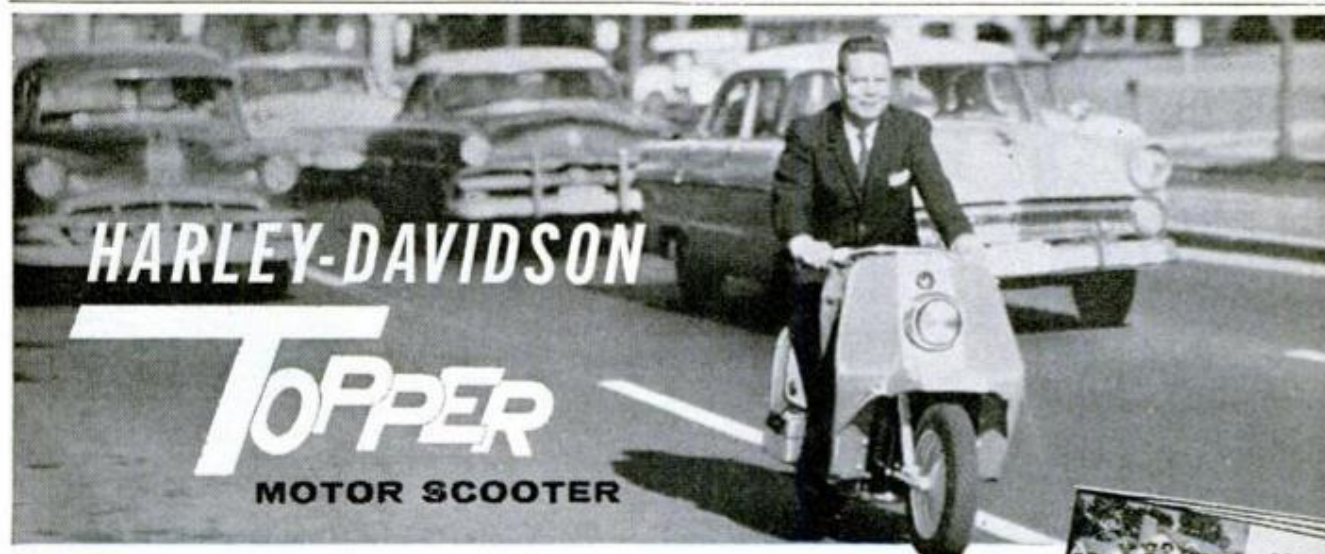

for the smartest distance between two points

Smartest way to get there. Topper is the set of wheels a modern family needs to get the most out of living. It's *economy*—up to 100 miles to the gallon. It's *convenience*—Scootaway automatic transmission does the shifting for you. It's *comfort*—large wheels and dual suspension smooth out rough roads.

Smartest looking scooter on the road, too. Topper is styled in exciting new colors for 1961 — Pepper Red, Granada Green and Strato Blue with Birch White panels. See the new Topper at your Harley-Davidson dealer. Or mail the coupon for this colorful new folder.

HARLEY-DAVIDSON MOTOR CO.
MILWAUKEE 1, WISCONSIN

HARLEY-DAVIDSON MOTOR CO.
Dept. P, Milwaukee 1, Wisconsin

Send me all the facts on the new Topper.

Name.....Age.....

Address.....

City.....State.....

Kid-Size Rodeo

(Continued from page 102)

pull in opposite directions and throw the steer to the ground. The header dismounts, ties the steer's hind legs and throws up his hands to show that they are finished. Sometimes this takes 50 seconds, sometimes as long as two minutes.

The barrel race, in which the contestants race one at a time around three barrels spaced 90 feet apart in a cloverleaf, is a test of the dodging, turning ability of a horse in cutting a desired animal out of a herd and in forcing a stray back toward the herd.

Contestant in the 5 to 12 age group get a number of breaks. When riding bareback they may use both hands to hang on to the surcingle if they wish. In the roping event they merely break a paper ribbon across the roped calf's shoulders instead of throwing it and tying its legs. Older division contestants, however, have to abide by the rules of the Professional Cowboys' Association. They hold on with one hand when riding a bronc or a Brahma steer bareback and are required to spur constantly. A bronc keeps bucking and twisting in an effort to dislodge the irritating strap that has been cinched around its flanks. If the rider lasts the required eight seconds, a pick-up

man gallops out to help him off while another rides to the far side of the animal to release the flanking strap.

The bucking horses and other stock that are used in rodeos are provided by contractors who try to collect the best animals for the purpose. Not every horse will buck even when irritated by a flanking strap, not every calf will run when released from the chute in a roping event. The contractors literally try out thousands of horses in putting together a string of bucking broncs. The worst, or "best," of these usually are wild horses that have been captured in the Northwest of Canada.

There seem to be no outstanding bucking horses today that compare with Steamboat, Midnight, Five Minutes to Midnight, Miss Klamath and other legendary horses of the past. Some rodeo contractors say it may soon be necessary to raise bucking stock just as fighting bulls are raised for the bull ring. There are few wild horses left, for one thing, and in at least some cases a bucking horse's colt tends to inherit the parent's desire to throw its rider.

Arizona calls Florence the "cowboy cradle of the great Southwest" because the Florence Junior Parada was the first of the junior rodeos. And, as far as it has been able to find out, Arizona believes it has another rodeo first. In 1938 the University



MEN WHO MARRY MIND READERS

Get Millers Falls' tools for Christmas

New Safe-T-Drill

Double protection through double insulation! Here, in a first-of-its-kind drill you get a "surge-tested" MF motor PLUS the added safety of an insulated chuck and a shatterproof NYLON housing. Complete line of Quik-Change Attachments, too.

No. 1144 Drill \$24.95



IT'S SHOCKPROOF!



IT'S GREAT! THE "888"

Always a favorite. 3 tools in 1: powerful 3/8" drill, portable 6" disc sander, and 6" polisher. Also drives complete 17 tool power workshop.

No. 888 . . . \$39.95



FREE BENCH TABLE

A perfect partner for the fast-cutting Millers Falls Sabre Saw. You get both for the price of the saw alone. A real value!

No. 3660 . . . Reg. \$35.90
NOW \$29.95



\$4.55 BONUS

This big 6 1/2" circular saw sails through tough jobs in a hurry. Powerful 1 H.P. motor.

No. 626 . . . Reg. \$49.50
NOW \$44.95



A BARGAIN IN QUALITY!

The No. 1040 Power Drill now combines traditional Millers Falls quality with exceptional low price. 2.5 amp. power rating. Drives Quik-Change Attachments.

of Arizona held what may be the first college rodeo and today this is an annual university event. A couple of years later the rodeo became an intercollegiate event, with entries from five other schools. Today the National Intercollegiate Rodeo Association has member colleges all through the West and South, broken into four regions to reduce travel time. The University of Arizona, meanwhile, has instituted a new college course, rodeo physical education. Students say it's rough, but they like it.

★ ★ ★

Electronic Guard for Art Museum

Chicago Art Institute each night is filled with high-frequency sound waves to prevent thieves from stealing any of its \$170,000,000 worth of paintings and art objects. Five hundred detectors set inconspicuously throughout 200 rooms, and a central control room or guard station make up the newly installed, burglar-alarm system.

Each detector consists of two units—a sound-wave transmitter, and a receiver and motion detector. The transmitter floods the room with inaudible sound waves at a frequency of 2400 cycles per second, creating a pattern of direct and reflected waves. If this pattern, picked up by the receiver, is disturbed by someone entering the room,

a signal is tripped in the guard room. A thief's progress could thus be followed room to room.

Generally only one transmitter and one receiver are needed to protect a room. But for odd-shaped rooms or those containing large objects—statues, for example—up to four transmitter-receiver units are used. Minneapolis-Honeywell engineers, who developed the system, selected the 2400-cycle-per-second-frequency because these waves are short enough to sense even a small movement of a man, but are not so short that a buzzing fly or mosquito would set off the alarm. The sound waves completely fill the room, bouncing from every object, so there is no place an intruder can hide to escape detection.

Liquid Washes and Waxes Car

Chemists of a wax manufacturer have rendered wax water-soluble by emulsification to develop a new product that can be used to wash and wax an automobile without need for rinsing. Four ounces of the product is mixed with one gallon of water and applied to part of the car with a cloth. The surface is then wiped with another cloth, removing dirt and reconverting the wax to an insoluble state. The wax is buffed with a third cloth.

SAVE
\$5



If he works with wood, he'll work wonders with this finish sander! A wonderful saving, too! No. 580 ... Reg. \$39.95
NOW \$34.95



14 GIFTS IN ONE

Steel carrying case contains 14 basic hand tools, including an automatic drill, 3 screwdrivers, hammer, combination square, pliers, block plane, torpedo level, lifetime hand sander.
No. 8 Hand Tool Kit ... **\$29.95**



CARPENTER'S COMBINATION SQUARE

It's a try square, mitre square, depth gauge or marking gauge. Accurate graduation on 12" blade are deep-etched for easy reading. No. 1200 ... **\$2.25**



YOU CAN'T MISS

Anyone with a power drill needs a set of high speed steel bits. 6 sizes from 3/8" to 1".
No. 8006 ... **\$7.80**



A SHARP IDEA

Real craftsmen's chisels in a handy pouch. 1/4", 1/2", 3/4" and 1" sizes.
No. 1434 ... **\$7.25**



SOMEONE YOU KNOW ...

wants this fine block plane. Polished sides. Screw adjusts cutter depth. Lever cam lock. No. 75 ... **\$3.98**



PLEASE A HE-MAN

A sturdy, solid camper's axe for that outdoor man. Perfect balance. A pleasure to swing.
No. 599 ... **\$6.95**



BOUND TO PLEASE

Who doesn't need a set of screwdrivers — or an extra set? 4" and 6" standard, 3" cabinet and 4" Phillips.
No. 8514 ... **\$3.95**



HANDIEST HACKSAW

Top quality nickel-plated steel frame. Unbreakable black "Tenite" pistol grip. 10" blade included.
No. 48 ... **\$4.39**



MILLERS FALLS COMPANY

Dept. PM-36, Greenfield, Mass.

BUILD THE BEST ELECTRONIC EQUIPMENT



it's fun to build
years-ahead money-saving

knight-kits®

A PRODUCT OF ALLIED RADIO

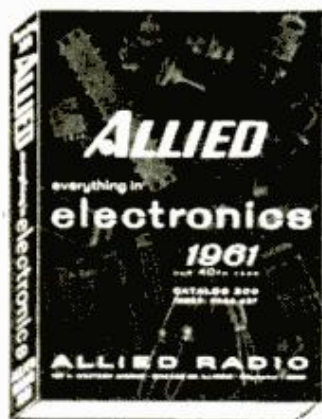

featured in the
ALLIED
Big 444-Page 1961
ELECTRONICS
CATALOG

free

build-your-own..
it's easy..it's fun

BIG SAVINGS



KITS FOR ANY NEED

Hi-Fi
Hobby
Instrument
Amateur

See the exciting 1961 line of KNIGHT-KITS—available only from ALLIED. They're lowest in cost, convenience-engineered for easiest assembly, outstanding for performance—the only kits offered with Free Inspection Privilege. Send today for the 1961 ALLIED Catalog—select your KNIGHT-KITS—and...

SAVE ON EVERYTHING IN ELECTRONICS



Get more for your money in: Stereo hi-fi systems and components • Recorders and tape • Amateur station equipment • Citizen's 2-way radio • TV tubes, antennas, accessories & test instruments • Electronic parts, tubes, transistors, tools • Send today for your FREE 444-page 1961 ALLIED Catalog!

only \$2 down
on orders up to \$50

FREE
catalog



ALLIED RADIO

ALLIED RADIO, Dept. 24-L
100 N. Western Ave., Chicago 80, Ill.

Rush FREE 1961 ALLIED Catalog.

Name _____

Address _____

City _____ Zone _____ State _____

than this same theoretical maximum under the year's average circumstance of weather, other arrivals, etc. A few years ago, under approximately the same airport conditions, six million passengers were declared the desired annual limit for Midway. The Commissioner of Public Works then declared that this generous figure "should never be exceeded." Last year over nine and a half million passengers survived Midway's crowded terminals, schedules, and airspace. The same problem, on varying scales, confounds the situation at Newark, Boston, San Francisco and the 20 other terminals from which more than two-thirds of all the air traffic in the country originates.

It should be understood that these terminals are what actually determines the number of planes aloft. Although there is crowding along the airways, it is above and on the airports themselves that the situation becomes critical. This is why projects such as the FAA acquisition of the multi-billion dollar, obsolescent SAGE warning system are being studied. High-speed taxiways which will permit a 60-mile-an-hour turnoff from main landing runways, and the AGACS gadget by which 250 aircraft contacts may be established every minute without blocking the others out are also in the works—for several years hence. But we live in the present.

For an admittedly egregious example, what did I have to look forward to when, some 45 minutes after starting our sluggish rectangle over Chicago Heights, I was given permission to make an approach? By taking over a golf course and some railway property in 1946, the city managed to increase Midway's dimensions to an exact square mile, set in the middle of a manufacturing, commercial and residential area. Its longest runway is 6410 feet, six of its other seven are less than 5000, which means that every heavy plane landing must shave the tops of the surrounding buildings.

It is a poor joke that this is one of several places in the country that a pilot may pick up a traffic ticket on his final approach. The patrons of restaurants and motels along Cicero Avenue duck and dive for cover as a DC-7 or Viscount appears ready to slice through the window, and even the hardened waitresses wince. This goes on continually, not occasionally.

As for lights, which I would certainly need that night, the Airline Pilots' Association and other aviation representatives have fought for a long time to have adequate approach lighting installed. Center-line lights were finally placed last year on

(Continued to page 248)

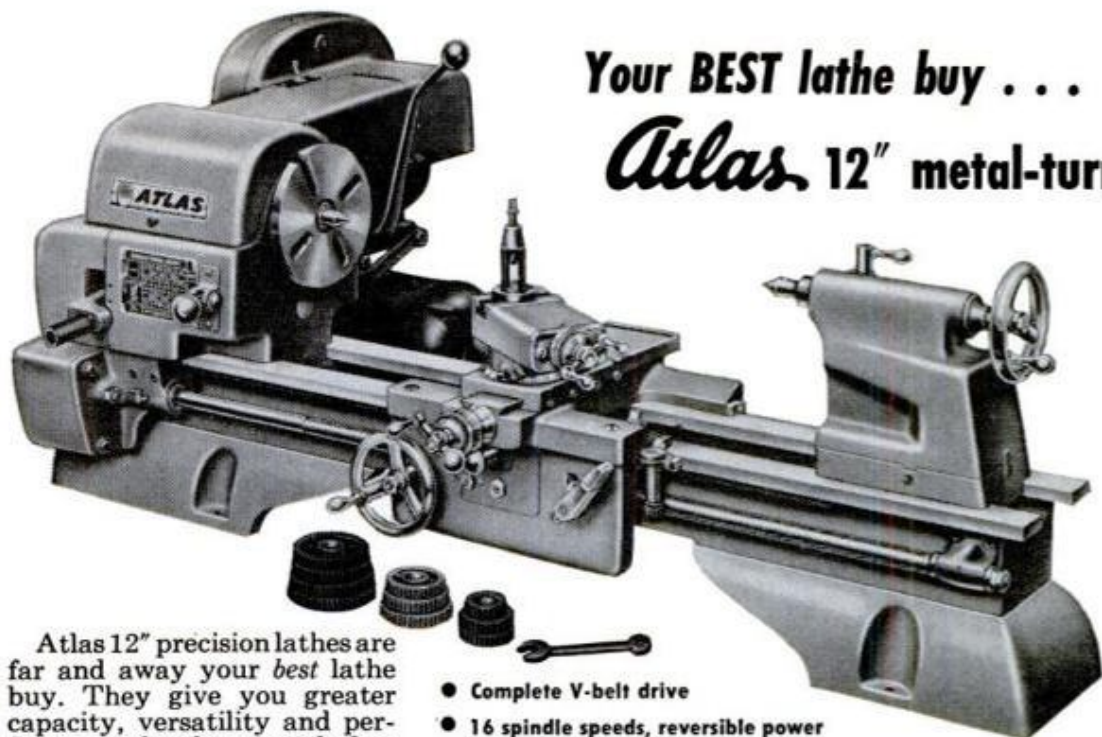

Your **BEST** lathe buy . . .
Atlas 12" metal-turning **LATHE**

only
\$340⁰⁰
 f.o.b. factory



352

Atlas 12" precision lathes are far and away your *best* lathe buy. They give you greater capacity, versatility and performance than have ever before been available at or near their low price. Look what they give you:

- 12 1/4" swing over bed, 12" over saddle wings, 24" or 36" between centers
- Timken tapered spindle bearings
- Precision ground bed ways

- Complete V-belt drive
- 16 spindle speeds, reversible power cross feed and longitudinal feed
- Wide thread cutting range — 54 selections

These and other costly-lathe features are standard on *all* Atlas lathes: bench, pedestal base with underneath drive, and 6-inch bench lathes. See Atlas before you invest.

Write for new catalog

ATLAS PRESS CO.
 11-24 N. Pitcher St.
 KALAMAZOO, MICHIGAN

BUILD FINE GRANDFATHER CLOCKS NOW

The simple sensible **SPEEDE** Red-i-Kut way as thousands have — FOR YOURSELF OR SELL AT A GOOD PROFIT. SAVE HUNDREDS OF DOLLARS. SHOP TESTED PLANS "SPIRIT OF THE CENTURY" Narrow waist 23" tall or stately straight side "SPIRIT OF AMERICA." EASY-to-FOLLOW photopack PLANS & LIFE SIZE PATTERNS tell all—plus MOVEMENT BROCHURE \$40 up, of heavy brass weight (Kuempel original) Westminster, tube BELL chime, movements, gorgeous bronze-silver MOVING MOON dials, 3/4" solid-mahogany Jiffy Joint-Kwik-Bit case kits. Send \$1.00 today — Both plans RUSH \$1.50 as folks have for over forty years.

Kuempel Chime Clock Works, #9 Kuempel Bldg., Minneapolis 16, Minn.

G E A R S

In Stock — Immediate Delivery

Gears, speed reducers, sprockets, thrust bearings, flexible couplings, pulleys, etc. A complete line is carried in our Chicago stock. Can also quote on special gears of any kind. Send in your blueprints and inquiries.

Send for Complete Catalog No. 10
CHICAGO GEAR WORKS
 440-50 N. Oakley Blvd., CHICAGO 12, ILL.

use the solder that most home owners use!

KESTER SOLDER

For your electrical work, radio-TV, do-it-yourself projects . . . always use the best . . . **KESTER SOLDER**. Send for FREE 16-page book that tells you how!

KESTER SOLDER COMPANY
 4251 Wrightwood Avenue • Chicago 39, Illinois
 OVER 60 YEARS' EXPERIENCE IN SOLDER AND FLUX MANUFACTURING

THERE'S A **HEAT-THIEF** IN YOUR ATTIC stealing heating dollars!

He's there, that is, if your attic's not insulated, or if old insulation has deteriorated. To foil him completely just pour Zonolite vermiculite between joists right over old worn-out insulation. Fuel bills shrink up to 30% and stay low because Zonolite never loses efficiency in any way. Costs so little too! Mail the coupon for full details.

ZONOLITE COMPANY 135 S. LA SALLE CHICAGO 3, ILL.

ZONOLITE COMPANY P M 110
 135 S. LaSalle, Chicago 3, Ill.
 Rush free booklet HI-110, "Homeowners Guide to Insulation."

Name _____
 Address _____
 City & Zone _____ State _____

AT LUMBER AND BUILDING SUPPLY DEALERS

the instrument runway, 13 right, and a condenser discharge light is operating on its other approach end, 31 left, which I would be using on this landing—if all went well. A similar blinker is on the approach to 4 right.

But center-line lights are effective for minimum visibility approaches *on that runway only*; as for the others, positively identifying one flashing light in the midst of an unfamiliar sparkle is difficult indeed, especially in the few seconds given to a pilot breaking through a low overcast.

Still, it was better than coming in with a marginal three-mile visibility, as it had happened before, and pretending that we were VFR (flying under visual flight rules). On any of the other runways, where three or four aircraft with their standard three-mile separation must be preceding you in order to maintain the traffic flow, simple addition shows that you are more than three miles distant as you turn on final. In brief, you are making a visual approach to a runway which theoretically, and frequently, you cannot see.

No amount of chart study will enable a pilot to make an approach by taking a bearing from Joe's All-Night Hamburger Heaven—only familiarity will do this. Would it shock the brave passengers who crowd these inadequate terminals and who apparently believe that the airport procedure is all governed by an unfailing electronic network to know that pilots have been using Joe's as a check point for years at Midway, or the factory stacks at Newark, or a brilliant gas station at Burbank?

Even with the delay, I was glad we were on instruments. The last time I had landed at Midway by visual means I was making a left base leg for 13 left, as directed, when I met a Constellation coming in the opposite direction, on a right base for 13 right, the parallel runway. These runways are separated by only a few hundred yards, which is a disturbingly short distance at a closure rate of over 300 miles per hour. The Connie and I had made our turns courteously, like two square dancers bowing in the middle of a do-si-do and had proceeded down the final approach hand in hand.

This was safe enough as long as the visibility was good, but unfortunately I had run into the cloud of smoke which usually drifts over the place from the factories to the north and west. When the lights went out, I unconsciously—and rightly—made a sharp turn away from the Connie until I broke into the clear. This is just one of those hazards which don't show up on the charts either for this airport or any other

which is squeezed into the middle of a city.

Yet in every such incident the real threat to safety lies in this single factor: the congestion of traffic necessarily assumes perfection at every hand. The fact that this has not spelled disaster many times over is not a credit to the system in operation, yet disaster is the only acceptable proof of danger to the authorities who regulate this traffic and, apparently, to the public as well. Even birds know you can get only so many birds on a wire.

We left Chicago Heights with 30 seconds of our estimated departure time, just as Approach Control asked us what the delay was, and were cleared to the tower. Then what had been startling became amazing, what had been recommended became absolutely demanded.

"Capitol-four-oh-nine cleared two-two-right after six landing has passed American-forty-three . . . Number two to land three-one-left . . . United-twenty-nine cleared immediately to cross two-two-left . . . Lake Central-six report Lake Shore to departure one-one-nine-point-nine good night . . . Continental-four get your transmitter fixed and call me again . . . TWO-FOUR-METRO REPORT KEDZIE IN-BOUND. . ."

It was only a normal transmission. You get used to it—or don't come back to Midway. By this time, of course, I had retuned my VOR from Chicago Heights to the back door ILS (instrument landing system), identified its signals, noted the deflection on my instrument's needle, calculated how far it was from Kedzie marker to runway THREE-ONE-LEFT and how many feet per minute I would have to descend in order to break out of the overcast in position to land without taking along any of the neighbors' TV antennas, had lowered the gear and quarter flaps, adjusted the low frequency homer to Kedzie, approved the landing check list recited by the copilot, and was listening carefully at the same time to the tower's Gilbert-and-Sullivan patter because there was a Viscount coming in fast behind me, according to that patter.

And sure enough! We managed to report Kedzie as we passed and were almost to the runway, if my figures and descent were correct, when I caught something else out of the stream from the tower.

". . . immediately two-two-right . . . TWO-FOUR-METRO BREAK OFF APPROACH AND LAND THREE-ONE-RIGHT . . . Braniff sixteen taxi in position and hold. . ."

At this moment several miscellaneous
(Continued to page 250)



Winner at Sebring: John Bentley (above) Index of Performance winner, and 6 out of 10 class winners used Champions.



Winner at Daytona: Junior Johnson wins the 500-mile Sweepstakes. *Every* Daytona winner has used Champions.



Winner at Charlotte: Joe Lee Johnson wins the first World 600 with Champions. 8 of the first 10 to finish used Champions.

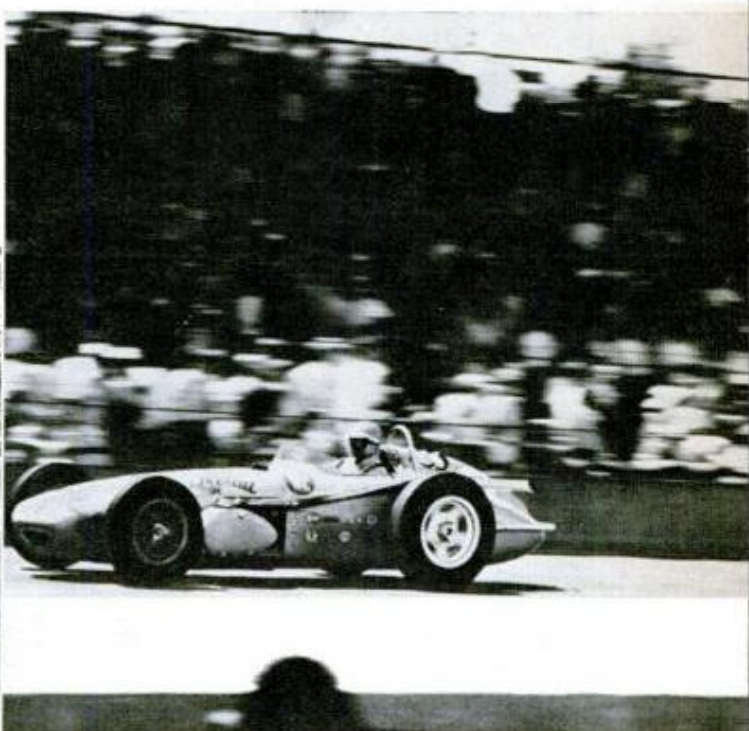

Winner at Indianapolis: Jim Rathmann sets a new record to win the "500". Like 10 of the last 11 "Indy" winners, he chose Champions.

Q. Why do winners of 9 out of 10 major races use Champion spark plugs?

A. Experts know they can depend on Champions to wring every bit of performance out of every drop of gas. Your car will perform better, too (and save money on gasoline) with new Champions. Put in a set every 10,000 miles.

Worn spark plugs waste lots of gas—so check your plugs every 5,000 miles!



GRAVELY MOVES SNOW FAST!



Conquer Snow With POWER!

Get out and go in spite of snow! Powerful 6.6 HP Gravelly Tractor and its big 26" Snowblower attachment clears your sidewalk and the drive in minutes. No need for hours of hard work—just guide the Gravelly and watch the snow go! All-gear Drive, Power Reverse, optional Electric Starter.

Snowblower, Snowplow two of 30 tools for year-round lawn and garden work.



FREE 24-Page POWER Vs. Drudgery Booklet tells all. Write Now!
GRAVELLY TRACTORS
P.O. BOX 601-L DUNBAR, W. VA.

PERFORMANCE-PROVED SINCE 1922

screens, upholstery, carpets...

hundreds of other uses.

You name 'em!*



Swingline 101 Staple Gun

Staples practically anything. Exclusive push-button loading and built-in staple extractor. At your stationery, department or hardware store.

only **4⁹⁵**

*Win \$5 per Idea!

Swingline pays \$5 for each practical new idea on how to use the SWINGLINE STAPLE GUN...to be published in "Tips for Tacking." Send your ideas today!

Send for FREE 12-page booklet "Tips for Tacking!"



Swingline INC.

38-00 Skillman Ave., Long Island City 1, New York

lights showed through the murk—at about 200 feet. (Who is going to break off an approach at minimum altitude when the tower and everyone else is insisting the ceiling is 300?) I sighed, rassed the C-46 off the approach, did several vertical turns at air-show altitude above the tenement tops, chopped power and screamed for full flaps, prayed a little, and managed to hit the end of the short and slippery runway with space enough to coax the bird almost to a stop before we piled into deep snow halfway down its length. (And when would they have had time to clean it off?)

"Thank you, Two-Four Metro. . . ."

Before we stopped rolling the Viscount was alongside on the parallel runway, passing us with snow blasting the wrong way from its reversed props.

"You're quite welcome," I thought, but didn't find room to make my courtesy heard in the tower.

The copilot, for some reason, was shaking his head, this being his first trip.

"Aw, come on," I said, as we plowed through the drifts and switched to ground control. "Don't give up now. Think what it will be like in another few years. They are expecting 10 times more traffic by 1975."

"They'll never make it," he swore. "Not on these airports." ★ ★ ★

This Month's "Great Pioneer in Science"

(Page 24)



Galileo Galilei (1564-1642)

Automated Bus Garage

Buses operating from a new, \$2,000,000 garage of the New York City Transit Authority are serviced in 3½ minutes on an assembly-line basis. When a bus pulls into the heavily automated garage for its daily servicing, a series of operations start simultaneously. A hose is hooked to the fuel tank and, as submerged pumps drive diesel fuel near the full mark, a warning whistle sounds. Another hose fills the water tank. At the same time, a huge funnel swings out from a stand and glues itself against the open front door of the bus. The funnel

is part of the cleaner which sucks up air at the rate of 20,000 cubic feet a minute and drags along dust and trash which is carried into a metal compartment where it is sprayed with water to precipitate dust; moistened trash is automatically conveyed to a metal dustbin. The bus then moves a few feet and soap is applied by hand. The bus moves through an automatic washing machine which sprays water at high pressure against its sides; automatic, plastic scrub brushes buff the sides and a king-sized mop cleans the roof.



PORTER WAGONER
OF "GRAND OLE OPRY"

The proof is in the puffing

and P. A. has the flavor
most favored in the U. S. A.



R. J. Reynolds
Tobacco Co.,
Winston-Salem,
N. C.

- always tastes fresh
- mild, mellow flavor
- cool 'n' steady burning

PRINCE ALBERT

America's Largest-Selling Smoking Tobacco!

JERROLD

The Leader in Master
Antenna Systems presents
**2 GREAT NEW TV-FM
RECEPTION AIDS!**

NEW

magic carpet*

**INDOOR ANTENNA—
OUTDOOR PERFORMANCE**

So easy to install—in the attic, crawl space or closet! Banish that rooftop antenna or rabbit ears. Get signal gain across all TV and FM frequencies. Comparable to an outdoor conical antenna.



List
MODEL MK-1 \$9.95

*Trademark Patent Pending

NEW

Amplified TV-FM 3 SET COUPLER

Efficiently increases signal from any antenna—feeds 3 TV or FM sets. Rugged, compact, single tube... 24 hour operation. No-strip twin-lead terminals.

MODEL HSA-43 List **\$29.95**

Available At Leading Distributors Everywhere

NOTE: Jerrold offers a full line of specialized reception aids including outlets, plugs, twin-lead TV wire, etc. Write for literature.

JERROLD

ELECTRONICS CORPORATION
Distributor Sales Division
Dept. No. IDS-99, Philadelphia 32,



"Thermorar-Luxus," Messrs. Maybaum, Sundern/Sauerland, West Germany

German Appliance Heats or Cools

Not a coffee table, though it serves nicely for that purpose, a new German appliance combines electric heating and forced-air circulation in three combinations for either heating or cooling. It works as a fan alone, as a two-stage heater with the fan, or as a convection heater with the fan turned off. As an incidental bonus, the large slotted top allows hot air to escape upwards from the element and keeps food or hot beverages warm.



Spray Gun for Riot Control

Army riot-control units are now being equipped with a new portable irritant chemical spray for dispersing mobs. A modified flame-thrower, it can fire up to 30 seconds without reloading.

10 SHOTS IN LESS THAN 3 SECONDS!

AS FAST AS YOU CAN PULL THE TRIGGER

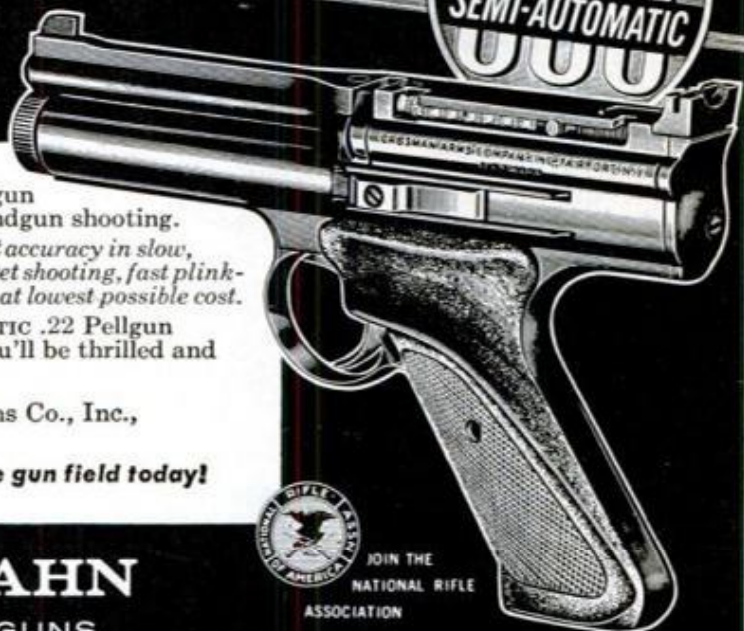

Another "world's first" by Crosman! A major breakthrough in CO₂ gas powered gun engineering... opens a whole new era in handgun shooting. Now, for the first time you can enjoy match target accuracy in slow, timed, and rapid-fire competitive or practice target shooting, fast plinking, fun shooting... anywhere... anytime... at lowest possible cost. The revolutionary new "600" SEMI-AUTOMATIC .22 Pellgun Pistol is truly a superb precision handgun you'll be thrilled and proud to shoot.

ONLY \$1995 Write for literature: Crosman Arms Co., Inc., Dept. PM-47, Fairport, N. Y.
Suggested Retail **Biggest value... best buy in the gun field today!**

Crosman CO₂ GAS **HAHN**
PELLGUNS BB GUNS



WORLD'S LARGEST MANUFACTURERS OF CO₂ GAS-POWERED RIFLES AND PISTOLS

Modelmakers Are in a Tizzy

Read what's happening in
a humming industry
in the

DECEMBER

Popular Mechanics



NEW CATALOG!

FINE DOMESTIC & IMPORTED

WOOD

and over 1500 items for the
HOME WORKSHOP

BIG DISCOUNTS
on Latest Models
STANLEY
POWER TOOLS
Upholstery Materials
Lamp Parts
Mosaic Tile Supplies
Modern and Traditional Turned Legs
Metal Legs—
All finishes
Craftsman Hardware
Music Box Move-
ments
Hand and Power Tools

**Hardwoods, Veneers, Plywoods,
Mouldings, Mosaic Tile, Ornaments,
Tools, Archery and Skiing Woods**

AT LOWEST MONEY-SAVING PRICES!

Your complete wood and workshop buying guide... new 132 page edition now ready! Starting savings on everything you need! Your complete wood buying guide and project book. Craftsman is your best, most complete source of finest kiln-dried domestic and imported woods. Beautiful wood inlays, colorful bandings, matched plywoods, embossed mouldings, carved ornaments, newest wood-working tools, "hard-to-find" cabinet hardware; more than 1,500 items! Packed with newest patterns, project ideas and money making plans. Enclose 25c (refunded with first order) to help pay mailing and handling cost. Write NOW! **CRAFTSMAN WOOD SERVICE CO.** Dept. A-11, 2729 S. Mary St. Chicago 8

**RUSH
COUPON
NOW**

Craftsman Wood Service Co., Dept. A-11
2729 S. Mary St., Chicago 8, Ill.
Enclosed find 25c. Rush new CRAFTSMAN WOOD CATALOG.

NAME _____
ADDRESS _____
CITY _____ ZONE _____ STATE _____

FREE PLAN

Tells How To Start
Your Own Business

FILING SAWS

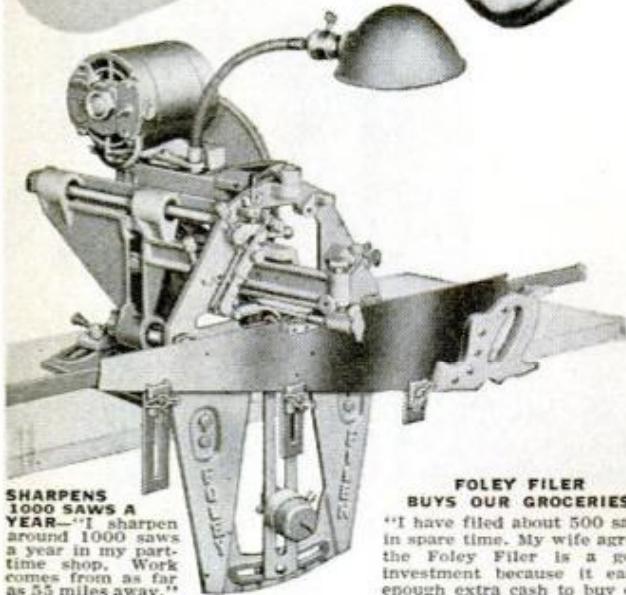

SHARPENS 1000 SAWS A YEAR—"I sharpen around 1000 saws a year in my part-time shop. Work comes from as far as 55 miles away."
—Joe H. Walker.

FOLEY FILER BUYS OUR GROCERIES
"I have filed about 500 saws in spare time. My wife agrees the Foley Filer is a good investment because it earns enough extra cash to buy our groceries." — R. J. Kreuser.

FOLEY FILED SAWS BRING NEW CUSTOMERS

Here is a steady repeat CASH business that pays from \$3 to \$6 an hour, and you can start in your own basement or garage in your spare time. Every saw you sharpen with the machine accuracy of the Foley Saw Filer is an ad that brings more customers. J. C. Delbert wrote us: "Since I got my Foley Filer five years ago, I have averaged 4 1/4 saws each day over all this time." Howard Kuhns says: "We operate 2 Foley Filers, and our business averages about 500 saws per month. The count last year was 5,798 saws."

The new model 200 Foley Saw Filer (shown above) is the first and only machine that automatically sharpens combination (rip and cross cut) circular saws—also all hand saws, band saws and crosscut circular saws. The adjustments are simple—there is no eyestrain—and you can start right away to turn out perfect cutting saws. Exclusive jointing action evens up irregular teeth — old saws cut like new!

"MONEY MAKING FACTS" explains how you can get business from hardware stores, home owners, farmers, carpenters, schools, mills, factories, etc. Just think, with a modest investment, no overhead, no stock of goods to carry, you can start right in on a cash business that will help pay the rent, buy groceries, or a new car. Time Payments available; send coupon today for this practical money making plan. No salesman will call.



Send for **FREE BOOK**

**FOLEY MFG. CO., 1116-0 Foley Bldg.,
Minneapolis 18, Minn.**

Send me free book "MONEY MAKING FACTS" and
TIME PAYMENT PLAN.

Name

Address

An Eye on Space

(Continued from page 116)

where, automatically, a parachute opens on the capsule, while the spent emergency rocket falls away.

If we are talking about a more advanced system, then the worries are associated with this situation: A booster lifts a spaceship into orbit—did it go well? In orbit, the astronaut positions the spaceship (or this is done for him from ground); retro-rockets are fired (properly?); the spaceship itself, not just a capsule, comes down, enters the atmosphere, uses fuel for braking purposes, prepares to land. At this point, a decision has to be made: Should the whole spaceship land, can it do so safely or should the spaceship catapult away the capsule which will come down by parachute? The Russians did this with the two dogs; but the spaceship itself landed safely, they reported. The catapulting was a precautionary measure.

Very soon, now, everyone's dreams may be of a more peaceful variety: Spaceships will rise easily, on nonexplosive fuel, they will ease into orbit, and they will come down, all the way, intact, with the travelers, be they Ivans or Joes, Belkas or Rovers. ★★★

Pellet Insecticides Help Control Mosquitoes

Using small pellets of inert composition coated with high-powered insecticides, a University of California scientist has worked out a method of killing mosquito larvae that breed in water standing under heavily-foliaged plants where ordinary sprays can't reach. Dr. M. S. Mulla and technician Harold Axelrod discovered that granules, scattered over the plants, fell through the leaves and released their poison on the water, killing the larvae before they could mature. An application of the pellets on dry land will produce complete control after flooding, something not possible with sprays. Besides producing the desired results, the pellet method also turned out to be safer (no spray to drift on the air), easier (no big spray equipment necessary), and left no deposit of harmful chemicals on the plants. The latter advantage eliminates harm to beneficial insects and animals and prevents toxic residues in food and forage crops. By using certain organophosphates and carbamates, they found new mixtures as deadly as parathion, the most toxic of all compounds, but which were safer to use and which killed mosquitoes which had built up immunities to standard pesticides.

EMERSON ELECTRIC

NEW POWER For Your Tools...

There's an Emerson Electric Motor for every tool... sanders, saws, joiners, pumps, lathes, drills, buffers, etc... Home workshop or commercial. Operate in any position... exclusive dust-proof contact points. One year guarantee.



**multi
duty
MOTORS**

Write today for prices and FREE MOTOR SELECTOR GUIDE... tells you the exact motors you need for your tools.

EMERSON ELECTRIC of St. Louis
8100 Florissant • St. Louis 36, Mo.

THE KING MIDGET



FOR 1961

World's Most Exciting Lowest Priced Car. Drive it for 75c per week. Rider Agents Wanted. Send 25c for 32 page picture book, full details. Or send \$1 (refunded first order) for this plus Service and Repair Manual and 16 5x7 photos of car and factory.

MIDGET MOTORS CORPORATION, Athens 1, Ohio

GEORGE HILL REPORTS

1961

POPULAR MECHANICS'

HOT ROD

ANNUAL

75c

85c IN CANADA

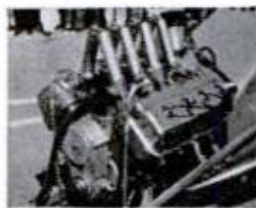

HERE COME THE KARTS
HOPPING UP THE '60 ENGINES



WORLD'S RECORD BATTLE
LATEST SPEED EQUIPMENT
COMPLETE RESULTS FROM
• BONNEVILLE NATIONALS
• AHRA DRAGS
• DETROIT NATIONALS

NOW ON SALE!

NOVEMBER 1960

The Handiest Plier of them All

use it
as a
PLIER

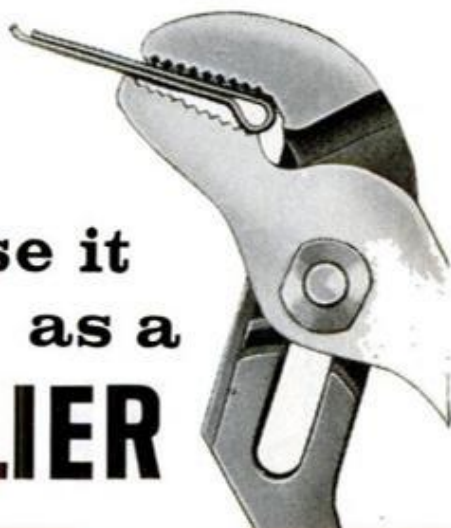

CHANNEL LOCK

use it
as a
WRENCH



You'll do hundreds of jobs faster, easier with a CHANNELLOCK Plier. Gives you terrific, parallel-jaw gripping power. Five undercut, machined channels can't slip... the tighter you grip, the tighter they lock. Long and compact... a jim-dandy on hard-to-reach jobs. Available in three jaw capacities: $\frac{7}{8}$ ", $1\frac{1}{2}$ " and 2". Ask your tool supplier for a genuine CHANNELLOCK Plier. If he's out of them, ask him to order one for you.

Write for Catalog of Complete Line of Pliers

CHAMPION DEARMENT TOOL COMPANY

MEADVILLE 1, PENNSYLVANIA

255

**THE FIRST OF ITS KIND
AT THIS LOW PRICE**

Warren
Quik-Drive
**SCREWDRIVER CLUTCH
ATTACHMENT**

**DRIVES ANY TYPE OF SCREWS
INTO ANY MATERIAL**
... EASIER ... QUICKER
... WITH GREATER SAFETY

Quik-Drive is precision-built for maximum efficiency and power combined with safety and durability. Yet ... with all its quality it sells for a fraction of the price of other screwdriver attachments of this type.

**MAKES ANY ELECTRIC DRILL
A SAFE POWER SCREWDRIVER**

- Fits any electric hand drill
- Takes all standard push drill bits
- Stops automatically when screw is driven
- Will not damage screw heads
- Including standard and Phillips bits

**Unconditionally \$3⁸⁸
Guaranteed**



Warren 

DADO SAWING WASHERS

With Warren Dado Sawing Washers on your present power saw you can cut 40 different, parallel grooves. Engineered to cut clean and accurate. 40 micromatic adjustments ... just dial the desired width. Strengthens blade, eliminates vibration. Leave on saw for straight cuts. No burning or chewing. Guaranteed.

\$4⁹⁵ PER SET
POSTPAID INCLUDING TAX

PLEASE GIVE YOUR ARBOR SIZE 1/2", 3/8", 3/4", 1"
Send For **FREE DESCRIPTIVE BOOKLET**
SEE YOUR DEALER OR WRITE DIRECT

WARREN DADO SAWING WASHER CO.
BOX 98, NORTH END STATION • DETROIT 2, MICH.

Enc. \$3.88 1 WARREN QUIK-DRIVE SCREWDRIVER CLUTCH
 Enc. \$4.95 1 Set WARREN DADO WASHERS

Both Postpaid _____ My Arbor Size _____

NAME _____
ADDRESS _____
CITY _____ STATE _____

WARREN DADO SAWING WASHER CO.
BOX 98 NORTH END STATION • DETROIT 2, MICH.

Rockets for Civilians

(Continued from page 142)

other hand, many scientists enthusiastically claim great effectiveness. One series of California experiments using ground-based sodium iodide dispersal apparatus showed no significant difference in rainfall between seeded and unseeded clouds. However, another series of experiments in the same state showed "a significant difference" caused by seeding.

In the meantime, rocket firms continue to develop seeding rockets and techniques for the day when the market may open for them. Aerojet-General is working on rockets that can be launched either from the ground or from an airplane at 15,000 to 30,000 feet. The sodium iodide is packed in a plastic container that easily breaks into tiny pieces, and most of the rocket's parts are made of equally brittle material so there is no hazard to aircraft. Farmers in Italy have not waited for scientific proof or court rulings. They already support a wide market for very small seeding rockets developed by Angelo Patti. The rockets look very much like Fourth of July rockets—small, sharp-nosed cylinders attached to sticks that are launching guides.

Several companies that are selling small, inexpensive research rockets are also selling a line of laboratory rockets that never leave the ground. These are modifications of the tiny vernier and retro rockets that turn, stabilize or slow satellites and large rockets. Most of them fit comfortably in the palm of the hand—or in a clamp-down rig on a metallurgical lab bench. They are fired to test new alloys, ceramics and heat-resistant plastics. Their exhausts provide ultra-high temperatures and very high speed abrasion at low cost. Their thrusts range from 1½ ounces to 10 pounds.

Laboratory rockets are made in many shapes to meet different job requirements. Some look very much like their larger brothers but most of them look either like a piece of ordinary plumbing pipe, or a flat disk. Nevertheless, they are really rockets. The ones that look most like rockets or pieces of pipe usually contain a solid-propellant charge. The discs are seldom more than an exhaust-directing outlet for burning fuels piped in from separate containers.

Industry is learning that there is a double savings in using small test rockets:

(1) The cost of the rocket is much lower than the operating cost of conventional plasma jet devices and arc furnaces that have been used;

(2) The rocket can be used in an average laboratory that has been modified for safe-

(Continued to page 258)

PEEL PAINT OFF



Furniture



Floors



Boats



Woodwork



KLEAN-STRIP PAINT REMOVER

Fast • Clean • Non-inflammable

THE KLEAN-STRIP CO., INC.
2340 S. Lauderdale, Memphis 6, Tenn.

FREE THE HISTORY OF
THE COMPASS
SEND FOR YOUR COPY

New DINSMORE *Celebrity* COMPASSES

in Beautiful GOLD or SILVER

A jeweled, precision instrument—designed for modern cars. Full, indirect illumination. Sharp, clear letters. Silver or gold Celebrity models \$7.45, standard models \$5.95, illuminated \$6.95

APPROVED BY AUTO MAKERS
Fine Quality Compasses for over 31 Years

DINSMORE INSTRUMENT CO.
1802 Kelso St., Flint 1, Michigan



Write
for Folder

Dr. Grabow *Pre-Smoked* PIPES

Only Dr. Grabow pipes are mechanically pre-smoked with fine tobacco. Need no breaking-in. Sweet and cool from the first puff.



Viscount
\$5.

Others to \$10.
Imported Briar

For Free Booklet Write:
Dr. Grabow Pre-Smoked
Pipes • Greensboro, N.C.

LOOKING FOR LONG WEAR IN SERVICE SHOES?

TRY

Santa Rosa Brand



SHOES

WITH NEOPRENE SOLES!

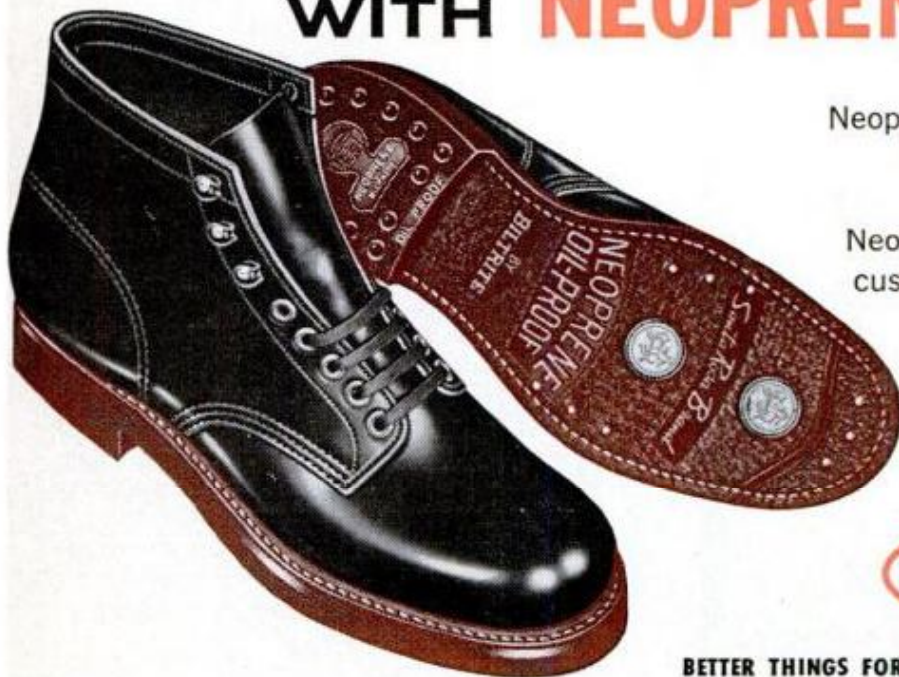

Neoprene soles give long wear... resist oil, grease, chemicals and cold weather cracking. Neoprene soles are resilient... cushion each step... help make standing jobs less tiring.

Ask for neoprene soles the next time you buy service shoes.



BETTER THINGS FOR BETTER LIVING...THROUGH CHEMISTRY

New Dexall Caulking Compound

- Caulks stucco, wood, concrete, brick, stone.
- Permanently elastic.
- Easy-to-use cartridges.

Tough seal lasts for years!

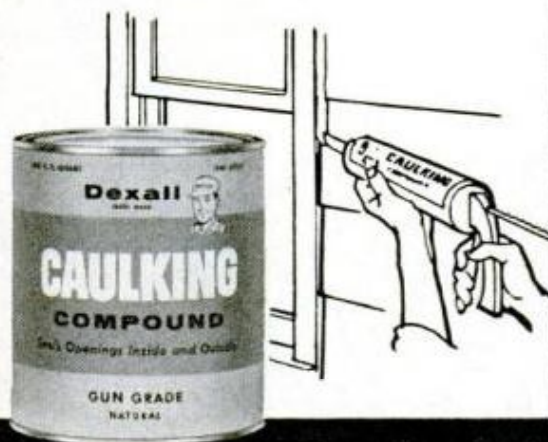

DESHLER PRODUCTS, INC.
Deshler, Ohio



*Fast, easy, foolproof way
to repair wall cracks!*

New Dexall Patching Paste

- New, improved, ready to use, for plaster and wood.
- Won't crack; water-resistant, smooth, easy-working.
- Dries fast, anchors firmly, sands easily.

At paint and hardware stores everywhere.

ty, where the larger devices require specially constructed buildings for their operation.

T. Keith Glennan, head of the National Aeronautics and Space Administration, knows as well as any person in the country the importance of new materials to our missile and space effort. He has described new ceramic materials for rocket nozzles, vanes and nose cones that were made possible through repeated laboratory tests using heat and friction from small rockets.

One of the more intriguing civilian markets being considered by the rocket industry is sports. The much-publicized strap-on-the-back infantry rockets—sometimes dubbed *Buck Rogers* or *Grasshopper*—are now being developed for the Army. In less than five years, the responsible engineers say, quantity production for the Army will make a low-cost civilian modification possible.

The jump belts and flying belts will be used in sports, old and new. Alexander Bohr and Harry Burdette, engineers at Thiokol Chemical Corporation's Reaction Motors Division, first disclosed the individual troop rockets two years ago. Then as now they were enthusiastic about low-cost, lightweight rockets to propel skiers to the tops of good ski hills that have no tows. They believe this will be one of the first ways civilians will use the rockets when the price is brought under \$300 and the fuel is made cheap enough. Already, Thiokol can make them for little over \$300, light enough and reliable enough for Army evaluation. However, they have to be lighter and much more reliable for use in civilian firefighting, police and construction work. And before they can be sold to the general public for sports use, the belts must be made absolutely foolproof.

The Army and some civilian organizations are interested in two types of rocket belts. The more spectacular, but farther from reality, is the true flying belt that will lift a man and fly him for several miles at 40 to 60 miles per hour. The operator will have full control over speed and direction. So far, Thiokol and Aerojet-General are studying designs for flying belts. They have built dummy models for publicity photographs to stimulate military and Congressional interest.

The other rocket belt type is already a reality. It is a "jump belt" which assists the operator's own muscle power and eases the load on his legs. Thiokol engineers have made running broad jumps up to 25 feet with experimental models. They have made standing high jumps of 6½ feet, remaining upright the whole time. This is equivalent

(Continued to page 260)

NEW! Stanley's Lightweight FINISHING SANDER

- **Powerful Stanley-Built Motor**
2.2 amps at 115 volts.
- **Perfect Balance**
Use the H37 Finishing Sander—tirelessly!
- **Maximum Ventilation**
For cool, efficient operation.
- **Designed for Flush Sanding**
Gets into small work areas.
- **Positive Gear Drive**
Delivers maximum power to the sanding pad.



- **Out-Of-Way Cord**
Does not interfere with work area. Heavy-duty cord protectors prevent cord breakage.
- **Non-Slip Pistol Grip**
With grooved housing for perfect hand control. Ideal for vertical sanding.
- **Trigger Switch**
With locking pin gives complete operating control.
- **Quick, Easy Paper Changing**
Saves time and effort.

only **\$34⁹⁵** at your Stanley dealer

Electric tools . . . built for the professional, priced for everyone



STANLEY ELECTRIC TOOLS, Div. of The Stanley Works, New Britain, Conn.

GET THE HABIT OF
OUR CLASSIFIED ADS.
Wonderful Opportunities Amazing Bargains

Exclusive Double-Bearing HEAVY-DUTY PUMPS
IRRIGATE • DRAIN • CIRCULATE • SPRAY
Use 1/4 HP motor or larger . . . 1 HP for up to 5,200 GPH; 1,000 GPH 60' high; or 3,000 GPH from 25' well. 1 1/4" inlet; 1" outlet. Stainless shaft. TYPE X—2 oil-less bronze bearings. Won't rust. . . . **\$10.95**
TYPE XB—Ball bearing model. . . . **\$12.95**
Postpaid if cash with order. Rush your order today!
MONEY BACK GUARANTEE
Centrifugal and Gear Pumps in All Sizes
LABAWCO PUMPS, Belle Mead 2, N. J.

Share your
Christmas
Joy
Give to
The Salvation Army

The NEWEST and FINEST: Buck's 400 Series
CHROME EDGE CHISELS
You get: ★ The Finest Cutting Edges
★ Tough Tenite II Handles with Inserted Steel Caps
★ Rust Proof Tools

1" - \$2.90
3/4" - \$2.70
1/2" - \$2.40
3/8" - \$2.30

Plastic pocket Kit - 4 Sizes \$10.30
Most complete line of Chisels, Gauges and Carving Tools
CATALOG AVAILABLE!
BUCK BROS. INC.
RIVERLIN WORKS MILLBURY, MASS.

HOW TO GET THOSE **"BIG PROFIT" WELDING JOBS**

(A) Shop Type Transformer (B) Weld and Power Combination (C) Home Work Shop Model

HOBART BROS. CO., Box M-110, Troy, Ohio, Phone FE 2-1223

Have a paying business of your own!
You're just a step away from a profitable welding business of your own. Hobart has just the unit for you—low cost—real money makers. Machines illustrated give you an idea of the wide selection to choose from. "Power/Weld" (center) also supplies 110 v. AC power to run lights, tools, motors, sprays, etc. Do top quality work right away—welding is in big demand throughout the country. Investigate today. Get complete information. No obligation.

✓ CHECK HERE
 A B C
Put name and address in margin of this ad and mail.

to a non-athlete loaded with working clothes and 40 pounds of equipment making a conventional high jump *horizontally* across a bar 10 feet high.

When these belts go into production, they will use a compact high-energy solid propellant. Right now Thiokol works with hydrogen peroxide-powered belts weighing from 11 pounds to 25 pounds. Using a 25-pound model, the average man can run 300 yards at 30 miles per hour without tiring. Men have run over 35 miles per hour for several seconds without being winded. They have jumped across gullies 20 feet wide and have made standing broad jumps of 11 feet.

Bohr and Burdette see other sports uses for their rockets besides skiing: Mountain climbing, hiking for elderly people, swimming and entirely new sports that cannot even be imagined until personal rockets are widely available.

Aerojet-General Corporation holds the Army's other study contract for personal rockets. Aerojet's engineers also have been working with belts powered by hydrogen peroxide, but believe, with Thiokol's engineers, that a cheap solid propellant will make a civilian belt practical. They also agree that the personal rockets—they call theirs "AeroPAK"—will find wide use in rescue work, fire fighting, construction, transportation and sports.

Some of the earliest types of rockets still are aiding civilians daily. They are the *JATO*—Jet-Assisted Take-Off—rockets that reduce the runway length needed for airplane take-off and allow planes to leave the ground with heavier loads.

They permit mining and prospecting companies, for example, to use airplanes in country too rugged for full-length runways. They convert farm pastures and country lawns into airstrips for craft heavier than the smaller light planes. They are especially useful on seaplanes because they greatly reduce the take-off run. This means that in choppy water they reduce the time that the plane is exposed to potential structural damage.

New uses are being reported for *JATO* units. One industry source says stunt car drivers are using them to provide bursts of power for quick starts, sudden stops and trick turns. Engineers are studying rockets similar to *JATOs* for emergency brakes on heavy trucks. The major problem is to compromise the amount of thrust and the direction so the rockets will not injure bystanders or damage property, but still will be effective emergency brakes.

Although the former National Advisory Committee for Aeronautics, now NASA,

has changed its emphasis to space interests, it is still active in research on aircraft. NASA still helps airplane manufacturers with their research, and rockets are a big part of the help. Rockets replace wind tunnels in many tests on models of new aircraft.

Scale models of airplanes, or even of other rockets, are mounted as pay loads on the noses of rockets. These range from one to six stages. Sometimes large models are used and the propelling rocket is mounted within the model.

The rocket with its test model is propelled to the top speed needed in the experiment. As the model decelerates, instruments gather various data and radio it to the launching station, usually Wallops Island, Va. During the model's free flight, accelerometers measure aerodynamic forces. Instruments measure the model's response to programmed controls, detect disturbances, instability, tendencies to flutter and buffet, and pressures and temperatures at various points. These are radioed to the ground.

In the simplest tests, a cheap rocket serves as the basic vehicle. Stabilizing fins added to the rear equip it for flight. An instrumented test model is mounted in the nose. This method is as effective as a wind tunnel for most purposes. It is also considerably cheaper. In addition, it develops free flight information that cannot be determined in most tunnels because they are too small to permit a model's free flight for more than a second or two. Free flight information can be taken for five minutes from rocket-launched models.

Sometimes a rocket is used to provide power that is not applied like ordinary rocket thrust—a rocket provides power that could be provided by a compressor, but provides it much faster. Such devices sometimes are called rockets, which they are, but more often are called "gas generators" which describes how they are used rather than what they are. When power is needed in a hurry and in a small volume, it can be provided by a stick of dynamite as an explosion. But, to be more useful, quick power in a small volume is provided by the very rapid burning—but not explosion—of a rocket propellant. Such rockets provide the power to drive gas turbines, drill oil wells, or start heavy engines. They can crack an egg gently, or bring a freight train to a screaming halt.

When such rockets are used within large missile to provide the power to operate fuel pumps or to turn nozzles, they are called auxiliary power rockets. The same rockets are being modified to meet similar power

(Continued to page 264)

FREE

Full Year's Subscription to
RADIO SHACK'S Electronics Catalogs
See the world's most complete line of electronic equipment

- Stereo
- Hi-Fi
- Ham Radio
- Transistors
- Test Equipment
- Kits and Parts



DETACH AND MAIL BOUND-IN POST CARD
or Clip Coupon Below Immediately

Send for your free catalogs today. Receive the latest 1960-61 Radio Shack Buying Guide plus every issue—hot off the press for one full year! Free and postpaid!

Radio Shack is one of the oldest and most famous corporations in Radio and Electronics. The name came from the term used for the communication center of ships at sea since earliest wireless days. Today as always, Radio Shack is dedicated to bringing the newest and best in electronics to millions—both individual electronic devotees and industry all over America.

Shop Radio Shack catalogs for quality electronic equipment and scores of other items—all priced at truly remarkable savings. Buy on credit, open a charge account. 15-day no-risk home trial on any item. Money back guarantee of satisfaction! Get what you want, when you want it from RADIO SHACK. Mail tear-off card or clip coupon today for your FREE catalogs.

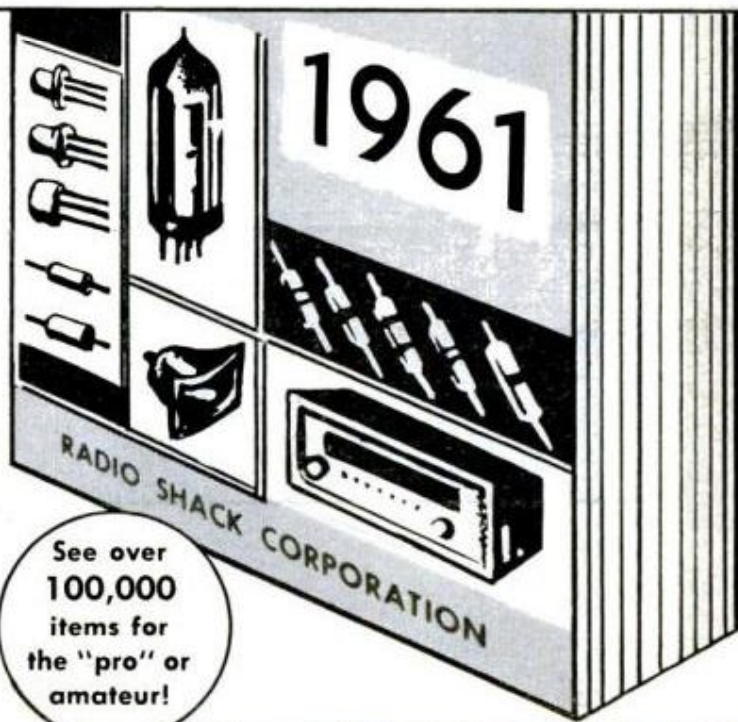

See over
100,000
items for
the "pro" or
amateur!

Three Typical RADIO SHACK VALUES



Realistic 2-speed
Tape Recorder
Compare at \$99.95
\$49.50



Complete Code
Practice Set
key and buzzer included
\$1.79



Realistic Stereo
Fully Wired Amplifier
A complete stereo unit
\$9.95

RADIO SHACK CORPORATION

730 Commonwealth Ave., Boston 17, Massachusetts

NOVEMBER 1960

RADIO SHACK CORPORATION

Dept. 60L3A

730 Commonwealth Ave., Boston 17, Mass.

Without obligation, please send me FREE and POSTPAID, your latest Electronics Catalog plus every new issue for one full year.

Name _____

Address _____

Post Office _____
or City _____ Zone _____ State _____

**DRIVING IS
MORE FUN WHEN
YOU KNOW
YOU'RE HEADED
THE RIGHT WAY**



with a **NOMAD AUTO COMPASS** by

Airguide

On highway, by-way or winding streets, in darkness, rain or daylight, this smartly styled and popular direction guide helps to keep you on the beam. Saves you miles, minutes and temper. Finest Alnico V magnet and exclusive VISI-DOME® dial assure easy steady readings under all conditions. At night just press the button. Self-contained flash cell illuminates dial with a soft green glow. Fits any car. No wiring. Simple to install and adjust. Wonderful gift idea for motorists.

Model No. 79
NOMAD
\$750



Made by
Airguide
Instrument
Company,
Chicago 47, Ill.

At better stores everywhere

put **SKILL** in your hands
Dremel MOTO-TOOL

In your workshop, on your job — it's the handiest tool you'll ever own! Moto-Tool is ideal for precision grinding, polishing, carving, drilling, engraving, deburring, sharpening — does fine detail work with pin-point accuracy. It eliminates time-consuming hand work, gives the finished job a professional look. Moto-Tool weighs only 13 oz. — fits your hand like it belongs there. Fastest, most powerful tool of its kind — develops 27,000 rpm! Widely used by tool and die makers, model builders, craftsmen, lab technicians, repairmen, gunsmiths, schools.



Moto-Tool Kit No. 2
with steel case \$27.50
No. 2 Moto-Tool
only\$19.95

See your dealer or write
for free catalog.

DREMEL MFG. CO., Dept. 110-L, Racine, Wis.
Quality Power Tools Since 1934

needs, but in civilian situations. For example, the Rocketdyne Division of North American Aviation produces small rockets for auxiliary power in *Terrier* and *Tartar* missiles. They are solid-propellant gas generators that develop power to operate electrical generators. The electricity, in turn, operates the hydraulic system—drives the fuel pumps and coolant pumps. They will soon go to work for civilians.

Rocketdyne is developing, and plans to test, a number of the small solid-propellant rockets that would be used to start turbojet engines. This would eliminate much of the ground starting equipment housed now at airports for starting the turboprop, or "propjet" planes. Rocketdyne engineers say they will be about six inches long and six inches in diameter. They will weigh about eight pounds.

Other small rockets and gas generators provide the quick power for emergency cockpit ejection in military planes. The aircraft industry is now working on adaptations to civilian planes. One plan calls for rocket-actuated separation of whole sections of aircraft in an emergency. Smaller rockets will pull parachutes from their packs.

A Navy fire extinguisher sprinkler system that appeals to industry uses small solid-propellant rockets to exert pressure on a liquid extinguisher. It is a high speed system that pours out large amounts of liquid immediately on fire command. Ordinary air and gas-pressure systems would be caught by surprise and the pressure would drop almost instantly below the effective working level. The rockets build pressure almost instantaneously. The Naval Research Laboratory maintains nearly constant pressure either by using a slow, steady-burning nitroguanidine propellant, or by using a battery of rockets firing in series.

Another Naval Research laboratory development that will be going into civilian work soon uses the rocket's first cousin as a power source. Studies on pulse jets were among the most important developments that led to aircraft rockets and then to missiles. Not at all alike in appearance, rockets and pulse jets have much in common. Most important: They are compact sources of quick, cheap power based on hot gas expansion. Naval Research Laboratory uses a pulse jet to power a posthole digger designed to operate in frozen ground.

After developing the posthole digger, the Laboratory began experimenting with Army Chemical Corps fog generators. These are pulse-jet engines in which oil is added to the hot gas chamber. The oil

(Continued to page 266)

**LIMITED
TIME
ONLY!**

SPECIAL CHRISTMAS OFFER!

**GIVE A
POPULAR
MECHANICS
BOOK
FOR
CHRISTMAS**

**GET A
BONUS
BOOK
FOR JUST
10c
MORE!**

NOW, for the first time, you can get special Bonus Books for less than the cost of postage! For each Gift Book you buy at the regular price, pick a Bonus Book for just 10c more. All books are written and fully illustrated in the famous Popular Mechanics style—with never a detail missing! ORDER NOW so you'll have them in time for Christmas giving—for each Gift Book you order, pick out a Bonus Book for just 10c more. Send in your order today—this is a limited-time offer!

GIFT BOOKS

KEY	TITLE	PRICE	J	TITLE	PRICE
A	There's Adventure in Atomic Energy	\$2.95	K	A Guide to Stereo Sound	4.95
B	There's Adventure in Chemistry	2.95	L	The Sound of High Fidelity	4.95
C	There's Adventure in Electronics	2.95	M	Mr. Wizard's Science Secrets	2.95
D	There's Adventure in Geology	2.95	N	Out of This World	3.95
E	There's Adventure in Jet Aircraft	2.95	O	Science Milestones	4.95
F	There's Adventure in Marine Science	2.95	P	Modern Furniture You Can Build	2.95
G	There's Adventure in Rockets	2.95	Q	All About Boats	2.95
H	There's Adventure in Civil Engineering	2.95	R	Outdoor Living Rooms	2.95
I	There's Adventure in Meteorology	2.95	S	Auto Album	3.00
				Fifty Years of Popular Mechanics	5.00

BONUS BOOKS

KEY	TITLE	REGULAR PRICE	BONUS PRICE	KEY	TITLE	REGULAR PRICE	BONUS PRICE
1	Getting Started With Power Tools	\$1.95	10c	11	Farm Manual	3.00	10c
2	Concrete Handbook	2.00	10c	12	Build-It-Yourself Ranch-Type House	3.50	10c
3	Christmas Handbook	2.50	10c	13	Concrete Block House	2.00	10c
4	Do-It-Yourself-Materials Guide	2.95	10c	14	Home Plumbing Guide	3.50	10c
5	100 Best Woodworking Projects	2.00	10c	15	How to Paint With Brush and Spray	1.95	10c
6	Planning Your Home Workshop	2.50	10c	16	Lawn and Garden Book	2.50	10c
7	Portable Electric Tools	2.00	10c	17	Fix-It-Yourself Television Manual	3.00	10c
8	Guide to Good Hunting and Trapping	2.95	10c	18	Album of Aviation	3.00	10c
9	How to Tempt a Fish	2.00	10c	19	How to Restore Antique and Classic Cars	3.50	10c
10	Developing a Profitable Dairy Herd	3.50	10c	20	Build-It-Yourself Book for Boys	2.95	10c
				21	Golf for Boys and Girls	3.95	10c

Dept. PM 11
Popular Mechanics Press
200 E. Ontario Street
Chicago 11, Illinois

Please RUSH the following books to me prepaid. For each Gift Book at the regular price, I am entitled to a Bonus Book for just 10c more:

GIFT BOOKS

Quantity	Key	Price	Total
_____	A	\$2.95	_____
_____	B	2.95	_____
_____	C	2.95	_____
_____	D	2.95	_____
_____	E	2.95	_____
_____	F	2.95	_____
_____	G	2.95	_____
_____	H	2.95	_____
_____	I	2.95	_____
_____	J	4.95	_____

BONUS BOOKS

Quantity	Key	Bonus Price	Total	Quantity	Key	Bonus Price	Total
_____	1	10c	_____	_____	12	10c	_____
_____	2	10c	_____	_____	13	10c	_____
_____	3	10c	_____	_____	14	10c	_____
_____	4	10c	_____	_____	15	10c	_____
_____	5	10c	_____	_____	16	10c	_____
_____	6	10c	_____	_____	17	10c	_____
_____	7	10c	_____	_____	18	10c	_____
_____	8	10c	_____	_____	19	10c	_____
_____	9	10c	_____	_____	20	10c	_____
_____	10	10c	_____	_____	21	10c	_____
_____	11	10c	_____	_____	TOTALS	_____	_____

I AM ENCLOSING

NAME _____
STREET _____
CITY _____ ZONE _____ STATE _____

\$ _____

STOP WATER DAMAGE...



Wood
Plywood
Shingles
Asbestos siding
Concrete blocks
Concrete
Mortar
Stucco
Plaster
Brick
Paint
Wallboard
Tile
Canvas
Leather
Linoleum
Fabrics

Prevents warping, swelling, mildew, mold, water stains, seepage, dampness, rot.

Keeps moisture out 5 years and longer.

Use on all woodworking jobs, boats, patio furniture, planter boxes, shutters, screen doors, window sash, shingle roofs. Stops seepage in basement walls, concrete silos, foundations. Waterproofs canvas, tarps, tents, awnings, leather boots, shoes, outdoor clothing. Won't harden or crack leather or fabrics. Perfect underseal for oil base or alkyd paints. Deep penetrating, colorless. Apply by brush, spray or roller. At paint or hardware stores or order direct. 16 oz. spray can \$1.89, Qt. \$1.75, Gal. \$5.35, 5 Gal. \$25.25, ppd., tax incl. Send check or money order to **E. A. Thompson Co., 1355 Market St., San Francisco 3, Calif.** No COD's please. (Since 1929.)

NEW BELSAW MULTI-DUTY POWER TOOL



SAWS

PLANES

MOLDS

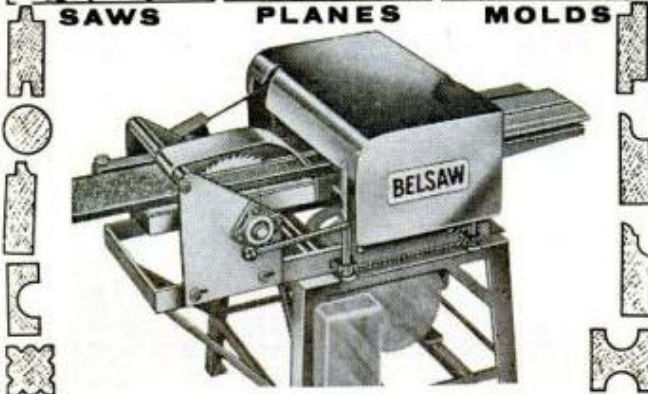

Now you can use this **ONE power feed shop** to turn rough lumber into high-value moldings, trim, flooring, furniture... **ALL popular patterns.**

RIP...PLANE...MOLD... separately or all at once by power feed... with a one horsepower motor. Use 3 to 5 HP for high speed commercial output.

LOW COST... You can own this **MONEY MAKING POWER TOOL** for only **\$3000** down payment

Send coupon today

BELSAW POWER TOOLS 901 Field Bldg., Kansas City 11, Mo.
Send me complete facts on the **MULTI-DUTY Power Tool.**
No obligation.

Name _____

Address _____

City _____

State _____

vaporizes as a warm fog. This can be used to screen troops and equipment, or as an aerosol vehicle to carry chemical warfare agents on air currents over enemy lines. The Naval Research Laboratory found that minor modifications in the Army's fog generator produced the ideal device for defrosting aircraft-carrier decks. It also de-ices streets and sidewalks. And, pulse-jet fog generators—one generator to a large area—will replace smudge pots in Florida and California orchards. Instead of setting out the pots when the temperature drops suddenly, fruit growers will be able to turn on a centrally located fog generator and then forget about it.

Some winter, not too long from now, a man may sit down to breakfast in Chicago and see this stamped on his orange:

"Protected by pulse jet, delivered by rocket." ★ ★ ★

Tiny Radiation Detector Fits Into Surgical Probe



Hughes Aircraft Company, Newport Beach, Calif.

Cancer treatment control is one use for a radiation detector so tiny that it fits into the tip of a surgical probe. With it, doctors can determine the amount of radiation to which a precise area of a cancer patient is exposed. Other applications: Space exploration, for measuring cosmic rays and radiation belts; military, for determining the amount of radioactivity in an area; and nuclear power control, for measuring radiation level in nuclear reactors.

NEW! LIFE GUARD RULE

YELLOW BLADE CLAD IN MIRACLE MYLAR* PAT. PENDING

- Yellow for maximum visibility!
- Outlasts other blades 3 to 1!
- Acid-proof, wear-resistant!

SEE THIS NEW TAPE RULE AT YOUR HARDWARE STORE NOW

STANLEY®

THE TOOL BOX OF THE WORLD

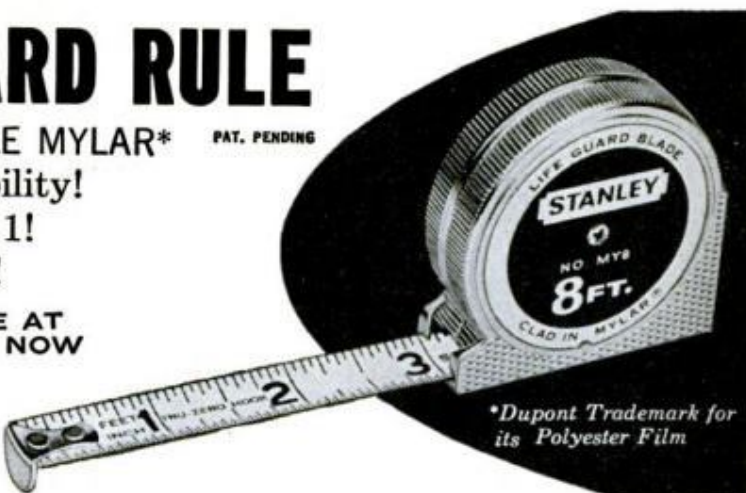

*Dupont Trademark for its Polyester Film



MAGNETS

PERMANENT ALNICO

FOR HOBBYISTS, INVENTORS, SCHOOLS, FISHERMAN & INDUSTRY

Government Surplus Retriever—150 Lb. Pull	\$8.95
Government Surplus Retriever—75 Lb. Pull	6.95
Magnet Retriever Assembly—50 Lb. Pull	2.95
Alnico 5 Pot Holder Magnets. 20 for \$1.40 50 for	3.00
Pencil Type Pick Up Tools. 4 for	1.00
Bulletin Board Magnets. 10 for \$1.00 50 for	4.00
12 Assorted Small Magnets	1.50

Sample Magnets and Literature—25c

10 DAY MONEY BACK GUARANTEE

SEND CHECK OR MONEY ORDER—SORRY NO C.O.D.'s

THE MAGNET HOUSE

Suite 212 16033 Ventura Blvd. Encino, California



Works in seconds!

Loosens Rusted Bolts
nuts, screws, "frozen" parts!

LIQUID WRENCH®

SUPER-PENETRANT

The super-penetrating rust solvent that quickly loosens rust and corrosion.

AT ALL HARDWARE AND AUTO STORES

RADIATOR SPECIALTY COMPANY
CHARLOTTE, N. C.



What are little men (and women) made of?

Vivid imagination and creative energy! Direct those precious qualities into constructive play with these exquisite miniatures. Each model is a sturdy, accurately-scaled replica—brilliantly enameled in pressure die-cast metal with moving parts. Priced so low that you can afford to collect them all. (Fun for the entire family!)

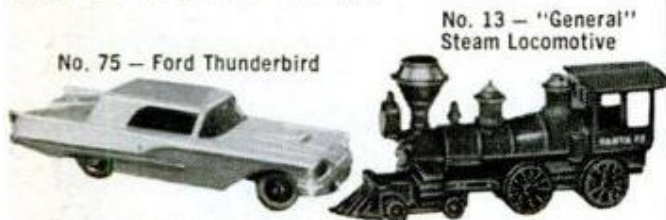

No. 75 — Ford Thunderbird

No. 13 — "General" Steam Locomotive

"MATCHBOX" SERIES
Modern, sport and racing cars; trucks, military equipment—and more! Suited to HO layouts—detailed, and beautifully finished. Each in multi-color "Matchbox." 75 models, only 49¢ ea. 10 Acces. and Major Packs, 49¢ to \$1.25.

"MODELS OF YESTERYEAR"
Oldtime sport cars, steam engines, locomotives, buses and lorries—true collector's items! Each box carries the background story of the vehicle—a history lesson in itself. 14 authentic, historic models, 59¢ to \$1.00.



(Shown above) No. M-1 — Caterpillar Scraper

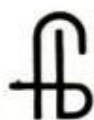

IMPORTED FROM ENGLAND—
Sold at most Department Stores,
Toy and Hobby Shops,
(Available in attractive Gift Sets, too.)

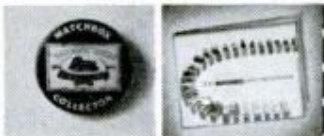

TOY IMPORTS

Send for FREE "Matchbox" Collector's Button and Full Color Catalog →

Fred Bronner Corporation
251 Park Ave. South, N. Y. 10, N. Y.

Please send me FREE Button and Catalog

Name.....

Address.....



On the **MARKET** for Do-It-Yourselfers

1. SNAP-IN, SNAP-OUT DIVIDERS convert any single-pane sash to a multi-pane sash in less than a minute's time. Available in a range of square pane sizes and also in diamond pane designs which simulate Swiss windows or traditional leaded-glass sashes. Dividers snap out for painting sash frame or washing glass
Zegers, Inc., 8090 S. Chicago Ave., Chicago 17, Ill.

2. NATURAL OIL FINISH is a new compound of special oils and additives that penetrate and dry within the wood, not on the surface. Reduces finishing of all common cabinet woods to two basic steps—saturation and light wiping to remove surplus oil from surface. Eliminates the need for multicoat surface finishes
Wateo-Dennis Corp., 1756 - 22nd Street, Santa Monica, Calif.



3. DOOR-BOTTOM WEATHERSTRIP is surface mounted, raises and lowers automatically when door is opened and closed. Eliminates under-door drafts on interior doors such as those opening into bedrooms, basements, attics. Mounts with screws and can be cut 4 in. to fit standard doors; is attractively finished
Reese Metal Weatherstrip Co., 712 Park Ave., Minneapolis 15, Minn.

4. SPLASH-FREE PAINT ROLLING is now available for do-it-yourself decorators. Paint supply is carried in a shoulder knapsack and is fed to roller through plastic tube. To recharge roller simply lower arm occasionally while painting. Roller is made of foam plastic. Kit includes full instructions for operation
Wallmaster Co., 1232 Milwaukee Ave., Chicago 22, Ill.
(Continued to page 270)

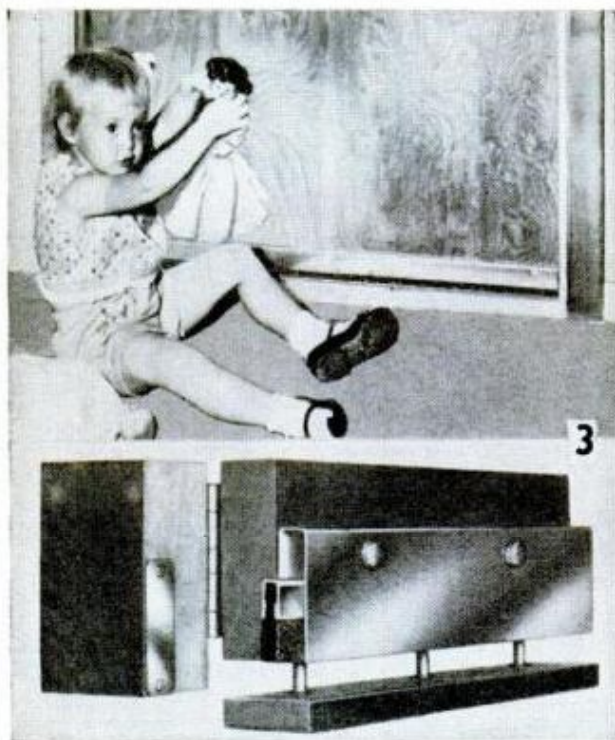

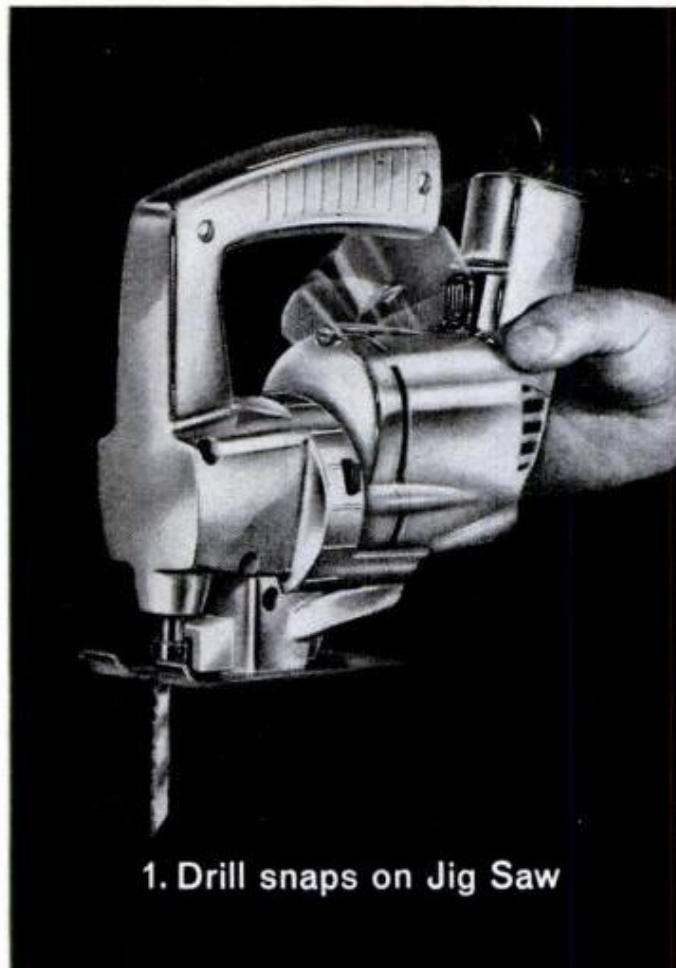

1. Drill snaps on Jig Saw



2. Drill snaps off Jig Saw

Skil 1/4" Drill converts to Jig Saw, 5 other Snap/Lock Tools...costs just \$16.95!

New Skil Snap/Lock Tools are a revolutionary development! You just snap them on or off the Skil and other 1/4" drills that power them. No complicated assembly using screwdrivers, wrenches or easy-to-lose parts as with ordinary attachments. These tools snap on the drill, lock solidly in place and *stay* that way.

You'll appreciate the rugged power and performance of Skil's 1/4" drill. It has a full 2.5 amp. motor to drive these Snap/Lock tools, or handle tough drilling jobs.

For just \$16.95 each you can outfit your workshop with this Skil 1/4" drill and Snap/Lock Tools to do your sawing, sanding and grinding jobs. Skil Snap/Lock garden tools for clipping, edging grass and trimming hedges are only \$19.95 each. Get a complete matched set or buy one at a time at your hardware or lumber dealer.

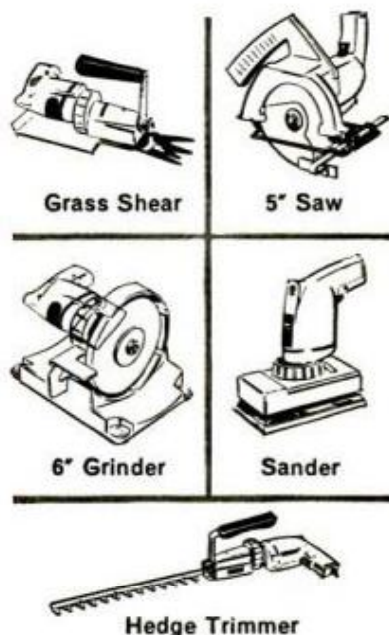

Grass Shear

5" Saw

6" Grinder

Sander

Hedge Trimmer



...AND SKILSAW POWER TOOLS

Skil Corp., Chicago 30, Ill. Prices higher in Canada

On the MARKET

for Do-It-Yourselfers



A SIMULATED stained-glass window symbolizing the special significance of the Christmas season can be yours for the making. It's done simply by pasting a colored translucent pattern on your picture window. Religious patterns, 34 x 44-in., like those seen in many churches, are available on special paper. Individual sections, color-keyed, are first cut from a larger 16-section sheet bearing the complete design. These sections are then laid on a piece of plain paper—not newspaper—and both sides are coated with oil, rendering the design translucent. Baby oil, mineral or cooking oil will do. Both sides of the paper are colored with ordinary crayons, using heavy, bold strokes. The oil helps blend the colors but will not destroy the translucence. When colored, the individual sections are taped together in their original order and then the entire pattern is taped to the window.

Stained Glass Color Art, P. O. Box 82, Waukesha, Wis.

AS YOU CAN SEE ABOVE AND BELOW, the picture pattern is built up in sections which are color-keyed to make planning and assembly easy. The simple ABC steps detailed at the right show how the sections are prepared for placement

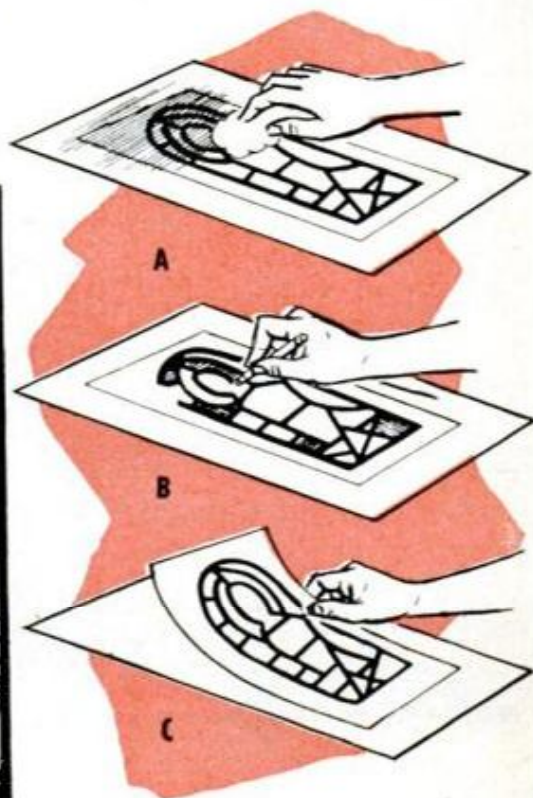

ELECTRIC WELD - BRAZE & CUT

REPAIR MOST EVERYTHING MADE OF METAL

Home Appliances, Auto parts, Farm-garden equipment, toys. Make and repair playground equipment, lawn chairs, tables, ornamental iron work, gates, wagons, etc. Solder, heat, bend, and straighten, with terrific heat from arc torch.



Cut and weld up to 1/4" steel plate. A million uses for Home, auto, farm, inventors, factories, etc. Works from any home 110 volt plug-in. Complete with dark welder's mask, arc torch, supply of carbon welding and brazing rods and complete Welding Instruction Book. Efficient—durable—1 year guarantee. Wt. only 4 lbs.

SEND ONLY \$3 (cash, ck, mo) and pay postman \$9.95 plus COD postage on arrival or send \$12.95 and we will send postpaid. Ideal gift for mechanically minded home owners, relatives, friends. Order now for early delivery. Available only from

MIDWAY WELDER Dept. DPM-11 Kearney, Nebraska



10" TILT/ARBOR SAW

Wood, steel, and aluminum construction, ball bearing arbor. Big machine capacity & performance. Simplified Plans, full size patterns, build easily with hand tools only. Kit with 10" comb. blade \$27.40. Enclose this ad for **FREE DELIVERY**. Money back guarantee. Order NOW. Or Send \$1.00 for Plans refundable with Order NEW DRILL PRESS-LATHE KIT. FREE CATALOG.

GILLIOM POWER TOOLS MFG. CO.
Dept. PM-11, 1109 N. 2nd Street, St. Charles, Missouri

~~\$150~~
BUILD IT YOURSELF
\$23.95

COMPLETE PLANS
Only
\$100 Each
POSTPAID



America is a Better
America —
thanks to Advertising!

Send 10¢ for a complete illustrated catalog to:



2202 Santa Fe Avenue, Los Angeles 54, California

GUNK® degreases

At better automotive supply and hardware retailers everywhere.



Cleans engines, garage floors, power mowers, greasy walls economically and safely.
In aerosol or pour spout cans.



GUNK CHICAGO CO., River Forest, Illinois
serving the Midwest and Southwest
RADIATOR SPECIALTY CO., Charlotte, No. Carolina
serving the East, Southeast and far West

NOVEMBER 1960

Another User Testimonial:

"Over \$200 Profit in 20 hours with a Homelite Chain Saw"

Set your sights on Extra Money with a **FAMOUS HOMELITE**

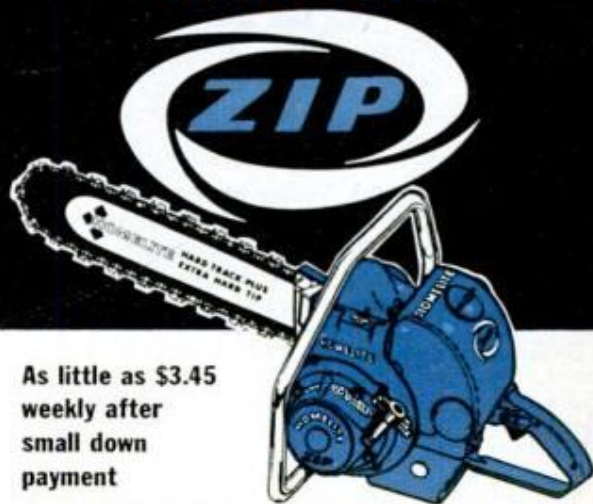

As little as \$3.45 weekly after small down payment

- direct drive • 18 pounds less bar and chain • fells trees up to 3 feet in diameter
- 16" plunge-cut bow and brush cutter attachments
- flush-cut handle

Ask your nearby dealer for a free demonstration of the famous Homelite ZIP. After a few cuts, we think you'll agree that it's ideal for clearing land, cutting firewood or fenceposts, building a shelter or cutting a cash crop to earn extra money.

In Springfield, Missouri for instance, Mr. Oscar Earnest Williams paid his bills with the help of a Homelite chain saw. In just 20 hours he cut 58 ricks of fireplace wood which he sold for a **NET PROFIT** of \$207.67.

Before you buy, try the dependable Homelite ZIP. And be sure to see the rest of the new full line of 8 Homelite chain saws. There's one to fit your need and your budget.

Now! Homelite Guide Bars and Homelite Chain to make cutting even easier!

HOMELITE A DIVISION OF **TEXTRON INC.**
611 Riverdale Avenue, Port Chester, New York
Homelite chain saws are priced as low as \$162.70 (Model 500 complete with 12" bar and chain) F.O.B. nearest factory branch.



HOMELITE "Shoot the Works" Contest

WIN!



First prize — A \$4,000 Mohawk Vacation Lodge PLUS the Homelite chain saw of your choice

714 other prizes — Famous Harrington & Richardson rifles and shotguns.

See your Homelite dealer for contest rules and entry blank. Or write to: Homelite, "Shoot the Works" Contest, Port Chester, N.Y.

Hurry! Contest closes Midnight Nov. 30, 1960

271

REPAIR

FOR YOUR B&D TOOLS



Check the Yellow Pages under "Tools-Electric" for the location of the nearest Black & Decker factory service branch or authorized service station.

Free tool inspection when requested • Genuine B&D parts used • Factory-trained technicians • Standard B&D Guarantee at completion of recommended repairs • Fast service, reasonable cost, always.

Or write for address of nearest of the more than 50 branches and service stations to: THE BLACK & DECKER MFG. CO., Dept. 8011-S, Towson 4, Md.



Now Add Reverberation To Your Stereo System

(Continued from page 80)

bracket. An output transformer with a 10 K primary and 3.2-ohm secondary is also mounted on the bracket of Sp-2 with the secondary winding connected to the voice coil. Both speaker assemblies are then firmly mounted to a wooden base 18 inches long.

Satisfactory results can be obtained with just about any light and highly flexible spring. Springs have been used with $\frac{3}{16}$ inch to $\frac{1}{4}$ inch diameter and the lengths varied as indicated. However, before a permanent installation is made, it is recommended that you experiment not only with the springs, but also with the separation of the speakers. You may find the results most pleasing to you with one or two springs only. Do not place this reverberation unit close to the speaker in your system, because it might result in acoustic feedback, producing a squeal or howl.

The next step is to prepare the amplifier necessary to drive the modified speaker assemblies. As mentioned before, any a.c.-d.c. amplifier will do, and it is not necessary to build one, if you have an old radio on hand. Disable the RF section by shorting out the tuning capacitor, and connect the reverberation control potentiometer to the top lug of the volume control in the radio. If you decide to build a separate amplifier, either buy one of the commercially available kits (1-3 watts), or follow the schematic diagram. This amplifier has a little different twist in its circuitry: by using a pentode as a voltage amplifier, there is sufficient gain available to employ negative feedback in the output stage. This results in a much better hum level characteristic, which is always a problem in a.c.-d.c. devices.

Once all the necessary subassemblies are finished, you are ready for the final hookup. One word of caution: use a shielded cable for the connections between components and employ the braid on the cable as a ground bus. If you experience any hum in your system, reverse the a.c. plug on the reverberation amplifier. The reverberation control with the 100K isolation resistor can be mounted in any spot convenient to you. This potentiometer controls the duration of the echo effect, and its setting will vary with the type of program you are listening to. If you find that the tuner input on your preamplifier is not sensitive enough for this application, connect the cable to the microphone input jack, which always has a flat frequency response (no equalization) and sufficient gain to produce full rated power

Hobbyists

REPLACE
HIGH-FRICTION BUSHINGS
WITH
MINIATURE BALL BEARINGS

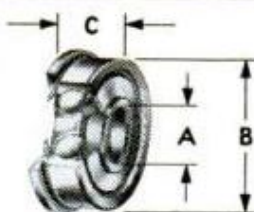

First Time Offered to Model Builders — Miniature Ball Bearings to take $\frac{3}{32}$ " , $\frac{1}{8}$ " , $\frac{3}{16}$ " or $\frac{1}{4}$ " shafts:

Bearing Number	Dimensions		
	A	B	C
359	$\frac{3}{32}$ "	$\frac{5}{16}$ "	$\frac{9}{64}$ "
159	$\frac{1}{8}$ "	$\frac{5}{16}$ "	$\frac{9}{64}$ "
331	$\frac{3}{16}$ "	$\frac{3}{8}$ "	$\frac{1}{8}$ "
113	$\frac{1}{4}$ "	$\frac{1}{2}$ "	$\frac{3}{16}$ "

Reduce Power Loss! Increase Speed, Efficiency! Easy rotation — low friction — long life — lubricated — equipped with dirt shields also flange for easy installation. Titan • Atlas • Sidewinder and other missiles using millions of same bearings in Guidance and Control. \$4.00 ea. postpaid. 24-Hour Mail Service. Use Order Form Today!

SHIP:ea. #359ea. #331
.....ea. #159ea. #113

Send \$4.00 for each bearing ordered.
Name
Street
City Zone State
Enclose Check Money Order Amount

ADDRESS: Dept. PM-1

NEW HAMPSHIRE BALL BEARINGS, INC.
PETERBOROUGH, N. H.

output of your amplifier. The second reverberation unit is based on delay lines designed and produced by Hammond Organ Co. Several hi-fi set manufacturers, by the way, are adding this delay line to their new fall models with different modifications of the circuits. The Hammond unit consists of two delay lines connected between two ferrite rotors with a coil winding connected to the input and output jacks. The delay is between 30 and 40 milliseconds, and the over-all effect is excellent. Because of its nature, a special driver-amplifier and mixer stage is required, and it becomes an integral part of the monophonic or stereo system. Some purists might point out that this additional circuitry will degrade the performance of the hi-fi system, but on the other hand, one has to admit that this addition helps to create a reproduction very close to concert hall quality.

The recommended electronics are fairly simple, and the layout is not critical. We have managed to fit all the components into a 4x5x6-inch box, but the performance will be the same on a chassis twice that size. It is important that all ground connections are brought to a common ground lug, and a hum pot should be incorporated across the filaments. Both of these precautions will reward you with hum-free performance. All jacks (input and output) have to be insulated from the chassis, and you can either use the plastic type (self-insulating), or you can do as shown on the model: use the inexpensive metal jack, and insert a piece of phenolic (or friction tape) between the body of the jack and the chassis. The ground connections, of course, from all six jacks (in stereo connection) are brought to the common bus. Use shielded cable for these connections to avoid any hum and cross-talk problems.

The recommended power transformer is rated 1 amp. at 6.3 VAC and the tubes used require 1.2 amps. However, we have found that because of the low current requirement on the high voltage winding, the transformer will run very cool even though the current capacity in low voltage is exceeded by 20 percent. The larger transformer has B+ too high, which necessitates high-wattage dropping resistors with their heat problems. There does not seem to be any good reason to include an ON-OFF switch, because the circuit has to be turned on any time you wish to listen to your system. A switched a.c. receptacle on your equipment is the best choice for power source, so that one switch on your present equipment controls the power for all your components.

(Continued to page 274)

Cut it with WISS



As versatile as they are powerful, Wiss Snips are an all-purpose cutting tool no home work bench should be without. Above: No. V-13, seven-inch pocket size. Others from 8" to 17" in aviation, combination, and solid steel styles. At hardware and department stores.

WISS SNIPS CUT EVERYTHING!



Cut Tile



Cut Leather



Cut Fish and Poultry



Cut Fencing and Screens

J. WISS & SONS CO., NEWARK 7, N. J.
World's Largest Manufacturer of Shears, Scissors, Pinking Shears, Skalloping Shears, Metal Cutting Snips and Garden Shears

LESSEE
900 miles,
203 m.p.g.
\$241.38....
Plus....



YOU, TOO, CAN BE RICH!

Want a New Set of Golf Clubs... A New Tennis Racket, Shop Tools?... IF SO... do as thousands of people are doing daily, JOIN the fabulous Super Cub Club, and have FUN while you save transportation dollars. Remember, MORE people ride HONDA Super Cubs than any lightweight in the world... To the market, to work, or to the beach, it's amazing... Electric "Push Button" starting the CA-102 gives

SUPER CUB

\$245 P.O.E.



Electric Starter
\$30 additional

you over 200 m.p.g. features 3 speed trans and automatic clutch. Its famous 50cc Over-Head valve engine rates as the finest 4 stroke ever engineered... It's real easy to ride, economical... AND IT'S FUN!

• 8 Models available (50cc thru 305cc) • Electric starters

Write Dept. PM-11

AMERICAN HONDA MOTOR CO., INC.
4077 W. Pico Blvd., Los Angeles 19, Calif.

The reverberation amplifier with the delay lines can be inserted between the tuner and the amplifier, or between the preamplifier and basic amplifier. There are other possible connections, but these would require modification of your components. The potentiometer R_{12} controls the length of the delay, and when closed no echo is audible. If you wish to impress your friends with your "reverberating" system, be sure to pick out programs with soloists or small orchestras. Music passages of high levels do not produce the maximum effect, and the listeners might be disappointed. ★ ★ ★

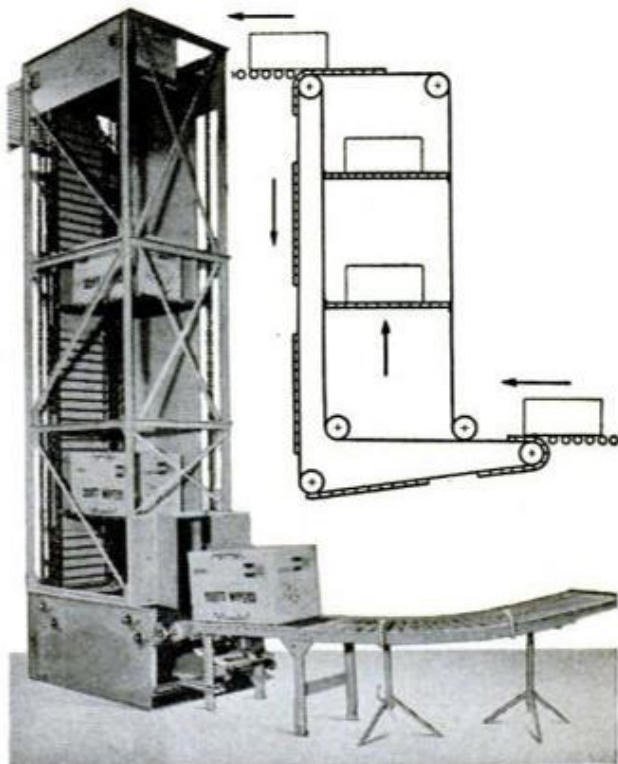

Standard Conveyor Co., North St. Paul 9, Minn.

Continuous Elevator

As continuous in operation as a conveyor, a new elevator is self-loading and self-unloading. It is designed for vertical movement of packaged or unit goods, and for use in buildings where freight elevators are slow, or where lack of space prohibits installation of ordinary inclined conveyors. It may be used to carry goods either up or down. To accomplish its job, the elevator has horizontal lifts which fold flat automatically to assume a space-saving vertical position for the return trip.

FREE

GIANT 1961 204 PAGE CATALOG

B-A 1961

ANNUAL CATALOG #11

SINCE 1927

A Complete Buying Guide for Everything in

RADIO TV ELECTRONICS

SAVE UP TO
50% ON B-A
SELECTED
KITS

HI-FI AND
STEREO
SYSTEMS &
COMPONENTS

TOP VALUES
IN POWER
AND HAND
TOOLS

30 PAGES
OF BARGAINS
NOT IN ANY
OTHER CATALOG

BURSTEIN-APPLEBEE CO.

Dept. PM, 1012 McGee St., Kansas City 6, Mo.

Send Free 1961 B-A Catalog No. 611

Name _____

Address _____

City _____ State _____

**SEND
FOR IT
TODAY**

PROTECT YOUR CAR WITH

Latest and best automotive products
—you'll find them advertised in PM.

POPULAR MECHANICS

ALL NEW!

1961 Edition of Constantine's WOODWORKING CATALOG & MANUAL



Get the biggest Constantine Catalog & Manual—2000 items! World's largest source since 1812 for rare imported and domestic woods in veneers, lumber, plywoods, bandings, inlays, mouldings, carvings . . . hard-to-find hardware, new solid brass hardware, wood finishing and upholstery supplies, patterns, tools, wood-working materials—at bargain prices! Also exclusive Inlaid-Wood-Picture Kits. . . . Identification Chart of 60 rare woods in color . . . Inspiring projects, plans, etc.

FREE—Year's subscription to "Chips & Chats" . . . brings news of exciting woodworking ideas and latest offerings . . . Free with Catalog!

For all-new 1961 Catalog & Manual, send 25c (refunded on first order). Write today!

ALBERT CONSTANTINE AND SON, INC.
2050 Eastchester Rd., Dept. S-5
New York 61, N. Y.

18 FT. CRUISER KIT
FREE CATALOG



MASS PRODUCTION MAKES THESE PRICES POSSIBLE
EASY TERMS
FROM \$520 Freight Prepaid

With one-piece, ventilated fiberglass cabin.

TAFT MARINE WOODCRAFT
Dept. PM-1160, 636 39th Ave. N.E., Minneapolis 21, Minn.

SAVE MONEY! MAKE MONEY! WITH PORTABLE CEMENT MIXER!



It's easy, fast, fun to do your own work with the MIXAL Mixer. Build barbecues, patios, sidewalks for yourself, for others! Mixes 3' x 8' sidewalk every hour! Uses any 1/4 HP motor. Thousands used by contractors! Try it on **MONEYBACK GUARANTEE!** Send for **FREE HOW-TO-DO-IT CEMENT MIXING BOOKLET.**

2995 PP

KOL, INC., Dept. PM-11, 2323 Ellis Ave., St. Paul, Minn.

POPULAR SERVICE BUREAU FREE REFERENCE KEY MECHANICS

Unlock the answers to hundreds of Do-It-Yourself problems with this tremendous Service File list of Popular Mechanics' booklets, books, full-size patterns, and blueprints. Send self-addressed stamped envelope to

SERVICE BUREAU, Popular Mechanics
Room 520D, 200 E. Ontario, Chicago 11, Illinois

ARMY-NAVY SURPLUS SALE!

<p>WELDING</p>  <p>• Item #672. Famous new-condition P-1 200-250 amp aircraft generator. 1000s giving excellent service as welders. Other uses are DC power plant, fast battery charge. Easy to adapt to portable welder, using 10-12 HP engine or drive off tractor pulley. 200-250 amp 24' 28 v. 2500-3500 rpm. Size 13"x8". Wt. 48 lbs. Gov't. cost \$300.</p> <p>SALE \$16.95 FOB</p>	<p>GENERATOR</p> <p>• Item #716. Genuine W.E. modern, hi-efficiency dial phone. Use for extension to main line on private system. Use several for complete private system. Work on any system. Shipping weight 8 lbs. Cost Gov't \$29.50.</p> <p>SALE \$9.25 FOB</p>	<p>POWER PLANTS</p>  <p>• Amazing buys in Deluxe Gov't. 115-v 60-c plants. Large selection.</p> <p>ALL FOB</p> <ul style="list-style-type: none"> • 1000 W \$159.95 • 1500 W 179.95 • 3000 W 249.50 • 5000 W 449.50 • 10000 W 995.00 • 3000 W DC 169.50
<p>STANDARD DIAL PHONE</p> <p>• Item #311. Powerful ball-bearing winch. Reversing switch mounted on winch. For cars, trucks, docks. Use on 6 or 12-v battery. 1000-2000 lb. pulling capacity. Will hold up to 40' cable. Wt. 54 lbs. Gov't. cost \$280.</p> <p>SALE \$46.75 FOB</p>		<p>115-W Water HEATING UNIT</p> <p>• Item #1127. Westinghouse water heating elements. Use for heating water, oil, &c. Makes ideal stock tank heater. Totally enclosed. 1 1/4" pipe threads. 3 heats—800, 400, 200 watts. Gov't cost \$17.50.</p> <p>PPD SALE \$3.95</p>
<p>EXAMPLE BARGAINS IN NEW CATALOG</p> <ul style="list-style-type: none"> \$ 43.00 Centrifugal Blower, 15" . . . \$ 29.90 FOB \$ 38.00 Air Tank s/steel . . . 10.95 FOB \$ 20.95 Sleeping Bag, deluxe . . . 16.95 FOB \$295.00 Electric Car Motor . . . 15.79 FOB \$ 66.00 Gear Reducer 80 to 1 . . . 8.98 PPD \$112.00 Level Transit Outfit . . . 92.50 PPD \$ 45.00 Hand Hyd. Pump Syst. . . 29.50 FOB \$ 4.25 Battery Booster Cables, . . . 2.75 FOB \$ 30.00 Hand Winch 1500 lb. cap. . . 15.95 FOB \$ 69.50 Hydraulic Cylinder 2-way, 2 1/2"x16 1/2" . . . 19.95 FOB \$ 27.95 Battery Charger 6 Amp., 6-12v . . . 16.95 FOB \$ 80.00 Centrifugal Pump . . . 19.49 FOB \$ 24.50 German Stop Watch . . . 14.96 PPD \$ 4.50 Telegraph Sending Key . . . 1.99 PPD <p>SURPLUS CENTER LINCOLN, NEBR DEPT 813</p>		

SPARE-TIME MONEYMAKING OPPORTUNITIES
READ OUR CLASSIFIED ADS
HUNDREDS OF BARGAINS AMAZING OFFERS

CONCRETE BIRD BATHS AND OVER 250 OTHER MONEY MAKING ITEMS



You've seen them all over the country . . . concrete bird baths, garden seats, flower boxes, appealing statuary, and many other items that add charm around the house and lawn. They're made by enterprising people, just like you, from our **COPYRIGHTED ALUMINUM MOLDS.** It's easy. It's fun. It's profitable.

Send \$2.00 today for this 82-page "How to" book. 20 pages of clear instructions. Valuable trade secrets. Over 250 items beautifully pictured (with description, dimensions, and prices of molds). Rushed to you by first class mail.

CONCRETE MACHINERY CO., INC.
HICKORY 2, NORTH CAROLINA

Name _____
Address _____

HOW TO TURN CONCRETE INTO GOLD

LICKITY LOG SPLITTER

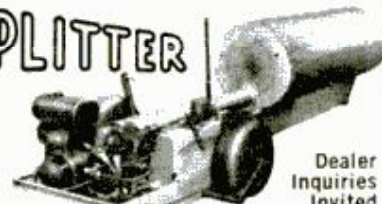

Ends Wood Splitting Drudgery

Dealer Inquiries Invited

Smooth 18 ton hydraulic power splits big profits for you from the toughest woods, including American Elm. 7 HP trailer unit squats under own power to receive large logs without "dead" lift. Has 2 speeds, auto-shift and auto-stroke. 26" ram travel splits up to 34" lengths, any diameter—or, with extended frame and adjustable wedge, splits up to 52" lengths, any diameter. Write for details.

THE WACO AIRCRAFT CO., Dept. D, Troy, Ohio



1

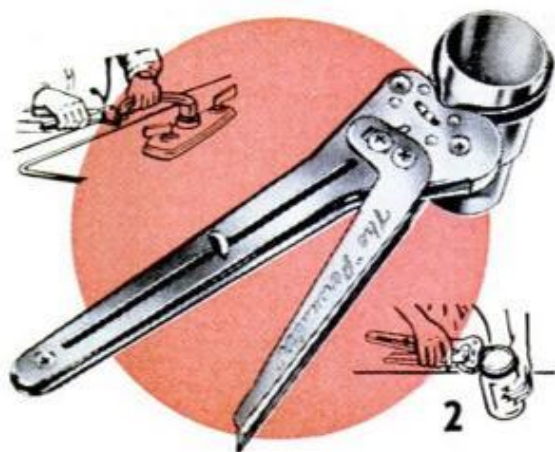

2

SHOPPING FOR TOOLS

1 MIST COOLING of cutting tools is now available for use on drill presses, metal saws, milling machines and other types of machine tools which require application of cutting oils at the point of operation. This new device features intermittent operation which eliminates waste of coolant and air as the mist, or spray, is automatically turned off during loading and unloading operations or idling cycles

The DeVilbiss Co. Toledo, Ohio

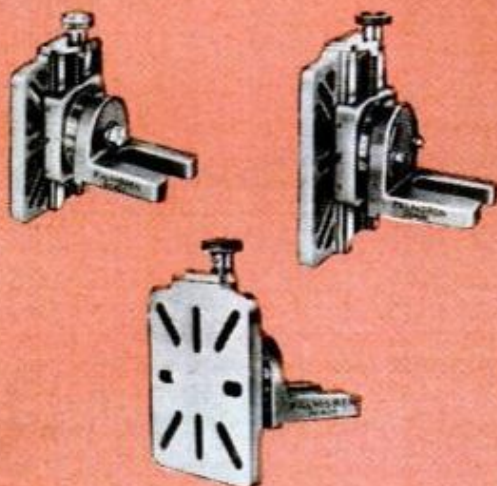

3

2 LOOP WRENCH will grip any round object without crushing, marring or scoring the metal. Tightens or loosens chrome-plated fittings without a scratch. Will loosen or tighten metal jar caps without crushing. Material from which the loop is made is flexible yet it will not absorb oil or grease as will some types of webbing used in similar wrenches. Available in 4 and 5-in. loop sizes, closed or open loops

Long Industries, Inc., 15 N. Madison St., Chilton, Wis.

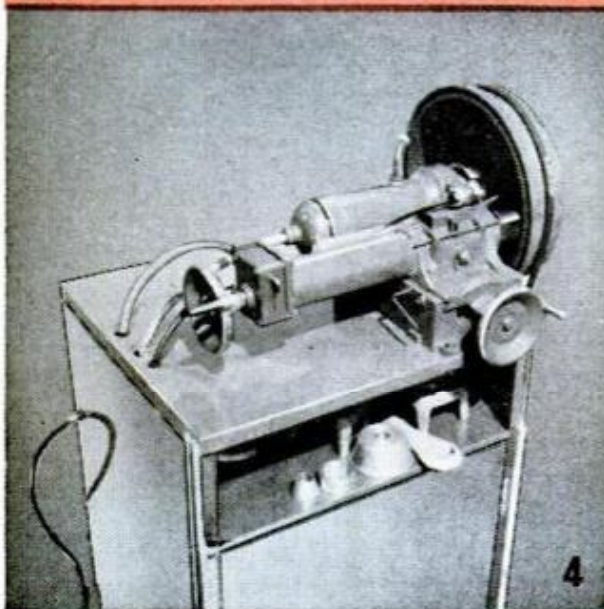

4

3. PLATE-TYPE LATHE MILLING ATTACHMENTS are designed to hold large or irregular shaped workpieces which are difficult to hold in the ordinary vise-type milling attachments. To attach to lathe, simply remove tool post ring, fit U-shaped base of the milling attachment around the tool post and tighten the tool post screw in the same manner as with any other lathe tool. Available with 6 x 6 and 9 x 9-in. plates

Chicago Tool & Engineering Co.,
8383 S. Chicago Ave., Chicago 17

4. BRAKE LATHE for the garage mechanic has been designed for servicing brake drums on passenger cars and light trucks. Spindle is carried on roller bearings. Enclosed, sliding boring bar minimizes chatter, eliminates exposed V-ways and threaded spindles which collect dirt and grit. A direct reading dial gives true tool settings, eliminates the possibility of turning the drum too large. Machine is belt driven by motor

Ateco Tool Co., 97-26 Sutphin Blvd., Jamaica, N. Y.

(Continued to page 278)

POPULAR MECHANICS

SAVE Your Heart!

America's Best Snow Plow-Tractor Value. Big 3 h.p. B. & S. engine, bigger tread, 6" x 12" tires plus heavy-duty 36" snow blade, adjustable. Both for only \$139.50. Built for lifetime use by one of oldest U. S. garden tractor mfrs., 2 year warranty. Substitute heavy-duty cultivator for snow blade if desired. Or add \$20. for cultivator also. Sold only by mail. Send check or money order now for immediate delivery, prepaid in U.S. Satisfaction Guaranteed. **WILMOR Co., Box 216, Ravenna 10, Ohio.**



3 h.p. Tractor and 36" Snow Blade \$139.50
Heavy-Duty Cultivator \$20.

IDEAL CHRISTMAS GIFT FOR ANY MAN

WELD BRAZE
SOLDER CUT **4WAY**
ONLY \$14.75
f.o.b. factory



Acclaimed by thousands of Homeowners, Mechanics and Hobbyists as the welder of 1001 uses. Easily operated from properly wired 110 volt AC or DC line. The ideal gift with a life-long use. Order today on 10 day money back guarantee. Send only \$3.00 today. Pay postman balance C.O.D. plus charges. Literature on larger equipment on request.
FOUR-WAY WELDER CO., Dept. F2-M
1810 S. Federal St. Chicago 16, Ill.

WELDER
Complete with Twin Carbon Arc Torch and accessories... to handle all metal-craft work.

NO MUSS... NO FUSS!
KRYLON SPRAY PAINT
DRY IN MINUTES!
IF YOU PRIZE IT... KRYLON-IZE IT!



GENUINE ALNICO MAGNETS

AMAZING, PERMANENT, NON-ELECTRIC, HIGHLY PRACTICAL. Conduct interesting experiments. Hundreds of uses. Retrieve valuable steel items such as pins, tackle from fresh or salt water; tools from tanks & drains. **GUARANTEED.** Try any magnet one week. Money back if you are not well-pleased.
No. M-710 (Wt. 53 oz.) Has pull of 225 lbs. on steel block... \$18.00
No. M-625 (Wt. 70 oz.) Has pull of 125 lbs. on steel block... \$10.00
No. M-575 (Wt. 18 oz.) Has pull of 75 lbs. on steel block... \$ 7.00
No. M-500 (Wt. 13 oz.) Has pull of 50 lbs. on steel block... \$ 5.00
No. M-40 (Wt. 5 oz.) Has pull of 15 lbs. on steel block... \$ 3.50
No. M-47 Hot Pad Magnets, 10 for \$1.00... \$ 1.00
No. M-35 Hobbyist assortment of 8 magnets... \$ 2.00
Send M.O. or check. We pay postage. Sorry no C.O.D.'s.
MIAMI MAGNET COMPANY, 3240 N.W. 27th Ave., Miami 42, Fla.

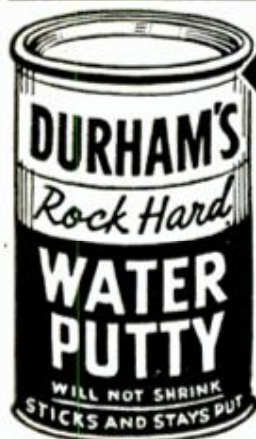

The Modern PLASTIC for lasting Home Repairs

PERMANENTLY mends cracks or holes in wood, tile, stone or plaster. Sticks and stays put—Does not chip, shrink or fall out. Easy to use. Economical. Mold it, chisel it, polish or paint it. The big 4-lb. can is obtainable from your lumber, paint or hardware dealer at \$1.40; or will be shipped direct postpaid (in U. S.) for \$1.75. Complete satisfaction guaranteed or your money refunded.

DONALD DURHAM CO.
Box 805-T Des Moines, Iowa

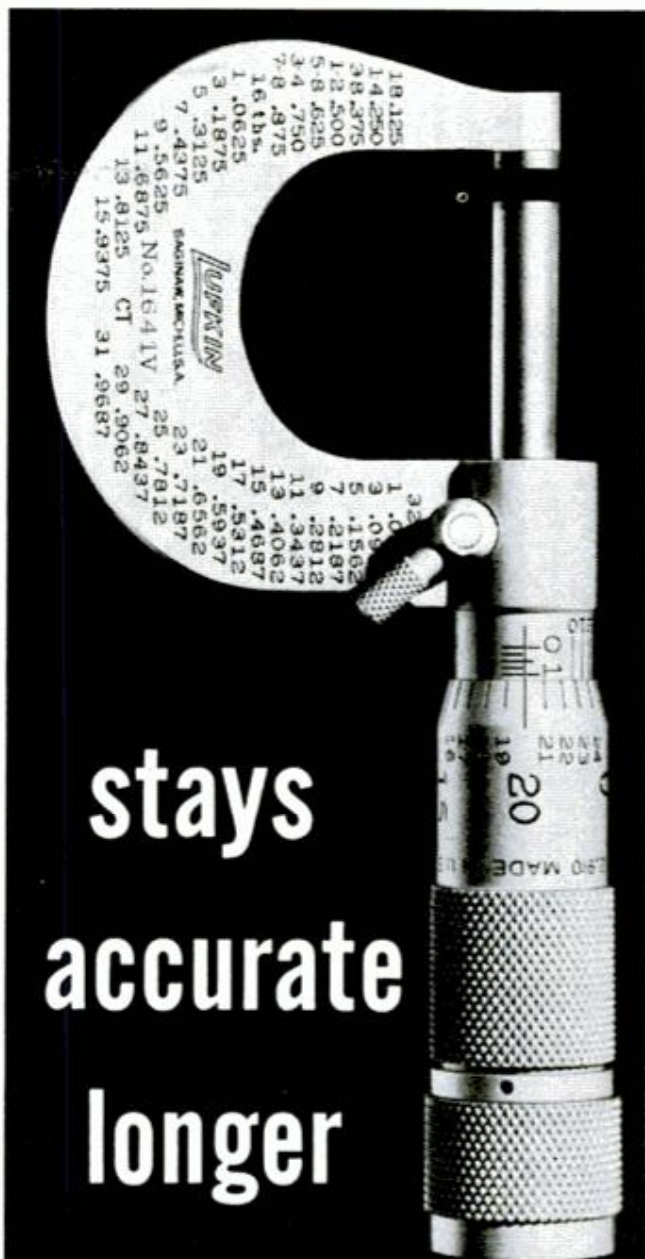

stays
accurate
longer

A LUFKIN EXCLUSIVE: 5 to 7 fewer parts than other micrometers... less to get out of adjustment! One-piece frame and hub simplifies wear adjustment, assures greater accuracy. Exclusive cam lock prevents reading errors. Ratchet stop top. Easy-to-read markings on nonglare *Chrome Clad*® finish.

Leading Industrial Distributors feature Lufkin—the new leader in precision tools.



LUFKIN
SAGINAW, MICHIGAN

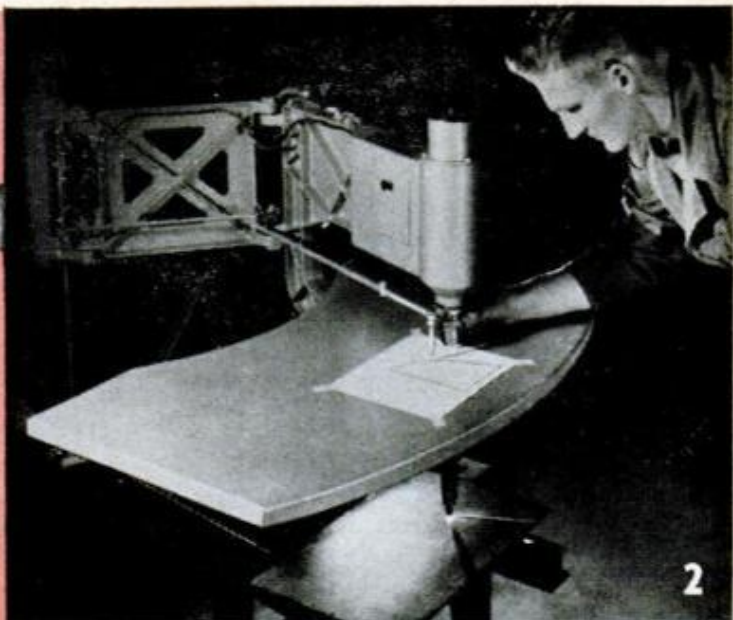

SHOPPING FOR TOOLS

1. CLAW HAMMER is a ball-peen hammer, soft hammer and nail hammer all in one kit. Hatchet is an accessory. When fitted with nail-driving bell, unit is a conventional claw hammer having a standard 16-oz. head. Interchangeable heads, or bells, are machined to a tight friction fit and are removed with a knockout pin, or drift, which is supplied with kit

The Dumas Co., Inc., 1 Jackson St., Worcester 8, Mass.

2. FLAME CUTTER offers controls which permit operator to duplicate directly from a sketch or detail drawing by means of a manually controlled tracing pencil. Also has precise magnetic control for template work, automatic right angle, straight or circular cuts. Designed especially as a versatile production tool for development and prototype work

Earth Equipment Corp., 1409 Santa Fe Ave., Los Angeles 21 Calif.

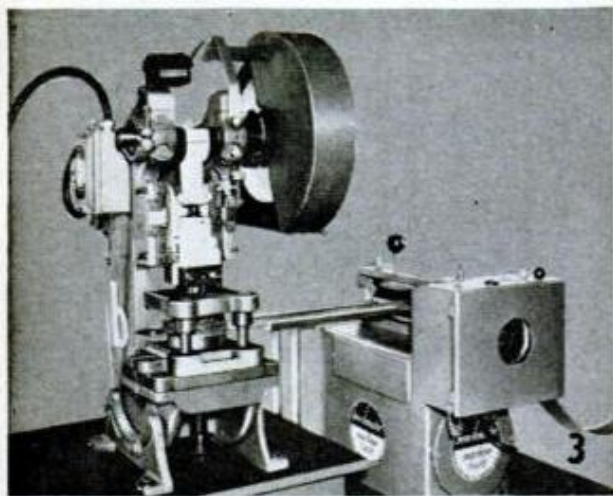

3. AUTOMATIC FEEDING UNIT for small presses feeds uniform, predetermined lengths of material and can be used to feed flat materials, coiled stock or round stock with specially contoured rolls. Standard feed speed is 50 surface feet per minute but other feed ranges and speeds can be supplied. Can be manually tripped or made to cycle with any machine motion

Benchmaster Mfg. Co., 1835 W. Rosecrans Ave., Gardena, Calif.

4. BUILDING-BLOCK GUIDE enables even a beginner to lay concrete, cinder and composition block with the skill of a craftsman. Use of the guide assures correct alignment, uniform spacing and thickness of mortar joints. Moving a hand lever releases the guide for easy withdrawal without disturbing the block setting. Builder can work either from left or right

Viscer Associates, P. O. Box 3, Pleasantville, N. Y.

(Continued to page 280)

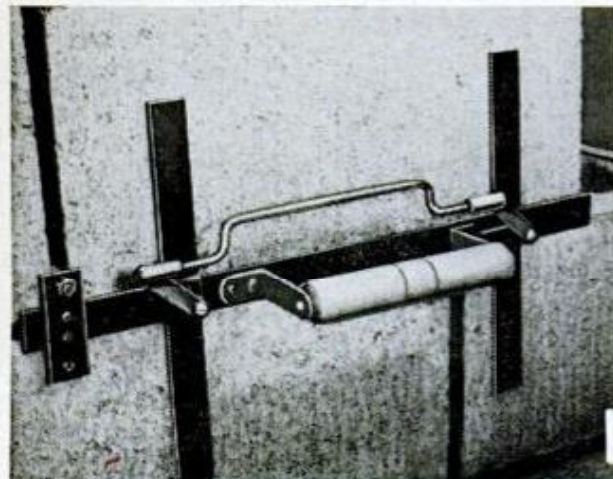

DEWALT is first to give you this 2-model choice!

You'll be proud to own either one!



DE LUXE 925-H, \$249

This is first choice with shopwise men! Exclusive, "years-ahead" features give you built-in motor brake, totally-enclosed 2 H.P. motor, up-front drop-leaf safety table, cut-off scale and other benefits.

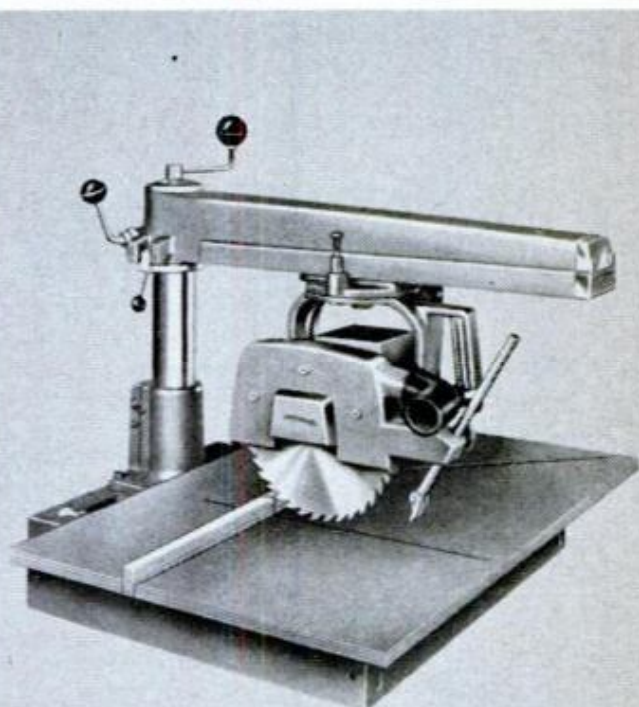

THRIFTY 925-E, \$199

Introduced by popular demand for the thrifty-minded! You save \$50—and get features not found in competitive makes costing 25% more. You'll enjoy genuine DeWalt quality, safety, accuracy and versatility.

SEE BOTH...TRY BOTH!

The easiest way to make your choice is to visit your DeWalt dealer *now*. See both demonstrated! Choose yours. Buy it on easy, low-budget terms.

DEWALT, Inc., Dept. PM-611, Lancaster, Pa.

Please send FREE 20-PAGE DEWALT CATALOG and name of nearest dealer.

Name _____

Address _____

City _____ State _____

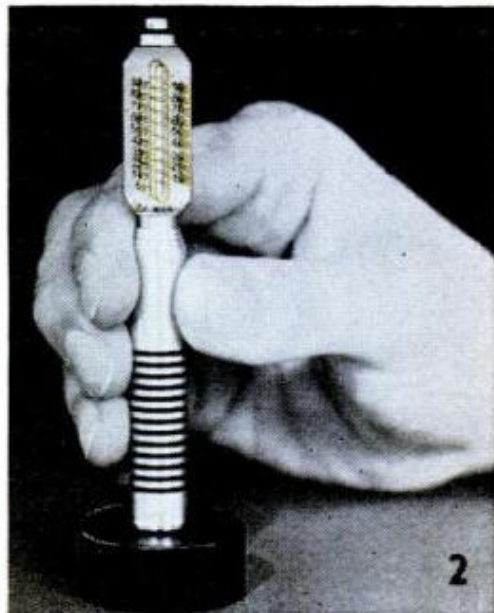
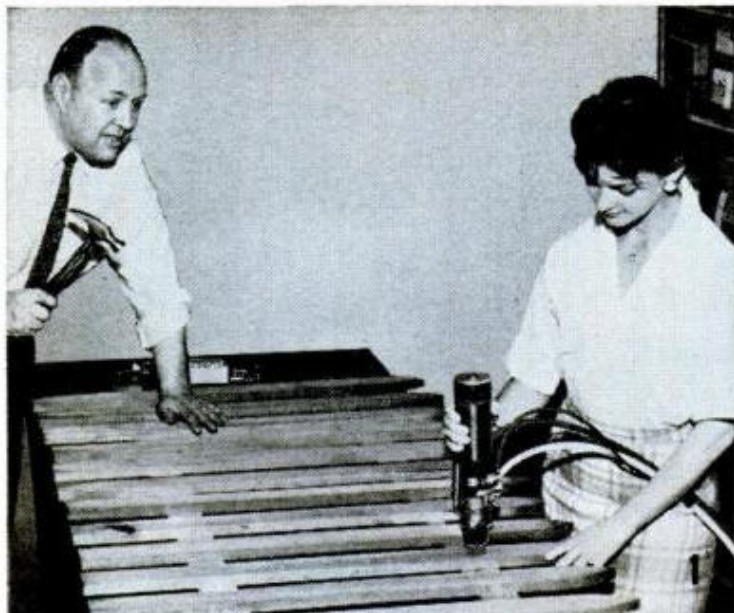

SHOPPING FOR TOOLS



1. PNEUMATIC NAILER drives all types and sizes of nails five times faster than can be done with an ordinary hammer. Nails are fed from a hopper to the air-driven head which drives them home with a single blow. Gun is not only a nail driver; a screwdriver attachment also is available
 United Shoe Machinery Corp., Boston, Mass.

2. HARDNESS GAUGE, or tester, is used in accurately measuring the hardness of such materials as rubber in its various manufactured forms and also plastics of varying degrees of hardness. The gauge indicates in Durometer units that comply with A.S.T.M. specs for rubber hardness
 Rex Gauge Co., P. O. Box 46, Glenview, Ill.

3. SELF-LOCKING WING NUTS are made of a die cast alloy and are fitted with a nylon locking collar which prevents the nut from loosening under impact, vibration or stress reversal, whether fully seated or positioned at any point on a bolt or stud. Nuts are available in five thread sizes
 Elastic Stop Nut Corp. of America, 2330 Vauxhall Rd., Union, N. J.

4. HOBBYIST'S VISE features rotating jaws and an auxiliary clamp which will hold hexagonal, octagonal, oval or round shapes. A long screw provides a jaw opening of 8 in. By removing the auxiliary clamping attachment the vise can be used as a C-clamp. Can be set up on either end of bench top
 Little Wonder, Inc., Div. of Schiller-Pfiefer, Inc., Southampton, Pa.

5. HOT BLAST PAINT SCRAPER consists of a propane torch with a special burner and a steel scraper. The unit blisters and peels off layers of old paint in a once-over, one-hand operation. Speed of paint removal reduces fire hazards to a minimum. Leaves the surface clean and ready for repainting
 Turner Corp., Sycamore, Ill.

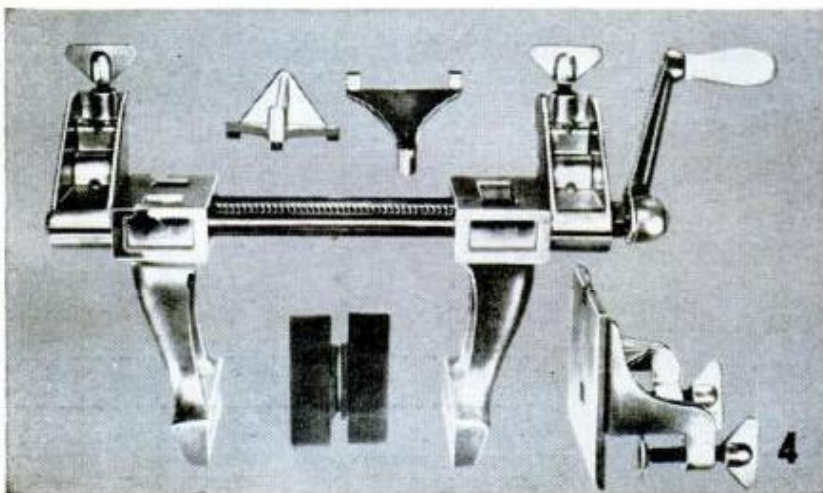

For sportsmen
6 to 60!



Broad line of models

KITS less motors, from **\$39⁹⁵**

Complete kits with motors from \$109.95
Send 50¢ for 22-page catalog.

ARNOLD-DAIN CORP.

Box 78, Mahopac, N. Y.
Dealer Territories Available

**FREE
CATALOG!**

**TREMENDOUS SAVINGS ON
HUNDREDS OF SURPLUS AND
NEWLY MANUFACTURED ITEMS!**

New 1960 edition contains over 50 pages of
tools and equipment for farm, home, work-
shop, factory. Hydraulic equipment, pumps, mo-
tors, construction and diesel equipment and parts!
Write for your **FREE CATALOG** Today.

GROBAN SUPPLY COMPANY

1139 South Wabash Ave., Dept. G11 Chicago 5, Ill., WEbster 9-3793



All Aluminum Boat Kits



Assemble a 14 ft. boat yourself
in one weekend for \$99! Factory-
finished aluminum parts, one-unit
hull. No bending, no
riveting. Save up to
60% of factory-built
prices. Perfect car-
toppers for sports-
men. Models up to 14
feet. Send 10c today
for complete catalog.

**\$58
UP**

Alumabit® Co., Inc. Pat. Pend.
1117 Shetland Industrial Park, Salem, Mass.

**The second most important tool...
for every
woodworking shop**

A VERSATILE

W&H

MOLDER-PLANER

is second only
to a saw... it
molds, planes and rabbets.
"Your savings pile up as your
shavings pile up."



**SEND FOR
FREE BROCHURE**

WILLIAMS & HUSSEY MACHINE CORP.
CLINTON ST., MILFORD, NEW HAMPSHIRE

End Skidding and Wheel Spinning!



SKIDMASTER®

DETACHABLE GRIT SPREADER



*Revolutionary new grit release
device provides "push button" traction!*
ONLY \$29.95 INSTALL-IT-YOURSELF!

Napco, leading manufacturer of highway sanders for trucks, trailers, and buses, introduces an entirely new concept in passenger car grit release devices! *Skidmaster* is controlled by a patented new vacuum release valve connected by hose to the windshield wiper line or vacuum spark advance... there are no electrical connections... no drilling or cutting into car.

Skidmaster more than pays for itself... saves damage to transmission from "rocking", eliminates tire wear and wasted gas from "spinning".

Skidmaster helps you climb hills, park alongside of curbs, pass cars; start, slow down, or stop on curves and at intersections.

After simple installation, the outside units are easily removed, stored in trunk and attached in seconds, when needed. You'll never again use costly skid chains, ineffective snow tires and sand bags.

Fits any make or model car or station wagon. Simple installation kit with STEP-BY-STEP INSTALLATION INSTRUCTIONS. If you are not completely satisfied your money will be refunded. Shipped parcel post prepaid.



Flexible bracket fits into window opening, does not interfere with window operation.



Flexible plastic discharge tube slides into pre-adjusted receptacle.

SKIDMASTER SALES CO., Dept. PM
512 Nicollet Avenue, Minneapolis 2, Minnesota
Gentlemen: Enclosed please find \$_____ for _____ set(s)
SKIDMASTER GRIT SPREADER(S) @ \$29.95 per complete
set, with instructions.

Name _____

Address _____

City _____ Zone _____ State _____

Enclosed: Check Money Order Sorry, no C.O.D.'s.

Hanging Decorator Clocks

(Continued from page 183)

look well in the newer case designs and therefore you may have to make new hands. Before doing so you first ascertain which of the two or three concentric spindles are the second, minute and hour spindles. Scribe the shape of the hands on sheet metal and drill the spindle holes before cutting out the hands. The hole should be smaller than the spindle diameter by several drill sizes. Then a tapered point such as an ice pick is pushed through the hole to enlarge it to exact size. This will extrude metal along the edge of the hole thereby forming a short sleeve that will grip the spindle firmly. Another method is to sweat-solder a small piece of metal to the hand at the hole position, then drill and enlarge it to fit. Sometimes the smallest spindle is threaded, which then requires a tapped hole in the hand.

Concealing the Cord

To avoid a visible cord on an electric wall clock you can have a sunken wall outlet located directly behind the clock and concealed by it. This presupposes a permanent location for the clock. If it is to be moved from place to place, it will be better to use cords extending to the nearest base-

board outlets. A cord can be made less conspicuous by concealing a portion of it behind an appropriate piece of furniture, and then painting the visible portion to match the wall. The clocks shown were all provided with screweyes to permit secure attachment to a picture hook or nail. ★ ★ ★

Do You Know This Old-Timer?

(Answer to quiz, page 18)

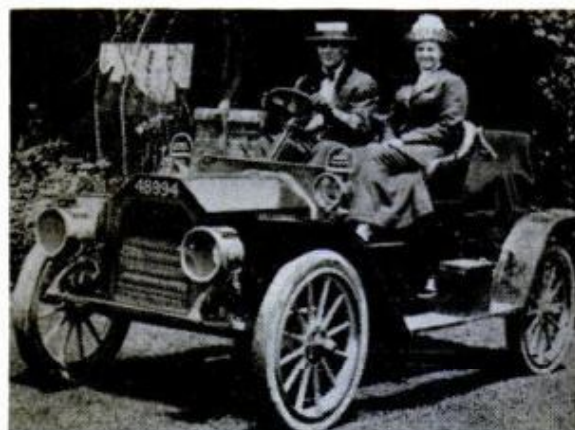

1905 Reo



New from Wolverine!

WORLD'S LIGHTEST SERVICE SHOES

Most comfortable ever! Weigh a pound less than ordinary work shoes. Their exceptional lightness is so easy on the feet. Uppers are flexible elk-tanned leather . . . soles are springy, oil-resistant, neoprene cushion crepe, nearly three-quarters of an inch thick. Steel shanks, of course. And smart sports styling plus handsome Burgundy color add good looks to the comfort.

WOLVERINE
ROCKFORD, MICHIGAN

Service Oxfords
Boots

Work Shoes
Safety Shoes



West Point Products Corp., West Point, **Texas**

Battery-Powered Mower

Push-button starting and near-silent operation are two of the features of a battery-powered lawn mower which can mow more than 15,000 square feet of lawn on one battery charge. The "energy cell" plugs into any house current and recharges in about two days at a cost of two cents. It can be recharged hundreds of times.

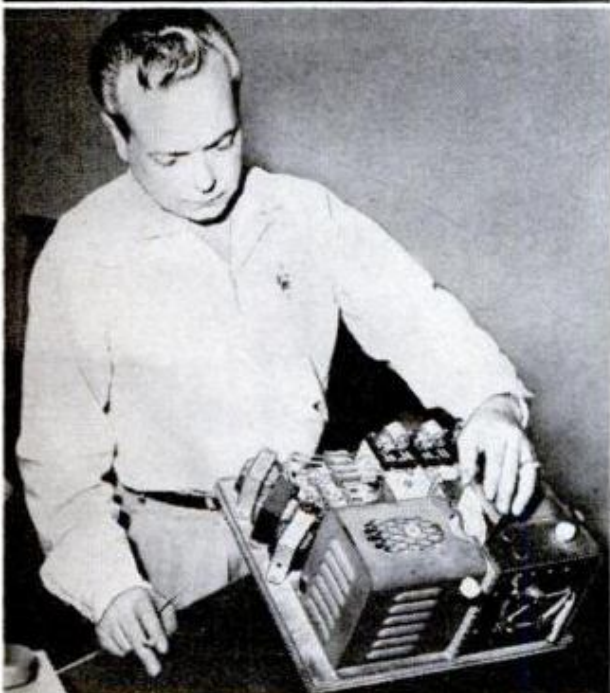

Surber Electronic Research Corp., Wichita Falls, Texas

Machine Identifies Paper Money

Designed for blind businessmen, a money-detecting machine can identify \$1, \$2, \$5, \$10 and \$20 bills. The bill is folded around a metal plate and inserted into the reading area. Each bill presents a different pattern to photoelectric cells which, in turn, cause appropriate buttons to rise.

NOVEMBER 1960

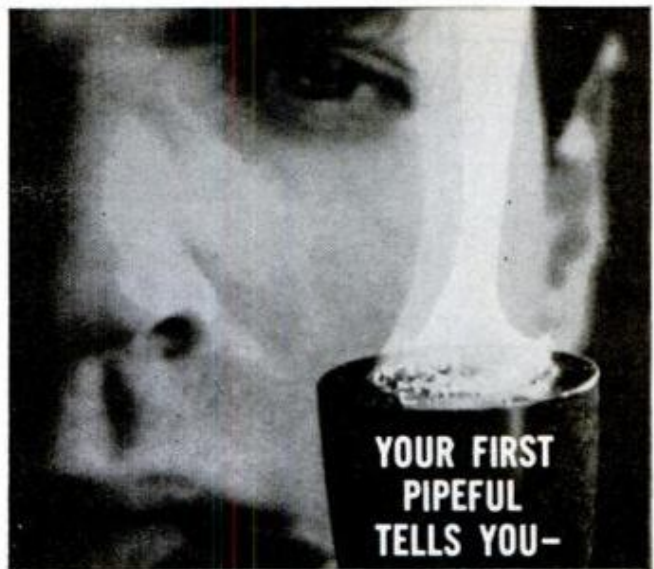

YOU'LL GET ALONG FINE WITH AMPHORA

Make your *next* pipeful **AMPHORA**; the even-burning, longer lasting, gentle blend from The Netherlands, at tobacco counters everywhere.



U.S. Importer: Romick's International Tobacco Co., 11607 Vanowen St., North Hollywood, Calif.

New "PULL-GEAR" SPEED-REDUCING PULLEY

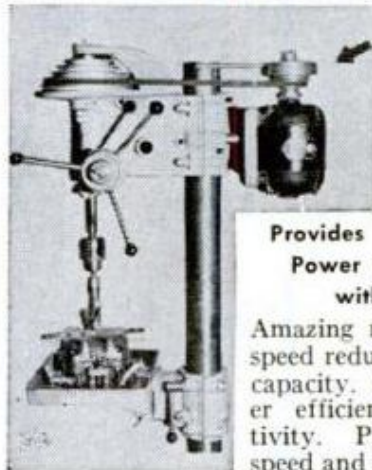

Provides Correct Speed and Power to Drill Up to 1 3/8" with 1/2 H.P. Motor

Amazing new internally geared speed reducer doubles drill press capacity. Greater power, greater efficiency, greater productivity. Provides the correct speed and power for larger drilling, reaming, tapping and boring on light presses. Easily installed in five minutes. Adaptable to all type machines. Spindle speed range 45 to 3000 RPM. *Write for Literature.*

PULL-GEAR CO.

13523 E. Eight Mile Rd.
Warren, Michigan

Boston, Mass.—Chandler & Farquahar Co., Longwood 6-7800
Chicago, Ill.—Chicago Supply & Tool Co., Everglade 4-3933
McMaster-Carr Supply Co., Andover 3-3161
Cleveland, Ohio—Reynolds Machinery Co.
Hillside, N. J.—Tool Specialties Co., MURdock 6-8700
Los Angeles, Calif.—Almquist Brothers, LUDlow 8-9111
New York City—Rudolf Bass, WALKer 5-0440
San Diego, Calif.—Acme Tool & Supply Co., CVpress 8-7181
Seattle, Wash.—Star Machinery Co.

ANNOUNCING



THE NEW **CRATEX**

TOOL & DIEMAKERS KIT

Rubberized abrasives for light deburring, smoothing, polishing.

80 wheels and points in the most popular sizes and shapes, equally assorted in 4 grit textures... plus 4 mandrels for 1/8" chuck... packaged in compartmented plastic box.

\$7.50 Postpaid, cash with order; or C.O.D., plus postage. Money back guarantee.

FREE—8 page catalog and name of nearest distributor. Write:

CRATEX Manufacturing Co., Inc.
1602 Rollins Road, Burlingame, Calif.

SAVE MONEY ASSEMBLE and INSTALL

the **Skuttle** K-711

HUMIDIFIER

This automatic humidifier will keep your family comfortable at lower temperatures which results in fuel savings. Simple to assemble—easy to install in your furnace. The K-711 is a complete unit and includes 5 Vapoglas plates, stainless steel plate rack, brass fittings and copper tubing. You save up to \$20.00 by assembling and installing the Skuttle K-711 Humidifier.



\$11.95

F.O.B. FACTORY

VAPOGLAS PLATES

Skuttle Patented Vapoglas Plates are compressed pure glass wool, are more porous and resist clogging longer than ordinary plates. Available in packs of 5.



On sale at your hardware store, heating dealer or write to:
Skuttle MANUFACTURING COMPANY: MILFORD, MICHIGAN

284



Home Haircut Guide Co., 20 West Jackson Blvd., Chicago 4, Ill.

Jig Guides Razor For Home Haircuts

Do-it-yourself haircuts or trims with a safety razor come out even on both sides with a new haircutting guide that keeps the razor at the right angle while guiding it at the right distance for the desired cut. Adjustable for any style haircut, the guide can be used with any safety razor.

Make Your Own
Christmas Gifts
and

Decorations—

17 Pages of Ideas
Are Coming in

The Craftsman Section

NEXT MONTH

POPULAR MECHANICS

V Belt Pulley kit w/spl coupling . . . \$15.50
 G-1 160-250 amp New \$19.50 good C \$14.95
 R-1 300 amp. G.E. recond. \$24.50 good 16.95

Accessories Kit For Arc Welder for above generators has helmet, gloves, elect. holder, volt reg. rheostat, RC relay, voltmeter, Gr. Clamp, including switch plus splined coupling. . . . \$23.50
 & 30' cable with G-1 generator. \$36.50
 Reactor coil w/ solenoid control \$14.95

Multi-Weld (M), D.C. Arc Welding Kit Complete with G.E. R-1. 300-350 amp gen. incl. accessory kit, reactor coil w/ solenoid control \$52.50

AC-DC WELDER KIT—511 G.E. Generator. Makes 1250 Watts AC light plant and 200 amp. DC welder and battery charger. Includes all items listed in accessories kit. AC-DC generator & instr. \$38.50

Rotary Vane Vacuum pump air or fluid 15 C.F.M. 4500 RPM 10" suction. 24" HG pressure reversible. 3/4" ports. wt. 9 lbs. Gov't cost \$101.00. New \$22.50 — good C. \$14.50. Pump with 4.5 C.F.M. 26" vacuum, 3/4" ports. wt. 5 lbs. New C. \$16.50 — good C. \$12.95

400GPH water-fuel pump with 24-12VDC 8 amp motor. . . . \$8.95

NEW HYDRAULIC CYLINDERS

Bore	Stroke	Shaft C.	Length	D.A.	2000 PSI
1 1/2"	4 1/2"	1 1/8"	10"	3 1/2"	\$ 3.75
1 3/8"	2 3/4"	1"	38"	1"	\$12.95
1 1/2"	8 1/2"	3/4"	13"	8 lbs.	\$ 9.95
2 3/8"	18"	1 1/2"	26"	11 lbs.	\$19.95
2 1/2"	9"	1 1/2"	24"	12 lbs.	\$14.95
3 1/4"	9"	1 1/2"	18"	10 lbs.	\$17.95
3 1/2"	8 1/2"	1"	20 3/4"	12 lbs.	\$21.50
3 1/2"	10"	1 1/4"	27"	21 lbs.	\$24.50
3 1/2"	8 5/8"	1 1/4"	20 1/4"	12 1/2 lbs.	\$19.95
3 1/2"	2 1/8"	1 1/4"	31"	15 lbs.	\$24.50
4 7/8"	8"	2"	22"	35 lbs.	\$32.50

HYD. ACCUMULATORS 3000 P.S.I.
 50 cu. in. 11" L x 3 1/2" D 6-lbs. . . . \$ 8.95
 100 cu. in. 21" L x 3 3/4" D 15-lbs. . . . 12.95
 200 cu. in. 36" L x 3 1/2" D 15-lbs. . . . 14.50
 Speed Reducer 10-1 ratio 2HP. . . . 6.95

New Linear Actuators with 24 V DC motors. runs on 6-12 V adj. travel & reversible
 HP watts RPM Amps. Travel Tens-Comp
 1/8 HP 7500 9 5 1/4" 2800 lbs \$8.50
 72 W 10000 5.5 4 1/2" 1200 lbs \$7.95
 .64 HP 10,000 3 3 1/2" 350 T \$4.95
 25 Volts—2.1" per second—9" travel—2700 lbs.—T-C. 1 1/2" dia. shaft—Wt. 11 lbs. \$15.50

HYDRAULIC SNOW PLOW LIFT KIT—Consists of 1 Stratopower hyd. pump 450 cu.in. 1400 PSI, drive from engine or power take-off; 1 D.A. cyl. 2 3/8" bore, 9 1/4" stroke; 4 way control valve; tank; filter; hose & fittings — \$75.40 value \$54.25 with 3"x10 1/2" cyl \$59.75

NEW HYDRAULIC SYSTEM KIT

#400 K heavy duty power driven rated 16000 lbs lift. Consists of 2 D.A. hyd cylinders 3 1/2" bore x 2 1/8" stroke ea. rated 8000 lbs with 1000 P.S.I. 1 four way hyd control valve with built in relief #821 1 Vickers hyd pump 375GPH 1000 PSI 3750 RPM filter, gauge 2000 PSI hose & fittings. Value \$169.95 save \$90.00 \$79.95 Same kit with Two D.A. Cylinders 3 bore x 10 1/4" stroke \$69.95

NEW HYDRAULIC PUMP-MOTOR SYSTEM KIT Offers fluid drive of varying power, consist of 2 new Vickers p.d.is. pumps ea. .410 cu. in. rev. 3750 RPM 1000 PSI 375 GPH where one pump is belt driven as motor, 1 four way c. valve with variable speed control, reservoir, filter, gauge, hose & fittings. Value \$98.10, \$49.95

HYDRAULIC POWER SERVO STEERING SYSTEM KIT for large or small boats, power steering & remote control. Consists of 2 precision special purpose Servo cylindered D.A. 3/8" 2x4" to act as "master" & "slave," Two 4 ft. hose & fittings. Instructions incl. \$14.75

4 Way Hyd. C. Valve w/adj. press. 3/8" ports \$14.95
 3 Way Control \$8.95

GENERAL SALVAGE CO Check or M.O.
 2922 E. 27 St., Dept. 116, Kansas City 27, Mo.

CLOSE OUT!
Powerful Germanium Diode Radio Kit
 Complete with Earphone & Aerial Kit Accurate tuning Loud, clear reception. Entertaining-educational Easy to follow instructions Large selection of low cost kits available Write for bulletin PM 2
3.95
PARTS UNLIMITED INC. 1 State St. Bloomfield, N. J.

NEW PISTON RINGS CUT OIL WASTE

It's Sharp . . . keep it that way with the right sharpening stone by.

CARBORUNDUM®

—NOW—IN—JUST 4'—OF—SPACE—
LET YOUR FAMILY ENJOY THE REAL THRILL OF PHOTOGRAPHY



COMPLETE BESELER HOME DARKROOM!



Start tonight! Just unpack the box — and only 4 feet of space in your bathroom, basement or closet becomes a fully equipped, modern home darkroom!

The world famous Beseler 23C Enlarger is the "heart" of the Dream Darkroom Outfit. It's so versatile and precisely engineered that you can make enlargements as big as you want them—even mural size—in black and white or full, brilliant colors from 8mm up to 2 1/4 x 3 1/4 size negatives. Beseler 23C is the very same enlarger used in thousands of small studios and advanced amateur darkrooms. Yet, it works so simply that you'll produce big, beautiful prints the first time you try it.
 And with this precision enlarger you receive everything else you need to set up your darkroom—25 pieces of custom matched equipment.

MAKES AN IDEAL LIFETIME GIFT FOR THE ENTIRE FAMILY . . . WRITE FOR FREE BOOKLET

CHARLES BESELER COMPANY
 210 South 18th Street, East Orange, New Jersey
 Please send FREE booklet, "Fun In The Darkroom"
 Name _____
 Address _____
 City _____ Zone _____ State _____

Worldwide Adventure

(Continued from page 105)

years, devised a shorthand understood by hams of every nationality. "NM NW OM CUL" translates as "No more now, old man; see you later." A young lady is "YL"; when she gets married she becomes "XYL" (ex-young lady); and if she's real handy with a key, she has a good "fist." Also, "73" is regards, "88" love and kisses, "HI" signifies laughter, and a really good joke rates "HI HI." BCNU, of course, is "Be seeing you."

No one seems to know exactly where the word "ham" originated, but whatever the origin, "hamdom" today is in full flower. Last year, amateurs forked out some 30-million dollars for equipment. The American Radio Relay League—amateur radio's combined country club and alma mater—lists a current world membership of 100,000 (90,000 in the United States). In addition there are some 100,000 other U.S. amateurs and 100,000 foreign hams.

The Federal Communications Commission, which monitors and regulates all U.S. frequencies and power, makes sure that no ham uses more than 1 kilowatt, or 1000 watts, of power. The average ham uses about 200 watts (the power required for a good-sized lamp), to establish contact anywhere in the world. In fact, last July 17, a

group of hams in San Carlos, Calif., talked to another group of hams in Medfield, Mass., by bouncing signals off the moon—a round trip of 478,000 miles.

Few hobbies can provide the thrills and suspense that are the hams' daily fare. With whom will he talk next—a student in Moscow,* a bearded Sikh in India, the Lord Mayor of Canterbury? Don Wherry, an Iowa boy, was idly twirling the dial on his set one night when he picked up an SOS from a Norwegian whaling ship sinking in icy seas north of the Arctic Circle. Don relayed the SOS and the ship's position to a ham in Jersey, who notified the U.S. Coast Guard. Within an hour another whaler in the vicinity, whose wireless operator had not heard the emergency signal, was speeding to the rescue. All hands were saved—and a hero's medal went to Don Wherry!

There is little formality among hams. Everything is on a first-name basis; it saves time, and, besides, who cares what you do for a living as long as you can operate a key or talk over a mike, and have something to say? Of course, there are exceptions. An enlisted man at Westover Air

(Continued to page 288)

*It has been only within the last five years that the Soviet government has permitted amateur radio communication with the outside world; before that, Soviet hams listened in to the worldwide traffic but talked only with fellow hams in Iron Curtain countries.

INCREASE HOME VALUE-MAKE NEEDED IMPROVEMENTS NOW



"John was a radio operator in the Navy."

TOOLS WHOLESALE

\$100 PUTS YOU IN BUSINESS

Start your own business, sell tools to your friends and neighbors, or buy tools for your own use and **SAVE MONEY \$\$\$**

A MILLION DOLLAR INVENTORY AT YOUR FINGERTIPS. NO STOCK TO CARRY. ORDER AS YOU NEED IT.

BUY AT WHOLESALE PRICES. Extra \$25.00 profit on your accumulated purchases. \$1.00 refund on first purchase or refunded if you are not 100% satisfied.

THOUSANDS!! of Nationally Advertised items of Hand Tools, Power Tools, Machinist Tools, Tool Chests, Paint Sprayers, Light Fixtures, Appliances, Guns, Gifts, Toys and other items too numerous to mention.

WE SHIP COAST TO COAST Whise. Disc. up to 50% off

Dept. **SILVO HARDWARE CO., PM-11 107 Walnut St., Phila. 6, Pa.**

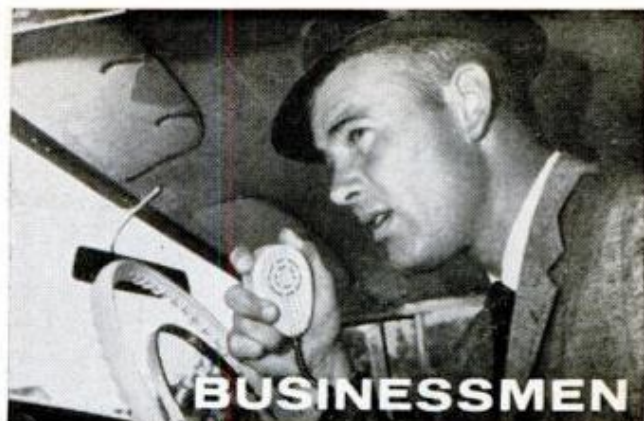

BUSINESSMEN

• Talk from truck, car, or boat to your home or business!

2-WAY RADIO

from \$134.95

The finest Citizens' Transceiver available! Excellent sensitivity and selectivity for maximum range. 23 channel coverage—maximum legal power—built-in squelch—Automatic Volume Control—Automatic Noise Limiter. Easy to install anywhere. With tubes, push-to-talk microphone and crystals for one channel.



SEND FOR FREE COLOR BROCHURE

Send full details on the "Messenger"

NAME _____

ADDRESS _____

CITY _____ STATE _____



E. F. JOHNSON CO.

1602 2nd Ave. S. W., Waseca, Minn.

AUTOMATIC RETOOTHER

MAKES NEW PROFITS

for HAND SAWS

Cuts new teeth in 50 seconds—any size 4 to 16 points. Old teeth fall off as chips. Easy to operate. A per-foot job.

BURR MFG. CO.
8933-N VENICE BLVD.
LOS ANGELES 34, CALIF.

Send For Free Literature

Want a voice in the people's choice?
DON'T PASS THE BUCK—
VOTE!

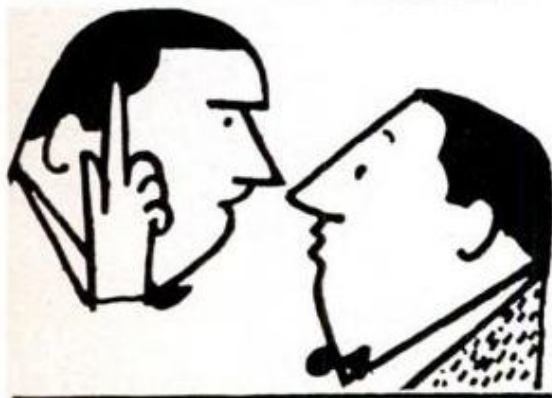

DIG DOWN! Contribute
DIG IN! Work for your Party
and VOTE!

Published as a public service in cooperation with The Advertising Council.



Elmer's Glue-All. Handy, easy to use. No muss, no fuss. Dries fast, clear and strong. The best all-purpose household glue you can buy. Send a stamped, self-addressed envelope for free copy of "Elmer's Guide To Good Gluing." 16 pages of gluing hints and tips. Borden Company, 350 Madison Ave., Dept. PM-110, New York 17, N. Y.

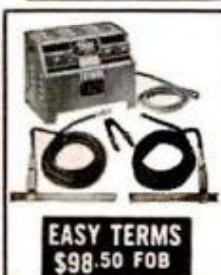

HOMES, FACTORIES, FARMS NEED THIS TRINDL PIPE THAWER

Thaw frozen pipes of Iron, Copper or Lead the Trindl way. No flame—no fire hazard. Save time, money and labor. No need to dig up frozen ground, tear out floors, plastered walls or ceilings. Unlimited year 'round use sweating copper pipes, brazing, soldering, etc. Plug in any 110 or 220 V. outlet. Specify voltage. Complete with 40 ft. output cable, 10 ft. power cord, plug attached, clamps, simple instructions. Only \$98.50 FOB or send for details. Time payments available. Dealers' inquiries invited.

TRINDL PRODUCTS, LTD., Dept. TP-2M, 1807 S. Clark St., Chicago 16, Ill.



Manufactures a complete line of arc welders and supplies

Any man will enjoy new

AIRGRATE

YELLO-BOLE

1. Smokes sweeter!

Imported briar bowl lined with *real honey*. Starts caking the instant you light up. Hence, no break-in.



2. Smokes drier and healthier! Metal grate condenses moisture, tars, nicotine. No wet heel.



3. Smokes cooler!

Air-vented chamber draws in fresh air. Aluminum fins and shank throw off heat, cool the smoke.

Famous honey-lining!

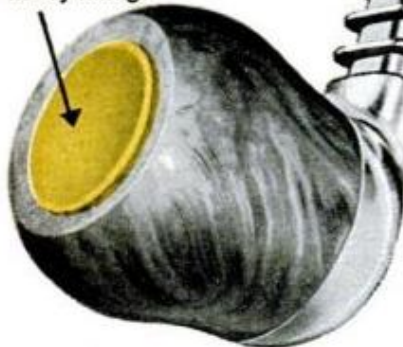

\$295

Extra interchangeable bowls—\$1.50 each

"Icepak" Set—Airograte Yello-Bole Pipe plus two extra bowls, \$5.95

Other Yello-Bole Pipes, also of imported briar \$1.95 to \$4.95

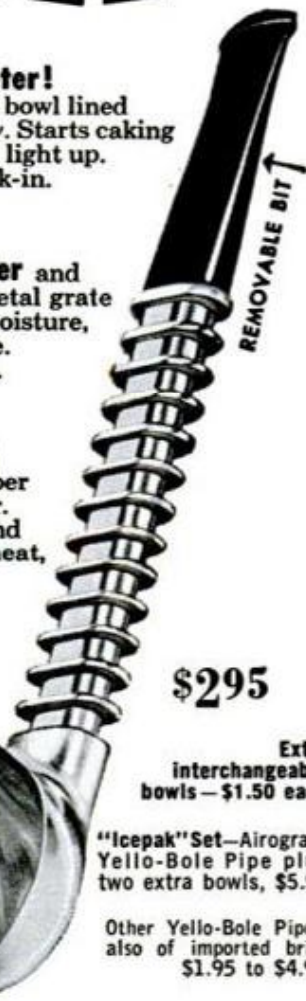

Send for FREE FOLDER, YELLO-BOLE PIPES, Inc., Dept. Y83, N.Y. 22

AConomize on Gasoline

Get more miles per dollar—install an AC ACon-O-Mizer between your fuel pump and carburetor. Reduces flooding and stalling . . . tailors fuel pressure—precisely and instantly—to every driving condition from idle to full throttle. The best answer yet to real gasoline economy!

suggested retail price

\$7⁹⁵



ACon-O-Mizer

At Your Nearby Service Station, garage or General Motors Dealer

AC SPARK PLUG THE ELECTRONICS DIVISION OF GENERAL MOTORS

288

Force Base reports that when he is talking to General Curtis LeMay, Vice Chief of Staff, USAF, an enthusiastic ham, he always says, "Curt . . . sir . . ." just to be on the safe side.

Clamping on the head-set is almost a sure way to be an "Earwitness" to history. A Chicago ham was once talking to an Archduke of Austria when the latter announced, "QRX (wait), I think I'm going to have a little trouble." He broke off and did not resume the conversation. It was March 12, 1938, the day Germany marched into Austria. But hams rarely close down their rigs permanently. Today the Archduke is once more on the air, this time as plain Mr. Anton Habsburg of *Am Mondsee*, Austria.

Last March, just four hours after the great earthquake struck Agadir, French Morocco, Earl Harrison of Paducah, Ky. was getting the on-the-scene story of the stricken city from a Navy man, Bill Wright. As soon as Wright, a ham at a Navy base near Agadir, heard of the disaster, he had immediately rushed his radio equipment to Agadir, knowing that the city would be without communications. Although in doing so Wright broke regulations which require all hams to notify the government when they move location, he was reassured by a message from the Crown Prince of Morocco. "Don't worry about it," said the Prince, himself a ham. "If you lose your license, you can use mine." It was largely because of Wright's reporting that help reached Agadir so quickly.

The world of ham radio belongs today as much to the "YLs" and the "XYLs" as to the men, and the ladies have proved their worth in countless instances. Some years ago, when a child was lost in the Maine woods, the late Kay Kibling won national acclaim by successfully handling radio contacts with the searching parties. In 1952, two Florida teen-age girls, by way of their small rigs, provided the only link with the outside world when a hurricane wiped out all telephone lines to their town. And in 1939, when Worcester, Mass., was hit by a tornado, the first news from the devastated city came from an alert "XYL," Gertrude Hines. Her appeals for help through the night brought immediate response from nearby towns and distant cities. Today, Gertrude Hines is teaching her daughter the intricacies of ham radio. Asked why, she replies: "Don't you think it's nice for a small girl to have her own magic carpet to take her all over the world?"

This wonderland of travel exists for all hams. Byron C. Sharpe, an attorney in Glencoe, Ill., says, "This morning before breakfast I chatted with a young man in

(Continued to page 290)

POPULAR MECHANICS

WAR SURPLUS AND OTHER BARGAINS SAVE UP TO 90%

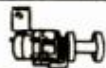

ELECTRIC STORAGE BATTERY WINCH

Powerful reduction gear, fully reversible, ball bearing, safety locking device. Handles from a 1000 to more than 2000 lbs. pull. Use on 6, 8, 12, 24, 32 V. battery. Holds 50' of 1/4" cable. For tractors, boats, tow trucks, etc. Complete with bracket for mounting in any position. Heavy-duty equipment. Approx. GOVT. COST \$400. NEW, \$49.50.

DC JET GENERATOR ARC WELDING KIT Complete with GE Type CM-77 Generator (30 volts D.C., 400 Amp., 3000 RPM up; ampere rating is for continuous duty, intermittent amperage is 500 to 600 amps.), also 2 rheostats, 1 voltage regulator, 1 voltmeter, 1 electrode holder, 2 ea. 25 ft. lengths No. 0 welding cable, 1 welder's mask, 1 toggle switch, 10 lbs. vacuum packed 1/8 in. welding rods, pair welder's gloves & spline coupling. All units guaranteed pre-tested. Wt. 110 lbs. Approx. GOVT. COST \$900. All items, now only \$64.50.

*G.E. Generator noted above can be purchased separately. Makes deluxe heavy-duty welder comparable to the finest commercial welders available. Wt. 90 lbs. Approximate GOVT. COST \$700. Gen. alone—\$49.50.



"DELUXE 11" ARC WELDING KIT

Consists of 200 AMP. Gen., voltage reg., ammeter, shunt, adjustable helmet, electrode holder, pr. welder's gloves, 30' welding cable, reactor coil, toggle switch, rheostat. Approx. GOVT. COST \$650. Units guaranteed pre-tested. \$34.95 complete.



"SUPER 9" 200 AMP WELDING KIT

With Deluxe accessories consisting of one 200 AMP. Gen., adjustable helmet, electrode holder, ammeter & shunt, rheostat, giant toggle switch, voltmeter, voltage reg., 1 pr. heavy-duty welder's gloves. All units guaranteed pre-tested. Approx. GOVT. COST \$500. Most items new—all perfect. \$26.00.



SPECIAL ON \$4770 NAVY AIR-COOLED POWER UNITS

Tremendous power package. Can be used as a portable or stationary unit. Makes terrific welder. Great engine for 1/4 midget racers. 30D-1A Lawrence. 24V. 2 Cylinder opposed 4 cycle 10 1/2 H.P. Complete with various generators. Net wt. 180 lbs. Gross wt. 250 lbs. Like NEW. With 24 to 32 V. D.C. Gen., 160 to 200 amps, 2500 RPM \$149.50. With 24 to 32 V. D.C. Gen., 175 to 250 amps, 2500 RPM \$155.75. With 24 to 32 V. D.C. Gen., 200 to 300 amps, 2500 RPM \$162.75. With NBA-5 AC-DC Gen., 24-32 V. D.C., 175 to 220 amps, 110 V. A.C. 10.5 amps, 800 cycle, 1250 watts \$167.50. Engine only \$137.50.



DOUBLE-V SPLINE 3" PULLEY

For P-1, R-1, GE Gen. shown above. Heavy-duty machine-broached steel. Heavily constructed, will handle any job. Spline receptacle will fit most types of aircraft generators. Set screw locked. Shpg. Wt. 3 lbs. NEW. \$5.95. Triple-V Spline 3" Pulley—NEW—\$6.95.

BENDIX GEROTOR PUMP & MOTOR—NEW!

Use wherever fluid pumping required. Excellent for hydraulic installations and as crankcase drain pump for marine engines. Has 3/4" pipe connections, built-in relief valve adjustable up to 1500 lbs. Max. cap. 6 GPM. 1 1/2 H.P., 24 V. motor. Use on 12 to 32 V. Approx. GOVT COST \$350. \$10.95.



COMPLETE 2-WAY TELEPHONE SYSTEM

For that extra phone in the home, shop, farm, school, etc. Excellent intercom with 2-way buzzer system. Mfd. by Western Electric. Can carry clear conversation for miles. Not a toy. Wt. 11 lbs. Complete with battery & 50' weather-proof wire—ready for use. All this for only \$13.95.



11 PIECE CROWFOOT WRENCH SETS

Wrenches snap onto T-bar in 3 different positions. The only wrenches for hard-to-get-to places. Mfd. by Plomb Tool Co. for U.S. Armed Forces. Finest case hardened tool steel. No shop mechanic should be without this set. Approx. GOVT. COST \$47. NEW. \$5.95 ppd.



140-1 REDUCTION GEAR

For beaching boats, winches, hoists. Ideal motor in golf or boy's electric car. DC motor & clutch. Easily reversible wiring diagram furnished. Hi torque, 105 RPM. Runs on 6-12 or 24-32 V. 65 lbs. gross. Approx. GOVT. COST \$300. \$12.00. Matched splined gear—\$3.00 ea. *225-1 Reduction Gear—\$13.50.



ELECTRIC PUMP WITH CONTROL UNIT

Runs on 12 or 24 V. Centrifugal type. Draws 5.2 AMPS. Has built-in removable filtering screen. Great for bilge, circulating or sump pump... bait tanks, etc. Pumps 500 GPH. Complete with variable control rheostat. Explosion-proof motor. Mfd. by Ingersoll-Rand. Shpg. Wt. 7 lbs. Approx. GOVT. COST \$195. NEW \$8.95.



NEW 1961 CATALOG!

Tremendous catalog—our biggest ever—fully illustrated—1000s of bargains in war surplus & other items. Send 25c in coin for your copy today or free copy with order. Where reqd. indicated applies to US only. Other prices FOB Culver City, Cal. Send cash, check, money order. 30% dep. COD.



AIRBORNE SALES CO., INC. DEPT. PM 1160

8501 Stellar Drive, Culver City, Calif

SMALL! POWERFUL!

ECONOMY TRACTOR

Unequaled value! Low price!
America's finest tractor. Ruggedly built. Easy to operate. 790 lbs. Borg-Warner clutch, trans. and diff 140 to 1 reduction. 40% more drawbar pull than ordinary tractors 8-1/4 H. P. engine. 20 quick change implements. HOOD, FENDERS.

Thousands In Use Write for complete details.
Engineering Products Co.
1005-K-11 Anoka Ave.
Waukesha, Wis.

Print Your Own

Cards, Stationery, Advertising, Circulars, labels, photo and movie titles, church work, tags, etc. Save money. Sold direct from factory only. Raised printing like engraving, too.

Own a Printing Business

Print for Others, Good Profit. Have home shop. Junior press \$15; Senior \$29 up. We supply everything. Easy rules. Pays for self in short time. Write now for free details.
KELSEY PRESSES, 2-37 Meriden, Conn.

ADJUSTABLE MITER BOX & CORNER CLAMP

No. 44—COMBINATION MITER BOX AND CORNER CLAMP

Holds the wood and holds your saw. Uses any handsaw for accurate cuts from 0° to 180°. Full 3" capacity. Sides of joints exposed for nailing, gluing. \$2.75 PPD.

No. 33 Works the same as No. 44, but without saw guide attachment. \$1.75 ppd.

SAW SHARPENING IS EASY

Super Filer No. 11 joints and sharpens hand and circular saws 6" to 10" with all teeth correct in height, depth, pitch, bevel. When file hits steel roller, teeth are finished. Saw runs true with no side pull. \$9.95 PPD. Includes 8" file.

"TRU-CIRCLE" saw set automatically sets teeth at 10° or more. \$2.95 PPD.

MONEY BACK GUARANTEE

A. D. MCBURNEY, 5908 Hollywood Blvd., Hollywood 28, Cal., Dept. A-110

ARROW 50

ALL-PURPOSE HEAVY DUTY STAPLE GUN

SHOOTS A STAPLE WHEREVER YOU'D DRIVE A NAIL!!!

At Hardware, Building, Lumber and Stationery Dealers Everywhere.
ARROW FASTENER COMPANY, Inc. 1 Junius Street • Brooklyn 12, N. Y.

Uses 6 Staple sizes:
1/4", 5/16", 3/8", 1/2", 5/8", and CEILTILE

12.50

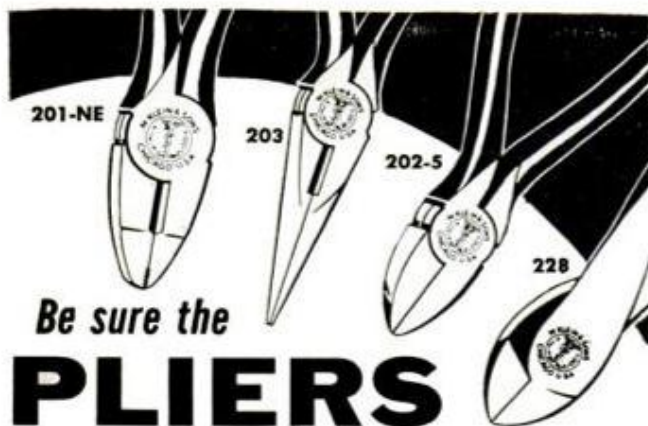

Be sure the
PLIERS
 you use are
KLEINS

"Since 1857" the name Klein has stood for the finest in tools. Linemen, electricians and good workmen everywhere prefer Kleins because of the high standard of quality that is back of every pair. Now Klein Pliers are available in a wider selection of styles and sizes than ever before.

Ask your supplier for genuine Klein Pliers or write for a new Klein Plier Catalog.
 FREE Klein Plier Catalog. On request.

Mathias KLEIN & Sons
 Established 1857 Chicago, Ill., U.S.A.
 7200 McCORMICK ROAD • CHICAGO 45, ILLINOIS

If it's worth painting
 it's worth sanding...
 with sandpaper by

CARBORUNDUM®

PALMGREN .. introduces
 a New "ALL PURPOSE"
DRILL PRESS
TABLE that permits
 (without removing piece from table)
DRILLING—MILLING—GRINDING—INDEXING

on any popular size bench or floor model drill press, one compact unit for thousands of difficult jobs in one setting for more accurate work, FASTER. Convert your present drill press to a sturdy milling machine. Models to fit all popular sizes and makes. Write today for complete facts and prices, stating col. dia. and distance from center of column to spindle center.

PALMGREN PRODUCTS
 8365 So. Chicago Ave., Chicago 17, Ill. Phone SAginaw 1-9675

Honduras and a Marine colonel in California, learned about life in the Arctic from a chap who lives on the edge of the Greenland ice-cap, and shared experiences with a fellow American stationed in a little Italian town. This afternoon I have an appointment with a man at the South Pole."

For the operator who specializes in distance (DX), there is the opportunity to speak with a Saudi Arabian prince, an American Embassy official in Tunis, or one of the two descendants of the "Bounty" mutineers on lonely Pitcairn Island. Or it is possible to talk with a Ukrainian worker. It has been only within the last five years that the Soviet government has permitted their version of "free" communication with "capitalistic" society though before that an operator was aware that the Soviets were listening to the outside world and talking with fellow hams in Iron Curtain countries.

Today, in the midst of the cold war, U.S. hams have a special role. In the event of a national emergency, thousands of amateurs are ready to contribute their equipment and their know-how to this country's service. Many are members of the Radio Amateurs Emergency Service (RACES), and should this nation be attacked RACES stations would be the only amateur stations permitted on the air.

This feeling of true service is one of the trademarks of hams. There's Don Mullican of Searcy, Ark., who stuck to his short-wave set for more than five days to bring emergency aid to tornado victims in his town. There's Stan Surber of Peru, Ind., called the "Arctic Mailman," who in three years handled over 18,000 messages to and from servicemen in the far North. There's Mrs. Mary Burke, of Morton, Pa., who operates eight hours a day transmitting an average of 3000 messages a month from servicemen overseas to their families.

And there's Amory (Bud) Waite of Oceanport, N. J., whose job it was to maintain contact with Adm. Byrd when he was isolated in his one-man observation post at the South Pole. Waite, at the base station in Little America, was the first to become aware of the erratic change in Byrd's sending, and, despite the Admiral's reassurances that he was all right, was able to convince his colleagues that something was wrong. This initiated the famous trek to Byrd's post to find him almost dead of monoxide poisoning. For his deed, Waite was awarded a medal.

Now, a new horizon has opened up for amateur radio operators—space! Last March, Raphael Soifer and Perry Klein, two teen-aged hams using homemade equipment established two-way communi-

(Continued to page 292)



Our "Thrifty Three" controls small engine power!

Start, idle or reverse standard small gasoline engines and motors with this Thrifty Three—some: packaged reversible transmission... eliminates gear shifting levers, belt tighteners; automatic centrifugal clutch... with highest torque per inch per dollar; internal expanding brakes... compact, self-energizing.

Each of these F-M accessories is quickly, easily installed on racing carts, power mowers, saws, lawn sweepers, portable elevators, golf carts—many other types of existing or original equipment. Each saves dollars for workbench enthusiasts, permits designers to specify less expensive units.

Write to Fairbanks, Morse & Co., Magneto and Engine Accessories Division, Beloit, Wis.

Fairbanks, Morse

Magneto and Engine Accessories Division

A MAJOR INDUSTRIAL COMPONENT OF FAIRBANKS WHITNEY CORPORATION

KIT BOATS

Boat Plans Patterns Frame Kits

KIT CATALOGS—Over 50 Models—Pre-assembled. Runabouts, Cruisers, Fishing (8' to 19'). Anyone can assemble. Complete Marine Accessories, Fiberglass plastics, Trailers, Paint, etc. Also Catalog on 50 Modern Plans and Patterns. Prefab Frame Kits—SEND 10c FOR 2-COLORED CATALOGS

CREDIT TERMS

FREE FREIGHT—SAVE 2/3

CRAIG-CRAFT, Tonawanda 1L, N. Y.

OWN THE WORLD'S FINEST POCKET PISTOL!

BERETTA PANTHER

NEW 25 CAL. FEATHERWEIGHT—9 SHOT

Sensational Beretta Panther carries more cartridges for its size and weight than other pocket pistols. Always dependable, reliable and accurate. Fits pocket or purse.

FREE! Genuine Leather Holster... Order by Mail Today!

Send \$5.00 down, bal. C.O.D.

GODFREY IMPORT CORP., Dept. PM11, 261 Broadway, N. Y. 7, N. Y.



Std. Blue \$32.00
Std. Blue, Pearl Hds. 37.50
Chrome—Pearl Hds. 43.50
25 Auto Clps (50) 3.85

Shop PM Ads for Exciting Direct-Mail Offers



World's THRIFTIEST Light Plants

700 Watt, push button start, 115 v. 60 cyc. AC. 2.2 HP. easy starting Briggs eng. No wiring necessary; just plug in and operate. Plenty of current for any oil burner, freezer, brooder, emergency lights, etc. which require up to 700 watts. Ideal for television and radios. Complete with voltmeter and built-in winding to charge auto batteries. (Item 24) Wt. 7.5 lbs. Easily fits in car trunk. Be prepared if storm knocks out power lines. Reg. \$275... **\$149.50**

1500 Watt Plant (Item 45) same as Item 24 but larger generator and engine with 50% greater output. **\$199.50**

ELECTRONIC BRAIN Now Available On All Our Plants—Write



HEAVY DUTY D-C ARC WELDER

Use as portable or shop welder. Up to 300 amps, Senior model. Made for years of trouble-free, continuous service. Will handle light or heavy jobs. Easily welds up to 3/4" plate using 1/4" rods. Built-in air cooling system. Arc is easy to strike and hold, because of specially designed arc stabilizer. Hi-lo switch and dial control gives wide range of welding heats. Run welder at 2600 rpm, with tractor, jeep or 15 hp. gas engine, and triple V belt or flat pulley. You can pay more, but you can't buy a better welder. Wt. 110 lbs. \$400.00 value... **\$119.50**

with mounting flange (item 38)

WELDING KIT. Two 10 ft. leads, welding helmet, electrode holder, ground clamp. Sold only with welder at... **\$10.50**

STANDARD DIAL PHONES

Western Electric dial phones same as used by all telephone companies. Ideal as extensions on any system. Phones are converted to work without central station for use as private communication systems. Merely dial to ring other party. Rings loud and clear. Several may be connected on same line. Fine for long distances. Standard 110 v. current used one end. Needs 4 cond. wire for private line. Item 855 Wt. 8 lbs. each... **\$8.95**

Wire—4 cond. 22 gauge, 250 ft. coil... **\$4.95**
Wire—4 cond. 19 gauge (for distances over 500 ft.) 250 ft. coil **\$7.95**



HEATING AND VENTILATING FAN

(Item 10) Easily installed in furnace pipes. Forces even heat to all rooms. Over range removes kitchen smoke and odors. Powerful, continuous duty motor, 110-120 v. AC. Mount in wall or ceiling to ventilate any area. Quiet, super-efficient fan moves huge volume of air. (400 to 600 CFM).

8" Pipe, wt. 5 lb. **\$6.85**
9" Pipe, wt. 6 lb. **\$7.85**
10" Pipe, wt. 7 lb. **\$8.85**
12" Pipe, wt. 8 lb. **\$9.85**

HEAVY DUTY FAN. Semi-enclosed motor, suitable for spray booths, restaurant exhausts, poultry houses, etc. 10" Fan, wt. 8 lbs. (Item 10E) ... **\$11.95**

12" Fan, wt. 10 lbs. (Item 10D) ... **\$12.95**

HIGH SPEED BARN FAN similar to above, but larger, high speed motor moves huge volume of air. 12" Fan (Item 10f) ... **\$14.95**

14" Fan (Item 10g) ... **\$17.95**

Heats instantly anything from a cup of water to a bathtub full... much faster than any stove or costly heater. Indispensable for laundry, dishes, baths, etc. Terrific for coffee, tea, soups. Made of unbreakable shock proof "Nyalite." Simple and cheap to operate... just plug it in. 1200 watts, 115 v. A.C. Money back guarantee. Item 856. Shipped prepaid, only... **\$3.95**

Send 10c for 100 page Catalog—FREE with order. Prices f.o.b. factory—Send check or M.O.



MASTER MECHANIC MFG. CO., Dept. A-116, Burlington, Wis.

Southern Customers Order from Dept. A-116, Box 65, Sarasota, Fla.

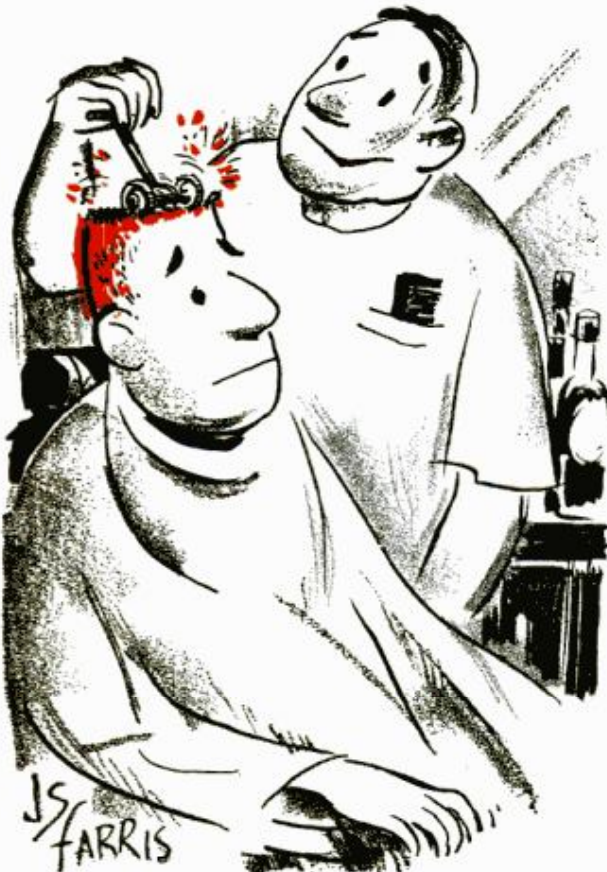

new **FORMICA**® table top?

Laminated Plastic



It's easy when you use (1) Formica Safe-Bond, the new non-toxic, non-flammable adhesive that "tells" you when to contact and (2) Formica laminated plastics in the smart new Raymond Loewy designs. Get Formica Safe-Bond and sheet stock at your local lumber dealer. Formica Corp., a subsidiary of American Cyanamid, Cincinnati.

a product of

CYANAMID

UNMATCHED



Unequaled in quality and performance. Free catalog to tool-makers and machinists.

GERSTNER TOOL CHESTS
460 Columbia St., Dayton 7, Ohio

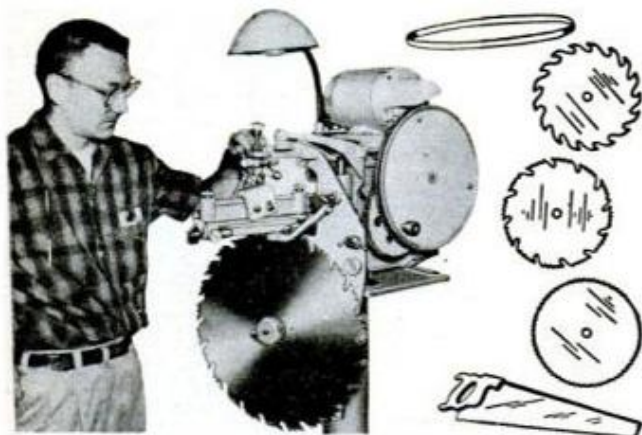

CASH FILING SAWS

Here is a steady repeat CASH business you can start at home. No experience needed—no canvassing—every saw you sharpen will bring new customers. You can make up to \$3 or \$6 an hour—\$20 to \$30 a week in your spare time as a starter. "My spare time saw filing business has made me \$952 these first ten months," says R. T. Chapman.

The new model 200 Foley Saw Filer automatically sharpens combination (rip and crosscut) circular saws, hand saws, band saws and crosscut circular saws.

Free Book—"MONEY MAKING FACTS" shows you how to get into this CASH business. Time Payments if desired. Mail coupon now. No salesman will call.

FOLEY MFG. CO.
1143-O Foley Bldg., Minneapolis 18, Minn.
Send me free book "MONEY MAKING FACTS"
and Time Payment Plan.

Name _____

Address _____

City _____

State _____



cation by bouncing radio signals off a man-made satellite. "We know now," said an expert in a major radio network, "that the possibilities for communication throughout the universe are almost limitless." On August 11, an epic 2500-mile message from Goldstone, Calif., to Holmdel, N. J., was bounced off the U.S. Echo I satellite—sent into orbit for that very purpose. The technique is almost routine.

Hams are everywhere, poking out into the far and little-known corners of the world—in search of person-to-person adventure. Their password is "Calling CQ." For "Calling CQ" is the way hams have of saying: "Does anybody, anywhere, feel like talking—about anything?" ★ ★ ★



Ultraviolet Gun Kills Germs

Installed above the operating room in Mount Sinai Hospital, Los Angeles, Calif., a mammoth ultraviolet gun bathes the area with germ-killing rays. The gun has 72 chambers, each of which is 36 inches long and 7½ inches in diameter; each chamber holds a high-intensity ultraviolet lamp. The sterilizing process is 99.9 percent effective against airborne microbes. The photo shows how the ultraviolet-sterilized air is routed from the chambers. Holes have been drilled in the operating lamp so the air may "wash" germs from patients.

Inexpensive Food Supplement

Containing the protein and vitamin A content of fresh milk, an inexpensive food supplement named Incaparina promises to help prevent malnutrition among people in underdeveloped countries. A day's supply in Guatemala, where it was formulated, costs three cents, for example, compared to 15 cents for milk containing an equivalent amount of vitamin and protein.

Incaparina consists of cottonseed meal, corn, sorghum, Torula yeast, vitamin A and calcium carbonate (ordinary limestone). It takes its name from the Institute of Nutrition of Central America and Panama, in Guatemala City.

Most other countries can produce Incaparina from products grown within their borders, says Richard L. Shaw, a member of an advisory group to the Guatemalan government. Countries with rice as a main crop, for example, could substitute this for corn in the formula and thus provide protein to their citizens sooner than if they waited to develop a cattle industry.

In Guatemala, Incaparina is marketed as a powder which buyers cook with water to make a drink known throughout Central America as "atole." In tests, 80 percent of the children given Incaparina atole liked it and more than 75 percent drank two to three glasses a day. Weight gains and general health improvement "exceeded all the predictions that had been made on the basis of exhaustive laboratory studies," says Shaw.

Army Tests Throw-Away Uniforms

Clothing that can be worn once and thrown away is becoming a reality in Army Quartermaster experiments with nonwoven fabrics. Doctors and nurses at Fort Sam Houston, Tex., are wearing paper-based surgical clothing, and infantrymen are testing disposable combat uniforms made of processed paper. But nonwoven fabrics extend to other fibers as well, including cotton, nylon, Dacron, and other plastics and synthetic materials. One of man's oldest clothing materials, felt, was the first nonwoven material, and most of the modern nonwovens are made in much the same way, with fibers laid out parallel, crisscross, or in random directions, then bonded together with a binding chemical under pressure. Although the nonwoven materials account for only two percent of our textile output, new fibers and binders are improving the elasticity, drapability, and cleanability of new types, and work is continuing toward inexpensive, durable fabrics that will perform well once or a few times, then can be thrown away.

JUST PURCHASED THE MOST FANTABULOUS BUY IN OUR HISTORY! 10,000 DOUBLE ACTION HYDRAULIC CYLINDERS...

SAVE 82%

2000 PSI HEAVY DUTY

All sizes, bores and strokes. This purchase made possible by a contract termination on mobile equipment. NOW offered to you at "once-in-a-lifetime", LOW - LOW Palley PRICES. Compare - Buy NOW for future needs and insure against breakdowns. Engineered for Earth Moving Equipment, Presses, Tail Gates, Agriculture Equipment, Industrial Machines, Lift Assemblies, Oil, Fields and hundreds of other uses requiring unusual strength and durability.

ATTENTION PURCHASING AGENTS for Mrs., City, County, State and Government Agencies. All inquiries promptly handled. Send for special Hydraulics Brochure

Part No.	Bore	Stroke	Length	Shaft Dia.	PRICE
H-70A	2-1/2"	8-3/8"	18-3/4"	1-1/2"	9.88
H-70B	2-1/2"	10"	21-1/4"	1-1/2"	10.88
H-70C	2-1/2"	15"	26-1/8"	1-1/2"	12.88
H-70D	2-1/2"	23-3/4"	35-1/2"	1-1/2"	18.88
H-70E	2-1/2"	30"	40-1/2"	1-1/2"	24.88
H-70F	2-1/2"	48-1/2"	64-3/8"	2"	29.88
H-70G	3-1/2"	8"	19"	2"	17.88
H-70H	3-1/2"	10-1/4"	21-1/4"	2"	19.88
H-70I	3-1/2"	15-1/8"	26-1/8"	1-3/4"	23.88
H-70J	3-1/2"	22-15/16"	34-1/4"	2"	29.88
H-70K	3-1/2"	30"	41"	1-3/4"	34.88
H-70L	3-1/2"	43-1/2"	55-1/8"	1-3/4"	44.88
H-70M	3-1/2"	47"	64-1/2"	2"	49.88
H-70N	4"	22-1/4"	34-3/8"	2"	36.88
H-70P	5"	43"	55-1/8"	2-1/4"	79.88

Mod. No. K15365-10AC CESSNA HYD. PUMP
Ideal for use with above cylinders. Delivers 12 GPM at 1800 RPM... 2000 PSI. 3/4" inlet & 1/2" outlet pipe ports. 3/4" shaft. 2-hole magneto mount. **4950**

50% OFF on NEW BACKHOES and FRONT LOADERS
WRITE FOR DETAILS

16 mm GUN CAMERA
Operates on 24 v, DC at 16, 32 or 64 frames per second. Has f/3.5 lens. Magazine load for B&W or color film. SAVE at our low price. **2249**

BLOWER / EXHAUST FAN
4" diam. fan forces air through a 5" long housing. Has 1/100 HP, 27.5 V, DC motor. Ideal for ventilation. **ONLY 488**
TRANSFORMER for above. 120 V, 60 cycle. 25 V output. . . . \$3.88

400 GPM FUEL PUMP AND MOUNT
Only 1195
Delivers 400 GPM at 20 PSI. Vane type. Has 3/4" pipe ports, and relief valve for adjusting the pressure. Complete with foot mount and 1/2" keyway shaft for driving with belt, gear or pulley.

25 GPM PESCO PUMP
CAT. NO. 2795 H-P25SU
A positive displacement, 25 GPM Pump at 3450 RPM. Has pressure limit of 1000 PSI. Worth twice our low - low surplus price.
PUMP MOUNT - For above pump. Has foot mount and key slot drive. Ball bearings. 1695

1. MAKE YOUR OWN ARC WELDER
Now you can make your own Arc Welder and SAVE as never before.
1. R-1 GENERATOR - Gen. Elect. 300 Amps, 24-32 V, DC. 4400-10,000 RPM.. 3/4" splined shaft **1695**
2. WELDING REACTOR - 10.95 3. 24 V. RHEOSTAT - 1.95
4. THROTTLE CONTROL SOLENOID \$7.95
5. "V" BELT PULLEY ADAPTER 12.95

2000 PSI HYDRAULIC HAND PUMP
Capacity 1.5 cu. in. per cycle. Has built-in diverter valve. No. HP-3VSU **988**

100 to 1 GEAR HEAD MOTOR
Gives tremendous take-off power to 24 V, DC motor. 375 ft. lbs. clutch setting. **2450**

0.5 to 1 RATIO GEAR DRIVE
Use where great power at low take-off speed is desired. Shafts are 1-1/4" & 3/8" **995**

600 PSI GEAR PUMP & MOTOR
1 1/2 HP, 24V DC motor. Del. 3 1/2 GPM. . \$8.88

1500 PSI 4-WAY HYD. VALVE - Sliding piston type. 788
Reg. \$12.75 -

palley's
2263 E. VERNON AVE., Dept. PM-110 LOS ANGELES 58, CALIF.

TO ORDER - Send check or M.O. 1/2 deposit with C.O.D.s. All prices are F.O.B. Los Angeles Warehouse. All items sent postage or freight collect.

A new way to work from Chevrolet!

CORVAIR

95

★ ★ ★ ★ ★ ★ ★ ★ ★ ★
TRUCKS

What you see here is not merely a new truck model . . . it's a new kind of truck. An ideal truck design that gives you many more feet of load space than a conventional half-tonner because of a no-hood design that's unique in the industry. A design that puts the engine in the rear, where it doesn't detract from load area. (Of a Corvair 95's short 15-foot length, almost a full 10 feet is for cargo!) Here's truck weight that's distributed evenly, front and rear, to enable a Corvair 95 to carry up to 1,900 lbs. of payload with a trim 4,600-lb. Gross Vehicle Weight. Here's a short 95-inch wheelbase that pays off in easy, nimble maneuvering. *

Dollar-saving performance starts with the engine—an air-cooled "pancake" 6 that never needs antifreeze or radiator repairs . . . and never stops whittling down fuel costs! And, because of its rear-end position, the Corvair 95 power plant helps provide an extra measure of surging traction for grinding through the rough spots. Ideally suited for trouble-free truck duty, also, is the tough chassis build of Corvair 95, which includes frame and body designed as a rugged one-piece unit to withstand slam-bang runs. And there's 4-wheel independent suspension (first time in a U.S. truck!) to add new stability to truck performance and take the roughness out of road surfaces.

The list of Corvair 95 design advantages is as long as your arm. There's low loading height, for example; load space so accessible that the truck practically loads and unloads itself! There's exceptional driver comfort in the roomy cab. (With no hood projecting out in front, visibility has never been better.) And that snappy Corvair 95 styling is sure to spruce up any business. It's a wing-ding of a truck idea—available in pickup and van body versions. You can see 'em at your Chevrolet dealer's right now. . . . Chevrolet Division of General Motors, Detroit 2, Michigan.

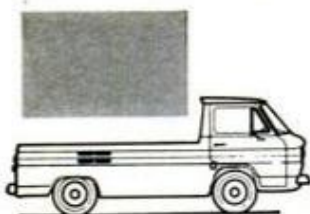

Less truck weight allows more cargo weight! Thanks to an ideal truck design, new Chevrolet Corvair 95's weigh almost $\frac{1}{2}$ ton less than corresponding conventional models. Yet they'll carry up to 1,900 lbs. of cargo!

Less wear on heavy-cargo runs! Corvair 95's balanced 50-50 weight distribution reduces strain on chassis and tires. Husky 2,500-lb. capacity suspensions, front and rear, share truck and load weight equally.

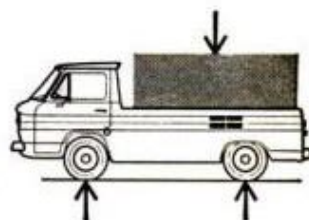

More load space, less road space! A Corvair 95, with 2 feet less overall length, eases into tight spots like no conventional half-tonner can. But Corvair 95's carry bigger cargoes—nearly two-thirds of the length is used for load space!

Easiest to get around in! Corvair 95 turning radius (less than 20 feet) is less than that of ordinary trucks. That means easier maneuvering and parking, faster hauls in congested areas.





Corvair 95 Rampside



Corvair 95 Corvan



Corvair 95 Loadside



STOP

*before you put that
boat and motor away
...read this!*

Start your 1961 boating season now! Before you lay up your outfit, see the new '61 Evinrudes . . . designed for the space age . . . powered for pure pleasure . . . with new features like battery-saving UNI-CHARGER, and foolproof fixed-jet carburetion. Motors so new that you're missing a lot if your present motor is two years old. If it's more than three years old, you're missing out on a dozen major improvements that can make your boating better this fall!

TRADE NOW! SAVE NOW! Save with a bigger fall trade-in allowance. Save on depreciation, winterizing and winter storage. Now is your best time to *drive* a good boating bargain!

Free 1961 catalog. Ask your dealer, or write: Evinrude Motors, 4022 N. 27th Street, Milwaukee 16, Wis. (In Canada: Peterborough, Ont.)
A Division of Outboard Marine Corp.



EVINRUDE



FIRST IN OUTBOARDS