

60 PAGES OF HOME IDEAS

POPULAR MECHANICS

OCTOBER, 1960
35 CENTS

PM HOUSE OF BUILT-INS

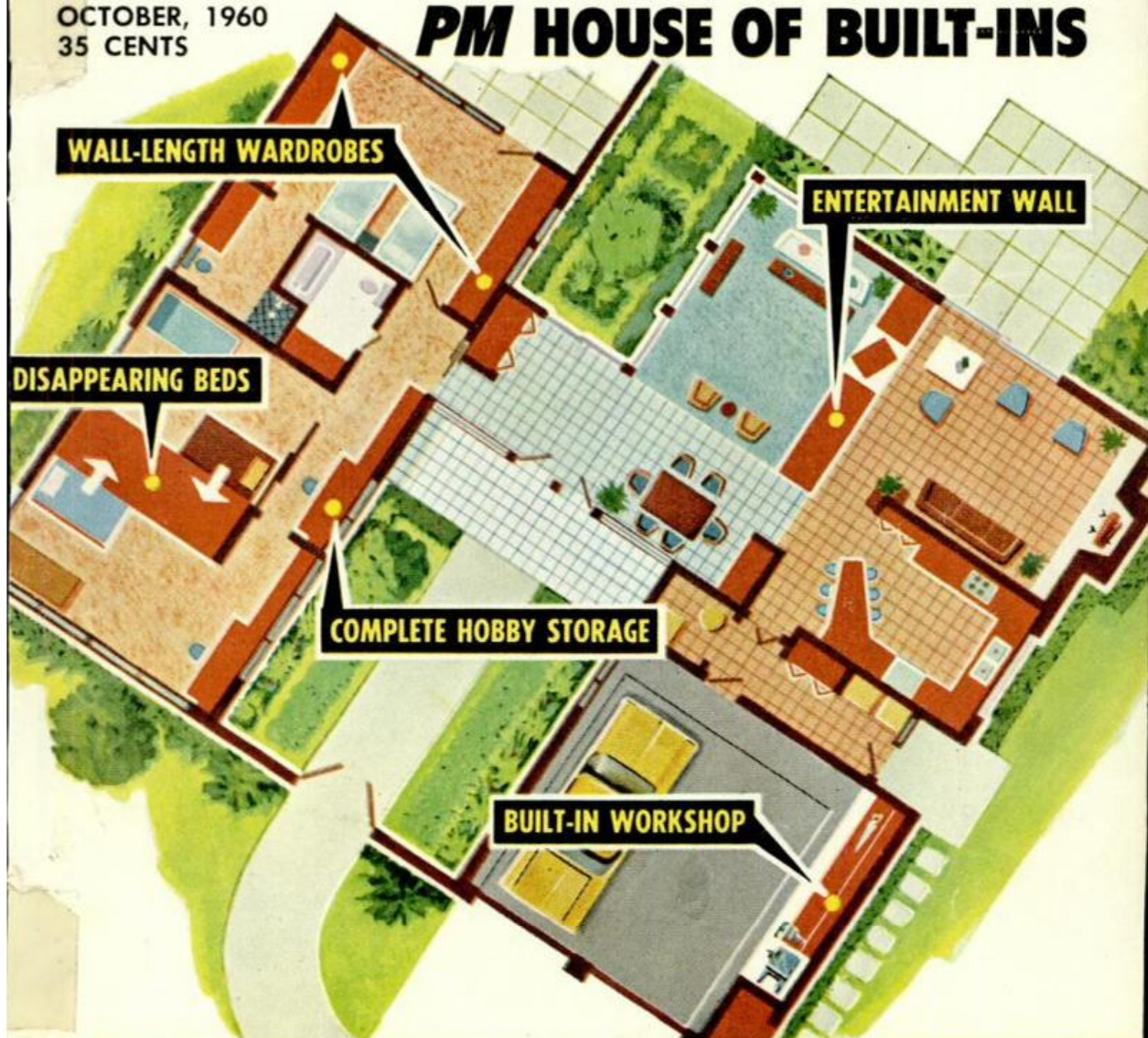

FIRST LOOK AT THIRTEEN 1961 CARS
—including two **BRAND NEW** compacts

the new 1961
EVINRUDES
are out
.....in front!

New! And looks it! If you've been waiting for your dream motor, wait no more. Evinrude's all new Starflite III is here. What does it offer? The might of 75 hp! The smoothness of a V-4 engine! The speed of Jetstream Drive! The quiet of sound-sealed, cushioned power!

New fixed-jet carburetion is combined, for the first time, with thermostat-controlled engine temperature for the ultimate in efficient, fool-proof performance. A new AC generator, with transistorized regulation, lets you enjoy all the latest electrical accessories with never a worry about battery drain.

For 1961... Evinrude presents two brilliant Starflite models, a new, luxury-performing 40 hp Lark, the "big buy" 40 hp Big Twin, and four other models of efficiency from 3 to 18 hp.

Fall is your best time of all to drive a good boating bargain. See your Evinrude dealer now. Ask for your FREE 24-page 1961 catalog, or write: Evinrude Motors, 4017 N. 27th St., Milwaukee 16, Wis. (In Canada: Peterborough, Ont.) A Division of Outboard Marine Corp.

EVINRUDE
FIRST IN OUTBOARDS



Announcing

THE FINEST ROI-TAN EVER MADE!



**NOW...WITH
STA-FIRM
HEAD!**

**STAYS FIRM AND NEAT
FROM FIRST PUFF TO LAST!**

Firmer—Finer—Fresher...

And you enjoy the smooth flavor and mildness of Roi-Tan's finer quality tobaccos *all the way*. For every puff comes through the remarkable new STA-FIRM HEAD free and easy—right to the end! Have a fresh new Roi-Tan today—there's a size for every taste.

MAN TO MAN...SMOKE ^{new}

ROI-TAN

AMERICA'S LARGEST-SELLING CIGAR—AT 10¢

Product of The American Tobacco Company — "Tobacco is our middle name"



IN BOXES
OF 50
AND HANDY
5-PACKS.

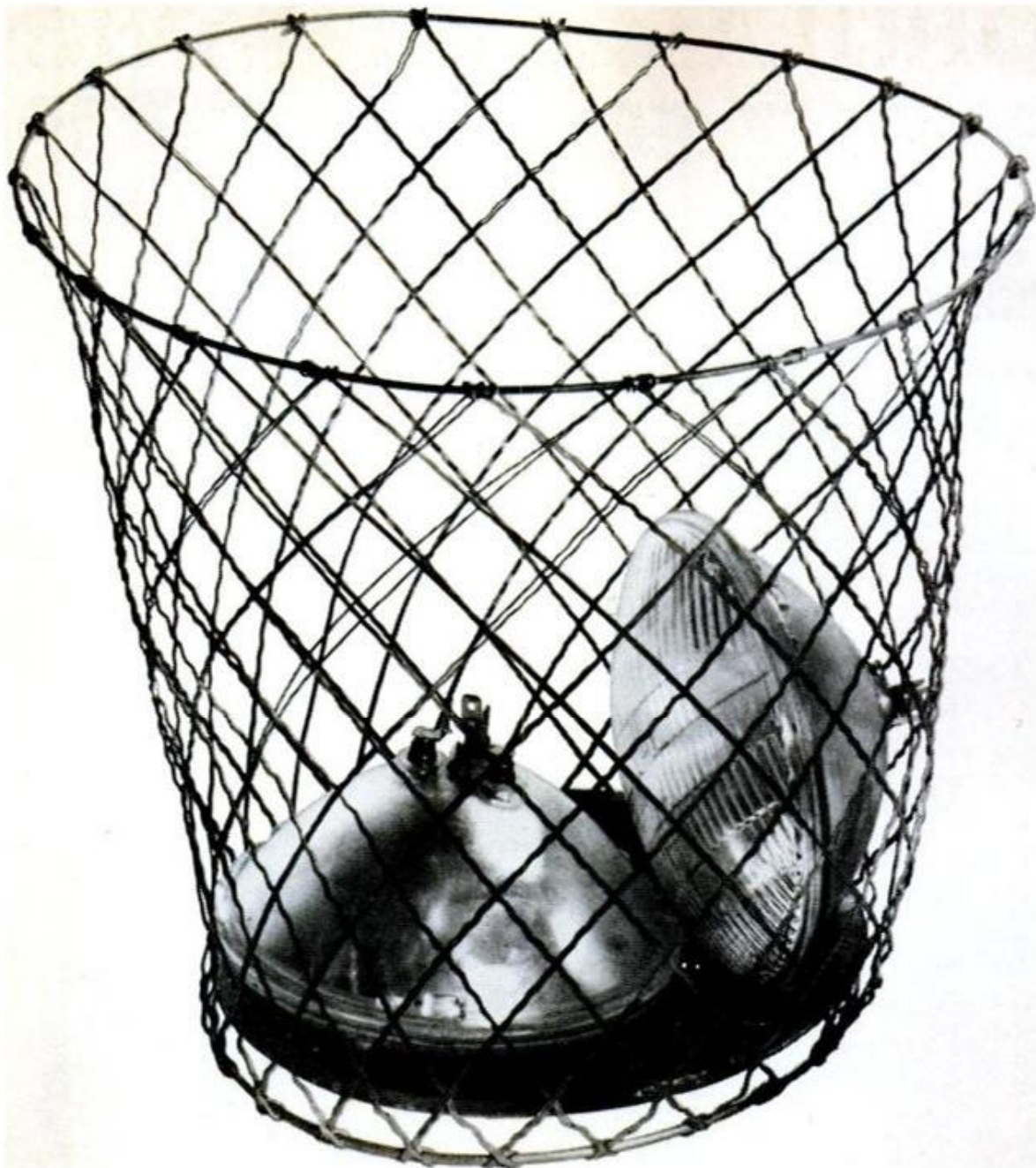

Why are people throwing away both headlamps when one still lights?

Because a pair of G-E SUBURBAN Headlamps gives their 2-headlamp cars twice as much light where it's needed! It's almost like driving a new 4-headlamp car when you switch on the low beam of your new General Electric SUBURBAN Headlamps! Only G-E SUBURBAN Headlamps, among all the brands made for two-headlamp cars, have the low beam filament on focus to give you a "spotlight effect". This gives you twice as much light where you need it . . . down the right side of the road. So you see better in spite of the other car's lights . . . even if he fails to "dim" for you!

If you have a two-headlamp car, don't even wait for *one* headlamp to burn out. Have a pair of new General Electric SUBURBAN Headlamps installed and aimed today! See how much easier and more relaxing night driving can be. General Electric Company, Miniature Lamp Dept. M-024, Nela Park, Cleveland 12, Ohio.

Progress Is Our Most Important Product

GENERAL  ELECTRIC

POPULAR MECHANICS®

Address communications to: 200 E. Ontario St., Chicago 11, Illinois. **SUBSCRIPTION SERVICE:** Mail all subscription orders, changes of address, correspondence concerning subscriptions, and Postmaster notices of undeliverable copies to Popular Mechanics, 250 West 55th St., New York 19, N. Y.

Editor
RODERICK M. GRANT

Executive Vice-President
RICHARD E. DEEMS

Publisher
G. HARRY CHAMBERLAINE

Managing Editor
CLIFFORD B. HICKS

Shop Notes and Crafts Editor
WAYNE C. LECKEY

Associate Editor, General Features
JOHN A. LINKLETTER

Associate Editor, Automotive
JAMES R. WHIPPLE

Associate Editors, Shop Notes and Crafts
W. CLYDE LAMMEY, EARL WOBECK

Radio-Television, Electronics Editor
BYRON G. WELS

Assistant Editors, General Features
JAMES BIERY, KEVIN V. BROWN
R. B. KIRKPATRICK

Assistant Editors, Shop Notes and Crafts
GUERRINO F. AMATI, ROBERT L. HERING

Assistant Editors, Makeup
WALLACE MYERS, JEAN KAVANAUGH

Art Staff
FRANK BEATTY, Director
HENRY NEHRBASS, Assistant Director
RICHARD A. POTTS, Art Editor

Eastern Editor
RICHARD F. DEMPEWOLFF
959 Eighth Ave., New York 19, N. Y.

Western Editor
THOMAS E. STIMSON, JR.
Suite 1003, 3460 Wilshire Blvd.
Los Angeles 5, Calif.

Advertising Manager
JOSEPH R. BUELL, JR.

Director, Bureau of Information
ALLAN CARPENTER

Advertising Offices

Chicago: 200 E. Ontario St., Whitehall 4-0100;
New York: 959 Eighth Ave., COlumbus 5-7300;
Detroit: General Motors Bldg., TRinity 5-8711;
Cleveland: Hanna Bldg., 1422 Euclid Ave.,
PRospect 1-0456; Los Angeles: 3460 Wilshire,
DUnkirk 2-8458; San Francisco: Russ Bldg.,
235 Montgomery St., YUkon 2-0823.

Published monthly by Popular Mechanics Company, 200 E. Ontario St., Chicago 11, Ill. Richard E. Berlin, President; Richard E. Deems, Executive Vice-President; Fred Lewis, Vice-President and General Manager; Robert F. MacLeod, Vice-President; John R. Miller, Vice-President; G. Harry Chamberlaine, Vice-President; G. O. Markuson, Treasurer; R. F. McCauley, Secretary. Single copy in the United States and Canada, 35 cents; subscription rates in the United States and possessions and Canada, 1 year \$3.50; 2 years, \$6.00; 3 years, \$8.00. In countries of the Pan-American Postal Union, 1 year \$4.50; 2 years \$8.00; 3 years \$11.00. In all other countries 1 year \$5.50; 2 years \$10.00; 3 years \$14.00. If you plan to move, notify us at least 30 days in advance so you will not miss an issue. Give both your old and new addresses. Second-class postage paid at Chicago, Illinois, and at additional mailing offices. Entered as Second Class Matter at Post Office Dept., Canada. Registered as Second Class Matter at the Post Office at Mexico, D.F., Mexico, June 20, 1950. ©1960 by Popular Mechanics Company. All rights reserved. Printed in the United States of America.

OCTOBER 1960

INTERNATIONAL EDITIONS
SPANISH: Mexico-Caribbean, Southern Hemisphere
FRENCH, DANISH, SWEDISH, GERMAN, PORTUGUESE, DUTCH

Volume 114

OCTOBER 1960

Number 4

In This Issue...

PM Looks at the First of the 1961 Cars	- - - -	97
The Dam That Spans the Canyon	- - - -	117
Mr. Rescue and His Bloodhounds	- - - -	129
Our Moon Program Starts Now	- - - -	138
"Poly" Coddles Plants	- - - -	146
Leap for Life!	- - - -	150
T'ai Chi for Your Muscles	- - - -	156

ANNUAL HOME SECTION—

PM House of Built-Ins	- - - -	160
How to Build the Sleeping Wall	- - - -	170
It's New . . .	- - - -	176
The House Your Kids Will Live In	- - - -	178
Where Does the Money Go?	- - - -	182
Sun, Shade and Wind Where You Want Them	- - - -	185
Before You Buy—	- - - -	190
Before the Siren Sounds	- - - -	196
What to Do About Excess Humidity	- - - -	202
Wiring Your Basement Playroom	- - - -	208

For the Craftsman...

They're Off and Running	- - - -	214
Play It Safe With the Right Lock	- - - -	216
Fluxless Soldering at Last	- - - -	228
Combination Shop Tool	- - - -	231
Lathe Doubles as Metal Shear	- - - -	234
Radio, TV and Electronics	- - - -	236

Regular Departments...

GUIDE TO THIS ISSUE - - - 6

Know This Old-Timer!	- - - 12	Spotlight: Triumph Herald	- - - 92
Tune In on the Inventors	- - - 17	Detroit Listening Post	- - - 113
Pentagon Sidelights	- - - 18	An Eye on Space	- - - 124
What's Up in the Air	- - - 33	Solving Home Problems	- - - 218
Keeping Up With the Atom	- - - 36	Clinic for Homemakers	- - - 244
Science Bulletins	- - - 39	On the Market . . .	- - - 274
Items From All Outdoors	- - - 42	Shopping for Tools	- - - 302

Turn to detailed index on page 6. Sources of additional information on items in this issue are shown on the Where-to-Find-It List, available without charge by writing the Bureau of Information, Popular Mechanics, 200 E. Ontario St., Chicago 11, Ill.

Next Month...

THE 1961 CARS will appear in full color. All the American manufacturers will be represented in a comprehensive display . . . A veteran pilot recounts his experiences in making an approach and landing a transport plane at an overcrowded municipal airport in "Let's Bring Our Planes Down Safely" . . . Five-year-olds on bucking broncs? Yup—they do it out West; see "Kid-Sized Rodeo"



COMMERCIAL SOD GROWER: Louis DeLea, East Northport, Long Island, N.Y. "With Super Mileage Lugs we get the traction we simply must have in the sod field, yet they're giving us real good wear out on the highway."

FLOTATION TIRES EASE 16-TON LOADS OF SOD OUT OF SOFT FIELDS

Firestone

proved where profit depends on performance

It takes flotation and traction to pull giant 16-ton loads out of soft, slippery fields. Long Island's largest commercial sod grower does it daily—with Firestone tires which he uses exclusively on all his trucks. On the highway, too, Firestones deliver top performance at a low, low cost per mile. In fact, they run 425-million grueling test miles annually to prove the strength of Firestone Shock-Fortified cord and Firestone Rubber-X, longest-wearing rubber ever used in Firestone truck tires. It's true: where profit depends on performance, truckers depend on Firestone tires. Get them at your Firestone Dealer or Store.

Copyright 1960, The Firestone Tire & Rubber Company



Transport*
*Firestone T.M.

Super Mileage Lug*

Super All Traction*

Rib Excavator*

Rock Grip Excavator*

All Traction*

*Here's owner proof of
Firestone truck tire
performance!*



LUMBER PRODUCTS HAULER: Maury Goodloe, Chicago, Illinois. "Running 2,000 miles a week over Route # 66 can be murder on tires. That's why we've switched to Firestones. They can really take the torture."



PRODUCE HAULER: John Romkema, Grand Rapids, Michigan. "Getting fresh produce to market on time demands a tight schedule. I can't afford any delays with tire trouble. That's why I'm 100 per cent on Firestones."



GRAVEL HAULER: Grove Lawson, Des Moines, Iowa. "I've never had a Firestone blow-out in all the years I've used them on my truck. I would recommend Firestones to anyone on the basis of the performance they've given me."



GUIDE TO THIS ISSUE

With Sources of New Products

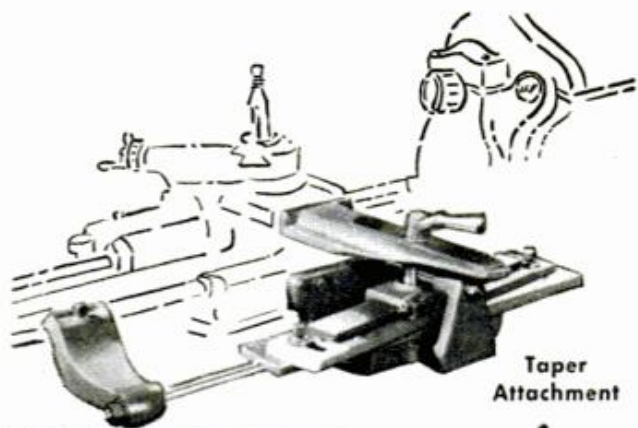

Taper Attachment

Get More Work out of Your Lathe

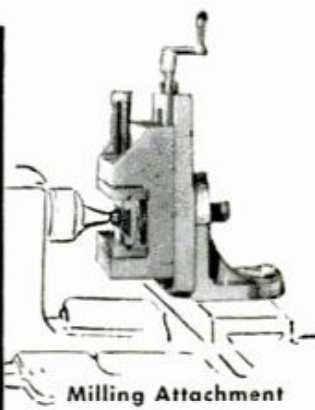

Milling Attachment



Steady Rest

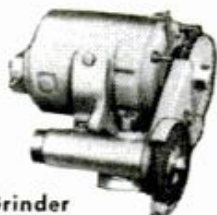

External Grinder



Live Centers

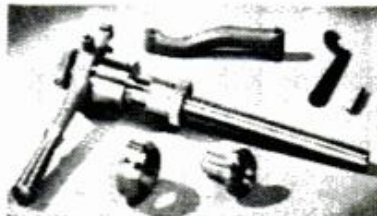

Handlever Collet Attachment

Use South Bend Attachments to . . .

Cut Machining Time • Simplify Difficult Jobs
Speed up Tooling • Handle More Types of Jobs • Perform Non-lathe Operations

Write for complete information on the largest selection of lathe attachments, tools and accessories made.

SOUTH BEND LATHE

South Bend Lathe, Inc., South Bend 22, Indiana

Builders of Lathes, Milling Machines, Shapers, Drill Presses, Pedestal Grinders

Up to 36 months to pay



Look! no splash!.....	116
Compact projector for slides with sound ("Mite-E-Mite" DuKane Corp., St. Charles, Ill.).....	116
Custom tail pipes from straight pipe (Nu-Era Corp., Rochester, Mich.).....	116
Flying saucer? well, yes and no (Avro Aircraft, Ltd., Box 4004, Terminal A. Toronto, Ontario).....	122
Double-duty pump handles liquids or air.....	122
Arrester system for jets remodeled for air transports.....	125
Projects light beam brighter than the sun.....	125
Master of the woodcut.....	126
Big pipe cleaner.....	128
Boating on the railroad.....	128
Pay-TV decoder.....	128
Jets use runway three days old.....	134
Tank trucks load fuels from pipelines.....	134
Atomic rocket launcher.....	135
Luxury home for the road.....	136
Simple chemical treatment restores old books and manuscripts.....	143
"Power wheel" for bicycle (Propo-wheel, D. S. Kuehl & Son, 5959 Howard St., LaGrange, Ill.).....	144
Trailer with a "basement".....	144
Chemical "glues" sand down (Pacific Assoc., P. O. Box 2538, Airport Springs, Calif.).....	145
Typewriter for Eskimo dialect.....	145
"Poly" coddles plants (Mr. Troy Gary, Route 1, Box PHC, Santa Paula, Calif.).....	146
Operator services cars and observes the stars.....	148
Alarm system maps A-blasts.....	149
Rub-a-dub-dub, a motorized tub.....	149
Wigwag warns driver of unsafe air brakes (Monroe Standard, Inc., Wyandot Bldg., Galion, Ohio).....	149
Electrocutor kills insects (Ram Meter, Inc., 1100 Hilton Rd., Ferndale, Detroit 20, Mich.).....	154
Newark airport gets 150-foot control tower.....	154
King-sized vacuum unlocks boat hold.....	155
Movie projector is also a viewer (The Kalart Co., Inc., Plainville, Conn.).....	155
Truck reaches high to unload cargo.....	155
Audience turns toward action in seating bowl.....	158
Car slide sideways in parking garage.....	158
Do-it-yourself kit.....	159
Rapid-fire field gun for marine corps.....	159
"Half built" ranch house (Finest Mfg. Co., Leesburg, Fla.).....	184
Winterproof your air conditioner.....	195
Louvers in color.....	200
It warns you when the sump pump fails (K. C. Joylin Co., 238 E. Irving Park Rd., Wooddale, Ill.).....	201
Prefinish wall paneling this easy way.....	213
Plastic spray protects book covers.....	213
They're off and running.....	214
Garments kept on line when airing outside.....	218
Removable heat shield for barbecue grill.....	218
Cord holder for electrical appliances.....	218
Glue prevented from hardening.....	218
Painting areas that are difficult to reach.....	218
Safe place for hot pressing iron.....	219
House mouse trap.....	219
Carpet laying time.....	219
Avoid periodic oiling of squeeking door hinges.....	219
Paper cone aids printing.....	220
Cord indicates distance.....	220
Towel protects enlarger cover.....	220
Pointing board for leads.....	220
Luggage rack for the guest room.....	221
Sheath protects steel square.....	222
Can of corn attracts fish.....	222
Braille yardstick.....	222
Attaching hinge to plywood edge.....	222
Strap wrench turns, holds, clamps anything.....	223

(Continued to page 8)

Are You "STANDING STILL" on your job?

**SAME OLD
JOB . . .
SAME LOW
PAY . . . ?**

You can justify a real pay raise and a better position—by making one simple move—the move that opens the way to more earnings and promotions—*practical training*.

If YOU are "standing still" on your job—no promotions—only token increases in pay—then you had better do something about it. You know that if you are untrained, your chances of getting ahead are slim. **NOW IS THE TIME TO PREPARE.**

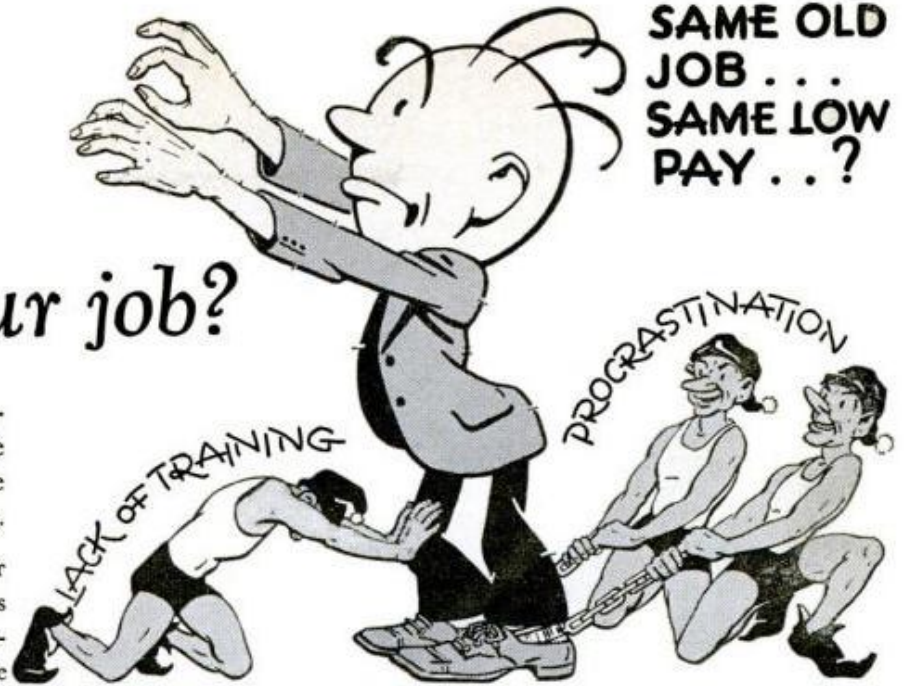

WILL RECOGNITION COME?

The only answer, as you know, is that success *does* come to the man or woman who is really *trained*. LaSalle has provided the "key to success" for many thousands of ambitious people who have sought our training for more than fifty years.

Get all the facts. Investigate the opportunities in your chosen field. It costs you nothing to learn about LaSalle's proven and tested accredited correspondence courses in the major fields of business. You can train right in the privacy of your own home, progressing at your own rate.

You lose no time from work, and your instructors guide you every step along the way through our famous Practical Problem Method. Low cost—easy terms.

Don't let promotions pass you by—do something **TODAY** about your future.

LaSalle

EXTENSION UNIVERSITY
A CORRESPONDENCE INSTITUTION

417 So. Dearborn St. Dept. 1064X Chicago 5, Ill.

The coupon below is for your convenience. Simply mark the program in which you are most interested, and mail at once. We'll send you, without obligation, free booklets describing that field together with the opportunities and what you must know to be a success.

ACCREDITED MEMBER, NATIONAL HOME STUDY COUNCIL

LA SALLE EXTENSION UNIVERSITY, A Correspondence Institution
417 South Dearborn Street, Dept. 1064X Chicago 5, Illinois

Please send me your booklet describing the program I have checked below:

ACCOUNTING

- Modern Bookkeeping
- Basic Accounting
- Practical Accounting
- Principles of Acctg.
- Cost Accounting
- Federal Income Tax
- Accounting Systems
- Business Law
- Auditing Procedure
- Controllorship
- CPA Training
- Complete Accounting

TRAFFIC & TRANSPORTATION

- Organization & Mgt.
- Classification, Rates & Tariffs
- Transportation Agcy. & Services
- Transportation Law & Regulation
- Rate Making & Rate Cases
- Complete Traffic & Transportation

LAW

- Law of Contracts
- Insurance Law
- Claim Adjusting Law
- Law for Trust Officers
- Business Law I
- Business Law II
- General Law
- First Year Law
- American Law and Procedure (LL.B. Degree)

FOREMANSHIP & PRODUCTION METHODS

- Foremanship Training

STENOTYPE

(machine shorthand)

- Secretarial

SALESMANSHIP

- LaSalle Sales Training

BUSINESS MANAGEMENT

- Principles of Management
- Psychology in Business
- Selling & Sales Management
- Advertising and Marketing
- Production Problems
- Business Financing
- Credits and Collections
- Office Management
- Managing Men
- Accounting & Statistical Control
- Business Correspondence
- Organization & Reorganization
- Legal Problems
- Complete Business Management

MANAGEMENT COURSES

- Basic Management
- Production Management
- Sales Management
- Advertising & Sales Promotion
- Financial Management
- Personnel Management
- Sales & Executive Training

Name.....Age.....

Address.....

City, Zone, State.....

TOP TO BOTTOM/Style 1150, Style 888 (Style 780 similar to 888 with eyelets instead of hooks), Style 784



Pass inspection
on the job in...

RANGER

**Workday Shoes
with the Saturday Look**

Now Ranger gives you work shoes that will take a beating on the job... yet are so light and dressy they feel like those comfortable shoes you wear on those hours "on your own." All the styles you see above feature soft-as-a-glove Spice Tan uppers, light cushion crepe soles, springy cushion insoles. Your size and width cost just

\$12.95 to \$17.95

Write for the name of your nearest Ranger dealer.
Endicott Johnson Corporation, Endicott 1, New York.

Trouble shooting the tough ones.....	224
Loose pump-arm screw.....	225
Hard starting	225
Sticking ignition switch.....	225
Removing spring retainer.....	225
Pilot assures accurate drilling.....	226
Crush-proof shield for plug cap.....	226
A patch for Tillie.....	227
Fluxless soldering at last (Chemalloy Electronics Corp., Gillespie Airport, Santee, Calif.).....	228
Small parts held in place for weld fabricating.....	230
Scale cemented to yardstick.....	230
Four-step pulley supports clamp.....	230
Tape reinforces sandpaper edges.....	230
Combination shop tool.....	231
Haystack skidded to feed lot.....	233
Extendable drawbar for farm trailer.....	233
Lathe doubles as metal shear.....	234
Electronics are built-in, too!.....	236
Powdered paint	256

NOTICE—It is the intention of this magazine to provide its readers with information regarding the latest developments in the mechanical arts. Except where otherwise indicated, this magazine has no information as to any unexpired patents in respect of the developments reported herein. In the event that commercial use is to be made of any of the developments reported herein, it is suggested that legal counsel be consulted to avoid liability for patent infringement. It is not the purpose of this magazine to encourage patent infringement but, as indicated, it is the intention of this magazine to report on the latest developments in the mechanical arts.

Trencher Digs by Itself



Davis Mfg., Inc., 1500 McLean Blvd., Wichita, Kans.

Built for small jobs that would be too uneconomical for larger equipment, a trench digger is self-powered, self-propelled and portable. A winch line is laid along the ground where the trench is to be dug and hooked to a stake. The motor is started, and the digger, driven by a simple six-speed winch mechanism, draws itself straight down the line toward the stake. Its trenches, which are as much as four inches wide and a yard deep, are used for electric and telephone lines, gas and water pipes, lawn sprinkling systems, yard lights and other small jobs.

For a Successful Career in Radio-Television Electronics

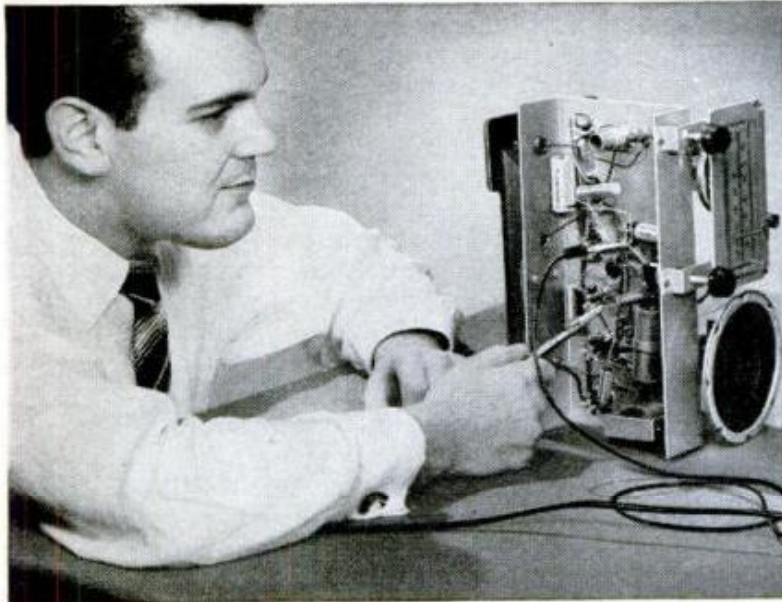

Train at Home
in Spare Time
with N. R. I.
**OLDEST and
LARGEST**
Home Study Radio-Television School

N.R.I. Trained These Men

Prosperous Fast Growing Industry Offers You GOOD PAY-BRIGHT FUTURE-SUCCESS

ENGINEER STATION WHPE
"Thanks to NRI, I operated a successful Radio repair shop. Now I am an engineer for WHPE."
VAN W. WORKMAN, HIGH POINT, NORTH CAROLINA



It's the trained man who gets ahead—gets the better job, drives a better car, lives in a better home, is respected for what he knows and can do. For a job with a future—find out how you can train at home for Radio-Television.

at home in spare time for Radio-TV. With NRI 50-50 method, you study basic principles AND learn by practicing with actual equipment NRI furnishes. You learn with your hands and your head. You get dependable training, backed up by the reputation of the oldest and largest home study Radio-TV school.



QUICK SPARE TIME CASH

"Knew nothing about Radio-TV when I enrolled. After 15 lessons started repairing sets. My future looks bright."
DONALD B. ACKERMAN, MINNEAPOLIS, MINNESOTA

TODAY'S OPPORTUNITY FIELD

Training PLUS OPPORTUNITY is the ideal combination for success. And today's OPPORTUNITY field is Radio-Television. Over 125 million home Radios plus 30 million sets in cars, plus 40 million TV sets mean big money for trained Technicians. More than 4,000 Radio and TV broadcasting stations offer interesting and important positions. Color television, portable TV sets, Hi-Fi, assure future growth. Find out about NRI. Since 1914—for more than 40 years—NRI has been training ambitious men

ADD TO YOUR INCOME SOON \$10-\$15 A WEEK IN SPARE TIME

Soon after enrolling many start earning extra money fixing sets. Many open their own full time Radio-TV shops after getting NRI Diploma. MAIL COUPON. Get FREE Sample Lesson and 64-page Catalog showing equipment supplied, outlines of courses, opportunities in Radio-TV. Price is low—terms easy. Address: NATIONAL RADIO INSTITUTE, Dept. OKA, Washington 16, D. C.

HAS OWN TV BUSINESS
"Quit my job to do Television work full time. I love it and do all right financially."
WILLIAM F. KLINE, CINCINNATI, OHIO



You Learn Servicing—Broadcasting at Home—By Practicing with Kits N.R.I. Sends



Nothing takes the place of practical experience. That's why NRI training is Learning-by-Doing. With Servicing Course you build Radio shown at top and other equipment. With Communications Course you build Transmitters at left and other equipment. Catalog shows all equipment you get.

Available To
VETERANS
Under G.I. Bills



SAMPLE LESSON AND CATALOG **FREE**

MAIL COUPON TODAY

National Radio Institute
Dept. OKA, Washington 16, D. C.

Mail me Sample Lesson and 64-Page Catalog FREE. (No salesman will call. Please write plainly.)

Name _____ Age _____

Address _____

City _____ Zone _____ State _____

ACCREDITED MEMBER, NATIONAL HOME STUDY COUNCIL

When the light says "go"
but your car says "no"



Clean your carburetor with **GUMOUT**

Car behaving like a balky mule? Maybe it stalls, starts hard, picks up slow, wastes gasoline. Chances are your carburetor is dirty! Gum and varnish build up in your carburetor every mile you drive . . . rob your car of pep and power.

GUMOUT CLEANS YOUR CARBURETOR...WHILE YOU DRIVE

Just add a can of GUMOUT to your gas tank. It dissolves the gum and varnish . . . gives you easier starts, smoother running, better gas mileage, too! Millions of motorists use GUMOUT regularly. Ask for it at your Service Station or Auto Supply Store.



GUMOUT DIVISION

PENNSYLVANIA REFINING CO., CLEVELAND 4, OHIO

Home Is the Hunter—In Orange

That red hunting coat may not be giving you the protection you think, according to Army tests in which 30,154 observations were made by military personnel to determine what colors were most visible to the most people. Eight percent of the observers were color-blind in varying degrees, but even they could see the winning color, a fluorescent "blaze orange." Second was a fluorescent "neon red," with the traditional red and yellow scoring lowest of any colors used. In the nonfluorescent colors, the bright shades of orange and red were found most visible—the brighter the better. The yellows tested were found to be even dangerous when hunting deer, since many hunters mistake light color for white when it is seen briefly through brush, and a deer hunter looks for the fleeting white tail of a running deer. The tests, run at Fort Devens, Mass., are to be followed by another series under snow conditions.

How Much Energy Is She Using?



Authenticated News photo

Student-teachers at Bwiru Girls Secondary School in Mwanza, Tanganyika, Africa, wear portable breath-collectors strapped to their backs while doing chores. The purpose is to find how much energy is used during manual labor. The results will help establish nutritional needs. As she works, each volunteer wears a clamp on her nose and breathes through a mouthpiece into a bladder. About .3 percent of each breath is collected during the 20-minute tests. The amount of oxygen mixed with the carbon dioxide and nitrogen helps calculate how many calories of energy have been burned up during the test.

You'll soon be happy in a great new job...

...earning **BIG** money...

...if you start training **NOW** for success in

AIR CONDITIONING AND REFRIGERATION

You could be earning top pay in months. It's mostly a matter of getting your training now. Your best bet is to be a mechanic in the air conditioning and refrigeration field. This industry is growing so fast that *20,000 newly trained mechanics are needed each year*. Over 150 million units are in use; over 5 million new air conditioners, freezers and refrigerators are sold annually. Skilled men are desperately needed for installation and repair work. Be a mechanic! *Mail coupon for free success booklets on CTI's amazing new Home Training Plan.*



You can earn cash during your training

Because CTI training is so *practical*, you'll soon be making profitable service calls. Perhaps you'll work on your own. Or, you may prefer to get a part-time job with a local appliance dealer or air conditioning contractor. You can add to your present income this way. With extra cash, you can buy additional shop equipment, pay your tuition, even bank money.



You could go in business and be independent

Own a business—and enjoy independence! Thrill to the satisfaction of being the boss. Give orders—not take them! The refrigeration field is ideal for getting started on your own. You can make friends as you make service calls. In time, you'll have a list of potential customers. You can also sign service contracts with food stores, taverns, restaurants, etc. Ever so many CTI graduates have their own successful shops. Most of them began with nothing more than their new training and pluck. You, too, can start small and grow big. Be a business man!

You could get into the profitable new auto air conditioning field

Hundreds of thousands of new cars are being equipped with air conditioners. Auto dealers are advertising for skilled refrigeration mechanics, offering premium pay, to set up service departments. Or, you can go in business for yourself, and contract with auto agencies to do this type of installation and repair. You can make big profits either way.



This is the home of CTI, one of the world's great home study schools. Through this Institute you receive "training you can trust." Over 40,000 career graduates from coast to coast.

COMMERCIAL TRADES INSTITUTE
1400 Greenleaf Avenue • Chicago 26, Illinois

FIRST GET THE FACTS—THEN DECIDE
Mail Coupon Today for 2 Free Booklets

ONLY CTI SENDS PARTS
AND TOOLS TO BUILD A
CONDENSING UNIT!



You learn fast because you practice with real equipment—Get experience

You train at home in spare time. No need to give up your present job; no need to leave home to attend a resident school. *CTI sends 25 kits of parts and tools to build a heavy-duty, commercial-type, 1/4 h.p. refrigeration high-side (illustrated above.)* You do 10 troubleshooting and service jobs—it's almost like field training!

After assembling and working projects with your unit, you may build an air conditioner, refrigerator, freezer, or milk cooler. *All parts and tools are sent without extra charge—they are yours to use and keep.*

You get all these quality mechanic's tools



You get special "tools of the trade" as part of your training. Included is a pressure gauge, vacuum gauge and testing manifold. You'll use these tools to assemble and test the condensing unit. Thus, you get not just tools—but *equipment to practice with.* (Why settle for one without the other?)

You must look into your opportunities

Thousands of CTI graduates (and students) tell us they are getting better jobs, earning more money, working steady. Many are going in business. It is surprising how many report the best benefit of all is that they gained self-confidence. With so much at stake, can you afford to neglect *your opportunities?* Isn't it worth a few minutes of your time to *find out?* Just fill out and mail the handy coupon! Be sure to act today.

COMMERCIAL TRADES INSTITUTE

1400 GREENLEAF AVENUE
CHICAGO 26, ILLINOIS

DEPT. R-784

Send me your two opportunity booklets, *Success in Air Conditioning & Refrigeration*, and *Lesson Sample*. Both **FREE**.

Name _____ Age _____

Address _____

City _____ Zone _____ State _____



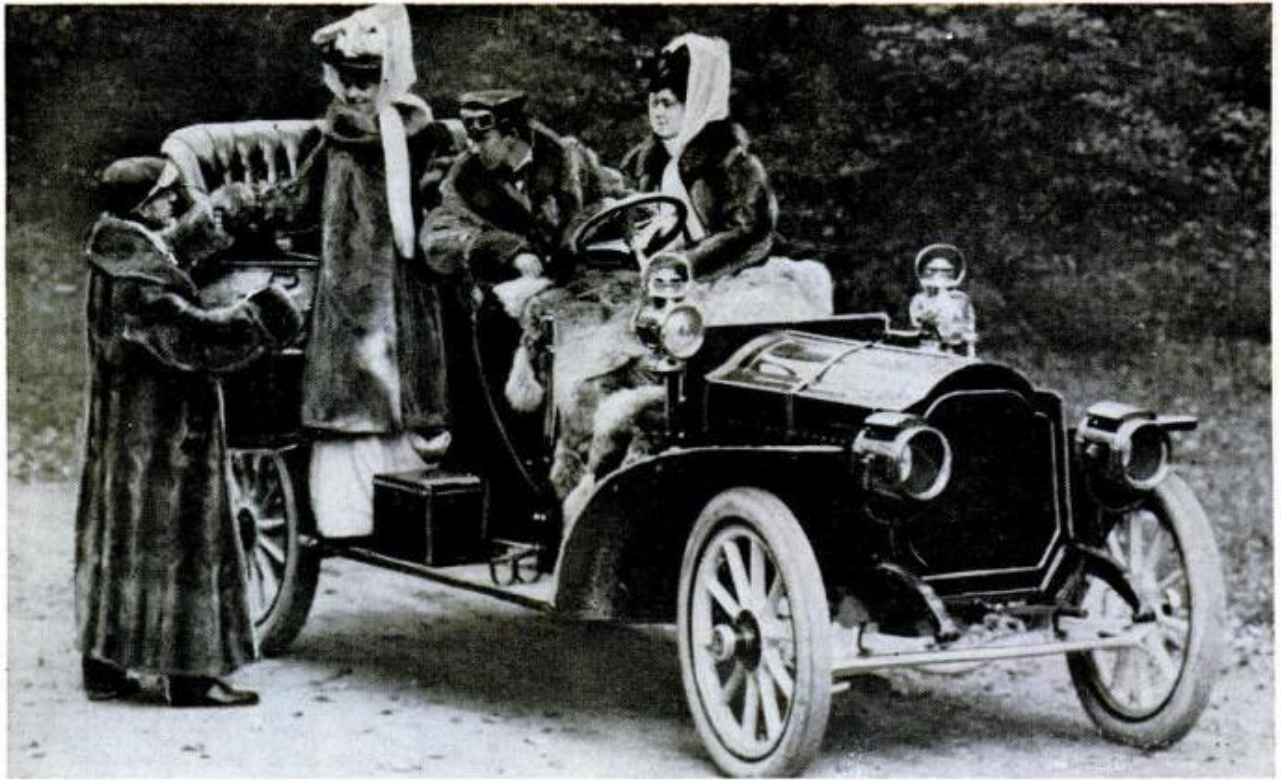

Do You Know This Old-Timer?

Everybody recognizes this car. One famed feature makes its identity apparent. No, the scene is not Yellowstone and that is not a tame bear begging for food. It's a

normal, richer-than-average man begging his lady to stroll with him through the park. Let's hope they're not mistaken for bears. The car name? See page 298.



WOLVERINE'S SECRET TRIPLE-TANNING PROCESS TANS NATURALLY TOUGH HORSE-HIDE AND PIGSKIN SUPER SOFT TO STAY SOFT -EVEN DRY SOFT AFTER SOAKING.

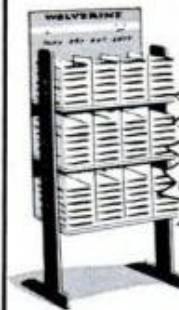

WOLVERINE OFFERS THE MOST COMPLETE LINE OF HORSEHIDE, PIGSKIN, STEERHIDE AND BUCKSKIN GLOVES AVAILABLE - ALL LONG ON WEAR ... LOW IN PRICE!

Check these features



GET SURE GRIP OF THE WHEEL, FREER ACTION WITH SOFT FULL-GRAIN HORSEHIDE GLOVES. KEYSTONE THUMB ELIMINATES CHAFING. GREAT FOR HANDYMEN, TOO!



RUGGED CONSTRUCTION WORK DEMANDS THIS HEAVYWEIGHT SUEDE PIGSKIN GLOVE. TOUGH LEATHER KNUCKLE STRAP, TIPS, SHIELD, THUMB AND INDEX FINGER MEANS MONEY-SAVING EXTRA WEAR.

ONCE YOU WEAR 'EM, YOU WON'T BE WITHOUT 'EM!
AT STORES EVERYWHERE.

WOLVERINE GLOVES

Wolverine Shoe and Tanning Corp., Rockford, Mich. - Canada: Huck Glove Co., Kitchener, Ont.

**NOW...GET
EVERYTHING
YOU NEED TO
PREPARE TO EARN
REAL MONEY IN**

ELECTRONICS

**From RADIO • TELEVISION • RADAR
To GUIDED MISSILE CONTROL, etc.**

One of
Today's
BRIGHTEST
Opportunity Fields!



Today's great Electronics field offers you a chance of a lifetime to prepare for highly interesting work and a wonderfully promising future! With so many new developments coming up in Electronics, opportunities for trained men were never brighter. Send coupon for details.

Right in your own home you may now get one of today's most interesting . . . PRACTICAL WAYS to prepare for a good job or your own business in Electronics. No previous technical experience or advanced education are needed! DeVry Tech brings you a unique 3-WAY COMBINATION of texts, home movies and real equipment—the same type of basic equipment as found in our well-equipped Chicago and Toronto Laboratories.

EMPLOYMENT SERVICE
. . . helps you get started toward a good job, or toward advancement in the company you now work for. FREE to all graduates.

EARN WHILE YOU LEARN
DeVry Tech's practical program helps you to earn EXTRA MONEY in your spare time, servicing Radio and TV sets.

Your Guide

to PROFITABLE JOB OPPORTUNITIES

See how YOU may get ready for Jobs as:

- TV-Radio Broadcast Technician
- Color Television Specialist
- Radar Operator • Laboratory Technician
- Airline Radio Man • Computer Specialist
- Quality Control Manager

Your Own Sales & Service Shop... PLUS MANY OTHERS

SEND FOR FREE BOOKLET!

One of North America's Foremost Electronics Training Centers"



Accredited Member of
National Home
Study Council

**DeVRY TECHNICAL
INSTITUTE**
CHICAGO 41, ILLINOIS

300 EXPERIMENTS

Build over 300 practical projects from many shipments of Radio-Electronic parts. You build and operate TV-Radio circuits . . . wireless microphone . . . and many other major projects—all designed to provide outstanding practical experience at home.



HOME MOVIES

Thanks to this exclusive home training aid, many important fundamentals quickly become "movie clear." Now you can actually see electrons on the march and other "hidden actions"—a wonderful advantage that is almost like having a teacher at your side.



BUILD YOUR OWN TEST EQUIPMENT

As part of your home laboratory projects, you BUILD and KEEP a fine quality 5-inch COLOR OSCILLOSCOPE and a Jewel Bearing VACUUM TUBE VOLTMETER. You will find this equipment ideal for helping you earn in your spare time while a student—and later when working full time in the field.



BUILD AND KEEP A BIG 21-INCH TV SET

For added practical experience, you can also build and keep this quality 21-inch TV SET that provides TV reception at its finest (DeVry Tech also offers another home training without the TV set).



MAIL COUPON TODAY!

DeVRY TECHNICAL INSTITUTE
4141 Belmont Avenue, Chicago 41, Ill., Dept. PM-10-Q

Please give me your FREE booklet, "Electronics in Space Travel," and tell me how I may prepare to enter one or more branches of Electronics.

Name _____ Age _____

Street _____ PLEASE PRINT Apt. _____

City _____ Zone _____ State _____

2046 Canadian residents address: DeVry Tech of Canada, Ltd.

970 Lawrence Avenue West, Toronto, Ontario

UNUSUAL BARGAINS

See the Stars, Moon, Planets Close Up!
3" ASTRONOMICAL REFLECTING TELESCOPE
 60 to 180 Power — Famous Mt. Palomar Type! An Unusual Buy!



Assembled—Ready to use! You'll see the Rings of Saturn, the fascinating planet Mars, huge craters on the Moon, Star Clusters, Moons of Jupiter in detail. Galaxies! Equatorial mount with lock on both axes. Aluminized and overcoated 3" diameter high-speed f/10 mirror. Telescope comes equipped with a 60X eyepiece and a mounted Barlow Lens, giving you 60 to 180 power. Low-cost accessory eyepiece available for higher powers. An Optical Finder Telescope, always so essential, is also included. Sturdy, hardwood, portable tripod. FREE

with Scope:—Valuable **STAR CHART** plus 272 page "**HANDBOOK OF HEAVENS**" plus "**HOW TO USE YOUR TELESCOPE**" BOOK.
 Stock No. 85,050-H.....\$29.95 postpaid

KNOW THE TRUTH ABOUT POWER. Telescope experts will confirm that an Astronomical Telescope will only give you practical powers to about 50 or 60 times per inch of objective diameter—powers above this only produce empty magnification — make viewing dim, difficult and unsatisfactory.

4 1/4" ASTRONOMICAL TELESCOPE! UP TO 255 POWER!
 New Vibration-Free Metal Pedestal Mount



With this scope you can see everything as above but with greater power plus will split finer stars. Mirror has twice the light gathering power. Rack and pinion focusing, real equatorial mounting—only one adjustment follows stars! Aluminum tube 6 power finder telescope. 2 standard size eyepieces and mounted Barlow lens give you powers of 40X, 90X, 120X, and 255X. Low-cost accessory eyepiece available for higher powers. FREE with Scope — Valuable **STAR CHART** plus 272 page "**HANDBOOK OF HEAVENS**" plus "**HOW TO USE YOUR TELESCOPE**" BOOK. Shipping wt. 25 lbs.

Stock No. 85,105-H.....\$79.50 f.o.b.

War Surplus American-Made 7x50 Binoculars

Big savings! Brand new! Crystal clear viewing — 7 power. Every optical element is coated. An excellent night glass — the size recommended for satellite viewing. Individual eye focus. Exit pupil 7mm. Approx. field at 1,000 yds. is 376 ft. Carrying case included. American 7 x 50's normally cost \$195. Our war surplus price saves you real money.



Stock No. 1533-H.....only \$55.00 postpd. (Tax included)

Terrific Buy! American Made! OPAQUE PROJECTOR

Projects illustrations up to 3" x 3 1/2" and enlarges them. No film or negatives needed. Projects charts, diagrams, pictures, photos, lettering in full color or black-and-white. Operates on 115 volt, A.C. current. 6-ft. extension cord and plug included, operates on 60 watt bulb, not included. Size 12" x 8" x 4 1/2" wide.



Weight 1 lb., 2 oz. Plastic case with built-in handle.
 Stock No. 70,199-H.....\$7.95 Postpaid

NEW! CIRCULAR SLIDE RULE!
 Pocket Size—Fast—Easy to Use!

Multiples, divides, figures fractions, percentages, squares, cubes, roots, proportions, circumferences, areas, prices, fuel consumption. Faster, easier to learn and use. Directions included.

Stock No. 30,336-H.....\$4.95 postpaid



CIRCULAR DIFFRACTION GRATING JEWELRY
 A Dazzling Rainbow of Color

Shimmering rainbows of gem-like color in jewelry of exquisite beauty—made with CIRCULAR DIFFRACTION GRATING REPLICA. Just as a prism breaks up light into its full range of individual colors, so does the Diffraction Grating.

Stock # 30,349-H Earrings.....\$2.75 Ppd.
 Stock # 30,350-H Cuff Links.....\$2.75 Ppd.
 Stock # 30,372-H Pendant.....\$2.75 Ppd.
 Stock # 30,373-H 2 Pins.....\$2.75 Ppd.
 Stock # 30,390-H Tie-Clasp.....\$2.75 Ppd.



Order by Stock No.—Send Check or M.O.—Money-Back Guarantee
EDMUND SCIENTIFIC CO., Barrington, New Jersey

MAIL COUPON for FREE CATALOG "H"

128 Pages! Over 1000 Bargains!

EDMUND SCIENTIFIC CO., Barrington, N. J.
 Please rush Free Giant Catalog-H.

Name.....

Address.....

City.....Zone.....State.....



Over the Editor's Desk



To the Editor:

I have been reading your magazine and enjoying it for over 25 years. I have found it to be by far the most popular magazine in my waiting room for the last 10. The reason is the clarity of your photos and text in explaining the new aspects of our world.

In the June issue on page 183 you use the word designwise. Please PLEASE PLEASE don't go Madison Avenue on your old friends. The sentence does beautifully without this word and it mars your always excellent style. The father of one of my patients is an English professor in a technical college and he tells me he always uses *PM* as an example of saying things in a straightforward and easily-read way.

Please run this up the flag pole and see who salutes.

Thank you for many hours of fun and aid to my house, repairwise that is.

Dr. Jack M. Breuer
 Ossining, N.Y.

☆☆☆

To the Editor:

I feel that I owe *PM* many thanks for the plans of the "Crusette" in the May 1954 issue. You see, I lost the use of my legs from a broken back caused by a falling tree. I spent a year in the V.A. Hospital.

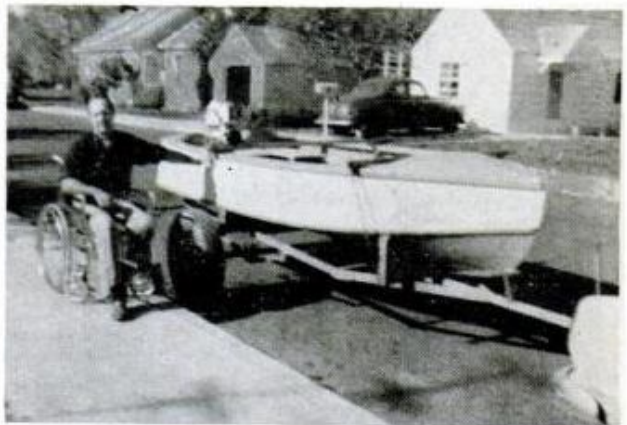

After being released I had more time on my hands than I could take. Some friends gave me about six years back issues of *PM* to read. To build the Crusette sitting in a wheel chair was the challenge I needed for mind and body. I borrowed a welder from a friend and built the trailer also.

Vernon C. Henrichs
 Salem, Ore.

Hats off to Mr. Henrichs!

(Continued to page 16)

“Phase detector of the Moving Target Indicator receiver misaligned on the FPS-3...realignment procedure must be followed.”



YOU MAY HANDLE A SITUATION LIKE THIS...

If you measure up to the Aerospace Team

This man is on a team. And the situation facing the team is a moving target. Mission? Intercept same. This man is an expert. He was given thorough training in his specialty. Now he is a skilled technical specialist with an assured future. He is a man who measured up to the requirements of the Aerospace Team...a man you can depend on.

Are you that man? If you have what it takes, an exciting and interesting career may lie before you. You will be eligible for valuable

training for a key job in the rapidly unfolding age of air and space travel. Also, there will be the opportunity to further your formal education, perhaps even win a college degree—with the Air Force paying a substantial part of your tuition costs.

If you are interested in a career of steady advancement, solid security...a career where you will handle situations of increasing responsibilities, we of the Air Force would like to talk to you. Just clip and mail this coupon.

U.S. AIR FORCE

There's a place for tomorrow's leaders on the Aerospace Team

PASTE COUPON ON POSTCARD AND MAIL TO:

Airman Information, Dept. MM010, Box 7608, Washington 4, D. C.

Please send me more information on my opportunities in the U.S. Air Force. I am between the ages of 17-27 and reside in the U.S.A. or possessions.

Name _____

Address _____

City _____ Zone _____ County _____ State _____

To the Editor:

Within the past year or so you have published designs for children's play houses. Recently you published a design for a small kitchen sink with cabinets.

Some of the house designs appear somewhat "boxy" and I felt, therefore, that you would be interested in the enclosed picture of my attempt to construct a miniature house which would have the proportions of a full-scale house. The scale for most details is one-half; the over-all dimensions being 8 ft. by 16 ft. with 4-ft.-high walls.



The living room is 7½ ft. by 10 ft. and has a miniature fireplace, front and rear doors, the latter opening onto a small patio. The kitchen is 4 ft. by 6 ft. and includes a sink with cabinets, having sliding doors, above and below. A stove and refrigerator are located on each side of the window. A garage, 4 ft. by 6 ft., is located behind the kitchen and is provided with an overhead door. The house is of frame construction with Masonite siding and asphalt-tile roof. The floors are linoleum tile.

E. S. Turner
Ottawa, Ont.

☆☆☆

To the Editor:

Just the other evening I was saying to my fiancée, "Y'know, Honey, scrying is a hazardous occupation." From the look she gave me, I could tell she thought I was kidding her, but the look vanished when I showed her those very words printed on page 250 of the June issue of *PM*. We know that it must be true if *Popular Mechanics* printed it, but one thing bothers us a little: Whazzit mean?

Other than this, thanks for conducting the "Owners Report" section. How about more reports on foreign cars?

Forest P. Clark
Bradford, Pa.

Webster says scrying is "to practice crystal gazing."

To the Editor:

I read with interest your very nice feature on trailer parks, Blue Skies, in particular in the July issue of *Popular Mechanics*. It was gratifying to see the photographs of the "Cathay" oriental model and sketch of same used for the cover.

I am the designer of this model and of seven others for this park. I am at present designing an Egyptian model called the "Pharaoh" for clients in the park.

I certainly would appreciate credit given to me in the next issue of *Popular Mechanics*. It would help me considerably.

Polly di Mayle, A.I.B.D.
Palm Desert, Calif.

☆☆☆

To the Editor:

In your January issue you refer to the 1960 Rolls Royce as being the first V8 Rolls Royce. I beg to differ.

The first V8 R.R. was produced in 1906, at which time most of those great ugly egotistical American motor cars were running round in short pants.

The car in question was a 20 hp. (RAC) V8, producing 20 B.H.P., and governed to a speed of 20 m.p.h., being produced exclusively with Town Carriage coachwork. It was known as the Silent 20.

Harold Hill
Wellington, N.Z.

☆☆☆

To the Editor:

Enclosed are pictures of the pontoon boat I built from *PM* plans of March and April 1959, constructed in three months in spare time. It is powered by a 25 hp. outboard with electric starting and remote control.

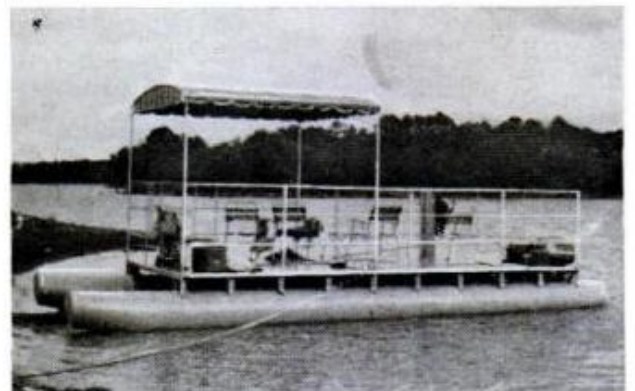

Also I built a trailer to transport it to and from Kerr Reservoir on the Virginia-North Carolina border where we used the boat last summer. The construction is very strong and it practically steers itself. The large deck provides ample space for our lawn furniture and we enjoyed weekends swimming, fishing and picknicking.

Richard O. West
Danville, Va.

Postage
Will Be Paid
by
Addressee

No
Postage Stamp
Necessary
If Mailed in the
United States

BUSINESS REPLY MAIL

FIRST CLASS PERMIT No. 1000, Sec. 34.9 P. L. & R. :: SCRANTON, PA.

INTERNATIONAL CORRESPONDENCE SCHOOLS
SCRANTON 15, PA.



You can cash in on a new career by mailing this postcard today!



Free Career Kit with 3 valuable booklets is yours as a gift from International Correspondence Schools to prove how you can earn more pay, find new opportunity, enjoy real job security. Includes (1) "How to Succeed," career guide, (2) Career catalog of job opportunities, (3) Sample lesson (math) to demonstrate the famous method used by millions of ambitious men and women to achieve lasting success.

SEE OTHER SIDE FOR FULL DETAILS

BOX 48953K, SCRANTON 15, PENNA.

(In Hawaii, reply P.O. Box 418, Honolulu)

(Partial list of courses)

Without cost or obligation, send me "HOW to SUCCEED" and the opportunity booklet about the field BEFORE which I have marked X (plus sample lesson):

ARCHITECTURE and BUILDING CONSTRUCTION

- Air Conditioning
- Architecture
- Arch. Drawing and Designing
- Building Contractor
- Building Estimator
- Carpenter Builder
- Carpentry and Millwork
- Heating
- Painting Contractor
- Plumbing
- Reading Arch. Blueprints

ART

- Commercial Art
- Magazine Illus.
- Sign Painting and Design'g
- Sketching and Painting

AUTOMOTIVE

- Automobile
- Auto Body Rebuilding and Refinishing
- Auto Engine Tuneup
- Auto Electrical Technician
- Diesel Engines

AVIATION

- Aero-Engineering Technology
- Aviation Engine Mech.
- Reading Aircraft Blueprints

BUSINESS

- Accounting
- Advertising
- Bookkeeping and Cost Accounting
- Business Administration
- Business Management
- Clerk Typist
- Creative Salesmanship
- Managing a Small Business
- Professional Secretary
- Public Accounting
- Purchasing Agent
- Real Estate Salesmanship
- Salesmanship
- Salesmanship and Management
- Traffic Management

CHEMICAL

- Analytical Chemistry
- Chemical Engineering
- Chem. Lab. Technician
- General Chemistry

- Oil Field Technology
- Pulp and Paper Making

CIVIL ENGINEERING

- Civil Engineering
- Construction Engineering
- Highway Engineering
- Professional Engineer (Civil)
- Reading Struc. Blueprints
- Sanitary Engineer
- Sewage Plant Operator
- Structural Engineering
- Surveying and Mapping
- Water Works Operator

DRAFTING

- Aircraft Drafting
- Architectural Drafting
- Drafting & Machine Design
- Electrical Drafting
- Electrical Engineer Drafting
- Industrial Piping Drafting
- Mechanical Drafting
- Sheet Metal Drafting

ELECTRICAL

- Electrical Appliance Servicing
- Electrical Engineering

- Electric Motor Repairman
- Elec. Engr. Technician
- Elec. Light and Power
- Practical Electrician
- Practical Lineman
- Professional Engineer

HIGH SCHOOL

- Good English
- High School Diploma
- High School General
- H. S. College Prep. (Eng'r'g & Science)
- High School Math
- High School Science
- Short Story Writing

LEADERSHIP

- Industrial Foremanship
- Industrial Supervision
- Personnel-Labor Relations
- Supervision

MECHANICAL and SHOP

- Diesel Engines
- Gas-Elec. Welding
- Heating and Air Conditioning
- Industrial Engineering
- Industrial Instrumentation

- Industrial Safety
- Machine Shop Practice
- Mechanical Engineering
- Plumbing and Heating
- Professional Engineer
- Quality Control
- Reading Shop Blueprints
- Refrigeration and Air Conditioning
- Tool Design
- Tool Making

RADIO, TELEVISION

- General Electronics Tech.
- Industrial Electronics
- Practical Radio-TV Eng'r'g
- Radio-TV Servicing
- TV Technician

RAILROAD

- General Railroad

STEAM and DIESEL POWER

- Combustion Engineering
- Power Plant Engineer
- Stationary Diesel Engr.
- Stationary Steam Engines

TEXTILE

- General

Name _____ Age _____ Home Address _____

City _____ Zone _____ State _____ Working Hours _____ A.M. to P.M. _____

Occupation _____

Canadian residents send coupon to International Correspondence Schools, Canadian, Ltd., Montreal, Canada. . . . Special low monthly tuition rates to members of the U. S. Armed Forces.

Cast your ballot for a successful future!

249 I.C.S. COURSES



Whether you stand at a machine or sit at a desk . . . whether you're making \$85 a week or \$85 hundred a year . . . whether your interest is Power Plants or Paper Pulp, Advertising or Electronics . . . chances are I. C. S. has exactly the course you need to get ahead.

I. C. S. is not only the oldest and largest correspondence school. It also offers the most courses. 249 in all. Each one success-proved by graduates who rose to top technical and administrative positions. Chief engineers. Superintendents. Foremen. Managers. Executive assistants.

I. C. S. Courses cover bedrock facts and theory plus practical, on-the-job applications. Texts are prepared by leading business and industrial authorities working with I. C. S. editors and educators. They are reviewed and revised in line with current developments.

As an I. C. S. student, you study in your spare time, set your own pace. No time lost getting to class or waiting for slower students to catch up. If you wish, I. C. S. will make progress reports to your employer. You win recognition as a "comer," one who is ready to move ahead. Thousands of students report pay increases and promotions within a few months of enrollment. All graduates win the coveted, approved I. C. S. diploma.

FREE CAREER KIT! Check the subject that interests you in the coupon above. I.C.S. will rush you a free Career Kit including (1) a special booklet outlining your opportunities in this field, (2) the 32-page gold mine of career tips, "How to Succeed;" (3) a sample I. C. S. lesson (math) demonstrating the famous I. C. S. Method. "X" MARKS OPPORTUNITY.



For Real Job Security—Get an I. C. S. Diploma! I. C. S., Scranton 15, Penna.

Accredited Member, National Home Study Council

“NOW EARN 5 per annum $\frac{1}{2}$ % paid quarterly”

**on your savings account...by mail!
it's safe and more profitable”**

*SAYS A. G. NEUMEYER,
President,
First Western Savings*



First Western Savings, Nevada's largest, and Southern Nevada's oldest savings association, operating under the savings and loan laws of the State of Nevada, is able to offer higher than average interest rates because we are located in the fastest growing area in the nation, where dollars are needed to finance our remarkable growth. We pay more for this money and in turn, because of our dynamic growth economy, earn more money on our lending program than would be possible in a slower growing area. Specifically, on December 6, 1959, the United States Census Bureau revealed that our area is growing at 4.1 times the Los Angeles rate, and 10.6 times the national rate!

The current interest paid to First Western savers is: $5\frac{1}{2}$ % per year on accounts of \$5,000 or more, and $5\frac{1}{4}$ % per year on all others.

We have paid substantially higher rates year in and year out to our more than 18,000 prudent savers from all fifty states and fifty-one foreign countries. In fact, this new rate follows 17 consecutive interest payments to First Western savers of 5% per year or more!

Saving by mail at First Western, is easy, and most profitable. We are no further away than your mail box. To open an account send check or money order. To transfer an account from your present financial institution, just send your passbook or certificate to us. We'll attend to all the details.

Remember: at First Western interest is paid quarterly on all accounts. Withdrawals have always been paid instantly. Airmail postage is prepaid both ways. Funds received by the 15th of any month earn from the 1st. \$1.00 opens an account.

Mail funds to:

FIRST WESTERN SAVINGS

AND LOAN ASSOCIATION, DEPT. T

118 Las Vegas Blvd., South, Las Vegas, Nevada • A. G. Neumeyer, Pres.

RESOURCES OVER \$36,000,000.00



FREE!

TRIAL LESSON



Trial lesson in DRAFTING



LEARN AT HOME IN SPARE TIME

Check the want ads in any newspaper — SEE the big-pay opportunities open to you as a draftsman. What's more, you can learn this well-paid, prestige profession at home — quickly, easily! No special talent needed! Get complete, step-by-step Chicago Tech lessons in the mail, spend a few pleasant hours studying each week. In a short time you'll be a well-trained draftsman, ready to take your pick of many good jobs. Act now!

FREE INFORMATION—MAIL COUPON TODAY!

Get FREE TRIAL LESSON plus information about C.T.C. practical training. Learn what successful Chicago Tech graduates say about high pay and opportunities in drafting. No charge, or obligation.

Accredited National Home Study Council

CHICAGO TECHNICAL COLLEGE

N-218 Tech Bldg., 2000 So. Michigan Ave.
Chicago 16, Illinois

Mail me FREE Lesson with information about big opportunities in DRAFTING.

Name..... Age.....

Address

City..... Zone..... State.....

ENGINEERING SCIENCE MATH

DEGREE IN 27 or 36 MOS.



ACCELERATED YEAR-ROUND PROGRAM prepares for early employment in fields of SCIENCE AND ENGINEERING. Regular 4-year program for B.S. Degree completed in 36 months, special engineering degree program in 27. Classes start quarterly — January, March, June, July, Sept. QUALITY EDUCATION. Graduates employed from coast to coast. Government approved for veteran training. Students from 50 states, 49 countries. 20 buildings: dorms, gym. Campus. SAVE TIME AND MONEY. EARN BOARD while studying. Write for catalog and complete information.

INDIANA TECHNICAL COLLEGE

5100 East Washington Boulevard, Fort Wayne 2, Indiana

Please send me free information on Bachelor's Degree Programs in Engineering and Science as checked below:

- | | |
|---|--|
| <input type="checkbox"/> Aeronautical Engineering | <input type="checkbox"/> Mechanical Engineering |
| <input type="checkbox"/> Chemical Engineering | <input type="checkbox"/> Metallurgical Engineering |
| <input type="checkbox"/> Civil Engineering | <input type="checkbox"/> Physics |
| <input type="checkbox"/> Electrical Engineering | <input type="checkbox"/> Chemistry |
| <input type="checkbox"/> Electronic Engineering | <input type="checkbox"/> Mathematics |

Name.....

Address.....



Sidelights from the PENTAGON

By William R. Kreh

SMOG-BOUND Californians, through their tear-stained faces and tortured lungs, may find consolation in the fact that they're helping the Navy guard against submarine attack. A "sniffer" system, being installed on Navy S2F Tracker and P2V Neptune antisubmarine planes, is an outgrowth of an atmosphere sampler developed several years ago to warn Southern Californians when a wave of smog was rolling in. Aboard low-flying planes it can tell if a snorkeling sub is nearby by detecting carbon monoxide given off by its engine. Cruising at about 1500 feet, where surface winds level off, the plane takes about five samples per second. When a photoelectric cell detects the carbon monoxide, the plane dives to attack.

The GI urge to itch may soon be scratched, thanks to a new Army apparatus which can clear a square-mile area of all winged insects — mosquitoes, flies, and the like—in less than 10 minutes. Developed by the Engineer Corps, it throws a poison fog over the countryside. The fog consists of fine particles of DDT or other similarly potent insecticide which is released during favorable winds. The "fogger," driven by a gasoline engine, was developed primarily for sanitation of Army camps in the tropics, but it could also be adapted, the engineers say, for civilian resort areas.

This could easily be misinterpreted, but many wives might agree—it takes 59 rats to equal one man. That's the number of white rats being used to test space capsules because that's the number it takes to use the same amount of oxygen as one human being and give off the same amount of carbon dioxide and moisture in their breath and body heat.

Navy researchers, studying the greatest of all teachers, Nature, have developed a shark

(Continued on page 20)

WHAT ALL AUTO MECHANICS WANT TO KNOW

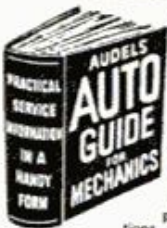

This Big Practical Book gives full information, with working diagrams, covering the principles, construction, ignition, service and repair of modern cars, trucks and buses.

Air Conditioners, Hydraulic & Fluid Drives Fully Explained.

A complete guide of 1132 Pages, with over 1000 Illustrations showing inside views of working parts, with instructions for service jobs. Completely up-to-the-minute! Priced at only \$6.

CIRCLE No. 1 IN COUPON



HOW TO FIX HOME APPLIANCES

REFRIGERATORS WASHERS TOASTERS DRYERS IRONERS RANGES VACUUMS FREEZERS

Many other GAS AND ELECTRIC APPLIANCES



Handy Reference for Electric & Gas Servicemen, Mechanics, Dealers and Homeowners. Explains clearly and simply how to locate troubles, how to test, reassemble and connect. Wiring diagrams, 1000 Facts. Easy to read. Answers ALL your questions. 864 Pages. Illustrated. Only \$6.

CIRCLE No. 2 IN COUPON



TV TELLS HOW TO ANSWER RADIO RADIO T.V. QUESTIONS SERVICE LIBRARY

HERE IS LATEST INFORMATION IN A HANDY FORM FOR RADIO AND TELEVISION REPAIRMEN, SERVICEMEN AND STUDENTS. TWO COMPLETE VOLUMES—1568 Pages—1055 Illustrations and Diagrams. 1001 Important Facts and Figures on Modern T.V., Radio, Electronic Devices. INCLUDES TRANSISTORS & Transistor Circuits, Rectifiers, Record Changers, P.A. Systems, Photograph Pick-ups, F.M., Auto Radio, Short Wave,

Basic principles, Construction, Installation, Operation, Repair, Trouble Shooting, How to get Sharp, Clear T.V. Pictures. Install Aerials, How to Test. Explains COLOR SYSTEMS, Methods of Conversion, Terms, etc. Includes Ultra High Frequency. Quick ready reference or use as a home study course. Only \$8 for BOTH volumes.

CIRCLE No. 3 IN COUPON

OIL BURNERS

New, complete, explaining in detail both domestic and industrial oil burners. Includes electrical hook-ups and wiring diagrams. Fully covering the theory, construction, installation, operation, testing, servicing and repair of all equipment. Indexed for ready reference. Over 415 Pages. 320 Illustrations and Diagrams. Only \$2.

CIRCLE No. 28 IN COUPON



ALL TYPES OF BLUEPRINT READING

How to read scales, the standard symbols, detail and assembly prints, working drawings, short cuts, helps, hints and suggestions. THE MAN WHO CAN READ BLUEPRINTS IS IN LINE FOR A BETTER JOB. This book gives you the secret language, step by step in easy stages. 445 Pages. Very Fully Illustrated. Priced at \$3.

CIRCLE No. 25 IN COUPON

PLUMBERS AND STEAMFITTERS GUIDES

Practical Trade Assistant & Reference Set. Explains in plain language and by clear illustrations, diagrams, charts, graphs and pictures the principles of modern plumbing practice including Pipe Fitting and Air Conditioning. 4 Vols.—2624 Pages—3642 Diagrams & Illustrations. Only \$8 for the complete set of 4 vols.

CIRCLE No. 6 IN COUPON

7-DAY FREE EXAMINATION

SEND NO MONEY—Pay the postman nothing! We are glad to send you any of the Audel Guides for absolutely FREE examination in your own home. We take all the risks and leave all the decisions up to YOU. There is no obligation! If you decide to keep the books of your choice you may pay for them under our astounding easy-pay plan of only \$2 a month.

HERE IS ALL YOU DO

IT'S EASY TO ORDER: In the No-Risk Mail Order Coupon at the right just draw a circle around the number of Audel Guides you want us to send you for FREE EXAMINATION. We will send them to you at once to help you build a brighter future by increasing your SKILL. If for any reason at all you are not COMPLETELY satisfied, return the books to us, and that will end the matter! NO STRINGS OR CATCHES TO THIS OFFER.

THEO. AUDEL & CO.
49 West 23rd Street, New York 10, N.Y.

CARPENTERS AND BUILDERS GUIDES



PRACTICAL STOREHOUSE OF MODERN CONSTRUCTION INFORMATION (4 vol. set) for carpenters and all woodworkers. Explains in easy language and by profuse illustration principles, advances, short cuts, trade secrets, all based on the NEWEST information.

Vol. 1—Tools, steel square, saw filing, joinery, furniture, etc.; Vol. 2—Builders' mathematics, drawing plans, specifications, estimates, etc.; Vol. 3—House and roof framing, laying out, foundations, etc.; Vol. 4—Doors, windows, stair building, millwork, painting, etc. 4 vols. 1904 Pages. 2750 Illustrations. Whole set only \$8. CIRCLE No. 8 IN COUPON

PRACTICAL ELECTRICITY

A COMPLETE HANDBOOK—Quick, simplified, ready reference. Complete instructions and practical information on the rules and laws of electricity—Maintenance of Machinery—A.C. and D.C. Motors—Armatures—Wiring Diagrams—House Lighting—Power Wiring—Meters—Batteries—Transformers—etc. Simple to understand. 1052 Pages. 2600 Illustrations. Priced at \$5. CIRCLE No. 4 IN COUPON

DIESEL

ALL THERE IS TO KNOW ABOUT MODERN DIESEL ENGINES—Basic principles, starting valves, timing, fuel pumps, fuel injection compressor, air compressors, pistons, cylinders, lubrication, cooling systems, etc. Answers on operation, calculations. 640 Pages. Fully Illustrated. Priced \$3. CIRCLE No. 9 IN COUPON

MASONS & BUILDERS GUIDES

A PRACTICAL ILLUSTRATED 4 VOL. SET—Explaining in clear, simple language and profuse illustration, principles, advances, short cuts, trade secrets, based on modern practice—including how to figure and calculate various jobs. Vol. 1—Brick work, bricklaying, bonding, design. Vol. 2—Brick foundations, arches, tile setting, estimating. Vol. 3—Concrete mixing, placing forms, reinforced stucco. Vol. 4—Plastering, stone masonry, steel construction, blueprints. 4 Vols. 1440 Pages. 2067 Illustrations. Complete Set only \$8. CIRCLE No. 26 IN COUPON

MATHEMATICS MADE EASY

A COMPLETE HOME STUDY COURSE—Starting with the first principles of arithmetic, advancing step by step through the various stages of mathematics, including the rules and calculations for mechanical and electrical problems. New EASY correct methods. Includes plane and solid geometry, trigonometry, algebra, calculus, etc. Practical tests, reference tables and data. How to use slide rule. 672 Pages. 550 Illustrations. Priced at only \$3. CIRCLE No. 11 IN COUPON

NEW MACHINISTS AND TOOLMAKERS HANDBOOK

MODERN MACHINE SHOP PRACTICE—For every Machinist, Toolmaker, Draftsman or Student. Tells how to set up and operate lathes, shapers and milling machines, shapers, drill presses and all other machine tools. A COMPLETE INSTRUCTOR AND REFERENCE BOOK 1250 Pages. Fully Illustrated. Priced at only \$6. CIRCLE No. 12 IN COUPON

ELECTRIC MOTORS

THIS GUIDE covers the construction, hook-ups, control, maintenance and trouble shooting of all types of motors. Includes armature winding. Explains entire subject in great detail in simple language. Over 1056 Pages of information. 617 Diagrams. All types of motors fully illustrated and indexed for ready reference. Priced at only \$5. CIRCLE No. 27 IN COUPON

REFRIGERATION & AIR CONDITIONING

FOUR BOOKS IN ONE—basic principles, servicing, operation, repair of: 1. Household Refrigeration. 2. Special Refrigeration Units. 3. Commercial & Industrial Refrigeration. 4. Air Conditioning Systems. A GOLD MINE of essential information. Completely up-to-date. 1560 Pages. Fully Illustrated and Indexed. Priced at only \$6. CIRCLE No. 14 IN COUPON

New MECHANICAL DICTIONARY

THE AUTHORITATIVE WORD BOOK FOR MECHANICS TECHNICIANS AND STUDENTS

With the revolutionary progress being made today in all mechanical fields, new words and phrases come into use. Any mechanic who wants to be up to date must know this new trade language.

Audel's New Mechanical Dictionary gives you all these new words and also the old. Every mechanic will find his job made easier if he knows the exact meaning and use of technical words that come up every day at work. It is an engineer's shop companion and a student's guide.

TABLES, FORMULAS, PROCESSES AND PRACTICAL SUGGESTIONS

Constant use of Audel's New Mechanical Dictionary will increase your knowledge and skill in a matter of days without any conscious effort on your part. The right word at the right time is like the right tool—be sure you have it and use it! Defines 17,000 words—terms phrases—rules and formulas, 712 pages only \$6.95.

CIRCLE No. 44 IN COUPON

THE NEW ELECTRIC LIBRARY

A COMPLETE ENCYCLOPEDIA explaining in the simplest terms the fundamental principles, rules and applications of applied electricity.

A COMPLETE COLLEGE EDUCATION!

Fully illustrated with diagrams and sketches, calculations and tables for ready reference. Questions and answers. Trial tests for practice study and review. All based on the most modern theory.

Vol. 1—Principles and rules of electricity, magnetism, armatures, repairs, etc. No. 15

Vol. 2—Dynamoes, DC Motors, construction, installation, maintenance, etc. No. 16

Vol. 3—Testing instruments and tests, storage battery constr. and repairs. No. 17

Vol. 4—Alternating current, power factor, alternators, transformers. No. 18

Vol. 5—A.C. Motors, windings, maintenance, converters, switches, fuses, etc. No. 19

Vol. 6—Relays, condensers, regulators, rectifiers, meters, switchboards, etc. No. 20

Vol. 7—Wiring, house light and power, circuits, high

tension, plans, code, etc. No. 21

Vol. 8—Railways, signals, elevators, ignition, etc. No. 22

Vol. 9—Radio, telephone, telegraph, television, motion pictures. No. 23

Vol. 10—Refrigeration, illumination, welding, x-ray, electrical appliances, Index. No. 24

6,000 fully illustrated pages. Priced at only \$20 for the ENTIRE SET. Also sold individually for \$2 each.

CIRCLE No. 44 IN COUPON

tion, plans, code, etc. No. 21

Vol. 8—Railways, signals, elevators, ignition, etc. No. 22

Vol. 9—Radio, telephone, telegraph, television, motion pictures. No. 23

Vol. 10—Refrigeration, illumination, welding, x-ray, electrical appliances, Index. No. 24

6,000 fully illustrated pages. Priced at only \$20 for the ENTIRE SET. Also sold individually for \$2 each.

CIRCLE No. 44 IN COUPON

WELDERS GUIDE—Covers Electric, Oxy-acetylene, Thermit, Unionmelt welding for sheet metal, spot and pipe welds, pressure vessels and aluminum, copper, brass, bronze and other metals. Airplane work, surface hardening, hard facing, cutting, brazing, etc. 608 Pages. Fully Illustrated. Only \$3. CIRCLE No. 10 IN COUPON

ADDITIONAL IMPORTANT TITLES

The following Audel Guides are all the best in their fields, written in clear simple fashion, all lavishly illustrated. Circle the numbers wanted in the MAIL ORDER COUPON below. All books are sent for FREE EXAMINATION.

No. 5 TRUCK & TRACTOR GUIDE. 1376 Pages	\$5.00
No. 7 PAINTING & DECORATING MANUAL. 417 Pages	3.00
No. 13 WIRING DIAGRAMS (Light & Power). 304 Pages	2.00
No. 29 SHEET METAL PATTERN LAYOUTS. 1152 Pages	7.50
No. 30 SHEET METAL WORKERS HANDY BOOK. 448 pages	2.00
No. 31 MECHANICAL DRAWING GUIDE. 192 Pages	2.00
No. 32 MECHANICAL DRAWING AND DESIGN. 410 Pages	3.00
No. 33 ELECTRONIC DEVICES. 304 Pages	3.00
No. 34 ELECTRICIANS EXAMINATIONS. 272 Pages	2.00
No. 35 ELECTRIC POWER CALCULATIONS. Page 480	3.00
No. 36 ELECTRIC DICTIONARY. 9000 Terms	3.00
No. 37 POWER PLANT ENGINEERS GUIDE. 1568 Pages	5.00
No. 38 ENGINEERS AND FIREMANS EXAMS. 544 Pages	2.00
No. 39 OPERATING ENGINEERS LIBRARY. 3 Book Set	12.00
No. 40 PUMPS, HYDRAULICS AND AIR COMPRESSORS. 1760 Pages	6.00
No. 41 HOUSE HEATING GUIDE. 966 Pages	5.00
No. 42 MILLWRIGHTS & MECHANICS GUIDE. 1248 Pages	5.00
No. 43 DO-IT-YOURSELF ENCYCLOPEDIA. 2 Book Set	8.95

MAIL THIS NO-RISK COUPON TODAY!

THEO. AUDEL & CO.—Self Improvement Publishers Since 1879— P10 1 2 3 4 5 6
49 W. 23rd Street, New York 10, N.Y.

Please mail me for 7 days' FREE EXAMINATION the books I have circled at right. I agree to mail \$2 in 7 days on each book or set ordered, and to further mail \$2 a month on each book or set ordered until I have paid the purchase price, plus shipping costs. If I am not completely satisfied with my Audel Guides I may return them.

NAME _____ 17 18 19 20 21

ADDRESS _____ 22 23 24 25 26

OCCUPATION _____ 27 28 29 30 31

EMPLOYED BY _____ 32 33 34 35 36

SAVE SHIPPING COSTS! Check here if you enclose complete payment with order. We pay postage charges. You have same return privilege. 37 38 39 40 41 42 43 44

Short Cut TO A Good Job

Learn Auto Mechanics at Home in Spare Time

The auto-repair industry makes it easy for you to gain success! Consider the rewards: A mechanic earns excellent pay—up to \$3 an hour. He works steady—there are 100,000 job opportunities. He can go in business—America needs 25,000 more shops.



Let CTI train you at home. Along with simple, illustrated lessons, you get professional Mechanic's Tools and fine-quality Testing Instruments. CTI also includes instruction on Diesel Mechanics or Body & Fender Rebuilding at no extra cost. You may earn cash as you train. Mail coupon today for booklet and lesson samples.

COMMERCIAL TRADES INSTITUTE Dept. A-65
1400 Greenleaf Avenue • Chicago 26, Illinois
Send booklet, Make Big Money in Auto Mechanics.

Name _____ Age _____
Address _____
City _____ Zone _____ State _____
Accredited by National Home Study Council



PROFESSIONAL DEVICE AVAILABLE

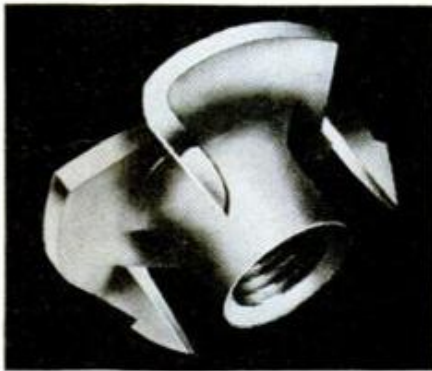

DOT TEENUTS

Use this flush mounted, "can't slip" nut that needs no washer! . . . get the strength of steel threads in wood. Fast, easy, sure. The professional fastener!

Now specified in EASI-BILD PATTERNS

Get them both at Hardware, Variety and Lumber Stores:

Ask for TEENUTS!

COLUMBIA FASTENER COMPANY
Chicago 8, Illinois



repellent that may prove sufficient protection for swimmers and sea crash survivors. The scientists got the idea—and the substance—from the sea cucumber, a lowly animal that protects itself from carnivorous and noxious marine enemies by secreting the substance. In addition, investigators hope to discover the chemical composition of poisons developed by the sea cucumber and the poisonous sea urchin to pave the way for antidotes for these and other marine biological toxins.

A "ghost" ship, a robot that can operate completely without crew, is being studied by the Maritime Administration. The ship would sail unmanned from the point where the pilot is dropped on the outbound trip to the point where another pilot boards it at her destination. The ship could operate completely unmanned for at least 30 days and without major maintenance for 90 days.

Speaking of pilots, probably the most difficult ships they have to guide in and out of harbors are the Naval aircraft carriers. It's chiefly because their island bridges are off to one side of the flight deck, instead of dead center, making it awkward to judge the true fore and aft centerline. The problem is so acute that, when one is going through the Panama Canal, a temporary wooden scaffolding is built on the deck's centerline and connected to the ship's bridge by telephone. The Canal pilots give their orders to a talker in the wheelhouse and the entire operation is thus carried out by remote control.

Air Force Capt. Duane E. Graveline may be the cleanest man in service. He recently spent a week in a tub, although he really didn't need a bath in the first place. Capt. Graveline was submerged, except for his head, in a specially designed tank to study some of the effects of weightlessness on a man's physical resources and responses. Clad in a skindiver's suit, his body was "bugged" with wires to check his heartbeat, respiration, blood pressure and other reactions. During the test, he worked mechanical problems, drank special liquid foods, watched television, and slept. His only break was an hour each day when he changed suits and had his blood pressure and blood tested. His chief reaction was that the hourly break got harder each time; he was weaker each day and found it hard to stand and move.

Army troops will soon be issued a radiation detector 1000 times faster and infinitely smaller than old ones. Made of silicon smaller than a pinhead, it can measure atomic particles and give off an electrical current of warning. ★ ★ ★

Get into...

PLASTIC LAMINATING AT HOME!

Sensational New
**"ONE MAN
BUSINESS"**
...pays \$10 to \$20 profit
for each dollar of cost.

Make Up to \$5 an Hour by
our **MAGIC MAIL PLAN**... get
orders and cash from your mailman!



Here's the newest and most fascinating of all home-operated businesses. For the first time, a simplified machine brings the fabulous profits of Plastic Sealing and Plastic Laminating within the reach of the small operator. Can be

operated in a corner of the kitchen, basement, or garage. And any man or woman, regardless of age, education, or experience—can learn this interesting work in a few minutes of reading—can turn out professional jobs after one hour's practice.

TWO EXCITING FIELDS FOR BIG PROFITS!

No house-to-house canvassing. No face-to-face selling. We not only supply the equipment you need for the work, but also show you exactly how to cash in big daily profits from two big demand fields.

A FORTUNE IN PLASTIC SEALING

Millions of people want to protect valuable cards, photographs, documents and papers against wear, soil, and damage. By our **MAGIC MAIL Plan** you get this business through the mails. Open envelopes and take out money and orders. Details of this plan will amaze you. It will be sent free. Just mail coupon.

ENORMOUS PROFITS IN LAMINATING

A creative, artistic business. Gift shops sell your entire output. Just a few of thousands of giftwares illustrated on this page. Beautiful colors. Endless designs. Exclusive "one of a kind" appeal brings sales at ten to twenty times the cost of materials. Beautiful illustrations and instructions for making these artistic novelties sent free.

**NO MONEY—
Just Send Name!**



WARNER ELECTRIC CO.
1512 Jarvis, Dept. L-2-L Chicago 26, Illinois

The opportunities in Plastic Laminating are so big that space here does not permit even skimming the surface. To get any idea

FREE at all of the size of these markets and your place in this sensational business you must read the details. See for yourself how easy it is to do the work—how you can put plastic sheets into your machine and take out a fortune—how money and orders come to you in the mail—how gift shops clamor to get more and more of your creations—how you can start with one machine and build up a big production plant with others doing the work—how you can get money and business from every State in the Union—how you can achieve independence without study or experience.



RUSH COUPON

Never before has such an opportunity been offered the small, home-operator—an opportunity to gain complete personal independence in a big money business of your own. Don't lose a minute. Get the facts at once. All information, fully illustrated with pictures, is free. Send the coupon—or send your name and address on a postcard. There is no charge now, or at any other time. Send for the information on this exciting opportunity today.



Cash Money Comes to You in the Mail

By our **MAGIC MAIL Plan** you sit at home, send out mail, and get back money and orders. Additional profits in supplying lifetime protection for **SNAPSHOTS—IDENTIFICATION CARDS—DISCHARGE PAPERS—DRIVERS' LICENSES—SOCIAL SECURITY CARDS—VOTERS REG. CARDS—MENUS—BIRTH CERTIFICATES—CREDIT CARDS—BIRTH AND WEDDING ANNOUNCEMENTS—PASSES—DOCUMENTS.**

Lifetime protection. See how laminating prevents soiling, wear, and moisture damage with flexible, plastic covers.



Thousands of Beautiful ART CREATIONS

Made by Laminating as explained in our Free information. Send coupon for list and pictures of **COSTUME JEWELRY—JEWELS—CIGARETTE BOXES—CUFFLINKS—NOVELTY BUTTONS—TRAYS—CANDLESTICKS—COASTERS—CLOCK CASES—LAMP BASES—PICTURE FRAMES—BOOK ENDS—CHARMS—ADVERTISING SIGNS—NAME PLATES—BELT BUCKLES—CHECKERS—PAPER KNIVES—CHESSMEN—BOOKMARKS—TIE RACKS—KEEPSAKES OF ALL KINDS.**

WARNER ELECTRIC CO., Dept. L-2-L
1512 Jarvis Avenue, Chicago 26, Illinois

Please mail, postage prepaid, complete information with illustrations showing the things I can make and the money possibilities in Plastic Laminating. All this is free. No Salesman is to call. Also, tell me how I get orders and money from my Postman by the **MAGIC MAIL Plan.**

NAME _____
ADDRESS _____
CITY _____ ZONE _____ STATE _____

Not everyone does as well, but T. N. CODY, who started a business of his own, reports...

For 12 months I've averaged

\$800

per month income

— most of it clear profit for me!

Many men have discovered how to be independent, to be free of layoffs and bosses. C. G. Naples grossed more than \$200 his first week. A father-son combination grossed \$44,000 their second year. H. Lemon says, "I netted \$133 in one 8-hour day."

How much you make depends largely on you. You need no special skill, no large investment. Start part time if you wish.

NO SHOP NECESSARY • Our Electric Deterger shampoos rugs, carpets right on floor—removes dirt and grime and helps to show their natural color and beauty. So efficient and safe it is used by largest railroads and hotels.

This is not a lease proposition. You own the machine, you work when and where you please and all the money you take in is your own. No risk. Machines fully guaranteed.

Mail
Coupon
Today
for
FREE
Book

VON SCHRADER MFG. CO.,
N10 "R" Pl., Racine, Wis.

Without obligation send me **FREE** booklet about your RUG DETERGER and tell me how I can start my own permanent, profitable business.

Name _____

Address _____

City _____ Zone _____ State _____

LEARN FIBERGLASSING at Home in Spare Time

Interstate's complete home training course in Plastics Fabrication teaches fibreglassing, plastic molding, casting, laminating, internal carving, etc. Shows how to make hundreds of salable articles of plastic. Professionally prepared. Special materials furnished. Send postcard for FREE booklet.

INTERSTATE TRAINING SERVICE
Dept. C-3, Portland 12, Oregon

HOTELS CALL FOR TRAINED MEN

"As a result of Lewis Training, I became Manager of a fine hotel." — M. F. Finch.



Record-breaking travel means nation-wide opportunities and a sound substantial future for trained men in the hotel, motel and hospitality field. Fascinating work; fine living; quick advancement. You can qualify at home or through resident classes in Washington. Previous experience proved unnecessary. Placement Service FREE. Write for FREE Book, "Your Golden Opportunity."

"After Lewis Training, I became Assistant in a fine hotel." — Melvin L. Dalrymple.



Approved for ALL Veteran Training
LEWIS HOTEL TRAINING SCHOOL
Desk FR-312, Wash. 7, D.C. 45th Yr.

Write today for FREE BOOK!

Great Pioneers in Science Do You Know Them?

—By James S. Thistle—

THIS PIONEER may well be called the greatest figure in electrical research in the first half of the 19th Century. His discoveries marked the beginning of the age of electricity in the home and in industry. Born in poverty and with only an elementary schooling, he rose to become a professor and director of the London Royal Institution.

In 1831 he moved a magnet through a coil of copper wire and produced an electric current in the wire known as electro-magnetism. Upon this great discovery rests the principle on which all electric motors and dynamos are now built. Our modern electrical appliances are everlasting reminders of the practical usefulness of our Pioneer's experiments in pure research.

Other discoveries by this scientist were methods of liquefying gases, the laws of electrolysis and the discovery of benzene, which is the basis of many aniline dyes, high explosives and perfumes.

*These letters, unscrambled,
spell the name of this
month's Great Pioneer
in Science:*

FAMEHAYRADICAL

(First and Last Names)

Write the correct name here:

Now turn to page 272 for the answer.

THIS MAN IS ON THE WAY UP

-and you can be too,
with *training*



Get ahead in **HEAVY EQUIPMENT OPERATION**

through quick, intensive home study *plus* actual experience on modern equipment. Train on easy budget terms, while holding present job.

Without obligation, you can find out how to quickly and thoroughly "broaden the base" of your technical and engineering experience. Men already in the heavy equipment field, with the training and "push" to rise higher, are needed to carry on the enormous multi-billion dollar highway and building programs now under way all over America. Thousands of bigger jobs, higher-pay jobs, opening constantly. They will be filled by men with skills, training, eagerness to get ahead. *Many will be graduates of this school.* Northwest graduates are filling some of these bigger jobs now.

NEW TRAINING PROGRAM INCLUDES COVERAGE OF:

Engineering Fundamentals	Blueprint Reading
Highway Construction	Operating Controls
Grade and Grade Stakes	Estimating
Actual Work on Equipment	Field Maintenance



ACCEPT FREE OFFER: Send now for low tuition rates, easy budget plan and complete information, plus an interesting booklet with stories typical of what our graduates are doing. No obligation. No red tape. You will be personally interviewed. **WRITE NOW.**



NORTHWEST SCHOOLS

PORTLAND • HOLLYWOOD • CHICAGO

A National Training Institution — Founded 1946

HEAVY EQUIPMENT TRAINING

Northwest Schools, Inc. Dept. M-10
1221 N. W. 21st Avenue, Portland 9, Oregon

Name _____

Address _____

City _____ State _____

County _____ Phone _____

Education _____ Age _____



\$100 a Week to BEGIN. Car Furnished.

Compare THIS Job to the One You Have GOT

**Then—if you'd like to switch
—I'll Show You How to DO It**

Yes, I'll show you how to get into one of the best paying professions in America today—Auto Claim Investigating. Here's why employers are glad to pay top salaries to men in this particular field.

This year more than 25 million auto accident claims will have to be settled! No wonder Auto Claim Adjusters are so greatly needed. No wonder insurance companies pay as much as \$450 a month to start; often provide a private office, a secretary and a car for personal use—all expenses paid! That's why the money-making opportunities in this field are so great. Even if you have only an average education you can go far in this exciting new profession. Let me teach you at home by mail. In a few weeks you can learn enough to get on the road to a five-figure salary. You can either work for yourself or for a big reliable company. No need to change your location. No tedious office hours! You owe it to yourself to find out all about this interesting profession. Get in touch with me right away. **ERIC P. McNAIR**, President, **LIBERTY SCHOOL OF CLAIM INVESTIGATING**, Dept. 910, Libertyville, Illinois.

BE A MAGICIAN!

Get started today! Become a popular man of mystery. Earn and learn in spare time. Magic is fun and profitable too. Be the Life of the Party. Astonish your friends!

RUSH 25¢ now for

PROFESSIONAL MAGIC CATALOG

160 pages thick • 800 Illus. • 1000 Mysteries
Also Jokes, Puzzles, Secrets, Illusions.

FREE MAGIC TRICK INCLUDED

HOUSE OF 1000 MYSTERIES • DEPT. PM 10 • TRUMBULL, CONN.



KEEP YOUR... ON
BENJAMIN

**Largest Selection in the World—
Single Shot & Repeaters
for Every Shooter's Needs!**

**HI-COMP
AIR GUNS
AND
POWERFUL
CO₂ GUNS**

25 MODELS

No. 3600
\$19.95

You Can **DEPEND ON BENJAMIN** . . . for
Safety—Power—Accuracy—Convenience—Economy



No. 2600 BENJAMIN
Super 35-Shot BB
Gas Pistol. Safe—

No Pumping—Uniform Hi-Power.
For Target & Small Game. \$18.95

No. 2620 BENJAMIN 20-Shot Cal.

22 Gas Pistol. Economical. \$20.95

No. 1300 50-Shot BB Air Pistol \$23.50

No. 1320 BENJAMIN 35-Shot Cal. 22 Air Pistol \$25.50

No. 3600 BENJAMIN
Super 100 Shot BB Gas
Rifle. Non-Toxic—Safe
—Convenient—Uniform
Hi-Velocity Power.

No. 3620 BENJAMIN
Super 85 Shot Cal. 22
Gas Rifle . . . \$21.95

No. 3100 Super 100
Shot BB Air Rifle. Adj.
Shooting Force \$24.95

No. 3120 BENJAMIN
Super 85 Shot Cal. 22
Air Rifle . . . \$26.95

FREE Catalog All Models Benjamin Single Shot & Repeaters—Cal. BB
or 177 or 22. Also, Special Hunting & Fishing Knife Offer.

BENJAMIN AIR RIFLE CO., 896 MARION ST., ST. LOUIS 4, MO.



TUNE IN ON THE INVENTORS

By **John Linkletter**

BOMBARDING colorless diamonds with high-energy electrons will color them blue or blue green, according to Ronald A. Dugdale of Harwell, England, who was granted patent No. 2,945,793 on the process. Most natural diamonds have some color, Dugdale points out. The tints seem to be caused by atoms having been forced out of position in the crystal lattice. These atomic displacements are known as Frenkle defects. When the colorless diamonds are placed in an atomic pile or other source of electrons with energies of 500,000 to 2 million electron volts for about an hour, they emerge either blue or blue green. Dugdale assigned his patent to the U. S. Atomic Energy Commission.

Ernst Wild of Zurich, Switzerland, has come up with a back saver for housewives who make beds daily. Around the mattress he's added a frame which pivots into vertical position. The bed maker simply drapes bedclothes over the frame and lowers frame and all over the mattress. The device won patent No. 2,947,008.

A burglar trying to make off with a car protected by a new alarm system will be plagued by the sounding of the car's horn. The alarm, invention of **Otto C. Wehrig** of Seguin, Tex., is a circuit-closing device. Unauthorized activity in the auto causes a steel ball to fall into a funnel-shaped opening in the alarm. The ball forms a contact between two wires—and the horn goes off. Patent number is 2,946,867.

Smoke—the Indians' traditional communication medium—may also be used in modern military signaling. **Bruce E. Del Mar** of Los Angeles, Calif., has invented an airborne smoke bomb that contains a number of smoke capsules which may be set to be released in a predetermined sequence. Patent number is 2,945,222.

And, talking about smoke, **Alexander Konrad** of Parma, Ohio, has come up with a dual-flavored cigar or cigarette that gives the smoker an option of two flavors—depending on which end he chooses to light. Konrad received patent 2,947,310. ★ ★ ★

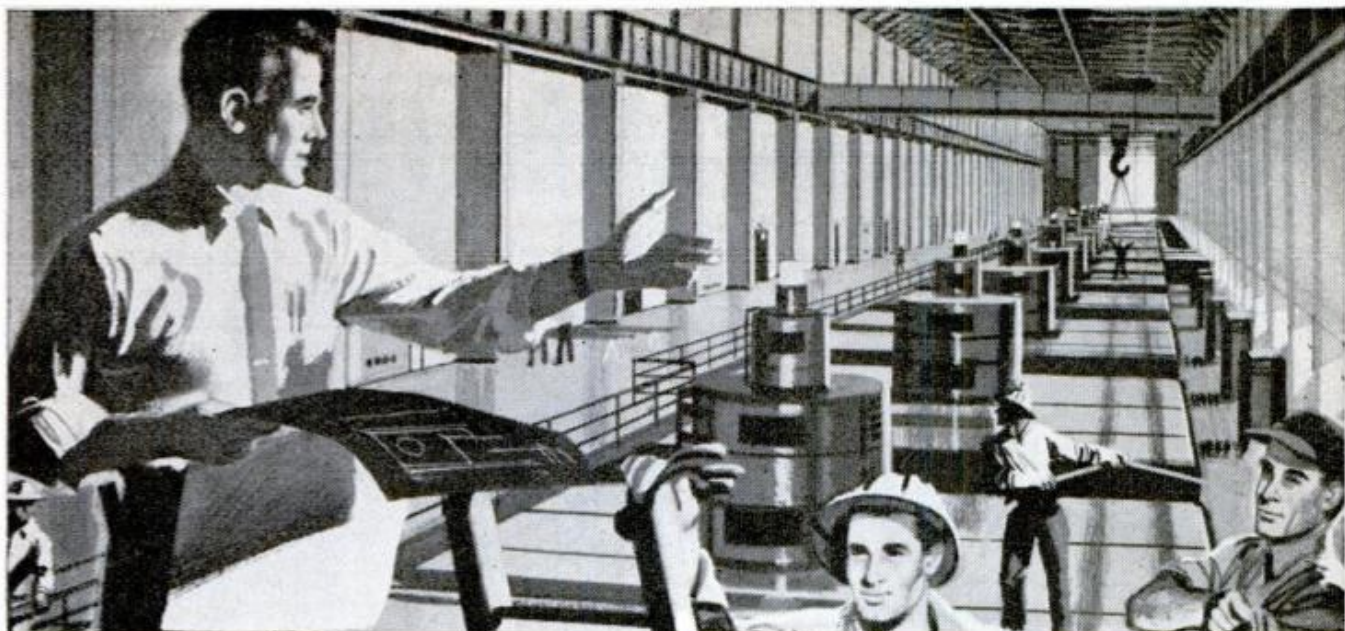

Learn **BIG-PAY** ELECTRICAL WORK

Prepare **Now** at Home for a Fine Career in this Fast-Growing Field

Train now in your spare time at home for a big money career in Electrical Work. Become an expert at repairing Motors, Dynamos, Wiring, Ignition and Electrical Systems of all kinds. Upon completion of training, go into a profitable business of your own as Electrician, Electrical Contractor, Shop Manager—or step into a big-pay career job as Plant Maintenance Man, Foreman, Superintendent—jobs that can pay \$10,000 a year and more—jobs that let you choose where in this great country you want to live and work!

I.T.I. can train you for this profitable work just as we've trained more than 400,000 men since 1916—including many Servicemen during World War II. You'll start by doing simple, easy, interesting experiments with actual equipment we provide. Learn to locate electrical troubles fast with professional Portable Tester we show you how to build from parts we furnish. Most schools simply teach appliance repairs. I.T.I.'s practical approach teaches you the basics—then gives you the skills it takes to succeed!

Make Good Money **REPAIRING APPLIANCES** While You Learn

Part of the *practical training* you'll receive is instruction in the repair of everyday household appliances—training that, while it teaches you the fundamentals of Electrical Work, can also bring you extra money in spare time! Many I.T.I. students have made a profit on their Electrical Training, doing appliance repair work while they are still studying for graduation! This wonderful experience is like money in the bank—people pay you for fixing their appliances while you are getting valuable experience that will help advance your career!



INDUSTRIAL TRAINING INSTITUTE
Dept. 1K, 2150 Lawrence Ave., Chicago 25, Illinois

FREE ACTUAL LESSON

Find out without cost or obligation what Electrical Work offers you—THEN make up your mind whether you want to get into the field. Send coupon below for a **FREE Typical Sample Lesson** so that you can judge how easy Electrical Work really is. You'll also receive **FREE** big, illustrated Catalog of Opportunities, information telling how, for a few dollars a month, you can get *career training* that should add several thousand dollars to your income. Send coupon now—today.



INDUSTRIAL TRAINING INSTITUTE, Dept. 1K
2150 Lawrence Avenue, Chicago 25, Illinois

Send me—**FREE**—Sample Lesson and Catalog of Opportunities along with information about the money I can make in Electrical Work.

Name..... Age.....
(Please Print)

Address.....

Town..... State.....

EARN \$125 A WEEK AND UP

BE AN AUTO DIESEL EXPERT — LEARN A TRADE YOU LIKE

You learn fast in our shops because you learn with tools on real equipment. Students short of money may earn most of their expenses by doing part-time work. Experienced instructors explain WHY and show you HOW, then you DO IT YOURSELF. Many of our graduates earn \$125 a week and up. Approved for veterans. Day and evening classes. Free bulletin-write today.

MAIL THIS COUPON TODAY!

NASHVILLE AUTO-DIESEL COLLEGE
226 7th Ave., No., Dept. 86, Nashville, Tenn.
Please send without obligation free catalog.

NAME _____
(please print or write plainly)

ADDRESS _____

CITY _____ STATE _____



MECHANICAL DENTISTRY

A profession offering unlimited opportunities. Most modern and complete course embracing every branch from Plate to Porcelain Work, which prepares you to work for Dentists or start your own business. Individual instruction — practical training in day or night school. No books — no classes. Catalog upon request.

McCARRIE SCHOOL OF MECHANICAL DENTISTRY
207 N. Broad Street Dept. 105 Philadelphia 7, Penna.



Make Money with MULTICRETE

Get into the garden masonry business — where manufacturing is easy, where the market is broad, and where income potentials are highly attractive.

Multicrete is a line of concrete masonry for building many things around house and garden — patios, walks, terraces, steps, barbecue pits, lattice walls, piers, planters, and many more. There's a place for Multicrete around almost every home.

The new Multicrete machine is compact and self-contained. Easy to operate because of hydraulic movements and automatic controls. Requires very little space. High production with low labor costs. Requires only moderate investment, with time-payments where desired. Write for free literature.



Patio Stones
Screen Block
Brick, etc.



W. E. DUNN MFG. CO.
401 W. 24th Street
HOLLAND, MICH.

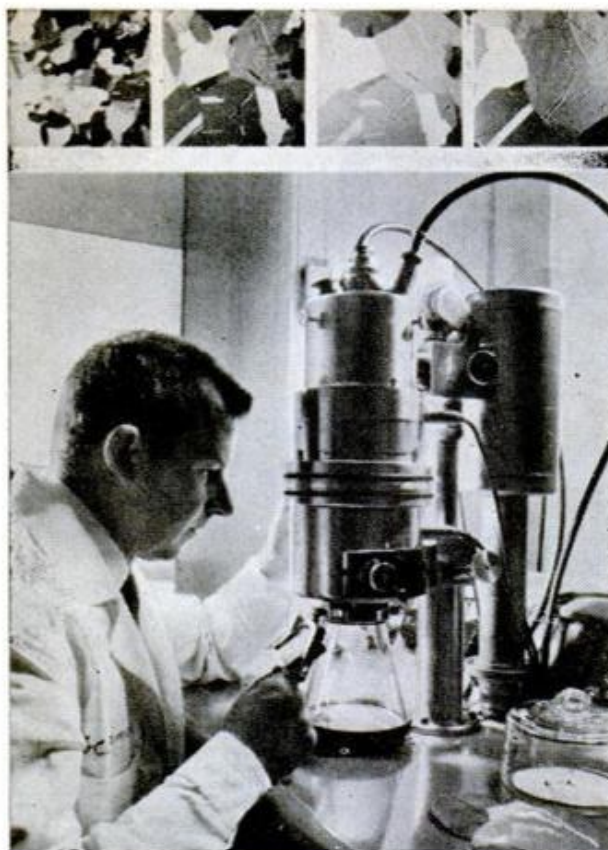

Microscope's Viewing Screen Shows Effect of Heat on Metal

For observing behavior of metals at high temperature, the physics department of General Motors research laboratories developed a thermionic emission electron microscope: Metal samples magnified up to 3000 times can be watched continuously on the microscope's viewing screen as they are heated in a built-in furnace. The strip of pictures across the top of this column shows microstructural changes occurring in a steel sample at temperatures ranging, from left to right, at 1800 degrees F. to 1950 degrees.

Airplane's Radio Altimeter Measures Depth of Glacier

Investigations of Arctic airplane crashes have turned up a way to measure the thickness of glacial ice. Many of the crashes occurred, Army scientists believe, because the altitude-measuring pulse from a radio altimeter penetrates the glacier instead of bouncing off it. If the plane is actually only 10 feet over a glacier, the altimeter may read about 2010 feet because the solid earth lies 2000 feet beneath ice. Army scientists are now experimenting to learn if, indeed, a radio altimeter can be used as a fast, accurate instrument to measure glacier thickness.

Superior's New Model 70 UTILITY TESTER®

FOR REPAIRING ALL ELECTRICAL APPLIANCES MOTORS • AUTOMOBILES • TV TUBES



As an electrical trouble shooter the Model 70:

- Will test Toasters, Irons, Broilers, Heating Pads, Clocks, Fans, Vacuum Cleaners, Refrigerators, Lamps, Fluorescents, Switches, Thermostats, etc.
- Will test all TV tubes for open filaments, inter-element shorts, burned out tubes, etc.
- Measures A.C. and D.C. Voltages, A.C. and D.C. Current, Resistances, Leakage, etc.
- Will measure current consumption while the appliance under test is in operation.
- Incorporates a sensitive direct-reading resistance range which will measure all resistances commonly used in electrical appliances, motors, etc.
- Leakage detecting circuit will indicate continuity from zero ohms to 5 megohms (5,000,000 ohms).

As an Automotive Tester the Model 70 will test:

- Both 6 Volt and 12 Volt Storage Batteries • Generators • Starters • Distributors • Ignition Coils • Regulators • Relays • Circuit Breakers • Cigarette Lighters • Stop Lights • Condensers • Directional Signal Systems • All Lamps and Bulbs • Fuses • Heating Systems • Horns • Also will locate poor grounds, breaks in wiring, poor connections, etc.

IT'S SO EASY!!



With tester's cord in outlet, current consumption of appliance is read direct on meter when line cord is connected to receptacle on panel. This typical iron takes 7 amperes (Good).



Small electric fan motor indicates 30 ohms (normal resistance).



Control circuits of most furnaces use 24 volts obtained from step-down transformer. Here's how to check room thermostat to see if wires to it are live.

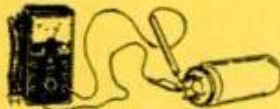

Manual supplied with Model 70 shows meter needle moves to right when test leads are connected to pins 3 and 6 of this 6AU6 tube. Procedure for testing all tubes used in TV are detailed in manual.



Test Generators

Test Auto Fuses

Test Storage Batteries

Test Circuit Breakers

READ THIS!

READ THIS!

READ THIS!

You don't pay for the Model 70 until AFTER you have examined it in the privacy of your home! Model 70 is

SHIPPED ON APPROVAL NO MONEY WITH ORDER — NO C.O.D.

Try it for 10 days before you buy. If completely satisfied then send \$3.85 and pay balance at rate of \$4.00 per month for 3 months — No Interest or Finance Charges Added! If not completely satisfied, return to us, no explanation necessary.



INCLUDED FREE!!

This 64-page book—practically a condensed course in electricity. Learn by doing.

Just read the following partial list of contents:

- What is electricity? • Simplified version of Ohms Law • What is wattage? • Simplified wattage charts • How to measure voltage, current, resistance and leakage • How to test all electrical appliances and motors using a simplified trouble-shooting technique.
- How to test all TV tubes; also simple procedure for determining which specific tube (or tubes) is causing the trouble.
- How to trace trouble in the electrical circuits and parts in automobiles and trucks.

Model 70 comes complete with above book and test leads. Only . . .

15⁸⁵

MOSS ELECTRONIC INC.

Dept. D-802 3849 Tenth Ave., New York 34, N. Y.

Please rush me one Model 70. If satisfactory I agree to pay \$3.85 within 10 days and balance at rate of \$4 per month until total price of \$15.85 plus postage is paid. If not satisfactory, I may return for cancellation of account.

Name _____

Address _____

City _____ Zone _____ State _____

LEARN MEAT CUTTING AT NATIONAL

Pay After Graduation

National School of Meat Cutting, Inc., Dept. 50-K, Toledo 4, Ohio
 Send me your FREE school catalog on National Training at Toledo in Meat Cutting, Meat Merchandising and Self-Service Meats. No obligation. No salesman will call.

Name _____ Age _____
 Address _____
 City _____ State _____
 Approved for Veterans

The steady dependable trade of Meat Cutting taught easily in 8 short weeks. YOU LEARN BY DOING under actual meat market conditions in big modern school at Toledo.

For beginners or men with experience. Get a profitable store of your own. Remember, PEOPLE MUST EAT! Big pay jobs. Free employment help. Thousands of successful graduates.

Buying, cutting, percentage, pricing, advertising, selling, etc. A complete retail meat education. National School established 37 years. Get National training NOW. Pay your tuition in easy monthly payments after you graduate. Send coupon for FREE 40 page school catalog — TODAY. G.I. approved.

Home Training in AUTO MECHANICS



includes
BIG TOOL OUTFIT
 Testing Instruments

Be an AUTO MECHANIC—learn at Home in spare time. You get top-notch training. School chartered "not-for-profit." Est. 1898. Free Booklet tells about Employment and Consultation Services—plan for success in Own Business or Good Paying Job.

47 Piece Tool Kit Plus 3 Testing Instruments **FREE BOOKLET—MAIL TODAY**

American Technical Society, Dept. BH-100
 850 East 58th Street, Chicago 37, Illinois
 Please send Free Booklet and full information telling how I can train at Home to be an Auto Mechanic.
 Name _____ Age _____
 Address _____
 City _____ State _____
 Accredited Member National Home Study Council

LEARN TO MOUNT BIRDS



ANIMALS, FISH, PETS

Be a Taxidermist. Save your hunting TROPHIES. Have a fine home-museum. Hunters, save and MOUNT your beautiful DUCKS, QUAIL, DEER, TAN skins and FURS. Great Fun. Spare-time PROFITS.
FREE BOOK Tells ALL about it. 100 fine wild-game pictures. 48 pages. Send TODAY, don't delay. Get this WONDERFUL FREE BOOK, MEN AND BOYS. Learn Taxidermy. Double your hunting pleasure. Rush letter or POSTAL today. STATE AGE. N.W. SCHOOL OF TAXIDERM, Dept. 2510, Omaha, Neb.

Model K312

CHARGES 12-VOLT CAR BATTERY OVERNIGHT



ONLY \$14.95 POSTPAID

Avoid run-down battery troubles—own this high-grade SCHAUER Charger. Has automatic circuit breaker. Pays for itself many times over in longer battery life; sure, quick starts. Get yours now. If your dealer can't supply, send check or money order. Money-back guarantee. The best made, most beautiful charger you can own is a SCHAUER. Other 6 and 12 volt models available. Send for free catalog.

4532 Alpine Avenue
SCHAUER MFG. CORP. Cincinnati 42, Ohio

SHORTHAND in

Famous SPEEDWRITING shorthand. 120 words per minute. No symbols; no machines; uses ABC's. Learn at home or through classroom instruction. Lowest cost. For business and Civil Service. 500,000 graduates. Typing available. 38th year. Write for FREE booklet.

6 WEEKS

© 1959

Speedwriting

Dept. 1510, 55 W. 42 St., New York 36 (R)

\$6.00 OR 2 FOR \$11.00!
 With 40 ft. of wire. Additional wire 3c ft. TESTED AND GUARANTEED. Write for free list of all types of telephones. Shipments FOB Simpson, Pa.
TELEPHONE ENGINEERING CO., Dept. 1080, Simpson, Pa.



Telrite Industries, Inc., 226 S. Wabash Ave., Chicago 4

Portable Prompter Is an Aid To Speech-Making Executive

Operating like the prompting devices used in the television industry, a smaller desk-top prompter enables speakers to have their talks before them at luncheons, board sessions and other such meetings. The device holds the script on spools and automatically moves it across an illuminated panel at a speed controlled by the speaker. Each spool holds an hour or more of continuous script.

Here's WHY Novo Distributors MAKE BIG MONEY EVERY DAY

... Even While
Sleepin'

It ain't sellin'— just servicing!
... you can start in your spare time!

Nope! The amused and happy looking lady you see isn't the Novo Wholesale Distributor. (He's sound asleep at the moment!) She's typical of a host of NOVO Greeting Card customers! At the moment, she's selecting an assortment of side-splitting all-occasion cards right from the NOVO Permanent Card Rack. A penny ante business? Brother, you'll be surprised! Right now it's a \$500 million business . . . and getting bigger every day. It's the easiest business to get into, and it only takes a little time and very little money. All you do is place NOVO Display Self-Selling Racks in stores in your area . . . spend a few minutes a week refilling the racks and then collect your profits on every card sold. You don't have to take time off from your regular job if you don't want to. You don't do any house-to-house canvassing. No order taking worries. No doorbells to ring. No long hours or tiring, back-breaking work. Age is no barrier; experience is unnecessary and it's ideal for both men and women. Here is the booming WHOLESALE SERVICE BUSINESS you've been looking for all your life . . . a business that pays you big money every day—even while you're asleep. And just think of it—it's a business you can get into in your spare time, operate from home and earn an extra week's pay . . . every week!

You Make Money Without Selling

You don't have to be a salesman to sell this nationally advertised (Life, etc.) 29-year old line of Humorous and Novelty Greeting Cards; in fact you do no real selling at all . . . ever! Stores, cigar stands, super markets, book shops, depots, gift shops, all WANT NOVO Greeting Card Racks on their premises. Why? Well, these are not ordinary, run-of-the-mill greeting cards, but HUMOROUS and NOVELTY Cards, the kind in biggest demand today—they sell fast and produce profits every hour of the day—they're on consignment and cost the dealer nothing—most im-

portant of all, retailers need and must have NOVO Cards even if they carry conventional cards. Not to replace, but to complete their regular greeting card lines. This type of greeting card draws heavy traffic to the location with no advertising expense. In addition the location owner does practically nothing—no work—no inventory problems; all he does is accept payment from customers. HE GETS HIS PROFIT IN ADVANCE—so of course he's delighted to pay the NOVO Wholesale Distributor his profit.

Year 'Round Repeat Profits

The NOVO LINE is complete—cards for birthdays, "get-well," Christmas, Valentine, Mother's Day, Father's Day, Graduation, New Babies, Weddings, Anniversaries—a card for every occasion. Cards with clever verses, original drawings, gadgets, moving

parts, noise, music sounds—all aimed at getting a hearty laugh. No wonder NOVO Humorous and Novelty Greeting Cards repeat week after week—all year 'round! And the nicest part of this business is that anybody can get into it in just 24 hours!

SHOWS HOW YOU CAN GET STARTED

In This Tremendously Successful Business

Most companies take your money before showing you what it's all about. NOVO'S FREE 32-PAGE BOOK shows you all the sure-fire money-making "secrets" of the Greeting Card Business before you invest a postage stamp. If you're really interested in a year-round 24-hours-of-the-day business of your own, where you do no selling; invest little time and money, here's your big opportunity.

Mail the coupon right now. EVERYTHING FREE!!

SAMPLES and 32-PAGE BOOK FREE!

NOVO CARD PUBLISHERS, INC.
Dept. X-18
3855 Lincoln Avenue, Chicago 13, Illinois

RUSH

Yes, rush me without obligation of any kind, samples and big free 32-page book which shows me how to become a high-paid NOVO Greeting Card Distributor.

NAME.....

ADDRESS.....

CITY..... ZONE..... STATE.....



This bit of action puts profits into NOVO Distributor's pockets EVERY DAY IN THE WEEK ... 365 DAYS A YEAR!



Up to \$10.00 PROFIT per rack for 30 MINUTES a week!

Bill Swinford services 35 NOVO Greeting Card Racks in spare time. Here he's shown refilling a rack that pays him \$7 to \$10 profit a week . . . in less than 30 minutes.

JUDGE FOR YOURSELF!

You'll say it's the best moneymaking proposition ever offered. Send in the coupon and by return mail, we'll rush you our big free book that gives you the entire self-selling story. You'll see how reliable men and women (NOT high pressure super-salespeople) with no experience and with very little effort, earn from \$35 to \$250 weekly; mostly in spare time. You don't risk a penny so mail the coupon below for everything. Do it now to be sure.

NOVO CARD PUBLISHERS

INC.

Dept. X-18
3855 Lincoln Avenue
Chicago 13, Illinois

**MY SPARE TIME HOBBY
MAKES ME
\$5⁰⁰ an hour
CASH PROFIT**

—Grover Squires



START YOUR OWN SPARE TIME BUSINESS

You can turn your spare time into Big Cash Profits with your own **COMPLETE SHARPENING SHOP . . .** Grind saws, knives, scissors, skates, lawn mower blades . . . all cutting edges. Your Own Cash Business with no inventory . . . right at home . . . no experience needed.

FREE BOOK tells how you can start your own spare time business while you are still working at your regular job. Low Cost — time payments only \$15.00 a month. Send coupon today.



BELSAW SHARP-ALL CO., 711 Field Bldg., Kansas City 11, Mo.

Send Free Book "LIFETIME SECURITY". No obligation.

Name _____

Address _____

City _____

State _____

**HOME
IMPORT
BUSINESS**

MEN... WOMEN... MAKE BIG PROFITS... Buy dazzling bargains abroad. Sell to friends, stores or mail order. New Drop Ship Plan puts you in *direct contact with overseas sources*—starts you full or spare time, without product investment or previous experience. Complete details **FREE**. Write today!

Transistor Radio with battery \$3.82



17-Jewel Watch \$2.87



Derringer Pistol \$5.14



Tape Recorder with Mike \$13.50

MELLINGER CO., Dept. C25A
1717 Westwood, Los Angeles 24, Calif.

... Plan shows where you get bargains like these for big profit sales. **DO NOT ORDER FROM US**

MONEY in WORMS

Sell 20,000 fishworms per week @ \$4 per 1000 from a bed 3 feet wide and 8 feet long. We teach you how to raise and where to sell fishworms and crickets. Write for free literature.

CARTER WORM RANCH, PLAINS, GEORGIA

Read our success story in LIFE MAGAZINE, December 25, 1959 Issue.

JEEP OWNERS

RE-POWER NOW WITH A V-8 OR 6 CYL. ENGINE — USE FORD—CHEV—MERCURY—GMC—PONT—STUDE—DODGE OR PLYMOUTH in Jeeps, Jeepsters, Sta-Wgn, trucks, Kaiser & H. J. cars. Conversion Kits \$45.35 to \$56.90. Want fast action? Give us full information, send \$15.00 Dep. and we will ship correct kit. **Bal. COD.** Send full amount for prepaid shipment. Wire, phone or write today. Details **FREE**

HOOSIER MACHINE PRODUCTS CO.

312 S. E. 6th St. Phone CR 6-3442 Pendleton, Oregon

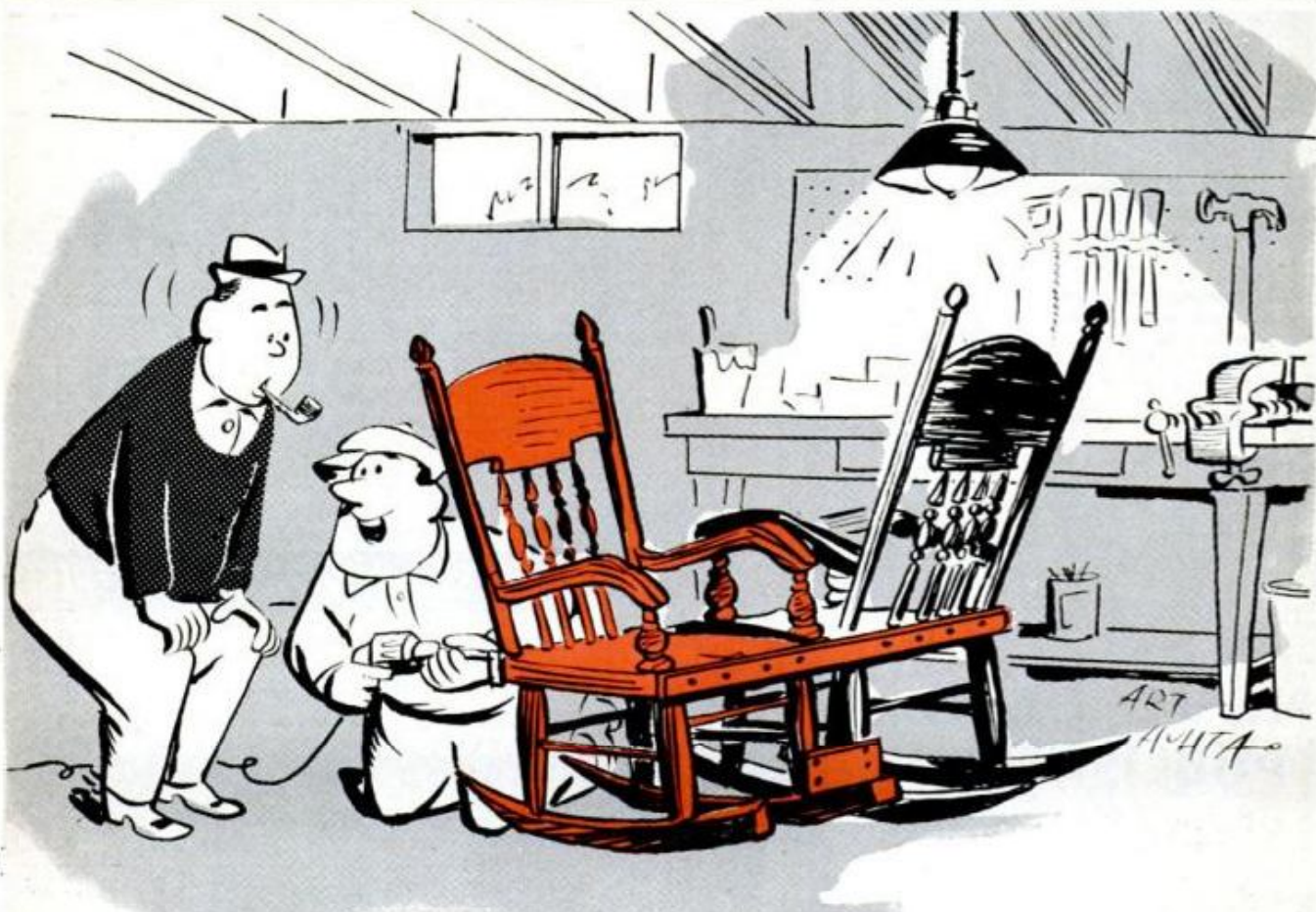

"It's a love seat for their 50th anniversary."



PAUL PEMPER
(Wisconsin)

USED BY U.S.
ARMED FORCES
OVER 3,000,000
COPIES SOLD

"I never knew anything about car repairs until I got this wonderful book. It has paid for itself time and time again."

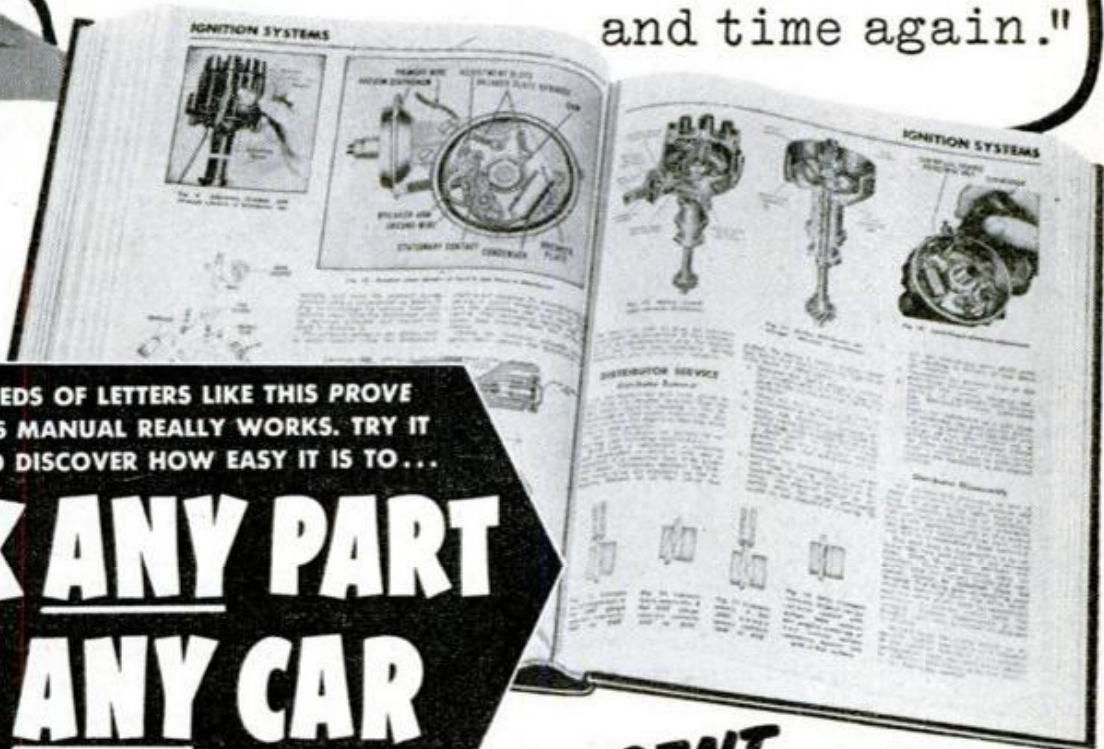

HUNDREDS OF LETTERS LIKE THIS PROVE
MOTOR'S MANUAL REALLY WORKS. TRY IT
FREE AND DISCOVER HOW EASY IT IS TO...

FIX ANY PART OF ANY CAR

IF YOU could see the hundreds and hundreds of letters of praise in our files, you wouldn't hesitate to take advantage of this Free Trial offer.

Some of them are from crack mechanics like Mr. V. Lauria of Nevada who writes "I have been a mechanic for 25 years, but MOTOR'S Manual still takes me out of the tight spots."

Others are from beginner mechanics like Michael Baliczky of New Jersey who says "I amazed myself and my friends, too. I now do jobs that stumped me before."

All have one thing in common: They agree that MOTOR'S Manual makes any auto repair job a "cinch". No wonder you'll find this famous how-to-do-it book on almost every garage workbench in the country. And no wonder that more than 3,000,000 copies - yes, THREE MILLION copies - have been sold.

Eliminates Guesswork - Shows Exactly "How to Do It"

MOTOR'S Manual is so simple, so complete, you just can't go

wrong. You'll master any car repair the way the experts do - without guesswork, without false starts, without wasting time, energy or money.

Just look up the job in the giant Troubleshooter Index. Turn to the right page. Follow the crystal-clear step-by-step instructions and pictures. And presto - the job is done, quickly, easily, and right!

It's like having a factory expert right at your elbow, guiding your hands through every job - showing you where to start, exactly what to do every step of the way!

Everything You Need to Know

This new revised edition brings you the "guts" of 176 Official Shop Manuals. Covers 1,967 car models from 1953 through 1960. Includes 225,000 service and repair facts on engines, automatic transmissions, ignitions, carburetors, steering gears, generators, distributors, power steering, brakes, starters, etc. - everything from bumper to rear end!

SEND NO MONEY

Mail the coupon today. Use the Manual as your own for a whole week, FREE. If you don't agree that it is the greatest time and work saver you've ever seen, simply return it in 7 days and owe nothing. Mail the coupon now! **MOTOR Book Dept., Desk 010, 250 West 55th Street, New York 19, N. Y. (Schools, Bookstores: Write for discounts.)**

SENT FREE

for 7-Day Examination

See for yourself 1,100 double-size pages, 2,850 drawings and photographs, 30,000 essential specifications, 195 "Quick-Check" Charts, 225,000 service and repair facts - all at your fingertips!

Covers All
These Makes
- 1953 thru 1960

- | | |
|-------------|-------------|
| Buick | Hudson |
| Cadillac | Imperial |
| Chevrolet | Jeep |
| Chrysler | Lincoln |
| Continental | Mercury |
| Corvair | Nash |
| Corvette | Oldsmobile |
| Dart | Plymouth |
| De Soto | Pontiac |
| Dodge | Rambler |
| Edsel | Studebaker |
| Falcon | Thunderbird |
| Ford | Valiant |

MAIL COUPON NOW FOR 7-DAY FREE TRIAL

(Attach to postcard for faster action)

MOTOR BOOK DEPT., Desk 010,
250 West 55th St., New York 19, N. Y.

Rush to me at once (check box opposite book you want):

MOTOR'S New AUTO REPAIR MANUAL. If O.K., I will remit \$2 in 7 days, \$2 monthly for 2 months and a final payment of \$1.95 (plus 45¢ delivery charges) one month after that. Otherwise I will return the book postpaid in 7 days. (Foreign price, remit \$10 cash with order.)

MOTOR'S New TRUCK REPAIR MANUAL. If O.K., I will remit \$3 in 7 days, and \$2 monthly for 3 months, plus 45¢ delivery charges with final payment. Otherwise I will return book postpaid in 7 days. (Foreign price, remit \$11 cash with order.)

Print Name..... Age.....

Address.....

City..... Zone..... State.....

Check box and save 45¢ delivery charge by enclosing WITH coupon in envelope entire payment of \$7.95 for Auto Repair Manual (or \$9 for Truck Repair Manual) plus sales tax. Same return-refund privilege.

Same FREE Offer on MOTOR'S New Truck Manual

Brand new! Covers EVERY job on EVERY popular make gasoline and Diesel truck made since 1952. FREE 7-Day Trial.



Sworn statement from CHAS. LEMMING reads:

"After starting my own business



I've averaged \$100 A DAY —most of it clear profit!"

• If you want to be independent—free from layoffs, bosses—start profitable, year 'round business of your own. Ours is NOT a lease proposition. You own the machine, you work when and where you please, and all the money you take in is your own. FREE book tells you how.

MAIL COUPON TODAY FOR FREE BOOK

VON SCHRADER MFG. CO.
N10 "D" Pl., Racine, Wisconsin

Without obligation rush your FREE booklet about how I can start my own permanent, profitable electric Upholstery Cleaning business.

Name _____

Address _____

City _____ Zone _____ State _____

Not everyone does as well...

Mr. Lemming owns two machines

In city of less than 50,000, Mr. Lemming started his own business after filling in coupon like one below. He averaged \$100 a day during first year, some days \$200. F. E. Doran grossed \$1050 in single month. Geo. Held grossed \$300 in one week.

How much you earn depends largely on you. No special skill, no large investment required for our electric upholstery cleaning machine. Start spare time until full time justified. Hire helpers as needed.

NO SHOP NECESSARY • You clean upholstered furniture on customers' premises—homes, hotels, motels, etc. Auto upholstery, too. No hauling; operate from your home. Watch business grow as satisfied customers tell friends. Supplies cost little, profits high.

IT'S FUN TO BE AN ARMCHAIR ADVENTURER



With a NATIONAL NC-60 SPECIAL Shortwave Radio Receiver you can cross the six continents in the comfort of your favorite chair, visit foreign lands, eavesdrop on aircraft, ships at sea and radio hams. Enjoy standard broadcast too, with its powerful new radio receiver. Suggested price only \$59.95. Write for literature and name of nearest dealer.

JOIN THE NATIONAL ASSOCIATION OF ARMCHAIR ADVENTURERS

SEND 50c for membership certificate and exciting new book on Shortwave Listening. Tells when, where, how to listen, provides log for listing countries you hear. SEND 50c to:

National RADIO CO., INC.
MELROSE 76, MASS.

A wholly owned subsidiary of National Co., Inc.



Export: AD AURIEMA, INC. 85 Broad St., New York, N.Y., U.S.A.
In Canada: CANADIAN MARCONI CO., Toronto 17

LEARN WHILE YOU SLEEP!



Experiment in this fascinating, educational new field. Use your phono, recorder or amazing new "Electronic Educator" endless tape recorder. Free catalog lists over 200 unusual tapes, records, equipment for sleep-learning & hypnosis experimenters. Sleep-Learning Research Ass'n., Box 24-A, Olympia, Wash.

**Shrinks Hemorrhoids
New Way Without Surgery
Stops Itch—Relieves Pain**

For the first time science has found a new healing substance with the astonishing ability to shrink hemorrhoids and to relieve pain—without surgery.

In case after case, while gently relieving pain, actual reduction (shrinkage) took place.

Most amazing of all—results were so thorough that sufferers made astonishing statements like "Piles have ceased to be a problem!"

The secret is a new healing substance (Bio-Dyne*)—discovery of a world-famous research institute.

This substance is now available in suppository or ointment form under the name Preparation H.* Ask for it at all drug counters—money back guarantee. *Reg. U.S. Pat. Off

POPULAR MECHANICS

WHAT'S UP IN THE AIR

By Kevin V. Brown

SUPERSONIC jet fighters are fine fighting machines, but frustrating for pilots who need practice using them for what they were intended—as aerial weapons. Until recently there haven't been targets fast enough to shoot at. In tests at Edwards Air Force Base, Calif., however, an F-101A Voodoo towed a missile-shaped target at Mach 1.25 velocities. The 16-foot target is attached to a short pylon on the underside of the Voodoo. In flight it is dropped and reeled out automatically on the end of a special "stepped" cable, one that gradually reduces in size to permit more wire on the reel and to reduce drag. The target is towed about 40,000 feet, roughly 7½ miles, behind the tow plane. The long separation is necessary to protect the plane and pilot at supersonic speeds. The target contains radar and special scoring devices to record hits. Besides its speed, it has another advantage over subsonic drone planes, previously used as targets. It can be reused as many as five times, and it even has a parachute to float it to earth safely in case the cable snaps. After a normal mission, however, the pilot, who operates the target from the cockpit, reels it in and it automatically refastens to the carrying pylon.

That great American invention, the mail-order house, is replacing an even greater American invention, the airplane. It's happening in Alaska where bush pilots have been the only means of communication with the outside world for some wilderness settlers. Improved mail facilities, however, have put many of them out of business. Now the Last Frontier's pioneers just thumb through the catalog and write away for supplies.

Tail gunners, the loneliest of all airborne soldiers, recently rejoined their fellow airmen in the forward part of the ship. Closed-circuit television has been installed in all B-52G Stratofortresses which allows the tail gunner to sit up front and watch what's going on behind through a special optical system that scans the entire area back of the plane. He aims and fires his guns by remote control. The move forward places the tail gunner closer to the bomber's center of gravity where less turbulence and vibration make it easier to focus guns. ★ ★ ★

Make More Money Soon Fixing Electric Appliances

Train at Home in Spare Time



Better Pay—More Opportunities

Get into a field where there is important work and opportunity for the trained man. Millions of electric appliances are sold every year. Every wired home now has an average of 8. Many of them need service and repair. Owners pay well to have them fixed quickly, properly. This is your opportunity for a better job, your own part time or full time business. NRI can give you the training you need, at home, in your spare time.

Spare Time Earnings Start Soon

Soon after starting you will be able to earn extra cash fixing toasters, clocks, fans, vacuum cleaners, etc., for neighbors and friends. Keep your job while learning and earning. Put spare time to work for you. Work in your basement, garage, spare room. You'll be amazed how easily, quickly you, too, can start earning many extra dollars. NRI shows you how. Even before you finish training your spare time earnings may pay for the course and equipment.

NRI Sends Tester to Learn and Earn

You need proper equipment to service today's automatic appliances. With this course you get parts to build professional type, multi-use Appliance Tester. You learn to use it. Takes guess work out of servicing. Mail coupon for FREE book and Sample Lesson. See how easy it is to learn. Find out about NRI—a school that for more than 40 years has been training men, through home study, for success, good pay jobs. Our reputation, record, experience back up this course. Write now to: NATIONAL RADIO INSTITUTE, Dept. AKO, Washington 16, D. C.



FREE Lesson and Book
Mail this NOW!

NATIONAL RADIO INSTITUTE

Dept. AKO, Washington 16, D. C.
Send me Lesson and Book Free. No Salesman will call.

Name.....Age.....

Address.....

City.....Zone.....State.....

ACCREDITED MEMBER NATIONAL HOME STUDY COUNCIL

FREE PLAN

tells how to start your own business

FILING SAWS

Here is a steady repeat CASH business you can start in your own basement or garage in your spare time and make up to \$3 or \$6 an hour. You can file hand, band and both combination and cross-cut circular saws on the Foley Saw Filer. No eyestrain—no experience needed. "The first saw I sharpened with my Foley Filer came out 100%"—writes Clarence E. Parsons.

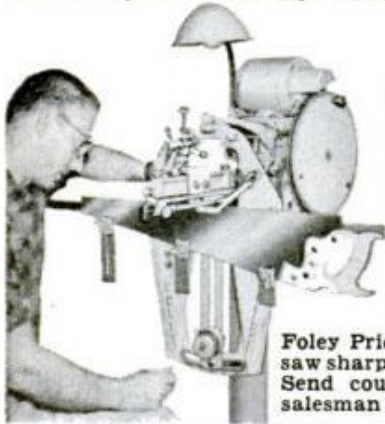

Every saw you sharpen with the Foley Saw Filer brings you more customers. "I rented a two-car garage and have all the work I can do"—

Charles H. Smith.

FREE BOOK
Shows How to Start

Foley Price Guide gives saw sharpening charges. Send coupon today. No salesman will call.

Send Coupon for **FREE BOOK**

FOLEY MFG. CO.
1043-O Foley Bldg., Minneapolis 18, Minnesota.

Send **FREE BOOK**—"Money Making Facts," and Time Payment Plan.

Name.....

Address.....



YOU CAN BE A REAL HE-MAN!



CHARLES ATLAS

DON'T let anybody tell you that you're just "naturally" skinny . . . flabby . . . soft. I'll show how you can have the handsome muscle-mighty HE-MAN BODY that Nature meant you to have! In just 15 minutes a day I can make you a NEW MAN! I'll build smooth, powerful layers of muscle wherever you want 'em—arms, chest, stomach, back, legs, etc.—and wonderful new pep and energy surging through your whole body!

Send for **FREE BOOK**

WRITE FOR FREE BOOK. Tells about famous "Dynamic Tension," the NATURAL way I built my own famous body. How I've built up other fellows. What I can do for YOU. Address:

CHARLES ATLAS, Dept. 810
115 E. 23rd St., New York 10, N. Y.
In England: Chitty St., London, W1



Alimak Verken A.B., Skelleftea, Sweden

Elevator for TV Tower

Installed during construction as a working platform, a self-propelled elevator was left inside a TV tower in Sweden and is now used for maintenance. Powered by a 9.7-hp. motorcycle engine, it travels up and down a single rail with a rack-and-pinion drive. A centrifugal brake stops the car.

BRONZE FOUNDRY

Since 1935

Schools • Home Workshops • Inventors

Make your own castings of aluminum, copper, bronze, silver. Foundry sets are available in six sizes, capacity 1 1/2 lb. to 48 lb. of red brass. 2400 Deg. F. blast furnace included with each. Write for Free Circular.



KANSAS CITY SPECIALTIES CO. DEPT. P-10
MARYSVILLE, KAN.



LOOK
AT THE AMAZING PRICES
PAID AT GOV'T SURPLUS SALES

Autos.....\$78	Tractors.....\$68
Trucks.....\$212	Motors.....99¢
Boats.....\$5.90	Typewriters..\$6.80
Compressors..\$9.69	Generators..\$8.78

PAY 2 or 3¢ on the DOLLAR

for 1000's of Useful Items of

U.S. GOV'T SURPLUS

You BUY DIRECT from U. S. Government at TREMENDOUS savings. Eliminate middlemen—Save BIG MONEY! Pay as LOW as 2¢ on the dollar. Our DIRECTORY Gov't Surplus Sales lists 100's Army, Navy, Air Force Surplus Depots all over the world. BUY JEEPS, sports equipment, hunting, fishing and photographic equipment and supplies, radio, electronic and electrical equipment, trucks, boats, airplanes. Plumbing, hardware, office equipment & supplies. Tools, machinery, furniture. This 1960 book tells how to buy Gov't Surplus DIRECT. No dealer profits to pay. Get on the gravy train NOW! Send \$1 TODAY for "Gov't Surplus DIRECTORY" to **AVIATION SURPLUS, Dept. PM-10, Box 789, York, Pa.**

If you take

Color Pix

8mm - 16mm - 35mm 127 • 120 • 620

You must get our MONEY SAVING

Free Catalog

Listing all popular KODAK and ANSCO Film Type and Sizes . . . WRITE TODAY!

SOLAR CINE PRODUCTS, Inc.

"Direct-by-Mail" Film and Processing Specialists for almost a quarter century" Dept. ME
4247 S. Kedzie Chicago 32,

TELEPHONE



HANDSETS

Use as inter-house phone, talk house to garage, as loud speaker system, etc. You receive transmitter, receiver, 3 conductor cord and simplified, illustrated installation diagrams. Handsets are guaranteed to be the same as used in our great National Telephone System. Price delivered \$2.95. Two for \$5.00!

TELEPHONE REPAIR AND SUPPLY CO.
DEPT. PM-131 1760 Lunt Ave., Chicago 26

FREE OUTFIT STARTS YOU IN BIG MONEY SHOE BUSINESS!



Run your own profitable "shoe store" business from home! Represent fast growing million dollar firm in spare or full time. We give you—FREE—complete Starting Outfit that makes you \$217 EXTRA each month for just 2 easy orders a day. Feature 195 fast-selling dress, sport, work shoe styles for men, women. Air-cushion shoes, many special features! Sizes 2½-15—AAAA to EEEE. Sell to friends and folks where you work. Rush postcard for FREE Outfit!

MASON SHOE, Dept. G-303, Chippewa Falls, Wisconsin

OIL LEASES

Many now enjoy "Second Incomes" from Oil Leases up to \$100.00 per day plus Big Bonus payments. Let me tell you how you can be an Oil Lease owner that may mean financial security to you.

**Chas. W. Crader, P. O. Box 867-PM
Fort Worth 1, Texas**

RUPTURED

BE FREE FROM TRUSS SLAVERY

Surely you want to THROW AWAY TRUSSES FOREVER, be rid of Rupture Worries. Then Why Do you put up with wearing a griping, chafing and unsanitary truss the balance of your life? If you do, it will NOT be through necessity but through choice on your part.

Now there is a new modern Non-Surgical treatment that is designed to permanently correct rupture. These Non-Surgical treatments are so certain, that a Lifetime Certificate of Assurance is given. Write today for our New FREE Book that gives facts that may save you painful, expensive surgery. Tells how non-surgically you may again work, live, play, love and enjoy life in the manner you desire. There is no obligation.
Excelsior Medical Clinic, Dept. H6124, Excelsior Springs, Mo.

These men are getting practical training in ...

ELECTRICITY



ELECTRONICS

ON REAL

Motors • Generators
Switchboards • Controls
Modern Appliances
Automatic Electronic
Control Units

TELEVISION



Radio Electronics

ON REAL

TV Receivers
Black & White and Color
AM-FM and Auto Radios
Transistors • Printed
Circuits • Test Equipment

Train in NEW Shop-Labs of COYNE

In Chicago—Electrical and Electronic Center of the World. Prepare for a better job and a successful future in a TOP OPPORTUNITY FIELD. Train on real full size equipment at COYNE where thousands of successful men have trained for 60 years—largest, oldest, best equipped school of its kind. Professional and experienced instructors show you how, then do practical jobs yourself on more than a quarter of a million dollars worth of equipment. No previous experience or advanced education needed. Employment Service to Graduates.

Start Now — Pay Later — Liberal Finance and Payment Plans. Pay most of tuition after graduation. Part-time employment help for students. Choose from nine yearly Starting Dates.

Mail Coupon or Write to Address Below for Free Book—"Guide to Careers." Whether you prefer ELECTRICITY, TELEVISION-RADIO or COMBINED ELECTRONICS TRAINING, which includes both fields, this book describes all training offered.

Information comes by mail. No obligation and NO SALESMAN WILL CALL.

B. W. Cooke, Jr., Pres. Founded 1899

COYNE ELECTRICAL SCHOOL

Chartered as an Educational Institution Not for Profit
1501 W. Congress Pkwy., Chicago 7, Ill., Dept. 70-3C

MAIL COUPON OR WRITE TO ADDRESS BELOW

COYNE ELECTRICAL SCHOOL
New Coyne Building, Dept. 70-3C
1501 W. Congress Pkwy., Chicago 7, Ill.

Send BIG FREE book and details of all the training you offer. However, I am especially interested in:

Electricity Television Both Fields

Name _____

Address _____

City _____ State _____

(Unlike most other schools, we do not employ salesmen.)



FREE! 53 ORIENTALS



Send today for this Spectacular Oriental Collection! More than 50 fabulous genuine postage stamps from Taiwan, Korea, Viet Nam, Japan, Singapore, Burma, Pakistan, Indonesia, Thailand, Hong Kong, Laos, many other strange, remote lands of the mysterious Far East. Sensational stamps picturing weird beasts, birds, ancient ships, queens, kings, beautiful women. Extra! Big Bargain Catalog, exciting offers and other thrilling stamps for your free examination. Send 10c for mailing expense — Double your money back if not delighted!

Jamestown Stamp Co. Dept. C100PM, Jamestown, New York
 RUSH my Free Collection of 53 Orientals & other offers.
 I enclose 10c for mailing costs.
 PLEASE PRINT

Name

Address

City & State

Would YOU Like to Make \$1,000 A MONTH?

That's what Stanley Hyman made selling the amazing new PRESTO Fire Extinguisher!



Amazing new kind of fire extinguisher. Tiny "Presto" does job of bulky extinguishers that cost 4 times as much, are 8 times as heavy. Ends fires fast as 2 seconds. Fits in palm of hand. Never corrodes. Guaranteed for 20 years? Sells for only \$4.95! Over Three Million Sold!



STANLEY HYMAN

Show it to civil defense workers, owners of homes, cars, boats, farms, etc. and to stores for resale—make good income. H. J. Kerr reported \$20 a day. C. Kama, \$1,000 a month. Write for FREE Sales Kit. No obligation.

MERLITE INDUSTRIES, Presto Div., Dept. P-15U
 114 East 32nd Street, New York 16, New York
 IN CANADA: Mopa Co., Ltd., 371 Dowd Street, Montreal 1, P.Q.

Keeping up with the ATOM

By James Biery

AFTER WARMING UP for one hour, the world's most powerful atomic accelerator recently speeded a beam of protons to an energy of more than 30-billion electron volts, the highest energy achieved on Earth by a man-made device. The machine at Brookhaven National Laboratory, Upton, N.Y., is of the type popularly called "atom-smashers." Key to its accomplishment is a magnet 843 feet in diameter which holds the protons in a circular course as they race around its outer edge building up the high level of energy. The proton beam is accelerated by 12 radio frequency stations around the ring. Each station accelerates the beam by 8000 volts each time it passes. To reach the final energy of 30-billion electron volts, some 300,000 revolutions must be made by the proton beam in one second. The protons then "smash" into a target, such as the nucleus of an atom, at almost the speed of light. One result is the creation of new atomic particles.

The pattern of radioactive fallout from nuclear test explosions is becoming defined, according to investigators at Naval Research Laboratory. They compared amounts of radioactive tungsten-185 and strontium-90 in the air at various times after the 1958 Pacific tests and concluded fallout is "considerably lower" in Southern than in the Northern hemispheres.

Radioactive contamination of milk will probably be the most widespread hazard resulting from a nuclear accident or explosion which deposits fission products on agricultural land, according to an English study. Milk taken from 40 cows allowed to graze three weeks in a field contaminated with strontium-90 showed a 500-percent increase in radioactivity.

Researchers at Los Alamos, N.M. Health Research Laboratory are studying familiar objects which might be used to find quickly the amount of radiation a person might receive from an accident or explosion. Locks of hair, coins and, especially, gold wedding bands have proved to be good neutron collectors. ★ ★ ★

MAKE EXTRA CASH

SHARPENING LAWN MOWERS THE MODERN WAY



As Low As
\$250.00

Start your own shop! Full or spare time. Earn many dollars in a short time... average \$5.00 per hour. Many mowers need sharpening. With MODERN'S Extra Heavy Duty LAWN MOWER SHARPENER AND BED KNIFE GRINDER you have 6 machines in one. All operations are done quickly and easily. You make money from the start. Write for free details.

MODERN MFG. CO.
160 N. Fair Oaks Ave. Dept.
Pasadena, California 10-6

ADDING MACHINE \$1.97 or 2 \$3.49 ea. for

+ - × ÷
ADD — SUBTR. — MULT. — DIVIDE



Does all 4 operations. Handles 9 columns of numbers. Settle for no less. Leatherette case. Lowest price adder made in America. Beware of cheapened foreign imitations. Money back guarantee. Agents wanted. \$1.97 add 4% tax in Pa.

TOM THUMB P. O. Box 5066, Dept. O-10
Philadelphia 11, Pa.



119 JIG SAW PATTERNS

FULL-SIZE... trace on wood and saw out. Clever, ORIGINAL designs, things you can make to SELL. Wall shelves, lawn signs, planters, book ends, others. postpaid

BURGESS VIBROCRRAFTERS, INC.

Rush \$1 today. DEPT. C-169, Grayslake, Illinois

Learn LANDSCAPE GARDENING

AND GROWING OF PLANTS. Latest information on propagation, soil-testing, plant growth regulators, garden design. Start a profitable business or wonderful hobby. Unique and modern home study course—accredited. Earn your certificate at home. May I send FREE, and without obligation, my informative booklet? **NORM MORRIS NATIONAL LANDSCAPE INSTITUTE** DEPT. M-100, 11826 SAN VICENTE BLVD., LOS ANGELES 49, CALIF.

GOVERNMENT OIL LEASES LOW AS \$1 PER ACRE

You do no drilling, pay no taxes, may realize a king-size profit without ever leaving home. Write for free map and literature.

AMERICAN OIL SCOUTS, Dept. PM
8350 Santa Monica Blvd. Los Angeles 46, Calif.

27 YEARS IN BUSINESS AT THE SAME ADDRESS.

Beat the high cost of new tires. **EXTRA MILEAGE TOP GRADE Tires, ANNIVERSARY SPECIAL. SEND AD WHY PAY MORE? UP TO 15,000 MI.**

Our entire stock of good used tires.			
ALL SIZES IN STOCK. White Walls \$1.00 extra			
600-16	\$4.72	670-15	\$4.72
600-16(6)	7.92	710-15	4.72
650-16(6)	8.82	760-15	4.72
750-14	4.72	800-15	4.72
800-14	4.72	820-15	4.72
750-16(6)	10.02	700-16(6)	10.02
700-15(6)	\$10.92	750-20(8)	\$12.22
750-16(8)	11.02	825-20	19.92
700-17	10.72	900-20	18.92
750-17	10.92	1000-20	19.92
850-14	4.72	1100-20	19.92
700-20	10.92	1000-20	20.92

SNOW TIRES \$7.82 AND \$6.00 ANY SIZE

BLACK WALL PASS. SUBURBANITE OR TOWN & COUNTRY TREAD. Thousands of tires shipped all over the U.S.A. All tires shipped F.O.B. Phila. Send Check or M.O. with this ad. Dept. 2 No C.O.D.

STANDARD 834 N. Broad St., Philadelphia 30, Pa.

Prepare for your career in

METALLURGY AIR CONDITIONING INDUSTRIAL TECHNOLOGY MECHANICAL ENGINEERING



Missiles or machinery, rockets or refrigeration, MSOE equips you for a career in many fields:

PRODUCT DESIGN • RESEARCH DEVELOPMENT • QUALITY CONTROL • TIME STUDY PURCHASING SALES ENGINEER

When you graduate from the Milwaukee School of Engineering, you are prepared for a dynamic career as a Mechanical Engineer or Engineering Technician. Under a faculty of specialists, you gain a sound technical education in modern, completely equipped laboratories and classrooms. As a result, MSOE graduates are in great demand and highly accepted by industries nationally.

AT MSOE you will meet men from all walks of life and all parts of the country—some fresh out of high school or prep school, others in their twenties—veterans and non-veterans.

You can start school in any one of four quarters and begin specializing immediately. Engineering technicians graduate in 2 years with an Associate in Applied Science degree. For a Bachelor of Science degree in Engineering, you attend 4 years. A 3-month preparatory course also is available.

Send for Free Career Booklet



MILWAUKEE

SCHOOL OF ENGINEERING

Dept. PM-1060, 1025 N. Milwaukee St., Milwaukee, Wis.

Please send free Career Booklet. I'm interested in:

- Mechanical Engineering Air Conditioning
 Industrial Technology Metallurgy
 Electrical Engineering

Name _____ Age _____

Address _____

City _____ Zone _____ State _____

I'm eligible for veterans education benefits.

MS-147

HIGH SCHOOL

AT HOME IN SPARE TIME

Low monthly payments include standard text books and instruction. Credit for subjects already completed. Progress as rapidly as your time and abilities permit. **DIPLOMA AWARDED**

SEND FOR BOOKLET—TELLS YOU HOW

-----OUR 63RD YEAR-----

AMERICAN SCHOOL, Dept. H745
Drexel at 58th, Chicago 37, Illinois.
Please send **FREE High School booklet.**

NAME.....

ADDRESS.....

CITY & STATE.....

Accredited Member NATIONAL HOME STUDY COUNCIL

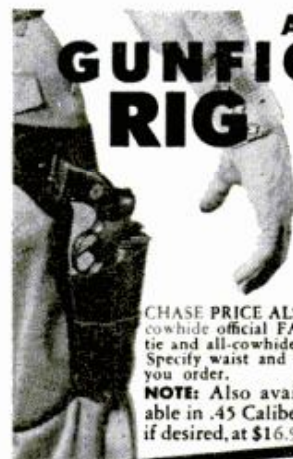

Authentic Western GUNFIGHTING RIG

\$16.95 complete

You receive one .38 SMITH & WESSON CALIBER SIXSHOOTER, guaranteed mechanically perfect. Will fire standard .38 S & W ammo available in any sporting goods store. PUR-

CHASE PRICE ALSO INCLUDES one top grain all-cowhide official FAST DRAW HOLSTER with leg tie and all-cowhide matching BUSCADERO BELT. Specify waist and right or left hand holster when you order.

NOTE: Also available in .45 Caliber, if desired, at \$16.95

TO ORDER: Send check, cash or money order. \$5 deposit for C.O.D. Shipped F.O.B. Culver City. 10-day money back guarantee.

2-Gun Rig, \$31.95

NEW! WAX LOAD KIT
FOR FAST DRAW PRACTICE. Kit of 50 primed .38 S&W or .45 ACP Cal. Brass cartridges, loading wax and instructions. Complete \$2.45

WEAPONS, INC. 11029 WASHINGTON BLVD. CULVER CITY 32, CALIF.

EARN ABOVE-AVERAGE INCOME WITH YOUR OWN GREETING CARD

Franchise

Be your own boss as an independent rack distributor. Service stores of all types with exclusive fine quality greeting cards for every occasion. New humorous Studios, Slims, traditional designs. No previous experience required. We show you how to get started. Operate full or spare time. Big profits pay off small initial investment in merchandise fast. Established routes can bring steady income. Write today for **FREE** facts. **TREASURE GREETINGS**, 14 Lake Street, Elmira, New York.

HURRY!

The Backyard PLAYBOY MOTOR SCOOTER



The newest fun for Junior! Perfect as a birthday or Xmas gift for the youngster who "has everything". His own personal motor scooter with a safe, quiet, seven-tenths Hp. two-stroke gas engine. Simple as a side-walk bike. A seven-year old can learn in minutes. Friction clutch, 12 Mph. Weighs only 42#. Thousands in service. And for adults, too! A barrel of fun on the patio for your guests. Stows easily in plane or boat.

AND A NEW **\$9750** LOW PRICE fob

Folder on Request

3074 Broadway

HAP ALZINA

Oakland, Calif.



Exciting Jobs—Big Pay... Operating EARTH MOVING EQUIPMENT

Men needed now for good paying jobs in booming road and construction work. Learn how to operate heavy road machinery: cranes, bulldozers, earth carriers, etc. Actual "on the job" training: 5 to 13 1/2 week courses. Classes start every Monday. Reserve your space now. Complete catalog and reservation facts **FREE**. Approved for veterans. Write

Greer TECHNICAL INSTITUTE
Atten.: P. L. Hutch, Box 368, Braidwood, Ill.

LAW FREE BOOK THE LAW TRAINED MAN

Write today for a **FREE** copy of illustrated law book, "THE LAW-TRAINED MAN," which shows how to earn the professional Bachelor of Laws (LL.B.) degree through home study of the famous Blackstone Law Course. All necessary books and lessons provided. Moderate cost; convenient monthly terms. Write for **FREE** law training book today.

Blackstone School of Law, 307 N. Michigan Ave.

Founded 1890

Dept. 57, Chicago 1, Illinois



Print Your Own

Cards, Stationery, Advertising, Circulars, labels, photo and movie titles, church work, tags, etc. Save money. Sold direct from factory only. Raised printing like engraving, too.

Own a Printing Business

Print for Others, Good Profit. Have home shop. Junior press \$15; Senior \$29 up. We supply everything. Easy rules. Pays for self in short time. Write now for free details.

KELSEY PRESSES, Z-37 Meriden, Conn.

GET INTO ELECTRONICS

V.T.I. training leads to success as technicians, field engineers, specialists in communications, guided missiles, computers, radar, automation. Basic & advanced courses in theory & laboratory. Assoc. degree in 20 mos. B.S. obtainable. ECPD accredited. G.I. approved. Graduates with major companies. Start Feb., Sept. Dorms, campus. H.S. graduate or equivalent. Catalog.

VALPARAISO TECHNICAL INSTITUTE
DEPT. D VALPARAISO, INDIANA

FOR KING-SIZE MEN ONLY!



SIZES 10-16 — WIDTHS AAA-EEE!

We specialize in **LARGE SIZES ONLY**—sizes 10 to 16; widths AAA to EEE. Dress, sport, casual and work shoes; golf shoes; insulated boots; sock; slippers; rubbers; overshoes; shoe trees. Also... sport shirts in your exact, extra-long sleeve length.

Enjoy perfect fit in your hard-to-find size at amazingly low cost. Satisfaction Guaranteed. Sold by mail only. Write for **FREE Style Book TODAY!**

SEND FOR FREE CATALOG

KING-SIZE, INC. 2760 Forest St. • Brockton 64, Mass.

POPULAR MECHANICS

BULLETINS *from the world of* SCIENCE

By James Biery

HARD AS SAPPHIRE, a fiber developed from aluminum oxide may find use as a skin for space vehicles to prevent them from blazing like meteorites when re-entering Earth's atmosphere. The fiber was created by Horizons, Inc., a Cleveland, Ohio, research firm. It is said to be so resistant that a man wearing a suit of it could stand having a flaming welding torch played over his back. One fiber will withstand a pull of three-million pounds per square inch and temperatures of 3750 degrees F. This is 25 percent higher than the temperature which turns steel to white liquid.

Out of the laboratory of Prof. Robert B. Woodward, Harvard University chemist, has come one of the world's greatest achievements in chemistry — the total synthesis of chlorophyll, the green pigment that captures energy from sunlight for the making of food for all living things. Professor Woodward has also synthesized quinine, cortisone and rauwolfia.

Stony meteorites may provide Moon explorers with oxygen for breathing. Dr. Kurt Komarek has explored this possibility at New York University, assuming that early Moon parties will take along algae or other green plants which will breath in the members' carbon dioxide and give off oxygen, and that this closed system would be subject to oxygen leaks. Dr. Komarek heated stony meteorites, which contain about 36 percent oxygen, in the presence of hydrogen. He got a yield of three to four pounds of oxygen for each 100 pounds of meteorite. From this, it was estimated that a five-man crew could replenish oxygen losses indefinitely by processing about 200 pounds of meteorite a month. The process would boil out oxygen from iron oxides in the meteorites, would use hydrogen to pull off oxygen in the form of water vapor. The water would be separated into hydrogen and oxygen by electrolysis.

An earthbound space explorer, Dr. Rudolf Minkowski, has photographed two galaxies in collision some 36 billion miles out in space, using the 200-inch Mt. Palomar telescope. The speck of light, moving away from Earth at about 90,000 miles a second, may, upon further study, help prove the universe was born in a huge explosion and has been expanding ever since. ★ ★ ★



MEN! Make up to \$1,000⁰⁰ IN A MONTH!

without "SELLING"

Sensational Demand for Low-Priced Fire Alarm PLUS Sure-Fire "No-Selling" Plan Offers Ambitious Men Huge Profit Opportunities

AMAZING NEW INVENTION



Even beginners who never sold anything in their lives are cleaning up unbelievable profits with the first practical effective, low priced Fire Alarm ever invented . . . needed, wanted in homes, factories, offices, stores, on farms, for boats, everywhere. Professional salesmen are making biggest profits in years! Later in this ad I'll tell you about the plan that's producing orders for 1 to 12 Fire Alarms per sale from 8 out of 10 prospects . . . without selling. Here are the facts about the Fire Alarm. It hangs on the wall like a picture—no wiring, no installation. It's always on guard . . . It 'smells' a fire before danger point. When temperature rises, Fire Alarm goes off automatically, howls loud warning that can be heard 1/5 mile, wakes up soundest sleeper, give precious time to put out fire, call fire department, or escape. And it sells for only \$4.95 with profit up to \$2.70 on each one.

Nearest Thing to AUTOMATION SELLING



With our field-tested plan customers sell themselves. No cold canvassing. No hard selling. It's the nearest thing to 'Automation Selling.' Imagine a sales plan even a child can use successfully because the sales tools we give you (and which you leave with your prospects) do all your selling even while you sleep! No room here to give you all the details but if you want big money fast rush the coupon now.

Make This Lighted-Match Demonstration

Sensitive! Lighted match triggers Alarms in 3 seconds.

Free Sales Kit

Send no money. Just rush coupon below for all the exciting moneymaking facts, complete illustrated Sales Kit, everything you need to make money your first day. Learn how selling only 20 Fire Alarms a day pays

Made \$26.52 in 3 Hours!

"Received first shipment about noon. Worked 3 hours and made \$26.52 profit. It's a terrific seller!" —Stanley, Calif.



you \$1,080.00 profit in a month. No competition anywhere. Get in on the ground floor now. Rush this coupon.

MERLITE INDUSTRIES, Inc.

(ALARM DIVISION)

114 E. 32nd St., Dept. F-15U

New York 16, N. Y.

ALVIN WESLEY, Sales Manager

Merlite Industries, Inc. (Alarm Division)

114 E. 32nd St., Dept. F-15U, New York 16, N. Y.

Rush FREE SALES KIT and full details about your "No-Selling" plan which gives me opportunity to make up to \$1,000.00 in a month without cold canvassing and hard selling —automatically. I am not obligated.

Name

Address

City..... Zone..... State.....

In Canada: Mopa Co., Ltd., 371 Dowd St., Montreal 1, P. Q.

FREE!



1961 LAFAYETTE ELECTRONICS CATALOG 610

From the world's leading supplier of electronics and stereo hi-fi equipment.

OUR 40TH YEAR

The biggest and best catalog in our history, featuring the latest equipment from all major manufacturers at prices that can't be beat anywhere.

HUNDREDS OF EXCLUSIVE LAFAYETTE FINE-QUALITY ITEMS AVAILABLE IN THIS CATALOG ONLY

The "complete shopping center" for the audiophile, hobbyist, technician, student, engineer, serviceman and dealer. Mail the coupon today for your free copy.

LAFAYETTE LOCATIONS

JAMAICA • BRONX • NEW YORK CITY
NEWARK • PLAINFIELD • PARAMUS • BOSTON

Lafayette Electronics Dept. LI-6
P.O. Box 190
Jamaica 31, N. Y.
Send me the **FREE** 324-pg. 1961 catalog 610.

Name.....

Address.....

City..... Zone..... State.....



STEP ASIDE for NO MAN LEARN KARATE... DEADLY DEFENSE

You can master Karate, the world's most deadly form of unarmed combat. In his new fully illustrated booklet, 'KARATE, Open Hand and Foot Fighting,' Bruce Tegner's pictorial method enables you to learn: (1) Karate striking methods, how to make lethal use of 13 parts of your body; (2) Nerve centers, how to temporarily paralyze your opponent; (3) Defense and attack methods. WALK WITH CONFIDENCE. Start today—

Send only \$2.98 to: **KARATE** Dept. 430
7471 Melrose Ave., Los Angeles 46, California

95% PROFITS YEAR 'ROUND

Be your own boss, Operate a **SIMPLEX** lawn-mower sharpening service in your community. One compact machine grinds all mowers, sharpens cutlery. Low investment, 95% profit. Pays for itself in average month.

SIMPLEX

—4 Machines in One!

Reel Grinder—sharpens any mower reel in or out of mower.
Bed Knife Grinder—grinds with either round or cup wheel.

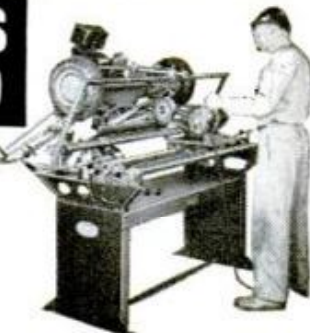

Rotary Blade Grinder—hollow grinds any rotary mower blade.
Cutlery Knife Grinder—sharpens cutlery, tools, scissors.

Send for free, money-making details!

The **FATE-ROOT-HEATH** Company - Dept. PM-10, Plymouth, Ohio

More Comfort Wearing FALSE TEETH

Here is a pleasant way to overcome loose plate discomfort. **FASTEETH**, an improved powder, sprinkled on upper and lower plates holds them firmer so that they feel more comfortable. No gummy, gooey, pasty taste or feeling. It's **alkaline** (non-acid). Does not sour. Checks "plate odor" (denture breath). Get **FASTEETH** today at any drug counter.

Here's the Offer No Other Radio-TV School DARES MAKE

ALL FINANCED WITHOUT INTEREST OR CARRYING CHARGES

RADIO-TV TRAINING SCHOOL
815 E. Rosecrans Ave. Dept. PM-100
Los Angeles 59, California

RTS will train you at low cost and when you graduate will help you open a service shop of your own and will supply all of the equipment you need plus a full inventory of parts and supplies.

NO SALESMAN WILL CALL ON YOU!!!

REAL ESTATE BE A BROKER

PAYS BIG! SEND FOR FREE, BIG, ILLUSTRATED CATALOG NOW! Graduates report making substantial incomes. Start and run your own business quickly. Men, women of all ages, learn easily. Course covers Sales, Property Management, Appraising, Loans, Mortgages, and related subjects. **STUDY AT HOME** or in classrooms in leading cities. Diploma awarded. Write **TODAY** for free booklet! No obligation.



Approved for World War II and Korean Veterans
WEAVER SCHOOL OF REAL ESTATE (Est. 1936)
2020R Grand Avenue Kansas City, Mo.



Circus Big Tops Trucked on Spools

Most touring circuses today travel on the flatbeds of trucks rather than on the flatcars of trains and, as one result, the main tent, or big top, is getting streamlined handling. The big top formerly was made of many sections of canvas which had to be spread on the ground and laced together by hand before the tent could be raised to the top of the center pole. Now the big tent is carried in two sections only; each section is wound around one of two chain-driven spools on a truck and is lowered into place on one side or the other of the center pole. The sections are quickly laced together and raised.

NEW HO COLLECTORS ITEM!

NEVER BEFORE AVAILABLE!

B & O

"TEAKETTLE"

OLD TIME LOCO

\$7.95

ONLY **\$7.95** P.P. A beauty to display . . . a dependable performer that hauls long loads effortlessly. Colorful, authentic . . . a real value! R.T.R. Order today!

LIFE TIME GUARANTEE



Send For:

Giant RR Catalog—Lionel-A.F.-Hobbies . . . only 25c **FREE** WITH EVERY ORDER!

GAMERMAN'S

Dept. R 3615 Bank Street
Baltimore 24, Maryland



Finish **HIGH SCHOOL** AT HOME
IN YOUR SPARE TIME

DIPLMA AWARDED
Learn more! Earn more! Enter professional or technical schools. Advance socially. Live a happier, fuller life. Individual Courses or complete schedule. Write for School Bulletin.

ACADEMY FOR ADULTS

30 W. Washington, Dept. PM-1060, Chicago, Ill.

MAKE YOUR FORTUNE



Sell famous Spring-Step Cushion Shoes for all the family—men, women, children and babies! Earn big money daily plus Cash Bonus and Retirement Income with amazing 2-minute demonstration that sells on sight. Big repeat business. Full or spare time. America's Biggest Selection of Shoes for all the family. Free outfit given. No investment ever. Write today.

ORTHO-VENT Shoe Co., Inc.
11010 Brand Road Salem, Virginia

FREE AMAZING NEW BOOK "HOW TO ANSWER ADS"



Never before have you seen anything like this. Tells you in simple language the correct way to answer ads. Gets you quicker replies—better results, and greater satisfaction. Will save you time and money and it's **ABSOLUTELY FREE**. No obligation whatever. Every reader of advertising should have this booklet. Send a postcard for your copy NOW. **F. W. JOHNSON**, Popular Mechanics Magazine, Room 600-A, 204 East Ontario Street, Chicago 11, Ill.

"How to Make Money with Simple Cartoons"



A book everyone who likes to draw should have. It is free; no obligation. Simply address

FREE BOOK

CARTOONISTS' EXCHANGE
Dept. 910-D Pleasant Hill, Ohio

NO JOB WORRIES

PLASTEX INDUSTRY needs manufacturers on small scale for big production of Lamps, Clock Stands, Art Goods, Novelties in Plastic Marble imitation. No Experience necessary. 1/2¢ material makes regular 10¢ store sellers. Moulds furnished for fast production. Small investment brings good profit. Big wholesale orders now being placed. Ambitious men have chance for real prosperity and job security. Our NEW FREE booklet will interest and benefit you.

PLASTEX INDUSTRIES, Dept. A
3400 Third Ave. New York 56, N.Y.

94.6% OF BAILEY GRADUATES ARE EMPLOYED AT TOP PAY IN THE FIELDS WHICH THEY WERE TRAINED!



DIESEL-AUTO MECHANICS DESPERATELY NEEDED!

We have a far greater demand for our students than we can fill!

We can show you an actual waiting list of leading companies throughout the world who have tried Bailey graduates — found them outstanding, and are coming back for more!

Bailey Graduates are Successful . . . RECEIVE BIG PAY — HAVE SECURE FUTURE!

The Famous Bailey Course prepares you for **BOTH Diesel and Gasoline Mechanics.**

This is a **must-due** to the advent of using Diesel principles, such as 'Fuel Injection' on passenger cars . . . use of gasoline engines for starting Diesel engines, etc. You learn all this at Bailey in the amount of time ordinarily required to learn just one of these subjects, **ALL FOR THE PRICE OF ONE.**

Don't be satisfied with a 'futureless', one-type job — learn how you can make **big money** now!

Write today for Free Booklet that takes you on a step-by-step camera tour through our spacious, modern shops — See Bailey students in action as they Learn-by-doing with the Famous Bailey Method of training!

We provide you with housing and part time jobs while in school, plus nation-wide placement service for graduates.

BAILEY Technical SCHOOLS

1634 S. GRAND ST. LOUIS 4, MO.

MAIL TODAY!

Please mail immediately this free booklet without obligation.

FREE BOOKLET



Name.....

Address.....

City..... State.....

APPROVED FOR VETERAN . . . NON-VETERAN

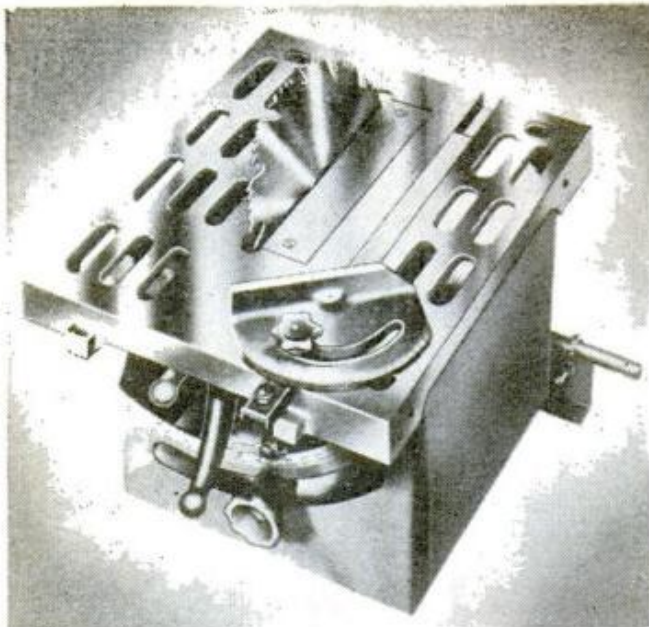

Power Saw only \$9.95 Don't question the price! Don't doubt the value! Don't try to beat it! You can't! We operate large foundry—own patents—sell direct. Blade tilts, table stays level. All cast iron and steel construction. Precision ground cast iron table. Massive cast iron mitre gauge. Patented motor drive fits any motor. Does everything accurately and quickly—as a saw costing 5 times as much. Cross cuts, rips, bevels, dados, cuts compound angles. Adjustable depth of cut 0 to 2¼. Exactly as shown less blade.

Send cash or check for \$9.95. Or, send \$2 deposit for C.O.D. All machines sent express collect. We will give you your money back immediately if you are not completely delighted. 480,000 now in use. See for yourself. Order right now.

AMERICAN MACHINE & TOOL CO.
Royersford 82, Pa.

ITEMS FROM ALL OUTDOORS

By Dick Kirkpatrick

FISHING TACKLE IN OCTOBER? Sure—why not? Fishing's better now than it was during your vacation this summer, anyway. But that's not the point. Late summer and early fall are when your sporting goods dealer buys his fishing tackle to show you next spring. And the dealers are buying some very interesting new gear . . .

Bait casters who've been struggling to cast with monofilament line intended for spinning reels will be happy to see the new monofilaments especially designed for rotating-spool reels. At least three manufacturers, Western, Cortland, and Gladding, are coming out with flat and oval monofilament that will lie smoothly on an open spool without digging into the line below it, and which spools off smoothly without springing, ballooning, or backlashing. As a bonus, the new lines take up less room on the spool, increasing line capacity, and have higher knot strength than round line.

While rotating-spool reel fans rejoice, spinning is moving into one of their last retreats—surf casting and heavy-duty fresh water fishing. The new Zebco 89 is an extra-big closed-face spin-casting reel designed for straight-handled rods. It'll give the surfer and musky fisherman the backlash-free distance he needs without sacrificing the needed strength of straight-handled rods. The same company will also introduce a new fresh water model, the ZeeBee which uses the new Kralastic MH plastic to produce a reel with all the spincasting features that sells under six bucks.

Reels with gear shifts will begin showing up next year, too. At least three—the big Langley "Dyna-Flo" salt water models, the Denison-Johnson "Sabra" spin-casting reel, and the South Bend "Sup-Matic" spinning reel, will let you shift from high gear for a fast retrieve into low gear for more power for playing heavy fish.

Probably the newest idea at this year's trade show, though, came from the Instant Bait Company of Mattapar, Mass. Its new line of artificial baits is impregnated with fish-attracting scents, activated when the bait hits the water.

Looks like next year, as usual, it'll be almost as much fun to browse through the tackle shops as it is to go fishing. ★ ★ ★

POPULAR MECHANICS

... TURN CONCRETE INTO GOLD!

MAKE UP TO \$75 A DAY IN YOUR OWN BUSINESS

If you want to have your own business — to start a business on your own — here's your big opportunity! New high speed, low cost General block machine produces up to 1,000 concrete blocks a day. Sell all you make to builders, supply houses, and others for homes, factories, buildings, garages. Cash in on the building boom! You can make profits of 100% to 150% — up to \$75. a day! General block machine equipped with ½ h.p. electric motor — or can be supplied with gasoline engine — works anywhere, in little space, indoors or out. Operates from ordinary house light socket. Simple, foolproof 3 step operation — so easy a child can do it. Makes superior 3 core blocks any size from 4" to 12". Also makes chimney, ash, corner and other types. Blocks meet any building code anywhere in the country. Materials — sand, water, cement, available anywhere. Simple illustrated operating instructions and mixing formulae for cement and cinder blocks supplied with each machine. Write for FREE folder with full information.

MOTOR DRIVEN

R. L. T. of New York City reports: "MY GENERAL BLOCK MACHINE PAID FOR ITSELF IN FIRST 2 WEEKS!"

Hundreds now in use the world over! Write for FREE details today!

EXTRA Amazing illustrated book gives floor plans for 6 sensational concrete block bungalows. Tells how to lay blocks, lay out building lines, mix concrete, build steps, porch and concrete floors all at great savings. Written by experts. Can save many times the cost of the machine! Get it now! No strings attached. Send \$1.

BOOK SENT FREE IF YOU BUY MACHINE. \$1 REFUNDED IF YOU BUY LATER.

GENERAL ENGINES CO.
DEPT. M-100, ROUTE 130, THOROFARE, N. J.

HOW TO BUILD YOUR OWN CONCRETE BLOCK HOME
Only \$1 Prepaid

cabana marrone



**PLAN YOUR FUTURE NOW...
have a business of your own**

Luxurious, high-fashion fur now being ranch-raised in U.S.A. and Canada. All select, pedigreed, registered stock. Easy and economical to raise in any climate. One pair should produce 10 to 15 young per year. Warranty assures life and production. You may qualify for membership in CNBA (Cabana Nutria Breeders Association), the largest and strongest Nutria association. Free ranch training program. Cabana Marrone Nutria garments nationally advertised.

Cabana Marrone available only through authorized distributors. Write for complete information. Distributor inquiries invited.



CABANA NUTRIA INC.
Dept. 71 636 West Lemon Arcadia, Calif.

I'll Send You This Handsome SAMPLE CASE-FREE



**and Show You How to Make
Up to \$30.00 in a Day**

WRITE for this FREE Tailoring Sample Case packed with 100 beautiful, big-value suits and overcoat fabrics. Take orders from friends, fellow-workers, others, for fine quality, made-to-measure clothes. Pocket big cash profits in advance. Because wearing our suits and overcoats brings more orders, we make it easy for you to get your own clothes without the cost. No experience is needed. **SATISFACTION GUARANTEED. SEND NO MONEY.** Rush your name, address, and age—today!
**W. Z. GIBSON, INC., 500 South Throop Street
DEPT. L-516 CHICAGO 7, ILLINOIS**



SEND FOR THIS FREE!

Make money. Know how to break and train horses or ponies. Write today for this book FREE, together with special offer of a course in Animal Breeding. If you are interested in Gaiting and Riding the saddle horse, check here (). Do it today—now.

**BEERY SCHOOL OF HORSEMANSHIP
Dept. 11010 Pleasant Hill, Ohio**

FREE GERMAN STEEL HUNTING KNIFE



4-INCH BLADE

We give you handiest hunting and fishing knife you've ever had! Has 4-INCH LONG highly tempered steel blade—VERY SHARP! Attractive handle. We send knife FREE to acquaint you with our below-wholesale bargains. Please send 25c for handling. NO LIMIT—but send 25c handling for each knife. Order TODAY!
HUNTING KNIFE, Dept. K-513, Box 881, St. Louis, Mo.

New Table Top Invention Puts You In...

PROFITABLE RUBBER STAMP BUSINESS

**Home Operators now make
\$9.20 AN HOUR in business
once monopolized by
a few big companies**

Special rubber stamps bring high prices—cost only pennies to make on new, low-cost table top machine. Take 27 cents worth of material, make perfect stamps, the kind businesses and offices now buy by the dozen at \$1.80 each. Make up to \$9.20 an hour. Start in spare time in your own home. Run machine on kitchen table using ordinary electrical outlet. Make any kind of stamp. We'll send you free information without obligation about this established, highly profitable business, now open to individuals for the first time. For free information send name today on a post card to
Rubber Stamp Div. 1512 Jarvis, Dept. R-2-L, Chicago 26, Ill.



TRAIN AT HOME

**in Your Spare Time or in
the Great Allied School**

1338-42 South Michigan Ave.
Chicago 5, Ill.

DRAFTING—All Branches
• Mech. • Structural • Aeronautical

ENGINEERING
• Industrial Engineering
• Tool Engin. & Designing

ELECTRONICS

AUTO MECHANICS

AIR CONDITIONING
Refrigeration — Heating & Cooling

TOOL & DIE MAKING
Machinist Trade

*Now you can
attend Allied under the
Education Fund Plan. Get Details.*

PREPARE for the best jobs in your spare time at home. With ALLIED'S practical home study program you can progress so rapidly that big new opportunities will soon be open to you. Students planning a career in engineering can begin their training in short courses at Home or at Allied Institute and continue progressively toward an Engineering Degree in 31 months. Enjoy benefits of Allied's Education Fund Plan and Industrial Coop Plan. Pay almost all your tuitions from earnings. Allied is approved by Industry, National Home Study Council, Department of Education, Office of Public Instruction, State of Illinois, U. S. Department of Justice.

ALLIED INSTITUTE OF TECHNOLOGY,
1338-42 South Michigan Ave., Dept. PM-100, Chicago 5, Ill.

Send me without obligation information on your courses:

- | | |
|---|--|
| <input type="checkbox"/> MECHANICAL DRAFTING | <input type="checkbox"/> AUTO MECHANICS |
| <input type="checkbox"/> STRUCTURAL DRAFTING | <input type="checkbox"/> ELECTRONICS |
| <input type="checkbox"/> ELECTRONIC DRAFTING | <input type="checkbox"/> AIR CONDITIONING |
| <input type="checkbox"/> AERONAUTICAL DRAFTING | <input type="checkbox"/> REFRIGERATION |
| <input type="checkbox"/> INDUSTRIAL ENGINEERING | <input type="checkbox"/> TOOL & DIE MAKING |
| <input type="checkbox"/> TOOL & DIE DESIGNING | |
| <input type="checkbox"/> HOME STUDY | <input type="checkbox"/> RESIDENT |
| | <input type="checkbox"/> EDUCATION FUND |
| | <input type="checkbox"/> VETERAN |

NAME AGE.....

ADDRESS

CITY..... COUNTY..... STATE.....



HEAVY EQUIPMENT OPERATION

Schools like the one pictured above teach operating engineers the technique for handling heavy equipment

by B. Richard

Towering 210 feet tall, weighing 7000 tons, able to lift 173 tons of material—this is the mammoth stripping shovel being built today for a strip coal mining company.

It's an example of the gigantic, highly specialized construction machinery that is playing an increasingly important part in the growth of America.

This tremendous shovel uses 52 electric motors delivering 12,000 horsepower and is operated by one man from an air conditioned "office." The operator of this machine is known as an operating engineer, and he is a well paid, highly trained man with the direct responsibility for the machine and the great expense it represents.

Power-driven construction machinery is in wide use in virtually all of today's construction projects. Cranes, derricks, paving machines, bulldozers, tractors, hoists and pile drivers are just a few of the many machines in constant use because of this coun-

try's greatly increased construction activity, and, in particular, because of such projects as the government's multi-million dollar highway construction program.

In 1958 an estimated 190,000 operating engineers were at work operating, maintaining and repairing this machinery. This number has been increasing steadily and a continued rapid rise in employment is predicted for the 1960's.

Not only does an experienced operating engineer handle a variety of construction equipment, but his light, sure touch makes the huge boom of a crane, for example, an actual extension of his own arms and legs.

Operators with skill such as this, skill developed through intensive training and experience, qualify for the top wages paid by construction companies, utility companies, manufacturers and government agencies. Many of these men, with overtime are re-

(Continued to page 46)

[AT LAST! The full secret of your]
 [mighty subconscious mind revealed]
HOW YOU CAN DIRECT YOUR
"HIDDEN BRAIN POWER"
TO GET YOU WHATEVER YOU WANT



NAPOLEON HILL

The name Napoleon Hill means success in practically every English-speaking community in the world. He is today unquestionably the world's best known and most successful writer on self-improvement subjects. His "Think and Grow Rich" has for more than 20 years been America's most stimulating and influential contribution to the science of personal accomplishment. Hill has spent his lifetime studying the secrets of success and has personally interviewed those men who could give him first-hand information: Andrew Carnegie, Henry Ford, William Wrigley, Jr., John Wanamaker, George Eastman, John D. Rockefeller, Thomas Edison, F. W. Woolworth, and many others. Napoleon Hill has come a long way from the one-room log cabin in Virginia in which he was born.

This amazing new book shows you how to set free your marvelous "INNER MIND" to bring you success . . . success beyond your most optimistic dreams. Financial success! Health success! Spiritual success! Marital success! Practical, step by step directions given to you in understandable language in this daring new book:

**SUCCESS THROUGH A
 POSITIVE MENTAL ATTITUDE**

by Napoleon Hill and W. Clement Stone



W. CLEMENT STONE

Get ready to explode all your old theories about the limits of what you are capable of. Get ready to see your hidden strengths revealed . . . see new forceful personality appear as if by magic.

The sleeping giant within you awakes . . . and you see this stupendous power start to work for you before your very eyes. Here are just a few of the tremendous revelations explained in this book:

- How to acquire wealth by using "other people's money"
- The 17 proved, tested success principles—and how you can start them working for you at once
- How to keep your mind ON the things you do want and OFF the things you don't want
- Your amazing subconscious mind—and how you can use it with push-button ease
- The "magic ingredient" of success
- 2 sure ways of breaking the habits of self-doubt and defeat
- Secret of recharging your mental and physical energy
- How to motivate others—how to get them to do what you want them to do
- How to make up your mind when you're undecided what to do

You've heard them say, "If he's so smart why isn't he a millionaire." Well, W. Clement Stone IS smart and he IS a millionaire—more than 35 times a millionaire! And he started with capital of only \$100. This man is eminently well qualified to write about success. In just a comparatively few years the principles explained in this book enabled him to provide high protection, full coverage, low cost accident and health insurance to millions of people. W. Clement Stone is now president of Combined Insurance Company of America, Hearstone Insurance Company of Massachusetts, Combined American Insurance Company, First National Casualty Company . . . General Manager of Napoleon Hill Institute . . . Publisher of Success Unlimited magazine.

**PRAISE! PRAISE! EVEN
 THE EXPERTS CHEER...**

"The contents of this wonderful book should be read in every college."—Eddie Rickenbacker, Eastern Air Lines, Inc.

"It will contribute to general happiness, which comes from successful accomplishment."—Arthur H. "Red" Motley, President, Parade Publications, Inc.

"Unlimited Congratulations for this tremendous book! One of the most interesting and sound books on personal development that I have ever read."—Norman Vincent Peale.

**TEST THIS METHOD FREE—
 GET RESULTS IN 10 DAYS!**

Send no money—Free examination

Just mail the coupon below to get a trial copy on free approval. See for yourself what SUCCESS THROUGH A POSITIVE MENTAL ATTITUDE can do for you . . . make this method PROVE itself to you. Its priceless benefits will start coming to you almost instantly. After 10 days' trial if you are not thrilled with results, simply return the book, pay nothing, owe absolutely nothing. Otherwise pay only \$4.95 plus a few cents for postage. Mail coupon now.

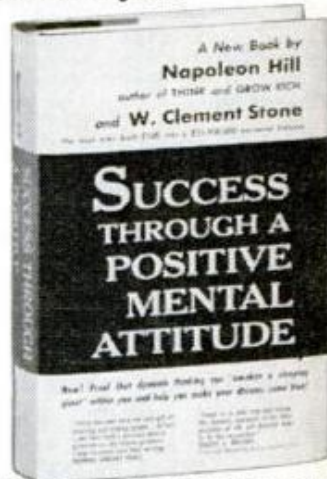

FREE GIFT

IF YOU SEND COUPON NOW



This unique story contains the philosophy of success. Its magic influence on everyone who reads it is irresistible. You can get this unusual pocket-size book absolutely free simply by mailing this coupon promptly. "The Magic Story" by Frederic Van Rennselaer Dey will be sent to you as a gift . . . and

it is yours to keep whether or not you keep the examination copy of "Success Through a Positive Mental Attitude." Supply of gift copies is limited—mail this coupon now!

MAIL THIS FREE-TRIAL COUPON TODAY

Combined Registry Company, Dept. KP-2
 5050 Broadway, Chicago 40, Ill.

Please send me for 10 days' FREE examination—copy of "Success Through a Positive Mental Attitude." I will put this method to the test. If I am not fully satisfied with results I will return book, pay nothing, and be under no obligation. Otherwise I will remit only \$4.95 (plus a few cents postage) in full payment. In any case I am entitled to keep the free gift copy of "The Magic Story."

NAME _____

ADDRESS _____

CITY & STATE _____

SAVE: Send \$4.95 with this coupon and we pay postage. Same return and refund guarantee.



FREE!
CANADIAN
STAMP
COLLECTION

RUSH reply. Big-value collection, historic Canadian Commemorative Stamps given free! Choice, scarce stamps issued over the years. Many large size, multi-colors including Royal Family, British Columbia Centennial, other colorful historic issues. All genuine, all different. Here's a rare chance to round out and increase the value of your collection. This offer never made before. Rush name, address for your FREE stamps and other valuable offers for FREE inspection. Include 10¢ for handling and postage. Garcelon Stamp Co., Dept. OPMM, Calais, Maine.

GARCELON STAMP CO., Dept. OPMM, Calais, Maine. Rush Free Canadian Commemoratives, other offers for inspection. Enclosed 10¢ for handling. PLEASE PRINT.



BIG MONEY OR EXTRA INCOME
Home Appliance Repair

LEARN TO EARN MORE... QUICKLY AND EASILY!

Wide-open field for men of all ages. Millions of Home Appliances need fixing... Every home is your market for Full-Time Career or Spare-Time "Second Income" opportunities. Save on your own repairs. N.T.S. Shop-Tested HOME TRAINING is streamlined, modern, low-cost, practical. Qualifies you fully and you start earning early in your course. Includes Tools and Appliance Tester. Send for FREE Opportunity Book and actual lesson. No Obligation. No Salesman Will Call!

NATIONAL TECHNICAL SCHOOLS Dept. HB-100
Los Angeles 37, California

Name _____ Age _____
Address _____
City _____ Zone _____ State _____



IT'S EASY TO ROLL OUT THIN LINES with

Master PAINT STRIPER

You can do professional striping on furniture, boats, autos, bikes, plywood, etc. Master Striper rolls out uniform lines on wood, glass, plastic, ceramics, almost any surface with paint, temperas, glue, textile-paint or underglaze; also used in industry.



- TYPE M Tool with 1/16" roller tip... \$1.50
- Other size Tools (1/64", 1/32", 3/64", 5/64", 3/32", 1/8")..... 2.00
- Extra Roller Tips, Sizes above, ea..... 1.00
- Extra Roller Tips, 1/4" ea..... 1.25
- Special complete set with 7 tips, only 5.50
- DOUBLE STRIPE KIT—5 combinations 3.50 (COD's. Postage Collect)

MAKES CLEAN, STRAIGHT OR CURVED LINES; VARIOUS WIDTHS AVAILABLE.

WENDELL MFG. CO., 4234 LINCOLN AVE. DEPT. 44 CHICAGO 18, ILL.

ported to have yearly earnings in excess of \$10,000.

A number of these experienced operating engineers received their initial training in heavy equipment operation from private institutions teaching the subject. Many of these institutions employ a good-sized fleet of machines of all types so that students can learn by actually taking over the controls and through constant practice.

In addition to practical operational training, private schools often offer technical courses in such subjects as engineering, maintenance and blueprint reading so that students can get the technical background they need to prepare them for the top jobs in heavy equipment operation.

In most cases young men interested in getting started as an operating engineer find their initial training is highly informal. Men without school training ordinarily start as an oiler or helper or are assigned the job of operating simpler machines such as air compressors.

Men without previous training are usually advanced as they gain experience and as openings occur. They proceed gradually until there is a chance for them to operate more complex equipment for which the pay rate is higher.

Because of the informality of this type of training, men who have learned how to operate a variety of equipment in a good school training program can expect more rapid progress and better earnings.

Men who have school training in blueprint reading, maintenance and other technical subjects already have a good deal of the knowledge ordinarily necessary for supervisory jobs. This gives the trained school graduate an added advantage over the man who picks up all his training on the job.

Job opportunities for operating engineers are not limited to large-scale construction projects. One of the advantages of this field is that operating engineers can find employment in a variety of industries. For example in factories and mines, machine operators handle cranes, hoists and other power-driven machinery.

Heavy equipment operation is exclusively a job for men—coordination, skill and technical knowledge are the prerequisites for success. Operating engineers have a unique opportunity for travel and for making an important contribution toward the growth of this country.

For Popular Mechanics' free SKILLS for AMERICA Booklet, detailing opportunities in this and other important fields, write Popular Mechanics, Dept. SFA, 200 East Ontario Street, Chicago, Illinois.

.308 WINCHESTER CALIBER SPORTING RIFLE

\$24.95 with adjustable open sights

.308 WINCHESTER SPORTER WITH 4 POWER SCOPE

\$29.95 complete!

SURPLUS SCOPE purchase allows us to make this fantastic offer! We have picked up just a few hundred of these 4X color corrected scopes (adjustable for windage and elevation) at an inventory clearance. We mount and boresight at our cost with purchase of rifle.

the official NEW NATO caliber, sporting and target ammo available at all sporting goods stores. Add \$4 per rifle for selected collector's grade exterior.

SPECIFICATIONS: Lightening fast 5-shot bolt action, box magazine fed, 22" bbl., sharp, accurate bores, rear sight adjustable for elevation and windage, all milled parts. \$75 value.

ACCESSORIES AND AMMO: .308 softpoint hunting ammo: 20 rds., \$2.95. Leather sling, \$2. Cleaning rod, \$1. Gun case, heavy duty, \$2. Cleaning kit, (patches, bore cleaner, gun oil) 75c.

TO ORDER: Enclose check, cash or money order. \$10 deposit for C.O.D. Shipped F.O.B. Culver City. 10-day money back guarantee. Calif. resid. add 4% state tax.

MARTIN B. RETTING, INC.

11029 Washington Blvd., Culver City 39, Calif.

NEW NATO HIGH VELOCITY CALIBER

SPECIAL CLOSEOUT PURCHASE! Our gunsmith

customizes this superb European rifle, converts prime walnut stock to sporter contours, lightens, rounds forestock, installs swivels, rebeds, headspaces, testfires. .308 Winchester is

INVENTIONS WANTED! FREE PATENTS!

Get full information on SHAW'S PATENT PROMOTION PACKAGE . . . Your invention fully protected while we run down patent, manufacture, merchandising, sales . . . **YOU RAKE IN PROFITS** . . . small registration fee covers everything!

Write today.

SHAW ENTERPRISES

— Inventors' Agents —

Dept. PM-10, 908 N.W. 79th St., Miami 50, Florida
Plaza 8-2645 • Member, Miami-Dade Co. Chamber of Commerce

BE A CLAIM INVESTIGATOR



INVESTIGATE ACCIDENTS!

Many earning \$750 to \$1000 a month. Thousands of insurance companies, steamship lines and Government Offices need Claim Investigators. Also big opportunities for your own spare time business. We train you at home. National Placement Service FREE of extra charge. Bill King writes: "Your course has paid off for me with large earnings. You can quote me — your Adjuster Training Course is worth many times the cost." Write TODAY for FREE book.

UNIVERSAL SCHOOLS

University Park, Dept. PM-10, Box 8202, Dallas 5, Texas

SAVE UP TO 1/2 ON FINE ITALIAN

CHORD ORGANS

Buy Direct-From-Importer... GET BIG DISCOUNTS

PLAY ON SIGHT! NO LESSONS NEEDED!

Here's the new musical instrument sensation that's suddenly captured the entire country! You and the children can play old and new songs in just a matter of minutes! . . . thanks to the famous DA-MAR System, included FREE! Makes music fun right from the start. Brings the whole family closer together as everyone joins in playing everything from hit tunes to lovely hymns. Best of all . . . you actually save 1/2 off mfr's list prices . . . buying direct from the importer. Pay only a small amount down . . . the rest just pennies a day!

HAND CRAFTED IN ITALIAN TRADITION OF QUALITY

Many domestic-made Electric Chord Organs use inferior plastic reeds . . . but every Philharmonic reed is made of finest, carefully treated Swedish Stainless Steel for superbly richer tonal quality and volume. Your Philharmonic Electric Chord Organ is largely hand crafted, just as any outstanding instrument should be! A giant in performance—yet it's light in weight, fully portable. Choose from a wide selection of models, including Piano-Keyboard model for those with piano background. DOUBLE GUARANTEED. Get new FREE Color Catalog and lowest Direct Importer-to-You Discount Prices. Rush Coupon . . .

PIANO-KEYBOARD MODELS ALSO AVAILABLE

FREE BONUS GIFTS

- Big Solo Kit...with special easy-play arrangements of favorite songs.
- Plastic Protective Cover
- Expandable Music Portfolio
- Chemically Treated Polishing Cloth
- DOUBLE GUARANTEE...gives you 100% certified protection.

Rush coupon for details

5 DAY FREE HOME TRIAL

Try it—play it—enjoy it in your own home on 5-FULL DAYS' FREE TRIAL. Only then can you appreciate how much fun the Philharmonic can bring into your home. Details free.



**EASY TERMS
SMALL DOWN PAYMENT
BALANCE only
PENNIES A DAY**

24
MODELS

FREE! GET COLOR CATALOGS AND DIRECT IMPORTER-TO-YOU DISCOUNT PRICES

Philharmonic Organ Corporation—Dept. R-100
2003 W. Chicago Avenue, Chicago 22, Ill.

Rush Color Catalogs and Lowest Discount Prices

NAME _____

ADDRESS _____

CITY _____ ZONE _____ STATE _____

PHILHARMONIC ORGAN CORPORATION

Dept. R-100 2003 West Chicago Avenue, Chicago 22, Illinois



You can make money in

WATCH REPAIR

Learn at home the low cost Sweazey Way

Watch repairing pays up to \$6 an hour, part time watch makers report on survey. Unique and modern Sweazey home study System starts you making repairs right away on Swiss and American watches. Professionally prepared training. No previous experience needed. Special tools provided for practice. Tuition only \$5 a month. Diploma Awarded. Free sample lesson and opportunity book give all facts. Write today. No obligation.

CHICAGO SCHOOL OF WATCHMAKING
2330 N. Milwaukee Avenue, Dept. 1100, Chicago 47, Illinois

FREE BOOK and SAMPLE LESSON

CHICAGO SCHOOL OF WATCHMAKING
2330 N. Milwaukee Ave., Dept. 1100, Chicago 47, Illinois
Please rush FREE BOOK and Sample Home Study Lesson.

Name _____ Age _____
Address _____
City _____ Zone _____ State _____

"MINIATURE MACHINE SHOP

No Bigger Than A Typewriter, Outperforms Machines Many Times Its Size!"
That's what a popular publication says about UNIMAT in their 3 page feature story in the May issue. If you want a reprint of this story plus complete information about this amazing 10 in 1 combination precision tool write to:

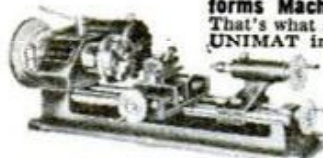

AMERICAN EDELSTAAL, Inc.
UNIMAT DIV., DEPT. GJ, 350 BROADWAY, NEW YORK 13



ART—LEARN AT HOME Enjoy glamorous high-pay career or profitable hobby. Learn Commercial Art, Painting, Cartooning, Fashion Art, Lettering, TV, etc. We train you at home, in spare time. TWO 22-pp. art outfits included free of extra charge. **LOW COST**—only 20c a day. Write for **FREE** Book describing easy method. No salesman will call. **Washington School of Art, Studio 1410, Port Washington, N. Y.** (Etabl. 1914) Tear this out as a reminder.

SCIENCE ENGINEERING

Bachelor's degree in 27 or 36 months
Accelerated year-round program: Aero., Chem., Civil, Elec., Mech., Metal.; Math., Chemistry, Physics. Modest rate. Earn board. New classes Jan., March, June, July, Sept. Catalog. 16100 East Washington Blvd., Fort Wayne 2, Indiana

INDIANA TECHNICAL COLLEGE

MAKE MONEY!

REPAIR HYDRAULIC JACKS



Earn While You Learn At Home
Make up to \$5 an hour, full or part-time, in the competition-free field of Hydraulic Jack Repair. Millions of jacks in auto service stations, truckers, body shops, riggers, farms, need servicing. We show you HOW. Easy step-by-step directions.

Get Folder PM 10 & free bonus offer

Institute of Hydraulic Jack Repair

P.O. BOX 60 • BLOOMFIELD, N. J.

A Correspondence School Licensed by N.J. Bd. of Ed.

NOW ON SALE

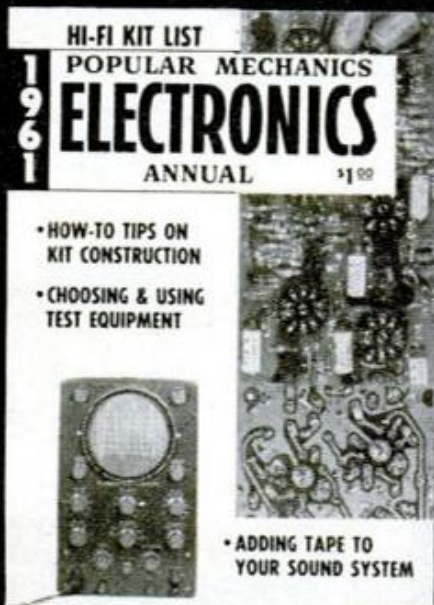

- HI-FI KIT DIRECTORY
- CHOOSING & USING TEST EQUIPMENT
- HOW-TO TIPS ON KIT CONSTRUCTION
- ADDING TAPE TO YOUR SOUND SYSTEM

WATCH FOR IT AT YOUR NEWSSTAND

BIG DEAL IN ANY LANGUAGE!

New TABLE-TOP MYSTERY MACHINE

Brings BIG HOME PROFITS almost over night!



**PRŌSŌ PHELO SOI
CHREMASIN ETHUS
EPISTELLE AITĒNA**
(SEE TRANSLATION BELOW)

**MAKE UP TO \$25 AN HOUR
\$300 A MONTH EASY-SPARE TIME**

Fabulous profit opportunity for *everyone* ambitious to make money at home. Top of ordinary table is room enough. Machine operates so easily that even teen-agers and grandparents can help. Make up to \$10 & \$15 an hour—even to \$25 on some jobs! Money for a new car, home improvements, children's education, the vacation trips you could never before afford. All this *and more* can now be yours—through the miracle Plasti-Form invention!

ORDERS COME BY MAIL

...You Can Live Anywhere

Complete "Business-by-Mail" Plan brings cash orders from *everywhere*, no matter *where* you live. Thousands of families, stores & factories are waiting for Plasti-Form products. Don't risk missing it by unnecessary delay. Mail coupon *now!*



- FABRICATES
- PLATES IN BRONZE, COPPER, CHROME
- LAMINATES WAY BELOW STANDARD COSTS
- MOULDS THOUSANDS OF BIG-DEMAND PRODUCTS
- ENCASES IN PLASTIC FOR PACKAGING DISPLAY

**MAKES \$10 ITEMS
WITH MATERIALS COSTING 50¢**

Sensational new device! Endless applications! From any small model, moulds *thousands more* for only pennies each—even if the original cost \$5, \$10, or more. Laminates *anything* in *permanent* plastic seal, any rainbow color—also chrome, silver plate, etc. Bronzes baby shoes for less than ¼ cost of other methods (now outmoded)! Wall plaques selling up to \$15 in stores can be duplicated in Plasti-Form Machine for 50¢. Plastic dishes, ash trays, book ends, toys, costume jewelry—in all, I estimate you can make over 15,000 items and still make a *huge profit!*

**I WILL HELP
FINANCE YOU!**
Mail Coupon Now!

**NO COSTLY DIES,
JIGS, FIXTURES**

Plasti-Form Machine is complete. No special dies and "set-ups" which make production so expensive in big factories. In small quantities or large, you can undersell everybody—make huge profits at same time—start NOW!

FREE!

AIRMAIL COUPON TODAY!

ALL THREE

- 1 Complete Revealing Plasti-Form Machine Booklet
- 2 Confidential Table-Top Manufacturing Ideas
- 3 Special Home Mail-Order Plan Details

**PLASTI-FORM COMPANY, Dept. F-10
15125 So. Broadway, Gardena, Calif.**

I'd like to know all about your incredible new Plasti-Form Machine, and the opportunity it offers me for a **big profit Home Business**. Mail complete FREE revealing booklet, confidential Table-Top Manufacturing Ideas, and Home Mail-Order Plan details. All to be mailed **without cost or obligation** to me.

Name _____
Street _____
City, (Zone), State _____



Power Pack Starts Jet Engines

Small enough to be hand-held, a solid-propellant starter is used to start the jet engines of the Air Force's supersonic fighters, enabling them to be airborne in seconds instead of minutes. Previously, huge and clumsy storage batteries, mounted on carts, were required to ignite the engines.

**DAN LURIE
America's
Champion
Muscle Builder**



BUILD YOUR MUSCLES FAST WITH DAN LURIE BARBELLS

Get results as no other method can. See as low as your arms, chest, legs grow like magic, no other method compares. Get \$10.00 BODY MOLD COURSE FREE with order. Results guaranteed. Buy direct and save.

50 lb. set \$ 9.48 • 100 lb. set \$15.98
150 lb. set \$23.48 • 200 lb. set \$29.98

Semi-steel sets approx. 10% higher. Extra wts. 15¢ per lb. Send 50% cash, balance COD., F.O.B. Plant. Order today. Dan Lurie Barbell Co., 1661-M10 Utica Ave., Dept. 59K, Bklyn. 34, N.Y.

**Shop PM Ads for Exciting
Direct-Mail Offers**

NEW WESTERN HAIG .12 CALIBER SPECIAL FACTORY OFFER!



\$300
post-paid

USES POWDER CHARGE

This small bore gun shoots .12 cal. lead bullets fired by small 4.4 mg. powder charge. Not a CO₂ gun! You'll like the handsome lines, grip, and balance. Western in style, but patented ball and cap action allows this low price. 9 3/4" steel barrel cased in knurled styrene stock, overall 13 1/2". Develop pistol form, accuracy at a fraction of cost of large caliber pistols. Comes with 50 lead bullets. Satisfaction guaranteed. Send \$3 to: HAIG MFG. CO., Box 30-Y, San Gabriel, Calif.



Play Right Away!

ANY INSTRUMENT

Now it's EASY to learn ANY INSTRUMENT—even if you don't know a single note now. No boring exercises. You play delightful pieces RIGHT AWAY—from very first lesson! Properly—by note. Simple as A-B-C. You can make amazing progress—at home, in spare time, without teacher. Only few cents per lesson. 1,000,000 students including Lawrence Welk. (Established 1898—Licensed by N.Y. State Education Dept.)

FREE BOOK Shows how easily you can learn music. Write for it. No obligation; no salesman will call. **U. S. SCHOOL OF MUSIC.** Studio 3010, Port Washington, New York.



OWN THE WORLD'S FINEST POCKET PISTOL!

BERETTA PANTHER

NEW 25 CAL. FEATHERWEIGHT—9 SHOT

Sensational Beretta Panther carries more cartridges for its size and weight than other pocket pistols. Always dependable, reliable and accurate. Fits pocket or purse.

FREE! Genuine Leather Holster

... Order by Mail Today!

Send \$5.00 down, bal. C.O.D.

GODFREY IMPORT CORP., Dept. PM10, 261 Broadway, N.Y. 7, N.Y.



Std. Blue

\$32.00

Std. Blue, Pearl Hcls. 37.50

Chrome—Pearl Hcls. 43.50

25 Auto Cps (50) 3.85



BETTER THAN YOUR OWN SHOE STORE AT HOME!

Earn \$10.00 to \$50.00 weekly extra cash, with great Kushiontred Shoes! No experience or investment! Spare time only! Write for big FREE outfit!

TANNERS SHOE CO. • 736 Brockton, Mass.



FREE

MUSCLE BUILDING INFORMATION

Sensational New Methods

Less Time—Less Effort—Better results

BODY-TONE, Box 638, North Miami 61, Fla.

ENGINEERING

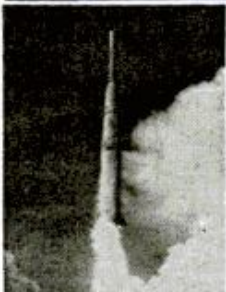

U.S. AIR FORCE Photo. Missile headed for outer space. Courtesy of Space Technology Laboratories, Inc.

ENROLL NOW FOR NEW TERM

Heald College Ranks FIRST West of the Mississippi in "Who's Who in America"

HEALD Engineering College

Van Ness at Post, Dept. PM

San Francisco, California

NAME _____

STREET _____

CITY _____ STATE _____

AMERICAN INDUSTRY NEEDS TRAINED ENGINEERS NOW BACHELOR OF SCIENCE DEGREE, 30 MONTHS

SAVE 2 YEAR'S TIME

B.S. Degree Courses:

- | | |
|---|---|
| <input type="checkbox"/> Electronic Engineering | <input type="checkbox"/> Mechanical Engineering |
| <input type="checkbox"/> Electrical Engineering | <input type="checkbox"/> Civil Engineering |
| <input type="checkbox"/> Electronic Technician | <input type="checkbox"/> Architecture |

Diploma Courses:

- | | |
|--|---|
| <input type="checkbox"/> Radio-Television Plus Color | <input type="checkbox"/> Architectural Drafting |
| <input type="checkbox"/> Electronic Technician | <input type="checkbox"/> Mechanical Drafting |
| | <input type="checkbox"/> Structural Drafting |

APPROVED FOR VETERANS

Send for FREE Information

"And Now for Today's Weather..."

By Theodore Berland

IF YOU'RE LIKE many Americans, the first thing you do after waking each morning is flip on the radio. Not that you necessarily hanker for rise-and-shine music—it's the weather you're interested in.

Unless you're a resident of Honolulu, where you know each day will be a pleasant one, or a Los Angeles squinter who is sure the smog will rise with the sun, you've come to rely on some announcer to tell you how to dress for the day.

Now from Chicago, a town in which the weather changes as quickly as a woman's mind, comes the comment: "tsk, tsk."

The head-shaker is Prof. Horace R. Byers, head of the Department of Meteorology at the University of Chicago.

Trouble is, says Byers, we just don't look around anymore. If we bothered to watch the sky for weather signs as our grandfathers did, we'd be calling up the radio stations and giving them *our* forecasts!

How do you do it? Well, here are nine simple rules to follow each morning:

1. Throw away your barometer, or at least regard it as only an attractive ornament. You've probably never used it anyway. Just as well. "A barometer, no matter how finely calibrated, can only give you one small clue as to what the weather is like *now*. It responds to nothing more than the pressure of the air currently around you," Byers explains. "It can't tell you what the weather is going to be like, unless you sit there and measure how fast or slowly the needle is moving."

2. Watch the clouds. Notice the direction in which they're traveling; this will tell you from which direction the wind at their level is coming. Also, note the type of cloud.

If it's summer and the clouds are the puffy variety that look like cotton candy, you can be sure of scattered showers. Tricky, those last two words. "Scattered showers" means that it's going to rain here and there. Not even a professional meteorologist can tell you, though, if the rain that's coming will fall where you are.

However, you can tell if the possibilities of rain already have passed you by. Easy. Watch for lightning or for those towering majestic clouds with thin caps known as

(Continued to page 52)

FREE GUIDE Reveals 200 Ways to Make Extra Money

YOU can turn your spare hours into cash (\$25 to \$100 a week)! Ask for *Free Subscription to Opportunity Magazine*, nationwide guide to extra cash for millions of men and women. Contains hints, plans, hundreds of offers. No matter what your age, experience, or occupation—write TODAY for next 6 issues FREE. Send no money—just your name. OPPORTUNITY, 850 N. Dearborn, Dept. 170, Chicago 10, Ill.

PROFIT IN YOUR SPARE TIME

FIX SMALL GASOLINE ENGINES
Outboard • Powermower • Chain Saw • Tractor
MAKE EXTRA MONEY—or, repair your engines and SAVE. Illustrated, easy-to-understand, Home Study Course. FREE information. Write TODAY!



LINCOLN TECHNICAL INSTITUTE
Suite 10-E, 472 Market Street, Newark 5, New Jersey

HIGH BLOOD PRESSURE is DANGEROUS!



CHECK YOURSELF AT HOME WITH THIS TESTER. Not as elaborate as a doctor's, but it is accurate. Full instructions tell how to test, what it means, and what to do to avoid or reduce the damaging effects of high blood pressure. Outfit includes a mercury gauge, arm bandage and bulb, professional stethoscope and full instructions. Send just \$10.75 (includes postage and handling); or COD plus charges. Money back guarantee. Additional information upon request.

RESEARCH SPECIALTY CO.
2035-A N. Western Ave. Chicago 47, Illinois



Metal Specialties Mfg. Co., 1975 Cornell Ave., Melrose Park, Ill.

Power-Driven Eraser Whisks Away Mistakes

Chalk up another improvement for the secretary. A power eraser—driven through a flexible shaft by a small electric motor—removes errors, cleans type, brushes away eraser dust, and highlights some types of drawings. With a long flexible shaft, it will reach across even a wide drawing board. Since the eraser works at high speed, it removes typewriter or pencil marks quickly and without need of pressure on the paper, which eliminates "slipsheeting" to avoid marking lower copies through carbon paper. The eraser is self-cleaning and self-sharpening.

"I Earn Two Incomes Now"



Says John Bennie, Pittsburgh, Pennsylvania
"Thanks to your wonderful training, I have been able to earn \$20 to \$25 extra each and every week doing little locksmith jobs at home—after work at my regular job. This is the best trade a man can take up!"

Be a LOCKSMITH

Add 50%-100% to YOUR INCOME with easy spare time earnings. Cash in on nationwide shortage — trained locksmiths in demand! Quickly step into a big-pay opportunity job — high-profit shop of your own.

Earn Extra Money RIGHT AWAY! All Special Tools, Supplies Furnished FREE. Age, education, minor physical handicaps don't matter in this growing trade. You can quickly qualify as a skilled locksmith. Study at home as little as one hour a week. Gain practical experience through well-illustrated lessons. Do real jobs on car locks, house locks, padlocks and safe locks, under the guidance of experts.

MAIL COUPON FOR FREE BOOK
For a future as your own boss or in a high-pay job, write now for FREE illustrated book! Only school of its kind. Lic. State of N.J., Accredited NHSC. **Locksmithing Institute**, Dept. 110, 150 Park Ave., E. Rutherford, N.J. (Div. Tech. Home Study Schools) **Approved for Veteran Training.**

MAIL COUPON NOW

LOCKSMITHING INSTITUTE, Dept. 110
150 Park Avenue, E. Rutherford, N.J.

Please send Free Illustrated Book without obligation.

Name _____
(Print here)

Address _____

City _____ Zone _____ State _____

Check if Veteran. No salesman will call.

GET THE HABIT OF READING OUR CLASSIFIED ADS.

Wonderful Opportunities Amazing Bargains

Draw CARTOONS



Learn at Home in Spare Time...
EARN BIG MONEY
You don't need previous training or art ability with the "Famous System of Manual Training!" With this modern streamlined method, you learn rapidly, easily... start to cartoon immediately, without tedious study or exercises.

U.S. Pat. Applied For
WIDE DEMAND FOR CARTOONISTS
... **EARN WHILE YOU LEARN**
... Magazines, newspapers, movies, television, ad agencies—all are searching for new cartoon ideas and talent. As a successful, Continental-trained Cartoonist, your earnings are not limited. Many of our students start earning after first few lessons. A wonderful pastime, too.

WE SUPPLY EVERYTHING... As our student, you receive FREE of extra cost a big 15-piece Professional Kit with all equipment and materials you need, and valuable Articulated Model to help you draw any human pose.

GET ALL THE FACTS FREE... Big, colorful Free Catalog gives all details, plus pages of useful information. Use coupon now.

Continental Schools, Inc.
DEPT. A-10, 4201 S. BROADWAY, LOS ANGELES 37, CALIF.

Continental Schools, Inc.
Dept. A-10, 4201 S. Broadway, Los Angeles 37, Calif.
Please rush me your Free Catalog and other information by return mail. No charge or obligation, no salesman will call.

NAME _____
ADDRESS _____
CITY _____ ZONE _____ STATE _____

SEND COUPON FOR FREE BOOK

LEARN TO EARN
HIGH WAGES
 AS A HEAVY EQUIPMENT OPERATOR!



Secure a high paying future in the exciting construction industry today! Learn to operate bulldozers, draglines, cranes, back hoes, scrapers and motor graders on our actual construction projects!

- ONLY CONTRACTOR OWNED AND OPERATED SCHOOL IN WORLD
- ASSOCIATE MEMBER ASSOCIATED GENERAL CONTRACTORS
- MODERN EQUIPMENT
- V. A. APPROVED FOR G. I. TRAINING
- BUDGET PAY PLAN AVAILABLE

WESTERN NATIONAL
 SCHOOL OF HEAVY EQUIPMENT OPERATION

DEPT. B-9 BOX 510
 WEISER, IDAHO PHONE 910

WRITE TODAY FOR FREE SCHOOL CATALOG



Perpetual Motion Machine

Up to 2000 revolutions per minute! No Electricity. No Fuel. **RUNS FOREVER** until parts wear out. Even runs under water! Same principle as solar batteries used in space flights.

World's Most Fascinating Motor New Solar Engine

Baffles most people. What makes it run? Operates wherever there is light. The brighter the light, the faster it runs. Many entertaining uses & experiments. Money back guarantee: it must delight, amaze & amuse you & your friends. 2 for \$3.75. 3 for \$5.35. Each Postpaid.....\$1.98

JOHNSON SMITH CO., Dept. 918, Detroit 7, Mich.

Take Correspondence Courses For a Better Education

100 POUND SET \$12.80



BARBELLS
 140-Pound, CHROME DELUXE Barbell-Dumbbell set only \$19.80.
 This is our feature set and is the finest ever manufactured.

Training with adjustable weight is the **BEST** way to keep fit: the **ONLY** way to develop great strength and a perfect body. As the oldest and best equipped barbell company, BUR gives value and prices no one can equal.

SEND FOR FREE CATALOG
BUR BARBELL CO.
 Lyndhurst 9, New Jersey

Extra Plates Only 12c Pound

Counts & Wraps Coins Fast!

Counts Pennies, Nickels, Dimes, Quarters Automatically!

This Automatic Coin Counter ends fuss, fumbling and possible errors of slow old-fashioned manual way of counting & wrapping coins. Automatic Coin Counter is absolutely 100% accurate! Thousands in use in banks, schools, churches, offices, etc. Exclusive feature: With Thoresen Coin Counter, you use plain paper, flat wrappers or tubular wrappers! No. 789 Thoresen Automatic Coin Counter only 99c plus 11c post. & hdg. Order 2 for \$2 complete. Satisfaction guaranteed or money back. Sorry, no COD's.



Not \$1.98 **99c**

Sold Only by **THORESEN, Inc., Dept. 6-L-789**
 585 WATER STREET, NEW YORK 2, N. Y.

thunderheads. Note the direction in which the clouds right over you are moving. If the lightning is flashing from the east and the wind is coming from the west, for example, you know the storm has passed.

3. See if the sun is out. If it is, and the season is summer, you're in for a blisterer. If it's winter, and the sun is alone in the deep-blue sky, it's probably the coldest day of the week and is not likely to warm up right away. "Clear winter days represent cold air. The sun is not a powerful heating factor then," Byers points out. "On the East Coast, particularly, the sunniest days are the coldest because the winds sweep down from the Appalachians, leaving the clouds behind."

4. Keep track of the wind. In the winter, winds from the west and northwest mean it's going to get colder (except just east of the Rockies, where the famous snow-melting chinooks sweep down from the mountains); southerly winds (from the south) mean warmer days are coming. In the summer, southerly winds always mean the humidity is going to rise; southwesterly to northwesterly winds (except at the Pacific Coast) tell you the air will get drier.

5. If, after the sun is supposed to have risen, the morning is so gray you have to turn on the lights, and there is a stiff wind blowing, you're in for a storm. If there's no wind, or if the morning is just lightly gray, there probably will be no rain or snow.

It may be difficult to gauge how dark the morning is because your eyes adjust themselves to darkness. The most reliable guide is a photographic light meter, suggests Byers. On a genuinely rainy morning, point it at the horizon (or, if you're a city dweller, toward where the horizon should be) and record the reading so you'll be able to predict by meter reading the next time.

6. Look around as you walk your dog before retiring. If it's spring and the night is still, expect a drop of 10 degrees by dawn. Look at the sky. It can tell you something about tomorrow. For instance, if there are a jillion stars out and you notice that a mild wind is coming off the land, you can be sure that tomorrow's top temperature in winter will be 10 degrees higher than the morning temperature, or in summer, 20 degrees higher. If you live in the mountains or desert, add another 10 degrees.

7. Don't pay attention to the relative humidity figure you are given. It tells you

(Continued to page 56)

WHAM-O. \$1.50 40 LB. PULLY

HITS LIKE A RIFLE—
KILLS RABBITS, SQUIRRELS

Powerful, silent, accurate
For hunting, target,
routing pests.

Sportsman's choice
sold world
over!

NEW! surgical quality pure gum rubber

275 heavy extra steel balls 98c

Heavy duty 7" ash stock,
40 heavy steel balls, extra rubber,
target, adapter for shooting arrows,
GUARANTEED. Professional model of
Nat'l Slingshot Assn. At dealers, or write
WAMO MFG. CO., Box 15-Y, San Gabriel, Calif.

FREE catalog on crossbows, knives, games, pistols, etc.

HUNTING
SLINGSHOT

Secrets of VENTRILOQUISM
Now Revealed!

Easy to learn in 60 to 90 days with our
Home Study Course. **RESULTS GUARANTEED.**
Make Money! Be Popular! Have Fun! Big Op-
portunity! Radio, Television, Stage Appear-
ances! For FREE Information regarding price
and terms WRITE. You must state your age.
Dummy Catalog 25c.

MAHER HOME COURSE OF VENTRILOQUISM
Box 36, Studio PM-10, Kensington Station
Detroit 24, Michigan

"YOU ARE UNDER ARREST!"

Help Bring Crooks to Justice Through Scientific
CRIME DETECTION!

We have taught thousands this exciting, profitable, pleasant
profession. Let us teach you in your own home. Learn Finger
Printing, Firearms Identification, Police Photography, Secret
Service Methods thoroughly, quickly, at small cost.
Over 800 of all American Bureaus of Identification employ
I.A.S. students or graduates. Write for FREE "Blue Book
of Crime." State age. (A Correspondence School Since 1916)

Institute of Applied Science, 1920 Sunnyside Ave., Dept. 1357, Chicago 40, Ill.

Buying a new gun?

READ

**"What to Look for
In a Gun"**

in the

**NOVEMBER
ISSUE**

**LEARN
UPHOLSTERY**
in your spare time
run your own
business
AT HOME

FREE TOOLS
WITH COURSE

BE YOUR OWN BOSS
Earn more from the start! Set up your own
profitable business, in your own home, enjoy
steady income, independence for life. You're
in demand in the booming field of Custom
Furniture Upholstery.

Right off, you start upholstering with the
tools, complete frames, fabrics and materials,
included **FREE** with N.Y. State-approved
UTS Home Study course. You learn skilled
professional custom upholstery, reupholstery,
furniture finishing, repairs, how to make
beautiful slip covers, cushions and draperies.
EARN WHILE YOU LEARN, in your spare
time **AT HOME** . . . the UTS easy way.
FREE ILLUSTRATED BOOK—FREE SAMPLE LESSON
Get ready for well-paid job and big profits, from
steady work, as your own boss, running your
own business. Mail coupon **NOW** for **FREE**
BOOK! Training in N. Y. School also available.
VET APPV'D. ACCREDITED BY N.H.S.C.

UPHOLSTERY TRADES SCHOOL
Dept. MR-310, 721 B'way, N. Y. 3, N. Y.
Please send me **FREE** book. "Your New Way
to a Successful Career," and **FREE** sample
lesson. No obligation—no salesman will call.
 Home Study Training in N. Y. School

Name _____
Please Print Plainly
Address _____
City _____ Zone _____ State _____
 Check if Korean Veteran

**With Course
You Make:**

SLIPPER
CHAIR

CLUB
CHAIR

OTTOMAN

**PLUS
SLIP COVERS
Yours to Keep
or Sell**

FREE

**GIANT 1961
204 PAGE
CATALOG**

BA 1961
ANNUAL CATALOG 611

SAVE UP TO
50% ON B-A
SELECTED
KITS

HI-FI AND
STEREO
SYSTEMS &
COMPONENTS

TOP VALUES
IN POWER,
AND HAND
TOOLS

30 PAGES
OF BARGAINS
NOT IN ANY
OTHER CATALOG

**RADIO TV
ELECTRONICS**

BURSTEIN-APPLEBEE CO.

Dept. PM, 1012 McGee St., Kansas City 6, Mo.

Send Free 1961 B-A Catalog No. 611

Name _____

Address _____

City _____ State _____

**SEND
FOR IT
TODAY**

Don't be half-trained CHOOSE YOUR CAREER



Train at home...
in spare time...
in one of America's
Big 3 industries!!!

TELEVISION RADIO-ELECTRONICS

MAKE MORE MONEY...
Successful Career... Security...
Yours NOW in Modern Industry!

One of the "Big 3" industries...TV-RADIO-ELECTRONICS...AUTO MECHANICS AND DIESEL...AIR CONDITIONING-REFRIGERATION-ELECTRICAL APPLIANCES...each is growing at a tremendous pace. Now is the best time for you to get into the industry of your choice! You can be a part of its growth...you can increase your earning power...really build a Successful, Secure Future...with all the good things life has to offer!!! Get this information NOW...TODAY. We'll give you facts by mail. There is no obligation on your part or we will be inconvenienced...as NO ONE WILL CALL ON YOU!!!

TRAINS YOU RIGHT, FAST AND EASY!
N.T.S. "short-cut" training limits your earning potential...disqualifies you for top-pay jobs. N.T.S. training in All Phases...to qualify you for top jobs in your field...for greater profits all year long!

YOUR N.T.S. TRAINING IS BETTER, MORE COMPLETE, LOWER COST!
Approved and tested in N.T.S. Resident Schools and Laboratories, by the OLDEST and LARGEST School of its kind in the world. Established in 1905.

COMPLETE...you learn ALL Phases, and you GET EVERYTHING YOU NEED—Lessons, Manuals, Diagrams, and many big Professional Kits with parts, instruments for your experimental, repair, and trouble-shooting projects. You also receive valuable training "Extras" to assure your success.

LOWER COST...other schools make several courses material in each one of our MASTER COURSES...and charge you more for less training in any one of our "Big 3" at ONE LOW TUITION.

EARN AS YOU LEARN
We'll show you how you can earn money right from the start. Many students pay for their courses—and while studying. So can you!

SEND FOR YOUR
FREE
OPPORTUNITY BOOK
AND ACTUAL LESSON
NOW!!!



YOU ARE NEEDED in All Phases of TELEVISION-RADIO-ELECTRONICS...Servicing, Communications, Broadcasting, Manufacturing, Automation, Radar and Micro Waves, Missile and Rocket Projects, plus all the other high-pay branches of this vigorous industry. N.T.S. Shop Tested Home Training gives you ONE MASTER COURSE...at ONE LOW TUITION...to train you for these unlimited opportunities, including many technical jobs leading to supervisory positions.

YOU BUILD MANY EXPERIMENTAL AND TEST UNITS WITH KITS AND PARTS WE SEND YOU...you advance step by step, perform more than 100 experiments, and you build a complete, modern circuit TV set from the ground up! The set is yours to keep, including the big new TV picture tube we send you at no extra charge. You also build and keep a Short Wave-Long Wave Superhet Receiver. In addition, you receive a valuable Multimeter for your repair, service, and trouble-shooting job projects.

UP-TO-DATE, PRACTICAL LESSONS AND INSTRUCTION MATERIAL...you'll find that every N.T.S. Shop Tested Home Training lesson and manual is easy to understand, with many numerous illustrations and diagrams. See for yourself. Check the Actual Lesson: you receive FREE along with our Opportunity Book. Clip and mail coupon NOW!

RESIDENT TRAINING AT LOS ANGELES
If you wish to take your training in our Resident School at Los Angeles, start NOW in our big, modern Shops and Labs. Here you work with latest equipment, professionally installed... finest most complete facilities offered by any school. Expert, friendly instructors. Personal attention. Graduate Advisory Service. Help in finding home near school... and part time job while you learn. Check box in coupon for full information.



NATIONAL TECHNICAL SCHOOLS
WORLD-WIDE TRAINING SINCE 1905
4000 S. FIGUEROA ST.
LOS ANGELES 37, CALIF., U. S. A.

NATIONAL TECHNICAL SCHOOLS
WORLD-WIDE TRAINING SINCE 1905

MAIL NOW TO
National Technical Schools, Dept. B-100
4000 S. Figueroa St., Los Angeles 37, Calif.

Please rush FREE Book and Actual Lesson checked below. No obligation. No salesman will call.
(CHECK ONE ONLY)

"My Future in TV-Radio-Electronics" Book
 "My Future in Auto-Mechanics & Diesel" Book
 "My Future in Air Conditioning, Refrigeration & Electrical Appliance" Book

Name _____ Age _____
Address _____
City _____ Zone _____ State _____

Check here if interested ONLY in Resident Training at Los Angeles.

VETERANS: Give date of discharge _____

Be a MASTER TECHNICIAN

ONE OF THESE 3 BIG PAY INDUSTRIES

AUTO-MECHANICS & DIESEL

SEND FOR YOUR
FREE
OPPORTUNITY BOOK
AND ACTUAL LESSON
NOW!!!



TAKE YOUR CHOICE...be a successful all-around car, truck and heavy-engine Mechanic. Or specialize in your favorite field...Tune-Up, Automatic Transmissions, Farm Mechanics, Trucks and Buses, Stationary Installations, Foreign Cars, or get into Auto Air Conditioning, Engine Rebuilding, Diesel, and all the other high-pay fields too numerous to mention here. Or go into business for yourself. Remember...a qualified ALL AROUND MECHANIC always has a good job!

EVERY PHASE SHOP TESTED...our streamlined lessons, manuals and other training materials are easy to understand, completely practical and right up-to-date. YOU ALSO GET AND KEEP VALUABLE PROFESSIONAL EQUIPMENT. We send you a complete set of Mechanic's tools...an All-Metal Tool Box...a Motor Analyzing Set containing three valuable instruments in a sturdy carrying case...plus a Top Quality Socket Wrench Set with Fittings.

PROVE IT TO YOURSELF...N.T.S. gives you everything you need to make more money in today's big, opportunity filled Auto Mechanics and Diesel Industry. Send coupon!

AIR CONDITIONING REFRIGERATION & ELECTRICAL APPLIANCES

SEND FOR YOUR
FREE
OPPORTUNITY BOOK
AND ACTUAL LESSON
NOW!!!



FUTURE BRIGHT FOR TRAINED MASTER TECHNICIANS...over 30,000 new Technicians must be trained annually. You are needed to help service and repair the 50 million air conditioners, refrigerators and electrical appliances that will need fixing this year alone. No wonder the Master Technician has steady work, at high pay, year after year. You can go places in your own business or with a manufacturer, dealer, distributor or department store. With All-Phase training, your earning power is unlimited!

JOB TRAINING AT HOME...you get Professional Technician's Tools, Precision Instruments, PLUS a factory-made APPLIANCE TESTER...a full set of PRACTICAL, professional equipment! You use them to conduct over 100 experiments...in your Spare Time Work while in training...and in your service, repair, and trouble-shooting work later on. It is all yours to keep!

DON'T LOSE OUT—FIND OUT...we'll rush you our big, illustrated OPPORTUNITY BOOK AND ACTUAL LESSON. No obligation. It costs nothing to find out. Mail coupon...DO IT NOW!

SEND ONE OF THE 3 COUPONS TODAY! ASK ONE OR TWO FRIENDS TO DO THE SAME. IT'S FUN TO STUDY TOGETHER.

NATIONAL TECHNICAL SCHOOLS

WORLD-WIDE TRAINING SINCE 1905

MAIL NOW TO

National Technical Schools, Dept. B-100
4000 S. Figueroa St., Los Angeles 37, Calif.

Please rush FREE Book and Actual Lesson checked below. No obligation. No salesman will call.

(CHECK ONE ONLY)

- "My Future in Auto-Mechanics & Diesel" Book
 "My Future in TV-Radio-Electronics" Book
 "My Future in Air Conditioning, Refrigeration & Electrical Appliance" Book

Name _____ Age _____

Address _____

City _____ Zone _____ State _____

Check here if interested ONLY in Resident Training at Los Angeles.

VETERANS: Give date of discharge _____

NATIONAL TECHNICAL SCHOOLS

WORLD-WIDE TRAINING SINCE 1905

MAIL NOW TO

National Technical Schools, Dept. B-100
4000 S. Figueroa St., Los Angeles 37, Calif.

Please rush FREE Book and Actual Lesson checked below. No obligation. No salesman will call.

(CHECK ONE ONLY)

- "My Future in Air Conditioning, Refrigeration & Electrical Appliance" Book
 "My Future in TV-Radio-Electronics" Book
 "My Future in Auto-Mechanics & Diesel" Book

Name _____ Age _____

Address _____

City _____ Zone _____ State _____

Check here if interested ONLY in Resident Training at Los Angeles.

VETERANS: Give date of discharge _____

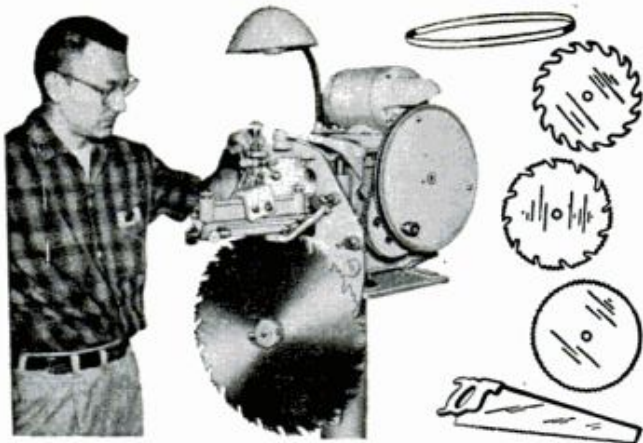

CASH FILING SAWS

Here is a steady repeat CASH business you can start at home. No experience needed—no canvassing—every saw you sharpen will bring new customers. You can make up to \$3 or \$6 an hour—\$20 to \$30 a week in your spare time as a starter. "My spare time saw filing business has made me \$952 these first ten months," says R. T. Chapman.

The new model 200 Foley Saw Filer automatically sharpens combination (rip and crosscut) circular saws, hand saws, band saws and crosscut circular saws.

Free Book—"MONEY MAKING FACTS" shows you how to get into this CASH business. Time Payments if desired. Mail coupon now. No salesman will call.

FOLEY MFG. CO.
 1016-O Foley Bldg., Minneapolis 18, Minn.
 Send me free book "MONEY MAKING FACTS" and Time Payment Plan.

Name _____
 Address _____
 City _____ State _____



Also
 FREE Photo Book
 of Strong Men

Jowett Institute, Dept. PM-010, 220 Fifth Avenue, N. Y. 1, N. Y.

Millions have done it so can YOU!

Stop being **SKINNY** like I was
 Quickly **GAIN 25 LBS.** of
 HANDSOME, POWER-PACKED MUSCLES like I did

- Send for these 5 AMAZING PICTURE COURSES
 All 5 FREE before \$1 price goes back
1. How to GAIN MIGHTY ARMS
 2. How to GAIN A BIG CHEST
 3. How to GAIN A MIGHTY BACK
 4. How to GAIN POWERFUL LEGS
 5. How to GAIN A GRIP OF STEEL
- Send 10c for postage for all 6 items



nothing about comfort. The new temperature-humidity index tells a little more, but the dewpoint is the real indicator. That's the temperature at which the moisture in the air will condense or form dew and then fog. Some radio stations reveal it with aviation forecasts. Any local weather bureau will give it to you over the phone. The general rule is that 55 or lower is comfortable. You can take your own reading by swinging a wet-bulb thermometer around your head (to induce evaporation of the thermometer's wet wick, Byers explains). The rule here is that below 60 is comfortable.

8. If you live near the South or East coasts of the United States, and the wind is pounding and gusty, and you're sure a storm is brewing, act quickly. Flip on the radio and listen for advice to evacuate or stay put. Those are the symptoms of a hurricane, which usually strikes in late August or September. If you live in a "tornado alley" where people still talk about the tornado of a few years back, be wary of violent spring thunderstorms. They often breed twisters during March to June and the funnels often follow the same routes.

9. What about rheumatism and corns? Sure, says Byers. Both are good gauges of humidity. So is human hair (which is used in humidity gauges). If your hair is naturally curly or naturally straight, high humidity will tend to return it to its original state. "As for myself, I can always tell when the humidity is rising by an ache in my neck," he says.

Those are the basic rules. All you need are open eyes, although a thermometer and light meter will help. If you're interested in pursuing the science of meteorology further, you can buy combination wind-direction, wind-speed, barometer and rain-fall gauges in a range of prices, from a few to a few hundred dollars. There also are plenty of books available that will teach you to read weather maps, explain what weather "fronts" are, help you identify cloud types, and assist you in becoming an amateur meteorologist. The one to start with is "Weather Forecasting." It's available for 25 cents from the U.S. Government Printing Office, Washington 25, D.C.

If you're a youngster and begin to feel that weather forecasting is the career for you, that's fine, says Byers. The nation desperately needs more weathermen.

But for the rest of us, these nine rules can give a new independence from the early morning disk jockey and a new self-reliance as we start each day. ★ ★ ★

If there's some fixin' that oughta be done, By a wife, a husband or anyone, Choose a LUXCO Product Do it now!

The story on the package will tell you how. It works the best as you'll soon know When the name on the pack Says **LUXCO**

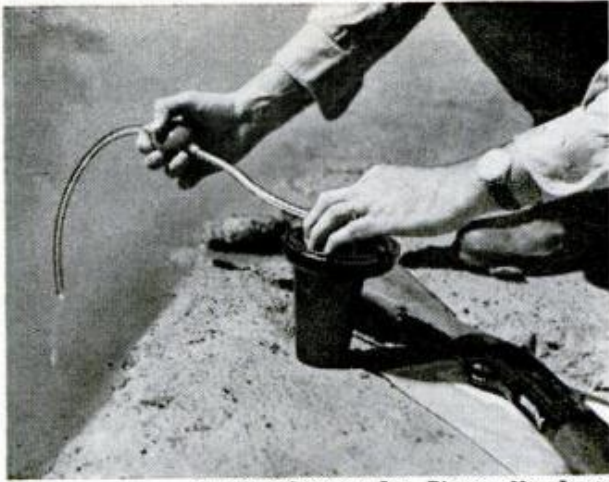

Sure Pure Company, Inc., Ringoes, New Jersey

Pocket Filter Purifies Water

Safe, clean drinking water can be extracted from any water source except the ocean with a new pocket-sized filter. Based on a system used in commercial water installations, the filter element is made of specially refined asbestos fibers, molecularly charged and treated with insoluble chemicals. At the rate of about one ounce per squeeze of the bulb, the filter removes all bacteria, coliform, dirt, odors and chemicals in suspension and neutralizes harmful elements at the same time. The filter pad is replaceable; the case will last indefinitely.



Unlock the answers to hundreds of Do-It-Yourself problems with this tremendous Service File list of Popular Mechanics' booklets, books, full-size patterns, and blueprints.

More than 500 classifications of projects, plans, instructions, service and repair information have been cataloged for the first time in one reference file.

This invaluable listing is the key to an extremely wide variety of do-it-yourself data on every subject from aquaplanes to zinc plating, from dollhouses to backyard roller coasters, from cabin cruisers to model sailboats, from patios to papier-mache.

For your free copy of the Service File listing, fill in the coupon below and mail today. Supply is limited.

**SERVICE BUREAU, POPULAR MECHANICS, Room 520A
200 E. ONTARIO, CHICAGO 11, ILL.**

Please send me a free copy of the PM Service File listing. I enclose a self-addressed, stamped envelope.

Name.....

Address.....

City..... State.....

OCTOBER 1960

AVIATION CAREER

SPECIALIZED EDUCATION / PROFESSIONAL TRAINING... only 16 months to 2 years

Top-pay prestige positions, bright future in aviation. Job opportunities waiting for you as soon as you're ready. Airframe and Powerplant Technician, Aeronautical Engineering Technologist, Business or Executive Pilot. Classes in Miami.

SEND FOR FREE 80-PAGE BOOK

Embry-Riddle Aeronautical Institute
Dept. B Miami, Florida (Founded 1926)

Name.....

Address.....

City.....Zone.....State.....



FORTUNES IN DIVING

Train at Home in Spare Time

Write Today for Amazing Free Booklet

Here is one of the greatest opportunities of our time. Make big money fast in Skin and Lung Diving. Trained divers needed in hundreds of industries and by government. Build a successful business of your own. Hourly rates among highest paid in any field. Training program by E. R. Cross, world famous master diver. Get the facts now. Mail coupon for **FREE BOOKLET TODAY!**

DIVEMASTER, Dept. PM-100

5637 W. 63rd Place, Chicago 38, Ill.

Send me free information about Diving.

Name..... Age.....

Address.....

City..... State.....

PREPARE FOR BETTER JOB, BIGGER PAY IN SPARE TIME-AT HOME

Today, choose the job you want—and prepare for it in time you might otherwise waste. Or if you are already in the work you like best, start training now for quicker promotion and increased pay. During the past 63 years AMERICAN SCHOOL has helped ambitious people to reach higher goals. Check subject that interests you and mail coupon for full information.

AMERICAN SCHOOL, Dept. G745, Drexel at 58th, Chicago 37, Ill.

Without obligation, please send FREE and postpaid, full particulars about the subject checked below.

- | | | |
|--|---|---|
| <input type="checkbox"/> Accounting | <input type="checkbox"/> Diesel Technician | <input type="checkbox"/> Machinists |
| <input type="checkbox"/> Apprenticeship Courses | <input type="checkbox"/> Drafting—Building Trades | <input type="checkbox"/> Mechanical Engineering |
| <input type="checkbox"/> Architecture & Building | <input type="checkbox"/> Drafting—Machine Trades | <input type="checkbox"/> Mechanical Technology |
| <input type="checkbox"/> Automotive Technician | <input type="checkbox"/> Electrical Engineering | <input type="checkbox"/> Metalworking Courses |
| <input type="checkbox"/> Better Foremanship | <input type="checkbox"/> Electricity—Practical | <input type="checkbox"/> Plumbing—Practical |
| <input type="checkbox"/> Bookkeeping | <input type="checkbox"/> Electronics—Industrial | <input type="checkbox"/> Private Secretary |
| <input type="checkbox"/> Business Management | <input type="checkbox"/> HIGH SCHOOL COURSES | <input type="checkbox"/> Retail Merchandising |
| <input type="checkbox"/> Civil Engineering | <input type="checkbox"/> Human Relations | <input type="checkbox"/> Sheet Metal Work |
| <input type="checkbox"/> Contracting | <input type="checkbox"/> Instrumentation | <input type="checkbox"/> Tool Making |

NAME..... OCCUPATION.....

HOME ADDRESS..... AGE.....

CITY..... STATE.....

Accredited Member NATIONAL HOME STUDY COUNCIL

MAIL COUPON NOW



BIG EARNINGS WAITING

Be a TYPEWRITER REPAIRMAN



FREE
Professional Tools,
Typewriter Supplied



Earn while you train at home. Take your place in this booming multi-million dollar field. Skilled men are in demand—thousands more needed. Quickly step into a big-pay job or business of your own. Learn to repair all makes easily. You get expert guidance, clearly illustrated lessons, practice assemblies, a real typewriter and all professional tools you use FREE with course.

SEND FOR FREE BOOK—Get vital government facts about urgent need for trained typewriter repair men. Free Book describes the vast opportunities waiting for you.

i.e. by N. J. Dept. of Education.
(Div. Technical Home Study Schools)

MAIL COUPON TODAY!



Typewriter Repair School, K-10, 150 Park Ave., E. Rutherford, N. J.
Send FREE Book, "Opportunities Unlimited", no obligation.

Name.....

Address.....

City..... Zone..... State.....

Exclusive Double-Bearing HEAVY-DUTY PUMPS

IRRIGATE • DRAIN • CIRCULATE • SPRAY

Use 1/2 HP motor or larger . . . 1 HP for up to 5,200
GPH; 1,000 GPH 60' high; or 3,000 GPH from 25' well.

1 1/4" inlet; 1" outlet. Stainless shaft.

TYPE X—2 oil-less bronze bearings. Won't rust. . . . **\$10.95**

TYPE XB—Ball bearing model. . . . **\$12.95**

Postpaid if cash with order. Rush your order today

MONEY BACK GUARANTEE

Centrifugal and Gear Pumps in All Sizes
LABAWCO PUMPS, Belle Mead 2, N. J.



75 POWER TELESCOPE \$3.98

25X-45X-75X

NEW 3 in one telescopes, 3 variable 25X
45X-75X magnification. Brass bound.
25 power for ultra bright images
45 & 75 power for long range.
Guaranteed to bring dis-
tant stars, moons, ob-
jects, sports 75
times closer.

Most powerful scope sold anywhere near this amazing low price. American made, 3 sections. & polished lenses. Can also be used as powerful compound microscope. Mass production enables us to offer telescope complete at \$3.98 postpaid. Money back guarantee.

CRITERION CO., Dept. PMB-86, 331 Church St., Hartford, Conn.



WANT MORE MONEY? GET INTO PHOTOGRAPHY

Coast to coast, high-paying jobs in photography are waiting for people with the "know-how" to fill them. You can quickly, easily qualify at home with the world-famous NYI Learn-by-Doing Method. Write today for free catalog. Also resident training in N. Y. Our 51st Year. Approved for Veterans.

NEW YORK INSTITUTE OF PHOTOGRAPHY

Dept. 49 10 West 33 St. New York 1, N. Y.



OWN a BUSINESS!

We'll Train and Establish You

Start part-time if employed. You'll be trained by a nearby dealer and at 5-day training school. As carpet-upholstery cleaning expert, you provide 6 services to multiply profits and customer satisfaction. No shop needed. Just 2 average jobs a day nets \$8,750 first year. We help build your business with 27 continuous services: counseling, nat'l advertising (McCall's, Parents, House Beautiful, others), newspaper ads mats, etc. Send for FREE booklets.

DURACLEAN CO., 0-160 Duraclean Bldg., DEERFIELD, ILLINOIS



"My, what a cute room divider."

engineering degree in 27 months

Share rewards awaiting college men . . . higher income . . . advancement. Important firms visit Tri-State campus to interview seniors. *Bachelor of Science Degree in 27 Months* in Electrical Engineering (Electronics or Power major), Mechanical, Civil, Aeronautical, Chemical Engineering. In 36 Months a B.S. in Business Administration (General Business, Accounting, Motor Transport Management majors). For earnest, capable students. Small classes. More professional class hours. Well-equipped, new and modernized, buildings, labs, dorms. *Modest costs.* Year-round operation. Enter January, March, July, Sept. Founded 1884. Write J. E. McCarthy, Director of Admissions, for Catalog and "Your Career in Engineering and Commerce" Book.



TRI-STATE COLLEGE

4100 College Avenue Angola, Indiana

"\$7,108.50 First Year
SERVICING RADIATORS!"



NEW!
— Hank Konter, Newcastle, Wyo.
Make good money servicing auto-truck-tractor radiators with new Inland 1-Piece Radiator Shop. Easy to test, clean and repair radiators. Inland, world's largest radiator equipment mfr., trains you free. Small down payment starts you. Proved merchandising assures volume. Profitable dept. for garage or service station. Write.

INLAND MFG. CO., PM-10, 1108 Jackson St., Omaha 2, Nebraska

SIGN PAINTING

Home-Study Course — Only \$5.95

Teaches you commercial sign painting and sign building as it is being done TODAY in leading shops all over the country. Complete practical course for self-instruction. Shows latest methods of truck lettering, office doors, wood letters, reflecting signs, plastics, sprayed signs, gold leaf, silk screen process, up-to-date alphabets, money-making business information, etc.



SATISFACTION GUARANTEED OR REFUND!

Contains all the instruction of a high-priced correspondence course. Full price, only \$5.95, postpaid. Or C.O.D. plus postage. No Risk—order today. Satisfaction or money back! Order "Sign Painting Course" NELSON-HALL CO., 210 S. Clinton St., Dept. 2KP-2, Chicago 6, Ill.

The New Cars Parade

in full color

in the

NOVEMBER

POPULAR MECHANICS

OCTOBER 1960

**NO TIME LIMIT
FREE
REPLACEMENT
GUARANTEE**

MAKE BIG MONEY
with the **ONLY Light Bulb**
Backed by this
**SENSATIONAL
GUARANTEE!**

**ONCE YOU BUY MERLITE LIGHT BULBS
YOU NEVER HAVE TO BUY LIGHT BULBS
AGAIN—NEVER!**

**Home Owners Buy 12 to 24 and More at a Time!
You Make up to \$50 and More in a few Hours!**

Everybody who hears the fabulous Merlite Light Bulb No-Time-Limit Free Replacement Guarantee is an immediate customer for you! Sell 12 to 24 per home at 89¢ each, make up to 120% PROFIT ON COST! In several spare time hours, you can pocket \$50 profit. Merlite Bulbs burn so much longer than ordinary bulbs, we can afford to make this daring Free Replacement Guarantee . . . and you can make fantastic profits just telling friends, neighbors, relatives, others about this Guarantee.

Make Biggest Profits Selling to Retailers! We'll supply Merlite Light Bulb Self-Selling Display Racks at no cost to you. Put them in retail stores of all kinds. Give retailers 40% profit on bulbs sold from rack, refill rack weekly, make big repeat profits automatically!

FREE! Complete Big-Money-Making Details. Mail coupon now for complete details of the biggest money-making opportunity in years. Everything FREE, no obligation.

MERLITE INDUSTRIES, Inc., Dept. C-15U
(Light Bulb Div.) 114 E. 32nd St., New York 16, N.Y.
Rush complete Merlite Light Bulb big-money-making information —FREE and without obligation.

Name
Address
City Zone State

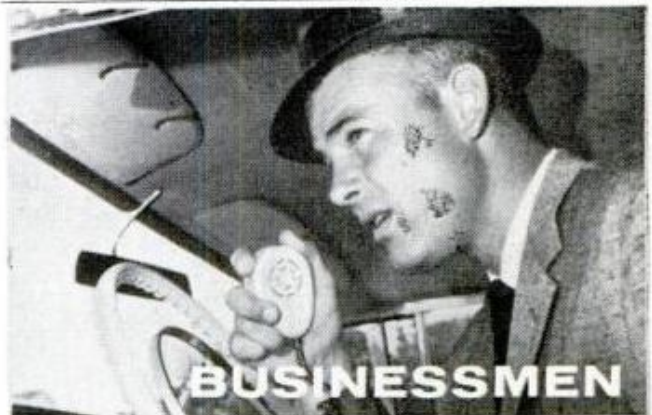

BUSINESSMEN

● Talk from truck, car, or boat to your home or business!

**2-WAY
RADIO**
from \$134.95

The finest Citizens' Transceiver available! Excellent sensitivity and selectivity for maximum range. 23 channel coverage—maximum legal power—built-in squelch—Automatic Volume Control—Automatic Noise Limiter. Easy to install anywhere. With tubes, push-to-talk microphone and crystals for one channel.



SEND FOR FREE COLOR BROCHURE

Send full details on the "Messenger"

NAME _____

ADDRESS _____

CITY _____ STATE _____

VIKING
Messenger

E. F. JOHNSON CO.

1602 2nd Ave. S. W., Waseca, Minn.

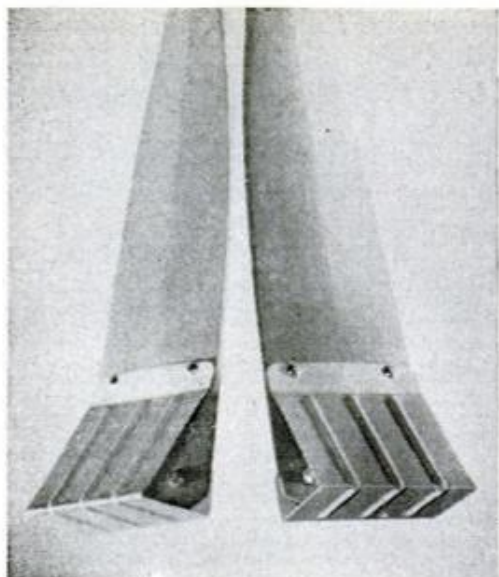

"Shoe" Makes Oar Into Push Pole

Oars are made for rowing—not for pushing or fending off rocks, docks or mud bottoms, but everyone does it. A new "oar shoe," however, puts several square inches of pushing surface on the tip of the oar and makes it a fine pusher, even on mud bottoms. And the hooked shape improves rowing performance.

Oar-Shoe Manufacturing Co., Box 367, Wayzata, Minn.



**LESSEE... 287 miles,
78 cents... that's
\$6 DOLLARS MORE!**

HONDA

Famous for its **ECONOMY** and outstanding dependability, the Electric "Push Button" starter **HONDA CA-95** gives an astonishing 141 m.p.g. and features the world's finest in 4-stroke (O.H.C.) engine design. **SMOOTH... QUIET and RUGGED... IT'S one of 8 in the world's largest motorcycle family... n' BESIDES IT'S FUN!**
8 models available (50cc through 305cc)

CA-95 (150cc)
Develops 16.5 H.P. at 10,500 r.p.m. • Features 4 speed trans., 87 m.p.h., 141 m.p.g., 10 to 1 compression.
\$460.00 P.O.E.
*ELECTRIC STARTER

Dealer Inquiries Invited Write...

AMERICAN HONDA MOTOR CO., INC.
4077 WEST PICO BLVD. • LOS ANGELES 19, CALIFORNIA

HEAVY EQUIPMENT MECHANICS WANTED:

Men to train for excellent pay, exciting work, wide-open future! Learn how to maintain, trouble shoot heavy duty construction and earthmoving equipment. Work for major contractors or your own business! Train on latest model diesel bulldozers, trucks, cranes, scrapers, etc.! Experienced instructors. 13½ week intensive course. Write today for **FREE** Catalog. Complete details.

GREER TECHNICAL INSTITUTE—Earthmoving School
Attn.: P. M. HUTCH, Box 368, Braidwood, Illinois

SPECIAL OFFER!

NEVER BEFORE AT THIS LOW PRICE

HIGH SPEED DRILL BITS

MORSE TAPER SHANK or ½" SHANK
SELECT ANY 10 OF THE FOLLOWING SIZES:

Dia.	Dia.	Dia.	Dia.	Dia.	Dia.
33/64	5/8	3/4	55/64	31/32	1-5/64
17/32	21/32	49/64	7/8	63/64	1-3/32
35/64	43/64	25/32	57/64	1 inch	1-7/64
9/16	11/16	51/64	29/32	1-1/64	1-1/8
37/64	45/64	13/16	59/64	1-1/32	1-9/64
19/32	23/32	53/64	15/16	1-3/64	1-5/32
39/64	47/64	27/32	61/64	1-1/16	1-11/64
					1-3/16

F.O.B. DETROIT—SEND \$1.00 FOR POSTAGE. GUARANTEED: Sold subject to your inspection and satisfaction. Can be returned freight collect.

SELECTION LIMITED TO ONE DRILL OF ANY ONE SIZE

\$70.00 VALUE **\$24.95**

SEND 10c FOR CATALOG
5000 DIFFERENT TOOLS AT REAL SAVINGS

WHOLESALE TOOL CO., INC.
10248 GRAND RIVER • DETROIT 4, MICH.



TURN YOUR HANDS, FINGERS, ELBOWS & FEET INTO SUPER WEAPONS!



WITH EASY TO LEARN **KARATE** QUICKER, BETTER THAN JUDO!

FEAR NO ONE! WITH KARATE A 98 POUND WEAKLING CAN EASILY OVER-POWER A 220 LB. HE-MAN IN SECONDS WITH HIS BARE HANDS!



Karate teaches you the pressure points, etc., of your opponent so that you can render him absolutely helpless in seconds.

Devised by the ancient Japanese Professionals Karate is the self-defense Hand to Hand combat system that is faster, more effective than Judo. Karate has been used in Japan for hundreds of years! Karate was published with action packed photos teaching you how to handle gun and knife attacks, street fighters and muggers.

You will learn just where the Karate striking points and positions are. You will learn the best defense against annoying attacks and serious attacks. Karate was used by the hand picked guards of the Japanese Emperor. Yet men and women find it easier to learn than Judo. Until recently Karate Technique was kept secret and originally used only for the Emperor's guards. In this very well illustrated book you are taught by one of the outstanding authors on Karate Technique and everything is simplified, explained and shown so that you can more easily master the art. The anatomical charts show the pressure points for fatal, serious and mild blows. You'll see how easy it is to render your opponent completely helpless. You'll never know how confident you will feel even among men much bigger than you are until you learn Karate. **With this book you will fear no man.** You will turn your feet, your elbows, fingers and your hands into such super weapons that it will amaze you and your friends. Learn Karate self defense now! You never know when you need it! **It's for men and women.**

SOLD ON MONEY BACK GUARANTEE

After receiving this Karate Technique Book look it over, it must do everything this advertisement promises, it must raise your confidence in your ability Physically, it must teach you more about self defense than you ever knew before or you get your money back! Don't delay order now on this money back guarantee. Mail coupon now!

Best Values Co., Dept. W-94
403 Market St., Newark, New Jersey

Rush my copy of Karate Technique. I enclose \$2.98. Send book Postage Pre-Paid. My money will be refunded if not satisfied. Send Two Copies of Karate Technique. I enclose \$5.00. Send Postage Pre-Paid. My money will be refunded if not satisfied.

NAME

ADDRESS

CITY ZONE..... STATE.....

make your own Gems 36⁵⁰

The Gem Maker comes complete with all necessary equipment, including a super-charged diamond blade for sawing, and all the wheels for grinding, shaping and polishing; also complete instructions. The complete equipment as shown, less motor and belt for only \$36.50, f.o.b., Burlington, Wisconsin. Write today for information and literature.

B&I MANUFACTURING CO.
Dept. P Burlington, Wis.

earn as TAX EXPERT

\$15 HOUR

Our students earn as much as \$3,000 in 3 short months preparing income tax returns in spare time. Also operate lucrative year-round Business Tax Service Digital home-office business. Experience unnecessary. We train you; help you start. State approved home training program. Write today for free prospectus.

UNION INSTITUTE, Lakewood 20R, N. J.

Finish HIGH SCHOOL HOME AT IN YOUR SPARE TIME

DIPLOMA AWARDED

Learn more! Earn more! Enter professional or technical schools. Advance socially. Live a happier, fuller life. Individual Courses or complete schedule. Write for School Bulletin.

ACADEMY FOR ADULTS
30 W. Washington, Dept. PM-1060, Chicago, Ill.

\$540 CLOSE OUT!

TRANS-ATOMIC RADIO KIT

- High gain Germanium Transistor
- Compact unbreakable plastic case
- Slide rule dial for precision tuning
- Loopstick for long range reception

For other low cost kits write for Bulletin PM 1

PARTS UNLIMITED INC. 1 State St. Bloomfield, N. J.

Eliminate Dangerous HEADLIGHT GLARE!

Now you can **ELIMINATE** dangerous **GLARE** at once with this amazing new invention—**LITENITE NIGHT DRIVING GLASSES**. These remarkable glasses are made of special amber lenses that reduce harmful glare. Headlamps of on-coming cars look like soft amber lights—and dangerous glare is softened instantly! Amazing, unbelievable until you actually put **LITENITE** on! **LITENITE** are **NOT** sunglasses but scientifically developed **NIGHT LENSES** used by airplane pilots to see more clearly through darkness and haze. Wonderful also for **WALKING** at night, TV and hunting and fishing.

NOT THIS — BUT THIS

Beautifully made with **24-KARAT GOLD-PLATED** Aviation frame, comfortable temples, adjustable nose-pads, wide-angle lenses. **FREE!** Rich-looking Leatherette Carrying Case. **TRY AT OUR RISK** for full week. **MONEY BACK** if you don't say night driving is a pleasure! Send check or money order—or order COD plus postage.

REGULAR Style only \$2.98. **CLIP-ON** Style for use over prescription glasses only \$2.15. **Stato** STYLE and whether for **MAN** or **WOMAN**. **DE LUXE** Style with large Rhodium-Plated frame—\$5.00.

STUYVESANT TRADING CO., INC. Dept. 418
130 W. 42nd St., New York 35, N. Y.



The Beautiful Schober CONSOLETTA

—only small organ with two full 61-note keyboards and 22 stops. Requires only 2'x3'2" floor space! Commercial value approximately \$1600 or more.

BUILD THIS SUPERB Schober ORGAN FROM SIMPLE KITS and save over 50%!

Give Your Family A Lifetime of Musical Joy With A Magnificent Schober Electronic Organ!

Now you can build the brilliant, full-range Schober CONSOLETTA or the larger CONCERT MODEL with simple hand tools! No skills are needed; no woodworking necessary. Just assemble, clearly marked electronic parts guided by step-by-step instructions. You build from kits, as fast or as slowly as you please...at home, in your spare time — with a small table serving as your entire work shop.

Pay As You Build!

Start building your organ at once, investing just \$18.94! The superb instru-

ment you assemble is as fine, and technically perfect, as a commercial organ...yet you save over 50% on quality electronic parts, high-priced labor, usual store mark-up!

THE GREAT CONCERT MODEL meets specifications of **American Guild of Organists**

Free Booklet

Send for 16-page booklet in full color describing Schober organs you may build for home, church or school, plus articles on how easy it is to build your own organ and how pleasant it is to learn to play. Also available is 10" LP demonstration record (price \$2.00 — refundable on first order). Send for literature. No obligation and no salesman will call.

Mail This Coupon For FREE Schober Literature And Hi-Fi Demonstration Record TODAY!



The Schober Organ Corp., Dept. PM-4
43 West 61st St., New York 23, N. Y.

Please send me FREE full-color booklet and other literature on the Schober organs.

Please send me the 10" hi-fi Schober demonstration record. I enclose \$2.00 (refundable on receipt of my first kit order).

Name.....

Address.....

City..... Zone... State.....

make \$10 an hour—
\$300 a week
HELP US
SUPPLY THE OVERWHELMING DEMAND
FOR OUR NEW, REVOLUTIONARY
sunmaster "Multi Million-Prism"
5 YEAR BULBS
Wonderfully soft, flattering, eye-comfort light unconditionally guaranteed for 5 years. (Outlasts 13 ordinary bulbs). Unlimited earning possibilities! **ONE-TIME-ONLY OFFER** — Send \$1.98 for six sample bulbs worth \$4.69. Sell them or return for full refund.

Silicate-treated to assure positive overall light for 5 years

Write for free Dynamic Sales Kit.
SUNMASTER ELECTRIC PRODUCTS, INC.
Dept. PM10, 366 Fifth Ave., New York 1, N. Y.
In Canada: Dept. PM10, 539 King Street West, Toronto, Ont.

Locksmithing AND KEY MAKING
Now Made Easy! Practical up-to-date course teaches you how to pick locks, de-code, make master keys, repair, install, service, etc. New self-instruction lessons for every handyman, homeowner, carpenter mechanic, service station operator, fix-it shop, hardware dealer, gunsmith. 53 easy illustrated lessons. Full price only \$5.95 postpaid; or C. O. D. plus postage. Satisfaction or refund guaranteed.

Complete course \$5.95
... now only \$3.95

NELSON-HALL CO., DEPT. KP-2
210 S. Clinton Chicago 6, Ill.

LEARN DRAFTING
AT HOME IN SPARE TIME
Choice of Mechanical, Architectural, Aeronautical under guidance of licensed engineers and architects. V.A. approved. Write for FREE success book and sample lesson.
CLEVELAND ENGINEERING INSTITUTE
Dept. PM-10K • 6300 Euclid • Cleveland 3, Ohio

KNOBS FOR ALL TV SETS
HARD TO GET RADIO & TV COMPONENTS—COMPLETE HI-FI & STEREO EQUIPMENT. Receiving Tubes at discounts. Special Coils, Special Resistors, Transformers, Controls, Condensers, Diodes, etc. Free Technical Hints and Tips for repair and maintenance of TV Sets.
SEND FOR FREE CATALOG
Stevens Electronics, Inc., 459 Broadway, Hicksville L. I., N. Y.

MEN PAST 40
Afflicted With Bladder Trouble, Pains in Back, Hips, Legs, Nervousness, Tiredness.
If you have these troubles, particularly bladder trouble, then your condition may be traced to Glandular Inflammation... a constitutional disease. Neglect of this condition often leads to premature old age and sometimes incurable malignancy.
The Excelsior Medical Clinic has a New Free Book that tells how thousands of men have been successfully treated here at Excelsior Springs for Glandular Inflammation by NON-SURGICAL Methods. They found soothing relief and a new outlook in the future of life.
This Free Book may prove of utmost importance in your life. Write Today. There is no obligation.
Excelsior Medical Clinic, Dept. B6129, Excelsior Spgs., Mo.

**WORLD'S
BEST
WANT-AD
MEDIUM**

CLASSIFIED ADVERTISEMENTS



Advertisements in this section \$1.30 per word, each insertion, minimum 10 words, payable in advance. To be inserted under proper classification, copy must be in our office the 18th of the second month preceding date of issue
F. W. Johnson, Manager, Classified Advertising
Popular Mechanics, 200 East Ontario Street, Chicago 11, Illinois

YOU'LL PROFIT

By reading and answering the classified ads in this section. Hundreds of opportunities for you to make and save money

AUTOMOBILES. MIDGET CARS

JEEP Headquarters. New and used jeeps, parts, plows, winches. Every type of special equipment. Miniature Jeeps \$1.00 postpaid. Franklin-Weber Pontiac, 6101 N. Clark, Chicago 26, Illinois.

NEW 1/4 Midget racers with full race Continental engines. List \$625—our price \$279. 1/3rd with order, bal. on delivery. European Motors, Inc., Rossville, York Co., Penna.

GO-KART Parts and accessories. Manufacturers of complete line. Illustrated catalogue and price lists 25¢. Dealer inquiries invited. Nationally advertised. Semco Products Inc., Dept. P.M., 544 Walt Whitman Rd., Huntington Station, L. I., N. Y.

OLD Car magazine. Interesting classic, antique car pictures, ads, articles. 12 issues \$1.00. Free sample. Franson's Motor News, Box 1568, San Diego 12, California.

NON-PROFIT Organization offers automobile literature—old, modern, foreign; dealer books, service manuals, glossy photographs; free motor magazines. Write immediately, get on free mailing list. Auto Maniacs A, Box 451, Mt. Clemens, Mich.

HISTORICAL Record of 1960 U.S. and foreign cars, fully illustrated. Detailed specifications on all models. 160-page "Car Facts Book, 1960," \$1.00. Service Bureau, Room 517C, Popular Mechanics, 200 E. Ontario, Chicago 11, Ill.

HOT Rod racing book reports 1959 races, trials, drags. Expert advice on hopping up engines, tuning the stock Corvette, supercharger selection. Send 75¢ (85¢ in Canada) to Service Bureau, Room 517D, Popular Mechanics, 200 E. Ontario, Chicago 11, Ill.

GO-KART Parts and supplies. Complete information 25¢ to cover postage. Rocky, Galveston, Indiana.

AUTO SUPPLIES AND EQUIPMENT

JUST Out: New 404-page, illustrated catalog offering savings up to 50% on over 100,000 auto parts and accessories, many hard-to-get. All makes (1920 to 1960 models), trucks, foreign and sports cars. Also Hollywood accessories, custom styling, hi-speed equipment. Send 25¢ for postage, packing—refundable on first order. Whitney, 1919 PM-10 Archer, Chicago 16, Ill.

AUTO Shop welding repair training in world's largest non-profit welding school. Low tuition. Free booklet. Hobart Welders, Box M-1001, Troy, Ohio.

JEEP Owners — V8 conversions. Read Jeep Owners ad, page 30.

GREATEST Auto parts catalog. Thousands racing and restyling accessories for all cars. Only 25¢ (refundable). Newhouse Automotive Industries, 5805-PM10, Beverly, Los Angeles 22, Calif.

JEEPS—\$223.00, Trucks—\$212.00, tractors—\$68.00, tools, guns. Typical government surplus prices. Buy direct. List of depots, procedure, full details only \$1.00. New York Enterprises, Wall Street, Box 402-X, New York 5.

VOLKSWAGEN Fuel gage system \$8.95. Longmire, Box 97, Goleta, Calif.

PARTS, Model "A." List 25¢. (Refundable) Matco, Box 135, San Pedro, Calif.

FREE! Catalog, bargains. Spark plugs 25¢ each (8 or more), Champion, AC—20,000 mile guarantee, renewed. 100—19¢ each. Gift. AAA, Crenshaw, Box 8513, Los Angeles, Calif.

NEW Cars and old need Sola Cell's rust and corrosion protection against engine overheating. \$1.00 (ppd). George Roach, Box 355X, Carlsbad, Calif.

SPACE Frames. Designed in Europe, using VW parts. Reversed engine and transmission (VW or Porsche). Fantastic performance. Send \$2.00 for diagrams, photo parts list and prices. Refundable on purchase of tubular space frame \$385. F.O.B. European Motors, Rossville 3, Penna.

CRANKSHAFT Grinder. Hand operated. Makes bearings fit without taking engine apart. \$4.00. Literature. L. D. McGee, 719 Cascade St., Wenatchee, Wash.

NEW And used parts at savings. Complete guaranteed parts service for all models cars and trucks, 1924 and later. Largest in the West. Jeep and army parts specialists. Newest type shifting hubs for all jeep and all military and latest production front end drive vehicles. \$27.50 and up. Also, foreign car parts. Write. Pioneer Auto and Truck Parts Co., 734 W. 13th Avenue, Denver 17, Colo.

FREE! New catalog. Speed, power, mileage increasing equipment. Discounts! Almqvist Engineering, Milford PM5, Penna.

JEEP Parts! For military and civilian. At great savings. Largest inventory. Catalog for owners and dealers. Inquiries invited. American Auto Parts Co., 1830-PM Locust, Kansas City, Mo.

RING-Valve job while driving. \$6.00 postpaid. Guaranteed! Nothing like it! Lasts 100,000 miles! Motaloy, Grantham, Penna.

SILENCE Hydraulic valves \$3.00 postpaid. Free literature. Micro-Moly Products, Garrison 1, Kentucky.

1909-1934 FORD Parts. Illustrated catalogue 195¢. Mark Auto, Layton, N. J.

BURGLAR Alarm system for your car. Send \$2.00 for kit with materials and self instructions. A&W Electronics, 215 Baldwin Rd., Oakdale, Penna.

NEW Magnetized warning signal reflector. Warns and slows down all traffic making it safe for you in any emergency when stopping on any dark highway. No bulbs or batteries needed. As shown Page 81, May 1960, Popular Mechanics. Only \$2.50 postpaid. A. Scarpello, Box 1031, Secaucus, New Jersey.

LUBRICATION System. Guaranteed. Details free. Karr-Lube Co., Box 4134-F, Birmingham 6, Ala.

FREE Booklet: Cause, effect and cure for battery corrosion. U. S. Polymer, Rockaway, New Jersey.

AERO Tires 8 ply for go-carts, scooters, etc., 12 1/2 inches high, 4 inch center, \$2.50. Knapton Tire Company, 216 S. Wabash St., St. Paul, Minn.

MONA-TONE Guttled mufflers for car owners, hot-rod fans. More power! More mileage! Rich, mellow tone! Fits all cars. \$5.95 plus COD and postage. Give year, make, model. Universal, Box 7823M, Nashville 9, Tennessee.

AUTO TRAILERS

PICKUP Coach blueprints. Kits. Literature 10¢. Comstock Trailers, Parsons, Kansas.

BUILD Expanding eight foot trailer. Accommodates five. Literature 10¢. Fram-Mar Company, Wilmington, Mass.

MOTORCYCLES, BICYCLES, MOTORSCOOTERS AND SUPPLIES

MOTORCYCLE Parts. New, used. List 25¢. Ballak, 811 N. 9th, St. Louis 1, Mo.

RECONDITIONED Motorcycle motors. Chrome accessories. Complete stock Indian parts. Expert rebuilding. Fast service. Indian Motorcycle Sales, Kansas City 27, Missouri.

HARLEY-Davidsons — Used bargains. New, used parts, accessories, all models. Bulletin 25¢. Knuth's (Factory Dealer), 1753 Muskego, Milwaukee, Wis.

BABY Seats for bicycles \$4.00. Dawes, Box 191, Arlington 74, Mass.

AMERICAN Motorscooter \$15, midget car \$20, motorbike \$35, gyro copter, Crosley station wagon \$75, Harley servi-car \$45, Cushman engine \$8, others \$5 up. (Mailorder only). Send 25¢ (35¢ for first class mailing) for Directory-Catalogue Number 97, listing these and hundreds of other bargains in go carts, motorscooters, homebuilders parts, plans, etc. Midget Motors Directory, Athens, Ohio.

BICYCLE Supplies. American, foreign. Postpaid. Attleboro Cycle, County Street, Attleboro, Massachusetts.

AVIATION

AVIATION Surplus bargain catalogue. One dime. Box 22PM, Thomasville, Penna.

BUY Govt. surplus: Aircrafts; helicopters; boats; jeeps; tractors; misc. Individuals can buy direct now from govt. Send for "U.S. Depot Directory & Procedures," \$1.25. Brody Surplus, Box 425-PM, Nanuet, New York.

AIRLINE Careers. Adventure! Prestige! Promotion! Four-week course. Free placement service with 35 airlines. G. I. approved. Free catalog B. McConnell Airline School, 1030 Nicollet, Minneapolis, Minnesota.

HELICOPTER—Completely engineered, assembly drawings and parts available. Send \$2.00 for photo, 3 view drawings, specifications and design information. Send additional \$2.00 for book "Basic Helicopter Aerodynamics" uses our helicopter as example problem for performance calculations. Helicopter Research Co., Box 121, La Mirada, Calif.

BATTERIES, GENERATORS

BATTERY Charger. The Addam continuous duty combination 6v-12v. Guaranteed. Send \$13.95. Boats, autos, tractors, etc. Addam Pmts., 4111-9th St. No., St. Petersburg 3, Fla.

BATTERY Repair Manual \$3.00. Hydraulic Jack Repair \$3.00. Bayer, 938N Betty Avenue, Neenah, Wisconsin.

ELECTRICAL SUPPLIES

LAMP—Appliance parts wholesale. Catalogue 25¢. Seco, 26 South 20th Street, Birmingham 3, Alabama.

ELECTROLUMINESCENCE: Revolutionary new area light source by Westinghouse. Wafer-thin, requires no bulbs, wires or filaments. Ideal as night, safety or dark room light. Burns night and day for less than penny a year. Sensational! Send \$1.50 for each lamp. Money-back guarantee. Approved Products, 666 Third St., Newark, N. J.

LAMP, Electrical parts, wholesale. Thousands of items for repairing, converting. Catalog 25¢. Brown Lamp, Box 305, Clayton 5, Mo.

LAMPS. 25¢ Brings parts catalog. Refunded first order. Gyro, 5208P N.W. 35th Ave., Miami 42, Florida.

ELECTRO-Scribe! Engraves all metals, \$2.00. Beyer Mfg., 10511-H Springfield, Chicago 55.

WELDING, SOLDERING, PLATING

FREE Catalog, welders, welder kits. Build 350-ampere welder using aircraft generator, plans 25¢. Dunbar Manufacturing, Minneapolis 8, Minnesota.

WELDERS, 110/220, \$39.50. Morris, 1070 Inner Drive, Schenectady 3, New York.

PLATING Equipment, supplies. Complete line of anodes, solutions. Home workshops, industrial sizes. Hollywood Bronze Supply, Dept. C, 1624 East First, Los Angeles 33, California.

WELDING Equipment and supplies. Build or buy inexpensive 350-ampere welder plans 25¢ Free Welder Kit catalog. LeJay Co., Minneapolis 20, Minnesota.

ENGINES, MOTORS, DYNAMOS

FREE Wholesale catalog—motor rewinders, supplies, instructions, equipment, plans. Modern, Box 8715, Kansas City 14, Mo.

REWIND Motors yourself. Complete instructions. \$1.00. Lewis Manufacturing, Howell, Michigan.

WINDING Data. 275 motors, single and three phase \$1.10. Data Company, 512 Kensington, Kansas City 24, Mo.

MACHINERY, TOOLS, SUPPLIES

ACCURATE Low cost milling machine. Rough or semi-finished castings supplied. Free literature. McKin Manufacturing, 4223 Lincoln, Venice, California.

FREE New catalog showing only complete line of work holding tools available anywhere. Drill press vises, angle and swivel machine vises, rotary tables, production and heavy duty angle vises. 68 different models, fully described with prices. Palmgren Products Co., 8365 South Chicago Ave., Chicago 17, Illinois.

SHEET Metal brakes: 36" \$45.00. Also 49", 61". Bench shears. Free catalog. Vyke Co., P4158 Jason, Denver 11, Colo.

BOATS, OUTBOARD MOTORS

FIBERGLAS Permanent boat waterproofing. Special 25% discount. Complete kits, \$9.45 up. Guaranteed materials. Easy application. Full instructions. Free literature. Mail post card. Ajax Plastics, P. O. Box 1323, Fort Worth, Texas.

BRADLEY Water sled with steering control. Literature free. Merryman Distributors, Formosa, Ark.

FRAME Kits, plans or full-size patterns for 35 inboards and outboards. Prepared for amateur builders. New 80 page illustrative catalog, 50¢. Glen Designs, 9152 Rosecrans, Bellflower, Calif.

BOAT Plans. Literature 25 cents. Harvey Bellis, Hayward 3, Wis.

BUILD Your own boat from our large-scale blueprints. Books of plans give how-to-build help. Hundreds of professional designs—motor, sail or auxiliary—for amateur builders. Free catalog. MoTOR Boat-ing, 572A Madison Ave., New York 22, N. Y.

300 BOAT Plans, kits. Catalogs: Powerboat \$1.00. Sailboat 25¢. Trailer kits. Marinecraft, Box 161-M, Brighton 35, Mass.

MARINE Conversions. Ford, Chevrolet, Jeep engines. Catalog 25¢. Lehman Manufacturing Company, 800 Elizabeth Avenue, Linden 4, N. J.

NEW, Used, rebuilt marine motors. Marine conversions, fittings. Free catalog. Stokes Marine Supply, Dept. 24, Coldwater, Michigan.

FULL Size, cut-to-shape boat patterns, blueprints, 7½-38 feet. Big new 88 pg. illustrated "Build a Boat" catalog of naval architect-designed Catamarans, cruisers, runabouts, skiffs, outboard boats, sailing, racing, houseboats, 50¢. "How to Build a Boat" booklet \$2.50. Cleveland Boat Blueprint Co., Dept. A-66, Box 1651, Cleveland, Ohio.

MARINE Conversions, Willys to Cadillac, kits and parts. Catalog and conversion hints free. Barr Marine, 2706A Castor Avenue, Philadelphia 34, Penna.

I want to send you proof of the wonderful pulling power of Popular Mechanics classified pages. What's your proposition? Write me today. Include literature if possible. F. W. Johnson Manager Classified Advertising, Popular Mechanics Magazine, 200 E. Ontario St., Chicago 11, Ill.

ATHLETIC EQUIPMENT, BODY BUILDING COURSES

ACT At once! Get free five \$5 picture-packed body building courses by world's greatest trainer. Send 10¢ for postage; state age. Jowett Institute, 220-B Fifth Avenue, New York 1.

JUDO—20 Best tricks. Offense-defense. Easy to learn. Fully explained. Brief Judo dictionary added. Plain wrapper. Send \$1.00 to: National, PO Box 63-RM Brooklyn 14, N. Y.

"KARATE" Jiu Jitsu. Men, women any age learn easily. Protect your life or honor bare-handed. Fear no man, knives, guns or clubs. Thirty-six knockout blows without fists. Overpower biggest bullies. Amazing photographic illustrated home-study course copyrighted by world-famous military and official police instructor. Complete, only \$1.00 postpaid. Jorgensen, Box 5082-3100, Seattle 7, Washington.

RUBBER Sweat suits. Free details. Jerry's, Box 2344, Providence 6, R. I.

MUSCLES By mail. Free brochure on the latest, fast body building methods. Write Milo Institute, P.O. Box 1060, Johannesburg, South Africa.

4 MUSCLE Courses 25¢. 12 large courses \$2.00. Big deal \$3.00 (guaranteed). Agents wanted. Sid's System, PMc4, 8421-C Evergreen, Southgate, California.

DEADLIEST "Fighting Arts Orient." Elemental Karate, Kung-Fu manual. 336 illustrations. Break planks bare-handed using breath, sand, straw, \$3.98. Positively no minors. Oriental Book Sales, P.O. Box 1183, Oakland 4, Calif.

OUTSTANDING Physical development! Any age. New guaranteed discovery uses only a rope! Strength, health, muscles. Gain—reduce. Free booklet. Roperise, 4834 Art, San Diego 15, California.

"BIG Muscles. The Quick Way." Dr. Young's revolutionary discovery. Free information. Gaucho, Box 9309-S7, Chicago 90.

FREE Muscle building information. Body-Tone, Box 638B, North Miami, Florida.

LIVE Longer! Trim your waistline in one minute a day! New 1-minute waistline method. Guaranteed results. Exer-cord and instructions \$2.00 postpaid. Write for brochure. Pacific Mart, 1953 (104A) Camden Ave., Los Angeles 25.

SPORTING GOODS, GUNS, FISHING, SKIN DIVING, ARCHERY

154 PAGE Catalog—A real dream book for fishermen! It's free! Nectcraft Company, Dept. B-10, Toledo 13, Ohio.

FREE Brochure on the most useful outdoorsman's aid ever devised. B&W, Delaware City 1, Del.

5000 GUNS, Swords, war relics. Catalog 50¢. Smith Firearms, Runnemedde, N. J.

MINNOW Graders. Free circular. Crescent Mfg., Box 3303, Ft. Worth, Texas.

MOLDS For fisherman's sinkers, jigs, squids, casting and spinning lures. Free catalog. Sweet's Molds, Tonawanda 1, New York.

MOLDS—For casting your own fishing sinkers. Free illustrated booklet. Reading Instrument Co., Box PM78, Reading, Penna.

BIG Money raising crickets and 12 inch African fishworms. Free literature. Carter Ranch, Plains, Georgia.

FREE—Wholesale catalog. Beads. Spinners. Lure parts. Sinkers molds. Jigs. Reels. FinnySports (ME), Toledo 6, Ohio.

AMAZING Wholesale sporting catalog. Save 70%. Tremendous selections. Econ-O-Mart, Whippany 2, New Jersey.

KILL Submersed water weeds which foul up motor propellers, tangle fishing gear, with R-H Weed Rhap-20, Granular 2,4-D. Inexpensive, easy to use, sure results. For free information write Reasor-Hill Corporation, Box 36PM, Jacksonville, Arkansas.

JAP Rifle altering to 30-06, \$6.00. Jap-shells, \$3.95. Catalog 10¢. T. P. Shop, West Branch 11, Mich.

CONVERT Fishing boat to Jet! Nothing below hull! Tried, tested, operating perfectly in waters impossible with any other type propulsion. Go Jet! Complete plans, layout, instructions, photos, etc. for the do-it-yourself guy. Free details. Fisherman's Jet Boat, Inc., 704 Inland Bldg., Indianapolis, Ind.

10,000 GUNS. Antiques, moderns, swords, armour. Every description. Giant catalog \$1.00. Agramonte's, Yonkers 2 G, N. Y.

CAMPING EQUIPMENT AND TENTS

TENTS—Premium quality, lightweight, German made. Free catalog: Sportberger, Box 571-X, Minneapolis 40, Minnesota.

STATION Wagon owners—build portable dressing room attached to your wagon. Easy, illustrated plans \$1.00. Ada-Cabana, 1397 Hedding, San Jose 26, Calif.

CAMPING Equipment, tents, world's largest selection. Send 25c for new 160 page catalogue-handbook-camp site directory. (Print name, address). Morsan Tents, 10-21R 50th Ave., Long Island City 1, New York.

EARTHWORMS, CRICKETS, FROGS

AFRICAN Nightcrawlers, 100—\$2.00. 500—\$7.00 (Dealers quoted). Ozark Worm Farm-J, Willow Springs, Missouri.

BIG Money raising fishworms and crickets. We teach you how to raise and where to sell. Free literature. Medium redworms, 3000, \$5.95; 10,000, \$16.95. Carter Redworms, Plains, Georgia.

FREE Picture folder, "How to Make \$3,000 Yearly, Spacetime, Backyard, Raising Earthworms!" Oakhaven-56, Cedar Hill, Texas.

RAISE Fishworms and rabbits on \$500 month plan. Free details. White's Rabbitry, Mt. Vernon, Ohio.

FAT Red Worms, 1000—\$3.00, 2000—\$5.00, 5000—\$11.00. Postpaid with raising instructions, live delivery guaranteed. Worm Gardens, 324 David Drive, Waco, Texas.

CRICKETS—Worms. Hy-bred. Wholesale, retail. Fischer's Bait Barn, Rt. 4, Box 17, Robstown, Texas.

BINOCULARS, TELESCOPES, MICROSCOPES, MAGNIFIERS

TELESCOPE Kits—Direct from manufacturer. Other optical hobby kits. Large selection. Free booklet. Esco Products, Oakridge, N. J.

BUILD Your own reflector telescopes. Complete kits: Mirrors, eyepieces, tripods, all other accessories. Request free illustrated literature. Criterion Manufacturing, Dept. DPM-69, Hartford 1, Conn.

REFLECTING Telescope, 60X, completely assembled. Guaranteed observatory clearness. Free information. Skyscope, P.O. Box 55, Brooklyn 28, N. Y.

WAR Surplus bargains: Millions of lenses, instruments, telescopes, binoculars, components and complete line of astronomical telescope items. World's greatest optical market-place! Send only \$1.00 for beginner's 10-lens kit and big instruction booklet Stock 2-CH. Write for Catalog CH free! Edmund Scientific Co., Barrington, New Jersey.

BARGAINS, Binoculars, telescopes, microscopes. Free catalog. Adventure Sales, Box 2133, San Diego 12, California.

TELESCOPES, Binoculars, all sizes. Complete telescope makers supplies. Free catalog. Suffolk Science, Mattituck, New York.

SWIFT Binoculars. Big discount. C. A. Phillips, 132 Lincoln Avenue, Syracuse 4, New York.

FREE Booklet, plus discount catalog. Microscopes, telescopes, binoculars. Craig's, 2705 Meadowview, Columbus 2, Georgia.

BINOCULARS, Telescopes, microscopes: Terrific values—\$3.98 up! Request free money-saving catalogue. Criterion, Dept. P-95, Hartford 1, Conn.

BARGAIN Telescope, microscope catalog 25¢. Winn Chemicals, 124 West 23 Street, New York 11, New York.

AMAZING Prices precision binoculars. Folder "Binocular Selecting," catalog free. Prentiss Importers, Mercury Bldg., West Los Angeles 25, Calif.

DYNASCOPE—Amazing world-famous reflector telescope. Request free brochure. Criterion, Dept. DP-72, Hartford 1, Conn.

MICROSCOPES, Radios, surveying, everything Japanese. Catalog 25¢. Magnification Instrument, 2 East 45, New York City 17.

PLANTS, SEEDS, BULBS, NURSERY SUPPLIES

DWARF Iris. Ten assorted colors, \$1.00 postpaid. Free catalog. Buena Vista Iris Gardens, Vermillion, S. D.

GINSENG Bringing \$14 pound. Have seeds, plants, Goldenseal. Full information. K. Collins, Viola, Iowa.

GROW Dwarf trees! Instructions and seeds, 35¢. Mail Order Specialties, 1439-PM-K, Sabraton Ave., Morgantown, W. Va.

HOMEOWNERS Guide. Preparation and growth of plant cuttings. Illustrated \$1.00. 301 Ruth Street, Longview, Texas.

PETS—DOGS, BIRDS, RABBITS, HAMSTERS, ETC.

HUNTING Hounds: Cheap. Trial. Literature free. Dixie Kennels, D35, Herrick, Ill.

POINTERS And Setters. All ages. Reasonable. Ira Griste, Route 8, Memphis, Tenn.

ANGORA Rabbit magazine. Carpenter's, Piqua, Ohio. Year \$1.00. Sample 15¢.

WHITE German police AKC pups. Theatrical tricks. Knoff, Nashotah, Wisconsin.

GOLDEN Hamster, cage, book, water-bottle, \$5. Winch's Hamstery, Box 582, Fort Wayne 6, Indiana.

EARN \$10,000 Yearly raising Angora rabbit wool for us. Information 25¢ coin. American Angora Company, Malta 12, Montana.

GOLDEN Hamsters—Pedigreed breeders \$3.85 pair. Albinos Whitebands. Literature. Moore's Hamster Ranch, Shepherdstown 25, West Virginia.

MAKE Money raising chinchillas, mink rabbits, cavies for us. Free catalog. Keeney Brothers, New Freedom 2, Penna.

RAISE Rabbits on \$500 month plan. Free details. White's Rabbitry, Mt. Vernon, Ohio.

HAMSTERS—Ideal pets, \$2.95 pair. Free booklet. Jer-fre's Hamstery, 1447 Apple, Muskegon 13, Michigan.

SKUNKS, Reptiles, hawks, raccoons. Illustrated catalogue, 25¢. Trails End Co., St. Stephen, S. C.

RAISE Rabbits successfully by knowing facts. 48 page illustrated book describing 25 breeds. Housing, feeding, breeding, marketing, etc. Plus bulletin. 25 cents. American Rabbit Association, 36 Arba Building, Pittsburgh, Penna.

FUR BEARING ANIMALS

MINK Raising information free. Complete. Lake Superior Mink Farm, Superior, E.E1, Wisconsin.

FARMS, FARM LANDS, REAL ESTATE

CANADIAN Vacation lands: Full price \$285.00. 40 acres, \$10.00 month. Suitable cottage sites, hunting, fishing, investment. Free information. Land Corporation, 3768-C Bathurst, Downsview, Ontario, Canada.

\$5.00 MONTHLY Buys 5 acres. Near town, excellent fishing. Price \$100. Free list. Box 425P, Carthage, Mo.

FREE Strout catalog! Farms, homes, businesses, resorts, retirement properties. Over 3000 values in 36 states. 60 years service. World's largest! Write Strout Realty, 7-CJ S. Dearborn, Chicago 3, Ill.

STATE — Government lands cheaply available. Free information. Shonback, 2737 Clement, San Francisco 21, California.

FARM Bargain extraordinary! Beautiful 242-acre southwest Missouri beef and broiler setup going for only \$14,500! Modern 3-bedroom ranch-type home. Abundantly-watered pasture system to accommodate herd of about 75 head, 100 acres cropland. Fully equipped 7,500-bird broiler plant. Enormous natural water supply from sparkling spring-fed stream, 3 dependable springs, 2 large ponds ready for stocking. Deer and small game hunting! Three barns, utility house. On county road, 7 miles town. Disabled owner offers one of the year's best buys at only \$14,500, less than one-third down. New free 184-page Fall catalog, 1,250 photos, bargains coast to coast! United Farm Agency, 2825-PM Main St., Kansas City 41, Mo.

ARMSTRONG'S, Shook, Missouri. Sell Ozark lands. Write them. Listings mailed free, quarterly.

FLORIDA—Silver Springs area. ¼ acre waterview homesites. \$795.00, \$10.00 month. Free color photos. Write: Smith Lake Estates, Box 5681, Belleview, Florida.

OPPORTUNITIES! Government land, U. S., Alaska, Canada. Sledge Surveys, Macon, Mississippi.

FARM MACHINERY AND SUPPLIES

ELECTRIC Welders. New, heavy-duty, 180 amp. Free trial. Dealerships open. 20 year warranty. 8159 South Pleasant Department A1, Minneapolis 20, Minn.

PROFITABLE OCCUPATIONS

MAILORDER Beginner's manual, 25¢. Carnahan Bros., 9610 Acacia, Fontana, Calif.

INVESTIGATE Accidents. Earn \$750 to \$1,000 monthly. Thousands of airlines, insurance companies, steamship lines urgently need accident investigators. Make excellent full time or spare time income. Free book! No obligation. GI approved. Write: Universal Schools, CPM-10, Box 8227, Dallas 5, Texas.

FACTORY Prices! Thousands nationally advertised products. Typewriters, housewares, jewelry, watches, appliances, television, cameras, etc. New factory buying plan saves up to 40% below wholesale. Details free. Factory Supply Company, Bloomfield 1, New Jersey.

FREE Book "990 Successful, Little-Known Businesses." Work home! Plymouth-7M, Brooklyn 4, New York.

WANT To make \$5,000.00 yearly or more in respectable, easily learned mailorder business? Send 25¢ for complete plan, details! Columbia, 45-09-M Broadway, Long Island City 3, New York.

BECOME Independent with your own franchise business. Thousands earning handsome incomes. Request interesting facts today. National Franchise Reports, PM-528, 333 North Michigan, Chicago 1.

BAKE New greaseless doughnuts in kitchen. Sell stores. Free recipes. Michael, 3605 South 15th, Minneapolis 7, Minn.

BIG Money raising fishworms and crickets. Free literature. Carter Wormery, Plains, Georgia.

VENDING Machines. No selling. Operate a route of coin machines and earn amazing profits. 32-page catalogue free. Parkway Machine Corporation, Dept. #25, 715 Ensor Street, Baltimore 2, Maryland.

GROW Mushrooms. Cellar, shed and outdoors. Spare, full time, year round. We pay \$4.50 lb. dried. We have 29,000 customers. Free book. Mushrooms, Dept. 99, 2954 Admiral Way, Seattle, Wash.

SHARPEN Scissors, pinkers. Inexpensive machine. Clipper sharpener. Black-hawks, Sheldahl, Iowa.

JANITOR Service: Start your own from home. Earn \$6.00 hour. Others do. Details \$1.00. Simco, Box 109, Westfield, Mass.

BARGAINS! Buy wholesale! Save money! Free general merchandise catalog! Norris, 487-TT Broadway, New York.

WHOLESALE Magazine subscriptions. Highest commissions. Bonus! Qualified Agencies, 451RA Kingston, Brooklyn 25, N. Y.

BOOKS, PERIODICALS, PICTURES, POSTCARDS

BOOKS By mail new used rare world wide search service. Book Service, 1423-PM Catalpa Ave., Waukegan, Illinois.

SELF-HELP Books. Free catalog. Rudolph, 6454 Newgard, Chicago, Illinois.

BIBLE \$15.95 for \$11.95. King James Teachers Edition. Price, 4813 Hurford, Chester, Penna.

SAVE 20% To 80% on books. Free catalog. Discount Reader's Service, MU-5435, Upland Way, Philadelphia 31.

HUNGARY Fairy tales "Three Bears" collection given approval buyers. William Deems, Ravenswood, West Virginia.

GAMBLER'S Packets, unsurpassed values, 50¢. No approvals. Weyer, Layton, N. J.

U.S. Plate blocks, singles. Price list free. Carlos Elbert, Box 222, Mt. Clemens, Michigan.

500 WORLDWIDE For 25¢! Contains U.S.A., Russia, first U. N., Summit Conference, Olympics, space satellite—hundreds more! Approvals, illustrated offers included. Horace Gatewood, Winston-Salem, North Carolina.

FREE! Surprise packet with approvals. Chamberlin, Box 113, Hesperia, California.

HUNDREDS Of stamps on paper. Unpicked from missions all over the world. With approvals. Quarter pound \$1.00, trial lot 25¢. Laurentian, 5600 Beurling, Montreal 19, Canada.

EXTRAORDINARY! Free! 20 different Finland to those requesting approvals. Rosenberg, Box 1303, Chicago 90.

80 DIFFERENT U.S. stamps. Includes 19th century commemoratives. High values. Plus 1943 Flag stamp of occupied nations. All for only 25¢. Approvals included. Willett Co., Box 338-C Yorktown Heights, N. Y.

THREE Months trial subscription, 25¢. National Stamp News, Anderson, South Carolina.

1000 DIFFERENT Worldwide stamps \$1.00. Valued over \$20.00. Universal, Box 6, Kenosha 5, Wisconsin.

21,000 ALL Different stamps, yours for only pennies a day on our systematic payment plan. Details free. Sjoquist, 1435 Cherrydale, San Jose 25, California.

FREE 50 Worldwide, mailed with inexpensive approvals. University Stamps, P.O. Box 95, Tamiami Station, Miami 44, Florida.

ALBUM! Hundreds of spaces! Only 10¢. Postpaid! Stampart, Hartford 1, Conn.

FREE! \$1.00 Worth, your choice, from first selection. No strings! Adults only. Rush request now. Philatelics, Dept. RF, New Paltz, N. Y.

INTRODUCING Our better United States approvals we offer 15 United States stamps including Columbian, Bi-Centennials, famous American, airm, others; only 10¢. Ocean Stamps, Box 64-PM, Brooklyn 29, New York.

PENNY Approvals. Thousands. Bargains for pennies. Gifts with purchases. Penny Stamps, Orange, California.

UNITED Nations. Five different 10¢. Approvals. Anderson, 1112 Harrison, San Francisco 3, Calif.

25 DIFFERENT Commemoratives 1893 up 10¢. U. S. approvals. K&B, Box 70, Brooklyn 23, N. Y.

307 WORLDWIDE Different stamps only 25¢. Approvals. Niagastamp, St. Catharines 671, Ontario.

MINT U.S. at face! Older commemoratives only. Send 25¢ for all different packet with first selection mint U.S. approvals. Western, Box 1689P, Salinas, California.

80 DIFFERENT U. S. (30 commemoratives) 25¢. No approvals. Seidenberg, Appleton, Wisconsin.

GIANT Approvals, thousands different. 1¢ and 2¢ each. Wahl's Stamp Exchange, 7008P Farragut, Chicago 31, Ill.

UNITED States commemorative collection containing 33 different—10¢. Approvals. White, 516-A Avenue L, Brooklyn 30, New York.

SELL Your surplus good grade stamps. Write, describing fully what you have. Vanroy Shirk, Lebanon, Pennsylvania.

AMAZING OFFER! 200 United States stamps — including commemoratives, airmails, high denominations to \$1.00. Only 10¢ to approval applicants! Illustrated bargain lists free. Mystic Stamp Co., Dept. 80, Camden, New York.

100 STAMPS, 10¢ With approvals. Smith, 508A Brooks, College Station, Texas.

OLD Scarce U.S. seconds on approvals. Slight imperfections, lowest prices. Herrfeld, Clintonhill Sta., Newark 8, N. J.

100 OLD United States between 1861 and 1935, \$1.00. Roush Stamps, 51 Chestnut, Mansfield, Ohio.

225 STAMPS For only 10¢! This mammoth value includes airmails, pictorials; stamps from strange countries cataloging up to 25¢ each! Also approvals. Mystic Stamp Company, Camden 80, New York.

UNITED States price list, 116 pages, price 25¢. Mark Hanna, 335 Fifth Ave., Pittsburgh 22, Penna.

SELL Stamps to our readers. Your ad in this space will be read by thousands of stamp buyers. I'll prove that to you. Write now for Folder "S." P. W. Johnson, Classified Advertising Manager, Popular Mechanics, 200 E. Ontario St., Chicago 11, Ill.

14,000 DIFFERENT! Amazing new plan builds your collection systematically, country by country. Only 50¢ weekly. Free details. L. G. Ware, Stepney 75, Conn.

U. S. Mint flag set, complete, \$1.00. Free list. Brooks, 2323 Avenue X, Brooklyn 35, New York.

103 DIVERSIFIED British colony stamps only 10¢. Approvals. Niagastamp, St. Catharines 671-A, Ontario.

50 DIFFERENT British colonials 10¢. Approvals. Robert Searjeant, Mendon, N. Y.

102 DIVERSIFIED Worldwide stamps 10¢. Approvals. Linstamp, St. Catharines 618, Ontario.

PENNY Approvals! Regardless catalogue! Kloster, 4164—52nd St., San Diego 5, Calif.

25 DIFFERENT Large American commemoratives 10¢. With approvals. Linstamp, St. Catharines 618-A, Ontario.

105 BRITISH Colony stamps, all different 10¢. Approvals. Crown Stamp Company, 901, Virgil, Ontario.

508 DIFFERENT World-wide from Formosa, Morocco, Indonesia, etc., cataloging over \$15.00, only 35¢. Offer to adults only. Approvals. Littleton Stamp Company, Littleton Q1, New Hampshire.

INTERESTING Worldwide animal stamp collection 10¢. With approvals. Niagastamp, St. Catharines 671-B, Ontario.

FREE! World's largest! Strange, valuable 7 x 14½" beauty. Send 10¢ handling now! Norrisco, Milwaukee 7, Wis.

FREE Packet! Five different foreign countries. Request fascinating approvals. Coral, Box 55, Valle Crucis, N. C.

BIG U.S. price list free! Bailey, 45-G Bromfield, Boston, Mass.

BEAUTIFUL Topical approvals two-three-five cents each. Large selections. Postage paid. Circle Stamps, Box 112, Stoneham 80, Mass.

1002 DIFFERENT Worldwide for approval buyers only. Jacobsen, Crompond, N. Y.

HUMAN Rights set free with approvals. Collier, Box 265, Chamblee, Ga.

FREE Monaco nudes. Approvals. Stamp Ranch, 902 Addison, Chicago 13, Ill.

FREE. 250 Peelable hinges and 20 different Brazil with approvals. Jaydee, 218 Dickinson S.W., Grand Rapids 7, Mich.

SEAWAY Stampack: Very unusual group stamps for dollar bill. Also several hundred million used Canadian and U.S.A. Stamps needed. Details from Bileski, Station B, Winnipeg, Canada.

FOREIGN F.D.C.'s mailed direct. 20 years experience. Contacts in every quarter of the world. Brumsey, 2418 First, Ft. Myers, Fla.

FREE! U.S. Roosevelt set with approvals. Philpot, 1902 Losey, La Crosse, Wis.

U.S. Stamps. Giant discount catalog 20¢. Raymax, 37VZ Maiden Lane, New York City 38.

ROCKETS! Satellites! 10¢ with approvals. Schaefer, Californiastrasse 16, Wiesbaden, Germany.

250 DIFFERENT. Includes 50 U.S. 25¢ with approvals. Bob's, Box 3045, Saint Louis 30, Mo.

LOOK! Six Queen Elizabeth mint sets from Singapore, Malta, Virgins, Mauritius, Montserrat, St. Kitts! 21 brilliant pictorials, 25¢. Attractive approvals! Gannon Stamps, Box 931, Canton 1, Ohio.

ECONOMICAL 1½¢-3¢ Approvals, 39,000 varieties. Dresel, Box 128-N, West Englewood, New Jersey.

151 DIFFERENT U.S. commemoratives \$1.00. Approvals. Carstamps, 739 Ordway, Freeport, Illinois.

INDIA. 50 Different 10¢. Approvals. Hildebrand, Box 92, Mt. Eden, California.

OLYMPIC Bicolors. Paraguay's mint set has color, action, excitement. 10¢ with approvals. Ftacek, Box 169-P, Ottawa, Illinois.

STAMP Grab bag featuring exclusively animals, trains, flags, ships, triangles, maps, planes. Send dime. Stampliner, Route 3, North Bay, Ontario.

100 MINT British Colonies \$1.00 with worldwide approvals. Binkowski, 944 Park, Schenectady, New York.

TEN Complete sets 10¢, with attractive approvals. Stamp Imports, Peterborough, Canada.

BULLFIGHTERS And five complete sets, 10¢ with interesting approvals. Kawartha Stamps, Box 513, Peterborough, Canada.

FREE Packet—sports, animals, flowers. Approvals. Telco, Box 127, Long Island City 4, New York.

WANTED — Stamp, coin collections. Murray Gold, 62-95P Saunders, Rego Park 74, N. Y.

VOLCANO Triangle, Mexico's largest stamp, Ghana Lincoln statue, animal set, many others, all large pictorials. 10¢ with approvals. Nomad Stamp Co., Box 117, Shalimar, Florida.

222 DIFFERENT Worldwide plus 66 different U.S. 25¢. Approvals. Casto, Box 357, Dunbar, W. Va.

GENERAL Foreign grab bag lot \$1.00. Try one and you will order more. Stroskey, 223 Market St., Perth Amboy, N. J.

KOREA. Eight different cataloguing \$2.00; 10¢ with approvals. Quynn's, Scotland 8, Penna.

ANTIQUES, RELICS, INDIAN GOODS, CURIOS

SELLING 20,000 Ancient arrowheads, spearheads, etc. List free. Lear's, Glenwood, Arkansas.

4 ARROWHEADS \$1.00. List. Smith, 841 N. Tacoma, Indianapolis 1, Indiana.

FIND Buried battle relics, coins, silverware. Transistorized M-Scope electronic locator. Guaranteed. From \$59.50, easy terms. Free catalog. Fisher Research, Dept. C-1, Palo Alto, Calif.

PRECIOUS STONES, MINERALS

SEMI-Precious uncut gems. Ten different for \$1.00. Request list 26. Prospectors Shop, 201 San Francisco, Santa Fe, New Mexico.

FREE Bargain gem list. Lapidary and silversmith catalog, 56 pages, 25¢. O'Brien's, 1116M Wilcox, Hollywood 38, Calif.

EARTH Science. Rockhound's National Magazine. Subscription \$2.50. Sample 35¢. Box 1357-PM, Chicago 90, Ill.

QUALITY Sterling silver and gold filled mountings. Catalog free. Rockhound, Dept. P-M, Box 307, Onida, S. D.

SAPPHIRES: Genuine uncut stones from N. C. Satisfaction guaranteed. \$1.00 each. W. H. Cochran, Box 3171, Greenville, S. C.

LAVA Shiny black; Puna eruption. Rare, unique. Supply \$1.00. Box 8488, Waikiki, Hawaii.

ROCKHOUNDS, Gem cutters, jewelry makers. New free catalog just off the press! Biggest supplier to hobbyists and craftsmen offers you tools, materials, equipment, introductory items and know-how. Free catalog. Write Grieger's, Dept. C-12, 1633 E. Walnut, Pasadena, Calif.

PROSPECTORS! Learn from experienced geologists how to locate and identify rocks and minerals. A comprehensive home study course designed for anyone interested in exploring for valuable ore deposits. Write now for free literature. Pacific School of Mines, Dept. B10, Box 2538, Palm Springs, California.

HOBBIES AND COLLECTIONS

AMERICAN Newspaper, complete, original, dated in 1790's, \$1.50. 15¢ stamps brings catalogue. D. R. Spaight, Book-seller, Tall Timbers 1, Maryland.

SEA SHELLS—100 assorted \$1.00 post-paid. Offer good anytime. Varbles, 1505 N. Parkwood, Harlingen, Texas.

SEASHELL Collectors' illustrated lists 10¢. Melvin, 863 Watertown, West Newton, Mass.

COLLECT Medals, American, French, German: Three different regulation size; send \$2.00, get five foreign emblems free. Catalog 25¢. Insignia Club, 550-B, Fifth Ave., New York City.

COLLECTORS Matchbook covers, 100 different unused, \$1.00. Catalog 25¢. Album \$3.00. Charles Edelman, 1311-C East 84, Cleveland 3, Ohio.

WAR II Souvenirs, 6 samples and large illustrated book. Lists \$1.00. Hobbyland, Calgary, Canada.

PHOTOGRAPHY, CAMERAS, PHOTO SUPPLIES

PHOTOGRAPHIC Equipment. Free wholesale catalog. RNG Sales, PM, Wildomar, California.

PHOTOGRAPHY For pleasure or profit. Learn at home. Practical basic training. Long established school. Free booklet. American School of Photography, 835 Diversey Parkway, Dept. 343C, Chicago 14.

164 PAGE Photographic bargain catalog, listing thousands of photographic bargains. Send 25¢ for your copy, credited on first order. Dept. 1-C10, Central Camera Company, 230 So. Wabash Ave., Chicago 4, Illinois.

A WOODEN Box: one continuous exposure; like a camera. James Leonard Height, Martinsburg, Iowa.

PHOTO FINISHING

SAVE On photo service. Kodachrome 8 exposure roll—\$2.50. 12 exposure—\$3.50. Reprints 25¢. Black and white 8—50¢. 12—70¢. Reprints—5¢. Fast Kodachrome, Ektachrome and Anscochrome processing. Free mailers and price list. Save on: Photo Service, Box 50, Watertown, Wis.

A Triple value. Quality, price, service. Color or black and white, 12 exp. (black and white) 59¢. 20 gift photos \$1.00. Holiday Photos, Dept. 16, Box 666, Denver, Colo.

A 3-in-1 value. Price, quality, service. 20 gift photos, \$1.00. 12 exposure rolls (black and white), 59¢. Color or black and white. Interstate Photos, Dept. 11, Box 15, Aurora, Ill.

TWELVE Exposure rolls 49¢. Wallets 20 for \$1.00. Lincoln Studios, Dept. K, Box 13, Lincoln, Nebr.

KODACHROME-Ektachrome guaranteed kodak processing. Prompt 8mm or 35mm 20 exp. \$1.40. Free list-mailers. Color Pix, Dept. P, CPO Box 30, Kingston, N. Y.

TWO Beautiful prints from each picture on roll 8 exposure 45¢; 12 exposures 55¢. Thirty-nine years of satisfied customers. Quick service. Lens Photos, Dept. J-4, Janesville, Wis.

8 x 10 BLACK And white photo enlargement of any snapshot only \$1.00. No negative needed! Photo Enlargements, 417 N. State St., Chicago 10, Ill.

INTRODUCTORY Special. Processing Kodachrome 8mm movie or 35mm 20 exp. \$1.00. Kodachrome 8 exp. complete \$2.00; 12 exp. \$3.00. Black and white 8 jumbos 40¢. Jumbo reprints 5¢. Quality guaranteed. Prompt service. Write for free mailers. Fast-X-Foto, Dept. PM-10, Box 7A, Jersey City, N. J.

A Roll of fresh Kodak film returned to you absolutely free for each roll of black and white or Kodachrome sent in for developing and printing. Fast service, low prices, guaranteed quality. Send for free mailers. Economy Photo Service, Dept. PM, P.O. Box 1111, Albany 1, New York.

COPY Any photo, enlarge to 8 x 10, send \$1.00. 20th Century Studio, 13014 Ventura Blvd., Studio City, California.

NO Gimmicks! Just good B&W fine grain finishing, 5¢ ea. Jumbo prints. Free Mailers. Prairie Photo, Box 1063, Decatur, Ill.

MOTION PICTURES AND SOUND EQUIPMENT

8MM Movies, 50', comedies, cartoons, travel, airplanes, hunting, fishing. Limited offer. Send \$1.00 each. Movieland, Box 10-M, Van Nuys, Calif.

16MM SOUND—8mm films. New, used. Free list. Entertainment films, 236 W. 55, N. Y. C.

SPECIAL Entertainment—8 mm. b&w, 50 feet \$12.00. 16 mm., b&w, 100 feet \$20.00. Parée, Box 368, Terminal A, Toronto, Canada.

16MM. Sound feature films \$20.00. Bedner, 5300 So. Talman, Chicago 32.

16MM. Sound Shorts. Tremendous assortment features. \$16.50 up. Used 16mm. sound projectors, \$79.50 up. Catalog. Abbe Films, 417 West 44th Street, New York 36, N. Y. PLaza 7-2219.

5,000 8-16 MM. Movie films. Free catalogues. International, Greenvale, N. Y.

8MM-16MM Color and B & W film and supplies. Save money. Free catalog. Superior, 448 N. Wells, Chicago 10.

FREE Every month. Blackhawk's newspaper-size catalog 8mm., 16mm. movies, 2"x2" color slides. Biggest selection in USA. Bargains in used 16mm. sound films, projectors. Blackhawk Films, Davenport 14, Iowa.

MOVIE Camera film: 8mm. roll \$1.50. 16mm. 100' \$3.00. Free processing. Better Films, 742 New Lots, Brooklyn, N. Y.

16MM. Sound films. Bargain bulletin. Duquette, 97-T Snow, Fitchburg, Mass.

MOVIE Film! Free catalog! ESO-R, 47th Holly, Kansas City 12, Missouri.

16MM. Sound, projectors, films. Sale, rental, exchange. Visit store or write for catalog. National Cinema, 71 Dey St., New York City.

COLOR SLIDES

LINCOLN Story, complete in 500 color slides. Catalogue and sample. 35¢. Willems, Box 1515-A, Chicago 90.

TITLES, Travel and wildflower slides. 8mm titles. Free catalog. Title-Color, Box 35521T, Dallas 35, Texas.

TRANSPARENCIES Wanted. Up to \$500.00 each. For information write: American Color, 1008 N. Stanley Ave., Hollywood 46, Calif.

SOUTHSEAS—Hawaii, Tahiti, Fiji, Samoa, New Zealand, Australia. Eight 2 x 2 color slides \$1.00. Catalogue, sample, 20¢. Avery, Box 8261, Honolulu 15, Hawaii.

ALASKA Wildlife in color, slides, 8mm, 16mm. Alaska Film, Box 5-621, Mt. View, Alaska.

MUSIC & MUSICAL INSTRUMENTS

CHORD Organs. Save ½. Italian craftsmanship. Play without lessons! Terms. Free trial! Free catalogs. Philharmonic Importers, Department R, 2003 Chicago, Chicago 22.

WE Repair and overhaul band instruments, all woodwinds and brass. Expert repairs at reasonable prices. New England Musical Instrument Repair Service, 125 Maple St., Greenfield, Massachusetts.

POEMS Wanted for musical setting and recording by America's largest song studio. Send poems. Free examination. Five Star Music Masters, 630 Beacon Building, Boston.

POEM Revised, leadsheet, \$5.00, includes melody. Guaranteed. Authors, 232 Lincoln, Perrysburg, Ohio.

SONGPOEMS And lyrics wanted. Mail to: TinPan Alley, Inc., 1650 Broadway, New York 19, N. Y.

POEMS Wanted for musical setting and recording. Send poems. Free examination. Crown Music Company, 49-C West 32 Street, New York 1.

POEMS Needed immediately for new songs and records. Free examination and appraisal. Send poems: Songcrafters, Acklen Station, Nashville, Tenn.

GUITAR Making books, plans, imported woods, tools. List 10¢. Satinwood, 510 East 11th Street, New York 9, N. Y.

ELECTRIC Guitars, amplifiers, wholesale. Free catalog. Carvin, PMM, Covina, Calif.

SONGWRITERS! Money waiting for your poems! Information free! Successful Songs, Box 608, Danbury, Conn.

ACCORDIONS! Direct from importer—savings to 50%. Free home trial. Trades accepted. Easiest terms. Famous makes. Free 1961 catalog. Accordion Corporation, Dept. R, 2003 Chicago, Chicago 22.

POEMS Wanted! Best songs recorded free with 7-piece orchestra. Melodies written. Send poems, free examination. Songmakers, 1472-M Broadway, New York 36.

SONGWRITERS. With publisher contacts, want song ideas. Share royalties. No fees. Send poems: Songwriters' Associates, 1650 Broadway, New York City 19-G.

VIOLIN Making supplies. Free catalog. Fred Artindale, Box 71992, Los Angeles 1, Calif.

GUITARS! Discount prices! Direct wholesaler-to-you. Free trial. Famous brands. Easy terms. 100 models. Color catalogs free. Guitar World, Department R, 2003 West Chicago, Chicago 22.

SWISS Musical movements (best) \$2.50. Electrical \$6.50. Spielman, 131 West 42nd, New York 36.

PIANO! Beginners learn. Six short weeks! Beethoven! Jazz! Pops! Complete course \$3.75. Symprovised Music, Box 1-M, Noroton, Connecticut.

PIANO Tuning. Home study course. Diploma granted. American School of Tuning, Box 707, Gilroy, Calif.

ACCORDIONS-Organs, buy direct from importer. Big savings. 5 day trial. Free color catalog. Dept. PM 10. Accordion Import Center, 7120 Galli Drive, San Jose, Calif.

SEND Poems, records. Tested free on radio. Sound, Box 35833, Miami, Florida.

RADIO, TELEVISION AND ELECTRONICS

FREE! Giant wholesale catalog on electronics, hi-fi, transistor, scientific, hobby, optics, photographic, housewares, jewelry, tools, novelties, toys. Write: Lektron, 131M Everett Ave., Chelsea 50, Mass.

FREE Antenna with instructions. Experiment with nature's electronics. Stillwater, Box 317-J, Morris Plains, New Jersey.

GOVERNMENT Surplus radios, parts. Picture catalog 10¢. Meshna, Malden 48, Mass.

TAPE Recorders, Hi-Fi components, sleep learning equipment, tapes. Unusual values. Free catalog. Dressner, 69-02M, 174 St., Flushing 65, N. Y.

LEARN While asleep with amazing "Electronic Educator" endless tape recorder. Details free. Research Association, Box 24-N, Olympia, Washington.

ELECTRIC Guitars, amplifiers, wholesale. Free catalog. Carvin, PMR, Covina, Calif.

RADIO And TV tubes at manufacturer's prices! 100% guaranteed! Brand new! No re-brands or pulls! United Radio, Box 1000-M, Newark, N. J.

HI-FI Components, recorders. Free wholesale catalogue. Carston, 125-Y East 88, N. Y. C. 28.

FIX Your own TV. Save 80%! Send for free illustrated chart showing how! We'll include giant electronics catalog. Zalytron, 220-M West 42 St., New York City.

GIANT Bargain flyer free! Electronics, gadgets, binoculars, telescopes. Imperial Mfg., 2324 North Third Street, Milwaukee 12, Wisconsin.

FREE 444-Page 1961 Allied Electronics Catalog! See products and values available only from Allied. See everything in stereo hi-fi systems and components; latest money-saving build-your-own Knight-Kits; tape recorders; TV accessories; public address systems; world's largest stocks of parts, tubes, transistors, test instruments, tools, books. Only \$2 down on orders up to \$50. Write for value-packed free catalog! Allied Radio, 100 N. Western Ave., Dept. 96-K, Chicago 80, Ill.

DON'T Buy hi-fi components, kits, tape, tape recorders until you get our low, low return mail quotes. "We guarantee not to be undersold." Wholesale catalog free. Hi-Fidelity Center, 1797M First Avenue, New York 28, N. Y.

LOW Quotes. Hi-Fi equipment. Stereo tapes. Catalog. Hi-Fi, Roslyn 6, Penna.

SEND And receive Morse Code in 30 minutes. Send \$1.00 for complete code kit. Code, Box 666-A, Whittier, California. Money back guarantee.

STEREOPHONIC Phonographs, radios, recorders. Wholesale catalog free! Towers, Box 3022, Philadelphia 50.

TRANSISTOR Radio bargains. Free literature. Kalenak, 1100 Heeney, Johnstown, Penna.

RADIO-TV announcing. Learn at home. Complete professional course on long-playing records. Free information and study program schedule. 461 Statler Office Bldg., Boston, Mass.

6 TRANSISTOR Radio \$17.25 or less. Mickey DelBello, Manvel, Tex.

CRYSTAL Radio kit \$1.00. Amplifier and speaker for same \$6.95. Catalogue. Clearco Crystal Company, 2966 No. 4th, Milwaukee 12, Wisconsin.

BUSINESS OPPORTUNITIES

FRANCHISES Make profits! Operate your own exclusive franchised business. Write today for free interesting details. National Franchise Reports, W-528, 333 North Michigan, Chicago 1.

START Profitable home business of your own. Write for details. Constant, 5417 West End, Chicago 44, Ill.

FREE! Name brands catalog! Your own high profit business. Sell name brands, full or part time. No inventory, no investment. More than 2,000 name brand items; lowest wholesale prices. Watches, jewelry, cameras, hi-fi, stereo radios-phonos, appliances, housewares, hardware, power tools, luggage, musical instruments, garden equipment, sporting goods, toys, many others. 8 floors of name brands. Million dollar inventory. Orders shipped complete in 24 hours! Send for free, beautifully illustrated catalog now! Separate wholesale price list. H. B. Davis Corp., Dept. 11, 145 W. 15 St., New York 11, N. Y.

FREE! Beautiful Mexican curios! Rush 30¢ stamps mailing. Sylviako, Apartado 9036, Mexico City.

DISTRIBUTE Lowest priced wholesale catalogue. Felix, 160-04-16th, Whitestone 57, N. Y.

WANT To make big money at home? \$10.00 profit in an hour possible with invisible mending. Make tears, holes disappear from clothing, fabrics. Steady year-round demand from cleaners, laundries, homes. Details free. Fabricon, 6234 Broadway, Chicago 40, Ill.

MARKETS Everywhere. Make artistic concrete birdbaths, pottery. Best coloring. Home workshop. Hundred varieties. Hollywood Cementcraft, 8527-S Wonderland, Hollywood 46, California.

LEARN Sewing machine repairing. To \$125 weekly. Sparetime. Supplies. Add to present business. Write today! Taylor Service, Box 2126, San Bernardino, Calif.

IMMEDIATE Profits with no capital or experience. Take orders for all magazine subscriptions. Friends and neighbors are your prospects. Write now for complete, free kit. McGregor Magazine Agency, Dept. 6B, Mount Morris, Illinois.

FREE Picture folder, "How to Make \$3,000 Yearly, Sparetime, Backyard, Raising Earthworms!" Oakhaven-38, Cedar Hill, Texas.

VENDING Machines. No selling. Operate a route of coin machines and earn amazing profits. 32-page catalogue free. Parkway Machine Corporation, Dept. #27, 715 Ensor Street, Baltimore 2, Maryland.

BIG Money raising fishworms and crickets. Free literature. Carter Farms, Plains, Georgia.

BUSINESSES, Resorts, motels, investment property, ranches. Our special service dept. at your disposal. No obligation. World's largest, 58 years' service. Strout Realty, 7-MB S. Dearborn, Chicago 3, Ill.

TO \$100.00 Weekly. Sparetime, home operated mailorder business. Successful beginner's plan. Everything supplied. Lynn, 10420-M National, Los Angeles 34.

PIANO Tuning learned quickly at home. Tremendous field! Musical knowledge unnecessary. Information free. Empire School of Piano Tuning, Champaign, Ill. (Founded 1935).

I Want to send you proof of the wonderful pulling power of Popular Mechanics classified pages. What's your proposition? Write me today. Include literature if possible. F. W. Johnson, Manager Classified Advertising, Popular Mechanics Magazine, 200 E. Ontario St., Chicago 11, Ill.

COPUBLISH Mail Sale Advertiser, leading mail order paper. Details, latest copy, dime. Vanroy Shirk, Lebanon, Penna.

11,000 NEW Prospects daily. Baby record books, shoes, albums. Sell mailorder. Use our literature. Write: No-Co-Ro, Capitola, California.

BRONZE Baby shoes: Instructions, equipment and mountings for genuine electroplating process. Largest supplier of all plating equipment, supplies. Free catalog. Hollywood Bronze Supply, Dept. B-3, 1624 East First, Los Angeles 33, Calif.

OPERATE Profitable mail order business. Write Walter Service, 4159A East 112th, Cleveland 5, Ohio.

EARN Good money sharpening chain saws, scissors, cutters, knives. Free manual. Treycor, North Tonawanda, N. Y.

BAKE New greaseless doughnuts in kitchen. Sell stores. Free recipes. Montgomery, 3605 South 15th, Minneapolis 7, Minnesota.

IF You like motorcycles and money then send for Harley-Davidson dealership book on how to become a dealer of motorcycles and a new line of motorscooters. Here's a chance to own your own business with a very modest investment. The youth market is beginning to explode and the next few years promise a chance to cash in on it. Write for free illustrated dealership book today. Harley-Davidson Motor Company, Dept. P, Milwaukee 1, Wisconsin.

\$3.00 HOUR—Home, sparetime, assembling pump lamps. Easy. Free details. Ougor, Caldwell, Arkansas.

RAISE Rabbits on \$500 month plan. Free details. White's Rabbitry, Mt. Vernon, Ohio.

\$400.00 MONTHLY Raising giant worms. Odorless soilless method. Charlie Morgan, Bushnell, Florida.

LIQUID Molding rubber, free sample. Shellcraft supplies. Chaney's, 1907-A East Road, Jacksonville 11, Fla.

VENDING Machine catalog. Rakes, 609P Spring Garden, Philadelphia 23, Penna.

PLATE Baby shoes, jewelry, gifts, bronze and colored pearl. We finance. Free booklet. Platex, 11029 South Vermont, Los Angeles 44

MAKE Fabulous weekly profits clipping newspaper items for publishers. Some clippings worth \$5.00 each. Particulars free. National, 81-PM, Knickerbocker Station, New York City.

COLORGLAZED Concrete pottery made without molds. Patented method. Cemetery products, novelties, tiles. Basement leak-sealing. Money-making projects. Booklet, details free. Men only. National Potteries Company, Grand Rapids, Minnesota.

RECAST Junk batteries into new. Latest achievements. Battery Laboratories, Bayou LaBatre, Alabama.

\$34.70 TWO Hours. Manufacturing concrete products. No selling. Castings #3, 2907 Dundee, Rapid City, South Dakota.

CANDIED Popcorn and potato chip equipment. Eakins, Box 933-AO, Springfield, Ohio.

FREE Details! Make money at home. Respectable field. Experience unnecessary. No public contact. Free help. Columbia, 45-09-PM Broadway, Long Island City 3, New York.

BUY Direct from factories. Appliances, cameras, watches! Free details! Cam Co., 6810PM-20th Ave., Brooklyn 4, N. Y.

PROSPER By selling "The World's Most Usable Bible." Sales quick, easy and highly profitable. To start earning a better living, write today. International Book Company, Department M., Box 118, Wichita 1, Kansas.

MAIL Order, home workers, dealers, hobbyists opportunities. Part time or full. Earn extra income. Details. Sterling, Box 626-PM, Dania, Florida.

TOOL Steel. Make hunting knives, parallels, V-blocks, sinebars, jigs, fixtures. 16 page sketch book \$1.00. Alcon Production Tool Co., 579 Baird Street, Akron 11, Ohio.

MAILORDER Beginners no cost plan. Armstrong's, 154 Darrington S.W., Washington 24, D. C.

MAKE Fast selling children's item from scrap plywood. Details free. Clifford Richards, Castalia, Ohio.

PLASTERCRAFT Molds, liquid rubber, plasters, flocks, candle supplies. Catalog and manual free. Blue Rapids Supply, Blue Rapids, Kansas.

SELL Books by mail. 400% profit. Royal, Box 368-X, Cleveland 27, Ohio.

BECOME Refrigerator serviceman. Complete instructions \$3.00. Information free. Lincoln, P. O. Box 52R, Hempstead, N. Y.

TRAVEL The world! At 75% discount or more. Opportunity. Profitable. Be a travel agent. Experience unnecessary. Free details. United States Travel Research Associates, 708 Lucerne Ave., Lake Worth, Florida.

EARN \$10,000 Yearly raising Angora rabbit wool for us. Information 25¢ coin. American Angora Company, Malta 77, Montana.

\$70 WEEKLY—Home, spare time. Simplified mail bookkeeping. Immediate income—easy! Auditax, 3475A, Los Angeles 34.

COLLECT Names for us, \$1.00 each. Instructions 25¢. Wilson's Specialties, Box 61-M, Mt. Pleasant, Michigan.

EVERYBODY Likes candy and popcorn specialties. Learn to make professionally home. (Our 50th year.) Ragsdale Candies, B-107, East Orange, New Jersey.

\$1,670.00 PROFITS In 90 days. New home mailorder opportunity. Everything furnished. New 45 r.p.m. record shows you how to make \$1,670.00 in 90 days. "Ferguson received 52 orders in one day." Details. Record mailed postpaid. Send \$2.00 (refundable) to Jesco Gifts, Wholesale Division, P.O. Box 411-M, 401 Cravens Building, Oklahoma City 1, Oklahoma.

MAILORDER Techniques, rules, laws, regulations. Do's, don'ts. Complete "how-to" mailorder guide—\$1.00. Dean Products, Box 40-PM, Elberton, Georgia.

NEW Home-import mail order profitability! Your mailbox stuffed with money! No selling. No experience. No investment. We supply everything. Free details. Mail Order Distributors (Import Division) Dept. B5AC, 15201 South Broadway, Los Angeles, Calif.

BIG Money—Operate own fix-it shop. Service household appliances, motors, mowers, saws, skates, etc. Free book. Christy Trades School, A-9503, 3214 Lawrence, Chicago 25.

UNHAPPY With your income? Get in on top new offers in franchises, new products, real estate, mail order, foreign trade, other little known profit ventures for small capital. Write for free research service letter. Dept. W-19, Research Information Institute, 150 West 30th Street, New York 1, N. Y.

INVISIBLE Reweaving: \$5-\$10 per job possible reweaving burns, tears, moth-holes. Spare-full time. Free details. Skill-Weave, Dept. WC-1610, 335 W. Madison, Chicago 6, Illinois.

STRIKE It rich with home repairs at set prices. My \$160,000 yearly business makes fantastic profits. Free details. House Clinic National, Dept. P-10, P.O. Box 4804, Dallas 6, Texas.

START Successful mailorder business without inventory, packaging, delivery headaches. Dropship Buyers' Guide reveals how. Send for free details. Rutward, 115 Bryant Ave., Columbia Station, Ohio.

ANSWER Ten ads, ten seconds. Personalized postcards carry your message. You just address. Sample free. Raifer, North Boston 10, N. Y.

OPERATE Home mailorder business. Vosacek Distributors, 4444A1 Ute, San Diego 17, Calif.

BE A spare time musical instrument dealer. Sell drums, guitars, violins, trumpets, saxophones and accessories. Guaranteed full dealer discounts, on new imports and domestic products. Exclusive. Georges Music Supply, 619 State St., Schenectady, N. Y.

EXCEPTIONALLY Profitable opportunity in tape recording! Free information. Baron's, Lynden, Washington.

MAKE Money from old tires. Operators clearing \$400 weekly. Equipment costs \$640. Get facts. S & S Patents, Inc., 1307 N. Clark, Chicago 10.

INTERNATIONAL Mailorder business made easy. Individual setup service. Not just instructions. Hermes, 142 West 42, New York City 36.

IMPORT Anything from anywhere. Represent manufacturers. Sell suits, 100% profit. Monthly bulletins. Franchises. 1960 Trade Directory covers 80 countries. Benko, Box 188-A, New York 21.

MAILORDER To motels, institutions, churches. Complete individual set-up, not just instructions. Hermes Advertising, 152 West 42, New York City 36.

MAKE Extra money—Big cash commissions plus premiums for you and your customers. Sell advertising book matches. Sensational new tenoramas, glamour girls, hillbillies; dozens others. All sizes. Quick daily sales; big repeat business. Free master kit makes selling easy. No experience necessary. Superior Match, Dept. MX-1060, 7530 Greenwood, Chicago 19.

\$250.00 WEEK Spare time profit possible. Earn at home with new fascinating printing method. \$5 starts you—send no money now. Free confidential facts and valuable sample. Screen-Print, OR, Los Angeles 61.

MAIL Order franchise. No experience needed. Spencer Gifts, a well-established and successful mail order firm, starts you in business. Supplies catalogs with your own name imprinted. No investment in stock. No shipping merchandise. Catalog items pre-tested for salability. Initial investment of less than \$50 can get you started. Write for free information kit. Spencer Gifts, EZ-51 Spencer Building, Atlantic City, N. J.

START Your own business on credit (U.S. and Canada). Your own boss. 1396 dealers sold \$5,000 to \$25,500 in 1959. We supply stocks, equipment on credit. 200 home necessities. Sales experience unnecessary. Pleasant profitable business backed by world-wide industry. Write Rawleigh's, Dept. J-U-PPM, Freeport, Ill.

INCREDIBLE New "table-top" machine manufactures over 15,000 salable products. Also laminates, encases, moulds and plates in bronze, chrome, or copper. 20¢ materials produce \$10.00 products. Free confidential details and home-business plan. Plasti-Form, Dept. PM-10, Gardena, Calif.

PRACTICAL Mailorder. Start small. Money-maker 106. 722 East Silver Spring, Milwaukee 17, Wisconsin.

LEARN Landscaping and the growing of plants. Start a profitable business part or full time. Free information without obligation. National Landscape Institute, Dept. MC-100, 11826 San Vicente Blvd., Los Angeles 19, Calif.

500% PROFIT Selling mailorder folios. Dean Products, Box 40-PM, Elberton, Georgia.

PACKAGE At home for profit! We supply everything. No selling, ready market. Free details. HPC, 2212BL Jesse Street, Los Angeles 23.

IMPORT-Export opportunity, profitable, world-wide, mail-order business from home, without capital; or travel abroad. Established world trader ships instructions for no-risk examination. Experience unnecessary. Free details. Mellinger, C70A Los Angeles 24.

MADE \$10,000 Typing at home. Guaranteed proof. Amazing information 15¢. Lenore Felgen, 30 Washington, Oak Park, Ill. Dept. PM.

BECOME Finance specialist. Handsome profits. Tucker Associates, 3633 Warder N.W., Washington 10, D. C.

\$1.00 BRINGS You \$18.00 spare-full time home business opportunity! Amazing new velvet-spray transforms old cheap lamps, TV-radios, figurines, furniture, anything, into valuable products! Free samples, 50 business opportunities booklet. Send no money. Flok-Kraft OR, Los Angeles 61.

CASH From sawdust, tin-cans, newspapers. Over 200 methods. Instructions \$1.00. Charles Company, 42-GPN, Norwood, Ohio.

MAIL Order! Imports! Anything—worldwide. Details free. Kolesar's, 611 Naysmith, McKeesport, Pennsylvania.

OWN Profitable distributing business. Free literature. Buyrite Specialties, Findlay, Ohio.

WANTED: Home producers, to be sub-contractors. Cast plastic products for manufacturers in our clearing house service. Thousands of easily made items required. Cash in at home, without previous experience. Plastic Service Associates, Dept. 10-PM, East Boston 28, Massachusetts.

WANTED: Race promoters, concession operators, franchised dealers. Big money in "Karting" the fastest expanding sport-hobby. No experience required. Horton, 2245 North 39th, Milwaukee 8, Wisconsin.

"HOW To make money by mail." Write: American Distributors, Box 409-P, Niles, Michigan.

RED Hot items, timely, unique, mail order or direct sales. \$1.00 brings samples. Refundable. Artcraft, 321 W. Cumberland, Knoxville 2, Tenn.

RAISE Nightcrawlers, redworms — brownse. Easy new soilless method. Three Oaks Ranch, Dresden, Tenn.

FREE Book "990 Successful, Little-Known Businesses." Work home! Plymouth-72M, Brooklyn 4, New York.

MOLD Statuary, pottery, tiles, novelties. 5¢ materials makes dollar sellers! Particulars free. Marbleizing Service, Edwardsville, Illinois.

JAPAN—European directory. Source, 17 jeweled watches, \$3.75; 30 free foreign wholesale catalogs. 50,000 foreign bargains. Directory, \$1.00. Dean Products, Box 40-PM, Elberton, Georgia.

MONEY Making Acme saw and lawn-mower sharpeners. Finest made. Easiest and most profitable to operate. Thousands of satisfied users. Terms. Free literature. Made and guaranteed by Max Manufacturing Co., 138 Stockton Ave., San Jose 26, Calif.

BIG Profits possible in library research! Easy! Pleasant! Full-spartime! Write: Trotta, JA-2036—66th, Brooklyn 4, New York.

VALUABLE "Mailorder Business Franchise" absolutely free. Neil H. Tasker, Shamokin, Penna.

HOMEWORKERS, What can you make? We sell all type Craft products through nationwide markets. Produce and ship to our customers. We pay you cash. Crafters Marketing Service, Box 1534, Birmingham 4, Alabama.

48 OPPORTUNITIES To make money in Florida. Copyright book \$1.00. Xotic's, Box 471, Largo, Florida.

SAVE Money. Be smart. Don't be fooled by misleading statements in credit buying. Thousands have learned the secret of true interest. Act now. Send \$1.00 for proven information and save hundreds. Putnam, 4325 Franklin, Los Angeles 27, California.

BE Independent, be secure, have your own big money mail order business. Earn \$10,000 and up annually. Start from home. Start small and grow big. We set you up—show you how—guarantee results. You never invest one cent in inventory. All orders shipped for you. Collect cash in advance. Exciting details free. National Mail Order Corp., Dept. 45A, P.O. Box 828, Preakness Station, Wayne, N. J.

OPPORTUNITY Of lifetime. More money Quicker advancement. Amazing information. Free. Fred Morris, 719 Mangum, Durham, N. C.

STATUES, Figurines, plaques, liquid rubber, plastercraft supplies, molds. Free sample, details. Lavin Novelties, Box 296 E. Flora Rd., Leavittsburg, Ohio.

SELL By mail. High income! Everything furnished. Irvin, Box 1052, Oklahoma City 1, Oklahoma.

MAKE \$46 From square foot plywood; jigsaw necessary. Free details. Woodarts, Bridgewater, Mass.

FOUNTAINS; Electric lighted, operated. Portable. Beautify gardens, lawns, patios, florist, nursery, commercial displays. Littleford, Riverside, Salisbury, Maryland.

MAKE, Sell, artificial flowers; plastic flowers. Wholesale catalog 10¢. Franchise available. Cleveimports, 4500B167 Lorain, Cleveland 2, Ohio.

MONEYMAKING OPPORTUNITIES

AMAZING Successes through franchises! Become exclusive franchise holder your territory. Information rushed. National Franchise Reports, MP-528, 333 North Michigan, Chicago 1.

WIN Contest money. General Contest Bulletin gives hundreds of tips. Lists current contests, rules. Sample magazine 25¢. General Contests, 1609½ East 5th, Duluth 12, Minnesota

LEARN Sign painting, cartooning. Strahley, 410 So. Western, Springfield, Ohio.

MAKE Money in your spare time, or even go into business for yourself. Write today for free details. Address all correspondence to: Zephyr Enterprises, Box 1484-D, Hartford 1, Connecticut.

IN 1952 I was unemployed, broke. Today own \$18,000 home, drive Cadillac, have bank account. Anyone can do this. Write Norris Cole, 217 West 49th, Bradenton, Florida.

\$200.00 MONTHLY. Spare time. With tablesaw, bandsaw or jigsaw. Write. Holiday House, 7228 4th Plain, Vancouver, Washington.

FREE Details! Make money at home. Respectable field. Experience unnecessary. No public contact. Free help. Columbia, 45-09-M Broadway, Long Island City 3, New York.

MAKE Fabulous weekly profits clipping newspaper items for publishers. Some clippings worth \$5.00 each. Particulars free. National, 81-PM, Knickerbocker Station, New York City.

GET Listed for life! Receive hundreds free magazines, samples, special offers. Rush 25¢, stamped, addressed envelope. Columbia, 45-09-MH Broadway, Long Island City, New York.

EASY To earn extra money! Free 100 page catalog. Tandy Leather Company, Box 791-T37, Fort Worth, Texas.

100% PROFIT. No investment. Stamp brings samples, details. Miller, Box 584, Brooklyn 1, New York.

MINK Raising information free. Complete. Lake Superior Mink Farm, Superior, E.E1, Wisconsin.

VENDING Machines. No selling. Operate a route of coin machines and earn amazing profits. 32-page catalogue free. Parkway Machine Corporation, Dept. #26, 715 Ensor Street, Baltimore 2, Maryland.

GROW Mushrooms. Cellar, shed and outdoors. Spare, full time, year round. We pay \$4.50 lb. dried. We have 29,000 customers. Free book. Mushrooms Dept.: 173. 2954 Admiral Way, Seattle, Wash.

CIGARETTES: Make 20 plain or filter-tops for 9¢. Facts free. Moberly, Box 821, Owensboro, Kentucky.

EARN Money evenings copying and duplicating comic cartoons for advertisers. Adservice. Argyle 1. Wisconsin.

YOUR Own. easy-to-start, home mail-order business. sparetime. Fascinating; profitable! Information free. Alfano, 19-PM Pine. Closter, N. J.

BIG Money raising fishworms and crickets. Free literature. Carter Hatchery, Plains, Georgia.

READ "Progressive Mailtrade," the magazine that tells how to make money by mail. Quarter brings sample and special offer. Progressive Mailtrade, Box 357, Sheboygan, Wisconsin.

MAKE Big money with fast-selling line self-help manuscripts, many titles! Imprints available; drop shipments if desired! Complete details to established mailorder dealers only! Economy, Box 2580-PM, Greensboro, North Carolina.

12 SURE-FIRE Mail order business plans plus 30 fast-selling products to manufacture in your basement. Complete \$1.00. Lekoa Enterprises, 2968B Wilson, Campbell, Ohio.

10,000 DOLLAR-Making formulas! Arkin, 1448 Crotona Park East, New York 60.

MONEY-MAKING Opportunity. Financial independence for ambitious individuals. Details. Mail Order Planners (C-4), 150 Broadway, New York 38, New York.

BOOKS: Terrific profits! No investment. Lindstroms, 48 Boylston, Cambridge, Mass.

SPARETIME Homework. Typewriter required. Money-making instructions 50¢, refundable. Interstate, 37 Besch, Albany 9, N. Y.

TEAR Out this ad, and mail with name, address for big box of home needs and cosmetics for free trial, to test in your home. Tell your friends, make money. Rush name. Blair, Dept. 31DT, Lynchburg, Va.

MAKE \$5,000 Yearly sparetime raising mink, chinchillas, nutria, etc. Free booklet reveals proved plans. Write: Furs, 588 Mt. Pleasant Road, Toronto 1, Canada.

MEN - Women! Start money-making plastic laminating business at home in spare time. Material that costs 11¢ brings back \$2.58. No canvassing or selling but mail orders bring in \$20 a day. Write for full particulars free. Rush name on postcard to Warner, Room CL-2-L, 1512 Jarvis, Chicago 26, Ill.

EARN Extra money at home. Details free. Captain, Box 501-PC, Reading, Mass.

EASY To start rubber stamp business at home in spare time. Make up to \$9.80 an hour without experience. Facts free. Write Roberts, 1512 Jarvis, Room CR-2-L, Chicago 26.

SIZEABLE Profits, buying, selling antique items locally. Information free. O'Rourke, 201B Arlington, Jersey City 5, New Jersey.

START Big-pay business at home in spare time. No experience needed to operate little table-top machine for bronzing baby shoes. Make \$5.46 profit on every pair. Full particulars free. Send postcard to Mason, 1512 Jarvis, Room CM-2-L, Chicago 26, Ill.

WANT A second income? Write: Wagner, 110 Callodine, Buffalo 26, New York.

SHELLCRAFT Supplies. Highest quality. Lowest prices. Large Catalogue 25¢. Pace's, Cortez, Florida.

NEW Magazine shows you how to operate profitable mail order business. Free details. Mail Order Business, Dept. L-102, 550 Fifth Ave., New York 36.

WANTED Men, women bait raisers. Guaranteed market. Everything supplied. Down-East, PM6, Box 149, Bangor, Maine.

TERRIFIC Profits. Easy. Assemble and sell waitress name plates. All businesses. Free details. Box 182P, Maywood, Calif.

UNUSUAL Profits in pocket change. Giant, illustrated guide of wanted coins, plus amazing free offer, only 25¢. Albetco, Box 843, Union, New Jersey.

DYNAMIC Mail order plans. Everything furnished. Details 25¢. Donovan, 79-PM Greenbelt, Levittown, New York.

MONTHLY Puzzle contests. Cash prizes! Spence, Box 11569, St. Petersburg, Fla.

CASH From discarded tires, valuable information, \$1.00. Woodson & Shay, 128½ Woodland Road, Asheville, N. Car.

FREE: 40 Wholesale catalogs to 900 pages. Sources \$1.00. DaleLum, 721 Solano Ave., Los Angeles 12, Calif.

SELL Perfume. Wholesale list, sample. Geller, 2089P Matthews, New York 62, New York.

EXPORT — IMPORT

IMPORT Bargains. Free gifts, catalog 25¢. Carle Distributors, 2 Empire Street, Buffalo 12, New York.

SWISS And German watches. Save to 90%. 200 styles. Catalog 25¢. K-P Imports, 493 Glenwood, Buffalo, N. Y.

JAPAN: Direct mail-order. 26 page catalogue, kimono, dolls, novelties, gifts, business information, manufacturers' names, addresses. Send \$1.00. Clarence Yamagata, 814 Toginbiru, Marunouchi, Tokyo.

SCIENCE & CHEMISTRY

232 PAGE Catalog \$2.00. Laboratory Materials, 7319 Vincennes, Chicago, Ill.

AMAZING New book of science experiments, formulas, and catalogue of laboratory supplies. Only 35¢. National Scientific Co., 13 S. Park Avenue, Dept. PM-10 Lombard, Illinois.

BARGAIN! Twelve Chemistry-Science booklets, \$1.00. Franks, 3121 South Racine, Chicago 8.

MICROSCOPE Slides, anatomical. Free list. Bay, 409 Roosevelt, San Francisco 14, California.

CHEMISTRY Catalog, 25¢. Expendables kit offer! Laboratory Sales, Box 161-A, Brighton 35, Mass.

WHOLESALE Rocket chemicals, apparatus. Catalog 25¢. Keefe Scientific, 159-10 Hillside Avenue, Jamaica, New York.

NEW Chemistry catalog 25¢. Winn Chemicals, 124 West 23 Street, New York 11, New York.

CHEMICALS, Apparatus, glassware. Illustrated catalog 25¢. Bio Chemical Products, Somerset, Belmont 70, Massachusetts.

CHEMICALS And apparatus for industrial, analytical, and private laboratories. Catalog 25¢. Dept. M-50. Biological Supply Co., 1176 Mt. Hope Ave., Rochester 20, N. Y.

ILLUSTRATED Catalog: Chemistry, mineralogy, biology 25¢. Tracey Laboratories, Evanston, Illinois.

ROCKET Supplies for amateur rocketry. Catalog 25¢. Mervin Hill Company, R.D. #1, Seward, Penna.

POPULAR Mechanics book, "Science Year," illustrated survey of last year's developments in science. Covers rockets, medicine, astronomy, electronics, etc. Send \$1 to Service Bureau, Room 517E, Popular Mechanics, 200 E. Ontario, Chicago 11, Illinois.

UNUSUAL Chemistry books, courses, kits! Rare chemicals, cheap! Catalog 25¢. NSC, Box 11133, Palo Alto, Calif.

EXPERIMENTERS: New! Bigger catalog and "Experimenters Booklet." Only 25¢. Hagenow Laboratories, Manitowoc, Wis.

ROCKETEERS: Illustrated catalog, plans, formulas, 25¢. Central Rocket Company, Waupaca, Wis.

FORMULAS, PLANS, ETC.

FORMULAS For latest money-making discoveries. New! Good! Valuable literature free! Miller, Chemist, 1517-D, Tampa, Florida.

RESILVER Mirrors—make one-way mirrors. Both \$1.00. Kem-Mir, Park Ridge, Illinois.

LATE, Modern manufacturing formulas. List free. Moon Chemical, Martville, New York.

FORMULAS: All kinds, moneymakers. Three catalogs, dime. Kemixal, Park Ridge, Ill.

FORMULAS For 10,000 products \$4.95. Ervin Sales, Box 366, Roseburg, Ore.

PLASTICS

CELLULOID Scrap. Sheets. State thickness, colors. Box 333, Kearny, N. J.

PLASTIC. Vinylite, laminating supplies, machines. Solomson, 4 Beacham, Everett 49, Mass.

PLASTIC Vacuum-forming machine. Hobby. Easy. Profitable. Details. Burr, 330 East Center, Kalamazoo, Michigan.

NEW Liquid casting plastic, clear, colors. Embed real flowers, butterflies, photos, coins. Send 25¢ for two handbooks "How to Cast Liquid Plastics" and "How to Make Extra Money at Home." Castolite, Dept. L-101, Woodstock, Illinois.

LOW Plexiglas prices. Plastic fabrication. Industrial and mine models to scale. Catalog 15¢. Plastic Shop, 2025 Nevada, Butte, Montana.

PLASTICS And accessories for casting, molding, embedding and jewelry. Make unique Christmas gifts for pleasure or profit. Send 25¢ for 64 page catalog. Castcraft Corporation, Dept. M-10, P.O. Box 555, Palo Alto, Calif.

AMERICAN Hydraulic plastic press complete with supplies to start your laminating business immediately. Price reduced for limited time. \$295.00. American Machine Manufacturing, Box 1246, Savannah, Ga.

PLASTIC And supplies for laminating. Colamco, 12 Center, New Haven, Conn.

BOXES, Plastic. 200 sizes. Free list. Althor, 170 Bay 23 Street, Brooklyn, N. Y.

AGENTS WANTED

800 WAYS To make money with no selling effort! Pre-tested best selling gifts for men, women, children, the home! Distinctive greeting cards, stationery, novelties, jewelry, cosmetics, toys, gadgets. Make up to 92% profit. No minimum order. Samples on approval. Write today for colorful free catalog. Greetings Unlimited, 6-208 Park Square, St. Paul 1, Minn.

GET Terrific money making catalog free! Take orders for toys, jewelry, all-occasion cards, collector's items and household gadgets. Generous cash profits for you on everything you sell. Work your own hours. No experience necessary. No obligation. For free catalog, just write: North Star, Dept. 6-606, 251 East Fifth Street, St. Paul 1, Minnesota.

NEW Car thief signal. Lightning seller. Thirty day trial. Northwest Electric, 505, Mitchell, South Dakota.

ANSWER Ten ads, ten seconds. Personalized postcards carry your message. You just address. Sample free. Rafters, North Boston 10, N. Y.

MAKE Big money selling famous Swami polishing cloths, treated with General Electric Silicone oil. Over one million sold. Write Swami Cloth, Box 11, Great Neck, N. Y.

SELL Electric chord organs to homes, churches, clubs. Multivox, 565 Sixth Avenue, New York 11.

\$300 WEEKLY Selling electronic overhead door controls to garage door dealers. Transmatic Co., Sedalia 3, Mo.

AGENTS—300% Profit selling genuine gold window letters; stores and offices. Free samples. Metallic Sign Letter Co., 1217-D West Newport, Chicago.

NEW Sleeping comfort means generous profits with Electro-Warmth. Beats electric blankets 10 ways, costs less. Adds no top covering you sleep on it. Best season starting. Patented Products Corp., Dept. PM-1060, Danville, Ohio.

CHRISTMAS Cards—with customer's name imprinted. Personal and business designs—all in one album. These deluxe cards pay deluxe commissions. Earn \$300 to \$500 (plus bonuses) easily this season, even in spare time. Sales experience unnecessary. Free sales kit includes sample album and easy-to-follow selling instructions. Send for kit now; pocket profits next week! Write: Process Corp. (reliable for 39 years), Dept. PM-4, 1954 S. Troy, Chicago 23, Ill.

MEN-Women agents: Sensational new moneymakers—beautifully hand-pointed, plastic personalized photo enlargements, compacts, rings, bracelets, lockets, etc. Simply take orders, pocket 40% commission. We deliver and collect. Sales outfit free. Novelco, 3343 North Ave., Chicago 47.

SEEKING New products? Get my outfit 47 money-making specialties. Latest conveniences for home, car. Send no money. Just your name. Kristee, 76, Akron, Ohio.

"FOG-STOP" Windshield cloth. Instantly removes blurry mist, frost, sleet, snow. Stops windshield fogging. Samples sent on trial. Kristee 75, Akron, Ohio.

\$25 DAY Easy with 60% profit: Friends, neighbors will thank you for demonstrating new beauty secrets and glamorous ways to use famous Studio Girl Hollywood Cosmetics. Information I send quickly qualifies you as beauty advisor. \$5.00 hour for spare time alone or \$25 day full time. Send name on postcard to me personally for free samples, details. Harry Taylor, Studio Girl Cosmetics, Dept. 12010X, Glendale, California.

FAST-Selling specialties—Jewel Cleaner, Bouquet-Magic, many others. Excellent profits. Free catalog, special offer. Shaklee Products, 300 12th St., Oakland 7, Calif.

YOUR Own business—Used suits \$1.50; overcoats 65¢; mackinaws 35¢; shoes 12½¢; ladies' coats 30¢; dresses 15¢. Enormous profits. Catalog free. Nathan Portnoy Associates, 2109-AA Roosevelt Road, Chicago 8, Ill.

AUTOMATIC Fire extinguisher. Salesman costs \$3.95. Out-O-Matic, 1737B East 31st Avenue, Denver 5, Colorado.

REAL Diamond rings. Nationally advertised. Sell direct. Make big middleman's profit. No investment. Experience unnecessary. Free catalog, details. Gleamlight, 111-B9 North Columbus, Mount Vernon, N. Y.

NEW 29¢ Kitchen gadgets. 300% profit. Sensational sellers—housewives, stores, mail. Catalog free. Two samples 25¢. Dohn-MN-Marks, Broadview, Illinois.

100% PROFITS From new sensational birthday candle. Free details. Mayflower House, 14401 Shadywood, Plymouth, Mich.

BE The Popular Mechanics representative in your neighborhood and earn big profits in your spare time. Write Popular Mechanics, Room 10-A, 250 West 55th St., New York 19, N. Y.

PRINTING. Advertising salesmen—Excellent moneymaking sideline selling decalomania name plates, small quantities. Automobile initials, sign letters. Free samples. Ralco, XL, Boston 19, Mass.

SELL Champion, AC, Autolite spark plugs. Reconditioned, electroplated, guaranteed 10,000 miles. 100% profit. Free sample. Lee Plugs, 1608-E Roberts, Houston 3, Texas.

START Making money now. Earn top commissions taking orders for all magazine subscriptions. Friends and neighbors are your prospects. No experience needed. Write for free money-making kit. McGregor Magazine Agency, Dept. 5A, Mount Morris, Illinois.

RUN A spare-time greeting card and gift shop at home. Show friends samples of our new 1960 Christmas and all-occasion greeting cards and gifts. Take their orders and earn to 100% profit. No experience necessary. Costs nothing to try. Write today for samples on approval. Regal Greetings, Dept. 79, Ferndale, Mich.

MAKE Up to \$50.00 a day soliciting delinquent accounts. Terrific commissions. Write today. National Credit, 304Y Pickwick Bldg., Kansas City 6, Mo.

BIG Profits. Stamp social security plates, key protectors. Sample 50¢. Catalog free. General Products, 11 No. Pearl St., Albany 7, N. Y.

FREE! Beautiful Mexican curios! Rush 30¢ stamps mailing. Sylviak, Apartado 9036, Mexico City.

MAKE Profitable men's-women's wear. Sample free. Sunmade, Brockton 64, Mass.

SELL Amazing glow-in-dark pictures. Big profits. Samples free. Madison Mills, 303 Fourth Ave., New York 10, N. Y.

SPARETIME Profit. New household item. Every housewife a customer. 10¢ information. B. Schueter, 1600 Decarie, St. Laurent, Quebec, Canada.

YOUR Ad in this space will get some good agents for you. Yes, I'll prove it. Write for Folder "A" right now. P. W. Johnson, Classified Advertising Manager, Popular Mechanics Magazine, 200 E. Ontario St., Chicago 11, Ill.

BUY IT WHOLESALE

2,000 PAGES Wholesale catalogs! Write: Mosaser, Box 47-B, Newark, Ohio.

PHOTOGRAPHIC Equipment. Free wholesale catalog. RNG Sales, PM, Wildomar, California.

ELECTRIC Guitars, amplifiers, wholesale. Free catalog. Carvin, PMW, Covina, Calif.

WHOLESALE: 850,000 Items. Supply source directory 25¢. Idealer, Park Ridge, Illinois.

LARGEST Wholesale supply source in U.S.! Furniture, clothing, appliances, housewares, automobiles and accessories, tools, sporting goods, hobby supplies, farm equipment, imports, new products, bargain merchandise. Free details. Associated Wholesalers, Box 2068-DD, Sioux City 4, Iowa.

USED And new watches \$2 up. Free list. Southern Watches, 5-PM So. Wabash, Chicago 3.

BELOW Wholesale most merchandise. Write: Factory Buyer, 446, Jacksonville, Illinois.

BUY Everything wholesale! Huge catalog, \$1.00. Parmelee's Supply, Marshfield, Wisconsin.

BULOVA, Benrus watches like new \$5.95 up. Illustrated catalog with hundreds of bargains, free. Cosmos, New York 35, N. Y. Dept. 616.

100,000 PRODUCTS Wholesale! Terrific bargains! United Wholesalers, 1265-M Broadway, New York 1, N. Y.

NEWLY Namebrand merchandise and toy catalog. \$1.00 for both plus postage. Strom Sale Service, Box 141, Templeton, Mass.

JOIN Now and save 20% to 50% on nationally advertised appliances, furniture, carpeting, photo equipment and other famous brand merchandise. Limited exclusive membership. Write for free brochure to Mutual Buyers Club, Inc., Dept. PM-2, 1000 W. Roosevelt Road, Chicago 8, Ill.

250,000 ITEMS Wholesale. Famous brands. Catalog \$1.00. Weisger, 28 Fenway, Boston 15.

BELOW Wholesale. Clothing, appliances, etc. Catalog 10¢. Wambaugh, 7316 Lawndale, Philadelphia 11, Penna.

WHOLESALE Catalog. You profit. Free details. Loeber, 224-E Wyatt, Lincoln, Ill.

FACTORY Prices! Thousands nationally advertised products. Typewriters, housewares, jewelry, watches, appliances, television, cameras, etc. New factory buying plan saves up to 40% below wholesale. Details free. Factory Supply Company, Bloomfield 2, New Jersey.

TREMENDOUS Wholesale buys! Big catalog! Postcard! Spartan, Box 1204F, Chicago 90.

WHOLESALE! World's largest supply. Buy from 679 American, European, Japanese wholesalers. Tailormade suits from Hongkong. 123 dropship catalogs. Rock-bottom prices. Free details. International Buyers, 216-M Jackson, Chicago 6, Illinois.

NEW DeLuxe Multicolor wholesale catalog, automobile catalog, and others. Nationally advertised merchandise. Housewares, appliances, refrigerators, freezers, washers, dryers, television, radios, rugs, furniture, sewing machines, clothing, luggage, binoculars, phonographs, musical instruments, recorders, cameras, projectors, typewriters, power tools, toys, notions, sporting goods, watches, jewelry, novelties, vitamins, drug sundries, cosmetics, books, school supplies, practically everything. Famous brands. Huge discounts up to 40 to 70%. Postcard: Selbyco, Decatur 5, Illinois.

TYPEWRITERS. Cameras, watches, outboard motors, blades, shavers, gold coins, exercisers. Simms, Warwick, N. Y.

EXOTIC Housewares, gifts, gadgets. Catalog 25¢ (refundable first order). Lifetime, 211 Genesee, Auburn 5, New York.

EARRINGS—5 Pairs \$1.00. Make 100% profit. Tested Products, Box 393, Radio City Station, New York 19.

BUY Direct from factories. Appliances, cameras, watches! Free details! Cam, 116 Malden Street, Worcester, Mass.

BUY Your watch in Switzerland at wholesale price. Catalog \$1.00. Argosy, Box 221, Montreal 25, Canada.

SALESMEN—DISTRIBUTORS

MAKE Up to \$50.00 a day soliciting delinquent accounts. Terrific commissions. Write today. General Finance, 304V Pickwick Bldg., Kansas City 6, Mo.

IF You're interested in making money in selling, see the hundreds of exceptional opportunities in Salesmen's Opportunity Magazine. Send name for your copy, absolutely free. Tell us what you're selling now. Opportunity, 848 N. Dearborn, Dept. 17, Chicago 10, Illinois.

MONEYMAKING Opportunity in fast growing market selling attractive outdoor advertising pennants. Write: Radder Products, Box 31, Colvin Station, Syracuse 5, New York.

BIG Money now to New Years! Show fabulous new sculpture embossed calendar line to stores, offices your area. Three dimensions, vivid color. Look, feel real. Many designs—kids, sports, etc. Sell on sight. Free sales outfit. Hurry! Write Arrow Press, 513 Fourth Ave., South, Dept. 83-P, Minneapolis, Minn.

WILL You wear new suits and topcoats without one penny cost and agree to show them to friends? You can make up to \$30.00 in a day even in spare time, without canvassing. Pioneer Tailoring Co., Congress & Throop Sts., Dept. L-1226, Chicago 7, Ill.

MAKE Extra money—Big cash commissions plus premium for you and your customers. Sell advertising book matches. Sensational new tenorama, glamour girls, hillbillies; dozens others. All sizes. Quick daily sales; big repeat business. Free master kit makes selling easy. No experience necessary. Superior Match, Dept. M1060, 7530 Greenwood, Chicago 19.

MONEY-Making opportunity! Take big profit orders for world famous patented varieties fruit trees. Also flowering shrubs, roses, vines. Big sales outfit free. Stark Bro's, Desk 30101, Louisiana, Missouri.

PROFITABLE Lifetime oil business. Franchises still available for automotive Molybdenum. Small investment. Pacific Lubricants, 5807-PM10 Beverly, Los Angeles 22, Calif.

YOUR Own spare time home-operated business. Take over your area as our service distributor keeping retail stores supplied. Nationally advertised 30-year-old line pays up to \$20.00 hour. Under \$100.00 for merchandise gets you started. For samples, highly successful plan, write Novo, 3855 Lincoln, Desk X-85, Chicago 13.

MAKE Extra money selling advertising matchbooks. Free catalog and sales outfit. Matchcorp, Dept. PM-100, Chicago 32.

ANYONE Can sell famous Hoover uniforms for beauty shops, waitresses, nurses, doctors, others. Miracle fabrics—nylon, dacron, wash 'n wear cottons. Exclusive styles, top quality. Big income, real future. Equipment free. Hoover, Dept. M-100, New York 11, N. Y.

\$1,000.00 A Month for making dramatic 3-second demonstration of amazing light-weight Presto Fire Extinguisher. New chemical used by Airforce snuffs out fires instantly. Only \$4.95. Terrific commissions. Millions want it. Free kit. Merlite, 114 E. 32nd, Dept. 8-86U, New York 16.

MAKE Small fortune even spare time with sensational new longer-burning light bulbs, with amazing free replacement guarantee—never again buy light bulbs. Homes, stores, offices, etc. Multi-million dollar market. Free sales kit. Merlite (Bulb Div.), 114 E. 32nd, Dept. C-73U, New York 16.

WILL You test new items in your home? Surprisingly big pay. Latest conveniences for home, car. Send no money. Just your name. Kristee 102, Akron, Ohio.

MAKE Up to \$147.50 daily with simple 30-second demonstration sensational new Easy-Fone. Frees both hands, permits work while phoning, hold 2-way phone talk anywhere in room. Transistorized, no installation. Offices, stores, factories order 1 to 6; housewives order fast. Make \$14.75 and more each. Ten sales daily possible spare or full time. Money-making plans free. Write Easy-Fone Div., Merlite, 114 E. 32nd St., Dept. A-67U, New York 16.

DEMONSTRATE Patented illuminated moving message displays. Every business your prospect. Make more money now! Top commissions. Salescaster Displays, 1001 E. Elizabeth Avenue, Linden, New Jersey.

STEADY Profits. Made - to - measure shirts. Free sales kit. Dept. PM-10, Henlein, Cincinnati 2, Ohio.

SALESMEN—Distributors. To market government approved home study music courses produced on recordings. Piano—guitar—accordion. Vast market. No competition! Vavro Recording Institute, Inc., South St. Paul, Minnesota.

VITAMINS! Private labels! Exclusive sales! We furnish product, plan, literature. You provide management, employ salesmen. Terrific profits. Repeats! Sample and details free. VimVite, 2908-E Beverly Boulevard, Los Angeles 57.

24" **CLOWN** Doll, 11" Scotty, Stiff-like animals—36 samples only \$21.60 FOB. Free catalog. Representation wanted. Ace Toy, Dept. PM, 536 Broadway, N. Y. C.

EMPLOYMENT INFORMATION

JOBS: High pay. Foreign countries, U.S.A. All trades. Write Dept. 55C, National Employment Information, 1020 Broad, Newark, N. J.

LATEST Foreign jobs! Highest wages. Unlimited opportunities. Laborers, clerical, construction, electronics, oil fields, civil service. \$2.00 (c.o.d.'s accepted). America's leading overseas employment researcher. Plus newest South American, Alaskan, Venezuelan listings. Universal Research, Box 4912, Baltimore 20, Md.

GOOD Salaries — Petroleum, construction, manufacturing, teaching, etc. Technical, professional personnel. Travel paid, living allowances, bonuses, U.S. tax exempt. Information \$2.25 air mailed. Colombian Opportunities, Apartado Aereo 14448, Bogotá, Colombia.

JOBS On ships and yachts traveling foreign countries. Davenport's, 1354-K, G.P.O. New York 1, N. Y.

100s **GOVERNMENT** Jobs. Civil Service security. Overseas, in States. West Point-Annapolis entrance. Learn how to come out high in exams. \$1 starts you. Tole House, Box 2521M, Hollywood 28, Calif.

FOREIGN Employment information. Work overseas. Travel, adventure. Europe, Africa, Asia, Canada, Alaska. Earn as much as \$1,600 monthly. Construction men, truck drivers, clerks, teachers, professionals, etc. Fabulous opportunities. Most complete information, application blanks, etc. Sent by return mail same day received. Send \$2.00 to Dept. PM, Foreign Bureau, P.O. Box 512, New Orleans, Louisiana.

MERCHANT Marine jobs! Top wages. Men and women. Travel. Details free. Captain, Box 501-P, Reading, Mass.

FREE Information—U.S.A., overseas jobs. High pay, transportation. Futures, Dept. M, 215 West 34th Street, New York City 1.

JOBS On ships. \$100 weekly, beginners. Travel, adventure. Write: Seamans Service, Box 17-M, Brooklyn 8, N. Y.

FOREIGN Jobs—Latin America, Alaska, Canada, up to \$1500 monthly. Up-to-date 1960 foreign service directory gives complete information; hot list of firms hiring for military and civilian construction, aircraft, oil, exporters-importers, mining. How-when-where to apply. 12th successful year. \$1.00. Global Reports, Box 8873-S, Los Angeles 8, Calif.

AMERICAN—Overseas jobs. Higher pay. Transportation, benefits. Men-women. All occupations. Details. Write: Employment Headquarters, 79 Wall Street, Dept. B-13, New York 5.

VOCATIONAL Counseling by mail. Tests include aptitude, ability, interest and personality. Interpreted by professional counselors. Complete case study \$5. Free details. Counseling Institute, 427 N. College, Bloomington, Ind.

PHOENIX Arizona. Job and business opportunities or housing. Specify. Send \$1.00. J Bar M, Box 11041, Phoenix, Arizona.

U.S.A. Foreign jobs, up to \$1600.00 monthly. Construction, clerical, supervisory, etc. Skilled, unskilled. Free transportation. Unusual opportunities. Complete information plus Worldwide project listings. Only \$2.00 (\$2.25 airmail). Satisfaction guaranteed. International Reports, 109 W. 42, New York 36C., N. Y., or Box 621, San Jose 6D, California.

LIST Of names—addresses. 100 American contractors with large overseas projects. Only \$1.00. Contractor Services, Meramec Building, St. Louis 5-PMA, Missouri.

PLENTY Jobs. Stateside-worldwide. High pay. Elsing, Box 12, Detroit 13, Michigan.

DIRECTORY Reports. Construction, aviation, shipping, oilfields, government, manufacturing, trucking, etc. Foreign-stateside. Helpful information plus job-getting tips on preparing application letters. Unconditional money-back guarantee of satisfaction. Act today. Only \$2.00 (\$2.25 airmail). (C.O.D.'s accepted). Research Services, Meramec Building, St. Louis 5-PM, Missouri.

JOBS Abroad. Top pay with travel, adventure, unlimited opportunities. Latest report covers construction, oil, shipping, aviation, governmental and international organizations. Skilled, unskilled, clerical, supervisors, engineers. Only \$2.00. Money-back guarantee. Included free, "Student Opportunities Abroad" and "Jobs on Yachts." Covington Distributors, Box 704-H, Camden 1, New Jersey.

HIGH Pay overseas, domestic jobs. Men, women. Generous benefits. Companies pay transportation. For information write: World Wide, Dept. B4, 149 N. Franklin St., Hempstead, N. Y.

SPECIAL SERVICES

INFORMATION On anything. Ferguson Research Specialists, 43-11 64 St., Woodside 77, N. Y.

IRISH Coats of Arms booklet of officially recorded family names. Guaranteed accurate and authentic, \$1.00. Pioneer Arms, 65 Tenafly Drive, New Hyde Park, N. Y.

EDUCATIONAL AND INSTRUCTION

OPERATE Restaurant or diner. Free booklet reveals plan. Write School of Restaurant Business, Dept. KC-359, 335 W. Madison, Chicago 6, Illinois.

ENGINEERING And art degrees earned through home study. Electronics, electrical, mechanical, civil, physics, liberal arts. When writing, specify course desired. Pacific International College of Arts & Sciences, primarily a correspondence school. Resident classes also carried. 5719-B Santa Monica Boulevard, Hollywood 38, Calif.

PIANO Tuning learned at home! Profitable, uncrowded profession. Write Tune-craft, Box 5074-M, St. Paul, Minnesota.

POPULARITY Through music! Make new friends. Earn extra money. Learn accordion, guitar. Easy lessons. Instrument furnished. Satisfaction guaranteed. Free information. National Conservatory of Music, P.O. Box 1938, New Haven, Connecticut.

BILLION Dollar technical industry needs qualified men! Our unique combination home training assures high earnings. Free placements. Vital information furnished. Northeast Schools, New Haven 9, Conn.

INVESTIGATOR Training—Free booklet covering approved home-study plan. Write National Detective Academy, Dept. E, 722 West Chapman Avenue, Orange, Calif.

BE A Real Estate Broker. Insure security for yourself and your family. Study at home. Prepare for state examination. GI approved. Write for free book today. Weaver School of Real Estate, 2018 P Grand, Kansas City, Missouri.

LEARN Auctioneering. Free catalog. Missouri Auction School, Box 9252X3, Kansas City, Missouri.

LEARN World interlanguage approved by UNESCO. Textbook 25¢. Esperanto, Middleton, Wis.

LEARN Asleep or awake. Self-help books, tapes, recordings. Free catalog. Drawer PM-697, Ruidoso, New Mexico.

HIGH School diploma at home. Licensed teachers. Approved materials. Southern States Academy, Station E-16, Atlanta, Ga.

WANT A diesel job? Higher pay? Advancement? We can help you qualify! Complete diesel, tractor and heavy equipment and Cummins Diesel Engine Shop-method home-training courses available. Write today. Interstate Training Service, Dept. B-3, Portland 12, Ore.

DEVELOP Mind power, personality while asleep. Use your phonograph, recorder. Amazing psychological tapes, records now available. Details free. Sleep-Learning Association, Box 24-N, Olympia, Washington.

EARN While you learn. Auto and diesel mechanics master this top paying trade. Many graduates earn \$100 a week and up. Approved for Korean veterans. For free information write Dept. No. 256, Nashville Auto-Diesel College, Nashville 3, Tenn.

PHYSICAL Therapy and massage. Home training. Practice privately or work with doctors and hospitals. Free catalogue. National Institute, Desk 4, 159 E. Ontario, Chicago, Ill.

BOOKS, Free general catalog, 100 pages. Text, vocational, educational, instructional subjects. Millions of volumes, new and used. Bargain prices. Books bought. Fst. 1902. Long's College Book Co., Dept. PM, Columbus 1, Ohio.

STRENGTHEN Your voice—for more success in business, social life! Free booklet. (Give age.) PV Institute, Studio EP-2, 210 South Clinton, Chicago 6.

PIANO Tuning pays. Big money in spare time. Learn at home in 30 days. No musical knowledge necessary. Phonograph, records, tools and instructions furnished. Personal instructions available. Free catalog. Capital Piano Tuning School, 3160 S.W. 16th Court, Fort Lauderdale, Fla.

INVESTIGATOR Training—Robert B. Phillips Sr., Founder, former U.S. Government Special Agent. Write to 1917-K North Kenneth, Chicago 39, Ill.

USED Correspondence courses and books sold and rented. Money back guarantee. Catalog free. (Courses bought.) Lee Mountain, Pisgah, Alabama.

BOOKKEEPERS. Operate your own "Dollar-A-Week" system. Ellis, Box 200, Cedar Grove, North Carolina.

ANALYZE Handwriting for profit, pleasure. Free sample lesson, catalog reveals plan. Write IGAS, Inc., Dept. 2, Springfield 4, Missouri.

OWN Collection agency. Little "gold mine." Franklin Credit, Roanoke, Va.

PIANO Tuning pays. Learned easily at home. GI approved. 59th year. Free booklet. Niles Bryant School, Dept. P, 3731 Stockton, Sacramento 20, Calif.

PROFESSIONAL Investigators. Home study. Lapel pin, certificate, future. Box 41197-F, Los Angeles 41, California.

SWEDISH Massage. Home study. Diploma. Illinois Licensed School, 3809 Alta Vista, Chicago 13.

DRAFTING Pays big money, is light, interesting work. Learn drafting at home in spare time. Professional set drafting instruments, portable drafting table, drafting equipment given you. Easy payment plan. Free book. Christy Trades School, Dept. CD-4803, 3214 W. Lawrence, Chicago 25.

FINISH High school at home. No classes. Texts furnished. Diploma awarded. If 17 or over and left school, write for free assignment and catalog. Wayne School of LaSalle Extension University (A Correspondence Institution) Dept. 1059 WC, 419 S. Dearborn, Chicago 5, Ill.

MASTER Watchmaking at home. Free sample lesson. Chicago School, 2328-YK, Milwaukee, Chicago 47.

FINGERPRINTING Course \$12.00. Diploma awarded. Details free. Alabama School of Fingerprinting, Box 185, Fairfield, Alabama.

BE A locksmith! Earn while you learn. Big opportunities await you in this fascinating, profitable trade. Earn quickly—step into a wellpaid job or start a business of your own, full or part-time. Learn easily at home, all materials and special tools supplied. Write for free book today! Locksmithing Institute, Dept. 6710, 150 Park Avenue, East Rutherford, N. J.

GOOD Paying jobs open! Operate, repair heavy earth moving equipment! Learn "on the job" operating latest cranes, bulldozers, earth carriers! V.A. approved. Free catalog. Write, T. L. Hutch, Greer Technical Institute, Braidwood, Illinois.

BIBLE Lessons orthodox, evangelical, interdenominational. Home Bible Studies, Box 316, Elkhart, Indiana.

CIVIL Service. Learn about this field of work and how you can prepare yourself by home study for a high entrance mark. Private organization. Free booklet. No obligation. Franklin Institute, Dept. W30, Rochester 4, N. Y.

GAME Warden, government hunter, forestry, park and wildlife service announce job openings regularly. Enjoy outdoor work, good pay real security. Complete information free! Write North American School of Conservation, Dept. 17AB, 810 Dodsworth, Covina, Calif.

OIL Coloring photographs—A fascinating hobby or profitable sideline for those with artistic talent. Learn at home. Easy simplified method. Free booklet. National Photo Coloring School, 835 Diversey Parkway, Dept. 3437, Chicago 14.

"HOW To Train Horses"—A book everyone who likes horses or ponies should have. Free. No obligation. Simply address Beery School, Dept. 11010-C, Pleasant Hill, Ohio.

COMPLETE Your high school at home in spare time with 63-year-old school. Texts furnished. No classes. Diploma. Information booklet free. American School, Dept. X745, Drexel at 58th, Chicago 37, Illinois.

ELECTRONICS. Learn at home. Training equipment furnished. Catalog free. National Radio Institute, Dept. OKAA, Washington 16, D. C.

READ Russian! Home-study textbook \$3. Slavic Library, 3330 Thirteenth, Boulder, Colorado.

PATENT Specification writing taught. Patentry, 610 "C" Southeast, Washington, D. C.

LEARN Civil and criminal investigation at home. Earn steady, good pay. State age. Institute Applied Science, 1920 Sunnyside, Department 167, Chicago 40, Ill.

SEND And receive Morse Code in 30 minutes. Send \$1.00 for complete code kit. Code, Box 666-B, Whittier, California. Money back guarantee.

SLEEP Induction offers you many benefits besides restful sleep. Free brochure. Troy's Record Service, 173 W. San Fernando 13 San Jose, California.

REAL Estate course. Economical home-study. Prospectus free. Howard Schools, 320 Glover Building, Kansas City 5, Missouri.

DANCE! Free lesson proves you can! Castle, 307 Fifth Avenue, New York 17.

NEW Amazing sub-conscious method for effective speaking, improved singing, master salesmanship, dynamic concentration, and powerful memory, along with 20 other revolutionary courses. Works wonders. Easy, pleasant. Guaranteed. Write: Alpha Distributing Co., Box 765, Chicago 90, Ill.

FREE BOOK "990 Successful, Little-Known Businesses." Work home! Plymouth 71M, Brooklyn 4, New York.

SECRET Investigations. Experience unnecessary. Investigators particulars free. George Wagner, M125 West 86th, New York City 24.

ORGAN Instruction. New approach. Free details. Afsco Publications, 414 E. Valley, San Gabriel, California.

INEXPENSIVE Correspondence courses—Science, Psychology, Engineering. Earn diplomas, institutes abroad. Aurecas, Central Valley, New York.

PROFESSION—Correspondence course. Physical therapy, massage. Diploma. Northwestern Institute, Box 368, Rock Falls, Illinois.

INTERESTED In advancement? If it is dependent on receiving high scores on educational type tests, I can help you. Details free. B. W. Nielsen, Box 1756, St. Louis 1, Mo.

NEGOTIATE Your own personal injury claim. Keep everything. New! Sensational booklet reveals professional insurance adjusting secrets, \$3.00. Wilkes Enterprises, P.O. Box 4103, Mobile, Alabama.

PLAYS, STORIES, MANUSCRIPTS

ATTENTION All writers! Authorship means prestige! Your short stories, articles, books, plays, will receive our prompt sales handling! Write immediately for free literature! Literary Agent Mead, 915 Broadway, New York City 10.

WANT Your book published? Learn how we publish, advertise, promote, distribute. Many successes. Free booklet PM. Vantage, 120 West 31, New York City. Or 6253 Hollywood Blvd., Hollywood 28, Calif.

CARTOONING, COMMERCIAL ART, SHOWCARD & SIGN PAINTING, TATTOOING

LEARN Art and cartooning. Guaranteed portfolio of 24 proven lessons only \$4.95. Southgate Press, 711 Empire Building, Birmingham, Alabama.

"HOW To Make Money With Simple Cartoons"—A book everyone who likes to draw should have. It is free! No obligation. Simply address Cartoonists' Exchange, Dept. 910-C, Pleasant Hill, Ohio.

LEARN Sign painting at home. Free talent test. Ben Kerns, Box 812-PM, Greenville, S. C.

LEARN Profitable, fascinating tattooing. Illustrated information \$1. Zeis, 728-C Leslie, Rockford, Illinois.

LEARN Sign painting with fascinating system. Straley, 410 S. Western, Springfield, Ohio.

CARTOON Your way to success! Internationally known instructor, Raye Burns, will personally teach you to create original, salable cartoons at home. Cost of course is very low. Write for free details. Raye Burns School, Box 3583-P, Cleveland 18, Ohio.

BOOKS Plus optional inexpensive assistance. De-Signs, Box 2024F, Davenport, Iowa.

CARTOONERAMA Teaches you cartooning in a new 24 lesson course. Free brochure. CFA, Box 263G, Branford, Connecticut.

ART Course. 75 lessons. Details free. Antom, Box 143, Tewksbury, Mass.

ADVERTISING AGENCIES, LETTER WRITERS, FOR ADVERTISERS

ADVERTISE: 24 Words, 100 Canadian newspapers, \$5.50. Lists free. Advertising Bureau, 10511-C Springfield, Chicago 55.

ADS, Letters worded to pay, prompt, reliable, reasonable. Kelley, 84 Longview, White Plains 11, N. Y.

FREE! Red-hot book, "More Profit From Your Advertising." Lists—best mail order magazine, newspapers. Adservice, 516 Cornelia, Chicago 13.

ADVERTISE "Mail order weekly" 2¢ per word, \$1.00 minimum. Sample copy 10¢. Hartford, 2704 W. 32, Denver 11, Colo.

"AMAZING New Book"—"Profits From Classified Advertising." Tells how and what to advertise. Be sure to read this book before you invest one cent in advertising. Write for your copy now. Just send 10¢ for postage and handling. W. Johnson, Classified Advertising Manager, 203 East Ontario Street, Chicago 11, Illinois.

MAILING Lists most any classification \$5.00 1000. Your circulars mailed with ours \$4.00 1000. Write for our literature. Dixie Mailers, King, N. C.

CREATIVE Advertising. Magnetic copy. Dramatic layouts. Moran Agency. Shoemakersville, Pennsylvania.

ADVERTISING Ratebook leading newspapers, magazines, free. Chicago Advertising Agency, 28-E Jackson, Chicago 4.

SAVE! Circulars, brochures, folders, catalogs designed and printed. Samples! Flair, 8 West 45th, New York City 36.

NOW Ready: New, amazing Classified Advertising Record Book—prepared especially for classified advertisers. Here is a book that tells you instantly whether or not your advertising in any publication is paying you real results. You can tell immediately how many inquiries each publication produced—how much cash received from every ad. Spaces are provided for the name and address of the publication, date of issue, space used, rate, cost of ad, key number, etc. You have a complete record of each publication right before your eyes. Plenty of space to keep accurate record of 28 separate publications. You can have a copy by sending only 10¢ to cover postage and handling. Send for your copy now. W. F. Johnson, Classified Adv. Mgr., Popular Mechanics Magazine, 204 E. Ontario Street, Chicago 11, Illinois.

TYPEWRITERS, DUPLICATORS, OFFICE DEVICES

DUPLICATING Machines. Write: Debbie-Lynn, 4425 E. 57th St., Maywood (B), California.

WHOLESALE Typewriters, business machines. Free catalog. Continental Distributing Company, Box 71, Temple City, California.

MIMEOGRAPH! 3500 Copies hourly—in colors! Details. Scheetz's, Sellersville, Penna.

MIMEOGRAPHS, Duplicators. New. Inexpensive. Information 5¢. Box 52, Woodlyn, Penna.

RECONDITIONED Typewriters, duplicating, printing devices. \$25.00 up. Supplies. Appliances. DixieGraph, King, N. C.

PRINTING, MULTIGRAPHING, MIMEOGRAPHING, GUMMED LABELS

RAISED Letter business cards \$3.00 per 1,000. Kavanagh, 607-PM, Knickerbocker Ave., Brooklyn 21, N. Y.

BUSINESS Cards—1000, \$2.95. Rubber stamps. Weiss, Box 8304, Kansas City, Mo.

PHOTO-Offset, samples, prices free. Litho, 53 Laurie, Fort Walton Beach, Fla.

1000 2-COLOR Business cards (3 ply), 6 lines \$3.50 postpaid. Free value packed catalog. Emco Printing, P. O. Box 4322, Dallas 8, Texas.

1,000 BUSINESS Cards. Raised letters \$3.95. Samples. Pioneer, PM-10, Island Park, N. Y.

BUSINESS Printing. Reasonable. Catalog free. Howprint, 723-G Eunice, Webster Groves 19, Missouri.

DISTINCTIVE Envelopes, letterheads. Samples free! Ink-Daubers, 933 Longfellow, Jackson, Mich.

100 LETTERHEADS 8½ x 11, 100 Envelopes 6¾, carefully printed, \$2.35. Postpaid. Race Printers, Hudson, New York.

LOWEST Prices. Personalized printing, labels, rubber stamps. Miller, Box 859, North Miami, Florida.

ENVELOPES No. 10, 1000—\$7.45, 6¾—\$5.45. Printed, postpaid. Neal Printers, 249 Sunrise, Nashville 11, Tennessee.

1,000 ADDRESS Labels! \$1. Three line pocket stamp. \$1. Lynnette's, Box 1-P, Noroton, Connecticut.

PRINTING Unlimited, postpaid! Free catalog. Cargman Press, 5925 Franklin, Hollywood 28, California.

OFFSET Printing, 1000 8 1/2 x 11, \$5.50. Alpine, Box 676-EA, Cupertino, Calif.

LETTERHEADS: 500—\$4.50. Free sample, Carlayne, 1803 Fremont, Rapid City, South Dakota.

MIMEOGRAPHING—Letters, pricelists, formulas, instructions. Lowest prices. Lem's Letter Shop, 5710 Stanton, Detroit 8.

ADS Running under this heading sell printing. Ask me for proof. I'll gladly send you amazing facts. Ask for Folder "P." F. W. Johnson, 200 E. Ontario St., Chicago 11, Ill.

FREE Catalogs postpaid printing. Rubber stamps. DM Press, Sebastopol, Calif.

1,000 BUSINESS Cards. Raised printing. \$3.75. Agents wanted. Elco, 5909 Highlandview, Sylvania, Ohio.

MIMEOGRAPHING Service U.S.A. Swanson, 834 (X) Harvey Road, Toms River, New Jersey.

COLORED Or white 8 1/2 x 11 offset. \$6.50—1,000; \$18—5,000. Fast! Flair, 10 West 45th, New York City 36.

PRINTING OUTFITS AND SUPPLIES

HARD Type for rubber stamp making, printing. Introductory offer. 10 or 12pt. 20th Cent. or Stymlie medium. Caps \$2.00. L.C. \$2.00. Catalog. Barco Type, 64 Wagner, Northlake, Ill.

TYPE For printers and rubber stamp makers. Send 25¢ for big new 96 page catalog. Largest selection in U. S. Acme Type, 633 Plymouth Court, Chicago 5, Ill.

RUBBER Stamp presses, hydraulic operated, electrically heated. Sizes 5"x8", 8"x12", 10"x15". Starting outfits, supplies. Printing presses. Custom Manufacturing, 507-P N. Jefferson, Springfield, Missouri.

PRINTING Presses, type, supplies. Lists 4¢. Turnbaugh Service, Mechanicsburg, Penna.

RUBBER Stamp presses, supplies. Kiewiet, 2025 Barney Road, Kalamazoo, Mich.

MAKE Your own self-molding rubber stamps and printing cuts. Plexirubber, Argyle 1, Wisconsin.

DO Your own printing. Save money. Simple rules. We supply everything. Print for others; good profit. Raised printing like engraving too. Have home shop. Details free. Kelsey Presses, V-11, Meriden, Connecticut.

RUBBER STAMPS AND OFFICE SUPPLIES

SPECIAL Introductory offer. 3 line pocket stamp 59¢. Junior, Box 227, Valparaiso, Ind.

HANDY Plastic pocket rubber stamp. 3 lines \$1.00. Holland, 132 Grace St., Syracuse 4, New York.

OFFICE Labels 2 1/2" long perforated 1" wide, 500 on roll white gum paper, 50¢ postpaid. Maine Press, Marcy 2, New York.

11¢ WORD Minimum 66¢. Newest method. Resembles sharpest printing. Sacrificing 300 stamp molds. Engesser, Box 82, St. Peter, Minnesota.

FREE Type styles sheet. Free stock stamp literature. Free printing catalog. Pads, racks, Xmas stamps. Youngers Stamp Shop, Princeton, Iowa.

HANDY Pocket size printer, \$1.00, c.o.d. P.O. Box 2512, West Lawn, Penna.

INDEXED, Cushioned 3 line stamp \$1.00. Each additional line 25¢. Stock stamps, novelty stamps, stamp pads. Rubber Stamp Service, 109 North Hyatt St., Tipp City, Ohio.

FREE—Rubber stamp catalog. Martin, 1425 Major Drive, Jefferson City, Missouri.

FOR INVENTORS

YOU Can easily apply for patents. Save with complete professional kit, featuring "Exclusive Demonstrator Method" and fill-in forms. Free registration certificate. Patent Associates, 1214 Commonwealth Building, Philadelphia 7, Pennsylvania.

SAVE! New Inventor's Patent Kit makes it easy to apply for patents yourself. Free "Registration Form." Miss Suzan Blaine, 306 Carry Building, Washington 5, D. C.

DON'T Pay high fees! Obtain U.S. patent yourself. It's easy with Professional Kit with fill-in forms. Free "Registration Form." Patent Protection Institute, 2000 P Street, N.W., Washington 5, D. C.

INVENTORS' Complete service. Cash-royalties sales. Inventions researched. Patent development engineering. Free invention certificate. George Spector, Licensed Invention Engineer, 3615 Woolworth Building, New York.

INVENTIONS Wanted now by my manufacturer clients. Patented. Unpatented. Write Gilbert Adams, Patent Broker, 80 Wall St., Financial District, New York City.

PATENT Searches, including copies of nearest patents, \$6.00. Reports airmailed within 48 hours. More than 200 registered patent attorneys have used my service. For free invention protection forms, write Miss Ann Hastings, P. O. Box 176, Washington 4, D. C.

WE Have the markets if you have the ideas. Harvey Engineers, Cambridge 1, Maryland.

INVENTORS: Test the commercial value of your patented or unpatented inventions, quickly and inexpensively. Write for free information. Institute of American Inventors, Dept. 40-B, 635-F St., N.W., Washington 4, D. C.

PATENT Searches, including complete copies of nearest patents, \$6.00. Inventors, attorneys, manufacturers use my original world-wide airmail service. "Proof of Invention" protection form and "Information Every Inventor Needs" sent free. Miss Jean Hayward, 1029 Vermont Avenue, NW, Washington 5, D. C.

INVENTORS! Determine patentability of your invention. Searches of the Patent Office Records administered professionally—\$6.00. For free invention protection forms, dependable service write Washington Patent Office Search Bureau, 1436 G Street, N. W., Washington 5, D. C.

QUALITY Patent searches, \$6.00. Copies of closest patents forwarded. Free "Protection Certificate." American Patent Search Co., 422 Washington Bldg., Washington, D. C.

PATENTS Skillfully prepared for maximum commercial value, with useful product development. High record of success in proving and claiming patentability. Valuable market service. Patent prepared for a fee as low as \$200.00. Send for self-protecting record of invention forms free. Patent search with valuable engineering report \$15.00. Foreign patents filed at low cost. Thirty years established. Joseph O'Brien, Patent and Development Engineer, 132 Nassau St., New York 38, N. Y.

INVENTORS! Outright cash sale or royalties for your inventions. Patented. Unpatented. Constant demand from our client manufacturers. Write: United States Invention Brokerage, 78 Wall Street, New York 5, N. Y.

LIST Of 10 patent attorneys and agents near you \$1.00. Box 1533, Tallahassee, Fla.

INVENTIONS Needed immediately for manufacturers. For additional information write Kessler Corporation, C-510-FI, Fremont, Ohio.

NEW Toy ideas wanted. We have markets for good new toys. Outright purchase or royalty. Will be an Art Linkletter product. Link Research Corp., 9460 Wilshire Boulevard, Beverly Hills, California.

INVENTORS: Save time and money. Our complete "Patent Kit" makes it easy to prepare and file your own patent application. Free "Registration Certificate." National Inventors Service, Box 88, Benjamin Franklin Station, Washington, D. C.

PATENT Searches, \$6.00, complete with comprehensive report and official Patent Office copies of related patents. Certified, airmailed. For free "Invention Protection Form," and "Patent Information," write: U.S. Inventors Service Bureau, Headquarters Building, Washington 6, D. C.

HIGHEST Cash, royalties. Ideas developed into products, drawings, patent search, protected. Nation-wide manufacturers contacts. Inventors Creative Service, 354 South Spring, Los Angeles 13, Calif.

PROFESSIONAL Patent searches, \$5.00, complete with report and related patent copies. Complete patent and trademark services. Free forms; write: Congress Invention Institute, 210B, McKim Building, Washington 5, D. C.

PATENT Searches including copies of closest patents \$6.00. Quality searches expertly administered. Free protection forms. Write Professional Patent Office Search Bureau, 412 Abee Building, Washington 5, D. C.

"PREPARE Your Own Patent Application." 40 pages, illustrated; tear-out Patent Office signature sheet. \$2.00. Gardena Printing Co., Gardena, California.

INVENTIONS Sold; patented and patent pending. Write: Kenwal Enterprises, Box 584, Watertown, South Dakota.

PATENT Searches, \$5.00, including patent copies. Reliable reports. Same accurate search as conducted for attorneys. Free protection forms. 15 years dependable service. Patent Service Institute, 945-A Pennsylvania Avenue, Washington 4, D. C.

INVENTORS! Consider our offer first before selling or licensing your invention on a cash or royalty basis. Patented. Unpatented. Inventions on Demand, 79 Wall Street, New York 5, N. Y.

INVENTIONS WANTED

INVENTORS Needing help with any problem, financial, development, securing manufacturer, obtaining patent. Write the organization that delivers action and results—not promises. Pioneer Inventions, 150 Broadway, New York 38, New York.

INVENTORS! Outright cash sale or royalties for your inventions. Patented. Unpatented. Constant demand from our client manufacturers. Write: United States Invention Brokerage, 78 Wall Street, New York 5, N. Y.

INVENTORS—Get the best offer first! Patented or unpatented. Write Carl Sommer, Director, Industrial Invention Sales, 3136-A Sylvania Ave., Toledo 13, Ohio.

INVENTORS' Complete service. Cash-royalties sales. Inventions researched. Patent development engineering. Free invention certificate. George Spector, Licensed Invention Engineer, 3615 Woolworth Building, New York.

INVENTIONS Wanted; patented, patent pending. 29 years experience promoting inventions. National Service Bureau, 3120 Meramec, St. Louis 18, Mo.

INVENTIONS Wanted now by my manufacturer clients. Patented. Unpatented. Write Gilbert Adams, Patent Broker, 80 Wall St., Financial District, New York City.

INVENTORS: Hundreds of manufacturers have requested our assistance in locating marketable new products. Complete information free. Institute of American Inventors, Dept. 40-D, 635-F St. N.W., Washington 4, D. C.

INVENTIONS Wanted. Patented; unpatented. Tremendous manufacturers lists. Global Marketing Service, 2420 77th, Oakland 5, California.

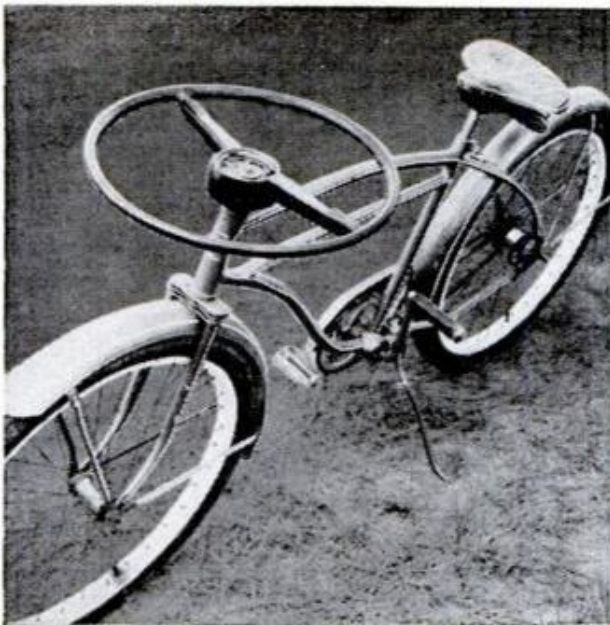

Look, No Handlebars!

Automobiles aren't the only vehicles on which the owner can lavish custom styling. Virgil Hannig, a teen-ager in Carlyle, Ill., was not completely satisfied with the effect he got by pin-stripe painting his bicycle so he gave a more personal, and custom touch to his wheel by substituting an automobile steering wheel for the handlebars. Friends queue up for rides, he says.

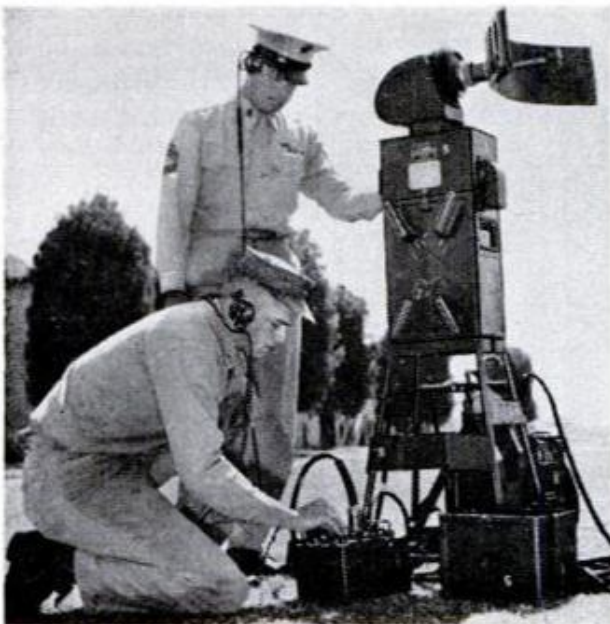

Radar Picks Up Footsteps

Movement as slight as a half-inch and as far away as 20,000 yards can be picked up on a portable, 250-pound radar set that a Marine Corps unit can set up for operation in 10 minutes. During amphibious landings, the equipment is placed in watertight containers, thrown overboard and towed to shore. Through earphones, a Marine can detect movements of vehicles or troops.

OCTOBER 1960

FAST DRAW!



Three times more fast draw shooting fun—safer, anywhere, at lower cost—with the Crosman Single Action 6, .22 cal. CO₂ gas-powered revolver. True action... authentic styling... real gun weight, feel

Ask your Crosman Select Dealer for a free demonstration.

WRITE Crosman Arms Co., Inc., Dept. PM-7, Fairport, N. Y.

CONCRETE BIRD BATHS AND OVER 250 OTHER MONEY MAKING ITEMS



You've seen them all over the country... concrete bird baths, garden seats, flower boxes, appealing statuary, and many other items that add charm around the house and lawn. They're made by enterprising people, just like you, from our COPYRIGHTED ALUMINUM MOLDS. It's easy. It's fun. It's profitable.

Send \$2.00 today for this 82-page "How to" book, 20 pages of clear instructions. Valuable trade secrets. Over 250 items beautifully pictured (with description, dimensions, and prices of molds). Rushed to you by first class mail.

CONCRETE MACHINERY CO., INC. HICKORY 2, NORTH CAROLINA

Name _____

Address _____

HOW TO
TURN
CONCRETE
INTO
GOLD

LOOK!
New!
Improved!



**POCKET-SIZE
BLOW TORCH**
only \$2²⁵

Now—solder, braze, fix leaks. Do wiring, plumbing, loosen frozen nuts and bolts, 1001 odd jobs. Butane gas blow torch gives intense 3500° pin point flame that lasts ½ hour, turns on or off. Extra "chargers" 49¢ for two. Send \$2.25, check or money order for Jet King Blow Torch with one charger, or send \$2.95 for complete soldering kit: Blow Torch, two chargers, soldering tip, roll of solder. Send coupon now! Money back guarantee!

Kidde Manufacturing Co., Inc., 1004 Farrand St., Bloomfield, N. J.

Send me _____ JET KING BLOW TORCHES @ 2.25 ea.*

Send me _____ JET KING SOLDER KITS @ 2.95 ea.*

Send me _____ Boxes of Extra Chargers @ .49 per box.

My check, _____ money order _____ for \$ _____ is enclosed
(*Add \$1.00 Extra per unit for Canada)

NAME _____

STREET _____

CITY _____

STATE _____



Convair Division, General Dynamics Corp., 3165 Pacific Highway, San Diego 12, Calif.

This Might Be the First Atomic Aircraft

Unconventional in both looks and source of power, an atomic aircraft is under study that could fly nonstop perhaps beyond the limits of the crew's endurance. Its swept-back wings have two conventional jet engines; the nuclear-powered engines are in

the tail. Another version has only the two nuclear engines. Stabilizers and rudders are on the wing tips, and the elevators near the nose. This canard configuration places the crew 100 feet from the atomic power plant. It's expected to fly 600 miles an hour.

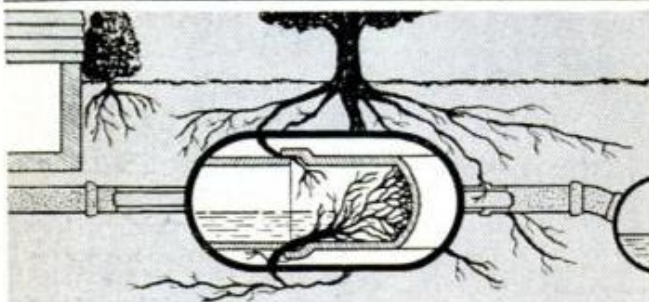

END SEWER-LINE ROOT MESS, SAVE ON COSTLY REPAIRS!

Roots are just naturally thirsty. They force their way through joints in your sewer line, eventually clog it. Toilets and sinks "back up", soon overflow. Now you can avoid costly digging or mechanical cleaning this easy, permanent way.



Pour one box of revolutionary Hercules R-D into toilet bowl. R-D kills and decomposes roots permanently, often overnight. To keep sewer lines root free, apply R-D twice a year. Safe to handle. Safe in septic tanks. Don't wait for trouble. Get R-D now from your plumbing or hardware dealer. It works, or your money back. Only \$3.95 for 2 lb. box. Send for literature.



HERCULES CHEMICAL CO., INC.
416 Broadway, New York 13, N.Y.

Always at your fingertips
LEWIS MAGNETIC OILER

A convenient dispenser for all oils—including cutting oils, for lathes, drill presses, milling machines. Sliding magnet holds it in any position. Unbreakable, squeeze any part of bottle for oil. Great for the home workshop **\$1.50** (postpaid)

Send check or money order to
R. B. LEWIS CO.
1473 Fulham St., St. Paul 8, Minn.

*After the city,
Before the state
The ZONE keeps your mail
From being late*



The Post Office has divided 106 cities into postal delivery zones to speed mail delivery. Be sure to include zone number when writing to these cities; be sure to include *your* zone number in *your* return address — after the city, before the state.

FINAL OFFER!



**FEW
REMAINING
SETS OF**

**POPULAR
MECHANICS**

FAMOUS DO-IT-YOURSELF ENCYCLOPEDIA

We think you'll find this the greatest treasury of do-it-yourself information you've ever seen.

12 volumes, 6 in. by 9 in.,
bound in gold-stamped grease-proof
Sturdi-Tan
2,970 pages with over
9,000 illustrations in an
Imported maple book rack

Information straight from Popular Mechanics Magazine, carefully detailing every step necessary for success in almost every home, hobby, shop, sport or travel subject.

This offer is made on the final few sets of this edition. It will be many months before a revised edition is published. We cannot guarantee that our small supply will meet the demand and we reserve the right to return your money if the sets are sold out by the time we receive your order; first checks received will get the few remaining sets.

Please act at once if you want this encyclopedia at this bargain price.

This offer carries a money-back guarantee if upon receipt of the set you find it does not live up to your expectations.

Send JUST \$17.95

Cash, check, or money order

POPULAR MECHANICS, Dept. PA 9
250 W. 55th Street, New York 19, N. Y.

Please send me _____ set(s) of POPULAR MECHANICS DO-IT-YOURSELF Encyclopedia, including my free imported wooden book rack for it. I understand that if I am not satisfied, I may return it within 7 days.

Name

Address

City..... State



22 cal. rim fire MAGNUM RIFLES

Bolt action, 5-shot clip repeaters—and a single shot—made specifically for the new, powerful, 22 caliber rim fire magnum cartridge.

**Deluxe
Model 640KS \$49.95**

Custom grade, selected walnut stock, hand checked. Gold-plated trigger, front sight and rear sight elevator.

**Standard
Model 640K \$39.88**

**Single shot
Model 620K \$28.88**

The new varmint rifles everyone's talking about. High velocity, flat trajectory. At your dealer's.



FREE CATALOG

O. F. MOSSBERG & SONS, INC.
9710 ST. JOHN ST.,
NEW HAVEN 5, CONN.

Mossberg
for accuracy

NOW! ACCORDIONS

UP TO 1/2 OFF retail prices of comparable accordions...



IMPORTER TO YOU!

Buy DIRECT from World's Largest Dealer. Compare our low Importer-to-You prices... see how much you save! All famous Italian makes... over 30 models... latest features, new colors! Small down payment—amazingly E-Z terms. 5-day FREE Playing Trial. 100% customer satisfaction assured. Free Bonus Gifts for promptness. Trade-ins welcomed—free appraisal. Rush coupon for new color catalogs. No obligation. Write

ACCORDION CORPORATION OF AMERICA
2003 West Chicago Avenue
Dept. R-100 - Chicago 22, Illinois

**5 DAY
FREE TRIAL**

ACCORDION CORPORATION OF AMERICA
Dept. R-100, 2003 W. Chicago Avenue, Chicago 22, Illinois
Rush Color Catalogs and "Importer-to-You" prices on famous-make accordions... FREE.

NAME.....

ADDRESS.....

CITY..... Zone..... STATE.....

1961 OUTBOARDS-



NEWEST OF THE NEW MOTORS for '61 is the West Bend Tiger Shark 800, above right, a tall, four-cylinder in-line rated at 80 horsepower. Its introduction gives West Bend the broadest horsepower range in the business, with motors rated at 80, 40 (above center), 25 (above left), 18, 12, 7½, and 2 horsepower. Two innovations in the line are a full year's warranty on all motors and no fuel tank, so the customer can pick either the six or 12-gallon tank or none if his tanks are built into his boat (the motor prices are cut accordingly). And the little two-horse "Shrimp" features an unbreakable nylon prop

JOHNSON MOTORS' Super V-75A for next year features many refinements led by a transistor-regulated a.c. generator rectified to convert to d.c. to operate all sorts of electrical accessories—ship-to-shore phone, depth finder, refrigerator, lights, or even a baby bottle warmer. Other developments are fixed high-speed carburetor jets, new remote controls, improved soundproofing, permanent power cable connections, starting in gear at low speeds, and panel lights

SCOTT'S BIGGEST, the Flying Scott, remains the smallest and lightest motor in its power range—engineering improvements raise the horsepower of the '61 model from 60 to 75.2 with no increase in weight. With a carburetor on each of the three cylinders, it gives faster acceleration, but a 15 percent fuel saving over last year's Flying Scott. Scott de-emphasizes horsepower by removing numbers from their hoods, but motors rate at 75.2, 43.7, 27.7, 14.1, 7.5, and 3.6

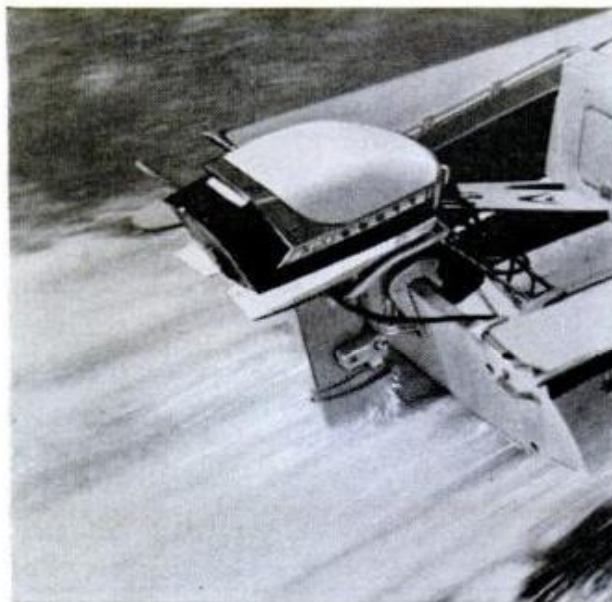

THE BIG KICKERS

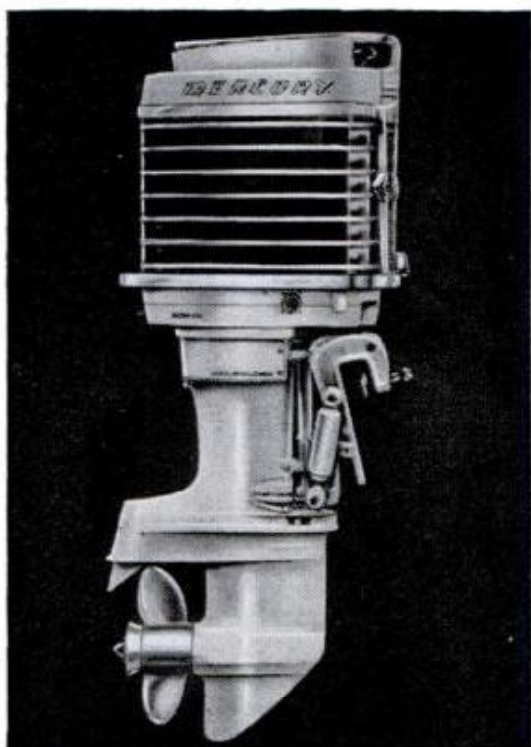

Here's a look at the future for big outboard fans—the leaders from the "big six" manufacturers for next year...

BIG NEWS AT THE KIEKHAEFER CORP. is a full forward-neutral-reverse gearshift on their six-cylinder Mercury motors, the 80-hp. Merc 800 (left) and 70-hp. Merc 700. (The old direct-reversing models, preferred by many experienced outboarders, remain in the line). Also new are the 50-hp. Merc 500, 40-hp. Merc 350, and an entirely new fishing motor, the 6-hp. Merc 60. Others in the line are the 45-hp. Merc 400, 22-hp. Merc 200, and 9.8-hp. Merc 100. Accessories, like a choice of ten props for some motors and remote controls for all motors, offer the industry's widest choice of options

EVINRUDE'S new shroud, created by designer Brooks Stevens for sound control, has no flat "talking surfaces" and no abrupt angles, plus a new sound-absorbent material inside, so their quiet 75-hp. Starflite III is even quieter. Other features include fixed-jet carburetion, a.c. generator that charges at idle speed, dash-panel warning lights, and others. Other motors in the line rate at 40, 18, 10, 5½, and 3 hp.

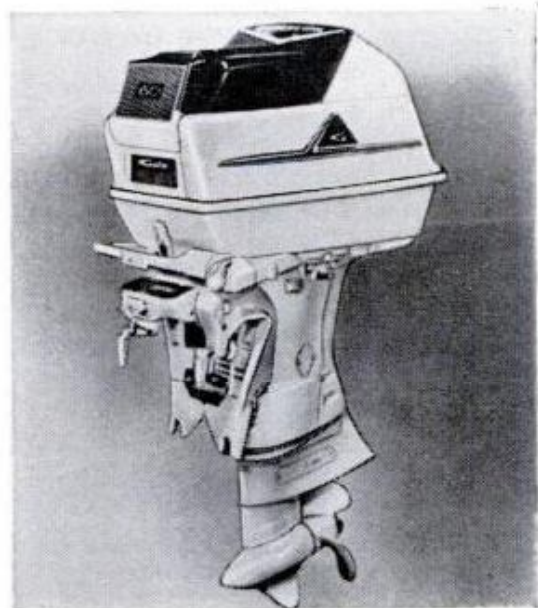
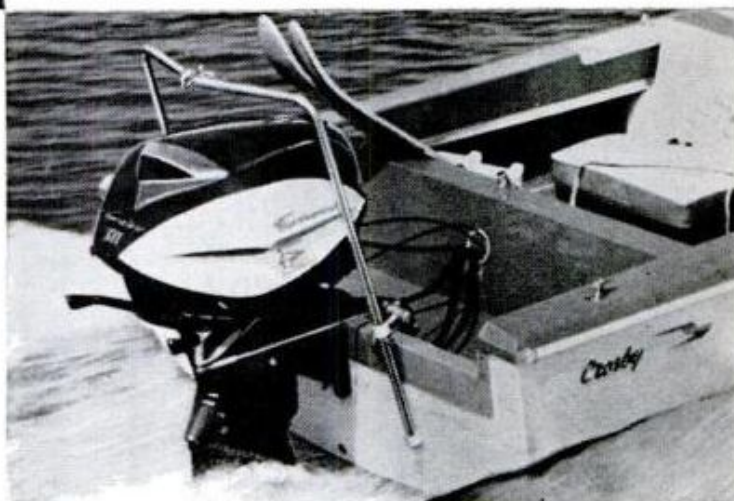

GALE'S '61 line features styling and engineering changes—the most noticeable will be the addition of bright "Buccaneer Orange" as highlight color on the Buccaneer models (40, 25, 15, 5, and 3 horsepower), and new "Mariner" styling on the whole Gale Group. The big Sovereign motors, the 60 (left) and 40 Electric, feature quick-disconnect electrical systems for easy installation and service, the advanced "torpedo" lower unit with a new half-spoon sized exhaust to reduce water disturbance, and the universal-type motor mounting bracket, cast in one piece and adaptable to any transom



DURO-PLASTIC® MENDS EVERYTHING!

but a **BROKEN HEART**
and **THE CRACK OF DAWN**
(Well, just about everything)

You've got a fix-it problem? DURO-PLASTIC has the answer. DURO-PLASTIC ALUMINUM, PLASTIC RUBBER, PLASTIC PORCELAIN REPAIR, Liquid STEEL, rust REMOVER, LOCK-it, E-POX-E GLUE . . . and others in tubes and cans. Available at all better hardware, automotive, paint and variety stores.

In \$1.00 and 59c sizes (in Canada \$1.29 and 69c)



WOODHILL CHEMICAL CO. Cleveland 14, Ohio
IN CANADA: 840 Montee De Liesse Road, Montreal 9, Quebec

INCREASE HOME VALUE-MAKE NEEDED IMPROVEMENTS NOW

ELECTRIFY PLAYER PIANOS
PUMP ORGANS

YOU CAN QUICKLY END TIRESOME FOOT-PUMPING
With a Compact Low-Cost Lee Silent Suction Unit



EASY TO INSTALL
FULLY GUARANTEED
1000'S IN USE

write to
LEE MUSIC MFG. CO.
Box 595, Tujunga, Calif.



18 FT. CRUISER KIT



FREE CATALOG

MASS PRODUCTION
MAKES THESE PRICES POSSIBLE
EASY TERMS

With one-piece, ventilated fiberglass cabin. FROM **\$520** Freight Prepaid

TAFT MARINE WOODCRAFT
Dept. PM-1060, 636 39th Ave. N.E., Minneapolis 21, Minn.

1,000,000 have sent for it!



Mail
Coupon
for
Your

SAVE
on over
30,000
famous-make
items

FREE

**1961 Electronics
CATALOG**

plus full year's FREE SUBSCRIPTION to
all other Radio Shack catalogs!

See the latest and best in electronics

- Stereo
- Hi-Fi
- Ham Radio
- Transistors
- Test Equipment
- Kits & Parts
- Related Items

Radio Shack Corp. Dept. 60K3
730 Commonwealth Ave., Boston 17, Mass.

Send latest Electronics Catalog plus
every new issue for one year, FREE.

Name _____

Address _____

Post Office _____

or City _____ Zone _____ State _____

SUBSCRIBE TO

**POPULAR
MECHANICS
MAGAZINE**

SAVE UP TO \$2.40!*

Don't miss a single one of the great
issues to come. *Subscribe and be sure!*

MAIL THIS COUPON NOW!

POPULAR MECHANICS, Dept. PM-1060
200 East Ontario St., Chicago 11, Illinois

Please enter my subscription to POPULAR
MECHANICS Magazine for:

- ONE YEAR \$3.50** (Saving me 70c*)
 TWO YEARS \$6.00 (Saving me \$2.40*)

Please enclose remittance in full.

Name _____ Please Print

Address _____

City _____ Zone _____ State _____

*All savings based on single-copy price

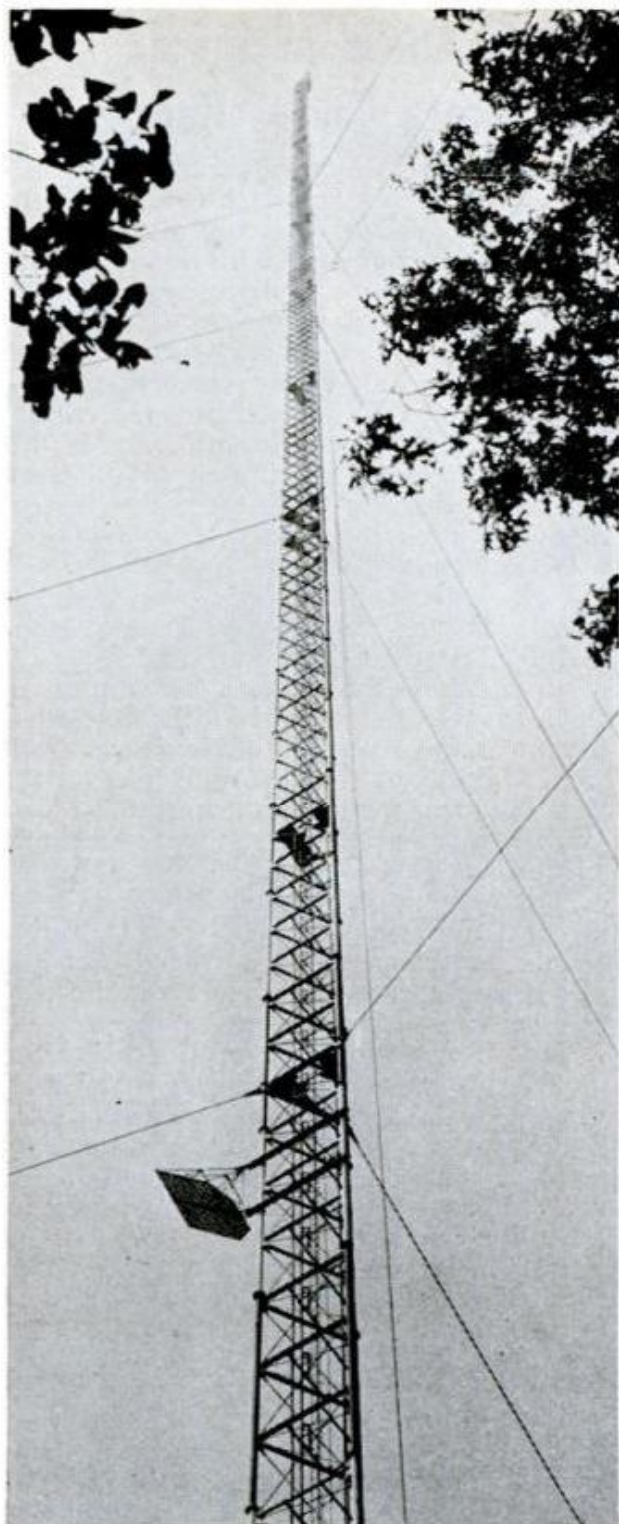

Mighty Tall Tower

Up, up, up—the television tower of Station KFVS, Cape Girardeau, Mo., reaches 1676.55 feet into the sky. It is 204 feet taller than the Empire State Building, the world's tallest building. The new tower is constructed of nickel-alloy steel in 30-foot triangular sections and stands on a concrete base supported by 18 guy cables. Weight of tower and guys exerts two-million pounds of pressure on the base, or a pound for each person in the six-state area who now receive KFVS' programs.

OCTOBER 1960



AT LAST...
**A PROFESSIONAL
 MODEL MAKERS
 POWER TOOL only \$4.95**

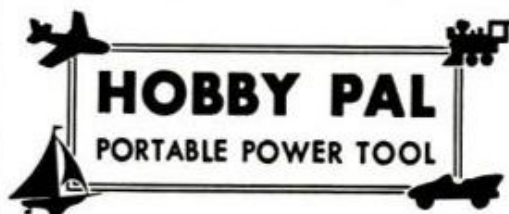

*precision built for professional
 results... simple and safe—*
DRILLS—SANDS—REMOVES FLASH

Never before a power tool so perfect for model building... never before a power tool priced so right. Only Thompson Designs could bring you this precision-built professional model makers power tool... and, for just 4.95. The X-2 motor is specially designed for maximum torque, and maximum battery life... Hobby Pal is a must for everyone who takes pride in his models. Get yours at your favorite hobby shop!



another fine product manufactured and guaranteed by
THOMPSON DESIGNS, Inc.
 3550 MARTENS ST., FRANKLIN PARK, ILL., U.S.A.

EASTERN REGIONAL SALES OFFICE
 303 FIFTH AVE. • NEW YORK CITY

patent no. 2,861,578

made in U.S.A.

Meat-in-the-freezer favorite!

Marlin Micro-Groove Model 336 "Texan"

In a choice of brush-cutting calibers (.30-30 and .35), this western-style carbine puts down deer, black bear and elk for keeps! The straight grip permits fast draw from a saddle scabbard.

Like all Marlin rifles, this rugged game-getter has Micro-Groove Rifling, an exclusive Marlin advantage that gives up to 25% better accuracy!

You save \$10 when you buy the Model 336 and Marlin Micro-Power Hunting Scope "combo." In 2½X or 4X, this quality scope has coated lenses, eye shade, positive click adjustments with weatherproof caps. Receiver is drilled and tapped for easy mounting — all mounts included.

All Marlin Model 336 high-powers have these quality features: 6- or 7-shot tubular magazine; solid-top receiver with automatic side ejection to permit low scope mounting; 2-piece firing pin prevents firing before gun is fully cocked; gold-plated trigger; drilled and tapped for Marlin Micro-Power Hunting Scope or Lyman 66LA peep sights; blued steel barrel made of Special Analysis Ordnance Steel with crowned muzzle; stock of high-grade walnut with special weather-resistant finish.

Priced at \$82.00, only \$8.00* down, with 4X Marlin scope, \$121.95, only \$12.00* down.



Marlin Firearms Co., New Haven, Conn., Dept. G-10

Please send me the new 90th Anniversary Marlin illustrated catalog in full color, plus illustrated booklet on telescopic sights. I enclose 25¢ to cover handling and mailing.

NAME _____

ADDRESS _____

CITY _____ ZONE _____ STATE _____

Prices subject to change without notice

*Under Marlin Pay-Later Plan

Who's Ahead in Space? It's Like a Caucus Race

In "Alice in Wonderland" the Dodo tells Alice about a race in which everyone runs around in circles, starting or stopping whenever they choose, with no real beginning or end. And everybody wins.

The race for space resembles a caucus race. It began Oct. 4, 1957—when Russia launched Sputnik I—but since then it's a little confusing. The contestants (satellites) are all going off at different times in different directions, all aiming at different goals and using different means (instruments) of reaching them.

Who's ahead?

Well, everybody is, so everybody is equal. But, as they say in Russia, some people are more equal than others.

Russia certainly was first in some areas, the first satellite (Sputnik I), the first satellite to carry something alive (Sputnik II with Laika), the first satellite to orbit the Sun (Lunik I), the first to hit the Moon (Lunik II), and the first to produce pictures of far side of Moon (Lunik III).

But we're ahead, too, and perhaps even more ahead than others.

Our satellites have:

Discovered radiation belts around Earth, perhaps most important discovery to date.

Used Sun's rays as source of indefinite power. Vanguard I, which may orbit 1000 years, is still sending signals with its solar battery nearly three years after launching.

Discovered Earth is pear-shaped.

Made first pictures of Earth from space. Studied weather, sending back thousands of pictures of world's cloud cover.

Set up navigation signals for ships, a forerunner of world-wide navigation system.

Detected missile launchings from Earth, a forerunner of defensive satellites.

Broadcast first voice messages from space, using both active (sending) and passive (echoing) satellites, forerunners of world-wide communication systems.

Recovered first satellite from orbit, a forerunner of what must be done with manned space ships.

And made additional studies of Earth's magnetic field, environmental conditions in space, solar X rays and cosmic rays, all preliminaries to successful space travel.

Beginning next month, to bring some order out of this apparent chaos, PM's space writer, Dr. Dan Q. Posin, will focus his "Eye on Space" column on the satellites and explain their significance. His series may help make up your mind about who's ahead in this race for space.



This is the charming Wiechec residence in Plymouth Meeting, Pa., newly protected with Sun-Shield Aluminum Roof Coating, made by Monsey Products Co., Philadelphia 29, Pa.

FRANK WIECHEC BRUSHED ON SUN-SHIELD COLORED ALUMINUM COATINGS—SAVED 80% OF THE COST OF A NEW ROOF



Frank Wiechec, Trainer
Philadelphia Phillies

Frank Wiechec, famous trainer for the Philadelphia Phillies and the Eagles, reports he found out three things about Sun-Shield Colored Aluminum Coating. *One*, it stopped troublesome leaks in his roof. *Two*, it saved 80 per cent of the cost of a new roof—he did the job himself. And there was an extra dividend—Mr. Wiechec says the second floor was noticeably cooler this past summer after Sun-Shield was applied.

Mr. Wiechec, who reports coverage of more than 100 sq ft per gallon, has discovered the easy, economical way to weatherproof *and* beautify any property. Made with ALCOA® Pigments, an aluminum coating like Sun-Shield seals roofs, protects against surface deterioration, extends property life.

There's a choice of harmonizing, fadeproof colors that stay new-looking for years. In fact,

weathering actually intensifies the colors. And reflective aluminum turns back much of the sun's heat, helps keep interiors cooler in summer.

Ideal for composition, asphalt shingle, slate, tile, tar paper roofs . . . brick, masonry, concrete or metal siding. Apply with brush or squeegee. Ask your dealer for Sun-Shield or one of the other fine colored aluminum brands made with ALCOA Pigments.

ALCOA does not make roof coatings, but we will be happy to refer you to reputable manufacturers who do. Send coupon for our booklets.

Aluminum Company of America
1748-K Alcoa Building, Pittsburgh 19, Pa.

Please send your free booklets:

- Painting With Aluminum In Color*
 Aluminum Roof Coatings Make Time Stand Still

Name _____

Address _____

City _____ Zone _____ State _____



For exciting drama watch "Alcoa Presents"
every Tuesday evening—ABC-TV

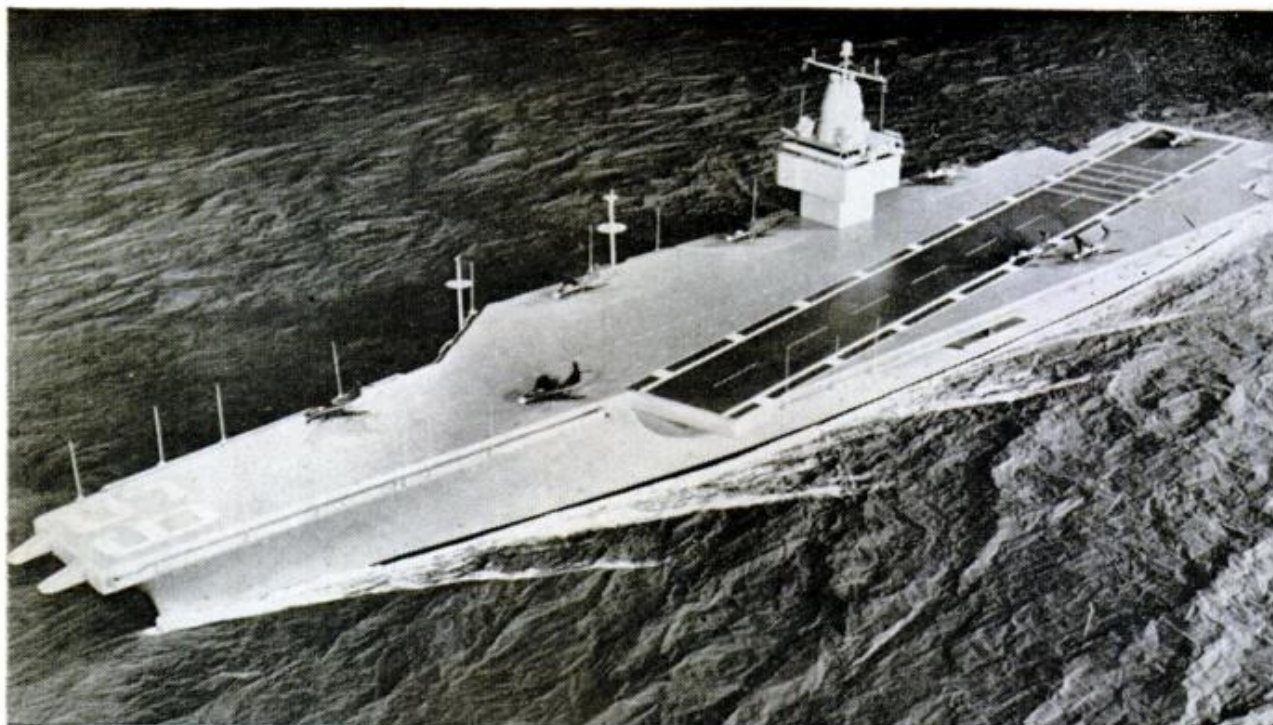

Nuclear Supercarrier Hits the Water

Largest ship in the world, and the first nuclear-powered aircraft carrier, the USS *Enterprise* was launched last month in Newport News, Va. The flight deck is 1100 feet long and 252 feet wide, and can handle takeoffs and landings at the same time,

making the 86,000-ton supercarrier a mobile air base. Its eight nuclear reactors can operate for five years of normal service use on their first charge of fuel, and can drive the ship at 30 knots for practically unlimited periods.



WHEN LOAD IS MORE THAN SPRINGS CAN BEAR.. SIMPLY ADD A LITTLE AIR!

ADD AIR TO YOUR TIRES, AND YOUR AIR LIFT OVERLOAD AIR SPRINGS TO LEVEL THE LOAD AND BALANCE YOUR CAR — (in 10 Seconds)

Only AIR LIFT Overload Air Springs give you Completely Adjustable Help!
NO-STEEL-OVERLOAD-SPRING-CAN-DO-THIS

Air Lift Air Controlled Springs will absorb the impact of chuck-holes and bumps. You'll N-E-V-E-R hit bottom again. *Air Lift Air Springs for Cars & Trucks*



Low As
\$26⁹⁵



Free Booklet HOW TO OVERLOAD SAFELY Write Dept. 410

AIR LIFT COMPANY

LANSING, MICHIGAN

In Canada 18 Hook Ave. Toronto 9 Ontario

What a
Difference
a Fact
Makes!



One simple fact about the world's shape opened a whole new phase of history ...

One small formula ($E=MC^2$) has unleashed more energy than man has ever known ...

Our history books are full of great events—which were triggered by a single fact ...

This is true of magazines, too ...

Just a few facts about the buyers of this magazine tell an advertiser much of what he can say—and how he should say it—to multiply sales.

Other facts tell the editors what to include in the magazine ... and what to omit.

How can the advertisers, the editors, and *you* be sure of the facts about a magazine?

The answer is as easy as A.B.C.

The Audit Bureau of Circulations actually verifies the circulation figures of member publications like this one you're reading. They make sure that circulation figures ... and reports of magazine subscription offers ... are accurate and dependable.

The Audit Bureau of Circulations sets high standards for its member publications. Honest, and square dealing, earn this A.B.C. Seal. Look for it; it's your guarantee of a *quality* publication.



TRIPLE!

ALLIED
MONEY-SAVING 1961
ELECTRONICS CATALOG

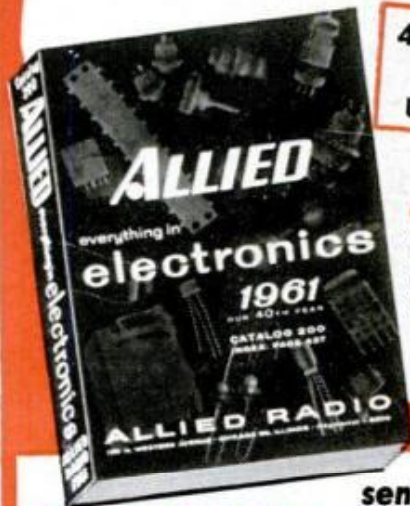

**444-PAGES
COMPLETE
UP-TO-DATE**

ONLY \$2 DOWN
on orders up to
\$50; only \$5 down
up to \$200; \$10
down over \$200

send for it today!

Largest Selection—Lowest Prices

Send for the leading buying guide to everything in Electronics, including products available only from ALLIED. Builders, experimenters, hi-fi fans, Amateurs, servicemen, engineers—save most on:

- KNIGHT-KITS®—Best in Build-Your-Own
- Everything in Stereo High-Fidelity
- KNIGHT® Super-Value Stereo Hi-Fi
- Tape Recorders & Phono Equipment
- TV Tubes, Antennas, Accessories
- Parts, Tubes, Transistors
- Everything in Tools & Technical Books
- Amateur Station Equipment
- Citizen's Band 2-Way Radio
- Public Address & Paging Systems
- Latest Test & Lab Instruments



SAVE on everything in Electronics at ALLIED. Get every buying advantage: fastest shipment, expert personal help, easiest-pay terms, satisfaction guaranteed or your money back. Send today for your value-packed, **FREE 1961 ALLIED Catalog.**

YOU CAN DEPEND ON THE WORLD'S **our 40th**
LARGEST ELECTRONIC SUPPLY HOUSE **year**

ALLIED RADIO

**SEND FOR
FREE
CATALOG**

**ALLIED RADIO, Dept. 5-K
100 N. Western Ave., Chicago 80, Ill.**

Rush **FREE 1961 ALLIED Catalog**

Name _____

Address _____

City _____ Zone _____ State _____

Your '61 MERCS are here!

MERC 800—80 hp six

MERC 500—50 hp four

MERC 60—6 hp twin

The motor that
started it all
...leads them all

MERCURY

world's No. 1 outboard!

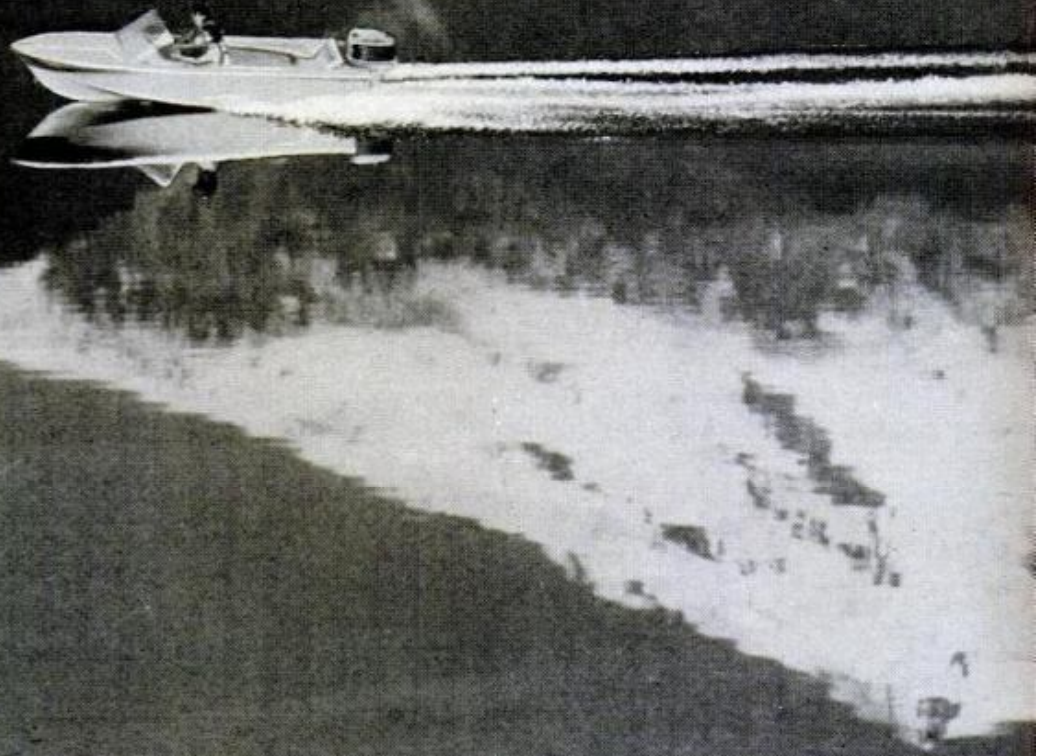
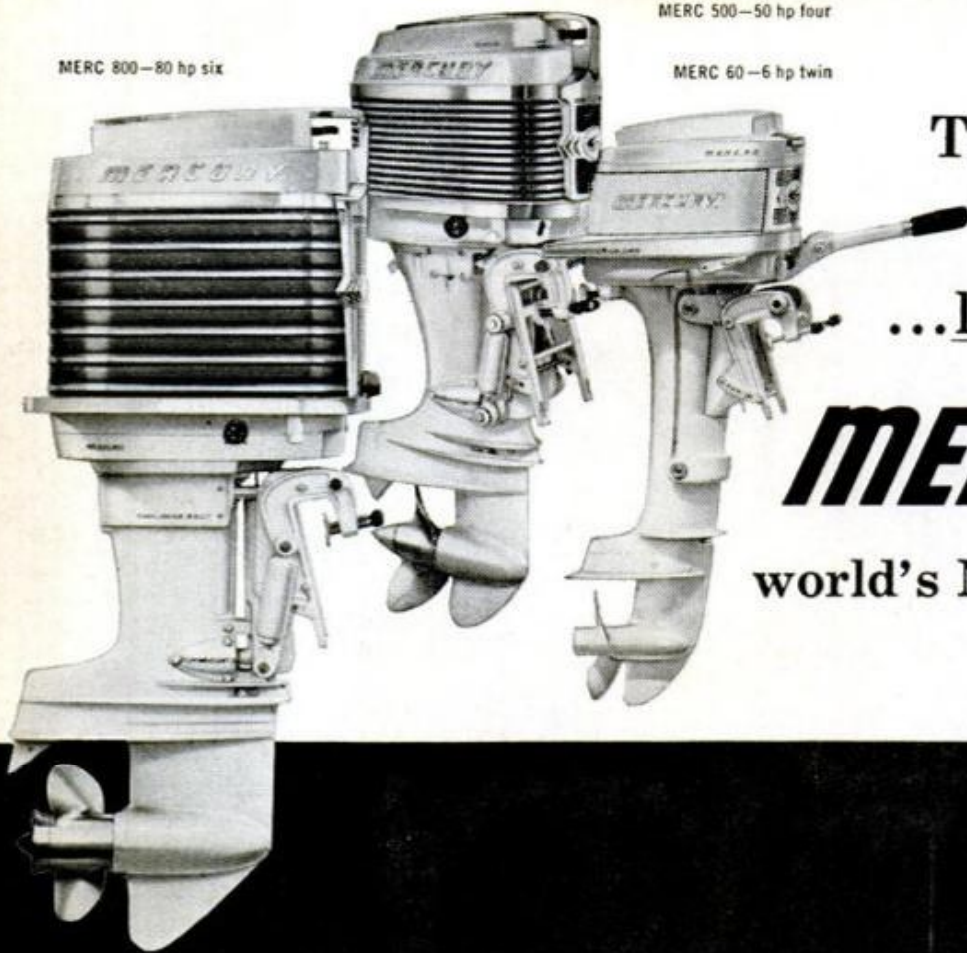

Only 12 years ago Mercury introduced the 10 hp "Lightning" It blazed a new trail for the outboard industry, sparked a family recreational revolution, cracked the inboard monopoly in cruising and skiing power.

The industry's old heads had dismissed the idea of family outboarding, or of a market for motors larger than 7½ hp, when Mercury's "Lightning" struck its new concept: (1) More power, not less; (2) More compactness, less weight and bulk; (3) More durability, with slower-moving, smaller, tougher reciprocating parts; (4) More advanced engineering, using proved aircraft and automotive design principles. Mercury leadership helped boat builders design roomier, safer boats to make family outboarding a reality . . . helped to make water skiing a national sport.

Today, other outboards have "caught on" to Mercury's concept—but they haven't caught up! The motor that started it all, leads them all! See 1961 Mercury and you'll know why.

One lever, one hand, controls throttle and shift with running neutral in every horsepower class—6 to 80 hp! Exclusive with Mercury!

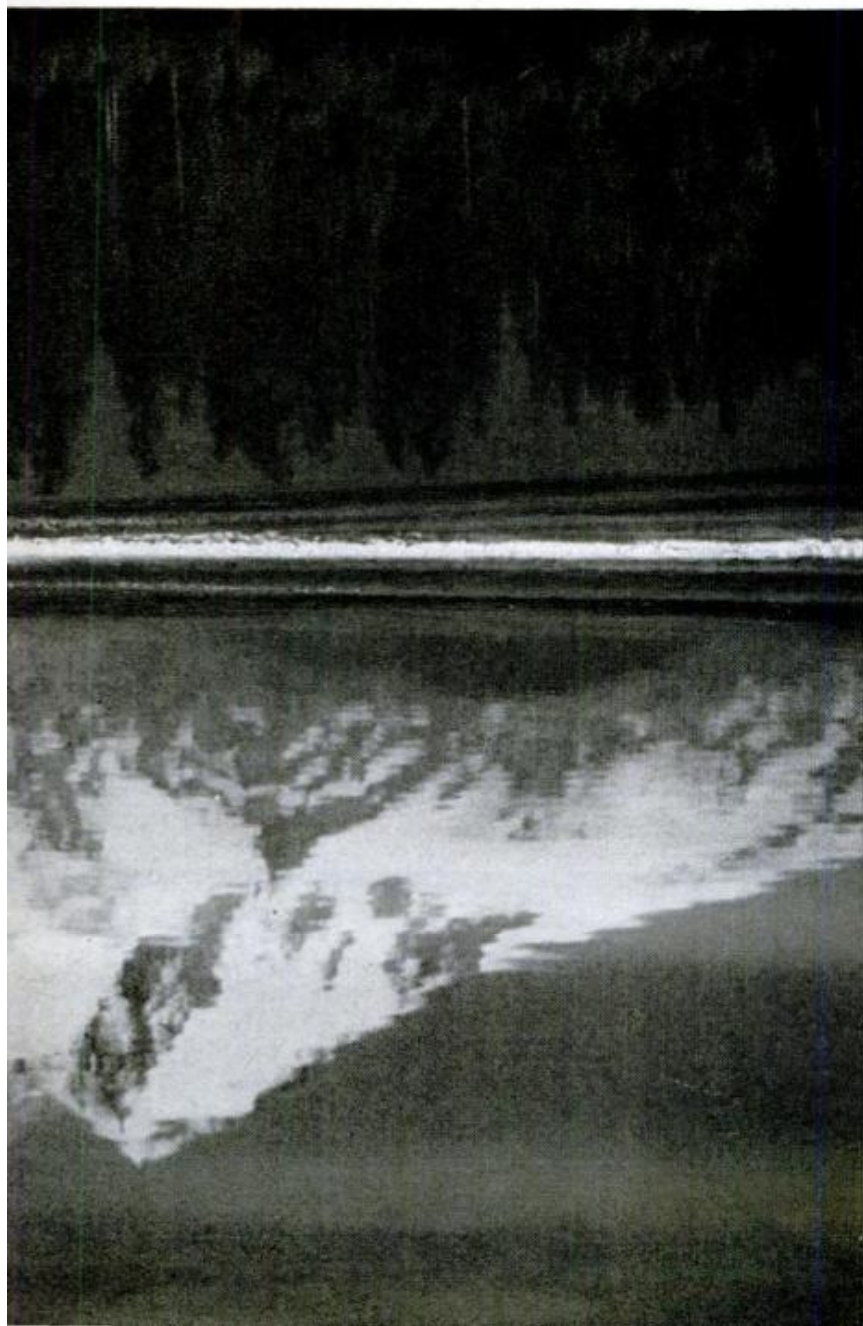

All new for '61

80 hp MERC 800

WITH FULL GEAR SHIFT AND SIX CYLINDERS

50 hp MERC 500

MOST POWERFUL IN MERC 4-IN-LINE HISTORY

6 hp MERC 60

MOST ADVANCED OF ALL FISHING TWINS

Exclusive Mercury 6-in-lines—80 hp Merc 800, 70 hp Merc 700.

World's most powerful family outboards! Choice of two single-lever power control systems: full gear shift lower unit, for those who prefer running neutral; Mercury's exclusive direct-reversing engine, which eliminates shifter clutch, reverse gear and shift mechanism from lower unit. Sixes feature: Jet-Prop drive fires exhaust gases through propeller hub, improves performance, submerges sound and fumes; economy throttle linkage yields up to 50% more mileage at cruising speed; shock absorbers minimize impact effects of submerged or floating obstacles. The auto industry trend is to 6-cylinder-in-line engines for economy, light weight, compactness; in outboards, *only* Mercury builds sixes!

Exclusive Mercury 4-in-lines—50 hp Merc 500, 45 hp Merc 400, 40 hp Merc 350.

Outboarding's most proven fours start you water skiing and cruising! Full gear shift with running neutral, single-lever remote control. Shock absorbers available on Merc 400 and 500 to increase outboarding safety. One of the best outboard buys ever!

Exclusive Mercury Glide-Angle Twins—22 hp Merc 200, 9.8 hp Merc 100, 6 hp Merc 60.

Automatic transmission (Merc 200 and 100) combines forward-neutral-reverse shifting with twist-grip throttle. All-new Merc 60—lightest fishing motor for its performance—has full gear shift with forward-neutral-reverse lower unit. Twins feature: slanted design glides over rocks, through weeds; Jet-Prop drive; single-lever remote control, Ride-Guide steering available. The Merc 60 is the most modern of light outboards . . . a real honey!

Write for FREE CATALOG

©1960

Kiekhaefer Corporation
Fond du Lac, Wisconsin



Why every home needs all 3 . . .



LUFKIN MEZURMATIC® TAPE RULE. Zip it out smoothly and measure curves, around corners, or straight up! Automatic; touch-control blade. Press to retract, release to stop. Easy to read markings on exclusive *White Clad®* steel blade. 6, 8, 10, and 12-ft. lengths. 12-ft., \$2.29.

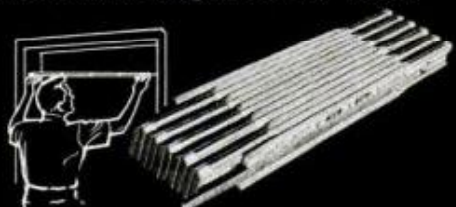

LUFKIN RED END® WOOD RULE X46. Hang a picture, hang a door, or measure *inside* a cabinet drawer. Carpenters' favorite! 6" brass extension for hard-to-get-at measuring. Sturdy hardwood, rustproof, riveted joints. Bold, black markings imbedded in wood, plastic coated. 6-ft., \$2.50.

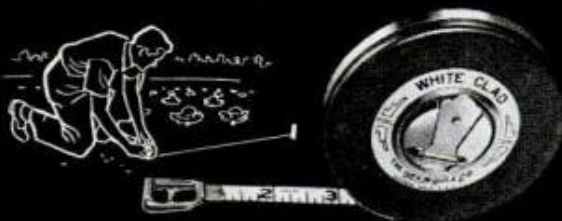

LUFKIN BANNER® 50' TAPE. Perfect for fast, accurate *long-distance* measuring, in home, garage or yard. Hook folding end here, read line there — without help! Bold, black markings on exclusive *White Clad®* steel line. Glides easily on double rollers. Vinyl-covered steel case. 50- and 100-ft. lengths. 50-ft., \$5.49.

Leading hardware and building supply stores feature Lufkin . . . measure for measure, the finest made

LUFKIN

SAGINAW, MICHIGAN

Spotlight on the **TRIUMPH HERALD**

By Jim Whipple

IF YOU ENJOY driving a sports car like an MG, Triumph TR-3, or Austin Healey, you've probably wondered if the trigger-quick handling and rocklike roadability of these nimble two-seaters could be incorporated in a four-passenger sedan with roll-up windows and a really useable trunk.

Family cars from Europe and Detroit are getting nearer to this ideal every year, but the closest yet for my money is a new economy car called the Triumph Herald. This intriguing two-door sedan is manufactured in England by Standard Triumph Motor Company, Ltd., maker of the justly famous TR-3 sports roadster.

A few other European manufacturers turn out four and five-passenger sedans of near sports-car capabilities, but all are at least twice the Herald's modest price of \$1849 delivered at Eastern, Gulf and Midwest ports.

To those who are familiar with the boxy little Triumph four-door sedan that formerly shared salesrooms, but not sales figures, with the TR-3, I hasten to add that the Herald is an entirely different car. It's a fresh design from its rubber-sheathed bumpers—how considerate can you get?—to the crisp contours of its roof line.

Although the Herald is a small car (you might call it a "supercompact") it is by no means in a class with desperately cramped "mini-cars" put out by motor-scooter factories with "big ideas." The Herald is a full, four-passenger car with a respectable 91½" wheelbase, over-all length of 153 inches and a robust weight of 1820 pounds.

Clues as to the nature of the Herald come from the land of its origin and the experience of its maker. It is an economical car

(Continued to page 94)



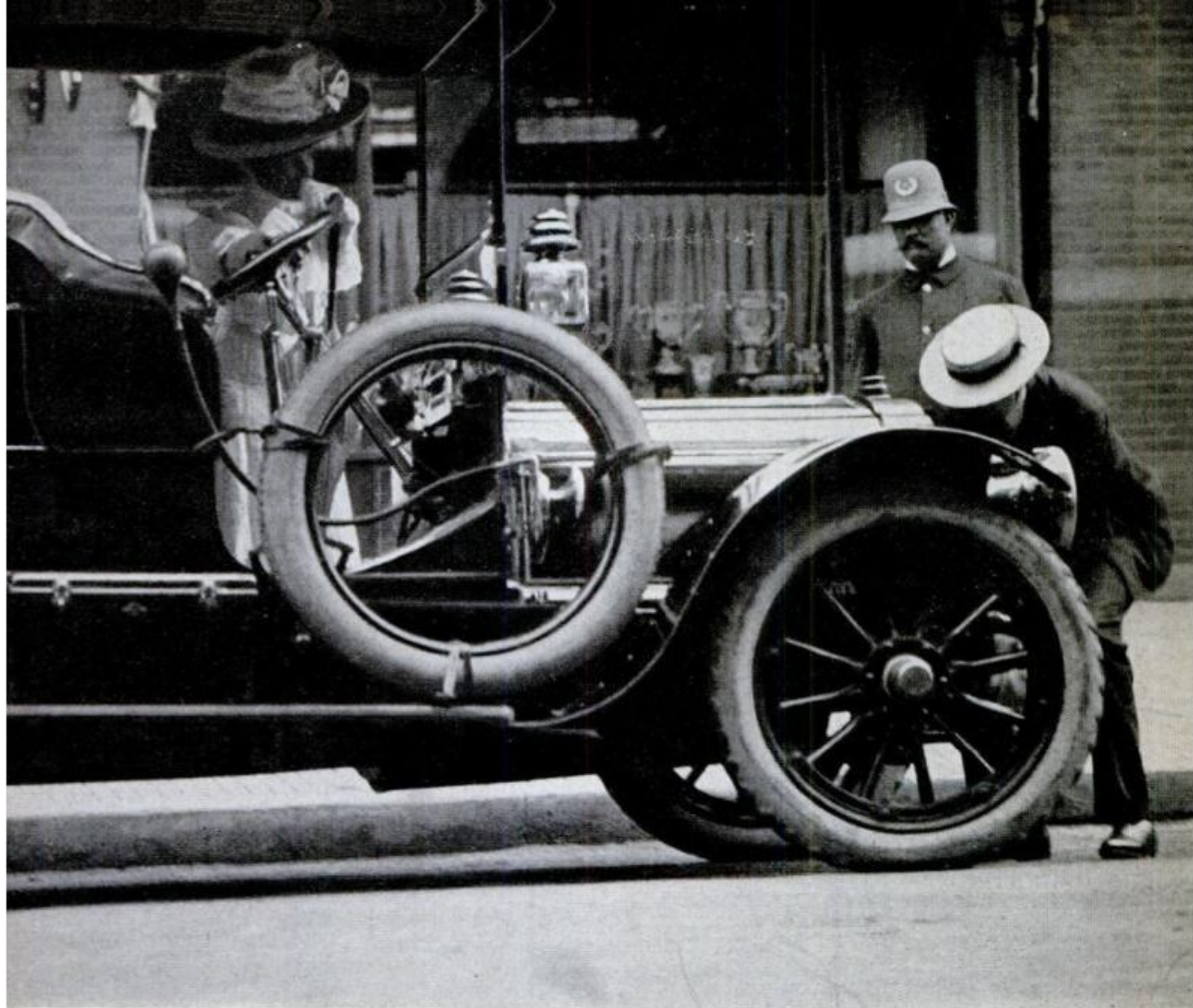

What torque really means

When grandfather cranked his car, he was applying torque. Torque is simply the twisting effort such as you apply when turning a door-knob.

Grandfather applied torque by pushing down on a crank. (Pulling up was far safer, since it avoided a possible kick-back and a broken arm.) In either case, the torque he generated could have been measured by multiplying the *pounds* of his force on the crank-handle by the length of the crank-arm in feet. Unless grandfather was very husky, his torque probably didn't amount to more than 50 *pounds* times 1 *foot* or 50 *pound-feet*.

Torque is important to you because it, and not horsepower, actually starts your engine and moves your car. Explosive forces

on the pistons of your engine are transmitted by the connecting rods to the crankshaft cranks which generate torque on that shaft. But the largest 1960 passenger car engine generates only 470 pound-feet of torque, which is still not enough to move a stationary car. However, the transmission and differential are able to increase engine torque six or seven times. The rear wheels then convert it into powerful traction at the road surface which reacts to propel the car.

To develop maximum torque, your engine needs 100% Climate Controlled Texaco gasoline—either Texaco Sky Chief Supreme or regular-price Texaco Fire Chief. Drive with more pleasure and save for good measure with Texaco.

Buy the best...buy TEXACO

TUNE IN: TEXACO HUNTLEY-BRINKLEY REPORT/MONDAY THROUGH FRIDAY/NBC-TV



AUTOMOTIVE MECHANICS

be your own boss...
EARN \$30 OR MORE A DAY

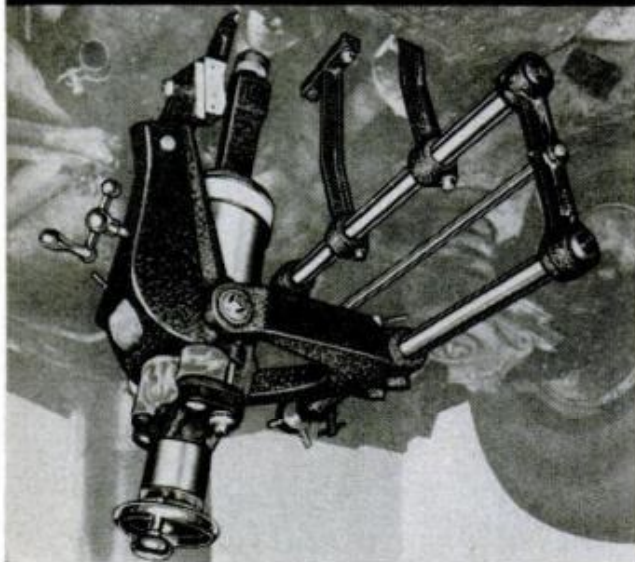

WITH A SUNNEN PORTABLE CRANKSHAFT GRINDER

Many Sunnen Grinder Operators make as much as \$75 a day with this heavy-duty precision machine.

These specialists use the Sunnen Grinder because it's the fastest cutting, most accurate and easiest to operate.

Built-in precision controls guarantee factory accuracy of roundness, straightness and alignment of journals.

Grinds all throws with one set-up! Cup wheels need no truing, grind full width of journal with each pass.

Range: ¼" to 7" journal dia.

Why not get into this profitable business yourself?
Write for complete information now.

SUNNEN®

7954 Manchester Ave. • St. Louis 17, Mo.
Canadian Factory: Chatham; Ontario

A104 R



appealing to buyers in countries where gasoline is very expensive. Thus the small (57-cubic-inch displacement) four-cylinder engine.

This willing little powerplant rolled our test Herald along at 70 m.p.h. with a payload of 400 pounds. On a trip, cruising at 65 m.p.h. for 180 out of 200 miles, gasoline consumption was 30 miles per gallon.

The Herald's designers also had Britain's narrow, winding roads in mind when they packed much of their TR-3's flat cornering and pitch-free stability into the car. These qualities help the Herald's driver maintain a very respectable average speed with as little slowdown as possible on sharp curves.

And yet at the same time Standard-Triumph engineers designed a suspension system that's unusually comfortable on rough-surfaced roads. This makes the Herald one of the top economy choices in countries which lack the smooth-surfaced roads of Britain.

One big reason for the Herald's comfortable ride is the independent rear wheel suspension, similar in principle to that of the tremendously popular Volkswagen and Renault Dauphine.

For secure, near effortless control and nimble action the Herald has rack-and-pinion steering.

The result of this chassis design is a car that gives you much of the roadability and control of the TR-3 sports roadster yet at the same time provides a remarkably bounce-free ride for a small family sedan.

Small though it may be, there's a great deal of useable passenger room built into the Herald. Seats are at a comfortable 12-inch elevation from the floor, yet there's 35 inches of headroom in the front seats, 34 in the rear.

The Herald looks a good deal higher than

(Continued to page 96)

Turner Torch

90th Anniversary Special!



The famous Turner Torch... for soldering, light brazing, thawing frozen pipes, burning weeds, removing paint, laying tile and hundreds of uses... now on sale with the green tank that contains 10% more fuel than any other disposable tank.

SAVE \$1.00. Buy the regular Turner Torch now with two tanks for only **\$7.89** complete

Available wherever hardware is sold or write

Turner Corporation

839 Park Avenue, Sycamore, Illinois



MAGNETS

- TSX-15 Magnet Assembly (150 lb. pull) Each....\$9.50
 TS-1 Magnet Assembly (50 lb. pull) Each..... 2.95
TSX-15 TS-2 Alnico 5 Pot Holder Magnets 50 for \$3.50, 20 for 1.50
 TS-4 Pencil Magnet with clip, 29c each, 4 for..... 1.00
 TS-5A Rectangular U's (4 lb. pull) 10 Magnets..... 3.25
 TS-6 Sample Magnets & Catalog (over 200 sizes listed)..... 25c
- Money Back Guarantee**—Send check or money order, sorry, no C.O.D.'s
TERRY SALES CORP., 1043 Silver Beach Rd., Riviera Beach, Fla.

KILLS MOSQUITOS / MOTHS / MILLERS / FLIES / GNATS / FISH FLIES / ETC.

USES NO CHEMICALS, GASES, ETC.
 No insect recovery. Harmless. Guaranteed. Built to last 25 years. Beautiful outdoor lighting. Plug into any 110 volt socket. Very reasonably priced...
NO AREA CONTAMINATION
 Uses up to 200 watt bulb. Grid costs 10c per month. Complete with fly attractor. Dead insect catcher. Write to **SING SING BUG CHAIR, INC.** BOX P 3708 / OAK PARK 37, MICH.

OVER ACRE
 BOX SIZE 15 1/2" x 15" x 19"
 WEIGHT 7.12 LBS.

PURE WATER

GUARANTEED FOR 10 YEARS!

Amazing new Purifier removes IRON, RUST SULFUR, CHLORINE, ODORS, etc. Eliminates stains on sinks, dishes, clothes. City or well water tastes better, cleaner. Easy to install—no motor, no chemicals, no refills. FREE water analysis. FREE literature. **SIBCO** Dept. PM-10, 8 Livingston St., Newark 3, N.J.

DOG, PET OWNERS, SPORT & FISHERMEN

ATTENTION! FIELD TESTED & PROVEN AUTO TRUNK "VENT" & "LOCK"

CONVERTS TRUNK TO TRAVEL-SAFE ROOM!

GUARANTEED & Precision Built to Fit most cars 1950-1961... from \$3.65

INSTALLED IN MINUTES
 WRITE FOR LITERATURE

VENT-LOK SALES COMPANY
 Dept. P.M., 9224 VAN DYKE, DETROIT 13, MICHIGAN

GUNK® degreases

At better automotive supply and hardware retailers everywhere.



Cleans engines, garage floors, power mowers, greasy walls economically and safely.
 In aerosol or pour spout cans.



GUNK CHICAGO CO., River Forest, Illinois
 serving the Midwest and Southwest
RADIATOR SPECIALTY CO., Charlotte, No. Carolina
 serving the East, Southeast and far West

CHOOSE GOERLICH® Master or Standard

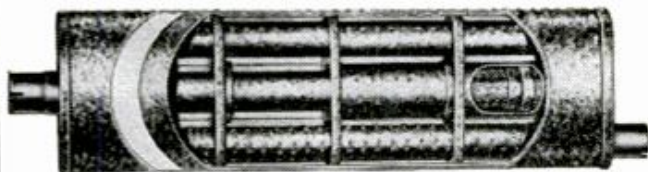

GOERLICH Master

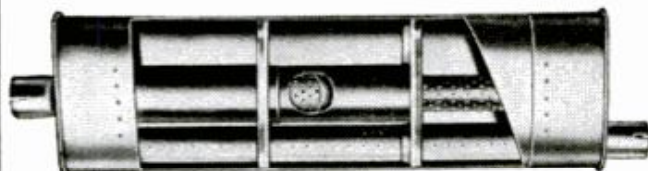

GOERLICH Standard

Either one gives you more service

Master The finest muffler your money can buy anywhere. Up to 41% more steel than ordinary mufflers. Rust-resisting design. Double shells. Zinc-coated steel. Asbestos liners. Heavier end caps. If quality is your first consideration, ask to see a Master. It costs no more than ordinary mufflers!

Standard A proud new economy version of Goerlich. Though priced for the thrifty, this is no tinny makeshift. It is a heavy, durable muffler, the equal of most higher priced mufflers on the market. That's why we call it Standard.

For a fine glass-packed muffler with a unique quiet power tone, ask about the new flat oval Dyna-Glas®—now custom engineered for your car.

GOERLICH'S, Inc.

MUFFLERS AND PIPES

Dept. 2K, 619 Smith St., Toledo 1, Ohio

it is (only 52 inches) because of the crisp, vertical lines of the body pillars and the generous measure of glass area from belt-line to roof. This big "greenhouse" of windshield and windows coupled with short hood and rear deck makes for excellent visibility and easy maneuvering.

Seating is well designed. The individual front seats are both adjustable over six inches of fore-and-aft travel. Vertical adjustment of the driver's seat is made possible by rotating eccentric rubber support blocks around the tubular seat frame thus varying the distance between seat and floor. As a result it's fairly easy to accommodate drivers of many different shapes and sizes.

Seat construction is unique in that interlaced rubber bands replace conventional springwire support for the foam rubber cushion. Upholstery is thick, handsomely tailored vinyl that looks more than a bit like leather. It all adds up to exceedingly comfortable seating, although the non-porous vinyl prompts perspiration in hot weather.

Rear-seat position is comfortable with good back angle and plenty of foot room under the front seats. Knee room is at a premium (just 5¾ inches) when the front seats are all the way back in their tracks. Result, tall rear-seat passengers cannot sit behind long-legged front seat occupants. So, if you plan to travel with more than two six-footers, somebody will be riding with his knees under his chin.

Although the rear seat is narrowed slightly by the encroachment of the rear-wheel housings, the driveshaft tunnel doesn't lump up under the center of the seat, so that three under-teen-age children can ride comfortably in the rear seat.

Incidentally, a considerable plus in the use of the Herald lies in the "station wagon" arrangement of rear compartment and trunk which is made possible by unsnapping the rear seat back. Doing so permits the seat back to swing forward and down, converting it into a board-shod load platform and at the same time revealing a rectangular open hatchway into the trunk. "Converting" the Herald in this manner provides a total of 30 cubic feet of cargo space enclosed behind the driver and front-seat passenger. Thirty cubic feet is approximately half of the capacity of a small American station wagon.

The trunk itself is well laid out with the spare tire countersunk into the floor under the mat. The gas tank is tucked into the left side of the trunk but has a flat smooth side that doesn't threaten scratchable luggage. The trunk opening commences at the bumper level for easy loading.

The Herald is very well equipped, with sun visors, trip odometer, windshield washer, interior light with door-operated switches, full carpeting and an excellent fresh air heater-defroster system, standard.

Owners who choose to do their own maintenance and tuning get a real break with the Herald's one-piece hood-and-fender assembly which is hinged at the front. After a latch on each side is opened, it swings forward to reveal engine, brakes, wheels, suspension and steering mechanism and plenty of room to work on these items.

Ironically, in view of ease of accessibility to the front suspension and steering, you don't need to lubricate anything except the two lower steering spindle bearings and those only every 6000 miles. Considerable bother and expense is thus eliminated for Herald owners.

Driving the Herald in traffic is almost as much fun as whipping around on winding country roads, thanks to one of the smoothest four-speed, synchromesh transmissions this side of a Grand Prix racer. The shift control is a proper stick within easy reach of the wheel rim and as quick and crisp in action as any sports car. Synchromesh is on all forward speeds and virtually unbeatable so that you can up or downshift as fast as you can coordinate. The hydraulically actuated clutch is smooth, positive and will take up as fast as you need to.

So far I've built the image of the Herald as a thoroughly enjoyable four-passenger enclosed sports car—a veritable TR-3 or Sprite sedan. Unhappily this picture lacks one important detail; sufficient engine power to accelerate and cruise the Herald at speeds which its really great suspension, steering and brakes would easily permit.

Another 15 or 20 horsepower would permit quieter operation—from the standpoint of engine noise—much pleasanter cruising at higher speeds and plenty of acceleration for traffic and third gear passing.

As a matter of fact Standard Triumph does make a more powerful engine—50 horsepower instead of 40—available on special order at extra cost. This is the engine that is standard equipment in the Herald Sports Coupe and Convertible.

To sum up: The Herald is the most driveable and comfortable of the small economy imports. It is a perfect small car for nimble hopping around town and short trips. With more power it would be almost equally good for cross-country cruising for two adults and a child or two. As it stands it is a well-built, superbly engineered product well worth the consideration of anyone in the market for a car of its type. ★ ★ ★

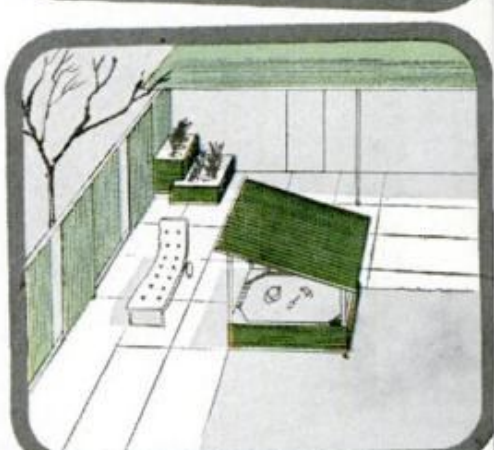
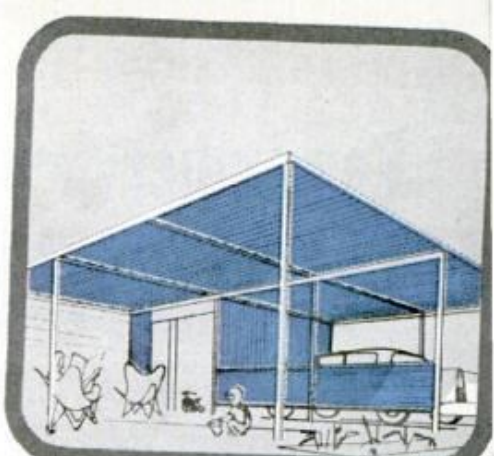
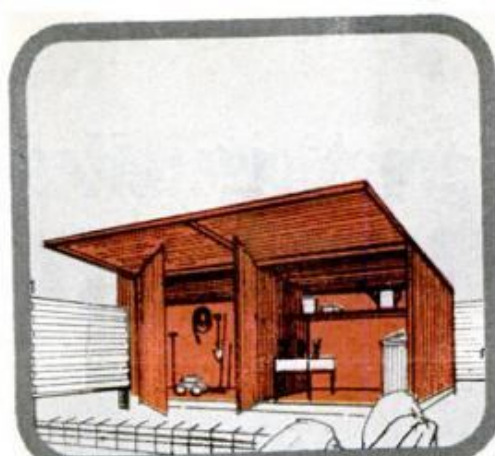

NEW!

ALUMINUM COLORIB

PANELS Made By ALCOA

Surround Any Home with Beauty . . . in 7 Exciting Colors!

Create a cool, colorful oasis on your patio . . . shield your backyard play area from annoying winds, prying eyes, roving pets . . . protect your auto's finish from weather . . . make all the areas on your lot accessible for Care-free living—for pleasure and privacy—by surrounding your home with the beauty of Alcoa® COLORIB Panels. Choose from seven exciting colors, developed especially for Alcoa, and add the durable protection of aluminum to your patio, yard, game room and workshop.

Do-it-yourselfers only need household tools to install Alcoa COLORIB Panels. Easy-to-handle sizes—8-, 10-, 12-ft lengths, over 4 ft wide. Baked enamel finish means colors never chip, peel or blister. Combination of ribbed shape and diamond-embossed surface gives strong, stylish panel that resists wear for years and years.

Visit your building products supplier soon to see Alcoa COLORIB Panels . . . and send coupon now.

®Trademarks of Aluminum Company of America

Your Guide to the Best in Aluminum Value



For exciting drama watch "Alcoa Presents" every Tuesday, ABC-TV.



SEND TODAY FOR FREE IDEA FOLDER

Aluminum Company of America
1881-K Alcoa Building, Pittsburgh 19, Pa.

Send me free copy of Alcoa COLORIB idea folder showing how to use.

Also send free booklet on MOBILE HOMES. (Check if desired.)

NAME _____

ADDRESS _____

CITY _____ ZONE _____

STATE _____

Материал, защищенный авторским правом

Remember how great cigarettes used to taste?
LUCKIES STILL DO

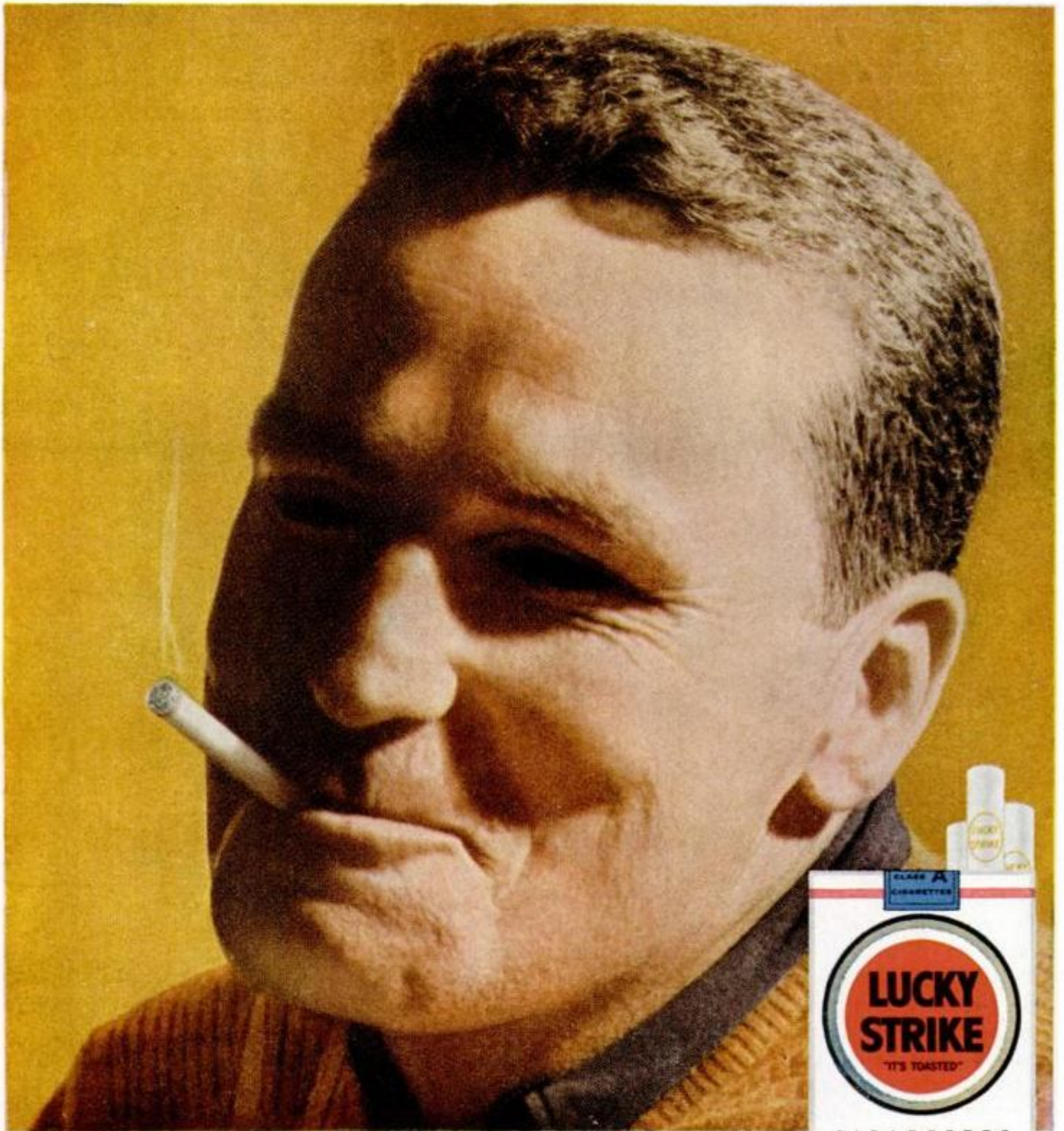

CHANGE TO LUCKIES

and get some taste for a change!

TOBACCO AND TASTE
TOO FINE TO FILTER



1961 Special has a different shape, but "portholes" and sculptured panels mark it as indisputably Buick

A Brand New Baby from Buick: The Special

The Special is back and this time Buick has really made it something "special." Not only is this an all new car but it, and its GM companion cars, the Olds F-85 and the Pontiac Tempest, belong in a new and different category.

Compared to the Buick LeSabre, with its wheelbase of 123 inches and over-all length of 17 feet 9 inches, the Special's 112-inch wheelbase and 15-feet-8-inches over-all length would seem to classify it as a compact car. It's smaller too, than the "low-

priced" cars like Chevy, which has a 17-foot-5-inch over-all length and 119-inch wheelbase.

Approached from the compact angle, however, we find that the Special is markedly less compact than say Studebaker's Lark which is over a foot shorter.

Semantics notwithstanding—it matters little whether you call the Special a "big" small car, or a "small" big car—it is a bona-fide six-passenger automobile with space inside where the passengers can use it.

The Special has crisp roofline, high windows which make it look taller than its 53-inch over-all height



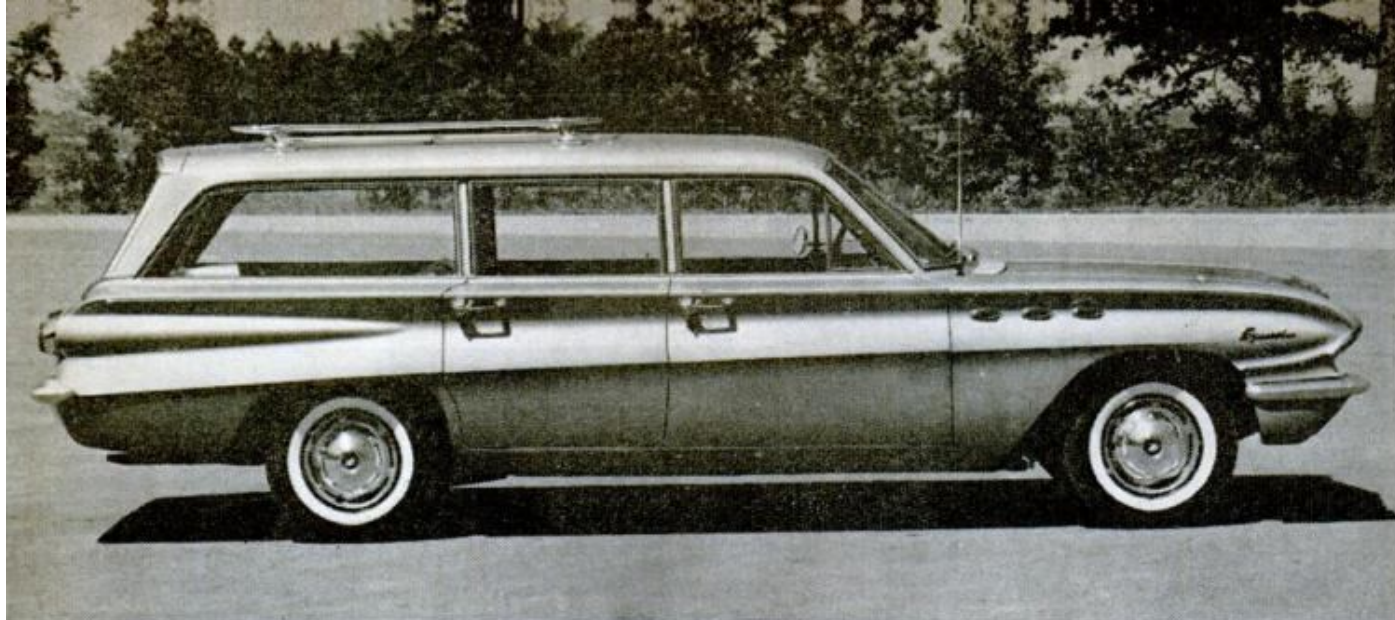

Special station wagon comes in four-door, six-passenger model only. Tailgate is hinged at top and counter-balanced to swing up-out-of-the-way for easy loading. Chrome-plated roof rack is optional at extra cost

The Special has a brand-new unit construction body in four-door sedan and four-door station-wagon models. Layout is conventional—engine is front mounted, water-cooled and directly connected to the transmission, which in turn, powers a conventional “solid,” unsprung rear axle.

However, within this conventional outline the Special is loaded with engineering innovations.

The all-aluminum engine, for example, is a 215-cubic-inch displacement V-8 rated at 155 horsepower developed at 4400 rpm. Compression ratio is a relatively modest 8.8 to 1 permitting use of “regular” grades of gasoline. In spite of use of iron cylinder bores or “sleeves” cast into the aluminum block, the stripped engine (minus generator, starter, fan, exhaust manifolds, etc.) weighs only 318 pounds.

This engine is of short-stroke design with a bore of 3.5 inches and stroke of 2.8 inches.

Combustion chambers are typically Buick in design with centrally located spark plugs and valves set high on the “inside” or intake side of the heads. Identifi-

cation of the engine is easy because it has the narrow, uptilted valve rocker covers that have marked the Buick V-8 since it first appeared.

The aluminum V-8 has an intake manifold with cast-in water passages that collect the hot water from the cylinder heads and convey it to the radiator top tank. On the way the coolant serves to heat the intake manifold for more efficient operation in cold weather. This eliminates the need for any exhaust crossover passage and thermostat valve to heat the fuel mixture.

Carburetor is a single, dual-throat model with automatic choke. The exhaust line is also single with a “Y” to each of the four-port manifolds.

This is “the” engine. There are no options or power packs at this time or are they contemplated in the near future. Engine specifications are the same for both three-speed manual and automatic transmissions.

The automatic, incidentally, is an all-new unit combining two-speed planetary gearing with a 2.4-to-1 ratio torque converter.

This transmission is unique in that after

Complete “package” front suspension for Buick Special is built around heavy, stamped crossmember. It includes springs, upper and lower arms, steering gear and linkage, shock absorbers and rubber mounts

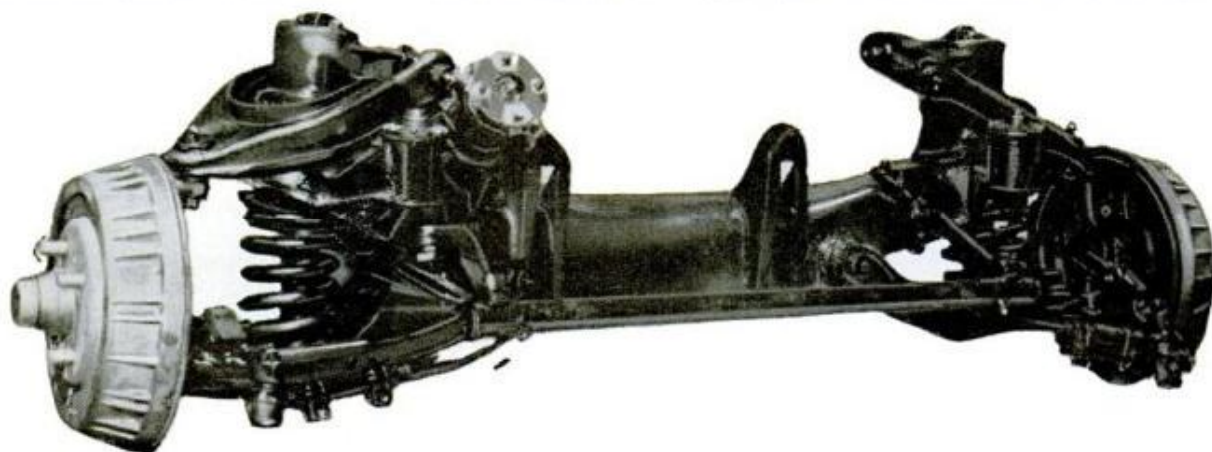

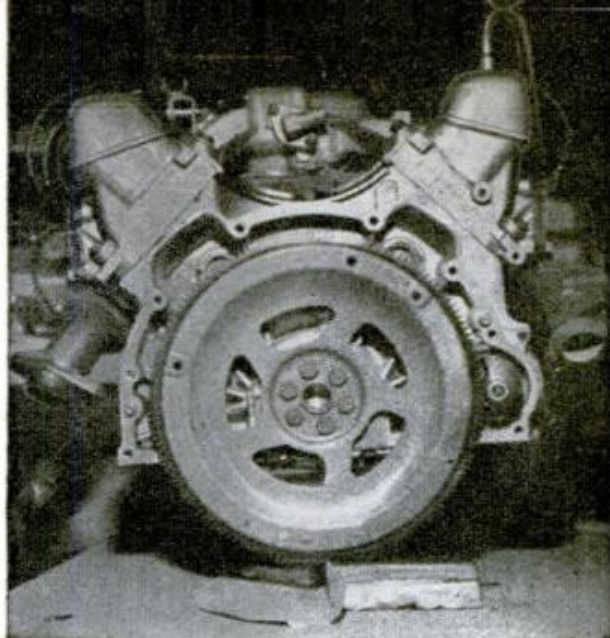
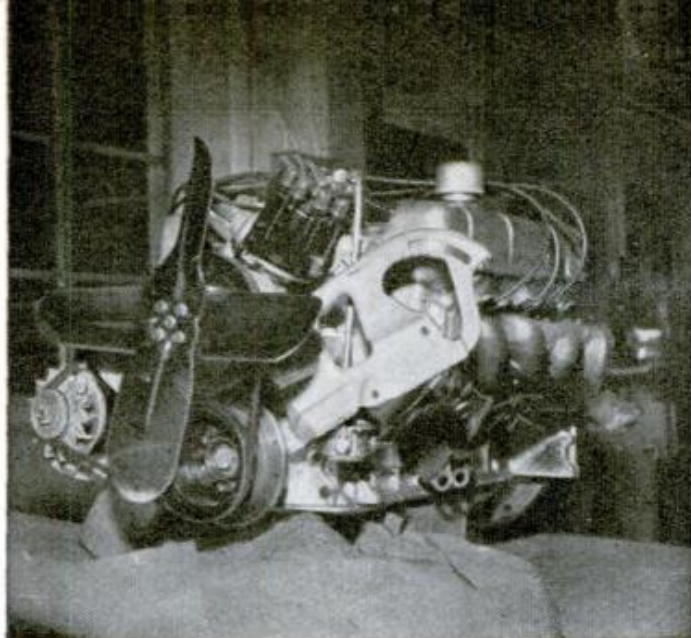

Two views of Buick Special's 215-cubic-inch displacement aluminum V-8. Front, at left, shows accessible distributor and spark plugs. Rear view, at right, shows unique angular valve rocker covers

the planetary gearset has shifted from "Low" to "Drive," the engine's input torque is split—with 36.6 percent going through a mechanical path (converter clutch to output shaft) and 63.4 percent through the hydraulic path of the converter itself.

As a result the transmission is a "semi-direct" connection between the engine and rear wheels and greater efficiency (i.e., less hydraulic slippage) and gasoline mileage is the result.

The Special's suspension and drive line is a radical departure from traditional Buick practice and embodies several features new to U.S. cars.

Front suspension is coil spring independent with ball-joint spindles. Upper and lower "A" frames, springs, shock absorbers,

steering gear and linkage are all mounted on a single, heavy stamped-steel cross-member.

This crossmember in turn is mounted to the unit body structure on three rubber pads or "pucks." This helps to further isolate the body from harsh surface vibration. The steering column connects to the steering gear by means of a fabric coupling to prevent vibration from traveling up to the wheel.

The Special has a two-piece driveshaft that enables the body designers to minimize the tunnel in the floor to such an extent that it does not cause any discomfort or inconvenience to center-seat passengers.

(Continued to page 308)

Underside of Buick Special's unit body and frame below left, is strengthened by built-in "frame rails" as well as outer body sills. Trunk, below right, is average in accessibility, has fair amount of room

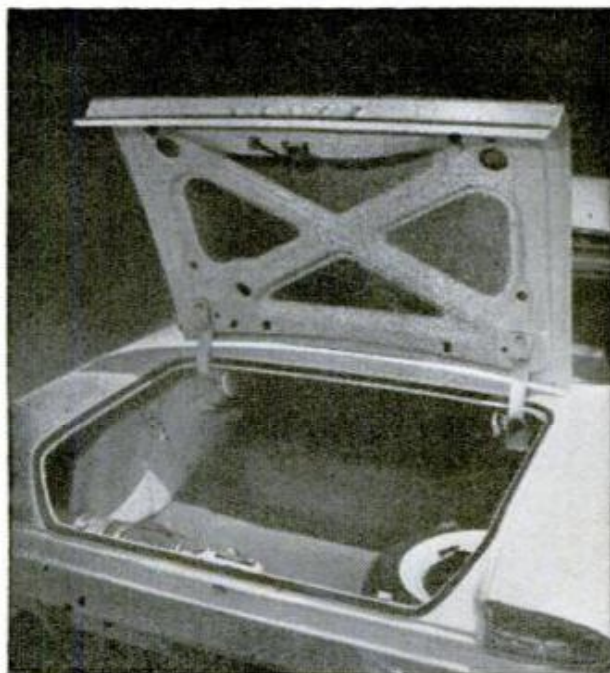
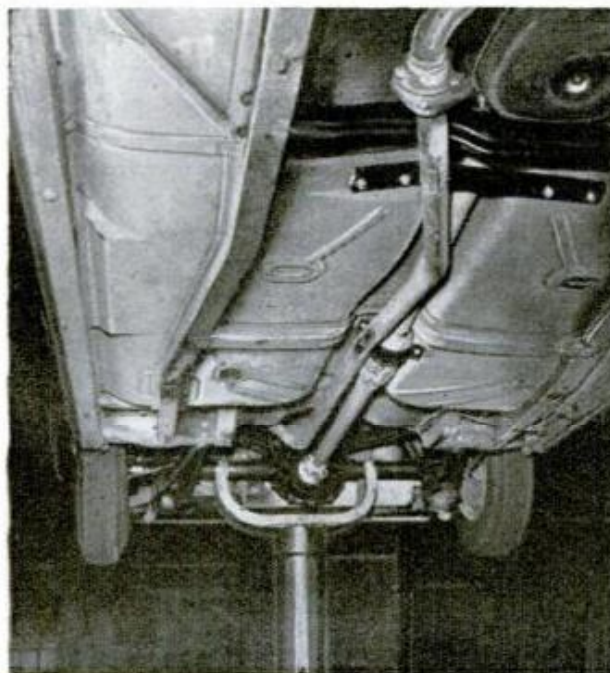



Clean, sculptured lines of Olds F-85 have little or no chrome. The 13-inch wheels make car look larger

Olds F-85: Another Rocket Hits the Road

General Motors is doing its level corporate best to make sure that no compact-car buyer will have a chance to walk up or down his town's automobile row without running into a showroom containing a GM compact or smaller-size car. Perhaps it's only fitting that America's largest automaker should now have twice as many new compacts as any of its competitors.

For those who want a smaller compact at lowest cost there is the Corvair. For a larger, more powerful car at just a few dollars above the Corvair there will be Pontiac's lively Tempest. A couple of hundred dollars up the scale comes the difficult choice between a well-matched and attractive pair, the Olds F-85 and the Buick Special.

Here are four cars in what we strongly suspect will be three different price ranges all within the budget of anyone who can afford a Chevy Bel Air with average equipment.

Choice between the F-85 and the Buick Special will be a real teaser for most interested buyers because the two cars are very nearly identical in body size and chassis yet offer enough differences in engine, styling and automatic transmissions to make the choice more than just a coin flip.

The F-85 comes within a fraction of an inch here and there of equalling all dimensions and within a few pounds of equalling the Buick's weight. Both cars have 112-inch wheelbases and over-all lengths of 188 inches.

Here is a direct comparison of the space in passenger compartments and ease of entry between the Olds F-85, left, and the "big" Olds Super 88, at right. Only difference is slightly less legroom in smaller car



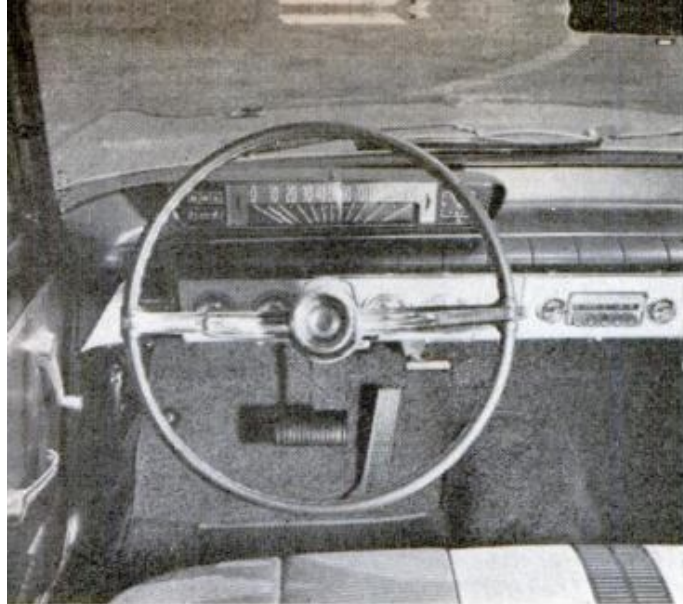

Olds F-85 instrument panel is neat, simple, readable and attractive. Forward vision is excellent



High-swinging lid provides good access to F-85's trunk which is roomy, and has fully useable space

Like the Special, the F-85 has the same unit construction four-door sedan and wagon bodies with front-mounted water-cooled aluminum V-8 engines of 155 horsepower.

Suspension systems too, are similar except for shock absorber calibration. The F-85—a name that sounds as if it were stolen from the Air Force—has four coil springs. Up front, the independent suspension is mounted on a single large pressed-steel cross member which in turn is isolated from the body frame by three rubber spool mountings arranged in a broad-based triangle.

Similarly the rear axle is attached to the frame by four links, all rubber bushed.

The drive shaft is a two-piece job, like the Special's with a constant-velocity double universal joint between the two sections and a midship ball bearing mounted in a rubber sleeve insulator.

Although sharing the same bodies and appearing quite similar, no one should have trouble telling the F-85 from either of its sister cars—the Buick Special or the Pontiac Tempest—as all three have different front fender and rear quarter panels as well as different hoods, grilles, deck lids and bumpers.

Careful inspection will reveal however that all door panels are identical, it's just the individual treatment of the quarter panels that makes them appear different.

With equal interior dimensions the F-85 has the same comfortable seating package for six passengers as the Special. Luggage compartments, too, are vitrually identical in dimension and layout.

Although based on the same iron-sleeved aluminum cylinder blocks, the Olds F-85 engine has cylinder heads as well as manifolds, valves and pistons of its own design.

Like the Buick Special's engine, the F-85's power plant has a water-heated, in-



Tapered rear deck of F-85 is smooth and uncluttered and shows the sculptured contours of the car's body

Broad hood swings up to reveal F-85's engine which has "most serviced" items easy to reach



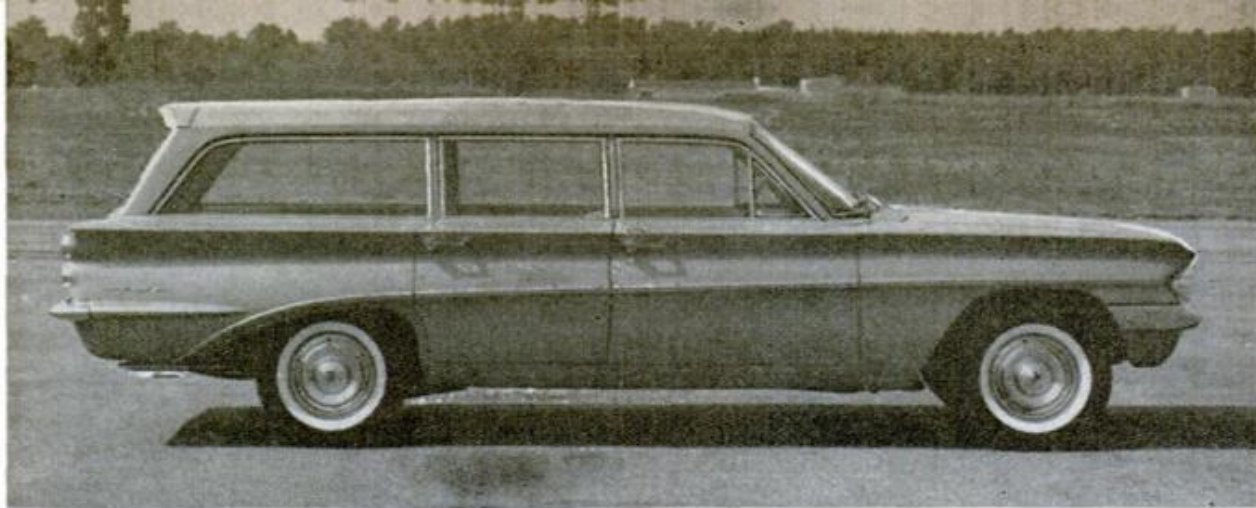

Six-passenger, four-door wagon is just same height as sedan, has total of 75 cubic feet of load space. Engine and transmission, left, is almost all aluminum

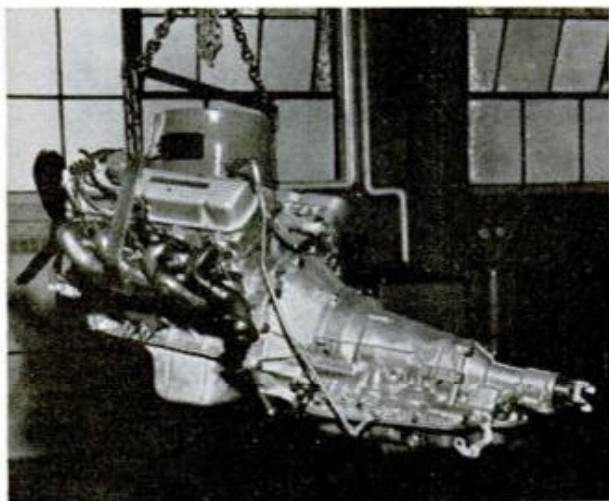

take manifold. A unique feature of the Olds engine however, is the air-cleaner cover that covers not only the polyurethane plastic filter element but the entire carburetor as well.

This setup is intended to provide a flow of fresh, cool air around the carburetor body at all times during warm weather and prevents percolation and vapor lock. In cold weather this same arrangement aids in warmup and helps prevent carburetor icing.

The automatic transmission used on the F-85 is a brand new version of the Hydra-Matic that Oldsmobile pioneered over 20 years ago. This transmission has the same fluid coupling as current Hydra-Matics except that there is an inner torque multiplying turbine member in the fluid coupling.

Olds calls this device the Accel-A-Rotor. It provides torque multiplication only in starting, i.e., "Low" gear. This gives a starting or stall ratio of 3.64 to 1.

As the car speeds up from a standstill the fluid multiplier phases out of operation and the ratio is reduced to 3.03 to 1, where-

(Continued to page 310)

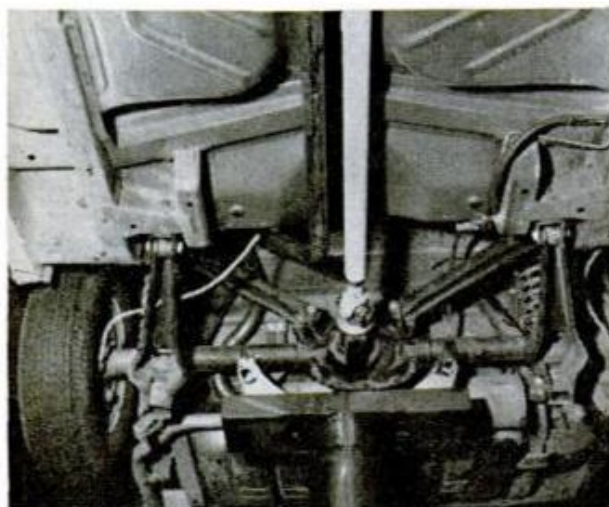

worm's eye view of F-85's rear suspension reveals four links connecting axle to chassis. Side view of F-85, below, shows well balanced proportions

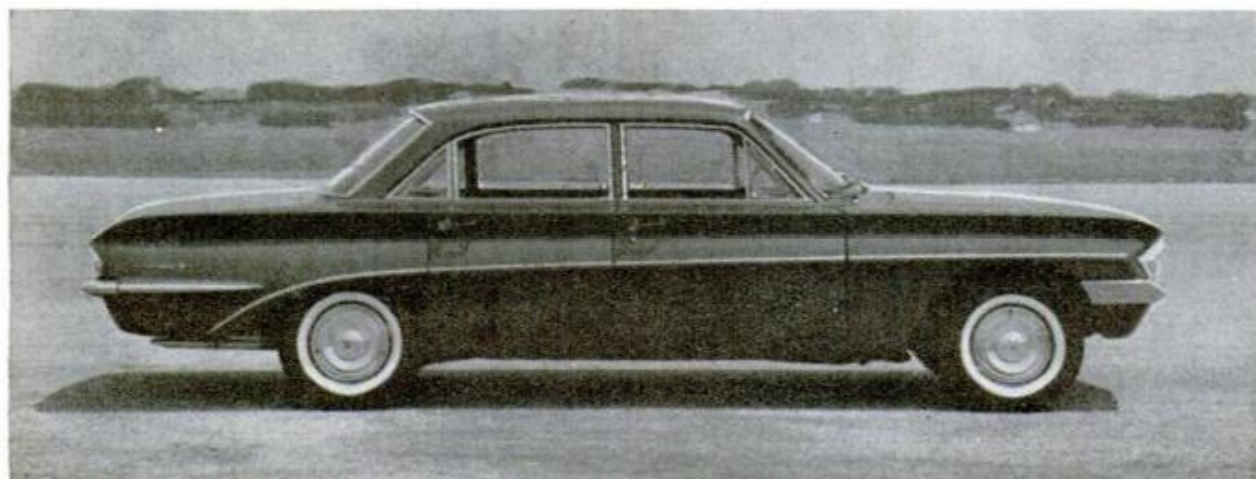



Side view of 1961 Buick Electra sedan shows clean, sculptured lines, familiar "portholes," wider rear door

Big Buicks Have New Bodies, Frames, Suspension for '61

The big Buicks, LeSabre, Invicta and Electra have been changed in every respect except the engine, transmission and basic details of the front suspension. Their ride and handling, ease of entry, and interior comfort have been improved so much as to make them vastly different cars.

Perhaps the most precedent-shattering change is the elimination of the torque tube—a Buick engineering trademark dating back to the first World War.

In doing away with this heavy tube which connected the rear axle to the transmission, Buick engineers have been able to remove some of the jounce-creating unsprung weight and switch to a thin, two-piece drive shaft with a double, constant-velocity universal joint.

This in turn has permitted a lower drive-line and smaller tunnel under the floor and seats. Buick has also switched to a cruciform or "X" frame with the midship universal joint mounted in the hollow center of the "X" member.

This new frame has enabled the body designers to make the floor lower and flatter. Seating positions are high and comfortable and there's more than enough headroom, yet the cars are not overly high—an inch lower than the '60 models in fact.

Rear suspension retains coil springs, but positions the axle with a linkage that's unique with Buick. In this new system two trailing links support the springs and take driving torque, a track bar positions the axle laterally and a short, upper link between differential and frame controls axle "windup."

Engines remain unchanged, with a 364-cubic-inch, 250-horsepower V-8 used on the LeSabre and a 401-cubic-inch, 325-horsepower version on the Invicta and Electra models.

★ ★ ★

Rear deck lid is wide and flat. Gone is the "gull-wing"-look of '59-'60 Buicks. Trunk is much larger

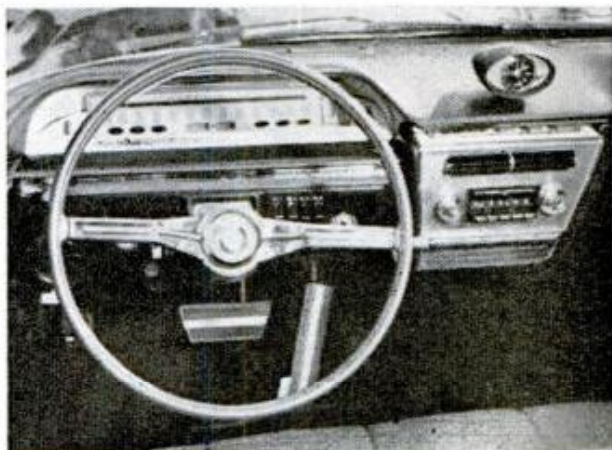

Instrument panel retains adjustable mirror-image speedometer introduced in 1960. Control setup is new



Grille, hood and headlamp arrangements are changed, yet over-all appearance, above, is typically Buick

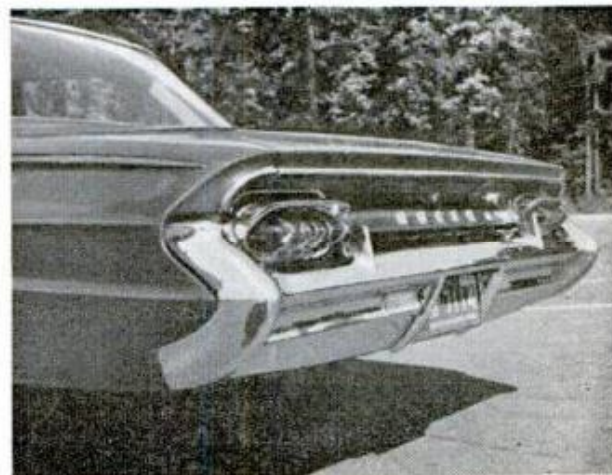



Although Lancer shares body and fender sheet metal with Plymouth's Valiant, it manages to have an identity of its own, thanks to a longer hood and "V" grille, top, and trunk lid without dummy spare, above

Now Dodge Gets a Compact All Its Own—The Lancer

As a follow up to the successful introduction of Valiant, Dodge Division has brought out a similar compact called the Lancer. This car is available in four-door sedan, four-door station wagon and two-door hardtop.

Lancer shares the basic unit body and chassis with the '61 Valiant, has the same

torsion bar independent front suspension, semi-elliptic rear suspension, engine and transmissions.

Wheelbase of 106.5 inches is identical to Valiant's but overall length of 188 inches is four inches greater, due principally to Lancer's extended "V" grille and front sheet metal. ★ ★ ★

A new body style for Lancer—also shared with Valiant—is sporty looking two-door hardtop, below

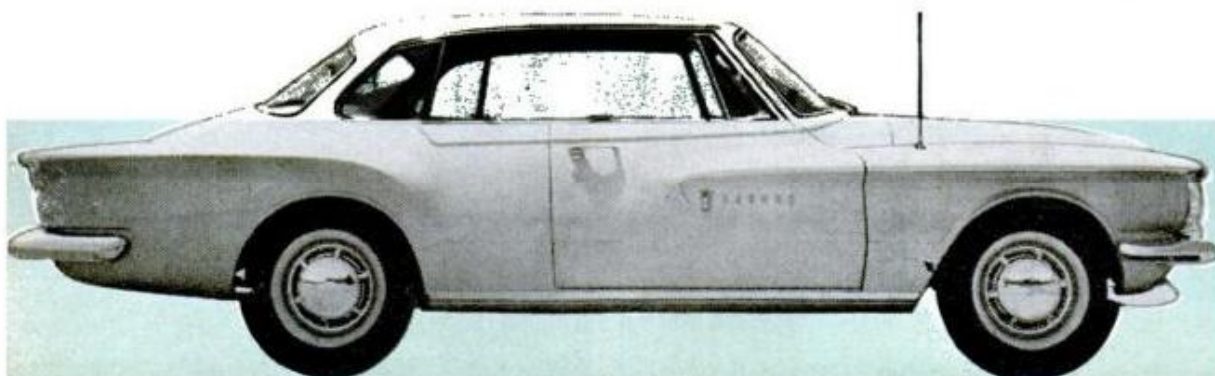



Fairlane above is plainest, lowest priced '61 Ford. Door handles are countersunk into the body panels

Ford Gets a Conservative Restyling Job for 1961

The success of the squarish, conservative and highly successful 1959 Ford line a little less than two years ago has had a definite influence on the styling of the '61 Ford.

This new Ford is the 1960 body shell with new sheet metal below the window line which adds up to a plainer, more conservative car than the swooping, flat-backed '60.

The hood line has been raised to make room for a more conventional concave grille. At the rear end, overhang has been shortened so that the over-all length is 3.7 inches less than on '60 models.

The tricky, narrow, depressed center section of the trunk and rear window has been replaced by a conventional, flat trunk lid that's 10 inches wider for easier access.

The modest, low fins used on '57 and '59 Fords are back, as are the big, "bullseye" tail lamps that seem to have become a Ford trademark.

All lubrication points on the front suspension and steering linkage are prelubricated at the factory with a special molybdenum-disulfide grease and sealed with screwed plugs.

These plugs are to be replaced "after an extended period" with conventional grease fittings and the lubricant replenished. Unofficially, as *PM* goes to press, this "extended period" is reported to be 30,000 miles, a long ride between grease jobs!

The simple, mechanical, self-adjusting device pioneered on Mercury brakes is now standard on all Ford models. Engines remain 226-cubic-inch displacement six plus 292, and 352-cubic-inch V-8s. Also a "super" 390-cubic-inch V-8 has been added as a "power package" option. ★ ★ ★

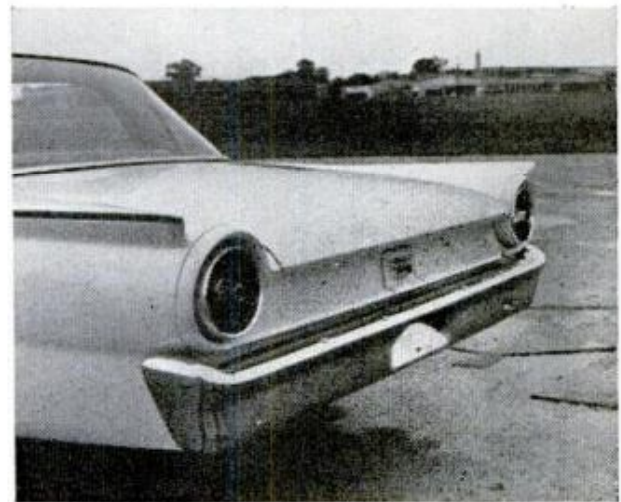

Rear end of '61 Ford shows clean uncluttered lines, familiar, big "bullseye" taillamps and wider deck lid

Beefier new bumper, more prominent headlamps and a simple, mesh-type grille mark front of '61 Ford





Total change of appearance from the '60 model is the result of new grille, hood, fenders, rear quarter panels and rear deck. Fury model, below left, no longer carries dummy tire cover on rear deck lid



Plymouth Is Sleek, Finless

The 1961 Plymouth retains its basic unit-construction body shell with front stub frame, while changing all exterior sheet metal except for the roof, glass and doors.

Hood and rear deck are flat and rounded off with the only trim a raised, bright metal highlight in the center of the rear deck.

Windshield has been simplified by the elimination of the compound curve at the top. Biggest engineering change is adoption of alternator used on 1960 Valiant.



Valiant's handsome new two-door hardtop, above, shows the small trim changes on sculptured knife edges of front and rear fenders. Grille was changed from '60 by painting center of squares black



Valiant Gets a Hardtop

Valiant has slight styling changes with some detailed improvements such as cable-controlled ventilator doors. Biggest change is addition of a two-door hardtop model.

This is a unique hardtop in that it uses the same roof and rear quarter as the four-door sedan, which enabled designers to combine roomy sedan seating with hardtop's coupe styling. There is also a two-door sedan model.



The '61 Comet is changed in appearance by the switch to a new grille made up of short horizontal bars. Also new are chrome chevrons on front fenders. Rear view, below, remains virtually unchanged

Comet Has Bigger Engine

Comet has been given a much-needed lift in the way of a healthy power increase. An optional version of the basic 144-cubic-inch displacement Comet engine has a longer piston stroke, displaces 170 cubic inches and develops 112 horsepower compared to the smaller engine's 90.

Either engine will be available in any of the two and four-door sedan and station wagon models.



Falcon's sculptured side panels are highlighted by stainless-steel trim strips, above, handsome new convex grille, below, which changes car's personality. Falcon continues use of single head lamps

Face-Lifted Falcon For '61

Ford's Falcon compact has been little changed for 1961. A new, more attractive grille has been added and the sculptured areas on the side panels on all models have been trimmed with a narrow bead of stainless steel.

A 170-cubic-inch displacement version of the Falcon six-cylinder engine developing 112 horsepower is available as an option to the 144-cubic-inch standard engine.



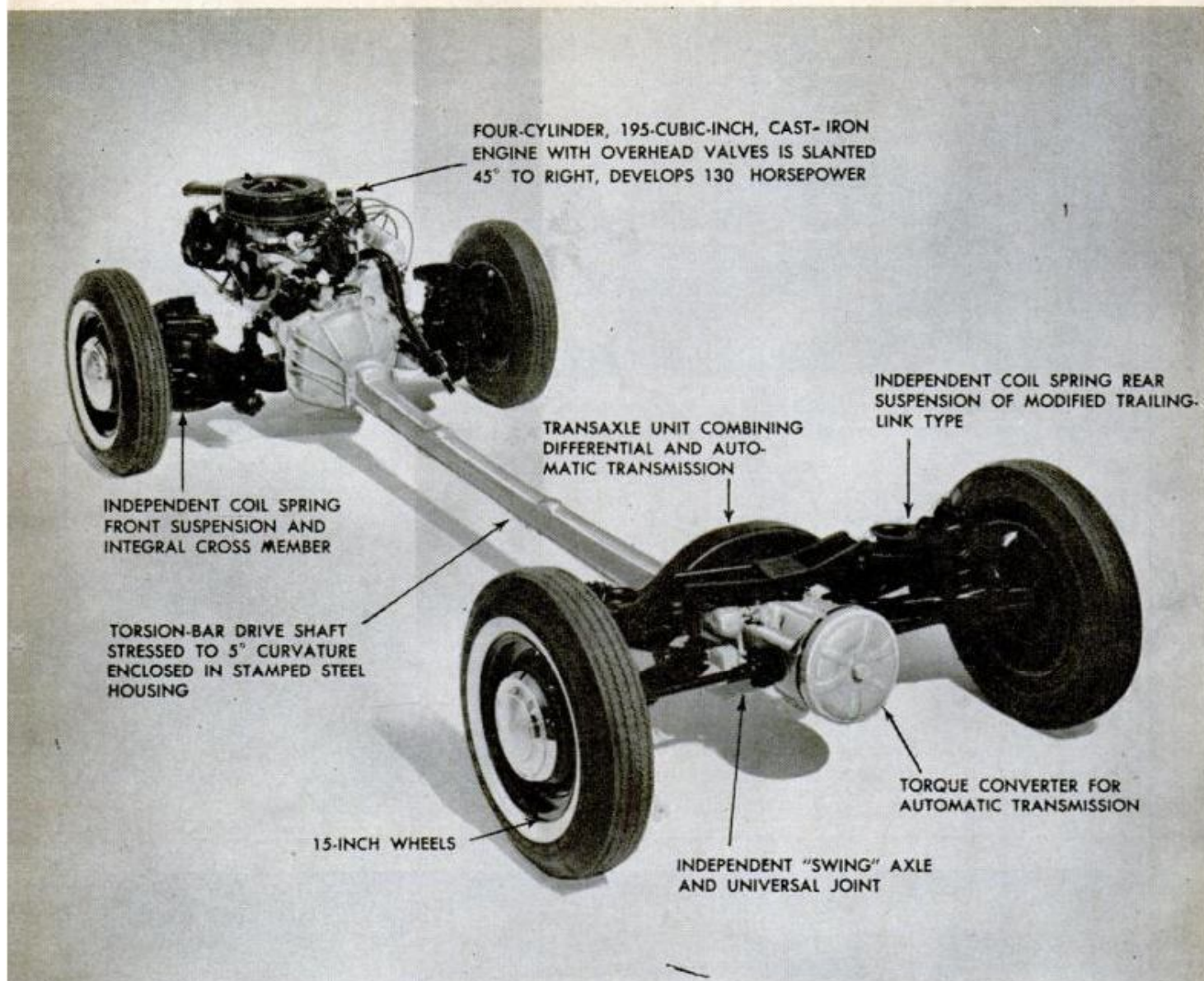

"Chassis" of Pontiac Tempest consists of engine, front suspension, drive shaft, transaxle, rear suspension

Pontiac Tempest: The Engineering Story

Public announcement date of the 1961 Pontiac Tempest automobile occurs after the publication date of this issue of *POPULAR MECHANICS*. However, as the release date for engine and chassis details of the new compact precedes the release of the full Tempest story by several weeks, we are able to bring you pictures and the complete story on the mechanical components of the car.

For an approximate idea of how the car itself will look, study the Buick Special and Olds F-85 (pages 97 through 102), as these cars share the same basic bodies—four-door sedan and four-door wagon—with the Tempest. Next month *PM* will show the Tempest in color and black-and-white photos.

From an engineering standpoint Pon-

tiac's Tempest is without doubt the most imaginative of all the 1961 automobiles. In fact, of all the cars built since the close of World War II, only Chevy's rear-engined, air-cooled Corvair could top it.

For example, the Tempest is the only car around with a front-mounted engine and the transmission in the rear. It has the first "transaxle"—transmission-differential combination—seen on an American car. (True, Corvair has the engine, transmission and differential in one unit, but this isn't a "pure" transaxle.)

The Tempest is also first in the U.S. to have independent suspension on all wheels combined with a forward engine location. It has the first four-cylinder engine to appear on a General Motors car since 1928. It has no universal joints on the drive shaft

and transmits power through a curved torsion bar. And, oh yes, its engine is slanted 45 degrees to the right!

The Tempest engineering story begins with the objective of Pontiac Division to produce a compact car of the same dimensions as the Buick Special and Olds F-85 to sell at several hundred dollars less. (As *PM* goes to press no prices have been announced for either the Tempest or other GM compacts.)

Inasmuch as the integral body-and-frame structure used on the Tempest is virtually identical to that of the F-85 Olds and the Buick Special, it is evident that cost cutting was impossible in that area.

The savings, then, must come in reduced tooling and production costs of the engine, suspension and drive line. Here's where Pontiac's ingenious engineering department went to town.

Chief engineer E. M. Estes and his associates started out with the premise that one half of a big engine already in production should be cheaper than tooling up for a brand-new, small-size V-8 of approximately the same displacement and horsepower. Accordingly, Pontiac made some special molds enabling the foundry to cast the right bank of the big Pontiac 389-cubic-inch V-8 without the left bank. This made for a somewhat lopsided four-cylinder engine, but permitted Pontiac engineers to machine it on the same production line used for the V-8, using the identical tools to drill the four-cylinder engine as are used to drill the right bank of the V-8.

As a matter of fact, fours and V-8s alternate on the production line and are handled automatically in any sequence. The four-cylinder engine, displacing 195 cubic inches, uses the same cylinder heads, valves, pistons, connecting rods and exhaust manifold as the V-8. Only the crank and camshafts, intake manifold, water pump, fan and carburetor are different. Result: A big, muscular four-cylinder engine at less than the cost of any new engine!

Further economies were gained by using basically the same front and rear coil-

(Continued to page 312)

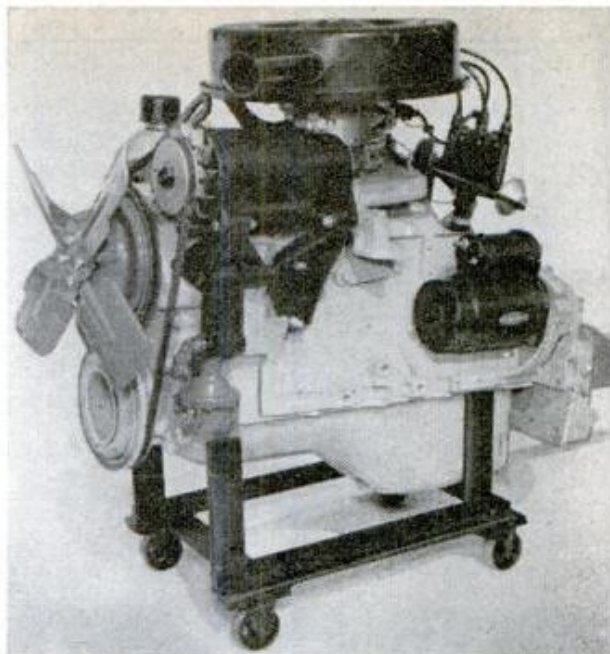

Left-hand side of Tempest's four-cylinder engine with water pump, generator, carburetor, intake manifold and distributor sitting above crankshaft as cylinder block is tilted 45 degrees to the right of center

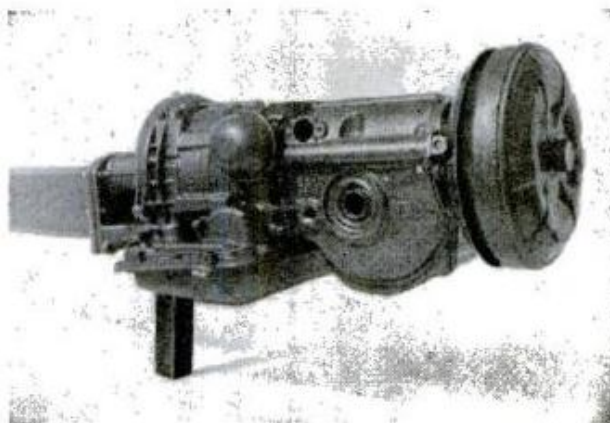

Here's Tempest's transaxle minus axleshafts and universals. From left to right; transmission gearing, valve body, differential (hole shows where axle shaft fits), torque converter. Many parts are aluminum

Tempest's power train with engine connected to transaxle by curved torsion bar shaft in tubular housing





A smooth, flat hood with a definite down curve and a wide, concave grille make a complete change in '61 Dart's appearance. Hood panel is adorned with dummy louvers near cowl opening

Dart Has a New Look

Dodge Division's Dart series became the automotive success story in its price class in 1960. However Dodge isn't resting on its laurels. Result, a complete restyling job on three series of Darts.

Only the door panels and glass areas remain unchanged. Under the hood there are numerous improvements, one being the use of the alternator in place of conventional d.c. generator.



Dodge can be told from Dart by ornamental medallion in grille, lower trim strip on side panels, and rocket tube tail lamps

Revamped '61 Dodge

The "big" 122-inch wheelbase Dodge Polara has been restyled from roof to rocker panels as has its 118-inch wheelbase companion car, the Dart.

The Polara has unique, rocket-tube tail lamps faired into the side of the fenders while the Dart's lamps are just above the rear bumper. Standard engine is a 361-cubic-inch V-8 of 265 horsepower.





Restyled Chrysler Adds an Economy Line — The Newport

For 1961, Chrysler Division has reshuffled its lineup, broadened its price range and restyled all its cars. Top series remains the New Yorker with its 126-inch wheelbase. The Saratoga, middle line of the 1960 Chryslers, has been discontinued.

The 122-inch-wheelbase Windsor continues in its position as a medium-priced car with four-door sedan, and two and four-door hardtops.

The Newport also on 122-inch wheelbase, and new for '61, comes in five body styles: sedan, two and four-door hardtops, convertible and a four-door hardtop wagon. New Yorker has same model lineup.

No prices have been released as *PM* goes to press, but it is expected that the Newport will sell in competition with lower-medium priced cars.

Engine in the Newport is a 361-cubic-inch V-8 of 265 horsepower designed to run on "regular" gasoline. Standard transmission on both Newport and Windsor will be a new three-speed manual with floor shift.

★ ★ ★

Rear treatment of Chrysler for '61, right, brings the tail lamps down from the fins and molds them into the body. Newport, below, has plainer grille, different side trim, than the New Yorker or Windsor

Chrysler New Yorker, above, has silhouette similar to 1960 model. Big change is on front end, below





Sleek DeSoto two-door hardtop, above, retains those sweeping, "Forward Look" fins that have become a Chrysler Corporation trademark. Grille, below, is now two-piece with aluminum mesh in upper section



DeSoto Keeps Its Fins

A brand new face for the '61 DeSoto comes in the form of a dual section grille and interestingly canted pairs of headlamps.

Basic body shell is same as on '60 models. DeSoto has two models, a two and a four-door hardtop in the 122-inch-wheelbase Fireflite series.

Appearance from the rear has been changed considerably by moving the tail-lamps from the trailing edge of the fins down into the body itself. Major mechanical change is the switch from d.c. generator to Chrysler Corporation's new alternator.



Big Imperial still has distinctive two-section roof paneling, shown above, but adds a totally different front-end treatment with thin-barred grille and chrome-plated pairs of free-standing headlamps



Imperial Gets Novel Front

The big luxurious Imperial continues with its separate body and frame construction and basically the same body shell used on the 1960 models.

Biggest change lies in the radical restyling of the front end where the two pairs of head lamps have been removed from the body sheet metal and now stand free as separate units in bullet-shaped housings on the bumper apron.



DETROIT LISTENING POST



By Jim Whipple



Twenty-eight new cars on the market for 1961. An almost bewildering choice awaits buyers.

As the new-car announcements pour out, it becomes evident that the automotive industry is in an even more fluid condition—if that's possible—than it was during the '60 model year just closed.

Everybody's getting in the compact game. The great, "economy car" gamble has paid off for those who looked at **Rambler's** healthy sales during the 1958 recession and said "Let's go!"

Studebaker was first to follow with the **Lark**—a long shot that put the company back in the black.

Then came the big three with **Falcon**, **Corvair**, **Valiant** and now for '61 the rest of the pack. As of this moment we have 11 separate and distinct compacts, either on the market or just coming out. They range from **Rambler's** doughty little **American** to the sleek, powerful **Buick Special**.

What makes it even more startling is to check down the list and find that there are just 17 of the so-called "full-sized" cars, ranging from **Ford**, **Chevy** and **Plymouth**, to **Cadillac**, **Imperial** and the new "compact" luxury car, **Lincoln Continental**.

In other words, between 35 and 40 percent of all makes of U.S. cars being marketed are compacts.

With a total of 28 cars (not counting the two-passenger **Corvette**) the buyers' choices become bewildering. Furthermore, so many compacts are pegged in a narrow price range that the buyer will find that he has at least half a dozen all within a \$100 bill of each other's price.

Lark, **Rambler**, **Falcon**, **Valiant**, **Lancer**, **Corvair**, **Pontiac Tempest** and **Comet** are all expected to overlap in price at about \$2000 to \$2100.

For the favorite player, the guy who votes the straight **GM**, or **Ford** or **Chrysler** ticket, this intramural competition can make choice of a new compact a really puzzling venture. Should the **Chrysler** fan go **Valiant** or **Lancer**? Which way should the confirmed **Ford** product owner jump, to **Comet** or **Falcon**? And what is the dedicated **General Motors** buyer to do when faced with **Corvair**, and **Pontiac**

Tempest, with a compact **Buick** and **Olds** just a few hundred dollars farther up the scale?

Similar difficult choices lie in wait for the full-sized car buyer who has such combinations of similar sized, priced and engineered cars as **Ford** and **Mercury** overlapping in two out of three series, or **Dodge Dart** and **Plymouth**, identical in size and basic engineering.

Familiar landmarks are fading in the medium-price field too, with the new economy medium **Chrysler Newport** expected to sell against the most popular models of **Pontiac** and **Oldsmobile**.

Pity the poor dealer who no longer knows who his competition is or where the next big buying wave is going to hit. As he tosses in sleepless quandary, the dealer asks himself such questions as "Will **Lancer** repeat in the compact field what **Dodge Dart** did in the 'low-priced' field last year?" or, "Will **Mercury** find new life as a 'low-priced-three' car as **Dart** did?"

There's plenty of method behind all this seeming madness; Detroit is out to catch the new generation of auto buyers (as well as old established buyers who've changed their tastes) and pin them down by offering compact and full-sized cars at ever more attractive prices.

By down-grading large cars and up-grading small ones, the harassed auto makers will be trying their best to solidify the market, hoping that these groups of buyers with their varying needs, wants and prejudices will sort themselves out and give the industry a settled market pattern once again.

It's something like a tremendous game of musical chairs, except that the manufacturer who guesses wrong too many times winds up on the floor when the music stops.

That music incidentally, is made by you, the new-car buyers all over America, when you scratch your pens across those sales contracts. ★ ★ ★



Photos by the author

Pat the Pig delights three visiting youngsters when he addresses them by name in a Minnesota supermarket

Talking Animals

By Ken Berglund

MOBILE ANIMALS that answer questions and call youngsters by name are appearing these days in St. Paul and Minneapolis, Minn. retail stores—to the benefit of merchants and the delight of small fry.

The talking-animal promotional displays have been developed by Alec Seymour, St. Paul display man. Animals include a donkey, pig and poodle.

The animals talk with the aid of the operator who stands nearby wearing a throat microphone and holding a control cable. The operator's voice is transmitted to the animal, while his hands control movements of the mouth, ears and tail.

The mobile attractions do not have to be plugged into an electrical outlet. Thus they have great freedom of movement indoors and out. A battery-operated loudspeaker built into the animal's mobile platform amplifies the voice.

A switch connected to the throat microphone enables the operator to channel his voice through the animal's mouth. When



Alec Seymour, St. Paul display man who developed the talking-animal attractions, chats with the donkey



It doesn't take long for Roger, a talking dog, to find someone his own size to have conversation with

the switch is off, his voice is heard in the normal fashion.

The animals were originally imported from Germany and adapted by Seymour for voice effects. They have been popular in the Twin Cities and surrounding areas for use in supermarket promotions and other retail sales efforts.

The pig has been a prime favorite with children. Parents often whisper the name of their child to Seymour, who then has the animal call the child by name—much to the youngster's surprise.

One supermarket manager reported that business increased 10 percent over normal while the pig was exhibited. ★ ★ ★

Close-up shows how pig's hinged lower jaw swings open as he talks with passersby. Amplifier is concealed under platform

An offbeat character is the talking frog with striped bathing suit and saxophone

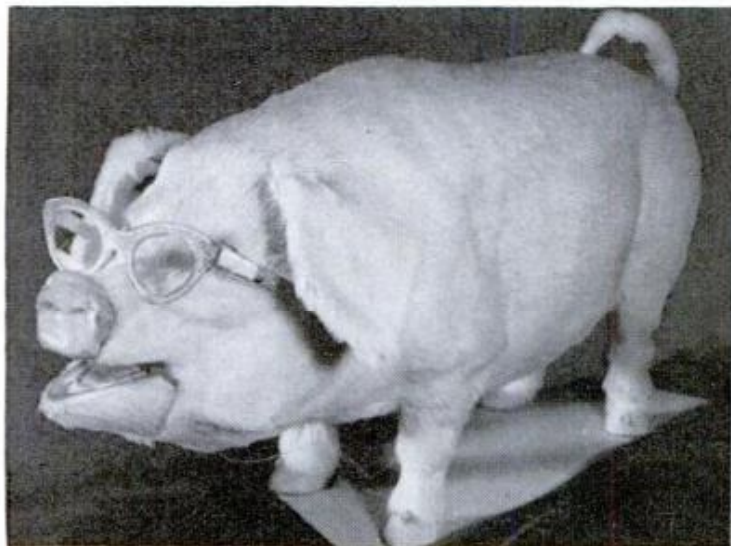



Look! No Splash!

New York's Department of Sanitation has placed 30 no-splash flushing trucks into service. They are equipped with 15 nozzles that spray water vertically onto the street, eliminating the horizontal sprays that used to spray nearby pedestrians as well as the street. The trucks, which can also be equipped with blades for snow removal in winter, carry 2500 gallon tanks.



Compact Projector For Slides With Sound

Built for any kind of slide projection—with sound—from a desk-top sales talk to a group showing, a compact projector with a built-in phonograph fits into a 13½ by 13½ by 7⅜-inch case and weighs only 10½ pounds. The phonograph takes records from 7 to 12 inches at 45 or 33⅓ r.p.m. The outfit includes a short-range screen built into the case and a lens that has been modified for close-up projection.

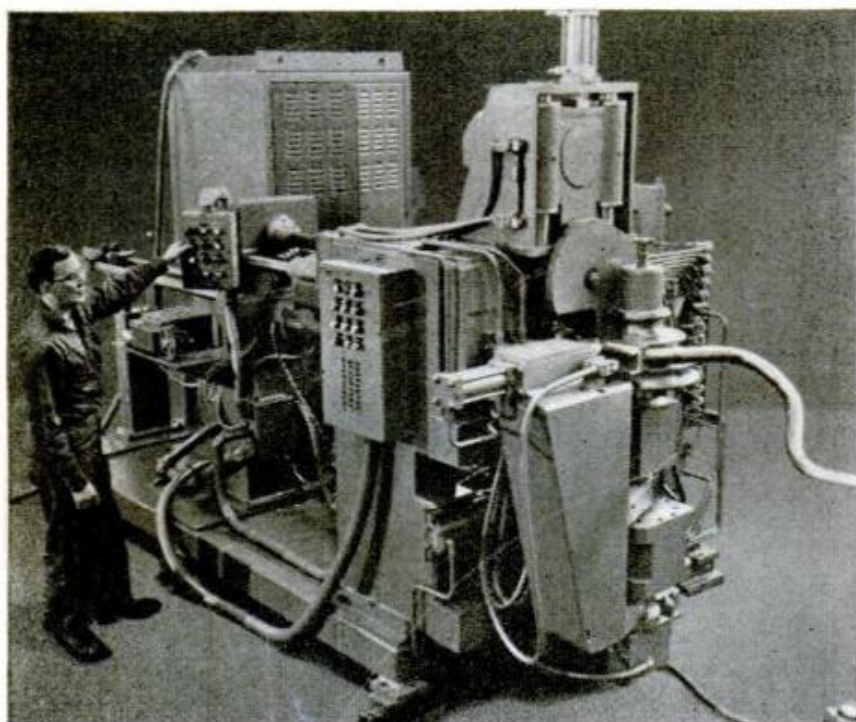

Custom Tail Pipes From Straight Pipe

Auto-parts distributors can replace large stocks of different model tail pipes by installing a new machine that automatically bends straight pipe into custom-made tail pipes for any make automobile. A punched tape, coded for each car model, is inserted in the machine. The proper diameter of straight pipe is set in place and the starting button pushed. The rest is automatic. In less than two minutes as many as 12 bends are made in the pipe, according to specifications punched into the tape.



Glen Canyon Dam, shown in artist's sketch, will be world's third tallest when completed in 1964. It will create world's fourth largest reservoir and open up vast new, and virtually unknown, areas for development

The Dam That Spans the Canyon

By Thomas E. Stimson, Jr.

ONE OF THE world's major dams is under construction in an almost unknown part of northern Arizona. The new Glen Canyon Dam is part of a big scheme for extracting every possible bit of use from the mighty Colorado River.

Glen Canyon is a spectacular vertical-walled gorge 1000 feet wide and 700 feet deep that cuts across flat tablelands. At the start of construction it was necessary to make a 200-mile detour to move a car or truck from one side of the canyon to the other. There were no roads in the area, no inhabitants except a few Indian families.

For a time the contractors used light planes to shuttle back and forth across the canyon.

Vertical walls were one problem scaled by construction crews



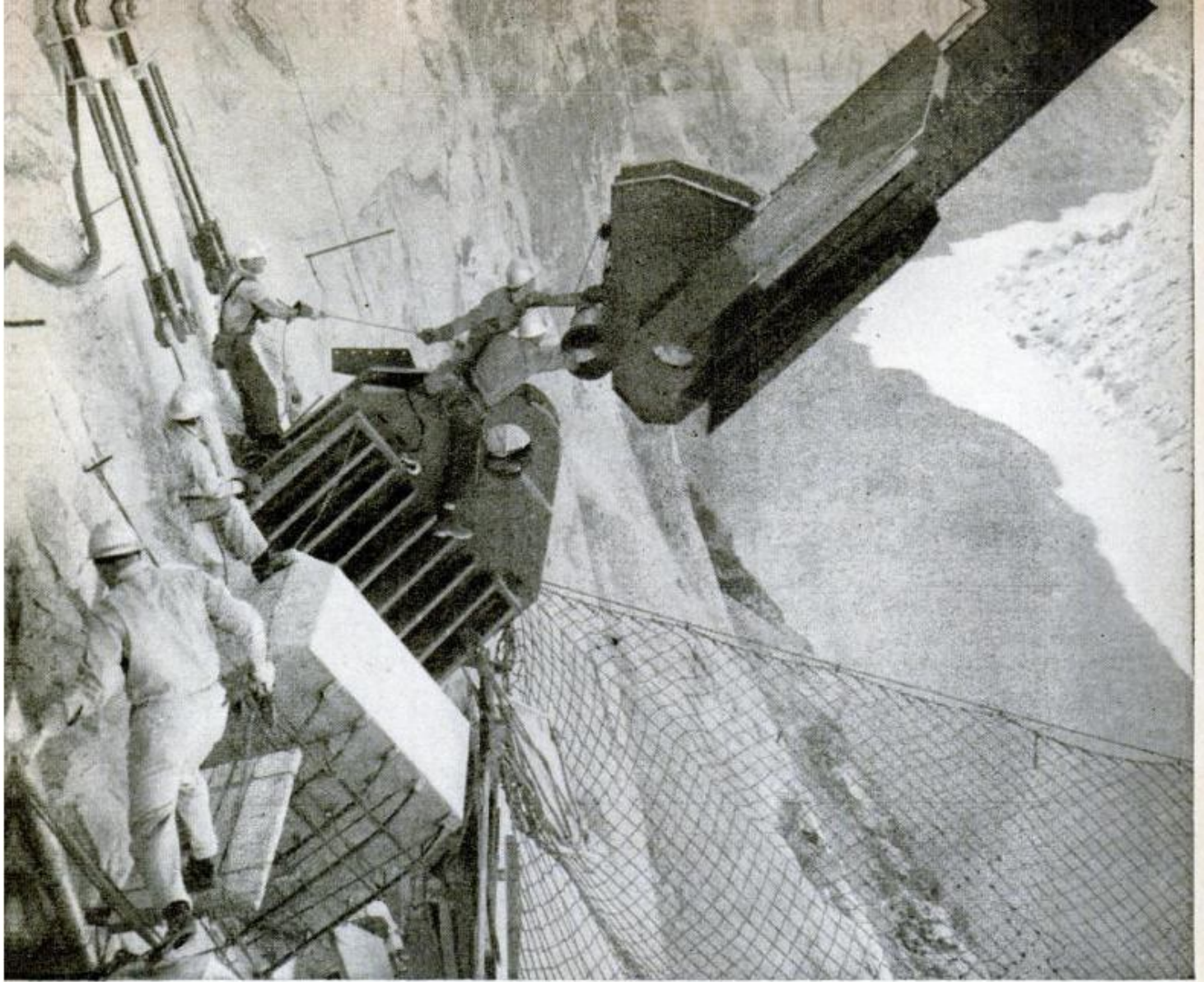

The region is so remote and the dam project is so huge that four years have been spent simply in preparing to erect the dam. Not until this past summer was the first concrete poured into the forms.

To begin with, it was necessary to build heavy-duty roads into the area, then construct a small city from scratch on an adjacent mesa. Today the city of Page has paved and lighted streets, a shopping center, schools and churches. It has a hospital, golf course and airport. At the peak of construction its population will swell to 8000; it is to have a permanent population of around 4000.

Another adjunct was the construction of the world's highest steel-arch bridge, a \$4.5 million structure that spans the top of the gorge a few hundred feet downstream from the damsite. It was impractical to erect falsework from the bottom of the deep canyon to support the bridge during construction, so the builders started out from each canyon wall, using tie-back cables to hold the steel in place and a pair of cableways to swing new steel into position. Eventually the spans were joined in the center, then a flat 40-foot-wide roadway

was installed across the top of the span.

With the new main road that has been built from the south, and the new highway that goes west to Kanab in Utah, the bridge is now part of the main route from Flagstaff to Kanab.

Not only was it impossible to cross the canyon at the start of construction, there was no way to descend to the canyon's floor. This was solved by stringing a pair of cableways from one rim to the other. With these, heavy trucks and equipment could be swung out over the canyon, then gently lowered to its bottom. Men descended in cages attached to the cableways and also by a "monkey slide" elevator that dropped out of sight from one rim.

Eventually a road was built to the bottom, an underground road in the form of a two-mile-long tunnel 50 feet inside one of the canyon's walls. Expensive as it was to blast the tunnel it was still cheaper than trying to pin a road to the clifflike wall.

New industries had to be created in the area before the dam could be built and some of these industries will be permanent parts of the economy. For instance, a giant cement mill was constructed at Clarkdale,

Workers scramble along wall face to install first chord member of Glen Canyon arch bridge. Too high for ground support, bridge was built entirely from above by using overhead cables

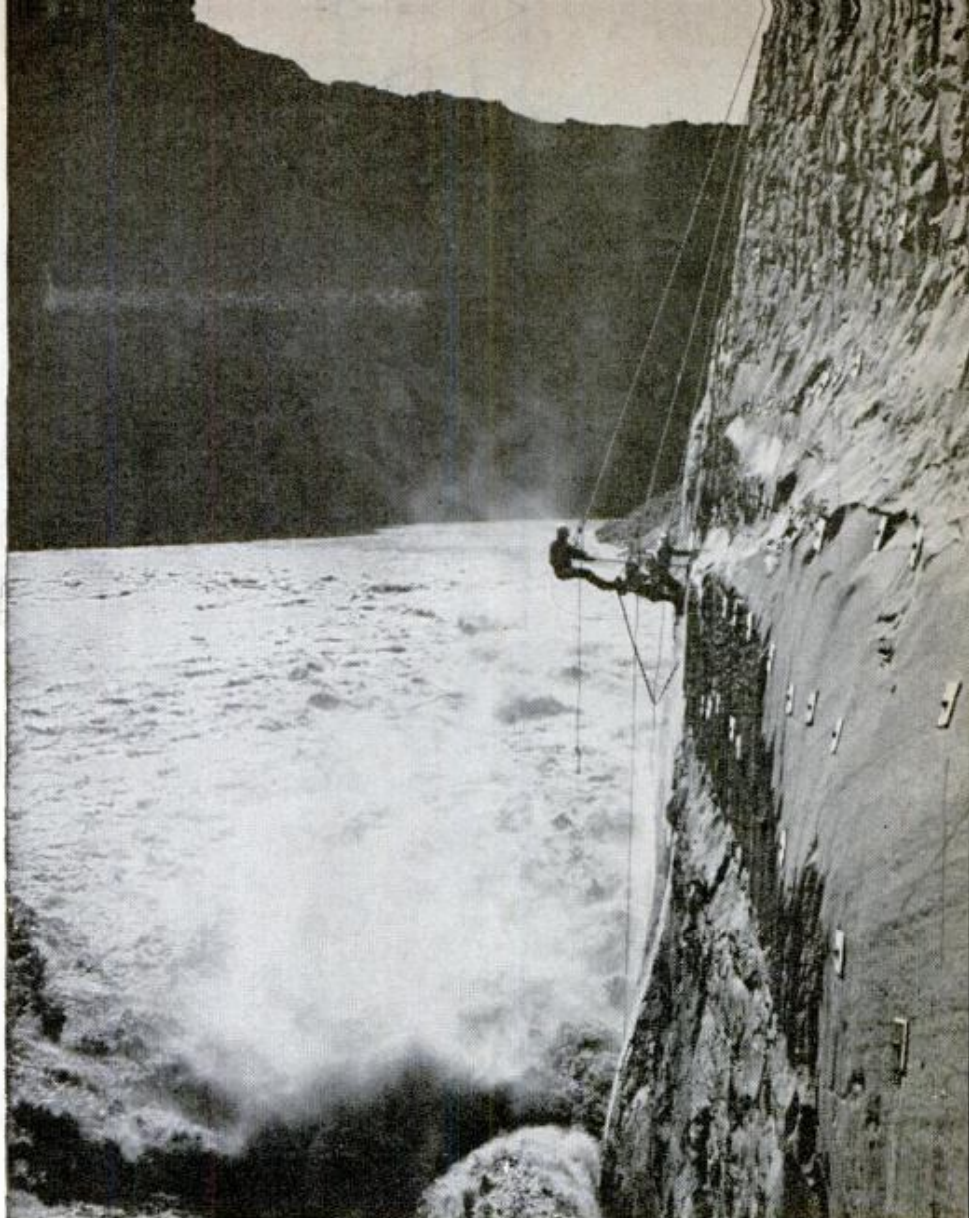

High scalers, suspended above outlet of diversion tunnel, drill holes for long bolts that pin surface rock and prevent it from falling away. Some of the bolts are visible in foreground

Problem of easy access to river bed was solved by digging two-mile-long tunnel inside one wall of canyon. Large enough for trucks, it's used for delivering equipment to construction area

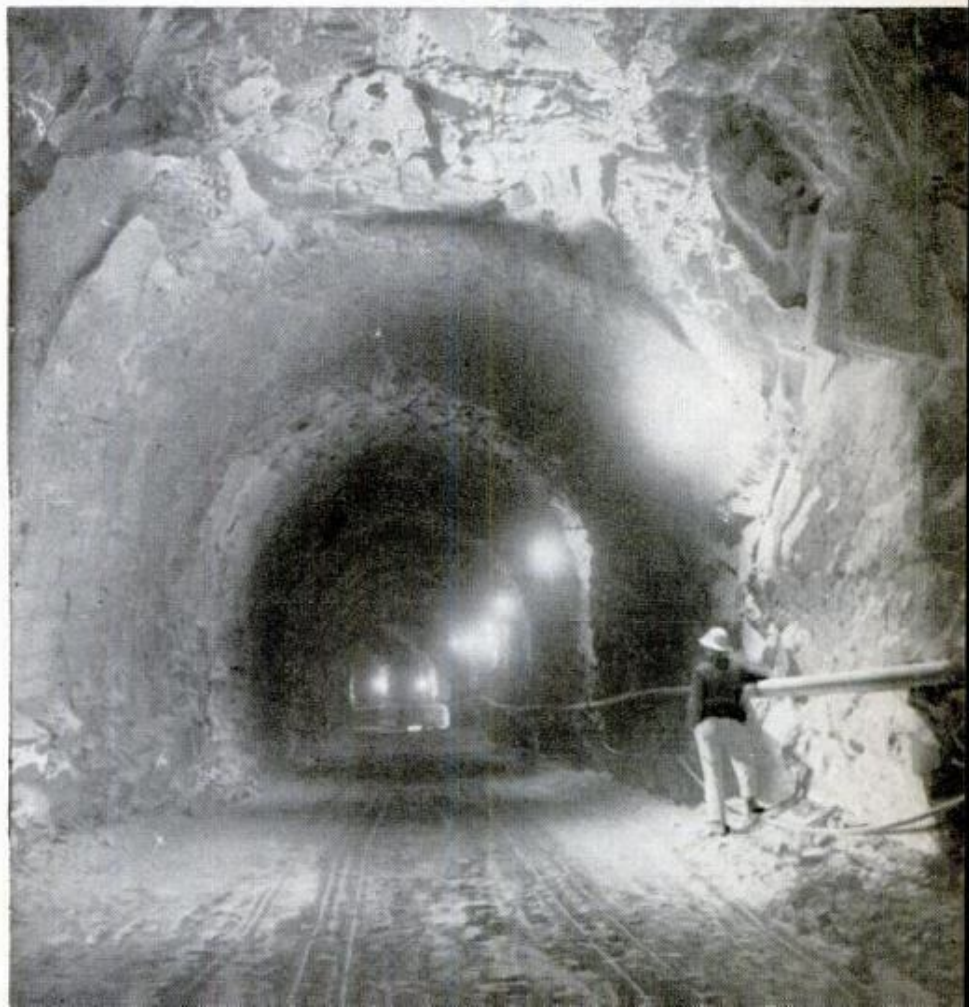

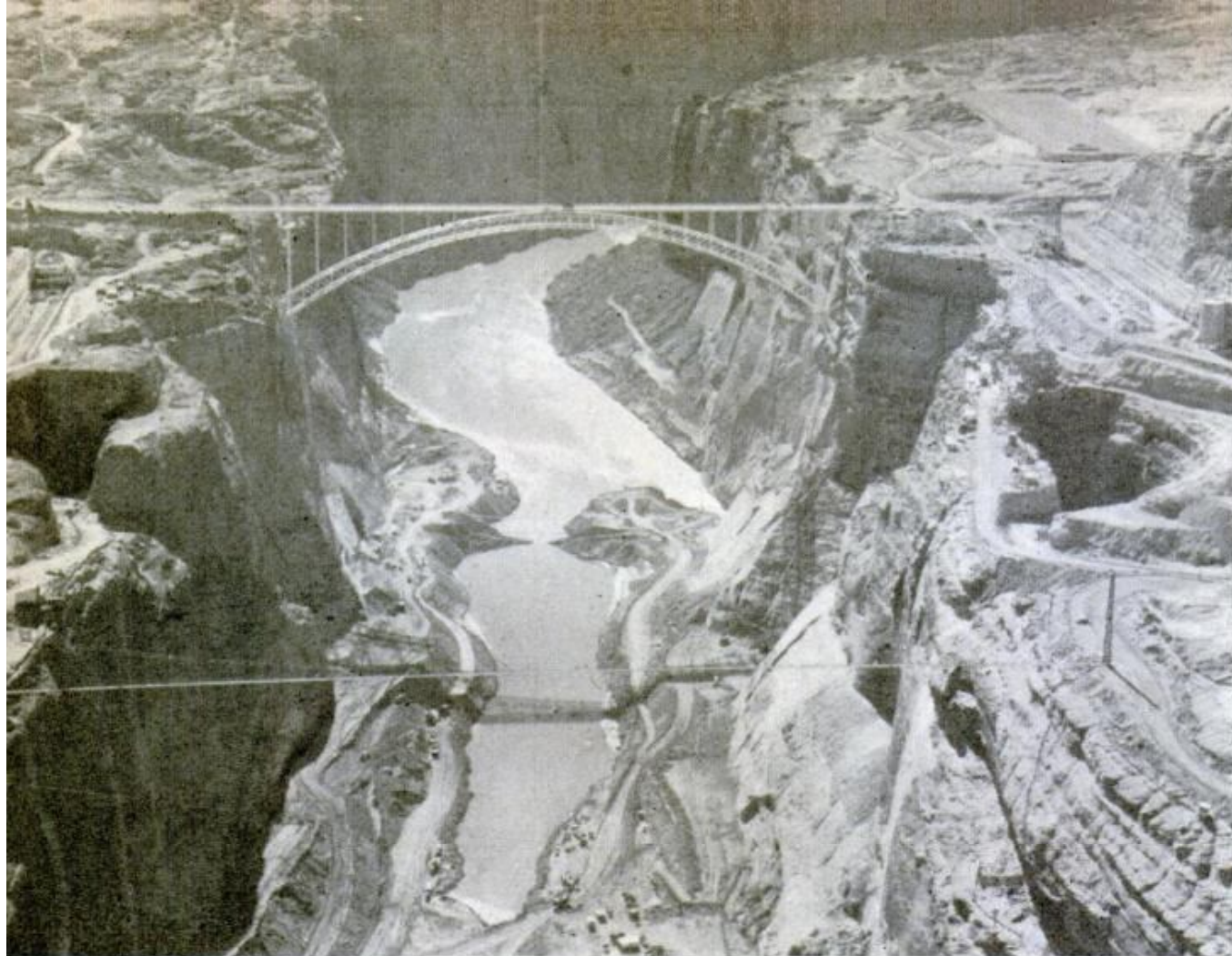

Cofferdams, which help turn river into diversion tunnels and give crew dry area to work in, are raised from river bed above and below damsite. Upstream cofferdam (foreground) is complete; downstream cofferdam (center) is nearing completion. Steel arch bridge, the world's highest, is in use at this stage of work

Ariz., 140 miles away, to supply the three million barrels of cement that will be used.

Near Flagstaff, a quarter-million tons of pumice are being ground into flour to provide the pozzolan that is used as an additive in the concrete. Pozzolan reduces the amount of cement required, is cheaper than cement and reduces the amount of heat that fresh concrete generates.

Glen Canyon Dam is a Bureau of Reclamation project and is being built by Merritt-Chapman & Scott under a prime contract amounting to \$108 million. This represents

only a portion of the whole cost. Counting the new bridge, the city of Page, the highways and the new industries, the full cost of the project is estimated at \$325 million.

The dam is to be a concrete-arch structure containing nearly five-million cubic yards of concrete and rising almost to the top of the canyon, some 700 feet above bedrock. Its mass of concrete will be about half that of Grand Coulee Dam on the Columbia River and will be greater than the amount in Hoover Dam, 370 miles downstream on the Colorado. Glen Canyon

Scaled drawings show comparative dimensions of Glen Canyon and two other important American dams. Only Hoover and Mauvoisin Dam in Switzerland (780 feet) are taller; only three others in world have larger reservoirs

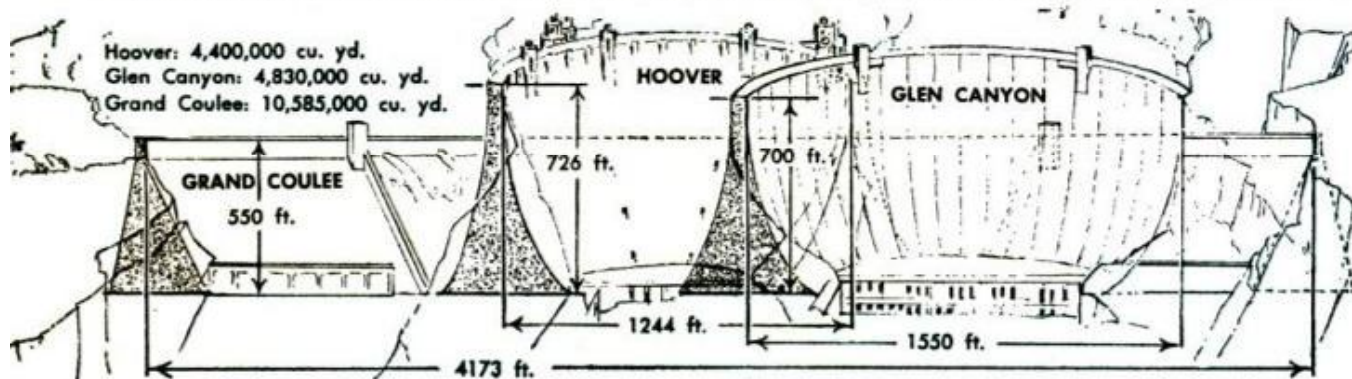

will be the third highest dam in the world, and will create the largest reservoir in the United States, extending 186 miles upstream. Its hydroelectric powerplant will be the seventh largest in the U. S. and at full capacity will produce 900,000 kilowatts of power.

The purpose of the dam is to provide holdover storage capacity so that downstream needs can be met. It also will collect much of the silt that is now reducing the capacity of the reservoir at Hoover Dam. Other benefits include power production and the opening of a vast new recreation area.

Engineers have developed an almost routine procedure for building a big dam like this. First, diversion tunnels must be cut through the canyon walls to detour the river around the damsite, and keyways must be cut into the walls of the canyon to receive the ends of the dam. The material that is removed from the tunnels and keyways is then used to build a high cofferdam barrier across the river, forcing the water into the diversion tunnels. A smaller cofferdam is built downstream to prevent backflooding. The site of the dam is then pumped out and loose materials are removed until solid bedrock is exposed. To strengthen this foundation, deep holes are bored into the bedrock and cement grouting is forced into the holes under high pressure. The grouting permeates any seams or cracks in the rock. Finally, forms are erected and the actual job of pouring concrete to create the dam begins.

This simple explanation doesn't begin to tell the whole story. It doesn't tell of the ingenious methods that are invented by the engineers to solve their day-to-day problems. It doesn't suggest the adventures of the "high scalers," the men who nonchalantly drill holes or set steel into the vertical rock, hundreds of feet above the river, while dangling in bosun's chairs or standing on scaffolds.

And this explanation doesn't give any idea of the magnitude of the project. At Glen Canyon, for instance, each diversion tunnel is 41 feet in diameter and represents a major construction job in itself. The explanation doesn't even

(Continued to page 314)



Before tunnel was built, trucks were lowered to river bed by cables. Below, concrete mixing plant rests on canyon shelf



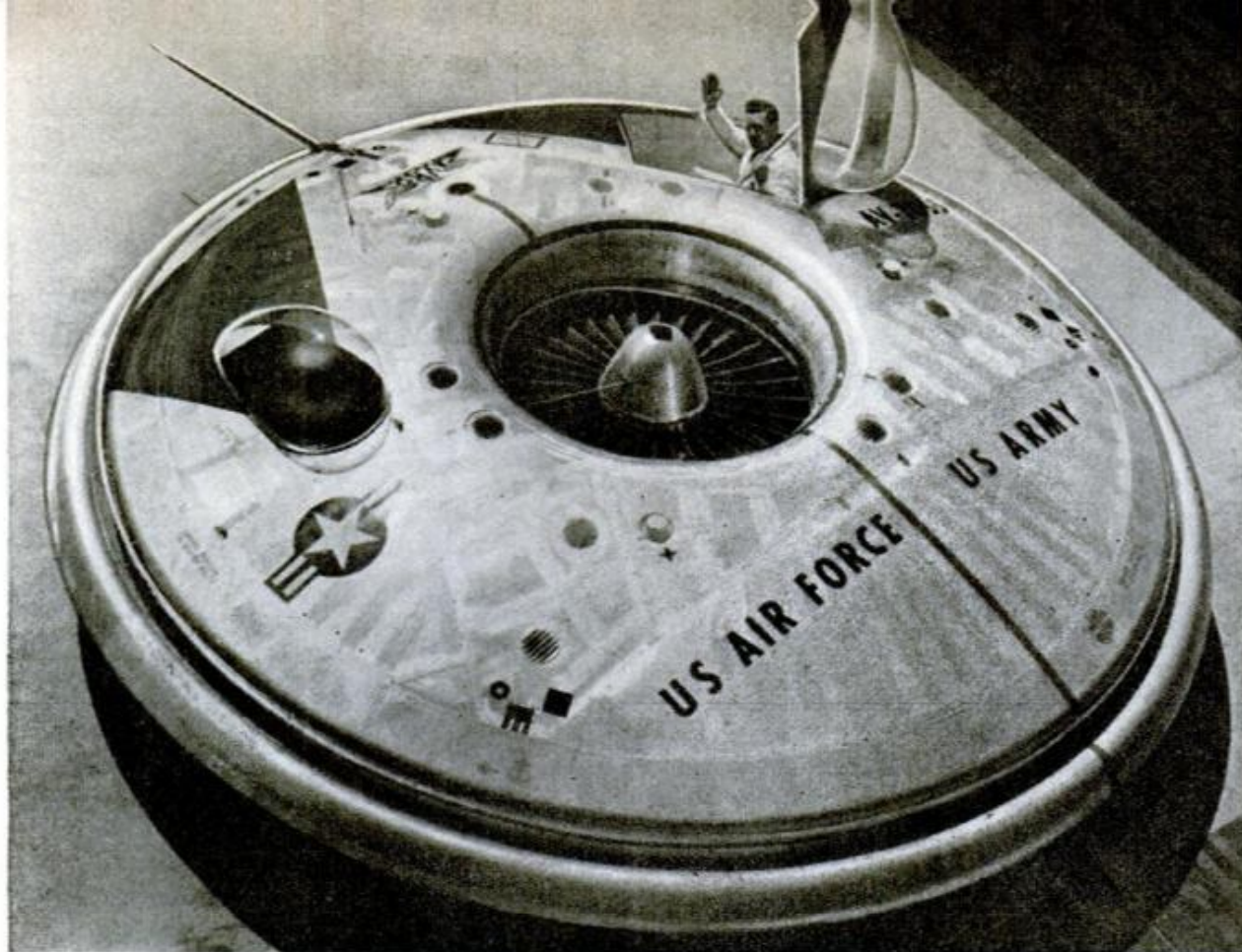

Flying Saucer? Well, Yes and No

It looks like a saucer and it flies, but it's not really a flying saucer. It's a new air car developed jointly by the Army and Air Force for transport of troops over any kind of terrain, even water. It takes off verti-

cally, like other air cars, but once it attains minimum velocity, it functions as an aircraft, getting lift by aerodynamic forces generated by its forward motion. Details of its performance are still classified.

Double-Duty Pump Handles Liquids or Air

Versatile enough for almost any household or outdoor pumping job, a new lightweight plastic pump is equipped with two hoses and double fittings. With the larger hose, it will pump water from a boat or do

light industrial jobs such as moving chemicals from open vessels into smaller containers. With the smaller hose, which has an air-valve attachment, it will pump air to fill tires, mattresses or pneumatic toys.



Knighted by Queen Elizabeth after he became the first man to climb Mt. Everest, in 1953, Sir Edmund Hillary of Auckland, New Zealand, next became co-leader of the scientific expedition that crossed the continent of Antarctica in 1957-58. This month he is leading an expedition sponsored by The World Book Encyclopedia into the high Himalaya Mountains.



My Most Exciting Moment

By Sir Edmund Hillary

THE MOMENT that gave me my biggest thrill was not when I stood atop Mt. Everest, but when we got our three farm tractors up the Skelton Glacier to the Polar Plateau, at 8200 feet. One of my duties on the Antarctic expedition was to establish a route from McMurdo Sound to the Plateau and on to the South Pole. Originally we were going to do this with dog teams as we did not have Sno-cats, the ideal vehicle for our purposes. We did have three light tractors, and I decided to use them if we could, for a satisfactory performance by the tractors would give us a strong second line of support to the Beaver aircraft we also were using. The tractors were ordinary rubber-tired machines with a belt running over their wheels, improving their ability. We spent time trying to improve their performance but when they struck heavy snow they bogged down. They had no heated cabs so we put up canvas awnings.

We set off on October 14, 1957, and crossed 180 miles over the Ross Ice Shelf. We had some trouble with soft snow but managed to keep going over it, and established a depot at the foot of Skelton Glacier. Our job then was to make our way up the Glacier. It's 90 miles long, heavily crevassed and rises from 1000 to 8200 feet. We did manage to drag our loads up the glacier but we had a few frights. There were areas where the crevasses were bridged with snow. The snow would support the front wheels of the tractors, but when the back wheels went over they sank in and we doubted sometimes whether we could get them out. We crossed one area of 60 or so crevasses and crashed into many. If we had been unlucky we could have crashed down, although we had the tractors roped together to break the fall if one went down. The weather was bad, the visibility was very poor, so we were always afraid of straying into the bad crevasse areas.

I had arranged for a ski plane to fly into a spot on the Plateau. It was to bring three or four men and a couple of dog teams. Our objective was to reach this depot. We made our way to the head of the glacier and were still about 30 miles from the depot position. We were having strong winds and drifting snow and it was difficult to navigate, but we drove on, navigating as best we could, relying on the sun and surrounding peaks. It was difficult to be accurate due to the poor visibility. We went through fog and drift, getting cold and miserable and, finally, after what seemed a lifetime, we came through a wall of mist. It was astonishing. We passed through the edge of the mist and two miles beyond was a black triangle—the tent of the depot.

This was the moment I believe that gave me my biggest thrill. As far as I was concerned, getting the tractors to the depot determined whether we could get to the Pole. I knew, when we accomplished this, we could go on.

AN EYE ON SPACE

By Dr. Dan Q. Posin

PROFESSOR OF PHYSICS, DE PAUL UNIVERSITY
SCIENTIFIC CONSULTANT AND ADVISOR, COLUMBIA BROADCASTING SYSTEM

LAST MONTH we showed you how to measure the distance to a far-away star by forming a triangle, using the Earth, the Sun and the star. If, however, the star is very, very far away, the two long sides of the triangle are almost completely parallel, and it's hard to make a reliable measurement. So what to do?

Try this: go back to the nearby distances where you *can* draw a good triangle and find a pulsating star, one that expands and contracts, and measure how bright it is. Now find exactly the same kind of pulsating star very far away (say the kind that goes very bright, then dim, then very bright again in five hours, repeatedly). If the light from this distant star is four times weaker, then this star is twice as far away. If the light from the distant star is 100 times weaker, then the star is 10 times farther away.

You might even find this particular type of star (the five-hour period) in some other galaxy. You would measure the light intensity of that star, and *calculate* the distance of the star. Then you would know how far away the other *galaxy* is.

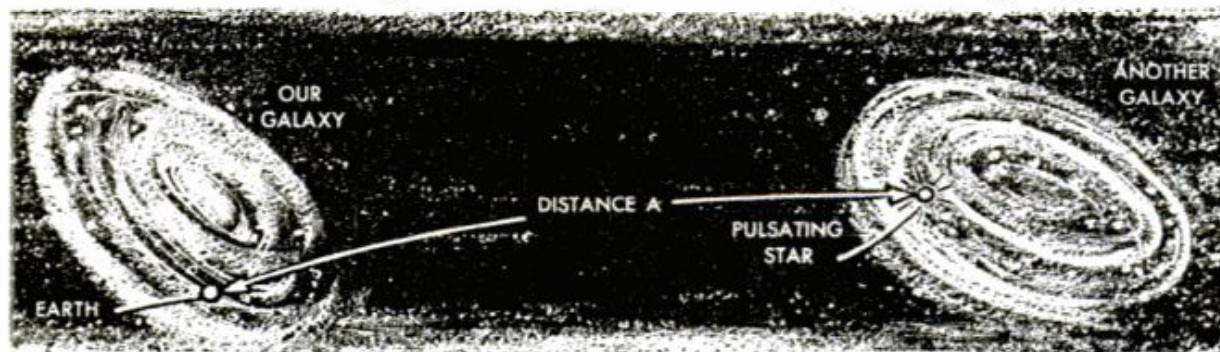

Now while you are having these remarkable successes, do one more thing:

Study the colors coming from this other galaxy. I mean, let the light from that galaxy pass through a prism. Then you'll get a spread of colors. Now all these colors will be of longer wavelength than the corresponding colors of light on Earth.

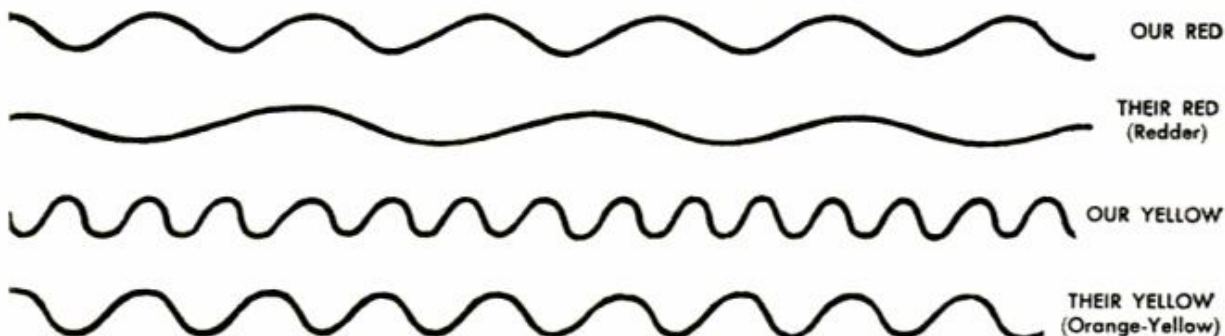

This "red shift" is believed to be due to the other galaxy's running away from us. But what has this to do with *distance*? Here is the payoff: Say you study very, very distant galaxies, and they are so far away that you cannot see a familiar type of pulsating star to measure its intensity and therefore calculate its distance. So what do you do? You study the wavelengths of the various colors. And if the change in wavelength is twice as much as it was in the previous case (where we got the distance A), then this galaxy is running away from us twice as fast as the other, and is also twice as far away.

So it's not so hard to measure distances to planets and stars and galaxies. It's a little harder, however, to *travel* these distances. ★ ★ ★



Arrestor System for Jets Remodeled for Air Transports

Successfully used to slow down high-speed Air Force jet fighters (*PM*, April, 1957), a runway emergency arrestor system has been enlarged to accommodate huge air transports. Designed to prevent overshoot accidents, the system works on the "water squeeze" principle. A hook drops

from the tail of the aircraft and catches a cable strung across the runway. The cable pulls two loose-fitting pistons through 1400-foot tubes, which are buried on either side of the runway and partially filled with an antifreeze mixture. "Squeezing" of the fluid can stop a fully loaded 707 Jetliner.

Projects Light Beam Brighter Than the Sun

Called a major breakthrough in the search for a "coherent" light source—one that coordinates the light radiated from each of its atoms—a new device jumps the frequency gap from 50,000 million to 500,000 billion c.p.s. and produces a narrow beam of light brighter than the sun at its core. Called "laser" (from light amplification by stimulated emission of radiation), it has important applications in space communications, in photographing astronomical bodies, and in medical diagnosis. A light source (top, right) irradiates a synthetic ruby crystal (on pedestal), raising its atoms to a higher energy state. The excited atoms are coupled to an atomic resonator and stimulated to radiate together, or coherently. Atoms in ordinary light sources radiate individually at random, or incoherently. A laser beam, projected from a satellite 1000 miles up, could be focused within 200 feet.

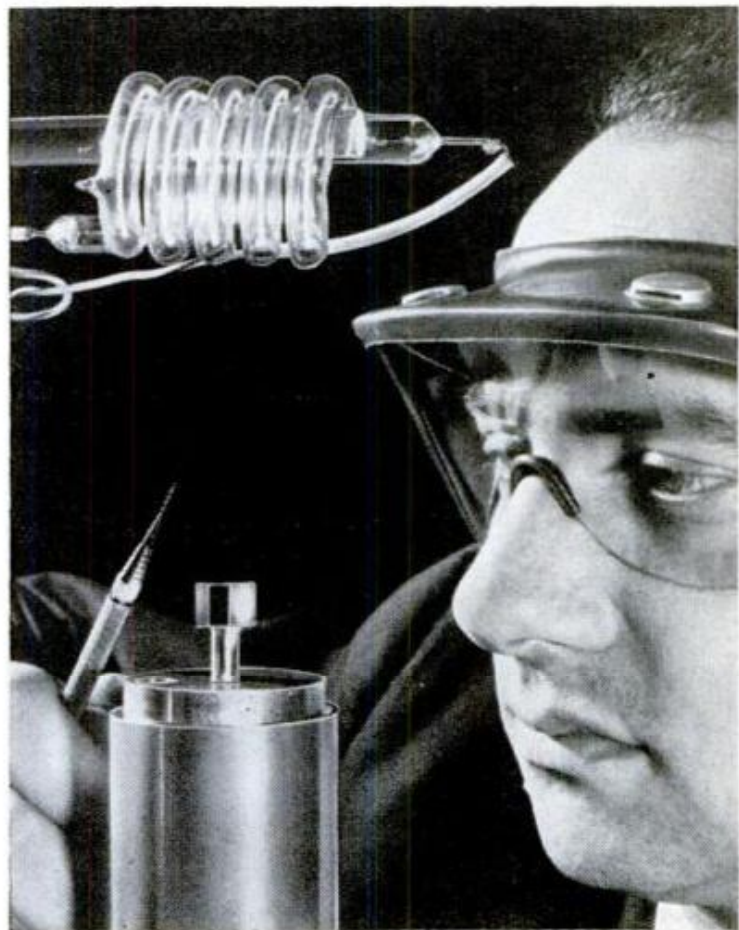



Irving Amen prefers to stand when making a woodcut. He first sketches his idea in ink and then transfers it to the woodcut block with carbon paper. He makes the sketch loose so he can further create in the wood

Master of The Woodcut



GOUGING AND RIPPING, artist Irving Amen plunges his knife furiously into a slab of white pine and, in a day, a woodcut is carved into being. The print, transferred by placing handmade Japanese paper against the inked block, may go on display in the Metropolitan Museum of Art, the Museum of Modern Art, or in any number of respected galleries. For New Yorker Amen is a master of the woodcut whose special distinction is that his prints reflect the creative process—the battle of wood, knife and man. Amen slashes at the soft wood. He works rapidly and never takes more than a day for a five-color woodcut. His ideas are roughed out in India ink and roughly transferred with carbon paper to the wood. This looseness allows him to create further with knife, gouge, and the rasps and ballpeen hammer with which he adds texture. When a print is pulled from the hewn block, it must reflect the struggle with wood or, to Amen, it is a failure.

Amen inks sections of stencil paper and lays them on the print paper to give areas of color. The forms of the print will be printed over these areas. He then inks the block with a roller and puts paper on it



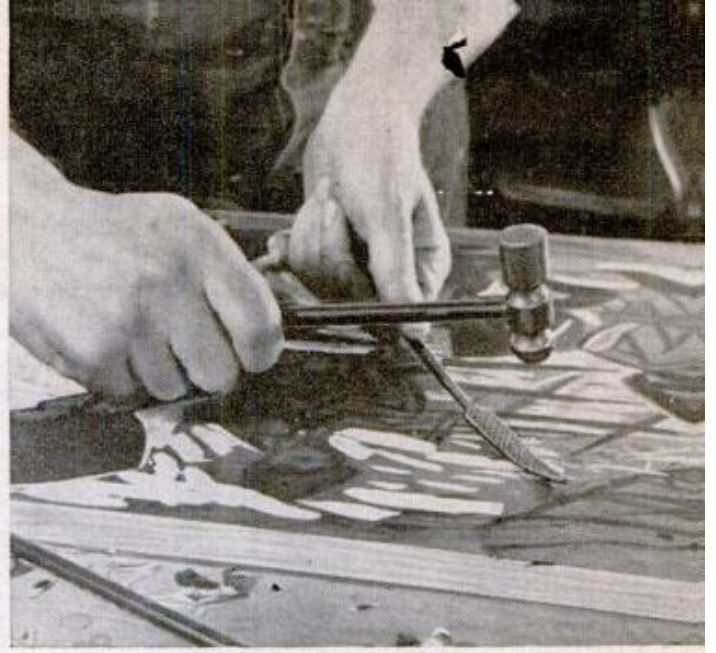

Holding his knife like a dagger, Amen outlines the forms distinctly. He gouges out other areas at a furious clip, taking no more than a day to make a five-color print. He uses a rasp (right) to texture the wood

The finished print. It's called "Shadow Play" and is shown on the opposite page. Museums collect Amen's work





Boating on the Railroad

When heavy rains flooded parts of Luke County, Mich., with two feet of water, the Duluth, South Shore & Atlantic Railroad switched to old steam engines as the water shorted out the diesel equipment. One section crew, with no such alternate for its stalled motor car, made it through by rigging a transom mount on the "stern" of the car and attaching a 7½-horsepower outboard motor. They plowed between Soo Junction and Hulbert, Mich., at five to six miles an hour.

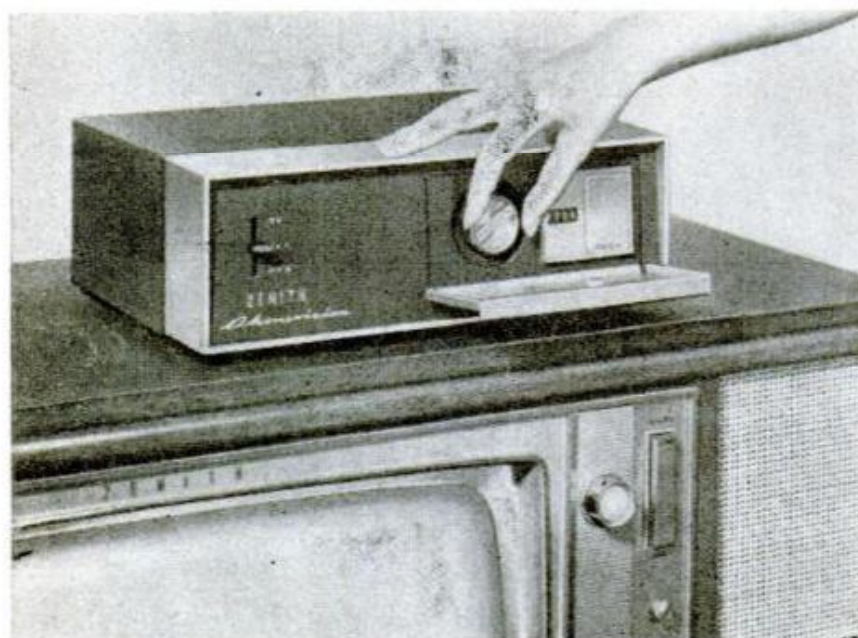

Pay-TV Decoder

Designed for a new pay-TV system, a decoder unscrambles subscription telecasts. The little box is placed atop the TV set. The viewer turns a single knob until a code number, provided in a listing of advance programs, appears in a window. Opening the decoder door automatically switches the TV set to the Phonevision system. The unit records the viewing time, thus providing information for billing the subscriber. The system may be tested in the Hartford, Conn., area.

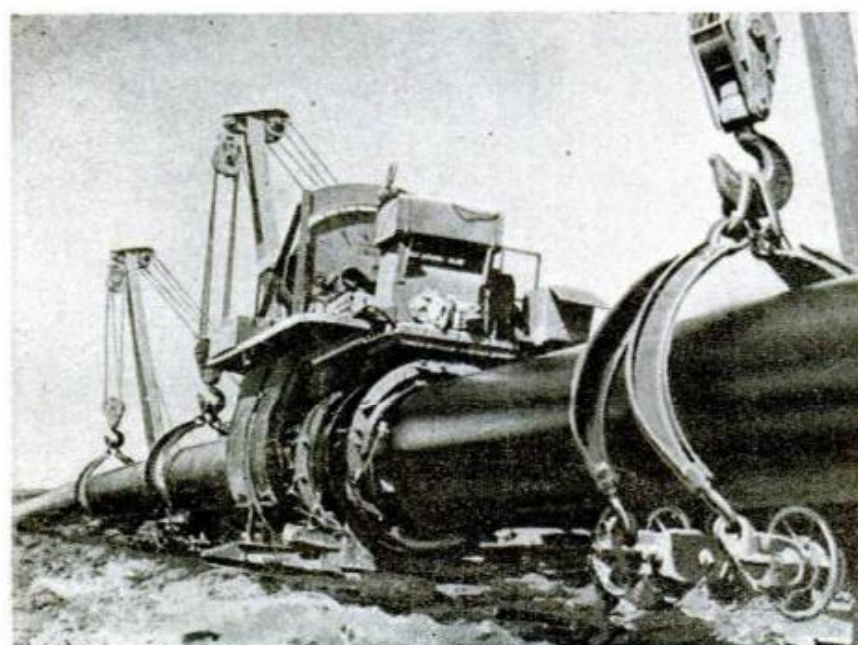

Big Pipe Cleaner

Crawling along a Russian gas pipeline, two new self-propelled machines clean, prime, insulate and wrap the three-foot, four-inch pipe automatically at speeds from 300 to 2000 feet per hour. Six big jib cranes lift the pipe on roller hooks while the machines do their work, then lower it carefully into its trench. A team of one cleaning machine and one insulating machine, with six, or seven cranes, can **clean and lay about 3300 feet of pipeline** in a working day.

Russ Cone with Daniel Boone. In 145 searches, the dogs have found 90 percent of the victims in less than 24 hours



Photos: Cliff Essex and Russ Cone

Mister Rescue and His Bloodhounds

By Cliff Essex

THE HUNTER crawled through the forest brush, clawing it aside with bleeding fingers. Completely lost for two days, he was weak from exhaustion and a savage hunger, and his clothes were shredded. Suddenly, rounding a bush, he came face to face with a bloodhound, and looking it right in the eye, he groaned, "Thank God you're here, but where've you been?"

Russ Cone, who had the bloodhound on a ten-foot tracking leash, didn't feel slighted that the man ignored him and spoke to the hound. There are no social errors in rescues, and Russ was already busy unlimber-

ing emergency rations as he walkie-talkied news of his find to a base camp.

Russ has saved dozens of lives in 145 rescues, 80 of these in the past three years. With his methods and his mobile Rescue Unit, he can direct search parties that may include 1000 men. His services are used mostly in California, where there are 23,400,000 acres of forest land available to the public seeking outdoor life each year. The value of his service was officially recognized last year when the Assembly of the California Legislature passed a resolution congratulating him, and noting that 90 per-

cent of his missions have found the lost person alive within 24 hours.

Few people know that this man is completely self-trained, and that ten years ago he had never even seen a bloodhound! The search project was long regarded as a hobby, but an absorbing one that kept the Cone family broke trying to support it.

The Cones came to their present home in Los Gatos (which means The Cats!) in a house trailer, and lived in it five years on their patch of ground along an old stagecoach trail in the hills. Work was scarce, but Russ, a master patternmaker, found a job as an appliance repair man. Now they wouldn't live any place else, for this is the kind of country that smiles back at you.

On his job Russ heard of a bloodhound pup that was for sale, and eventually bought it, sight unseen, by telephone. He still can't explain this yen for a hound, but he was mightily impressed when it was delivered—the "pup" weighed 85 pounds and had a tail-wag that dented the sides of the trailer.

A deputy sheriff saw him exercising the pup one day and suggested that a trained bloodhound would be of value in tracking the many people who get lost in the area. Russ and his wife, Thanis, trained the hound, called Daniel Boone, without any previous experience, or even any advice. They coaxed him around corners and over terrain with bits of food. Then they tried articles of clothing *plus* food, and at last got the pup to follow any scent.

It was strictly trial-and-error, and Russ believes that if the dog had not been a "natural," they would have failed. More than half the dogs that have since come to him have been dismissed because of "failure traits," like a tendency to lie down on an unfinished job when tired.

Today he devotes six months and 150 miles of hiking to train each dog, but Daniel Boone only had two months' schooling before they went on their first case, successfully trailing an elderly woman 14 miles into the hills. Holding the powerful hound on a hand leash, Russ suffered severely from shoulder strain, so he designed a body belt by which he could hitch the dog to his waist.

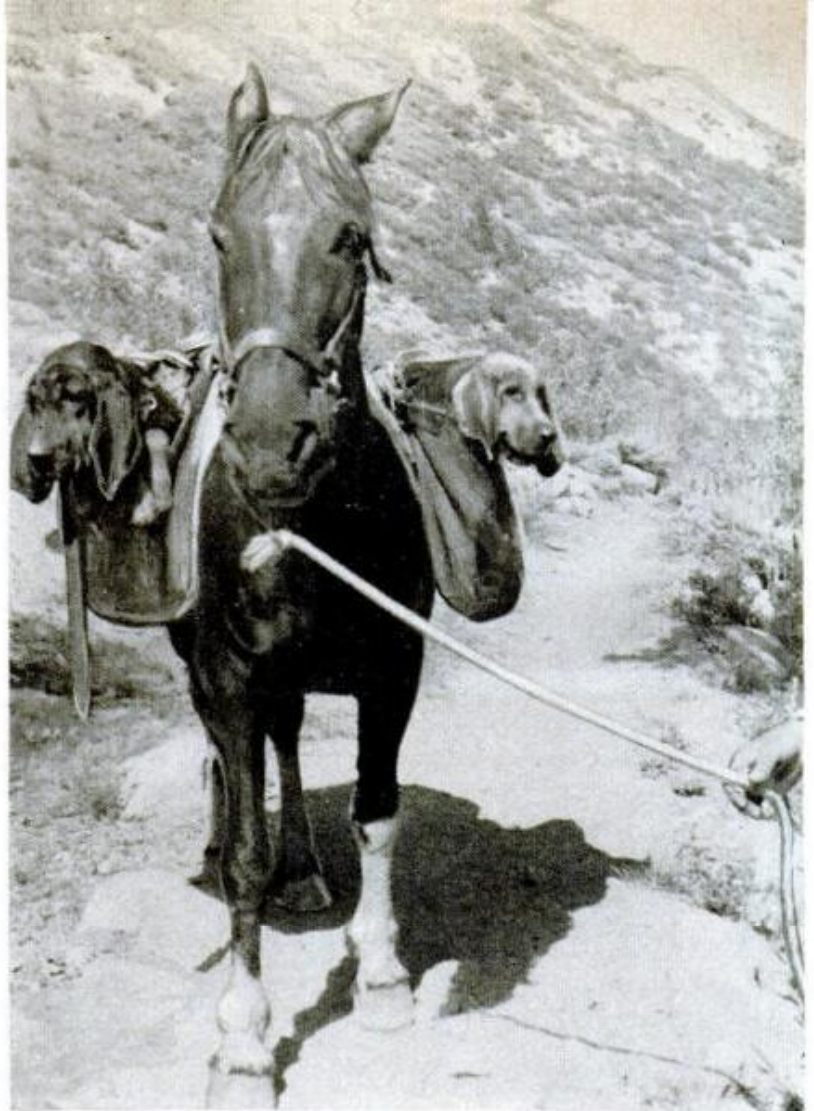

On long, rough mountain trips, dogs ride horses—and love it

Radios in Cone's home and car keep him constantly available





Found! Tracked down by the dogs 43 hours after he wandered away from a mountain camp, boy gets hot meal

Typical of excellent cooperation Cone gets from the armed forces, a helicopter from Alameda Naval Air Station



In the past, Russ says, hounds have been used on searches only when all else has failed, which is unfair. They were given a footprint to sniff, then were roundly criticized when they failed.

But hounds follow a scent that floats in the air, not one that lies on the ground, he points out. Pieces of the lost person's clothing or bedding are ideal scent guides, though a toy or some other recently-handled object will also work. Whoever calls Russ in on a case is asked to obtain a scent guide, handling it only with a clean stick or a pair of clean pliers, and to put it in a clean paper bag or carton to avoid contaminating the scent.

He cautions officials to be certain the scent guide is that of the right person, for a mistake—and there have been some—could cost a life as the wrong scent means the wrong trail or no trail at all.

Hounds are also criticized when they are in the vicinity of a find, but do not actually go right to a victim. Russ points out that they follow a scent in the air, which is often

shifted about by wind. Even so, he said, the dogs point out the correct direction for a search when, without them, rescuers might have to try all points of the compass.

When enough men are available, Russ actually directs that a party go ahead of the dogs. Hounds travel about eight miles per hour on trail, and in particularly rough country may have to be lifted over rocks and other obstacles, which slow them down. The forward party often gets credit for a find, even though they were directed that way by the canine smellers.

On his biggest job, Russ was out for eight days in the Mendocino National Forest seeking a lost boy. Flood conditions, 18 inches of snow on the ground, and high winds kept the dogs from working efficiently, and the victim was eventually found only after a foot-by-foot search was made, using a "string corridor" procedure.

Balls of string one mile long were used here. Starting where the victim was last seen or could logically be placed, helpers unwind the strings, staying fifty feet apart,



Five-year-old boy, lost for 18 hours near Big Bear Lake, is reunited with his parents as members of the successful search party look on

Leash belt saves handler's arms; the pockets hold survival equipment

Cone's employers, Calo Pet Food Company, provide this complete mobile rescue unit as a public service





Jeeps, summoned by walkie-talkie, winch in through snowdrifts to bring medical aid to a rescued boy

so that a corridor, or series of corridors, is formed over the terrain. Going down these lanes, four men, evenly spaced, look under every bush, scan each tree, and move all debris. Nothing is overlooked, and ten feet behind this group comes an observer who makes sure the others miss nothing. No log, no possible hiding place is overlooked.

On the Mendocino case, the boy's body was found at the very end of the sixteenth corridor, and being well covered, it might never have been found by any other search method.

The 12-year-old victim in this case had only been missing about four hours before a hunt was organized, which emphasizes the importance of quick action when someone is lost. This lad, who was not in robust health, had apparently died within 24 hours, and was only two miles from where he lost his way, but there was no way to tell how far he might have circled.

This case was a fine example of the cooperation always found on searches, Cone said. In addition to personnel from the Sheriff's office, this mission was also served by the Forestry Service, fire crews, Air Force and National Guard units, a doctor and clergyman each day, a county road crew, Senior Boy Scouts and executives of their Council, and the sheriff's mounted posse.

The amount of work involved is shown by the jobs performed by these and other volunteers. There were mounted and foot

searchers, crew leaders, portable-radio operators and radio technicians, an Indian tracker, bus driver, truck driver, airplane and helicopter pilots and observers, Paramedics, cooks, dishwashers, water haulers, woodcutters, a horse shoer, Civil Air Patrol liaison officer, bulldozer and grader operators, Weasel operator, repair mechanics, observation and lookout posts, road blocks, supply coordinator, hay haulers, cowboys and packers, waiters, Rangers and Foresters, telephone repairmen, guides, and stringers for laying out corridors.

Averaging 3700 miles a month on his job, Russ is kept in touch with home, office and officials by modern radio and sound equipment. He uses a radio telephone that operates two ways on two channels. This instrument is tied into his car horn circuit, a bell and a light. If he's leaving the car to enter a restaurant, for example, he switches the phone to "horn." If a call comes in, the horn blows. After seven seconds the horn stops and a bright light turns on and must be turned off manually. So, if he doesn't hear the signal, the light will still let him know that a call is waiting for him when he returns.

Radio equipment includes an HF transmitter on 4585 kc, or Civil Air Patrol's Channel 5. There are two portables that operate on the car's frequency so they can maintain contact in the field. They cover about eight miles. There is also an air-to-

(Continued to page 272)



Tank Trucks Load Fuels From Pipelines

Automatic and unmanned, a tankless terminal allows fuel trucks to load directly from underground pipelines, eliminating long round trips to remote storage areas and, in fact, eliminating storage. On arrival at the terminal, the driver telephones the central dispatcher to make sure the fuel

he wants is flowing through the line on schedule. (At different times, different fuels flow through the same pipeline, including regular and premium gasoline, kerosene, heating oil and diesel fuel.) If the right fuel is coming through, the dispatcher releases a valve at the terminal by dialing

Tactical jet fighter blasts off from short runway, helped along by a jet-assisted takeoff system. Runway aids jets in supporting infantry



Jets Use Runway Three Days Old

"Marines have landed and jets are using the beach!" This unusual communique was given out during a recent drill on Formosa, where the Marines constructed an aluminum runway, called a "Short Expeditionary Landing Field," in three days. Jets landed and took off as soon as the last of 9852 aluminum planks was bolted in place. The strip was 3400 feet long and 60 feet wide. The planks from which it was made measured 12 feet long, two feet wide, three inches thick and weighed 160 pounds each. Planes were stopped with an arresting gear.

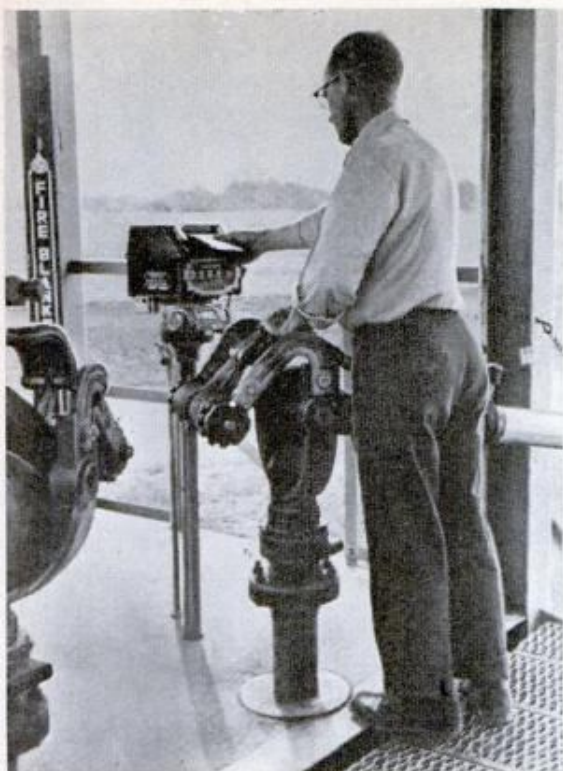

a code number from the central office. The driver then inserts his delivery ticket into a printing meter and, with a special key, unlocks both the meter and the valve and loads his tank. When his order is filled, valve closes automatically.



Atomic Rocket Launcher

Appearing in U.S. Army exercises is the launcher of the Davy Crockett rocket designed to deliver a low-yield nuclear punch at close range. The portable weapons system packs an atomic warhead with a small destructive radius so troops using it would not be endangered. Weight, size and shape of the warhead are classified.

Field is designed to be used no more than 30 days, or until a landing strip is taken

Engineers bolted together 9852 aluminum planks to form the 3400-foot strip in about 50 hours. Each plank weighs 160 pounds



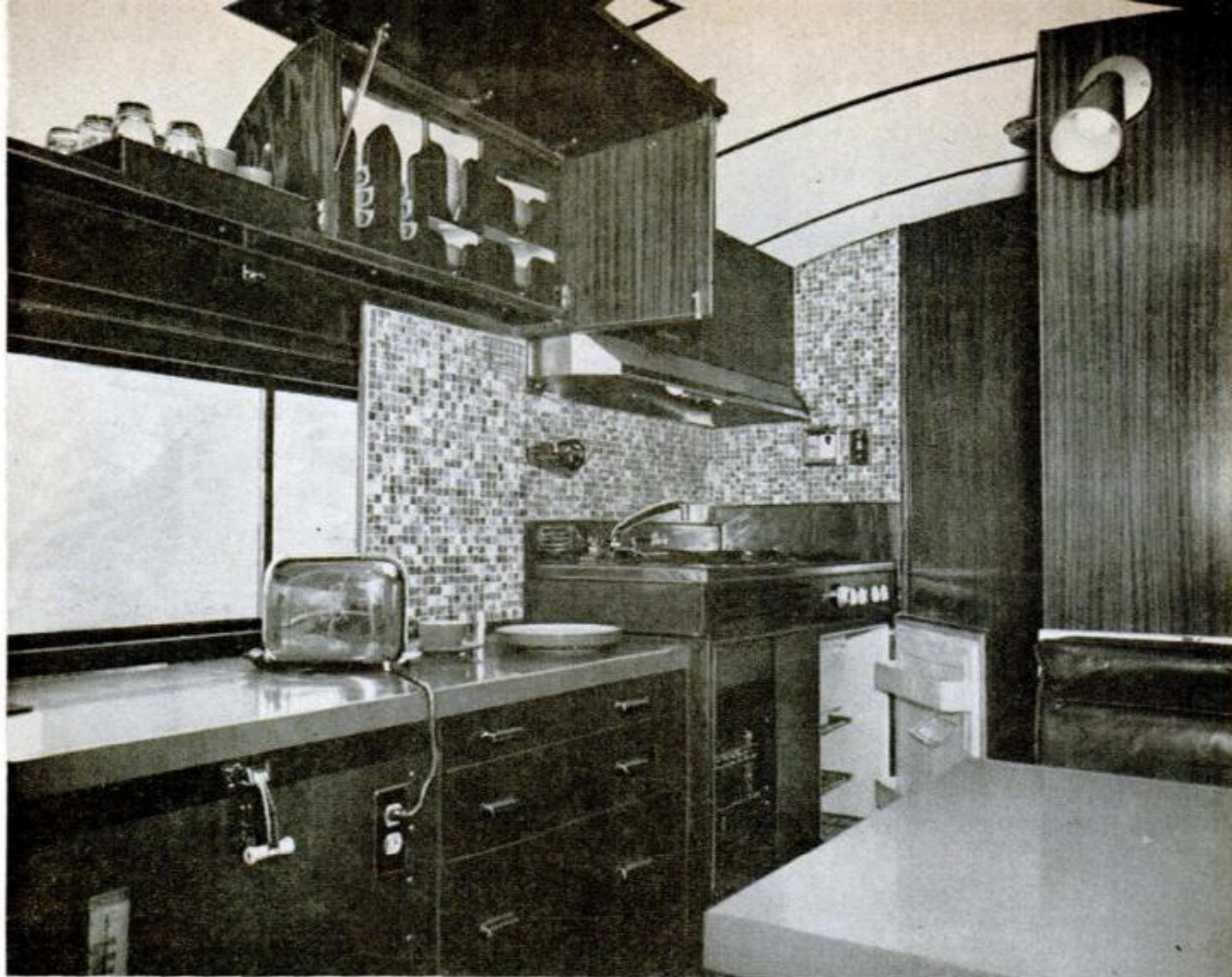

Galley has the convenience of a swanky motel. It is walled in mosaic tile, paneled in Honduras mahogany

Luxury Home for the Road

HIGHWAYS SHOULD BE happy ways indeed to occupants of the Bower Land Cruiser, the latest of the elegant mobile homes. First of all its owners could afford the \$40,000-plus charged by manufacturers Frank and Ralph Bower, a father-and-son pair of luxury lovers in Goshen, Ind. The Cruiser's appointments should go the rest of the way toward providing kicks on any route. Designed for six, it complies with all national road rules and enjoys the privilege of curbside parking. Finished in green, gold and cream, the prototype body was specially designed and is mounted on a General Motors chassis. No expense was spared in decorating the interior—since these are custom-built jobs, only the purchaser's sense of expense limits the decoration—and beyond the chauffeur's seat the swank begins. A partitioned dinette converts into a double bunk. Table top and counters are of flame-colored formica, and dishes and table service for eight are stored in handsome cabinets of Honduras mahogany.

The galley holds a four-burner stove, a deep freeze, refrigerator, oven with hood and ventilating fan, sink and disposal unit.

Both galley and bath are walled with green and white mosaic tile. All accommodations can be used during travel. Bath facilities include tub and shower; hot water is supplied from a 125-gallon tank, heated by an automatic, gas-fired heater.

The rear of the bus is a lounge with two 80-inch couches convertible to 36-inch-wide beds; two berths drop from the ceiling over them. A counter unit opens to form an illuminated vanity. Other features include a television set, air-conditioning, and bar. The ceiling is insulated and a rich, gold, wall-to-wall carpet covers the floor. The galley and bath are floored in gold vinyl. The striking note of opulence is the soft, olive-green, horsehide upholstery cut from seven oversize skins imported from Germany. Tinted and curved panoramic windows are draped in blending fabrics, linen in the lounge, glass fiber in galley and dinette. Electric power is furnished by a 5000-watt gasoline-powered generator delivering 110 volts from an outside-serviced compartment in the rear. A 12-volt heavy-duty battery provides alternate service.

The cruiser gets six miles to the gallon, should run a million miles.



Frank Bower, builder, views TV in lounge of Cruiser. It is upholstered in opulent, olive-green horsehide

Body is finished in green, gold and cream and is of stretched steel riveted to a welded frame

Chauffeur's compartment, lower left, is padded with sponge rubber covered with soft leather. Behind it, lower right, is a dinette that converts into a double bunk. Cruiser measures 35 by 8 feet on outside



OUR MOON PROGRAM STARTS NOW

THIS FALL the United States begins a stepped-up campaign to learn all it can about the Moon. The purpose, of course, is to prepare for the time when men will land on the Moon and later return safely to Earth. There's no telling when this will be achieved. It may happen in less than 10 years, it may not.

First on the immediate program and scheduled for this year is an attempt (backed by a spare) to put a satellite in orbit around the Moon. Space Technology Laboratories of Los Angeles is in charge of the project under a contract with National Aeronautics and Space Administration, but that's about all that's known about the orbiter. STL hasn't been allowed to give any details.

Next, in mid-1961, Caltech's Jet Propulsion Laboratory will begin its Ranger series of Moon shots. The first two rounds are intended to be near-misses, to check out techniques and learn more about conditions in space. The last three Rangers will carry capsules that are to be landed on the Moon to detect moonquakes and gather other information. The first of these should be launched in 12 to 18 months from now.

Spending many millions of dollars to study moonquakes is not as silly as it sounds. The information will tell scientists a great deal about the composition of the Moon, whether its interior is solid or molten, whether it has a crust and the kind of rock that predominates. The same seismometer that registers the quakes will also obtain information about the frequency and size of meteorites that strike the Moon.

With this big program in front of them the people at Jet Propulsion Laboratory have designed a basic

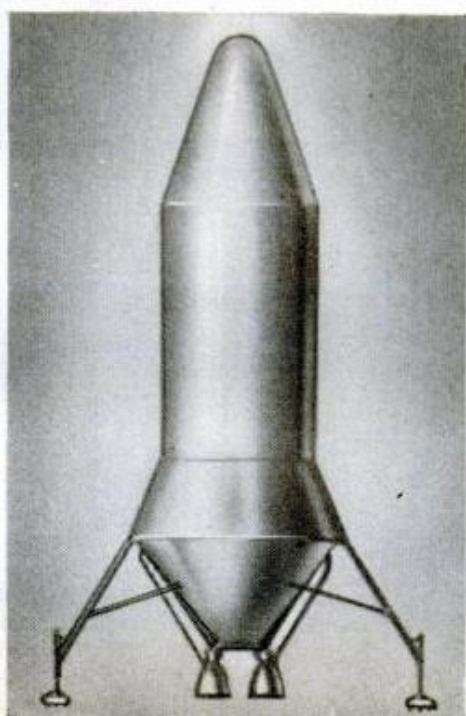
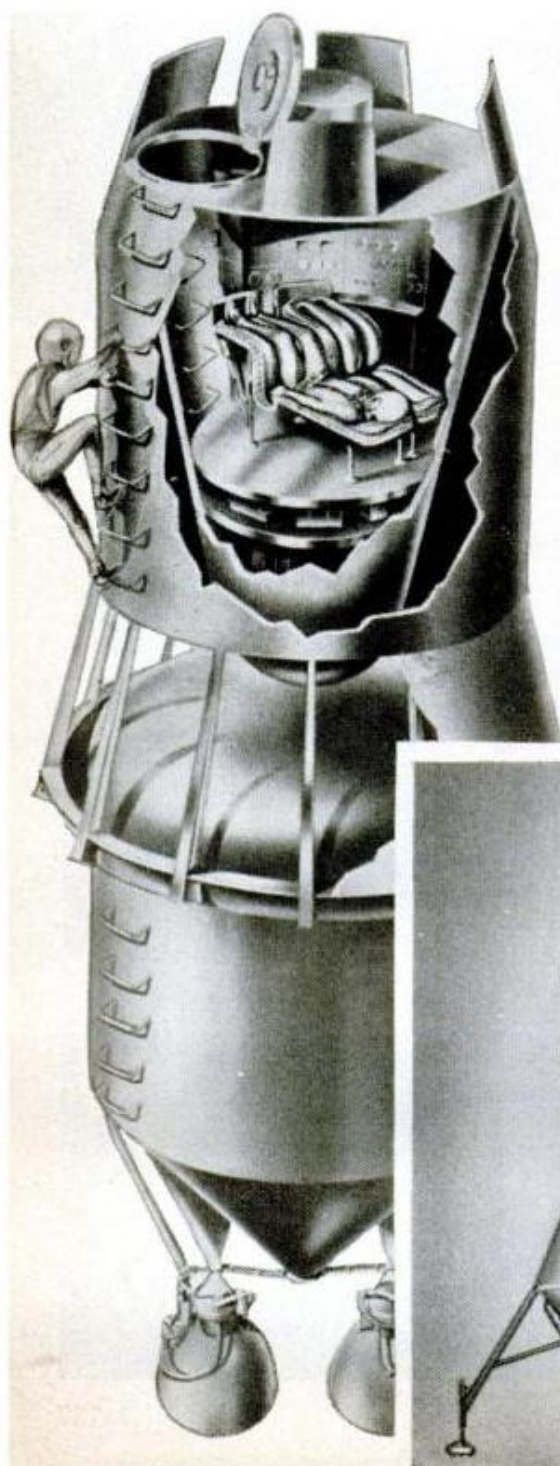

◆ Moon program involves three series of launchings, Ranger, Saturn and Nova. Saturn series (final stage of vehicle shown at left in exterior and cutaway views) will be first to put man on Moon and return

Ranger series will do preliminary ◆ exploring, eventually place capsule of instruments on Moon. Capsule (right) drops away from its spacecraft (bottom of picture) and, using retro-rocket, slows down for landing. Nova series (far right), last and most ambitious of program, could send expeditions of settlers to Moon and even beyond to other planets

By
Thomas E. Stimson, Jr.

"space bus" that can carry passengers in the form of numerous instruments, or a few instruments plus a 300-lb. lunar capsule. The bus is an ungainly collection of hardware assembled for a specific job instead of for looks. There's no need for sleek streamlining in empty space. The vehicle has its own logic circuits so that it can take care of itself as well as respond to radio commands from Earth.

The space bus carries two six-foot panels coated with solar cells for converting solar energy into 190 watts of electrical power. It has a 50-lb. thrust hydrazine rocket motor for in-course guidance maneuvers, plus small jets for changing attitude and stabilization. It has long-range-radio facilities, a back-up battery and other equipment. For the Ranger shots the bus and its cargo will be accelerated to escape velocity by a rocket consisting of an Atlas booster and an Agena-B second stage.

After the bus with its instruments and lunar capsule leaves the Earth it is designed to shed its outer protective covering and extend its solar panels and its antenna dish. Then its logic circuits take over, in effect saying "Start tumbling on your long axis while your solar sensors look for the Sun. Good. Hold it! Stabilize yourself and continue pointing at the Sun so its rays fall on the solar panels.

"Now rotate until your infrared Earth-seekers find the Earth. Hold it! Tip the antenna dish until it homes on the signal

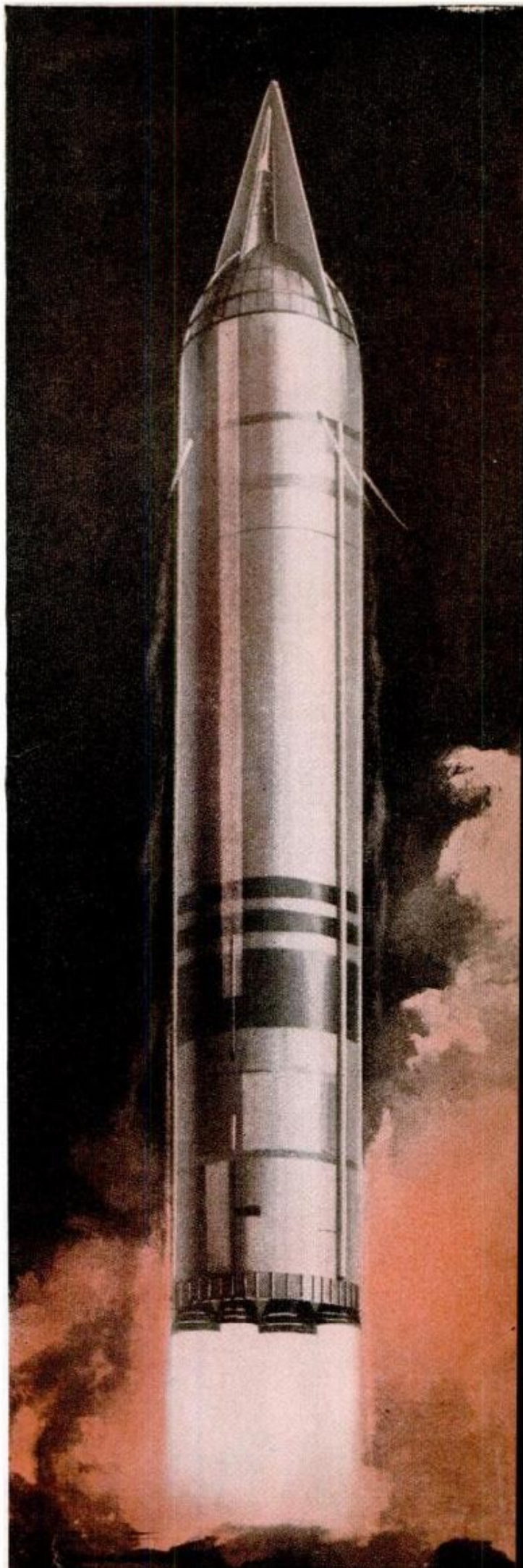
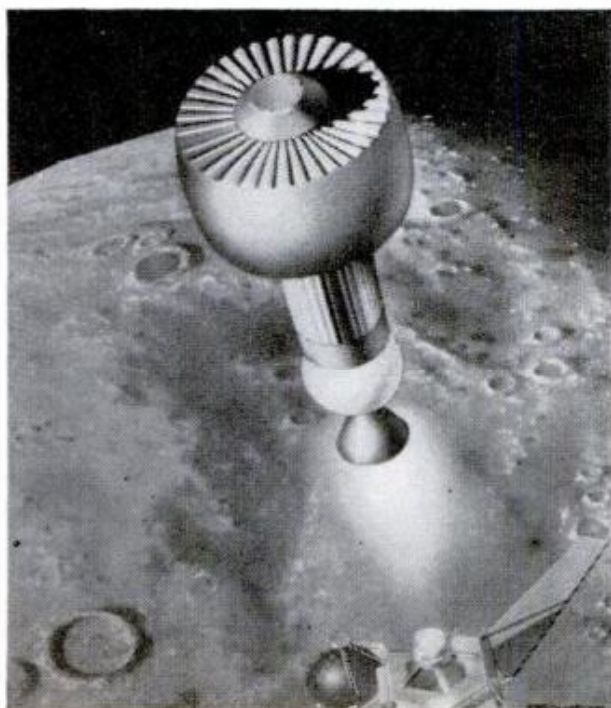

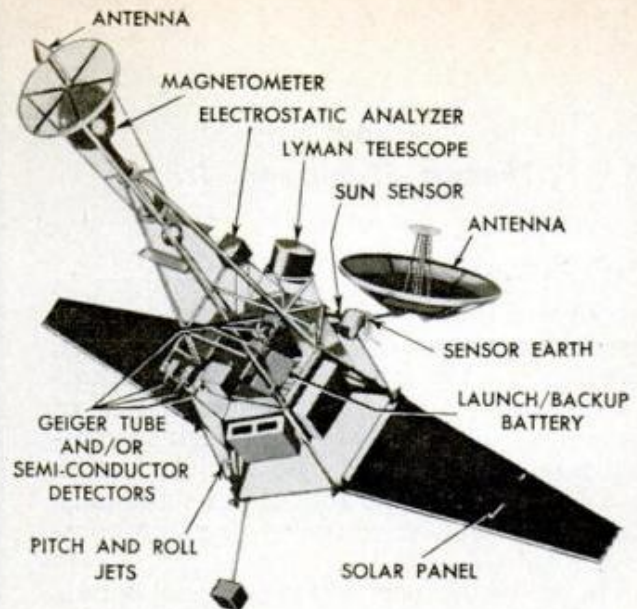

Mockup of Ranger One and Two spacecraft is studied at Jet Propulsion Laboratories (left). Diagram (above) shows instrumentation. Solar panels, folded up at launching, unfold in flight. Rangers Three, Four and Five will be modified to include Moon capsule

Dramatic difference in size and power between Saturn and Nova: Saturn engine (foreground) will be used in cluster of eight to power first stage. However, huge Nova engine (rear) will develop as much power as all eight Saturn engines. Using cluster of these engines, Nova will produce 12 million lb. of thrust

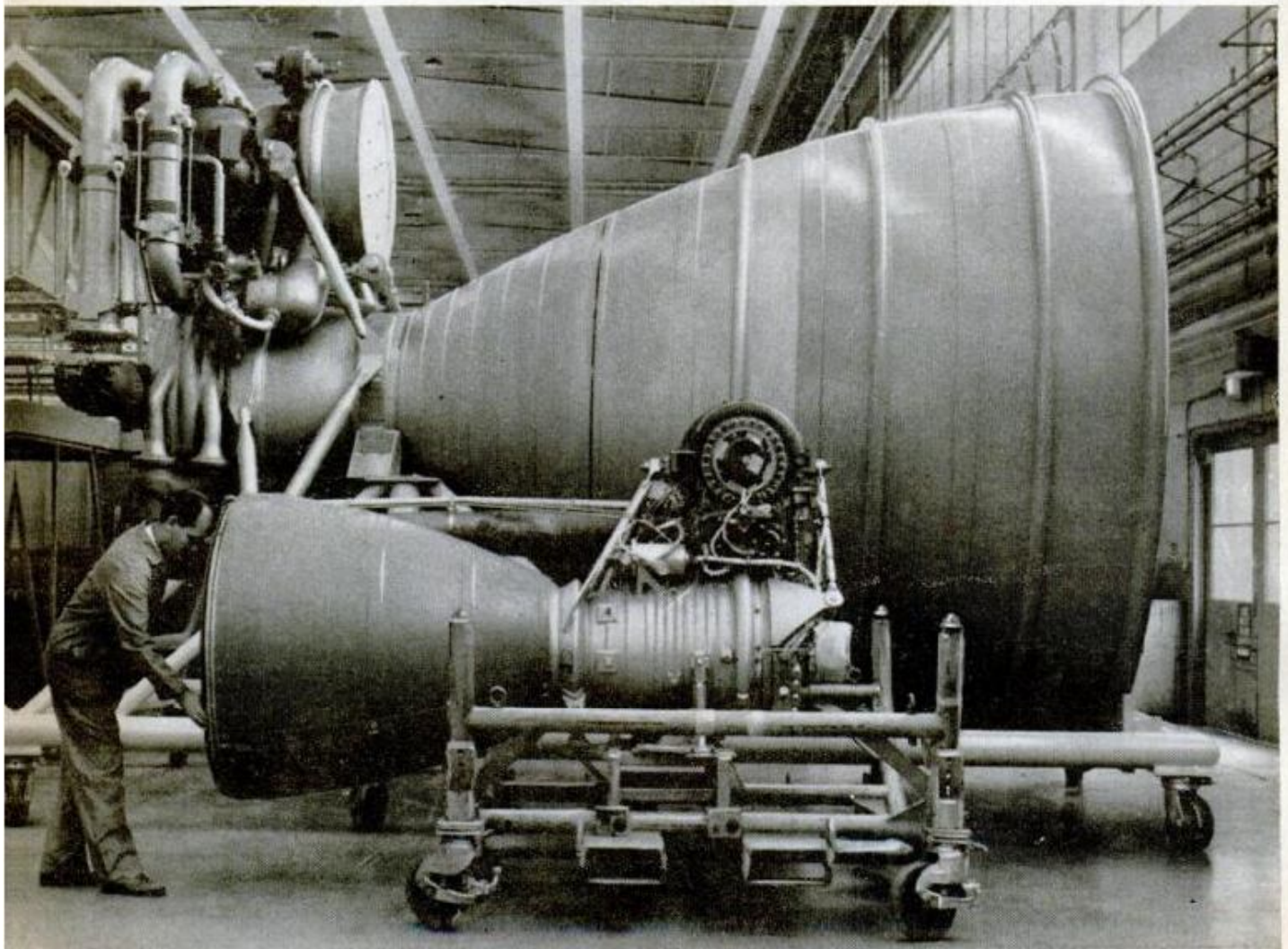

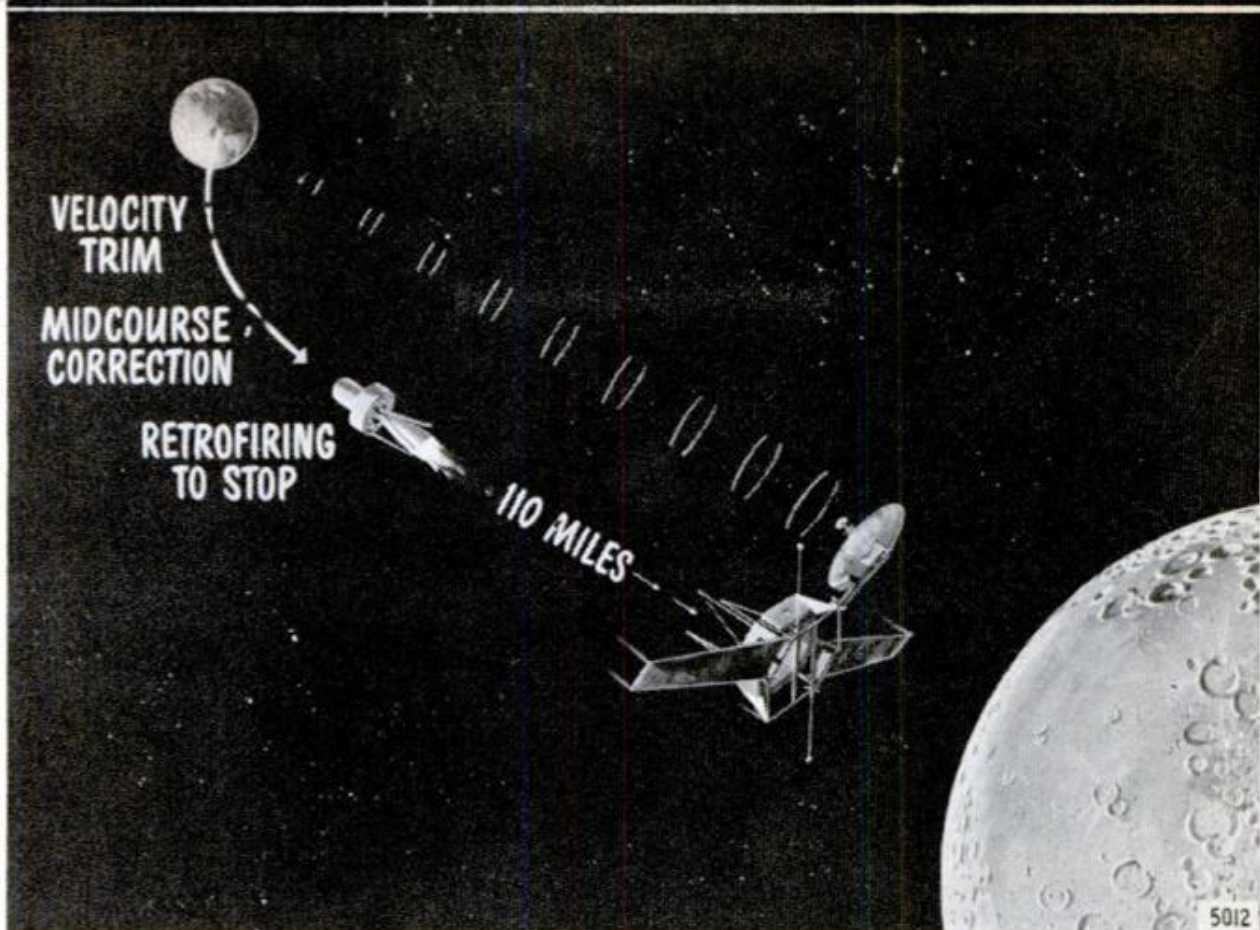

View of Moon flight by Ranger Three, Four or Five. Moon capsule, after separating from spacecraft, uses retro-rocket to slow down to safe landing speed of 200 m.p.h. Spacecraft continues coasting at 6500 m.p.h.

from the Goldstone tracking station in the California desert. Good! Stay in this attitude!"

Close to the halfway point on the 66 or 67-hour journey, computers on Earth will come up with a course correction that must be radioed to the space craft so that it will hit within a predetermined 100-mile target area on the Moon's northeast portion.

The guidance command may say "Roll 28 degrees, pitch 55 degrees and turn on motor for 19 seconds." After this is accomplished the craft's logic circuits will again restore the craft to its previous cruising attitude, locked on to the Sun and Earth.

An hour before impact and in response to another radio command the craft's attitude jets will turn it so that it points base-first toward the Moon. At this point a television camera will go to work, transmitting high-resolution pictures of the Moon's surface. A gamma-ray spectrometer will switch on to analyze and transmit information on what kinds of metals exist on the surface, what the rocks are made of.

Meanwhile a radio altimeter begins measuring the distance to the surface and when the distance is down to around 20 to 30 miles the altimeter triggers a retro-rocket attached to the landing capsule. The capsule backs off from the bus and slows down to around 150 miles per hour. The bus continues on and hits the Moon at 6500 miles per hour while the capsule, picking up a little speed because of gravity, "coasts" in at around 200 miles per hour.

The capsule is a pretty marvelous thing, a complicated mechanical organism. It can protect itself from injury even though it smashes into a moon mountain at 200 m.p.h. After impact it can move or turn itself over so that its radio antenna points up toward the sky. It can keep itself at a comfortable operating temperature through the bitter lunar night when the temperature drops to 250 degrees below zero and during the torrid day when the temperature is above the boiling point of water. The capsule can measure vibrations on the Moon's surface and radio a record of them back to Earth. It is designed to remain "alive" for 30 days or more.

To create a device that will do all these things, JPL first studied the ideas submitted by 14 different companies and then paid three of them (North American Aviation, Hughes and Aeronutronic) to make additional studies. On the basis of these studies the award for building the capsule was given Aeronutronic, a division of Ford Motor Company.

It's hard to think of how a mechanism can do all the things the capsule is to do but it seems simple after you learn how the Aeronutronic engineers solved the problems.

First of all, they are protecting the capsule with a thick outer coating of balsa wood, honeycomb or some other crushable material that will absorb the tremendous impact of the landing without transmitting too great a strain to the instruments.

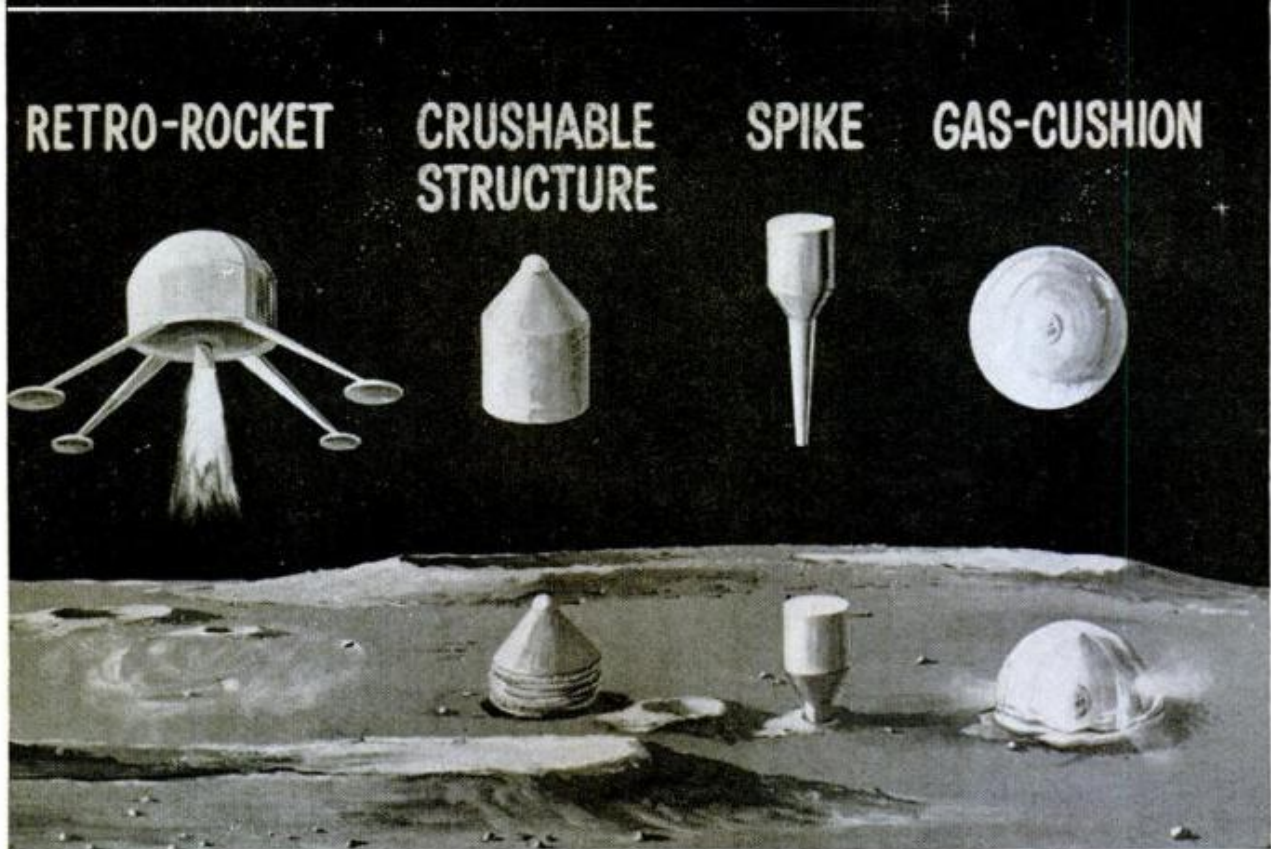

Four landing systems are under study for safely placing instruments on Moon. Ranger Three will combine first two

The capsule itself will consist of two spheres, one inside the other and separated by a liquid so that the inner sphere floats in the liquid. The inner sphere contains all the instruments and purposely will be built out of balance so that its heaviest portion is opposite to the part of its surface that serves as the radio antenna. This allows the inner sphere

(Continued to page 276)

Saturn sketch (right) shows three-stage configuration. Full-scale cross section (below) shows size of Saturn booster

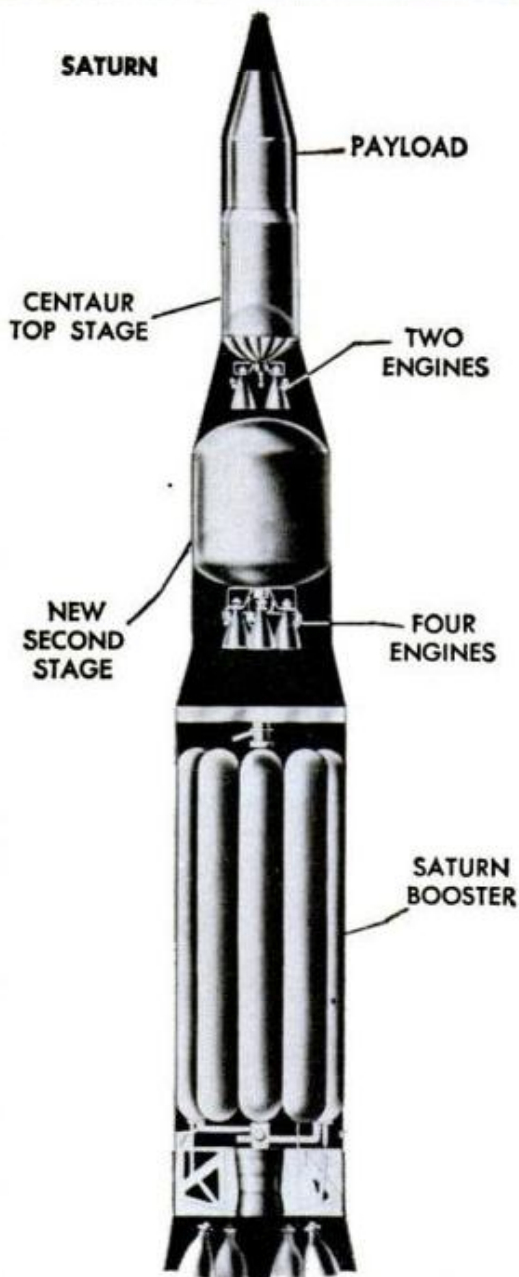
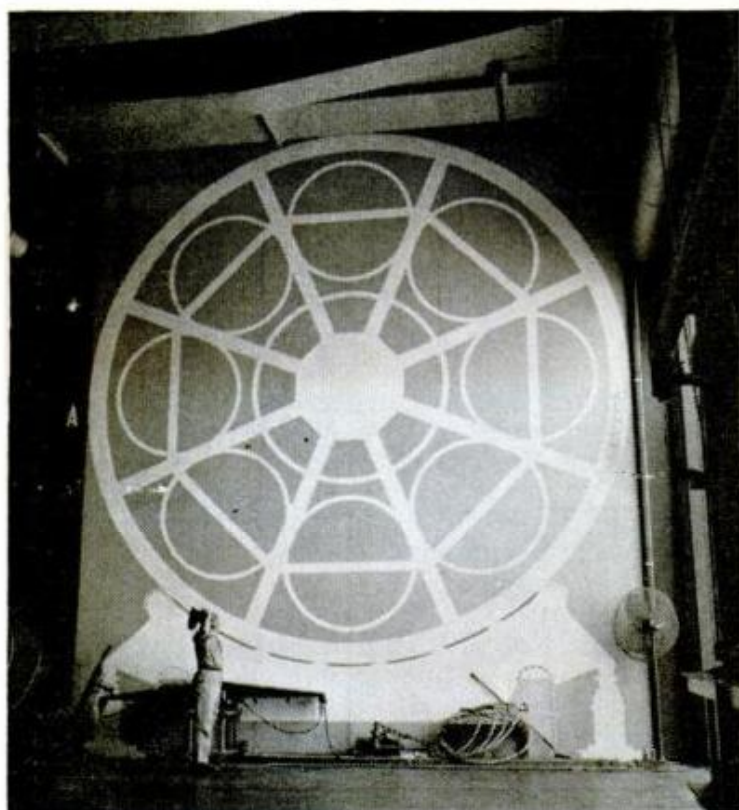



Simple Chemical Treatment Restores Old Books and Manuscripts

Age and careless storage are the biggest problems facing book collectors, and countless books, prints and manuscripts are lost as art treasures because of stains, mildew spots and "foxing" (rusting of bits of iron in the paper). Since the old paper is brittle and weak, the handling necessary for cleaning often results in damage or complete disintegration.

David Resnick, Los Angeles chemist and book collector, tackled the problem and, after 10 years of work, has developed a chemical process that not only cleans and

restores the paper to its original whiteness, but also preserves it from future damage.

In his process, single sheets can be dunked in a pan, then allowed to dry, then treated with the preservative, for about 15 cents. Bound volumes are treated with a dry method, with the book hung in an airtight cabinet and the vaporized chemical blown over the pages as they are flipped by a fan. After that treatment they are finished by hand. The chemicals used in both processes are relatively inexpensive and harmless, according to Resnick.

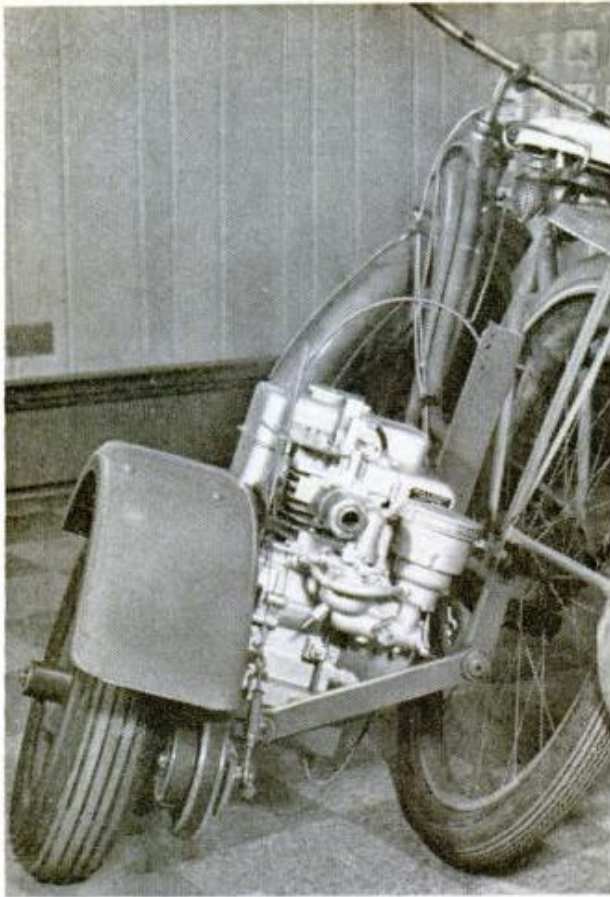

"Power Wheel" for Bicycles

Attached to the rear frame of any 24 or 26-inch bicycle, a new three-horsepower drive unit will move the bike up to 25 miles an hour with an average gas mileage of 100 miles per gallon. Double-hinged and pivoted, the 15-pound drive wheel does not restrict bike movement. It includes a hand-controlled grip-lever clutch, twist-grip throttle, and automatic free wheeling. The motor is air cooled and drives the wheel through a series of belts.

Trailer With a "Basement"

Short of parking space in his yard for his three-room mobile home, John F. Carter of Sonora, Calif., built a parking platform out over a rock ledge bordering the property, then enclosed the platform framework to make a "full basement" under a trailer. The framework is the same length as the trailer but twice as wide, and is enclosed with standard aluminum siding buttressed with random-laid fieldstone. The trailer was moved into place on rollers cut from two-inch pipe, and can be rolled easily off the "basement" for road trips.

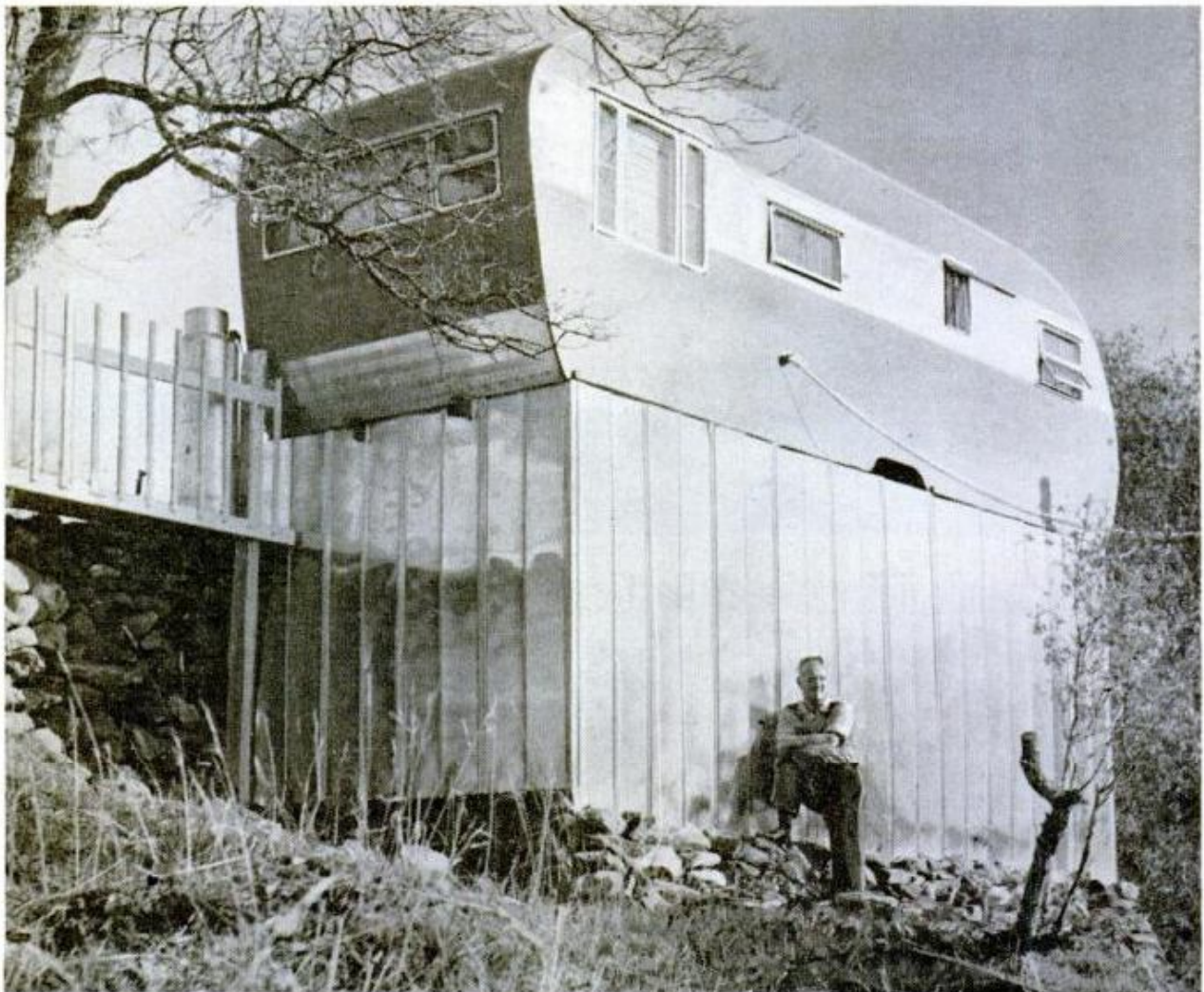

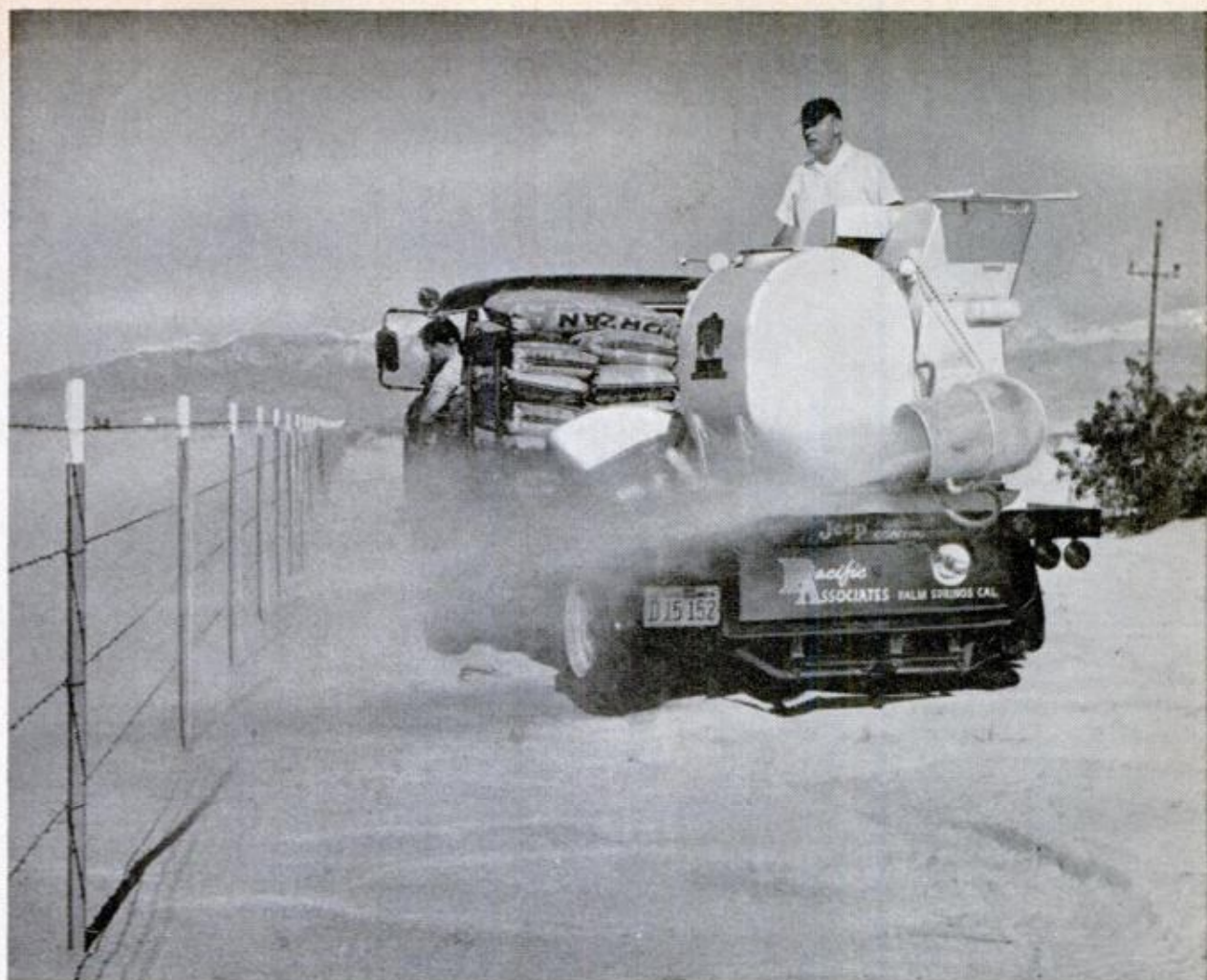

Chemical "Glues" Sand Down

Like oil on choppy water, a new chemical spray, Turbozan-14, stabilizes blow sand along highways, airfields, rail lines and pipelines to prevent it from blowing, even in high winds. The chemical, a paper-mill waste product, is applied by a high-velocity turbine sprayer mounted behind a truck, which throws the stabilizer over a 100-foot swath at a velocity of 180 miles an hour. Sprayed over loose sand as thinly as three ounces to a square yard (at a cost of two cents), Turbozan hardens to form a crust-like heavy frost (right), effectively "gluing" the surface in place. The blower can also be used to plant grass in sandy areas.



Typewriter for Eskimo Dialect

Ever seen anything written in Inuktitut? The 46 sets of characters at right are the keys of a typewriter designed by Leo Manning, Eskimo linguist, for writing the difficult Eskimo dialect in syllabic characters. The typewriter will be used in preparing a new quarterly magazine published by the Canadian Department of Northern Affairs for 3500 Eskimo families scattered over half a million square miles. Delivery will be by plane, boat and dogsled.

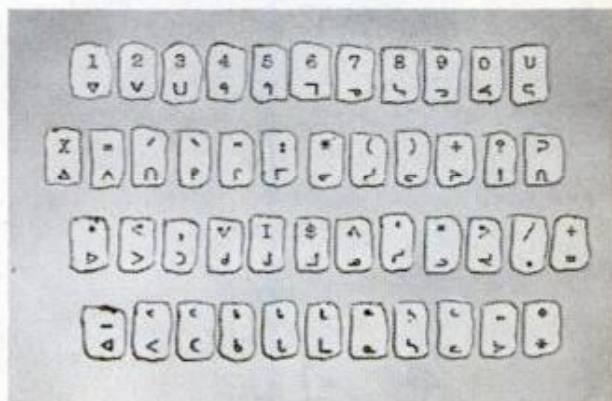

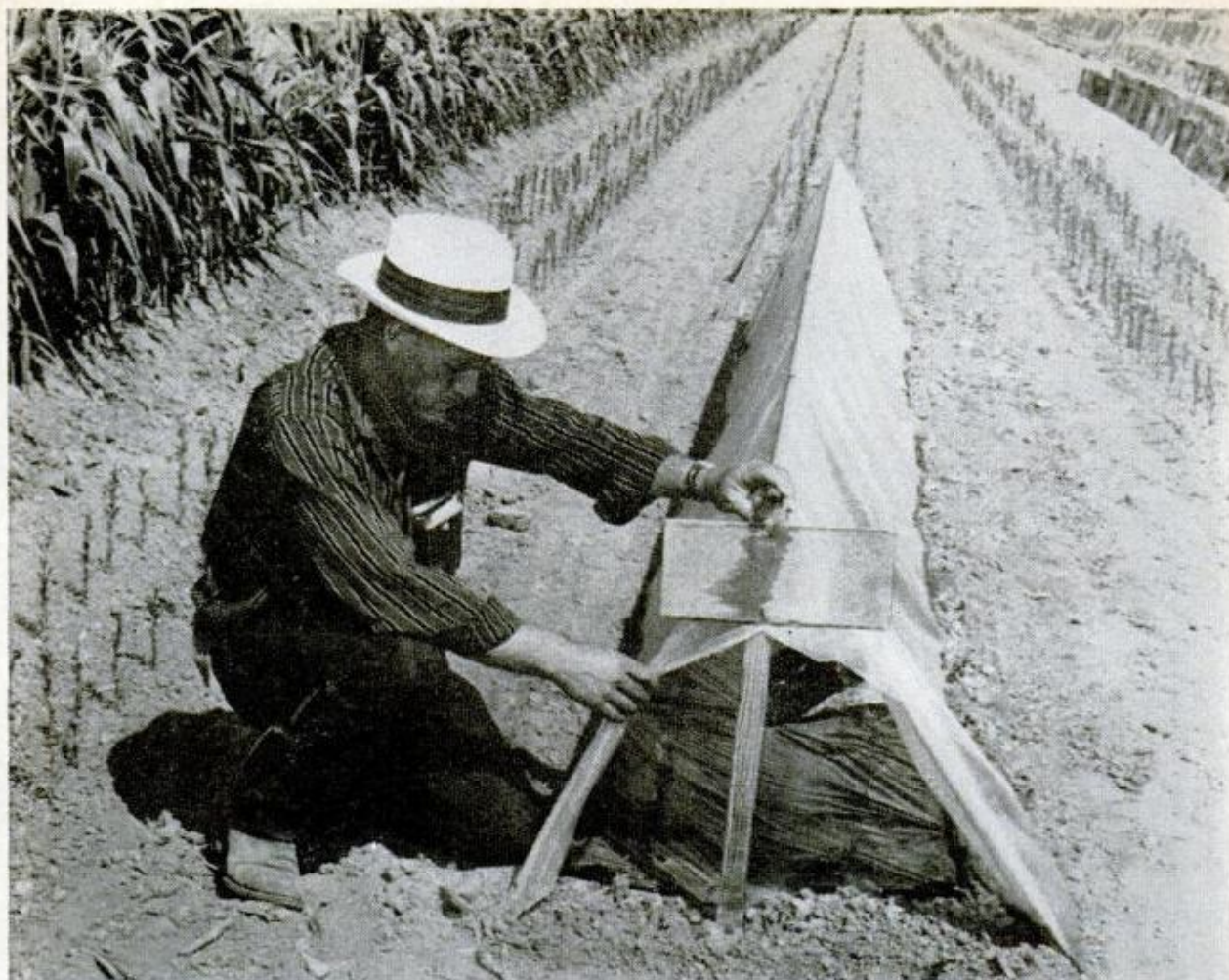

Troy Gary shows ultimate use of polyethylene: clear sheets for sides and roof, black sheets for mulch covers

Two rows of young trees dramatize results of experiment. Vigorous trees on left were grown with plastic mulch covers and windbreaks. Smaller trees on right were planted at same time but without polyethylene



"Poly" Coddles Plants

By Thomas A. Dickinson

INEXPENSIVE polyethylene plastic has been successfully tested as a substitute for greenhouses for nursery stock.

A citrus grower, Troy Gary of Santa Paula, Calif., used both black and clear polyethylene sheets as mulch covers for the earth surface and as lean-to windbreaks above the ground.

Primary purpose of the plastic is to store up heat from the sun. Resulting temperatures around the roots and foliage was 5 to 12 degrees above prevailing temperature.

(Continued to page 252)



Gary indicates black plastic sheets on ground which serve as mulch covers for young citrus seedlings. The covers help increase the temperature around the plants, help the soil retain irrigation water and protect it from harmful mineral deposits, and also help prevent the growth of weeds around the plants

Plastic windbreaks became more valuable for increasing temperatures at ground level than for protecting plants from strong winds. Chief windbreaking was done by tall corn in background, because plastic sheets were not always strong enough to stand up under stiff breezes. Clear plastic allows sun's rays to penetrate





During the evening, astronomer Richter divides time between service station and observatory in nearby field

Operator Services Cars and Observes the Stars

WHEN amateur astronomer Henry Richter is not working at his Cecil, N. J., service station, he usually can be found around back, in his observatory, tracking a star.

Richter, 55, combined his work and hobby when he built the observatory. In many cases, for example, he substituted auto-

mobile parts for expensive equipment. The cost of the telescope—nine feet long, with a 12½-inch reflecting mirror—totaled \$562.

“The whole observatory actually was built from junk and contributions from friends and neighbors,” he says. It has a revolving dome 16 feet in diameter set on a 20-foot-square building with six-foot-high walls.

Three brake drums from wheels of Richter’s 12-year-old Chevrolet were used in mounting the telescope. One is used for vertical tracking; another for horizontal tracking; the third, offset and filled with 70 pounds of concrete, is a counterbalance. A motor and gearbox from a washing machine drag a bicycle chain which turns the 900-pound dome. Dome and base are covered by Fiberglas salvaged from a local manufacturer.

Richter, a member of the Rittenhouse Astronomical Society of Philadelphia, keeps his service station open until midnight. His observatory keeps longer hours.

Three brake drums from an old automobile form telescope mounting which rests in one ton of concrete



Rub-A-Dub-Dub, A Motorized Tub

Some people sing in their bathtubs and let it go at that, but garage owner Jaap Swart, of Wormerdam, Holland, cruises around the streets of Amsterdam in his. He built it from old motorcycle parts and, of course, a bathtub. There's a chain drive to the front wheel, which is mounted through a cutout. He steers the strange vehicle through the two rear wheels, and has the headlights mounted under the original faucets, which he has polished and left in place.

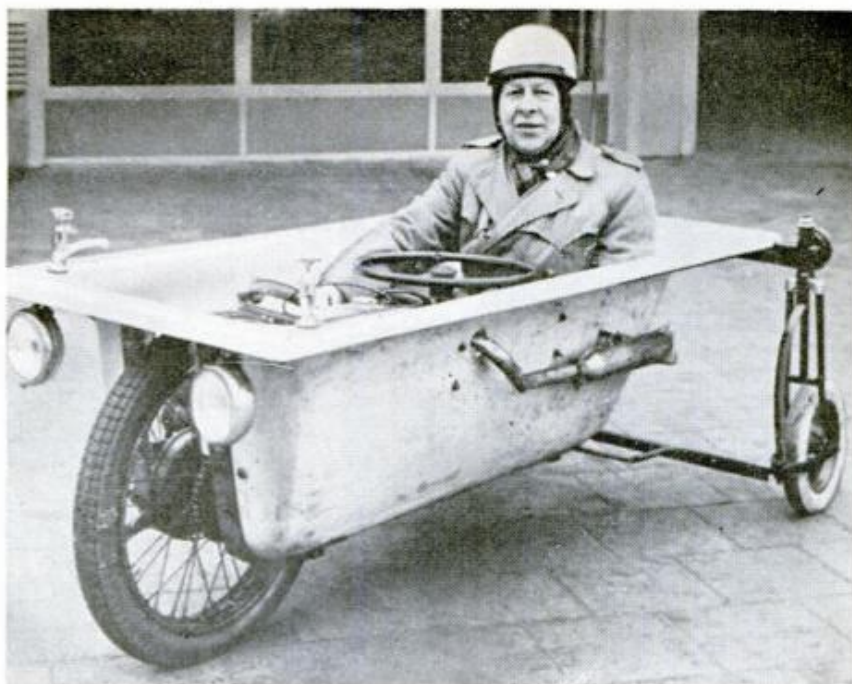

Alarm System Maps A-Blasts

First phase of a one-second national alarm system for detecting and reporting possible sneak-attack nuclear explosions on U.S. target areas is now operational. Air Force Col. Joseph Hannah (pictured at right) said the system, built around a device that senses the blast and transmits the signal to a central headquarters where it is mapped, is designed never to transmit a false alarm. Eventually 100 areas in 48 states will have sensors.



Wigwag Warns Driver Of Unsafe Air Brakes

Warning bus and truck drivers of brake failures due to loss of air pressure (or vacuum failure), a new signaling instrument mounts above the driver's line of vision above the windshield, but drops instantly into view when there's trouble. The signal is connected to the brake system in the engine compartment, and cannot be reset until the brakes are safe.

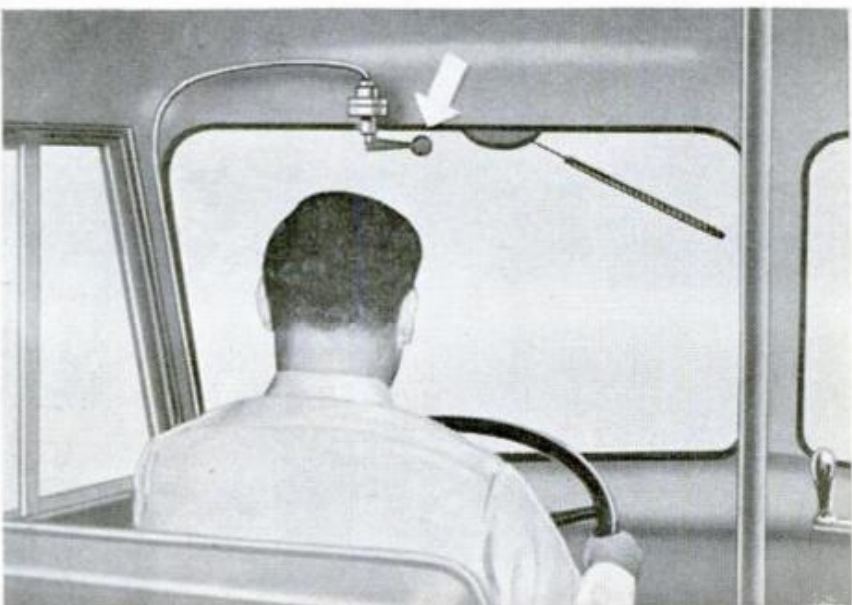



Leap

**for
Life!**

Happy-landing technique here is demonstrated by Capt. Burnett S. Lillard of the Santa Monica, Calif., Fire Department. He lands on the small of his back just about on the belt line



By Eugene M. Hanson

WHAT YOU LEARN on these pages could save your life if you are ever trapped on an upper floor of a burning building. With smoke and flames roaring up the elevator shafts and stairwells, there's sometimes no way out but to jump into a lifesaving net—then this knowledge almost certainly will save you.

Many have been saved by lifesaving nets, but a great many more have leaped to their deaths. A little-known statistic is that only about five percent of those who leap toward the nets are saved. It's a useless loss of life,

however, because the 95 to 5 ratio could be reversed. At least 95 percent of those who jump, firemen insist, *could* land safely—it's all a matter of knowing how. Experience has demonstrated that leaping into a lifesaving net can be actually enjoyable.

Every fireman is taught the technique of jumping into the net in the early part of his rookie training and is required to make practice jumps periodically as long as he continues working as a fireman. These practice jumps by firemen run into hundreds of thousands every year—and it is unheard-

Many parents panic when trapped in burning buildings with small children. Few will wait for the big net

Children, falling relaxed, have a good chance, but they must be thrown outward, face up, to land flat





WRONG: Don't try to break your fall with arms or legs—let the firemen cushion the impact with their arms



of for a fireman to be injured in a jump.

Chief Charles Carrell of the Santa Monica, California, fire department, whose firemen assisted with these pictures, takes his jumps right along with the rest of the men, although he is under no obligation to do it. He enjoys net jumping as a sport. Firemen keep in good physical condition, but that's not the reason they can cheerfully jump several stories into a 9½-foot net held by ten buddies.

There was a case of a woman more than 70 years old leaping from the sixth floor of a Chicago hotel in October, 1957, into a lifesaving net without injury. She was unhurt, not because of athletic ability, but because she happened to jump correctly and land in the right position.

Landing in just the right position, you see, can make all the difference in whether you are killed, injured, or hardly shaken at all by your desperate leap.

Trained net crew in their special stance—arms flexed and legs positioned to move in any direction



RIGHT: A perfect landing, with arms and legs up and the body nearly flat in a relaxed, half-sitting position

But first, you must make sure you land in the net at all. Worst possible mistake, of course, is to miss the net altogether, and this is the cause of most of the rescue attempts that fail, yet, it is the error which is easiest to remedy. To be sure of hitting the net, simply jump as far away from the building as you can. Firemen are trained to move the net quickly and catch the leaper like a baseball player fielding an infield fly ball. But if you timidly slide off the window ledge, falling almost in contact with the side of the building, the firemen are nearly helpless. They can't get the net close enough to the building to break your fall properly.

They have a trick in these cases of leaning the net against the building, slanting it down against the ground so the fall is at least partially cushioned when the body hits the slanted net and caroms off to the ground. It may save a life but can hardly avoid injury.

When you leap out boldly as far as you can jump, the firemen, who stand ready to

move in any direction, will see that you land exactly on target.

Firemen hold the net, too, to absorb the shock with their muscles so you won't be hurt at all—if you land properly.

Landing properly means, specifically, on the small of your back with your arms and legs up. Jumping to land feet first is the common mistake, for this means broken legs or worse injuries. If you land on your feet with knees flexed, the knees can be rammed up against the face with bone-shattering impact. Still worse, from extreme heights, the thigh bones might be driven right through their sockets and into vital organs of the body.

But just lift your legs and arms and lean back as you fall, as if you were trying to make a big splash in a swimming pool—and don't try to break your fall with extended arms, either—and you'll live to tell about your leap for life.

And as you tell the story over and over through the years, you might even be tempted to try it again some day. ★ ★ ★



Newark Airport Gets 150-Foot Control Tower

Standing like a jet-age lighthouse between Newark Airport's two active runways is a new, 150-foot-high control tower that is crammed with \$1,000,000 worth of electronic equipment. The 13-story struc-

ture—it will be topped by a "radome" to protect radar equipment—will house some 90 Federal Aviation Agency employees. On a round-the-clock basis, they will operate radio transmitters and receivers, direction finders and air-surveillance radar. In addition, navigational aids including two instrument-landing systems, associated approach lighting systems and a telecommunications network will be operated from the tower. It is located near the center of the 2300-acre airport, which served 3,000,000 passengers last year and expects to handle 6,000,000 by 1965. It will give controllers the best possible view of runways, taxiways and ramp areas.



Electrocutor Kills Insects

Wherever insects are abundant—at swimming pools, beaches, patios or terraces—getting rid of them often can be a losing proposition. One ingenious way of solving the problem is an insect electrocutor that attracts insects—by a special black light—to a high-voltage grid and kills them instantly. A metal guard protects against a nonlethal but unpleasant shock if the grid is touched. The electrocutor can be mounted on a post or the side of a building out of human reach, however. Costing no more than a light bulb to operate, it controls flies, mosquitoes and nearly all night-flying insects.

Truck Reaches High To Unload Cargo

For tilting bulk cargo directly into railway cars or hoppers, an East German dump truck has a three-way dump body mounted on a hydraulic scissors-action elevating frame. It can raise a 2.8-ton load 10 feet above the truck chassis. The standard four-ton truck body is braced and stabilized at the rear by hydraulic legs that extend to the pavement during operation.

☐ A group of Italian firms plans to build an underwater pipeline to transport gas from the Sahara to Sicily.



Movie Projector Is Also a Viewer

As an aid to home movie editing, the manufacturer of a new 8-mm. projector equipped it with a viewing screen. The screen measures $2\frac{1}{4}$ by $3\frac{1}{8}$ inches. At the flip of a lever, the picture can be instantly switched from the distant projection screen to the built-in viewer while the projector is in operation. Families now may preview movies or edit film without setting up a screen or darkening the room.

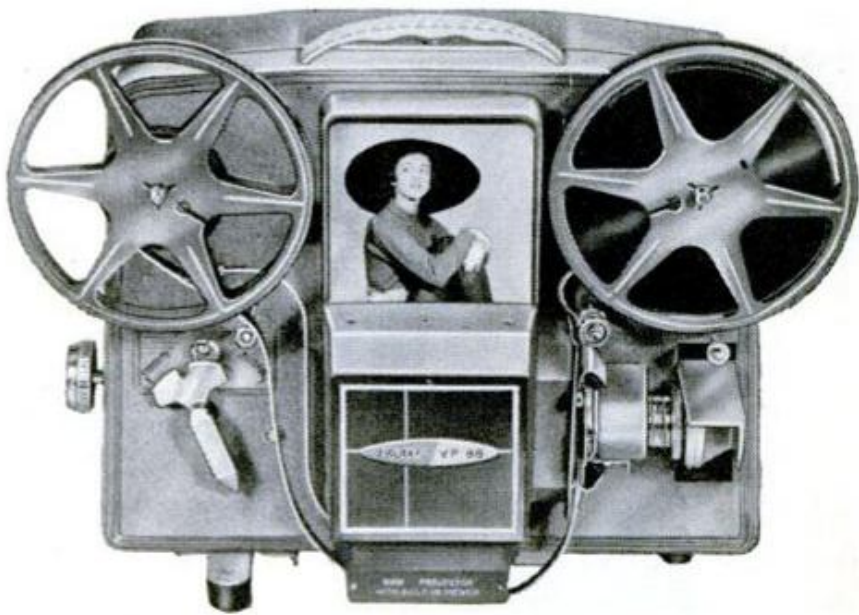

King-Sized Vacuum Unloads Boat Hold

Speeding the unloading of shiploads of copra at the Cargill copra terminal in San Francisco, Calif., a giant vacuum hose sucks up the dried coconut meat with the help of only one man, who loosens the packed cargo with a pick. The big "sucker" inhales the hard-to-handle copra and shoots it quickly into the Cargill plant ashore, where its coconut oil is extracted and processed into food and oils.





New York Times photo

Many employes of the UN meet once a week with teacher Sophia Delza to practice the exercise's 108 movements

T'ai Chi



Milwaukee Journal photo

Miss Delza glides into the posture called "The Snake Creeps Down." The exercise was set in its final form around 1000 A.D.



"The Brush Knee Twist Step" describes this action. Performers of the movements never strain themselves

Milwaukee Journal photos
They move easily from one position into the other. This one is "The Golden Cockerel Stands on One Leg"

for Your Muscles

By James Biery

HERE AND THERE throughout the United States a growing number of people are setting aside at least 20 minutes a day to perform an ancient graceful Chinese exercise called T'ai Chi Ch'uan. The name, pronounced "taw-jee-twawn," may be translated as "The Art of Gymnastic Movement" and is one of many branches of physical culture that come under the heading of Chinese boxing. The present form of T'ai Chi dates back to 1000 A.D. and is the culmination of experiment and thought on exercise by boxers, surgeons, monks and rulers.

T'ai Chi differs from similar exercises such as toe-touching and push ups. It not only develops flexible muscles, it is also claimed to activate the body for the development of physical, emotional and mental

well-being. When it is mastered there is no sense of strain, nor is there the hustle and bustle of repeating the exercise, as in push ups, with a vigorous one-two, one-two movement. Instead, it resembles a graceful, solitary dance. The performer moves slowly and with ease from one to another of 108 positions without stopping.

"We in the West are apt to overexert ourselves in exercise and sports, believing that a hard, tense movement indicates strength, and that power comes from the ability to expend energy violently," says Sophia Delza, the leading teacher of the exercise in this country. "Contrary to such a point of view, it is in the philosophy of T'ai Chi Ch'uan that true energy can be controlled, strength balanced, vitality stabilized, only

(Continued to page 256)

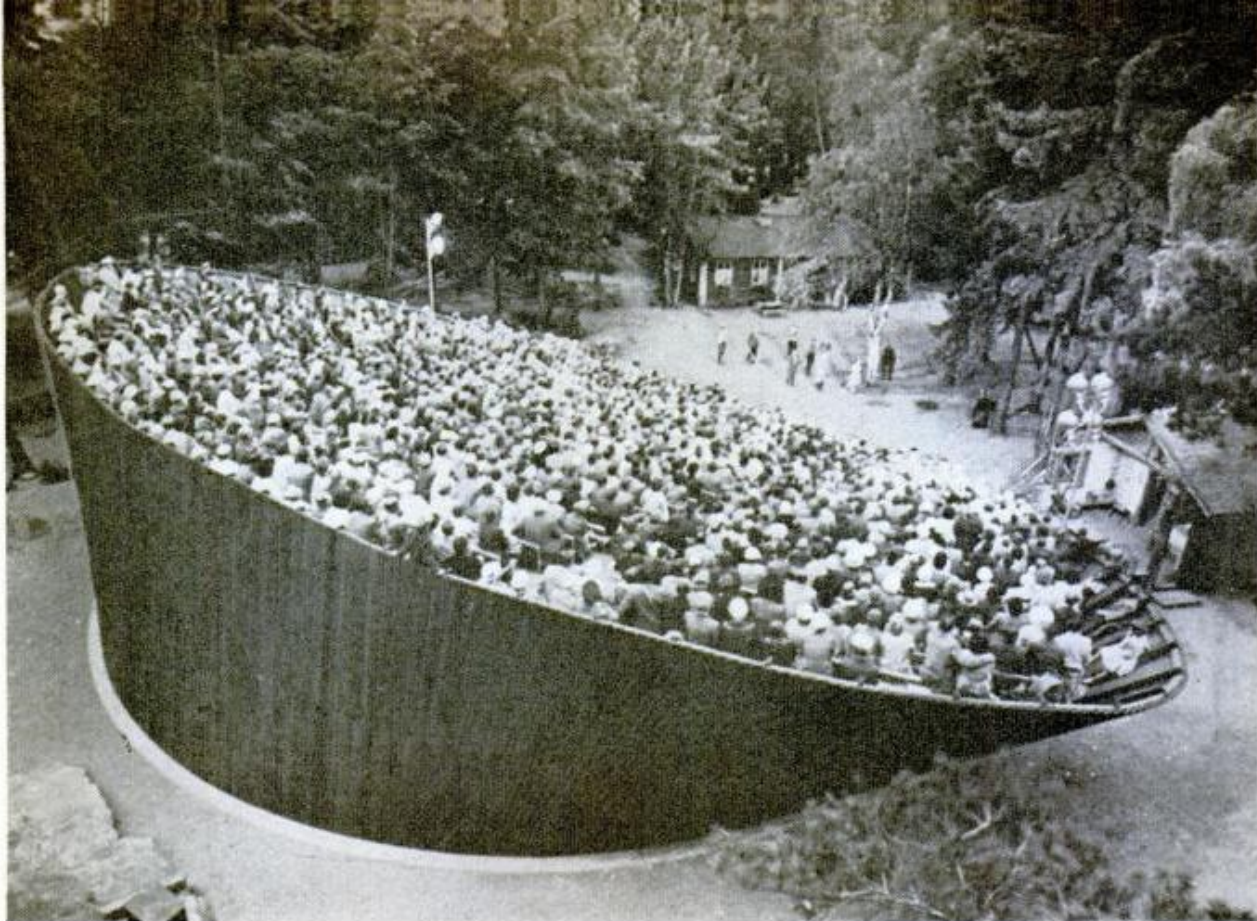

Audience Turns Toward Action in Seating Bowl

Spectator "pan" like a movie camera to follow the action in the outdoor auditorium at Tampere, Finland. A seating bowl, mounted on tracked rollers, can be turned from scene to scene or to follow moving

actors. While spectators are turned to one setting, stagehands can prepare new scenes behind their backs. As the bowl turns to the new scenes, a narrator can work on foot in front of the audience.

Cars Slide Sideways in Parking Garage

Ramps that move sideways on a guide rail are the key element in a car-parking system that is designed to pack garages to capacity. In use in London, England, the system consists of rows of ramps which may be moved by hand or by electric

power. The back row of the garage is parked solid. In all the other rows, one ramp is omitted. The remaining ramps may be rolled to one side or the other until the opening, or series of openings if there are more than two rows of cars, appears.





Marine gun crew, using dummy ammunition, shown drilling with the new XM-70 fieldpiece at Quantico, Va.

Rapid-Fire Field Gun for Marine Corps

First American automatic field artillery piece, and considered the most important development in artillery since 1940, the Marine Corps' new XM-70 "Moritzer" can fire six 115-mm. rounds in 2½ seconds—about the speed of a good pistol shooter. The weapon uses ammunition that fires like a conventional shell, then is boosted by a rocket propellant that ignites after it leaves the barrel.

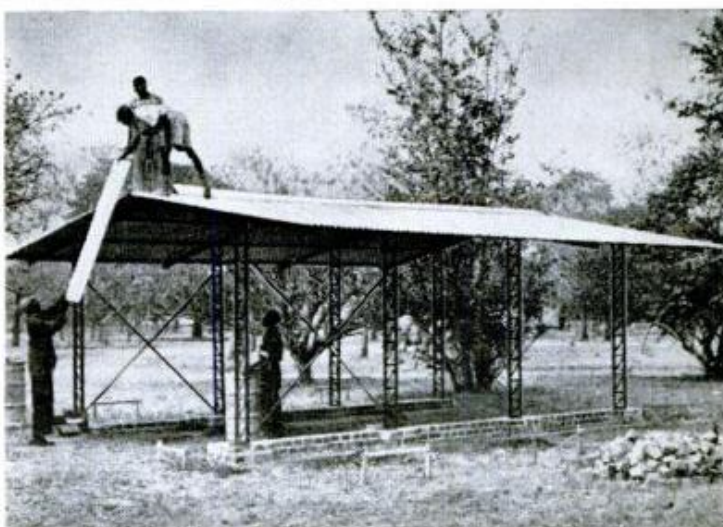

Do-It-Yourself House Kit

To help African tribal natives raise their housing standard above their traditional mud-walled, thatched huts, the government of Northern Rhodesia has developed a do-it-yourself home-building kit. It permits a family to erect a weatherproof, fireproof, and insect-tight three-room home for as little as \$450. The kit consists of a steel framework that can be bolted together, a corrugated steel roof and prefabricated steel window and door units. The buyer can carry the kit home on his bicycle (in several trips), have the frame built and roofed in a day, then use any material such as native brick to fill in the walls.



With considerable pride, we lead off the Eighth Annual Home Section—60 pages devoted to your home of today and tomorrow—with the

PM HOUSE of BUILT-INS

- **Build it from our plans (page 162)**
- **Adapt the built-ins to your existing home (page 170)**
- **Build in the electronic equipment (page 236)**

*I*MAGINE A HOME WHERE:

- The kids can make up their beds and slide them into the wall, leaving uncluttered play space.
- Each member of the family has a complete wardrobe wall, tailor-made to his own needs.
- The built-ins throughout the home require only a minimum investment in furniture.
- Stereo, hi-fi, an intercom system and rotating TV are built into the wall.
- Further, imagine that this home has an inner garden court and glass walls to bring the outdoors inside, yet offers privacy from every angle.

Imagine, finally, that the house has a broad, sweeping exterior that hugs the ground; a beautiful home you'd be proud to own.

That's the *PM* House of Built-Ins.

More than a year ago the editors of *Popular Mechanics* made a broad survey of the trends in housing and concluded that built-ins were the biggest news in the home-building field. A house full of built-ins, including built-in privacy, was obviously the kind of a house most families wanted.

To design the home, we selected Milton A. Schwartz of Honeymead Farm, Barrington, Ill. Schwartz is a relatively young but experienced architect with a crew-cut head full of ideas. There's a touch of freshness in everything he does. Most important, his prize-winning homes are filled with built-ins designed to make easy living still easier.

(Continued to page 284)

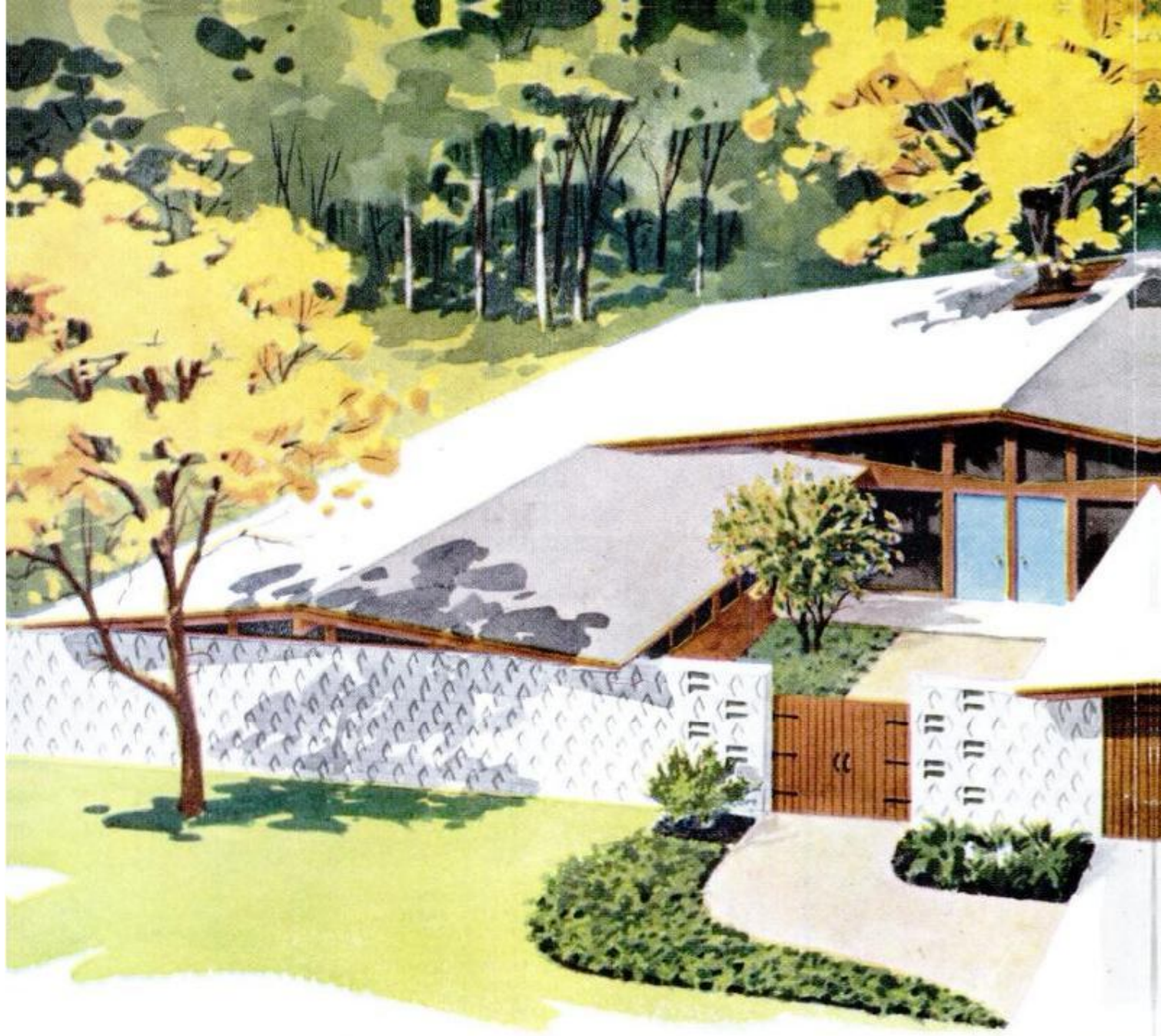

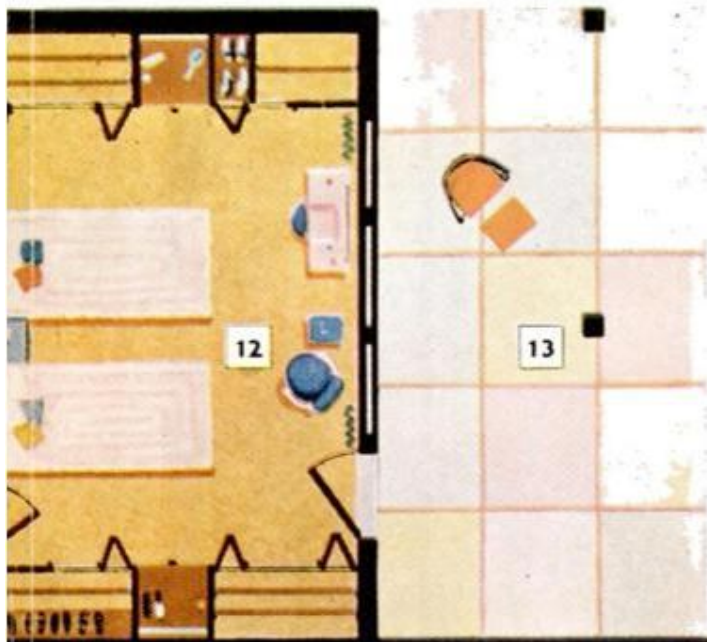

1. LANDSCAPED ENTRY COURT

Size: 20' by 23'.

Features: Privacy behind masonry wall and decorative gate. Optional intercom speaker at gate.

2. ENTRY AND DINING AREA

Size: 8'-9" by 9'-6".

Features: Double entry door, guest closet, dining area adjacent to kitchen, yet isolated from it, china storage.

3. LIVING ROOM

Size: 12' by 16'.

Features: Complete built-in entertainment wall, two walls of glass overlooking patio and interior garden court. Stereo hi-fi equipment and intercom built into end of entertainment wall.

4. FAMILY ROOM

Size: 13'-5" by 18'.

Features: Complete built-in entertainment wall, fireplace wall, direct access to kitchen, glass wall with access to patio-pool area.

5. KITCHEN

Size: 10'-4" by 13'-6".

Features: Built-in range, oven, refrigerator and dishwasher; shallow storage for canned goods; double sink beneath window; eating bar at normal table height.



6. UTILITY ROOM

Size: 5'-7" by 19'-2".

Features: Built-in laundry, mud closet, furnace, water heater, optional air conditioner.

7. TWO-CAR GARAGE

Size: 21'-4" by 22'-8".

Features: Raised curb, built-in workshop, built-in garden storage with access from yard.

8. BEDROOM

Size: 9'-4" by 19'-2".

Features: Disappearing bed, complete wardrobe wall, hobby or toy storage, fold-down study desk.

9. BEDROOM

Size: 10' by 19'-2" (with doors open).

Features: Disappearing bed, wardrobe wall, hobby storage, fold-down desk. (Linen adjacent to desk.)

10. BATH

Size: 6'-8" by 8'-4".

Features: Built-in lavatory, tub.

11. MASTER BATH

Size: 8'-4" by 8'-8".

Features: Built-in lavatory, shower.

12. MASTER BEDROOM

Size: 12' by 19'-2".

Features: Two wall-length wardrobes with built-in clothing storage and adult-hobby storage; glass wall.

13. PRIVATE PATIO

14. INNER GARDEN COURT

15. FAMILY PATIO

Features: Access to living room and family room, ideal spot for pool.



View from center of the kitchen shows built-in natural-charcoal barbecue and table-height eating bar. More formal dining area is on the other side of the barbecue wall



Kitchen is compact yet efficient. There's a long window above the sink, and shadowless strip lighting above the eating bar. In addition to the built-in dishwasher, there's an in-the-wall oven, a countertop range and a shallow, no-reach cabinet for canned goods



↑ Family-room side of the entertainment wall has all the warmth and beauty of natural wood. The wall features plenty of storage space—both open and hidden—a pull-down desk, and a TV set that can be pivoted for viewing from the living-room side of the wall

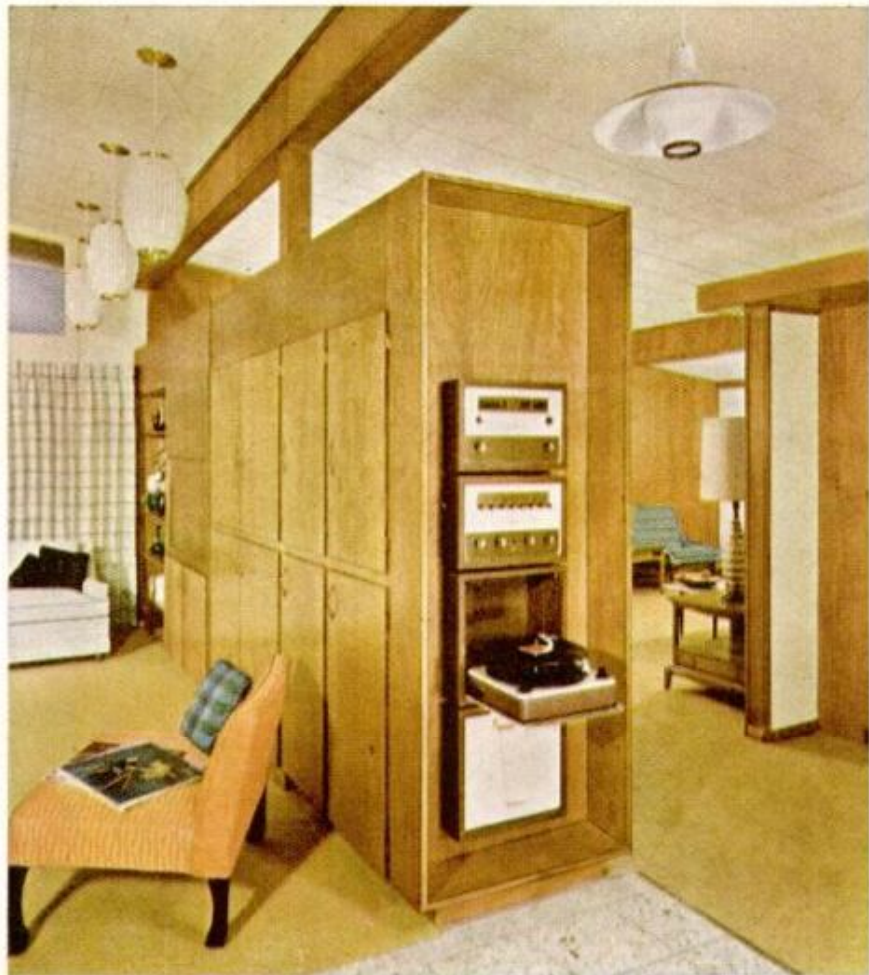

Inner garden court flows → into the house beside the glass wall of the living room, offering a beautiful view from inside or out

← Built-in electronic components are at the end of the entertainment wall. The record player folds into the wall when not in use

From the rear, the home → glitters like a jewel at night. Fluorescent tubes inside the skylights wash the chimney with light





Fireplace stretches along one entire wall of the family room. Key blocks, recessed one inch, cast interesting shadows in the light of the skylights. The wall is a fine example of what can be done with ordinary concrete blocks and an architect's imagination. Behind the drapery is the sliding door to the patio



As you open the gate, you are greeted by this private court. Walk through the door, and you are met by the inner garden court flowing in from the back of the house



Of all the built-ins, perhaps the most novel is this wall separating the two smaller bedrooms. On each side, a made-up bed glides into the wall. Above the bed is storage for pillows, and display space for those items dear to the heart of every child. Beside the bed is a large wardrobe closet. The two rooms are basically identical, though reversed

See It
In Your
Area—



THE *PM* HOUSE OF BUILT-INS

CHICAGO, ILLINOIS

Barrington Summit (5 miles west of Barrington on County Line Rd.)
Built by Barrington Development Co.
Furnished by John M. Smyth Co.

CHICAGO, ILLINOIS

2335 Robertson Lane, Flossmoor (In Golf View Manor—Western Ave. and Flossmoor Rd.)
Built by Burnside Construction Co.
Furnished by John M. Smyth Co.

DENVER, COLORADO

30th and Taft
Built by Clarence Cosman, Builder, and Garrett Patty, Realtor
Furnished by Del Teet Furniture Co.

FORT WORTH, TEXAS—*NOT BUILT*

4308 Lanark Avenue (Loop 217 to South Drive—North to Lanark)
Built by W. W. Couch Construction Co.
Furnished by Monnig's

LOS ANGELES, CALIFORNIA

5241 Del Moreno Drive, Woodland Hills (From Los Angeles take Ventura Freeway to Winnetka turnoff, left to Ventura Boulevard, right one block, left on Del Moreno.)
Built by Construction Management, Inc.
Decorated by Benter and Healy Interiors

LUBBOCK, TEXAS

2111 68th Street
Built by Cicero Smith Lumber Co.
Furnished by Fairmart Furniture

PORTLAND, OREGON

10750 Southwest Wedgwood, Cedar Hills
Built by American Builders, Inc.
Furnished by Sieverts For Modern (Beaverton)

SAN ANTONIO, TEXAS

1) 8411 Laurelhurst Drive
2) 245 Rockhill Drive
Built by Tom McGovern Associates
Furnished by Honigblums

SEATTLE, WASHINGTON

Northlake (In Kenmore)
Built by Albert Balch Community Builders

SOUTH BEND, INDIANA

19470 Widener Lane, Fellows Wood
Built by McCracken Homes
Furnished by Decor Interiors, St. Louis, Mo.

ST. LOUIS, MISSOURI

Tealbrook Drive in Ladue (Off Lindbergh between Ladue and Olive Road)
Built by Carouthers & Lee Community Developers, Inc.
Furnished by Bly-Moss Furniture

TULSA, OKLAHOMA

6052 E. 57th Street
Built by Royal Homes, Incorporated
Furnished by Bull Furniture Company

HOW TO BUILD THE SLEEPING WALL

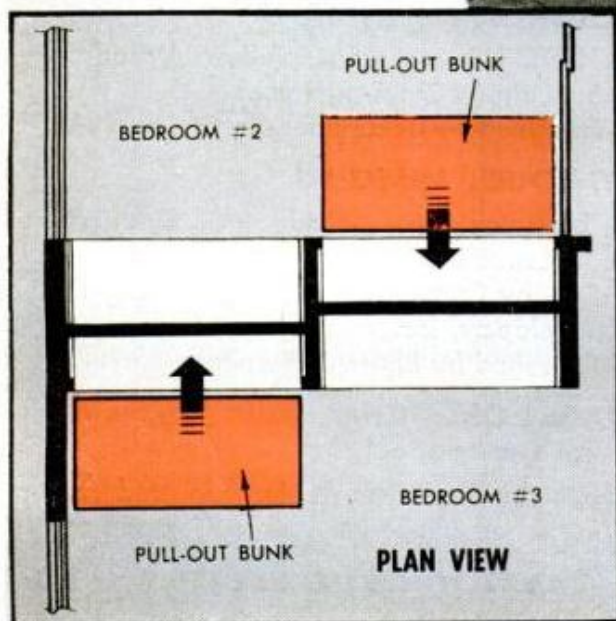

THERE'S NO wasted space here. An island wall is organized to serve two bedrooms, back to back. The wall not only conceals the bed, but it also provides ample storage, wardrobe, closet and desk space.

The bedrooms serve the dual purposes of sleeping and study areas. There's a place to tuck away everything, and even the beds can be scooted into the wall whenever more floor space is desired for converting the room quickly to rainy-day play space. And it gives mother a break, too, because the rooms are easy to tidy up.

The ideas used in the sleeping wall can be changed to fit the needs of each family. Except for the bed and two or three chairs,



everything else is built in to give maximum flexibility and economy. In an existing house a large room can be divided by the sleeping wall, or a non-bearing wall between two bedrooms can be removed and the dual sleeping wall installed.

The permanent walls are built as in the plan at the left. The off-center dividing walls clear the floor just enough to allow the beds to slip under, as shown in the sec-

tional detail, A-A, Fig. 1. Space for the sleeping wall should be approximately 4 ft. deep by 13 ft. long, giving enough room for 39-inch beds to slide underneath into separate compartments. Otherwise the plan can be adapted to meet individual needs.

After the permanent walls are in place, plywood is fitted the full width of the sleeping wall to form a floor for the wardrobe closet in one room and the desk-storage

unit in the opposite bedroom. Cleats support the plywood floor at the ends and nails also are driven up through the panel and into the bottom edge of the short dividing walls. On the wardrobe side of the wall (the side with the greatest depth), box in the space between the room floor and the closet floor with plywood to make enclosed compartments for the beds. The beds slide in place from opposite rooms. Enough space should be allowed for the bedding. Before starting the project it would be wise to measure the height of the bed (including casters) plus a normal amount of bedding. Then you can allow the proper clearance.

On the wardrobe side of the wall a clothes rod extends the full width of the closet opening, supported by two pole brackets or notched wood cleats. Shelves for hats and shoes are added above the clothes rod and near the wardrobe floor. Standard bi-fold doors using track-type folding-door hardware cover the wardrobe compartments.

On the opposite side of the wall, in the second bedroom, a fold-down desk is built 30 in. above the floor. A facing panel fills the space between the plywood floor and the let-down desk. A continuous hinge and two supporting metal braces support the fold-down writing surface. The desk may extend back to the wall and the space be-

tween the closet floor and the desk used for drawer space, or the space may be left open, as in Section A-A, to provide more storage space for pillows and blankets. The top of the desk is about 16 in. above the writing surface and is supported by cleats and ver-

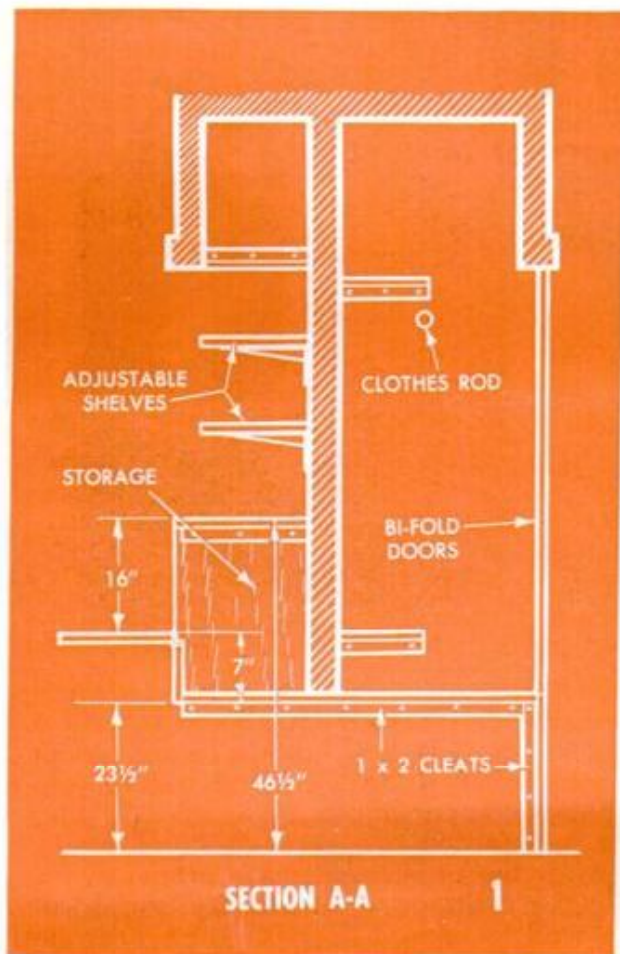

tical end pieces. Both sides of the sleeping wall are alike but simply built in a reverse position. Magnetic catches hold the hinged desk in the closed position. Add a drawer pull to complete each desk.

A plywood panel is cut to the size of

the bed opening, attached to the bed frame, and used as a finish board to hide the bed after it has been pushed into the wall. If a double bed is used, omit this board and use the section of the bed that extends into the room as a sofa or couch.

The wall above the desk is faced with sheet cork cemented to the wall with contact cement. A pair of adjustable self brackets are screwed to the cork-faced wall.

The cork, which adds a tackboard, and the adjustable shelf brackets, provide complete flexibility of the storage space. Materials and pictures may be tacked on the wall and the shelves set as close or as far apart as desired.

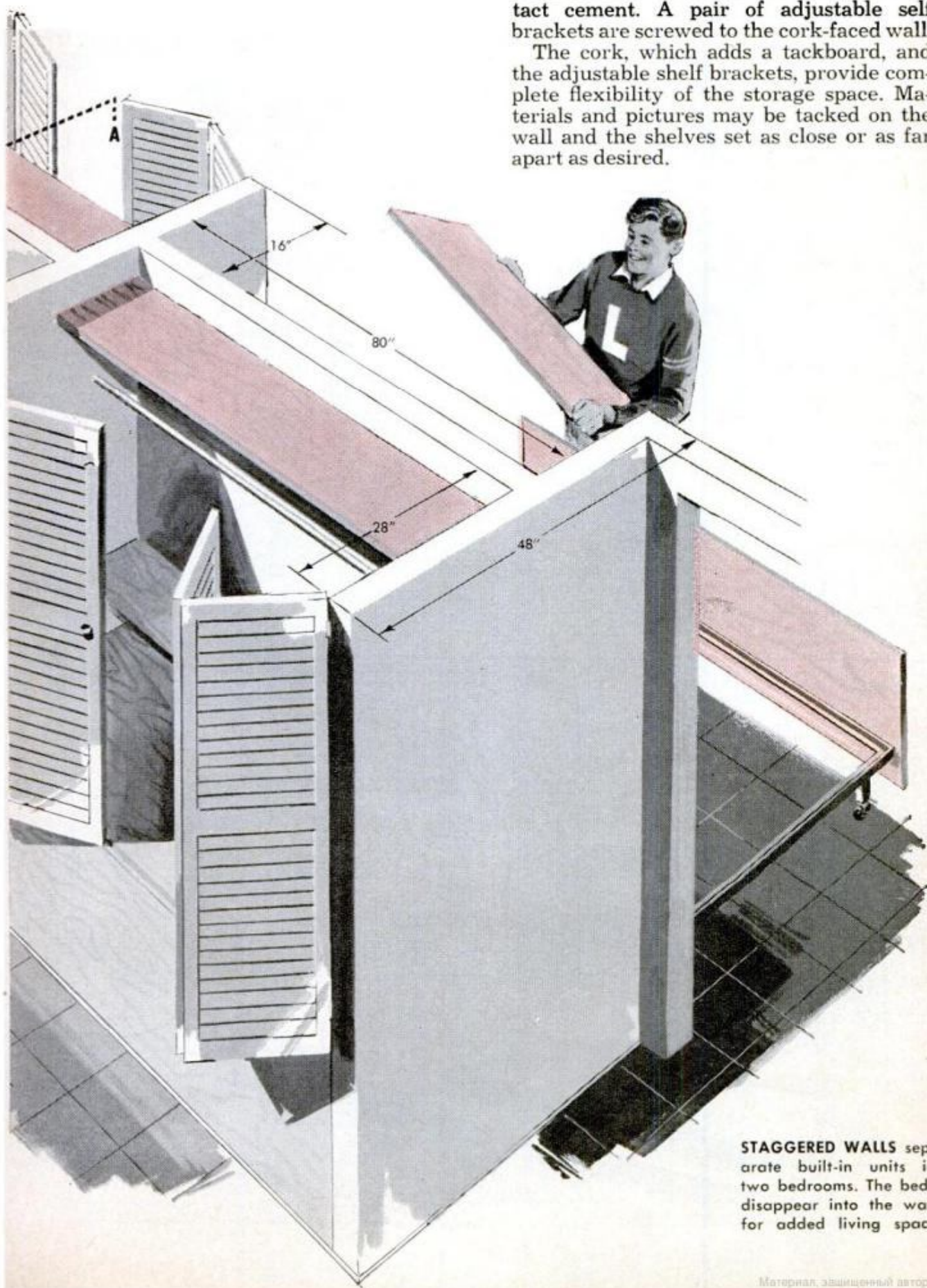

STAGGERED WALLS separate built-in units in two bedrooms. The beds disappear into the wall for added living space

BEDROOM BUILT-IN MAKES IDEAL LINEN STORAGE AND HOBBY UNIT

The study areas in the two small bedrooms for the House of Built-Ins provide ample storage space for books, bed linens and personal possessions. And the fold-down desks are perfect to use as private corners for studying and working on hobbies. The ideas shown in these cabinets can be adapted to individual needs and the dimensions changed to fit the spacing of the walls. This built-in is designed particularly for young people. It provides a usable wall that the individual can arrange as he wishes.

The built-in storage units and desks eliminate moving the furniture around and the need for dusting under the dressers, desks and in hard-to-get-at corners, as the unit fits snugly to the floor and along the entire wall, Fig. 2.

Framing for the cabinet and desk is plywood and 1-in. lumber. The built-in units fit directly against the wall and do not require wood back panels. Exposed plywood edges present a better appearance if covered with thin hardwood facing strips that match the rest of the cabinet. However, if the cabinet is painted, the facing strips can be omitted if desired. The framing which separates the drawers and cabinets are made of 1x2's.

Drawers for the cabinets are of standard construction. Dimensions of the drawers should be carefully planned for using the

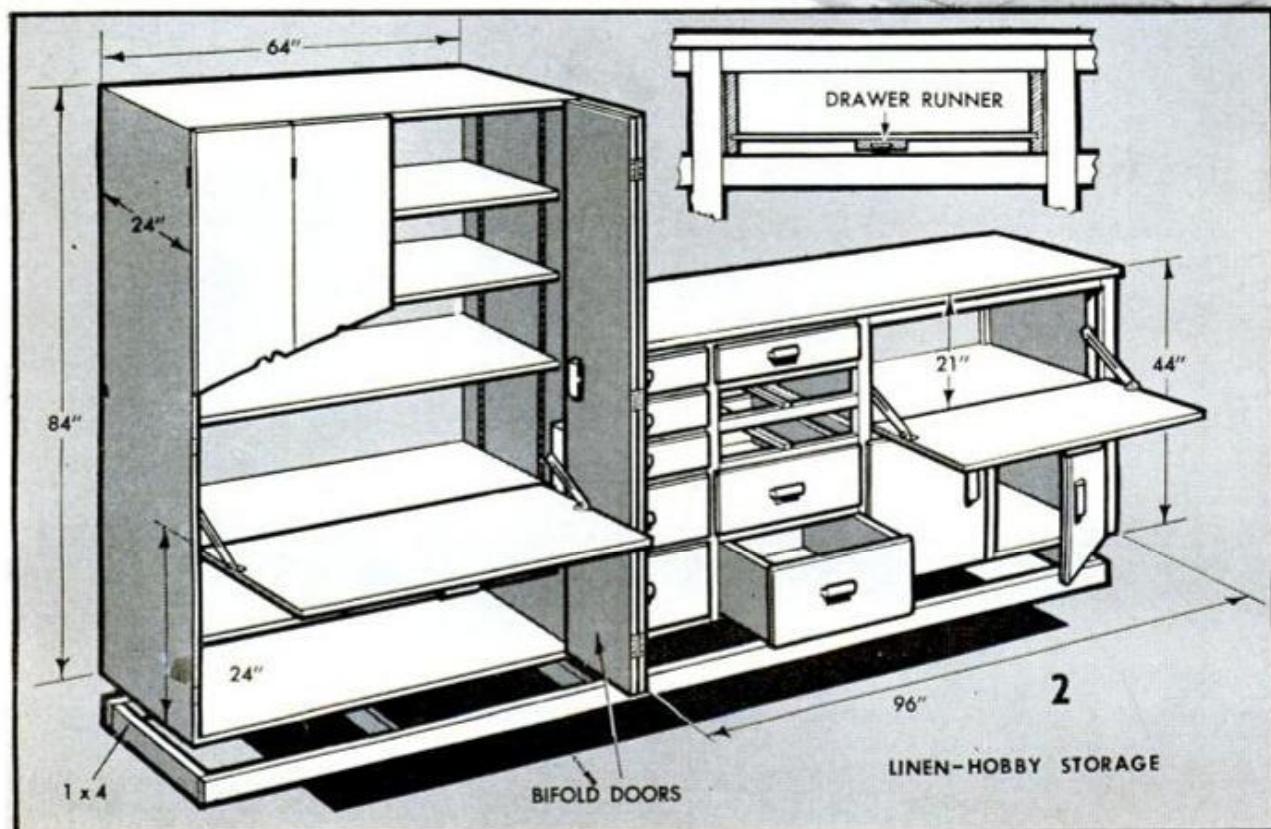



space to the best advantage. The fronts are rabbeted to overlap the 1x2 dividing strips in the cabinet. Bottoms of the drawers fit the grooves cut in the side and end pieces, and the backs dado into the side pieces. A grooved runner attached to the bottom of the drawer rides a strip of wood in the cabinet frame.

If a natural wood finish is desired such as the finish on the birch cabinets in the House of Built-Ins, obtain top-grade match-

ing lumber and plywood. Partitions, framing and drawer sections that are hidden most of the time inside the cabinet can be cut out of inexpensive fir plywood and construction-grade lumber.

The bi-fold plywood doors in the tall cabinet swing on three hinges that are set into the back of each panel. Magnetic catches hold the doors closed. The fold-down desks have continuous hinges and folding metal braces to support them. ★ ★ ★

LOTS OF AIR

IT'S NEW...



One of the biggest headaches for homebuilders, the warping and peeling of vulnerable exterior roof overhangs, can be solved with aluminum soffit. Economical and easy to install, the aluminum soffit will not rust, rot or warp, and is immune to termites. And, best of all, it leaves no ugly paint peelings

LOTS OF LIGHT

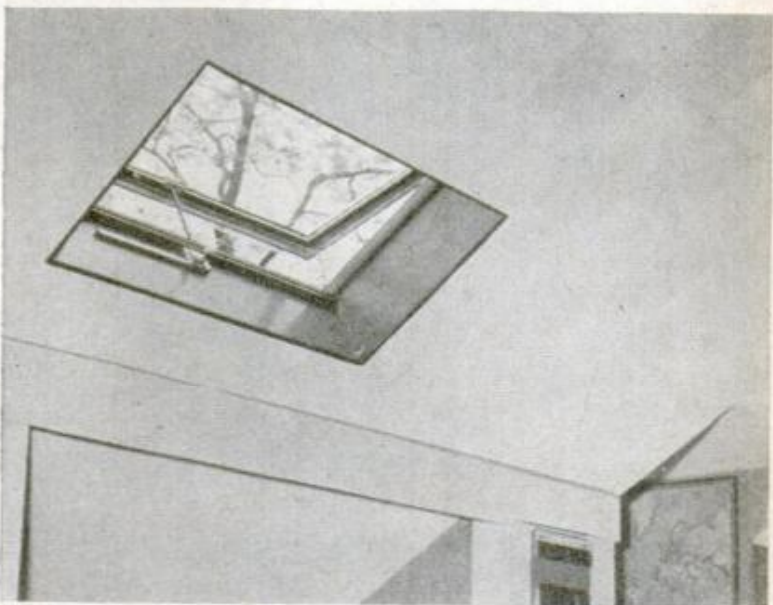

Designed for use on pitched roofs, domelike skylight offers high ventilation, excellent light and minimum alteration expense. Especially useful for one-window attic bedrooms, windowless bathrooms, or unlighted stairways, it is sold as package unit with screen, flashing and operator handle and can be easily installed by one man in a few hours. Also available for use in office buildings

LOTS OF INSULATION

Triple-wall concrete blocks with staggered air cells, into which aluminum-foil insulators are inserted, reduce wall building and insulating costs and keep heat loss to a minimum. Insulators are sealed in with strips of asphalt paper. Exterior stucco or interior plaster can be applied to block

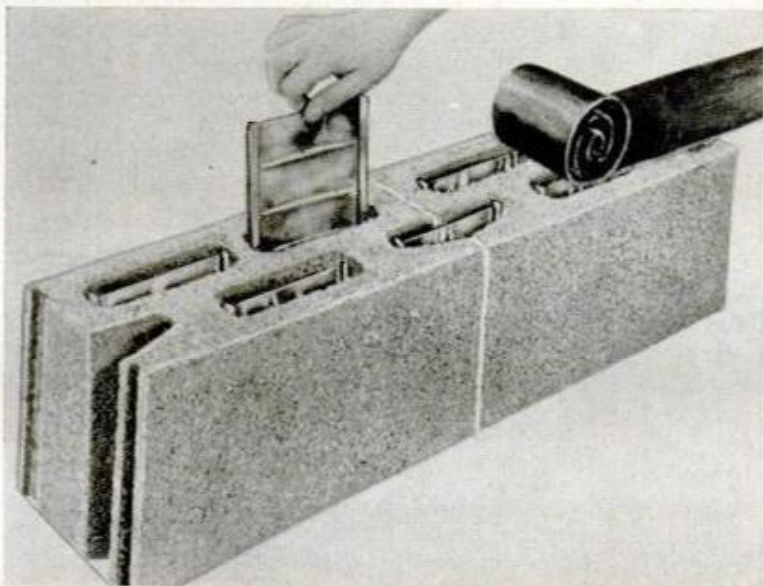

LOTS OF SHADE

Opaque aluminum panels that clip to jalousie window panes serve as economical shades. Simple enough to install in minutes, the shades open and close with windows and are maintenance-free. They come in three colors—white, green and blue

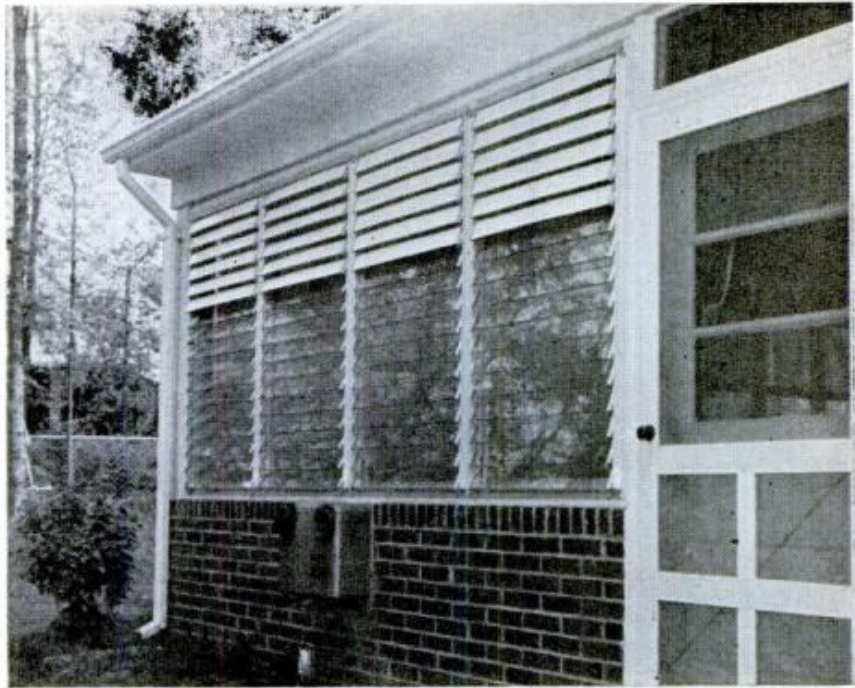

Do-it-yourself, all-aluminum cottages, retailing from \$3500 to \$5500, can be erected in five days. They are made of aluminum panels, which are faced on two sides by aluminum and insulated with a thick cushion of Styrofoam. The panels interlock, just like children's building sets, and are completely interchangeable. Electricity and plumbing are easily coordinated with house plans and, after the slab is prepared and plumbing roughed in, two semiskilled workers can finish the home

LOTS OF HOUSE

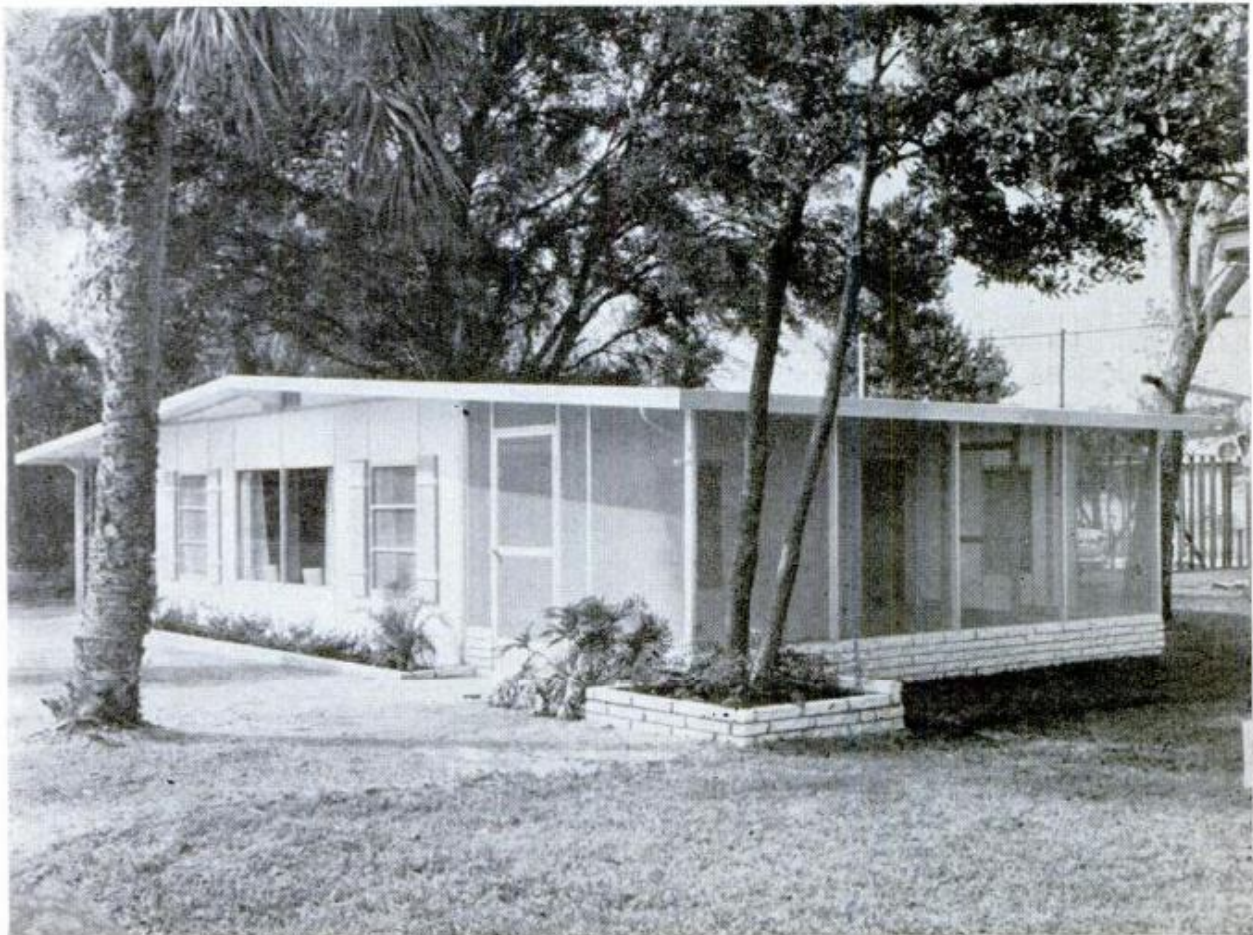

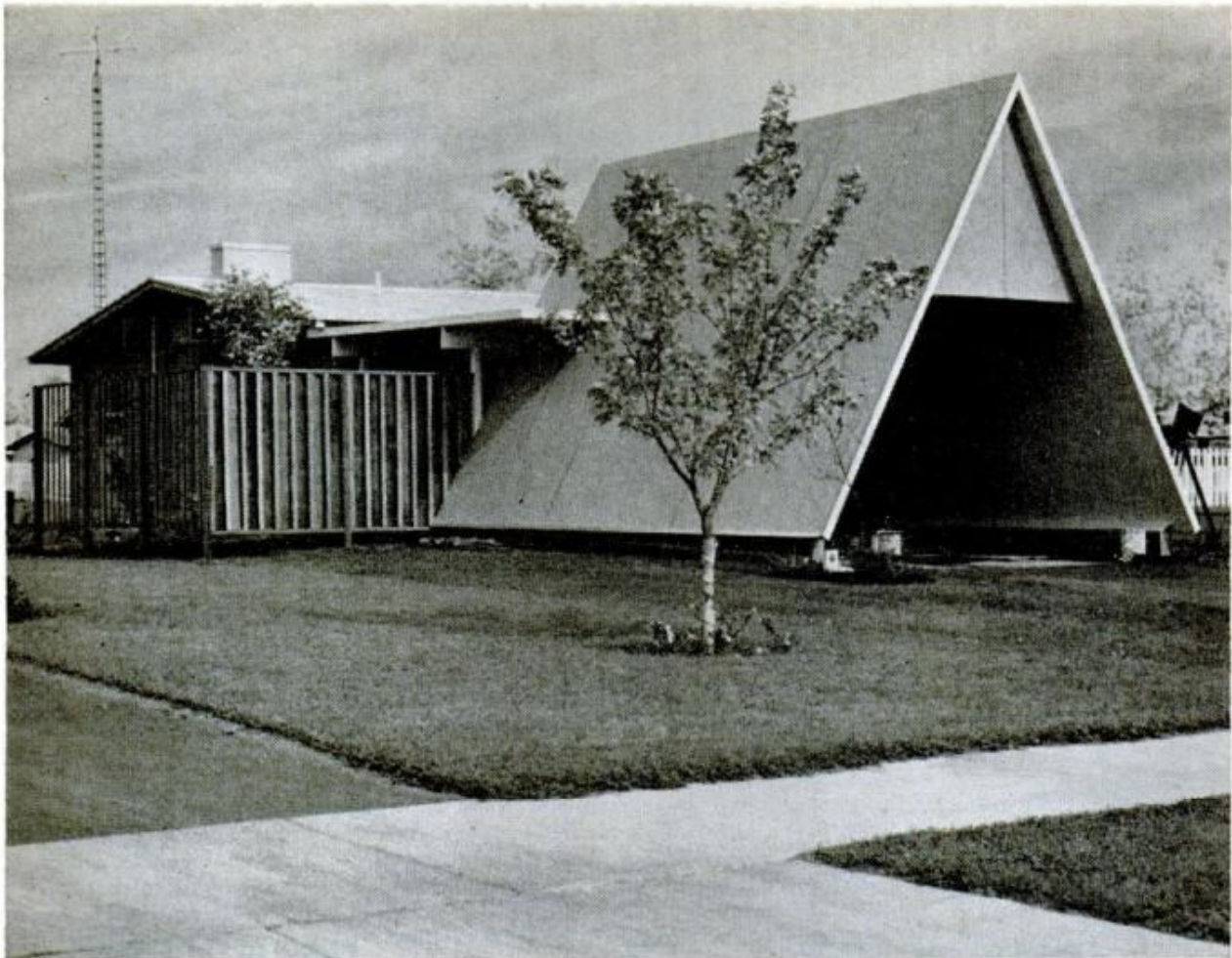

Built two years ago, NAHB research house has pointed way to new techniques, may be typical home of future

THE HOUSE YOUR KIDS WILL LIVE IN

QUESTION: *Twenty years from now, do you anticipate bubble houses of new lightweight plastic and aluminum being flown by helicopter to the site and set down?*

JOHNSON: I think this is a possibility. It depends on the progress in other areas, such as our ability to solve foundation and mechanical and electric equipment problems. It also depends on solving transportation problems.

What changes in general configuration may we see in 20 years?

JOHNSON: We have to remember that 20 years from now children of the space age will be buying the houses. They'll be conditioned to accept shapes and materials that the people of today might not accept.

In other words, we are not going to be limited by the basic rectangle just for tradition's sake?

JOHNSON: No, except that the basic rec-

tangular shape has evolved for important reasons. It produces more house for less cost than any other shape. It is practical to build and sell.

BARTLING: If you can make a dramatic reduction in cost, people will accept the change in shape.

JOHNSON: The big volume, in style and appearance, lags about a generation behind. Children tend to buy the kind of houses that represented status when they were young. The status house of a generation ago was a house on a hill with a detached garage. Now the modern house with swimming pool and automatic equipment is the status house.

Designs for the American Institute of Architects' competition get more extreme every year. This year the houses all had movable interior partitions; or glass walls, drape covered; or dividers instead of walls;



Panel members King, Johnson and Bartling say new materials will radically change homes in next 20 years

We wanted no flights of fancy. We wanted to find out the kind of home the next generation will live in, based on today's research. Here are the answers from the organization that will be most involved in tomorrow's building patterns—the National Association of Home Builders. Panel members were Martin Bartling, President of NAHB; Ralph Johnson, Director of NAHB's Research Institute; and John King, Assistant Director of the Research Institute.

sweeping cathedral ceilings, curved or arched instead of straight. Isn't there a likelihood that future homes may go in this direction?

BARTLING: That's true if brought about by a saving in cost. If they are purely for architectural innovation, they will not become the house of the future. These houses at present are more expensive. They are specialty houses.

Aren't contemporary design houses all over America today the specialty houses of 15 years ago?

BARTLING: Yes. Progress is always made by a few pioneers.

KING: My general feeling about the design of houses is probably more optimistic than others. We are gradually improving design. This is reflected in two ways. First, there's a gradual change in the attitudes of the home buyer, who is now more willing to accept innovations. Second, to achieve econ-

omies the builder must make the best use of materials and equipment. Often the most efficient use reflects itself in clean design. In the AIA houses the design is often expressed by the structural use of materials—self-supporting cathedral ceilings, panelized construction. In Europe people are willing to accept the articulation of panel joints. In the U. S. you have to cover them up, particularly on the exterior.

BARTLING: My personal experience is that as long as the total effect is pleasing, most people don't mind visible joints. In our research house in Knoxville, where there were many joints, no one complained about them. Surveys showed they liked the effect.

JOHNSON: In our Kensington and Knoxville research houses some joints had a function. They helped with organization of storage, for efficient use of space, for a place to hang shelves, lights, and so on.

"Lower costs...by completing the house in the factory..."



Foam-core, load-bearing wall has face of lightweight powdered brick, reconstituted to resemble brick veneer



Prebuilt electric panel will be one component of future wall. Other panels will "plug into" this one

If we should go to more radical designs for the custom-built house, do we go to new shapes for the industrialized low-cost house of the future, too?

KING: There is a difference. But a component system of panelization offers distinct advantages in providing flexibility in the design of larger, custom-type houses. In the lower cost houses I feel there will be distinct advantages in providing a more standardized product, with variations in finish materials, and limited variations in floor plans and fenestration. But this house would be turned out more as a complete unit. Lower costs will be achieved by completing the whole house in the factory and transporting it to the site in one or two pieces.

A refinement of the trailer as we know it?

KING: Different structurally-shaped houses could be brought directly to the site by helicopter, trailer or some other means of commonly used transportation. In this lower cost house, which is standardized to a greater extent and built in larger component units, home buyers will be more willing to accept new innovations in structural shapes than buyers of custom-type houses.

BARTLING: People may very well accept changes in the interior sooner than on the exterior. Inside they seem to have no in-

hibitions and will accept all kinds of shapes and forms. Modern inside, traditional outside.

What directions do you believe interior design will take?

BARTLING: Privacy is important. Architects know you need open planning as an element to get the effect of more space, but this isn't accepted by women when it loses privacy.

JOHNSON: You arrive at the best compromise. Take the concept of the interior door. Instead of a six-foot, eight-inch door placed in the opening in our research houses, we used an eight-foot-high door placed on the opening. This has important benefits. It is difficult for children and aged people to grasp and turn a smooth round knob. Our design makes it possible to open and close the door from either side by hooking a finger and pulling or pushing. This door improves the circulation of air. There is more uniform temperature in the house and it opens up the appearance of the small house. As one woman said, it looks 'modern.' It provides privacy and is lower in cost. There are lower trim costs. You can prefinish the door and put on the hardware.

Isn't this entirely contrary to what the architects are doing in the competition houses? They go for open planning with eye-high curved brick walls, open floor areas, and island dividers that slide back.

"Open design is a matter of personal taste."



Fibers of these real wood tiles are stretched and dried, making tile flexible and dimensionally stable



Basic building material of tomorrow probably will have plywood or other faces laminated to foam core

JOHNSON: You can still provide open areas in certain parts of the house. The two are not incompatible.

BARTLING: An architect friend of mine in California built a large house with no partitions higher than an ordinary door. They were all on rollers so they could be moved. But in order to control sound, he had to introduce noise as an element of design. So he had an intercom system playing music at different decibel levels 24 hours a day to cut down on transmission of sounds—like footsteps and conversation—so the place could be lived in.

JOHNSON: Open design is a matter of personal taste. Both kinds of houses are sold. Open design should be confined to the living area as opposed to the sleeping and bath area. The big question is whether the work area—the kitchen—is open to the living area in the usual sense. Obviously, all of the parts of the house are open to each other if you leave the doors open. It's a matter of degree.

BARTLING: It might be useful to talk a little more about the industrialized house of the future. There's a trend among manufacturers of basic building materials to produce more and more large parts that go together to form a house. This may be tomorrow's house in the truest sense. What I am talking about, we call component construction.

Does this mean, for instance, that you would have complete factory-built walls instead of pre-cut rafters and studs?

BARTLING: That's right. One example is a material we have used in two of our research houses to date. It is a foam-plastic core with different types of faces. It makes our structural panels completely self-contained—exterior, interior, finish and insulation—produced in one continuous process.

JOHNSON: It produces a whole wall in one layer instead of 12 or 13 conventional layers.

Mr. King wrote an article not long ago in which he discussed component construction. In it he referred to extruded panels made entirely of plastic. Would all this come out in one piece—like toothpaste from a tube?

KING: We are talking generally about two or three materials. One is the core which forms an insulation. The structural part of the panel forms the faces. This is a laminated type of construction, so we can envision assembly line methods of laminating the faces to the core or conversely forming in place a material that adheres to the faces. This could be done in a continuous process so you could extrude or weld panels and cut them off at required lengths. These would form the solid portions of exterior walls, interior partitions and structural roof panels. We

(Continued to page 290)

WHERE DOES THE

HOW MUCH DOES IT REALLY COST to build a house? Is the contractor pocketing too big a wad of your hard-earned, long-saved dollars? What percentage of your nest-egg actually goes into materials, from concrete to finishing nails? What percent into labor?

The typical house on these pages would cost about \$26,500 in some areas. While costs may be higher—or lower—in other areas, the breakdown of cost percentages is about the same whether it costs \$10,000 or \$100,000. So to see where the money goes, imagine yourself building this house. If the story sounds grim at first, don't be depressed—there's an upbeat ending!

The bill for materials on your \$26,500 house will be \$6000. In general, the cost of concrete, lumber, fixtures and other materials will be a fourth to a fifth of the total. So, in effect, you pay \$26,000 for \$6000 worth of materials. Where does the rest go?

First, the building site will average \$5000 for a house of this size. Your architect's fee for the plans and specifications will be about \$1500. That leaves \$14,000 for assembling the raw materials into a home. About \$9000 of that amount goes for labor; about \$5000 for the overhead and profit of the general contractor and his subcontractors. Many builders will take exception to these figures—and there are exceptions—but these proportions are a good rule of thumb.

The overhead of each specialist repre-

sents his expense of doing business—fees, tools, phone bills, transportation and a score of incidentals. The profit is the wage that each one pays to himself. For example, a concrete subcontractor may add five percent for overhead and ten percent profit to the cost of the concrete and labor of pouring and finishing it. The sheet-metal man may add 10 percent overhead and 15 percent profit.

The general contractor who oversees the entire job adds his own five percent overhead to the net cost, then adds his ten percent profit. He gets the big bite—but it isn't a very big bite at that. On this job his profit is \$1785. It will take about four months to build this house, and the general contractor must be on the job or on call a good part of the time; his profit here amounts to less than \$112 a week.

As recently as 10 years ago, the average contractor handled most of the work himself. He had his own concrete men, carpenters and painters, and subcontracted only such major items as plumbing and electrical work. Today, specialists can usually do the work cheaper—and better—than he can. Excavation machinery, automatic nailing devices, stapling machines, pneumatic plaster guns and other new tools require the specialists. Without such special tools, building costs would be greater.

Overhead charges and profits, in general, are pretty fair. The stiff competition in home building determines the profit rate.

HOUSE—\$26,500 (\$5000 lot—\$1500 architect's fee)

JOB	PERCENT OF COST	COST IN DOLLARS
1. Site clearance, excavation.....	1%	\$ 200
2. Concrete work	7	1400
3. Lumber	5½	1100
4. Rough carpentry	3	600
5. Plumbing	10	2000
6. Electrical work, fixtures	6½	1300
7. Sheet metal	2	400
8. Masonry	3	600
9. Heating, air conditioning	5	1000
10. Roofing	3	600
11. Lath and plaster	11	2200
12. Sash and doors	3	600
13. Painting	4	800
14. Tile	3	600
15. Hardware	1	200
16. Resilient flooring	1	200
17. Carpeting or hardwood flooring	3	600
18. Finish carpentry	2½	500
19. Cabinetry	4	800
20. Kitchen built-ins	1½	300
21. Miscellaneous (lawns, fences, etc.)	5	1000
	85%	\$17,000
General contractor's overhead	5%	\$ 850
	90%	\$17,850
General contractor's profit	10%	\$ 1,785
	100%	\$19,635
Balance in building fund		\$ 365
		\$20,000

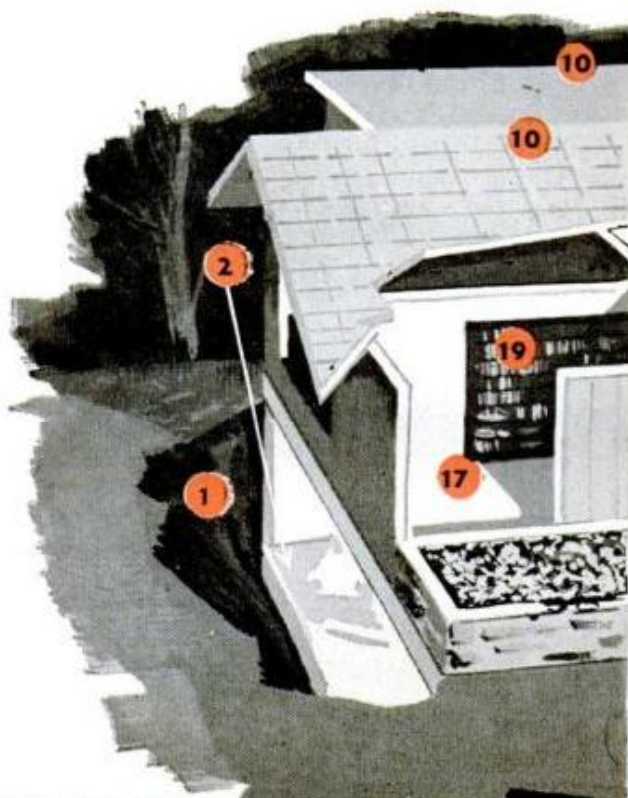

MONEY GO?

By
Thomas E. Stimson

These figures may help explain why \$6000 worth of materials adds up to \$26,500 in the finished house. But there are a good many other factors yet to consider. It's a trite saying that a home is the biggest investment a man ever makes. The fact is that the average man doesn't realize just how much his home costs him. The job table on page 182 shows \$365 left in your building fund after all the bills were paid. This sum is about to vanish, along with a lot more of your money. So far we haven't discussed financing. And few can pay cash.

We'll suppose you owned the \$5000 site and have paid the architect. The lot will serve as your down payment, so all you need is \$20,000. We'll assume that you can borrow the money at six percent interest—higher in some areas, lower in others, and it changes from time to time.

One common way of financing a new home is by a short-term construction loan that is later converted into an ordinary long-term loan. The construction loan will cost you around \$900, including brokerage, interest, title insurance and escrow charges. Deducting the \$365 left in the building fund, this means that your \$26,500 home actually costs \$27,035 by the time it's built. If you buy a new home instead of building it yourself, similar charges are included in the price. Even if you buy a tract house in a large subdivision, you are paying for construction financing, no matter what the salesman says.

In any event, you are finally ready to move into the new home and start paying off that twenty grand. It's a six percent, 20-year loan; your monthly payment will be about \$143.

Now multiply \$143 by 240, the number of months in 20 years. The answer you'll get is \$34,320. That means that in addition to repaying the borrowed money, you also are paying about \$14,500 in interest. (Of course, you can hedge on that figure if you get a raise or come into an inheritance by increasing your monthly payment. On this house, a \$40 increase to \$183 per month would shorten the pay period by 4½ years, cutting the interest to about \$11,500; a saving of almost \$3000.) Add the \$14,320 to the \$27,035 cost of the house, and you find that you are paying a total of \$41,355 for what started out as \$6000 worth of materials and a \$5000 lot. And when you move in you can start paying for insurance, taxes and maintenance costs.

Sound grim? Not really. If you rented the same house for, say, \$200 a month for 20 years, it would cost you \$48,000, and the equity in the house you own is as good as money in the bank.

Right now, millions of Americans are saving their pennies and dollars for a down payment on their own home. They want to raise their children in their own home, and to improve or remodel the structure as they see fit. It's the biggest, best and most enjoyable investment of their lives. ★★

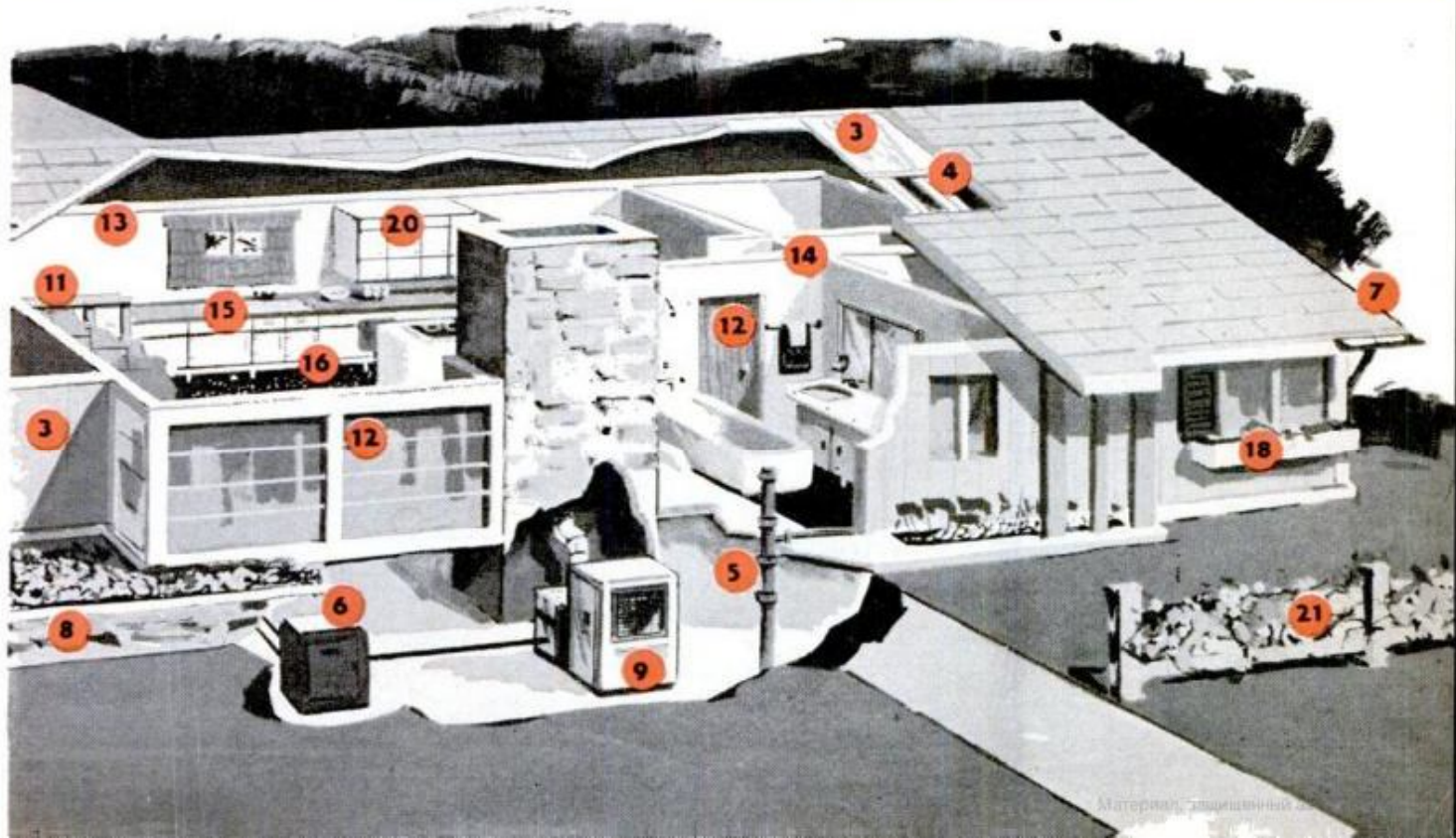



Halves of a manufactured 680-square-foot ranch house are hauled by truck to the buyer's building site

"HALF BUILT" RANCH HOUSE

Carried in halves to a building site, a 680-square-foot ranch house can be bolted together and ready for occupancy in 12 hours. Finest Manufacturing Company of Leesburg, Fla., assembles in its plant the halves of the home—with dry walls, kitchen cabinets, light fixtures and other finishing materials in place. A carport and a

large screened patio also are added at the job site, extending the exterior lines of the 34 by 20-foot home and placing 1502 square feet under roof. The halves of the two-bedroom home are 10 feet wide, making it possible for trucks to transport the manufactured sections over highways without danger or inconvenience.

With the sections bolted together and roof extended over patio and carport, house is ready for occupants



Sun, Shade and Wind Where You Want Them

By Richard F. Dempewolff

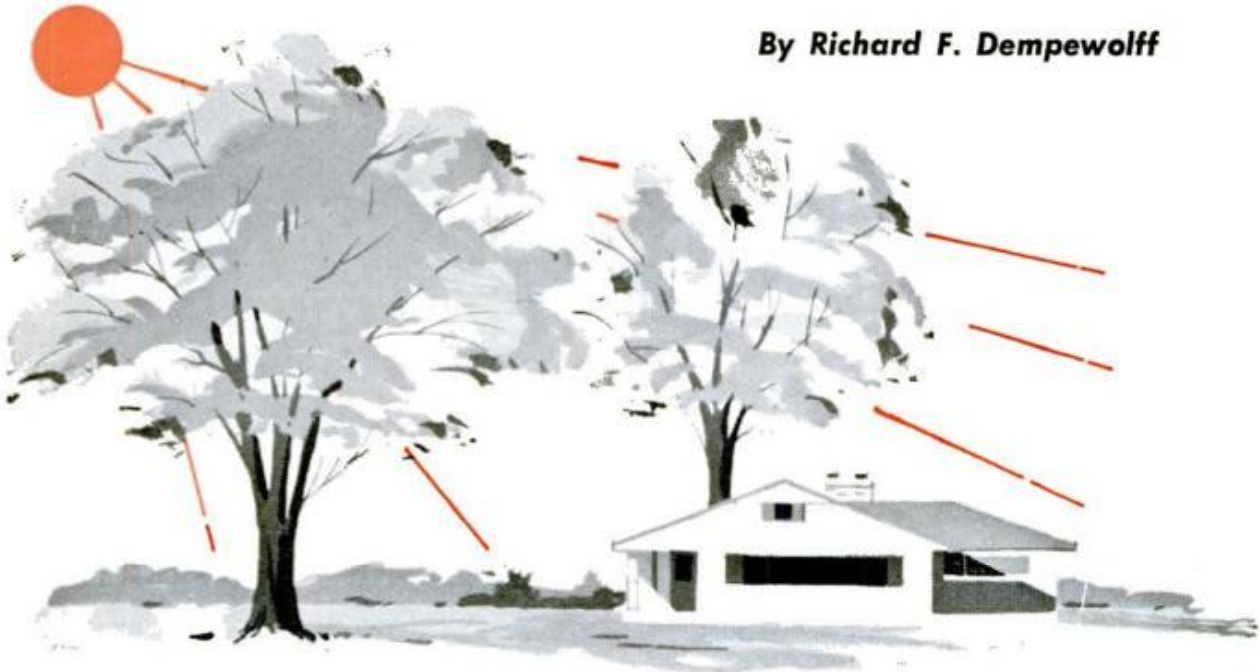

Tall deciduous trees, planted on south and west sides of house, block hot afternoon sun which is high in sky during summer months. Thick branches thus help insulate home and yard during hottest season of year

MILLIONS OF WORDS have been written about smart people who built new homes with an eye to "solar orientation." If a house is scientifically positioned on the terrain it occupies, intelligently landscaped, has glass walls in the right places, and proper overhangs, then Nature will help make the place cool in summer and snug in winter. These are established facts and sound practices, if you plan to build a new home on a spacious acre or so.

But what if you, like most people, already have a house fully equipped with flush eaves, double-hung windows, and a mortgage—all squared off on an average lot with no particular reference to prevailing winds or where the sun rises and sets? Is there anything *you* can do to control the climate around the old homestead—besides saving up for air conditioners and installing a bigger furnace? The answer is "yes," emphatically.

Clayton Steen, one of this country's out-

Then, when leaves fall and sun drops lower in sky, its rays penetrate bare branches, bathing house in warmth during coldest months. Deciduous trees are best because their leaves, thick in summer, shed in winter



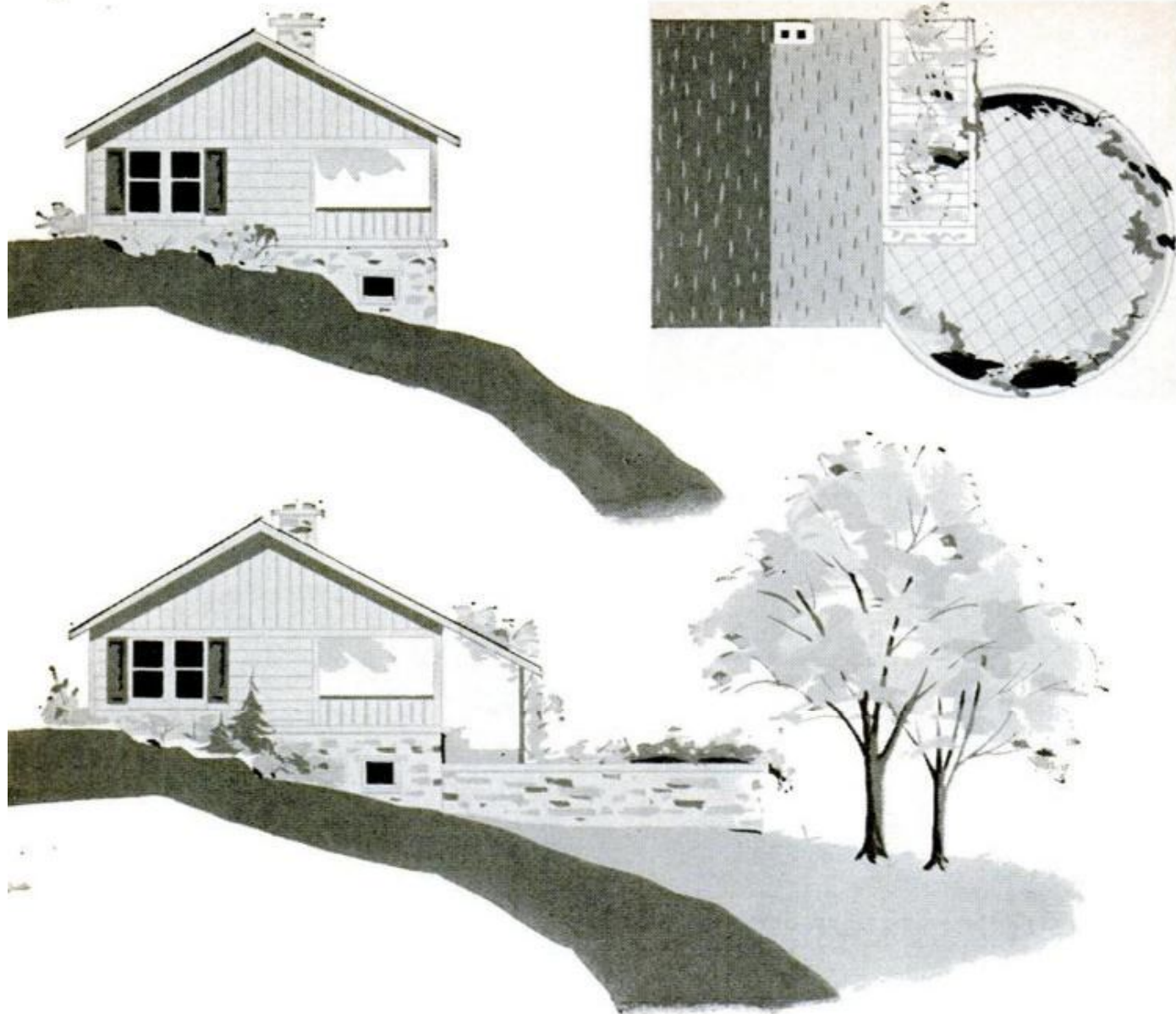

Hillside lots, spectacular for views, are useless for recreation areas. Home is improved by extending roof line for patio and, with fill, installing paved terrace and shade trees. Upper right: bird's-eye view

standing young landscape architects, has devoted much of his career to correcting the mistakes of builders who were not solar oriented, wind oriented or terrain oriented. There are, he points out, dozens of simple and effective ways to make the sun work for you instead of against you on an average house lot. Certain types of shrubs and trees planted in the right places, an attractive pergola or covered patio, a small pool in a hot corner, a scientifically shaded terrace—any or all of these things, strategically planned with the help of a nurseryman or landscape expert—may be all it takes to make your home more comfortable all year 'round no matter where you live.

Intelligent planting alone around a poorly situated house has been known to moderate temperatures by as much as 20 to 40 degrees, offsetting the improvement cost in fuel savings, and spelling the difference be-

tween comfort and misery. In homes without shade during the hot summer months, air-conditioner manufacturers report that their equipment must work as much as 40 percent harder. Temperatures of 140 degrees have been recorded on sun-baked roofs.

"There are no hard and fast rules to cover all situations," Steen warns. "Everything is qualified by a homeowner's particular situation, the requirements of his family, what part of the country he lives in, and what particular problem he wants to solve. In chilly country, people may want more summer sunshine, not less."

There are, however, some basic tricks for solving common problems. Where you go from there to increase the comfort and enjoyment of your property, is up to you and your budget.

In temperate zone summers, and southern areas, shade and cool breezes are some-

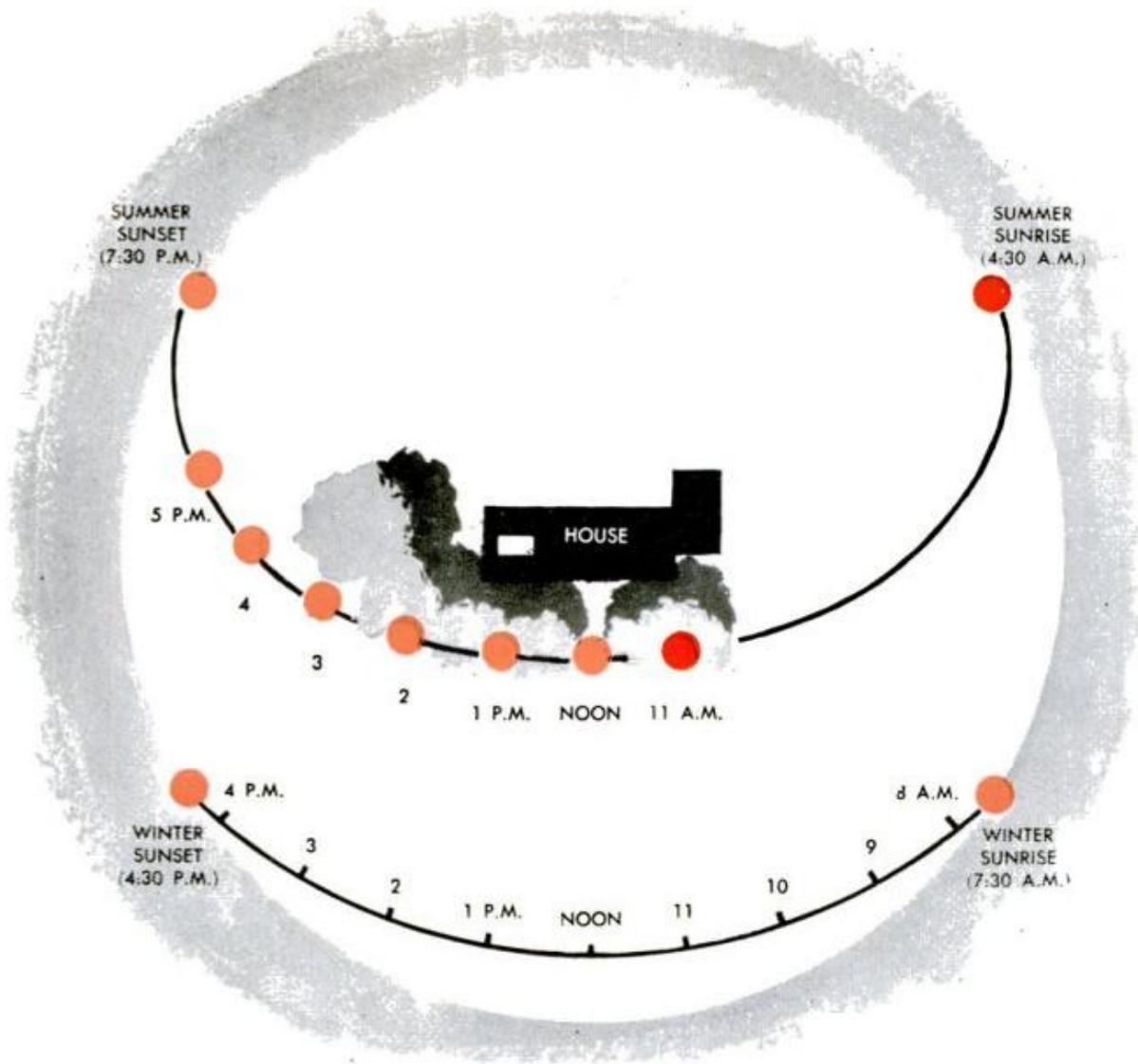

Two paths show sun's long and high arc during summer (top) and short and low arc during winter (bottom)

times worth more than diamonds. The trick is to capture them and put them where you want them *when you want them there*. "Breakfast on the terrace is a delight when warm sun floods the table top," says Steen, "but you'd fry on an unshaded terrace during a hot summer afternoon,

and an unshaded house would, too. So, through the heat of the day, both terrace and house should be shaded. Offhand, that sounds like having your cake and eating it. But thanks to the earth's tilted axis, it is easily achieved with certain types of trees, properly located."

Curving evergreen hedge on north and east traps cool summer breezes, serves as windbreak in winter

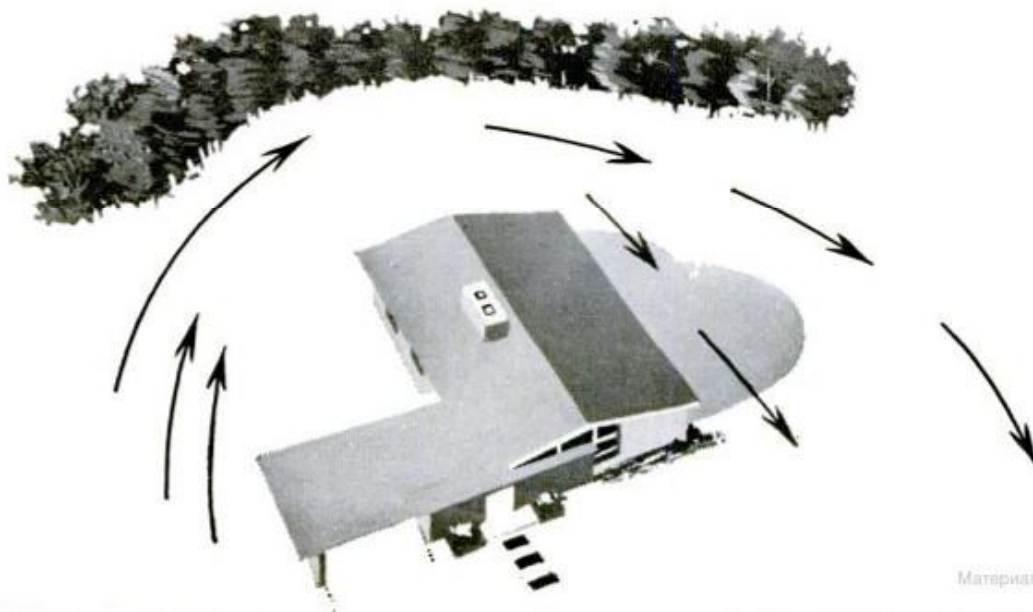



Summer sun (about 73° on June 21) is blocked from south windows by 2½-foot overhang of vines

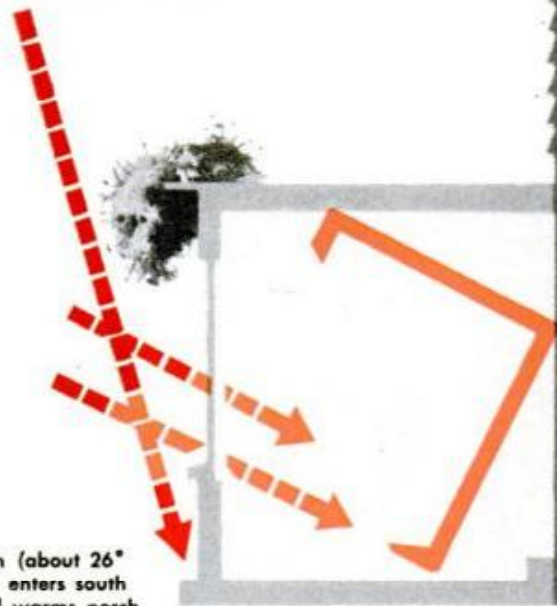

Winter sun (about 26° on Dec. 21) enters south windows and warms porch

Flat-roofed sun porch can be given attractive "plant awning" that will serve as solar overhang. Flowering vines such as wisteria can be trained up a trellis and along wire-mesh support secured to edge of roof. Overhang will shade porch from high-angle summer sun, but allow low-angle winter sun to penetrate

Where do you put shade trees, and why? The summer-winter solar diagram on page 187, provides the clue. Along the 40th latitude, which slices the United States almost in half between Red Bluff, Cal. and Philadelphia, Pa., the summer sun rises in the northeast sky, and sets in the northwest. South of that latitude the setting sun is more westerly; north of latitude 40 it is more northerly. "The hottest part of the summer day," Steen points out, "is early afternoon—from about 2 to 5 p.m.—when

the sun sweeps the southern sky and heads for the northwest horizon. So, generally speaking, the trick is to plant fast-growing shade trees so that, when full grown, they will cast shadows across the roof and walls only during those hours. In most places this will mean perhaps one tall, high-crowned tree on the south side, to act as a parasol against the steep rays of early afternoon sun. A smaller tree with low branches, on the west side, will stop the

(Continued to page 264)

Shaded terraces should have light-colored surface for cool, clean look. In winter it will also reflect low sun's rays through windows, adding warmth. On unshaded terraces, however, bright paving would cause unpleasant glare. Such situations call for cooling lawn, ground cover or dark paving for best results



California-style ranch house keeps its walls cool—and attractive—with variety of trellis climbers that break severity of white expanse. Alternative method uses carefully pruned fruit trees that are trained to grow flat against wall, branching upward like tines of a fork

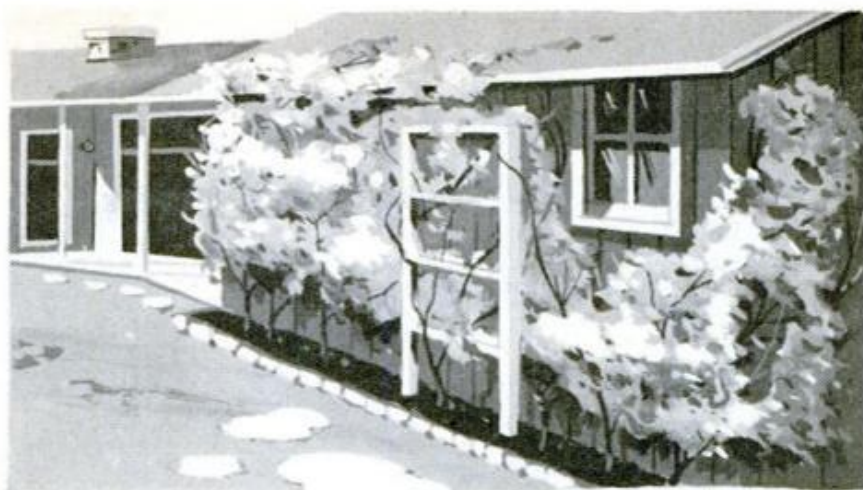

Shade-giving overhangs can be added to existing houses without spoiling lines, by simple construction of arbor or pergola. Lace vines can be trained up a trellis, across the arbor and along eaves, or open lattices can be patterned to give shade without need for vines at all



White concrete walks or terraces in open sun, adjacent to house, can reflect considerable undesirable heat through windows. Reflected heat is partially absorbed by thick, leafy planting of giant zinnias along foundation, wired to stay upright—an attractive and functional plan



Even a small pool in part of yard used for outdoor living makes difference of several degrees on hot afternoons and evenings. If trapped with dense hedges and plantings, air in immediate vicinity of pool will be considerably cooler. Water will absorb much of the heat



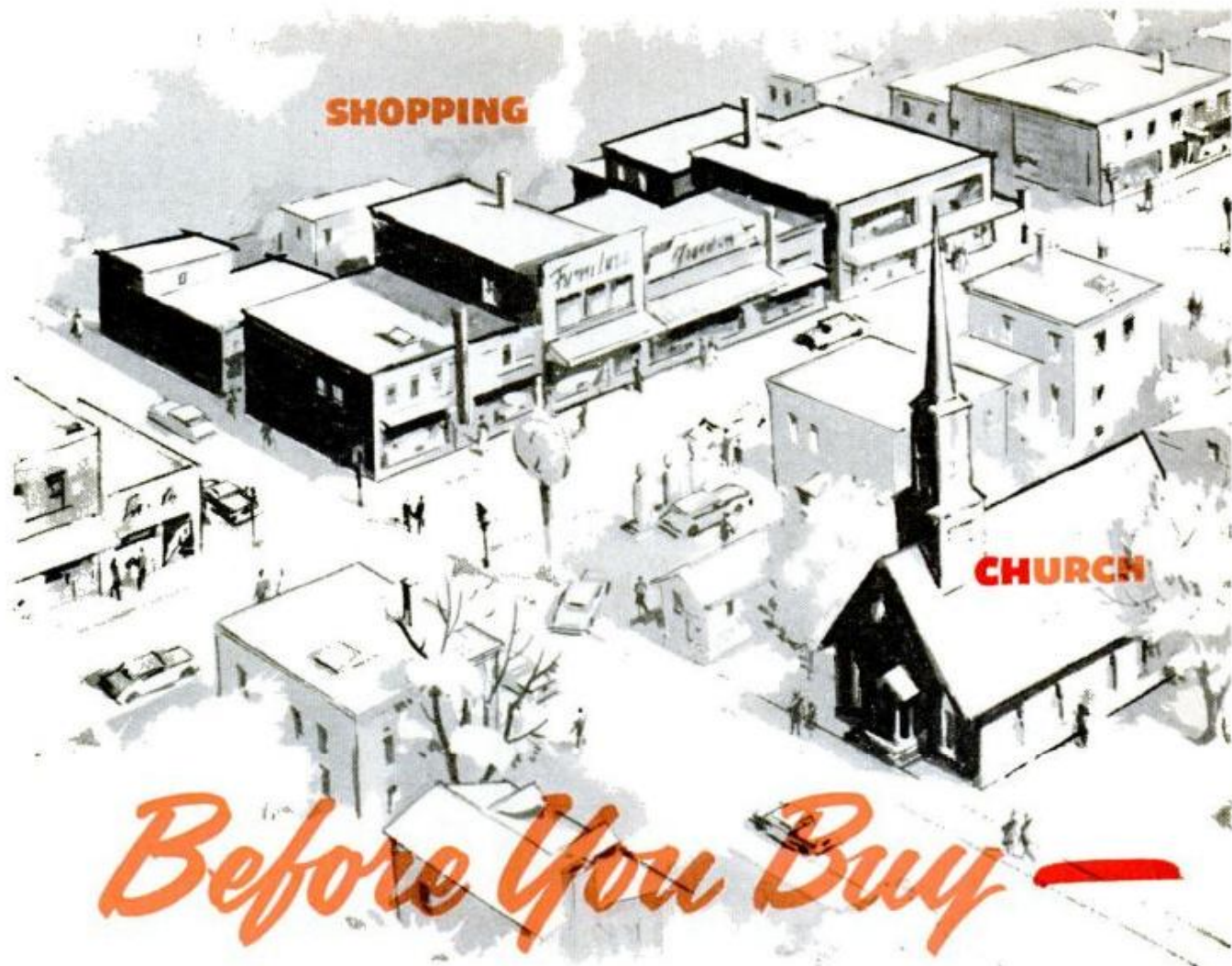

SHOPPING

CHURCH

Before You Buy —

By Charles D. Neal

IT'S WELL WORTH spending time learning how to get the most for your money in a home. It may be the most important purchase that your family will make. Knowing what to buy can save you money and enable you to choose a home that your family will be happy to live in. Before you start house hunting, think over what kind of family you are. Do you need plenty of yard for games and cook-outs and a corner for flowers? Or doesn't outdoor activity interest you? Will there be room for family hobbies?

A check-list will help you compare and balance the plus features against the drawbacks to arrive at a sound decision. Without such a list it's easy to forget seemingly minor points that later you may regret.

When house buying, you're strictly on your own. No one else is so vitally concerned with finding a home that satisfies your needs. The realtor isn't going to point out the bad features of the houses he's trying to sell.

Is a used house a bargain or a lemon? Only by carefully checking its condition will you be able to know. Actually an older house may have many advantages over a

new one. For one thing the older house usually offers a lot of space at a bargain rate, but you will have to decide if your family can use that space to advantage. All utilities will be in, and the chances are you won't have to start from scratch with landscaping, shrub plantings and lawn seeding.

What Does the Location Offer?

Even your dream house can be unsatisfactory if located in a rundown, declining neighborhood. To find out the general appearance of a community, drive or better, walk through the surrounding area. Observe the homes, the grounds and public buildings. Compare values and talk with the people. Is the neighborhood attractive, and will you like your new neighbors?

Locate in a neighborhood that you'll enjoy. The district should have a high percentage of homeowners, a good neighborhood that is increasing in value, because then your property will also increase in value with the years.

You will want to know that the zoning restrictions and building codes protect you and yet meet your needs and desires. Most restrictions are positive protections, which

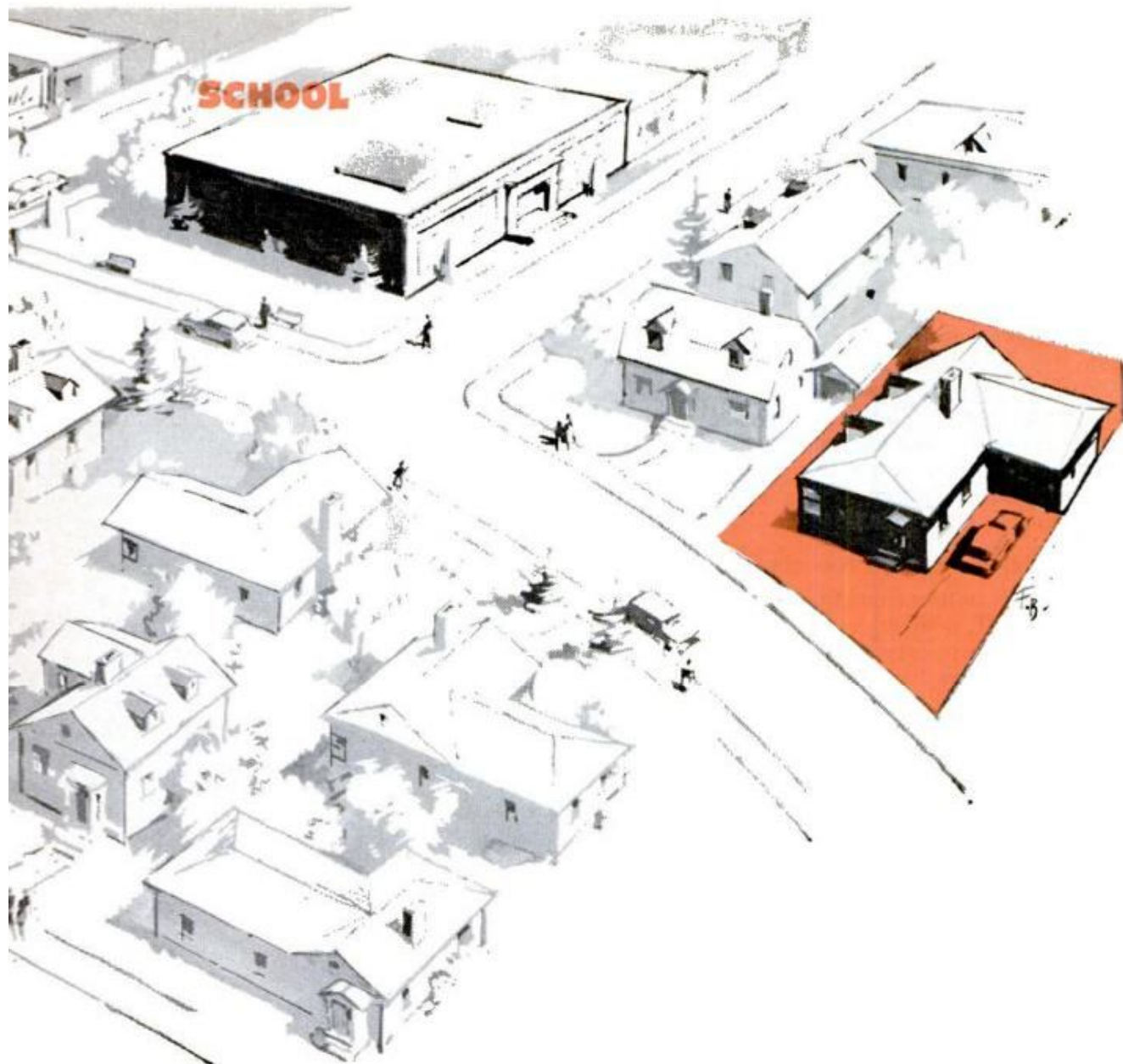

Purchasing a home means buying a share in a neighborhood. That share is a school for your children, playgrounds, police and fire protection—all that goes with an established community.

should never be considered undesirable. Is the district zoned for residential building only? A property in an outlying, unzoned area may be cheap, but such a neighborhood has a doubtful future. Although you will not want shopping centers and playgrounds across the street, you will want to know they can be reached quickly. But avoid an area where zoning permits all types of commercial buildings.

Desirable residential restrictions place a minimum limit on the cost of a house and on how close houses can be built to lot lines. Since zoning restrictions differ from one residential district to another, be sure that you understand those which apply to the neighborhood you are considering.

Are there any foreseeable condemnation possibilities? Governmental agencies, such as highway departments, public schools, and institutions of higher learning, make expansion plans well in advance. If you don't check such possibilities, you may find a future highway being built near or across part of your property. A trip to the local city planning commission will give you the answers to these questions.

What estimates can safely be made of the future value of the neighborhood properties? Check for the nearest encroachment of industry and low-rent areas.

Because you may be fortunate to have good commercial and public services now, don't take them for granted! Are the util-

ities such as water, electricity, gas and telephone adequate? How about police and fire protection? What provisions are made for trash and garbage removal? What about public transportation?

Are there curved or dead-end streets in the neighborhood to discourage high-speed driving? Try to avoid a location that will require your children to cross heavily traveled streets on their way to school—the less traffic in the neighborhood the better. If the streets are soon to be repaired, find out what the assessments will be, if any.

Schools, churches and shopping centers should be reasonably near and suitable to your family needs. You may want to visit the schools and churches before deciding.

What are the recreational opportunities? Are there parks, playgrounds and other recreational facilities nearby?

Selecting the Property

No house is better than the lot on which it stands. You'll need to know the size and shape of the property. Learn where the boundary lines are located before you buy. If your abstract or title policy doesn't define them clearly, have a survey made. In some locations a lot less than 60 ft. wide will tend to reduce privacy.

A lot is judged according to its public, private and service areas. To some home buyers a corner lot is more desirable than an inside lot. Usually a corner property gets a somewhat higher valuation for tax purposes. The public area in front of the house is best if relatively small—about 30 ft. is considered deep enough today. Such a yard cuts down on the length required for driveways and walks, and it reduces the amount of maintenance. A long driveway, coated with ice and snow, is inconvenient and makes a lot of unnecessary work.

The private, outdoor living space should be the largest area, designed for family living, relaxation and entertaining. Usually this area is shielded from the street, neighbors and service areas by plantings, fences and the house itself.

The third area is the family service or utility area, which should be located near the kitchen and garage. The service area can be relatively small, but there should be room to dry the family wash and space for trash and garbage cans, plus a small outdoor work area.

Good drainage is essential. A close look at the lay of the land will tell you a lot about drainage characteristics of the area.

STRUCTURAL DEFECTS THAT REQUIRE MAJOR REPAIRS



FOUNDATION should be in good condition. Look for water stains and other indications of dampness. Be suspicious of cracks and bulging walls, especially in an area where ground is mostly clay. Repairs can be prohibitive



CHECK CONDITION of joists, bridging and posts from the basement. Then go upstairs to find out if the floors are finished to your satisfaction. Both the bathroom and the kitchen should have modern, easy-to-clean floors



ROOF. An inspection of the roof and attic should be made to determine its condition. Water leaks usually show up as stains on the framing inside the attic. Also, are the gutters and downspouts in good repair?



DO WINDOWS and doors have good weatherstripping? The windows should also raise and lower with ease, and there should be storms and screens for all of them. But check them—don't take somebody else's word for it

Should the prospective lot have poor drainage and possibly need grading, fill or a retaining wall, better check on the cost before buying. Such work can sometimes make a house too expensive. And should the property be in an area that floods occasionally, buy elsewhere. Such a property is too expensive no matter what the price.

Should drainage appear to be a problem, drive past the property during a heavy rain storm. If water runs towards the foundation, you can expect at least some dampness in the basement.

Many a family has fallen in love with an attractive property and bought it before considering all the work that the place would require. Too late they found there was more grass to mow and maintain than they expected. And the garden, which looked wonderful before they moved in, now takes most of their week ends to keep attractive. So take a hard look at the place to make sure your family will be happy with it right from the beginning.

Best House for You

Most important, does the house itself satisfy your family's needs? Will it be large enough for future needs? And is there enough space, or too much? You may

think there's never too much space, especially for a growing family, but a large home can sometimes be inconvenient and include space that's too expensive for you to heat, maintain and decorate.

Never decide to buy or not to buy on eye appeal alone. Any house, especially an older one, will represent a compromise. You can never expect to find all the desirable features that you'd like in one house. Instead, you should first decide what are "must" features. Make a list of these. Add to it those features that should be included and, then, those that your family would like to have but could easily do without, at least for the present.

Probably the most vital consideration is the floor plan. While a family can live happily in a house that has about any style of architecture, the floor plan must be reasonably convenient, or the family will never be satisfied. The floor plan is a personal consideration which your family must decide for itself. It should be arranged for living in the way the family enjoys. If privacy and seclusion are important, the plan should provide rooms for individual activity. Or if relaxed outdoor living is important, the area should be convenient to the house.

CHECK THESE—THEY'RE COSTLY TO REPLACE

HEATING. If there's any doubt as to the condition of the heating plant, have a heating contractor check it. Replacing a furnace is always a major expense, so the value of the house should be discounted accordingly



ELECTRIC SERVICE. Does the house have at least a 100-amp. service entrance? If it hasn't, you may soon need to replace the wiring system to take care of all the new appliances, lights and TV's that are now in use



INSULATION. If there's good insulation in the walls and ceiling, give the house a big plus, for insulation adds a lot to your comfort during both winter and summer. Make sure walls also have a good vapor barrier



WATER HEATER. Find out the age of the heater. Chances are that it will need replacing soon if it is nearly 10 years old. And in the hardwater areas many of the inexpensive heaters give out in less than 5 years





VISIT SCHOOLS in neighborhood to see that facilities are satisfactory and classrooms are not overcrowded



For privacy and quiet the bedrooms should be separated from the rest of the house. And, unless the house is air conditioned, there should be good cross-ventilation. The doors and windows in every room should be located to provide space for satisfactory furniture arrangements.

The kitchen should be located conveniently to the living and dining areas. Also, there should be direct access from the kitchen to the outdoor service area and garage to save unnecessary steps.

There is no rigid formula for determining the total amount of storage space needed, other than it should meet your needs.

(Continued to page 298)

TRAFFIC PATTERN that creates hallway through living room reduces privacy and makes arranging furniture difficult. The central entry hall gives direct access to all rooms without going through living room. Direct garage-to-kitchen route is desirable

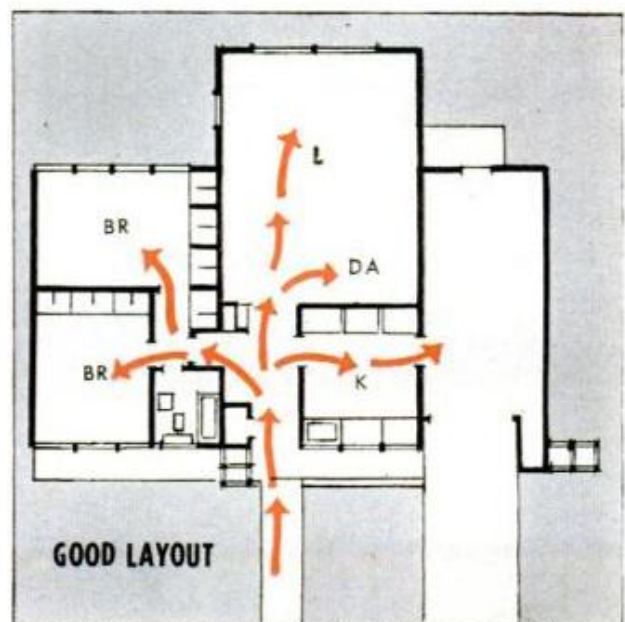
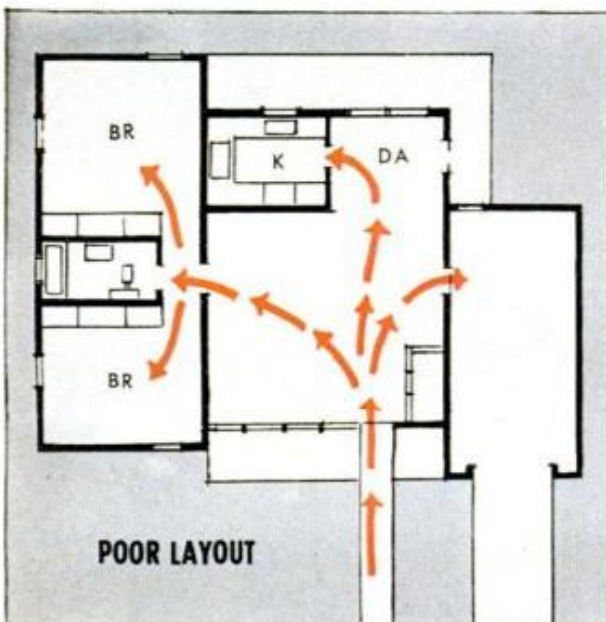

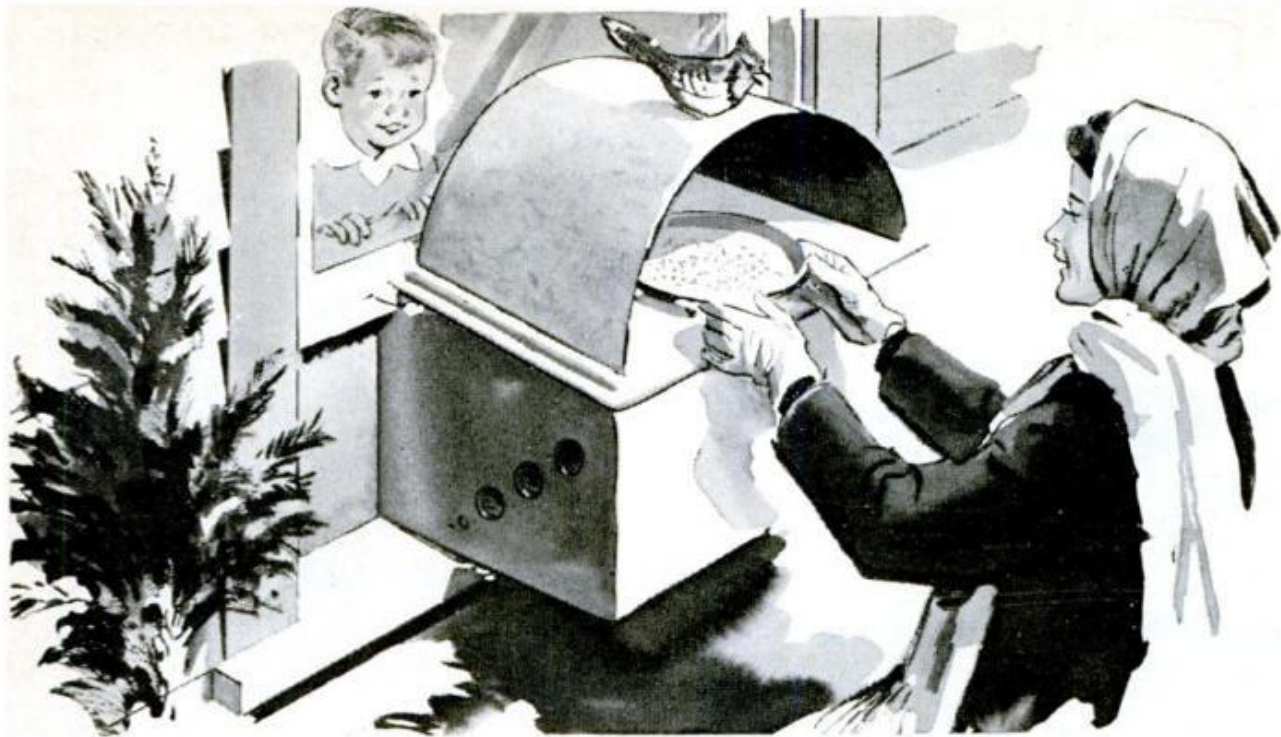

WINTERPROOF YOUR AIR CONDITIONER

THIS HARDBOARD COVER not only protects a window air conditioner from snow, ice and freezing rain, it also serves as a sheltered bird feeding station by the simple addition of a curved hardboard top, or roof. The cover may be installed any time in the fall months without affecting operation of the conditioner during a late autumn warm spell, as the design includes vents which can be opened from inside the house to admit outside air.

The first step in making it is to take careful measurements of the conditioner so that you know how long to cut the frame members of 1 x 2-in. stock. Make an allowance for weatherstripping as in the left-

hand detail. Rip all pieces of the frame to width and square off to length. Then clamp together with glue on the joining and fasten with corrugated fasteners. Add blocks, or strips, to the front uprights to close the space. Then add the weatherstripping and the 1/8-in. hardboard covering panels. Finish up the job by boring three 1 1/2-in. dia. holes in each end panel and fitting the spring-loaded vent covers. Set the cover in place, wedge it as in the sectional view and fit screen hooks and eyes to hold it securely in place. Fit the curved cover which forms the bird feeder with the end supported by strips cut from shoe mold as in the right-hand detail. ★ ★ ★

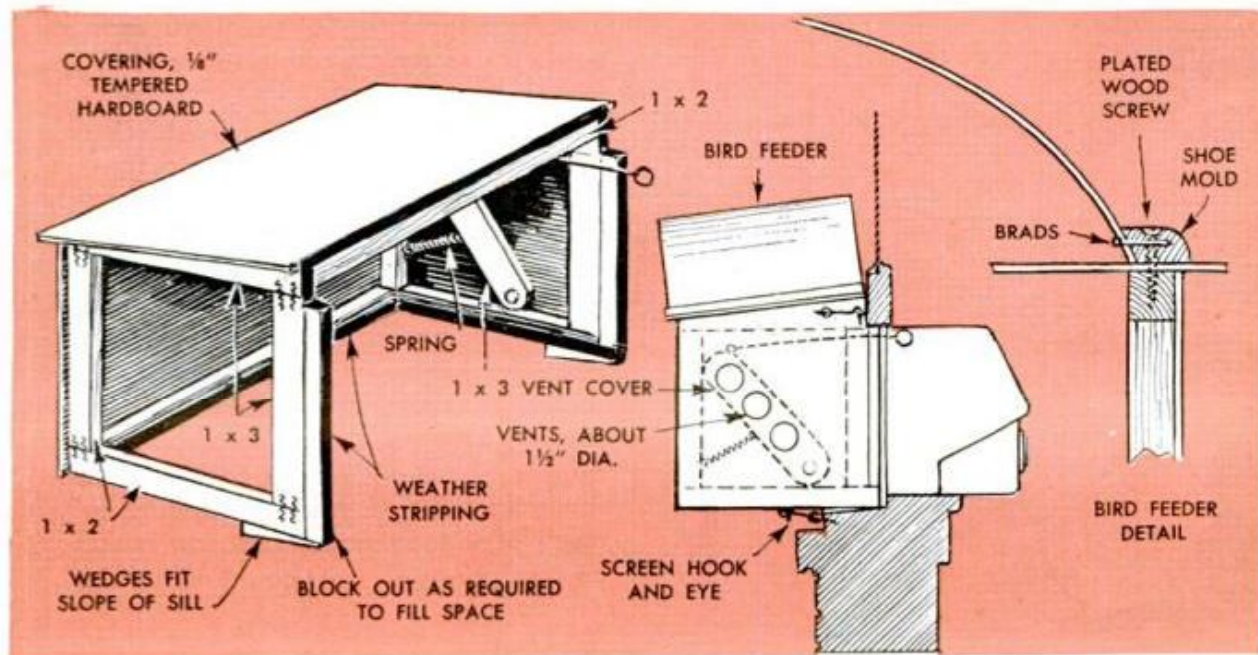

A bomb is dropped on a key target. But who cares, you live miles away. Fallout can't reach you. But soon you and your family become ill, dangerously ill. Now you wish you had heeded the importance of a family fallout shelter. If you decide to build one, first consult your local building code and the Civil Defense authorities.

Before

WHAT IS FALLOUT?

Fallout is tiny pieces of dust and debris which are made radioactive by nuclear explosions. When a hydrogen bomb is exploded close to the ground, thousands of tons of these tiny particles of dust and debris are sucked upward into the air. They help form the mushroom cloud which is always seen with one of these explosions. Some of this radioactive matter spills out of the cloud near the explosion. Most of it, however, is carried by the wind for many miles. Eventually it settles to earth where it pollutes the air you breathe and attacks the vital organs of the body. You can't feel or see fallout. But if you are exposed to much of it long enough, it can make you seriously ill. It could kill you!



the Siren Sounds

CALL IT fallout apathy if you will, but chances are that less than one in fifty will bother to provide in advance adequate shelter against radioactive fallout—if and when. However, the fact remains, every family should have a safe hideout prepared in or near their home where they can go to escape the deadly after effects of fallout.

Where is the best place to go and stay? Underground, says the Office of Civil Defense. An underground shelter having at least three feet of earth or sand over it, plus an adequate door and air filter, will give you almost complete protection. Any mass of material placed between you and the fallout cuts down the amount of radiation that reaches you. Where's the next best place to go? In your basement. Merely staying in the basement will reduce your exposure to about $\frac{1}{10}$ the outside exposure. Sandbagging the basement windows will reduce the amount further. And a special refuge built in the basement, with a mass of material around and above it, can reduce exposure to about $\frac{1}{100}$ of the outside exposure. A point to remember is that the best protection is not good enough if you cannot stay in your shelter until told to come out. In the case of a basementless

home, an underground shelter outside the home would have to be considered. A basement shelter is generally the least expensive and easiest type for the homeowner to build, since two walls of the shelter are already formed by existing basement walls. Solid, 8-in. concrete blocks provide enough density for adequate shielding. If hollow blocks are used, they should be filled with concrete to provide the equivalent protection. Or, a brick wall 10-in. thick will give as much protection as a wall made of 8-in. solid concrete blocks. Such a shelter could be incorporated in the plans for a new house. The shelter might double as a hobby, storage or darkroom, but emergency equipment and supplies would need to be kept in the shelter at all times. For a family shelter 10 sq. ft. of floor space per person is considered adequate.

The shelter area is first laid out on the basement floor. Along the guide lines set into mortar a row of solid concrete blocks. Build up the corner section about six blocks high and lay up the rest of the wall to the same height. Again, build the corner up about six blocks high and raise the walls to an equal height. Continue this construction until the desired height is reached. At



BASIC ESSENTIALS for living as long as two weeks in family fallout shelter should always be kept on hand

least 16 in. should be left overhead between the walls and the joist to allow enough space for building the roof. The open entranceway together with a series of small vents installed in one layer of blocks near the floor give the necessary ventilation.

Fasten the supporting studs for the roof to the basement walls with anchor bolts. The ledger board nails to the studs and wall. The two studs on the other wall should be the same height as the main block walls.

Before laying the roof, allow the mortar in the wall to dry for at least a day. The roof joist rest on the inside 4 in. of the block wall, and the outside 4-in. space is filled with a row of blocks set on edge in mortar. Nail the joist to the ledger and add headers at both ends of the joist to hold them in place. On the entrance wall, the headers set flush with the inside wall surface.

Slide the roof boards into place across
(Continued to page 258)

THIS ABOVEGROUND SHELTER is built outdoors of masonry, and is suitable for locations where it is impractical to build underground—wherever rock or ground water may be a problem. The shelter has two concrete block walls which sit at least 20 in. apart, and the space between has an earth or gravel fill. The roof is a 6-in. reinforced concrete slab covered with at least 20 in. of gravel. Instead of using concrete, heavy wooden beams could be used to support a dirt roof. This shelter would cost considerably more than one built inside a basement where earth and basement walls form two protective sides of the shelter





PRESHAPED METAL or precast concrete form effective fallout shelters when mounded over with earth. The shelter shown would provide almost absolute protection from fallout radiation

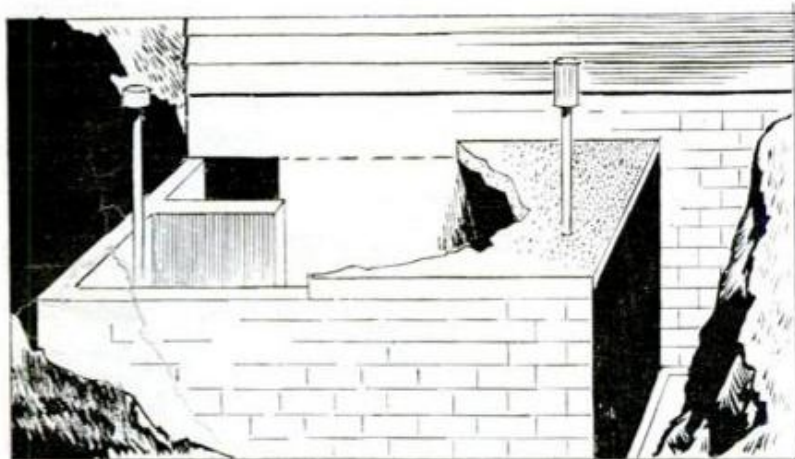
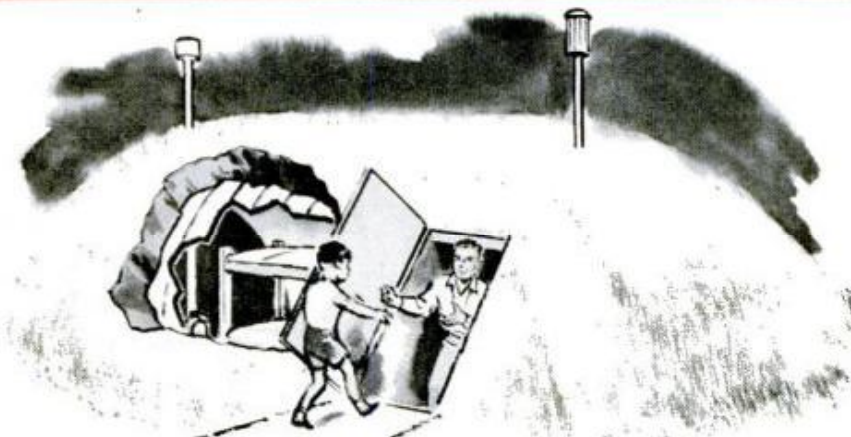

THIS SHELTER could be built as an additional basement room at the time the house is under construction. It would add about \$500 to the cost of the house

ANOTHER TYPE of underground shelter providing excellent fall-out protection is built of reinforced concrete. Either a stairway or a hatchway entrance is used. Such a shelter would best be constructed by a contractor

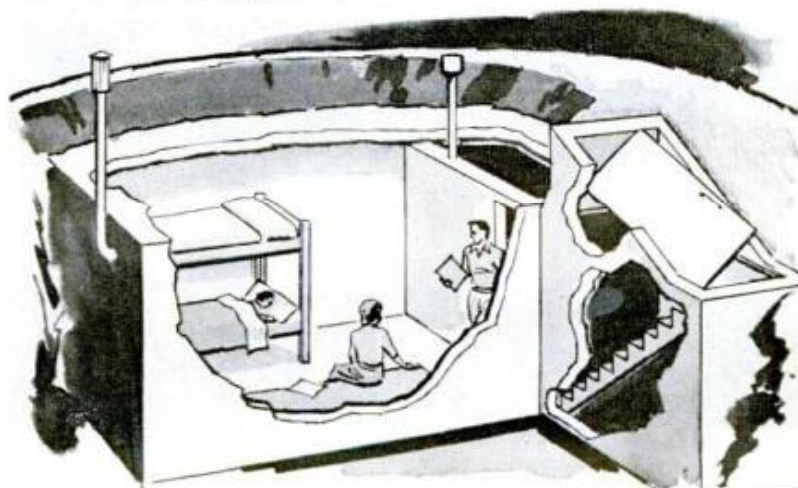



LOUVERS IN COLOR

LOOKING FOR a new wrinkle in home decoration that you can carry out yourself? Then give a thought to what you could do with louvered doors and louvered panels having colored slats of $\frac{1}{8}$ -in. glass fiber. There's that small, plain-paneled door that closes the closet in the smaller bedroom. Think what a spot of color could do for that room. Or, consider the stark, unbroken white of the kitchen cabinets, the need for a colorful folding screen or possibly a louvered room divider to update the living room.

Use $\frac{3}{4}$ -in. clear, straight-grained white pine for the stiles and rails of the louvered-door frames. Rip the parts to width and square the ends of the rails. The parts should be cut slightly oversize. Then measure and cut the grooves for the louver slats. On small doors these grooves are spaced about 1 in. apart and normally are cut $\frac{1}{8} \times \frac{1}{8}$ in. at a 55-deg. angle.

After the parts have been cut to size join with glue and dowels. Make sure before the glue dries that the frame is square and that it is $\frac{1}{16}$ to $\frac{1}{8}$ in. oversize. If the measurements both ways are a trifle over, you can easily plane it to fit the opening for which it is intended. Then slide the slats into the grooves and finish with a screen molding as in the detail. Miter the molding at the four corners and fasten in place with $\frac{3}{4}$ -in. brads. Finish the frames to match adjoining woodwork.—James A. Lockhart

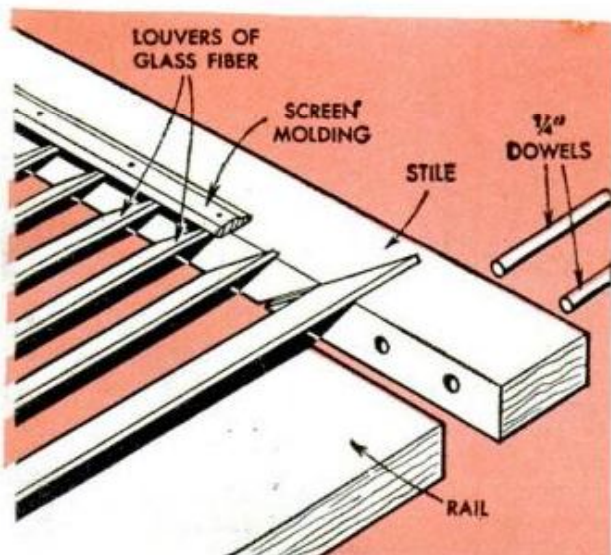

SAW CUTS for the glass-fiber slats should be made approximately 1 in. apart and at a 55-deg. angle

INSERTION OF THE SLATS is a simple matter of pressing them into snug-fitting saw cuts $\frac{1}{8}$ in. deep

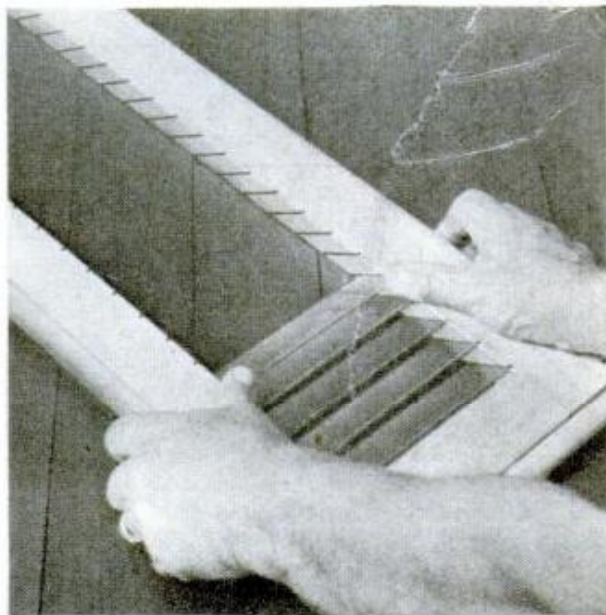
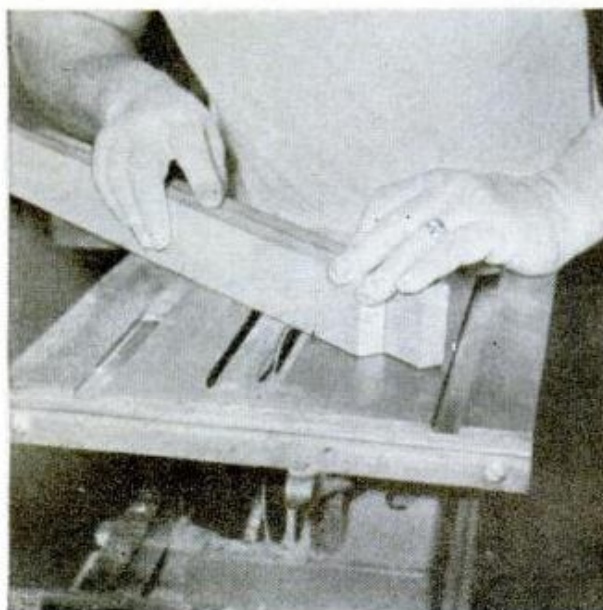



IT WARNS YOU When the Sump Pump Fails

IT'S NIGHT. There's a heavy rainstorm and water is rising in the sump in your basement. The pump starts, runs for a time. Then there's an extremely bright flash of lightning, a long roll of thunder. Lights go out along the street. The pump stops. You're sound asleep while all this is going on.

A sump pump can become inoperative for any one of a number of reasons other than current failure due to natural causes, a tripped thermal unit, a sticking float, a "frozen" driveshaft—defects or causes you may be entirely unaware of until the damage is done.

You can now buy a unit, called "Trusty-Warns," that wakes or warns you in time to get your auxiliary pump working if you have one, get the sump pump started again, or remove valuable property from the basement ahead of the flood. The alarm is battery operated, not dependent on house current, and the detail at right shows how it works on a sump pump. When that bell rings it's loud enough and urgent enough to bring you running from almost anywhere, upstairs or down, asleep or awake. Similar units are available for hooking up to serve as burglar and fire alarms, also to a home freezer.

THE ALARM KIT (below) is designed to fit any sump pump

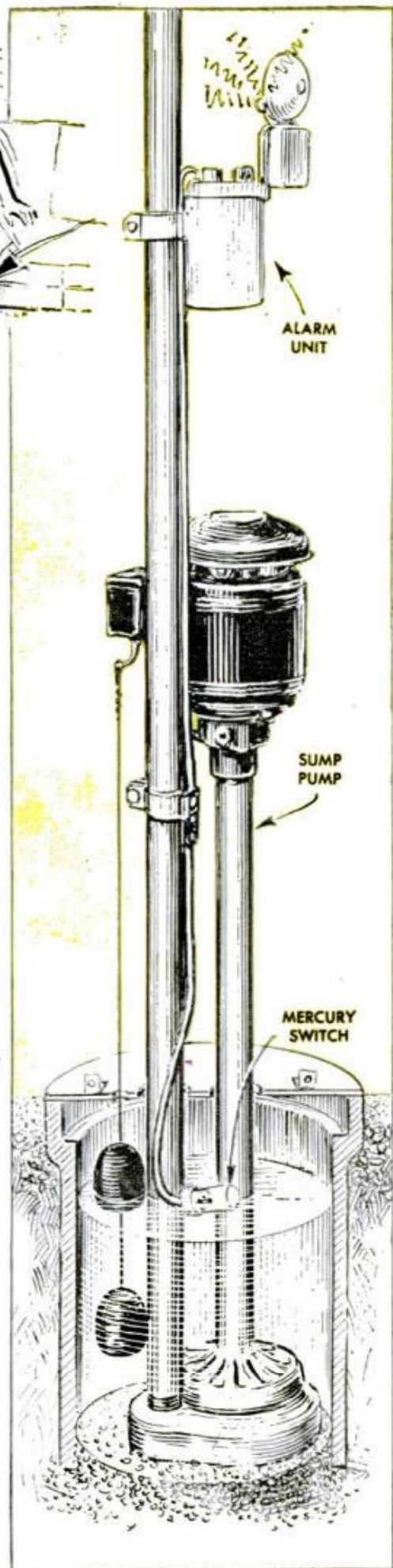

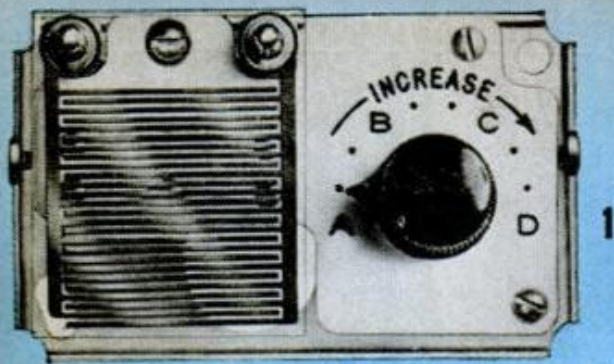

Minneapolis-Honeywell Regulator Co.

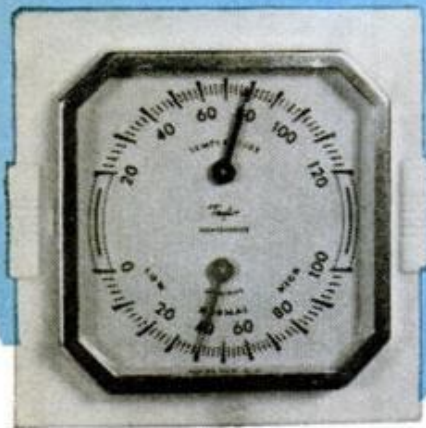

2

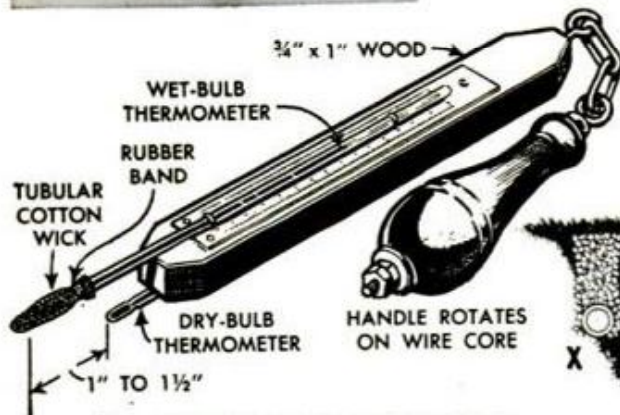

3 HOMEMADE SLING PSYCHROMETER

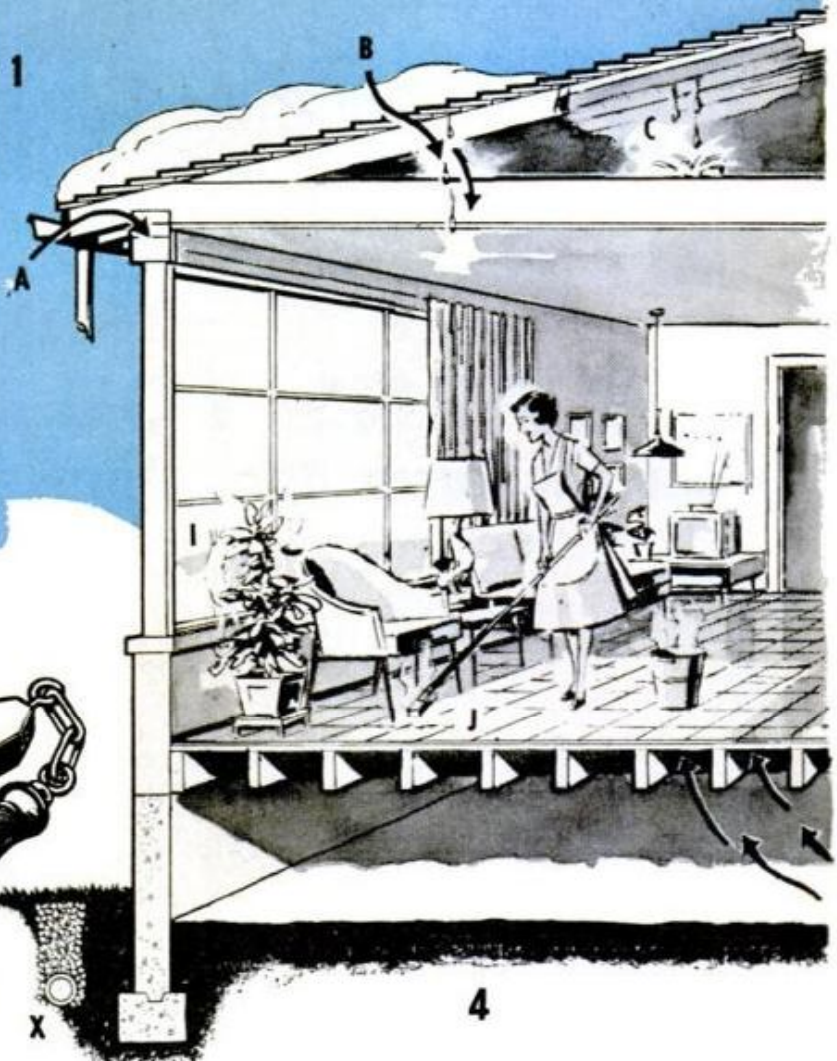

4

What to do about EXCESS HUMIDITY

By E. R. Haan

ALTHOUGH a moderate percentage of humidity in your home is essential, too much can cause all kinds of trouble. Often, in older houses, it is difficult to maintain enough humidity, but in the newer and more tightly constructed houses of today, the problem is just the opposite—how to get rid of excess humidity.

Nowadays more moisture is produced per cubic foot of living space than formerly since the average size of houses has shrunk, but cooking facilities causing moisture have remained the same or increased, there are now more baths and showers, and laundry equipment has in-

vaded kitchens. Damp crawl spaces and poorly insulated slab floors add to the woes of excess humidity.

Some Excess Humidity Troubles

Fig. 4 shows numerous sources of excess humidity and some of the results. Repeated condensation on windows lifts paint and varnish, rots wood, rusts steel, damages wallpaper, plaster and floors. When condensation takes place in outerwalls the insulation deteriorates and ice may form on the sheathing. The ice melts when temperature rises and the water runs down on the sheathing and studs to the sills,

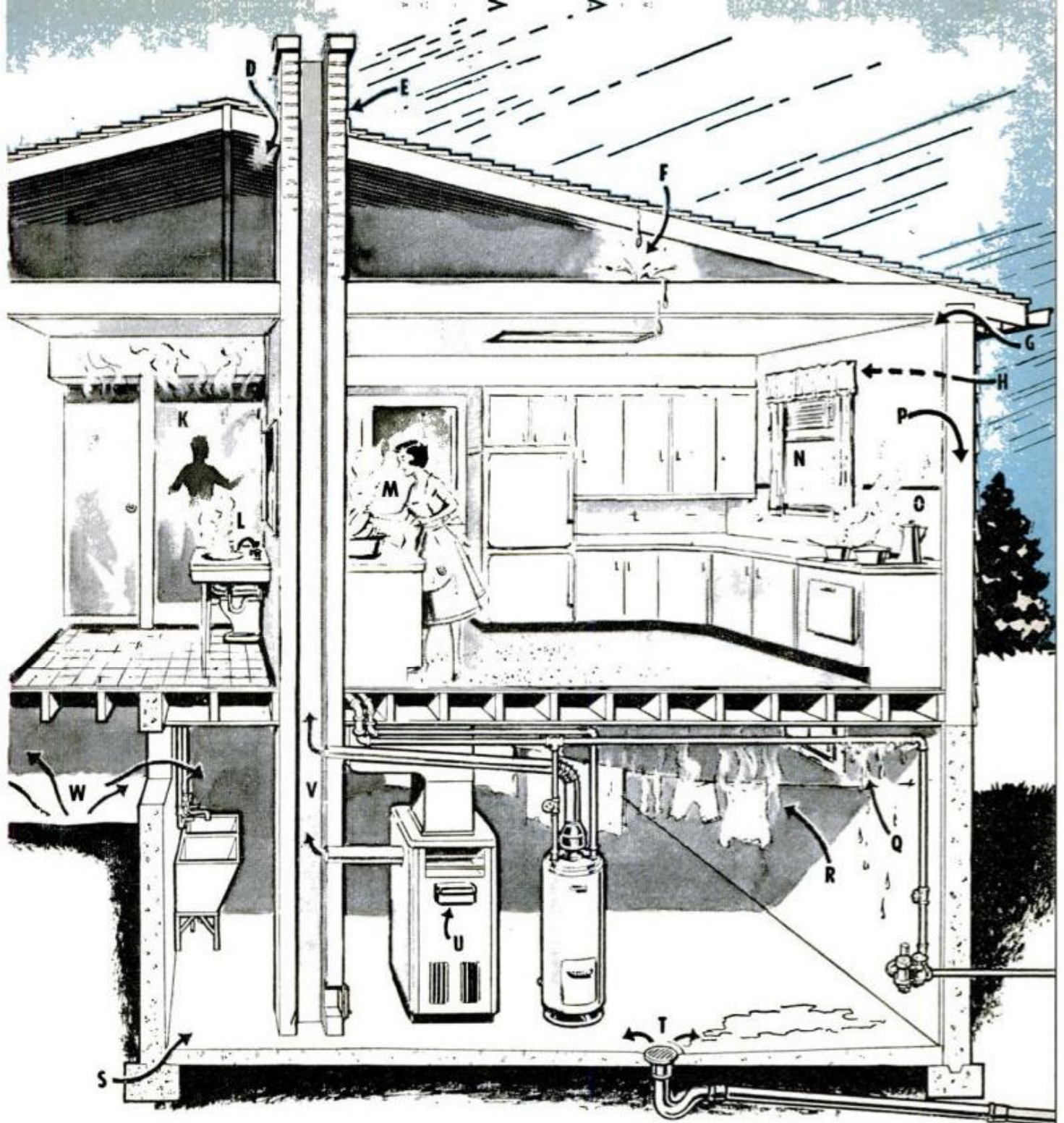

SOURCES AND RESULTS OF EXCESS HUMIDITY

- A. Leaky or clogged gutter can let water drain into walls.
- B. Melting snow on low-pitch roof; water may rise between shingles and find way inside.
- C. Ice on underside of roof sheathing, from condensed vapor, melts when temperature rises.
- D. Water leaks at flashing.
- E. Driven rain enters defective mortar in brickwork.
- F. Roof leaks.
- G. Driven rain forced through poor joints between siding and trim.
- H. Defective window flashing lets water enter wall.
- I. Evaporation from flower pots almost equals water put into them.
- J. Mopping 8 x 10-ft. floor adds about 2.4 lb. of water to air.
- K. Hot shower evaporates about $\frac{1}{2}$ lb. of water.
- L. Constant evaporation from splattered water drops of dripping faucets.
- M. From $\frac{1}{2}$ to $\frac{3}{4}$ lb. water evaporated when washing dinner dishes for family of four in sink.
- N. Condensation on inside of windows indicates high humidity.
- O. One day's cooking for family of four adds 5.8 lb. of water to air.
- P. Lack of vapor barrier lets vapor get into wall and condense on sheathing.
- Q. Sweating cold-water pipes, a common humidity problem in summer.
- R. Laundering in open tubs and drying inside, for family of four, releases 30.7 lb. of water into air.
- S. Leaks through walls and floor keep basement damp.
- T. Sewer backflow is occasional serious problem.
- U. Humidifier of warm-air furnace may require adjustment for less evaporation.
- V. Water vapor produced by gas-burning appliances (and oil burners) disintegrates mortar joints of chimney not having a continuous flue liner.
- W. Moist air in crawl space penetrates house.
- X. Diverting water with drain-tile line to prevent it from collecting in crawl space.



American Blower Co.

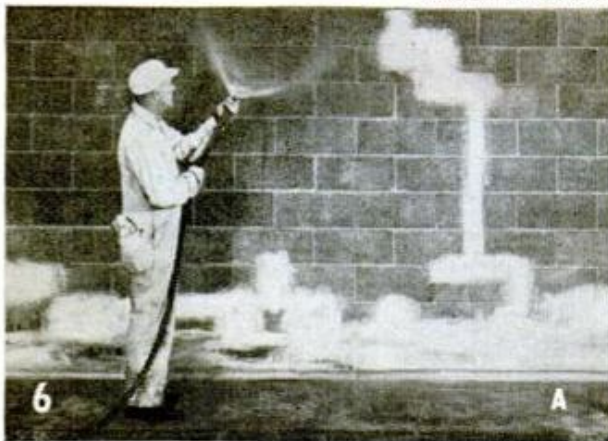

Standard Drywall Products

AFTER PLUGGED OPENINGS have been coated with sealer, entire wall is sprayed with water, above, followed by two applications of a heavy concentrate of sealer applied 3 hrs. apart, starting with a 3-ft. strip



causing the wood to rot. Excess moisture in walls also causes paint failure on the outside.

In unheated and unventilated attics, excess moisture contacting cold roof sheathing also may form a coating of ice. When several months' accumulation melts in spring, the water can run down to rooms below. A damp and poorly ventilated crawl space may cause the floor above it to rot and collapse. Slab floors not provided with adequate insulation may accumulate puddles of water during cold weather when moist, warm air in the house contacts the cold slab or the floor covering. Dampness also causes mildew damage to furniture, fabrics, cloths, rugs, books, wallpaper and other materials. Condensation in basements is mainly a summer problem; can be controlled usually with a dehumidifier.

Humidity Recommendations

Troubles such as those mentioned above usually can be avoided by keeping the humidity in your home within the recommended limits given below, which were based on the findings of the Engineering Experiment Station of the University of Minnesota.

Outside air temp. (F.)	Inside relative humidity at 70° F.
—20 or below	15% or less
—20 to —10	20% " "
—10 to 0	25% " "
0 to 10	35% " "
10 and above	40% " "

To measure humidity you can use a sling psychrometer. A homemade one is shown in Fig. 3. It consists of a dry and a wet-bulb thermometer on a common base. It is swung in a circle and the readings are compared to figures in a table to find the relative humidity at various temperatures and air pressures. You also can use a hygrometer or humidity indicator of the dial type. One which is combined with a thermometer is shown in Fig. 1. In addition to humidity indicators there are humidistats which are highly sensitive to humidity changes and are used to automatically control electric motors and other devices. Fig. 2 shows a humidistat which has a sensitive electronic element. This unit is used with a relay.

Moisture Sources in Homes

Most of the moist air in a house is produced by cooking, dishwashing, laundering and showering. Other sources include tub bathing, floor washing, watering flowers and plants, furnace and radiator humidifiers, leaks in the water-supply sys-

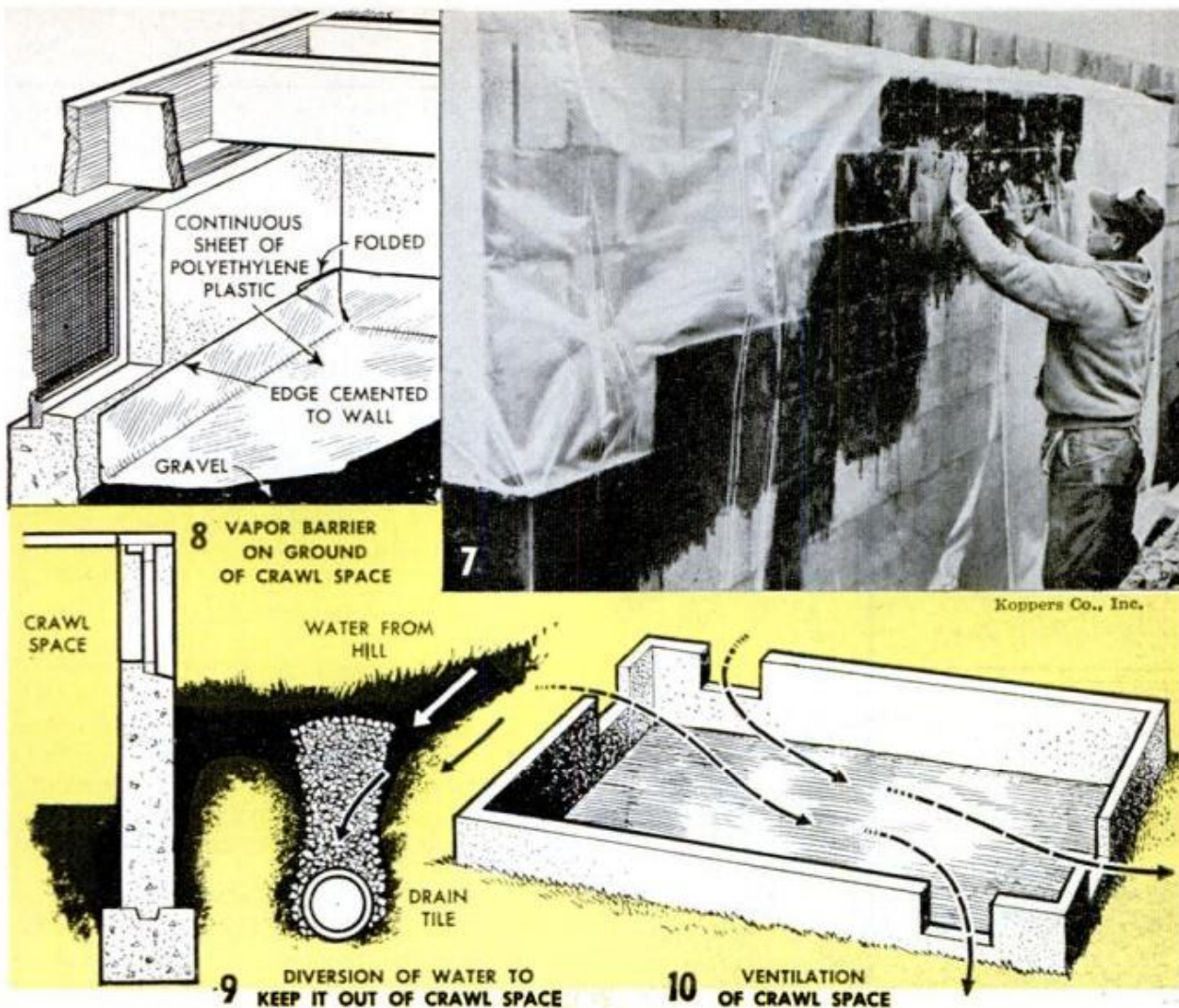

Koppers Co., Inc.

tem, operation of gas and oil-burning appliances. People also give off considerable moisture by respiration and perspiration.

If you have a warm-air heating system, one of the first things to do is to adjust the furnace humidifier for less evaporation. It may even be necessary to stop evaporation completely. In a hot-water or steam-heating system, it may be necessary to stop using evaporating pans on radiators, or separate humidifiers. For the average family of four, the amount of moisture introduced into the air daily by cooking three meals and dishwashing is about 4.8 lbs. according to the Engineering Experiment Station at Purdue University. Therefore, an exhaust fan in a kitchen, installed in a canopy over a range, or in a wall as in Fig. 5, is practically a necessity.

Most clothes driers should be vented outdoors. In the absence of a drier, drying clothes add considerable moisture to the air. In such cases an exhaust fan should be provided for ventilation. Moisture caused by floor mopping should be eliminated in the same way.

Gas-fired appliances, including furnaces, ranges, space heaters and refrigerators,

produce water vapor. A gas furnace may produce as much as 7,000 lbs. of water in a single heating season. An oil furnace produces 8 lbs. of water vapor per gallon of oil burned. This moisture goes up the chimney and invades masonry joints and causes them to disintegrate. A stainless-steel flue liner will prevent this. When chimneys are built, the mortar used should not contain any lime as this makes it more water-absorbent. Crumbling of moist mortar is accelerated by frost.

Moisture That Comes From the Outside

All of the excess humidity in homes is not produced inside. Some is introduced from the outside as for example the evaporation of water leaking into basements through cracks in walls and floor. Modern methods of waterproofing concrete include the use of quick-setting compounds in various consistencies to plug cracks and seal pores as in Fig. 6. A dry basement also is assured by "wrapping" it in a continuous layer of polyethylene plastic as in Fig. 7, preferably done at the time of building. This material comes in rolls of 10 to 20 ft. in width, and therefore requires few joints.



Fastener Corp.

In basementless homes having heated crawl spaces of which the vents are closed during cold weather, continuous evaporation of water from the earth often produces excess humidity throughout the entire house. The easiest way to prevent this is to seal off the moist earth with a polyethylene vapor barrier, Fig. 8. Edges of the plastic are brought up on and cemented to the walls. If ground water rises above the level of the crawl-space floor, or if water drains toward a crawl space from a higher location, the plastic film may require weighting down with sand to keep it in place and prevent its rupturing.

A second way to control damp crawl spaces is to divert water that flows toward them from a higher level as indicated in Fig. 9. A third way is to provide adequate ventilation. The vents should be located on opposite sides at corners as shown in Fig. 10 to take advantage of prevailing wind direction. The total area of vents covered with $\frac{1}{2}$ -in. wire mesh should be 2 sq. ft. per 100 lineal feet of crawl-space perimeter, plus one-third of one percent of the crawl-space ground area. Where existing vents are inadequate, an exhaust fan can be installed in a large-diameter sheet-metal pipe as shown in Fig. 12.

Condensation forming along the walls of a basementless house on a slab floor can be stopped by installing an adequate amount of perimeter insulation as in Fig. 13. Sewer backflow is best prevented by installing a good backwater valve in the house drain near the point where it joins the house sewer so the valve will be accessible for servicing. Water leaks through roofs, those at window and dormer flashings, water seeping into walls from clogged or overflowing roof gutters, or other outside

(Continued to page 254)

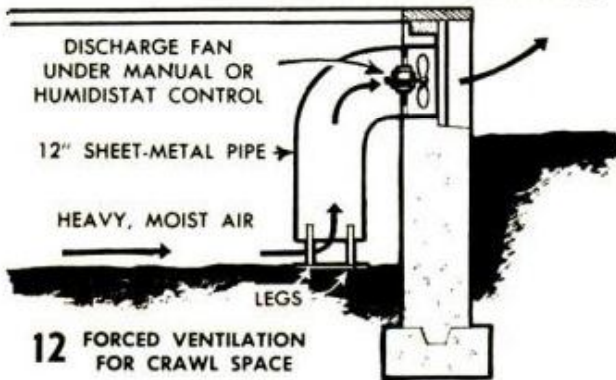

12 FORCED VENTILATION FOR CRAWL SPACE

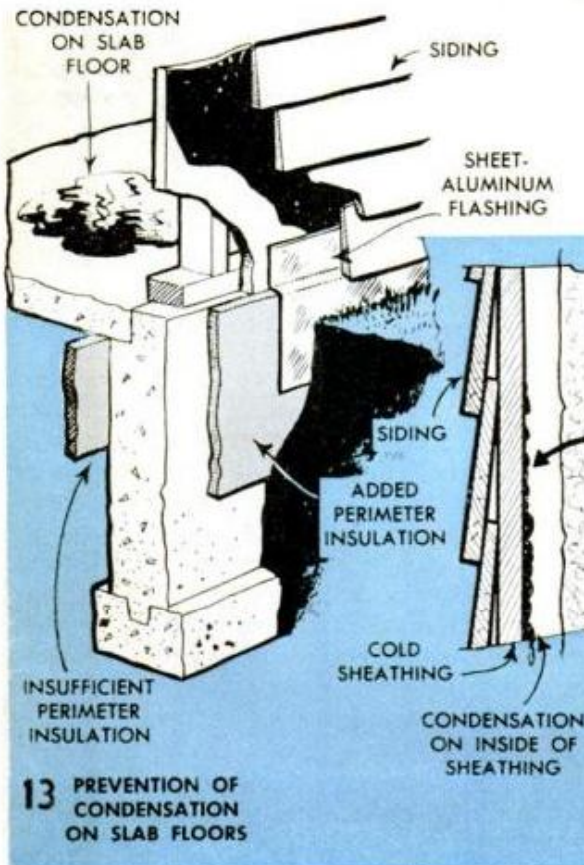

13 PREVENTION OF CONDENSATION ON SLAB FLOORS

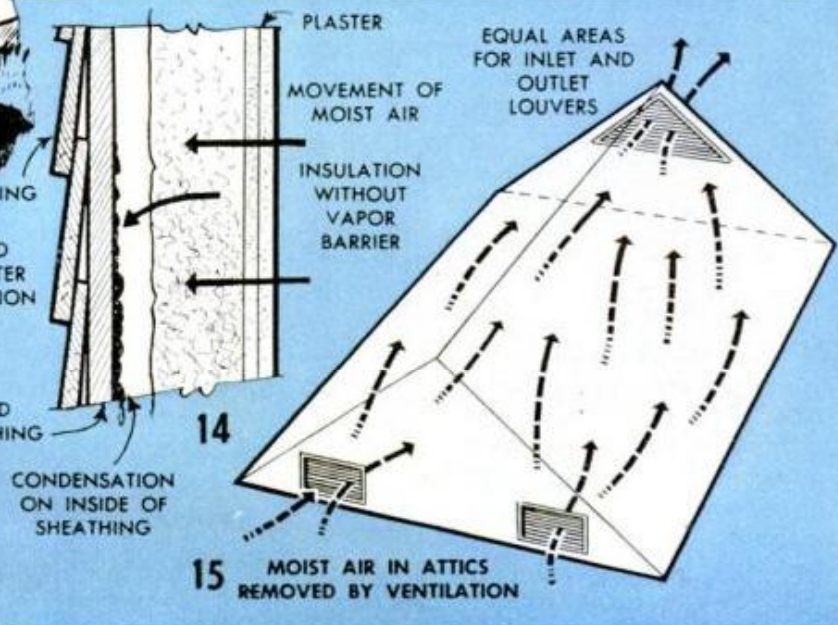

14

15

NEW FRAMING TECHNIQUES

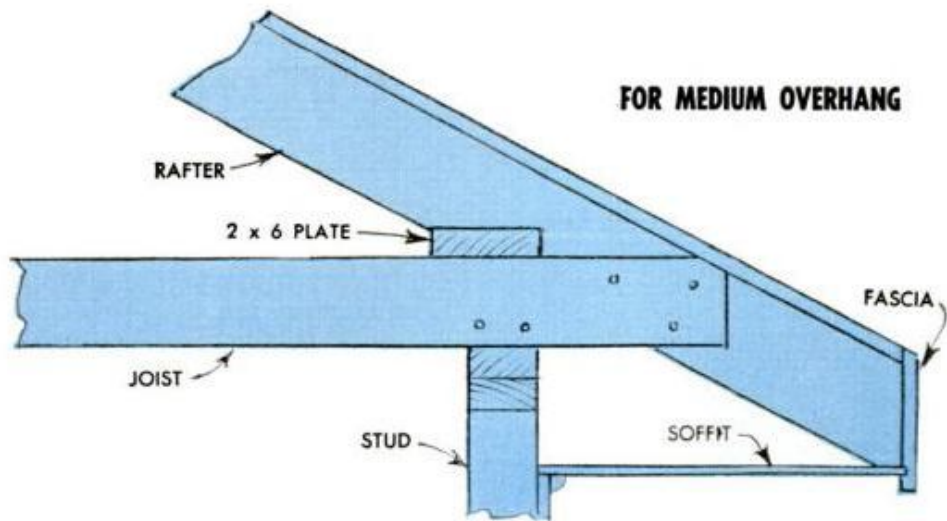

FOR MEDIUM OVERHANG



THIS FRAMING METHOD allows the use of a wider projection on the overhang without lowering the window line—as required when rafters rest directly on double plate

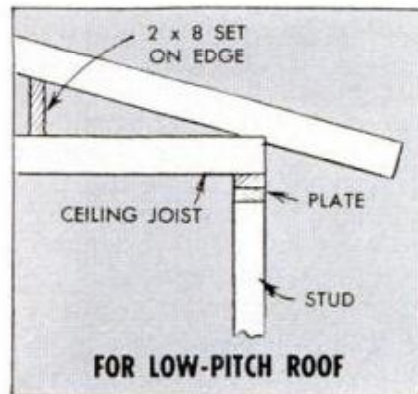

FOR LOW-PITCH ROOF

WHEN FRAMING a low-pitch roof, support is added by nailing 2x8s on edge between joists and rafters

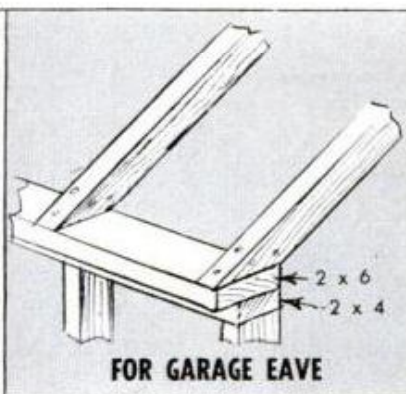

FOR GARAGE EAVE

LABOR IS SAVED by forming a simple garage eave with 2x6 top plate. Rafter sets flush on inside

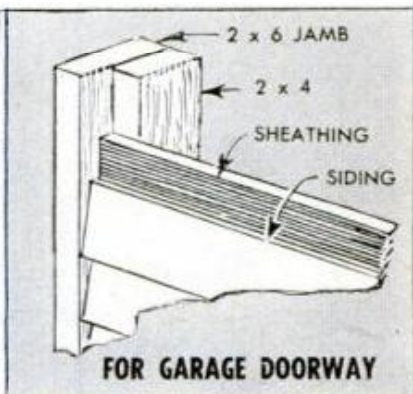

FOR GARAGE DOORWAY

GARAGE DOORWAYS are framed easily and quickly by using 2x6s for jambs, 2x4s for nailing strips

TO FORM an extra-wide overhang without lowering the roof line, use this method. Ties and jack stud add strength, and rafters rest directly on the joists

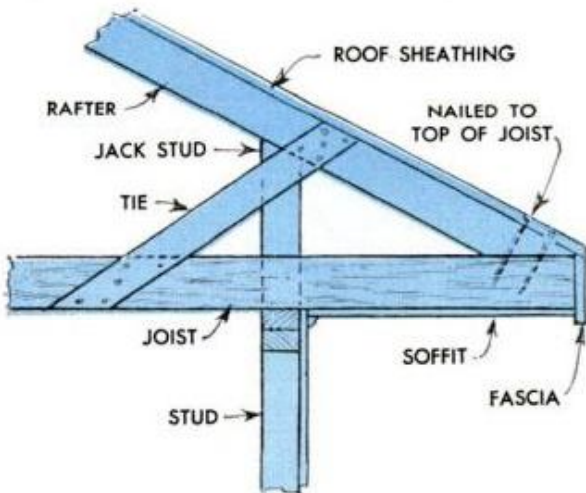

FOR WIDE OVERHANG

SPIKING A 2x10 to top plate increases strength of framing and provides a better nailing surface for ceiling material. Notch hip rafter to fit gusset

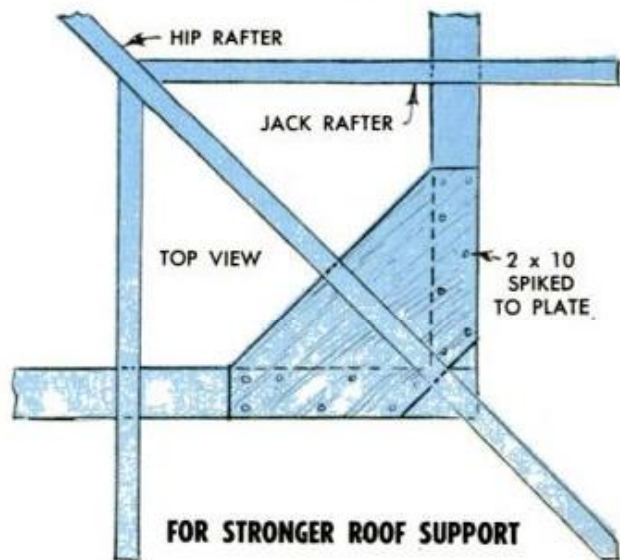

FOR STRONGER ROOF SUPPORT

WIRING YOUR BASEMENT PLAYROOM



NEW CIRCUITS for light and power can be tapped-in at service entrance or into a branch circuit box

PLANNING AND BUILDING a recreation room in the basement can be a lot of fun from paneling the walls to tiling the floor and ceiling. Manufacturer's instructions for applying their products have made it easy for any do-it-yourselfer to transform a dingy basement into a glamorous playroom. But how about the wiring? This is an important step that must be done before paneling and tiling, and while individual requirements will differ, the basic wiring information given in this article can be adapted to any particular layout. The diagram in Fig. 7 is a typical two-circuit hookup which can be followed in adapting it to suit your own needs and desires. During the planning stage, you should first check your local electrical code requirements as to the type of installation allowed. For example, some codes require the use of only rigid conduit in the basement. Your local power company or city inspector's office can answer your questions.

A basement recreation room needs a high level of illumination to make it an enjoyable place for games, reading and working on family hobbies. Where ceilings are low, you should use flush lighting fixtures, Fig. 14, and plan to set them between

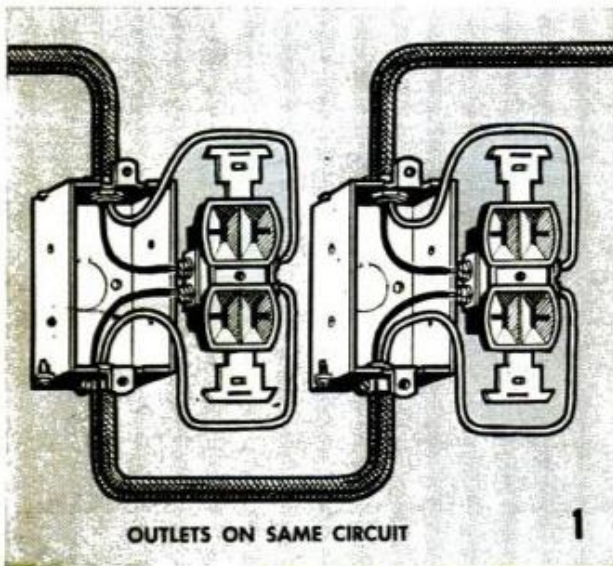

OUTLET AND SWITCH CONNECTIONS. The two recreation-room circuits connect as shown in Figs. 1, 2 and 3. These circuits run directly to the service entrance or, for top efficiency, to a branch circuit box that sets in or near the room where the power is used

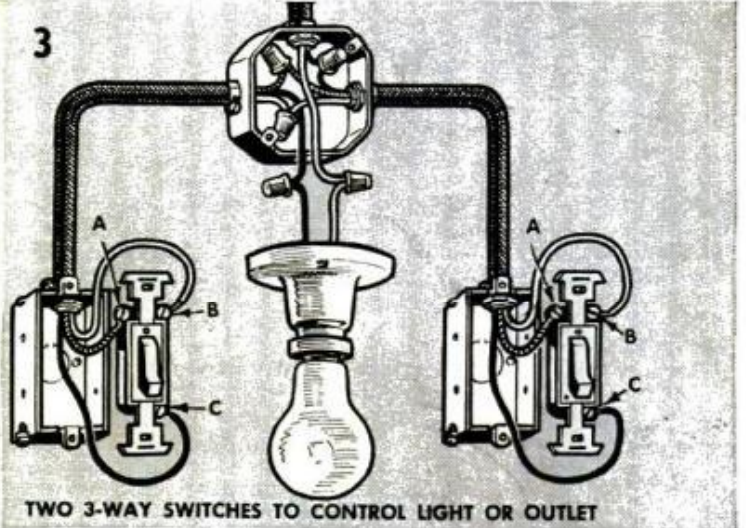
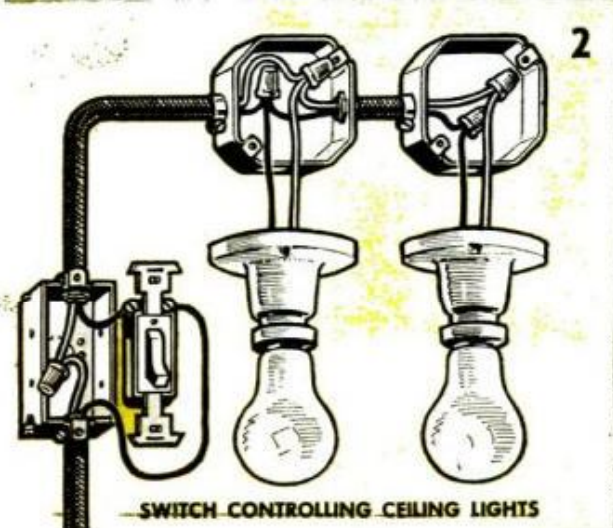



Armstrong Cork Co. photo

BRIGHTLY LIGHTED RECREATION ROOM soon becomes the center of family activities for hobbies and relaxation

the joists. These will provide the necessary general illumination. Then use portable lights to supply concentrated illumination for reading and close-up work. Plan for a minimum of two 20-ampere circuits to supply the family recreation area.

The two circuits may be run directly from the main entrance panel or from a branch circuit box. With the increased use of electrical power the idea of using one or more branch panels makes good

sense. One line, consisting of a 2-wire No. 8 or a 3-wire No. 6 cable, supplies plenty of power from the service entrance to the branch panel. Then several circuits run from the branch panel. The National Electrical code recommends No. 12 wire be used for all general-purpose circuits. You will notice that all the ceiling light fixtures in the wiring layout are on one circuit. The other circuit supplies only the outlets, Fig. 7. A minimum of one outlet is required

WIRE CONNECTIONS always should be securely joined either by soldering or by approved wire connectors

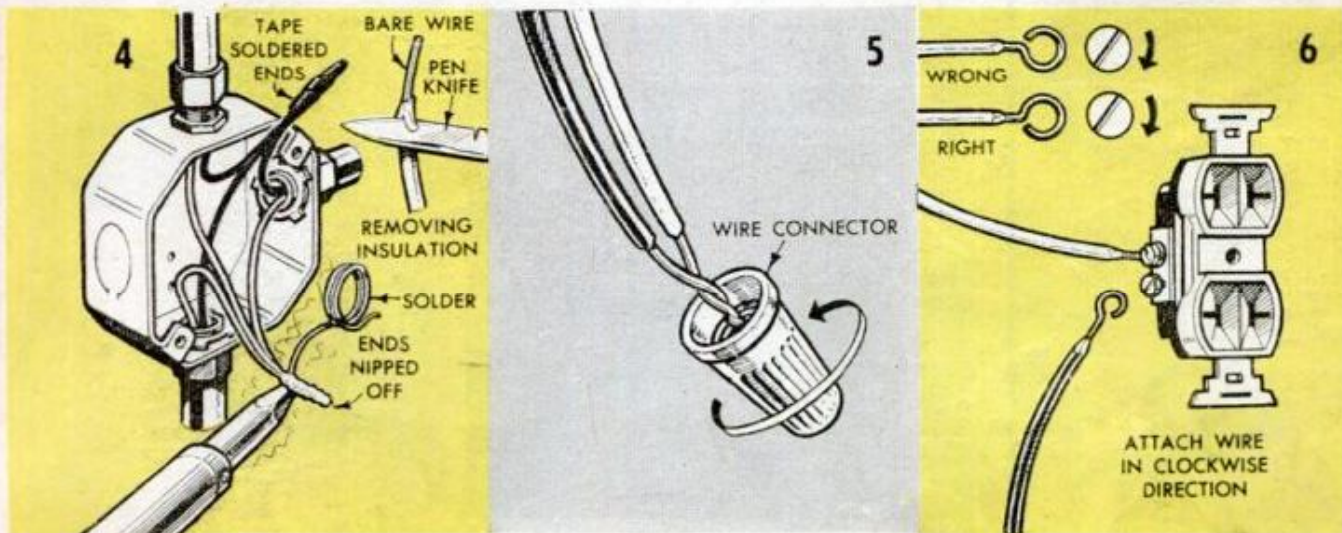

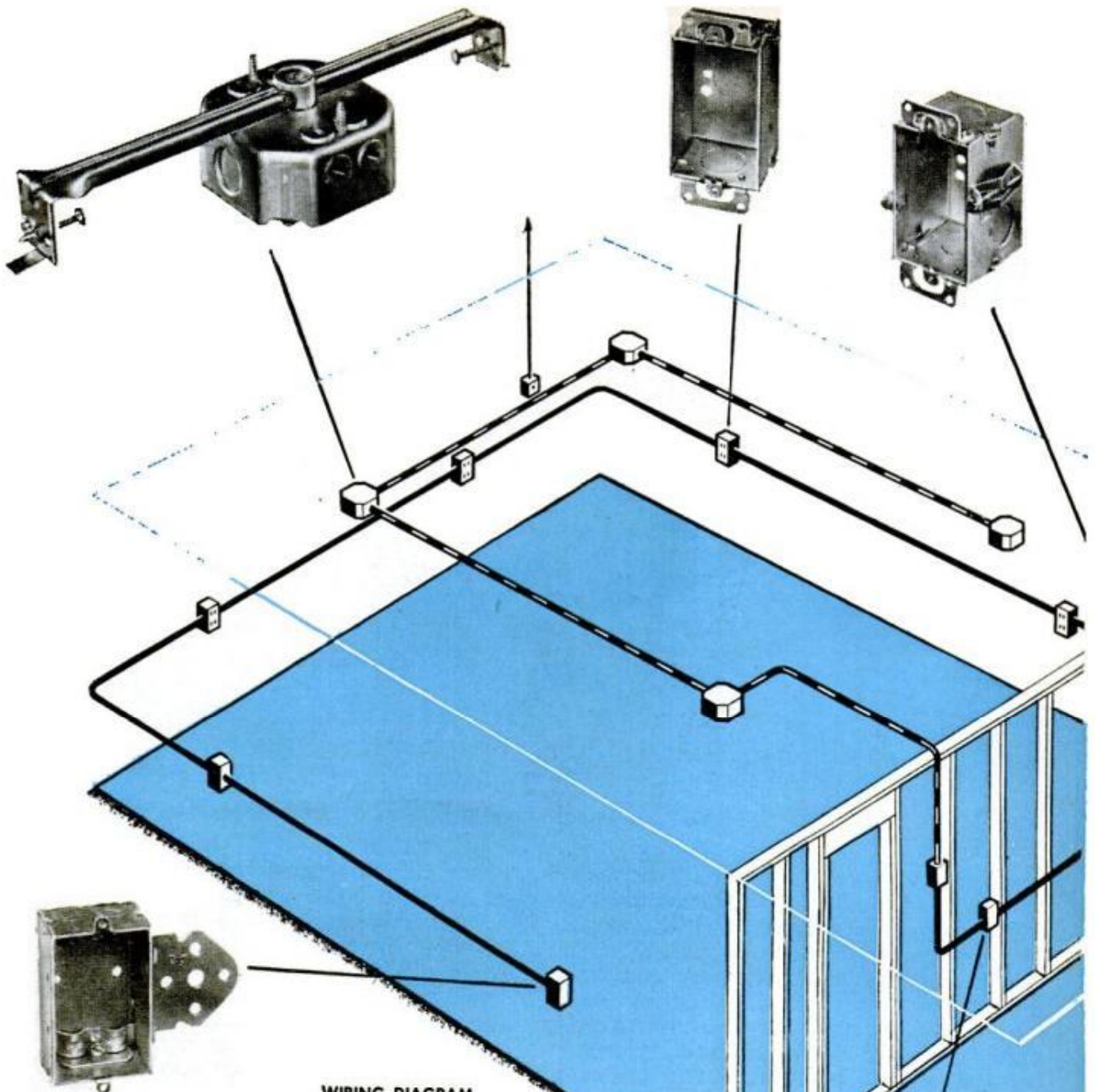

WIRING DIAGRAM

Courtesy All Steel Equipment, Inc.

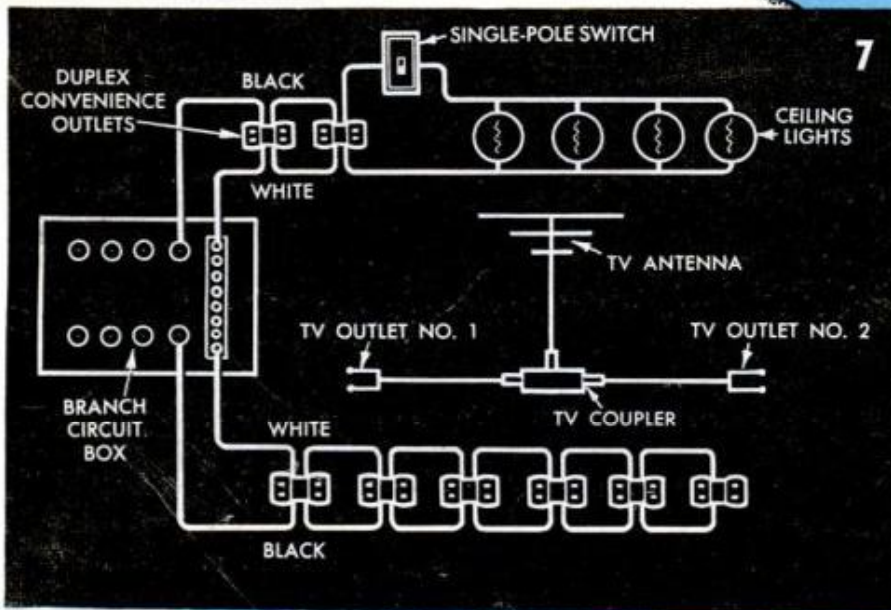

7



check folder for permit

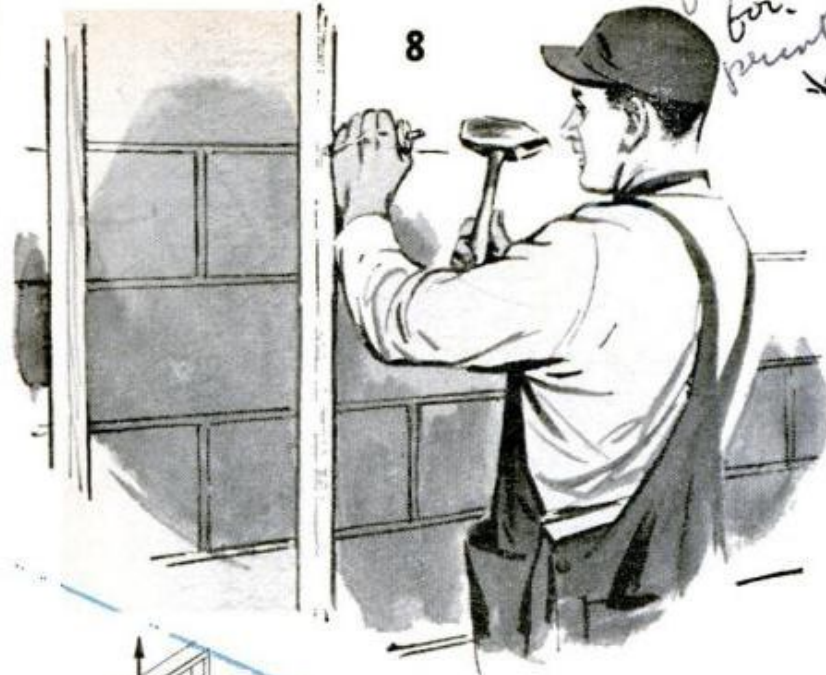

WOODEN FURRING strips for attaching wall paneling can be fastened to masonry walls in a number of ways. A stud driver (non-explosive type) is fastest. Plan to coat wall with hot asphalt before paneling is applied

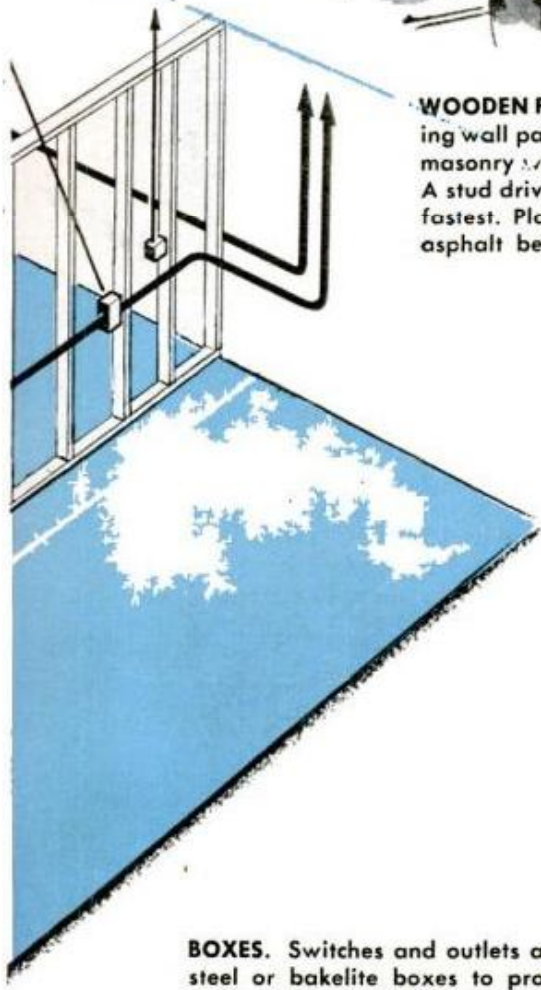

BOXES. Switches and outlets are mounted inside the steel or bakelite boxes to protect the wire connections and reduce fire hazards. Dozens of different sizes, shapes, brackets, covers and mountings are available for the boxes. Deep boxes are used where space permits, giving more room for wires and for making connections. The various types of mountings make it easy to attach the boxes to plasterboard, studs or ceiling joists. Five typical boxes are shown on the opposite page. These boxes have knockouts of various sizes that accept conduit, armored cable or non-metallic sheathed cable. Also, many of the boxes include clamps to hold the sheathed cables. When shopping for boxes, be sure to specify where and how they will be used, including the depth of the mounting space and type of wire being installed



CUT CONDUIT WITH PIPE CUTTER OR HACKSAW

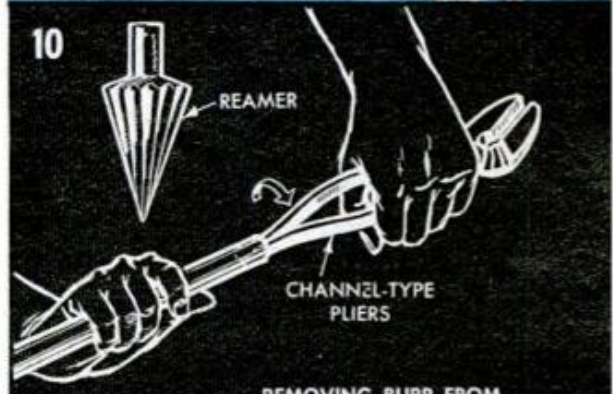

REMOVING BURR FROM CUT PIPE ENDS

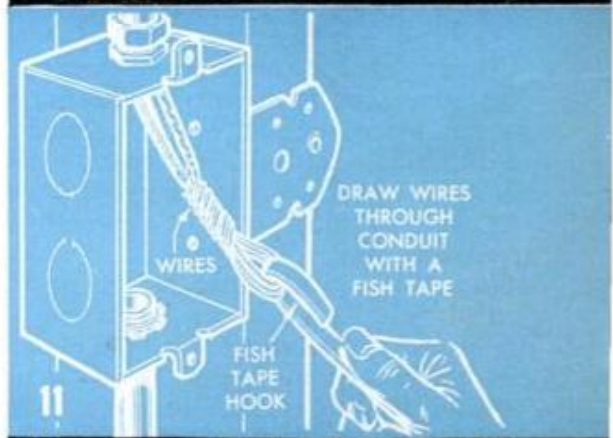

DRAW WIRES THROUGH CONDUIT WITH A FISH TAPE

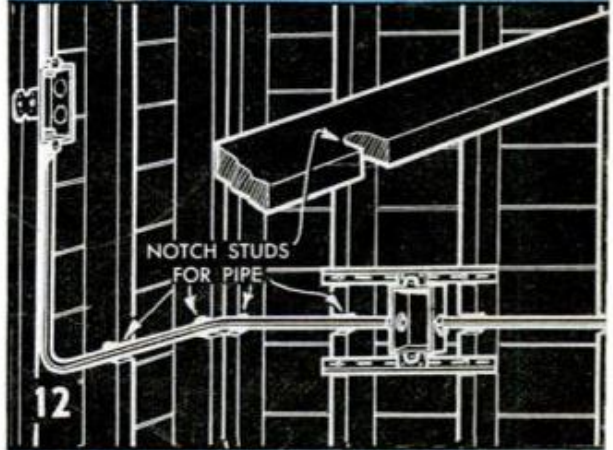

NOTCH STUDS FOR PIPE



STRAP CABLE TO JOIST

JOIST DRILLED FOR CABLE

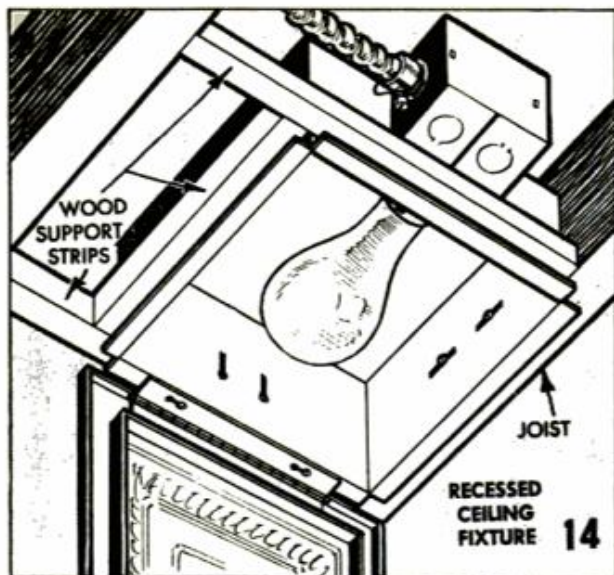

FLUSH FIXTURES allow more headroom in low basement

every 12 ft. along the walls—attach no more than 6 to 8 outlets or lighting fixtures to each 20-ampere circuit.

Circuit Hookups

Wiring circuits are easy to connect when the color code is observed. The black conductor is the hot wire and connects only to other black wires or brass terminals. The white conductor is the ground wire and connects to other white wires or light-colored terminals. This rule of white wires connecting with white wires and black with black, Figs. 1 and 2, holds true except for a few switching circuits. Then it may be convenient to use the white wire as a hot wire. When this connection is used, you should identify by wrapping a band of tape around the white wire near the splice to show the wire is hot.

A 3-way switching circuit requires a 3-wire cable between the two switches. See

A, B, C in Fig. 3. The white wire always runs to the light fixture first, and the black wire runs through both switches before connecting to the fixture. The red wire completes the switching circuit, and this wire is hot. Generally approved methods of making connections in boxes are shown in Figs. 4, 5 and 6.

Types of Wiring

For home-wiring installations three types are used: conduit, non-metallic sheathed cable and armored (BX) cable. Many local electrical codes now require using metal conduit for all new installations below grade level. But flexible armored cable or non-metallic sheathed cable are frequently used in areas that do not require conduit. There's also a relatively new plastic cable that is flexible and has some of the advantages of metal conduit. This cable can be buried in the ground or in plaster.

Thin-wall and rigid metal conduit is the most expensive type of wiring, but it provides the best protection for the wires and grounds the entire system. Metal conduit is installed before the framing and furring is covered. After the walls are paneled, the insulated wires are pulled through the conduit. See Figs. 9 through 12 for generally accepted methods of wiring in conduit.

Conduit is available in 10-ft. lengths. Couplings join the sections together, and conduit connectors secure the pipe to the steel boxes (only metal boxes are used with conduit). Joists, studs, and furring strips are notched, Fig. 12, to receive the conduit. Steel straps support the pipe every 10 ft. for concealed work and every 6 ft. for open work. If a pipe cutter, Fig. 9, is not available, a fine-tooth hacksaw can be used. Ream the cut ends on the inside to remove the rough edges, Fig. 10.

(Continued to page 250)

ARMORED CABLE PROVIDES good mechanical protection, but it should only be used indoors in dry locations

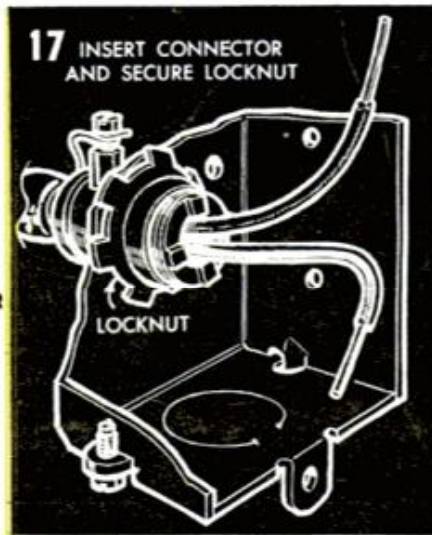
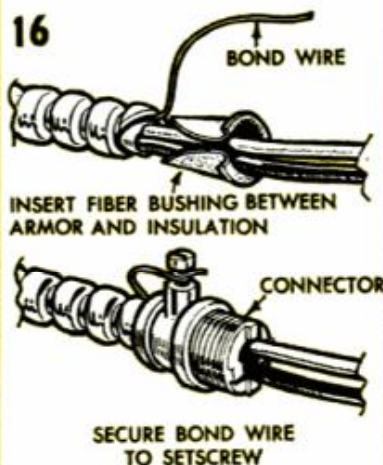



Prefinish Wall Paneling This Easy Way

Paneling a wall or an entire room can be simplified considerably if you prefinish the panels before installing them. To speed up the prefinishing job, set up a small production line so that each unit can be handled efficiently. Lightly sand rough spots with 6/0 paper and dust off the surface with a dry brush. Place individual panels across two sawhorses or on a large table. Apply clear wood finish quickly and evenly with a mohair roller. By using a roller to apply such finishes on flat surfaces you are assured full, even coverage. Sight across the panel to be sure there are no dull spots. Most clear finishes are applied without thinning, but follow the instructions.

After a panel is coated, set it aside to dry. Before applying a second or final coat to the front of the panel, rub the surface lightly with 4/0 steel wool or 7/0 sandpaper. If semi-gloss finish is desired, go over the last coat lightly with 4/0 steel wool. The number of coats used will depend on the porosity of the wood and the finish desired. To prevent moisture getting under the finish, back-prime each panel.

Prefinishing has the advantage that it can be done in the workshop at your convenience and without messing up living areas. If panels are finished immediately after being delivered, the wood has less tendency to darken and warp.

Plastic Spray Protects Book Covers

Clear plastic spray, available in spray cans, makes a good protective coating for book and magazine covers. Hold the spray can at a distance of 8 to 10 in. from the surface and use a back-and-forth motion. The plastic dries quickly to a smooth, glossy coat, which remains clear and flexible. The spray helps restore fading colors on book jackets. Books treated in this way can be cleaned with a damp cloth.—Ken Murray

Foam rubber for which there are so many uses is awkward to cut, but by compressing the slab with a board it can be sliced easily with a sharp knife.



SHOP NOTES AND CRAFTS

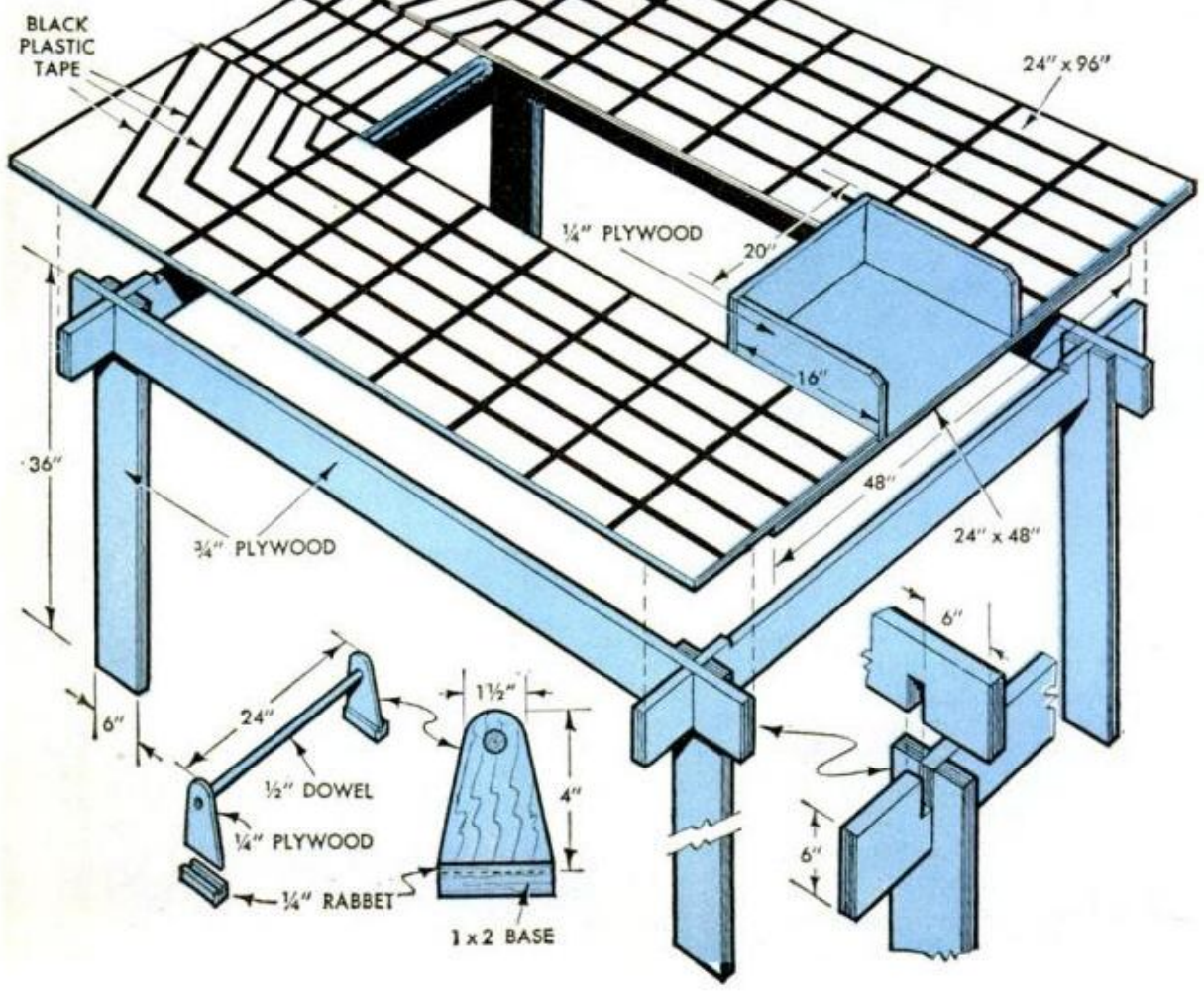
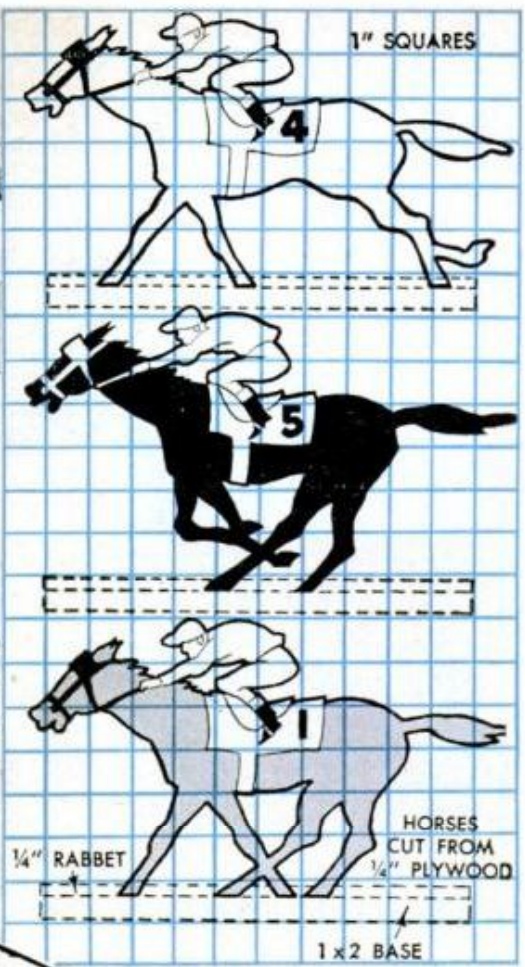



Douglas Fir Plywood Association

THEY'RE OFF AND RUNNING

Horseracing in your backyard? It's legal in this case since it is just an exciting group participation game that can be played indoors and out. You'll find it a sure-fire party mixer, a fund raiser for a charity bazaar or just plain fun for the entire family

A ROLL of the dice and they're off—down the straightaway, around the turn and into the stretch. With play money backing the horses, nobody goes broke and all the long shots pay off handsomely in pure fun. No track ever started off at better odds since all you need to set up your own "mutuel" are a 4 x 8-ft. panel of $\frac{3}{8}$ -in. fir plywood (exterior grade), two smaller pieces measuring 16 x 48 in., a $\frac{3}{4}$ -in.-thick panel for the supporting stand, some $\frac{1}{4}$ -in. plywood for the dice box and horses, a $\frac{1}{2}$ -in. dowel, paint and plastic tape—all for less than \$10.00.

Begin by cutting the $\frac{3}{8}$ -in. panel in half lengthwise to provide the long sides of the track. The smaller 16 x 48-in. pieces provide the ends, forming an 8-ft. U-shape track with an open space in the center for the "bookie" who manipulates the horses and holds the bets. A three-sided box at the starting gate provides a place to roll the dice. The nags and jockeys are cut from $\frac{1}{4}$ -in. plywood

and glued in grooved bases. Plastic tape divides the track into lanes after the plywood is painted. The rules are simple: One person rolls the dice. The horses are moved the number of spaces that show on the dice. The sample racing card specifies the number of dice used in each racing event, four being used in some, two in others. ★ ★ ★

RACE CARD	
FIRST RACE	<p>FOUR DICE—Two Hurdles—Double to jump and double to finish.</p> <p>1. Flash of Gold 2. Chiromino Golden 3. Golden Sensation 4. Gay's Golden Rose 5. Gay Blaze 6. Blue Dusk</p>
SUNSET HANDICAP	
SECOND RACE	<p>TWO DICE—Two Laps—One die shows number of horse; other shows number of spaces; single to finish.</p> <p>1. Diamond Pride 2. Cascade Izard 3. Sonora Lady 4. Barbara Genius 5. Brown Bennett 6. Caesar Lincoln</p>
BOURBON HIGH HANDICAP	
THIRD RACE	<p>TWO DICE—Straightaway—Single to finish.</p> <p>1. Troubles Josephine 2. Chief Geranimo 3. Maxey Nicodemus 4. Rex Franklin 5. Rhodes Star 6. Peep O'Dawn</p>
PAYNE HANDICAP	
FOURTH RACE	<p>FOUR DICE—One Hurdle—Double to jump and double to finish.</p> <p>1. Susan's Folley 2. King's Ransom 3. My Souvenir 4. Star Rocket 5. Vanity Fair 6. Midnight Moon</p>
MARTINI DERBY	
FIFTH RACE	<p>FOUR DICE—Mule Race—Single to start and double to finish. Last mule in is the winner.</p> <p>1. Congo 2. Hilo 3. Toni 4. Pico 5. Cody 6. Kini</p>
MULETEER'S STAKE	
SIXTH RACE	<p>FOUR DICE—No Hurdles—Double to start and double to finish.</p> <p>1. War Star 2. Lady H. 3. Pan Cheval 4. Lucky Lady 5. Pentago 6. Tiffany</p>
WESTWARD HO MEMORIAL	

PLAY IT SAFE WITH THE



FRANTIC EFFORTS to rescue a youngster locked in a bathroom are avoided by fitting door with panicproof lock which permits opening from outside in emergency

FROM the half million burglaries that occur each year only a small fraction of the intruders are able to get past truly modern locks. Today, maximum security is within the reach of everyone through the use of the cylindrical lock.

Lock makers have made it easy for anyone to replace an old-fashioned (unsafe) mortise lock with a modern pick-proof cylindrical lock. Replacement kits are now available which contain king size escutcheons to hide the scars and holes of the old

lock which means there are no puttied holes to mar the looks of the new installation. When buying outside door locks, be sure they are the key-in-the-knob type with a guard-bolt feature. This feature makes it impossible for the lock-jimmying intruder to slip his way in by pressing back the movable part of the latch since guard-bolt prevents the lock from being opened except with a key. This safeguard actually costs only about a dollar more and

DON'T make it easy for the would be prowler—think of an unusual place to hide the key which is away from the front door. Under mats, in mailboxes, over doors are common hiding places where he is almost sure to look



1. TO REPLACE old fashioned mortise lock with modern cylinder lockset, remove screws holding the knobs, side plates, striker and the lock itself

2. LOCKSET OF REPLACEMENT KIT fits same mortise in edge of door but requires boring larger hole through face of door to accommodate larger lockset

*How to
replace
old mortise
Lock*

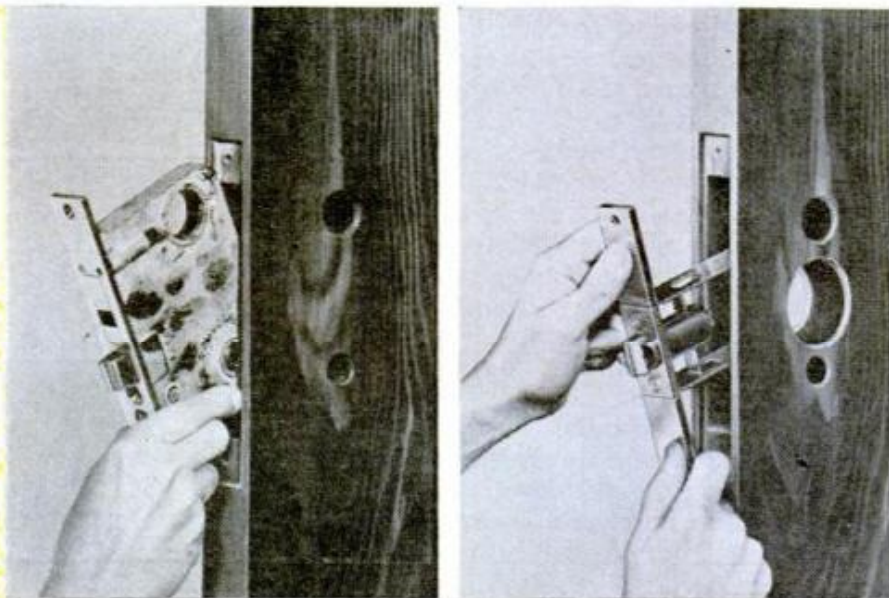

RIGHT LOCK

is well worth it. Choose a lock with a 5 or 7-in. backset. The backset principle allows you to place the lock any distance from the edge of the door, which not only creates a more balanced and attractive design, but allows more knuckle clearance when opening the door. Lock escutcheons (ornamental plates that back-up the knobs) are available in an exciting range of metals and finishes, ranging from polished and brushed brass to satin aluminum.

A well lighted entrance doubles the protection against prowlers. When you go out for the evening, make it a practice to leave the front-door light burning. Most prowlers will pass up a lighted home for fear of being seen. You also can help protect your home against entry by working for better street lighting in the neighborhood. Make sure each member of your family has a key. If you hide an extra key, try to be just a bit original in selecting a hiding place. Don't choose the usual places such as under the door mat, in the potted plant or mail box; instead, choose a place that's completely away from the front door.

The privacy locks you select for bathrooms or bedrooms should have a panic-proof feature with an emergency release. Younger or older members of the family sometimes lock themselves in, and panic or sickness may prevent them from remembering how to get out. Instead of standing helpless on the other side of the door, you have only to insert a nail file or some such thin instrument into the tiny slot on the outside and release the lock. ★ ★ ★

3. AFTER NEW REINFORCING UNIT with latch and faceplate attached is installed, screw holes of old side plates are concealed by new kingsize escutcheons



LEAVING AN ENTRANCE LIGHT burning while you are out for the evening is a smart thing to do—the average prowler shuns the limelight for fear of being seen. You can outsmart the housebreaker further by leaving bathroom light on since this is one room where light is seldom left burning even when family is at home

4. AS LAST STEPS, cylindrical lock is inserted through holes in escutcheons and then new strike plate is screwed to the door jamb to replace old one

Schlage photos

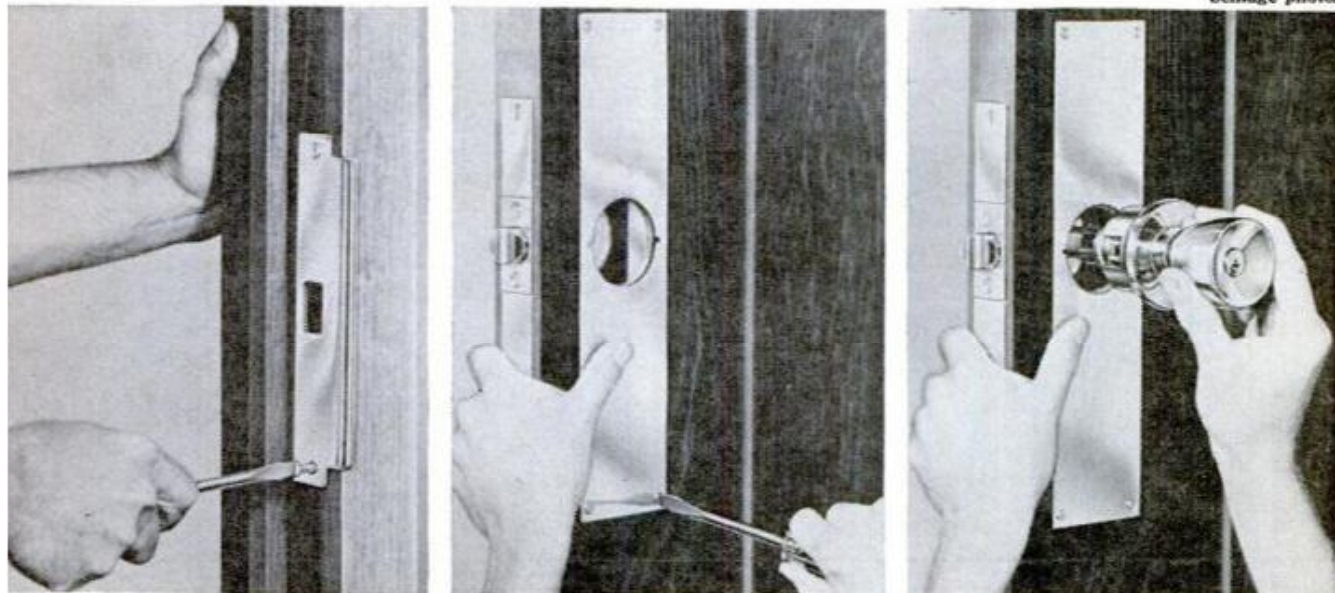

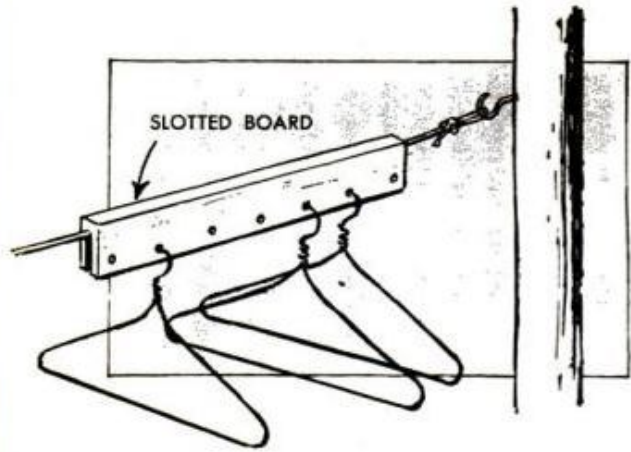
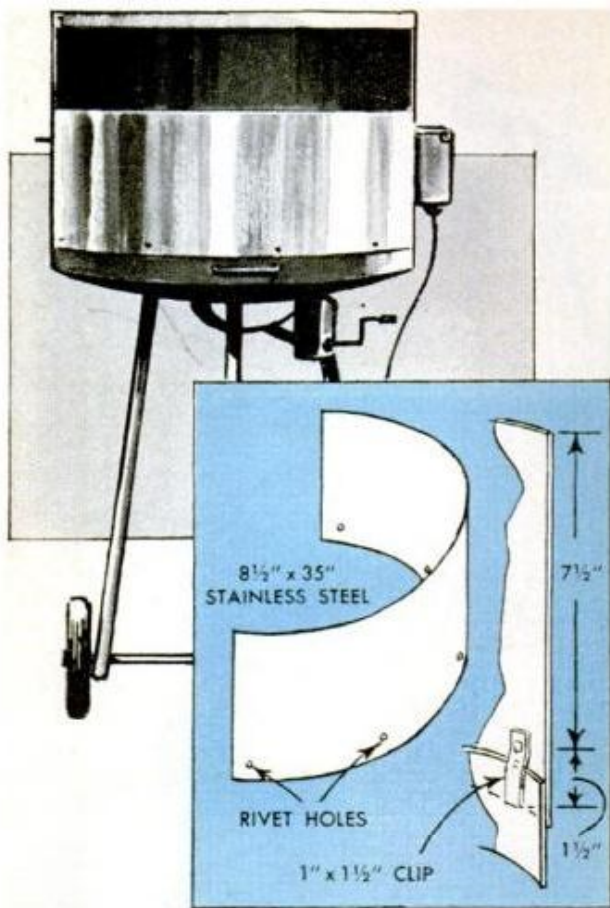

WEATHER PERMITTING, you may want to air garments outside on a line but keeping them on the line on a windy day is a problem. They'll stay put if you groove a board to fit over the line and drill it crosswise with a row of holes. When the hangers are hooked through the holes they just can't blow off

REMOVABLE HEAT SHIELD made to clip around the open front of a barbecue grill will speed up outdoor cooking and keep the wind from blowing ashes onto your steaks. Heat reflecting off a stainless-steel shield will save as much as an hour's time when roasting a large turkey or barbecuing a cut of beef

SOLVING HOME PROBLEMS

HANGING THE CORDS from your waffle iron, fry pan and other electrical appliances from a nail is poor practice—such cords are not made to take sharp bends. You'll prolong their life if you store them on a hanger of greater diameter than a nail. A thread spool sawed off at an angle makes a fine holder



EVER REACH for a previously uncapped tube of glue, cement or wood putty and find that prolonged storage has caused it to harden? Next time play it safe and store the partially used tube inside a screw-top container. Double capping will keep air from reaching the contents and causing the materials to harden



A COMPLETE JOB of painting should include the areas behind radiators and other permanently installed fixtures. Although these areas may be difficult or impossible to reach with a brush or roller, a synthetic sponge may be nailed to the end of a yardstick and dipped in the paint to get the necessary reach



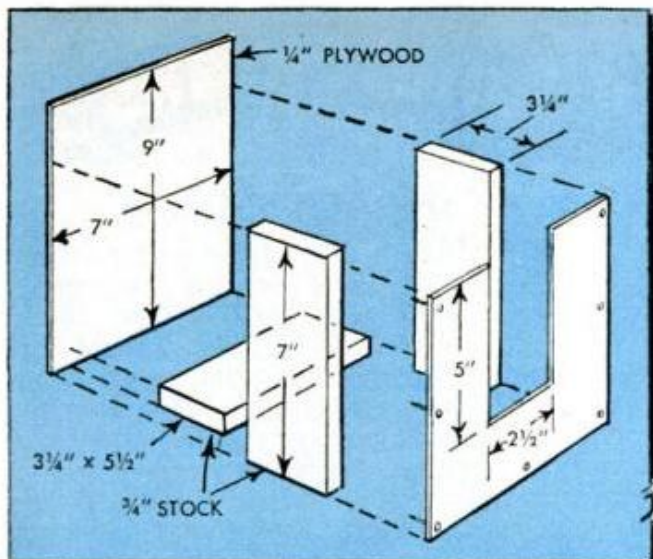

WHERE'S A SAFE PLACE to put a hot pressing iron when you are through with it? Answer: In this wall holster. Made of plywood scraps and lined with sheet asbestos, the holster provides a safe place for the iron to cool, as well as a handy place to keep it. Holster can be mounted on wall or inside cupboard door

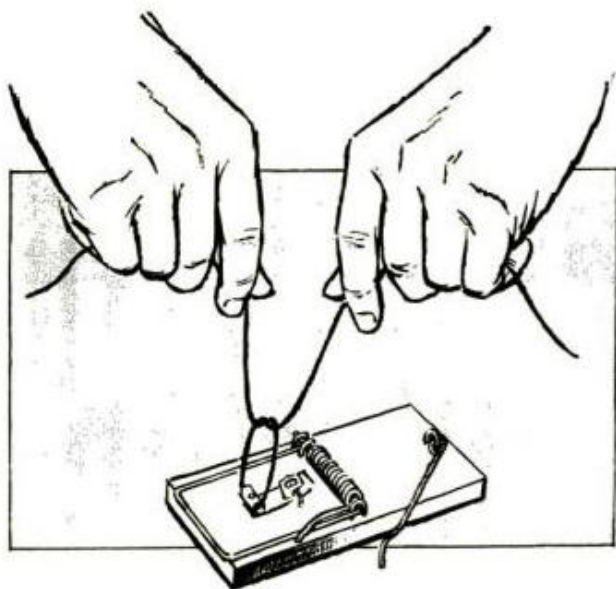

WHEN IT COMES TO ANIMAL INGENUITY the house mouse rates a spot somewhere near the top of the list. Often he's smart enough to leave a bait-empty, un-sprung trap as evidence of his I.Q. But don't let him get the best of you. Bait the trap with string soaked in bacon drippings, knotting string tightly to holder. To date no mouse is known to have undone a knot. If he does, adopt him—you may learn something

COME CARPET-LAYING TIME it may be necessary to move that heavy radiator in and out of the room. Don't take the chance of marring the floor or the new carpet by dragging it. Cut two sections from the cardboard tubing around which the carpet is wrapped, cut slots in them as shown and slip under the radiator legs. The tube sections, serving as nonmarring runners, will let you skid it like a sled



PERIODIC OILING of squeaking door hinges is avoided when a flat is filed on the hinge pins. The flat forms a lubricant reservoir the full length of the pin which, when filled with petroleum jelly, will continue to self-oil the hinge parts without any further attention

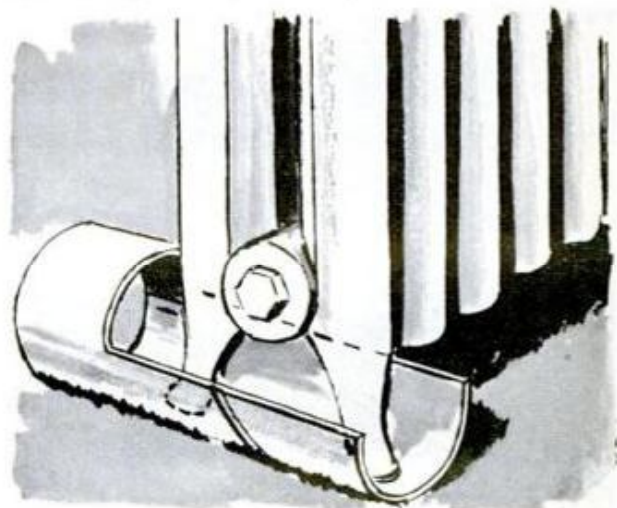

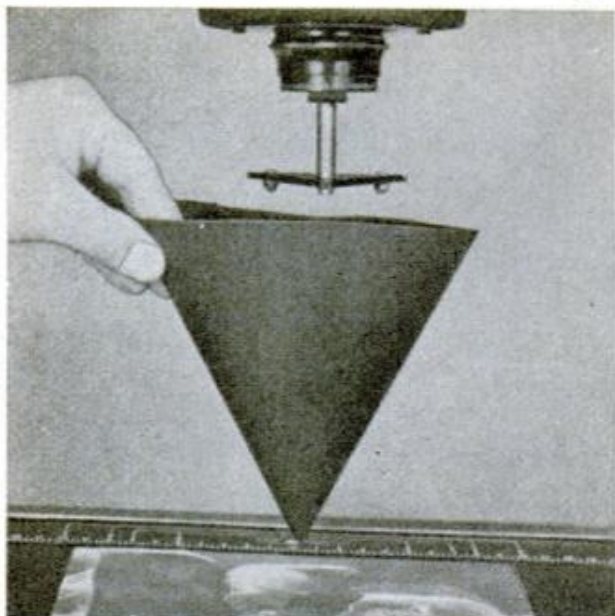

PHOTOKINKS

Paper Cone Aids Printing

A paper cone is perfect for spot printing and burning-in areas during enlarging. Simply shape a piece of 6 x 6-in. black paper into a cone. With this, control the enlarging light by moving the cone around to blend the areas together. By varying the size and shape of the cone opening you can time your spot printing to produce the best results. Such control is particularly useful when combined with multi-contrast paper and a series of contrast filters.

—Bil Toman

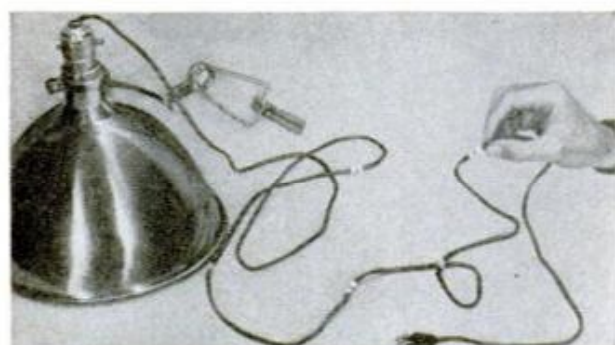

Cord Indicates Distance

To simplify positioning photoflood and flash reflectors at the proper distances from the subject, mark the cords at one-foot intervals. These points are wrapped with white strips of tape, and the footages marked on the tape. The cord is used as a tape measure by extending it to the subject and reading the distance indicated.

—Henry Hanscom

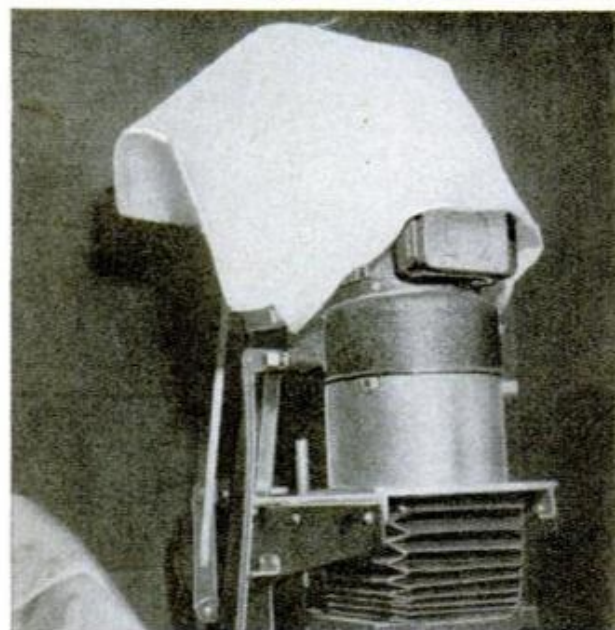

Towel Protects Enlarger Cover

A bath towel, folded and laid over the lamp housing of the enlarger, helps to protect the plastic dust cover. The towel serves as a cushion between the sharp edges and corners of the frame and the plastic. The plastic cover should be made long enough so that it rests on the bench top, fully protecting the enlarger from dust.

—A. M. Wettach



Ever have several rolls of film to develop and lacked the large tanks to do the job quickly? By cutting off the tops of half-gallon milk cartons you can have all the serviceable multiple-roll developing tanks you need. The plastic handle of a print paddle can be used as an agitator by passing it through the centers of the developing reels.

Pointing Board for Leads

Small emery boards of type used to manicure fingernails are handy for pointing retouching pencils. The boards are easy to hold and they take little space among pencils and other retouching materials. To point the lead hold the pencil at a slight angle on the emery board and rotate the holder between the fingers, moving the lead back and forth over the board.

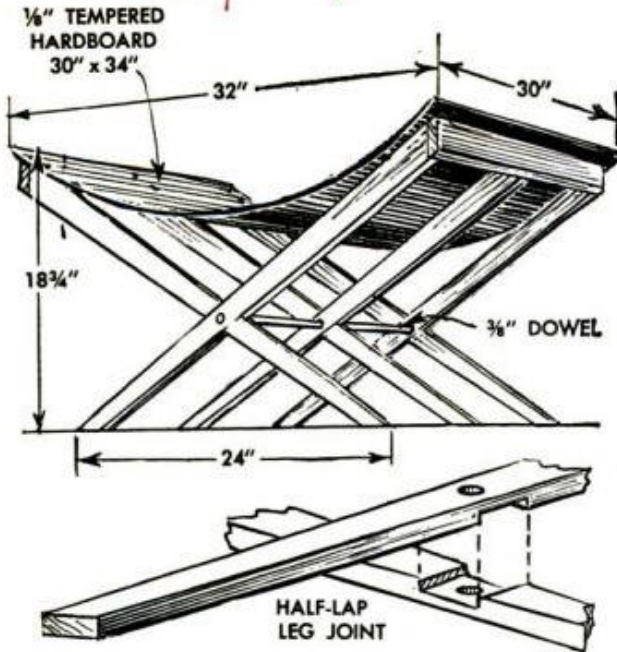

LUGGAGE RACK FOR THE GUEST ROOM

YOUR WEEK-END GUESTS will appreciate the convenience of having a luggage rack at their disposal, and this curved-top one does a perfect job of cradling an open suitcase. When it is not being used to support luggage it will pinch-hit nicely as a smart king-size magazine rack. Its high-style appearance is created by the scooped top, which is simply a piece of 1/8-in. tempered hardboard fastened to three pairs of legs with screws set in cup-type washers. A black-lacquer top contrasts sharply with white legs.

The half-lapped joints add strength to the rack. These, plus the 3/8-in. dowel stretcher and the hardboard top, provide enough support to insure against sway. The only unusual thing about the construction is the method of bending the piece of hardboard prior to attaching it to the legs. This is done by first building a rectangular framework of 1x2s 30 in. wide by 32 in. long and nailing 1x2 cleats across the ends to form ledges as shown in the illustration. The tempered hardboard is sprung into this temporary form, which holds the piece bowed. Now the frame, along with the curved piece of hardboard, is placed over the leg assembly and centered so it overhangs evenly all around. Two holes are drilled through the hardboard and into each leg. Then, before driving the screws, glue is applied to the surfaces of the legs which contact the hardboard top. Once the top is screwed in place the framework can be lifted off. The rack top is large enough to accommodate a man's two-suitcase. ★ ★ ★



Courtesy The Masonite Corp.

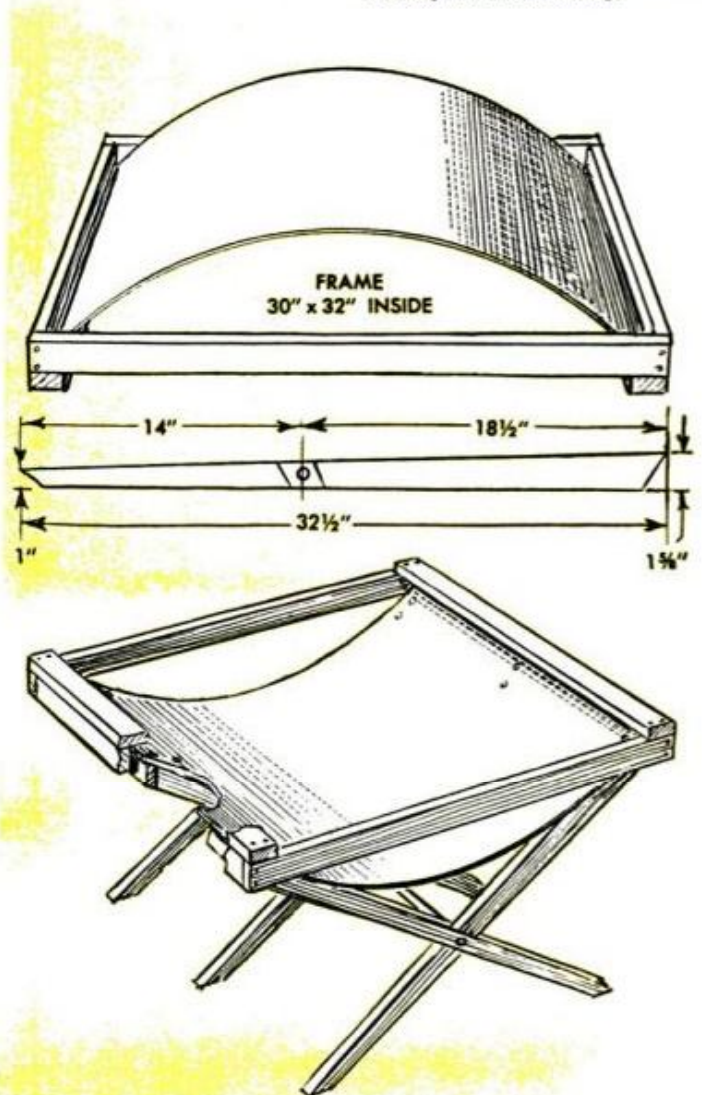

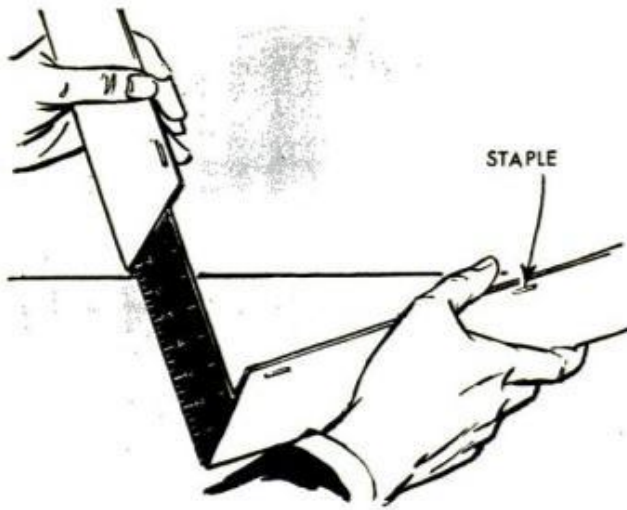

Sheath Protects Steel Square

An unprotected steel square carried in a tote box with other tools usually gets scored and nicked, making it difficult to read the graduations. But it takes only a few minutes to make a two-piece sheath from cardboard that will keep the square in new condition for years, no matter how much it's banged about. Cut strips of cardboard, fold and staple along the edges to make pockets that will fit snugly over both the body and tongue of the square. Miter the ends to a neat fit. When storing the square in the sheath keep the blade oiled to prevent rusting.—H. Hanscom

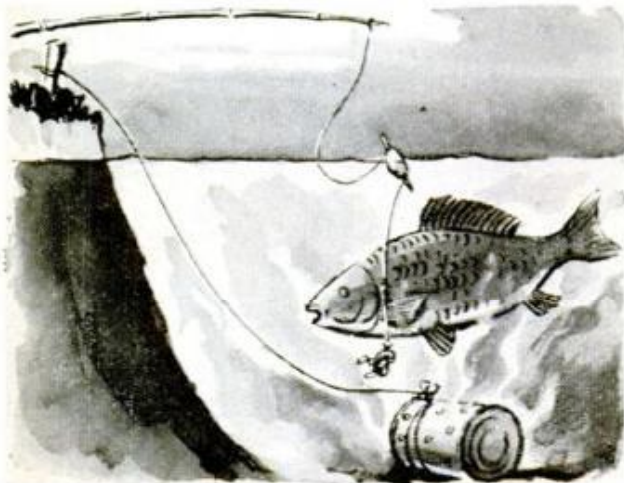

Can of Corn Attracts Fish

Fish, such as carp and suckers, put up sufficient fight to provide a thrill for the average fisherman. A Wisconsin sportsman claims that such fish can be lured by puncturing a can of sweetcorn with holes about the size of a 20d nail, tying the can to a stout line and lowering it into the water. Since fish are unable to reach the corn, they will take the baited hook. The can of corn should last for several hours of fishing. Raise the can occasionally and shake to loosen kernels and release more fluid when the can is returned to the water.

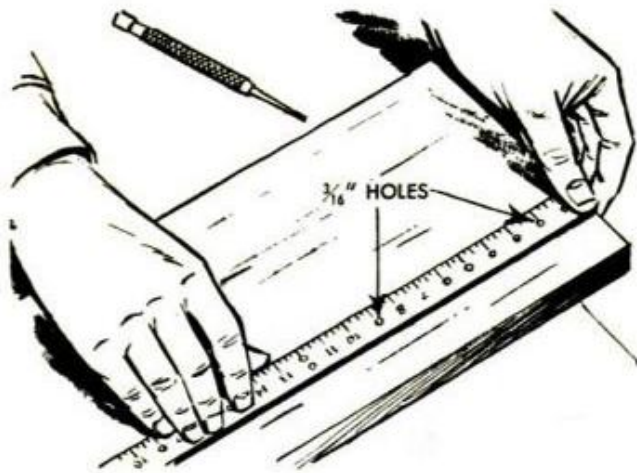

Braille Yardstick

This is how I altered a yardstick for use by a blind friend who wanted to try woodworking: Starting with the ordinary yardstick I drilled $\frac{3}{16}$ -in. holes on the inch marks the full length of the yardstick. Then I drilled pairs of holes at 3-in. intervals after the 6-in. mark. Of course, these pairs of holes can be located in any other combination along the length. The holes permit measurements to be made by feel alone. They also allow you to take measurements in hard-to-see places.

—James E. Stout

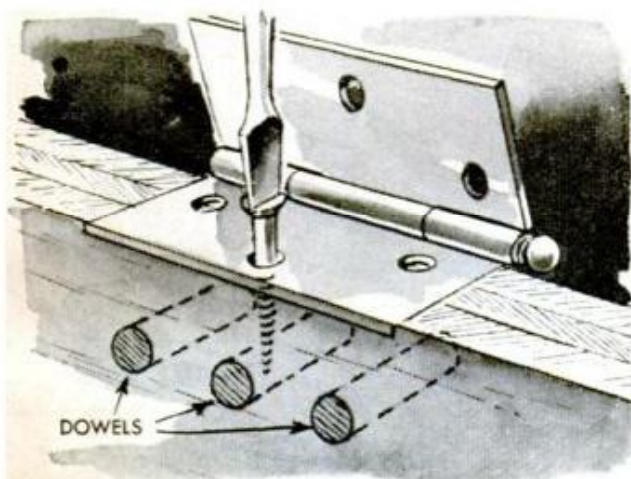

Attaching Hinge to Plywood Edge

To provide enough holding power for hinge screws in plywood edges or in edges weakened by repeated reuse, drill $\frac{1}{4}$ -in. holes crosswise through the panel in the path of the screws. Then apply glue and drive $\frac{3}{8}$ -in. dowels into the holes. The dowels will provide the extra holding strength needed to keep the screws from pulling out.—Joseph Federico

Old sheet music adds interest to recreation-room decor when it is pasted to panel or door and coated with white shellac.

STRAP WRENCH

URNS, HOLDS, CLAMPS ANYTHING

YOU WON'T soon run out of uses for this strap clamp in the home or the workshop. It will hold a glass jar while you turn off the stubborn vacuum cap, grip the chrome-plated sink drain without ever a scratch or dent, clamp work for gluing or drilling as in the photo and hold small parts in place for assembling with screws, nails or other fasteners. Specifications below call for a strap, or band, 36 in. long, but you can assemble it with a longer strap and use it as a column clamp or chair clamp. The latter type of clamp is widely used in repair and refinishing shops for clamping chair frames after cleaning and regluing.

It will be noted from the details below that the handles can be locked together after tightening with a U-shaped metal clip, or lock, which is pivoted near the end of one handle. This permits the wrench to serve either as a holder or clamp simply by adjusting the band to the correct length, drawing tight and locking the handles to hold parts together under tension.

Construction is simple and you likely have most of the necessary parts at hand. Select two pieces of straight-grained hardwood for the handles, cut to the rough shape shown and then finish with a half-round rasp and sandpaper. Make and fit the steel links and loops. When making the links from flat steel, file both to identical size and shape, then clamp together and drill for the bolts. This procedure assures uniformity of the parts. Bend an eye from light sheet metal and rivet to one end of the strap, or band. Note that the eye pivots on one of the loops.—Howard R. Clark

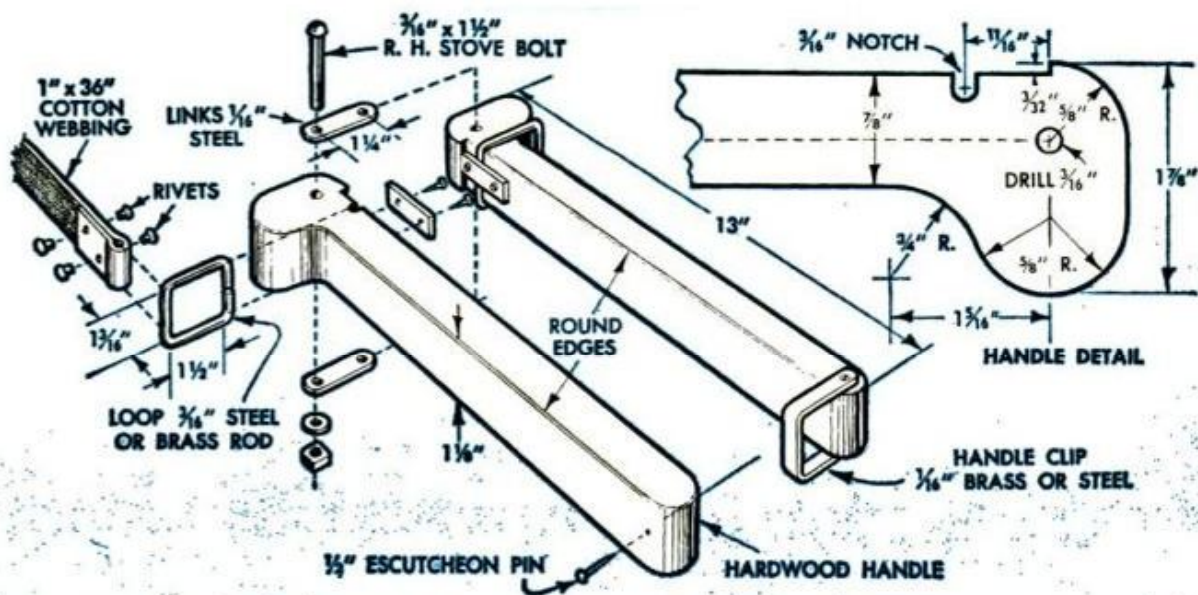
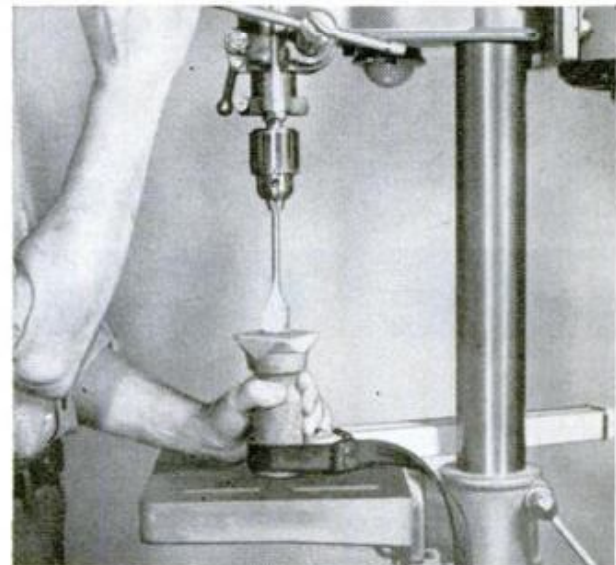



Trouble Shooting THE TOUGH ONES

By Ben L. Davis

RECENTLY a well-run '55 Chevy eight was brought in the shop with clicking valve lifters. According to the owner, they had been clicking badly for quite some time. As the first attempts to quiet them, such as running the engine hot with a good tune-up oil, an oil change and new filter, did little good, I recommended a new set of lifters.

This job completed, the loud valve noise showed up once more. The thought of the lifters being starved for oil crossed my mind but this was not too discouraging since it was normal for the oil to work its way through the motor before it could reach the lifters.

But after warming, the engine still didn't perform. It misfired. Somehow I was doubtful about the firing order. I looked up the mechanic's guide for that model. Checking the diagram against the car, I found the plug wires had been shifted two cap towers from their original seats. Although this was a minor point so long as the firing order followed in sequence, my decision was to set the car by the book.

To do this, the distributor had to be taken out and the drive gear set to permit returning the wires to the towers as they were originally.

Again the motor was started and this time it ran quietly and very smoothly as a good Chevy motor should. Trouble on the right bank had cleared up and I could give the credit only to altering the distributor position.

Sometime later I had the opportunity to service another Chevy '55 and took pains to recheck the cause of the earlier trouble. Sure enough, unless the distributor was replaced as it was originally, oil feed to the right bank would be cut off and the lifters on this oil line, running dry, could become clickers.

This being the concluding article in our series on "Trouble Shooting the Tough Ones," the editors are most anxious to hear from readers who have enjoyed reading about the personal experiences of a garage mechanic. If sufficient reader interest is shown, the series will be continued.

Unusual Locations Where Trouble May Occur

Loose Pump-Arm Screw

Some Plymouths in the several-years-old bracket stall or lose full control of the accelerator pedal due to a lost or loosened pump-arm screw. A loosened screw is easy to miss in a routine check and the mechanic working on a stalled car should keep this possibility always in mind. Ordinarily, a loose screw should be replaced but often the original can be made to do simply by flattening the threads on the shouldered end slightly so they will take securely in the aluminum air horn.

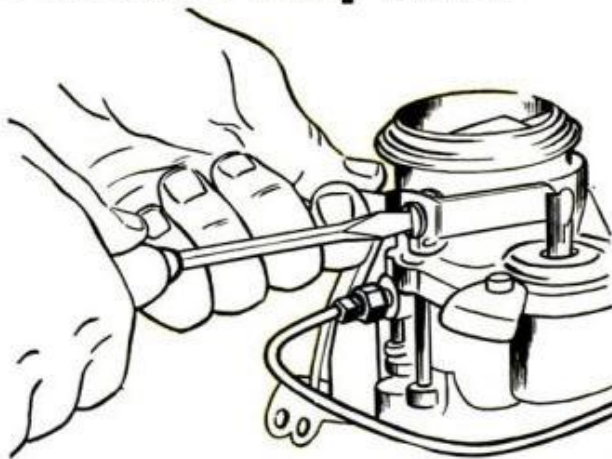

Hard Starting

Percolation, or bubbling, of fuel often causes hard starting in warm weather, more especially after the engine has been fully warmed up. On some cars which develop this trouble it is possible to minimize or cure it entirely by replacing the accelerator pump plunger with a newer ball-check vented type of plunger and including a later type metering rod. Although a stalled car often can be started simply by holding the accelerator pedal about half-way down while the starter is in operation, the basic cause of hard starting should be corrected.



Sticking Ignition Switch

When fuel and temperature gauges fail to indicate just after starting the engine of the '60 Mercury the cause can be a sticking ignition switch. Usually this is due to a rough surface on the seat inside the switch housing, or bezel. This seat is indicated by the cross-hatched area in the sketch at the right. Remove the switch and smooth the seat with a fine abrasive cloth until any scratches or other burrs are eliminated. Clean thoroughly and before replacing the switch lay a very thin film of grease over the entire surface of the seat.



Removing Spring Retainer

Mechanics who have struggled with car-door handles can fully appreciate this simple tool. It's made from a standard hacksaw blade and it enables one to remove the spring retainer, or clip, that holds the handle on the spindle. File a notch in the blade as in the detail; the shape of the notch will suit the purpose for most car door handles. Then simply press the door panel inward sufficiently to permit the notched end of the blade to slip down behind the handle and reach the end of the retainer. Lift up and off it comes.



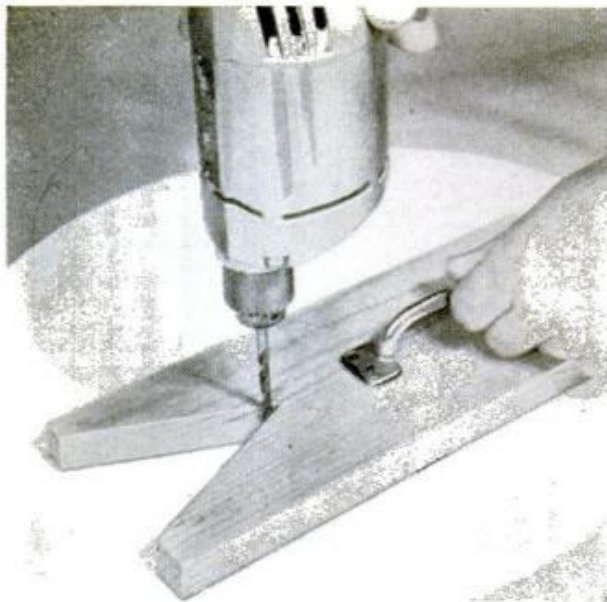

Pilot Assures Accurate Drilling

Where absolute drilling accuracy is required, it isn't always possible to rely on the hand and eye alone. Accurate spotting of the drill, especially on vertical surfaces, is assured with this simple drill pilot. It can be made from a piece of scrap lumber with a sash lift screwed on for convenient handling. Place the bottom of the V notch directly over the spot where the hole is to be drilled and rest the drill bit in it. A piece of felt glued to the underside will protect finishes and make the pilot less likely to slip from the desired position.

Metal Venetian blinds and curtain rods will be easier to operate, collect less dust and can be kept from rusting if they are given a good coat of wax.



Crush-Proof Shield for Plug Cap

If you're using an electric drill or other portable power tool and must unplug it frequently to move from place to place, chances are that sooner or later someone will step on the plug cap and crush it. This means tying up the power tool until the cap can be replaced. Safety measures to prevent this, however, are simple enough. Just tie a screw-base plug to the cord. When the cord is disconnected it will be an easy matter to slip the plug over the cap, providing it with a crush-proof shield.

Need a first-aid kit for that vacation trip? Dad's old lunch pail is ideal. Fill it with bandages, medicines and supplies and rest assured they'll travel unbroken.

COMING UP NEXT...

Mothballing Your Outboard. Keeping an outboard in condition over winter is more than just taking it out of the water. An outboarder's feature gives you the scoop on how to condition your motor for winter layup.

Hang-Up Wall Clocks. They serve a twofold purpose—tell the time of day un-failingly and decorate the wall in the modern manner. You have a choice of several eye-catching designs in this November feature, all of which you can make yourself.

Button Up Your Home. Already you're closing doors and windows against the first chill winds of autumn and now's the time to seal cracks with calking. This photo-caption story shows you how and where.

Cold-Weather Battery Booster. Your car battery will get numb with the cold some zero morning, unless, of course, you take the time to build the quick-charge booster described in this timely feature.

Portable Drill Lathe. With accessories, your 1/4-in. portable drill can do just about anything you put it to, but here's still another use for it—serving as the head-stock of a wood lathe. Construction details in the next issue.

A PATCH FOR TILLIE

By Peter Whittal



PHIL SAVAGE, my next door neighbor, was fit to be tied when one of the kids ran his favorite fishing punt, "Tillie," onto the rocks, poking a hole the size of your foot at the water line. In his own words, "the boat was a mess." Mrs. Savage, entitled to a touch of sarcasm occasionally as are all wives, suggested that Phil take the boat out in the middle of the lake and leave it there because, in her opinion, it was beyond repair. But, just to convince ourselves that husbands are smarter than wives, Phil and I decided to do a repair job rather than scuttle such a beloved craft. The procedure is passed on here to other salts whose craft may be dealt a similar foul blow at some time or other.

First, outline the patch dimensions on the boat, being sure to include all damage within it as shown in the drawing. Then, make the cutout to take a wooden patch as in the photo below the drawing. The patch (plywood in this case) will fit snugly if a piece of the same thickness as the planking is held against the opening and a tracing of the latter is made directly on the piece. Next, a backing block is screwed to the inside of the boat, overlapping the cutout by at least 2 in. as indicated. The patch, having been cut and fitted, is then coated on all contacting surfaces with waterproof glue and screwed in place flush with the planking as in the photo above. Now, you can sand the repair area and either apply two coats of paint, or glass it. The latter procedure will result in a much stronger, positively permanent repair. Follow the manufacturer's directions and apply at least three coats of resin, using one layer of glass-fiber cloth if the repair is in an area of minor stress, two layers otherwise. Use medium-weight cloth cut to a square outline that overlaps the patch on all sides by 3 in. or so. ★ ★ ★

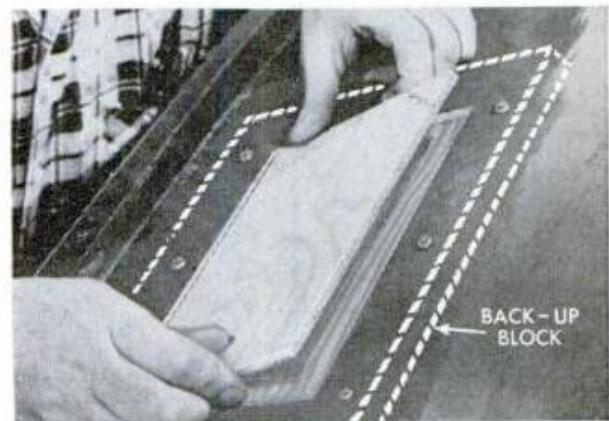
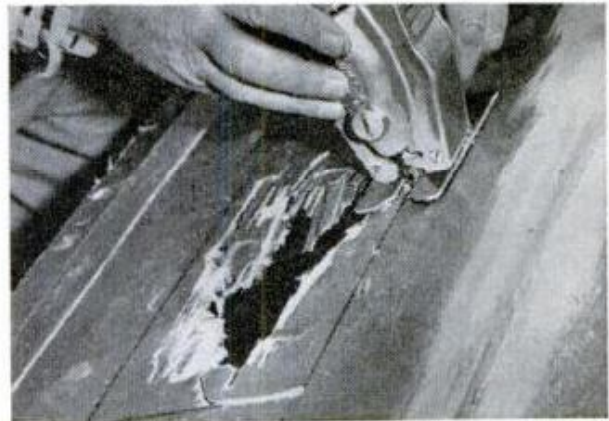

FLUXLESS

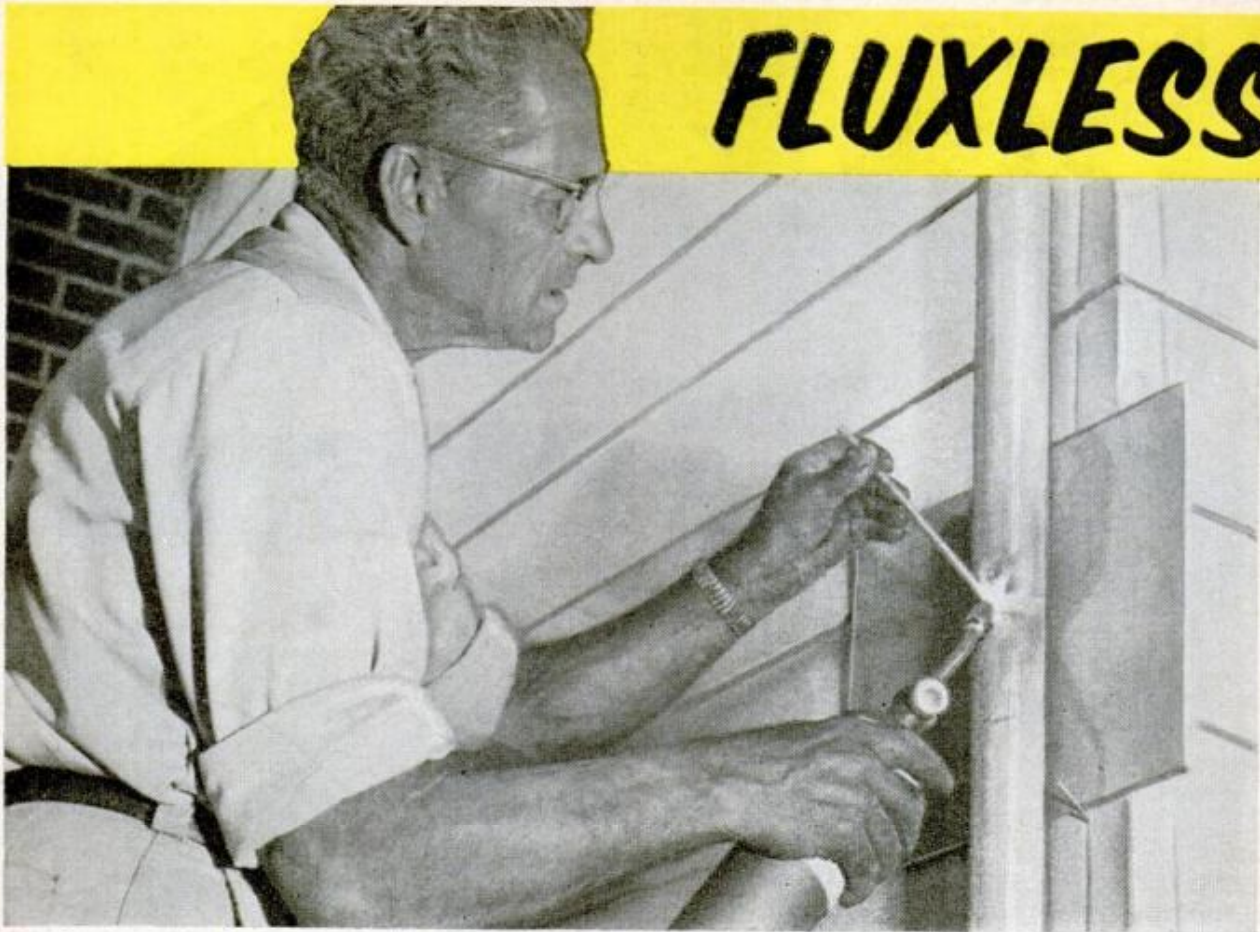

FLUXLESS SOLDER easily mends breaks in aluminum sheet metal, such as downspout shown above and boat below. Board protects paint from heat of torch



Here is the answer to the amateur's soldering problems

SUCCESS AT SOLDERING, or welding aluminum no longer is an accomplishment to be enjoyed exclusively by the experts. A fluxless solder marketed recently for do-it-yourselfers under the name of Chemalloy, makes it possible for anyone to repair cracks in aluminum, or join other metals to it or to each other. The protective oxide film that normally makes soldering or welding aluminum difficult is easily penetrated by the molten solder, forming a tenacious bond with the parent metal when solidified.

Being a special zinc-lead-tin alloy, the solder requires no flux or follow-up metal treatment. Several types of repairs are shown in the photos on this and the facing page. The procedure for making a repair or joining pieces of metal together is the same regardless of the type of joint or metal. The heat source may be a propane torch, gas burner, blow torch, or any other device that will heat the repair area to a minimum temperature of 500 deg. F. An acetylene torch is too hot for most soldering jobs. For best results, work with the lowest temperature above the melting point of the solder (500 deg. F.) and maintain this temperature for several seconds after the joint is soldered.

SOLDERING AT LAST



MOST METALS may be soldered by this new fluxless solder, including galvanized sheet metal mail box

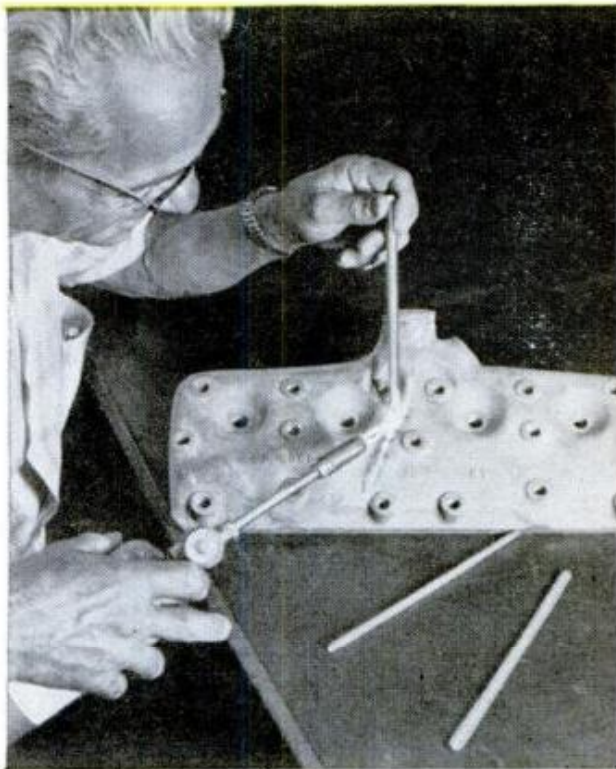

SOLDER BECOMES FUSED with aluminum casting by continued application of heat after solder flows

This tends to cause the fusion of the two metals similar to that which takes place when welding with arc or acetylene, producing a stronger joint than would result from mere surface contact of ordinary soft soldering. Visible uplift at the fringe of the solder puddle indicates there is adequate heat penetration for fusion.

Individual parts to be soldered together

should be clamped in the required position, or placed in a holding jig such as the one shown in the photo below, left, so that the parts do not move while the molten solder hardens. When joining metal pieces of different sizes, let the heat favor the largest mass to equalize fusion. File down excess solder buildup to get a neat joint. In a corner use a round file to form a fillet. ★★★

MITER JOINT is held together on plywood while soldering by pegging tubing in place with nails

CRACK IN ALUMINUM CASTING of portable electric circular saw is solder-fused for lasting repair

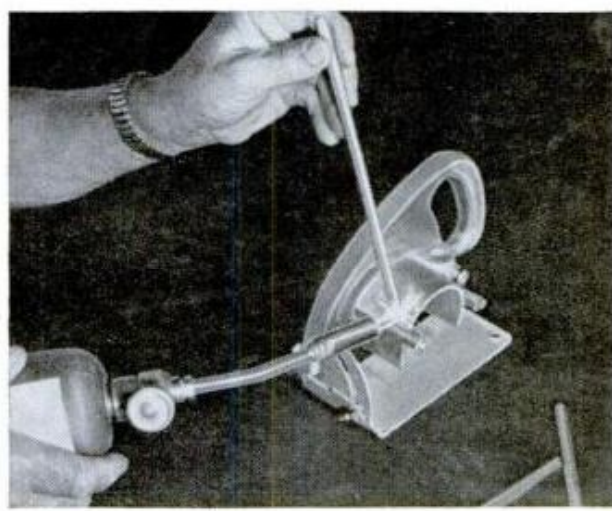
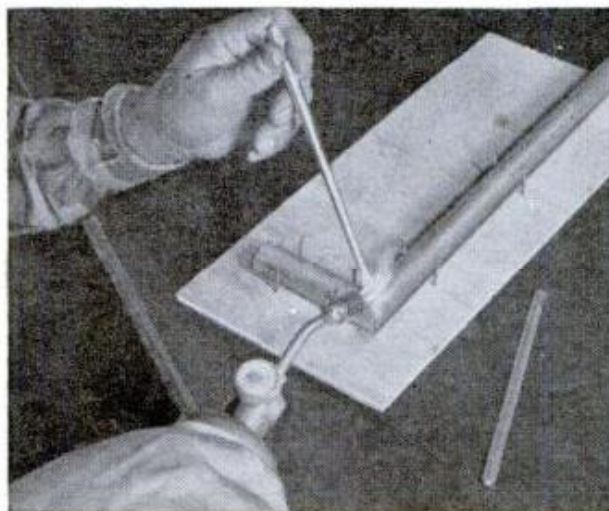



Small Parts Held in Place For Weld Fabricating

Welders fabricating units from a number of small parts often have trouble holding these parts in position for joining. This hold-down can be made right in the shop and often it will do the trick when no conventional clamp will serve. It's made by welding three legs to a length of round steel 1½ to 2 in. in diameter. Note that the pair of legs are made by bending a length of ¾-in. steel rod to a U-shape. The third leg, or foot, is cut from ¼-in. flat steel and welded in place. Ends of the pair of legs are ground to a sharp point so that the unit will stand firmly wherever it is placed.

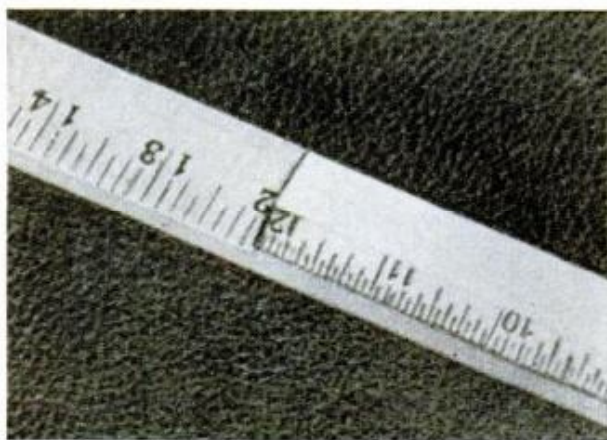

Scale Cemented to Yardstick

By cementing a 6-in. steel scale or a 12-in. wooden ruler to a yardstick you can add to its usefulness for taking close measurements. The scale or ruler should be of the type graduated in 16ths of an inch. A thin hardwood ruler of the type supplied for school use is just right. Scrape the varnish off the back of the ruler to provide a good bonding surface for the cement. Spread cement, locate the ruler with the graduations on both ruler and yardstick in register and clamp until the cement is dry.

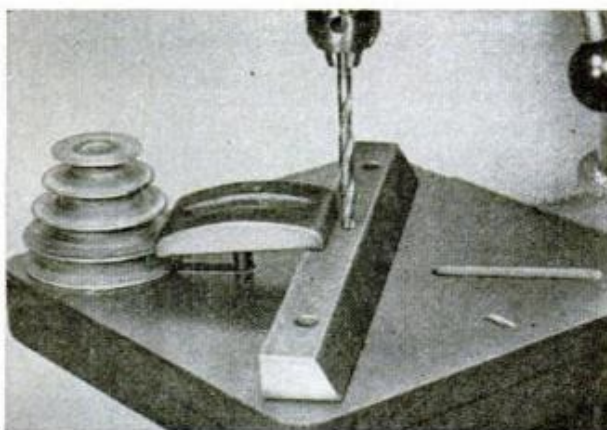

Four-Step Pulley Supports Clamp

When a stepped steel block is lacking for strap clamp height adjustment, a four-step V-pulley makes a good substitute when the required clamping pressure is not too great. Usually there is room to make the setup even on a small drill-press table and ordinarily it is not necessary to bolt the pulley to the table. In making the setup adjust the clamp so that it inclines only slightly upward as pictured. Otherwise the supported end might slip off the sloping side of the V-groove in the pulley.



Tape Reinforces Sandpaper Edges

Fine sandpaper has a tendency to tear when clamped to the shoe of an orbital sander. Even a slight tear may slacken the tension on the paper just enough to prevent it from moving with the shoe which, of course, renders it almost entirely ineffective. Tearing can be prevented by sticking strips of masking tape across the ends of the sandpaper sheet after cutting to size. Use only a wide masking tape and cut the ends flush with the edges of the sandpaper.

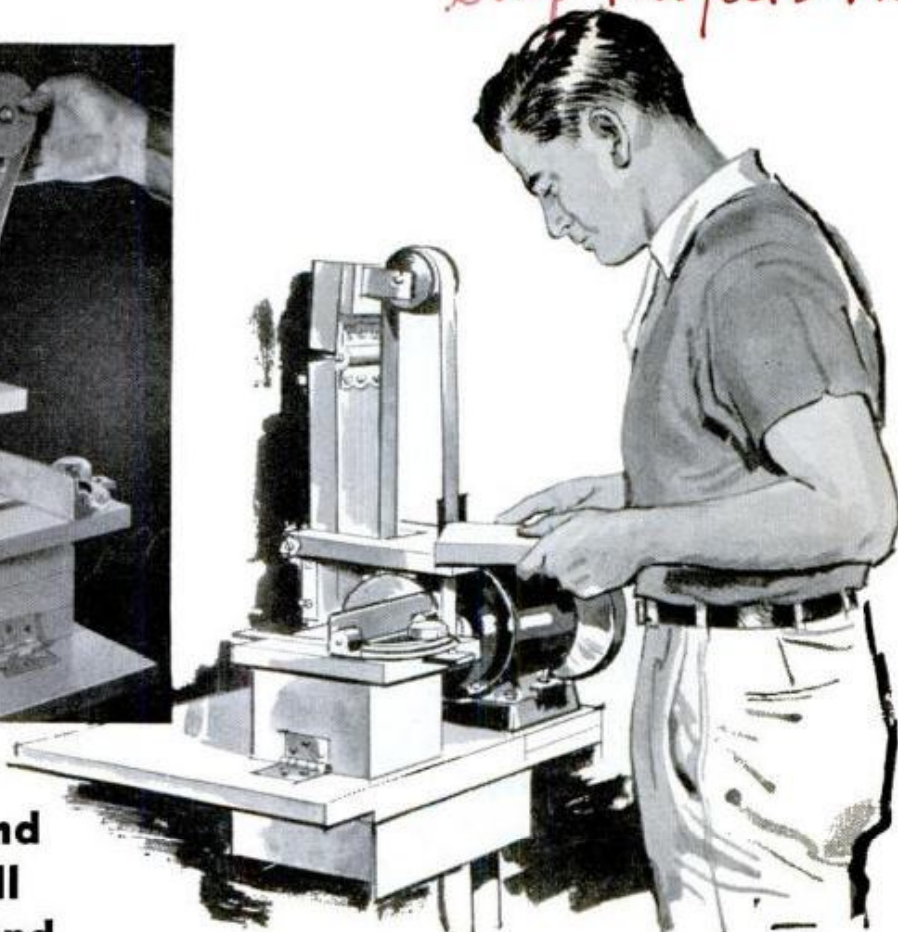
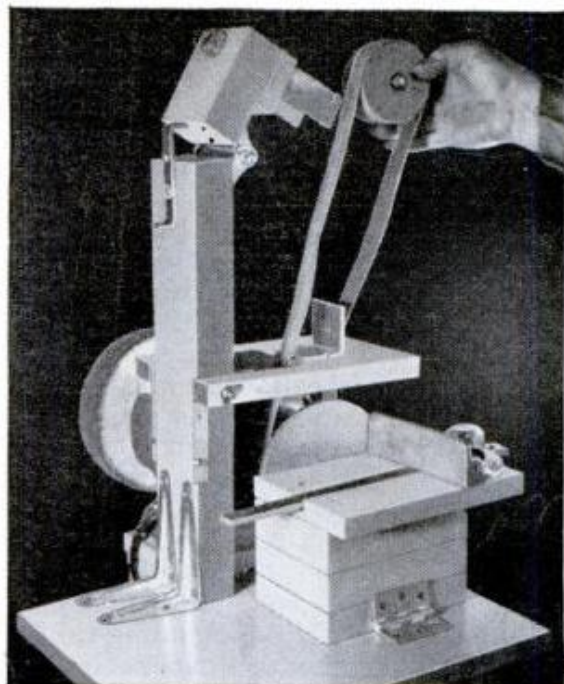

**You can band-sand
or disk-sand small
parts, also buff and
polish with this handy**

COMBINATION SHOP TOOL

By William G. Waggoner

ALL THREE MACHINES, band sander, disk sander and buffer are combined in one bench-type unit and are driven by a double-shaft motor. The band wheels, or pulleys, are designed for abrasive bands 1 in. wide and as will be noted from the photos of the machine above and at the right, the band is backed at the table level so that you can do precise sanding, finish grinding and polishing on wood and metals. The sanding disk, lower band wheel and buffing wheel are carried on adapters mounted on the motor shafts. Note that the disk-sander table is hinged so that it can be tilted to permit changing abrasives or removing the disk.

The 2 x 4 upright which carries the idler is in two parts which are joined with a spring hinge of the type used on screen doors. When the abrasive band is in position on the pulleys, the hinge provides the necessary tension as in the photo at the right. The hinge also permits the top member of the upright to be tilted forward so that abrasive bands can be removed and replaced. Note the photo above.

The length of the abrasive band (meas-

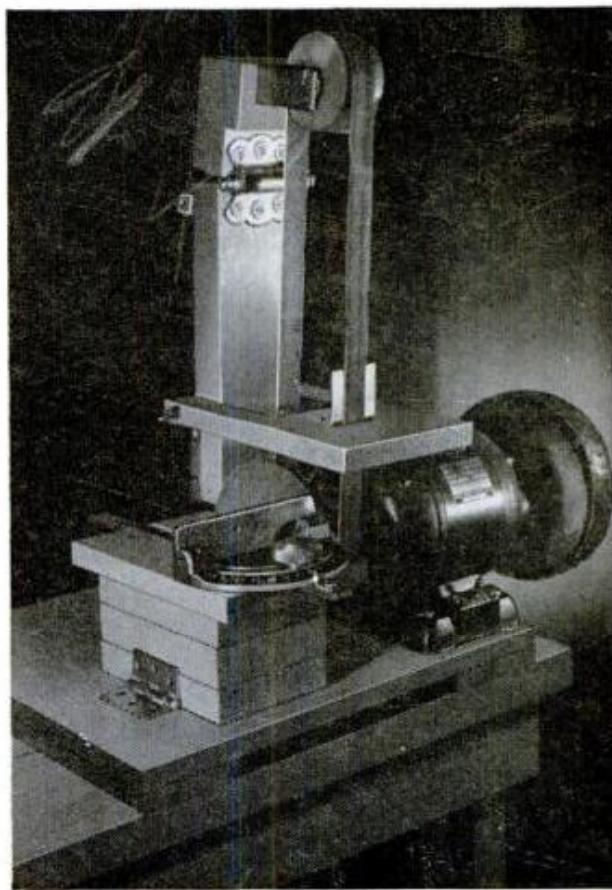

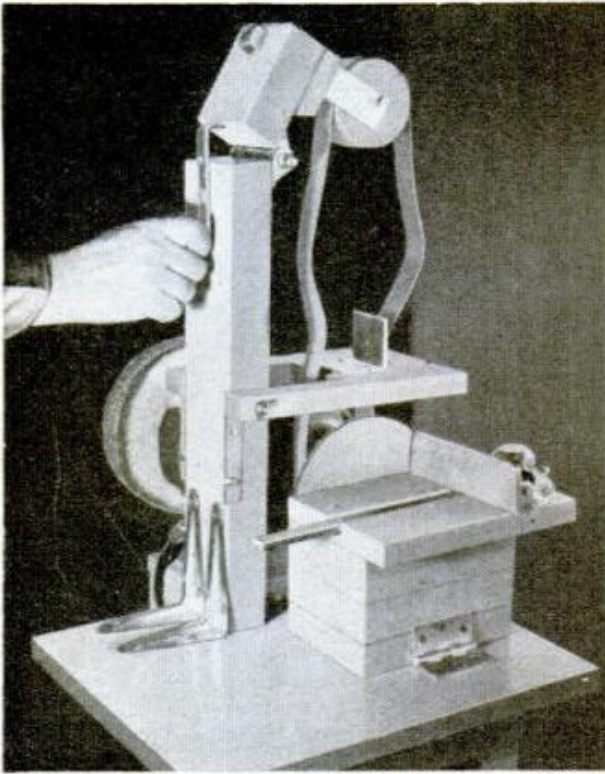

A PIVOTED STOP holds the idler in tilted position so that it can be lifted from the yoke for changing the band as in the upper photo on preceding page

ured around the pulleys) and the height of the motor shaft determine the length of the upright. The band used on the machine pictured is 1 x 42 in. and this is a convenient length. Before you cut the upright in place so that you can determine the height of the motor shaft above the base of the machine. This measurement, plus the length of the belt measured around the pulleys determines the over-all height of the upright. The S-shaped stop shown being positioned in the photo at the left is made from $\frac{1}{16}$ x $\frac{1}{2}$ -in. flat steel and is attached to the lower member of the upright with a screw. Its purpose is to hold the upper section of the upright in a tilted position while the belt is removed or replaced. It can be omitted if desired.

It's a good idea to make and fit the yoke for the idler and attach the sanding table to the upright before attaching the latter permanently to the machine base. In this way you can align the band so that it runs perpendicular to the table surface.

Suitable pulleys can be turned from close-grained hardwood. Note that the idler is fitted with a bronze bushing. ★★

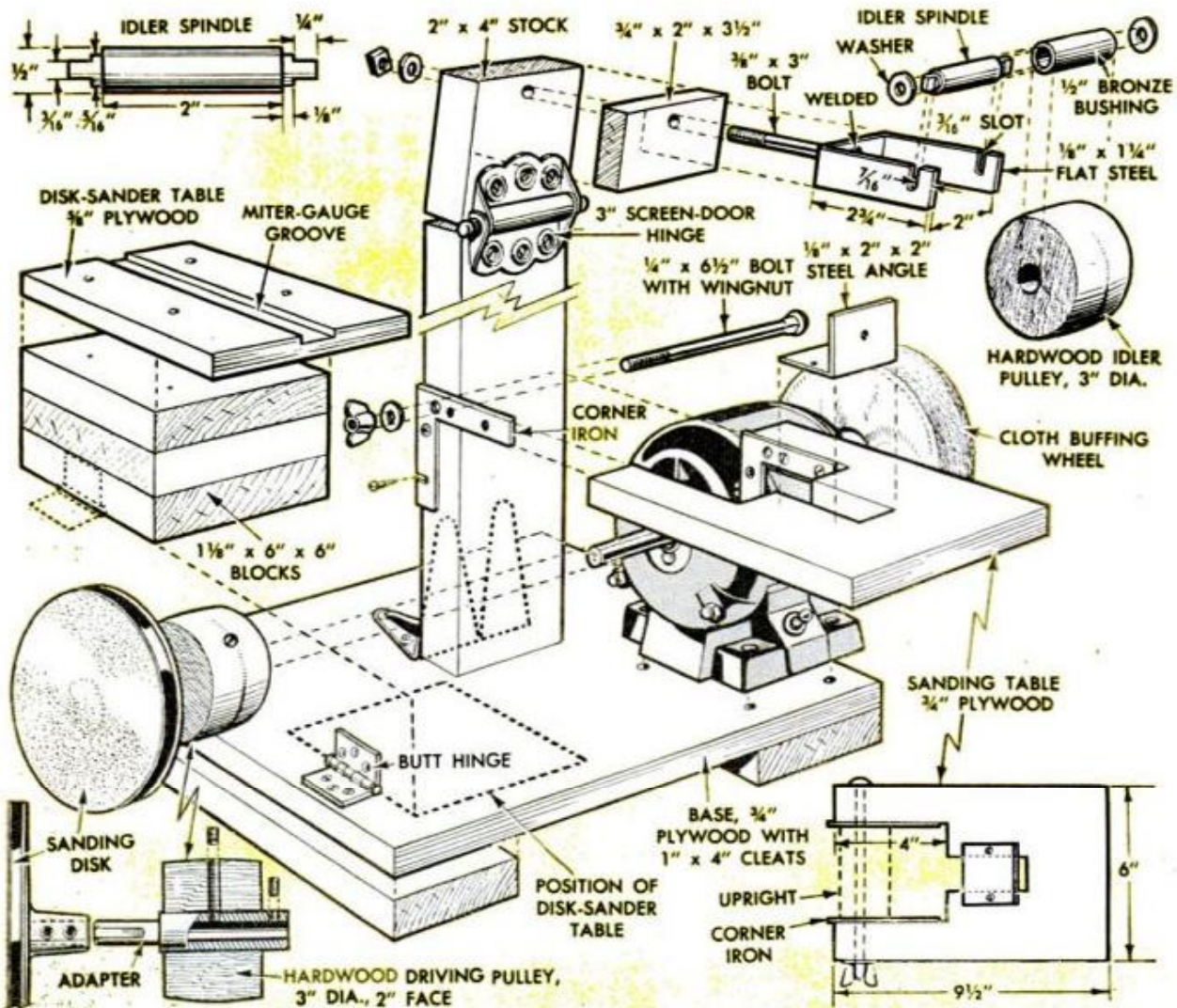

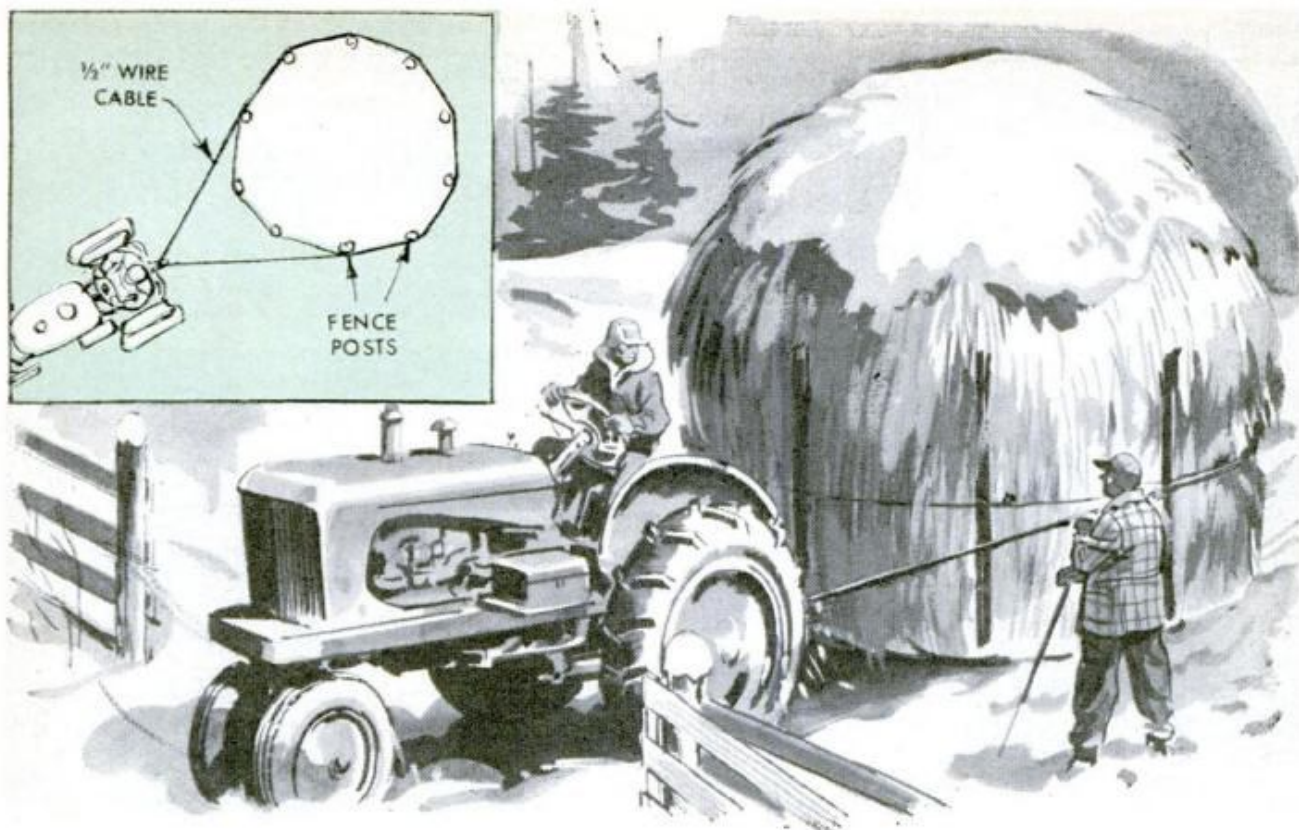

HAYSTACK SKIDDED TO FEED LOT

To save at least one handling I store my hay in small round stacks. I stand a number of small fence posts around each stack, space them uniformly and join with a length of smooth wire. I pull this wire tight so that each post is drawn inward against the stack. This is done immediately after stacking so that the posts tend to prevent

the stacks from tipping or being pushed over by stray stock. Then in the winter after a snowfall I back my tractor up to a stack, swing a 1/2-in. steel cable around it and support the cable at the center of the posts with short wire ties. Then I attach the cable to the tractor drawbar and away I go to the feed lot.—Peter E. M. Hofer

Extendable Drawbar For Farm Trailer

Farmers who work trailers alongside or directly behind such tractordrawn machines as corn pickers and balers are well aware of the advantages of a trailer drawbar that can be lengthened or shortened quickly and easily. One way is to make a drawbar from heavy pipe in two sections having couplings on the ends so that nipples of various lengths can be inserted as in the photo and detail. With this arrangement it takes only minutes to adjust the drawbar to the correct length.

Small burlap bags filled with stones make serviceable drags for animal traps in sets made along rocky streams where it may be difficult to stake traps in the regular way. "Sew" the open ends of the bags with wire, then attach the wire to the trap chains.

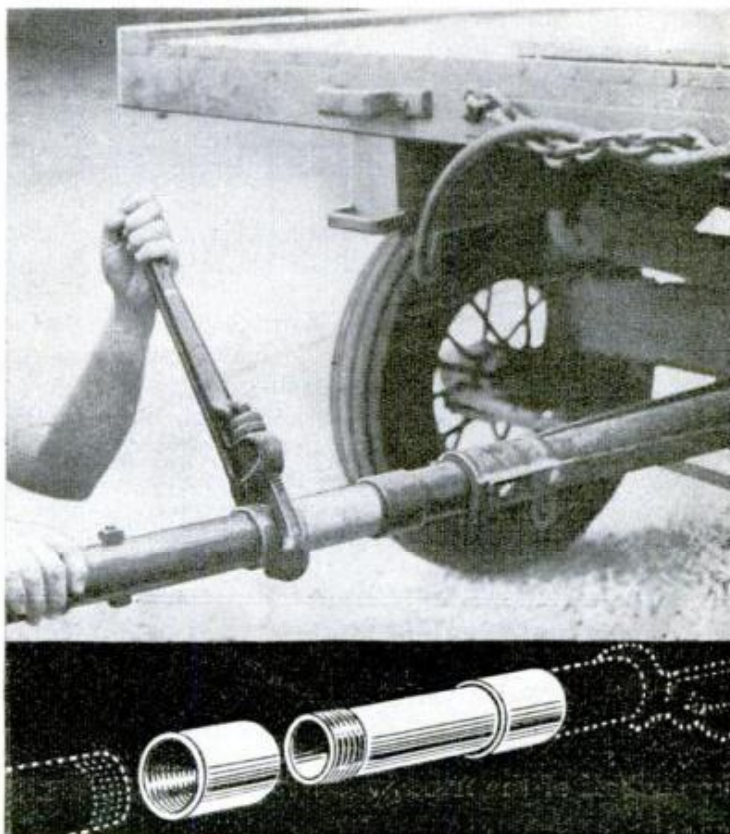

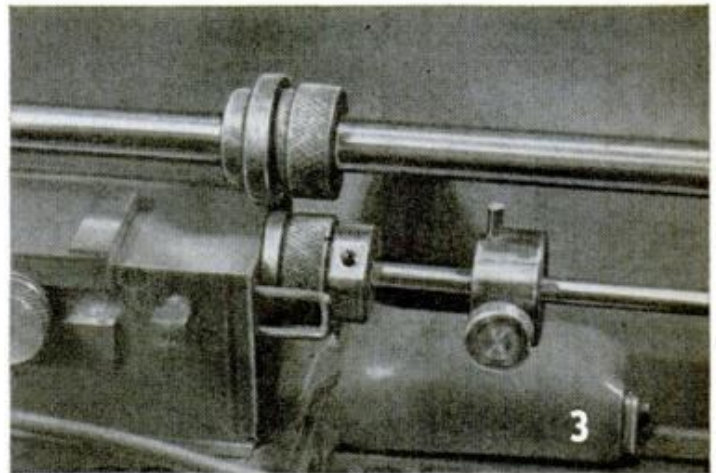
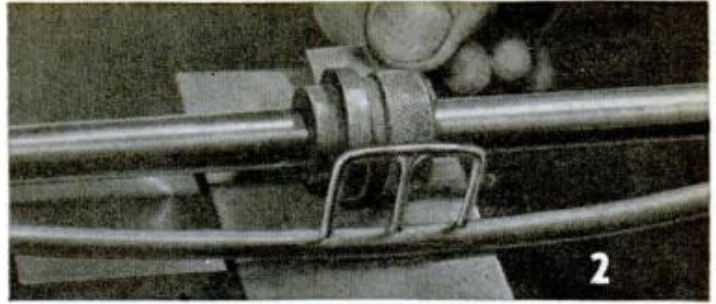

LATHE DOUBLES AS METAL SHEAR

By Walter E. Burton

THIS ROLL-TYPE metal shear is designed as a lathe accessory. It will cut light sheet metal without distorting or curling the material. It also cuts cardboard, thin sheet plastic, even heavy paper and some laminates. It's been dimensioned to fit a 9-in. metal-turning lathe and as will be noted from the detailed parts in Fig. 5, it consists of two cutting rolls, one driven roll and one idler, a specially machined base for mounting on the lathe cross slide, finger guards and an adjustable guide and a stop.

The shear is self feeding, the knurled sections of the rolls (cutters) serving as feed rolls. Cutter A is the driven roll and is mounted on a spindle 10 in. long, Figs. 1 and 5. This length has been found to be about the maximum for a 1/2-in. spindle. If made longer, it may tend to deflect somewhat under heavy cutting pressure. In use, the spindle is mounted between centers in the lathe as in Fig. 4 and driven either by a collet chuck as pictured or by means of a lathe dog. The finger guard that rides on top of the work, Figs. 2, 3, 4, and 5 is optional and can be arranged in any one of several ways, depending on the lathe used. In the original the right end of the guard arm is held in place by means of a band clamp on the tailstock spindle, Figs. 4 and 5. The left end is filed down to fit tightly into the socket-head screw which holds the upper half of the headstock bearing. Note

also that there is a second finger guard which, when the unit is in operation, is below the work and just ahead of the lower cutter, Figs. 3 and 5. It is here that there is the greatest danger of fingers being caught by the knurled sections of the cutters and for this reason this guard is essential to safety.

The bearing surface for the cutter B on the spindle C, Fig. 5, must be turned to diameter with a minimum tolerance and the center hole through the cutter should be drilled and the hole reamed to size. Note that the spindle C, Fig. 5, is turned to four diameters, the section turned to 1/2 in. in diameter forming the bearing for the cutter B. Note that the length of the bearing surface provides for 1/16-in. endplay. In operation the edges of the cutters overlap, the amount of overlap being controlled by moving the lathe cross slide.

The guide, Fig. 5, is made from a short length of steel angle, the fillet being filed square so that the angle will seat on a corner of the base block. One web of the angle is slotted so that the guide can be adjusted to permit cutting strips of a given width and length.

Cutters can be turned from tool steel and hardened or they can be turned from mild steel and casehardened. For soft materials cutters turned from tool steels will serve very well without hardening. ★ ★ ★

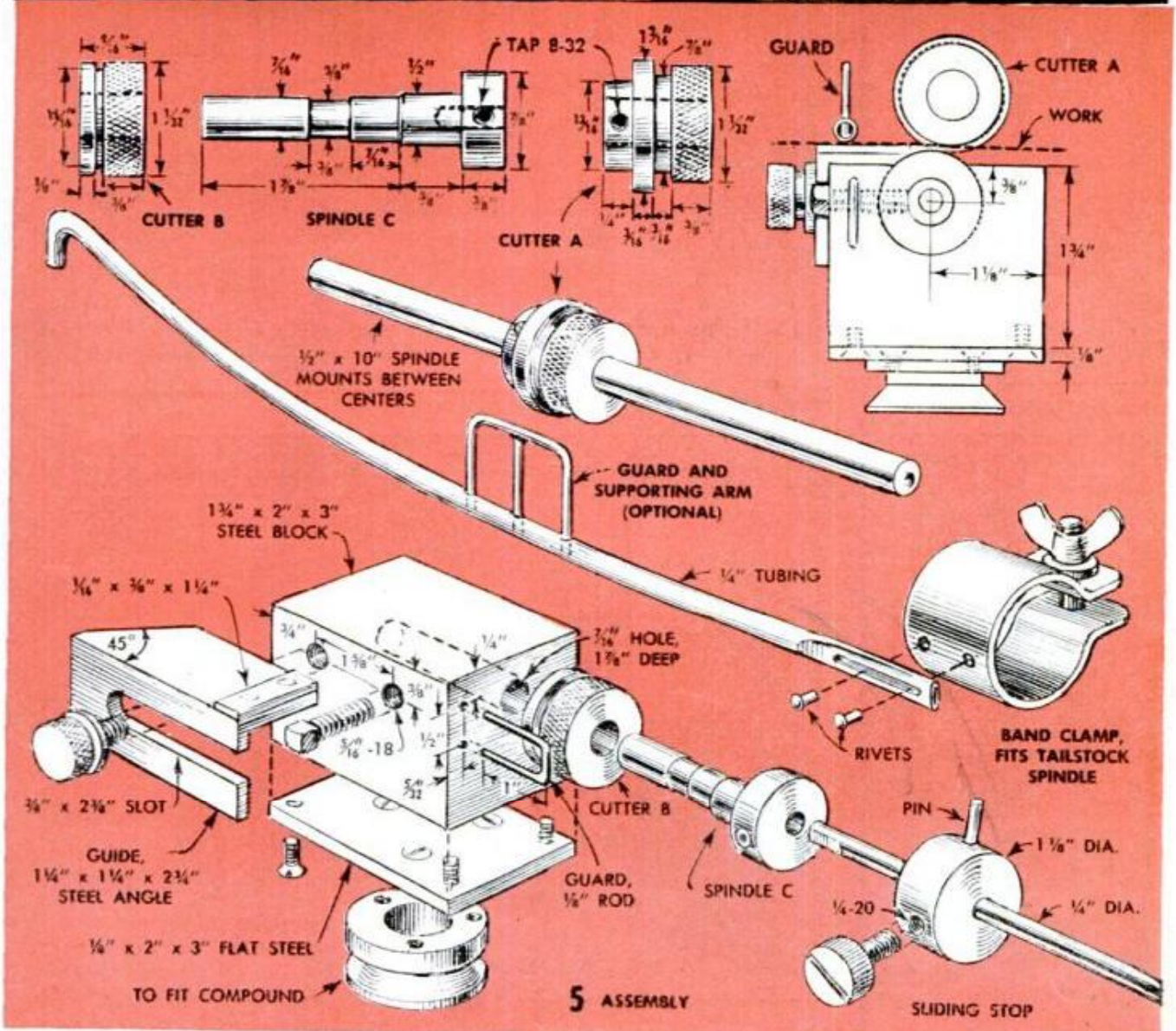
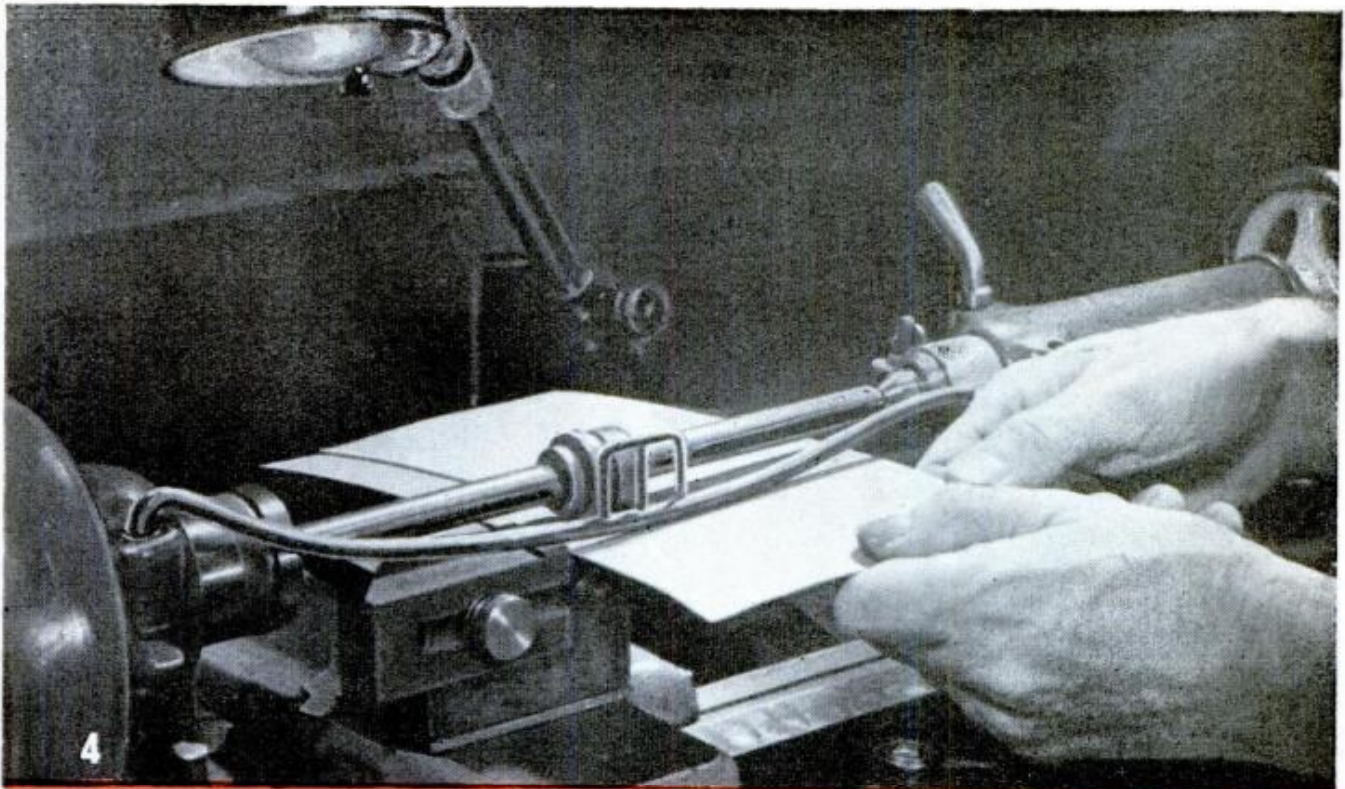

RADIO TV HI-FI

ELECTRONICS

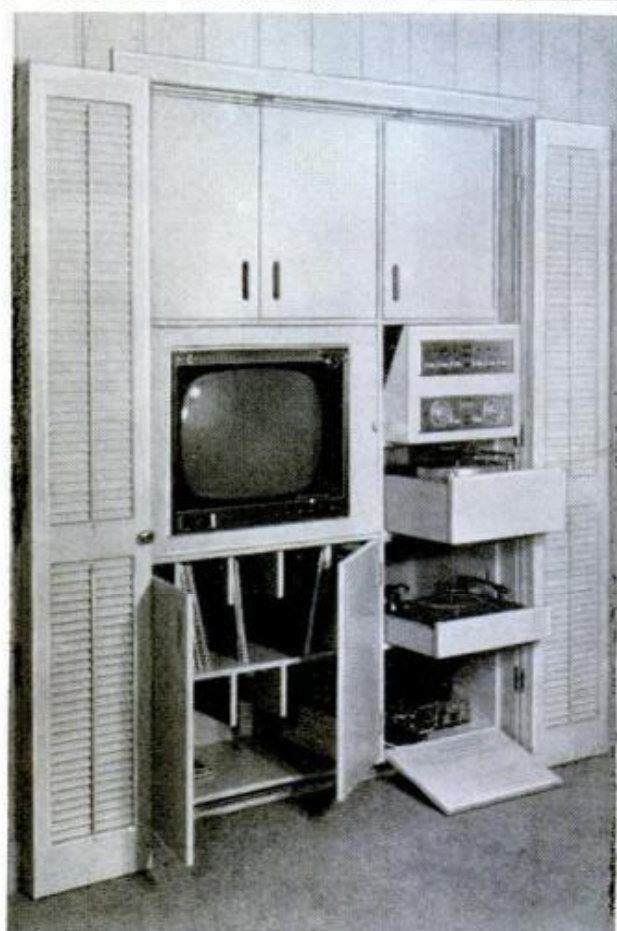

Complete built-in system fits neatly in a corner of the room. A different treatment is seen above right, with the system hidden behind louver doors. Below, *PM's* House of Built-Ins unique entertainment wall

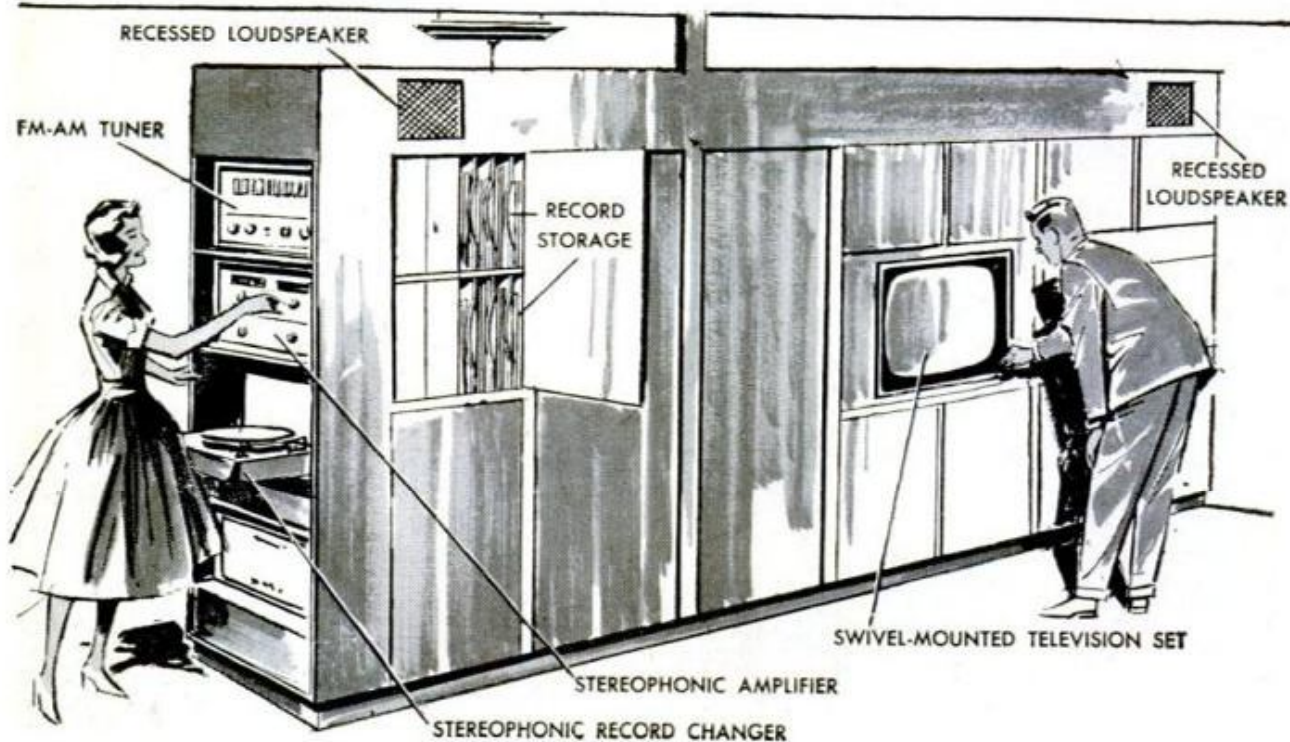

Electronics Are Built-In Too!

By Byron G. Wels



Turntable, enclosed in wall housing, pulls down to operating position. Record-storage cabinet matches phonograph panel, pulls down to expose records which are stored in the approved vertical position behind panel

THE PM HOUSE OF BUILT-INS features equipment which is the last stereophonic word in modern living. The entertainment wall provides a complete entertainment center for the entire family—television, stereophonic high-fidelity equipment, even record-storage space. What's more, in keeping with the theme, it is all built in.

The stereo amplifiers are dual 30-watt units. This is more than adequate to fill the needs of the home. For ease in servicing, the entire amplifier chassis may be tilted forward away from the wall. The unit is easily expandable so that new equipment can be added in the future. For example, should the homeowner care to add a tape deck, he can do it by simply removing one of the blank panels in the entertainment wall and cut it out to accommodate a tape deck of his choice. The loudspeakers

throughout the house are eight-inch coaxial units with each serving as a remote intercom unit. The tuners are FM-AM units so that stereocasts can be received. When FM multiplex transmissions are more common, the homeowner can easily add the multiplex adapter. The record player swings down on hinges to the horizontal playing position. Very little depth is required as the record player stores vertically when not in use. The cartridge in the record player is a dual-channel ceramic type with a diamond stylus for long use. If the units are intended for custom installation, the panels and controls of the amplifier and tuner are identical within the limitations of function. The record-storage cabinet, when closed, matches the record-player cabinet.

The television receiver is mounted on a Lazy Susan base which permits the set to



Integrated intercommunication system permits residents to interrogate callers and invite them to enter

be turned to face either side of the entertainment wall. A remote control unit permits ease of tuning and the speaker is placed at the front of the set to avoid interfering with activity in the family room when the set is being viewed in the living room. One television set thus can do double duty.

A unique benefit is derived from this system. The integrated intercom permits any of the remote stations to call any of the other stations. Each speaker can be used either as a remote loudspeaker for the high-fidelity system or can be changed to an intercom, simply by throwing a switch. The speaker in the nursery, for example, can be switched to an intercom, and mother, in the kitchen can hear baby if he cries. While she prepares the bottle, she can soothe the baby over the intercom.

When a caller presses the doorbell, an electronic chime sounds through all the loudspeakers. Pressing the intercom switch on any of the speakers, the homeowner can speak to the visitor. The weatherproof intercom installed at the front door permits the visitor to answer.

Other electronic devices can also be built in. Some fulfill functional needs, such as a fire-alarm system. One new system consists of many small detectors, each resembling a miniature light-bulb socket without a bulb.

Placed at strategic points in the home, these heat-sensitive detectors provide a small electronic pulse when fire breaks out.



Visitors identify themselves to owners through weatherproof loudspeaker-microphone at front door

This small signal is amplified and fed to a master panel. On the panel two things happen: A loud bell rings, indicating that fire has broken out; a light goes on indicating the area in which the fire has occurred. One glance at the panel tells the homeowner where the fire has started. Outside the house a horn sounds to summon help in case the residents are not at home.

Another possible built-in is a garage-door operator. The radio-controlled device of early days was a bulky box under the dashboard, taking much space from the driver or passenger of the car. The receiving unit was not very selective; kids with radio-controlled airplanes, hams on the 10-meter band and neighbors with garage-door operators, all could send the doors up and down. With the advent of transistors, the problem of operating garage doors is much simpler. One operating device is a small transmitter that can easily be carried in pocket or purse. Pretuned and crystal controlled, the unit has a small pushbutton that is depressed in range of the receiver. The small physical size of the transistor circuitry, plus the low current drain has eliminated the need for bulky power supplies and the transistor unit has much longer life than the older tube types.

Still another electronic built-in for the modern home is the electronic touch-plate for turning lights on and off. A capacity-operated relay is installed in the wall behind the metal plates that now enclose



Intercom unit above baby's crib amplifies all sounds. With volume highest, even breathing can be heard



Elsewhere in the house, mother can soothe child or play music into nursery while heating baby's bottle

switches. When the plate is touched, the lights go on; another touch turns them off again. These units can easily be added to existing homes simply by replacing the switches in the house with the new capacity relays.

What built-ins may be included in the house of the future? The latter part of 1960 saw the development of reverberation. Reverberation was devised by the manufacturers of electronic organs to provide richer tonal qualities to their organs. A reverberation unit consists of two sensitive pickups and a length of spring. The signal from the stereo amplifier actuates the reverberation spring and this in turn feeds the loud-

speaker. The amount of reverberation can be varied so that the homeowner can actually dial the acoustics he desires right in his living room. In the ordinary stereo system, a symphonic concert comes through with the same acoustic effect as does the five-piece jazz combo. By adding reverberation, the symphonic concert sounds the way it does in a concert hall. Decrease reverberation and the jazz combo can sound as though it is playing in an intimate supper club. Last year stereo was considered to be the last word. This year it is stereo with reverberation. Next year development laboratories may even make reverberation obsolete.

Matched units in cabinet-mounted system are more than decorative. Balanced system means better sound

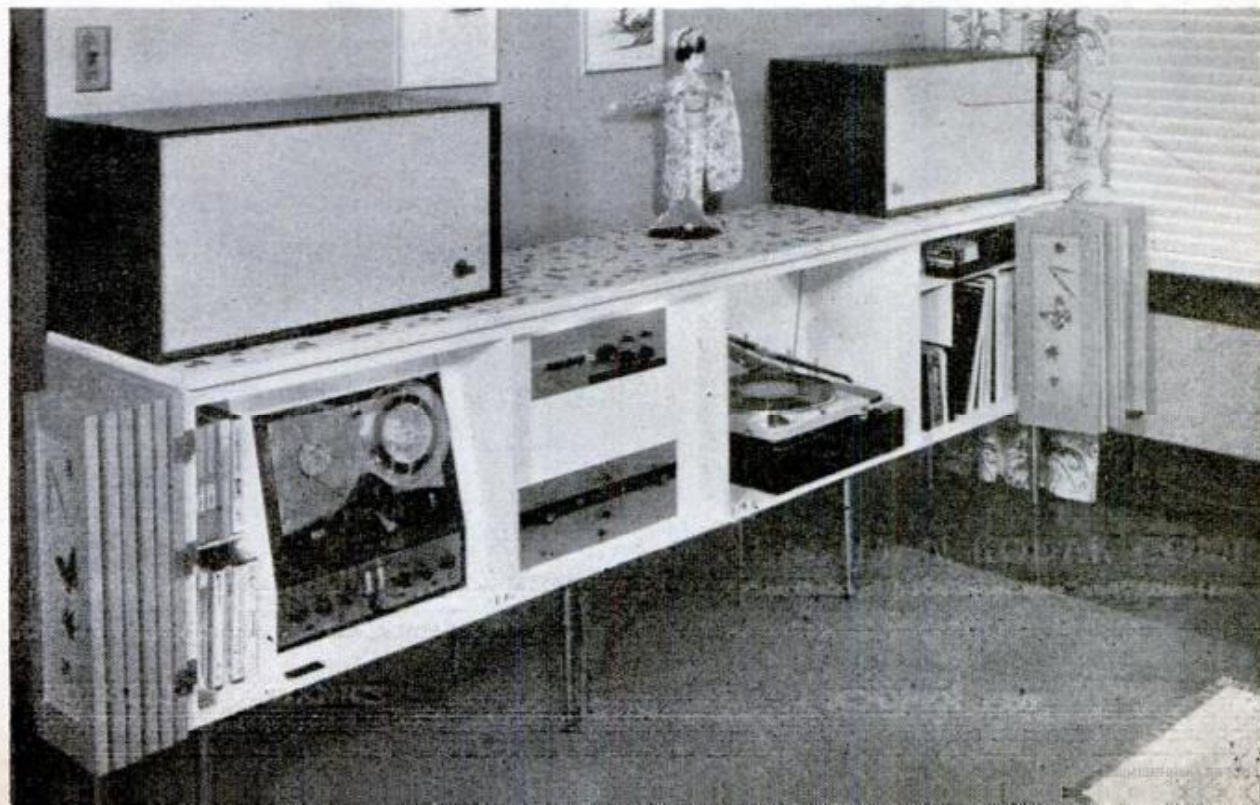



Radio-controlled garage-door operator in leather case can be carried easily. Pressing button raises door

Engineers are designing TV picture tubes with larger and larger scan angles. This makes for flatter tubes with shorter necks. The result is a thinner television set. One manufacturer has been experimenting with a picture tube based on an entirely new principle which promises to be less than

three inches thick. Couple this with modern transistor circuits, and picture-frame television may someday be a reality.

In selecting electronic built-ins for the home, remember that such built-ins can operate at maximum efficiency only if the power lines are not overloaded. ★ ★ ★

Panel and bell tell location of house fire; push-switch tests unit. Outdoor horn notifies neighbors



Handiest nailing tool since the hammer!

ARROW

T-50 ALL-PURPOSE STAPLE GUN



Uses 6
staple sizes:
1/4", 5/16", 3/8", 1/2", 9/16"
and ARROW'S CEILTILE STAPLE
Especially Designed for Ceiling Tile!

MODEL NO
T-50
ONLY
\$12.50

SHOOTS A STAPLE WHEREVER YOU'D DRIVE A NAIL!

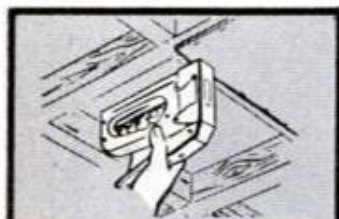

CEILING TILE



INSULATING



WIRE FENCING

Why put up with the slow, laborious hammer-and-nail method of fastening? Grip the gun that gets the job done *faster, easier and better!* It's a breeze! One *squeeze* and you've nailed it — with Arrow's one-hand operated T-50 Automatic Staple Gun! And you always have other hand *free* to hold work and balance self! This rugged, jam-proof, all-steel professional tool is built to stand up for 1001 heavy duty nailing jobs!

CREATED FOR THE HOME HANDYMAN!

ARROW'S Amazing, New T-50MP Multi-Purpose KIT

Contains Arrow's versatile T-50 Automatic Staple Gun . . . 5000 Assorted Arrow Staples . . . 3 Interchangeable SLIP-ON Attachments for wire, screen and window shade fastening . . . and a Staple Lifter. Here's everything a home craftsman needs to do an all-around fastening job — all in one handy, portable kit! Makes perfect Christmas gift.



If purchased individually, items in this kit would cost **\$19.50**

SPECIAL KIT PRICE: \$17.50

You can BUY the Arrow T-50 Staple Gun at your local Hardware, Lumber, Building Supply or Stationery dealer.

ARROW FASTENER COMPANY, INC.

ONE JUNIUS STREET • BROOKLYN 12, N. Y.

"Pioneers and Pacesetters for Over a Quarter Century"

New Ideas in Photography



Brownie
Starmatic
Camera

 Lens "squints" for beach or snow scenes . . .

 opens up a bit in average sunshine . . .

 opens wide in shade for clear pictures

Picture it now—
See it again and again

Automatic Camera is Amazingly Accurate

This automatic electric-eye camera is not only easier to operate than a separate light meter and camera—it's also more *accurate*.

The reason? In each Brownie Starmatic Camera, the built-in meter and shutter are custom-matched to each other by a final factory adjustment. Thus, any of the common variations of meters and shutters are balanced out, and exposure errors are eliminated!

Shoot in bright sunlight or in shade, the lens opening adjusts automatically for correct exposures. When light is too dim, a signal tells you to use flash.

You get snapshots or slides, 12 beautiful pictures to a roll on economical 127 film. Can't take an accidental double exposure. Brownie Starmatic Camera costs less than \$30, or as little as \$3 down.

"Electric Fingers" Thread the Film For Automatic Movie Projectors

Now you can get your movie shows under way with no fuss, no fumbling. Just choose a Kodak automatic movie projector.

All you do is insert the end of the film in a slot. "Electric fingers" then take over, to start your show automatically. They thread the film through the gate . . . form the loops . . . and guide the film down to the take-up reel, which picks it up automatically! It's quick, reliable, all automatic, and astonishing to see.

There's a Kodak 8mm automatic movie projector in every price range. See them at your dealer's.

Brownie 8 Movie
Projector, A15,
less than \$55.



Kodak Cine Showtime
Projector, A20, less than \$125;
Model A30, less than \$150.

Brownie 500 Movie
Projector, A5, less than \$95.

from Kodak

Sensitized Photo Balloons Used in Diagnosis of Stomach Cancer

Rubber balloons coated on the inside with special Kodak photographic emulsion are being used with great accuracy to detect stomach cancer.

A patient is fed a tiny amount of radioactive phosphorus 32. Then he swallows an emulsion-coated balloon which is inflated until it is in contact with the stomach walls.

Cancerous tissues absorb more "P32" than normal tissues, and show up as darkened areas on the balloon when it is removed from the stomach and processed.

Knowledge gained by Kodak in creating such specialized products for medical, scientific, and industrial use, also helps produce finer films and equipment for amateur photography.

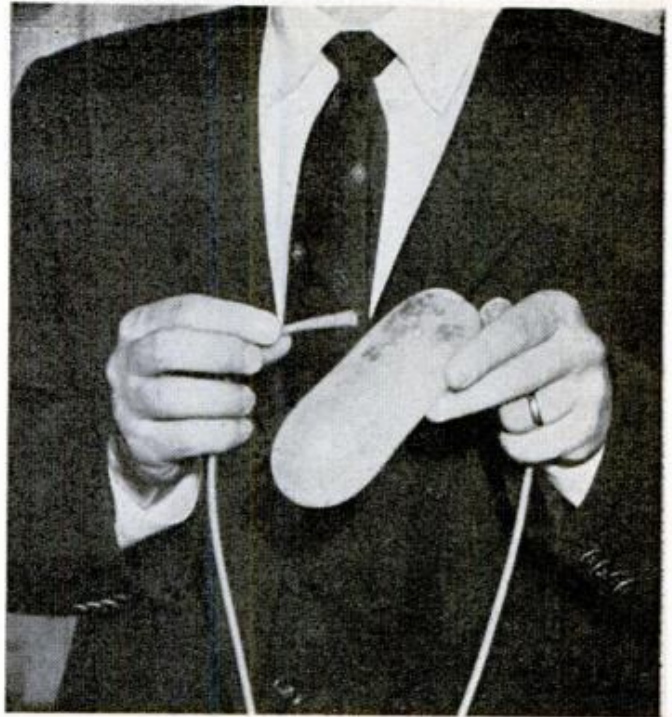

Dark areas on balloon reveal presence of stomach cancer. Kodak scientists worked for several years to develop a fast, flexible emulsion for the balloon coating. The balloons are now available to physicians.

Versatile Slide Projector Lets You Use Any of 3 Changer Systems

This handsome new Kodak 500 Projector, Model B, puts the accent on versatility. It lets you choose any of *three* modern slide-change systems—fast-action Kodak Readymatic, Airequipt magazine, or Universal tray.

And it gives you great performance. The 500-watt lamp and big condensers show both 35mm and super slides brilliantly. The 4-inch *f*/3.5 lens gives big-screen images even in small rooms.

A quiet, turbine-type blower pulls cool air in over your slides and around the lamp. Elevation and focus knobs are on top for easy adjustment. Handsome two-tone styling. Sturdy case cover.

With Kodak Readymatic Changer and 4-inch lens, Kodak 500 Projector, Model B, is less than \$68, or as little as \$7 down. Ask your dealer to show you how smoothly it works with each of the changers.

Prices are subject to change without notice.

See your dealer for exact retail prices

Kodak 500 Projector, Model B

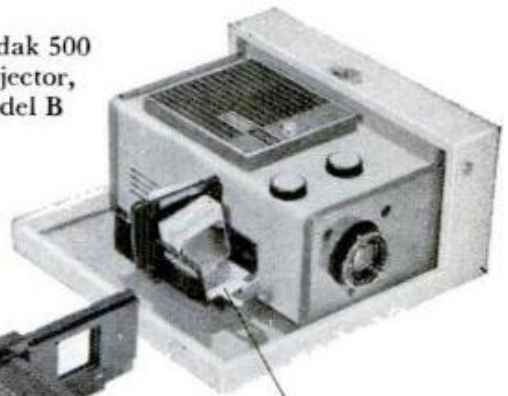

Kodak Readymatic Changer for cardboard mounts. Quickest from slide-box to screen.

Kodak Universal Changer is versatile—handles card, glass, plastic or metal mounts in trays.



Airequipt Magazine Changer stores each slide in a sturdy, durable metal frame.

EASTMAN KODAK COMPANY, Rochester 4, N. Y.

See Kodak's "Ed Sullivan Show" and "Adventures of the Nelson Family"

Kodak
TRADEMARK

Shake hands with a JET ROCKET

\$4⁴⁹

You can feel the dynamic power and balance in this famous tool. You'll enjoy the aliveness of the JET ROCKET as it centers the power of your swing and smoothly absorbs impact shocks.

Head is permanently locked to tubular-steel handle. Comfortable cushion grip won't slip, even when wet. Shake hands with a JET ROCKET at your favorite hardware store today. True Temper, 1623 Euclid Avenue, Cleveland 15, Ohio.

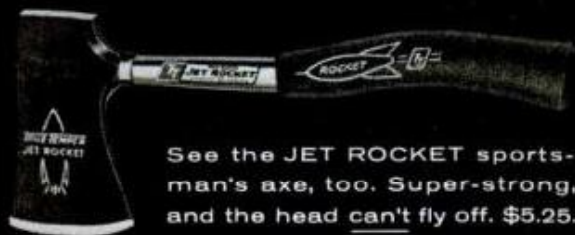

See the JET ROCKET sportsman's axe, too. Super-strong, and the head can't fly off. \$5.25.

TRUE TEMPER
THE RIGHT TOOL FOR THE RIGHT JOB

Clinic for Homemakers



As a service to our readers in solving the hundreds of problems pertaining to a home—inside or out—the editors of *Popular Mechanics* invite you to present your problems to The Clinic Editor for help and advice. Address your questions to The Clinic Editor, *Popular Mechanics Magazine*, 200 East Ontario Street, Chicago 11, Ill.

Propagating Clematis



Q—I have a flowering clematis vine about 5 years old. The blooms are purple and I would like to have several more of the same kind to plant in different locations about my yard and house. But I have tried without success to obtain small plants from nearby nurseries. No one I've asked seems to know how to obtain new plants from the original plant other than by

seed. Is there some way?—S.W., Tenn.

A—Propagation of the many varieties of clematis can be done with seed, and also by layering, division, cuttings under glass, and by grafting. In your case, inasmuch as you want plants of the same type and characteristics, it probably would be best to try propagating from the original plant by layering. This method, when successful, reproduces a replica of the original plant, without any of the variations such as may occur in plants produced from seed. It is possible to propagate by layering in your locality in the fall, but you are likely to have better success in spring. There are several methods of layering, but probably you would succeed best with what is known as simple layering. In this procedure, the long branches, or trailers, are bent downward into a short, shallow trench and located so that the tips are above ground level. Then that portion of the trailer which is in the shallow trench is covered with soil. Cover the loose soil with a board weighted with a stone. Keep the soil damp. It must never be permitted to dry out. After three weeks to a month, depending to some extent on local temperature and weather conditions, the trailer will root in the area covered by soil. As soon as the new root system is well developed the trailer is cut from the parent plant at ground level or a few inches above, and you have a new plant. This same system can be carried out on several trailers simultaneously and if done in the spring it usually succeeds. In the fall the results are less certain. Rooting of the layered portion of the trailer can be speeded up somewhat by lightly scraping away the bark, or covering, at several points along the length of that portion of the trailer that is to be buried in the shallow trench. This should be done with care, working only with a sharp knife. When transplanting the newly rooted sections cut from the parent plant, be careful to remove the entire root system.

(Continued to page 246)

New Du Pont LUCITE[®] House Paint adds years of beauty... saves real money



“Lucite” makes the difference... and only Du Pont makes “Lucite”

Outstanding durability, superior blister-resistance, easy application make Du Pont “Lucite” the greatest house paint discovery in 30 years.

OUTLASTS ORDINARY PAINTS. Du Pont research chemists tested new “Lucite” Acrylic House Paint for years in all kinds of weather, in all parts of the country. Result: proof that “Lucite”, applied according to directions over Du Pont Blister-Resistant Primer, can actually last 50% longer than conventional house paints.

COMBATS BLISTER PROBLEM. Moisture blistering, once the homeowner's most serious problem, has been solved. Tests show that “Lucite” over Du Pont Blister-Resistant Primer, on new wood or old surfaces from which the paint has been removed, effectively resists blistering.

GOES ON EASILY, DRIES FAST. Never before has an exterior house paint been so easy to apply. New “Lucite” flows on without effort. Dries quickly. Ideal for wood and masonry surfaces.

Send for new 12-page booklet, “How to Get Extra Years of Beauty from Your Next House Paint Job.” Write Du Pont Finishes Div., Dept. PM-10, Wilmington 98, Delaware. Or ask your Du Pont Dealer. He's in the Yellow Pages of your telephone directory.

*Buy the paint that's worth
the work...the beauty lasts*

DU PONT
REG. U. S. PAT. OFF.

Better Things for Better Living
...through Chemistry

LOOK, MISTER!
No Hands

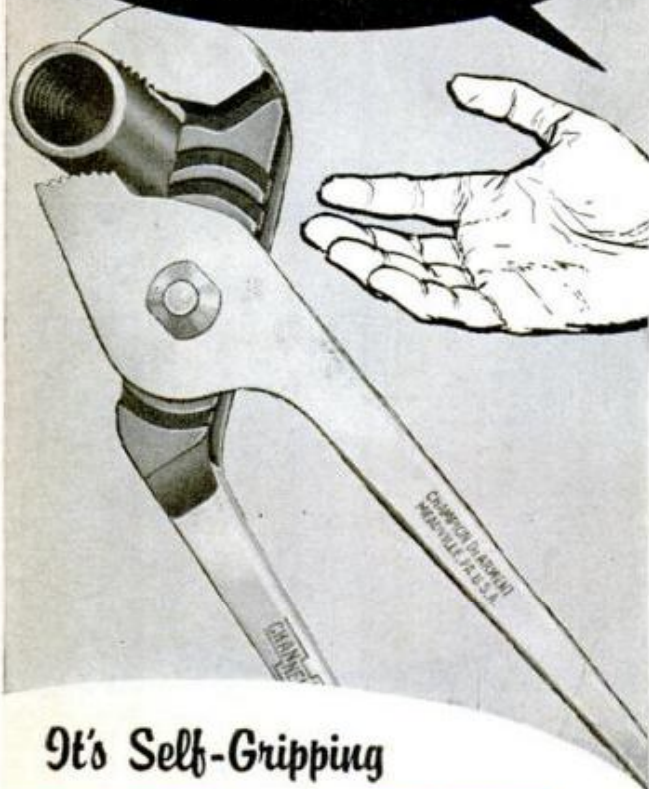

It's Self-Gripping

CHAN NEL LOCK
No. 410

HEAVY-DUTY PLIER

How's this for gripping power? You won't know your own strength 'til you grab hold with this heavy-duty self-gripping plier. The Channellock No. 410 HEAVY-DUTY is actually a combination plier-wrench . . . and it will get into tight places you can't reach with a pipe wrench. A mighty handy, multi-purpose tool with four jaw adjustments up to 1-1/8".

ASK YOUR TOOL SUPPLIER FOR A
CHANNELLOCK No. 410 HEAVY-DUTY PLIER

BE SURE IT'S
A GENUINE
CHANNELLOCK



LOOK FOR THE
TRADEMARK
ON THE HANDLE

CHAMPION DeARMENT TOOL COMPANY
MEADVILLE, PENNSYLVANIA



Decorating Problem

Q—In my older home, in all the downstairs rooms, there are picture moldings located about 20 in. below the ceiling. I believe these are called drop ceilings. The rooms are rather small and the ceilings are 9 ft. high. I want to re-decorate the place but what to do with these areas above the moldings is my problem. If I remove the moldings it seems to me that the rooms will look bozy and uninviting

no matter what I do with decorative colors. Have you any suggestions?—O.W., Wis.

A—We assume you plan to decorate with paint rather than wallpaper. In effect, in most rooms, you can bring the ceiling down by painting it a dark color, but in many rooms, especially those with windows to the north only, this is not advisable. You might also consider installing a false ceiling, but of course, this is rather expensive, even in a single room of average size. In some rooms having high ceilings a paneled wainscot is quite effective. Horizontal contrasting paint stripes, horizontal paneling on one or more walls also are methods of lowering high ceilings. Of course, the picture molding is removed when any of these approaches to solution of the problem is carried out. Another much less expensive method which is quite effective in the average room having a high ceiling is to leave the picture molding where it is, paint the walls below the molding in a bright, cheery color, paint the ceiling an off-white and then cover the area between the ceiling and the picture molding with a wallpaper in a contrasting color. In all cases the wallpaper should have subdued figure and preferably a textured surface.



Wants Dark Woodwork

Q—I want to stain some of the woodwork in my older home a dark color as a part of the decorative scheme. It has been painted but I've found that I can remove the paint quite easily to the bare wood with a remover. None of the stains available seems to give the effect I want, that is, they are too light even when applied and allowed to dry full strength. I know that most re-

finishers want the woodwork a lighter color, but I want it dark. How can I get what I want?

—M.M., Vt.

A—You do not make your requirement very clear. We can assume from what you say that you are refinishing old wood that has been painted. This being so, the wood already has absorbed a portion of the oils that were in the original coat of paint or primer. If a primer was used as a first coat. These oils, having long since oxidized, will tend to prevent absorption of a penetrating stain. Although you did not say, it occurs to us that you may be planning to match a stain on old woodwork. If this guess is correct, then it should be remembered that the old woodwork has darkened to its present color by age. It was not originally as dark as it now appears. It also should be kept in mind that any dark stain you apply now will tend to darken as it ages. A pigmented walnut oilstain will normally give a dark, brownish color on softwood, but in your case one coat may not darken the wood sufficiently to meet your requirements, due to the oils the wood already has absorbed. Much depends on whether you want a color shading to brown or red and whether you wish the grain of the wood to show through the finish coats, or obscure it entirely. You can mix special stains by using artists oil colors. Van Dyke brown oil color reduced with turpentine will give a dark stain color on softwoods.

3 secrets of professional woodworking—by Weldwood

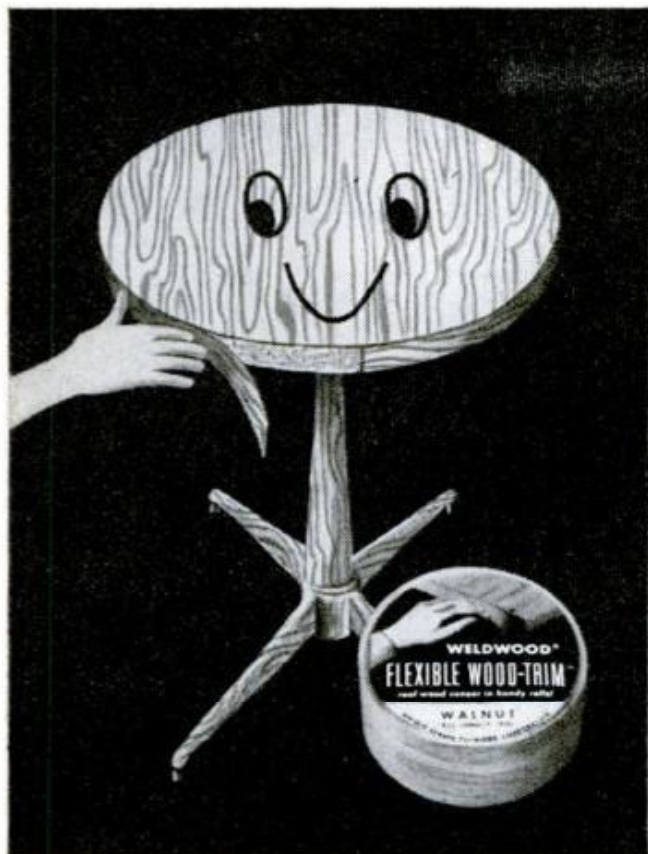

1. Hide rough edges with
WELDWOOD FLEXIBLE WOOD-TRIM



2. Bring out wood's beauty with
WELDWOOD SATINLAC



3. Protect the finish with
WELDWOOD PASTE WAX

WELDWOOD® FLEXIBLE WOOD-TRIM®, real wood, paper-backed, in handy 8' rolls. For edging plywood, lumber. Comes in 6 different woods. Apply with Weldwood Contact Cement or Presto-Set® Glue.

WELDWOOD SATINLAC®, self-sealing finish gives glowing, soft-sheen luster, brings out the wood's natural beauty without "plate glass" shine. For extra-light finishes, use first coat of Weldwood Satinlac Lightener.

WELDWOOD WAX is a rich, high-carnauba *paste*. It's quick, easy, self-cleaning—puts the finishing touch on lasting wood beauty. Resists water spotting, won't harm wood, protects as it beautifies.

WELDWOOD—the people who *know* what's good for wood . . . makers of world-famous Weldwood prefinished wood paneling.

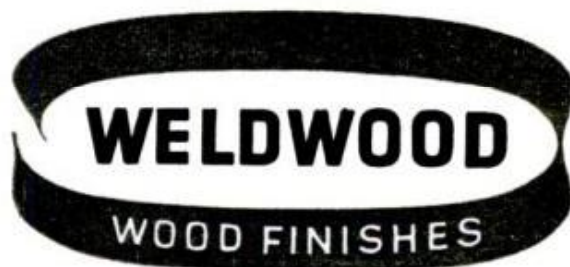

Products of United States Plywood

STANLEY*Ideas***TO BETTER YOUR
HOME ON YOUR OWN**

These STANLEY FALL SPECIALS help

Now is the time to plan the improvements you've always wanted to make in your home.

This Fall, install that playroom or the built-in bookcases your wife has always talked about.

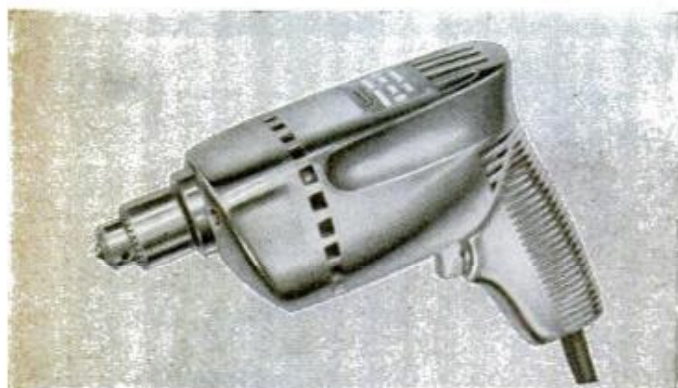

Powerhouse! \$5.00 off on this 1/4" drill. Reg. \$24.95—**Now only \$19.95!** Most powerful 1/4" drill for the price on the market. Use it for sanding and polishing, tool



Stanley Swirlaway Sander. Fits any electric drill. Sands fast. No marring or gouging. **Only \$2.98** with free woodcraft plans by Steve Dohanos, famous POST artist.

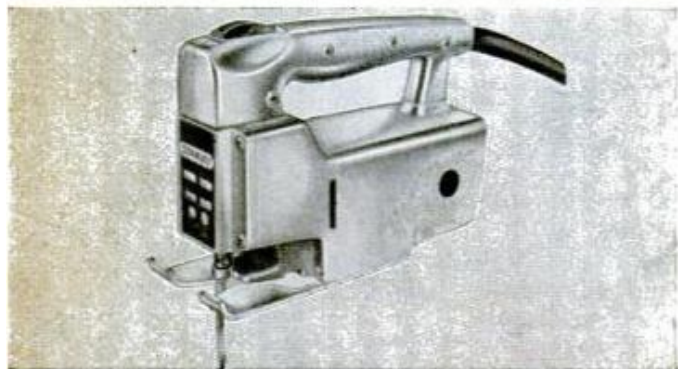

Heavy-duty Sabre Saw—only \$46.95—with 7 assorted blades worth \$4.90 **FREE!** Cuts scrolls, curves, wood, metal. Perfect for all valances and cabinets.

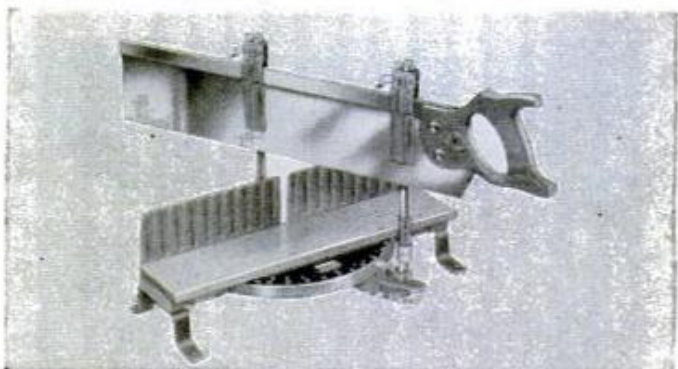

Save \$4.35 on Mitre Box with saw! Fine for mitre cuts on mouldings, picture frames, cornices with joints. Reg. \$44.30—**Now \$39.95.** For joints that really fit.



NEW! Stanley Finishing Sander . . . only \$34.95! 2 packages of assorted sanding sheets **FREE.** Sands and fine-finishes all furniture. Ideal for small work areas.



6 months free subscription with each of these tools

Steelmaster Hammer—only \$5.25! "Tempered Rim" minimizes chipping. Non-slip grip. **Stanley Plane—\$11.00!** The favorite of home craftsmen everywhere.

Free!

This 50¢ booklet free at your dealer's with the purchase of any one of these Stanley Fall Specials! Features 20 illustrated pages of home improvement "how to" with the accent on ideas for better living. If dealer's supply is temporarily exhausted, write The Stanley Works, 6210 Elm Street, New Britain, Connecticut.



you make exciting ideas come true

Refinish fine furniture... design attractive kitchen cabinets... add a carport. Just look

at the wonderful Fall Specials now being featured at your favorite Stanley dealer's!

REAL CLOSET LUXURY!

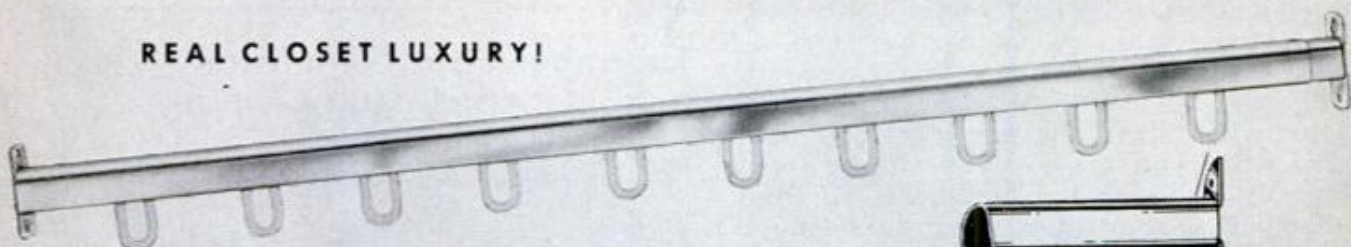

Eliminate hanger tangle with Stanley "snap-in" glides that slide easily and quietly—*automatically* space your clothes. Or if you must crowd your closets, go ahead. This bar is strong, stays rigid however you load it with extra clothes hangers. Long-lasting bright nickel finish.

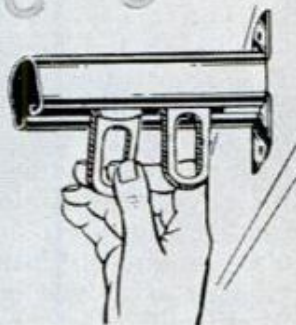

NEW! Stanley Adjustable Closet Bar with 10 smooth-riding nylon hanger glides... Reg. \$2.88

—Now **\$2.29!** Installs in seconds with only 4 screws, ready for immediate use. Size 30"—adjustable up to 48"

SEE DOZENS OF OTHER hardware home improvement items at **Stanley Hardware Centers** in leading stores near you.

NEW! Stanley Shelf-Master Kit

24 pieces... only **\$4.98**
(Reg. \$5.98)

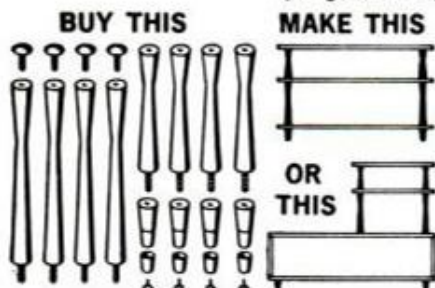

... or make dozens of other tables, bookcases, desks, etc. Kit includes 4 each 10" and 14" spacers and legs; 4 brass ferrules, 4 no-mar glides, and instructions. In natural finish, ready to stain.

WOOD LEG SETS of 4

only **\$2.49** and up



Decorator style, gracefully tapering hardwood legs for bed frames, chairs, tables and easy, quick furniture modernizing or repair. In natural finish, ready for stain. All hardware included. 6"—\$2.49 (reg. \$2.98); 12"—\$3.49 (reg. \$3.98); 28"—\$5.98 (reg. \$6.98). Also 4", 8", 16", 20" and 28" sizes.



No-mar, self-leveling, self-locking feet.

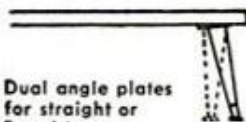

Dual angle plates for straight or flared legs.

Special offers end December 31, 1960 • Prices slightly higher in Canada

STANLEY

REG. U.S. PAT. OFF.

AMERICA BUILDS BETTER AND LIVES BETTER WITH STANLEY
This famous trademark distinguishes over 20,000 quality products of The Stanley Works, New Britain, Conn.—hand tools • electric tools • builders hardware • industrial hardware • drapery hardware • automatic door controls • aluminum windows • stampings • springs • coatings • strip steel • steel strapping—made in 24 plants in the United States, Canada, England and Germany.

CANADIAN PLANTS: HAMILTON, ONTARIO AND ROXTON POND, P. C.

Wiring Your Playroom

(Continued from page 212)

Bending the conduit is usually done with a conduit bender, but a pipe tee connected to a length of pipe makes a good substitute tool. The bends should be gradual and not more than four 90-deg. bends should be used in a run between two boxes. The connector locks the pipe to the box through one of the 1/2-in. knockouts. After installing the conduit and boxes and finishing the walls, use a fish tape or length of steel wire to pull the insulated wires through the pipe, Fig. 11. Shaking some talc on the wires helps to lubricate them and makes it easier to pull the wires through conduit bends.

Armored cable commonly called BX is flexible and easy to handle, but it must be used indoors in dry locations and only with metal boxes, never bakelite or porcelain boxes. Cut the armor with a fine-tooth hacksaw, being careful to avoid the insulated wires. Hold the saw at an angle and saw across one turn of the sheathing. Twist sharply to break the metal, Fig. 15, and then pull off the armor. For splices remove about an 8-in. section of armor.

It is important that fiber bushings be used to protect the insulated wires from jagged metal edges of armor. Unwrap the paper backing and insert the fiber bushing between armor and insulation, Fig. 16. The connector slips over the end of the wire, and the bond wire fastens under the set-screw. A locknut holds the connector securely in the box, Fig. 17.

Staples or straps support the cable every 4 1/2 ft. and within 12 in. of every box. The cable can also be supported by running it through holes drilled in the joists.

Non-metallic sheathed cable should be used only in dry places. An exception is the plastic-covered cable, which may even be used underground. The advantage of sheathed cable is in its flexibility and ease of handling. It is inexpensive and generally used to install additional wiring in finished houses. The protective sheathing is easily removed by pulling the rip cord, Fig. 13. Both metal and non-metallic boxes may be used. Most boxes have built-in clamps to hold the sheathed cable.

Connecting and Splicing Wires

Wires must run continuous from box to box, and all splices and connections must be made inside the boxes. The splices and connections require special attention to make the system safe and strong and get full use of the electric power.

For a good terminal connection the wire is twisted around the screw in a clockwise direction to avoid loosening it as the screw

is tightened, Fig. 6. The easiest way to join two or three wires is by wire connectors, often called wire nuts. These connectors do not require soldering or taping. About 1/2 in. of the wire is scraped bare, and two or three wires are joined by screwing the connector over them, Fig. 5.

All other splices are made with solder and tape. To make the splice, scrape about 3 in. of insulation from the wire until bright and clean. Twist the ends together and coat them with a non-corrosive soldering flux. Then dip the wires in solder or apply solder with a torch or iron. The bare wires are wrapped with plastic electrician's tape, extending it over the insulation to make the wires waterproof and provide the proper insulation. ★ ★ ★

Thermoelectric Generator Delivers 5000 Watts of Power

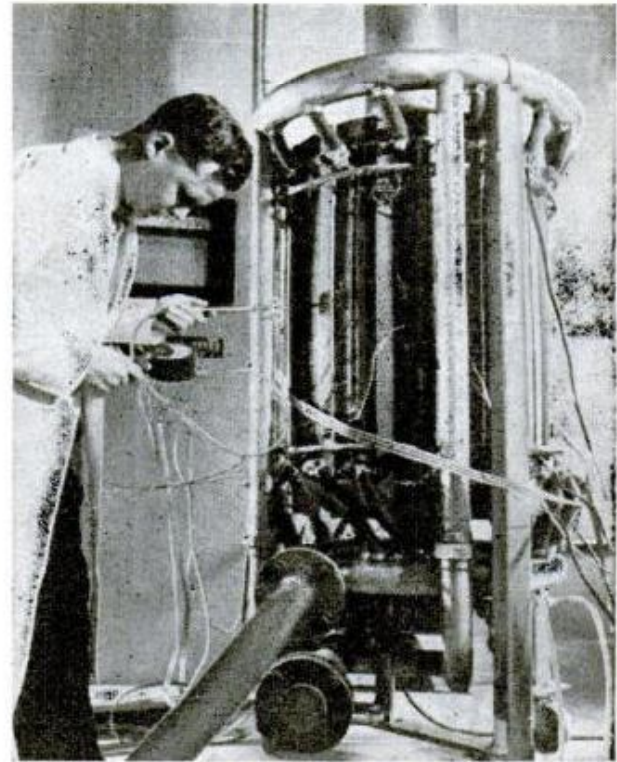

Directly converting heat into electricity, a new thermoelectric generator developed by Westinghouse for the U.S. Navy has no moving parts but delivers 5000 watts of power—enough to light 8 to 10 average-size homes. It is built in 2500-watt sections, each resembling a hollow cylinder 30 inches across and 30 inches high. Kerosene is burned inside the cylinder while the outside surface is cooled by water. Electricity is generated when heat flows from the hot to cold faces. Pumps for the water and the fuel burners are operated by electric motors taking their power from the generator.

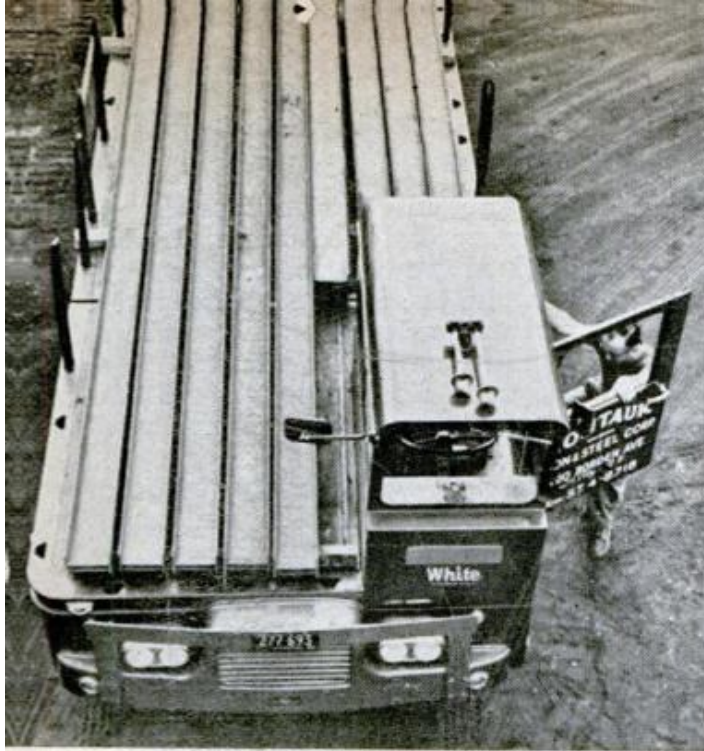

*17 out of 21 U. S. truck makers
specify Champions . . .*

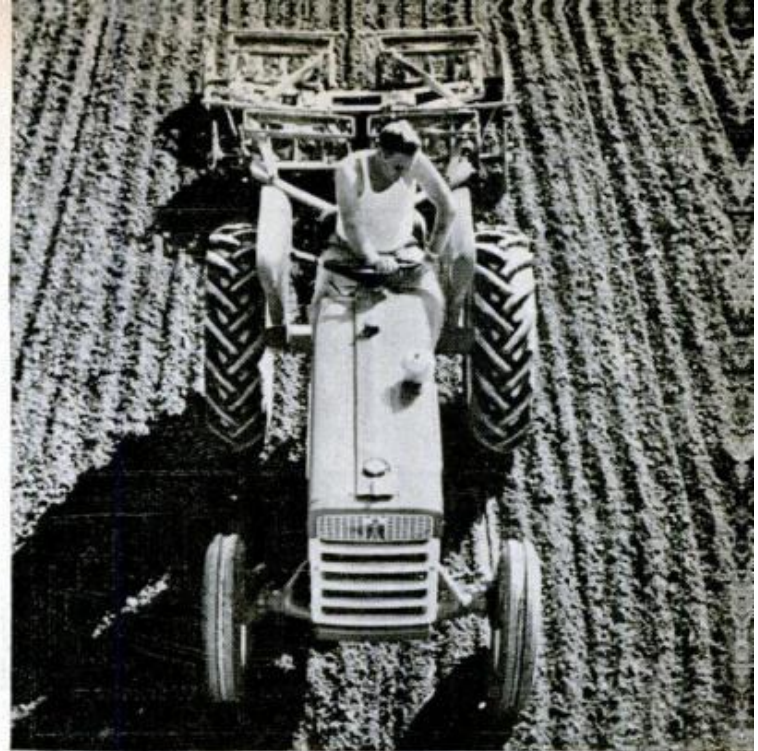

*Every major U. S. tractor maker
specifies Champions . . .*



*Every major U. S. small-engine maker
specifies Champions . . .*



*Over twice as many car manufacturers
specify Champions.*

Q.

Why are Champion spark plugs overwhelming favorites with men who design and build engines?

A.

Because they know they can depend on Champions to deliver every bit of performance they've built into their engines. Your car will perform better (and save on gasoline) with new Champions. Put in a set every 10,000 miles!

*Worn spark plugs waste lots of gas—
so check your plugs every 5,000 miles!*



Материал, защищенный авторским правом

6 do-it-yourself ideas

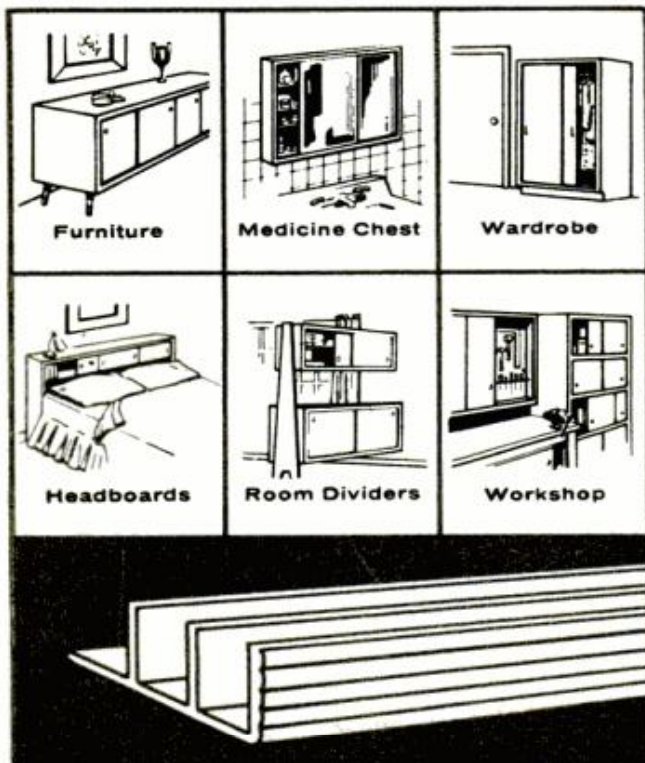

with Reynolds Aluminum sliding door track

Make 'em yourself fast and easy. Get free "how-to" project sheets from your dealer or mail coupon below. Sliding Door Track available for use with $\frac{1}{4}$ ", $\frac{3}{8}$ " and $\frac{1}{2}$ " plywood, pegboard, screen and storm window sections.

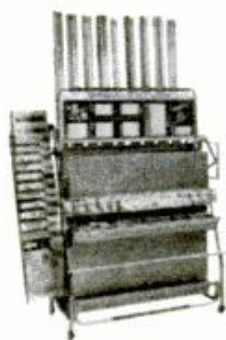

Look for this rack at most hardware and building supply stores.

sheets, tubing, tubing fittings, window and screen frame sections, fasteners, rod, bar, angle

Reynolds Metals Co. • Richmond 18, Va.

Please send Do-It-Yourself Aluminum How-To booklet with free sliding door track plans.

Name

Address

City Zone State

Dept. PM

"Poly" Coddles Plants

(Continued from page 147)

Such increases not only prevent frost damage in winter but greatly accelerate growth during the warm growing season.

In addition, the plastics tend to keep irrigation moisture on or near the surface longer, minimize unwanted mineral deposits in topsoil, discourage growth of weeds, and prevent damage from high winds.

Chief advantage over glass or plastic greenhouses is the cost, plus mulching benefits and weed prevention. Black plastic is especially helpful with weeds.

Necessity Breeds Invention

Gary began his experiments because of an irrigation problem. The water is scarce near his nursery and Santa Paula's water has a high mineral content.

For mulching, polyethylene strips are spread on the ground around each tree, covering the earth from the circumference of the tree trunk to a point about six inches beyond its foliage. For lean-tos, the plastic sheets are stapled to wood stakes which are driven into the ground at an angle on one side of the plants.

Gary reports a 20 percent increase in growth with mulch coverings alone, and a 40 percent increase when plastic windbreaks are used, too. He also found that the windbreaks are more important for increasing ground temperature than for windbreaking, and he is now experimenting with windbreaks on both sides of the plants to get maximum benefit from the plastics.

Grows Trees, Plants, Rootstocks

Gary specializes in the production of disease-resistant orange and lemon trees for commercial growers and retail outlets. To obtain budwood for such trees, he grows plants with seeds from diseased trees (such plants are usually nonsusceptible to their parent's ills) and then determines which seedlings are capable of producing acceptable fruit. In some cases, he must let them grow eight years.

Disease-resistant rootstocks are also grown, and these can usually be budded in two years or less, depending upon how fast they grow. And since he grows far more rootstocks than full-grown trees, the speeding-up process of the plastics is important.

Gary estimates he spends only 1½ cents per square foot in polyethylene, for which he has been able to utilize his land with 40 percent greater efficiency. ★ ★ ★



Races through 2x8's even at 45° angle



Perfectly balanced for comfortable one hand control



Fast, accurate, precision cuts in any material



Famous B&D dependability, prized on top construction jobs



NEW B&D #437 Utility 7 1/4" Saw. Extra capacity and power in an economically priced 7 1/4" Saw. Complete adjustment for cutting-depth and bevel sawing up to 45°

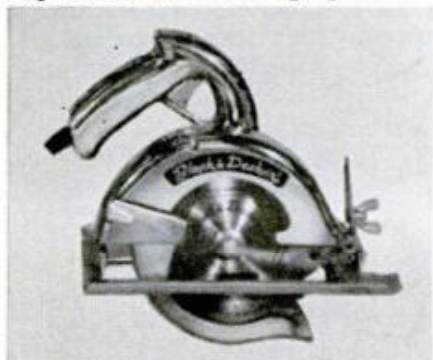

B&D #63 Heavy-Duty 6 1/2" Saw. Famous B&D built motor. Tough, durable, yet a doll to handle. Professional features and performance make it the choice of the experts.

B&D Saws speed up any cut in any material, on any job

You'll like the versatility and power of B&D Saws. They're built to take it . . . to do a full *day's* work, *every* day, *all* year. Built to respond with trigger-quick action for fast, precision, swerve-free cutting. Famous B&D dependability keeps work moving at a fast pace.

Pick up any B&D Saw and you're assured of greater job accuracy with easier handling control. You'll especially like the way husky B&D power flows out over the heat-treated, triple strength gears and lubricant sealed bearings.

When you try a B&D Saw notice the totally enclosed blade, depth and bevel adjustments, heat-treated reinforced brackets and shoes, and automatic safety-release switch. You can count on B&D Saws even on the toughest job. Black & Decker Saws give you *real* action and important *labor saving* features. Prices start at only \$49.95. For free catalog, write: THE BLACK & DECKER MFG. Co., Dept. D-100, Towson 4, Md.



Black & Decker®

WORLD'S LARGEST MAKER
OF POWER TOOLS



RP[®] EZ KLEEN[™]

the air filter with everything

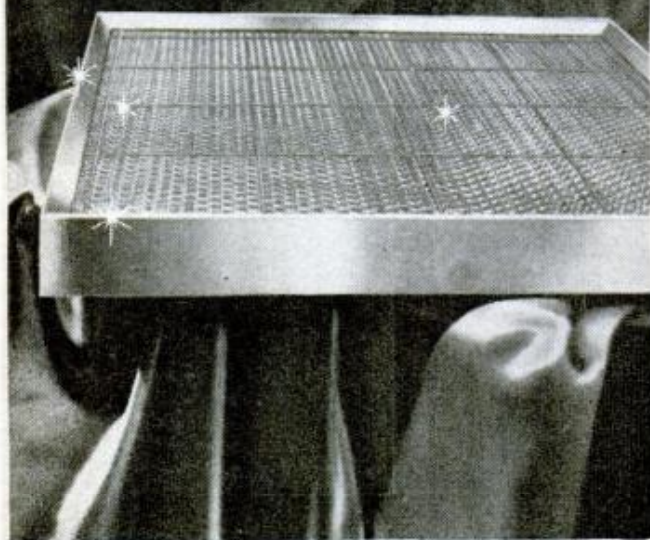

for furnaces and air conditioners

- * REMOVES DUST, DIRT, POLLEN
- * REMOVES ODORS
- * KILLS BACTERIA
- * ALUMINUM
- * CONVENIENT
- * WASHABLE
- * LONG LASTING
- * EFFICIENT

Send for **FREE Booklet**
Complete information on what
to look for in an air filter

There is a
difference
in **AIR
FILTERS**

See Your Dealer or Write
RESEARCH PRODUCTS Corporation
Dept. 2009, Madison 1, Wisconsin

IN CANADA: HICKS-BAKER LTD., WINNIPEG • SPALL-BOWMAN LTD., GUELPH

Excess Humidity

(Continued from page 206)

sources, should be tracked down and remedied.

Condensation in Walls

During cold weather warm, humid air inside of a house always moves toward outer walls, floors and ceilings because of its attraction to cold, dry air with which it unites to release its moisture content. Water vapor slowly but steadily passes through most materials of which walls are made. To prevent this penetration and subsequent condensation on sheathing in outer walls as shown in Fig. 14, insulating batts and blankets used in house construction have vapor-barrier coverings. A wall filled with blown-in insulation requires a separate vapor barrier, which may be a sheet of polyethylene plastic or other equally effective membrane. Vapor barriers are always placed on the side of the wall facing the heated interior. Besides membranes, there are a number of highly effective sealers that are applied by brush or spray gun.

Vapor barriers also are needed at ceilings under unheated attic spaces. A room added to the outside of a house should have its ceiling covered with a vapor barrier, as in Fig. 11, before the plaster base or dry-wall materials are applied. Floors over unheated crawl spaces should also be provided with vapor barriers, usually directly above the insulation, if the latter does not already have a vapor barrier. It is highly important that vapor barriers be continuous, all laps and joints being sealed tightly with appropriate cement. Builders of new homes should insist that suitable barriers be installed on the room side of exterior walls, also ceilings.

Ventilation of Attics

Sometimes the partitions of a house serve as flues that conduct moist air from the basement to the attic. The cure for this is to seal the openings at the basement. Unheated attic spaces require adequate ventilation to carry off humid air and replace this with fresh outside air. Vents also help to keep the attic cool during hot summer months.

Ventilation in attics under gable roofs may be accomplished with louver-type vents as shown in Fig. 15, the intake and outlet vents being at opposite ends. The total area of the louvers should be $\frac{1}{500}$ of the area of the attic space. Other types of roofs require other types of vents. Even the small spaces between rafters of a flat roof require adequate ventilation. ★ ★ ★



MARLITE RANDOM

PLANK... beautiful Trendwood® paneling for wash-and-wear walls anywhere!

You can remodel a room in a weekend with this new fully-finished paneling that provides almost unlimited decorating possibilities. Six exclusive Trendwoods—Danish Birch, English Oak, Swedish Cherry, Italian Cherry, Swiss Walnut, American Walnut—are styled by American Color Trends for any interior, any decor. And Marlite with its baked melamine plastic finish needs no painting or further protection; resists scuffs, stains, dents. An occasional damp cloth wiping keeps Marlite new looking for years. Before you build or remodel, see your building materials dealer, or mail coupon below.



Each tongued-and-grooved plank (16" x 8' x 1/4") goes up over furring strips or existing walls without muss or fuss.

Marlite®
plastic-finished paneling

Marlite Division of Masonite Corporation,
Dept. 1042, Dover, Ohio
Please send full-color building and remodeling
folder on new Marlite Random Plank.

Name _____

Address _____

City _____ State _____

ANOTHER QUALITY PRODUCT OF MASONITE® RESEARCH



T'ai Chi for Your Muscles

(Continued from page 157)

by using the body in such a way as *not* to strain the muscles, *not* to overactivate the heart, *not* to exert oneself excessively."

A teacher and performer of modern dance and of Chinese theater dances, Miss Delza introduced the exercise to her pupils on her return, in 1952, from a four-year residence in China. Among others, pupils include stage and screen stars, and employes of the United Nations, in New York, where she teaches the exercise once a week. She tells her students that with one lesson a week, plus diligent practice, the movements—which have such names as "Single Whip," "Flying Oblique," "The Snake Creeps Down"—and their definite order can be learned in six months.

An example of one of the simpler movements is called "The White Crane Flaps Its Wings."

Says Miss Delza: "Start with feet parallel and the length of your own foot apart. Place the right hand against the forehead with palm out. Raise the left hand with bent wrist over the head. You should feel as if you are suspended by a thread from the top of your head. Bend forward at the waist, left arm moves down and out. Do not move the right arm. This is part of the still-

as-a-mountain one side and flowing-as-a-river on the other. As you come up, bring your arm to shoulder height. Stand erect and bring the left arm to the forehead like the right. Then curve both arms in a position called 'holding the ball.' Bend your knees, keep a straight back. Then exercise the right arm, repeating the sequence.

"This kind of exercise requires patience and poise," she says. "You must feel everything. These movements are never boring and they bring into play every part of the body from the smallest finger joint to the largest muscle." Because such movements must be made in a state of attention, doing the exercise itself, says Miss Delza, makes one alert and easy.

That the exercise is effective in preparing a person physically is borne out by the fact that in Shanghai, where matches have been held, no Western boxer has yet beaten a boxer who trained on T'ai Chi to get balance and power.

That the exercise has wide appeal was shown from results of a television appearance Miss Delza made in New York City at the beginning of the year: More than 1000 people from 40 states wrote in asking for more information on how to perform it. In answer to this, and similar requests from more recent TV demonstrations, she is preparing a book on the subject. ★ ★ ★



"I am drying the dishes, dear!"



**PERFECT CIRCLE
PISTON RINGS ARE BUILT
TO TAKE IT**



THOUSANDS OF GRINDERS IN EVERY CYLINDER

Dirt particles in a cylinder act just like tiny grinding wheels to wear away the face of a piston ring. To protect against this abrasive wear, Perfect Circle 2-in-1 rings are plated with solid chrome—the hardest, longest-wearing surface you can buy.

As a result, wear is reduced an average of 75% over non-plated rings. And, Perfect Circle's chrome plating is 25% thicker than the average of competitive plated rings to provide extra protection and extra life.

In every way, Perfect Circle rings are built to take it. Insist on Perfect Circles—first choice of leading engine manufacturers and mechanics everywhere.



PERFECT  CIRCLE

**PISTON RINGS • PRECISION CASTINGS
POWER SERVICE PRODUCTS • SPEEDOSTAT
HAGERSTOWN, INDIANA • DON MILLS, ONTARIO, CANADA**

Материал, защищенный авторским правом

To save time . . .

Every Tool Box Needs
a compact, easy-to-carry

RIGID

Drop Head Threader Set

Snap a die head in the ratchet ring...cut your thread! Threading pipe, conduit, rod or bolts is as simple as that with a RIGID drop head threader. Heads can't fall out...dies reverse quickly for close-to-wall threading. Finest quality RIGID long wearing dies. Bolt and conduit dies available.

At Your
Dealer's!

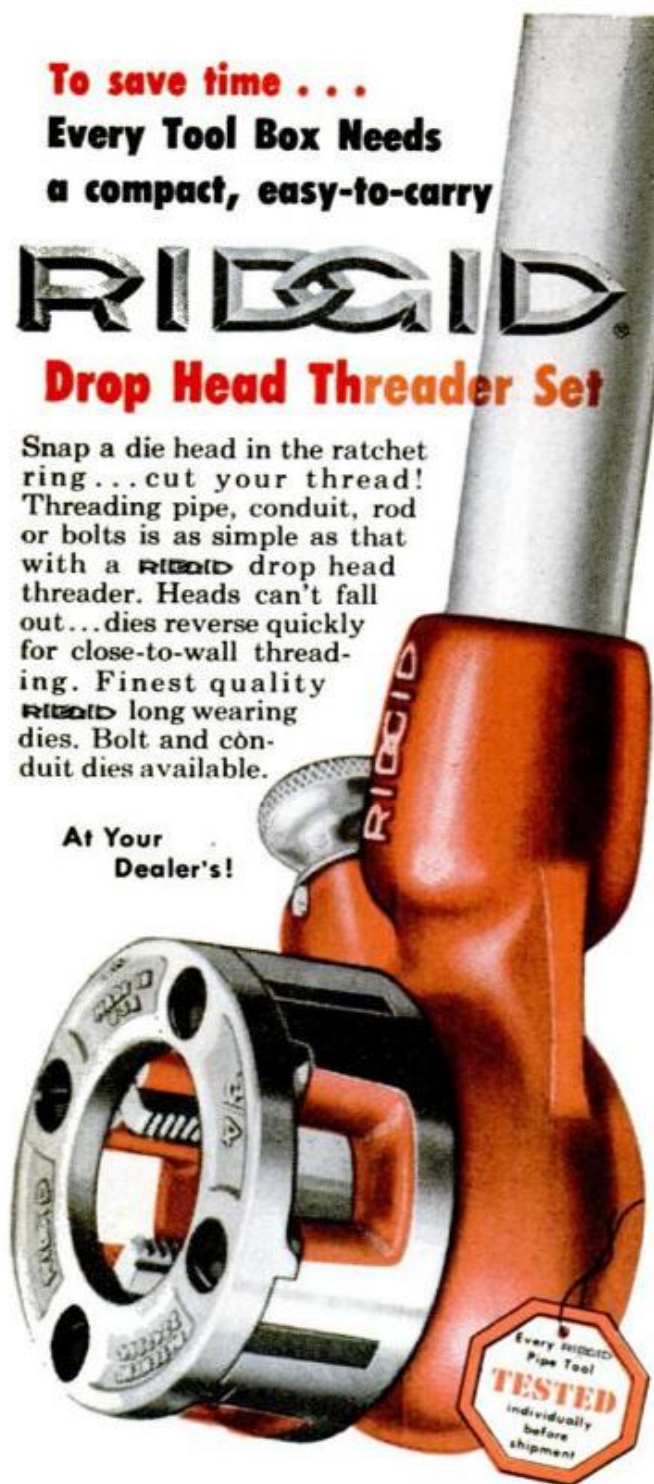

Hand Carrier Free With All Sets Except No. 12-R
(Order in sets or any combination)



Exposed Ratchet Type

For pipe— $\frac{1}{8}$ " to 1"—OO-R

$\frac{1}{4}$ " to $1\frac{1}{4}$ "—111-R

$\frac{1}{8}$ " to 2"—12-R

For bolts— $\frac{1}{4}$ " to 1"—OO-RB



Enclosed Ratchet Type

For pipe— $\frac{1}{8}$ " to 1"—O-R

$\frac{1}{4}$ " to $1\frac{1}{4}$ "—11-R

RIGID

The Ridge Tool Company • Elyria, Ohio, U.S.A.

Before the Siren Sounds

(Continued from page 199)

the beams. First, nail two of the boards to the joist from inside the shelter. Over the sheathing place two layers of concrete blocks using no mortar between them. The work on the roof continues in this manner until the last roof board is covered with concrete blocks from outside the shelter. After all the roof blocks are in place, complete the wall by setting the final rows of blocks in mortar.

Basement walls above ground level require additional shielding. There is approximately an equal amount of shielding in 8 in. of concrete as in 16 in. of books, 20 in. of earth, or 30 in. of wood. Bags of earth or gravel could be stored in the shelter. Then, in case of an emergency, the bags would be ready to stack along foundation walls to provide enough extra protection.

A shelter entrance requires at least one right-angle turn to scatter the radioactive dust. The entranceway and vents usually provide plenty of ventilation for a basement shelter, but a blower is essential for some, especially those built completely underground. In these shelters, vent pipes and filters are used to cross-ventilate the whole area.

Radiation fallout cannot be detected by taste, sight, touch, hearing or smell, and so far no inexpensive test equipment is available. In a shelter a battery-powered radio is essential for receiving local defense instructions and information about when it is safe to come out. The shielding material in the walls cuts down radio reception so much that an outside antenna is needed.

Besides having flashlights with fresh batteries, a shelter should be provided with a 4-cell, hot-shot battery to light a 150-milliamper, flashlight-type bulb. With such a battery, low-level lighting is obtained that furnishes continuous light from a fresh battery for at least 10 days. Besides these emergency lights, regular electric outlets should be available in the shelter for periods when the current is on.

The housekeeping problems of shelter living would require careful family planning. Containers for waste should be on hand. And a 2-week supply of canned food should be kept in the shelter, as well as plenty of water.

For additional information on the construction of fallout shelters, ask your local civil defense organization. Or write the Federal Civil Defense Administration, Battle Creek, Mich. ★ ★ ★

RIDE THE SUNNY SIDE OF THE STREET!



DELUXE DUO-GLIDES
— world's finest motorcycles

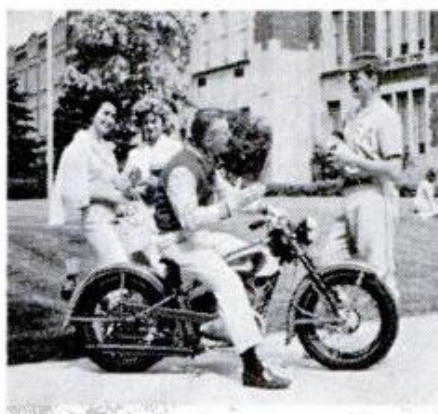

SUPER-10
— most economical lightweight



SPORTSTER CH
— the active man's motorcycle



SPORTSTER H
— most versatile motorcycle



TOFFER — world's top motor scooter



THE NEW SPRINT
— a new class of motorcycling

Get on the beam in 1961 — get there on one of these *six* outstanding models. If your spirit is *wheeling*, you'll visit your Harley-Davidson dealer today. He has 1961 models on his floor ... easy-pay plans that fit your pocketbook. Or mail the coupon for this colorful new folder.

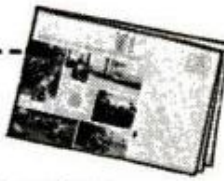

**HARLEY-DAVIDSON
MOTOR CO.**
Dept. P,
Milwaukee 1, Wis.

Send me the facts — how I can have more fun in '61 on a Harley-Davidson motorcycle.

Name Age

Address

.....

HARLEY-DAVIDSON MOTOR CO., Milwaukee 1, Wisconsin



Charles R. Smith, Sr., of Cabin John, Maryland, owns this model 11A 1925 Touring Car, one of the finest Franklins made.

"I keep my classic Franklin in perfect condition with Quaker State, and my new car, too!" This Franklin, with the only air-cooled engine of its day, required a motor oil with unheard of (for those days) stamina and heat resistance. Only one oil—Quaker State—met the test, and the manufacturer *specified* it. Today—35 years later—this car is still in excellent running condition. And Quaker State is still best for protection, and endurance. Refined from 100% pure Pennsylvania Grade Crude Oil. There is no finer motor oil.

Available most everywhere . . . always ask for Quaker State by name.

For the name of your nearest dealer, call Western Union by number and ask for Operator 25.



QUAKER STATE OIL REFINING CORP., OIL CITY, PA.
Member Pennsylvania Grade Crude Oil Association



Heath Company, Benton Harbor, Michigan

Matching Components For Music Center

Concealed behind wood doors (above) or semi-exposed (below), new stereophonic components provide the maximum variety in listening. Either system provides the user with a choice of tapes, FM or AM radio or stereophonic or monophonic records. Note that all equipment is placed in easy reach and the components which require continuous resetting, such as tuners, are positioned near the top for comfortable viewing during tuning. The use of matched components throughout the system insures maximum stereophonic separation and quality for full stereophonic effect.

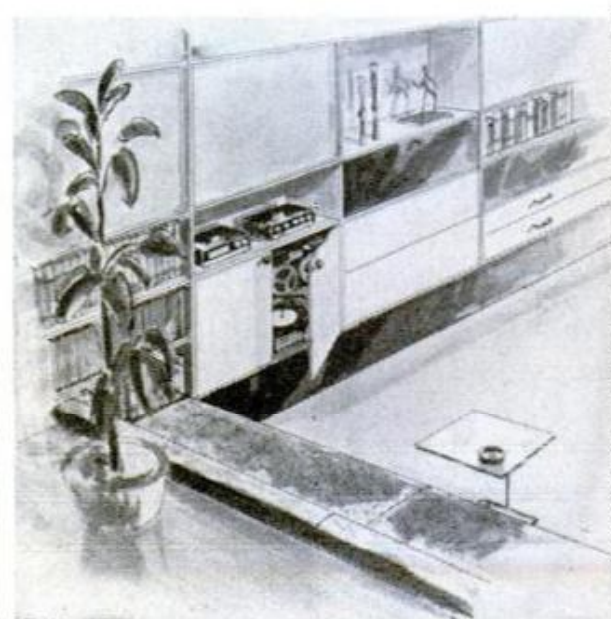

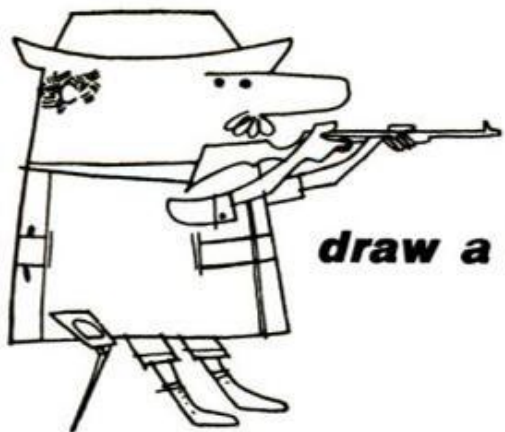

draw a bead on the best!



STOVES AND LANTERNS

Aim straight for your sporting goods or hardware dealer and get the finest stove and lantern that ever came up the road. That's saying a lot, but the facts and figures prove it. For 60 years, more hunters and fishermen have chosen Coleman outing products than any other line in the field.

A Coleman Folding Camp Stove and Floodlight Lantern are your choice for happy hunting. See your Coleman dealer and the complete line of Coleman outing products.



The Coleman Company, Inc. / Wichita, Kansas

SAVE \$

DELTA HOME

on two of the most useful



SAVE \$22.05
Reg. price \$144.95
SALE price 122.90
YOU SAVE \$22.05

Basic tool in every wood-working job—the 9" Circular Saw delivers all the power and built-in precision you need for faster, easier, more accurate cutting. It offers big capacity for ripping, cross-cutting, mitering or beveling—plus extra operations such as dadoing and tenoning. It's the saw you'd want at *any* price—yours to start enjoying *now* at a big \$22.05 savings.*

Cat. No. 34-005 Delta Homecraft
9" Tilting Arbor Circular Saw
equipped with Extension Wings and
Steel Stand.

DON'T MISS THIS LIMITED TIME OFFER!

Hurry on down to your Delta Dealer (listed under "TOOLS" in the Yellow Pages) or visit your leading Department, Hardware or Building Supply Store soon.

SAVE \$

WORKSHOP SALE!

power tools you can own



You can use the new, improved Delta Dust Collector with almost any wood-working power tool for collecting dust and chips at the source—use it for general cleaning in your basement, attic, and garage—or use it for paint spraying and dozens of other jobs. You'll really appreciate the versatility and portability this unit provides—and even more, the \$10.00 you save* on it during this sale.



Cat. No. 49-576 Delta Dust Collector complete with motor and hose.

GET VALUABLE SHOP BOOK

Deltacraft hard cover book, **GETTING THE MOST OUT OF YOUR CIRCULAR SAW**, gives you 120 pages crammed with shop-tested ideas, photographs and drawings. Send check or money order for \$1.00 to: Rockwell Manufacturing Company, Delta Power Tool Division, 502K N. Lexington Ave., Pittsburgh 8, Pa.

**Prices and savings slightly higher in the West*

DELTA POWER TOOLS

another fine product by

ROCKWELL



Sun, Shade and Wind Where You Want Them

(Continued from page 189)

blazing glare of the late, lowering sun so it won't pour in beneath the foliage and bathe the west wall in heat. Depending on the way your house sits on the property, or if you have a terrace on the south side, it may be advantageous to spot a small shade tree in the southeast quadrant to catch the morning sun at about 10 o'clock when it begins to heat things up."

Use Tall Trees for Summer

There are good reasons for using tall high-crowned trees on the south side. The high angle of summer sun varies from about 73 degrees on June 21 to 50 degrees as the season wanes. So, south-side shade trees are most effective if their high canopies overhang the roof. As summer fades, days grow cooler, and the sun creeps further south in the sky, you'll want some warmth. If trees have high crowns, then the lower late-season sun will shoot in under the branches and flood the house. For the same reason high shrubs should not be used near the south side of the house.

What kind of trees are best for shade? Local nursery men and landscape experts can tell you which do well in your area. In most cases, however, shade trees should be deciduous varieties. They are trees that shed their leaves each fall, allowing winter sunshine to filter through bare branches and help warm the house. Steen has a few words of sound advice regarding varieties: "The Norway maple, while beautiful and hardy," he says, "should not be used where you want lawn. The canopy is too dense and its shallow root system robs the topsoil of nourishment. White oak, tall, stately and high-canopied, is subject to an oak blight and should be avoided where the disease is prevalent, just as you'd avoid American Elm in the northeast. Fruit trees tend to branch low, so they make excellent shade candidates for the western side of the property. But be ready to gird yourself for a rigid schedule of spraying throughout the budding and fruiting season, or you'll wind up with an unsightly mess of rotting, wormy fruit on the lawn. This can make the trees more of a handicap than an asset."

Chart Lists Shade Trees

The best shade trees, according to Steen, are those with a lacy bower, deep roots, no pods or shedding bark to dirty the lawn, and dense, sturdy wood to withstand wind, ice and snowstorms—especially in northern areas (see chart for a few shade tree suggestions).

SHADE TREES

Eastern Areas

American Beech
Locust (thornless and podless varieties)
Sugar Maple
Pin Oak
Tulip Tree

Southern Areas

Magnolia
American Beech
Locust (thornless and podless varieties)
Sugar Maple
Pin Oak
Tulip Tree

Midwestern Areas

Little Leaf Linden
American Beech
Locust (thornless and podless varieties)
Sugar Maple
Pin Oak

Western Areas

Tulip Tree
Magnolia

*Many other trees will thrive in specific local areas. Check your nurseryman. Avoid trees that are soft or brittle, such as Chinese elm or soft maples that come apart in storms; shallow-rooted poplars that steal food from lawns and raise walks; "dirty" trees like arbutus and sweetgum that litter the lawn with fruiting pods and bark. Trees like willows, box elder and poplars should be far from septic fields and tanks because their roots intrude the lines, break them and plug them. Trees subject to local diseases—like white birch and American elm in the northeast, and white oak in many areas—should be avoided at all cost in those areas.

Roof overhang of two to four feet on a one-storey house will serve as well as trees in shading a south wall during summer's height. But if your home isn't architecturally suited to such a device, and shade trees aren't practical, don't give up. A "plant awning" can be just as effective and, in the right place, surprisingly attractive. A plant awning is simply a vine, such as ivy, wisteria or climbing hydrangeas, trained up a trellis at one corner of the house. Wire mesh, tacked along the wall above the window frames, will give the creeper a natural pathway to follow. And it will grow along the track by itself, filling out more and more each year until it forms a bushy green eyebrow two to three feet thick along the length or breadth of the house. If you pick a vine that drops its leaves in winter, the living awning will provide shade in summer, and allow winter sun to penetrate and warm the wall area it covers. If flowering vines are used, your house will wear a unique garland in the season of bloom.

Many older homes have sun rooms and sun porches with huge window areas facing west or southwest. Usually they're fine and cool in the morning when no one uses them; maybe even too chilly and dark for breakfast on a nice morning. But on hot summer evenings, for which they were de-

(Continued to page 267)

**FREE PLANS
FROM MASONITE FOR**



built-in entertainment center



What a wonderful way to divide a room...and add loads of useful fun and storage space!

And it's so easy to make. Complete plans show every detail and complete bill of materials. With easy-to-work *Masonite hardboards**, that built-in entertainment center you've wanted can now be a reality.

**Only Masonite makes hardboard by the exploded wood-chip process.*

"DRESS-UP" TIP: For added decorative beauty you can finish the walls adjacent to any built-in or create an accent wall with Masonite Royalcote cherry or walnut grained panels. They go up in easily handled 16" wide, tongue and grooved planks and stay put—with all their good looks—for years. See these exciting cherry panels with the exclusive patented clip application system at your nearby lumber dealer's.



SEND FOR FREE PLANS



©Masonite Corporation—manufacturer of quality panel products for building and industry. Masonite and Royalcote are registered trade-marks of Masonite Corporation.

Masonite Corporation
Dept. PM-10, Box 777, Chicago 90, Ill.
(In Canada: Masonite Corporation,
Gatineau, Quebec)

Please send free plans for built-in entertainment center.

Name.....
Address.....
City..... State.....
Zone..... County.....



Ruberoid Vinyl-Asbestos Tile—Confetti #777

The most beautiful floors on earth are made by Ruberoid

RUBEROID Floor Tile is the perfect answer to invasions of junior space men and other forms of household wear. It's easy to clean—it's greaseproof and resists household acids. And RUBEROID Tile is so easy to apply. You can do a large room in a

single weekend. Here's a floor tile that's practical enough for kitchens, yet elegant and lovely enough for living rooms. Choose from a wide selection of patterns, colors and styles at your RUBEROID building material dealer's display room.

RUBEROID® **FLOOR TILE**

THE RUBEROID CO., 500 FIFTH AVE., N.Y. 36, N.Y.

signed, they are often the hottest place in the house because they are perfect traps for the blazing afternoon sun. Even blinds don't help because they block the breeze. The hot walls and flat roof of the typical sun porch make an oven of the place.

This is where a vine-covered arbor or pergola, simply constructed against the southwest or west wall with framing lumber and open-work lath, can work miracles. And if you build a flagstone, brick or concrete pad under the pergola, you will have enhanced your home with a high usable, semicovered terrace for outdoor eating. Arbors don't have to be green tunnels, either. Framing and lath can be worked into patterns and designs that cast enough shadow themselves to provide dappled shade. Side walls can be louvered. Variations in design can be effected to match your taste and the style of your home.

Sun room or no sun room, the "hot spot" for most homes is the wall facing most nearly southwest or west. This wall can absorb a phenomenal amount of heat during late afternoons in summer if no shade trees protect it. All night long, the stored-up heat is radiated to the rooms inside. The entire wall becomes, in fact, a radiant heat panel. If a pergola or structural sunshade would spoil the lines of the house, or isn't feasible for other reasons, there still are tricks you can try. Ivy-covered brick, stucco or stone will cut wall temperatures as much as 30 percent. Since vines tend to creep under shingles and clapboard, ivy won't do on such homes. For these, trellises of lath or metal placed a few inches from the bare outside walls will readily support fast-growing climbing plants such as roses. Leafy barriers like vines and climbers not only shade the walls, but also transpire to the air around them. Evaporation of this moisture uses up considerable heat, and you'll usually find that the air pocket between a trellis and a house wall is several degrees cooler than the general outdoors.

If you have a green thumb and like to work at grafting and pruning, a spectacular wall cover can be achieved with ornamental espaliered trees. Usually slow-growing varieties of fruit trees, these decorative plants are carefully cut back each year. Only the shoots that extend in the pattern desired are permitted to grow. The branches of an espaliered tree, grown flat against a house wall, can be pruned and trained to bracket windows or arch over doorways in graceful, blossoming designs. Such plantings can provide your home with a decorative, pictorial effect, eliminate the severe look of large expanses of bare wall and, most important, give needed protec-

tion against merciless summer sunshine.

"Arbors, plant awnings and other plantings that overhang windows and bays," Steen points out, "have the added advantage of protecting drapery fabrics, carpets and furniture upholstery from fading and deterioration due to strong sunlight. But there's something to remember about wall climbers. On a wood-shingle or clapboard house, you will be faced with the problem of a paint job. Espaliered trees, trellis climbers and vines are a pain in the neck against painted walls when painting time arrives. For natural-colored masonry, all right. But," he adds, "if flowering climbers or trees are used against the house, give some thought to how the color of the blossoms will look beside the wall colors. You can achieve some ghastly effects with magenta blossoms against red brick, for instance."

Not everyone wants to block out sun and loosen up foliage so breezes can drift through. "In North Dakota, where I grew up," says Steen, "people are more interested in shelter belts to break the winter prairie gales and summer winds than they are in shade. And in the chilly North and West, it may be desirable to soak up sunlight in traps during the heat of the day, so outdoor areas are comfortable for evening cookouts."

Many people think of windbreaks as long, straight rows of trees or high slatted fences. This is hardly necessary, or even good. In most areas, cold winds blow in from the north, northeast or northwest; soft, warm desirable summer breezes hail from the south, southwest and west. If a wind fence, or a high hedge of dense evergreens and shrubs—such as hemlock and arborvitae—is constructed so that it curves around the northern and easterly sides of your home, it will block the northern gales throughout the winter, deflecting them from house and environs. The same curved hedge, however, being open to south and west, will scoop up summer breezes and guide them in toward the house and across any patio enclosed by it. If the curving line of the hedge or fence comes in closer at one corner of the house, it will tend to squeeze the breeze through the bottleneck, increasing air motion across the area beyond the corner. A patio or terrace located there would be noticeably cooler than any other place around.

If your area differs from the norm, the same idea can be adapted to accommodate any condition of prevailing wind. And it will pay off abundantly. According to controlled tests, such a wind buffer, if it slows a winter blast from 12 to 3 miles an hour

(Continued to page 268)

(Continued from page 267)

when the temperature is 32 degrees, will cut fuel consumption for that day precisely in half. Properly built and located windbreaks have reduced annual fuel costs by nearly 23 percent at government agricultural experiment stations.

When it comes to terraces and "outdoor living rooms," Clayton Steen is at his best. "This is where you want real comfort," he says. "Sun and shade must be in the right places at the right times. For the kids, the sand box calls for sun during sand-box time; the playhouse should be shaded from hot afternoon sun. The terrace must be sheltered from cold wind, but should snare evening breezes so grownups can use it at night. It should be dappled with warm sunlight on a summer morning if the family likes to breakfast outdoors. Everything, besides being pleasant and decorative, must be geared to the use that the family will make of it. It's a family affair."

To achieve desired effects, Steen has dozens of ingenious tricks up his sleeves. On a cold, windy hill overlooking a broad sweep of valley or lake where winds build up, his circular terrace may be dropped below grade, with a curved windbreak hedge or sapling fence on the windward side. In this way, the sun's warmth collects in the pocket during summer afternoons,

and radiates gently during chilly evenings without being blown away by damp breezes off the water. "Such an arrangement allows the terrace to be used much earlier in spring, and late into fall," he says.

Suppose the view is on the windward side? A curving fence or hedge can be built around a glass window frame of the same height with considerable effect.

"Today," Steen points out, "you can get good looking louvered fences in wood or aluminum, and arrange the louvres so that they break unwanted winds, but catch desired breezes during hot periods and swirl them around the entire area."

The landscape expert has used fan-shaped sun "visors" covered with plastic panels to shade particular parts of a terrace from unwanted sun. "One spot can be warming up while another corner is cooling, by applying ideas like this in combination with plantings," he says.

Small pools can do a great deal to cool a protected corner on a terrace, and all good landscape architects use them effectively. It takes a tremendous amount of heat to evaporate water, and cool air around an attractive pool is almost always present if you can box it in with dense plantings so it doesn't dissipate too quickly. "Even the cool 'look' of a pool is a psy-

(Continued to page 270)



Velvet-smooth smoking is milder smoking — cool and comfortable — from first puff to last. Velvet's aged burley tobaccos are selected and cut to burn slower and smoother in any pipe.

Spend the rest of your life on Velvet!

IN POCKET TINS,
REGULAR
AND LARGE SIZE
HUMIDORS

© 1959 LIGGETT &
MYERS TOBACCO CO.

Tips from Weldwood—the people who know what's good for wood

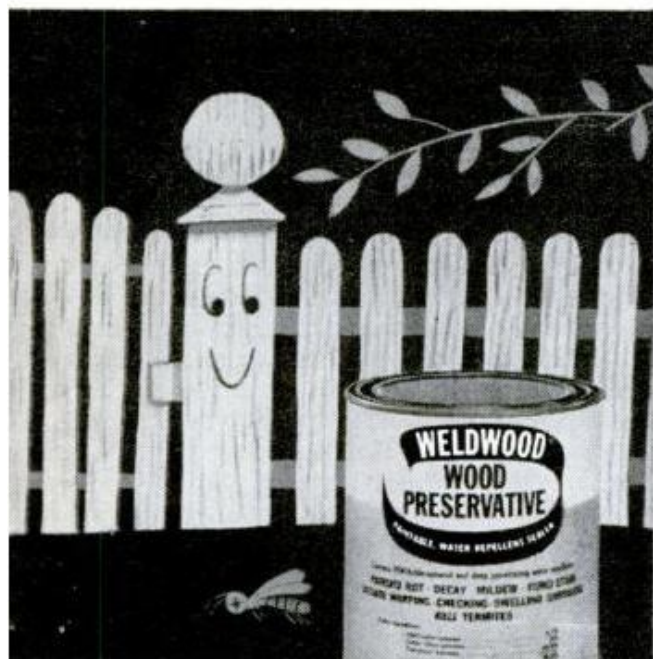

Kill termites, prevent rot with
WELDWOOD WOOD PRESERVATIVE . . .



Add lasting color to outdoor wood with
WELDWOOD EXTERIOR STAINS . . .



Seal and prime outdoor wood with
WELDWOOD FIRZITE . . .



Protect and beautify outdoor wood with
WELDWOOD SPAR VARNISH . . .

WELDWOOD® WOOD PRESERVATIVE, essential where wood is in contact with earth, contains full 5% pentachlorophenol.

WELDWOOD EXTERIOR STAINS, 4 beautiful "woody" colors: Redwood, Driftwood, Cascade Green, Sierra Brown.

WELDWOOD FIRZITE®, a penetrating resin-sealer for fir plywood, pine, etc. Comes in *Clear* to prevent "wild grain" on stain jobs; and in *White*, a pigmented prime coat to combat checking in paint jobs.

WELDWOOD SPAR VARNISH, durable, high gloss exterior clear varnish that resists discoloring even in severe weather.



Products of United States Plywood

AIR PRESSURE FOR 101 JOBS!

JOHNSON RED HEAD PORTABLE AIR COMPRESSOR

for home, shop
and farm

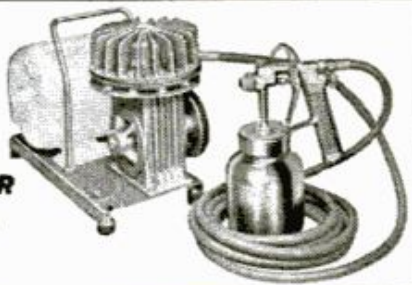

There's simply no end to the jobs you can do with this new all-purpose unit! Red Head lets you do scores of chores better, faster, easier! For example:



SPRAY PAINTING—furniture, fences, siding, screens, porches, boats. Red Head gives smooth, professional quality results, cuts painting time up to 85% or more! Easily handles heaviest multi-color paints!

GARDEN SPRAYING—spray insecticides, fungicides, weed killers. Protect roses, shrubs, flowers, vegetables. Fine mist covers all surfaces. No waste.

INSECTICIDE FOGGING—enjoy outdoor living more. Use your Red Head to spray away pests and bugs around patio, fireplace, lawn.

AUTO CARE, HOBBIES—do your own greasing, waxing, refinishing. Cleans, sprays, blows, inflates. Every workshop needs a Red Head!

FARMS—sprays heavy machinery enamels easily. Cleans machines in a jiffy! Use Red Head *Insectospray* attachment for push-button barn fogging. Red Head saves time, money—pays for itself!

MOST EFFICIENT UNIT MADE!

Powerful Red Head delivers full 3.5 cfm free air and 50 psi pressure—easily out-performs many larger ½ hp units. Finest quality features throughout. Compare Red Head's price, quality and power with other compressor outfits. Fully portable. Only 10" high, weighs under 30 lbs.

COMPLETE KIT includes compressor, spray gun, 15 ft. air hose, pulleys, V-belt, tire chuck and fittings. Use any ¼ hp or larger motor.

NEW POWER AIRE Model

Model 105 offers the same rugged power and efficiency as the Red Head. Has built-in compact ½ hp GE electric motor. Delivers clean, oil-free air. Portable. Carry unit anywhere—weighs only 23 lbs. Sold with same complete kit as Red Head.



36 Other Models from \$30

Write for Catalog

Johnson Service Co., Compressor Div.

Dept. CE, Milwaukee 1, Wisconsin

Please send free catalog describing the Johnson line of compressors and sprayers.

NAME _____

ADDRESS _____

CITY & STATE _____

chological help on a hot evening," Steen maintains. "And so are the colors and textures you use on a terrace. In shaded areas, white paving, sand, and light tones have a clean, warm appearance. In hot spots, darker tones—gray gravel, slate, flagstone—appear much cooler. And such things make for easy maintenance."

If the terrace is relatively unshaded, and close to the house, light-colored paving material should not be used, according to Steen. "Hot summer sun will reflect from it and glare through the windows, radiating off ceilings and walls," he points out. Even concrete walks close to the house are heat-bouncers, and thick plantings between them and the house will help lick the problem if you're stuck with such a walk. By making a walk of small flagstones, separated intermittently by patches of lawn, the heat reflection factor will be considerably reduced.

"Sometimes the smallest things make a big difference," Steen says. "Even poorly-chosen colors can wreck a perfectly good control idea. With a highly reflective, light-colored terrace, you avoid painting a house white, yellow or pink. Those are better with a dark-surfaced, shady terrace. For the bright one, the house should go to gentle grays, off-browns and tans.

"And," he continues, with a grimace, "I wish people would learn that shocking colors on a house may look fine in the advertisements, but most of them clash forever after with any flowers the owners plant around them. The fact is that most flower gardens look their best against a dark gray house.

"The whole thing is a matter of fitness and common sense." ★★★

Powdered Paint

Dry painting—spraying powdered paint onto a surface for instant drying—now is being developed to replace liquid spraying or painting in some applications. In explaining the process, Joseph Gaynor, a chemical process engineer for General Electric, said that a constant injection of air or gas can keep particles of paint mixing in automobile-factory paint bins, for example, thus eliminating the need for a solvent. Getting the dry paint to stick can be done by heating the metal just above the melting point of the paint particles so that they melt and flow into a smooth coating, said Gaynor. Applying glue or a tacky substance to the metal before the paint is sprayed also would make the paint stick until it is heated.

Now...You Can Have a House of Built-Ins with...

NuTone Built-Ins

For Convenience, Comfort and Family Fun

FEATURED IN

POPULAR
MECHANICS



America's Finest homes include NuTone Built-Ins . . . because they make housekeeping easier and add luxury at low cost

NOW—AN INDOOR BUILT-IN BARBECUE AND A BUILT-IN STEREO SYSTEM

Pictured at the right is NuTone's fabulous new Built-In Barbecue . . . also NuTone's Hood-Fan which keeps the kitchen air fresh, clean and odor-free. Below is the NuTone Built-In Stereo Music System for Stereo records, tape, radio and intercom in every room. Easy to install in standard 4" walls.

NuTone's 5000 Series Hood-Fan
Installed over Built-In Barbecue

BUILT-IN
BARBECUE
and Rotisserie



BUILT-IN
STEREO

for music
and intercom



IF YOU ARE PLANNING TO DO . . .

Remodeling or Building

. . . BE SURE TO INCLUDE NUTONE

- NuTone Hoods & Fans for fresh clean air
- NuTone Intercom-Radio to save steps
- NuTone Door Chimes for a friendly "hello"
- NuTone Electric Heater for bathrooms
- NuTone Food Center . . 6 appliances in 1
- NuTone Built-In Barbecue for indoors
- NuTone Built-In Stereo music system

NuTone

NuTone, Inc., Cincinnati 27, Ohio

Send 4-color brochures about NuTone Built-Ins

NAME _____

ADDRESS _____

CITY _____ STATE _____

Why not enjoy the wonderful world of convenience in your own home . . . with NuTone Electrical Built-Ins!

Free

4-color brochures —
Write NuTone, Inc., Dept. P
Cincinnati 27, Ohio

OCTOBER 1960

271

Mister Rescue and His Bloodhounds

(Continued from page 133)

ground portable unit to be used only on assigned emergency frequencies.

Russ is authorized to work the new VHF channel reserved for search and rescue work, and CAP's Channel 7, which is good for about 15 miles.

Mounted atop the station wagon is the business end of a high-output PA system. Its amplifier peaks out at 40 watts, or about 110 decibels, through a 4½-ft. air column in the horn. It is loud enough that a speaking voice can be heard and understood through it, from two miles away in flat country. This horn is also used for speaking directly to a lost person thought to be nearby, as an aid to getting through heavy road traffic, and a handy means of directing volunteers gathered for a search.

To provide current for this equipment an alternator is used instead of a generator. This device is widely used on police cars because it creates no radio interference, utilizing slip-rings instead of a commutator. It generates alternating current which is rectified to 12 volts d.c., and will provide 50 amperes as long as the motor runs, or about half that amount while it's idling.

For the first five years of his rescue work Russ had none of this fine equipment. He worked with a wobbly Model-A Ford panel truck and second-hand camping gear and paid his own expenses. This was double-tough because when he was called out he had to leave his job without pay. Now and then gasoline money was offered, but this didn't put groceries in the Cone larder.

Here was an odd situation—he was performing a service that was becoming more important every month. (One deputy is on record as saying that Russ and his dogs are worth 400 men on a search.) Lives were being saved, and Russ had only to witness the reunion of one lost child with tearful parents to realize that his job, as he puts it, is "the world's greatest." His scrapbook bulged with stories lauding his work and authorities praised him highly—but he was dead broke and got that way doing the job. His wife had been working to help out, but with a baby on the way she had to stop.

When the two of them had to dine on a lone can of beans one night, the Cones decided search work had to go. Thanis suggested finding a sponsor. But how do you do that? Russ didn't know, but he started for Oakland the next morning with his scrapbook in a last-ditch struggle to rescue his rescue project.

Rattling into town, he noticed the sign on the Calo Pet Food Company, stopped the truck on a hunch and went in. He was tak-

en to Charles Mel, president of the company, who asked to look through the scrapbook. Three weeks later Russ was provided with a fully equipped station wagon and was on the Calo payroll at a regular salary plus expenses.

There wasn't a happier man in California that day, but Russ was a little fearful that he was going to be used as an advertising medium. Mr. Mel calmed his fears by stating flatly, "Even if the Rescue Unit never sells one can of dog food, Russ, we feel that a service such as yours should be maintained as a free public service without you having to suffer for it." And that's the way it is.

RUSS CONE SAYS:

If you are lost, admit it to yourself, then observe these five rules:

1. Stay where you are.
2. Make some kind of shelter or windbreak.
3. Hang a garment where it can be seen.
4. Make noise by pounding a log.
5. Eat, sparingly, anything that does not taste bad or have a milky sap.

★ ★ ★

This Month's "Great Pioneer in Science"

(Page 22)



Michael Faraday (1791-1867)

get
 professional
 finishes -
 wood,
 leather,
 marble
 - in minutes!



... new **DINO-LITE** pressure-sensitive plastic veneer
 ... just press down and trim!

Here's what you've been looking for to take the work out, put the fun back in your finishing and re-finishing jobs. It's **DINO-LITE**, a new pressure-sensitive vinyl veneer that produces wood, leather or marble finishes even the best professional cabinet makers would be proud of!

All you do is peel off the paper backing, press **DINO-LITE** down and trim with scissors. The built-on adhesive sets in 48 hours, giving you a permanent finish that matches wood or other veneers costing five times more!

Produced in America's most beautiful grain and color patterns, **DINO-LITE** is fade-proof, washable, stain and abrasive resistant, and can be polished to a high gloss.

DINO-LITE SALES DEPT. D • 1700 LONDON ROAD • CLEVELAND 12, OHIO
 A PRODUCT OF DI-NOC CHEMICAL ARTS, INC.



WALNUT



CHERRY



WHITE MARBLE

**TRY OUR LIMITED
 \$2 SAMPLE OFFER -**

full 24" x 48" sheet in walnut or cherry woodgrain, or white marble . . . ready to install . . . with full instructions included. Send check or money order along with coupon to above address. Satisfaction guaranteed or money back.

**DINO-LITE Sales Dept. D
 1700 London Road, Cleveland 12, Ohio**

Enclosed is my check money order for \$2.00. (No stamps, please.) Please send me (post paid) a 24" x 48" sample sheet of walnut, cherry, or white marble **DINO-LITE**.

Name _____

Address _____

City _____ Zone _____ State _____



On the
MARKET
for Do-It-Yourselfers

1. BRUSH-ON ADHESIVE simplifies the job of installing ceiling tile directly over plaster. The adhesive is applied with a small brush to the back of the tile in small dabs. Tile is then pressed firmly into contact with plaster and stapled through tongue

Armstrong Cork Co., Lancaster, Pa.



2. PUTTY IN A CARTRIDGE is applied with a calking gun. Cartridge comes with a shaped nozzle that applies putty in a ribbon of correct size and simultaneously smooths it into a triangular fillet. Smoothing with putty knife after application not necessary

Gibson-Homans Co., 2366 Woodhill Rd., Cleveland 6, Ohio

3. DRY LUBRICANT is greaseless and nontoxic. It also is a nonconductor of electricity and as such it is suitable for lubricating electronic equipment such as relays, switches, rheostats, sockets, dials and solenoids. It's perfect lubricant for photo equipment

Strauss Photo Technical Service, Inc., 930 F Street N.W., Washington, D. C.

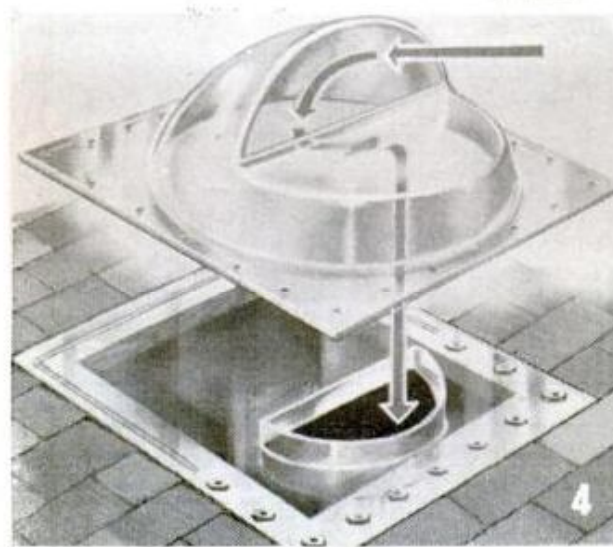

4. SKYLIGHT combines a ventilator that provides a constant flow of fresh air with no chance of rain, sleet or snow getting inside the structure. It's transparent, is easily attached to roof. Comes in various sizes for homes, industrial buildings and boats

Sudbury Laboratory, Sudbury, Mass.

5. FLEXIBLE, PERMANENT MAGNET comes in a strip only slightly larger than ordinary lamp cord. Can be fastened by stapling or gluing. Can also be sewn into shower curtains, drapes, pot holders, or stapled or glued into drawers for holding metallic items

The Crest Co., 26 Avenue B, Newark, N. J.

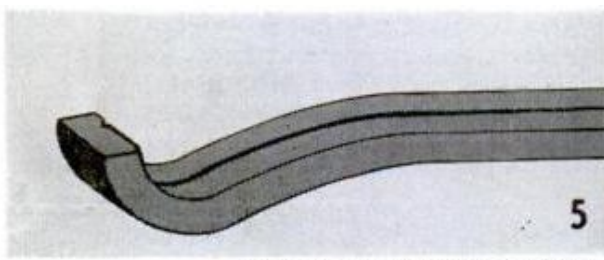

HERE'S ALL YOU NEED FOR ANY BUILDING JOB

No. "888"
Power Unit
\$39.95

No. 8811 Portable
6" Saw \$16.50

No. 8820 Floor
Polarizer \$29.95

No. 886 Portable
Jig Saw \$12.50

No. 8818
Plane \$22.50

No. 882 Orbital
Sander \$15.50

A No. 8821 Hedge Trimmer \$12.95	F No. 2180 Lathe \$34.50
B No. 881 Bench Stand \$ 3.95	G No. 8810 Bench Grinder \$ 7.95
C No. 883 Bench Saw \$29.50	H No. 889 Bench Sander \$ 9.95
D No. 8814 Drill Press Stand \$24.50	I No. 8815 7-to-1 Speed Reducer \$13.50
E No. 8816 Drill Press Vise \$ 5.95	J No. 887 Jig Saw Table \$ 1.95



3 tools in 1
3/8" drill
6" disc sander
6" polisher

*... even major
construction!*

INEXPENSIVE MATCHED ATTACHMENTS—many with new attach-in-seconds Quik-Change feature—make the "888" Power Unit a complete 17-tool power workshop. You can tackle *any* project, from the roof down! Costs much less than individually-powered tools, too. Power increased 25% to full 1/3 H.P. Handsome new high-polish finish. Ask your dealer to let you see and try this amazing, versatile tool today!

Write for free folder
MILLERS FALLS COMPANY
Dept. PM-38
Greenfield, Mass.



JERROLD

The Leader in Master
Antenna Systems presents
**2 GREAT NEW TV-FM
RECEPTION AIDS!**

NEW

magic carpet*

**INDOOR ANTENNA —
OUTDOOR PERFORMANCE**

So easy to install—in the attic, crawl space or closet! Banish that rooftop antenna or rabbit ears. Get signal gain across all TV and FM frequencies. Comparable to an outdoor conical antenna.



MODEL MK-1 **\$9.95**

*Trademark Patent Pending

NEW

Amplified TV-FM 3 SET COUPLER



Efficiently increases signal from any antenna—feeds 3 TV or FM sets. Rugged, compact, single tube... 24 hour operation. No-strip twin-lead terminals.

MODEL HSA-43 List **\$29.95**

Available At Leading Distributors Everywhere

NOTE: Jerrold offers a full line of specialized reception aids including outlets, plugs, twin-lead TV wire, etc. Write for literature.

JERROLD

ELECTRONICS CORPORATION
Distributor Sales Division
Dept. No. IDS-78, Philadelphia 32,

Our Moon Program Starts Now

(Continued from page 142)

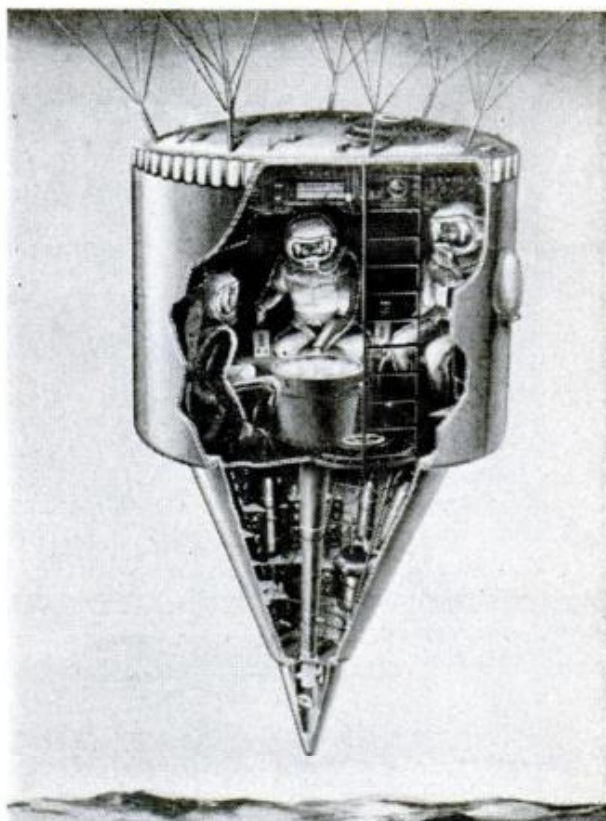

Successful moon shot will end with this scene: Crew floats back to Earth in capsule held up by parachutes

to right itself in its liquid bath after it comes to rest, automatically pointing its antenna away from the Moon.

In righting itself the inner sphere will puncture an exterior seal and the liquid will soon vaporize away. Thus the sphere will settle against its outer shell, making a firm contact through which quake vibrations can be transmitted to its seismometer.

The seismometer is a special design in which Caltech and Columbia are cooperating. It is both rugged and delicate. It is being dropped without protection from a helicopter at 1000 feet altitude, then examined for failures.

The capsule will be heavily insulated against lunar temperatures and will constantly develop some heat of its own because of its battery-powered circuits. This heat will be used to boil water (three pounds of water will be carried on board for that purpose) and the resulting vapor will escape, keeping the interior within safe temperature limits. The principle is something like that of an evaporative cooler. Minimum amounts of water will boil away during the bitter nights, more water will be consumed during the long hot days.

JPL engineers think that capsules of this type will have many uses in the future.

((Continued to page 278))

BUILD THE HOME YOU WANT-



with greater quality—at lower cost
—in less time than you ever imagined!

FOR A HOME OF ANY TYPE OR SIZE

P-B COMPONENTS

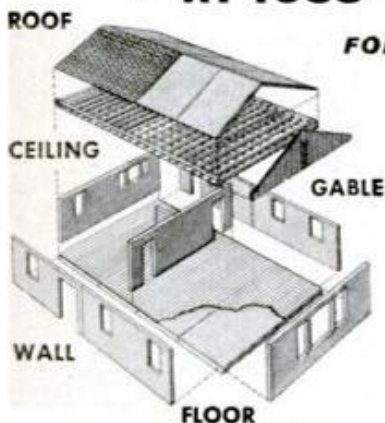

give you today's most advanced engineering techniques in home construction ... Your home is built entirely to your own plan—with the finest building materials and skilled workmanship and is ready for occupancy in less time.

P-B Components save you as much as \$1000. The wall components are wall-size—not in any arbitrary units. Interior finish, insulation, sheathing or exterior finish and factory-finished oak flooring are already in place. (You

have a wide choice of interior and exterior finishes.) Your home is weather-tight—free from drafts, mildew and cracking; walls and ceilings are quiet; you hear no bathroom noises.

Stop dreaming about your new home—build now! Ask the Lumber Dealer who displays our Franchise—or write us for a free 8-page brochure, which tells the full story of how you can build a quality home with low maintenance costs and high resale value. Please address your inquiry to Dept. K-25.

To save money in conventional building—send us your blueprints for a free Cost-Reduction Analysis. They will be returned with an engineering report on the savings you can make with Homasote Materials.



HOMASOTE COMPANY

Trenton 3, New Jersey

Homasote of Canada, Ltd., 224 Merton St., Toronto 7, Ontario



"It's about those electric buses we ordered from your company!"

CUTS A
FANCY
CORNER—

HANDLES
"BIG TOOL"
PROJECTS



Dremel moto-shop

Versatile, multi-purpose tool for every workshop — and one the whole family can use. Handles delicate scroll work, or "big tool" projects. Moto-Shop is basically a 15-inch jig saw with a power take-off. It has a powerful ball-bearing motor — cuts through 1 $\frac{3}{4}$ " wood, light metal, tile, plastics. Table tilts to 45° for angle and bevel cuts, raises and lowers to new, sharp blade area. 4-way blade holder permits cutting in any direction. Moto-Shop is self-contained — no belts or pulleys. Unique blade guard makes it safe for the whole family.

Model 571 Moto-Shop — 15-inch Jig Saw with disc sander attachment..... **\$33.95**

Model 572 Deluxe Moto-Shop — 15-inch Jig Saw with disc sander, grinding wheel and guard, wire and cloth buffing wheels, 30" flexible shaft and a 12 piece accessory set..... **\$49.95**

Ask your dealer for a demonstration — or
WRITE FOR POWER TOOL CATALOG

Dremel POWER SANDERS



Straight-Line action gives you a professional cabinetmaker finish. You sand *with the grain* — eliminate scratches, swirl marks — save time! Three models — from **\$14.85** to **\$37.50**

Quality Power Tools Since 1934

DREMEL MFG. CO., Dept. 110-K, Racine, Wis.

They think such a capsule would be ideal for the first explorations of Venus, the mysterious planet whose surface has never been seen. A capsule that is made to float would remain on Venus' surface no matter whether the surface is liquid or solid.

A capsule's radio would be too weak to reach all the way back to earth from distant Venus and so the engineers propose that the space bus that delivers the capsule be used as a relay station. They would put the bus into a near-miss trajectory or else into an orbit around the planet. In either case it would pick up the weak signals from the capsule and retransmit them with its own powerful equipment.

Instead of carrying capsules, Ranger One and Ranger Two are to transport a whole array of instruments on a magnesium framework that looks something like an oil-well derrick. Each of these craft will be 12 feet tall, 5 feet in diameter and will weigh 610 pounds. The instruments include a rubidium vapor magnetometer for measuring the magnetic field of the craft's environment, devices for measuring the intensity of the Sun, others for measuring the hydrogen intensity in space around the Earth and an ion chamber for measuring cosmic-ray radiation.

There will be an instrument for measuring the impact of micrometeorites. One box will contain a "lubrication experiment." A big question about space travel is whether a lubricant will evaporate away, allowing bearings to stick and gears to seize. Some information about this will be obtained from the lubrication-friction experiment.

In Pasadena today the JPL engineers are discussing the color schemes for all the Ranger craft. Black and white are the two most popular colors. Black absorbs heat and can keep an instrument warm, white reflects heat and can keep a device cool.

The instrument cone of one probe that was shot toward the Moon was ornamented with long white stripes because it was to fly parallel with the Sun and could have over-heated. Yet if the shot had been postponed a few days, when the Moon was away from the Sun, the cone would have been redecorated with black stripes. Presenting a smaller surface to the Sun, it would have needed the black ornamentation to keep warm.

This principle of space decoration works so well that in the case of two space probes for which an interior temperature of 86 degrees was desired, one of the probes reported by radio that its temperature was little more than 100 degrees while the other reported an interior steady state temperature of 88 degrees.

(Continued to page 280)

**ONLY SIMPLE CARPENTER'S TOOLS
NEEDED TO BUILD YOUR OWN**

COFFEE TABLE

**with JOHNS-MANVILLE
CORRULUX® PANELS**

Corrulux makes possible many exciting do-it-yourself projects, combining colorful beauty with easy-to-work, light-weight fiber glass. You can nail it, saw it, drill it with ordinary carpenter's tools. Available in beautiful translucent colors. Strong and lasting, shatterproof Corrulux combines well with other materials. Send coupon and 5¢ in coin for detailed construction plans and list of materials for coffee table illustrated above or any other plans listed.

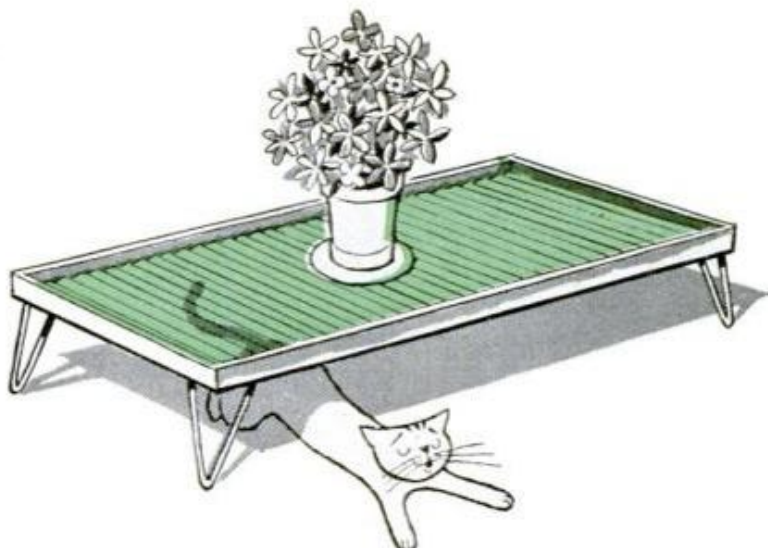

Johns-Manville, Dept. PM-1060, Box 60, N. Y. 16, N. Y.
In Canada, Plastic and Allied Building Products, Ltd.
Box 250, Dundas, Ontario.

Please send me the plans checked. Enclosed find.....
in coins. (If all 12 plans are desired, enclose 30¢)

Plan No.

- | | |
|--|---|
| 1. <input type="checkbox"/> Patio Roof | 7. <input type="checkbox"/> Fluorescent Ceiling |
| 2. <input type="checkbox"/> Room Divider | 8. <input type="checkbox"/> Indirect Lighting Fixture |
| 3. <input type="checkbox"/> Folding Decorative Screen | 9. <input type="checkbox"/> Adjustable Wind Screen |
| 4. <input type="checkbox"/> Weather-protected Entrance | 10. <input type="checkbox"/> Wind and Sun Screen |
| 5. <input type="checkbox"/> Woven Fence | 11. <input type="checkbox"/> Planter Box Screen |
| 6. <input type="checkbox"/> Window Awning | 12. <input type="checkbox"/> COFFEE TABLE |

NAME

ADDRESS

JOHNS-MANVILLE



BUY GREAT NECK HAND TOOLS
... for long-lasting performance

**Precision Balanced
NAIL HAMMER**



One-piece, forged steel, rubber-cushioned, no-slip grip

GREAT NECK SAW MFRS., Inc.

MINEOLA, N. Y. — SEE YOUR LOCAL STORE

EMERSON ELECTRIC

PORTABLE WELDER
High Capacity... Low Price

Ideal for farm, home workshop. Cuts, brazes, solders, welds. One man can carry... only 68 lbs. 6 welding heats up to 180 amps... 3/32" to 3/16" rod sizes. Write today for prices and receive **FREE WELDING SELECTOR GUIDE**... gives working data you need in seconds!

DEPT. W-552



EMERSON ELECTRIC of St. Louis
8100 Florissant • St. Louis 36, Mo.

FREE!
BELT HOLSTER
NOW WITH EVERY
EVANS TAPE

Sizes from 6 ft. to 12 ft.



CLIPS ON BELT!



YOURS FREE! — A fitted belt holster with each EVANS "White-Tape" that you buy! Metal-reinforced holster provides great on-the-job convenience — clips to the belt, for easy carrying and quick measuring.

On Evans Tapes only
at your hardware dealer

Evans RULE CO.

Factories at:
Elizabeth, N. J. and Montreal, Que.

BUILD THE BEST ELECTRONIC EQUIPMENT



it's fun to build
years-ahead money-saving

knight-kits®

A PRODUCT OF ALLIED RADIO

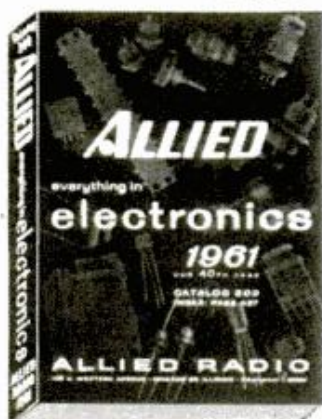

featured in the

ALLIED

Big 444-Page 1961

ELECTRONICS CATALOG

free

build-your-own..
it's easy..it's fun

BIG SAVINGS



KITS FOR ANY NEED

Hi-Fi
Hobby
Instrument
Amateur

See the exciting 1961 line of KNIGHT-KITS—available only from ALLIED. They're lowest in cost, convenience-engineered for easiest assembly, outstanding for performance—the only kits offered with Free Inspection Privilege. Send today for the 1961 ALLIED Catalog—select your KNIGHT-KITS—and...

SAVE ON EVERYTHING IN ELECTRONICS



Get more for your money in: Stereo hi-fi systems and components • Recorders and tape • Amateur station equipment • Citizen's 2-way radio • TV tubes, antennas, accessories & test instruments • Electronic parts, tubes, transistors, tools • Send today for your FREE 444-page 1961 ALLIED Catalog!

only \$2 down
on orders up to \$50

FREE
catalog



ALLIED RADIO

ALLIED RADIO, Dept. 24-K
100 N. Western Ave., Chicago 80, Ill.

Rush FREE 1961 ALLIED Catalog.

Name _____

Address _____

City _____ Zone _____ State _____

Instead of absorbing heat, black also can be used to dissipate excess heat into space. The backs of the solar vanes on the Ranger craft will be black. The solar cells on the front surfaces would become excessively hot except for the black rear surfaces that will radiate much of the heat away.

By the time the Ranger program is finished a new and somewhat more powerful launching rocket, the Atlas Centaur, will be available. With its thrust it will be able to deliver a capsule to close-by planets or even soft-land a fairly heavy load of instruments on the Moon.

The big step, that of manned travel to the Moon and back, must wait until the 200-foot-tall Saturn rocket becomes operational. The first trial launchings are scheduled for 1964. Its motors, using conventional fuels, are under development now by Rocketdyne, while Aerojet is conducting parallel studies of liquid-hydrogen engines.

The way JPL engineers see it, several Saturn rockets would be used to soft-land one-ton packages of survival gear and housing, surface vehicles, breathing oxygen and other supplies on the Moon, then a seven-stage Saturn carrying a crew in a sealed cabin would be fired toward the Moon. Three stages would get them to the target and the fourth stage would be used for terminal maneuvering and for backing down to the surface. The last three stages, relatively small because of the Moon's weak gravity, would suffice for the return to Earth. With the possibility of liquid-hydrogen engines and other breakthroughs it may be that the Saturn program will become less complicated than it now appears.

Terminal guidance and maneuvering will be one of the big factors in a successful lunar mission. The manned cabin with its return stages must be guided to the exact point where the earlier equipment packages were landed. A near-miss of just 10 miles would be disastrous. No one could walk that distance, even on the Moon, while carrying enough oxygen to remain alive and in a suit insulated against lunar temperatures.

Preliminary work also has started on the biggest launching rocket of all, the Nova that will have 6 to 12 million pounds of thrust. This monster would have eight engines for its first stage, each developing as much power, or more, than Saturn's entire first stage. Nuclear power is being considered for its upper stages. With this vehicle it would be possible to populate the Moon or land exploring expeditions on Mars with power to spare for the return trip.

★ ★ ★

STOP

that **DRAWER**
from **STICKING**
Easy—Quick—Forever!



Action Compares
with Costly Slides



Rear View

Nail two Roll-eez "N" on rail at drawer opening. If drawer has center guide, nail third Roll-eez "N" on top of back in the middle, and Roll-eez "M" on bottom of back, straddling guide.

WITH

Roll-eez SET "A"

ROLLER BEARINGS FOR WOODEN DRAWERS

Eliminates friction of wood-against-wood, keeps drawers in proper alignment. Makes wooden drawers work like magic—even in hot, humid weather! Made with improved NYLON rollers mounted on steel frames. Each drawer set includes simple instructions and nails. Anyone can apply. Ideal for furniture as well as built-ins. Used by cabinetmakers to provide lasting convenience in homes of every price range.

49¢

SET FOR ONE DRAWER

At Hardware, Lumber and Building Supply Stores.

Building? Remodeling? Insist on Roll-eez for Better Drawer Action—Lowest Cost!

JOBBERS DEALERS WRITE

Junior-Pro Prod. Co., Dept. M, 118 E. Marceau, St. Louis 11, Mo.

THE KING MIDGET

World's Most Exciting Lowest Priced Car. Rider Agents Wanted. Send 25c for 32 page picture book, full details, dealer price. Or send \$1 (refunded first order) for this plus Service and Repair Manual and 16 5x7 photos of car and factory.



MIDGET MOTORS CORPORATION, Athens 1, Ohio

NEXT MONTH

An air pilot who has been through it writes:

"BRING OUR PLANES DOWN SAFELY"

OCTOBER 1960

new!

DIAL-A-CUT

COMET

QUICK-SET

DADO

\$19.95

only

SHIPPED TO YOU PREPAID



UNCONDITIONALLY GUARANTEED!

You must be completely satisfied with your Comet Quick-Set Dado, or you may return it and have the full purchase price refunded!

NEVER BEFORE A DADO SO EASY TO USE!

- * GET PERFECT DADO CUTS, GROOVES, rabbets, panels, bevels, ploughs and miters every time!
- * DIAL INSTANTLY ANY CUT YOU WANT WITHOUT REMOVING IT FROM THE ARBOR! Actual widths are marked right on the dial. Get cuts from 1/4" to 1 3/16" or any hairbreadth in between.
- * USE IT ON ANY TABLE OR RADIAL ARM SAW! Fits 3/4", 5/8" and 1/2" shafts.
- * ADAPTABLE FOR EITHER RIGHT-OR LEFT-HAND ROTATION!
- * AMAZING ACCURACY FOR PERFECT SIDES AND BOTTOMS AT SPEEDS UP TO 7000 RPM! Perfectly balanced with no wobble, vibration, or burning.
- * STAYS SHARP 5 TIMES LONGER THAN OTHERS! Its eight Silvanite, tough, high-speed, tool-steel blades are self-cooling. Pays for itself 6 times over in resharpening costs.

— SEND FOR YOUR COMET DADO TODAY! —

**MAIL TO: COMET MANUFACTURING COMPANY
P. O. Box 2098-D, Pasadena, California**

Please send me the new Dial-A-Cut Quick-Set Dado. I understand my money will be fully refunded if I am not completely satisfied.

- Check or money order enclosed. Ship postage paid.
- Send C.O.D. plus postage and C.O.D. fee. Please check the shaft size of your table or radial arm saw 3/4" 5/8" 1/2"

Name _____

Address _____

City _____ State _____

My hardware dealer is _____

Address _____

IF YOU LIVE IN CANADA

The price of the Comet Dado is \$24.75 (duty included)
PLACE THIS COUPON IN AN ENVELOPE AND MAIL TO:

W. A. ACKHURST CO., LTD.
215 W. SECOND AVE., VANCOUVER 10, B.C.

281

FRIGIDAIRE Plan-it-Yourself file for a "Holiday from Apron Strings" Kitchen



Now you can plan your kitchen yourself—one work-saving, step-saving center at a time. And you can do-it-yourself, too, because Frigidaire Appliances are so easy to install. (Or, if you wish, take your plans to a contractor.) Before you start planning, though, see your Frigidaire Dealer. He will be glad to help you with information on models, colors, and sizes. Frigidaire Division of General Motors, Dayton 1, Ohio.

Food Preparation Center



Wall Ovens . . . Such a Joy to Use and Clean!

- Drop-Leaf Door to make cleaning easier than ever
- Automatic Cook-Master Control to turn oven on and off
- Fits wall opening 28½H x 21½W x 23¾D
- Can be installed with a screwdriver in as little as 7 minutes, 52 seconds (from roughed-in opening and wiring)

Seven other models available with such features as Double Ovens, French Doors, Pull 'N Clean Ovens, Meat Tender Controls.

Cooking Top Convenience, Finger-tip Controls

- Heat-Minder Unit for safe, no-burn cooking
- Speed-Heat Unit gets red hot in seconds
- Only 3½D x 19W x 31L opening needed
- Installs by adjusting only two clamps

Other models available to fit 24" cabinets or with remote control panels. Fold-Back Surface Units, too.

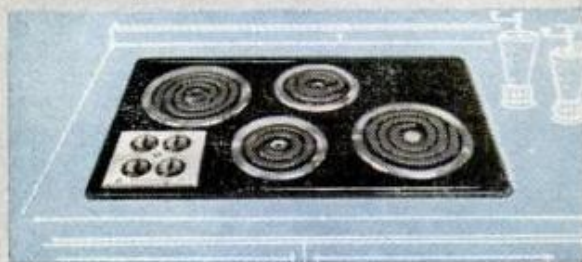

New Frigidaire Flair Built-in glamour . . . in a free-standing range

- See-Level Ovens with exclusive Glide-Up Doors
- Roll-To-You Cooking Top at hand-high level
- Slides into the place of your present 30 or 40 inch range—no carpentering

Kitchen Clean-Up Center

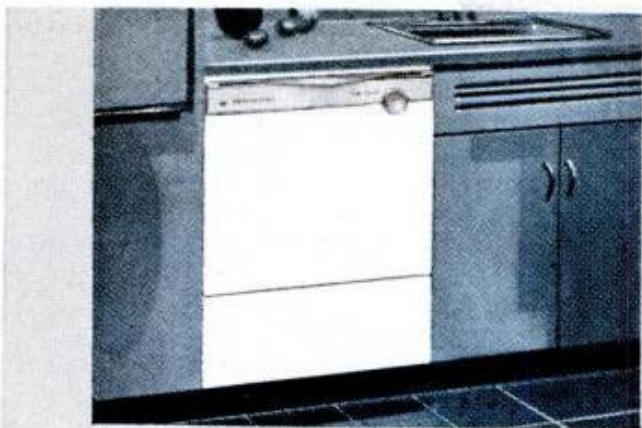

Automatic Dishwashing at its Magic Best

- Exclusive Swirling Water Washing Action gets all your dishes hygienically cleaner than hand-washing
- Big capacity Roll-To-You Racks are extra easy to load
- "Spots-Away" Rinsing "slides" water off the surfaces to combat spotting
- 34 $\frac{1}{4}$ "H-Min. x 24"W x 24 $\frac{1}{2}$ "D-Min. Opening

Free-standing cabinet models, and Dishmobile model (which can be built-in later) also available.

Frigidaire Disposers

- 30-35% faster than many comparable models
- Quiet—insulated jacket (FDZ-1), rubber cushioned connections
- Fits most 3 $\frac{1}{2}$ " drain openings

Food Storage Area

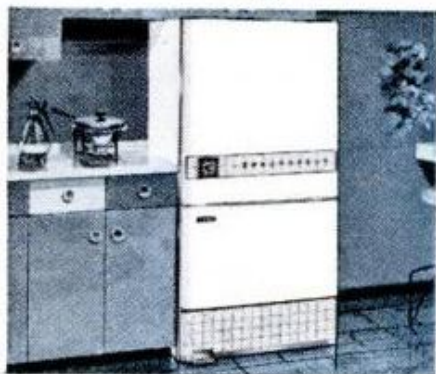

Handiest Frost-Proof Foodkeeping

- No frost in freezer or refrigerator sections
- "Sculptured Sheer Look" fits in with built-ins
- Handy kits for "recessed" installation

Choose from 16 refrigerator models to fit your family needs—matching Food Freezers, too.

Laundry Center



1961 Frigidaire Custom Imperial "Three-Ring Agitator" Washer

- Exclusive "Somersault Washing Action" bathes deep dirt out without beating
- Dispenses detergent and bleach automatically underwater

1961 Frigidaire Custom Imperial No-Vent Dryer

- Exclusive "Moisture-Minder" eliminates venting, keeps steamy vapors out of room
- "Wrinkles-Away" Wash 'N Wear cycle, automatic sprinkler

Choose from 27 matching pairs of automatic washers and dryers to fit every budget.

FACTORY-TRAINED
Dealer Service available
everywhere



FRIGIDAIRE
PRODUCT OF GENERAL MOTORS

Advanced Appliances designed with you in mind

PM House of Built-Ins

(Continued from page 160)

For several months Milt and his team of assistants worked over the problem of designing a House of Built-Ins specifically for *Popular Mechanics* readers. Several design concepts were scrapped. Finally Milt came up with a concept that, from its inception, not only excited him but the editors of *PM*. Weeks of work went into the final plans and details.

On these pages you see the results of that work. In general terms, the home is a three-bedroom, 1964-square-foot house (plus a garage area of 538 square feet) with a family room as well as a living room.

But the house can't really be described in general terms. It's packed with ideas—ideas that can be plucked from this plan and incorporated into existing homes. The storage walls, the disappearing beds, the study areas—all can be built in any home by any craftsman. On page 170 are how-to-do-it instructions for one of the built-ins. Still others will be shown next month. Anyone planning to remodel or add to an existing home may well adapt these built-ins to individual needs.

As soon as Milt's plans were complete, down to the last electrical outlet, *PM* editors began a search for a builder. We wanted a pilot model of the home built, both as a study of the practicability of the plans, and to photograph for these pages. We wanted the very best builder. Recommendations came in from several sources, and the name Jim Nuckolls popped up frequently. A visit to Jim in Tulsa, Okla., showed why. Only 37 years old, he still is one of the most experienced builders in the Southwest (last year he built 145 homes). Over the years he has developed several new construction techniques that have been adopted by other builders. Most important, Jim is a perfectionist. He considers every home he builds as *his* home, and refuses to turn over the keys to a proud new homeowner until he is satisfied that every detail is complete.

After one look at the plans for the *PM* House of Built-Ins, Jim gave a low whistle and decided to build it. Typical of any good builder, he made one or two minor changes to suit his own construction techniques and his own geographical area, then went to work.

We wanted as many readers as possible to walk through the house, not just look at the plans. Other topnotch builders were shown the blueprints, and several of them enthusiastically agreed to build the house. Starting the week of Sept. 25, it's

open house for *PM* readers in each of these model homes. On page 169 is a list of the builders, and the address of each home. If you live in one of these areas, we're sure that a visit will make you as enthusiastic as everyone else connected with this project. And if you seriously consider building the home, a trip of a few hundred miles would be a worthwhile investment.

As you approach the home, you'll immediately see how Schwartz has achieved complete privacy, yet brought a great deal of the outdoors inside. Across the entire front of the H-shaped house is a masonry wall, interrupted only by a pair of gates with heavy ornamental iron. Walk through the gates and you are in a landscaped entry court, with a double door beckoning you inside the house itself.

The view that greets you as you walk through the door is spectacular. You literally are met by the landscaping from the rear of the house, which flows in toward the front door by way of an inner garden court. As you stand at the front door, all the walls facing you are glass.

To your left is a guest closet, to your right the living room and dining area. The living room is a showpiece—a throwback to Grandma's old-fashioned parlor, and the only room in the house with a somewhat formal atmosphere. In Schwartz's words, it's the one room in the house that's "always ready for company" because the family will instinctively gravitate toward the family room-kitchen wing, leaving the living room free for formal entertaining or those embarrassing moments when uninvited callers drop in and "the rest of the house is a mess."

The dining area is to the right of the front door, convenient to the kitchen, yet isolated from it. In this corner there's room for built-in china storage.

Between the living room and the family room is a built-in entertainment wall. One feature is a turn-around TV which can be viewed from either room. Both sides of the entire wall are accessible, and can be subdivided to meet the needs and interests of the individual family. We show it with built-in stereo speakers, and display and storage space for books, collections of glassware and those absolutely useless yet beautiful items that you can't display in most homes.

At the open end of the entertainment wall—in the doorway to the kitchen—is a built-in panel of components and controls for a stereo hi-fi-intercom system. One auxiliary station for the intercom system is in the bedroom wing. There's another at the front gate, so the housewife can de-

(Continued to page 286)

NEW DEWALT for only \$199!

Economy 925-E Power Shop,
quality-built as always

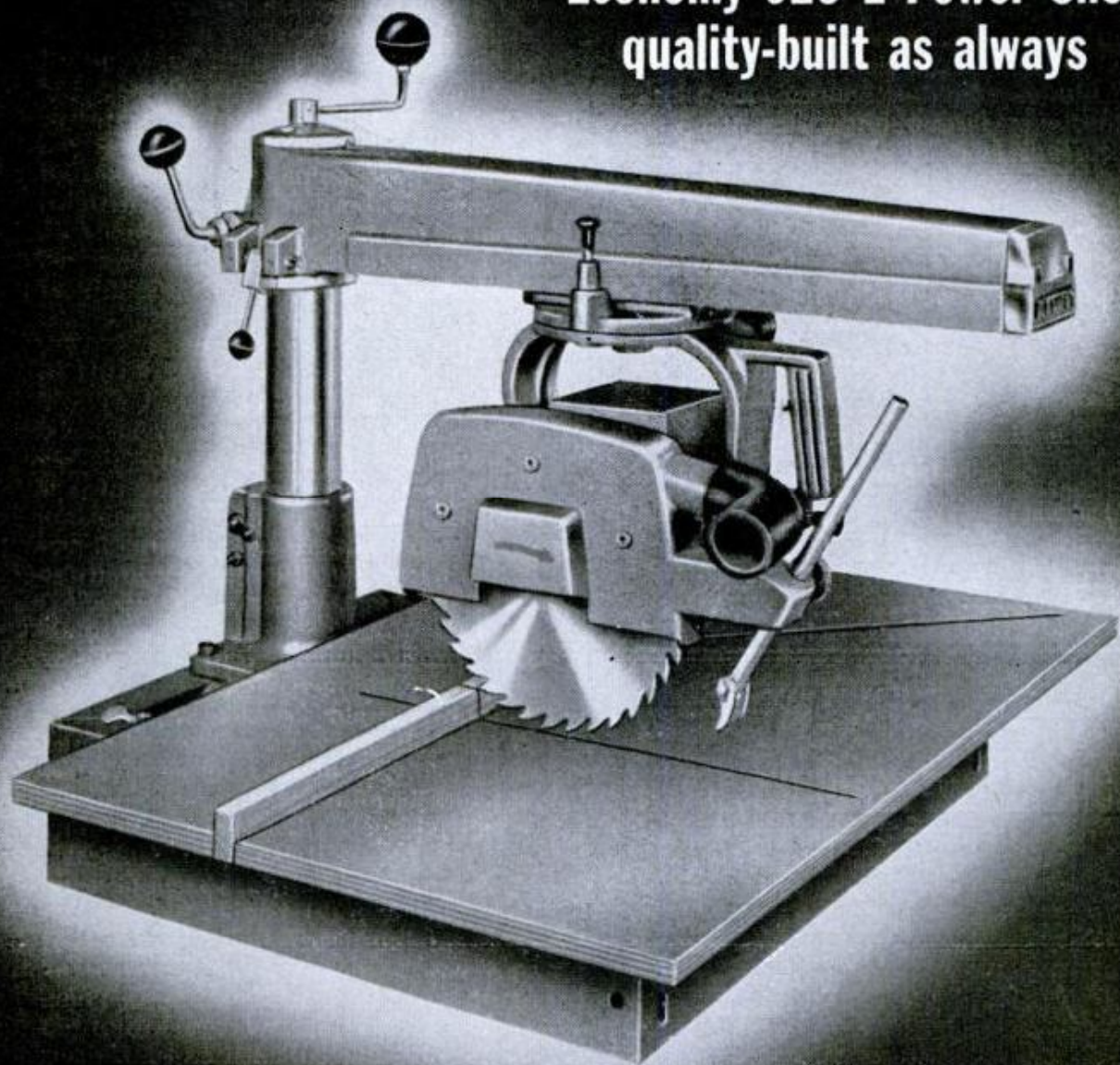

YOU SAVE \$50

This 925-E DEWALT gives you features not found in other makes costing 25% more. It's cut-tested for accuracy, power-packed, versatile, safe. See it at your dealer's now. Send coupon for free catalog.

DEWALT, INC., Dept. PM-610, Lancaster, Pa.
Please send me free, 20-page catalog on
DEWALT.

Name _____

Address _____

City _____ State _____

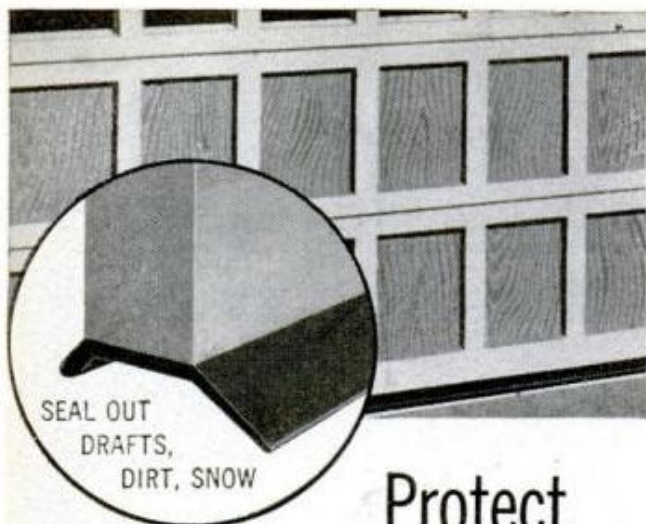

Protect costly garage doors with **STANSTRIP***

Now . . . for less than \$3.00 . . . in less than 10 minutes . . . you can put StanStrip on an 8-foot overhead garage door. And what a difference it makes!

The thick, rubber "pad" cushions the shock of closing . . . prevents damage to doors, spares the windows, ends the crash of closing.

And, just as important, the double lips of StanStrip flex to follow every irregularity in the floor . . . seal the opening completely against dust and dirt; rain and snow. Your garage stays cleaner, drier, warmer. Your car starts easier in winter.

And does it last! You just can't hurt StanStrip. The special rubber compound was developed from hundreds of formulas tested for this purpose. Stays flexible even in coldest weather. Get StanStrip now at hardware and building supply stores.



SEAL HOME DOORS AND WINDOWS, TOO
Ask for StanSeal®, the grey rubber compound strip that you uncoil and nail as you go. A tight, permanent seal in minutes. You can paint to match the frame.

For the ultimate in door-seal beauty, with no nails showing, get *deluxe* StanSeal. As easy to install and can be painted over, too.

*Trademarks

The Standard Products Co.
PORT CLINTON, OHIO

termine the identity of any caller or give instructions to servicemen without opening the front door. For more details on this and other built-in electronic equipment, see page 236.

The real focal point of the home is the family room. Stretching along one wall is a massive and beautiful (but relatively inexpensive) fireplace made of concrete block. Schwartz has given a dramatic facade to the fireplace merely by recessing key blocks one inch. These keys are highlighted by twin skylights, with hidden fluorescent lights, that flood the fireplace wall with light both by day and night.

The family room lends itself to all kinds of recreation, from boisterous play to contemplative relaxation in front of the fire. Furthermore, such activity can flow right on out through the glass doors to the patio. The patio area, adjacent to both the family room and living room, is an ideal spot for a family swimming pool, as it can be seen from everywhere in the house except the two smaller bedrooms. Mom can even keep a wary eye on the pool from one end of the kitchen.

The kitchen itself not only is a show-place, but is highly efficient. Schwartz believes that a kitchen should be compact yet, properly equipped, capable of serving up to 20 people with ease. From any point in the U-shaped kitchen the housewife can reach any other point in four steps, yet there's plenty of countertop working area and a built-in range, oven and dishwasher. Furthermore, it's so finely detailed that there's even a shallow cabinet for canned-goods storage—eliminating stretch, squat or reach-over to find a particular can. It's a bright kitchen, too, with plenty of window area and shadowless strip lighting. Jim Nuckolls has even included a built-in charcoal broiler.

Just off the kitchen is the utility room with built-in washer, drier, furnace, water heater and optional air conditioner. In the basement version of the plan, this area includes the stairway, but the laundry equipment is kept upstairs where it belongs, still separated from the kitchen. In both versions there's a mud closet for storing bad-weather clothing and footwear. A home freezer can be installed either in the mud-closet area, or just outside the door in the raised-curb area of the garage.

This curb is built up around the sides of the two-car garage. Along one wall is a complete workshop. Built into this same wall is storage space for mowers, rakes, shovels and other lawn tools, with access from the outside.

(Continued to page 288)

NEW BELSAW MULTI-DUTY POWER TOOL
SAWS—PLANES—MOLDS

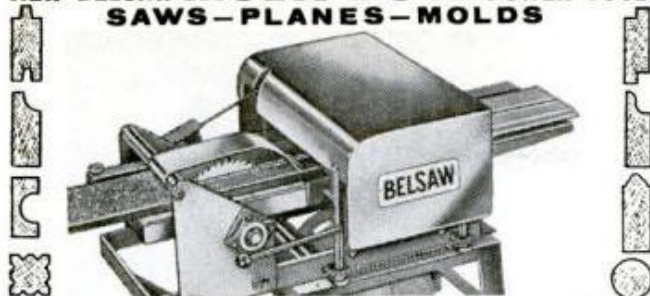

Now you can use this ONE power-feed shop to turn rough lumber into moldings, trim, flooring, furniture... ALL popular patterns. RIP... PLANE... MOLD... separately or all at once with a one HP motor. Use 3 to 5 HP for high speed output. Low Cost... You can own this power tool for only \$30.00 down payment.

Send postcard today for complete facts.

BELSAW POWER TOOLS, 901 Field Bldg., Kansas City 11, Missouri

Works in seconds!



Loosens Rusted Bolts
nuts, screws, "frozen" parts!

LIQUID WRENCH
SUPER-PENETRANT

The super-penetrating rust solvent that quickly loosens rust and corrosion.

AT ALL HARDWARE AND AUTO STORES

RADIATOR SPECIALTY COMPANY
CHARLOTTE, N. C.



Tractor From Old Auto Parts

Parts of a half dozen old cars and a nine-horsepower, one-cylinder engine went together in six months of spare time to build a "compact" tractor for Ronald Herbert, of San Bernardino, Calif., who uses it for landscaping and weed-cutting and plans to make it part of a rental equipment business. The tractor, which cost about \$300, is equipped with a front and rear scraper and a ripper, and will soon have a five-foot rotary weed-cutter. It has enough power through its four V-belt drive to dig holes with the rear tires if it can't move an obstacle, but will make 35 miles an hour in high gear even though Herbert didn't work out a gear reduction ratio.

Cut it with
WISS



As versatile as they are powerful, Wiss Snips are an all-purpose cutting tool no home work bench should be without. Above: No. V-13, seven-inch pocket size. Others from 8" to 17" in aviation, combination, and solid steel styles. At hardware and department stores.

WISS SNIPS CUT EVERYTHING!



Cut Tile



Cut Leather



Cut Fish and Poultry



Cut Fencing and Screens

J. WISS & SONS CO., NEWARK 7, N. J.
World's Largest Manufacturer of Shears, Scissors, Pinking Shears, Skalloping Shears, Metal Cutting Snips and Garden Shears

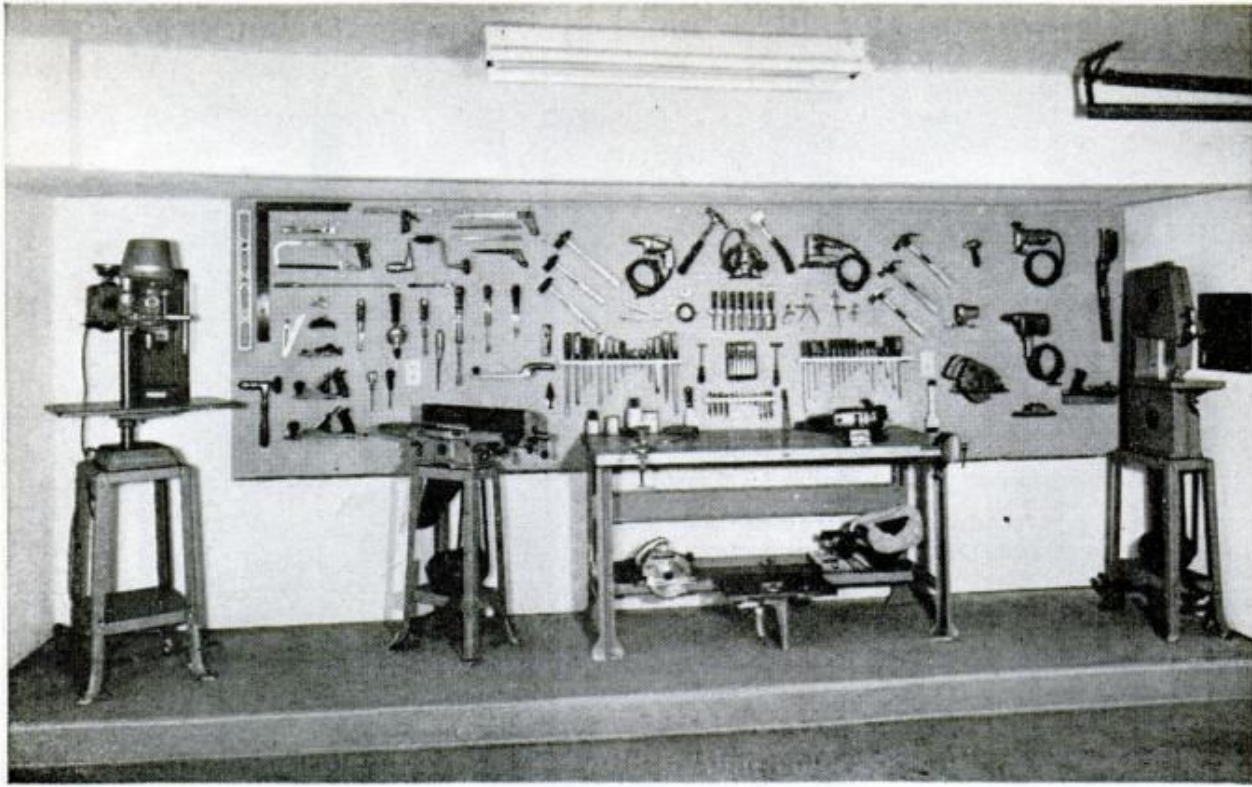

Built-in workshop covers most of one wall of the garage. A raised curb sets the shop apart from the rest of the garage area. There's plenty of room along the wall for a big tool-display panel with matching sets of hand tools. Power tools have their own floor space on the platform. In the basement version of the plan, the built-in shop can be moved downstairs, and this shop area utilized for bicycles and smaller vehicles

Across the house, in the opposite wing, are three bedrooms and two baths. Because this area is a separate entity that can be closed off by one sliding door, the house lends itself to zone control for heating and air conditioning.

Two opposite walls of the master bedroom are covered with built-in wardrobes. There are drawers, shelves and hanging rods galore, with a designated spot for every item of clothing. These two walls have so much built-in storage space that there's room for adult hobby equipment such as guns, fishing tackle, cameras and sewing materials. Again, this built-in lends itself to individual treatment. The space is there, and the built-ins can be arranged to fill particular needs.

Outdoor Privacy

The rear wall of the master bedroom is glass, and opens out onto a patio screened by an optional privacy wall from the family patio. (This wall does not appear in the photographs, as it would have interfered with the photography.) Thus parents can enjoy their own private spot outdoors while teen-agers are entertaining in the family room and the main patio.

One look at the plan will show you how Schwartz has made clever use of hallway space that ordinarily is wasted. Along one

wall is storage space not only for linens, but for model airplanes, toys, dolls and other items of vast importance to children. Along this same wall are twin study areas with fold-down desks. The location—far removed from the other activities of the home—makes this an ideal spot for study.

Unusual Feature

Perhaps the most unusual feature of the *PM* House of Built-Ins is the wall between the two smaller bedrooms—a wall four feet deep. The two beds, one from each room, disappear into the lower section of this wall. Made up in the morning, the beds simply are given a shove and glide back into the wall, opening up the rooms completely for play and for easy maintenance. Either bed can be built as a single bed or a full-width double bed. In the latter case, the finish board is left off the forward edge. Then, when the bed is shoved into the wall, just enough projects into the room to serve as a comfortable built-in sofa. In the wall above the beds is built-in storage for clothing and personal property.

That's the *PM* House of Built-Ins. We think it's one of the finest homes of its size ever designed, a home full of ideas. Best of all, even if you aren't interested in building a new home, many of the ideas may be applicable to your existing one. ★ ★ ★

SKIL JIG SAW IS FASTER!

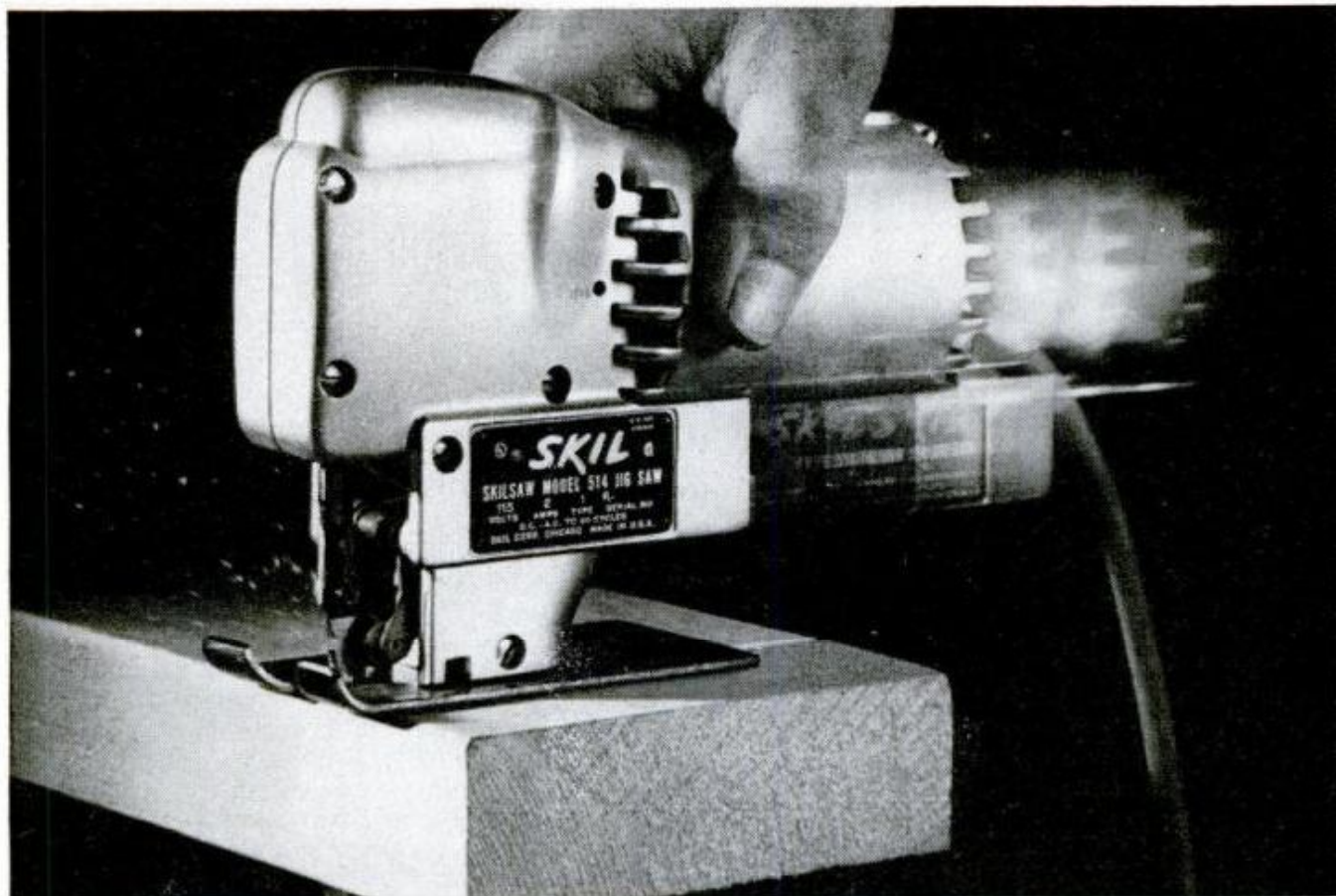

Saws 2 x 6 board in 14 seconds! Cuts straight lines, circles—even in metal. Now only \$39.95

If you think cutting with a jig saw is slow work, you haven't used a Skil. Its powerful orbital cutting action eliminates blade drag, makes it the fastest cutting jig saw you ever used.

You'll appreciate its speed in cutting wood up to 2", plastic, rubber, leather, corrugated or sheet metal—even light metal bars and pipe up to 1/2". And you'll like its versatility for making cross-cuts, rips, scrolls, notches. Even starts its own hole for pocket cuts.

Other Skil quality features include: Automatic blower that keeps sawdust off line of cut. Ball and anti-friction bearings throughout for extra long life. Exclusive blade support and guide that minimize blade breakage. Comes equipped with one metal cutting and two wood cutting blades.

See this outstanding Skil Jig Saw at your hardware or lumber dealer. Try it . . . you'll appreciate its true professional qualities.

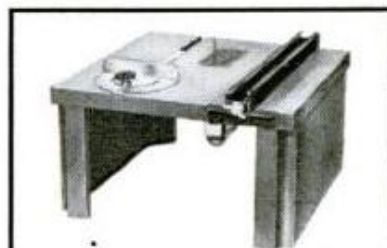

**SKIL JIG SAW TABLE
ONLY \$16.95**

Converts saw to stationary unit. Includes miter guide and rip fence. Top is 15" x 15" and stands 8" high.



... AND SKILSAW POWER TOOLS

Skil Corporation, Chicago 30, Illinois. Prices higher in Canada.

**STOP
THAT
DRAFT!**



Seal with DAP®

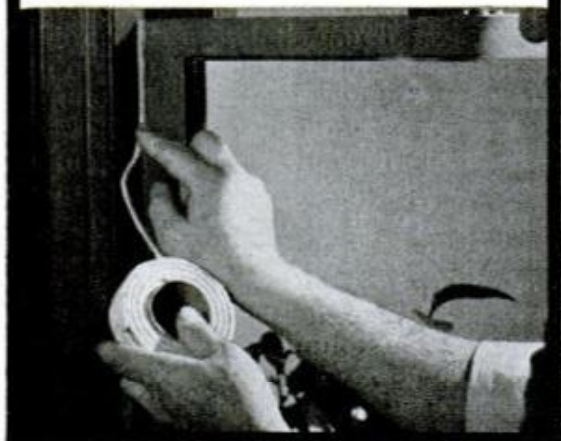

DAP Rope Caulk makes a perfect weatherstrip. Keeps out air, water, dust, insects—saves heat. Just press into place with fingers. Easy to remove. Get DAP Rope Caulk at hardware, paint and building supply dealers. Write for free do-it-yourself folder.

DAP

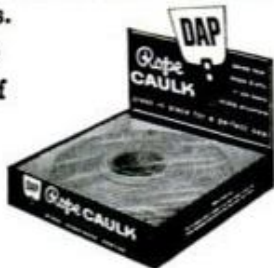

DAP inc., General Offices: Dayton 31, Ohio

PURIFIES AIR

**... with NO
outside
ducts!**



Ductless Hood®

BANISHES COOKING ODORS, removes smoke, grease—even pollen—by time-tested scientific miracle of recirculation through filters of Activated Charcoal—the substance that purifies air in atomic submarines.

Self-contained DUCTLESS HOOD permits total freedom in kitchen design.



ORDINARY HOOD... ducts costly to install — use shelf space — waste of house heat and conditioned air.

Write for literature: **THE DUCTLESS HOOD CO., INC.**
601 Plandome Road, Manhasset 18, N. Y.

The House Your Kids Will Live In

(Continued from page 181)

can use solid panels between window and door panels, or take long panels and cut in the window and door openings. You determine which method is more economical.

BARTLING: It is also feasible to "squeeze out" from one material a structural substance that will have different faces on each side—in terms of the density as compared to the core. Theoretically, this is possible now. In 20 years it's safe to assume that technology will catch up and there will be such a squeezed-out material, as you call it.

Is such a laminated piece desirable because of the wide variety of material you can laminate to the core?

BARTLING: Yes. You can still get the warmth and beauty that people like in wood and bricklike materials. It's entirely possible that new wonder materials will be put together in more or less conventional forms as we know them now—brick finish, wood finish, tile and so on. But they will be revolutionary in terms of the materials used. We have had a resurgence of colonial houses. Even though we have more modern forms, people still seem to respond emotionally to the old forms of architecture. I think it would be a fallacy to assume that in 20 years from now the forms won't be the same, even though technology has put us in a wonderland. People don't change as rapidly as science would permit.

JOHNSON: We can be certain that there will be substantial changes in the next 10, 20 and 30 years in technology. If an entirely different looking house could be produced for half the cost, with all the living conveniences and functions that are present today, whether or not it looked different, you'd have a big market for it. For example, sandwich panels and stress-skin construction of component parts can be used today to produce a house that looks "colonial." Our Knoxville house has a kitchen ceiling of a single layer that is at once acoustical, insulating and finished surface. It substitutes one piece for three layers.

BARTLING: The new materials will be multipurpose and multifunctional. Bathrooms will make more and more use of components. Electrical and plumbing systems may be built into the panels. Fixtures will be designed to plug together like radio parts. A two or three-piece bathroom would include medicine cabinets, mirrors and tile.

The really spectacular changes seem to be for the builder in the erection of houses on the site, rather than for the home owner.

(Continued to page 292)

ADJUSTABLE MITER BOX & CORNER CLAMP



Adjusts to any angle!

No. 44—COMBINATION MITER BOX AND CORNER CLAMP
 Holds the wood and holds your saw. Uses any handsaw for accurate cuts from 0° to 180°. Full 3" capacity. Sides of joints exposed for nailing, gluing. **\$2.75 PPD.**
No. 33 Works the same as No. 44, but without saw guide attachment. **\$1.75 PPD.**

SAW SHARPENING IS EASY

Super Filer No. 11 joints and sharpens hand and circular saws 6" to 10" with all teeth correct in height, depth, pitch, bevel. When file hits steel roller, teeth are finished. Saw runs true with no side pull. Includes 8" file. **\$9.95 PPD.**

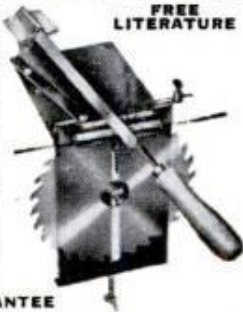

FREE LITERATURE



"TRU-CIRCLE"
 saw set automatically sets teeth at 10° or more. **\$2.95 PPD.**

MONEY BACK GUARANTEE

A. D. McBURNEY, 5908 Hollywood Blvd., Hollywood 28, Cal., Dept. A-100

BUILD FINE GRANDFATHER CLOCK NOW

The simple sensible **SPEEDE** Red-i-Kut way as thousands have — FOR YOURSELF OR SELL AT A GOOD PROFIT. SAVE HUNDREDS OF DOLLARS. SHOP TESTED PLANS "SPIRIT OF THE CENTURY" Narrow waist 43" tall or stately straight side "SPIRIT OF AMERICA." EASY-TO-FOLLOW photopaper PLANS & LIFE SIZE PATTERNS tell all—plus MOVEMENT BROCHURE \$40 up, of heavy brass weight (Kuempel original) Westminster, tube BELL chime, movements, gorgeous bronze-silver MOVING MOON dials, 3/4" solid-mahogany Jiffy Joint-Kwik-Bilt case kits. Send \$1.00 today — Both plans RUSH \$1.50 as folks have for over forty years.

Kuempel Chime Clock Works, #9 Kuempel Bldg., Minneapolis 16, Minn.

FAST ANSWER FOR DIRECTION MIX-UPS

HULL AUTO COMPASS

When direction mix-ups happen, hundreds of thousands of HULL owners have the fast, easy answer to trouble and delay. At your dealer's or write for literature.

Beaconline \$8.95
Streamline \$5.95
 See Hull Boat Compasses, Too

HULL MFG. CO., Box 246-D-10, Warren, Ohio



"Who mixed it with the LP records?"

OCTOBER 1960

CRESCENT ADJUSTABLE WRENCHES



Crescent offers unequalled value, performance and selection in Adjustable Wrenches. Choose CRESTOLOY for greatest strength and finest finish in 4" to 24" sizes, single and double end patterns; CRESCENT for toughness and durability at lesser cost in 4" to 18" sizes. Also insulated handles on the 12" CRESTOLOY. See CRESTOLOCK, the new locking adjustable wrench.

Sold by hardware dealers everywhere.



Crescent is our trade-mark, registered in the United States and abroad, for wrenches and other tools. Sold by leading distributors and retailers everywhere and made only by **CRESCENT TOOL COMPANY, JAMESTOWN, N. Y.**

RIDE..and Watch LEAVES VANISH!



Prepare your home grounds to be attractive all winter long! Gravelly Power Equipment does the leaf mulching, fall plowing, mowing, and clean-up work, fast.

POWERFUL-6.6 HP. VERSATILE-choose from 30 year round tools. All-gear drive, power reverse, plus optional starter. Built for tough jobs!

Ride while your Tractor does the work.

FREE BOOKLET -- 24 page
POWER Vs. DRUDGERY
tells all. Write Now!



GRAVELLY TRACTORS

P.O. BOX 601-K, DUNBAR, W. VA.

PERFORMANCE-PROVED SINCE 1922

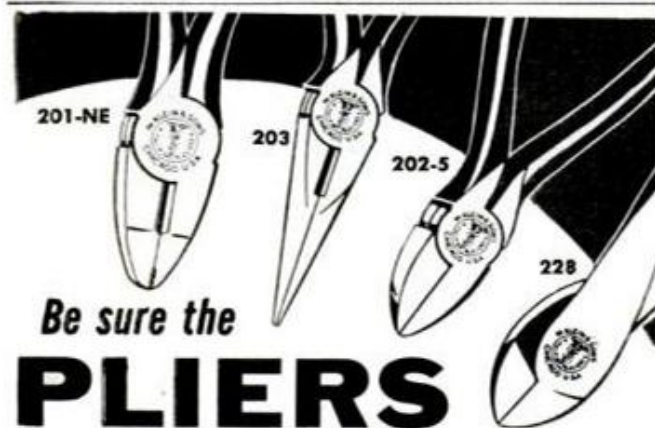

Be sure the
PLIERS
you use are
KLEINS

"Since 1857" the name Klein has stood for the finest in tools. Linemen, electricians and good workmen everywhere prefer Kleins because of the high standard of quality that is back of every pair. Now Klein Pliers are available in a wider selection of styles and sizes than ever before.

Ask your supplier for genuine Klein Pliers or write for a new Klein Plier Catalog.

FREE Klein Plier Catalog. On request.

Mathias **KLEIN** & Sons
Established 1857 Chicago, ILL. U.S.A.
7200 McCORMICK ROAD • CHICAGO 45, ILLINOIS



KING: Not at all. So far, the shell of the house has been the subject. The greatest cost savings, however, will be in three other areas—the foundation, finishes and trim, and the mechanical systems of the house. For example, many manufacturers are developing more durable and permanent finishes providing maintenance-free surfaces.

Dust-free walls for example? Or walls you can wipe down?

JOHNSON: Better than that. Today it is possible to produce a finish in the factory for less than half the cost of the conventional exterior paint system. It will be as good at the end of 20 years as the ordinary paint will be at the end of five years.

BARTLING: The advantages *will* be in maintenance-free houses in the future. The housewife will be the chief benefiter: Materials that can be hosed down, floor finishes that are almost permanent. The greatest impact will occur in the mechanical end—plumbing, wiring, heating and kitchen assemblies, possibly using new energy sources.

What are some specific things the public will get for the money?

JOHNSON: A built-in electrostatic-precipitator air filter will bring the dust-free house to all. It will cost less than an automatic transmission in an automobile. On interior surfaces you'll see wall coverings from which you can wipe crayon marks with a damp rag and which require no painting for 20 years. There will be maintenance-free floors.

What material would you use for such flooring?

JOHNSON: There are clear coatings for wood that look like varnish, but may well last 10 years even in modern applications on the outside of the house. You'd get the beauty of wood without the problem of maintenance.

BARTLING: The old standby materials such as wood, brick, stone, are being refined. It would be a mistake to assume that all materials will be wonder materials. I can see hardwood flooring treated to change the very chemical nature of wood so that it will answer a wide variety of requirements.

Are there any specific wonder woods in the wind?

JOHNSON: Some chemical companies are impregnating wood so that is fireproof.

BARTLING: It should be possible to take a core of low grade wood, wrap it in aluminum foil or cover it with plastic film, and come up with a material that would have different characteristics than either of the

(Continued to page 294)

HUOT ROLLING TOOL CHEST

PROTECTS YOUR VALUABLE TOOLS



Goes where your work is! It's a handsome professional piece of equipment!

This complete rolling cabinet is ruggedly built of heavy formed and welded steel for permanent service on the job or in your home workshop. Three top drawers are cork-lined for precision tools—two heavy duty bottom drawers are extra deep for power tools. Complete with built-in lock.

MODEL 250 **HUOT** Rhymes With Do-It!

Write for free bulletin showing this and 15 other models!
HUOT MFG. CO., 555 N. Wheeler St., St. Paul 4, Minn.



GENUINE ALNICO MAGNETS

AMAZING, PERMANENT, NON-ELECTRIC, HIGHLY PRACTICAL. Conduct interesting experiments. Hundreds of uses. Retrieve valuable steel items such as guns, tackle from fresh or salt water; tools from tanks & drains. **GUARANTEED.** Try any magnet one week. Money back if you are not well-pleased.

- No. M-710 (Wt. 53 oz.) Has pull of 225 lbs. on steel block... \$18.00
 - No. M-625 (Wt. 70 oz.) Has pull of 125 lbs. on steel block... \$10.00
 - No. M-575 (Wt. 18 oz.) Has pull of 75 lbs. on steel block... \$ 7.00
 - No. M-500 (Wt. 13 oz.) Has pull of 50 lbs. on steel block... \$ 5.00
 - No. M-90 (Wt. 3 oz.) Has pull of 15 lbs. on steel block... \$ 3.50
 - No. M-44 Rod Magnets for Electric Guitars, 3/4" Dia. x 1 1/4" 12 for \$4
 - No. M-47 Hot Pad Magnets, 10 for \$1.00... 50 for \$ 4.87
 - No. M-35 Hobbyist assortment of 8 magnets... \$ 2.00
- Send M.O. or check. We pay postage. Sorry no C.O.D.'s.

MIAMI MAGNET COMPANY, 3240 N.W. 27th Ave., Miami 42, Fla.



This point lets you bore holes up to 1 1/2" with small electric drill

It's hollow ground to bore cleaner, faster at any angle

NOW YOU CAN increase the boring range of your small electric drill or drill press. New Irwin Speedbor "88" bits bore faster, cleaner holes up to 1 1/2" in any wood. 1/4" shank chucks perfectly. No wobble, no run-out. Sharp cutting edges on Irwin exclusive hollow ground point start holes faster, permit spade-type cutters to bore up to 5 times faster. All Irwin Speedbor "88" wood bits are forged from single bar of special bit steel, tempered full length and machine-sharpened for extra accuracy, longest life. 17 sizes, 1/4" to 1 1/2". Buy individually or in sets from your Irwin hardware or building supply dealer.

Only 75c each, sizes 1/4" to 1"
 Only \$1.25 each, sizes 1 1/8" to 1 1/2"

IRWIN SPEEDBOR "88" WOOD BITS
 at Wilmington, Ohio, since 1885

GET BOTH HOME PROJECT BOOKS—FREE!



1. "101 HOME IDEAS"—24 pages, many in full color, feature home-building, remodeling and decorating ideas using wood paneling. For living rooms, dens, playrooms, dining and kitchen areas, storage and utility rooms, bathrooms, bedrooms . . . traditional and contemporary. Tips on choosing grades, species, patterns to fit your way of living. Section on built-ins, finishes and effects.



2. "COLOR IDEAS & HOW TO COLOR FINISH WOOD" features full-color photos of wood-paneled interiors. Ideas on unusual bright and pastel shades, textures, ways of installing paneling for exciting effects. How-to-do-it instructions cover sanding, sealing, choosing, mixing and applying colors, highlighting grain and knots, finish coats, maintenance and care.

Mail coupon to **WESTERN PINE ASSOCIATION**

DEPT. 4290-N, YEON BLDG., PORTLAND 4, OREGON

YOUR NAME _____ STREET ADDRESS _____
 CITY _____ ZONE _____ STATE _____

WHEN YOU
BUILD
TELEVISION
INTO YOUR
HOME...

BUILD
IN THE
BEST



Fleetwood

HI-FI COMPONENT TV

Now you can witness as fine a TV picture in your home as the engineer sees in the studio. The new Fleetwood television receiver is manufactured by Conrac, Inc., nation's leading manufacturer of master monitors for TV stations and networks. Fleetwood is built to the same professional standards. It is easy to install in wall or cabinet and is readily connected to your high fidelity system. Fleetwood is a high fidelity component and is sold only through Audio Specialists. Write for the name of the Specialist nearest you and a description of the dramatic new Fleetwood.

Fleetwood Component Television is marketed by JBL International, Los Angeles 39, California



STOP WATER
DAMAGE...



Wood
Plywood
Shingles
Asbestos siding
Concrete blocks
Concrete
Mortar
Stucco
Plaster
Brick
Paint
Wallboard
Tile
Canvas
Leather
Linoleum
Fabrics

Prevents warping, swelling, mildew, mold,
water stains, seepage, dampness, rot.

Keeps moisture out 5 years and longer.

Use on all woodworking jobs, boats, patio furniture, planter boxes, shutters, screen doors, window sash, shingle roofs. Stops seepage in basement walls, concrete silos, foundations. Waterproofs canvas, tarps, tents, awnings, leather boots, shoes, outdoor clothing. Won't harden or crack leather or fabrics. Perfect underseal for oil base or alkyd paints. Deep penetrating, colorless. Apply by brush, spray or roller. At paint or hardware stores or order direct. 16 oz. spray can \$1.89, Qt. \$1.75, Gal. \$5.35, 5 Gal. \$25.25, ppd., tax incl. Send check or money order to E. A. Thompson Co., 1355 Market St., San Francisco 3, Calif. No COD's please. (Since 1929.)

original ones. One chemical company is doing research on wrapping wood in a plastic film and getting a completely inert material. They haven't solved the problem of how to fasten it because when you fasten it, you puncture it.

In all this let's not overlook the oldest material known to man—masonry. It is being used increasingly both from an architectural and decorative point, outside and inside. It is used on the facade of buildings to give texture. In Texas much masonry is used for decorative and screening effects at low cost. New shapes and textures are handsome.

What are some of the new things being done with brick?

KING: The brick people have found ways to reduce weight. They slice it into 1/4-inch faces and apply it to plywood or other material to form a lightweight structural panel that has the surface qualities of brick but none of the weight disadvantages. For the Michigan State research house brick was ground up, reconstituted and applied to an asbestos-cement board.

What interesting systems might be in the wind for the homeowner due to developments in electronics and energy sources?

BARTLING: New light sources in the future. More and more use of electrical energy for heating, getting electrical energy from the sun or through the transmission lines we have today. Already some utilities are reducing the cost of power to make such things feasible.

JOHNSON: The next step in the component parts for the shell of the house is to incorporate heating and artificial light. It's possible to do this today, but not economically feasible on a production-line basis.

BARTLING: It is economically feasible now to incorporate resistance electric wiring into the exterior wall panels and when the walls are up have some simple method to connect them. Or we can introduce hidden or surface films that are conductive by the introduction of carbon black and other materials.

JOHNSON: There are several things you can be sure about. The house of the future will continue to be a more comfortable house. It will be easier to heat, cool, keep clean, will be acoustically controlled—with either a slight, or no increase in cost. Possibly a reduction in cost.

BARTLING: One physical change you may see in lower-cost homes may be brought about by the cost of land. It is one of the main deterrents to low-cost homes. With our expanding population there will be an increasing tendency for lower-income

housing accommodations to move back to the central cities. This would indicate to me a tendency for housing to become more vertical.

You mean there's a chance our children will be cliff dwellers again?

BARTLING: There's nothing illogical about it. There's no reason why in vertical housing the desirable amenities could not be incorporated with a proper distribution of park and play areas, so we could get away from monolithic type of land use. More problems could be solved by licking the sewage-disposal problem than some of the more technical problems of building. A lot of things that increase the cost of land now would disappear. We could get marginal land, and greatly reduce the cost of home building.

JOHNSON: To lick this land-cost problem you have to get away from the two-dimensional transportation system for individuals. This ties each house to a set of highways and roads which are expensive. Secondly, free the individual house from its tie to the water line, sewer line, electric line and gas line. Development of a low-cost energy system is necessary. The only thing now that looks like a possibility to do this economically, is solar energy. With this it might be possible to take the water out of the air and return all the waste thereto by incineration.

Just how does this cheap energy solve the waste problem?

JOHNSON: A room air conditioner, for example, has some dehumidifying action. In ordinary size houses today, water from it runs out into a sewer. This water theoretically could fill the needs of a whole family if there were storage tanks. This is taking water out of the air. In reverse, with cheap energy you could incinerate waste and produce a readily disposable ash.

BARTLING: We can have this in less than 20 years if there is a revolutionary breakthrough in solar energy. It could come at any time.

Aren't there research houses now at MIT and elsewhere using solar energy?

BARTLING: The heat-collecting mechanisms cost more than the house, so this is not economically feasible. You may, in 20 years or so, have a five-pound nuclear reactor for a house. The problem so far is that there is no feasible way to dispose of radioactive waste by-products. Present methods using leaded containers and burying them at sea, are impractical in terms of 10 million homes.

Has anybody done any actual design work on a domestic atomic power source?

(Continued to page 296)

HOW
TO CHOOSE
THE
LOUDSPEAKER
FOR
YOUR

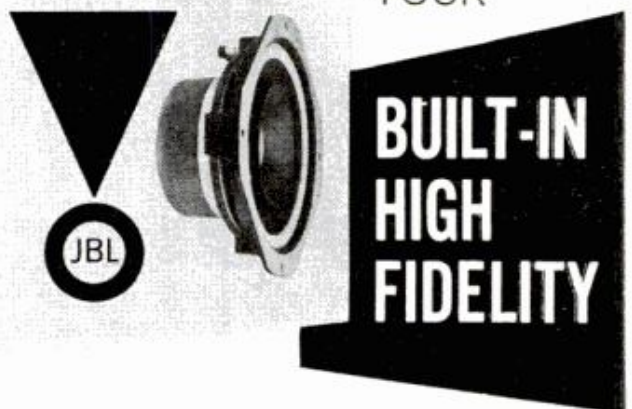

Look for the signs of permanent quality...precision workmanship, solidity, a rugged cast frame, large voice coil. Pay special attention to speakers bearing the JBL trade mark. Observe the dignity that stems from their purely functional design. Listen long and carefully; note the clean, accurate, free way a JBL precision speaker reproduces every tone from the highest to the lowest. Visit your Audio Specialist to hear the speakers worthy of being permanently built into your home. Write for his name and new JBL catalog.

Products of James B. Lansing Sound, Inc., are marketed by JBL International, Los Angeles 39, California

For **QUALITY** Results
STANDARDIZE on

Southern Screws

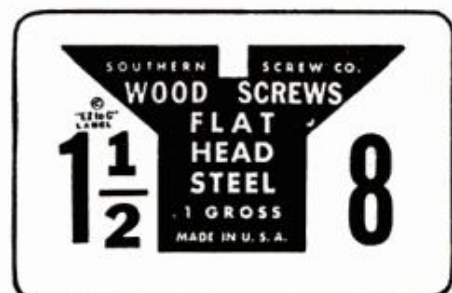

Wood Screws
Stove Bolts
Carriage Bolts
Drive Screws
Tapping Screws
Machine Screws
Machine Screw Nuts



**THIS LABEL IS YOUR
GUARANTEE OF
QUALITY SCREWS**

● SPECIFY SOUTHERN!

Buy 'em by the box and save!

Only a screw holds like a screw!!



SOLD THROUGH LEADING HARDWARE AND BUILDING SUPPLY DEALERS

Remove old

PAINT



Wash it off! Scrape it off!
It's easy either way with

HEAVY-BODIED KLEAN-STRIP



One application of Heavy-Bodied Klean-Strip will easily and quickly peel off several layers of paint or any other finish. Semi-paste consistency makes it ideal for use on overhead or vertical surfaces. Non-inflammable, needs no neutralizer or afterwash.

THE KLEAN-STRIP CO., INC.

2340 S. Lauderdale, Memphis, Tenn.

screens, upholstery, carpets...

hundreds of other uses.

You name 'em!*



Swingline 101 Staple Gun

Staples practically anything. Exclusive push-button loading and built-in staple extractor. At your stationery, department or hardware store.

only **4⁹⁵**

*Win \$5 per Idea!

Swingline pays \$5 for each practical new idea on how to use the SWINGLINE STAPLE GUN...to be published in "Tips for Tacking." Send your ideas today!

Send for FREE 12-page booklet "Tips for Tacking."



Swingline INC.

38-00 Skillman Ave., Long Island City 1, New York

JOHNSON: I don't think so. There have been designed and developed working models weighing 10 or 12 pounds produced for transportable military power. When such energy is feasible it could be used to do many household chores now done by hand. For example: Vacuum cleaning could be done with a simple electronic brain. A self-contained guided unit would vacuum across the floor, back and forth, all by itself. Using component construction, you might eventually even eliminate the wiring system in a house and broadcast the energy from a single source to a receiving mechanism.

In summing up, would you say there will be more of a trend toward the packaged or manufactured house?

KING: There is now a definite trend toward the industrialized approach to housing. This is separate from the packaged-house concept in this sense—manufacturers of basic building products will produce more completely fabricated components designed on a modular basis to integrate with components produced by other manufacturers. For example, window manufacturers will produce structural window panels which will fit the plywood manufacturers' structural wall panels.

JOHNSON: There will be an increase in the use of component parts that will fit together. This will not mean more standardization in the appearance of houses. One study showed 26 standard shell parts could be used to produce between three and four million different kinds of houses—not with unusual shapes or colors—but all with different surface appearances. Rectangles, L-shapes and so on.

BARTLING: One thing must be emphasized. Antiquated building codes will not permit any of these things to be done. The people in the community must be aroused to make this feasible.

JOHNSON: NAHB is trying to develop a science of building. We must have scientific facts about building houses—physics, chemistry, hydraulics—to really engineer a house for the people who will occupy it. Codes that permit the use of new knowledge and building science are vital to progress.

BARTLING: We must also develop new sources of mortgage money to build these houses. We must completely revolutionize the existing housing laws. These laws are 26 years old and are due for reappraisal. If you can't get acceptance by the people who lend the money, you really haven't gotten anywhere. We must have an integrated approach. You can't have one without the other. ★ ★ ★

Why let
a "gadget"
sprinkler
water down
your home
investment?

Poorly designed sprinklers cost home owners thousands of dollars annually in damage to steps, walks, patios and house walls, for constant soaking of these areas can cause deterioration, cracking, dry rot or termite trouble. The "water, water everywhere" kind of sprinkler generally leaves lawns and gardens incorrectly watered.

Specify
RAIN BIRD
the greatest name in lawn and garden sprinklers



Rain Bird Sprinklers, Valves and Spray Heads are scientifically designed and engineered by irrigation experts. There's no water waste, no soaking of outside areas.

Your investment in landscaping, plants, seed, garden tools, and time is costly... protect it with watering equipment made for lawn-time beauty. There is Rain Bird equipment engineered to meet your specific requirements—assuring correct, deep water penetration and long-time ease of operation. See your Rain Bird dealer today! *Write for free booklet, PM-10.*

NATIONAL RAIN BIRD SALES AND ENGINEERING CORP.
P.O. Box 547 • Azusa, California



Surface Spray Head



Pop-Up Spray Head



25PJ-DA Sprinkle
on Sled Base



Sprinkler on self-closing
lawn valve mounted on riser
from underground pipe.

FIBERGLASS or PLYWOOD

\$41.95 Up: EASY TERMS
FREE CATALOG

Write Now

50 Models 8-22 ft.



Cruisers, houseboats, runabouts, convertibles, fishing, sailing. Pre-assembled, pre-formed units anyone easily assembles. Equal factory-built. Save 1/2 to 2/3. Free catalog has all details, color photos, paint, accessories, Fiberglass supplies, trailers. **WRITE TODAY.**

LUGER BOAT KITS

Dept. B-10, 9200 Access Road, Minneapolis 20, Minn.

SAVE Your Heart!

America's Best Snow Plow-Tractor Value. Big 3 h.p. B. & S. engine, bigger tread, 6" x 12" tires plus heavy-duty 36" snow blade, adjustable. Both for only \$139.50. Built for lifetime use by one of oldest U. S. garden tractor mfrs., 2 year warranty. Substitute heavy-duty cultivator for snow blade if desired. Or add \$20. for cultivator also. Sold only by mail. Send check or money order now for immediate delivery, prepaid in U.S. Satisfaction Guaranteed. **WILMOR Co., Box 216, Ravenna 10, Ohio.**



3 h. p.
Tractor
and 36"
Snow Blade
\$139⁵⁰

Heavy-Duty
Cultivator \$20.



WOOD FOLDING DOORS

ASH • BIRCH • OAK • PINE • PHILIPPINE MAHOGANY
AMERICAN WALNUT MAKE ROOMS DO DOUBLE DUTY.

Divide children's room with PELLA WOOD FOLDING DOORS. Closed, there's privacy. Open, ample room to play. Also use PELLA DOORS to separate kitchen, dining and living areas; make a guest room and for storage areas. Easily installed. Order unfinished and save. Distributors in U.S. and Canada.

••••• THIS COUPON ANSWERED WITHIN 24 HOURS •••••
• **ROLSCREEN COMPANY**, Dept. LC-44, Pella, Iowa •
• Please send free folder on PELLA WOOD FOLDING DOORS. •
• NAME _____ •
• ADDRESS _____ •
• CITY & ZONE _____ STATE _____ •

Before You Buy—

(Continued from page 194)

Many older homes are inadequate in this respect. The best storage area is that which is convenient to the point of use. A central storage for linens and a closet near the entrance for guests are all desirable.

The kitchen usually is the only completely furnished room in the house. Here, be sure to check for storage space. Adequate counter space needs to be located next to the major appliances and sink.

Does the garage or outdoor storage unit provide ample space for storing bulky garden equipment such as the lawn mower? Or must heavy equipment be lugged each time up from the basement through an outside entrance?

The age of the house has considerable bearing on its real value. When a house becomes five years old, it will cost approximately two percent of the purchase price for annual repairs and replacements. The older the house the more likely it will need major repairs. For instance, when considering two houses that are evenly priced, discount the value of the one that will soon need a new roof or other major replacements such as wiring.

If you notice any unusual architectural styles or unsightly additions, remove the house from your prospective list. An exterior using a minimum of different materials and without gingerbread ornamentation is usually best to consider.

In the construction of the house look for good materials and sound workmanship. Put all visible flaws under suspicion. In the basement you can observe much of the house structure. And the basement is the place to look for signs of flooding and excessive dampness. The attic, like the basement, is a place where structural faults are likely to show up.

Examine as much of the house framing as possible. Take note of doors and windows that stick. Study cracked plaster. These usually are indications that the house has settled abnormally and major problems may develop as a result.

Don't take someone's word that the house is fully insulated. This can mean almost anything. If in doubt about the quality of the construction, have an expert give you an opinion. A local appraiser is well worth his fee for checking the condition of the house and estimating its market value.

Unless you're experienced, you will be money ahead to have the wiring, heating plant and water heater checked by a professional. To replace any of these items will run to major expense.

Don't overlook the possibility of termite infestation in an older home in areas where termites are known. If there is any doubt, have an expert make a check of the structure.

Making the Deal

Every house depreciates in value at a regular yearly rate, but the rate varies from house to house and from neighborhood to neighborhood. A well-built house depreciates slower than a poorly-built one. A house in a declining neighborhood has a lower market value than the same house in an attractive, improving neighborhood. But in periods of inflation the cost of new houses raises the market value of old ones, and they usually sell for more than their original cost. Also, the forces of supply and demand are always at work, varying from community to community. If the house has been sold a number of times, check the downward or upward trend of local prices and see how they compare with the asking price of the property you are considering. Also, see what similar houses in the neighborhood have sold for recently. Finally, don't forget to check the taxes on the property and you might also remember to inquire about any special assessments. ★★

QUOTE:

"There is no direct evidence that the artificially created low-level, prolonged ambient radiation to which the bulk of the world's population is now subjected has caused any damage to man or his animals. It is my facetious estimate that there is more human hazard from the heat of the arguments than from the present ambient low-level radiation."

—DR. JOHN RUST,
Head of Nuclear Medicine,
University of Chicago

Do You Know This Old-Timer?

(Answer to quiz, page 12)



1909 Packard

Now you can use the "House of Built-Ins" ideas in your home!



NEW HINES WIDEWOOD®

makes built-ins easy

Most versatile new wood product since plywood ends all problems of edge-finishing! Combines the advantages of lumber and plywood to give you wood in one piece as wide as you want. Hines Widewood consists of selected pieces of fine Ponderosa Pine precision-joined and electronically bonded into large planks and panels. Ideal for shelves, cabinetry and many other uses. Unlike plywood, edges are solid wood and need no special finishing. Unlike lumber, wide widths resist warping, twisting, cupping. Easier than plywood to work. Convenient 18", 24" and 36" widths at your lumber dealer's now. Other widths up to 54" available.

Send 10¢ for complete plans of illustrated built-ins.

Stereo hi-fi built-in • book shelves • rotating TV built-in • hobby storage unit • foldaway desk • study wall • bedroom storage design

HINES

Edward Hines Lumber Co.

200 S. Michigan Ave., Chicago 4, Ill.

Enclosed is 10¢ in coin or stamps... please send complete plans and material list for the illustrated built-ins from the Popular Mechanics "House of Built-Ins"... plus full information about new Hines Widewood.

Name _____

Street _____

City _____

Zone _____ State _____

©1960, EDWARD HINES LUMBER CO.

HOW TO SPOT AND CURE A TIRED CAR ENGINE

No hard-working mechanical part will last forever and that goes for the key parts in your car engine, too. Your crankshaft makes millions and millions of revolutions. It's no wonder that engine bearings and rings eventually begin to show wear.



Fouled spark plug from an engine with badly worn bearings

HOW TO SPOT TROUBLE

Here are some of the symptoms to look for: black smoke from your exhaust, sluggish performance, gas mileage that keeps dropping off . . . and oil consumption that keeps creeping up.

PLENTY OF MILES LEFT

Your engine is still good for many thousand miles, *but it does need an overhaul.* A first-class mechanic can save you hundreds of dollars by putting new-car spirit back into your engine, *plus extra years of service.*

REPLACE ENGINE BEARINGS, TOO

Be sure you get a *complete* overhaul, including new main, connecting rod and camshaft bearings. Worn bearings can throw off as much as 25 times the normal amount of oil and *even new piston rings can't control that.* You'll avoid costly repair bills later by getting the job done right the first time.



Heavy carbon deposits from excessive oil throw keep valves from seating tightly

FEDERAL-MOGUL FOR ORIGINAL POWER

Bearings are the heart of your engine, but it takes a *precision* bearing for like-new performance and maintenance-free mileage. Federal-Mogul engine bearings are the world's standard for quality and precision. Ask any mechanic. There are F-M bearings for every leading imported car, too.



FEDERAL-MOGUL SERVICE



Division of Federal-Mogul-Bower Bearings, Inc. • Detroit 13, Michigan

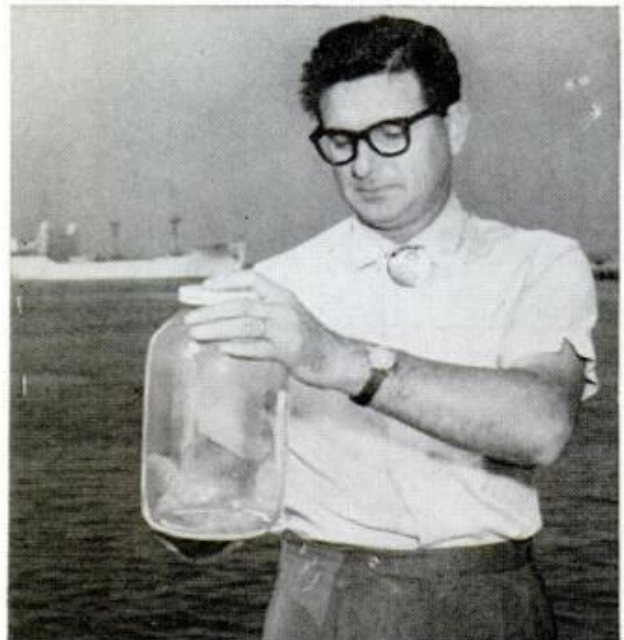

Illuminated Pickle-Jar Guides Missile-Tracking Ship

When a severe storm threatened to blow their ship off course during a missile-tracking operation in the South Atlantic testing range, the crew improvised an illuminated buoy from two-by-fours, flashlight bulbs and a pickle jar. The ship, the Coastal Sentry, was one of six responsible for bridging the instrument gap between distant islands along the 5000-mile range, and it was essential to be in exactly the right position to pick up telemetry signals from an Atlas ICBM, then being launched. A heavy overcast prevented continuous celestial navigation, so the crew, led by Operations Manager Mike Salone, fashioned a buoy by nailing together three two-by-fours and attaching two empty oil drums as floats. At one end of the two-by-four pole they tied a 30-pound weight, and at the other end they wrapped some "glow tape" and fastened three six-volt, battery-powered flashlight bulbs. Over this they placed an empty gallon pickle jar to protect the batteries from the sea. The crew was sure that the buoy, immune to the winds, would drift with the known ocean current to the exact position the ship had been assigned, and that's exactly what happened. At T-minus 90 minutes the homemade buoy was dropped into the ocean, and for the next hour and a half the crew, through binoculars in inky darkness, followed the bouncing beam of light. This navigational ingenuity helped the ship participate in the 17th consecutive successful Atlas launch. This string of successes was broken a few weeks later, but not because of any lack of home-made missile tracking equipment. The missile misfired at takeoff.

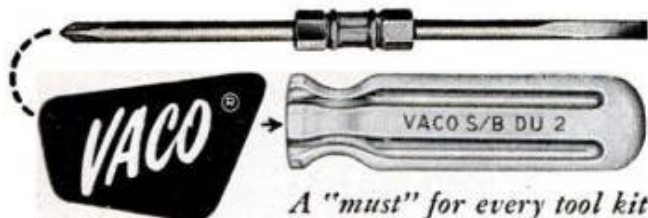

A "must" for every tool kit

Reversible Screw Driver

Invaluable Reference Catalog 40 pages of screw drivers, nut drivers, and special tools. Illustrated in full color. Send 25c for mailing and handling.

A professional quality, unconditionally guaranteed screw driver. Insert blade one way . . . it's a 3/16" straight slot driver. Insert the other way . . . it's a No. 1 Phillips. Made by America's leading screw driver manufacturer. \$1.36, P.P.

At Better Stores Everywhere or Write:

VACO PRODUCTS CO. • 317 E. Ontario St. • Chicago 11, Ill.

The second most important tool... for every woodworking shop

A VERSATILE

W&H MOLDER-PLANER

is second only to a saw . . . it molds, planes and rabbets.

"Your savings pile up as your shavings pile up."

Thousands in Use!



SEND FOR FREE BROCHURE
WILLIAMS & HUSSEY MACHINE CORP.
CLINTON ST., MILFORD, NEW HAMPSHIRE



British Nylon Spinners, Ltd.,
68 Knightsbridge, London, S. W. 1, England

Folding Nylon Gas Carrier

Carrying gasoline, for emergencies or any purpose, is simple with a new plastic-impregnated nylon "can" developed by the same British manufacturer who builds huge flexible oil barges. The lightweight bag folds into a small package when empty, but holds four gallons which can be poured quickly and without air lock through an outlet hose.

OCTOBER 1960

Now—Use the Finishing Secret of World-Famous Furniture Manufacturers

WATCO DANISH OIL FINISH

NEVER BEFORE AVAILABLE TO YOU



PROVED BY PROFESSIONALS—YET SO EASY FOR YOU TO APPLY ON FURNITURE, PANELING, CABINETS AND DOORS

For the first time available to you is the original time-proved WATCO Danish Oil Finish used by international names in luxury furniture. WATCO is used to produce the same beautiful, natural wood finish you see in the finest furniture and paneling—yet, it's so easy to use...in one simple application you can seal, prime and finish new wood.

Secret is in the polymerizing oils in WATCO that give you the toughest and richest oil finish of any in existence. Use it clear to bring out gorgeous color and natural grain, or use with stains. Save wasted hours spent sealing and sanding...save money, because you need only WATCO!

Get envied, superior results...the remarkable natural wood finish that resists stains and mars.

1 Easy Application

PRIMES!
SEALS!
FINISHES!

American Walnut Manufacturers Association recommends WATCO . . . may be used on all woods . . . specifically walnut, oak, birch, cherry, teak, mahogany, knotty pine and cedar.



RIGHT NOW TAKE ADVANTAGE OF THIS SPECIAL OFFER

FULL QUART REG. \$2.95
60 DAY INTRODUCTORY OFFER—\$2.00

MAIL TODAY

WATCO-DENNIS CORPORATION

1756 - 22nd Street, Santa Monica, Calif.
Rush to me full qt. of WATCO Danish Oil Finish with Wood Finishing booklet at special price of \$2.00.

Name _____
Address _____
City _____ Zone _____ State _____

My local dealer's name is: _____
10 DAY MONEY BACK GUARANTEE—send check or money order for postpaid shipment—or shipped C.O.D. plus postage.

301

SHOPPING FOR TOOLS

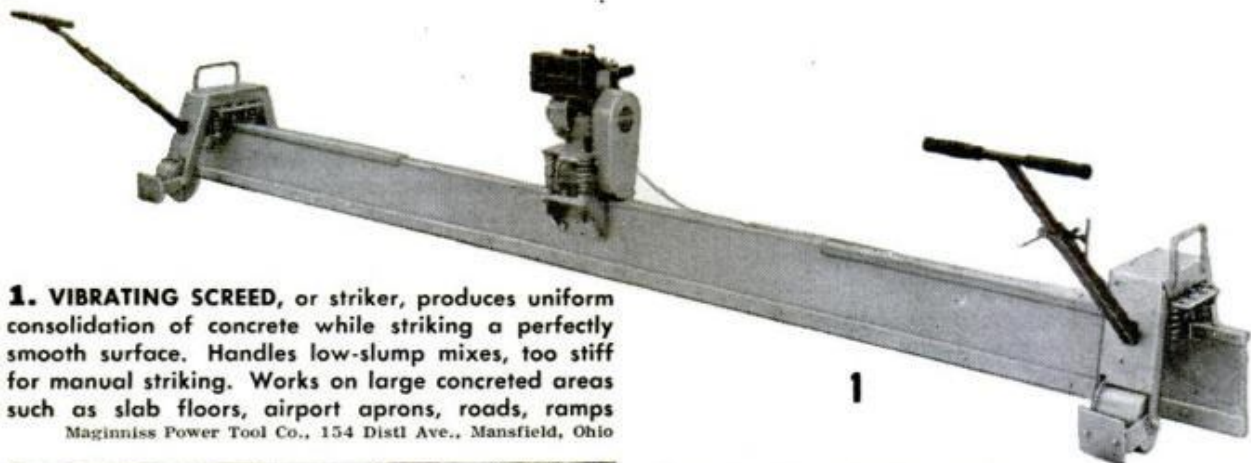

1. VIBRATING SCREED, or striker, produces uniform consolidation of concrete while striking a perfectly smooth surface. Handles low-slump mixes, too stiff for manual striking. Works on large concreted areas such as slab floors, airport aprons, roads, ramps
Maginniss Power Tool Co., 154 Distl Ave., Mansfield, Ohio

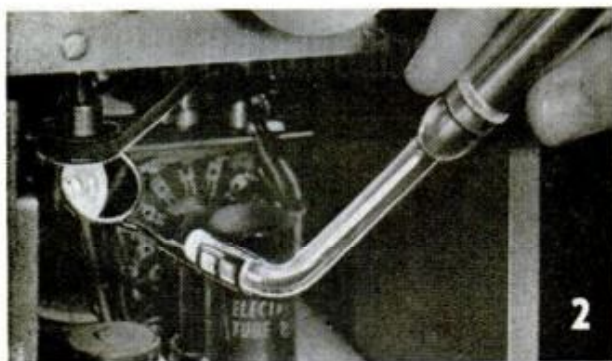

2. INSPECTION LIGHT "looks" into recesses, tubes, anywhere it is necessary to see parts clearly that cannot be viewed from above or from either side. Plastic light conductors transmit 90 percent of bulb's light to distortion-free mirror. Two conductors are furnished with kit, one straight, one with 24-degree curve
New Industrial Supplies, 100 W. Monroe St., Rm. 1401, Chicago 3

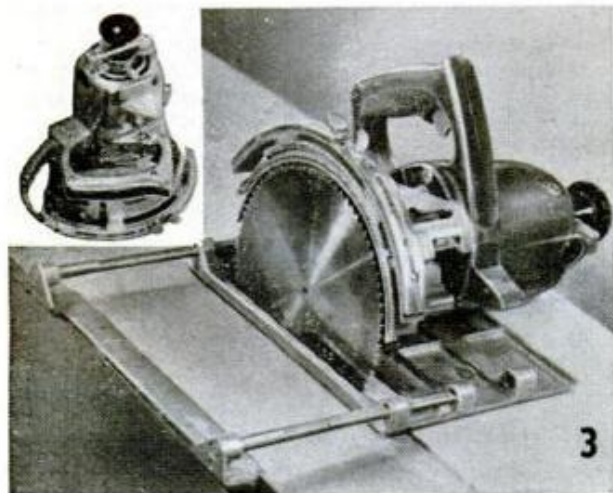

3. PORTABLE SAW works in conventional horizontal position, or in the vertical position for undercutting inside corners, door frames, window sills, also for cutting flashing grooves in masonry. Accessories are available for removing hard putty and for disk and belt sanding. Regularly supplied with 7-in. blade
Algo Specialties, Inc., 210 E. Chicago Ave., Algonquin, Ill.

4. NEW TYPE COLLET CHUCK has handwheel-operated, nose-type closure, offers complete collet chucking facilities at greatly reduced cost over conventional draw-in type of collet. Collet jaws are rubber-mounted, which greatly increases range and gripping power. Kit consists of handwheel chuck and 10 collets
The Jacobs Mfg. Co., West Hartford 10, Conn.

5. FLAME-CUTTING MACHINE features a new photo-cell tracer which is guided by a simple, exact-size pencil sketch of almost any intricate shape it is desired to produce. Sketches are made on ordinary paper; no costly metal or plastic templates or silhouettes are required. No part of machine contacts the drawing
Linde Co., Div. of Union Carbide Corp., 270 Park Ave., New York 17

(Continued to page 304)

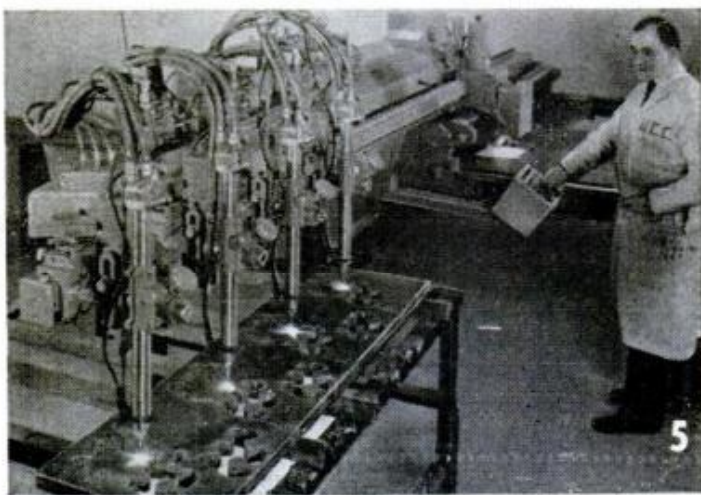

IMPERIAL Brush Cleaner



**Cleans
Fast**

No mixing, no long soaking of brush. Leaves bristles like new—glossy, springy—never flabby. Effective on hardest caked paint and other finishes. At paint and hardware stores.

● Send 25c for illustrated Refinishing Manual or write for free folder "Care of Paint Brushes." Wilson-Imperial Co. 118 Chestnut St., Newark 5, N.J.



"The Master Touch"

Lots of folks are inclined to skip over the important step of "polish sanding"—fine sanding or rubbing between coats. Then they wonder why they don't get that true professional look to their job.

In the photo, dried bubbles and trapped particles are cleared away by hand rubbing with TUFBAK DURITE Paper Sheets, Extra Fine grit 320-A, using water or oil as a lubricant. Fold a standard 9" x 11" sheet twice to make a convenient pad.

In another instance, the first liquid coat on bare wood tends to curl up numerous surface fibers, resulting in stiff rough nubs. Use the same 320-A TUFBAK, dry or with lubricant, on a handy BEAR Sanding Block. Of course, repeat the polishing between additional coats.

Remember for your preliminary rough sanding, use BEAR ADALOX paper for a quick, easy job. ADALOX sands much faster than ordinary sandpaper—cuts down on the uninteresting part of the job. Dept. PM-10, BEHR-MANNING CO., Troy, N. Y., a division of Norton Company.



Abrasives

Parker COUNTERSINK BITS for WOOD SCREWS
No. 4
For all standard drills, drill presses and hand drills

Drills and Countersinks
2 depths for flush or recessed screws
— in 1 operation —
4 Bits for the 8 most popular
WOOD SIZES

Automatic stop
adjusts to 2 depths

TO ADJUST STOP

PARKER MANUFACTURING CO.
MILWAUKEE 7, WIS.

Drill and Countersink
Holes for Wood Screws
in ONE Operation.

4 Bits 24 Combinations

\$1.70 PER
SET

Parker

MANUFACTURING CO.
WORCESTER 1, MASS., U.S.A.

(Item 24)

World's THRIFTIEST Light Plants

700 Watt, push button start, 115 v. 60 cyc. AC. 2.2 HP, easy starting Briggs eng. No wiring necessary; just plug in and operate. Plenty of current for any oil burner, freezer, brooder, emergency lights, etc. which require up to 700 watts. Ideal for television and radios. Complete with voltmeter and built-in winding to charge auto batteries. (Item 24) Wt. 75 lbs. Easily fits in car trunk. Be prepared if storm knocks out power lines. Reg. \$275... **\$143.50**
1200 Watt Plant (Item 45) same as Item 24 but larger generator and engine with 50% greater output... **\$199.50**
ELECTRONIC BRAIN Now Available On All Our Plants—Write

MASTER MECHANIC MFG. CO., Dept. A-106, Burlington, Wis.
Southern Customers Order from Dept. A-106, Box 65, Sarasota, Florida

use the solder
that most
home owners
use!

KESTER SOLDER

For your electrical work, radio-TV, do-it-yourself projects... always use the best... KESTER SOLDER. Send for FREE 16-page book that tells you how!

KESTER SOLDER COMPANY
4251 Wrightwood Avenue • Chicago 39, Illinois
OVER 60 YEARS' EXPERIENCE IN SOLDER AND FLUX MANUFACTURING

SHOPPING FOR TOOLS

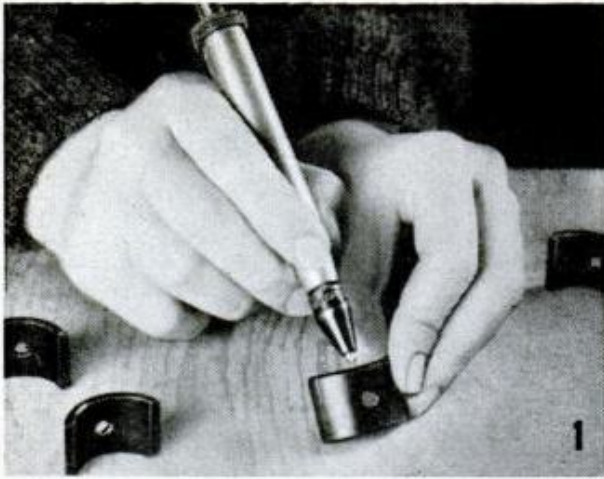

1. AIR-OPERATED PENCIL, or graver, writes on metals with a carbide-tipped stylus which makes 12,000 strokes per minute. Operates on 40 to 100 pounds per square inch air pressure. Writes on any of the common steels and nonferrous metals, plastics, ceramics and glass, by actually cutting or relieving the characters on the surface. Weighs only 5½ oz.
Rotor Tool Co., 26300 Lakeland Blvd., Cleveland 32, Ohio



2. INSTRUMENT LUBRICANT packaged in hypodermic applicator assures a perfectly clean supply of lubricant to technicians assembling and testing fine mechanisms. Applicators insure pinpoint application of minute quantities of special instrument oils. Although inexpensive enough to be considered disposable, the applicators are easily refilled if desired.
Servishops Supply Department, Box 174CO, Englewood, Colo.



3. PORTABLE DRILL has nylon housing which eliminates danger of electrical shock. Grounding is not necessary; can be used with two-prong plugs. Nylon housing will take roughest usage to which drills are subjected in normal use without cracking or chipping. Comes regularly with geared chuck and can also be used to power accessory units made by manufacturer
Millers Falls Co., Greenfield, Mass.

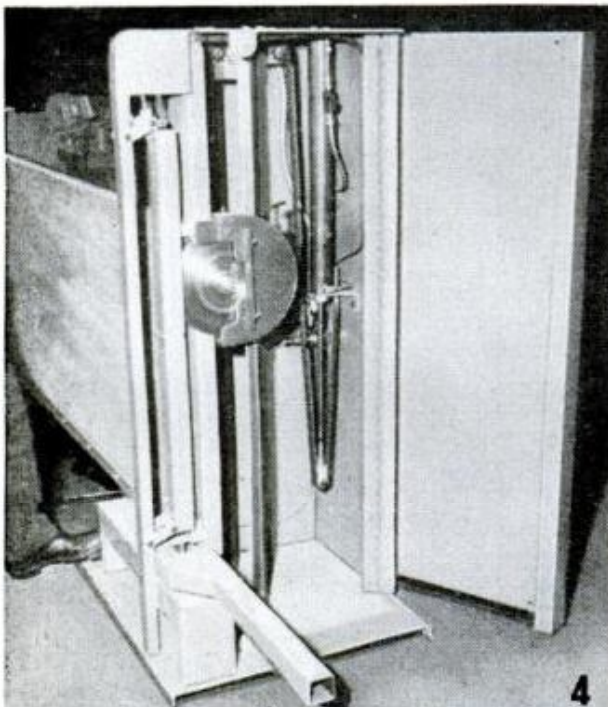

4. TRIM SAW cuts doors to length in a fraction of the time required by other methods. Blade makes smooth, true cut without chipping. Machine is foot-pedal operated, saw being raised vertically by hydraulic mechanism to make cut in single stroke. When saw reaches top of stroke, completing cut, it is lowered automatically and door clamp released
Turn-A-Bore Equipment Co., 5916 E. Rosedale, Ft. Worth, Tex.

5. BARBED WIRE STRETCHER draws the wire taut and then holds it while it is being stapled. Folds compactly for carrying in a pocket, in saddlebags, glove compartment or tractor tool box. Handy tool for ranchers and farmers for making quick repairs to barbed-wire fences. In working position, tool grips both post and wire and can be used on either side of round or square post
Grosco, Inc., 626 E. Locust St., Des Moines 9, Iowa

(Continued to page 306)

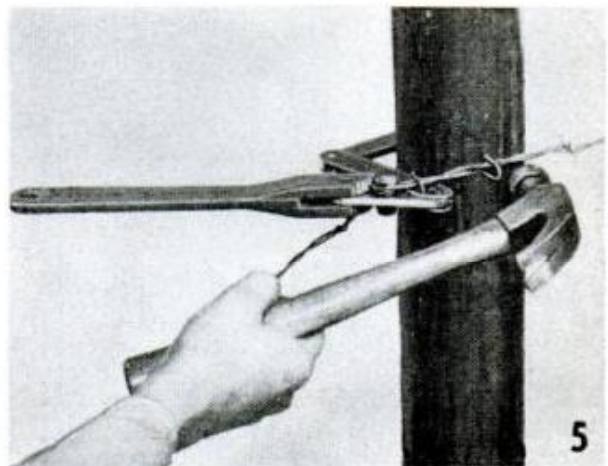

2½ hours from now,
 this garage door will open
 and close at the touch
 of a button 



That's all the time it takes to make that overhead garage door of yours fully automatic. And never again will you have to get out of your car in the rain or cold or late at night to play tug of war with your garage door. Just tap the Delco-matic button on your dashboard, and the Delco-matic Garage Door Operator will do the rest. (Think how your *wife* will love that!)

Simplified all-transistor design of both the transmitter and receiver units makes Delco-matic virtually trouble-free and dependable in all kinds of weather. Because Delco-matic is interference-guarded by an exclusive frequency range, no other type of control unit can operate the door.

And the reasonably priced Delco-matic is the one garage door operator with all the finest safety features. A special load-sensitive, stop-door control protects children, pets and property, as well as door and operator against wear and strain. There are no slipping belts or slip clutches to wear out.

Delco-matic is sold and installed by the Crawford Door Company and authorized Delco-matic distributors, serviced by United Motors System electronics dealers. Write us for full details.

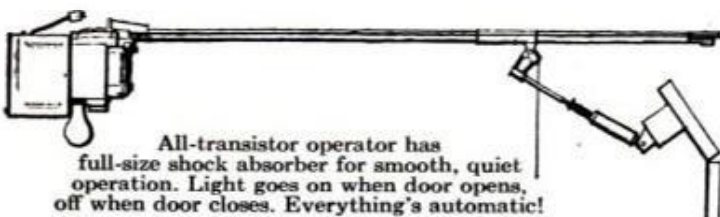

All-transistor operator has full-size shock absorber for smooth, quiet operation. Light goes on when door opens, off when door closes. Everything's automatic!

The Delco-matic Garage Door Operator is a featured appliance in the Popular Mechanics HOUSE OF BUILT-INS



Delco-matic / DELCO PRODUCTS

Division of General Motors, Dayton 1, Ohio

SHOPPING FOR TOOLS

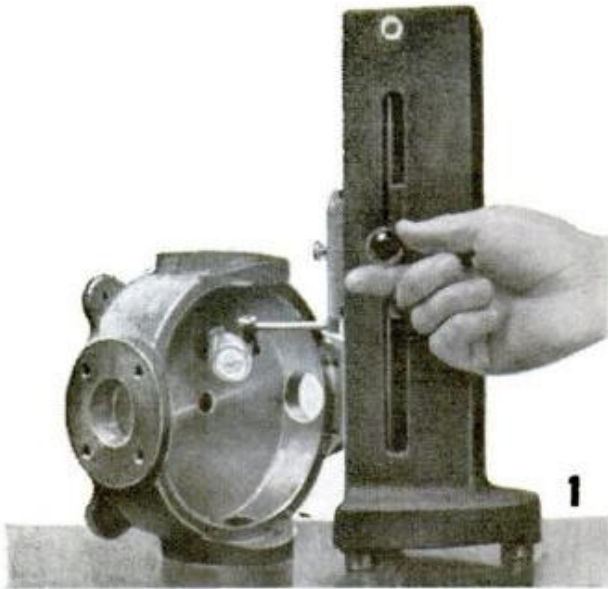

1. MACHINIST'S SQUARE checks precision work for squareness and straightness with an accuracy of .0001 in every 8 in. Designed especially for tool inspection, tool-room setups, parts inspection and quality control. Consists of a three-footed stand and vertical sliding head which carries ball-point indicator
Indi-Square Co., 1119 E. Ridge Rd., Rochester 21, N. Y.

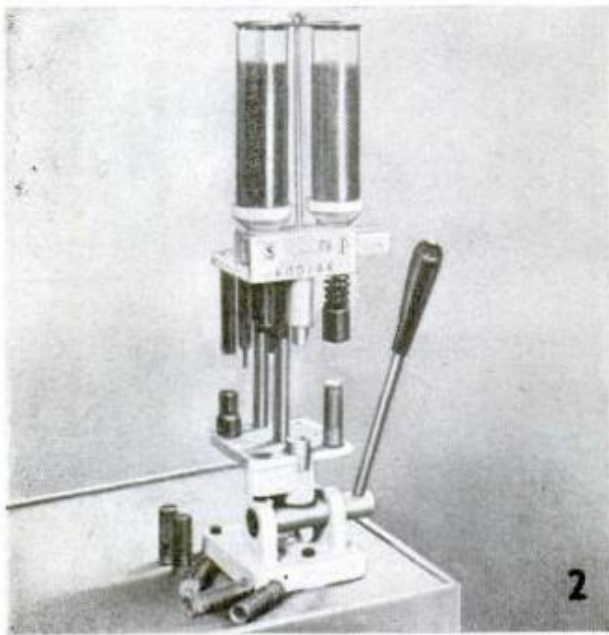

2. SHOTSHELL RELOADER accurately and dependably meters powder charge and shot when reloading paper shotgun shells. Wad-pressure indicator gives the uniform wad seating so necessary to consistently uniform shot patterns. Available in 12, 16 and 20-gauges; 12 and 20 gauge sizes handle 3-in. magnum loadings
Cook, Smith & Colwell, Inc., 310 Old Tavern Rd., Orange, Conn.

3. HORIZONTAL BORING MACHINE is designed to mount on a bench as you see it pictured in the left-hand view. Table raises and lowers by means of a handwheel and motor-driven boring head moves horizontally to carry bit to work. Boring head is actuated by foot pedal and is adjustable to give 6-in. stroke
Clarence Siegel, 4751 W. River Dr., Box 41, Comstock Park, Mich.

4. COUNTERSINK for wood screws drills the pilot and body holes and countersinks for driving the screw flush or below the surface in one operation. Cutting lips, or scoring edges, eliminate splintering of the wood around the hole. Works at an angle as well as at 90 degrees with the surface. Available in 20 sizes
Norfolk Products Corp., Norfolk, Conn.

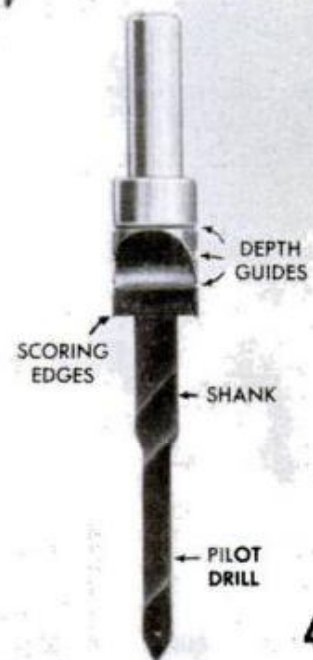
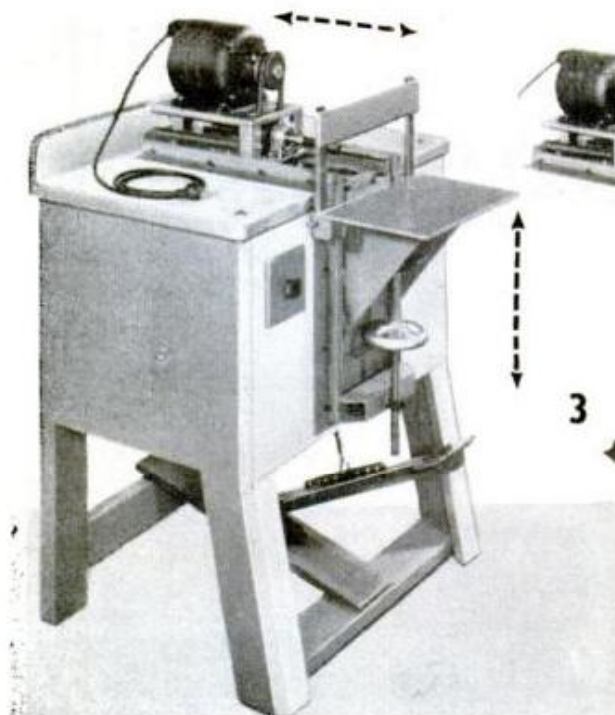

New Valuable Guide for Men

"HOW TO MAKE WOOD A BEAUTIFUL PART OF YOUR HOME"

Wood grains, patterns, textures you can choose! Striking effects you can create! Practical new designs, plans and ideas! Hundreds of the things you want to know about natural wood finishing, decorating and building . . . yours for just 50c in one 56-page booklet . . . by the makers of REZ® — world's most colorfully complete line of natural wood finishes!

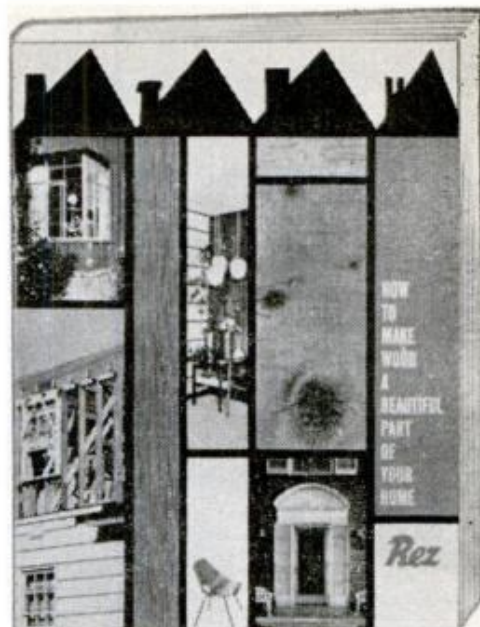

Now a wonderfully helpful booklet is ready for you—a complete how-to-do-it guide for decorating with wood and REZ natural grain sealer-finishes. Now you can choose from hundreds of wood grains and patterns, textures, colors and finishes

and achieve exactly the results you want every time.

See the woods you want for your home . . . Woods—light, sun-warm and refreshing. Woods—of rich dark tones. Woods—with dramatic whorls and patterns. Woods—with subdued grain tracings of quiet charm. Compare the most popular practical woods and plywoods. You actually see how their nature-grown beauty is enriched with a colorful variety of REZ grain-revealing finishes.

New booklet shows how natural wood becomes part of your color scheme with Color-Toned REZ. Outside, you can capture the charm and "feel" of forest, desert, mountain, seacoast or country landscape on your siding, carport, fence, trim or patio . . . inside, you can follow the same color scheme on paneling, cabinets, doors, valances, woodwork — coordinate wood color with carpeting, draperies and upholstery.

Saves you money . . . helps you select your favorite wood in the least expensive grade for your use — buy lumber, paneling, unfinished furniture and finish it easily in a few hours — enjoy all the luxury of good wood at low cost.

Easily adaptable ideas — illustrated ways to make home improvements you've always wanted — get more living space with built-ins, add on a family patio-porch, convert your basement into an activity room or rathskellar. 35 new designs. Guide plans. Easy to build.

New ideas in wall paneling . . . money-saving suggestions. How you can install and finish paneling yourself—save 25% to 60% of total cost you pay for wood.

Built-in, multipurpose cabinets you can custom-build to save space, make better use of existing storage area and open up more floor space for active use.

Different fence designs for beauty, privacy, sun screen, wind protection.

A treasure-chest of valuable additions to your home. Ways to make old rooms into new rooms with storage walls, book shelves, room dividers, closet stretchers.

Professional wood finishing made easy! Amazingly simple, sure ways to create a satiny, hand-rubbed look without rubbing or waxing . . . any color effect on any wood and enrich the natural beauty of the grain . . . a "bleached" or blond look without chemically bleaching. Tricks by master craftsmen you can use to bring out the distinctive best of redwood, pine, gum, fir, cedar, oak, birch and others. REZ solves every wood-finishing problem for you: no cracking or peeling, controls grain raise, ends mottled and uneven colors, protects against spotting from alcohol and water, defies stains and abuse. Brush it on as easily as water . . . REZ penetrates, seals, finishes — lasts for years — will not peel or blister — guards woods from sun and weather outside — gives lasting beauty inside.

USE HANDY COUPON

REZ Wood-Tones, Inc.

P.O. Box 123, Dept. PM, Springdale, Pa.

Send me the color-filled, 56-page guide, "How to make wood a beautiful part of your home." I enclose 50c.

Name _____

Address _____

City _____ Zone _____ State _____

End Skidding and Wheel Spinning!



SKIDMASTER®

DETACHABLE GRIT SPREADER



Revolutionary new grit release device provides "push button" traction!
ONLY \$29.95 INSTALL-IT-YOURSELF!

Napco, leading manufacturer of highway sanders for trucks, trailers, and buses, introduces an entirely new concept in passenger car grit release devices! *Skidmaster* is controlled by a patented new vacuum release valve connected by hose to the windshield wiper line or vacuum spark advance . . . there are no electrical connections . . . no drilling or cutting into car.

Skidmaster more than pays for itself . . . saves damage to transmission from "rocking", eliminates tire wear and wasted gas from "spinning".

Skidmaster helps you climb hills, park alongside of curbs, pass cars; start, slow down, or stop on curves and at intersections.

After simple installation, the outside units are easily removed, stored in trunk and attached in seconds, when needed. You'll never again use costly skid chains, ineffective snow tires and sand bags.

Fits any make or model car or station wagon. Simple installation kit with STEP-BY-STEP INSTALLATION INSTRUCTIONS. If you are not completely satisfied your money will be refunded. Shipped parcel post prepaid. \$29.95, SET OF TWO



Flexible bracket fits into window opening, does not interfere with window operation.



Flexible plastic discharge tube slides into pre-adjusted receptacle.

SKIDMASTER SALES CO.

512 Nicollet Avenue, Minneapolis 2, Minnesota

Gentlemen: I herewith enclose _____ for _____ Skidmaster Detachable Grit Spreader(s), complete, with instructions.

Name _____

Address _____

City _____ Zone _____ State _____

Enclosed: Check Money Order Sorry, no C.O.D.'s.

The Buick Special

(Continued from page 99)

Two-piece drive shafts have been used before, the major difference in the Buick setup (large Buicks use the same system) is that the center universal joint is a double constant-velocity joint that is made up of two single joints mounted back to back and piloted by a ball socket.

This double joint operates smoothly at a much greater angle than the single joint which permits the dip in the drive line, in turn minimizing the tunnel.

The rear axle is a conventional hypoid design of light weight. It is located by four stamped steel links rubber bushed at both ends. The lower links take driving and braking torque as well as provide the support points for the coil springs. Upper links are attached to brackets on the differential and position the axle laterally as well as prevent "axle wrap-up" on acceleration.

Brakes are conventional duo-servo hydraulic with 9½-inch cast-iron drums. Lining area is 130 square inches and seems to be adequate to do any stopping job unassisted as power brakes are not available.

Power steering is an option that many owners will want but not one that every owner will need. The Special can be handled nicely without it, but the GM power steering is smooth-acting and gives a bonus of "quicker" action, i.e. reduced turning requirement.

Although the Special's unit construction body-frame is low, only 53 inches from ground to roof, seating positions are good; there's average-to-good headroom front and rear and the seat cushions are well up off the floor.

Doors are well proportioned and have generous seat-to-roof dimensions so that entry is easy. The rear door is quite wide and the front door opening is not encumbered with a jutting, "dog-leg" windshield frame.

In width too, Special's passenger compartment measures a comfortable 58 inches although the car is just 71 inches wide.

Visibility is good through a moderately wrapped windshield and wide rear window.

To sum it up, the new Buick Special is an attractive, perhaps handsome car of modest, comfortable size, thoroughly engineered, efficiently designed, weighing only about 2700 pounds, offering satisfactory fuel economy (an estimate of capability) and brisk, powerful performance.

If it is priced, as we suspect, at about \$2500 at the factory the Special will represent a genuinely new and worthwhile addition to the U.S. automotive lineup. ★ ★ ★

New Ultra Precision Radial Arm & 7" Portable Saw from **SHOPMATE**

*Amazing combination
from America's most advanced
Power Tool Engineers*

Now enjoy all the cuts and features of expensive radial saws—plus the advantages of a portable saw to take to any job! Wide panel ripping, compound, cross-cut and tapered rip sawing—plus rabbet, contour, fluting, radius and chamfer cuts!

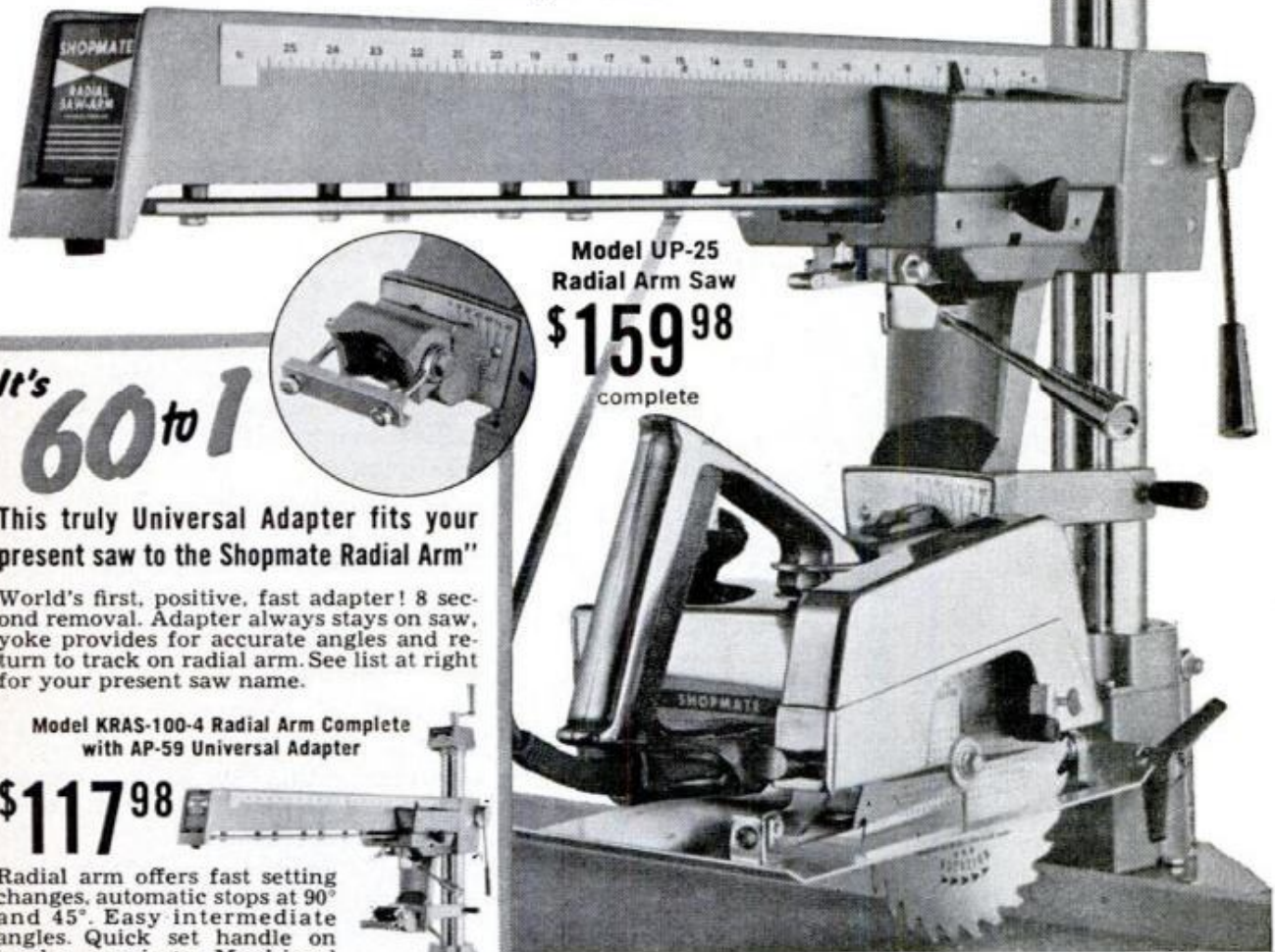

Model UP-25
Radial Arm Saw
\$159⁹⁸
complete

*"It's
60 to 1"*

This truly Universal Adapter fits your present saw to the Shopmate Radial Arm"

World's first, positive, fast adapter! 8 second removal. Adapter always stays on saw, yoke provides for accurate angles and return to track on radial arm. See list at right for your present saw name.

Model KRAS-100-4 Radial Arm Complete with AP-59 Universal Adapter

\$117⁹⁸

Radial arm offers fast setting changes, automatic stops at 90° and 45°. Easy intermediate angles. Quick set handle on husky carriage. Machined track has adjustable ball bearings, lifetime lubrication.

SHOPMATE 7" Safety Clutch Saw
Perfect as portable or with radial arm. Safety clutch ends kick-back, prevents burn-out, adds years to life. 115 volt AC motor, 5000 rpm no load.

Model SC-700M
Sold separately **\$49⁹⁸**

SHOPMATE Radial Arm Adapts to all these saws—and more!

- | | | | |
|--|--|--|--|
| AMERICAN —Models 6-00, 7-00 | McGRAW-EDISON —Models 1055, 1055A, 256A | SEARS —Mod. 02784, 02790, 02796, 02789, 02787, 25880, 27870 | STANLEY —Models H-65, H-68, H-70 |
| BLACK & DECKER —Models 430, 63, 730, 830 | MILLER FALLS —Models 626, 727, 646, 747 | SHOPMATE —Models SC-700, SC-700M, SC-700-3, SC-7100, SC-7100M, 6208 | STARFLYTE —Model SC-730M |
| CUMMINS —Models 717-01, 737-01, 757-01, 7800-01 | MILWAUKEE —Models S-16, S-17, S-18 | SKIL —Models 533, 536, 552, 553, 554, 698 | SUNBEAM —Models 72, 72-3, HD-199 |
| DORMEYER —Models CS-2, CS-8, CS-5 | PET —Models 630M, 635M | SPEEDWAY —Models 460, 475, 485 | TRUSTWORTHY —Models TW700, TW7100 |
| ELECTRO —Mod. 701 | PORTER-CABLE —Models 66, 160 | | WARDS —Model 8900 |

PORTABLE ELECTRIC TOOLS, INC.
320 West 83rd Street, Dept. P.M. 10,
Chicago 20, Illinois

Please send complete information about the new Shopmate Radial Arm with Universal Adapter for my saw ; Complete Shopmate Radial Arm with portable 7" saw ; Shopmate 7" Safety clutch saw .

Name

Address

City Zone State

Favorite Dealer

My Present Saw is:

Brand

Model

For complete information
MAIL THIS COUPON TODAY!

Portable Electric Tools, Inc.

320 West 83rd Street, Chicago 20, Illinois

In Canada: Portable Electric Tools Ltd.,
452 Birchmount Road, Scarborough 13, Ontario

ONE SIMPLE ADJUSTMENT TO YOUR HOLLEY CARBURETOR

If you are getting poor idle or unsatisfactory fuel economy, one cause may be improper fuel level in the bowl. Because of the accessibility of the adjustable needle and seat arrangement on Holley 2-barrel and 4-barrel carburetors,

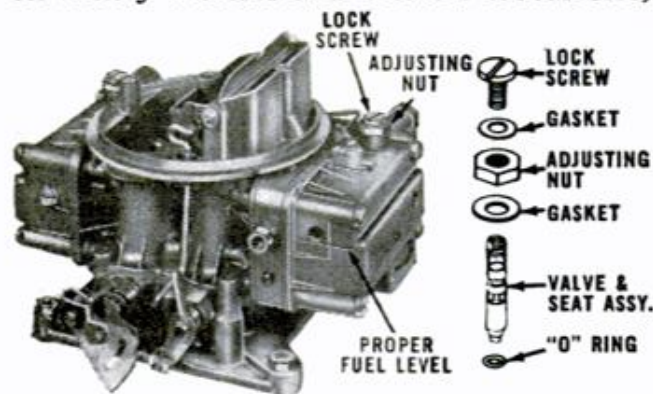

it's a simple matter to check the fuel level. Here are the easy steps: (1) Make sure the car is on level ground, then start the engine. (2) Remove the sight plug to check the fuel level in the bowl. (It should just reach the lower lip of the sight plug.) (3) If the level is too high or too low, loosen the lock screw with a screwdriver. Turn the adjustment nut clockwise to lower the fuel level—counter-clockwise to raise it. A 1/6 turn is the equivalent of 1/16-inch wet fuel level in the bowl. (4) Operate the engine until the fuel level is stabilized, then recheck level at the sight plug. Be sure to replace the sight plug. This adjustable needle and seat arrangement is one of many important developments of Holley's continuous research and engineering. There are, of course, other causes of unsatisfactory idle and economy. If this simple adjustment does not correct the trouble, your Holley dealer will be glad to make a thorough check of the carburetor.

★ ★ ★

When you make your own carburetor or ignition repairs and parts are required, be sure to use *genuine* Holley parts. Your Authorized Holley Distributor or Dealer, listed in the Yellow Pages, has a complete stock of Holley carburetor minor over-haul kits, tune-up kits, ignition parts, and brand-new replacement carburetors priced competitively with rebuilds. All are engineered and built to exacting *original equipment standards*. It will pay you to buy or specify Holley Parts.



THE
COMPLETE LINE
OF CARBURETION
and
IGNITION EQUIPMENT

C-1

11955 E. Nine Mile Road • Warren, Michigan
ORIGINAL EQUIPMENT MANUFACTURERS FOR OVER 55 YEARS

The Olds F-85

(Continued from page 102)

upon the planetary gearing is shifted to "Second" gear with a ratio of 1.58 to 1. At the proper engine and car speeds a final shift is made to "High," which is of course the direct 1-to-1 ratio.

Thus the new transmission has what amounts to the four "gears" of the original Hydra-Matic, yet one mechanical shift has been eliminated.

This new transmission weighs 95 pounds less than the automatic transmission used on 1960 Olds 88 models.

With a curb weight of around 2700 pounds for the four-door sedan it's not surprising that the F-85 has pretty lively performance. Horsepower-to-weight ratio works out to about 17.5 pounds of car weight per horsepower. Acceleration time from 0 to 60 miles per hour (indicated) is slightly less than 12 seconds.

Like the Buick Special, the F-85 has optional power steering which makes for a noticeably easier and slightly quicker steering car. Oldsmobile engineers feel that that power brakes are unnecessary to aid in stopping a 2700-pound car.

For those desiring the pleasure of Oldsmobile ownership at the lowest possible cost the F-85 with manual three-speed transmission and manual steering is expected to sell at a price that will be hard to resist.

No prices for the F-85 (or other GM cars) have been released as *PM* goes to press.

The F-85 is available in "Standard" and extra cost "Deluxe" trim. The differences between the two are principally the more luxurious interior on the Deluxe.

As much as we could determine from preliminary investigation, (thorough testing will come later,) Olds F-85 and Buick Special are closely matched. Riding qualities are very similar. In handling, the Special seemed to have a shade less roll or lean in cornering, due possibly to slight differences in shock-absorber setting.

In performance the difference in the two cars' automatic transmissions shows in that the F-85's acceleration seems more pronounced and a shade quicker while the Special seems definitely smoother in takeoff.

Like the Special, the F-85 is solidly built, smooth riding, brisk performing and easy handling. Above all it goes about its business quietly and has a great deal of the luxury "feel" of its big brothers the Dynamic 88, Super 88 and 98. The F-85 will make the choice of a 1961 car in the \$2500 price range a really tough proposition. ★★★

"Build in-or Attach on"

handy susan stor 'n' pour set

"I love it!" The compact, easy pouring HANDY SUSAN! It replaces bulky canisters and saves counter space. HANDY SUSAN comes in a variety of wood finishes and decorator colors. The bins are of high impact polystyrene and are identified with gold stamped letters. *"Wouldn't you love one too?"*

HOLDS 5 LBS. AIR TIGHT 26 1/4" x 5 1/2" x 11 1/2"

SEE AT LEADING STORES

CARSON PIRIE SCOTT CHICAGO

Or if you wish order direct from the manufacturer with this coupon. We ship immediately.

DEALER INQUIRIES INVITED

HANDY SUSAN SALES CO., 1696 Centinela St., Inglewood 3, Calif.

Please send me _____ Handy Susan set(s) @ \$19.95 ea. plus \$1.00 for postage, enclosed my check or money order.

NAME _____

ADDRESS _____

CITY _____ STATE _____

WOOD FINISH

- birch
- ash
- mahogany

BIN COLOR

- sno white
- lemon yellow
- true copper

DO-IT-YOURSELF

5 individual bins can be ordered without cabinet. Building plans enclosed.

Send me _____ Do-it-yourself kit(s) @ 11.95 ea., no postage necessary. Check bin color. **MAIL ORDER ONLY.**



900 LATEST HOME DESIGNS

In 8 Vols. • Floor Plans Included

OVER 500 PAGES of beautifully illustrated designs for ranch, split-level, 2-story, vacation homes, etc. Construction blueprints available for every design! Order today!

\$3.50

SATISFACTION GUARANTEED!

HOME PLANNERS, INC. Dept. PM, 16310 Grand River Ave. Detroit 27, Michigan

CRAFTSMEN—GET NEW 132 PAGE CATALOG



WOOD

and Workshop Supplies, Equipment

World's Largest Selection, Rare, Fancy & Imported Woods, Mosaic Tile, Lamp and Upholstery Supplies, Tools & Hardware! ALL AT MONEY SAVING PRICES!

Send for this complete new wood buying guide and project book. Craftsman is your best, most complete source of finest kiln-dried domestic and rare imported woods, beautiful wood inlays, colorful bandings, matched plywoods, embossed mouldings, carved ornaments, newest woodworking tools, "hard to find" cabinet hardware and fittings... more than 1,500 items! Packed with new patterns, project ideas and money making plans. Enclose 25c (refunded with first order) to help pay mailing and handling cost. Write: **CRAFTSMAN WOOD SERVICE CO., Dept. A-10 2729 South Mary St., Chicago 8, Ill.**

NOW—Stanley Power Tools at Discount Prices!

new FORMICA® counter top?

Laminated Plastic



It's easy when you use (1) Formica Safe-Bond, the new non-toxic, non-flammable adhesive that "tells" you when to contact... and (2) Formica laminated plastics in the smart new Raymond Loewy designs. Get Formica Safe-Bond and sheet stock at your local lumber dealer. Formica Corp., a subsidiary of American Cyanamid, Cincinnati.

a product of **CYANAMID**

For new construction or remodeling...



**NO OTHER POWER SAW
WILL DO AS MANY JOBS
AS WELL AS THE
WELLSAW
400
ELECTRIC HAND SAW**

The Wellsaw 400 is an all around cutting tool that will do just about any job you can do with a hand saw. It handles much like a hand saw, too. You just apply firm guiding pressure, the husky 7 amp. motor does the work delivering 8,000 $1\frac{1}{8}$ " cutting strokes per minute. There's no kick, no pull, no whip.

8" BLADE is all usable, supported and guided its full length.

SAFE—blade stops in less than $1\frac{1}{2}$ seconds after trigger is released.

ECONOMICAL "THROW-AWAY" BLADES, fine, medium and coarse, are changed quickly and easily.

QUALITY BUILT to heavy duty industrial standards.

Try a Wellsaw 400 at your dealer's, or use the coupon below for further information.

**SAW SPECIALISTS
SINCE 1925**

Wells

Wells Manufacturing Corp.
490 Service Road, Three Rivers, Mich.

Send descriptive bulletin on Wellsaw 400

Send name of nearest dealer

Name _____

Street _____

City _____ Zone _____ State _____

PM-1060

The Pontiac Tempest

(Continued from page 109)

spring independent suspension units already tooled up for the Corvair. The Corvair's differential and swing axles went along with the deal too.

The automatic transmission uses some Corvair Powerglide parts but is basically a new design with coaxial powerflow running from the drive shaft on through the transmission and differential back to the torque converter which is mounted on the very rear of the transaxle like a doughnut.

In principle the Tempest's automatic is a "split torque" setup similar to Buick Special's where after the shift to "Drive" range, and at a certain speed, approximately one-third of the drive becomes mechanical or "direct" while the remaining two-thirds of the engine's power is routed through the hydraulic torque converter.

One of the most spectacular items in this imaginative design is the drive shaft, a long, one-piece torsion bar bolted to the flywheel at the front end and to the transmission input shaft at the other.

This shaft is stressed so that it bends or bows downward some five degrees from the engine and upward to the transmission.

To appreciate the operation of this shaft hold a thin dowel or twig at each end and bend it slightly while rotating it slowly. You will see that if the angle is not too great it will rotate quite easily.

The Tempest's bowed shaft is maintained at the precisely correct angle by two bearings that "divide" its length into thirds. These bearings in turn are held within the U-shaped, stamped shaft tunnel or tube which is bolted to the bell housing at the forward end and to the transmission case at the rear. This tube serves as the "spine" that holds engine, driveshaft and transaxle all in one rigid unit.

This engine-power train unit is mounted on two rubber mounts at the sides of the engine and does not contact the car's frame until it reaches two additional mounts where the transaxle connects to the rear suspension cross member!

This unique construction does much to isolate and thus eliminate vibration of power plant and drive line components from the car. Manual transmission models have the clutch in the conventional location at the flywheel.

The brilliance of the precedent-shattering engineering job done on the Tempest can only be appreciated by driving the car and noting the unbelievable silence and smoothness of the engine and drive.

PM will carry a complete analysis of the Tempest's ride, handling and road behavior in a subsequent issue. ★ ★ ★



Ivan Wood, 2500 Leyden St., Denver, Colo.

Asphalt-Coated Ditch Liner Installed With Blowtorch

Farmers using a new material to line irrigation ditches need little equipment other than a blowtorch. Developed after 15 years of research at Utah State University, the material, soon to be introduced comes in 40-in-wide rolls. In the manufacturing process, the core of the liner, burlap, is treated to prevent rot and mildew. It is then dried and saturated with asphalt containing a high penetration additive to insure the coating of all fibers, and again coated with asphalt.

The ditch to be lined is cleared of all loose material and a sterilant is applied to the grade area to prevent vegetation from growing through the liner. In field tests at agricultural stations, it was found that the lining process can be speeded up by the joining of four or six strips on level ground before placing them in the ditch. All joints are overlapped about 2½ inches in the direction of flow.

Joining is accomplished by heating the asphalt surface with a blowtorch on both surfaces to be joined. When the surfaces are pressed together, a strong joint results. Patching a hole in the liner is accomplished by cutting a patch from the liner larger than the hole, heating the edges and pressing it into place.

The liner, which was developed on a project sponsored by the U.S. Department of Agriculture, seems to work best when applied to ditches of about 15 cubic feet per second capacity. While it is not meant to replace concrete liner, there are some site conditions where rigid lining cannot be used, or where extreme heaving from frost occurs. Since the new liner is a worthy moisture barrier, it should find application at these troublesome spots.

OCTOBER 1960

New Proto locking feature

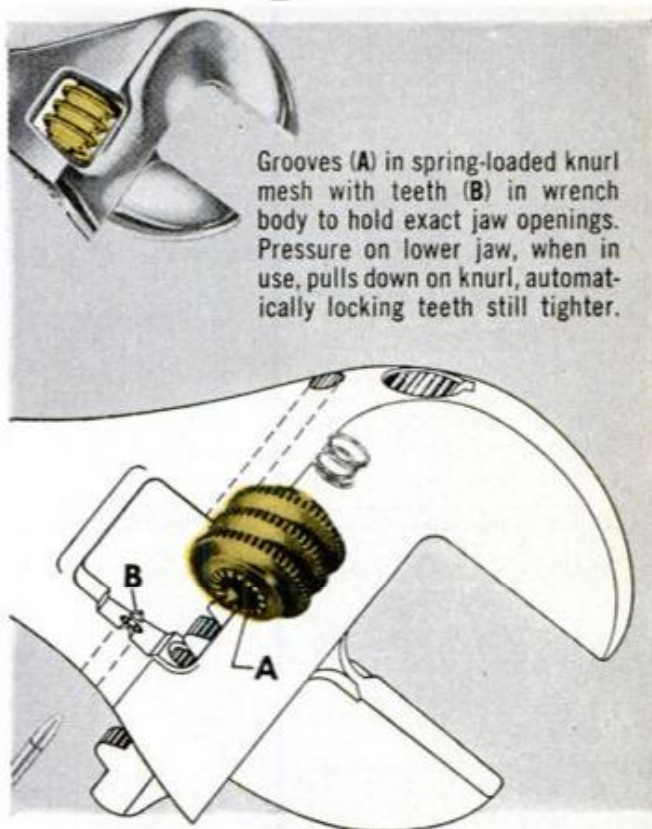

Grooves (A) in spring-loaded knurl mesh with teeth (B) in wrench body to hold exact jaw openings. Pressure on lower jaw, when in use, pulls down on knurl, automatically locking teeth still tighter.



No knuckle busting here! With Clik-Stop's automatic locking, you do more work in less time...and your hands are much safer.

No need to reset every time you go back to same size fittings. Jaws won't "creep." No levers or gadgets to set. Proto's Clik-Stop is the only locking adjustable available in all sizes, 4" through 20". The locking feature is automatic. Buy Clik-Stops from your Proto supplier. (See the Yellow Pages.)

Available in ALL sizes

704L	706L	708L	710L	712L	715L	716L	720L
4"	6"	8"	10"	12"	15"	16"	20"

Meets Federal Specifications: GGG-W-631A, Type 1



DIVISION OF PENDLETON TOOL INDUSTRIES, INC.

2202 Santa Fe Avenue, Los Angeles 54, Calif.;
502 Allen Street, Jamestown, New York;
1702 Oxford East, London, Ontario, Canada

313

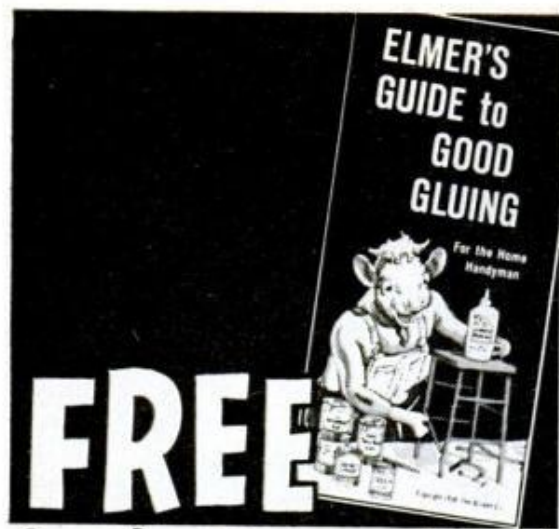

FREE
for glue-it-yourselfers!

The ins and outs of gluing. Hints, tips and shortcuts. Tells you what glue to use for every job indoors and out. Send a stamped, self addressed envelope for your free copy. The Borden Company, 350 Madison Ave., N.Y. 17, N.Y.

NOW YOU TOO CAN HAVE A

Brick Kitchen!

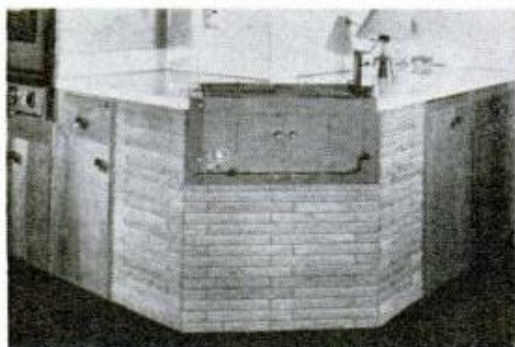

Apply elegant Z-Brick in any kitchen. Only 1/4 the bulk and 1/10 the weight of other brick or stone. 4 decorator colors.

**EASY TO CLEAN • NO MORTAR • NO FOUNDATION
APPLIES EASILY WITH ADHESIVES • FIREPROOF**

Z-Brick - at home improvement or building supply stores, or write for free brochure: Vermiculite Mfg. Co., Dept. A-2, 2107 North 34th Street, Seattle 3, Washington.

NAME _____

ADDRESS _____

CITY _____ STATE _____

The Dam That Spans the Canyon

(Continued from page 121)

mention the enormous problem of developing the aggregates, finding a source of millions of tons of sand, gravel and stone, and screening them and delivering them to the concrete mixers.

The aggregates for Glen Canyon are obtained from a source only six miles away. Some of this material, however, is unsatisfactory because it is so light in weight that it could produce "pop-outs" on the surface of the dam when frozen and thawed. To get rid of these materials a flotation process similar to that used in extracting valuable metals from their ores is used. The process is called heavy-media flotation and consists of dumping the materials into a tank containing water in which large amounts of fine ground ferrosilicon and magnetite are suspended. Light materials float to the top of this heavy solution and are washed away, while the heavy materials that sink to the bottom are caught on a conveyor belt that carries them to the stockpiles.

All the materials for the concrete are delivered to storage areas at the damsite by truck, then move by pipes or conveyor belts to bins and silos at the concrete mixing plant. This plant, located on a ledge that was blasted out of the canyon wall, consists of six 4-cubic-yard mixers that can produce 9000 cubic yards of concrete per day.

After a series of transfers the concrete is delivered to buckets suspended from an overhead cableway, and the cableway then transports the buckets out to the area of the dam that is being poured. Each bucket carries 12 cubic yards of concrete at a time and each cable that spans the canyon is four inches in diameter.

To facilitate construction, the dam is being created as a series of columns or blocks that are keyed together, with construction joints between the blocks. Upon completion, the contraction joints will be grouted under high pressure, converting the whole structure into a single monolithic mass.

Concrete generates heat while it is curing, and an enormous mass such as a dam normally would require years to cool. In doing so, it shrinks and possibly develops cracks. Today engineers have ways of preventing this and they have actually learned how to put the thermometer to work to create a stronger dam.

On the Glen Canyon job the Bureau of Reclamation specifies that all concrete placed in the dam must have a temperature of between 40 and 50 degrees when placed, even though summer temperatures at the site may rise as high as 110 degrees.

(Continued to page 316)



The
"GIBRALTAR"
Home Shop
Work-Bench
\$15.95
F. O. B. Factory
The Basic Necessity
For the
Home Work Shop

JUMBO SIZE—6' Long, 22" Wide, 34" High, 1 1/2" Thick

CONSISTS OF ONLY 4—EASY to assemble parts: (1) Top with tool rack built on; (2) Shelf unit for bottom; (3) Leg unit for right end; (4) Leg unit for left end. ALL SCREWS AND BOLTS FURNISHED—FUN TO PUT TOGETHER—QUICK—EASY.

1 1/2" Glued up top, solid construction of hard yellow pine provides excellent base for saws and vices. Manufactured and sold at a price less than materials alone, not assembled, would cost you.

Order Direct From Factory
Challenger Mfg. Co., Inc.
342-346 N. Royal P. O. Box 1107
JACKSON, TENNESSEE
We can accept cash, checks or money orders only, please.

ELECTRIC WELD - BRAZE & CUT

REPAIR MOST EVERYTHING MADE OF METAL

Home Appliances, Auto parts, Farm-garden equipment, toys, Make and repair playground equipment,



lawn chairs, tables, ornamental iron work, gates, wagons, etc. Solder, heat, bend, and straighten, with terrific heat from arc torch. Cut and weld up to 1/4" steel plate. A million uses for Home, auto, farm, inventors, factories, etc. Works from any home 110

volt plug-in. Complete with dark welder's mask, arc torch, supply of carbon welding and brazing rods and complete Welding Instruction Book. Efficient—durable—1 year guarantee. Wt. only 4 lbs.

SEND ONLY \$3 (cash, ck, mo) and pay postman \$9.95 plus COD postage on arrival or send \$12.95 and we will send postpaid. Ideal gift for mechanically minded home owners, relatives, friends. Order now for early delivery. Available only from
MIDWAY WELDER Dept. DPM-10 Kearney, Nebraska



Remington Arms Co., Inc., Bridgeport, Conn.

Shells With Plastic Bodies Resist Rough Treatment

Shotgun shells made with steel bases and polyethylene plastic bodies, called Premium Grade SP shells, have performed normally after treatment that destroyed the older brass-based, paper-bodied shells (above). The new shells are scuff and marproof, waterproof, won't swell in moisture, and maintain ballistic stability in any weather.

OCTOBER 1960

"My Homelite chain saw helped pay for a brand new car".

Another user testimonial for

HOMELITE

500

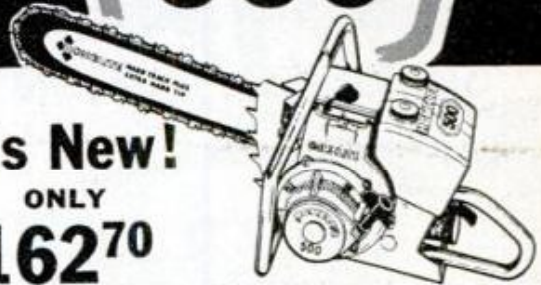

It's New!

ONLY
\$162⁷⁰

Complete with 12" bar and chain F.O.B. nearest factory branch

- Only 19 pounds, less bar and chain
- Easy to carry, easy to use
- Fells trees up to 3 feet in diameter
- Fast direct drive
- Perfect for clearing campsites, cutting firewood, fenceposts, and lumber for shelters

In just six weeks, Mr. Richard Sisson of Hines, Minnesota cut 10,000 feet of timber from his 40-acre woodlot. His NET profit was \$511.80 which helped him buy a new car.

Set your sights on extra money with a new Homelite 500! See a free demonstration at your nearby dealer's. And be sure to see the new full line of 8 Homelite chain saws. There's one to fit your job and your budget.

HOMELITE A DIVISION OF TEXTRON INC.
610 Riverdale Ave., Port Chester, N. Y.

As little as \$3.05 weekly after small down payment
Ask for Homelite Guide Bars and Homelite Chain

HOMELITE

"Shoot the Works" Contest

WIN!



FIRST PRIZE
A \$4,000 Mohawk Vacation Lodge PLUS the Homelite chain saw of your choice.

714 OTHER PRIZES
Famous Harrington & Richardson rifles and shotguns.



See your Homelite dealer for contest rules and entry blank. Or write to: Homelite, "Shoot the Works" Contest, Port Chester, N. Y.

315

MAC'S SEALER AND STOP LEAK

SEALS IN
ANTI-FREEZE

Withstands
20 lbs.
pressure



At
Service
Stations
Everywhere

Stops leaks in seconds



advanced techniques in
QUALITY CONTROL



double the life of
cars and trucks
with Precision-Built

**MUSTANG
REPLACEMENT ENGINES**

Precision refinements in testing and inspecting produce longer life, greater horsepower, top performance and unmatched value. Dependable, low cost transportation assured with written guarantee.

Sold on easy payment
plan by leading repair
shops and car dealers.



MUSTANG ENGINES

316 INTERNATIONAL ROAD • GARLAND, TEXAS

To cool their materials the contractors are using a big refrigeration plant that provides cold air that is forced through the batching silos in which gravel and rock are stored. In addition the plant provides cold water that is sprayed over the aggregates to cool them while they are traveling through insulated tunnels to the mixers and, finally, the refrigeration plant provides cracked ice that is dumped into the mixers themselves.

One thousand miles of one-inch aluminum tubing is being installed in the dam to bleed off the heat generated while the concrete is setting. Cold water that is circulated through the tubing will bring the temperature of the mass of concrete down to 40 degrees, after which grouting will be forced into the pipes under pressure to seal them. Then the dam will be allowed to come up to its permanent average temperature of around 60 degrees. The concrete will expand slightly as it warms up and this expansion will tighten the ends of the dam into the canyon rock, securely locking the dam in place so that it serves as a true arch.

Completion of the dam is scheduled for March of 1964.

Glen Canyon Dam is the key feature of what is known as the Colorado River Storage Project, a plan for holding surplus river water in the Colorado's upper basin until it is needed downstream in dry years. At the same time, some of the water that is held upstream will be available for local industry and agriculture. The upper basin consists principally of parts of Utah, Wyoming and Colorado, and is a region that is virtually undeveloped because of the lack of water and power in the past.

In addition to the Glen Canyon unit on the Colorado itself, three other large storage dams are planned for tributaries of the Colorado: Flaming Gorge Dam on the Green River in northern Utah, Curecanti Dam on the Gunnison in western Colorado and the Navajo Dam on the San Juan in northern New Mexico. These dams will provide water of 11 new irrigation districts that will comprise 130,000 acres of new farmland in addition to providing more water to 230,000 acres of existing farms.

Not the least of the benefits provided by Glen Canyon Dam will be the vast new recreational area that will be opened up by its 186-mile reservoir.

The National Park Service plans at least 10 major resorts centers on the shores of the reservoir, all of which will be available by roads and boats and some of which can be reached by light planes. Boating marinas, campgrounds, motels, and swimming and fishing facilities will be available at each of the centers. ★ ★ ★



All New!

DELTA ASTROLite

New beauty! Quality electric lantern. Brilliant spot. Flashing red light visible for a mile. Dual fingertip switches. Uses twin-pack 6-Volt battery. With Sealed Beam (illus.) \$9.25. With conventional bulb..... \$7.95



POWERlite. 800-ft. spot from side—wide floodlight from top. 6-V... \$6.15

POWER-KING. Powerful 1/4-mile beam. Adjustable head. 12-V. Only.... \$7.25

Prices are without batteries.



Delta

LIGHTS THE WAY

DELTA ELECTRIC COMPANY, 323 W. 33rd St., Marion, Indiana

Short ^{with WILHOLD®} Cuts

CON-TAX CEMENT

SAVES TIME

- ★ ONE COAT COVERS
- ★ APPLIES BY ROLLER
- ★ DRIES IN A JIFFY



TABLE AND SINK TOPS • BONDED EASILY WITH CON-TAX

WILHOLD GLUES INC.

- WATERPROOF
- BONDS ON CONTACT
- HIGH HEAT RESISTANCE

ASK YOUR WHOLESALE AD #1081

Los Angeles 31 Chicago 44

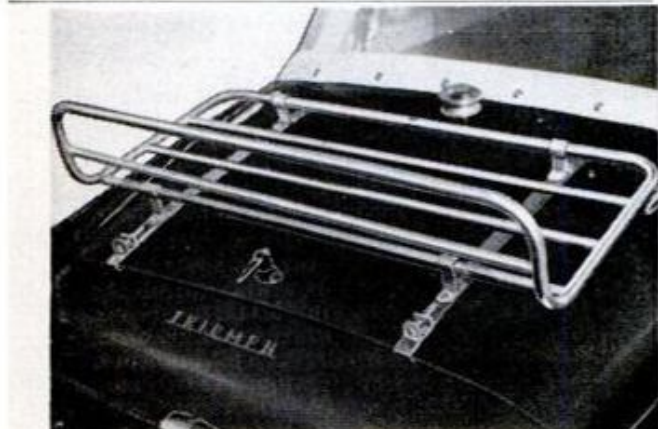

Baker's Worldwide Auto Parts, Inc.,
1073 Hempstead Turnpike, Franklin Square, Long Island, N. Y.

Sports Car Luggage Rack

One solution to the problem of locating a luggage rack on sports cars and small convertibles is an aluminum rack that clamps onto the trunk lid. The felt-padded steel straps fold over the front and back edges and clamp on with just a screwdriver, yet look like permanent fastenings.

OCTOBER 1960

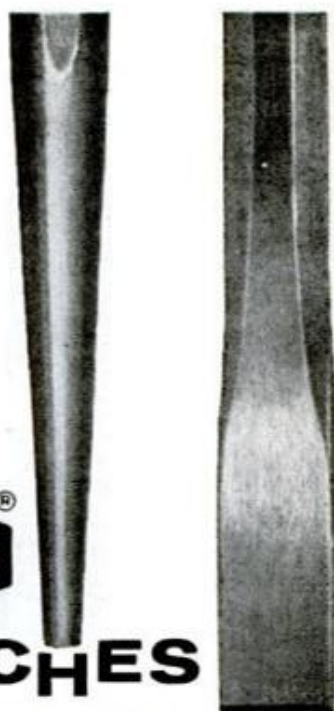

P & C

PUNCHES & CHISELS

Tough Tools for Hard Jobs

P&C quality punches and chisels will stand up to any hard jobs. They are precision ground, hot forged from alloy steel and scientifically tempered. Each tool has a beveled head, sand-blasted octagon handle and highly polished taper or bevel. Easy to hit, will not chip and lacquer-dipped to resist rust. Complete line of Cold, Cape, Round Nose and Diamond Point Chisels; Center, Prick, Drift, Aligning, Starter and Pin Punches.

You'll find P&C Punches and Chisels on the colorful P&C Merchandiser at your hardware store.



P & C TOOL COMPANY

Portland 22, Oregon

Chicago Warehouse
Box 87 Schiller Park, Illinois
In Canada, Box 366, London, Ontario

Subsidiary



317

HERE'S WHERE YOU CAN FIND MORE INFORMATION ON THE BUILT-IN CONVENIENCES YOU HAVE SEEN IN THE HOUSE OF BUILT-INS FEATURED IN THIS ISSUE . . .

Be sure to visit these lumber yards for all your built-in and remodeling needs:

ALABAMA

Birmingham
Wood's Do-It-Yourself
Centers
Mobile
J. E. Paterson Lumber Co.

ARIZONA

Douglas
Bassett Lumber Company

CALIFORNIA

Anderson
Diamond National Corp.
Arbuckle
Diamond National Corp.
Arcadia
Arcadia Lumber Company
Atwater
Diamond National Corp.
Auburn
Diamond National Corp.
Biggs
Diamond National Corp.
Buena Park
Buena Park Lumber
Chico
Diamond National Corp.
Colusa
Diamond National Corp.
Concord
Diamond National Corp.
Corning
Diamond National Corp.
Cotati
Diamond National Corp.
Dunsmuir
Diamond National Corp.
Esparto
Diamond National Corp.
Fairfield
Diamond National Corp.
Fair Oaks
Diamond National Corp.
Fresno
Diamond National Corp.
Galt
Diamond National Corp.
Grass Valley
Diamond National Corp.
Hanford
Diamond National Corp.
Lakeport
Diamond National Corp.
Lakewood
Build N'Save
Lincoln
Diamond National Corp.
Live Oak
Diamond National Corp.
Livermore
Diamond National Corp.
Lodi
Diamond National Corp.
Los Molinos
Diamond National Corp.
Manteca
Diamond National Corp.
Martinez
Diamond National Corp.
Marysville
Diamond National Corp.
Modesto
Diamond National Corp.
Northridge
Terry Lumber Company
Oakdale
Diamond National Corp.
Orland
Diamond National Corp.
Oroville
Diamond National Corp.
Paradise
Diamond National Corp.
Petaluma
Diamond National Corp.
Placerville
Diamond National Corp.
Ft. Reyes Station
Diamond National Corp.
Red Bluff
Diamond National Corp.
Redding
Diamond National Corp.
Roseville
Diamond National Corp.
Sacramento
Diamond National Corp.

Santa Rosa
Diamond National Corp.
Sebastopol
Diamond National Corp.
Stockton
Diamond National Corp.
Turlock
Diamond National Corp.
Ukiah
Diamond National Corp.
Vacaville
Diamond National Corp.
Walnut Creek
Diamond National Corp.
Williams
Diamond National Corp.
Winters
Diamond National Corp.
Woodland
Diamond National Corp.

COLORADO

Akron
Akron-Otis Lumber Co.
Arvada
Bestway Building Center
Boulder
Bestway Building Center
Brighton
United Lumber &
Hardware, Inc.
Craig
Bestway Building Center
Denver
Bestway Building Center
South Federal Lumber Co.
Fort Lupton
Bestway Building Center
Greeley
Bestway Building Center
Longmont
Bestway Building Center
Loveland
Bestway Building Center
Otis
Akron-Otis Lumber Co.
Windsor
Bestway Building Center

CONNECTICUT

Danielson
R. A. Tillinghast
Lumber, Inc.
Hartford
Hartford Building Supply
Co., Inc.
Hazardville
Amos D. Bridges' Sons, Inc.
Lakeville
Community Service, Inc.
Madison
Madison Lumber &
Supply Co.
Ellington
W. G. Glenney Co.
Manchester
W. G. Glenney Co.
Middletown
Gustav Loewenthal
Lumber Co.
New Haven
West Haven Lumber Co.
Norwich—New London
Building Supply Center
Waterbury
J. E. Smith & Co., Inc.
Willimantic
O. L. Willard Co.

FLORIDA

Gainesville
Contractors Supply, Inc.
Miami
Bailey's Lumber Yards, Inc.
South Miami
Bailey's Lumber Yards, Inc.
IDAHO
Aberdeen
Bestway Building Center
American Falls
Bestway Building Center
Arco
Bestway Building Center
Ashton
Bestway Building Center
Blackfoot
Bestway Building Center
Boise
Bestway Building Center

Buhl
Bestway Building Center
Burley
Bestway Building Center
Caldwell
Bestway Building Corp.
Cascade
Bestway Building Center
Driggs
Bestway Building Center
Eagle
Bestway Building Center
Emmett
Bestway Building Center
Filer
Bestway Building Center
Firth
Bestway Building Center
Gooding
Bestway Building Center
Hazelton
Bestway Building Center
Homedale
Bestway Building Center
Idaho Falls
Bestway Building Center
Kimberly
Bestway Building Center
Lewiston
Bestway Building Center
Marsing
Bestway Building Center
Menan
Bestway Building Center
Meridian
Bestway Building Center
Montpelier
Bestway Building Center
Moscow
Bestway Building Center
Mountain Home
Bestway Building Center
Nampa
Bestway Building Center
Parma
Bestway Building Center
Payette
Bestway Building Center
Pocatello
Bestway Building Center
Rexburg
Bestway Building Center
Rigby
Bestway Building Center
Ririe
Bestway Building Center
Roberts
Bestway Building Center
Rupert
Bestway Building Center
St. Anthony
Bestway Building Center
Shelley
Bestway Building Center
Shoshone
Bestway Building Center
Twin Falls
Bestway Building Center
Ucon
Bestway Building Center
Weiser
Bestway Building Center
Wendell
Bestway Building Center
Wildor
Bestway Building Center

ILLINOIS

Apple River
Spahn & Rose Lumber Co.
Arlington Heights
Hill Behan Lumber
Belleville
Hill Behan Lumber
Bensenville
Hill Behan Lumber
Blue Island
Mathieu Lumber & Supply
Buda
Fullerton Lumber Co.
Canton
Fullerton Lumber Co.
Chicago
Fordham Lumber Co.
1040 East 87th Street
Gee Lumber Co.
2600 West 79th Street

Hill Behan Lumber
5601 Elston Avenue
Hill Behan
6452 Higgins Road
Hill Behan
9501 S. Park
Edward Hines Lumber Co.
2431 S. Wolcott Ave.
Edward Hines Lumber Co.
5245 Archer Ave.
Edward Hines Lumber Co.
355 North Laverne Ave.
Edward Hines Lumber Co.
1168 North Halsted Street
Edward Hines Lumber Co.
3840 Milwaukee Ave.
Edward Hines Lumber Co.
5140 Milwaukee Ave.
Edward Hines Lumber Co.
3765 Lincoln Ave.
Edward Hines Lumber Co.
1834 Balmoral Ave.
Edward Hines Lumber Co.
4626 West 63rd Street
Edward Hines Lumber Co.
1620 West 59th Street
Republic Lumber Co.
5584 Northwest Highway
Star Lumber Co.
201 West 87th Street
Stoller Lumber Co.
1652 Milwaukee Ave.
Cicero
Edward Hines Lumber Co.
Downers Grove
Edward Hines Lumber Co.
East Alton
Hill Behan Lumber
East Moline
East Moline Lumber Store
Evanston
Edward Hines Lumber Co.
1613 Church Street
Edward Hines Lumber Co.
119 Chicago Ave.
Evergreen Park
Edward Hines Lumber Co.
Freeport
Fullerton Lumber Co.
Glenview
Edward Hines Lumber Co.
Highland
Hill Behan Lumber
Highland Park
Edward Hines Lumber Co.
Homewood
Edward Hines Lumber Co.
Itasca
Edward Hines Lumber Co.
Kewanee
Fullerton Lumber Co.
LaGrange
Edward Hines Lumber Co.
Melrose Park
Edward Hines Lumber Co.
Monmouth
Fullerton Lumber Co.
Morrison
J. A. Bull & Sons, Inc.
Mount Prospect
Edward Hines Lumber Co.
North Aurora
Hill Behan Lumber
Nora
Spahn & Rose Lumber Co.
Palatine
Edward Hines Lumber Co.
Park Ridge
Edward Hines Lumber Co.
Pearl City
Spahn & Rose Lumber Co.
River Forest
Edward Hines Lumber Co.
Rock Island
Rock Island Lumber Co.
St. Charles
Edward Hines Lumber Co.
Stockton
Spahn & Rose Lumber Co.
Villa Park
Edward Hines Lumber Co.
Wheaton
F. E. Wheaton & Co., Inc.
Winslow
Spahn & Rose Lumber Co.
Winchester
Fullerton Lumber Co.
(Continued to page 320)



WELD FOR PLEASURE OR PROFIT TRINDL INDUSTRIAL ARC WELDER

Own a Trindl 125 Amp Industrial Welder at less than smaller machines. Welds metals to 1/2" thick. Operates off properly wired 110 or 220 volt line. 16 heat stages from 20 to 125 amps. Make, repair anything of metal in the home, garage, farm or shop. No experience or training needed. Full "do-it-yourself" instructions. Guaranteed 12 months in continuous operation. Complete only \$98.50 FOB or write for details on 125A and other Heavy Duty Trindl Welders. Dealer Inquiries Invited.

Trindl Products, Ltd., Dept. T2-K, 1807 S. Clark St., Chicago 16, Ill.



EASY TERMS
\$98.50 FOB

FREE CATALOG!

TREMENDOUS SAVINGS ON HUNDREDS OF SURPLUS AND NEWLY MANUFACTURED ITEMS!

New 1960 edition contains over 50 pages of tools and equipment for farm, home, workshop, factory. Hydraulic equipment, pumps, motors, construction and diesel equipment and parts! Write for your **FREE CATALOG** Today.

GROBAN SUPPLY COMPANY

1139 South Wabash Ave., Dept. G10 Chicago 5, Ill., WEbster 9-3793

If it's worth painting
it's worth sanding...
with sandpaper by



CARBORUNDUM®

MAKE HOME IMPROVEMENTS NOW



Iron Fireman Manufacturing Co., Cleveland, Ohio

Chimneyless Oil-Heating Boiler Provides Own Mechanical Draft

Operating with a sealed combustion system into which the correct amount of air for efficient combustion is injected with an exact volume of oil vapor, an oil-heating boiler needs only a small exhaust pipe to the outdoors. A new oil-burner principle enables it to achieve "100 percent combustion of oil—with no smoke, soot or odors." The boiler will furnish hot water or steam heat, and a domestic hot-water system is an optional feature.



DRAINS cellars, cisterns, wash tubs; \$7.95 IRRIGATES - CIRCULATES - SPRAYS

1,001 uses. Stainless shaft. Won't rust or clog! Use 1/6 HP motor or larger... 3/4 HP for up to 2,400 GPH; 450 GPH 80' high; or 1800 GPH from 25' well. 1" inlet; 3/4" outlet. Coupling included free. **\$7.95.** HEAVY DUTY BALL-BEARING PUMP. Up to 5,200 GPH; or 3,000 GPH from 25' well. 1 1/4" inlet; 1" outlet. **\$12.95** Postpaid if cash with order. **MONEY BACK GUARANTEE** Centrifugal and Gear Pumps in All Sizes
LABAWCO PUMPS, Belle Mead 7, New Jersey



REPLACE YOUR WORN-OUT WOODEN HATCHWAY...

with an all-steel **BILCO** basement door



... and your basement entrance will be weathertight, good-looking — for a lifetime. A spring-balanced Bilco door floats open at a touch... locks securely... costs so little. And you can install it yourself — in just a few hours!

Bilco

The Bilco Co., Dept. R-910
New Haven 5, Conn.

Please send me your free illustrated folder and name of local dealer.

AMERICA'S FINEST BASEMENT DOOR

NAME _____
ADDRESS _____
CITY _____ ZONE _____ STATE _____



If your wife is nagging
you about shabby

WOOD FLOORS

Refinish them yourself in
just ONE DAY with

FABULON

the fabulous FLOOR FINISH

Give your floors the armor-like protection of FABULON, the original "bowling-lane" finish for home use. Applies easily with brush or roller. Your wife will love her FABULON-ed floors. . . NO MORE WAXING OR SCRUBBING. At paint, hardware and lumber stores everywhere. For comprehensive manuals on all phases of wood finishing, send 25c in coin to . . .



PIERCE & STEVENS CHEMICAL CORP.
710 OHIO STREET • BUFFALO 3, N. Y.
Available in Canada—Le Page's, Toronto 18, Ont.

**SAVE STRAIN
SAVE SKIN**

WITH
**Bridgeport
NEOPRENE**

**CUSHION
GRIP**

SCREWDRIVERS

**50%
GREATER TURNING
POWER**

16 sizes and
styles—Regular
and Phillips.
\$1.00 and \$2.70
At your hardware
store.

- SUPER COMFORTABLE
- NON-SLIP GRIP
- UNBREAKABLE HANDLE
- FULLY GUARANTEED
- ALLOY STEEL BLADE

Resilient Neoprene CUSHION GRIP lets you turn screws tighter with less work—and you don't hurt your hands. Tested and approved by Mechanics

THE BRIDGEPORT HARDWARE MFG. CORP., BRIDGEPORT 5, CONN., U. S. A.

More Built-Ins Information Centers:

- INDIANA**
Chesterton Morgan Construction Supply Co.
Decatur Arnold Lumber Co., Inc.
Frankfort Kramer Brothers Lumber Co.
Ft. Wayne South Side Lumber Co.
Griffith McFarland Lumber Co.
Hammond Standard Lumber Co.
Kouts Kouts Lumber Co.
Terre Haute Valley Supply Co., Inc.
Whiting Northern Indiana Lumber Co.
- IOWA**
Afton Spahn & Rose Lumber Co.
Albion Denniston & Partridge Co.
Allison Fullerton Lumber Co.
Altoona Denniston & Partridge Co.
Ankeny Denniston & Partridge Co.
Anthon Fullerton Lumber Co.
Arlington Spahn & Rose Lumber Co.
Avoca Fullerton Lumber Co.
Belmond Fullerton Lumber Co. Spahn & Rose Lumber Co. Yards
Blairstown Denniston & Partridge Co.
Bondurant Denniston & Partridge Co.
Bristow Fullerton Lumber Co.
Brooklyn Fullerton Lumber Co.
Burlington Fullerton Lumber Co.
Carson Fullerton Lumber Co.
Cedar Rapids Lampert Yards
Charles City Lampert Yards
Charlotte Hart Lumber Co.
Cherokee Rock Island Lumber Co. 210 S. 4th Street
Clarion Lampert Yards
Colfax Denniston & Partridge Co.
Collins Spahn & Rose Lumber Co.
Danbury Fullerton Lumber Co.
Davenport Denniston & Partridge Co.
Davenport The White Lumber Store 909 E. River Street
Dawson Denniston & Partridge Co.
Dubuque Spahn & Rose Lumber Co. Yards
Edgewood Spahn & Rose Lumber Co.
Emmetsburg Lampert Yards
Fairfax Denniston & Partridge Co.
Fonda Fullerton Lumber Co.
Fort Dodge Fullerton Lumber Co.
Greeley Spahn & Rose Lumber Co.
Greenfield Fullerton Lumber Co.
Grinnell Denniston & Partridge Co.
Griswold Fullerton Lumber Co.
Grundy Center Fullerton Lumber Co.
Hopkinton Spahn & Rose Lumber Co.
Ida Grove Fullerton Lumber
- Iowa City** Lampert Yards
Jesup Spahn & Rose Lumber Co.
Jewell Hart Lumber Co.
Kanawha Lampert Yards
Knoxville Spahn & Rose Lumber Co. Yards
Laporte City Spahn & Rose Lumber Co.
Latimer Fullerton Lumber Co.
LeClaire Hart Lumber Co.
Le Mars Lampert Yards
Linden Denniston & Partridge Co.
Lohrville Fullerton Lumber Co.
Lorimor Fullerton Lumber Co.
Manly Fullerton Lumber Co.
Manson Fullerton Lumber Co.
Marion Spahn & Rose Lumber Co. Yards
Massena Fullerton Lumber Co.
Maxwell Spahn & Rose Lumber Co.
Maynard Spahn & Rose Lumber Co.
Merrill Lampert Yards
Milton Denniston & Partridge Co.
Mingo Denniston & Partridge Co.
Mitchellville Denniston & Partridge Co.
Montezuma Fullerton Lumber Co.
Monticello Spahn & Rose Lumber Co.
Moville Fullerton Lumber Co.
Mt. Pleasant Spahn & Rose Lumber Co. Yards
Nevada Hart Lumber Co.
Newell Fullerton Lumber Co.
Newhall Spahn & Rose Lumber Co.
New London Spahn & Rose Lumber Co.
Newton Denniston & Partridge Co.
Nora Springs Fullerton Lumber Co.
Norway Denniston & Partridge Co.
Oakland Fullerton Lumber Co.
Olds Spahn & Rose Lumber Co.
Orient Fullerton Lumber Co.
Osage Spahn & Rose Lumber Co. Yards
Ottumwa Spahn & Rose Lumber Yards
Perry Denniston & Partridge Co.
Pleasantville Denniston & Partridge Co.
Readlyn Spahn & Rose Lumber Co.
Rockwell City Fullerton Lumber Co.
Salem Spahn & Rose Lumber Co.
Shelby Fullerton Lumber Co.
Sibley Lampert Yards
Sioux City Fullerton Lumber Co.
State Center Denniston & Partridge Co.
Taintor Denniston & Partridge Co.
Tama Spahn & Rose Lumber Co.
Union Denniston & Partridge Co.

(Continued to page 322)

CUT-TO-FIT HOMES CUT COSTS UP TO 40%

Save labor cost up to 100%, reducing completed home cost up to 40%. You can assemble any of 57 designs from easy-to-follow plans. No measuring or cutting . . . every piece precision machine pre-cut and marked. **BUY DIRECT FROM MILL.** Eliminate all between overhead, profit and labor

costs. Nothing to plan or figure. Complete with all lumber, hardware, paint, nails, glass, roofing, etc. Sterling Home quality material throughout. Freight paid most areas. Write today. Send 25c for illustrated, color catalog, floor plans and details.



INTERNATIONAL MILL & TIMBER CO. Bay City, Michigan, DEPT. PM 10

PRICED FROM
\$2250 up

CHOICE
OF
57
DESIGNS

FIVE EASY-PAYMENT PLANS



National Multiple Sclerosis Society

• FOR HANDS • FOR FLOORS • FOR WALLS

QUICKEE®

SPECIALIZED CLEANERS

Send for FREE HAND CLEANER SAMPLE, Dept. PM

At Stores Everywhere / Quickee Products, Inc., Yonkers, N. Y.

GIGANTIC SURPLUS SALE!

STANDARD DIAL PHONE



Cost govt. \$29.50. **SALE \$9.25 FOB**

• Item #716. Genuine W.E. modern, hi-efficiency dial phone. Use for extension to main line on private system. Use several for complete private system. Work on any system. Shipping weight 8 lbs.



DELUXE AIR COMPRESSOR KIT

• For painting, cleaning, tires, termites. Assemble own outfit.



• Item #468. DeLuxe Kit. Compressor, tank, gauge, regulator, paint gun, relief valve, fittings, hose, instructions. Weight 45 lbs. List \$67.50

SALE \$49.50 fob

AIR COMPONENT BUYS

Compressor \$21.50. Air Tank \$10.95. Regulator \$3.95. Pop Off \$1.75. Gauge \$1.75. Paint Gun \$8.75. Auto Switch \$4.75.

POWER PLANTS



• Amazing buys in DeLuxe Govt. 115-v 60-c plants. Large selection.

ALL FOB

- 1000 W \$159.95
- 1500 W 179.95
- 3000 W 249.50
- 5000 W 449.50
- 10000 W 595.00
- 3000 W DC 169.50

EXAMPLE BARGAINS IN NEW CATALOG

\$275 Battery Truck-Boat Winch \$46.75 FOB
 \$112 Level-Transit Outfit 92.50 PPD
 \$39.50 Motor Vacuum-Blower Unit 6.95 FOB
 \$27.95 Battery Charger 6 amps., 6-12V 16.95 FOB
 \$380 Welding Generator 300 Amp. 19.95 FOB
 \$ 75 Hydraulic "Servo" Cylinder 5.79 PPD
 \$ 80 Centrifugal Pump 19.49 FOB
 \$245 Golf Car Battery Motor 18.95 FOB
 \$ 39.95 Portable Electric Saw 7" 29.95 FOB
 \$ 55.00 Binoculars 7 x 50 with Case 24.15 FOB

SURPLUS CENTER
LINCOLN, NEBR. DEPT. 812

Write for
FREE
BIG 1960
CATALOG

Save to 70% on 1000's of Surplus and New Equip. Bargains.

MONEY BACK GUARANTEE ON ALL ITEMS



LICKITY LOG SPLITTER

Ends Wood Splitting Drudgery

Hydraulic power splits profits from waste wood
 • 7 HP trailer model • two speed • auto shift
 • auto stroke. Power "squats" to receive large diameter logs without "dead" lift—eighteen ton smooth hydraulic force cuts right through knots, 26" stroke handles up to 30" length, any diameter. Your name on a postal card will bring literature.

THE WACO AIRCRAFT CO., Dept. D, Troy, Ohio
Dealer Inquiries Invited

BIG Profits in arc welding!

earn extra money with these low cost welders

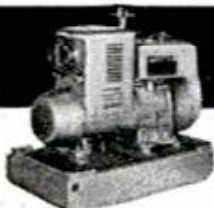

"HUSKY BOY" air cooled arc welder



Shop Type AC arc welder



"Handy Andy" home type welder

One of these low cost Hobart Arc Welders will immediately set you up in a highly profitable business - enabling you to capitalize on the ever expanding demand for emergency repair and

construction jobs. Hobart welders give high efficiency at low cost—let you weld right on the spot—saving costly tear-down and assembly. Write for complete details—no obligation.

HOBART BROS. CO., Box M-100, Troy, Ohio, phone FE 2-1223

Dr. Grabow Pre-Smoked PIPES

Only Dr. Grabow pipes are mechanically pre-smoked with fine tobacco. Need no breaking-in. Sweet and cool from the first puff.



Viscount
\$5.

Others to \$10.
Imported Briar

For Free Booklet Write:
Dr. Grabow Pre-Smoked
Pipes • Greensboro, N.C.

Saves work in painting

Why "break your back" washing and sandpapering woodwork before you refinish it? There's a far easier way—WIL-BOND!

This unique liquid removes all greasy dirt. At the same time it dulls the old finish—no messy, dusty sandpapering needed.

The new finish spreads without streaking, and bonds tightly. Fine job! Less work! At paint and hardware stores.

● Send 25c for illustrated Refinishing Manual or write for free Wil-Bond folder.

Wilson-Imperial Co. 118 Chestnut St., Newark 5, N.J.



HOW TO PROTECT YOUR INCOME!

Earn Extra Money With A Rapid

SHEAR SHARPENER AND KNIFE SERRATOR



Easy to operate—professional-type sharpener does a perfect job in just 2 minutes on all types scissors and shears, including pinking shears. Knife serrating attachment puts saw-tooth edge on any blade. Knife serrating attachment puts saw-tooth edge on hard or soft steel blades. Quick profits from homes, dressmakers, barbers, restaurants, hotels, butchers, etc. No experience needed. Big opportunities with this precision ball bearing machine. Has 1/4 h.p. motor. A money-making investment—write for FREE FOLDER

BEAVER MFG. CO P.O. BOX 434, 800 So. Isis Ave.
Inglewood, Calif.

More Built-Ins Information Centers:

Urbana
Lampert Yards
Van Meter
Denniston & Partridge Co.
Villisca
Fullerton Lumber Co.
Walnut
Fullerton Lumber Co.
Wapello
Denniston & Partridge Co.
Waterloo
Fullerton Lumber Co.
Waverly
Spahn & Rose Lumber Co.
Yards
Webster City
Spahn & Rose Lumber Co.
Yards
West Bend
Lampert Yards
Whittemore
Fullerton Lumber Co.
Williams
Spahn & Rose Lumber Co.
Worthington
Spahn & Rose Lumber Co.

KANSAS
Agra
Agra Lumber Co.
Alton
Alton Lumber & Coal Co.
Asherville
Asherville Lumber & Coal Co.
Beloit
Peoples Lumber & Coal Co.
Burr Oak
Burr Oak Lumber & Coal Co.
Cawker City
Cawker City Lumber Co.
Colby
Hardman Lumber Co.
Gaylord
Hardman Lumber Co.
Glen Elder
Dickinson Lumber Co.
Goodland
Hardman Lumber Co.
Great Bend
Rock Island Lumber Co.
1820 Main Street
Hayes
Hardman Lumber Co.
Hill City
Hardman Lumber Co.
Independence
Rock Island Lumber Co.
8th and Laurel
Lebanon
Lebanon Lumber Co.
Lenora
Lenora Lumber Co.
Linn
Rice & Johntz Lumber Co.
Oakley
Oakley Lumber Co.
Phillipsburg
Hardman Lumber Co.
Russell
Hardman Lumber Co. of Russell, Inc.
Smith Center
Smith Center Lumber Co.
Stockton
Stockton Lumber Co.
Wichita
Rock Island Lumber Co.

LOUISIANA
Bossier City
Bolinger Lumber & Supply Co., Inc.
Covington
Smith Hardware
Denham Springs
Hall-Denham Hardware
Harahan
Hill Behan Lumber
New Orleans
Campo Hardware
2601 Jackson Ave.
Doucet Brothers Hardware
9031 Jefferson Hwy.
Miller Hardware
3129 Gentilly Blvd.
Hill Behan Lumber
11030 Chef Menteur Hwy.
Vetter Hdw & Lumber Co.
5900 St. Claude Ave.
Shreveport
Clanton Lumber & Supply Co., Inc.
510 Creswell Street
Pelican Lumber & Supply Co., Inc.
6503 Line Ave.

MAINE
Eastport
L. Grossman Sons, Inc.

MASSACHUSETTS

Ayer
L. Grossman Sons, Inc.
Belchertown
L. Grossman Sons, Inc.
Billerica
L. Grossman Sons, Inc.
Chesterfield
Bisbee Brothers
Falmouth
L. Grossman Sons, Inc.
Fitchburg
L. Grossman Sons, Inc.
Foxboro
L. Grossman Sons, Inc.
Frammingham
L. Grossman Sons, Inc.
Granby
Street Lumber Corp. (Ingham Division)
Holyoke
L. Grossman Sons, Inc.
Hyannis
L. Grossman Sons, Inc.
Ipswich
L. Grossman Sons, Inc.
Malden
L. Grossman Sons, Inc.
Marshfield
L. Grossman Sons, Inc.
New Bedford
L. Grossman Sons, Inc.
Oxford
Chaffee Bros. Co.
Plymouth
Plymouth Lumber Co.
Quincy
L. Grossman Sons, Inc.
Sagamore
L. Grossman Sons, Inc.
Southbridge
Clemence Lumber Corp.
South Hadley Falls—Holyoke
Street Lumber Corp.
East Longmeadow—Springfield
Kelly-Fradet Lumber Co., Inc.
Stoughton
L. Grossman Sons, Inc.
Taunton
L. Grossman Sons, Inc.
Wareham
L. Grossman Sons, Inc.
Wellesley
L. Grossman Sons, Inc.
Westfield
Fitzgerald Building Supply
Whitman
L. Grossman Sons, Inc.

MICHIGAN

Birmingham
ERB—Restrict Lbr. Co.
Royal Oak
ERB—Restrict Lumber Co.
Byron Center
Rynbrandt Hdw. & Lumber
Dearborn
Liberty Lumber Co.
Detroit
Cal's Five Point Lumber & Supply Co.
25700 W. Seven Mile Road
Dewey's Lumberville
15495 Schaefer Road
Hurd Lumber Co.
7300 Dix Avenue
Kenney Lumber Co.
12375 Southfield Road
Frankfort
Frankfort Lumber & Fuel Co.
Grand Rapids
Wyoming Park Lumber & Hardware Co.
Hamtramck
Hamtramck Lumber Co.
Howell
Purdy & Woodruff Co., Inc.
Hudsonville
Hudsonville Lumber Co.
Ithaca
Ithaca Lumber Co.
Lansing
Freund Construction
Ludington
Abrahamson-Nerheim Co.
Midland
Nehil Lumber & Supply Co.
Mt. Clemens
Mt. Clemens Lumber Co.
(Continued to page 324)



Our "Thrifty Three" controls small engine power!

Start, idle or reverse standard small gasoline engines and motors with this Thrifty Three—some: packaged reversible transmission... eliminates gear shifting levers, belt tighteners; automatic centrifugal clutch... with highest torque per inch per dollar; internal expanding brakes... compact, self-energizing.

Each of these F-M accessories is quickly, easily installed on racing carts, power mowers, saws, lawn sweepers, portable elevators, golf carts—many other types of existing or original equipment. Each saves dollars for workbench enthusiasts, permits designers to specify less expensive units.

Write to Fairbanks, Morse & Co., Magneto and Engine Accessories Division, Beloit, Wis.

Fairbanks, Morse

Magneto and Engine Accessories Division

A MAJOR INDUSTRIAL COMPONENT OF FAIRBANKS WHITNEY CORPORATION

TOOLS WHOLESALE

Start your own business, sell tools to your friends and neighbors, or buy tools for your own use and **SAVE MONEY \$\$\$**

A MILLION DOLLAR INVENTORY AT YOUR FINGERTIPS. NO STOCK TO CARRY. ORDER AS YOU NEED IT.

BUY AT WHOLESALE PRICES. Extra \$25.00 profit on your accumulated purchases. \$1.00 refund on first purchase or refunded if you are not 100% satisfied.

SILVO HARDWARE CO., Dept. PM-10107 Walnut St., Phila. 6, Pa.

\$1.00
PUTS YOU IN BUSINESS

THOUSANDS!! of Nationally Advertised items of Hand Tools, Power Tools, Machinist Tools, Tool Chests, Paint Sprayers, Light Fixtures, Appliances, Guns, Gifts, Toys and other items too numerous to mention.

WE SHIP COAST TO COAST
Wholesale Disc. up to 50% off

THE ORIGINAL PACKAGED BOAT KITS

World's Largest Line—New Fiberglass Hulls. Over 200 styles Boats-Kits, Formed-Hulls, Semi & Custom finished. All types: Prams, Cruisers, Racers, Inboards, Outboards. Easy to build. Professional results. Dealers - Agents Inquire.

Send 15c for 3-Color Catalogs 52 pg. Kit Catalog plus 20 pg. Hardware and 8 pg. Armor Glass books. (SPECIAL OFFER!)

All 3-colored CATALOGS plus "Boating Handbook"... all for \$1.

CUSTOM • CRAFT

MADE ONLY BY *Crestline Boat Works*



★ BOAT PLANS, PATTERNS FRAME PACS

Over 400 Plans-Patterns, Frame Pak Kits. Prams, Kayaks, Racers, Runabouts, Catamarans, Cruisers. In- Outboards (6' to 40') Wood, Plywood and Steel. **Send 35¢ for 120 pg. Plan Catalog.** Catalog plus "Boat Building Handbook"... Send \$1.00.

Buffalo 7 L, N. Y.

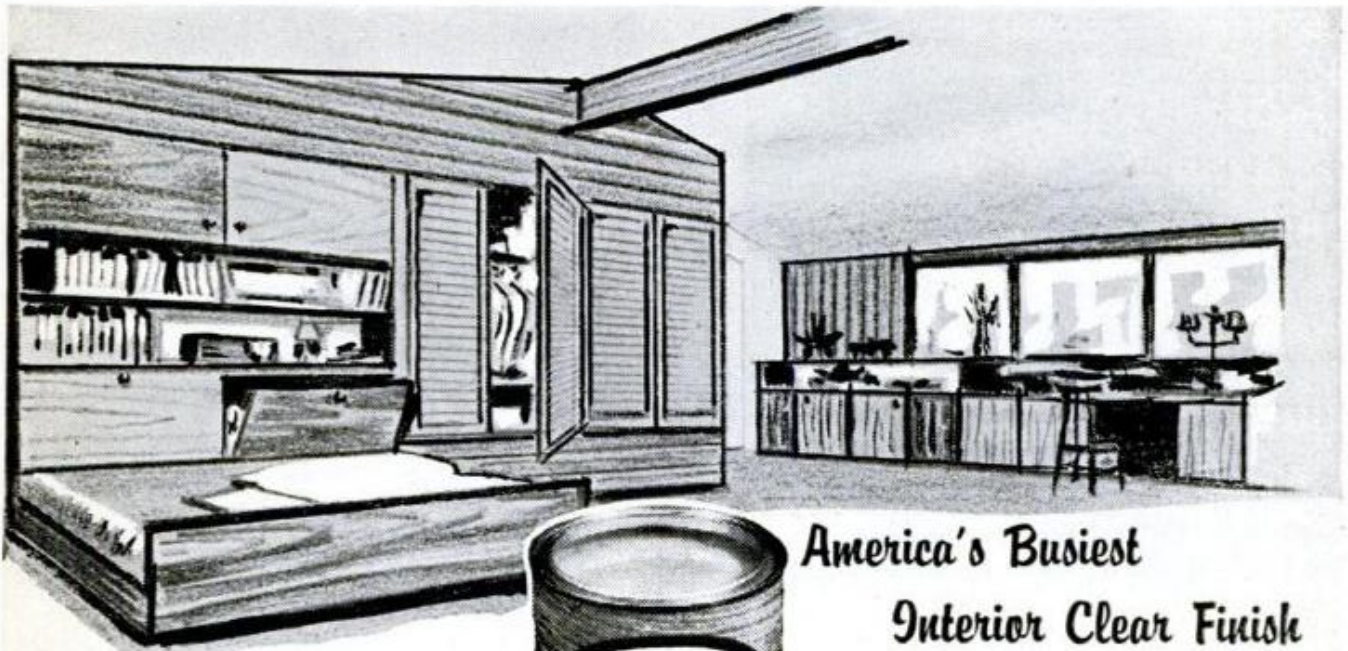

The complete wood finish in one can. Nothing else to use, fast dry and completely trouble-free. A clear semi-gloss that brings out the beauty of natural wood. Non-yellowing... will not darken with age. Mail coupon for free finishing chart folder. Dept. PM.

WHEREVER PAINTS ARE SOLD... Accept no substitutes

America's Busiest
Interior Clear Finish
SEALS... FINISHES, dries in 30 min.

DESMOND'S
P. O. Box 2216, Torrance, Calif. Dept. PM.

Please send me free finishing chart folder

Name _____

Address _____

City _____ Zone _____ State _____

**Build
Extra Storage
Space!**

It's easy with



**Aluma-Slide®
SLIDING DOOR TRACK**

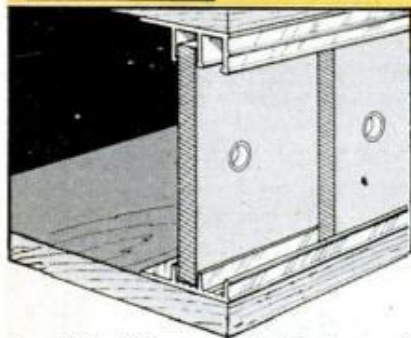

For 1/8 to 3/4-in. panels of plywood, hardboard, perforated panels, etc. Now, build your own extra storage cabinets. Installation is easy and fast! You'll think of dozens of more uses. Aluminum track sets come packaged ready to use. No special tools needed.

At Hardware and Lumber Dealers

MACKLANBURG-DUNCAN CO.
OKLAHOMA CITY, OKLA.

Now...
a new
compact



power saw

Always safe,
because there's no
dangerous chain

WRIGHT®
makes it **FUN**
to get things
DONE
safely

New kind of gasoline power saw for those 1001 cutting jobs. For limbing, trimming, clearing... cuts timber, firewood, fenceposts "like butter." Cuts with bottom edge only—there's no hazard from a dangerous, whipping, kicking chain. Cuts trees up to 20" wide. Powered by the most trouble-free power saw engine ever built. And... in two versatile models... #2016, COMPACT, LIGHT WEIGHT, 16" Blade... And #5020A, HEAVY-DUTY, 20" Blade. Priced from only \$139.50.

WRITE for FREE BOOKLET
and name of your nearby dealer
THOMAS INDUSTRIES INC.

Wright Saw Division

207 E. Broadway, Louisville 2, Ky., Dept. 60



More Built-Ins Information Centers:

- Newaygo**
Newaygo Lumber & Supply Co.
- Niles**
Williams Supply Co.
- Pontiac**
Poole Lumber Co.
- Port Huron**
Mortimer & Son Lumber Co.
- Rochester**
Nowels Lumber & Coal Co.
- Southfield**
Lawrence Lumber Co.
- Taylor**
Dombeck's Lumber & Supply Co.
- Utica**
Church & Church, Inc.
- Wayne**
Building Materials, Inc.
- WINNEBAGO**
Lampert Yards
- WINONA**
Fullerton Lumber Co.
- WOODSTOCK**
Lampert Yards
- MISSISSIPPI**
- Columbia**
Hall-Webb Hdw. Co.
Hill Hardware Co.
- Hattiesburg**
Ferrell Company, Inc.
- Jackson**
Batson Hardware, Inc.
Wilson-Geyer Co., Inc.
- Tylertown**
Tylertown Lumber & Building Material
- MISSOURI**
- Fenton**
Hill Behan Lumber
- Florissant**
Hill Behan Lumber
- Kirkwood**
Hill Behan Lumber
- Lemay**
Hill Behan Lumber
- Maryville**
Fullerton Lumber Co.
- Offton**
Hill Behan Lumber
- St. Louis**
Hill Behan Lumber
6039 Goodfellow
Hill Behan Lumber
6515 Page
Hill Behan Lumber
4438 Gravois
- MONTANA**
- Baker**
Fullerton Lumber Co.
- Terry**
Fullerton Lumber Co.
- Wilbax**
Fullerton Lumber Co.
- NEBRASKA**
- Alma**
Hardman Lumber Co.
- Beaver City**
Hardman Lumber Co.
- Crookston**
Fullerton Lumber Co.
- Norfolk**
Fullerton Lumber Co.
- North Platte**
Field-Birge Co.
- Omaha**
Chicago Lumber Co.
- Valentine**
Fullerton Lumber Co.
- Wahoo**
Fullerton Lumber Co.
- Wakefield**
Fullerton Lumber Co.
- Wayne**
Fullerton Lumber Co.
- NEW JERSEY**
- Bayville**
Nobles Building Supply
- Clifton**
William C. Van Handel & Son, Inc.
- Denville**
J. H. Jackson Lumber Co.
- Montvale**
P. S. Saunders Lumber & Hardware Mart
- Neptune**
Standard Supply Co., Inc.
- North Arlington**
Ridge Lumber Co.
- NEW HAMPSHIRE**
- Plymouth**
L. Grossman Sons, Inc.
- Portsmouth**
L. Grossman Sons, Inc.
- Salem**
L. Grossman Sons, Inc.
- NEW YORK**
- Baldwin, Long Island**
Zaret Lumber & Materials Corp.
- Brockport**
W. E. B. Stull Lumber Co.
- Cuba**
Jordan Lumber Co.
- Palmyra**
Wayne Coal & Lumber Corp.
- (Continued to page 326)

FREE MAGNIFIER that we dare you to compare!

"15x Ruper" Magnifier with full 1/2" diameter corrected



lens! Nickel plated metal folding frame. Many thousands in use — everyone likes it! Equivalent to other \$6 magnifiers. Get one FREE on our "new customer" offer!

FREE WITH \$3 PURCHASE FROM THIS AD!



GENUINE GEMS OFFER

10 Beautifully polished Baroque Gems of Citrine, Amethyst, Rock Crystal, Morganite and Aquamarine. 5/8" sizes total weight 50 carats.

Order as: 5-12-5 \$1.00

PROFESSIONAL SWIVEL BENCH VISE

2 SETS OF JAWS

Outstanding value — rotates in 2 different planes . . . top section in horizontal — jaws in vertical. Top sets of jaws are 2 1/4" wide — bottom set 1 3/4" — 180° rotation of jaws possible. Jaws open to 2". Flat area on top of vertical column for use as anvil. Jaws are smooth. A \$10 value. only \$5.95

Order as: 527-5



JEWELRY REPAIR KIT

What you've always needed to make or repair any necklace, earrings, etc. NOW get a small quantity of assorted sizes in a big money-saving offer! Includes 24 Bell Caps, 24 Jump Rings and 6 Spring Rings.

Z-99's - Gold Color . only \$1.00
Z-100's - Rhodium Color \$1.00

"COLLECTORS' SPECIAL"

4 Unusual 1 inch polished specimens: Carnelian, Blue, Green, and Gray Brazilian Agate. Normal Retail Value \$3. All 4 offered on "Let's get acquainted" spectacular deal.

Order as: 29-5 Only \$1.00

JEWELERS HORN ANVIL

A spectacular value . . . anvil is 4" long and 3 1/2" high. It is a \$3.30 value that we are offering at this special price to introduce our excellent line of tools to you.

Order as 520-5 Special \$1.49

CHOICE SLAB GEM STONES AT BARGAIN PRICES!

Imported from all parts of the world — guaranteed select quality. Expand your collection — each slab piece is workable "high quality." Get select specimens from "far-away places" at AMAZING LOW PRICES.

ITEM NO.	MATERIAL	ORIGIN	UNITS	PRICE
GP-11 S	Green Moss Agate	India	3 sq. in.	1.20
GP-12 S	Red-Green Moss Agate	India	3-oz.	1.20
GP-29 S	Green and White Jodite	Burma	2 sq. in.	3.00
GP-19 S	Bloodstone	India	3 sq. in.	1.50
GP-37 S	Assorted Color Moonstone	India	2-oz.	2.00
GP-94 S	Turquoise	Mexico	2-oz.	2.00

Many others — write for our complete list!

SPECIAL OFFER IN JEWELERS PLIERS

High polish, full chrome finish. Chain nose — the most useful jewelry pliers known. Better than most pliers that usually sell for \$2.00.

Order as 524-5 . . . introductory offer \$1.00

BAROQUE GEMS IN SPECIAL ASSORTMENT

A big 2-oz. bag of ass't sizes from Mexican Amethyst, Bird of Paradise Agate, Abalone Rainbow Pearl, etc. Very useful lot of gems for jewelry and for decorating hand bags. Don't pass this value up!

Order as 537-5 . . . bag only \$1.00

Everything you need — including 1 pair 1/2" handcut faceted genuine Brazilian Rock Crystal sparkling stars; 2 sterling silver bails and 1 pair sterling silver ear wires — ready for mounting. A normal \$3.50 value. Now yours on our "Let's Get Acquainted" offer.

Order as 2-21 5 . . . now only \$1.45

YOU CAN MAKE ROCK CRYSTAL STAR EARRINGS

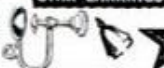

Order as 537-5

NEW epoxy ADHESIVE

So good it's replacing rivets

MIRACLE ADHESIVE — you've seen it on T.V. and in LIFE — it bonds materials stronger than anything else. Aircraft industry using it instead of Rivets — replaces nails and screws. Perfect for jewelry making — Unconditionally guaranteed! Kit of 2 jars with complete instructions.

Order as: 21-5 . . . only \$1.50



BONUS — FULL YEAR'S SUBSCRIPTION

Notice — customers also receive FREE famous "Rockhounder's News Bulletin" containing many fresh ideas and new gem stone finds!

ORDER BY MAIL — SEND CHECK OR M.O.

All items sold on Money Back Guarantee

GRIEGER'S 1633 E. WALNUT PASADENA, CALIF.

Prices include Taxes and Postage!

JEWELRY CRAFTS CATALOG FREE



AMAZING BRAKE EQUALIZER

Gives shorter, more reliable, straighter stops. DO-MOR Brake Equalizer eliminates "surge" in brake lines, increases brake efficiency, life of tires, brake linings and drums. Reduces costly brake repairs. Simple to install. Free brochure.

Only \$995 Ppd.

DO-MOR BRAKE ENGINEERING CO. Box 266 Orange 21, California

GIVE AMERICAN CANCER SOCIETY



It's Sharp . . . keep it that way with the right sharpening stone by

CARBORUNDUM®

NO MUSS . . . NO FUSS!
KRYLON SPRAY PAINT
DRY IN MINUTES!
IF YOU PRIZE IT . . . KRYLON-IZE IT!

WELD IN A JIFFY! IT'S DYNAMIC \$38.50 F.O.B.



Now any one can weld, cut, braze or solder almost any metal quick, safe and easy with this professional type welder. Make repairs in home or shop and farm; repair auto bodies and fenders, build wrought iron furniture, railings, fences, etc. — 1001 metal items. No previous experience necessary. Designed to operate on any properly wired 110 V. A.C. line. Order today! Literature on larger industrial equipment on request.

EASY PAY PLAN

Low down payment. Pay as you USE. Money back guarantee. Act now!

SEND ONLY \$6.00

CHECK, CASH or M.O. PAY POSTMAN BALANCE PLUS CHARGES 1 YEAR GUARANTEE 10 DAY MONEY BACK TRIAL

DYNAMIC WELDER COMPANY, 1808 S. Federal St., Dept. D2-K, Chicago 16, Ill.

Fill nail holes and defects

Magic WOODBLEND Putty Pencils



Putty Pencils fill nail holes and cracks in paneling . . . everything made of wood. 12 popular colors match every shade. Ready to use. Just rub over hole until filled. Won't shrink. 39c at all stores.

WRITE FOR FREE COLOR FOLDER

Professional Kit
of 12 pencils
1 of each color



\$4.68
delivered



Magic Iron Cement Co., Inc.

14215 Caine Ave. • Cleveland 28, Ohio
In Canada — Bernard Marks & Co. Ltd., Toronto

HANG FIXTURES SECURELY...



USE **MOLLY**
SCREW ANCHORS
and JACK NUTS®



JACK NUTS GRIP ANY MATERIAL, WORK IN NARROW SPACE

Jack Nuts need only 1/8" expansion space . . . now you can fasten fixtures to flush doors! Grip any material up to 1/4" . . . perfect for use in thin materials where wood or sheet metal screws won't hold!

BETTER THAN NAILS & SCREWS—Molly lets you put fixtures where you want . . . not just where studs are. Spider backing reinforces area in which used, won't pull through. BETTER THAN TOGGLE BOLTS—Easy to install, needs much smaller hole, fixtures can be removed and replaced in same anchor! Inexpensive, guaranteed. Ask your hardware dealer for genuine Molly . . . the name is stamped on the cap.

SEND \$1.00 FOR SAMPLE BOX OF 12

EXPANDS BEHIND WALL

MOLLY Corp., 200 N. 5th St., Reading, Pa.

Enclosed is \$1.00 for sample box of (check one) Mollys Jack Nuts

NAME

ADDRESS

CITY

ZONE

STATE

More Built-Ins Information Centers:

- Ozone Park, Queens**
Pisnoy Lumber & Trim Co., Inc.
- Rochester**
Nichols Wyman Lumber Co.
- Wellsville**
F. E. Lunn & Son Lumber Co.
- NORTH DAKOTA**
New England
Fullerton Lumber Co.
- OHIO**
Canton
The DeVille Lumber Co.
- Cleveland**
Rock Island Lumber Co.
- OKLAHOMA**
Altus
Wm. Cameron & Co.
- Mangum**
Wm. Cameron & Co.
- Marlow**
Wm. Cameron & Co.
- Oklahoma City**
The Lumber Shed
2601-7 N.W. 10th
Hatcher Lumber Co.
12 N.W. 12th
Morgensen Lumber Co.
2828 N.W. 38th Street
- Ponca City**
Rock Island Lumber Co.
- Tulsa**
Dale Carter's
4459 S. Sheridan
Tulsa Lumber Co.
4112 S. Peoria
- OREGON**
Cottage Grove
Sears Building Supply Co.
- Nyssa**
Bestway Building Center
- Ontario**
Bestway Building Center
- Portland**
King Building Supply
- Roseburg**
West Coast Building Supply Co.
- Vale**
Bestway Building Center
- PENNSYLVANIA**
Allentown
Trexler Lumber Co.
- RHODE ISLAND**
North Kingstown
L. Grossman Sons, Inc.
- Providence**
Harris Lumber Co., Inc.
- Woonsocket**
L. Grossman Sons, Inc.
- SOUTH CAROLINA**
Florence
Barringer Hardware Co.
- Greenville**
Cheatham Greenville Hardware Co.
- Greenwood**
Dixie Hardware & Mill Supplies, Inc.
- Pamplico**
Munn Hardware Co.
- Spartanburg**
Spartanburg Lumber & Millwork Co., Inc.
- Sumter**
Boyle Hardware & Gift Center
- SOUTH DAKOTA**
Armour
Fullerton Lumber Co.
- Burke**
Fullerton Lumber Co.
- Colome**
Fullerton Lumber Co.
- Corsica**
Fullerton Lumber Co.
- Emery**
Fullerton Lumber Co.
- Kimball**
Fullerton Lumber Co.
- Lemmon**
Fullerton Lumber Co.
- Mitchell**
Fullerton Lumber Co.
- Mount Vernon**
Fullerton Lumber Co.
- Plankinton**
Fullerton Lumber Co.
- Platte**
Fullerton Lumber Co.
- Salem**
Lampert Yards
- Tyndall**
Fullerton Lumber Co.
- Vermillion**
Fullerton Lumber Co.
- Wess. Springs**
Fullerton Lumber Co.
- Winner**
Fullerton Lumber Co.
- Yankton**
Fullerton Lumber Co.
- TEXAS**
Alicia
Alamo Lumber Co.
- Ballinger**
Wm. Cameron & Co.
- Bandera**
Alamo Lumber Co.
- Bay City**
Alamo Lumber Co.
- Belton**
Wm. Cameron & Co.
- Benavides**
Alamo Lumber Co.
- Big Spring**
Wm. Cameron & Co.
- Boling**
Alamo Lumber Co.
- Camp Wood**
Alamo Lumber Co.
- Carrizo Springs**
Alamo Lumber Co.
- Charlotte**
Alamo Lumber Co.
- Clifton**
Wm. Cameron & Co.
- Corpus Christi**
Alamo Lumber Co.
- Corsicana**
Wm. Cameron & Co.
- Crystal City**
Alamo Lumber Co.
- Cuero**
Alamo Lumber Co.
- Eagle Lake**
Alamo Lumber Co.
- Falfurrias**
Alamo Lumber Co.
- Floresville**
Alamo Lumber Co.
- Fort Worth**
Wm. Cameron & Co.
- Fredericksburg**
Wm. Cameron & Co.
- Freer**
Alamo Lumber Co.
- Gatesville**
Wm. Cameron & Co.
- Goliad**
Alamo Lumber Co.
- Grapevine**
Wm. Cameron & Co.
- Hillsboro**
Wm. Cameron & Co.
- Hebbronville**
Alamo Lumber Co.
- Hondo**
Alamo Lumber Co.
- Jourdanton**
Alamo Lumber Co.
- Junction**
Wm. Cameron & Co.
- Kaufman**
Wm. Cameron & Co.
- Kenedy**
Alamo Lumber Co.
- Killeen**
Wm. Cameron & Co.
- Knox City**
Wm. Cameron & Co.
- Lampasas**
Wm. Cameron & Co.
- Llano**
Wm. Cameron & Co.
- Lockhart**
Alamo Lumber Co.
- Longview**
Wm. Cameron & Co.
- Midland**
Wm. Cameron & Co.
- Munday**
Wm. Cameron & Co.
- New Braunfels**
Wm. Cameron & Co.
- Odessa**
Burton-Lingo Co.
205 S. Grant
Lynn Lumber Co., Inc.
2100 Andrews Highway
(Continued to page 328)

WAR SURPLUS AND OTHER BARGAINS SAVE UP TO 90%



COMPLETE 2-WAY TELEPHONE SYSTEM

For that extra phone in the home, shop, farm, school, etc. Excellent intercom with 2-way buzzer system. Mfd. by Western Electric. Can carry clear conversation for miles. Not a toy. Wt. 11 lbs. Complete with battery & 50' weather-proof wire—ready for use. All this for only **\$13.95.**

"SUPER 9" 200 AMP WELDING KIT

With Deluxe accessories consisting of one 200 AMP. Gen., adjustable helmet, electrode holder, ammeter & shunt, rheostat, giant toggle switch, voltmeter, voltage reg., 1 pr. heavy-duty welder's gloves. All units guaranteed pre-tested. Approx. GOVT. COST \$500. Most items new—all perfect. **\$26.00.**



ELECTRIC STORAGE BATTERY WINCH

Powerful reduction gear, fully reversible, ball bearing, safety locking device. Handles from a 1000 to more than 2000 lbs. pull. Use on 6, 8, 12, 24, 32 V. battery. Holds 50' of 1/4" cable. For tractors, boats, tow trucks, etc. Complete with bracket for mounting in any position. Heavy-duty equipment. Approx. GOVT. COST \$400. NEW, **\$49.50.**



R3 GENERATOR Terrific for making arc welder. 3000 RPM. 30 V. 300 AMP output. Approx. GOVT. COST \$750. Like NEW. **\$29.95.**



140-1 REDUCTION GEAR For heaving boats, winches, hoists. Ideal motor in golf or boy's electric car. DC motor & clutch. Easily reversible wiring diagram furnished. Hi torque. 105 RPM. Runs on 6-12 or 24-32 V. 65 lbs. gross. Approx. GOVT. COST \$300. **\$12.00.**
Matched spined gear — **\$3.00 ea.**
*225-1 Reduction Gear — **\$13.50.**



200 AMP D.C. WELDER 24-32 volts D.C., 200 amp gen. Extra heavy duty. Internal fan cooling. Brand new 9 H.P., ball bearing. Briggs & Stratton engine. 200 amp generator (direct coupling to engine). Portable wheeled frame mount. Voltage reg. Rheostat. Reactor coil. Welds 1/4" rod to SAE standard, any thickness metal. Complete. Wt. 200 lbs. NEW. A \$750 value. **\$199.50.**

BENDIX GEROTOR PUMP & MOTOR—NEW!

Used widely for sheep, cattle and weed oil spraying. Transfer pump for most fuels. Use wherever fluid pumping required. Excellent for hydraulic installations and as crankcase drain pump for marine engines. Has 3/4" pipe connections, built-in relief valve adjustable up to 1500 lbs. Max. cap. 6 GPM. 1 1/2 H.P. 24 V. motor. Use on 12 to 32 V. Approx. GOVT. COST \$350. **\$10.95.**



NEW 1961 CATALOG!

Tremendous catalog—our biggest ever—fully illustrated—1000s of bargains in war surplus & other items. Send 25c in coin for your copy today or free copy with order. Where ppd. indicated applies to US only. Other prices FOB Culver City, Cal. Send cash, check, money order. 50% dep. COD.



AIRBORNE SALES CO., INC. DEPT. PM 1060
8501 Stellar Drive, Culver City, Calif.



10" TILT/ARBOR SAW

Wood, steel, and aluminum construction, ball bearing arbor. Big machine capacity & performance. Simplified Plans, full size patterns, build easily with hand tools only. Kit with 10" comb. blade \$27.40. Enclose this ad for **FREE DELIVERY.** Money back guarantee. Order NOW. Or Send **\$1.00** for Plans refundable with Order NEW DRILL PRESS-LATHE KIT. FREE CATALOG.

GILLIOM POWER TOOLS MFG. CO.
Dept. PM-10, 1109 N. 2nd Street, St. Charles, Missouri

\$50
BUILD IT YOURSELF
\$23.95
COMPLETE PLANS Only
\$100 Each
POSTPAID

LIFE-LONG SERVICE



Gerstner Chests last and last. Free catalog to toolmakers and machinists.

GERSTNER TOOL CHESTS
460 Columbia St., Dayton 7, Ohio

COMPLETE WORKSHOP IN ONE TOOL!!!

IMPROVED GEARED Plierench

10 to 1 Gear Ratio
One Ton Gripping Power!

No home owner, mechanic, car owner or farmer can afford to be without this tool of a thousand uses. It's a powerful ratchet wrench, gripping edges and curved as well as flat surfaces. It's a wire-cutter. It's an Internal-External Pipe and Tube wrench securely gripping up to 2" O.D. It replaces complete sets of socket and open end wrenches, as well as all pliers. It is a monkey wrench—and because of its parallel jaws and lock-grip, is a perfect portable vise. Special gear transmission permits instant adjustment to any size. A precision tool, unconditionally guaranteed. Used by U. S. Army, Navy, Air Force, Coast Guard. **STANDARD KIT** consisting of 4 interchangeable jaws, including Universal Jaw; Utility-Pipe Jaw, Giant Utility Pipe Jaw; Giant Internal-External Jaw; — in handy pouch ... all for \$9.98. Satisfaction guaranteed or money refunded. Use coupon below to order:



CANAVERAL HAS NO MONOPOLY ON ROCKETS!

Read the exciting feature

“ROCKETS FOR CIVILIANS” IN NOVEMBER

American Specialty Co.
Dept. PM106, 4615 N. Ravenswood • Chicago 40, Ill.
Please ship me _____ Improved Plierench **STANDARD KIT** on your Satisfaction or Money Back Guarantee.
 I enclose \$9.98 (Check or M.O.) Send Postpaid.
 Send C.O.D.—I will pay \$9.98 plus postage, C.O.D. fee.
 Charge to Diners Club No. _____

Name _____ (Print)
Address _____
City _____ Zone _____ State _____

CONCRETE HOLD

with



NEW!

Helor Hi-Water Epoxy concrete adhesive fastens anything to concrete or masonry **without drilling!** • Studs • Brackets • Bolts • Pipes • All metals • Porcelain • Ceramics. Helor Hi-Water is stronger than concrete, waterproof-weatherproof, and, will not shrink or crack.

HELOR HI-WATER

Epoxy Products

A scientific **NEW** development from Epoxy Coatings Co.

EPOXY COATINGS CO., South San Francisco, Calif.



DYNA-MIGHT

Battery-Operated

POWER HYDRAULIC CONTROLS

HY-LO-JACK

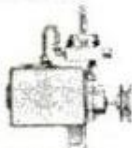

HY-LO FOR JEEP Fan-Belt Driven

instant up-and-down action

MONARCH

for snow plows

One man controls the plow from the cab . . . instant up-and-down action with the flick of a wrist. Snow removal is easier, faster, more economical with Monarch. See your dealer. Write for illustrated folder.

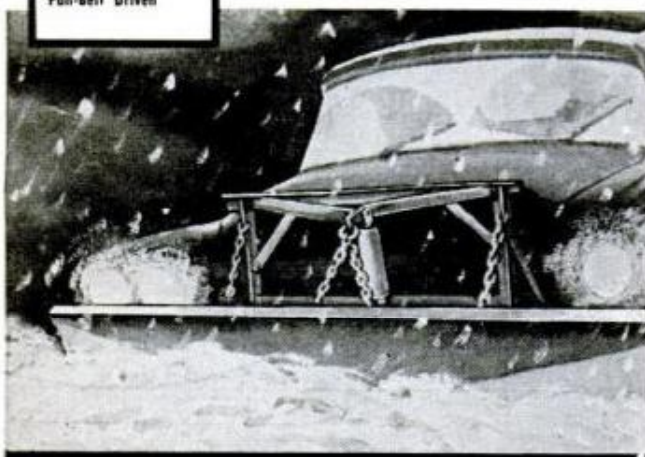

MONARCH ROAD MACHINERY COMPANY

1331 Michigan St., N.E.

Grand Rapids 3, Michigan

More Built-Ins Information Centers:

- Tadlock Home Improvement Center**
3120 E. 27th
- Pleasanton**
Alamo Lumber Co.
- Poteet**
Alamo Lumber Co.
- Rockdale**
Wm. Cameron & Co.
- Rocksprings**
Alamo Lumber Co.
- Rogers**
Wm. Cameron & Co.
- Sabinal**
Alamo Lumber Co.
- San Angelo**
Wm. Cameron & Co.
- Sanderson**
Alamo Lumber Co.
- San Marcos**
Wm. Cameron & Co.
- San Saba**
Wm. Cameron & Co.
- Seguin**
Alamo Lumber Co.
- Smiley**
Alamo Lumber Co.
- Sonora**
Wm. Cameron & Co.
- Sweeny**
Alamo Lumber Co.
- Taft**
Alamo Lumber Co.
- Taylor**
Wm. Cameron & Co.
- Temple**
Wm. Cameron & Co.
- Three Rivers**
Alamo Lumber Co.
- Uvalde**
Alamo Lumber Co.
- Waxahachie**
Wm. Cameron & Co.
- Wharton**
Alamo Lumber Co.
- Winnboro**
Wm. Cameron & Co.
- UTAH**
- Bountiful**
Bestway Building Center
- Brigham City**
Bestway Building Center
- Delta**
Bestway Building Center
- Layton**
Bestway Building Center
- Midvale**
Bestway Building Center
- Milford**
Bestway Building Center
- Murray**
Bestway Building Center
- Nephi**
Bestway Building Center
- Ogden**
Bestway Building Center
- Price**
Bestway Building Center
- Provo**
Bestway Building Center
- Richfield**
Bestway Building Center
- Salt Lake City (Sugarhouse)**
Bestway Building Center
- Tooele**
Bestway Building Center
- Tremonton**
Bestway Building Center
- VERMONT**
- Brattleboro**
L. Grossman Sons, Inc.
Putney Road, Route 5
L. Grossman Sons, Inc.
Corner Elm & Frost Sts.
- VIRGINIA**
- Hopewell**
Builders Supply Co. of Hopewell
- WASHINGTON**
- Auburn**
Bestway Building Center
- Bellevue**
Bestway Building Center
- Cheney**
Bestway Building Center
- Colfax**
Bestway Building Center
- Coulee City**
Bestway Building Center
- Ellensburg**
Bestway Building Center
- Encumclaw**
Bestway Building Center
- Everett**
H. O. Seiffert Co.
- Gig Harbor**
Bestway Building Center
- Harrah**
Bestway Building Center
- Kennewick**
Bestway Building Center
- Moses Lake**
Bestway Building Center
- Mount Vernon**
Lakeside Western Lumber Co.
- Naches**
Bestway Building Center
- Opportunity**
Bestway Building Center
- Pasco**
Bestway Building Center
- Prosser**
Bestway Building Center
- Pullman**
Bestway Building Center
- Quincy**
Bestway Building Center
- Rosalia**
Bestway Building Center
- Renton**
Bestway Building Center
- Ritzville**
Bestway Building Center
- Spokane**
Bestway Building Center
- Sunnyside**
Bestway Building Center
- Toppenish**
Bestway Building Center
- Yakima**
Bestway Building Center
- WEST VIRGINIA**
- Bluefield**
Bailey Lumber Co.
1118 Bluefield Ave.
Citizens Coal & Supply Co.
600 Bluefield Ave.
- Charleston**
Wright-Bachman Lumber
- South Charleston**
Evans Lumber Co.
- WISCONSIN**
- Amery**
Lampert Yard
- Arcadia**
Fullerton Lumber Co.
- Augusta**
Lampert Yards
- Barron**
Lampert Yards
- Beaver Dam**
Fullerton Lumber Co.
- Beloit**
Beloit Lumber & Fuel Co.
Fullerton Lumber Co.
- Birchwood**
Lampert Yards
- Bruce**
Lampert Yards
- Cameron**
Lampert Yards
- Chetek**
Lampert Yards
- Cumberland**
Lampert Yards
- Dallas**
Lampert Yards
- East Ellsworth**
Fullerton Lumber Co.
- Elk Mound**
Lampert Yards
- Janesville**
Fullerton Lumber Co.
- Kenosha**
Kenosha Lumber Co.
- Knapp**
Lampert Yards
- La Crosse**
Gateway Lumber Co.
- Ladysmith**
Lampert Yards
- Madison**
Brookwood Home Center
- Milwaukee**
Bliffert Lumber & Coal Co.
1014 East Chambers
Bliffert Lumber & Coal Co.
10733 W. Blue Mound Road
Bliffert Lumber & Coal Co.
2128 West Morgan Ave.
Bliffert Lumber & Coal Co.
6826 South 13th Street

More Built-Ins Information Centers:

- Bliffert Lumber & Coal Co.**
5030 North 35th Street
Bliffert Lumber & Coal Co.
8747 North 107th Street
Capitol Lumber & Hdw. Co.
400 West Capitol Drive.
Capitol Lumber & Hdw. Co.
3412 East Layton Avenue
Harris Lumber & Millwork
4350 North 35th Street
Holt Lumber Co.
11700 W. Silver Spring Dr.
M. H. Paulsen Lumber Co.
2837 West Stark
- West Allis**
Wilbur Lumber Co.
Waupaca
Fullerton Lumber Co.
Wausau
Fullerton Lumber Co.
Winter
Lampert Yards
- WYOMING**
Casper
Bestway Building Center
Casper Lumber, Inc.
Cheyenne, W. 20
Bestway Building Center
Cheyenne, Lway
Bestway Building Center
Evanston
Bestway Building Center
Green River
Bestway Building Center
Lander
Bestway Building Center
Laramie
Otto Builders Supply, Inc.
Swenson Lumber Co.
Lusk
Frontier Lumber Co.
Powell
Powell Lumber Co.
Rawlins
Bestway Building Center
Rock Springs
Bestway Building Center
- Monroe**
Fullerton Lumber Co.
Neillsville
Fullerton Lumber Co.
Osceola
Lampert Yards
Racine
Durand Avenue Lumber Co.
Radisson
Lampert Yards
Rice Lake
Lampert Yards
Ridgeland
Lampert Yards
Ripon
Fullerton Lumber Co.
Shell Lake
Lampert Yards
Spooner
Lampert Yards
Viroqua
Nuzum Lumber Co., Inc.



Kowa Display Co., Inc., 3-12 Kayaba-cho, Nihombashi, Chuo-ku, Tokyo, Japan.

Bear With Baby Buggy Ballyhoos for Brewery

Causing double takes among Tokyo shoppers is an incongruous group made up of a mechanical bear, baby buggy (with jovial passenger) and several cans of Nippon Brewery Company's best. The life-size robot bear walks, speaks and even sings as he pushes the carriage. The display is operated electrically by remote control. Necessary electronic apparatus—transmitter, receiver, speaker, etc.—is hidden in the bear and carriage.

SPECIAL "END OF SUMMER SALE"

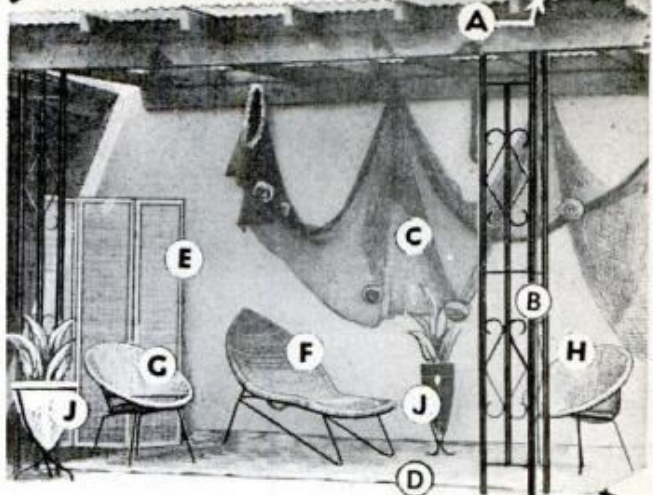

Take advantage of these special FALL Bargains. SAVE up to 50%. ALL items are shipped by the lowest Truck Rates to Save You Money!

A FIBERGLASS PANELING

For Patio, Car Port, Fence, Screens or Awnings. Top quality 8 oz. structural fiberglass. . . corrugated type, 26" or 34" wide, 4 to 12 ft. lengths. In most colors. Specify color, width, and length. Minimum order 4 SHEETS. FREE Sample on request. Value 90¢ sq. ft. **39¢** ~~59¢~~ **ET.**

B WROUGHT IRON TRELIS FOR PATIO ROOF SUPPORTS—DIVIDERS, etc.

Use INDOORS or OUTDOORS! Heavy 1-1/8"; black tubular iron supports with a handsome iron filigree between them. 8ft. high (can be cut to 7ft.), 12" wide. In either flat or corner type. Mounting flanges included.

FLAT TYPE **788** EA. CORNER TYPE **1088** EA.

C LUAU NET KIT

Gives South Sea Island atmosphere to your Den, Lanai, Patio, Pool or Playroom. A generous 60 sq. ft. . . comes with 2 cork floats, 2 leis, shells, glass floats, starfish and a sea fan. Specially priced for you . . . **299**

D sea grass MATTING

A casual, economical and durable floor covering from Formosa. 1/2" thick, 12" squares. Squares are sewn together to form 9 ft. wide rolls. Add or subtract squares as desired. **15¢** sq. ft. Special price good to Oct. 15

NEW 8'x10' PATIO KIT 69.95 **SAVE 50%** **DO-IT-YOURSELF**

Easy to assemble in 4 HOURS. Kit includes 2 wrought iron corner trellises, 6 wrought iron ceiling beams—8 ft. long, 1 beam 10 ft. long and 5 sheets of 8' x 26" Ornyte Fiberglass.

PHILIPPINE MAHOGANY PLYWOOD

Rotary cut for beauty of grain. Has both sides sanded, face side unjointed. Bonded with finest resins. FREE Sample on request. Minimum order 100 lbs., (4) 1/4" x 4 ft. x 8 ft. sheets or (8) 1/8" by 3 ft. x 6 ft. sheets. Sent at lowest truck rates. 1/8" x 3' x 6' **1.79** PER SHEET 1/4" x 4' x 8' **4.49** PER SHEET

paley's
2263 E. VERNON AVE., DEPT. PM-100
LOS ANGELES 58, CALIFORNIA

imported RATTAN FURNITURE

F dramatic LUAU LOUNGE
80 inches of lounging comfort, 26" wide, and 80 inches long. Regularly \$28.88 - NOW **\$14.88**

G dramatic SHELL CHAIR
Has a distinctive open weave. Sturdily set on black wrought iron frame. Size: 26" high with 17" x 18" seat. Worth \$6.95 each. **2 FOR \$6.88 388 EA.**

H famous BASKET CHAIR
For a carefree tropical air. Mounted on black wrought iron frame. Size: 26" high with a 17" x 18" seat. \$6.95 value. **2 FOR \$6.88 388 EA.**

J FIBERGLASS PLANTERS
A bone white planter, 15" wide by 21" high. Wrought iron stand. **2.98 ea.**
Black fiberglass planter & stand. 9" dia. x 22" in height. . . .

E SHOJI SCREENS.
Ideal room dividers or screens. Framed in hardwood with matchstick bamboo panels. Three panels 16" x 67". Leave natural or paint in color. **1295**

Other RATTAN SCREENS —
♦ **SUN BURST DESIGN** — 3-panels, 18" wide x 68" SPECIAL of **24.88**
♦ "Interlocking RINGS" design. 3-panel. **25.88**
♦ "Heart" Design screen. 60" wide x 72". **\$23.88**

RATTAN CORNER COMFORT with ECONOMY
White "Heart" design SETEE. 40" x 18" seat. SPECIAL of **\$21.88**

PEACOCK Victorian CHAIR
Seat dia. 19". Seat back 16" Overall height 48". . . **\$10.88**

South Pacific CHAIRS — With black wrought iron frame. Seat 17" dia.
ARM CHAIR — \$12.88
SIDE CHAIR — 10.88

South Seas CHAIR — 19" x 23" — **\$6.88**
OTTOMAN — 3.88
FREE 64 PG. IMPORT CATALOG

TO ORDER: Send Check or Money Order, 1/2 deposit with C.O.D.'s. All items sent freight or postage collect.

"I put it together with
my Wen Solder Gun"



Buster Heston

The Wen 100K Solder Gun Kit consists of a feather-light slim gun with 100 watts power. It heats in 2½ seconds. A built-in spotlight focuses on the work. In addition you get extra tips for hot cutting and smoothing as well as a supply of rosin core solder ... all in a strong metal box for neat compact storage. It's perfect for every home soldering job. Only **\$7.95**

YOU CAN ALWAYS DEPEND ON
NEWER AND FINER PRODUCTS FROM



FINE FINISH SANDER—Light, handy and quiet. Powerful motor delivers 14,400 straight-line-action strokes per minute. Perfect for fine finishing and polishing. Strong black plastic case. Comes complete with 6 assorted abrasive sheets and 2 polishing pads. **\$13.95**



MULTI-PURPOSE ½ HP "ALL-SAW"—Makes "one-job" saws obsolete. Does everything a Pattern Saw will do . . . more than a circular saw . . . many things normally done by a hand saw or nibbler—and many things that, until now, only a chain saw could do. UL "Industrially Rated," it cuts anything from a 6" log to intricate patterns in wood, metal, etc. Complete with 7 blades. **\$44.95**



¾" 2-Speed Power Drill.....**\$29.95**
Lightweight Sabre Saw.....**\$26.95**

WEN PRODUCTS, INC., 5810 Northwest Hwy., Chicago 31, Ill.

Nuclear Explosions Could Mine Sulfur

If sulfur deposits are discovered in the Gulf of Mexico, as is expected, the chances are they will be mined by nuclear explosions. This possibility has been studied by John M. Dales and Robert C. Dehart of the Southwest Research Institute, San Antonio, Tex. Using conventional rotary drilling techniques, the atomic device would be lowered to the sulfur deposit and detonated. The blast would raise the sulfur to the molten state for recovery at cost somewhat lower than by present methods, they said. One possible way to recover the molten sulfur would be to drill wells on the periphery of the sulfur well and force hot water into them to raise the sulfur. It might also be possible to force water from directional wells into the molten sulfur and the resulting stream would raise it to the surface.

Versatile Copier For Transparencies



Heiland Division, Minneapolis-Honeywell Regulator Co.,
Denver, Colorado

Built around an electronic flash unit in its base, a new color-slide reproduction system will perform more than 20 different color-reproduction processes, giving color photographers a versatility formerly limited to black-and-white only. The copier permits duplicating, cropping or enlarging; correcting for exposure, color balance or distortion; vignette and montage work; adding of textures and screens; creating or duplicating film strips; and creating sandwich effects. It will also produce negatives from slides.

Cardiograph of Power!



Pre-ignition Meter Shows Superior Performance of ACs

This AC engineer is tuned in on the heart-beat of an engine. He's using a special AC pre-ignition meter to check spark plug performance. Here, the meter shows all eight AC Spark Plugs are firing perfectly. This electronic instrument senses the combustion chamber temperature in each cylinder. If dangerous, engine-damaging pre-ignition occurs, the temperature rises sharply. The

sensitive meter connected to the cylinder, records the change. The needle moves over to the danger zone. This is just one of hundreds of proving ground and on-the-road tests that AC engineers perform to make certain that the spark plug recommended for your car gives you the best possible performance. When you replace spark plugs . . . at 10,000 miles . . . ask for ACs and be sure.

AC SPARK PLUG  THE ELECTRONICS DIVISION OF GENERAL MOTORS



Fire-Ring



Spark Plugs

THEY MUST BE THE BEST!

OCTOBER 1960

331

IT TAKES A REAL MAN TO WIN AN I.C.S. DIPLOMA!

Here's training for the man who can take it "straight"—without the fancy trimmings.

With I.C.S., your "classroom" is your home. Your "laboratory" or "shop" is the place you work. Every minute you spend is productive—no commuting, no long-winded discussion groups, no waiting for slower students to catch up.

You gauge your progress not by marks and grades alone but by pay boosts and promotions. And these are likely to come fast.

This is the most demanding kind of training. You select your own subjects, set your own pace, apply what you learn to your own specific needs—all while holding down a full-time job and possibly supporting a family.

Is it any wonder that men who can win I.C.S. diplomas often turn out to be leaders in their fields? I.C.S. has more of its former students now in supervisory and management positions than any other school.

It takes a real man to win an I.C.S. diploma. And the first step is mailing the coupon. Such a simple act sounds easy. Actually, it's the one thing that separates the "planners" from the "plodders." If you're the man we think you are, you'll mail the coupon NOW.



For Real Job Security—Get an I. C. S. Diploma!

I. C. S., Scranton 15, Penna.

Accredited Member,
National Home Study Council

INTERNATIONAL CORRESPONDENCE SCHOOLS



BOX 97953K, SCRANTON 15, PENNA.

(In Hawaii, reply P.O. Box 418, Honolulu)

(Partial list of courses)

Without cost or obligation, send me "HOW TO SUCCEED" and the opportunity booklet about the field BEFORE which I have marked X (plus sample lesson):

ARCHITECTURE and BUILDING CONSTRUCTION

- Air Conditioning
- Architecture
- Arch. Drawing and Designing
- Building Contractor
- Building Estimator
- Carpenter Builder
- Carpentry and Millwork
- Heating
- Painting Contractor
- Plumbing
- Reading Arch. Blueprints

ART

- Commercial Art
- Magazine Illus.
- Sign Painting and Design'g
- Sketching and Painting

AUTOMOTIVE

- Automobile
- Auto Body Rebuilding and Refinishing
- Auto Engine Tuneup
- Auto Electrical Technician
- Diesel Engines

AVIATION

- Aero-Engineering Technology
- Aviation Engine Mech.
- Reading Aircraft Blueprints

BUSINESS

- Accounting
- Advertising
- Bookkeeping and Cost Accounting
- Business Administration
- Business Management
- Clerk Typist
- Creative Salesmanship
- Managing a Small Business
- Professional Secretary
- Public Accounting
- Purchasing Agent
- Real Estate Salesmanship
- Salesmanship
- Salesmanship and Management
- Traffic Management

CHEMICAL

- Analytical Chemistry
- Chemical Engineering
- Chem. Lab. Technician
- General Chemistry

- Oil Field Technology
- Pulp and Paper Making

CIVIL ENGINEERING

- Civil Engineering
- Construction Engineering
- Highway Engineering
- Professional Engineer (Civil)
- Reading Struc. Blueprints
- Sanitary Engineer
- Sewage Plant Operator
- Structural Engineering
- Surveying and Mapping
- Water Works Operator

DRAFTING

- Aircraft Drafting
- Architectural Drafting
- Drafting & Machine Design
- Electrical Drafting
- Electrical Engineer Drafting
- Industrial Piping Drafting
- Mechanical Drafting
- Sheet Metal Drafting

ELECTRICAL

- Electrical Appliance Servicing
- Electrical Engineering

- Electric Motor Repairman
- Elec. Engr. Technician
- Elec. Light and Power
- Practical Electrician
- Practical Lineman
- Professional Engineer

HIGH SCHOOL

- Good English
- High School Diploma
- High School General
- H. S. College Prep. (Eng'g & Science)
- High School Math
- High School Science
- Short Story Writing

LEADERSHIP

- Industrial Foremanship
- Industrial Supervision
- Personnel-Labor Relations
- Supervision

MECHANICAL and SHOP

- Diesel Engines
- Gas-Elec. Welding
- Heating and Air Conditioning
- Industrial Engineering
- Industrial Instrumentation

- Industrial Safety
- Machine Shop Practice
- Mechanical Engineering
- Plumbing and Heating
- Professional Engineer
- Quality Control
- Reading Shop Blueprints
- Refrigeration and Air Conditioning
- Tool Design
- Tool Making

RADIO, TELEVISION

- General Electronics Tech.
- Industrial Electronics
- Practical Radio-TV Eng'g
- Radio-TV Servicing
- TV Technician

RAILROAD

- General Railroad

STEAM and DIESEL POWER

- Combustion Engineering
- Power Plant Engineer
- Stationary Diesel Engr.
- Stationary Steam Engines

TEXTILE

- General

Name _____ Age _____ Home Address _____

City _____ Zone _____ State _____ Working Hours _____ A.M. to P.M. _____

Occupation _____

Canadian residents send coupon to International Correspondence Schools, Canadian, Ltd., Montreal, Canada. . . . Special low monthly tuition rates to members of the U. S. Armed Forces.

A PROPHECY

For men and women with a sincere desire to succeed



the years that have passed since my
s on the faculty of RCA Institutes, I
e become even more firmly convinced
the individual who continues his edu-
on . . . particularly his technical educa-
. . . is the individual who profits both as
inking man and as a working man.
nce and industry will reward you for
r talents and energy. Out of your efforts
r come inventions, new products, proc-
s and services. There is everything good
to be accomplished in our lives and in
work. What man has done, man can do
er."

A handwritten signature in cursive script that reads "David Sarnoff".

Chairman of the Board,
Radio Corporation of America

RCA Institutes Offers the Career in the Rapidly Exp HOME STUDY

Courses in Radio and Electronic Fundamentals
• TV Servicing • Color TV • Electronics for Auto-
mation • Transistors

**Pay-Only-As-You-Learn With No Further Obliga-
tion.** RCA Institutes Home Study School, licensed by the
New York State Department of Education, offers a com-
plete program of integrated courses for beginners and
advanced students. All courses are available under the
liberal "Pay-As-You-Learn Plan." This plan affords you
the most economical possible method of home study train-
ing, *because you pay only for lessons as you order them*
. . . one study group at a time! If you drop out at *any*
time, for *any* reason, you do not owe RCA Institutes one

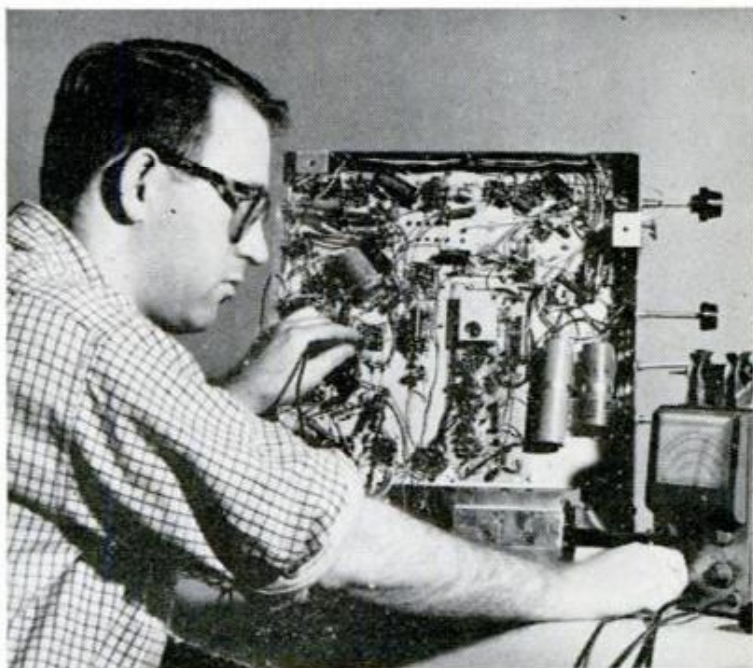

penny. No other obligations! No monthly installment
payments!

RCA Instruction is Personal. With RCA Home Study
training you set *your own pace* in keeping with *your own*
ability, finances, and time. The Institutes allows you ample
time to complete the course. Your lesson assignments are
individually graded by technically trained personnel, and
helpful comments are added where required. You get
theory, experiment, and service practice beginning with
the very first lesson. All lessons are profusely illustrated.
You get a *complete training package* throughout the entire
course.

You Get Prime Quality Equipment. All kits fur-
nished with the course are complete in every respect, and
the equipment is top grade. You keep all the equipment
furnished to you for actual use on the job . . . *and you*
never have to take apart one piece to build another!



Two Soldering Temperatures make this
the world's greatest soldering gun value!



**2 TRIGGER
POSITIONS**
give low 90-watt
and high 125-watt
heat at tip

Weller®

**DUAL HEAT
SOLDERING GUN KIT**

Features the new Weller Dual Heat Gun—most advanced soldering tool on the market. Not only does the heat and spotlight come on instantly when trigger is pulled, but 2 trigger positions give 2 soldering temperatures. You can switch instantly to high or low heat as your job requires.

Kit also includes
cleaning brush,
soldering aid
and solder

\$7⁹⁵
MODEL
8200K

You'll have many uses for a Weller Instant Heat Soldering Gun



REPAIR APPLIANCES
quickly and professionally. Wellertip has long reach—slips easily into tight places. Tip can also be bent.

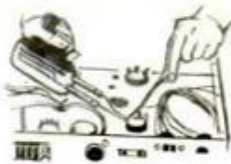

ASSEMBLE HI-FI KITS
with strong, noise-free connections. Use low heat for connections and high heat for chassis joints.



MEND METAL
easily and quickly. Copper, iron-plated tip provides superior heat transfer and outlasts other kinds of tips.



HOBBIES AND CRAFTS
are more fun with Weller Gun. Prefocused spotlight, pistol grip and perfect balance assure precision work.



Do sanding and refinishing easier with a
WELLER POWER SANDER

Big 25 sq. in. sanding surface gets jobs done fast. Straight-line action sands with the grain, never bucks or twists . . . goes into corners.

\$13⁴⁸
MODEL
700

AT YOUR HARDWARE OR HOBBY DEALER WELLER ELECTRIC CORPORATION
Easton, Pa.