

How Do Owners Like the PLYMOUTH?

POPULAR MECHANICS

WRITTEN SO YOU CAN UNDERSTAND IT

JULY, 1960
35 CENTS



TRAILERS JOIN THE COUNTRY CLUB
Uncle Sam's "How-to" Men Show the World
... SOUNDPROOF YOUR HOME ...

"SKIMOTORS" FROM GALE...

outboards built for skiing fun!

Hard-charging thrust for deepwater take-offs. Deep-biting response for jump starts. Blazing speed for slalom runs, steady performance for jumping or stunts. Here's broad-shouldered stamina for day-in, day-out ski club use. All the action you want, you get with a completely new, completely restyled Gale outboard...*plus* trouble-free dependability that is built into every motor by craftsmen who are skiers, too.

Gale has a "skimotor" for every purse... there's one for you and your gang. From the mighty V Sovereign to the budget-priced 25 hp Buccaneer, Gale brings you "Tank-Tested" professional performance and satisfying reliability. See 'em now at your Gale dealer's. Or write for colorful brochure (including all Gale outboards from 3 to 60 hp) to: Gale Products, Dept. P370, Galesburg, Ill.



Get a Gale and GO...**ANYWHERE**



Sovereign 35 hp.
Prince of outboards! Electric starting. Full gearshift. Swift, smooth, spirited action. High-output factory-installed generator now available on Sovereign models — on special order.



GALE PRODUCTS / GALESBURG, ILLINOIS • DIVISION OUTBOARD MARINE CORPORATION

Материал, защищенный авторским правом

Black & Decker
celebrates 50 years
of progress!



At your dealers:
Golden Jubilee Drill Sale

Black & Decker says "Thanks for 50 wonderful years!" with the sale of the year. It makes sense to us to give you a choice of the world's most popular drills at the lowest possible prices—without budging an inch on the famous B&D-built power, speed, stamina, versatility and all-around top quality that made them the leaders in the first place. Dollar for dollar, drill for drill—*now's the time to buy!*

For free power tool catalog, write: The Black & Decker Mfg. Co., Dept. D-070, Towson 4, Md.



World's Largest Maker of Portable Electric Tools

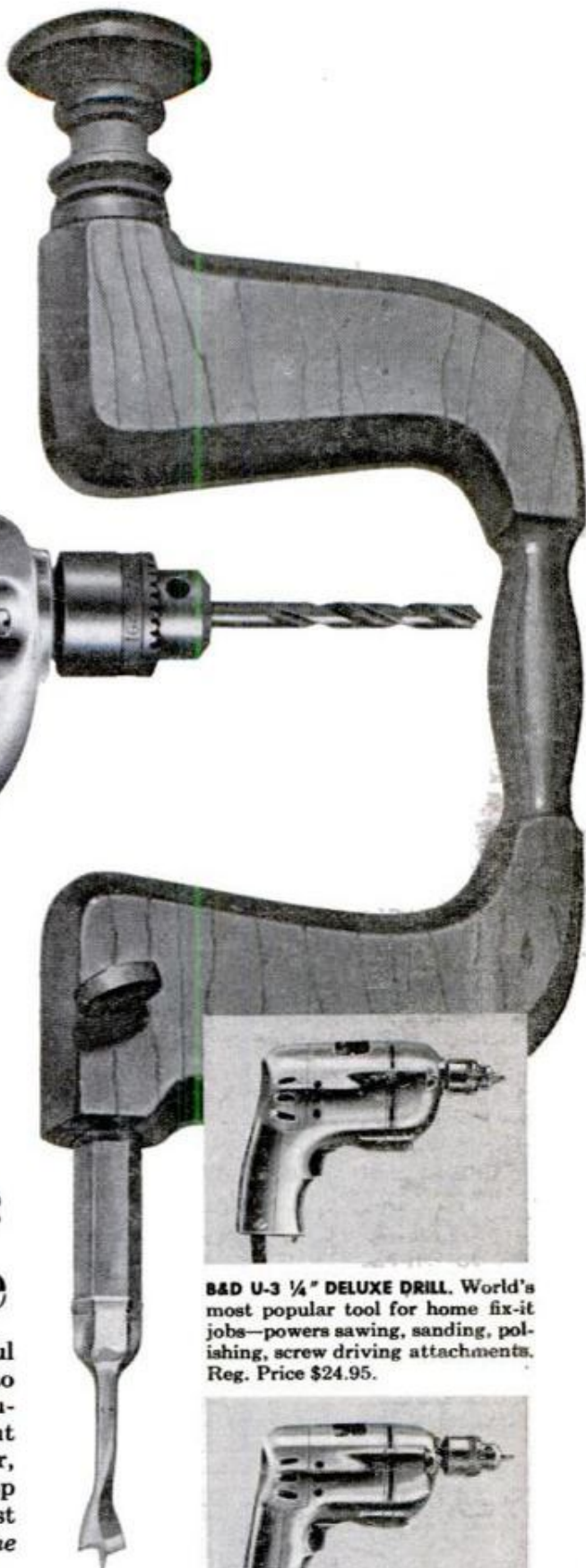

B&D U-3 1/4" DELUXE DRILL. World's most popular tool for home fix-it jobs—powers sawing, sanding, polishing, screw driving attachments. Reg. Price \$24.95.



B&D U-15 3/8" DELUXE DRILL. A real workhorse for pros and semi-pros—drives up to 3/8" twist drills, 1/2" masonry bits, 1/4" wood augers, 1 1/4" hole saws. Reg. Price \$39.95.

See "Tech Electric" -Yellow Pages- for Service & Sales

JULY 1960

This One



POPULAR MECHANICS®

Address communications to: 200 E. Ontario St., Chicago 11, Illinois. **SUBSCRIPTION SERVICE:** Mail all subscription orders, changes of address, correspondence concerning subscriptions, and Postmaster notices of undeliverable copies to Popular Mechanics, 250 West 55th St., New York 19, N. Y.

Editor

RODERICK M. GRANT

Executive Vice-President

RICHARD E. DEEMS

Publisher

G. HARRY CHAMBERLAINE

Managing Editor

CLIFFORD B. HICKS

Shop Notes and Crafts Editor

WAYNE C. LECKEY

Associate Editor, General Features

JOHN A. LINKLETTER

Associate Editors, Automotive

ARTHUR R. RAILTON, JAMES R. WHIPPLE

Associate Editors, Shop Notes and Crafts

W. CLYDE LAMMEY, EARL WOBECK

Radio-Television, Electronics Editor

BYRON G. WELS

Assistant Editors, General Features

JAMES BIERY, KEVIN V. BROWN

R. B. KIRKPATRICK

Assistant Editors, Shop Notes and Crafts

GUERRINO F. AMATI, ROBERT L. HERING

Assistant Editors, Makeup

WALLACE MYERS, JEAN KAVANAUGH

Art Staff

FRANK BEATTY, Director

HENRY NEHRBASS, Assistant Director

RICHARD A. POTTS, Art Editor

Eastern Editor

RICHARD F. DEMPEWOLFF

959 Eighth Ave., New York 19, N. Y.

Western Editor

THOMAS E. STIMSON, JR.

Suite 1003, 3460 Wilshire Blvd.
Los Angeles 5, Calif.

Advertising Manager

JOSEPH R. BUELL, JR.

Director, Bureau of Information

ALLAN CARPENTER

Advertising Offices

Chicago: 200 E. Ontario St., Whitehall 4-0100;
New York: 959 Eighth Ave., Columbus 5-7300;
Detroit: General Motors Bldg., TRinity 5-8711;
Cleveland: Hanna Bldg., 1422 Euclid Ave.,
PRospect 1-0456; Los Angeles: 3460 Wilshire,
DUnkirk 2-8458; San Francisco: Russ Bldg.,
235 Montgomery St., YUkon 2-0823.

Published monthly by Popular Mechanics Company, 200 E. Ontario St., Chicago 11, Ill. Richard E. Berlin, President; Richard E. Deems, Executive Vice-President; Fred Lewis, Vice-President and General Manager; Robert F. MacLeod, Vice-President; John R. Miller, Vice-President; G. Harry Chamberlaine, Vice-President; G. O. Markuson, Treasurer; R. F. McCauley, Secretary. Single copy in the United States and Canada, 35 cents; subscription rates in the United States and possessions and Canada, 1 year \$3.50; 2 years, \$6.00; 3 years, \$8.00. In countries of the Pan-American Postal Union, 1 year \$4.50; 2 years \$8.00; 3 years \$11.00. In all other countries 1 year \$5.50; 2 years \$10.00; 3 years \$14.00. If you plan to move, notify us at least 30 days in advance so you will not miss an issue. Give both your old and new addresses. Second-class postage paid at Chicago, Illinois, and at additional mailing offices. Entered as Second Class Matter at Post Office Dept., Canada. Registered as Second Class Matter at the Post Office at Mexico, D.F., Mexico, June 20, 1950. © 1960 by Popular Mechanics Company. All rights reserved. Printed in the United States of America.

INTERNATIONAL EDITIONS

SPANISH: Mexico-Caribbean, Southern Hemisphere
FRENCH, DANISH, SWEDISH, GERMAN, PORTUGUESE, DUTCH

Volume 114

JULY 1960

Number 1

In This Issue...

Uncle Sam's "How-To" Men Show the World	65
If It Can't Be Repaired—Send It Here	76
Owners Report on the Plymouth	86
Trailers Join the Country Club	94
Throw Back the Big Ones	108
Go to College Outdoors	116
Missile With a Frozen Heart	122
The Woodcarvers of Spillville	126
There Must Be a Better Way	129

For the Craftsman...

Step Table	134
Car-Top Boat Toters	138
More Quiet in Your Home	154
Lake-Front Float	162
Building a Long-Arm Buffer	172
New Rasps Shape Wood and Metal	178
Tips on Lubrication	182
Radio, TV and Electronics	188

Regular Departments...

GUIDE TO THIS ISSUE - - - 6

Spotlight: VW Microbus	18	Items From All Outdoors	62
Science Bulletins	23	An Eye on Space	73
Know This Old-Timer!	24	Detroit Listening Post	74
Pentagon Sidelights	28	What's New for Your Home	114
Pioneer in Science	34	Solving Home Problems	146
Tune In on the Inventors	36	On the Market	170
Keeping Up With the Atom	58	Shopping for Tools	184
What's Up in the Air	60	Clinic for Homemakers	196

Turn to detailed index on page 6. Sources of additional information on items in this issue are shown on the Where-to-Find-It List, available without charge by writing the Bureau of Information, Popular Mechanics, 200 E. Ontario St., Chicago 11, Ill.

Next Month...

SEE SOME of the most fantastic photographs ever taken—a bullet stopped in flight, an atomic bomb at the instant of detonation, a golf ball flattened at impact. . . . Also in August, veteran Rambler owners tell what they think of the new compact cars, and a PM editor, on the eve of the Olympics, explains the reasons behind the rash of broken records in track and field events

POPULAR MECHANICS

Mobilgas Economy Run proves more car and more economy go together . . . if it's a 1960 car from Chrysler Corporation



CHRYSLER CORPORATION CARS WIN IT BIG IN THE 1960 MOBILGAS ECONOMY RUN

Compact class	2nd Place—	VALIANT	27.29 MPG
6-cyl. low price class	1st Place—	PLYMOUTH	24.82 MPG
	2nd Place—	DODGE DART	24.74 MPG
	3rd Place—	PLYMOUTH	24.73 MPG
8-cyl. low price class	1st Place—	PLYMOUTH	22.88 MPG
	2nd Place—	PLYMOUTH	22.52 MPG
	3rd Place—	DODGE DART	22.28 MPG
Low medium price class	2nd Place—	DODGE	21.12 MPG
Upper medium price class	1st Place—	CHRYSLER New Yorker	20.87 MPG
	2nd Place—	DE SOTO	20.36 MPG
High price class	1st Place—	IMPERIAL	20.50 MPG

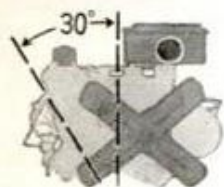

More car . . . New Economy Slant "6," with intake and exhaust pipes for each cylinder, delivers 20% more passing power, yet uses 12% less gas than last year's models.



More car . . . Torsion-Aire Ride irons out the bumps. Up front, torsion bars twist and untwist, hold wheels down. In back, leaf springs soak up bounce and pitch, help prevent seesawing.



More car . . . Unibody Construction, the better way to build cars, welds away squeaks and rattles, surrounds you with a solid, one-piece structure twice as strong as earlier construction.

Pure automobile . . . The Quick, the Strong, and the Quiet

from CHRYSLER CORPORATION

VALIANT • PLYMOUTH • DODGE DART • DODGE • DE SOTO • CHRYSLER • IMPERIAL

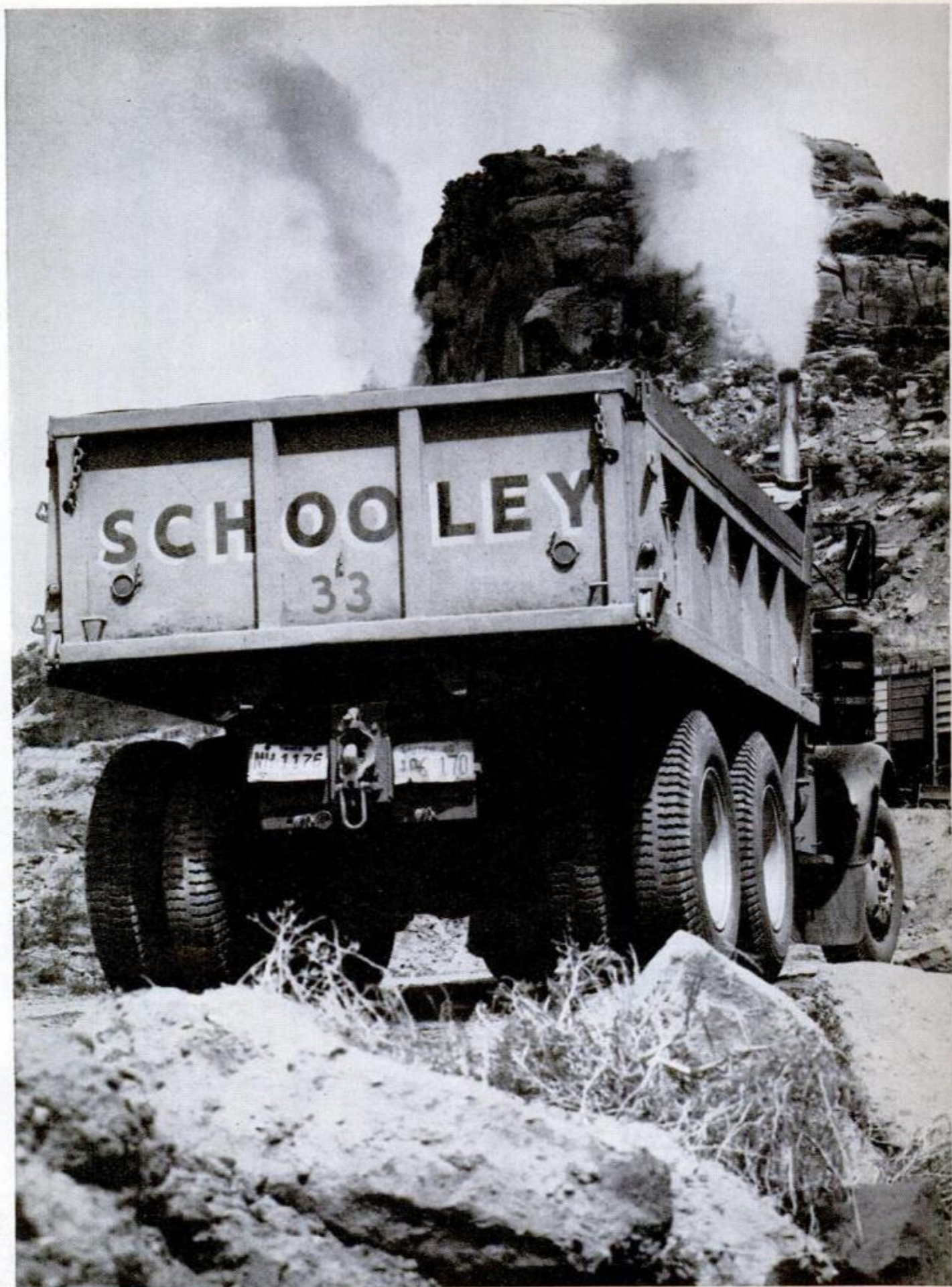

URANIUM ORE HAULER: L. E. Schooley, Grand Junction, Colorado. "Running on Firestone truck tires we travel over hot pavement and back-country trails without a worry!"

COOL-RUNNING TIRES RUSH "HOT" LOADS OF VITAL URANIUM ORE FROM MINES TO MILLS!

Firestone

proved where profit depends on performance

High speeds over hot pavement and "washboarding" over rutted wilderness trails are easy chores for Firestone truck tires. That's because Firestone tires undergo 425 million miles of test driving every year to prove they can take any job in stride. Testing like this has helped develop Shock-Fortified Cord and Firestone Rubber-X—the coolest-running and longest-wearing rubber ever used in Firestone tires. That's why, whenever profit depends on performance, truckers depend on Firestones for less cost-per-mile and on-time deliveries. If your trucking calls for tires that can take it, see your nearby Firestone Dealer or Store.

Copyright 1960, The Firestone Tire & Rubber Co.



Transport*

Super Mileage Lug*

Super All Traction*

Rib Excavator*

Rock Grip Excavator*

All Traction*

*Firestone T.M.

*Here's owner proof of
Firestone truck tire
performance!*



LIMESTONE HAULER: Francis Couch, Ottawa, Kansas. "Hauling out of limestone quarries is tough on tires. You've got to have Firestones!"



GRAVEL HAULER: Merle G. Ellsworth, Bloomington, Illinois. "I give tires a real beating but Firestones keep me rolling even in the toughest kind of going!"



HEATING CONTRACTOR: T. M. McKee, Memphis, Tennessee. "Firestone tires are the best buy in my book. They save us from expensive on-the-job downtime due to tires!"

Built to Last

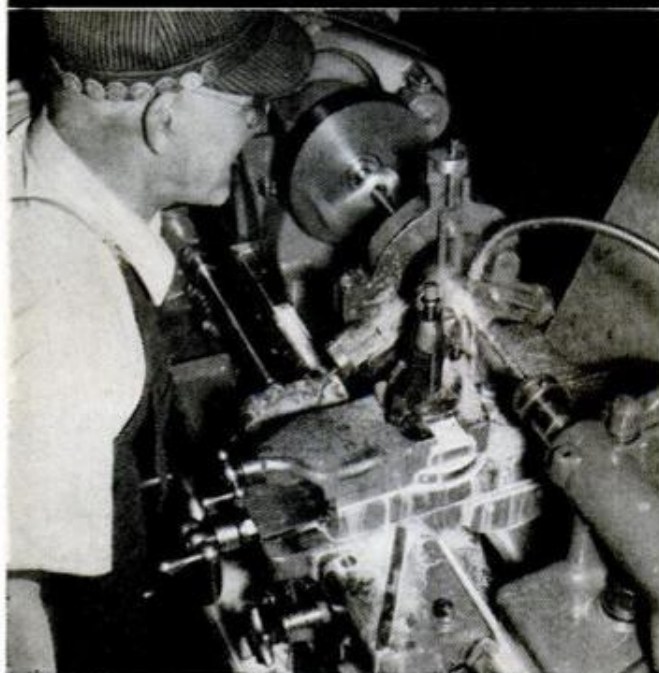

South Bend 13" and 14½" Lathes

Years mean nothing to these precision lathes, as they go on and on turning out accurate work at low cost with ...

- Microfinished bearings with no metal-to-metal contact.
- Belt drive to spindle for vibration-free operation—no gear marks.
- Precision-cut gears and ground shafts for smooth power feeds.
- Rugged, rigid construction that will stand up under hard usage.
- Exacting workmanship by skilled craftsmen.

SPECIFICATIONS	13"	14½"
Swing over cross slide.....	7¾"	8¾"
Maximum collet capacity.....	1½"	1½"
Spindle speed range.....	20-940	15-875
Shipping weight, 7' bed.....	1760 lbs.	2089 lbs.

Write for **FREE 80-page catalog.**



Up to 36
months to pay.

SOUTH BEND LATHE
SOUTH BEND 22, INDIANA

Building Better Tools Since 1906

GUIDE TO THIS ISSUE

With Sources of New Products

Aviation & Automotive

Helicopter proves successful at minesweeping (Sikorsky Aircraft, Stratford, Conn.).....	84
Compressed-air vacuum cleaner (M-M-A Inc., Lancaster, Pa.).....	84
Communist China's first passenger car.....	85
Window insert vents stale air (Brekke Distributors, Inc., 407 W. Park St., Livingston, Mont.).....	113
Second top for car keeps interior cool (Buskle Motors, Sydney, Australia).....	121

Boats

"Clinometer" indicates boat trim (John L. Chaney Instrument Co., Lake Geneva, Wis.).....	81
Boat top unzips to let air in, boaters out (Water Bonnet Marine Products Corp., P. O. Box 5296, Orlando, Fla.).....	93
He lets his (sailing) cat out of the bag (Carl Ehrman, 2982 Louis Rd., Palo Alto, Calif.).....	101
Compromise cruiser (J. W. Hamilton Co., 429 S. Sixth Ave., La Grange, Ill.).....	106
Hose connection flushes outboards (No Flo Div., Rex Metal-Craft Inc., 1717 Gent Ave., Indianapolis, Ind.).....	121
Hydraulics handle motors (Specialty Motors, Longview, Wash.).....	128

Construction

Military bridge floats without pontoons.....	93
Japanese house is boxed against the weather.....	101
"Orange peel" house (Egon Bruetsch, 60 Altenbergstrasse, Stuttgart-S, West Germany).....	104

Miscellaneous

Sacramento—ocean port.....	75
Lots of summer fun with outdoor toys.....	80
Portable sprayer with extension covers wide area (Courtney Enterprises, 1353 Highwood Blvd., Pontiac, Mich.).....	80
Ultrathin record slips into package (Rank Audio Plastics, 24 W. 57th St., New York, N. Y.).....	81
Battery corrosion preventive (U. S. Polymer Corp., Box 262, 1990 Broadway, New York 23, N. Y.).....	84
Radio for sunglasses has station selector (Precision Electronics, Box 3231 Beverly Hills, Calif.).....	85
Mosaic tile set in rubber (Joo-Gresite, 24 via Marco Bruto, Milan, Italy).....	91
"Belly Whopper" goes anywhere (The Irwin Corp., 200 5th Ave., New York 1, N. Y.).....	103
No more "bricklaying" with hay bales (New Holland Machine Co., New Holland, Pa.).....	104
Filter for back-yard pools (Lomart Industries, 199 Bleecker St., Brooklyn, N. Y.).....	105
VW doesn't go under down under.....	105
Camera can shift speed, zoom in (Bell & Howell, 7100 McCormick Rd., Chicago 45, Ill.).....	105
"Airlift" camera tripod (Karl Heitz Inc., 480 Lexington Ave., New York 17, N. Y.).....	106
Hand-propelled "water wings" (Argo Industries Corp., Woodside 77, New York).....	107
Chair has built-in tackle box (Towser Products, 215 N. Walnut St., Creston, Iowa).....	107
Traveling photographer builds a "photomobile".....	112
Roller on tractor levels rough land (Viking Mfg. Co., Manhattan, Kans.).....	113
Auto cooler features built-ins (G & B Mfg. Co., Inc., 3326 Atlantic Ave., Long Beach, Calif.).....	121
Aerial tramcar serves as "elevator".....	124
Camper's shower is set up on car (Goode Products Co., 7542 Maie Ave., Los Angeles 1, Calif.).....	124
Plastic balls float pulpwood chips to mill (Crown Zellerbach Canada, Ltd., Boston Bar, B.C.).....	125
The woodcarvers of Spillville.....	126
Magnetic door retainer (Fletcher Industries, Inc., P. O. Box 1133, Bristow, Okla.).....	128

(Continued to page 8)

5 reasons why ACCOUNTING

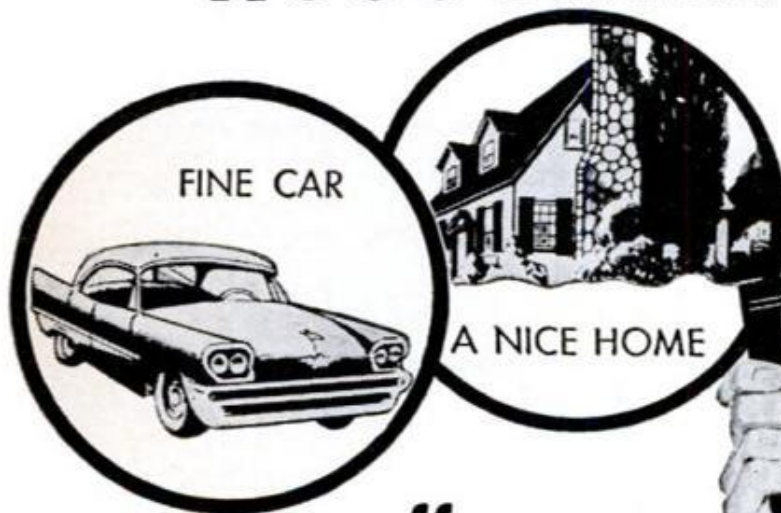

offers you

MORE MONEY and SUCCESS

**SEND FOR FREE
SAMPLE LESSON**

REASON #1. If you were an expert accountant right now, chances are you would find yourself in one of the best paid fields of business.

REASON #2. The demand for accountants is great—everywhere. All businesses must have trained accountants to cope with ever-growing requirements. It's a field offering wide opportunity—always—to the man who knows.

REASON #3. You can fit into any business, anywhere in the country—because accounting principles are universal. Think what this means in terms of security and independence!

REASON #4. Accounting is open to all. Any man or woman of good intelligence, who enjoys figure work and is willing to follow LaSalle's systematic "problem method" plan, can rapidly qualify for a highly profitable, enjoyable lifetime career . . . and he doesn't have to finish his training before beginning to "cash in."

LASALLE
417 S. Dearborn St.,
CHICAGO 5, ILL.

REASON #5. Without losing a day from your present work, you can prepare in spare hours at home, at low cost, under LaSalle's step-by-step "Problem Method" of "learning by doing." This famous plan accounts for LaSalle's remarkable record of having trained one out of every 13 of all Certified Public Accountants in the U. S. . . . and of having put many thousands of others into high-paying careers.

Send today for Free Sample Lesson and "Opportunities in Accounting." Learn about the several great fields of opportunity . . . and LaSalle's time-tested plan for helping men and women to rapid advancement, higher income and greater prestige. The coupon below will bring this information to you—without cost or obligation.

Accredited Member, National Home Study Council

SEND FOR FREE BOOK



LaSalle Extension University
A Correspondence Institution

Dept. 764H 417 S. Dearborn St., Chicago 5, Ill.

Please send me, free of all cost or obligation, free sample lesson and your latest book, "Opportunities in Accounting."

Name.....Age.....

Address.....

City, Zone, State.....



LAWN MOWERS



garden equipment, generators, stables,
laundries, lumber, luggage, labels
whatever you need—



Advertisers displaying this emblem
make your shopping easy.

Sound movie camera in 8 mm. (Fairchild Camera & Instrument Corp., 111 W. Washington St., Chicago, Ill.).....128
Pushbutton shear chews up freight cars.....133

Science

Strange Music 82
Army tests nuke zeus at White Sands..... 91
U. S. Navy's space surveillance system tracks all satellites... 92
Automatic system lands two planes a minute (Bell Aircraft Corp., P. O. Box 1, Buffalo, N. Y.).....100
Gyroscope spins at -456 degrees.....100
Retreat of glaciers indicates warmer climate.....103
Machine reads handwriting (Bell Telephone Lab., 463 West St., New York 14, N. Y.).....104
Missile with a frozen heart.....122
Even skin divers can use this flashlight (Mit-y-Lite, P. O. Box 2116, 1230 E. St. Gertrude Pl., Santa Ana, Calif.)...125
Beeps, hums, time signals are station WWV's program.....204

What's New for Your Home

Removable oven114
Dripless aluminum grill.....114
Center drawer refrigerator.....114
Adjustable shower head.....114
Hosiery dryer115
Electric broiler for patio.....115
Safety gate115
Remote control dial for water heater.....115

Radio-TV and Electronics

Inexpensive test set for radio experimenters.....188
Molecular electronics—a new concept in electronic technology191
Tuning in on new products.....192

Craftsman and Shopnotes Index

Automotive

Youngsters are safe behind station-wagon window screen...160
Trouble shooting the tough ones.....164
Replacement brackets164
Switch-arm breakage164
Loose jumper wire.....164
Air-filter rattles164

House and Home

Flower-pot match snuffer.....142
False beams decorate your living room.....160
Cord suspended from sun lamp gauges proper height.....161
Filing corrects striker plate fit.....168
Improved downspout guard made from hardware cloth.....168
Adjust binding on rattling sashes.....212

Solving Home Problems

Emergency repair for freezing water pipe.....146
Metal pulls and handles tightened.....146
Stepladder treads146
Substitute applicator for paste jar.....146
Handy place to store hose nozzle.....146
Burned out fuse easily located.....146
Old binder rings can be useful.....147
Protect marring lower panel of piano.....147
Clogged jets of gas-stove burners easily cleaned.....147
Starting a nail in a hard-to-reach place.....147
Shade rollers147

Lawn and Garden

"Dustpan" on hedge trimmer catches thick clippings.....142
From hoola hoop to sprinkler.....143
Mowing pattern keeps cord in tow.....149
Shower-curtain hook on hose keeps spare washers handy...153

On the Market

Cedar closets170
New roll-on trimmer.....170
Metal window sash.....170
Plastic-panel resurfacer170
New plug guard.....171

(Continued to page 10)

HOW TO MAKE YOUR BOSS SIT UP AND TAKE NOTICE



Best way we know of is to come up with the right answers on the job. Show him you have the drive and ambition it takes to get ahead.

How? By getting the right kind of training... training that enables you to come up with the right answers. Nowadays the crying need in business and industry is for men with special knowledge—skilled technicians, plant and office workers who have more to offer than on-the-job experience.

Without the right training you're just another one of the millions competing for the same, dull routine jobs, the same low salary.

But—when you have the right kind of training your boss can't help but sit up and take notice of you. He can see you're a man who is prepared to move ahead.

Now is the time to act! Choose the kind of training you need to get ahead from success-proven I.C.S. Courses—259 in all. Each I.C.S. Course was developed

by business and industry leaders who know—who can tell you—what you need to go places.

The instruction is practical, down-to-earth. What you learn has immediate "cash value." No waiting to see results. Students report increased earnings within as little as three months.

You get personalized guidance. Study in your spare time—at your own pace. Chances are by the time you get your coveted I.C.S. diploma you're already on your way to a better job, bigger pay.

Don't wait another day. Start this minute to make your boss sit up and take notice of you. Mark and mail the coupon.

For Real Job Security—Get an I. C. S. Diploma!

I. C. S., Scranton 15, Penna.

Accredited Member,
National Home Study Council

INTERNATIONAL CORRESPONDENCE SCHOOLS



BOX 16953X, SCRANTON 15, PENNA.

(In Hawaii, reply P.O. Box 418, Honolulu)

(Partial list of courses)

Without cost or obligation, send me "HOW TO SUCCEED" and the opportunity booklet about the field BEFORE which I have marked X (plus sample lesson):

ARCHITECTURE and BUILDING CONSTRUCTION

- Air Conditioning
- Architecture
- Arch. Drawing and Designing
- Building Contractor
- Building Estimator
- Carpenter Builder
- Carpentry and Millwork
- Heating
- Painting Contractor
- Plumbing
- Reading Arch. Blueprints

ART

- Commercial Art
- Magazine Illus.
- Sign Painting and Design's
- Sketching and Painting

AUTOMOTIVE

- Automobile
- Auto Body Rebuilding and Refinishing
- Auto Engine Tuneup
- Auto Electrical Technician
- Diesel Engines

AVIATION

- Aero-Engineering Technology
- Aviation Engine Mech.
- Reading Aircraft Blueprints

BUSINESS

- Accounting
- Advertising
- Bookkeeping and Cost Accounting
- Business Administration
- Business Management
- Clerk Typist
- Creative Salesmanship
- Managing a Small Business
- Professional Secretary
- Public Accounting
- Purchasing Agent
- Real Estate Salesmanship
- Salesmanship
- Salesmanship and Management
- Traffic Management

CHEMICAL

- Analytical Chemistry
- Chemical Engineering
- Chem. Lab. Technician
- General Chemistry

- Oil Field Technology
- Pulp and Paper Making

CIVIL ENGINEERING

- Civil Engineering
- Construction Engineering
- Highway Engineering
- Professional Engineer (Civil)
- Reading Struc. Blueprints
- Sanitary Engineer
- Sewage Plant Operator
- Structural Engineering
- Surveying and Mapping
- Water Works Operator

DRAFTING

- Aircraft Drafting
- Architectural Drafting
- Drafting & Machine Design
- Electrical Drafting
- Electrical Engineer Drafting
- Industrial Piping Drafting
- Mechanical Drafting
- Sheet Metal Drafting

ELECTRICAL

- Electrical Appliance Servicing
- Electrical Engineering

- Electric Motor Repairman
- Elec. Engr. Technician
- Elec. Light and Power
- Practical Electrician
- Practical Lineman
- Professional Engineer

HIGH SCHOOL

- Good English
- High School Diploma
- High School General
- H. S. College Prep. (Eng'g & Science)
- High School Math
- High School Science
- Short Story Writing

LEADERSHIP

- Industrial Foremanship
- Industrial Supervision
- Personnel-Labor Relations
- Supervision

MECHANICAL and SHOP

- Diesel Engines
- Gas-Elec. Welding
- Heating and Air Conditioning
- Industrial Engineering
- Industrial Instrumentation

- Industrial Safety
- Machine Shop Practice
- Mechanical Engineering
- Plumbing and Heating
- Professional Engineer
- Quality Control
- Reading Shop Blueprints
- Refrigeration and Air Conditioning
- Tool Design
- Tool Making

RADIO, TELEVISION

- General Electronics Tech.
- Industrial Electronics
- Practical Radio-TV Eng'g
- Radio-TV Servicing
- TV Technician

RAILROAD

- General Railroad

STEAM and DIESEL POWER

- Combustion Engineering
- Power Plant Engineer
- Stationary Diesel Engr.
- Stationary Steam Engines

TEXTILE

- General

Name _____ Age _____ Home Address _____

City _____ Zone _____ State _____ Working Hours _____ A.M. to P.M. _____

Occupation _____

Canadian residents send coupon to International Correspondence Schools, Canadian, Ltd., Montreal, Canada. . . . Special low monthly tuition rates to members of the U. S. Armed Forces.

when your car picks up
like a sleepy snail . . .



HOW LONG SINCE YOU CLEANED YOUR CARBURETOR ...WITH **GUMOUT**

Miss that frisky pick-up you used to get? Stalling in traffic? Stopping lots more often for gas? Then do something about that dirty carburetor!

CLEAN YOUR CARBURETOR WITH **GUMOUT**



It's easy! Just add GUMOUT to your gas tank. While you drive GUMOUT cleans carburetors completely . . . makes your engine start easier and run better . . . saves your gas dollars, too. GUMOUT is used by millions of motorists regularly, because only GUMOUT does the job. Ask for it by name. Sold at most service stations, hardware and auto supply stores.

GUMOUT DIVISION
PENNSYLVANIA REFINING COMPANY
CLEVELAND 4, OHIO

Three ladders in one	171
Ready-mixed spackling paste	171
Mix-it-yourself patching	171
Spring clips allow installation	171

Miscellaneous

Wax paper lines soap case	142
Ball points find their place among draftsman's equipment	143
Planned for cookouts	144
Four-sided pencil pointer	148
Match held to thermometer rejoins mercury-column	148
Tape mounted on waxed paper can be inserted in typewriter	148
Cellophane tape makes it easy to remove mailing wrapper	150
Decorator's lamp base from plywood	150
Clip and wire trammel scribes outside circles	152
Scales taped to triangle speeds scale drafting	152
Lake-front float	162
Meter case holds data	166
Print-tong holders	166
Stop for tripod screw	166
Faster film loading	166
Cable release through hand strap permits off-camera flash	167
"Painting" out backgrounds	167
Vacuum cleaner makes quick work of removing dust from boat bilge	168
Farm-built tools speed haymaking	177
Tips on lubrication	182
Washer aids in drawing ellipse	187

Shopping for Tools

Handle locking wedge	184
Hand-feed power threader	184
Cutting wheel	184
Carpenter's plane	184
Radial drill press	185
Steel bridging	185
Extractor	185
Drill press	185
Race-winning engines	186
Saw setter	186
Automatic contour cutter	186
Outside micrometer	186

Workshop Hints

Never a dull edge	142
Two-handed sanding block	150
Cement tube slipped over hook saves frequent recapping	152
Correct use of push stick	152
Inside cuts on circular saw	153
Nut run up on clamping screw forms shoulder for wrench forms	153
Small work on sandpaper base stays put under sander	153
Loose joints in old work anchored with steel wool	161
Slip-on stop block holds original setting	161
Mushroom anvil	169
Sheet-metal chip tray	169
Vibration dampener	169
Building a long-arm buffer	172
Double work range of bench saw	175
How to slot sheet metal	176
Scribe angles with "V" block	176
Straightening kinked wire	176
Use tape to back sandpaper	176
New rasps shape wood and metal	178
Lathe-dog insert grips work	180
Pulley hub holds round stock	180
Rack protects split dies	180
Rule used as wire stripper	180
Chip guard for saber saw	181
Guided punch for accurate layout	181
Improvised ring compressor	181
Chucks take pin-end blades	187
Driving rows of tacks in line	187
Power-cleaning a paint roller	187

NOTICE—It is the intention of this magazine to provide its readers with information regarding the latest developments in the mechanical arts. Except where otherwise indicated, this magazine has no information as to any unexpired patents in respect of the developments reported herein. In the event that commercial use is to be made of any of the developments reported herein, it is suggested that legal counsel be consulted to avoid liability for patent infringement. It is not the purpose of this magazine to encourage patent infringement but, as indicated, it is the intention of this magazine to report on the latest developments in the mechanical arts.

Learn Radio-Television Electronics

by Practicing at Home in Your Spare Time

WITHOUT EXTRA CHARGE YOU GET special NRI kits developed to give you actual practice with Radio-TV receiver or broadcasting circuits and equipment. All equipment is yours to keep.

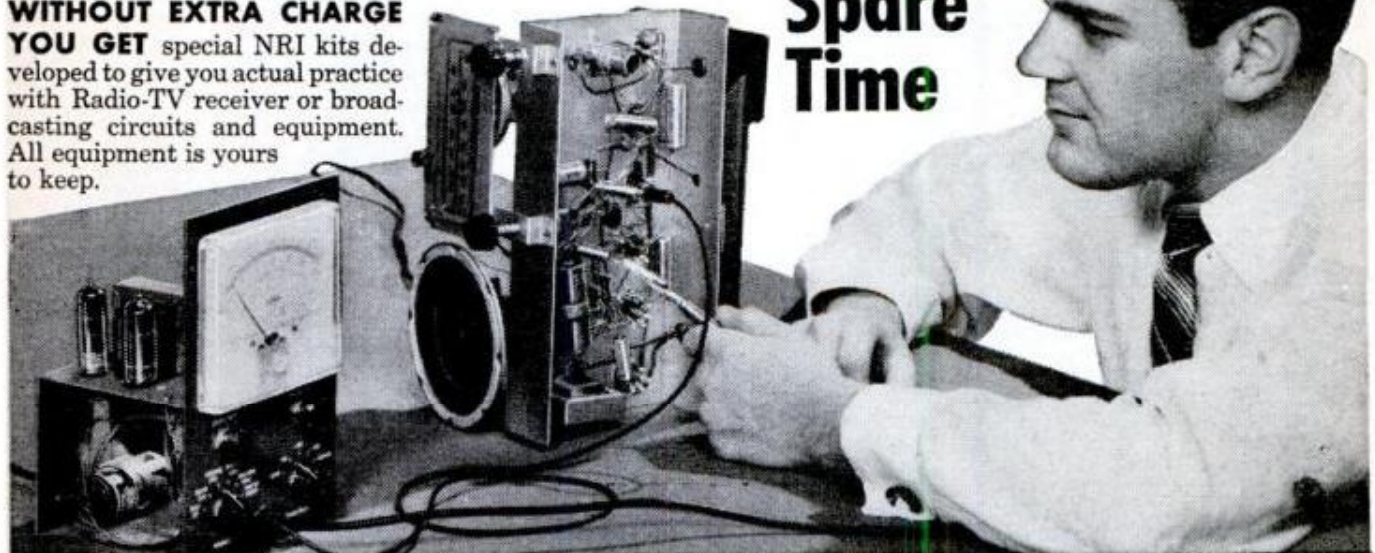

RADIO-TV BROADCASTING (see above) offers important positions as Operators and Technicians. **RADIO-TV SERVICING** Technicians (see below) needed in every community. Their services are respected, their skill appreciated.



Fast Growing Field Offers You Good Pay, Success, Bright Future



J. E. SMITH
founder

Bigger than ever and still growing fast. That's why Radio-TV has special appeal to ambitious men not satisfied with their job and earnings. More than 4,000 Radio and TV stations. More than 150 million home and auto Radios, 40 million TV sets. Color TV promises added opportunities. For the

trained man, there are good jobs, bright futures in Radio-TV Servicing or Broadcasting. Training PLUS opportunity is the ideal combination for success. So plan now to get into Radio-TV. The technical man is looked up to. He does important work, gets good pay for it. Radio-Television offers that kind of work. NRI can supply training quickly, without expense of going away to school. Keep your job while training. You learn at home in your spare time. NRI is the OLDEST and LARGEST home study Radio-TV school. Its methods have proved successful for more than 40 years.

Added Income Soon - \$10, \$15 a Week in Spare Time

Soon after enrolling, many NRI students start to earn \$10, \$15 a week in spare time fixing sets. Some pay for their training and enjoy extra luxuries this way. Some make enough to start their own Radio-TV shops. NRI training is *practical*—gets quick results. Easy to understand, well illustrated lessons teach you basic principles. And you LEARN-BY-DOING by practicing with kits of equipment which "bring to life" things you study.

Find Out What NRI Offers

NRI has trained thousands for successful careers in Radio-TV. Study fast or slow—as you like. Diploma when you graduate. Mail coupon now. Paste it on a postcard or mail in envelope. **ACTUAL LESSON FREE.** Also 64 page catalog that shows opportunities, shows equipment you get. Cost of NRI courses low. Easy terms. **NATIONAL RADIO INSTITUTE, Dept. OGA, Washington 16, D. C.**

N.R.I. TRAINED THESE MEN FOR SUCCESS



"I was repairing Radios by 10th lesson. Now have good TV job." **M. R. LINDEMUTH,** Fort Wayne, Ind.



"Doing spare time repairs on Radio and TV. Soon servicing full time." **CLYDE HIGGINS,** Waltham, Mass.

"I had a successful Radio repair shop. Now I'm Engineer for WHPE." **V. W. WORKMAN,** High Point, N. C.



"There are a number of NRI graduates here. I can thank NRI for this job." **JACK WAGNER,** Lexington, N. C.



VETERANS Approved Under G. I. Bills

SEND FOR BOTH FREE

National Radio Institute

Dept. OGA, Washington 16, D. C.

Mail me Sample Lesson and 64-Page Catalog FREE. (No salesman will call. Please write plainly.)

Name _____ Age _____

Address _____

City _____ Zone _____ State _____

Accredited Member National Home Study Council



Over the Editor's Desk



To the Editor:

I thought you would be interested in this model of a beautiful funeral coach which used to serve this locality. I have taken great pains to reproduce it as near like the original as possible, however all I had to



build it by was old photographs. The wheels have metal hubs and are held on by tiny burrs; the lights, handles on casket, railings, hames and buckles, etc., on harness are made of silver. It took me about 60 days to gather photographs, data, etc., draw the plans and build the model. The horses are made of soft pine. This model won a trophy at the State Fair.

Lyndon J. Graham
Fairview, Utah

To the Editor:

Travelers atop the Montana Continental Divide on U. S. Highway #10 where it crosses the Divide via MacDonald Pass are sometimes startled by the sound of a bear's roar, reverberating dramatically over the lonely landscape. The roar emanates from an animated group depicting a trapped grizzly bear harassed by a dog and trapper.

Constructed by resort owner John Quigley to advertise his unique "Frontier Town" atop the Divide, the group is mounted on



a concealed trailer for storage during the winter season when snow here lies many feet deep. The bear, paw in trap, roars frightfully and the little dog leaps frantically up and down. Sound comes from a record and P. A. system inside the base, activated by battery power, which also provides power for the mechanism for action.

Eric Thane
Helena, Mont.

(Continued to page 14)

INVESTIGATE ACCIDENTS

Train quickly in your own home for repeat income in the exciting, secure Claim Investigation and Claim Adjusting field. Our students and graduates are already earning \$4, \$5, \$6 an hour extra SPARE TIME — and up to \$10,000 a year Full Time. You need NO prior experience or higher education. Your age does NOT matter.

HERE IS YOUR CHANCE FOR ACTION AND REAL JOB SECURITY

As a trained Claim Investigator you will (1) INVESTIGATE FACTS and (2) DISTRIBUTE MONEY as the representative of wealthy organizations.

No other business offers you greater opportunities for success and security. Here's why: The huge, rapidly expanding Claim Investigation and Adjusting Profession right now distributes more money than any other service industry. And it's growing fast. Over 200 MILLION ACCIDENTS must be investigated this year for Insurance Companies, Airlines, Railroads, Steamship Lines, and Government Offices.

MAIL NOW for FREE BOOK



SEND TODAY for Big, FREE, Illustrated Catalog. Learn the exciting facts about Universal Schools' low cost training. No obligation. No salesman will call. GI APPROVED.



UNIVERSAL SCHOOLS

6801 Hillcrest Ave.
Dept. PM-7, Dallas 5, Texas

Please rush me your FREE book on Claim Investigation. This does not obligate me and no salesman will call.

Name _____ Age _____

Address _____

City _____ Zone _____ State _____

Approved by Government for Korean Veterans

A Practical New Way to End Your Job Worries!

TRAIN AT HOME FOR A SUCCESSFUL FUTURE IN AIR CONDITIONING AND REFRIGERATION

If you want an interesting job that pays real well and offers year-round work—get into Air Conditioning and Refrigeration! It's a big, *uncrowded* field that is well-established—yet growing fast! *Each year over 20,000 newly-trained mechanics are needed.* No wonder! Today there are 150 million units in use—and each year over 6 million new air conditioners, refrigerators and freezers are manufactured. All units need periodic service. The pay? It ranks with the best!

Refrigeration mechanics is an easy trade to learn... Especially when you get your training through CTI. *You can learn at home in spare time* by practicing with commercial equipment. Get all the facts about this wonderful new way to acquire a highly-profitable technical education. *Mail coupon today for fact-filled free booklets. No obligation whatever.*

**25
BIG KITS**



ONLY CTI SENDS PARTS AND TOOLS TO BUILD A CONDENSING UNIT!



Easy Way to Start a Business

Own a business—and enjoy independence. Thrill to the satisfaction of being the boss. Give orders—not take them! The refrigeration field is ideal for getting started on your own. You can make friends as you make service calls. In time, you'll have a list of potential customers. You can also sign service contracts with food stores, taverns, restaurants, etc. Thousands of CTI graduates have their own successful small shops.

Get Into Auto Air Conditioning

Experts say that over 400,000 air conditioners are to be installed in autos this year. The field is growing very fast. Already auto shops are advertising for skilled air conditioning mechanics. Opportunities are excellent for starting repair shops. Some day, air conditioners will be standard equipment on cars. So get in on the ground floor now. Our catalog has information on this specialized, profitable field. It's worth looking into.



You Get Experience as You Train Because You Practice with Commercial Equipment

Another CTI first! You learn by practicing—you get experience as you train—because CTI sends you 25 kits. You get all parts and tools to build a heavy-duty, commercial-type, 1/4 h.p. condensing unit (illustrated above.) *You build an air conditioner, freezer, refrigerator, or milk cooler.* You complete 23 field-type projects—do 10 service and trouble-shooting jobs! You "boil down" years of apprentice-like training into months. Kit training perfects your skill, provides practical knowledge, assures useful experience, and helps you learn faster! CTI makes your home a training center.

Earn Extra Cash in Spare Time as You Train

Because CTI training is so practical, you'll soon be making profitable service calls. Perhaps you'll work "on your own." Or, you may prefer to get a part-time job with a local appliance dealer or air conditioning contractor. You can add to your income this way. With extra cash, you can buy additional shop equipment, pay your tuition, even bank money. Be sure to mail coupon for complete details. Act today!—Commercial Trades Institute, Chicago 26, Illinois.

TYPICAL LETTERS FROM SUCCESSFUL STUDENTS

"I have been very busy. Had an offer to work for an appliance dealer but it looks like I'll be in business for myself before long."—*Frank Fuller, Wells, N. Y.*... "Am now working in the field. Earn \$40 more per month than before."—*Frank Krotzer, Houston, Texas*... "I not only got a job, but today am foreman, earning \$60 a week more than before I enrolled."—*E. E. Hughes, Chicago*... "Have my own business. Only problem is: Too much business!"—*Conrad King, Cynthia, Ky.* You can do as well as these men!

FIRST GET THE FACTS—THEN DECIDE
Mail Coupon Today for 2 Free Booklets

COMMERCIAL TRADES INSTITUTE

1400 GREENLEAF AVENUE
CHICAGO 26, ILLINOIS

A Non-Profit Organization

DEPT. R-738

Tell me how I can qualify for a better job or a business of my own. Send booklet, *Success in Air Conditioning & Refrigeration, and Lesson Sample.* Both FREE.

Name _____ Age _____

Address _____

City _____ Zone _____ State _____

Accredited by National Home Study Council





The Beautiful Schober CONSOLETTA

—only small organ with two full 61-note key-boards and 22 stops. Requires only 2'x3'2" floor space! Commercial value approximately \$1600 or more.

BUILD THIS SUPERB Schober ORGAN FROM SIMPLE KITS and save over 50%!

Give Your Family A Lifetime of Musical Joy With A Magnificent Schober Electronic Organ!

Now you can build the brilliant, full-range Schober CONSOLETTA or the larger CONCERT MODEL with simple hand tools! No skills are needed; no woodworking necessary. Just assemble, clearly marked electronic parts guided by step-by-step instructions. You build from kits, as fast or as slowly as you please... at home, in your spare time — with a small table serving as your entire work shop.

THE GREAT CONCERT MODEL meets specifications of **American Guild of Organists**

ment you assemble is as fine, and technically perfect, as a commercial organ... yet you save over 50% on quality electronic parts, high-priced labor, usual store mark-up!

Free Booklet

Send for 16-page booklet in full color describing Schober organs you may build for home, church or school, plus articles on how easy it is to build

your own organ and how pleasant it is to learn to play. Also available is 10" LP demonstration record (price \$2.00 — refundable on first order). Send for literature. No obligation and no salesman will call.

Pay As You Build!

Start building your organ at once, investing just \$18.94! The superb instru-

Mail This Coupon For FREE Schober Literature And Hi-Fi Demonstration Record TODAY!



The Schober Organ Corp., Dept. PM-3
2248 Broadway, New York 24, N. Y.

- Please send me FREE full-color booklet and other literature on the Schober organs.
- Please send me the 10" hi-fi Schober demonstration record. I enclose \$2.00 (refundable on receipt of my first kit order).

Name.....
Address.....
City..... Zone .. State.....

To the Editor:

Upon reading the automotive section of the January issue I note a statement which applied to the Thunderbird, page 161, which read "the first sliding sun roof on an American car as optional equipment."

However, I am of the opinion that this is not a T-Bird first, for to the best of my knowledge, Cadillac offered a Sunshine Turret top on its 1939 Series 60 Special sedan, and Series 61 4-door sedan. A similar panel was, I believe, offered on the 1939 La Salle Series 50, 2-door and 4-door sedans. The cost ran around \$40.

I enjoy your magazine a great deal and have been a faithful reader for many years.

John Kulik,
Cicero, Ill.

☆ ☆ ☆

To the Editor:

The enclosed picture shows a merry-mix-up garden tractor made of one old Dodge automobile transmission, one Harley-Davidson motorcycle transmission, one Briggs & Stratton 3½ hp. air-cooled engine for power plant. The master drive is an Olds 88 rear end with wheels and tires mounted; this unit not only serves as the main drive but also for steering by locking or slight braking of either right or left drive wheel,

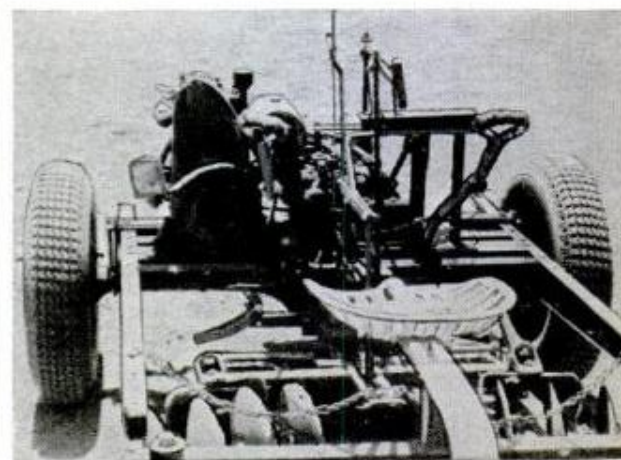

using for this a Chevy master cylinder mounted on right and left of operator's seat. By locking either side one can pivot in tracks. The tractor has nine forward speeds and three reverse. Mounted in the picture is an Oliver disc plow, or it will take just about anything one wants to hang on. No steering wheel, leaving hands free for lever work. Drive between units, three Duckworth motorcycle chains. Small air-tired wheels in rear are caster-mounted to allow for quick turn arounds.

Hugh McDaniel
Venice, Calif.

(Continued to page 16)

**GET FULL FACTS
FREE!**

Prepare for a
Profitable, Exciting Future

as an **Electronics
Technician!**

**No Previous Technical Experience
Required!**

Opportunities were never greater for the man who wants to get someplace and be somebody than they are today in the fast-expanding, profitable field of Electronics.

Let us tell you without cost or obligation how you may prepare for a real career in one or more branches of Electronics, either in our well-equipped Chicago or Toronto laboratories—or at home without interfering with your present job. Send coupon for **FREE** facts today!

**AN EXCELLENT OPPORTUNITY
FOR MEN 17-55!**

Even if you haven't an advanced education, find out how you may prepare in your spare time at home, to enter the **BIG OPPORTUNITY** field of Electronics. Mail coupon **TODAY!**

FREE! Sample Booklet!

We'll give you a free copy of an interesting booklet, "Electronics and YOU." See for yourself how you may take advantage of the opportunities in this growing field.



**NO ADVANCED
EDUCATION NEEDED!**

Prepare now for Electronic job opportunities in —

- | | |
|----------------|----------------|
| Radar | Remote Control |
| Guided Missile | Systems |
| Control | Automation |
| Computers | Electronics |
| Radio | Industrial |
| Television | Electronics |
| Broadcasting | Your Own |
| Communications | Service Shop |

Free Employment Service

DeVry Tech's Placement Department is in contact with some of the best-known employers in the Electronics field. The service is free to all graduates — and DeVry Tech's record in helping to place men has been outstanding.

Draft Age?

We have valuable information for every man of draft age; so if you are subject to military service, be sure to check the coupon.

Accredited Member of National Home Study Council



"One of North America's
Foremost Electronics
Training Centers"

**DeVRY TECHNICAL
INSTITUTE**

4141 Belmont Avenue • Chicago 41, Illinois

MAIL COUPON TODAY!

DeVRY TECHNICAL INSTITUTE
4141 Belmont Ave., Chicago 41, Ill., Dept. PM-7-Q

Please give me your **FREE** booklet, "Electronics and Space Travel," and tell me how I may prepare to enter one or more branches of Electronics as listed above.

Name _____ Age _____

Please Print

Street _____ Apt. _____

City _____ Zone _____ State _____

Check here if subject to Military Training.

Canadian residents address: DeVry Tech of Canada, Ltd.
2032 970 Lawrence Avenue West, Toronto, Ontario

"NOW EARN **5½%** per annum
paid quarterly
on your savings account... by mail!
it's safe and more profitable"



*says A. G. Neumeyer,
 President,
 First Western Savings*

First Western Savings, Nevada's largest, and Southern Nevada's oldest savings association, operating under the savings and loan laws of the State of Nevada, is able to offer higher than average interest rates because we are located in the fastest growing area in the nation, where dollars are needed to finance our remarkable growth. We pay more for this money and in turn, because of our dynamic growth economy, earn more money on our lending program than would be possible in a slower growing area. Specifically, on December 6, 1959, the United States Census Bureau revealed that our area is growing at 4.1 times the Los Angeles rate, and 10.6 times the national rate!

The current interest paid to First Western savers is: 5½% per year on accounts of \$5,000 or more, and 5¼% per year on all others.

We have paid substantially higher rates year in and year out to our more than 16,000 prudent savers from all fifty states and fifty-one foreign countries. In fact, this new rate follows 16 consecutive interest payments to First Western savers of 5% per year or more!

Saving by mail at First Western, is easy, and most profitable. We are no further away than your mail box. To open an account send check or money order. To transfer an account from your present financial institution, just send your passbook or certificate to us. We'll attend to all the details.

Remember: at First Western interest is paid quarterly on all accounts. Withdrawals have always been paid instantly. Airmail postage is prepaid both ways. Funds received by the 15th of any month earn from the 1st. \$1.00 opens an account.

Mail funds to:

**FIRST WESTERN
 SAVINGS AND LOAN
 ASSOCIATION**

*A. G. Neumeyer
 President*



Dept. T, 118 Las Vegas Blvd., South, Las Vegas, Nevada
RESOURCES OVER \$34,000,000.00

To the Editor:

Of increasing interest and rarity, a by-gone and curiosity, this bed-warmer is in Wilmington Priory, Sussex. To use this,

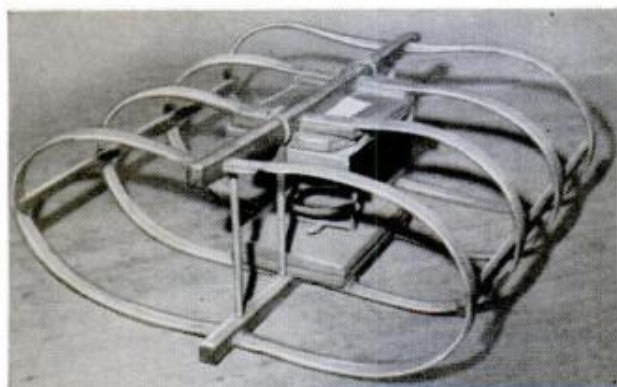

the bottom metal tray was covered with glowing embers, the contraption placed in bed and covered with bedclothes, the curved wooden ribs holding off and preventing the clothes catching fire.

J. Higham
 Sussex, England

☆☆☆

To the Editor:

Enclosed is a picture of the 1914 Stutz Bearcat I built for my daughter Lynn. The car is built to ½-scale of the original sport car. It has an automatic clutch, 6-volt light system, *ah-ooo-gah* electric horn, switch



key for the ignition, gas pedal, emergency brake, rubber-covered running boards, honeycomb copper radiator, Alemite fittings on every moving part for lubrication, and is powered by a 1½-hp. Briggs and Stratton engine. I worked on the car a few hours each Saturday for a year.

Russell W. Smith
 Norfolk, Va.

☆☆☆

Nike Protects Speeders:

It was recently disclosed that radar at a Cleveland Nike site not only protects the city from air attack but also protects speeders, on an adjacent highway, from arrest.

Beams from the giant radar interfere with police speed meters enabling speeding motorists to escape detection.

John A. Marotta
 Euclid 23, Ohio

How many of these Auto Repair Jobs can YOU do - Quickly... Easily... and Right - THE FIRST TIME?

- | | | | |
|--|---|--|--|
| <input type="checkbox"/> Repair Starting Motor | <input type="checkbox"/> Replace Brake Cylinders | <input type="checkbox"/> Adjust Carburetor | <input type="checkbox"/> Service Brakes |
| <input type="checkbox"/> Tune-Up Engine | <input type="checkbox"/> Correct Faulty Dash Gauges | <input type="checkbox"/> Repair Fuel Pump | <input type="checkbox"/> Repair Power Steering |
| <input type="checkbox"/> Adjust Spark Plugs | <input type="checkbox"/> Test Starter Switches | <input type="checkbox"/> Bleed Brakes | <input type="checkbox"/> Align Wheels |
| <input type="checkbox"/> Time Ignition | <input type="checkbox"/> Overhaul Transmission | <input type="checkbox"/> Adjust Valves | <input type="checkbox"/> Replace Voltage Regulator |
| <input type="checkbox"/> Repair Generator | | <input type="checkbox"/> Repair Overdrive | <input type="checkbox"/> Repair Front Suspension |
| | | <input type="checkbox"/> Fix Differential | |

NOW YOU CAN FIX ANY PART OF ANY CAR

with MOTOR's New AUTO REPAIR MANUAL - Giant Guide Turns Beginners into Experts and Shows Experts Many Time, Work, and Money-Saving Procedures!

FOR years, MOTOR's Manual has been the "Auto Repair Man's Bible." OVER THREE MILLION copies have been sold! What better proof can you have that MOTOR lives up to its promise that YOU can fix almost any part of any car listed below—quickly, easily, right the first time!

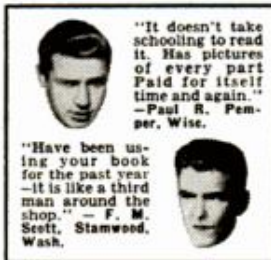

"Have been using your book for the past year—it is like a third man around the shop." — F. M. Sestl, Stamwood, Wash.

"It doesn't take schooling to read it. Has pictures of every part Paid for itself time and again." — Paul R. Pempfer, Wise.

step instructions, photos and diagrams show you where to start, what tools to use. Before you know it, the job is done—the right way!

MOTOR's Manual is designed especially for you—a guy who wants to work on cars without spending time and money fooling around. This giant Manual takes the "meat" from 176 Official Factory Manuals and hundreds of service bulletins—boils it down into simple, understandable me-to-you language.

No wonder repair men and schools all over the country—plus the Armed Forces—use this world-famous Manual!

1000 Big Pages - 2800 Pictures

Over 1,000 double-size pages... over 2,800 close-up pictures of actual service and repair procedures... 30,000 essential specifications... 225,000 repair facts... 195 Quick-Check charts... giant "Troubleshooter" Section that spots 2300 car troubles... tune-up data on 42 foreign cars... complete service and repair information for over 1,967 car models from 1953 through 1960! (Includes all the Compact cars.)

TRY MANUAL FREE FOR ONE WHOLE WEEK

Your credit is O.K. with us, so we'll be happy to send you a copy of the new MOTOR Manual for a FREE 7-day examination. Look it over. Use it. If it doesn't pay for itself on the first job, simply return it and forget the matter. You don't risk a penny—so rush the coupon TODAY to: **MOTOR Book Dept., Desk O 17, 250 W. 55th St., New York 19, N. Y.** (Schools, Bookstores: Write for discounts.)

Makes no difference whether you're a beginner or expert mechanic. MOTOR's Manual lets you tackle jobs you wouldn't even think of doing before! It's as if the men who actually build the cars were right beside you—guiding your hands through every step of every job.

How This Giant Manual Helps You

No guesswork. Nothing to study. Everything is made so crystal-clear you CAN'T go wrong! First, the giant "Troubleshooter" Section quickly pinpoints any one of 2300 car troubles—indicates the exact repair needed. Then simple step-by-

Covers All These	25 Makes	1953 Thru	1960
Buick	De Soto	Imperial	Plymouth
Cadillac	Dodge	Jeep	Pontiac
Chevrolet	Edsel	Lincoln	Rambler
Chrysler	Falcon	Mercury	Studebaker
Continental	Ford	Nash-'55-'57	Thunderbird
Corvair	Hudson	Oldsmobile	Valiant
Dart	'55-'57		

Same FREE 7-Day Trial on 1960 TRUCK REPAIR MANUAL

Covers every job on every popular make truck made since 1952, including GM, Mack and Cummins Diesels. Engines, fuel systems, ignition systems, starters, generators, transmissions, axles, brakes, steering, etc.,



NEARLY 1-FOOT HIGH
Over 1,000 Pages.
2,850 Illus.
Over 3 Million Copies Sold



MAIL COUPON NOW FOR 7-DAY FREE TRIAL

(Attach to postcard for faster action)

MOTOR BOOK DEPT.

Desk O 17, 250 W. 55th St., New York 19, N. Y.

Rush to me at once (check box opposite book you want):

MOTOR'S New AUTO REPAIR MANUAL. If O.K., I will remit \$2 in 7 days, \$2 monthly for 2 months and a final payment of \$1.95 (plus 45¢ delivery charges) one month after that. Otherwise I will return the book postpaid in 7 days. (Foreign price, remit \$10 cash with order.)

MOTOR'S New TRUCK REPAIR MANUAL. If O.K., I will remit \$3 in 7 days and \$2 monthly for 3 months, plus 45¢ delivery charges with final payment. Otherwise I will return book postpaid in 7 days. (Foreign price, remit \$11 cash with order.)

Print Name.....Age.....

Address.....

City.....Zone...State.....

Check box and save 45¢ shipping charge by enclosing WITH coupon in envelope entire payment of \$7.95 for Auto Repair Manual (or \$9 for Truck Repair Manual) plus sales tax. Same 7-day return refund privilege applies.



\$1

SAVE
ON SPECIAL
TURTLE WAX
COMBINATION OFFER



To Help You Keep Your Car Beautiful Inside and Out—

NEW Turtle Wax Upholstery Cleaner

Just push the button of this king sized can and the rich "Silicone Foam" instantly, magically helps to restore original color to leather, plastic, vinyl and fabric. This new kind of upholstery cleaner actually puts an "invisible seat cover" on your upholstery that repels dust and dirt.
WONDERFUL FOR CONVERTIBLE TOPS, TOO.

Turtle Wax Car Wax

Just one application which you can quickly and easily apply gives your car a brilliant, beautiful protective "HARD SHELL FINISH" that lasts up to ONE FULL YEAR!

Save Now During This Special Offer Wherever Fine Auto Products Are Sold!

© Turtle Wax, Inc., 1980

Spotlight on the

VW Microbus

By Art Railton

GOT A BIG family? Like to tour? If you answer "yes" here's a machine built to order.

It's the Volkswagen Microbus—a vehicle so roomy that a family of six rattles around in it and wonders where everybody went.

People may rattle around in it, but that's all. This solid body, unlike some wagons, is as rattle free as the VW sedan—and that's saying something.

This is the only car in which the driver gets lonesome while traveling with four children. There's so much room in it that the front seat is usually deserted (except for the driver, that is). If you've ever gone touring with four children (bless them!) you'll know how ecstatic loneliness can be on such occasions.

But wait. Before you rush out and trade the family sedan for one, let's look at its disadvantages. Right off, you'll notice the problem of getting into the front seat. The second and third seats are easy to enter, but not the front seat. Of course, if you're nimble and athletic, it's a cinch. But short-legged folk (especially tight-skirted varieties) find it virtually impossible.

Once in, you are lord of all you survey—and you survey plenty of territory. Sitting high and forward, you have visibility that beats a pedestrian's. The steering wheel (big and easy to turn) is almost horizontal atop a nearly vertical steering post. Within 10 minutes you'll be whipping the nimble machine through traffic like a kid on a scooter. The steering-wheel angle takes

(Continued to page 20)



POPULAR MECHANICS



MONEY ADVENTURE

can be yours NOW...

With Buried Treasures. Have the thrill of locating coins, gold and silver. New Transistorized Instruments for greater locating depth... operate on flashlight batteries... low as \$79.50. FREE literature... WRITE Today.

Authentic
Treasure Books & Maps
Now Available



GOLDAK COMPANY

1551-7 W. Glenoaks Blvd.
Glendale 1, California

- • **Finish HIGH SCHOOL at Home** • •
- in spare time. Progress at your own speed.
- Many finish in 2 years. Equivalent to resident school—prepare for college entrance exams. Standard H.S. texts furnished.
- Credit for subjects already completed. Single subjects if desired. Diploma awarded.
- Write today for Free Bulletin!
- **AMERICAN SCHOOL, Dept. HB45, Drexel at 58th, Chicago 37**

BUILD YOUR OWN AIR CONDITIONERS

From Junked Refrigerators for a Few Dollars **SPECIAL OFFER**
INSTRUCTION BOOKS SHOW YOU HOW 75c EACH 2 Books—\$1.00
"HOW TO BUILD a Low Cost Air Conditioner" 3 Books—\$1.50
"HOW TO BUILD an Automobile Air Conditioner" or all 5 for \$2.00
"HOW TO BUILD a Low Cost Home Freezer"
"HOW TO BUILD an Electrostatic Precipitator"
"HOW TO BUILD a Low Cost Dehumidifier!"

FREE!
Instructions
and Literature
on kits

Complete "Install-It-Yourself" Air Conditioner kits for home and automobile, 2 Ton capacity, Brand New Parts—\$92.00 and up.

KOOL ENGINEERING CO., Dept. A-7, 1318 N. Clybourn, Chicago 10, Ill.

"\$10,784 IN ONE YEAR" NEW!

SERVICING RADIATORS!"

— Sidney Radiator Shop, Sidney, Mont.
Make good money servicing auto-truck-tractor radiators with new Inland 1-Piece Radiator Shop. Easy to test, clean and repair radiators. Inland, world's largest radiator equip. mfr., trains you free. Small down payment starts you. "Pays-for-itself" Purchase Plan. Profitable dept. for garage or service station. Write for free information!



INLAND MFG. CO.
Dept. PM-7
1108 Jackson St., Omaha 2, Nebr.

Shrinks Hemorrhoids New Way Without Surgery Stops Itch—Relieves Pain

For the first time science has found a new healing substance with the astonishing ability to shrink hemorrhoids and to relieve pain—without surgery.

In case after case, while gently relieving pain, actual reduction (shrinkage) took place.

Most amazing of all—results were so thorough that sufferers made astonishing statements like "Piles have ceased to be a problem!"

The secret is a new healing substance (Bio-Dyne*)—discovery of a world-famous research institute.

This substance is now available in suppository or ointment form under the name Preparation H.* Ask for it at all drug counters—money back guarantee. *Reg. U.S. Pat. Off

RCA WILL TRAIN YOU

FOR A LIFETIME CAREER IN General Electronics TV Servicing Automation Color TV

SEND FOR THIS FREE 64-PAGE "CAREER" BOOK TODAY!



Countless opportunities are open in the rapidly expanding world of electronics. RCA Institutes offers you the finest of training at home in your leisure hours. Pay only as you learn. No previous technical training required. Courses for beginners and advanced students.



RCA INSTITUTES

A Service of Radio Corporation of America

In Canada: RCA Victor Company, Ltd.

5575 Royalmount Ave., Montreal 9, Que.

RCA Institutes, Inc., Home Study School Dept. PM-70
350 West Fourth Street, New York 14, N. Y.

Please rush me your FREE illustrated 64-page book "Your Career in Electronics," describing your home training programs. No obligation. No salesman will call.

Name..... Age.....
(please print)

Address

City..... Zone..... State.....

Korean Vets: Enter discharge date.....

Resident Schools in New York City and Los Angeles.
Catalog on request.

some getting used to as does the upright, church-pewish driver's seat.

How does it ride? Up front, the ride tends to be choppy. On concrete or smooth blacktop, the ride is excellent, but on a choppy roadway, you'll bounce a bit.

Riders in the other bench-type seats, however, enjoy Pullman-car luxury. Chair-high seats give as much comfort as you'll find in any car—more than in most. There is plenty of squirming room for long trips and sitting upright as you do, you don't feel as if you've been training for a space-capsule flight at the end of the day. Having driven these machines for 20 continuous hours on several occasions, I can discuss this with some authority.

In case you're beginning to suspect that the writer has a prejudice for this loaf of bread on casters, you're right. And with reason. My wife and I and our four children have covered thousands of enjoyable miles in these buses through the years. To our family, the Microbus is as comfortable on long trips as a Pullman bedroom. The kids, ranging in age from 12 down to 5, look upon this machine as a home on wheels and sleep better in it than in their own beds.

Here (offered as an aside) is one way for large families to travel long distances economically and without parental breakdowns. Bed the kids down in the bus (they sleep on the floor, on the seats and on the luggage shelf), a separate bed for each (including Mother), and drive all night. Mom and Dad take turns sleeping and driving. You may not go fast, but you go far and without feuding. Everybody still loves everybody else at journey's end!

What could be simpler? Or more economical. The bus, driven at about 55 miles per hour, averages 23.9 miles per gallon. On one vacation trip of 1844 miles, including about 200 miles of mountain driving, the over-all average was 22.3 miles per gallon. In a city-traffic test of 20 miles with four stops per mile, the bus went 23.7 miles per gallon.

This 1960 VW bus has a new engine and transmission, not yet available in the sedan models. The gearbox is fully synchromesh, including first gear. The throws are short and crisp. You can flip it into first gear while crawling along at five miles an hour without any gnashing of teeth.

At highway speeds, the interior is as quiet as a Cadillac. The engine is so far to the rear and so well insulated by the body that nothing gets through to the riders. You get the feeling you're in a sailboat.

Speaking of the wind, it's something you have to live with in this bus. Sitting up in the air like a shoebox, the bus is susceptible to wind. Headwinds reduce top speed

and gas mileage, tailwinds boost speed and mileage. Side winds buffet a lightly loaded bus considerably. Fully loaded, the bus is not bothered by wind wander much, but when empty it's a problem.

There are three bench-type full-width seats. On the right side, there's a double door which permits passengers to get in and out easily. There is no rear-seat entry on the driver's side. Optional is a split front seat that allows you to move from the front to the back without climbing over the seat. At the rear is a wide, carpeted luggage shelf on which the youngsters love to ride and sleep (right above the engine, the soothing purr seems to mesmerize them and touring parents couldn't ask for anything more).

None of the seats folds. None adjusts (an annoying disadvantage in the case of the driver's seat). The two rear seats are easy to remove and once they are out, you can haul a spinet piano inside (if you have any need for hauling one around). The middle seat can be turned around to face rearward (breakfast-nook style) if you want to get up a hand of bridge.

Over the windshield is a vent to bring in air. Thus you can drive with all windows closed. The heater (included in the price) keeps rear-seat passengers cozy, but the driver may have cold feet. Wipers are slower than they should be, but being electric, although slow, they are constant.

Ground clearance is unbelievable. It has 9.4 inches of clearance and will go just about anywhere you can push a wheelbarrow. It's great for those backwoods roads. Having very low gearing, it climbs like a mountain goat.

How much? It comes in various models ranging from the plain, comparatively glassless model at \$2245 to the fancy, glass-house, slide-back roof model (such as shown on page 18) that lists at about \$2650.

The engine is the regular VW air-cooled, four-cylinder rear design. However, the bus uses a new version of it. Displacement and power are the same. Reduction gears at the rear wheels give the extra power needed. Gear shifting is so easy, so pleasant, you'll wonder who thought an automatic transmission was necessary.

Altogether, this is as practical a car as you can imagine. But it has such limitations (including the psychological—after all, you do feel like a shrunken bus-line operator driving one) that you should get well acquainted with it before buying one. If you can adjust to its limitations, you'll have the most satisfying, most useful, most versatile machine you ever owned. It will give new dimensions, new horizons, to vacation touring with the family. ★★

DON'T BE HALF-TRAINED...

Be a **MASTER TECHNICIAN**
In One Of
AMERICA'S BIG 3 INDUSTRIES



train
at home
in
spare
time

FREE BOOK

TELEVISION RADIO-ELECTRONICS



Includes...
**RADIO SET
TV SET
MULTITESTER**

Business of Your Own or High-Pay Career in...
Service & Repair
Broadcasting & Communications
Hi-Fi & Stereo Sound Systems
Electronics for Guided Missiles
TV-Radio Manufacturing

Industrial Electronics
Automation & Computers
Radar & Micro Waves
TV-Radio Sales
FCC License Preparation

MAKE MORE MONEY
A Successful Career... Security...
Are Yours NOW in Modern Industry!

RIGHT NOW IS THE BEST TIME for you to get into the field of your choice! You can be a part of its growth, you can increase your earning power, you can really build a Successful, Secure Future. Send coupon for complete facts by mail... NO SALESMAN WILL CALL!!!

N.T.S. TRAINS YOU RIGHT, FAST and EASY! Incomplete "short-cut" training limits your earning power, disqualifies you for top-pay jobs. N.T.S. Shop-Tested Home Training is...

- ★ BETTER—classroom developed, lab and shop-tested, industry-approved, home study designed.
 - ★ MORE COMPLETE—you learn All Phases and you receive Everything You Need for Success...
 - ★ LOWER COST—One Master Course at One Low Tuition gives you more training at lower cost.
- TRAINING PAYS FOR ITSELF AND MORE... Earn your tuition—and more—while in training. We'll show you how. Many students have... so can you!

AUTO MECHANICS & DIESEL



Includes...
**TOOLS
SOCKET SET
ANALYZERS**

Business of Your Own or High-Pay Career in...
Service & Maintenance
Motor Tune-Up
Automatic Transmissions
Diesel & Fuel Injection
Overhauling & Rebuilding

Automobile Air Conditioning
Electrical Systems
Automatic Power Devices
Industrial & Marine Engines
Foreign Car Sales & Service

AIR CONDITIONING REFRIGERATION ELECTRICAL APPLIANCES



Includes...
**TOOLS
GAUGES
TESTER**

Business of Your Own or High-Pay Career in...
Air Conditioning—Refrigeration
• Domestic & Commercial
• Industrial & Mobile
Installation & Contracting
Automobile Air Conditioning

Electrical Appliances
• Small & Major
• Heating, Motor & Combination
Sales, Service & Repair
Manufacturing & Distribution

RESIDENT TRAINING AT LOS ANGELES
If you wish to take your training in our Resident School in Los Angeles, start NOW in our big, modern Shops and Labs. Here you work with latest equipment, finest and most complete facilities offered by any school. Expert, friendly instructors. Personal attention. Help in finding home near school... and part time job while you learn. Check box in coupon for full information.

MEMBER
 NATIONAL TECHNICAL SCHOOLS
World-Wide Training Since 1905
4000 South Figueroa Street
Los Angeles 37, Calif., U.S.A.

GET THE BENEFIT OF OUR OVER 50 YEARS EXPERIENCE

CHOOSE YOUR FIELD. SELECT ONE OF THE "BIG 3" NOW. CHECK COURSE DESIRED

Mail One of These
2 Coupons TODAY
for

FREE BOOK
and
ACTUAL LESSON

Ask a Friend
to Send the Other.
It's Fun to
Study Together!

NO OBLIGATION...
NO INCONVENIENCE...
NO SALESMAN WILL
CALL ON YOU!!!

NATIONAL TECHNICAL SCHOOLS

WORLD-WIDE TRAINING SINCE 1905

National Technical Schools, Dept. B-70
4000 S. Figueroa St., Los Angeles 37, Calif.

Please rush FREE Book and Actual Lesson checked below. No obligation. No salesman will call.

- TV-Radio-Electronics Book
 Auto-Mechanics & Diesel Book
 Air Conditioning, Refrigeration & Electrical Appliance Book

CHECK ONE

CHECK ONE

Name _____ Age _____

Address _____

City _____ Zone _____ State _____

Check here if interested ONLY in Resident Training at L.A.
VETERANS: Give date of discharge _____ N310F

NATIONAL TECHNICAL SCHOOLS

WORLD-WIDE TRAINING SINCE 1905

National Technical Schools, Dept. B-70
4000 S. Figueroa St., Los Angeles 37, Calif.

Please rush FREE Book and Actual Lesson checked below. No obligation. No salesman will call.

- TV-Radio-Electronics Book
 Auto-Mechanics & Diesel Book
 Air Conditioning, Refrigeration & Electrical Appliance Book

CHECK ONE

CHECK ONE

Name _____ Age _____

Address _____

City _____ Zone _____ State _____

Check here if interested ONLY in Resident Training at L.A.
VETERANS: Give date of discharge _____ N310

DRAFTSMEN



**CASH BIG
PAY CHECKS!**

**Train Now for
more success,
greater security**

**LEARN AT HOME IN SPARE TIME
(or at college in Chicago)**

Check the want ads in any newspaper—SEE the big-pay opportunities open to you as a draftsman. What's more, you can learn this well-paid, prestige profession at home—quickly, easily! No special talent needed. Get complete, step-by-step Chicago Tech lessons in the mail, spend a few pleasant hours studying each week. In a short time you'll be a well-trained draftsman, ready to take your pick of many good jobs. Act now!



Free Information—Mail Coupon Today!

Get FREE TRIAL LESSON plus information about C.T.C. practical training. Learn what successful Chicago Tech graduates say about high pay and opportunities in drafting. No charge, or obligation.

CHICAGO TECHNICAL COLLEGE

H-218 Tech Bldg., 2000 So. Michigan Ave.
Chicago 16, Illinois

Mail me FREE lesson with facts about big opportunities in DRAFTING.

Name _____ Age _____

Address _____

City _____ Zone _____ State _____



**NEW WORLD
OF OPPORTUNITY**
it's yours



IF YOU KNEW that professional homecare maintenance was the fastest-growing field for service and for products... *with*

ServiceMASTER®
WORLD FAMOUS AUTHORITY ON HOMECARE

FIND OUT how much an investment you need to obtain such a franchise (surprisingly low, surprisingly easy arrangements)

write ServiceMASTER

c/o Marion Wade, Dept. 106

2117 North Wayne Ave., Chicago 14, Illinois

LOCATE HIDDEN TREASURE

JEWELRY, COINS, METALS, MINERALS,
WIRES, PIPE, ETC.



**AUTHENTIC U.S. ARMY PORTABLE
MINE DETECTOR**

ORIG. \$2485 Complete with Batteries
\$233.00 Express Charges Collect

Model SCR625. Detects objects up to 24" depth. Comes complete in fitted chest and instructions. Chest is 28 1/4" long, 15" wide, 8 1/4" deep. Instrument is ideal for electricians, plumbers, utility companies, mineralogists, beach combers, scouts, etc. Like-new condition. No C.O.D.

A.M. AIRCRAFT PARTS CO.

307-309 West Broadway, New York 13, N. Y.

TELEPHONES



MODERN CRADLE STYLE

Genuine telephone company phones, re-conditioned. Ideal for Inter-House, House-to-Barn, Office to Shipping Room, etc. Battery operated. Guaranteed. Also, Magneto Telephones for Farms, Camps and Mines. Telephone Materials and Supplies of all kinds.

\$3.00

2 for \$5.00

TELEPHONE DEPT. PM-128, 1760 Lunt Avenue, Chicago 26
"America's Largest Independent Telephone Repair Shop"

WOODWORKING



**LOW COST HOME TRAINING COURSE
FOR BEGINNERS & ADVANCED CRAFTSMEN**

Make money. Learn skills and secrets of fine woodworking and tool use. Professionally prepared shop method training tells and shows how. Covers everything. Easy to master.

Write for
Free Booklet

INTERSTATE TRAINING SERVICE
DEPT. F-3, PORTLAND 12, OREGON



make your own Gems 36⁵⁰

The Gem Maker comes complete with all necessary equipment, including a super-charged diamond blade for sawing, and all the wheels for grinding, shaping and polishing; also complete instructions. The complete equipment as shown, less motor and belt for only \$36.50, f.o.b., Burlington, Wisconsin. Write today for information and literature.

B&I MANUFACTURING CO.
Dept. P Burlington, Wis.

MEN PAST 40

**Afflicted With Bladder Trouble,
Pains in Back, Hips, Legs,
Nervousness, Tiredness.**

If you have these troubles, particularly bladder trouble, then your condition may be traced to Glandular Inflammation... a constitutional disease. Neglect of this condition often leads to premature old age and sometimes incurable malignancy.

The Excelsior Medical Clinic has a New Free Book that tells how thousands of men have been successfully treated here at Excelsior Springs for Glandular Inflammation by NON-SURGICAL Methods. They found soothing relief and a new outlook in the future of life.

This Free Book may prove of utmost importance in your life. Write Today. There is no obligation.

Excelsior Medical Clinic, Dept. B6129, Excelsior Spgs., Mo.

POPULAR MECHANICS

By James Biery

THE MOON'S SURFACE, which sometimes looks like a mass of cliffs, is probably no more rugged than that of the earth. This conclusion was reached at the Air Force's Cambridge Research Center in Bedford, Mass. Scientists there have been studying photographs made of the moon during the past two years with a new technique in lunar photography.

In several observatories throughout the world, timing instruments moved telescopes so cameras could record the march of shadows from various prominences across the face of the moon. Charles Campen, program director, says the pictures indicate that "steep slopes of towering rock faces are absent from the lunar surface," although there might be some exceptions.

A MOON ILLUSION that has baffled astronomers for almost 2000 years — the way the moon looks larger on the horizon than overhead — has apparently been explained by two curious psychologists, Dr. Ervin Rock of Yeshiva University and Lloyd Kaufman, psychologist at the Sperry Gyroscope Co.

Their explanation, at first, seems to be contrary to good sense: Terrain or water between an observer and the horizon makes a low-hanging moon seem far away in comparison with the overhead moon, which is seen against an apparently flat, featureless background of sky. Good sense or not, this would make the overhead, or zenith, moon seem smaller, though it is perceived as being closer than the horizon moon.

Though the reason for this is not understood, scientists have long known that objects are usually perceived as having a constant size regardless of the variations in distance.

We see the moon as the same size in either position and perceive it as larger on the horizon by compensating for what seems to be a farther distance.

MORE MYSTERIES about the heavens will be unraveled when a new international astronomical center opens in the mountains of Chile. It will be the most powerfully equipped in the Southern Hemisphere. The telescope, for example, will be a 59-inch reflecting Schmidt, which can record stars of the 21st magnitude. ★ ★ ★

JULY 1960

prepare for your career in

ELECTRONICS ELECTRICAL ENGINEERING RADIO-TV COMPUTERS

At MSOE, you can equip yourself for a career in many exciting, growing fields:
MISSILES • RADAR • AVIONICS
AUTOMATION • RESEARCH
DEVELOPMENT • ELECTRICAL
POWER • ROCKETRY

When you graduate from the Milwaukee School of Engineering, you are prepared for a dynamic career as an Electrical Engineer or Engineering Technician. Under a faculty of specialists, you gain a sound technical education in modern, completely equipped laboratories and classrooms. As a result, MSOE graduates are in great demand and highly accepted by industries nationally.

At MSOE, you will meet men from all walks of life and all parts of the country — some fresh out of high school or prep school, others in their twenties — veterans and non-veterans.

You can start school in any one of four quarters and begin specializing immediately. Engineering technicians graduate in 2 years with an Associate in Applied Science degree. For a Bachelor of Science degree in Engineering, you attend 4 years. A 3-month preparatory course also is available.

**FREE CAREER BOOKLET!**

If you're interested in any phase of electronics, radio or television, be sure to look into the programs of study offered by the Milwaukee School of Engineering. Just mail the coupon.

MILWAUKEE SCHOOL OF ENGINEERING

Dept. PM-760, 1025 N. Milwaukee St.
Milwaukee, Wisconsin

Please send FREE Career Booklet. I'm interested in
 Electronics Electrical Power Television
 Mechanical Engineering Radio Computers
 Electrical Engineering Industrial Electronics

PLEASE PRINT

Name _____ Age _____

Address _____

City _____ Zone _____ State _____

 I'm eligible for veterans education benefits

MS-125

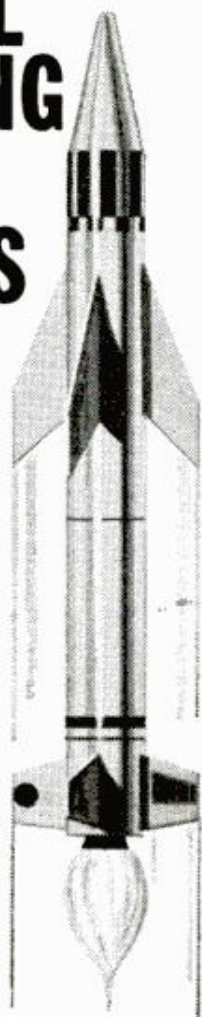



DO YOU KNOW THIS OLD-TIMER?

Detroit built (and is building) millions of cars, but never one with this name. And, like a frequently divorced woman, the car never found a name it liked as well as its

maiden name, going through several others before reverting to its original (with which it is now doing better than ever). For the name and year, turn to page 234.

Superior's New Model 70 UTILITY TESTER® FOR REPAIRING ALL ELECTRICAL APPLIANCES MOTORS • AUTOMOBILES • TV TUBES

As an electrical trouble shooter the Model 70:



- Will test Toasters, Irons, Broilers, Heating Pads, Clocks, Fans, Vacuum Cleaners, Refrigerators, Lamps, Fluorescents, Switches, Thermostats, etc.
- Will test all TV tubes for open filaments, inter-alement shorts, burned out tubes, etc.
- Measures A.C. and D.C. Voltages, A.C. and D.C. Current, Resistances, Leakage, etc.
- Will measure current consumption while the appliance under test is in operation.
- Incorporates a sensitive direct-reading resistance range which will measure all resistances commonly used in electrical appliances, motors, etc.
- Leakage detecting circuit will indicate continuity from zero ohms to 5 megohms (5,000,000 ohms).

As an Automotive Tester the Model 70 will test:

- Both 6 Volt and 12 Volt Storage Batteries • Generators • Starters • Distributors • Ignition Coils • Regulators • Relays • Circuit Breakers • Cigarette Lighters • Stop Lights • Condensers • Directional Signal Systems • All Lamps and Bulbs • Fuses • Heating Systems • Horns • Also will locate poor grounds, breaks in wiring, poor connections, etc.

Model 70 comes complete including 64 page book, only \$15.85

**SHIPPED ON APPROVAL
NO MONEY WITH ORDER — NO C. O. D.**

Try it for 10 days before you buy. If completely satisfied then send \$3.85 and pay balance at rate of \$4.00 per month for 3 months — No Interest or Finance Charges Added! If not completely satisfied, return to us, no explanation necessary.

MOSS ELECTRONIC, INC., Dept. D-776
3849 Tenth Ave., New York 34, N.Y.
Please rush Model 70. If satisfactory, I will pay on terms specified. Otherwise I will return tester.

Name _____
Address _____
City _____ Zone _____ State _____
All prices net, F.O.B., N. Y. C.

your customer saves gas, and

HERE'S EASY SOLUTION TO VAPOR LOCK

If fuel pump pressures in modern cars are reduced, gasoline tends to "boil", causing vapor lock. MILEAGE MINDER never reduces fuel pressure. But it does deliver a smooth, more constant fuel flow to carburetor, keeps engine from starving in hot weather. And MILEAGE MINDER traps vapors, condenses them, passes them on as liquid fuel. See your distributor, or write:

MILEAGE MINDER
537 TURK ST. SAN FRANCISCO 2, CALIF.

Would You Like to Make \$1,000 A MONTH?

That's what Stanley Hyman made selling the amazing new Presto Fire Extinguisher! Many others "cleaning up"—so can you! Amazing tiny new extinguisher ends fires fast as 2 seconds. Guaranteed for 20 years! Sells for only \$4.95. Write for Free sales kit.

MERLITE INDUSTRIES, Presto Div.,
114 E. 32nd St., Dept. P-15R, New York 16, N. Y.

Everything You Need for Sports and Adventure

DIVEMASTER

SKIN AND LUNG DIVING EQUIPMENT

Leading nationally known and foreign made products. Inspection tested at money saving prices. Underwater Breathing Apparatus. Swimming Masks and Fins. Diving Masks. Spear Guns. Water Skis. Diving Suits, etc. Send 50c for big illustrated Catalog.

DIVEMASTER
Dept. PM-70
5637 W. 63rd Place, Chicago 38, Ill.

MAKE EXTRA CASH

SHARPENING LAWN MOWERS THE MODERN WAY



As Low As
\$250.00

Start your own shop! Full or spare time. Earn many dollars in a short time... average \$5.00 per hour. Many mowers need sharpening. With MODERN'S Extra Heavy Duty LAWN MOWER SHARPENER AND BED KNIFE GRINDER you have 6 machines in one. All operations are done quickly and easily. You make money from the start. Write for free details.

MODERN MFG. CO.
160 N. Fair Oaks Ave. Dept.
Pasadena, California 10-5

Make up to
\$300
or more

IN
SPARE
TIME

21 Lovely
CHRISTMAS
Cards

Over 300 New Items For Quick
EXTRA MONEY
Now To Christmas

Just Show Fabulous New 1960 **EVANS** Line
No-Money-Down, No-Risk Starting
Sample Plan. You keep up to \$1.00
per item. Self-selling **EVANS**
Line, huge plant mean more sales,
faster service. Send today for
saleable boxes to be paid for or
returned—plus big Free Album of
Personalized cards, 2 big Order-
Getting Illustrated Catalogs of
over 300 items. Write now.

NEW ENGLAND ART PUBLISHERS, North Abington 740, Mass.

Hotels Call for Trained Men

Record-breaking travel means nation-wide opportunities and a sound substantial future for trained men in the hotel, motel and hospitality field. Fascinating work; fine living; quick advancement. You can qualify at home or through resident classes in Washington. Previous experience proved unnecessary. Placement Service FREE. Write for FREE Book, "Your Golden Opportunity." Accredited by N.H.S.C.

Course Approved for All Veteran Training. 44th Year.
LEWIS HOTEL TRAINING SCHOOL, Room FL-312, Wash. 7, D.C.



MECHANICAL DENTISTRY

To make Crowns, Plates, Bridgework, etc., for Dentists. Easy practical way to learn mechanical dentistry at home in spare time. FULL EQUIPMENT OF TOOLS AND MATERIALS INCLUDED WITH COURSE. Low tuition. Easy terms. Write for FREE BOOK about this money making profession that is not affected by machine age.

McCARRIE SCHOOL OF MECHANICAL DENTISTRY
207 N. Broad St., Dept. 102, Philadelphia 7, Pa.

JEEP OWNERS

RE-POWER NOW WITH A V-8 OR 6 CYL. ENGINE — USE FORD—CHEV—MERCURY—GMC—PONT—STUDE—DODGE OR PLYMOUTH In Jeeps, Jeepsters, Sta-Wgn, trucks, Kaiser & H. J. cars. Conversion Kits \$45.35 to \$56.90. Want fast action? Give us full information, send \$15.00 Dep. and we will ship correct kit. Bal. COD. Send full amount for prepaid shipment. Wire, phone or write today. Details FREE

HOOSIER MACHINE PRODUCTS CO.
312 S. E. 6th St. Phone CR 6-3442 Pendleton, Oregon

BEST SPORTS CAR YOU CAN OWN!

A 4-WHEEL DRIVE WITH WARN HUBS

Hi-ball on the highway in free-wheeling 2 w.d. with Warn Hubs on your 4 w.d.—no front end drag or whine, better gas mileage, easier steering. Save money, save road time. Switch in seconds into 4 w.d. when the going gets rough! Change to 2 or 4 w.d. automatically with Warn Lock-O-Matics, manually with Warn Locking Hubs. Guaranteed. Models for all makes 4 w.d.s to 1 1/2 tons. At your dealer's or write:

WARN MFG. CO., Riverton Bx 6064-A,
Seattle 88, Wash.



WARN
Selective Drive
HUBS

94.6% OF BAILEY GRADUATES ARE EMPLOYED AT TOP PAY IN THE FIELDS WHICH THEY WERE TRAINED!



DIESEL-AUTO MECHANICS DESPERATELY NEEDED!

We have a far greater demand for our students than we can fill!

We can show you an actual waiting list of leading companies throughout the world who have tried Bailey graduates — found them outstanding, and are coming back for more!

Bailey Graduates are Successful . . . RECEIVE BIG PAY — HAVE SECURE FUTURE!

The Famous Bailey Course prepares you for BOTH Diesel and Gasoline Mechanics.

This is a must—due to the advent of using Diesel principles, such as 'Fuel Injection' on passenger cars . . . use of gasoline engines for starting Diesel engines, etc. You learn all this at Bailey in the amount of time ordinarily required to learn just one of these subjects, ALL FOR THE PRICE OF ONE.

Don't be satisfied with a 'futureless', one-type job — learn how you can make big money now! Write today for Free Booklet that takes you on a step-by-step camera tour through our spacious, modern shops — See Bailey students in action as they Learn-by-doing with the Famous Bailey Method of training!

We provide you with housing and part time jobs while in school, plus nation-wide placement service for graduates.

BAILEY Technical SCHOOLS

1634 S. GRAND ST. LOUIS 4, MO.

MAIL TODAY!

Please mail immediately this free booklet without obligation.

FREE BOOKLET



Name.....

Address.....

City..... State.....

APPROVED FOR VETERAN... NON-VETERAN

AUDELS GUIDES

No. 1	AUTOMOBILE MECHANICS GUIDE. 1132 Pages	\$ 6.00
No. 2	HOME APPLIANCE SERVICE GUIDE. 864 Pages	6.00
No. 3	TV & RADIO SERVICE LIBRARY. 2 Book Set	8.00
No. 4	HANDY BOOK OF ELECTRICITY. 1052 Pages	5.00
No. 6	PLUMBERS & STEAMFITTERS GUIDES. 4 Book Set	8.00
No. 8	CARPENTERS & BUILDERS GUIDES. 4 Book Set	8.00
No. 9	DIESEL ENGINE MANUAL. 640 Pages	3.00
No. 10	WELDERS GUIDE. 608 Pages	3.00
No. 11	MATHEMATICS MADE EASY. 672 Pages	3.00
No. 12	MACHINISTS & TOOLMAKERS HANDBOOK. 1250 Pgs.	6.00
No. 13	WIRING DIAGRAMS. 304 Pages	2.00
No. 14	REFRIGERATION & AIR CONDITIONING. 1360 Pages	6.00
No. 15	ELECTRIC LIBRARY. 10 Volume Set	20.00
No. 25	BLUE PRINT READING. 448 Pages	3.00
No. 26	MASONS & BUILDERS GUIDES. 4 Book Set	8.00
No. 27	ELECTRIC MOTOR GUIDE. 1056 Pages	5.00
No. 28	OIL BURNER GUIDE. 416 Pages	2.00
No. 29	SHEET METAL PATTERN LAYOUTS. 1152 Pages	7.50
No. 30	SHEET METAL WORKERS HANDY BOOK. 448 Pages	2.00
No. 43	DO-IT-YOURSELF ENCYCLOPEDIA. 2 Book Set	8.95
No. 44	NEW MECHANICAL DICTIONARY. 712 Pages	6.95

7-DAY FREE EXAMINATION

SEND NO MONEY—Pay the postman nothing! We'll send you any of the Audel Guides for FREE examination in your home. If you decide to keep the books you may pay for them under our easy-pay plan of only \$2 a month.

HERE IS ALL YOU DO

IT'S EASY TO ORDER: In the No-Risk Mail Order Coupon below you need only draw a circle around the number of Audel Guides you want. We will send them to you at once. If you are not completely satisfied, return the books to us!

MAIL THIS COUPON TODAY!

THEO. AUDEL & CO.—Self Improvement Publishers Since 1879
49 W. 23rd Street, New York 10, N.Y.

P7

Please mail me for 7 days' FREE EXAMINATION the books I have circled. I agree to mail \$2 in 7 days on each book or set ordered, and to further mail \$2 a month on each book or set ordered until I have paid the purchase price, plus shipping costs. If I am not completely satisfied with my Audel Guides I may return them.

NAME _____

ADDRESS _____

OCCUPATION _____

EMPLOYED BY _____

1 2 3 4 6 8 9 10 11 12 Check Here for Free
13 14 15 25 26 27 28 29 30 43 44 Complete Catalog

SAVE SHIPPING COSTS! Check here if you enclose complete payment with order. We pay postage charges. You have some return privilege.

LEARN TO MOUNT BIRDS



ANIMALS, FISH, PETS

Be a Taxidermist. Save your hunting TROPHIES. Have a fine home-museum. Hunters, save and MOUNT your beautiful DUCKS, QUAIL, DEER, TAN skins and FURS. Great Fun. Spare-time PROFITS.

FREE BOOK Tells ALL about it. 100 fine wild-game pictures. 48 pages.

Send TODAY, don't delay. Get this WONDERFUL FREE BOOK, MEN AND BOYS. Learn Taxidermy. Double your hunting pleasure. Rush letter or POSTAL today. STATE AGE. N.W. SCHOOL OF TAXIDERMY, Dept. 2507. Omaha, Neb.

engineering degree in only 27 months

Realize your dream of becoming a graduate engineer. Then promotion will not pass you by. Share rewards awaiting college men . . . higher income . . . rapid advancement. Important firms visit Tri-State campus to interview seniors. Founded 1884. Bachelor of Science Degree in 27 months in Electrical Engineering (Electronics or Power major), Mechanical, Civil, Aeronautical, Chemical Engineering. In 36 Months a B.S. in Business Administration (General Business, Accounting, Motor Transport Management majors). For earnest, capable students. Small classes. More professional class hours. Well-equipped, new and modernized buildings, labs, dorms. Modest costs. Year-round operation. Enter Sept., Jan., Mar., July.

Write J. E. McCarthy, Director of Admissions, for Catalog and Career Book.



TRI-STATE COLLEGE

470 College Avenue • Angola, Indiana

Pocket Transistor Radio

Mighty Midget
\$5.95



Low Price!
Smart Design!

Size of cigarette package, yet thrilling performance. Weighs only 3 ounces. Listen to music, news, sports, programs, etc. on your personal portable set. Modern plastic case, ivory and blue with gold metal grille. Complete broadcast band. On-off switch one end. Uses standard penlight cells (included). Guaranteed. Complete. ready for immediate playing.



Postpaid Only \$5.95
JOHNSON SMITH COMPANY Dept. 907 Detroit 7, Michigan

"YOU ARE UNDER ARREST!"



Help Bring Crooks to Justice Through Scientific CRIME DETECTION!

We have taught thousands this exciting, profitable, pleasant profession. Let us teach you in your own home. Learn Fingerprinting, Firearms Identification, Police Photography, Secret Service Methods thoroughly, quickly, at small cost. Over 800 of all American Bureaus of Identification employ I.A.S. students or graduates. Write for FREE "Blue Book of Crime." (A Correspondence School Since 1918)

Institute of Applied Science, 1920 Sunnyside Ave., Dept. 135-B, Chicago 40, Ill.

Draw CARTOONS



...for a wonderful pastime or excellent earnings. Master cartooning at home in a few short weeks without waste of time or effort through the Famous System of Manual Training. Send for Big, Illustrated FREE Catalog!

CONTINENTAL SCHOOLS, INC., Dept. A-7
4201 South Broadway, Los Angeles 37, California

Learn LANDSCAPE GARDENING

AND GROWING OF PLANTS. Latest information on propagation, soil-testing, plant growth regulators, garden design. Start a profitable business or wonderful hobby. Unique and modern home study course—accredited. Earn your certificate at home. May I send FREE, and without obligation, my informative booklet? **NORM MORRIS NATIONAL LANDSCAPE INSTITUTE**
DEPT. M-70 11826 SAN VICENTE BLVD., LOS ANGELES 49, CALIF.



"It was a sudden south breeze did it, sir."

POPULAR MECHANICS



TIRED OF HIGH RENT ?

Learn how luxurious suburban **MOBILE** homes can save money and expensive moving. Comes fully and smartly furnished, including many major appliances. Modern mobilehomes have every home comfort. Conditioned air provides comfort in any climate. Multiple bedroom units have convenient spacious storage areas. Mobilehomes give you mobility, easy care, minimum maintenance.

Learn how in **TRAILER TOPICS**—the magazine of luxury low cost living.



SPECIAL OFFER 4 month subscription **Only \$1.00**

TRAILER TOPICS magazine

Suite 1573, 28 E. Jackson Blvd., Chicago 4, Ill.

LAW FREE BOOK THE LAW TRAINED MAN

Write today for a **FREE** copy of illustrated law book, "THE LAW-TRAINED MAN," which shows how to earn the professional Bachelor of Laws (LL.B.) degree through home study of the famous Blackstone Law Course. All necessary books and lessons provided. Moderate cost; convenient monthly terms. Write for **FREE** law training book today.

Blackstone School of Law, 307 N. Michigan Ave. Dept. 50B, Chicago 1, Illinois

Founded 1890

PROFIT IN YOUR SPARE TIME

FIX SMALL GASOLINE ENGINES
Outboard • Powermower • Chain Saw • Tractor
MAKE EXTRA MONEY—or, repair your engines and **SAVE**. Illustrated, easy-to-understand, Home Study Course. **FREE** information. Write **TODAY!**



LINCOLN TECHNICAL INSTITUTE
Suite 7-Z, 472 Market Street, Newark 5, New Jersey

LEARN UPHOLSTERY

EARN MORE MONEY

YOU'RE IN BUSINESS RIGHT OFF—Practical course, complete upholsterer's tools, materials, frames, all you need to earn while you learn **AT HOME**. N. Y. State-approved training in upholstery, slip covers, etc. **Big Opportunity Field**. **FREE** Illust. Catalog. **FREE** Sample Lesson. Write Today. Approved for Vets. Accredited by N.H.S.C.

Upholstery Trades School, Dept. ML-312, 721 Broadway, New York 3, N.Y.

LEARN MEAT CUTTING

Train quickly in 8 short weeks at Toledo for a bright future with security in the vital meat business. Big pay, full-time jobs—**HAVE A PROFITABLE MARKET OF YOUR OWN!** Pay after graduation. Diploma given. Job help. Thousands of successful graduates. Our 37th year! Send **NOW** for **FREE** catalog. No obligation. GI approved.
NATIONAL SCHOOL OF MEAT CUTTING, Dept. 50-G, Toledo 4, Ohio

I'll Send You This Handsome SAMPLE CASE—FREE



and Show You How to Make Up to \$30.00 in a Day

WRITE for this **FREE** Tailoring Sample Case packed with 100 beautiful, big-value suit and overcoat fabrics. Take orders from friends, fellow-workers, others, for fine quality, made-to-measure clothes. Pocket big cash profits in advance. Because wearing our suits and overcoats brings more orders, we make it easy

for you to get your own clothes without 1c cost. No experience is needed. **SATISFACTION GUARANTEED**. **SEND NO MONEY**. Rush your name, address, and age—today!
W. Z. GIBSON, INC., 500 South Throop Street DEPT. H-516 CHICAGO 7, ILLINOIS

RUPTURED

YOU CAN NOW BE FREE FROM TRUSS SLAVERY

Surely you want to **THROW AWAY TRUSSES FOREVER**, be rid of Hernia Worries and be able to again work, live, play and enjoy life's activities in the manner you desire.

Why should you put up with wearing a gripping, chafing truss the balance of your life? If you do, it will not be through necessity but through choice on your part—for most reducible Ruptures can be corrected **NON-SURGICALLY**.

NON-SURGICAL TREATMENTS

The successful **NON-SURGICAL** treatments of reducible Rupture used by the Excelsior Medical Clinic require no painful surgery, hospitalization, anaesthesia or long periods of convalescence. They have been developed by new techniques, new wonder drugs, research and years of experience and are fully recognized by medical authorities.

Thousands of satisfied patients from hundreds of communities have come here to be successfully treated. Our treatments are so certain that every patient accepted for treatment is given a Lifetime Certificate of Assurance. Treatments usually take but a short time and the cost is reasonable.

Do Something Today About Your Health

The chances are if your condition is not corrected it will only grow worse.

The Excelsior Medical Clinic has recently published a New **FREE** Book, fully illustrated, on how neglect of Hernia, Rectal and Colon disorders or Glandular Inflammation often results in painful surgery.

Gives knowledge and information that could prove of utmost importance in your future life. No obligation.

Write for Our New Free Book

Rectal Colon Glandular Inflammation

These disorders are amenable to our **MILD NON-SURGICAL** types of treatments. They can be treated at the same time we treat your Hernia condition. Full details given in our **FREE** Book.



EXCELSIOR MEDICAL CLINIC
Dept. H 6150
Excelsior Springs, Mo.

Gentlemen: Kindly send me at once, your New **FREE** Book. I am interested in full information on (Please Check Box)

- Glandular Inflammation Hernia
 Rectal-Colon

Name.....

Address.....

City..... State.....



**YOU
can
acquire**

LAW AT HOME! EARN LL. B. DEGREE

LaSalle's famous Law Library—used as reference in many Law libraries and Law offices—has enabled thousands to master Law surprisingly fast, in spare hours at home, for business and professional advancement.

These 14 remarkable volumes, compiled by leading professors and lawyers, cover the whole basic field of Law in condensed, orderly, simplified manner.

You advance rapidly with this great library, plus special lectures furnished. We guide you step-by-step with personalized Problem Method of instruction...you learn by doing—handling legal problems—not by memorizing rules.

Send for two FREE booklets, "Law Training for Leadership," and "Evidence," answering questions about Law and its value to you. Mail coupon below. No obligation.

Accredited member, National Home Study Council

LA SALLE EXTENSION UNIVERSITY A Correspondence Institution

417 S. Dearborn St. Dept., 764L. Chicago 5, Ill.

Send me your two FREE booklets described above, without obligation.

Name Age

Street

City, Zone & State



DRAINS cellars, cisterns, wash tubs; **\$7.95**
IRRIGATES - CIRCULATES - SPRAYS

1,001 uses. Stainless shaft. Won't rust or clog! Use 1/6 HP motor or larger . . . 3/4 HP for up to 2,400 GPH; 450 GPH 80' high; or 1800 GPH from 25' well. 1" inlet; 3/4" outlet. Coupling included free. **\$7.95.**
HEAVY DUTY BALL-BEARING PUMP. Up to 5,200 GPH; or 3,000 GPH from 25' well. 1 1/2" inlet; 1" outlet. **\$12.95**
Postpaid if cash with order. **MONEY BACK GUARANTEE**
Centrifugal and Gear Pumps in All Sizes
LABAWCO PUMPS, Belle Mead 7, New Jersey

MY SPARE TIME HOBBY MAKES ME \$5⁰⁰ an hour CASH PROFIT

—Grover Squires



START YOUR OWN SPARE TIME BUSINESS

You can turn your spare time into Big Cash Profits with your own **COMPLETE SHARPENING SHOP**... Grind saws, knives, scissors, skates, lawn mower blades... all cutting edges. Your Own Cash Business with no inventory right at home... no experience needed.

FREE BOOK tells how you can start your own spare time business while you are still working at your regular job. Low Cost—time payments only \$15.00 a month. Send postcard today.

BELSAW SHARP-ALL CO. 711 Field Bldg., Kansas City 11, Mo.



Sidelights from **the PENTAGON**

By William R. Kreh

THE JET AGE is catching up with that time-honored GI institution—the dog tag. Future servicemen may wear tags that resemble department-store charge plates.

The newly designed tags are now being test-worn by a few Marine Corps units. They contain up to 22 lines of information—everything from the usual name, rank and serial number to age, date of enlistment and even a photograph and signature of the serviceman.

The services believe the new dog tags should cut down on paperwork, since the information on them could easily be printed on routine lists and official papers.

The Navy's guided-missile cruiser *USS Canberra* set some sort of a "first" recently. She launched a missile that hit its target the day before it was fired!

It happened when the *Canberra* was crossing the Pacific near the International Date Line. She fired a Terrier from west of the line and the missile hit its target east of the line. The missile was actually shot on Monday and hit its target on Sunday!

The Army is studying a pill that may protect its fair-skinned soldiers from sunburn. Tests on albino mice have been successful.

The Air Force predicts that space vehicles will be lined with rubber padding so that weightless passengers, when not tied down, will bounce off unharmed. A new substance, Ensolite, tested at Wright-Patterson Air Force Base, Ohio, is so resilient that a raw egg, dropped from 14 stories, bounced off uncracked.

Utah's Army National Guard is issuing bows and arrows to its fighting forces. Maj. Gen. Maxwell E. Rich, Utah Adjutant General, says

(Continued to page 30)

INVENTORS

Protect your invention. The Patent laws are YOUR laws. A U. S. Patent gives you exclusive rights for 17 years. Take advantage of these rights by making application yourself for your U. S. Patent.

Send for FREE Registration Certificate and details of low-cost "Do-it-Yourself" Patent Kit. No obligation.

PATENT ASSOCIATES

Suite 1212 Commonwealth Bldg. (PM)
Philadelphia 7, Pa.

20x50 — \$29.95

High powered, whisper-weight (27 oz.) color corrected. Achromatic binoculars. 7" high! EZ to hold. EZ to focus. Instant finger-tip adjustment. Made in Japan. Hard Coated thru-out. Leather case and straps included.

USE 30 DAYS AT OUR RISK

If not satisfied return for refund. Add \$1 postage, handling and 10% Fed. tax.

UNITED BINOCULAR CO., 9043 S. Western, H-3208, Chicago 20. DEALERS WANTED



c.o.d.'s require \$2 deposit.

OWN a BUSINESS!



We'll Train and Establish You
Start part-time if employed. You'll be trained by a nearby dealer and at 5-day training school. As carpet-upholstery cleaning expert, you provide 6 services to multiply profits and customer satisfaction. No shop needed. Just 2 average jobs a day nets \$8,750 first year. We help build your business with 27 continuous services: counseling, nat'l advertising (McCalls, Parents, House Beautiful, others), newspaper ads mats, etc. Send for FREE booklets. DURACLEAN CO., 0-167 Duraclean Bldg., DEERFIELD, ILLINOIS

GOVERNMENT OIL LEASES LOW AS \$1 PER ACRE

You do no drilling, pay no taxes, may realize a king-size profit without ever leaving home. Write for free map and literature.

AMERICAN OIL SCOUTS, Dept. PM
8350 Santa Monica Blvd. Los Angeles 46, Calif.

Lift the Hood to a Bright Future

Be a Top Pay Auto Mechanic—Learn at Home in Spare Time



Tie this for opportunity: America needs 100,000 newly-trained mechanics—and 25,000 more repair shops! Skilled men earn up to \$3 an hour and more. Learn this well-paid, interesting, secure trade at home. CTI shop-method is easy, fast, sure. Diesel Mechanics or Body & Fender Rebuilding included at no extra cost. Mail coupon.



Tools & Tune-Up Kit Sent

CTI sends you professional Mechanic's Tools and valuable instruments, including a Compression Tester, Vacuum Gauge & Fuel Pump Tester, Ignition Timing Light; and a handy portable steel case.

MANY STUDENTS EARN CASH as they train. They fix cars on their own, or work in local shops. All facts free. Mail coupon now for Catalog and Sample Lessons.

COMMERCIAL TRADES INSTITUTE Dept. A1297
1400 Greenleaf Avenue • Chicago 26, Illinois

Send booklet, Make Big Money in Auto Mechanics

Name _____ Age _____

Address _____

City _____ Zone _____ State _____

Accredited by National Home Study Council



27 YEARS IN BUSINESS AT THE SAME ADDRESS.



Beat the high cost of new tires.
EXTRA MILEAGE TOP GRADE Tires,
(Written Insurance Guarantee). SEND AD
WHY PAY MORE? UP TO 15,000 MI.

Our entire stock of good used tires.					
12 MOS. Written Guarantee. White Walls \$1.00 extra					
600-16	\$4.82	670-15	\$4.92	700-15(6)	\$9.92
600-16(6)	7.92	710-15	4.92	750-16(8)	10.92
650-16(6)	8.82	760-15	4.92	700-17	10.72
750-14	5.92	800-15	5.52	750-17	11.42
800-14	5.92	820-15	5.62	850-14	5.92
750-16(6)	9.92	700-16(6)	9.92	700-20	11.02
				1000-22	20.92

"EXTRA SPECIAL" TOP QUALITY all size 4-ply pass. FREE TIRE with 2 or more of these.—W.W. \$1.00 Extra. Guarantee Sent. GIANT TIRE SALE. EA.

Thousands of tires shipped all over the U.S.A. All tires shipped F.O.B. Phila. Send Check or M.O. with this ad. Dept. 2 No C.O.D.

STANDARD 834 N. Broad St., Philadelphia 30, Pa.

Magic Mail Plan—Make up to \$5 an Hour!



Get ORDERS and CASH from your mailman—do work in SPARE TIME at home—or expand into FULL TIME business.

Send coupon for Free facts about the newest and most fascinating of all home operated businesses. For the first time a simplified machine brings the fabulous profits of Plastic Sealing and Plastic Laminating within the reach of the small operator. Anyone can learn to operate the machine with a few minutes practice—then with our Magic Mail Plan can get mail orders pouring in daily with cash in every envelope. No canvassing—no selling. We even

Get into PLASTIC LAMINATING at home

supply the circulars you mail to bring back cash and orders. Don't waste a minute. Rush your name. We'll send you FREE and postpaid, pictures, prices, details, and all the facts you need to start. Mail coupon or send name on postcard. No charge.

Warner Electric Co., 1512 Jarvis Av., Dept. L-2-H, Chicago 26, Ill.

Make Thousands of Beautiful Art Creations

COSTUME JEWELRY • CIGARETTE BOXES
TRAYS • CANDLESTICKS • COASTERS
LAMP BASES • BOOK ENDS...ALL IN
SPARKLING COLORED PLASTIC



WARNER ELECTRIC CO., 1512 Jarvis Av. Dept. L-2-H, Chicago 26, Ill.

At no cost to me, please rush complete details postage prepaid. I am under no obligation.

Name _____

Address _____

City _____ Zone _____ State _____

THIS MAN . . .

is taking out of the machine a Plastic Sealing Job—ordered by mail—only 11¢ in material cost brings back \$2.58 in cash by mail. Capacity of machine: \$25.00 profit per hour of operation.

Check the Kind of Body You Want

Charles Atlas

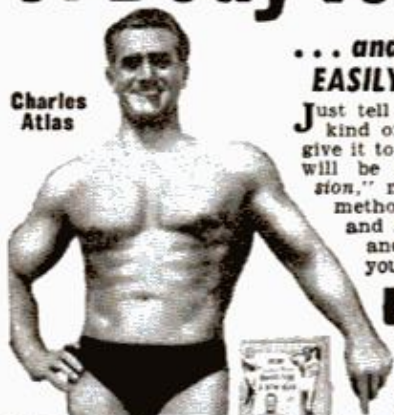

... and I'll Show You How EASILY You Can Have it!

Just tell me, in coupon below, the kind of body you want—and I'll give it to you SO FAST your friends will be amazed! "Dynamic Tension," my easy, 15-minutes-a-day method, will make your chest and shoulders bulge... arms and legs surge with power... your whole body feel "alive!"

FREE BOOK Learn how I became "World's Most Perfectly Developed Man" — Mail coupon! **CHARLES ATLAS**, Dept. 87, 115 East 23 Street, New York City 10, N. Y.

CHARLES ATLAS, Dept. 87, 115 East 23rd St., New York 10, N. Y.
In England: Chitty Street, London, W.1.

Dear Charles Atlas: Here's the Kind of Body I want:
(Check as many as you like)

- | | |
|---|--|
| <input type="checkbox"/> More Weight—Solid—in | <input type="checkbox"/> Powerful Arms, Legs, Grip |
| <input type="checkbox"/> The Right Places | <input type="checkbox"/> Slimmer Waist, Hips |
| <input type="checkbox"/> Broader Chest, Shoulders | <input type="checkbox"/> Better Sleep, More Energy |

Send me absolutely FREE a copy of your famous book showing how "Dynamic Tension" can make me a new man—32 pages, crammed with photographs, answers to vital questions, and valuable advice. No obligation.

NAME _____ AGE _____
ADDRESS _____
CITY _____ ZONE _____ STATE _____



FINISH HIGH SCHOOL AT HOME!

Vocational or College Prep.

No classes to attend. Easy spare-time training at home covers big choice of subjects. Many complete high school in two years. Friendly instructors; standard texts. Full credit for previous schooling. Diploma awarded. If you have left school and are 17 or over, write for FREE catalog!

Accredited Member, National Home Study Council

Wayne School of LaSalle Extension University

A Correspondence Institution

419 So. Dearborn, Dept. 759W, Chicago 5, Ill.

KEEP YOUR... ON

BENJAMIN

Largest Selection in the World—Single Shot & Repeaters for Every Shooter's Needs! • 25 MODELS

You Can **DEPEND** on BENJAMIN... for Safety—Power—Accuracy—Convenience—Economy

No. 2600

No. 2600 BENJAMIN
Super 35-Shot BB Gas Pistol. Safe—No Pumping—Uniform Hi-Power. For Target & Small Game. \$18.95

No. 2620 BENJAMIN 20-Shot Cal. 22 Gas Pistol. Economical. \$20.95

No. 1300 50-Shot BB Air Pistol \$23.50

No. 1320 BENJAMIN 35-Shot Cal. 22 Air Pistol \$25.50

No. 3600

No. 3600 BENJAMIN
Super 100 Shot BB Gas Rifle. Non Toxic—Safe—Convenient—Uniform Hi-Velocity Power. →

No. 3620 BENJAMIN
Super 85 Shot Cal. 22 Gas Rifle... \$21.95

No. 3100 Super 100 Shot BB Air Rifle. Adj. Shooting Force \$24.95

No. 3120 BENJAMIN
Super 85 Shot Cal. 22 Air Rifle... \$26.95

FREE Catalog All Models Benjamin Single Shot & Repeaters—Cal. BB or 177 or 22. Also, Special Hunting & Fishing Knife Offer.

BENJAMIN AIR RIFLE CO., 896 MARION ST., ST. LOUIS 4, MO.

—space age to the contrary—that "Unconventional warfare demands unconventional weapons." He explains that archery-trained units could be dropped behind enemy lines to organize guerilla fighters. Best weapon for the job, he says, would be the medieval, but silent, arrow which has an effective range of 300 yards.

The Navy's antisubmarine aircraft carrier USS *Bennington* is still unwinding. She has to.

The *Bennington* recently spent 40 straight hours making 308 left circles within a 2000-yard area. The purpose was antennae-radiation tests which required the ship to remain within a one-mile circle so that the radiation patterns could be calibrated.

It's reported that her crew had a persistent list to port when the ship finally straightened out.

The Navy has turned a new weapon loose in the war on insects—the 500-mile-an-hour jet.

At Jacksonville, Fla., they've been experimenting with jet planes to spray insecticides. Not too practical for peacetime use, the jet might have to be used in combat areas to control disease-carrying insects. Slower propeller-driven planes and helicopters would be too vulnerable to enemy attack. The jet, at close to supersonic speed, can fly at 150 feet and spray 300 gallons of insecticide per minute.

A Marine Corps recruiter, S/Sgt. Louis Manter, has patented an "oil-condition indicator"—a device that fits on an auto's dashboard and shows at a glance the condition of the engine oil. The instrument has two transparent tubes. One contains new oil and the other is connected to the car's oil system. Lights allow comparison of the oils.

The Air Force has put together a new, miniature cold-weather survival kit that will allow aircrew members who are forced to bail out to survive for nearly two days.

Compact and tight, the kit contains twelve matches, three fire-starter pads, one button compass, a needle, two fishhooks, a small knife, three water-purification pills, one Band-Aid, a small water container and three safety pins. The kit is stored in the parachute pack and attached to a riser.

During tests, one man survived for 41 hours in temperatures below 10 degrees.

The Naval Ordnance Laboratory discovered a new use for golf balls—to break up lumps of explosive mixtures in blender machines. It replaces a slower, and more dangerous, method of sifting the mixtures through screens. ★★

New Table Top Invention Puts You In... **PROFITABLE RUBBER STAMP BUSINESS**

Home Operators now make \$9.20 AN HOUR in business once monopolized by a few big companies

Special rubber stamps bring high prices—cost only pennies to make on new, low-cost table top machine. Take 27 cents worth of material, make perfect stamps, the kind businesses and offices now buy by the dozen at \$1.80 each. Make up to \$9.20 an hour. Start in spare time in your own home. Run machine on kitchen table using ordinary electrical outlet. Make any kind of stamp. We'll send you free information without obligation about this established, highly profitable business, now open to individuals for the first time. For free information send name today on a post card to Rubber Stamp Div., 1512 Jarvis, Dept. R-2-H, Chicago 26, Ill.

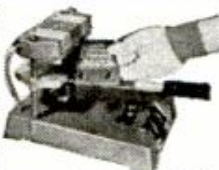

75 POWER TELESCOPE \$3.98 25X-45X-75X

NEW 3 in one telescopes, 3 variable 25X-45X-75X magnification. Brass bound. 25 power for ultra bright images 45 & 75 power for long range. Guaranteed to bring distant stars, moons, objects, sports 75 times closer. Most powerful scope sold anywhere near this amazing low price. American made. 5 sections. Opens 36", closes 1 ft.; contains 4 ground & polished lenses. Can also be used as powerful compound microscope. Mass production enables us to offer telescope complete at \$3.98 postpaid. Money back guarantee. **CRITERION CO., Dept. PMB-83, 331 Church St., Hartford, Conn.**



DOLLS!

Learn to make, repair and sell dolls and accessories at home. Excellent money making opportunities. May we send **FREE** informative booklet? No obligation!

NORM & SUE'S DOLL HOSPITAL SCHOOL, Studio M-70
11826 San Vicente Blvd., Los Angeles 49, Calif.

PICTURES THAT FREEZE TIME

See the
*millionth-of-a-second pictures
of a golf ball flattened,
a bullet stopped in mid-air
in the August issue of*

POPULAR MECHANICS

JULY 1960

**ENGINEERING
SCIENCE
MATH**

**DEGREE IN
27 or 36 MOS.**



ACCELERATED YEAR-ROUND PROGRAM prepares for early employment in fields of SCIENCE AND ENGINEERING. Regular 4-year program for B.S. Degree completed in 36 months, special engineering degree program in 27. Classes start quarterly—September, January, March, June. QUALITY EDUCATION. Graduates employed from coast to coast. Government approved for veteran training. Students from 50 states, 40 countries. 20 buildings; dorms, gym. Campus. SAVE TIME AND MONEY. EARN BOARD while studying. Write for catalog and complete information.

INDIANA TECHNICAL COLLEGE

570 East Washington Boulevard, Fort Wayne 2, Indiana

Please send me free information on Bachelor's Degree Programs in Engineering and Science as checked below:

- | | |
|---|--|
| <input type="checkbox"/> Aeronautical Engineering | <input type="checkbox"/> Mechanical Engineering |
| <input type="checkbox"/> Chemical Engineering | <input type="checkbox"/> Metallurgical Engineering |
| <input type="checkbox"/> Civil Engineering | <input type="checkbox"/> Physics |
| <input type="checkbox"/> Electrical Engineering | <input type="checkbox"/> Chemistry |
| <input type="checkbox"/> Electronic Engineering | <input type="checkbox"/> Mathematics |

Name _____

Address _____

MAKE MONEY FOR YOURSELF

as a Contract Truckman
pulling a Mayflower Van

- ▶ Begin a profitable business in partnership with Aero Mayflower Transit Company, Inc.
- ▶ Learn the moving business from experts, with on-the-job paid training.
- ▶ Earn big commissions. We do all the selling.

CUT THIS COUPON AND MAIL TO:

Mr. D. C. Swanner
Aero Mayflower Transit Co., Inc.
P. O. Box #107,
Indianapolis 6, Indiana

I own a new or late model tractor and am ready to come to Indianapolis to get started. (Check here)

I am financially able to arrange for a down payment on a tractor in my own home town and would like a personal interview in my area. (Check here)

Please send me complete details without obligation. (Check here)

I am over 22 and can pass ICC physical fitness test. (Check here)

Name _____

Address _____

City _____ State _____

31

Electronic Servicemen and Technicians—

ONE OF THE FASTEST-GROWING OCCUPATIONS IN THE U. S.

by B. Richard

Over 300,000 electronics technicians and servicemen were employed in this country during the year, 1958.

This number has been increasing steadily each year as the Armed Services demand more and more military electronic equipment, guided missiles and aircraft; and as industry puts to use ever greater quantities of electronic control equipment in manufacturing, communications and data processing.

Not only will employment opportunities grow in existing fields of Electronics, but many new areas of electronics work are expected to develop in coming years. This will create an unmeasured additional demand for skilled technicians and servicemen.

The advent of color television will do much to intensify the need for technicians and servicemen during the 1960's. It is expected that great numbers of color sets will be installed in the coming 10 years, and the fact that these sets will be, initially at least, considerably more complicated than black and white receivers will open up additional opportunities for highly skilled, specially trained television servicemen.

Electronics service and repair is a rapidly growing field with excellent employment opportunities for skilled workers who have an understanding of electronic principles.

Among the jobs in this field are radio and television repairman, broadcast technician, radio and radar operator, and electronic data machine serviceman. There are also an increasing number of openings for electronic production work in major industries, and highly-trained technicians are needed to assist engineers in the design of electronic systems and equipment for use in manufacturing, guided missiles production and aircraft work.

Salaries available in this field rise proportionately with a man's experience. In 1958, for example, experienced men in specialized electronics jobs were earning about \$10,000 a year, exclusive of overtime. In 1958, most radio and television servicemen earned up to \$130 per week.

Technicians who worked with companies manufacturing electronic equipment in 1958 were paid up to \$3.00 an hour with ample possibilities for overtime, especially in aircraft, military and commercial manufacturing plants where complex production schedules were required.

Also, it is often possible for technicians holding production jobs in manufacturing to repair television and radio sets in their spare time, and in this way, add a substantial amount to their income.

Therefore, not only do electronics technicians and repairmen earn far above average incomes, but as they accumulate additional knowledge and experience, they have the opportunity to earn greatly increased salaries by becoming specialists in the more complex electronic equipment that is becoming more and more a part of today's industry.

If you are interested in electronics, you should investigate this type of work, not only because of the opportunities that exist at present, but because even greater income potentials and an even larger number of job openings are being predicted for coming years.

How would you go about training for this field of employment? First of all, you should have an understanding of the basic principles of electronics in addition to a certain amount of practical training and experience so that you can specialize in a particular phase of the industry.

Most training authorities recommend a one or two-year course in electronics at a good technical school or institute as the best preparation for a high-level electronics job. These technical institutes provide classroom and workshop instruction in the fundamentals of electronics and often make night courses available so that you can continue your present full-time job.

Another good way to learn fundamentals is through correspondence training. Some institutes offering correspondence training in electronics even provide testing equip-

ment for their students' use at home, and the cost is included in tuition. This type of training has the advantage of letting students set their own classroom hours so that full-time jobs can be held while a course of instruction is in progress.

Because so many new developments are taking place in the field of electronics, workers must continue learning new techniques throughout their careers. Technical school courses, correspondence training, and manufacturer-sponsored training programs provide the training you need to take advantage of the extra income offered by more highly technical jobs.

The fact that employers often prefer technical school graduates for high-level electronics jobs doesn't prevent men who are just starting out from progressing to more highly skilled positions. Correspondence training and night technical school courses let you learn new skills while you are getting practical experience in your beginning electronics work.

It might be well for you to investigate the opportunities for valuable training and work experience offered by the Armed Services. Since World War II, Armed Forces technical schools have helped thousands of men qualify for well-paid civilian electronics jobs.

Because of the changing nature of our

Armed Forces, greatly increasing quantities of electronic equipment are being used. In 1958, more than a quarter-million members of the Armed Forces were engaged in operating and maintaining electronic equipment. More than 100,000 of these men specialized in the maintenance of such equipment as radar, guided missile controls, radio, and fire control instruments.

Obviously, if you are of service age, this is worth looking into because of the excellent training and experience you will receive while you are undergoing your service obligation.

As increasingly complex equipment comes into wider use, there will be more and more demand for highly-skilled and specialized electronics technicians who will be needed to keep this equipment in top operating condition.

This means there will be expanded numbers of jobs with upper-range income qualifications. More and more technicians with advanced training and specialized skills will have the opportunity to earn \$10,000 and over per year.

If your interests lie in this area, you should take steps to profit from this interest by looking into the training that is available. For further information write Skills for America, Popular Mechanics, 200 E. Ontario Street, Chicago 11, Illinois.

COYNE offers
LOW COST
TELEVISION
RADIO - COLOR TV

Training in
Spare Time AT HOME



The future is YOURS in TELEVISION!
A fabulous field—good pay—fascinating work—a prosperous future in a good job, or independence in your own business!

Coyne brings you MODERN-QUALITY Television Home Training; training designed to meet Coyne standards at truly lowest cost—you pay for training only—no costly "put together kits." Not an old Radio Course with Television "tacked on." Here is MODERN TELEVISION TRAINING including Radio, UHF and Color TV. No Radio background or previous experience needed. Personal guidance by Coyne Staff. Practical Job Guides to show you how to do actual servicing jobs—make money early in course. Free Lifetime Employment Service to Graduates.

COYNE
ELECTRICAL SCHOOL

CHARTERED AS AN EDUCATIONAL INSTITUTION
NOT FOR PROFIT

1501 W. Congress Parkway • Chicago 7, Dept. 80-H3



Send Coupon or write to address below for Free Book

and full details, including easy Payment Plan.
No obligation, no salesman will call.



COYNE Television Home Training Division
Dept. 80-H3, New Coyne Building
1501 W. Congress Pkwy., Chicago 7, Ill.

Send Free Book and details on how I can get Coyne Quality Television Home Training at low cost and easy terms.

Name _____
Address _____
City _____ State _____

**EARN \$125
A WEEK AND UP**

**BE AN AUTO DIESEL
EXPERT—LEARN
A TRADE YOU LIKE**

You learn fast in our shops because you learn with tools on real equipment. Students short of money may earn most of their expenses by doing part-time work. Experienced instructors explain WHY and show you HOW, then you DO IT YOURSELF. Many of our graduates earn \$125 a week and up. Approved for veterans. Day and evening classes. Free bulletin—write today.

MAIL THIS COUPON TODAY!

NASHVILLE AUTO-DIESEL COLLEGE
226 7th Ave., No., Dept. 86, Nashville, Tenn.
Please send without obligation free catalog.

NAME _____
(please print or write plainly)

ADDRESS _____

CITY _____ STATE _____



Play Right Away!

ANY INSTRUMENT

Now it's EASY to learn ANY INSTRUMENT—even if you don't know a single note now. No boring exercises. You play delightful pieces RIGHT AWAY—from very first lesson! Properly—by note. Simple as A-B-C. You can make amazing progress—at home, in spare time, without teacher. Only few cents per lesson. 1,000,000 students including Lawrence Welk. Established 1898. Licensed by N.Y. State Education Dept.

FREE BOOK Shows how easily you can learn music. Write for it. No obligation; no salesman will call. **U. S. SCHOOL OF MUSIC.** Studio 307, Port Washington, New York.

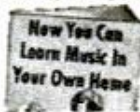

For sportsmen
6 to 60!



Broad line of models

KITS less motors, from **\$39.95**

Complete kits with motors from \$109.95
Send 50¢ for 22-page catalog.

ARNOLD-DAIN CORP.

Box 78, Mahopac, N. Y.
Dealer Territories Available

**Great Pioneer in Science
Do You Know Him?**

—By James S. Thistle—

OUR SCIENTIST THIS MONTH is best known for his discovery of the laws of gravitation which laid the foundation for much of modern science. Scientists believe that the work of Albert Einstein would have been impossible without the discoveries of this early Pioneer. His third law of motion, which states that for every action there is an equal and opposite reaction, is the principle of jet and rocket propulsion. The rearward thrust of the jet shoots the plane forward in a powerful motion by which it quickly gains altitude.

Almost equal in importance to gravitation were his contributions to the theory of light, explained in his *Optics*. He showed that white light is a combination of the seven colors of the rainbow, called the spectrum.

Among this man's other accomplishments were his inventions of a reflecting telescope and integral and differential calculus. His country honored him with burial in Westminster Abbey among England's greatest men.

*These letters, unscrambled,
spell the name of this
month's Great Pioneer
in Science:*

WAC SIN AN ETO

(First and Last Names)

Write the correct name here:

Now turn to page 220 for the answer.

95% PROFITS YEAR 'ROUND

Be your own boss, Operate a **SIMPLEX** lawn-mower sharpening service in your community. One compact machine grinds all mowers, sharpens cutlery. Low investment, 95% profit. Pays for itself in average month.

SIMPLEX

—4 Machines in One!
Reel Grinder—sharpens any mower reel in or out of mower.
Bed Knife Grinder—grinds with either round or cup wheel.

Rotary Blade Grinder—hollow grinds any rotary mower blade.
Cutlery Knife Grinder—sharpens cutlery, tools, scissors.

Send for free, money-making details!

The FATE-ROOT-HEATH Company • Dept. PM-7, Plymouth, Ohio

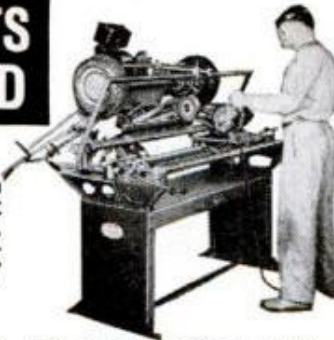

NOW—AVIATION WEATHER REPORTS, IN YOUR CAR

Be a weather expert! TC-1 Weather Radio receives 24 hour aircraft weather reports (200-400 K.C.) on your car radio. Minutes to install, no electrical connections, won't interfere with AM reception. Nationwide reception. 3 year guarantee. Send check or money order. \$35.50. postpaid.

Boulevard Electronics, 1229 W. Washington, Chicago Ill. Dept PM7



Send for free illustrated brochure



ACCORDIONS UP TO 1/2 OFF

Save up to 1/2 off retail prices of comparable accordions

5-DAY FREE TRIAL

Buy DIRECT from world's Largest Exclusive Dealer! Compare our Importer-to-You prices! See how you save! Over 30 models—finest genuine Italian makes! New, easier terms! 5-Day Free Home Playing Trial with satisfaction 100% assured, Bonus Gifts Free. Rush name and address for FREE Color Catalogs and direct Importer-to-You prices—FREE. Write TODAY! Accordion Corporation of America 2003 W. Chicago Av., Dept. R-70, Chicago 22

REAL ESTATE BE A BROKER

PAYS BIG! SEND FOR FREE, BIG, ILLUSTRATED CATALOG NOW! Graduates report making substantial incomes. Start and run your own business quickly. Men, women of all ages, learn easily. Course covers sales, Property Management, Appraising, Loans, Mortgages, and related subjects. **STUDY AT HOME** or in classrooms in leading cities. Diploma awarded. Write TODAY for free book! No obligation. Approved for World War II and Korean Veterans
WEAVER SCHOOL OF REAL ESTATE (Est. 1936)
 2020R Grand Avenue Kansas City, Mo.



MAKE YOUR FORTUNE

Sell famous Spring-Step Cushion Shoes for all the family—men, women, children and babies! Earn big money daily plus Cash Bonus and Retirement Income with amazing 2-minute demonstration that sells on sight. Big repeat business. Full or spare time. America's Biggest Selection of Shoes for all the family. Free outfit given. No investment ever. Write today.



ORTHO-VENT Shoe Co., Inc.
 1106 Brand Road Salem, Virginia

NO JOB WORRIES

PLASTEX INDUSTRY needs manufacturers on small scale for big production of Lamps, Clock Stands, Art Goods, Novelties in Plastic Marble imitation. No Experience necessary. 1/2¢ material makes regular 10¢ store sellers. Moulds furnished for fast production. Small investment brings good profit. Big wholesale orders now being placed. Ambitious men have chance for real prosperity and job security. Our NEW FREE booklet will interest and benefit you.

PLASTEX INDUSTRIES, Dept. A
 3400 Third Ave. New York 56, N.Y.



"I Earn Two Incomes Now"



Says John Beanie, Pittsburgh, Pennsylvania "Thanks to your wonderful training, I have been able to earn \$20 to \$25 extra each and every week doing little locksmith jobs at home—after work at my regular job. This is the best trade a man can take up!"

Be a LOCKSMITH

Add 50%-100% to YOUR INCOME with easy spare time earnings. Cash in on nationwide shortage — trained locksmiths in demand! Quickly step into a big-pay opportunity job — high-profit shop of your own.

Earn Extra Money RIGHT AWAY! All Special Tools, Supplies Furnished FREE.

Age, education, minor physical handicaps don't matter in this growing trade. You can quickly qualify as a skilled locksmith. Study at home as little as one hour a week. Gain practical experience through well-illustrated lessons. Do real jobs on car locks, house locks, padlocks and safe locks, under the guidance of experts.

MAIL COUPON FOR FREE BOOK

For a future as your own boss or in a high-pay job, write now for FREE illustrated book! Only school of its kind. Lic. State of N.J., Accredited NHSC. **Locksmithing Institute**, Dept. 107, 150 Park Ave., E. Rutherford, N.J. (Div. Tech. Home Study Schools) **Approved for Vets.**

Send for FREE Book

PROFESSIONAL Tools FREE with Course

MAIL COUPON NOW

LOCKSMITHING INSTITUTE, Dept. 107
 150 Park Avenue, E. Rutherford, N.J.

Please send Free Illustrated Book without obligation.

Name _____ (Print here)

Address _____

City _____ Zone _____ State _____

Check if Veteran

\$3.25 OR 2 FOR \$6.00!

With 40 ft. of wire. Additional wire 3¢ ft. **TESTED AND GUARANTEED.** Write for free list of all types of telephones. Shipments FOB Simpson, Pa.
TELEPHONE ENGINEERING CO., Dept. 7 80, Simpson, Pa.



Colorcretors are Needed Everywhere

C-9



More Colorcretors are needed to supply growing demand for the enduring, colorful beauty possible only from Colorcrete. Time-worn concrete, stucco and other old or new masonry walls are quickly transformed into clean freshness from a selection of 30 tints, tones and shades. Cementitious base—tough, tenacious, enduring. Colorcrete is applied under pneumatic air pressure by authorized Colorcretors. Machine is easy to operate and readily mobile. Opens up opportunities for men of modest capital. Broad markets with high income potentials. Write for Opportunity Book.

COLORCRETE

COLORCRETE INDUSTRIES, INC.
 570 Ottawa Ave., Holland, Mich.

ABSOLUTELY FREE!



**IN JUST
15 MINUTES
I'LL PROVE
I CAN GIVE
YOU A VIRILE,
RUGGED,**

HE-MAN BODY!

In just 15 minutes, right in the privacy of your own room, through my **TRIPLE-PROGRESSIVE COURSE**, I'll slap pounds of steel-like muscles all over your body. I'll add 4 inches of power-packed muscles to your chest — another 3 inches of steel-packed muscles to your arms — I'll give you lifeguard shoulders and speedy, athletic legs. I'll also build inner strength and give you that virile look that men envy and women admire. **LET ME PROVE AT MY OWN EXPENSE THAT EVERYTHING I SAY CAN BE DONE!**

Send me this coupon and I will rush you my **GIANT 48-PAGE COURSE** that teaches you privately how you can become a real HE-MAN. **DON'T MISS THIS ONCE-IN-A-LIFETIME OPPORTUNITY.**



JOE WEIDER Dept. 38-70W
"Trainer of the Champions"
803 Palisade Avenue
Union City, New Jersey

Dear Joe:

Rush me my **FREE POWER-PACKED MUSCLE COURSE**. I am under no obligation, and I enclose 10¢ to cover handling and postage charges.

Name

Address

City

State

Age

**AMAZING
FREE TRIAL
OFFER**

IN Canada: Write Joe Weider, 2875 Bates Road, Montreal, Que.

HEAD-QUARTERS FOR ALL SPORT CAR TIRE SIZES

ALL FAMOUS BRANDS!

TIRES!

FARM TRUCK AUTO

AT LESS THAN WHOLESALE

SAVINGS NEVER LESS THAN 50% up to 70% OFF REG. PRICE

FREE • SEND FOR YOUR FREE CATALOG • FREE!

RELIABLE TIRE DIST., 730 Morgan Blvd., Camden 4, N. J.

**Bensen
Copter for
Everyone**

Simple to fly—build it yourself with engine or as inexpensive glider type. Safer than planes—women fly and like it, too. Order 3 view drawing, specs and photo of Glider for \$1 or motor powered Gyro-Copter \$2. Building plans and kits also available.



Send
\$1
or
\$2

BENSEN AIRCRAFT CORP., Dept. PM-70
Raleigh-Durham Airport, Raleigh, N. C.

Name

Address



**TUNE IN ON THE
INVENTORS**

By John Linkletter

AMERICAN INVENTORS are a prolific crew when it comes to turning out new ideas. They bombard the U.S. Patent Office with an average of 350 patent applications every working day. And the Patent Office, in turn, grants some 1000 patents per week. Incidentally, that's a lively pace for such an old-timer as the Patent Office which celebrated its 170th anniversary this spring.

Troops in training can experience a realistic atom-bomb explosion with the help of an atom-bomb simulator invented by Patrick Lizza of Palos Verdes Estates, Calif. The device, claimed not to be dangerous outside a 100-foot radius of the point of explosion, puts forth a large column of white smoke which develops a mushroom head. Simulated fallout drops during and after the cloud formation. Its patent number is 2,934,013.

There's \$5000 waiting for the inventor who can devise a revolutionary wheel chair to make it easier for a physically handicapped person to move around in an industrial building. The chair must be able to carry a 200-pound occupant, negotiate stairs, fold to fit in a car and retail for no more than \$500. The National Inventors Council of the U.S. Department of Commerce will receive and screen ideas.

"Lower your heels, Mabel, you've got a short date tonight," may soon set Mabel to shortening the telescoping high heels of her shoes. And the adjustable-height heels, invented by Marion Mistarz of Oak Park, Ill., will also be a godsend to married men whose wives can make one pair of shoes serve as both medium-height afternoon shoes or high-heel dress shoes. The device was granted patent No. 2,934,840.

Fishhooks won't foul in weeds when outfitted with an attachment invented by William Meucci, Glenview, Ill. Relatively light pressure, such as a fish biting, exposes the point. Patent number is 2,932,114.

Robert Horton, St. Paul, Minn., says that the mild vibration and hum of his infant pacifying device (No. 2,932,821) keeps a youngster quiet. ★ ★ ★

GIANT ITALIAN HUNTING KNIFE!

CLOSES WITH LIGHTNING SPEED! Imported direct from Italy, this is the same knife that is world famous for its effectiveness in life or death hunting or fishing emergencies. Blade is of durable high test carbon steel, guaranteed to stay razor sharp. Has genuine bone handle. Unlike a switch blade knife, there are no buttons to fool with, no springs to break.

LOCKS IN OPEN POSITION FASTER THAN THE EYE CAN SEE. Easy to handle, easy to carry. 4 sizes: 13 1/2" \$7.95, 11" \$7.50, 9" \$6.95, 5 1/2" \$4.50. **SENT POSTPAID IMMEDIATELY.** Send cash, check or M.O. 10-day money back guarantee. Calif. res. add 4% state tax.

MERCHANTS, INC., Dept. PM-7, 1221 S. Grand Ave., Los Angeles 15, California



**TRAINED AND SKILLED MEN IN
CLOCK AND WATCH REPAIR**

Are Needed in Watchmaking, Electronics, Defense, Aviation, and other technical and precision instrument fields. **NOW IS THE TIME TO LEARN THIS VALUABLE TRADE.** But, **Before You Enroll in Any HOME STUDY Course in Watchmaking, Write for Your Copy of "LEARN THE FACTS."**

KANSAS CITY SCHOOL OF WATCHMAKING
1226 Admiral Blvd. Kansas City 6, Missouri

SHORTHAND IN 6 WEEKS

Famous **SPEEDWRITING** shorthand. 120 words per minute. No symbols; no machines; uses ABC's. Learn at home or through classroom instruction. Low cost. 500,000 graduates. For business and Civil Service. Typing available. 37th Year. Schools in over 400 cities. Write for **FREE** booklet.

Speedwriting
Dept. 1507
55 W. 42 St., N.Y. 36, N.Y.

SPARE-TIME MONEYMAKING OPPORTUNITIES
READ OUR CLASSIFIED ADS
HUNDREDS OF BARGAINS AMAZING OFFERS

Finish HIGH SCHOOL AT HOME IN YOUR SPARE TIME

DIPLOMA AWARDED

Learn more! Earn more! Enter professional or technical schools. Advance socially. Live a happier, fuller life. Individual Courses or complete schedule. *Write for School Bulletin.*

ACADEMY FOR ADULTS
30 W. Washington, Dept. PM-760, Chicago, Ill.

**After the city,
Before the state
The ZONE keeps your mail
From being late**

★ ★ ★

The Post Office has divided 106 cities into postal delivery zones to speed mail delivery. Be sure to include zone number when writing to these cities; be sure to include *your* zone number in *your* return address — after the city, before the state.

PRINT YOUR OWN MONEY!

Not really, of course. Uncle Sam doesn't approve. We'll send you an amazing new **printing invention** (weighs less than 10 lbs.!) that makes money so fast one user says, its almost like printing \$20 bills! Actually lets you turn out — on a small table in garage or corner of a bedroom — many printing jobs that are impossible on even a huge \$5000.00 press.

PRINT WITHOUT A PRINTING PRESS. Yes, with equipment so simple we supply it **FREE** with Instructions, you can actually *under-sell* the biggest, most elaborate printing establishments on many types of printing — for theatres, gas stations, markets, stores, offices, etc., and just about *every* business within 100 miles around. Screen-Print works on glass, metal, plastic, cloth, leather — anything at all — on curved surfaces as well as flat.

YOU, TOO CAN MAKE BIG MONEY AT HOME. Cash in on this sensational new home-business development. No experience needed! Learn in a *few hours!* Some don't earn money, but some use spare time to earn up to \$15 an hour — \$100 or more a week.

WE SUPPLY EVERYTHING YOU NEED. Complete instructions, Screen Print equipment, enough supplies to start you making money almost immediately, can now be yours for only *pennies a day!* We guide and help you, supply step-by-step directions for building a profitable home business *fast.* Send for **FREE** details, samples and exciting Home Business plan. No obligation.

Write TODAY SURE.
SCREEN PRINT CO. Dept. 27, 15127 S. BROADWAY, LOS ANGELES 6, CALIF.

ENGINEERING

Select any one of the 15 Modern Engineering Courses listed below. Any one of them will lead you to a Successful, Safe, and Secure Lifetime Career.

BACHELOR OF SCIENCE DEGREE, 30 MONTHS

SAVE 2 YEAR'S TIME

B.S. Degree Courses:

<input type="checkbox"/> Electronic Engineering	<input type="checkbox"/> Mechanical Engineering
<input type="checkbox"/> Electrical Engineering	<input type="checkbox"/> Structural Engineering
<input type="checkbox"/> Highway Engineering	<input type="checkbox"/> Civil Engineering
<input type="checkbox"/> Architecture	

Diploma Courses:

<input type="checkbox"/> Radio-Television Plus Color	<input type="checkbox"/> Architectural Drafting
<input type="checkbox"/> MECHANICIAN	<input type="checkbox"/> Mechanical Drafting
<input type="checkbox"/> Electronic Technician	<input type="checkbox"/> Structural Drafting
<input type="checkbox"/> Industrial Electronic Tech.	
<input type="checkbox"/> Die and Tool Design	

APPROVED FOR VETERANS

Send for **FREE** Information

HEALD Engineering College
Van Ness at Post, Dept. P.M.
San Francisco, California

NAME _____
STREET _____
CITY _____
STATE _____

Learn to FIX ELECTRIC APPLIANCES

BENEFIT THESE 5 WAYS



Jump in electrical appliances has increased need for servicemen. Good money-making opportunities for young and older men. *Benefit these five ways:* (1) fix appliances in spare time; (2) have full time service shop; (3) fill job openings being advertised; (4) go into sales and service business; (5) fix own appliances.

Beginners learn at home. Professional Tester Kit furnished. Low cost, monthly terms. Information free. Mail coupon.

NATIONAL RADIO INSTITUTE
WASHINGTON 16, D.C.

AGO

Name.....

Address.....

City..... Zone..... State.....

GOV'T SURPLUS BARGAINS for 2 or 3¢ on the \$1.



You BUY DIRECT from U. S. GOV'T at AMAZING savings. Our DIRECTORY lists 100's Surplus Depots. Buy JEEPS, trucks, cars, boats, planes, tools, mach., tents, furniture, pumps, generators, compressors, motors, typewriters, etc.

Send \$1.00 TODAY for list and instructions to: AVIATION SURPLUS, Dept. PM-7, Box 789, York, Penna.

Get an I.C.S. High School DIPLOMA

All that may be holding you back from a better job, bigger pay is a high school diploma. I. C. S. high school training is known and respected by thousands of leading companies. Graduates occupy top positions. Take only the courses you need. Study at home in your spare time. Expert personalized guidance. Write for 3 free booklets: (1) "How to Succeed," (2) High School Catalog, (3) Sample lesson (math) shows famous method.

INTERNATIONAL CORRESPONDENCE SCHOOLS

Box 10953G, Scranton 15, Pa.

Name.....

Home Address.....

City..... Zone..... State.....

"No matter what YOUR AGE 15, 20, 30, 40, 50
FREE! to YOU if you ACT at once

\$5 PICTURE-PACKED COURSES
my \$5 to Make YOU a SUPER-MAN

"1001" Professional Secrets on
How to **GAIN** or **LOSE** quickly
up to 50 LBS. while you become

**A NEW STREAMLINED
ALL-MALE HE-MAN"**

says George F. Jowett

World's Greatest Builder of He-Men
World's Greatest Strength Champion.

As soon as you write me, I'll let you know
HOW to also get \$80 worth of apparatus, etc., **FREE**
Send a dime and your age to JOWETT INSTITUTE,
220 Fifth Avenue, (Dept. PM-07), New York 1, N. Y.



**LAST
CHANCE!**



Steam-Powered Rockets Tested for Jet Takeoffs

Experiments with steam rocket to assist jet airliners on take-offs are being conducted by the Stuttgart Institute for Physical Research on Jet Motors in Stuttgart, Germany. The rocket would give the plane additional acceleration when leaving the ground, eliminating the necessity of lengthening airport runways. Solid-fuel rockets have previously been used for this purpose, notably by military jet from short runways and from Navy ships.

Missile's TV Camera Observes Target Damage

As the Redstone missile started its plunge toward a target, it ejected a tiny TV camera and transmitter. Descending more slowly, the instrument package photographed the impact of the Redstone's warhead and sent the pictures back 75 miles from the damage area. This feat was recently accomplished at White Sands Missile Range.

The test shows it would be possible for an Army field commander using such a TV reconnaissance device to know immediately whether a missile had destroyed its target.

The TV camera and transmitter were ejected in a small capsule at an altitude of 40 miles. As the capsule fell to earth, slowed by its aerodynamic design, the equipment transmitted high-resolution pictures of the area in which the missile was about to land.



**MECHANICAL
APTITUDE**
pays big! Deal in
products you like!

Plan shows
where you get bar-
gains like these for
big profit U.S. sales:

- Saws 15¢
- Electric Razors . . 33¢
- Spinning Reels . . 96¢
- Tape Recorders *13⁵⁰
- Transistor Radios *3⁹²

START YOUR OWN HOME-IMPORT BUSINESS

Make big profits. Buy dazzling bargains like these abroad. Sell to friends, stores, mail order. New Drop Ship Plan puts you in direct contact with overseas sources—starts you full or spare time, without product investment or previous experience. FREE details! Airmail reaches us overnight.
MELLINGER CO., Dept. C 257
1717 Westwood, Los Angeles 24, Calif.

START YOUR OWN MONEY MAKING BUSINESS

Clean rugs on customers' floors—upholstery in their homes—even painted walls—with highly efficient electric machines which are making big money for others and giving them independence. Write today for complete information. It's FREE!

VON SCHRADER MFG. CO., Dept. 710 "R" PL., Racine, Wis.

FREE AMAZING NEW BOOK "HOW TO ANSWER ADS"



Never before have you seen anything like this. Tells you in simple language the correct way to answer ads. Gets you quicker replies—better results, and greater satisfaction. Will save you time and money and it's ABSOLUTELY FREE. No obligation whatever. Every reader of advertising should have this booklet. Send a postcard for your copy NOW. F. W. JOHNSON, Popular Mechanics Magazine, Room 600-A, 204 East Ontario Street, Chicago 11, Ill.

MONEY in WORMS

Sell 20,000 fishworms per week @ \$4 per 1000 from a bed 3 feet wide and 8 feet long. We teach you how to raise and where to sell fishworms and crickets. Write for free literature.
CARTER WORM RANCH, PLAINS, GEORGIA
Read our success story in LIFE MAGAZINE, December 28, 1959 Issue

SCIENCE ENGINEERING

Bachelor's degree in 27 or 36 months
Accelerated year-round program: Aero., Chem., Civil, Elec., Mech., Metal.; Math., Chemistry, Physics. Modest rate. Earn board. New classes start Sept., Jan., March, June. Catalog.
1670 East Washington Blvd., Fort Wayne 2, Indiana

INDIANA TECHNICAL COLLEGE



America is a Better
America —
thanks to Advertising!



Amazing New Invention FREES BOTH HANDS...lets you WORK While TELEPHONING!

Make UP TO \$147⁵⁰ AND MORE in a DAY
demonstrating Sensational New
VOICECASTER

to offices, stores, factories, homes

Make a simple 30-second demonstration, prove to business firms and homes that amazing VOICECASTER increases work efficiency, saves time and effort. Make phone call, set phone headset on VOICECASTER, carry on 2-way phone conversation from any part of room, never touching phone, both hands free! No installation; transistorized, uses low-cost 18-month battery. Business order 1 to 6 at time at only \$39.95 (plus \$1.75 for battery). You make up to \$147.50 on each. Only 10 VOICECASTERS a day pay you \$147.50 spare time or full time.

FREE Check coupon for money-making plans, sent FREE, no obligation. Or send for actual VOICECASTER with battery, on 30-day money-back guarantee. Mail coupon TODAY!

Merlite Industries, Inc. (Voicecaster Div.)
114 E. 32nd St., Dept. A-15R, New York 16, N.Y.

Merlite Industries, Inc. (Voicecaster Div.)
114 East 32nd St., Dept. A-15R, New York 16, N.Y.

\$5.00 enclosed. Rush 1 VOICECASTER with battery (\$41.70 retail value). On delivery, I'll pay \$21.95 balance plus shipping. C.O.D. fees. (Or save shipping fees by enclosing \$26.95 now). I may return VOICECASTER within 30 days for money back, if not satisfied.

Rush money-making details FREE.

Name _____

Address _____

City _____ Zone _____ State _____

earn as TAX EXPERT

\$15
HOUR

Our students earn as much as \$3,000 in 3 short months preparing income tax returns in spare time. Also operate lucrative year-round Business Tax Service Dignified home-office business. Experience unnecessary. We train you; help you start. State approved home training program. Write today for free prospectus.

UNION INSTITUTE, Lakewood 20N, N. J.

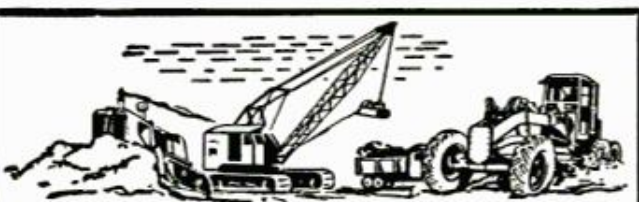

HIGH WAGES!

High wages can be yours as an Operating Engineer of heavy construction equipment! Learn NOW to operate our diesel engined bulldozers, draglines, cranes, back hoes, rubber-tired scrapers and motorgraders! Machines of major manufacturers are used in our training program. Contractors are on our advisory staff. Full courses of 220 hours for bulldozers, scrapers, motorgraders; 440 hours for cranes. We invite comparison and inspection of the nation's original construction equipment operator's training school. We are NOT a correspondence school, but a fully equipped educational institution in the beautiful Piedmont area of North Carolina where you will live while you learn. Budget plan available. VETERANS: Ask about G.I. Benefits. Booking NOW for July and August classes.

Write TODAY for FREE School Catalog,
no obligation, to

NATIONAL SCHOOL of HEAVY EQUIPMENT OPERATION

Dept. D-7 P. O. Drawer 8415, Charlotte, N. C.
Western office: P. O. Drawer 45272, Los Angeles, Cal.

UNUSUAL BARGAINS

See the Stars, Moon, Planets Close Up!
3" ASTRONOMICAL REFLECTING TELESCOPE

60 to 180 Power — Famous Mt. Palomar Type! An Unusual Buy!



Assembled—Ready to use! You'll see the Rings of Saturn, the fascinating planet Mars, huge craters on the Moon, Star Clusters, Moons of Jupiter in detail. Galaxies! Equatorial mount with lock on both axes. Aluminized and overcoated 3" diameter high-speed f/10 mirror. Telescope comes equipped with a 60X eyepiece and a mounted Barlow Lens, giving you 60 to 180 power. Low-cost accessory eyepiece available for higher powers. An Optical Finder Telescope, always so essential, is also included. Sturdy, hardwood, portable tripod. FREE

with Scope:—Valuable **STAR CHART** plus 272 page "**HANDBOOK OF HEAVENS**" plus "**HOW TO USE YOUR TELESCOPE**" BOOK.
 Stock No. 85,050-H.....\$29.95 postpaid

KNOW THE TRUTH ABOUT POWER. Telescope experts will confirm that an Astronomical Telescope will only give you practical powers to about 50 or 60 times per inch of objective diameter—powers above this only produce empty magnification — make viewing dim, difficult and unsatisfactory.

War Surplus American-Made 7x50 Binoculars

Big savings! Brand new! Crystal clear viewing — 7 power. Every optical element is coated. An excellent night glass — the size recommended for satellite viewing. Individual eye focus. Exit pupil 7mm. Approx. field at 1,000 yds. is 376 ft. Carrying case included. American 7 x 50's normally cost \$195. Our war surplus price saves you real money.
 Stock No. 1533-H.....only \$55.00 pstpd. (Tax included)



Terrific Buy! American Made! OPAQUE PROJECTOR

Projects illustrations up to 3" x 3 1/2" and enlarges them. No film or negatives needed. Projects charts, diagrams, pictures, photos, lettering in full color or black-and-white. Operates on 115 volt, A.C. current. 6-ft. extension cord and plug included, operates on 60 watt bulb, not included. Size 12" x 8" x 4 1/2" wide. Weight 1 lb., 2 oz. Plastic case with built-in handle.
 Stock No. 70,199-H.....\$7.95 Postpaid

MECHANICAL DRAWING SET

Regular Price \$18.00
 Our Price Only \$8.00 Pstpd.
 American mfr. couldn't compete with foreign imports—thus you get a terrific bargain, even far below import prices. 10 handsome pieces in velvet-lined case. Nickel plated brass—precision American-made. We guarantee you'll be satisfied or money refunded.
 Stock No. 50,200-H.....\$8.00 Postpaid

NOTICE: Edmund is now headquarters for Math Learning and Teaching Aids! See dozens of offerings in our FREE Catalog H.

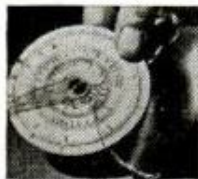

NEW! CIRCULAR SLIDE RULE!

Pocket Size—Fast—Easy to Use!
 Multiplies, divides, figures fractions, percentages, squares, cubes, roots, proportions, circumferences, areas, retail prices, fuel consumption. Faster, easier to learn and use. Directions included.
 Stock No. 30,336-H.....\$4.95 postpaid



BUILD A SOLAR ENERGY FURNACE

A fascinating new field. Build your own Solar Furnace for experimentation—many practical uses. Easy! Inexpensive! Use scrapwood! We furnish instructions. This sun powered furnace will generate terrific heat—2000° to 3000°. Fuses enamel to metal. Sets paper aflame in seconds. Use our Fresnel Lens—14" diameter...f.l. 14".
 Stock No. 70,130-H...Fresnel Lens...\$ 6.00 Pstpd.

Order by Stock No.—Send Check or M.O.—Money-Back Guarantee
EASY PAYMENT PLAN AVAILABLE! DETAILS WITH CATALOG!
EDMUND SCIENTIFIC CO., Barrington, New Jersey

MAIL COUPON for FREE CATALOG "H"

128 Pages! Over 1000 Bargains!
 EDMUND SCIENTIFIC CO., Barrington, N. J.
 Please rush Free Giant Catalog-H.

Name.....
 Address.....
 City.....Zone.....State.....



LEARN TO EARN

HIGH WAGES

AS A HEAVY EQUIPMENT OPERATOR!



Secure a high paying future in the exciting construction industry today! Learn to operate bulldozers, draglines, cranes, back hoes, scrapers and motor graders on our actual construction projects!

● ONLY CONTRACTOR OWNED AND OPERATED SCHOOL IN WORLD ● ASSOCIATE MEMBER ASSOCIATED GENERAL CONTRACTORS ● MODERN EQUIPMENT ● V. A. APPROVED FOR G. I. TRAINING ● BUDGET PAY PLAN AVAILABLE

WESTERN NATIONAL
 SCHOOL OF HEAVY EQUIPMENT OPERATION

WRITE TODAY FOR FREE SCHOOL CATALOG

DEPT. B-6 BOX 510
 WEISER, IDAHO PHONE 910



SIGN PAINTING

Home-Study Course — Only \$5.95

Teaches you commercial sign painting and sign building as it is being done TODAY in leading shops all over the country. Complete practical course for self-instruction. Shows latest methods of truck lettering, office doors, wood letters, reflecting signs, plastics, sprayed signs, gold leaf, silk screen process, up-to-date alphabets, money-making business information, etc.

SATISFACTION GUARANTEED OR REFUND!
 Contains all the instruction of a high-priced correspondence course. Full price, only \$5.95, postpaid. Or C.O.D. plus postage. No risk—order today. Satisfaction or money back! Order "Sign Painting Course," NELSON-HALL CO., 210 S. Clinton St., Dept. 2GP-2, Chicago 6, Ill.



GET INTO ELECTRONICS

V.T.I. training leads to success as technicians, field engineers, specialists in communications, guided missiles, computers, radar, automation, Basic & advanced courses in theory & laboratory. Assoc. degree in 29 mos. B.S. obtainable. ECPD accredited. G.I. approved. Graduates with major companies. Start Sept., Feb. Dorms, campus. H. S. graduate or equivalent. Catalog.
VALPARAISO TECHNICAL INSTITUTE
 DEPT. D VALPARAISO, INDIANA

KILLS MOSQUITOS / MOTHS / MILLERS / FLIES / GNATS / FISH FLIES / ETC.

USES NO CHEMICALS, GASES, ETC.
 No insect recovery. Harmless. Guaranteed. Built to last 25 years. Beautiful outdoor lighting. Plug into any 110 volt socket. Very reasonably priced...
NO AREA CONTAMINATION
 Uses up to 200 watt bulb. Grid costs 10¢ per month. Complete with fly attractor. Dead insect catcher, write to SING SING BUG CHAIR, INC. BOX P 3708 / OAK PARK 37, MICH.



GIANT 30 Ft. \$2



Inflate to Giant 20 to 30 ft. diameter with air or Gas. Flying Advt. visible for miles. Terrific for attracting crowds at Openings, Fairs, Roadside Stands, Gas Stations, Sports Events. Used as Water Markers and Buoys. Made of genuine Neoprene Rubber for extra durability. Never Used. Orig. cost U.S. Govt. \$20.00. Limited quantity. Special offer only \$2.00 each plus 50c each postage & handling charge (5 for \$10.00) complete. 6 ft. size 59¢ ea. (2 for \$1.00). 10 ft. size \$1.00 ea. (6 for \$5.00). No C.O.D.'s.
 33 2nd Ave., Dept. G-3225
 New York 3, New York

NOVEL MFG.



CLASSIFIED ADVERTISEMENTS



Advertisements in this section \$1.30 per word, each insertion, minimum 10 words, payable in advance.

To be inserted under proper classification, copy must be in our office the

18th of the second month preceding date of issue

F. W. Johnson, Manager, Classified Advertising

Popular Mechanics Magazine, 200 East Ontario Street, Chicago 11, Illinois

YOU'LL PROFIT

By reading and answering the classified ads in this section. Hundreds of opportunities for you to make and save money

AUTOMOBILES. MIDGET CARS

GO Karts, parts, accessories, kits, complete catalogue 25¢. Tegthof, Box 168, Highland, Illinois.

NON-PROFIT Organization offers automobile literature—old, modern, foreign; dealer books, service manuals, glossy photographs; free motor magazines. Write immediately, get on free mailing list. Auto Maniacs A, Box 451, Mt. Clemens, Mich.

HOTTSPARK. Starting, pep mileage. Varytper, multilith, mimeograph, \$195.00. EG, Elmsford, N. Y.

GO-KART Tire recapping molds. Electric. Make \$75.00 a day. Complete information & prices. 50¢ refundable. Independent Industries, 7000 Hillwood Road, Little Rock, Ark.

39 DIFFERENT Automobile advertisements 1900-1905. 36-page lithograph book. \$1.00. Next book 1906-1912. Order now. Highlands Historical Press, 4726 Cherokee Trail, Dallas 9, Texas.

AUTOMOBILES. Get maximum discounts. Learn "How to Buy." Method highly endorsed. Complete instructions \$2.00 (guaranteed). Details 10¢. Auto-reports, Box 15, Tonawanda, N. Y.

FIBERGLASS Sportscar bodies, tops, competition parts, accessories. Large illustrated catalog: \$1.00 (refundable). Evans Industries, 1276 E. Colorado, Pasadena 11, California.

HISTORICAL Record of 1960 U.S. and foreign cars, fully illustrated. Detailed specifications on all models. 160-page "Car Facts Book, 1960," \$1.00. Service Bureau, Room 517C, Popular Mechanics, 200 E. Ontario, Chicago 11, Ill.

BATTERY-Powered electric car plans. \$1.00. Magnuson Co., Box 15003, San Diego 15, Calif.

HOT Rod racing book reports 1959 races, trials, drags. Expert advice on hopping up engines, tuning the stock Corvette, supercharger selection. Send 75¢ (85¢ in Canada) to Service Bureau, Room 517D, Popular Mechanics, 200 E. Ontario, Chicago 11, Ill.

GO-KART Parts and supplies. Complete information 25¢ to cover postage. Rocky, Galveston, Indiana.

HOTRODDER Racer kits, \$14.95 less motor. Literature 10¢. Horsham Midgets, B-103, Horsham, Penna.

AUTO SUPPLIES AND EQUIPMENT

OUR Portable dual controls will turn your car into a profitable driving school. Same controls we sell high schools. Designed for Fords, Chevrolets, Plymouths from 1957 to date. Automatic transmissions, \$25; standard, \$30. Portable Dual Controls, 1701 Balmoral, Detroit 3, Mich.

PROTECT Eyes. \$1.50 sends windshield glare shields prepaid. Perma-seal Service, Elkhorn 7, Wisconsin

JUST Out! New 388-page, illustrated catalog offering savings up to 50% on over 100,000 auto parts and accessories, many hard to get. All makes (1920 to 1960 models), trucks, foreign and sports cars. Also Hollywood accessories, custom styling, hi-speed equipment. Send 25¢ for postage, packing—refundable on first order. Whitney, 1919 PM-7 Archer, Chicago 16, Ill.

GREATEST Auto parts catalog. Thousands racing and restyling accessories for all cars. Only 25¢ (refundable). Newhouse Automotive Industries, 5805-PM7, Beverly, Los Angeles 22, Calif.

STOP Noisy valves, increased power, compression, speed, mileage. Save oil, parts. Informative literature free. Micro-Moly Products, Garrison 1, Kentucky.

FREE Literature! National club for small and compact cars. Sac, 1717 Walnut, Philadelphia 3, Penna.

SPARK Plug conditioner. Unique tool—cleans, regaps points and plugs. Complete including instructions, clearance chart. \$1.00 postpaid. Money back guarantee. C & R Mailers, Box 306-E, Roslyn Heights, N. Y.

JEEP Owners—V8 conversions. Read Jeep Owners ad, page 25.

AUTO Shop welding repair training in world's largest non-profit welding school. Low tuition. Free booklet. Hobart Welders, Box M-701, Troy, Ohio.

RING-Valve job while driving, \$6.00 postpaid. Guaranteed! Nothing like it! Lasts 100,000 miles. Motaloy, Grantham, Penna.

PARTS, Model "A." List 25¢ (refundable). Matco, Box 135, San Pedro, Calif.

PUNCTURE Proof your tires. Seals nail punctures, slow leaks, rim leaks. Easy to do. Certified safe product. 2 tires \$5.00, 4 tires \$8.50. B. L. Marr, 9128 Commercial Ave., 2nd Fl., Chicago 17, Ill.

1909-1934 FORD Parts. Illustrated catalogue 50¢. Mark Auto, Layton, N. J.

ACCURATELY Calibrated charts tell you speed all race cars all tracks. Only \$1.00. Wallet size. Time-M.P.H. Charts, 628 Diamond, San Diego 9, California.

A.C., "Autolite," "Champion" spark-plugs. Perfect, renewed, guaranteed 10,000 miles like factory. 200 sparkplugs 20¢ each. Sample ten, \$2.95. Henfinkle, 130 West 42nd Street, New York 36, N. Y.

NEW And used parts at savings. Complete guaranteed parts service for all models cars and trucks. 1924 and later. Largest in the West. Jeep and army parts specialists. Newest type shifting hubs for all jeep and all military and latest production front end drive vehicles. \$27.50 and up. Also, foreign car parts. Write, Pioneer Auto and Truck Parts Co., 734 W. 13th Avenue, Denver 17, Colo.

FREE! New catalog. Speed, power, mileage increasing equipment. Discounts! Almqvist Engineering, Milford PM5, Penna.

DO-It-yourself mechanics. New Sand-master tool efficiently sandblasts spark-plugs. Price \$2.00. Edco Service, 37 Elmer Ave., Buffalo 15, N. Y.

JEEP Parts! For military and civilian. At great savings. Largest inventory. Catalog for owners and dealers. Inquiries invited. American Auto Parts Co., 1830-PM Locust, Kansas City, Mo.

HYDRAULIC Jack repair kits. Free catalog. Hydraulic Parts Supply, Box 4104, El Paso, Texas.

AUTO TRAILERS

TRAVEL Trailers, camping trailers, also plans, tent top, running gear, etc. Tents galore! Boats, finished-unfinished. Camping equipment! Finest selection! Lowest prices! 25¢ for 1960 catalog. Easy Camping, Inc., 128 Chicago, Evanston 1, Ill.

CAMPING Travel trailer blueprints. Booklet 25¢. Kamcraft, Box 1153, Milwaukee 1, Wisconsin.

FIVE City street maps \$3.00; 60 vacation guides \$1.95. Individual map services \$1.00. Bayer Publications, 938L Betty Avenue, Neenah, Wisconsin.

PICKUP Coach blueprints. Kits. Literature 10¢. Comstock Trailers, Parsons, Kansas.

BUILD A folding tent-trailer, ideal for low-budget family camping. New booklet contains plans for two single-axle campers. One unfolds endways from 10 x 7 x 2 box, sleeps four in two full-size beds, plus two on air mattresses on floor. The other sleeps four, unfolds sideways from 8 x 6 x 2½ box. Send 35¢ for Booklet 200 to Service Bureau, Room 517B, Popular Mechanics, 200 E. Ontario, Chicago 11, Ill.

BUILD Expanding eight foot trailer. Accommodates five. Literature 10¢. Framar Company, Wilmington, Mass.

MOTORCYCLES, BICYCLES, MOTORSCOOTERS AND SUPPLIES

WHIZZER Motorbike \$15, Childs gasoline car \$15, Go cart \$35, Cushman \$35, Villiers engine \$5, Outboard motor \$6. Mailorder only. Send 25¢ (35¢ for first class mailing) for 32-page Directory-Catalogue Number 96 listing these and hundreds of other bargains in midget cars, motorscooters, homebuilders parts, plans, etc. Midget Motors Directory, Athens, Ohio.

MOTORCYCLE Parts. New, used. List 25¢. Ballak, 811 N. 9th, St. Louis 1, Mo.

RECONDITIONED Motorcycle motors, Chrome accessories. Complete stock Indian parts. Expert rebuilding. Fast service. Indian Motorcycle Sales, Kansas City 27, Missouri.

DISMANTLING, Harleys all since 1930 including racers, Indians, Triumphs, others. Save, tell us your needs. Les Myers, factory dealer since 1926, 813 Ohio, Wichita Falls, Texas.

HARLEY-Davidsons — Used bargains. New, used parts, accessories, all models. Bulletin 25¢. Knuth's (Factory Dealer), 1753 Muskego, Milwaukee, Wis.

AVIATION

LIGHTPLANE Glider circulars illustrated 25¢. Kamcraft, Box 1153, Milwaukee 1, Wis.

GROUND-Air travel revolution. Aviation's unlimited opportunity! Read "An Airplane in Every Garage." \$4.50. Plane-Mobile, Dept. 20, 14273 Beaver St., San Fernando, Calif.

PROPELLERS, Plans, supplies for airboats and snowplanes. Latest designs, prompt delivery. Catalog 25¢. Banks-Maxwell, Box 3301E, Ft. Worth 5, Texas.

BUY Gov't surplus: Aircrafts; engines; helicopters; boats; Jeeps; misc. Buy direct now from gov't. Send for "Depot Directory & Procedure" \$1.00. Gov't Surplus Sales, Box 425-PM, Nanuet, New York.

ELECTRICAL SUPPLIES

ELECTRO-Probe safely tests any 110-550 volts AC, DC source. \$1.00. Hahn, Box 64532, Los Angeles 64.

CONDUIT Bending guide and bending tractor. \$1.90. Pal-Notes, Underwood, N. D.

FUEL Cell Handbook. Send \$2.00. Gates, 1218 Blackfield, Santa Clara, California.

APPLIANCE And lamp parts wholesale. Two completely illustrated catalogues 25¢. Seco, 26 South 20th Street, Birmingham 3, Alabama.

TRAVEL-Iron 1½ lbs., chrome plated, handle folds, \$3.98 postpaid. Wingfield Company, Dept. PM, Box 2404, Memphis 2, Tenn.

LAMP, Electrical parts, wholesale. Thousands of items for repairing, converting. Catalog 25¢. Brown Lamp, Box 305, Clayton 5, Mo.

LAMPS, 25¢ Brings parts catalog. Refunded first order. Gyro, 5208P N.W. 35th Ave., Miami 42, Florida.

REFRIGERATION AIR CONDITIONING

STOP Dripping and excess freezing. Prevent major repairs. The primary cause for defective operation is a worn or damaged refrigerator door gasket. Easy to install. Send make and model number to: Jacoby Refrigerator Gasket Co. of N. Y., 3312A Paulding Avenue, New York 69, N. Y.

WELDING, SOLDERING, PLATING

PLATING Equipment, supplies. Complete line of anodes, solutions. Home workshops, industrial sizes. Hollywood Bronze Supply, Dept. C, 1624 East First, Los Angeles 33, California.

FREE Catalog, welders, welder kits. Build 350-ampere welder using aircraft generator, plans 25¢. Dunbar Manufacturing, Minneapolis 8, Minnesota.

WELDERS, 110/220, \$39.50. Morris, 1070 Inner Drive, Schenectady 3, New York.

BUILD Or buy efficient inexpensive 350 ampere welder. Guaranteed plans 25¢. Free welder kit catalog. LeJay Manufacturing, Minneapolis, Minnesota.

ACETYLENE Welding outfits—arcwelders. Dealership open. Eagle Welding, Dept. PM, 5085 Broadway, Chicago 40, Ill.

MACHINERY, TOOLS, SUPPLIES

FREE New catalog showing only complete line of work holding tools available anywhere. Drill press vises, angle and swivel machine vises, rotary tables, production and heavy duty angle vises. 68 different models, fully described with prices. Palmgren Products Co., 8365 South Chicago Ave., Chicago 17, Illinois.

CEMENT Mixer \$29.95. Tools, electrical supplies, pumps, air compressors, fan kits. Big 3000 item catalog 50¢ returned first order. Reynolds Company, Sharon, Massachusetts.

SHEET Metal brakes: 36", \$45.00. Also 49", 61". Bench shears. Free catalog. Vyke Co., P4158 Jason, Denver 11, Colo.

SURVEYING INSTRUMENTS

NEW And guaranteed factory rebuilt transits and levels, sale or rent, with purchase option. We will repair, trade or buy old instruments. Write for list M-70. Warren-Knight Co. (Manufacturers of Surveying Instruments), 136 N. 12th St., Philadelphia 7, Penna.

ENGINES, MOTORS, DYNAMOS

REWIND Motors yourself. Complete instructions, \$1.00. Lewis Manufacturing, Howell, Michigan.

MOTOR Rewinding data, diagrams, supplies. Catalog. Modern, Box 8715, Kansas City 14, Mo.

DIESEL Injector parts and fuel pumps wanted. GM51-53-71-110. Bares, 7120 Carnegie, Cleveland 3, Ohio.

WINDING Data. 275 motors, single and three phase \$1.10. Data Company, 512 Kensington, Kansas City 24, Mo.

BOATS, OUTBOARD MOTORS

MARINE Conversions. Ford, Chevrolet, Jeep engines. Catalog 25¢. Lehman Manufacturing Company, 800 Elizabeth Avenue, Linden 4, N. J.

NEW, Used, rebuilt marine motors. Marine conversions, fittings. Free catalog. Stokes Marine Supply, Dept. 24, Coldwater, Michigan.

SAVE Money. New, used outboard motor parts. Send wants. Stamp appreciated. Outboard Motor Mart, 229-M State, Boston 9, Mass.

FRAME Kits, plans or full-size patterns for 35 inboards and outboards. Prepared for amateur builders. New 80 page illustrative catalog, 50¢. Glen Designs, 9152 Rosecrans, Bellflower, Calif.

I Want to send you proof of the wonderful pulling power of Popular Mechanics classified pages. What's your proposition? Write me today. Include literature if possible. F. W. Johnson, Manager Classified Advertising, Popular Mechanics Magazine, 200 E. Ontario St., Chicago 11, Ill.

PROPELLERS, Plans, supplies for airboats, snowplanes. Catalog 25¢. Banks-Maxwell, Box 3301F, Ft. Worth 5, Texas.

MARINE Conversions, Willys to Cadillac, kits and parts. Catalog and conversion hints free. Barr Marine, 2706A Castor Avenue, Philadelphia 34, Penna.

ALUMINUM Boat kits, easily assembled. Perfect car-topper for the sportsman. Send 10¢ for literature. Alumakit Co., 135 Shetland Industrial Park, Salem, Mass.

\$150 BUILDS Lakeboat. Complete plans \$2. Additional information 10¢. Rebel, Box 19, Smyrna, Ga.

FIBERGLAS Boat covering. Wholesale prices. Free literature and samples. Seifert's, Box 31M, DePere, Wis.

FULL Size, cut-to-shape boat patterns, blueprints, 7½-38 feet. Big new 88 pg. illustrated "Build a Boat" catalog of naval architect-designed Catamarans, cruisers, runabouts, skiffs, outboard boats, sailing, racing, houseboats. 50¢. "How to Build a Boat" booklet \$2.50. Cleveland Boat Blueprint Co., Dept. A-66, Box 1651, Cleveland, Ohio.

FIBERGLAS Permanent boat waterproofing. Special 25% discount. Complete kits, \$9.45 up. Guaranteed materials. Easy application. Full instructions. Free literature. Mail post card. Ajax Plastics, P. O. Box 1323, Fort Worth, Texas.

BRADLEY Water sled has steering control. Literature free. Merryman Distributor's, Formosa, Ark.

260 POWERBOAT Plans, patterns. Catalogs \$1.00. Sailboat catalog 25¢. Trailer kits \$69.50. Marinecraft, Box 161-M, Brighton, Mass.

ATHLETIC EQUIPMENT, BODY BUILDING COURSES

BARBELLS, Dumbbells. Courses. Booklet 10¢. Good Barbell Co., Siloam Springs, Arkansas.

OUTSTANDING Physical development! Any age. New guaranteed discovery uses only a rope! Strength, health, muscles. Gain—reduce. Free booklet. Ropercole, 4834 Art, San Diego 15, California.

"BIG Muscles. The Quick Way." Dr. Young's revolutionary discovery. Free information. Gaucho, Box 9309-S7, Chicago 90.

FREE Muscle building information. Body-Tone, Box 638B, North Miami, Florida.

SPORTING GOODS, GUNS, FISHING TACKLE, ARCHERY, TRAPPING

NOBODY Undersells Klein's! Send 25¢ for 144 page all-sports bargain catalog. Rush! Klein's, Chicago 6, Illinois.

SKIN Divers! Build your own underwater sea sled. Inexpensive to build and operate. Power driven—5 mph. Plans \$2. H&R Industries, Box 147, New Milford, Connecticut.

MOLDS For fisherman's sinkers, jigs, squids, casting and spinning lures. Free catalog. Sweet's Molds, Tonawanda 1, New York.

MOLDS—For casting your own fishing sinkers. Free illustrated booklet. Reading Instrument Co., Box PM78, Reading, Penna.

BIG Money raising crickets and 12 inch African fishworms. Free literature. Carter Ranch, Plains, Georgia.

FREE—Wholesale catalog. Beads. Spinners. Lure parts. Sinker molds. Jigs. Reels. Finnyports (ME), Toledo 6, Ohio.

AMAZING Wholesale sporting catalog. Save 70%. Tremendous selections. Econ-O-Mart, Whippany 2, New Jersey.

KILL Submersed water weeds which foul up motor propellers, tangle fishing gear, with R-H Weed Rhap-20, Granular 2.4-D. Inexpensive, easy to use, sure results. For free information write Reasor-Hill Corporation, Box 36PM, Jacksonville, Arkansas.

5000 GUNS, Swords, war relics. Catalog 50¢. Smith Firearms, Rummene, N. J.

JAP Rifle altering to 30-06, \$6.00. Jap-shells, \$3.95. Catalog 10¢. T. P. Shop, West Branch 11, Mich.

GUARANTEED Best weedless lures made. Write for catalog. Weedless Bait Company, Atkin, Minnesota.

NEW! Fishing barometer tells you if the fish will bite. Only 25¢. Clapper, 15 Webster Ave., West Springfield, Mass.

12 SPINNING Lures. None better, \$11.00 value. All different. Send \$3.00. Quaker, 438 Sedgley, Philadelphia 40, Penna.

RG-10 .22 CALIBRE Revolver. Imported from Germany. Brand new. \$13.95. Not a blank pistol. Import Associates Co., 2639 West Peterson Ave., Chicago 45.

MINNOW Graders. Free circular. Crescent Mfg., Box 3303, Ft. Worth, Texas.

CAMPING EQUIPMENT AND TENTS

CAMPING Equipment, tents, world's largest selection. Send 25¢ for new 160 page catalogue—handbook—camp site directory. (Print name, address). Morsan Tents, 10-21R 50th Ave., Long Island City 1, New York.

NORSE King hunting knife \$2.95. Havmor Mail, 100 Lefferts Ave., Brooklyn 25, N. Y.

EARTHWORMS, CRICKETS, FROGS

FAT Red worms 1000—\$3. 2000—\$5. 5000—\$11. Postpaid with raising instructions. Live delivery guaranteed. Worm Gardens, 324 David Drive, Waco, Texas.

WANTED, Men, women worm raisers. Sherwood, Dept. D-2A, Monmouth, Maine.

LARGE Red wigglers 5,000—\$16.50 postpaid. Bass Farm, Leslie, Georgia.

FANTASTIC Profits raising hybrid redworms. Complete information, covers all essentials of earthworm raising: bedding, feeding, pest control, etc., free to customers. Breeders 1,000, \$3.50; 5000, \$15.95. Bedruns 10,000, \$16.85, postpaid. Free literature. Satisfaction guaranteed. Georgia Worm Farms, Dawson, Georgia.

CRICKETS. 1000, \$7.50; 200, \$3.00. Walker's Cricket Ranch, Box #2, (Dept. M), North Little Rock, Ark.

AFRICAN Nightcrawler, 100—\$2.00, 500—\$7.00 (Dealers quoted). Ozark Worm Farm-J, Willow Springs, Missouri.

BIG Money raising fishworms and crickets. We teach you how to raise and where to sell. Free literature. Medium redworms, 3000, \$5.95; 10,000, \$16.95. Carter Redworms, Plains, Georgia.

FREE Picture folder, "How to Make \$3,000 Yearly, Sparetime, Backyard, Raising Earthworms!" Oakhaven-56, Cedar Hill, Texas.

OUR Famous Rocky Mountain hybrid worms. Mixed sizes. 10,000—\$19.95 postpaid. Dewey's Worm Ranch, Henderson, Colo.

RAISE Fishworms and rabbits on \$500 month plan. Free details. White's Rabbitry, Mt. Vernon, Ohio.

BINOCULARS, TELESCOPES, MICROSCOPES, MAGNIFIERS

FREE Booklet plus discount catalog. Microscopes, telescopes, binoculars. Craig's, 2705 Meadowview, Columbus 2, Georgia.

BINOCULARS, Telescopes, microscopes. Terrific values—\$3.98 up! Request free money-saving catalogue. Criterion, Dept. P-92, Hartford 1, Conn.

TELESCOPE Kits—Direct from manufacturer. Other optical hobby kits. Large selection. Free booklet. Esco Products, Oakridge, N. J.

DYNASCOPE. Amazing world-famous reflector telescope. Request free brochure. Criterion, Dept. DP-69, Hartford 1, Conn.

AMAZING Prices binoculars telescopes. Folder, "Binocular Selecting," catalog free. Prentiss Importers, Mercury Bldg., West Los Angeles 25, Calif.

REFLECTING Telescope, 60X, completely assembled. Guaranteed observatory clearness. Free information. Skyscope, P.O. Box 55, Brooklyn 28, N. Y.

WAR Surplus bargains: Millions of lenses, instruments, telescopes, binoculars, components and complete line of astronomical telescope items. World's greatest optical market-place! Send only \$1.00 for beginner's 10-lens kit and big instruction booklet Stock 2-CH. Write for Catalog CH free! Edmund Scientific Co., Barrington, New Jersey.

BINOCULARS, Telescopes, microscopes. Free catalog. National Optical Company, 505 New York Avenue, Union City, New Jersey.

BARGAINS, Binoculars, telescopes, microscopes. Free catalog. Adventure Sales, Box 2133, San Diego 12, California.

TELESCOPES, Binoculars, all sizes. Complete telescope makers supplies. Free catalog. Suffolk Science, Mattituck, New York.

BUILD Your own reflector telescopes. Complete kits: Mirrors, eyepieces, tripods, all other accessories. Request free illustrated literature. Criterion Manufacturing, Dept. DPM-66, Hartford 1, Conn.

PLANTS, SEEDS, BULBS, NURSERY SUPPLIES

FREE Color folder tells how to grow orchids in your own home. Gives complete details—from "world's largest grower of orchids for the home." Rod McLellan Co., 1462 El Camino, South San Francisco, California.

ORCHIDS: 50 Different named \$30.00. J. N. Bros, Kalimpong, India.

GROW Dwarf trees. Instructions and seeds, 35¢. Mail Order Specialties, 1439-H Sabraton Ave., Morgantown, W. Va.

GARDEN EQUIPMENT & SUPPLIES

REPAIR Your own lawn mower. Our instruction brochure shows how to eliminate 85% of all engine troubles with minor adjustments. Also, blade balancing. Lawn Care Company, 140P E. Cerro Gordo, Decatur, Illinois.

SHARPEN Your own lawn mower blade with a patented balancer. Easy to use. Fits any rotary mower blade, preventing vibration of engine and insuring better grass cutting. \$2.00 ppd. Lawn Care Company, 140 E. Cerro Gordo, Decatur, Illinois.

PETS—DOGS, BIRDS, RABBITS, HAMSTERS, ETC.

HORNED Toads \$1.00 postpaid. Racing homing pigeons \$10.00 pair. Express collect. Spears, Rt. 1, Clyde, Texas.

REGISTERED German Shepherd puppies. Father son of Rin-Tin-Tin. Lookout Kennels, Jacksonville, Texas.

EARN \$10,000 Yearly raising Angora rabbit wool for us. Information 25¢ coin. American Angora Company, Malta 12, Montana.

GOLDEN Hamsters—Pedigreed breeders \$3.85 pair. Albinos Whitebands. Literature. Moore's Hamster Ranch, Shepherdstown 25, West Virginia.

MAKE Money raising chinchillas, mink, rabbits, cavy for us. Free catalog. Keeney Brothers, New Freedom 2, Penna.

RAISE Rabbits on \$500 month plan. Free details. White's Rabbitry, Mt. Vernon, Ohio.

HAMSTERS—Ideal pets, \$2.95 pair. Free booklet. Jer-ire's Hamstery, 1447 Apple. Muskegon 13, Michigan.

SKUNKS, Reptiles, hawks, raccoons. Illustrated catalogue, 25¢. Trails End Co., St. Stephen, S. C.

RAISE Rabbits successfully by knowing facts. 48 page illustrated book describing 25 breeds. Housing, feeding, breeding, marketing, etc. Plus bulletin. 25 cents. American Rabbit Association, 36 Arba Building, Pittsburgh, Penna.

FARMS, FARM LANDS, REAL ESTATE

FLORIDA. Nice homesites, \$345 at \$10 monthly. Folder free. Howard Vernor, DeLand, Florida.

700 ACRES! Stocked! Equipt! 20 cows and calves, 5 milk cows, 2 sows, poultry flock, tractor, rake, mower, wagon included for \$20,850! Modern 5-room house. 48-ft. barn, good poultry house, fruit cellar, smokehouse. Back in scenic Ozark hills amid friendly neighbors. Fine deer hunting area, only 5 miles Bull Shoals. 625 acres mostly-wooded pasture, 5 ponds, 2 strong springs, 14 acres alfalfa, 75 tillable. Own a big piece of Missouri for \$20,850 complete, \$6,500 down. Free 160-page summer catalog, 950 photos, bargains coast to coast! United Farm Agency, 2825-PM Main St., Kansas City 41, Mo.

FREE Farm list with actual photos. Owensby, Realtor, Buffalo, Missouri.

CANADIAN Vacation lands. Full price \$285.00, 40 acres, \$10.00 month. Suitable cottage sites, hunting, fishing, investment. Free information. Land Corporation, 130C Shaftesbury, Downsview, Ontario, Canada.

ARMSTRONG'S, Shook, Missouri. Sell Ozark lands. Write them. Listings mailed free, quarterly.

FREE Strout catalog! Farms, homes, businesses, resorts, retirement properties. Over 3000 values in 36 states, 58 years' service. World's largest! Write Strout Realty, 7-MF S. Dearborn, Chicago 3, Ill.

FLORIDA—Silver Springs area. ¼ acre waterfront homesites. \$795.00, \$10.00 month. Free color photos. Write: Smith Lake Estates, Box 5681, Belleview, Florida.

FLORIDA 5 Acres full price \$695—\$10 month no interest. Send \$1 for contract and full information on this amazing tropical Collier County land offer. You must be convinced this best land bargain in Florida or deposit promptly refunded. Webb Realty Corporation, 639 NW 102 St., Miami 50, Florida. AD59021(c)(7).

FIFTY Beautiful lakes in the longleaf pines on Carolina coast near Wilmington. Ideal climate. Best fishing, hunting, swimming, boating. 25 square miles private recreation area. Special sections trailers, campers. Low living costs. Special introductory offer—only \$350 for large, level, high, dry, shady homesite, 70x150. \$5.00 down, \$5.00 monthly. No interest. Free literature. Charles Pratt, Fifty Lakes, Southport 1, N. C.

FARM MACHINERY AND SUPPLIES

ELECTRIC Welders. New, heavy-duty, 180 amp. Free trial. Dealerships open. 20 year warranty. 8159 South Pleasant Department A1. Minneapolis 20, Minn.

FUR BEARING ANIMALS

MINK Raising information free. Complete. Lake Superior Mink Farm, Superior, EE1, Wisconsin.

PROFITABLE OCCUPATIONS

MAKE Money making new greaseless doughnuts in kitchen. Sell stores. Free recipes. Michael, 3605 South 15th, Minneapolis 7, Minnesota.

BECOME Independent with your own franchise business. Thousands earning handsome incomes. Request interesting facts today. National Franchise Reports, PM-528, 333 North Michigan, Chicago 1.

BIG Money raising fishworms and crickets. Free literature. Carter Wormery, Plains, Georgia.

VENDING Machines. No selling. Operate a route of coin machines and earn amazing profits. 32-page catalogue free. Parkway Machine Corporation, Dept. #25, 715 Ensor Street, Baltimore 2, Maryland.

GROW Mushrooms. Cellar, shed and outdoors. Spare, full time, year round. We pay \$4.50 lb. dried. We have 29,000 customers. Free book. Mushrooms, Dept. 99, 2954 Admiral Way, Seattle, Wash.

SHARPEN Scissors, pinkers. Inexpensive machine. Clipper sharpener. Black-hawks, Sheldahl, Iowa.

BIG Money raising fishworms. Free details. Rabiro, Fox 2, Arkansas.

FREE Book "990 Successful, Little-Known Businesses." Work home! Plymouth-7G, Brooklyn 4, New York.

REALISTIC Plastic flowers. Postpaid. Free list. Meridian Imports, Hollydale, California.

START A magazine subscription business. Earn generous commissions on Popular Mechanics, Good Housekeeping and all others. Best commissions, bonus, all materials sent free. No experience needed. Write Popular Mechanics, Room 7-P, 250 West 55th St., New York 19, N. Y.

WHOLESALE Magazine subscriptions. Highest commissions. Bonus. Qualified Agencies, 451NA Kingston, Brooklyn 25, N. Y.

MONEY, Money, no work. I.Q. cards set \$1.00. Free instructions. Cards Co. (Dept. P21), 9655—107a Ave., Edmonton, Alta., Can.

BOOKS, PERIODICALS, PICTURES, POSTCARDS

BOOKS Located. Any subject. Book Mark, Box 68A, Mt. Clemens, Mich.

BOOKFINDING Our specialty. Try us. Babcock, 412 Lulu, Wichita 11, Kansas.

OUT-Of-print books at lowest prices! You name it, we find it! Fast service. No obligation. International Bookfinders, Box 3003-PM, Beverly Hills, Calif.

BRITISH Book bargains—Any subject. Catalogues free. Transatbooks, Wantagh, N. Y.

FREE Catalog. Self-help books. Write: Wilshire, 8721 Sunset, Los Angeles 46P.

BOOKFINDERS! All subjects. Send wants! Jaher Book Service, 183 Hazelwood Drive, Westbury, N. Y.

SCIENCE-Fiction book bargains. List free. Werewolf Bookshop, Verona, Penna.

GAMES, TOYS, NOVELTIES

ELECTRIC Baseball game \$6.95. Write for free list games and toys. M. S. Hardware, 1454 S. Newkirk St., Philadelphia, Penna.

FASCINATING Card games. Political Assassins@; \$2.50 ppd; Math@ \$1.50 ppd. Send check. Badler, 2063 East 18th Street, Brooklyn 29, N. Y. Money back guarantee, or write for circular.

MAGIC TRICKS, PUZZLES, JOKER NOVELTIES

TERRIFIC Telephone trick. Instructions 25¢. Shelly Publications, P.O. Box 201, Brightwaters, New York.

FUN With magic! Huge catalog 544 pages \$2.00. Terrific \$2.50 vanishing coin \$1.00. Lou Tannen, 120 West 42nd Street, New York 36, N. Y.

BE A magician! Large professional catalog of latest tricks, 35¢. Ireland, C-109 North Dearborn, Chicago 2, Illinois.

3100 NOVELTIES, Jokes, tricks, gadgets, funmakers, hobbies. Big catalog 10¢. Johnson-Smith, D-498, Detroit 7.

WORLD'S Finest professional magic. Joker novelties. Giant illustrated catalog 10¢. Top Hat, Evanston 12, Illinois.

CATALOG, Free trick, 25¢. (1,500,399 tricks, jokes). Magico, Box 4373-P, San Antonio 7, Texas.

3000 TRICKS, Pocket, parlor, stage. World's finest magic catalog (408 pages), \$2.50. Kanter's, M-1311 Walnut, Philadelphia 7.

500 TRICKS, Famous Douglas 120 page catalog number 33 now available. Complete catalog-magic tricks-equipment just 10¢. World's fastest service. Magicland, Dept. 14, Box 274, Dallas, Texas.

LOOK! 1000 World's greatest tricks, jokes, magic! Big 160 page professional magic catalog with free trick, 10¢. House of 1000 Mysteries, Dept. PM7C, Trumbull, Conn.

GET 12 For \$1. Rabbit feet. Attractive colors. Excellent party gift. Brand, 154 W. 27th, New York 1, N. Y.

COINS, TOKENS, CURRENCY

GET Profit and pleasure in collecting old coins. Send 25¢ for 68-page illustrated coin catalog. You'll be delighted with it. Send for it now. B. Max Mehl, Box 750-B, Costa Mesa, Calif. Oldest rare coin establishment in U.S. Established 59 years.

NEW 1961 Giant U. S. coin catalogue 25¢. Ace, 107 N. Dearborn, Chicago 2.

INDIAN Head cents, two different only 15¢. Approvals. Littleton Coin Company, Littleton R1, New Hampshire.

1959P, 1960P Cents per roll \$1.75. Gold's, Center City Station, Phila. 3, Penna.

OLD Money wanted. Will pay \$5,000.00 for nickel of 1913 with Liberty head (not buffalo). We pay cash premiums for all rare coins. Send 5¢ for large coin folder. May mean much profit to you. Numismatic Co., Box 750-A, Costa Mesa, Calif.

LINCOLNS, 45 Different 1909-1934 album, uncirculated Lincoln and price lists, \$5.00. Moneyback guarantee. DeWolf, 213 So. Tremont, Oceanside, California.

LINCOLNS, 1915D, 1916SD, 1917SD, 1918SD, 1919SD, all \$1.00 postpaid. United, 348 Grotto, Providence, R. I.

TRADE Your surplus coins for stamps, or your stamps for coins. Send what you have for what you want. Coin Shop, Box 2006, Salem, Oregon.

LINCOLN Cents 1924-S, 1921-S, 1916-S-D, 1927-S-D, 1928-S-D, 1920-S-D, 1909-P, 1925-S-D, 1938-S-D, 1930-S-D, 1955-S, 1917-S-D, 1918-S-D, 1919-S-D, 1929-S-D, 1931-P. Good to fine complete lot \$3.50. Rolls of 1955-S Lincoln cents fine to A.V. \$3.50 per roll. Berry, Box 306, Westminster, Calif.

FREE Indianhead cent. Monthly bargain lists 10¢. Richer, Box 9017, Schenectady 1, New York.

SIX Different Indian cents \$1.00. Free list. Collector's Bargains, New Hope, Penna.

UNCIRCULATED Mexican silver \$5.00 coin, \$1.00. Stewart, 3316-P Hamilton, El Paso, Texas.

1960 PROOF Set \$3.95; Canada proof-like \$4.50. Official Alaska, Hawaii medals—each \$4.50. Your name in gold on 1961 Guidebook \$2.25; Canadian \$2.00; World Coins \$4.50. World's greatest 96-page Bargain Catalogue \$1.00. Bebee's, 4514 North 30th, Omaha 11, Nebraska.

32 PAGE U.S. coin list 10¢. Contains almost 100 illustrations; over 5,000 delightful bargains. Stoney, 260 Washington, Boston 8, Mass.

LINCOLNS 50 Assorted dates, mints. Condition good to uncirculated. In coin folder. Send \$5.00 plus 35¢ toward postage. (No c.o.d.'s). New cleaning cloths for coins \$1.00 prepaid. Meyer Co., Box 868, Galesburg, Illinois.

WOW! Indian cent, foreign coin, bargain lists. 10¢. Hutchinson's, Box 4747, Philadelphia 34, Penna.

FOR Sale 1913S, 1924S, 1931P, 1932D, 1938S, 1939D cents. All six for \$2. Gasser, Box 34615, Los Angeles 34, California.

FREE List! U. S. coins. Lowest prices! Hugh's Coins, Hickory, N. C.

BRILLIANT Uncirculated United States five dollar gold pieces. \$15.00. Twenty dollar, fine, \$45.00. Rare Coin Company, 31 North Clark St., Chicago 2, Ill.

FREE Bonus offer! U. S. bargain list, 10¢ (refundable). Economy Sales Company, Mansfield, Massachusetts.

SIXTEEN Page 1960 retail price list of USA and Canadian coins for 10¢. Our selling prices on thousands of coins and coin collectors' supplies. Bryson Incorporated, 612A White, Toledo 5, Ohio.

SPECIAL Old Morgan dime, quarter, half dollar, 28 page coin catalogue, \$2.00. Hobby Sales, Box 4054, St. Paul 16, Minn.

RAREST CC mint dollar, 1885 uncirculated \$10.00. Coin catalogue 50¢. Shultz, Salt Lake 10, Utah.

LARGEST Coin magazine, 200 pages, 50¢. Scrapbook, 7320-J Milwaukee, Chicago 31.

STARTER Collections, 15 Indian cents, \$2.50. 12 Liberty nickels \$2.50. 23 Mercury dimes, \$5.00. 15 Barbour quarters \$8.00. 15 Barbour halves, \$15.00. In folders. All different postpaid. Prager, 470 27th Avenue, San Francisco, Calif.

RARE Unc. 1899-P silver dollar, each \$5.00. Butts, Box 889, Torrington, Wyo.

STAMP COLLECTING

WORLDWIDE Packet 10¢. Approvals. D. Bergeron, 400 Church, Houma, La.

1000 DIFFERENT Worldwide stamps \$1.00. Valued over \$20.00. Universal, Box 6, Kenosha 5, Wisconsin.

21,000 ALL Different stamps, yours for only pennies a day on our systematic payment plan. Details free. Sjoquist, 1435 Cherrydale, San Jose 25, California.

300 ALL Different 25¢. Approvals follow. Jim Cusick, Conimicut, Rhode Island.

FREE! 25 Egypt, 5¢ handling. Approvals. Bellett, Mapledale, Hazel Park, Mich.

SUMMER Offer 1100 worldwide stamps \$1.00. 3500 \$3.00. Harrison's Stamps, 1435 First Avenue, Oakland 6, Calif.

FREE 50 Worldwide, mailed with inexpensive approvals. University Stamps, P.O. Box 95, Tami Station, Miami 44, Florida.

ALBUM! Hundreds of spaces! Only 10¢. Postpaid! Stampmart, Hartford 1, Conn.

FREE! \$1.00 Worth, your choice, from first selection. No strings! Adults only. Rush request now. Philatelics, Dept. RF, New Paltz, N. Y.

INTRODUCING Our better United States approvals we offer 15 United States stamps including Columbian, Bi-Centennials, famous American, airs, others: only 10¢. Ocean Stamps, Box 64-PM, Brooklyn 29, New York.

PENNY Approvals. Thousands. Bargains for pennies. Gifts with purchases. Penny Stamps, Orange, California.

UNITED Nations. Five different 10¢. Approvals. Anderson, 1112 Harrison, San Francisco 3, Calif.

TERRIFIC Value. Eight complete mint sets 10¢ with approvals. Beatties, 58 Glenagar, Islington, Ontario, Canada.

25 DIFFERENT Commemoratives 1893 up 10¢. U. S. approvals. K&B, Box 70, Brooklyn 23, N. Y.

FREE Sample! Interesting, informative, illustrated. National Stamp News, Anderson, South Carolina.

307 WORLDWIDE Different stamps only 25¢. Approvals. Niagastamp, St. Catharines 671, Ontario.

MINT U.S. at face! Older commemoratives only. Send 25¢ for all different packets with first selection mint U.S. approvals. Western, Box 1689P, Salinas, California.

60 DIFFERENT U. S. (30 commemoratives) 25¢. No approvals. Seidenberg, Appleton, Wisconsin.

GIANT Approvals, thousands different, 1¢ and 2¢ each. Wahl's Stamp Exchange, 7008P Farragut, Chicago 31, Ill.

UNITED States commemorative collection containing 33 different—10¢. Approvals. White, 516-A Avenue L, Brooklyn 30, New York.

SELL Your surplus good grade stamps. Write, describing fully what you have. Vanroy Shirk, Lebanon, Pennsylvania.

AMAZING OFFER! 200 United States stamps — including commemoratives, airmails, high denominations to \$1.00. Only 10¢ to approval applicants! Illustrated bargain lists free. Mystic Stamp Co., Dept. 80, Camden, New York.

100 STAMPS, 10¢ With approvals. Smith, 508A Brooks, College Station, Texas.

OLD Scarce U.S. seconds on approvals. Slight imperfections, lowest prices. Hernefield, Clintonhill Sta., Newark 8, N. J.

100 OLD United States between 1861 and 1935, \$1.00. Roush Stamps, 51 Chestnut, Mansfield, Ohio.

225 STAMPS For only 10¢! This mammoth value includes airmails, pictorials; stamps from strange countries cataloging up to 25¢ each! Also approvals. Mystic Stamp Company, Camden 80, New York.

UNITED States price list, 116 pages, price 25¢. Mark Hanna, 335 Fifth Ave., Pittsburgh 22, Penna.

SELL Stamps to our readers. Your ad in this space will be read by thousands of stamp buyers. I'll prove that to you. Write now for Folder "S." F. W. Johnson, Classified Advertising Manager, Popular Mechanics, 200 E. Ontario St., Chicago 11, Ill.

14,000 DIFFERENT! Amazing new plan builds your collection systematically, country by country. Only 50¢ weekly. Free details. L. G. Ware, Stepney 75, Conn.

U. S. Mint flag set, complete, \$1.00. Free list. Brooks, 2323 Avenue X, Brooklyn 35, New York.

103 DIVERSIFIED British colony stamps only 10¢. Approvals. Niagastamp, St. Catharines 671-A, Ontario.

50 DIFFERENT British colonials 10¢. Approvals. Robert Searjeant, Mendon, N. Y.

102 DIVERSIFIED Worldwide stamps 10¢. Approvals. Linstamp, St. Catharines 618, Ontario.

PENNY Approvals! Regardless catalogue! Kloster, 4164—52nd St., San Diego 5, Calif.

25 DIFFERENT Large American commemoratives 10¢. With approvals. Linstamp, St. Catharines 618-A, Ontario.

105 BRITISH Colony stamps, all different 10¢. Approvals. Crown Stamp Company, 901, Virgil, Ontario.

50 DIFFERENT Stamps free! Approvals. Marford, Box 48, Queens Village 29, New York.

FREE! Liberia airmail triangle, diamond, midget, mammoth to approval buyers. Plymouth, Dept. A-8, Bell, California.

508 DIFFERENT World-wide from Formosa, Morocco, Indonesia, etc., cataloging over \$15.00, only 35¢. Offer to adults only. Approvals. Littleton Stamp Company, Littleton Q1, New Hampshire.

INTERESTING Worldwide animal stamp collection 10¢. With approvals. Niagastamp, St. Catharines 671-B, Ontario.

FREE! World's largest! Strange, valuable 7 x 14 1/2" beauty. Send 10¢ handling now! Norrisco, Milwaukee 7, Wis.

FREE Packet! Five different foreign countries. Request fascinating approvals. Coral, Box 55, Valle Crucis, N. C.

LOOK! Six Queen Elizabeth mint sets from Singapore, Malta, Virgins, Mauritius, Montserrat, St. Kitts! 21 brilliant pictorials, 25¢. Attractive approvals! Gannon Stamps, Box 931, Canton, Ohio.

ADULTS! Like stamps? Start your own approval business. Our free guidance shows exactly how, makes it easy, profitable. Details free. Columbia, 45-09-MP Broadway, Long Island City, New York.

JAPAN 100 Different plus 20 commemorative \$1.00! Yonehara, 248 Eifuku, Suginami, Tokyo, Japan.

BIG U.S. price list free! Bailey, 45-G Bromfield, Boston, Mass.

30 YEAR Old stock now offered at 1¢ each, your choice. Ask for a selection. Many surprises! Valley House, Box 2477, Van Nuys, Calif.

BEAUTIFUL Topical approvals two-three-five cents each. Large selections. Postage paid. Circle Stamps, Box 112, Stoneham 80, Mass.

100 DIFFERENT Dominican Republic, \$2.50; 50—\$1.00. Kyros Stamps, 52 Beekman Avenue, North Tarrytown, N. Y.

5 POUNDS U.S.A. mixture—\$2.50 plus postage. Utechs, 1143D North Keeler, Chicago 51.

VALUABLE Stamps 25¢ with approvals. Heitmueller, Box 322, Asbury Park, N. J.

105 DIFFERENT U.S. stamps 25¢. Approvals included. Shelron, Box 907-K, New York 8, N. Y.

DEALERS—Wholesale list. Postage 4¢. Frank, 5031 Queensberry, Baltimore 15, Maryland.

CANADA 100 Different 65¢, 200, \$4.00. J. Goselin, 58 South Moreau Ave., Quebec 10, Quebec, Canada.

GENUINE India "Court Tax" stamps free with approvals. Wm. Rice, 87 Washington Ave., Kingston 17, N. Y.

PRICE List, foreign, U.S. No approvals. Stamps, 5000 Miami, St. Louis 9, Mo.

CUBAN Castro's anniversary, \$1.00. Approvals. Seda-13, 1157 Vedado, La Habana.

TRIANGLES Diamond sets Monaco 50 others different 10¢. Approvals. Berchtold, RFD #1, Troy, Ohio.

100 DIFFERENT Foreign, plus topical mint set. 25¢. Approvals. Marvel, 1622 Joplin, Baltimore 24, Maryland.

TERRIFIC Stamp bargain! Israel, Iceland, Vatican assortment—Plus exotic triangle set. Also fabulous British Colonial accumulation. Plus large stamp book. All four offers free. Send 10¢ to cover postage. Empire Stamp Corp., Dept. PM, Toronto, Canada.

WILL Rogers air! Helicopter triangle! Plus Monte Carlo dove triangle! Stamp printed in solid gold! New York Empire State Bldg. airmail, lovely Congo orchids in full color, etc., 10¢ with approvals. Sunny Stamps, Apopka 2A, Florida.

FANTASTIC Fish triangles! Valuable "Ben Franklin" on Canal Zone! Flaming bi-colored volcano triangle! Lovely Olympics triangle! Plus icy Greenland, weird wild beast issue and others, 10¢ with approvals. Ozark Stamps, Spring Lake 2, Michigan.

VATICAN Coronation souvenir—Pope John XXIII card and 10 attractive stamps in protective plastic folder. Story of Vatican and coronation on reverse. A beautiful addition to any collection. 25¢ with approvals. Capital Stamp Co., Ferrysburg 2B, Mich.

FIRST U.N. set. Among world's prettiest. Only 10¢. Approvals. Welles, Box 1246R, New York City 8.

WANTED—Stamps. Illustrated buying catalog \$1.00. Box 1553, Washington 13, D. C.

COMPLETE Bahawalpur 1949 UPU mint set, 10¢ with our matchless approvals. Valley Forge, Kimberton 11, Penna.

100 DIFFERENT Large Latin American \$1.00. R. Hallberg, Almirante, Panama.

MUSCAT, Bahrain, Kuwait, Qatar free with approvals. Delval, P.O. Box 142, Pal Myra, New Jersey.

90,000 STAMPS: Bargain lot, hundreds stamps \$1. Extra special better stamps \$2. Giant assortment \$5. High value packet #3. Samples, something different, 31¢. Persile, 436 N. Y. Ave., Brooklyn 25, N. Y.

SPAIN. Latest colorful bullfighting collection—free! Approvals. William Deems, 226a Race, Ravenswood, West Virginia.

CANADIAN Mint stamps on approval. Hilson Tremere, Ormiston, Saskatchewan, Canada.

100 CANADIAN, 10¢ handling. Approvals. Roland Laforet, Tecumseh, Ontario.

25 DIFFERENT Mexico for 6 unused U.S., 5¢ stamps. Filatelistas Universitarios, Catolica 38-203, Mexico 1, D.F.

BUY Stamps at wholesale! Save, make money! Details free. Adults only. Columbia, 45-09-H Broadway, Long Island City, New York.

EARN Extra cash selling stamps. Samples, lists, particulars, 10¢. Supreme Stamps, Box 48487P Los Angeles 48, Calif.

U.S. Bargain. 50 different 10¢, with U.S. approvals. Price lists. Stamps, Kennebunk, Maine.

GODS Of Ancient Greece; Croatian legion; Roosevelt memorials; U.S.; U.N.; many others free when buying approvals. Stamp Farm, M2-24, Oxford, Wis.

FREE "Miss Universe" multicolored stamp, Australia Nativity set plus Monaco Princess Grace set. No approvals. Send 10¢ to cover postage. Supreme Stamp Service, Box 48487, Los Angeles 48, Calif.

FREE! Unusual animal packet. Request approvals. Dancer, 75-P11, Mansfield, Ohio.

1002 DIFFERENT Worldwide for approval buyers only. Jacobsen, Crompond, N. Y.

FREE! Giant bargain catalog. New edition listing thousands of bargains including U.S. and B.N.A. stamps, packets, mixtures, albums, accessories and supplies; sent with beautiful approvals. Jamestown Stamp, Dept. E70PM, Jamestown, New York.

100 MIXED Stamps, 10¢ with approvals. Harry Mitchell, Mazeppa, Lewisburg, Penna.

HUMAN Rights set free with approvals. Collier, Box 265, Chamblee, Ga.

FREE Monaco nudes. Approvals. Stamp Ranch, 902 Addison, Chicago 13, Ill.

AFRICAN Stamps from Africa. 250 for \$1.00. Includes stamps from various states of Africa. Africstamps, P.O. Box 9367, Johannesburg, South Africa.

U.S. \$1, \$2, \$5. Special—10¢, with approvals. Stevens, Box 24, Bay Station, Brooklyn 35, N. Y.

WOW! 110 All different Germany 10¢ zeppelins, semi-postals, airmails, high values, etc. Giant catalog, bargain lists included with beautiful approvals. Jamestown Stamp, Dept. A70PM, Jamestown, New York.

FREE. 250 Peelable hinges and 20 different Brazil with approvals. Jaydee, 218 Dickinson S.W., Grand Rapids 7, Mich.

91% DISCOUNT Special 25¢. Request approvals. Lakeside Stamps, Route 3-235, Newburgh, New York.

FASCINATING Hitler assortment plus giant worldwide collection. 25¢. Approvals. Banner, Box 54, Mount Prospect, Illinois.

ANTIQUES, RELICS, INDIAN GOODS, CURIOS

SELLING 20,000 Ancient arrowheads, spearheads, etc. List free. Lear's, Glenwood, Arkansas.

4 ARROWHEADS \$1.00. List. Smith, 841 N. Tacoma, Indianapolis 1, Indiana.

PRECIOUS STONES, MINERALS

GET Free catalog no serious rockhound, gem cutter, jewelry maker, hobbyist or craftsman can be without. Full of bargains, exclusive items, low prices from largest suppliers and authorities in the field. Free, new catalog just off the press, yours for the asking! Write Grieger's, Dept. C-11, 1633 E. Walnut, Pasadena, California.

NEW! Metals & Minerals Buyers Guide for 1960. Market values—who buys what and where. \$2.50 postpaid. Comprehensive Chemical Co., Box 41PM, Rancho Cordova, Calif.

PROSPECTORS! Learn from experienced geologists how to locate and identify rocks and minerals. A comprehensive home study course designed for anyone interested in exploring for valuable ore deposits. Write now for free literature. Pacific School of Mines, Dept. B7, Box 2538, Palm Springs, California.

FREE Bargain gem list. Lapidary and silversmith catalog, 56 pages, 25¢. O'Brien's, 1116M Wilcox, Hollywood 38, Calif.

EARTH Science. Rockhound's National Magazine. Subscription \$2.50. Sample 35¢. Box 1357-PM, Chicago 90, Ill.

QUALITY Sterling silver and gold filled mountings. Catalog free. Rockhound, Dept. P-M, Box 307, Onida, S. D.

HOBBIES AND COLLECTIONS

AMAZING Introductory offer: 10 different foreign military emblems, only \$1.50; 30 different countries, special, \$3.75. Foreign medal catalog 25¢. American catalog 25¢. Insignia Club, 550-B, Fifth Avenue, New York.

WAR II Souvenirs, 6 samples and large illustrated book. Lists \$1.00. Hobbyland, Calgary, Canada.

HISTORY Of Fort Sumner and Billy the Kid. Picture of grave and museum, two hexagon rocks, one pecos diamond souvenir, for two dollars. Write: Billy the Kid Museum, Fort Sumner, New Mexico.

PHOTOGRAPHY, CAMERAS, PHOTO SUPPLIES

EARN \$200 Month with your camera. Details free. Photo, Box 8008, Huntington, W. Va.

TAKE Panorama pictures with your roll film camera. \$21.00 attachment. Louis J. Combe, Riverside, Calif.

164 PAGE Photographic bargain catalog, listing thousands of photographic bargains. Send 25¢ for your copy, credited on first order. Dept. 1-C7, Central Camera Company, 230 So. Wabash Ave., Chicago 4, Illinois.

PHOTO FINISHING

INTRODUCTORY Special. Processing Kodachrome 8mm movie or 35mm 20 exp. \$1.00. Kodacolor 8 exp. complete \$2.00; 12 exp. \$3.00. Black and white 8 jumbos 40¢. Jumbo reprints 5¢. Quality guaranteed. Prompt service. Write for free mailers. Fast-X-Foto, Dept. PM-7, Box 7A, Jersey City, N. J.

10,000 PHOTOGRAPHIC Bargains! Anything & everything photographic. Still, movie, equipment etc. New or used. Send postal. Box 193-2E, Peabody, Mass.

TIRED Of poor photos? Write: Shcp 35, 432 F Street, San Diego 1, Calif.

SAVE On photo service. Kodacolor 8 exposure roll—\$2.50. 12 exposure—\$3.50. Reprints 25¢. Black and white 8—50¢. 12—70¢. Reprints—5¢. Fast Kodachrome, Ektachrome and Anscochrome processing. Free mailers and price list. Save on: Photo Service, Box 50, Watertown, Wis.

A Triple value. Quality, price, service. Color or black and white, 12 exp. (black and white) 59¢. 20 gift photos \$1.00. Holiday Photos, Dept. 16, Box 666, Denver, Colo.

A 3-In-1 value. Price, quality, service. 20 gift photos, \$1.00. 12 exposure rolls (black and white), 59¢. Color or black and white. Interstate Photos, Dept. 11, Box 15, Aurora, Ill.

TWELVE Exposure rolls 49¢. Wallets 20 for \$1.00. Lincoln Studios, Dept. K, Box 13, Lincoln, Nebr.

ROLL Developed, 8 beautiful enlarged prints 39¢; 12—59¢. Reprints 5¢. Willard's, Box 2554A, Cleveland, Ohio.

KODACHROME—Ektachrome guaranteed kodak processing. Prompt 8mm or 35mm 20 exp. \$1.40. Free list-mailers. Color Pix, Dept. P, CPO Box 30, Kingston, N. Y.

KODACOLOR Processing. Rolls 70¢. Jumbo prints 25¢. Edmar, Box 2355, Fall River, Mass.

TWO Beautiful prints from each picture on roll 8 exposure 45¢; 12 exposures 55¢. Thirty-nine years of satisfied customers. Quick service. Lens Photos, Dept. J-4, Janesville, Wis.

MOTION PICTURES AND SOUND EQUIPMENT

16MM Sound films. Early Jolson, Temple. Catalogs. Entertainment Films, 236 W. 55, New York City.

LARGEST Complete selection 16mm. sound films. Games, B-3243, Van Nuys, Calif.

SEE The world in color. 8mm-16mm. Kodachrome movies. Alaska, Hawaii, America, Europe, Africa, South Seas, U. S. National Parks. Also war and rocket test films. 185 subjects. Low prices. Write World in Color, Box 392-PM, Elmira, N. Y.

8MM Movies, 50', comedies, cartoons, travel, airplanes, hunting, fishing. Limited offer. Send \$1.00 each. MovieLand, Box 10-M, Van Nuys, Calif.

BARGAINS 16mm sound features \$20.00. Bedner, 5300 So. Talman, Chicago 32.

FREE Every month. Blackhawk's newspaper-size catalog 8mm, 16mm. movies, 2"x2" color slides. Biggest selection in USA. Bargains in used 16mm. sound films, projectors. Blackhawk Films, Davenport 14, Iowa.

MOVIE Camera film: 8mm. roll \$1.50. 16mm. 100' \$3.00. Free processing. Better Films, 742 New Lots, Brooklyn, N. Y.

16MM Sound shorts. Tremendous assortment features. \$16.50 up. Used 16 mm. sound projectors. \$79.50 up. Catalog. Abbe Films, 417 West 44th Street, New York City 36.

16MM Sound films. Bargain bulletin. Duquette, 97-T Snow, Fitchburg, Mass.

MOVIE Film! Free catalog! ESO-R, 47th Holly, Kansas City 12, Missouri.

16MM Sound, projectors, films. Sale, rental, exchange. Visit store or write for catalog. National Cinema, 71 Dey St., New York City.

10¢ BRINGS Big new cine manual for the 8mm-16mm. movie maker. Save money on fresh b&w and color movie film, all home processing equipment. Superior, 448 N. Wells, Chicago 10.

COLOR SLIDES

TRANSPARENCIES Wanted. Up to \$500.00 each. For information write: American Color, Box 38391, Hollywood 38, California.

700 TITLE Selections. Color slides or 8mm. Free list. Title-Color, FT-7, 3618 Marsh Lane Place, Dallas 20, Texas.

SOUTHSEAS — 2x2 Color slides. Eight for \$1.00. Catalogue, sample, 20¢. Avery, Box 8261, Honolulu, Hawaii.

LINCOLN Story, complete in 500 color slides. Catalogue and sample, 35¢. Willems, Box 1515-A, Chicago 90.

MUSIC & MUSICAL INSTRUMENTS

SONGWRITERS, Songs published, recorded. Free music. Free lyric course. Amateur Songwriters, 1075 Boylston Street, Boston, Massachusetts.

SONG Poems wanted. Free examination. Send poems. McNeill, Master of Music, 1112 PM Wilshire, Santa Monica, Calif.

PROFESSIONAL Services for amateur songwriters. Colonna Enterprises, Box 888, Burbank 1, Calif.

SONGWRITERS, With publisher contacts, want song ideas. Share royalties. No fees. Send poems: Songwriters' Associates, 1650 Broadway, New York City 19-G.

SONGPOEMS And lyrics wanted. Mail to: TinPan Alley, Inc., 1650 Broadway, New York 19, N. Y.

POEMS Wanted for musical setting and recording. Send poems. Free examination. Crown Music Company, 49-C West 32 Street, New York 1.

POEMS Needed immediately for new songs and records. Free examination and appraisal. Send poems: Songcrafters, Acklen Station, Nashville, Tenn.

GUITAR Making books, plans, imported woods, tools. List 10¢. Satinwood, 510 East 11th Street, New York 9, N. Y.

BUY Accordions—Organs direct from importer. Big savings. 5-day trial. Free color catalog. Dept. PM8, Accordion Import Center, 7120 Galli Drive, San Jose, Calif.

VIOLINMAKERS, Repairers. Fine tone wood, and all violin supplies. Send for free wholesale new price list. International Sales, 414-MPM E. Baltimore St., Baltimore 2, Maryland.

SONG Poems easily set to music by yourself. Melody kit \$1. Maljean, 44-10 MacNish St., Elmhurst 73, N. Y.

YOUR Song recorded. Vocalist, instrument. \$10.00 per song. Master demonstrator record. Athena, Lorain, Ohio.

WANTED! Poems, songs. Promotion. Free rhyming dictionary. Bengol, 93 Jefferson, Chelsea 50, Massachusetts.

MEXICO Imports: hand-decorated maracas, pair \$4.00; Bongo-drums, 7 1/4", \$15.00, 8 1/4", \$18.00 postpaid. Fiesta Traders, Box 3034, Tucson, Arizona.

MUSIC Or words composed. Recordings made. Big opportunity. Send songs. Swan Records, Box 47875, Los Angeles 47, Calif.

PHONOGRAPH Records cheap, postpaid. Catalogue. Paramount, Box 2026-M, Pine Castle, Florida.

ELECTRIC Guitars, amplifiers, wholesale. Free catalog. Carvin, PMM, Covina, Calif.

RADIO, TELEVISION AND ELECTRONICS

AUTO Radio. Distributor selling, servicing Blaupunkt Becker, FM-AM, other European American sets for all cars. Save 30%+. Square Electronics, 150-60 Northern Blvd., Flushing, N. Y. HI 5-2715—Dept. P.M.

TRANSISTOR Radio bargains. Free literature. Kalenak, 1100 Heeney, Johnstown, Penna.

GOVERNMENT Surplus radios, parts. Picture catalog 10¢. Meshna, Malden 48, Mass.

FREE! Giant wholesale catalog on electronics, hi-fi, transistor, scientific, hobby, optics, photographic, housewares, jewelry, tools, novelties, toys. Write: Lektron, 131M Everett Ave., Chelsea 50, Mass.

TAPE Recorders, Hi-Fi components, sleep learning equipment, tapes. Unusual values. Free catalog. Dressner, 69-02M, 174 St., Flushing 65, N. Y.

LEARN While asleep with amazing "Electronic Educator" endless tape recorder. Details free. Research Association, Box 24-N, Olympia, Washington.

FIX Your own TV. Save 80%! Send for free illustrated chart showing how! We'll include giant electronics catalog. Zalytron, 220-M West 42 St., New York City.

RADIO And TV tubes at manufacturer's prices! 100% guaranteed! Brand new! No re-brands or pulls! United Radio, Box 1000-M, Newark, N. J.

CASH For used short-wave ham receivers, transmitters and accessories, Treger, W9IVJ, 2023D N. Harlem Ave., Chicago 35, Tuxedo 9-6429.

HI-FI Components, recorders. Free wholesale catalogue. Carston, 125-Y East 88, N. Y. C. 28.

BUILD Crystal sets that bring amazing results. Design manual \$1.00. Meeker, 5251 Stockwell, Lincoln 6, Nebraska.

SAVE 100% To 250%. Buy direct: Tape-recorder 2-speed \$49.95; 2-band 8 transistor radio complete \$28.85; 6-transistor complete \$17.85. Free catalog. Wingfield Co., Dept. PM, Box 2404, Memphis 2, Tenn.

SPECIAL Offer. Newly developed combination short-wave and standard band shirt-pocket size portable transistor radio! Powerful 2 1/4" quality speaker, leather carrying case, lightweight. \$49.50, guaranteed. Norman Bailey, 63 Hall, North Adams, Massachusetts.

NEW Tubes, 50% off. Top brands. Top performance. List free. Lukacs, Dept. A, Box 353, Jersey City, N. J.

RENT Stereo tapes, 1500 different. Free brochure. Stereo-Parti, 811-X Centinela, Inglewood, California.

ELECTRIC Guitars, amplifiers, wholesale. Free catalog. Carvin, PMR, Covina, Calif.

BUSINESS OPPORTUNITIES

PLASTERCRAFT Molds, liquid rubber, plasters, flocks, candle supplies. Catalog and manual free. Blue Rapids Supply, Blue Rapids, Kansas.

MAKE Money at home. Mailing literature to new mothers. Everything furnished. Dobi Sales, Box 4012, Flint, Mich.

HOW To operate profitable mail order business. Write: American Distributors, Box 409-p, Niles, Michigan.

IMMEDIATE Profits with no capital or experience. Take orders for all magazine subscriptions. Friends and neighbors are your prospects. Write now for complete, free kit. McGregor Magazine Agency, Dept. 6B, Mount Morris, Illinois.

OPERATE Home mail-order business. Vosacek Printing, 4444A1 Ute, San Diego 17, Calif.

MARKETS Everywhere. Make artistic concrete birdbaths, pottery. Best coloring. Home workshop. Hundred varieties. Hollywood Cementcraft, 8527-S Wonderland, Hollywood 46, California.

LEARN Sewing machine repairing. To \$125 weekly. Sparetime Supplies. Add to present business. Write today! Taylor Service, Box 2126, San Bernardino, Calif.

EARN \$10,000 Yearly raising Angora rabbit wool for us. Information 25¢ coin. American Angora Company, Malta 77, Montana.

FRANCHISES Make profits! Operate your own independent franchised business as distributor, dealer or agency owner. Nationwide opportunities. National Franchise Reports is the recognized source for information regarding the booming franchise field. Write today for interesting free details of this helpful service. National Franchise Reports, W-528, 333 North Michigan, Chicago 1.

FREE Picture folder, "How to Make \$3,000 Yearly, Sparetime, Backyard, Raising Earthworms!" Oakhaven-38, Cedar Hill, Texas.

VENDING Machines. No selling. Operate a route of coin machines and earn amazing profits. 32-page catalogue free. Parkway Machine Corporation, Dept. #27, 715 Ensor Street, Baltimore 2, Maryland.

BIG Money raising fishworms and crickets. Free literature. Carter Farms, Plains, Georgia.

FREE! Name brands catalog! Your own high profit business. Sell name brands, full or part time. No inventory, no investment. More than 2,000 name brand items; lowest wholesale prices. Watches, jewelry, cameras, hi-fi, stereo radios-phonos, appliances, housewares, hardware, power tools, luggage, musical instruments, garden equipment, sporting goods, toys, many others. 8 floors of name brands. Million dollar inventory. Orders shipped complete in 24 hours! Send for free, beautifully illustrated catalog now! Separate wholesale price list. H. B. Davis Corp., Dept. 11, 145 W. 15 St., New York 11, N. Y.

BUSINESSES, Resorts, motels, investment property, ranches. Our special service dept. at your disposal. No obligation. World's largest, 58 years' service. Strout Realty, 7-MB S. Dearborn, Chicago 3, Ill.

TO \$100.00 Weekly. Sparetime, home operated mailorder business. Successful beginner's plan. Everything supplied. Lynn, 10420-M National, Los Angeles 34.

PIANO Tuning learned quickly at home. Tremendous field! Musical knowledge unnecessary. Information free. Empire School of Piano Tuning, Champaign, Ill. (Founded 1935).

WANT To make big money at home? \$10.00 profit in an hour possible with invisible mending. Make tears, holes, disappear from clothing, fabrics. Steady year-round demand from cleaners, laundries, homes. Details free. Fabricon, 6234 Broadway, Chicago 40, Illinois.

\$70 WEEKLY—Home, spare time. Simplified mail bookkeeping. Immediate income—easy! Auditax, 34757A, Los Angeles 34.

I want to send you proof of the wonderful pulling power of Popular Mechanics classified pages. What's your proposition? Write me today. Include literature if possible. F. W. Johnson, Manager Classified Advertising, Popular Mechanics Magazine, 200 E. Ontario St., Chicago 11, Ill.

COPUBLISH Mail Sale Advertiser. leading mail order paper. Details, latest copy, dime. Vanroy Shirk, Lebanon, Penna.

11,000 NEW Prospects daily. Baby record books, shoes, albums. Sell mailorder. Use our literature. Write: No-Co-Ro, Capitola, California.

BRONZE Baby shoes: Instructions, equipment and mountings for genuine electroplating process. Largest supplier of all plating equipment, supplies. Free catalog. Hollywood Bronze Supply, Dept. B-3, 1624 East First, Los Angeles 33, Calif.

MAKE \$46 From square foot plywood; jigsaw necessary. Free details. Woodart, Bridgewater, Mass.

FIX Typewriters. Free repair course. Home operated. Remit 25¢ for book explaining free course and agency appointment. Athey, Tarentum, Penna.

OPERATE Profitable mail order business. Write Walter Service, 4159A East 112th, Cleveland 5, Ohio.

EARN Good money sharpening chain saws, scissors, cutters, knives. Free manual. Treyco, North Tonawanda, N. Y.

BAKE New greaseless doughnuts in kitchen. Sell stores. Free recipes. Montgomery, 3605 South 15th, Minneapolis 7, Minnesota.

\$3.00 HOUR—Home, sparetime, assembling pump lamps. Easy. Free details. Ougor, Caldwell, Arkansas.

RAISE Rabbits on \$500 month plan. Free details. White's Rabbitry, Mt. Vernon, Ohio.

\$400.00 MONTHLY Raising giant worms. Odorless soilless method. Charlie Morgan, Bushnell, Florida.

BOSS Your own home business. Profits 1200% to 3000%! Make, distribute stunning Shellcraft jewelry. Sells itself wherever displayed. Big repeat demand. Details free: Shellcraft, Dept. A, Box 804, Panama City, Florida.

LIQUID Molding rubber, free sample. Shellcraft supplies. Chaney's, 1907-A East Road, Jacksonville 11, Fla.

VENDING Machine catalog. Rakes, 609P Spring Garden, Philadelphia 23, Penna.

IF You like motorcycles and money then send for Harley-Davidson dealership book on how to become a dealer of motorcycles and a new line of motorscooters. Here's a chance to own your own business with a very modest investment. The youth market is beginning to explode and the next few years promise a chance to cash in on it. Write for free illustrated dealership book today. Harley-Davidson Motor Company, Dept. P, Milwaukee 1, Wisconsin.

OUTSTANDING Profit potentials. \$10 monthly starts you in field gaining widespread acceptance. Free brochure. Columbia, 45-09-PM Broadway, Long Island City, New York.

LEARN Appliance service and repair. Motors, washers, refrigeration, cleaners, everything. Free booklet. Appliance, 3570 W. First St., Los Angeles 4.

PROSPER By selling "The World's Most Usable Bible." Sales quick, easy and highly profitable. To start earning a better living, write today. International Book Company, Department M., Box 118, Wichita 1, Kansas.

PLATE Baby shoes, jewelry, gifts, bronze and colored pearl. We finance. Free booklet. Platex, 11029 South Vermont, Los Angeles 44.

\$1.00 BRINGS You \$18.00 spare-full time home business opportunity! Amazing new velvet-spray transforms old cheap lamps, TV-radios, figurines, furniture, anything, into valuable products! Free samples, 50 business opportunities booklet. Send no money. Flok-Kraft JY, Los Angeles 61.

MAKE Fabulous weekly profits clipping newspaper items for publishers. Some clippings worth \$5.00 each. Particulars free. National, 81-PM, Knickerbocker Station, New York City.

COLORGLAZED Concrete pottery made without molds. Patented method. Cemetery products, novelties, tiles. Basement leak-sealing. Money-making projects. Booklet, details free. Men only. National Potteries Company, Grand Rapids, Minnesota.

BIG Money—Operate own fix-it shop. Service household appliances, motors, mowers, saws, skates, etc. Free book. Christy Trades School, A-9203, 3214 Lawrence, Chicago 25.

RECAST Junk batteries into new. Latest achievements. Battery Laboratories, Bayou LaBatre, Alabama.

LEARN Landscaping and the growing of plants. Start a profitable business part or full time. Free information without obligation. National Landscape Institute, Dept. MC-70, 11826 San Vicente Blvd., Los Angeles 19, Calif.

NEW Home-import mail order profitability! Your mailbox stuffed with money! No selling. No experience. No investment. We supply everything. Free details. Mail Order Distributors (Import Division), 15201 South Broadway, Los Angeles B57C, California.

PACKAGE At home for profit! We supply everything. No selling; ready market. Free details. HPC, Dept. 7D, 2212 East Jesse Street, Los Angeles 23.

DOLLS! Dolls! Dolls! We teach you to repair, make, sell all kinds of dolls and accessories including clothing. Study at home. Earn while you learn. Free catalog. Doll Hospital School, Studio MC-70, 11826 San Vicente Blvd., Los Angeles 49, Calif.

MAKE Extra money—Big cash commissions plus premiums for you and your customers. Sell advertising book matches. Sensational new tenorrama, glamour girls, hillbillies; dozens others. All sizes. Quick daily sales; big repeat business. Free master kit makes selling easy. No experience necessary. Superior Match, Dept. MX-760, 7530 Greenwood, Chicago 19.

START Your own business on credit (U.S. and Canada). Your own boss. 1396 dealers sold \$5,000 to \$25,500 in 1959. We supply stocks, equipment on credit. 200 home necessities. Sales experience unnecessary. Pleasant profitable business backed by world-wide industry. Write Rawleigh's, Dept. G-U-PPM, Freeport, Ill.

\$250.00 WEEK Spare time profit possible. Earn at home with new fascinating printing method. \$5 starts you—send no money now. Free confidential facts and valuable sample. Screen-Print, JY, Los Angeles 61.

OWN Collection agency. Little "gold mine." Franklin Credit, Roanoke, Va.

WANTED. Men, women. Raise bait for us at home. Full, spare time. Doesn't take up space. We furnish everything. Sherwood, Dept. D-2, Monmouth, Maine.

PAINT Signs using patterns. Do professional looking job. Starting kit \$5.00. Trial alphabet \$1.00. Harwell, PM-760, Byrdstown, Tennessee.

IMPORT-Export business made easy. Individual setup service. Not just instructions. Hermes, 152 West 42, New York City 36.

STATUES, Plaques, figurines, molds, liquid rubber, plastercraft supplies. Free sample and details. Lavin Novelties, Box 296B, Flora Rd., Leavittsburg, Ohio.

PROFIT With Popular Mechanics' subscription plan. No investment, no experience needed. Earnings begin immediately when you obtain subscriptions for Popular Mechanics, Good Housekeeping and others. High commissions, bonus. No experience needed. Deal directly with the publisher. Write Popular Mechanics, Room 7B, 250 West 55th St., New York 19, N. Y.

25¢ TO \$25.00. 1001 Moneymaking plans, formulas, ideas. Catalog free. Charles Company, 42-GNE, Norwood, Ohio.

MAKE Fast selling children's item from scrap plywood. Details free. Clifford Richards, Castalia, Ohio.

MAILORDER Beginners no cost plan. Armstrong's, 154 Darrington S.W., Washington 24, D. C.

MONEY At home raising bait for us. Down-East, PM-3, Box 149, Bangor, Maine.

TIES (\$1.00 Values), \$6.75 dozen. Assorted colors. Satisfaction. B. Hause, 2145 Vanderbilt Road, Birmingham 4, Ala.

MAILORDER To churches, motels, institutions. Complete individual set-up, not just instructions. Hermes Advertising, 152 West 42, New York City 36.

NATURAL Molding rubber, extra thick. Free samples. W. Wooley, 2801-A Latrobe, Peoria, Illinois.

IMPORT-Export opportunity, profitable, world-wide, mail-order business from home, without capital; or travel abroad. Established world trader ships instructions for no-risk examination. Experience unnecessary. Free details. Mellinger, C707, Los Angeles 24.

\$57.50 PUTS You in illuminated plastic sign manufacturing business. We supply starting stock completely wired, 6x14½" metal cabinets, plastic faces and plastic letters for your selling specially worded signs to doctors, shoe and watch repair establishments, retail stores, others. Profitable unworked field for handy-handed man seeking spare-time income. Gadgets by Becker, 2926 Anwood, Cincinnati 6, Ohio.

\$34.70 TWO Hours. Manufacturing concrete products. No selling. Castings #3, 2907 Dundee, Rapid City, South Dakota.

WANTED: Home producers, to be sub-contractors. Cast plastic products for manufacturers in our clearing house service. Thousands of easily made items required. Cash in at home, without previous experience. Plastic Service Associates, Dept. 7-PM East Boston 28, Massachusetts.

23 WAYS To build a home mail business, with lifetime repeat income! Amazing manual only \$1.00 postpaid! Satisfaction guaranteed. Glenn Publications—MP70, Box 507, Jacksonville, N. C.

SELL Books by mail. 400% profit. Royal, Box 368-X, Cleveland 27, Ohio.

DOLLARS Cash, quick, no investment needed. I.Q. cards set \$1.00. Free operating instructions. Cards Co. (Dept. 22), 9655-107a Ave., Edmonton, Alta., Can.

YOUR Own business. Dye carpets and furniture in customer's home. Exclusive sales and service territories. Earn up to \$200.00 per day. Training available. Armstrongs, Box 1447, Chicago 90, Ill.

MONEYMAKING OPPORTUNITIES

MEN—Women! Start money-making plastic laminating business at home in spare time. Material that costs 11¢ brings back \$2.58. No canvassing or selling but mail orders bring in \$20 a day. Write for full particulars free. Rush name on postcard to Warner, Room CL-2-H, 1512 Jarvis, Chicago 26, Ill.

PAYING \$92.00 for 89 certain Lincoln pennies. Album and complete instructions, \$1.00. Albetco, Box 843, Union, N. J.

IF You like to make money, and everyone does; then you'll want to take advantage of this money-making, money-saving offer. For a limited time only we will send you several giant magazines jammed full of exciting money-making opportunities. Write today for free details. Zephyr Enterprises, Box 1484-D, Hartford 1, Conn.

RAISE Nightcrawlers, redworms. Easy odorless soilless method. Three Oaks Ranch, Dresden, Tenn.

MAKE Beautiful concrete products for profit. Useful lawn and home items. Small investment in our fiberglass forms puts you in business. Zeidler, Clear Lake, Iowa.

MAKE Over \$6.00 per hour with small table saw. No experience necessary. Evans Enterprise, 6439—34th Terrace North, St. Petersburg, Florida.

GET Money for newspaper clippings. Free details. Write: Whitted-70A, 2815 Nicholson, Dallas 24, Texas.

EASY To start rubber stamp business at home in spare time. Make up to \$9.80 an hour without experience. Facts free. Write Roberts, 1512 Jarvis, Room CR-2-H, Chicago 26.

MAKE Fabulous weekly profits clipping newspaper items for publishers. Some clippings worth \$5.00 each. Particulars free. National, 81-PM, Knickerbocker Station, New York City.

HOMEWORKERS: Terrific profits! Easy. Free details. Stapleton Products, Lumber City, Georgia.

GET Listed for life! Receive hundreds free magazines, samples, special offers. Rush 25¢, stamped, addressed envelope. Columbia, 45-09-MH Broadway, Long Island City, New York.

EASY To earn extra money! Free 100 page catalog. Tandy Leather Company, Box 791-T37, Fort Worth, Texas.

EARN Big profits selling cord wood to homeowners. Lickity engine driven log splitter will put you in business. Waco Aircraft, Troy 10, Ohio.

START Big-pay business at home in spare time. No experience needed to operate little table-top machine for bronzing baby shoes. Make \$5.46 profit on every pair. Full particulars free. Send postcard to Mason, 1512 Jarvis, Room CM-2-H, Chicago 26, Ill.

START A profitable subscription business in spare time! We need men and women (young and old) as representatives for all leading national magazines. Liberal commissions on all subscriptions. Supplies free. No experience needed. Send this ad with your name and address to: Popular Mechanics, Room 7-O, 250 W. 55th St., New York 10, N. Y.

PUZZLE Fiends! Our magazine helps win prizes! Sample, 25¢. Spence, Box 11569, St. Petersburg, Fla.

TERRIFIC Novelty sells itself. Be convinced—show friends. Sample 25¢ (refund first order). Stein, 311 Delsea Drive, Woodbury, N. J.

DOUBLE Your money in a few months to a year. Absolutely no risk. Plan \$1.00 or send 10¢ for information. Sekeeg, Box 1525, Philadelphia, Penna.

CAR In bonus plan; plus profits, bonuses—selling our hosiery. Exceptional guarantee eliminates sales resistance. Phil Liston Company, Box 482-PM, Wooster, Ohio.

100% PROFIT. No investment. Stamp buying samples, details. Miller, Box 584, Brooklyn 1, New York.

CASH Money, no worries, no investments, all profit. I.Q. cards set \$1.00. Free instructions. Cards Co. (Dept. P23), 9655-107a Ave., Edmonton, Alta., Can.

MONEY Making ideas year round. No selling investment or hard work. Rush \$1.00 for seven complete working formulas. Henry James, 6926 Greenvale Parkway, Hyattsville, Maryland.

\$200.00 MONTHLY. Spare time. With tablesaw. Write. Holiday House, 7228 4th Plain, Vancouver, Washington.

MAIL Order fortunes will be made in the soaring 60's. Get your keys to success: "Mail Order Business Plans Directory" and "Mail Order Manufacturing Guide." Both for \$1.00. Lekoa Enterprises, 2968 Wilson, Campbell, Ohio.

17 PROVEN Ways to make money typing at home. Detailed instructions \$1 (refundable). Rycos, 210-A Fifth Ave., Suite 1102, New York 10.

PROFITABLE Mail order plans. Everything furnished. Information 25¢. Donovan, 79-PM Greenbelt, Levittown, N. Y.

10,000 DOLLAR-Making formulas! Arkin, 1448 Crotona Park East, New York 60.

LEARN Appliance service and repair. Motors, washers, refrigeration, cleaners, everything. Free booklet. Appliance, 3570 W. First St., Los Angeles 4.

OUTSTANDING Investment potentials. \$10 monthly starts you in field gaining widespread acceptance. Free brochure. Columbia, 45-09-M Broadway, Long Island City, New York.

MINK Raising information free. Complete. Lake Superior Mink Farm, Superior, EE1, Wisconsin.

VENDING Machines. No selling. Operate a route of coin machines and earn amazing profits. 32-page catalogue free. Parkway Machine Corporation, Dept. #26, 715 Ensor Street, Baltimore 2, Maryland.

GROW Mushrooms. Cellar, shed and outdoors. Spare, full time, year round. We pay \$4.50 lb. dried. We have 29,000 customers. Free book. Mushrooms Dept.: 173, 2954 Admiral Way, Seattle, Wash.

CIGARETTES: Make 20 plain or filter-tips for 9¢. Facts free. Moberly, Box 821, Owensboro, Kentucky.

EARN Money evenings copying and duplicating comic cartoons for advertisers. Adservice, Argyle 1, Wisconsin.

YOUR Own, easy-to-start, home mail-order business, sparetime. Fascinating; profitable! Information free. Alfano, 19-PM Pine, Closter, N. J.

BIG Money raising fishworms and crickets. Free literature. Carter Hatchery, Plains, Georgia.

READ "Progressive Mailtrade," the magazine that tells how to make money by mail. Quarter brings sample and special offer. Progressive Mailtrade, Box 357, Sheboygan, Wisconsin.

AMAZING Successes through franchises! Become exclusive franchise holder your territory. Information rushed. National Franchise Reports, MP-528, 333 North Michigan, Chicago 1.

MAKE Money writing short paragraphs! No tedious study. I tell you what to write, where and how to sell; and supply list of editors buying from beginners. Many small checks add up quickly. Write to sell, right away. Send for free facts. Benson Barrett, Dept. C-27-S, 7464 Clark, Chicago 26.

EXPORT — IMPORT

GUARANTEED Imported radios, cameras, binoculars. Catalog. Myers, 623 Gay Street, Knoxville, Tennessee.

JAPAN: Direct mail-order. 26 page catalogue, kimono, dolls, novelties, gifts, business information, manufacturers' names, addresses. Send \$1.00. Clarence Yamagata, 814 Toginbiru, Marunouchi, Tokyo.

320 LISTINGS Of foreign exporters, \$1.00. Arnold, 726 Dartmouth St., San Francisco 24, California.

RECEIVE—Import catalogs! Circulars! Foreign offers! Get listed—50¢. Mashburn's Importco, Box 202-M, Asheville, N. C.

SCIENCE & CHEMISTRY

CHEMICALS And apparatus for industrial, analytical, and private laboratories. Catalog 25¢. Dept. M-50, Biological Supply Co., 1176 Mt. Hope Ave., Rochester 20, N. Y.

ILLUSTRATED Catalog: Chemistry, mineralogy, biology 25¢. Tracey Laboratories, Evanston, Illinois.

ROCKET Supplies for amateur rocketry. Catalog 25¢. Mervin Hill Company, R.D. #1, Seward, Penna.

BOOKLET, "Scientific Oddities," free copy. Franks, 3121 South Racine, Chicago 8.

MINIATURE Recording instruments. Portable or fixed. Temperatures, pressures. Instrument Service Company, Sharon 39, Massachusetts.

AMAZING New book of science experiments, formulas, and catalogue of laboratory supplies. Only 35¢. National Scientific Co., 13 S. Park Avenue, Dept. PM-7, Lombard, Illinois.

CHEMICALS And apparatus catalog 25¢. Nu-Age Laboratories, Box 232, Bellmore, New York.

FREE. Six pyrex test tubes with \$4.00 order. Illustrated catalogue 25¢. Bio Chemical Products, Somerset, Belmont 78, Massachusetts.

EXPERIMENTERS: New! Bigger catalogue and "Experiments Booklet." Only 25¢. Hagenow Laboratories, Manitowoc, Wis.

POPULAR Mechanics book, "Science Year," illustrated survey of last year's developments in science. Covers rockets, medicine, astronomy, electronics, etc. Send \$1 to Service Bureau, Room 517E, Popular Mechanics, 200 E. Ontario, Chicago 11, Illinois.

SENSITIVE Hydrogen-ion (pH) indicator paper. 2 packets \$1.00. Ekstrand Laboratories, Arlington 10, Virginia.

UNUSUAL Chemistry books, courses, kits! Rare chemicals, cheap! Catalog 25¢. NSC, Box 11133, Palo Alto, Calif.

FORMULAS. PLANS. ETC.

FORMULAS For latest money-making discoveries. New! Good! Valuable literature free! Miller, Chemist, 1517-D, Tampa, Florida.

FORMULAS: All kinds, latest, best. Literature free. Kemixal, Park Ridge, Ill.

I Exchange formulas, analysis, information. Chemist, Montenegro 831, Guadaluajara, Mexico.

LATE. Modern manufacturing formulas. List free. Moon Chemical, Martville, New York.

RESILVER Mirrors—make one-way mirrors. Both \$1.00. Kem-Mir, Park Ridge, Illinois.

PLASTICS

PLASTIC And supplies for laminating. Colamco, 12 Center, New Haven, Conn.

BOXES, Plastic. 200 sizes. Free list. Aithor, 170 Bay 23 Street, Brooklyn, N. Y.

REPAIR False teeth yourself. Special, new professional plastic. \$2.00 postpaid. Guaranteed. Grant Dental Laboratory, 219 W. 7th St., Los Angeles, Calif.

VINYLITE. Laminating supplies, information free. Solomson, 4 Beacham, Everett 49, Mass.

PLASTIC Vacuum-forming machine. Hobby. Easy. Profitable. Details. Burr, 330 East Center, Kalamazoo, Michigan.

SIMPLIFIED Plastic molding, repairing, trial unit \$2.00. Hallmark Dental Co., Box 1924, Detroit 31, Mich.

NEW Liquid casting plastic, clear, colors. Embed real flowers, butterflies, photos, coins. Send 25¢ for two handbooks "How to Cast Liquid Plastics" and "How to Make Extra Money at Home." Castolite, Dept. H-101, Woodstock, Illinois.

FREE Sample plastic vacuum molding. 3 sizes of machines. Utilize ordinary vacuum cleaner. \$40 up. Makes 3D signs, pictures, displays, skin pacs. 2000 in use. Free sample, literature. RAB Industries, 6363 Wilshire, Los Angeles 48, Calif.

MAKE, Sell, signs. Plastic letters. Samples 25¢. Refundable. Dixie Plastics, Lakeland, Fla.

AGENTS WANTED

MEN-Women sell penny shoe shine and famous nationally advertised Turtle Wax products. Earn big money fast! Penny shine pre-sold by Bing Crosby coast to coast. Other big promotions. 122% profit possible. Send for free information. Plastone Sales, Dept. 60C, 1800 N. Clybourn Ave., Chicago 14, Ill.

MONEY For you... quickly, easily. Everybody is waiting to be shown our personalized costume jewelry. No investment. 100% commission. Free details and photo. Mag Jewelry Works Co., 143 Summer St., Providence 3, R. I.

SELL Low priced plastic laminating machines and supplies. Sipco, 4469 East Olympic, Los Angeles 23, Calif.

MAKE Your spare time profit time! Over 800 money-makers! Gifts for men, women, children, the home! Distinctive greeting cards, stationery, toys, novelties, jewelry, cosmetics, gadgets at prices for every pocketbook. No minimum order. Make up to 92% profit! Write today for exciting details, colorful catalog. Greetings Unlimited, 6-205 Park Square, St. Paul 1, Minn.

DOUBLE Spare-time earnings with 65¢ profit on exclusive, new \$1.25 Christmas card assortment. Imprints, 40 for \$1.50. Over 400 assortments, gifts retail \$1 up. Get samples on approval, \$1.25 assortment. \$1 gift on free offers. Cardinal, 1400 State, Dept. 36-A, Cincinnati 14.

UP To \$300 extra money. Show friends fabulous self-selling Evans Christmas card, gift line. Profits to 100%. Send no money—write for sample boxes to be paid for or returned, plus big free album personalized cards, 2 catalogs 300 items. New England Art Publishers, North Abington 740-C, Mass.

AMAZING Christmas card profits! Make 75¢, not 50¢, on fast-selling \$1.25 assortment; \$75.00 on 100. Gift bonuses. Complete line; assortments, novelties, \$1.00 up. 53 personalized samples free; assortments on approval. Free gift offer. Creative, 4401 Cermak, Dept. 506-P, Chicago 23.

MONEY Fast! Big profits! Sell Papoo-Seat (baby carrier) to individuals, stores. New! Weighs only 3 ounces! Not a gimmick! Part, full time. Details. Box 22505, Houston.

CHRISTMAS Cards—with customer's name imprinted. Personal and business designs—all in one album. These deluxe cards pay deluxe commissions. Earn \$300 to \$500 (plus bonuses) easily this season, even in spare time. Sales experience unnecessary. Free sales kit includes sample album and easy-to-follow selling instructions. Send for kit now; pocket profits next week! Write: Process Corp. (reliable for 39 years), Dept. PM-1, 1954 S. Troy, Chicago 23, Ill.

EVERY Man a prospect. Request refundable sales kit offer showing line of belt buckles, tie clasps, money clips, cuff links, lapels, individualized with customer's name and emblems. Cap badges for trucking, bus, taxi, police, firemen also heavy construction emblems. Choice 3000 emblems. Hook-Fast, Box 1425PM, Providence, R. I.

GOLD Or silver letters, numbers. Windows, doors, trucks. 1" to 6". 500% profit. Free samples. Atlas, Box 543-T, Oak Lawn, Ill.

MEXICAN Art goods! Free sample! Send 14¢ stamps mailing. Sylviak, Apartado 9036, Mexico City.

PRINTING, Advertising salesmen—Excellent moneymaking sideline selling decalcomania name plates, small quantities. Automobile initials, sign letters. Free samples. Raico, XL, Boston 19, Mass.

YOUR Ad in this space will get some good agents for you. Yes, I'll prove it. Write for Folder "A" right now. F. W. Johnson, Classified Advertising Manager, Popular Mechanics Magazine, 200 E. Ontario St., Chicago 11, Ill.

SELL Champion, AC, Autolite spark plugs. Reconditioned, electroplated, guaranteed 10,000 miles. 100% profit. Free sample. Lee Plugs, 1608-E Roberts, Houston 3, Texas.

YOUR Own business—Used suits \$1.50; overcoats 65¢; mackinaws 35¢; shoes 12½¢; ladies' coats 30¢; dresses 15¢. Enormous profits. Catalog free. National Mail Order, 2111-AA Roosevelt Road, Chicago 8, Ill.

DON'T Miss our ad under "Salesmen Wanted" in this magazine. National Press.

MAKE Profitable men's-women's wear. Sample free. Sunmade, Brockton 64, Mass.

BEAUTIFUL Feather pictures! Free details. Sample 20¢ stamps. Apartado 1668, Mexico 1, D.F.

BIG Free money-making catalog can make extra money for you! Take orders in your spare time. Show colorful catalog of jewelry, toys, gifts, greeting cards, collector's items and household gadgets. Work your own hours. No experience necessary. For free catalog, write: North Star, Dept. 6-603, 251 East Fifth Street, St. Paul 1, Minnesota.

START Making money now. Earn top commissions taking orders for all magazine subscriptions. Friends and neighbors are your prospects. No experience needed. Write for free money-making kit. McGregor Magazine Agency, Dept. 5A, Mount Morris, Illinois.

MAKE \$10-\$100 A day! Sell new 5 year light bulbs. Guaranteed. Send for sample 6 pak \$1.98. Sells for \$4.69. Free details. Sunmaster, 366 Fifth Ave., Dept. O7PMC, New York City.

MAKE Up to \$50.00 a day soliciting delinquent accounts. Terrific commissions. Write today. National Credit, 304Y Pickwick Bldg., Kansas City 6, Mo.

MEN-Women agents: Sensational new moneymakers—beautifully hand-painted, plastic personalized photo enlargements, compacts, rings, bracelets, lockets, etc. Simply take orders, pocket 40% commission. We deliver and collect. Sales outfit free. Noveico, 3343 North Ave., Chicago 47.

MAKE \$25-\$500. Sell Christmas, all occasion greeting card assortments; gifts, wrappings, stationery. Experience unnecessary. Big profits. Name imprinted Christmas cards. Salable samples on approval. Write Hedenkamp, 361 Broadway, Dept. PM-62, New York.

NEW Bathroom deodorizer. Hangs on wall. Banishes odors bathroom, kitchen. Lightning seller. Samples sent on trial. Kristee 73, Akron, Ohio.

MEN! Women! 60% profit on cosmetics. Famous nationally advertised Hollywood cosmetics pay 60%. Make \$25 day up. Hire others. For free samples, details, write Studio Girl, Glendale, California, Dept. 1207J.

BE The Popular Mechanics representative in your neighborhood and earn big profits in your spare time. Write Popular Mechanics, Room 7-A, 250 West 55th St., New York 19, N. Y.

SELL Famous Swami car and furniture polishing cloths, treated with General Electric Silicone Oil. Over one million sold. Write Swami Kloth, Box 155, Great Neck, N. Y.

DAMASCENE Earrings. Exotic oriental-ism. Huge profit. OHGA, PM-202, Sigakenkusatu, Japan.

SELL Aluminum embossed name plates for mailboxes, lawns, posts. Write: Star-metal, Stirling Road, Warren Twsp., Plainfield 12, N. J.

BIG Profits. Stamp social security plates, key protectors. Sample 50¢. Catalog free. General Products, 11 No. Pearl St., Albany 7, N. Y.

BUY IT WHOLESALE

BOOTS, Handsome western styles. Free catalog. Austin Boot Co., Box 5303J, El Paso, Texas.

BELOW Wholesale most merchandise. Write: Factory Buyer, 446, Jacksonville, Illinois.

10% BELOW Wholesale on appliances, housewares, tools, gifts, etc. Free catalog. Merit, Box 213, Burton, S. C.

NEW Deluxe wholesale catalog, automobile catalog, and others. Housewares, appliances, refrigerators, freezers, washers, dryers, television, radios, furniture, clothing, luggage, binoculars, phonographs, recorders, cameras, projectors, typewriters, power tools, toys, sporting goods, watches, jewelry. Name brands. Huge discounts. Postcard (any card): Selbyco, Decatur 158, Illinois.

2,000 PAGES Wholesale catalogs. Write: Mosaser, Box 47-B, Newark, Ohio.

100,000 PRODUCTS Wholesale! Terrific bargains! United Wholesalers, 1265-M Broadway, New York, N. Y.

SAVE 400% On sewing machines and parts. Send \$1.00 for wholesaler's list. Eddie, 641 N. Seventh, Baton Rouge, La.

FREE Power tool catalog. Roberson, 148 Brooks Drive, Austell, Georgia.

ELECTRIC Guitars, amplifiers, wholesale. Free catalog. Carvin, PMW, Covina, Calif.

WHOLESALE: 850,000 Items. Supply source directory 25¢. Idealer, Park Ridge, Illinois.

LARGEST Wholesale supply source in U.S.! Furniture, clothing, appliances, housewares, automobiles and accessories, tools, sporting goods, hobby supplies, farm equipment, imports, new products, bargain merchandise. Free details. Associated Wholesalers, Box 2068-DD, Sioux City 4, Iowa.

USED And new watches \$2 up. Free list. Southern Watches, 5-PM So. Wabash, Chicago 3.

WHOLESALE! World's largest supply. Buy from 679 American, European, Japanese wholesalers. Tailormade suits from Hongkong. Free details. International Buyers, 216-M Jackson, Chicago 6, Ill.

GOLF Clubs wholesale. Free price list. Crystal Golf Sales, Crystal, Mich.

SALESMEN—DISTRIBUTORS

SHINE Shoes without polish. New invention. Lightning seller. Shoes gleam like mirror. Samples sent on trial. Kristee, 40, Akron, Ohio.

CALENDARS, Advertising novelties, matches. All styles, including religious, varnished. 12 sheet, girls. Hundreds of advertising novelties, book matches, etc. Fleming Calendar Co., Sales Division, 6539 Cottage Grove, Chicago 37, Ill.

INTRODUCE Maintenance products to users of trucks and heavy equipment. Write for details: Lustrolyte Industries, Hookerton, North Carolina.

MAKE Extra money selling advertising matchbooks. Free catalog and sales outfit. Matchcorp, Dept. PM-70, Chicago 32.

STEADY Profits. Made-to-measure shirts. Free sales kit. Dept. PM7, Henlein, Cincinnati 2, Ohio.

MAKE Extra money—Big cash commissions plus premiums for you and your customers. Sell advertising book matches. Sensational new tenor, glamour girls, hillbillies; dozens others. All sizes. Quick daily sales; big repeat business. Free master kit makes selling easy. No experience necessary. Superior Match, Dept. M760, 7530 Greenwood, Chicago 19.

WILL You wear new suits and topcoats without one penny cost and agree to show them to friends? You can make up to \$30.00 in a day even in spare time, without canvassing. Progress Tailoring Co., 500 South Throop St., Dept. H-326, Chicago 7, Illinois.

MAKE Up to \$147.50 daily with simple 30-second demonstration sensational new Voicecaster. Frees both hands, permits work while phoning, hold 2-way phone talk anywhere in room. Transistorized, no installation. Offices, stores, factories order 1 to 6; housewives order fast. Make \$14.75 and more each. Ten sales daily possible spare or full time. Money-making plans free. Write Voicecaster Div., Merlite, 114 E. 32nd St., Dept. A-66R, New York 16.

BUSINESS Kit free! Postcard puts you in business! Complete line 230 shoe styles, jackets! New discoveries pay big commissions. No investment. Send for free kit. Mason, Chippewa Falls K-322, Wisconsin.

MONEY-Making opportunity! Take big profit orders for world famous patented varieties fruit trees. Also flowering shrubs, roses, vines. Big sales outfit free. Stark Bro's, Desk 30171, Louisiana, Missouri.

FULL, Part time. Babies' patented jumper-exerciser. Booming market. Nationally known. Big profits. Free testimonials, literature. Shurtliff Manufacturing, 225 Southeast Tenth, Pocatello, Idaho.

PROTECTED Territory, top commissions, bonus, repeat orders, offered to qualified men selling advanced building maintenance materials including Epoxy Coatings. Paramount, Box 1956, Cleveland 6, Ohio.

PERFUMES 6½¢ bottled. From \$5.00 gallon. Cologne, bases, closeouts. Associated Perfumers, 2132 Northwest Eleventh Avenue, Miami 37, Florida.

MAKE Up to \$50.00 a day soliciting delinquent accounts. Terrific commissions. Write today. General Finance, 304V Pickwick Bldg., Kansas City 6, Mo.

IF You're interested in making money in selling, see the hundreds of exceptional opportunities in Salesmen's Opportunity Magazine. Send name for your copy, absolutely free. Tell us what you're selling now. Opportunity, 848 N. Dearborn, Dept. 17, Chicago 10, Illinois.

MONEYMAKING Opportunity in fast growing market selling attractive outdoor advertising pennants. Write: Radder Products, Box 31, Colvin Station, Syracuse 5, New York.

EARN Big commission full or part time. Build profitable business of your own selling America's largest line low priced business printing. 360 page catalog, samples, hundreds of items used daily by business people. Imprinted ball pens low as \$6.95 for 100. Calendars low as \$5.95 for 100. Free sales kit. National Press, Dept. 8, North Chicago, Illinois.

EMPLOYMENT INFORMATION

BOOMING Latin America! Prosperous Brazil, Venezuela. Only hours from the States. New data regarding jobs, opportunities, conditions. American companies employing, etc. All skills required. Salaries to \$1,650.00 monthly; U.S. tax exempt. Bonuses, living allowances, travel expenses, exciting vacations, and more! First-hand information direct: \$2.00 (\$2.35 airmail) checks or money orders. Latin American Opportunities, Sabana Grande, Apartado 10212, Caracas, Venezuela.

JOBs On ships. \$100 weekly, beginners. Travel, adventure. Write: Seamans Service, Box 17-M, Brooklyn 8, N. Y.

FOREIGN Jobs—Latin America, Alaska, Canada, up to \$1500 monthly. Up-to-date 1960 foreign service directory gives complete information; hot list of firms hiring for military and civilian construction, aircraft, oil, exporters-importers, mining. How-when-where to apply. 12th successful year. \$1.00. Global Reports, Box 8873-S, Los Angeles 8, Calif.

JOBs On ships and yachts traveling foreign countries. Davenport's, 1354-K, G.P.O. New York 1, N. Y.

FREE Information—U.S.A., overseas jobs. High pay, transportation. Futures, Dept. M, 215 West 34th Street, New York City 1.

JOBs: High pay. Foreign countries, U.S.A. All trades. Write Dept. 55C, National Employment Information, 1020 Broad, Newark, N. J.

CALIFORNIA Job opportunities. Send \$1.00 for 2 latest issues "California Newsletter" (Monthly), 681 Market St., San Francisco 5, California.

CALIFORNIA Job opportunities. Free details. Write: Jim Smith, Box 6356, Los Angeles 55.

HIGH Pay overseas, domestic jobs. Men, women. Generous benefits. Companies pay transportation. For information write: World Wide, Dept. B, 149 N. Franklin St., Hempstead, N. Y.

FOREIGN Jobs with US firms. Details 10¢. Kam-Kovo, Box 85, Grand River Station, Detroit 8, Mich.

\$450.00 **MONTHLY** Start. Free meals, board, recreation. Foreign countries. Investigate today. Buttner, 68-66 Forest, Brooklyn 27, New York.

STOCK Car followers. New nationwide league, "Standardized Team Auto Races" needs drivers, team captains and team promoters. Tell others. Mr. Hurley (STAR) Box 1997-PM, Daytona Beach, Fla.

OVERSEAS Jobs are scarce but can be gotten. High pay, liberal benefits, low taxes, long vacations. Complete details, lists, etc., airmailed \$2.00. Bob Hallberg, Almirante, Panama.

SOUTHERN California opportunities. Specify jobs, housing, business, souvenir guide. Air mailed \$1. Meridian Imports, Hollywood, California.

COMPLETE "Job-Hunter's Guide." Free details. Jobsco, Box 312, Kearney, N. J.

ALASKA Life job information, opportunities, farms, oil leases boom conditions \$2. Alaska Life, 439 S. Western, Los Angeles.

AMERICAN—Overseas jobs. Higher pay. Transportation, benefits. Men-women. All occupations. Details. Write: Employment Headquarters, 79 Wall Street, Dept. B-10, New York 5.

LATEST Foreign job magazine only 25¢. New Horizons Monthly, 550 Fifth Avenue, New York 36, N. Y.

JOBs For high pay, top training, quick advancement, secure future. Copyrighted MBA research report only \$2.00. John Barry Associates, 131 State St., Boston 9, Mass.

EDUCATIONAL AND INSTRUCTION

MEN, 17 To 45. Train now as heavy equipment operators. Enormous nationwide highway and building program has careers for thousands of men. No interference with present job. Full, practical training with latest machines following completion of preparatory instruction. Information free. No obligation. Write to Heavy Equipment Training, Universal Schools, Dept. U-15, 11 E. 47 St., New York 17, N. Y.

DIVERS—Training in advanced methods of construction, salvage and general commercial diving. Send for free brochure. Commercial School of Deep Sea Diving, Inc., 2301 E. Anaheim, Wilmington, Calif.

HIGH School at home. No classes. Texts furnished. Diploma awarded. If 17 or over and have left school write for free assignment and catalog. Wayne School of LaSalle Extension University, A Correspondence Institution, Dept. 759 WC, 419 S. Dearborn, Chicago 5, Ill.

GOOD Paying jobs open! Operate, repair heavy earth moving equipment! Learn "on the job" operating latest cranes, bulldozers, earth carriers! V.A. approved. Free catalog. Write, TG Hutch, Greer Technical Institute, Braidwood, Illinois.

COMPLETE Your high school at home in spare time with 63-year-old school. Texts furnished. No classes. Diploma. Information booklet free. American School, Dept. XB45, Drexel at 58th, Chicago 37, Illinois.

BE A locksmith! Earn while you learn. Big opportunities await you in this fascinating profitable trade. Earn quickly—step into a well paid job or start a business of your own, full or part time. Learn easily at home, all materials and special tools supplied. Write for free book today! Locksmithing Institute, Dept. 6707, 150 Park Avenue, East Rutherford, N. J.

LEARN Civil and criminal investigation at home. Earn steady, good pay. Institute Applied Science, 1920 Sunnyside, Department 16B, Chicago 40, Illinois.

MASTER Watchmaking at home. Free sample lesson. Chicago School, 2328-YG Milwaukee, Chicago 47.

STUDY At home for personal advancement and spiritual unfoldment. Systematic study of Metaphysics or Metaphysical Psychology may help solve mental worries. Correspondence only. Free booklet. College of Universal Truth, 23 East Jackson, Dept. 3, Chicago 4, Ill.

BE A Real Estate Broker. Insure security for yourself and your family. Study at home. Prepare for state examination. GI approved. Write for free book today. Weaver School of Real Estate, 2018 P Grand, Kansas City, Missouri.

AUTOSUGGESTION. Home study courses with phonograph recordings. Free brochure. Write Clark Bellows, 135 Central Park West, New York 23A, New York.

LEARN Auctioneering. Free catalog. Missouri Auction School, Box 9252X3, Kansas City, Missouri.

DENTAL Technicians' practice kit. Artificial teeth, instruments, plastic, etc. Instruction manual free with kit purchase. Grant Laboratory, Haas Bldg, Los Angeles 14, Calif.

INVESTIGATOR Training. Free booklet covering approved home-study plan. Write National Detective Academy, Dept. E, 722 West Chapman Avenue, Orange, California.

LEARN Appliance service and repair. Motors, washers, refrigeration, cleaners, everything. Free booklet. Appliance, 3570 W. First St., Los Angeles 4.

ANYONE. Learn speedy scientific method for manipulating screwdriver. 50¢. Veejay, Box 69, Old Saybrook, Conn.

LEARN World interlanguage approved by UNESCO. Textbook 25¢. Esperanto. Middleton, Wis.

LEARN Asleep or awake. Self-help books, tapes, recordings. Free catalog. Drawer PM-697, Ruidoso, New Mexico.

PROFESSIONAL Investigators. Home study. Badge, certificate, future. Box 41197-F, Los Angeles 41, California.

HIGH School diploma at home. Licensed teachers. Approved materials. Southern States Academy, Station E-16, Atlanta, Ga.

WANT A diesel job? Higher pay? Advancement? We can help you qualify! Complete diesel, tractor and heavy equipment and Cummins Diesel Engine Shop-method home-training courses available. Write today. Interstate Training Service, Dept. B-3, Portland 12, Ore.

DEVELOP Mind power, personality while asleep. Use your phonograph, recorder. Amazing psychological tapes, records now available. Details free. Sleep-Learning Association, Box 24-N, Olympia, Washington.

EARN While you learn. Auto and diesel mechanics master this top paying trade. Many graduates earn \$100 a week and up. Approved for Korean veterans. For free information write Dept. No. 256, Nashville Auto-Diesel College, Nashville 3, Tenn.

PHYSICAL Therapy and massage. Home training. Practice privately or work with doctors and hospitals. Free catalogue. National Institute, Desk 4, 159 E. Ontario, Chicago, Ill.

BOOKS, Free general catalog, 100 pages. Text, vocational, educational, instructional subjects. Millions of volumes, new and used. Bargain prices. Books bought. Est. 1902. Long's College Book Co., Dept. PM, Columbus 1, Ohio.

PIANO Tuning pays. Big money in spare time. Learn at home in 30 days. No musical knowledge necessary. Phonograph, records, tools and instructions furnished. Personal instructions available. Free catalog, Capital Piano Tuning School, 3160 S.W. 16th Court, Fort Lauderdale, Fla.

INVESTIGATOR Training—Robert B. Phillips Sr., Founder, former U.S. Government Special Agent. Write to 1917-K North Kenneth, Chicago 39, Ill.

USED Correspondence courses and books sold and rented. Money back guarantee. Catalog free. (Courses bought.) Lee Mountain, Pisgah, Alabama.

BOOKKEEPERS. Operate your own "Dollar-A-Week" system. Ellis, Box 200, Cedar Grove, North Carolina.

ANALYZE Handwriting for profit, pleasure. Free sample lesson, catalog reveals plan. Write IGAS, Inc., Dept. 2, Springfield 4, Missouri.

OWN Collection agency. Little "gold mine." Franklin Credit, Roanoke, Va.

STRENGTHEN Your voice—for more success in business, social life! Free booklet. (Give age.) PV Institute, Studio EP-2, 210 South Clinton, Chicago 6.

ACHIEVE A dynamic personality with our proven Individual Sleep Records. Send 25¢ for sample record and details. Keane Records 1439A No. Western Ave. Hollywood 28, Calif.

CIVIL Service specimen exam questions with answers for over 100 jobs. \$2.00 complete. Send today. Exams, P.O. Box 162, Fall River, Mass.

CERAMICS Terrific hobby. Home study course \$1.50 postpaid. John's Ceramics, Box 878, Omaha 1, Nebraska.

FINGERPRINTING Course \$12.00. Diploma awarded. Men and women needed. Details free. Alabama School of Fingerprinting, Box 185, Fairfield, Alabama.

HOME Study courses. Free literature. Technical Training Service, 146ME, Brooklyn 14, New York.

EARN Degree from colleges abroad, taking test or courses. No travelling. Aureab, Central Valley, New York.

USED Correspondence courses, books. Satisfaction guaranteed. Catalog 10¢ refundable. Courses bought. Bayles, 78-B Courtright, Wilkes Barre, Penna.

WIN Promotion to foreman or supervisor. Illustrated book, inside secrets, \$2.00. Profit Study, P.O. Box 24, Auburn, Washington.

ENGINEERING And art degrees earned through home study. Electronics, electrical, mechanical, civil, physics, business administration, accounting, liberal arts. When writing, specify course desired. Pacific International College of Arts & Sciences, primarily a correspondence school. Resident classes also carried. 5719-B Santa Monica Boulevard, Hollywood 38, Calif.

PLAYS, STORIES, MANUSCRIPTS

AUTHORS! Publisher seeks manuscripts. Free details. Pan Press, Tahlequah, Oklahoma.

WANT Your book published? Learn how we publish, advertise, promote, distribute. Many successes. Free booklet PM. Vantage, 120 West 31, New York City. Or 6253 Hollywood Blvd., Hollywood 28, Calif.

ADVERTISING AGENCIES, LETTER WRITERS, FOR ADVERTISERS

FREE! Red-hot book, "More Profit From Your Advertising." Lists—best mail order magazine, newspapers. Adservice, 516 Cornelia, Chicago 13.

LISTS. Duplicate mail lists yourself fast and cheap. Information \$1.50. Duncan, P.O. Box 152, Times Square, New York 36.

ADVERTISING Ratebook leading newspapers, magazines, free. Chicago Advertising Agency, 20-W Jackson, Chicago 4.

"AMAZING New Book"—"Profits From Classified Advertising." Tells how and what to advertise. Be sure to read this book before you invest one cent in advertising. Write for your copy now. Just send 10¢ for postage and handling. W. Johnson, Classified Advertising Manager, 202 East Ontario Street, Chicago 11, Illinois.

SAVE! Circulars, brochures, folders, catalogs designed and printed. Samples! Creative, Box 2950, N. Y. C. 17.

MAILING Lists most any classification \$5.00 1000. Your circulars mailed with ours \$4.00 1000. Write for our literature. Dixie Mailers, King, N. C.

CREATIVE Advertising. Magnetic copy. Dramatic layouts. Moran Agency. Shoemakersville, Pennsylvania.

ADVERTISING. Result-getting ads prepared, placed newspapers, magazines, radio, anywhere! Lowest rates. Catalogue free. Baker Advertising Agency, 189 W. Madison, Chicago 2.

NOW Ready: New, amazing Classified Advertising Record Book—prepared especially for classified advertisers. Here is a book that tells you instantly whether or not your advertising in any publication is paying you real results. You can tell immediately how many inquiries each publication produced—how much cash received from every ad. Spaces are provided for the name and address of the publication, date of issue, space used, rate, cost of ad, key number, etc. You have a complete record of each publication right before your eyes. Plenty of space to keep accurate record of 28 separate publications. You can have a copy by sending only 10¢ to cover postage and handling. Send for your copy now. W. F. Johnson, Classified Adv. Mgr., Popular Mechanics Magazine, 204 E. Ontario Street, Chicago 11, Illinois.

CARTOONING, COMMERCIAL ART, SHOWCARD & SIGN PAINTING, TATTOOING

LEARN Sign painting at home. Free talent test. Ben Kerns, Box 812-PM, Greenville, S.C.

LEARN Profitable, fascinating tattooing. Illustrated information \$1. Zels, 728-C Leslie, Rockford, Illinois.

LEARN Sign painting with fascinating system. Straley, 410 S. Western, Springfield, Ohio.

LEARN Cartooning quickly, easily, economically! Write Southgate Press, 711 Empire Building, Birmingham, Ala.

"HOW To Make Money With Simple Cartoons"—A book everyone who likes to draw should have. It is free! No obligation. Simply address Cartoonists' Exchange, Dept. 97, Pleasant Hill, Ohio.

CARTOONING For profit! Learn at home, experience unnecessary. Famous system of manual training brings amazing results. Free book. Write Continental Schools, Dept. A71, 4201 S. Broadway, Los Angeles 37, Calif.

RUBBER STAMPS AND OFFICE SUPPLIES

BARGAIN Rubber stamps! Literature free. Arthur Johnson, 400 North Cicero, Chicago 44.

CUSHIONED 3 line stamp \$1. Handy for addressing envelopes. Johnson, Box 473, Newburg, Missouri.

INDEXED. Cushioned, 3 lines \$1.00, 4 or 5 lines \$1.50. (Script, print, old English.) Signature stamps \$3.50. All size stamp pads. Free stock stamp literature. Youngers Stamp Shop, Princeton, Iowa.

POCKET. 3 Lines \$1.00. Guaranteed. W. J. Specialty, 8464 Manhattan, Detroit 11.

FREE—Rubber stamp catalog. Martin, 1425 Major Drive, Jefferson City, Missouri.

3 LINE Handle stamp 90¢. Acme, 2816 Beacon, Columbus, Georgia.

AIRMAILED. Indexed, cushioned, 3 lines \$1.00. Each additional line 25¢. Chester Zorecki, 5221 Rambo, Toledo 13, Ohio.

TYPEWRITERS, DUPLICATORS, OFFICE DEVICES

RECONDITIONED Typewriters, duplicating, printing devices. \$25.00 up. Supplies. Appliances. DixieGraph, King, N. C.

PRINTING, MULTIGRAPHING, MIMEOGRAPHING, GUMMED LABELS

BUSINESS Cards, 1000—\$2.95. Rubber stamps. Other printing prices lowest. Weiss, P.O. Box 8304, Kansas City, Mo.

FINE Printing, reasonable prices. Free catalog. Forslund Printers, 109 East Stewart, Puyallup, Washington.

MIMEOGRAPHING—Letters, pricelists, formulas, instructions. Lowest prices. Lem's Letter Shop, 5710 Stanton, Detroit 8.

BUSINESS Cards (raised letters) 500—\$2.50. C.O.D. Samples free. Picha, 27600M Joy, Livonia, Michigan.

ADS Running under this heading sell printing. Ask me for proof. I'll gladly send you amazing facts. Ask for Folder "P." F. W. Johnson, 200 E. Ontario St., Chicago 11, Ill.

100 6 $\frac{3}{4}$ ENVELOPES, 100 5 $\frac{1}{2}$ x8 $\frac{1}{2}$ letterheads printed, \$2.35. M. Fortney, Route 3, Dillsburg, Penna.

100 #10 ENVELOPES \$1.95 postpaid. Letterheads same. Dornfeld, Iron Ridge, Wisconsin.

FREE Catalog, samples, quality work. Willis Printing, Box 661, Albany, Georgia.

FREE Catalogs postpaid printing. Rubber stamps. DM Press, Sebastopol, Calif.

BUSINESS Cards, letterheads, envelopes, advertising post cards, labels, rubber stamps, statements, offset printing. Free samples and catalog. Youngers Printing, Princeton, Iowa.

COLORED Or white 8 $\frac{1}{2}$ x11 offset. \$6.50—1,000; \$18—5,000. Fast! Printing, Box 2950, N. Y. C. 17.

1000 EMBOSSSED Business cards—\$3.95. Regular, embossed or engraved business and social printing. Samples, catalog. Stationery Sales, Box 113, New Orleans 3, La.

1,000 BUSINESS Cards. Raised letters. \$3.95. Samples. Pioneer, PM-7, Island Park, N. Y.

1,000 BUSINESS Cards. Raised printing. \$3.75. Agents wanted. Elco, 5909 Highlandview, Sylvania, Ohio.

100—5 $\frac{1}{2}$ x8 $\frac{1}{2}$ LETTERHEADS, 100—6 $\frac{3}{4}$ Envelopes \$1.10 each. Quality printing guaranteed. Free catalog. Escomd, 1240 Lockland, Dayton 4, Ohio.

250 8 $\frac{1}{2}$ x11 HAMMERMILL Letterheads \$2.95. 250 envelopes \$2.95. Offset printing. Samples! Davis, 7609 Spruce Road, Baltimore 22, Maryland.

QUALITY Printing. Reasonable. General Printing Co., Box 192, Parma, Michigan.

\$3.95, THOUSAND. Simulated engraved business cards. Quality, plus. Pocket rubber stamp, \$1.00. Steele, 7569-b University, La Mesa, California.

100 EACH 8 $\frac{1}{2}$ x11 Letterheads, 6 $\frac{3}{4}$ envelopes. \$2. Catalog rushed! Steinbergen, 1274R Stebbins, New York City 59.

100 LETTERHEADS 8 $\frac{1}{2}$ x11, 100 6 $\frac{3}{4}$ envelopes, printed, \$2.35. H. Hudson, Centredele 11, R. I.

1000 RAISED Letter business cards \$3.75 postpaid. Samples. Cooper Company, Salisbury 6, N. C.

1000 RAISED Business cards \$3.49. L-D, 534 State, Hammond, Indiana.

PRINTING OUTFITS AND SUPPLIES

MAKE Your own self-molding rubber stamps and printing cuts. Plexirubber. Argyle 1, Wisconsin.

DO Your own printing. Save money. Simple rules. We supply everything. Print for others; good profit. Raised printing like engraving too. Have home shop. Details free. Kelsey Presses, V-11, Meriden, Connecticut.

HARD Type for rubber stamp making and printing. Special introductory offer. 10 or 12pt. 20th Cent. medium or Stymlie medium. Cap ft. \$2.00. L.C. ft. \$2.00. Free catalog. Barco Type Founders, 64 Wagner, Northlake, Ill.

RUBBER Stamp presses, hydraulic operated, electrically heated. Sizes 5"x8", 8"x12", 10"x15". Starting outfits, supplies. Printing presses. Custom Manufacturing, 507-P N. Jefferson, Springfield, Missouri.

PRINTING Presses, type, supplies. Lists 4¢. Turnbaugh Service, Mechanicsburg, Penna.

RUBBER Stamp presses, supplies. Kiewiet, 2025 Barney Road, Kalamazoo, Mich.

RUBBER Stamp making machines, supplies. Helms Stamp Co., Bristol, Tenn.

FOR INVENTORS

INVENTIONS Needed immediately for manufacturers. For additional information write Kessler Corporation, C-57-FI, Fremont, Ohio.

"CASH In" your invention. Avoid mistakes. What you should know and do about protection. Send 25¢ coin for "The Inventor's Guide." Satisfaction guaranteed. Inventors Guidance Service, Calimesa, California.

INVENTIONS Financed and sold. Industrial Inventions, 53 West Jackson, Chicago 4, Illinois.

BASIC Patent information \$1.00. Brooks, 1436 19th Terrace, Lawrence 3, Kansas.

PATENT Searches \$6.00. 48-hour service. Formerly with U. S. Patent Office. Free invention protection forms. Write Raymond L. Smith, Patent Searcher, 620 Sheraton Building, Washington 5, D. C.

INVENTORS! Our Patent Search Department administers searches expertly. \$6.00. For dependable service, free invention protection forms write: United States Inventions Brokerage, 78-S Wall Street, New York 5, N. Y.

PROFESSIONAL Searches of the Patent Office records. Dependable. Reliable. \$6.00. For free protection forms write: Inventions on Demand, 412 Albee Building, Washington 5, D. C.

DON'T Pay high fees! Obtain U.S. patent yourself. It's easy with Professional Kit with fill-in forms. Free "Registration Form." Patent Protection Institute, 2000 P Street, N.W., Washington 5, D. C.

INVENTORS' Complete service. Cash-royalties sales. Inventions researched. Patent development engineering. Free invention certificate. George Spector, Licensed Invention Engineer, 3615 Woolworth Building, New York.

INVENTIONS Wanted now by my manufacturer clients. Patented. Unpatented. Write Gilbert Adams, Patent Broker, 80 Wall St., Financial District, New York City.

PATENT Searches, including copies of nearest patents, \$6.00. Reports airmailed within 48 hours. More than 200 registered patent attorneys have used my service. For free invention protection forms, write Miss Ann Hastings, P. O. Box 176, Washington 4, D. C.

WE Have the markets if you have the ideas. Harvey Engineers, Cambridge 1, Maryland.

INVENTORS: Test the commercial value of your patented or unpatented inventions, quickly and inexpensively. Write for free information. Institute of American Inventors, Dept. 40-B, 635-F St., N.W., Washington 4, D. C.

INVENTORS! Why be broke? Turn your invention into cash. If saleable, we can sell it. Write Universal Inventions, Box 298, Marion, Ohio.

SAVE! New inventor's Patent Kit makes it easy to apply for patents yourself. Free "Registration Form." Miss Suzan Blaine, 1850 General Post Building, New York 1, New York.

PATENT Searches \$6.00. 48-hour air-mail service. Invention protection forms free. Write Patent Engineering Service, 711 14th Street, N. W., Washington 5, D. C.

COMPREHENSIVE Search through patent office records \$10. "Protection" forms unnecessary. Complete inventor's service. Sales, market evaluation. Johns-Hanson Associates, 421 Washington Building, Washington 5, D. C.

PATENT Searches, including complete copies of nearest patents, \$6.00. Inventors, attorneys, manufacturers use my original world-wide airmail service. "Proof of Invention" protection form and "Information Every Inventor Needs" sent free. Miss Jean Hayward, 1029 Vermont Avenue, NW, Washington 5, D. C.

INVENTORS! Determine patentability of your invention. Searches of the Patent Office Records administered professionally—\$6.00. For free invention protection forms, dependable service write Washington Patent Office Search Bureau, 1426 G Street, N. W., Washington 5, D. C.

HOW To become wealthy through inventing! Complete book containing many new and practical ideas which could be developed. Suggested methods are provided. Procedures to be followed. Pitfalls to avoid. Many other aids. Valuable musts for all beginning and experienced inventors—\$1.00. Also patent searching—\$6.00. Lehigh Laboratories, Dept. XX, 2047 Somerset St., Philadelphia 32, Penna.

INVENTORS: Have you tried to sell your invention without success? Contact us. We succeed where others fail. Fischrup, 2533 N. Neva, Chicago 35, Illinois.

HIGHEST Cash royalties. Ideas developed into products, drawings, patent search, reliable protection, promotion, manufacturers lists. Inventors Creative Service, 354 South Spring, Los Angeles 13, California.

QUALITY Patent searches, \$6.00. Copies of closest patents forwarded. Free "Protection Certificate." American Patent Search Co., 422 Washington Bldg., Washington, D. C.

PATENTS Skillfully prepared for maximum commercial value, with useful product development. High record of success in proving and claiming patentability. Valuable market service. Patent prepared for a fee as low as \$200.00. Send for self-protecting record of invention forms free. Patent search with valuable engineering report \$15.00. Thirty years established. Joseph O'Brien, Patent and Development Engineer, 132 Nassau St., New York 38, N. Y.

YOU Can easily apply for patents. Save with complete professional kit. Free registration certificate. Patent Associates, 1214 Commonwealth Bldg., Philadelphia 7, Penna. See display ad Page 29.

INVENTORS. Inventions and patents publicized and channeled for proper sales or licensing. Jerrold Associates, 66 West 53, N. Y.

INVENTIONS WANTED

INVENTIONS Wanted for immediate promotion—patented, unpatented! Outright cash or royalties. Casco, Dept. G, Medical Science Building, Washington 5, D. C.

INVENTORS! Outright cash sale or royalties for your inventions. Patented. Unpatented. Constant demand from our client manufacturers. Write: United States Invention Brokerage, 78 Wall Street, New York 5, N. Y.

INVENTORS—Get the best offer first! Patented or unpatented. Write Carl Sommer, Director, Industrial Invention Sales, 3136-A Sylvania Ave., Toledo 13, Ohio.

INVENTORS' Complete service. Cash-royalties sales. Inventions researched. Patent development engineering. Free invention certificate. George Spector, Licensed Invention Engineer, 3615 Woolworth Building, New York.

INVENTIONS Wanted: patented, patent pending. 29 years experience promoting inventions. National Service Bureau, 3120 Meramec, St. Louis 18, Mo.

INVENTIONS Wanted now by my manufacturer clients. Patented. Unpatented. Write Gilbert Adams, Patent Broker, 80 Wall St., Financial District, New York City.

INVENTORS: Hundreds of manufacturers have requested our assistance in locating marketable new products. Complete information free. Institute of American Inventors, Dept. 40-D, 635-F St. N.W., Washington 4, D. C.

INVENTIONS Wanted. Patented; unpatented. Tremendous manufacturers lists. Global Marketing Service, 2420 77th, Oakland 5, California.

INVENTORS! Consider our offer first before selling or licensing your invention on a cash or royalty basis. Patented. Unpatented. Inventions on Demand, 79 Wall Street, New York 5, N. Y.

ARE You interested in offers from reliable manufacturers for your invention? Patented, unpatented. Harvey Engineers, Cambridge, Maryland.

INVENTORS! Don't sell your invention, patented or unpatented, until you receive our offer. Write Universal Inventions, Box 298, Marion, Ohio.

INVENTIONS Wanted for manufacturers. Free details. Write Allen, Dept. C., 712 Davis Bldg., Big D., Dallas, Texas.

PATENTS Or new products wanted by manufacturing company seeking diversification. Write to E. R. Meyer, c/o Kinkead Industries, 5860 North Pulaski Road, Chicago 46, Illinois.

FREE List needed inventions. Protection form. Inventors Sales and Engineering Bureau, Dept. 606-D, Box 4973, Washington, D. C.

IF Your invention is adaptable to promoting we will contract for selling on cash or royalty. Free booklet outlines royalty rates, requirements. Kessler Corporation, C-57-IW, Fremont, Ohio.

COMPARE Offers then deal with Inventors Guidance Service, Calimesa, Calif.

NEW Products wanted for manufacturers. Free information. Ketchum's Advertising, B-1058-A, Springfield, Illinois.

MANUFACTURING

MODELS—Small lot manufacturing. Metals, plastics, etc. Milburn, Burlington, Kentucky.

PROFITABLY Compound toiletries. Free lessons. Heckelmann, 4747 Magnolia, Chicago 40, Ill.

MODELS, MODEL SUPPLIES

SHIP Models. Most complete line in New England, kits, fittings, plans, books, tools, engines, motors. Illustrated catalog 35¢. James Bliss & Co., Inc., Dept. SM, 342 Atlantic Ave., Boston 10, Mass.

ROCKET Supplies—Nozzles, cones, tubes. Specials also made. Catalog 10¢. Sky Mfg., Mineral Point, Penna.

SHIP And yacht model fittings; blueprints. Send 40¢ for illustrated catalog listing hundreds of items. A. J. Fisher, Inc., 1002-1 Etowah Ave., Royal Oak, Mich.

SHIP Model kits and fittings: clippers, frigates, etc. Catalog, paint-tool list, book list, 25¢. Model Shipways, Box 85, Bogota, N. J.

"POWER Drives Handbook"—36 pages illustrating many types motor drives for model autos, boats, displays, turntables, etc. Mail 25 cents cash, returnable first order \$3.00 or more. Wilson's of Cleveland, Dept. PM, P.O. Box 8995, Ft. Lauderdale, Fla.

SHIP Models and yacht supplies complete. Large 68 page catalogue 50¢. Bill Wild's, 510 East 11 St., New York City 9.

ROCKETS: Three complete model rocket plans 25¢. For two sample one-pound NAR approved rocket motors with above plans send \$1.00. Estes Industries, 5505 Tejon, Denver, Colorado.

HOME CRAFTSMEN

FREE Leathercraft catalog. Quality kits, leather, tools. Handicrafters, Montrose, Calif.

FREE. New plans catalog. Make 2400 things. Fun. Profit. Craftplans, 1322-A Wabash, Chicago 5.

LEATHERCRAFT. Send 10¢ for catalog. Saxcrafts, Inc., 1101 N. 3rd, Milwaukee, Wisconsin.

FREE! Leathercraft catalog. Hundreds of new items. Write MacPherson Bros. Leather Company, Dept. E, 730 Mission St., San Francisco 3, Calif.

CHAIN Link fence. Save up to 2/3. Write Cordry Co., Brookhaven, Grandview, Mo.

LEARN Jewelry making at home. Inexpensive art metalcraft course teaches how to make all types cuff links, earrings, tableware, etc. of silver, gold, copper. Send postcard for free booklet. Interstate Training Service, Dept. L-3, Portland 12, Oregon.

FOUNDRYETTE, 2400° F. 1 1/2 to 48 lb. capacity. Free circular. Kansas City Specialties Co., Dept. P-7, Box 6022, Marysville, Kansas.

101 PATTERNS Of smart gifts, novelties, shelves, action windmills plus "Make Money Jig Sawing." \$1.00. Mastercraft, 75M, 7041 Olcott, Chicago 31.

WALNUT, Cherry, silver maple, kiln dried lumber, squares, blocks and picture frame moulding. Midland Lumber Company, Box 262, Savannah, Mo.

MAKE Large wooden action toys. Low cost humdingers. Full plans. Send stamp for details. Raymond Padgett, 728 Arlington Blvd., Falls Church, Va.

FREE "Do-It-Yourself" leathercraft catalog. Tandy Leather Company, Box 791-Q36, Fort Worth, Texas.

WORLD'S Only clear wood finish guaranteed for outdoor use. Will not crack, flake or fade. Perry's golden wood finish for log cabins, lawn furniture, boats, knotty pine interiors, etc. Old or new work. Satisfied users since 1940. Gallon \$7.50. Two for \$15.00. Express paid. L. H. Perry Company, Butler, Wisconsin.

WOODWORKERS: Build beautiful professional quality furniture. Contemporary, Danish, Swedish modern. Original designs, plans available. Illustrated brochure 25¢. Monroe Associates, Box 441, La Habra, California.

DO IT YOURSELF

LIFETIME Welder from junk. Fain Electric, R. 13, Fort Worth 3, Texas.

REPAIR Pianos and organs yourself. Send 25¢ for illustrated catalogue including player parts and rolls. Western Piano Supply, 705 Sixth Ave., San Diego, Calif.

SWIMMING Pool? Save! 42 page catalog one dollar (credited first order). Consolidated Pool Company, Dept. PM, Clymer, N. Y.

DO It Yourself electric exerciser, using old bicycle frame. Exercise whole body. Plans, photos, instructions, \$1.00. Goulet, 348 Slocum Road, North Dartmouth, Mass.

IN Or outdoor fireplace. Plans \$1. I. A. Schwan, 421-4th St., Devils Lake, N. Dak.

AIR Conditioners, home, automobile. See Kool Engineering ad page 19.

FREE Check-list covering more than 500 classifications of projects, plans, instructions, service and repair information detailed in Popular Mechanics famous series of instructional booklets, books, patterns, and blueprints. List covers an extremely wide variety of do-it-yourself data on home remodeling, repair and improvement, hobbies, crafts, boating, games, lawn and garden, and hundreds of others. For your free copy of this helpful list, write: Service Bureau, Popular Mechanics, Room 520, 200 East Ontario, Chicago 11, Ill.

DOG Obedience easy training book. Heel, fetch, etc. \$1.50 postpaid. Robert Ware, 324-54th, San Diego 14, California.

BOAT Lifters—anyone can afford. Lift boat, paint, protect, storage your property. National Insulcrete Corp., 50 Water-view Ave., Massapequa, N. Y.

WATCHES, OLD GOLD, JEWELRY

JEWELRY Scratched, dull, shine gone? \$1.00 cash or money order for generous supply of jewelers polishing compounds. Simple, quick, safe. Post Office Box 22101, Indianapolis, Indiana.

GOLD, Silver, platinum, discarded jewelry, watches, spectacles, gold teeth, coins. Highest prices paid immediately. Information free. Wilmot's, 1067-PM Bridge, Grand Rapids 4, Michigan.

HIGHEST Cash for old gold, jewelry, gold teeth, watches, diamonds, silverware, spectacles, platinum, mercury. Free information. Rose Refiners, Heyworth Building, Chicago 2.

WATCHMAKERS' Jewelers', lapidaries' catalog 25¢. Bengal, 8910 Venice, Culver City, California.

WATCH And clock repairing books. Free catalog. North American, 2320-AU Milwaukee, Chicago 47, Illinois.

WATCHMAKERS' Tools, materials, supplies, watches. Catalog. Gales, Box 1000, Chicago 90, Illinois.

WRIST Watch protectors for men and ladies. Just slip on plastic. Guards against perspiration, body heat, shock, allergy to metals, etc. 50¢ each, 3 for \$1.35. Money refunded if not satisfied, or will trade for 15 good condition Indian head cents. W-W Protectors, 1898 N.E. 33rd Street, Ft. Lauderdale, Fla.

NOTHING Down, factory fresh watches, \$1 monthly, old taken. Worldwide Imports, 1219 21st Street, Manitowoc, Wis.

OF INTEREST TO WOMEN

FREE Literature. New magic wand "spotstone" massager. Secors, Bradenton Beach, Florida.

DRESSES 29¢; Shoes 59¢; men's suits \$5.98; trousers \$1.38. Better used clothing. Free catalog. Transworld, 164-G, Christopher, Brooklyn 12, N. Y.

SELL Fine fabrics. Get yours wholesale. Box 863, Norwalk, Conn.

NEW Copyrighted sparetime plan \$1.00, refundable. Wentworth's Products, P.O. Box 143, Muskegon, Mich.

HUSBANDS & Housewives wanted! Big money. Spare or full time decorating and candy making. Turn your kitchen into a gold mine. No age, education limits. Complete instruction, learn and earn at home. Write for free facts. Candy and Cake, Dept. 712, Fallbrook, Calif.

HOUSEWIVES, Teachers, students, office workers, if you need extra cash each week but household or other duties prevent you from taking a part-time job, learn how you can earn by accepting orders to Popular Mechanics, Good Housekeeping and all other magazines. No experience needed. Write Popular Mechanics, Room 7W, 250 West 55th St., New York 19, New York.

PERSONAL

BORROW By mail. \$100-\$600. Anywhere. Air mail service. Postal Finance, 200 Keeline Building, Department 17, Omaha 2, Nebraska.

POSITIVE Popularity! Simplified plan. \$1.00. Shelly Publications, P.O. Box 201, Brightwaters, New York.

BORROW \$100 To \$600 by mail. Quick, easy, private. No co-signers. Repay in 24 small monthly payments. For the amount you want write today to Dial Finance Co., 410 Kilpatrick Bldg., Dept. G-1, Omaha 2, Nebraska.

LOANS By mail. \$50 to \$600 for any purpose. Employed men and women eligible. Confidential. 2 years to repay. Write for free loan application. American Loan Plan, City National Bldg., Dept. PM-6240, Omaha 2, Nebraska.

BIBLE Questions answered. Stamped envelope. Bylon, 17167 Bentler, Detroit 19, Michigan.

REMAILING SERVICE

CONFIDENTIAL New York City mailing, receiving, forwarding, address. Business, personal mail \$3.00 month. Remails 25¢. Birnhan, 109 West 42, New York 36, N. Y.

SECRET, Confidential, prompt. Remailing-forwarding 25¢. Monthly rates \$3.00. Antoinettes, 110 E. 177th St., New York 53, N. Y.

CONFIDENTIAL Worldwide remail-forwarding service. Smith, 1306 South Darlington, Tulsa 12, Oklahoma.

LETTERS Mailed 25¢; forwarded 30¢. Henri Labrie, Room 7, 380 Elgin St., Ottawa, Ont., Canada.

SECRET Mail address. \$3 month. Hedgpeth, Box 830, Alhambra 23, Calif.

CHICAGO Remails. Confidential. 25¢. Avers, Box 22, Forest Park, Illinois.

ITALY, Rome. Vatican letter airmailed \$1.00. Regular 50¢. Mumm, Via Bellotti Bon 10 Int. 11, Rome, Italy.

WASHINGTON, D. C. remails 25¢. Photographic and mailing services, Box 6993, Washington 20, D. C.

RENT Confidential mailing address. Details free. Agents since 1950. William McLaughlin, 800 Stewart, Columbus 6, Ohio.

SECRET Mailing system. Details free. Lillian's, Box VC3011A, No. Hollywood, Calif.

CONFIDENTIAL Address \$1 monthly. Details for stamp. Hartford, 2704 W. 32, Denver 11, Colorado.

FROM Romantic Spain \$1.00. Month \$4.00. Lambert, USAF Commissary, APO 285, New York.

MIAMI Remails 25¢. Monthly \$3.00. Box 50277, Miami 50, Fla.

CONFIDENTIAL Mail receiving-forwarding 25¢ per letter. Dependable. Jonelli, Box 943, Wenatchee, Wash.

SAN ANTONIO remails 25¢. Confidential, prompt, dependable. Monthly \$3.00 postpaid. Wayne, Box 11447, San Antonio 8, Texas.

REMAILS—25¢, \$3.00 Month. Doned, 5644 E. Pima, Tucson, Arizona.

NATIONWIDE Arrangements! Forwarding addresses! \$10.00 year! Interpost, Box 273, Santa Clara, California.

TREASURE FINDERS

TREASURE! Map, handbook, 25¢. Locators. Howe, 811 Kansas, Atchison, Kansas.

METAL Locator kits and assembled models from \$39.90. Transistorized and underwater models available. Free catalog. Electronic Applications, Dept. M, Box 8, Arlington 10, Virginia.

DISCOVER Buried loot, sunken treasure, gold, silver, coins; battlefield and ghost town relics, with powerful transistorized locators pioneered and perfected by Goldak. Low as \$79.50. Free, exciting information; literature on maps. The Goldak Co., 1541 West Glenoaks Boulevard, Glendale 1, California.

TREASURE! Buried coins, gold, silverware, relics. Transistorized M-scope locates them! From \$59.50. Easy terms. Free catalog. Fisher Research, Dept. C-1, Palo Alto, Calif.

UNBELIEVABLE! Pocket-size detector. Locate metallic mineral deposits, rare beryl, gold in placer, and buried pipes. Satisfaction guaranteed. \$3.00 postpaid. Shoffner's, Box 335, Hamilton, Montana.

GOLD-Silver detectors. Geiger counters. Viollets for tungsten, etc. Best available. Guaranteed. Information free. Detectron, Dept. 14, Sylmar, California.

FOR SALE—MISCELLANEOUS

LADYBUGS: Control garden and crop pests. Garden sizes: small \$1.25, pint \$2.00, quart \$3.00. Farm sizes: 1/4 gallon \$6.50, gallon \$8.00. Postpaid. Live delivery. Free literature. California Bug Co., Route 2, Auburn, California.

HEARING Aid batteries, wholesale. Free list. Habs, Box 51, York, Penna.

MISCELLANEOUS

FANTASTIC Bargains! Toys, household needs, etc., catalogue 25¢. Bill's 2432P Copper Street, El Paso, Texas.

HOW To poison black roaches known as water bugs. Information guaranteed. Instructions \$1.00. John Deck, 1333 Scott St., Covington, Kentucky.

AFRICAN Tribal wall masks. Rush 50¢ for catalog to J & M, P.O.B. 911, Wilmington, N. C.

LET Us tell you how to turn the reading habits of your friends into profit for you. \$10.00, \$25.00 or \$50.00 can easily and quickly be made under our Popular Mechanics subscription plan. No experience needed. Write Popular Mechanics, Room 7M, 250 West 55th St., New York 19, N. Y.

MEXICAN Information. Travel and retire. Both 25¢. McKell, 1008 Aston Ave., Santa Rosa, Calif.

1000 BALL Pens \$35.95. Twenty \$1.00. Hilltop, 424-PM Andover, Lawrence, Mass.

EVERLIT Candles. Relight automatically, \$1.00. Callin Novelities, 412 S.W. Fourth, Portland 4, Oregon.

BIG Interesting mails. Two months 25¢. Year \$1.00. Harvey Teeple, Dept. PM, Decatur, Indiana.

RECEIVE Mails. Offers from everywhere. Hundreds. Get listed 25¢. Rorick, Cincinnati 26, Ohio.

AMAZE Friends with 5/16" imported "lucky bean." Contains 12 hand-carved ivory animals! \$1.00. Carver, 215 Furr, San Antonio, Texas.

LOANS Entirely by mail—\$600 or less for any purpose. Strictly confidential. Repay in 24 low monthly payments. Employed men, women eligible anywhere. Write: Budget Finance Co., Dept. J-60, 114 S. 17, Omaha 2, Neb.

URINE Test-kit. Easy do booklet, acidity-alkalinity chemicals, for 36 specimens. \$1.00. Ekstrand Lab'tory, Arlington 10, Va.

STOP Leaky toilets. Two sensational new non-jiggle tank balls. Satisfaction guaranteed. Free gift with prompt orders—\$1.00. J. M. Rand Co., 1506 Lakeland Ave., Cincinnati 37, Ohio.

LIFETIME Listing. Receive valuable free samples. Interesting, educational books, moneymaking mailorder opportunities. 25¢. Ply-O-Film, Box 30G7, Berea, Ohio.

EPOXY Adhesive, \$1.50. Larger amounts on request. Box 372, Norwalk, Conn.

NEW Jewelry adhesive. Clear, quick drying, excellent adhesion. \$1.00. Box 372, Norwalk, Conn.

CEMENT Finishers. Now finish cement after dark with a light on trowling machine. \$2.00 and stamped self-addressed envelope for instructions to P.O. Box 641, Ames, Iowa.

BOOKS On antiques and their prices. Free circular! P. Warman Publishers, Uniontown, Penna.

YOUR Name wanted. We'll send 1000 publishers, mailers, wholesalers your name, on our list one year 25¢. Dixie Mailers, King, N. C.

CIGARETTES: Make 20 plain or filter-tips for 9¢. Facts free. Moberly, Box 915, Owensboro, Kentucky.

100,000 PRODUCTS Wholesale—Free catalog! Send postcard: Econ-O-Mart, Whippany 15, New Jersey.

SEND Us wool for blankets. Free literature. West Texas Woolen Mills, 421 Main, Eldorado, Texas.

JET Turbine raindrop garden hose nozzle. Last word. Patented. \$1.00, refundable. Swan Co., 858-G, Coronado, Calif.

70 BIBLE Lessons 25¢. Bulletin, Box 87, Cathedral Station, New York City 25.

**Thrills
Excitement
Perhaps
a career!**

**Send
young minds
soaring into
the amazing
realm of
science...**

*The sparkling adventures of
Randy and Sam Morrow in the
breathtaking world of science;*

**POPULAR
MECHANICS** each-
\$2.95

***There's
Adventure***
BOOKS

POPULAR MECHANICS



Available at your local bookstore
or write Dept. P.M.-760
Popular Mechanics, 200 E. Ontario St.
Chicago 11, Illinois

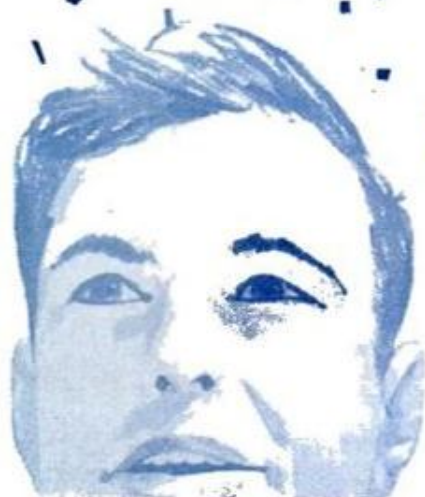

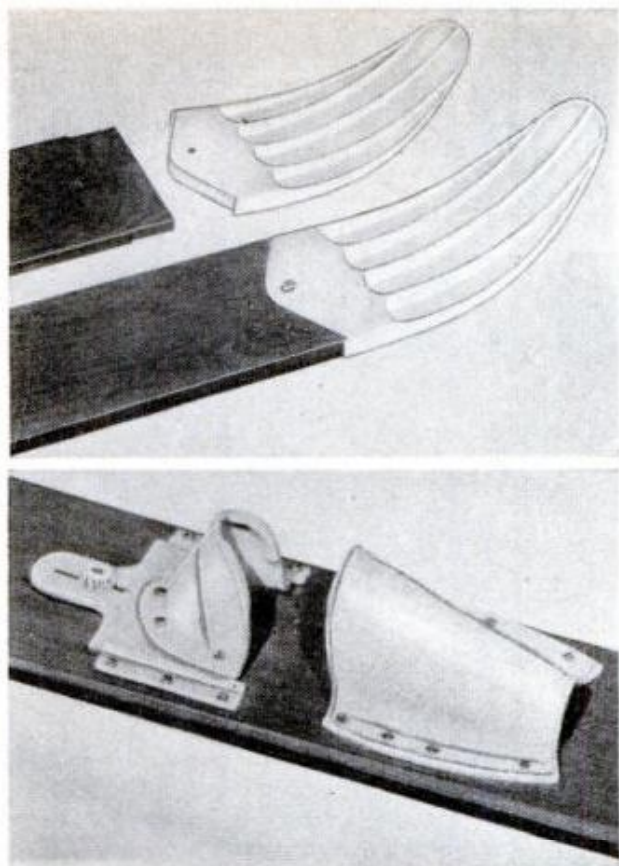

Drake Products, Greenville, Michigan

Water Skis Anyone Can Build

Two pieces of 5/8-inch flat board stock or marine plywood turn into a pair of low-cost water skis with the addition of a tip and binding outfit now available. The high-density polyethylene tip is installed with a single screw; the vinyl-and-nylon bindings screw into place amidships. The tips and bindings are available in various colors with complete assembly instructions.

Tape Secures Knob Setscrew

SOONER OR LATER that worn doorknob setscrew will loosen and fall out. Off comes the knob and the chances are that the screw will be lost. Prevent this by removing the screw and wrapping a single turn of cellulose tape over the worn threads. Turn the screw back in place and tighten.

Repairs for Sticking Doors

UNSTICKING A DOOR by planing the bottom or top, or one side or the other, leaves bare wood exposed. It will absorb moisture, swell, and may again bring about the condition you sought to remedy by planing. Prevent this and preserve the wood by coating any bared wood on the stiles (sides) with white shellac. If you plane the top or bottom to ease the fit of the door, fill the end grain of the stiles with petroleum jelly. This material will stay in place indefinitely, will protect the wood and prevent absorption of moisture.

JULY 1960

BIG EARNINGS WAITING

Be a TYPEWRITER REPAIRMAN

Earn while you train at home. Take your place in this booming multi-million dollar field. Skilled men are in demand—thousands more needed. Quickly step into a big-pay job or business of your own. Learn easily under expert guidance with clearly illustrated lessons. Work on a real typewriter, with professional tools.
SEND FOR FREE BOOK—Get vital government facts about urgent need for trained typewriter repair men. Free Book describes the vast opportunities waiting for you. Lic. by N. J. Dept. of Education

FREE Professional Tools, Typewriter Supplied



MAIL COUPON TODAY!

Typewriter Repair School, G-10, 150 Park Ave., E. Rutherford, N.J. Send FREE Book, "Opportunities Unlimited", at no obligation.

Name.....
Address.....
City..... Zone..... State.....

FREE



Full year's subscription to RADIO SHACK'S Sensational ELECTRONICS CATALOGS

Send coupon at once! See world's largest and best line of electronic equipment. Stereo, hi-fi, ham radio, tapes—over 100,000 items for pro or amateur—all at money-saving prices. 15-day no-risk home trial on any item.

MAIL COUPON NOW!

Radio Shack Corp., 730 Commonwealth Ave., Boston 17, Mass. Dept. 60-63 Without further request, send latest catalog plus every new issue for one full year—all FREE and POSTPAID.

Name.....
Address.....
Post Office.....
or City..... Zone..... State.....



BARBELLS

100 POUND SET \$12.80

140-Pound, CHROME DELUXE Barbell-Dumbbell set only \$19.80. This is our feature set and is the finest ever manufactured.

Training with adjustable weight is the BEST way to keep fit: the ONLY way to develop great strength and a perfect body. As the oldest and best equipped barbell company, BUR gives value and prices no one can equal.

SEND FOR FREE CATALOG
BUR BARBELL CO.
Lyndhurst 9, New Jersey

ELECTRONICS

Train in the new shop-labs of the world famous
COYNE ELECTRICAL SCHOOL on a quarter of a million dollars worth of equipment or learn at home in your spare time with Coyne's modern television training.

Use this coupon to get our free book
"GUIDE TO CAREERS"

COYNE ELECTRICAL SCHOOL
1501 W. Congress Pkwy.
Chicago 7, Ill., Dept. of Electronics II

NAME.....
ADDRESS.....
CITY..... STATE.....

Unlike most other schools, we do not employ salesmen.

NOW-

Series E Bonds

*turn \$18⁷⁵ into \$25⁰⁰
fourteen months quicker
than ever before*



Here are three new reasons why today's Savings Bonds are the best ones in history:

1. Every Bond bought since June 1, 1959, earns $3\frac{3}{4}\%$ interest when held the full term. Series E Bonds now mature in 7 years, 9 months—fourteen months faster than ever before.
2. Your older Bonds now earn more—an extra $\frac{1}{2}\%$ from June 1 on, until maturity.
3. All Series E Bonds, old and new, carry an automatic extension privilege now. This means they'll automatically keep earning liberal interest for 10 years beyond maturity.

You get these new advantages, plus complete safety, guaranteed return, and protection against loss or theft. And, you can buy Bonds automatically through the Payroll Savings Plan at work. Plan to start saving with U.S. Savings Bonds now.

**YOUR MONEY GROWS $33\frac{1}{3}\%$ IN JUST 7 YEARS
AND 9 MONTHS WITH NEW SERIES E BONDS**

YOU SAVE MORE THAN MONEY
with U.S. Savings Bonds

The U.S. Government does not pay for this advertising. The Treasury Department thanks The Advertising Council and this magazine for their patriotic donation.



CASH FILING SAWS

Make from \$3 to \$6 an hour spare time or start a full time business with the

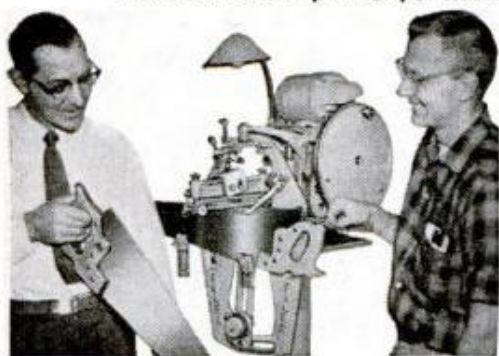

FOLEY SAW FILER

Here is a steady repeat CASH business you can start at home. No experience is necessary to turn out perfect cutting saws. With the new 1959 Foley Saw Filer you can file hand, band and both "combination" and cross-cut circular saws. Easy to operate—no eyestrain. You will find you can make from \$3 to \$6 an hour—\$20 to \$30 a week in spare time as a starter.

FREE BOOK
"MONEY MAKING FACTS" shows you how to get plenty of saws to file. Time payments if desired. Send coupon today—no salesman will call.

FOLEY MFG. CO., 743-O Foley Bldg.
Minneapolis 18, Minn.

Send me free book "MONEY MAKING FACTS" and Time Payment plan.

Name _____
Address _____
City _____ State _____



INCREASE HOME VALUE-MAKE NEEDED IMPROVEMENTS NOW

CASH IN ON **BIG PROFITS** in **HOME PACKAGING** WITHOUT SELLING!

HERE'S PROOF
that Packaging means
Big Profits for You!

Item Per Doz.	Bulk Cost	Sells For
Safety Pins	2½¢	15¢
Balloons	3½¢	19¢
Fish Hooks	2¢	50¢

Make profits like these on over 100,000 other products you can package right in your own home. We show you how!

Package bulk products. Help fill huge demand. Make profits up to 2500%! New Plan guides you step-by-step to big money in self-service packaging, contract packaging, gift wrapping. No selling—our nationwide sales force sells for you. Full or spare time. No experience needed. Everything furnished. Write today for FREE PLAN, details. No salesman will call.

HOME PACKAGING CO., Dept. C 257
2212 E. Jesse St., Los Angeles 23, Calif.

WATCH REPAIRING

**FREE
SAMPLE
LESSON**

Learn to repair Swiss and American watches. It's fascinating, profitable. Unique Sweazey System shows you how step by step. Shop method home training. Low terms. Diploma awarded.

CHICAGO SCHOOL OF WATCHMAKING
2330 N. Milwaukee, Dept. 170, Chicago 47, Illinois

MANUFACTURE THIS BEAUTIFUL CONCRETE OUTDOOR FIREPLACE

Right In Your
Own Backyard

\$4.00 Worth of
Sand & Cement
produces this
Attractive
Fireplace.

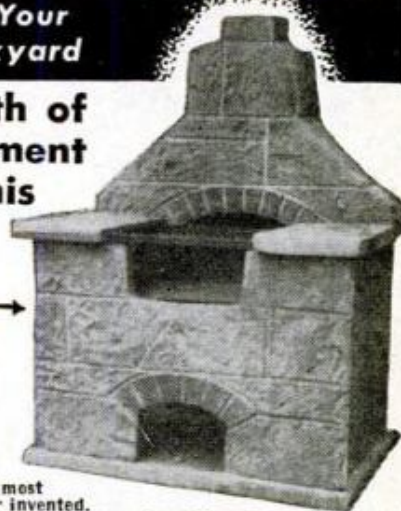

Sells on Sight
from \$60. to \$80.
Easy to start your
own Profitable
Business.

The General Fireplace Molds and Process are the most amazing and foolproof ever invented. Simple to operate. Two men can produce five fireplaces a day.

BIG DEMAND!!

Sell all you produce to Department Stores, Homeowners, Parks, Nurseries and Picnic Groves. Fireplaces sell on sight. No experience necessary. We supply full operating instructions and equipment plus the know-how that spells **BIG PROFITS**. This is an outstanding opportunity for men of vision and small capital to get into a busy rich paying field. Don't delay, be the only exclusive manufacturer in your own home town. Mail coupon at once for full details as to how you can reserve your territory. **Molds sold only on exclusive franchise.**

GENERAL ENGINES CO., Inc., Dept. MF-70
ROUTE 130, THORFARE, N. J.

Mr. Tor of Philadelphia writes:
Sold 250 in first 4 months. Selling to Sears Roebuck, John Wanamaker, and Gimbel Bros. in Philadelphia area.

Name _____
Address _____
City _____ Zone _____
State _____

POPULAR MECHANICS MAGAZINE

now complete on
MICROFILM

VOLUMES ONE THROUGH NINETY-SIX

Early volumes of POPULAR MECHANICS have been eagerly sought as collector's items. Now the monumental new microfilm collection makes this wealth of reference material available to all libraries.

Begun in 1902 as a weekly, POPULAR MECHANICS was one of the first "picture" magazines. It also pioneered the do-it-yourself idea, and its files contain plans for almost any project desired.

Ninety-six volumes — \$750.00 for the set.

UNIVERSITY MICROFILMS, Inc.

313 North First Street

Ann Arbor, Mich.

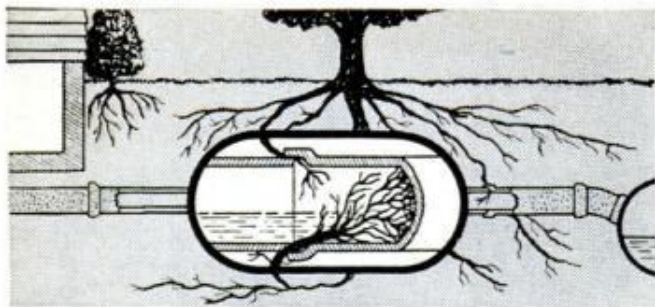

END SEWER-LINE ROOT MESS, SAVE ON COSTLY REPAIRS!

Roots are just naturally thirsty. They force their way through joints in your sewer line, eventually clog it. Toilets and sinks "back up", soon overflow. Now you can avoid costly digging or mechanical cleaning this easy, permanent way.



Pour one box of revolutionary Hercules R-D into toilet bowl. R-D kills and decomposes roots permanently, often overnight. To keep sewer lines root free, apply R-D twice a year. Safe to handle. Safe in septic tanks. Don't wait for trouble. Get R-D now from your plumbing or hardware dealer. It works, or your money back. Only \$3.95 for 2 lb. box. Send for literature.



HERCULES CHEMICAL CO., INC.
416 Broadway, New York 13, N.Y.

Keeping up with the ATOM

By Clifford B. Hicks

ELECTRICITY FROM the atom now is lighting the barnyard of an Illinois farmer. It's also operating his incubators, illuminating his home and powering the factory up the road. In fact, electricity from the atom has started flowing all over northern Illinois.

In a gradual start-up, the Dresden Nuclear Power Station is going "on the line." This is the first full-scale, privately financed nuclear power plant in the world. At its full capacity, which will be reached later this year, the plant will produce electrical energy at a rate of 192,000 kilowatts. About 12,000 kilowatts will be needed to operate the plant, leaving a net of 180,000 kilowatts. This is enough electricity to supply the needs of a city of 200,000 people.

The reactor core contains 65 tons of uranium dioxide. This fuel will produce as much power as a conventional plant burning 1700 tons of coal *a day*. One load of the nuclear fuel is expected to last 3½ years. During that period, a coal-fired plant of the same capacity would burn about two million tons of fuel.

BUT NOW THE question has been raised: Will nuclear reactors ever produce electricity on a worldwide scale? The answer is no, according to Dr. Niels Arley, an eminent Danish scientist.

"Never has mankind spent so much effort on international research projects which obtained so few results," he states.

He bases his judgment on two factors: 1. If fission were used on a worldwide scale, there would be so much radioactive waste that all the oceans in the world couldn't dilute it sufficiently. 2. If uranium were used to produce all the world's energy, there would be only enough uranium to last about 60 years.

Dr. Arley believes energy from the sun offers the best possibility for the future.

AND ANOTHER BLOW to atomic power: A panel of maritime and nuclear-energy experts recently agreed that the atom won't power merchant ships on a competitive basis for a good many years because of the high cost of nuclear-power machinery.★★★



save on
everything in
electronics

SEND FOR **ALLIED'S
BARGAIN SUPPLEMENT**

SAVE MOST on Stereo hi-fi systems and components, stereo records and tapes. See best buys in exciting build-your-own KNIGHT-KITS®. Hundreds of special values in recorders, amateur gear, P.A. systems, test instruments, TV accessories, electronic parts, tubes and tools. Send for your FREE Allied Supplement packed with bargains and new electronic products. Save as never before!



Exciting
Money-Saving
Knight-Kits



Bargains in
Stereo Hi-Fi

ALLIED RADIO

ALLIED RADIO, Dept. 62-G
100 N. Western Ave., Chicago 80, Ill.

Send FREE Allied Supplement No. 195

Name _____

Address _____

City _____ Zone _____ State _____

**FREE
SUPPLEMENT**

Houseful of children?



See next month's

Crafts Section

for good advice

on how to

"KIDPROOF" YOUR HOME



Unlock the answers to hundreds of Do-It-Yourself problems with this tremendous Service File list of Popular Mechanics' booklets, books, full-size patterns, and blueprints.

More than 500 classifications of projects, plans, instructions, service and repair information have been cataloged for the first time in one reference file.

This invaluable listing is the key to an extremely wide variety of do-it-yourself data on every subject from aquaplanes to zinc plating, from dollhouses to backyard roller coasters, from cabin cruisers to model sailboats, from patios to papier-mache.

For your free copy of the Service File listing, fill in the coupon below and mail today. Supply is limited.

SERVICE BUREAU, POPULAR MECHANICS, Room 520A 200 E. ONTARIO, CHICAGO 11, ILL.

Please send me a free copy of the PM Service File listing. I enclose a self-addressed, stamped envelope.

Name.....

Address

City..... State.....

JULY 1960

Here's one more proof...

PLIOBOND is the one adhesive that does the work of many

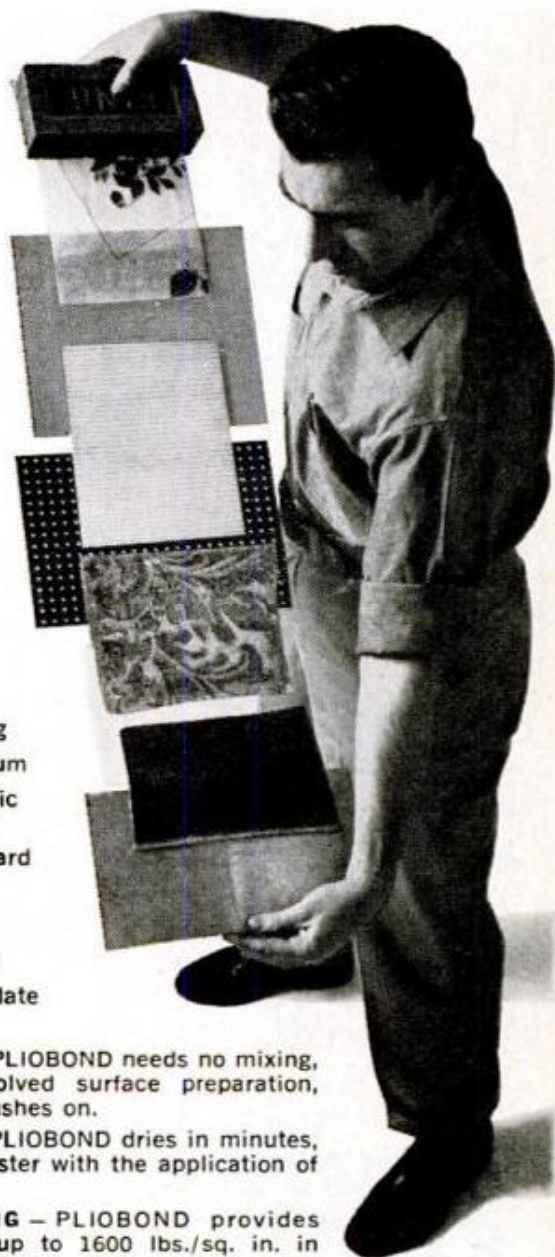

- Brick
- Plastic sheeting
- Aluminum
- Synthetic Rubber
- Hardboard
- Fabric
- Glass
- Leather
- Steel plate

EASY—PLIOBOND needs no mixing, no involved surface preparation, just brushes on.

FAST—PLIOBOND dries in minutes, even faster with the application of heat.

STRONG — PLIOBOND provides bonds up to 1600 lbs./sq. in. in shear tests.

LASTING—PLIOBOND resists heat, cold, water, most chemicals, oil—and age.

Goodyear, Chemical Division Q-9459, Akron 16, Ohio



Pliobond BY GOOD YEAR

CHEMICAL DIVISION

Pliobond—T. M. The Goodyear Tire & Rubber Company, Akron, Ohio

PREPARE FOR THE BEST JOBS

TRAIN AT HOME
in Your Spare Time
or at Allied Institute
in Chicago

Also
for FREE
SAMPLE LESSON

SEND FOR
FREE
BOOKS

- DRAFTING
- TOOL DIE-DESIGNING
- TOOL-DIE MAKING
- IND. ENGINEERING
- IND. ELECTRONICS
- AIR CONDITIONING
- REFRIGERATION
- AUTO MECHANICS

ALLIED INSTITUTE OF TECHNOLOGY
1338-42 So. Michigan Ave., Dept PM-70, Chicago 5, Ill.



FREE
MUSCLE BUILDING
INFORMATION
Sensational New Methods
Less Time—Less Effort—Better results
BODY-TONE, Box 638, North Miami 61, Fla.

BE A MAGICIAN!

Get started today! Become a popular man of mystery. Earn and learn in spare time. Magic is fun and profitable too. Be the Life of the Party. Astonish your friends!

RUSH **25¢** now for
PROFESSIONAL MAGIC CATALOG
160 pages thick • 800 illus. • 1000 Mysteries
Also Jokes, Puzzles, Secrets, Illusions.
FREE MAGIC TRICK INCLUDED
HOUSE OF 1000 MYSTERIES • DEPT. PM 7 • TRUMBULL, CONN.



FREE
EICO
CATALOG
Build Your Own
Hi-Fi, Radios,
Ham Gear, Test Inst., — Save 50%

Get started in **ELECTRONICS** the easy EICO way. No technical knowledge needed to build EICO kits. Simple, step-by-step "Beginner-Tested" pictorial instructions guide you all the way. **LIFETIME** service & calibration guarantee. Mail coupon now!

EICO, 33-00 Northern Blvd., L. I. C. 1, N. Y.
Please send **FREE** catalog & name of local dealer. Dept. PM-7

Name

Address

City Zone State

WHAT'S UP IN THE AIR



By Kevin V. Brown

AIR FORCE ground crews may all look like rabbits soon—but without the ears.

Fed up with reports of damage traceable to "foreign objects" that fell from the pockets of his crewmen when they were making periodic inspections of the intakes of jets, the maintenance officer at the U. S. Air Base at Bentwaters, England, asked one of his airmen to design some kind of wearing apparel that would eliminate pockets and cover the crewman from head to toe.

The result was a one-piece coverall with elastic wrist and neck bands that left only the hands and head uncovered. All green, except for a large red panel in front, the suits were officially dubbed "engine-intake uniforms," but the boys on the base promptly nicknamed them "bunny suits" and were quick to assure the ground crew that they looked real cute in them.

Small civilian airports near cities are getting caught in the same squeeze that has throttled the growth of the large metropolitan airports and made many of them obsolete. The growth of cities since World War II—a factor which should have encouraged the building of more airports to accommodate the increase in population—has actually eliminated many of those that already existed. They fell victims to suburban housing developments, superhighways, or high land taxes. The few new small airports are being built farther and farther out in the country.

Contrary to popular opinion, the external decor of airliners is not decided by the airline-president's wife. It's functional.

White paint on the upper half of the fuselage protects the plane from the sun and especially from solar heat when the plane is parked on the ground. This much is common to all airliners. The airlines differ on how they finish the job, but most are content with adding a second color and their own special identification and markings. About 17 gallons does the whole job on a DC-8 Jetliner.

After 13 years of investigating more than 6000 reported sightings, the Air Force was moved recently to announce once again that it has found "no evidence to confirm the existence of flying saucers." ★ ★ ★

COMING IN SEPTEMBER

SPECIAL SECTION ON WOODS
POPULAR MECHANICS
WORKSHOP
ANNUAL \$1.00



1961

INCLUDING...
SHOP NOTES Easy short cuts and how-to tips for the handyman
WHAT TO MAKE New build-it-yourself projects for the home craftsman

FIRST OF THE NEW
PM ANNUALS
AT YOUR NEWSSTAND



D. P. Harris Hdw & Mfg Co., 99 Chambers St., New York 7, N.Y.

For Indoor Skating "Tires" Slip Over Wheels

Kids can skate either inside or out without changing skates with a new "indoor-outdoor" skate wheel. All they do is pause at the door and install the neoprene slip-over "tire" over the standard steel wheel, thus converting it to a soft, noiseless tread that won't mar floors or furniture. The slip-over tires go on and off easily, and need no cement. They increase the diameter of the skate wheel somewhat, but indoor wheels are usually larger.

JULY 1960

FAST DRAW!



Three times more fast draw shooting fun—safer, anywhere, at lower cost—with the Crosman Single Action 6, .22 cal. CO₂ gas-powered revolver. True action... authentic styling... real gun weight, feel

Ask your Crosman Select Dealer for a free demonstration.

WRITE Crosman Arms Co., Inc., Dept. PM-6, Fairport, N. Y.

Learn ACCOUNTING

Business Administration
Bookkeeping, secretarial and allied subjects at home in your spare time or attend nationally approved resident school. Write for FREE Success Book giving complete details on courses, plans, rates and employment opportunities. G.I. approved. Write Dept. A

Hills BUSINESS UNIVERSITY AND EXTENSION SCHOOL
619 W. MAIN ST. OKLAHOMA CITY 2, OKLAHOMA

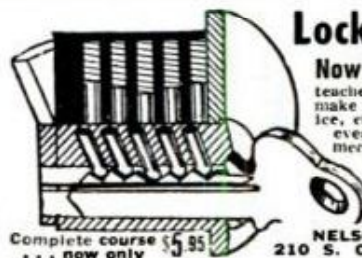

Locksmithing AND KEY MAKING

Now Made Easy! Practical up-to-date course teaches you how to pick locks, de-code, make master keys, repair, install, service, etc. New self-instruction lessons for every handyman, homeowner, carpenter mechanic, service station operator, fix-it shop, hardware dealer, gunsmith, 33 easy illustrated lessons. Full price only \$5.95 postpaid; or C.O.D., plus postage. Satisfaction or refund guaranteed.

NELSON-HALL CO., DEPT. GP-2
210 S. Clinton Chicago 6, Ill.

get into operating or repairing EARTH MOVING EQUIPMENT

Men needed now for good paying jobs in booming road and construction work. Learn operating or repair-rebuilding of heavy road machinery, cranes, bulldozers, earth carriers, etc. Actual "on the job" training. 5 to 13 1/2 week courses. Classes start every Monday. Reserve your space now. Complete catalog and reservation facts FREE. Approved for veterans. Write

Greer TECHNICAL INSTITUTE
Attn.: P. G. Hutch, Box 368, Braidwood, Ill.

MAKE MONEY! REPAIR HYDRAULIC JACKS



Earn While You Learn At Home
Make up to \$5 an hour, full or part-time, in the competition-free field of Hydraulic Jack Repair. Millions of jacks in auto service stations, truckers, body shops, riggers, farms, need servicing. We show you HOW. Easy step-by-step directions.

Get Folder PM 7 & free bonus offer

Institute of Hydraulic Jack Repair

P. O. BOX 50 • BLOOMFIELD, N. J.

A Correspondence School Licensed by N.J. Bd. of Ed.



VACATION TIRE SALE

Don't be misled! When buying tires look for the BEST QUALITY to safeguard your family. Besides TOP QUALITY, we offer LOWEST PRICES EVER—for we buy in carload lots and offer these BIG SAVINGS to YOU!! Don't wait—ORDER NOW!

SLIGHTLY USED			
600/16	4.31	670/15	4.71
600/16-6	6.91	710/15	4.81
650/16-6	7.41	760/15	4.91
750/14	6.81	800/15	4.91
800/14	6.81	820/15	4.91
750/16-6	8.71	640/15	4.31
700/16-6	8.71	700/15-6	8.71
		750/16-8	9.71
		700/17	9.91
		750/17	11.71
		650/20	9.91
		700/20	9.91
		750/20-8	12.31
		825/20	17.91
		900/20	17.91
		1000/20	18.91
		1100/20	18.91
		1000/22	19.91
		1100/22	18.91
		750/20-12	13.91

White Walls 50c extra... FREE TUBE with EACH TIRE PURCHASED
This is TOP QUALITY AT WHOLESALE PRICES—We are one of the largest DISCOUNT TIRE outlets in America. Money back guarantee. Send Order NOW!! All tires shipped f.o.b. Phila.—Send Check or Money Order to
AMERICAN CENTRAL TIRE CO. 186 W. Berks St. Phila. 22, Pa.

61

SPECIAL OFFER

FROM
DU PONT



**3 CAR
WASHES
ONLY 10¢**

Will not streak...safe for all cars!

Du Pont Car Wash is faster and safer. Won't harm wax, drains dry without wiping. One packet does entire car.

TEAR OFF END TAB
AND MAIL WITH 10¢



New Quick-Grip "Duco" Household Cement sticks quicker, holds better...dries fast. Waterproof, transparent, flexible, it mends 1,001 things — china, wood, metal, glass. Available at leading stores.



BETTER THINGS FOR BETTER LIVING...THROUGH CHEMISTRY

Du Pont Car Wash Offer
Department 209
Wilmington 98, Delaware

I enclose 10¢ in coin and end tab from a "Duco" Cement carton. Please send me 3 packets of Du Pont Car Wash. Offer expires Dec. 31, 1960.

Name _____

Address _____

City _____ State _____

ITEMS FROM ALL OUTDOORS

By Dick Kirkpatrick

CHOOSING the right propeller for your outboard boat and motor, even with the help of a qualified dealer, often ends up as an educated guess at best. Many dealers, though, are now using a "loan prop"—a variable-pitch outboard propeller with seven possible pitch settings from 9 to 15 inches. You try your own outfit under operating conditions at all the settings, then buy the fixed-pitch prop that best suits your needs. Or, if it becomes obvious that no one pitch will handle all your boating activities efficiently, you can always buy your own variable-pitch model.

TRANQUILIZERS GO UNDERWATER with the free diver's equivalent of the conservation officer's "stun gun," an expendable underwater projectile with a hypodermic syringe instead of a spearhead. Divers can use different drugs in the syringe to kill, paralyze, tranquilize or medicate fish up to two tons. The advantages are obvious—a fish "hunter" can tackle really big fish with impunity, since he won't be tied to an angry monster with his spear line. He can shoot, then follow until the drug takes effect. Diving biologists can stun fish and bring 'em back alive and unharmed for study or exhibition. It's made by James Chochos, Jr., Arlington Towers, Arlington, Va.

A NEW STUDY in fisheries research, by George J. Ridgway and George W. Klontz of the U. S. Fish and Wildlife Service in Seattle, Wash., has established that there are different blood types among salmon. This is expected to prove a valuable tool for fisheries management and conservation workers in identifying "races" or subpopulations within species of salmon, and in their never-ending job of charting salmon migratory patterns and routes.

GOOD NEWS for catamaran and pontoon boat owners—"cat" styled trailers are coming on the market, with side roller channels and hull supports designed to fit most of the standard hull shapes. One of the manufacturers, Tee-Neer Trailer Co., of Youngstown, Ohio, is also making a cat-conversion kit, with twin-hull rollers that can be used to convert their other trailer chassis. ★★★

dingy gray to matching blue in one afternoon



John Primeau chose blue Masticote to match his house. Masticote is made by The Madison Paint Co., Cleveland, Ohio.

Cleveland man stops roof leaks with Masticote Colored Aluminum Coating

John Primeau, of Cleveland, Ohio, reports solution to a familiar homeowner's problem—a dingy, leaking roof. He simply brushed on a new one—and did it in one afternoon—and color-styled it to harmonize with his house.

He used Masticote, a fibrated aluminum roof coating made with Alcoa® Pigments that offers the famous, all-season protection of aluminum in a choice of sun-proof colors.

It's weatherproof. An aluminum fibrated coating protects in any climate—stays firm on top, soft and pliable underneath, will not run or crack. It literally seals the surface, thus protects against surface deterioration and extends roof life. And reflective aluminum turns back part of the sun's heat, helps keep interiors cooler in summer.

One coat hides any surface. A coating like Masticote is ideal for

built-up composition roofing, asphalt shingles, tar paper and slate. Also seals and protects concrete, cinder block and stucco as well as corrugated steel, sheet metal and weathered, galvanized surfaces.

Handsome metallic colors. Good colored aluminum coatings are fade-proof, stay new-looking for years. Weathering actually intensifies the colors.

Easy to apply. Coatings like Masticote come ready mixed, require no thinning or heating. Apply with ordinary roofing brush or stiff bristle paint brush.



ALCOA does not make roof coatings, but we will be happy to refer you to reputable manufacturers who do. Send today for our booklets, *Painting With Aluminum*, *Painting With Aluminum in Color*, and *Aluminum Roof Coatings Make Time Stand Still*. Use the coupon.

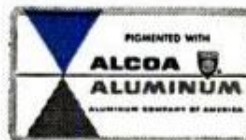

Look for this label . . . it's your guide to the best in aluminum value

For exciting drama watch "Alcoa Presents" every Tuesday, ABC-TV, and "Alcoa Theatre" alternate Mondays, NBC-TV

Aluminum Company of America
1748-G Alcoa Building, Pittsburgh 19, Pa.
Please send your free booklets:

- Painting With Aluminum—in Color*
 Aluminum Roof Coatings Make Time Stand Still

Name _____

Address _____

City _____ Zone _____ State _____

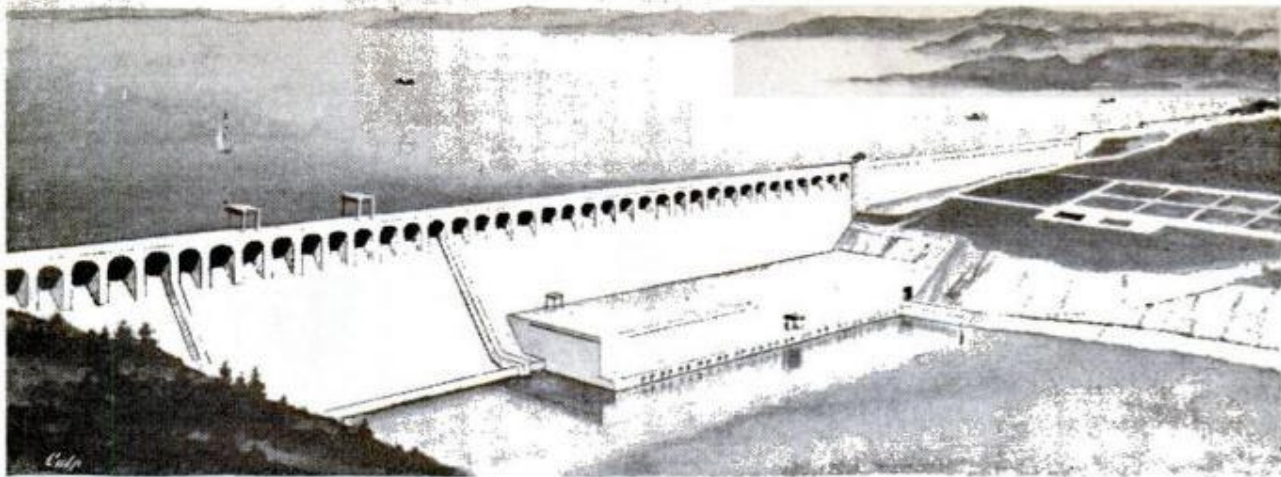

This is an artist's conception of how Bratsk hydroelectric station will look. It is one of several dams under construction

Huge Power Plant Rises in Siberia

NEAR THE TOWN of Bratsk, in mountainous Siberian wilds 3000 miles southeast of Moscow, U.S.S.R. engineers are building the world's largest hydroelectric station. Its 20 generators—each is of 225,000 kilowatts—will produce more than twice as much power as does the Grand Coulee, largest such U.S. project. Some of this power will be sent 2500 miles east on high-tension lines for use at Vladivostok, the Pacific Ocean port. At present, work is centered on a huge dam spanning the 1000-yard-wide gorge of the turbulent Angara River, the only stream to flow from Lake Baikal. When completed next year, the dam will rise 400 feet above the Angara, creating a reservoir 350 miles long.

Damming the turbulent Angara River will provide electric power for steel and iron production in the Siberian wilderness

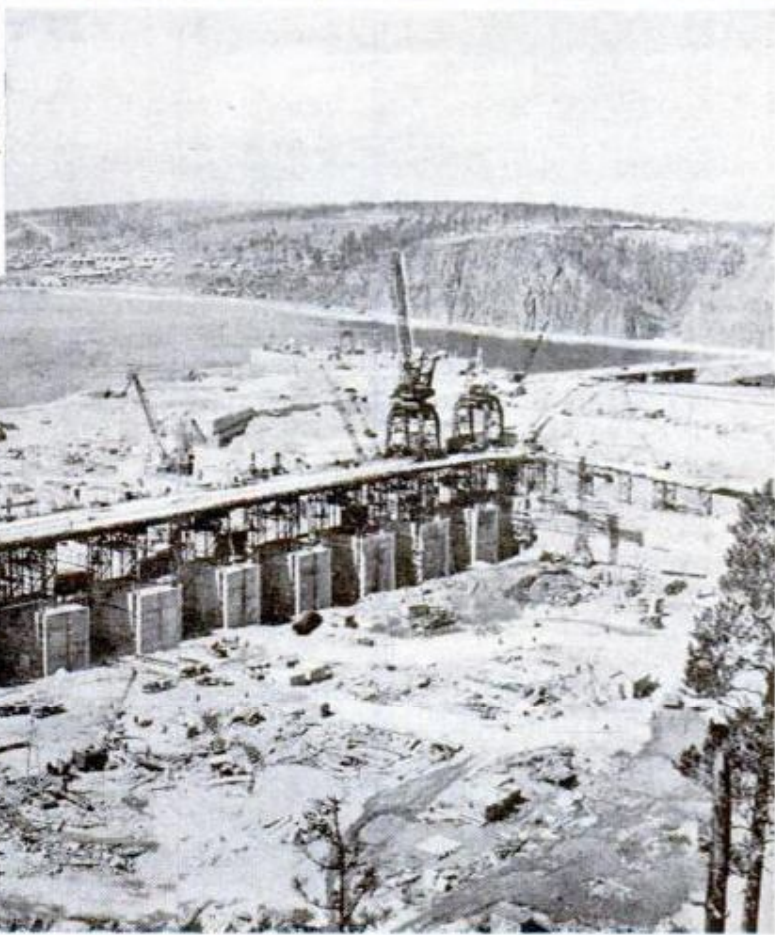
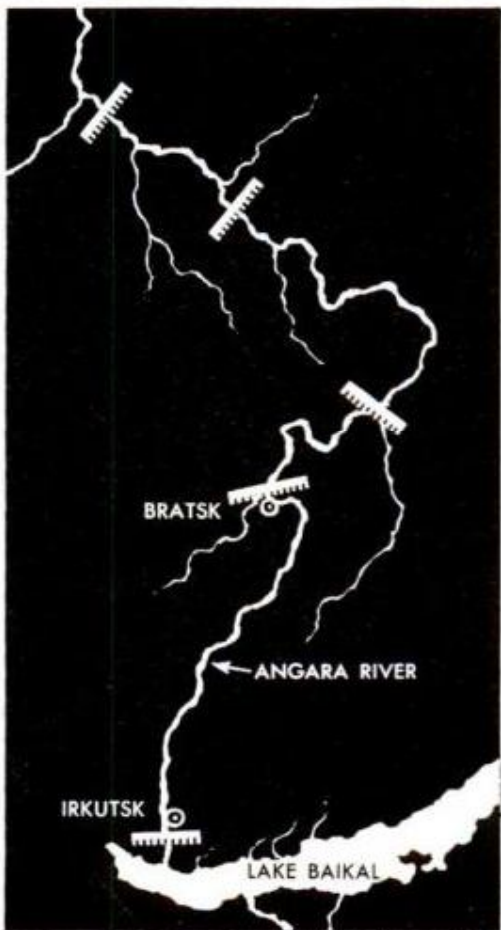

BUY IT BY THE SEAT OF YOUR PANTS

Behind the wheel, that's the place to buy Valiant. You'll feel real skedaddle, 101 horses worth, from an *inclined* engine that stretches regular gas like rubber bands. You'll feel a ride like nothing ever, mill-pond smooth, quiet as a clam. It's called Torsion-Aire, and it's teamed-up with a fully unitized body, rust, rattle and squeak proofed. You'll have an alternator electrical system that makes your battery last longer, a trunk as big as a cave (25 cubic feet of it), and plenty of traveling room for a family of six. Like what you read? You'll like driving Valiant better. Go see the man who sells 'em. You'll like him too. Valiant, the car you'd want at *any* price.



Valiant

KING OF THE COMPACTS

Get satisfying flavor...so friendly to your taste!

**NO FLAT "FILTERED-OUT" FLAVOR!
NO DRY "SMOKED-OUT" TASTE!**



Never too strong.
Never too weak.
Always just right!

You can light either end!

See how Pall Mall's famous length of fine, rich-tasting tobacco travels and gentles the smoke—makes it mild—but does not filter out that satisfying flavor!

HERE'S WHY SMOKE "TRAVELED" THROUGH FINE TOBACCO TASTES BEST



1 You get Pall Mall's famous length of the finest tobaccos money can buy.



2 Pall Mall's famous length travels and gentles the smoke naturally . . .



3 Travels it over, under, around and through Pall Mall's fine tobaccos . . . and makes it mild!

OUTSTANDING...and they are MILD!

© A. T. Co. Product of *The American Tobacco Company* — "Tobacco is our middle name"

UNCLE SAM'S "HOW-TO" MEN SHOW THE WORLD

about methanol gas

By Clifford B. Hicks

WHEN THEY SIT DOWN to dinner, a good many Pakistani men can thank a relatively unknown American for an improvement in their "vittles." Now, Pakistani housewives are really cooking with gas, and it's all due to Duncan Fisher's ingenuity.

Might be a bit crowded, but it gets there. Body parts are made locally, other parts imported with ICA aid





PAKISTAN

Taught by an ICA advisor, girls learn something their mothers never knew—how to preserve fruits and vegetables. This "new" technique is helping eliminate yearly famine periods

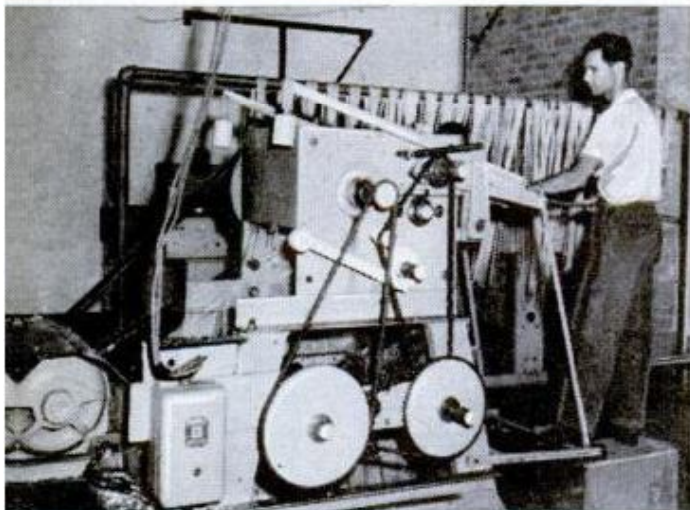

← Experimental machine produces fiber directly from several tropical plants found throughout the world. It is patented, and will be made available to interested countries

Below, students learn how to construct simple furniture from eucalyptus poles. The students then will return to their home areas to teach the same techniques to others

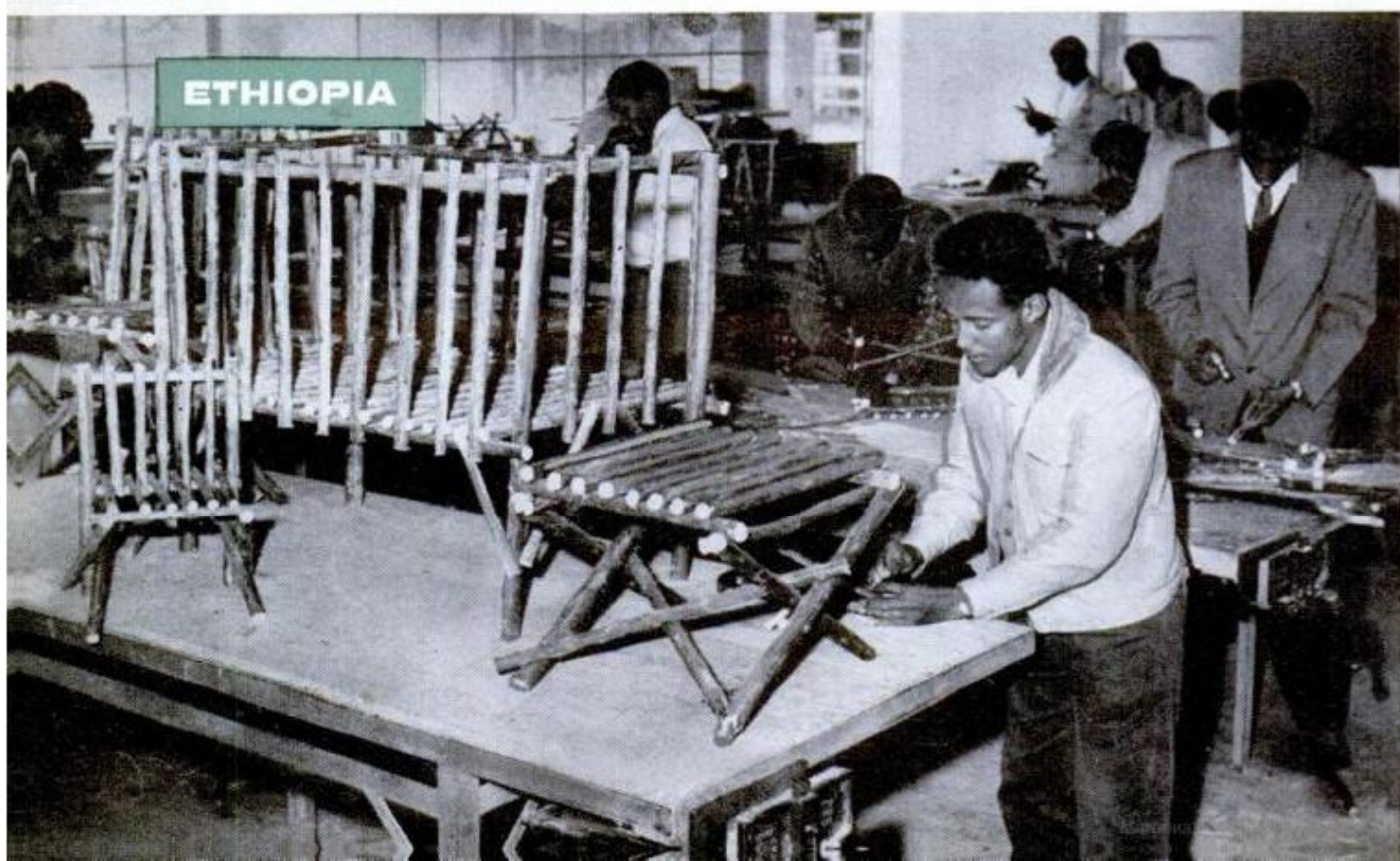

ETHIOPIA

A few years ago Fisher arrived in Pakistan as a representative of the International Cooperation Administration (ICA). His job, basically, was to help the villagers help themselves. He literally did it up brown, at least as far as their food was concerned, for he brought gas "ranges" to Pakistani homes—ranges almost as convenient as your chrome-trimmed model.

It wasn't a matter of giving the Pakistani housewife a taste of Western luxury. You have to unravel a long string of problems to see the significance of Fisher's gas stoves. Pakistan is an overpopulated and underfed nation. Many villagers live on a diet barely above the level of starvation, simply because farmers can't grow enough food to support all the people. If the land could be fertilized, food production could be stepped up significantly. The supply of fertilizer is no problem, for animal power is used to cultivate the land. But manure never has been used to improve the soil. In all of Pakistan there is very little fuel to burn. For centuries the Pakistanis have been burning caked animal dung to heat their homes and cook their food. Thus for countless generations the land has been robbed of its nutrients. The Pakistanis have been forced to overdraw their soil-bank account for untold years, and have never made any deposits.

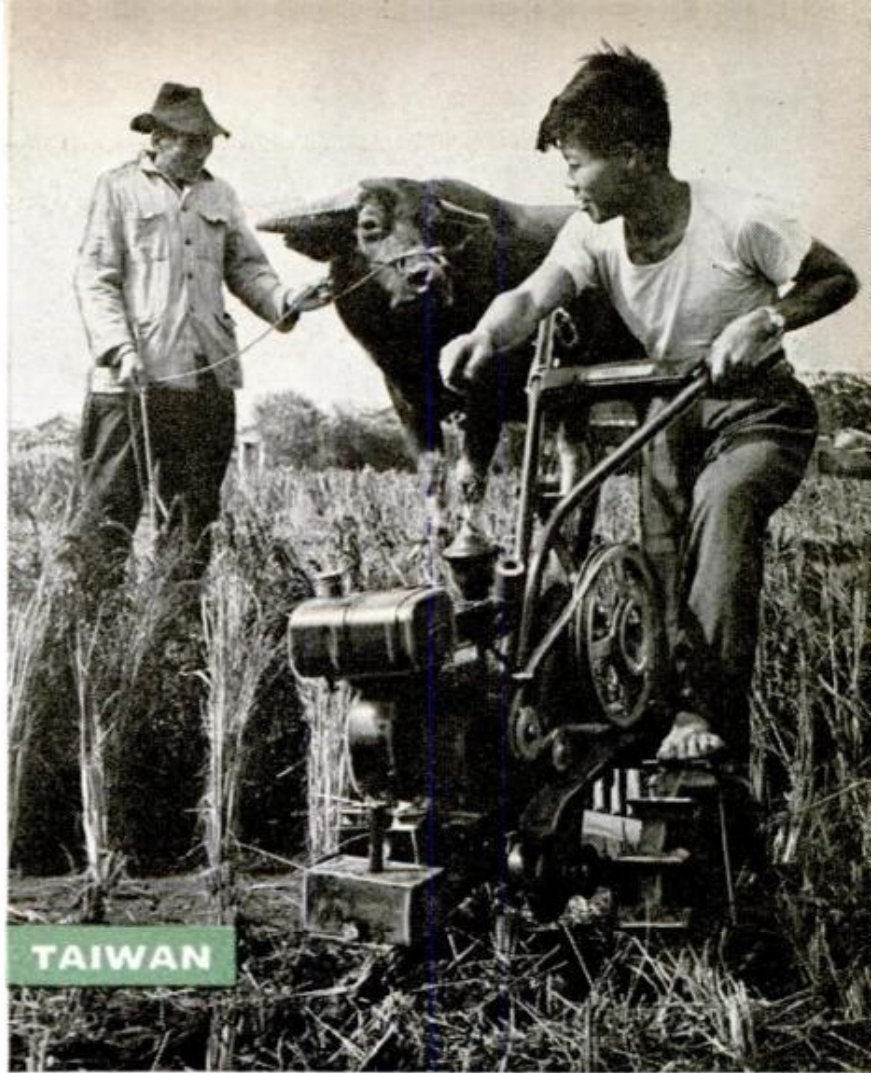

On the ancient farms of Taiwan, small power tillers are challenging the traditional position of the water buffalo. Some ICA machinery is developed on the spot, some is imported

Beach grass is planted from a tractor-drawn cart in the wastelands of Chile. The grass will help reclaim and control the sand dunes. ICA experts offer on-the-job help and advice





LIBERIA



LIBERIA

Top, workers stamp out mud blocks which are used as inexpensive building blocks. These particular blocks soon became wall of a new rural school

Above, simple hand press is used to mold clay into tiles, which then go into kiln. ICA hopes to foster small-industry loans for such projects. The loans would be granted to local businessmen

In a pilot study, ICA is helping three high schools in the Philippines in an effort to aid secondary education. Here a 14-year-old student proudly shows off a tremendous squash that was raised in the lush nursery of one of the schools

All of these problems were apparent to ICA advisers including Fisher. He figured that the basic problem was to save fertilizer, and to do this he had to come up with a new fuel. He managed to do it.

First he dug a fermentation pit 12 feet deep. Above the pit he suspended a storage tank five feet high. In the pit he placed liquefied animal dung. Meanwhile he designed and built gas-burner rings, which he attached to the stoves of a few of the villagers. He connected these to the storage tank by pipe.

For several days nothing happened. Villagers were beginning to look on Fisher as just another crazy American. Then the slurry in the pit began to ferment, producing pure methane gas, which was trapped in the tank. Fisher called the villagers together, turned a valve, lighted a burner and cooked some vegetables. The villagers were amazed. They were even more delighted when he put out the fire instantly, then relighted it. He pointed out that he was wasting very little heat because he could extinguish the fire as soon as the vegetables were cooked.

As a result of Fisher's crude but efficient gas generator, the ICA can proudly report that, at least in Pakistan, more people than ever are cooking with gas.

Best of all, the slurry from the fermentation pits can be used as fertilizer with no appreciable loss of plant nutrient. Thus at one stroke Fisher helped the Pakistani housewife, improved her husband's disposition with better-cooked food, and put more and better food on the table.

Duncan Fisher is just one of thousands of ICA workers who are helping the peoples of underdeveloped areas help themselves. For the most part their work

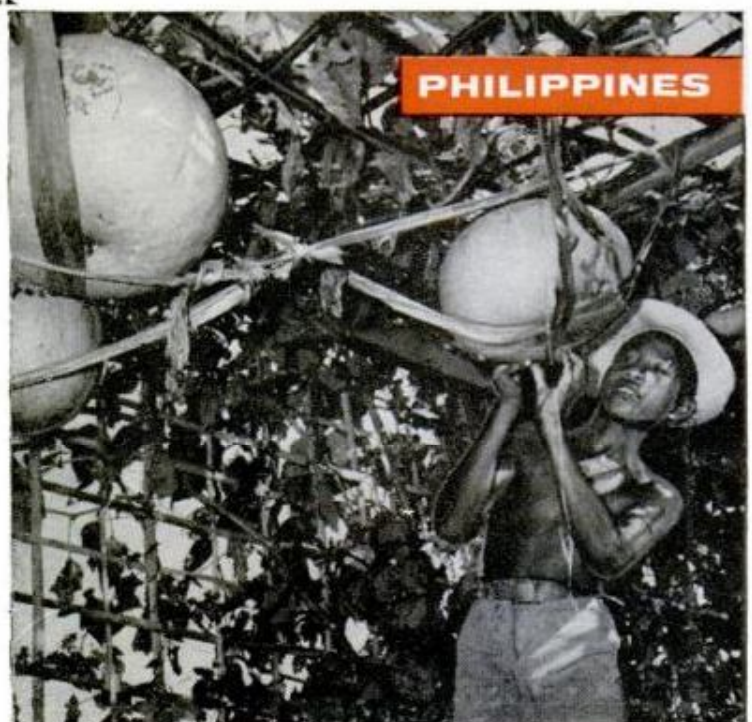

PHILIPPINES

INDIA



ICA helps provide steel for ancient Persian wheel. Blindfolded camel, started in circle, works for hours

goes unsung and unnoticed—except by the people they are helping. The ICA people are too busy bringing a little better life to fellow humans to consider the effects of their work on the cold war, or how many “uncommitted people” they can bring to “our side.” In an age when most of us are thinking about putting men on the moon, they are thinking about putting privies in the remote reaches of Brazil.

In this dedicated group, Fisher is not the only inventor. Many of them bring a strong streak of ingenuity to their work.

As an example, take Isadore J. Silverstone. Formerly of Rockaway Park, N.Y., Silverstone is an ICA water-supply engineer in the Philippines. This was the problem that ended up in his lap:

For several years, Philippine villagers have been drilling wells with American

Steel-drum “waterworks” designed by Silverstone removes high iron content from water used by villagers

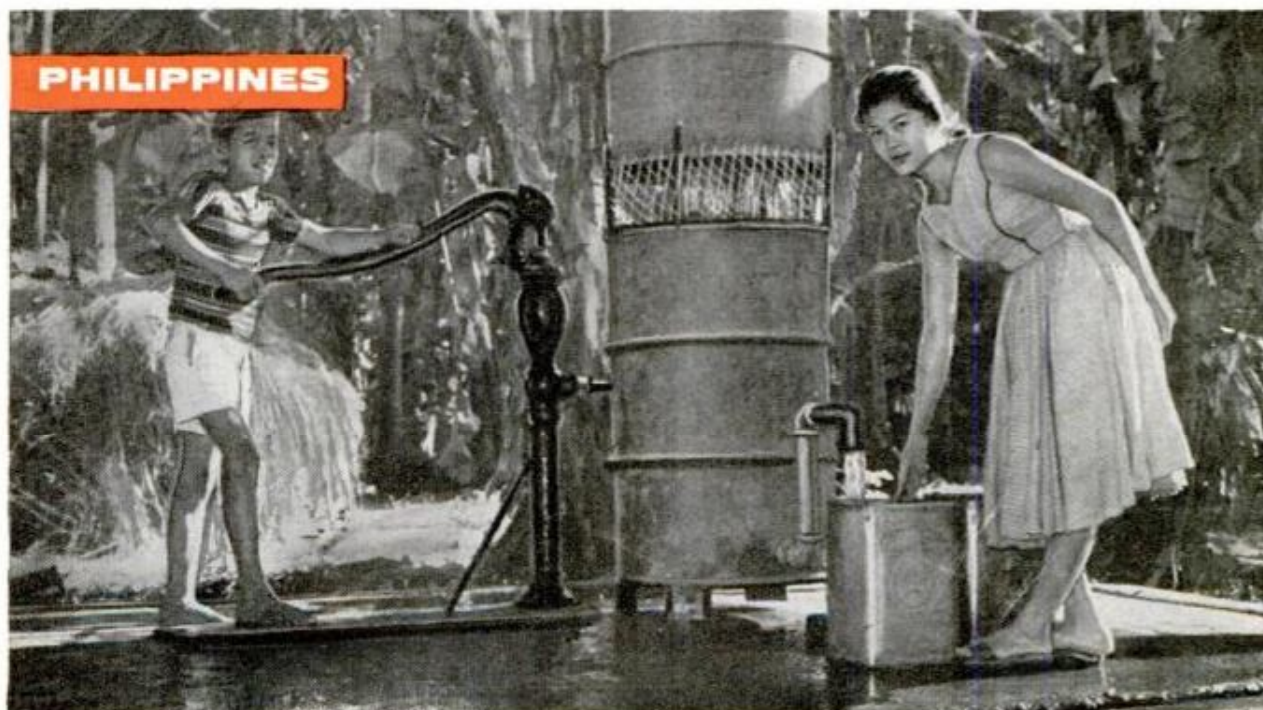

PHILIPPINES



PAKISTAN

Gas generator of unique design was devised by Duncan Fisher, ICA adviser. Animal dung, fermented in the tank, produces methane gas. Piped to a homemade stove, below, the gas provides flame for cooking in an area where there is virtually no fuel



economic assistance. Many of these wells, though, were scorned by the villagers. This was pointed out to the President of the Philippines, who soon pinpointed the trouble. The wells were producing red water. The red agent, which occurs naturally in the ground, really is rust—iron hydroxide. It wasn't damaging anyone's health, but it was downright unpleasant to behold. Coffee and tea turned black. There wasn't any tattletale gray in the housewife's laundry, but there *was* a muddy pink. And who wants to eat purple rice?

The President asked the director of the ICA mission if American technicians could solve the problem. The director pitched it to Silverstone. He knew he had to design a low-cost unit that could be built of readily available materials. In his tours across the countryside he had noticed an abundance of 55-gallon oil drums. Starting with these, he designed what has been billed as the "world's smallest public water-treatment plant." Any farmer or villager, almost anywhere in the world could build the unit to solve a local water problem.

Silverstone welded one drum atop the other. In the top drum he placed trays of slats (made of bamboo in the Philippines). The bottom drum he filled with layers of gravel topped with sand. From the well, water is pumped into the top drum. It cascades over the bamboo slats, is oxidized, and trickles down through the filtering layers. At the bottom it emerges clean, pure—and colorless.



INDONESIA

Silverstone's miniature waterworks was so efficient that the Philippine Government began building and installing the units across the countryside at a cost of \$10 apiece. At last count, 100 waterworks were in operation, and some villages were so impatient for units that they were building their own. Thanks to Silverstone, no more tattletale pink, no more purple rice.

East Pakistan had a more critical problem. During the growing season there is an abundance of food, but near-famine sweeps the country during other seasons. Strange as it may seem, the Pakistani housewife never has learned something that Grandma learned when she was still in pigtails: how to preserve food by canning it. ICA home-economics advisers figured it would be relatively simple to teach Pakistani housewives the art of canning—until they discovered that there wasn't a single manufacturer of glass jars in the entire country.

Meetings were held. A local glass manufacturer pledged his cooperation. CARE authorities agreed to ship several thousand jars to be used as teaching aids until jars could be produced locally. The East Pakistan Government organized classes. ICA gals started training "village workers" who in turn would train the housewives. The glass manufacturer, at his own expense, traveled around the world to study modern methods of making jars. Soon after his return, jars started rolling out of a local factory by the thousands. Today women throughout East Pakistan are canning

Soil-brick press permits one man to exert pressure of 20,000 pounds. It was developed by Ralph Dunkle, one of the most ingenious of ICA men. Below he is shown supervising the operation of a rice thresher operated by bicycle pedals and chain





LIBYA

Shifting sand dunes, constant threat to Libyan farmers, are being tamed with ICA aid. Vegetation is planted in a network across the sand-blown area. Later a tree will be planted in each of the squares

vegetables and fruits to supplement their meager fare during seasons of scarcity.

In August, 1957, E. B. Brown arrived in Ethiopia. No bands played, no delegations welcomed him, yet this man was to change the Ethiopian countryside. Bowen is a farm-machinery specialist, and his assignment was to help Ethiopian farmers produce more food. In his first trip through the farmland he noticed the Ethiopian plow, which had been changed very little in cen-

turies, was highly inefficient. It had a single shaft of eucalyptus, and a very narrow point which turned only a three-inch furrow. With this age-old plow the Ethiopian farmer had to plow and crossplow his field four or five times for each crop.

Bowen sensed that any new plow would have to resemble the traditional one or the farmer simply would turn his back on it. In a local supply dump were several two-

(Continued to page 222)

Carpenters work on the exterior wall of a prefabricated home. ICA advisers introduce new ideas under the philosophy of helping others help themselves. Their ultimate aim is to put themselves out of business



NEPAL

AN EYE ON SPACE

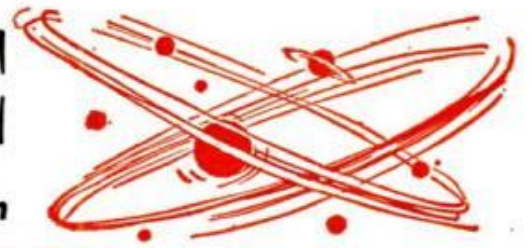

By Dr. Dan Q. Posin

PROFESSOR OF PHYSICS, DE PAUL UNIVERSITY
SCIENTIFIC CONSULTANT AND ADVISOR, COLUMBIA BROADCASTING SYSTEM

THANKS TO SATELLITES, we're gleaming a lot of information about space these days. Just how do these little spaceships send so much information back to Earth?

Vanguard I, the smallest of all satellites, has held its own in sending back information. It has been out there, since its launching on March 17, 1958, orbiting Earth, coming as near as 409 miles and swinging out as far as 2453 miles. And that is why it is still out there—it is so far out that it encounters virtually no friction drag, and should be able to retain its speed for perhaps another 1000 years!

It is small, as you recall, a "grapefruit" 6.4 inches in diameter and weighing 3.25 pounds, but it is mighty. It has learned much about space—or, rather, we have learned much about space by keeping track of the detailed motion of Vanguard I. For, the fact is, that Vanguard I sends us only its transmitter's radio signal, unmodulated by any instruments. Yet, as we keep tab on the satellite's flight we learn, for example:

1. The Earth's atmosphere at 400 miles, although extremely slight, is nevertheless about five times denser than we thought.
2. The Earth is pear-shaped, having a 50-foot peak at the North Pole and a 50-foot depression at the South Pole. (See page 211.)
3. The Moon's gravitational pull can be observed in the satellite's motion.
4. The Sun's rays can push a vehicle through space, and this has been observed as Vanguard I has gone slightly off course—rising and sinking by about one mile at its point of closest approach to Earth. In the course of one

(Continued to page 238)

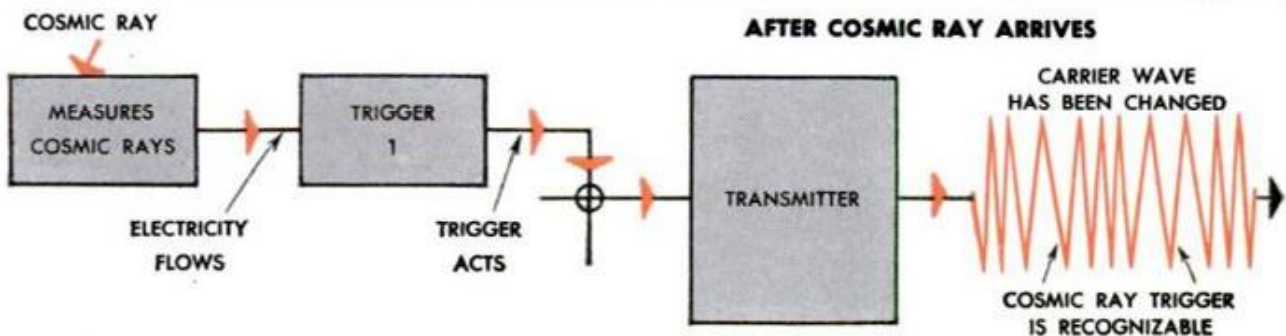
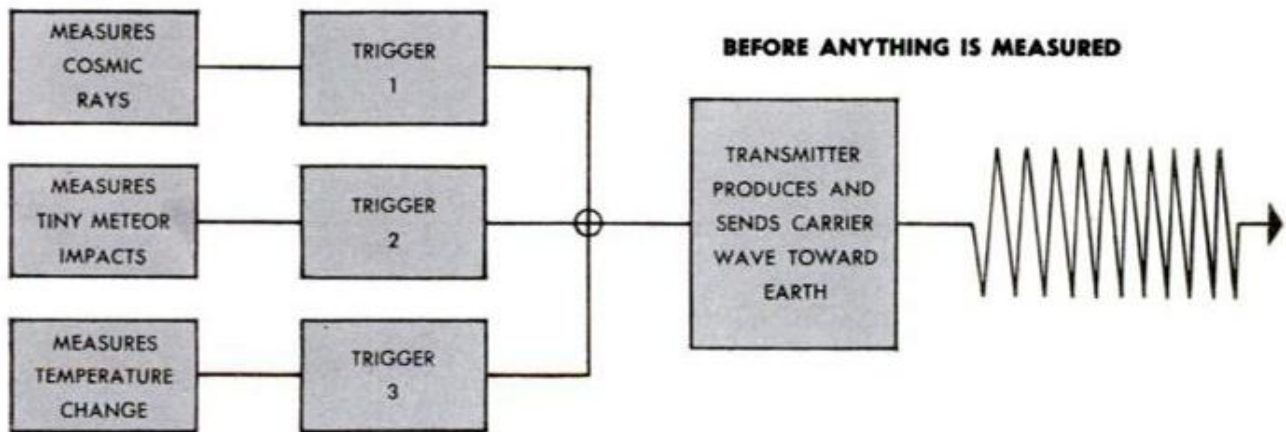



DETROIT LISTENING POST

By Jim Whipple

LIKE ALICE'S Wonderland, Detroit seems to grow "curiouser and curiouser." An early look at the '61 lineup reveals that the big ones are getting smaller and the small ones getting bigger. Compacts are growing less so. The trend started with the Comet, stretched inches longer than the Falcon from which it derived.

Now we will have the BOP cars, offshoots of GM's Buick, Oldsmobile and Pontiac Divisions, all of which will be longer in wheelbase and bumper-to-bumper dimensions than the Corvair from which they've borrowed their basic body shells. Typical will be Pontiac's Tempest with a wheelbase of 112 inches and an over-all length of approximately 187.

This trend toward a "medium" compact has grown from a well-founded suspicion that the public would react favorably to a slightly larger compact as long as it retained the blessings of maneuverability.

It is interesting to note in passing that these BOP compacts will shape up very close to the dimensions of Fords, Chevs and Plymouths of six or eight years ago. And those were cars that no one ever criticized for being big or unwieldy. If Comet's success is a bellwether, we can expect the BOP cars to follow suit.

At the other end of the seesaw, down come the over-generous dimensions of the mediums and the luxuries. By now the word is out that the BIG Lincoln will be scaled down to proportions more manageable in city traffic. Mercury is expected to offer luxury touches on a smaller scale as it once again shares bodies with Ford.

The larger GM cars, Pontiac, Olds, Buick, and quite possibly Cadillac, as they share basic body understructure, will all show beneficial results of the engineering Slenderella treatment.

Wheelbases will probably be down two to three inches and bumper-to-bumper measure may drop as much as six inches.

To make the picture really rosy there will be very noticeable improvements in passenger comfort with a couple of extra inches of headroom and more legroom for

all six passengers by virtue of wider, deeper "step-down" floor pans and lower transmission humps and drive-shaft tunnels.

Even better news for owners of crowded garages is the reduction in widths of these cars by as much as three inches. As a result of the paring-down process, weight has been reduced, bringing a welcome "free" boost in performance, or improved economy depending on engine and axle option.

It seems that Detroit has really gone in for "sensible shrinkage" in response to rumblings of discontent with the turnpike behemoths of recent years. They got the message back in 1958, but the curse of lead time between approval of wood and clay mockups and full production once again brought a frustrating delay. Three rousing cheers for smaller-on-the-outside-bigger-on-the-inside thinking that has resulted in genuinely better "big" cars for '61.

Could the compact philosophy applied to big cars combined with the stretch-out thinking re the compacts—if carried to ridiculous extremes—lead to 27 different versions of the same sized car?

It would not seem to be in the cards, as there's plenty of evidence that Detroit is trying, more than ever before, to meet the varied demands of 50-million customers. Proof—the compacts and the personal cars such as Thunderbird and Corvette. Balancing up the shift toward larger compacts for '61 is Rambler's American with an all-new body and, for the first time, genuine six passenger capacity.

American's styling will not be miniaturized 108-inch Rambler and there will be no hint of the old (1950) familiar ocarina shape. Wheelbase will remain at a truly compact 100 inches with improved seating dimensions a result of squeezing the passenger compartment nearer the front wheel housings, American's model lineup is broadened by addition of a four-door wagon and a convertible.

With expectations of holding the base price of the stripped two-door at the magic figure of \$1795, AM's new American could carve itself a really big slice of the market providing a full, six-passenger car at just \$100 or so above the popular imports and while undercutting its less compact competitors by the same amount.

Something for sporting types will definitely be under the hood of Pontiac's new compact Tempest. Believe it or not a big (195 cubic inches) short-stroke four! Rumor has it that the warmer version of this futuristic four-holer will develop 165 horsepower. And, to ice the cake for those who get their kicks from really driving, the manual transmission will be a fully synchronized, four-speed floorshift. ★★

Sacramento—Ocean Port

SEA-GOING VESSELS will sail 90 miles inland to reach port at Sacramento, Calif., when a new channel and turning basin are completed late next year. Origin of the new ship route is Suisun Bay near San Francisco, and terminal is a turning basin at Sacramento, capital of the state. The 90-mile channel, which was started in 1949, will be 30 feet deep and 200 feet wide. The twisting Sacramento River is too shallow for heavy ship traffic.

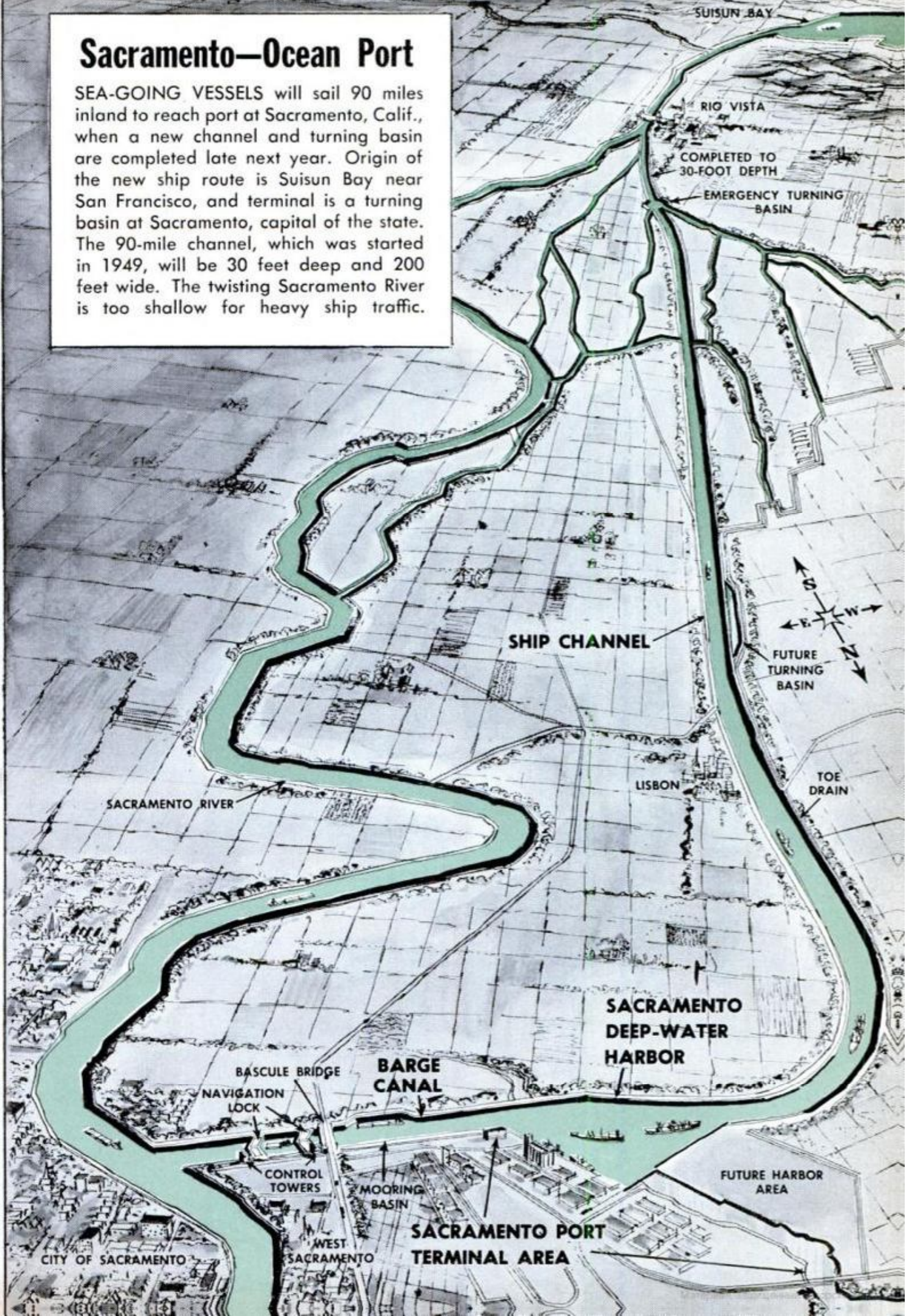

If It Can't Be Repaired-



BOWL. Kiokichi Sano drills holes in stems of china flowers so they can be set on metal pegs and replaced in the bowl. Some 25 large pieces will be joined with this technique; smaller splinters will be cemented

INSIDE HIS SMALL, quiet shop just around a corner from New York's bustling Third Avenue, a tall, energetic man named Gabriel Hirsch holds a court of last resort for people who break things—whether it be a handle on a cooking pot or an Etruscan vase thousands of years old.

The shop—it's called Hess Repairs, after the founder, Roscoe Hess, who died 12 years ago—has a reputation for repairing *anything* except large pieces of furniture or appliances. Many of its customers are referred from Tiffany's, the jewelry store; from Haviland & Co. and Josiah Wedgwood Sons, Inc., renowned china makers; from Baccarat & Porthault, Inc., the crystal mak-

ers, and from art museums and antique shops throughout the country.

Hirsch is aided by a group of men and women he advertises as being "Repairers of the Irreparable" and as some 2500 customers discover each year, if these artisans can't repair what's been broken, the chances are nobody can. Luckily for the butterfingers, few appeals for help are turned down.

All told, some 250,000 items have been repaired in the shop since it opened in 1945. They include teapots, bird cages, drinking glasses, toy pianos, dinner plates, French tapestries, fishing-rod reels, chess sets, lamps, clocks, ivory and lace fans,

SEND IT HERE

By
James Biery

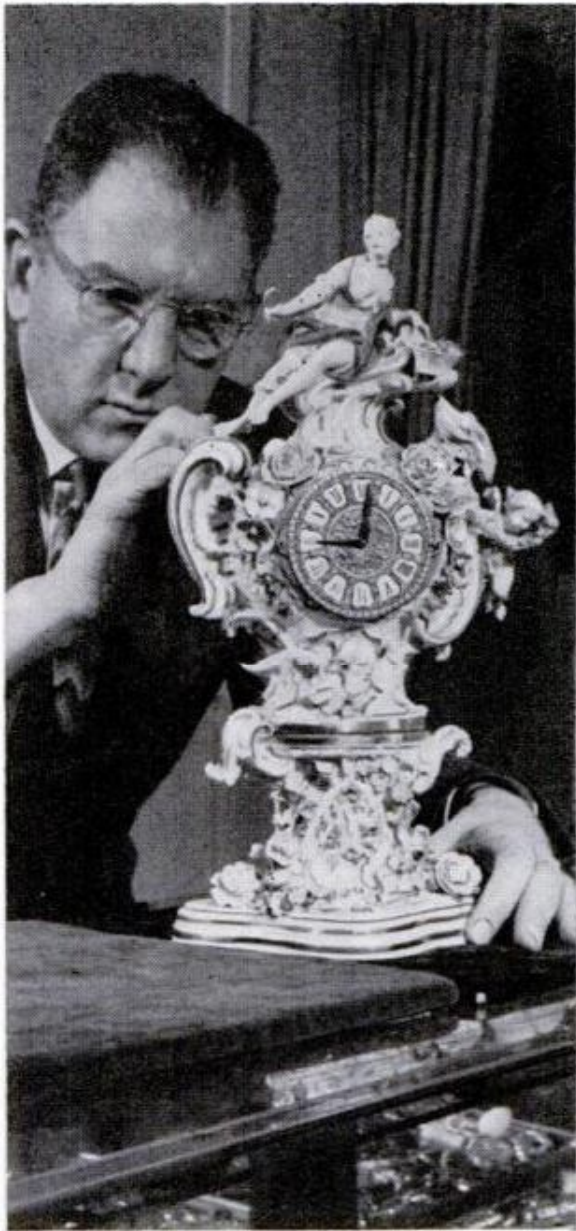

CLOCK. Shopowner Gabriel Hirsch test-winds a restored Meissen china clock

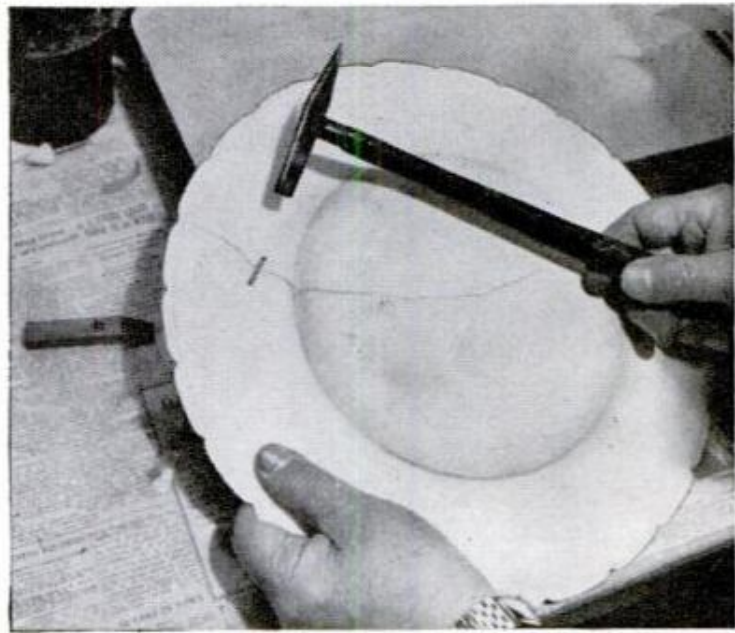
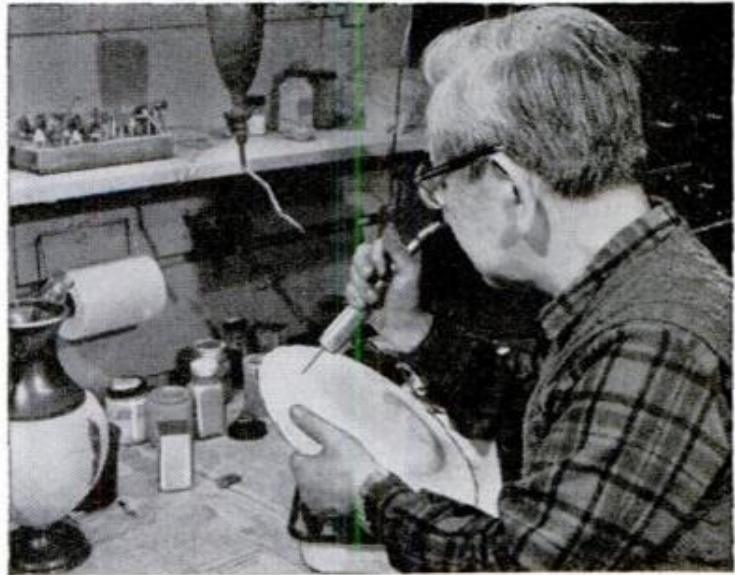

PLATE. Sano pounds a staple into holes he had driven alongside a crack. A porcelainlike material will cover staple

pepper mills, gold-mesh evening bags and umbrellas. All entered the shop either in pieces or smashed to smithereens, with parts missing or somehow not in working order. After an average stay of six weeks, they went out as good as new—or in extreme cases, as repaired as possible—to customers in all parts of the United States (including Alaska and Hawaii), Canada, Jamaica and the Virgin Islands.

There are, of course, no typical days at Hess Repairs. But one day recently, a visitor would have found Hirsch, his wife Bernice, Kiokichi Sano and Irena Marlewska processing some of the 500 items then awaiting repair. Staff member Al Bosle was

grinding nicks off drinking glass rims in his home workshop.

Hirsch examined an ivory chess piece and a cuff link a young woman had brought in. "We can fix these easily enough," he told her. He then made phone calls to locate cork (to be placed in the silver tops of bottle stoppers) and velvet (to be glued to the top of a daguerreotype case) before taking the items into a smaller room where Mrs. Hirsch catalogued objects accepted for repair.

Lying on a table were, among other things, a teapot with a broken spout, a worn daguerreotype case, a porcelain fisherman broken in two and a bamboo and brass pipe

with a shattered ceramic bowl. Taking each item in turn, Mrs. Hirsch taped on a numbered paper, marked the number on a customer's card in a filing cabinet, then wrapped each piece and splinter in tissue paper before placing each item in a separate jar bearing the matching number.

In a large workroom, Kiokichi Sano repaired a cracked marble plate. He bored a hole with a dentist's drill on each side of the crack, then snipped off a section of steel wire and formed a staple in a vise. He pounded the staple into the holes and brushed over it a porcelain-like material which, when dry, he would paint to match the plate. He next unwrapped from tissue paper a china bowl holding china flowers, most of which had broken off. He would restore the bowl using some pieces no bigger than a match head.

Irena Marlewska repaired a blue, 1844 Sevres plaque decorated with gold vines. Having stapled and cemented a seven-inch section of the rim into place, she extended the gold vine pattern to cover the crack and then painted gold vines at intervals around the rim, balancing the pattern. Her



PEGGING A BEAK. Irena Marlewska drills a hole in a porcelain bird beak to prepare for pegging the broken tip to it. Peg will sit in shellac

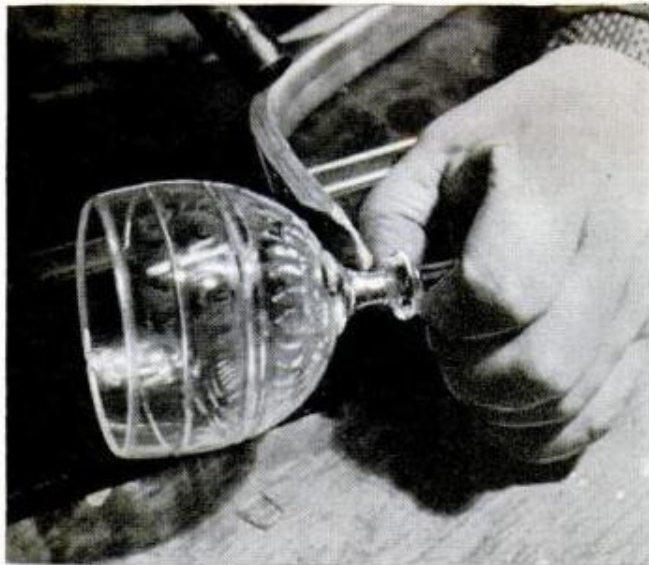

BANDING A GOBLET. Sano first cut a ring around each part of the broken stem. He then wound copper wire from one ring to the other, wrapping the break. He is applying solder over the wire

AWAITING PAINT. The join will be sanded flush and then painted a color matching rest of beak

second job that day was to fill in a gouge in a papier-maché figure of a boy. She began mixing paper and paste.

"I can't say we use many unusual methods," Hirsch said, "but I think we often are unique in our ingenuity. Take the red Bohemian glass hurricane lamp we repaired. It was shattered. The large pieces we put together with staples and then we sewed on the tiny pieces with silk thread. It was like closing a patchwork quilt to draw them together to form the lamp. We decorated with red paint and while you could see the lamp had been repaired, the customer was pleased because she could use it with another lamp as a pair."

Why do people want things repaired? So they can use it in a pair, because they have





Old-time portable phonograph restored by Sano is typical of the sort of items that wind up at Hess Repairs

a sentimental attachment to the object, because it must be in working order to be of use, or because it may be of great value. Or irreplaceable, as was a recent, difficult repair. A sculptress brought in a sack of fragments and crumbling bits of pottery that had been an Etruscan vase before her cat knocked it over (a common cause for repair) three years before. She provided a sketch of its shape from memory.

"Our man examined each piece, deciding how the potter might have used such a form," Hirsch said. "The sketch was not much help. But he patiently reconstructed it, cementing in all the little crumbles. When the sculptress called for the vase, she said 'That's it! That's how it really looked. I didn't remember when I gave you the sketch. How did you do it?'"

The ability to repair, Hirsch explained, depends upon skill, experience, imagination, and, perhaps most important, patience—a quality that is often sorely tried at Hess Repairs. He cited an experience of Sano.

"An archeologist brought in a silver object that looked like a cigarette case that had been run over by a truck. He had found it in some ruins and though he had no idea what it was, he wanted it restored. Mr. Sano began tapping it out with a hammer. The silver was old and thin and each time he tapped it split. So he hammered and soldered. When he was through, he'd re-

created a beautiful cup with raised figures around its outside."

The shop is willing to tackle any repair job, but it has a particularly fine reputation for repairing crystal, china, porcelain and glass. Hirsch suggested that the four basic methods of handling these delicate materials could also be adapted to other materials in the home workshop.

"We cement pieces together," he said, "and this is all right if the use is decorative, but not for soaking in water." Such a repair was made on a glass candlestick holder. It took five hours of uninterrupted work to piece together and paint the shattered base. But the repair was detectable to the touch only because the paint had a different texture than the glass. "It's like working the most intricate jigsaw puzzle," Hirsch said, "and cementing, itself, is an art. You must put the parts absolutely flush so you can run your fingers over the repair or test it with a level and it will be smooth. We use a special cement, not household glue as do many amateurs, because ordinary adhesives sometimes destroy such materials as porcelain."

Stapling, the method Sano used on the plate, is frequently used on fragile materials. On heavy pieces, and where it might show, the staple is laid in a trough and covered with the porcelainlike material.

(Continued to page 230)



Lots of Summer Fun With Outdoor Toys

Nylon net returns any ball thrown at it—giving a youngster fielding practice. A batter and pitcher can use net as "catcher"
Tigrett Industries, Jackson, Tenn.

Rockers, ladders and parallel bars of tubular steel form a versatile outdoor plaything. Boys, lower left, are rocking
Universal Manufacturing Co., Bossier City, La.

Bucking bronc is glass-fiber horse on a steel spring. It comes with portable base or can be mounted permanently in cement
Game-Time, Inc., Litchfield, Mich.



Portable Sprayer With Extension Covers Wide Area



Hinged spraying arms on a portable sprayer extend to seven feet, enabling the operator to spray an eight and a half-foot swath across lawn or garden. The tank can be pressurized by either a foot pump—which comes with the unit—or a portable compressor. The sprayer, which operates on low pressure, will handle liquid fertilizers and weed killers, and can also be used to spray paint on floors or driveways.

☛ To purify water contaminated by radioactivity in event of a nuclear war, Army engineers have developed a water-purification unit to be dropped from the air to areas hard to reach by land.

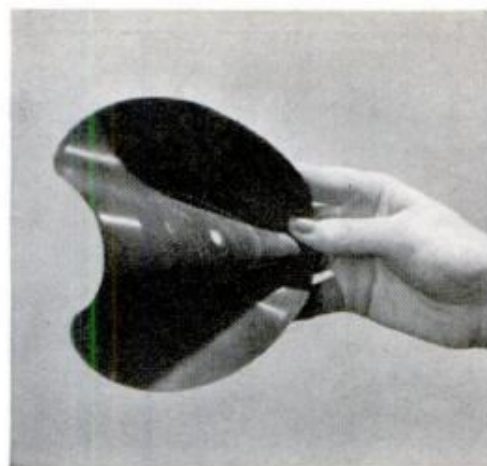

Ultrathin Record Slips Into Package

Pliable plastic platters—records made of polyvinyl chloride plastic only four thousandths of an inch thick—may be turning up in your cereal box or mail box soon. Available in all three speeds, the seven-inch, high-fidelity discs weigh only one-eighth ounce and are so flexible that they can be dropped into product packages, rolled in mailing tubes, or simply inserted in envelopes without special handling. The manufacturer expects to produce 40 million of the records in 1960, for use in sales promotion, direct-mail advertising, as inserts in books and magazines, and to provide vivid, verbal instructions to accompany new equipment and appliances in the home.

"Clinometer" on Instrument Panel Indicates Boat Trim

Boaters often underestimate the importance of lateral trim in small boats, though it's important for safe, efficient boating to keep the hull as level as possible. In sailboats, a few degrees of heel can cut your speed noticeably. A new "clinometer" for small boats gives an exact reading at any angle up to 70 degrees; it works by gravity with a glass ball sliding through a viscous liquid inside a tube.

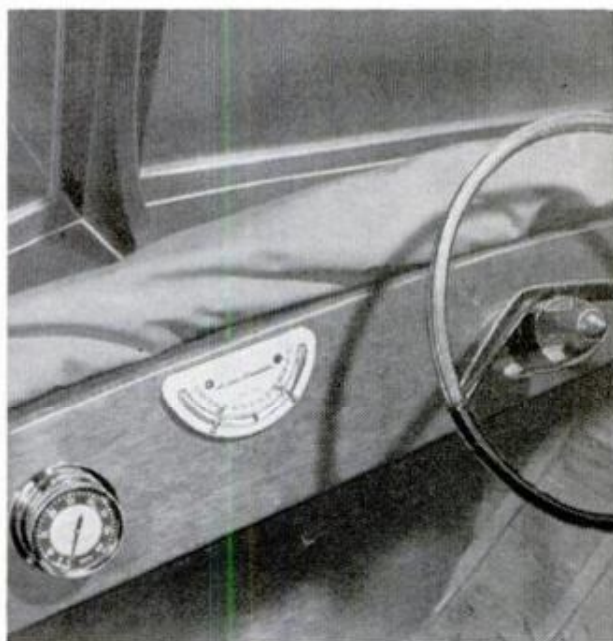



Strange-looking mandolin? The sounds that inventor Francois Baschet gets from it are even stranger

STRANGE MUSIC



ATOM-AGE musical instruments that look like designs for science fiction movies are making strange sounds in a quiet section of Paris. Two French musicians, in a workshop that looks as fantastic as it sounds, have invented guitars with soft soundboxes filled with air, pianos with glass tubes and violins that sound like altos. The secret is in the glass tubes, which replace the strings and make strange music when they are rubbed with wet fingers.

Composer Jacques Lasry tunes up contraption atop piano that gives piano notes unusual tone depths

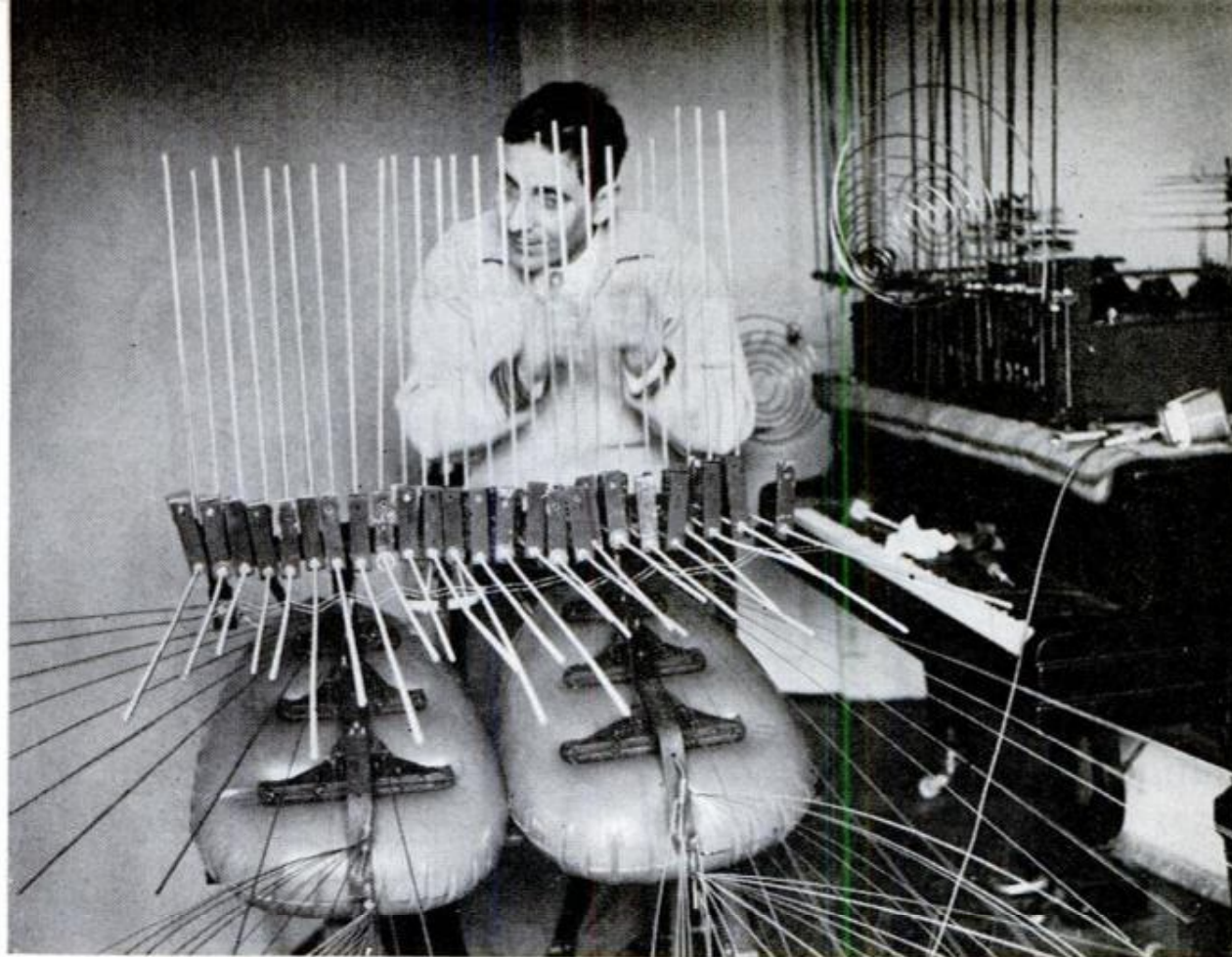

Soundboxes for this instrument look like seaplane floats, but when Lasry rubs the glass tubes with wet fingers, he produces some weird music. Below: Another instrument where glass tubes replace strings

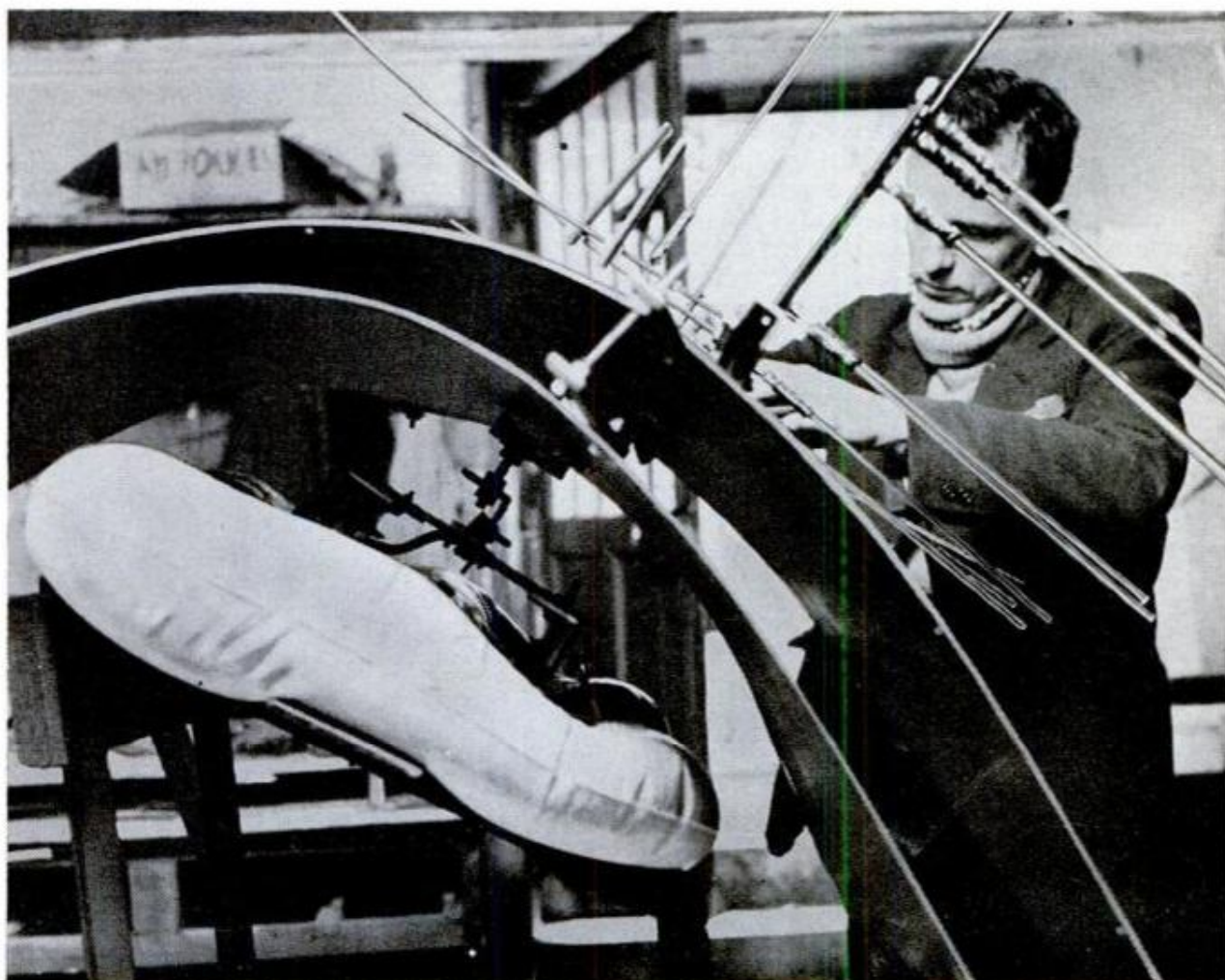



Helicopter Proves Successful at Minesweeping

Whirring above the Gulf of Mexico, a Sikorsky S-60 *Skycrane* recently demonstrated a new Navy technique for safely clearing mine-infested waters. The two-engine helicopter was fitted with a pod containing winch tows, cables and mine-

sweeping gear. As it flew along, the winches streamed out 600 feet of cable fitted to explode mines. The technique is safer than employing conventional surface minesweepers which, themselves, are vulnerable to mines.

Compressed-Air Vacuum Cleaner

Manufactured for use at automobile service stations or other places where compressed air is available, a new, hand-held vacuum cleaner picks up both wet and dry dirt by converting compressed air to suction. The conversion is made by drawing the air into a tube that is narrower on one end than the other and passing it through chambers which are angled. This creates a vacuum in the pickup chamber, causing material to be sucked in. It has no moving parts, no electrical connections and is operated by pressing a finger lever that controls the supply of compressed air.



Battery Corrosion Preventive

Using copper coins to prevent battery terminal and clamp corrosion is made possible by a new, polyethylene clamp which fits both positive and negative terminals of most batteries. The clamp holds the coins. The copper becomes a sacrificial metal, capturing acid fumes and keeping battery parts clean. This, of course, is a requirement for fast starting, long battery life and a minimum loss of voltage. The clamp may be installed permanently in a minute or so. It is designed to allow replacement of coins at the flip of a finger and without removal from the battery.





COMMUNIST CHINA'S first passenger car to show up at foreign exhibitions was displayed at the recent Leipzig Fair in East Germany. Called the "Red Flag," the big six-passenger sedan is powered by a V-8 engine developing 220 brake-horsepower at 4400 r.p.m. Length is 226 inches; wheelbase is 133.5 inches. It comes with automatic transmission, hydraulic-power steering, vacuum-assisted brakes and auto-tuning radio

Radio for Sunglasses Has Station Selector

People who have a yen for listening to the radio while outdoors or traveling, but balk at carrying a heavy portable or wearing a small one in their pocket with the cord and earphone showing, now can wear the radio in their sunglasses. The transistor radio-sunglasses have the radio parts built into the sidepiece, the left one of which also has a selector knob and a small button earphone. A piece of wire crossing the hinge gives the only clue they are not ordinary sunglasses. The glasses can be fitted with glass to match a prescription. They cost about \$34.50 for the standard type and come complete with an aerial which does not always have to be used.

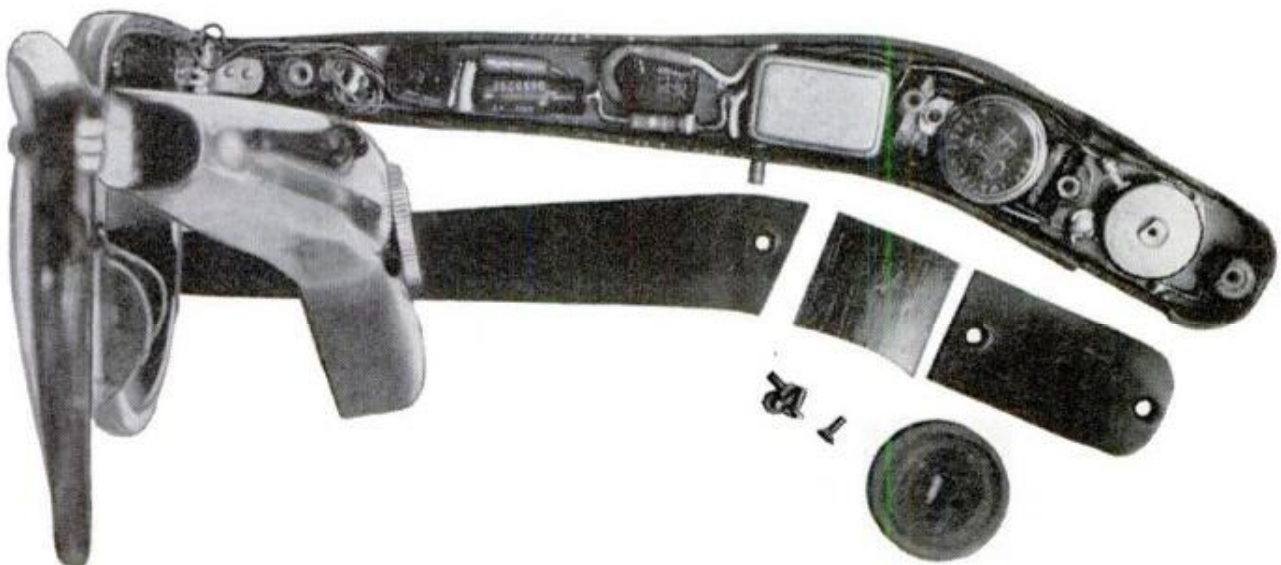

POPULAR MECHANICS

**OWNERS
REPORT**

A NATIONWIDE SURVEY

**BASED ON 1,678,825
OWNER-DRIVEN MILES**

How Good Is the Plymouth?

Owners like:

Handling ease	43.1%
Riding comfort	39.6%
Power, performance	24.8%

What's Wrong With It?

Owners dislike:

Poor workmanship	20.1%
Burns, leaks oil	12.8%
Doors, door latches	8.5%

Did Plymouth Buyers Consider a Compact Car?

Yes, did consider one35.3% No, did not consider one64.7%

Which Make Did They Consider?

Valiant	33.1%	Falcon	24.4%	Rambler	18.1%
Corvair	15.7%	Lark	7.1%	Dart	1.6%





Owners Praise Plymouth's Handling, Complain About Workmanship

FOR YEARS, Plymouth has been a fine handling car and this 1960 model is no exception. Plymouth owners rank handling ease tops, followed by riding comfort, power and performance, exterior styling, in that order.

Popular Mechanics surveyed 1000 owners of the 1960 Plymouth, asking them to tell us the good and bad features of their new cars. They did and this article is what they wrote, a nationwide report on the Plymouth.

In the complaint department, a new ogre is coming up fast to make the manufacturers tremble. For years, the big complaint of owners was poor economy of operation, but today that seems to be of less concern. Today's major complaint (in the Plymouth and also in the Ford, surveyed last month) is poor workmanship. Buyers are looking at their new cars and criticizing them for poor assembly-line workmanship.

Among Plymouth owners there are 20.1 percent who put poor workmanship on their complaint list. Second on the list (and principally among owners of the new slanted-six engine) is oil consumption and oil leaks with 12.8 percent mentioning it. Third is door design and latch operation.

Over-all the Plymouth, like the Ford last month, came up with a much lower rating than any of the three compact cars surveyed earlier this year. In fact, more Plymouth owners gave their cars a Poor rating than any group of owners we have surveyed in recent years.

But it is better to let the Plymouth owners tell the story. Here, in order of frequency of mention, are quotations describing the five best-liked features:

**MARGINAL COMMENTS
BY ART RAILTON
PM's AUTO EDITOR**

← *If each buyer refused to sign anything until he could check over the actual car he is getting, this trouble would vanish in a year. Problem is that we get so emotional about a new-car purchase that we can't see through the rosy glow until it's too late.*

← *V8 owners are twice as happy as Six owners: 6.3% of V8 owners rate the car Poor; 14.4% of the Six owners rate it Poor.*



Above, owners are generally satisfied with the gas economy of the 1960 Plymouth although many owners of the slant Six say it requires premium gasoline

Left, doors on the new body are thick and heavy, but do open wide for ease of exit from the rear seat

To a guy who drives a truck all day, the Plymouth may seem sportscarish, but a Sprite owner would disagree. It handles well, but is too big, too soft, to be as intimate as a sports car must be.

You mean people are still doing this?

There's restraint until you get inside a Fury—that was when the stylist reached for the panache box.

"Handles nice on highway, especially on curves and in windy conditions."—Illinois minister.

"The real reason I bought a Plymouth is that I want a car that handles like a sports car. I found Plymouth was the only one that came close."—California trucker.

"Easy ride on rough roads."—Tennessee attorney.

"Smooth ride. And I drive 28 miles to work daily, 9 miles on rutted rock roads, the rest on rough blacktop."—Kansas foundry worker.

"Plenty of torque and power. I can run off and leave any Ford or Chevy in a drag race."—California tire recapper.

"Had an Eight before, but think this new Six has more pep than the Eight did."—Virginia pattern maker.

"Plymouth style is well done, combining restraint and flair in a tasteful manner."—Ohio engineer.

"Looks a little better than most of the garbage Detroit makes."—New Jersey tool-and-die maker.

Most V8 automatic-shift owners say they get between 10 and 16 miles per gallon in city, 15 to 18 on trips

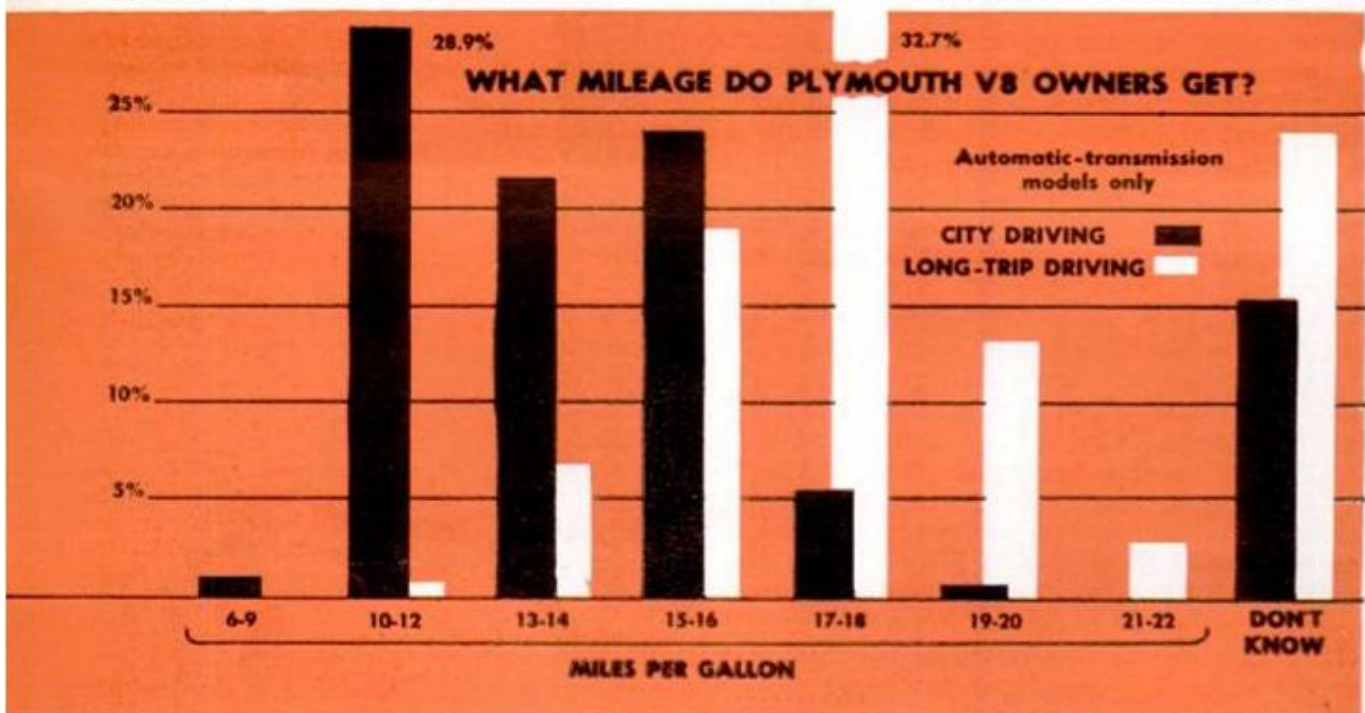



Checking master cylinder on a Plymouth with power brakes is tough. It's hidden under the power assist and can be felt but not seen by service attendant

Front-seat back is higher behind driver. It must be for styling as driver shouldn't lean back and nap



"Economy is the one feature I like best about the Plymouth. I came in first in a supervised economy run for Plymouth, getting 25.829 miles per gallon over-all with a handshift Six."—Louisiana businessman.

"I get 20 miles per gallon over-all with this handshift Six and like it. Can't see much use in buying an eight-cylinder engine."—Pennsylvania engineer.

← PM tested a Fury V8 with automatic shift. It averaged 13.3 miles per gallon in city; 14.7 on rural roads.

And Now the Gripes

The following quotations describe the complaints of the 1960 Plymouth owners in order of frequency:

"Poor workmanship. I found lots of things that were left off at the factory. Molding around tailgate and heater hoses were missing. Door handles fell off. If Chrysler can't build a better wagon than this for \$2745 I don't see how they ever hope to come to the top in sales."—Arkansas meat cutter.

"Too many things wrong with it. Split axle housing, bad

← I'd like to have seen the way this guy cut the meat the day his door handles fell off!

Electric wipers clear large portion of windshield. Rectangular steering wheel allows clearance for fat laps





Trunks are wider than ever and lower as well. The spare tire is carried horizontally and it interferes with loading convenience. Plymouth's tailfins are biggest in the business and a large percentage of owners say they do not like the bulkiness

What does he mean, if he were a dealer? He, the buyer, is the most important person. He can refuse poor workmanship. →

That speedometer is a nightmare. It's like reading a series of bar charts in a footnote. Who decided that a needle on a round dial was no good? →

points, defective spark advance, defective heater, bad seal on master cylinder, bad pressure cap."—Ohio estimator.

"If I were a dealer I would not accept the cars I have seen so far. Maybe some day the companies will discover the public would like to have a little workmanship."—Ohio flight coordinator.

"Burned a quart of oil every 400 miles. They finally put in new rings."—Illinois electrician.

"Oil leak in back of transmission has made hand brake useless on two occasions."—California shipping clerk.

"Speedometer makes a noise like a clock ticking. Dealer removed it six times, replaced parts, but it is still noisy."—Georgia postal clerk.

"Poor, poor, poor engineering of doors. A real safety hazard. They spring open to the touch."—Pennsylvania insurance agent.

"Automatic door locks had to be removed. They do not operate in cold weather. I feel they should be discontinued until perfected."—South Dakota accountant.

(Continued to page 226)

SUMMARY OF OWNERS REPORT: PLYMOUTH

Excellent 50.9%

Average 38.2%

Poor 10.9%



Satisfied V8 economy?		Best-liked exterior feature		Make of other car
Yes, satisfied 73.3%		Front end 15.7%		Another Plymouth 10.2%
No, not satisfied 26.7%		Low, streamlined look 13.4%		Another Chrysler make 5.5%
Satisfied Six economy?		Tailfins 9.0%		Ford Motor make 7.6%
Yes, satisfied 78.1%		Least-liked exterior feature		General Motors make 11.6%
No, not satisfied 21.9%		Tailfins 26.2%		Other U.S. make 3.8%
Best-liked features		Front grille 2.9%		Foreign make 2.3%
Handling ease 43.1%		Windshield 2.1%		How is dealer service?
Riding comfort 39.6%		Best-liked interior feature		Excellent 45.1%
Power, performance 24.8%		Seats 22.2%		Average 37.9%
Exterior styling 24.5%		Dashboard 20.1%		Poor 17.0%
Economy of operation 16.6%		Upholstery 10.2%		Would you buy from him again?
Roominess 13.1%		Least-liked interior feature		Yes, would buy again 53.9%
Roadability 12.2%		Lack of room 8.4%		No, would not 20.4%
Most-frequent complaints		Rear-view mirror 8.1%		No answer, don't know 25.7%
None at all 16.9%		Transmission hump 6.7%		What make was traded?
Poor workmanship 20.1%		Did consider a compact car?		Plymouth 42.0%
Leaks, burns oil 12.8%		Yes, did 35.3%		Other Chrysler make 11.7%
Door design, latches 8.5%		No, did not 64.7%		Ford Motor make 14.0%
Noisy speedometer 8.5%		What make compact?		General Motors make 13.6%
Not enough room 7.3%		Valiant 33.1%		Other U.S. make 5.5%
Cheap interior 7.0%		Falcon 24.4%		Foreign make 1.5%
Had trouble with V8?		Rambler 18.1%		No trade, no answer 11.7%
No trouble 84.3%		Corvair 15.7%		Next car will be?
Some trouble 13.9%		Lark 7.1%		Plymouth 33.5%
Considerable trouble 1.8%		Dart 1.6%		Other Chrysler make 6.7%
Had trouble with Six?		Plymouth only car in family?		General Motors make 7.6%
No trouble 56.5%		Yes, it is 62.1%		Ford Motor make 2.3%
Some trouble 22.9%		No, it is not 37.9%		Other U.S. make 0.3%
Considerable trouble 20.6%				Foreign make 1.5%
				Unnamed compact car 1.2%
				Undecided 46.9%

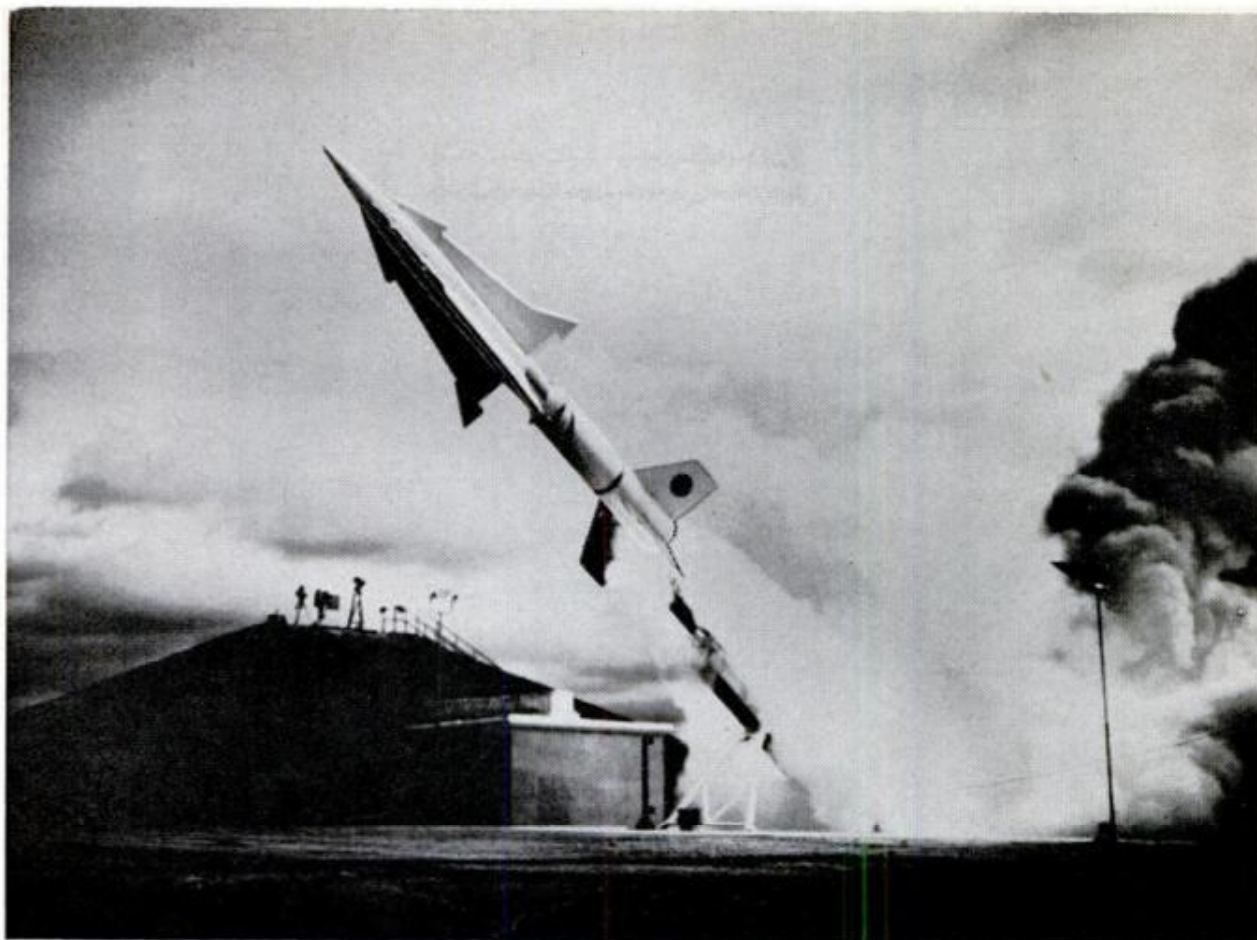

U.S. Army photo

Army Tests Nike Zeus at White Sands

Test firing of an early model of the U.S. Army's Nike Zeus missile has taken place at the White Sands, N.M., Missile Range. The weapon is now in the research and

development stage, the Army reports, and all performance details—such as speed, altitude and effective range—are still “highly classified.”

Mosaic Tile Set in Rubber

Developed in Italy, a new mosaic flooring has ceramic tiles set in rubber sheets for rapid laying as well as for under-foot cushioning, silence and nonslip properties. The tiles are held by molded cavities in the flexible matrix. They can be replaced easily if accidentally broken. The sheets come in 8 by 8-inch and 12 by 12-inch squares and are ready for cementing to the floor.

☐ Woven into a new British-made carpet is a heating element which produces 1000 watts of evenly distributed heat that is controlled by a thermostatic plug.

☐ Spent liquor from Scotch whiskey distilleries, formerly regarded as a waste product, is now being processed to produce a valuable food for livestock and poultry.

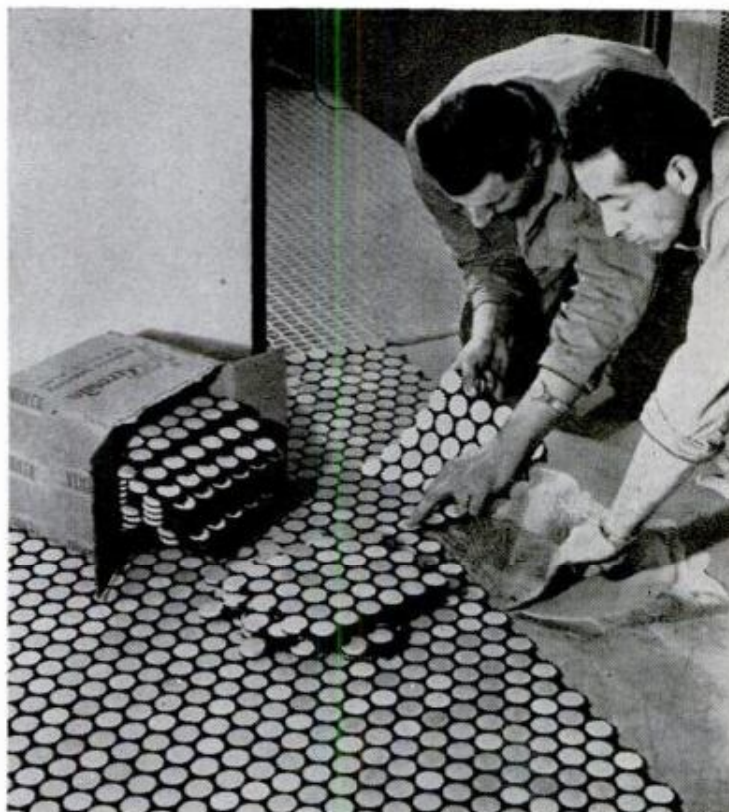

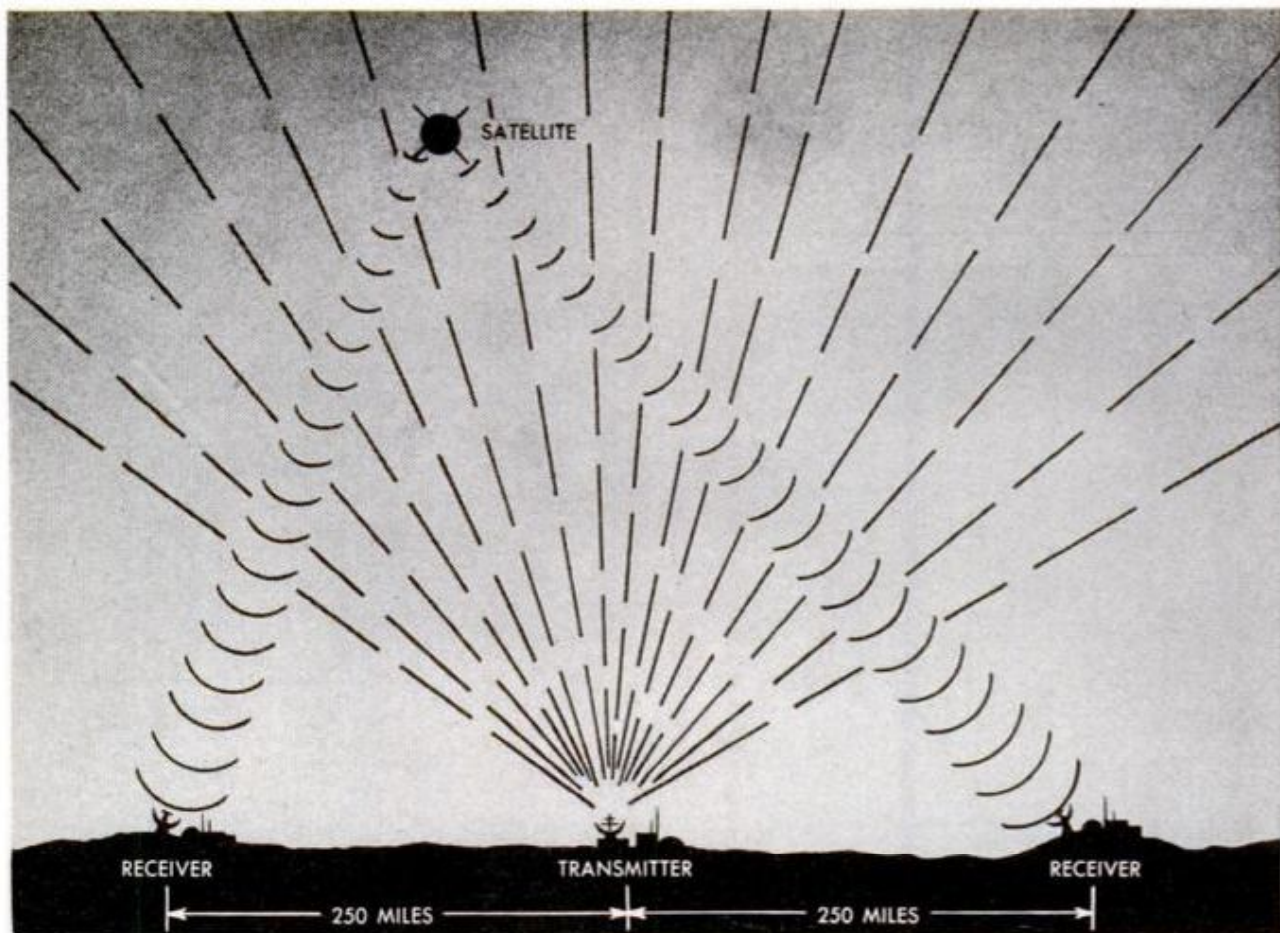

Artist's conception of one of two radar "fences" that gather information about all orbiting satellites

U.S. Navy's Space Surveillance System Tracks All Satellites

WHEN THE NAVY announced last February that a mysterious satellite was circling Earth, rumors that it somehow was spying for Russia obscured a more important bit of news. The news? That for the previous two years the Navy had been quietly spotting satellites and tracking same.

Its space-surveillance system, called "Spasur," was set up to detect, track and predict orbits of noncooperative or hostile satellites passing over the United States. Although still in the experimental stage, Spasur tells the Navy, minute by minute, just where each satellite that has been sent from Earth is moving. It even keeps track of the "garbage," the bits of rocket that float around after a satellite has orbited.

"Garbage," by the way, is what the Navy called both the mysterious satellite and rumors that it was Russian. Officially, it's the re-entry body of Discoverer V, an Air Force satellite.

Spasur is a complex of electronic and radar gear. Headquartered at Dahlgren, Va., is an illuminated map of the world. The map shows satellite positions at the moment of viewing, but a flick of the switch causes it to show what the locations and paths of the manmade moons will be hours, days and even weeks ahead.

Predicting is done by an electronic computing machine performing 15,000 arithmetical computations a second from data sent to it from two radar "fences" which stretch, like a belt, across the lower half of the U.S. Each fence is 500 miles long; each has a radar transmission station which sends signals far out into space in the shape of a fan. Signals bounced off a passing satellite are picked up by receiving stations at each end of the fence.

In the southeastern fence, the radar transmission is at Jordan Lake, Ala.; the receiving stations are at Fort Stewart, Ga., and Silver Lake, Miss. The southwestern fence has its transmitter at Gila River, Ariz.; receiving stations are near San Diego, Cal., and Truth or Consequences, N.M. In both fences, the transmitting and sending stations are fields of aluminum wire covering areas 1600 by 300 feet.

The receiving stations have the necessary equipment to measure in a very precise manner the direction from which the satellite reflections are received. With this information the Dahlgren computer determines in a fraction of a second the altitude, speed and course of the satellite—whether mysterious, Russian, or domestic—passing overhead.



Military Bridge Floats Without pontoons

Lumbering across the Rhine River at Koblenz, Germany, on a new type of military bridge, a heavy tank barely got its treads wet—though the bridge is con-

structed without pontoons. Instead, it is built with metal plates that are hollowed out to provide buoyant air spaces inside. The plates quickly lock together.

Boat Top Unzips to Let Air In, Boaters Out

Convertible tops are made to order for outboard runabouts for protection from sun and weather, but they often restrict air circulation and traffic inside the boat. A

new top, rigged with two zippered slits in the front, solves the problem by letting air in under the scooplike front, and allows the front to be opened like a hatch.





Problem—find the trailer in this oriental-motif mobile home installation in Bing Crosby's Blue Skies Park near Palm Springs, Calif. Below, view of the park from its private pitch-and-putt golf course

Trailers Join The Country Club

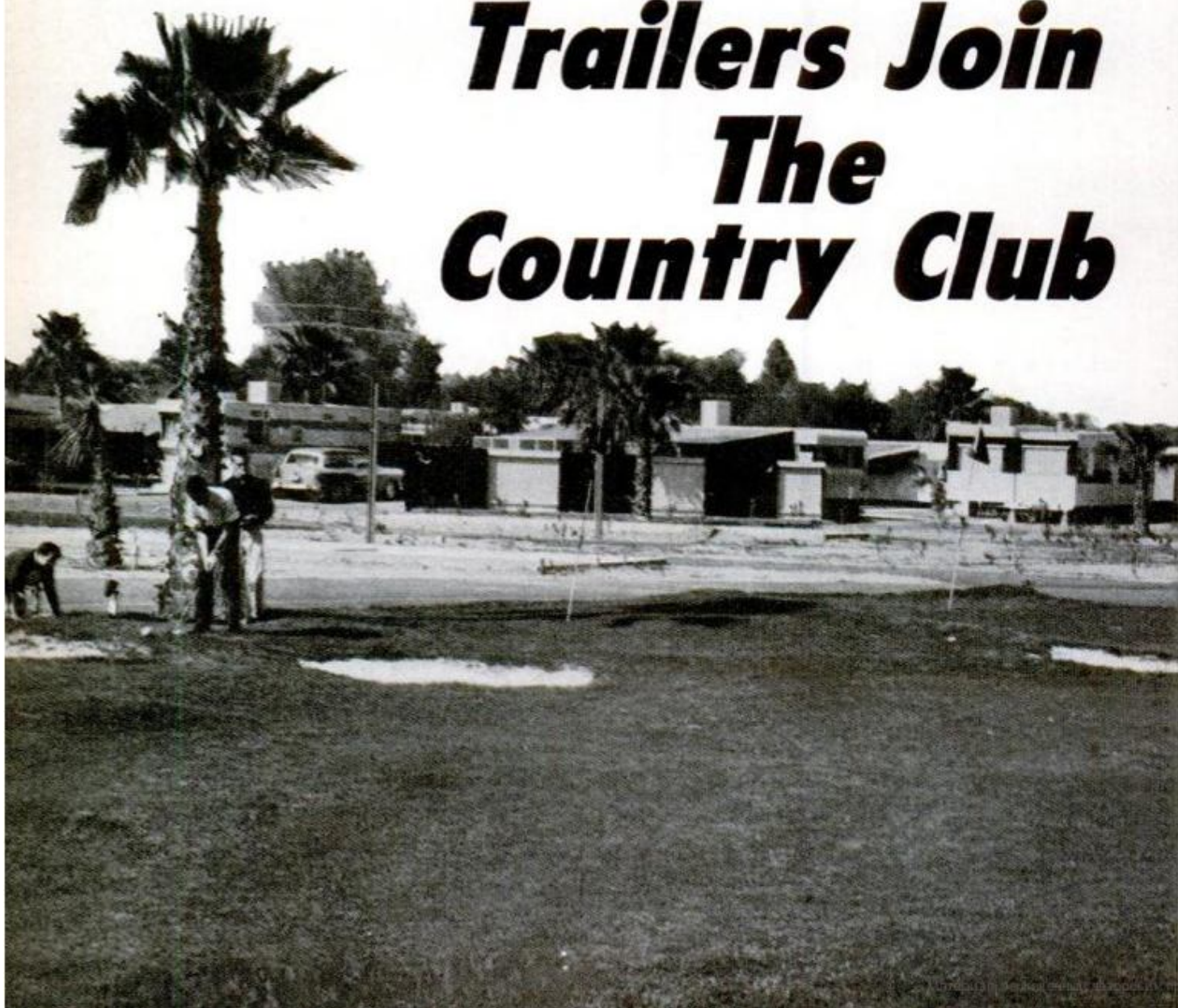

See OCT 60, 16

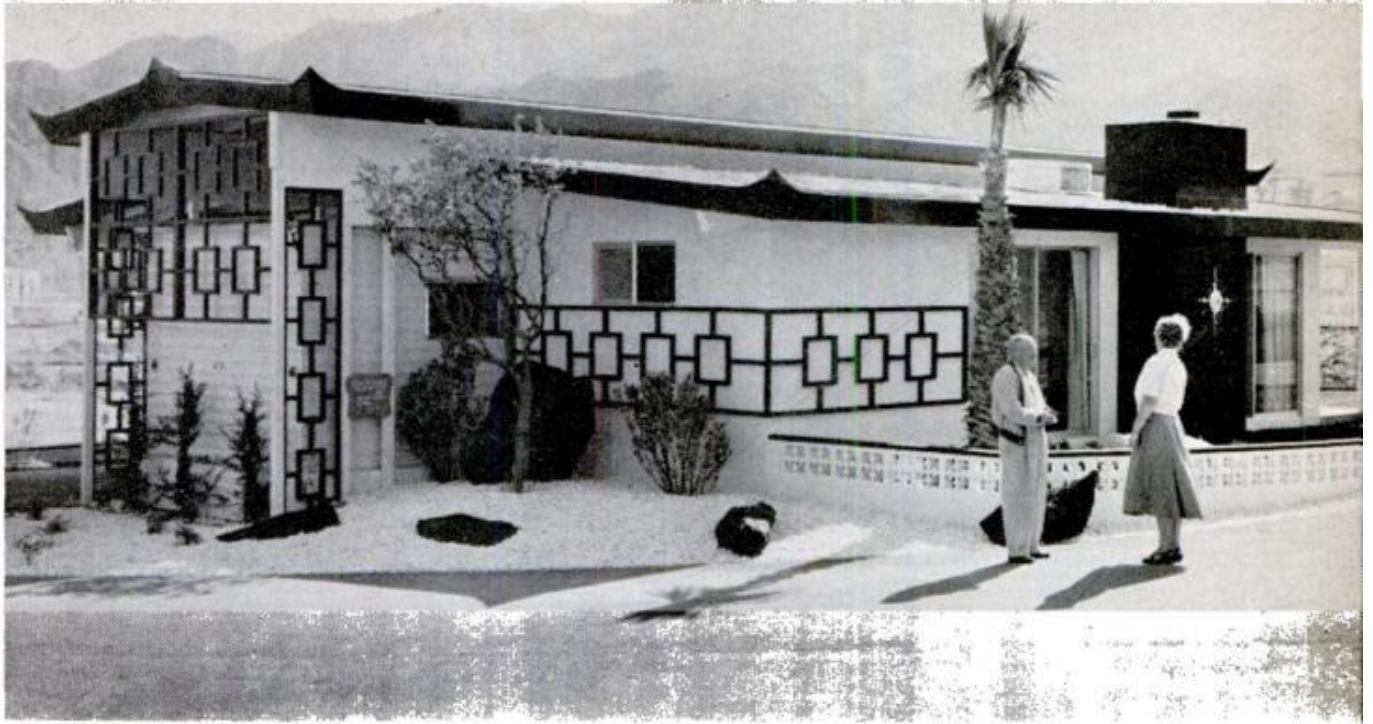

Another view of this month's cover "home." Trailer sits on concrete foundation which doubles as storage space

By Thomas E. Stimson, Jr.

HOW WRONG CAN YOU BE? That was the general reaction a couple of years ago when an economist predicted that 20 million Americans would be living in house trailers in 15 or 20 years. But now it's beginning to look like the forecaster knew what he was talking about. Some fabulous things are happening, and mobile homes are becoming permanent and luxurious residences.

Technically they are still trailers, and

the law says that they must have wheels and tires, a towing hitch and an annual license plate, but from the practical standpoint it's a real chore to uproot a 60-foot trailer and put it on the road.

All this started years ago when people with small vacation trailers first stretched an awning out to one side, creating outdoor space for a few folding chairs. Later they put down ground coverings, then put up screens to keep out the bugs. This



Homeowners in Back Bay Park can moor their boats in their front yards





Above, typical modern mobile home interior. Below, "Expando" trailer with concrete block patio screen

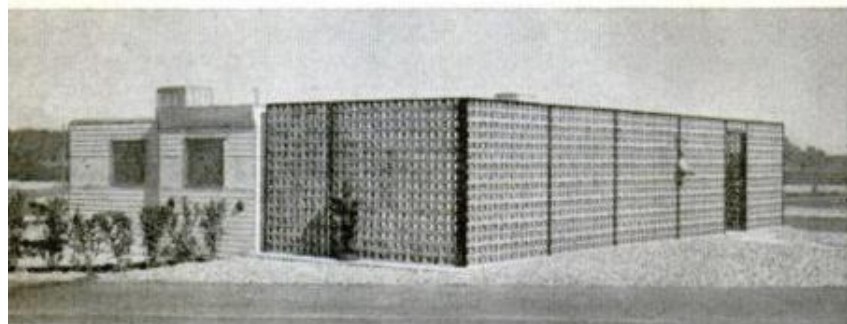

Below, interior in a new "tri-level" trailer. Full-draped walls and extra-length davenport minimize narrow living room

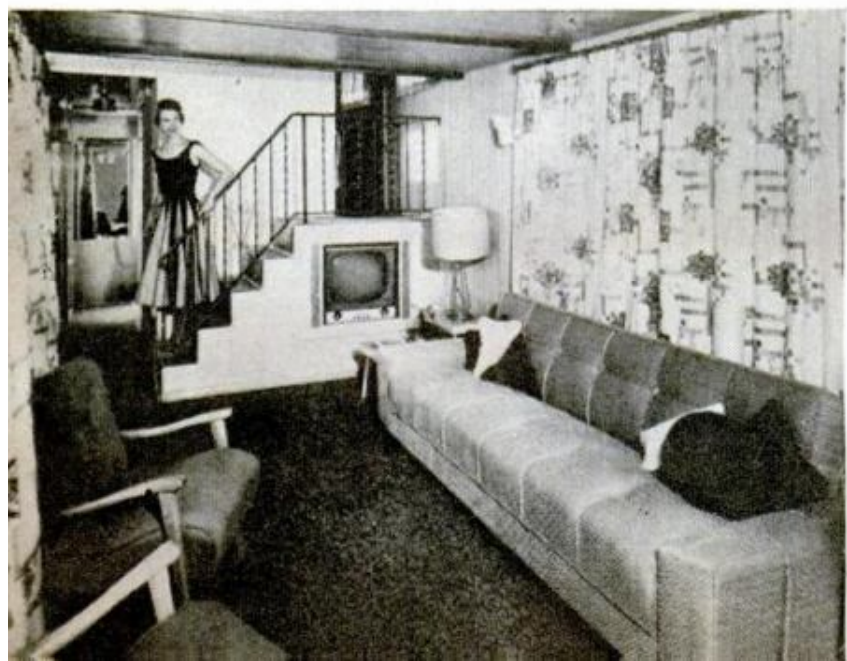

led to the cabana, a room with its own roof and walls attached to one side of a trailer. Meanwhile, some of the trailers were growing uncomfortably large for highways.

Look what has happened now. For a good look, visit "Blue Skies," Bing Crosby's new million-dollar trailer court near Palm Springs, Calif. Rex Thompson, Bing's manager, proudly shows you the park's swimming pool, the billiard and card rooms and the shuffleboard courts, the pitch-and-putt golf course and the big recreation building where visiting TV talent make personal appearances.

Still under construction, the park is to have its own small shopping center, a uniformed gateman and maid service for those who desire it. Thompson tells you that the 26 acres inside the park contain 152 trailer spaces, but there is hardly a trailer in sight. About all you can see are some small, beautiful homes, each attractively landscaped. Only a close look reveals that the end of a trailer projects somewhere from each structure.



Pool at Blue Skies Park. Other features include shopping center, recreation building, even maid service

These are residential mobile homes such as no one ever saw before. Each consists of three parts—the trailer itself; attached, permanent cabana, often with a fireplace and porch; and a ramada or separate roof that stretches over the trailer and an adjacent carport. Next to the carport there may be a row of storage lockers and a small building for the home laundry.

A typical 10 by 60-foot trailer at Blue Skies is custom-built and furnished and decorated by an interior decorator. Part of one wall is removed to open that side to the cabana, creating a living room some 20 feet wide. From inside, one can't tell where trailer and cabana join. Wall-to-wall carpeting covers the joint in the floor.

The utilities are all underground, and include natural gas for heating, 220-volt current for the electric kitchen, two phone lines (one to the park switchboard, one a private outside line), and water and sewer connections. An underground coaxial cable brings in color TV from a master antenna.

This is not cheap living—a deluxe trailer like that costs around \$15,000. The cabana and other structures, designed by an architect, cost about as much and Rex Thompson reports that some owners at Blue Skies are spending even more—up to \$40,000 for

their complete mobile homes. In addition, they pay a ground rent from \$720 to \$1200 per year, plus their own utilities.

Blue Skies is not the only example of a sumptuous trailer park. Just being completed at Newport Beach, Calif., is Back Bay Park on upper Newport Bay. Here the residents moor their boats in their own front yards. They have their own beach and a spectacular bay-front clubhouse.

At Back Bay the trailers are custom-designed to fit the cabanas instead of the other way around. Each trailer measures 10x50 feet; each cabana another 12x40 feet plus porch, outdoor barbecue and carport. The trailer-cabana combinations sell at from \$12,000 to \$25,000; ground rent runs from \$80 to \$150 per month.

Why should anyone pay prices like these when he can buy a permanent residence for the same money or less? There are a number of reasons. Most of the top-priced mobile homes are bought by well-to-do people who are retired or semiretired. They no longer want the bother of maintaining a large home, and a compact, efficient mobile home exactly fits their needs. The most expensive trailer parks are located in high-priced resort areas where *any* kind of living is expensive. Each resort

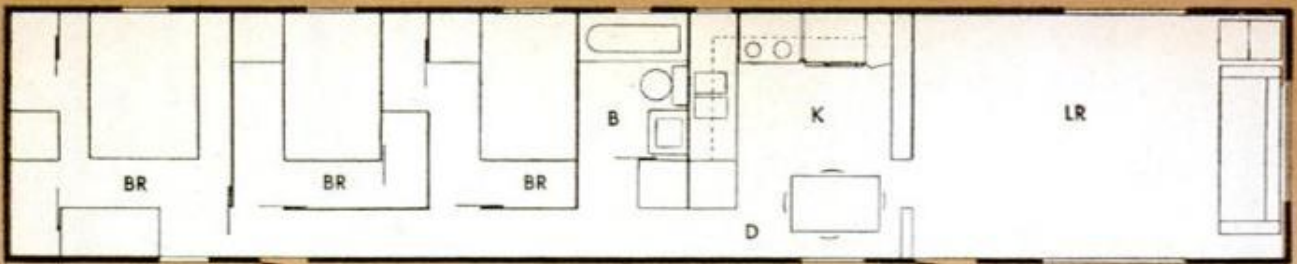

56 x 10 CAPRI—THREE-BEDROOM CONVENTIONAL

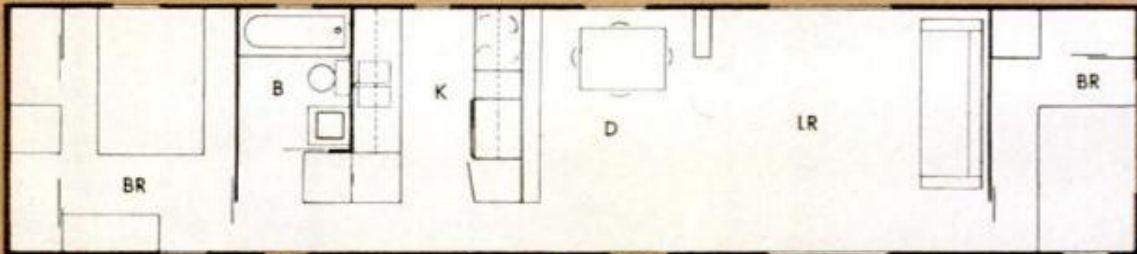

50 x 10 CAPRI—SPLIT THREE BEDROOMS



50 x 10 GOLDEN STATE—TWO BEDROOMS, FRONT KITCHEN



45 x 10 GOLDEN STATE—ONE BEDROOM, CENTER KITCHEN

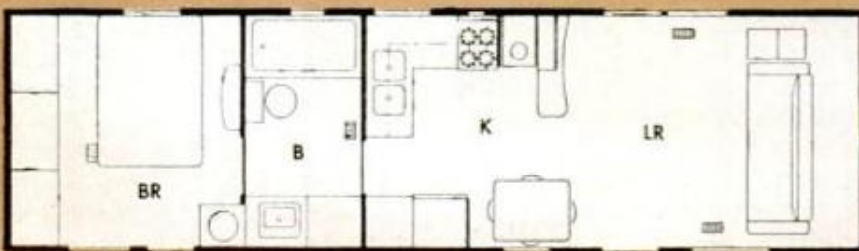

37 x 10 GOLDEN STATE—ONE BEDROOM, CENTER KITCHEN

Five examples of mobile home floor plans—several optional plans are usually available in standard models. Fronts are to the right. Trailers are completely furnished and feature many ingenious built-ins



Hillside Trailer Park near Santa Monica enjoys a fine view over the coastal highway toward the Pacific

park is like a private club and has a well-planned program of activities.

The Sahara mobile home park just outside of Palm Springs, for instance, has ballroom dancing twice a week in its recreation hall, and motion pictures in the hall on Wednesday nights. They have card parties and potluck dinners. Tennis courts, riding clubs and golf courses are only a few minutes away, and if a resident tires of all this he can hitch up his smaller trailer that is stored in a parking lot and take a vacation.

About every four years the average resi-

dent moves to another park in another region. If his residential trailer is a big one, say 10x50 feet, he hires a licensed towing service to do the job. In California a big mobile home may be towed on the highways only during daylight hours and not in inclement weather or on weekends or holidays. If the owner leaves a permanent cabana behind him, he arranges to sell it to the next occupant, in turn he buys any permanent improvements that are installed in the space he occupies at the new park.

(Continued to page 214)

Trailer seems almost incidental in this cabana-ramada installation at Sahara Trailer Park in Palm Springs

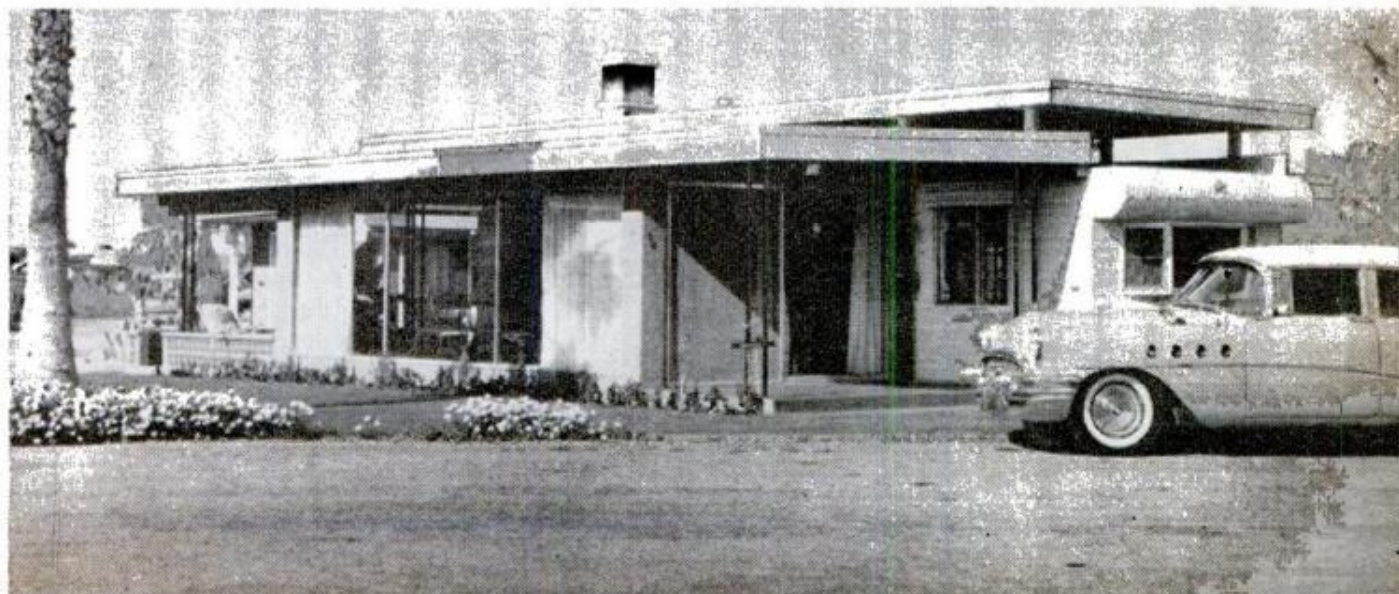

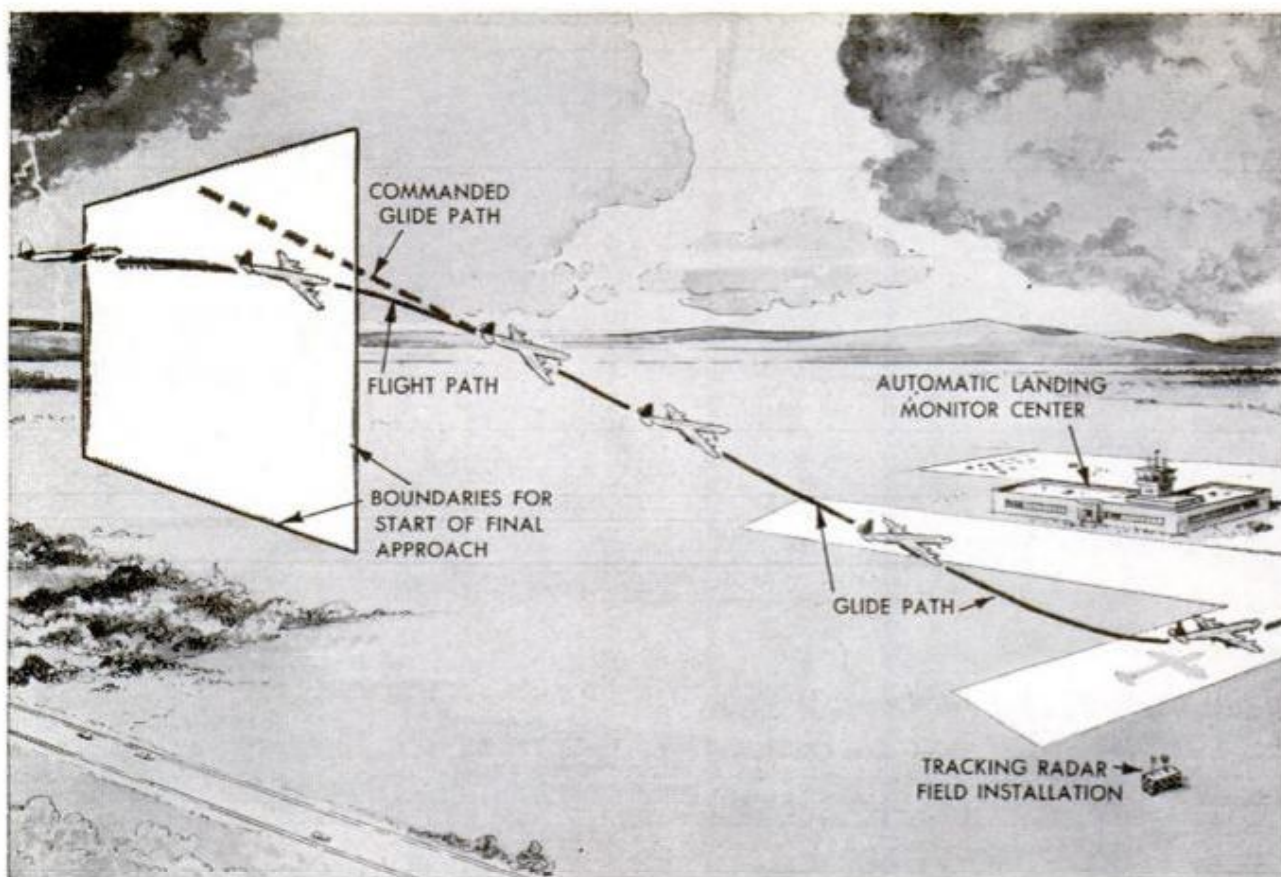

Automatic System Lands Two Planes a Minute

Even in stormy weather, two airplanes a minute are landing on a runway equipped with a system undergoing tests at the National Aviation Facilities Experimental Center, Atlantic City, N. J. The automatic landing system uses radar to track a plane and radio to transmit controls to the automatic pilot. The tracking radar "locks on"

the plane when it flies through an electronic window from two to four miles from the runway. Course corrections are automatically transmitted to the plane's automatic pilot. If the plane is not making a proper approach or is in danger of overtaking another landing plane, the system automatically waves it off.

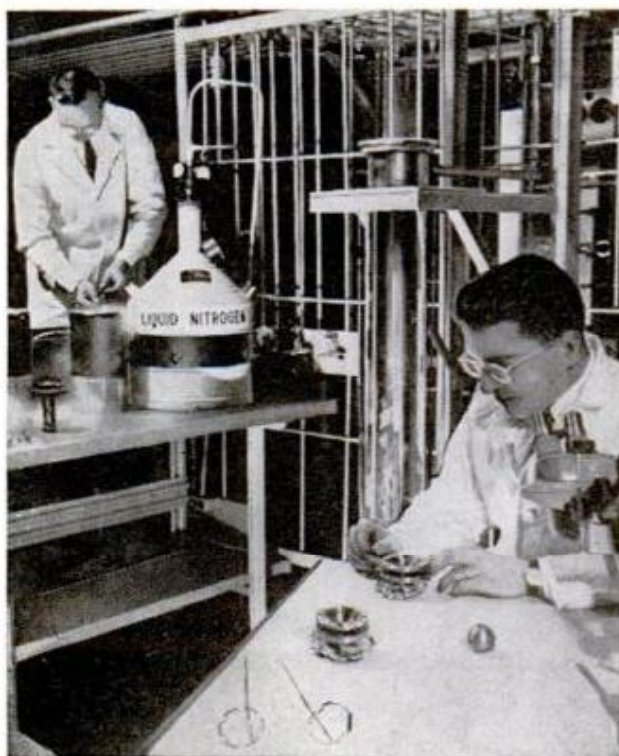

Gyroscope Spins at -456 Degrees

Tomorrow's voyager through space may navigate by using a gyroscope that spins at -456 degrees F. Such a device is under development at General Electric's laboratories. It's called a cryogenic gyroscope because it takes advantage of the fact that at extremely low temperatures some metals offer almost no resistance to electricity. The components of the gyroscope include a golfball-sized metal sphere that floats in a vacuum, suspended solely by an invisible magnetic field. It is spun by another magnetic field, and should be able to spin freely for many months or possibly years after once being set in motion. Liquid nitrogen and helium have been used to provide the low temperatures for testing the device. After further tests, experiments will be made to fit the gyroscope into inertial guidance systems for missiles, navigational systems for submarines and, it's hoped, for space.



He Lets His (Sailing) Cat Out of the Bag

When Carl Ehrman of Palo Alto, Calif., goes sailing, he carries his sailing catamaran down to the sea in two duffel bags. It takes about a half hour to inflate the two

pontoons, rig the deck, daggerboard keel, mast, and sail, and the 70-pound, 12-foot boat can be lifted easily. The boat is so successful that Ehrman is marketing it.

Japanese House Is Boxed Against the Weather

Built at Urasoe-Son, Okinawa, a model farmhouse combines the traditional open style of Japanese architecture with strength to weather a typhoon. It is tucked within a

concrete box formed by pillars and an overhanging roof. Shutters can close to protect the windows. The house can be built at the cost of \$100 for each 36 square feet.



TAKE YOUR MEASURE!

By Samuel Cabot, Jr.

TEST YOUR KNOWLEDGE of weights and measures by answering the 20 questions below. Check the answers that you think are correct, then compare them with the list of correct answers on next page. Any score over 12 is good—over 16, excellent.

1. What track event is known to sports writers as **the furlong**?
 - a. The two-mile run.
 - b. The 440-yard dash.
 - c. The 220-yard dash.
 - d. The marathon.
2. **Troy weight** is:
 - a. The standard weight system of western Turkey.
 - b. A small weight used on a balance scales.
 - c. A derogatory expression used in Upstate New York to signify short weight.
 - d. A weight system used by jewelers.
3. My Russian gazetteer says it is 240 **versts** from Minsk to Pinsk. How far is that?
 - a. About 1200 miles.
 - b. About 160 miles.
 - c. About 9 miles.
 - d. About half a mile; Minsk and Pinsk are sister cities separated by the Bulloni River.
4. On British scales, my wife weighs exactly **10 stone**. What does she tip the beam at in America?
 - a. 100 pounds.
 - b. 120 pounds.
 - c. 140 pounds.
 - d. 200 pounds.
5. A farm lad sang to his sweetheart, "I love you a **bushel and a peck**." How many quarts did he love her?
 - a. 10
 - b. 28
 - c. 36
 - d. 40
6. A **dekameter** is:
 - a. 100 decimeters.
 - b. 1/100th of a decimeter.
 - c. An instrument used in the lumber industry to measure decay.
 - d. A line of poetry containing 10 syllables.
7. A long ton is larger than a short ton, but how about a **metric ton**? Is it
 - a. Larger than a long ton?
 - b. Smaller than a short ton?
 - c. Larger than a short ton, but smaller than a long ton?
 - d. The same as a long ton?
8. When Eb and Flo drove to Canada, Flo was appalled at the price of gasoline. "It costs only 30 cents a gallon in the States," she complained. "But," said Eb, "these are **imperial gallons**, so if we overlook the exchange problem, we get just as much gas for a dollar here as at home." How much did gas cost in Canada?
 - a. 24 cents per gallon.
 - b. 36 cents per gallon.
 - c. 37.5 cents per gallon.
 - d. 40 cents per gallon.
9. In Shakespeare's "The Tempest," there is a song that starts "Full **fathom five** thy father lies." How deep is that?
 - a. 30 feet.
 - b. 50 feet.
 - c. 60 feet.
 - d. 100 feet.
10. A **dram** is:
 - a. A Swedish mile.
 - b. A Scottish unit of liquid measure, as a dram of whiskey.
 - c. A metric unit of dry measure.
 - d. Three scruples.
11. "The sailboat approached the buoy at **six knots per hour**." What's wrong with that statement?
 - a. No boat could sail that fast.
 - b. A knot is a measurement of speed, not distance—therefore the expression "knots per hour" is incorrect.
 - c. A knot is a measure of depth.
 - d. Boats are required by law to slow down when nearing buoys.
12. How many cubic feet in a **cord** of wood?
 - a. 32.
 - b. 48.
 - c. 96.
 - d. 128.
13. "**Half a league**, half a league, half a league onward!" How far did the Light Brigade charge?
 - a. A mile and a half.
 - b. Two miles.
 - c. Three miles.
 - d. Nine miles.
14. A **pedometer** is:
 - a. A gadget the shoe store clerk uses to measure your foot.
 - b. A device that measures how far you walk.
 - c. A measure of length in the metric system, equal to 10 kilometers.
 - d. A foot rule.
15. The **height of a horse** is usually expressed in:
 - a. Feet.
 - b. Rods.
 - c. Hands.
 - d. Fetlocks.

16. "Give him an inch and he'll take an ell," runs the old saying. What's an ell?
 a. A carpenter's square.
 b. A unit of cloth measure.
 c. Abbreviation for league.
 d. A square yard.
17. The two-armed instrument used to measure **diameters** is called a:
 a. Calibrator. c. Calibre.
 b. Capillary. d. Calipers.
18. The abbreviation **cwt.** stands for:
 a. Hundredweight.
 b. Counterweight.
 c. Pennyweight.
 d. Carat
19. Which of the following does **not** equal **16½ feet**?
 a. Perch. c. Pole.
 b. Stere. d. Rod.
20. The British periodical **The Fortnightly Review** is published:
 a. Every fourth night.
 b. The fourth of every month.
 c. Every two weeks.
 d. Every other month.

Take Your Measure!

Here are the correct answers to the questions on weights and measures that appear on these pages.

1. c. 2. d.
3. b. A verst is about two-thirds of a mile. Another Russian verst, used locally in Karelia, is slightly longer.
4. c. A stone is 14 pounds; 160 stone make a long ton.
5. d. 6. a.
7. c. Short ton, 2000 pounds; long ton, 2240 pounds; metric ton, 1000 kilos or 2205 pounds.
8. b. An imperial gallon is equal to about 1-1/5 U. S. gallons.
9. a. A fathom is six feet.
10. d. Scruples and drams are units of apothecaries' weight.
11. b.
12. d. A cord is 4 by 4 by 8 feet.
13. a. A league is three miles.
14. b.
15. c. A hand is four inches.
16. b. 17. d. 18. a.
19. b. A stere is a cubic meter.
20. c.



"Belly Whopper" Goes Anywhere

Indoors and outdoors, on land and on water, a roller-wheeled plastic toy lets youngsters "belly whop" to their heart's content. Made of unbreakable plastic, the craft is a little over a yard long, 15 inches wide and weighs six and a half pounds. The front roller wheel is guided by a side-arm steering handle. Being made of plastic, the little craft will not mar furniture and is rustproof. It will operate on sand, concrete, grass, snow, ice and water.

Retreat of Glaciers Indicates Warmer Climate

Glaciers in Russia are retreating faster, and ice formations in Russia and Finland are breaking up sooner in this century than they have in the past, says Russian scientist B. Sh. Tsomaya, confirming speculation that the climate is warming up. Tsomaya analyzed positions of glaciers in the central and eastern parts of the main Caucasus mountain range which have been measured since 1911. He found the speed of the glaciers' retreat is greater in recent years than in the preceding period. Especially large changes in the retreat speed began in 1930, he says. Some retreated three times faster than they had previously. Measurements also have shown that the rise in the snow line on the slopes of some mountains has increased three to four times during the past 100 years.

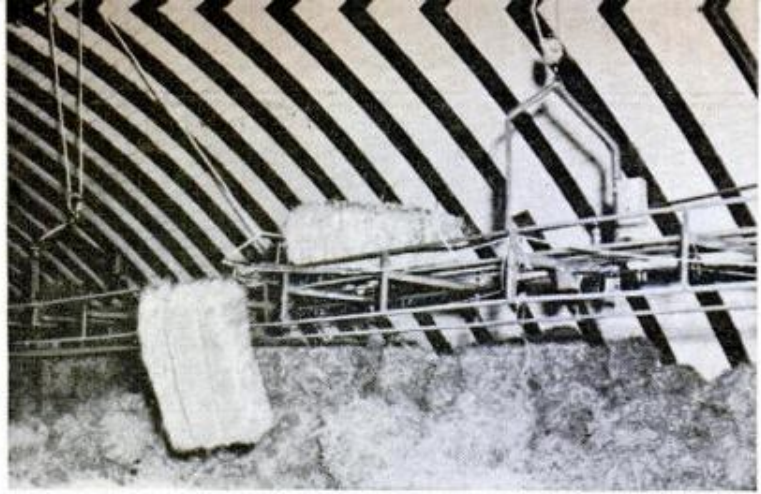

New Holland Machine Co. photo

No More "Bricklaying" With Hay Bales

One man can perform a tough farm job—that of storing hay—with a conveyor system that drops bales off automatically. The system fits the trend of random storage of short bales in preference to laborious hand stacking. The "bale locator," which tips bales off anywhere along the conveyor, is controlled remotely; a tug on a rope moves it to a new position. The conveyor system is lightweight, and will negotiate turns and dips.

Machine Reads Handwriting

Boasting a 10-word vocabulary, a machine the size of a briefcase reads handwritten words. Developed by Bell Telephone Laboratories, the handwriting reader can read the numbers "zero" through "nine," spelled out. While using the machine, the operator writes on a special surface with a metal stylus. When he touches an "identify" button, a light appears above the correct digit. Such machines may be valuable where data must now be translated into machine language.

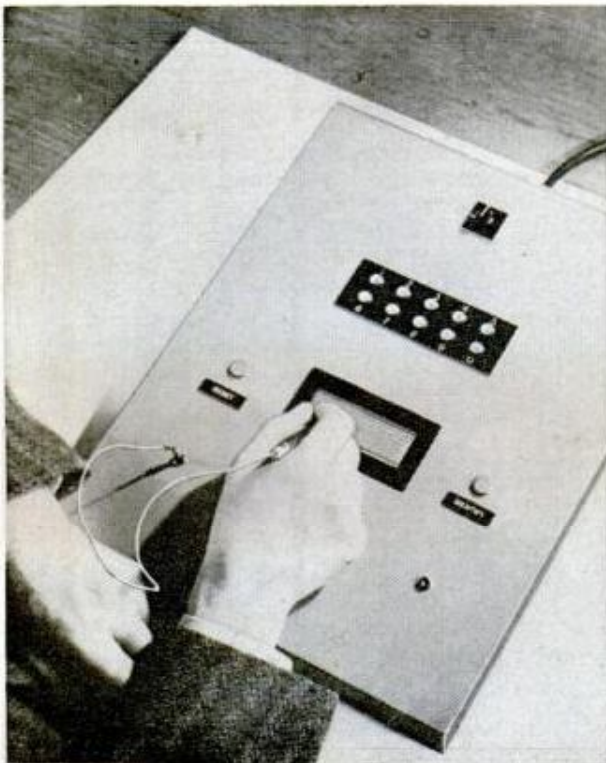

"Orange Peel" House

Eight plastic segments that fit together like pieces of orange peel form a small, spherical house now being produced in Germany. An adhesive used on the seams makes them weathertight. Inside the small dwelling are a kitchen, bathroom and living room—which doubles as a bedroom at night. The components of the house can be transported easily in a large chest. No foundation is necessary when it is erected. Inventor of the plastic structure is auto engineer Egon Bruetsch of Stuttgart.





VW Doesn't Go Under Down Under

Australian Peter Webster had a Volkswagen and wanted a boat. So he waterproofed the ignition system, ran snorkel pipes from the exhaust pipes, from the oil breather, and from the carburetor air intake. Then he attached a propeller to the fan-belt pulley, running the shaft through a bearing in a bumper slot. Thus equipped he headed for the beach, drove around the harbor for five miles and returned safely to land. To keep the "ship" from sinking, his passenger manned a small bilge pump.

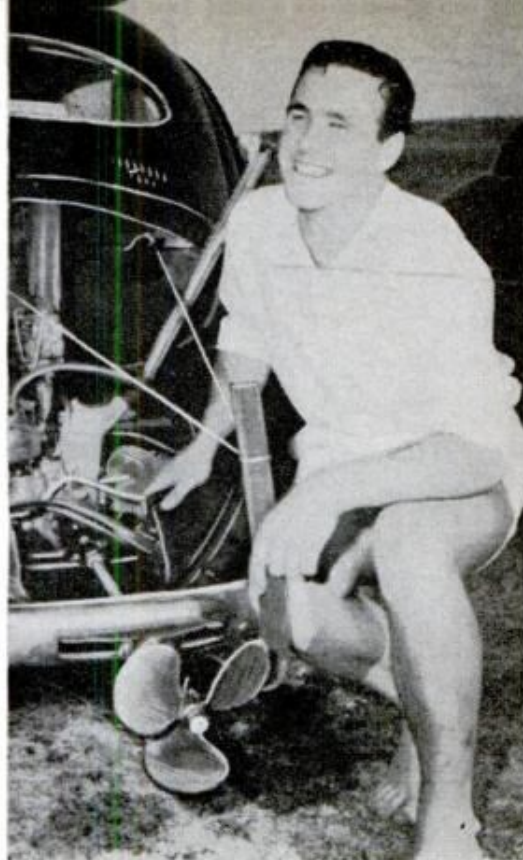

Camera Can Shift Speed, Zoom In

Apparently this young man is about to photograph the scene in the next column—and he can do it without any more concentration (on photography) than he shows here. The 8-mm. camera has an electric eye to adjust the lens aperture automatically, a zoom lens that lets him get close-ups without moving and a control that changes camera speed to slow motion and back without losing a frame. The f/1.8 lens zooms from 9 mm. to 27 mm.

Filter for Back-Yard Pools

Even the girl next door will come over to see what keeps your pool so clean. Explain that it's a filter specially designed for plastic pools. Water is pumped into the filter unit inside a 14-inch drum where it passes through a diatomaceous earth media. The filter bag, made of fabric woven from acrylic fiber, will last indefinitely. The unit will handle 987 gallons of water per hour—ample capacity for the average plastic pool.

Lomart Industries photo





Compromise Cruiser

For boaters who want the inexpensive comfort of a houseboat but would also prefer the performance of a cruiser hull, a new live-aboard cruiser offers both, but at about half the cost of a full-scale cruiser. The welded steel hull is 37 feet long and 11 feet, 10 inches across the beam; two 113-horsepower gas inboard engines push her to 16 miles an hour. The cabins have six-foot, four-inch headroom. The boat sleeps four or six depending on the floor plan chosen. It is wired for 12 or 110-volt current, and carries 120 gallons of gas and 60 gallons of water. The boat even has a "basement," 10 by 11 by 2½ feet, under the cabin deck.



"Airlift" Camera Tripod

Air pressure in the center column of a new camera tripod allows the photographer to raise, lower, and adjust his camera up to 62 inches high more smoothly than with manual tripods. A side lever (see arrow) controls pressure as needed. Designed chiefly for professional cameras, it will work on any with a 3/8 or 1/4-inch fitting.



Number, Please!

Whenever you write us to

- Renew your subscription
- Change your address
- Order your own or a gift subscription

... In fact, whenever you write us,

PLEASE INCLUDE YOUR CITY POSTAL ZONE NUMBER IN YOUR ADDRESS

This insures better delivery.

It helps you and it helps the postman.

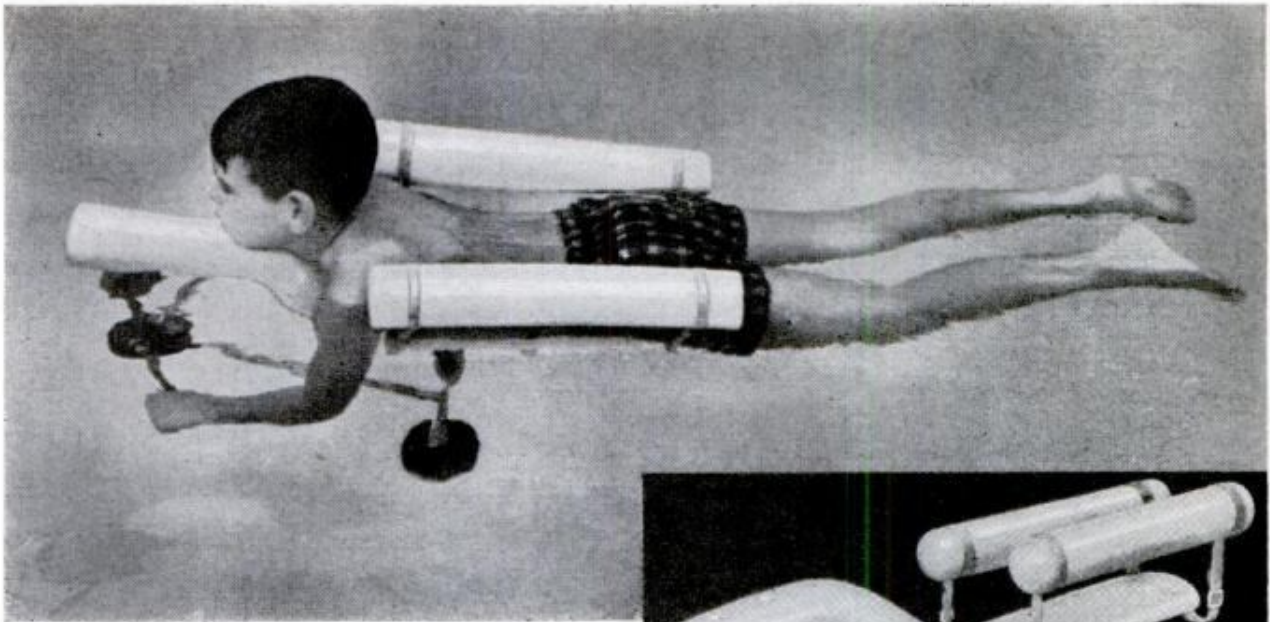

Hand-Propelled "Water Wings"

Strictly for fun in the water, a new hand-operated float lets a child "swim" around indefinitely whether he can swim or not. What's more, it can even be adjusted to fit adults. It's made of four soft polyethylene-foam floats connected by aluminum tubing, and cradles the body comfortably while the hand crank drives the safe polyethylene propeller. The float weighs seven pounds and folds for carrying.

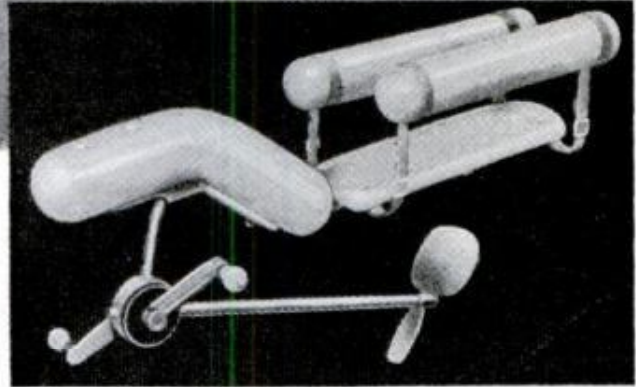

Chair Has Built-in Tackle Box

Still-fishermen seldom manage to relax as comfortably as the happy gentleman at right, who is demonstrating a new fishing chair that provides a seat, built-in tackle box, and double rod holder in one compact, folding unit. Made of lightweight steel tubing with washable or replaceable canvas back and seat, the chair is intended for bank and dock use, but also can be used by boat fishermen, especially trollers. The duck hunter can use the attached box to store his lunch and extra shells.

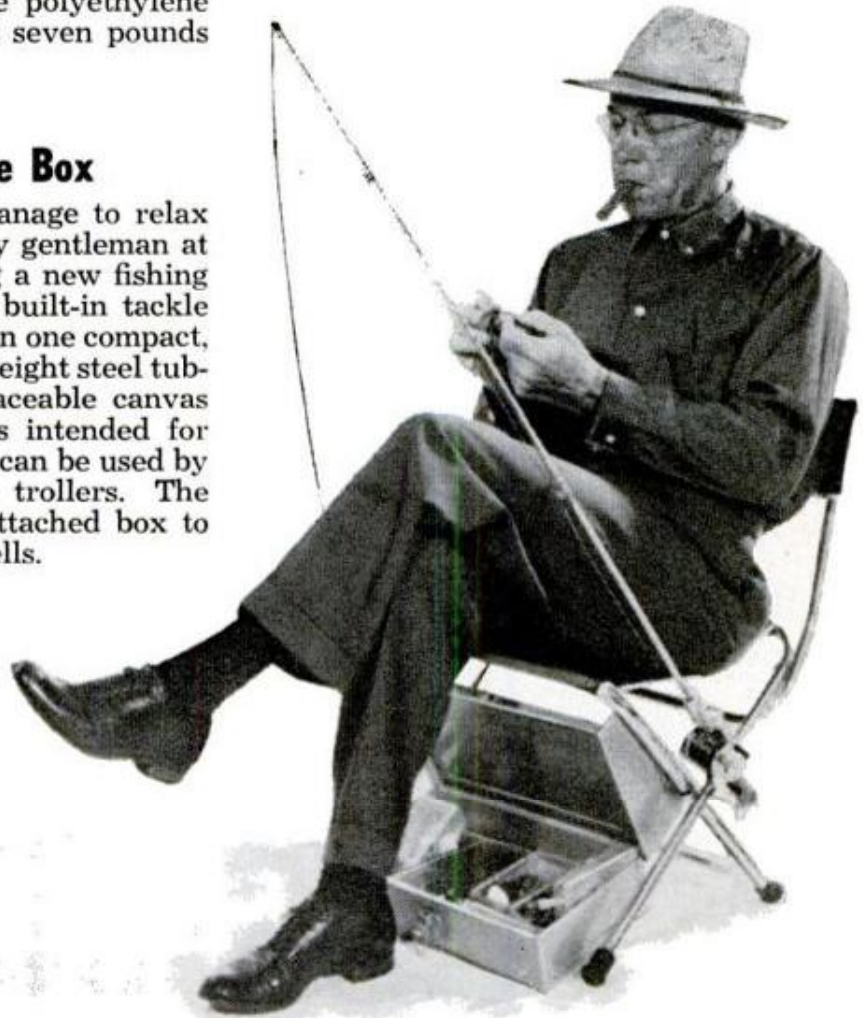

Throw Back The Big Ones

By Jack B. Kemmerer





A FEELING of overwhelming menace grips you. It's bearing down, ever down. Death feels imminent. You're not sick, especially, but you are haunted with fear—a blind, unreasoning fear. You know, beyond all reason, that your time is up—you're going to die. So strongly do your exposed nerves feel this that you lie down and wait for death to come.

Ten — twelve hours later, you awaken. The futile fear is gone, but in its place are memories so excruciating you feel as if you had been brought back from the dead.

What happened? You just ate a small piece of tropical fish containing natural poison which causes terrific hallucinations of depression and fear. This poison is but one of several new poisons found by the 20th century witch doctor of the seven seas, Dr. Bruce Halstead, in his worldwide hunt for the secrets of primitive witch doctors.

Thirty-eight-year-old Dr. Halstead is the Director of World Life Research Institute of Colton, California. He doesn't look his years and it is easy to mistake this tall, slender scientist dressed in his skin-diving equipment, for a weekend sportsman. Dr. Halstead, however, is recognized as the world's foremost authority on poisonous fishes.

Dr. Halstead has probably caught and handled more fish in his time than any man in the country. His years of intensive research in tropical regions have been centered mostly on one subject — poisonous fishes. In addition to the material gained from these scientific expeditions, the doctor has come up with one iron-clad rule for all fishermen:

"Between latitudes 35 degrees north and 34 degrees south in the central and western Pacific or the West Indies, *throw the big*

At left, Dr. Bruce Halstead in his own natural habitat, inspecting a porcupine fish speared off the Galapagos Islands on the equator just west of Ecuador. The porcupine fishes are puffer-like, and are among the most poisonous of the marine fishes

Parrotfish, above left, and red snapper, above right, picked up on an expedition to the central Pacific. Both are known causes of one type of ichthyotoxism

Happy hunting ground for scientist and fisherman alike, submerged wrecks on the floor of tropic seas are favorite hangouts for many species of ocean fish

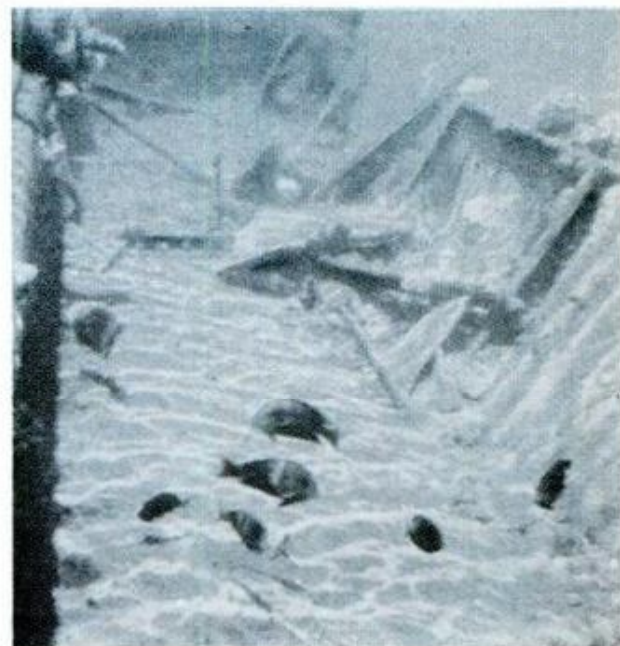

fish back, and the bigger they are, the more you should be careful of them." He adds, however, that cases of fish poisoning are quite rare in the waters off the west coast of the United States and Mexico, and in Florida's coastal waters.

The reason for Dr. Halstead's numerous expeditions actually had its beginning back during World War II when hundreds of American servicemen were poisoned by eating such common fish as the great barracuda, amberjack and sea bass caught in tropical waters. After the war the military decided that they wanted to be ready with new survival kits and instructions for their men in the event they were called upon to fight again in the tropics. Then the U. S. Public Health Service got into the act when sea bass caught in the Midway Island area poisoned a large number of people who dined on them in Honolulu.

So Dr. Halstead was selected to head an expedition. His problem: "Find out what fish are poisonous—where—and why?"

Nobody sent an expedition to the South Seas to examine spoiled fish that were poisoning people. It's not that kind of poisoning—in fact, it is entirely different from any other type of poisoning known today. This new poison, extremely deadly, often produces extraordinary results even when it is not fatal.

The poison, though, isn't a new one. Man's knowledge of eating poisonous marine organisms dates back to the time of the Pharaohs of ancient Egypt, to the

Toltec civilization, and to the days when Moses led the children of Israel out of the land of Egypt with the warning, "These shall ye eat of all that are in the waters; all that have fins and scales shall ye eat: And whatever hath not fins and scales ye may not eat: it is unclean unto you." (Deuteronomy 14: 9-10). The emperors of ancient Japan forbade their soldiers to indulge in the most poisonous of all fishes, the deadly puffer. Similar restrictions were issued by Alexander the Great to his soldiers, and Captain Cook almost terminated his famous world voyage in 1776 after eating poisonous fishes which were sold to him by the friendly natives of New Caledonia.

"It is an extremely interesting and yet baffling group of poisons to work on," Dr. Halstead says. "Poisonous fishes cannot be detected by their appearance, very little is known about the chemical and pharmacological properties of fish poisons, and no simple chemical test exists for poison testing in the field."

Dr. Halstead sees the danger increasing because more people are venturing farther from home. With big advances in the popularity of skin diving the danger is even greater. Many skin divers are constantly seeking new areas where there is warmer and clearer water, and more abundant sea life—a description that fits the tropics exactly.

The best safeguard, of course, is to know what fish is poisonous, but that's difficult,

(Continued to page 216)

Haul from one collecting expedition to the Las Perlas Islands being catalogued in the lab before analysis



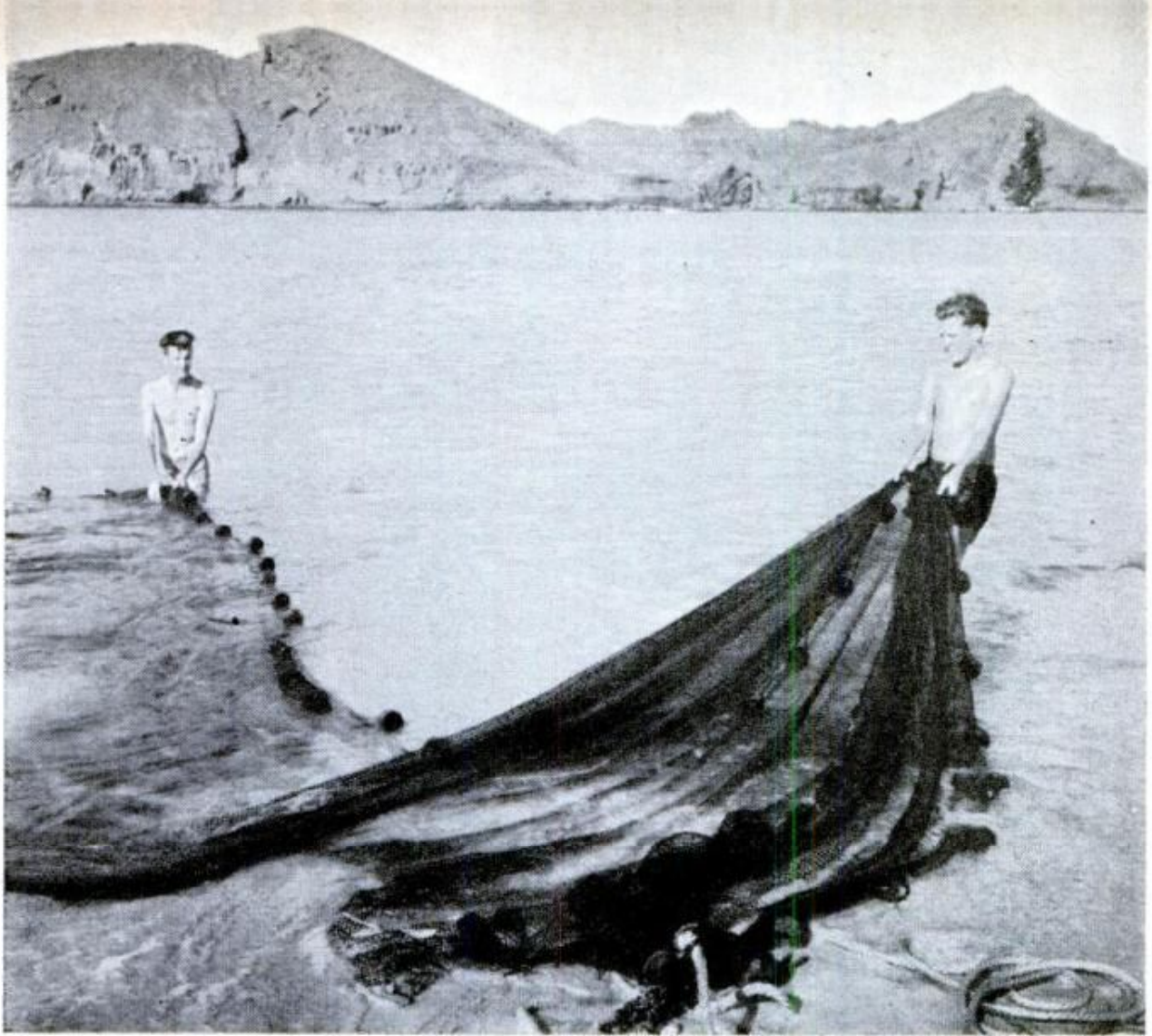

It isn't all fun and free diving—expedition members hauling a seine onto the beach in the Galapagos Islands

Collecting a shark liver for study — they are usually very poisonous in the tropics



Probing carefully for octopus, a member of the expedition searches the rocky shore of an equatorial Pacific Island

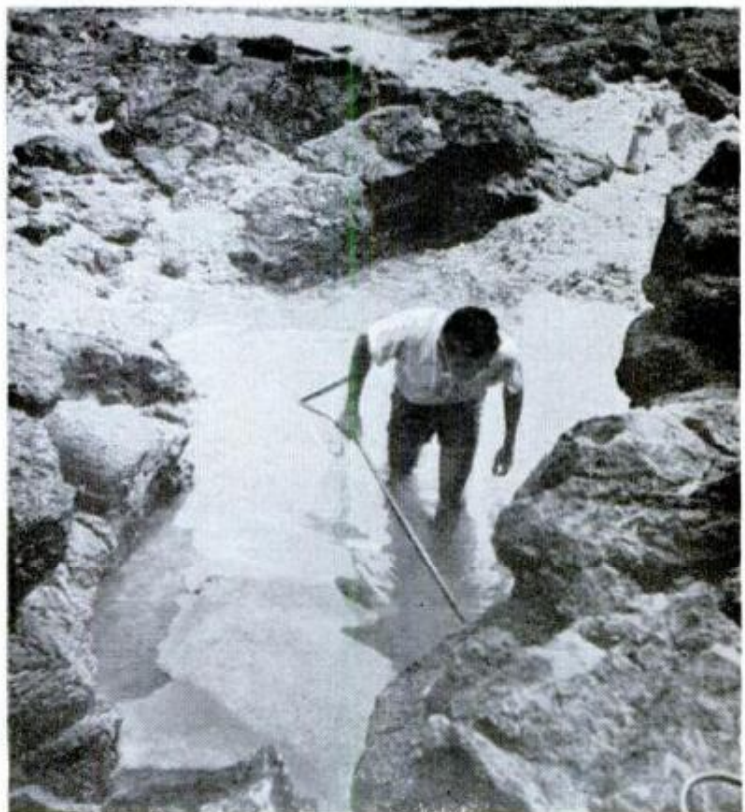



Photographer Wever raised the Volkswagen's roof to install a darkroom, painted it white to reflect heat

Traveling Photographer Builds a "Photomobile"

WHEN STEVE WEVER chucked his job as a newspaper photographer in Miami, Fla., to wander the country taking pictures, he first combined a darkroom with his means of transport—a converted 1959 Volkswagen delivery van he calls his "photomobile." He equipped it to operate under a variety

of conditions. Installed above the driver's compartment is a half-ton air conditioner to cool the darkroom in hot climates. He also carries an ice cooler to chill film developer and an electric generator for working far from town. The van also has water connections for hooking into city utilities.

He makes an enlargement, left, and, the job completed, pulls up his portable electric generator to move on

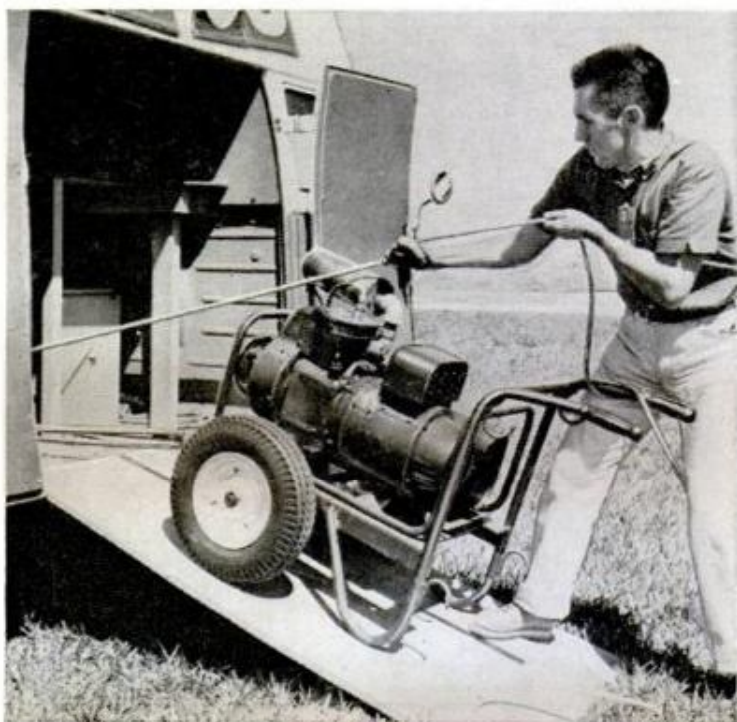

Desert Soilmaker

Desert sands could become fertile grasslands with a gelatine-like additive developed by West German chemist Herbert Kurth. Mixed with sand, the chemical enables it to absorb and hold large quantities of water—up to a gallon of water in an ounce of “soil.” A desert area carpeted with the material would hold the rainwater it now loses to runoff and evaporation, and would quickly bloom.

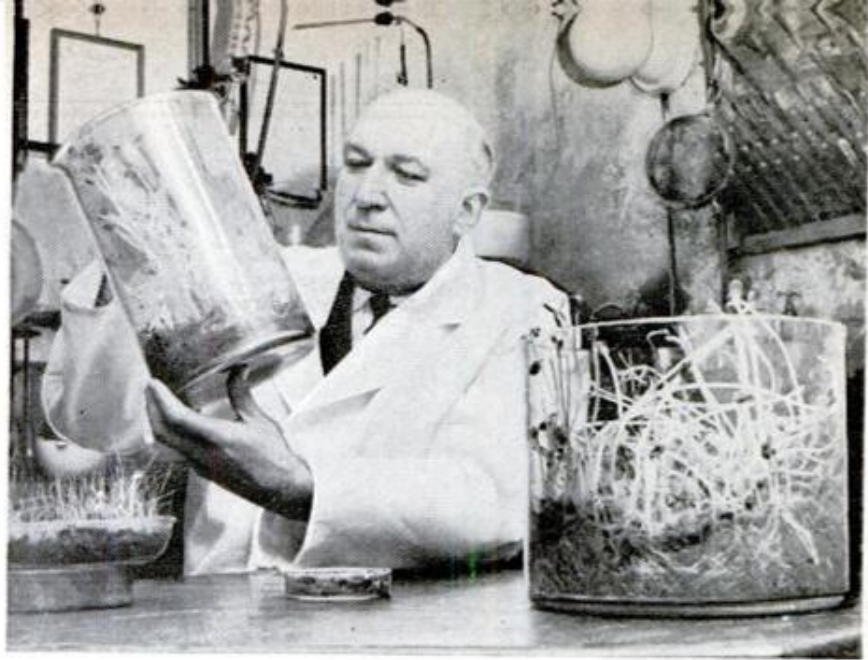

Roller on Tractor Levels Rough Land

Anyone who can drive a tractor can level a rough-graded area with a new roller blade that shears off the high spots as you drive over them. The roller, which floats behind the rear wheels, will also roll, seed, compact, and scarify land—or even spread salt on sidewalks in the winter. The manufacturer estimates that an inexperienced operator can turn 600 square yards of rough-graded land into a seed bed in 20 minutes.

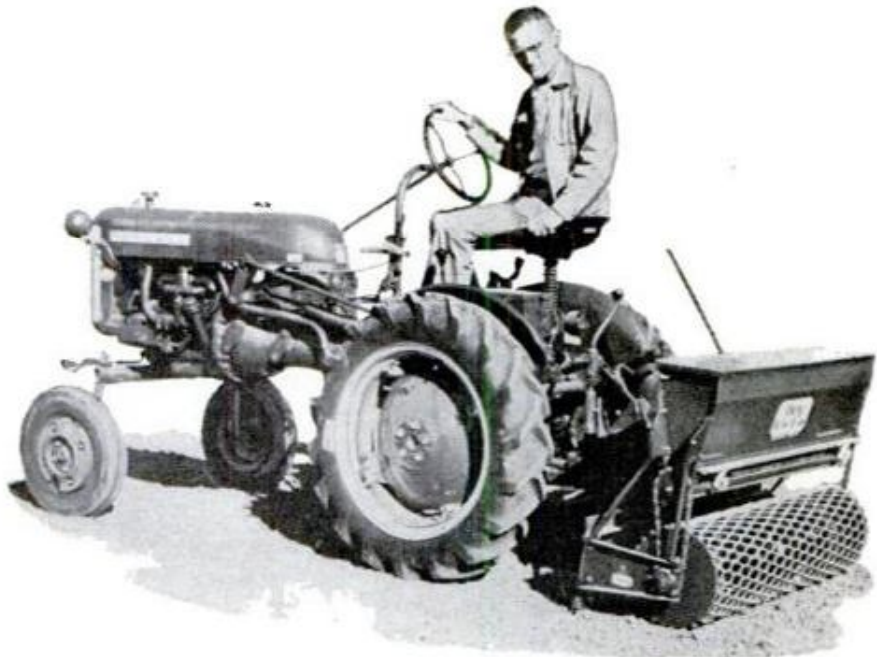

Window Insert Vents Stale Air

Even in stormy weather, the passenger compartment of a car or truck can be kept free from stale, smoke-laden air with a transparent insert that fits atop the window pane. The insert consists of a wide band of plastic that is perforated with a series of vent holes. Installed in the window channel above the door glass, it becomes a part of the door glass itself. If desirable, the window and insert can be lowered during hot weather. Three sizes are available and each is designed to be trimmed to fit any car.





BOTTOM OVEN of a new range pulls out like a drawer for cleaning and the shelves may be removed for washing at the sink. Its heating unit is sealed. The top oven has French doors for easy access and cleaning. Both have automatic controls

Frigitaire Div., General Motors Corp., Dayton 1, Ohio

REFRIGERATOR has a center drawer which can be opened without disturbing other parts of the appliance. It has two compartments. One is a 21-pound-capacity meat keeper said to keep meat fresh for seven days. The other is a large vegetable crisper

Westinghouse



114

WHAT'S NEW FOR Your Home



ALUMINUM GRILL is built to give intense heat but not drip grease into the brazier or onto the stove. Its slots are shielded and crossed by channels which carry the grease to a well that runs around the edge. The grill has a detachable handle

J-T Flameless Grill Co., 312 Wyzalhurst Ave., Baltimore 10, Md.

SHOWER HEAD can be adjusted in height. It may be raised for tall people, lowered to save women the inconvenience of wet hairdos, lowered further for children. The chrome-plated brass head, connected to the water supply by a hose, slides on a plate

Bickford Mfg. Co., Napa, Calif.

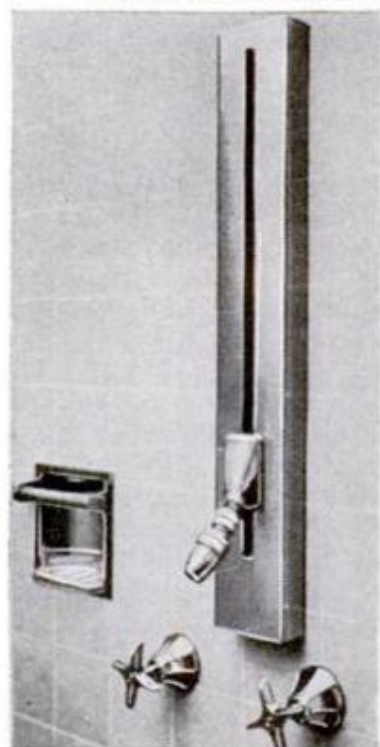

POPULAR MECHANICS



HOSIERY DRYER made of plastic resembles a sea shell ornament when not in use. Pulled down, the shell provides 32 slots for holding stockings, socks or gloves. The dryer comes in a variety of colors and has adhesive on its back for attaching to the wall
Hallmark Industries Corp., 2323 Biscayne Blvd., Miami, Fla.

ELECTRIC BROILER is mounted above a ceramic bed in a redwood patio cart. Equipment includes a temperature-control unit, a tilting grill mechanism with crank adjustment for efficient grease runoff and a revolving spit. The reflector lifts out for washing
Stanthony Corp., Los Angeles, Calif.



SAFETY GATE locks into a doorway without use of a screw or bolt. Spring tension forces the gate tightly against the door frame, but it can be set up or taken down with one hand. It has rubber bumpers on contact points so as not to mar the woodwork
North States Prod., Inc., 1011R W. Broadway, Minneapolis, Minn.

REMOTE CONTROL dial for a new water heater may be set to control temperature and the amounts of water to be heated. By choosing the proper setting on the dial, the user may cause the unit to function as a 30-gallon, 40-gallon or 50-gallon water heater
Rheem Mfg. Co., 7600 South Kedzie Ave., Chicago 52, Ill.

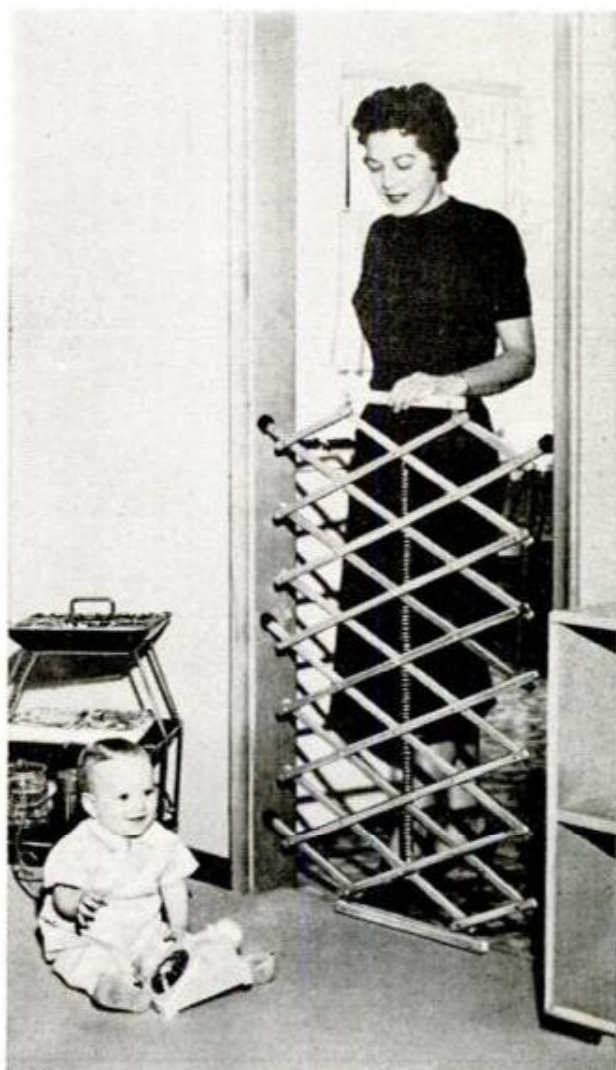

Go to College Outdoors

By George W. Martin

IT WAS a sunny afternoon in August and I was sitting in a high mountain meadow, overlooking Hoh Lake, where I could watch the shadows play on the glaciers and peaks of Mount Olympus, to the south across Hoh valley.

My reverie was interrupted by a jubilant shout, "Look here!" I looked at the ten-year-old running toward me with two twelve-inch rainbow trout. Right beside him was his father. I couldn't tell which was most excited.

"What do you think of that? Billy caught them himself! He and I have never been fishing together before, but there's going to be more fishing for us from now on!" Father and son hurried on to their own camp to show their catch to the boy's mother.

This is typical of the developments and changes I have seen take place among members of our college outdoor classes. Families live new and rare experiences together; young folks gain friendship and self-confidence through the informal camping; adult cares slip away in the refreshing and exhilarating experience of contact with nature.

This opportunity for outdoor living was developed by Olympic College, a junior college in Bremerton, Wash., to fill a long-



116



Photographers find subjects everywhere in the vast park; this pair focuses on a clump of wildflowers

standing need here. We are situated so close to the Olympic Range, towering on the western skyline, that it is natural for the people to turn to the mountains for recreation. Every August, Olympic College sponsors a 14-day class trip, hiking and camping through the most scenic part of Olympic National Park, in the northwestern corner of our state.

The purpose of the trip is the unusual and valuable experience of learning to be at home with nature in this great wilderness area. At least three college instructors.

POPULAR MECHANICS

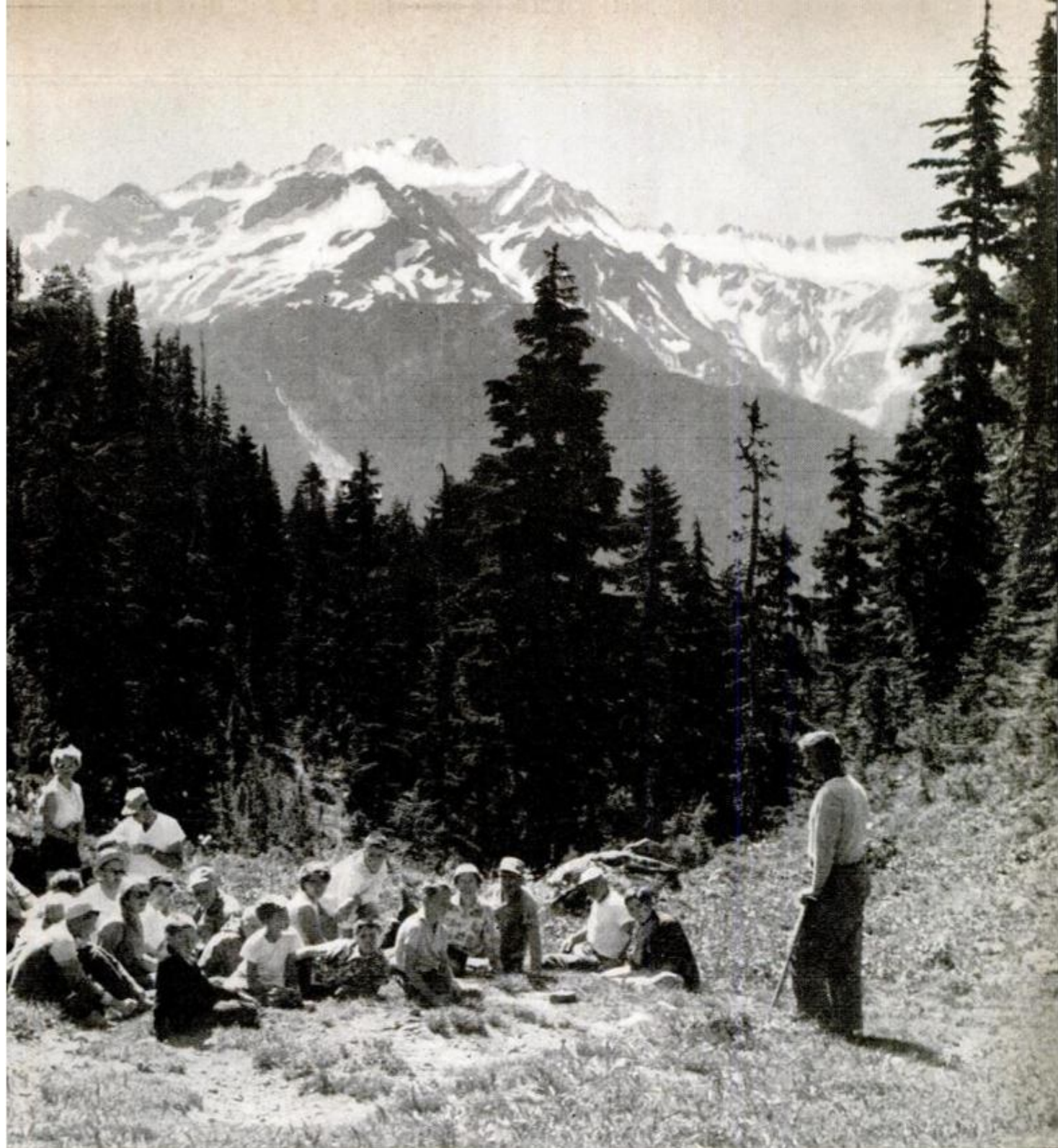

What better classroom for meteorology than the open air? Besides the regular guide-instructors, other instructors and park rangers rendezvous with the group along the way for special lectures or field trips

familiar with outdoor living in the mountains, lead the class and lend confidence to the group in its ventures. The class is instructed on such subjects as botany, geology, astronomy, meteorology, safety, first aid for hikers and general campcraft. Additional instructors and park rangers join the class at various points for special lectures and field trips. They travel on foot through an area that changes almost daily in its fascinating and magnificent growth.

The 75-mile route starts in the forest area at Solduc Hot Springs, 25 miles west of

Port Angeles. The trail winds its way up through the heavy forest by way of Deer Lake to the spectacular High Divide, with its alpine meadows and panoramic views; then on to Hoh Lake, which looks from above like a great blue jewel in a rich setting of golden ridges. From the lake shore, looking across a rippling outlet and through a wide ravine, there is an arresting view of Mount Olympus, the destination point. From Hoh Lake, a one-day downhill trek is necessary. The class experiences its greatest thrill after the next uphill climb

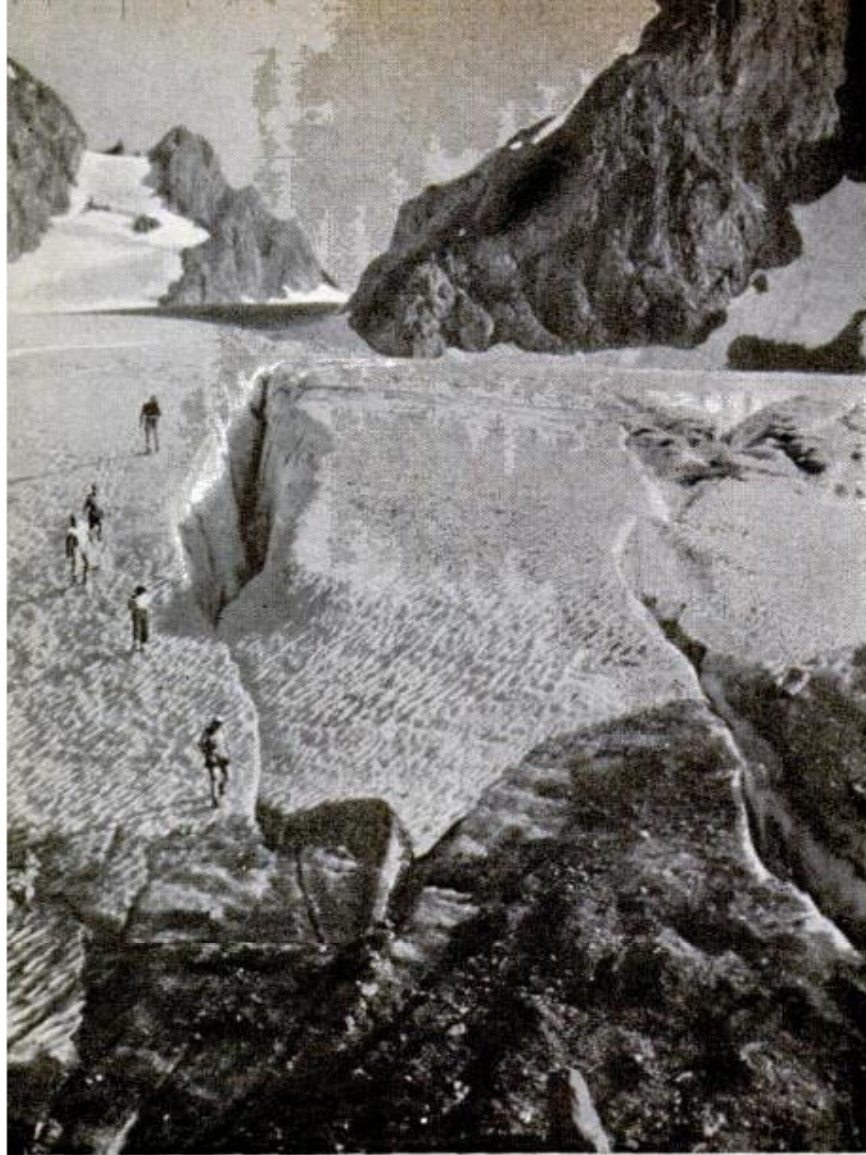

Practicing for the climb up Mount Olympus, a group circles a crevasse on Blue Glacier. Experienced mountaineers assist

when the hikers reach the alpine meadows, with a side trip across broad glaciers and the 7900-foot peaks of Mount Olympus itself.

Experienced guides and mountaineers assist the leaders in routing the class safely around dangerous crevasse areas and across the broad snowdome to the summit. Three days are spent at the base of Mount Olympus, then the return trek begins through the great forests, continuing down until it reaches the Hoh River. This expansive, low-level area is nationally famous for its rain forest and the 12-mile hike among towering Sitka spruce, Douglas fir, Alaska cedar and massive maple trees, ending with the famous nature trail. On every side the ground is covered with a soft, thick carpet of moss, and golden streamers of moss hang from the branches of the big trees.

Everywhere along the route those with cameras stop to record views of scenery, animals and flowers. Adventure waits around every corner; perhaps a herd of Olympic elk grazing in an alpine meadow or a big bear eating blueberries. A marmot may whistle to its mate from a rock slide, or a doe and fawn may stroll blithely through camp. Endless fields of

Eager would-be mountaineers find many side trips to challenge their climbing ability on the route to Mount Olympus. Here a "student" poses on a rock peak while the photographer (see shadow) mounts another





After a long, careful stalk, a student photographer caught this herd of Olympic elk resting in a snowfield. Bear, mountain goat, and deer also abound in the wilderness areas of the Olympic Peninsula

flowers include colorful lupin, tiger lilies, mimulus, buttercups, avalanche lilies and many others, generously mixed with heather.

There is time for fishing in lakes or relaxing on sunny slopes; eager mountaineers are taken on side trips. Every effort is made by the staff to help members enjoy their outdoor adventure and to learn as much as possible on the higher as well as lower levels of Olympic National Park.

The class is part of the regular college summer session and carries five-hour credit in physical education for those who claim

it. Since most members have had little experience in outdoor living, the first days are filled with instruction, informal talks and field trips. In fact, learning starts from the moment the class first meets. Preparing a packsack, hoisting a packboard, or holding an ice ax is a stimulating experience for the tenderfoot, as is setting up the first campsite with groundcloth and tarp.

The philosophy of learning by doing is applied in the group — all members cooperate in handling the work around camp. The class is divided into four teams, each with definite responsibilities. The teams

Mountaineers and guides lead the group across the broad snowdome near the summit of 7900-foot Mount Olympus. The college boasts that the Special Campcraft Class covers the area from sea level to ski level



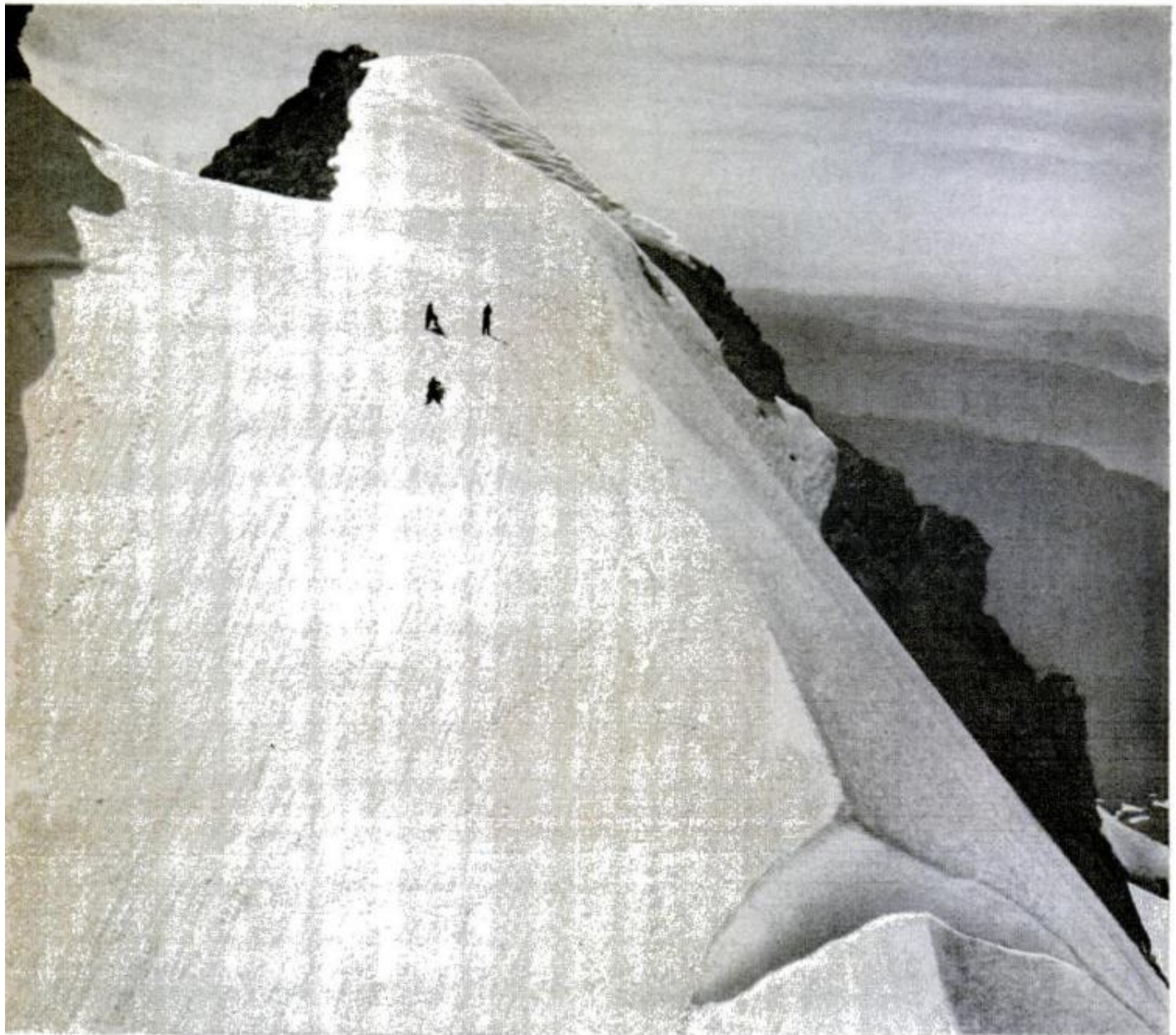

Gaining confidence with experience, the mountain-climbing field trip members glissade down a steep snow field near the summit of Mount Olympus, sliding on their heels with an ice ax behind for a brake

alternate fire-building, cooking, washing dishes and cleaning up, while the fourth group has earned the coveted free day, called "bye." Teams learn all phases of camping and are reorganized three times to allow members a chance to become better acquainted with the entire class.

Living amid open campfires in comparatively primitive style, surrounded by lush, relaxing, natural habitat is the value and real pleasure of the trip. Burdensome loads for hikers are discouraged at the beginning. All food is transported in advance by pack-horses and is cached every five or six miles along the route at base camps. The hiker then carries only his personal gear.

The class usually has a wide age range; children, teen-agers, college students, adults—even grandparents can enjoy the trip. Children from 10 to 16 must be accom-

panied by an adult and, of course, all must submit a doctor's certificate of fitness.

Our staff is continually amazed at the development of the class in the two short weeks. A letter from a fifteen-year-old member of a family of six who flew out from the east to join us is typical of their enthusiasm.

"I really don't know how to express myself when thanking you for the lovely trip in the mountains. When we started to prepare for the trip, I knew one member of the family would come home loving the trip, but never did I expect the whole family to rave about it as we all do. It's a trip for everyone."

Olympic College feels fortunate to be able to extend its campus to include the vast wilderness classroom of Olympic National Park. ★ ★ ★

Second Top for Car Keeps Interior Cool

Down Under, in Australia, a Sydney manufacturer is distributing a glass-fiber shield which, fitted above a regular auto top, is said to keep the car as much as 20 degrees cooler. There is a $\frac{3}{4}$ -inch gap between roof and shield.



Auto Cooler Features Built-Ins

Adaptable for either car or home use, a new portable cooler plugs into cigarette lighter socket or wall plug and blows over 550 cubic feet of air per minute through a spray of water to produce a cool breeze. Two and a half gallons of water will cool for four hours of driving. Built of high-impact Cyclolac plastic, it's rustproof and sloshproof, too. Other features include a built-in ice chest for cooling beverages on the road; built-in coasters and ash trays; even a cap lifter. It's adjustable to fit any car floor.



Hose Connection Flushes Outboards

Testing an outboard motor or flushing its cooling system without removing the motor from the boat is almost unheard-of with no water around; but a new connection allows outboarders to connect an ordinary garden hose to the cooling system intake and flush out salt water, silt, mud, or sand or test the motor for minor adjustments—in their own backyard. Six models will fit most engines without special tools; discharged water is allowed to run on the ground.

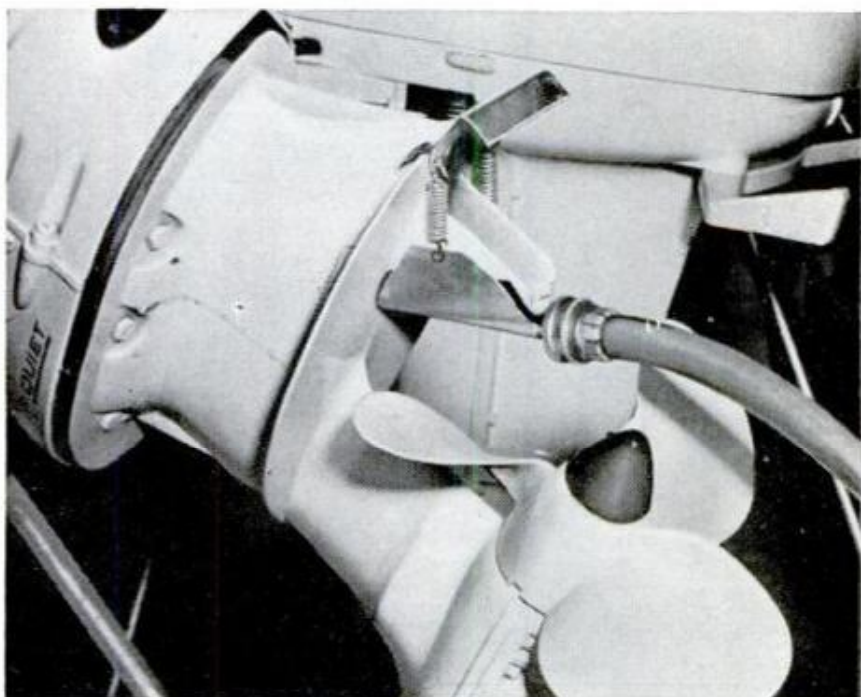

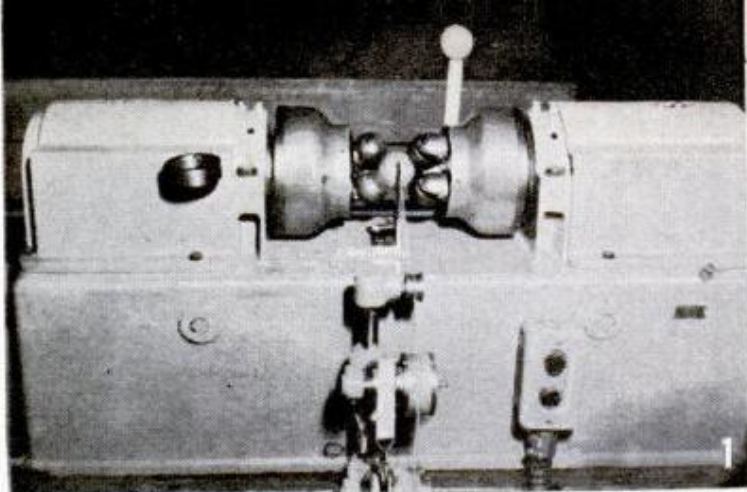

PGA photos



Missile With a Frozen Heart

By Bob Kelly

1. Raw rubber thread whips quickly around frozen liquid cores in the winding machine. Cycle takes only 20 seconds

2. Covers, molded separately under great heat, are hand-fitted over the wound cores like a shell over a nut meat

3. Covers are vulcanized into a single, seamless piece, then rinsed carefully by a tumbling process in still another machine

4. Painting machine handles 178 balls per minute. They are dried, tested, then branded and ready to go — see above right

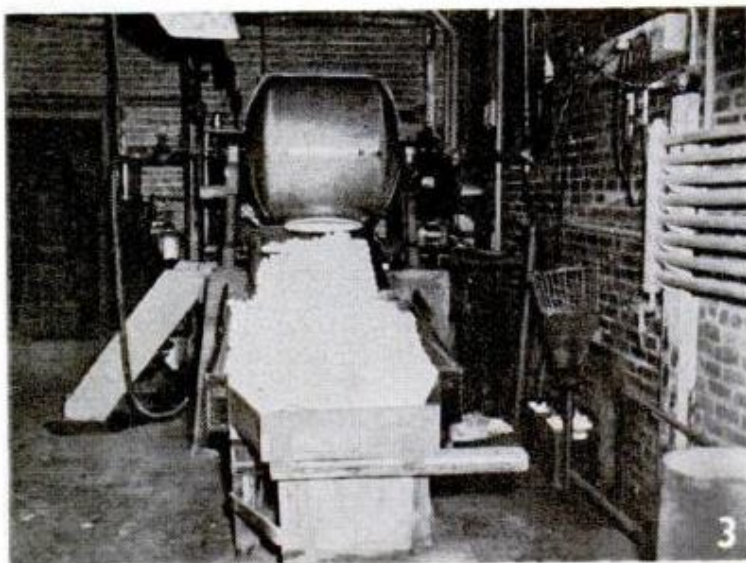

When champion professional golfer Chick Harbert addresses the ball for a tee shot, he must know what distance and direction to expect from his drive. Thanks to modern golf engineering, the same consistency is now available to everyone



DON'T FEEL SORRY for your golf ball. By the time your #2 wood sends that little pill into orbit (after distorting it to a lemon-shape as it leaves the tee) it has already been strangled with rubber thread, frozen at 120 degrees below zero, coated with South American gum, vulcanized, enameled, checked for compression and branded.

The reason it is coddled, exhaustively tested and fretted over is simple—better performance and lower score for You.

But it hasn't always been this easy. Prior to 1900, you batted a leather golf ball around. Then someone invented a solid ball made of gutta-percha, unhappily offering nothing to the golfer who took his game seriously.

Finally, shortly after the turn of the century, Colburn Haskell of Cleveland invented and patented the first golf ball to use a rubber-thread, center-core winding. This basic principle has remained unchanged through the years though the materials of construction have improved.

The PGA golf ball, for example, is born as a frozen liquid center. It is shaped in a mold at 120 degrees *below zero* before winding with the rubber thread. This simply insures perfect roundness while being wound in an automatic machine that completes the cycle in 20 seconds.

Speed is the most important phase of the winding operation, since the core eventually thaws and would lose its shape if not wound in time.

Next, refined Balata, the gum of a South American tree, is compounded with pigments and chemicals and molded over the rubber-wound core. Penetration into the windings is required to insure good adhesion. Specially molded covers are then vulcanized into place over prepared cores.

To give the ball a brilliant, long lasting finish, it is sprayed with three coats of high lustre, synthetic enamel. Names, brands and numbers are placed on the completed ball with high-speed marking machines that imprint in eight different positions on the ball.

The manufacturers, however, never trust the machines—and conduct regular tests. The finished products are checked for the all-important compression as well as for accuracy of weight and balance.

The golf ball is a sensitive thing—if you treat it that way, you'll be happy with the results. For instance, the cover of the ball is only 3/64 of an inch thick. Yet at the moment it is actually struck by the club it is compressed to one half of the ball's over-all thickness, which is normally 1.68 inches. And all without cracking!

(Continued to page 210)



Camper's Shower Is Set Up on Car

Campers can shower—in privacy—anywhere there's water with a collapsible, portable shower unit that is set up alongside a car, trailer, or truck body. The camper can undress inside the car, step into the shower, then step back into the car to dress again. Curtains on all four sides assure privacy and protect the car. Water comes from a two-gallon tank that sits on the roof of the car and runs through the hose by gravity; two gallons are enough for a pretty good showerbath if used sparingly. The 30 by 30-inch shower framework hangs from the car's rain gutter; plastic sheet covering hangs from the aluminum frame. The heavy plastic floor is a separate piece.

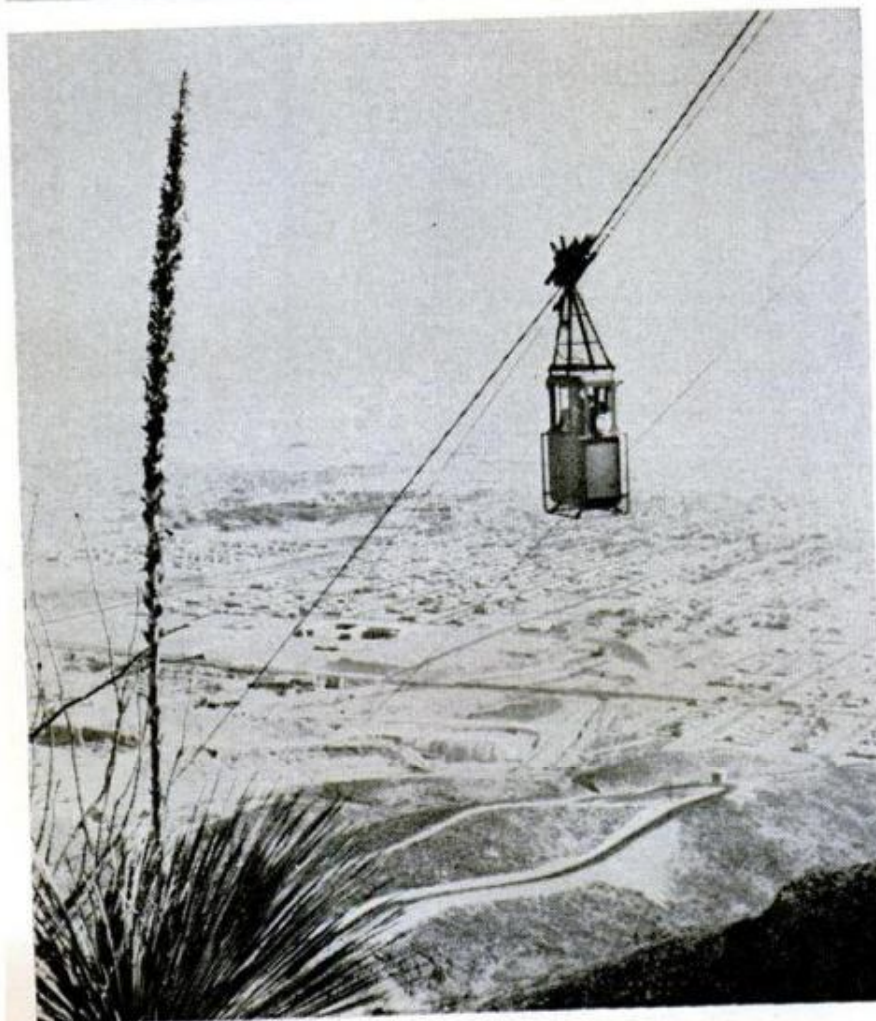

Aerial Tramcar Serves as "Elevator"

Employees at El Paso's new radio and TV station, KTSM, get a real thrill out of going to work. Instead of a driveway or an elevator, they use an elevated tramcar to shoot 960 feet up to their tower, sitting 2000 feet above the Texas city on 5692-foot Ranger Peak. The car travels 2300 feet in about three minutes, reaching a speed of 1000 feet per minute and often suspending the passengers 350 feet above the canyon floor. The capacity is six adults, and though it takes a bit of getting used to, the builder insists that the system is as safe as an elevator. Built as the best method of moving employees to their work, the tramway may soon be open to the public, too.

POPULAR MECHANICS



Even Skin Divers Can Use This Flashlight

Sealed inside a plastic shell behind thick Neoprene gaskets, a waterproof sealed-beam lamp is designed for firemen, police, miners, oilmen, outdoorsmen — even skin divers, since it works under water. It

can stand on several bases of its square battery case or hang from its nylon cord in several positions. The lamp generates 6000 candlepower with a six-volt battery. Case contains dehydrant to absorb condensation.

Plastic Balls Float Pulpwood Chips to Mill

Pulpwood chips and scrap, burned as waste in lumber camps but valuable in paper manufacture, may be saved through the use of a new method of river transportation. Stuffed into a bright red glass-fiber ball eight feet in diameter, a test load of

chips was floated 50 miles down Canada's Fraser River and arrived safe and dry. The "bobbers" need no supervision—a man at the pulp mill is posted to watch for the containers as they come floating downstream.

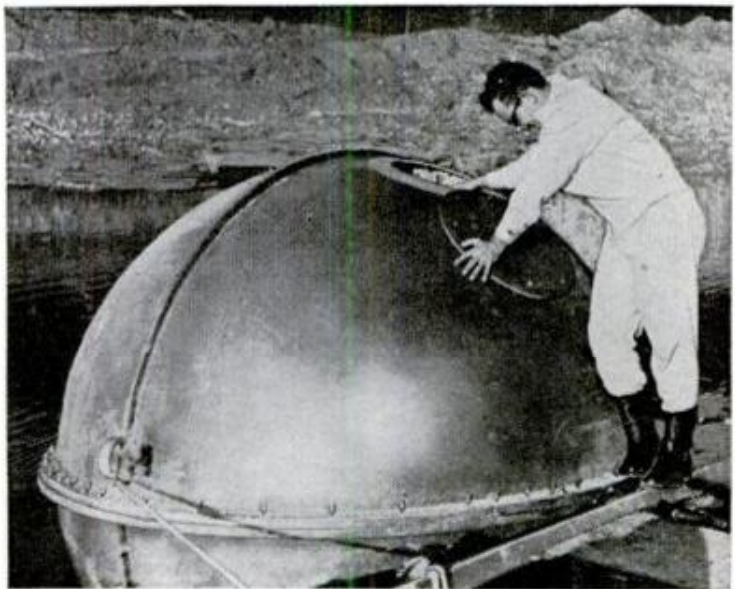

The Woodcarvers of Spillville

By
Elma
Waltner

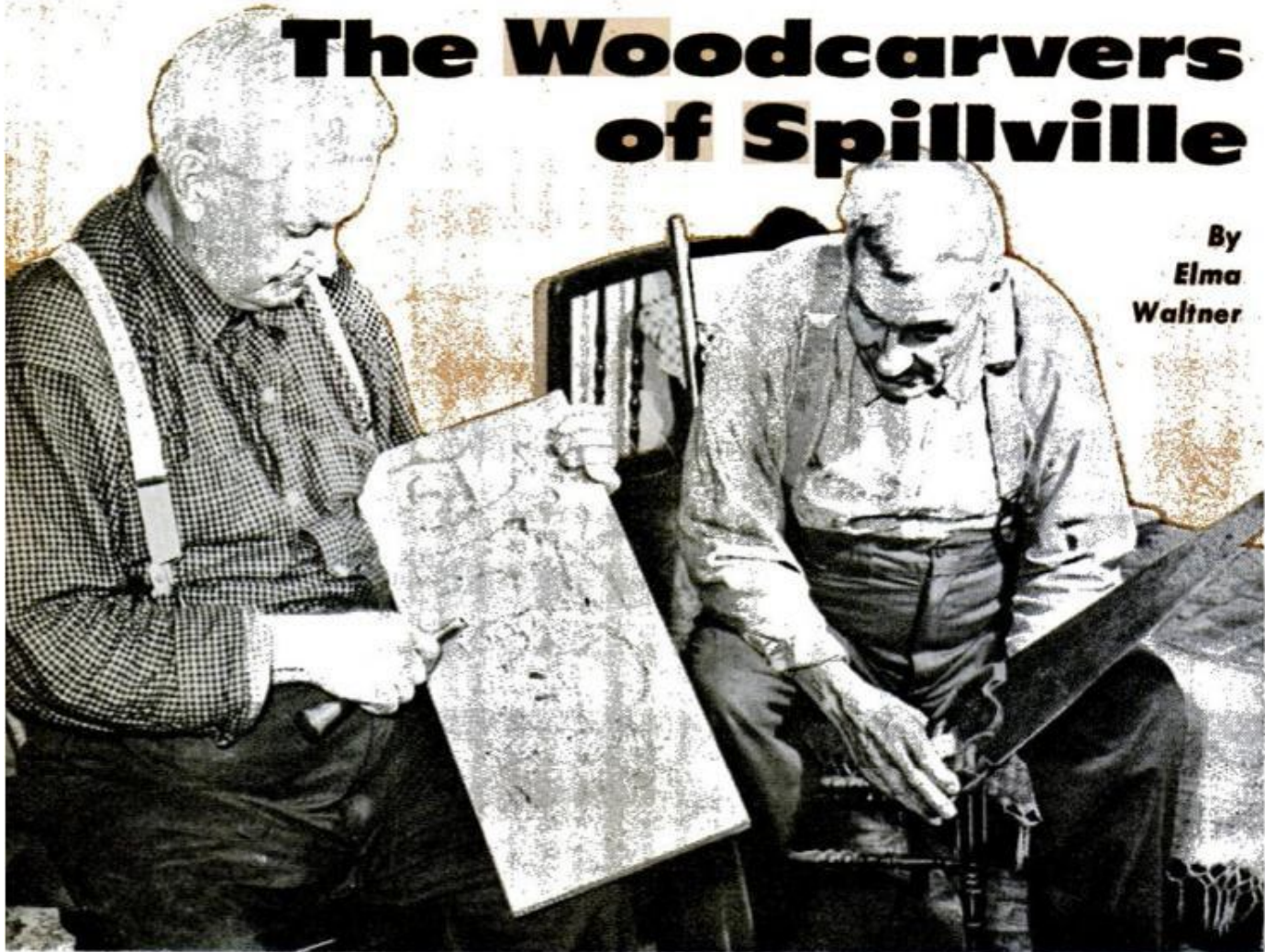

Frank and Joseph Bily have pursued their hobby of carving clocks since 1913. They use only hand tools and divide the labor in making their intricately beautiful creations. Frank, left, is the carver and Joseph, right, constructs the cabinets. Many people call at Spillville to see the display of their interesting collection

This is a miniature of the "Little Brown Church in the Vale." While chimes play, a bridal party comes around the church to the front and enters the door



WHEN FRANK BILY left school he was presented with his desk—which he had been elaborately carving for years. His activities resulted in an interesting work of art but ruined the desk for its originally intended purpose. Frank put it to good use, however. He converted the top into a gift for his mother by doing more carving to produce a plaque depicting the Holy Family. Today the plaque is admired by the many visitors who stop at Spillville, Iowa, where it is on display with other intricate carvings that make up the Bily brothers' carved clock collection.

The brothers, farmers and carpenters by trade during their younger years, are now in their late seventies. Woodcarving as a hobby occupied their spare time from childhood and continued to intrigue them in their adult years despite opposition by their father who told them they were wasting time which could be put to more profitable use in farming. Their carving talents first centered on clocks in 1913, when a neighbor brought them a clock base he had carved and asked help in installing the works. Through the years, they've built a collection of clocks, some being several

(Continued to page 200)

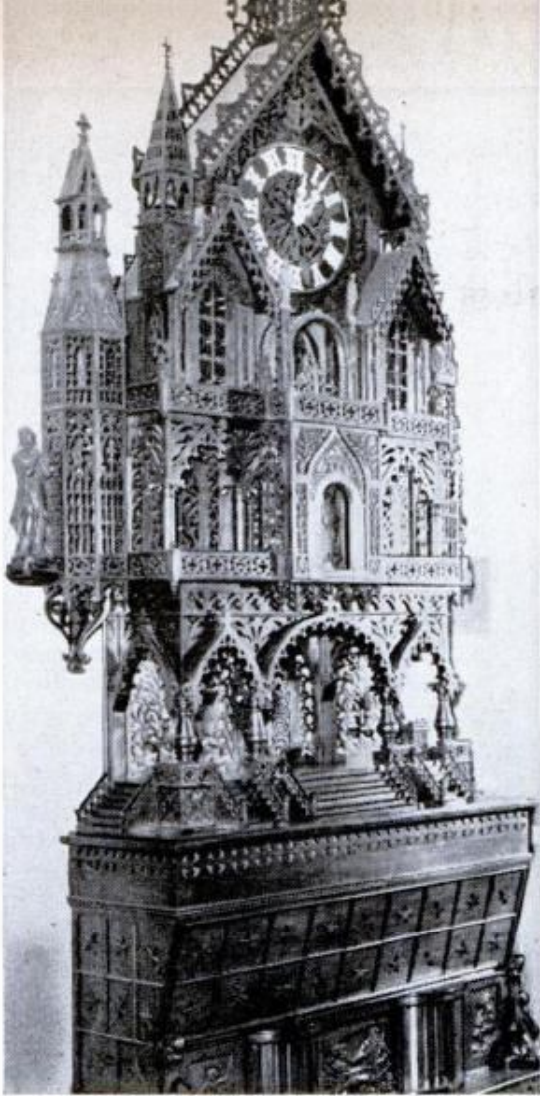

Religious and historical themes appear frequently in the collection. The Normandy Clock, left, has two sets of chimes: one is in the "Westminster Abbey" base. The brothers' masterpiece is the American Pioneer History Clock, at right. Four years in the making, the series of panels represents scenes from American history

Spillville's artisans respect the work of others. They restored the 300-year-old Deer Clock, of Swedish make, and added a rough-carved base to point out the earlier carver's precise work. Though they buy clock works, the Bilys make moving works themselves. As the clock chimes the "Anvil Chorus," the smithy hammers





Hydraulics Handle Motors

Even the heaviest of the big modern outboard motors can be handled easily by one man using a new hydraulic "Motor Toter," which lifts motors on and off boats or testing platforms with no need for manual lifting at all. The motor is held by self-locking rubber forks while a steel catch bar prevents the lower unit from swinging backward. The motor is lifted hydraulically to a preset height, then wheeled to its new location and lowered back onto its transom bracket. The clamps do not interfere with the transom clamps. The rubber forks allow the "toter" to handle outboard motors of any make, model, or size, regardless of their weight. Frame is heavy steel, and rolls on hardened steel axles, ball-bearing wheels, and semi-pneumatic tires.

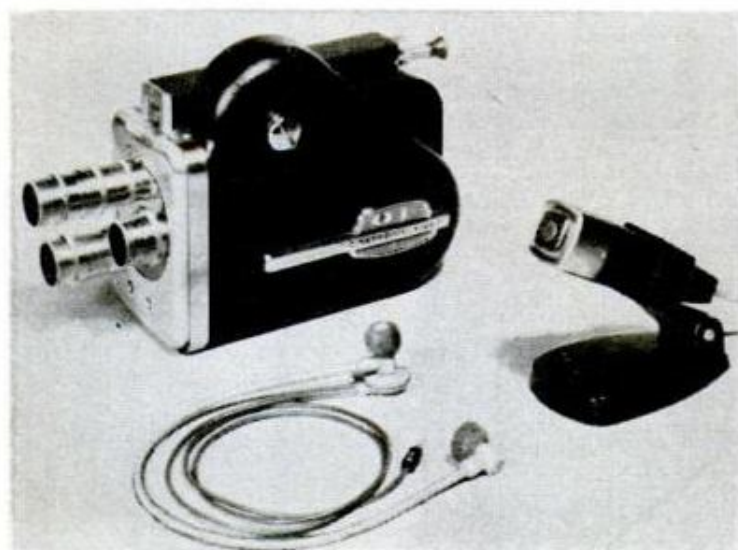

Sound Movie Camera in 8 mm.

Amateur moviemakers can make their own "talkies" with a new transistorized 8-mm. movie camera which can pick up and record the sounds of a scene onto the film simultaneously and with exact synchronization. The battery pack and sound amplifier are contained inside the camera body for easy operation and portability. Shown here with its microphone and headset for monitoring sound volume, the camera also has a companion sound projector which can also record new sound on the film or allow sound editing.

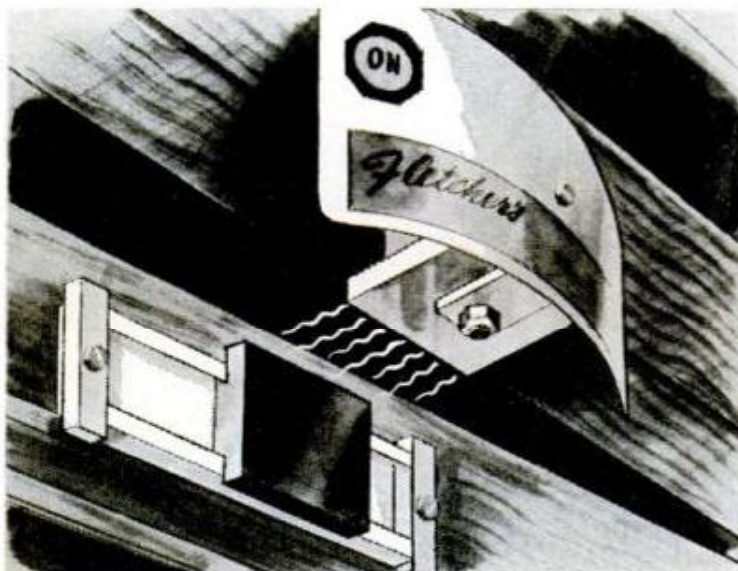

Magnetic Door Retainer

Winter's cold winds or summer's dusty gusts won't blow open doors equipped with an adjustable, magnetic retainer. It can be set to allow the door to open easily or with pressure. A steel block which slides on a track is screwed onto the top rail of the door. The magnet attaches to the underside of the door frame. When both pieces are in position, the magnet pulls flush against the block. If less than the full 50 pounds of pulling force is wanted, the block is moved on the track so it only partially contacts the magnet.

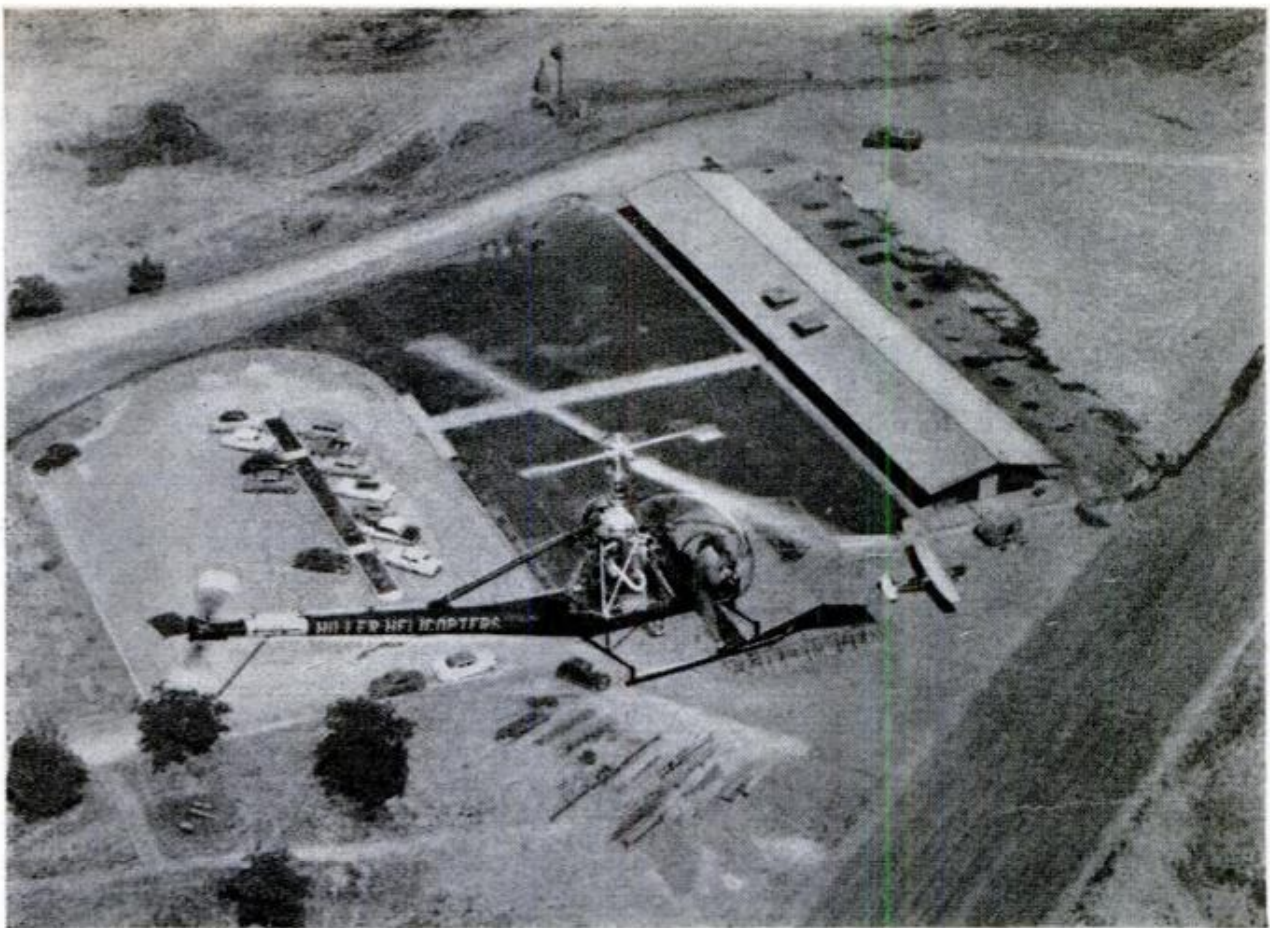

Whirlybird's-eye view of the Pick Laboratories on a leveled hilltop in California's Santa Cruz Mountains

There Must Be a Better Way

By Thomas E. Stimson, Jr.

That's what Vernon Pick said as he fought mountain lions, desert heat and rattlesnakes to find a fabulous uranium deposit. Now he's built a laboratory to find those better ways

CAN A super doodlebug be invented that will discover a body of ore that is buried 1000 feet underground? And do it from an airplane?

How about an airborne ultraviolet lamp so intense that minerals on the ground would fluoresce brightly in its rays? Or a source of "black light" so powerful that you could take night infrared flash shots of the terrain from an airplane?

These are some of the projects that are being studied at the Pick Laboratories in the Santa Cruz Mountains 50 miles south of San Francisco. The unique laboratory is

Airborne gravity gradiometer measures variations in gravitational pull, spots ore deposits from plane

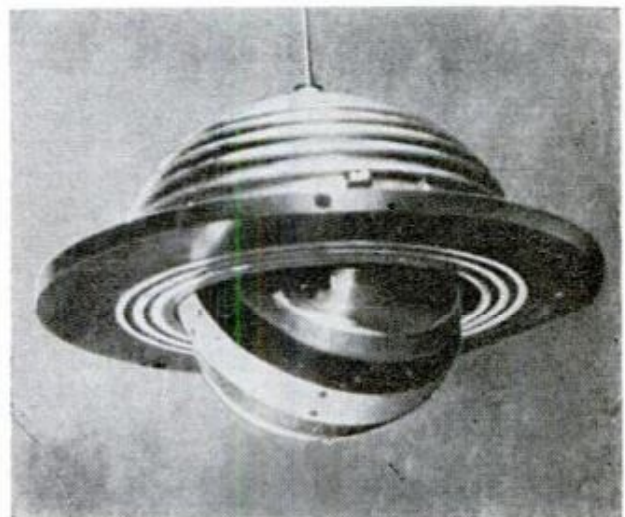

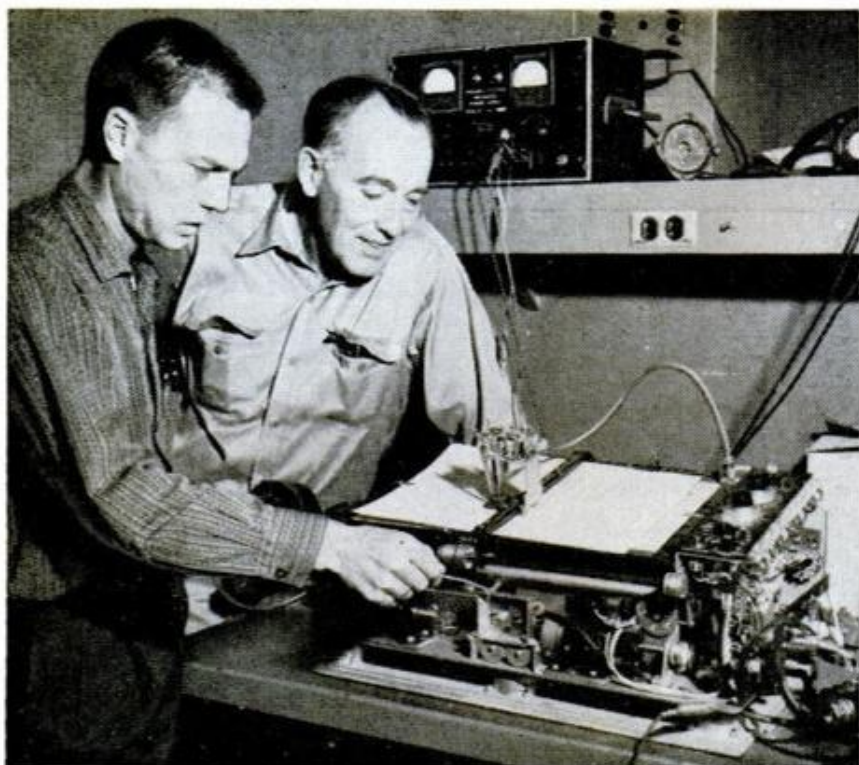

◀ Airborne scintillometer draws contour map in four colors to show location, size and shape of radioactive anomalies (hot spots) passing under the plane

Old aerial survey measures total gamma radiation; terrain and background radiation affect the reading. Pick Anomaly Locator rejects background; reads easily



financed and directed by Vernon J. Pick, famed uranium prospector.

When Pick was hunting for uranium on foot in 1954 in Utah he decided that there must be a better way to do it. Plodding across the desert in 120-degree heat, dodging rattlesnakes and tracked by mountain lions, he was convinced that there must be a better way.

Pick's story is one of the classics of the modern West. Almost at the end of his strength and ill from drinking poisonous water, he made one last hike into a remote

No operator needed on Pick's trap range—microphone at his feet actuates trap mechanism at word "Pull"

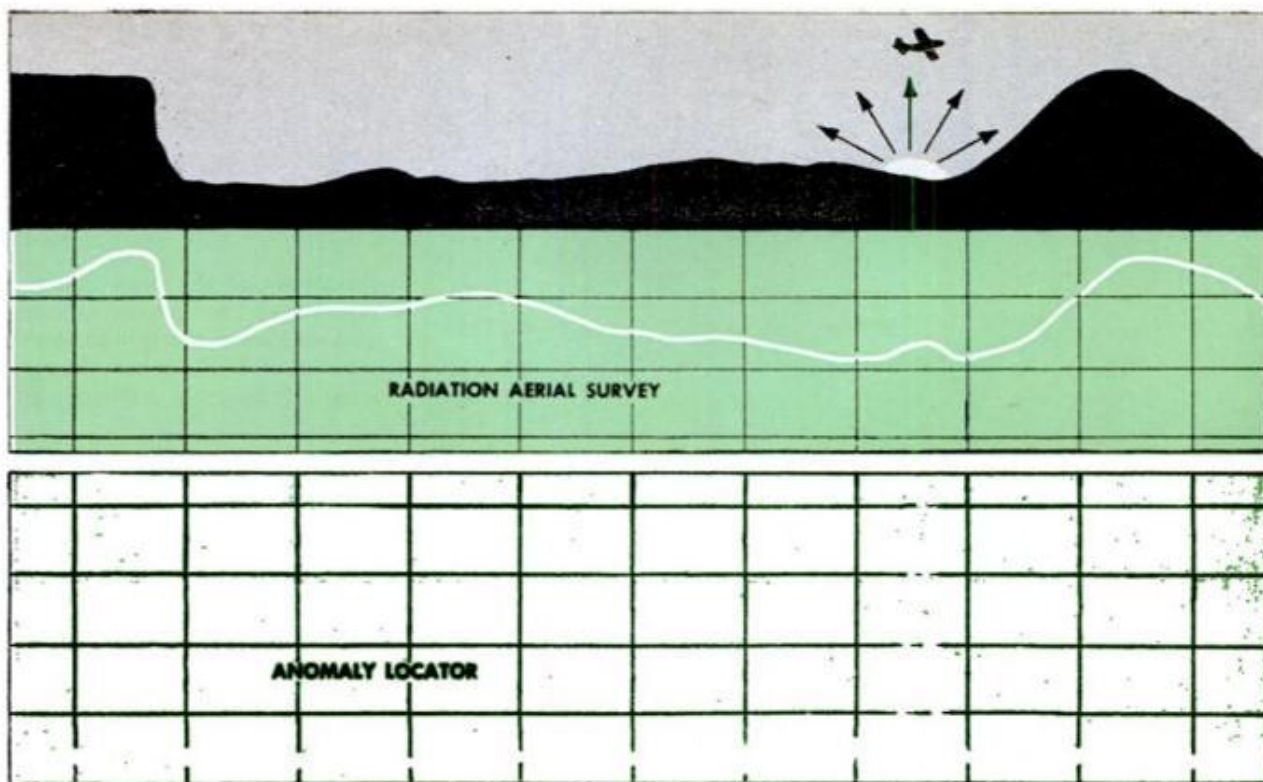

canyon and discovered one of the richest uranium mines in the world.

Today, six years and six million dollars later, Pick is devoting much of his energies and part of his fortune to finding a better way of doing a number of things. That, in fact, is the philosophy of his research organization.

The laboratory itself occupies a long, low building on 900 acres of leveled-off hilltop near the small town of Saratoga, Calif. He

Pick, right, tests isodose plotter designed by his laboratory to help in radiotherapy for cancer

wanted a site that was fairly close to the electronics industry centered around Palo Alto, but remote enough to allow undisturbed concentration on the problems being studied. The job of the lab is to take a new idea, develop it, build the device that's called for, test it thoroughly, and finally produce a practical working prototype ready to be marketed.

Twenty scientists, research people and technicians under Dr. R. Maurice Tripp,

Heat source goes into center of 30-inch parabolic reflector for "flashless" night aerial photography



JULY 1960

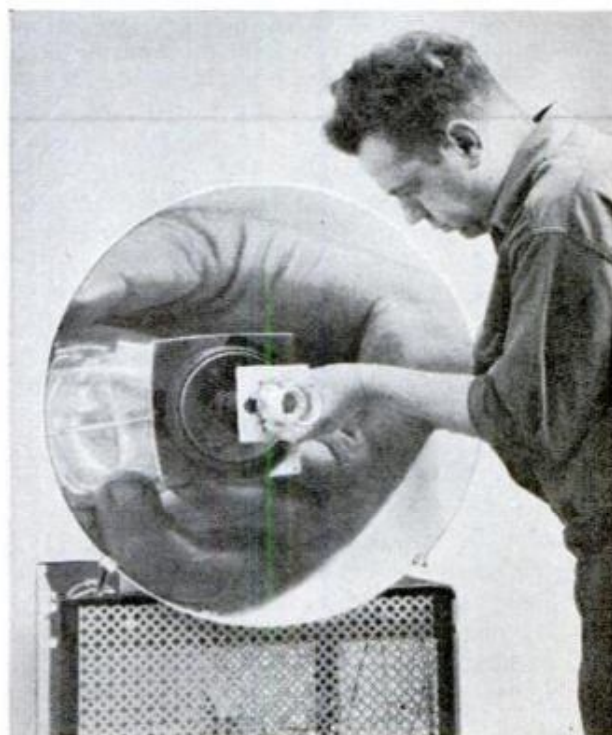

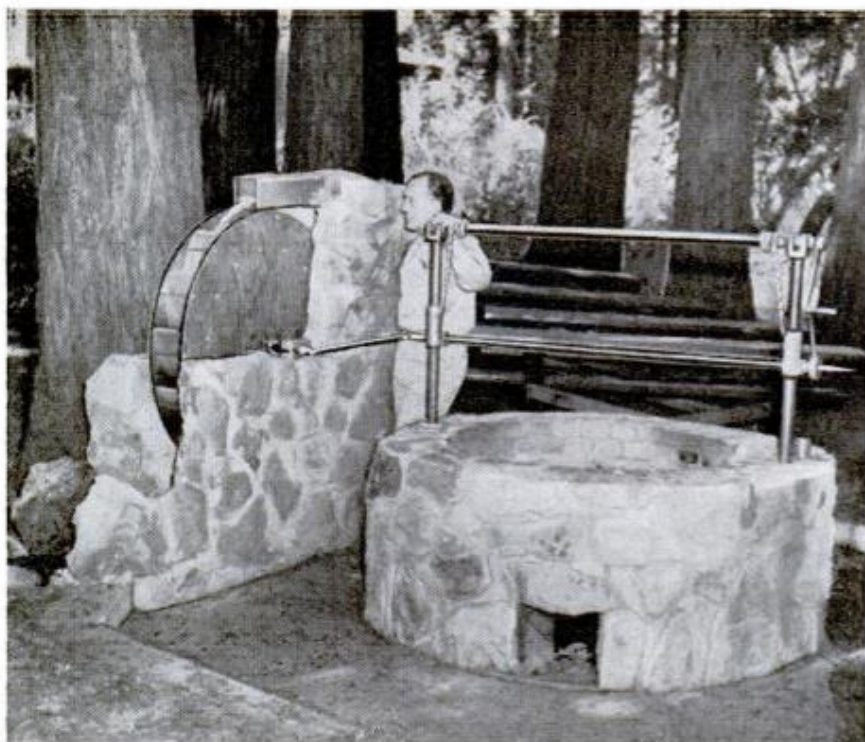

Developer of the most modern methods and equipment, Pick still uses man's oldest source of power—a waterwheel—to turn the spit over his own big barbecue pit

research manager, make up the staff. Among its other facilities the lab has a well-equipped machine shop, woodworking and pattern shop, metallurgical shop and electronics shop. It is intended to be as self-contained as is practical, so its facilities also include a photo lab and print shop.

In this environment the staff often tackles a new problem together, each member of the team contributing ideas based on his own training. All the projects are important, some are too technical to attract much public interest.

For instance there's the "multi-field isodose contour plotter" of which the laboratory is exceedingly proud. This long-winded name refers to a machine that saves time and money in treating cancer victims with radiotherapy. One of the great problems in such a treatment is avoiding an overdose of radiation to healthy tissue while irradiating a deep-seated tumor. The new machine plots a safe pattern of radiation in a few minutes as opposed to the present tedious process, which takes several hours.

Here's something that probably has a lot more popular appeal. Pick recently built a trap-shooting range near the lab building for himself and some of the members of the staff. On most trap ranges an operator is needed to release a clay pigeon every time the shooter calls "Pull!" But not here.

When the shooter calls for a target on the Pick range his voice is picked up by a portable microphone lying nearby. The electrical signal created by his voice is amplified and used to actuate the trap, automatically throwing a clay pigeon into the air. No operator is needed.

At his large home near the laboratory, Pick uses part of the flow of a mountain spring to maintain the water level in a small fishing pond. He puts the water to other uses as well. He installed a waterwheel alongside his big open barbecue pit and connected the shaft of the waterwheel to the spit. The spit rotates slowly over the fire when he opens a valve that sends water flowing over the wheel.

One of the things Pick has wanted is a better airborne scintillometer, a gamma-ray detector used in prospecting for uranium. These instruments already are available, of course, but they require constant attention in the air and it often takes weeks to evaluate the results of one day's flying.

The "Pick-Air Prospector" that the laboratory created is so great an improvement that it recently won an award from the mining industry. The new scintillometer does all its own paper work automatically and at once, drawing a picture that allows even an untrained operator to spot any unusual radiations beneath the plane. The device automatically rejects the background count, compensates for variations in terrain and altitude, and covers almost four times as much area in an hour and does it cheaper. With an associated three-dimensional plotter coordinated with ground radio transmitters, it can draw a radiation contour map in four colors, showing "hot" areas and their sizes and shapes.

The laboratory hasn't yet completed another of its projects, the device that would locate underground ore bodies from the air. The instrument is actually a gravity gradiometer that measures differences in

(Continued to page 202)

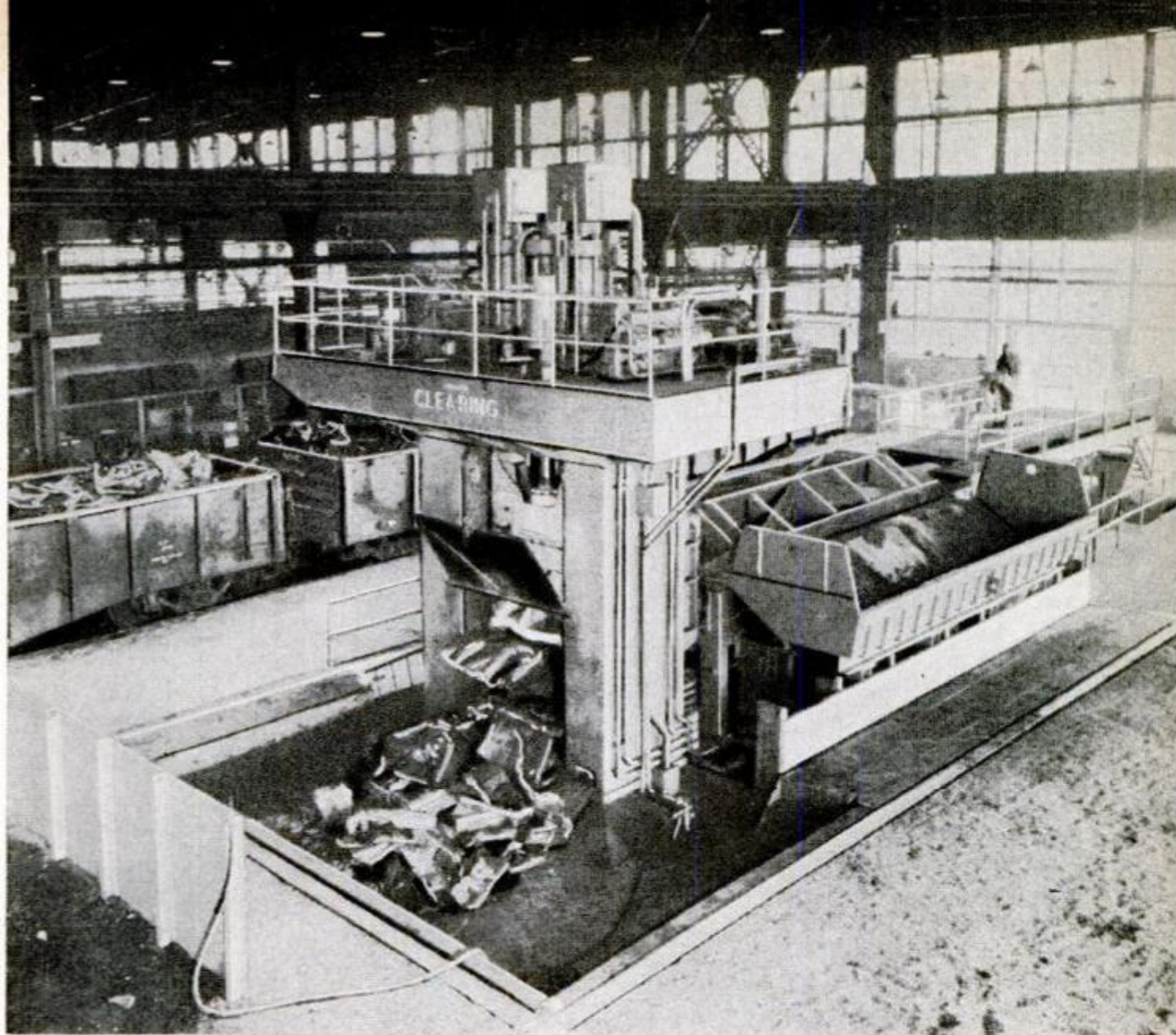

Cut into easy-handling size, the remains of an old freight car tumble from the shear's business end

Pushbutton Shear Chews Up Freight Cars

WITHOUT MOVING from the console of his big new shearing machine, the man at right can cut 30 freight cars a day into neat, easily handled chunks of scrap steel for melting in foundry furnaces. So big that he must have closed-circuit television to see what he's doing, the monster scissors weighs 335,000 pounds and stands two and a half stories high, and chops up over 400 carloads of scrap a month—a total of 18,000 tons of steel. First of its type to be used by a railroad, the machine is installed in the New York Central's Ashtabula, Ohio, scrap and reclamation plant, where it eliminates much of the torch cutting in the scrap yard. Adjustable to take bites of 6 to 48 inches at a time, the shear works on a 12-second cycle, using 600 tons of pressure.

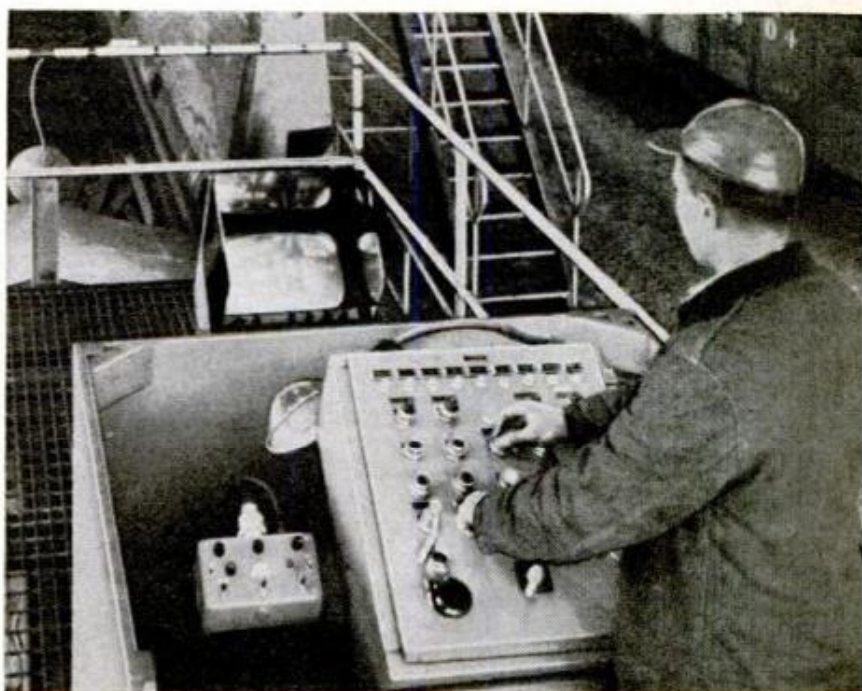

The CRAFTSMAN



By John Jefchak

Last Month You Built the Cocktail Table. Here's the

Clamping blocks are attached to table rails with hide glue—later removed and cleaned up with water

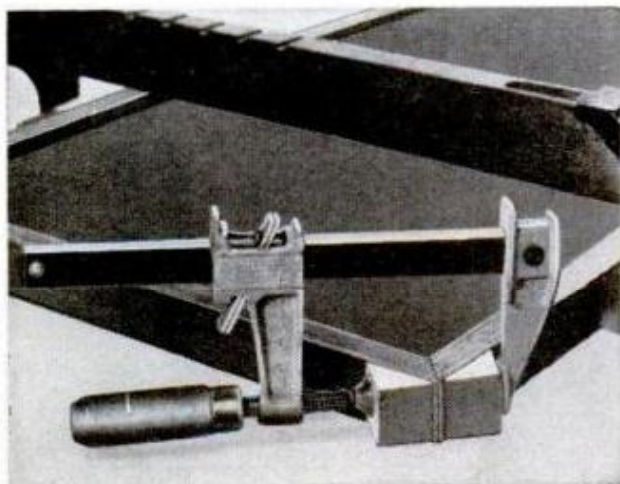

THIS STEP TABLE has a surprise feature that allows you to convert it to a table of many uses. You'll undoubtedly want two of them—for use as end tables on each end of your davenport. When used with the step, the design has a classical feeling. But with the tray and step removed, you have a pair of stunning end tables for casual use. Placed back to back, these tables form an unusual coffee table. Such convertability will be welcomed by the modern homemaker with limited space and budget.

Start with the table first. The rails are cut from solid stock—American walnut being used in the original. The side rails and the rear end rail are dadoed on the inside faces to fit over the edges of the

plywood table top. This dado measures $\frac{1}{2}$ in. wide and is cut $\frac{1}{4}$ in. deep, $\frac{1}{4}$ in. up from the lower edge of the rail. See the sectional detail A-A below Fig. 2. Note that the side rails measure $\frac{3}{4} \times 1\frac{1}{4} \times 29\frac{5}{8}$ in. and the rear end rail $\frac{3}{4} \times 1\frac{1}{4} \times 16\frac{3}{4}$ in. The curved front rail of the table is cut in precisely the same manner as described for the cocktail table presented last month. Starting with stock measuring $\frac{3}{4} \times 1 \times 14\frac{3}{4}$ in., you first rabbet the lower edge, then miter the ends and finally bandsaw it to the proper radius. See the top-view drawing and section B-B, Fig. 2.

Next, cut out eight triangular glue blocks and glue them to the rails $\frac{1}{8}$ in. from each mitered end. Hide glue should be used because it gives maximum strength and is soluble in water. It is a good idea at this time to sand the exposed inner faces of the rails.

Lay out the proper shape of the table top on $\frac{1}{2}$ -in. plywood measuring $15\frac{3}{4} \times 28\frac{7}{8}$ in. Check the drawing for respective radii. Note the straight length that extends for $9\frac{7}{8}$ in. along the sides. This coincides with the straight edge along the bottom of the step. Chamfer

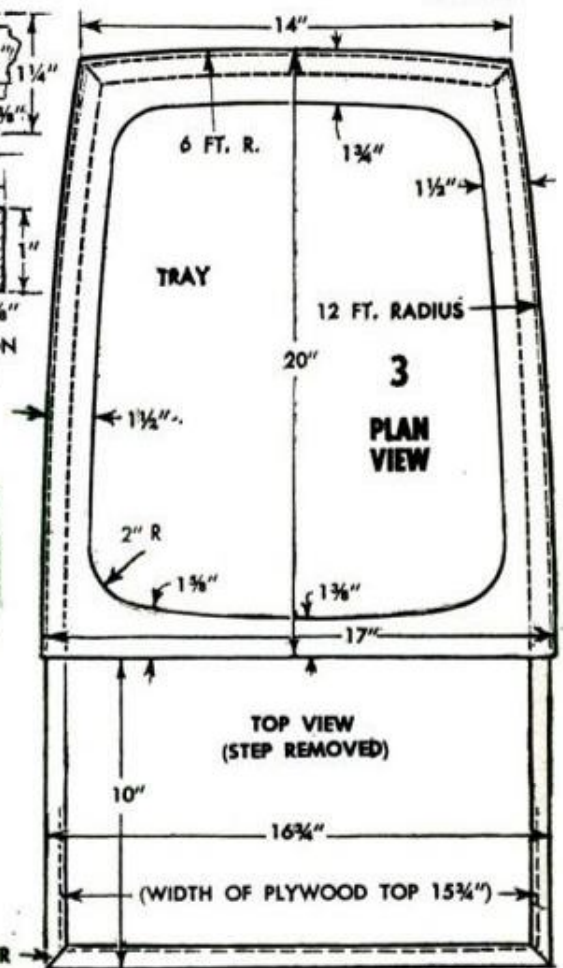
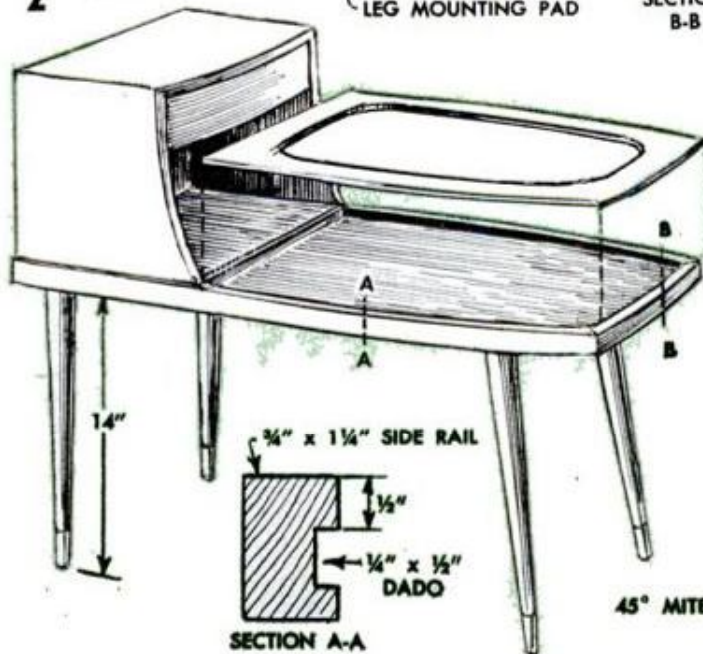
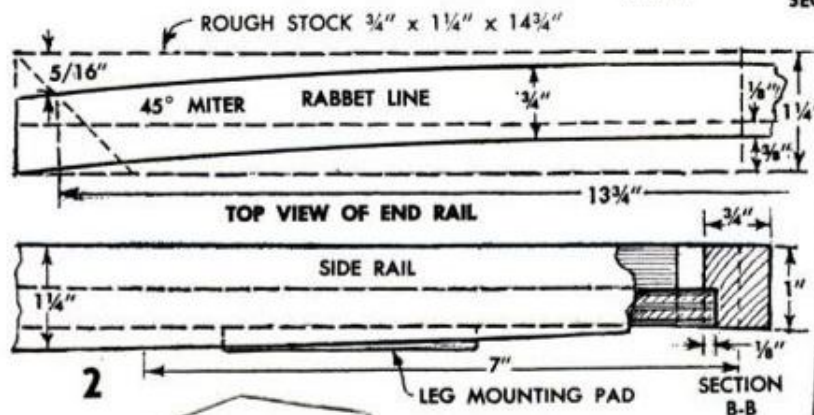
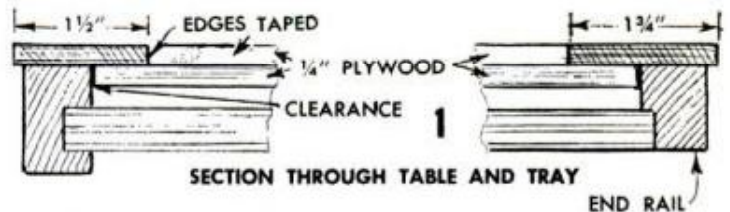



Curved pieces can be quickly sawed from the large sheets of plywood with a handy portable sabre saw

the edges of the $\frac{1}{2}$ -in. plywood slightly to allow slipping the piece easily into the dadoes. Assemble all parts dry and apply clamps to the glue blocks so that you can check the joinery. In gluing the work permanently, use a plastic resin glue or a similar positive adhesive since tension is created in bending the side rails. Prime the

mitered edges and allow them to dry thoroughly before gluing. Apply pressure carefully to prevent tearing off the glue blocks and wipe off all excess glue. In removing the glue blocks, use a chisel, observing normal caution. Remove traces of glue with a sponge and water.

The tray is identical in every respect to the trays described last month, two-layers of $\frac{1}{4}$ -in. plywood being glued together and the exposed edges covered with wood tape. Cut out the top and bottom parts of the tray following the dimensions given in Fig. 3. Note that the top part overhangs the rails $\frac{1}{8}$ in. all around and that the bottom part should have a $\frac{1}{16}$ -in. clearance inside the rails. To assemble the two parts of the tray, place a scrap piece of $\frac{1}{4}$ -in. plywood on the table top and position the bottom part of the tray on top of it, centering it between the rails. Now temporarily fasten the top part to the rails with masking tape. With this done, run a pencil around the inside of the top part of the tray to mark its position on the bottom. Remove the tray from the table and glue both parts together, watching to see that the top part registers with the pencil line. Apply clamps or carefully flip it over and weight with heavy objects. Be sure to clean off excess glue from top surface, since it will show under a clear finish. After gluing wood tape to the exposed edges of the tray, carefully trim it flush with the surface and sand lightly

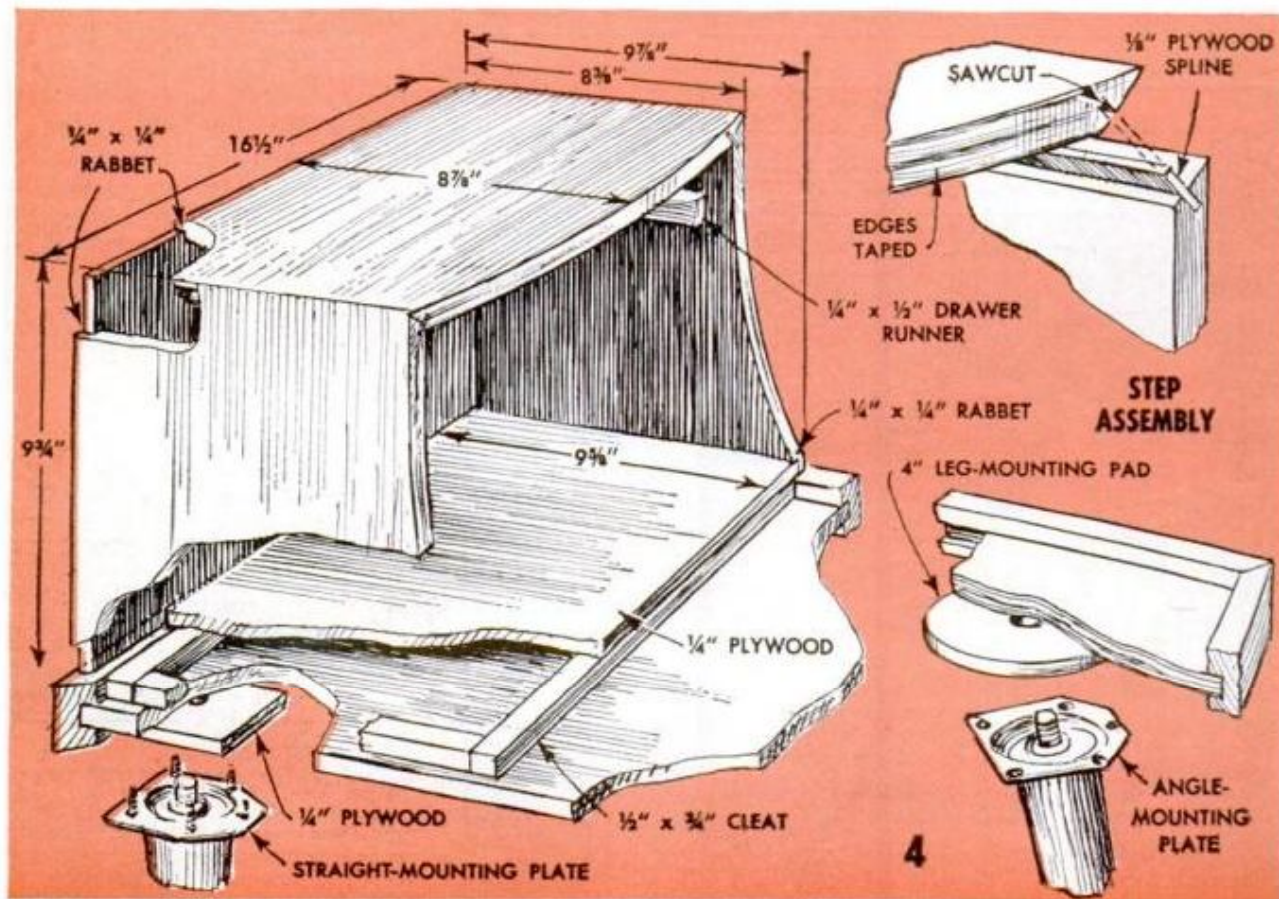

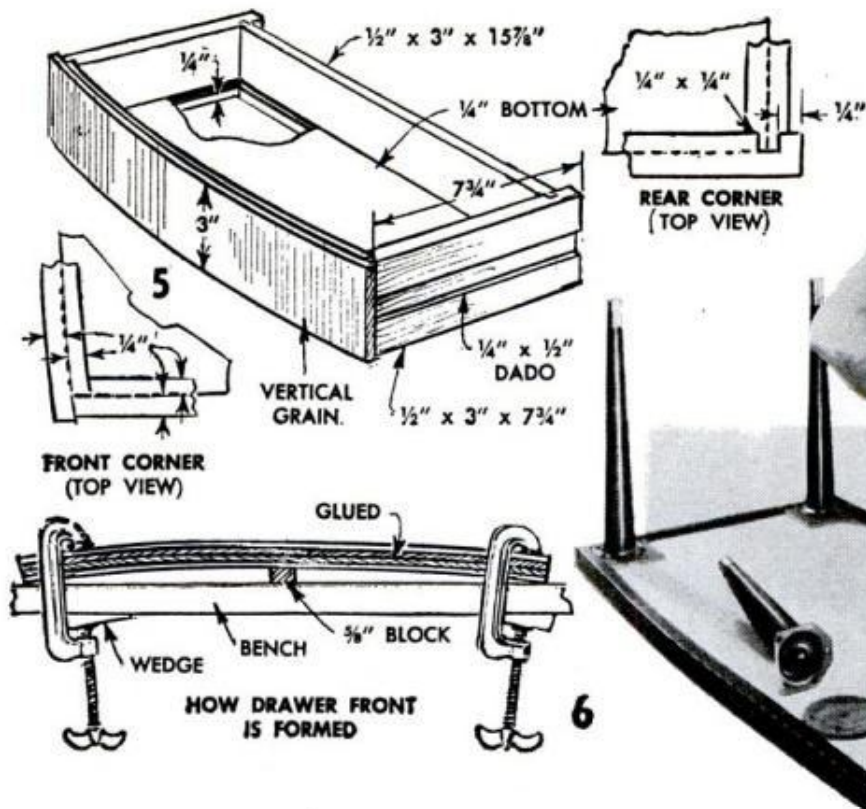

with fine garnet paper. You'll find that contact cement simplifies bonding the tape to the edges.

Building the "step" is next. Unless the plywood is faced on both sides, you can either apply a face veneer, or glue two $\frac{1}{4} \times 9\frac{3}{4} \times 9\frac{7}{8}$ -in. pieces together, back to back. To utilize the full beauty of your veneered stock, mark out the two sides and top from one continuous piece. The grain will then match when the pieces are assembled. Splined miters are used at the corners to produce strong joints. Cut sides and top of step to exact over-all size, then cut the miters and grooves to receive the splines. Cut the splines so that the grain runs crosswise and allow sufficient clearance to take care of excess glue and assure complete closure of the miter joint by cutting the spline slightly undersize.

Cut out $\frac{1}{4} \times \frac{1}{4}$ -in. rabbets to receive the bottom and back panels of the step. Mark and cut out the curved front edges of sides and top pieces and fasten three glue blocks along the mitered edges with water-soluble glue. Glue entire step at one time, using brads to secure bottom and back panels while glue sets. Check for squareness. Cut and fit a filler strip along front edge of bottom panel. Sand and apply edging strip, add cleats on the bottom to fit inside the rails. The exposed front edges of the step are faced with wood tape as before.

The curved front of the drawer is made from two pieces of $\frac{1}{4} \times 3 \times 15\frac{5}{8}$ -in. ve-

neered stock. Vertical grain was chosen to improve the design. Cut the dado on the inner piece before laminating. Apply glue, place back to back and sandwich between two similar scrap pieces. Center the work on a $\frac{5}{8}$ -in. block and draw down both ends with C-clamps as in Fig. 6. Allow to dry thoroughly. When dry, square all edges and fit the drawer front to the step, allowing for a $\frac{1}{16}$ -in. clearance. Cut rabbets on both ends of the curved front for the drawer sides and complete the drawer as in Fig. 5. The drawer bottom measures approximately $\frac{1}{4} \times 7\frac{7}{8} \times 15$ -in.

Test-fit the drawer before gluing to make certain it will slide properly. Locate
(Continued to page 212)

As was done in clamping table rails, blocks of wood are glued along step miters for applying C-clamps

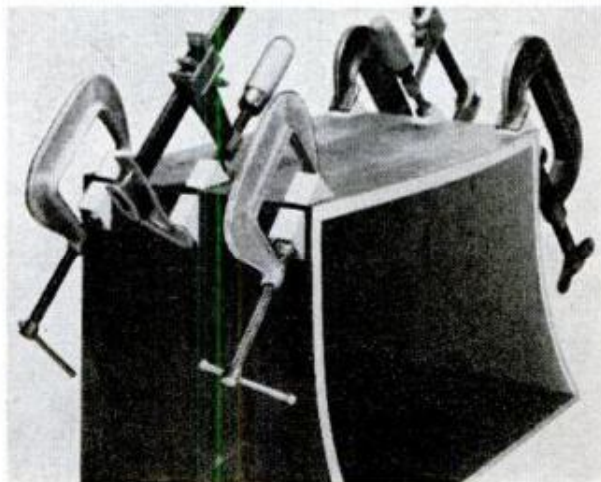

CAR-TOP BOAT TOTERS



Cascadian Mfg. Co., Ltd. photo

ONE OF THE EASIEST to use of the different types of car-top boat loaders available, the model illustrated on this page can handle boats up to 14½-ft. long with a maximum weight of 250 lbs. The unit consists of two components, a steel track that mounts on the carrier bars, and tubular stanchions, or arms, that mount on the rear bumper. In use, the bow eye of the boat is first connected to a dolly mounted on the track. Then, the boat is lifted at the transom (by the person loading it) and rolled up on the track as shown below, after which the transom is clamped to the stanchions. The boat then is raised further and rolled forward, completing the loading. A combination of springs and counterbalances leave little lifting to the skipper or mate

WITH THE rental demand for small outboard boats exceeding the supply in many good fishing and boating areas, many smart boaters are toting their own lightweight craft on car-top carriers like the ones shown on this and the next three pages. Special loading equipment that can be attached to the car or carrier eliminates heavy lifting, making it a snap even for the "weaker sex" to load a 200-lb. boat as shown in the photos. Boats weighing as much as 250 lbs. and up to 15 ft. in length can be accommodated on a car roof in this manner. For boats weighing more than 100 lbs., carrier bars that clamp to the rain gutter should be used since they concentrate the load at the extreme outer curvature of the roof where it is strongest. Car-top boat-loading devices make it possible to take a boat along on camp-out and vacation trips without having to tow a trailer.

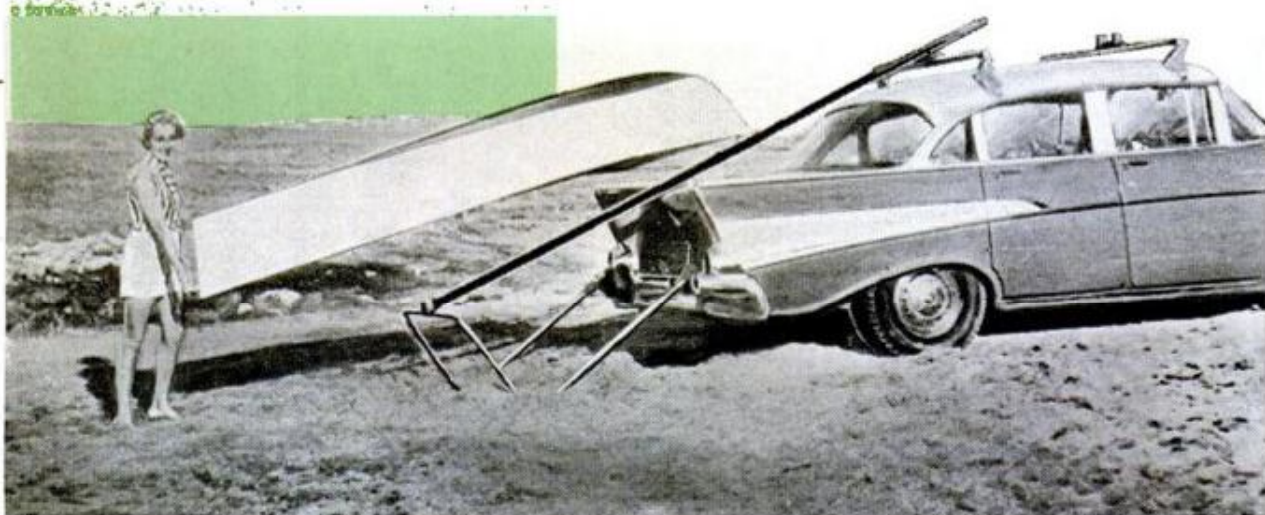



THE LOADER shown in the photos above and right is of the side-loading type. It consists of two segments, one of which is a tubular rack that fastens temporarily to the carrier bars. The other segment is a leg that pivots on the outboard end of the first one. Loading is accomplished by tipping the boat onto the rack, then raising the rack so that the center leg supports it level with the carrier bars, after which the boat is slid on the car and strapped in place. Finally, the rack-and-leg assembly is disconnected and placed under the boat where it is secured to the carrier bars. Use of a collapsible dolly permits one-man launching and elevates the boat for easy loading

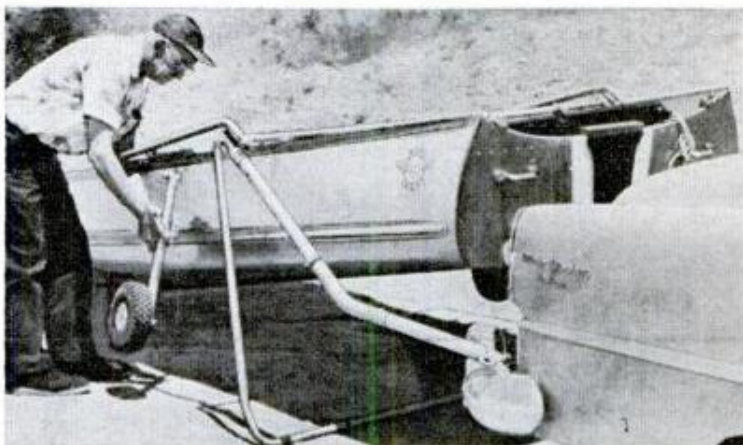

BUMPER-MOUNTED BOAT LOADER shown in the two photos at lower right, is designed for effortless loading of the heaviest boats that can be carried safely on a car roof. A roof load of more than 250 lbs. will tend to make a car top-heavy and may damage the roof, especially when traveling on rough roads. Mounted on the car's rear bumper, the unit is easily installed and removed. Its counterbalancing mechanism makes the boat's own weight lift the load. A pair of demountable wheels that snap into brackets on each side of the boat permit one person to wheel the boat to and from the water's edge. The wheels also elevate the boat to the right height when it is coupled to the loader. The brackets are attached permanently to the gunwales. A padded crossbar clamped to the gutter rails forward provides support for the boat bow



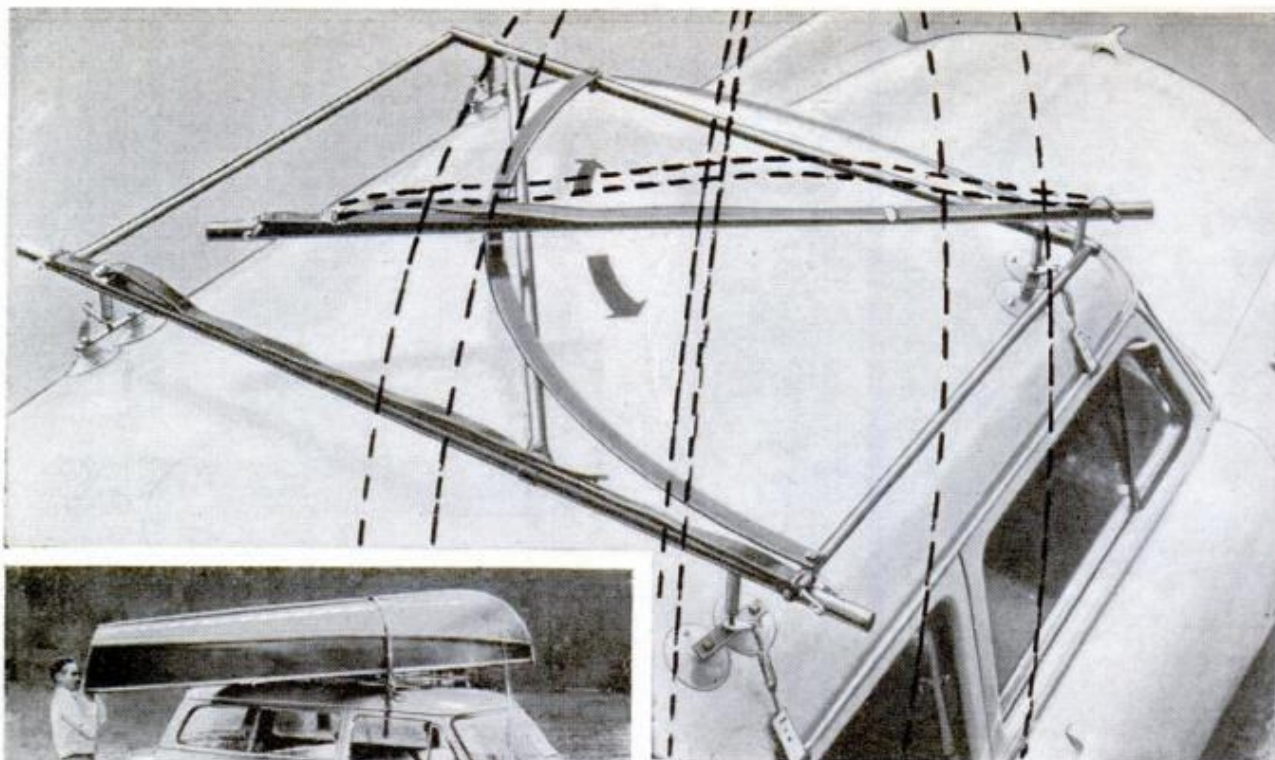

Pro-Weld Co. photo

ANOTHER SIDE-LOADING TYPE of boat loader is shown in the photo and inset above. Loader and carrier come as one unit that fastens to gutter rails as shown. Loading is accomplished in two easy steps. First, the boat is tipped on the stern and against the carrier sidebar, gun'ls down and strapped tightly to the traveling bar that pivots on the right-front corner of the carrier. Then, the boat is picked up at the stern, pivoted into position on the carrier and secured with a stern strap. The loader-carrier will handle boats up to 175 lbs. and 60 in. beam

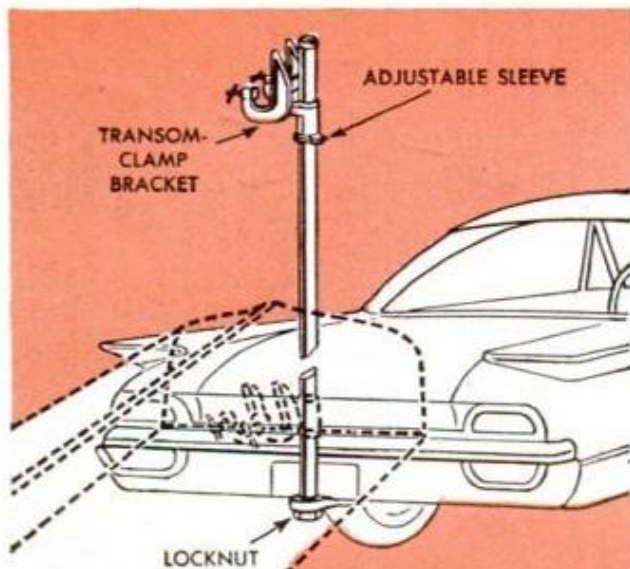

SHOWN IN THE DRAWINGS at left and below, is one of the simplest car-top boat loaders. It consists of a steel column having a transom clamp bracket that slides on it as shown. A U-clamp located below the bracket permits locking the latter at whatever height is desired. In use, the boat transom is clamped in the bracket at bumper height, then picked up at the bow, swung forward onto a carrier bar and lashed down. This loader is ideal for short-roofed cars; and it is suitable for medium-weight boats. One drawback is that a trailer hitch is required for mounting it, the base bolt being fastened in place of the ball

Brinkton, Inc. drawings

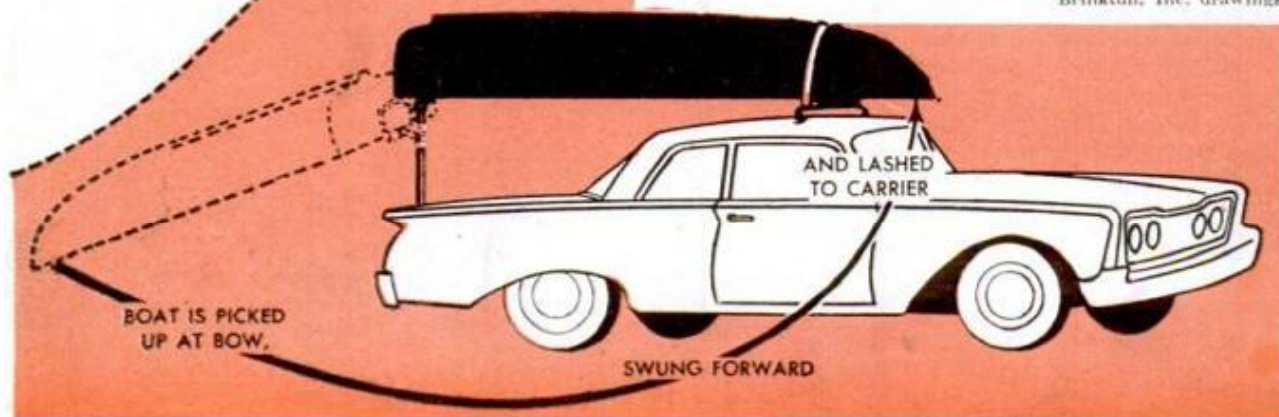

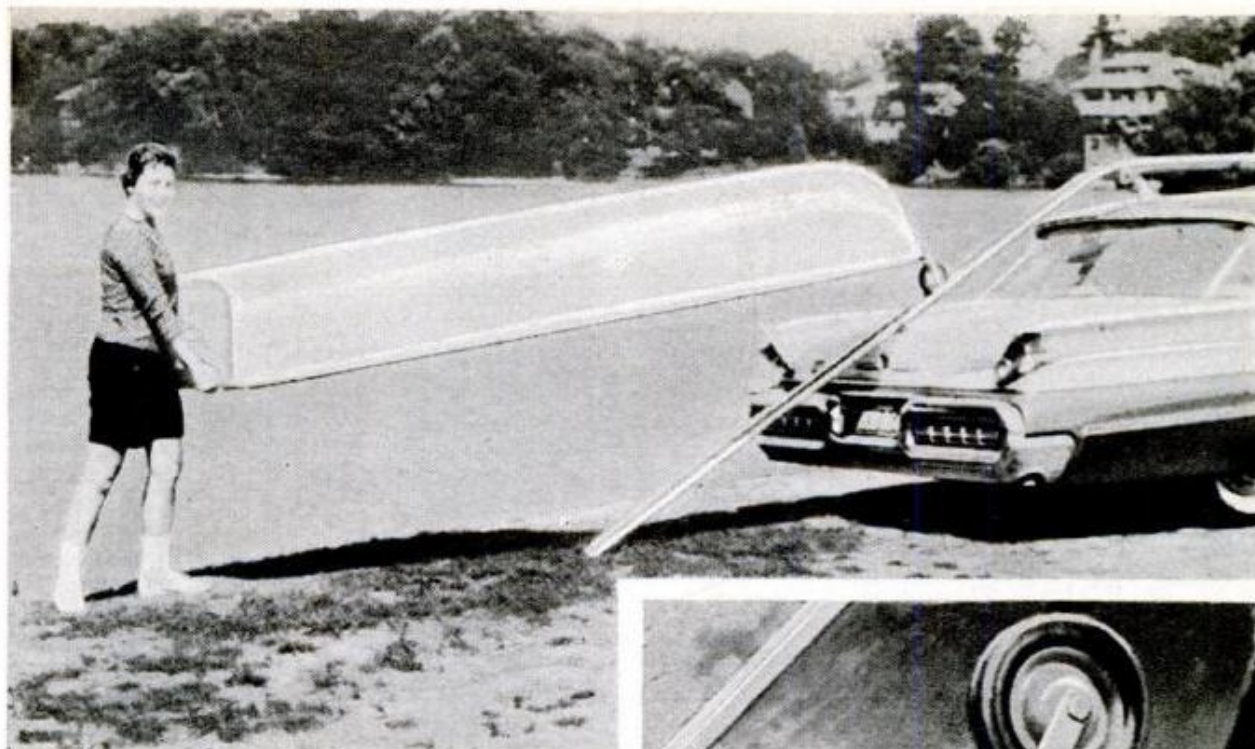

Market Forge Co., photos

THE BOAT LOADER illustrated on this page is about the easiest model to install and use. It features "wheelbarrow loading," and consists of a four-section, telescoping, channel-steel loading ramp, two carrier bars and a bow wheel. After a special bracket for the latter is installed on the boat, the wheel is simply inserted in it when loading or unloading as shown in the inset in the photo above. When boating, the wheel may be left ashore, or it may be kept in place for easy one-man portaging. Two bolts hold the wheel securely in place. The loader is designed to accommodate boats up to 200 lbs. and 14 ft. in length. The inclined portion of the loading ramp is removed and stored under the carrier bars when traveling. An adjustable bracket cushioned by two rubber suction cups is attached to the lower ramp section to stabilize it and protect the car-trunk finish. This carrier and the two models shown on the preceding page of this story sell for less than \$50, \$100 to \$140 for the ones shown on the first two pages





"Dustpan" on Hedge Trimmer Catches Thick Clippings

Attached to the comb of an electric hedge trimmer, a sheet-metal apron will do a fine job of collecting the clippings from the top of a hedge and permit tossing them aside with a sweeping motion. This saves the task of later raking the clippings from the top of the hedge which is generally necessary for appearance sake, particularly when the clippings are unusually thick. In most cases, the apron can be attached by the same machine screws that hold the comb to the cutter bar.—Hugh Lineback, Stillwater, Okla.

☞ When a damask or velvet-covered sofa or chair begins to show signs of wear along the edges of the sprung seat, you can cover up such worn places by trimming the seat with upholstering fringe. Use decorative-headed tacks in applying the fringe, driving them in a closely studded row.



Wax Paper Lines Soap Case

A wet cake of soap will invariably stick to the bottom of a plastic soap case and become a nuisance to remove. A simple way to keep it from sticking is to place a folded piece of wax paper in the bottom half of the case. The soap then will drop out with the wax paper stuck to it. The paper is easily peeled off the soap cake and replaced in the case. Remember this hint the next time you pack your bag for a business trip.—Donald Spichuk, Brooklyn, N. Y.



Flower-Pot Match Snuffer

If you are a pipe smoker and enjoy smoking while working in your basement shop, the fear of a carelessly tossed match starting a fire among loose shavings can be forgotten by having a match snuffer handy at your bench. This one is nothing more than a common clay flower pot inverted in an ashtray or saucer. Inserting the match in the hole in the bottom of the pot extinguishes the match instantly.

Never a Dull Edge

Tossing your sharp-edged tools in a tote box is, of course, poor practice. In contact with other tools they will soon lose their keen cutting edges. It is far better to wrap them individually in protective cloth sleeves soaked in linseed oil before putting them away.

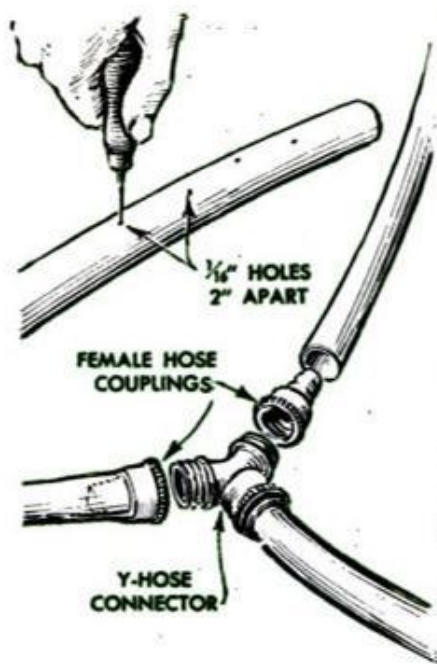

FROM HOOLA HOOP TO SPRINKLER

Got a castoff hoola hoop hanging in the garage? It takes only a few minutes and a few hose parts to convert it into a lawn sprinkler and shrub soaker. The kids will get new fun out of it, too, as a shower on hot summer days. Begin by removing the staples and the wooden plug which join the ends of the hoop. Cut away about 1 in. from each end and soften these ends by soaking them in hot water for ten minutes. This will make it possible to insert female hose couplings of the type that are normally used in plastic garden hose. Because the inside

diameter varies, it will be necessary to check the size before selecting the couplings. The assembly is completed by connecting the couplings to a hose connector. Beginning about 4 in. from each end, punch a series of 1/16-in. holes at 2-in. intervals in one wall of the hoop, slanting the holes so that the water will spray in all directions. Placed upside down around a shrub and the water turned on slow, the hoop makes an excellent soaker. As a king-size lawn sprinkler, the hoop will spray a wide area when the water is at full force.

Ball Points Find Their Place Among Draftsman's Equipment

Next time you need to ink a penciled drawing, or make a tracing use a ball point pen. It will make a sharp, clean line and won't require refilling like a regular ruling pen. Furthermore, it will never blot and spoil otherwise good inking. For use with a compass, drill out the graphite from a short section of pencil to form a sleeve into which a ball-point cartridge may be press fitted. Clamp this into the compass in the usual manner. A pencil tip may be similarly drilled to fit on the opposite end of the cartridge, making both pen and pencil available as needed.

☐ Ink can be erased from paper easily and quickly using commercial liquid bleach. Dip a cloth in the bleach, dab it gently over the area being erased and blot. Repeat the process until the ink disappears.

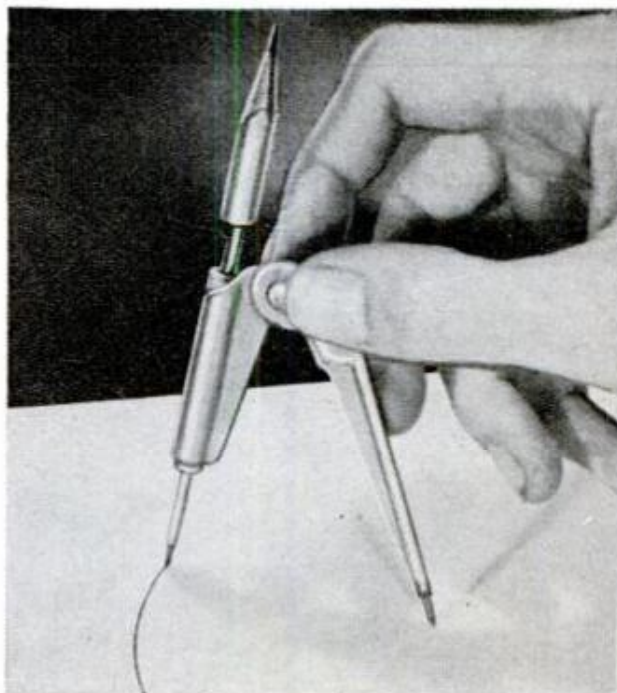

X677
PLANNED FOR COOKOUTS

CHARCOAL GRILL

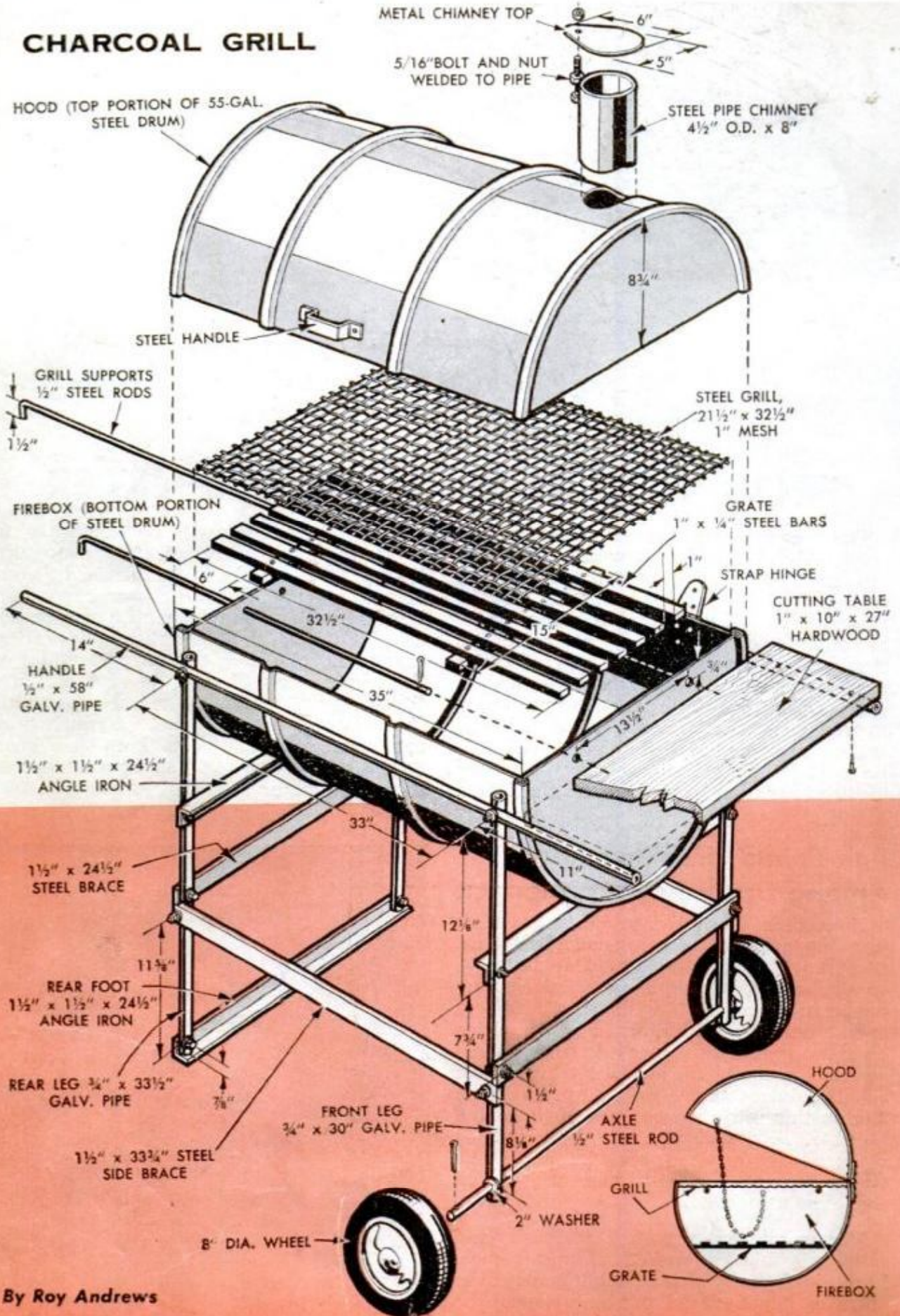

By Roy Andrews

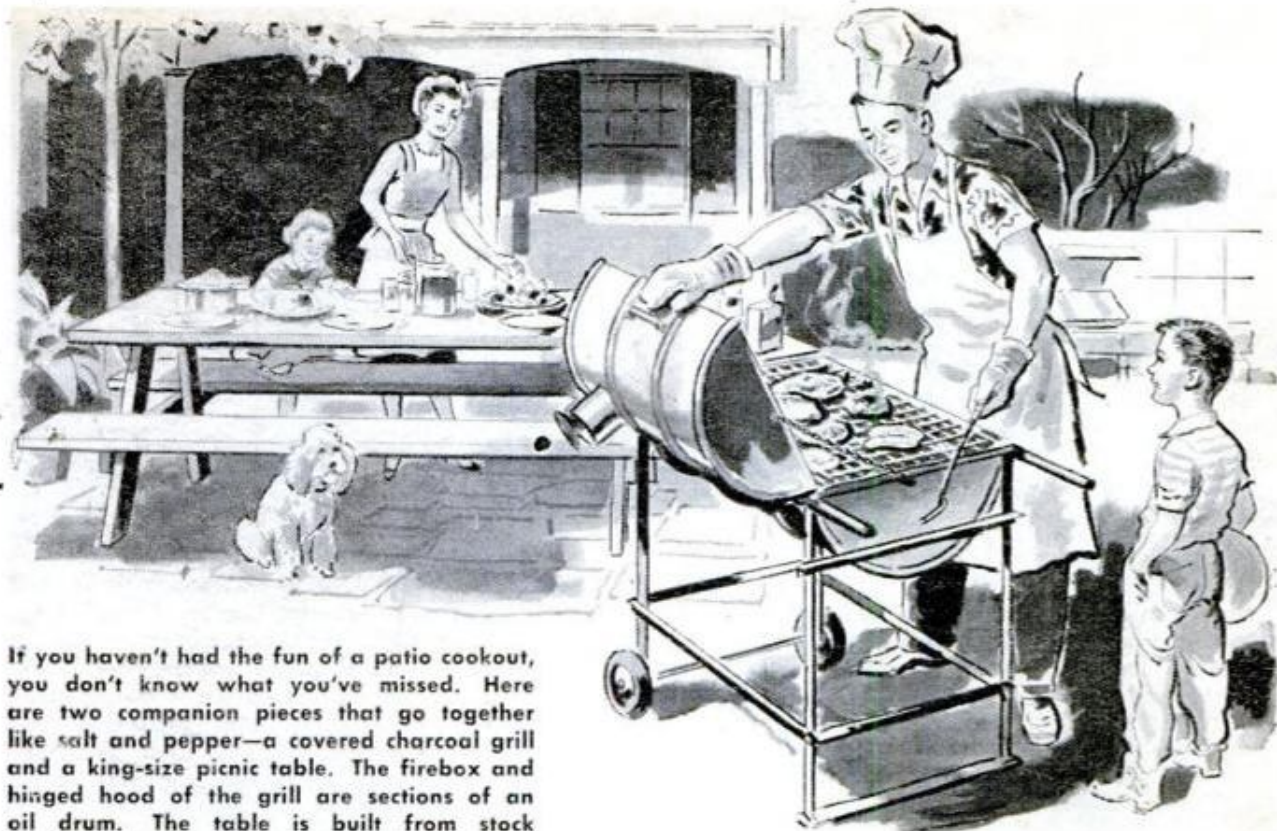

If you haven't had the fun of a patio cookout, you don't know what you've missed. Here are two companion pieces that go together like salt and pepper—a covered charcoal grill and a king-size picnic table. The firebox and hinged hood of the grill are sections of an oil drum. The table is built from stock lumberyard material. Both are all you need to give you the cookout fever all summer long.

PICNIC TABLE

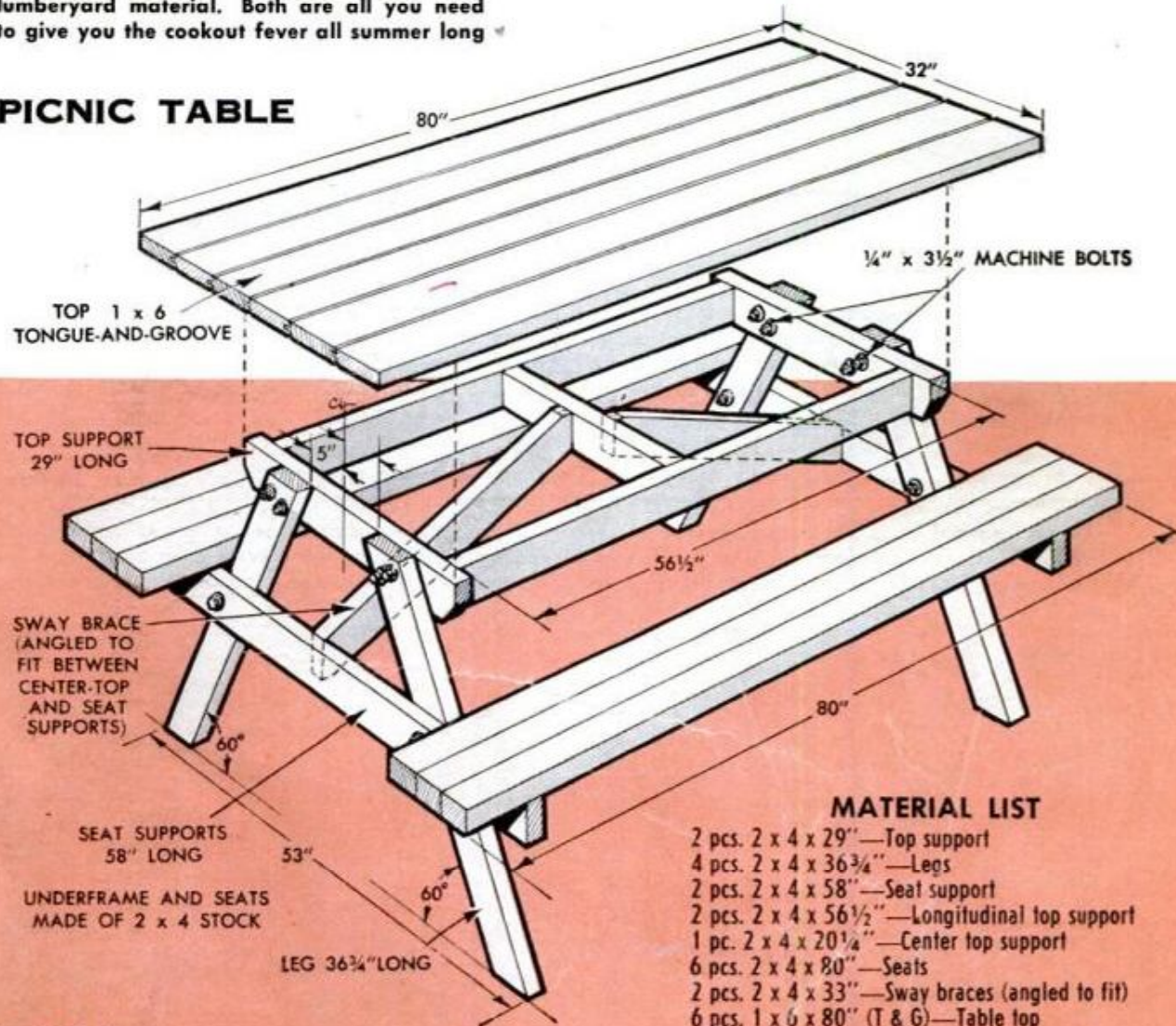

By W. H. Fogle

SOLVING HOME PROBLEMS

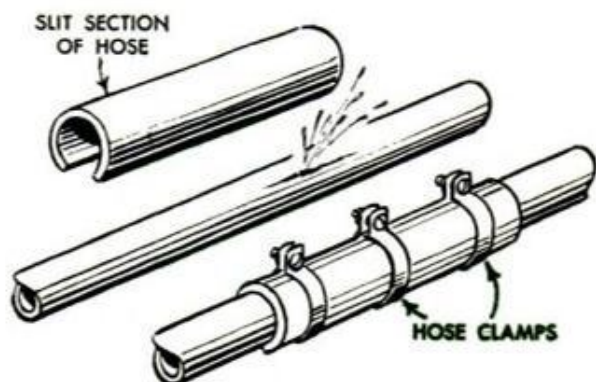

WHEN FREEZING bursts a water pipe an emergency repair can be made quickly with a length of radiator hose (or garden hose) and two or three hose clamps. First slit hose and trim meeting edges so that it fits tightly around the pipe. Then clamp securely in place

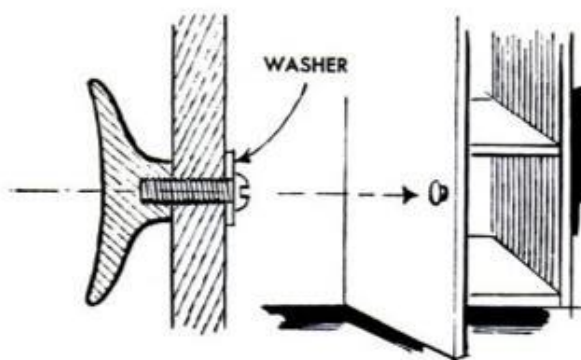

METAL PULLS AND HANDLES on wooden kitchen cabinets often loosen after a short period of use. This usually is due to slight shrinkage of the wood after installation. Tighten them permanently by placing metal washers under heads of the attaching screws



STEPLADDER TREADS can become treacherously slippery when wet. Reduce danger of a serious fall by covering treads with slate-surfaced roofing attached with cement and nails, or temporarily with tape. Slate coating will stay in place if coated with shellac



IF YOU LOSE the applicator that comes with the paste jar, a finger pad, or cot, makes a good substitute spreader as you can turn it with the holes up and wear it on a finger while you're assembling that scrapbook. A cot cut from a rubber glove also will do

HANDY PLACE to store a hose nozzle is right on the sill cock where you attach the hose. Cut threaded section from an old hose connector, remove screw that holds sill-cock handle, place a washer inside connector and screw back in place as in left-hand photo

A BURNED-OUT FUSE is not always easy to locate on a panel even if you use a flashlight. To make the dead fuse easier to see, place a heavy dot of sealing wax on the window of each one. When fuse blows the wax will melt, leaving the window clear

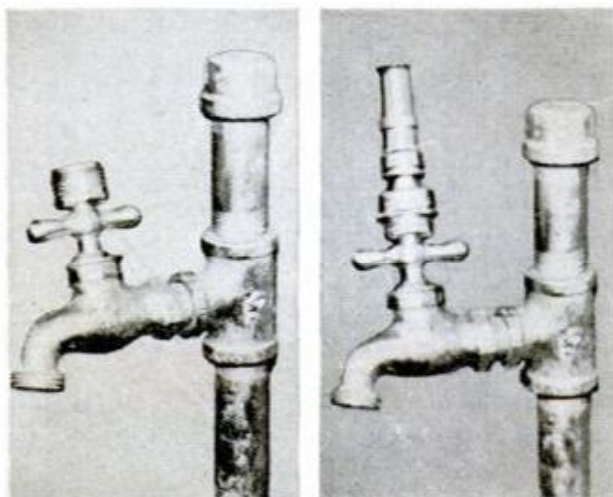

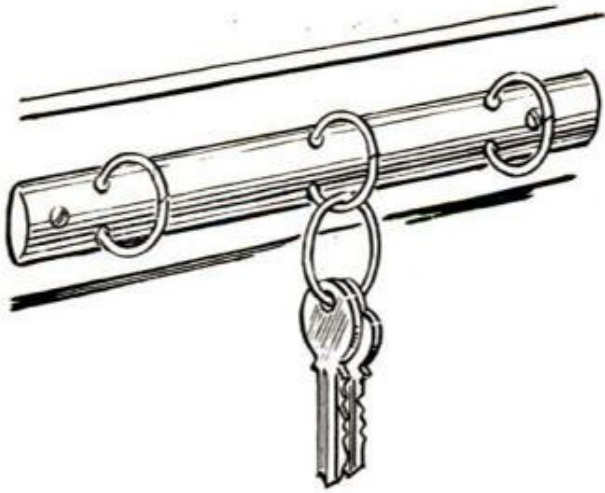

BEFORE YOU TOSS OUT that worn three-ring binder remove the back and take another look. It's a household key ring perhaps—or maybe even a hanger for utensils or tools that you don't use every day. You can easily adapt it to these and possibly other uses

JUNIOR MAY LEARN that it's fun to keep time with one foot or both while practicing at the piano. While this may be all to the good, it can be rough on finish of lower panel. Protect surface with a piece of carpet folded over top and bottom edges of panel

CLOGGED JETS of gas-stove burners should be cleaned periodically for efficient and economical operation. Use a short length of fine wire (furnace wire is just right) to remove encrustations from the orifices of the jets, then finish the job with a pipe cleaner

STARTING A NAIL in a hard-to-reach place often calls for a little ingenuity. Save fingers by remembering this trick: Roll up a small ball of putty between the palms and place it where you want to start the nail. Press nail into putty and there you are

IF YOU'RE FITTING new shade rollers and chance to cut one a trifle too short, there's an easy way to lengthen it. Remove the fixed pin and flanged metal protector from the end of roller, place a small metal washer inside protector, then tap pin back in place

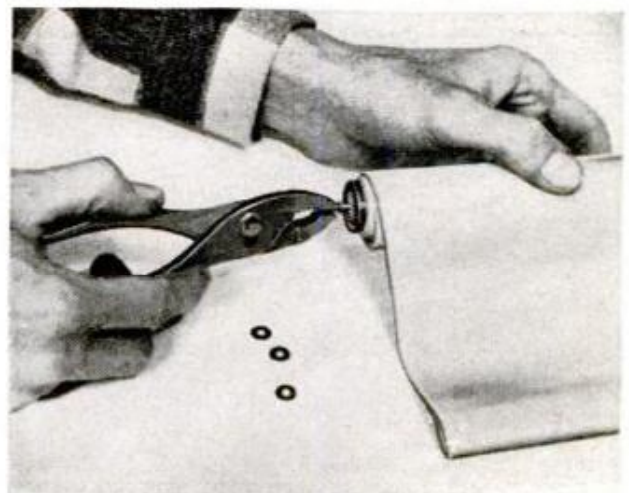
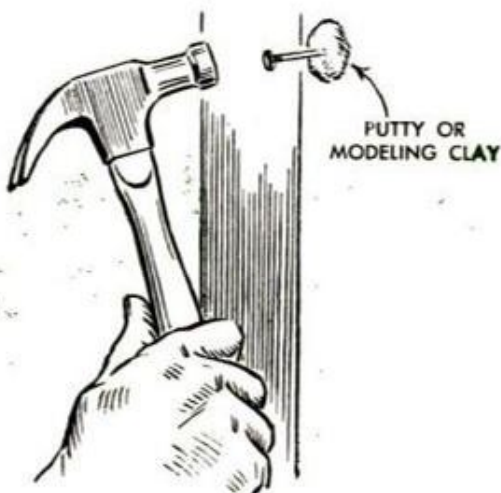



Four-Sided Pencil Pointer

While hand pencil pointers are nothing new to artists and draftsmen, they always have been messy to use. Graphite dust gets on the hands and eventually on the drawing. Such smudges are avoided with this novel pencil pointer in that it has a container to catch the dust. As the pencil lead is being pointed on a built-in abrasive block, the dust falls into the attached container. It's nothing more than a glass jar or can having a screw-top or slip-on cover in which a four-sided abrasive block is mounted. Tabs cut in the cover and bent downward to form a slot serve as bearings for the abrasive block. The latter is a block of wood faced on four sides with emery cloth and fitted with pin shafts, or axles, to rotate in holes made in the end tabs.—Yasiro Honda, Kanagawa, Japan

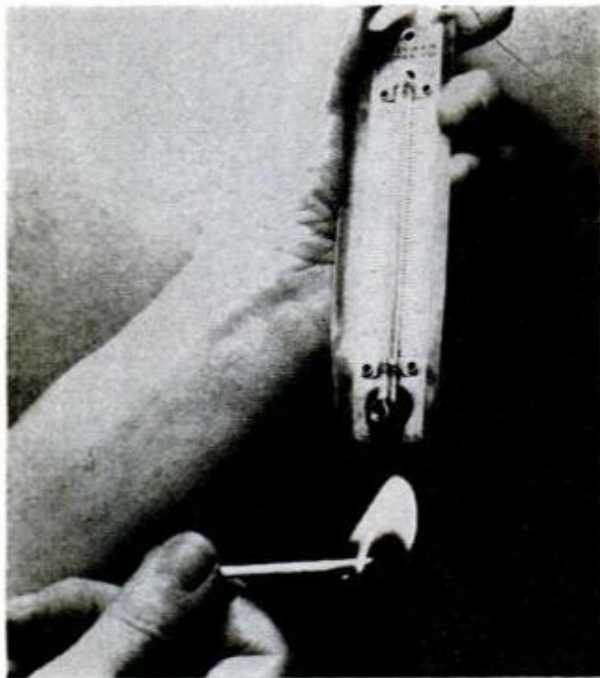

Match Held to Thermometer Rejoins Mercury Column

Mercury will sometimes separate into globules in the column. However, this does not mean that the instrument is no longer useable. In most cases, the mercury in the column can be rejoined by holding the flame of a match to the bottom of the tube for a few seconds. The heated mercury will rise quickly and rejoin the separated portion, after which the column will return to its proper level.—Wayne Floyd, Fayetteville, Tenn.

When using plastic electrician's tape in cold weather it can be made to adhere more effectively if it is first warmed slightly by holding the roll near a lamp bulb. Heat from the bulb will soften the adhesive making the tape adhere to itself firmly.



Tape Mounted on Waxed Paper Can Be Inserted in Typewriter

Labeling is done neatly when the data is typed on masking tape. But how to run the strips of tape through a typewriter presents a problem. One simple way to do it is to place the strips on a piece of waxed paper. This lets you run both through the machine, just like a sheet of typing paper. After typing, the tape is easily peeled from the waxed sheet.—Donald Spichuk, Brooklyn, N. Y.

Paint will adhere to new galvanized sheet metal if common household vinegar is first applied to the surface with a cloth swab or small sponge and left to dry.



MOWING PATTERN KEEPS CORD IN TOW

WATCHING to see that you don't cut or get tangled up in the cord of an electric mower is not the problem it might seem when a set mowing pattern is followed. The three diagrams at the right show how simple it is to keep the cord from underfoot when mowing either a rectangular or L-shaped yard. In the case of a rectangular shaped yard, you start mowing at the center and mow to a point which is half the width of the yard measured from the side and one end of the lot. From this point you simply keep doubling back and forth, making tight right and left turns as shown in the second diagram. In this manner, the cord is always trailing from behind and out of the cutting path.

In mowing an L-shaped yard, start out close to the house. Then follow an L-shape route as mapped out in the lower diagram, making tight right and left turns as before. As you can see in this mowing pattern, the cord will always be trailing the mower in the previously cut area where the cord is safe from being accidentally severed by the mower. In the two mowing patterns given here you will note that the convenience outlets are located at points handy to the area being mowed. Several outlets should be provided.

A. E. Hilliard, Rison, Ark.

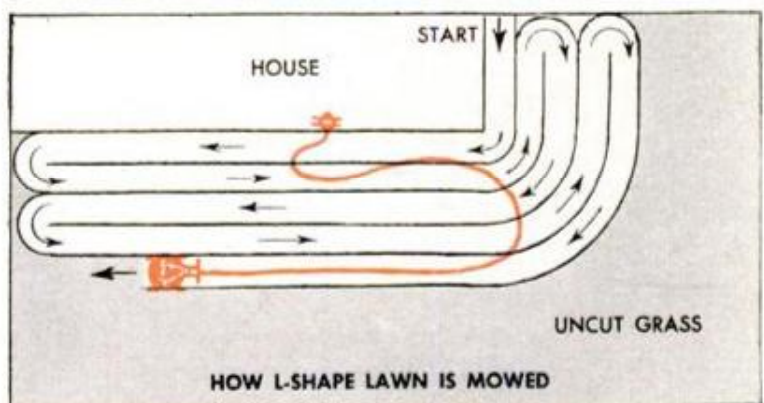
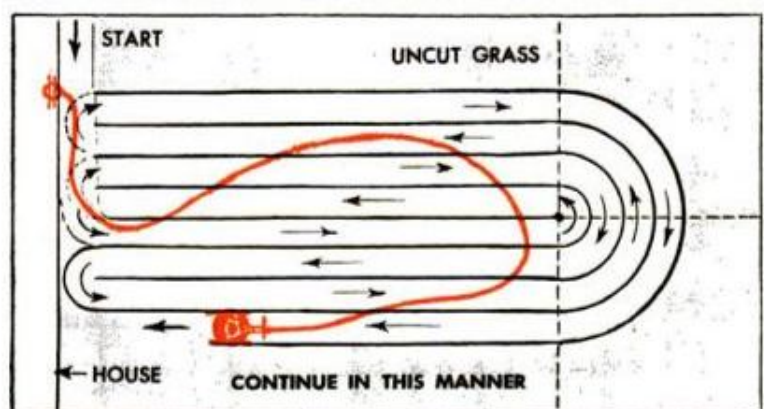
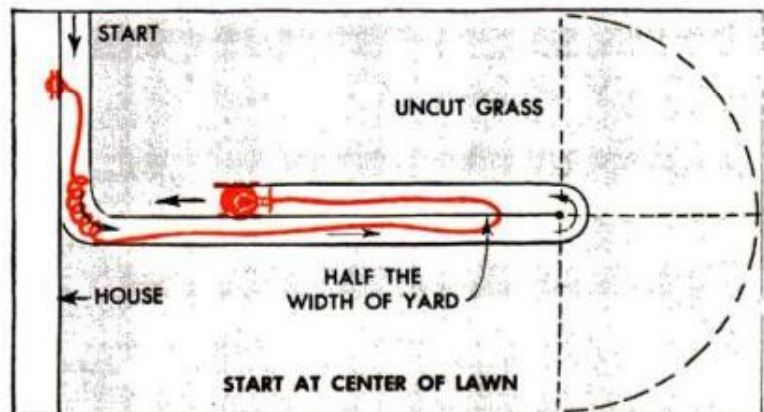

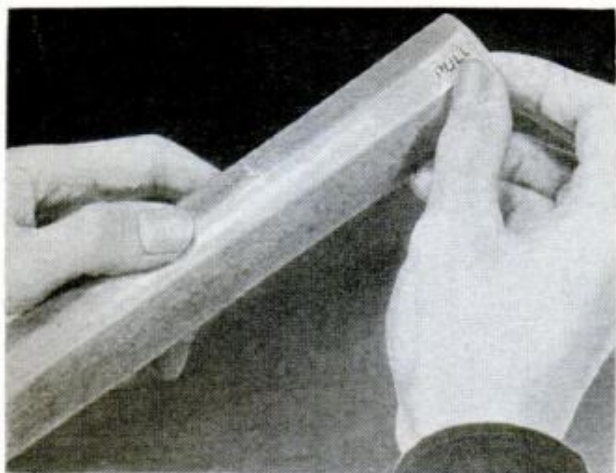

Cellophane Tape Makes It Easy To Remove Mailing Wrapper

When plans and drawings are wrapped around a mailing tube and then wrapped for mailing, you can make it very easy for the addressee to open the parcel without fear of damaging the contents if the wrapper is sealed with a strip of cellophane tape instead of gummed paper. The cellophane tape can be easily peeled off to open the wrapper whereas the gummed paper cannot, resulting in slitting the wrapper and damaging the contents. To make it doubly easy to grasp the end of the tape, add a tab and mark it 'pull'.

Two-Handed Sanding Block

In a pinch, your wood plane can be put to use as a dandy two-handed sanding block. Because of the two handholds it provides, you'll find the plane perfect for sanding large surfaces where it is desirable to exert a uniform downward pressure throughout the sanding stroke. The sandpaper is held by merely folding it up around the plane frame and securing with a rubber band. Naturally, you should first back off the plane iron so it does not extend beyond the sole.

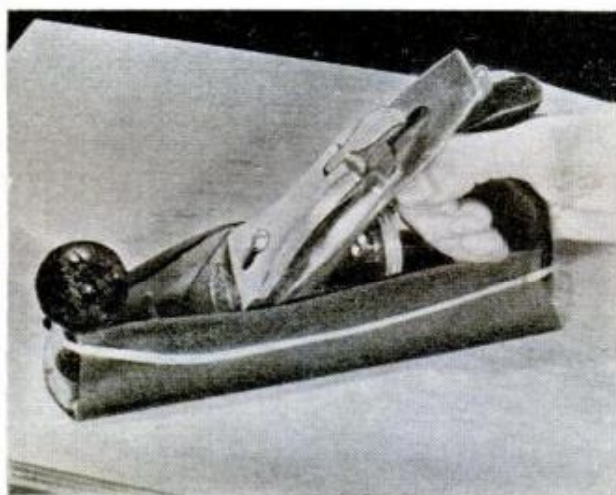

DECORATOR'S

Design flair and unusual wood-graining fit this lamp into any modern decorative scheme. It's big, nearly 3 ft. tall, a size which makes it contemporary with lamps accepted by decorators



LAMP BASE FROM PLYWOOD

IT'S THE final shape of the turning itself and the placement of the fir-plywood strips in the built-up block that give this lamp base its unusually smart appearance. When finished in the natural color of the wood, the surfaces of the base and finial present a pattern in a series of overlapping parabolic curves on four sides of the turning. The exposed glue joints appear much like inlaid veining.

Details A and B give the widths of the plywood blocks and show the order of assembly in gluing them up to make the base and finial. Finished length of the base is 15 in. but in cutting the blocks you should allow at least $\frac{1}{2}$ in. at each end for waste, making each block 16 in. long. Note that the two center blocks which are $1\frac{1}{2}$ in. wide, are grooved $\frac{3}{16}$ x $\frac{3}{8}$ in. before gluing. While the glue is drying make a template from plywood or hardboard to use as in the photo when turning the base block to profile. Plug both ends of the block as indicated, then mark centers and mount in the lathe. Use the slowest lathe speed and rough the block into round by using a turning gouge. Wear a face shield or protect the eyes with goggles. Take light gouge cuts as fir plywood tends to

splinter rather badly if you cut deeply. Resharpen and hone the gouge frequently, as a sharp cutting edge is essential to smooth work.

Bring the shape down with the gouge to within about $\frac{1}{8}$ in. of the finished size, checking frequently with the template to be sure you do not cut below the finish dimension at any point. Then shift to a higher lathe speed and bring the work to the finished size with a wide skew chisel. Be especially careful to prevent the chisel from digging in as you run the sloping cuts.

Examine the work all over and fill any small openings between the plys with matching stick shellac. Then sand the work with the lathe at medium speed, using several grades of coarse and fine sandpaper to get a smooth finish all over. Before applying a finishing material, drill the hole for the lamp cord and fit the section of $\frac{1}{8}$ -in. threaded pipe into the top end, so it will tap itself into the hole. Finish with two or three coats of white shellac or bar-top finish, rubbing down each coat with fine steel wool. Turn the finial on a screw center and drill a $\frac{3}{8}$ x $\frac{1}{2}$ -in. hole in the small end as indicated, so that it may be screwed directly onto the harp.

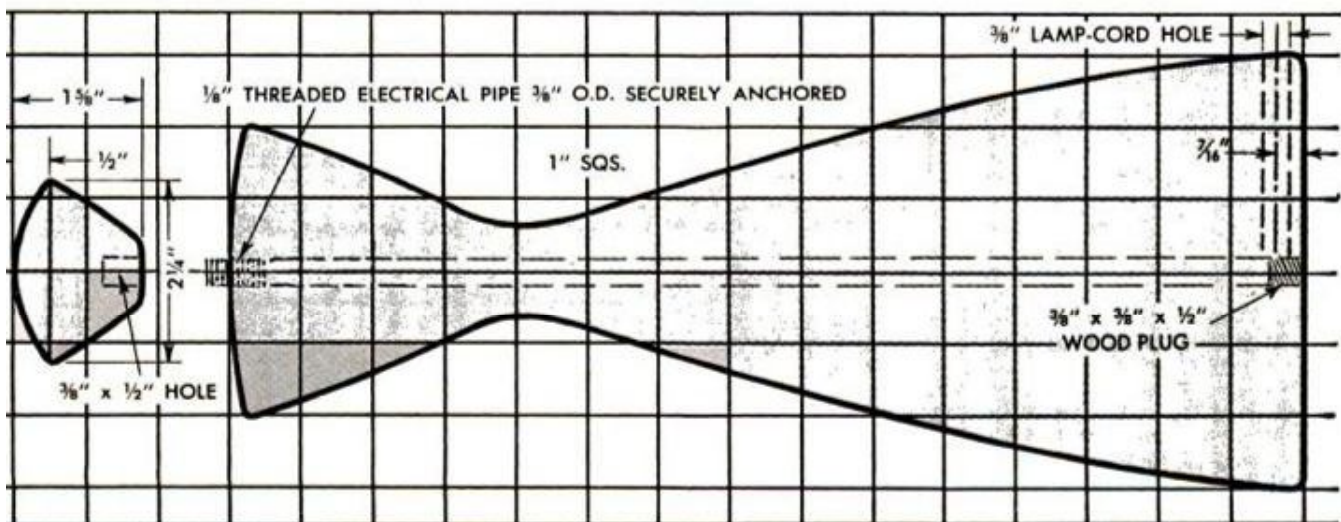
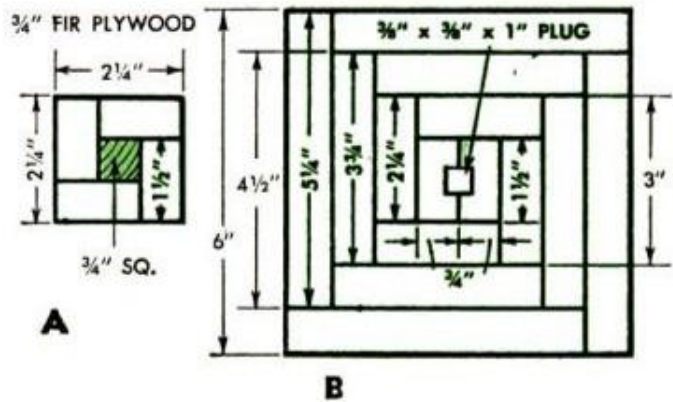
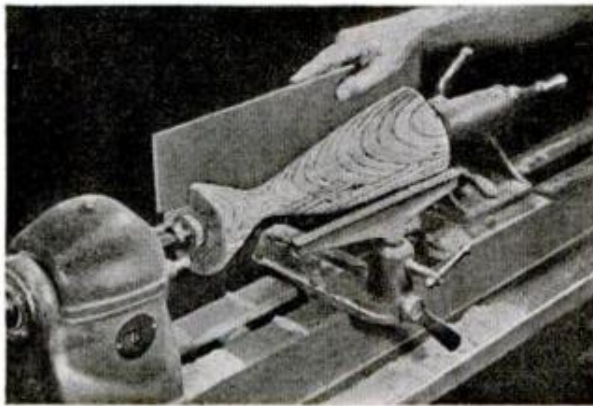

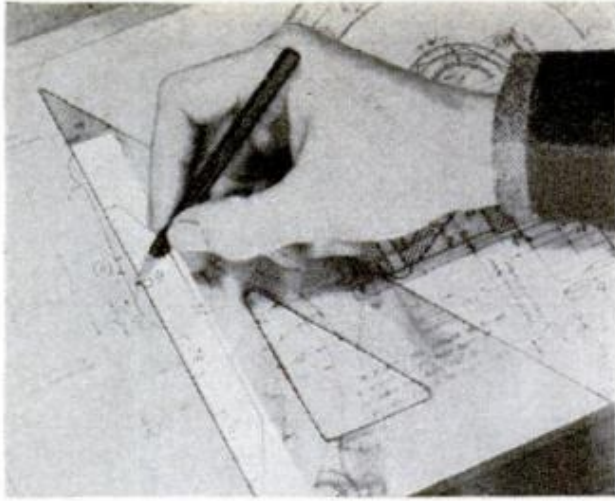

Scales Taped to Triangle Speeds Scale Drafting

The bother of constantly laying aside a triangle to pick up a draftsman's scale is avoided when making a scale drawing by having the particular scale right on the edge of the triangle. For example, if a scale of $\frac{3}{8}$ in. equals 1 ft. is being used, it will pay you to take the time to mark off the calibrations on a strip of self-adhering tape and stick it along the edge of the triangle. Here it is immediately available for quick reference. Different scales can be added by merely peeling off the others.

Correct Use of Push Stick

When ripping thin strips from short pieces you usually set the ripping fence a distance from the blade equal to the thickness of the strip and then use a push stick to aid in moving the stock past the blade. In this operation the trick is to keep the pressure equalized. If you apply greater pressure with the left hand, you will force the stock in a direction of the arrow. This closes the saw kerf, binds the blade slightly and results in scoring of the work.

Wayne Judy, International Falls, Minn.

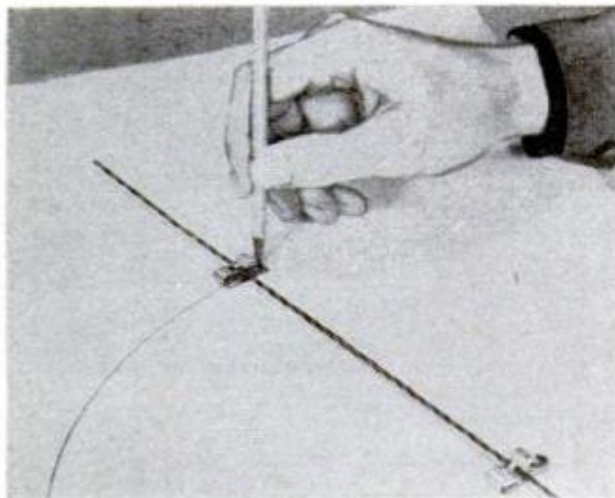
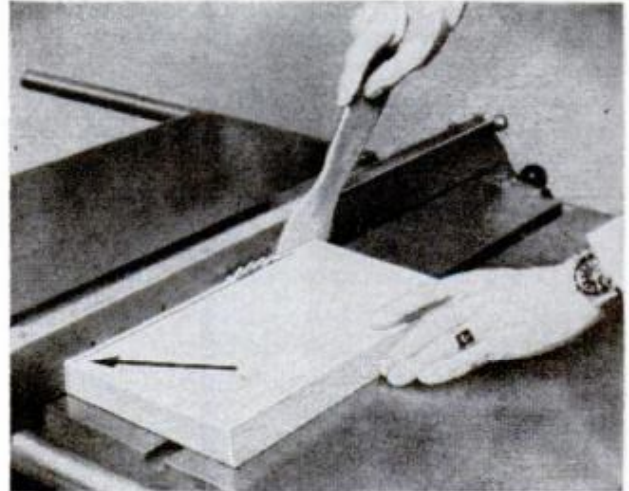

Clip and Wire Trammel Scribes Outsize Circles

If you are ever faced with the job of scribing a large arc or circle too big for a regular draftsman's compass, try making a trammel out of two Fahnestock clips and a piece of stiff, heavy wire. The clips are quickly positioned along the length of the wire to swing the proper diameter and one is fastened down with a tack to serve as the pivot point. A pencil or scriber can then be inserted through the hole in the other clip to scribe the circle.

Cement Tube Slipped Over Hook Saves Frequent Recapping

Small jobs requiring frequent use of a tube of household or rubber cement will proceed much faster if you don't have to continually recap the tube. One way to get around this is to screw a small L-hook into the workbench or a board. Instead of repeatedly recapping the tube simply slip the end of the tube over the L-hook and use it as a stopper. You'll find this idea particularly helpful when assembling plastic models.—Bil Toman, Palatine, Ill.

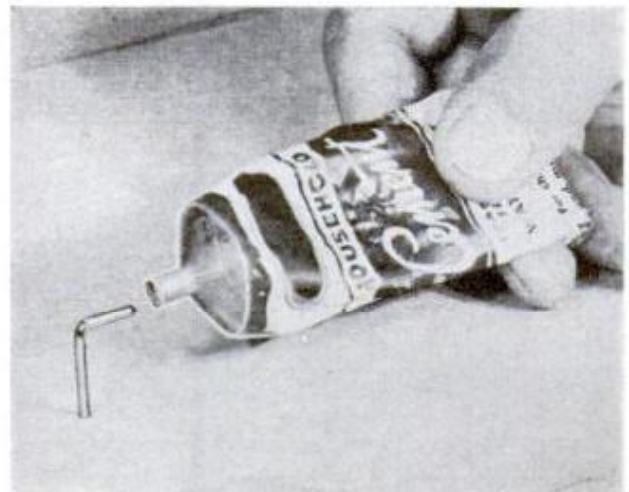

Nut Run up on Clamping Screw Forms Shoulder for Wrench

On some types of small lathe tool-holding clamps the screw is not provided with a shoulder, or flange, below the squared head. On certain types of work involving repeat operations it saves time to leave the box-end wrench on the screw head after tightening the screw. A flange to hold the wrench in place on the squared head of the screw can be provided by running a nut up to the head and tightening it so it will stay in place. The nut prevents the wrench from slipping down onto the threads.

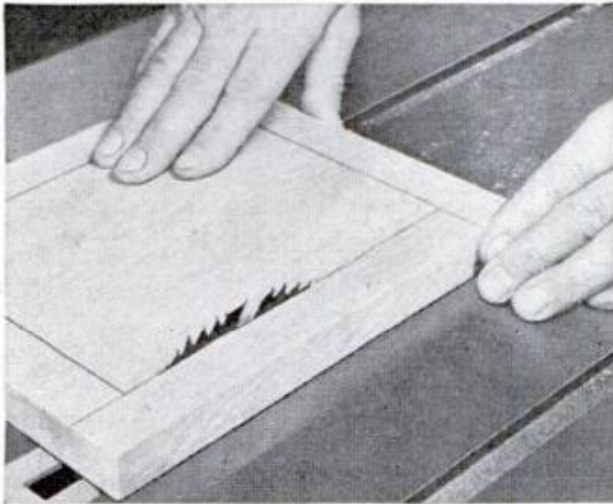

Small Work on Sandpaper Base Stays Put Under Sander

Using an orbital sander to surface relatively small wooden workpieces often is made difficult by the tendency of the pieces to follow the oscillating motion of the pad. This may be overcome if the pieces are placed on a board to which a large sheet of sandpaper is glued. The board then may be clamped to the workbench or to some other flat surface. A fine or medium-grade paper matching that on the sander will hold the work firmly until the job is finished.

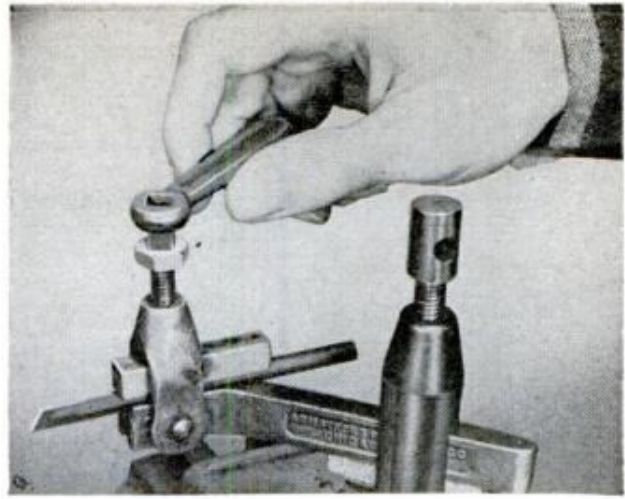
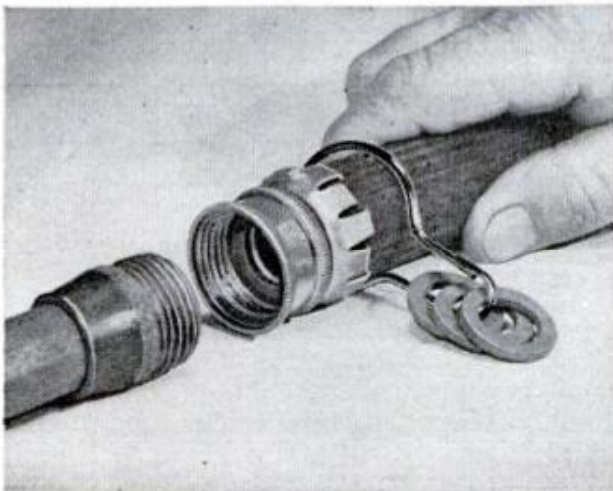

Inside Cuts on Circular Saw

Where undercut corners are not objectionable, openings can be cut in plywood or solid stock with a table saw. Measure from the face of the ripping fence to the opposite side of the blade, including the set of the teeth, and shift the fence until the distance is equal to the width of the opening required. Lower the blade below table level, place the stock over it, hold firmly in place and then raise the blade slowly until it cuts through the top surface. Run the cut to the end of the gauge line, then repeat the procedure.

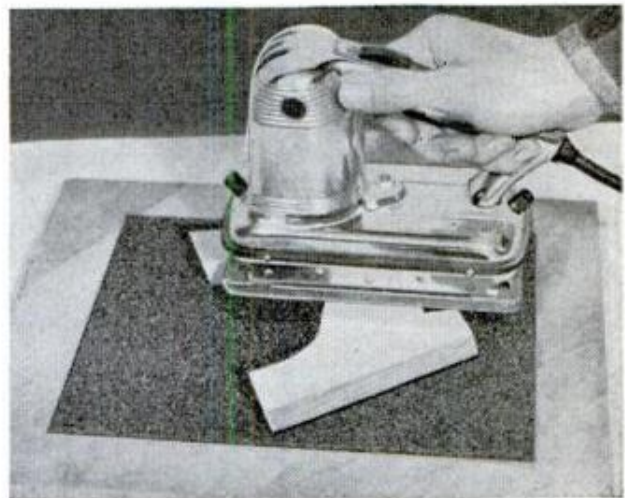

Shower-Curtain Hook on Hose Keeps Spare Washers Handy

Like many a proud owner of a lawn and garden, you have probably at one time or another coupled the sections of your garden hose only to find one coupling leaking because of a missing washer. This meant having to hunt up a spare. To save yourself this trouble, keep several spare washers on a shower-curtain hook clipped around the hose. Bend the round end so that it will grip the hose tightly. Since it is made of brass, the hook will not rust and should outlast the life of the hose itself.

MORE QUIET

IN YOUR HOME

Sound conditioning will lessen kitchen clatter, party patter and the din of modern living

By E. R. Haan

YOU NEEDN'T BE an acoustical expert to sound-condition your home for more peace and quiet. It's relatively simple to nip unnecessary noise—first, at its source and then by using soundproofing methods and materials to lessen unavoidable noise.

Nipping Noise at Its Source

Although each little noise in your home may not be disturbing in itself, it adds to the din. Eliminating or reducing these individual noises often can make a surprising difference. You can replace loud-snapping wall switches in or near bedrooms with noiseless mercury switches; a blatant doorbell with pleasing chimes; a raucous telephone with one having variable volume control.

Radios, TVs and phonographs can be operated at a temperate rather than at a tempestuous level. If you don't have a separate room for this equipment, an accordion-type "folding wall", Fig. 3, permits some members of the family to enjoy programs and records without annoying others.

To reduce transmitting sound through floors, mount the cabinets on rubber feet of suitable resiliency, Fig. 6. For this, use relatively stiff sponge rubber—about the same resiliency as crepe soles. Soft sponge rubber compresses easily and therefore defeats its purpose. Hardboard under the rubber permits you to slide cabinets slightly without removing the feet. Because of its weight, solid rubber, which is slightly more flexible than rubber heels, is best for pianos. Neither cabinet nor piano legs are set directly on the rubber, but on a rigid-cupped top piece, which distributes weight uniformly.

You can lessen sound transfer of a loudspeaker through the wall directly behind it by hanging a panel of acoustical tile at the open back of the cabinet. Sponge-rubber kneeling pads used under food mixers, Fig. 4, noisy fans and other small appliances are effective sound deadeners.



Wool Conversion photo

2

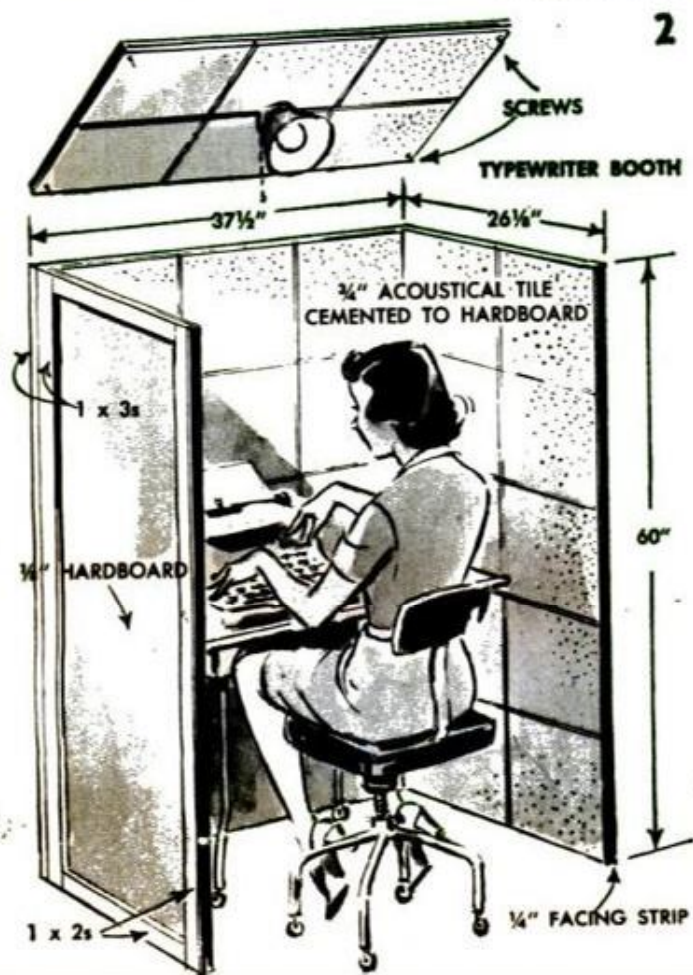



New Castle Products photo

Loud clatter of a typewriter can be muted by mounting the machine on acoustical tile cemented to a sponge-rubber kneeling pad, Fig. 5. If the noise is still disturbing, make a sound-absorbing booth, Fig. 2, which is similar to telephone booths in stores. Or, perhaps you may prefer to substitute a typewriter of the "noiseless" variety.

Most fans that are permanently installed in walls or windows can be provided with resilient mountings to minimize vibration to the wall or window frame. Fig. 7 shows four ways to provide resiliency between a motor and the fan housing. Bent or misaligned fan blades that cause excessive vibration should be bent and realigned to match the other blades.

A large fan rotor which is out of balance also causes vibration. Remove it from the motor shaft, slip it on a separate shaft, and place it in V-notches cut in two sheet-metal supports to hold it in a level, horizontal position, Fig. 8. Then to correct the condition,peen a piece of wire solder in a hole at the end of a blade as shown. End play of a fan or motor shaft causing rattle can be cured by reducing the clearance with a thin metal washer.

Measures to stop vibration noise of a

4

SPONGE-RUBBER
KNEELING PAD
UNDER MIXER



5

ACOUSTICAL TILE
GLUED TO SPONGE-
RUBBER KNEELING PAD



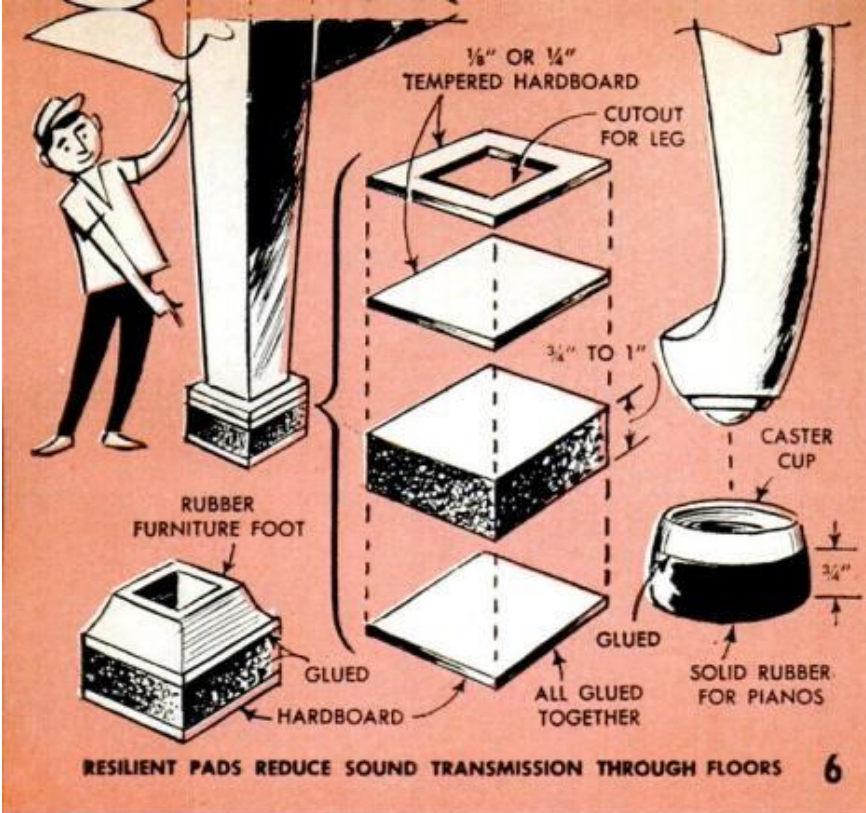

RESILIENT PADS REDUCE SOUND TRANSMISSION THROUGH FLOORS

6

fan will not decrease the noise that results from the friction of moving air on the blades. This is done only by reducing the fan speed. Consider this when purchasing a fan as various makes differ in the noise they produce.

Sounds from a warm-air heating plant or a central air conditioner, which "telegraph" through a house, can be reduced by resilient sleeves on the ducts, Fig. 9.

Hammering noises in water-supply pipes can be stopped by installing one or more air chambers, or by bleeding the existing ones that have filled with water. Where water pressure is high, a pressure-reducing valve helps to eliminate water hammer.

Dripping faucets, often accompanied by gurgling sounds in drains, require new faucet washers. High-pitched whistling in

toilet flush tanks is sometimes remedied by adjusting the water-intake valve. If this does not help, replace the valve. Sound of water slowly flowing into a toilet bowl is caused by a worn discharge valve that does not seat properly—usually it requires replacing.

To prevent noise of automatic washers from being conducted over water-supply pipes, install rubber-hose inserts, Fig. 11. Noise of clothes washers set on wooden floors can be arrested by setting them on rubber pads.

Use spiral nails to tighten loose floor boards and squeaky loose floor boards and squeaky treads. Also effective are shingles driven between joists and sub-floors at the squeaky area, Fig. 12. Silence rattling shutters by eliminating play at the fastening points. Weather stripping stops rattling of doors and windows, besides reducing heat losses.

Methods and Materials

Unavoidable and hard-to-control noises in homes result not only from increased use of mechanical and electronic equipment, but also from lightweight wall construction and more openly designed interiors in modern homes.

Noise control by construction methods and materials consists of (1) absorbing some of the noise in a room or area where it originates, and (2) by arresting most of the noise that travels to other areas. The first is done by means of sound-absorbing materials which soak up sound waves as a sponge soaks up water. The second is done by means of sound-insulating methods and materials to produce sound bar-

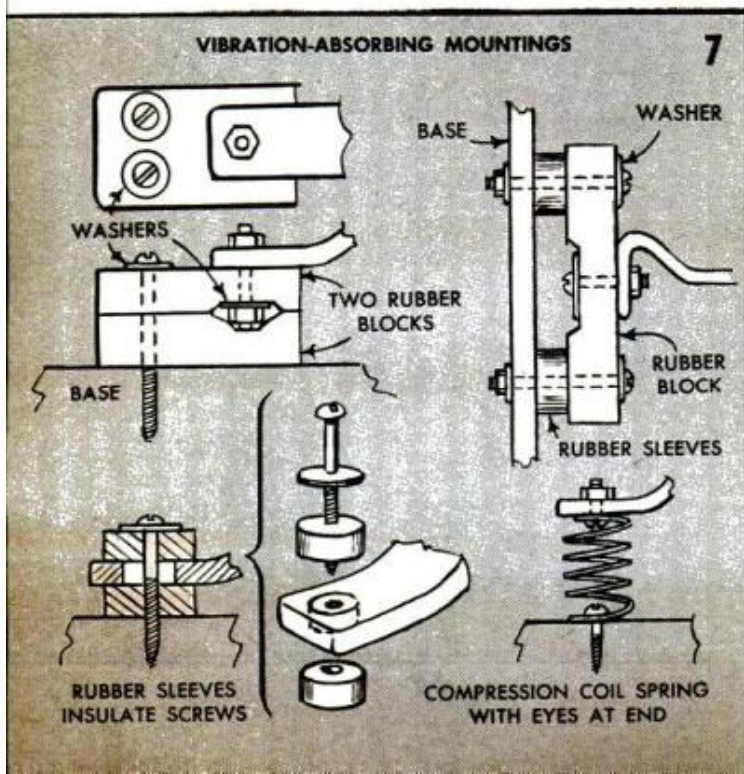

7

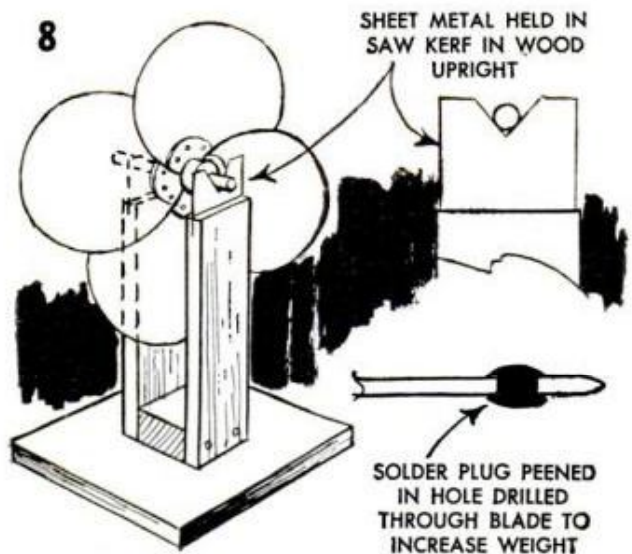

METHOD OF TESTING FAN FOR BALANCE

9 PREVENTING DUCTS FROM TRANSMITTING FURNACE NOISES

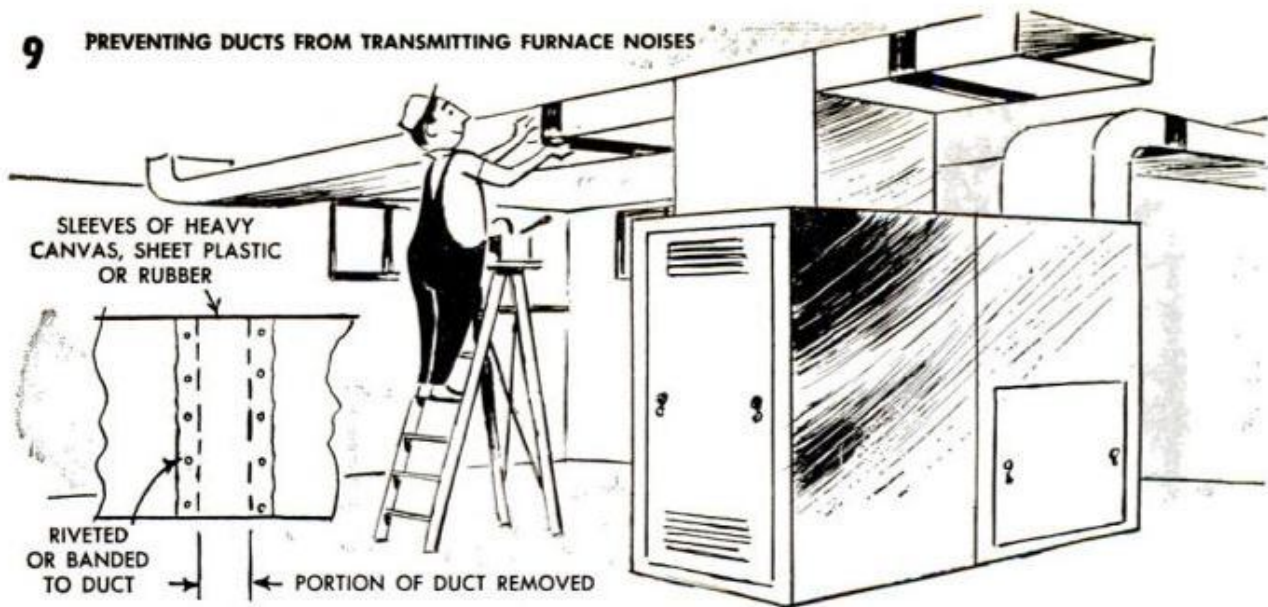

riers. Some materials are both sound-absorbing and sound-insulating, but an effective sound absorber is not necessarily a good sound insulator.

Noise Absorption

Sound waves produced in a room are reflected back and forth by hard surfaces such as walls, floors and ceilings. Overlapping of sounds creates a disturbing noise level. Heavy draperies, overstuffed furniture and wall-to-wall carpeting will absorb considerable sound, but this often is not enough. Also needed is acoustical material on ceilings and sometimes even on walls.

Acoustical tile is made of either mineral wool or cellulose fiber. It comes in 12 x 12, 12 x 24-in. and other sizes, and in various thicknesses up to 1 in. The edges are either tongue-and-groove or plain butt. There are many surface finishes, some of which are shown in Fig. 10.

Cellulose fiber tiles are the most pop-

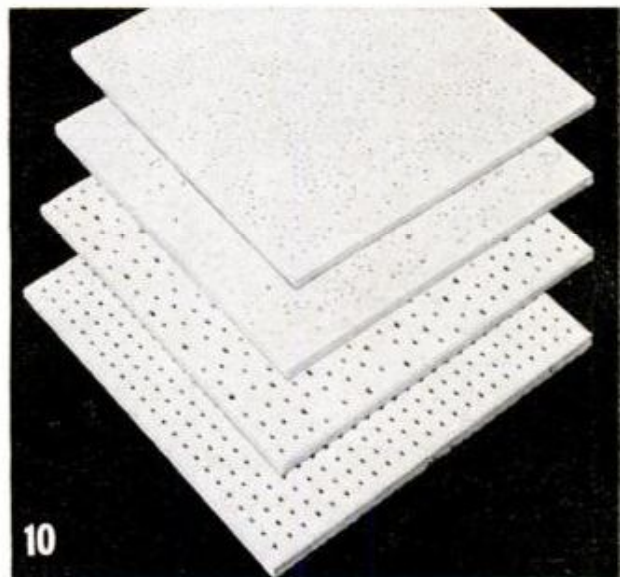

10



TONGUE-AND-GROOVE



BUTT EDGE

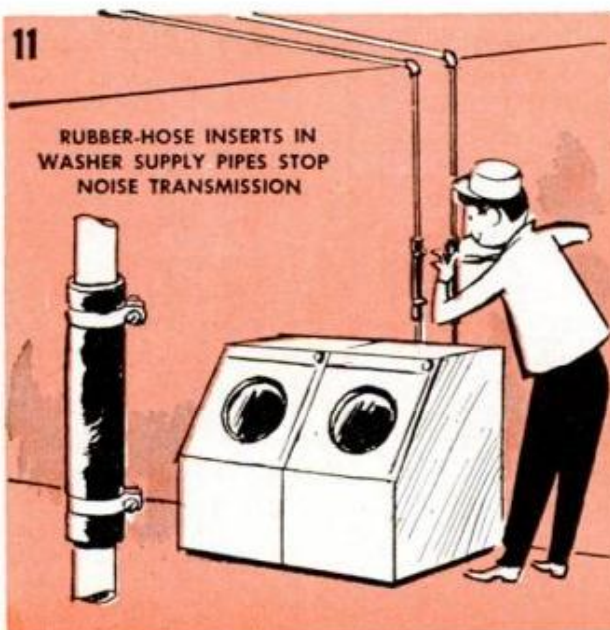

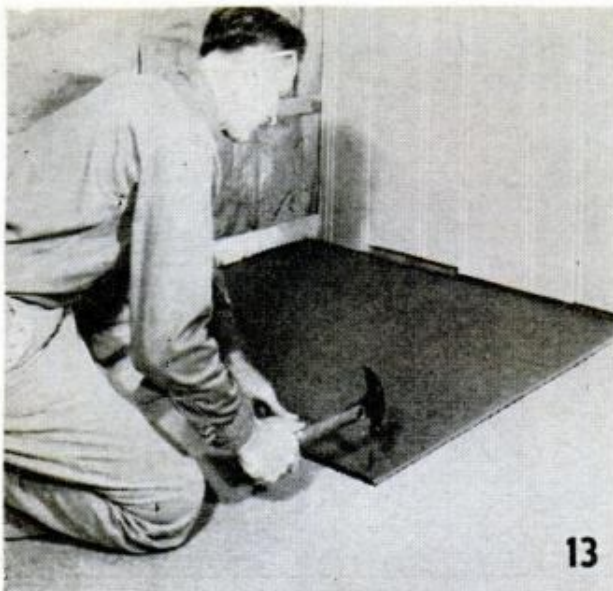

13

Insullite photo

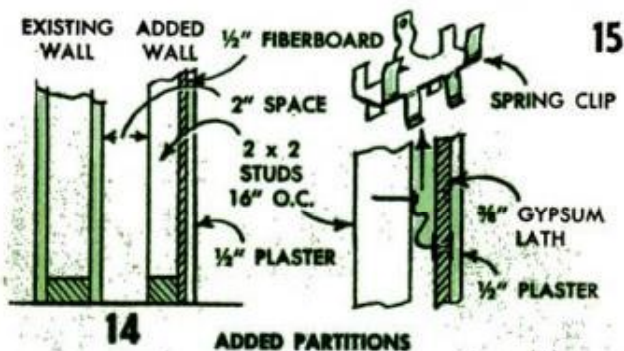

14

ADDED PARTITIONS

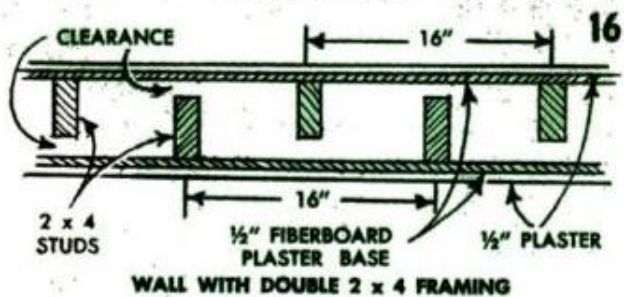

16

WALL WITH DOUBLE 2 x 4 FRAMING

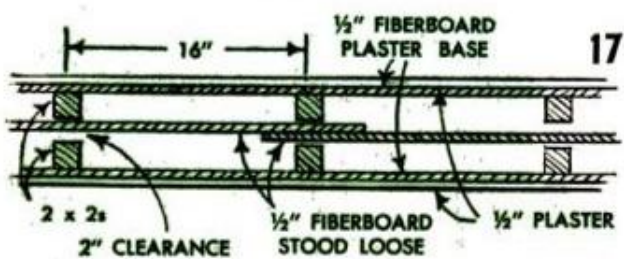

17

WALL WITH SEPARATE 2 x 2 FRAMING AND FIBERBOARD INSERT

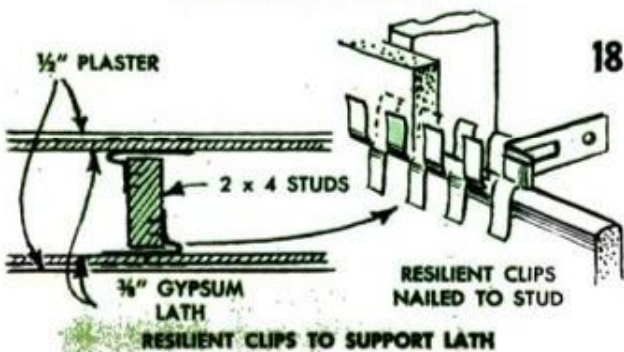

18

RESILIENT CLIPS TO SUPPORT LATH

lar for use in homes. They are low in cost, high in sound-absorbing efficiency and easy to install. They can be adhered directly with acoustical cement to smooth, sound and clean ceilings, Fig. 1. For uneven or cracked ceilings, the tiles are stapled, nailed or attached with clips to 1 x 3-in. softwood furring strips, Fig. 19.

Another method of installation is by mechanical suspension—tiles then being snapped or fitted into metal channels. Cove molding can be used to conceal irregular edges of the tile at walls.

There are other sound-absorbing materials. Plastic foam comes in 24 and 48-in.-wide rolls, 1/4 in. thick—also in tile form. Acoustical plaster can be applied to firm existing plaster. Some plastic sound-absorbing materials are sprayed to produce coatings as much as 3/4 in. thick.

Reducing Sound Transmission

Decreasing noise in a room by sound absorption doesn't necessarily prevent it from traveling to adjacent areas. An efficient sound-absorbing material such as low-density, cellulose-fiber tile, may transmit noise through itself. Transmitted sounds are either airborne, such as speech, or are produced by impact, such as walking. Airborne sounds striking a wall surface cause it to vibrate like the diaphragm of a telephone receiver.

Transmission of airborne sound can be reduced as follows:

- By walls and floors of heavy, high-density materials of suitable thickness, which remains relatively immovable when subjected to sound vibrations. Although concrete walls are effective for this purpose, they are impractical to install in an existing house. High-density, mineral-fiber, acoustical tile helps to reduce transmission of sound in addition to reducing the noise level in a room.

- By wall and floor construction and the use of materials to dampen and dissipate sound waves. Examples are resilient support for gypsum lath, or the use of low-density, glass-fiber blankets or batts. The latter may be put between furring strips and covered with rigid wall material such as hardboard or plasterboard. It may also be hung centrally in a divided partition instead of fiberboard installed as in Fig. 17. Or it may be placed between studs of a divided wall as shown in Fig. 16.

- By wall and floor construction in which there is no physical connection between the two sides, plus the use of materials that reduce sound transmission.

- By combinations of the above materials and arrangements, some of which are shown in Figs. 14 to 23.

Sound caused by impact such as walking

is reduced by providing suitable resiliency to absorb the shock, as provided by cork or rubber flooring, or thick carpeting on padding. Most overhead playrooms require measures to reduce transmission of both airborne sound and those from impact—in addition to acoustical material to reduce the noise level in the playrooms.

Highly effective results in reducing transmission of airborne sound through an existing wall are possible by adding a partition as in Fig. 14. In the added wall, still greater resistance to sound transmission is obtained by using resilient clips for attaching gypsum lath to studs as in Fig. 15. For new partitions, the construction methods shown in Figs. 16, 17 and 18 provide practically the same effect. In all these instances wider doorjambes are required.

When walls are sound-insulated, provide equivalent sound barriers at doors. Solid-core, flush doors or accordion-type plastic-covered, folding doors transmit much less noise than hollow-core or panel-type doors. Sound leakage at door edges can be reduced by using heavy felt weather stripping and a spring-activated closing device between door and floor.

Noise from an overhead room through an existing floor is reduced by installing an extra floor on sleepers as in Fig. 20.

For an overhead room not having a floor, you first cover the joists with subflooring, and then follow the arrangement shown in Fig. 20. Another solution, Fig. 21, applicable for high rooms, is to install a separate floating ceiling. In case a floating ceiling is desired in a room not over 8 ft. high, the arrangement in Fig. 22 only reduces room height a few inches. In both cases, the only indirect connection between the ceilings is at the walls. Noise from basement rooms, which penetrates to the first floor, can be decreased by construction shown in Fig. 23.

Barriers to Outside Noises

Transmission of outdoor noises into a house can be reduced by adequate sound barriers. Some effect will result from solid fences of suitable height, particularly fences of stone or brick. Thick, dense hedges also have some effect. However, the best barriers to stop noise from entering through windows are storm sashes installed tightly with felt strips at the edges, double-glass windows, felt weather stripping for all windows and heavy drapes.

Masonry walls conduct less airborne noise into a house than wooden walls. A thick cover of ivy on brick veneer or stucco walls helps to reduce noise transmission. Uninsulated frame walls can be made more resistant to noise with high-density insulation, such as vermiculite blown in. ★ ★ ★



Armstrong Cork photo

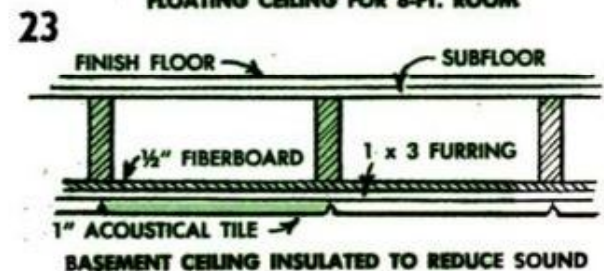
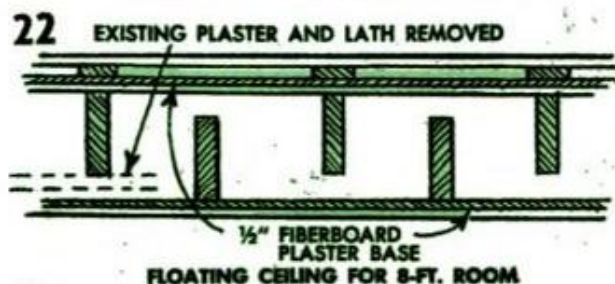
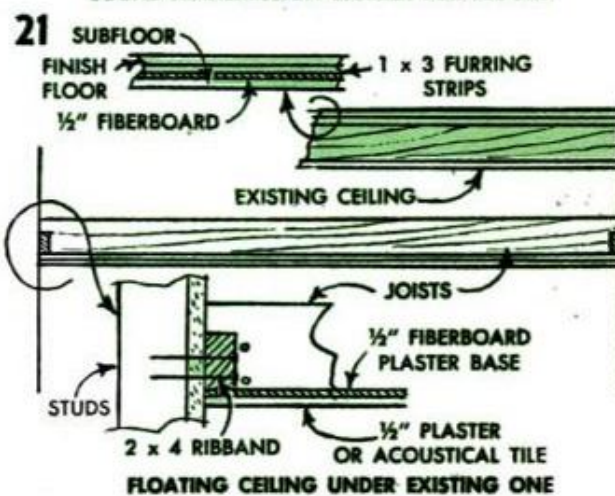
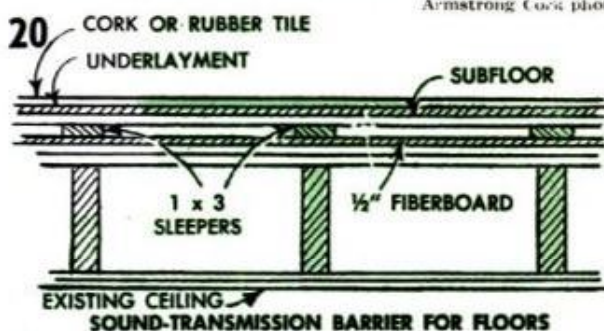

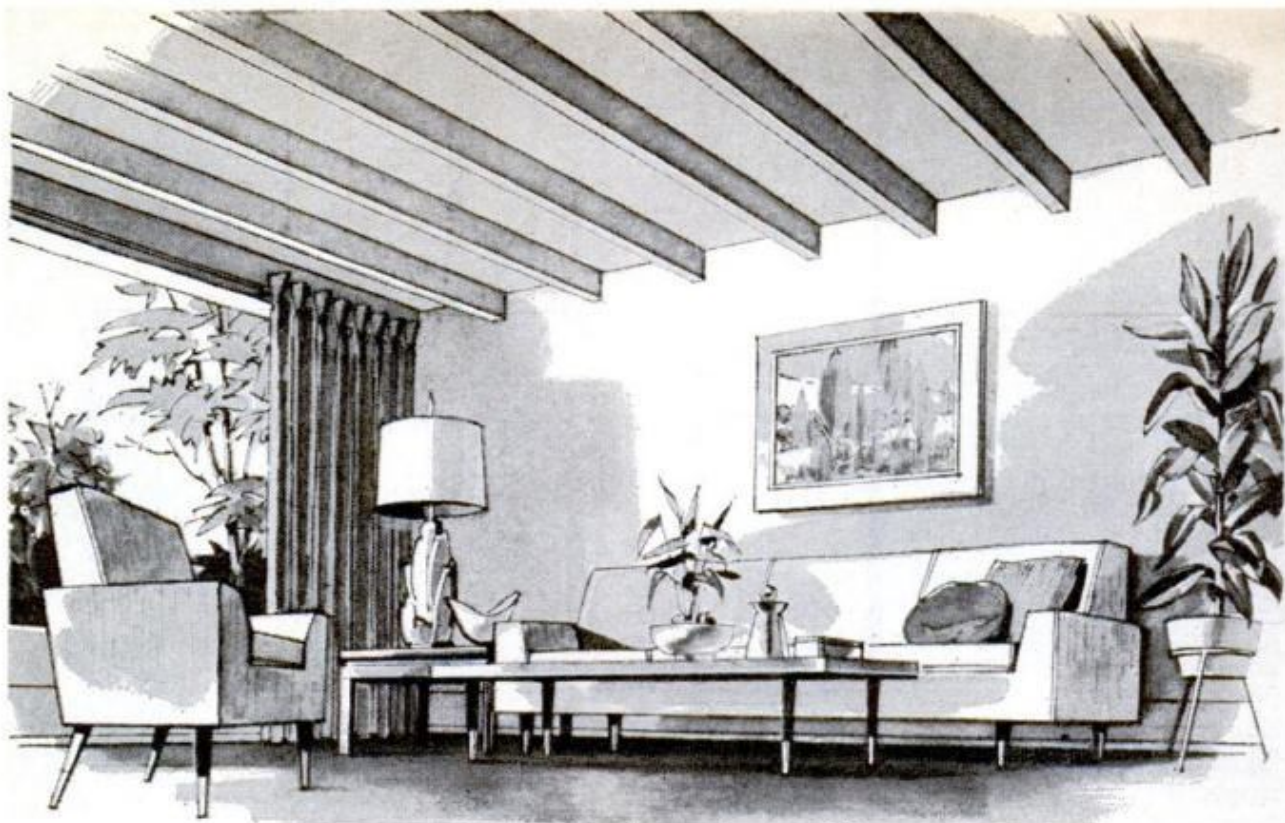

False Beams Decorate Your Living Room

By Bob McKinney

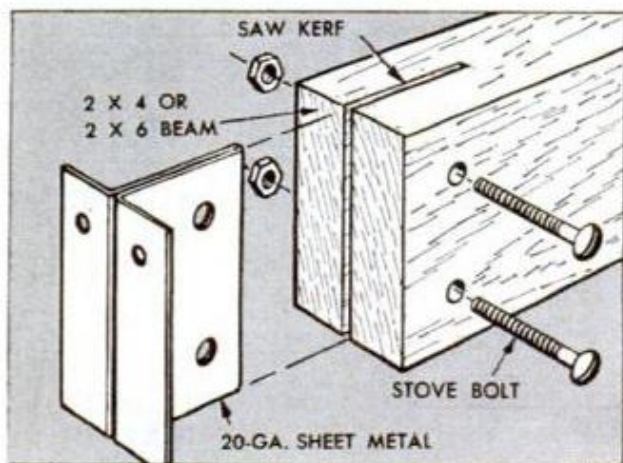

To give a living room a feeling of old adobe interior decor, ceiling beams can be installed by using metal brackets to support the ends. Selected 2 x 4 stock is preferred, but 2 x 6s can be used. Measure and cut the beams individually to length and finish as desired. Make the brackets from 20-ga. sheet metal, bending the metal back on itself and then bending the ends at right angles to form nailing pads. Kerf both ends of each beam to take the webs of the brackets. Kerfing can be done with a hand rip saw and an improvised guide, or with a portable electric saw. Nail the brackets to the plate at the ceiling, slide the beams up into place and fasten with stove bolts concealed in countersunk holes.

Youngsters Are Safe Behind Station-Wagon Window Screen



Rough-house play in the back seat of an open station wagon has brought more than one parent near to heart failure for fear of losing a youngster out the tailgate window. This led one station-wagon owner to safeguard his lively passengers with a safety screen that is inserted in the endgate window channels and locked in place. The screen is custom assembled from standard aluminum screen molding and screen wire which can be purchased in hardware stores. Special corner fixtures are provided to lock the mitered corners of the molding together, after which the screen wire is applied and held with a spline wedge.

Cord Suspended From Sun Lamp Gauges Proper Height

Sun lamps and other heat-producing bulbs can produce rather painful burns when improperly used. One way to avoid this is to first learn the recommended distance the lamp should be from the body. Once this has been determined, cut a piece of cord or ribbon to coincide and suspend it from the lamp. Thus, each time the lamp is used, it can be correctly positioned a safe distance without guesswork.

When a crack appears in the joint between the bathtub and wall due to settling and shrinkage and requires calking, a neat fillet may be formed with the rounded end of a frozen-sucker stick or a dowel. A fifty-fifty mixture of portland cement and sand is forced into the crack and then the mortar is struck, or troweled, by drawing the dowel along the joint. A $\frac{3}{8}$ or $\frac{1}{2}$ -in. dowel forms a perfect fillet which later can be given a top dressing of white grouting cement to match the tub.

Ted Fenn, Chicago

Slip-On Stop Block Holds Original Setting

Crosscutting duplicate work to length usually requires squaring one end of each piece of stock first before setting the stop rod in the crosscut gauge. But once the stop rod is set for length, further squaring off cannot be done without disturbing the initial stop-rod setting. To overcome this, Henry Hanscom of Elmhurst, Ill., fitted the rod with a slip-on stop block so the rod itself could be left undisturbed in making additional squaring-off cuts. Fitted on the L-shaped end of the rod which is originally set to point toward the operator, the wooden block is simply removed to allow long stock to pass.

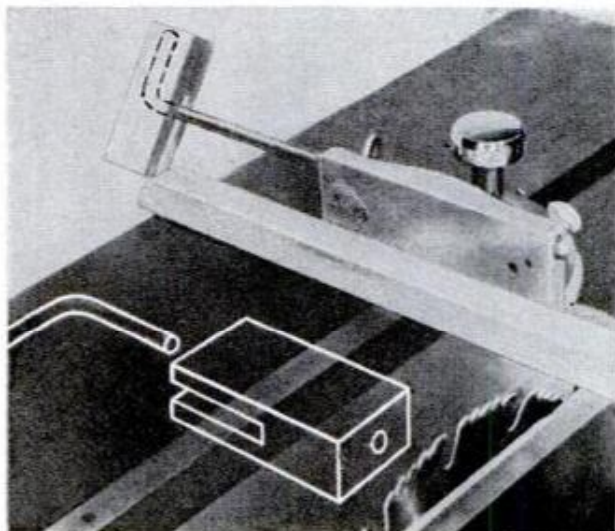

JULY 1960

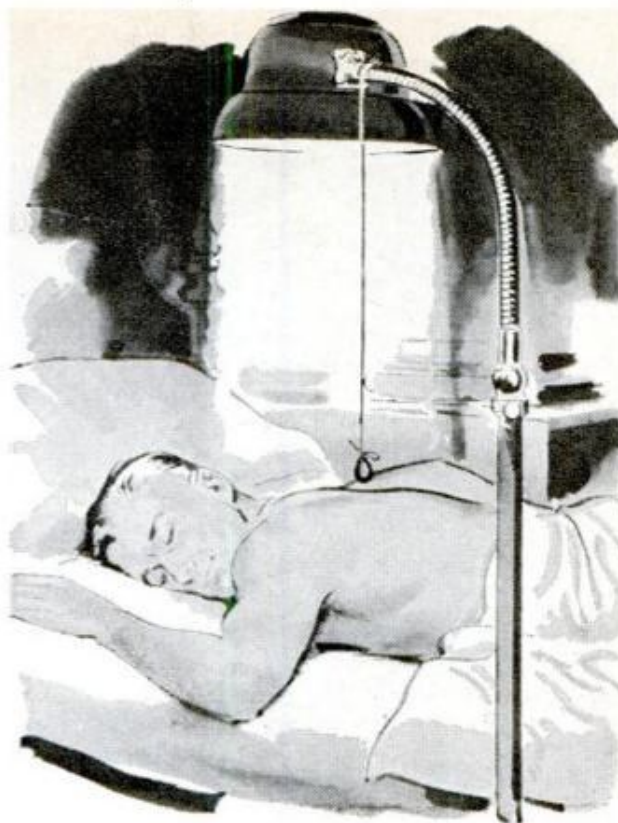

Loose Joints in Old Work Anchored With Steel Wool

When attempting to reglue the round-tenoned joints of old or antique pieces of furniture, you may find that the wood has shrunk, making the holes so small that there is no wood-to-wood contact. To reduce the size of the hole, try using steel wool. Coat both the mortise and the tenon with glue, place a layer of steel wool over the end of the tenon, force the latter in place and clamp. You'll find that fibrous steel wool serves as a wedge which when impregnated with glue anchors the member solidly in the mortise, making a joint which is almost as strong as new. You should use fairly coarse steel wool.



161

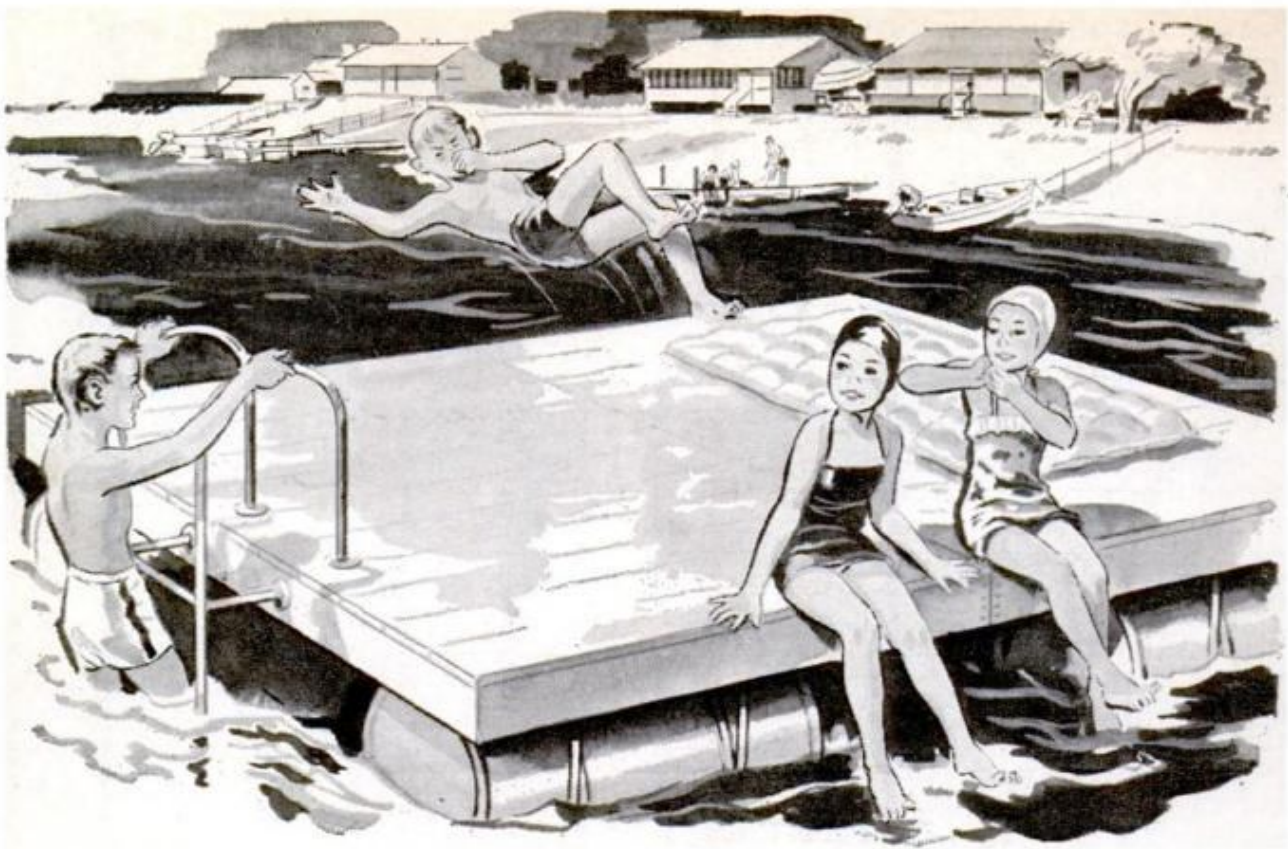

LAKE-FRONT FLOAT

By A. H. Slater

COTTAGE OWNERS whose lake-front property lacks good swimming facilities need not deny their youngsters the pleasure of convenient, safe swimming. A float, such as the one illustrated here, serves this purpose nicely without putting much of a dent in the family budget.

Made of lumber in stock sizes and using 55-gal. steel drums for flotation, the float

can be knocked together in one day. If the lumber is ordered cut to the lengths required, the project really is only an assembly job. A boarding ladder for the float is made of 1/2-in. galvanized pipe and fittings welded together as shown in the photo below and the drawings on the opposite page. If you don't have a welder or pipe bender, cut the pipe to the required

Below left, float sections are bolted together temporarily so that drums can be aligned with one another while mounting them on the float. Below right, flanges on steel pipe ladder are bolted to deck and float frame

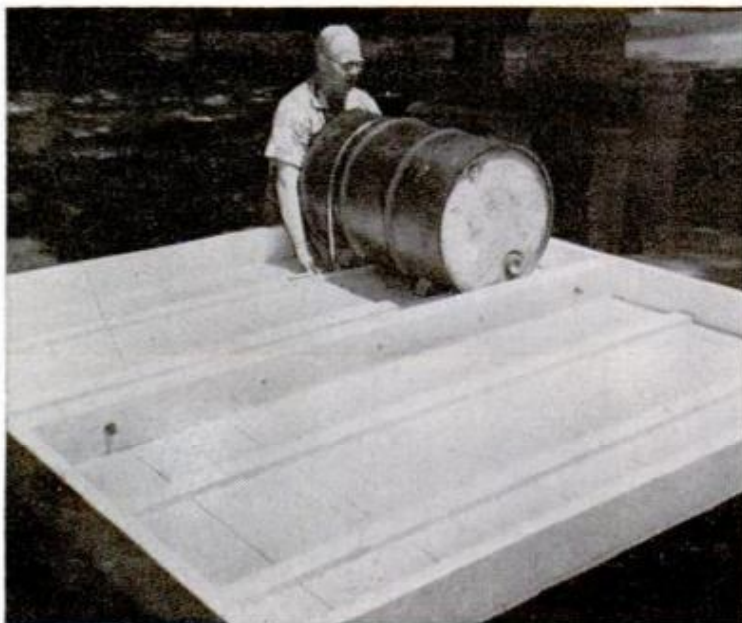

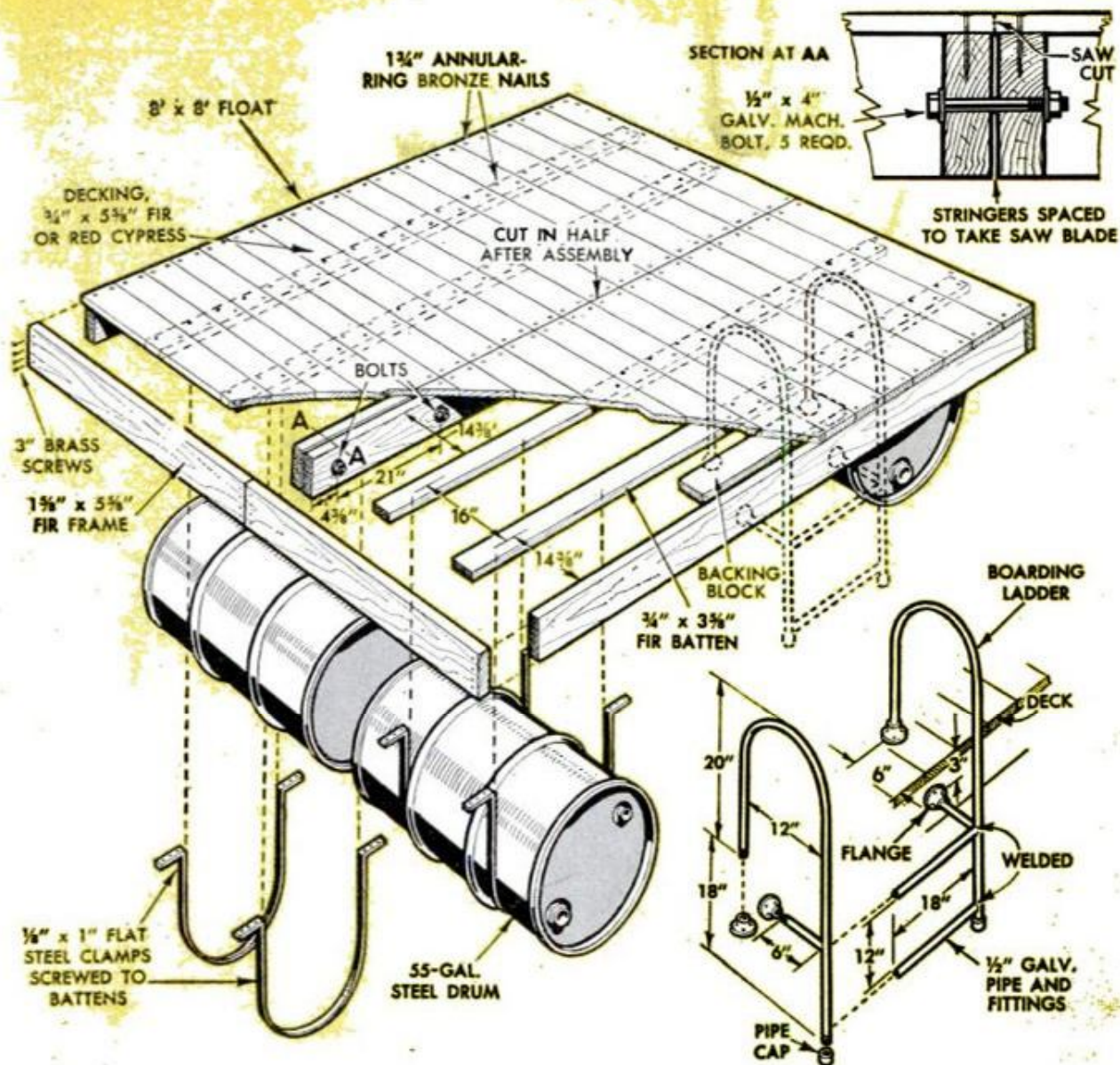

lengths and have this work done at a plumbing supply store, or put the ladder together with slip-on fittings. A small diving board may be installed on the float opposite the ladder.

The float deck consists of two 4 x 8-ft. sections which are bolted together as shown in the drawing and sectional detail. To save construction time and assure perfect alignment of bolted sections, the deck is assembled as a single unit, the double stringers at the center being drilled before cutting the deck in half. Note that these stringers are not nailed next to each other but are spaced to take a saw blade. Having the float in two sections makes it easy to haul, launch and retrieve the structure, an important consideration if it is not to be built and remain at the launching site. A float that is built at the launching site and left in the water permanently should be finished as a single unit, in which case only one stringer is placed at the center of the float instead of two as shown.

The float should be treated with a wood preservative and the underside painted before the steel drums are clamped in place. Use Cuprinol or Penta wood preservative and follow (when dry) with two coats of marine paint. Paint the top of the deck last to avoid scratching it when turned upside down to attach the drums.

Two 1/8 x 1-in. flat-steel clamps, drilled and screwed to the battens as detailed above, hold each drum in place. In the case of a two-sectioned float, the sections are bolted together temporarily to make it easier to align the drums as shown in the photo on the opposite page. If the float is to be taken out of the water each fall, it is advisable to fasten the clamps with 7/16-in. galv. carriage bolts instead of screws. Be sure the bungs have gaskets on them or they will leak. Turn them down tight before launching the float. To anchor it, connect a chain to an eyebolt fastened to the stringers and secure the other end to a heavy weight. ★ ★ ★

Trouble Shooting THE TOUGH ONES

By Ben L. Davis

LISTENING to the complaint of the pert young lady driver it was plain to me that she was more or less resigned to paying an expensive repair bill. I knew that from the way she banged the door of the '55 Dodge. I didn't like that because I don't want people to think of my shop as "that place where they do expensive repair jobs."

In a routine check of the Dodge I found it would idle quite smoothly, but would not take the throttle above idling speed. Tap the foot throttle and the engine sputtered and faded.

It must have been one of those days, or maybe it was the gal, but all I could think of was a general tuneup. Just as I had anticipated, the spark plugs were dirty and the gaps were nearly twice the specs, timing was late and the sediment I found in the filter could have been the cause of almost anything.

I finished servicing the common check shooting trouble wide of the mark. I got points with the gathering feeling I was into the car and flipped the starter key.

Now the engine idled rather nicely and I was feeling better until I kicked the foot throttle again. Much the same, only the sputter had become a vigorous backfire, soothing to a hotrodder, maybe, but more than a challenge to an old fellow like me.

I stopped the engine, then flipped the starter key again and did something I should have done at the outset. I watched the oil-pressure gauge closely as the engine took hold. The needle climbed to the stop on the high side and stayed there.

Of course. I should have known. The '55 Dodge has hydraulic valve lifters and something more than normal oil pressure was, in effect, pumping up the lifters and forcing the valves off their seats. That could only mean that the plunger of the oil-pressure regulator was stuck about halfway open. That would affect engine performance above idling speed. I dropped the oil pan and, sure enough, there it was. It was then a simple job to free the plunger and replace the oil-pressure gauge, which had been damaged.

Unusual Locations Where Trouble May Occur

Replacement Brackets

When '57 Fords come into the shop with broken upper shock-absorber brackets, due possibly to rough winter-road conditions or over-loading, don't try to reweld the parts. Use bolt-on replacements which can save you a lot of time and save your customer something on the labor charge.



Switch-Arm Breakage

Occasional failure of the curved actuating arm can make it impossible to operate the directional lights on '55 Plymouths. This arm is in the switch box under the steering wheel and connects the handlever on the post to the directional-light switch inside the box. Replace the arm.

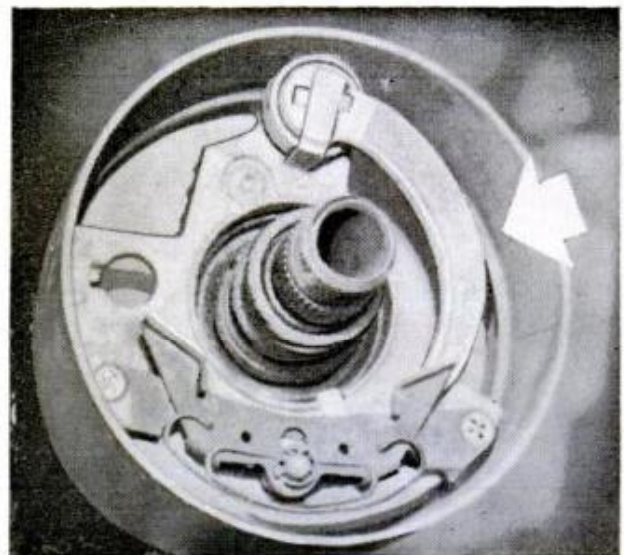



Loose Jumper Wire

When you have a horn complaint on the '59 Mercury, don't forget to check the jumper on the sectional steering post. Do this first and the chances are you'll locate the trouble. If the connections are loose or corroded or if the wire is broken, the horn either will be undependable or dead.

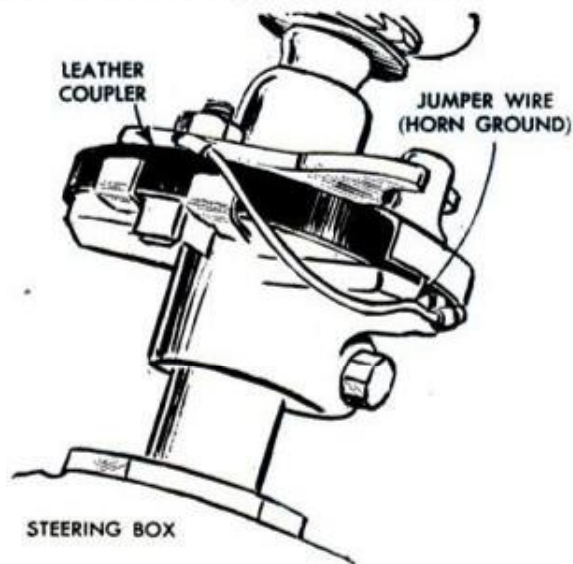

JULY 1960

Air-Filter Rattles

On some Metropolitans the air filter may persist in working loose after it has been removed the first time for servicing. A trick that usually works is to set the filter body level in its strap supports—you can see the side strap in the photo—then tighten the carburetor clamp.

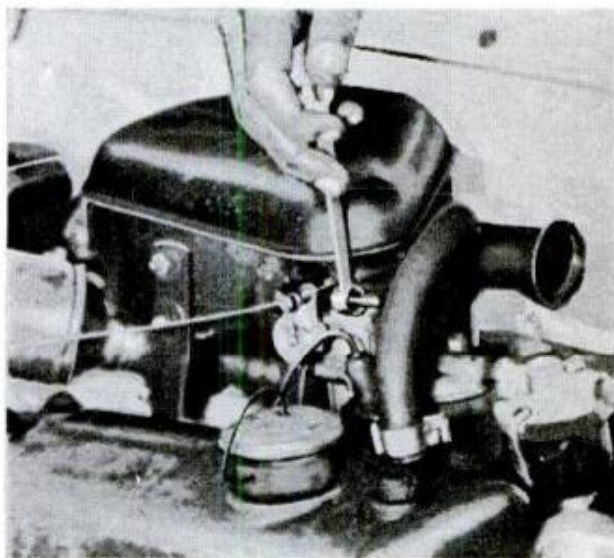

165

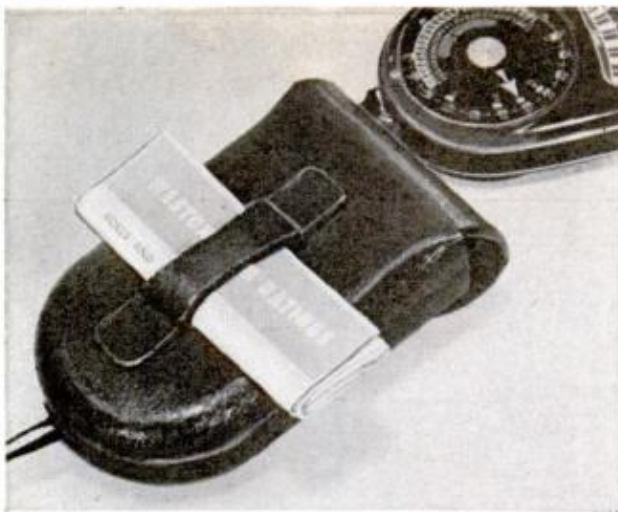

PHOTOKINKS

Meter Case Holds Data

Photo information can be carried conveniently in the belt loop of an exposure-meter case. Fold the sheets separately so they can be removed individually. The reference will always be handy for checking flash guide numbers, filter requirements, film rating and other data.

R. Hanscom, Elmhurst, Ill.

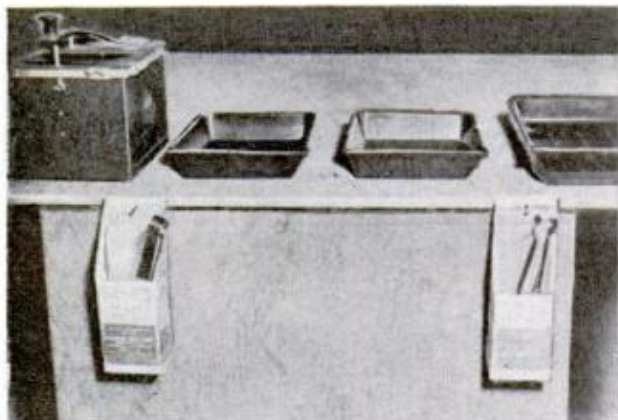

Print-Tong Holders

Ever have trouble keeping print tongs separated and their handles out of the "soup"? One way to avoid this and also reduce cleanup is to tack milk cartons—minus their tops—to the front of the bench. By cutting off the carton tops at the angle shown, tongs will be easy to pick up. The containers reduce the chance of getting the developer and hypo tongs mixed up and the solutions contaminated.

David A. Cleary, Fargo, N. D.



Stop for Tripod Screw

Some tripods have two slots in the pan head to permit shifting the base screw. This in turn allows the photographer to change the camera position so that a dropped camera can be used. But often the screw falls out and is lost. To prevent this, "behead" a $\frac{3}{8}$ -16 aluminum bolt,peen one end and add a screw slot. Now insert the bolt in the top of the head, making certain that it fits snugly. The bolt should be long enough to come through, but not long enough to interfere with the tilting head.

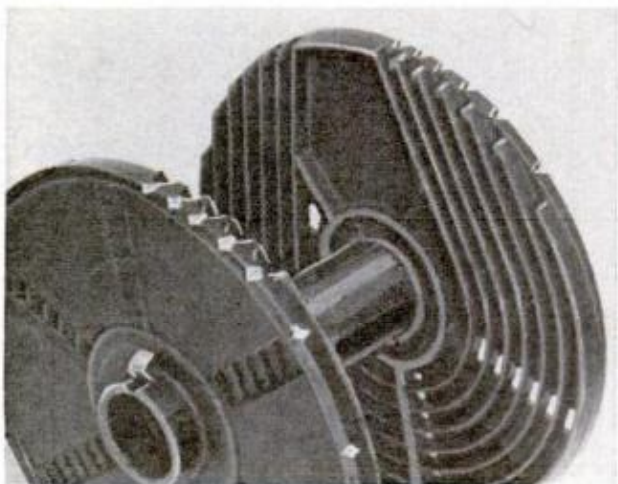

Faster Film Loading

A plastic cut-film developing tank can be loaded quickly if you first use a file to notch along the outside edges of the reel, indicating where each film should be inserted. Then, in the dark it's simple to locate the corresponding notches by feeling with a fingernail. Also, with the slots marked, it's easier to count the number of films that have been loaded.

☛ A kitchen sink spray is handy to use in the darkroom for cleaning trays and equipment. Even a discarded one is useful—just add a new hose and faucet coupling.

"PAINTING" OUT BACKGROUNDS WITH YOUR ENLARGER



Producing outlined prints with an enlarger is a simple trick which saves painting out unwanted backgrounds later. Briefly, it consists of preparing a mask from one print and then making a second or duplicate print by exposing the paper through the cutout portion of the mask without disturbing the enlarger setup. The important step is focusing the image precisely through the mask since overlapping of the opening will be evident in the final print. As focusing must be done after the mask is placed in the easel (preferably under glass) and on top of the unexposed print, registering the image must be done

with the enlarger turned on and focused through the red filter on the enlarger. A test exposure or two may be required before both register perfectly. The mask is prepared by developing and drying the first print and then carefully cutting out the figure with a sharp stencil knife. Here it must be remembered that any error in cutting outside the outline of the figure will be noticeable in the outlined print. Photos most suitable for outlining in this manner are ones where the subject predominates the composition, such as the example shown at upper left.

J. C. Cobb, Independence, Mo.

Cable Release Through Hand Strap Permits Off-Camera Flash

By looping the cable release through the hand strap on a press camera, the camera can be easily held and fired with one hand while shooting in the normal position. This is especially helpful when firing with synchronized flash through the shutter which would otherwise require three hands to hold the camera, press the release and hold the flashgun off camera.

Wayne Floyd, Fayetteville, Tenn.

☞ To help make your darkroom lightproof, try attaching a piece of weather stripping to the bottom of the door. Use the kind composed of a metal strip with felt attached. This will shut out any light that might filter in under the door yet at the same time allows for free movement of the door.

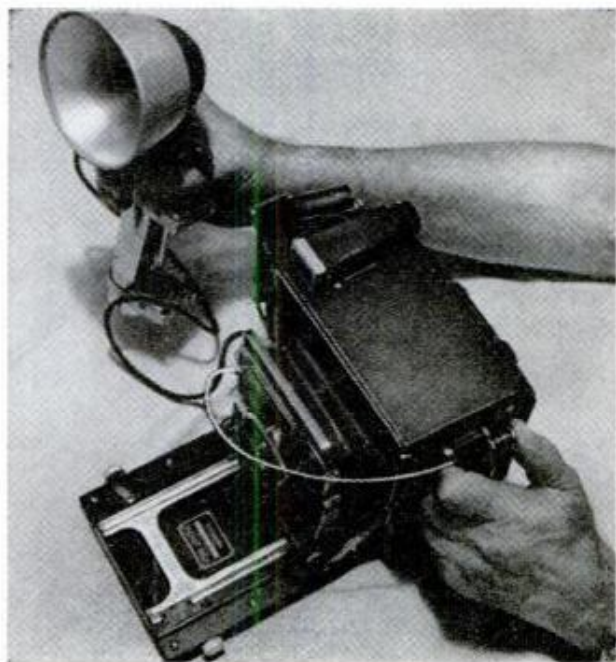

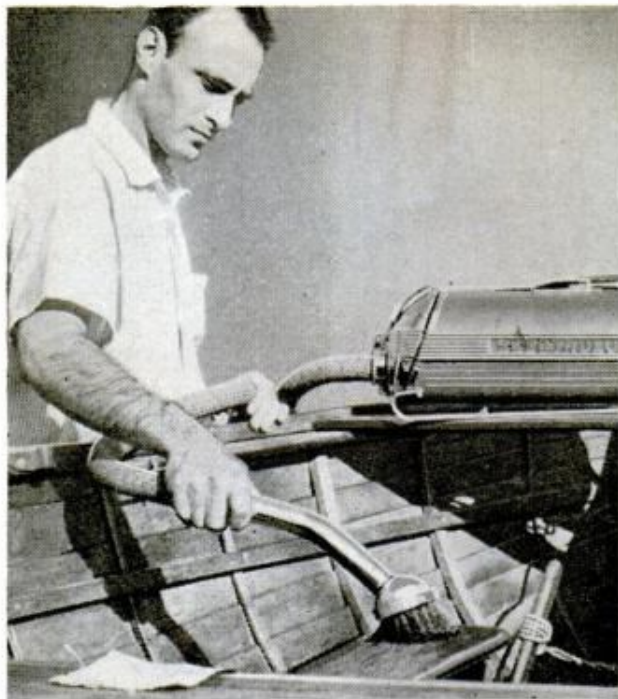

Vacuum Cleaner Makes Quick Work of Removing Dust From Boat Bilge

Cleaning out dirt and dust from the bilge area of a wooden boat after sanding is a job that can be done best with a tank-type vacuum cleaner. Use one of the narrow wand attachments for hard-to-reach places. The brush attachment, used for cleaning furniture, is fine for "dusting" sanded surfaces that are to be varnished. Follow with a tack cloth, such as is used by auto painters, to remove any last traces of dust.

P. S. Goldstone, Hollywood, Calif.

☐ When you shop for furniture, it is a good idea to make a pencil sketch of the room in which the new pieces will be located and take it along. Include room dimensions so that you can plan arrangement of your own furnishings.

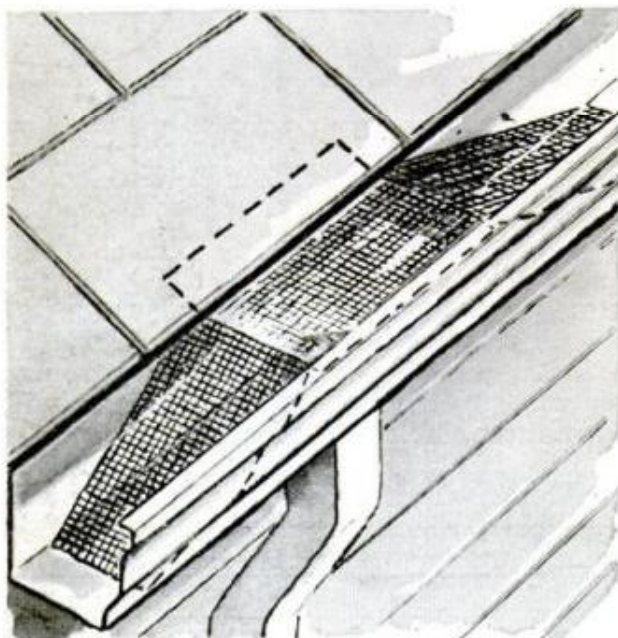

Improved Downspout Guard Made From Hardware Cloth

Wire-cage leaf strainers for downspouts prevent debris from washing down them but the strainers also clog very easily, making frequent cleaning necessary to keep the downspouts open. A better type of strainer is shown at left. It is cut from 1/4-in.-mesh hardware cloth and bent to the shape shown, leaving a narrow projecting strip on each side at the top. One strip is inserted under a shingle, the other is forced under the flange on the gutter. Of course, complete protection can be had by installing a strainer of the type that covers the entire gutter. These are available at most stores that sell rain gutters and are easy to install.

Robert L. Sargisson, Berwyn, Ill.



Filing Corrects Striker Plate Fit

When the striker on a door lock does not engage the striker plate on the jamb, a small amount of filing on the edge facing into the doorway usually will correct the difficulty. File away only enough metal to permit the striker to engage the plate opening. If too much metal is removed, the door will rattle when closed. If the plate is out-of-line considerably, it usually is best to remove the screws and relocate it.

☐ When it comes to being photogenic, cats have all the qualifications. However, if you want to shoot a candid action shot of your cat, put butter on her paws. While she is industriously licking them you'll have ample time to focus and shoot a "prize-winning" picture.

Mushroom Anvil

When you need a mushroom anvil for tapping dents out of sheet metal, planishing, forming and raising, you can make one suitable for many of these operations simply by screwing a pipe cap tightly onto a nipple. The convex ends of some pipe caps are rounded just right for the purpose; others you may have to file to the desired radius. Notch the lower end of the nipple on opposite sides as in the detail to form shoulders that will bear on the vise jaws.—Robert L. Sargisson, Berwyn, Ill.

When installing additional electrical outlets in the walls of rooms other than the kitchen or laundry, locate them 18 in. above the floor. At this height outlets are more easily reached. In the kitchen and laundry 48 in. is the recommended height.

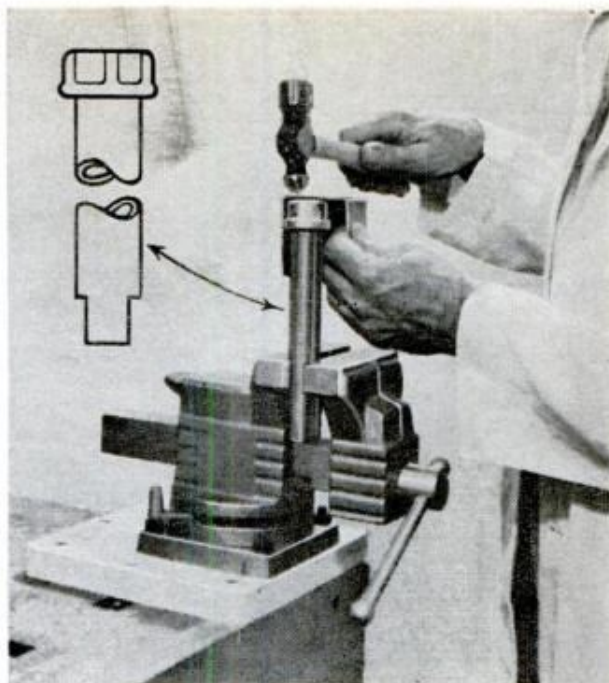

Sheet-Metal Chip Tray

It's much easier to make a small tray to catch fine metal chips, also the dust from a grinding operation, than it is to clean up the lathe after the job is done. Nearly all small lathes will accommodate a tray screwed to the compound slide and the extensions form shallow trays. Bend the tray from thin sheet aluminum so that it forms a saddle over the compound slide and the extensions form shallow trays. If desired, end pieces can be formed on each tray, but in actual use this was found not to be necessary. The open-ended trays are easier to clean and if the bottoms are coated with light grease before use, chips and dust will be retained.

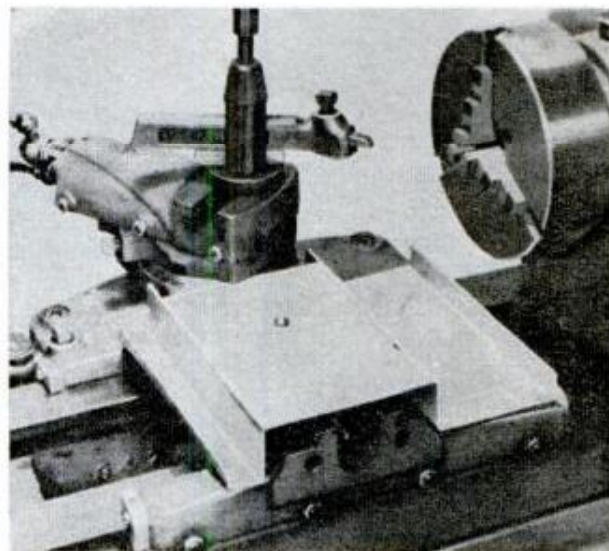

Vibration Dampener

Vibration of the handle of a pad sander can cause some discomfort if the tool is operated over a long period of time. The operator will tend to relax his grip on the handle which will reduce the efficiency of the sander. Solve this problem by wrapping the handle with several layers of rubber, using a strip cut from an old inner tube. Hold in place with wrappings of electrician's rubber tape. When making the wrappings, be sure that they do not interfere with free operation of the switch.

Before painting or repainting any sheet-metal kitchen utensil such as a canister or salt shaker, the Shellac Information Bureau advises that you prime the bare metal with a thinned coat of white shellac. Paint or enamel will adhere readily to the shellacked surface.

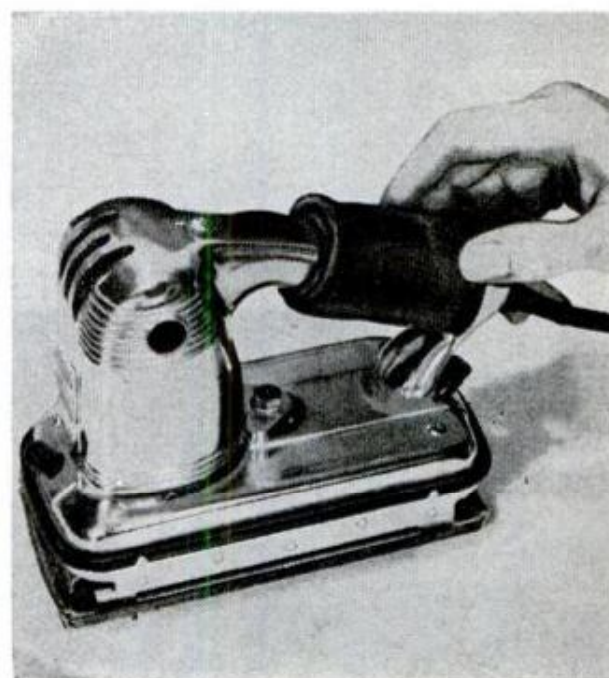



On the MARKET

for Do-It-Yourselfers

1. CEDAR CLOSETS ON DEMAND and any chest or cedar chest. This is possible through the use of a new product—pulverized aromatic cedar wood. Dissolved in water it may be brushed or sprayed onto any surface, or onto the walls of any closet, giving in effect a cedar-lined interior. One lb. covers 15 sq. ft. and fragrance and protective quality last almost indefinitely.

Cook Enterprises, 54 Holland St., Asheville, N. C.

2. NEW ROLL-ON TRIMMER assures a professional look when finishing narrow trim and sash frames. Plastic container holds half pint of enamel, varnish, water or oil-base paint. Foam-plastic roller turns easily when wet for an even distribution of paint. No chance of wavy edges or smears—roller shield holds you to the line, making even trimming a snap.

Damar's, 768 Damar Bldg., Elizabeth, N. J.



3. METAL WINDOW SASH can be installed in old wooden frames. First take out the old sashes and remove stops. Install metal head, jamb and sill liners from outside. Then screw-fasten double-hung window unit as in the section detail and fit wooden stop and wood trim. Standard sizes for all types of walls.

Per-Fit Products, Spickelmier Industries, Inc., 122 E. 52nd St., Indianapolis, Ind.

4. PLASTIC-PANEL RESURFACER restores the exterior finish of any weathered or discolored translucent glass-fiber panel. Quick-drying liquid may be applied with a brush and dries smoothly with no brush marks. Also can be used to deepen panel coloring to reduce heat and light transmission. Available in green, white, sand, clear, yellow, coral, blue or gray.

Chemiglass Inc., San Diego 9, Calif.

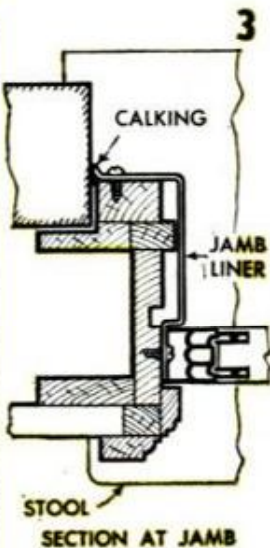

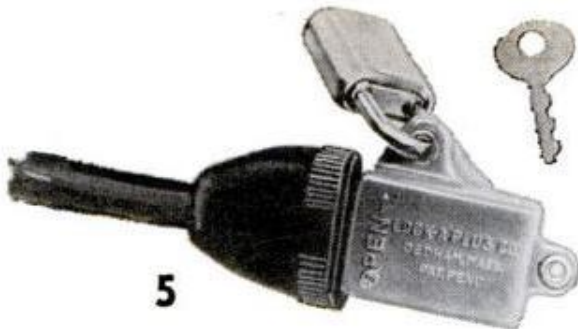

5

5. NEW PLUG GUARD keeps kids, sitters and other unauthorized persons from availing themselves of the use of your TV, hi-fi, power tools and other electrical equipment. Guard consists of a simple plastic fitting which locks over the plug prongs of the appliance cord
 Lock-A-Plug Co., Box 85, Dedham, Mass.

6. THREE LADDERS IN ONE, yet light enough to be carried by one person, the tough and weather-proof Saf-T-Ladder may be used in single 6-ft. sections or combined to full 15-ft. length as needed. Easily disassembled, sections may be stored in a minimum of space
 Murray-Black Co., 552 W. State St., Springfield 15, Ohio



6

7. READY-MIXED SPACKLING PASTE is a new boon to the do-it-yourselfer. Good for almost any interior or exterior repair job, may be applied to plaster, wood, hardboard, masonry, tile, metal and glass. Dries in an hour and may be sanded and finished
 The Reardon Co., St. Louis, Mo.

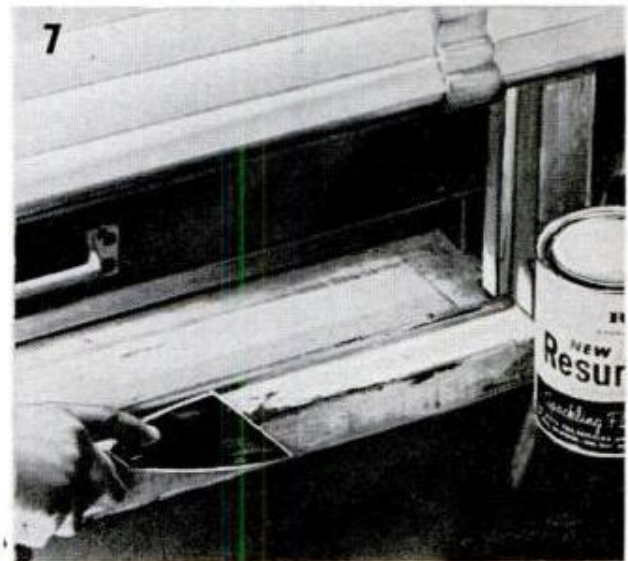

7

8. MIX-IT-YOURSELF PATCHING makes a quick job of ordinary concrete repair. Powder mixes with latex to form a paste which is quickly and easily applied as a durable and shrink-proof patch for steps, floors, masonry—any repair which would normally call for cement
 The Flintkote Co., 3 Rockefeller Plaza, New York 20, N. Y.



8

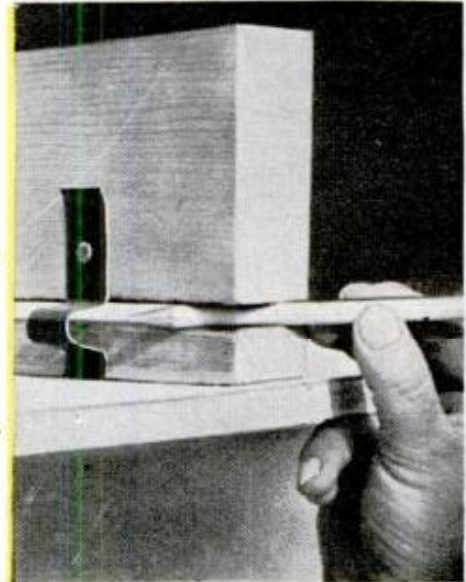

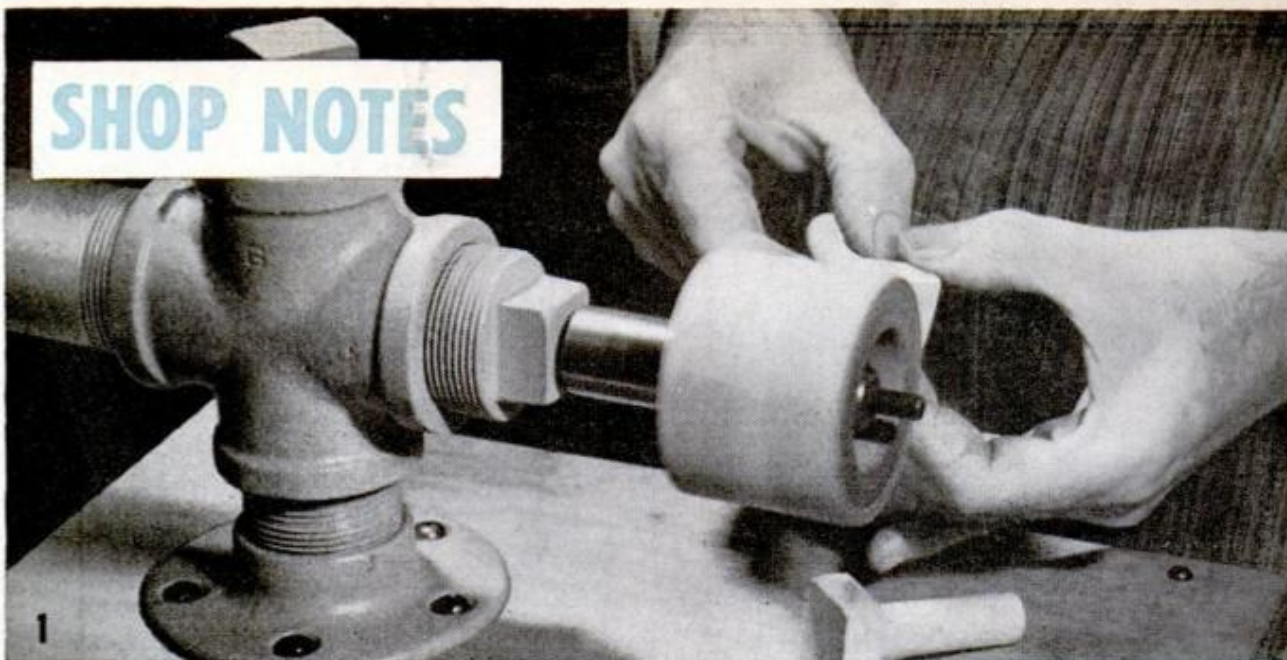

BUILDING A LONG-ARM

By Walter E. Burton

LONG-ARM BUFFERS handle those large and odd-shaped workpieces whose centers cannot be reached with regular polishing equipment. Small shops having only occasional use for a buffer of the long-arm type can make a single or double-arm unit easily by using parts and materials which are readily obtainable. Although a unit with only one long arm will serve for almost all ordinary applications, there are some types of work that can be done better and faster with a double long-arm unit. A wire wheel or a fiber-bristle wheel can be mounted on one arm while the other carries a cloth buffing wheel. This arrangement permits the operator to clean and polish a single workpiece

without changing wheels or stopping the machine.

The single-arm buffer pictured and detailed also can be made in the double-arm type, although single-arm construction permits use of both ends of the spindle as in Figs. 1 and 3. If desired, the unit can be assembled with two long arms of equal length. The only problem in making the double long-arm job is that of aligning the shaft in ball bearings mounted in pipe fittings. With care this can be done satisfactorily.

The frame of the unit is assembled as in Figs. 2 and 5, the latter a sectionalized view showing all parts in position. It should be remembered that there are

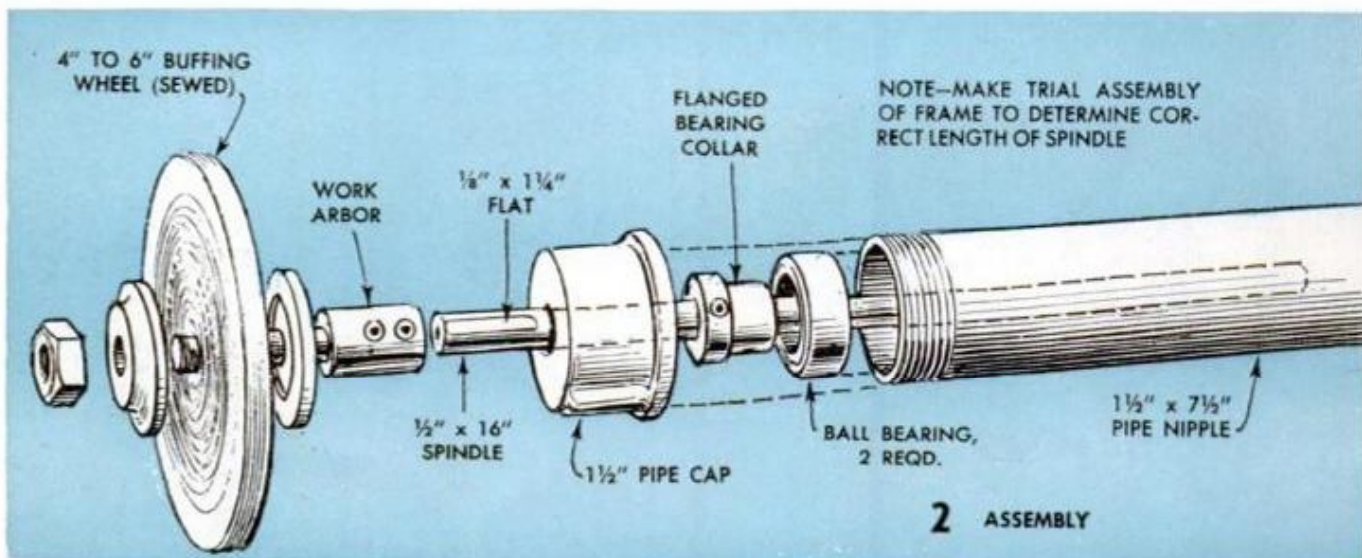

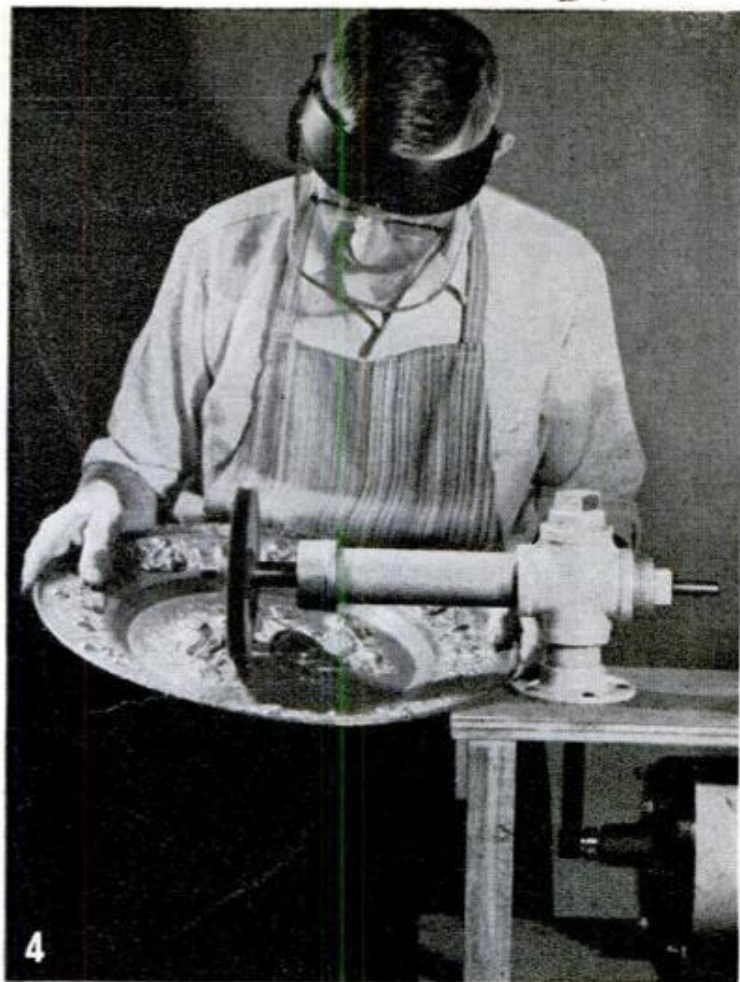
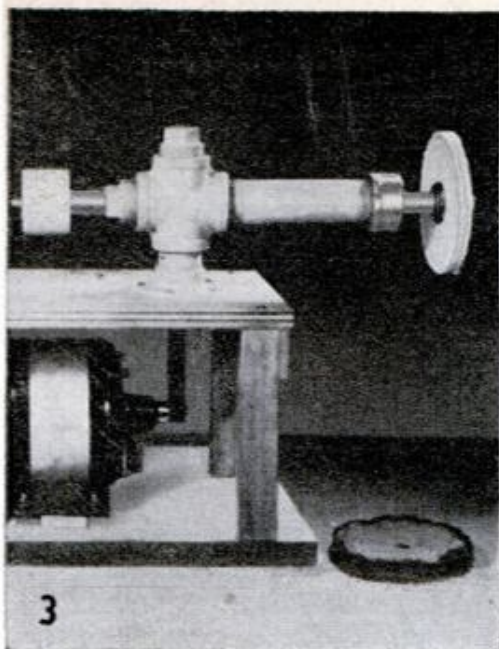

BUFFER

Above and at the right you see the long-arm buffer mounted on its bench-type base. Note that the reach of the long arm permits working to center of a large workpiece without interference from arm or base of machine. As a precaution, always wear a face shield when buffing or wire-brushing

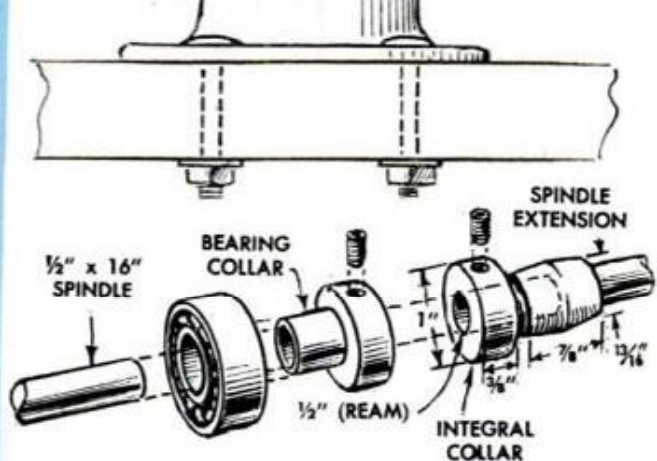
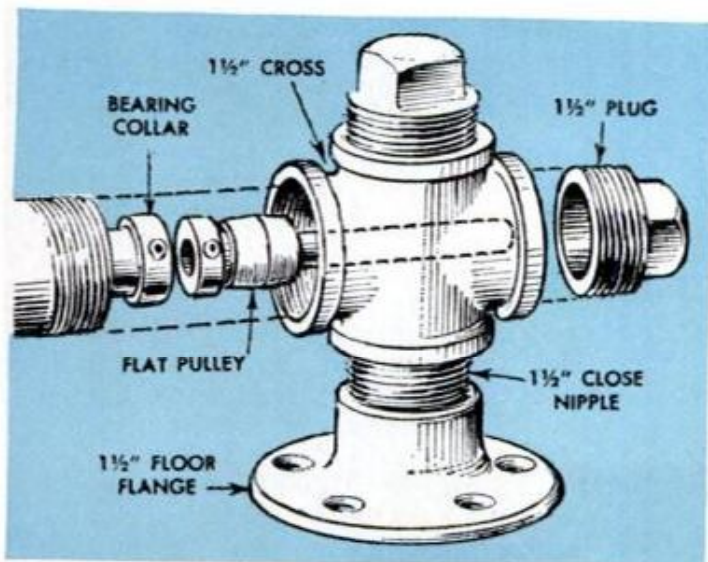
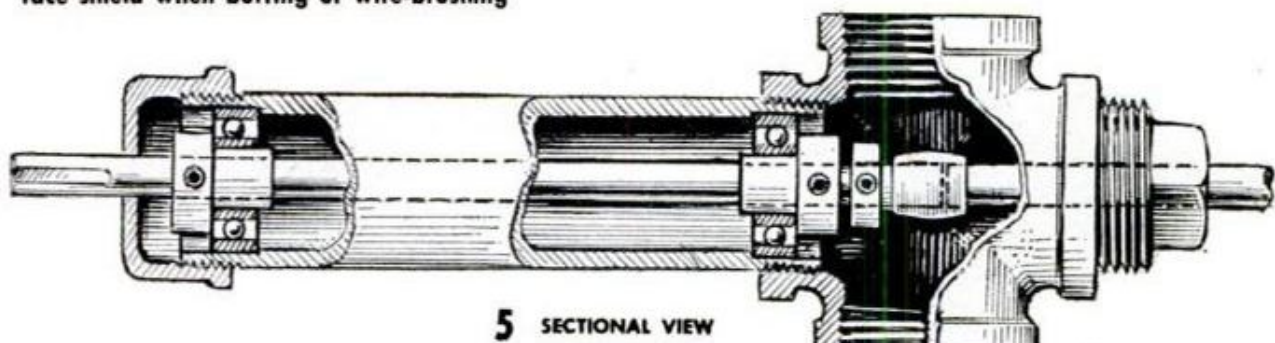

6 SPINDLE ASSEMBLY AT PULLEY END

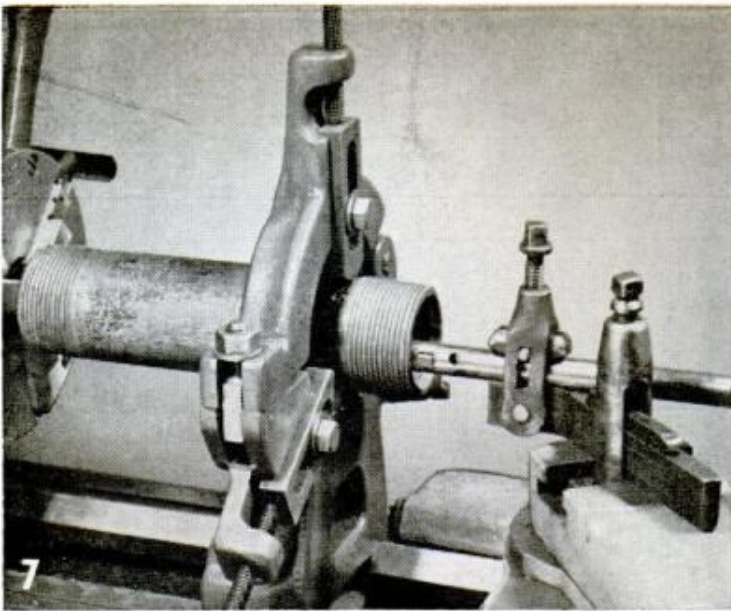

7
Ball bearings carrying the spindle are mounted in a pipe nipple. In some instances it may be necessary to machine the ends of the nipple in order to provide a suitable seat for bearings

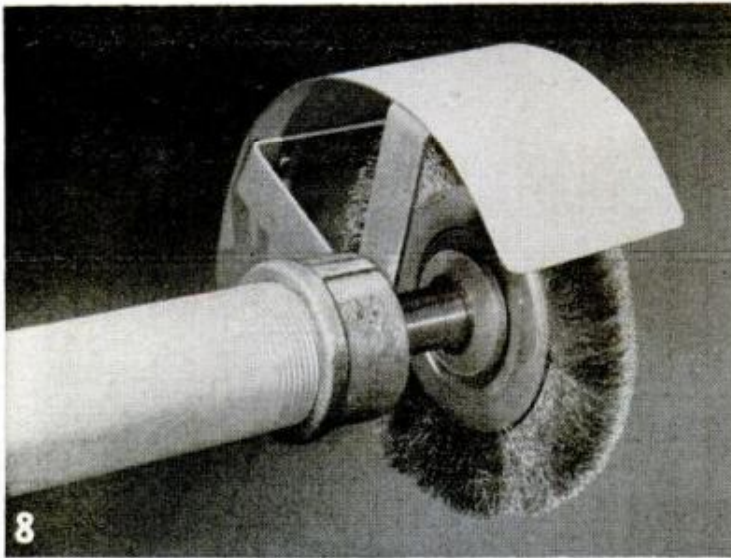

8
Above, if you don't have a face shield, then the wheel always should be guarded. Make a guard by riveting sheet metal to L-shaped brackets and attaching to pipe cap with small screws turned into holes drilled and tapped in the cap. Below, bearings are carried on flanged collars setscrewed to spindle

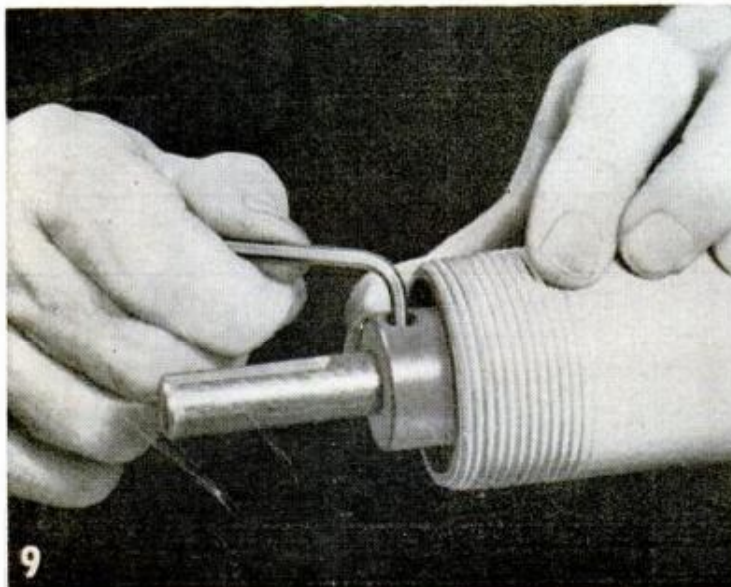

9

allowable variations in sizes of standard steel pipe and fittings. These variations may make it necessary to bore out the inner ends of the nipple which forms the long arm in order to form suitable seats for the outer races of the ball bearings, Fig. 7. Flanged bearing collars setscrewed to the shaft carry the inner races of the ball bearings as in the sectional view, Fig. 5. This type of assembly permits tightening the flanges against the inner races of the bearings (preloading) to prevent any end play or looseness, Fig. 9. The shouldered diameters of the bearing collars are machined sufficiently close to provide a light press fit of the collars in the inner races. This will assure that the races rotate with the collars.

Note in Fig. 6 the spindle assembly at the pulley end. The pulley is crowned for a flat belt and is machined with an integral collar. The collar end of this assembly, which also includes an integral spindle extension, is bored to take the end of the regular spindle. At this point it should be noted that, although the details show the frame assembled entirely from 1½-in. pipe fittings, you can use a larger pipe cross, floor flange and close nipple to obtain more belt and pulley space if desired. The 7½-in. nipple which forms the long arm can then be screwed into a reducer which has been turned into the pipe cross.

Wire wheels and cloth buffing wheels, or buffs as they are often called, are mounted on a work arbor, Figs. 2, 3, and 4. This is an accessory item available ready-made at a very nominal cost. The sleeve of the arbor is setscrewed to the buffer spindle, the setscrews bearing on a flat filed or milled on the end of the spindle as in Fig. 2.

Figs. 3 and 4 show the type of base which was designed for mounting the original buffer unit. It's a simple affair consisting of a plywood top, base and supporting posts. The motor is mounted under the top and drives with a short, flat belt. When using the buffer either wear a face shield as in Fig. 4, or provide a wheel guard as in Fig. 8. The guard should cover at least half of the wheel circumference. ★ ★ ★

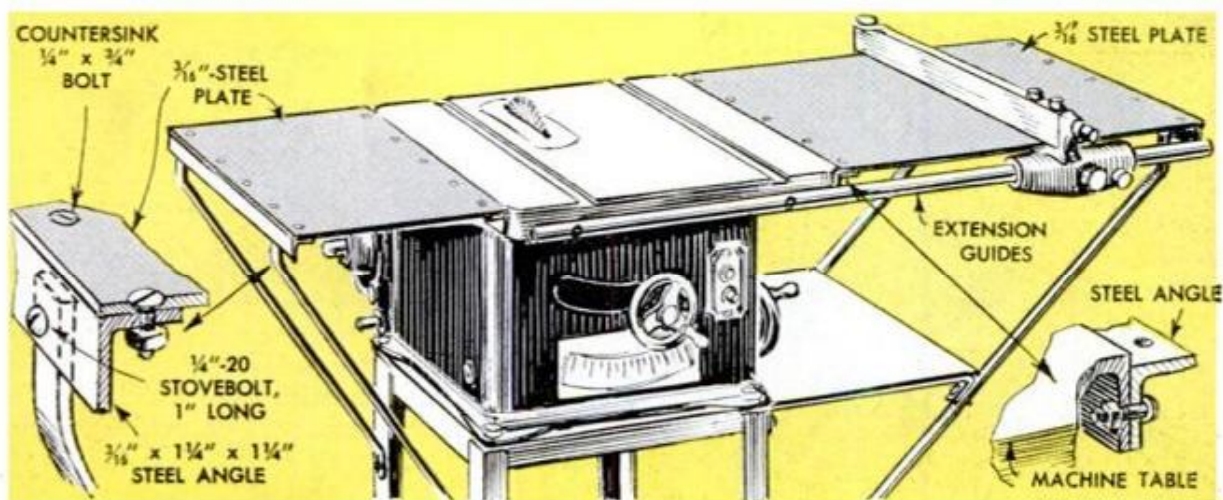

Table Extensions DOUBLE WORK RANGE OF BENCH SAW

BIG-SAW output from a small bench saw usually can be had simply by fitting the small machine with table extensions. Many of the older bench units were not equipped with tables having milled edges for attachment of table extensions, or wings, but generally it is possible to bolt small steel angles to the edges to support extensions

made of flat steel. The detail below suggests one way in which this can be done. No over-all dimensions are given as the extensions, guides and supports must be adapted to the individual machine. Bracing must be worked out which will maintain the extensions rigid and level.

Floyd D. Aldrich, Chicago, Ill.



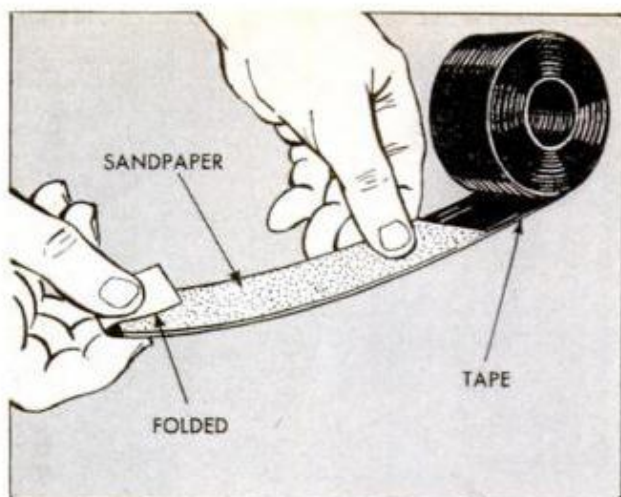

Use Tape to Back Sandpaper

When cloth-backed sandpaper is not available for sanding turnings and other lathe work, you can substitute plastic or cellulose tape as a good supporting material. Simply cut the sandpaper in strips and press them onto lengths of tape. Then fold the tape over to secure the ends of the paper and provide finger grips. Where the tape is too wide to sand intricate turnings it is simple enough to cut the tape into narrow strips after the sandpaper is applied. Extra strips can be made up with various grades of abrasive attached.

Daniel Bousha, Jackson, Mich.

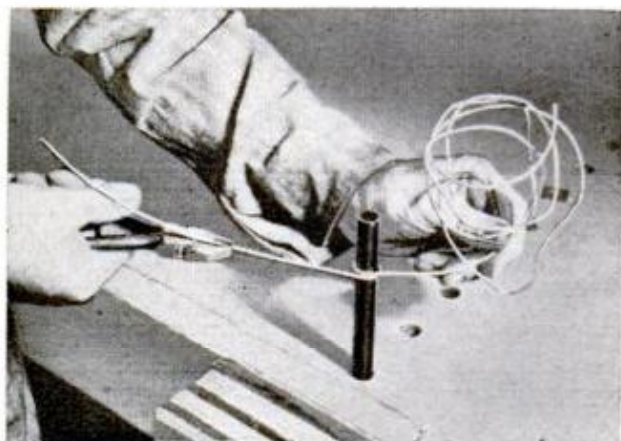

Straightening Kinked Wire

It's easy to straighten out those kinked pieces of wire—just draw them around a mandrel. This tool is a short length of iron pipe or a steel rod. Fasten the mandrel in a vise, or stand one end in a bench hole. Loop the wire around the pin and grasp the end with pliers. Draw the wire straight with a steady pull. To straighten wire of large diameter, use a correspondingly larger pin.

Wayne Judy, International Falls, Minn.

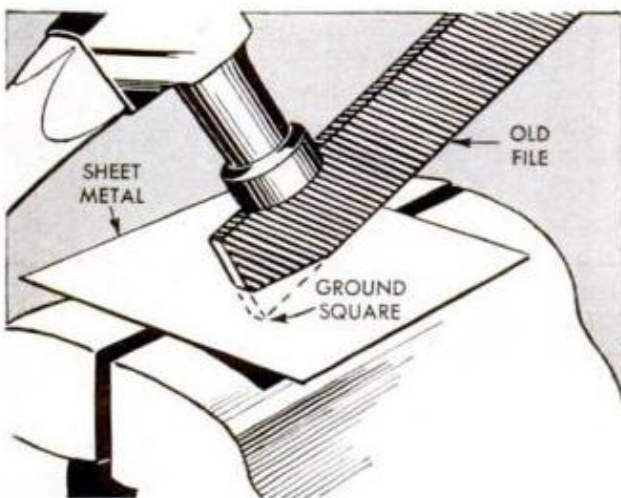

How to Slot Sheet Metal

To cut slots in sheet aluminum and other light-gauge metals, use a vise and an old file or a power hacksaw blade the thickness of the desired slot. Grind a flat, square corner on the cutting tool. Then set the jaws of the vise to just clear the tool. Position the cutting tool so the squared corner will pass through the sheet metal and between the jaws of the vise. Tapping the file with a hammer produces a shearing action through the metal. Snip off the waste at the end of the slot.

Norman W. Byrne, Hamilton, Ont.

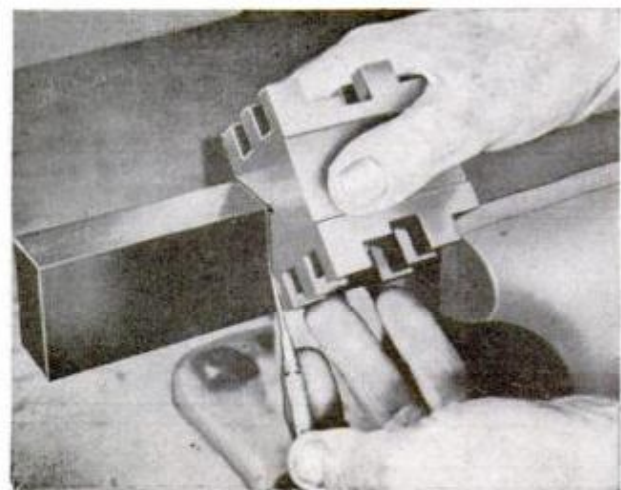

Scribe Angles With "V" Block

A precision V-block is superior to a machinist's square for scribing coincident lines across two adjacent surfaces of rectangular or square bar stock. First, make sure the V-block is seated against the two surfaces to be marked; then scribe the two lines as shown. When laid out with such a precision tool, the lines can be drawn accurately at right angles to the edges of the stock. The resulting lines on the four faces of the work will coincide perfectly with each other.

H. J. Gerber, Stillwater, Okla.



FARM-BUILT TOOLS SPEED HAYMAKING

IN HAYMAKING it's the handling that takes the labor and time. Farmers can make use of these shop-made helpers to lighten the work load and speed the handling job when every minute counts. Above, for example, you see a bale drag that brings the bales from the elevator back into the mow. Bales can be picked off the drag at any point for storing. The grapple fork pictured at right has its tines altered to a sharper angle so that it will pick up bales as well as loose hay. Operated from a carrier the fork is set and tripped in the conventional manner. A drawbar attached to the tractor mower, below, pulls a side delivery rake or a trailer. The belt tightener shown below at the right can save time at the bale elevator.

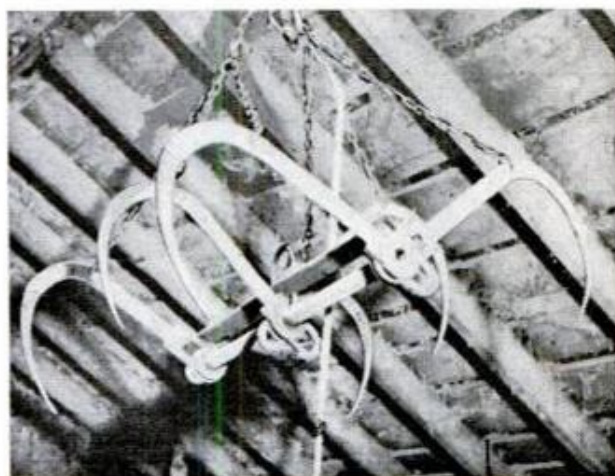

A grapple fork on carrier is sometimes used to get baled hay into mow. Fork tines are altered to grip bales

Special drawbar on tractor mower pulls a trailer to or from field, or a side-delivery rake behind mower



Adjustable belt tensioner saves time at the bale elevator. This one is shop-built from farm-machine parts

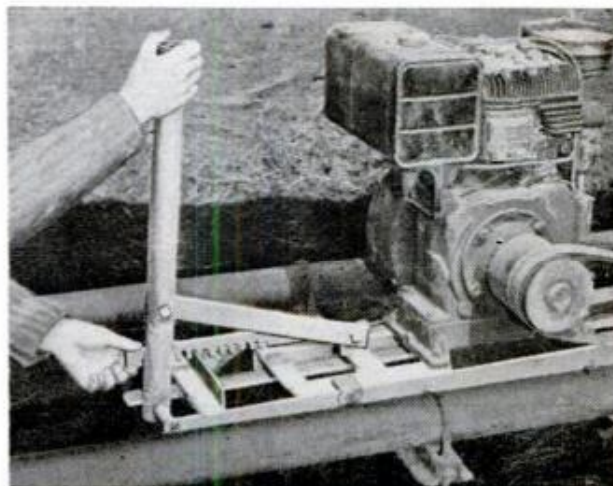

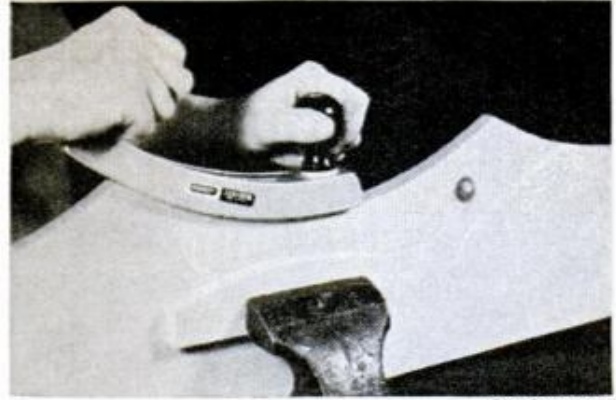

Stanley photos

Above you see the convex surface-forming tool being used like a hand plane on the curved edge of the scroll which has been rough-cut in wood and is being smoothed with a few strokes of the new forming tool

At the left you see the same forming tool working on a metal surface. This time it's used to smooth the repair job on an auto fender and it's being handled much as you would a plane or conventional body file



The straight forming tool can be used on metal or wood simply by changing the blade. Blades, or shoes, are available for work on flat or concave surfaces

Here's a block plane with more than a hundred blades, each having a beveled cutting edge. As you can see, it's block-plane size and is designed for one-hand use

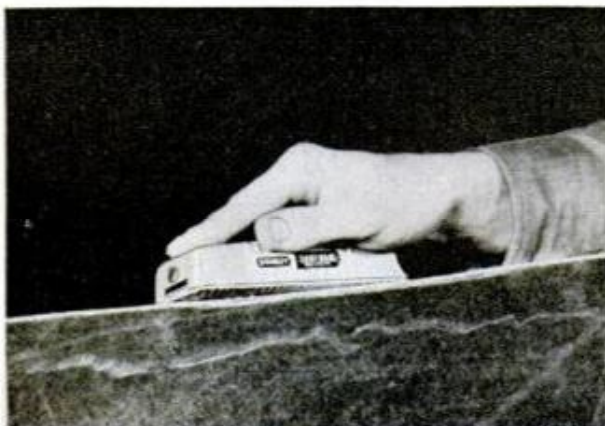

NEW RASPS

ALTHOUGH THESE surface-forming tools are designed to work in a manner similar to rasps, planes and sanding drums, their cutting action is a departure from that of the conventional tools. Each of the new tools is fitted with a detachable blade, or shoe, one face of which presents hundreds of individual, chisel-like cutting edges to the surface of the work. On all the different types of blades available, these cutting edges are staggered so that they do not track, and also are formed at an angle so that each makes a shear cut. Each cutting edge has its own chip-clearance opening, a provision which prevents clogging when working either wood or metal surfaces.

Two-blade patterns are standard. The regular cut is designed for fast removal of stock from the softer materials such as hard and soft woods, composition boards, asphalt tile and plastics. The second, or fine-cut, pattern works metals, ceramics, plaster and other hard and brittle material. Fine-cut blades take only half the bite of the regular type. Both regular and fine-cut blades are specially hardened to retain sharp cutting edges for long periods.

Note in the illustrations of the various tools at work that they can be used on convex, flat and concave surfaces, and also inside small openings. Due to the novel cutting action and automatic depth control, the tools are equally effective when hand and power operated. ★ ★ ★



Above, this form of the tool uses a flat blade and is handled just like the conventional jack plane. Of course, it can be used on wood or metal by changing the blade. Here the tool is used to bevel plywood

Right, rasp-type tool being used to ease a tight-fitting door, one of the many uses of surface-forming tools around the home. Myriads of tiny blades having beveled cutting edges remove stock rapidly



SHAPE WOOD AND METAL

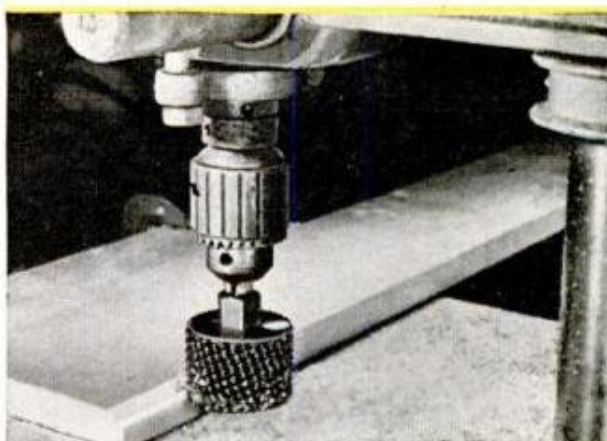

Two views of the rotary surface former give you an idea of how it works when power-driven in a drill press or by a portable electric drill. Tool consists of a multi-edged blade 2 in. in diameter attached to an adapter having a 1/4-in. shank for use in 1/4-in. portable drills. Cuts smoothly and exceptionally fast

Surface-forming tools will cut almost anything. Below you see the round rasp, or file, being used to enlarge a hole in a brick and for cutting half-round scallops in the edge of a board. On this tool the cutting edges are curved so that they cut cleanly, without leaving ridges or offsets on the curved surface of the work



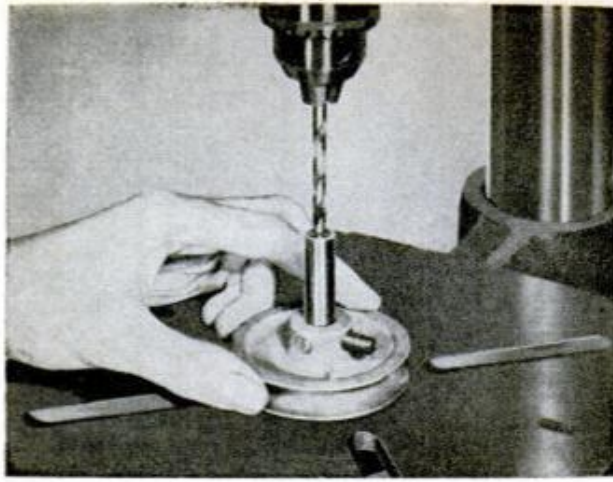

Pulley Hub Holds Round Stock

Without a suitable drill vise, center-drilling round stock poses the problem of improvising a method of holding the workpiece vertically and centering it under the drill bit. An ordinary V-pulley having a bore diameter near that of the workpiece will serve the purpose almost as well as a drill vise with a veed jaw. Place the pulley on the drill table with the extended side of the hub up. Drop the work into the bore, tighten the setscrew lightly and there you are. Best pulleys for the purpose are those made from cast iron. These have machined rims and accurately bored hubs.

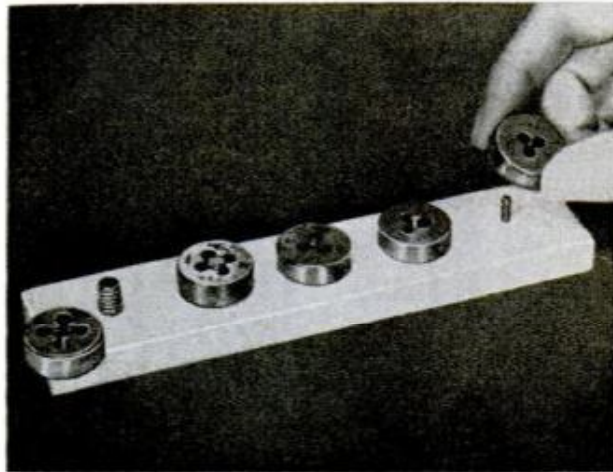

Rack Protects Split Dies

Split dies, or button dies, stored in a drawer with other tools are likely to be damaged and possibly lost. The simple rack pictured takes less time to make than any compartmented case and is just as effective. Line up the dies to be stored side by side, add an inch or more and you've got the length of the block needed. Cut it from $\frac{1}{2}$ -in. hardwood and drill spaced tap holes along the length. Then thread a short length of rod with the die to be stored and turn the threaded rod into the tap hole in the block.

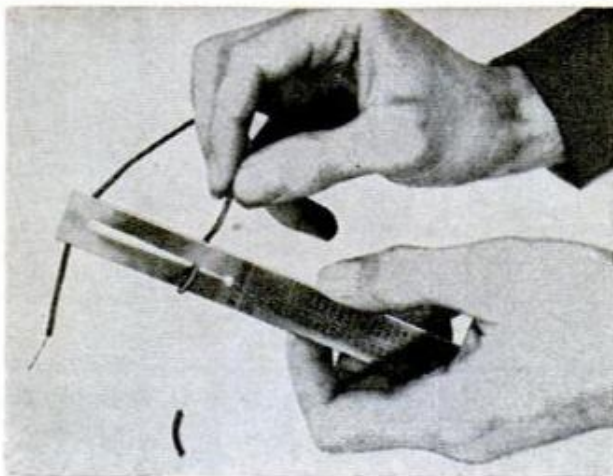

Rule Used as Wire Stripper

A steel rule of the type having a wire-gauge slot makes a good wire stripper for small-diameter insulated wire of either the solid or stranded type. To use, the wire is forced into the slot, given a half turn, then bent upward at the point where it enters the slot. A sharp, upward pull on the wire strips off the insulation neatly and cleanly without tearing or stretching. By filing the edges of the slot at a bevel to form cutting edges you also can strip insulation having a braided fabric covering. Filing the slot may tend to affect its accuracy when used as a wire gauge.

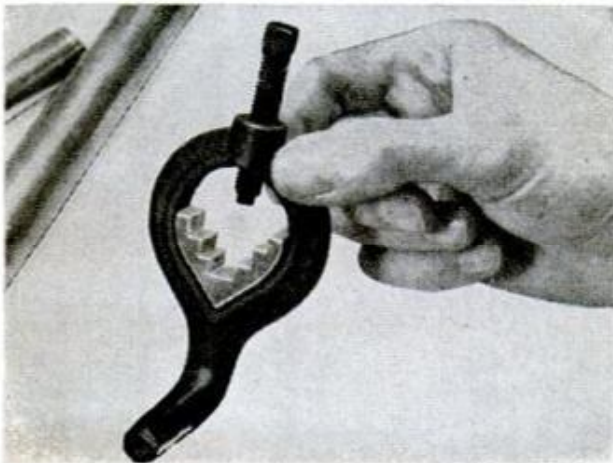

Lathe-Dog Insert Grips Work

If the lathe dog slips when you're cutting a thread, the workpiece, in most cases, will be ruined entirely. To guard against this possibility and to insure that the dog won't slip under any reasonable load, make and fit a steel insert as pictured. Mill or grind and file to the stepped form indicated and harden so that the sharp edges of the steps, or jaws, will bite into the workpiece when the screw is tightened. This gives the dog the holding power of a pipe vise and assures a positive drive.—R. Hanscom, Elmhurst, Ill.

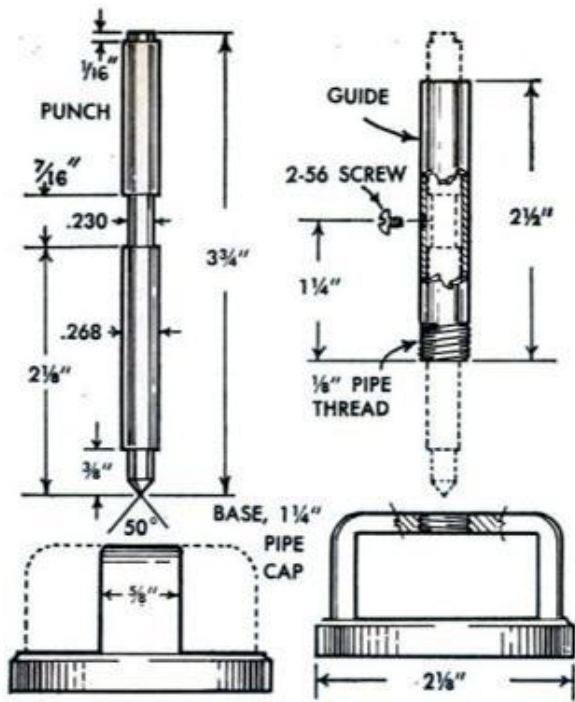

GUIDED PUNCH FOR ACCURATE LAYOUT

A guided punch, or toolmaker's punch as it is sometimes referred to, is preferred by many shop men for accurate layout work. This one is made right in the shop using a short length of steel or brass pipe for the sleeve-type guide and a steel pipe cap as the base. The punch is machined from a length of drill rod and hardened. The guide is reamed and the body of the punch is ground to provide a smooth, sliding fit. If steel pipe is used for the guide,

the body dimension of the punch may have to be varied slightly from that given as there are allowable variations in pipe sizes. For this reason brass pipe is to be recommended for the guide. To form the base, the pipe cap is machined all over. Then the section of the cap above the flange is cut away to form a bridge which is drilled and tapped to take the guide. When threading the end of the guide take special care to start the die accurately.

Improvised Ring Compressor

Should you need a piston-ring compressor in a hurry you can make this one in about 10 minutes. And it works perfectly. All you need is a strip of sheet metal (a strip cut from a No. 10 can will do) and a 1-in. hose clamp. The detail shows how to assemble these parts.—Guy R. Cantrel, Apache Jct., Ariz.

Chip Guard for Saber Saw

Portable jigsaws, or saber saws, cut on the upstroke and when working metal the fine chips are thrown upward with some force. If you don't have a face shield, take time to fit the saw with a clear-plastic guard as pictured. It's good insurance against eye injury.—Russel E. Cline, Sacramento, Calif.

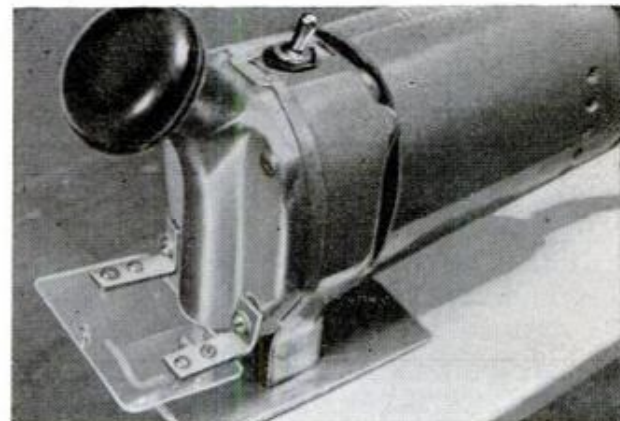
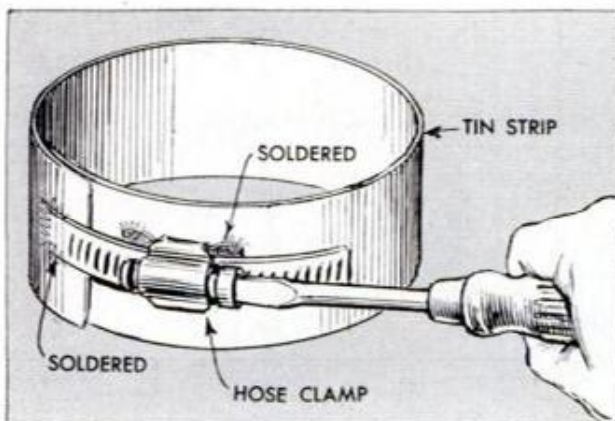

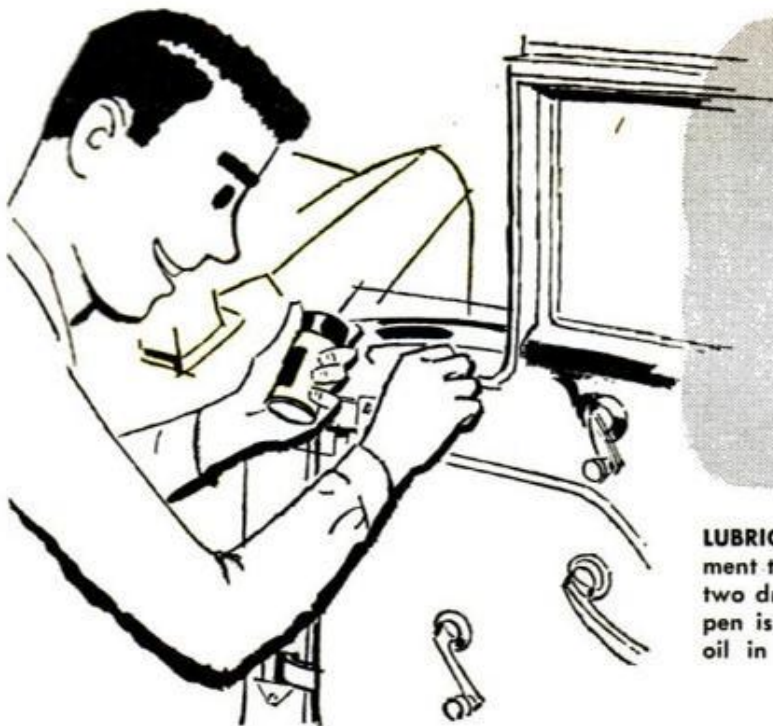

RUBBER CAR-DOOR GASKETS are dusted with tire talc to keep them from sticking to car body. Apply powdered graphite to door latches and wipe trunk gaskets with glycerin or glycol-base antifreeze during the cold months to keep rubber from freezing to the gutter

PASTE WAX wiped occasionally on a steel tape permits it to be pulled out and recoiled easily, and it protects painted calibration marks. Coat of same wax applied to plane or scissor's blades prevents rust



V-BELT SQUEAKS may be silenced by rubbing the veed surfaces with soap. When a belt creates static electricity that causes radio interference, wax and dust wear surfaces lightly with powdered graphite

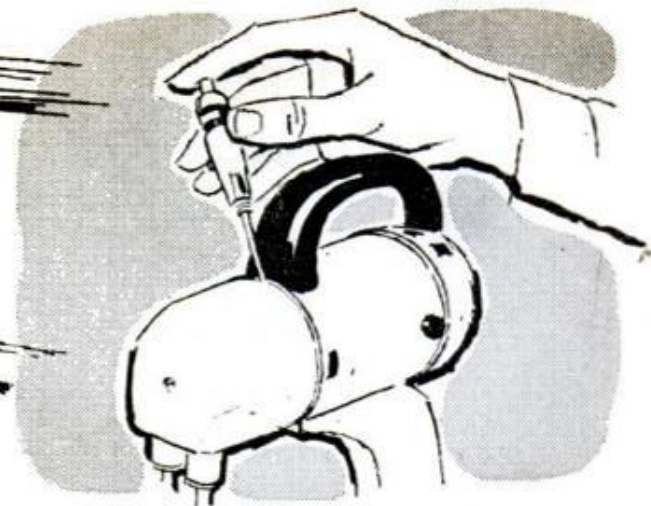
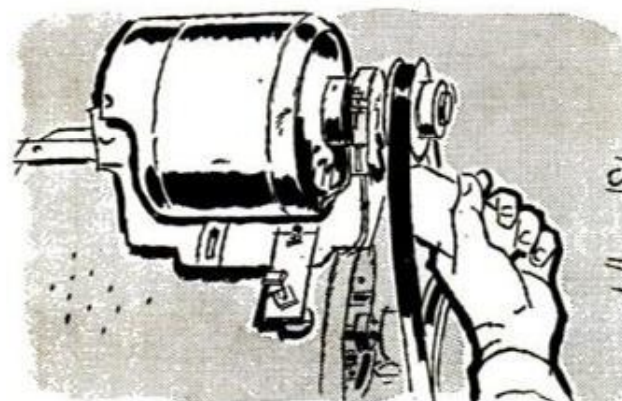

LUBRICATE most motor-driven household equipment twice a year, applying no more than one or two drops of light machine oil each time. An oil pen is handy for depositing the right amount of oil in tiny lubrication orifices on small motors

Tips

GREASE, OIL and other types of lubricants not only stop squeaks in the bearings and other wear parts of home appliances but help to keep them in good running order as well, when serviced periodically. The type of lubricant you should use depends upon the function of the device, or part of it, and its operational speed. But don't wait for squeaks to develop. Make a list of the appliances and keep lubrication dates with them.—Joe W. Rocke, Huron, S.D.

GEAR BOXES of portable power tools should be cleaned and repacked regularly, using multipurpose grease or lubricant specified by manufacturer. Oil armature bearings with lightweight motor oil



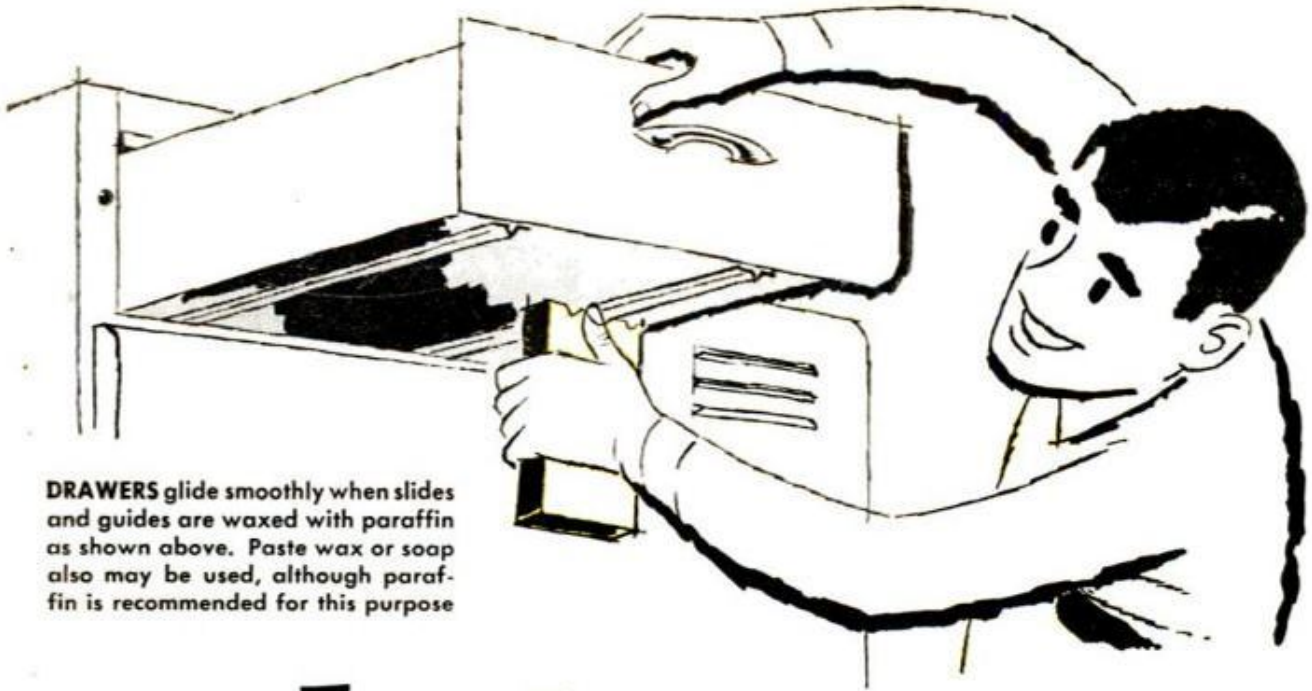

DRAWERS glide smoothly when slides and guides are waxed with paraffin as shown above. Paste wax or soap also may be used, although paraffin is recommended for this purpose

on Lubrication

BEARINGS on home-shop machines should be washed with solvent and repacked periodically, more often if given hard usage. Use long-fiber wheel-bearing grease for car wheel bearings, soft grease or heavy motor oil for high-speed bearings in light-duty machines

GREASE THREADS on spark plugs before installation to prevent them from becoming rust-seized in the holes. Since engine heat will cook out ordinary grease, use commercial antiseize compound available at most auto-supply stores, or make your own by mixing powdered graphite with pressure grease. Apply the mixture sparingly so as not to foul the electrodes

LUBRICATE BEARINGS on portable electric fans with a few drops of light machine oil two or three times a season, depending upon use. Soda straw slipped on oil-can spout provides flexible extension for filling oil cups located in difficult-to-reach places

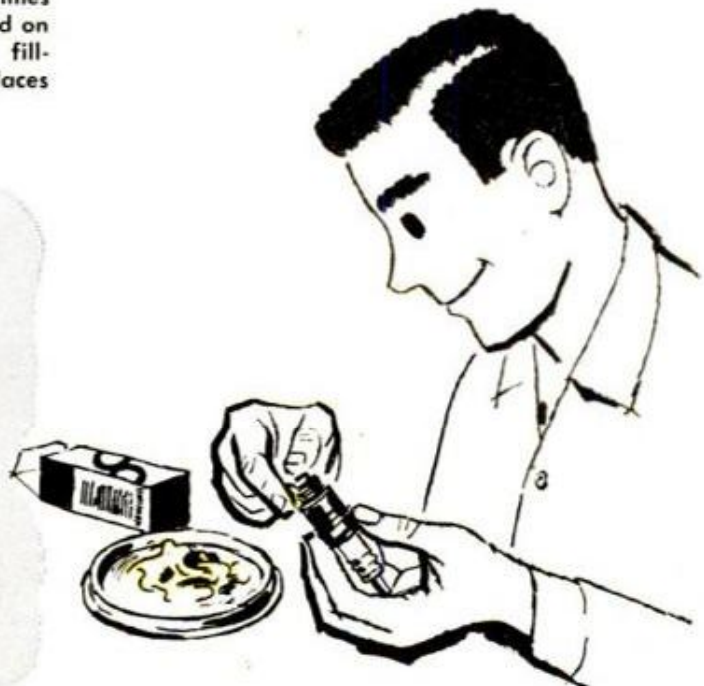

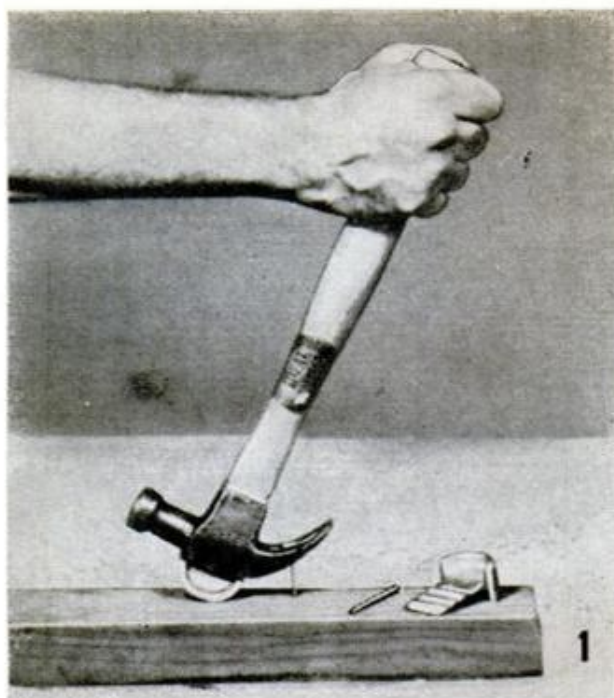

1. HANDLE LOCKING WEDGE

1. HANDLE LOCKING WEDGE includes a fulcrum for lifting and pulling nails without bending. Half-round curve of wedge is polished to prevent it from marring finished surfaces. Designed to replace standard handle wedge in hammers with wood handles, it has the same wedging action in holding the handle in the tapered eye of hammer head as does regular wedge

Specialty Sales Co., 8011 $\frac{1}{2}$ Houston St., Arlington, Tex.

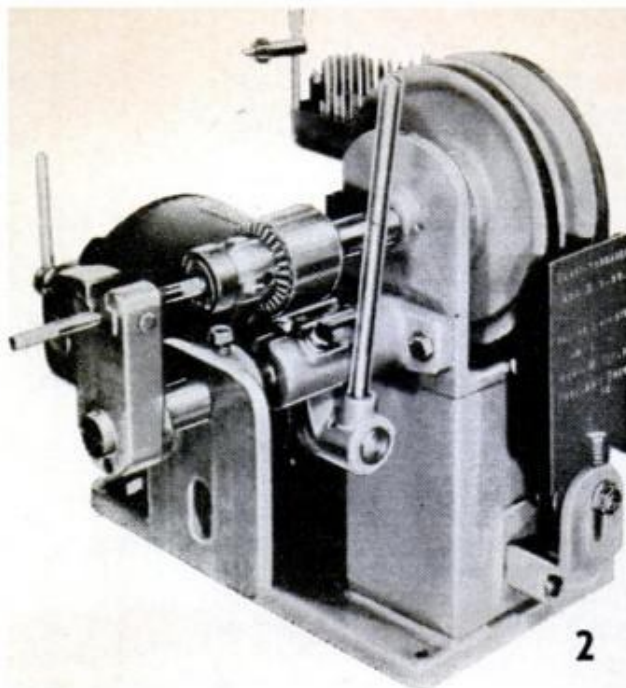

2. HAND-FEED POWER THREADER

2. HAND-FEED POWER THREADER for tapping and cutting external threads also performs other production jobs such as undersizing of threads to be electroplated, chamfering, deburring, countersinking, stud threading, reaming and spot facing. Designed exclusively for hand feeding of work which enables operator to control feeding rate throughout each operation

Sens-Threader Sales Co.,
4820-49th Ave., S.W., Seattle 10, Wash.

3. CUTTING WHEEL performs the same work on non-ferrous metals as an abrasive wheel and does it faster, smoother and without clogging. Especially effective on lead and soft aluminum. Wheels are made of hardened steel with faces and edges indented in a random pattern, each indentation producing a curved cutting edge which gives a shearing cut. Available in various sizes

Schmidgell Mfg. Co., 307 Cass St., Peoria 2, Ill.

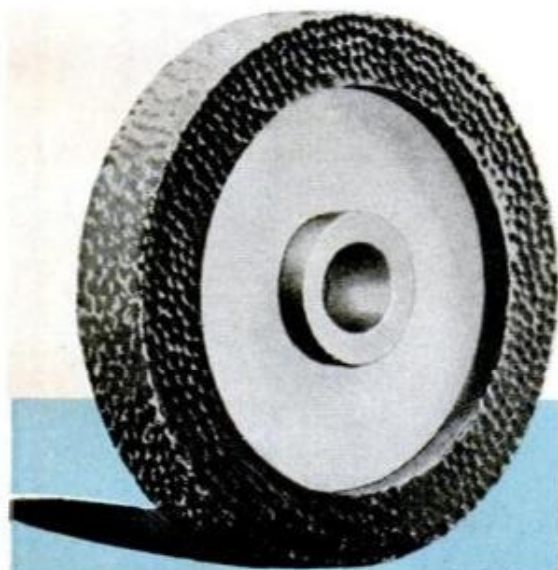

4. CARPENTER'S PLANE in a new simplified design features a four-edged disposable blade and an aluminum frame which is exceptionally light and easily controlled. Accurate adjustment of the cutter permits lifting shavings from tissue-thin to coarse on hard and soft woods. Special four-edged blade is factory-sharpened and is easily turned to present a new cutting edge

Sears, Roebuck & Co., 925 S. Homan Ave., Chicago 7, Ill.

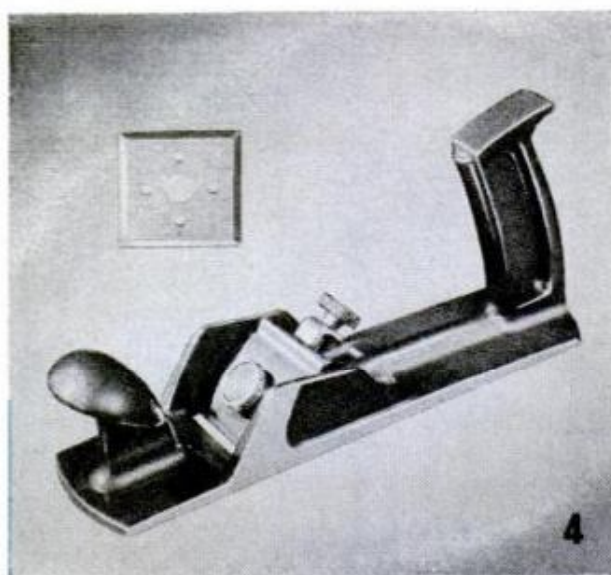

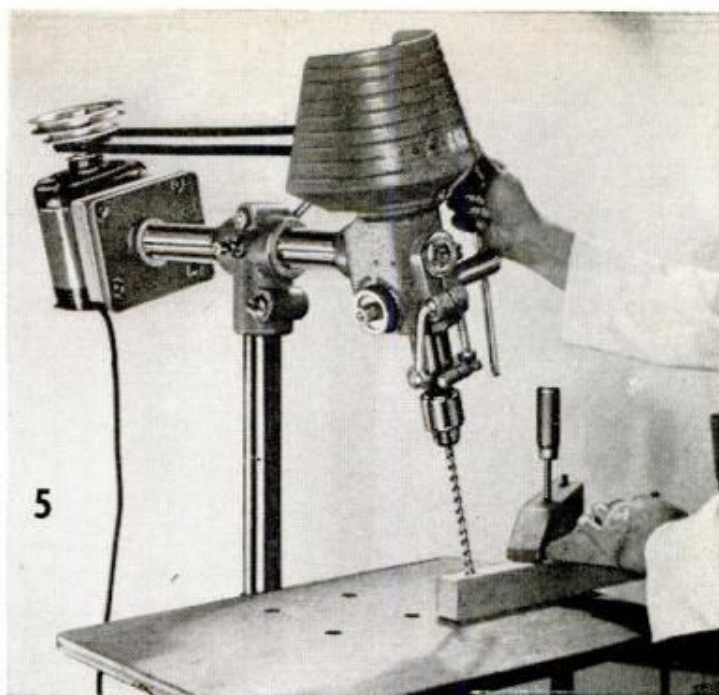
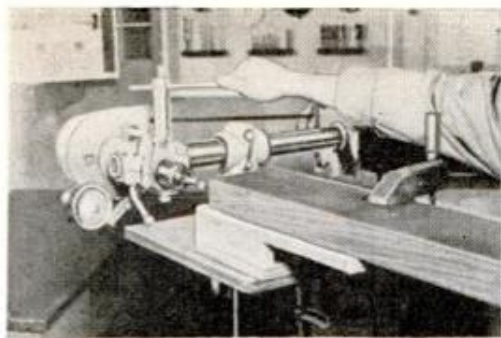

5. RADIAL DRILL PRESS does just about any drilling operation that can develop in a small shop. The head tilts, swings right or left in relation to the work, rotates about a center and can be moved outward far enough to work at the center of a 32-in. panel. Has choice of four speeds, 700, 1250, 2400 and 4700 r.p.m.

Delta Power Tool Div., Rockwell Mfg. Co.,
465 N. Lexington Ave., Pittsburgh 8, Pa.

6. STEEL BRIDGING snaps in place, without cutting and without nailing. Its use stops squeaks in old floors, reduces installation time on new construction. Made of metal, bridging can't loosen after installation due to warping or shrinkage. Metal is plated to prevent rusting. Widely used by home builders

Taber-Bushnell Co., Metropolitan Bldg., Minneapolis 1, Minn.

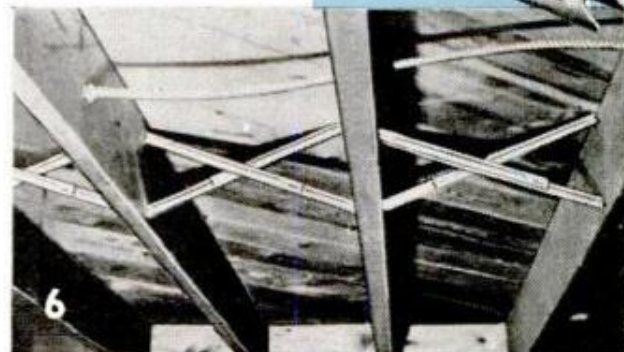

7. EXTRACTOR has been designed for removing Type S fuse adapters quickly and without damage to fuse block or Edison base screw shell. Tool is a time-saver for servicemen in the electrical and maintenance fields. Small enough to fit in any tool kit or can be carried in pocket. Full instructions are included

Trico Fuse Mfg. Co.,
North Fifth at West Chambers, Milwaukee 12, Wis.

8. DRILL PRESS is equipped with a six-station turret taking tools for performing six different operations on a single workpiece. There are two speeds for each spindle. Also has a built-in power indexing mechanism giving progressive sequence. Spindles are mounted on ball bearings and have overload clutches

Burgmaster Corp., 13226 S. Figueroa St., Gardena, Calif.

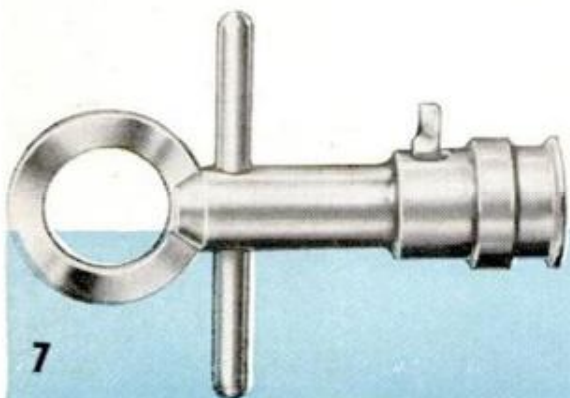



9. RACE-WINNING ENGINES for power carts are available in several models and displacements which qualify for Class A and Class B competition. Engines are fuel-lubricated and have chrome-plated cylinder bores. Series 580 is available in standard and deluxe models, standard model having a float-type carburetor and deluxe model comes equipped with a diaphragm-type carburetor. All engines have recoil starters
 Industrial Engine Div., West Bend Aluminum, Hartford, Wis.

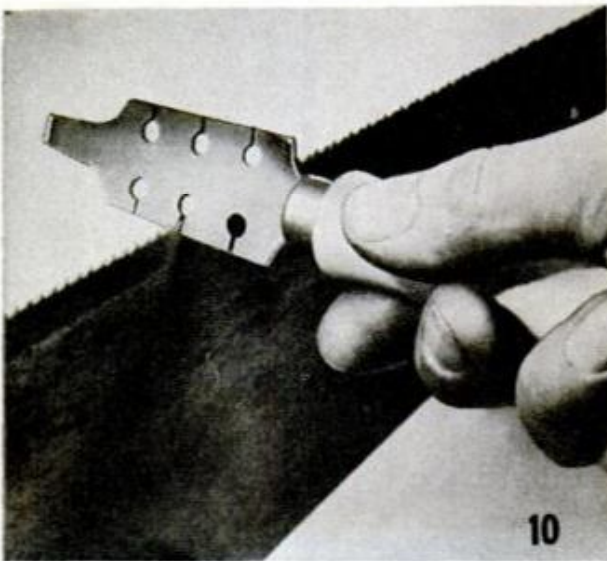

10. SAW SETTER has been designed especially for setting the teeth of handsaws of both ripping and crosscutting types. Consists of a handled blade having six slots, each of a different width to fit handsaw blades of varying gauges. To use, simply select a slot of a gauge equal to gauge thickness of blade, place slot over tooth and lift upward on handle. This action bends, or sets, each tooth
 Industrial Products Sales Co., 1182 Broadway, New York, N. Y.

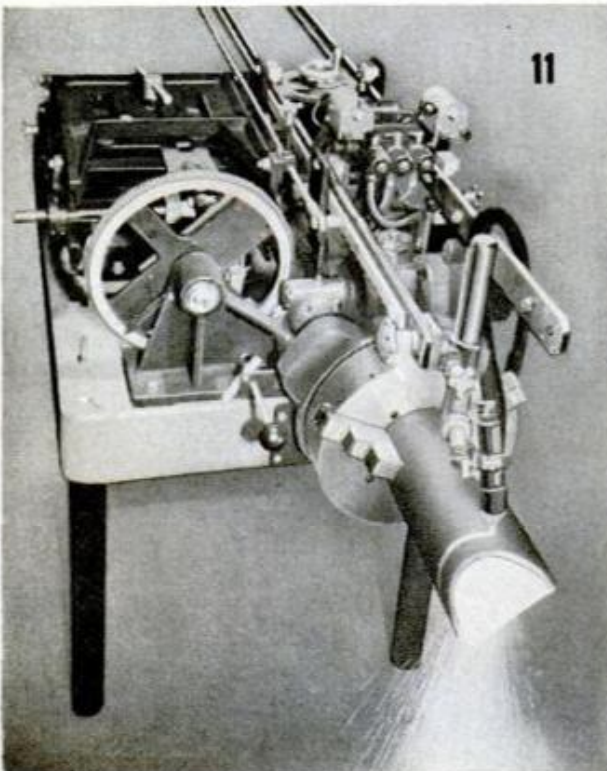

11. AUTOMATIC CONTOUR CUTTER eliminates templates, layouts and patterns when joining pipe or fabricated parts. Cutting head can be equipped with special gas torches for cutting carbon steel, stainless steel, copper, aluminum, magnesium and cast iron. Pipe to be contoured is clamped in 3-jaw chuck, an electronic controlling mechanism is set to produce desired contour. Machine is then activated by pushing button
 Steffan Mfg. Corp., 276 S. Lincoln St., Salem, Ohio

12. OUTSIDE MICROMETER has blade-type anvil and spindle for measuring diameters at the bottom of narrow grooves and other inside diameters where mikes with standard spindle and anvil won't reach. Otherwise instrument is standard in every way, with easy reading figures and rigid one-piece frame
 The L. S. Starrett Co., Athol, Mass.



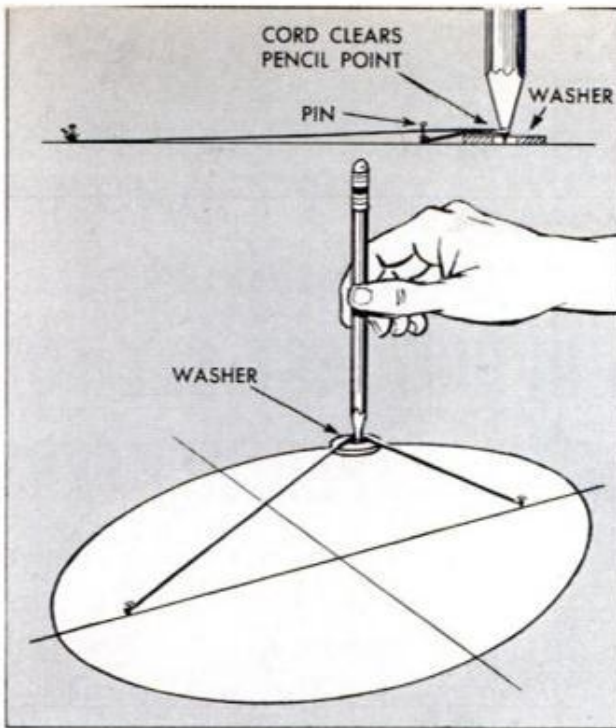

Washer Aids in Drawing Ellipse

When describing an ellipse by the cord-pins-and-pencil method it's difficult to prevent the cord from slipping under the pencil point. You can solve the problem by setting the pencil point in a small washer and then place the cord on top of the washer as illustrated.

Chucks Take Pin-End Blades

Jigsaw chucks that take both pin-end and crimped-end blades are timesavers when you're working a detailed scroll design. You can remove the blade, pass it through the starting hole in the work and replace ready to go again in seconds.

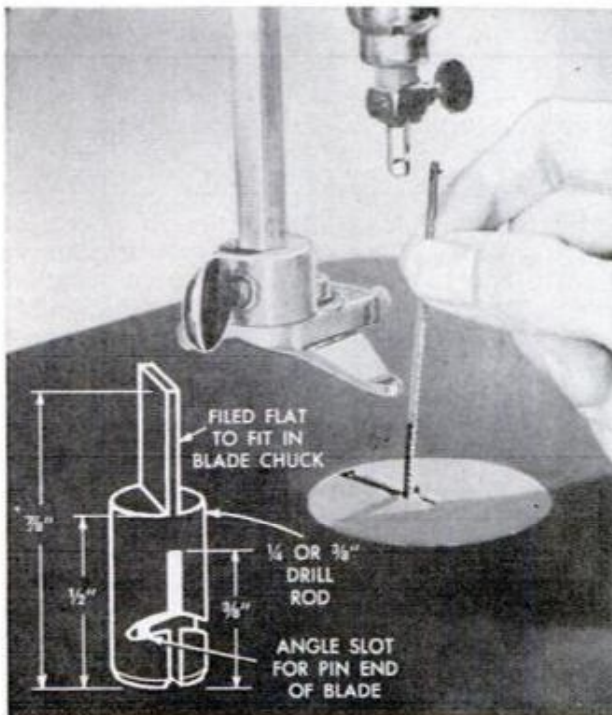

JULY 1960

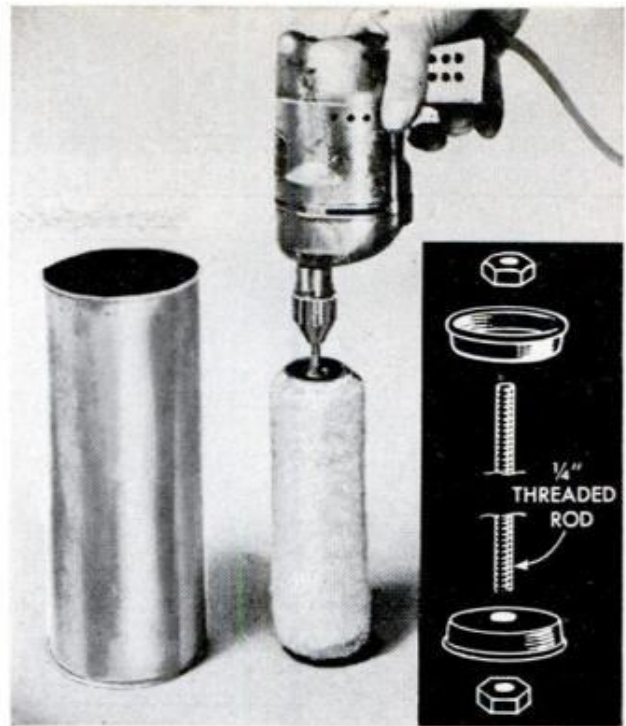

Power-Cleaning a Paint Roller

Paint rollers used with water-soluble paints can be cleaned with your portable drill. Mount the roller on a spindle made from threaded rod, chuck in the drill and insert the roller in a fruit-juice can containing water. Switch the drill on and off in short cycles until the roller is clean.

Driving Rows of Tacks in Line

There are occasions when it is necessary to drive a row of tacks uniformly spaced and precisely in line. Fold a sheet of paper, draw a pencil line if desired, press the tacks through the paper. Locate on the work and drive each tack individually.

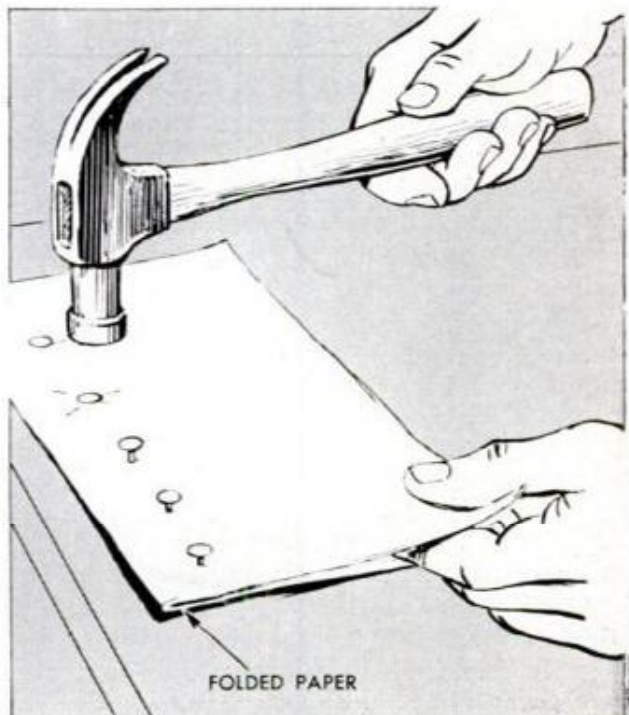

187

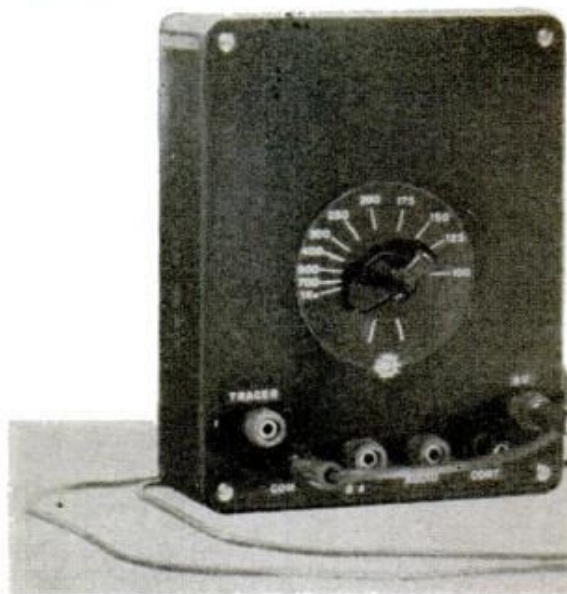

Simple and Inexpensive . . .

6-IN-ONE TEST SET FOR RADIO EXPERIMENTERS

By Otto Fried

THIS LITTLE test set won't exactly replace a shop full of elaborate test instruments, but it does duplicate some of the most-used functions of a number of them. It's easy to build, easy on the budget and easy to use. It is, therefore, a handy tool for the electronics hobbyist, basement experimenter, student, or part-time serviceman whose investment in test equipment must necessarily be limited.

Here is what it will do:

1. Measure d.c. voltages from a few volts to 500 volts. Measure a.c. voltages from about 100 to 500 volts.
2. Check parts and wiring for continuity—open or short circuits.
3. Check capacitors for leakage or short circuits.
4. Provide a test signal for checking audio stages in receivers and amplifiers.
5. Can be used as a signal tracer in r.f. and i.f. radio stages.
6. Act as a variable d.c. power supply with available output voltage from 0 to about 60 volts—for bias, a.g.c., transistor circuits or other low-current applications.

All this is accomplished with a handful of common parts, most of which are probably available from any experimenter's "junk box," but which cost less than a 10-dollar bill even if purchased brand new.

How does it work? To explain the operation of the test set, let's take a look at the simple, individual circuits which comprise the complete tester.

The simplified schematic of the voltage indicator is shown in Fig. 1. Here, the voltage to be measured is applied, via test leads connected to terminal posts J1 and J5, to the series-wired resistors R1 and R2. Because of the resistance ratio between R1 and R2, most of the applied voltage appears across the potentiometer R2. Neon bulb, P, is connected between the variable terminal and the end of R2 so that any portion of the voltage appearing across R2 may be applied to the bulb.

To fire the bulb, a voltage of approximately 80 volts d.c. is required. The bulb will light, therefore, when the potentiometer is rotated to the maximum clockwise position and the voltage under test is approximately 90 volts d.c. This, then, is the minimum external voltage that can be measured with this particular circuit configuration.

Voltages in excess of 90 volts can be measured with reasonable accuracy by rotating the potentiometer knob in a counter-clockwise direction until the bulb just goes out. The value of the voltage can then be read directly on a calibrated scale glued to the panel over the potentiometer shaft.

Precise calibration of the voltage-indicator scale would require a variable-voltage source and a vacuum-tube voltmeter. Reasonable accuracy, within about 5 percent, can be obtained merely by cutting out or copying the full-size calibrated scale of Fig. 7 and gluing it to the panel. The knob should be affixed to the potentiometer shaft so that with the pot. in the full-clockwise

position the pointer is aligned with the first reference line (the line below the "100"-volt calibration mark).

Accuracy of the calibrations can be checked by using the internal batteries. To do this, connect a wire externally between J2 and J5. Rotate the knob until the bulb just goes out. The knob should indicate 125 volts—the value of the internal batteries.

Since the bulb will light for a.c. as well as d.c. voltages, both types can easily be measured. To use the same scale calibrations, however, the capacitor C1 must be connected across the bulb. Without it, the instrument would indicate **peak** rather than **rms** a.c. voltages. Calibration accuracy for a.c. can be checked using the 115-volt a.c. line as a reference source. If the instrument indicates substantially less than 115 volts, replace the .003 mfd. capacitor C1 with a .002 mfd. unit.

Measuring Low Voltages. Voltages below 100 volts can be measured with the circuit shown in Fig. 2. In this circuit, the internal 125-volt battery is automatically connected in series with the external low voltage to be measured. The 125-volt line on the calibration scale, therefore, becomes the 0-volt point for low-voltage measurements.

When an unknown external voltage is applied between J2 and J5, and the knob is rotated until the bulb just goes out, the voltage value indicated by the pointer is that of the 125-volt battery plus the unknown voltage. The exact unknown voltage is that indicated on the scale minus 125. A second scale can easily be added for low-voltage measurements using the 125-volt line as 0, and the 250-volt line as 125 volts.

Continuity and Capacitor Checker

The circuit shown in Fig. 2 is used also for continuity tests and for checking capacitors for leakage and short circuits. In these applications, the potentiometer is set to the maximum clockwise position and the test leads connected to terminal posts J2 and J5. If the open ends of the test leads are shorted out, the bulb will glow because voltage from the internal batteries is applied to the bulb. Similarly, if the leads are connected into a circuit with less than 1.5 megohm resistance, the bulb will also light. If it does not light, the circuit is "open" or has more than 1.5 megohms resistance.

When the leads are connected across a capacitor with a value in excess of .02 mfd. the bulb will light for an instant as the capacitor charges, and then goes out. If it fails to go out, the capacitor is short circuited or has excessive leakage. Low-value capacitors, below .02 mfd., are not likely to give any charging indication. These can be checked only for leakage as indicated by a lit bulb.

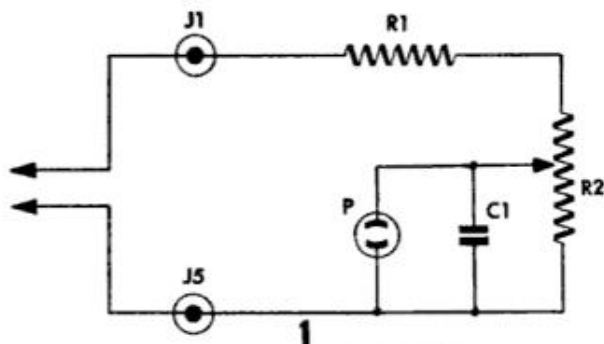

1
VOLTAGE TESTER—AC OR DC
(FOR 100 VOLTS OR GREATER)

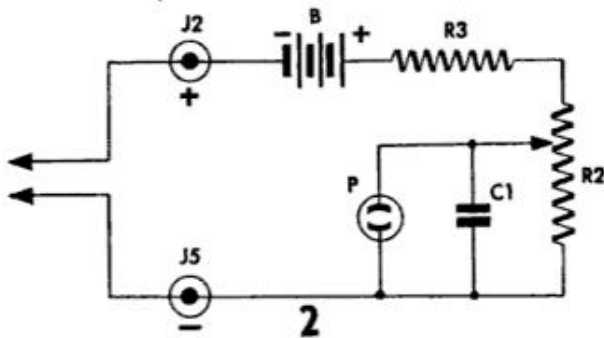

2
LOW DC VOLTAGE TESTER (LESS THAN 100 VOLTS)
CONTINUITY TESTER CAPACITOR CHECKER

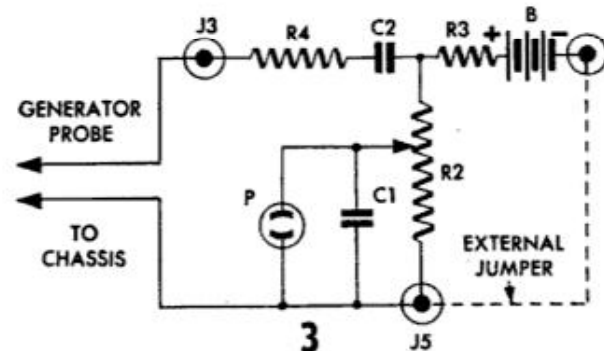

3
AUDIO GENERATOR

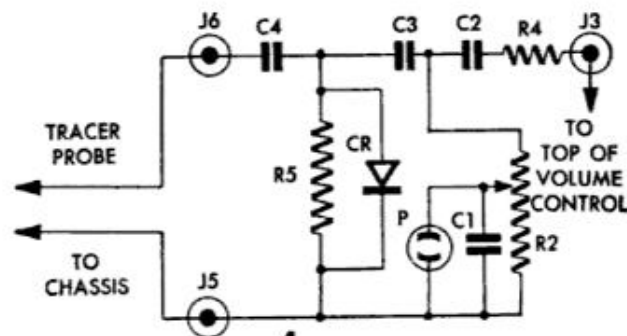

4
RF-IF TRACER

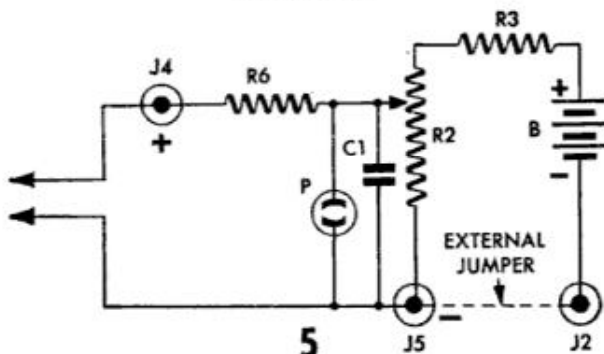

5
VARIABLE POWER SUPPLY

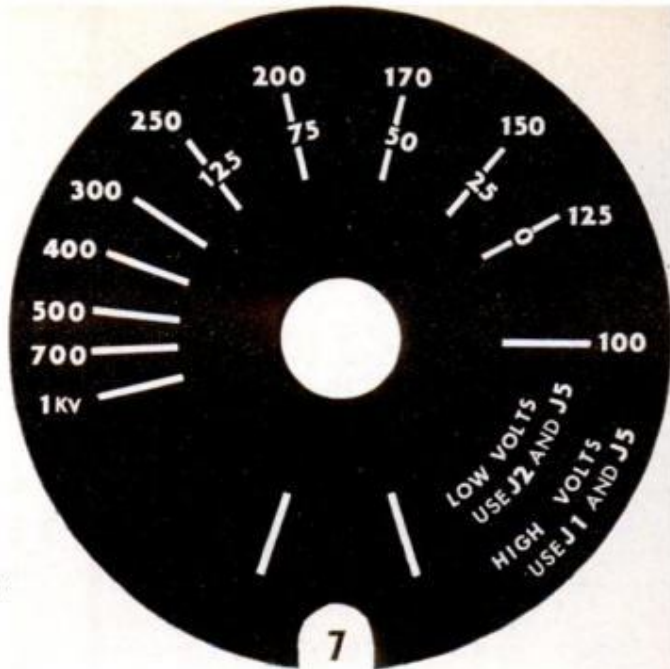
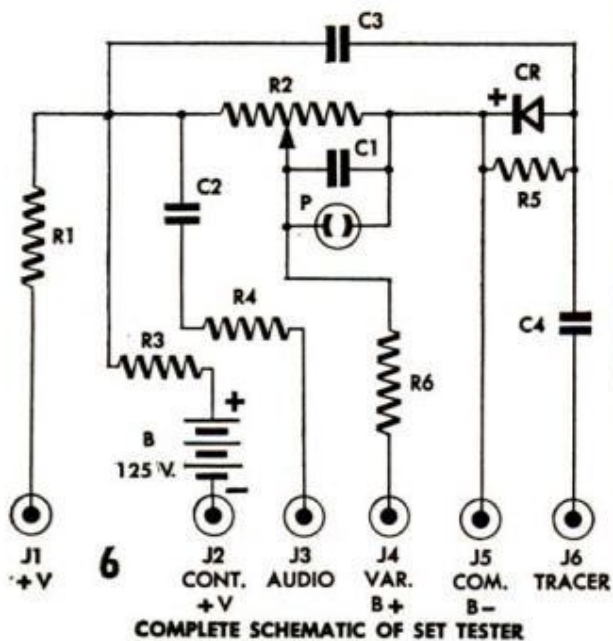

Audio Generator

Fig. 3 shows the circuit of a simple audio signal generator. Here, the neon bulb is used as a simple relaxation oscillator which generates a signal between 200 and 800 cycles depending on the setting of the potentiometer.

To use the generator, a wire must be connected externally between terminal posts

J2 and J5 and the potentiometer set to a point between 100 and 125 on the calibrated scale. The audio signal will then appear between test leads connected to J3 and J5. The signal is applied between grid and ground of an audio amplifier stage and if the stage is operating properly, an audible tone will be heard through the loudspeaker.

(Continued to page 204)

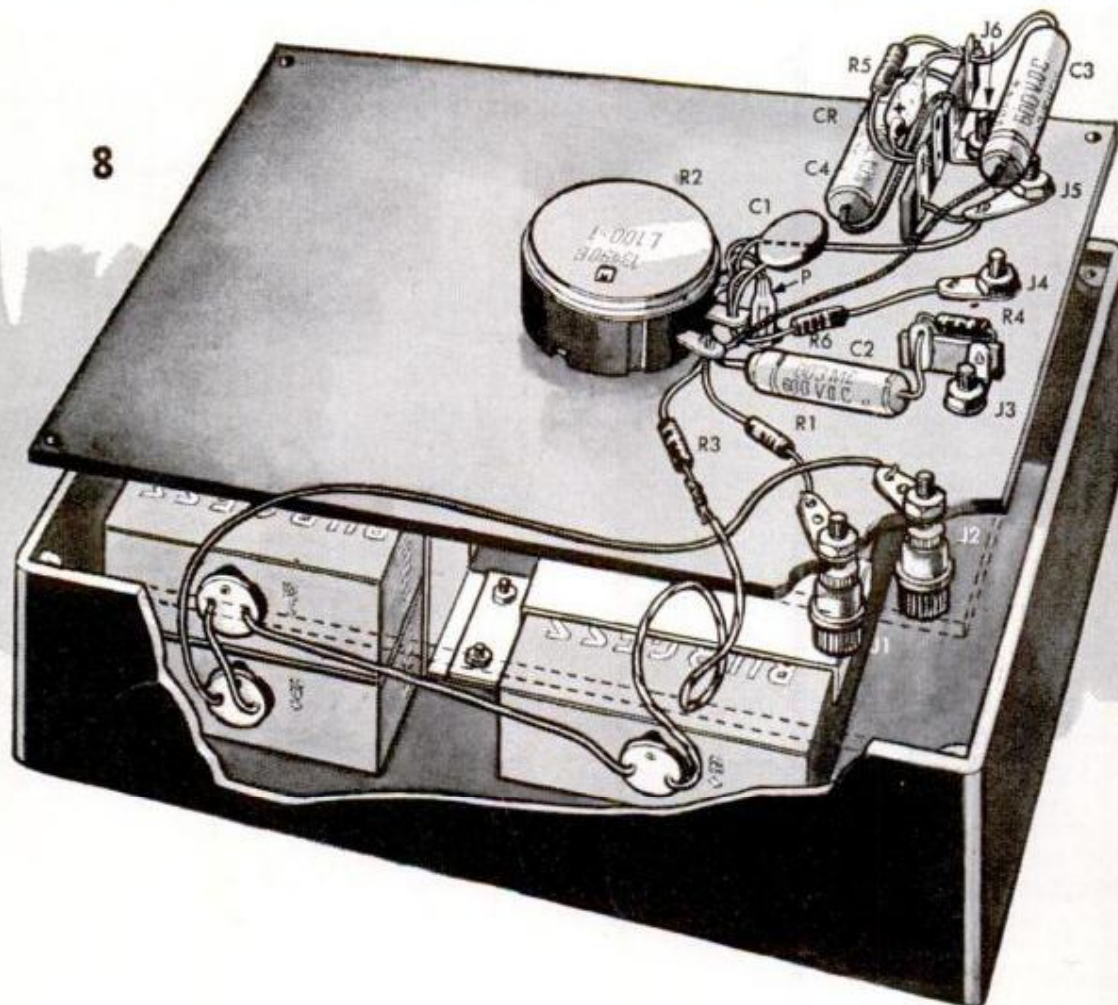

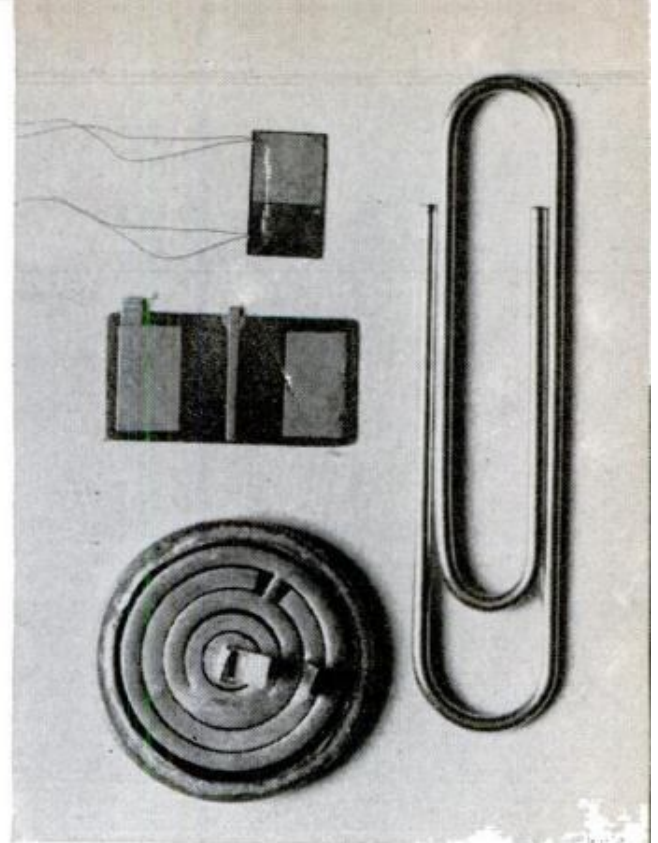

Button-like objects between turntable and speaker bear little resemblance to today's amplifiers and pre-amps., but perform the same jobs. Three of eight molecular electronics function blocks developed so far include (above, right) two-stage video amplifier, free-running multi vibrator and five-watt audio amplifier

MOLECULAR ELECTRONICS

A New Concept in Electronic Technology

AN AMPLIFYING SYSTEM the size of a dime; telemetry units weighing an ounce or less; complex electronic components reduced to the size of a wafer—these are only a few of the amazing things being produced by the latest and greatest stride yet made in electronics—the concept of molecular electronics. Size, however, is only one aspect of this important new field. Space-age engineering has already produced vast electronic systems on a scale suitable to the demands of space flight. But the critical factors involved here demand a degree of reliability and performance which even miniaturization, with its dependence on individual components, circuits and connections cannot deliver. Molecular electronics promises to solve these problems. It exploits a new concept in the design and function of electronic systems depending on phenomena occurring within and between domains of molecules in a solid state. The most promising break-through so far has been in the production of “function blocks.” These individual solid state elements provide, entirely within themselves, the functions of numerous components of bulky electronic hardware. Thus, these elements are not intended as “components” as such, in the

way we think of transistors and tubes, but rather as “subsystems.” That is, each of the function blocks performs the electronic job of numerous tubes, transistors, resistors, capacitors, and other small parts all working together. In this manner, individual blocks do the work of amplification, oscillation, telemetering, etc. Because there are no internal connections or components and the only external connections are for coupling inputs and outputs to the complete system, subsystems can be built whose risk of failure is equal to or less than that of familiar solid state devices, like diodes and transistors, and perhaps one-thousandth that of subsystems built of many parts for the same purpose. In addition to this high degree of reliability, the internal functions of units involve distances on the order of a few atomic spacings. Thus, they are almost microscopically small and virtually weightless.

The production of these blocks does not involve the assembly of various small components. Rather, it begins with a basic semiconductor wafer which is given the necessary “domains,” or areas of function, by the same techniques used in the production of conventional semiconductor de-

(Continued to page 206)



Tuning in on New Products

WHAT'S NEW in the way of new radios and phonographs? Plenty. And here's a sampling of recently announced new products. For example, in response to the demands of discriminating motorists who enjoy a more specialized programming, Mo-

torola has introduced America's first mass-produced, transistor-powered FM car radio, shown in Fig. 1. Installed under the dash, the radio has its own speaker and is in all respects an independent unit. This means it may be operated independent of or in addition to the car's existing AM radio. It is capable of reproducing the full range of audio transmitted by FM radio stations.

Hi-fi bugs will be interested in a new *lifetime* diamond phonograph needle, see Fig. 2. No, this doesn't mean the lifetime of the disks, nor the lifetime of the set. It is guaranteed for the lifetime of the *owner*. Jensen Industries of Forest Park, Ill., recognizing the fact that the needle is the most sensitive, yet the most abused part of a phonograph, has succeeded in perfecting a manufacturing method for processing diamond styli that results in a needle which need never be replaced. Replacement styli are available for most cartridges.

No, boat owners, they haven't forgotten you. Even you can enjoy your records while off on a cruise. RCA's Boat Victrola, Fig. 3, plays the records upside down, keeping the needle gently, but firmly in the groove despite the pitching of small craft.

After portable everything else, Emerson boasts a new-type portable phonograph, Fig. 4, which requires no turntable. Slip the records in and the battery-operated phono starts to play, automatically selecting the proper record speed.

Here is another one you may have been waiting for—a rechargeable battery for transistor radios, and a companion battery charger, Fig. 5, produced by Beamco Associates of Jenkintown, Pa. The battery has an average life of 15,000 hours, giving up to 15 hours of service per charge, even after months of disuse. The charger is plugged into any convenient a.c. outlet.

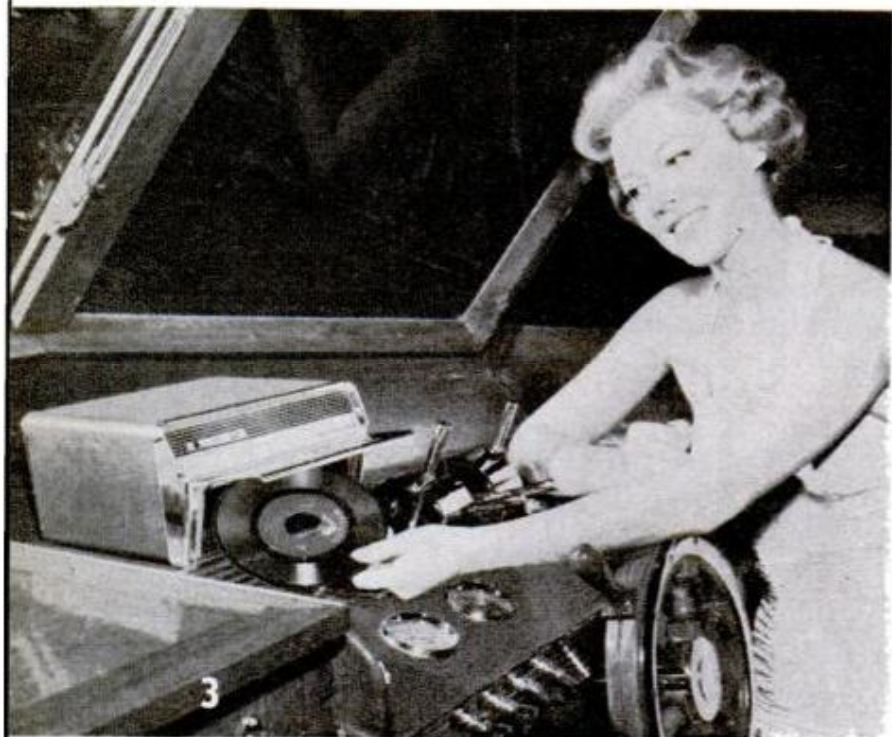

TRIPLE EXPOSURE at f11 is how our Speed Graphic caught this fellow flexing his muscles. Just try this exercise yourself. See how fast you tire out. When you do, remember that tires do 700 "push-ups" per mile as they roll along under your car.

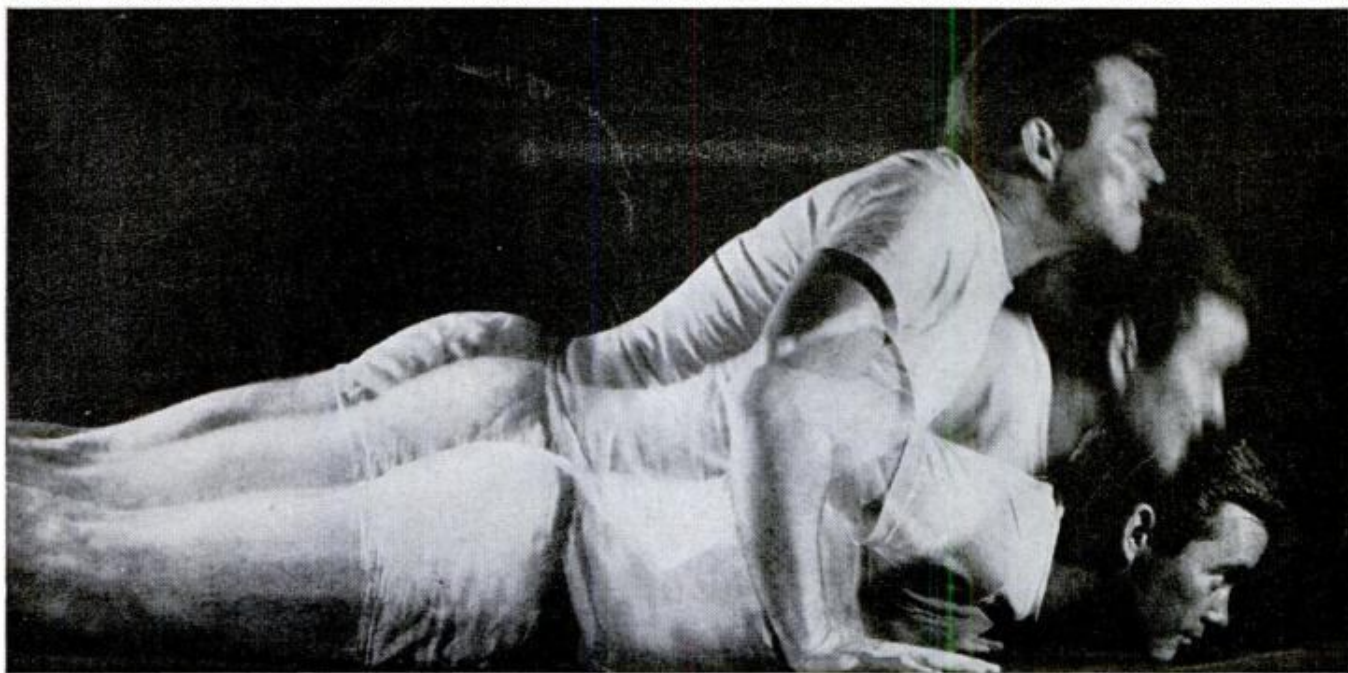

Too much flexing wears out people...and ordinary tires! But not
THE TIRE THAT DOESN'T GET TIRED

New *Low Profile** tire is actually made lower and wider so it flexes less, lasts longer.

Excessive flexing is what wears out, burns out tires, weakens rubber and fabric, increases blow-out danger. And ordinary tires do flex excessively.

But U. S. Royal has pioneered a new "Low Profile" shape tire that *flexes less, runs cooler, lasts longer*. It offers new protection against high-speed failure and heat blowouts.

Other tire designs don't give such thorough protection. Yet "Low Profile" tires cost no more than ordinary tires. So don't run the risk of tire failure. See the *complete* line of U. S. Royal "Low Profile" tires—now in 5 price ranges for every make and model car—at your U. S. Royal Dealer.



Same air pressure...but look at the difference

Excessive flexing pushes the temperature of ordinary tires above 240°F. That's the danger mark. But the lower, *wider* shape of U. S. Royal "Low Profile" tires reduces flex, keeps tires *cooler*, even at top highway speeds.



*"Low Profile" is United States Rubber Company's trademark for its lower, wider shape tire.

PIONEERED BY U. S. RUBBER AS THE ANSWER TO GREATER TIRE SAFETY AND LONGER WEAR

U.S. ROYAL *LOW PROFILE TIRES**



United States Rubber

Rockefeller Center, New York 20, N. Y.

New Ideas in Photography



Measures the light, tells you the setting for picture-perfect exposure

New Brownie Camera Has Electric-Eye Control

New production methods are making it possible to put deluxe-camera precision into electric-eye Brownie cameras—yet keep prices down to the traditionally low Brownie cost.



Kodak recently announced the low-cost

Brownie Starmeter Camera. Its photoelectric meter system is as sensitive as the meters on top-quality, high-priced miniature cameras. And the mechanism is rugged—built to withstand jolts as great as 50 G's.

Brownie Starmeter Camera eliminates exposure guesswork, gets 12 good shots on each roll of size 127 film. Yet it costs only \$19.95, or as little as \$2 down.

Picture it now—See it again and again

Everything You Need But the Scene Is Packed in Kodak Gift Outfits

Americans like cameras—and *convenience*. That's why the big new gift trend today—for family, friends, newlyweds, young people—is the complete camera outfit.

This is a real trend—no fussing around, everything in one box, ready to start shooting! For a quick survey of the way people enjoy buying gift cameras today, visit your Kodak dealer and look at the beautifully gift-boxed Kodak and Brownie outfits. You'll find combinations that fit every gift need—from \$11.35 up.



Most popular outfit includes Brownie Starflash Camera with built-in flashholder, film, flashbulbs, batteries, instructions. All attractively gift-boxed for \$11.35.



Home movie kit—for movies indoors and out—contains new Brownie 8 Movie Camera, $f/2.7$, and a 2-lamp light bar with reflector flood lamps. \$32.50.

from Kodak

Kodak Cell "Sees" Invisible Light, Lends Helping Hand to Weathermen

An ultra-sensitive Kodak heat-sensing device, first created for weapons use, is now helping meteorologists. Called the Kodak Ektron Detector, it forms the "eye" of two new instruments.

One instrument measures the height of clouds by bouncing a beam of infrared radiation off the base of a cloud formation. The echo is "sensed" by an Ektron Detector stationed a known distance away, and the cloud height is determined by triangulation.

The other instrument measures water vapor in the air. Scientists project two infrared beams of different wave lengths. The first is partially absorbed by water vapor, the second is unaffected. The difference in energy received by a Kodak Ektron Detector tells how much moisture is present.

The same kind of Kodak research that develops better ways to see and use light, leads also to finer films, filters, and lenses for amateur and professional use.

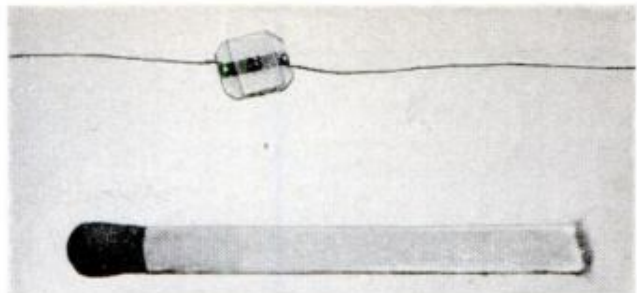

Special bits of glass are coated on one side with lead sulfide or lead selenide photo-conductive materials sensitive to invisible infrared radiation, to form Kodak Ektron Detectors. Picture above shows how Ektron Detector compares in size with a match.

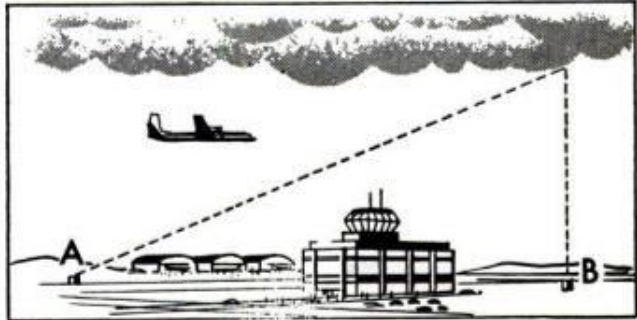

Used chiefly at airports, the cloud-height measuring system is accurate up to 5000 feet. A rotating projector (A) bounces infrared light off the cloud base to the detector (B). The signal is fed to an indicator at the control tower for computation.



New Brownie 8 Movie Light

Fits on top of the Brownie 8 Movie Camera, out of the way. Provides ideal "over-the-camera" illumination for indoor movies. Only \$5.95 (300-watt reflector flood lamps extra).

Kodak Movie Camera, Only \$24.50! Uses New "Rabbit Ears" Light Bar

This all-new Brownie 8 Movie Camera makes sharp, clear 8mm movies with snapshot ease. And it's the lowest-priced movie camera in Kodak history.

Outdoors, you just dial a setting like "Bright Sun" or "Open Shade" or, if you prefer, use the *f*/stop settings. Aim through the enclosed optical viewfinder and shoot—it's that simple.

Indoors, you use a new compact light bar that attaches to the top of the camera for easy handling and ideal lighting.

Other features you'll like: the inch-wide shutter release eliminates fumbling, and the footage meter resets automatically after loading.

Best of all, however—it's yours for as little as \$2.50 down. Ask your photo dealer for a demonstration.

Prices are list, include Federal Tax, and are subject to change without notice.

EASTMAN KODAK COMPANY, Rochester 4, N. Y.

SEE KODAK'S "ED SULLIVAN SHOW" AND "ADVENTURES OF THE NELSON FAMILY"

Kodak
TRADEMARK



You Need
All These
Basic Tools

...MOST
OF
ALL

CHANNEL LOCK

Ask any skilled electrician or auto mechanic about CHANNELLOCK Pliers. He'll tell you they're the handiest pliers of them all . . . basic tools he wouldn't be without. And this same all 'round usefulness will help you do hundreds of jobs . . . faster, easier. Be sure your basic tools include genuine CHANNELLOCK Pliers. Get them at your tool supplier's. If he's out of them, ask him to order for you. Available in three jaw capacities: $\frac{3}{8}$ " , $1\frac{1}{2}$ " and 2".



Use it as a plier



Use it as a wrench



Write for Catalog of Complete Line of Pliers

CHAMPION DEPARTMENT TOOL COMPANY

MEADVILLE 1, PENNSYLVANIA

Clinic for Homemakers

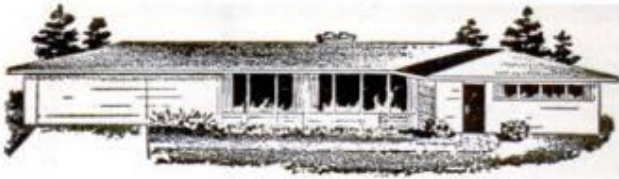

As a service to our readers in solving the hundreds of problems pertaining to a home—inside or out—the editors of *Popular Mechanics* invite you to present your problems to The Clinic Editor for help and advice. Address your questions to The Clinic Editor, *Popular Mechanics Magazine*, 200 East Ontario Street, Chicago 11, Ill.



Tree Won't Blossom

Q—I have an apple tree which is about 12 years old and it never blossoms in the spring. It appears to be perfectly healthy, the bark is in good condition and the shape is perfect. Although it serves well as a shade and ornamental tree, I would like to induce it to blossom and bear fruit. Is there any way this can be done successfully?

—Y.W., Ill.

A—Has the tree been pruned regularly? You do not say and we would guess that it has simply been allowed to grow normally and assume its own individual shape. If this conclusion is correct then the top growth should be reduced about 15 percent the first season and another 15 to 20 percent the following season. Pruning should be done when the tree is dormant, that is, any time after the leaves fall naturally. In the pruning procedure remove all interfering branches, but none of the frame branches, removal of which would alter the shape and general balance of the tree. Thin all clusters of twigs throughout the entire top of the tree, making the greatest reduction in numbers of twigs in the lower half of the top. In cutting off any larger branches and twigs, be careful to make clean cuts, without stripping the bark away from the wound at any point. Seal all wounds with asphaltum or with a preparation made especially for the purpose. Then, to compensate for the growth removed from the top, the roots should be pruned. This usually can be done adequately with a spade having a sharp cutting edge. Work at a distance from the trunk of the tree which is a little less than the maximum spread of the branches. Stand the spade vertically, force it into the ground the full length of the blade. Make adjacent cuts all the way around the tree, taking care to keep a fairly uniform distance from the trunk and inside the spread of the branches as already mentioned. Then punch random holes nearer the trunk and place a tablespoon or so of 4-12-4 fertilizer in each hole. Fill the holes with soil. This treatment usually will induce a tree to blossom, although it cannot be said to be reliable in all cases.

(Continued to page 198)



SAE MOTOR OIL VISCOSITY GRADE CLASSIFICATION SYSTEM

SAE VISCOSITY GRADE NUMBER	VISCOSITY, SAYBOLT UNIVERSAL SECONDS			
	AT 0° F.		AT 210° F.	
	MINIMUM	MAXIMUM	MINIMUM	MAXIMUM
5W		4,000	39	
10W or	6,000	12,000	40	
20W or	12,000	48,000	45	
20		48,000	45	58
30			58	70
40			70	85
50			85	110

Viscosity is measured by the time required for 60cc of oil in the Saybolt Viscosimeter Tube to flow through a standard opening, at a given temperature.

What viscosity really means

Viscosity is a liquid's *resistance to flow*. It varies among different liquids, and increases to some extent as temperature drops.

In the United States, the viscosity of oils is usually determined with a Saybolt Universal Viscosimeter. It simply measures the time in seconds required for a given quantity of oil to drain through a standard hole at some fixed temperature. The SAE Motor Oil Viscosity Grade Classification System (see chart above) uses these viscosity seconds to specify the viscosities of its SAE 5W, 10W, 20W, 20, 30, 40 and 50 motor oil grades. The first three "W" grades are especially suited for winter use.

The viscosity of your motor oil is very important. When you start your engine at a subzero temperature, a heavy, slow-flowing oil takes much too long to reach engine parts and permits more wear than thousands of miles of driving.

However, a light, fast-flowing winter oil

does not have enough viscosity to prevent wear at high summer temperatures. Thus, with ordinary oils, it is necessary to change grades seasonally.

Havoline Special 10W-30 Motor Oil is the wisest choice for any car owner because it magically combines the fast-flowing property of the Winter SAE 10W grade with the high temperature, wear-preventing quality of the Summer SAE 30 grade. It's the ideal, all-temperature oil. Use it *in all seasons*.

In addition, Texaco's special refining and exclusive additives in Havoline Special 10W-30 prevent the harmful sludge deposits and varnish that are so prevalent with ordinary oils in today's stop-and-go driving.

The few extra pennies for this finest of motor oils is your best insurance against engine damage and repair bills. See your Texaco Dealer for a change to Havoline Special 10W-30 ...and change it *regularly*.

Buy the best... buy TEXACO

TUNE IN: TEXACO HUNTLEY-BRINKLEY REPORT/MONDAY THROUGH FRIDAY/NBC-TV



Make 'em yourself in ONE EVENING

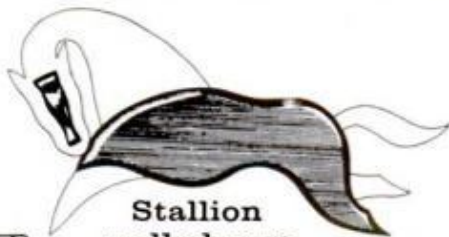

Stallion
wall plaque



Desk set

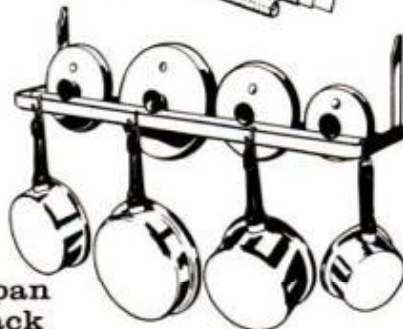
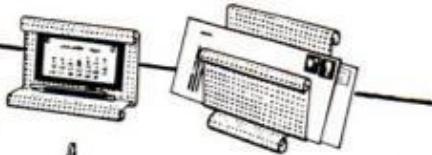

Kitchen pan
and lid rack

with Reynolds DO-IT-YOURSELF ALUMINUM

Make any of these handsome, useful aluminum articles in just one evening. Use ordinary woodworking tools. It's fun, it's satisfying . . . and we furnish free step-by-step plans (see coupon).

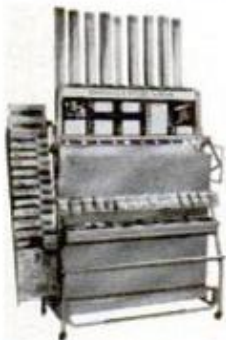

Look for this rack at most hardware and building supply stores.

sheets, tubing,
tubing fittings,
window and screen
frame sections,
fasteners, rod,
bar, angle

Reynolds Metals Co. · Richmond 18, Va.

Please send Do-It-Yourself Aluminum How-To booklet with free one-night project plans.

Name _____

Address _____

City _____ Zone _____ State _____

Dept. PM



Stop Mildew

Q—I painted my nearly new home a couple of years ago and lately I've noticed that the paint on the north side seems to be covered here and there with a grayish mold that cannot be removed entirely by scrubbing or even by brushing with a wire brush. My neighbor says it's mildew, but I never heard of it on paint. Is he right?

—N. H., Ga.

A—He is right. Mildew attacks paint which is not formulated to resist its growth under climatic conditions which favor it. It is caused by airborne spores which are present nearly everywhere in the warmer, more humid climates. Prolonged warm weather and relatively high humidity favor mildew growth on unprotected organic material, especially when the surface is shaded from the direct rays of the sun and is located where there is inadequate air circulation. After the growth has been well established on a painted surface it is rather difficult to remove, although once it is eliminated new growth can be prevented. The procedure is quite simple. You'll need a stiff-bristle scrubbing brush, trisodium phosphate, water, and time to do a thorough job. Mix a trisodium-phosphate solution in the proportions of about three heaping tablespoons to the gallon of water. There probably will be less waste of the solution if you apply it to the siding with a sponge and then immediately scrub the wetted surface with the stiff-bristle brush. Continue scrubbing on all surface affected until all the mold has been removed and the paint exposed. Then immediately apply a coat of mildew-resistant paint. It's important that there be no appreciable delay between scrubbing and painting with the mildew-resistant paint, as washing off existing mildew does not proof the surface against a new attack. **Caution:** When using a trisodium-phosphate solution in the manner described, wear rubber gloves and protect the eyes against spatters.

Tile Loosen



Q—Two years ago I laid linoleum tile in my kitchen. Tiles were laid over a hard-board underlayment. Now I notice that some individual tiles are loose; they can be lifted easily, while others seem perfectly solid. Those along the baseboards are all firmly attached to the underlayment, not a single loose tile. This puzzles me. Why should some individual tiles be loose?—C.H., N.J.

A—We don't know—for sure. Tiles do loosen, but this usually is due to failure to follow the instructions for laying in all details. Or, failure may be due to some peculiarity of the structure or some abnormal conditions under which the tiles were laid. One common cause of loose tiles is lack of care in spreading the cement to a uniform thickness. Unless one watches this detail closely there is a tendency to work cement to the edges of the area being coated and thus leave a thinner film in the center of the area. In some cases one tends to cover an area with cement which is so very nearly the exact size of the area covered by a given number of tiles that when an adjoining area is coated the cement will be thin along the edge of the tile just laid. Sometimes the underlayment is permitted to get wet, or is stored in a damp basement immediately before placement and laying of the tile. There are other causes, of course, but any of those outlined can cause failure of individual tiles to adhere solidly. You can, of course, relay the loose tiles by removing all the loose particles from the recesses, coating with a thin film of cement of uniform thickness and pressing the tiles back in the recesses, coating with a film of cement of uniform thickness and pressing tiles back in place.

192.001 MPH FOR STRAIGHTAWAY MILE!

ANOTHER WORLD'S RECORD SET WITH CHAMPION SPARK PLUGS!

It's further proof that every engine
does its best with Champions . . .

Slashing across the surface of Lake Washington with its Rolls-Royce engine screaming a song of speed, the unlimited-class hydroplane *Miss Thriftway* sets a new

World's Record for the Straightaway Mile
—192.001 miles per hour!

Again a World's Record has been set with Champion spark plugs.

In both inboard and outboard marine engines, Champions are the plugs that set most of the records, and win most of the races. In 1959, for example, all 11 winners of the National Outboard Championships were powered by Champion spark plugs. Also 8 out of 10 winners of the '59 National Stock Outboard Championships—plus 13 of 14 winners of the '59 National Outboard Association Championships!

You may never want to try for a record or run a race, but you do want dependable power from your engine. And Champions deliver *all* the power built into any marine engine. For racing, skiing, cruising or trolling, you can depend on Champion spark plugs.

DEPENDABLE
CHAMPION
MARINE SPARK PLUGS



CHAMPION SPARK PLUG COMPANY, TOLEDO 1, OHIO

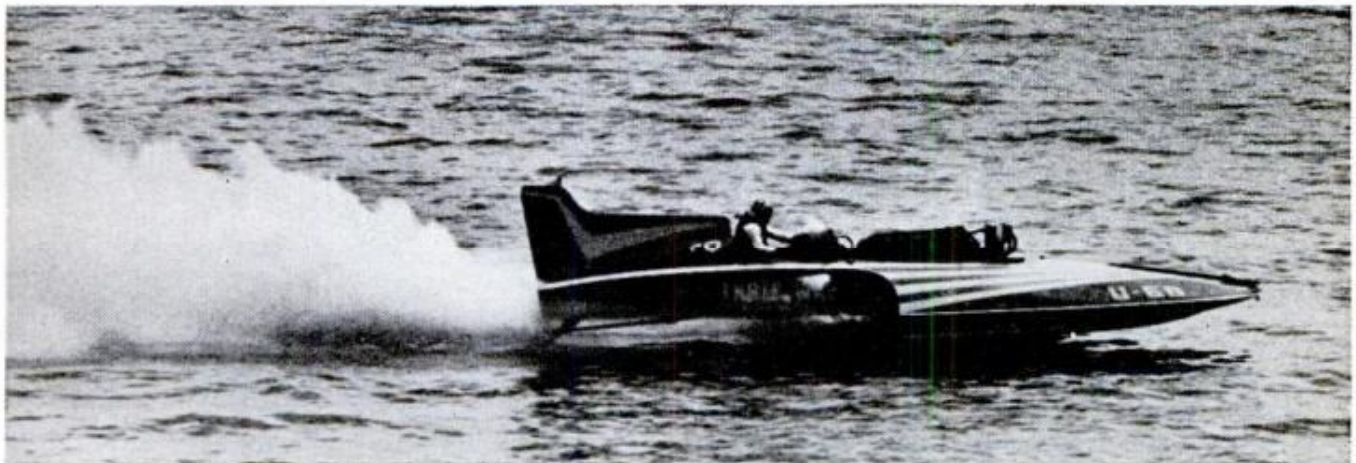



REFINISHING?

IT'S A SNAP
WITH
THE RIGHT
Red Devil
SCRAPER!



That's why Red Devil offers you a choice:
18 different kinds of Wood Scrapers! Find out
which is best for you at the most helpful dealer
in your neighborhood...the one who sells
Red Devil Tools:

Glass Cutters • Wall Scrapers • Glaziers' Tools
Wood and Paint Scrapers • Hardware Specialties
Putty Knives • Floor Polishers • Paint Conditioners

Red Devil Tools.

Dept. PM-7, UNION, N. J., U. S. A.

PLEASE SEND FREE BOOKLET
"How To Prepare Surfaces
For Finishing."



Name _____

Address _____

City _____ Zone _____ State _____ 2901

The Woodcarvers of Spillville

(Continued from page 127)

years in the making. Each base is carved around some central theme. They are equipped with chimes and musical works and many have animated figures. The working mechanism of these is of their own construction but clock works and chimes are factory-built with one exception which has carved wooden works.

Simple Tools and Simple Approach

The brothers are artisans of the old school and use simple hand tools. Frank is the carver and his older brother, Joseph, is the cabinetmaker. Some carving tools used by Frank are homemade from such lowly items as hatpins and needles: from these items he made a tool which he uses for some of the most delicate carving. Wood suitable for carving, Frank says, must be fine textured, tough and strong. They use American walnut, butternut, hard maple and oak. The carving technique is devoid of complications. It consists of putting a hunk of wood into a vise and hacking away until the figure takes the form Frank sees in his mind's eye.

When a new clock goes on display, it is not necessarily complete. New details may be added over a period of years as new ideas occur to the brothers. Ideas for designs come from many sources: events in history, the Bible, famous buildings or people, or experiences the brothers have had. A motor trip to scenic points in their own state, for example, sparked the idea which resulted in the "Struggle for Time" clock. It symbolizes the rapid tempo of life today.

Collection Not for Sale

Various offers have been made for the clocks, but all have been refused. Recently Frank and Joseph made arrangements for the entire collection to become the property of the town of Spillville after their death. It is never to be broken up in any way and is always to remain at its present location. It is housed in the Dvorak Building, in the lower floor of the home where Dvorak, the composer, spent a summer. The second floor houses a museum of pioneer implements and has one room dedicated to the composer.

If the Bily brothers' father knew that since the 1920s hundreds-of-thousands of visitors have stopped at Spillville expressly to see the Bily clocks, and that in a typical month, August, 1959, 6325 people from 39 states and six foreign countries admired his sons' work, he would have to admit their carving had been far from a waste of time. ★★

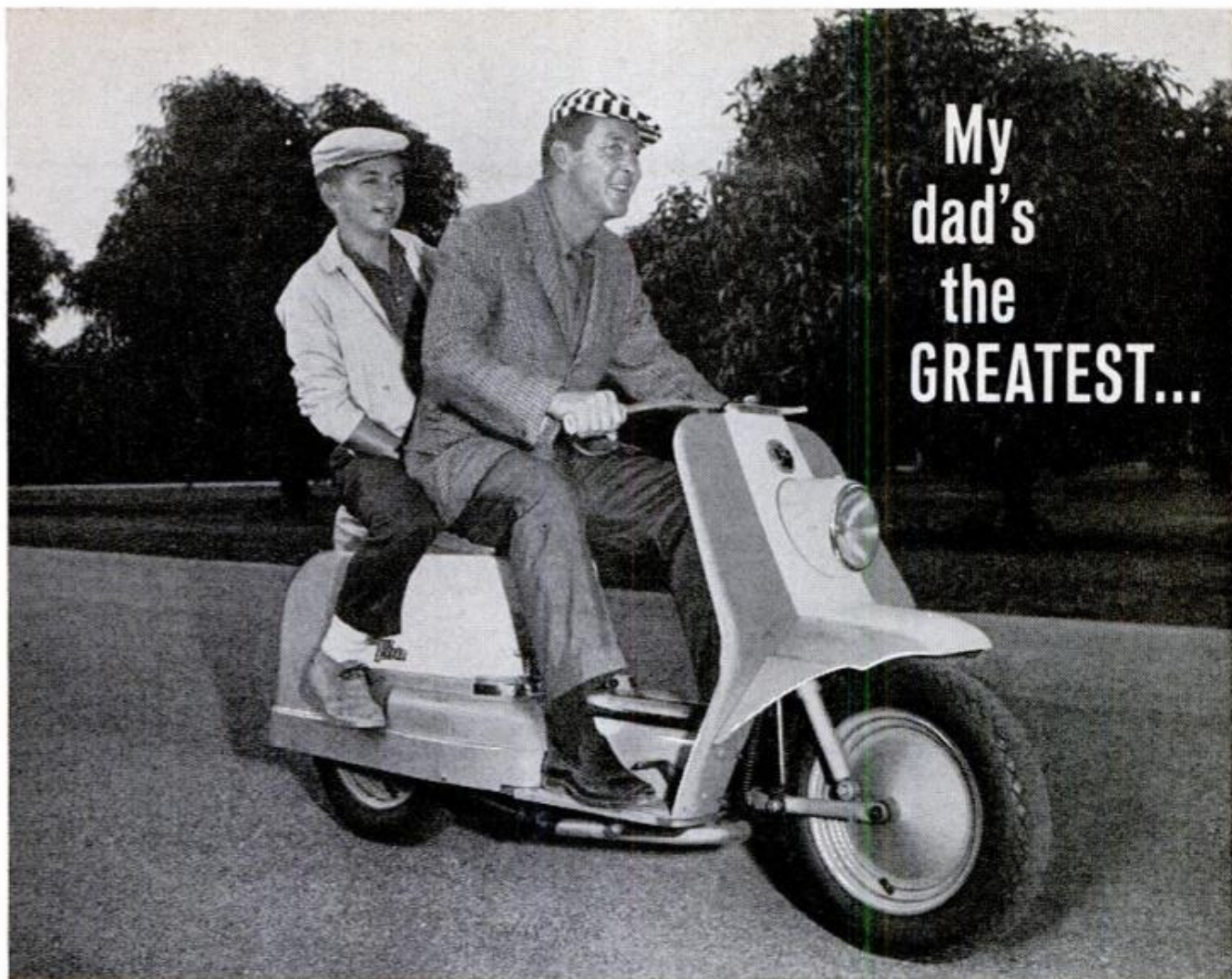

My
dad's
the
GREATEST...

and so is my new HARLEY-DAVIDSON **TOPPER**

Like father, like son... happy with the new Topper.

What a ride — gentle as a billowy summer cloud... with dual suspension and large foam rubber saddle. Dependability — plenty of get-up-and-go. Automatic *Scot-away* transmission—no shifting or clutching needed.

Dad is sold on safety features like the large diameter wheels and sure-stop front and rear drum brakes. Tells everyone about Topper economy — up to 100 miles to the gallon.

Mom's a Topper fan, too! She likes its good looks: sharp, clean

lines molded in tough beautiful fiberglass... two-tone color styling... chrome-plated instrument panel.

See your Harley-Davidson dealer. He will arrange a fun-filled demonstration ride. Or send in the coupon for literature.

HARLEY-DAVIDSON MOTOR CO.
Dept. P, Milwaukee 1, Wisconsin

Send me more information on
the Harley-Davidson Topper

Name.....Age.....

Address.....

.....

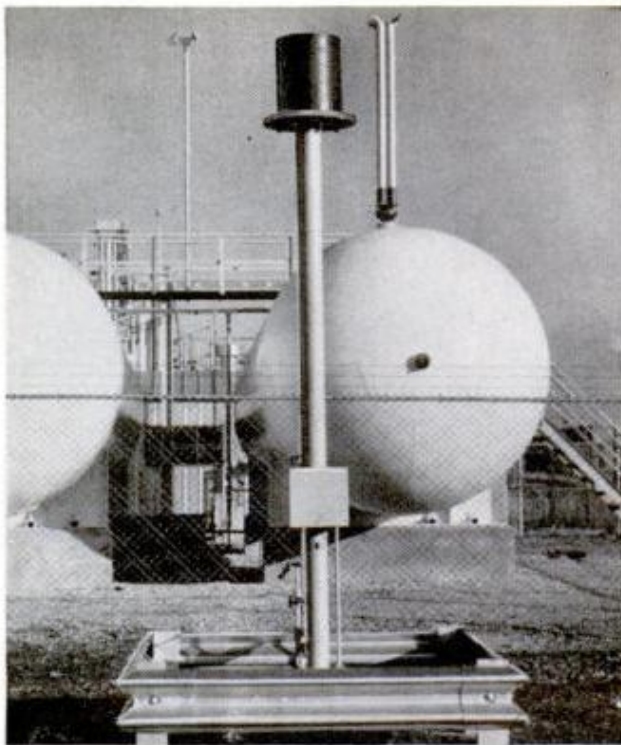

Safety Goes High Hat

Looking like a top hat that somehow got misplaced on the way to the opera, a flare sitting on a pole outside a gas works actually is an important safety device. It burns off excess mixtures of propane and air to prevent explosions at the works.

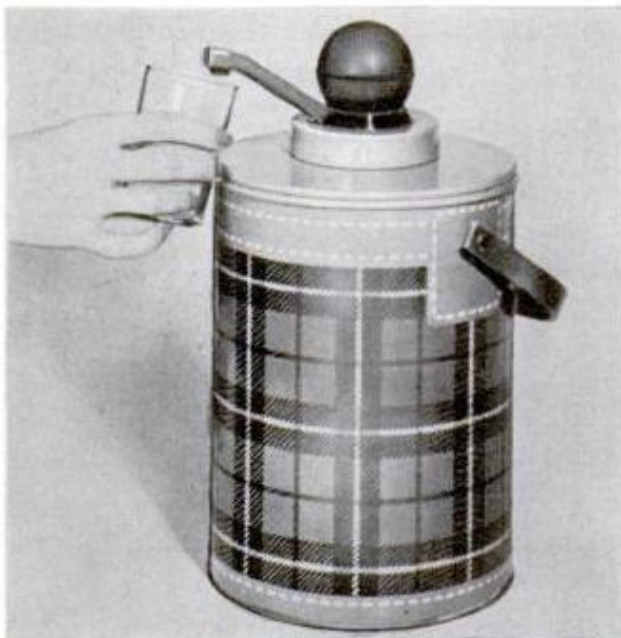

Hamilton-Scotch Corp., Hamilton, Ohio

Dispenser Atop Insulated Jug

Lifting and tilting large insulated jugs—difficult anywhere and downright acrobatic in a car or boat—is eliminated in a new model that features a pump and spout built into the top. Operated by squeezing the plastic bulb, the jug yields up a glassful for a couple of squeezes. There's no need to move the jug itself. Ice or fruit pulp won't jam it.

There Must Be a Better Way

(Continued from page 132)

gravity. A massive sulphide ore body, for instance, has a higher specific gravity than has the surrounding rock, hence in theory can be located even if it happens to lie deep below the surface.

A gradiometer that is to detect this difference from the air must be of unparalleled sensitivity. The instrument that the Pick scientists have been putting together is able to measure forces to one part in several billion, at the same time discriminating against other forces that are millions of times stronger. The instrument is so sensitive, in fact, that the influence of the moon is observable, a factor that is constantly changing because of the moon's rotation around the earth. The gradiometer may turn out to have other uses in addition to prospecting. It has big promise in the field of precise aerial navigation.

The black light or infrared studies that the laboratory has done are preliminary to a parallel study of ultraviolet. Some minerals, such as those of tungsten, fluoresce when exposed to ultraviolet light and it has been Pick's hope that a powerful UV beam from an airplane could fluoresce minerals on the ground so brightly that they could be seen from the aircraft. This kind of prospecting must be done after dark, of course.

So far the studies have been confined to infrared and a 30-inch parabolic mirror has been built with a heat source mounted at its focal point. Power that is built up in a set of condensers is fired through the heat source, creating a burst of infrared energy that is projected as a beam from the mirror. There's a chance that this kind of apparatus can be used in military reconnaissance for making aerial photos after dark, undetected from the ground.

For the last several summers Pick has been flying crews of prospectors into remote parts of Canada and Alaska, for one thing to test the airborne prospecting equipment that his laboratory puts together. The field trips are completely self-contained; everything moves by air.

Aerial prospecting has been a main subject of research at his laboratory but it isn't the only one. For instance, experiments are underway which seek to develop a process for taking aerial photographs having a three-dimensional effect without mechanical viewing aids. Work is also progressing on techniques for solving geophysical problems which also have application in other fields, including navigation in outer space. And Pick has a lot of other ideas that he wants to try out on the staff when some of the current work is completed. ★★★

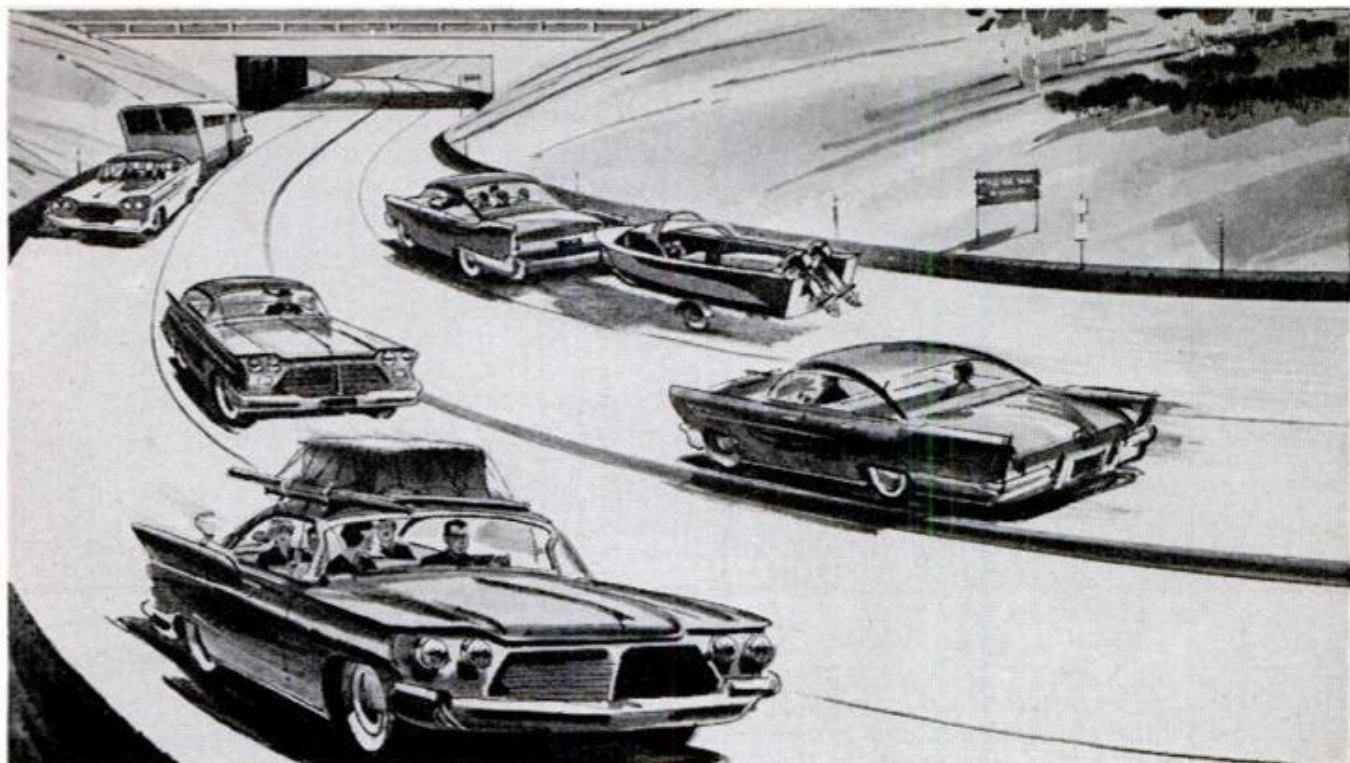

Now—a revolutionary new hydro-pneumatic suspension assist!

GOLDEN GLIDE Load-Absorbers

PAT. APPL'D. FOR

Give new load-carrying capacity without sacrificing riding comfort!

A sensational advance in ride engineering! Golden-Glide announces the self-compensating, adjustable hydro - pneumatic Load - Absorber. Installed in place of shocks in the rear of the car, Load-Absorbers do everything any combination of steel helper springs and shocks can do—and much more! Here at last is greatly increased load-carrying capacity and rear-end stability—at *no sacrifice in riding comfort.*

Carrying the load on a cushion of air, Load-Absorbers *automatically* sense changes in car load, *automa-*

tically compensate by hydro-pneumatic pressures to maintain level, stable riding qualities.

Golden Glide Load - Absorbers are factory-set for light, normal or heavy loads. But for *extremely* heavy loads, such as cars pulling trailers, Load-Absorber air pressure can be increased through an external valve—this keeps the rear of the car at the proper riding height. Be sure to ask for the amazing new Golden Glide Load-Absorbers, available now at your favorite service station, dealer or garage.



THE GOLDEN GLIDE SHOCK ABSORBER COMPANY

Cleveland 15, Ohio

GOLDEN GLIDE

Load-Absorber

PAT. APPL'D. FOR

6-in-One Test Set

(Continued from page 190)

By starting with the output stage and working backwards towards the input, a defective stage can easily be located.

RF-IF Signal Tracer

The signal tracer circuit, Fig. 4, is essentially a diode detector whose output appears between terminal posts J3 and J5. It is used for locating a defective r.f. or i.f. stage in a radio receiver.

To use this portion of the test set, it is assumed that the audio amplifier section of the receiver is operating normally, having been checked out previously with the signal generator. Used as a tracer, a lead from J3 is connected to the top of the receiver volume control and another from J5 to the radio chassis. A test probe connected to J6 can then be used to trace the r.f. and i.f. signal through these stages of the receiver.

When the probe contacts a point in the receiver r.f. or i.f. circuit where a signal is present, the signal is "detected" in the test set and the resultant audio is applied to the audio amplifier of the receiver and will be heard through the speaker. By starting at the antenna and working forward towards the detector, a defective stage can readily be recognized. In this application, the receiver volume control should be set for maximum volume and the potentiometer of the test set should be in the extreme counterclockwise position.

Variable Power Supply

A variable d.c. voltage is available between terminal posts J4 and J5. The voltage can be varied between 0 and approximately 60 volts by rotating the potentiometer. Either a positive or a negative voltage can be obtained, depending on which of the terminal posts is used as the common ground point.

Very little current can be drawn from this power supply, but it provides a handy substitute for low-voltage batteries used in many transistor radios.

Building the Test Set

The complete test set is illustrated schematically and pictorially in Figs. 6 and 8. Neither parts layout nor wiring is in any way critical. Construction, therefore, requires little additional explanation. There are, however, a few precautions that should be carefully observed.

For safety's sake the unit should be built into a plastic or wood box as indicated in the list of materials. While the tester constitutes no shock hazard, a metal case could become dangerously "hot" during measurements of high external voltages.

When soldering the 1N34 diode, CR, into the circuit, the diode lead about to be soldered should be grasped with a pair of long-nosed pliers at a point between the diode body and the solder junction. This prevents excessive heat from the soldering iron from reaching and possibly damaging this heat-sensitive part.

Complete All Wiring

Finally, all wiring should be completed before the battery plugs are inserted in the corresponding battery sockets. Though the individual battery voltages are too low to be dangerous, wired in series as they are, they have a potential of about 125 volts. And that's enough to give you an unpleasant shock should you become careless and touch the opposite ends of the series-wired battery assembly simultaneously.

LIST OF MATERIALS

Resistors: (All $\frac{1}{2}$ -watt carbon, $\pm 10\%$. K=1000 ohms) R1, R3=470K; R4=51K; R5=10 megohms; R6=330K; R2=4-megohm pot., 2 watts, linear taper, (Allied Radio Corp. #31MM110 or equiv.).

Capacitors: C1=.003 mfd. disc ceramic; C2=.003 mfd. 400-v. tubular; C3, C4=.005 mfd. 600-v. tubular.

Misc.: CR=1N34 diode; P=NE-2H neon bulb; J1-J6=insulated terminal posts; B=Burgess XX30P1 battery (2 required), Burgess XX22 (1 required)—connect in series; Plastic case, $6\frac{1}{16} \times 5\frac{9}{16} \times 2\frac{5}{16}$ in., with matching plastic panel, (dimensions non-critical); hardware; wire; solder.

★ ★ ★

Beeps, Hums, Time Signals Are Station WWV's Program

Radio station WWV, broadcasting 24 hours a day from Beltsville, Md., has perhaps the most important, if smallest, audience of any station in the U. S. It is operated by the National Bureau of Standards and offers a continuous program of hums and beeps which are supplemented, at five-minute intervals, by a voice, on tape, giving time announcements. The audience is located in industry, research centers and laboratories throughout the country, and it uses the program in ways that eventually affect the lives of most citizens. The watch-making industry times its products by the broadcasts. The research centers, makers of aeronautical and electronic equipment and power plants, use the 86,400 beeps a day to keep equipment properly cycled. Manufacturers of musical instruments pitch them according to the hum. Operators of short-wave receivers can pick up the signals on frequencies of 2, 5, 10, 15, 20 and 25 megacycles.

TIRE FACTS THAT CAN SAVE YOUR LIFE

ONLY ARMSTRONG TIRES HAVE PATENTED INTERLOCKING SIPES

"SIPES" are the slots put in a tire's tread to give more gripping edges, to stop skidding. Armstrong's interlocking, S-shape siping (see magnified view at left) provides grip in ALL directions, gives you sharply improved protection against both forward and side skids.

AND UNLIKE tires which have siping just cut into the tread, Armstrong siping is *molded* in, deeply. Long after the mileage that wears away the shallow siping of ordinary tires, Armstrong siping continues to give you full protection. Safeguard your car against deadly skids . . . compare, and see how Armstrong gives you far more siping than other leading tires.

ONLY ARMSTRONG TIRES HAVE PATENTED SAFETY DISCS

*—Grip the road to
stop deadly skids
as no other
tires can!*

ARMSTRONG TIRES



TREAD STAYS OPEN

Like fist above with discs between fingers, tread CAN'T squeeze shut. Hundreds of Armstrong Safety Discs hold tread's gripping edges open, always ready to "bite."

ORDINARY TIRES



TREAD CAN CLOSE

Without discs, tread CAN squeeze shut, like fist above. Tire's gripping edges are pushed together, lose their grip. Even brand new tires can go smooth like this . . . and you skid!

ARMSTRONG RUBBER COMPANY
Home Office, West Haven, Connecticut



WHAT THE HECK

IS A "MOTOR MINDER"?

Technically speaking, it is a special kind of vacuum gauge, but to the man who knows engines it's a great deal more. It tells you more about what is going on inside your engine than any other instrument on your dash.

A Stewart-Warner Motor Minder alerts you in time to these five types of common engine troubles: (1) Bad valve timing (2) Leaking valves (3) Improper ignition timing (4) Obstructed exhaust system (5) Defective spark plugs and points.

What's more, the Motor Minder helps you save fuel by indicating the proper range for most economical engine operation.

*Ask for it at your service station, garage,
or automotive parts store!*



1840 Diversey Parkway, Chicago 14, Ill.

Molecular Electronics

(Continued from page 191)

vices—diffusion, plating, electronic-beam machining, etching, cutting, radiation, alloying, and photographic processes. Although the function block at this stage performs its function, it must then be encapsulated to protect it against shock and vibration and make it stable under the conditions of radiation and temperature it will encounter.

Perhaps the most remarkable development so far has been the rapid production of semiconductor crystals in a form that requires no cutting or removal of material to make the basic substance suitable for use as an electronic element. This is the *dendrite* process. Here the germanium crystals in the form of a ribbon $\frac{1}{8}$ -in. wide and a few thousandths of an inch thick, are "grown." That is, they are produced by drawing them from a molten mass. In this continuous process, the germanium grows at a rate of 6 to 12 in. per minute and in the precise direction of crystal growth needed for application. In contrast to the conventional system where crystals are grown as thick ingots, no cutting, and hence no X-ray or crystallographic examination is necessary. The surface of the ribbon is always correctly oriented, optically flat and immediately usable as a working surface.

All the potentials of this process have yet to be realized. Its greatest significance is its ability to bring about a number of completely new processes for the production of function blocks. For example, a recent modification makes it possible and practical to carry out diffusion, plating, and evaporation processes directly on the crystal as it grows from the furnace. With this technique it is possible to create semiconductor devices all ready for the attachment of leads. Lengths of ribbon have been produced along which multiple-junction systems are distributed. Since the ribbon can be easily processed to become a long series of tiny amplifiers, it may be snipped into lengths to provide amplifiers of whatever gain is desired. Although near-automatic production of semiconductor devices and function blocks is a long-range objective, it is highly probable that it will be possible to grow multizoned crystals while simultaneously performing radiation, photographic and other operations on it as it issues from the furnace. This means that entire systems of electronic equipment, such as radio receivers and amplifiers, may eventually be grown directly from molten materials without additional processing. ★ ★ ★

**ONLY SIMPLE CARPENTER TOOLS
NEEDED TO BUILD YOUR OWN**

PATIO ROOF

**with JOHNS-MANVILLE
CORRULUX PANELS**

STRONG, lightweight fiber glass Corrulux is the answer to a handyman's dream...nail it, saw it, drill it with ordinary carpenter tools. Available in beautiful translucent colors. And, because Corrulux panels are lightweight, minimum framing is required. Send coupon and 5¢ in coin for detailed construction and materials of patio illustrated above or any other plans listed.

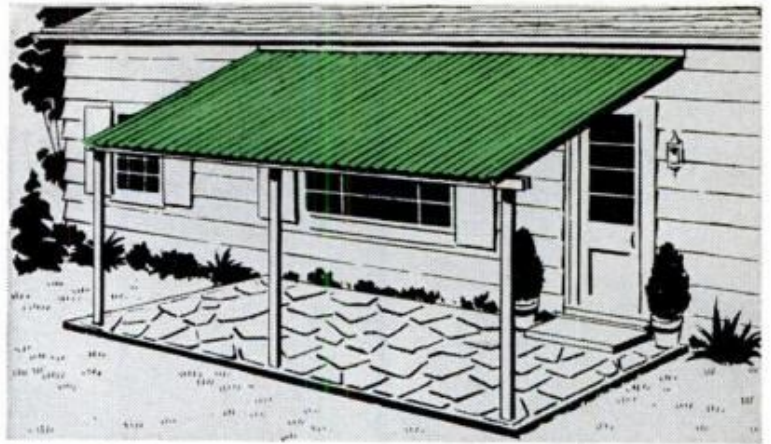

Johns-Manville, Dept. PM-7, Box 60, N. Y. 16, N. Y.
In Canada, Plastic and Allied Building Products, Ltd.
Box 250, Dundas, Ontario.

Please send me the plans checked. Enclosed find
in coins. (If all 12 plans are desired, enclose 30¢)

Plan No.

- | | |
|--|---|
| 1. <input type="checkbox"/> PATIO ROOF | 7. <input type="checkbox"/> Fluorescent Ceiling |
| 2. <input type="checkbox"/> Room Divider | 8. <input type="checkbox"/> Indirect Lighting Fixture |
| 3. <input type="checkbox"/> Folding Decorative Screen | 9. <input type="checkbox"/> Adjustable Wind Screen |
| 4. <input type="checkbox"/> Weather-protected Entrance | 10. <input type="checkbox"/> Wind and Sun Screen |
| 5. <input type="checkbox"/> Woven Fence | 11. <input type="checkbox"/> Planter Box Screen |
| 6. <input type="checkbox"/> Window Awning | 12. <input type="checkbox"/> Coffee Table |

NAME

ADDRESS



JOHNS-MANVILLE

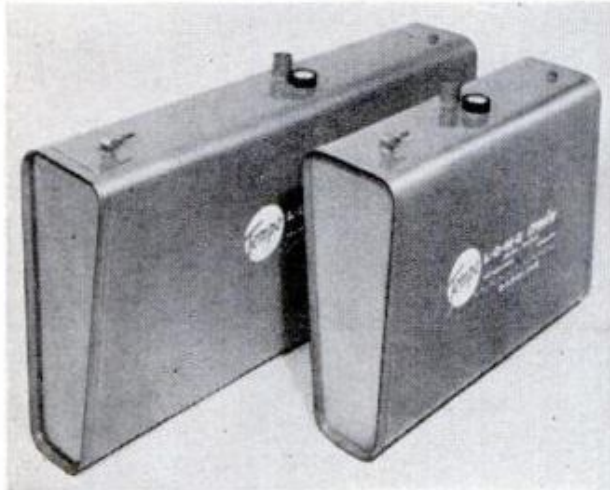

Tempo Products Co., 2062 E. 70th St., Cleveland 3, Ohio

"Contour" Fuel Tanks For Outboard Boats

Taking advantage of every inch of otherwise wasted space under motor wells or inside flared hulls, a new line of "contoured" fuel tanks for outboard boats allows greater fuel capacity for extended cruising. Available on some boats as original, built-in equipment, the tanks are also sold for installation in existing boats. An optional fueling kit allows extension of the filler tube outside the hull for greater convenience and safety in fueling operations.

Space Heaters

Keep Alaska Highway Open

Canadian army engineers charged with maintaining a 1225-mile stretch of the Alaska Highway — from Dawson Creek, B. C. to the Yukon-Alaska border — last winter tried a new technique to keep northern sections of the road open to traffic. At Beaver Creek, mile 1140, they installed space heaters in drainage ditches to keep the ground from freezing and the water running freely. In previous years, sheets of ice piled across the highway because the water froze before draining.

Two-Zone Climate for Home

Regulated heating or air conditioning of two areas in a home can be accomplished with a two-zone control system that features multiblade dampers on the furnace or central air conditioner. A thermostat in each of the two areas of the house controls a damper for that zone. Dampers are actuated by a motor mounted directly on the damper casing. The Rheem Auto-Zone System allows living and sleeping areas to be maintained at different temperature levels automatically. The thermostats bring about constant repositioning of the floating dampers, allowing the proper percentage of heated or cooled air to pass into each zone.

**YOUR FIRST
PIPEFUL TELLS
YOU—YOU'LL
GET ALONG
FINE WITH
AMPHORA**



Make your *next* pipeful AMPHORA; the even-burning, longer lasting, gentle blend from The Netherlands, at tobacco counters everywhere.



AMPHORA

U.S. Importer: Romick's International Tobacco Co., 11607 Vanowen St., North Hollywood, Calif.

PEEL PAINT OFF



Furniture



Floors



Boats



Woodwork



**KLEAN-STRIP
PAINT REMOVER**

Fast • Clean • Non-inflammable

THE KLEAN-STRIP CO., INC.
2340 S. Lauderdale, Memphis 6, Tenn.

CHANGE SPARK PLUGS REGULARLY

**FREE
THE HISTORY OF
THE COMPASS
SEND FOR YOUR COPY**

New **DINSMORE
Celebrity
COMPASSES**

in Beautiful **GOLD OR SILVER**

A jeweled, precision instrument—designed for modern cars. Full, indirect illumination. Sharp, clear letters. Silver or gold Celebrity models \$7.45, standard models \$5.95, illuminated \$6.95

APPROVED BY AUTO MAKERS
Fine Quality Compasses for over 31 Years

DINSMORE INSTRUMENT CO.
1802 Kelso St., Flint 1, Michigan



Write
for Folder

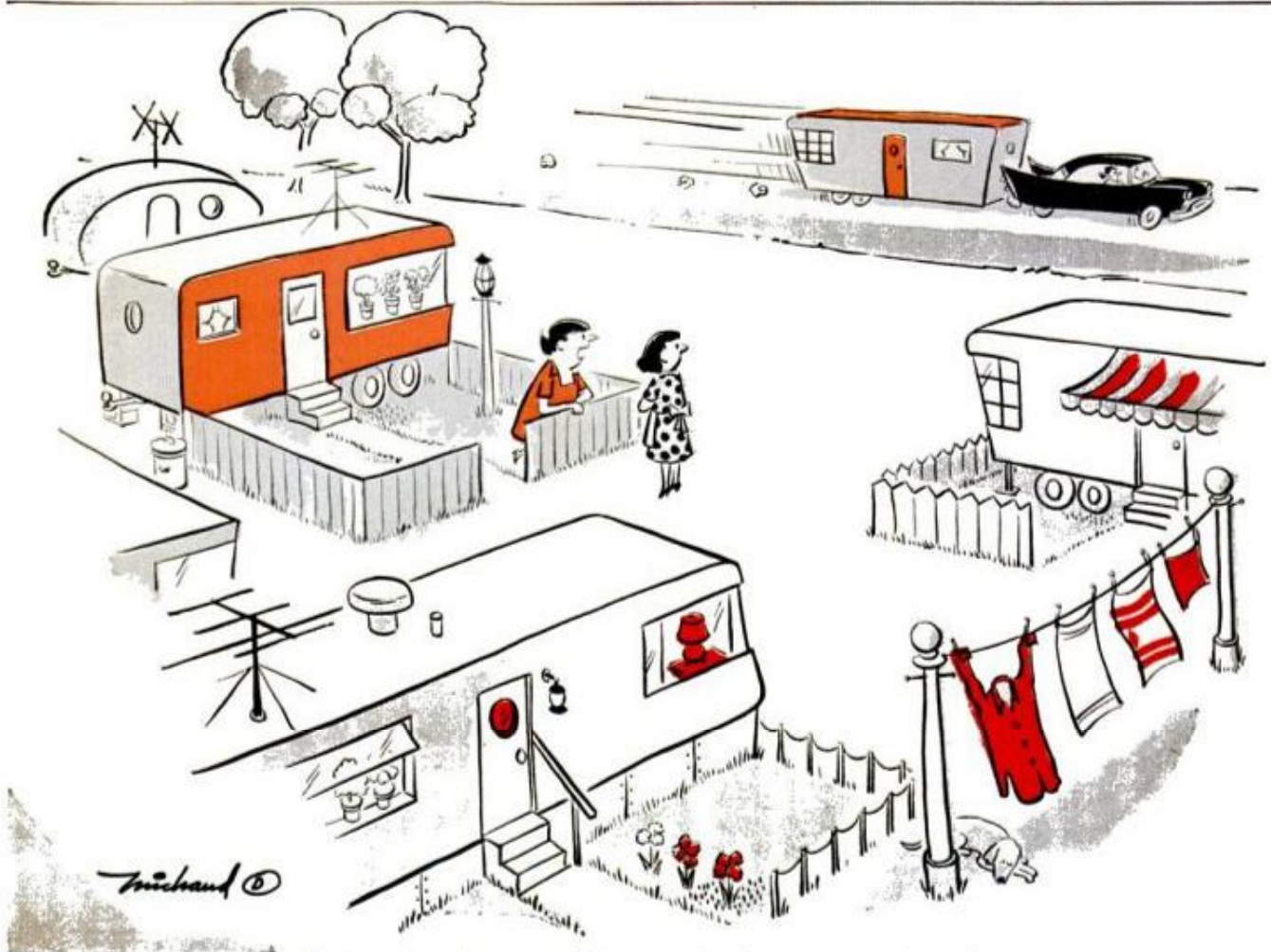

"Now there's something you don't see very often."

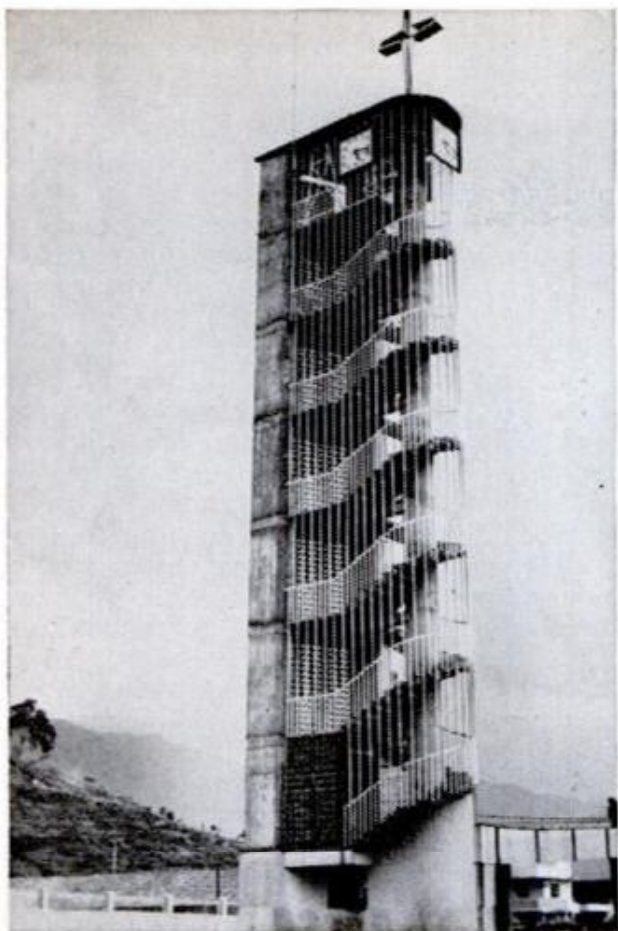

Bell-Tower Stairway

Appearing at first glance to be nothing but spiral stairs and landings, the bell tower of Our Lady of Fatima church in the city of Medellin, Colombia, looks like a futuristic fire escape. The bells and machinery are located inside the tower walls, and the tower is situated some distance from the church building.

QUOTE:

"And be assured that chemists, physicists and engineers continue to have the plight of the housewife very much in mind. Before long she may have sufficient time at her disposal to pursue the advanced engineering degree that she will need to understand, and possibly maintain, the functioning of her fully automated household."

—DR. GUY SUITS,
Director of Research
General Electric Company

SUPPORT
YOUR
MENTAL
HEALTH
ASSOCIATION



ONE SIMPLE ADJUSTMENT TO YOUR HOLLEY CARBURETOR

If you are getting poor idle or unsatisfactory fuel economy, one cause may be improper fuel level in the bowl. Because of the accessibility of the adjustable needle and seat arrangement on Holley 2-barrel and 4-barrel carburetors,

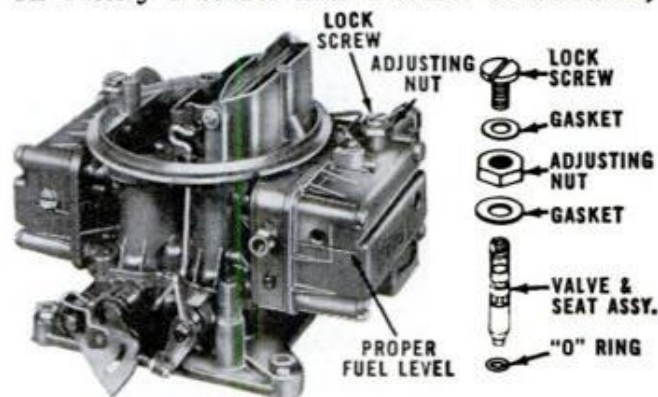

it's a simple matter to check the fuel level. Here are the easy steps: (1) Make sure the car is on level ground, then start the engine. (2) Remove the sight plug to check the fuel level in the bowl. (It should just reach the lower lip of the sight plug.) (3) If the level is too high or too low, loosen the lock screw with a screwdriver. Turn the adjustment nut clockwise to lower the fuel level—counter-clockwise to raise it. A 1/6 turn is the equivalent of 1/16-inch wet fuel level in the bowl. (4) Operate the engine until the fuel level is stabilized, then recheck level at the sight plug. Be sure to replace the sight plug. This adjustable needle and seat arrangement is one of many important developments of Holley's continuous research and engineering. There are, of course, other causes of unsatisfactory idle and economy. If this simple adjustment does not correct the trouble, your Holley dealer will be glad to make a thorough check of the carburetor.

★ ★ ★

When you make your own carburetor or ignition repairs and parts are required, be sure to use *genuine* Holley parts. Your Authorized Holley Distributor or Dealer, listed in the Yellow Pages, has a complete stock of Holley carburetor minor over-haul kits, tune-up kits, ignition parts, and brand-new replacement carburetors priced competitively with rebuilds. All are engineered and built to exacting *original equipment standards*. It will pay you to buy or specify Holley Parts.

HOLLEY
Carburetor Co.

THE
COMPLETE LINE
OF CARBURETION
and
IGNITION EQUIPMENT

C-1

11955 E. Nine Mile Road • Warren, Michigan
ORIGINAL EQUIPMENT MANUFACTURERS FOR OVER 55 YEARS

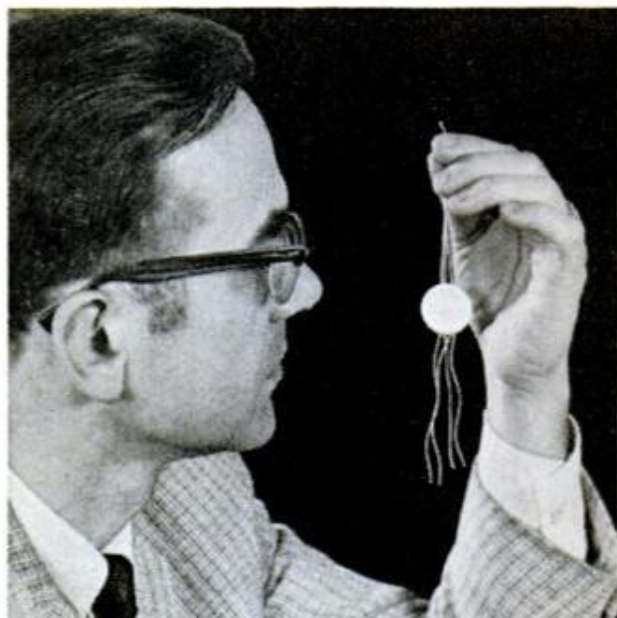

The Franklin Institute, Benjamin Franklin Pkwy., Philadelphia 3

Temperature Transmitter for Animals

Implanted in a laboratory animal for its lifetime, a temperature-recording device promises to give researchers accurate information on fever—man's natural defense against germs. The telemeter works when the animal in which it is placed is surrounded by a low-frequency power field. From the power field, the device gets energy to send its findings to a receiver.

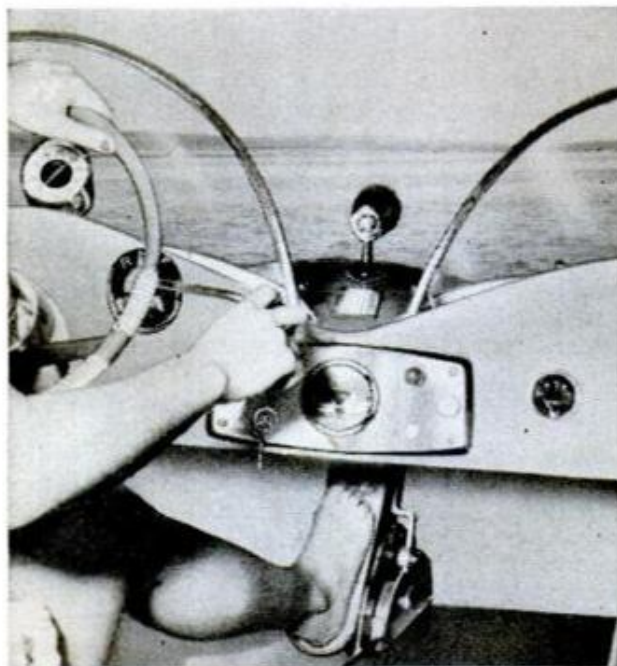

Tempo Products Co., 2062 E. 70th St., Cleveland 3, Ohio

Drive Your Outboard Like a Car

Taking advantage of coordination and reflexes learned in driving an automobile, a new outboard-boat control outfit has a dashboard gearshift and foot throttle. It simplifies control of speed and direction, especially in docking or maneuvering in winds or currents. The gearshift is adaptable to the control cables of most motors.

Missile With a Frozen Heart

(Continued from page 123)

While most professional golfers average 250 to 275 yards with their drives, the average golfer sends his tee shot off at a speed of 160 m.p.h., the same as the pro although probably to somewhat less yardage. And the ball attains this amazing speed from contact with the club of only .0004 of a second.

Do you rotate your golf ball on tee shots? If you don't you may be permanently altering its shape, and you will lose control of direction on your drives. If possible, rotate the ball each time you drive so that the impact will be distributed.

Heat and cold affect the liveliness of the ball. If you're golfing on a chilly or even a cold day, warm the ball before placing it on the tee. You'll notice the pros keep the golf ball in their trouser pocket prior to the shot in an attempt to warm the compressed core. The reason is simple. The warmer the ball, the more "bounce" you'll receive when you hit the ball, and this means more yardage.

Many average golfers are not aware of the fact that golf balls are available with two surfaces. A cut-resistant, tough cover for duffers and a regular cover for better golfers. The ladies can avail themselves of golf balls with the same general specifications with the exception that their models have lower compression factors more suitable to the lighter feminine touch.

With 4,000,000 golfers in the United States, of which 800,000 are women, it's quite easy to see how over 5700 golf courses of all types in this country find a ready clientele. In 1959, these golfing Americans played 72,000,000 rounds of golf. And the object of our discussion, the golf ball? 42 million were sold in 1959!

The golfing industry as a whole is growing rapidly too. Nearly \$70,000,000 worth of golfing equipment was sold last year, twice as much as ten years ago.

There's little doubt that modern technology and design have played a big part in the tremendous increase in popularity which the game of golf now enjoys, but a good portion of the credit goes to the little golf ball, to many early-rising week-end duffers a marvel of engineering. ★ ★ ★

QUOTE:

"There is as yet no substantial statistical, epidemiological or research evidence that breathing polluted air in our communities causes lung cancer."

—SEWARD MILLER, Director
University of Michigan
Institute of Industrial Health

It's a Pear-Shaped World

Scientists at the National Aeronautics and Space Administration are changing our concept of the shape and structure of the Earth through their studies of the orbital variations of the Vanguard I satellite. The fact that the Earth is really not round, but is an "oblate spheroid, slightly flattened at the poles" is an old one, but their work has shown now that the Earth is also slightly pear-shaped; higher at the North Pole and in the Southern Hemisphere, and lower at the South Pole and in the Northern Hemisphere than had been thought. The seemingly slight change, amounting to

about 50 feet at the poles and less elsewhere, is important in that it indicates that the Earth's structural strength is much greater than once thought. Dr. John A. O'Keefe of the NASA concluded from the figures that the Earth's mantle, 1800 miles thick, is not a large mass of rock being churned by convection currents, but is a material of about the same structural strength as brick. The calculations changed the old measurement of the Earth's flattening at the poles and means that the Earth's radius at the poles is about 13 miles shorter than at the equator.

The proof is in the puffing

and P. A. has the flavor
most favored in the U.S.A.



R. J. Reynolds
Tobacco Co.,
Winston-Salem,
N. C.

FARON YOUNG
OF "GRAND
OLE OPRY"

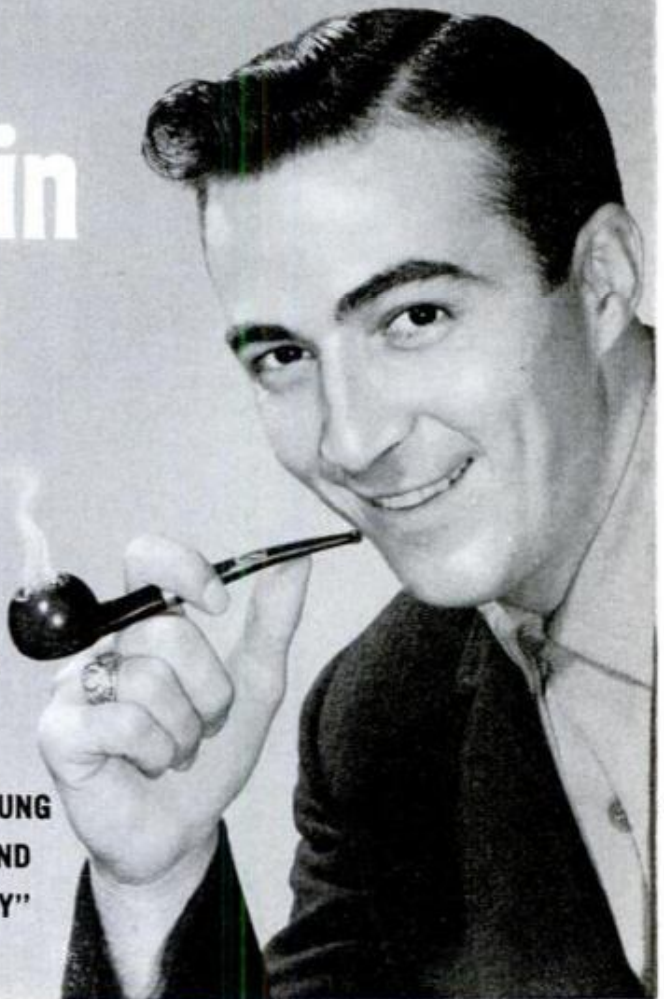

- always tastes fresh
- mild, mellow flavor
- cool 'n' steady burning

PRINCE ALBERT

America's Largest-Selling Smoking Tobacco!



Perardua Products, Box 46, Old Greenwich, Conn.

Shade Fits Any Size Lens

Designed to fit any size camera, a flexible shade eliminates the necessity of carrying a separate shade for each lens. Instead of screwing into the lens, the shade is held in place by a flexible band around the back of the camera. Filters can be slipped in behind the shade and held in place. Thus the largest size filter will accommodate any lens, and only one set of filters need be carried.

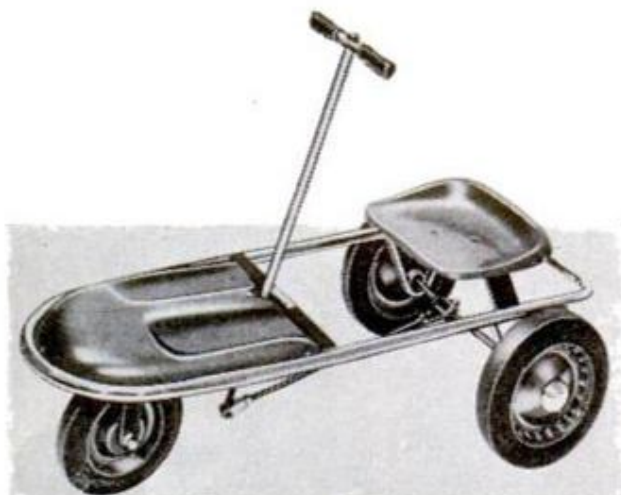

MG Industries, PO Box 7226, Minneapolis 12, Minn.

Velocipede for Crippled Children

Crippled or handicapped children who have retained the use of at least one arm can have greater freedom and mobility and enjoy themselves while exercising with an arm-powered velocipede. It is propelled and steered with a single lever, which drives the rear wheels. Designed originally for a paraplegic child but now available for home, hospital and school use, the glass-fiber and steel vehicle is built low for stability. Backrest and safety belt are optional accessories.

Step Table

(Continued from page 137)

runners ($\frac{1}{4}$ x $\frac{1}{2}$ x 7-11/16 in.) and fasten with brads and glue. The bottom edge of the drawer front serves as a drawer pull.

The 14-in. tapered walnut legs and mounting plates are purchased in sets of four, four angle-mounting plates being required to splay the front legs of a pair of tables. To provide added thickness to the table top for screwing the leg mounting plates to it, $\frac{1}{4}$ -in. plywood pads are glued to the underside at the locations indicated. Finish the completed tables to match the cocktail table.

MATERIAL LIST

TABLE

Solid Stock

- 1 pc.—1"x1 $\frac{1}{4}$ "x14 $\frac{3}{4}$ "—End
- 1 pc.— $\frac{3}{4}$ "x1 $\frac{1}{4}$ "x16 $\frac{3}{4}$ "—End
- 2 pcs.— $\frac{3}{4}$ "x1 $\frac{1}{4}$ "x29 $\frac{3}{8}$ "—Sides

Plywood

- 1 pc.— $\frac{1}{2}$ "x15 $\frac{3}{4}$ "x28 $\frac{7}{8}$ "—Top
- 4 pcs.— $\frac{1}{4}$ "x3 $\frac{1}{4}$ "—Support blocks for legs

TRAY

Plywood

- 1 pc.— $\frac{1}{4}$ "x17"x20 $\frac{1}{8}$ "—Frame
- 1 pc.— $\frac{1}{4}$ "x15 $\frac{1}{8}$ "x18 $\frac{3}{8}$ "—Bottom

STEP

Plywood

- 2 pcs.— $\frac{1}{2}$ "x9 $\frac{3}{4}$ "x9 $\frac{7}{8}$ "—Sides
(or, 4 pcs.— $\frac{1}{2}$ "x9 $\frac{3}{4}$ "x9 $\frac{7}{8}$ "—See text)
- 1 pc.— $\frac{1}{2}$ "x8 $\frac{7}{8}$ "x16 $\frac{1}{2}$ "—Top
- 1 pc.— $\frac{1}{4}$ "x9 $\frac{3}{8}$ "x16"—Bottom
- 1 pc.— $\frac{1}{4}$ "x9 $\frac{1}{2}$ "x16"—Back panel

DRAWER

Plywood

- 2 pcs.— $\frac{1}{4}$ "x3"x15 $\frac{5}{8}$ "—Front
- 2 pcs.— $\frac{1}{2}$ "x3"x7 $\frac{3}{4}$ "—Sides
- 1 pc.— $\frac{1}{2}$ "x3"x14 $\frac{7}{8}$ "—Back
- 1 pc.— $\frac{1}{4}$ "x7 $\frac{7}{8}$ "x15"—Bottom

Solid Stock

- 2 pcs.— $\frac{1}{4}$ "x $\frac{1}{2}$ "x7 $\frac{11}{16}$ "—Runners

MISCELLANEOUS

- 2—8' Rolls edging tape (matching veneer)
- 4—14" Legs with hardware
- White glue, plastic resin glue
- Contact cement
- Garnet paper, 4/0, 6/0
- Steel wool, No. 000
- Glue blocks

★★★

Adjust Binding or Rattling Sashes

OFTEN IT IS POSSIBLE to prevent a window sash from rattling, or, conversely, from binding at some point, simply by shifting the metal weather stripping. This can be done with a putty knife, a dull chisel or a short length of flat steel, anything having a square edge that can be placed against the edge of the weather stripping. A light mallet tap or two on the handle of the putty knife or chisel will shift the weather strip slightly, just enough to ease a binding sash or prevent a loose sash from rattling.

LOOKING FOR LONG WEAR IN SERVICE SHOES?

TRY **Thorogood**[®]
JOB-FITTED

SHOES WITH
NEOPRENE SOLES!



By Weinbrenner Corp.,
a Division of Textron, Inc.

Neoprene soles give long wear...
resist oil, grease, chemicals
and cold weather cracking.
Neoprene soles are resilient...
cushion each step...help make
standing jobs less tiring.

*Ask for neoprene soles
the next time
you buy service shoes.*



BETTER THINGS FOR BETTER LIVING...THROUGH CHEMISTRY

FIBERGLASS or PLYWOOD

\$41.95 Up: EASY TERMS
FREE CATALOG

50 Models 8-22 ft.

Cruisers, houseboats, run-
abouts, convertibles, fishing,
sailing. Pre-assembled, pre-formed units anyone easily assembles. Equal
factory-built. Save 1/2 to 3/5. Free catalog has all details, color photos,
paint, accessories, Fiberglass
supplies, trailers. WRITE TODAY.



LUGER BOAT KITS

Dept. B-7, 9200 Access Road, Minneapolis 20, Minn.

NOW! a hi-compression
staple gun
for only
\$4.95



With Exclusive
Push-button Loading
and Built-In
Staple Extractor.

Indispensable for home use...and never before
priced so low! This compact, all steel, powerful
SWINGLINE 101 staple gun is ideal for insula-
tion, carpentry, upholstery, screening, wire fencing,
plus thousands of other uses. Handle locks to
fit pocket. Lightweight, maneuverable, jam-proof!
Staple sizes 1/4", 5/16". Send for FREE book—"Tips
for Tacking".

Swingline[®] INC.

Dept. PM-70, Long Island City 1, New York

The NEWEST and FINEST: Buck's 400 Series

CHROME EDGE CHISELS

You get: ★ The Finest Cutting Edges
★ Tough Tenite II Handles
with Inserted Steel Caps
★ Rust Proof Tools

1" - \$2.90
3/4" - \$2.70
1/2" - \$2.40
1/4" - \$2.30

Plastic pocket Kit -
4 Sizes \$10.30

Most complete line of Chisels,
Gouges and Carving Tools

BUCK BROS. INC.
RIVERLIN WORKS MILLBURY, MASS.

CATALOG AVAILABLE!

Trailers Join the Country Club

(Continued from page 99)

But everyone knows you don't have to be a millionaire to enjoy trailer living. You can buy a fairly large and extremely comfortable mobile home for three or four thousand dollars. A good rule of thumb is \$125 per running foot. Financing is about the same as with an ordinary home, and there are plenty of modern, attractive trailer parks that charge no more than \$30 or \$40 per month space rent.

There is a trend now toward trailer-park subdivisions in which you *buy* your plot of ground instead of renting it. The largest of these, and probably the world's largest trailer park, is Trailer Estates near Sarasota, Fla. The 1500 lots in the park each measure 2400 square feet or more and are sold for \$1800 to \$3000. Each lot owner pays a \$10 per month maintenance fee, which goes to the upkeep of the paved streets, street lighting, central TV antenna, watchman and other facilities. Trailer Estates has its own moorings for pleasure boats, for which an extra fee is charged.

If you haven't walked through a modern residential trailer you have a real surprise coming. It is a complete home. A purchaser has his choice of up to a dozen floor plans and can select his own color combinations and interior styling. The trailers are completely furnished and feature many ingenious built-ins.

A 10x50-foot trailer is apt to have a 10x17-foot living room and two separate bedrooms in addition to full-sized kitchen and bath. Walls and ceilings are expensive veneers, the sturdy floor is carpeted wall-to-wall. Kitchens have hot and cold running water and all the usual facilities including a combination refrigerator-freezer. Some have garbage disposers, dishwashers and automatic clothes washers. Bathrooms have standard plumbing, including tub-shower combinations.

When a cabana is added, the cabana is often divided into a living room space that augments the trailer's living room, and a dressing room that is entered separately from one of the trailer's bedrooms. Sometimes a cabana contains an extension of the trailer's living room plus an extra bedroom and extra bath.

Modern mobile homes are well insulated and have their own central heating plants that duct hot air to floor registers in every room. They can be equipped with space coolers or refrigerated air conditioning for the hot months. In California, where a number of the manufacturers of large mobile homes are located, the state housing authority enforces minimum standards for heating, plumbing and electrical installa-

tions that are comparable to those for conventional houses.

The Trailer Coach Association estimates that four million people are living in mobile homes today and that one out of every nine housing starts is a mobile home. The association expects that 50,000 of the large residential units will be built and sold this year. There are something like 14,000 trailer parks in the U.S. and new ones being built at the rate of about 1000 per year.

It costs from less than \$100,000 to over a million dollars to open a new park for mobile homes, depending on the cost of the land and the improvements that are installed on it. Paved streets, the latest in sanitary systems, parking areas, a service building that includes washing machines, dryers, and showers, and good recreational facilities are necessary in a modern park.

Trailer parks for semi-permanent mobile homes are divided broadly into two groups: commercial parks adjacent to cities or other work areas and whose occupants have regular jobs, and parks in resort areas whose occupants are retired or on vacation. Florida and California have most of the resort parks, although these luxury accommodations are spreading rapidly.

Trailer parks have become such a big business that several firms specialize in the design and engineering of parks. The firm of Walters & Son, Corona Del Mar, Calif., has designed more than 300 parks and has work representing \$6 million in costs on its drawing boards at present. K. W. Walters of this concern expects that the high-grade accommodations that are available in mobile home parks will be extended shortly to parks that cater to the smaller travel trailers. Such parks would compare with quality motels in the services that they offer. One of their features will be a series of parallel driveways that allow drivers to pull their trailers up alongside utility islands for the night and from which they can depart in the morning by driving straight ahead. The system eliminates backing or jockeying of the trailers.

This idea is to be used in a \$2.5 million vacation marina on the west shore of the Salton Sea in southeast California. The whole project includes a 150-room motel, a mobile home park with 150 spaces, and a travel-trailer park with 200 spaces. In addition there will be restaurants, boat storage, boat launching ramps and boat docks.

Eventually, Walters believes, parks that cater to the overnight travel trailers will provide a permanent cabana at each trailer space. It would contain all the comforts that a travel trailer usually lacks, including a large living room with TV and a bathroom with tub and shower. ★ ★ ★

10 SHOTS IN LESS THAN 3 SECONDS!

AS FAST AS YOU CAN PULL THE TRIGGER

CROSMAN
600
SEMI-AUTOMATIC



Another "world's first" by Crosman!
A major breakthrough in CO₂ gas powered gun engineering... opens a whole new era in handgun shooting.
Now, for the first time you can enjoy match target accuracy in slow, timed, and rapid-fire competitive or practice target shooting, fast plinking, fun shooting... anywhere... anytime... at lowest possible cost.
The revolutionary new "600" SEMI-AUTOMATIC .22 Pellgun Pistol is truly a superb precision handgun you'll be thrilled and proud to shoot.



Write for literature: Crosman Arms Co., Inc.,
Dept. PM-43, Fairport, N. Y.
See it at your Crosman Select Dealer Sales Center

Crosman CO₂ GAS **HAHN**
PELLGUNS BB GUNS



JOIN THE
NATIONAL RIFLE
ASSOCIATION

WORLD'S LARGEST MANUFACTURERS OF CO₂ GAS-POWERED RIFLES AND PISTOLS

KIT BOATS



**Boat Plans
Patterns
Frame Kits**

KIT CATALOGS—Over 50 Models—Pre-assembled. Runabouts, Cruisers, Fishing (8' to 19'). Anyone can assemble. Complete Marine Accessories, Fiberglass plastics, Trailers, Paint, etc. Also Catalog on 50 Modern Plans and Patterns. Prefab Frame Kits—

**CREDIT
TERMS**

FREE FREIGHT—SAVE 2/3

CRAIG-CRAFT, Tonawanda 1L, N. Y.

SEND 10c FOR 2-COLORED CATALOGS



BUILD FINE GRANDFATHER CLOCK NOW

The simple sensible Red-i-Kut way as thousands have — **SAVE HALF. SHOP TESTED PLANS "SPIRIT OF THE CENTURY"** Narrow waist 83" tall or stately straight side **"SPIRIT OF AMERICA."** **EASY-TO-FOLLOW photopack PLANS** tell all—plus **BROCHURE** of heavy brass weight Westminster, tube chime, movements, gorgeous bronze-silver dials, 3/4" solid mahogany case kits. Send \$1.00 today—Both plans \$1.50 NOW. Kuempel Chime Clock Works, 28 Kuempel Bldg., Minneapolis 16, Minn.

(Item 24)

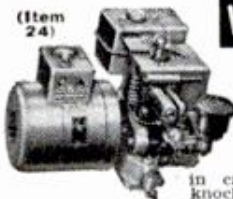

World's THRIFTIEST Light Plants

700 Watt, push button start, 115 v. 60 cyc. AC, 2.2 HP, easy starting Briggs eng. No wiring necessary; just plug in and operate. Plenty of current for any oil burner, freezer, brooder, emergency lights, etc. which require up to 700 watts. Ideal for television and radios. Complete with voltmeter and built-in winding to charge auto batteries. (Item 24) Wt. 7.5 lbs. Easily fits in car trunk. Be prepared if storm knocks out power lines. Reg. \$275... **\$143.50**

1200 Watt Plant (Item 45) same as Item 24 but larger generator and engine with 50% greater output... **\$199.50**

ELECTRONIC BRAIN Now Available On All Our Plants—Write

MASTER MECHANIC MFG. CO., Dept. A-76, Burlington, Wis.

Southern Customers Order from Dept. A-76, Box 65, Sarasota, Florida



GENUINE ALNICO

MAGNETS

AMAZING. PERMANENT. NON-ELECTRIC. HIGHLY PRACTICAL. Conduct interesting experiments. Hundreds of uses. Retrieve valuable steel items such as guns, tackle from fresh or salt water; tools from tanks & drains. **GUARANTEED.** Try any magnet one week. Money back if you are not well-pleased.

- No. M-710 (Wt. 53 oz.) Has pull of 225 lbs. on steel block... **\$18.00**
- No. M-625 (Wt. 70 oz.) Has pull of 125 lbs. on steel block... **\$10.00**
- No. M-575 (Wt. 18 oz.) Has pull of 75 lbs. on steel block... **\$ 7.00**
- No. M-500 (Wt. 13 oz.) Has pull of 50 lbs. on steel block... **\$ 5.00**
- No. M-90 (Wt. 5 oz.) Has pull of 15 lbs. on steel block... **\$ 3.50**
- No. M-300 Kit of Flat Bars 5 pairs (10 Magnets)... **\$ 3.00**
- No. M-47 Hot Pad Magnets, 10 for \$1.00... **50 for \$ 4.87**
- No. M-35 Hobbyist assortment of 8 magnets... **\$ 2.00**

Send M.O. or check. We pay postage. Sorry no C.O.D.'s.

MIAMI MAGNET COMPANY, 3240 N.W. 27th Ave., Miami 42, Fla.



Elmer's Glue-All. Handy, easy to use. No muss, no fuss. Dries fast, clear and strong. The best all-purpose household glue you can buy. Send a stamped, self-addressed envelope for free copy of "Elmer's Guide To Good Gluing." 16 pages of gluing hints and tips. Borden Company, 350 Madison Ave., Dept. PM70, New York 17, N.Y.



Throw Back the Big Ones

(Continued from page 111)

too. Fish that are good to eat in one area may be extremely poisonous in another. The dual personality of these fish has caused much confusion and the fact that a fisherman may have eaten a particular fish on hundreds of occasions with no harmful results is no guarantee that this same fish, under slightly different conditions or in some other locality, will not produce intoxication and rapid death.

The big problem facing Dr. Halstead and other ichthyologists today is learning how the fish become poisonous and what factors contribute to the condition. While the answers are still unknown, it is believed that in most cases the fish become poisonous through their feeding habits, with the poison originating in a marine plant. Plant-eating fish feed on these plants, manufacture the poison in their bodies, and in turn are eaten by carnivorous fishes, making both groups poisonous—but not poisoning either group of fish.

Believed to be the most poisonous of all marine animals are the puffer-like fishes; this group includes ocean sunfishes, sharp-nosed puffers, the true puffers and the porcupine fishes. The true puffers are the greatest offenders and there are about 90

or more species in this group. A characteristic of all puffers is their unusual ability to blow themselves up—hence the name—to as much as eight times their usual size. The puffer accomplishes this trick by gulping in large quantities of air or water.

“To make things more confusing, some puffers are not poisonous,” Dr. Halstead says. “However, some that are poisonous can cause death to a full grown adult as quickly as 17 minutes after the first bite of fish is eaten.”

Oddly enough, the fresher the puffer the more deadly this fish is likely to be. And still odder is the fact that of all food fish to be found in Japan—world’s largest fish eaters—the puffer brings the highest price. In the old days, according to the doctor, puffer flesh was reserved strictly for the emperors of Japan, probably because of the effects often derived from eating the fish.

In Japan the puffer is called fugu, and is prepared and sold in special restaurants hiring specially trained fugu cooks. The fugu chefs soak the puffer’s flesh in water for three hours, then cook and serve it in very small pieces. The result is something like smoking a marijuana cigarette—the diner is “sent,” as the beatniks put it. He has a sense of great well-being, of floating lightly through the air and of being very pleased and happy with life in general.

Here's the "Hoola Hoop" of water sports that's fun for kids of all ages from 6 to 60. It's the sensational new

"Park-n-Sail"

Park-n-Sail, the country's newest fad, packs more water fun into its 3' square hull than ever thought possible. Because of its all white polyurethane hull, it is completely safe and nonsinkable. She also boasts of a 9' aluminum mast with 5½' boom and a bright orange sail. Weighing only 20 lbs., she can be carried by small tots and easily disassembles for transporting in the trunk of your car. Be among the first to enjoy the newest thrill in water sports. Order yours today! \$89.50 complete—plus shipping charges.

MAIL COUPON TODAY

Park-n-Sail
Tri-Star Division, P.O. Box 3841, Detroit 5, Mich.

Please rush to me the sensational new Park-n-Sail. I enclose \$20.00 check or money order for deposit. Balance to be paid upon delivery plus shipping costs.

Name _____

Address _____

City _____ State _____

Please send more details

- Non-sinkable • Sail in it—not on it
- Lightweight portable
- Fun for all, use it in your swimming pool

\$89⁵⁰
complete
plus
shipping charges



This is exactly the opposite of the effect that was described in the beginning of our story. Nevertheless, with all the special treatment, puffer fish is still the number one cause of fatal food poisoning in Japan. It has been estimated that as many as 200 Japanese have died from it in a single year.

"At best, eating puffer is a game of Russian roulette," Dr. Halstead grinned. "Unless you feel that you are a fugu connoisseur, leave puffers alone. You'll probably live longer."

When puffer is eaten unsuspectingly the symptoms of poisoning are quick to appear. Within 10 to 45 minutes the lips and tongue begin to tingle. When you feel this, it is time to call your lawyer for the tingle soon reaches the fingers and toes and they become numb. If you can take it (and are lucky) you might make it; less than 40 people survive out of every hundred poisoned. However, it will be a long time before you are sure—recovery often takes months.

Another form of ichthyotoxism, as poison from eating fish is called, is ciguatera. More than 300 species of ocean fish have been traced as causes of this type of poisoning. Fish most commonly involved are sea bass or grouper, barracuda, snapper, parrotfish, wrasse, surgeon fish, and other types of reef fish.

An odd symptom, unknown to any other disease, crops up with this type of poisoning. It is a reversal of temperature sensations. Cold things may feel hot and hot things cold.

Dr. Halstead tells of a case concerning a naval officer who was poisoned by eating amberjack in the Virgin Islands during fleet maneuvers. He suffered only a mild attack and soon recovered.

Four weeks later, however, he was observed in the wardroom unconsciously blowing on his ice cream, which was "burning" his tongue.

When a victim does survive, his recovery and convalescence may be very prolonged, with extreme weakness, sensory disturbances, and excessive loss of weight the last symptoms to disappear. If the poisoning has been severe, complete recovery has been known to take several years. Several cases are on record in which the symptoms persisted for as long as 25 years.

Unfortunately, poisonings resulting from fishes are very frequently confused with a variety of other ailments because of a similarity of symptoms.

Other symptoms from ichthyotoxism include vomiting, diarrhea, severe abdominal pains, extreme muscular weakness and

(Continued to page 218)

You can do more with

DELTA

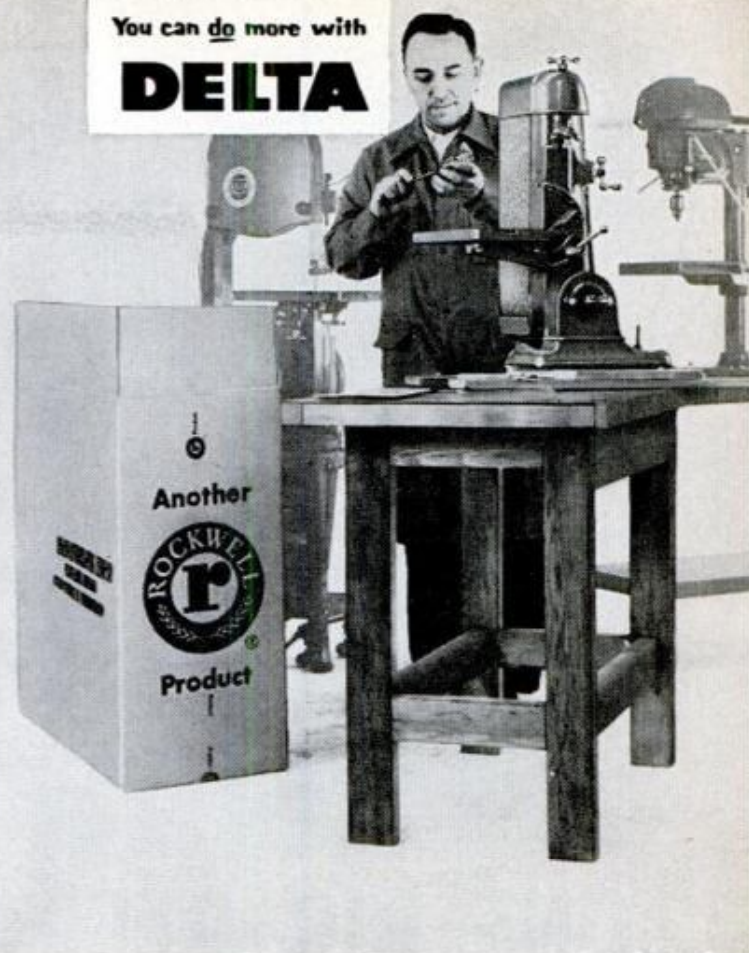

where every tool counts

you'll want a DELTA

You just couldn't ask for more *UTILITY* than this machine delivers! Finishing, mitering, deburring, chamfering, hundreds of unexpected jobs—in both wood and metal—are all in a day's work for this Delta 6" Belt Abrasive Finishing Machine. You can always keep the work piece level—operate the belt horizontally, vertically, or at any angle in between. Rugged as it is dependable, this machine has many quality extras you'll have to see to really appreciate. Good tools are so *basic* to profitable work—why not start with the best? Call your Delta Distributor (listed under "TOOLS" or "MACHINERY" in the Yellow Pages) for details on this or any wood or metalworking tool in Delta's complete line. For FREE catalog, write: Rockwell Manufacturing Company, Delta Power Tool Division, 502G N. Lexington Ave., Pittsburgh 8, Pa.

DELTA INDUSTRIAL TOOLS

another fine product by

ROCKWELL





ONE BIG STEP

to a more beautiful lawn

WEEDONE

CRAB GRASS KILLER SODAR

When you use WEEDONE CRAB GRASS KILLER SODAR you're taking a giant step toward the lawn of your dreams! It's the fast-acting chemical that's best for killing this lawn-spoiling weed, yet it will not kill desirable grasses. Don't break your back this year—control crab grass the modern, chemical way with WEEDONE CRAB GRASS KILLER SODAR and step up to a beauty of a lawn!

SPRAY IT:

Liquid 1 pt. can \$1.95
Powder 4-oz. can \$1.25

SPREAD IT:

Dry 5-lb. bag \$2.25
(slightly higher west of Rockies)
Larger sizes available.



WEEDONE

CRAB GRASS KILLER SODAR

Amchem Products, Inc. (Formerly American Chemical Paint Co.)
St. Joseph, Mo. • AMBLER, PA. • Niles, Calif.

ORIGINATORS OF 2,4-D and 2,4,5-T WEED KILLERS

Amchem and Weedone are registered trademarks of Amchem Products, Inc.

pain along with partial or complete paralysis. Skin disorders are frequently reported consisting of intense itching, red rash, blisters, extensive loss of skin, especially on the hands and feet, and occasionally ulceration. There may also be loss of hair and nails.

If you are living under survival conditions, and questionable fishes must be eaten, it is advisable to cut the fish into thin fillets and to soak them in several changes of water—fresh or salt—for at least 30 minutes. This will serve to leach out the poison which is somewhat water-soluble. It should be emphasized that ordinary cooking methods do not destroy or even weaken the poison.

Dr. Halstead has long been interested in fish. He has made so many expeditions that he's lost count but does remember making his first trip at the age of 17 when he was hired to assist in making a fish census of a large lake. When his high school class was taken through the San Francisco aquarium, the aquarium's curator offered a job without pay to any boy who wanted to help. The Halstead boy took the job and fish have been his occupation and pre-occupation ever since.

Today, Dr. Halstead is the director of World Life Research Institute now under construction in the mountainous foothills of Colton, California, which lies about 60 miles east of Los Angeles. The Institute already possesses one of the largest libraries in existence in medical marine biology, particularly on marine biotoxicology. They receive letters from all over the world asking for information on fish. "The trouble is," Dr. Halstead says, "many of the questions have no answers—but someday they will."

Scientific interest in fish poisoning underwent another revival with the remarkable sequence of poisonings which took place between February 1946 and April 1947 at Fanning Island in the Line Islands—a small group of coral islands lying along an almost straight line between Hawaii and the equator. During this period there were 95 cases of fish poisoning among a population of 224 persons, caused by eating the same fish species they had always eaten before with complete impunity!

Investigation revealed that a startling change in the edibility of the shore fishes began about 1943, involving the islands of Midway, Johnston, Kingman Reef, Palmyra, Fanning and Christmas Island. These poisonings reached a peak about 1947, and have continued, somewhat abated, to the present time. Strange to say, the fishes of most of the Hawaiian Islands and Washing-

(Continued to page 220)

WORLD'S MOST EXCITING LOWEST PRICED CAR

New KING MIDGET

15 years continuous production—Thousands of proud, satisfied owners from Alaska to Ecuador. Many report 50 to 75 miles per gallon. Rear mounted air-cooled engine, smooth fully automatic transmission, four wheel hydraulic brakes. A safe and amazing small car you can own and drive at a fraction of the cost of any other. You owe it to yourself to get the surprising facts and prices. Buy it at the dealer price if no dealer near you. Rider Agents wanted. Send 25c for 32 page book, full details, dealers price, or \$1 (refunded first order) for this plus Service and Repair Manual and 16 5x7 photos of car and factory.

MIDGET MOTORS CORPORATION
ATHENS 1, OHIO

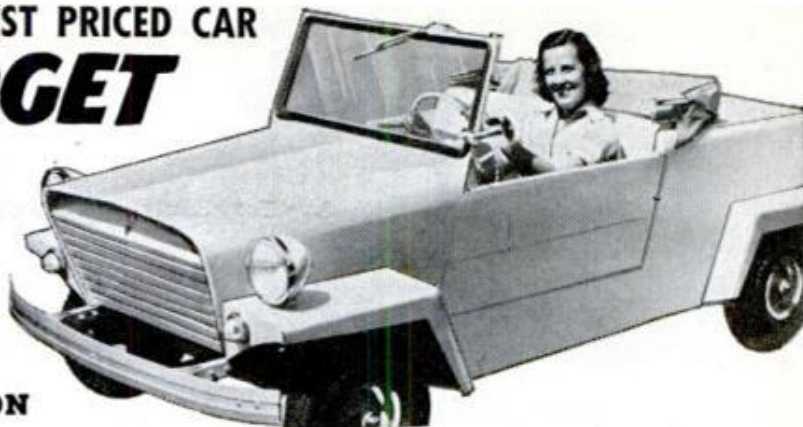

FREE 32-PAGE BOOKLET

... from your lumber, building material or hardware dealer ... with complete instructions for building, patching or repairing with Sakrete ready-to-use Cement Mixes — your assurance of smooth working, high strength concrete or mortar.

INSIST ON GENUINE

SAKRETE

ADVERTISED AND SOLD NATIONALLY



FREE CATALOG!

TREMENDOUS SAVINGS ON HUNDREDS OF SURPLUS AND NEWLY MANUFACTURED ITEMS!

New 1960 edition contains over 50 pages of tools and equipment for farm, home, workshop, factory. Hydraulic equipment, pumps, motors, construction and diesel equipment and parts! Write for your FREE CATALOG Today.

GROBAN SUPPLY COMPANY

1139 South Wabash Ave., Dept. G-7 Chicago 5, Ill., WEbster 9-3793



Here Is The Tool that makes a Hard Job QUICK and EASY

Speeds removal and replacement of universal joint bearings ... no damage to U-joint bearings or seals ... reversible jaw permits use on most American cars and trucks ... tested and approved by two of America's leading universal joint manufacturers ... compact and lightweight.

\$24.95

postpaid

Satisfaction guaranteed or money back within 30 days.

PRECISION BUILT FOR PROFESSIONAL MECHANICS AND SERVICE STATION OWNERS

Dealer inquiries invited

UNI-MATIC CORPORATION

6229 Bartmer Ave.

St. Louis 30, Mo.

Phones Permit Direct Calls By Dialing Single Number

Fancy phones that soon may service hotels and motels let guests call for reservations, paging service or room service by dialing a single digit. Using the telephone, developed by General Telephone Laboratories, Inc., a guest can call room service by dialing "8" or maid or valet service by dialing "7," for example. He may call the garage to have his car delivered by dialing "6." The phones also permit one guest to call another guest directly, without going through the operator.

Scientists Find Huge Island Submerged in Arctic Ocean

Four Columbia University scientists have discovered a huge island submerged 900 feet below the icy surface of the Arctic Ocean. About 14,000 square miles in area on top, it resembles some of the great tablelands in western United States. Underwater photographs show abundant marine life on top of the island. Specimens taken by trawls along the top included eight-inch starfish, four-inch bristled flat worms, a strange two-inch tadpolelike creature resembling a teardrop with large blue eyes, and a new species of a small mosquitolike creature with a long antenna.



Plastic "Levees" for Rice Fields

Rice growers in California's Sacramento Valley hope to increase their production with lower costs by using plastic "levees" developed by the University of California. Two-foot-wide strips of polyethylene sheeting are staked into a foot-deep trench. According to the Experiment Station, plastic makes a superior water barrier, cuts weed-seed population in half, wastes only five percent as much land as earth levees, and is removable for harvesting.



WOOD ROTTING?

FIX IT QUICK!

The job is easy with the one and only Plastic Wood. Can be sanded and painted.



For surest results always use GENUINE

PLASTIC WOOD

Handles like putty—hardens into wood!

This one's really built! MFG

Its tough MOLDED FIBER GLASS lapstrake hull is molded under heat and high pressure in matched metal dies . . . reinforced with 3 aluminum beams, an aluminum keel, several dozen crosswise fiber glass ribs. COMPARE THIS WITH ANY OTHER FIBER GLASS BOAT! Then compare performance, beauty, cost. You'll buy "MFG". 5 sizes, 12 models. Write for literature.



MOLDED FIBER GLASS BOAT COMPANY 71 Fourth Avenue, Union City, Pennsylvania

8" POWER SAW NOW ONLY \$9.95

Blade tilts — table stays level. All iron and steel construction. Single hand-wheel control. Blade raises and lowers. Sold direct from factory at unusual saving. Money back guarantee. Send for FREE fully illustrated booklet.



ONLY \$9.95

AMERICAN MACHINE & TOOL CO. ROYERSFORD 55, PA.

YOUR OWN 2-WAY RADIO!



Messenger
FROM \$129.75

Anyone can operate—
license issued by the FCC on request!

The very finest Citizens' Transceiver available! Excellent selectivity and sensitivity for maximum range. Maximum legal power. Dozens of features!

WRITE TODAY FOR FULLY ILLUSTRATED BROCHURE



E. F. JOHNSON COMPANY

162 SECOND AVE. S. W. • WASECA, MINNESOTA

ton Island have remained unaffected and without any change in their edibility.

For centuries it has been known that a fish species may be edible in one area and violently poisonous in another. Toxicity in a fish seems to develop without apparent cause, but this is undoubtedly only because we do not completely understand the mechanisms involved.

The most recent surge of poisonings caused by the eating of marine organisms, namely squid, octopus and certain types of oceanic fish, took place in Japan, the Philippines and elsewhere in the Indo-Pacific region. It has been estimated that more than 40,000 persons were involved in the 1955-56 outbreaks. The unknown cause of this outbreak is the big question for the underwater medical researchers of the future to answer. The sea represents a vast reservoir of latent resources, whose combined values attain astronomical proportions. Even Dr. Halstead insists that the greatest gain from his work with poisonous fishes is the exploration of sources for useful organic chemical agents so far unknown to medical science. It is the last great frontier left to us and man must continue to unravel the mysteries hidden in the ocean depths. ★ ★ ★

This Month's "Great Pioneer in Science"

(Page 34)



Isaac Newton (1642-1727)

EMERSON ELECTRIC

NEW POWER For Your Tools...

There's an Emerson Electric Motor for every tool...sanders, saws, joiners, pumps, lathes, drills, buffers, etc...Home workshop or commercial...Operate in any position...exclusive dust-proof contact points. One year guarantee.



Write today for prices and FREE MOTOR SELECTOR GUIDE...tells you the exact motors you need for your tools.

EMERSON ELECTRIC of St. Louis
8100 Florissant • St. Louis 36, Mo.



Get New 132 Page Catalog of **WOOD AND WOODWORKING MATERIALS**

WORLD'S LARGEST SELECTION—Lowest Prices
Your buying guide for finest kiln dried domestic and rare imported woods, inlays, bandings, matched plywood, mouldings, ornaments, etc. Biggest selection of tools and hard-to-find hardware. Packed with scroll saw patterns, projects, wood facts and money making ideas. Enclose 25c (refunded on first order) to help pay mailing and handling costs. Write today to **CRAFTSMAN WOOD SERVICE COMPANY** 2729 S. Mary Street, Dept. A-7, Chicago 8, Ill.

Print Your Own
Cards, stationery, circulars, etc. Save money. Print for Others, Good Profit; easy rules sent. Raised Printing like engraving, too. Junior press \$15; Senior \$29 up. Sold direct from factory only. We furnish everything. Write for free details. **KELSEY PRESSES, Y-37 Meriden, Connecticut**

Jaloppies and superspeedsters will be roaring across the Bonneville Salt Flats next month.

For a preview of the exciting action, don't miss the August feature article—

"IT'S BONNEVILLE TIME AGAIN!"

HOW A FEW LOW-COST PARTS CAN GIVE YOUR CAR THOUSANDS OF EXTRA MILES!

Which parts to replace is as important as when to replace

Nobody wants to put out good money for an engine overhaul if there's no real need for one. But when key parts such as bearings are too far gone, your car engine can no longer operate efficiently.



WHEN TO GET AN OVERHAUL

Know the signs, and you'll know the time. You'll probably notice that your engine has lost much of its original pep. Gas mileage drops off, oil consumption begins to get out of hand... and your engine may knock or misfire. Your car isn't ready to be retired yet. Do as fleet owners do. Treat your engine to a *complete* overhaul. Your car will purr like new again.

WHICH PARTS NEED REPLACING

Get a first class mechanic, and *don't compromise on parts*. Parts represent the smallest portion of the cost. You'll probably need new main, connecting rod, and camshaft bearings. These bearings control the amount of oil that lubricates vital parts in your motor. And for bearings to give proper oil clearances, they must be manufactured to tolerances as small as .00025".

FEDERAL-MOGUL MEANS LONG SERVICE

Your car engine is a precision mechanism, and bearings—main, connecting rod and camshaft—are the very heart of it. Yet it costs no more to use the best—Federal-Mogul. Ask any mechanic. *There's a Federal-Mogul engine bearing to fit every domestic and leading imported make of car.*



FEDERAL-MOGUL SERVICE



Division of Federal-Mogul-Bower Bearings, Inc. • Detroit 13, Michigan



The Finest
craftsmen use the
Finest Fasteners!



Buy SOUTHERN SCREWS for Best Results every time. . . . Save Time and Money too!

For every home project and repair, be sure you have the right size Southern Screw to do the job. Have 'em at the right time, too, rather than having to wait overnight or over a weekend until your supplier's store opens. Stock up now! Put a box of each of the popular sizes of Southern Screws on your workshop shelf today! Save time—and you'll save money, too, when you buy Southern Screws by the box instead of by the dab!

Remember: Only a SCREW Holds Like a Screw!

Wood Screws • Stove Bolts • Machine Screws • Machine Screw Nuts • Tapping Screws • Carriage Bolts • Drive Screws

SOLD THROUGH LEADING HARDWARE AND BUILDING SUPPLY DEALERS



Works in seconds!



Loosens Rusted Bolts nuts, screws, "frozen" parts!

LIQUID WRENCH
SUPER-PENETRANT

The super-penetrating rust solvent that quickly loosens rust and corrosion.

AT ALL HARDWARE AND AUTO STORES

RADIATOR SPECIALTY COMPANY CHARLOTTE, N. C.



Exclusive Double-Bearing HEAVY-DUTY PUMPS

IRRIGATE • DRAIN • CIRCULATE • SPRAY
Use 1/4 HP motor or larger . . . 1 HP for up to 5,200 GPH; 1,000 GPH 60" high; or 3,000 GPH from 25' well. 1 1/2" inlet; 1" outlet. Stainless shaft.

TYPE X—2 oil-less bronze bearings. Won't rust. . . . \$10.95

TYPE XB—Ball bearing model. . . . \$12.95

Postpaid if cash with order. Rush your order today

MONEY BACK GUARANTEE

Centrifugal and Gear Pumps in All Sizes

LABAWCO PUMPS, Belle Mead 2, N. J.



TOOLS WHOLESALE

Start your own business, sell tools to your friends and neighbors, or buy tools for your own use and SAVE MONEY \$\$\$

A MILLION DOLLAR INVENTORY AT YOUR FINGERTIPS. NO STOCK TO CARRY. ORDER AS YOU NEED IT.

BUY AT WHOLESALE PRICES. Extra \$25.00 profit on your accumulated purchases. \$1.00 refund on first purchase or refunded if you are not 100% satisfied.

SILVO HARDWARE CO., Dept. PM-7

THOUSANDS!!! of Nationally Advertised items of Hand Tools, Power Tools, Machinist Tools, Tool Chests, Paint Sprayers, Light Fixtures, Appliances, Guns, Gifts, Toys and other items too numerous to mention.

WE SHIP COAST TO COAST

White. Disc. up to 50% off

\$100
PUTS YOU IN
BUSINESS

107 Walnut St., Phila. 6, Pa.

Uncle Sam's "How-To" Men

(Continued from page 72)

handle plows which had been imported some 15 years before, but never accepted by the farmers. Bowen converted them to one-handle plows and altered the share to resemble the traditional Ethiopian plow. The significant difference was that the new plow turned a six-inch furrow. As soon as Bowen demonstrated it, farmers got the point. With such a tool they would have to plow their fields only twice, instead of four or five times.

Today the new plows are in use in all the farming areas of Ethiopia. Thanks to a simple change in a basic farm tool, Bowen has the confidence of the Ethiopian farmers. This has permitted him to introduce more advanced implements of his own design—simple harrows, cyclone seeders and corn shellers. Such tools have never been seen on Ethiopian land, but promise to increase production significantly. Furthermore, local industries are beginning to produce the new implements in quantity, and the farm-implement business is booming.

It's an oversimplification, but in a way you can trace most of this bootstrap improvement to a man of ingenuity who spotted a slight improvement he could make in the point of a plow.

Perhaps Miss Sybil Bates set herself the highest goal. A home-economics adviser with the ICA in India, the determined Miss Bates set out to improve home laundry techniques. Changing a housewife's methods of doing the washing isn't easy, as any housewife will testify.

The energetic Miss Bates has come up with a variety of arm-powered washing machines. One resembles an old-fashioned butter churn; another is a true agitator type that is about as efficient in cleaning clothes as your own automatic.

Another washing machine—the famous Pettit-Holtzclaw contraption—is the most successful gadget in the history of ICA. The idea has been exported throughout the world, and thousands of washers are popping up from the wilds of Canada to the hidden valleys of Burma. Why Canada? Sportsmen are building them to do their laundry at remote fishing cabins! Any sportsman interested will find plans in the July, 1959 issue of *Popular Mechanics*.

But the prize for top inventor in ICA must go to a balding middle-aged man named Ralph Dunkle. A design engineer by profession, Dunkle has come up with a wide variety of simple easy-to-build machines that have been mass-produced in Indonesia to increase productivity and

(Continued to page 224)

PM ANNUALS

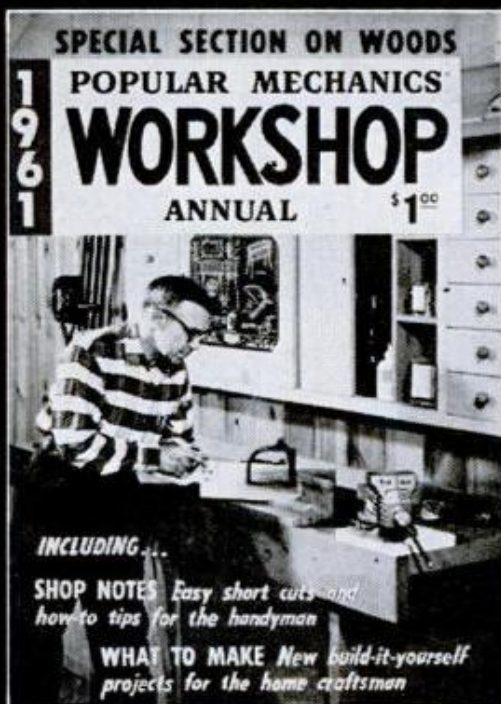

(ON SALE SEPTEMBER 1)

POPULAR MECHANICS ANNOUNCES A NEW LINE OF SPECIAL-INTEREST PUBLICATIONS

SEVEN AREAS IN WHICH POPULAR MECHANICS IS WELL-KNOWN FOR ITS COMPLETE AND AUTHORITATIVE COVERAGE. WATCH FOR THEM IN THE MONTHS TO COME

WORKSHOP ANNUAL

EXCITING PROJECTS AND HOW-TO HINTS FOR THE HOME CRAFTSMAN—BIG BONUS SECTION ON WOODS. SEPTEMBER

HI-FI ANNUAL

HOW TO BUY A STEREO SOUND SYSTEM—WHAT'S NEW IN TAPE—SPECIAL SECTION ON HI-FI KITS. OCTOBER

HOT ROD ANNUAL

COMPLETE RESULTS FROM BONNEVILLE, AHRA DRAGS AND DETROIT NATIONALS—HOPPING UP THE COMPACTS. NOVEMBER

CAR FACTS ANNUAL

PM'S AUTOMOTIVE EDITOR REPORTS ON THE 1961 MODELS—COMPLETE SPECS OF ALL THE NEW CARS. DECEMBER

SCIENCE ANNUAL

THE YEAR'S EXCITING BREAKTHROUGHS IN SCIENCE AND TECHNOLOGY—REPORT ON PROJECT MERCURY. JANUARY

BOATING ANNUAL

BUYING A USED BOAT—VACATION FUN AFLOAT—NEW BOATS—HOW TO BUILD YOUR OWN HOUSEBOAT. MARCH

HOME ANNUAL

HOW TO LANDSCAPE, MAINTAIN AND REMODEL YOUR HOME—THE LATEST IN OUTDOOR LIVING. APRIL

AT YOUR NEWSSTAND



NOW You Can Straighten Bent Crankshafts without Dismantling Engine!

You'll make money for yourself, save money for your customers with a Little Brute in your shop. Little Brute straightens crankshafts in Briggs, Clinton, Lauson, nearly every vertical shaft small 4-cycle engine made. It takes just 7 minutes average time to straighten a bent crankshaft to manufacturer tolerances . . . and the average price by shops using Little Brute for this service is \$10.00. Order today . . . or write for information.



NOphms 1-3564 317 E. FIRST STREET
MONTICELLO, IOWA

ONLY
\$34.95
f.o.b.
Factory

GUNK® degreases

At better automotive supply and hardware retailers everywhere.



Cleans engines, garage floors, power mowers, greasy walls economically and safely.
In aerosol or pour spout cans.



GUNK CHICAGO CO., River Forest, Illinois
serving the Midwest and Southwest
RADIATOR SPECIALTY CO., Charlotte, No. Carolina
serving the East, Southeast and Far West

Send for your **FREE**



1960 CATALOG

HI-FI, HAM RADIO MARINE . . . TEST

Over 150 do-it-yourself electronic kits are illustrated and described in this complete Heathkit Catalog.



DO-IT-YOURSELF . . . IT'S FUN
IT'S EASY & YOU SAVE UP TO 1/2

HEATH COMPANY/Benton Harbor 17, Mich.

DAYSTROM, INCORPORATED
a subsidiary of

Please send the FREE Heathkit Catalog.

NAME _____

ADDRESS _____

CITY _____

ZONE _____

STATE _____



ICA has helped spread 4-H Club movement throughout world. Here a happy youngster displays first crop

raise the standard of living. ICA has how-to-do-it plans for several of his machines—a rice thresher operated by bicycle pedals, a press for turning out bricks made of soil cement, a wind pump that resembles the old windmill, except that it's more efficient.

Last year you, as an "average" American, gave about 1 1/3 cents per day to support the work of Dunkle, Miss Bates, Bowen, Silverstone, Fisher and thousands of other dedicated workers. You gave a lot more, too. To Ecuador you gave one small flock of chickens. The chickens multiplied, and today hundreds of flocks are paying for the education of scores of Ecuadorean boys. Many of these lads, because of their educational advantage, will become the leaders of Ecuador within a few years, and very likely will lift the country to a higher standard of living. Quite a payoff for one small flock of chickens.

To Vietnam you gave the leadership of a man named Millard Cox, who showed 10,000 singing, sweating Vietnamese how to construct an irrigation canal in four days. That one canal boosted the local community's production of corn, rice and beans by 1000 tons a year.

To some 60 nations, through ICA and its part in the Point 4 program, you gave the skills, knowledge and ability of dedicated and ingenious Americans.

Most of all, you gave to millions of people the prospect of a little more food, a little less drudgery, a better life. ★ ★ ★



CHIPPER CHARLIE

Never been sick a day in his life. But he knows it can happen to him—so he gets a health check-up every year—just in case. He also supports the American Cancer Society's Crusade. Send your contribution to "Cancer," in care of your local post office.

AMERICAN CANCER SOCIETY



Electric Model
\$64.95



5 GAL. PORTABLE MIXER

Not a toy—built for long hard use. Mixes cement plaster, paints, chemicals, plastic, feed, fertilizer. One man operation can mix 15 cubic feet per hour. Comes complete with 5 gal. removable pail, agitator, electric motor, switch and cord ready to plug in and go to work. Gasoline powered model with 10" wheels. \$89.95. Write Dept. M.

Modern Mfg. Co. 160 N. Fair Oaks, Pasadena, Calif.

GET THE HABIT OF READING OUR CLASSIFIED ADS.
Wonderful Opportunities Amazing Bargains

Start a profitable business of your own

easy-to-own!

NEW SHOP TYPE WELDER—The 180 amp. "Hustler" welds, cuts, burns holes, hard-surfaces, and heats metal for bending and forming. It's a complete welding package—including accessories, and meets REA requirements.



Get complete information...no obligation! →



...there's BIG MONEY in arc welding

NEW COMBINATION WELDER—The 200 amp. "Power/Weld" furnishes DC current for welding and simultaneously provides 110/220 v. AC power for running tools, pumps, lights, sprays, etc. Can also be used as an emergency power source.

for outside or shop use.

HOBART BROS. CO., Box M-70, TROY, OHIO, Ph. FE 2-1223

GIGANTIC SURPLUS SALE!

FISH & WORM SHOCKER

● **Item # 670.** Harvest worms, clear private ponds of coarse fish. Powerful 110-v AC hand geared generator creates powerful electric field in ground or water. Amazing results.
● Also fascinating for experimental use for fun at parties. Has Super-Alnico magnets. Govt. cost over \$12.
SALE.....\$3.89 Ppd.

Write for **FREE BIG 1960 CATALOG**

Save to 70% on 1000's of Surplus and New Equip. Bargains.

MONEY BACK GUARANTEE ON ALL ITEMS

SPECIAL OF THE MONTH ANTIQUE MAGNETO TELEPHONE

● **Item # 704.** Attractive oak case phone in workable condition. Refinishes beautifully. Unique novelty—all the rage in California. Use as extension phone, built-in kitchen radio, plant-er, home inter-com. etc. Charming in den, library, kitchen, etc. Wt. 18 lbs. Orig. cost \$25.
\$5.95 FOR SALE..... (2 for \$11)

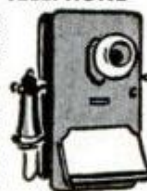

FARMER-CONTRACTOR PUMP

● **Item # 200.** 2 1/2" size, 16,500 gph. Brand new bronze ball-bearing centrifugal pump. Fine for irrigation-contractor pump, industrial uses. 280 gpm. 65 ft. head. Complete with 6" pulley, 2 1/2" intake, 2" discharge. Wt. 37 lbs. Govt. cost \$98.
\$49.50 FOR SALE.....



STANDARD DIAL PHONE



● **Item # 715.** Modern hi-efficiency attractive dial phone. Use for extension to main line on private system. Use several for complete private system, etc. Complete. Work on any system. Govt. cost \$25.
\$8.95 Ppd. SALE.....

SURPLUS CENTER
LINCOLN, NEBR. DEPT. 809

It's Sharp... keep it that way with the right sharpening stone by



CARBORUNDUM®

CONCRETE BIRD BATHS AND OVER 250 OTHER MONEY MAKING ITEMS



You've seen them all over the country... concrete bird baths, garden seats, flower boxes, appealing statuary, and many other items that add charm around the house and lawn. They're made by enterprising people, just like you, from our **COPYRIGHTED ALUMINUM MOLDS.** It's easy. It's fun. It's profitable.

Send \$2.00 today for this 62-page "How to" book. 20 pages of clear instructions. Valuable trade secrets. Over 250 items beautifully pictured (with description, dimensions, and prices of molds). Rushed to you by first class mail.

CONCRETE MACHINERY CO., INC.
HICKORY 2, NORTH CAROLINA

Name _____

Address _____

HOW TO TURN CONCRETE INTO GOLD

Owners Report on the Plymouth

(Continued from page 90)

Windshields bowed to progress 20 years ago. Flat vertical panes are best. They're coming back in trucks and buses now. →

"Styling is pleasing, but not comfortable. I'd like to see the seats raised and the roof raised. You must almost place the heel of your hand on the door sill and support your weight on it as you 'roll' out of the car. The windshield is so far back into the roof that on a sunny day you feel like you are in a solar furnace."—Tennessee supervisor.

"Grunt, groan and strain getting out, particularly if near a curb, causing knees to be higher than fanny."—New York engineer.

What About the New Six?

New for 1960 is a slanted overhead-valve Six (it is incidentally the same design, although not the same size, as the Valiant engine). As you might have expected, the Six, being brand new, had a few bugs.

Over 5 times as many Six owners had "considerable" engine trouble as V8 owners—the reason, of course, is that the Six is all-new, the V8 is not. →

Here are some quotations about the troubles the owners had with the new engine:

"Six cannot be timed to burn regular gas. It is advertised to burn regular. Dealer says the ad does not state that it will not knock on regular, just that it will burn it."—Louisiana construction superintendent.

"Very bad spark knock. Have to use high-test gas."—South Carolina salesman.

"Oil burning. Had new rings at 4500 miles."—Illinois produce manager.

"One bearing reversed, burned a rod out. Engine was replaced. Second engine had been coated with a preservative during steel strike and oil-ring holes were plugged. Got new rings."—Florida piano teacher.

"Motor out of balance in rods or shaft."—Illinois atomic engineer.

Other Best-Liked Features

Sixth on the list of best-liked features is roominess, a point especially stressed by station-wagon owners. Here are quotations describing this and other best-liked features in order of frequency of mention:

It should have room. It's the same size as the Chrysler New York wagon. If that's not big enough, you need a bus. →

"Station wagon has lots of room. I have four children. Wish it was a nine-passenger. I was talked out of a nine-passenger by the salesman. I am going to try to buy a third seat and install it myself."—Maryland cataloguer.

"Roadability. Has a stable feeling on all types of roads."—Maryland salesman.

"I like the full-time power steering. My wife is crazy about the way she can park it."—California maintenance man.

Chrysler Corporation is up to its eardrums in acoustics and it's beginning to pay off. →

"Combined torsion bars and ball joints make front suspension great."—Utah truck driver.

"Quiet running car."—Florida student.

"Low hood enables me to see without pillow."—Georgia airline stewardess.

"Trunk is large and easily accessible."—Ohio product designer.

"Most solid. Not one rattle. No noise on the road."—South Dakota salesman.

Heater push buttons are good, make sense. Can't say same for transmission buttons. Each year, there's a new pattern to learn. →

"Brakes stop better than the power brakes I formerly had on my Dodge and this Plymouth doesn't have power brakes."—Georgia insurance agent.

"Doors open wide to permit entering and exiting with ease."—Michigan housewife.

"Defrosters and heater best I've seen."—Massachusetts foreman.

Imitation Vitamins Starve Clothes Moths

CIGAR SMOKERS who carelessly drop ashes on rugs and say, "Let them be, they keep the moths away," are, out of laziness, keeping alive an old folk tale that definitely is false.

Entomologists who have experimented with imitation vitamins, called antimetabolites, which actually starve to death clothes moths and carpet beetle larvae—chief destroyers of textiles—say that cigarette and cigar ashes really attract, rather than repel, these insects!

The reason is that fabric-feeding insects depend on vitamins in woolen fibers and certain vitamins within the B-complex in order to grow. Clean fibers do not have enough food value to support them through a life cycle. But the required vitamins are added in all sorts of stains, perspiration and body oils.

"Even cigar and cigarette ashes yield traces of micronutrients that attract rather than repel clothes moth larvae," says Roy J. Pence, associate specialist in entomology, University of California, Los Angeles.

Antimetabolites closely resemble, in chemical structure, vitamins or other growth substances. But, by design, perhaps a single atom has been omitted or added where it does not belong when the substance is manufactured. It may, however, smell or taste like a vitamin to a fabric-feeding insect. But it will never serve the same purpose. When eaten it becomes antagonistic to the vitamin it resembles.

When antimetabolites in a water solution, for example, are sprayed onto fabric, the young larvae, driven to eat increasing amounts of the pseudo-vitamins soon die of either a vitamin deficiency or some other form of starvation, Pence says. The more-mature larvae eat sparingly of the treated fibers and then move off.

Effective vitamin antimetabolites are quite inexpensive, have long-lasting properties and seem to immunize the fibers against future attacks. In laboratory demonstrations, the richest of nutrients added to treated fabric did not yield suitable food for the insects. Also, when the treatment was applied over existing food and liquid stains high in elements of the vitamin-B complex, it neutralized the nutritional values in the stains. The antimetabolites, Pence says, probably will never be resisted by the insects.

At last, cigar smokers, we have a good five-cent moth repellent!

JULY 1960

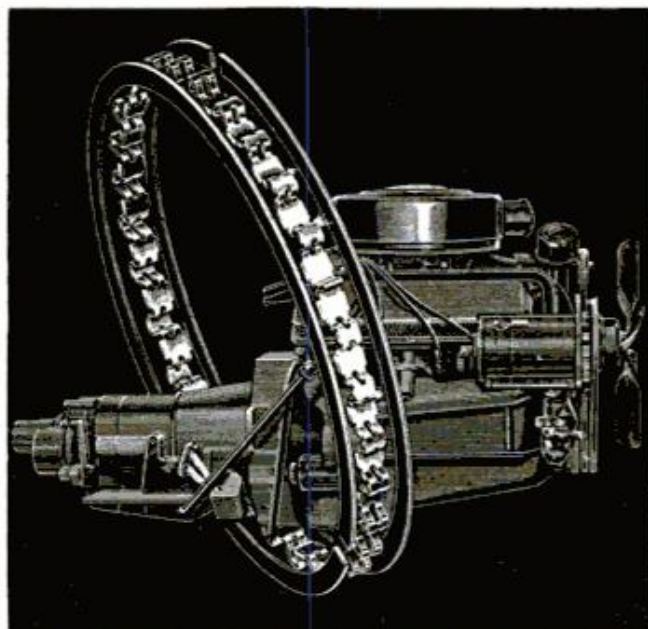

STAINLESS STEEL OIL RING, U.S. PAT. NO. 2,789,872

Sealed Power has *Stainless Steel* ...the very best oil ring metal ever used!

Stainless steel oil rings deliver superior oil control—and for easily understood reasons. First, stainless steel resists the corroding and pitting effects of the gases of internal combustion engines. This means the oil ring surface stays clean. There is nothing for sludge or carbon to cling to. Thus the return oil vents stay open and you get the *long lasting* oil control you expect.

Second, stainless steel has no significant tension loss at engine operating temperature. This is unlike carbon steel oil rings. No tension loss assures proper tension of the side rails of the oil ring against the cylinder walls—even in tapered and out-of-round bores. Again, this proper tension is exerted for the entire life of the ring which means better oil control longer.

Sealed Power KROMEX PISTON RING SETS Preferred Performance

Pistons • Pins • Sleeves and Sleeve Assemblies
Valves and Valve Parts • Tappets • Water Pumps
SEALED POWER CORPORATION • MUSKEGON, MICH.

227

Other Complaints

Sixth on the complaint list is poor quality of the interior finish, including upholstery. Here are quotations describing this and other complaints in order of frequency of mention:

"Very cheap ceiling and seat covering."—Illinois supervisor.

"Bad fit on upholstery."—Wisconsin plant manager.

"Speedometer taken out three times and it still rattles. Gas pedal rattles. Plastic cover over radio speaker rattles. If the rattle is in the book, I've got it."—Pennsylvania electronics engineer.

"Something should be done with rear-view mirror on dash. Front seat too low. I'm unable to see out of the mirror."—New York grocer.

"Car is really just a four-passenger, even though it's a four door. No foot room in rear. Driveshaft hump ruins foot space and seat for third person in either front or back seat."—Tennessee chemist.

"Transmission jumps with a thump from first to second gear. Dealer tells me it is proper to do so, but I am still not convinced."—Maine tile setter.

"Tailfins too high. In rear-view mirror it looks like someone is behind you."—California letter carrier.

"Tailfin sticks up in my side-view mirror. Must be careful how I back up."—Michigan fireman.

"Shock absorbers are noisy after 3000 miles and must be renewed. Others have same complaint."—Ohio secretary.

"In cold weather the back shocks are noisy until you run a ways then noise disappears."—New York carman.

"Every rainstorm or snowstorm the car floor is soaked. I mean really soaked. I know a convertible leaks a little but should it leak enough to have a large pool of water on the floor?"—New Hampshire cook.

"Trunk deck leaks. All welds are rough and paint comes off welded places."—Texas minister.

"Steering ratio too high. It takes too many turns to make a sharp corner. Rectangular steering wheel is difficult to hold when allowing wheel to spin back after a turn."—Ohio clerk.

"Steering wheel cuts view of generator and oil warning lights. Driver would not catch either of these lights during daylight."—Nevada locomotive engineer.

"Separate speedometer pod is utterly foolish. It is unattractive and no advantage."—Michigan minister.

"Speedometer is so located as to make you duck your head to read it, thus your eyes leave the road longer than they should."—Indiana soldier.

"Wish front seat was straight instead of inclined. One has the feeling of being in a semi-reclining position. I don't care what's in the sky! I would like to see the road."—Rhode Island housewife.

"Poor steering with passengers riding in third seat of station wagon."—Michigan surveyor.

"Difficult to read total mileage recorded. I have to crouch down in the seat to see it and I am not tall. Someone surely goofed on that."—Minnesota housewife.

"Automatic rear window in wagon constantly breaks down and there is no way to raise or lower it by hand when this occurs."—Pennsylvania merchant.

That is the story of the 1960 Plymouth as told by the owners—a story based on 1,678,825 miles of driving experience. For a complete summary of the percentages turn back to page 90. Next month, the owners will tell you about the 1960 Rambler. ★ ★ ★

More progress: Average 1927 car was 67 inches wide; average 1960 car is 77 inches wide. Average 1927 car was 162 inches long; average 1960 car is 208 inches long. Both seat four persons in comfort, six in pain. That's progress.

Patience, sir. Next year, the Plymouth folds its wings.

No!

Cornering with that rectangular wheel is like juggling a cigar box.

Miscellaneous:
Instrument panel is almost indecent, it's so jazzy. When the rectangular gold-flecked plastic steering wheel is added, it embarrasses anyone whose bow tie doesn't light up. Seats are a good height and comfortable except in the middle. Odometer scale is hidden by square steering-wheel, so are amp and oil warning lights. Couldn't see them if they came on. Best spot on the dash is devoted to a clock, which probably is not accurate anyway. A sweet driving car, but too big for relaxed city driving. Seems little reason for more expensive cars when this "low price" car is so deluxe. It's a good big car that, despite the boxing adage, is being hurt by a good small car (the Valiant).



Alloys of Ice and Fiberglas Form Arctic Building Material

Scientists at Ice Research Laboratory, Massachusetts Institute of Technology, added small amounts of Fiberglas to ordinary ice and produced an alloy 10 times stronger than ice. It has a tensile strength of 2000 pounds per square inch, allowing the men pictured above to support a heavy typewriter from a narrow bar of the material. A stick of the new ice alloy only a quarter of an inch in diameter can bear the weight of a man. Laboratory experiments are designed to learn how to use ice and snow for Arctic building material.



advanced techniques in QUALITY CONTROL



double the life of
cars and trucks
with Precision-Built

MUSTANG REPLACEMENT ENGINES

Precision refinements in testing and inspecting produce longer life, greater horsepower, top performance and unmatched value. Dependable, low cost transportation assured with written guarantee.

Sold on easy payment plan by leading repair shops and car dealers.



MUSTANG ENGINES

316 INTERNATIONAL ROAD • GARLAND, TEXAS

ADJUSTABLE MITER BOX & CORNER CLAMP



**No. 44
COMBINATION
MITER BOX AND
CORNER CLAMP**
Holds the wood and holds your saw. Uses any handsaw for accurate cuts from 0° to 180°. Full 3" capacity. Sides of joints exposed for nailing, gluing.
\$2.75 ppd.
No. 33 Works the same as No. 44, but without saw guide adjustment.
\$1.75 ppd.



**SUPER FILER
No. 11**
For both hand and circular saws. Steel rollers give all teeth correct height, pitch and bevel.
\$9.95 ppd.
**SEND FOR
FREE Catalog.**

A. D. McBurney, 5908 Hollywood Blvd., Hollywood 28, Calif. Dept.: A-70

Jiffy SAWHORSE BRACKETS



NO NAILS NO SCREWS NO BOLTS
Now a sawhorse in a jiffy! Just use Jiffy Brackets and 2x4s. Sold by hdw. and bldg. supply stores everywhere, or order direct. \$1.95 A pair. *Higher W. Coast*
GRAND HAVEN STAMPED PRODUCTS CO.
Grand Haven, Mich.

WELD IN A JIFFY! IT'S DYNAMIC \$38.50 F.O.B.



Now any one can weld, cut, braze or solder almost any metal quick, safe and easy with this professional type welder. Make repairs in home or shop and farm; repair auto bodies and fenders, build wrought iron furniture, railings, fences, etc. — 1001 metal items. No previous experience necessary. Designed to operate on any properly wired 110 V. A.C. line. Order today! Literature on larger industrial equipment on request.

EASY PAY PLAN
Low down payment. Pay as you USE. Money back guarantee. Act now!
SEND ONLY \$6.00
CHECK CASH or M.O. PAY POSTMAN BALANCE PLUS CHARGES 1 YEAR GUARANTEE 10 DAY MONEY BACK TRIAL

DYNAMIC WELDER COMPANY, 1808 S. Federal St., Dept. D2-6, Chicago 16, Ill.

STOP WATER DAMAGE...



Wood
Plywood
Shingles
Asbestos siding
Concrete blocks
Concrete
Mortar
Stucco
Plaster
Brick
Paint
Wallboard
Tile
Canvas
Leather
Linoleum
Fabrics

Prevents warping, swelling, mildew, mold, water stains, seepage, dampness, rot.

Keeps moisture out 5 years and longer.

Use on all woodworking jobs, boats, patio furniture, planter boxes, shutters, screen doors, window sash, shingle roofs. Stops seepage in basement walls, concrete silos, foundations. Waterproofs canvas, tarps, tents, awnings, leather boots, shoes, outdoor clothing. Won't harden or crack leather or fabrics. Perfect underseal for oil base or alkyd paints. Deep penetrating, colorless. Apply by brush, spray or roller. At paint or hardware stores or order direct. 16 oz. spray can \$1.89, Qt. \$1.75, Gal. \$5.35, 5 Gal. \$25.25, ppd., tax incl. Send check or money order to **E. A. Thompson Co.** 1356 Market St., San Francisco 3, Calif. No COD's please. (Since 1929.)

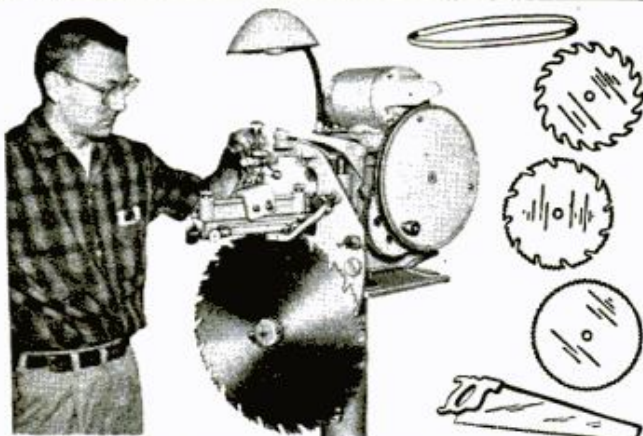

CASH FILING SAWS

Here is a steady repeat CASH business you can start at home. No experience needed—no canvassing—every saw you sharpen will bring new customers. You can make up to \$3 or \$6 an hour—\$20 to \$30 a week in your spare time as a starter. "My spare time saw filing business has made me \$952 these first ten months," says R. T. Chapman.

The new model 200 Foley Saw Filer automatically sharpens combination (rip and crosscut) circular saws, hand saws, band saws and crosscut circular saws.

Free Book—"MONEY MAKING FACTS" shows you how to get into this CASH business. Time Payments if desired. Mail coupon now. No salesman will call.

FOLEY MFG. CO.
716-O Foley Bldg., Minneapolis 18, Minn.
Send me free book "MONEY MAKING FACTS"
and Time Payment Plan.

Name _____
Address _____
City _____ State _____



If It Can't Be Repaired

(Continued from page 79)

"Pegging is a method we frequently use to join porcelain figures such as the fisherman we just received. We drill holes in the parts to be joined, then insert metal pegs in a base of shellac or other adhesive," Hirsch explained.

"Banding is one repair few other shops make. We repair crystal and glass goblets with this technique. We drill a groove around each of the parts to be joined. We wind copper wire from one groove to the other, covering the break. The wire is covered with solder which is ground down, polished and sometimes painted to match the decoration."

Hirsch broke off his explanation to greet a woman bearing a goblet that lacked a base, and a bottle stopper in three pieces. He told her he would locate a base of proper height. The charge was \$12.50 for banding together the stopper.

"Stoppers are a big item," he said. "Sometimes we get wine decanters or perfume bottles with stoppers broken off in them. There's nothing to get hold of to work them out. Sometimes a few drops of oil left in the top to filter down will ease them out. Sometimes we boil the bottle. We drill them out as a last resort, for this might break the bottle."

But anything can be fixed if the customer has the patience to wait and the money to pay for it, he said. The cost of repairs in the shop that day ranged up to \$30 for a cameo pin broken in three parts to \$75 for a silver lamp needing dents hammered out to \$1000 for a porcelain-and-metal bird cage that was rusted and broken. Though Hirsch counsels customers that unless they have a special reason for the repair, it might not be worthwhile to have it done, sentimental attachment often outweighs the economics involved. This was shown by the action of a woman who wanted an inexpensive plate pieced together. The job would cost \$12. On one of his many trips down Third Avenue—the home of many antique stores, second-hand shops and hand craftsmen—Hirsch found a set of plates identical to the broken one, selling for \$2 each. He phoned his customer, but she told him to go ahead with the repair, because she really wanted the old plate, not a new one.

The shop has gained its reputation, in part, because it is one place that will go to great lengths to get something fixed. This often involves a great deal of legwork, as illustrated by the repair of a 100-year-old cast-iron clock. Missing from its top was

(Continued to page 232)

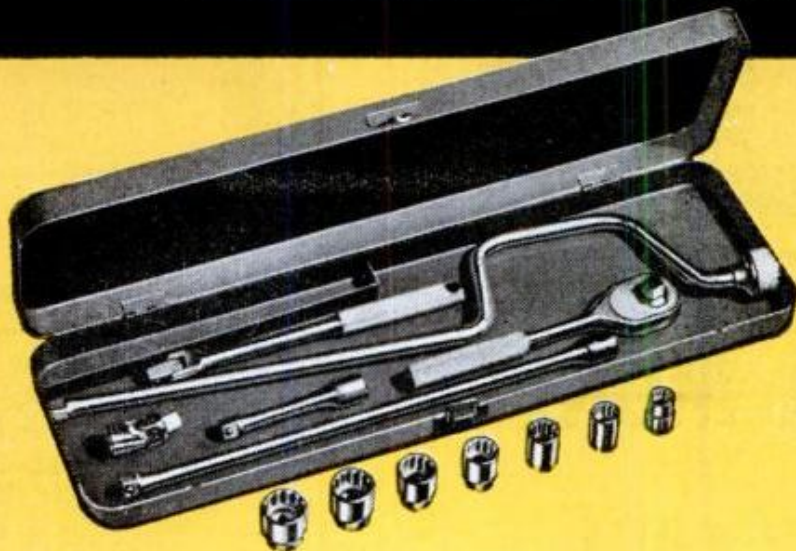

PROTO 3/4" DRIVE SOCKET SET NO. 5200AB—A beautiful basic socket set for the amateur or professional mechanic, with the most needed sockets, handles and attachments. All forged or hot formed in Protoloy® alloy steel for professional performance; heavy chrome plate; all guaranteed. Contents: Seven 12-point Sockets—3/8" thru 3/4" opening. 7" Ratchet. 3 1/2" and 12" Extension. 7 3/8" Hinge Handle. U-Joint. 16 7/8" Speed Handle. In Red Steel Box with extra space for other tools.

Get yours at your local Proto Hardware or Auto Parts Dealer

PROTO TOOLS
PROFESSIONAL QUALITY TOOLS

Division of Pendleton Tool Industries, Inc.

2202 Santa Fe Avenue, Los Angeles 54, California • 502 Allen Street, Jamestown, New York • 1702 Oxford East, London, Ontario, Canada

How do the Ramblers
rate with their owners?



Read the "Owners Report"
next month for a
down-to-earth story of
what they like
and dislike about the

RAMBLER



Jet Sound Barriers

Postal workers at all of West Germany's large airfields have added an unusual kind of earmuff to their working uniform. Made of plastic and filled with oil, the muffs are an effective barrier against the piercing sounds generated by jet airliners during take-offs and landings.



An Easy Way to Earn **EXTRA MONEY** For Your **NEW CAR!**

POPULAR MECHANICS—the magazine that helps you to *save money* on hundreds of projects—now offers you an opportunity to earn *extra money* as a spare-time or full-time subscription representative for POPULAR MECHANICS and *all other* leading national magazines.

Thousands of men, and women too, are earning substantial sums daily through this pleasant, convenient and profitable work. What *they* are doing, you can do too, just as easily and successfully. The rapidly growing interest of men in all kinds of practical crafts has created millions of potential subscribers for POPULAR MECHANICS — one of the easiest of all magazines to sell.

MAIL THE COUPON NOW!

Few ways of earning extra money at home are so convenient to engage in, so easy to start, so certain to add worthwhile amounts to your personal or family income. Let us send you complete details of our plan, free supplies—everything you need to start earning extra money at once.

POPULAR MECHANICS, Dept. 760
250 West 55th St., New York 19, N. Y.

Please send me, without obligation, complete details of your subscription plan.

NAME _____

ADDRESS _____

CITY & ZONE _____

STATE _____

a figure of a knight. Hirsch suggested his receptionist might find such a figure in a Third Avenue shop.

"She started at 34th Street and walked to 59th Street. Then she walked over to Second Avenue and was coming back down when she located a cigarette lighter shaped like a knight. We bought it, sealed up the lighter, japped it to match the clock and it worked out just right."

Although 90 percent of the repair work is done in his shop, Hirsch believes it is just as important to know where to get materials and to find people who have old or odd skills as do the actual repair work.

"You often need specialists, he said. "When I started I found this business overwhelming. I didn't know how we could ever repair many of the things people brought in. One day we had to repair a brush set. The handles were of expensive silver, but the bristles were worn. Well, I had to find someone who puts bristles in brushes—that's a trade in itself." Over the years, he has found many such skilled men and women. "I make use of a daguerreotype restorer around the corner on 35th Street. There is a housewrecker at 87th Street who takes chandeliers, glass globes, tubes and lamps from old hotels, and I get parts from him. There's a lapidary in the downtown business district who provides me with stones and gems. I know a barometer worker in Greenwich Village: we do the wood restoring and he works with the mercury. A lady two blocks away reweaves tapestries, and I've located a dry cleaner who cleans old materials without ruining them."

One problem that plagues Hirsch is locating people who have the necessary qualities to take on any sort of job as staff members. "We can't get a replacement just by advertising and not many young people want to learn artisan work. Also, it's difficult to keep at this type of work very long. You can't work eight hours a day at it. Irena may paint for a half-hour on a project, such as the plaque, using a magnifying glass. The eyes get bleary if you work longer. The people who have done the best work are patient, and they've included men with such diverse backgrounds as an art professor between university posts and a retired sea captain. Skill is not necessary in the beginning but talent and patience are essentials." Of his present staff, Miss Marlewska did similar work in London, 76-year-old Kiokichi Sano had his own shop for a number of years and on retirement agreed to work part time, and Al Bosle has worked with glass for 35 years.

All day long, packages of "irreparable" items had arrived in the shop at 168 East

(Continued to page 234)

TRAVELOUNGER



2 DR. FALCON
PAINTED....7.95
CHROMED..9.95

TRAVELOUNGER

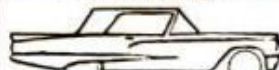

THUNDERBIRD
19.60

TRAVELOUNGER



COMET
PAINTED....7.95
CHROMED..9.95

VOLKALOUNGER



**VOLKSWAGON
& GHIA....6.95**

PEMCO
SEAT ATTACHMENTS

AN Easy to install ADAPTER THAT PUTS RECLINING SEATS IN YOUR CAR



Be able to really enjoy your car. With a flip of the wrist passenger can lay back and relax. Driver can rest at the side of the road. Changes any ride of over an hour from aches to pleasure for your passenger.

See your dealer. If he is out write us direct.
1425 Jefferson • Salt Lake City, Utah

Meteorite Provides Clues To Solar System Origin

Elements that make up our solar system finished evolving 4950 million years ago, according to observations of a meteorite made by a University of California scientist. The meteorite fell in Richardton, N. D., 41 years ago. Dr. John H. Reynolds, associate professor of physics, reached his conclusion after studying traces of the rare gas xenon dissolved in the meteorite.

Remote-Control Generator Operated by Telephone

Serving 10,000 people in England, a quiet-running, 3000-kilowatt generator plant springs to life when electrical engineers, 100 miles away, press a few buttons and dial a telephone number. Instrument readings on the remote power plant are flashed back to the control panel. The generator weighs only 2240 pounds, needs no cooling water and requires no warmup period.

ESCAPE THE
GRAVITATIONAL
PULL OF
EVERYDAY CARES

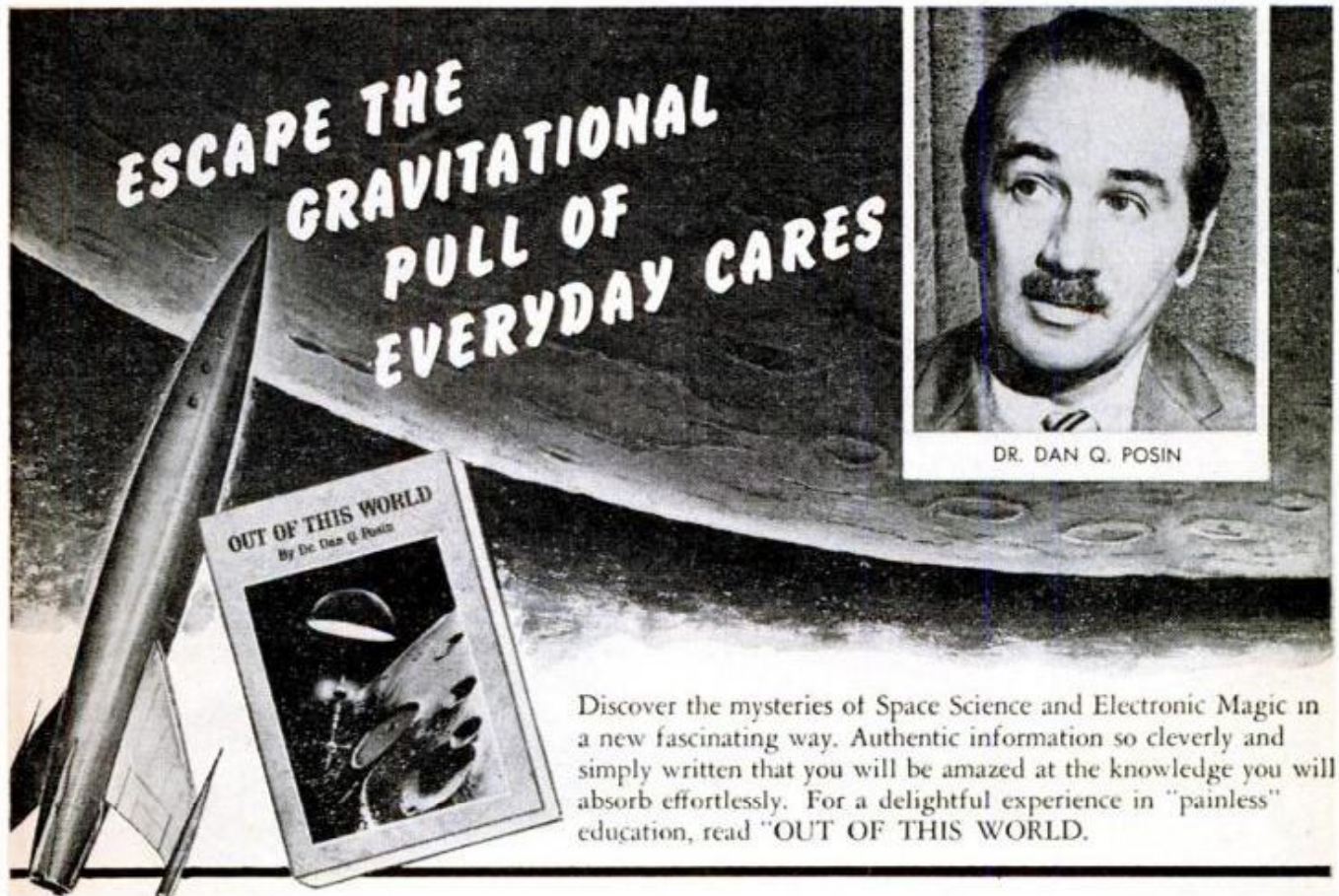

DR. DAN Q. POSIN

Discover the mysteries of Space Science and Electronic Magic in a new fascinating way. Authentic information so cleverly and simply written that you will be amazed at the knowledge you will absorb effortlessly. For a delightful experience in "painless" education, read "OUT OF THIS WORLD."

AVAILABLE AT YOUR FAVORITE BOOKSTORE OR WRITE DIRECT — \$3.95
POPULAR MECHANICS PRESS—200 EAST ONTARIO ST. CHICAGO 11, ILL.

WISE-GRIP



**DOES
MORE JOBS
EASIER THAN
ANY OTHER TOOL**

AT YOUR
DEALER

only
\$2.15
to
\$2.95



PETERSEN MFG. CO.

DE WITT, NEBRASKA
Dept. No. PM-7

If it's worth painting
it's worth sanding...
with sandpaper by



CARBORUNDUM®

**HOW TO SUPERCHARGE YOUR
CAR FOR ONLY A DOLLAR**

ONE BOTTLE OF **PLUS** CONDITIONS
EIGHTY GALLONS OF GASOLINE



Cleans carburetor and complete fuel system of gums and varnishes... prevents fuel line clogging for faster starting and better gas mileage. Frees sticky valves and removes carbon... restoring power and pick-up and improving compression. Reduces engine rumble and excessive gas knock.

One bottle treats 80 gallons of gasoline

Now A.S.T.M. tests prove Power-Pal products disperse and remove more gums in fuels than other leading brands tested.

At your local dealer or send one dollar today to:

Motive Specialties Division
NUTMEG CHEMICAL COMPANY
Dept. PM, 130 Haven St., New Haven, Connecticut

ALSO MANUFACTURERS OF POWER-PAL FOR DIESEL ENGINES

33rd Street. They came from Beatrice, Neb., Battle Creek, Mich., Buffalo, N.Y. and elsewhere. And, toward evening, a woman came in, stunned.

"You've done work for me," she told Hirsch, "but this is out of this world." She laid a cracked china lamp on the counter. It was held together by adhesive tape. "The four-year-old twins finally broke this one, too."

"We can take care of it," Hirsch told her. "We'll fasten it with staples and paint them white."

When the woman left, appearing much relieved, Hirsch said, "This business suits my temperament. It's a challenge, and we like to help people. There's one repair, though, we don't try anymore—and that's fixing butterfly dishes."

These dishes, he explained, had an outer shell. Dried butterflies were placed on the bottom in an adhesive. A glass liner was placed over the butterflies. "If that glass breaks, there's no way of getting it out without tearing up the butterflies. We've done a few, but no more."

He took the cracked lamp to the filing room and, looking at the table of unusual items awaiting repair, he said, thoughtfully, "But if we ever hit on a way..." ★★★

QUOTE:

"Once in space there is no air resistance to be overcome, nor any friction heat to contend with. This friction in the atmosphere reduces the strength of our known metals to essentially that of putty at speeds of between 1500 and 2000 miles per hour."

—LT. GEN. B. A. SCHRIEVER,
USAF, Air Research and
Development Command

Do You Know This Old-Timer?

(Answer to quiz, page 24)



1908 Rambler

WAR SURPLUS AND OTHER **BAIGAINS** **SAVE UP TO 90%**



CORNELIUS AIR COMPRESSOR Ideal for filling underwater diving tanks, air horn tanks, etc. Three stage USAF air compressor. Has built-in 1/3 HP, 27 V. DC electric motor. Develops 1500 PSI or may be reset to 2000 PSI. Delivers .04 CFM. Approx. GOVT. COST \$375. Like NEW. \$29.95.



PILOT'S MAGNETIC COMPASS Used by Air Force in Jet fighters. Fully jewelled. Dual compensators. Accurate to 1° for readings at every point. Will operate in all temp. from -55° to +70°C. Graduated in 5° increments. Ideal for panel mounting. Electrically lighted. 2 1/4" W. x 2 3/8" H. Approx. GOVT. COST \$100. Like NEW. \$12.95 (limited quantity).



BUILD YOUR OWN ARC WELDER, LIGHT PLANT OR BATTERY CHARGER \$37.50

Kit incl. 1 Navy NEA-5 Gen. combination AC-DC type. AC 115 V. DC 24 V., 200-300 Amps. 2 complete generators in 1, yet no larger than reg. gen. Ideal for home, shop and farm lighting plants. Delivers 1200 Watts AC, DC side for charging batteries, welding and operating war surplus motors. Also in kit: 2 Voltage Regs., AC & DC, Reverse Current Relay, 30' New Welding Cable, 1 Ammeter, Rheostat, Electrode Holder, Toggle Switch, Welder's Shield, Wiring Diagram for kit. Wt. under 100 lbs. Approx. GOVT. COST \$650. Kit—\$37.50. Navy NEA-5 Gen. as above, purchased separately, \$23.50.



DOUBLE-V SPLINE 3" PULLEY For P-1, R-1, GE Gen. shown above. Heavy-duty machine-broached steel. Heavily constructed, will handle any job. Spline receptacle will fit most types of aircraft generators. Set screw locked. Shpg. Wt. 3 lbs. NEW. \$5.95. Triple-V Spline 3" Pulley—NEW—\$6.95.

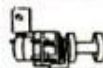

ELECTRIC STORAGE BATTERY WINCH

Powerful reduction gear, fully reversible, ball bearing, safety locking device. Handles from a 1000 to more than 2000 lbs. pull. Use on 6, 8, 12, 24, 32 V. battery. Holds 50' of 1/4" cable. For tractors, boats, tow trucks, etc. Complete with bracket for mounting in any position. Heavy-duty equipment. Approx. GOVT. COST \$400. NEW, \$49.50.

ELECTRIC PUMP WITH CONTROL UNIT

Runs on 12 or 24 V. Centrifugal type. Draws 5.2 AMPS. Has built-in removable filtering screen. Great for bilge, circulating or sump pump... bait tanks, etc. Pumps 500 GPH. Complete with on and off switch rheostat, explosion-proof motor, 2 speeds (hi & lo). Mfd. by Ingersoll-Rand. Shpg. Wt. 7 lbs. Approx. GOVT. COST \$195. NEW—\$8.95.



BENDIX GEROTOR PUMP & MOTOR—NEW!

Use wherever fluid pumping required. Excellent for hydraulic installations and as crankcase drain pump for marine engines. Has 3/4" pipe connections, built-in relief valve adjustable up to 1500 lbs. Max. cap. 6 GPM. 1 1/2 H.P. 24 V. motor. Use on 12 to 32 V. Approx. GOVT COST \$350. \$10.95.



NEW 1960 CATALOG!

Tremendous catalog—our biggest ever—fully illustrated—1000s of bargains in war surplus & other items. Send 25c in coin for your copy today or free copy with order. Where ppd, indicated applies to US only. Other prices FOB Culver City, Cal. Send cash, check, money order. 50% dep. COD.



AIRBORNE SALES CO., INC. DEPT. PM 760
8501 Stellar Drive, Culver City, Calif.

FOR HANDS • FOR FLOORS • FOR WALLS

QUICKEE®

SPECIALIZED CLEANERS

Send for FREE HAND CLEANER SAMPLE. Dept. PM
At Stores Everywhere / Quickee Products, Inc., Yonkers, N. Y.

Outboard

MOTOR MOUNTS

For Increased Speed and Performance

Heavy duty, rubber-cushioned for single or dual motors. Also, trolling and emergency mounts. Special aluminum alloy—no corroding.

Send for free literature.
Dealer inquiries invited.

MAGIC TOOL, INC.

991 Williams — San Leandro, Calif.



"First I added a little bit of red and it wasn't right, so I added a little bit of white, then..."

SEVEN-MAN DUTCH FACTORY MAKES PISTON RINGS

By J. Mortimer Sheppard

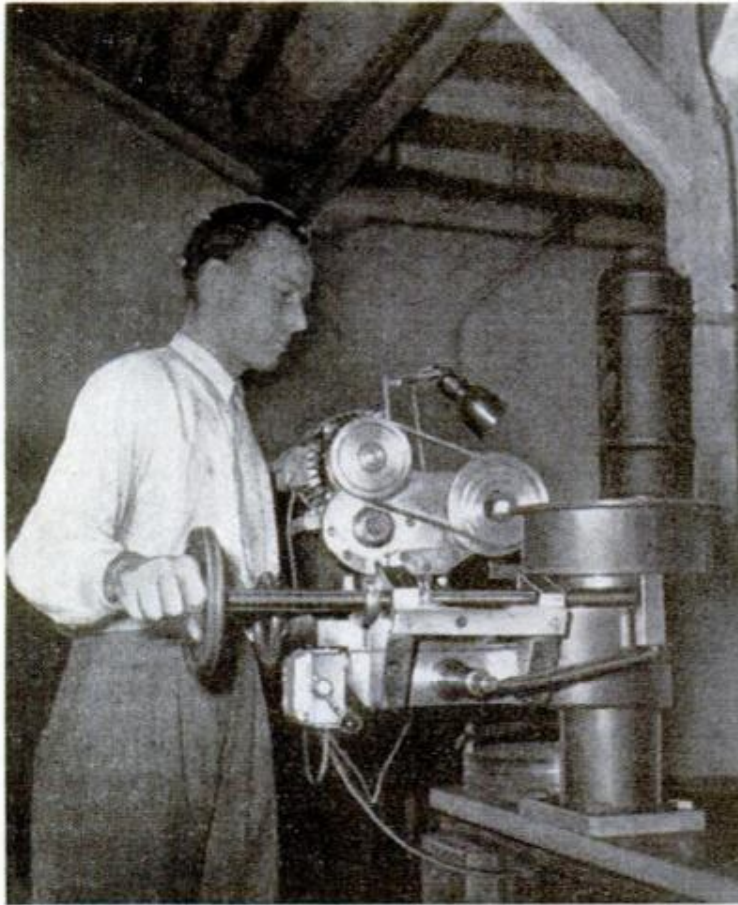

Six hundred atmospheres of pressure leakproof the slots in piston rings in the machine above, built for the plant. Below, the new "Rodel" portable shipboard grinding and milling tool

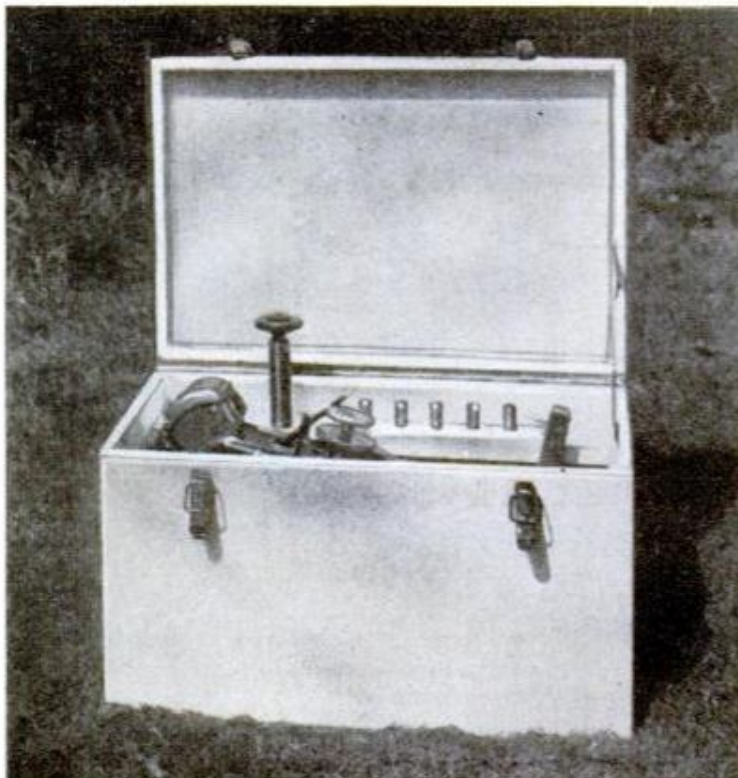

THERE IS AN international saying of unknown vintage that maintains: "You can't beat the Dutch" and Bennard Rottink of the village of Delden in Holland, personifies that saying.

The father (now deceased) of 34-year-old Rottink raised hogs successfully and was a man of some means. It was the elder Rottink's hope that his son would carry on with the hog business, but Bennard had more lofty ambitions; he wanted to manufacture diesel piston rings.

Friends told young Rottink that it was impossible—that piston rings are manufactured by large firms, and he had only limited capital. But he sold off the family's hogs, took a special course in a technical school, then returned to his home, set up a few machines and gathered a skeleton crew of men who had faith in his idea.

That was shortly after the end of the late World War when Bennard Rottink was barely past 21. Now he heads a small but profitable business housed in the same building in which his father fattened hogs for market.

Three of the Rottink machines were made right in the tiny plant by his own men. These include a grinding machine for surfacing piston rings, a machine for making leakproof slots, and another that cuts slots for scraper rings. The little firm makes piston rings up to 32 inches in diameter.

The company offers to make piston rings to order and guarantees delivery within 24 hours. This remarkable service brings business on rush orders from ships that have urgent need of rings and are willing to pay for speed in delivery so that valuable cargoes will not be delayed and schedules upset.

Working at full capacity, the little Rottink factory can turn out a thousand piston rings per week in steel, bronze or cast iron. Although the total staff of the factory numbers only seven men besides

POPULAR MECHANICS

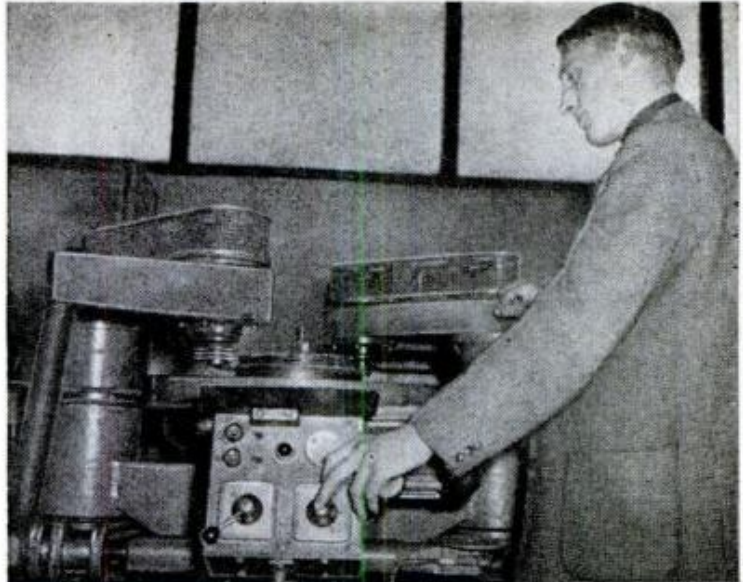
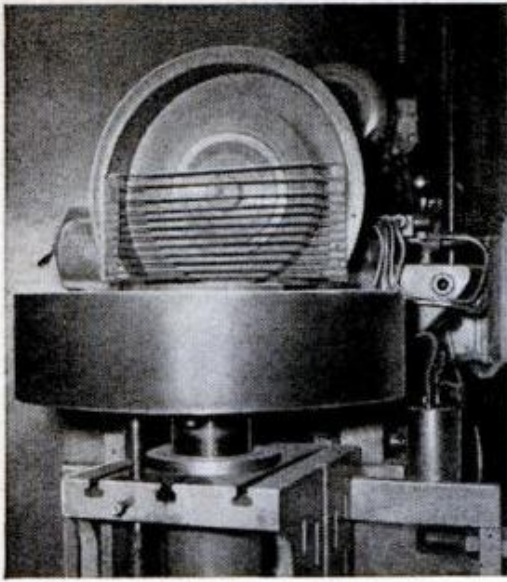

Above, special grinding machine built for surfacing piston rings. Above right, a milling machine built in the tiny factory for handling oil rings from 4 to 32 inches in diameter. Below, a standard metal lathe, not for ring-making, but for the building of special machines and tools used in precision piston ring manufacture

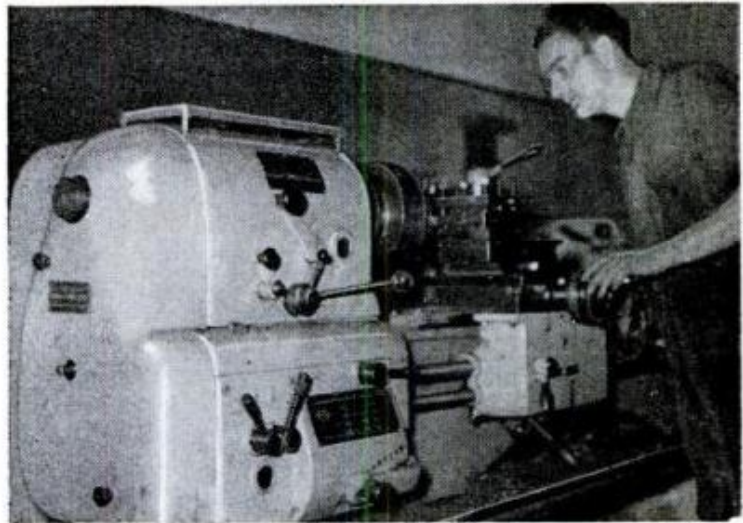

the owner, the crew often works all night on rush orders. "Normally," Mr. Rottink told this reporter, "we work a 45-hour week, but 60-hour weeks are not unusual for us. My boys are not clock watchers, and when there is a job to be done, they simply get on with it."

Cottage industry is usually confined to women's work in sewing, knitting or weaving, and rarely found or expected in such a line as the manufacture of piston rings. Yet that is exactly what this business is—a small "cottage" affair with the factory nothing more than an extension of the owner's home. And as might be expected, there is a "family" attitude in the work. On jobs that call for night work, the working crew will troop into Mrs. Rottink's kitchen for a midnight snack, or she will bring a tray of sandwiches and a big pot of coffee into the factory. The Rottink home is the center of their activities; there are celebrations on the Queen's birthday, at Christmas, and other holidays, and the men bring their wives and children to share their fun in the Rottink home.

While your reporter was visiting the Rot-

tink factory, a wireless message was received from a small freighter in the North Sea that was heading for the Dutch port of Rotterdam. The message stated the date and hour that the ship hoped to reach Rotterdam, and went on to explain the exact dimensions and number of piston rings that would be needed. Rottink's men had 34 hours' notice on this job. "The rings," Mr. Rottink stated, "will be on the dock when that ship pulls in."

Two years ago Rottinks developed a machine which they call the "Rodel," a portable attachment for lathes in the machine shop of ships that will do a first-rate milling and grinding job. The machine has ten speeds, operates at from 350 to 6000 r.p.m. and is priced at 1200 Dutch guilders or about \$350. Rottinks are receiving orders for their Rodel from many ships under numerous flags, but piston rings constitute the little firm's main line of endeavor.

At 34 years of age, Bennard Rottink has achieved a modest but growing success in life. From pigs to piston rings is quite a jump, but when a Dutchman sets his mind to anything, he sees it through. ★ ★ ★

An Eye on Space

(Continued from page 73)

year, it has been calculated, the Sun's light is able to push the satellite off course by one mile.

We have said that the satellite's radio signal is unmodulated—just a single monotonous wave. But this is not exactly so. The signal changes very slowly as the skin temperature changes. The lowest temperature so far indicated by this effect is 40 degrees F., while the interior temperature is a rather constant 70 degrees.

The newer satellites have radio arrangements which enable them to send information, instead of having it inferred from the satellite's motion. Thus, the findings relative to space dust, charged particles, temperature, solar energy, magnetism, all can be made to change the carrier wave of the transmitter, each in a special way, which can then be detected at home. How is this done? One way is to have a series of low-frequency wave-makers (oscillators), each triggered by one effect, such as the impact of tiny meteorites. And, as one of these oscillators is thus activated, it puts its effect upon the real carrier wave. But each of these oscillators has its own special frequency, so we see that the same carrier wave can be modulated in a distinctive way by each of the oscillators. The distinctiveness is preserved in the carrier no matter how far it travels, and the unscrambling is easy to achieve at home, either by visual examination (as on an oscilloscopic display), or on a punched tape.

The various oscillator circuits for individual experiments may be called "channels," but, as we have said, only one carrier wave is transmitting.

The input works like this, let's say for a temperature experiment:

The temperature of a wire ("thermistor") is changing; this changes its electrical conductivity; this effectively changes the frequency of the temperature-experiment oscillator.

This in turn changes the form of the carrier wave.

Of course, there usually exists at least one more transmitter, operating at another carrier frequency. This may be called upon to transmit stored information in a satellite; that is, findings which were recorded on a tape. The storage section may be triggered on command from the home base, on Earth. And still another transmitter may be always broadcasting so that the satellite can be tracked continuously. But, generally, a few transmitters with many channels suffice to inspect the universe. ★ ★ ★



HOUSEWIVES LOVE
WD-40

A fingertip spray keeps away rust on screens, tarnish on chrome fixtures. Frees rust-stuck window cranks, traverse drapery rods... stops squeaks, even loosens nail-tearing dress zippers.

WD-40 prevents re-rusting, too!
Dealer inquiries invited.

12 OZ. SPRAY CAN

Money-back guarantee! At your hardware, paint, marine, bike or sporting goods store... or send

1⁹⁵ money order (ppd) to

ROCKET CHEMICAL CO., INC.
P.O. Box 20027 San Diego 20, Cal.



FREE GERMAN STEEL HUNTING KNIFE

4-INCH BLADE

We give you handiest hunting and fishing knife you've ever had! Has 4-INCH LONG highly tempered steel blade—VERY SHARP! Attractive handle. We send knife FREE to acquaint you with our below-wholesale bargains. Please send 25c for handling. NO LIMIT—but send 25c handling for each knife. Order TODAY! HUNTING KNIFE, Dept. K-497, Box 881, St. Louis, Mo.

MAKE HOME IMPROVEMENTS NOW



HAVE A HONDA SUPER CUB!

Model, C. 100A

50c.c. 4.5 HP/9,500 r.p.m. Max. speed 45 m/h with automatic centrifugal clutch.



AMERICAN HONDA MOTOR

4077 WEST PICO BLVD.
REpublic 1-2596, 1-2597
LOS ANGELES 19, CALIF.

FOR PANELING... BUILT-INS... CABINETS... FURNITURE

The Complete Interior WOOD FINISH



in One Can

READY TO USE

A finer clear, semi-gloss for natural wood beauty. Non-darkening. ANYONE can use Deft... it's so easy.

Wherever paints are sold, or write Dept. SSPM
Deft, 1526 W. 228th St., Torrance, Calif.

Free Shop Chart on Wood Finishing, Write Dept. SSPM.

MASS PRODUCTION MAKES THESE PRICES POSSIBLE EASY TERMS

18 FT. CRUISER KIT WITH ONE-PIECE FIBERGLAS CABIN ONLY \$520



FREE COLOR CATALOG

TAFT MARINE WOODCRAFT

Dept. PM-760, 636 39th Ave. N.E., Minneapolis 21, Minn.

PROTECT YOUR CAR WITH

Latest and best automotive products — you'll find them advertised in PM.

DO MORE PLANING JOBS WITH LOW COST BELSAW



Exclusive MONEY-MAKING Features: Full 12 3/4" x 6" capacity • Power feeds at 14" to 34" a minute • Provides for Grinding Knives in the Cutter-head • Attachments for Jointing, Rabbering, Tongue, Matching, Groove. Convert low cost rough lumber into high priced stock. Easy to make flooring and popular patterns. Send Today for FREE Literature and Prices.

Belsaw Machinery Co., 2051 Field Bldg., K.C. 11, Mo.

LOW DOWN PAYMENT EASY TERMS



JULY 3rd to JULY 9th

BUILD-IT-YOURSELF AND SAVE 50%



PALLEY 2-TANK DIVING KIT

Allows approximately 1 hour diving time. Has 2 22 cu. ft. tested tanks, shut-off valves, air hoses, a dilutor-demand type air regulator, harness, safety belt and a weight belt. Equal to \$80.00 diving units. Complete kit only... **4595**

SINGLE TANK PALLEY SKIN DIVING KIT -

Has 38 cubic ft. tested and dated Air Tank - allows approx. 45 minutes of diving time. Complete with shut-off valve, web cradle, and harness, air hoses, dilutor-demand air regulator, connector assembly, mouth piece, etc. Cat. No. PSD-11 **Now 3995**



NOW! FILL AIR TANKS TO 2250 PSI CORNELIUS COMPRESSOR WITH NEW 115 V. AC MOTOR

A Special Palley Bargain! Consists of a Surplus Cornelius Compressor combined with a New 1/2HP, 115/230V., 60 cycle AC motor; a mounting frame & and built-in carrying handle. Pressure tested up to 3000 PSI. Fill diving tanks or ideal for use in laboratory for high pressure air. **9950**

Surplus CORNELIUS COMPRESSOR - Same compressor as above but unconverted. Rated to 2500 PSI. Has built-in 1/3HP, 27V., DC motor. **4250**



AIR OR OXYGEN TANKS

Pressure tested to 500 PSI. Ideal for air, acids, chemicals, experimental uses, etc. Has 1/4" pipe parts. Size: 12-1/2" x 24" 2100 cu. in. **1195**
No. G-1U - Used
No. G-1N - NEW... **1595**

SAVE

UP TO 85% ON HYDRAULIC CYLINDERS



1500 PSI Dbl. Action HYD. CYLINDER Has 2-3/8" bore, 19" stroke, 1-1/4" shaft, 30% lgh. Gov't cost approx. \$75.

NEW LOW PRICES No. H-53AU - USED... **1275**
No. H-53AM - NEW... **1975**

1500 PSI - Double Action CYLINDER Bore 2-3/8", Stroke adjustable from 7-3/8" to 9-5/8", Shaft 7/8", eye-to-eye length is 20". **788**
No. H-17USU - Used...
No. H-17NSU - New... **\$14.88**

1500 PSI HYDRAULIC CYLINDER - Has Bore of 3-1/2", Shaft 1", Stroke of 21-5/8", Length 29-3/4", Ports are 3/8" AN (9/16"-18 thread). **2975**
Cat. No. H-27-ASU NEW...

NEW CONDITION MARK II ASTRO COMPASS

Meal for the Yachtsman, Airman, Boat Owner, Maritime Service, Air Line Operations, etc. **Now Only 950**

Gives absolute true heading, determines bearings and compass errors and can be used in identifying stars, etc. Also functions as a straight pelorus with a fast & simple operation. A precision instrument. Originally cost \$87.50. Complete with instructions, carrying case and mount.

Special SAVE

HYDRAULIC STEERING CYLINDERS

Connect two of these cylinders together and eliminate the need for cables, ropes, pulleys, etc. in steering systems or any other desired application. When connected together by tubing one cylinder acts as a Master the other as a Slave. Each has a stroke of 4", shaft 3/8", length 12" FREE hook-up instructions **499** included. Price per pair ONLY... **999**

25 GPM PESCO PUMP

A positive displacement, 25 GPM pump at 3450 RPM. Has a pressure limit of 1000 PSI. **SAVE NOW at 2795**
Catalog No. H-P25SU

PUMP MOUNT for above - Will adapt pump to key slot drive shaft. Has sealed-in bearings and 4-hole foot mount... **\$16.95**

2000 PSI HYDRAULIC HAND PUMP

Capacity is 1.5 cu. in. per cycle. Has operating pressure of 2000 PSI. Built-in diverter valve allows selection of suction and pressure ports for two independent systems. Regularly \$11.75. **988**

2500 LB. LIFT WINCH HOIST

Ideal for Garages, shops, on boats, jeeps, truck, etc. Has a 24 to 1 gear ratio thru worm gear drive. Has free-spool, pull-out clutch and a three-speed hand crank. Comes with mounting frame and 18 ft. of 3/16" high tensile strength steel cable. Lifts up to 2500 pounds. **3750**

TO ORDER: Send Check or Money Order. 1/2 deposit with C.O.D.'s. All items sent freight or postage collect. California residence add 4% state tax.

palley's

2263 E. VERNON AVE., DEPT. PM-70 LOS ANGELES 58, CALIFORNIA

HEFT A MAN'S HAMMER



ROCKET
\$5.49

Heft a ROCKET. It has a vitality all its own. Grip it. It's as secure in your hand as if it were gripping back. Swing it. The balance is perfect. You'll feel its shock-absorbing action as it delivers a power-centered blow.

Polished head is permanently locked to tubular steel handle. Cushion grip won't slip.

Heft a ROCKET at your hardware store today. True Temper, 1623 Euclid Ave., Cleveland 15, O.

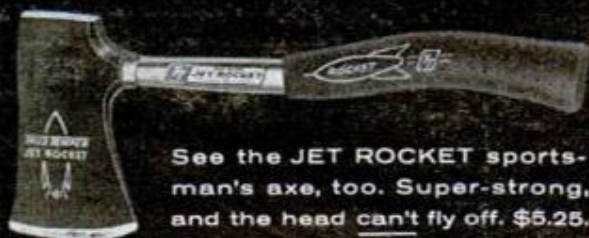

See the JET ROCKET sportsman's axe, too. Super-strong, and the head can't fly off. \$5.25.

TRUE TEMPER
THE RIGHT TOOL FOR THE RIGHT JOB

Engineer Ants Give Lessons In How to Live Underground

By Bert Reichert

SCIENTISTS are studying a species of mound-building ants to learn how they survived the destruction of their prairie environment in southwestern Wisconsin. They believe this information could be useful in teaching man how to live and work underground — knowledge that could become important in this age of increasing population and spreading industry.

Having somehow survived the invasion of man and his plows, the mound-builders now occupy a strip of virgin land, known as Ipswich Prairie, along a railroad siding near Platteville, Wis. The strip is about a mile long and averages the width of a large living room but the ants remain there, refusing to enter cultivated fields only a few feet away.

Known to science as *Formica Ciner Ciner*, the ants build mounds that sometimes reach a height of 16 inches above ground. A man-sized equivalent of the mounds in construction would be something like 400 feet high and 500 feet in diameter. But the above-ground section is only a small part of the colony. Underground, secure from the elements, is a honeycomb city that may go down as far as eight feet.

Russell O. Wagner, associate professor of biology at Wisconsin State College, Platteville, and his associates counted 159 ant mounds inside the area of a city lot and have counted more than 6000 inhabitants in a single mound colony. Each colony has a queen and some winged ants capable of reproduction. The other inhabitants are workers whose job is providing food and carrying on duties necessary for survival. In warm weather, many carry the pupae of new ants out into the sunshine each day and back inside when the sun goes down.

When a mound is disturbed or damaged, the ants apparently become confused. But not for long. As if in obedience to the commands of a single intelligence, they quickly regain their composure and begin making necessary repairs. Within a few hours the mound is again fully covered and the damaged runways inside are repaired and again in use.

Although they always seem busy, the ants do no unnecessary work. In warm weather, their occupied quarters may extend only a short distance underground. But with the approach of cold weather, the ants wisely go deeper to quarters below the frost line.

STOP STALLING

BECAUSE OF HIGH UNDERHOOD TEMPERATURES



SEE YOUR ROCHESTER-GM CARBURETOR SPECIALIST

Stalling is always annoying, and sometimes downright dangerous. You can easily stop the kind of stalling that's caused by excessive underhood heat. Just let your expert Rochester-GM specialist install a Carb-AIRator on your car. This low-cost device is a hot idle compensator that fits *all* cars. It cures stalling, hard starting and rough idle caused by temperature build-up under your hood, winter and summer. Rochester-GM engineers designed it to meet and beat such conditions. Installs in a jiffy and saves you time and trouble. Rochester Products Division of General Motors, Rochester, New York.



Small, rugged Carb-AIRator is easily installed in either carburetor vacuum take-off or intake manifold.

If quality service is your business, ask your UMS distributor about Carb-AIRator and the other fast-moving items in the top-quality Rochester-GM Service Line.



America's number one original equipment carburetors

ROCHESTER CARBURETORS

Smoking more now...
but enjoying it less?

Have a real
cigarette...
CAMEL

"For real taste, there's nothing like a Camel"

Orin Murray Field Survey Engineer, Glen Canyon Dam, Arizona

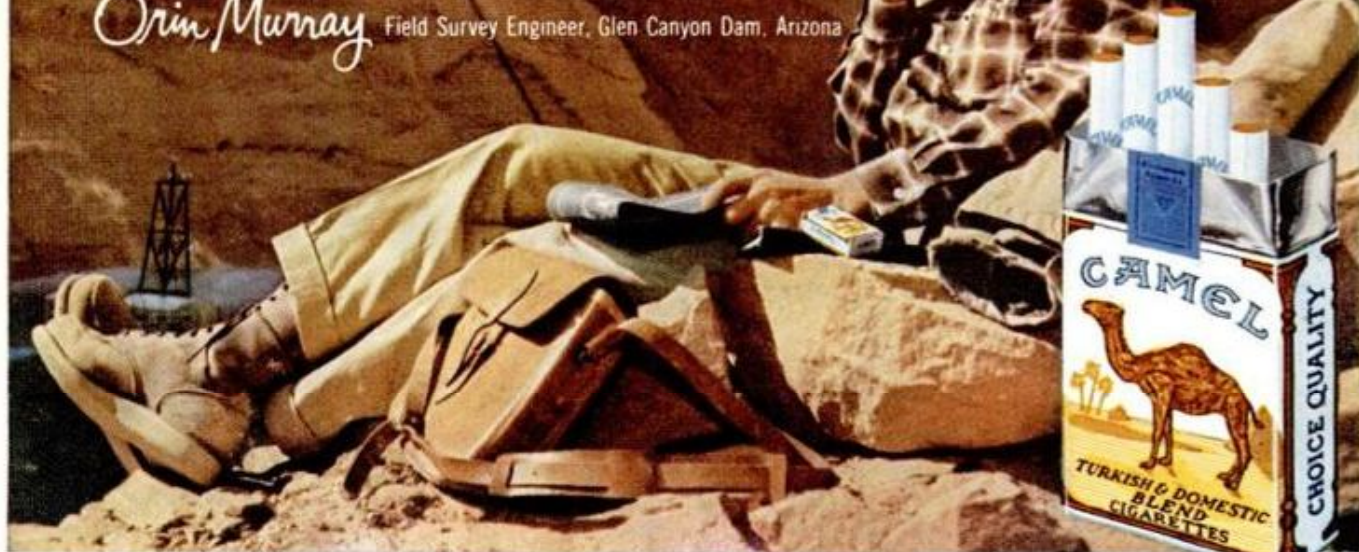

R. J. Reynolds Tobacco Co., Winston-Salem, N. C.

The best tobacco makes the best smoke