

**SPECIAL VACATION SECTION**

# POPULAR MECHANICS

WRITTEN SO YOU CAN UNDERSTAND IT

MAY, 1960

35 CENTS



EXPLORE THE WILDERNESS



SEARCH FOR RARE STONES

## 10 UNUSUAL VACATIONS

**Tips on Tenting**

*How Good Can a Compact Be?  
Read What Valiant Owners Say*



DIG FOR MAYAN TREASURES

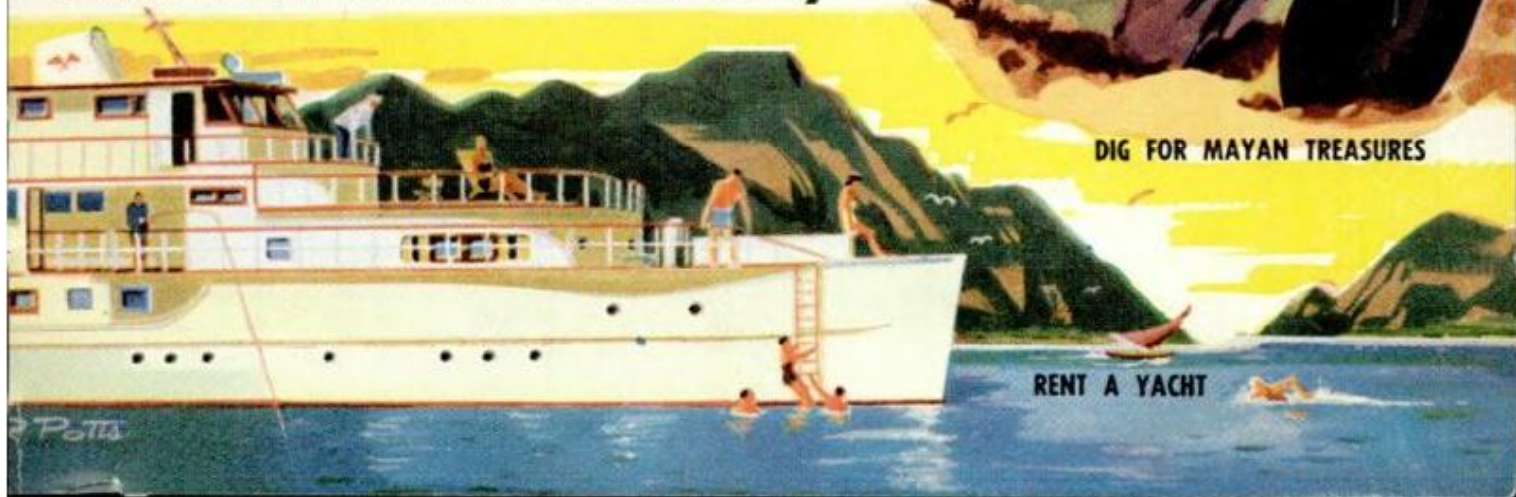

RENT A YACHT



*In case this is the only view you ever see  
of Evinrude's 75hp. Starflite II...*



*...here's how it looks from the driver's seat.*

Try it and see why it's  
today's top-performance motor...at  
your Evinrude dealer now.

Ask for free catalog—  
or write Evinrude Motors,  
4229 N. 27th St., Milwaukee 16, Wis.

A Division of Outboard Marine Corporation  
In Canada: Mfd. by Evinrude Motors, Peterborough

**EVINRUDE**

FIRST  
IN  
OUTBOARDS

Материал, защищенный авторским правом



Heading north on California's Bay Shore Freeway—an easy-driving, scenic approach to San Francisco.

## The World's First Turnpike-Proved Tires

Now precision-built with electronic controls... to give you the three great new tire advances of 1960...

1. Up to 25% more safe mileage than before—anywhere. Now, the mixing of Goodyear's super-tough tread compound is controlled by electronics. And the other major reason for Turnpike-Proved mileage—triple-tempered 3-T Cord (Rayon or Nylon)—is produced and built into tires with the precision control of electronic eyes.
2. New whisper-quiet, cushion-soft ride. New chemicals permit us to soften tread rubber *without sacrificing mileage*. In fact, because we've been able to produce a rubber that's softer, yet tougher, Goodyear tires now give you up to 25% more safe mileage than before.
3. New 3-way sureness on the road. Quicker starts—safer stops—better car control on turns. Again, this 3-way Goodyear advance comes not only

from design factors, but from the precision we get from *electronic controls*.

Without question, these are the finest tires we've ever built. You can get them now at your nearby Goodyear dealer—and they won't cost you one cent more. Goodyear, Akron 16, Ohio.

# GOODYEAR

MORE PEOPLE RIDE ON GOODYEAR TIRES THAN ON ANY OTHER KIND

Watch the award-winning "Goodyear Theater" on TV every other Monday evening.



Precision-Built  
**TURNPIKE-  
PROVED**

This One



Y9BG-Z42-5F7Z

ATTENTION OWNERS OF 2-HEADLAMP CARS

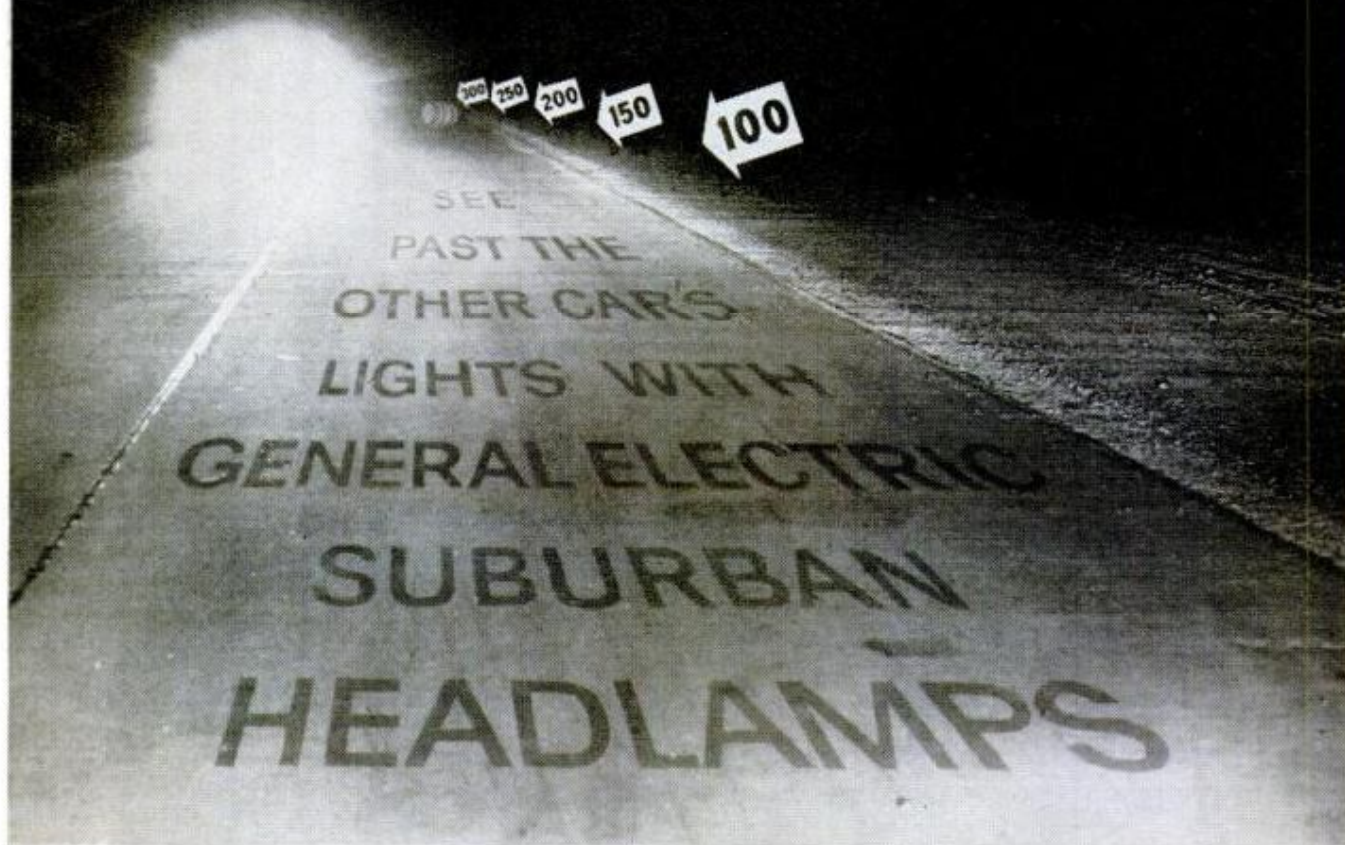

This picture was taken with new G-E SUBURBAN Headlamps *on the low beam*. See the barrel in the road beyond the lights of that oncoming car? With the low beam of ordinary headlamps, you'd be lucky if you saw it in time.

With new G-E SUBURBAN Headlamps you can see better in spite of the other car's lights—even when drivers fail to "dim" for you. Only General Electric puts the low beam

filament *on-focus* to provide a "spotlight" effect that gives you *twice as much light as previous two-headlamp systems*—down the right side of the road where you need it.

Get a pair of G-E SUBURBAN Headlamps for *your* 2-headlamp car—and be sure you have them aimed properly. Enjoy safer night driving from now on! General Electric Co., Miniature Lamp Dept. M-05, Nela Park, Cleveland 12, Ohio.



Have a pair of G-E SUBURBAN Headlamps installed and aimed today. Look for the big G-E monogram (bigger than a quarter).

*Progress Is Our Most Important Product*

**GENERAL  ELECTRIC**

POPULAR MECHANICS

# POPULAR MECHANICS®

Address communications to: 200 E. Ontario St., Chicago 11, Illinois. **SUBSCRIPTION SERVICE:** Mail all subscription orders, changes of address, correspondence concerning subscriptions, and Postmaster notices of undeliverable copies to Popular Mechanics, 250 West 55th St., New York 19, N. Y.

Editor

**RODERICK M. GRANT**

Executive Vice-President

**RICHARD E. DEEMS**

Publisher

**G. HARRY CHAMBERLAINE**

Managing Editor

**CLIFFORD B. HICKS**

Shop Notes and Crafts Editor

**WAYNE C. LECKEY**

Associate Editors, General Features

**ARTHUR R. RAILTON, Automotive**  
**JOHN A. LINKLETTER**

Associate Editor, Shop Notes and Crafts

**W. CLYDE LAMMEY**

Radio-Television, Electronics Editor

**LOTHAR STERN**

Assistant Editors, General Features

**JAMES BIERY, ROBERT L. HULL, JR.**  
**R. B. KIRKPATRICK**

Assistant Editors, Shop Notes and Crafts

**EARL WOBECK, GUERRINO F. AMATI**

Assistant Editors, Makeup

**WALLACE MYERS, JEAN KAVANAUGH**

Art Staff

**FRANK BEATTY, Director**

**HENRY NEHRBASS, Assistant Director**

**RICHARD A. POTTS, Art Editor**

Eastern Editor

**RICHARD F. DEMPEWOLFF**  
Room 4102, Empire State Bldg.,  
New York City 1

Western Editor

**THOMAS E. STIMSON, JR.**  
Suite 1003, 3460 Wilshire Blvd.,  
Los Angeles 5, Calif.

Advertising Manager

**JOSEPH R. BUELL, JR.**

Director, Bureau of Information

**ALLAN CARPENTER**

Advertising Offices

Chicago: 200 E. Ontario St., Whitehall 4-0100;  
New York: Empire State Bldg., 350 Fifth Ave.,  
Longacre 5-7580; Detroit: General Motors  
Bldg., TRinity 5-8711; Cleveland: Hanna  
Bldg., 1422 Euclid Ave., PRospect 1-0456; Los  
Angeles: 3460 Wilshire, DUmkirk 2-8458; San  
Francisco: Russ Bldg., 235 Montgomery St.,  
Yukon 2-0823.

Published monthly by Popular Mechanics Company,  
200 E. Ontario St., Chicago 11, Ill. Richard E.  
Berlin, President; Richard E. Deems, Executive  
Vice-President; Fred Lewis, Vice-President and  
General Manager; John R. Miller, Vice-President;  
G. Harry Chamberlaine, Vice-President; G. O. Mar-  
kuson, Treasurer; R. F. McCauley, Secretary. Sin-  
gle copy in the United States and Canada, 35 cents;  
subscription rates in the United States and pos-  
sessions and Canada, 1 year \$1.50; 2 years,  
\$6.00; 3 years, \$8.00. In countries of the Pan-  
American Postal Union, 1 year \$4.50; 2 years  
\$8.00; 3 years \$11.00. In all other countries 1  
year \$5.50; 2 years \$10.00; 3 years \$14.00.  
If you plan to move, notify us at least 30 days in  
advance so you will not miss an issue. Give both  
your old and new addresses. Second-class postage  
paid at Chicago, Illinois, and at additional mail-  
ing offices. Entered as Second Class Matter at  
Post Office Dept., Canada. Registered as Second  
Class Matter at the Post Office at Mexico, D.F.,  
Mexico, June 20, 1950. © 1960 by Popular  
Mechanics Company. All rights reserved. Printed  
in the United States of America.

INTERNATIONAL EDITIONS

SPANISH: Mexico-Caribbean, Southern Hemisphere

FRENCH, DANISH, SWEDISH, GERMAN, PORTUGUESE, DUTCH

Volume 113

MAY 1960

Number 5

## In This Issue...

The "Big E" Dies With Her Boots On	- -	65
Automatic Brakes "Read" the Road	- -	72
The X-15 Points Into Space	- - - -	76
Owners Report on the Valiant	- - - -	86
Rehearsal for Undersea Escape	- - - -	94
<b>VACATION SECTION—</b>		
10 Unusual Vacations	- - - -	112
Tips for Tenting	- - - -	119
America's Toll Roads	- - - -	122
Vacation Homes	- - - -	126
Look South for Your Future	- - - -	134

## For the Craftsman...

Radio, TV and Electronics	- - - -	141
Lazy-Susan Server	- - - -	146
Halting Fire With a Paintbrush	- - - -	154
Swimming Pools—Part II	- - - -	162
Which Boat for You?	- - - -	172
Using a Flexible Shaft	- - - -	188

## Regular Departments...

GUIDE TO THIS ISSUE - - - 6

Pentagon Sidelights	- - - 20	What's New for Your Home	- 138
Pioneer of Science	- - - 22	Solving Home Problems	- 150
Spotlight: Simca Etoile	- - - 60	On the Market	- - - 180
An Eye on Space	- - - 71	Shopping for Tools	- - - 198
Detroit Listening Post	- - - 75	Clinic for Homemakers	- - 204

Turn to detailed index on page 6. Sources of additional information on items in this issue are shown on the Where-to-Find-It List, available without charge by writing the Bureau of Information, Popular Mechanics, 200 E. Ontario St., Chicago 11, Ill.

## Next Month...

WHAT'S ALL THIS about air cars? Do they really have a future, or are they just publicity stunts? Will a cushion of air ever replace the wheel? Next month a PM editor tells what it feels like to ride several of the air cars, and assesses their true value. Also in June you'll find a fascinating story on the man who owns more tanks than Rommel ever commanded in Africa . . . the Owners Report on the Ford . . . and information on how to waterproof your basement

# CUDDLES THE SHARPEST CORNERS



*Lark under test at Sebring, Fla.*

## THAT'S ONE OF THE MANY REASONS WHY

YOU'LL LOVE THAT

# LARK

➤ How come The Lark can corner with such sure-footed alacrity? Look underneath and you'll find a suspension system of utmost design simplicity, yet engineered to a highly refined level. ➤ Up front, hydraulic shocks are surrounded by variable rate coil springs. Spring action is progressive so that under the stress of hard cornering or rough roads, the spring rate (oscillations per minute) increases . . . as you need it. ➤ At the rear . . . good old substantial semi-elliptics, *but*, mounted asymmetrically to the wheel. Hydraulic shocks angled outwards for greater stability. ➤ And on the V-8 Lark, link-type stabilizer bar for anti-sway action. ➤ Want a pleasant surprise? See your Studebaker Dealer and try The Lark on the nearest twisting roads.

# SPECIAL

## GOLD KEY VALUE

MADE ONLY BY

# LUFKIN

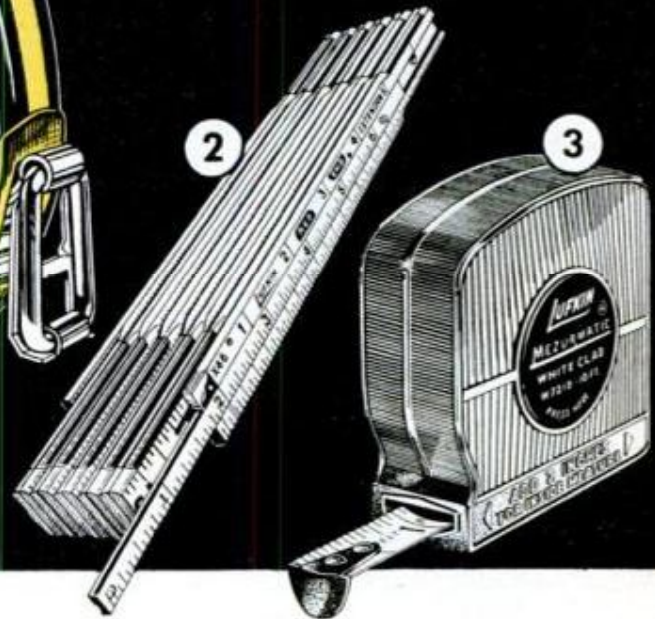
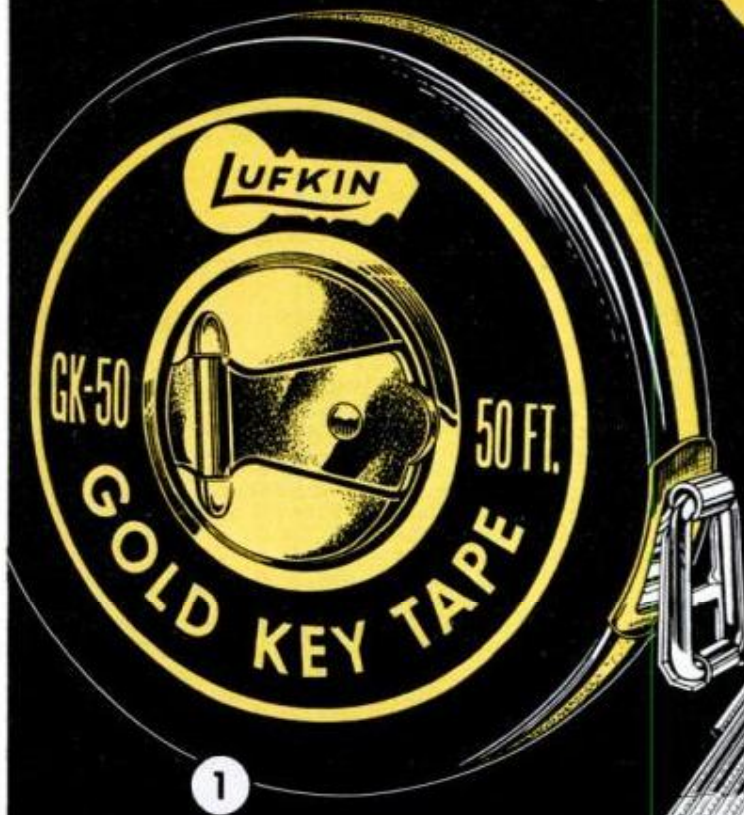

**1. Special Value Tape.** 50' smooth-action steel tape for long measurements in home or yard. Vinyl-finished, rustproof case. Bold black markings on plastic-coated white line. Special price: *only \$4.79.*

**2. Red End® Rules.** Only the best wood rules carry the name Red End—proven by millions of users. The X46 has 6" brass extension for inside measurements;

select hardwood sections; rustproof, triple-locking joints; bold, easy-to-read markings coated with tough plastic. *\$2.50.*

**3. MezurMatic® Tape Rules.** Press button and tape returns automatically at speed you control. Release for *instant* stopping—won't creep. Gleaming chrome case; bold, easy-to-read markings.

W7210 ½" x 10' White Clad® *\$1.98.*



*always look for the*  
**LUFKIN "TARGET"**  
*where your hardware man displays*  
*his finest measuring tools.*

# GUIDE TO THIS ISSUE

## With Sources of New Products



**NOW!**  
no spindle  
deflection

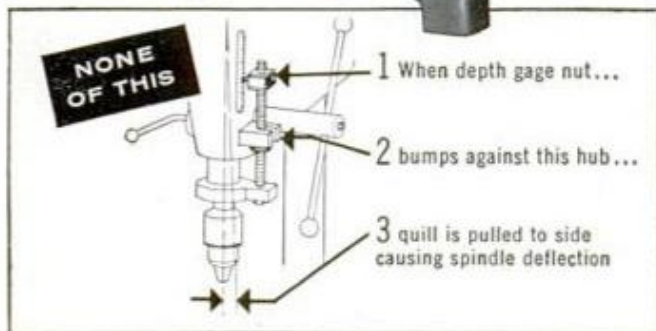

South Bend's design eliminates the major cause of inaccuracies common to all drill presses—spindle deflection resulting from depth gage pressure. *There is no depth gage collar on the quill.* Travel of the quill is controlled by an exclusive Rack Type Depth Gage that limits the rotation of the quill feed shaft. Write for more details about South Bend's exclusive features.

Prices of South Bend 14" Precision Drill Presses start at \$128 f.o.b. factory

# SOUTH BEND

## LATHE

South Bend Lathe, Inc., South Bend 22, Indiana

Builders of Lathes, Milling Machines, Shapers, Drill Presses, Pedestal Grinders

Up to 36 months to pay



### Automotive

- Magnetized reflector mounts anywhere on car (SOS Magnetized Reflector, A. Scarpello, P.O. Box 140, Secaucus, New Jersey) ..... 81
- "500" Cockpits ..... 82
- Automatic garage handles nine cars a minute ..... 108
- Even a motor scooter can haul collapsible trailer (Southbourne Sheet Metal Co., Ltd. of Clovelly Rd., Southbourne, Hampshire, England) ..... 133

### Boats

- Motor governor controls ski boat (Aqua-Meter Instrument Corp., Roseland, New Jersey) ..... 74
- Houseboat from pickup coach (Coons Custom Coach Mfg. Co., Oswego, Kans.) ..... 84
- Big plastic sailboat molded in three parts (Aeromarine Plastic Corp., Foot of Spring St., Sausalito, Cal.) ..... 104
- Kit packs trailer bearings (Continental Boat Accessories, 650 So. Clarence, Los Angeles 23, Cal.) ..... 105
- He builds boats aboard ship ..... 140

### House and Home

- Vacation homes (Pease Woodward Co., 900 Forest Ave., Hamilton, Ohio) ..... 196
- Tub-side television shows who's at door (Lacnite Ltd., Halfway, Walton-On-Thames, Surrey, England) ..... 140
- Humidifier removes odors, cleans air automatically ..... ~~150~~

250

### Miscellaneous

- Special wheelchair for injured skiers ..... 81
- Underground cruiser assembled in cave (Aero-Craft Boats, 400 Water St., St. Charles, Michigan) ..... 81
- It's flamed and pin-striped—what is it? (Ken MacDowell, 4406 W. 60th St., Cleveland 9, Ohio) ..... 91
- Letter sorter cancels stamps (Pitney-Bowes, Inc., Stamford, Conn.) ..... 92
- Model "mother" feeds animals (International Animal Nursery, Surf Ave. at W. 8th St., Coney Island, Brooklyn, N. Y.) ..... 92
- Turn signals on cargo ship (Marine Electric Co., Brooklyn, N. Y.) ..... 92
- Flying saucer? No, a Shakespearean theater ..... 97
- Pipeline carries molten sulphur beneath ocean (Freeport Sulphur Co., Freeport, La.) ..... 103
- Latest aquatic sport—surfing in the sand ..... 105
- Can you tie this? ..... 111
- Mailbox at your front door ..... 111
- Rockets protect his vineyard ..... 111
- Tiny trailer becomes 13-ft. sleeping room (Poppet Tent Trailer, Fox, Bunting and Partners, Ltd., 127 Premanade, Cheltenham Glos, England) ..... 128
- America's toll roads ..... 129
- Pier changes hazard into kid's play spot ..... 129
- Stop! Thief! (Mr. J. Koopman, 116 Village Road, Enfield (Mddx) England) ..... 132
- Model maché serves as roadbed (Shreddi-Mix Co., Brighton, Ill.) ..... 140
- U.S. military services need help of inventors ..... 209

### Science

- This photograph came from the moon! ..... 74
- "Bustle" for missile ..... 84
- Artificial planetoid explores space between Earth and Venus ..... 85
- Do-it-yourself vacuum tubes from kits (Massachusetts Institute of Technology, Cambridge 39, Mass.) ..... 93

(Continued to page 8)





How these 18 Experts can help you  
**Get into a High Pay**  
**ACCOUNTING CAREER**

LaSalle's famous staff of Accounting authorities are helping thousands prepare for fast promotions and bigger pay. They can do the same for you!

If your heart is set on a larger income and all that it means... better home—fine car—larger bank account—more of the good things of life....

If that's your ambition and you are really serious about it, then you owe it to yourself to get the REAL FACTS about LaSalle Accounting, and the many good-pay opportunities that can be YOURS through LaSalle's famous Problem Method plan.

It matters not whether you've had a single day of experience in this field—or whether you have already started but want to climb higher. LaSalle's expert training is designed to take you from where you are... to where you want to be... in higher positions and a lifetime career of security and good income.

**WHY YOU CAN'T FAIL TO GAIN**

You see on this page a panel of experts who know Accounting from A to Z... all the way from Basic Accounting on up through Accounting Systems, Cost Accounting, Auditing, Federal Income Tax, and training for the CPA certificate. These are only part of our instruction staff. But what is most important to you... These CPAs and Expert Accountants know how to impart their knowledge to others... how to help you prepare quickly yet thoroughly for success in this lucrative field.

The proof? What stronger proof could there

be than that more than 4,500 Certified Public Accountants (one out of every 13 of the U.S. total) has trained with LaSalle? Or the hundreds of thousands of men and women whom LaSalle has helped qualify rapidly for more money, a brighter future, in a high-pay-lifetime career? These thousands came to us with different backgrounds of experience and varying degrees of ambition. Many have reported raises and promotions after only a few weeks of training. Thousands of them have written to say they are now earning 50% more—even double their former incomes—often in less than a year. These letters are published in book form for your inspection. They were written by real people, with real income problems and ambitions—people who might be your next-door neighbor.

Yes, if you are really sincere in wanting to better your position—start your income climbing—enjoy a lifetime career of high standing and high reward—this friendly staff of experts can help you.

**SAMPLE LESSON SENT FREE  
 MAIL COUPON BELOW**

You don't have to wonder what LaSalle's Accounting plan is like. You will be sent a free sample lesson, which does not obligate you in any way. Study it—keep it—see for yourself how simple, clear, and easy it is to master. This is an actual lesson right out of the regular training—to show you exactly how LaSalle's Problem Method has trained more than 1,400,000 men and women from all walks of life.

Also... the latest book, "Opportunities in Accounting," gives all the latest facts about the new and growing opportunities in several different fields of profitable employment.

This can be an important day in your life. A coupon like the one below has started hundreds of thousands of men and women toward a bigger job, a larger income. It can do the same for you.

Accredited Member, National Home Study Council

*Mail the Coupon Today!*

FREE BOOKS



**LA SALLE EXTENSION UNIVERSITY**

A Correspondence Institution

417 S. Dearborn Street Dept. 564H Chicago 5, Ill.

Send me free Sample Lesson in Accounting—also, latest free book, "Opportunities in Accounting," and "Success Reports"... all without cost or obligation.

Name..... Age.....

Address.....

City & Zone..... State.....

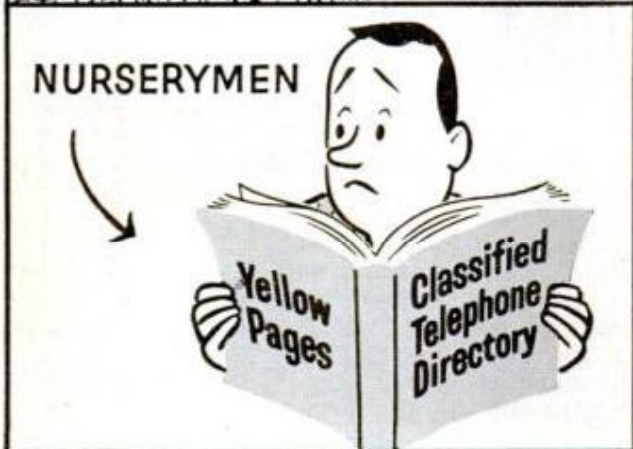

**lawn mowers, carburetors, loans,  
pianos, caterers, nursing homes**

*whatever you need—*



**Advertisers displaying this emblem  
make your shopping easy.**

Periscope of Japanese sub gives view of city (Edmund Scientific Co., 101 Gloucester Pike, Barrington, N. J.)	109
Bad-weather watchdog (John Neubauer, 11941 Bluhill Rd., Silver Spring, Md.)	110
Huge antenna tracks satellites (Philco Corp., 455 E. Tioga St., Philadelphia, Pa.)	111
Battlefield rescuator revives gas victims	129
Ballistic missile to carry TV station	137
Fuel cells power tractor (Allis-Chalmers Mfg. Co., 864 S. Shalmers St., Milwaukee, Wis.)	137
Laboratory highway cuts testing time (Standard Oil Co., of Indiana, Public Relations Dept., 910 S. Michigan Ave., Chicago 80, Ill.)	137
Lab mice recover from cancer when given stimulating agent	228

### What's New for Your Home

Shoe shine kit	138
Under-pillow alarm	138
Utility cart	138
Quilt frame	138
Hose hider	139
Grease trap	139
Utility oven	139

### Radio, TV, Electronics

Radio-controlled model car and boat	141
-------------------------------------	-----

## Craftsman and Shopnotes Index

### Automotive

Trouble shooting the tough ones	178
Loose Rivets	179
Accelerator lever	179
Insufficient clearance	179
Fuel gauge	179
Four-tier rack for used tires	186

### Farm and Farming

Lock nuts cut from coupling	149
Milk cartons cut in half serve as seedling flats	170
Obsolete fuel-delivery truck serves as farm water wagon	170
Plant protectors	171
Roof for round corncrib hoisted with elevator	195

### House and Home

Hanging wall desk made of plywood and pine	149
Loop improves paint-pail hook	152
Milk carton ignites charcoal	159
Pulling stakes the easy way	159
Clear-plastic boxes store odds and ends	160
Digging tunnel under walk	161
Wooden hangers hold moth balls	161
Sunglasses for your windows	168
Shear pin in post saves rural mailbox from damage	176
Outdoor oven has underground smoke pit	177
Ridge saddle is safe on steep roof	195
Seal out that condensation	212
Keeping gutters free of leaves	218
Painted spouts give longer service	222

### Miscellaneous

Disposable wren house	152
Tote box set on picket legs	152
Raft for lifesaving and play	153
Nonslip boating gloves	158
Capsule bottle cap removed by cellophane-tape tab	160
Tape around lure hooks prevents injury and tangling	160
Pull-out leaf houses typewriter in knee-hole desk	161
Tangleproof dog-chain anchor	170
Chalked line measures water depth	176
Staple spaces shingle courses	176
Dishpan sink for darkroom beginners	183
Filter on faucet assures clean water at darkroom tap	183
Spillproof container	197

(Continued to page 10)

# Are you a guy who didn't MARRY THE BOSS'S DAUGHTER?



They tell us it's a good way to get ahead. The tough part is... there aren't enough bosses' daughters to go around. But there's another way to call your shots.

How? Look at the want ads! Business and industry are crying for men with special training. 60,000 Engineers—Industrial Supervisors, Communications and Traffic Specialists are urgently needed. Demand has never been greater—or salaries higher—for trained people.

With the right kind of training you can step into one of these jobs — write your own ticket. Without it you must compete with a few million other guys who are in the same boat. And, if times get tough, it's not going to be a good boat to be in.

So act now! Choose the education for men who want to get ahead fast. Pick your future from success-proven I.C.S. courses. Whichever field you choose it will be *right* because all I.C.S. courses are developed by business and industry leaders who know what *you* need to know to go places.

You get *personalized* guidance. Earn as you learn. Study in your spare time — at your own pace. And when you get the coveted I.C.S. diploma, it's the frosting on the cake. Chances are by that time you've already been snapped up for a bigger job with a bigger price tag.

Don't wait another day! Choose your course and send for the free career booklets offered below.

**For Real Job Security—Get an I. C. S. Diploma!**

**I. C. S., Scranton 15, Penna.**

Accredited Member,  
National Home Study Council

INTERNATIONAL CORRESPONDENCE SCHOOLS				ICS
<b>DEPT. A, SCRANTON 15, PENNA.</b>		In Hawaii reply P. O. Box 418, Honolulu		(Partial list of courses) 67953Y
Without cost or obligation, send me "HOW TO SUCCEED" and the opportunity booklet about the field BEFORE which I have marked X (plus sample lesson):				
<b>ARCHITECTURE and BUILDING CONSTRUCTION</b> <input type="checkbox"/> Air Conditioning <input type="checkbox"/> Architecture <input type="checkbox"/> Arch. Drawing and Designing <input type="checkbox"/> Building Contractor <input type="checkbox"/> Building Estimator <input type="checkbox"/> Carpenter Builder <input type="checkbox"/> Carpenter and Millwork <input type="checkbox"/> Carpenter Foreman <input type="checkbox"/> Heating <input type="checkbox"/> Painting Contractor <input type="checkbox"/> Plumbing <input type="checkbox"/> Reading Arch. Blueprints <b>ART</b> <input type="checkbox"/> Commercial Art <input type="checkbox"/> Magazine illus. <input type="checkbox"/> Show Card and Sign Lettering <input type="checkbox"/> Sketching and Painting <b>AUTOMOTIVE</b> <input type="checkbox"/> Automobile <input type="checkbox"/> Auto Body Rebuilding and Refinishing <input type="checkbox"/> Auto Engine Tuneup <input type="checkbox"/> Auto Technician	<b>AVIATION</b> <input type="checkbox"/> Aero-Engineering Technology <input type="checkbox"/> Aircraft & Engine Mechanic <b>BUSINESS</b> <input type="checkbox"/> Accounting <input type="checkbox"/> Advertising <input type="checkbox"/> Business Administration <input type="checkbox"/> Business Management <input type="checkbox"/> Cost Accounting <input type="checkbox"/> Creative Salesmanship <input type="checkbox"/> Managing a Small Business <input type="checkbox"/> Professional Secretary <input type="checkbox"/> Public Accounting <input type="checkbox"/> Purchasing Agent <input type="checkbox"/> Salesmanship <input type="checkbox"/> Salesmanship and Management <input type="checkbox"/> Traffic Management <b>CHEMICAL</b> <input type="checkbox"/> Analytical Chemistry <input type="checkbox"/> Chemical Engineering <input type="checkbox"/> Chem. Lab. Technician <input type="checkbox"/> Elements of Nuclear Energy <input type="checkbox"/> General Chemistry <input type="checkbox"/> Natural Gas Prod. and Trans. <input type="checkbox"/> Petroleum Prod. and Engr. <input type="checkbox"/> Professional Engineer (Chem.) <input type="checkbox"/> Pulp and Paper Making	<b>CIVIL ENGINEERING</b> <input type="checkbox"/> Civil Engineering <input type="checkbox"/> Construction Engineering <input type="checkbox"/> Highway Engineering <input type="checkbox"/> Professional Engineer (Civil) <input type="checkbox"/> Reading Struc. Blueprints <input type="checkbox"/> Sanitary Engineer <input type="checkbox"/> Structural Engineering <input type="checkbox"/> Surveying and Mapping <b>DRAFTING</b> <input type="checkbox"/> Aircraft Drafting <input type="checkbox"/> Architectural Drafting <input type="checkbox"/> Drafting & Machine Design <input type="checkbox"/> Electrical Drafting <input type="checkbox"/> Mechanical Drafting <input type="checkbox"/> Sheet Metal Drafting <input type="checkbox"/> Structural Drafting <b>ELECTRICAL</b> <input type="checkbox"/> Electrical Engineering <input type="checkbox"/> Elec. Engr. Technician <input type="checkbox"/> Elec. Light and Power <input type="checkbox"/> Practical Electrician <input type="checkbox"/> Practical Lineman <input type="checkbox"/> Professional Engineer (Elec.) <b>HIGH SCHOOL</b> <input type="checkbox"/> High School Diploma	<input type="checkbox"/> Good English <input type="checkbox"/> High School Mathematics <input type="checkbox"/> High School Science <input type="checkbox"/> Short Story Writing <b>LEADERSHIP</b> <input type="checkbox"/> Industrial Foremanship <input type="checkbox"/> Industrial Supervision <input type="checkbox"/> Personnel-Labor Relations <input type="checkbox"/> Supervision <b>MECHANICAL and SHOP</b> <input type="checkbox"/> Diesel Engines <input type="checkbox"/> Gas-Elec. Welding <input type="checkbox"/> Industrial Engineering <input type="checkbox"/> Industrial Instrumentation <input type="checkbox"/> Industrial Metallurgy <input type="checkbox"/> Industrial Safety <input type="checkbox"/> Machine Shop Practice <input type="checkbox"/> Mechanical Engineering <input type="checkbox"/> Professional Engineer (Mech) <input type="checkbox"/> Quality Control <input type="checkbox"/> Reading Shop Blueprints <input type="checkbox"/> Refrigeration and Air Conditioning <input type="checkbox"/> Tool Design <input type="checkbox"/> Tool Making <b>RADIO, TELEVISION</b> <input type="checkbox"/> General Electronics Tech.	<input type="checkbox"/> Industrial Electronics <input type="checkbox"/> Practical Radio-TV Eng'g <input type="checkbox"/> Practical Telephony <input type="checkbox"/> Radio-TV Servicing <b>RAILROAD</b> <input type="checkbox"/> Car Inspector and Air Brake <input type="checkbox"/> Diesel Electrician <input type="checkbox"/> Diesel Engr. and Fireman <input type="checkbox"/> Diesel Locomotive <b>STEAM and DIESEL POWER</b> <input type="checkbox"/> Combustion Engineering <input type="checkbox"/> Power Plant Engineer <input type="checkbox"/> Stationary Diesel Engr. <input type="checkbox"/> Stationary Fireman <b>TEXTILE</b> <input type="checkbox"/> Carding and Spinning <input type="checkbox"/> Cotton Manufacture <input type="checkbox"/> Cotton Warming and Weaving <input type="checkbox"/> Loom Fixing Technician <input type="checkbox"/> Textile Designing <input type="checkbox"/> Textile Finishing & Dyeing <input type="checkbox"/> Throwing <input type="checkbox"/> Warming and Weaving <input type="checkbox"/> Worsted Manufacturing
Name _____		Age _____		Home Address _____
City _____		Zone _____	State _____	Working Hours _____ A.M. to P.M. _____
Occupation _____				
Canadian residents send coupon to International Correspondence Schools, Canadian, Ltd., Montreal, Canada. . . . Special low monthly tuition rates to members of the U. S. Armed Forces.				

# UNUSUAL BARGAINS

See the Stars, Moon, Planets Close Up!  
**3" ASTRONOMICAL REFLECTING TELESCOPE**  
 60 to 180 Power — Famous Mt. Palomar Type! An Unusual Buy!

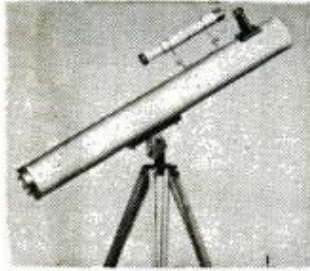

Assembled—Ready to use! You'll see the Rings of Saturn, the fascinating planet Mars, huge craters on the Moon, Star Clusters, Moons of Jupiter in detail. Galaxies! Equatorial mount with lock on both axes. Aluminized and overcoated 3" diameter high-speed f/10 mirror. Telescope comes equipped with a 60X eyepiece and a mounted Barlow Lens, giving you 60 to 180 power. Low-cost accessory eyepiece available for higher powers. An Optical Finder Telescope, always so essential, is also included. Sturdy, hardwood, portable tripod. FREE

with Scope—Valuable **STAR CHART** plus 272 page "**HAND-BOOK OF HEAVENS**" plus "**HOW TO USE YOUR TELESCOPE**" BOOK.  
 Stock No. 85,050-H.....\$29.95 postpaid

**KNOW THE TRUTH ABOUT POWER.** Telescope experts will confirm that an Astronomical Telescope will only give you practical powers to about 50 or 60 times per inch of objective diameter—powers above this only produce empty magnification—make viewing dim, difficult and unsatisfactory.

## War Surplus American-Made 7x50 Binoculars

Big savings! Brand new! Crystal clear viewing—7 power. Every optical element is coated. An excellent night glass—the size recommended for satellite viewing. Individual eye focus. Exit pupil 7mm. Approx. field at 1,000 yds. is 376 ft. Carrying case included. American 7 x 50's normally cost \$195. Our war surplus price saves you real money.  
 Stock No. 1533-H.....only \$55.00 postpd. (Tax included)



## Terrific Buy! American Made! OPAQUE PROJECTOR

Projects illustrations up to 3" x 3 1/2" and enlarges them. No film or negatives needed. Projects charts, diagrams, pictures, photos, lettering in full color or black-and-white. Operates on 115 volt, A.C. current. 6-ft. extension cord and plug included, operates on 60 watt bulb, not included. Size 12" x 8" x 4 1/2" wide. Weight 1 lb., 2 oz. Plastic case with built-in handle.  
 Stock No. 70,199-H.....\$7.95 Postpaid



## CLOSE OUT! MECHANICAL DRAWING SET

Regular Price \$18.00  
 Our Price Only \$8.00 Postpd.

American mfr. couldn't compete with foreign imports—thus you get a terrific bargain, even far below import prices. 10 handsome pieces in velvet-lined case. Nickel plated brass—precision American-made. We guarantee you'll be satisfied or money refunded.  
 Stock No. 50,200-H.....\$8.00 Postpaid

**NOTICE:** Edmund is now headquarters for Math Learning and Teaching Aids! See dozens of offerings in our FREE Catalog H.

## NEW! CIRCULAR SLIDE RULE!

Pocket Size—Fast—Easy to Use!

Multiples, divides, figures fractions, percentages, squares, cubes, roots, proportions, circumferences, areas, retail prices, fuel consumption. Faster, easier to learn and use. Directions included.  
 Stock No. 30,336-H.....\$4.95 postpaid



## BUILD A SOLAR ENERGY FURNACE

A fascinating new field. Build your own Solar Furnace for experimentation—many practical uses. Easy! Inexpensive! Use scrapwood! We furnish instructions. This sun powered furnace will generate terrific heat—2000° to 3000°. Fuses enamel to metal. Sets paper aflame in seconds. Use our Fresnel Lens—14" diameter... f.l. 14".  
 Stock No. 70,130-H.....Fresnel Lens.....\$ 6.00 Postpd.

Order by Stock No.—Send Check or M.O.—Money-Back Guarantee  
**EASY PAYMENT PLAN AVAILABLE! DETAILS WITH CATALOG!**  
**EDMUND SCIENTIFIC CO., Barrington, New Jersey**

## MAIL COUPON for FREE CATALOG "H"

128 Pages! Over 1000 Bargains!  
 EDMUND SCIENTIFIC CO., Barrington, N. J.  
 Please rush Free Giant Catalog-H.

Name.....  
 Address.....  
 City.....Zone.....State.....



## On the Market

Wood sealer .....	180
Top finishing material .....	180
Masonry sealer .....	180
Sanitation chemical .....	180
Pressurized hand sprayer .....	180
Decorative plastic laminate .....	181
Damp surfaces .....	181
Pail holder .....	181
Repair of porcelain finishes .....	181
Louver rails .....	181

## Short Cuts That Help Solve Shop Problems

Broken twist drill removed from work .....	196
Locked clamping pliers loosened .....	196
Depth gauge .....	196
Fence staples .....	196
Irregular workpieces .....	196
1/4-inch drill can drill large holes .....	196
Long boring bars .....	196
Nut with badly rounded corners removed easily .....	196
When boring row of holes, prevent bit from running out .....	196

## Solving Home Problems

Cloth measuring tape .....	150
Ladies hats kept from being crushed on shelf .....	150
Plastic bags .....	150
Hardened drops of paint .....	150
Defrost refrigerator in a hurry .....	151
Filling a hot-water bottle .....	151
Proper temperature setting for cooking certain foods .....	151

## Shopping for Tools

All-metal fire stop .....	198
Tilting-arbor saw .....	198
Rack-and-pinion steering unit .....	198
Portable punch press .....	198
Internal-expanding brake .....	198
Portable electric impact wrench .....	199
Magnetic workholder .....	199
Dial-type calipers .....	199
Auxiliary drill chuck .....	199
Special C-clamp .....	199
Driving unit .....	200
Calibrated "batterboard" .....	200
Multipurpose bench punch .....	200
Liquid spring .....	200
4-in. jointer-planer .....	200

## Workshop Hints

Filter fitted to garden sprayer .....	149
Drill cranks power mower .....	152
You'll find many extra uses for colorful plastic cups .....	159
Altered Fahnestock clips are easier to use .....	160
Both sides of storm sash painted at one "setting" .....	170
Locators help align decorative laminate on table top .....	176
Custom-made grommets made of liquid rubber .....	182
Dowel pins cut in quantity using wooden safety "paddle" .....	182
Quick double-vice setup saves milling time .....	182
Thread helps position gasket .....	182
Data charts on torque wrench .....	186
Locking pliers serve as vise .....	186
Two-position cross-feed stop .....	186
Odd-job lathe bits .....	187
Large work dogged to mandrel .....	192
Power-drive your grindstone .....	192
Reducing oversize hole in hub .....	192
Straddle bar holds flanged work .....	192
Lathe-bit clearances ground accurately .....	193
Steel wool on legs of magnet picks up metal filings .....	193
Drill metal safely .....	194
Portable parts cleaner .....	197
Swamp shoes for tractor .....	197

**NOTICE**—It is the intention of this magazine to provide its readers with information regarding the latest developments in the mechanical arts. Except where otherwise indicated, this magazine has no information as to any unexpired patents in respect of the developments reported herein. In the event that commercial use is to be made of any of the developments reported herein, it is suggested that legal counsel be consulted to avoid liability for patent infringement. It is not the purpose of this magazine to encourage patent infringement but, as indicated, it is the intention of this magazine to report on the latest developments in the mechanical arts.

# Learn Radio-Television Electronics

by Practicing at Home in Your Spare Time

**WITHOUT EXTRA CHARGE YOU GET** special NRI kits developed to give you actual practice with Radio-TV receiver or broadcasting circuits and equipment. All equipment is yours to keep.



**RADIO-TV BROADCASTING** (see above) offers important positions as Operators and Technicians. **RADIO-TV SERVICING Technicians** (see below) needed in every community. Their services are respected, their skill appreciated.



## Fast Growing Field Offers You Good Pay, Success, Bright Future



J. E. SMITH  
founder

Bigger than ever and still growing fast. That's why Radio-TV has special appeal to ambitious men not satisfied with their job and earnings. More than 4,000 Radio and TV stations. More than 150 million home and auto Radios, 40 million TV sets. Color TV promises added opportunities. For the trained man, there are good jobs, bright futures in Radio-TV Servicing or Broadcasting.

Training PLUS opportunity is the ideal combination for success. So plan now to get into Radio-TV. The technical man is looked up to. He does important work, gets good pay for it. Radio-Television offers that kind of work. NRI can supply training quickly, without expense of going away to school. Keep your job while training. You learn at home in your spare time. NRI is the OLDEST and LARGEST home study Radio-TV school. Its methods have proved successful for more than 40 years.

### Added Income Soon - \$10, \$15 a Week in Spare Time

Soon after enrolling, many NRI students start to earn \$10, \$15 a week in spare time fixing sets. Some pay for their training and enjoy extra luxuries this way. Some make enough to start their own Radio-TV shops. NRI training is *practical*—gets quick results. Easy to understand, well illustrated lessons teach you basic principles. And you **LEARN-BY-DOING** by practicing with kits of equipment which "bring to life" things you study.

### Find Out What NRI Offers

NRI has trained thousands for successful careers in Radio-TV. Study fast or slow—as you like. Diploma when you graduate. Mail coupon now. Paste it on a postcard or mail in envelope. **ACTUAL LESSON FREE.** Also 64 page catalog that shows opportunities, shows equipment you get. Cost of NRI courses low. Easy terms. **NATIONAL RADIO INSTITUTE, Dept. OEA, Washington 16, D. C.**

### N.R.I. TRAINED THESE MEN FOR SUCCESS



"I was repairing Radios by 10th lesson. Now have good TV job." M. R. LINDEMUTH, Fort Wayne, Ind.



"Doing spare time repairs on Radio and TV. Soon servicing full time." CLYDE HIGGINS, Waltham, Mass.

"I had a successful Radio repair shop. Now I'm Engineer for WHPE." V.W. WORKMAN, High Point, N.C.



"There are a number of NRI graduates here. I can thank NRI for this job." JACK WAGNER, Lexington, N. C.



**VETERANS Approved Under G. I. Bills**

### SEND FOR BOTH FREE

#### National Radio Institute

Dept. OEA, Washington 16, D. C.

Mail me Sample Lesson and 64-Page Catalog FREE. (No salesman will call. Please write plainly.)

Name \_\_\_\_\_ Age \_\_\_\_\_

Address \_\_\_\_\_

City \_\_\_\_\_ Zone \_\_\_\_\_ State \_\_\_\_\_

Accredited Member National Home Study Council



# New 1960 German Adding Machine Adds & Subtracts to ONE BILLION!

Now with **9 NEW** exclusive features--Still Only **1<sup>98</sup>**

- ↓  
Pocket for  
Coins and \$1,  
\$5, \$10 Bills!
- ↓  
200 Year  
Perpetual  
Calendar!
- ↓  
Fine Grain  
Fitted  
WALLET!
- ↓  
Easy-Flow  
Clearing  
Lever!
- ↓  
Magic Reckoner  
for Multiplying  
& Dividing!

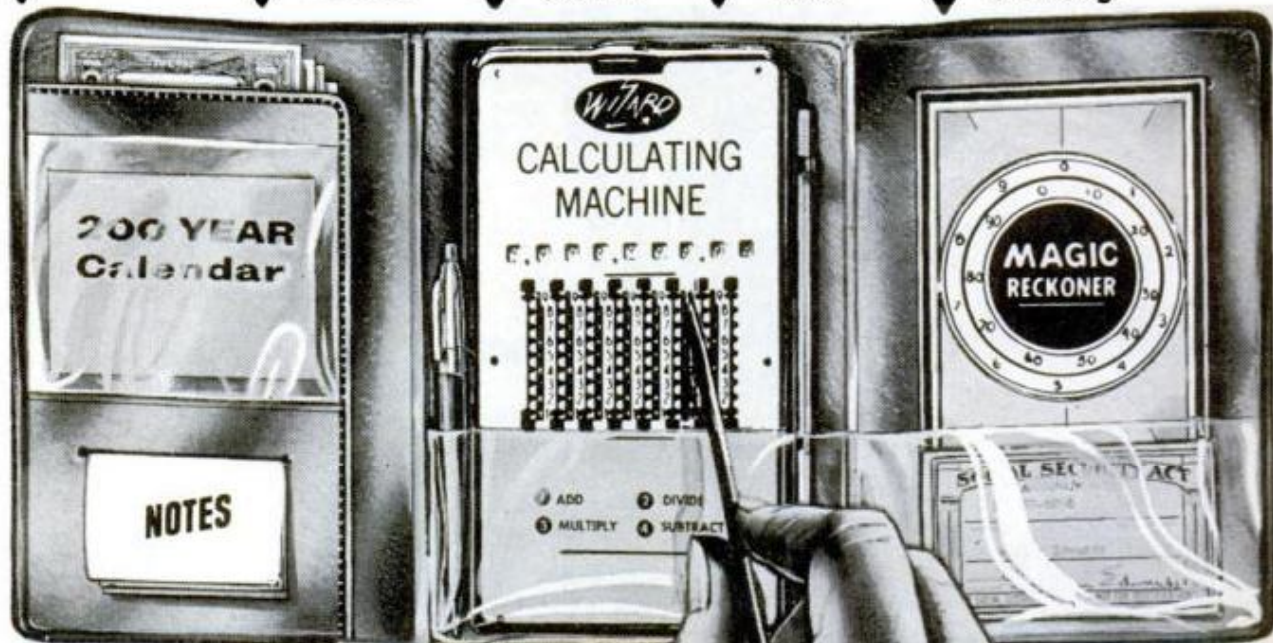

Fitted Slot  
for Notes,  
Memo Pad!

Midget  
Ball Point  
Pen!

All  
Metal  
Stylus

Pocket for  
Social Security  
Card, Photos,  
Licenses!

Now yours—the all-new 1960 Wizard Calculator—direct to you from the world's greatest importer of adding machines—THORESEN. This improved, 1960 high speed calculator is so small! It's actually a custom-fitted Secretarial Wallet that slides into your pocket or purse. Yet it's a precision-made high-speed calculator. Made with enduring Korium Steel working parts. It adds and subtracts with amazing speed up to ONE BILLION and never makes a mistake! It's the only calculator in the entire world with a fitted MAGIC RECKONER for instant multiplication and division—without pencil or paper. The 1960 Model also has a 200-YEAR Perpetual Calendar for finding the date, weekday and month of any year. It has a genuine Metal Stylus and a fine Ball Point Pen. All this is contained in a Fine Grain Wallet with Pocket for notes, coins, tokens, \$1, \$5 and \$10 bills; Pocket for licenses, credit cards, social security and photos. Really an all-purpose portable pocket secretary that goes with you EVERYWHERE! You'd expect to pay \$4.00 to \$5.00 for a Secretarial Wallet alone—yet you get the Wallet and complete Calculating System at a huge saving—direct from the importer.

Folds Flat  
to Fit  
Pocket!



Fully Open



Fold Over Once



Fold Over Twice



Slip Into Pocket

### Answers Pop Into View—Automatically!

All you do is "feed" it your list of figures, small or big, and instantly the correct answer pops up in the 9 tiny windows—AUTOMATICALLY! For multiplication or division you use the MULTIRECKONER and get lightning-fast answers.

### This Type Adding Machine Used in 48 Countries of the World!

Over 4 million men, women and students use pocket adding machines in 48 countries. 4,000,000 people can't be wrong! Needed in every home, store, office, factory, engineering firm, school and college.

### Saves Time, Work and Money

Avoids frazzled nerves. Prevents costly human mistakes—because this mathematical marvel can't make a mistake! You add mountains of numbers in MINUTES while others take hours. Now it's so fast, so easy to check all purchases, statements, even restaurant bills. Keeps a running tab of market purchases as you take food off shelves. Records car mileage. Helps you maintain a budget, figure out your income tax, checks, children's home work, keeps bridge & canasta scores, figures discounts, insurance and stock dividends, salesman's expenses. The 1960 WIZARD gives you freedom from figuring slavery.

### Developed in West Germany where Quality of Workmanship Reigns Supreme!

Do not confuse with cheaper, erratic, look-alike, all plastic calculators imported from the Orient! The WIZARD is a mechanical marvel developed by German Mathematicians—renowned craftsmen! Human beings can make mistakes but this machine NEVER DOES! Precision-made with genuine Korium Steel mechanism—no gears, no wheels to wear out . . . virtually lasts a lifetime!

### Packed with New Features

The new WIZARD is better in many ways—new, better lever action . . . new deluxe secretarial wallet for your currency, cards, etc. . . . new all metal stylus . . . new instant clearing lever . . . fitted midget pen . . . pockets for notes, photos, licenses . . . perpetual 200-year calendar . . . Magic Reckoner for quick dividing! All this is yours for a fraction of what you expect to pay! But hurry! Factory is working night and day to fill tremendous demand for the Wizard Calculator. Avoid disappointment. Mail that FREE-trial coupon for 10-day FREE trial. Satisfaction guaranteed or money refunded. \$5.00 value—only \$1.98 plus 22c mailing cost. Rush \$2.20 check, cash or money order for prompt delivery ANYWHERE in USA or Canada. COD's plus 50c COD fee (enclose \$1 deposit).

**THORESEN, Inc., Dept. 6-E-668**  
585 Water Street, New York 2, N. Y.

Rush the new 1960 Deluxe Wizard Calculator for \$1.98 plus 22c mailing cost.  
**TOTAL: \$2.20. Money Back Guarantee!**

- Check, cash or money order enclosed.
- Send COD plus 50c COD fee.

PRINT NAME AND ADDRESS .....

.....  
.....  
.....  
.....

**THORESEN, Inc., 6-E-668, 585 Water Street, New York 2, N. Y.**

# You'll soon be happy in a great new job...

...earning **BIG** money...

...if you start training **NOW** for success in

## AIR CONDITIONING AND REFRIGERATION

You could be earning top pay in months. It's mostly a matter of getting your training now. Your best bet is to be a mechanic in the air conditioning and refrigeration field. This industry is growing so fast that *20,000 newly trained mechanics are needed each year*. Over 150 million units are in use; over 5 million new air conditioners, freezers and refrigerators are sold annually. Skilled men are desperately needed for installation and repair work. Be a mechanic! *Mail coupon for free success booklets on CTI's amazing new Home Training Plan.*



### You can earn cash during your training

Because CTI training is so *practical*, you'll soon be making profitable service calls. Perhaps you'll work on your own. Or, you may prefer to get a part-time job with a local appliance dealer or air conditioning contractor. You can add to your present income this way. With extra cash, you can buy additional shop equipment, pay your tuition, even bank money.



### You could go in business and be independent

Own a business—and enjoy independence! Thrill to the satisfaction of being the boss. Give orders—not take them! The refrigeration field is ideal for getting started on your own. You can make friends as you make service calls. In time, you'll have a list of potential customers. You can also sign service contracts with food stores, taverns, restaurants, etc. Ever so many CTI graduates have their own successful shops. Most of them began with nothing more than their new training and pluck. You, too, can start small and grow big. Be a business man!

### You could get into the profitable new auto air conditioning field

Hundreds of thousands of new cars are being equipped with air conditioners. Auto dealers are advertising for skilled refrigeration mechanics, offering premium pay, to set up service departments. Or, you can go in business for yourself, and contract with auto agencies to do this type of installation and repair. You can make big profits either way.



*This is the home of CTI, one of the world's great home study schools. Through this Institute you receive "training you can trust." Over 40,000 career graduates from coast to coast.*

**COMMERCIAL TRADES INSTITUTE**  
1400 Greenleaf Avenue • Chicago 26, Illinois

**FIRST GET THE FACTS—THEN DECIDE**  
Mail Coupon Today for 2 Free Booklets

ONLY CTI SENDS PARTS  
AND TOOLS TO BUILD A  
CONDENSING UNIT!

25  
BIG KITS



### You learn fast because you practice with real equipment — Get experience

You train at home in spare time. No need to give up your present job; no need to leave home to attend a resident school. *CTI sends 25 kits of parts and tools to build a heavy-duty, commercial-type, 1/4 h.p. refrigeration high-side (illustrated above.)* You do 10 troubleshooting and service jobs—it's almost like field training!

After assembling and working projects with your unit, you may build an air conditioner, refrigerator, freezer, or milk cooler. *All parts and tools are sent without extra charge—they are yours to use and keep.*

### You get all these quality mechanic's tools



You get special "tools of the trade" as part of your training. Included is a pressure gauge, vacuum gauge and testing manifold. You'll use these tools to assemble and test the condensing unit. Thus, you get not just tools—but *equipment to practice with.* (Why settle for one without the other?)

### You must look into your opportunities

Thousands of CTI graduates (and students) tell us they are getting better jobs, earning more money, working steady. Many are going in business. It is surprising how many report the best benefit of all is that they gained self-confidence. With so much at stake, can you afford to neglect your opportunities? Isn't it worth a few minutes of your time to *find out?* Just fill out and mail the handy coupon! Be sure to act today.

## COMMERCIAL TRADES INSTITUTE

1400 GREENLEAF AVENUE  
CHICAGO 26, ILLINOIS

DEPT. R-719

Send me your two opportunity booklets, *Success in Air Conditioning & Refrigeration*, and *Lesson Sample*. Both FREE.

Name \_\_\_\_\_ Age \_\_\_\_\_

Address \_\_\_\_\_

City \_\_\_\_\_ Zone \_\_\_\_\_ State \_\_\_\_\_



When rough idling  
shakes you up...

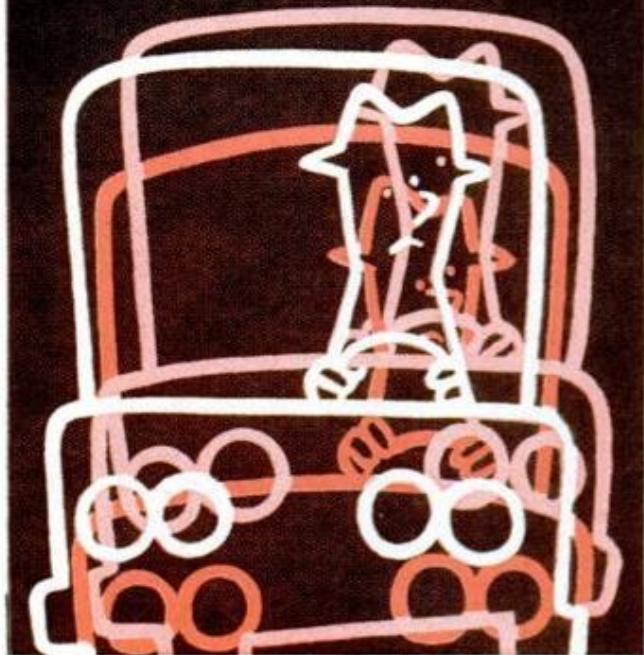

## HOW LONG SINCE YOU CLEANED YOUR CARBURETOR WITH **GUMOUT**

Ever notice that your car doesn't idle as smoothly as it once did? Maybe it stalls occasionally. Might be a little harder to start. Or it lacks pep and power. All because your carburetor is dirty!



### CLEAN YOUR CARBURETOR WITH GUMOUT

Just add GUMOUT to your gas tank. *Only* GUMOUT dissolves gum and varnish completely . . . restores engine power, stops gasoline waste. Don't take chances with substitutes. Insist on GUMOUT. Every car needs GUMOUT!

On sale at most service stations and auto supply stores.

**GUMOUT DIVISION**  
PENNSYLVANIA REFINING COMPANY  
CLEVELAND 4, OHIO

## Over the Editor's Desk



FROM THE AZORES, aboard the SS *Flying Endeavor* of the Isbrandtsen Co., Ellis Beaumont writes:

"I enjoyed the article on 'Miracle Glues' (*PM* July, 1959) very much, also a recent article on 'Do-It-Yourself Steel' (*PM* November, 1959). I certainly can use the former, in fact I've shown the article to our Chief Engineer; he may use it to repair a broken low-pressure water-pump cylinder—thanks to your article, sir. I do woodwork—amateur, of course—so the epoxies may aid me too. Thank you for very good articles on important subjects."

☆ ☆ ☆

### To the Editor:

You may want to show the home we built, copied from the (*PM*) book by Richard F. Dempewolff.

Although we have \$5500 in the complete house instead of the \$3800 as mentioned in Mr. Dempewolff's book, we feel the extra was well spent for features that we wanted. Some of them are listed below:

1. Oil perimeter heating furnace with register in each room.
2. Glass sliding doors to rear patio.
3. Colored-tile bath.
4. Built-in oven and range.
5. 255 lb. roofing shingles instead of 210 lb.
6. Custom-made kitchen cabinets 12 feet long.
7. Acoustical ceiling tile.
8. Mahogany flush doors.
9. Stone planter between living and dining area.
10. Concrete-slab construction.
11. Three 10x12 bedrooms.

The price mentioned includes everything from the septic tank and drilled well to the

(Continued to page 16)





**NOW!**  
at a price  
you can afford!

# MAKE MORE MONEY in TELEVISION RADIO-ELECTRONICS

**BETTER...MORE COMPLETE...LOWER COST...  
WITH NATIONAL SCHOOLS SHOP-METHOD  
HOME TRAINING!**

**BETTER...** Training that is proved and tested in Resident School shops and laboratories, by a School that is the **OLDEST** and **LARGEST** of its kind in the world.

**MORE COMPLETE...** You learn **ALL PHASES** of *Television-Radio-Electronics*.

**LOWER COST...** Other schools make several courses out of the material in our **ONE MASTER COURSE** . . . and you pay more for less training than you get in our course at **ONE LOW TUITION!**



These  
**two FREE books** will  
show you how!

You get all information  
by mail . . . You make  
your own decision . . . at  
home! **NO SALESMAN  
WILL CALL**

## TOP PAY... UNLIMITED OPPORTUNITIES LIFETIME SECURITY CAN BE YOURS!

You are needed in the Television, Radio, and Electronics industry! Trained technicians are in growing demand at excellent pay—in **ALL PHASES**, including Servicing, Manufacturing, Broadcasting and Communications, Automation, Radar, Government Missile Projects.

**NATIONAL SCHOOLS SHOP-METHOD HOME TRAINING**, with newly added lessons and equipment, trains you in your spare time at home, for these unlimited opportunities, including many technical jobs leading to supervisory positions.

**YOU LEARN BY BUILDING EQUIPMENT WITH KITS AND PARTS WE SEND YOU.** Your National Schools course includes thorough *Practical training—YOU LEARN BY DOING!* We send you complete standard equipment of professional quality for building various experimental and test units. You advance step by step, perform more than 100 experiments, and you build a complete TV set from the ground up, that is yours to keep! A big, new TV picture tube is included at no extra charge.

**EARN AS YOU LEARN.** We'll show you how to earn extra money right from the start. Many of our students pay for their course—and more—while studying. So can you!

### RESIDENT TRAINING AT LOS ANGELES

If you wish to take your training in our Resident School at Los Angeles, the world's TV capital, start **NOW** in our big, modern Shops, Labs and Radio-TV Studios. Here you work with latest Electronic equipment - - professionally installed - - finest, most complete facilities offered by any school. Expert, friendly instructors. Personal attention. Graduate Employment Service. Help in finding home near school - - and part time job while you learn. Check box in coupon for full information.

**LESSONS AND INSTRUCTION MATERIAL ARE UP-TO-DATE, PRACTICAL, INTERESTING.** Every National Schools Shop-Method lesson is made easy to understand by numerous illustrations and diagrams. All instruction material has been developed and tested in our own Resident School Shops, Laboratories and Studios.

**SEND FOR INFORMATION TODAY . . .** it can mean the difference between **SUCCESS** and failure for you! Send for your **FREE BOOK "Your Future in Television-Radio-Electronics"** and **FREE Sample Lesson.** Do it **TODAY**, while you are thinking about your future. It doesn't cost you anything to investigate!

### GET THE BENEFITS OF OUR OVER 50 YEARS EXPERIENCE

Approved for  
GI Training



MEMBER



**NATIONAL SCHOOLS**  
Los Angeles 37, Calif.

### YOU GET...

- 19 Big Kits—**YOURS TO KEEP!**
- Friendly Instruction and Guidance
- Job Placement Service
- Unlimited Consultation
- Diploma—Recognized by Industry
- **EVERYTHING YOU NEED FOR SUCCESS!**

### SHOP-METHOD HOME TRAINING COVERS ALL PHASES OF INDUSTRY

1. Television, including Color TV
2. Radio AM & FM
3. Electronics for Guided Missiles
4. Sound Recording and Hi-Fidelity
5. FCC License
6. Automation and Computers
7. Radar & Micro-Waves
8. Broadcasting and Communications

## NATIONAL TECHNICAL SCHOOLS

WORLD-WIDE TRAINING SINCE 1905

### MAIL NOW TO

National Technical Schools, Dept. RB-50  
4000 S. FIGUEROA ST., LOS ANGELES 37, CALIF.  
Rush free TV-Radio "Opportunity" Book and sample lesson. No salesman will call.

NAME \_\_\_\_\_ AGE \_\_\_\_\_

ADDRESS \_\_\_\_\_

CITY \_\_\_\_\_ ZONE \_\_\_\_\_ STATE \_\_\_\_\_

Check if interested **ONLY** in Resident School training at Los Angeles.

VETERANS: Give date of Discharge \_\_\_\_\_

recording fees for the lot. It took me one year of spare time to build the house with the help of my father on the tough jobs.

I would certainly recommend this home to anyone who is an amateur, and would like to build. We have lived in it four months and I don't know of one change I would make in the construction. I think the PM book for \$2.50 was the best investment we ever will make.

Lawrence Taylor  
Mt. Gilead, Ohio

☆☆☆

### Apologies to the Navy

Several readers have pointed out an error in the February article, "Fastest Boat in the World," wherein we referred to "the Air Force's Blue Angels precision flying team." We should know better, as we featured the Air Force Thunderbirds acrobatic air team in January 1958. The Blue Angels wear the Navy uniform.

☆☆☆

### Another Fire Tragedy

"The same day I picked up my February issue of PM," writes Robert Baker, a Toronto fireman, "the Toronto Telegram printed the enclosed clipping. I only hope the article in PM, 'What to Do Until the Firemen Come,' is received and digested. Thanks for a well-written article."

The clipping tells of a mattress fire that

was "put out once," only to rekindle and suffocate a Toronto man. Our article warned of the danger of assuming a fire has been extinguished unless the experienced firemen have assured that it is really out.

☆☆☆

### To the Editor:

I have just read the November issue of *Popular Mechanics*. I was particularly interested in an article titled, "Nature Pulls Plug—Lake Loses Water," by James J. Cox.

I have no idea who Mr. Cox received his information from, but I have never read an article in a national magazine with so many complete falsehoods in it.

For one thing, and I quote Mr. Cox, "within a few days the five-mile long lake changes from fresh water to salt water." This statement could not be further from the truth. At no time in the history of the lake has it ever changed from fresh water to salt. It is true that there is a hole in the lake which, when the lake is high, drains off the excess water into the Gulf of Mexico. But only once has any salt ever got into the lake, and that was only a slight amount, about four percent of the amount in the Gulf. Since we are only six feet above sea level, it is rather difficult for salt water to go uphill into the lake, but at one time that did happen. The lake had just dropped

(Continued to page 18)

## Hotels Call for Trained Men

Record-breaking travel means nation-wide opportunities and a sound substantial future for trained men in the hotel, motel and hospitality field. Fascinating work; fine living; quick advancement. You can qualify at home or through resident classes in Washington. Previous experience proved unnecessary. Placement Service FREE. Write for FREE Book, "Your Golden Opportunity." Accredited by N.H.S.C.

Course Approved for ALL Veteran Training. 44th Year. LEWIS HOTEL TRAINING SCHOOL, Room FE-312, Wash. 7, D.C.

## GOVERNMENT OIL LEASES LOW AS \$1 PER ACRE

You do no drilling, pay no taxes, may realize a king-size profit without ever leaving home. Write for free map and literature.

AMERICAN OIL SCOUTS, Dept. PM  
8350 Santa Monica Blvd. Los Angeles 46, Calif.

# INVESTIGATE ACCIDENTS

Train quickly in your own home for repeat income in the exciting, secure Claim Investigation and Claim Adjusting field. Our students and graduates are already earning \$4, \$5, \$6 an hour extra SPARE TIME — and up to \$10,000 a year Full Time. You need NO prior experience or higher education. Your age does NOT matter.

### HERE IS YOUR CHANCE FOR ACTION AND REAL JOB SECURITY

As a trained Claim Investigator you will (1) INVESTIGATE FACTS and (2) DISTRIBUTE MONEY as the representative of wealthy organizations.

No other business offers you greater opportunities for success and security. Here's why: The huge, rapidly expanding Claim Investigation and Adjusting Profession right now distributes more money than any other service industry. And it's growing fast. Over 200 MILLION ACCIDENTS must be investigated this year for Insurance Companies, Airlines, Railroads, Steamship Lines, and Government Offices.

### MAIL NOW for FREE BOOK

SEND TODAY for Big, FREE, Illustrated Catalog. Learn the exciting facts about Universal Schools' low cost training. No obligation. No salesman will call. GI APPROVED.



#### UNIVERSAL SCHOOLS

6801 Hillcrest Ave.  
Dept. PM-5, Dallas 5, Texas

Please rush me your FREE book on Claim Investigation. This does not obligate me and no salesman will call.

Name \_\_\_\_\_ Age \_\_\_\_\_

Address \_\_\_\_\_

City \_\_\_\_\_ Zone \_\_\_\_\_ State \_\_\_\_\_

Approved by Government for Korean Veterans

**NOW...GET  
EVERYTHING  
YOU NEED TO  
PREPARE TO EARN  
REAL MONEY IN**

# ELECTRONICS

**From RADIO • TELEVISION • RADAR  
To GUIDED MISSILE CONTROL, etc.**

**One of  
Today's  
BRIGHTEST  
Opportunity Fields!**



Today's great Electronics field offers you a chance of a lifetime to prepare for highly interesting work and a wonderfully promising future! With so many new developments coming up in Electronics, opportunities for trained men were never brighter. Send coupon for details.

Right in your own home you may now get one of today's most interesting . . . PRACTICAL WAYS to prepare for a good job or your own business in Electronics. No previous technical experience or advanced education are needed! DeVry Tech brings you a unique 3-WAY COMBINATION of texts, home movies and real equipment—the same type of basic equipment as found in our well-equipped Chicago and Toronto Laboratories.

**EMPLOYMENT SERVICE**  
... helps you get started toward a good job, or toward advancement in the company you now work for. FREE to all graduates.

**EARN WHILE YOU LEARN**  
DeVry Tech's practical program helps you to earn EXTRA MONEY in your spare time, servicing Radio and TV sets.

## Your Guide

### to PROFITABLE JOB OPPORTUNITIES

See how YOU may get ready for Jobs as:

- TV-Radio Broadcast Technician
- Color Television Specialist
- Radar Operator • Laboratory Technician
- Airline Radio Man • Computer Specialist
- Quality Control Manager
- Your Own Sales & Service Shop...PLUS MANY OTHERS

**SEND FOR FREE BOOKLET!**

"One of North America's Foremost Electronics Training Centers"



Accredited Member of  
National Home  
Study Council

**DeVRY TECHNICAL INSTITUTE**  
CHICAGO 41, ILLINOIS

### 300 EXPERIMENTS

Build over 300 practical projects from many shipments of Radio-Electronic parts. You build and operate TV-Radio circuits . . . wireless microphone . . . and many other major projects—all designed to provide outstanding practical experience at home.



### HOME MOVIES

Thanks to this exclusive home training aid, many important fundamentals quickly become "movie clear." Now you can actually see electrons on the march and other "hidden actions"—a wonderful advantage that is almost like having a teacher at your side.



### BUILD YOUR OWN TEST EQUIPMENT

As part of your home laboratory projects, you BUILD and KEEP a fine quality 5-inch COLOR OSCILLOSCOPE and a Jewel Bearing VACUUM TUBE VOLTMETER. You will find this equipment ideal for helping you earn in your spare time while a student—and later when working full time in the field.



### BUILD AND KEEP A BIG 21-INCH TV SET

For added practical experience, you can also build and keep this quality 21-inch TV SET that provides TV reception at its finest (DeVry Tech also offers another home training without the TV set).



## MAIL COUPON TODAY!

**DeVRY TECHNICAL INSTITUTE**  
4141 Belmont Avenue, Chicago 41, Ill., Dept. PM-5-Q

Please give me your FREE booklet, "Electronics in Space Travel," and tell me how I may prepare to enter one or more branches of Electronics.

Name \_\_\_\_\_ Age \_\_\_\_\_

Street \_\_\_\_\_ Apt. \_\_\_\_\_

City \_\_\_\_\_ Zone \_\_\_\_\_ State \_\_\_\_\_

2045

Canadian residents address DeVry Tech of Canada, Ltd.  
626 Roselawn Ave., Toronto 12, Ont.

# DRAFTSMEN



**CASH BIG  
PAY CHECKS!**

**Train Now for  
more success,  
greater security**

**LEARN AT HOME IN SPARE TIME  
(or at college in Chicago)**

Check the want ads in any newspaper—SEE the big-pay opportunities open to you as a draftsman. What's more, you can learn this well-paid, prestige profession at home — quickly, easily! No special talent needed. Get complete, step-by-step Chicago Tech lessons in the mail, spend a few pleasant hours studying each week. In a short time you'll be a well-trained draftsman, ready to take your pick of many good jobs. Act now!



**Free Information—Mail Coupon Today!**

Get FREE TRIAL LESSON plus information about C.T.C. practical training. Learn what successful Chicago Tech graduates say about high pay and opportunities in drafting. No charge, or obligation.

## CHICAGO TECHNICAL COLLEGE

E-218 Tech Bldg., 2000 So. Michigan Ave.  
Chicago 16, Illinois

Mail me FREE lesson with facts about big opportunities in DRAFTING.

Name \_\_\_\_\_ Age \_\_\_\_\_

Address \_\_\_\_\_

City \_\_\_\_\_ Zone \_\_\_\_\_ State \_\_\_\_\_



## MECHANICAL DENTISTRY

To make Crowns, Plates, Bridgework, etc., for Dentists. Easy practical way to learn mechanical dentistry at home in spare time. FULL EQUIPMENT OF TOOLS AND MATERIALS INCLUDED WITH COURSE. Low tuition. Easy terms. Write for FREE BOOK about this money making profession that is not affected by machine age.

McCARRIE SCHOOL OF MECHANICAL DENTISTRY  
207 N. Broad St., Dept. 100, Philadelphia 7, Pa.

## 95% PROFITS YEAR 'ROUND

Be your own boss, Operate a SIMPLEX lawn-mower sharpening service in your community. One compact machine grinds all mowers, sharpens cutlery. Low investment, 95% profit. Pays for itself in average month.

### SIMPLEX

—4 Machines in One!  
Reel Grinder—sharpens any mower reel in or out of mower.  
Bed Knife Grinder—grinds with either round or cup wheel.

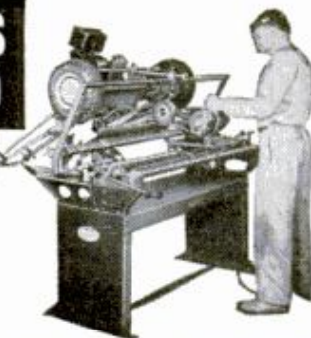

Rotary Blade Grinder—hollow grinds any rotary mower blade.  
Cutlery Knife Grinder—sharpens cutlery, tools, scissors.

Send for free, money-making details!

The FATE-ROOT-HEATH Company • Dept. PM-5, Plymouth, Ohio

to the lowest level in years, and at the same time we had unusually high tides backed by a wind off the Gulf which did force some salt water into the lake.

Mr. Cox also claims that the last time the lake "pulled her stopper" was in August of 1957. This also is not true. The lake has been up and down at least five times this year alone. It is very doubtful that the hole is ever stopped up. We had about 73 inches of rain this year, and the lake has been high from time to time all year. When we get a lot of rain in a short time, the lake rises, since the hole cannot handle all the water pouring into the lake. As soon as the rain stops, the lake starts dropping. The hole is always open.

Also, to my knowledge there has been only one salt water fish caught in Lake Tarpon—a 4¼ pound sheepshead, which was caught a short time ago. There are many ways that the fish could have gotten into the lake besides through the hole. Most salt water fish will live in fresh water, though they will not usually reproduce.

You may wonder why, if the hole is always open, the lake doesn't dry completely. There is a logical explanation for that. The hole is shaped like the drainage for a toilet bowl. When the lake is high, the pressure causes the water to rise and run through the trap and into the gulf until it sinks below the trap level. It holds that level until it rises again.

When the lake is going down there is no visible sign at the hole, but at the outlet it boils up over the usual water line. The water flowing through the outlet forces out the salt water fish which normally stay in the outlet, and the result is very good fishing for a few days. I have never heard of any fresh water fish being caught at the outlet; when they feel the lake going down they swim away from the current. I have fished many times in the hole while the lake is going down, but I have never caught any kind of fish in it. Fishing will be good all around the hole, as they feed on the bits of food that are drawn to the hole.

There is no "billion-gallon exchange," as Mr. Cox describes it. It's strictly a one-way deal. He was evidently misinformed.

Lake Tarpon produces some of the largest largemouth bass in the world. We have customers from all over the country who come to fish for our lunker bass. When they read that the lake has turned to salt, they wondered if the salt killed out the fresh water fish in the lake. Since many of them don't fish in salt water, the article has done the lake a lot of harm.

Terence M. Hallo,  
Scheer's Piers,  
Palm Harbor, Florida

# This Is The Story Of How A Man Built A \$200 Investment Into A Mail Order Business Now Doing Over \$3,000,000 Yearly. It Could Be Your Story, Too.

## It Could Be Your Path To Financial Security And Independence

by **MAX ADLER**, Chairman of the Board, Spencer Gifts, Inc.



**ATLANTIC CITY, N. J.**—A little over twelve years ago, I decided I was tired of working for other people . . . tired of waiting for tiny raises . . . tired of worrying about losing my job. I decided to heck with it! I decided to go into business for myself.

I had no experience in the business I chose. All I started with was \$200. My friends called me an out-and-out fool, and perhaps I was. But today, the mail order business I started with \$200 has assets of over \$1,000,000!

What has this got to do with you? Plenty, if you, too, want to start your own mail order business . . . be your own boss . . . and start making money, from your home. If this is what you want, you can learn from my experience—and without the blood, sweat and tears it cost me to learn how to run a successful mail order operation. You can rely on the fact that I know what I'm talking about when it comes to mail order. Here is the record. It speaks for itself!

### \$200 GREW INTO BIG BUSINESS

I began my mail order company in 1947. As of April 30, 1959, the end of our last fiscal year, my company—Spencer Gifts—had assets of \$1,070,272.72\*. My modern mail order plant has 63,000 square feet of space, contains one of the most modern conveyor systems in the industry, and a branch of the U. S. Post Office. I employ up to 350 people, depending on the season. My \$200 investment has come a long way!

### A FRANCHISE DEALERSHIP FOR YOU!

Now, I am ready to help you make money in mail order through my new independent franchise dealership plan. I won't promise you'll make a million overnight. This is not one of those "get-rich-quick" schemes. It is a practical, sensible plan that will enable me to expand my business and help you get a good solid start in your own mail order business at the same time!

Spencer Gifts, a large, successful, well-established retail and wholesale mail order organization, can and will offer these specialized mail order methods and guidance. The mail order business is one of the greatest potential growth businesses in the country. Obtain one of the franchises that I am offering, and you're really getting in on the ground floor!

### HARD WORK? INDEED IT IS!

I told you before that this is not a "get-rich-quick" plan. Anything worthwhile in life takes effort. I used lots of elbow grease, shoe leather and determination, and you will, too, if you expect to succeed. You just can't sit back and expect to make a success without effort. For instance, I have in my instructions an easy method of personal selling, which when combined with mailing catalogs, should build your mailing list and profits faster than mailing catalogs alone would do.

\*Certified statement by M. Olesker & Co., C.P.A., Atlantic City, N. J.



Out Of An Initial \$200 Investment Grew This Gigantic Mail Order Plant

This is the Spencer Gifts plant in Atlantic City, N. J. containing 63,000 square feet of space and a U.S. Post Office. Hundreds of employees are kept busy filling orders from mailings of Spencer Gifts catalogs.

### NO EXPERIENCE NEEDED

Why am I so willing to help you get into the mail order business? Why am I offering a valuable franchise for which I could charge you a big fee? Well, I love my fellowman as much as anyone else, but I'm a businessman—not a philanthropist. I am offering a limited number of franchises because I have decided this is the fastest, most practical way to expand my own business! I expect you to sell merchandise and make money right from the start, and I expect to make money right along with you.

### CATALOGS BEAR YOUR NAME

If you qualify as a Spencer Gifts franchise dealer, you will operate your own mail order business **UNDER YOUR OWN NAME**. Spencer Gifts will serve as your wholesaler, supplier, shipping department and warehouse. Spencer Gifts will produce catalogs—the basic selling tools of any mail order business—and you, as an independent franchise dealer, will circulate these catalogs to sell the products they contain.

The catalogs, **WITH YOUR NAME PRINTED ON THEM**, are prepared by skilled mail order advertising copy writers, artists, layout men and printers . . . each a highly-trained specialist in his field. The catalogs are yours at a price which is a fraction

of what it would cost you to produce them yourself. Our tremendous volume makes this low cost possible. And just as Henry Ford's mass-produced automobiles were far better, as well as cheaper, than any car produced by hand, so our catalogs are far superior than any produced by amateur methods.

### SALEABILITY OF ITEMS PRE-TESTED

Even with my 12 successful years in mail order and the help of an expert staff, I can't always tell in advance what is going to be a "best-seller" and what will be a "lemon". The customers make the final decision on this! With the volume of business I do, and the solid foundation of my big organization behind me, I can afford to pre-test the merchandise that will appear in your catalogs.

For example, my big Spencer Gifts catalog, printed by the millions in the course of the year, month after month, offers up to 1,000 items I think have a good chance of selling in volume. Out of this number, perhaps 25% will be out-and-out flops. About 50% will be medium to average. 25% will really hit. From this cream-of-the-crop 25% top-selling items, are the items that are selected for your catalogs!

### NO INVESTMENT IN STOCK

Spencer Gifts does it for you! Send no money until your customers pay you. People



### You Stock No Inventory. Pay for Only What You Sell!

This conveyor system—one of the most modern in the mail order industry—assures prompt handling and service in a warehouse containing generally between \$200,000 and \$500,000 worth of new mail order products depending on the season of the year. Every item stocked has been tested and proven for merchandising value. We ship your order to your customer promptly.

want prompt service when they order by mail. Therefore, a well-run, money-making mail order retail business must carry a large stock, at all times. Spencer Gifts generally carries an inventory between \$200,000 and \$500,000. This means you don't have to invest one penny for merchandise in advance! **YOU WON'T HAVE TO SPEND ONE CENT FOR MERCHANDISE UNTIL YOU GET PAID BY YOUR CUSTOMERS!**

### YOU WON'T HAVE TO SHIP ORDERS

Handling, packaging, mailing—the whole job is taken off your hands—handled promptly and efficiently, as only a big modern shipping department like Spencer Gifts, can do it! What's more, your orders are shipped with your own labels on each package. Your customers get to know you, as a mail order retailer, not Spencer Gifts.

### START EARNING MONEY FROM YOUR HOME!

Under one of our plans, an initial investment of less than \$50 will get you started in the mail order business! This small investment may be the turning point of your life. And the information is **FREE!**

Remember, as a franchise dealer, Spencer Gifts will invest in the merchandise, package and ship for you, advise you—step by step—as your business grows and you want to expand.

### FRANCHISES LIMITED! ACT NOW!

For full details, sample catalog and franchise application—All Free—Send this coupon **NOW . . .**

## SPENCER GIFTS

WHOLESALE DIVISION  
EZ-2 Spencer Bldg., Atlantic City, N. J.

### FREE—Mail Coupon Now!

SPENCER GIFTS, Wholesale Division

EZ-2 Spencer Building, Atlantic City, N. J.

Yes, I want to make money in mail order! Please send me **FREE**, without obligation, complete details on the Spencer Gifts Dealer Franchise Plan, a sample catalog and franchise application. No salesman will call.

Name.....

Address.....

City.....

Zone.....

State.....

This offer limited to residents of U.S.A.  
21 years of age or over.

Entire contents © 1960 Spencer Gifts,  
Atlantic City, N. J.

# MEN PAST 40

**Afflicted With Bladder Trouble,  
Pains in Back, Hips, Legs,  
Nervousness, Tiredness.**

If you are a victim of these symptoms, your trouble may be due to Glandular Inflammation. A constitutional Disease that requires special types of medical treatment. Neglect of such Inflammation causes men to grow old prematurely and before their time.

Most men, if treatment is taken in time, can be successfully NON-SURGICALLY treated for Glandular Inflammation. If the condition is aggravated by lack of treatment, surgery may be the only chance.

## NON-SURGICAL TREATMENTS

The NON-SURGICAL New Type treatments used at the Excelsior Medical Clinic are the result of discoveries in recent years of new techniques and drugs, plus over 20 years research by scientific technologists and doctors.

Men from all walks of life and from over 1,000 communities have been successfully treated here at Excelsior Springs. They found soothing and comforting relief and new health in life.

### EXAMINATION AT LOW COST

When you arrive, our Doctors, who are experienced specialists, make a complete examination. You then decide if you will take the treatments needed, which are so mild, hospitalization is not needed—a considerable saving in expense.

#### RECTAL-COLON

Are often associated with Glandular Inflammation. These disorders, we can successfully treat for you, at the same time we treat Glandular Inflammation.

#### REDUCIBLE HERNIA

Is also amenable to a painless Non-Surgical treatment that we have developed. Full details of this treatment given in our Free Book.

### Write For FREE BOOK

The Excelsior Medical Clinic has published a New FREE Book that deals with diseases peculiar to men. It could prove of utmost importance to your future life. Write today. No obligation.



**EXCELSIOR  
MEDICAL CLINIC**  
Dept. B6150  
Excelsior Springs, Mo.

Gentlemen: Kindly send me at once, your New FREE Book. I am interested in full information. (Please Check Box)

- Glandular Inflammation       Hernia  
 Rectal-Colon

Name.....

Address.....

City..... State.....



## Sidelights from the PENTAGON

By William R. Kreh

YOU'D BE SURPRISED at what things become dangerous in atomic submarines.

Things like hobby kits, paint, deck wax and even cigarettes.

It all boils down to the fact that when you stay submerged for long periods of time, toxic substances in what are otherwise harmless things begin to build up.

The Navy found, for example, that the adhesive in hobby kits was 99 percent benzene, a highly toxic hydrocarbon. Commercial deck wax emitted more hydrocarbons, and cigarette smoke produced so much carbon monoxide over a period of time that on one of her early voyages the *Nautilus* had to come up for air. Conventional subs never had these problems because they couldn't stay submerged for more than 12 to 18 hours. The Navy says it has solved most of the toxic substance problems, but it's not saying how.

Speaking of submarines, men aboard them soon will be able to play shuffleboard. How? Simple. Mess tables are going to be installed in the subs with shuffleboard game markings on them and the men will play the game on the tables. Likewise for checkerboards and backgammon games. By painting them on the tables, there's no space required to store them.

The assault gun section of an Army cavalry unit in Korea has developed a sub-caliber firing device to be used on its M-56 tank destroyers. It's a 30-cal. carbine mounted in a steel support atop the recoil mechanism of each 90-mm. gun. The device is fired by sighting through the telescope of the gun and triggering the carbine with the electric trigger normally used to fire the big gun. Thus,

(Continued to page 58)

# LAW TRAINING for BUSINESS

*[in spare time at home]*

## Earn LL.B. Degree



Thousands of men and women who never intend to practice are studying Law in spare time at home—not for a legal career but as an aid to business advancement.

Law today is involved in almost every major business decision. In many lines of work it is almost indispensable—credits and collections, accounting, traffic and transportation, employee relations, real estate, insurance, finance, taxation, etc. For all types of work, Law training develops keen, clear, quick, correct, and decisive thinking.

You can study LaSalle's American Law and Procedure right in the privacy of your own home—progressing as rapidly as your time and ability permit. LaSalle has, for over 50 years, helped more than 1,400,000 ambitious people get ahead in the business world. Thousands of letters in our files from grateful students and businessmen who have achieved greater success speak of—better jobs, more money and the satisfaction it brings, prestige and leadership.

### A MOST UNUSUAL LAW LIBRARY

This training includes the fourteen-volume LaSalle Law library—AMERICAN LAW AND PROCEDURE, which is the basis of all the instruction service. This library has been compiled by leaders in the field of Law. It covers the whole basic field of Law in an orderly and simple manner that is easy to learn and understand. Collateral reading and printed lectures on legal problems which are furnished at regular intervals throughout the training, supplement the text. Law instructors personally supervise your program from the first assignment to the LL.B. degree or diploma. Under the LaSalle method you deal with legal problems—you learn by doing—actu-

ally solving legal problems—not just memorizing rules.

### WRITE TODAY FOR TWO FREE BOOKS

You are determined to get ahead—to prepare for greater future possibilities—and to earn more money. Send the coupon below and find out how to qualify yourself for the many openings available to the Law-trained man. In our FREE books, "Law Training for Leadership" and "Evidence," you will find answers to all your questions about the study of Law and the LaSalle method.

No investment is likely to pay higher returns than an investment in yourself, by enrolling in the American Law and Procedure training. Send coupon today for full information—no obligation, of course.

ACCREDITED MEMBER, NATIONAL HOME STUDY COUNCIL

### LaSalle Extension University A Correspondence Institution

Dept. 564L 417 S. Dearborn St., Chicago 5, Ill.

Gentlemen: Please send me your two free booklets, "Law Training for Leadership" and "Evidence," which tell how I may study Law at home and qualify for the LL.B. degree.



Name.....Age.....

Street.....

City.....Zone....State....

My name is Charles Atlas. I can't promise you'll win the title of "World's Most Perfectly Developed Man" as I did. But I do believe I can make a powerful He-Man of you -- in a very short time. You can prove it to yourself -- at my risk. My big free book tells how to do it.



**FREE BOOK** Mail coupon now for free 32-page book. Tells how I can give you "Stand-Out" muscles -- how "Dynamic Tension" can make you a new man -- confident, popular, successful. Rush coupon to me personally: **CHARLES ATLAS, Dept. 85, 115 E. 23 St., N.Y. 10.** In England, write: 10 Chitty St., London W. 1

**CHARLES ATLAS, Dept. 85, 115 East 23rd St., New York 10, N. Y.**

Dear Charles Atlas -- Here's the Kind of Body I Want: (Check as many as you like)

- Slimmer Waist, Hips  More Powerful Arms, Grip  
 Broader Chest, Shoulders  More Powerful Legs  
 More Weight, Solid  Better Energy, Sleep

Send me, absolutely FREE, a copy of your famous book showing how "Dynamic Tension" can make me a new man. 32 pages, crammed with photographs, answers to vital questions, and valuable advice. No obligation.

Name..... Age.....  
 (Please Print or Write Plainly)

Address.....

City..... Zone... State.....

# Short Cut TO A Good Job

## Learn Auto Mechanics at Home in Spare Time

The auto-repair industry makes it easy for you to gain success! Consider the rewards: A mechanic earns excellent pay--up to \$3 an hour. He works steady--there are 100,000 job opportunities. He can go in business--America needs 25,000 more shops.



Let CTI train you at home. Along with simple, illustrated lessons, you get professional Mechanic's Tools and fine-quality Testing Instruments. CTI also includes instruction on Diesel Mechanics or Body & Fender Rebuilding at no extra cost. You may earn cash as you train. Mail coupon today for booklet and lesson samples.

**COMMERCIAL TRADES INSTITUTE** Dept. A1268  
 1400 Greenleaf Avenue • Chicago 26, Illinois  
 Send booklet, Make Big Money in Auto Mechanics.

Name..... Age.....

Address.....

City..... Zone... State.....

Accredited by National Home Study Council



## Great Pioneers in Science Do You Know Them?

By James S. Thistle

HERE IS AMERICA'S FIRST great scientist, one of the most versatile men who ever lived. He completely changed the thinking of his age when, by flying a homemade kite, he proved that lightning and electricity are the same.

One of this great man's many inventions was the lightning rod which helped to save many lives and to protect property. He used terms in electricity commonly used today, such as *positive*, *plus*, *negative* and *minus*. How much in advance of his day this man proved himself to be is revealed in his assertion that the aurora borealis is an electrical phenomenon, in his invention of a condenser, in his discovery that dark colors absorb heat and in his knowledge of weather prediction.

This great pioneer also wrote on such subjects as meteorology, geology and earthquakes. Indeed, many of his works on scientific subjects were published in London and translated in foreign languages throughout Europe.

*These letters, unscrambled, spell the name of this month's Great Pioneer in Science:*

# LARKNFINEJAMNBIN

(First and Last Names)

Write the correct name here:

Now turn to page 238 for the answer.

POPULAR MECHANICS



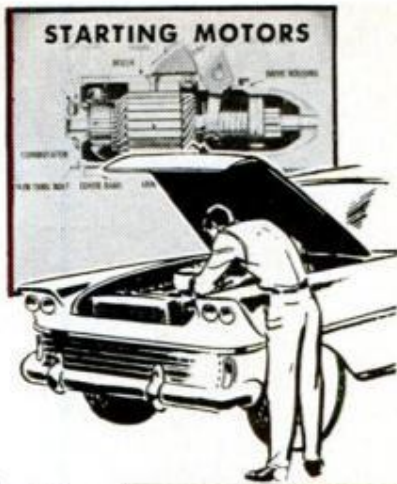
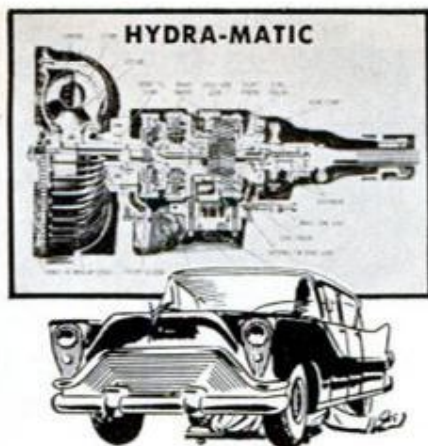

# Thousands now find it a cinch to FIX ANY PART OF ANY CAR

OVER 3 MILLION  
COPIES SOLD!  
USED BY U.S.  
ARMED FORCES

Now — Whether You're a Beginner or Expert Mechanic  
You, too, Can "Lick" ANY Auto Repair Job —  
With 2,850 "This-Is-How" Pictures, 225,000 Service and  
Repair FACTS, ABC Factory-Expert Methods

YES, this famous "Auto Repair Man's Bible" has turned thousands of beginner mechanics into experts. Helped thousands of experts save time, trouble and money "brezing thru" the toughest jobs. Now, the new edition can put YOU right on "top" of practically ANY job on ANY car listed — 1953 thru 1960!

No guess work! No false starts! This giant illustrated guide tells you, then shows you, with crystal-clear pictures and step-by-step directions — how to find the trouble fast — where to start... what tools to use... how to "wrap up" the job "in double-quick time!"

"Never knew anything about repairing cars until I got this book. Has paid for itself time and time again."



—P. Pempfer, Wis.

### So Simple You CANT Go Wrong!

Here's everything you need to know to repair over 1967 car models. Over 1,100 giant pages, 2,850 "this-is-how" pictures, 291 "Quick-Check" charts, 30,000 essential repair specifications, 225,000 service and repair facts.

All the instructions and pictures are so complete, so clear that you can't go wrong. That's because

your hands are guided by the men who actually build the cars. For this book brings you the time and work-saving methods from 176 Official Shop Manuals!

### Everything You Need to Know

Here's complete ILLUSTRATED guidance on Engines, Automatic Transmissions, Ignition, Carburetors, Fuel Pumps, Steering Gears, Brakes, Generators, Distributors, Power Brakes, Power Steering, Dash Gauges, Voltage Regulators, Starter Switches, etc., etc. Plus a big Trouble-Shooting Section that shows how to spot any one of 2300 car troubles.

"Have been a mechanic 25 yrs. Manual still takes me out of tight spots. It's simple enough to be understood by average person."



—V. Lauria, Nev.

No wonder this guide is used by the U.S. Armed Forces and hundreds of thousands of repair men. It's guaranteed to help even a beginner mechanic do a good job. And top-notch mechanics are amazed by the time-saving methods it brings them.

### Try It FREE 7 Days

SEND NO MONEY! Just mail coupon. (Paste it to a postcard for fast action.) Use Manual for a whole week, free. If you don't agree it's the greatest time and work-saver you've ever seen — return book in 7 days and pay nothing. Mail coupon today! MOTOR Book Dept., Desk 015, 250 West 55th St., New York 19, N. Y. (Schools, Bookstores: Write for discounts.)

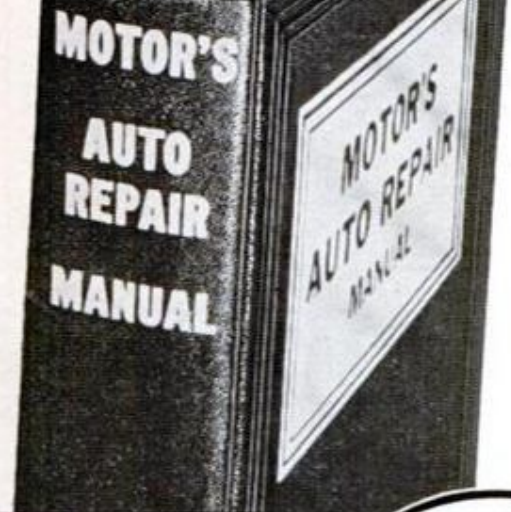

- COVERS ALL THESE MAKES 1953 Thru 1960
- |             |          |             |
|-------------|----------|-------------|
| Buick       | Dodge    | Nash        |
| Cadillac    | Edsel    | Oldsmobile  |
| Chevrolet   | Falcon   | Plymouth    |
| Chrysler    | Ford     | Pontiac     |
| Continental | Hudson   | Rambler     |
| Corvair     | Imperial | Studebaker  |
| Dart        | Jeep     | Thunderbird |
| De Soto     | Lincoln  | Valiant     |
|             | Mercury  |             |

TRY BOOK  
**FREE**  
FOR A WHOLE WEEK

### Same FREE 7-Day Trial on TRUCK REPAIR MANUAL



Covers every job on every popular make truck from 1952 thru 1960, including GM, Mack and Cummins Diesels. Engines, fuel systems, ignition systems, starters, generators, transmissions, axles, brakes, steering, etc., etc. For FREE TRIAL, check box in coupon.

### MAIL COUPON NOW FOR 7-DAY FREE TRIAL (Attach to postcard if more convenient)

MOTOR BOOK DEPT.

Desk 015, 250 W. 55th St., New York 19, N. Y.

Rush to me at once (check box opposite book you want):

MOTOR'S New AUTO REPAIR MANUAL. If O.K., I will remit \$2 in 7 days, \$2 monthly for 2 months and a final payment of \$1.95 (plus 45¢ delivery charges) one month after that. Otherwise I will return the book postpaid in 7 days. (Foreign price, remit \$10 cash with order.)

MOTOR'S New TRUCK REPAIR MANUAL. If O.K., I will remit \$3 in 7 days and \$2 monthly for 2 months, plus 45¢ delivery charges with final payment. Otherwise I will return book postpaid in 7 days. (Foreign price, remit \$11 cash with order.)

Print Name.....Age.....

Address.....

City.....Zone.....State.....

Check box and save 45¢ shipping charge by enclosing WITH coupon in envelope entire payment of \$7.95 for Auto Repair Manual (or \$9 for Truck Repair Manual.) Same 7-day return refund privilege applies.

# Do You Know This Old-Timer?

We think of today as the era of advertising. But a generation ago this made more for the art than anybody's done since. It convinced the customer that he entered a wonderful new world when he took the wheel. Never mind about 56 horsepower, or 245.6 cubic inches, or 120-inch wheelbase, just stress the fun, not the complexity, of driving. Ironically, it went out of business in five short years, but its influence has lived on. Its name? Turn to page 246 for the answer.

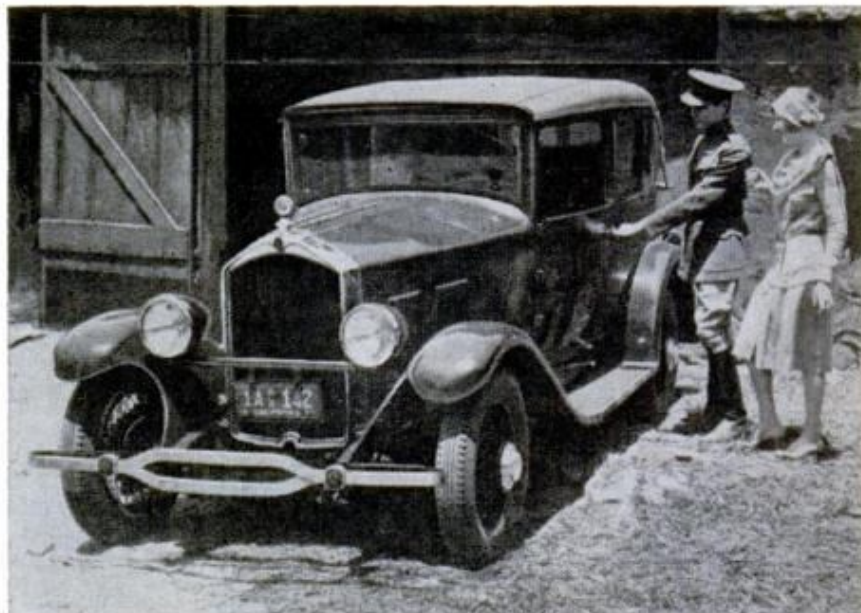

## Learn LANDSCAPE GARDENING

AND GROWING OF PLANTS. Latest information on propagation, soil-testing, plant growth regulators, garden design. Start a profitable business or wonderful hobby. Unique and modern home study course—accredited. Earn your certificate at home. May I send FREE, and without obligation, my Informative Booklet?  
**NORM MORRIS NATIONAL LANDSCAPE INSTITUTE**  
 DEPT. M-50 11826 SAN VICENTE BLVD., LOS ANGELES 49, CALIF.

**\$3.25 OR 2 FOR \$6.00!**  
 With 40 ft. of wire. Additional wire 3c ft. **TESTED AND GUARANTEED.** Write for free list of all types of telephones. Shipments FOB Simpson, Pa.  
**TELEPHONE ENGINEERING CO., Dept. 5 B0, Simpson, Pa.**

**EARN \$125  
 A WEEK AND UP**

**BE AN AUTO DIESEL  
 EXPERT—LEARN  
 A TRADE YOU LIKE**

You learn fast in our shops because you learn with tools on real equipment. Students short of money may earn most of their expenses by doing part-time work. Experienced instructors explain WHY and show you HOW, then you DO IT YOURSELF. Many of our graduates earn \$125 a week and up. Approved for veterans. Day and evening classes. Free bulletin—write today.

**MAIL THIS COUPON TODAY!**

**NASHVILLE AUTO-DIESEL COLLEGE**  
 226 7th Ave., No., Dept. 86, Nashville, Tenn.  
 Please send without obligation free catalog.

NAME \_\_\_\_\_  
 (please print or write plainly)

ADDRESS \_\_\_\_\_

CITY \_\_\_\_\_ STATE \_\_\_\_\_

**KILLS • • NO CHEMICALS, GASES, ETC.**

• MOSQUITOES • MOTHS, MILLERS  
 • FLIES, GNATS • FISH FLIES, ETC.

OVER ¼ ACRE HANG IT ANYWHERE

No insect recovery. Harmless. Guaranteed. Built to last 25 years. Beautiful outdoor lighting. Plug into any 110 volt socket.

**NO AREA CONTAMINATION**  
 Uses up to 200 watt bulb. Grid cost 10c per month. Complete with fly attractor. Dead insect catcher. Cord, Directions, Etc. Very reasonable price—Write to—  
**SING SING BUG CHAIR, INC.**  
 Box P 3708, Oak Park 37, Mich.



BOX SIZE—WT.  
 15X18X18—8 LBS.

## JEEP OWNERS

RE-POWER NOW WITH A V-8 OR 6 CYL. ENGINE—USE FORD—CHEV—MERCURY—GMC—PONT—STUDE—DODGE OR PLYMOUTH In Jeeps, Jeepsters, Sta-Wgn, trucks, Kaiser & H. J. cars. Conversion Kits \$45.35 to \$56.90. Want fast action? Give us full information, send \$15.00 Dep. and we will ship correct kit. Bal. COD. Send full amount for prepaid shipment. Wire, phone or write today. Details FREE

**HOOSIER MACHINE PRODUCTS CO.**  
 312 S. E. 6th St. Phone CR 6-3442 Pendleton, Oregon

**BEST SPORTS CAR  
 YOU CAN OWN!**

**A 4-WHEEL DRIVE  
 WITH WARN HUBS**

Hi-ball on the highway in free-wheeling 2 w.d. with Warn Hubs on your 4 w.d.—no front end drag or whine, better gas mileage, easier steering. Save money, save road time. Switch in seconds into 4 w.d. when the going gets rough! Change to 2 or 4 w.d. automatically with Warn Lock-O-Matics, manually with Warn Locking Hubs. Guaranteed. Models for all makes 4 w.d.s. to 1½ tons. At your dealer's or write:  
**WARN MFG. CO., Riverton Bx 6064-A, Seattle 88, Wash.**



**WARN  
 Selective Drive  
 HUBS**

For sportsmen  
6 to 60!



Broad line of models

**KITS** less motors, from **\$39<sup>95</sup>**

Complete kits with motors from \$109.95  
Send 50¢ for 22-page catalog.

**ARNOLD-DAIN CORP.**

Box 78, Mahopac, N. Y.  
Dealer Territories Available

**Make \$5 an Hour CASH PROFIT**



**THE DAY YOU START!**  
Start your own business at Home...  
Sharpen Household,  
Garden and Shop  
Tools in Spare Time.

Turn spare time into Big Cash Profits with new Belsaw Sharp-All. No experience needed to sharpen knives, scissors, shears, ice skates, mower blades, hedge trimmers, axes, chisels and circular saws... Learn how easily you can start your own spare time business. Amazing low cost easy-payment plan. Send Postcard for **FREE BOOK**. **BELSAW SHARP-ALL CO** 710 Field Bldg., Kansas City 11, Mo.

**MAKE MONEY!**  
**REPAIR HYDRAULIC JACKS**



**Earn While You Learn At Home**  
Make up to \$5 an hour, full or part-time, in the competition-free field of Hydraulic Jack Repair. Millions of jacks in auto service stations, truckers, body shops, riggers, farms, need servicing. We show you HOW. Easy step-by-step directions.

Get Folder PM-5 & free bonus offer

**Institute of Hydraulic Jack Repair**

P.O. BOX 50 • BLOOMFIELD, N. J.

A Correspondence School Licensed by N.J. Bd. of Ed.

**ARTHRITIS—RHEUMATISM VITAL FACTS EXPLAINED**

**FREE DESCRIPTIVE BOOK**

How crippling deformities may be avoided. This amazing **FREE BOOK** explains why ordinary methods give only temporary relief—if that. Describes a drugless method of treatment successfully applied in thousands of cases. Write for this 36-page **FREE BOOK** today. No obligation. **BALL CLINIC, DEPT. 756 EXCELSIOR SPRINGS, MO.**

**BVI** Painting is Easy!  
**Electric PAINT SPRAYER**

only **\$12<sup>95</sup>** complete

with built-in motor

Fully Guaranteed

Just plug in, pull trigger and spray paint, varnish, enamel, garden sprays and insecticides. 3 to 7 times faster than painting with a brush! Features sapphire nozzle, instant adjustment for heavy or light spray. Foolproof and trouble-free! Available now at dealers everywhere!

**Burgess Vibrocrafters Inc.**  
Grayslake, Illinois



**RCA WILL TRAIN YOU**  
**FOR A LIFETIME CAREER IN**  
**General Electronics**  
**TV Servicing**  
**Automation**  
**Color TV**

**SEND FOR THIS FREE 64-PAGE "CAREER" BOOK TODAY!**



Countless opportunities are open in the rapidly expanding world of electronics. RCA Institutes offers you the finest of training at home in your leisure hours. Pay only as you learn. No previous technical training required. Courses for beginners and advanced students.



**RCA INSTITUTES**

A Service of Radio Corporation of America

In Canada: RCA Victor Company, Ltd.

5001 Cote de Liesse Rd., Montreal 9, Que.

ANOTHER WAY RCA SERVES EDUCATION THROUGH ELECTRONICS

RCA Institutes, Inc., Home Study School Dept. PM-50  
350 West Fourth Street, New York 14, N. Y.

Please rush me your **FREE** illustrated 64-page book "Your Career in Electronics," describing your home training programs. No obligation. No salesman will call.

Name..... Age....  
(please print)

Address .....

City..... Zone..... State.....

Korean Vets: Enter discharge date.....

Resident Schools in New York City and Los Angeles.  
Catalog on request.

## YOU BELONG IN THIS PICTURE



**EARNING \$9,000 TO \$13,000 FOR 8 MONTHS' WORK!**

Here is a ground-floor opportunity to come in with Mister Softee, leader in the booming mobile soft ice cream field and one of America's most successful enterprises! An initial investment of \$4,000 puts you in the driver's seat, with the balance on a pay-as-you-profit basis. And profit you will . . . for we give you advertising and promotional support, and work with you until success is assured. Write today!

### Fleet Operators Invited!

Multi-unit operations can be supervised with hired management, and a working capital of \$20,000 should earn \$25,000 to \$30,000 the first year!

*Mister Softee*<sup>®</sup>  
INC.

Dept. PM-2  
Runnemedede, N. J.

**KEEP YOUR... ON**

**BENJAMIN**

**Largest Selection in the World - Single Shot & Repeaters for Every Shooter's Needs! • 25 MODELS**

**You Can DEPEND on BENJAMIN . . . for Safety - Power - Accuracy - Convenience - Economy**

**HI-COMP AIR GUNS AND POWERFUL CO<sub>2</sub> GUNS**

**No. 3600 \$19.95**

**No. 2600**

**No. 2600 BENJAMIN Super 35-Shot BB Gas Pistol. Safe - No Pumping - Uniform Hi-Power. For Target & Small Game. \$18.95**

**No. 2620 BENJAMIN 20-Shot Cal. 22 Gas Pistol. Economical. \$20.95**

**No. 1300 50-Shot BB Air Pistol \$23.50**

**No. 1320 BENJAMIN 35-Shot Cal. 22 Air Pistol \$25.50**

**No. 3600 BENJAMIN Super 100 Shot BB Gas Rifle. Non-Toxic - Safe - Convenient - Uniform Hi-Velocity Power. →**

**No. 3620 BENJAMIN Super 85 Shot Cal. 22 Gas Rifle . . . \$21.95**

**No. 3100 Super 100 Shot BB Air Rifle. Adj. Shooting Force \$24.95**

**No. 3120 BENJAMIN Super 85 Shot Cal. 22 Air Rifle . . . \$26.95**

**FREE** Catalog All Models Benjamin Single Shot & Repeaters - Cal. BB or 177 or 22. Also, Special Hunting & Fishing Knife Offer.

**BENJAMIN AIR RIFLE CO., 896 MARION ST., ST. LOUIS 4, MO.**

**I'LL SHOW YOU HOW TO MAKE EXTRA MONEY!**

**MY FAMOUS "PORTABLE SHOE STORE" CAN SET YOU UP IN YOUR OWN FULL OR SPARE TIME BUSINESS—with-OUT EXPERIENCE or INVESTMENT!**



It's no trick at all to make big money with the only shoe line featuring nation's biggest line of shoes for all the family from baby to pop and mom. For work, dress, play. Amazing "Spring Step" Cushion construction proves them America's most comfortable with 1 second miracle demonstration. Profits are BIG. Orders sure and easy. Everything furnished Free! Write TODAY!

**ORTHO-VENT SHOE COMPANY**  
1104 Brand Rd., Salem, Virginia

**DAN LURIE**  
America's  
Champion  
Muscle Builder



Send  
10c  
For  
Catalog

## BUILD YOUR MUSCLES FAST WITH DAN LURIE BARBELLS

Get results as no other method can. See your arms, chest, legs grow like magic. as low as  
no other method compares. Get \$10.00 BODY **948**  
MOLD COURSE FREE with order. Results guaranteed. Buy direct and save.

50 lb. set \$ 9.48 • 100 lb. set \$15.98  
150 lb. set \$23.48 • 200 lb. set \$29.98

Semi-steel sets approx. 10% higher. Extra wts. 15c per lb.  
Send 50% cash, balance COD., F.O.B. Plant. Order today.

DAN LURIE BARBELL CO., 52-M5 Bristol St., Dept. 59E, Bklyn. 12, N.Y.

## TRAINED AND SKILLED MEN IN CLOCK AND WATCH REPAIR

Are Needed in Watchmaking, Electronics, Defense, Aviation, and other technical and precision instrument fields. NOW IS THE TIME TO LEARN THIS VALUABLE TRADE. But, Before You Enroll in Any HOME STUDY Course in Watchmaking, Write for Your Copy of "LEARN THE FACTS."

**KANSAS CITY SCHOOL OF WATCHMAKING**  
1226 Admiral Blvd. Kansas City 6, Missouri

## MONEY in WORMS

Sell 20,000 fishworms per week @ \$4 per 1000 from a bed 3 feet wide and 8 feet long. We teach you how to raise and where to sell fishworms and crickets. Write for free literature.

**CARTER WORM RANCH, PLAINS, GEORGIA**

Read our success story in LIFE MAGAZINE, December 23, 1959 Issue

## LAW FREE BOOK THE LAW TRAINED MAN

Write today for a FREE copy of illustrated law book, "THE LAW-TRAINED MAN," which shows how to earn the professional Bachelor of Laws (LL.B.) degree through home study of the famous Blackstone Law Course. All necessary books and lessons provided. Moderate cost; convenient monthly terms. Write for FREE law training book today.

**Blackstone School of Law, 307 N. Michigan Ave.**

Founded 1890

Dept. 55, Chicago 1, Illinois

**BATTEN DOWN THAT JUG, BAIT CAN OR GAS CONTAINER WITH A**

## Thingama JUG

Holds any size or shape container securely, safely in place, without danger of rolling or sliding yet permits removal without unstrapping.



Sturdy, triple-chrome-plated steel. Mounts anywhere - boat, car, or campsite.

**\$2.95**

**ORDER NOW!** Sent postage-paid with check or money order. Ohio residents please add 3% sales tax.

**CARLSON PRODUCTS**  
Box 141, Cincinnati 11, Ohio

Dealer Inquiries Invited

# Shrinks Hemorrhoids New Way Without Surgery Stops Itch - Relieves Pain

For the first time science has found a new healing substance with the astonishing ability to shrink hemorrhoids and to relieve pain - without surgery.

In case after case, while gently relieving pain, actual reduction (shrinkage) took place.

Most amazing of all - results were so thorough that sufferers made astonishing statements like "Piles have ceased to be a problem!"

The secret is a new healing substance (Bio-Dyne\*) - discovery of a world-famous research institute.

This substance is now available in suppository or ointment form under the name Preparation H.\* Ask for it at all drug counters - money back guarantee. \*Reg. U.S. Pat. Off

# FREE CAREER BOOKLET



To guide you to a successful future in  
**METALLURGY  
MECHANICAL  
ENGINEERING  
AIR CONDITIONING  
INDUSTRIAL  
TECHNOLOGY**

This interesting pictorial booklet tells you how you can prepare for a dynamic career as a Mechanical Engineer or Engineering Technician in such rewarding fields as: **DEVELOPMENT • RESEARCH • SELLING  
PRODUCT DESIGN • PURCHASING  
QUALITY CONTROL • TIME STUDY**

Get all the facts about job opportunities, length of study, courses offered, degrees you can earn, scholarships, part-time work - as well as pictures of the Milwaukee School of Engineering's educational and recreational facilities. No obligation - it's yours free.

**MILWAUKEE SCHOOL OF ENGINEERING**

**MAIL COUPON TODAY!**

**Milwaukee School of Engineering**  
Dept. PM-560, 1025 N. Milwaukee St., Milwaukee, Wis.  
Please send FREE "Your Career" booklet  
I'm interested in  Metallurgy  Air Conditioning  
 Industrial Engineering  Mechanical Engineering  
 Electrical Engineering.

Name \_\_\_\_\_ Age \_\_\_\_\_  
PLEASE PRINT  
Address \_\_\_\_\_  
City \_\_\_\_\_ Zone \_\_\_\_\_ State \_\_\_\_\_  
 I'm eligible for veterans education benefits.  
Discharge date \_\_\_\_\_ MS-118

Switzerland \$147  
Japan 82 WITH CASE

## HOME-IMPORT BUSINESS . . . .

Men, women. Make big profits buying low cost imports abroad (see examples at left) and selling to friends, stores or by mail order. Famous world trader guides you—shows you how to find thousands of exotic imports for full or spare time business, how to pocket profits in advance on foreign drop shipment plan. Full details FREE! Airmail reaches us overnight. Write Today!  
**MELLINGER CO., 1717 Westwood**  
Dent. C255, LOS ANGELES 24, CALIFORNIA

HEAD-QUARTERS FOR ALL SPORT CAR TIRE SIZES

ALL FAMOUS BRANDS!

## TIRES!

FARM TRUCK AUTO

AT LESS THAN WHOLESALE

SAVINGS NEVER LESS THAN 50% up to 70% OFF REG. PRICE

FREE - SEND FOR YOUR FREE CATALOG - FREE!

RELIABLE TIRE DIST., 730 Morgan Blvd., Camden 4, N. J.

BUILD YOUR OWN

## AIR CONDITIONERS

From Junked Refrigerators for a Few Dollars

INSTRUCTION BOOKS SHOW YOU HOW 75c EACH

"HOW TO BUILD a Low Cost Air Conditioner" 2 Books - \$1.00  
"HOW TO BUILD an Automobile Air Conditioner" 3 Books - \$1.50  
"HOW TO BUILD a Low Cost Home Freezer" or all 5 for \$2.00  
"HOW TO BUILD an Electrostatic Precipitator"  
"HOW TO BUILD a Low Cost Dehumidifier"

Complete "Install-It-Yourself" Air Conditioner kits for home and automobile, 2 Ton capacity, Brand New Parts—\$92.00 and up.

**FREE!**  
Instructions and Literature on kits

**KOOL ENGINEERING CO., Dept. A-5, 1318 N. Clybourn, Chicago 10, Ill.**

# OWN a BUSINESS

Be a Specialist in Booming Industry

Get in on the ground floor of a booming \$750 million a year industry. Fill the need in your area for safe, effective "on location" cleaning of carpets and upholstery. Every home houses a customer! We'll train and establish you in YOUR OWN lifetime business! Start part-time if employed. You'll be trained by a nearby dealer and at 50-hr. school to get you quickly established. You provide 6 services to multiply profits. No shop needed. Just 2 jobs a day nets \$8,750.00 first year. We back you with 27 services: counseling, nat'l advg. . . McCalls, Parents, etc., conventions, advg. kits, others. Booklets explain everything—no obligation, no salesman will call. Send for Free Booklets.

**DURACLEAN COMPANY**  
0-165 Duraclean Bldg., Deerfield, Ill.

# AUDELS GUIDES

No. 1	AUTOMOBILE MECHANICS GUIDE. 1132 Pages.....	\$ 6.00
No. 2	HOME APPLIANCE SERVICE GUIDE. 864 Pages.....	6.00
No. 3	TV & RADIO SERVICE LIBRARY. 2 Book Set.....	8.00
No. 4	HANDY BOOK OF ELECTRICITY. 1052 Pages.....	5.00
No. 6	PLUMBERS & STEAMFITTERS GUIDES. 4 Book Set.....	8.00
No. 8	CARPENTERS & BUILDERS GUIDES. 4 Book Set.....	8.00
No. 9	DIESEL ENGINE MANUAL. 640 Pages.....	3.00
No. 10	WELDERS GUIDE. 608 Pages.....	3.00
No. 11	MATHEMATICS MADE EASY. 672 Pages.....	3.00
No. 12	MACHINISTS & TOOLMAKERS HANDBOOK. 1250 Pgs.....	6.00
No. 13	WIRING DIAGRAMS. 304 Pages.....	2.00
No. 14	REFRIGERATION & AIR CONDITIONING. 1360 Pages.....	6.00
No. 15	ELECTRIC LIBRARY. 10 Volume Set.....	20.00
No. 25	BLUE PRINT READING. 448 Pages.....	3.00
No. 26	MASONS & BUILDERS GUIDES. 4 Book Set.....	8.00
No. 27	ELECTRIC MOTOR GUIDE. 1056 Pages.....	5.00
No. 28	OIL BURNER GUIDE. 416 Pages.....	2.00
No. 29	SHEET METAL PATTERN LAYOUTS. 1152 Pages.....	7.50
No. 30	SHEET METAL WORKERS HANDY BOOK. 448 Pages.....	2.00
No. 43	DO-IT-YOURSELF ENCYCLOPEDIA. 2 Book Set.....	8.95
No. 44	NEW MECHANICAL DICTIONARY. 712 Pages.....	6.95

## 7-DAY FREE EXAMINATION

SEND NO MONEY—Pay the postman nothing! We'll send you any of the Audel Guides for FREE examination in your home. If you decide to keep the books you may pay for them under our easy-pay plan of only \$2 a month.

## HERE IS ALL YOU DO

IT'S EASY TO ORDER: In the No-Risk Mail Order Coupon below you need only draw a circle around the number of Audel Guides you want. We will send them to you at once. If you are not completely satisfied, return the books to us.

## MAIL THIS COUPON TODAY!

THEO. AUDEL & CO. — Self Improvement Publishers Since 1879  
49 W. 23rd Street, New York 10, N.Y. PS

Please mail me for 7 days' FREE EXAMINATION the books I have circled. I agree to mail \$2 in 7 days on each book or set ordered, and to further mail \$2 a month on each book or set ordered until I have paid the purchase price, plus shipping costs. If I am not completely satisfied with my Audel Guides I may return them.

NAME \_\_\_\_\_

ADDRESS \_\_\_\_\_

OCCUPATION \_\_\_\_\_

EMPLOYED BY \_\_\_\_\_

1 2 3 4 6 8 9 10 11 12  Check Here for Free  
13 14 15 25 26 27 28 29 30 43 44 Complete Catalog

SAVE SHIPPING COSTS! Check here if you enclose complete payment with order. We pay postage charges. You have some return privilege.

New Table Top Invention Puts You In...

## PROFITABLE RUBBER STAMP BUSINESS

Home Operators now make **\$9.20 AN HOUR** in business once monopolized by a few big companies

Special rubber stamps bring high prices—cost only pennies to make on new, low-cost table top machine. Take 27 cents worth of material, make perfect stamps, the kind businesses and offices now buy by the dozen at \$1.80 each. Make up to \$9.20 an hour. Start in spare time in your own home. Run machine on kitchen table using ordinary electrical outlet. Make any kind of stamp. We'll send you free information without obligation about this established, highly profitable business, now open to individuals for the first time. For free information send name today on a post card to Rubber Stamp Div., 1512 Jarvis, Dept. R-2-E, Chicago 26, Ill.



## CABINET MAKING



**LOW COST HOME TRAINING COURSE FOR BEGINNERS & ADVANCED CRAFTSMEN**

Make money. Learn skills and secrets of fine woodworking and tool use. Professionally prepared shop method training tells and shows how. Covers everything. Easy to master.

Write for Free Booklet

**INTERSTATE TRAINING SERVICE**

DEPT. F3, PORTLAND 12, OREGON

## Finish HIGH SCHOOL AT HOME

Complete 4 Yrs. in 12 Months

Learn More! Earn More! Enter professional or technical schools. Advance Socially. Live a Happier, Fuller Life. Individual Courses or complete schedule. **WRITE FOR SCHOOL BULLETIN.**

**ACADEMY FOR ADULTS**

30 W. Washington, Dept. PM-560, Chicago, Ill.

## DOLLS!

Learn to make, repair and sell dolls and accessories at home. Excellent money making opportunities. May we send FREE informative booklet? No obligation!

**MORN & SUE'S DOLL HOSPITAL SCHOOL, Studio M-50**  
11826 San Vicente Blvd., Los Angeles 49, Calif.



C-10

**Beauty by Colorcrete Can Earn High Incomes**



Beautiful buildings by Colorcrete is a business opportunity awaiting men of modest capital everywhere. Owners of homes, stores, motels, schools — almost any type of construction — are looking for means to give lifetime eye-appeal to drab or dirty concrete, stucco and similar masonry surfaces. Colorcretors can do such jobs, in little time and at little cost, and pocket generous profits. Colorcrete is a cementitious material, applied by air pressure. Tough, tenacious, enduring; 30 colors. Investigate this low-investment enterprise by writing for the Opportunity Book.

**COLORCRETE INDUSTRIES, INC.**  
570 Ottawa Ave., Holland, Mich.

**COLORCRETE**



**DRAINS** cellars, cisterns, wash tubs; **\$7.95**  
**IRRIGATES - CIRCULATES - SPRAYS**

1,001 uses. Stainless shaft. Won't rust or clog! Use 1/8 HP motor or larger... 3/4 HP for up to 3000 GPH; 450 GPH 80' high; or 1800 GPH from 25' well. 1" inlet; 3/4" outlet. Coupling included free. **\$7.95.**  
**HEAVY DUTY BALL-BEARING PUMP.** Up to 7,500 GPH; or 3,000 GPH from 25' well. 1 1/2" inlet; 1" outlet. **\$12.95**  
Postpaid if cash with order. **MONEY BACK GUARANTEE**  
Centrifugal and Gear Pumps in All Sizes  
**LABAWCO PUMPS, Belle Mead 7, New Jersey**

## START YOUR OWN MONEY MAKING BUSINESS

Clean rugs on customers' floors—upholstery in their homes—even painted walls—with highly efficient electric machines which are making big money for others and giving them independence. Write today for complete information. It's FREE!

**VON SCHRADER MFG. CO., Dept. 510 "R" PL., Racine, Wis.**

## RUPTURED

### BE FREE FROM TRUSS SLAVERY

Surely you want to THROW AWAY TRUSSES FOREVER, be rid of Rupture Worries. Then Why Do you put up with wearing a gripping, chafing and unsanitary truss the balance of your life? If you do, it will NOT be through necessity but through choice on your part.

Now there is a new modern Non-Surgical treatment that is designed to permanently correct rupture. These Non-Surgical treatments are so certain, that a Lifetime Certificate of Assurance is given. Write today for our New FREE Book that gives facts that may save you painful, expensive surgery. Tells how non-surgically you may again work, live, play, love and enjoy life in the manner you desire. There is no obligation.  
**Excelsior Medical Clinic, Dept. H6124, Excelsior Springs, Mo.**

# DIVING

## WORLD'S MOST COMPLETE CATALOG

Illustrated—All Types and Kinds of World's Best Equipment for  
**COMMERCIAL—MILITARY—SPORTS DIVING—LUNGS**

MASKS & FINS SNORKELS POWER DIVERS WET SUITS DRY SUITS GUNS-SPEARS UNDERWATER CAMERAS	U. S. D., VOIT, HEALTHWAYS, SCOTT, SWIMASTER, SPORTSWAYS	DEEP SEA HELMETS DESCO MASKS VALVES COMPRESSORS WATER LIGHTS BELTS-TOOLS MAGNETS-KNIVES NAUTICAL CHARTS
--	--	--

**Make-It-Yourself**  
Suit Kits, Plans, Floats  
Cameras, Air Lift  
Novelties  
DECOMPRESSION Chambers

BREATHING APPARATUS—WATCHES—COMPASSES—JEWELRY

Thousands of Items—Most Complete Catalog Ever Published on  
DIVING — 80 pages

SEND \$1.00—REFUNDABLE ON YOUR FIRST ORDER  
M & E MARINE SUPPLY CO., Box 601Y, Camden 1, N. J.

# TELEPHONES



## MODERN CRADLE STYLE

\$3.00

2 for \$5.00

Genuine telephone company phones, re-conditioned. Ideal for Inter-House, House-to-Barn, Office to Shipping Room, etc. Battery operated. Guaranteed. Also, Magneto Telephones for Farms, Camps and Mines. Telephone Materials and Supplies of all kinds.

TELEPHONE DEPT. PM-126, 1760 Lunt Avenue, Chicago 26  
"America's Largest Independent Telephone Repair Shop"



## 119 JIG SAW PATTERNS

FULL-SIZE . . . trace on wood and saw out. Clever, ORIGINAL designs, things you can make to SELL. Wall shelves, lawn signs, planters, book ends, others. **\$1** postpaid

BURGESS VIBROCRRAFTERS, INC.

Rush \$1 today. DEPT. C-144, Grayslake, Illinois

26 YEARS IN BUSINESS AT THE SAME ADDRESS.

Our entire stock of slightly used  
**EXTRA MILEAGE TOP GRADE Tires,**  
(Written Insurance Guarantee). SEND AD

### WHY PAY MORE?

EVERYBODY MAY DEDUCT **10% off** ON EVERY TIRE

12 MOS. Written Guarantee. White Walls \$1.00 extra

600-16	\$6.92	670-15	\$6.82	700-15(6)	\$9.72	750-20(8)	\$12.42
600-16(6)	8.62	710-15	6.92	750-15(8)	10.82	825-20	18.92
650-16(6)	9.32	760-15	6.92	700-17	10.42	900-20	18.92
750-14	7.72	800-15	6.92	750-17	12.22	1000-20	19.92
800-14	7.72	820-15	6.92	650-20	10.02	1100-20	19.92
750-16(6)	9.82	700-16(6)	9.92	700-20	11.82	1000-22	20.92

Thousands of tires shipped all over the U.S.A. All tires shipped F.O.B. Phila. Send Check or M.O. with this ad. Dept. 2. No C.O.D.

STANDARD 834 N. Broad St., Philadelphia 30, Pa.

# MAKE EXTRA CASH

SHARPENING LAWN MOWERS THE MODERN WAY



As Low As  
**\$250.00**

Start your own shop! Full or spare time. Earn many dollars in a short time . . . average \$5.00 per hour. Many mowers need sharpening. With MODERN'S Extra Heavy Duty LAWN MOWER SHARPENER AND BED KNIFE GRINDER you have 6 machines in one. All operations are done quickly and easily. You make money from the start. Write for free details.

**MODERN MFG. CO.**  
160 N. Fair Oaks Ave. Dept.  
Pasadena, California 10-5

# DON'T BE HALF-TRAINED! Be A Master Technician



## AIR CONDITIONING-REFRIGERATION ELECTRICAL APPLIANCES

NOW ONE Modern Master Home Training Course  
IN ALL 3 PHASES  
ALL AT ONE  
LOW TUITION

Only National Technical Schools gives you this complete training at no extra cost!

YOU GET AND KEEP ALL THIS EQUIPMENT



Incomplete training limits your earning power, even disqualifies you for top-pay jobs. The big service companies require complete, all-phase training. If you open your own shop, you'll be called upon to service and repair all types of refrigerators, air conditioners and appliances. With complete training — as only N.T.S. gives you — you can accept every job, make big profits all year round.

### Future Bright For Trained Master Technicians

Over 30,000 new technicians must be trained annually. You are needed to help service and repair the 50 million air conditioners, refrigerators and electrical appliances that will need fixing this year alone. No wonder the Master Technician has steady work, at high pay, year after year. He can go places in his own business or with a manufacturer, dealer, distributor or department store. Armed with all-phase training, his earning power is unlimited.

### The Most For Less

We give you illustrated Shop-Tested Lessons and Manuals . . . many other training aids . . . privilege of CONSULTATION with our instructors and engineers. Every lesson, every manual has been SHOP tested and approved.

### Job Training At Home

You get Professional Tools, Precision Instruments, PLUS a Factory-Made APPLIANCE TESTER! A shop-full of PRACTICAL, professional equipment. Use them to conduct over 100 experiments . . . also in Spare Time Work and ON THE JOB. It is all yours to keep . . . no EXTRA MONEY DEPOSITS . . . no EXTRA COST on your equipment kits.

### Earn As You Learn

We show you how. Many of our students pay for their entire course — and more — in Spare Time while learning. So can you. Graduate Advisory Service, too.

### FREE!

ACTUAL LESSON

and

ILLUSTRATED FACT BOOK

and

ACTUAL LESSON

Clip Coupon now

### NATIONAL TECHNICAL SCHOOLS

WORLD-WIDE TRAINING SINCE 1905

4000 S. FIGUEROA ST., LOS ANGELES 37, CALIF., U.S.A.

N.T.S. also offers training in

TV - RADIO - ELECTRONICS

and AUTO MECHANICS - DIESEL

## NATIONAL TECHNICAL SCHOOLS

WORLD-WIDE TRAINING SINCE 1905

MAIL NOW TO

National Technical Schools, Dept. CB-48

4000 S. Figueroa St., Los Angeles 37, Calif.

Rush FREE "Opportunity" Book and Actual Lesson. No Salesman will call.

NAME \_\_\_\_\_ AGE \_\_\_\_\_

ADDRESS \_\_\_\_\_

CITY \_\_\_\_\_ ZONE \_\_\_\_\_ STATE \_\_\_\_\_

Check here if interested ONLY in Resident Training at Los Angeles.



MEMBER

# Even Draftsmen Beginners Command Big Pay

**START NOW to Qualify for a  
High Pay Job in the Space Age**

**Short Cut Method Lets You  
Learn at Home in Spare Time**



**Only \$4.75  
IF YOU KEEP IT**

Aircraft, Missile companies and other fast moving industries need DRAFTSMEN. This book can be your first step toward a high pay job in a company with a future. Begin your training at home in your spare time by following this simple step-by-step method. No drawing skill required. Quickly make layout drawings, pattern drawings, cut-away exploded views—everything made clear, easy. 288 pp., more than 400 illustrations.

**EXAMINE FREE.** We'll send latest and illustrated new edition of DRAFTING for FREE examination. After 5 days return and owe nothing or pay \$4.75 plus delivery charges. Or send \$4.75 now and save shipping costs. Same 5 day money back trial. Mail coupon now!

**AMERICAN TECHNICAL SOCIETY, Dept. ANA**

**848 East 58th Street - Chicago 37, Illinois**

**American Technical Society, Dept. ANA**  
848 East 58th St., Chicago 37, Illinois  
Please send me for FREE EXAMINATION a copy of your new book DRAFTING. I will either return it in 5 days and owe nothing or pay \$4.75 plus delivery costs later.

NAME \_\_\_\_\_  
ADDRESS \_\_\_\_\_  
CITY \_\_\_\_\_ ZONE \_\_\_\_\_ STATE \_\_\_\_\_  
 Check here if you wish to save shipping charges by enclosing \$4.75. Same money back trial.

## ... TURN CONCRETE INTO GOLD!

### MAKE UP TO \$75 A DAY IN YOUR OWN BUSINESS

If you want to have your own business — to start a business on your own — here's your big opportunity! New high speed, low cost General block machine produces up to 1,000 concrete blocks a day. Sell all you make to builders, supply houses, and others for homes, factories, buildings, garages. Cash in on the building boom! You can make profits of 100% to 150% — up to \$75. a day! General block machine equipped with 1/2 h.p. electric motor — or can be supplied with gasoline engine — works anywhere, in little space, indoors or out. Operates from ordinary house light socket. Simple, foolproof 3 step operation — so easy a child can do it. Makes superior 3 core blocks any size from 4" to 12". Also makes chimney, sash, corner and other types. Blocks meet any building code anywhere in the country. Materials — sand, water, cement, available anywhere. Simple illustrated operating instructions and mixing formulae for cement and cinder blocks supplied with each machine. Write for FREE folder with full information.

**MOTOR DRIVEN**

R. L. T. of New York City reports: "MY GENERAL BLOCK MACHINE PAID FOR ITSELF IN FIRST 2 WEEKS!"  
Hundreds now in use the world over!  
Write for FREE details today!

**EXTRA** Amazing illustrated book gives floor plans for 6 sensational concrete block bungalows. Tells how to lay blocks, lay out building lines, mix concrete, build steps, porch and concrete floors all at great savings. Written by experts. Can save many times the cost of the machine! Get it now! No strings attached. Send \$1.

**BOOK SENT FREE IF YOU BUY MACHINE.  
\$1 REFUNDED IF YOU BUY LATER.**

**GENERAL ENGINES CO.**  
DEPT. M-50, ROUTE 130, THOROFARE, N. J.

**HOW TO BUILD YOUR OWN CONCRETE BLOCK HOME**  
Only \$1 Prepaid

# \$1 BRINGS YOU \$18

**Discover Flok-Kraft and Earn \$\$\$\$\$ AT HOME**

Earn up to \$15.00 per hour spare time. Amazing new Velvet-fiber spray instantly makes any object (Lamps, Radio & TV Cabinets, Figurines, Signs, Auto dash boards, toys, furniture, draperies — anything) worth expensive \$\$\$\$\$ Prices... like magic, you can spray anything with this beautiful new suede-like finish that feels like rich Velvet.

**EARN UP TO \$300.00 PER WEEK SPARE TIME**

Imagine, materials cost only 3c per square foot. (Average TV or radio cabinet can be beautifully sprayed with this startling new 3-dimensional Velvet finish in 15 minutes at a cost of only 34c in materials. Your charge for this job is at least \$10.00.)

**REPRESENTATIVES IN YOUR AREA URGENTLY NEEDED**

Own your own business. Work at home in your spare time. Help fill the huge growing demand for this amazing new beautiful Velvet-fiber finish. Orders come from stores, offices, homes, architects, auto dealers — everywhere. Possible \$20,000,000.00 worth of jobs to be done. Investigate today — be first in your area! Actual samples in 16 Radiant Colors, Booklet of 50 Home Business Opportunities and Confidential Details all sent free! Send No Money. Write: **Coast Industries, Los Angeles 61, Calif., Dept. B-5**

## AGGORDIONS UP TO 1/2 OFF

retail prices you'd expect to pay!  
**5-DAY FREE TRIAL**

Buy DIRECT from world's Largest Exclusive Dealer! Compare our Importer-to-You prices! See how you save! Over 20 models — finest genuine Italian makes! New, easier terms! 5-Day Free Home Playing Trial with money back guarantee. Bonus Gifts Free. Rush your name and address for FREE Color Catalogs and direct Importer-to-You prices — FREE. Write TODAY!

**ACCORDION MANUFACTURERS & WHOLESALE OUTLET**  
2003 W. Chicago Av., Dept. R-50, Chicago 22

## Would You Like to Make \$1,000 A MONTH?

That's what Stanley Hyman made selling the amazing new Presto Fire Extinguisher! Many others "cleaning up" — so can you! Amazing tiny new extinguisher ends fires fast as 2 seconds. Guaranteed for 20 years! Sells for only \$4.95. Write for Free sales kit.

**MERLITE INDUSTRIES, Presto Div.,**  
114 E. 32nd St., Dept. P-15N, New York 16, N. Y.

## Locksmithing AND KEY MAKING

**Now Made Easy!** Practical up-to-date course teaches you how to pick locks, de-code, snake master keys, repair, install, service, etc. New self-instruction lessons for every handyman, homeowner, carpenter mechanic, service station operator, fix-it shop, hardware dealer, gunsmith. 53 easy illustrated lessons. Full price only \$5.95 postpaid; or C.O.D. plus postage. Satisfaction or refund guaranteed.

**NELSON-HALL CO., DEPT. EP-2**  
210 S. Clinton Chicago 6, Ill.

## LEARN MEAT CUTTING

Train quickly in 8 short weeks at Toledo for a bright future with security in the vital meat business. Big pay, full-time jobs — HAVE A PROFITABLE MARKET OF YOUR OWN! Pay after graduation. Diploma given. Job help. Thousands of successful graduates. Our 37th year! Send NOW for FREE catalog. No obligation. GI approved.

**NATIONAL SCHOOL OF MEAT CUTTING, Dept. 50-E, Toledo 4, Ohio**

## Everything You Need for UNDERWATER Sports and Adventure

# DIVEMASTER

**SKIN AND LUNG DIVING EQUIPMENT**

Leading nationally known and foreign made products. Inspection tested at money saving prices. Underwater Breathing Apparatus. Swimming Masks and Fins, Diving Masks, Spear Guns, Water Skis, Diving Suits, etc. Send 25c for big illustrated Catalog.

**DIVEMASTER**  
Dept. PM-50  
5637 W. 63rd Place, Chicago 38, Ill.



## Give Yourself A CHANCE

Success begins with *you*. Don't handicap yourself! Learn your potentials and talents! Write today for the fascinating free book, *The Mastery of Life*, which explains. Address: Scribe S.J.N.



**The ROSICRUCIANS**

(NOT a Religion)

SAN JOSE

CALIFORNIA

## SALE 20 X 50

High powered, whisper-weight (27 oz.!) Color corrected. Achromatic binoculars. 7" high! EZ to hold. EZ to focus. Instant finger-tip adjustment. Made in Japan. Hard Coated thru-out!  
**USE 30 DAYS.** If not satisfied return for refund. Add \$1.50 postage, handling.  
UNITED BINOCULAR CO., 9043 S. Western, HP-3108 Chicago 20. **DEALERS WANTED**

Including case and straps!  
**\$29.95**

Add 10% Tax



c.o.d.'s require \$2 deposit.

## "How to Make Money with Simple Cartoons"



A book everyone who likes to draw should have. It is free; no obligation. Simply address

FREE BOOK

**CARTOONISTS' EXCHANGE**  
Dept. 95-D Pleasant Hill, Ohio

## SCIENCE ENGINEERING

Bachelor's degree in 27 or 36 months  
Accelerated year-round program: Aero., Chem., Civil, Elec., Mech., Metal.; Math., Chemistry, Physics. Modest rate. Earn board. New classes start June, Sept., Jan., March. Catalog. 1650 East Washington Blvd., Fort Wayne 2, Indiana

**INDIANA TECHNICAL COLLEGE**



## MOVING WITH THE JOB?

Opportunity seekers find success the convenient, comfortable way in their Travel Trailers. Fully and smartly furnished, including showers, cooking facilities, your home on wheels adapts to any climate or site. Weatherized life-time construction, with conditioned air, gives you every home comfort, with ample storage space. Learn how to do it in **TRAILER TOPICS** the magazine of successful trailer living.

**SPECIAL OFFER \$1.00**  
4-Month subscription only

**TRAILER TOPICS** magazine

Suite 1572, 28 E. Jackson Blvd., Chicago 4, Ill.

## Learn Now at Home to Make BIG MONEY in ELECTRICITY!



New Course is Really 3 in 1 — Shows You How To

## MAKE MORE MONEY IN YOUR SPARE TIME

Make a lot more money this time next year! Get into Electrical work, the growing field of Opportunity. Demand for trained men at all time high. Easy to learn. Your income can start upward within surprisingly short time. Go as far as YOU like—a highly respected, highly paid career can be yours upon completion of training.

Most courses in Electrical work teach you to repair appliances (which can be very profitable) and stop right there. But I.T.I.'s Electrical course is really 3 courses at the price of one! First you learn, at home, in spare time, to fix fans, motors, vacuum cleaners, toasters, all appliances and wiring found in the home today. This can pay off for you immediately in the form of sideline neighborhood electrical repair work at \$5 to \$8 an hour!

## —Or Enjoy Profitable Business of Your Own

Most Electrical Courses stop here, but not I.T.I. You'll be receiving training that will enable you, upon completion, to go into business for yourself—make good money (as much as \$110 to \$175 weekly, depending on kind of work you choose) as Electrician, Electrical Contractor, Shop Manager. You'll know your business, too—you'll learn by doing, and you receive as part of your I.T.I. course Kits to construct valuable Testing Equipment you'll use to good advantage later—Equipment that would cost you hundreds of dollars if you bought it, pre-assembled, through regular Electrical Supply sources.

## —OR GO ON TO A TOP PAY CAREER

You will be ready, if you choose, to take your place among top-pay Electrical men with most any company, just about anywhere in the U.S. you want to live and work—as fully qualified Plant Electrician, Maintenance Man, or Electrical Foreman. Advancement is usually accelerated because I.T.I. training, though deceptively easy, is also thorough—you'll know your business and your employers will know you know it, too. In fact, I.T.I. has successfully trained over 400,000 men since 1916—proof that, regardless of age, education, past experience, YOU can learn profitable Electrical Work too! See for yourself—rush Coupon for FREE SAMPLE LESSON and complete details right now!

**INDUSTRIAL TRAINING INSTITUTE, Dept. 1E**  
2150 Lawrence Avenue, Chicago 25, Illinois.

Industrial Training Institute, Dept. 1E  
2150 Lawrence Avenue, Chicago 25, Illinois.

Please rush FREE SAMPLE LESSON, details of the exciting Opportunities for me in Appliance Repairs, a business of my own, or a top-pay Career in Electrical work.

Name \_\_\_\_\_

Address \_\_\_\_\_

Town \_\_\_\_\_

State \_\_\_\_\_

Age \_\_\_\_\_

Occupation \_\_\_\_\_

# MODEL CHANGEOVER SALE! 1959 MODEL—BELOW COST!

## 8" TILT ARBOR SAW

### BLADE TILTS—TABLE REMAINS LEVEL

Heavy duty all cast iron and steel construction. Precision ground cast iron table. Price includes massive cast iron mitre gauge and patented motor drive that fits any motor.

Cross cuts, rips, bevells, mitres, dadoes, cuts compound angles — everything expected of saws costing four times as much. Depth of cut adjustable; 0" to 2 1/4" — table always level. Send check or M.O. \$2.00 deposits on C.O.D.'s.

**SPECIAL BARGAIN** — This saw is our 1959 model. Each saw is brand new — sent to you in factory sealed cartons. Sold and guaranteed direct from the factory to you at a fantastic bargain.

### FREE 10 DAY TRIAL — MONEY BACK GUARANTEE

Try this famous saw 10 days. If you are not satisfied that it does the work of any tilt arbor saw, regardless of price, return for immediate money back refund.

Sent Express Collect.

We reserve right to refund money if stock is exhausted

## AMERICAN MACHINE & TOOL CO.

ROYERSFORD 22, PA.



MODEL 590

NOW  
**\$9.95**  
Was \$24.95

Shipped Complete as shown Less Blade

## BOAT PLANS—PATTERNS & FRAME KITS

Designed by a Naval architect & specially prepared for amateur builders.

New 80-page catalog illustrates over 35 "Build-it-Yourself" power boats with step-by-step photos and instructions for building your own boat at a big savings.

Send for your copy now  
Only 50c

GLEN L. 9152T Rosecrans  
Bellflower, Calif.



## MAKE \$5.00 AN HOUR IN SPARE TIME BIG, EASY "AT HOME" PROFITS—METALIZING

It's so easy to earn Big Money right at home in fascinating new spare time business. Little easy-to-run table-top machine returns Cash Dollars for a few cents cost. We furnish everything to put you in business for yourself, "eternalizing" baby shoes, and other keepsakes. Write TODAY for full facts FREE. No salesman will call on you. No obligation.

WARNER ELECTRIC, 1512 Jarvis, Dept. M-2-E, Chicago 26, Ill.

### NEW! BUILD MUSCLES & HEALTH with BODY BUILDER



Only **\$1.00** Postpaid  
This new Chest Pull Body Builder develops powerful he-man muscles F-A-S-T. Ideal for the beginner to give him a real start in championship muscularity and perfect for the more advanced body builder to combine with his regular training for faster, all around muscle growth. Body Builder is wonderful for developing massive arms, shoulders, chest and back. Mail your order today. Only \$1.00 postpaid. No C.O.D.

MEDFORD PRODUCTS, Inc.  
Dept. 904G, P. O. Box 39, Bethpage, New York

## OWN CALIFORNIA LAND

STATE GOV'T LANDS. 500,000 Acres as low as \$2. per acre — min. offer 40 to 640 Acres. Ranch and Farm Tracts. Southern and Northern California Locations.

NO HOMESTEADING! NO IMPROVEMENTS! NO SALES TO ATTEND! You select, apply and BUY DIRECT through the mail. Lists & maps now available. WRITE RESEARCH DIV.

PIONEER RANCHES 8228 Sunset Blvd., Dept. 9  
Hollywood 46, Calif.  
LARGEST LAND CORPORATION OF ITS KIND IN THE WORLD

## High School at Home

### MANY FINISH IN 2 YEARS

No classes. No time wasted going to and from school. Progress as fast as your time and abilities permit. Standard H.S. texts supplied. Thousands enroll each year in this 63-year-old school. Send for FREE descriptive booklet.

AMERICAN SCHOOL, Dept. H-545  
Drexel at 58th St., Chicago 37, Ill.

Without obligation, please send FREE descriptive booklet.

Name \_\_\_\_\_

Address \_\_\_\_\_

Accredited Member National Home Study Council

## 75 POWER TELESCOPE \$3.98

NEW 3 in one telescopes, 3 variable 25X, 45X-75X magnification. Brass bound. 25 power for ultra bright images 45 & 75 power for long range. Guaranteed to bring distant stars, moons, objects, sports 75 times closer. Most powerful scope sold anywhere near this amazing low price. American made, 5 sections. Opens 36", closes 1 ft.; contains 4 ground & polished lenses. Can also be used as powerful compound microscope. Mass production enables us to offer telescope complete at \$3.98 postpaid. Money back guarantee.

CRITERION CO., Dept. PMB-81, 331 Church St., Hartford, Conn.



# NO SELLING REQUIRED!!

## SUPPLY NATIONAL SALESFORCE WITH FAST SELLING ITEMS

**SENSATIONAL NEW HOME PLAN** puts men and women into big profit full time-spare time business. Package for self-service racks articles you make, buy in bulk at low cost or exchange with others. Earn big pay by contract packaging for mfrs. and retailers; set up much needed gift wrapping service.

**WE TRAIN, ESTABLISH YOU:** You need no previous experience! HPC furnishes materials, supplies, know-how—everything required to start you in your own home. Old or young, you can grow big with our help.

**FILL HUGE DEMAND:** Impulse buying created a multi-million dollar market for packaged items. We show you how to get your share with full sales assistance and unique exchange plan. Send, today, for full free details without obligation.

HOME PACKAGING COMPANY Dep't D-5 2212 East Jesse Street, Los Angeles, California

## You Can Make a BIG LINE of Concrete Products on a SMALL INVESTMENT

Brick . . . patio stones . . . screen block . . . flag-stones, slump brick and many other items can be made on the low-cost, easy-to-operate Gardencrete Machine. \$1.00 worth of material can be turned into \$5.00 to \$8.00 worth of products to build patios, planters, walks, barbecues, walls, terraces, etc. A cash-and-carry business with large, waiting market. Every home can use Gardencrete.

### As Little as \$810.10 Cash

Can procure you a Gardencrete Machine, with up to three years to pay the balance. Easy to set up in shed or garage. Gives opportunity to turn idle hours into profit and build a spare-time activity into a full time enterprise. Full information in 4-color brochure — free. Write today.

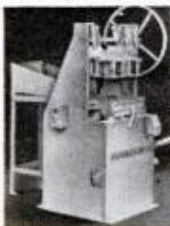

COLORCRETE INDUSTRIES, INC.  
704 Ottawa • Holland, Mich.  
**GARDENCRETE**



G-6

## SIGN PAINTING

Home-Study Course — Only \$5.95

Teaches you commercial sign painting and sign building as it is being done TODAY in leading shops all over the country. Complete practical course for self-instruction. Shows latest methods of truck lettering, office doors, wood letters, reflecting signs, plastics, sprayed signs, gold leaf, silk screen process, up-to-date alphabets, money-making business information, etc.

**SATISFACTION GUARANTEED OR REFUND!**

Contains all the instruction of a high-priced correspondence course. Full price, only \$5.95, postpaid, or C.O.D. plus postage. No risk-order today. Satisfaction or money back! Order "Sign Painting Course," NELSON-HALL CO., 210 S. Clinton St., Dept. 2EP-2, Chicago 6, Ill.



## PLANT CHRISTMAS TREES for PROFIT

Write for free catalog to . . . .

*Pikes Peak Nurseries*

Quality Nursery Stock For More Than 35 Years

801 WATER STREET INDIANA 11, PA.



# INVENTORS

Before you do ANYTHING, send for information on WHAT you should do. Write for FREE copy of "The Inventor's Guide" and learn how to protect, evaluate, and market your ideas. No obligation, of course.

## INVENTORS GUIDANCE SERVICE

Calimesa, California

### Bensen Copter for Everyone

Simple to fly—build it yourself with engine or as inexpensive glider type. Safer than planes—women fly and like it, too. Order 3 view drawing, specs and photo of Glider for \$1 or motor powered Gyro-Copter \$2. Building plans and kits also available.



Send  
\$1  
or  
\$2

BENSEN AIRCRAFT CORP., Dept. PM-50  
Raleigh-Durham Airport, Raleigh, N. C.

Name .....

Address .....

## 94.6% OF BAILEY GRADUATES ARE EMPLOYED AT TOP PAY IN THE FIELDS WHICH THEY WERE TRAINED!

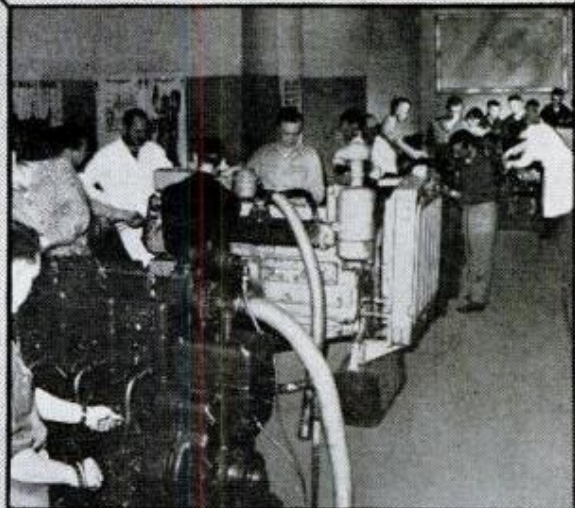

## DIESEL-AUTO MECHANICS DESPERATELY NEEDED!

We have a far greater demand for our students than we can fill!

We can show you an actual waiting list of leading companies throughout the world who have tried Bailey graduates — found them outstanding, and are coming back for more!

Bailey Graduates are Successful . . . RECEIVE BIG PAY — HAVE SECURE FUTURE!

The Famous Bailey Course prepares you for BOTH Diesel and Gasoline Mechanics.

This is a must—due to the advent of using Diesel principles, such as 'Fuel Injection' on passenger cars . . . use of gasoline engines for starting Diesel engines, etc. You learn all this at Bailey in the amount of time ordinarily required to learn just one of these subjects, **ALL FOR THE PRICE OF ONE.**

Don't be satisfied with a 'futureless', one-type job — learn how you can make big money now!

Write today for Free Booklet that takes you on a step-by-step camera tour through our spacious, modern shops — See Bailey students in action as they Learn-by-doing with the Famous Bailey Method of training!

We provide you with housing and part time jobs while in school, plus nation-wide placement service for graduates.

## BAILEY Technical SCHOOLS

1634 S. GRAND

ST. LOUIS 4, MO.

### MAIL TODAY!

Please mail immediately this free booklet without obligation.

FREE BOOKLET



Name.....

Address.....

City.....

State.....

APPROVED FOR VETERAN...NON-VETERAN

**ENGINEERING  
SCIENCE  
MATH** **DEGREE IN  
27 or 36 MOS.**



Accelerated year-round program prepares for early employment in fields of Science and Engineering. Regular 4-year program for B.S. Degree completed in 36 months, special engineering degree program in 27. Classes start quarterly—June, September, January, March. Quality education. Graduates employed from coast to coast. Government approved for veteran training. Students from 50 states, 40 countries, 20 buildings; dorms, gym. Campus. Save time and money. Earn board while studying. Write for catalog and complete information.

**INDIANA TECHNICAL COLLEGE**

550 E. Washington Boulevard, Fort Wayne 2, Indiana

Please send me free information on Bachelor's Degree Programs in Engineering and Science as checked below:

- |   |  |
|---|--|
| <input type="checkbox"/> Aeronautical Engineering | <input type="checkbox"/> Mechanical Engineering    |
| <input type="checkbox"/> Chemical Engineering     | <input type="checkbox"/> Metallurgical Engineering |
| <input type="checkbox"/> Civil Engineering        | <input type="checkbox"/> Physics                   |
| <input type="checkbox"/> Electrical Engineering   | <input type="checkbox"/> Chemistry                 |
| <input type="checkbox"/> Electronic Engineering   | <input type="checkbox"/> Mathematics               |

Name.....

Address.....

**LEARN TO MOUNT BIRDS**



**ANIMALS, FISH, PETS**

Be a Taxidermist. Save your hunting TROPHIES. Have a fine home-museum. Hunters, save and MOUNT your beautiful DUCKS, QUAIL, DEER, TAN skins, FURS. Great Fun. Spare-time PROFITS. **FREE BOOK** Tells ALL about it. 100 fine wild-game pictures, 48 pages. SEND TODAY, don't delay. Get this WONDERFUL **FREE BOOK, MEN AND BOYS.** Learn Taxidermy. Double your hunting pleasure. Rush letter or **POSTAL** today. **STATE YOUR AGE.** N.W. SCHOOL OF TAXIDERMISTRY, Dept. 2595, Omaha, Neb.

**FREE**



**MUSCLE BUILDING  
INFORMATION**

Sensational New Methods  
Less Time—Less Effort—Better results  
**BODY-TONE**, Box 638, North Miami 61, Fla.

**Learn to FIX ELECTRIC  
APPLIANCES**

Tremendous jump in electrical appliances and devices has increased need for service-men. Good money-making opportunities for young and older men. Benefit soon these five ways: (1) fix appliances after hours, weekends; (2) have full time service shop; (3) fill job openings being advertised; (4) go into sales and service business; (5) save, fix own appliances. Modern training program. Beginners learn in spare time at home. Professional Tester Kit furnished. Low cost, monthly terms. Information free. Mail coupon.

**NATIONAL RADIO INSTITUTE**  
**WASHINGTON 16, D.C.**

AEO

Name.....

Address.....

City.....Zone.....State.....

**NEW WESTERN HAIG**  
**.12 CALIBER**  
**SPECIAL FACTORY  
OFFER!**



**\$3.00**  
post-paid

**USES POWDER CHARGE**

This small bore gun shoots .12 cal. lead bullets fired by small 4.4 mg. powder charge. Not a CO<sub>2</sub> gun! You'll like the handsome lines, grip, and balance. Western in style, but patented ball and cap action allows this low price. 9 3/4" steel barrel cased in knurled styrene stock, overall 13 1/2". Develop pistol form, accuracy at a fraction of cost of large caliber pistols. Comes with 50 lead bullets. Satisfaction guaranteed. Send \$3 to: HAIG MFG. CO., Box 30-N, San Gabriel, Calif.

**"YOU ARE UNDER ARREST!"**



**Help Bring Crooks to Justice Through Scientific  
CRIME DETECTION!**

We have taught thousands this exciting, profitable, pleasant profession. Let us teach you in your own home. Learn Finger Printing, Firearms Identification, Police Photography, Secret Service Methods thoroughly, quickly, at small cost. Over 800 of all American Bureaus of Identification employ I.A.S. students or graduates. Write for FREE "Blue Book of Crime." (A Correspondence School Since 1918)

Institute of Applied Science, 1920 Sunnyside Ave., Dept. 1355, Chicago 40, Ill.

**GET THE HABIT OF  
READING**

Wonderful Opportunities Amazing Bargains

**NO JOB WORRIES**

PLASTEX INDUSTRY needs manufacturers on small scale for big production of Lamps, Clock Stands, Art Goods, Novelties in Plastic Marble imitation. No Experience necessary. 1/2¢ material makes regular 10¢ store sellers. Moulds furnished for fast production. Small investment brings good profit. Big wholesale orders now being placed. Ambitious men have chance for real prosperity and job security. Our NEW FREE booklet will interest and benefit you.

**PLASTEX INDUSTRIES, Dept. A**  
3400 Third Ave. New York 56, N.Y.

**After the city,  
Before the state  
The ZONE keeps your mail  
From being late**



The Post Office has divided 106 cities into postal delivery zones to speed mail delivery. Be sure to include zone number when writing to these cities; be sure to include your zone number in your return address — after the city, before the state.



## LOCATE HIDDEN TREASURE

JEWELRY, COINS, METALS, MINERALS,  
WIRES, PIPE, ETC.

### AUTHENTIC U.S. ARMY PORTABLE MINE DETECTOR

ORIG. \$2485 Complete with Batteries  
\$233.00 Express Charges Collect

Model SCR625. Detects objects up to 24" depth. Comes complete in fitted chest with bulbs and instructions. Chest is 28 1/4" long, 15" wide, 8 1/4" deep. Instrument is ideal for electricians, plumbers, utility companies, mineralogists, beach combers, scouts, etc. Like-new condition. No C.O.D.

**A.M. AIRCRAFT PARTS CO.**

307-309 West Broadway, New York 13, N. Y.

## 250 POWER . . . .



Telescope Lens Kit only \$3.49 postpaid

Computer Space, Explore the Universe, Planets, Moon Craters, New Stars, etc. Complete Lens Kit consists of 80 inch focal length ground and polished objective lens, eyepiece lenses for 50 POWER, 100 POWER, 150 POWER, 200 POWER, 250 POWER, and all necessary lens fittings. Easy to make from simple step by step instructions. (Tripod and mount not included.) Money back guarantee.

**BUSSE SALES CO., Hartford, Conn., Dept. PM-84**

## SHORTHAND IN

Famous **SPEEDWRITING** shorthand. 120 words per minute. No symbols: no machines: uses ABC's. Learn at home or through classroom instruction. Low cost. 500,000 graduates. For business and Civil Service. Typing available. 37th Year. Schools in over 400 cities. Write for FREE booklet.

**Speedwriting**  
Dept. 1505  
55 W. 42 St., N.Y. 36, N.Y.

**6  
WEEKS**

## REAL ESTATE BE A BROKER

**PAYS BIG! SEND FOR FREE, BIG, ILLUSTRATED CATALOG NOW!** Graduates report making substantial incomes. Start and run your own business quickly. Men, women of all ages, learn easily. Course covers Sales, Property Management, Appraising, Loans, Mortgages, and related subjects. **STUDY AT HOME** or in classrooms in leading cities. Diploma awarded. Write **TODAY** for free book! No obligation. Approved for World War II and Korean Veterans  
**WEAVER SCHOOL OF REAL ESTATE (Est. 1936)**  
2020R Grand Avenue Kansas City, Mo.

**FREE  
BOOK  
TELLS  
HOW**

## Secrets of VENTRILOQUISM Now Revealed!



Easy to learn in 60 to 90 days with our Home Study Course. **RESULTS GUARANTEED.** Make Money! Be Popular! Have Fun! Big Opportunity! Radio, Television, Stage Appearances! For **FREE** information regarding price and terms **WRITE.** You must state your age. Dummy Catalog 25c.  
**MAHER HOME COURSE OF VENTRILOQUISM**  
Box 36, Studio PM-5, Kensington Station  
Detroit 24, Michigan

## BRONZE FOUNDRY



Since 1935  
Schools • Home Workshops • Inventors  
Make your own castings of aluminum, copper, bronze, silver. Foundry sets are available in six sizes, capacity 1 1/2 lb. to 48 lb. of red brass. 2400 Deg. F. blast furnace included with each. Write for Free Circular.

**KANSAS CITY SPECIALTIES CO.** DEPT. P-5, P.O. BOX 6022,  
MARYSVILLE, KANSAS

MAY 1960

35

# FOR YOU BETTER PAY and a BRIGHTER FUTURE IN AUTO MECHANICS AND DIESEL



Your spare time  
pays off **BIG**  
with our world-famous  
**SHOP TESTED**  
Home Training



MAKE YOUR FUTURE AS  
BRIGHT AS THEIRS

In a matter of months, you can quit your no-future job for a big-pay, big-future career as an Auto-Diesel Mechanic. Free Illustrated Book gives you the facts. Send coupon below. No Obligation. No Salesman will call.

### All Phase Training

N. T. S. students become skilled, all-around mechanics. Crystal-clear lessons, Shop-Tested manuals, real professional equipment, make it easy to learn. Big equipment kits, yours to keep. Earn as you learn...we show you how. Graduate Advisory Service.

N.T.S. Training is Better,  
More Complete, Lower Cost  
**BETTER...**

Because training is **SHOP-TESTED** in Resident School Shops & Labs. **MORE COMPLETE...** You learn all phases of Auto Mechanics & Diesel. **LOWER COST...** One low tuition covers entire cost of course and all equipment.

### Unlimited Opportunities

Trained mechanics make top money...are in demand at dealer shops, garages, large bus and truck lines, construction projects, government labs, factories, and many others.

YOU GET AND KEEP ALL THIS  
PROFESSIONAL EQUIPMENT



## NATIONAL TECHNICAL SCHOOLS

WORLD-WIDE TRAINING SINCE 1905  
4000 S. FIGUEROA ST. LOS ANGELES 37, CALIF., U.S.A.



**FREE!**  
Illustrated Fact Book  
& Actual Lesson  
Mail coupon now.

Complete TV-Radio Electronics training also available.

**RESIDENT TRAINING  
at Los Angeles!**  
If you wish to take Resident Training at Los Angeles, in our Big, Modern Shops & Labs, check special box in coupon for full information.

## NATIONAL TECHNICAL SCHOOLS

WORLD-WIDE TRAINING SINCE 1905

MAIL NOW TO  
NATIONAL TECHNICAL SCHOOLS, Dept. DB-50  
4000 S. FIGUEROA ST., LOS ANGELES 37, CALIF.  
Send for **FREE** Auto-Diesel Opportunity Book and actual Lesson.

NAME \_\_\_\_\_ AGE \_\_\_\_\_

ADDRESS \_\_\_\_\_

CITY \_\_\_\_\_ ZONE \_\_\_\_\_ STATE \_\_\_\_\_

Check if interested **ONLY** in Resident School training at Los Angeles.

VETERANS: Give date of Discharge \_\_\_\_\_



# WHAT TO LOOK FOR IN SCHOOLS

by B. Richard

*A wise school investment offers you opportunity . . . a bogus education can mean disappointment. Invest your time and money in a school that offers the training and education you want, not merely in a diploma.*

Some of the most startling manpower changes ever to take place in the economy of this country are expected to occur during the next 10 years.

The United States Department of Labor forecasts that industry's demand for skilled craftsmen, professional, and technical workers will increase by almost five million in the next decade. Obviously allied occupations like accounting, law, real estate, and others will increase accordingly. This means that there will be literally millions of job opportunities for ambitious men who have technical knowledge and special skills, and who can put these skills to practical use in industry and daily living.

The Department of Labor forecasts there will be a one-million-worker decrease in industry's requirements for unskilled labor. Only a few years ago, the demand for unskilled labor was such that the great majority of job opportunities fell into the unskilled category. Experience during recent years shows that this picture has changed drastically and will continue to change at an increasingly accelerated pace in coming years.

What will happen to unskilled men who suddenly find themselves out of work, or facing less remunerative jobs, and how will the five million Americans needed to fill the demand for skilled positions, get the education and training necessary to increase their technological ability? The answer to this question lies in the field of adult education, and, for the most part, it will be advanced education and training that will permit students to work while in the process of learning new skills.

Among the major sources of adult education and training are correspondence and resident-training schools. To a greater degree than ever, such schools will help ambitious men realize the satisfactions and rewards that highly technical and responsible jobs can bring them.

There are three main types of adult schools providing this type of training. Correspondence schools, for example, have been helping Americans learn new skills for many, many years. Education by means of correspondence has the advantage of

letting students set their own classroom hours so full-time jobs can be held while instruction courses are being taken. Lessons are worked out at home and returned to the school by mail. The school grades the student's work and usually returns the corrected material with a new lesson.

Resident-training schools combine classrooms and practical laboratory work. Students either live near the school, or, in some cases, stay at school dormitories during their courses of study. This type of school offers on-the-spot instruction in fields that require actual laboratory practice which the student does not have in his regular job or previous experience. In both types of schools students can hold part-time jobs while completing their education.

Some schools combine correspondence and resident training, and offer whichever method best suits the applicant's particular course of study and employment problem and meets his individual requirements.

All of these schools are providing a real service for the nation by giving ambitious men the opportunity for increased income and a better way of life and by helping to fill industry's demand for highly-skilled technicians, and trained job holders.

Because of greatly increasing opportunities for technically trained men, you might be thinking of taking correspondence or resident-training courses. Here are some key points to watch for and steps you can take to get your money's worth:

In order to check on the school of your choice before you enroll, you might want to personally take a look at the school's facilities. If this is possible, you will be able to see first-hand the school's physical set up, personnel and method of operation; and you will be able to form an accurate judgment as to whether or not the school is satisfactory.

For many this is impossible. So another good check is to ask the school for names and addresses of graduates in your own community or state. Schools should be happy to furnish names so you can write or call on graduates in your neighborhood to get their views of the school and its courses.

(Continued to page 38)

**LEARN TO EARN**  
**HIGH WAGES**  
 AS A HEAVY EQUIPMENT OPERATOR!



Secure a high paying future in the exciting construction industry today! Learn to operate bulldozers, draglines, cranes, back hoes, scrapers and motor graders on our actual construction projects!

- ONLY CONTRACTOR OWNED AND OPERATED SCHOOL IN WORLD
- ASSOCIATE MEMBER ASSOCIATED GENERAL CONTRACTORS
- MODERN EQUIPMENT
- V. A. APPROVED FOR G. I. TRAINING
- BUDGET PAY PLAN AVAILABLE

**WESTERN NATIONAL**  
 SCHOOL OF HEAVY EQUIPMENT OPERATION

DEPT. B-4 BOX 510  
 WEISER, IDAHO PHONE 910



WRITE TODAY FOR FREE SCHOOL CATALOG

**"\$10,784 IN ONE YEAR**  
**SERVICING RADIATORS!"**

— Sidney Rad. Shop, Sidney, Mont.  
 Make good money servicing auto-truck-tractor radiators. Easy to learn. Inland, world's largest radiator equip. mgr., offers complete package — equipment merchandising, "Pays-for-itself" Purchase Plan, free training. Small down payment on equipment starts you. Profitable dept. for garage or service station. Write:

**INLAND MFG. CO., Dept. PM-5, 1108 Jackson St., Omaha 2, Nebr.**



**PROFIT IN YOUR SPARE TIME**

**FIX SMALL GASOLINE ENGINES**  
 Outboard • Powermower • Chain Saw • Tractor  
**MAKE EXTRA MONEY** — or, repair your engines and SAVE. Illustrated, easy-to-understand, Home Study Course. FREE information. Write TODAY!

**LINCOLN TECHNICAL INSTITUTE**  
 Suite 5-E, 472 Market Street, Newark 5, New Jersey



**Learn ACCOUNTING**  
 Business Administration

Bookkeeping, secretarial and allied subjects at home in your spare time or attend nationally approved resident school. Write for FREE Success Book giving complete details on courses, plans, rates and employment opportunities. G.I. approved. Write Dept. A

**Hills BUSINESS UNIVERSITY AND EXTENSION SCHOOL**  
 629 W. MAIN ST. OKLAHOMA CITY 2, OKLAHOMA



**SUPPORT YOUR MENTAL HEALTH ASSOCIATION**



**LEARN UPHOLSTERY**  
 in your spare time  
**run your own business AT HOME**



**FREE BOOK with sample lessons with course**

**YOU MAKE SLIPPER CHAIR CLUB CHAIR OTTOMAN**

**PLUS SLIP COVERS Yours to Sell or Sell**

**BE YOUR OWN BOSS**  
 Earn more from the start! Set up your own profitable business, in your own home, enjoy steady income, independence for life. You're in demand in the booming field of Custom Furniture Upholstery. Right off you start learning and earning with tools, complete frames, fabrics and materials, included FREE with N. Y. State-approved UTS course. You learn skilled professional custom upholstery, reupholstery, furniture finishing, repairs, how to make beautiful slip covers, cushions and draperies. **EARN WHILE YOU LEARN**, in your spare time AT HOME... the UTS easy way.

**FREE ILLUSTRATED BOOK - FREE SAMPLE LESSON**  
 Get ready for well-paid job and big profits, from steady work, as your own boss, running your own business. Mail coupon NOW for FREE BOOK! Training in N. Y. School also available. **VET APP'VD. ACCREDITED BY N.H.S.C.**

**UPHOLSTERY TRADES SCHOOL**  
 Dept. ME-310, 721 B'way, N. Y. 3, N. Y.

Please send me **FREE** book, "Your New Way to a Successful Career," and **FREE** sample lesson. No obligation—no salesman will call.  
 Home Study  Training in N. Y. School

Name \_\_\_\_\_ Please Print Plainly  
 Address \_\_\_\_\_  
 City \_\_\_\_\_ Zone \_\_\_\_\_ State \_\_\_\_\_  
 Check if Korean Veteran

Get Into One Of Today's TOP OPPORTUNITY FIELDS

**ELECTRICITY**  
**— ELECTRONICS**  
**TELEVISION**  
**RADIO · ELECTRONICS**

Train in the New Shop-Labs of Oldest, Best Equipped School of Its Kind in U.S. Founded 1899

in Chicago—Electrical and Electronic Center. Prepare for a better job and a successful future. Train on real equipment — no advanced education or previous experience needed. Lifetime employment service to graduates. Part time employment help to students. Finance Plan—enroll now, pay most of tuition later.

**FREE BOOK**— Mail Coupon or write to address below for Big Free Illustrated Book—"Guide to Careers."

Information comes by mail. No obligation and NO SALESMAN WILL CALL.

**COYNE ELECTRICAL SCHOOL**  
 Chartered as an Educational Institution Not for Profit  
 1501 W. Congress Pkwy., Chicago 7, Ill., Dept. 50-3C

**COYNE ELECTRICAL SCHOOL, Dept. 50-3C**  
 1501 W. Congress Pkwy., Chicago 7, Ill.

Send **FREE** Book, "Guide to Careers" and details of all training you offer. I am especially interested in

Electricity  Television  Both Fields

Name \_\_\_\_\_  
 Address \_\_\_\_\_  
 City \_\_\_\_\_ State \_\_\_\_\_

( I understand no salesman will call )

**Want BIG PAY—  
Your Own Business?**

**Be a  
LOCKSMITH**



You can quickly step into a well-paid job or start a big-profit business of your own. Shortage of locksmiths means opportunities everywhere, spare-time or full-time.

**EARN EXTRA MONEY FROM THE START!**  
All Special Tools, Supplies Furnished Free

Age, education, minor physical handicaps don't matter in this growing, steady-income trade. You learn fast at home—gain practical experience through well-illustrated lessons. You do real jobs under the personal guidance of experts.

**ILLUSTRATED BOOK—FREE**  
For a future as your own boss, or in a big pay job, send for FREE illustrated book. Mail coupon today. No salesman will call. Lic. State of N. J.; Accredited by Nat'l Home Study Council. Approved for Vets. **LOCKSMITHING INSTITUTE, Dept. 105, 150 Park Avenue, E. Rutherford, N. J.**



Locksmith Inst., Dept. 105, 150 Park Ave., E. Rutherford, N. J.  
Please send FREE and without obligation Illustrated Book.

Name \_\_\_\_\_  
Address \_\_\_\_\_  
City \_\_\_\_\_ Zone \_\_\_\_\_ State \_\_\_\_\_

Schools offering law, medical, or other technical degrees should be thoroughly checked if the degree can be earned in a very brief course. Degrees of this sort sometimes take years of intensive study and preparation, and a college degree might be considered a prerequisite. Institutions offering "doctor degrees" in such subjects as Hypnosis, Eclectic, Naturopathy, Metaphysics, for example, should be considered on the basis of what value the degree earned has in the community or area where you intend to practice.

If you are now in high school or are a recent graduate, your high school principal or advisor will be able to help you decide whether you are qualified for the particular training you have in mind. It is a good idea, if possible, to consult with such an advisor to be sure you're on the right track.

Be alert if the school salesman contacting you uses "high pressure" methods in getting you to sign a contract. You might well be wary if the salesman seems willing to sign everyone right on the spot, regardless of that individual's qualifications. Most schools screen applicants to be sure they meet set requirements before they are allowed to sign a contract, or suggest alternate courses if they feel the applicant is better suited to some other course of study.

You should be aware that schools usually cannot guarantee employment after you complete your course of instruction. It's true that schools can open the way for increased job opportunities and higher earnings, and many schools do have special departments organized to help students secure jobs; but, in the final analysis, the challenge of getting a better job rests with you. You must "sell" yourself, and your training, to a prospective employer.

At no time in your nation's history has there been such an accelerating demand for new techniques, skills, and for the trained and experienced man to translate this technical knowledge into action. The highly complex products and services of today's industrial system require well-trained men for technical and service work that is essential. The untrained, unskilled laborer, on the other hand, will be faced with decreased job opportunities and limited earning power.

Each one of us, therefore, should be quick to take advantage of the opportunities that more education and greater training provide, not just for the benefit of ourselves and our families, but to help keep our nation stronger than ever in the years to come.

## Get an I.C.S. High School DIPLOMA

All that may be holding you back from a better job, bigger pay is a high school diploma. I. C. S. high school training is known and respected by thousands of leading companies. Graduates occupy top positions. Take only the courses you need. Study at home in your spare time. Expert personalized guidance. Write for 3 free booklets: (1) "How to Succeed," (2) High School Catalog, (3) Sample lesson (math) shows famous method.

**INTERNATIONAL CORRESPONDENCE SCHOOLS**

Box 10953E, Scranton 15, Pa.

Name \_\_\_\_\_  
Home Address \_\_\_\_\_  
City \_\_\_\_\_ Zone \_\_\_\_\_ State \_\_\_\_\_



## HIGH WAGES!

High wages can be yours as an Operating Engineer of heavy construction equipment! Learn NOW to operate our diesel engined bulldozers, draglines, cranes, back hoes, rubber-tired scrapers and motorgraders! Machines of major manufacturers are used in our training program. Contractors are on our advisory staff. Full courses of 220 hours for bulldozers, scrapers, motorgraders; 440 hours for cranes. We invite comparison and inspection of the nation's original construction equipment operator's training school.

We are NOT a correspondence school, but a fully equipped educational institution in the beautiful Piedmont area of North Carolina where you will live while you learn. Budget plan available. VETERANS: Ask about G.I. Benefits. Booking NOW for June and July classes.

**Write TODAY for FREE School Catalog, no obligation, to**

**NATIONAL SCHOOL of  
HEAVY EQUIPMENT OPERATION**  
Dept. D-5 P.O. Drawer 8415, Charlotte, N. C.  
Western office: P. O. Drawer 45272, Los Angeles, Cal.



# GIANT ITALIAN HUNTING KNIFE!

**CLOSES WITH LIGHTNING SPEED!** Imported direct from Italy, this is the same knife that is world famous for its effectiveness in life or death hunting or fishing emergencies. Blade is of durable high test carbon steel, guaranteed to stay razor sharp. Has genuine bone handle. Unlike a switch blade knife, there are no buttons to fool with, no springs to break.

**LOCKS IN OPEN POSITION FASTER THAN THE EYE CAN SEE.** Easy to handle, easy to carry. 4 sizes: 13 1/2" \$7.95, 11" \$7.50, 9" \$6.95, 5 1/2" \$4.50. **SENT POSTPAID IMMEDIATELY.** Send cash, check or M.O. 10-day money back guarantee. Calif. res. add 1 1/2% state tax.



MERCHANTS, INC., Dept. PM-5, 1221 S. Grand Ave., Los Angeles 15, California

**ONLY \$945 and up**

**ADD MASSIVE MUSCLE TO YOUR ARMS, LEGS, AND CHEST, NOW!**

**KING BARBELLS**

50 lb. set ..... \$ 9.45    150 lb. set ..... \$23.45  
 100 lb. set ..... \$15.95    200 lb. set ..... \$29.95

Extra weights 14c lb., 50% deposit, send check or money order, Pay COD on arrival, FOB Plant, PENN.

A royal welcome to good health and greater body development!

**KING BARBELL CO., 915 Broadway, Dept. PM, New York, N.Y.**

**Finish HIGH SCHOOL AT HOME**

**Complete 4 Yrs. in 12 Months**

Learn More! Earn More! Enter professional or technical schools. Advance Socially. Live a Happier, Fuller Life. Individual Courses or complete schedule. **WRITE FOR SCHOOL BULLETIN.**

**ACADEMY FOR ADULTS**  
 30 W. Washington, Dept. PM-560 Chicago, Ill.

**BIG EARNINGS WAITING for TYPEWRITER REPAIRMEN**

Skilled men are in demand in the new, uncrowded field of typewriter repair. You'll quickly step into a big-pay job or business of your own, full or part time. **EARN** while learning easily at home under expert guidance. Materials, tools, typewriter supplied. Write **TODAY** for **FREE** book.

**TYPEWRITER REPAIR SCHOOL, INC.**  
 Dept. E-10, 150 Park Ave., E. Rutherford, N. J.  
 Lic. by New Jersey Dept. of Educ.

**POPULAR SERVICE BUREAU FREE REFERENCE KEY MECHANICS**

Unlock the answers to hundreds of Do-It-Yourself problems with this tremendous Service File list this tremendous Service File list

of Popular Mechanics' booklets, books, full-size patterns, and blueprints. More than 500 classifications of projects, plans, instructions, service and repair information have been cataloged for the first time in one reference file. This invaluable listing is the key to an extremely wide variety of do-it-yourself data on every subject from aquaplanes to zinc plating, from dollhouses to backyard roller coasters, from cabin cruisers to model sailboats, from patios to papier-mache.

For your free copy of the Service File listing, fill in the coupon below and mail today. Supply is limited.

**SERVICE BUREAU, POPULAR MECHANICS, Room 520A 200 E. ONTARIO, CHICAGO 11, ILL.**

Please send me a free copy of the PM Service File listing. I enclose a self-addressed, stamped envelope.

Name.....  
 Address.....  
 City..... State.....

**free**

**ELECTRONICS CATALOG**  
 plus every new issue for 1 year

Yours free if you act now! Radio Shack's big 312-page catalog featuring the newest and best in electronic equipment! Stereo, hi-fi, ham radio, tapes and scores more items for amateur, pro. Also receive **FREE** subscription to all new issues for year!

**MAIL COUPON NOW**

Radio Shack Corp., 730 Commonwealth, Boston 17, Mass., Dept. 60E3  
 Send **FREE** Catalog—Also every new issue for 12 months, a year's subscription **Free.**

Name.....  
 Address.....  
 Post Office.....  
 or City..... Zone..... State.....

**RADIO SHACK CORPORATION**

**LEARN REAL ESTATE**

Men and women, regardless of education or experience you **CAN GET OUT OF THE RUT!** Learn this high-paying profession easily by listening to records. We train and start you, full or part time, your own boss. First lecture free. Lee Institute, Brookline, Mass.

**ENGINEERING**

**American Industry Steps Up Its Demand for Trained Engineers. Train Now at Healds**

**BACHELOR OF SCIENCE DEGREE, 30 MONTHS**  
 SAVE 2 YEARS' TIME

**Degree Courses:**

- Electronic Engineering
- Electrical Engineering
- Highway Engineering
- Mechanical Engineering
- Structural Engineering
- Civil Engineering
- Architecture

**Diploma Courses:**

- RADIO-TELEVISION Plus Color Technician**
- Electronic Technician
- Industrial Electronic Tech.
- Tool & Die Design
- Architectural Drafting
- Mechanical Drafting
- Structural Drafting

**Approved for Veterans**

Photo of Heald Students in Electrical Laboratory

**Enroll Now for New Term**  
 Heald College Ranks **FIRST** West of the Mississippi in "Who's Who in America"

Send for **FREE** Information

**Heald Engineering College**  
 Est. 1963  
 Van Ness at Post, Dept. P.M.  
 San Francisco, California

NAME.....  
 STREET.....  
 CITY.....  
 STATE.....

# HEAVY EQUIPMENT OPERATORS & MECHANICS TRAINING

OR TRAIN WITH OTHER GREER DIPLOMA COURSES

- CONSTRUCTION EQUIPMENT OPERATORS TRAINING
- CONSTRUCTION EQUIPMENT MECHANICS TRAINING
- AUTO MECHANICS
- DIESEL MECHANICS
- BODY & FENDER REPAIR
- GAS-ARC WELDING
- REFRIGERATION
- AIR CONDITIONING
- MACHINIST TRADE
- ADVANCED MACHINIST

Skilled men are needed in every part of the country. Earn top pay in established shops or start your own business. Greer's expert instruction and actual shop training teaches you how. You learn by doing—quick, easy courses using the latest tools and equipment. Day, evening and part time instructions available.

Job placement and convenient living accommodations are yours while training. Contact GREER'S FREE JOB PLACEMENT ASSISTANCE when you enroll if you wish part time or full time employment.

All Courses Approved  Civ. or  G. I.

Please rush me free literature on the trade indicated.

NAME \_\_\_\_\_ AGE \_\_\_\_\_

STREET \_\_\_\_\_

TOWN \_\_\_\_\_ ZONE \_\_\_\_\_ STATE \_\_\_\_\_

**GREER SHOP TRAINING**  
Box E, 2236 S. Michigan Ave.  
Chicago 16, Illinois



## Play Right Away!

ANY INSTRUMENT

Now it's EASY to learn ANY INSTRUMENT—even if you don't know a single note now. No boring exercises. You play delightful pieces RIGHT AWAY—from very first lesson! Properly—by note. Simple as A-B-C. You can make amazing progress—at home, in spare time, without teacher. Only few cents per lesson. 1,000,000 students including Lawrence Welk. (62nd successful year).

**FREE BOOK** Shows how easily you can learn music. Write for it. No obligation: no salesman will call. **U. S. SCHOOL OF MUSIC.** Studio 305, Port Washington, New York.



## CONCRETE BIRD BATHS AND OVER 250 OTHER MONEY MAKING ITEMS



You've seen them all over the country . . . concrete bird baths, garden seats, flower boxes, appealing statuary, and many other items that add charm around the house and lawn. They're made by enterprising people, just like you, from our **COPYRIGHTED ALUMINUM MOLDS.** It's easy. It's fun. It's profitable.

Send \$2.00 today for this 82-page "How to" book, 20 pages of clear instructions. Valuable trade secrets. Over 250 items beautifully pictured (with description, dimensions, and prices of molds). Rushed to you by first class mail.

**CONCRETE MACHINERY CO., INC.**  
HICKORY 2, NORTH CAROLINA

Name \_\_\_\_\_  
Address \_\_\_\_\_

**HOW TO TURN CONCRETE INTO GOLD**

## Precision MINIATURE CAMERA



Size of pocket watch, yet takes good pictures! Imported bargain! Take surprise, candid or regular shots. Weighs 2 1/2-oz. Easy to carry wherever you go! Solid metal construction, leather-lined body, chrome trim, 1-25-sec. or time shutter. Takes ten 1 1/2 x 1 1/2" pictures per roll on 16 mm. film. Fine enlargements. Precision ground lens. Money back guarantee. **\$150 Camera Only** . . . . .

Camera & Leather ever-ready Case \$1.98. Film 15c roll 3 for 40c.

**Johnson Smith Co., Dept. 879, Detroit 7, Michigan**  
Catalog of 2900 Novelties, Science, Funmakers, etc. 10c

## WATCH REPAIRING

**FREE SAMPLE LESSON**

Learn to repair Swiss and American watches. It's fascinating, profitable. Unique Sweazey System shows you how step by step. Shop method home training. Low terms. Diploma awarded.

**CHICAGO SCHOOL OF WATCHMAKING**

2330 N. Milwaukee, Dept. 150, Chicago 47, Ill.

## OWN THE WORLD'S FINEST POCKET PISTOL!

### BERETTA PANTHER

**NEW 25 CAL. FEATHERWEIGHT—9 SHOT**

Sensational Beretta Panther carries more cartridges for its size and weight than other pocket pistols. Always dependable, reliable and accurate. Fits pocket or purse.



Std. Blue \$32.00

Std. Blue, Pearl Hds. 37.50

Chrome—Pearl Hds. 43.50

25 Auto Cps (50) 3.85

**FREE! Genuine Leather Holster**

... Order by Mail Today!

Send \$5.00 down, bal. C.O.D.

**GODFREY IMPORT CORP., Dept. PM5, 261 Broadway, N. Y. 7, N. Y.**

## GET INTO ELECTRONICS

V.T.I. training leads to success as technicians, field engineers, specialists in communications, guided missiles, computers, radar, automation. Basic & advanced courses in theory & laboratory. Assoc. degree in 29 mos. B.S. obtainable. ECPD accredited, G.I. approved. Graduates with major companies. Start Sept., Feb. Dorms, campus, H. S. graduate or equivalent. Catalog.

**VALPARAISO TECHNICAL INSTITUTE**  
DEPT. D VALPARAISO, INDIANA

## Draw CARTOONS



...for a wonderful pastime or excellent earnings. Master cartooning at home in a few short weeks without waste of time or effort through the Famous System of Manual Training. Send for Big, Illustrated FREE Catalog!

**CONTINENTAL SCHOOLS, INC., Dept. A-5**  
4201 South Broadway, Los Angeles 37, California



## MONEY ADVENTURE can be yours NOW...

With Buried Treasures. Have the thrill of locating coins, gold and silver. New Transistorized Instruments for greater locating depth... operate on flashlight batteries... low as \$79.50. FREE literature... WRITE Today.

**Authentic Treasure Books & Maps**  
Now Available



**GOLDAK COMPANY**  
1551-5 W. Glenoaks Blvd.  
Glendale 1, California

**WORLD'S  
BEST  
WANT-AD  
MEDIUM**

# CLASSIFIED ADVERTISEMENTS



Advertisements in this section \$1.30 per word, each insertion, minimum 10 words, payable in advance.

To be inserted under proper classification, copy must be in our office the 18th of the second month preceding date of issue

F. W. Johnson, Manager, Classified Advertising

Popular Mechanics Magazine, 200 East Ontario Street, Chicago 11, Illinois

## YOU'LL PROFIT

By reading and answering the classified ads in this section. Hundreds of opportunities for you to make and save money

### AUTOMOBILES, MIDGET CARS

**MIDGET Racer, Go-Kart** tire recapping molds. Make \$75.00 a day. Independent Tire Co., 2424 Wright, Little Rock, Ark.

**SUPERCHARGER, Latham Axial Flow.** Available for all popular engines. For both competition and street use. Precision-machined. Send \$1.00 for supercharging information and Latham decal to Latham Mfg. Co., Box 165-K, West Palm Beach, Florida.

**GO-KART Parts and supplies.** Complete information 25¢ to cover postage. Rocky, Galveston, Indiana.

**HOBBY Karts, 12 mph, bargain \$49.50** without motor, photos, description \$1.00 refundable. Phillips, Box 81, LaGrange, Illinois.

**BUILD Your power-driven auto.** Plans 35¢. S&R Company, P.O. 5231, East Gary, Indiana.

**BATTERY-Operated electric car plans,** \$1.00. Magnuson Co., Box 15003, San Diego 15, Calif.

**CATALOG On parts kits for golf buggy** or Jr. sports car. 25¢. Indus Corporation, 1815 Madison, Indianapolis.

### AUTO SUPPLIES AND EQUIPMENT

**CHAMOIS Direct from importer.** Best Australian 30"x20" \$2.25. Best English 30"x20" \$2.70. 38"x24" \$3.50. Dozens 10% off. Kerr's, 635-41st, Brooklyn 32, N. Y.

**STEERING Wheels, Midgets, etc., \$3.95** up. Literature 10¢. Steerite Products, Dept. PM-5, Box 221, Long Branch, N. J.

**GREATEST Auto parts catalog.** Thousands racing and restyling accessories for all cars. Only 25¢ (refundable). Newhouse Automotive Industries, Department PM-5, 5805 Beverly, Los Angeles 22, Calif.

**1960 EDITION.** It's new! It's different! Get world's largest auto accessories and parts catalog, save up to 50%. 356 pages, over 10,000 items, earliest to 1960 models including Hollywood accessories, custom styling and Hi-Speed Equipment. All parts and sports cars. We have that hard to get part. Jam packed with bargains. Completely illustrated. Send 25¢ (refundable). J. C. Whitney, 1919 PM-5 Archer, Chicago 16, Illinois.

**AUTO Shop welding repair training** in world's largest non-profit welding school. Low tuition. Free booklet. Hobart Welders, Box M-501, Troy, Ohio.

**3-D Headlites.** Installed 15 minutes. Amazing illumination. Complete \$3.95 postpaid. Motorlax, Box 681, Waterloo 2, Iowa.

**USED—Rebuilt—New parts for all years** and makes trucks and cars. World's Largest Auto Parts, 250 South 3rd St., Brooklyn 11, N. Y.

**DO-It-yourself mechanics.** New Sandmaster tool efficiently sandblasts spark-plugs. Price \$2.00. Edco Service, 37 Elmer Ave., Buffalo 15, N. Y.

**VOLKSWAGEN Owners.** No more kicking. Send for useful hand extension for spare gas valve. Mail \$2.00 to Autocraft, 1955 Watson Street, Victoria, B. C., Canada.

**AUTO-Radios for imported and domestic cars.** 25¢ (refundable) brings complete catalog. Telefix, M-5, 78 Gardiners Ave., Levittown, N. Y.

**PERMANENT Type carburetor air cleaner.** New plastic foam replaces expanded paper cartridges on 1957-60 cars. Free sample. Dust-O-Matic Filter Company, 28038 Los Olas, Warren, Michigan.

**RING-Valve job while-u-drive.** \$6.00 postpaid. (10th successful year.) Guaranteed! Nothing like it. Lasts 100,000 miles. Motaloy, Grantham, Penna.

**JEEP Owners—V8 conversions.** Read Jeep Owners ad, page 24.

**EVERY Car owner needs our fast, efficient cleaning polishing cloths.** New idea, no mess. Sample set prepaid \$1.00. Meyer Company, Box 868, Galesburg, Illinois.

**JEEP Parts! For military and civilian.** At great savings. Largest inventory. Catalog for owners and dealers. Inquiries invited. American Auto Parts Co., 1830-PM Locust, Kansas City, Mo.

**NEW And used parts at savings.** Complete guaranteed parts service for all models cars and trucks. 1924 and later. Largest in the West. Jeep and army parts specialists. Newest type shifting hubs for all jeep and all military and latest production front end drive vehicles. \$27.50 and up. Also, foreign car parts. Write, Pioneer Auto and Truck Parts Co., 734 W. 13th Avenue, Denver 17, Colo.

**PARTS, Model "A."** List 25¢ (refundable). Matco, Box 135, San Pedro, Calif.

**1909-1934 FORD Parts.** Illustrated catalogue 50¢. Mark Auto, Layton, New Jersey.

**FREE! New catalog.** Speed, power, mileage increasing equipment. Discounts! Almqvist Engineering, Milford PM5, Penna.

**CRANKSHAFT Grinder.** Hand operated. Makes bearings fit without taking engine apart. \$4.00. Literature. L. D. McGee, 719 Cascade St., Wenatchee, Wash.

**HYDRAULIC Jack repair kits.** Free catalog. Hydraulic Parts Supply, Box 4104, El Paso, Texas.

**SILENCE Hydraulic valves.** More power, speed, gas & oil mileage. Guaranteed. \$3.00 postpaid. Literature. Micro-Molly Products, Garrison 1, Kentucky.

### AUTO TRAILERS

**PICKUP Coach blueprints.** Kits. Literature 10¢. Comstock Trailers, Parsons, Kansas.

**TRAVEL Trailers, camping trailers.** Also plans, tent top, running gear, etc. Tents galore! Boats (finished-unfinished). Camping equipment! Finest selection! Lowest prices! 25¢ for 1960 catalog. Easy Camping, Inc., 128 Chicago, Evanston 1, Ill.

**NEW Loxon trailer hitch,** pulls from car frame, remove and replace in seconds, chrome, \$15.00 postpaid or \$5.00 balance c.o.d., Money-back guarantee. Ramco Manufacturing, 404 Martin Ave., Wausau, Wis.

**BUILD A folding tent-trailer.** Ideal for low-budget family camping. New booklet contains plans for two single-axle campers. One unfolds endways from 10 x 7 x 2 box, sleeps four in two full-size beds, plus two on air mattresses on floor. The other sleeps four, unfolds sideways from 8 x 6 x 2 1/2 box. Send 35¢ for Booklet 200 to Service Bureau, Room 517B, Popular Mechanics, 200 E. Ontario, Chicago 11, Ill.

**TRAVEL Trailer large floor plans.** Includes booklet illustrating 5 models, \$1.00. Kamcraft, Box 1153, Milwaukee 1, Wisc.

**BUILD Expanding eight foot trailer.** Accommodates five. Literature 10¢. Framar Company, Wilmington, Mass.

### MOTORCYCLES, BICYCLES, MOTORSCOOTERS AND SUPPLIES

**1000 MOTORCYCLE.** Motorbike, bicycle bargains. Parts, accessories. Bargain catalog 35¢. Bunico, 146PM, Covington, Virginia.

**MOTORCYCLE Parts.** New, used. List 25¢. Ballak, 811 N. 9th, St. Louis 1, Mo.

**RECONDITIONED Motorcycle motors.** Chrome accessories. Complete stock Indian parts. Expert rebuilding. Fast service. Indian Motorcycle Sales, Kansas City 27, Missouri.

**HARLEY-Davidsons — Used bargains.** New, used parts, accessories, all models. Bulletin 25¢. Knuth's (Factory Dealer), 1753 Muskego, Milwaukee, Wis.

**WHIZZER Engine \$9.** Whizzer motorbike \$25. Doodlebug motorscooter \$35. Cushman \$50. Crosley sedan \$75. James motorcycle \$28.50. (Mailorder only). Send 25¢ (35¢ for first class mailing) for 32-page Directory-Catalogue Number 95, listing these and hundreds of other bargains in engines, Go Carts, homebuilders parts, plans, etc. Midget Motors Directory, Athens, Ohio.

**USED Cycles, parts, bulletin one dime.** Les Myers, 813 Ohio, Wichita Falls, Texas.

**BUY, Sell that midget car, motor-scooter, motorcycle, motorbike, or parts, kayak, surfboard, hydroplane.** Bulletin, three dimes. Vera Bursleson, Fillmore, Ill.

## AVIATION

BUY Gov't surplus: Aircrafts; engines; helicopters; boats; Jeeps; misc. Buy direct now from gov't. Send for "Depot Directory & Procedure" \$1.00. Gov't Surplus Sales, Box 425-PM, Nanuet, New York.

SPORTPLANE Building manual \$1.50. Circulars illustrated lightplanes, etc., \$ .50. Kamcraft, Box 1153, Milwaukee 1, Wisc.

HELICOPTER — Completely engineered, assembly drawings and parts available. Send \$2.00 for photo, 3 view drawing, specifications and design information. Send additional \$2.00 for book "Basic Helicopter Aerodynamics" uses our helicopter as example problem for performance calculations. Helicopter Research Co., Box 121, La Mirada, Calif.

ROTARY Wing sky crane. VTOL captive trainer. Two 8x10 gloss flight photographs, plus design parameters \$1.00. Complete plans, detail pictures \$3.00. Flight Dynamics, Box 5443, Raleigh, N. C.

HELICOPTERS Are our business, not our sideline. A-W, originators of home built helicopters (not autogiros), sells more kits, plans than all others combined! Learn why—photos, specifications, complete prices; 25¢. Adams-Wilson Helicopters, Inc., Lakewood 1, California.

## ELECTRICAL SUPPLIES

CONDUIT Bending guide and bending protractor. \$1.90. Pal-Notes, Underwood, N. D.

NOW! Easily assembled fluorescent fixture kits, parts. Inexpensive! Postcard brings catalog. Shoplite, 650 Franklin, Nutley 10, New Jersey.

APPLIANCE Parts wholesale. catalogue 25¢. Seco. 26 South 20th Street, Birmingham 3, Alabama.

RANGE Oven thermostats rebuilt. Save money. Send for price list. F. Baumgartner Co., P.O. Box 12711, St. Petersburg 33, Florida.

ELECTRO-SCRIBE! Engraves all metals. \$2.00. Beyer Mfg., 10511-H Springfield, Chicago 43.

LAMP. Electrical parts, wholesale. Thousands of items for repairing, converting. Catalog 25¢. Brown Lamp, Box 305, Clayton 5, Mo.

LAMPS. 25¢ Brings parts catalog. Refunded first order. Gyro, 5208P N.W. 35th Ave., Miami 42, Florida.

BOOK 200 Electrical stunts \$1.00. Kuttington, 875 Arastradero, Palo Alto, Calif.

## WELDING, SOLDERING, PLATING

WELD, Solder, cut, braze. 1/8" welder complete \$8.95. Flame torch, \$3.95. Postage 50¢. 75 ampere transformer welder 1/2", \$24.95 complete. F.O.B. Essay Mfg. Co., Quincy 69, Mass.

ACETYLENE Welding outfits. New, arc-welders. Eagle Welding, Dept. PM, 5085 Broadway, Chicago 40, Ill.

NEW! 10' Ferris wheel economy kit \$139.95 P.O.B. Instructions, welded parts furnished. \$35.00 cash, balance C.O.D. Specialty Welding, Hialeah, Florida.

PLATING Equipment, supplies. Complete line of anodes, solutions. Home workshops, industrial sizes. Hollywood Bronze Supply, Dept. C, 1624 East First, Los Angeles 33, California.

FREE Catalog, welders, welder kits. Build 350-ampere welder using aircraft generator, plans 25¢. Dunbar Manufacturing, Minneapolis 8, Minnesota.

WELDERS. 110/220, \$39.50. Morris, 1070 Inner Drive, Schenectady 3, New York.

## MACHINERY, TOOLS, SUPPLIES

WANTED, Small manufacturers: Aggressive industrial development corporation in Iowa community, prepared to assist small manufacturer anxious to grow. Contact: W. E. Petersen, President, Building Corporation, Harlan, Iowa.

POWER Tools wholesale. Free catalog. Roberson, 14G Brooks Drive, Austell, Ga.

BOLT And nut assortment 5/16 to 7/8 to 6 in. Hexhead, new government surplus, \$15.00 per 100 lbs. f.o.b. Check with order. Rolling-Equipment, 1125 Military Rd., Kenmore 17, N. Y.

## SURVEYING INSTRUMENTS

NEW And guaranteed factory rebuilt transits and levels, sale or rent, with purchase option. We will repair, trade or buy old instruments. Write for list M-50. Warren-Knight Co. (Manufacturers of Surveying Instruments), 136 N. 12th St., Philadelphia 7, Penna.

## ENGINES, MOTORS, DYNAMOS

FREE Catalog. Motor rewinders supplies, winding data, diagrams. Modern, Box 8715, Kansas City 14, Mo.

REWIND Motors yourself. Complete instructions, \$1.00. Catalog. Lewis Manufacturing, Howell, Michigan.

DIESEL Injector parts and fuel pumps wanted, GM51-53-71-110. Bares, 7120 Carnegie, Cleveland 3, Ohio.

WINDING Data. 275 motors, single and three phase \$1.10. Data Company, 512 Kensington, Kansas City 24, Mo.

## BOATS, OUTBOARD MOTORS

BUILD Boat trailers, pleasure, profit. Blueprints \$2.00. Circulars illustrated 6 models wholesale parts list 50¢. Kamcraft, Box 1153, Milwaukee 1, Wisc.

KYAK—Easily built, 10 feet. Stable, light, inexpensive. Folds compactly, sets up in 30 seconds. Plans \$1.00. Alligator Kyaks, 482 Arch St., San Francisco 27, Calif.

BOAT Plans. Build durable, good-looking, inexpensive boats from used auto parts. \$1.00 for plans. Boat Plans, Box 187, Washington, Iowa.

BOATS? Finished! Unfinished! See Easy Camping, Inc.'s ad under "Auto Trailers."

MONEY-Saving boat supplies. Outboard, inboard, sail, gameroom, gear, equipment, hardware, jewelry, instruments, controls, refrigeration. New inboard gasoline—diesel engines. We take old engine in trade—by mail. 125 page illustrated catalog, \$1.00 (rebated, first order). Free floating key ring sent with catalog. Boat Equipment Unlimited, Oceanport 2, N. J.

300 BOAT Plans, patterns; 215 pages, catalogs \$1.00. Marinecraft, Box 161-M, Brighton, Mass.

BATTERY Powered Boatloder. From water to cartop in one sweep. Send stamp for details. Boatloder, 2314 NW Marshall, Portland, Ore.

FIBERGLAS Boat covering, wholesale prices. Free literature and samples. Seifert's, Box 31M, DePere, Wis.

FAMOUS Waterbikes, Boca Raton, Florida. Details, photos, four models, \$1.00.

FREE Boat anchor plans, with air boat plans, material list, detailed instructions, photo, \$2.00. Normay, Box 427, Bensenville, Illinois.

WATER Proof, cast aluminum tail light with stop and directional control wiring. \$5.45 factory c.o.d. P.O. Box 555, Hawthorne, California.

FULL Size, cut-to-shape boat patterns, blueprints. 7 1/2-38 feet. Big new 88 pg. illustrated "Build a Boat" catalog of naval architect-designed Catamarans, cruisers, runabouts, skiffs, outboard boats, sailing, racing, houseboats. 50¢. "How to Build a Boat" booklet \$2.50. Equipment catalog \$2.00. Cleveland Boat Blueprint Co., Dept. A-66, Box 1651, Cleveland, Ohio.

MARINE Conversions. Ford, Chevrolet, Jeep engines. Catalog 25¢. Lehman Manufacturing Company, 800 Elizabeth Avenue, Linden 4, N. J.

SAVE Money. New boat anchor plans, 50¢. Normay, Box 427, Bensenville, Ill.

NEW, Used, rebuilt marine motors. Marine conversions, fittings. Free catalog. Stokes Marine Supply, Dept. 24, Coldwater, Michigan.

FORDS And Jeeps 100% marine engines with famous Convo-Kits. Deluxe catalogue 25¢ coin. Oscomotors, 3627B Lawrence, Philadelphia 40, Penna.

SAVE Money. New, used outboard motor parts. Send wants. Stamp appreciated. Outboard Motor Mart, 229-M State, Boston 9, Mass.

FRAME Kits, plans or full-size patterns for 35 inboards and outboards. Prepared for amateur builders. New 80 page illustrative catalog, 50¢. Glen Designs, 9152 Rosecrans, Bellflower, Calif.

FIBERGLAS Permanent boat waterproofing. Special 25% discount. Complete kits, \$9.45 up. Guaranteed materials. Easy application. Full instructions. Free literature. Mail post card. Ajax Plastics, P. O. Box 1323, Fort Worth, Texas.

FACTORY Propeller repair, inboard & outboard. Prompt and quality workmanship. Cochell Marine Company, 9135 Hall, Detroit 13, Michigan.

WHOLESALE: Buy direct from the factory. Fiberglass and coreglass runabouts, fishing boats, pontoon boats and houseboats. Free estimates on complete boat, motor and trailer packages. Also boats, pontoon boats and houseboats available in kits. Free catalog. Osage Mfg. Co., Box 117-M, Osage, Minnesota.

FISHERMEN. Build pontoon raft. Unique design, low cost. Particulars free. Carroll Haigler, Route #2, Box 366, Lenoir, N. C.

I Want to send you proof of the wonderful pulling power of Popular Mechanics classified pages. What's your proposition? Write me today. Include literature if possible. F. W. Johnson, Manager Classified Advertising, Popular Mechanics Magazine, 200 E. Ontario St., Chicago 11, Ill.

## ATHLETIC EQUIPMENT, BODY BUILDING COURSES

"BIG Muscles. The Quick Way." Dr. Young's revolutionary discovery. Free information. Gaucho, Box 9309-S7, Chicago 90.

BARBELLS, Dumbbells, Courses. Booklet 10¢. Good Barbell Co., Siloam Springs, Arkansas.

FREE Muscle building information. Body-Tone, Box 638B, North Miami, Florida.

MUSCLE Building course. Complete \$2.95. Durell, Box 321, Snowdon P.O., Montreal, Canada.

4 MUSCLE Courses 25¢. 12 courses \$2.00. Guaranteed. Sids System, PM-C3, 8421-C Evergreen, Southgate, California.

DEADLY Karate. Kung-fu fighting. Break planks bare-handed using breath, sand, straw, pebbles. Illustrated manual \$3.98. Oriental Book Sales, P.O. Box 1183, Oakland 7, Calif.

BACKACHE Sufferers. Many helped. Free literature. Lou Stein, 311 Delsea Dr., Woodbury, N. J.

## SPORTING GOODS, GUNS, FISHING TACKLE, ARCHERY, TRAPPING

BIZIBUG For spinning. New action! More bass! Free literature and introductory offer. Shaw Tackle Company, R. 2, Montevallo, Alabama.

MOLDS For fisherman's sinkers, jigs, squids, casting and spinning lures. Free catalog. Sweet's Molds, Tonawanda 1, New York.

10,000 GUNS. Antiques, moderns, swords, armour. Every description. Giant catalog \$1.00. Agramonte's, Yonkers 2 G, N. Y.

MOLDS—For casting your own fishing sinkers. Free illustrated booklet. Reading Instrument Co., Box PM78, Reading, Penna.

BIG Money raising crickets and 12 inch African fishworms. Free literature. Carter Ranch, Plains, Georgia.

FREE—Wholesale catalog. Beads. Spinners. Lure parts. Sinker molds. Jigs. Reels. FinnySports (ME), Toledo 6, Ohio.

AMAZING Wholesale sporting catalog. Save 70%. Tremendous selections. Econ-O-Mart, Whippany 2, New Jersey.



MR. Property Owner—Want a map of your property? Write Deed-Ettes, Mt. Pocono, Penna.

FREE Strout catalog! Farms, homes, businesses, resorts, retirement properties. Over 3000 values in 36 states. 58 years' service. World's largest! Write Strout Realty, 7-MF S. Dearborn, Chicago 3, Ill.

FLORIDA. Nice homesites, \$345 at \$10 monthly. Folder free. Howard Vernor, DeLand, Florida.

CANADIAN Tax sale lands, average price five dollars an acre. Small monthly payments. Farms, timber, hunting and fishing camps, minerals. Limited number of properties. Write at once for free catalogue. Tax Sale Service, Room 105, 120 Bloor Street, West, Toronto 5, Canada.

FLORIDA—Silver Springs area. 1/4 acre waterfront homesites. \$795.00, \$10.00 month. Free color photos. Write: Smith Lake Estates, Box 5681, Belleview, Florida.

OPPORTUNITIES! Government land, U. S., Alaska, Canada. Sledge Surveys, Macon, Mississippi.

FLORIDA Lot bargain! Only \$149 full price! (for limited time.) No money down—\$5.00 per month. On U.S.#441-27 between Ocala and Orlando. High and dry. Hard surface streets, electricity, phones, schools, churches. 3000 fishing lakes closeby. Write for free photos. Dept. 214A, Orange Blossom Hills, Box 1222, Leesburg, Florida.

CANADIAN Vacation lands: \$285.00 full price. 40 acres, \$10.00 month. Suitable cottage sites, hunting, fishing, investment. Free information. Land Corporation, 130C Shaftesbury, Downsview, Ontario, Canada.

#### FARM MACHINERY AND SUPPLIES

GARDEN Tractor—Nationally known—now sold at discount. Eliminates all hand hoeing, also tills. Nothing like it. Patent 2742840. Discount catalogue free. Autohoe, DePere 68, Wis.

ELECTRIC Welders. New, heavy-duty, 180 amp. Free trial. Dealerships open. 20 year warranty. 8159 South Pleasant Department A1. Minneapolis 20, Minn.

#### PROFITABLE OCCUPATIONS

MAKE Money making new greaseless doughnuts in kitchen. Sell stores. Free recipes. Michael, 3605 South 15th, Minneapolis 7, Minnesota.

BECOME Independent with your own franchise business. Thousands earning handsome incomes. Request interesting facts today. National Franchise Reports, PM-528, 333 North Michigan, Chicago 1.

BIG Money raising fishworms and crickets. Free literature. Carter Wormery, Plains, Georgia.

\$200 WEEKLY Extra introducing buyers to sellers, weekends. Men, women enjoy learning real estate by listening to records. First lecture free. Lee Institute, Brookline, Mass.

AUCTIONEERING—Home study course. Diploma granted. Auction School, Ft. Smith, Ark.

RAISE Pheasants on \$100 week plan. Little capital and space can make you independent. Free details. Great Central System, Columbus 1, Kansas.

VENDING Machines. No selling. Operate a route of coin machines and earn amazing profits. 32-page catalogue free. Parkway Machine Corporation, Dept. #25, 715 Ensor Street, Baltimore 2, Maryland.

GROW Mushrooms. Cellar, shed and outdoors. Spare, full time, year round. We pay \$4.50 lb. dried. We have 29,000 customers. Free book. Mushrooms, Dept. 99, 2954 Admiral Way, Seattle, Wash.

EARN \$240.00 A month at home, spare time doing only two \$5.00 invisible mending jobs a day. Big money paid for service that makes cuts, tears disappear from fabrics. Steady demand. Details free. Fabricon, 6236 Broadway, Chicago 40, Ill.

MAKE Flexible molds. Cast plaques, figurines. Free sample. Tooker, 1045-M Fairview, Hamilton, Ohio.

SHARPEN Scissors, pinkers. Inexpensive machine. Clipper sharpener. Black-hawks, Sheldahl, Iowa.

INVESTIGATE Accidents—Earn \$125 week to start. Claim investigators are urgently needed to investigate more than 490,000 accidents daily. Work full time for insurance company, railroad, steamship line, or government office. Or step into your own profitable spare time business. No experience needed. Free book. Now! Universal Schools, CPM-5, Box 8227, Dallas 5, Texas.

START A magazine subscription business. Earn generous commissions on Popular Mechanics, Good Housekeeping and all others. Best commissions, bonus, all materials sent free. No experience needed. Write Popular Mechanics, Room 5-P, 250 West 55th St., New York 19, N. Y.

FREE Book "990" Successful, Little-Known Businesses. Work home! Plymouth-7Y, Brooklyn 4, New York.

CONSTRUCTION Estimating—Learn professional career at home. General construction estimating course now available. High salary openings. Free information. Dept. B, Builders Publications, 1135 West Huntington Drive, Arcadia, Calif.

WHOLESALE Magazine subscriptions. Highest commissions. Bonus. Qualified Agencies, 451LA Kingston, Brooklyn 25, N. Y.

#### FUR BEARING ANIMALS

MINK Raising information free. Complete. Lake Superior Mink Farm, Superior, EE1, Wisconsin.

THOUSANDS Good chinchillas U.S.A., Canada. Star Queen, 749 Durward, Vancouver, B.C., Canada.

#### BOOKS, PERIODICALS, PICTURES, POSTCARDS

SIX Issues informative, interesting illustrated Alaska magazine, catalog and picture booklet only \$1.00. Alaska Specialties Company, Ketchikan, Alaska.

YOUR Complete bookstore. Free booklet. Reader-Services Company, Drexel Hill, Pennsylvania.

"HOW To" books. Many other fascinating subjects. Free catalog. Doran, 12-A Daffodil Lane, Wantagh, New York.

BOOKS. If it is a book you want, write to us. You name it—we'll get it for you. Prices reasonable. Wallace Hill Books, Box 97, Malvern, Ark.

LOCATE Any book. No obligation. Aardvarks Search Service, Santee, Calif.

BOOKFINDING Our specialty. Try us. Babcock, 412 Lulu, Wichita 11, Kansas.

OUT-Of-print books at lowest prices! You name it, we find it! Fast service. No obligation. International Bookfinders, Box 3003-PM, Beverly Hills, Calif.

BRITISH Book bargains—Any subject. Catalogues free. Transatbooks, Wantagh, N. Y.

FREE Catalog. Self-help books. Write: Wilshire, 8721 Sunset, Los Angeles 46P.

BOOKFINDERS! All subjects. Send wants! Jaher Book Service, 183 Hazelwood Drive, Westbury, N. Y.

NATIONAL Geographic magazines, 1888-1960, any issue. Periodical Service, Box 465-PM, Wilmington, Delaware.

SPARETIME Repeat profits taking magazine subscriptions. Special offers. Cassell Agency, Boynton Beach, Florida.

#### GAMES, TOYS, NOVELTIES

MAGNETS. Plastic. (12). \$1.00. Cosmic Enterprises, 4526 Miller, Gary, Indiana.

#### MAGIC TRICKS, PUZZLES, JOKER NOVELTIES

500 TRICKS. 1960 Edition Douglas 120-page catalog now available. Complete catalog—magic tricks and equipment. Just 10¢. World's fastest service. Douglas Magicland, Dept. A, Dallas, Texas.

EXCLUSIVE Tricks! \$2.50 precision made vanishing coin for \$1.00 plus "Top Hat Topics" booklets. Lou Tannen, 120 West 42nd Street, New York 36, N. Y.

BE A magician! Large professional catalog of latest tricks, 35¢. Ireland, C-109 North Dearborn, Chicago 2, Illinois.

3100 NOVELTIES, Jokes, tricks, gadgets, funmakers, hobbies. Big catalog 10¢. Johnson-Smith, D-498, Detroit 7.

WORLD'S Finest professional magic. Joker novelties. Giant illustrated catalog 10¢. Top Hat, Evanston 12, Illinois.

PROFESSIONAL Catalog. 175 pages, 25¢. Williams, 900 Plymouth, Ellwood City, Penna.

CATALOG. Free trick, 25¢. (1,500,399 tricks, jokes). Magico, Box 4373-P, San Antonio 7, Texas.

3000 TRICKS. Pocket, parlor, stage. World's finest magic catalog (408 pages). \$2.50. Kanter's, M-1311 Walnut, Philadelphia 7.

NEW! Learn tricks. Be a magician. Subscribe to Zombie, the magicians magazine! Send \$2.00 for subscription. 15217 Groveswood, Cleveland, Ohio.

DOLLAR Magic trick with catalog 50¢. Catalog only 10¢. Lohmers, 825 Lima P 56, Burbank, Calif.

#### COINS, TOKENS, CURRENCY

COIN Insert. Makes sorting, counting, inserting, and wrapping coins faster and easier, \$2.00. Free circular. Coin Find Company, 200 South Harding Road, Columbus 9, Ohio.

HAWAII Statehood dollar size coin. Brass 107 nickel silver 225 coins. 2950 Manoa Rd., Honolulu, Hawaii.

GOLD Poke, Colorado Centennial 25¢ piece. Four for \$1. Gold, 2955 17th, Boulder, Colorado.

INDIAN Head cents, two different only 15¢. Approvals. Littleton Coin Company, Littleton R1, New Hampshire.

HIGHEST Cash paid for U.S.A., Canadian coins. Illustrated catalogue 50¢. Metrocoins, 3104 N. Main, Fort Worth 6, Texas.

40 CAREFULLY Selected, all different. Lincoln cents \$2.50. 1959 Mint sets \$5.00. Lewis Martin, 43 Martin Lane, Radcliff, Kentucky.

FOREIGN Coin, banknote and large illustrated coin list for 5¢ postage. Bargains: Indian head cent, 10¢; Wooden nickel, 10¢; Chinese dollar, 53¢. Approvals included with every order. Tatham Coin Company, Springfield 30, Massachusetts.

CONFEDERATE State of North Carolina 5¢ note, crisp, \$1.00. Rasimas, 261 Millbury, Worcester 10, Mass.

TEN Fine (S) mint dimes 1946S-1955S \$3.00. Collectors list. Send stamp. United, 101 Cranston, Providence, R. I.

LINCOLNS, 25 Different 1909-1934, \$1.50. Harris, 1457 Moreno, Oceanside, Calif.

RARE: Canadian brown nickel, VF, 25¢. Louis Arpin, Stanbridge East, Miss., Quebec, Canada.

BRILLIANT Proof sets—1956 \$5.65; 1957 \$4.50; 1958 \$9.50; 1959 \$4.95; 1960 \$2.95. Beautiful uncirculated complete sets—Australia, Bulgaria, Denmark, Greenland, Hungary, Lebanon, Seychelles, Siam, Somalia—each \$1.65. World coin book \$4.15. World's greatest bargain catalogue \$1.00 (deductible first \$10.00 order). Bebee's, 4514 North 30th, Omaha 11, Nebraska.

SIX Different Indian cents \$1.00. Free discount list. Collector's Bargains, New Hope, Penna.

AMERICAN Buying list. 25¢. Kings Coins, Box 481, Oshkosh, Wisconsin.

40 DIFFERENT Jefferson nickels in folder, \$5.00. 100 different cents, \$8.00. Harlan Gates, 400 James St., Syracuse, N. Y.

LINCOLNS 50 Assorted dates, mints. Condition good to uncirculated. In coin folder. Send \$5.00 plus 35¢ toward postage. (No c.o.d.'s). New cleaning cloths for coins \$1.00 prepaid. Meyer Co., Box 868, Galesburg, Illinois.

\$42.95 FOR 30 Certain Lincoln cents. Details 50¢ (refundable on receipt of coins). Gary, Box 608, Maysville, Okla.

\$9,000.00 for 1913 Liberty Head nickel. We paid \$6,500.00 for one silver dollar, \$2,300.00 for one cent. Thousands of others we paid \$20.00 to \$1,400.00 each. Wanted certain dates: Cents before 1932—\$2,000.00; Nickels before 1940—\$275.00; Dimes before 1943—\$4,000.00. Canadian coins — 1921 Nickel \$200.00, 1889 Dime \$250.00, 1875 Quarter \$75.00, 1921—50¢—\$1,000.00. Hundreds of others listed in our catalogue worth \$100.00 to \$25,000.00 each. For complete alcoin information, before sending coins, purchase our large illustrated guaranteed Buying-Selling Catalogue \$1.00. Catalogue dollar refundable. Thousands of persons have sold us coins. Incorporated 1938. Worthycoin Corporation (K-440-C), Boston 8, Massachusetts.

WOW! Indian cent, foreign coin, bargain lists. 10¢. Hutchinson's, Box 4747, Philadelphia 34, Penna.

FOR Sale 1913S, 1924S, 1931P, 1932D, 1938S, 1939D cents. All six for \$2. Gasser, Box 34615, Los Angeles 34, California.

BRILLIANT Uncirculated United States five dollar gold pieces, \$15.00. Twenty dollar, fine, \$45.00. Rare Coin Company, 31 North Clark St., Chicago 2, Ill.

FREE List! U. S. coins. Lowest prices! Hugh's Coins, Hickory, N. C.

NEW 1960 Giant U. S. coin catalogue 25¢. Ace, 107 N. Dearborn, Chicago 2.

COIN News Magazine, 35¢, subscription \$3.00 year. Dept. P, 231 North 18th, E. Orange, N. J.

NUMISMATICS Largest newspaper. Semi-monthly. Sample 25¢. \$2.00 yearly. Numismatic News, Box 452, Iola, Wis.

FREE Bonus offer! U. S. bargain list, 10¢ (refundable). Economy Sales Company, Mansfield, Massachusetts.

SIXTEEN Page 1960 retail price list of USA and Canadian coins for 10¢. Our selling prices on thousands of coins and coin collectors' supplies. Bryson Incorporated, 612A White, Toledo 5, Ohio.

SPECIAL Old Morgan dime, quarter, half dollar, 28 page coin catalogue, \$2.00. Hobby Sales, Box 4054, St. Paul 16, Minn.

RAREST CC mint dollar, 1885 uncirculated \$10.00. Coin catalogue 50¢. Shultz, Salt Lake 10, Utah.

LARGEST Coin magazine, 200 pages, 50¢. Scrapbook, 7320-J Milwaukee, Chicago 31.

STARTER Collections. 15 Indian cents, \$2.50, 12 Liberty nickels \$2.50, 23 Mercury dimes, \$5.00, 15 Barbours quarters \$8.00, 15 Barbours halves, \$15.00. In folders. All different postpaid. Prager, 470 27th Avenue, San Francisco, Calif.

RARE Unc. 1899-P silver dollar, each \$5.00. Butts, Box 889, Torrington, Wyo.

### STAMP COLLECTING

ALBUM! Hundreds of spaces! Only 10¢. Postpaid! Stampmart, Hartford 1, Conn.

GIANT-Size issues collection: Laos elephant set, Brussels Fair, Olympic, Jet aircraft, Boy Scout, Somali animals complete. Romania flags. Togo set, diamond popes, UN set, etc., plus big stamp dictionary and approvals. Everything 10¢! Stampex, Box 47-KM, White Plains, N. Y.

FREE. 250 Peelable hinges and 20 different Brazil with approvals. Jaydee, 218 Dickinson S.W., Grand Rapids 7, Mich.

FREE! \$1.00 Worth, your choice, from first selection. No strings! Adults only. Rush request now. Philatelies, Dept. RF, New Paltz, N. Y.

U.S. \$1, \$2, \$5. Special—10¢, with approvals. Stevens, Box 24, Bay Station, Brooklyn 35, New York.

150 DIFFERENT United States stamps, fabulous value only \$1.00. Free United States price list. Universal, Box 6, Kenosha 5-C, Wisconsin.

INTRODUCING Our better United States approvals we offer 15 United States stamps including Columbian, Bi-Centennials, famous American, airmail, others: only 10¢. Ocean Stamps, Box 64-PM, Brooklyn 29, New York.

10 BEAUTIFUL Mint British Colonies 10¢ with approvals. Bennett, Candor 3, N. Y.

PENNY Approvals, Thousands, Bargains for pennies. Gifts with purchases. Penny Stamps, Orange, California.

UNITED Nations. Five different 10¢. Approvals. Anderson, 1112 Harrison, San Francisco 3, Calif.

TERRIFIC Value. Eight complete mint sets 10¢ with approvals. Beatties, 58 Glenagar, Islington, Ontario, Canada.

25 DIFFERENT Commemoratives 1893 up 10¢. U. S. approvals. K&B, Box 70, Brooklyn 23, N. Y.

FREE Sample! Interesting, informative, illustrated. National Stamp News, Anderson, South Carolina.

TRADE Your duplicates toward our approvals! (Foreign only.) Complete information, 10¢. Variety Stamps, Box 98-P, Newton Highlands 61, Mass.

307 WORLDWIDE Different stamps only 25¢. Approvals. Niagastamp, St. Catharines 671, Ontario.

MINT U.S. at face! Older commemoratives only. Send 25¢ for all different packet with first selection mint U.S. approvals. Western, Box 1689P, Salinas, California.

60 DIFFERENT U. S. (30 commemoratives) 25¢. No approvals. Seidenberg, Appleton, Wisconsin.

GIANT Approvals, thousands different, 1¢ and 2¢ each. Wahl's Stamp Exchange, 7008P Farragut, Chicago 31, Ill.

UNITED States commemorative collection containing 33 different—10¢. Approvals. White, 516-A Avenue L, Brooklyn 30, New York.

SELL Your surplus good grade stamps. Write, describing fully what you have. Vanroy Shirk, Lebanon, Pennsylvania.

AMAZING OFFER! 200 United States stamps — including commemoratives, airmails, high denominations to \$1.00. Only 10¢ to approval applicants! Illustrated bargain lists free. Mystic Stamp Co., Dept. 80, Camden, New York.

100 STAMPS, 10¢ With approvals. Smith, 508A Brooks, College Station, Texas.

OLD Scarce U.S. seconds on approvals. Slight imperfections, lowest prices. Hernefield, Cliftonhill Sta., Newark 8, N. J.

100 OLD United States between 1861 and 1935, \$1.00. Roush Stamps, 51 Chestnut, Mansfield, Ohio.

225 STAMPS For only 10¢! This mammoth value includes airmails, pictorials: stamps from strange countries cataloging up to 25¢ each! Also approvals. Mystic Stamp Company, Camden 80, New York.

UNITED States price list, 116 pages, price 25¢. Mark Hanna, 335 Fifth Ave., Pittsburgh 22, Penna.

SELL Stamps to our readers. Your ad in this space will be read by thousands of stamp buyers. I'll prove that to you. Write now for Folder "S." F. W. Johnson, Classified Advertising Manager, Popular Mechanics, 200 E. Ontario St., Chicago 11, Ill.

14,000 DIFFERENT! Amazing new plan builds your collection systematically, country by country. Only 50¢ weekly. Free details. L. G. Ware, Stepmey 75, Conn.

U. S. Mint flag set, complete, \$1.00. Free list. Brooks, 2323 Avenue X, Brooklyn 35, New York.

103 DIVERSIFIED British colony stamps only 10¢. Approvals. Niagastamp, St. Catharines 671-A, Ontario.

50 DIFFERENT British colonials 10¢. Approvals. Robert Searjeant, Mendon, N. Y.

90,000 STAMPS Sale. Terrific bargain lots, hundreds of stamps \$1.00. Giant assortment better stamps \$5.00. High value packet \$3.00. Persile, 436 N. Y. Ave., Brooklyn 25, N. Y.

102 DIVERSIFIED Worldwide stamps 10¢. Approvals. Linstamp, St. Catharines 618, Ontario.

FREE United States price list of singles, plate blocks, FDC's. Introductory discount. Bailey, 45-G Bromfield, Boston, Mass.

PENNY Approvals! Regardless catalogue! Kloster, 4164—52nd St., San Diego 5, Calif.

25 DIFFERENT Large American commemoratives 10¢. With approvals. Linstamp, St. Catharines 618-A, Ontario.

105 BRITISH Colony stamps, all different 10¢. Approvals. Crown Stamp Company, 901, Virgil, Ontario.

50 DIFFERENT Stamps free! Approvals Marford, Box 48, Queens Village 29, New York.

FREE! Liberia airmail triangle, diamond midget, mammoth to approval buyers. Plymouth, Dept. A-8, Bell, California.

SUPERIOR Worldwide mission mixture Amazing variety! Six ounces \$1.65. Pounds \$3.95. Bay Nielsen, 4545B Harvard, Montreal 28, Canada.

100 DIFFERENT Belgium free. UPU. Brussels Fair, railroad stamps free. Approval applicants only. Trylon, Box 31-P, Brooklyn 30, N. Y.

FINE U.S. stamps, \$5.00 Coolidge of the 1938 Presidential series, and the \$5.00 Hamilton of the 1954 series. Both for only \$1.00. Fine U.S. approvals included. Willert Co., P.O. Box 338, Dept. 45, Yorktown Heights, N. Y.

FREE! Over 100 different, \$2.50 value, including space satellite. Israel, British, U.S., first U.N., Siberia. Approvals. Send 25¢ for mailing. Horace Gatewood, Winston-Salem, N. C.

508 DIFFERENT World-wide from Formosa, Morocco, Indonesia, etc., cataloging over \$15.00, only 35¢. Offer to adults only. Approvals. Littleton Stamp Company, Littleton Q1, New Hampshire.

FREE Any volume Scott's International albums. Scott's 1960 catalogues, even master Global Albums free, when you buy our sensational foreign approvals. Bargain Stamps, Redlands 2, California.

FREE Monaco nudes. Hurry. Stamp Ranch, 902 Addison, Chicago 13, Ill.

1002 DIFFERENT Worldwide for approval buyers only. Jacobsen, Crompond, N. Y.

50 CHINA 10¢. Approvals, gifts. Coast, P.O. 2187A, Santa Ana, California.

BONANZA! 100 Different pictorials, mostly large, 20¢. Approvals. Curran Stamps, 16 Curran, Whitesboro, N. Y.

LOOK It's different. Packet worldwide pictorials identified ready for album. One dollar. Langford's, 53 Durham Road, San Anselmo, Calif.

50 FREE Approvals, Adults, Patton's Stamps, 660 Cal., Boulder City, Nev.

FREE! Afghanistan, Bahawalpur, Negri Sembilan, Tanganyika, Thailand. Inexpensive approvals accompany. Nade's, 6316 Crescentville, Philadelphia 20, Penna.

STAMP Grabs 50¢. Three for \$1.00. Lore Company, Dedham, Mass.

40,000 FOREIGN Stamps! 2¢ each! Request thrilling approvals! ABC, Box 849-AM, San Francisco 1, California.

INTERESTING Worldwide animal stamp collection 10¢. With approvals. Niagastamp, St. Catharines 671-B, Ontario.

QUEEN Elizabeth on stamps. A beautiful collection of 50 different stamps from 22 countries, all bearing the portrait of the Queen of England. 10¢ with approvals. Capital Stamp Co., Ferrysburg 2A, Mich.

TOGO Olympics, complete mint, 20¢ with request for approvals. Rasimas, 261 Millbury, Worcester 10, Massachusetts.

FREE 400 Genuine postage stamps! Worth \$10.00 at catalogue prices. Africa, Europe, Asia, British Emp. A fascinating, valuable mixture from foreign convents, banks, etc. Who knows what you will find. Also free helpful collectors handbooks. Adults only. Fine approvals enclosed. Fraese Co., PM, White Plains, N. Y.

FREE. 10 Different Korea with approvals. Andrew Bakasy, 4th Missile Command, APO 8, San Francisco, Calif.

TERRIFIC Stamp bargain! Israel, Iceland, Vatican assortment—Plus exotic triangle set. Also fabulous British Colonies accumulation. Plus large stamp book. All four offers free. Send 10¢ to cover postage. Empire Stamp Corp., Dept. PM, Toronto, Canada.

BASUTOLAND Provisional free, approvals. Rushstamps, Rushington Avenue, Totton, Hampshire, England.

100 DIFFERENT U.S. commemoratives 50¢. Approvals included. Shelron, Box 907K, New York 8, N. Y.

DEALERS—Wholesale list. Postage 4¢. Frank, 5031 Queensberry, Baltimore 15, Maryland.

125 DIFFERENT U.S.A.—\$1.00. Approvals. Utechts, 1143D North Keeler, Chicago 51.

LARGE Pictorials. 10¢ with approvals. Schaefer, Californiastrasse 16, Wiesbaden, Germany.

10 CANAL Zone 25¢. Approvals! Merkel Stamps, 30 Grandview, South Hadley Falls, Mass.

DAMAGED Old U.S., ½ catalog. Approvals. K. Swartz, Malden Bridge, N. Y.

FANTASTIC Fish triangles! Valuable "Ben Franklin" on Canal Zone! Flaming bi-colored volcano triangle! Lovely Olympics triangle! Plus icy Greenland, weird wild beast issue and others, 10¢ with approvals. Ozark Stamps, Spring Lake 2, Michigan.

FREE! World's largest! Strange, valuable 7 x 14½" beauty. Send 10¢ handling now! Norrisco, Milwaukee 7, Wis.

FREE 10 Japan war stamps. Approvals. Schroeder, 1486½ Sherburne, St. Paul 4, Minn.

WILL Buy entire collections. Cash. What have you? What's your price? Remit \$1.00 for appraisal. Pyramid, 712 Elizabeth, Fresno 4, Calif.

U.S. Stamps. Giant discount catalog—20¢. Raymax, 37VZ Maidenlane, New York City 38.

SPECIAL! 105 Stamps 10¢ with approvals. Harlon Hicks, Calhoun, Kentucky.

BRITISH Colonies. Better approvals. Adults, Ardee, 1909 Polk, Wichita Falls, Texas.

WEST Indies assortment 25¢. Approvals. Binkowski, 944 Park, Schenectady, New York.

JAPAN Mint lowest, airmail approvals. Write now legibly. Taiyo Stamp Co., Box 22, Adachi, Tokyo, Japan.

151 DIFFERENT U.S. commemoratives \$1.00. Carstamps, 739 Ordway, Freeport, Illinois.

STOP Looking for beginners for penny approvals. Schnobelen, Columbiana, Ohio.

SPRING Offer 1100 worldwide stamps \$1.00. 3500 \$3.00. Harrison's Stamps, 1435 First Ave., Oakland 6, Calif.

SWEDEN—100 different, 25¢! Inexpensive, worldwide approvals. Carling, Howard City, Michigan.

U.N. Commemorative set 10¢ to approval applicants. Fine Stamp Co., Box 71, Detroit 24, Mich.

FREE Packet! Five different foreign countries. Request fascinating approvals. Coral, Box 55, Valle Crucis, N. C.

FREE—Larger smaller triangles. 25 others. Approvals. The Tepp Company, Box 123, Baldwin, New York.

FREE! Set of six stamps from Cyprus with approvals. Fire Island Stamp Company, Box 37A, West Islip, New York.

LOOK! Six Queen Elizabeth mint sets from Singapore, Malta, Virgins, Mauritius, Montserrat, St. Kitts! 21 brilliant pictorials. 25¢. Attractive approvals! Gannon Stamps, Box 931, Canton, Ohio.

FREE Surprise "mystery" packet. Request approvals. Dancer, 75-P10, Mansfield, Ohio.

ZOWIE 50 Different U.S.—10¢ with U.S. approvals. Price lists. Stamps, Kennebunk, Maine.

BUILD Collections from packets. Sherman, 6728 N. Talman, Chicago 45, Ill.

CHEAPEST ¼¢ To 1¢. Excellent foreign. ½ catalogue. Tobysco, Gloversville, N. Y.

25 LARGE U.S. commemoratives 10¢ with approvals. Jack Clancy, Box 2187, Portland 14, Oregon.

FREE! 25 Different Australia. Approvals included. CBR, 6931 South Merrill, Chicago 49, Ill.

ADULTS! Like stamps? Then start your own mail-order business. Our free guidance program shows you exactly what to do. makes it easy, profitable for you. Details free! Columbia, 45-09-MP Broadway, Long Island City, New York.

GODS Of ancient Greece; Croatian Legion; Roosevelt memorials; U.S.; U.N.; many others free when purchasing approvals. Stamp Farm, M2-22, Oxford, Wis.

FREE Set with penny approvals. Filafancar, Box 578, Aguadilla, P. R.

UNITED States, Canada, British Colonies' Quality approvals. Enclose 10¢. Peterson, 405 Northwestern Bank, St. Paul 1, Minn.

HUNGARY, Latest bicolored "Butterflies"—free! Approvals. William Deems, 226 Race, Ravenswood, West Virginia.

50 DIFFERENT Icelandic stamps. Sent postpaid \$1.00. Box 809, Reykjavik, Iceland.

#### ANTIQUES, RELICS, INDIAN GOODS, CURIOS

FIND Buried battle relics, coins, silverware. Transistorized M-Scope electronic locator. Guaranteed. From \$59.50, easy terms. Free catalog. Fisher Research, Dept. C-1, Palo Alto, Calif.

WANTED—Mechanical penny banks, cap pistols. Top prices paid. Description, price. David Appel, 145 Grandview Blvd., Yonkers, New York.

SCALPING Knife, spearhead, thunderbird \$4.00. Catalog free. Arrowhead, Glenwood, Arkansas.

ANCIENT Grooved stone tomahawk \$3.00. Indian relic list free. Lear's, Glenwood, Arkansas.

4 ARROWHEADS \$1.00. List. Smith, 841 N. Tacoma, Indianapolis 1, Indiana.

#### PRECIOUS STONES, MINERALS

GET Free catalog no serious rockhound, gem cutter, jewelry maker, hobbyist or craftsman can be without. Full of bargains, exclusive items, low prices from largest suppliers and authorities in the field. Free, new catalog just off the press, yours for the asking! Write Grieger's, Dept. C-11, 1633 E. Walnut, Pasadena, California.

PROSPECTORS! Learn from experienced geologists how to locate and identify rocks and minerals. A comprehensive home study course designed for anyone interested in exploring for valuable ore deposits. Write now for free literature. Pacific School of Mines, Dept. B5, Box 2538, Palm Springs, Calif.

FREE Bargain gem list. Lapidary and silversmith catalog. 56 pages. 25¢. O'Brien's, 1116M Wilcox, Hollywood 38, Calif.

"GEMS & Minerals Magazine," largest rock hobby monthly. Field trips, "how" articles, pictures, ads. \$3.00 year. Sample 25¢. Box 687A, Mentone, California.

INDIA Importer has crystal and gem specimens for rock collectors; uncut; this material not perfect enough for gems, but will greatly enhance your collection. India star rubies from 75¢ to \$1.25. Moonstones 65¢ to \$1.00. E. D. Skinner, Box 4252, Station K, Milwaukee 10, Wis.

SEMI-Precious uncut gems. Ten different for \$1.00. Request list 26. Prospectors Shop, 201 San Francisco, Santa Fe, New Mexico.

EARTH Science, the rockhounds national magazine. Subscription \$2.00. Sample 35¢. Box 1357-PM, Chicago 90, Ill.

#### HOBBIES AND COLLECTIONS

ARMOR, Swords, daggers, illustrated list 10¢. Cavalier, Box 57, Middle Village 79, N. Y.

COLLECT Military medals: Medal of Honor, \$1.50; Silver Star, 50¢; Air Medal, 50¢; Bronze Star, 50¢. American and Foreign Catalog, 25¢ each. Hobbies, Box 71-M, Rockaway 94, N. Y.

COLLECTORS Matchbook covers, 100 different unused, \$1.00. Catalog 25¢. Album \$3.00. Charles Edelman, 1311-C East 84, Cleveland 3, Ohio.

HOME Developing. Easy, fascinating. Printing box instructions, diagrams, \$1.00. P. J. Macko, 521 Blossom, Campbell, Ohio.

NEWEST Periodical for the collector of anything! Year, \$3.00. Copy, 35¢. The Collector, Millersburg 3, Penna.

SHELLS—100 Assorted \$1.00 postpaid. Price list 10¢. Varble's, Harlingen, Texas.

WAR II Souvenirs. 6 samples and large illustrated book. Lists \$1.00. Hobbyland, Calgary, Canada.

#### PHOTOGRAPHY, CAMERAS, PHOTO SUPPLIES

EARN \$200 Month with your camera. Details free. Photo, Box 8008, Huntington, W. Va.

164 PAGE Photographic bargain catalog, listing thousands of photographic bargains. Send 25¢ for your copy, credited on first order. Dept. 1-C5, Central Camera Company, 230 So. Wabash Ave., Chicago 4, Illinois.

#### PHOTO FINISHING

SAVE On photo service. Kodachrome 8 exposure roll—\$2.50. 12 exposure—\$3.50. Reprints 25¢. Black and white 8—50¢. 12—70¢. Reprints—5¢. Fast Kodachrome, Ektachrome and Anscochrome processing. Free mailers and price list. Save on! Photo Service, Box 50, Watertown, Wis.

INTRODUCTORY Special. Processing Kodachrome 8mm movie or 35mm 20 exp. \$1.00. Kodachrome 8 exp. complete \$2.00; 12 exp. \$3.00. Black and white 8 jumbos 40¢. Jumbo reprints 5¢. Quality guaranteed. Prompt service. Write for free mailers. Fast-X-Foto, Dept. PM, Box 7A, Jersey City, N. J.

FILMS—Developed and printed 50¢—127, 620, 120 film. Color film developed and printed, save 25 to 33½ discount on all color work. World's finest quality. Send for mailers-price list. Apex Photo, Box 511, Paoli, Penna.

FREE! Kodak film for life. New Kodak film for every roll you send to develop. Jumbo size. Black and white: 8 exp. 80¢; 12 exp. \$1.05. Kodachrome: 8 exp. \$3.50; 12 exp. \$4.50. Send for price catalog for more savings. Satisfaction guaranteed. Yankee Photo Service, Box 1820-PM, Bridgeport 1, Conn.

A Triple value. Quality, price, service. Color or black and white, 12 exp. (black and white) 59¢. 20 gift photos \$1.00. Holiday Photos, Dept. 16, Box 666, Denver, Colo.

A 3-In-1 value. Price, quality, service. 20 gift photos, \$1.00. 12 exposure rolls (black and white) 59¢. Color or black and white. Interstate Photos, Dept. 11, Box 15, Aurora, Ill.

KODACHROME Processing by Kodak. 8mm. roll or 35mm., 20 exp., \$1.40. Prompt service. Write for mailers and prices. Color Pix, Dept. P, CPO Box 30, Kingston, N. Y.

TWELVE Exposure rolls 49¢. Wallets 20 for \$1.00. Lincoln Studios, Dept. K, Box 13, Lincoln, Nebr.

ROLL Developed, 8 beautiful enlarged prints 39¢: 12—59¢. Reprints 5¢. Willard's, Box 2554A, Cleveland, Ohio.

REPRINTS 3¢. Return postage 10¢. Photos, Box 342, Oshkosh, Wis.

BEAUTIFULLY Colored. Guaranteed natural. 8x10 \$1.00. 8 jumbo prints promptly 39¢. 12—59¢. Dick's Photo, Louisville 12, Ky.

#### MOTION PICTURES AND SOUND EQUIPMENT

FREE Every month. Blackhawk's news-paper-size catalog 8mm., 16mm. movies, 2"x2" color slides. Biggest selection in USA. Bargains in used 16mm. sound films, projectors. Blackhawk Films, Davenport 14, Iowa.

5,000 8-16MM. Movie films. Free catalogues. International, Greenvale, N. Y.

MOVIE Camera film: 8mm. roll \$1.50. 16mm. 100' \$3.00. Free processing. Better Films, 742 New Lots, Brooklyn, N. Y.

16MM. Sound shorts. Tremendous assortment features, \$16.50 up. Used 16 mm. sound projectors, \$79.50 up. Catalog. Abbe Films, 417 West 44th Street, New York City 36.

16MM. Sound films. Bargain bulletin. Duquette, 97-T Snow, Fitchburg, Mass.

MOVIE Film! Free catalog! ESO-R, 47th Holly, Kansas City 12, Missouri.



16MM. Sound, projectors, films. Sale rental, exchange. Visit store or write for catalog. National Cinema, 71 Dey St., New York City.

10¢ BRINGS Big new cine manual for the 8mm.-16mm. movie maker. Save money on fresh b&w and color movie film, all home processing equipment. Superior, 448 N. Wells, Chicago 10.

SPECIAL Entertainment—8 mm. b&w. 50 feet \$12.00. 16 mm., b&w, 100 feet \$20.00. Tex, Box 368, Terminal A, Toronto, Canada.

ADD Sound to 8mm. movies. Write: Phototronic, Fort Atkinson, Wis.

16 MM. Sound—8mm. Sale, rental. Entertainment Films, 2021 Broadway, New York City.

BARGAINS 16MM sound features shorts. Bedner, 5300 So. Talman, Chicago.

35MM. Films, free lists. Advance, 4423 June, St. Louis 20, Mo.

CARTOONS Title movies add fun to your films. Large list 8mm, 16mm free. Covers every situation. Cartoon Movies, 105 Washington St., Boston 8, Mass.

16MM. Sound movie features at lowest prices. Free list. Cinemart Films, Box 75695, Los Angeles 5, Calif.

### COLOR SLIDES

LINCOLN Story, complete in 500 color slides. Catalogue and sample, 35¢. Willems, Box 1515-A, Chicago 90.

TRANSPARENCIES Wanted. Up to \$500.00 each. For information write: American Color, Box 38391, Hollywood 38, California.

COLOR Slides of American beauties. Listings. Slides, Box 384, Chicago 90, Ill.

FIVE Cents each! Sampler assortment 20 beautiful 35mm. scenic color transparencies \$1.00. Five samples 25¢. Mounts 3¢ for 50¢. Slide Supply, Box 1031-P, Canton, Ohio.

TITLE Your films. 8mm or 2"x2" slides. Sample plus illustrated catalog 25¢. Title-Color, FT-5, 3618 Marsh Lane Place, Dallas 20, Texas.

### MUSIC & MUSICAL INSTRUMENTS

SONG Poems wanted. Free examination. Send poems. McNeil, Master of Music, 1112 PM Wilshire, Santa Monica, Calif.

PROFESSIONAL Services for amateur songwriters. Colonna Enterprises, Box 888, Burbank 1, Calif.

ELECTRIC Guitars, amplifiers, wholesale. Free catalog. Carvin, PMM, Covina, Calif.

SONGWRITERS, With publisher contacts, want song ideas. Share royalties. No fees. Send poems: Songwriters' Associates, 1650 Broadway, New York City 19-G.

SONGPOEMS And lyrics wanted. Mail to: TinPan Alley, Inc., 1650 Broadway, New York 19, N. Y.

POEMS Wanted for musical setting and recording. Send poems. Free examination. Crown Music Company, 49-C West 32 Street, New York 1.

POEMS Wanted for musical setting and recording by America's largest song studio. Send poems. Free examination. Five Star Music Masters, 630 Beacon Building, Boston.

POEMS Needed immediately for new songs and records. Free examination and appraisal. Send poems: Songcrafters, Acklen Station, Nashville, Tenn.

GUITAR Making books, plans, imported woods, tools. List 10¢. Satinwood, 510 East 11th Street, New York 9, N. Y.

LEARN Musical instrument of your choice—easy: New home study course, tape recorder furnished. Write for free brochure. Carver School, Box 366-P, Palos Heights, Ill.

VIOLINMAKERS. Repairers. Fine tone wood, and all violin supplies. Send for free wholesale new price list. International Sales, 414-MPM E. Baltimore St., Baltimore 2, Maryland.

16 TOP Tunes on 45 RPM records. \$2.00 postpaid. Babson, 1209 South Kerr, Wilmington, N. C.

LYRICS Revised \$2.00. Satisfaction guaranteed. H.S.R. Service, 1916 W. 78th Place, Los Angeles, Calif.

### RADIO, TELEVISION AND ELECTRONICS

AMPEX Tape recorders. Components. Boynton Studio, 10-PM Pennsylvania, Tuckahoe, N. Y.

TUBES—TV, radio, transmitting, special purpose types. Bought, sold, exchanged. Unused only. Send details to Barry Electronics Corp., 512 Broadway, Dept. PM, New York 12, N. Y.

CASH For used short-wave ham receivers, transmitters and accessories. Treger, W9IVJ, 2023 N. Harlem Ave., Chicago 35, Tuxedo 9-6429.

FREE! Giant wholesale catalog on electronics, hi-fi, transistor, scientific, hobby, optics, photographic, housewares, jewelry, tools, novelties, toys. Write: Lektron, 131M Everett Ave., Chelsea 50, Mass.

TAPE Recorders, Hi-Fi components, sleep learning equipment, tapes. Unusual values. Free catalog. Dressner, 69-02M, 174 St., Flushing 65, N. Y.

LEARN While asleep with amazing "Electronic Educator" endless tape recorder. Details free. Research Association, Box 24-N, Olympia, Washington.

GOVERNMENT Surplus radios, parts. Picture catalog 10¢. Meshna, Malden 48, Mass.

ELECTRIC Guitars, amplifiers, wholesale. Free catalog. Carvin, PMR, Covina, Calif.

RECORDERS, Hi-Fi. Free wholesale catalogue. Carston, 125-PM E. 88, New York City 28.

SOUNDLESS Television commercials with my ingenious device, \$3.25. Picture stays on. Moneyback guarantee. Voice Control, 234 Monroe St., Passaic, New Jersey. Patent Pending.

FIX Your own TV. Save 80%! Send for free illustrated chart showing how! We'll include giant electronics catalog. Zalytron, 220-M West 42 St., New York City.

RECORDING Tape by America's number 1 manufacturer. 1200'—3 for \$4.65. 1800' Polyester, 3 for \$6.95. 2400' Mylar, 3 for \$9.60. Add 15¢ per spool parcel post. 12 reels or over, additional 10% discount. Send for low, low quotation any Hi-Fi component or tape recorder. Hi-Fidelity Center, 1797M 1st Ave., New York 28, N. Y.

RADIO And TV tubes at manufacturer's prices! 100% guaranteed! Brand new! No re-brands or pulls! United Radio, Box 1000-M, Newark, N. J.

HI-FI Cabinets direct from factory at large savings. Also good deals on custom components. Send 10¢ for information. Daily Mfg. Co., Rockwell, N. C.

FACTS And shortcuts to TV repair. Best booklet available. \$1.00. Electronics, Box 7242, Oklahoma City 12, Oklahoma.

HI-FI Radio kit, complete, only \$2.00 postpaid. Matteson, 909 West Michigan Avenue, Jackson, Michigan.

SPECIAL—A one transistor pocketsize radio \$5.95 postpaid. Free literature in U. S. Alessi Sales, Main P.O. Box 323, Yonkers, N. Y.

### BUSINESS OPPORTUNITIES

\$10,000 YEARLY. Finish figurines, plaques, lamps, etc., at home. Details and illustrated catalogue 25¢. Figurines, Box 1175, Lansing, Michigan.

"50 NEW Home-Business Ideas" booklet, sample free. Spray exotic Velvet-Suede on anything. Flokcraft-MY, Los Angeles 61.

HOW To operate profitable mail order business. Write: American Distributors, Box 409-p, Niles, Michigan.

LEARN Landscaping and the growing of plants. Start a profitable business part or full time. Free information without obligation. National Landscape Institute, Dept. MC-50, 11826 San Vicente Blvd., Los Angeles 19, Calif.

FORTUNES In small sign shops. Strahley, 410 So. Western, Springfield, Ohio.

MAILORDER. America's most unique no cost plan for beginners. Armstrong's, 154 Darrington S.W., Washington 24, D. C.

NATURAL Molding rubber, extra thick. Free samples. W. Wooley, 2801-A Latrobe, Peoria, Illinois.

I Got rich in dry cleaning business with no investment, so can you. Free details. Write: Imperial School of Dry Cleaning, Dept. PMC, 1700 Touhy Avenue, Chicago 26, Illinois.

ADULTS. Receive several different magazines jammed full of exciting business opportunities that you can't afford to miss out on. Send only \$1.00 to: Zephyr Enterprises, Box 1484, Dept. D, Hartford 1, Connecticut.

DOLLS! Dolls! Dolls! We teach you to repair, make, sell all kinds of dolls and accessories including clothing. Study at home. Earn while you learn. Free catalog. Doll Hospital School, Studio MC-50, 11826 San Vicente Blvd., Los Angeles 49, Calif.

PROFIT With Popular Mechanics' subscription plan. No investment, no experience needed. Earnings begin immediately when you obtain subscriptions for Popular Mechanics, Good Housekeeping and others. High commissions, bonus. No experience needed. Deal directly with the publisher. Write Popular Mechanics, Room 5B, 250 West 55th St., New York 19, N. Y.

START Your own business on credit (U.S. and Canada). Your own boss. 1396 dealers sold \$5,000 to \$25,500 in 1959. We supply stocks, equipment on credit. 200 home necessities. Sales experience unnecessary. Pleasant profitable business backed by world-wide industry. Write Rawleigh's, Dept. E-U-PPM, Freeport, Ill.

SPECIALIZED Magazines. Free list. Over 5,100 current copies, all trades, hobbies, sports. Thousands of self-help books. Publications, Box 55429, Indianapolis 5, Indiana.

\$250.00 WEEK Profit possible. Earn at home spare time with fascinating printing method. \$5 start up. Send no money now. Free confidential facts and valuable samples. Screen-Print MY, Los Angeles 61.

IMMEDIATE Profits with no capital or experience. Take orders for all magazine subscriptions. Friends and neighbors are your prospects. Write now for complete, free kit. McGregor Magazine Agency, Dept. 6B, Mount Morris, Illinois.

IMPORT-Export opportunity, profitable, world-wide, mail-order business from home, without capital; or travel abroad. Established world trader ships instructions for no-risk examination. Experience unnecessary. Free details. Mellinger, C705, Los Angeles 24.

WANTED, Men, women. Raise bait for us at home. Full, spare time. Doesn't take-up space. We furnish everything. Sherwood, Dept. B-2, Monmouth, Maine.

MAKE Extra money—Big cash commissions plus premiums for you and your customers. Sell advertising book matches. Sensational new tenorama, glamour girls, hillbillies; dozens others. All sizes. Quick daily sales; big repeat business. Free master kit makes selling easy. No experience necessary. Superior Match, Dept. MX-560, 7530 Greenwood, Chicago 19.

SALES Representatives, distributors wanted! National sales organization being formed to sell an imported spark plug! High quality, priced to sell, solid profits! Big potential market: automotive, motorcycle, scooter, outboard motors, commercial fields. Write: Hap Jones Distributing Co., 2 Clinton Park, San Francisco 3, California.

TRAILER, Boat, auto dealers. Sell sensational new inflatable travel trailer. Patent pending. Write: Spacecraft, P.O. Box 7984, Kansas City, Missouri.

START A smoke fish business for a large profit. Smok'em for real eat'en pleasure. Every sportsman should know how to smoke fish. \$1.25 postpaid. Write: J. G. Osborn, P.O. Box 747, Newark, Ohio.

NEW Home-import mail order profitability! Your mailbox stuffed with money! No selling. No experience. No investment. We supply everything. Free details. Mail Order Distributors (Import Division), 15201 South Broadway, Los Angeles B55C, Calif.

BECOME Finance specialist. Handsome profits. Tucker Associates, 3633 Warder N.W., Washington 10, D. C.

**INVISIBLE** Reweaving: \$5 in one hour possible reweaving burns, tears, moth-holes. Spare-full time. Free details. Skill-Weave, Dept. WC-165, 335 W. Madison, Chicago 6.

**AMAZING** Home-business. Big earnings, sparetime. Typewriter helpful. Samples, instructions 50¢, refundable. Interstate, 37-1 Besch, Albany 9, N. Y.

A Business of your own. National company seeks a sincere mechanically handy individual looking for a good solid business. Work from home full or part time to start, servicing repeat customers. We train. No canvassing. No high pressure. Our business is a necessity and provides a lifetime secure high paying income. Small investment. Please submit brief resume. ECA Corporation, 15 S. 21st Street, Philadelphia 3, Penna.

**MAKE Money!** Pocket size business. Sell "Blu-Arc" king size lighter flints. Every smoker a prospect. Attractive, colorful plastic tubes containing 6 flints each. Cost 5¢, sell 15¢. 100 tubes \$5.00, cash or money order. Bay Products Co., Bay Village, Ohio.

**CALIFORNIA** Report 1960 shows how you can share in soaring sixties. California profits. Jobs, land, real estate, business, sunshine living. Published by successful California engineers. Step-by-step procedures, contacts, profit areas for individuals with desire. Skeptical? Only one person in 1000 will take full advantage of the California report. This is an honest opportunity. Not a get-rich-quick deal. Price \$3.00. Satisfaction guaranteed. James MacKay, Prof. Eng's., 356A West Avenue 43, Los Angeles 65.

**WANTED:** Home producers, to be subcontractors. Cast plastic products for manufacturers in our clearing house service. Thousands of easily made items required. Cash in at home, without previous experience. Plastic Service Associates, Dept. 5-PM East Boston 28, Massachusetts.

**NEW World of opportunity!** It's yours, when you discover the fastest-growing field for service and products—professional homecare maintenance, led by the world's most responsible franchising system—ServiceMaster. Find out now what investment you need to obtain a ServiceMaster franchise. Find out how all-inclusive it is, how high your first-year income level can be. Today—write ServiceMaster, c/o Marion Wade, Dept. 111, 2117 N. Wayne, Chicago 14, Ill.

**MAILORDER** To churches, motels, institutions. Complete individual set-up, not just instructions. Hermes Advertising, 152 West 42, New York City 36.

**IMPORT-Export** business made easy. Individual setup service. Not just instructions. Hermes, 152 West 42, New York City 36.

**HAVE** Home mail business! We supply literature, lists. Fill your orders. Help you write. Gateway, Box 327, Forest City, N. C.

**SALES** Franchise available for self-computing 200-year calendar. \$40 starts profitable business. For sample, details, write: Novelty Calendars, Box 626, Norfolk 1, Va.

**WHOLESALE!** World's largest supply. Buy from 257 American, European, Japanese wholesalers. Tailormade suits from Hongkong. Free details. International Buyers, 216-MX Jackson, Chicago 6, Ill.

"23 WAYS To Build a Home Mail Business," with lifetime repeat income. Rush \$1.00 for amazing manual. Guaranteed. Glenn Publications, Dept. MP41, Box 507, Jacksonville, North Carolina.

**STATUES, Plaques, figurines, molds, liquid rubber, plastercraft supplies.** Free sample and details. Lavin Novelty, Box 296, Flora Rd., Leavittsburg, Ohio.

**PROFITABLE** Home mailorder business. Mailing literature to mothers. Everything furnished. Enterprises, Box 1592, Beverly Hills, Calif.

**BIG** Mail send 10¢. Buller's, 7 Pearl St., Springfield 3, Mass.

**START** Successful mailorder business without inventory, packaging, delivery headaches. Dropship Buyers' Guide reveals how. Send for free details. Rutward, 113 Bryant, Columbia Station, Ohio.

**READY** Cash raising bait at home for us. Down-East, PM-1, Box 149, Bangor, Maine.

**NEW Products.** Triton lists many new products, services, enterprises. Details free. Triton, C104, 760 Market, San Francisco 2.

**NEED** Cash-capital? For practical methods & sources to raise money write Capital, 105 Bank Bldg., Cole Camp, Mo.

**PACKAGE** Bulk merchandise at home. High profits! Franchise available for contract packaging, gift wrapping, rack merchandising. No selling required! Free details, HPC Dept. 5D, 2212 E. Jesse Street, Los Angeles 23.

**MAKE** Fabulous weekly profits clipping newspaper items for publishers. Some clippings worth \$5.00 each. Particulars free. National, 81-PM, Knickerbocker Station, New York City.

**BIG** Money in formulas! Concentrates! Products! Small investments! Write: Blomberg, Burt Lake, Mich.

**CURTISS** Mail Order Guide, laws, rules. Wholesale information, listing mail order publications. \$1.00. Curtiss Publications, 308½ Olive, Porterville, Calif.

**PROSPER** By selling "The World's Most Usable Bible." Sales quick, easy and highly profitable. To start earning a better living, write today. International Book Company, Dept. M, Box 118, Wichita 1, Kansas.

**DOLLS:** Repair and sell. For complete information, send \$1.00 for catalog to Grand Wig Co., Inc., 139 Fifth Avenue, New York 10, N. Y.

**DEAL** In old jewelry. I pay \$10.00 ounce. No selling. Complete instructions. D'Amico, 24-K North Wabash Ave., Chicago 2.

**LIQUID** Marble. Colorful, glossy! Molded, brushed, sprayed! Particulars free. Marbleizing Service, Edwardsville, Ill.

**PROFITABLE** Home businesses. Realistic information. Royal, Box 1224-B, Clarksburg, W. Va.

**PERSONAL** Radiation detection and protection service. Needed by everyone, especially boys and young men to detect personal exposure to ionizing radiation, present in the background and as a result of routine X-ray exposure. This opens up a vast, new moneymaking market. Write for details today. Small Industries Services, Inc., 140 East 37th Street, New York 16, N. Y.

**MOTEL-Resort** management. Quality for hundreds fascinating, leisurely, well-paid executive openings. Learn at home. Free booklet. Motel Managers Training School, PM-1, 612 S. Serrano, Los Angeles 5.

**GUARANTEED** Market. Raise fishworms for us. Free details. Golden Farms, Lubbock 12, Texas.

**NEW** Products first time on market. Big money. Write: Fenbro Company, 8652 Monticello, Skokie, Illinois.

**AMAZING** Safety invention sells on sight to 85,000,000 drivers. Laboratory-tested, proven. Unique no-work bonus plan builds every \$4.00 sale to \$103.75 extra profits without investment. Spare, full time; terrific lifetime income potential. Write: Vislo, Dept. PM-1, Great Neck, N. Y.

A & W Drive-in franchises available in choice U. S. locations, including Hawaii, and foreign countries. Reasonable investment. High returns. Financing available upon credit approval. Write for free brochure. A & W Root Beer Co., Box 1039-(CP5), Santa Monica, Calif.

**ANYONE** Can cash in on big profits. Manufacture boats, toys, furniture, etc., in garage or workshop. We supply equipment, materials and instructions. Inquire: Fibermold Industries, P.O. Box 6622, Redford Heights Branch, Detroit 40, Michigan.

**OPERATE** Home mail-order business. Vosacek Printing, 4444A1 Ute, San Diego 17, Calif.

**MARKETS** Everywhere. Make artistic concrete birdbaths, pottery. Best coloring. Home workshop. Hundred varieties. Hollywood Cementcraft, 8527-S Wonderland, Hollywood 46, California.

**LEARN** Sewing machine repairing. To \$125 weekly. Sparetime. Supplies. Add to present business. Write today! Taylor Service, Box 2126, San Bernardino, Calif.

**CO-PUBLISH** "Home Business Digest." Free details! GPO, Box 972-po, New York 1.

**EARN** \$10,000 Yearly raising Angora rabbit wool for us. Information 25¢ coin. American Angora Company, Malta 77, Montana.

**FRANCHISES** Make profits! Operate your own independent franchised business as distributor, dealer or agency owner. Nationwide opportunities. National Franchise Reports is the recognized source for information regarding the booming franchise field. Write today for interesting free details of this helpful service. National Franchise Reports, W-528, 333 North Michigan, Chicago 1.

**FREE** Picture folder, "How to Make \$3,000 Yearly, Sparetime, Backyard, Raising Earthworms!" Oakhaven-38, Cedar Hill, Texas.

**VENDING** Machines. No selling. Operate a route of coin machines and earn amazing profits. 32-page catalogue free. Parkway Machine Corporation, Dept. #27, 715 Ensor Street, Baltimore 2, Maryland.

**SELL** Books by mail. 400% profit. Royal, Box 368-X, Cleveland 27, Ohio.

**BIG** Money raising fishworms and crickets. Free literature. Carter Farms, Plains, Georgia.

**FREE!** Name brands catalog! Your own high profit business. Sell name brands, full or part time. No inventory, no investment. More than 2,000 name brand items; lowest wholesale prices. Watches, jewelry, cameras, hi-fi, stereo radios-phonos, appliances, housewares, hardware, power tools, luggage, musical instruments, garden equipment, sporting goods, toys, many others. 8 floors of name brands. Million dollar inventory. Orders shipped complete in 24 hours! Send for free, beautifully illustrated catalog now! Separate wholesale price list. H. B. Davis Corp., Dept. 11, 145 W. 15 St., New York 11, N. Y.

**IF** You like motorcycles and money then send for Harley-Davidson dealership book on how to become a franchised dealer of motorcycles and a new line of motor-scooters. Here's a chance to own your own business with a very modest investment. The youth market is beginning to explode and the next few years promise a chance to cash in on it. Write for free illustrated dealership book today. Harley-Davidson Motor Company, Dept. P, Milwaukee 1, Wisconsin.

**BUSINESSES,** Resorts, motels, investment property, ranches. Our special service dept. at your disposal. No obligation. World's largest. 58 years' service. Strout Realty, 7-MB S. Dearborn, Chicago 3, Ill.

**TO \$100.00 Weekly.** Sparetime, home operated mailorder business. Successful beginner's plan. Everything supplied. Lynn, 10420-M National, Los Angeles 34.

**PIANO** Tuning learned quickly at home. Tremendous field! Musical knowledge unnecessary. Information free. Empire School of Piano Tuning, Champaign, Ill. (Founded 1935).

**WANT** To make big money at home? \$10.00 profit in an hour possible with invisible mending. Make tears, holes, disappear from clothing, fabrics. Steady year-round demand from cleaners, laundries, homes. Details free. Fabricon, 6234 Broadway, Chicago 40, Illinois.

**\$70 WEEKLY—Home, spare time.** Simplified mail bookkeeping. Immediate income—easy! Auditax, 34757A, Los Angeles 34.

I Want to send you proof of the wonderful pulling power of Popular Mechanics classified pages. What's your proposition? Write me today. Include literature if possible. F. W. Johnson, Manager Classified Advertising, Popular Mechanics Magazine, 200 E. Ontario St., Chicago 11, Ill.

**COPUBLISH** Mail Sale Advertiser, leading mail order paper. Details, latest copy, dime. Vanroy Shirk, Lebanon, Penna.

11,000 **NEW** Prospects daily. Baby record books, shoes, albums. Sell mailorder. Use our literature. Write: No-Co-Ro, Capitola, California.

**BRONZE** Baby shoes: Instructions, equipment and mountings for genuine electroplating process. Largest supplier of all plating equipment, supplies. Free catalog. Hollywood Bronze Supply, Dept. B-3, 1624 East First, Los Angeles 33, Calif.

**MAKE** \$46 From square foot plywood; jigsaw necessary. Free details. Woodart, Bridgewater, Mass.

**FIX Typewriters.** Free repair course. Home operated. Remit 25¢ for book explaining free course and agency appointment. Athey, Tarentum, Penna.

**OPERATE** Profitable mail order business. Write Walter Service, 4159A East 112th, Cleveland 5, Ohio.

**EARN** Good money sharpening chain saws, scissors, cutters, knives. Free manual. Treco, North Tonawanda, N. Y.

**RE-Cast** junk batteries into new. Latest achievements. Battery Laboratories, Bayou LaBatre, Alabama.

**BAKE** New greaseless doughnuts in kitchen. Sell stores. Free recipes. Montgomery, 3605 South 15th, Minneapolis 7, Minnesota.

**\$3.00 HOUR**—Home, sparetime, assembling pump lamps. Easy. Free details. Ougor, Caldwell, Arkansas.

**BE A notary.** Information: Stationers, 515 East 33rd, Kansas City 9, Missouri.

**MAKE** Flexible molds. Cast plaques, figurines. Free sample. Tooker, 1045-R Fairview, Hamilton, Ohio.

**CANDIED** Popcorn and potato chip equipment. Eakins, Box 933-AO, Springfield, Ohio.

**RAISE** Rabbits on \$500 month plan. Free details. White's Rabbitry, Mt. Vernon, Ohio.

**OPERATE** Your own home mail order business. It's profitable. Write: Webb Imports, Pico Rivera, Calif.

**"MAIL Order World of Opportunities."** Free subscription, details. GPO, Box 972-P, New York 1.

**\$400.00 MONTHLY** Raising giant worms. Odorless soilless method. Charlie Morgan, Bushnell, Florida.

**BOSS** Your own home business. Profits 1200% to 3000%! Make, distribute stunning Shellcraft jewelry. Sells itself wherever displayed. Big repeat demand. Details free; Shellcraft, Dept. A, Box 804, Panama City, Florida.

**LIQUID** Molding rubber, free sample. Shellcraft supplies. Chaney's, 1907-A East Road, Jacksonville 11, Fla.

**LEARN** "Mailorder Do's and Don'ts", other selections. 50¢. Carruthers, Box 626-A, Dania, Florida.

**BIG** Profits selling ball point pens. Bonomp, 54 Jefferson, Brooklyn 6, N. Y.

**START** Your own business trimming windows. Full instructions on trimming, how to get work, etc., only \$1.00. Jem, Box 144, Cranford, N. J.

**\$200.00 MONTHLY.** Spare time. With table saw. Write. Holiday House, 7228 4th Plain, Vancouver, Washington.

**FIBERGLASS** Awnings—No investment. Part, full time. Fiberlux, 29 Elm Avenue, Mt. Vernon, N. Y.

**\$34.70 TWO** Hours. Manufacturing concrete products. No selling. Castings #3, 1803 Fremont, Rapid City, South Dakota.

**WORLD'S** Easiest mailorder business. (Designed especially for beginners). Details free. Tasker, Box 3131, Alexandria, Virginia.

**VENDING** Machine catalog. Rakes, 609P Spring Garden, Philadelphia 23, Penna.

**JAPAN** Directory. 145 Japanese manufacturing exporters. Japan and Hong Kong trade journal information. Asia opportunities. \$1.00 today. Nippen Annal, Box 6266, Spokane 28, Washington.

**HAIR** Coloring Pomade. Successful mail order item 8 years. Drop shipments. Marion Labs., Sunnyside, L.I.C. 4, N. Y.

**BUY** Direct from factories. Appliances, cameras, watches! Free details! Cam Co., 6810PM-20th Ave., Brooklyn 4, N. Y.

**PYRAMID** Income. Operate garden golf. Sell equipment. Brockway, Box 3924, Portland 8, Oregon.

**PENNY,** Nickel, and dime counter and packager, accurate fast. Free details. Sample \$1.00. Sterling, P. O. Box 626, Dania, Florida.

**IMPORT** Anything from anywhere. International 1960 copyright trade directory. Contact 50 countries. William Benko, Box 188-A, New York 21.

**BECOME** Independent. Own your own rug and upholstery cleaning business. \$229.00 full price includes everything. Write: Alladin, Shawano, Wisconsin.

**"23 WAYS** To Build a Home Mail Business," with lifetime repeat income. Rush \$1.00 for amazing manual. Guaranteed. Glenn Publications, Dept. MP40, Box 507, Jacksonville, North Carolina.

### MONEYMAKING OPPORTUNITIES

**MEN — Women!** Start money-making plastic laminating business at home in spare time. Material that costs 11¢ brings back \$2.50. No canvassing or selling but mail orders bring in \$20 a day. Write for full particulars free. Rush name on postcard to Warner, Room CL-2-D, 1512 Jarvis, Chicago 26, Ill.

**YOUR** Name on our giant mailing list brings you moneymaking and other mail offers galore! Send 25¢ today! Direct Mail Service, Dept. GM, Box 581, Bakersfield 7, California.

**MONEY?** Big money! 900% profit. Fabulous Moneymaking Secret. Mailorder. Guaranteed. Details 25¢. Opportunities, 940 East Broadway, Phoenix, Arizona.

**MINK** Raising information free. Complete. Lake Superior Mink Farm, Superior, WI. Wisconsin.

**VENDING** Machines. No selling. Operate a route of coin machines and earn amazing profits. 32-page catalogue free. Parkway Machine Corporation, Dept. #26, 715 Ensor Street, Baltimore 2, Maryland.

**GROW** Mushrooms. Cellar, shed and outdoors. Spare, full time, year round. We pay \$4.50 lb. dried. We have 29,000 customers. Free book. Mushrooms Dept.: 173, 2954 Admiral Way, Seattle, Wash.

**CIGARETTES:** Make 20 plain or filter-tips for 9¢. Facts free. Moberly, Box 821, Owensboro, Kentucky.

**EARN** Money evenings copying and duplicating comic cartoons for advertisers. Adservice, Argyle 1, Wisconsin.

**YOUR** Own, easy-to-start, home mail-order business, sparetime. Fascinating; profitable! Information free. Alfano, 19-PM Pine, Closter, N. J.

**START** Big-pay business at home in spare time. No experience needed to operate little table-top machine for bronzing baby shoes. Make \$5.46 profit on every pair. Full particulars free. Send postcard to Mason, 1512 Jarvis, Room CM-2-D, Chicago 26, Ill.

**BIG** Money raising fishworms and crickets. Free literature. Carter Hatchery, Plains, Georgia.

**READ** "Progressive Mailtrade," the magazine that tells how to make money by mail. Quarter brings sample and special offer. Progressive Mailtrade, Box 357, Sheboygan, Wisconsin.

**WIN** Contest money. General Contest Bulletin gives hundreds of tips. Lists current contests, rules. Sample magazine 25¢. General Contests, 1609½ East 5th, Duluth 12, Minnesota.

**AMAZING** Successes through franchises! Become exclusive franchise holder your territory. Information rushed. National Franchise Reports, MP-528, 333 North Michigan, Chicago 1.

**IN 1952** I was unemployed, broke. Today own \$18,000 home, drive Cadillac, have bank account. Anyone can do this. Write Norris Cole, 217 West 49th, Bradenton, Florida.

**BIG** Money opportunities—Jobs, businesses, investments. Retirement opportunities. Free details. Shoreland, 20 W. Jackson, Suite 1412-K, Chicago 4.

**MAKE** Money typing. Details 17 proven plans. Crafts, Mulino, Oregon.

**MAKE** Money writing short paragraphs! No tedious study. I tell you what to write, where and how to sell; and supply list of editors buying from beginners. Many small checks add up quickly. Write to sell, right away. Send for free facts. Benson Barrett, Dept. C-27-S, 7464 Clark, Chicago 26.

**EASY** To start rubber stamp business at home in spare time. Make up to \$9.80 an hour without experience. Facts free. Write to Roberts, 1512 Jarvis, Room CR-2-D, Chicago 26.

**MAKE** Fabulous weekly profits clipping newspaper items for publishers. Some clippings worth \$5.00 each. Particulars free. National, 81-PM, Knickerbocker Station, New York City.

**START A** profitable subscription business in spare time! We need men and women (young or old) as representatives for all leading national magazines. Liberal commissions on all subscriptions. Supplies free. No experience needed. Send this ad with your name and address to: Popular Mechanics, Room 5-O, 250 W. 55th St., New York 10, N. Y.

**TERRIFIC** Novelty sells itself. Be convinced. Show friends. Sample 25¢—cover postage, packaging. Stein, 311 Delsea Drive, Woodbury, N. J.

**DYNAMIC** Mail order plans. Everything furnished. Information 25¢. Donovan, 79-PM Greenbelt, Levittown, New York.

**I** Sold stories, articles. Booklet tells all \$1.00. Foley, Box 72, Brooklyn 18, N. Y.

**GET** Money for newspaper clippings. Free details. Write: Whitted-50A, 2815 Nicholson, Dallas 24, Texas.

**PLASTICS**—Manufacture your own. \$2.00 trial unit. Hallmark Dental Co., Box 1924, Detroit 31, Mich.

**MAKE** Extra money without working. Complete stock market course \$3. Bomar, 4252 Wyoming, St. Louis 16, Mo.

**NEW** Products. Triton lists many new products, services, enterprises. Details free. Triton, C105, 760 Market, San Francisco 2.

**BOAT** Refinishing business. Make big money in spare time. Free details. Plastic Sales, 3023 McGee Trafficway, Kansas City, Missouri.

**EARN** Money using any camera. Experience not necessary. Proved method. Club benefits too. Work at home, anywhere. Write today. CPC, Box 1066A, Richmond, Calif.

**MAIL** Dealers! Agents! part-timers! Motorists dream came true. "Muffolin" silicized muffler-rust preventer is here! Superior brand, very profitable. Exclusively from distributor: Specialty Trading Company, P.O.B. 323-P, New York 21.

**PLATE** Baby shoes. Make jewelry, novelties. Start with \$3.00 refundable investment. Free details. Jo-Ca, 468-D Northwest 79th Street, Miami 50, Florida.

**MONEYMAKING** Formulas! Write: Arkin, 1448 Crotona Park East, New York 60.

### EXPORT — IMPORT

**JAPAN:** Direct call order. 26 page catalogue, kimonoes, dolls, novelties, gifts, business information, manufacturers' names, addresses. Send \$1.00. Clarence Yamagata, 814 Tuginbiru, Marunouchi, Tokyo.

**FREE** Complimentary copy import bulletin, How to Import for Profit. Write: Boisclair Buyers Service, P.O. Box 276, Napa, California.

**DIRECTORY** Listing over 400 firms in foreign countries \$1.50. Hoffman Imports, R.C.A.F. Stn., Comox B.C., Canada.

**300 MORE** Foreign exporters, \$1.00. Imports Unlimited, Dept. PM-560, 5916 California St., San Francisco 21, Cal.

**IMPORTS** Below wholesale to fully illustrated "World Shoppers" subscribers. \$1.00 year. Ric-Atate, 29 Orleans, Valley Stream, N. Y.

**IMPORTED** Oriental "Goddess of Mercy." Genuine Ivory, about 5" with dark teakwood stand. Included original manufacturers illustrated catalog of more than 250 unusual ivory items. Import direct at absurd prices! Catalog indispensable to importers, collectors, retailers. \$5—both. Imports Unlimited, Dept. PM560, 5916 California St., San Francisco 21, Calif.

### SCIENCE & CHEMISTRY

**EXPERIMENTERS:** — "Terrific Bargains" scientific catalog. 25¢. Hagenow Laboratories, Manitowoc, Wisconsin.

**SPECTROSCOPE** For quick analysis \$3.00. Kuttington, 875 Arastradero, Palo Alto, Calif.

**STROBOSCOPE**—"Stop" motion with strob. Kit, \$7.50. Mechanics, experimenters, science teachers send for free brochures. Morris Lee, 294 Elm St., Buffalo 3, N. Y.

**CHEMICALS** And apparatus for industrial, analytical, and private laboratories. Catalog 25¢. Dept. M-50, Biological Supply Co., 1176 Mt. Hope Ave., Rochester 20, N. Y.

**ILLUSTRATED** Catalog: Chemistry, mineralogy, biology 25¢. Tracey Laboratories, Evanston, Illinois.

**CHEMISTRY** Catalog, 25¢. Special offer! Laboratory Sales, Box 161-A, Brighton, Mass.

**AMAZING** New book of science experiments, formulas, and catalogue of laboratory supplies. Only 35¢. National Scientific Co., 13 S. Park Avenue, Dept. PM-5, Lombard, Illinois.

**FREE**—Six Pyrex test tubes with \$4.00 order. Catalogue 25¢. Bio Chemical Products, Somerset, Belmont 78, Massachusetts.

**ROCKET** Fuel chemicals, model missile kits, parts. Catalog 25¢. Central Rocket Company, Waupaca, Wis.

**ROCKET** Supplies for amateur rocketry. Catalog 25¢. Mervin Hill Company, R.R. #1, Seward, Penna.

### FORMULAS, PLANS, ETC.

**FORMULAS** For latest money-making discoveries. New! Good! Valuable literature free! Miller, Chemist, 1517-D, Tampa, Florida.

**FORMULAS**; All kinds, latest, best. Literature free. Kemixal, Park Ridge, Ill.

**LATE**, Modern manufacturing formulas. List free. Moon Chemical, Martville, New York.

**RESILVER** Mirrors—make one-way mirrors. Both \$1.00. Kem-Mir, Park Ridge, Illinois.

### PLASTICS

**NEW** Liquid casting plastic, clear, colors. Embed real flowers, butterflies, photos, coins. Send 25¢ for two handbooks "How to Cast Liquid Plastics" and "How to Make Extra Money at Home." Castolite, Dept. E-101, Woodstock, Illinois.

**VINYLLITE**, All colors, all gauges, for laminating, printing, vacuum forming, silk screening, etc. Free price list. Solomon, 4 Beacham, Everett 49, Mass.

**LEARN** Plastics fabrication for spare time income. Low cost home training now available. Write for free booklet. Interstate Training Service, Dept. D-3, Portland 12, Oregon.

**BOXES**, Plastic. Free list. Althor, 170 Bay 23 Street, Brooklyn, N. Y.

**PLASTIC** And supplies for laminating. Colamco, 12 Center, New Haven, Conn.

**PLASTICS**—Plexiglas, polyester, fiberglass, acetate, vinylite, supplies. Manufacturers' distributor, sheets, rods, tubes, liquids, coatings, films, boat plastics. Large, small quantities. Complete instructive catalog, 25¢. Gem-O-Lite, 5529-A Cahuenga Blvd., North Hollywood, Calif.

**BOXES**, Plastic. 200 sizes. Free list. Althor, 170 Bay 23 Street, Brooklyn, N. Y.

**NOW!** Electric plastic laminating kit. Hobby. Easy. Profitable. Burr, 330 East Center, Kalamazoo, Mich.

**PLASTIC** Embedding for fun and profit, no oven. Make beautiful jewelry, decorative panels, science specimen castings. Catalog 25¢. Natcol Plastics, Box 444, Yucaipa, Calif.

**CELLULOSE** scrap. Sheets, state thickness, colors. Box 333, Kearny, N. J.

### AGENTS WANTED

**EVERY** Man a prospect. Request refundable sales kit offer showing line of belt buckles, tie clasps, money clips, cuff links, lapels, individualized with customer's name and emblems. Cap badges for trucking, bus, taxi, police, firemen also heavy construction emblems. Choice 3000 emblems. Hook-Fast, Box 1425PM, Providence, R. I.

**GOLD** Or silver letters, numbers. Windows, doors, trucks. 1" to 6". 500% profit. Free samples. Atlas, Box 543-T, Oak Lawn, Ill.

**BIG** Profits. Stamp social security plates, key protectors. Sample 50¢. Catalog free. General Products, 188-PM State, Albany 10, N. Y.

**MEXICAN** Art goods! Free sample! Send 14¢ stamps mailing. Sylviak, Apartado 9036, Mexico City.

**PRINTING**, Advertising salesmen—Excellent moneymaking sideline selling decalcomania name plates, small quantities. Automobile initials, sign letters. Free samples. Ralco, XL, Boston 19, Mass.

**YOUR** Ad in this space will get some good agents for you. Yes, I'll prove it. Write for Folder "A" right now. F. W. Johnson, Classified Advertising Manager, Popular Mechanics Magazine, 200 E. Ontario St., Chicago 11, Ill.

**SELL** Champion, AC, Autolite spark plugs. Reconditioned, electroplated, guaranteed 10,000 miles. 100% profit. Free sample. Lee Plugs, 1608-E Roberts, Houston 3, Texas.

**YOUR** Own business—Used suits \$1.50; overcoats 65¢; mackinaws 35¢; shoes 12½¢; ladies' coats 30¢; dresses 15¢. Enormous profits. Catalog free. National Mail Order, 2111-AA Roosevelt Road, Chicago 8, Ill.

**DON'T** Miss our ad under "Salesmen Wanted" in this magazine. National Press.

**NATION'S** Best bed warmers. Agents wanted. Get literature. Send 10¢. Wentworths, P.O. Box 143, Muskegon, Mich.

**400% PROFIT**—Men, women, teenagers. Free sample. Stamped self-addressed envelope. Moneymaker, Box 88, Berwyn, Illinois.

**START** Making money now. Earn top commissions taking orders for all magazine subscriptions. Friends and neighbors are your prospects. No experience needed. Write for free money-making kit. McGregor Magazine Agency, Dept. 5A, Mount Morris, Illinois.

**BE** The Popular Mechanics representative in your neighborhood and earn big profits in your spare time. Write Popular Mechanics, Room 5-A, 250 West 55th St., New York 19, N. Y.

**WANT** To make \$20 or more in a day for part or full time route work? Man or woman. Write McNess Co., Freeport 24C, Ill.

**FREE** Sales kit, fire extinguisher-burglar alarms. Emergency Mfg. Co., Dept. P, 250 South 3rd St., Brooklyn 11, N. Y.

**DAMASCENE** Earrings; Exotic orientalism. Huge profit. Ohga, PM-184, Sigakenkusatu, Japan.

**MAKE** \$10-\$100 A day! Sell new 2 year light bulbs. 450% longer burning life guaranteed. Customers save money, you make money. Free details. Solar Electric Products, 366 Fifth Ave., Dept. 05PMC, New York City.

**MAKE** Top commissions selling our fine maintenance products. Full or part time. Rockland Chemical, Nanuet, N. Y.

**MEN!** Women! 60% profit on cosmetics. Famous Nationally advertised Hollywood cosmetics pay 60%. Make \$25 day up. Hire others. For free samples, details, write Studio Girl, Glendale, California, Dept. 1205J.

**SEEKING** New products? Get my outfit 47 money-making specialties. Latest conveniences for home, car. Send no money. Just your name. Kristee 38, Akron, Ohio.

**BIG** Profit. Sell nameplates. Waitresses, beauticians, others. Two samples \$2.00. Six samples all different \$5.00. Rivers Farley Co., Box 924, Tampa, Fla.

**MAKE** Profitable men's-women's wear. Sample free. Sunmade, Brockton 64, Mass.

**FAST** Money, faster repeats. Cash in on the revived interest in "old frontier" remedies. Protected territory. Blackroot, 31201AA North High Street, Columbus 2, Ohio.

**BIG** Earnings selling amazing floor treatments, business firms, factories, institutions, homes. Exclusive territory. Free sales kit offer. Sheridan Chemicals, 1417 Sheridan Street, Camden 4, N. J.

**EXCLUSIVE** New cosmetic. 300% profit. Fast seller. Proven repeater. Free details. Meche, Trilby, Florida.

**DOWLRITE** Pocket adding machine, \$7.20 dozen. Sample \$1.00. Dowlrite, Box 754, Atlanta 1, Ga.

**SELL** Business cards. Substantial profit. Savemore, 216 W. Jackson, Chicago 6.

**TERRIFIC** Earnings and bonuses selling nylon hosiery. Sales amazingly easy. Every individual needs them. Exceptional guarantee eliminates sales resistance. Write: Phil Liston Co., Box 482-PM, Wooster, Ohio.

### BUY IT WHOLESALE

**WHOLESALE** Catalog. Lowest prices anywhere. Guaranteed. \$1. Refundable first order. Loeber, 224-C Wyatt, Lincoln, Illinois.

**BOOTS**, Handsome western styles. Free catalog. Austin Boot Co., Box 5303J, El Paso, Tex.

**WHOLESALE**: 850,000 Items. Supply source directory 25¢. Idealer, Park Ridge, Illinois.

**ELECTRIC** Guitars, amplifiers, wholesale. Free catalog. Carvin, PMW, Covina, Calif.

**USED** And new watches \$2 up. Free list. Southern Watches, 5-PM So. Wabash, Chicago 3.

**LARGEST** Wholesale supply source in U.S.! Furniture, clothing, appliances, housewares, automobiles and accessories, tools, sporting goods, hobby supplies, farm equipment, imports, new products, bargain merchandise. Free details. Associated Wholesalers, Box 2068-DD, Sioux City 4, Iowa.

**2,000** PAGES Wholesale catalogs. Write: Mopam, Box 47, Newark, Ohio.

**WHOLESALE!** World's largest supply. Buy from 257 American, European, Japanese wholesalers. Tailormade suits from Hongkong. Free details. International Buyers, 216-M Jackson, Chicago 6, Ill.

**NEW** Deluxe wholesale catalog, automobile catalog, and others. Housewares, appliances, refrigerators, freezers, washers, dryers, television, radios, furniture, clothing, luggage, binoculars, phonographs, recorders, cameras, projectors, typewriters, power tools, toys, sporting goods, watches, jewelry. Name brands. Huge discounts. Postcard (any card): Selbyco, Decatur 156, Illinois.

**BULOVA**, Benrus watches like new—\$5.95 up. 32 page illustrated catalog free. Cosmos, New York 35, Dept. 561.

**JUST** Off the press. New wholesale tool and equipment catalog. Buy at the same prices as the big industrial plants. Send 50¢ for your copy, refunded with first order. General Industrial Supply, Inc., Dept. PM, 822 Sixth Street, Racine, Wis.

**GENUINE** "Joe Hall" handmade western boots. Free catalog. Box 246-M, Ysleta Station, El Paso, Texas.

**BUY** Wholesale or less. Catalogs and information only 25¢. Gateway, Box 327, Forest City, N. C.

**WHOLESALE!** Catalog 50¢. Details 4¢. Reimer, RD-1119 Chestnut, Saginaw, Michigan.

**WHOLESALE** Catalog! Appliances, cameras, watches! Cam, 116 Malden Street, Worcester, Massachusetts.

**JOB** Lots general merchandise. Quarter postage brings year's bulletins. Closeouts, 3931 Washington, Boston 31, Mass.

**2** LARGE Wholesale catalogs 50¢. Refundable. Gibson's, Box 232, Murray 7, Utah.

**FREE** Catalog offer! Tools, appliances, clothing, etc. United Wholesalers, 1265-M Broadway, New York 1, N. Y.

**300** WHOLESALE Sources European, Japanese, American. Complete \$2.00. Mashburn's Importico, Box 202, Asheville, N. C.

**GOLF** Equipment wholesale. Free price list. Crystal Golf Sales, Crystal, Mich.

**DIFFERENT** Genuine wholesale catalog of necessary family merchandise 25¢. Your Supply House, 445-PM Woodrider, East Alton, Illinois.

**MONOFILAMENT** Flyreel. Guaranteed tangle-free. Springtime, Box 3911, Seattle 44, Washington.

**30** WHOLESALE Companies will send you free catalogs. Send 50¢ for list. Wellington Company, Oswego, Kansas.

**SAVE** 80%. Brand name appliances, watches, tools, etc. Catalog 25¢. Cam. Mount Tom Road, Pawling, New York.

## SALESMEN—DISTRIBUTORS

**MAKE** Extra money—Big cash commissions plus premiums for you and your customers. Sell advertising book matches. Sensational new tenor, glamour girls, hillbillies; dozens others. All sizes. Quick daily sales; big repeat business. Free master kit makes selling easy. No experience necessary. Superior Match, Dept. M-560, 7530 Greenwood, Chicago 19.

**CALENDARS**, Advertising novelties, matches. All styles, including religious, varnished. 12 sheet, girls. Hundreds of advertising novelties, book matches, etc. Fleming Calendar Co., Sales Division, 6539 Cottage Grove, Chicago 37, Ill.

\$1,000.00 A Month for making dramatic 3-second demonstration of amazing light-weight Presto Fire Extinguisher. New chemical used by Airforce snuffs out fires instantly. Only \$4.95. Terrific commissions. Millions want it. Free kit. Merlite, 114 E. 32nd, Dept. P-66N, New York 16.

**100% PROFIT**. Nationally advertised cosmetics for colored people. Buy on sight. Free sample offer. Valmor, Dept. TU, 2451 Michigan, Chicago 16.

**WILL** You wear new suits and topcoats without one penny cost and agree to show them to friends? You can make up to \$30.00 in a day even in spare time, without canvassing. Pioneer Tailoring Co., Congress & Throop Sts., Dept. F-1226, Chicago 7, Ill.

**MAKE** Extra money selling advertising matchbooks. Free catalog and sales outfit. Matchcorp, Dept. PM-50, Chicago 32.

**ANYONE** Can sell famous Hoover uniforms for beauty shops, waitresses, nurses, doctors, others. Miracle fabric—Nylon, Dacron, Wash 'N Wear cottons. Exclusive styles, top quality. Big income, real future. Equipment free. Hoover, Dept. E-100, New York 11, N. Y.

**MAKE** Up to \$50.00 a day soliciting delinquent accounts. Terrific commissions. Write today. General Finance, 304V Pickwick Bldg., Kansas City 6, Mo.

**MAKE** Up to \$50.00 a day soliciting delinquent accounts. Terrific commissions. Write today. National Credit, 304Y Pickwick Bldg., Kansas City 6, Mo.

**EARN** Big commission full or part time. Build profitable business of your own selling America's largest line low priced business printing. 360 page catalog, samples, hundreds of items used daily by business people. Imprinted ball pens low as \$8.95 for 100. Calendars low as \$5.95 for 100. Free sales kit. National Press, Dept. 8, North Chicago, Illinois.

**IF** You're interested in making money in selling, see the hundreds of exceptional opportunities in Salesmen's Opportunity Magazine. Send name for your copy, absolutely free. Tell us what you're selling now. Opportunity, 848 N. Dearborn, Dept. 17, Chicago 10, Illinois.

**MONEYMAKING** Opportunity in fast growing market selling attractive outdoor advertising pennants. Write: Radder Products, Box 31, Colvin Station, Syracuse 5, New York.

**EXCELLENT** Profits. Guaranteed signature rubber stamps. Yours \$2.00. Boardman Engraving, Houghton, New York.

**SALESMEN**, Agents, write for free literature. D & R Industries, Lucama, N. C.

**MAKE** Money selling uniforms, accessories direct to schools, clubs, fraternal organizations. Bowling shirts, sports jackets, softball, baseball and industrial uniforms. Fraternal regalia, jewelry. Embroidered and felt lettering. Commission. Exclusive territories. Arnold's Uniform and Embroidery, Box P, 1355 N. Milwaukee Avenue, Chicago 22, Illinois.

**MAINTENANCE** products are always needed! Ours have been among the best since 1916. Qualified men offered dignified sales career with protected territory, top commissions and bonus. Paramount, Box 1956, Cleveland 6, Ohio.

**SELL** Service stations new line plastic foam permanent type carburetor air cleaners. Free sample. Dust-O-Matic Filter Company, 28038 Los Olas, Warren, Michigan.

**LAFF**-Lighters. America's hottest selling new novelty. Make \$25.00 to \$60.00 daily easy, fast. Details free. Clever Creations, Dept. P, Terminal Sales Building, Seattle 1, Washington.

**WE** Will franchise individuals with exclusive territory for the nationally distributed "Detroit" line of 22 different automotive care products. Minimum financial requirement \$1512. You service weekly the dealers we secure. Mail or wire Detroit Motors Corporation, 83 Warburton Ave., Yonkers, N. Y.

**SELL** All purpose liquid repair. Carded. Soldax Co., Hoosick Falls, N. Y.

**DO** You sell from your car or truck? Big profits in selling cleaning polishing cloths sets. Sample prepaid \$1.00. Refunded on first wholesale order. Meyer Company, Box 868, Galesburg, Ill.

## EMPLOYMENT INFORMATION

**WORLDWIDE** Foreign job list only 25¢. New Horizons Monthly, 550 Fifth Avenue, New York 36, N. Y.

**FAIRBANKS**, Alaska classifieds \$1.00. General delivery. George Johnson, Fairbanks, Alaska.

**JOB**s in California Newsletter. 2 issues \$1.00; \$4.50 year. Monadnock Bldg., San Francisco 5.

**"GO Foreign!"**—U.S. companies operating in South America offer extraordinary opportunities of employment and life-time careers. Supervisory, technical, clerical, sales, trades. Fabulous salaries, benefits. Factual information tips—only \$2.00 (Airmailed). Checks, money orders OK! Included free: "Living Overseas" report. Globetrotter, Casilla 5439, Guayaquil 7, Ecuador.

**EMPLOYMENT** in Florida. Details 25¢ (refundable). Fairbrothers, 710 Dora, Jacksonville 4, Florida.

**JUST** Out: Exclusive 1960 USA-worldwide job directory. Only \$2.00. Elsing, Box 12, Detroit 13, Mich.

**MERCHANT** Marine jobs. Men and women. Top wages. Travel. Details 10¢. Captain, Box 501-P, Reading, Mass.

**BOOMING** Latin America! Prosperous Brazil, Venezuela. Only hours from the States. New data regarding jobs, opportunities, conditions. American companies employing, etc. All skills required. Salaries to \$1,650.00 monthly; U.S. tax exempt. Bonuses, living allowances, travel expenses, exciting vacations, and more! First-hand information direct: \$2.00 (\$2.35 airmail) checks or money orders. Latin American Opportunities, Sabana Grande, Apartado 10212, Caracas, Venezuela.

**JOB**s On ships. \$100 weekly, beginners. Travel, adventure. Write: Seamans Service, Box 17-M, Brooklyn 8, N. Y.

**FOREIGN** Jobs—Latin America, Alaska, Canada, up to \$1500 monthly. Up-to-date 1960 foreign service directory gives complete information; hot list of firms hiring for military and civilian construction, aircraft, oil, exporters-importers, mining. How-when-where to apply. 12th successful year. \$1.00. Global Reports, Box 8873-S, Los Angeles 8, Calif.

**JOB**s On ships and yachts traveling foreign countries. Davenport's, 1354-K, G.P.O. New York 1, N. Y.

**COPYRIGHTED** Reports. Best paying companies, travel, adventure, promotions. Construction, aviation, shipping, oil fields, laborers, clerical, trades, supervisory, factory, unusual opportunities. Skilled, unskilled. Foreign, stateside. Only \$2.00 (\$2.25 airmail) (COD'S accepted). Satisfaction guaranteed. Included free: Special reports on Alaska, Venezuela, South America. Research Services. Meramec Building, St. Louis 5-PM, Missouri.

**FREE** Information—U.S.A., overseas jobs. High pay, transportation. Futures, Dept. M, 215 West 34th Street, New York City 1.

**JOB**s: High pay. Foreign countries, U.S.A. All trades. Write Dept. 55C, National Employment Information, 1020 Broad, Newark, N. J.

**FLORIDA!** Jobs, male, female. Homes, farms, businesses. Miami classifieds. \$1.00. Margo, Box 2681, Miami Beach 40, Florida.

**LATEST** Foreign jobs. Highest wages. Unlimited opportunities. Laborers, clerical, construction, electronics, oil fields, civil service. \$2.00 airmailed. (COD'S accepted.) America's leading overseas employment Researcher. Plus: newest South American, Alaskan, Venezuelan listings. Universal Research, Box 4912, Baltimore 21, Maryland.

**JOB**s Overseas right now. Good pay and good opportunity. Send \$2.00 and employment opportunities will be air mailed to you. Free consultation service. N. Y. Employment Service, Box 473, Wall Street Station, N. Y. 5, N. Y.

**AMERICAN** Overseas jobs. Higher pay. Transportation paid. Men-women. Act now! Free information. Employment Headquarters, 79 Wall Street, Dept. B-8, New York 5.

## SPECIAL SERVICES

**INFORMATION** On anything. Ferguson Research Specialists, 116-14 141 St., South Ozone Park 36, N. Y.

**WE** Swap 10 in. and 12 in. L.P. records, \$1.00, 7 in., 50¢. Send a list of five choices. Stereos included. Greene's, 1359-51 St., Brooklyn 19, N. Y.

**ANY** Fact question answered or money back, \$2. First time \$1! William Lamdin, Brooklandville, Maryland.

**BUSINESS** Records and tax service. Professional Business Service, Brookfield, Conn.

## EDUCATIONAL AND INSTRUCTION

**PIANO** Tuning learned at home! Profitable, uncrowded profession. Write Tune-craft, Box 5074-M, St. Paul, Minnesota.

**ANYONE**. Learn speedy scientific method for manipulating screwdriver, 50¢. Veejay, Box 69, Old Saybrook, Conn.

**LEARN** World Interlanguage approved by UNESCO. Textbook 25¢. Esperanto, Middleton, Wis.

**PEACE** of mind. Lucrative profession. Study psychology, mental science, nutrition, philosophy, related sciences. Earn degrees. Free brochure. Psychonomic Research Center, 1213 N. Highland Ave., Suite 205-PM, Los Angeles 38.

**ENJOY** Life! Be well! Solve personal problems by self-mastery. Free information. Leavitt Science, Clinton, Illinois.

**AUTOSUGGESTION**. Home study courses with phonograph recordings. Free brochure. Write Clark R. Bellows, 200 West 57th St., New York 19A, N. Y.

**LEARN** Asleep or awake. Self-help books, tapes, recordings. Free catalog. Drawer PM-697, Ruidoso, New Mexico.

**SECRET** Investigations. Experience unnecessary. Investigators particulars free. George Wagner, M125 West 86th, New York City 24.

**PROFESSIONAL** Investigators. Home study. Badge, certificate, future. Box 41197-F, Los Angeles 41, California.

**HIGH** School diploma at home. Licensed teachers. Approved materials. Southern States Academy, Station E-16, Atlanta, Ga.

**BE** A real estate broker. Study at home. Write for free book today. GI approved. Weaver School of Real Estate, 2018P Grand, Kansas City, Missouri.

**WANT** A diesel job? Higher pay? Advancement? We can help you qualify! Complete diesel, tractor and heavy equipment and Cummins Diesel Engine Shop-method home-training courses available. Write today. Interstate Training Service, Dept. B-3, Portland 12, Ore.

**DEVELOP** Mind power, personality while asleep. Use your phonograph, recorder. Amazing psychological tapes, records now available. Details free. Sleep-Learning Association, Box 24-N, Olympia, Washington.

**SING**, Speak with power. Self-training records. Amazing! Canfield, 2018-A Fifth Avenue South, Minneapolis 4, Minnesota.

**EARN** While you learn. Auto and diesel mechanics master this top paying trade. Many graduates earn \$100 a week and up. Approved for Korean veterans. For free information write Dept. No. 256, Nashville Auto-Diesel College, Nashville 3, Tenn.

**PHYSICAL** Therapy and massage. Home training. Practice privately or work with doctors and hospitals. Free catalogue. National Institute, Desk 4, 159 E. Ontario, Chicago, Ill.

**BOOKS**, Free general catalog, 100 pages. Text, vocational, educational, instructional subjects. Millions of volumes, new and used. Bargain prices. Books bought. Est. 1902. Long's College Book Co., Dept. PM, Columbus 1, Ohio.

PIANO Tuning pays. Big money in spare time. Learn at home in 30 days. No musical knowledge necessary. Phonograph records, tools and instructions furnished. Personal instructions available. Free catalog. Capital Piano Tuning School, 3160 S.W. 16th Court, Fort Lauderdale, Fla.

INVESTIGATOR Training—Robert B. Phillips Sr., Founder, former U.S. Government Special Agent. Write to 1917-K North Kenneth, Chicago 39, Ill.

USED Correspondence courses and books sold and rented. Money back guarantee. Catalog free. (Courses bought.) Lee Mountain, Pisgah, Alabama.

BOOKKEEPERS. Operate your own "Dollar-A-Week" system. Ellis, Box 200, Cedar Grove, North Carolina.

LEARN Real estate business fast. Unlimited opportunities. Economical home-study course. Particulars free. Gordon-Howard Institute, 320 Glover Building, Kansas City 5, Missouri.

PIANO Tuning pays. Learned easily at home. GI approved. 59th year. Free booklet. Niles Bryant School, Dept. P, 3731 Stockton, Sacramento 20, Calif.

ANALYZE Handwriting for profit, pleasure. Free sample lesson, catalog reveals plan. Write IGAS, Inc., Dept. 2, Springfield 4, Missouri.

OWN Collection agency. Little "gold mine." Franklin Credit, Roanoke, Va.

SWEDISH Massage. Home study. Diploma. Illinois Licensed School, 3809 Alta Vista, Chicago 13.

MASTER Watchmaking at home. Free sample lesson. Chicago School, 2328-YE Milwaukee, Chicago 47.

FINISH High School at home, spare-time. No classes. Diploma awarded. Write for free catalog. Wayne School, Catalog HF-104, 2527 Sheffield, Chicago 14.

STUDY Mathematics at home. All branches. Free test. Write: Mathematics Institute, Essex 14P, Mass.

LEARN Civil and criminal investigation at home. Earn steady, good pay. Institute Applied Science, 1920 Sunnyside, Dept. 165, Chicago 40, Illinois.

STUDY At home for personal advancement and spiritual unfoldment. Systematic study of Metaphysics or Metaphysical Psychology may help solve mental worries. Correspondence only. Free booklet. College of Universal Truth, 23 East Jackson, Dept. 3, Chicago 4, Ill.

BECOME Tax consultant. Graduates earn \$1,000-\$3,000 every tax season preparing returns evenings. State approved. Union Institute, Lakewood 2L, N. J.

GOOD Paying jobs open! Operate, repair heavy earth moving equipment! Learn "on the job" operating latest cranes, bulldozers, earth carriers! V. A. approved. Free catalog. Write: T. E. Hutch, Greer Technical Institute, Braidwood, Illinois.

COMPLETE Your high school at home in spare time with 63-year-old school. Texts furnished. No classes. Diploma. Information booklet free. American School, Dept. X545, Drexel at 58th, Chicago 37, Illinois.

PROFESSION—Correspondence course—physical therapy, massage. Diploma. Northwestern Institute, Box 368, Rock Falls, Illinois.

PROFITABLE Welding training available Hobart Welding School, Box M-502, Troy, Ohio. GI approved. Finest equipment in U.S.A. Reasonable prices. Request catalog.

LEARN Another language at home, easily, quickly, naturally with Linguaphone, the World's Standard Conversational Method. You learn to speak French, Spanish, German, Russian, Modern Greek, any of 34 modern languages available on life-like conversational recordings. It's like living in another country. Complete language course available on free trial. Send for free book and details of free trial. No obligation. Linguaphone Institute, T-83-050 Radio City, New York City 20.

INEXPENSIVE Correspondence courses. Science, Arts, Psychology, Engineering. Earn diplomas, colleges abroad. Aurecas, Central Valley, New York.

INSTRUCTION courses, manuals, folios: \$1.00 to \$9.95. Free catalog. Spaulding Co., P.O. Box 122, Fond Du Lac, Wis.

USED Correspondence courses, books. Satisfaction guaranteed. Catalog 10¢ refundable. Courses bought. Bayles, 78-B Courtwright, Wilkes Barre, Penna.

STRENGTHEN Your voice—for more success in business, social life! Free booklet. (Give age.) PV Institute, Studio EP-2, 210 South Clinton, Chicago 6.

CIVIL Service. Learn about this field of work and how you can prepare yourself by home study for a high entrance mark. Private organization. Free booklet. No obligation. Franklin Institute, Dept. V-80, Rochester 4, N. Y.

CORRESPONDENCE Courses, bought, sold. Lists free. Lohmer, 825 Lima P56, Burbank, Calif.

STUDY High school and college subjects at home. Free catalog. Technical Training Service, Dept. 146MC, Brooklyn 14, N. Y.

INVESTIGATORS Course. Credentials, diploma. Free information. Southwestern Institute Criminology, Box 2117-A, Lawton, Oklahoma.

DIVERS—Training in advanced methods of construction, salvage and general commercial diving. Send for free brochure. Commercial School of Deep Sea Diving, Inc., 2301 E. Anaheim, Wilmington, Calif.

COLLEGE Outlines, High School paperbacks. Free lists. Bookseller, 3121 South Racine, Chicago 8.

ACHIEVE A dynamic personality with our proven Individual Sleep Records. Send 25¢ for sample record and details. Keane Records 1439A No. Western Ave. Hollywood 28, Calif.

ENGINEERING. Home study. Mid-west Engineering School, 10923 Hillcrest, Hickman Mills, Missouri.

ELECTRONICS. Drafting, gunsmithing, auto-mechanics, building-trades. Earn AAS degree in 2-yrs. Public, coeducational college established 1925. Technical and engineering levels offered. Moderate costs. Adequate housing. Trinidad State Junior College, Trinidad 4, Colorado.

#### PLAYS, STORIES, MANUSCRIPTS

AUTHORS! Publisher seeks manuscripts. Free details. Pan Press, Tahlequah, Okla.

WANT Your book published? Learn how we publish, advertise, promote, distribute. Many successes. Free booklet PM. Vantage, 120 West 31, New York City. Midwest office: 220 S. Michigan Ave., Chicago, Ill.

FREE 32 Page brochure to writers seeking a book published (fiction, poetry, non-fiction). Learn how to become a published author in five months, get 40% royalties, publicity and recognition. Write Perry Matson, Exposition Press, 386 Fourth Ave., New York 16, N. Y.

PUBLISH Your book! Join our successful authors. Publicity, advertising, promotion, handsome books. All subjects invited. Send for free manuscript report and our detailed booklet. Comet Press Books, Dept. MP-5, 200 Varick Street, New York City 14.

#### ADVERTISING AGENCIES, LETTER WRITERS, FOR ADVERTISERS

RECENT—Retired pensioned names, \$9.00 thousand on gummed labels. RR, Deriter Company, 527 Lincoln, Collingswood 7, N. J.

ADVERTISING Ratebook leading newspapers, magazines, free. Chicago Advertising Agency, 20-W Jackson, Chicago 4.

FREE! Red-hot book, "More Profit From Your Advertising." Lists—best mail order magazines, newspapers. Adservice, 516 Cornelia, Chicago 13.

ADVERTISE: 24 Words, 100 Canadian newspapers, \$5.50. Lists free. Advertising Bureau, 10511-C Springfield, Chicago 43.

"AMAZING New Book"—"Profits From Classified Advertising." Tells how and what to advertise. Be sure to read this book before you invest one cent in advertising. Write for your copy now. Just send 10¢ for postage and handling. W. Johnson, Classified Advertising Manager, 202 East Ontario Street, Chicago 11, Illinois.

MAILING Lists most any classification \$5.00 1000. Your circulars mailed with ours \$4.00 1000. Write for our literature. Dixie Malters, King, N. C.

CREATIVE Advertising. Magnetic copy. Dramatic layouts. Moran Agency, Shoemakersville, Pennsylvania.

ADVERTISING. Result-getting ads prepared, placed newspapers, magazines, radio, anywhere! Lowest rates. Catalogue free. Baker Advertising Agency, 189 W. Madison, Chicago 2.

NOW Ready: New, amazing Classified Advertising Record Book—prepared especially for classified advertisers. Here is a book that tells you instantly whether or not your advertising in any publication is paying you real results. You can tell immediately how many inquiries each publication produced—how much cash received from every ad. Spaces are provided for the name and address of the publication, date of issue, space used, rate, cost of ad, key number, etc. You have a complete record of each publication right before your eyes. Plenty of space to keep accurate record of 28 separate publications. You can have a copy by sending only 10¢ to cover postage and handling. Send for your copy now. W. F. Johnson, Classified Adv. Mgr., Popular Mechanics Magazine, 204 E. Ontario Street, Chicago 11, Illinois.

#### CARTOONING, COMMERCIAL ART, SHOWCARD & SIGN PAINTING, TATTOOING

YOU Can entertain with chalk talks. Catalog 10¢. Balda The Cartoonist, Oshkosh, Wis.

CARTOON Your way to success! Internationally known instructor, Raye Burns, will personally teach you to create original, salable cartoons at home. Cost of course is very low. Write for free details. Raye Burns School, Box 3583-P, Cleveland 18, Ohio.

LEARN Sign painting at home. Free talent test. Ben Kerns, Box 812-PM, Greenville, S.C.

LEARN Profitable, fascinating tattooing. Illustrated information \$1. Zeis, 728-C Leslie, Rockford, Illinois.

LEARN Sign painting with fascinating system. Straley, 410 S. Western, Springfield, Ohio.

"HOW To Make Money With Simple Cartoons." A book everyone who likes to draw should have. It is free; no obligation. Simply address Cartoonists' Exchange, Dept. 95-C, Pleasant Hill, Ohio.

CASH For artists! Amazing details free. Al Ecker, 1429 Hoover, Eau Claire, Wis.

MAKE Signs, stencils; Patterns to 6" \$1.00. Anderson Studio, 1034 East Colfax, Denver 18, Colorado.

CARTOONISTS Paper, Cartoon markets, lessons, articles, tips, idea creating. Two introductory copies, \$1.00 postpaid. Hartman, 2776 California Ct., Lincoln 10, Nebraska.

CARTOONING For profit! Learn at home, experience unnecessary. Famous system of manual training brings amazing results. Free book. Write Continental Schools, Dept. A51, 4201 S. Broadway, Los Angeles 37, Calif.

SPEEDILY Produce colorful signs, showcards, advertising. Write: Rapid Screen-Process Service, Edwardsville, Illinois.

#### RUBBER STAMPS AND OFFICE SUPPLIES

POCKET, 3 Lines \$1.00. Guaranteed. W. J. Specialty, 8464 Manhattan, Detroit 11.

RUBBER Stamp, three lines, \$1.00. Free literature. Grimsley's, Box 5314, North Charleston, S. C.

**INDEXED, Cushioned, 3 lines \$1.00, 4 or 5 lines, \$1.50. Signature stamps, \$3.50. (Script, print, or old English.) Free stock stamp literature. Youngers Stamp Shop, Princeton 4, Iowa.**

**FREE—Rubber stamp catalog.** Martin, 1425 Major Drive, Jefferson City, Missouri.

**4-LINE Pocket stamp, \$1.00. Self-inking case. Two (different), \$1.50.** Retter, 223-PM, Tipp City, Ohio.

**50¢ FIRST Line, 25¢ each additional line.** Harwaell, Byrdstown, Tennessee.

**POCKET Stamp, 3 line, \$1.00. Free gift.** R. Anderson, Box 128, Kingsville, Missouri.

**DELUXE Mounted, three lines \$1.25, four \$1.50. Fast service. Catalog free.** Warner, Box 482B, Aberdeen, Maryland.

### **TYPEWRITERS, DUPLICATORS, OFFICE DEVICES**

**RECONDITIONED Typewriters, duplicating, printing devices. \$25.00 up. Supplies. Appliances. DixieGraph, King, N. C.**

### **PRINTING, MULTIGRAPHING, MIMEOGRAPHING, GUMMED LABELS**

**OFFSET Printing, 1000 8½x11 \$4.95.** Alpline, Box 676-E, Cupertino, California.

**MIMEOGRAPHING—Letters, pricelists, formulas, instructions. Lowest prices.** Lem's Letter Shop, 5710 Stanton, Detroit 8.

**BUSINESS Cards (raised letters) 500—\$2.50. C.O.D. Samples free.** Picha, 27600M Joy, Livonia, Michigan.

**FREE Catalog, samples, quality work.** Willis Printing, Box 661, Albany, Georgia.

**FREE Catalogs postpaid printing. Rubber stamps.** DM Press, Sebastopol, Calif.

**ADS Running under this heading sell printing. Ask me for proof. I'll gladly send you amazing facts. Ask for Folder "P."** F. W. Johnson, 200 E. Ontario St., Chicago 11, Ill.

**100 6¼ ENVELOPES, 100 5½x8½ letterheads printed, \$2.35.** M. Fortney, Route 3, Dillsburg, Penna.

**750 NAME Address labels 35¢. Catalog 10¢.** Scheetz's, Sellersville, Penna.

**PERSONALIZED Items: iron-on cloth labels, stationery, informals, envelopes, shipping labels, etc. Free circular.** A. Golfieri, 103 Revere St., Revere 51, Mass.

**BUSINESS Cards, letterheads, envelopes, post cards, labels, rubber stamps, offset printing. Free samples.** Youngers Printing, Princeton, Iowa.

**CIRCULARS, Letterheads, etc. Price list.** Valattis, 1705 South 2nd, Philadelphia 11.

**100 INVOICES \$1.50 postpaid. Statements, envelopes same.** Dornfeld, Iron Ridge 7, Wisconsin.

**250 LETTERHEADS 8½x11 \$2.95.** 250 6¼ envelopes \$2.95. Samples! Davis, 7609 Spruce Road, Baltimore 22, Maryland.

**1000 EMBOSSED Business cards \$3.99.** Free samples. Winters, Box 333P, Pleasantville, N. J.

**250 LETTERHEADS 8½x11; 250 envelopes. \$4.95!** Vall, 334, Hicksville, N. Y.

**1,000 BUSINESS Cards. Raised letters, \$3.95. Samples. Pioneer, PM-5 Island Park, N. Y.**

**1000 SIMULATED Engraved business cards \$4.95 ppd. Samples free.** J. P. Charters, Box 527, Encino, Calif.

**MIMEOGRAPHING. Printed quality. Acme Duplicating, 340 Perry NW, Canton 8, Ohio.**

**QUALITY Printing, 100 each 8½x11 letterheads, 6¼ envelopes. \$2.00 postpaid.** Roycraft, 2263 Sibley Road, Augusta, Georgia.

**ENVELOPES—1000 No. 10 \$6.95, 1000 6¼ \$4.95. Printed. Postpaid.** Neal, 249 Sunrise, Nashville 11, Tennessee.

**RAISED Letter business cards \$3.00 per 1,000.** Kavanagh, 607-PM, Knickerbocker Ave., Brooklyn 21, N. Y.

**FREE Money saving price list—postpaid printing.** Basin Press, 2001 W. New Jersey, Midland, Texas.

**750—NAME-Address labels 50¢.** Falco, 1122 Prospect, Lansing 12, Mich.

**SIMULATED Engraved business cards. Citation plate. Strictly classy. \$3.95 thousand. Post cards \$7.95 thousand. Prepaid. Free information.** Steele, 7569-A University, La Mesa, California.

**1,000 BUSINESS Cards, raised letters, \$3.75 postpaid. Samples.** Elco, 5909 Highlandview, Sylvania, Ohio.

**OFFSET—Free layouts, graphic art, copy rewriting.** Grosch, Fox River Grove, Illinois.

**1000 BUSINESS Cards, embossed, \$3.49 ppd.** L-D, 534 State, Hammond, Indiana.

### **PRINTING OUTFITS AND SUPPLIES**

**TYPE And cuts for printers and rubber stamp makers. Largest selected in U. S. Catalog free.** Acme Type, 633 Plymouth Court, Chicago.

**PRINTING Presses, type, supplies. Lists 4¢.** Turnbaugh Service, Mechanicsburg, Penna.

**RUBBER Stamp presses, supplies.** Kiewiet, 2025 Barney Road, Kalamazoo, Mich.

**RUBBER Stamp presses, hydraulic operated, electrically heated. Sizes 5"x8", 8"x12", 10"x15". Starting outfits, supplies. Printing presses, supplies. Custom Manufacturing, 507-P N. Jefferson, Springfield, Missouri.**

**MAKE Your own self-molding rubber stamps and printing cuts.** Plexirubber, Argyle 1, Wisconsin.

**DO Your own printing. Save money. Simple rules. We supply everything. Print for others; good profit. Raised printing like engraving too. Have home shop. Details free.** Kelsey Presses, V-11, Meriden, Connecticut.

**HARD Type for rubber stamp making and printing. Special introductory offer. 10 or 12pt. 20th Cent. medium or Stymlie medium. Cap ft. \$2.00. L.C. ft. \$2.00.** Free catalog. Barco Type Founders, 64 Wagner, Northlake, Ill.

### **FOR INVENTORS**

**PATENT Searches, including copies of nearest patents, \$6.00. Inventors, patent attorneys, manufacturers use my Airmail service to determine patentability of inventions! "Proof of Invention" protection form and "Information Every Inventor Needs" sent free!** Miss Jean Hayward, 310 Realty Building, Washington 5, D. C.

**INVENTIONS Needed immediately for manufacturers. For additional information write Kessler Corporation, C-55-FI, Fremont, Ohio.**

**PATENT Searches \$6.00. 48-hour service. Formerly with U. S. Patent Office. Free invention protection forms. Write Raymond L. Smith, Patent Searcher, 620 Sheraton Building, Washington 5, D. C.**

**INVENTORS! Our Patent Search Department administers searches expertly. \$6.00. For dependable service, free invention protection forms write: United States Inventions Brokerage, 78-S Wall Street, New York 5, N. Y.**

**MAKE Money from ideas. Information free.** Grayland, 5312 Grace, Chicago 41.

**PROFESSIONAL Searches of the Patent Office records. Dependable. Reliable. \$6.00. For free protection forms write: Inventions on Demand, 412 Albee Building, Washington 5, D. C.**

**"DON'T Pay high fees! Obtain U.S. patent yourself. It's easy with Professional Kit with fill-in forms. Free "Registration Form." Patent Protection Institute, 2000 P Street, N.W., Washington 5, D. C.**

**FREE! A valuable booklet full of information every inventor needs. Tells how to protect, evaluate, and market your invention. Can save you time and money. Write for free copy of "The Inventor's Guide." No obligation. Inventors Guidance Service, Calimesa, Calif.**

**INVENTORS—Get the best offer first! Patented or unpatented. Write Carl Sommer, Director, Industrial Invention Sales, 3136-A Sylvania Ave., Toledo 13, Ohio.**

**YOU Can easily apply for patents. Save with complete professional kit. Free registration certificate. Patent Associates, 1214 Commonwealth Bldg., Philadelphia 7, Penna.**

**PATENTS Skillfully prepared and filed for total service charge of \$200.00 for U. S. and Canada for simple invention, with valuable development and market service. Accurate receipt for any data sent me. Patent search and valuable report \$15.00. 30 years' experience as patent and development engineer. Foreign patents obtained. Joseph O'Brien, 132 Nassau St., New York, N. Y.**

**INVENTORS! Determine patentability of your invention. Searches of the Patent Office Records administered professionally—\$6.00. For free invention protection forms, dependable service write Washington Patent Office Search Bureau, 1426 G Street, N. W., Washington 5, D. C.**

**INVENTORS' Complete service. Cash-royalties sales. Inventions researched. Patent development engineering. Free invention certificate. George Spector, Licensed Invention Engineer, 3615 Woolworth Building, New York.**

**INVENTIONS Wanted now by my manufacturer clients. Patented. Unpatented. Write Gilbert Adams, Patent Broker, 80 Wall St., Financial District, New York City.**

**PATENT Searches, including copies of nearest patents, \$6.00. Reports airmailed within 48 hours. More than 200 registered patent attorneys have used my service. For free invention protection forms, write Miss Ann Hastings, P. O. Box 176, Washington 4, D. C.**

**WE Have the markets if you have the ideas.** Harvey Engineers, Cambridge 1, Maryland.

**INVENTORS: Test the commercial value of your patented or unpatented inventions, quickly and inexpensively. Write for free information. Institute of American Inventors, Dept. 40-B, 635-F St., N.W., Washington 4, D. C.**

**HIGHEST Cash, royalties. Inventors having good ideas that need developing, drawing, patent search, marketing. Write Inventors Creative Service, 354 South Spring, Los Angeles 13, California.**

**INVENTORS! Why be broke? Turn your invention into cash. If saleable, we can sell it. Write Universal Inventions, Box 298, Marion, Ohio.**

**SAVE! New inventor's Patent Kit makes it easy to apply for patents yourself. Free "Registration Form." Miss Suzan Blaine, 1850 General Post Building, New York 1, New York.**

**PROTECT Your ideas. Filled with us, you have positive record of ownership. Explore idea value, before patent expense. Safest method, you reveal nothing. Plan fee \$3.00. Print name, address. Priorgard, Box 3385, Granada Hills, Calif.**

**PATENT Searches \$6.00. 48-hour airmail service. Invention protection forms free. Write Patent Engineering Service, 711 14th Street, N. W., Washington 5, D. C.**

**COMPREHENSIVE Search through patent office records \$10. "Protection" forms unnecessary. Complete inventor's service. Sales, market evaluation. Johns-Hanson Associates, 421 Washington Building, Washington 5, D. C.**

**INVENTIONS Financed and sold. Industrial Inventions, 53 West Jackson Blvd., Chicago 4, Illinois.**

### **INVENTIONS WANTED**

**INVENTORS! Outright cash sale or royalties for your inventions. Patented. Unpatented. Constant demand from our client manufacturers. Write: United States Invention Brokerage, 78 Wall Street, New York 5, N. Y.**

**INVENTORS—Get the best offer first! Patented or unpatented. Write Carl Sommer, Director, Industrial Invention Sales, 3136-A Sylvania Ave., Toledo 13, Ohio.**

**INVENTIONS** Wanted: patented, patent pending. 29 years experience promoting inventions. National Service Bureau, 3120 Meramec. St. Louis 18, Mo.

**INVENTORS'** Complete service. Cash-royalties sales. Inventions researched. Patent development engineering. Free invention certificate. George Spector, Licensed Invention Engineer, 3615 Woolworth Building, New York.

**INVENTIONS** Wanted now by my manufacturer clients. Patented. Unpatented. Write Gilbert Adams, Patent Broker, 80 Wall St., Financial District, New York City.

**INVENTORS:** Hundreds of manufacturers have requested our assistance in locating marketable new products. Complete information free. Institute of American Inventors, Dept. 40-D, 635-F St. N.W., Washington 4, D. C.

**INVENTIONS** Wanted. Patented; unpatented. Tremendous manufacturers lists. Global Marketing Service, 2420 77th, Oakland 5, California.

**INVENTORS!** Consider our offer first before selling or licensing your invention on a cash or royalty basis. Patented. Unpatented. Inventions on Demand, 79 Wall Street, New York 5, N. Y.

**ARE** You interested in offers from reliable manufacturers for your invention? Patented, unpatented. Harvey Engineers, Cambridge, Maryland.

**CASH,** Royalty, obtainable for good ideas, inventions. Ketchum's Advertising, B-1058A, Springfield, Illinois.

**INVENTORS!** Don't sell your invention, patented or unpatented, until you receive our offer. Write Universal Inventions, Box 298, Marion, Ohio.

**INVENTORS—**Do you want to sell or license your invention on cash or royalty basis? Write Kessler Corporation, C-55-IW, Fremont, Ohio.

**INVENTIONS** Wanted for immediate promotion—patented; unpatented. Outright cash or royalties! Casco, Dept. G, 1424 "K" Street NW, Washington 5, D. C.

**INVENTIONS** Wanted for manufacturers. Free details. Write Allen, Dept. C., 712 Davis Bldg., Big D., Dallas, Texas.

#### PATENTS FOR SALE

**JUST** Patented most sensational fish lure guide. Used for bobber, still fishing, surface and sub-surface trolling. Tollefson, Bonilla, South Dakota.

**LIFE-Saving** vehicle door bolt lock. Chas. Burke, 48 Great George, Charlotte-town, P.E.I. Canada.

#### MANUFACTURING

**MODELS**—Small lot manufacturing. Metals, plastics, etc. Milburn, Burlington, Kentucky.

#### MODELS, MODEL SUPPLIES

**LIONEL** Trains. Big discounts. Catalog 25¢. Mack Bros., 2043-P Chicago Ave., Chicago 22.

**SHIP** Models. Most complete line in New England, kits, fittings, plans, books, tools, engines, motors. Illustrated catalog 35¢. James Bliss & Co., Inc., Dept. SM, 342 Atlantic Ave., Boston 10, Mass.

**ROCKET** Supplies—Nozzles, cones, tubes. Specials also made. Catalog 10¢. Sky Mfg., Mineral Point, Penna.

**SHIP** And yacht model fittings: blueprints. Send 40¢ for illustrated catalog listing hundreds of items. A. J. Fisher, Inc., 1002-1 Etowah Ave., Royal Oak, Mich.

**SHIP** Model kits and fittings: clippers, frigates, etc. Catalog, paint-tool list, book list, 25¢. Model Shipways, Box 85, Bogota, N. J.

**MODEL** Cars, electrified roadways. Electromat Company, Box 13742, Dallas, Texas.

**DECK** Cannon, "Old Ironsides." Authentic, beautifully appointed. Complete ¾ scale working drawings. Only \$1.00. Parts or kits available. Howjay & Company, Halesite, New York.

**"POWER** Drives Handbook"—36 pages illustrating many types motor drives for model autos, boats, displays, turntables, etc. Mail 25 cents cash, returnable first order \$3.00 or more. Wilson's of Cleveland, Dept. PM, P.O. Box 8995, Ft. Lauderdale, Fla.

**½" POPLAR** Plywood—finished two sides. Excellent for hobbyists and jig saw projects. 10 sheets 13"x7" \$2.00 postpaid. Other sizes and prices available on request. Ply-Craft, Box 27, Millville, N. J.

**ROCKETS:** Three complete model rocket plans 25¢. For two sample one-pound NAR approved rocket motors with above plans send \$1.00. Estes Industries, 5505 Tejon, Denver, Colorado.

#### HOME CRAFTSMEN

**HARDWOOD** Turnings, furniture parts, dowels. Write: Robert Flick, Bridgton, Maine.

**FREE** Leathercraft catalog. Quality kits, leather, tools. Handicrafters, Montrose, Calif.

**CRAFT** Catalog free. Mosaics, leathercraft, enameling, plastic casting, metal tooling, floralcraft, shellcraft. Many more. Kit Kraft, 205, Studio City, Calif.

**101 PATTERNS** Of smart gifts, novelties, shelves, action windmills plus "Make Money Jig Sawing." \$1.00. Mastercraft, 55M, 7041 Olcott, Chicago 31.

**BUILD** Dutch windmill and wishing well dog houses. Two plans \$1.00. Craft Shop, Peotone, Illinois.

**WALNUT,** Cherry, maple, kiln dried lumber, squares and blocks. Midland Lumber Co., Bx 262, Savannah, Mo.

**25 WINNING** Ideas for cartoons \$1. A. Schloss, 490 Bleeker Avenue, Mamaroneck, New York.

**FREE.** New plans catalog. Make 2400 things. Fun. Profit. Craftplans, 1322-A Wabash, Chicago 5.

**WOODWORKING** And cabinetmaking course for beginning and advanced home craftsmen. Only complete low-cost home training program available. Write for free booklet. Interstate Training Service, Dept. G-3, Portland 13, Ore.

**KNOCKDOWN** Cedar chests and lumber. Free price list. Bedford Lumber Company, Shelbyville, Tennessee.

**LEATHERCRAFT.** Send 10¢ for catalog. Saccrafts, Inc., 1101 N. 3rd, Milwaukee, Wisconsin.

**FREE** Do-it-yourself leathercraft catalog. Tandy Leather Company, Box 791-K34, Fort Worth, Texas.

**FREE!** Leathercraft catalog. Hundreds of new items. Write MacPherson Bros. Leather Company, Dept. E, 730 Mission St., San Francisco 3, Calif.

**LEARN** Art metalcraft and jewelry making. Complete, inexpensive, home training course now available. Metals and materials furnished. Send postcard for free booklet. Interstate Training Service, Dept. L3, Portland 12, Oregon.

**PROFITS** To 3,000% making Shellcraft jewelry. We show you how to cash in! Details, illustrated booklet, wholesale catalog 25¢. Shellcraft, Dept. AA, Box 804, Panama City, Florida.

#### DO IT YOURSELF

**SWIMMING** Pool. Read how I built a 12' x 27' excavated pool and filter for around \$300.00. Illustrated booklet \$3.00. Bob Garmater, Box 16, Woodburn, Ind.

**FREE** Do-it-yourself leathercraft catalog. Tandy Leather Company, Box 791-K34, Fort Worth, Texas.

**REPAIR** False teeth yourself. Special, new professional plastic. \$2.00 postpaid. Guaranteed. Grant Dental Laboratory, 219 W. 7th St., Los Angeles, Calif.

**INSTALL** The new inside Loxem burglar proof lock yourself. Write to John Pyskaty Locksmith, 3458 West 62nd Street, Chicago 29, Ill.

**INTERCEPT** A conversation more than 100 yards away. Low-cost transistorized unit. Complete diagram and plans \$2.00. F. J. D'Imperio, P. O. Box 4281, Philadelphia 44, Penna.

**WATER** Softeners, filters, knocked down. You assemble save one half. McCarty Co., 7136 W. State, Milwaukee 13, Wis.

**BUILD** Inexpensive swimming pool solar heater; adds months to swimming season. Build pool filter under \$50.00. Out-performs many commercial units. Instructions, plans, \$1.25 each; both \$2.00. Sun Heater Co., 441 Pickwick Drive, Napa, California.

**AIR** Conditioners, home, automobile. See Kool Engineering ad page 27.

**HOW** To give haircuts at home. By expert barber. Completely detailed. Illustrated. \$1.00. Enterprise, Layton, N. J.

**WILL,** Instructions prepare your own. \$1.00. Evin Associates, 8248A Studebaker, Warren, Michigan.

**FREE** Check-list covering more than 500 classifications of projects, plans, instructions, service and repair information detailed in Popular Mechanics famous series of instructional booklets, books, patterns, and blueprints. List covers an extremely wide variety of do-it-yourself data on home remodeling, repair and improvement, hobbies, crafts, boating, games, lawn and garden, and hundreds of others. For your free copy of this helpful list, write: Service Bureau, Popular Mechanics, Room 520, 200 East Ontario, Chicago 11, Ill.

#### WATCHES, OLD GOLD, JEWELRY

**BULOVA** Watches etc. Out of pawn. \$2.95 up. Cosmos, New York 35.

**COSTUME** Jewelry supplies, settings, rhinestones, etc. 88 page illustrated catalog. 30¢. Millady, Box 1328, G.P.O., New York City.

**FREE** Catalog. Costume jewelry parts. Supplies. Reasonable prices. Fast service. Guaranteed quality. Unique merchandise. Folsom's, Box 52, Medford 55, Mass.

**HIGHEST** Cash for old gold, jewelry, gold teeth, watches, diamonds, silverware, spectacles, platinum, mercury. Free information. Rose Refiners, Heyworth Building, Chicago 2.

**WATCHMAKERS'** Tools, materials, supplies, watches. Catalog. Gales, Box 1000, Chicago 90, Illinois.

**JEWELRY,** Diamonds, watches. Guaranteed wholesale price plus 6% service charge. Os Aron, 62 West 47, New York, N. Y.

**HIGHEST** Cash paid for old gold, jewelry, gold teeth, diamonds, watches, silver. Mail articles today. Information free. Chicago Gold Refining Co., 6 E. Monroe, Dept. 2258, Chicago 3.

**WATCHMAKERS'** Jewelers', lapidaries' catalog 25¢. Bengal, 8910 Venice, Culver City, California.

**WE** Make your old watches and jewelry like new. Ask for estimate. Cosmos, New York 35.

**WATCH** And clock repairing books. Free catalog. North American, 2320-AS Milwaukee, Chicago 47, Illinois.

**POCKET** Watches 16s railroad model. Prices to suit you. W. E. Russell, 704 Skyview Drive, Nashville 6, Tennessee.

**EASY** To make costume jewelry. Catalog 10¢. Introductory kit including catalog \$1.00. J & M Novelties, Dept. CE-3, Box 173, Broadview, Ill.

**TIMEX**-Westclox—Pin lever watches repaired \$1.10. Jeweled watches \$3.50. Guaranteed. Nothing added. Send cash, save C.O.D. Davis Jewelry, Box 563, Alamogordo, N. Mex.

#### RAZORS, BLADES, SHARPENING

**RAZORMATE** Patented strop accents "safe" in safety shaving! Makes each blade give you ten bloodless velvet-smooth shaves! Send only 25¢ to Razormate, P.O. Box 15934, Los Angeles 15, Calif.

#### FOR THE HOME

**REDWOOD** Signs for home or trailer. Large script carved into natural redwood and lacquered bright-white. Beautiful contrast. Your name \$2.95, name and number \$4.95, with mounting bracket \$5.95. Order now. Postpaid. Satisfaction or refund. Descriptive folder 10¢. Postmarket, 11168 Santa Monica Blvd., Box 194, Los Angeles 25, Calif.



**MAKE** Fancy cookies 5¢ dozen. Automatic cookiepress from Sweden. Makes 2 sizes; 15 designs. Write: The Maillette, 1502 S. Lowell, Santa Ana, California.

### OF INTEREST TO WOMEN

**FREE** Catalog. Unique children's games. Betrick, Dept. 113, 1603 Orrington, Evanston, Illinois.

**HOUSEWIVES**, Teachers, students, office workers, if you need extra cash each week but household or other duties prevent you from taking a part-time job, learn how you can earn by accepting orders to Popular Mechanics. Good Housekeeping and all other magazines. No experience needed. Write Popular Mechanics, Room 5W, 250 West 55th St., New York 19, N. Y.

**DRESSES** 24¢; Shoes, 39¢; men's suits, \$4.95; trousers, \$1.20. Better used clothing. Free catalog. Transworld, 164-G Christopher, Brooklyn 12, N. Y.

**FREE** Import catalog. Get free gifts. We explain how. Send 25¢. Wentworths, P.O. Box 143, Muskegon, Michigan.

**YOUR** Inked handwriting analyzed free. Maurice, 13930 Monica, Detroit 38, Mich.

**MAKE** Money at home mailing literature to new mothers. Big earnings. Everything furnished. Write: I. B. Service, Box 317, Dept. P, Mission, Kansas.

**MAKE** Money weaving rugs at home for neighbors on \$89.50 Union Loom. Thousands doing it. Booklet free. Union Loom Works, Dept. 3, Boonville, N. Y.

**SELL** Fine fabrics. Get yours wholesale. Box 863, Norwalk, Conn.

### PERSONAL

**BORROW** \$100 To \$600 by mail. Quick, easy, private. No co-signers. Repay in 24 small monthly payments. For the amount you want write today to Dial Finance Co., 410 Kilpatrick Bldg., Dept. E-1, Omaha 2, Nebraska.

**LOANS** By mail. \$50 to \$600 for any purpose. Employed men and women eligible. Confidential. 2 years to repay. Write for free loan application. American Loan Plan, City National Bldg., Dept. PM-4240, Omaha 2, Nebraska.

**STOP** Stammering! By home study system! Immediate improvement! Small tuition! The Johns Institute of Speech, Box 102M, Scranton, Penna.

**BIBLE** Questions answered. Stamped envelope. Bylon, 17167 Bentler, Detroit 19, Michigan.

### REMAILING SERVICE

**CONFIDENTIAL** Worldwide remail-forwarding service. Smith, 1306 South Darlington, Tulsa 12, Oklahoma.

**LETTERS** Mailed 25¢; forwarded 30¢. Henri Labrie, Room 7, 380 Elgin St., Ottawa, Ont., Canada.

**CHEYENNE** Remails, 25¢. Monthly \$3.00. Ray, Box 2434, Cheyenne, Wyoming.

**REMAILS** From Chicago! 25¢. Avers, Box 22, Forest Park, Ill.

**WASH.** D.C. remails 25¢. Studios. P. O. Box 6993, Washington 20, D. C.

**WIESBADEN**, Germany, remails \$1.00. German newspaper \$1.00. Helke Roberson, Box 6054, Wiesbaden, Germany.

**TANGIER**, Morocco. Home of Kasbah. Re-airmails \$1.00. Robert, Box 137.

**VENEZUELA** Re-airmails, \$1.00. Write: Brengle, El Pao, Estado Bolivar, Venezuela.

**SECRET** Mail. Receiving, forwarding. \$4.00 month. Loyd Moffitt, 2911 North Flagler, West Palm Beach, Florida.

**CONFIDENTIAL** Mail receiving-forwarding 25¢ per letter. Dependable. Jonell, Box 943, Wenatchee, Wash.

**SECRET** Mail address. \$3 month. Hedgpath, Box 830, Alhambra 23, Calif.

**SAN FRANCISCO** Remails and forwarding. \$4.00 month. Souveniers, Box 783, San Francisco 1, Calif.

**SECRET** Mail receiving, forwarding. Details free. Cook, Box 1474, Poughkeepsie, N. Y.

**CALIFORNIA** — Confidential mail received, forwarded, 25¢ letter. Souvenir postcards furnished free. Also business mailings. Crisdale, Box 2226, Hollywood 28.

**MAIL** Received, forwarded. Prompt. confidential. 25¢. Pyramid Exchange, 712 Elizabeth, Fresno 4, Calif.

**CONFIDENTIAL** New York City mailing. Receiving, forwarding, address. \$3.00, month. Remails 25¢. Birnhan, 109 W. 42, New York 36, N. Y.

**DENMARK** Reairmails \$1. Sandwich recipes \$1. Gifts available. Holmes. Aeginaves 16, Copenhagen. S.

**RENT** Re-mailing, receiving-forwarding address. Postal agents since 1950. William McLaughlin, 800 Stewart, Columbus 6, Ohio.

**DISCREET**, Reliable, confidential letters remailed from heart of Manhattan 25¢. Receiving and forwarding service \$3.00 monthly. Howard Services, 1170 Broadway, New York City 1, N. Y.

**SECRET** Mailing system. Details free. Lillian's, Box VC3011A, No. Hollywood, Calif.

**FORT WORTH** Remails—25¢, \$3.00 monthly. Confidential. Gibson, Box 14241, Ft. Worth 17, Texas.

**FOREIGN** Remail 50¢. Monthly \$3.00. Arbin Ignatiigr, 4 Stockholm C Sweden.

### TREASURE FINDERS

**GOLD**—Silver detectors. Geiger counters. Violites for tungsten, etc. Best available. Guaranteed. Information free. Detectron, Dept. 10, Sylmar, California.

**TREASURE!** Map, handbook, 25¢. Locators. Howe, 811 Kansas, Atchison, Kansas.

**445 TREASURES**, United States map 2x3 feet, plus catalogue. \$1.00. Foul Anchor, Rye 2, N. Y.

**METAL** Locator kits and assembled models from \$39.90. Transistorized and underwater models available. Free catalog. Electronic Applications, Dept. M, Box 8, Arlington 10, Virginia.

**DISCOVER** Buried loot, sunken treasure, gold, silver, coins; battlefield and ghost town relics, with powerful transistorized locators pioneered and perfected by Goldak. Low as \$79.50. Free, exciting information; literature on maps. The Goldak Co., 1541 West Glenoaks Boulevard, Glendale 1, California.

### FOR SALE—MISCELLANEOUS

**POWER** Mower save 50%. Nationally advertised 3 H.P. Briggs & Stratton engine. New Rotary, self-propelled with wind-up starter. Mail post card for information. Easy terms available. Dept. CA-46, Farm & Home Equip. Co., 6420C Olive Blvd., St. Louis 30, Mo.

**FREE** Money-saving catalog. Surplus and newly manufactured equipment and tools for workshop, home, boats, farm, factory. Write: Groban, 1139 South Wabash, Chicago 5, Illinois.

### WANTED—MISCELLANEOUS

**I BUY** old toy train catalogs. Howell Day, Dunellen, New Jersey.

**OLD** Cast iron mechanical coin banks. Pay top prices. Write describing fully condition, action, price. James Capron, Boonville, New York.

**QUICKSILVER**, Platinum, silver, gold. Ores analyzed. Wholesale Terminal, Norwood, Mass.

### MISCELLANEOUS

**TRADESMAN**, Handyman, homeowner. Lay your own brick, rock, stone work. Excell the professionals. No special training needed. Use our new revolutionary guard guide tools. You'll be amazed and satisfied. 10 day money back guarantee. Order today kit #4. Only \$3.95 postpaid. Quist Mfg. Co., Box 307, Dept. P5, Puyallup, Washington.

**LOANS** Entirely by mail—\$600 or less for any purpose. Strictly confidential. Repay in 24 low monthly payments. Employed men, women eligible anywhere. Write: Budget Finance Co., Dept. J-40, 114 S. 17, Omaha 2, Neb.

**LET** Us tell you how to turn the reading habits of your friends into profit for you. \$10.00, \$25.00 or \$50.00 can easily and quickly be made under our Popular Mechanics subscription plan. No experience needed. Write Popular Mechanics, Room 5M, 250 West 55th St., New York 19, N. Y.

**HAWAIIAN** Candy, gifts. Catalogue 20¢. Maier Products, 3109 Waialae, Honolulu.

**HILARIOUS** Caricature of you! Send snapshot (returned) and \$1.00. The Drawing Board, Empire Bldg., St. Petersburg, Fla.

**MIRROR** — Transparent back. Watch, photograph people, secretly! 8"x10", \$2.00; 16"x20", \$5.00. One-Way Mirror, PM-560, Box 625, Mt. Vernon, N. Y.

**FREE** Gift plus fabulous name-brands bargain catalog. \$1.00 (refundable). J & M, Box 15 Crane, Schenectady 3, New York.

**POWER** Mower gasoline gauge kit. Fits your cap. Warns when low on gas. Inexpensive. Free details. Charles Leinhaus, 813 Maurer Road, Pottstown, Penna.

**LIFETIME**-Listing. Receive valuable free samples-educational books, money-making mailorder opportunities, 25¢. Ply-O-Film, Box 30G5, Berea, Ohio.

**SWAP** Unwanted neckties for crisp, fresh ones. Write: York, Denton, Md.

**BOOKS** On antiques and their prices. Free circular! P. Warman Publishers, Uniontown, Penna.

**GET** Samples, opportunities, magazines, catalogs, offers galore! Your name in 5000 big mail directories, 25¢. Results guaranteed. King's, Moorestown, Ontario, Can.

**ORNAMENTAL** Iron designs. Book of 1600 beautiful, practical designs for railings, columns, etc. Free literature. Cunningham, 3881 South 3200 West, Salt Lake City 4, Utah.

**YOUR** Name wanted. We'll send 1000 publishers, mailers, wholesalers your name, on our list one year 25¢. Dixie Mailers, King, N. C.

**CIGARETTES**: Make 20 plain or filter-tips for 9¢. Facts free. Moberly, Box 915, Owensboro, Kentucky.

**100,000 PRODUCTS** Wholesale — Free catalog! Send postcard: Econ-O-Mart, Whippany 15, New Jersey.

**RECEIVE**—Magazine samples, mail offers, bargains from everywhere. Get listed 25¢. Rorick, Cincinnati 26, Ohio.

**SEND** Us wool for blankets. Free literature. West Texas Woolen Mills, 421 Main, Eldorado, Texas.

**GENUINE** Marble & granite tombstones \$12.50 up, including lettering and footstone. Freight paid. Free catalog. Allstates Monument Co., Station F-26, Atlanta 6, Georgia.

**LEARN** The cha-cha-cha, waltz, fox-trot and many other popular dance steps. Book only \$4.50. Reynec, 31 University, Buffalo 14, N. Y.

**CHECKWRITERS** Protect your bank account. Only \$14.95. Details free. Check-writers, Box 587, Bellevue, Nebr.

**RECEIVE** Samples! Offers! Catalogs! Bargains! Magazines! Mail! From everywhere—25¢. Lee Wiersma, Orange City, Iowa.

**MAKE** Puzzling pay! Only 25¢ for America's foremost contest magazine. Spence, Box 11569, St. Petersburg, Fla.

**50 STAR** American flags. Banners, decorations, accessories. What you need, we've got. Free information. National Flag Distributors, P. O. Box 664, Dept. 150, Brunswick, Maine.

**PRAYER** Token, coin size, very impressive. Reminds its owner to pray. 35¢, 3/1.00. Box 300, Summerland, Calif.

**CAMPING** Maps, U. S. A. New guide book lists thousands of campsites, facilities in all 48 states. Authentic, 1960 edition. \$2.00. Books, Box 106, Highlands, N. C.

**FREE** Bargains. Close out lists with import directory \$1.00. Enterprise's, P. O. Box 546, Port Hueneme, Calif.

**THE** Sacred and mystical teachings of the early Christian church. 36-page book. \$1.00 cash or m.o. Mid-America, 600 W. Van Buren, Chicago 7.

# PREPARE FOR THE BEST JOBS

**TRAIN AT HOME**  
in Your Spare Time  
or at Allied Institute  
in Chicago

Also  
for FREE  
SAMPLE LESSON

SEND FOR  
**FREE**  
BOOKS

- DRAFTING
- TOOL DIE-DESIGNING
- TOOL-DIE MAKING
- IND. ENGINEERING
- IND. ELECTRONICS
- AIR CONDITIONING
- REFRIGERATION
- AUTO MECHANICS

**ALLIED INSTITUTE OF TECHNOLOGY**  
1338-42 So. Michigan Ave., Dept. PM-50, Chicago 5, Ill.



AC Spark Plug Division, General Motors, Flint 2, Mich.

## Hand-Pump Radiator Tester

Pressure caps and radiators get a quick checkup with a new tester that is operated by pump action. The instrument tests cooling systems at pressures from 1 to 30 pounds. Unlike other testers, the new device uses an expansion mechanism that fits inside of the radiator filler neck instead of on the shoulder. The extension adapter, attached to the unit, fits most cars and trucks. A pressure gauge tells whether the radiator cap is good or faulty or whether there is a leak in the cooling system.



The Martin Company, Baltimore 3, Md.

## Rotating Assembly Wheels Replace Conveyor Belts

Rotary wheels that take up no more space than a standard workbench are doing the work of assembly-line conveyor belts at a missile-parts factory in Baltimore. Each wheel, holding 24 job-pieces, has three work stations for assembly personnel. Working as a team, the operators each accomplish one-third of the work assigned to the wheel. Time spent on each assembly can be regulated from 2 to 180 minutes. Pneumatic pressure rotates the wheels.



## BARBELLS

140-Pound, **CHROME DELUXE** Barbell-Dumbbell set only \$19.80. This is our feature set and is the finest ever manufactured.

Training with adjustable weight is the **BEST** way to keep fit; the **ONLY** way to develop great strength and a perfect body. As the oldest and best equipped barbell company, BUR gives value and prices no one can equal.

**SEND FOR FREE CATALOG**  
**BUR BARBELL CO.**  
Lyndhurst 9, New Jersey

**100 POUND SET \$12.80**

Extra Plates Only 12c POUND

Shop PM Ads for Exciting Direct-Mail Offers



# YOU NEED THIS

## FREE GIANT 1960 B-A CATALOG



*A Complete Buying Guide for Everything in*  
**RADIO 1960 TV ELECTRONICS**  
ANNUAL CATALOG 601  
**BA**  
SINCE 1927

**204 KING-SIZED PAGES**

EVERYTHING IN RADIO TV AND ELECTRONICS

100'S OF NEW ITEMS LISTED HERE FOR 1ST TIME

21 PAGES OF BARGAINS NOT IN ANY OTHER CATALOG

**BURSTEIN-APPLEBEE CO.**  
Dept. PM, 1012 McGee St., Kansas City 6, Mo.

Send Free 1960 B-A Catalog No. 601.

Name.....  
Address.....  
City..... State.....

**SEND FOR IT TODAY**

**Funpacked FOLBOT** fits in every home or car

**FREE** catalog

Famous PORTABLE and FOLDING Folbots

Most seaworthy, all colors and sizes, 1 to 4 seaters. Exclusive low and high seats, SWIVEL backs. Comfy Cruising, fishing, hunting. Use motors, Sails, Paddles. NO upkeep. Goes anywhere. PREFAB or Factory Finished on \$15 monthly terms.

**BIG TRAVEL CRAFT** from **\$88** PREFAB

**\$89.-** Complete SAIL RIG factory finished Folbot \$147 up

**MAIL COUPON TODAY**  
to: FOLBOT CORP. P.M. Charleston, S. C.

Name.....  
Address.....  
City..... State.....

**BRAND NEW 25 H.P. ENGINE \$97<sup>50</sup>**

Government Surplus List \$376.00

Harley Davidson 25 H.P. 2 cylinder

air-cooled 4 cycle 45 Cu.in.

REPLACEMENT; AIR SLEDS; GYRO-COPTERS; STATIONARY ENGINE

Motorcycle engine Model HRD-1-40M. Stroke 3-13/16"; bore 2-3/4"; H.P. 25 at 4500 Rpm Complete with model 32E generator, carburetor, spark plugs and 30 tooth engine sprocket.

"The best air-cooled engine ever made"—"They never wear out"—"Rugged" are phrases heard by people experienced with this engine. Horsepower may be increased to 50 H.P. by changing cams, heads and the usual 'soup-up' methods. Parts available at your Harley-Davidson dealer or through this company. Shipped in original wooden overseas wood container with preservatives.

No Rust—Brand New. Ship. Wt. 176 lbs.

Dealers price \$75.00 ea. lots of 6 or more.

**ESSE RADIO COMPANY** 42 W. South Street Indianapolis 25, Ind.



**Worry of FALSE TEETH**

**Slipping or Irritating?**

Don't be embarrassed by loose false teeth slipping, dropping or wobbling when you eat, talk or laugh. Just sprinkle a little FASTEETH on your plates. This pleasant powder gives a remarkable sense of added comfort and security by holding plates more firmly. No gummy, gooey, pasty taste or feeling. It's alkaline (non-acid). Get FASTEETH at drug counters everywhere.

**YOUR OWN 2-WAY RADIO!**



*Messenger*  
FROM **\$129<sup>75</sup>**

Anyone can operate—license issued by the FCC on request!

The very finest Citizens' Transceiver available! Excellent selectivity and sensitivity for maximum range. Maximum legal power. Dozens of features!

WRITE TODAY FOR FULLY ILLUSTRATED BROCHURE

**E. F. JOHNSON COMPANY**  
162 SECOND AVE. S. W. • WASECA, MINNESOTA

MAY 1960

**AVIATION CAREER**

**SPECIALIZED EDUCATION / PROFESSIONAL TRAINING... only 16 months to 2 years**

Top-pay prestige positions, bright future in aviation. Job opportunities waiting for you as soon as you're ready. Airframe and Powerplant Technician, Aeronautical Engineering Technologist, Business or Executive Pilot. Classes in Miami.

**SEND FOR FREE 80-PAGE BOOK**

Embry-Riddle Aeronautical Institute  
Dept. B Miami, Florida (Founded 1926)

Name.....

Address.....

City.....Zone.....State.....

**MANUFACTURE THIS BEAUTIFUL CONCRETE OUTDOOR FIREPLACE**

*Right In Your Own Backyard*

**\$4.00 Worth of Sand & Cement produces this Attractive Fireplace.**



**Sells on Sight from \$60. to \$80. Easy to start your own Profitable Business.**

The General Fireplace Molds and Process are the most amazing and foolproof ever invented. Simple to operate. Two men can produce five fireplaces a day.

**BIG DEMAND!!**

Sell all you produce to Department Stores, Homeowners, Parks, Nurseries and Picnic Groves. Fireplaces sell on sight. No experience necessary. We supply full operating instructions and equipment plus the know-how that spells **BIG PROFITS**. This is an outstanding opportunity for men of vision and small capital to get into a busy rich paying field. Don't delay, be the only exclusive manufacturer in your own home town. Mail coupon at once for full details as to how you can reserve your territory. **Molds sold only on exclusive franchise.**

**GENERAL ENGINES CO., Inc., Dept. MF-50**  
ROUTE 130, THOROFARE, N. J.

Mr. Tor of Philadelphia writes: Sold 250 in first 4 months. Selling to Sears Roebuck, John Wanamaker, and Gimbel Bros. in Philadelphia area.

Name.....  
Address.....  
City..... Zone.....  
State.....

57

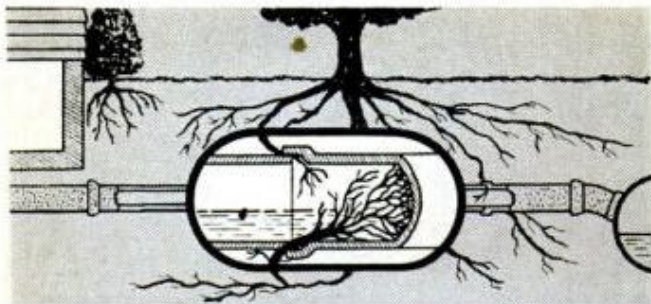

## END SEWER-LINE ROOT MESS, SAVE ON COSTLY REPAIRS!

**Roots are just naturally thirsty.** They force their way through joints in your sewer line, eventually clog it. Toilets and sinks "back up", soon overflow. Now you can avoid costly digging or mechanical cleaning this easy, permanent way.



Pour one box of revolutionary Hercules R-D into toilet bowl. R-D kills and decomposes roots permanently, often overnight. To keep sewer lines root free, apply R-D twice a year. Safe to handle. Safe in septic tanks. Don't wait for trouble. Get R-D now from your plumbing or hardware dealer. It works, or your money back. Only \$3.95 for 2 lb. box. Send for literature.

**HERCULES CHEMICAL CO., INC.**  
416 Broadway, New York 13, N.Y.

### Superior's New Model 70 UTILITY TESTER® FOR REPAIRING ALL ELECTRICAL APPLIANCES MOTORS • AUTOMOBILES • TV TUBES

As an electrical trouble shooter the Model 70:



- Will test Toasters, Irons, Broilers, Heating Pads, Clocks, Fans, Vacuum Cleaners, Refrigerators, Lamps, Fluorescents, Switches, Thermostats, etc.
- Will test all TV tubes for open filaments, inter-element shorts, burned out tubes, etc.
- Measures A.C. and D.C. Voltages, A.C. and D.C. Current, Resistances, Leakage, etc.
- Will measure current consumption while the appliance under test is in operation.
- Incorporates a sensitive direct-reading resistance range which will measure all resistances commonly used in electrical appliances, motors, etc.
- Leakage detecting circuit will indicate continuity from zero ohms to 5 megohms (5,000,000 ohms).

As an Automotive Tester the Model 70 will test:

- Both 6 Volt and 12 Volt Storage Batteries • Generators • Starters • Distributors • Ignition Coils • Regulators • Relays • Circuit Breakers • Cigarette Lighters • Stop Lights • Condensers • Directional Signal Systems • All Lamps and Bulbs • Fuses • Heating Systems • Horns • Also will locate poor grounds, breaks in wiring, poor connections, etc.

Model 70 comes complete including 64 page book, only \$15.85

**SHIPPED ON APPROVAL**  
**NO MONEY WITH ORDER — NO C.O.D.**

Try it for 10 days before you buy. If completely satisfied then send \$9.85 and pay balance at rate of \$4.00 per month for 8 months — No Interest or Finance Charges Added! If not completely satisfied, return to us, no explanation necessary.

MOSS ELECTRONIC, INC., Dept. D-745  
3849 Tenth Ave., New York 34, N.Y.  
Please rush Model 70. If satisfactory, I will pay on terms specified. Otherwise I will return tester.

Name \_\_\_\_\_  
Address \_\_\_\_\_  
City \_\_\_\_\_ Zone \_\_\_\_\_ State \_\_\_\_\_  
All prices net, F.O.B., N. Y. C.

the unit is able to train tankers without wasting expensive rounds. The Army says it's as effective as the real thing.

The Marine Corps, which always needs to move its gear in a hurry, is testing a new 50,000-gallon fuel-storage tank. When empty, the nylon, rubber-coated collapsible tank can be rolled and packed in a canvas bag.

The trade winds may prove to be as big a boon to modern communications men as they were to old-time sailing skippers. In experiments with the Air Force, the Navy found a radio-message funnel 500 feet thick at an altitude of 5000 feet, stretching between the coasts of South America and Africa, along the same path as the trade winds.

The duct, which can carry signals for long distances with small loss of power the year around, is formed by the temperature-inversion layer—that is, where the temperature is warmer at high altitudes than it is at lower ones. This is caused when the prevailing trade wind rides up over the cooler air below. It forms a channel which catches a radio signal and bounces it along the 500-foot duct until it is detected by a receiver. With a transmitter of only 100 watts, signals were picked up 1430 miles away. The equipment operated at a frequency of 220 megacycles.

The Air Force and Navy are now looking into the possibility that the same holds true in other trade-wind areas.

An Air Force staff sergeant recently made a simulated plunge of 7½ miles in less than a second.

The "fall" took place in the altitude chamber at Mitchell Air Force Base, N. Y. The sergeant was placed in the chamber and an altitude of 65,000 feet was simulated. Suddenly he was "dropped" 25,000 feet while an electronic brain recorded his reactions. It measured the sergeant's body temperature, respiration flow, respiration rate, heartbeat rate, blood pressure and galvanic skin resistance during his fall. This electronic "doctor" was designed to monitor human reactions under severe environmental conditions such as those which the Astronauts will encounter.

The tradition of blackening rifle sights with soot may be on its way out. The Army's trying nongloss flat paint to see if it will do the trick. Also there is reportedly a move afoot to discourage use of the time-tested term "fox-hole" among Army personnel. Some observers would like to substitute a name such as "fighting hole." The idea is that a foxhole is a refuge from which a fox is seldom seen to emerge!



This is Metallic Green. It's actually fun to bring old roofs and sidings to life with weatherproof Al-Chroma, a product of the Al-Chroma Paint Co., Stevens Point, Wis.

## MR. SOPPA BRUSHES ON A NEW GREEN METALLIC ROOF IN ONE DAY

He used **Al-Chroma** —an aluminum coating available in 13 colors

Here's the answer to a major home maintenance problem. Two years ago, faced with a dingy, worn-out roof, Mr. Joe Soppa, of Milwaukee, Wis., simply brushed on a new one in less than a day—and color-styled it to harmonize with his house. Today, after two years, he reports a weatherproof surface with color actually intensified.

**He used Al-Chroma**, an exclusive formulation made with Alcoa® Pigments that gives the famed protection of aluminum fibrated roof coating *plus* a choice of 13 sunproof colors.

**It's weatherproof.** An aluminum fibrated coating protects in any climate—stays firm on top, pliant underneath, will not run or crack. It literally seals the surface, thus protects against surface deterioration and extends roof life. And reflective aluminum turns back a lot of the sun's heat, helps keep interiors cooler in summer.

**One coat hides any surface.** An aluminum coating like Al-Chroma is ideal for shingle, slate, tile, composition or concrete roofs—even well-cleaned, rusty metal.

**Ideal for siding.** Wide choice of pastel colors permits matched or contrasted siding. Brush or spray colored aluminum coatings on shingle, metal siding, concrete and cinder blocks, stucco and brick.

**Easy to apply.** A coating like Al-Chroma comes ready mixed, requires no thinning or heating. Apply with ordinary roofing brush.

**Alcoa does not make roof coatings**, but we will be happy to refer you to reputable manufacturers who do. Send coupon today for our free booklets.



Color-style your whole house with a matched or contrasting color on the siding.

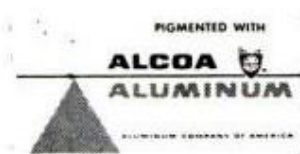

Look for this label when you buy aluminum paint

For exciting drama watch "Alcoa Presents" every Tuesday, ABC-TV, and "Alcoa Theatre" alternate Mondays, NBC-TV

Aluminum Company of America  
1748-E Alcoa Building, Pittsburgh 19, Pa.

Please send your free booklets:

- Painting with Aluminum*  
 *Aluminum Roof Coatings Make Time Stand Still*

Name \_\_\_\_\_

Address \_\_\_\_\_

City \_\_\_\_\_ Zone \_\_\_\_\_ State \_\_\_\_\_



**save on everything in electronics**

**free** SEND FOR **ALLIED'S BARGAIN SUPPLEMENT**

**SAVE MOST** on Stereo hi-fi systems and components, stereo records and tapes. See best buys in exciting build-your-own **KNIGHT-KITS®**. Hundreds of special values in recorders, amateur gear, P.A. systems, test instruments, TV accessories, electronic parts, tubes and tools. Send for your **FREE Allied Supplement** packed with bargains and new electronic products. Save as never before!

Exciting Money-Saving Knight-Kits

Bargains in Stereo Hi-Fi

**ALLIED RADIO**

**FREE SUPPLEMENT**

ALLIED RADIO, Dept. 62-E  
106 N. Western Ave., Chicago 80, Ill.

Send **FREE Allied Supplement No. 195**

Name \_\_\_\_\_

Address \_\_\_\_\_

City \_\_\_\_\_ Zone \_\_\_\_\_ State \_\_\_\_\_



**get into operating or repairing EARTH MOVING EQUIPMENT**

Men needed now for good paying jobs in booming road and construction work. Learn **operating or repair-rebuilding** of heavy road machinery, cranes, bulldozers, earth carriers, etc. Actual "on the job" training, 5 to 13 1/2 week courses. Classes start every Monday. Reserve your space now. Complete catalog and reservation facts **FREE**. Approved for veterans. Write

**Greer TECHNICAL INSTITUTE**  
Attn: P. E. Hutch, Box 368, Braidwood, Ill.

## engineering degree in only 27 months

Realize your dream of becoming a graduate engineer. Then promotion will not pass you by. Share rewards awaiting college men . . . higher income . . . rapid advancement. Important firms visit Tri-State campus to interview seniors. Founded 1884. *Bachelor of Science Degree in 27 months* in Electrical Engineering (Electronics or Power major), Mechanical, Civil, Aeronautical, Chemical Engineering. *In 36 Months* a B.S. in Business Administration (General Business, Accounting, Motor Transport Management majors). For earnest, capable students. Small classes. More professional class hours. Well-equipped, new and modernized buildings, labs, dorms. *Modest costs*. Year-round operation. Enter July, Sept., Jan., Mar.

Write J. E. McCarthy, Director of Admissions, for Catalog and Career Book.

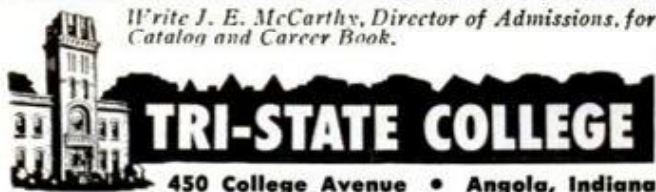

## Spotlight on the Simca Etoile

By Art Railton

FOREIGN ENOUGH to be fascinating, but not so foreign as to be strange, the Simca Etoile "naturalizes" easily. Even avid America-Firsters won't have trouble liking this French import.

Biggest problem is learning how to pronounce its name. Etoile means "star" in French and is pronounced "Eh-twall" (if that doesn't help you, Berlitz is your only hope).

A major facelift of the Aronde, the 1960 Etoile is a neat compromise of fashion and utility. It's not flashy, neither is it drab.

The engine is an overhead-valve Four of 78.7 cubic inches. Compression is 6.8 to 1. It operates quietly on regular gasoline. Not quite square, the engine has a 2.91-inch bore and a 2.95-inch stroke, a conservative but not old-fashioned ratio.

Horsepower is rated at 50 which, in the foreign-car environment, sounds like a lot until you realize that the car weighs 2050 pounds, almost 500 pounds more than a Volkswagen and 12 pounds heavier than a Corvair.

Despite this weight, it gives reasonably good economy. In a city driving test on a cold March day with the temperature 10 above zero, the Etoile averaged 30.5 miles per gallon with sane, reasonable driving. A high-speed country test (with lots of hard driving) came up with fewer miles per gallon. The test route covered 45 miles of rural roads with about 20 stops and several hills. The average was 25.8 miles per gallon. For much of the route, the car was at full throttle (about 74 miles per hour true).

(Continued to page 63)



**CHROME VANADIUM  
29 Pc. DRILL SET**

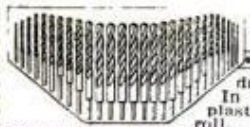

Specialty made speed for drilling. In sturdy plastic tool roll. Finest alloy steel drills hardened and precision ground to the sharpest, longest lasting cutting edge obtainable; will easily and cleanly bite through hardwoods, plastics, aluminum, iron and the toughest steels. Unconditionally guaranteed for thousands of drillings. Full Jobber lengths. Sizes by 64ths from 1/16" to 1/2".

Also available with Turned Down Shanks to fit all 1/4" drills. In individual pocket roll . . . . .

**\$6.49** ppd.

**\$8.95** ppd.

**60 Pc. Set Wire Gauge  
CHROME VANADIUM DRILLS**



Top quality German import high test Chrome Vanadium Drills designed for speed drilling through toughest steels, woods, plastics, iron and aluminum. Precision ground, long-lasting cutting edges. Guaranteed to give years of satisfaction. A full 60 pc. set, Nos. 1 through 60.

A 14.95 value—

**NOW ONLY \$5.40**

**PLUS 35c PP. & HDLG.**

Same set above available with Huot Metal Index container. **PLUS 35c PP. & HDLG.**

Also Available **20 Pc. Set—Nos. 61-80**

**WIRE GAUGE DRILLS** In plastic kit with marked pocket for . . . . .

**\$2.50** ppd.

**75c ea. for Finest Imported PRECISION PLIERS!**

- Flat NOSE • Combination • Diagonal Cutter • End Cutting Nippers • Round Nose • One Side Flat—One Side Round • Snipe



FOR JEWELERS, OPTICAL WORKERS, HOBBYISTS, CRAFTSMEN OF ALL KINDS! These superb European instruments are of deep-forged, heat-treated high quality tool steel, fabricated to most exacting specifications. All-over ground and polished to smooth hard surfaces. Jaws meet perfectly to safely and securely hold even the most delicate objects. Each plier is 4" long and veritable gem of precision and strength.

**75c each . . . . . ALL 7 for \$5.00 ppd.**

**MONEY BACK GUARANTEE—Send Check or M.O.—C.O.D. Plus Fee**

**SCOTT-MITCHELL HOUSE, INC.**

**Dept. HC32, 415 S. Broadway, YONKERS, NEW YORK**

Here's one more proof...

**PLIOBOND** is the one adhesive that does the work of many.

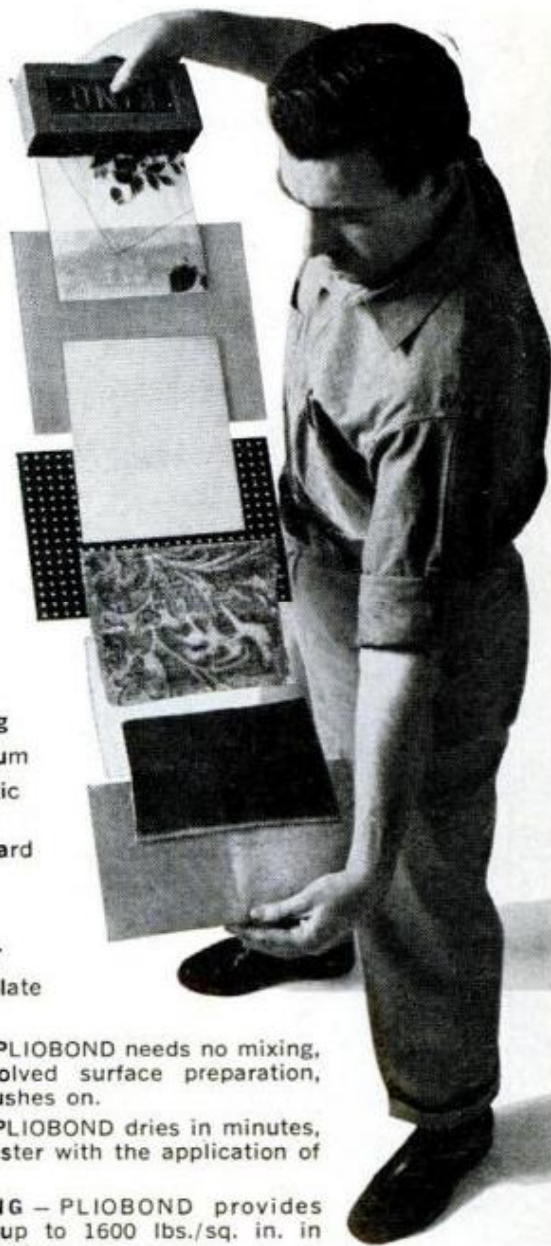

- Brick
- Plastic sheeting
- Aluminum
- Synthetic Rubber
- Hardboard
- Fabric
- Glass
- Leather
- Steel plate

**EASY**—PLIOBOND needs no mixing, no involved surface preparation, just brushes on.

**FAST**—PLIOBOND dries in minutes, even faster with the application of heat.

**STRONG**—PLIOBOND provides bonds up to 1600 lbs./sq. in. in shear tests.

**LASTING**—PLIOBOND resists heat, cold, water, most chemicals, oil—and age.

Goodyear, Chemical Division  
Q-9459, Akron 16, Ohio



*Pliobond*  
BY  
**GOOD YEAR**

CHEMICAL DIVISION

Pliobond—T. M. The Goodyear Tire & Rubber Company, Akron, Ohio

Take Correspondence Courses  
For a Better Education

**Next Month**

**READ**



**THE MAN**

**WHO OWNS A**

**TANK CORPS**



*Pick the training you want!*  
choose-it-yourself... before enlistment

The Army's new "Choose-it-Yourself" System lets you do the choosing! Here's how it works: **1. choose** . . . before enlistment. Choose your training from fields like Construction Equipment Operation, Electronics, Missiles, Machine Accounting, Radar & TV Repair—and many more. **2. qualify** . . . before enlistment. Take aptitude and physical exams to qualify for your chosen training. **3. know** . . . before enlistment.

If you qualify, you know you'll get the training you like. Your choice is written right into your future Army record—guaranteed before you enlist.

**no obligation!** Choose, qualify and know—without the slightest obligation to enlist. This week, ask your Army recruiter to show you his complete list of available training fields.

CHOOSE IT

YOURSELF VOCATIONAL TRAINING SYSTEM

**US ARMY**



Here are some average acceleration times based on several two-way runs: From 0 to 60, 25.5 seconds; from 0 to 30, 6.2 seconds; from 40 to 60, 14.7 seconds (using third as a kicker). These are good figures for an economy sedan.

The speedometer is hopelessly optimistic. At 50 miles per hour on the speedo, true speed is 43. At 60, true speed is 52; at 70, true speed is 62 miles per hour.

The odometer is wrong in the other direction. You go two percent farther than it shows. When it reads 100 miles on the trip indicator, you have actually gone 102 miles.

Cornering is excellent. Those so inclined can drift it nonchalantly. There's a complete feeling of confidence on high-speed turns. Steering is fast and precise. The shift lever of the four-speed gearbox is on the steering column, but it doesn't suffer too much for it. You can drive the car without using the nonsynchromesh Low, except in hilly starts.

Ride has none of the "feel of the road" harshness you might expect. On chuckholes, it is pleasantly soft, has no tendency to break loose. On the boulevard, it smoothes such minor irregularities as tar strips quietly and without fuss.

Seats are high and well formed, providing plenty of thigh and back support. The back is especially comfortable (except for legroom) by small-car standards. Width is adequate only for two adults. Floor humps, front and rear, are small and unobtrusive. A stepdown in the rear increases seat height to a comfortable level.

Rear-wheel housings obtrude into the corners of the rear seat back, but are so positioned as not to interfere with comfort. This is a four-adult car, although six can be carried if two are small children.

The automatic choke is sensitive to the foot—beware! The engine kicks over promptly on the coldest day if you don't touch the accelerator pedal. Once it's firing, you can feed it gas, but before then, stay off it.

Turn signals are time-controlled so you won't drive along with a blinker operating when you don't want to. They are thermostatically controlled, heat from the current flow operating the shutoff. It blinks for about 15 seconds. Occasionally, this is a nuisance. Long stoplight intervals sometimes make it necessary to restart the lights.

Price at the port of entry is \$1798, a bit high by import standards, but it includes such extras as heater, undercoating, windshield washer, full-flow oil filter, electric wipers, armrests on all four doors, dual

horns and a trip mileage indicator. This last item (rare on today's cars) is reset by a button right beside it.

A warning light blinks on when the gas tank level drops to one gallon. Generator and oil-pressure warning lights are so faint as to be useless on a sunny day. The high-beam indicator light is too far to the left to be a constant reminder to the driver that his brights are on. The dimmer switch is hand operated (part of a complex light switch located where the turn-signal lever normally is). This is good, it being easier to operate a dimmer switch with the hand than with a foot, especially in situations where braking and shifting are required.

The hot-water heater is inadequate on the highway at zero degrees, good in traffic. However, it does suck in exhaust fumes from the car ahead to such an extent that you often have to shut it off in self defense. The blower is much too noisy. By partially covering the heater grille (ahead of the radiator), heat is somewhat improved at highway speeds, says Simca.

It's impossible to fill the gas tank without spillage. There's no ashtray in the rear seat. At full throttle, there is an annoying resonance in the car, although at 60 miles per hour the noise level is low. The glovebox door is all plastic, including the hinge, and appears fragile.

Trunk room is excellent. The spare is carried in a well in the floor. Jacking points are provided near each wheel.

Wonder of wonders, the ignition key will go into the lock either way up, eliminating fumbling. The horn ring is a piece of heavy wire bent into the shape of a kidney and located beneath the steering wheel spokes. You flip the ring upward from underneath to blow the horns. Two horns are provided. A switch allows you to use both (a cheerful chirpy sound) or just one (a low-cost, tourist-rate sound). The horn ring, incidentally, does not turn with the wheel so it's always easy to find, even when cornering.

Wheelbase is 96.3 inches. Over-all, the car measures 13.5 feet. Width is 61.3 inches, leaving plenty of room in the garage for such important items as bikes and lawnmowers.

Altogether, it's a most satisfactory car to drive in the city. It is reasonably nimble, pleasant to park, easy to enter and leave (although the pushbutton door handles are clumsy to use).

One word of warning: When you buy a Simca select your dealer carefully. In any car this is important, but in a foreign car it is vital. Make certain the man you buy it from understands the car, likes the car and genuinely wants you to like it. ★ ★ ★

# HEFT A MAN'S HAMMER

ROCKET  
\$5.49

Heft a ROCKET. It has a vitality all its own. Grip it. It's as secure in your hand as if it were gripping back. Swing it. The balance is perfect. You'll feel its shock-absorbing action as it delivers a power-centered blow.

Polished head is permanently locked to tubular steel handle.

Cushion grip won't slip.

Heft a ROCKET at your hardware store today. True Temper, 1623 Euclid Ave., Cleveland 15, O.

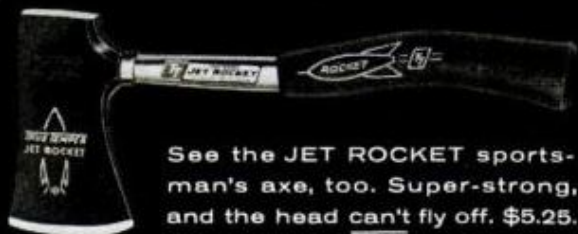

See the JET ROCKET sportsman's axe, too. Super-strong, and the head can't fly off. \$5.25.

**TRUE TEMPER**  
THE RIGHT TOOL FOR THE RIGHT JOB

## Looking for a Bargain? Try the Post Office

By Robert Gannon

WOULD YOU like to buy four slightly damaged FM radios for \$23? An electric skillet, a toaster and a slightly dented electric percolator—all for \$13? Or maybe you'd prefer 328 wigs for \$93. These items were sold for those amounts at a recent post-office auction, part of the contents of the half-a-million packages lost or damaged in the mail every year.

Held periodically in more than a dozen major cities, post-office auctions are open to everyone, with lost or damaged items going to the highest bid over one dollar. Notices of up-coming auctions appear in newspapers, are tacked up on post-office walls and are mailed to regular customers. You can pick up free catalogs at the gallery before the sale, and some postmasters will even send you a catalog if you ask them.

However, to get rid of the thousands of items quickly, most of the material is gathered together in lots. So if you have your eye on a power saw, you may have to buy a belt sander and a sabre saw as well. Or, if you're looking for a cuckoo clock, you may end up with a dozen of them.

Lots on display the day before the auction are labeled with catalog numbers. Most articles are sold "as is," but if mechanical items are damaged, they are either listed as "in working order," which usually means that they are merely dented or scratched, or "not in working order."

On sale day, a fast-talking auctioneer sells lots at the rate of 100 per hour, with bidding done by lot number. A 50 percent deposit is required on all purchases.

Items cannot be picked up the day of the sale, but must be out of the post office within a few days. Transportation home is up to you, as is the job of boxing your purchases. Post offices often have extra cartons that are yours for the asking.

Private bidders find dealers chief competition (something like four-fifths of the merchandise is bought for resale), so you have a better chance to get bargains if you're interested in offbeat items.

Biggest dead-parcel branches are in New York and Chicago, where auctions are held three or more times a year. Other cities, where there are at least two sales a year (depending on volume of goods on hand) are Atlanta, Boston, Cincinnati, Fort Worth, New Orleans, Omaha, St. Louis, St. Paul, San Francisco, Seattle, Washington, D. C., San Juan, P.R. and Honolulu.

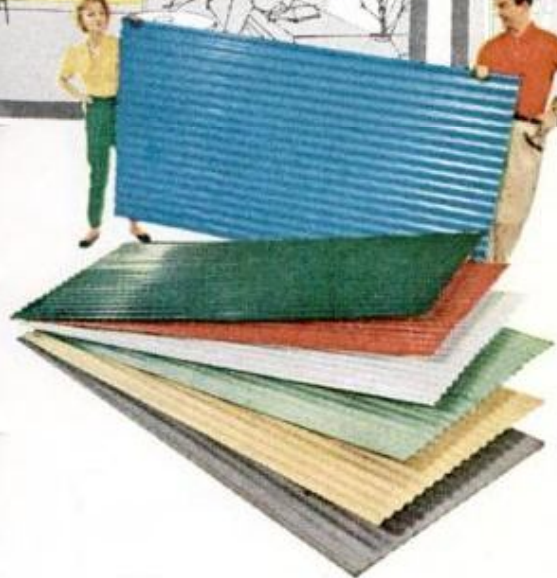
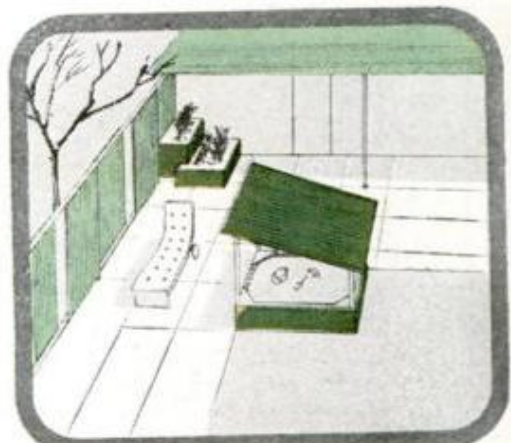
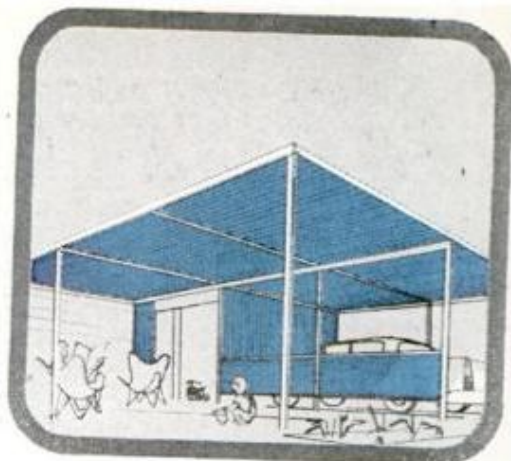
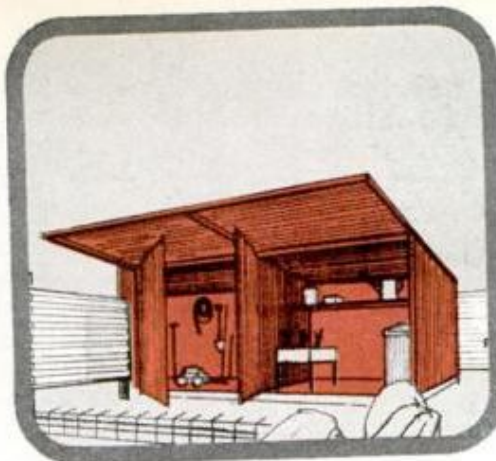

# NEW!

## ALUMINUM COLORIB

### PANELS Made By ALCOA

*Surround Any Home with Beauty . . . in 7 Exciting Colors!*

Create a cool, colorful oasis on your patio . . . shield your backyard play area from annoying winds, prying eyes, roving pets . . . protect your auto's finish from weather . . . make all the areas on your lot accessible for Care-free living—for pleasure and privacy—by surrounding your home with the beauty of Alcoa® COLORIB Panels. Choose from seven exciting colors, developed especially for Alcoa, and add the durable protection of aluminum to your patio, yard, game room and workshop.

Do-it-yourselfers only need household tools to install Alcoa COLORIB Panels. Easy-to-handle sizes—8-, 10-, 12-ft lengths, over 4 ft wide. Baked enamel finish means colors never chip, peel or blister. Combination of ribbed shape and diamond-embossed surface gives strong, stylish panel that resists wear for years and years.

Visit your building product supplier soon to see Alcoa COLORIB Panels . . . and send coupon now.

\*Trademarks of Aluminum Company of America

*Your Guide to the Best in Aluminum Value*



For exciting drama watch "Alcoa Presents" every Tuesday, ABC-TV, and "Alcoa Theatre" alternate Mondays, NBC-TV



**SEND TODAY  
FOR FREE  
IDEA FOLDER**

Aluminum Company of America  
1881-E Alcoa Building, Pittsburgh 19, Pa.

Send me free copy of Alcoa COLORIB idea folder showing how to use for home improvement.

NAME \_\_\_\_\_

ADDRESS \_\_\_\_\_

CITY \_\_\_\_\_ ZONE \_\_\_\_\_

STATE \_\_\_\_\_

# MERCURY is the world's

## No. 1 outboard in

### Engineering!

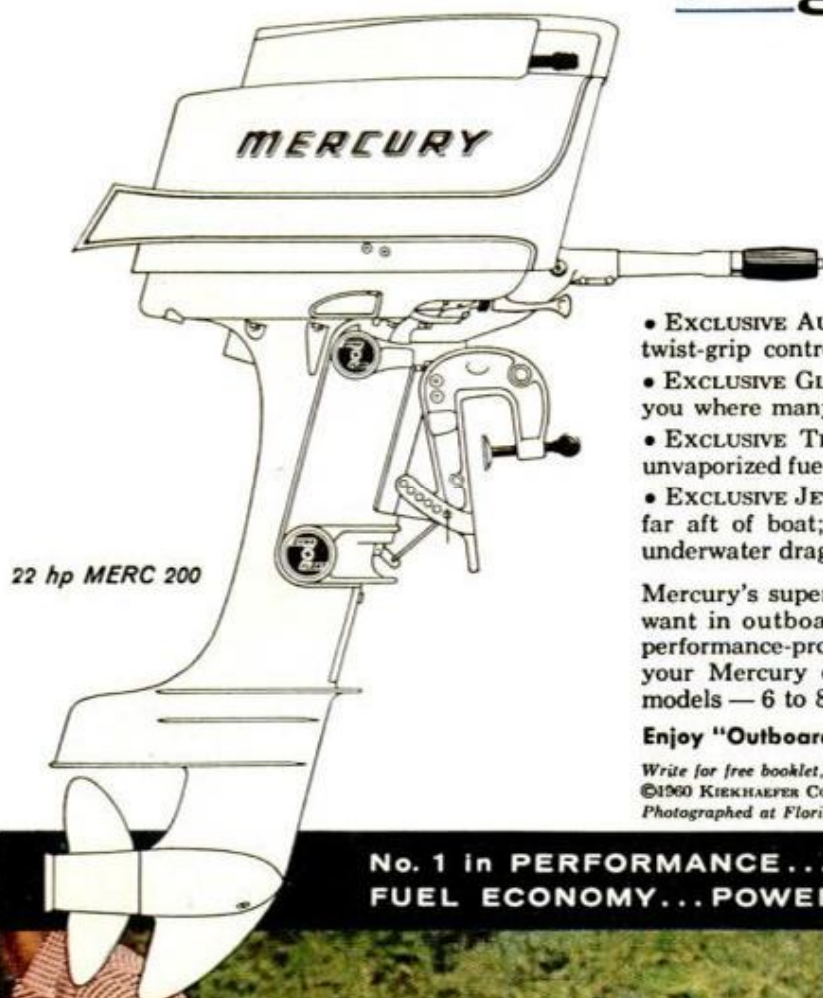

22 hp MERC 200

More than 70 industry "firsts" — many of them now standard outboard features — speak for Mercury's engineering leadership! Mercury gives you exclusive features *today* which *others will copy in years to come*. Mercury "Glide-Angle" Twins are outstanding examples.

- EXCLUSIVE AUTOMATIC TRANSMISSION gives you one-hand, twist-grip control of throttle, forward, neutral and reverse.
- EXCLUSIVE GLIDE-ANGLE DESIGN, naturally weedless, takes you where many other outboards can't navigate.
- EXCLUSIVE TILTED POWERHEAD prevents accumulation of unvaporized fuel, permits smooth, steady trolling all day long.
- EXCLUSIVE JET-PROP EXHAUST submerges fumes and sound far aft of boat; improves engine performance and reduces underwater drag.

Mercury's superior engineering gives you more of what you want in outboards — gives it to you only in action-tested, performance-proved applications — gives it to you *first!* See your Mercury dealer for a demonstration ride. Nine new models — 6 to 80 hp, in twins, fours and sixes.

Enjoy "Outboard Living Days" at Mercury Dealer's Now!

Write for free booklet, "Fishing With an Outboard".  
©1960 KIEKHAEFER CORPORATION, FOND DU LAC, WISCONSIN  
Photographed at Florida's Silver Springs

No. 1 in PERFORMANCE... RELIABILITY... SAFETY...  
FUEL ECONOMY... POWER... STYLING... FEATURES



# POPULAR MAY 1960 MECHANICS

WRITTEN SO YOU CAN UNDERSTAND IT  
VOL. 113 NO. 5



## The "Big E" Dies With Her Boots On

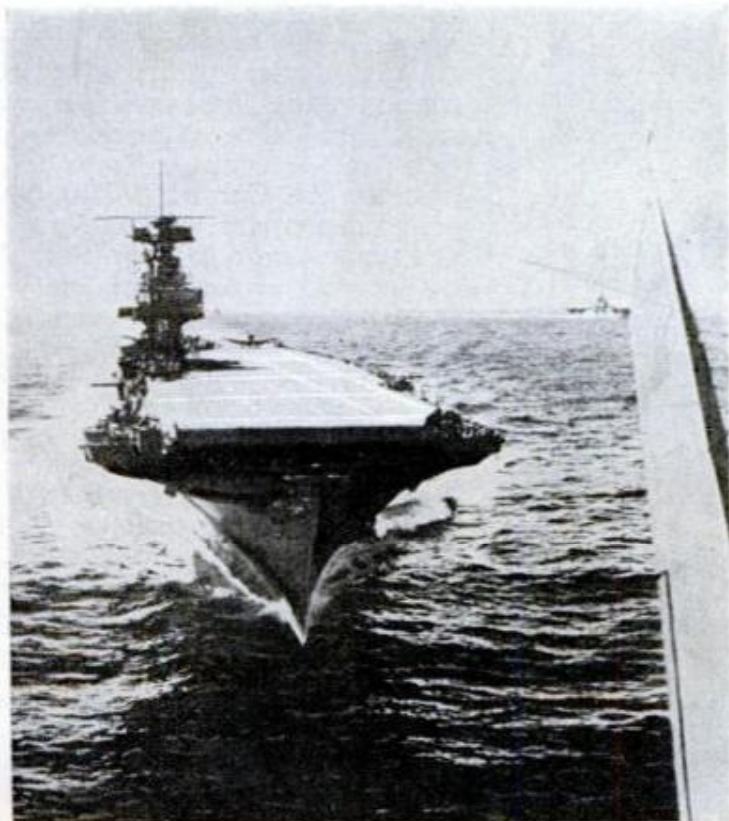

Popular Mechanics commissioned artist Donald Van Dyke of Leonia, N.J., to sketch the death of the USS Enterprise in a Kearney, N.J. shipyard. The text is by Richard F. Dempewolff, PM Eastern Editor.

**L**AST WINTER, a deafening staccato roar echoed through the cavernous hangar deck of the U.S.S. Enterprise. The ragged din was punctuated by an occasional boom as gigantic chunks of her steel superstructure broke loose and fell screeching against torn bulkheads. The glare of white fire slashed the dark spaces below decks. . . .

The scenic and sound effects were nothing new to the "Big E."

U.S.S. Enterprise, seen over the tail of one of her fighters, was battered seven times but never quit. Above, battle scene just after a Kamikaze hit on the bridge

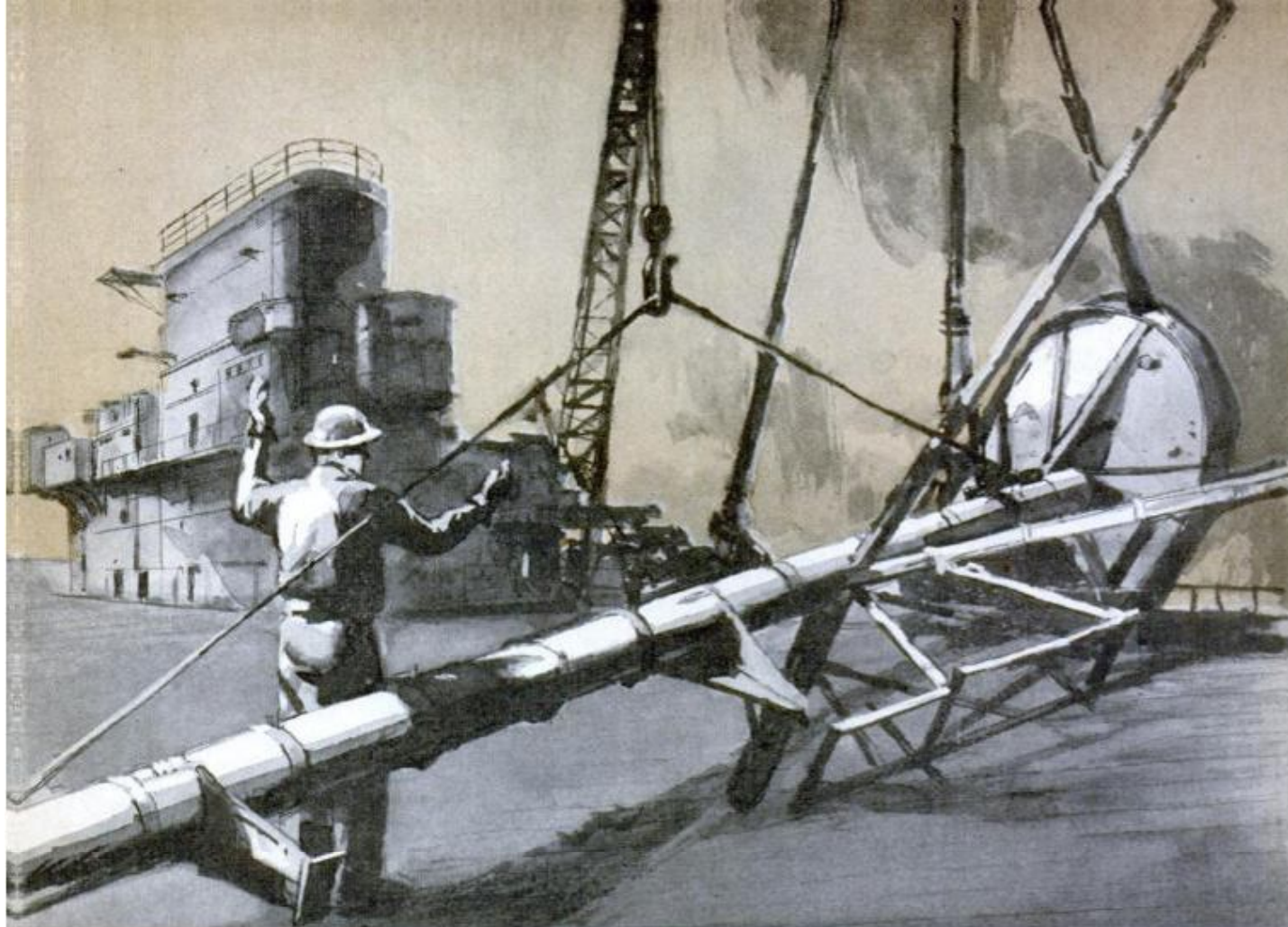

Artist's impressions of the demolition. Above, Big E's 36-foot mast went first, to clear New York's bridges. Below, the island comes off in 15-ton chunks while air hammers chew on the wooden flight deck

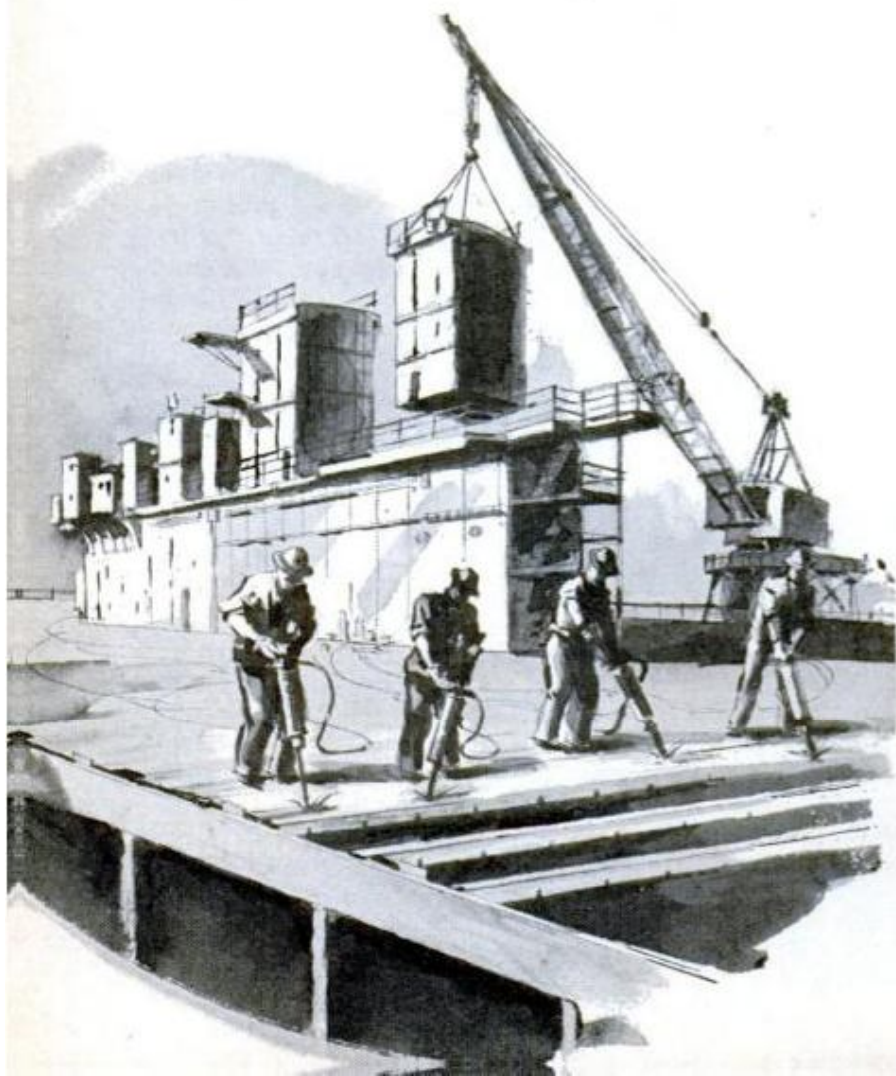

Launched at Newport News, Va., in 1936, the mighty flattop was in the thick of nearly every major Pacific battle during World War II. On June 4, 1942, in the Battle of Midway—remembered in Navy circles as “The Stalingrad of the Pacific”—the big aircraft carrier got her baptism of fire in a hell-roaring fight that saw her own squadrons kill three Japanese carriers and a cruiser. From then, through the Coral Sea and Solomons campaigns, the Big E's guns and planes were seldom silent. In her second engagement she absorbed a thundering cascade of Jap bombs and torpedos—the first of seven terrible batterings she was to take from Kamikazes, torpedo bombers and enemy subs before the end of the war. After each one, the gallant lady patched up her wounds and returned to fight again. All told, she fought in 20 of the 22 naval battles in the Pacific and was credited with sinking 71 enemy ships and destroying 911 of his planes.

But this time she won't be back. The chattering racket was not her 40-mm. antiaircraft batteries spat-

tering the sky with flak, but a battery of air hammers chewing up her flight deck. The booming roars of tumbling steel involved no enemy bombs. The fires glared from oxyacetylene torches. All last winter the Big E was coming apart systematically, piece by piece, in a dreary shipyard on the Hackensack River in Kearney, N. J. As you read this the last chunks of her once great hull are rumbling away in gondola cars to the melting pots.

Dismantling a 21,622-ton, 827-foot seagoing monster takes a lot of doing—you don't just start chopping her willy-nilly from the top down. Careless changes in balance and buoyancy would capsize her or set up stresses that would bend her backbone and split her wide open. More than a year ago, when the *Enterprise* was bought by Lipsett, Inc. for \$561,000 (she had cost more than \$19 million to build), the company turned her over to W. Henry Hoffman, their square-jawed, veteran ship-demolisher. Hoffman had directed the dismantling of the battleships *New Mexico*, *Idaho* and *Wyoming* shortly after the war, and was the master mind behind the nearly impossible job of cutting up the fire-weakened hulk of the French liner *Normandie* after it had been righted and refloated.

The first job on the *Enterprise*, says Hoffman, was to cut down her 36-foot mast and lower it to the deck so she'd clear the East River bridges on the way out of the Brooklyn Navy Yard. Once tied up in the Hackensack, 100 men swarmed over the big ship armed with oxyacetylene torches and jack

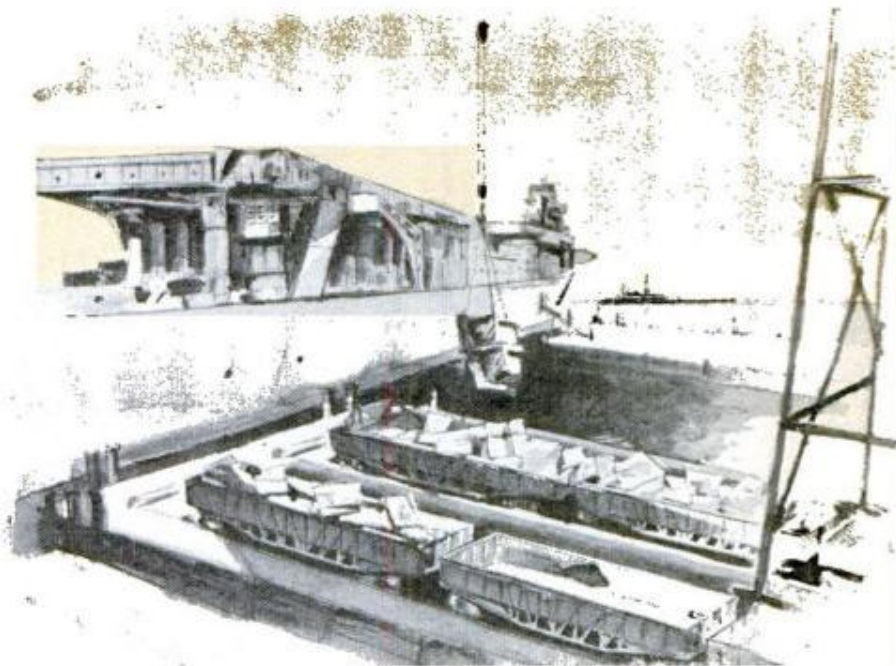

Steel moves from cutters' torches right into waiting gondola cars for the trip to the melting pots

hammers, fed by hoses that snaked across the decks in every direction. First to go was the bridge and island structure, sliced into great vertical sections by the torches, boomed over the side in 15-ton chunks and lowered into waiting gondola cars. The biggest piece measured 36 feet long, 15 feet wide and 9 feet high.

But the biggest nuisance was the flight deck. "There's a prevailing idea that all old carriers had teak flight decks," says Hoffman. "They haven't—most were Douglas fir, and so was the Big E's. The fastest way to get it out was to smash it apart with air hammers." For weeks, rows of men, shuddering over the bouncing bars of their demolition weapons, marched slowly down

Heavy armor plate of high-grade steel was cut from the carrier's topside in 8 x 40-foot sections. At right, hundreds of miles of copper cable were cut into short pieces by a big power shearing knife



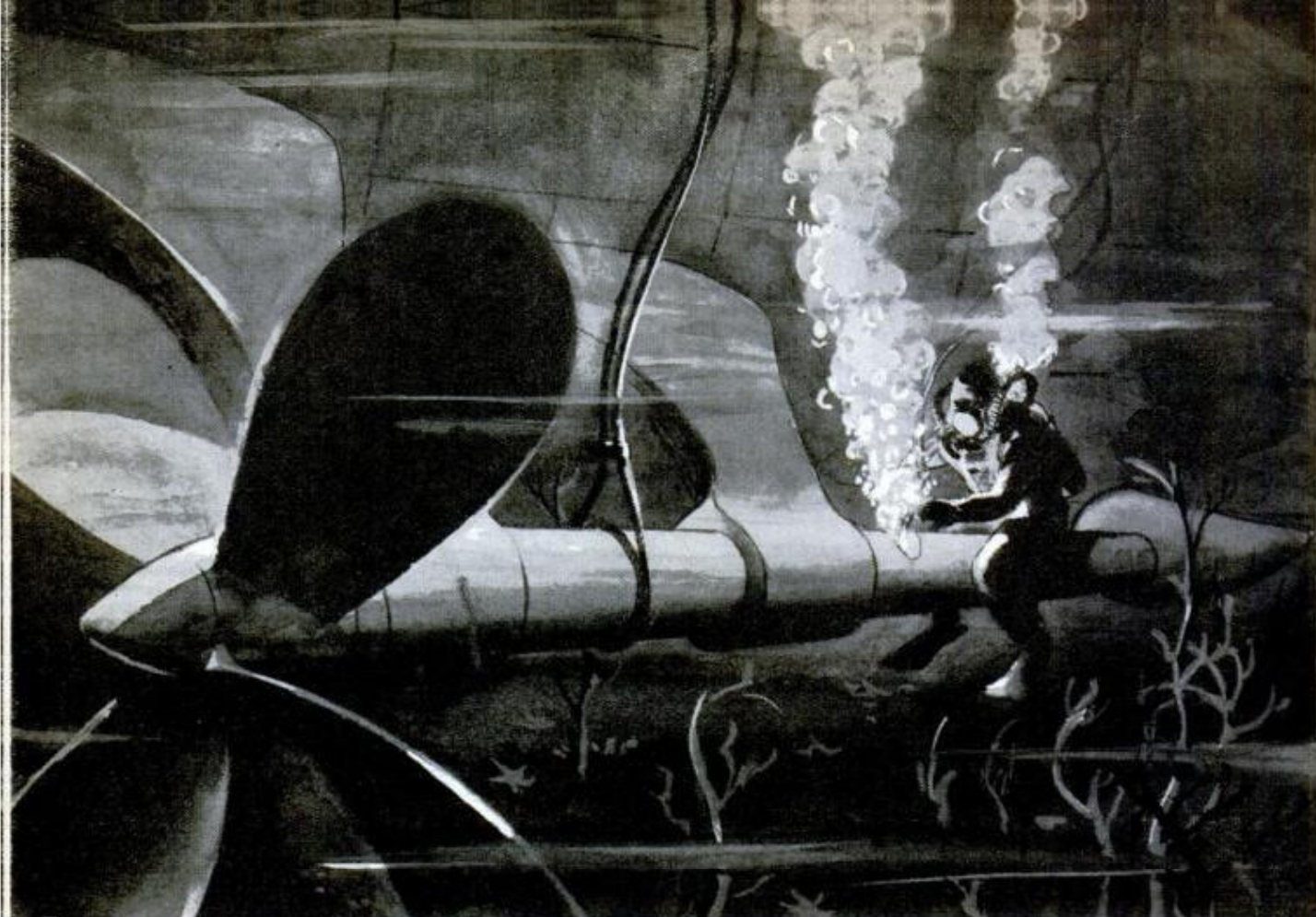

To remove outboard shafts and propellers, weighing 39 tons each, divers burned shafts halfway through under water, then flame-cut supports and dropped the assembly. Below, fantail came off in one piece

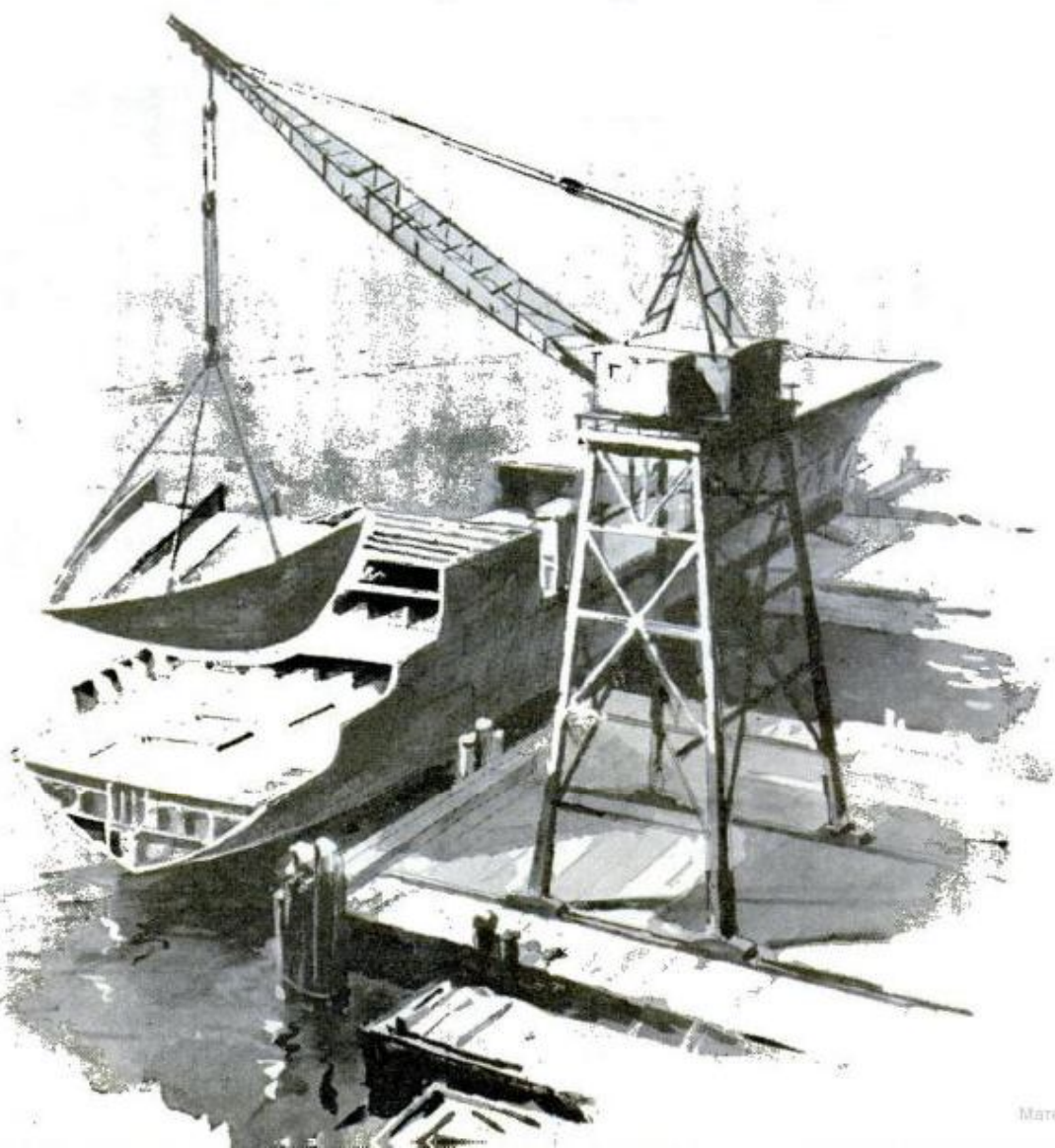



a flight deck equal in size to three football fields, and sent the splinters flying. And for weeks bonfires roared in the yard as incredible mountains of lumber were burned.

Out came the three huge airplane elevators—"One hundred percent aluminum," says Hoffman—sliced by the torches into 8 by 20-foot slabs that could be stacked in the railroad cars. Hull and deck plating, cut into 8 by 40-foot chunks, soared away on the cranes. In the meantime, hundreds of miles of heavy copper cable from the ship's complex electrical nervous system was hauled up on deck and chopped into two-foot sections by a thumping table shear that operated like a guillotine. The cable chunks were tossed like logs onto fires where the insulation was burned away so the valuable copper conductors could be melted down later at the scrap yard.

Torch cutters began to whittle away cautiously at the 140-foot stern overhang—removing the entire fantail in one gigantic piece. Then off came a chunk of bow superstructure, to balance the fore and aft weight. Nibbled away first at one end, then the other, the once mighty *Enterprise* gradually assumed the look of a row of building blocks, stacked four high in the center and

dropping away in giant steps to the water line at each end.

"You've got to watch your stresses like a hawk," Hoffman points out. "When the top decks are off, rain water collects in the hull and can add a lot of weight where you don't expect it. Then, too, there's no buoyancy in the bow keel—it's a dead weight tugging against the rest of the ship." You could see what he meant when you stared down at the 140-foot, sword-like projection of steel jutting forward from the fat, tapering hull. To check the stresses along the ship's deck plates and hull structure, Hoffman prowled through her each morning with a delicate strain gauge, ordering so many tons taken from here and moved to there, like a chemist adjusting a balance, but on a Paul Bunyan scale. "If you don't do it," he says, "you're heading for trouble."

The veteran ship un-builder can cite a dozen grim examples of near catastrophes on other salvage jobs. In one instance, the hull of a big liner, in the process of demolition, cracked in two places reaching far below the water line from heavy strains on the structure in an unexpected storm. Hoffman saved it by putting a crew to work sewing two gigantic canvas tubes which he

Massive boilers were hoisted from deep in the ship's belly after removal of hangar deck had exposed the engine spaces aft

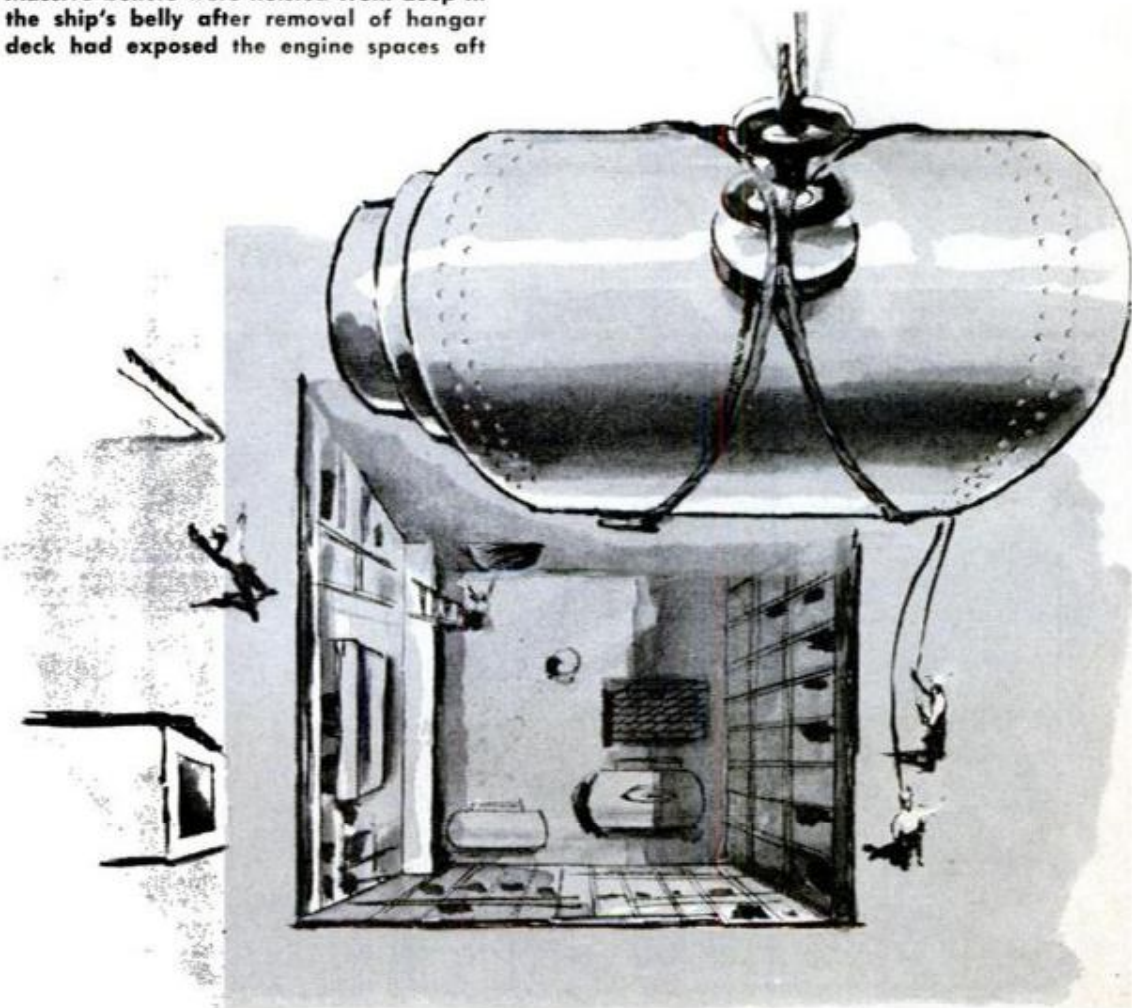

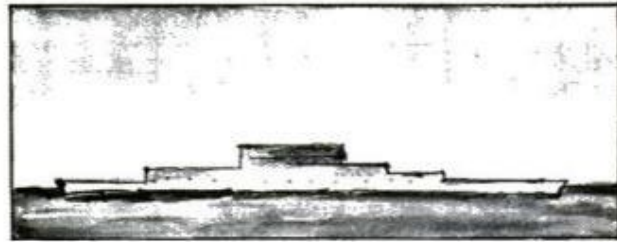
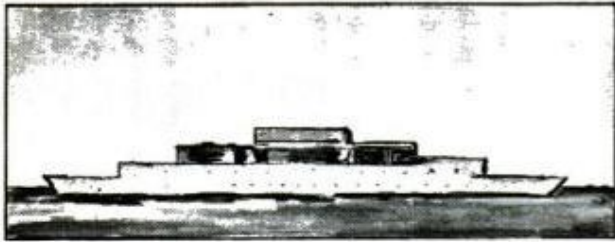
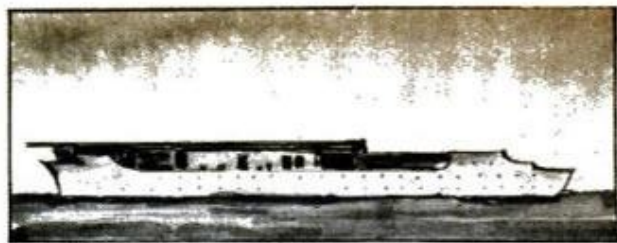
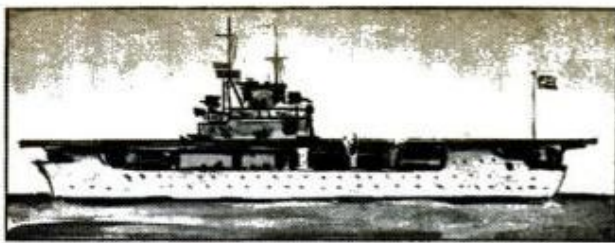

Sketch sequence shows how salvagers chop the ship away from both ends to prevent breakup or imbalance

wrapped around the hull over the splits and inflated like a couple of tires.

To remove the *Enterprise's* heavy, non-buoyant chunk of bow, crews first loaded tons of scrap steel in the empty well of the aft boiler room. The effect was like putting a fat man in the stern of a light dinghy. The bow lifted and the burners went to work with their torches.

Hoffman is proudest of the way he solved the problem of removing the carrier's four monster shafts and propellers. "The outboard shafts extended 85 feet from the hull housings, and they were still four feet under water after we'd lightened her up as much as possible," he reveals. "They weighed 26 tons apiece, plus 13 tons for each

propeller. So I sent down a skin diver who put a buoyed cable choker around the shaft. Then the diver sat on the shaft, near the housing where it entered the ship, and burned a deep notch in the top half of it with an underwater torch. When he finished, we burned off the outboard bearing supports—and the whole shaft broke right off, just like a tree being felled. We picked up the buoy, hooked the choker to the hoist on a 50-ton gantry crane, and lifted the whole works out of the mud. In two days, all the shafts and propellers were up in the yard."

With shafts out, sternbacks could be burned away and the upper decks

(Continued to page 236)

Nonbuoyant bow, 140 feet long, is cut to water level to lessen its weight, which could snap hulk in two



# AN EYE ON SPACE

By Dr. Dan Q. Posin

PROFESSOR OF PHYSICS, DE PAUL UNIVERSITY  
SCIENTIFIC CONSULTANT AND ADVISOR, COLUMBIA BROADCASTING SYSTEM

*I*F WE'RE GOING SPACE TRAVELING, we'd better take a look at the Universe we're heading into.

One view is that our known Universe is a shining collection of galaxies which perhaps is limited in extent, which is curved, and which somehow doubles back on itself, leading us always home again. Another theory holds that the Universe is "straight," that it stretches endlessly, and is infinite and expanding.

Still another theory says that our Universe is infinite, but is negatively curved—and expanding, too. It may be possible for Earthlings to discover the architecture of the Universe by studying the distribution of galaxies in space. In any case, these are the thoughts of some scholarly Earthlings. This is how they feel about the unending wonder of creation.

We also should think about *time*—how long it has gone on or could go on. What was the "beginning" of the Universe?

First let's take the views of the British mathematician and astronomer, Fred Hoyle. He and his colleagues believe that it is possible to think of a Universe which *never* actually had a beginning, but always existed—what is called a "steady state" Universe. Thus time never had a beginning. This Universe is always changing; galaxies form and disappear, hydrogen is converted to helium, mass disappears and radiant energy appears.

Thus, according to Hoyle, matter remaining in our known Universe changes in amount when galaxies go "over the border" at a distance of several billion light-years. (At the "border" galaxies are traveling away from us at almost the speed of light. Thus the *space* there is expanding with almost the speed of light, and the light coming toward us from such a galaxy can't quite make up the ever-growing new distance.) On the other hand, hydrogen somehow appears within our reach or within our view to take the place of the lost galaxies. This particular aspect Hoyle calls "continuous creation" in a Universe of flux, or a "steady state" Universe.

In contrast, along with Abbe LeMaitre, we can think of a definite moment of "beginning"—the moment, for example, when the primitive atom containing all matter and energy exploded. Such a Universe is called an "evolving" one, the galaxies forever moving apart, the Universe "thinning out."

Once upon a time Earthlings thought that their region—called Europe and Asia—constituted the Universe. Later they thought that other regions and great oceans made up the Universe, and they called it Earth. The heavens, they thought, moved around this Earth. Still later, they learned that the sun had a family, and Earth was only one member. At last came the knowledge that other stars were suns and perhaps had families of their own.

The Universe grew. Or, rather, the *minds of Earth-people grew*. The Universe only waited to be discovered.

There are a trillion other galaxies within reach of our telescopes. But the telescopes are puny. The known Universe is not much known.

"I feel a religiosity," said Einstein, contemplating the grandeur of the shining heavens. It is not necessary to board a space ship in order to go out of this "world" to the suburbs of infinity. Earth-people are already in space. The Earth is a space ship circling the sun. And the sun is but a minor member of a galaxy rushing away from other galaxies through a great space that may be a minor part of a Universe of incredible beauty.

# Automatic Brakes "Read" The Road

By Guerrino Amati

Shown here is the antiskid unit, the "brain" of the braking system. Despite simple construction and small size, the unit "reads" the road conditions and applies brake power accordingly

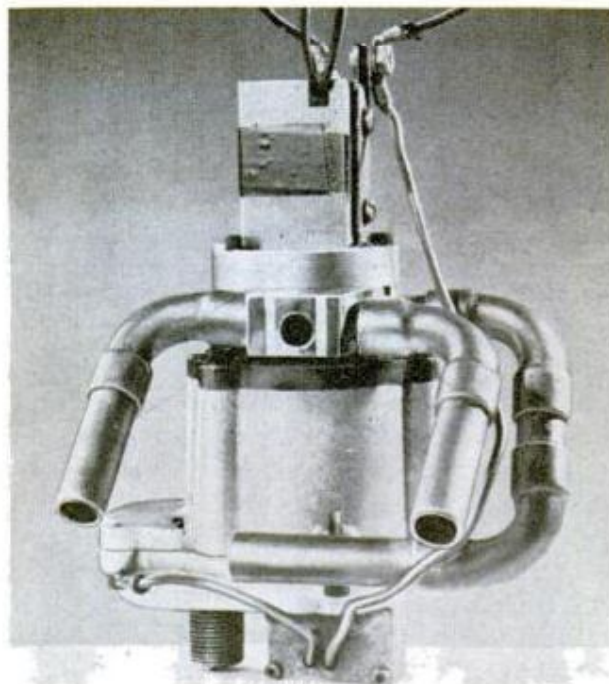

Antiskid unit is easily installed by gearing it to the speedometer drive mounted on the drive shaft

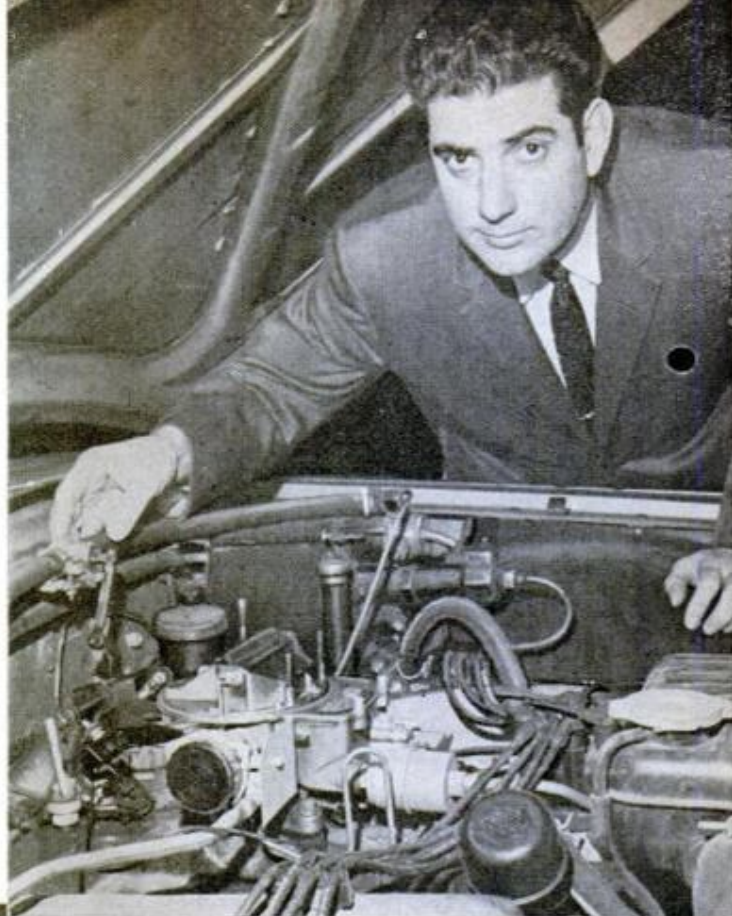

Working off a combined brake and accelerator pedal, the automatic brake is connected to the carburetor. Inventor Frank Perrino indicates the small modulating control valve which controls all normal braking

**S**TEP ON the pedal and it is an accelerator. Release your foot and it becomes the brake. This single-unit accelerator and brake for automobiles has an antiskid mechanism that makes it virtually impossible for a driver to lock wheels and skid.

Developed by Perma Research of Pawtucket, R. I., the automatic brake will be on the market by fall.

Many automobile accidents result from the inability of the driver to apply the optimum in braking action demanded by existing road conditions. Until now, the principle of the automobile brake has been essentially the application of pressure transmitted from pedal to pump and lines, to the cylinders and brake shoes and drums. Control of that pressure in relation to adverse road conditions has, until now, been impossible. In a panic situation, human reactions dictate sudden braking action, and the results of this action, locked wheels and skidding, take control of the car out of the driver's hands. The ideal, of course, would be a system positively preventing wheel lockup while maintaining maximum braking on the road surface. This the automatic brake does quickly and efficiently.

Extensive testing has shown that optimum braking is achieved when and if the brakes are applied to the extent that they hold the wheels *on the verge of locking*—at a point where the movement of the wheel

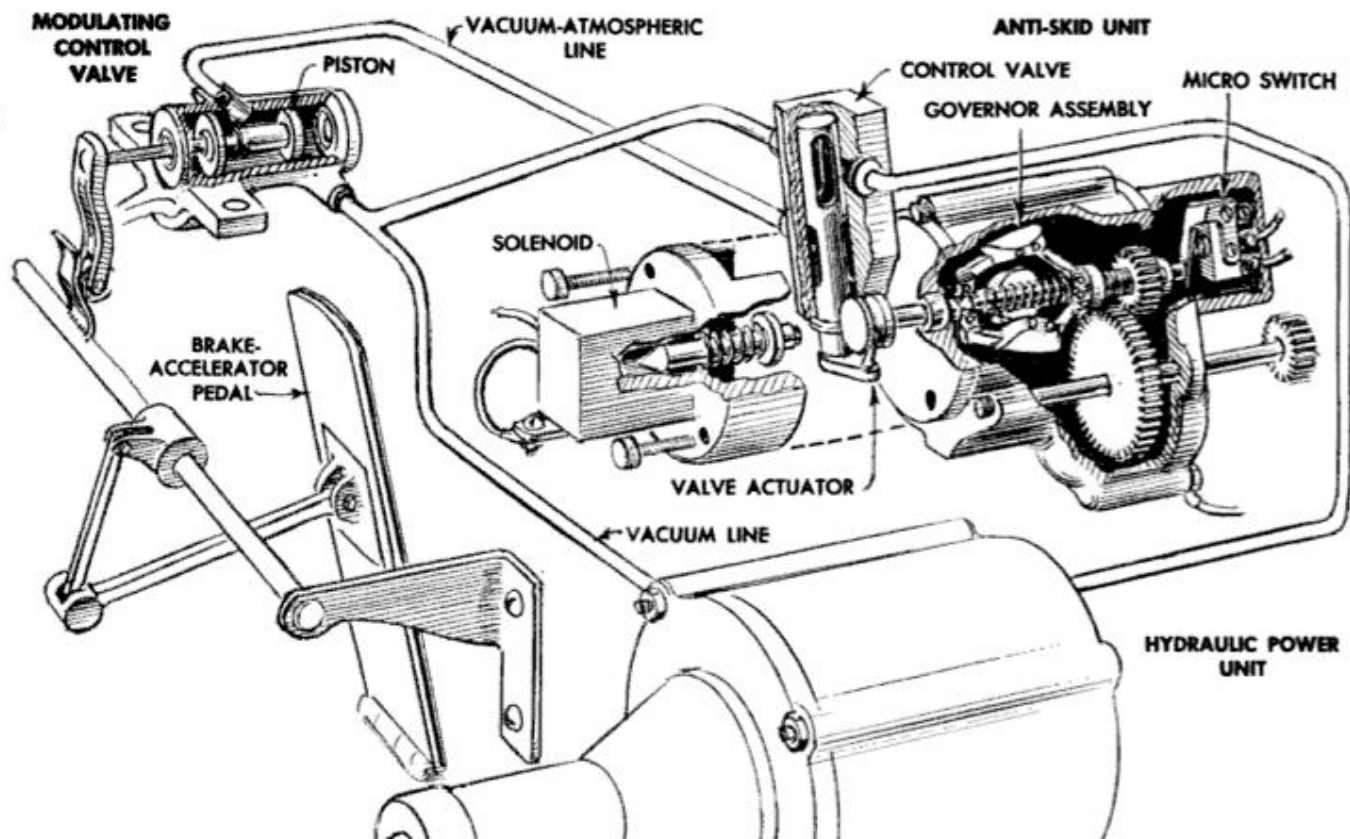

This exploded view shows the component parts of the automatic brake. The modulating valve controls normal braking functions, while the antiskid unit overrides it in the event of panic and "over braking"

is about to change from a roll to a skid. The skill of the average driver is not enough to do this in the time involved. Locked wheels mean greater stopping distances. Locked rear wheels result in a spin; locked front wheels in a loss of directional control. These are the problems the automatic antiskid brake is intended to solve. Its entire assembly weighs about eight pounds. Shown above is a diagram of the brake's component parts—the modulating control valve and the antiskid unit, working in conjunction with a conventional hydraulic brake unit. A combination accelerator and brake pedal is connected to the modulating control valve. Upon release of the pedal into its braking zone the throttle linkage rotates, moving the valve's piston. By means of this valve and piston arrangement, the vacuum and atmospheric pressure operating the hydraulic power unit are controlled according to the speed with which the driver removes his foot from the pedal. Thus the power unit supplies any amount of power for brake pressure without any effort on the driver's part. With about five minutes of practice this writer was able to bring the car to a halt at speeds ranging from a slow glide to a quick smooth stop with two wheels on pavement and two on gravel at over 50 m.p.h.—without a skid. Without the necessity of having to remove one's foot from pedal to pedal, total reaction time is cut by more than half. Tests indicate that at 60 m.p.h., stopping distance is cut by 66 ft.

The antiskid unit remains inactive during normal driving and braking conditions. However, in an emergency, where there is a tendency to "over brake," it jumps into action. Imagine a situation where a quick stop is necessary and the road is slick. Another car suddenly appears. The average driver's first reaction—slam on the brakes! With no pedal to push, however, braking would begin the moment the driver's foot left the pedal. As full and sudden braking pressure is applied, the wheels tend to lock. Here the antiskid unit relieves just enough braking pressure to prevent a wheel lock-up. Should the ice suddenly give way to dry surface, the governor senses the change and as the wheels find greater traction, the increase in speed causes the governor to speed up. Just enough braking pressure is reapplied to slow the wheels again. Thus the governor responds instantaneously with the optimum pressure necessary to effect as rapid a deceleration as road conditions permit.

Mechanical failure in any part of the braking system, including the antiskid unit itself, immediately triggers a safety circuit. A loss of vacuum pressure is immediately made up for by rendering the fluid system independent of vacuum supply so that emergency braking power is available. Should there be a loss of fluid, the remaining fluid is diverted to serve as a reserve, in which case a warning light alerts the driver. The brakes then lock making it impossible to drive a brakeless car. ★★



## This Photograph Came From the Moon!

Demonstrating the effectiveness of their new Moon-relay radio system, Navy communications experts transmitted this radiophotograph of the carrier *Hancock* from Opana, Hawaii, to Annapolis, Md., making the round trip of 480,000 miles in 2½ sec-

onds. The ultrahigh-frequency transmission is not disturbed by sunspots, ionospheric disruptions or geomagnetic storms, and it is almost impossible for an Earth-bound enemy to jam unless he can get between the Earth and the Moon.

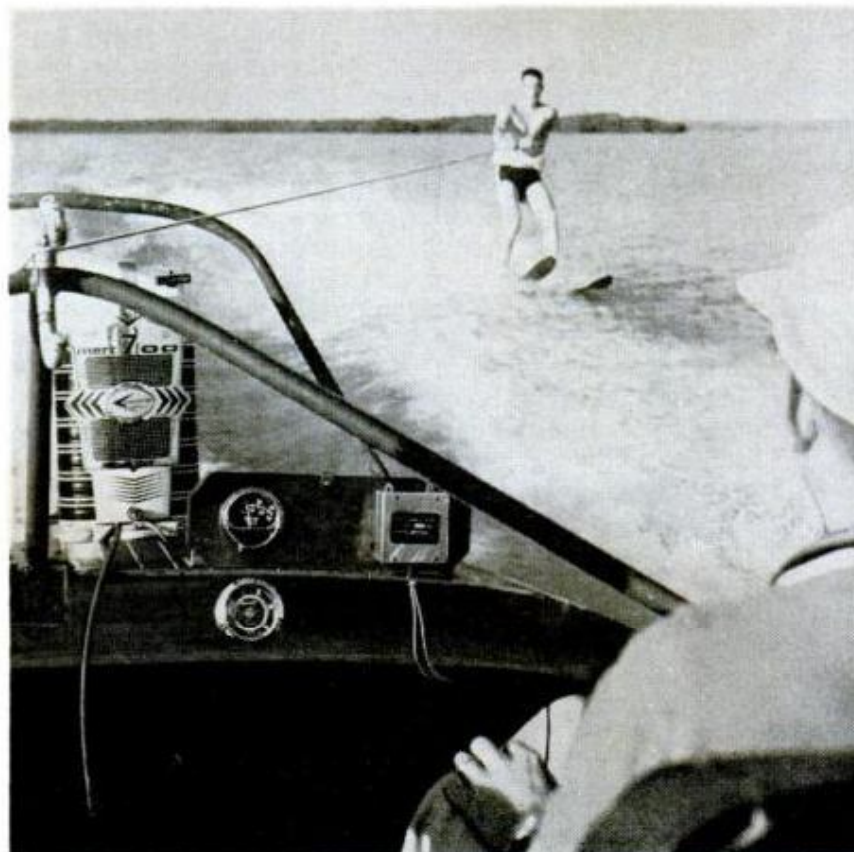

## Motor Governor Controls Ski Boat

One of the toughest boat-driving jobs is maintaining a constant speed while pulling water skiers in a tournament; the rules only allow a one-mile-per-hour variation, which is very difficult for a human driver to manage. A new automatic speed limiter, actually a speed governor, holds the boat at a preset speed, despite a skier's deliberate efforts to slow it down by heavy crisscrossing through the wake. The instrument works on the Bourdon principle, measuring the water resistance to a curved metal tube, then controlling the boat's speed electrically through the ignition system.

HOW MUCH revolution can you take? Detroit continues to bust its seams with new ideas.

Gone are the quiet, let's-pace-ourselves years in which a major decision was the shape of the hood ornament. Now the industry runs scared—scared of the other fellow's imagination and daring.

Next comes a revolution in trucks. A whole new concept is about to be born. Much credit here (as in the small-car revolt) goes to Volkswagen. It opened Detroit's eyes to an economy-truck market.

**In 1959 Volkswagen sold 30,000 trucks (including station wagons). The ubiquitous VW commercial vehicle is as much in demand as the sedan (in some places in greater demand).**

Ford and Chevrolet know a money maker when they see one. This fall, Ford introduces a line of economy trucks patterned after the VW—except it will have a front engine, rear-wheel drive.

Both makes will offer a wagon, a panel truck and a pickup. All will be cheap-to-run, light-load-capacity vehicles for dry cleaners, bakers, appliance dealers, dress shops and the hundreds of other businesses that require lots of "cubics" but relatively little weight capacity.

Ford's engine will probably be the Falcon six (perhaps with a little more displacement). It will mount between two front seats. Later may come front-wheel drive.

**Corvair's commercial line will have the air-cooled rear engine, of course. Those who have driven the bus model say it runs so quietly and smoothly that you suspect it's a jet! There's no vibration or engine fuss at all, they say. Big as a house inside, the bus is regular Corvair length over-all. There's much less "bus-iness" about it than in the VW, especially for the driver.**

Don't lie awake worrying how Chevrolet solved the rear loading problem. The platform above the rear engine is said to be only 30 inches or so above the pavement. The trick may have been to use two air cleaners, one on each side. This would reduce engine height several inches under that in the passenger car.

Look for a boom in camping conversions for these bus-type vehicles. In Europe, such conversions are big business. Once the American camper discovers how convenient touring can be in one of these motorized homes, custom builders will boom.

**What about the big cars? Interest in them seems to be lagging somewhat as the compacts run with the ball this year. Next year, things may be different.**

For 1961, the entire GM big-car line will be freshly styled with a nice-to-have-it-back emphasis on common sense. Seats will be higher, cushions thicker, windshield



## **DETROIT LISTENING POST**

**By Art Railton**

won't wrap so much. Sense is even returning to the trunk. Lids are said to open so wide and so low that you'll almost be able to slide your luggage into the trunk. Overall lengths will be down slightly and roofs (you'll never believe this) will be raised!

But there won't be any transaxle—that is aimed at 1962. So much has to be retooled for that (floorpan, drive line, rear axle) that there isn't enough time.

Buick's up-coming compact has a full width, egg-crate grille with, of course, four headlights (even the up-coming Rambler American has four). Side panels on the Buick small car are sculptured very similarly to those on the 1960 Buick. Taillights are small. No fins. The rear deck is wide and flat; the trunk roomy.

American Motors is rushing ahead a new six-cylinder engine, but it's still a year or two away. Studebaker's new six is expected to be ready for 1961.

**Lincoln may come out only as the Continental Mark something-or-other. Two models are expected: A four-door hardtop; a four-door softtop. Lincoln apparently has given up its battle for the diamond-tiara crowd and now is going after the thick-walleted young-in-hearts.**

Cadillac keeps the same engine, but is more conservative with higher roof.

Corvair styling is virtually unchanged, but there will be more trunk room, a bigger gas tank and an improved heater.

Chrysler engineering is working for the most part on refinements. Displacements will be smaller in all but the Imperial. The alternator will be used across the board. You won't recognize Dodge and Plymouth, so drastic will be sheet-metal changes. The body shell will not change from 1960. There will be a 1961 DeSoto. As usual, it will be a Chrysler with jazzed-up trim.

Ford and Mercury may share the same body shell next year, with Mercury dropping a couple of its models.

An all-new and spectacular German Ford Taunus is coming. Maybe this is to be Ford's big bid for the under-100-inch-wheelbase market. ★★★



# ***THE X-15 POINTS INTO SPACE***

Essentially a manned rocket, the X-15 drops from the wings of the B-52 that carried it to 38,000 feet and blasts off. In 88 seconds, its engine can zoom it into a ballistic trajectory at speeds of up to 4000 m.p.h.

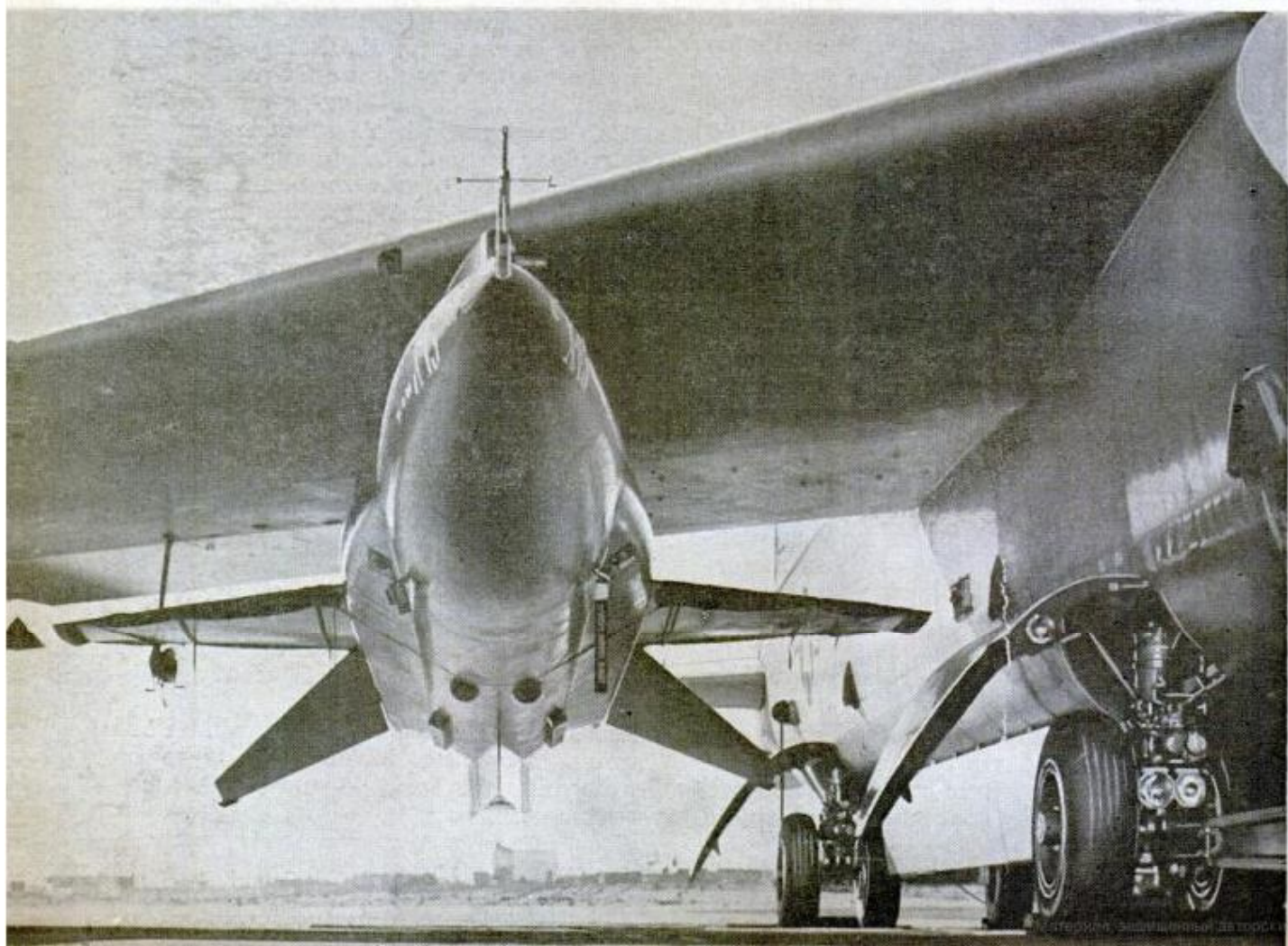



More than an hour before take-off, the X-15 pilot is dressed in an \$18,000 space suit made of heat-reflecting aluminum cloth. Taped to his body are sensing devices so that his rate of breathing, temperature and heartbeat can all be monitored



By Thomas E. Stimson

**T**HE ROCKET with the man in its nose was starting its plunge toward earth and Q. C. Harvey was watching its descent on the radar screen in the high-range control room at Edwards.

Harvey pushed the button on his mike. "X-15 this is Earphone One," he said. "You look real good. Everything appears normal. Do you read me?"

"Rog, Q.C. Have started re-entry procedure."

The X-15 rocket was still in space over a neighboring state and yet from the windowless control room at Edwards Air Force Base, Calif. the test conductor was figuratively peering over the pilot's shoulder.

The radar plotting board showed the geographical location of the X-15 as well as its speed and altitude. Oscillographs duplicated the readings of important cockpit instruments. Technicians were watching scores of meters that told the story of temperatures, pressures and performance.

Even the heartbeat of the pilot was being recorded. All this information was coming by radar and radio telemeter from the X-15.

Q. C. Harvey is responsible for the lengthy, careful countdown that precedes a flight and can cancel it right up to drop time if something goes wrong. During a flight he advises the pilot on procedures

#### A COMPARISON OF THE X-15 AND V-2 ROCKET

	<u>X-15</u>	<u>V-2</u>
Length	50 ft.	47 ft.
Takeoff Weight	32,775 lb.	28,334 lb.
Fuel	Ammonia	Alcohol
Oxidizer	Liquid Oxygen	Liquid Oxygen
Thrust	50,000 lb.	59,500 lb.
Maximum Velocity	4000 m.p.h. (estimated)	4000 m.p.h.
Peak Altitude	More than 100 miles	116 miles
Payload	2000 lb.	2000 lb.

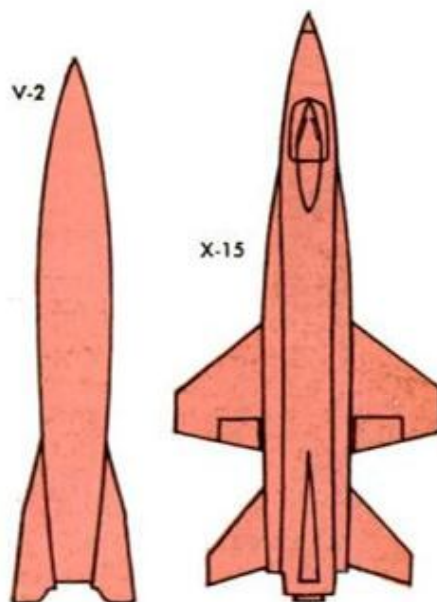

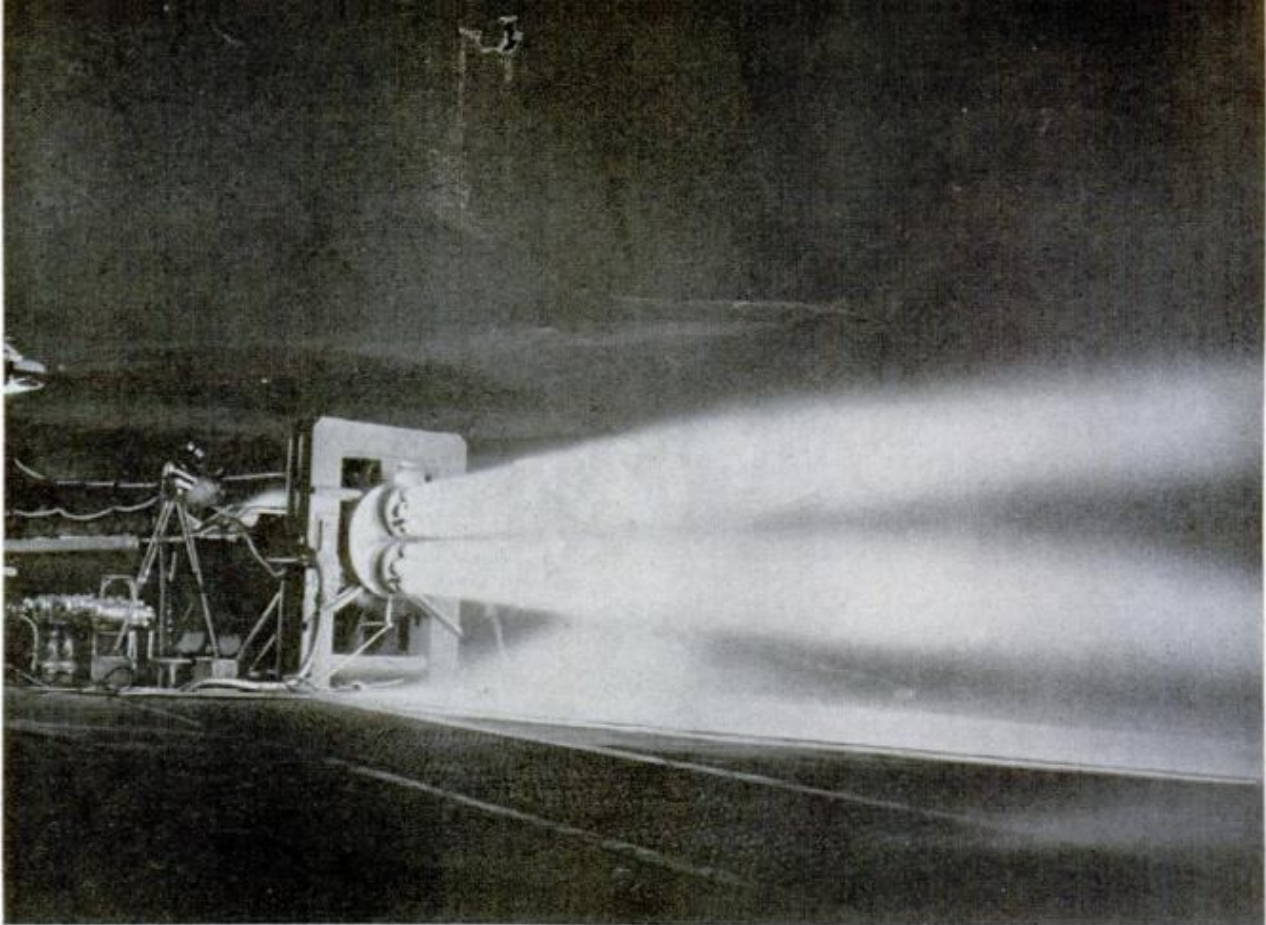

Two-engine power plant of the X-15 is test-fired. A more powerful single-engine plant has been developed

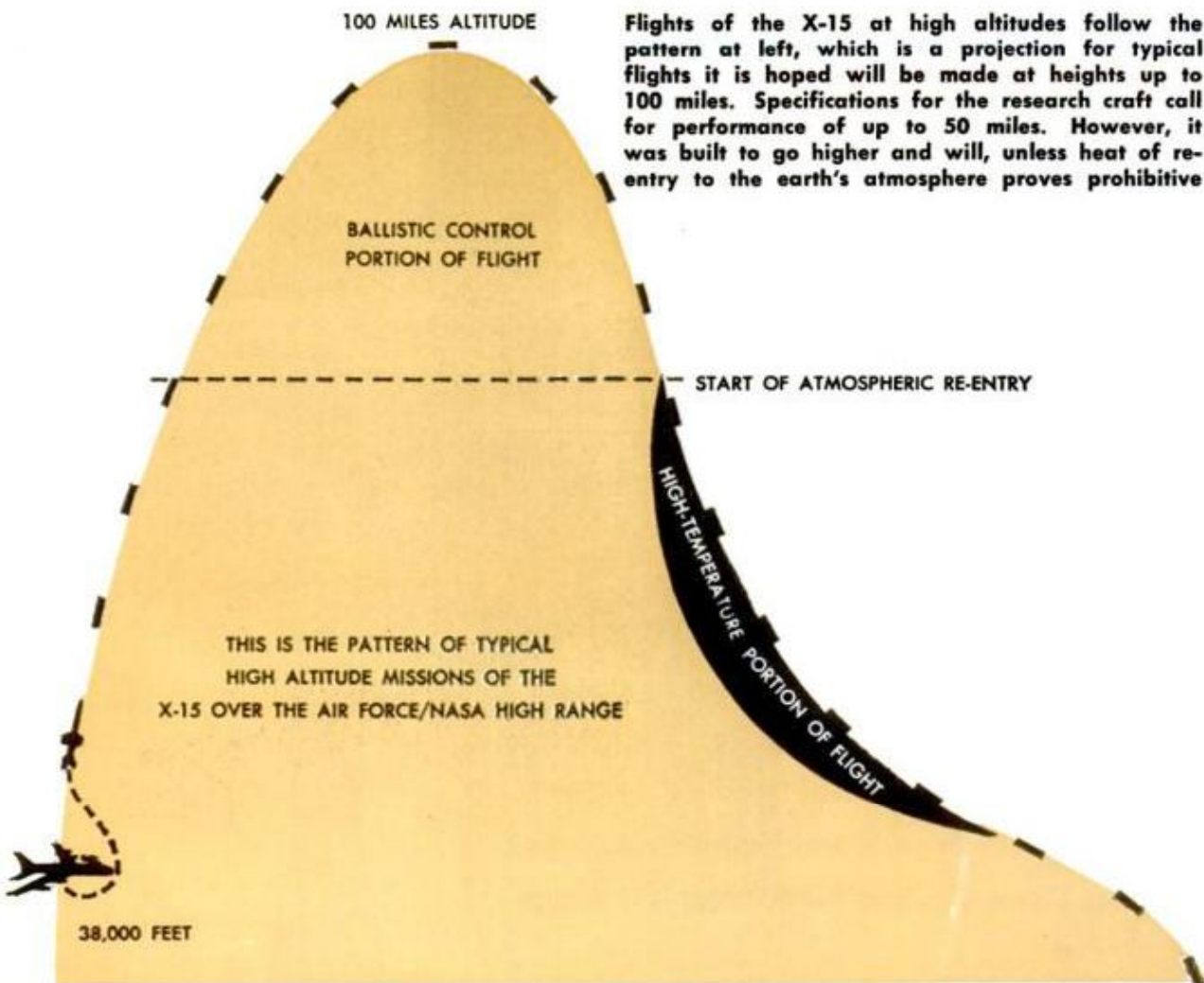

Flights of the X-15 at high altitudes follow the pattern at left, which is a projection for typical flights it is hoped will be made at heights up to 100 miles. Specifications for the research craft call for performance of up to 50 miles. However, it was built to go higher and will, unless heat of re-entry to the earth's atmosphere proves prohibitive

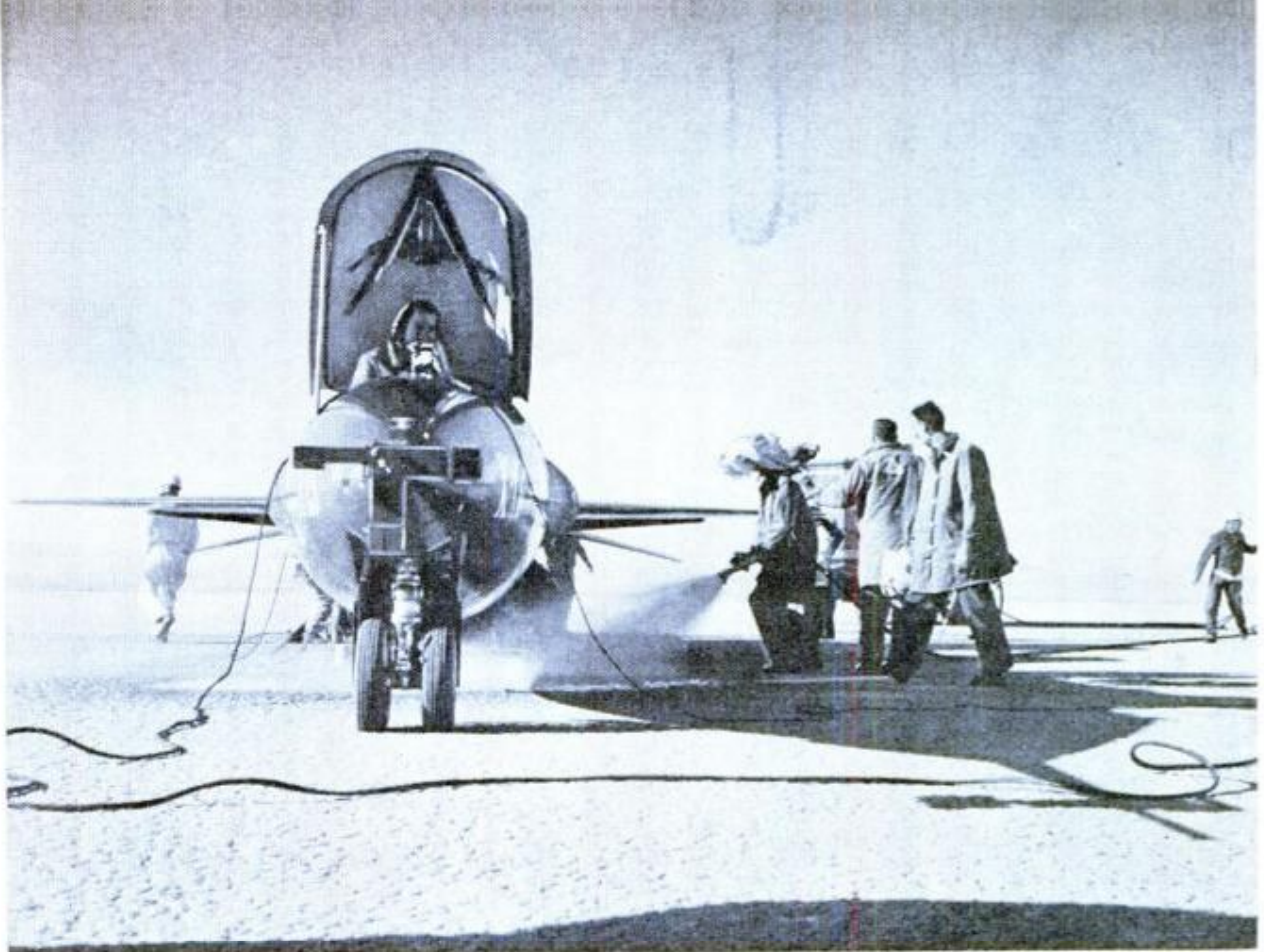

Firemen wash down the landing area in dry lake bed after chemicals were purged from the X-15's many tanks

and passes on information that may be radioed from chase planes.

Usually Q.C.'s job looks easy. The pilot flies from memory a flight he had rehearsed on a simulator. He knows when to pull the nose of the X-15 up toward the sky, when to go over the hump in a ballistic trajectory and the angle at which he should re-enter the atmosphere.

Harvey can tell at once if the vehicle

departs from its program. Usually nothing goes wrong but there are alternate procedures that can be adopted, alternate landing fields that can be used if something does.

The X-15 is called a manned research vehicle rather than an airplane. It has a stubby wing and landing gear so it can land like an airplane. But in most other respects it is a true rocket. In many ways

Cutaway drawing of the X-15 shows how the big, 50,000-pound-thrust engine crowds the craft when installed

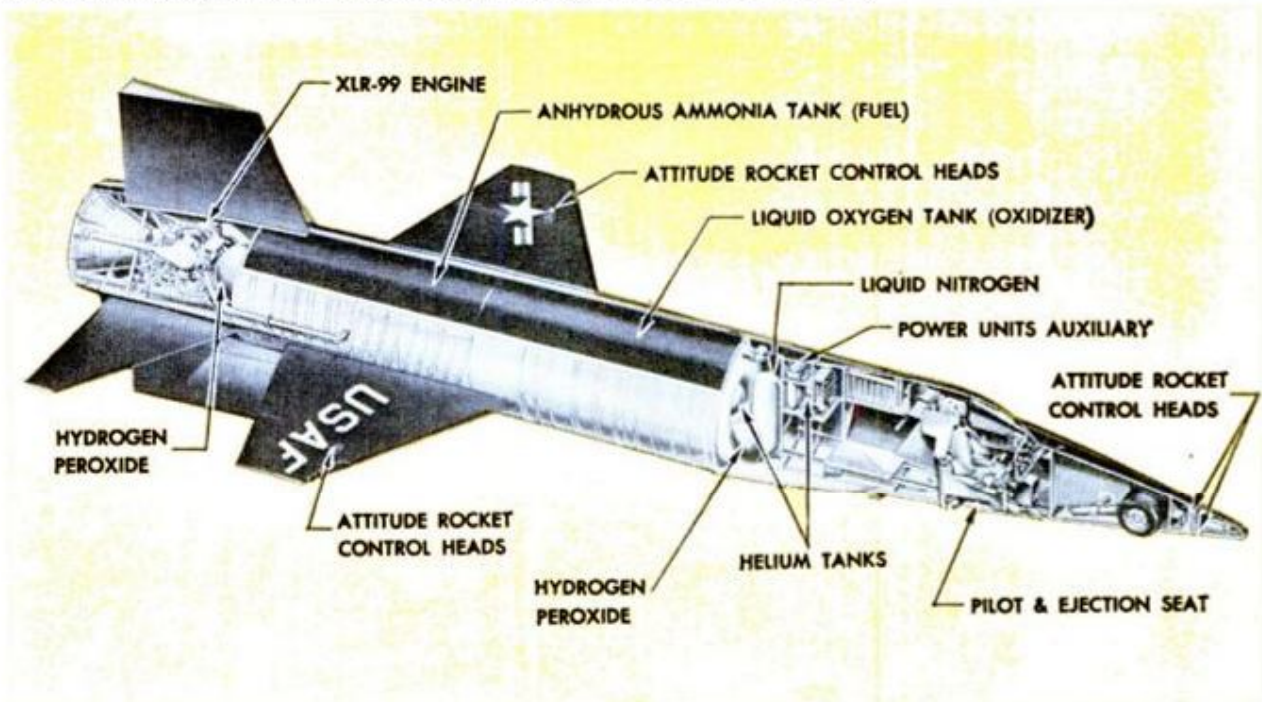



Test conductor Q. C. Harvey, in dark sweater at the high-range control room, talks pilots down should something go wrong

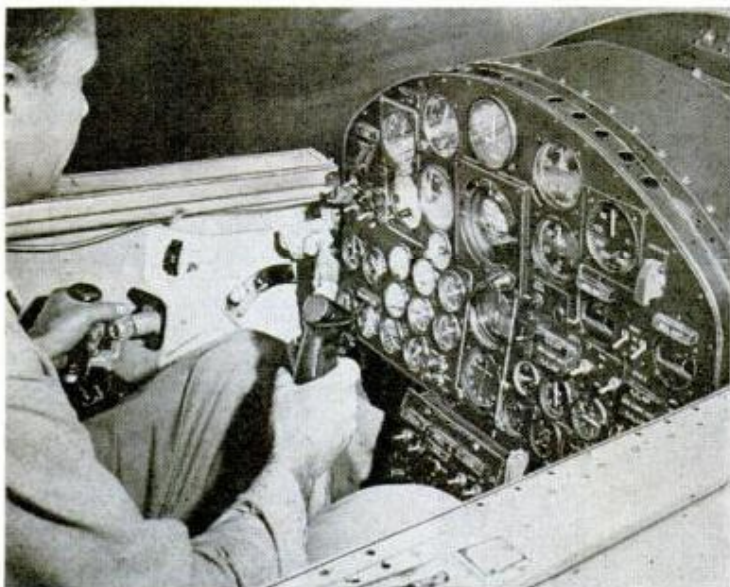

Ground crewman checks out cockpit instruments and controls of X-15 several days before a new flight is scheduled to begin

it is like a wartime German V-2. It is three feet longer, weighs a couple of tons more and develops almost as much thrust. Its estimated top speed, in excess of 4000 m.p.h., compares with the 4000 m.p.h. top speed of a V-2. Its peak altitude, in excess of 100 miles, is about the same. It carries 2000 pounds of pilot and instruments instead of 2000 pounds of explosive.

North American Aviation has built three X-15's under a contract with the Air Force, Navy, and National Aeronautics and Space Administration. Each craft is 50 feet long with a span of 22 feet. The skin is a heat-treated nickel-steel alloy over a structural frame of titanium and stainless steel. Aluminum is used internally. In addition to its ordinary aerodynamic controls the X-15 has eight tiny jet nozzles in the nose and four in the wings. These reaction controls are used by the pilot at the edge of space.

The first X-15's early flights were powered by a pair of rocket motors that developed 16,000 pounds of thrust on water-alcohol and liquid oxygen. Later a single motor that develops 50,000 pounds of thrust on liquid ammonia and liquid oxygen was installed. The motor can be throttled, can be turned on and off in flight. It consumes more than seven tons of fuel and oxidizer in 88 seconds at

(Continued to page 264)

Its research done, an X-15 lands on nose wheel and two rear skids. Some 100 men are involved in each flight

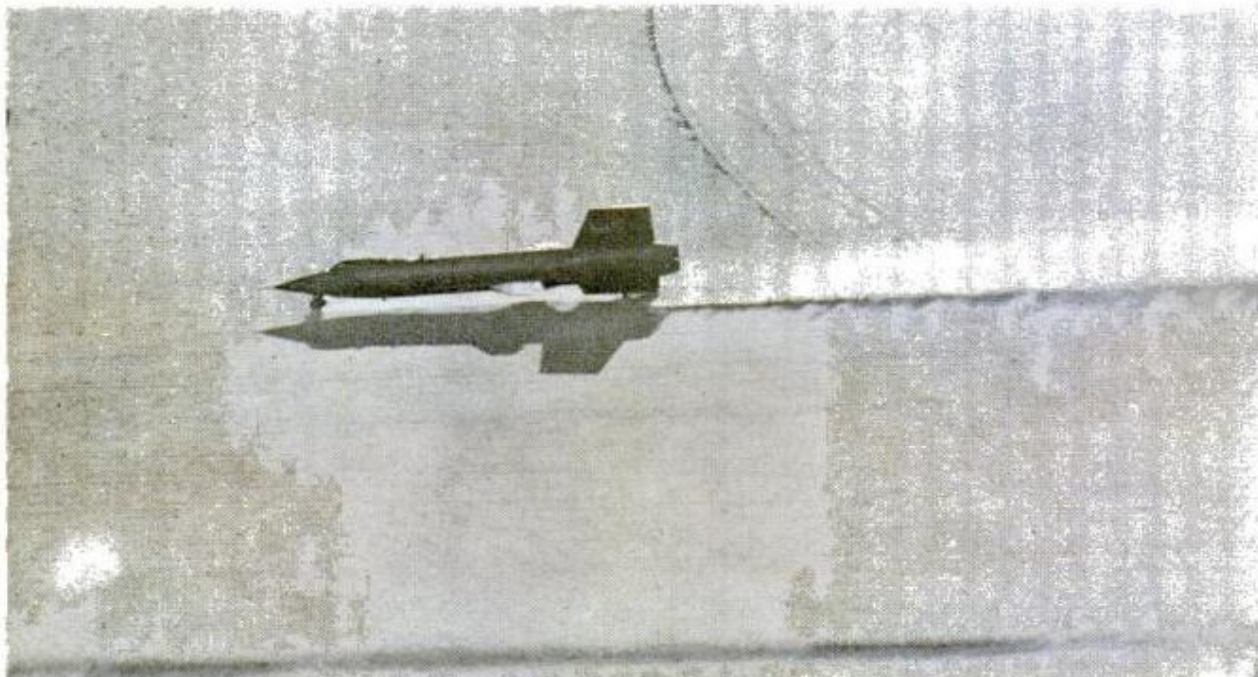

## Special Wheelchair For Injured Skiers

So many banged-up ski enthusiasts (or ex-enthusiasts) were arriving at Tokyo's Ueno Station that a special wheelchair was put into use to move them around. The big chair is primarily a help to station employees who complained that they were tired of carrying the injured on their backs from trains to waiting cars and taxis. The chair will carry four injured skiers.



UPI photo

## Magnetized Reflector Mounts on Car

For night highway stops where passing cars present a hazard, a new reflector is a convenient warning device. Small enough to fit in any glove compartment, the reflector has a powerful permanent magnet in its base; the driver can reach out the car window and mount it on the roof in a matter of seconds. It clings to any part of the car, on trailers, or any steel surface, and eliminates the chance of dead warning-lamp batteries.



## Underground Cruiser Assembled in Cave

Too big to be carried into the depths of Mammoth Cave, Ky., in one piece, a 20-foot aluminum cruise boat had to be taken to the 300-foot level in preformed sections. There it was assembled by riveters on the banks of the Echo River. The big boat has a 54-inch beam, is 15 inches deep, and will carry up to 20 visitors at a time on underground river cruises.

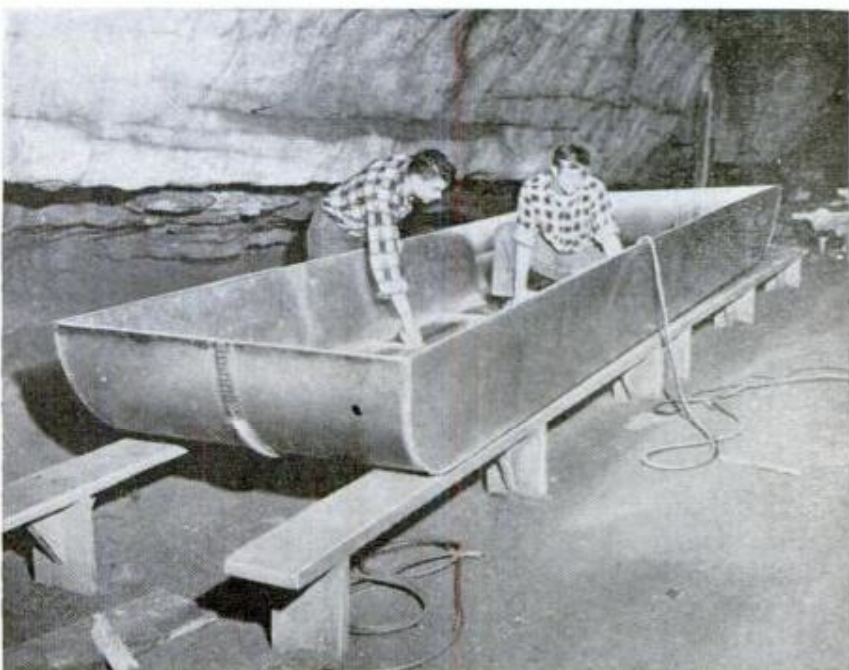

☐ It is estimated that, of the 39 million persons boating in 1959, less than four percent were members of boating clubs.

# "500" Cockpits

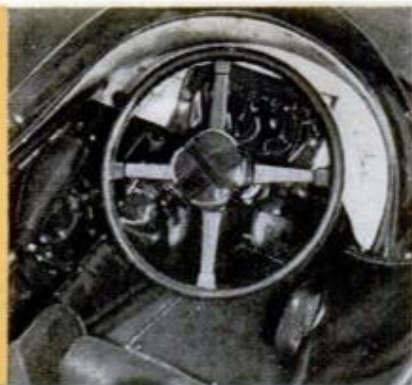

Eddie Sachs' dash has no dials, just a handy carry-all pocket

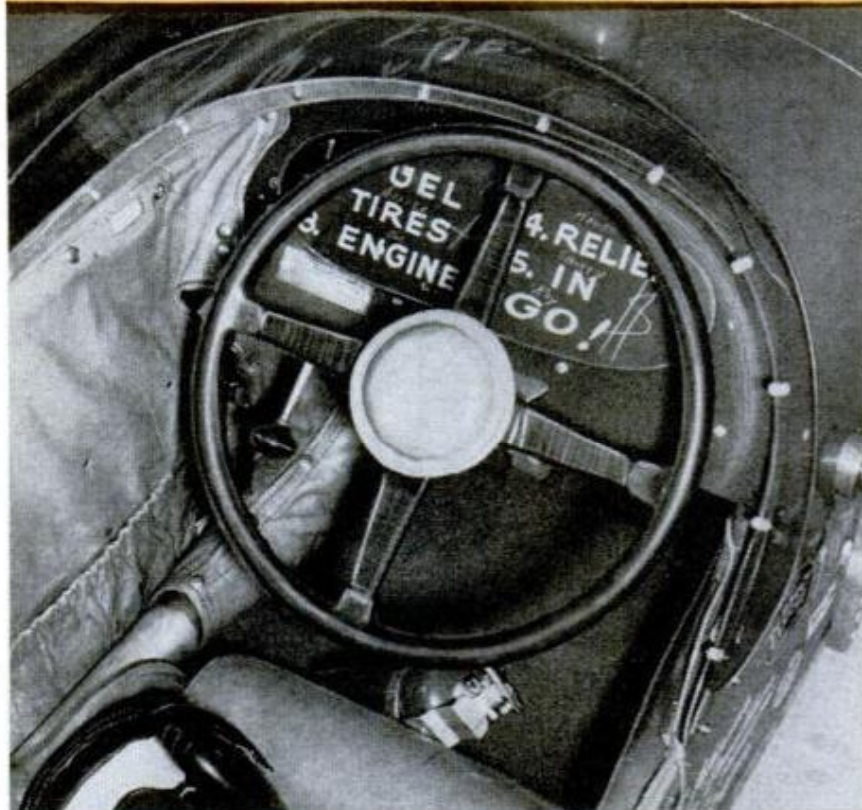

At left, Eddie Johnson painted pit signals (plus a \$ sign) on the dash so he couldn't forget

WHIZZING past at 170 miles per hour, all Indianapolis race cars look alike—and to a great extent, they are.

Through the years, the experts have settled on fundamentals and it takes a bold man to run counter to the trend.

But inside the cockpit, no such restriction applies. To the driver, the cockpit is his castle. These photos show what the driver has in front of him as he speeds toward the checkered flag.

One thing he doesn't have is a speedometer—He simply goes as fast as he can!

On the dash of his 1958 racer Johnnie Parsons taped pictures of his family and his new home

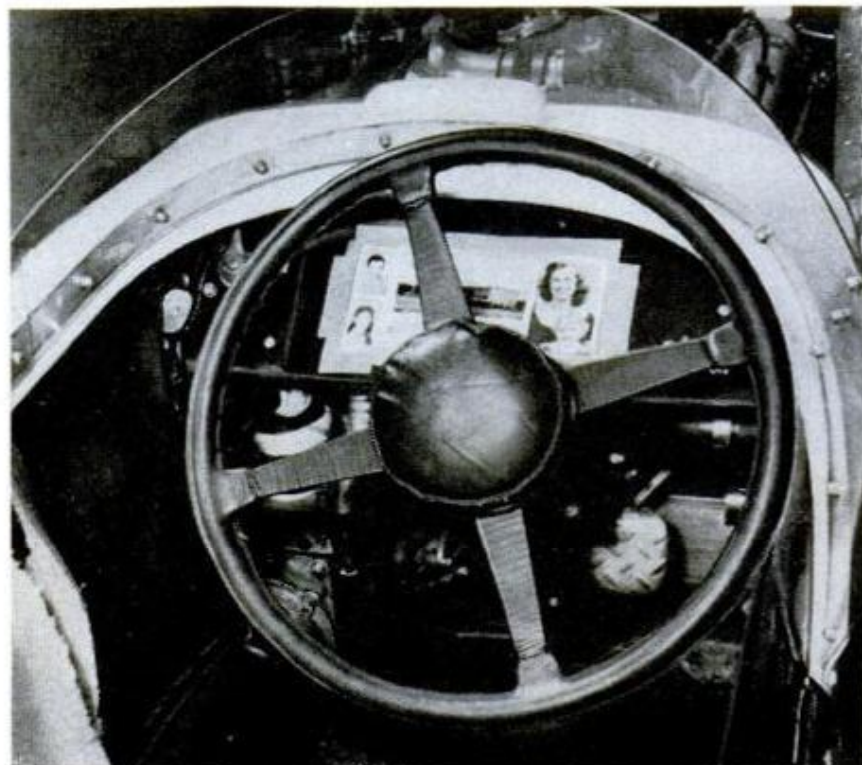

Photos by Joe Fletcher



Nothing fancy about Dick Rathmann's 1958 dash—just money!

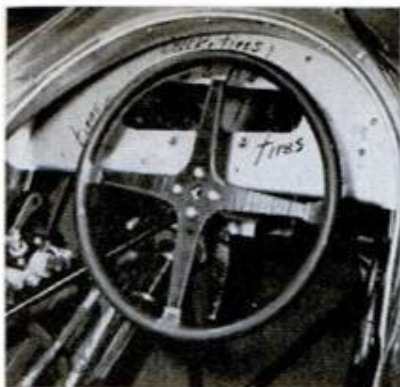

All dials were removed, leaving only one big warning: Check tires!



Only dial visible is the tach. The others carry a message for driver



Gauges are all covered. On one is written: "Stand on it and turn left"

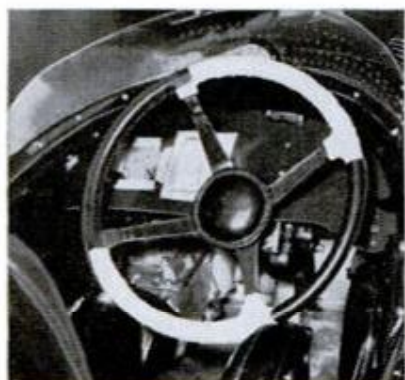

Carter's dash carries a list of drivers who must be passed to win



Message to A. J. Foyt reads simply: "Relax Dad only 500 to go"



No room for error here. It tells Don Freeland exactly what to do

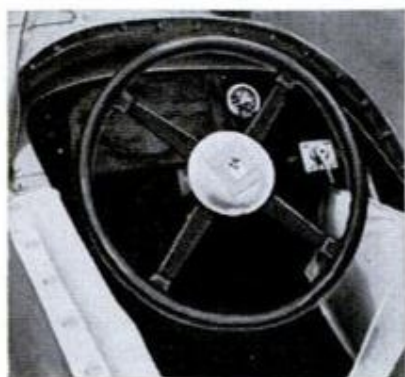

Jack Turner taped this four-leaf clover on hub of steering wheel



Driver can sip a drink via tube that goes into Thermos at left



Jimmy Bryan's dash is orderly, all work. No monkeyshines here

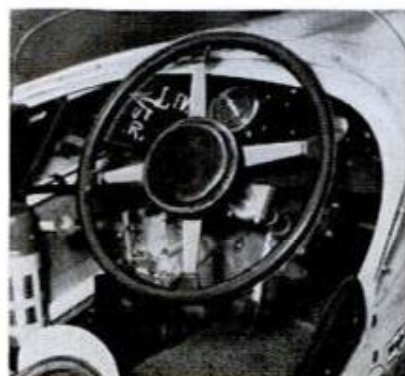

Winner Rodger Ward left a tach and temperature gauge uncovered



Chessbourg had all dials visible, pit signals taped on windshield

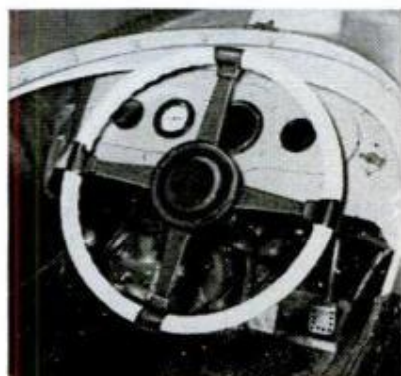

Jimmy Daywalt wrapped wheel in white tape, left temp gauge open

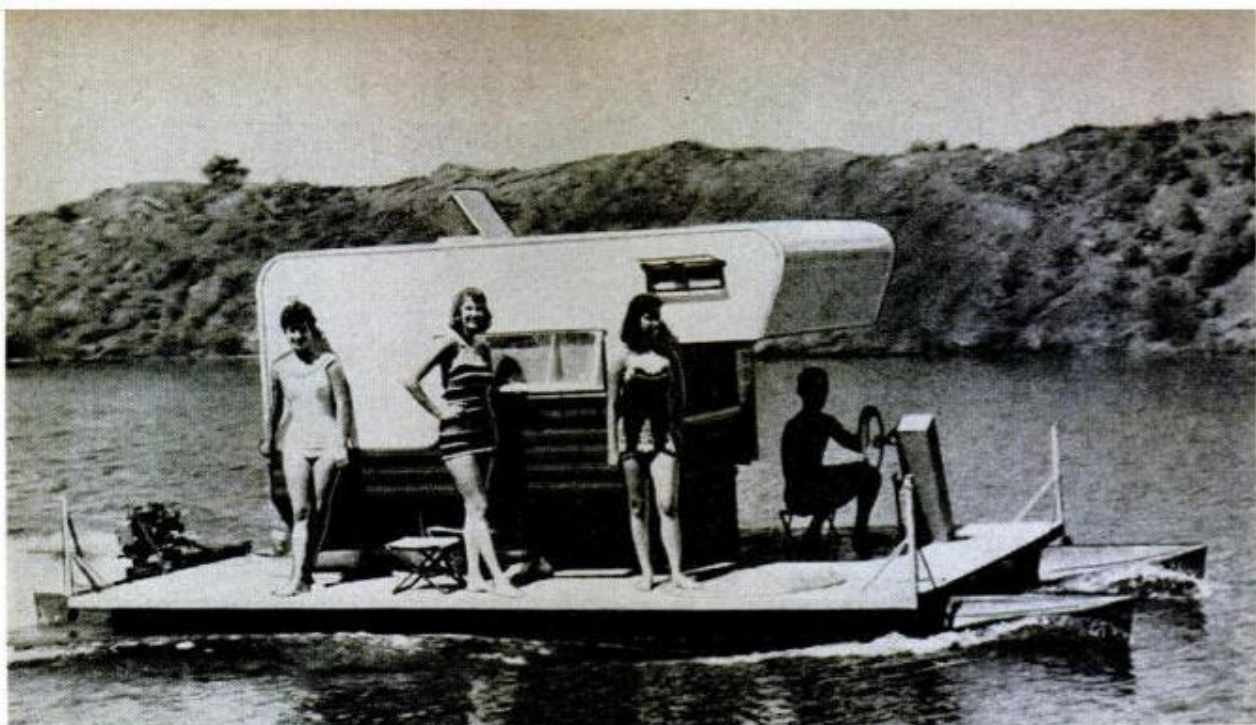

### Houseboat From Pickup Coach

Piggy-back coaches to fit pickup truck bodies have become pretty common sights—on pickup trucks—but one manufacturer has gone a step further. His coach also mounts on a decked pontoon float to become a houseboat as well. Three basic units—truck, float and coach—provide a mobile home, office, houseboat, or hunting cabin. The cab-over model is best for houseboat uses, since the overhang not only provides more sleeping space but doubles as a sunshade for the driver when the coach goes vacationing afloat.



### "Bustle" for Missile

Built into the Martin Mace tactical missile for use during training and test flights, two air-inflated, Neoprene-coated nylon bags have provided the answer to the problem of recovering the fast, wheelless craft intact. The "ground pilot" brakes the remote-controlled missile with three 100-foot cargo chutes, which lower it onto the air cushions for a soft landing on any surface. The recovery method has made the Mace a reusable training tool and a safe vehicle for instrument testing, where before it was a one-shot weapon with no landing equipment. If a malfunction should occur after launching on a test flight, the missile can then be flown back, landed, and reused without damage or loss of the expensive test instruments.



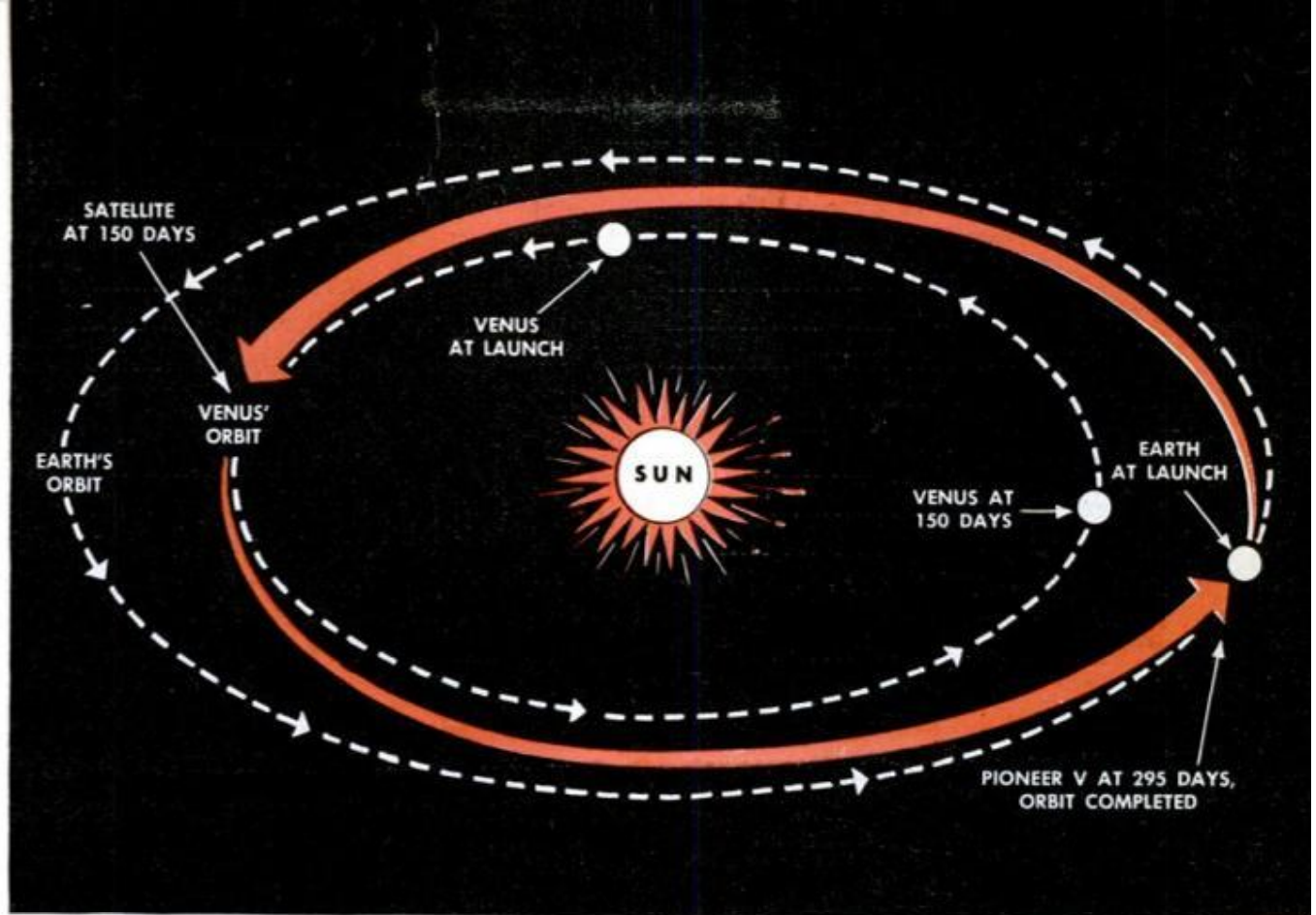

## Artificial Planetoid Explores Space Between Earth and Venus

AT EIGHT O'CLOCK in the morning on March 11, a big three-stage Thor-Able missile left Cape Canaveral, Fla., balanced on its fiery tail with 165,000 pounds of thrust. Four and a half minutes later, at an altitude of about 300 miles, it hurled Pioneer V, our tenth successful space-research vehicle, into interplanetary space at 24,869 miles an hour, 575 miles an hour above escape velocity and only 150 miles an hour short of its planned speed.

Inside the 26-inch, 94.8-pound sphere are two radiation counters, a magnetometer, a device to count micrometeorites, and two radio transmitters. Mounted on paddle-wheel appendages outside the sphere are 4800 solar cells that charge the batteries to operate the radio transmitters.

The instruments will report on experiments in communication, radiation, magnetism, and matter in the solar corona. It is the first space vehicle to penetrate "deep space" and report its findings.

Launched in the direction opposite to the Earth's path around the sun (although it will orbit in the same direction as the Earth), Pioneer V will drop backward and sunward into an elliptical orbit between the orbits of Earth and Venus. As it breaks out of our gravitational field and into the sun's, it will accelerate and stabilize its speed at around 70,000 miles an hour, about halfway between the speeds of Earth and

Venus. Traveling 527 million miles in its 311-day orbit, it will reach the innermost point (perihelion) on the 151st day out—74.7 million miles from the sun and six or seven million miles outside Venus' orbit. Pioneer V's orbit was first predicted at 295 days (see diagram above), but corrected calculations place it at 311. Its outermost point (aphelion), will be about 93 million miles from the sun. At that time Earth will be at a different point in its own orbit, and the two satellites of the sun won't be likely to collide, though within the next 10 years the planetoid may come within several hundred thousand miles of Earth—a near miss by astronomical standards. After the first few million miles, the five-watt radio transmitter in Pioneer V isn't strong enough to maintain contact, and the big 150-watt transmitter goes to work, using the smaller unit as a booster amplifier. It broadcasts only five minutes in each five hours, storing accumulated information in tiny memory devices between transmissions while the solar cells recharge the batteries for the next five-minute transmission.

The 150-watt signal should be received by the Jodrell Bank radiotelescope until Pioneer V is 50 million miles out. Since the transmitter is designed to work indefinitely, it is hoped that it will still be working when the satellite swings back within radio range sometime in 1963.

## HOW GOOD IS THE VALIANT?

### Owners like:

Handling ease .....	60.9%
Riding comfort .....	45.8%
Power, performance .....	38.3%

### Why did they pick Valiant?

Exterior styling .....	58.2%
Over-all size .....	45.2%
Economy of operation .....	42.8%

## WHAT'S WRONG WITH IT?

### Owners dislike:

Poor workmanship.....	20.0%
Water leaks in body.....	19.6%
Poor gas mileage.....	15.7%

### What should be changed?

Gearshift design.....	12.4%
Gas-tank filler tube .....	4.9%
Rear-end styling.....	4.3%

## WILL THE VALIANT CUT INTO IMPORTED-CAR SALES?



YES say 79.3%

NO say 20.7%

### Valiant has:

Good looks  
Better service  
Right size

### Imports have:

More economy  
Lower price  
Better quality

## Valiant Handles Well, Is Peppy

MARGINAL COMMENTS  
BY ART RAILTON  
PM's AUTO EDITOR

*Sense is returning, no doubt about it. Styling will be less gimmicky. You raised the roof with your screaming, tomorrow Detroit will raise the roof of its cars.* →

*Industry dilemma: How to keep from hurting your best friend—the guy who rushes out to buy the first car off the line, paying full price. He usually gets clobbered. First come, worst served.* →

COMPACTS ARE here to stay. At least they are if Valiant owners are indicative of the public taste. These people like this new size of automobile and don't hesitate to talk about it.

PM asked 1000 new Valiant owners to be frank about their cars. This report is what they said and it reflects an enchantment with the compact concept.

Here, for example, are some quotes:

"This is one of the most generally satisfying cars I've ever owned. It represents a return to sanity in American car design. It retains all the practical and desirable features without any excesses."—California engineer.

"It has no extreme or ridiculous styling. Windshield and rear window are sensible, not extending way up into the roof. In general, a well-constructed, honest automobile."—Ohio research physicist.

"I feel like a VIP every time I stop because people crowd around and ask questions. I enjoy all the attention my dear little Valiant and I, an ordinary homemaker, are getting!"—Georgia homemaker.

But these same owners have some misgivings about buying a brand-new model—any brand-new model.

"The Valiant is such a new car that all the kinks are not ironed out. I'm inclined to be tolerant of a few disturbing troubles which I would not excuse in another make."—Michigan librarian.

**BASED ON 1,432,309  
OWNER-DRIVEN MILES**

**OWNERS  
REPORT**



## But Workmanship Poor, Say Owners

"I was fully aware that I would have some new-car bugs. When speaking to the dealer about defects, his attitude seemed to be that you have to expect these things from a mass-produced Detroit car. In desperation I called the factory and again the same attitude prevailed."—Michigan salesman.

"The Chrysler Corporation apparently relies on the dealer to take the many bugs out of the car. The dealer however, feels he is not properly reimbursed for this extensive project. The buyer is caught somewhere in this squeeze."—New York public relations man.

What do these owners like most about their Valiants? Tops on the list is handling ease, followed by riding comfort, power and performance, exterior styling and roadability in that order. Here are some quotations describing these likes:

"Fun to drive. Never since I was a kid have I enjoyed driving any car as much as I have this Valiant."—Ohio branch manager.

"A pleasure to drive. Driver feels he's part of the machine."—Massachusetts physician.

"Handles like a sports car. Has good pickup through the gears and really digs in on curves."—Kentucky salesman.

"Has one of the best rides I've ever experienced. Very firm with no chop, yet absorbs bumps well."—Washington electronics technician.

**Don't let dealers kid you. Oftimes they pocket the warranty money and chuckle at the number of suckers in the world—this is true among all makes.**

**Owners are learning there's more to compactness than pennies per mile. It's a whole new world, a world some like, some don't like, but a new world nevertheless.**



Above, many owners complain that the floor-mounted shift lever is awkward and that it interferes with center rider in front seat. Left, another complaint is that the fuel tank cannot be filled completely without spilling due to the horizontal intake pipe

**Zero-to-60 time for automatic transmission Valiant: 15.6 seconds. 40-to-60: → 7.2 seconds. Those are plenty adequate times for normal humans.**

**Fun? You bet. But he → probably gripes about his gas mileage!**

"Covered 2198 miles in 47½ hours driving time and finished feeling very fresh and relaxed."—Pennsylvania salesman.

"More power than expected."—Ohio engineer.

"Has been clocked up to 78 miles per hour with plenty of pedal left."—Utah radio station manager.

"Sufficient power for even these steep Palos Verdes hills which some top imports cannot climb."—California boiler-maker.

"I find myself racing in and out of traffic with an ease that amazes me. Best fun is racing Volkswagens, Falcons and Corvairs. It leaves them cold."—Illinois traffic manager.

"I like the styling. It does not copy any other make. No high tailfins."—Connecticut technician.

"Neat and clean looking. Not all jazzed up with fins and chrome. Lots of style without flash."—Michigan owner.

"Most beautiful small car on the road. It takes the woman's eye."—California dress cutter.

"Corners like a sports car."—Florida manufacturer.

Largest group of handshift Valiant owners gets 19 to 20 miles per gallon in the city, 23 to 24 in country

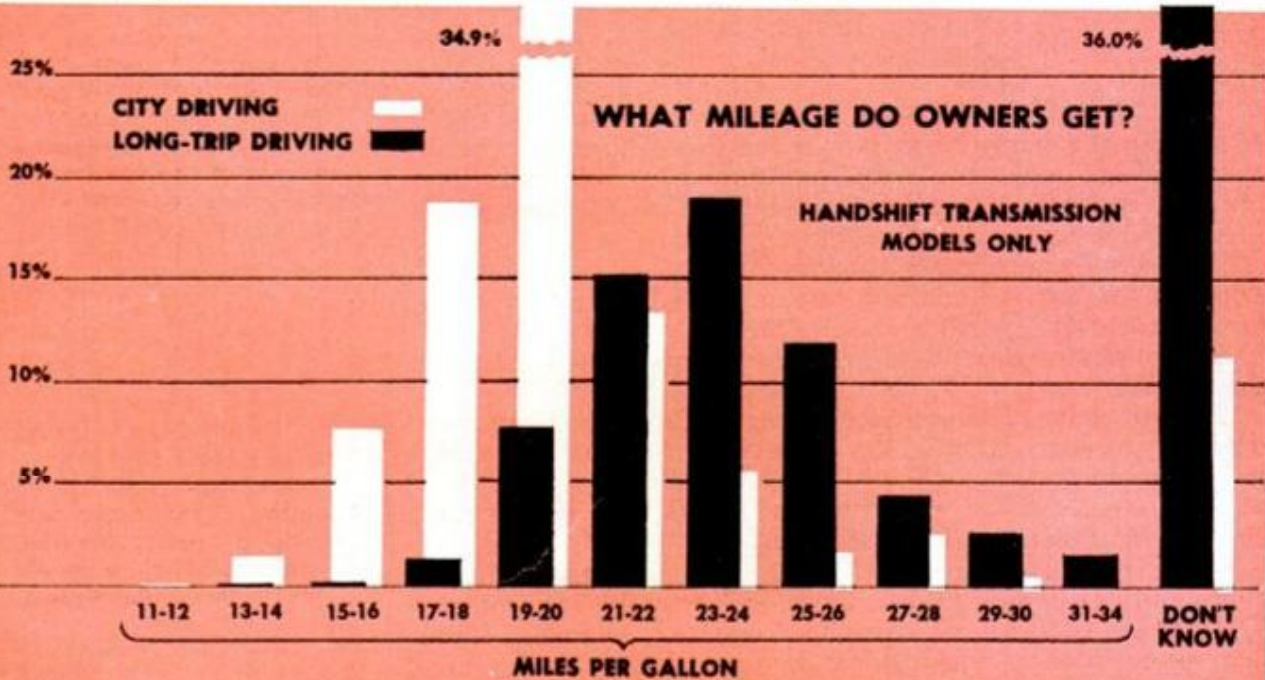



Above, trunk space is excellent in the Valiant as the spare tire is carried in a well in the floor. Note the horizontal gas filler pipe, left center. Right, dashboard is neat, although plastic frame around dials is extremely jazzy. Push buttons on left are for three-speed automatic transmission

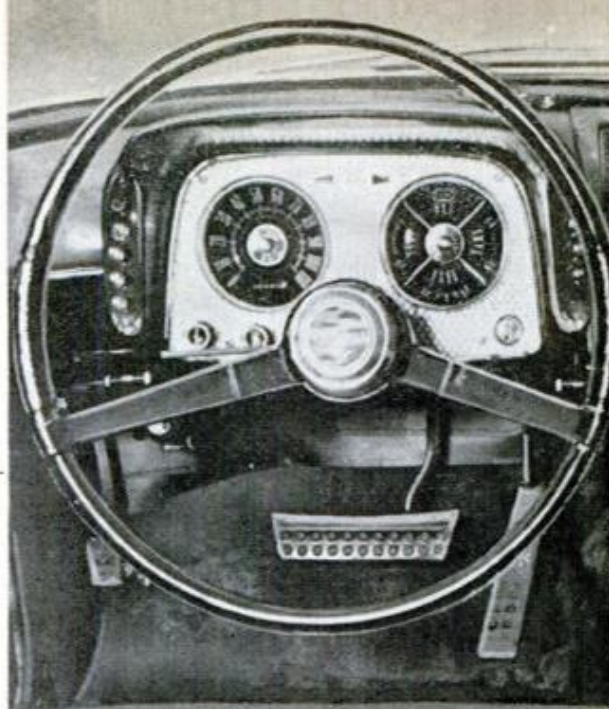

"Holds the road better than heavier cars."—Massachusetts hide broker.

### And Their Complaints

But everything is not perfect—it never is. And these Valiant owners have some gripes. However, 14.7 percent of them say there's not a thing wrong with the car.

Leading the complaint list is poor workmanship with 20.0 percent mentioning it. After this, come water leaks in the body, poor gasoline economy, door design and operation, and then body rattles and squeaks, in that order. These quotations describe the complaints:

"General workmanship is only fair. Here and there, bolts are not tight, some are missing. Wires are snarled, paint not uniform, welding in body especially sloppy, sheet-metal screws stripped. Bumper is rusting already."—New York engineer.

"In heavy rain, trunk and right door leak."—Pennsylvania housewife.

"Gas mileage always less than 20 miles per gallon. On a metered gas test it got 23 miles per gallon at 50 miles per hour, 13 miles per gallon at 75. I must use high-test gas to keep engine from pinging. I get 17 miles per gallon overall and have a handshift transmission."—Texas sales manager.

"Lousy gas mileage. I have an automatic transmission and get 14.2 miles per gallon in the city. If you could get the economy advertised this car would be a natural for a small family."—Minnesota vice-president.

"Difficulty with doors. They won't close properly. If I lock doors I can't open them."—Illinois physician.

"Door latches freeze so doors won't stay shut after washing car in low temperature."—New York broker.

"Even though it is of unibody construction, the rattles are paramount. I have had the entire car checked seven times by the dealer for this."—Michigan district manager.

"Shift lever is too short. We have added a four-inch extension and find it better, especially when shifting to second."—Florida foreman.

"Shifting although smooth is troublesome. The passenger space is shortened considerably. There is no reason why shift couldn't be on the steering column."—New York unemployed worker.

← Here's the new public lament: Workmanship. You demanded and got smaller cars. Let's see what you can do about workmanship.

← In a PM test, an automatic-transmission Valiant sedan averaged 16.7 miles per gallon in the city, 17.8 in the country. Temperature was in the 20s.

← Next year's lever will probably be longer, but you don't have to wait. You can buy an extension for it right now.

SOLED BY:

ROBT. W. HOYERMAN 89  
17512 RIDGEVIEW DR.  
WAYZATA, MINN.

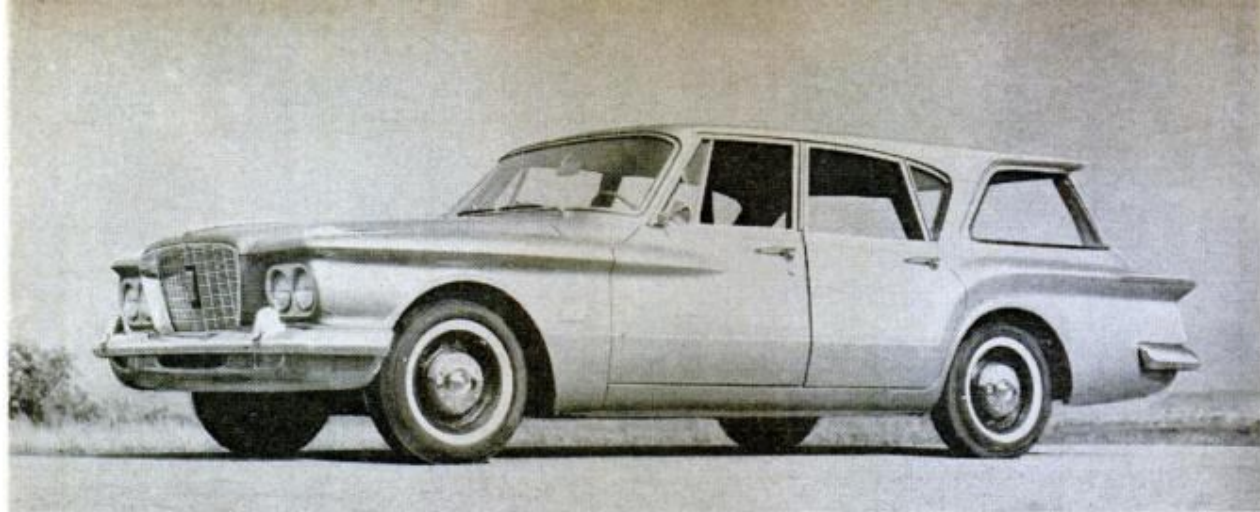

Taut of line, the Valiant wagon has none of the boxcar look that is characteristic of most station wagons

### What About Imports?

PM asked Valiant owners whether they think this new concept in the American automobile will cause a drop in imported-car sales. Most of them think it will, but a minority of 20 percent expressed the opposite view. When only those who currently own an imported car (in addition to the Valiant, that is) were considered, nearly 40 percent said these new compacts would *not* cut into foreign-car sales.

Here are some quotes on the subject:

"The type who buys foreign will continue to buy foreign."  
—Michigan sales engineer.

"I would like more quality and workmanship to put it into the category of a poor man's Jaguar 3.4. It has many qualities of an ideal car."—Wisconsin mathematician.

"I would much rather buy American cars. But they should be delivered in better shape. My Volkswagen was delivered in perfect condition. I think it is very important that the American manufacturers be careful about this detail."—Michigan supervisor.

"Have owned Anglia, Volkswagen car, Volkswagen bus,

(Continued to page 262)

**Who's he kidding?**  
There's no "type" that buys foreign cars. Owners range from sophisticates to truck drivers. →

**Until Detroit stops bringing out new models every other year, it will be plagued with misfit-itis. Yet who's for misonicism? Not this kid!** →

## SUMMARY OF OWNERS REPORT: VALIANT

Excellent 74.7%

Average 20.9%

Poor 4.4%



<b>What about gas mileage?</b>	Gas filler pipe . . . . . 4.9%	No. would not . . . . . 17.5%
Satisfied with it . . . . . 59.5%	Rear styling . . . . . 4.3%	Don't know, no answer . . . 29.1%
Not satisfied . . . . . 37.3%	<b>Why did they pick Valiant?</b>	<b>What make was traded?</b>
No answer . . . . . 3.2%	Exterior styling . . . . . 58.2%	Plymouth . . . . . 21.5%
<b>Best-liked features</b>	Over-all size . . . . . 45.2%	Another Chrysler make . . . 12.2%
Handling ease . . . . . 60.9%	Expected economy . . . . . 42.8%	General Motors make . . . 19.9%
Riding comfort . . . . . 45.8%	Engineering features . . . . 39.9%	Ford Motor make . . . . . 15.0%
Power, performance . . . . . 38.3%	Initial price . . . . . 15.3%	Other U.S. make . . . . . 4.7%
Exterior styling . . . . . 37.3%	<b>What like best in styling?</b>	Foreign make . . . . . 4.8%
Roadability . . . . . 23.0%	Front-end design . . . . . 21.8%	No trade, no answer . . . . 21.7%
Interior room . . . . . 21.2%	Rear-end design . . . . . 13.2%	<b>What make will buy next time?</b>
<b>Most-frequent complaints</b>	Foreign look . . . . . 9.8%	Another Valiant . . . . . 31.4%
None at all . . . . . 14.7%	<b>What like least in styling?</b>	Some other Chrysler make . 10.1%
Poor workmanship . . . . . 20.0%	Rear-deck styling . . . . . 15.8%	General Motors make . . . . 3.1%
Body leaks . . . . . 19.6%	Small bumpers . . . . . 4.5%	Ford Motor make . . . . . 1.5%
Poor gas economy . . . . . 15.7%	Front grille . . . . . 4.5%	Other U.S. makes . . . . . 0.7%
Door design, operation . . . 12.6%	<b>What like best inside?</b>	Foreign make . . . . . 2.6%
Rattles, squeaks . . . . . 9.4%	Seat design, height . . . . . 18.3%	Undecided, no answer . . . 50.6%
<b>Had engine trouble?</b>	Roominess . . . . . 15.4%	<b>Large enough for "family" car?</b>
No trouble at all . . . . . 70.2%	Dashboard . . . . . 13.8%	Yes, it is . . . . . 82.2%
Some trouble . . . . . 26.6%	<b>What like least inside?</b>	No, it is not . . . . . 12.0%
Considerable trouble . . . . 3.2%	Glove compartment . . . . . 11.3%	No answer . . . . . 5.8%
<b>What was trouble?</b>	Gearshift location . . . . . 8.3%	<b>Is it only car in family?</b>
Alternator, regulator . . . . 7.6%	Ashtray location, shape . . . 5.8%	Yes, it is . . . . . 51.5%
Ignition trouble . . . . . 5.1%	<b>How is dealer service?</b>	No, it is not . . . . . 48.5%
Carburetor, auto. choke . . . 3.1%	Excellent . . . . . 47.6%	<b>What is other car?</b>
<b>What one thing should be changed?</b>	Average . . . . . 38.9%	Another Chrysler make . . . 42.1%
Nothing or no answer . . . . 28.3%	Poor . . . . . 13.5%	General Motors make . . . . 25.5%
Gearshift design . . . . . 12.4%	<b>Would buy from him again?</b>	Ford Motor make . . . . . 17.1%
	Yes, would . . . . . 53.4%	Other U.S. make . . . . . 7.6%
		Foreign make . . . . . 7.7%

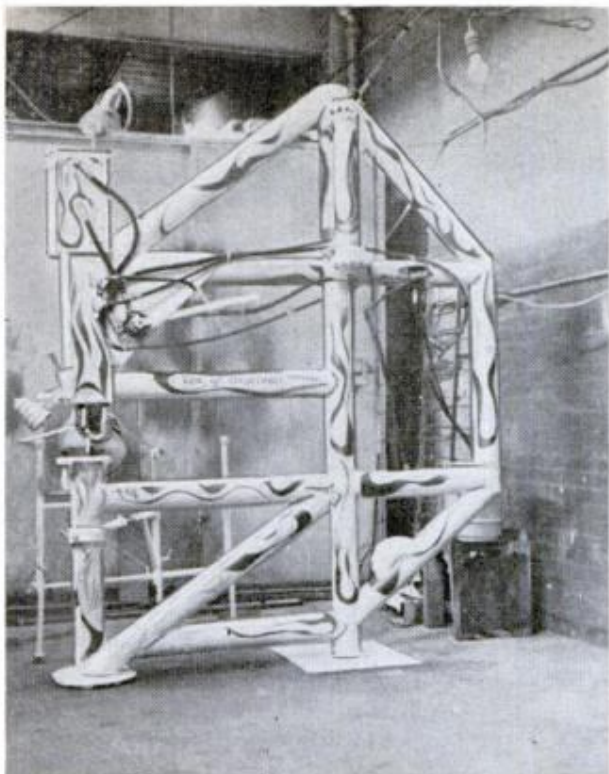

## It's Flamed and Pin-Striped— What Is It?

"THE ONLY flamed and pin-striped louver press in captivity"—that's how Ken MacDowell describes his strange-looking interconnection of pipes at a body shop in Cleveland, Ohio. Ken completed the press when he was discharged from the Army. He built it by himself and "striped and flamed it just to be different," he says. And different it is, so different that it's difficult to tell what it might be used for. His louver press makes the familiar vents often found in car hoods. Such vents remove hot air from the engine compartments of hot rods and race cars, and also give a mark of individuality to custom cars and stock cars. The frame of the press is five-inch welded tubing. The press operates by hydraulic pressure with a two-horsepower motor and a 1000 p.s.i. pump. Incorporated in the system is an accumulator filled with 800 pounds of air, used to give speed to the upper louver die, insuring a clean cut. A pressure relief valve cuts out at 950 p.s.i., after the accumulator has been filled with the specific volume to complete one punch. Movement of the die is controlled by a solenoid-operated selector valve. There is a maximum hydraulic pressure of 15,000 pounds, which is more than adequate to form louvers in average-size hood metal. The body shop where Ken uses his machine is called "Customville," quite an appropriate place for such a customized louver press.

MAY 1960

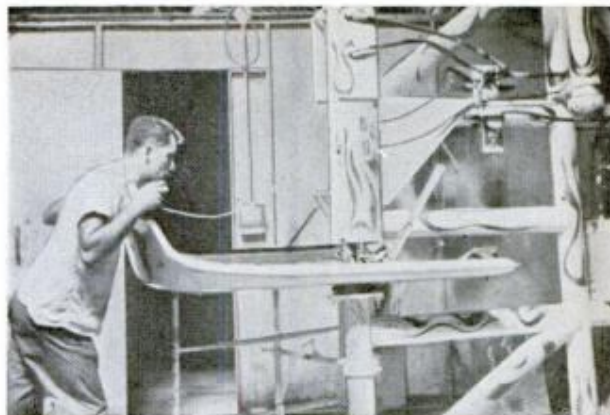

Holding selector valve switch, Ken MacDowell starts car hood into louver press for customizing work

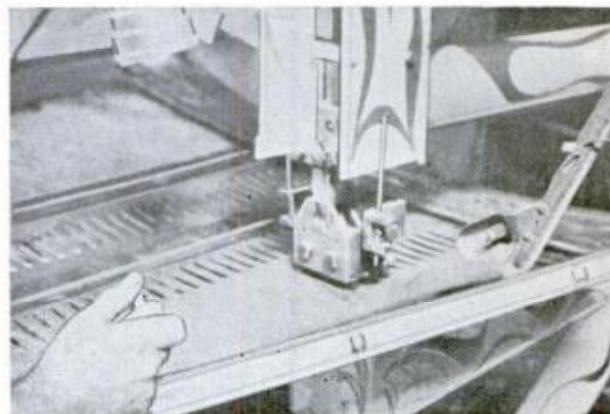

Hydraulically-run die punches vents in hood under 15,000-pound pressure. Below, the finished product

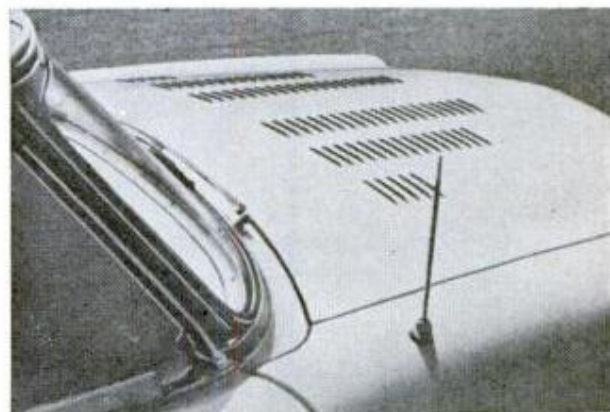

### *Number. Please!*

Whenever you write us to

- Renew your subscription
- Change your address
- Order your own or a gift subscription

. . . In fact, whenever you write us,

**PLEASE INCLUDE YOUR CITY POSTAL ZONE NUMBER IN YOUR ADDRESS**

*This insures better delivery.  
It helps you and it helps the postman.*

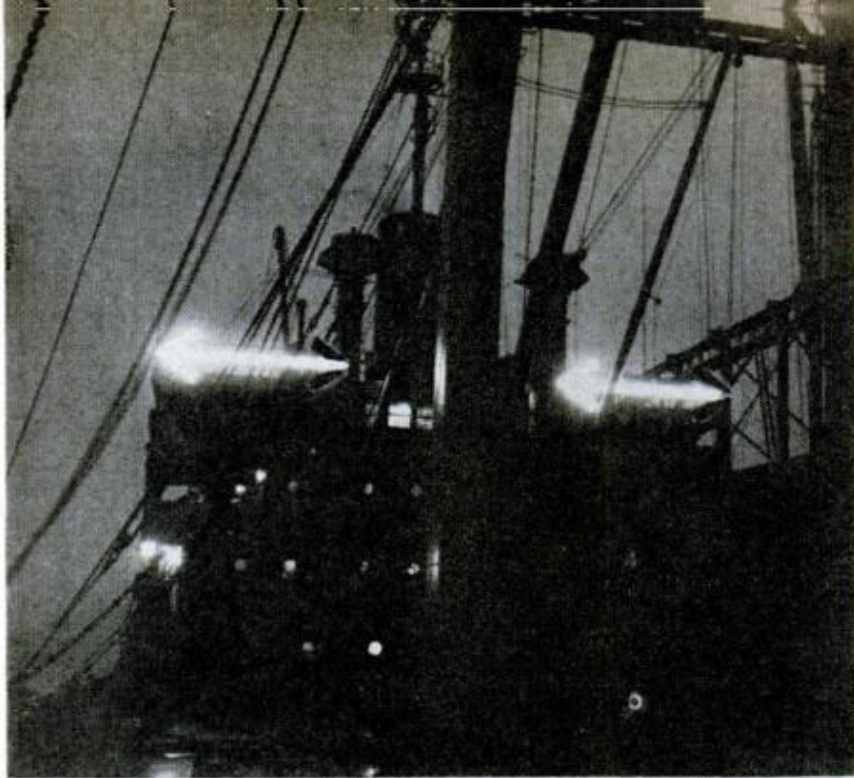

## Turn Signals On Cargo Ship

USNS *Golden Eagle*, a cargo vessel of the Military Sea Transportation Service, shows off her new turn-signal lights at Norfolk, Va. The signals are an attempt to reduce confusion—and collisions—caused by the frequent misunderstanding of whistle signals on large ships; Lloyd's of London reports there are 45 such collisions a week. The arrows are made up of 28 100-watt bulbs in amber globes, controlled from the bridge.



## Letter Sorter Cancels Stamps

Electronic letter sorters that also cancel 500 stamps a minute are being introduced into U.S. post offices. Actually two machines working in tandem, the "facer-scanner" does away with the chore of separating long and short envelopes. As the envelopes stream through, the machines' electronic scanners locate positions of the stamps and directs the envelopes to one of four canceling dies, and then stacks them automatically.

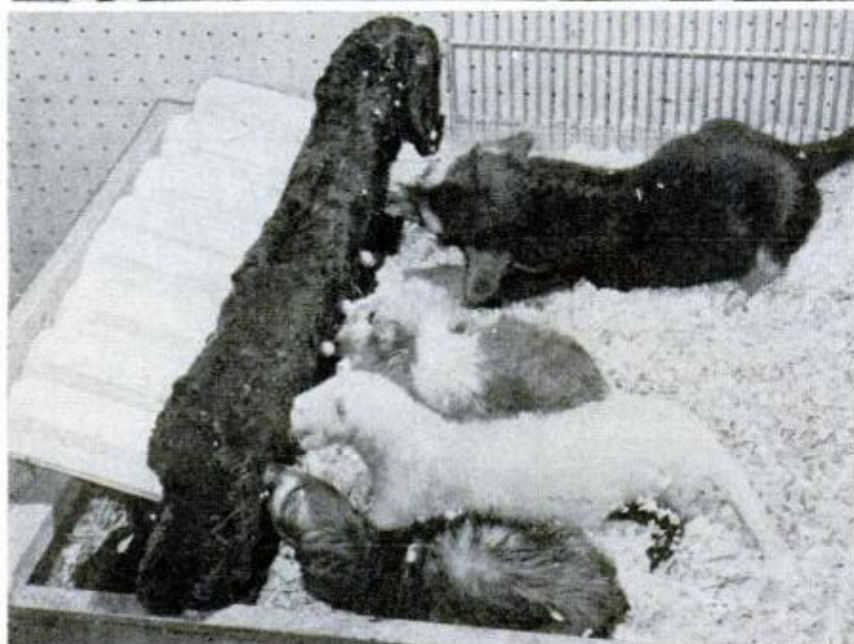

## Model "Mother" Feeds Animals

Orphan and stray animals who are taken to a Brooklyn, N.Y., shelter are fed milk from an artificial "mother." The device is effective in pacifying many species of animals. "Mother" consists of eight bottles with nipples stuck through holes in a board. The board itself has been covered with rabbit fur. On occasion, dogs, cats, minks, ferrets and other animals have peacefully dined together at this unique feeding board.

U.P.I. Photo





MIT student fuses glass tubing at 520 degrees in lab oven

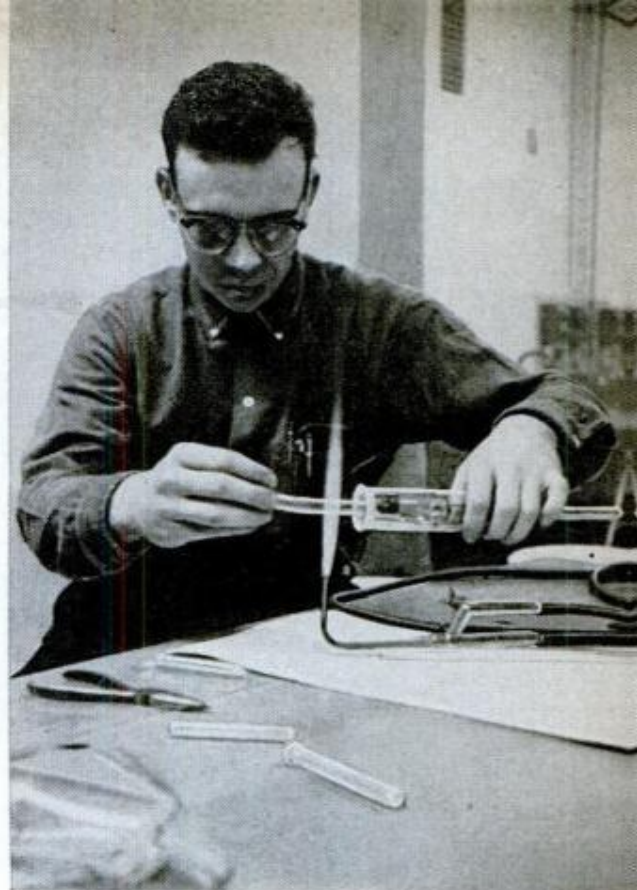

Electrodes in place, the tube is flame-sealed

## Do-It-Yourself Vacuum Tubes From Kits

MODERN physics requires experiments with mysterious, expensive vacuum tubes which defy production in ordinary school laboratories. A new technique now being evaluated in several colleges allows students to construct workable tubes without glassblowing, welding or vacuum-pumping skills or equipment. Glass fusing is done

in an ordinary lab oven; vacuum is attained with chemical "getters," which are put in before the tubes are closed, then evaporated to create the vacuum. The kits are being prepared by J. H. Owen Harries, a consulting scientist in Bermuda, and may soon be produced for high-school lab use with instructions to fit into textbook work.

Testing for a tight seal with vacuum pump and testing coil



Final tube looks strange, but works fine

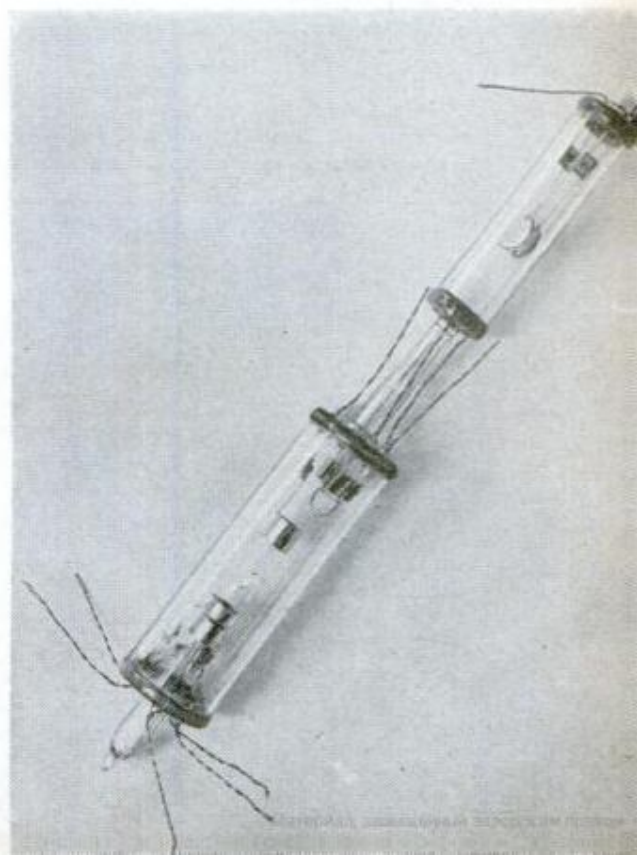



## Rehearsal for Undersea Escape

U.S. Navy photos  
Can a jet pilot fire his ejection seat underwater? A Navy pilot rides a seat down on a rig to find out

By William R. Kreh

**T**HE NAVY NEEDS a device that will automatically get a pilot out of his plane after it crashes into the sea. That was the conclusion of Navy scientists who recently completed unusual underwater tests designed to find:

- What happens to a jet and its pilot when it crashes in water?

- Why don't some pilots escape?
- Can a pilot open a plane's canopy 20 feet under?
- Would a pilot drown trying to swim up from a depth of 100 feet?
- What happens when a pilot fires his ejection seat underwater?

Down and out. Navy scientists dropped planes from the height of an aircraft carrier to learn how to save pilots from drowning. Right, water pressure at depth of 20 feet burst the canopy of the jet plane being raised

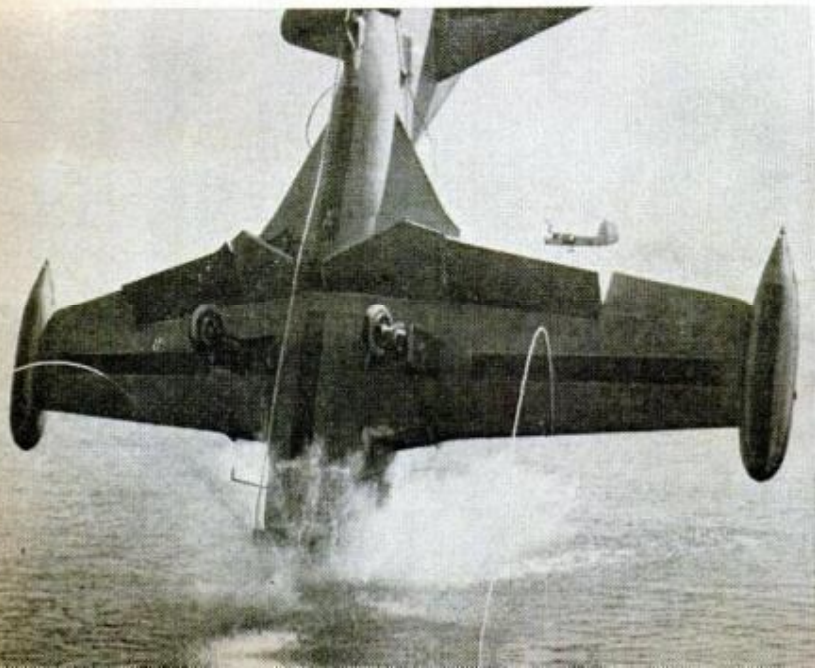



Divers at the Naval Diving Tank prepare to test flier's oxygen system to see if it will work underwater

During World War II, pilots who crashed at sea had several minutes to escape from their comparatively buoyant planes. Present-day jet planes generally sink within 20 seconds after crashing. The Navy wanted to know why more pilots who crashed into the sea couldn't be saved.

Under direction of the Navy's Engineering Development Department at the Naval Air Development Center, Johnsville, Pa., a group of obsolete fighter planes was sent to Key West, Fla. The planes were crashed into the Gulf Stream from a height of 50 feet to simulate an accidental fall from the deck of an aircraft carrier. The pilot should have a good chance to live in this type of accident, but many of them have died. Underwater cameras, instruments and a man-shaped dummy were installed inside the aircraft to obtain a record of the effect of water impact. Underwater photographers took movies of the aircraft as it sank and instruments registered information to a depth of 130 feet. Salvage divers recovered the aircraft so recording equipment could be removed and the aircraft inspected for structural damage that might cause death.

These tests revealed that the pilot in all probability will be stunned and that the

plane will sink fast. At a depth of 20 feet, water pressure crushed the canopy covering the cockpit and the Plexiglas slashed the dummy pilot. To prevent this implosion of the canopy, a valve has been designed which allows water to fill the cockpit gradually and reduce the pressure.

When a plane sinks, the rush of water is directed against the canopy. Could a pilot push the canopy off against this flow and escape? Tests were performed with a cockpit section of an aircraft mounted on the deck of a submarine to determine what force was needed to push the canopy open. A diver dressed in a pilot's standard flight equipment rode the seat down as the submarine submerged to simulate a sinking aircraft. Underwater television cameras and instruments relayed information to engineers inside the sub. The diver, who was in good physical condition, was able to push his way free.

Would the pilot drown while swimming to the surface from a depth of 100 feet? Divers at the Naval Diving Research Tank at New London, Conn., answered that question. They tested the latest pilot bail-out oxygen system that had been modified for underwater use. It proved to be satisfac-



Ready to ride down on the side of a submarine, rescue divers and photographers follow each experiment

Dummies as well as human volunteers tested the ejection seat under water. It was no way to escape

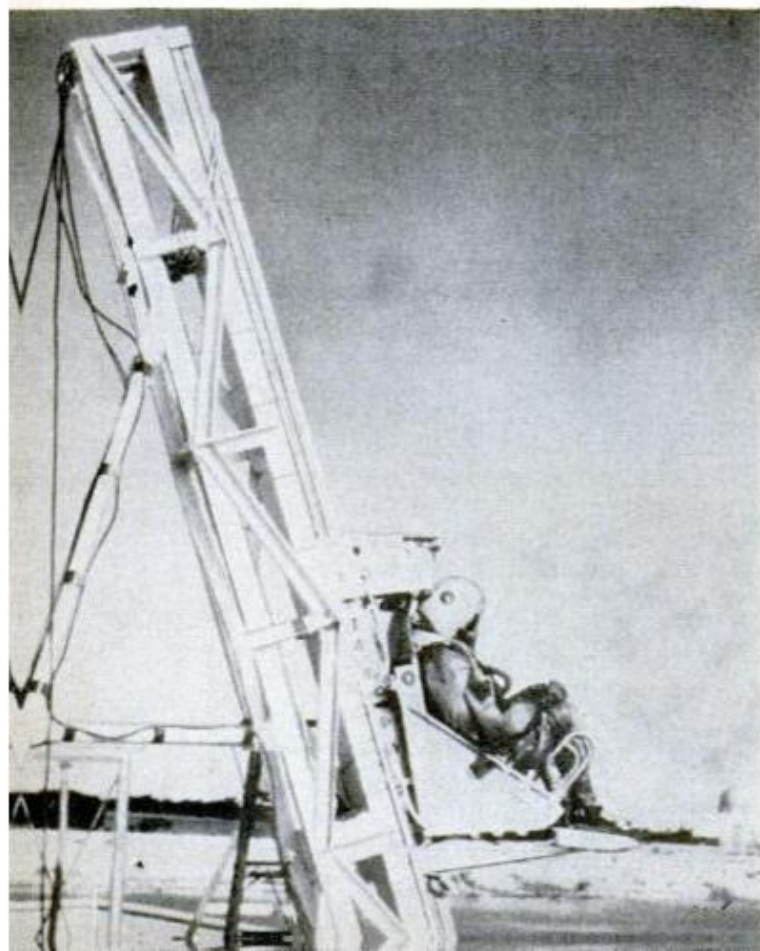

tory even when used at a depth of 100 feet. Pilots will now be able to breathe underwater as well as at high altitudes.

The tests, as well as actual accidents, indicate it will be necessary to develop a system which will automatically remove a pilot with safety from his aircraft should it crash into the sea, for most pilots are stunned or knocked unconscious by the impact. Even a well-trained pilot sometimes is unable to perform the necessary steps to get out of his plane. It was hoped that a temporary solution to this problem might be to fire the pilot's ejection seat underwater until an automatic system could be developed. Human and dummy ejection tests were conducted at Key West to evaluate the ejection seat. Preliminary tests indicated that the seat wouldn't operate underwater unless certain modifications were made. And then, even though the seat was made to fire underwater, it wasn't a safe means of escape: It travels through the water at such great speeds a pilot can be injured by the waterdrag forces.

Navy researchers, with the help of these unusual experiments, are now trying to develop a device that will save high-flying jet pilots from the sea. ★ ★ ★

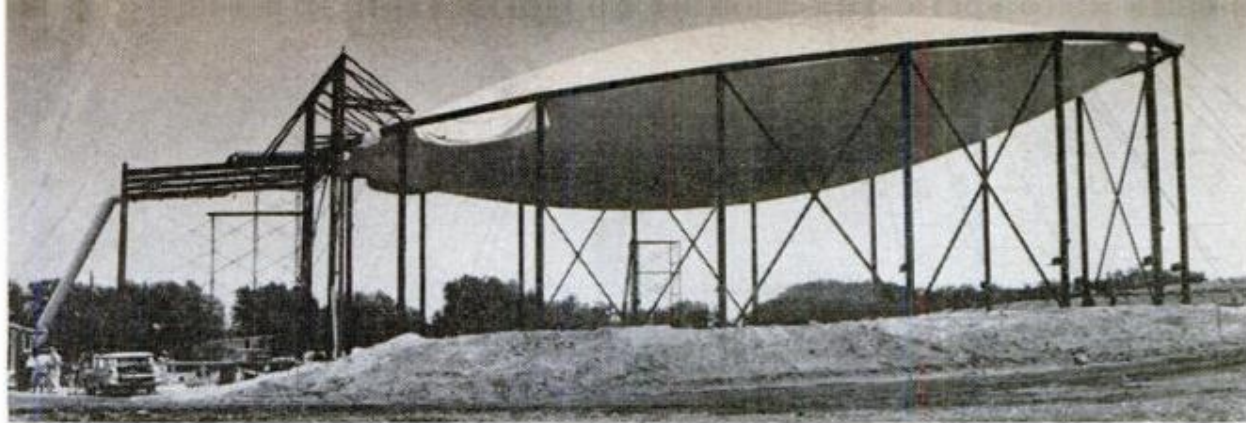

Roof of Metropolitan Boston Art Theater eliminates need for center supports. Air pressure keeps it up

## Flying Saucer? No, a Shakespearean Theater

WHAT APPEARS to be the launching site of a spectacular flying saucer is actually the roof of the unusual Shakespearean theater in Boston. Eliminating the need for center supports, the nylon roof consists of two layers, 145 feet in diameter, joined at the outer edges by an oversize zipper and anchored to a steel hoop by turnbuckles. The central area between the two layers is 20 feet thick. Tilting downward toward the stage at a noticeable angle, the saucer gives the appearance that it is sailing

through space. Constant air pressure within the envelope is delivered from a pump house by a metal pipe, extending up over the stage like a hot-air furnace duct. Atop the dome, an aluminum air vent allows a set amount of pressure to escape for safety control. This air, in turn, is used for the cooling system. Besides withstanding winds up to 70 miles an hour, engineers claim that the novel design of the roof gives the unusual Shakespearean theater excellent acoustics.

Flexibility helps nylon roof withstand strong winds. It bounces freely six inches in each direction



Strange in appearance with its flying-saucer roof, this tentlike structure has excellent acoustics





Winslow Grullemans flies his own Bonanza for high-speed delivery of highly perishable plants and bulbs

By Sheldon A. Mix

Photos by Frank P. Fritz

**A**T WAYSIDE GARDENS in Mentor, Ohio is a room in which there are 150,000 frozen plants. The plants, all perennials, were dug out of the ground last November and can stay refrigerated at 26 degrees below freezing until the end of June. From the freezer these perennials will be thawed and sold to Wayside's late-ordering customers in first-rate condition for replanting—first-rate because their frozen dormancy has prevented them from reacting to the spring growing season. And since there will be no top growth, there will be no danger of heating and decomposition while the packed plants are enroute to customers—nor will there be wilting or difficulties for the customer after planting late in the season.

Wayside Gardens' plant-freezing operation is just one of many innovations this nursery has added to its grounds in the

past five years. All but a few of Wayside's mechanical improvements, in fact, have appeared since World War II: Electronic business machines, irrigation and freezing systems; mechanical weeders, planters and diggers; wrapping and stapling machines; and steam-sterilization equipment (used to sterilize potting soil). Many non-mechanical improvements, too, have marked big-nursery progress since the end of World War II.

When J. J. Grullemans, president of Wayside Gardens, co-founded the nursery back in 1920, he and his men used horses for pulling cultivating and digging machines. Such a machine as a front-end loader, regarded now as a necessity at the nursery, was unknown. Today there are no horses on Wayside's 600 acres—in their place are 14 tractors, nine trucks and two electric carts. Labor was cheap and



Mechanical planter, top, plants 50,000 shrubs a day, keeps four men busy feeding it seedlings. But no machine can beat experienced hands for jobs like cutting and planting delicate plants, shown in lower photo

plentiful in 1920. But this has changed since Mentor, 22 miles northeast of Cleveland, began sprouting industry. Now much of the work that was done by hand labor is done by machine.

The mechanical planter, for instance, can put 50,000 shrubs in the ground in a single day, with the help of four men. Without this machine, it once took 15 or 20 men to plant 10,000 shrubs in a day's time. And the machine does a better job!

In Wayside's offices, the bookkeeper's ledger shows a big saving since the recent introduction of modern packaging machines. Another saver of time and labor is the mechanical weeder, an attachment that can be added to any small tractor. It consists of three pairs of slowly revolving sets of pointed, fingerlike appendages, the first two sets made of rubber. Without hurting the plants, these rubber appendages agitate the top quarter-inch of soil around the plants and keep weed seedlings

from rooting. The third set of appendages—thin steel spokes—throw dirt back to the plants. One of these rigs can keep 50 acres clean of weeds.

Many of the new mechanical ideas that have come to the nurseries were conceived by the nurserymen themselves—the wrapping machine and mechanical weeder both had their inception in the minds of nurserymen who wanted to improve their operation. A Minnesota nurseryman invented the hydraulic balling machine, which has eliminated hand-balling of trees plucked out of the ground.

Grullemans is now experimenting with a process that, if successful, will replace the present methods of mulching, the most popular of which is to pack horse manure up against the sides of the cold frames containing young plants. Mulching keeps out the extreme cold and serves to protect the vulnerable young plants against the quick freezes and thaws that can

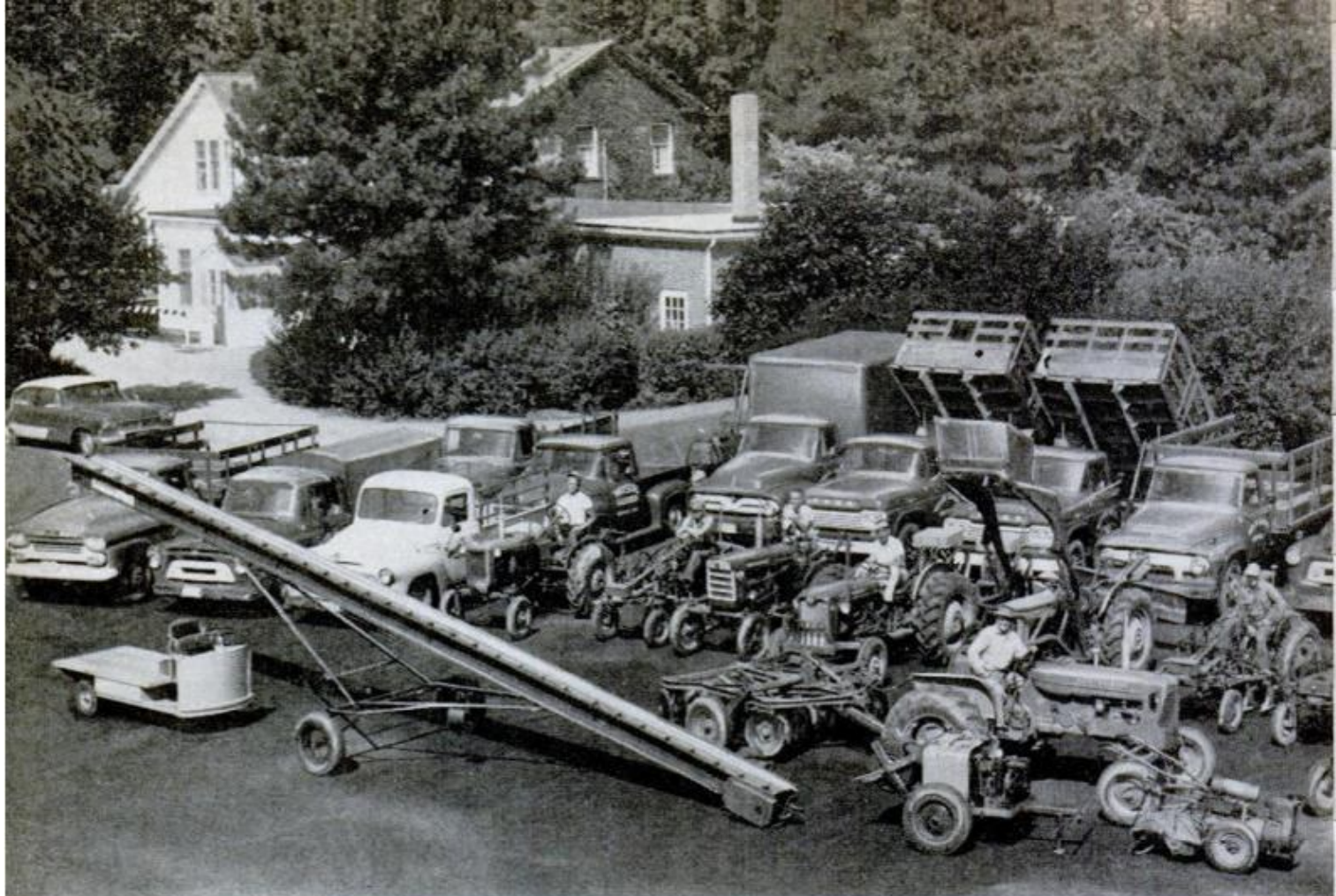

mean their death. Each fall, 150 truckloads of manure are delivered for Wayside's 12 acres of frames. It takes two months to complete the deliveries. Laborers then have a full-scale project on their hands, carefully piling the manure in the area between the frames and up to the top of the sides. In the spring, the manure has to be removed. Grullemans' experiment is centered on two foam-plastic-cored frames. One frame has a four-inch core of foam encased in one inch of concrete. The other has six inches of foam within a half-inch of concrete. (All of Wayside's other frames are made either of concrete or wood.)

Grullemans has his fingers crossed, hoping that the foam will supersede horse manure as a protector of young plants. If his styro-foam-core frames fail winter's test, Grullemans plans to install electric heating cables under the frames.

Nurserymen are accustomed to helping progress along. Sometimes they make their own improvisations, sometimes they pass along an idea to a man and make it worth his while to develop it. Such a man was Dr. John Mahlstedt, professor of horticulture at Iowa State College, who developed plant-refrigeration, which is the most revolutionary change to come to



Left, mist propagating beds help young shrub-cuttings take root by spraying a fine mist over them during rooting period

Right, mechanical weeder uses two sets of rubber fingers to agitate soil without disturbing tender plants. Third set of steel spokes kicks the dirt back in place around base of the plants



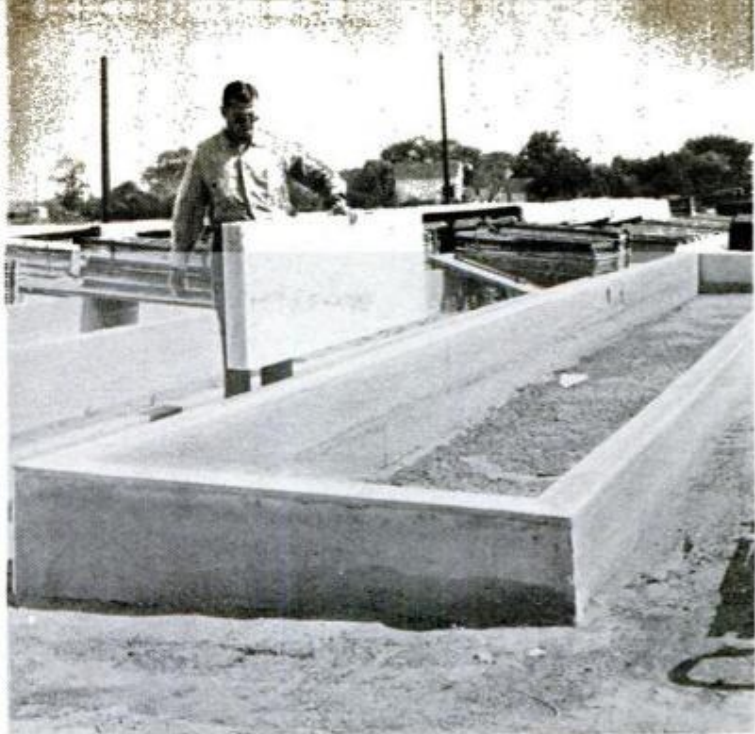

**Above, foam plastic encased in concrete builds an insulated cold frame that may eliminate a difficult winter mulching job**

**Left, Wayside Gardens' motor pool includes 14 tractors, nine trucks, two electric carts and whole sheds full of attachments for the tractors. There isn't a horse on the entire 600 acres**

Wayside Gardens since the end of World War II. Dr. Mahlstedt began work on his freezing project at the request of several mail-order nurserymen in Iowa. They financed the project, and about five years ago Dr. Mahlstedt announced success.

Wayside was one of the first mail-order nurseries to add the new freezing system. So far as Winslow Grullemans knows, only four other nurseries have the system now. First of all, the system is applicable only to the mail-order type of nursery. Secondly, it is practical only in a nursery that does business on a truly big scale—and Wayside's scale is one of the biggest.

Its 3200 varieties of plants and shrubs have earned Wayside at least \$1,500,000 a year for the past 15 years. During the nursery's peak selling seasons—spring and fall—its delivery truck averages three daily trips to the post office. A portion of the late-spring delivery is made up of perennial plants that had been in frozen storage 36 hours earlier, and had been there since they were dug out of the ground several months before.

Wayside's refrigerative system is in two parts: a large air-conditioned room in which 150,000 rosebushes are held dormant from November to June at a 36-



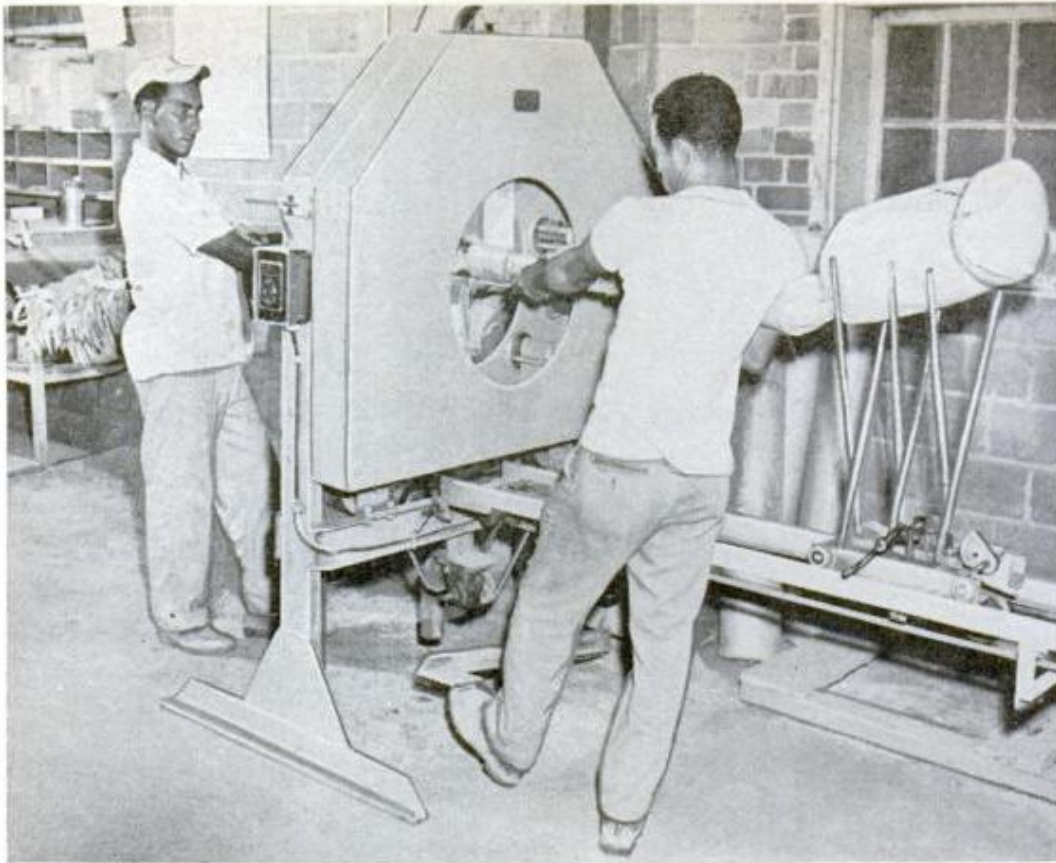

**Modern wrapping (above), packing, and stapling machines have not only speeded up Wayside's mail-order business, but the machines do a better job than the old hand-wrappers did**

degree temperature (they are never frozen); and a two-room building in which 150,000 perennial plants are stored in one room from November to June at a temperature of 26 degrees below freezing, and thawed at 36 degrees in an adjoining room. The plants are transferred to the thawing room 36 hours before mailing.

The building that houses the freezing and thawing rooms is built of styrofoam-cored concrete; it was from the freezing room that Grullemans got his idea for a styrofoam-core cold frame. The freezing room has two 7½-horsepower compressors operated by time clock to control the defrosting operation. Both the freezing and thawing rooms have high-low temperature controls, and on the roof are two condenser units with pressure-control valves to maintain proper head pressures during the colder months of the year. This has been arranged so that the units operate when the outside temperatures exceed the setting for the rooms.

For mail-order nurseries like Wayside Gardens, the chief advantage of the plant-freezing system is that it extends the shipping season until late June. Before Dr. Mahlstedt developed his refrigeration process, the nurseryman had to sell all his plants right out of the ground—and he had to do it before the plants started growing. This meant that the shipping season was

usually over by mid-May. If the nurseryman mailed out a plant after it started its growing cycle, the heat within the enclosed package would often decompose the green top growth. Then, too, it's not advisable to transplant a plant once it has begun its growing cycle. The freezing system hurdles both of these one-time headaches of the nurseryman by keeping a plant dormant until late June.

"It's taken some education to convince our customers that it's not harmful to freeze a plant," says Winslow Grullemans. "Some people have the impression that sending a plant to them from the freezer is not as good as sending it to them straight out of the ground. We've had to explain not only that the freezing is harmless, but that it's smart to ship a plant in dormant condition, because then it begins its growth cycle *after* it gets to the customer and is placed in the ground. The dormant condition is important. Let's say we send a plant cross-country. This would not be unusual, because we've got customers throughout the country, and overseas, too. Let's say we take this plant out of the ground before it has started its growing cycle. In transit, though, warmth is likely to start top growth, and then you have the danger of decomposition. Or the customer may disturb that growth in

(Continued to page 252)

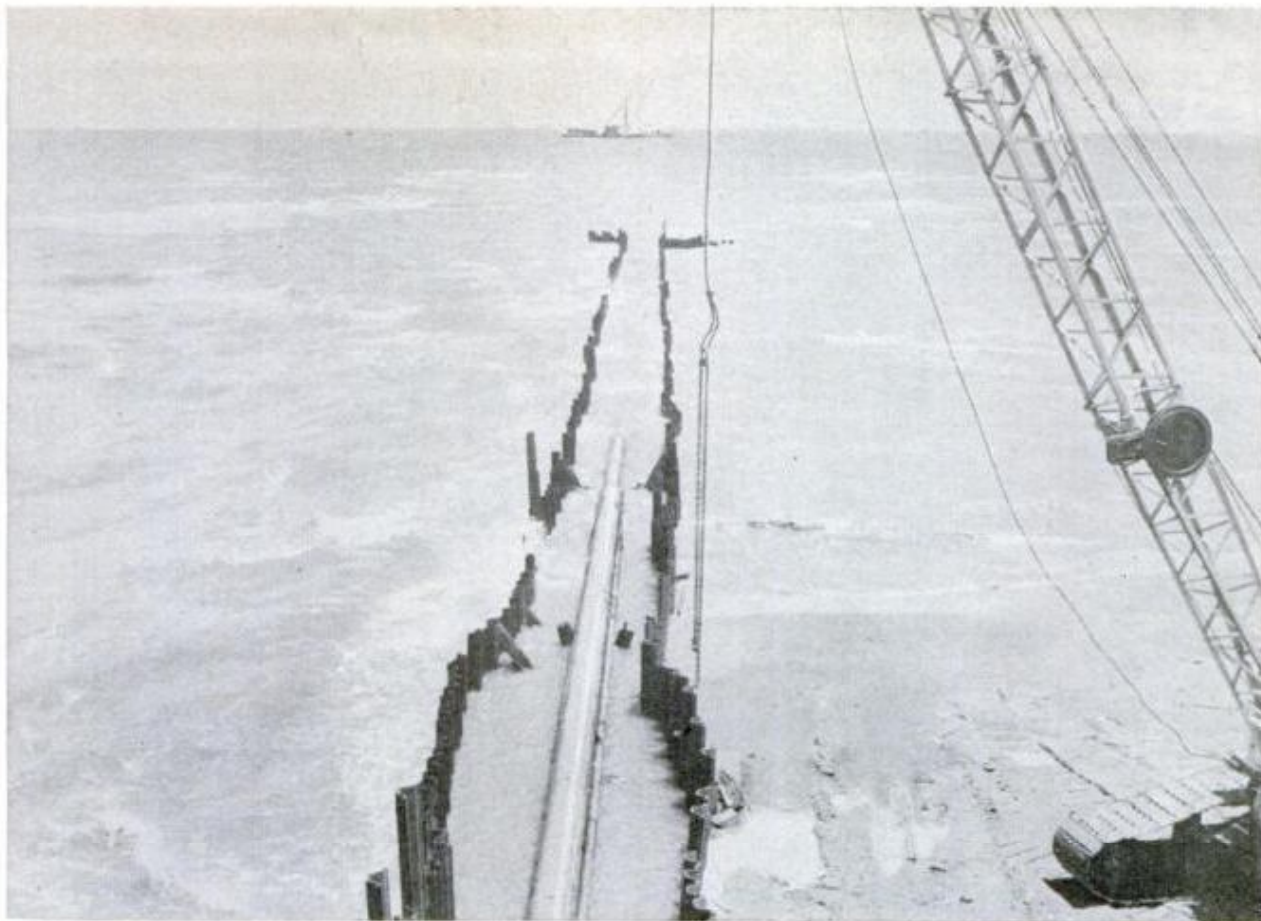

Seven miles of complex pipeline are laid in the ocean floor off the Gulf of Mexico to carry molten sulphur

## Pipeline Carries Molten Sulphur Beneath Ocean

BURIED BENEATH the ocean in the Gulf of Mexico, a seven-mile pipeline, made up of three concentric pipes, transports molten sulphur from 2000 feet under the ocean to the shore at Grand Isle, La. The unique pipeline, built by Freeport Sulphur Company, is made of a special high-strength alloy steel, manufactured for the first time as a tubular product. The three pipes are a 14-inch outside protective casing, a 7 $\frac{7}{8}$ -inch hot-water jacket and a 6-inch sulphur line. Because of unusual stresses involved, the two smaller pipes are made of manganese molybdenum alloy steel. This metal has a minimum yield strength of about 60,000 pounds per square inch. As the molten sulphur pours through, the lines have an operating temperature of 300 degrees F., which means that the pipeline ordinarily would expand 55 feet in length when heated. Since the line was buried five feet in the ocean floor, engineers believed that the usual way of providing for expansion — by using joints or loops — would be too expensive. So after the pipeline

was laid, the inner lines were heated and allowed to expand, and at that point were fastened to a stretched outer casing. Thus, when sulphur passes through, the inner pipes expand very little. The pipeline is designed to deliver 5040 tons of sulphur a day to tank barges on the mainland, where the sulphur is taken over an inshore route 25 miles to Port Sulphur, La.

Molten sulphur enters smallest pipe, made of alloy steel. Center pipe keeps sulphur hot. Outer casing is for protection

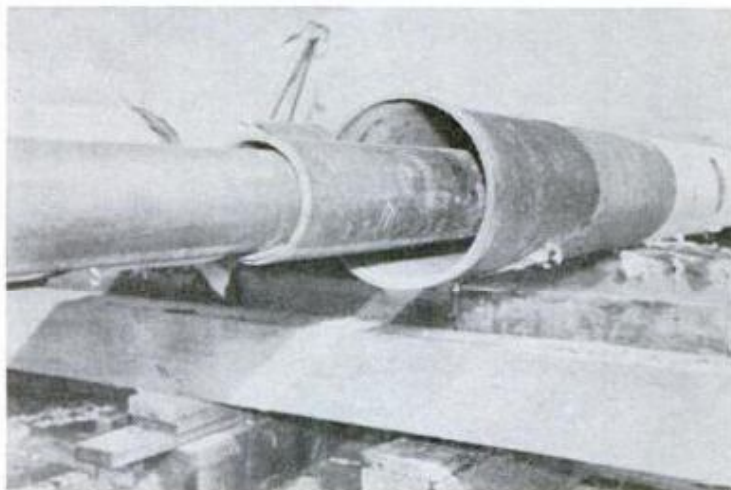

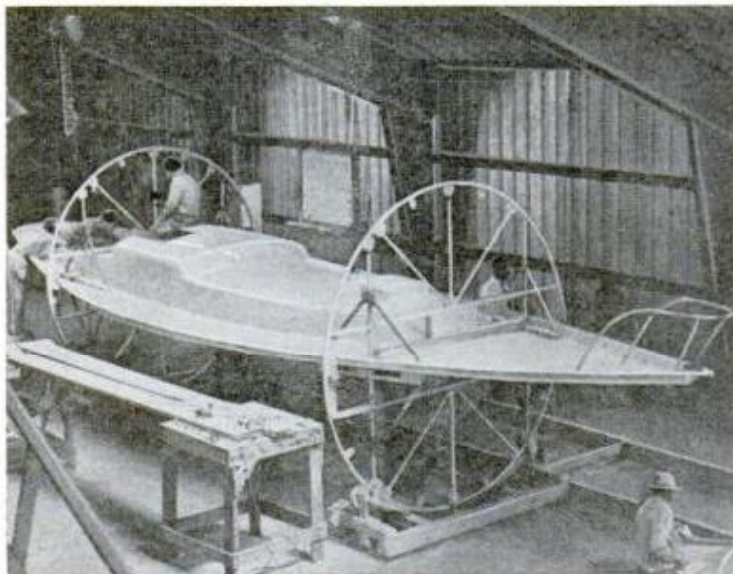
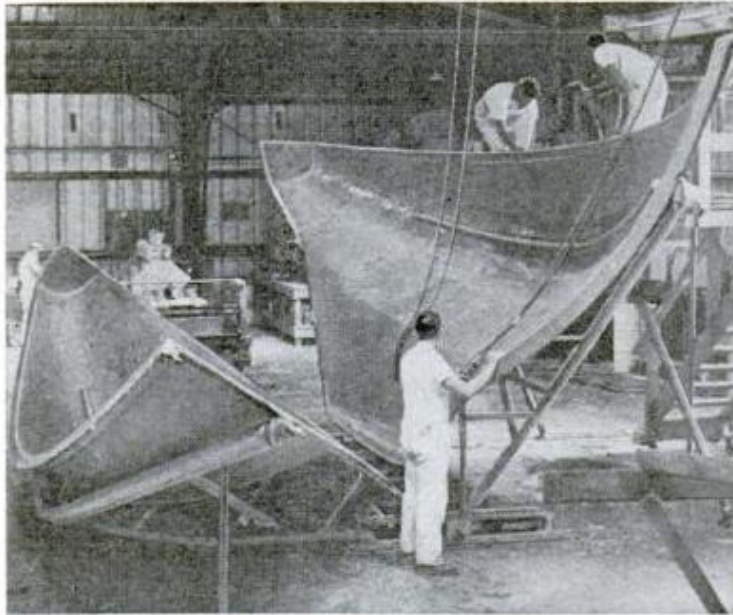

## Big Plastic Sailboat Molded in Three Parts

MAINTENANCE isn't much of a problem for owners of the 40-foot *Bounty II*, which has a molded plastic hull, Dacron sails and aluminum mast. In addition, use of plastics enables the manufacturer to construct the boat more quickly and at a lower price than is possible with conventional building methods.

The hull of the *Bounty II* is built up with layers of glass cloth impregnated with colored resins that give the craft a permanent color so that it never needs a coat of paint. Layer after layer of the resin-impregnated cloth is lapped inside two molds which form the two halves of the hull. From seven to ten layers of cloth and resin—depending on the location—are laid in the molds, which are then folded together like a giant clamshell so that the hull sections can be bonded together chemically. In less than eight hours, the 40-foot hull is formed.

A four-ton iron keel goes into place, and water tanks are installed. The builder adds a plastic sink and icebox and then locates the prefabricated plywood bulkheads.

The deck and cabin top—one 40-foot piece of molded glass cloth complete with lights, hatch covers, winches and deck cleats—is lowered into place. Then the mast is stepped, the sails set, and the craft is ready for the water.

In a fair breeze, the vessel will spank along at eight knots. For periods when power is needed, it carries a 25-horsepower engine.

The firm that manufactures the *Bounty II*, the Aeromarine Plastics Corporation, turns out two of the sailboats a week in its factory at Sausalito, Calif. The craft sells for \$30,000. Also being planned by the company is a sailboat in a lower price range.

Alginon, a new seaweed compound, can substitute for whole blood in transfusions without damaging the spleen or causing hemorrhages in the skin, according to two Japanese surgeons.



## Latest Aquatic Sport— Surfing on the Sand

Teen-agers along the Southern California coast enjoy a sport as exciting as surf-riding, but not nearly as expensive—they call it wet sand surfing. They take a piece of  $\frac{3}{4}$ -inch plywood two feet wide, shape it like a disk and round off the edges. This strange device then slides easily along wet sand. And these disks are nowhere near as expensive as an \$85 conventional surfboard. The participant holds the board in both hands and races along the sand just as a wave washes in. At the right moment, he drops the board ahead of his flying feet and mounts it in the next step. With the wave retreating, he glides along on the coaster as far as 50 yards. It's perfect for a belly-flop, too. Adding further flavor to the sport, youths vie with each other by painting weird designs on the top sides of their boards.

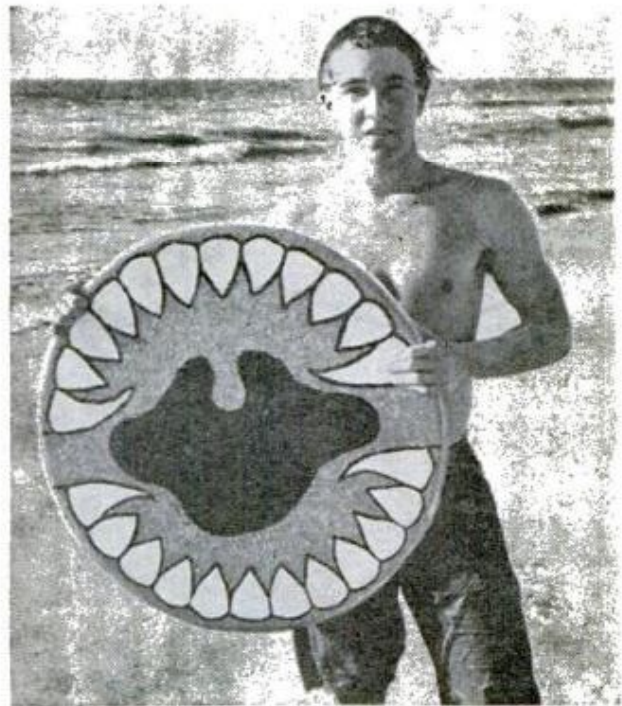

## Kit Packs Trailer Bearings

Boat-trailer wheels receive great punishment from dirt, rust, heat and immersion in water. Their bearings need frequent cleaning and packing, but the usual preventive maintenance involves either hauling the whole rig to a service station or keeping a bulky and often expensive grease gun around the garage. A California trailer and boat-accessory manufacturer has developed a do-it-yourself bearing lube kit. It includes a lubricant designed for boat-trailer bearings packaged in a throwaway tube similar to a toothpaste tube except that it has standard fittings to provide a high-pressure packing job without special tools. The kit includes a wrench, cleaning brush, knockout pin and spare cotter keys.

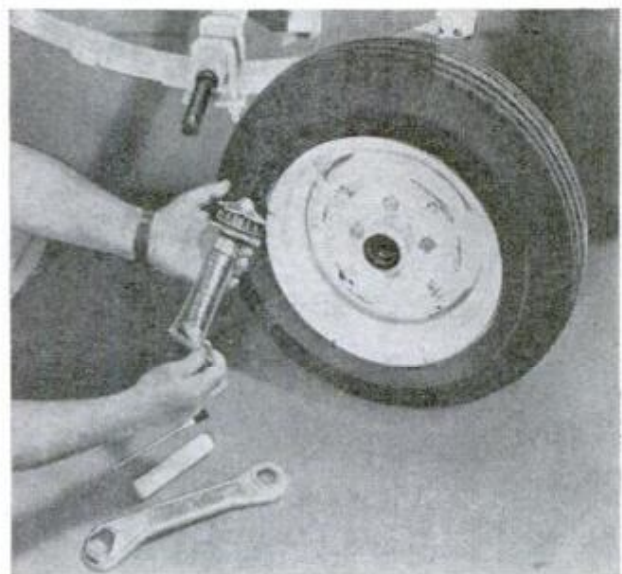

**I**N CANADA—as in the United States—everyone is bowling. It's the number one participant sport. But the Canadians use only half as many pins as their south-of-the-border counterparts.

Originated by the ancient Egyptians, bowling was brought to North America by Dutch settlers as the game of ninepins. Eventually somebody added a pin, and today some 26.5 million bowlers in this country are taking aim at the 10 big maple splinters. In Canada, though, the number of pins went down to five.

Fivepins differs from American bowling, not only in the number and size of the pins and ball, but in the number of times the ball is rolled per frame. If all the pins go down with the first ball, you've earned a strike; if all the pins go down with the second ball, you're given a spare. But you're given one last try in the Canadian version. Knocking down all the pins with your third ball does not give you a carryover score, however.

There's a difference in scoring, too. In fivepins, each pin has its own point value. The head pin counts five, two of the pins count three, and the other two, as in the diagram below. (Actually, there are two different scoring systems used in Canada, but the system shown here is the "national count," by far the more popular.) There's another vital difference in scoring—you *must* knock down the left corner pin or you get no score for that frame.

The ball is small enough to be palmed, and has no finger holes. The bowler aims for the same pocket as in the American game.

A perfect game in the Canadian version is 450. The person who bowls a solid 170 in tenpins probably would average over 200 if he moved north of the border.

Canadians insist that their southern friends can't possibly miss the pins with such a large ball, while Americans insist that having three tries at the pins makes high scoring a snap! ★ ★ ★

There's a big contrast between fivepin and tenpin equipment. Each of the smaller Canadian pins has a rubber ring around it



All balls are identical in Canada, so the bowler can make his three rolls per frame as fast as he wishes

# Five-Pin Bowling— The Canadian Version

By Hal Higdon

Diagram shows value of each pin. If you miss circled pin, you fail to score

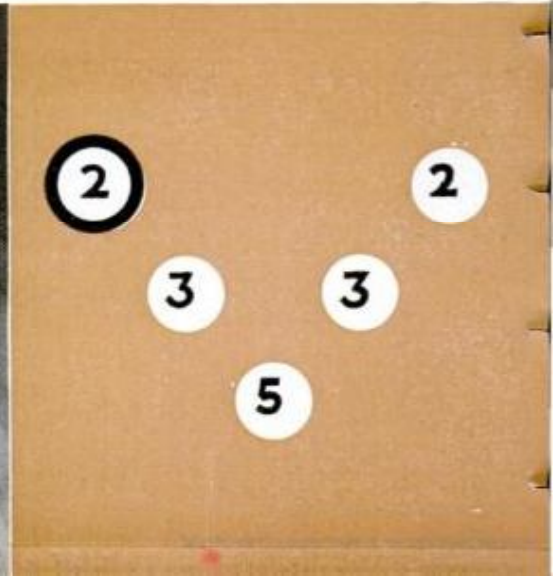
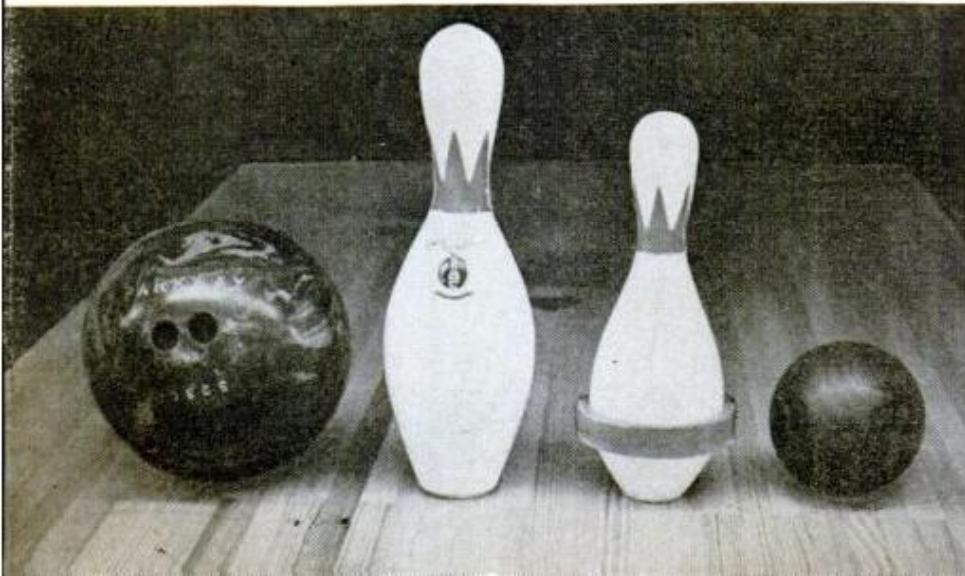



Joe Serge photo

Canadian bowler aims for the same pocket as the bowler in this country, but most Canadians roll a straight ball with no hook. Below is a section of a Canadian scoring sheet, showing typical frames with point totals

1. KNOCKED DOWN ALL BUT THE RIGHT CORNER PIN—COUNT 13

2. GOT ALL PINS DOWN ON SECOND BALL — SPARE (15 POINTS). ADD NUMBER OF PINS ON FIRST BALL NEXT FRAME

3. MISSED LEFT CORNER PIN—NO SCORE

4. STRIKE — 15 POINTS PLUS SCORE OF NEXT TWO BALLS

5. ALL PINS DOWN ON THREE BALLS — 15 POINTS, BUT NO CARRY-OVER TO NEXT FRAME

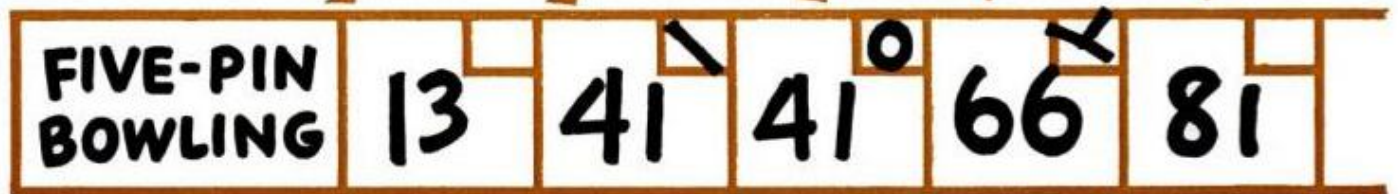

Tenpin bowler has a big target compared to the fivepin bowler, but Canadian gets three balls per frame

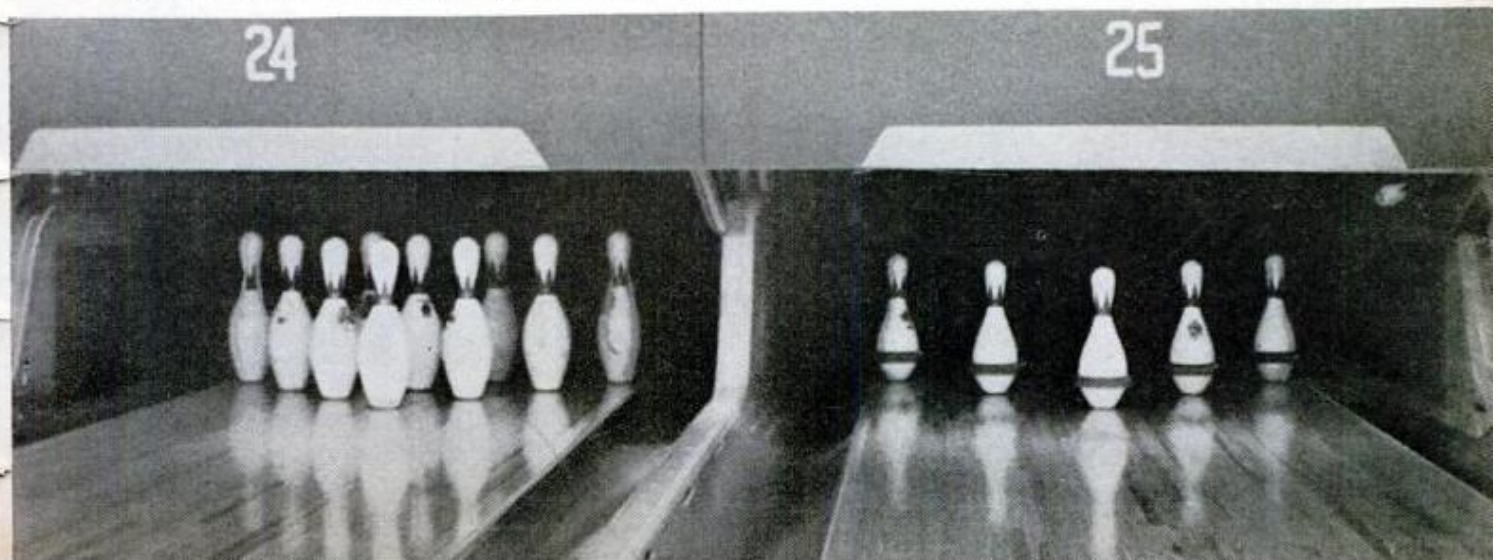

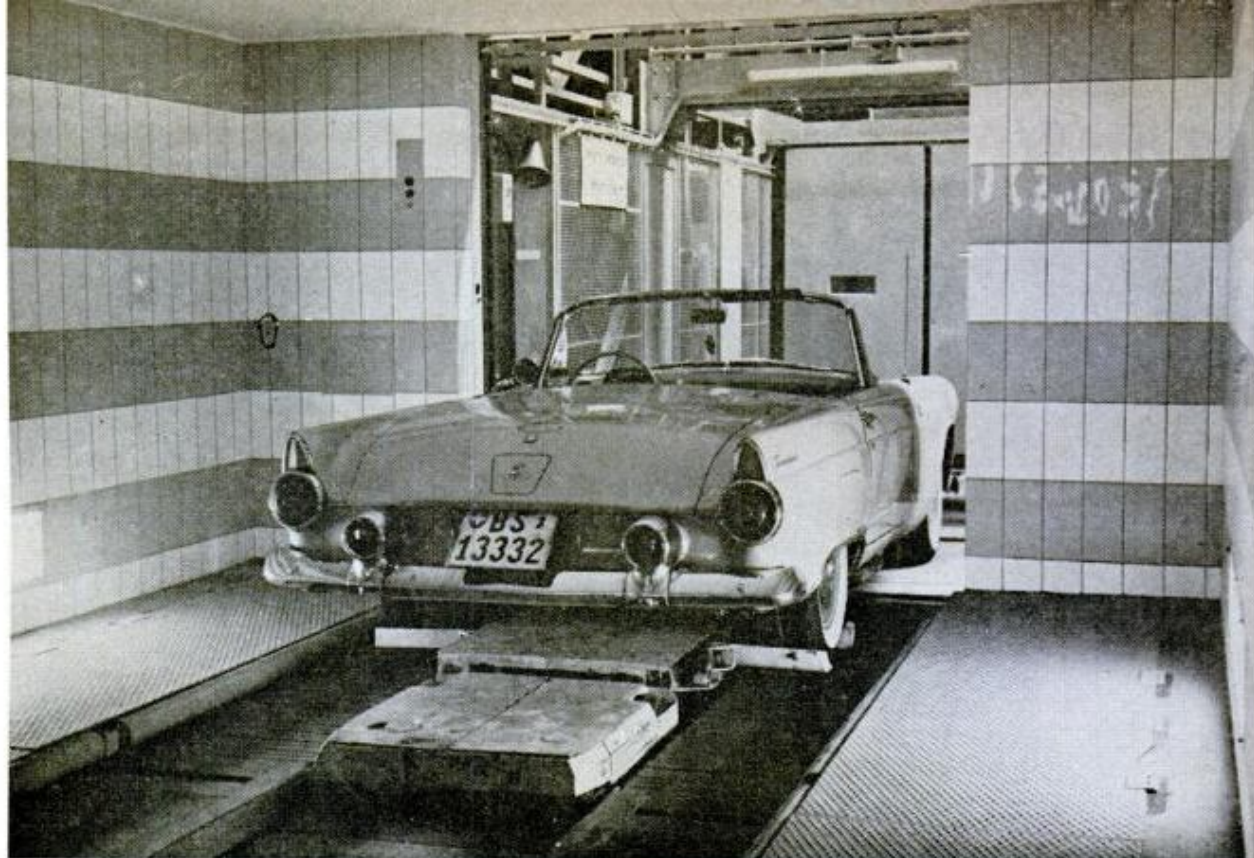

## Automatic Garage Handles Nine Cars a Minute

One attendant can park and return 400 cars in 45 minutes—without leaving his seat—in an unusual Swiss parking garage. His job is to push buttons in the control room of an electronically guided garage. The rest of the job, left to machines, is done with more ease and greater care than a motorist could ever expect in a manually

**This is the inside of the garage at Basel, Switzerland. Electronically run elevators park the cars**



operated garage. Nine cars can be handled at once and it takes just 59 seconds to park and return them. As the motorist drives in, two electric eyes photograph his car and give length, width and height dimensions to the attendant who selects the right size stall for the car. In a few seconds the driver receives his ticket and drives up to an elevator. He gets out, tells the attendant the car is ready, and the rest is left to electronic magic. Grip arms place the car in the elevator and the car is carried to the proper floor. From there it is pushed straight into the correct stall. In just 59 seconds, the elevator parks the car and returns another to its driver.

**Only man on the job, attendant gives the lady her ticket, then pushes the buttons that do the work**

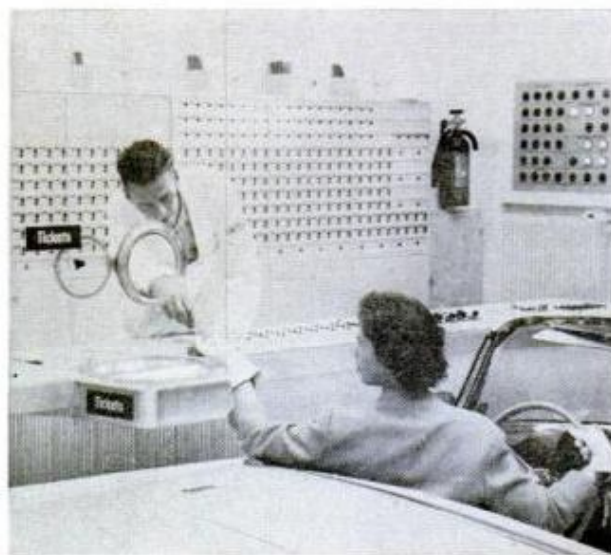





Designed to hop into the air with the ease of a kangaroo, this new Australian light plane, *The Jackaroo*, can take off in 40 yards. It has a specially sprung tricycle landing gear, for its makers designed the plane for use by businessmen and other travelers whose trips take them to places where airport facilities are either primitive or lacking. *The Jackaroo* costs \$5400 and will fly 35 miles on one gallon of fuel

## Periscope of Japanese Sub Gives View of City

Viewing Philadelphia through the periscope of a Japanese submarine may seem a fantastic idea—but it's being done nowadays. The periscope, taken from a captured undersea vessel, was installed in the factory store of Edmund Scientific Company, Barrington, N. J., when the store expanded recently. Within the range of the periscope

—and visible to viewers—is the city of Philadelphia some nine miles away. The 1.5 to 6-power instrument has been popular with visitors at the firm's store. As far as company officials know, their periscope is the only submarine periscope in the country that is operating outside a submarine.





## Bad-Weather Watchdog

WITH such accomplishments as first warning of the tropical storm Irene under its belt, the Navy's experimental automatic weather station stands as a watchdog against bad weather in the Gulf of Mexico. Anchored by cables and chains extending to depths of 12,000 feet, the buoy reports by radio at six-hour intervals from its anchorage 300 miles south of the mouth of the Mississippi River. It makes possible fast and highly accurate Navy forecasting.

1875 FATHOMS



### Huge Antenna Tracks Satellites

Towering above a Palo Alto, Calif. laboratory is a huge antenna built for the U. S. Air Force for reception of telemetered information from satellites and missiles in any phase of their flight. The 60-foot reflector weighs 15 tons, can move in three directions.



### Mailbox at Your Front Door

Your future mailman might well become a living letterbox if William Fondike of Cambridge, England, has his way. Fondike has invented a lightweight mailbox that postmen can carry on their backs. That way, wherever you saw a mailman, you could drop your letter into the box.

### Can You Tie This?

One fastidious Londoner who found the city's dust and fog continually soiling his clothes devised a neat way to keep them dust-free. He had a tiny nylon brush stitched to the end of his tie for giving his jacket a fast brush when needed.

Copyright: Rex Features Ltd.



MAY 1960

### Rockets Protect His Vineyards

On the lookout for starlings, farmer Wilhelm Kaethner protects his grape vineyards at Oppenheim, Germany, with rockets. Whenever any of these pesky birds that damage the grapes appear, he fires the rockets to frighten them away.



111

# 10 Unusual Vacations

By Richard Dunlop

**A** VACATION CAN BE UNUSUAL and exciting if you let it reflect your hobbies and interests. Of course, you should get away from your job and responsibilities, but you will have far more fun if you don't try to get away from the activities that enliven your leisure hours at home.

Today all North America is easy to reach and magnificently stocked with unusual vacation opportunities. If, for example, you have an armchair interest in mining, you can bring it to life with a "flight-seeing" trip through the rugged sourdough country of Alaska—and get a firsthand look at the scenic grandeur of our 49th state.

You don't have to go to Alaska to enjoy the out-of-doors. You can have a camping adventure in any part of the U.S. or Canada where national, state and provincial parks and forests contain better and more numerous camp sites than ever before. Take along your scientific hobby for it will give an extra dimension to your fun. Rock hounds scout for rare and beautiful minerals in the Sierra Nevada. Families safely canoe through the Minnesota-Ontario border wilderness while guides teach them forest conservation.

Rail fans junket out the line which stretches over the quaking muskeg to remote Hudson Bay. Anthropology bugs make the trip too in order to study the Eskimos and Indians of the sub-Arctic. On the other hand, amateur archeologists may want to head in the opposite direction to visit tropical Yucatan where under the supervision of experts they can delve into the ruins of Mayan Chichen Itza.

Then, too, a man might simply want to have his children enjoy the delights of country living. He can take his family to stay with a farm family.

Weekend sailors get a taste of sailing the briny deeps in the crew of a schooner out of a Maine port. Steamboat fans recapture the days of paddle wheelers with a boat trip down the Mississippi. A party of fishermen, skin divers, shell collectors or just plain sun worshippers can rent a yacht in Miami and cruise the Caribbean.

Here are 10 unusual vacations selected from hundreds to appeal to some of the many interests of *Popular Mechanics* readers.

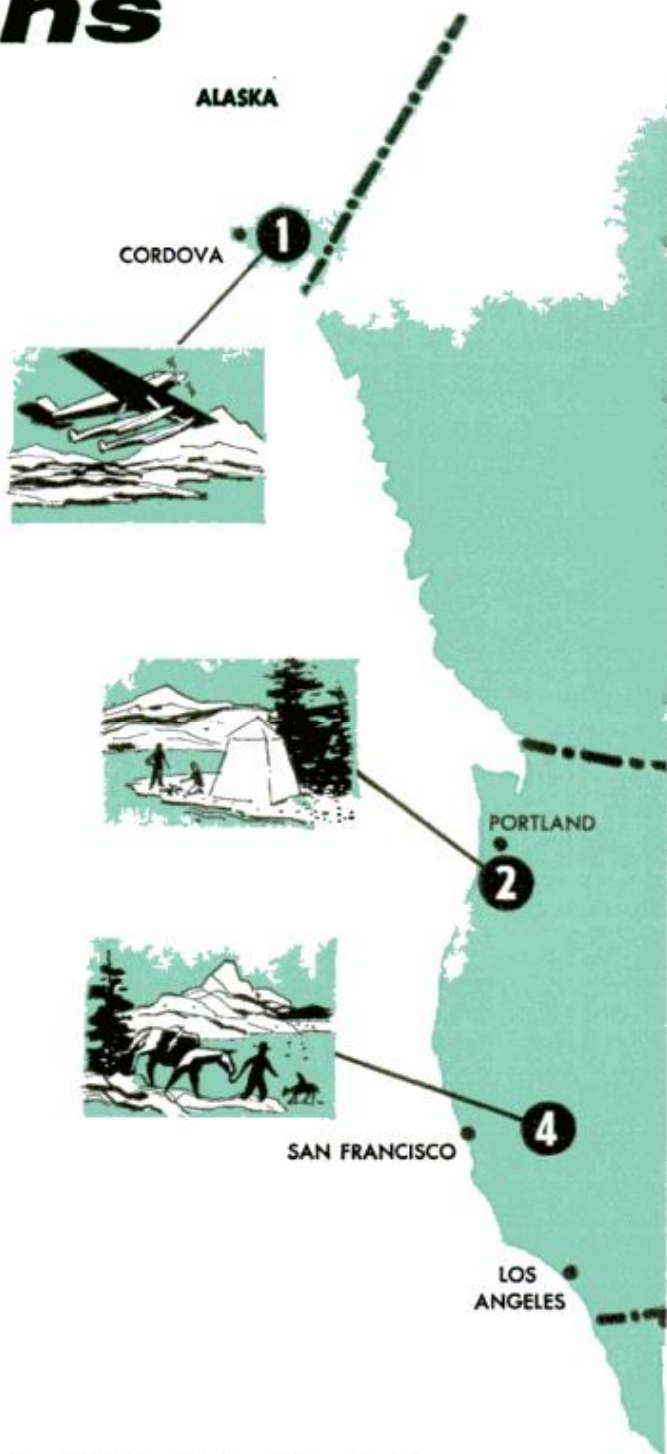

- 1—"Flight-Seeing" in Alaska
- 2—Camping in Forests and Parks
- 3—Railroading to Hudson Bay
- 4—Rock Hounding in the Sierra Nevada
- 5—Exploring the Border Wilderness
- 6—Farm Vacation in Ohio
- 7—Sailing Out of New England
- 8—Steamboating on the Mississippi
- 9—Rent a Yacht in Florida
- 10—Amateur Archeology in Yucatan

Do something different this summer! Try one of the vacations described on these seven pages. See page 250 to learn where you can write for further details.

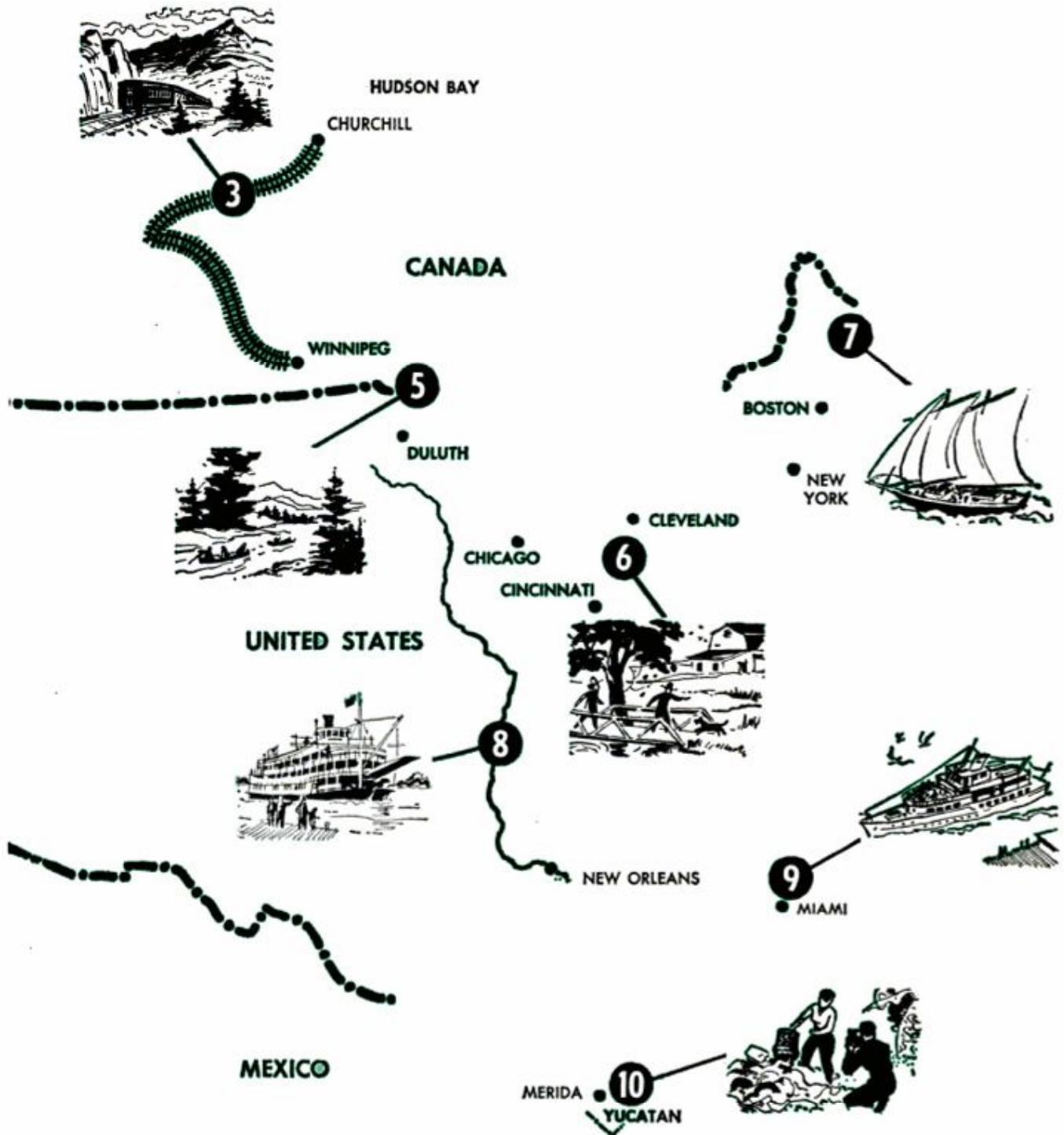

**1**

## "Flight-Seeing" in Alaska

Sourdough trippers ride Alaskan-style bus, a Model-T Speeder, over abandoned railroad at ghost town of McCarthy



Ward W. Wells photo

WHEN THE MINES closed down in McCarthy, Alaska, every family in town pulled up stakes and climbed aboard the last train. They left their homes and stores intact down to the lace curtains. Today bush pilots fly mining enthusiasts on a "flight-seeing" tour of the sourdough country. They soar over the rich Matanuska Valley farms, weird glaciers and 16,000-foot mountains. They set down in the Copper River Valley from which more than a billion dollars in copper and gold have been extracted.

But it is the ghost town of McCarthy, which is the highlight of the tour. There amateur miners pan for glistening flakes of gold and silver. The boardinghouse reach comes back into its own at the McCarthy lodge where sourdoughs mingle with visitors at mealtime and spin tales about rich strikes and lost mines. Everybody clambers onto an Alaskan-style bus, a Model-T Speeder, for a spectacular ride over the abandoned Kennecott Railroad. Guides take visitors through McCarthy for a glimpse of yesterday's roaring frontier.

**3**

## Railroading to Hudson Bay

Hudson Bay train waits while a young fisherman and his dad try their luck in a stream. Rail fans look on from the trestle



Canadian National Railways photo

THIS SUMMER rail fans will climb aboard a Canadian National Railways train at Winnipeg and go adventuring in the sub-Arctic. Their train will follow the line built north over the quaking muskeg to Churchill on Hudson Bay. Deep in the wilderness trading area of the Hudson's Bay Company, they will see Eskimos, Husky dogs, scarlet-coated officers of the Northwest Mounted Police and ruined forts dating back to when the English and French struggled for the fur trade.

From time to time the train will stop to allow the adventuresome to scout the wild country along the right-of-way. Passengers will leave the cars to boat or fish in northern streams. Then the train pushes on deeper into the land of the lobster pine. The terrain becomes ever more barren for little grows in the permanently frozen ground over which the rails pass. At last, deep in the land of the northern lights, the train pulls into historic Churchill, back-door port to North America.

## 2

### Camping in Forests and Parks

Mount Bailey looms over crystal waters of Oregon's Diamond Lake where campers settle on a shore of unspoiled beauty



Oregon State Highway Department photo

DIAMOND LAKE nestles in a national forest just a few miles north of Oregon's Crater Lake National Park. Pitch your tent on the shore at one of the 100 available camp sites where you can look across the sparkling waters to snow-topped Mount Bailey. You can draw close to nature in such a wilderness solitude, study the plants and animals or swim and hike.

Diamond Lake is just one of thousands of beauty spots which await your tent. Between Acadia National Park on the rocky shore of Mount Desert Island off

the Maine coast to the California desert country of the Joshua Tree National Monument stretches the breadth of a continent containing a wealth of national parks, forests and monuments as well as state parks.

In the larger parks guided trips on foot or by automobile take visitors to see natural phenomena and wildlife. At all parks and monuments rangers and naturalists are particularly eager to help visitors with a scientific hobby. Youngsters working on a project are given special attention.

## 4

### Rock Hounding in the Sierra Nevada

Rock hounds break camp to set out on John Muir Trail through High Sierras. Specimens abound on mountains and canyon floors



Wampler Trail Trips photo

NATURALIST John Muir called the Sierra Nevada "The Range of Light" because of the dazzling granite peaks sparkling in the sunlight. Rock hounds find the range among the most exciting specimen sources in the U.S. They gather at Huntington Lake, Calif., under the guidance of mountaineer Joe Wampler and pack over the 200-mile John Muir Trail from Tuolumne Meadows to Whitney Portal. They trek through parts of Inyo and Sierra national forests and Sequoia, Kings Canyon and

Yosemite national parks, passing close to towering Mount Whitney.

Rock hounds ride or hike as they range the backbone of California. Photography addicts, bird watchers, plant, insect and animal collectors as well as trail followers go along. There are plenty of peaks to scale, and a chance to visit isolated Indian tribes.

Sleeping under the stars after a zestful day on the trail, trippers agree with John Muir who said, "Everyone needs such beauty places to play in and pray in."

## Exploring the Border Wilderness



U.S. Forest Service photo

Amateur foresters put out onto a broad, pine-girdled lake in the north country — unchanged since the days of the voyageurs

**THE VAST** Quetico-Superior wilderness of broad lakes and tree-studded islands, of rushing streams which knew the canoes of voyageurs, spans the U.S.-Canadian border in Minnesota and Ontario. Every July the American Forestry Association takes a canoe expedition of youngsters and adults through the labyrinth of waters to show them the beauty of the unspoiled woods and teach the know-how of forest conservation.

The party takes to its boats at Moose Lake, 20 miles from Ely, Minn. Dipping

paddles propel the canoes between rocky islands and narrows where deer watch from wooded shores. None of the travel is rough so the trip is ideal for families.

Although the first portage seems tough to city forestry amateurs, by the time the trip is over they are effortlessly lugging the canoes from one stream to the next. Camps are made at old logging sites, in the middle of vast stands of white pine, on beaches where swimming is good or at outstanding fishing spots. A side trip takes the party to the Kekekabac Fire Tower.



William W. Cross photo

## Sailing Out of New England

Under full sail, a Yankee windjammer cuts through seas off Maine coast. Week-end sailors trim sheets and cat her anchor

**WEEK-END TARS** with a yen for the seas board tall-sparred Maine schooners and put out from port for a week's cruise along the rocky coast. They lend the crew a helping hand at hoisting sails, catting the anchor or trimming sheets. Even the landlubber enjoys a turn at the wheel.

Every night the schooner puts into a different port, depending upon the daily changes in wind and tide. Crews go ashore on island beaches to steam lobsters over a driftwood fire. Sometimes they join in-

habitants of the Outer Islands in a spirited square dance, or visit historic spots.

The schooners which make the voyages are not fancy yachts but the last of the American merchant sailing vessels, the windjammers. Forecastle and cargo hold have been converted into small cabins. Living aboard is simple and informal.

Sails stretch taut in the wind, and the rigging flaps. The sturdy schooner rides the swells. With the deck rising and falling beneath him, the sailor is home on the sea.



# 6

## Farm Vacation in Ohio

Farm boy introduces a city youngster to his dad's tractor as they get acquainted on an Ohio down-on-the-farm vacation



Crawford Cox photo

CITY PARENTS are discovering that it is hard to keep their kids back in the city once they've spent a carefree vacation down on the farm. Farmers throughout the U.S. and Canada are opening homes and hearts to visitors from town. At reasonable rates, city dwellers can enjoy country-fresh meals, comfortable beds in high-ceilinged farmhouse bedrooms and the chance to help with the chores.

"Good will is the best crop that I raise on my farm," reports one Wisconsin farmer. He is happy that his city visitors go

home with a better idea of his problems and pleasures. His wife smiles, recalling how the visiting children's appetites grew as they spent happy days out-of-doors.

At a typical farm which takes summer guests, located near Tiffin, Ohio, city folks not only help with the farm work and go berrying but swim in nearby pools and explore the countryside for covered bridges, Indian remains and quiet scenic views. Farm families, admittedly, are busy in the summer, but they find plenty of time for genuine hospitality and friendship.

# 8

## Steamboating on the Mississippi

The *Delta Queen*, last reminder of the days of racing river packets, steams down the Mississippi on way to the Dixie river ports



STEAMBOAT FANS mourn the passing of the proud paddle wheelers from our inland waterways. Last of the old time floating palaces is the *Delta Queen*, which cruises the Mississippi, the Ohio and the Tennessee during the summer months.

Dropping down the Father of Waters through the heart of America, the steamboat slips imperceptibly into yesterday. You see Mark Twain's river flowing past you, see clammers, lamplighters and snaggers at work and tugs pushing barges.

Evenings passengers dance on the Texas deck or go ashore to explore river towns. In the morning a chime boy awakens them with a lighthearted tune which is traditional on the river. The boat passes through the brilliantly engineered cutoffs on the middle Mississippi, steams past levees protecting cotton fields, touches at Natchez, noted for its ante-bellum mansions, skirts the Cajun country and docks at New Orleans, now as in the days of steamboating, the queen city of the river.

## Rent a Yacht in Florida



Once the plaything of a rich man, a luxury yacht heads for tropical seas, chartered by mid-western YMCA skin diving club

ONCE ONLY MILLIONAIRES chartered yachts for a Caribbean cruise. Today at Miami a party of 30 can charter the luxurious *Bahama Queen*, complete with a captain and crew of seven and set sail for the Bahamas, San Salvador, Puerto Rico, Jamaica, Haiti and Dominica.

Skin-diving clubs, including YMCA groups from the Midwest and Texas, have chartered the *Queen*. A party of marine biologists from Connecticut took the yacht in search of specimens. Scientists chartered her to test equipment in the Baha-

mas. She is ready to take parties of shell collectors to isolated beaches or sight-seers on cruises. Fishermen charter the ship for light-tackle fishing for albacore, fishing for snapper on reefs or casting for bonefish in a tropical inlet.

Guests sun tan on the spacious sun deck, dine and dance in a paneled dining room, relax in a commodious lounge. Their state-rooms are finished in modern woods and feature double beds. No wonder that they go back home literally feeling like the proverbial million dollars.

## Amateur Archeology in Yucatan

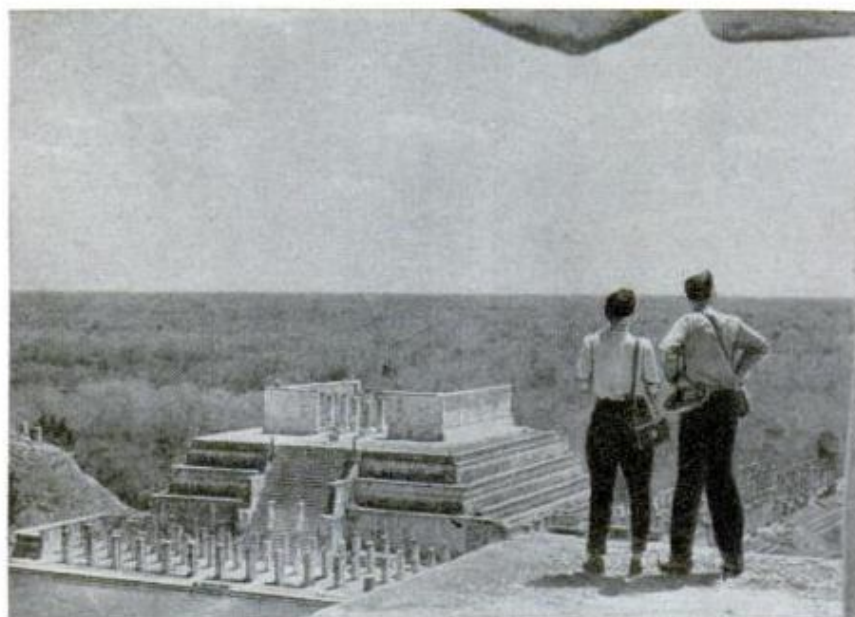

Mexicana de Aviación photo

Amateur archeologists view ancient Chichen Itza. Yucatan's Mayan ruins have long excited the students of mankind's past

UNDER THE SUPERVISION of professional archeologists, amateurs are having a chance for "dig-it-yourself" vacations in the Mayan ruins of Yucatan. They fly to Merida by Cia Mexicana de Aviación and explore the famed Chichen Itza.

It was almost 120 years ago that a group of amateurs sailed to Yucatan to make the first serious explorations of the great Mayan cities of Chichen Itza, Uxmal, Kabah, Tulum and Copan. They found giant trees had grown up in the plazas and

courtyards. The strangler fig covered stairways and roofs. Long-armed spider monkeys lived in the acropolis of Copan. Everywhere they saw monuments so impressive that they reported to the world that they were "equal in workmanship to the finest monuments of the Egyptians."

It is believed that all the major discoveries have now been made, but there is always hope of learning more about Mayans, described as "the most brilliant aboriginal people on this planet." ★ ★ ★



## TIPS FOR TENTING

*By Rafe Gibbs*

**D**USK WAS SETTLING DOWN several years ago on the banks of the St. Joe River in northern Idaho—but I wasn't. I was struggling in the dim, tree-filtered light to read the directions on how to put up a spanking new umbrella tent.

My wife, who had started cooking operations, paused now and then to cast a hopeful glance at the man she married for worse.

Fortunately, a neighboring camper strolled by.

"My tent is just like yours," he said.



Erect tent in the back yard and check equipment before setting out on a camping trip—especially if it is your first one

Rafe Gibbs photos

Right, a water jug is almost indispensable in a car, boat and tent, particularly if children accompany you on a camping trip

“First, you nail down the bottom of the tent with those spikes in that sack over there; then you fix the umbrella ribs this way—be sure you don’t get them upside down—and next you step inside the tent and . . .”

That was lesson No. 1 in the art of tenting—an art that has become so popular in the U.S. that more tents are now sold annually in the country than were used by both Blue and Gray soldiers throughout the entire Civil War.

The modern umbrella tent, which has become a favorite with campers, is tricky to erect the first time. Simple, the second. So it’s a good idea to conduct a dry run with

a new tent in your own back yard before you start out on a camping expedition. It may be raining at your camp site.

Other equipment can do with some testing, too. Even if you have used a gas stove for years—and especially if you have—it’s a good idea to check it out.

While camped last summer with the family at Oregon’s huge Honeyman State Park, I was visited by a lady in distress. Her stove wouldn’t work. She had wandered through the camp looking for a stove just like hers. Ours matched. Would I help?

Remembering the kindly gentleman of the St. Joe, I walked—for miles, it seemed—to the lady’s camp where her husband

Sheet of heavy plastic (building-supply stores sell it) on the tent site prevents moisture from seeping through floor of tent

Tent floor stays clean if there’s a throw rug or towel at entrance for wiping feet





was busily munching cookies while awaiting her return. Disconcerted, I nevertheless went to work and, with a borrowed bobby pin, unclogged the gas line.

Planning a camping trip with a family is a big part of the fun. Everybody takes an interest in lining up the gear. Besides, it's fun just to take a look at it now and then and speculate on what is coming.

It is recommended that you give assignments and establish responsibilities before starting. You will be pleasantly surprised to find how eagerly the children will carry them out.

Air mattresses are standard equipment

for camping now. If your lungs need exercise, you can blow and blow. But about \$3 will get you a small and efficient hand pump. Beauty of this is that the youngsters will fight for the privilege of blowing up the mattresses. Even our five-year-old daughter insisted on taking her turn.

If the plastic valve stem on a mattress becomes worn and won't hold in the pump, you can build the stem up again by applying plastic glue—the same material you use for patching the mattress. In a hurry, you can wrap some plastic tape around pump and valve stems to hold them together.

(Continued to page 230)

Having fish for supper? A piece of aluminum foil on the frying pan will make that job of dish washing afterwards a lot easier



Hand pump saves breath in inflating air mattress; children like to pump



# AMERICA'S TOLL ROADS

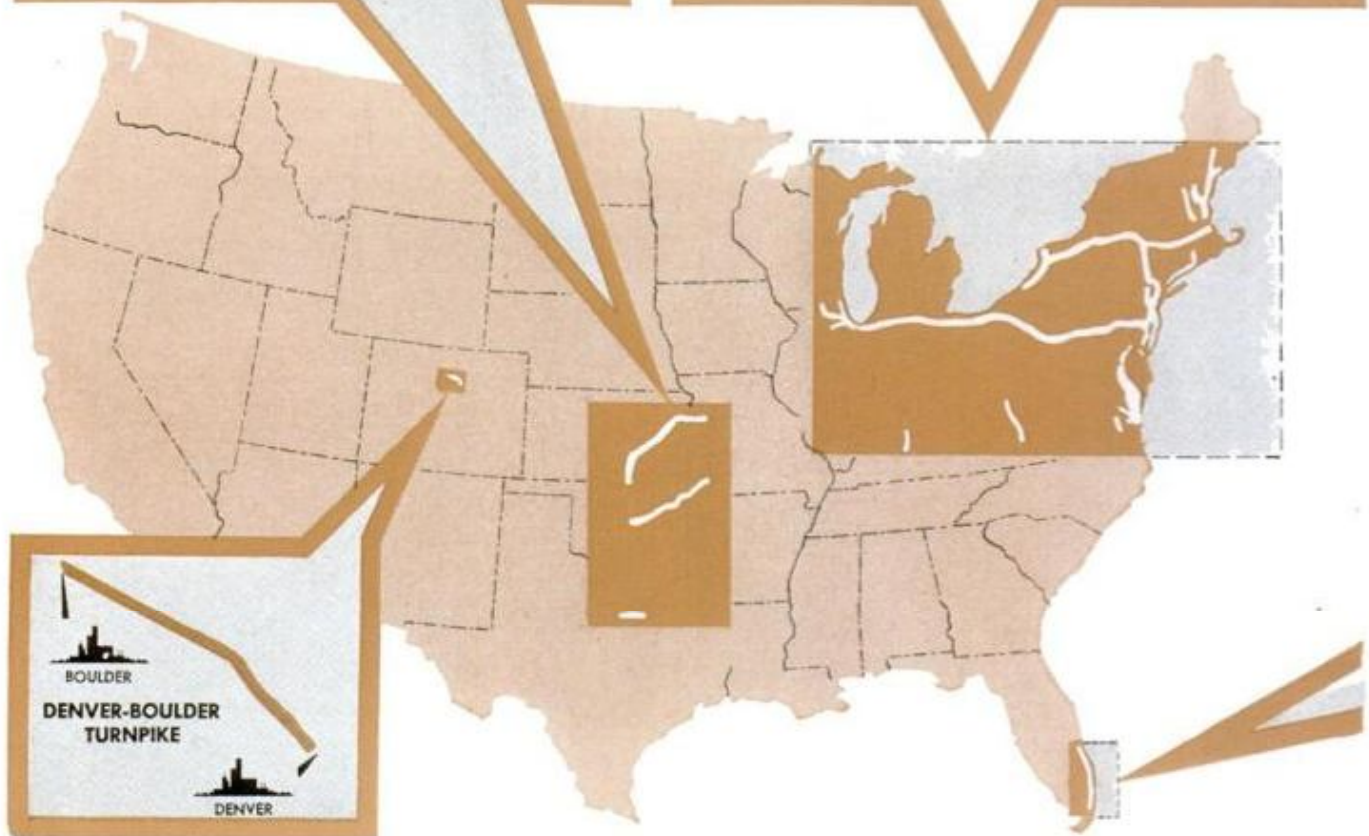
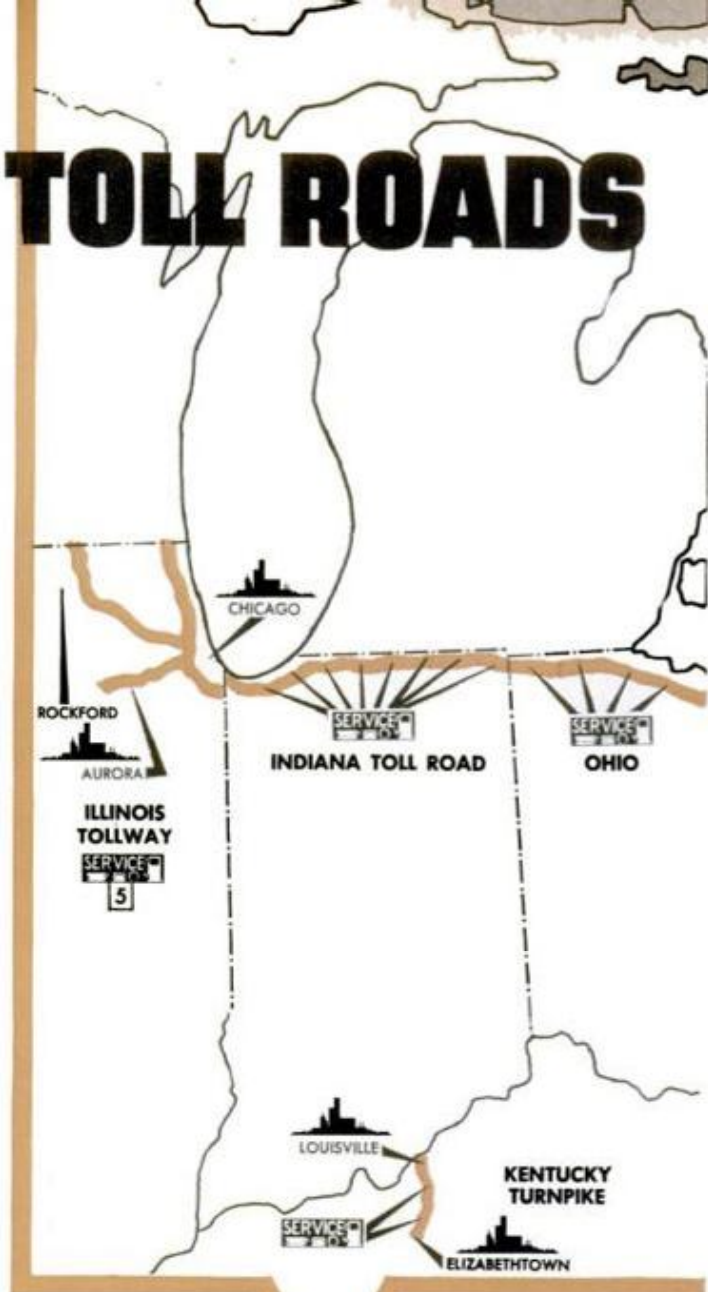
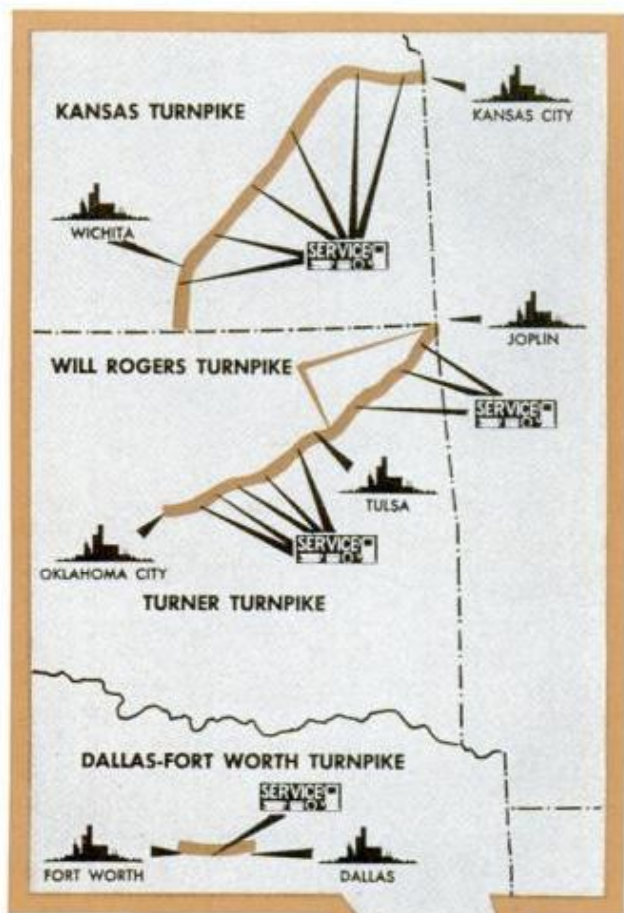

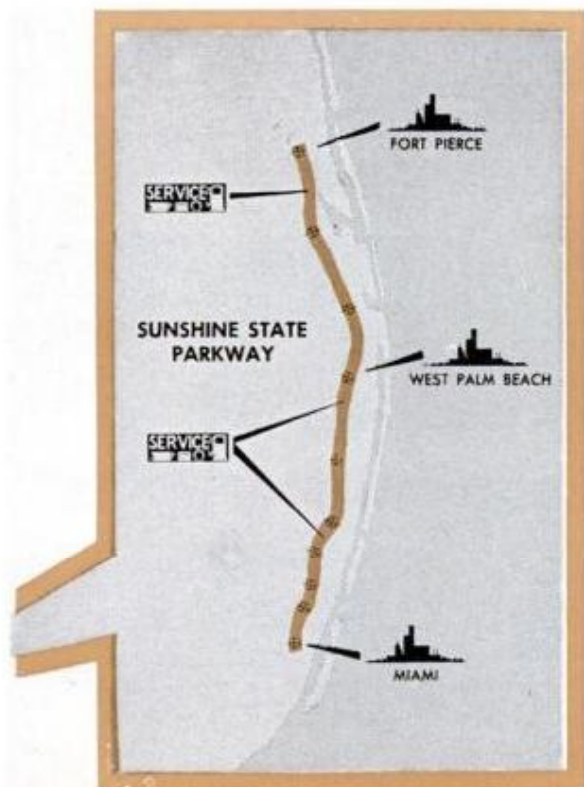
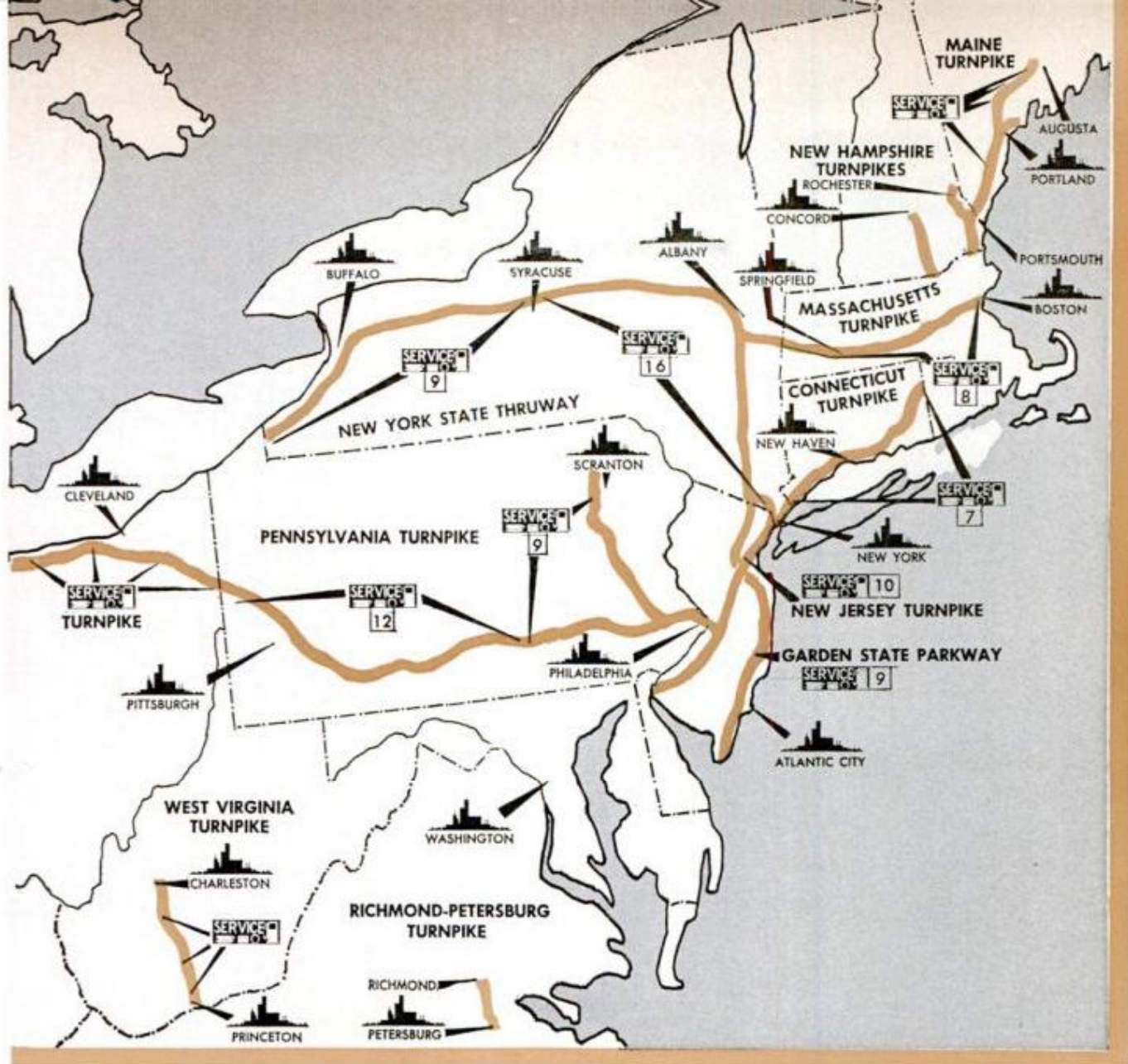

TOLL ROADS are great when you're in a hurry—or when you've been that way many times before. They speed you across the miles with an ease you never expected. Thanks to their uninterrupted smoothness, traveling in thickly populated eastern states can be as fast as in the wide-open spaces of the Middle West.

And they give added safety, 24-hour service, regular and considerate patrols, billiard-table riding comfort and reduced driver fatigue.

For these reasons, and perhaps others, you should consider America's 19 turnpikes in planning your vacation trip. On these four pages *PM* presents a quick summary of the roads.

But there are some disadvantages. A major one, perhaps, is that you seem to get through a state without having "seen" it—it's almost like flying. To be sure, you were there, but skipping towns and cities as you do, you never "meet" the state face-to-face.

All service-center restaurants seem alike, all stamped from one mold. Local color doesn't exist. There's no inclination to gracious dining.

So toll roads are not really for touring, but for traveling—for that there's none better.



ILLINOIS



CONNECTICUT



INDIANA



COLORADO



GARDEN STATE (N. J.)



MAINE



PENNSYLVANIA



WEST VIRGINIA



KENTUCKY



KANSAS

## HERE'S WHAT YOU SHOULD

Turnpikes	Total Length	Average Cost Per Mile? Car	Cost Per Mile? Car & Trailer*	How Many Service Areas?	Average Miles Between Them?
COLORADO	17	1.5c	2.3c	None	—
CONNECTICUT	129	1.6c	2.1c	7	18.4
FLORIDA	110	2.1c***	3.3c	3	36.6
GARDEN STATE (N.J.)	173	1.6c	2.4c	9**	19.2
ILLINOIS	187	2.0c	2.0c	5	37.4
INDIANA	156	1.3c	1.8c	8	19.5
KANSAS	236	1.7c	2.5c	6	39.3
KENTUCKY	40	1.5c	1.5c	2	15.0
MAINE	106	2.1c	3.0c	4	26.5
MASSACHUSETTS	123	2.0c	2.5c	8	15.4
NEW HAMPSHIRE	77	1.3c	1.3c	None	—
NEW JERSEY	131	1.5c	2.3c	10	13.1
NEW YORK	553	1.6c	2.0c	25	22.1
OHIO	241	1.5c	2.0c	8	30.1
OKLAHOMA	176	1.6c	2.4c	8	22.0
PENNSYLVANIA	470	1.0c	1.8c	21	22.4
TEXAS	30	1.7c	3.4c	1	15.0
VIRGINIA	35	2.0c.	4.0c	None	—
WEST VIRGINIA	88	2.2c	3.4c	3	29.3

\* One axle trailer

\*\* Two service areas are for gas only

\*\*\* 1.8c from 10 pm until 6 am; 2.7c for gas and trailer. Entrance time determines the rate





OKLAHOMA



NEW YORK

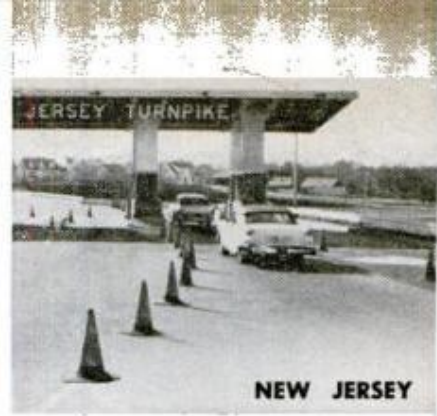

NEW JERSEY

## KNOW ABOUT THE TURNPIKES

Gas?	If You Break Down, How Much Will It Cost for:*			How Soon Could You Expect Help?
	Tire Change?	Tow?	New Tire?	
—	—	—	—	No reg. time
\$2.66	\$2.50	\$2.50 up	\$24.36	30 min.
3.67	3.50	\$15 max.	23.90	30 min.
3.56	4.00	\$10 max.	24.41	20 min.
4.66	5.00	\$20 max.	22.40	35 min.
3.18	2.50	No set fee	24.37	30 min.
2 gal. free†	1.30	\$8.00	24.37	30 min.
4.00	4.00	\$15 max.	24.37	15 min.
2.64	2.20	No set fee	24.36	30 min.
No set fee	No set fee	\$10 day \$15 night	No set price	30 min.
2 gal. free†	2.00 up	\$5.00 up	24.37	15 min.
4.08	3.75	\$9.00	31.72	15 min.
2 gal. free†	1.50	\$10 max. day, \$15 max. night	26.62	30 min.
3.64	\$3 + labor	\$14 max.	22.05	20 min.
2.76	2.10	\$6.75	20.52	30 min.
5.63	6.50 max.	\$10 max.	23.73	30 min.
3.62	3.50	\$3.00	24.37	25 min.
2 gal. free†	3.00	\$4.00 up	23.00	15 min.
No charge†	6.00 max.	\$6.00 max.	14.00**	1 hr.

\* Based on a breakdown eight miles from nearest service area. Price is for two gallons of regular gas. Tire price is for cheapest 7.50 x 14 tire and does not include highway service

\*\* Price is for second line tire. First line tire sells for about \$22 † Patrol cars carry free gas



MASSACHUSETTS



VIRGINIA



NEW HAMPSHIRE



OHIO

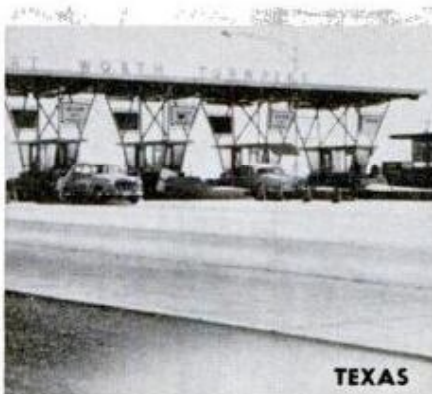

TEXAS



FLORIDA

*For the Seaside, Mountains or Woods...*

# VACATION HOMES



Pease Woodwork Company

Summer cottage is a geodesic dome made of plywood panels

**S**ECOND HOMES—retreats built in out-of-the-way places where families can run off for a vacation or a week end—are rapidly becoming a familiar part of American life.

It is estimated that vacation homes are being erected at the rate of 75,000 per year and that some two million families own a second home. They're going up on sea and lake shores, in the woods and on mountain slopes—any place that attracts vacationers. Generally second homes are fairly close to the family's year-round residence so that travel doesn't consume too many of those free hours.

The seclusion of the building sites allows unusual design in the cabins, since there are no neighborhood patterns to adhere to. Geodesic domes or A-frame cabins, for instance, are not ordinarily found in suburban neighborhoods.

Prefabricated home, located on seashore, features large porch, three bedrooms, dining room, kitchenette

Techbuilt Inc.





George T. Rockrise, A.I.A., architect

Mountain home, built in the shape of a T, clearly demonstrates the flexibility of the A-frame cabin design

Prefabrication is also part of the picture, with a number of manufacturers offering factory-built components to be assembled on the site. Techbuilt, Inc., has a prefabricated vacation cottage designed by Carl Koch, A.I.A. The three models of the cottage can be built as summer dwellings or, by use of a winterizing package, can be turned into skiing cabins or year-round retreats.

An unusual shape in prefabricated summer housing is the geodesic dome offered by Pease Woodwork Company. The house is composed of 38 factory-built triangular

plywood panels which are bolted together at the building site.

The triangular construction of an A-frame cabin makes a very rigid structure, and there is no need for interior bearing walls. Thus, the partitions may be located wherever the owner wishes. Depending on the cabin size, too, a small sleeping loft or a relatively full second story may be included.

But whatever the style, second homes are making it possible for more families to "get away from it all" often and easily.

★ ★ ★

Typical A-frame cabin—one of the scores being built in mountain areas nowadays—is popular in heavy snow fall regions because roof sheds snow easily



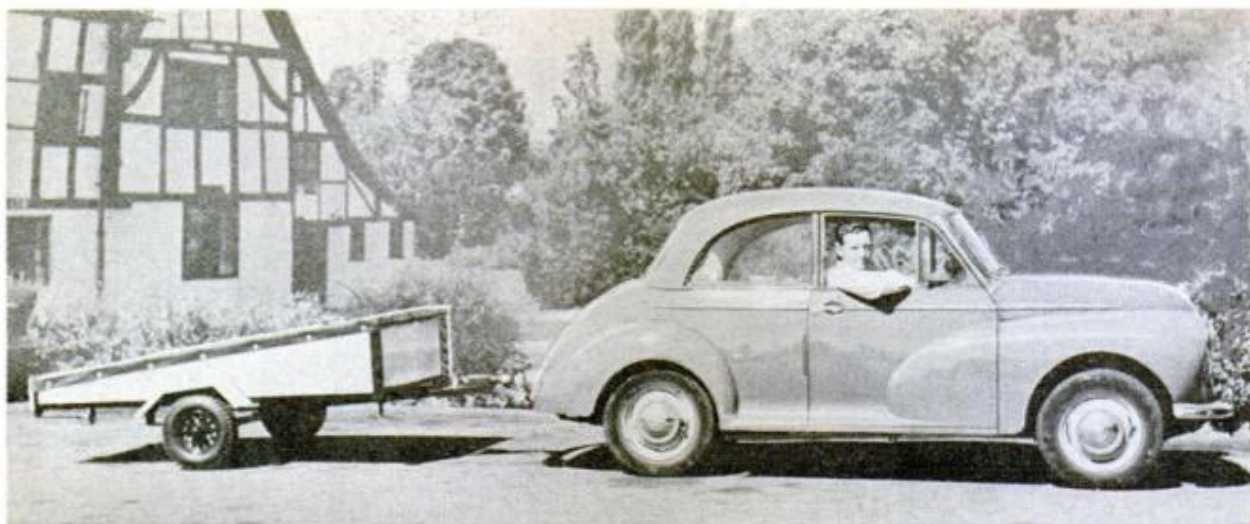

## Tiny Trailer Becomes 13-Foot Sleeping Room

Easily towed by a small car, a tiny, wedge-shaped trailer unfolds to form a tent that's 13 feet long, 4 feet wide and 6½ feet high. An extension of the floor slides out and rests on telescoping legs. The canvas

top then pulls into place. The trailer-tent, built by a British manufacturer, weighs 450 pounds. Folded down for towing, the unit stands only 2½ feet high and does not obscure rear vision.



## Washbasin for Motorists

Four pints of water and a supply of toilet articles can be carried in a plastic washing pack designed especially for the use of motorists. Molded into the water bottle are recesses for a mirror, comb, liquid soap and nail file. A cover, into which the pack fits, serves as a basin and permits washing inside the car.

### QUOTE:

*"We have strengthened our positions substantially and shall possibly arrive at this first objective [controlled thermonuclear reaction in the laboratory] within the next two to five years."*

—JOHN H. WILLIAMS, Commissioner  
U.S. Atomic Energy Commission

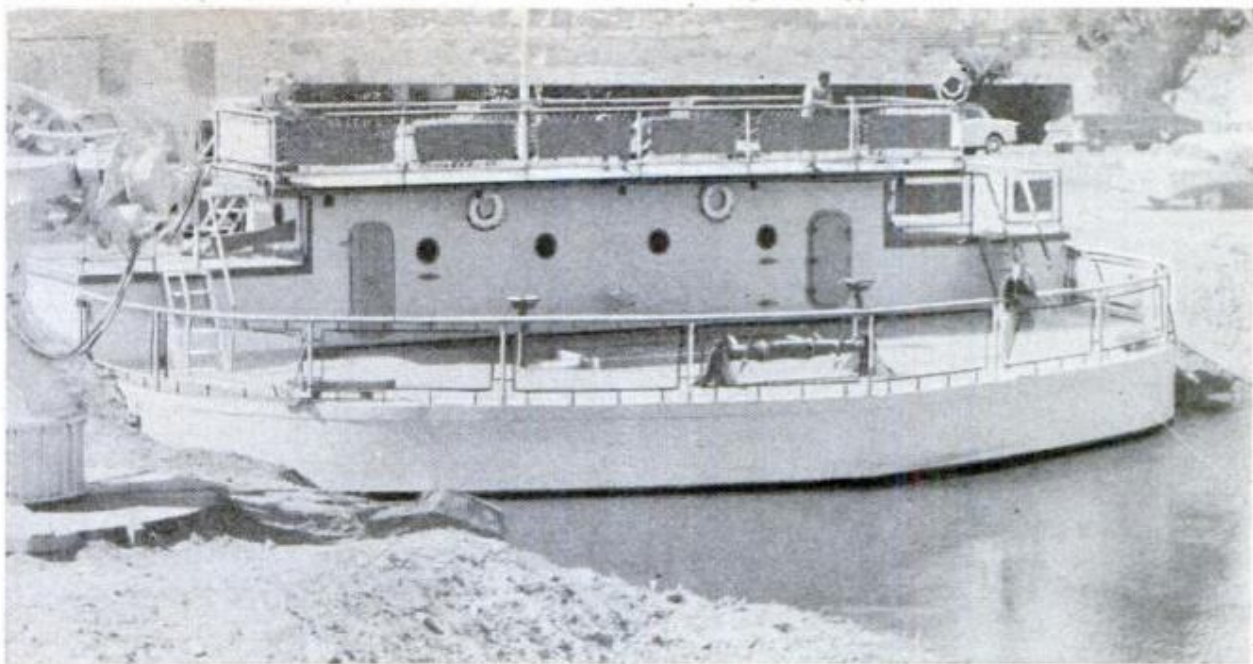

### Pier Changes Hazard Into Kid's Play Spot

After several children drowned in a tidal canal serving Lake Merritt near Oakland, Calif., the local Lions Club built a ship-shaped fishing pier to give the kids a

place to play away from the steep banks. It has proved so popular that several others are being planned as a safe, modern version of the old fishin' hole.

### Battlefield Resuscitator Revives Gas Victims

Nerve-gas casualties with characteristic constriction of bronchial tubes can be treated with a battlefield resuscitator that forces air under pressure into the victim's

lungs. The patient may inhale through a mask or plastic tube in his windpipe. Several resuscitators can operate from a single source of compressed air.



# Amphibious Home

By George X. Sand

**On moving day, the captain of this seagoing back-yard houseboat just cranks up his house and moves**

WHEN DR. S. W. JOHNSTON, a dentist in Ft. Lauderdale, Fla., built a 49-foot, 16-ton houseboat in his back yard, neighbors chuckled and made joking reference to Noah and his ark, since the nearest body of water is more than a mile from the Johnston home. But they stood and stared when the job was finished, for the big boat put down four steel pipe legs and hoisted itself off the ground while a flatbed trailer backed under the hull for the trip to the water for launching.

The hoisting system is only one of a dozen unusual features of the Johnston boat, designed and built as a year-round floating home by a family that has lived aboard boats for about 20 years. When it's finished, the boat will serve as a land and water home for Dr. Johnston's son, Bill, and his family while he attends medical and dentistry schools in Florida and Mary-

land. With its retractable legs it will be equally at home in a Florida harbor or a Maryland trailer court.

The hand-cranked hoist system uses 4:1 pulleys and 72:1 reduction worm gears which allow it to be raised with only 12 pounds of pressure on the cranks. On land, the Johnstons will use a conventional doorway into the living quarters. In the water, the watertight door is sealed and the boat is entered through gangplanks onto the fore and aft upper decks.

Other features in the two-bedroom boat include twin-pane windows controlled from a central panel; a built-in vacuum cleaning system that serves every room and blows the dirt out a small vent on the bow; built-in hi-fi music system, movie projector and screen, and color television set. In the kitchen, the electric oven, washer and dryer fit under the foredeck, saving floor space and keeping their heat out of the cabin.

The boat has radiant heating through a network of copper tubing laid under the decks and fed by the electric hot-water system. A two-ton air conditioner is augmented by a roof sprinkler system which keeps the deck cool under-foot and helps cool the interior.

The 49-foot hull is 12 feet, 11 inches across the beam, and is overlaid below the water line with heavy creosoted pine planking. Dr. Johnston and his son have done all the work themselves, working from a scale model instead of a set of plans. The younger Johnstons think it will be easier and cheaper to live in the boat than in a trailer or temporary housing ashore. Dr. Johnston says, "I guess none of us cares much for living in houses."





Mrs. Johnston works in kitchen of her new amphibious home. Washer and dryer flank wall oven



Mrs. Johnston and her son enjoy open upper deck. This is the area cooled by the sprinkler system

Dr. Johnston holds the original scale model. In the background, son Bill stands on the finished foredeck





This thief is mighty surprised. When he pulls at the money case, the bottom of the case opens. As the money falls out, it is sprayed with a jet of dye, soaking the bills and making them useless to the thief.

## Stop! Thief!

Money cases that do nearly everything but arrest the thief are flooding the London briefcase market—all in an attempt to halt the current outbreak of paycheck robberies. In the London area, Friday or payday is known as a black day with thefts of wages reaching as high as four each Friday. One money case has a bottom that falls out, scattering the money on the pavement. As the bottom opens, a spray of dye soaks the bills, making them useless to the thief. Other money cases are just as unique. One sounds a screaming horn as the case is grabbed. Another not only sounds a horn but surrounds the thief with choking fumes. One case has not quite made it off the drawing board yet—it has a mechanical hand that clutches the thief until help comes. The main idea is to draw attention to the thief.

One-pound and five-pound notes are placed inside the case, and the door to the trick bottom closed



When the thief jerks on the box, this cord opens the trick door and causes the dye to squirt the money

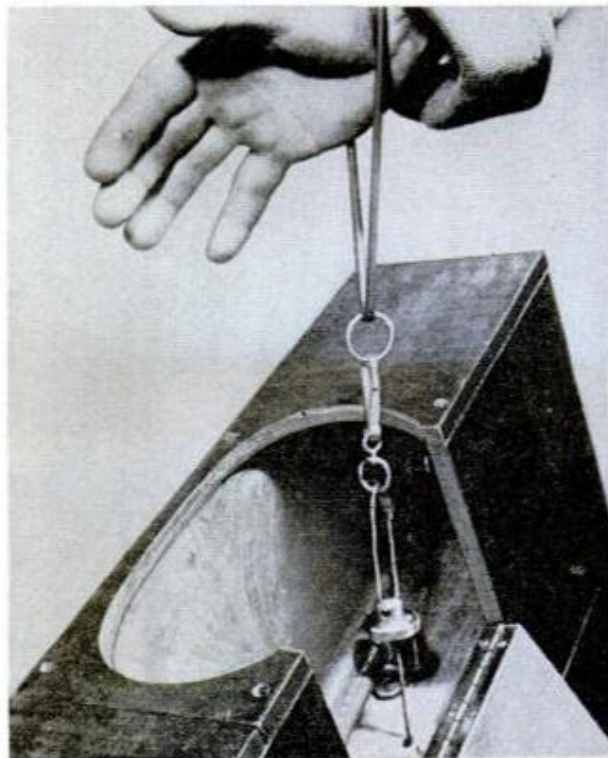



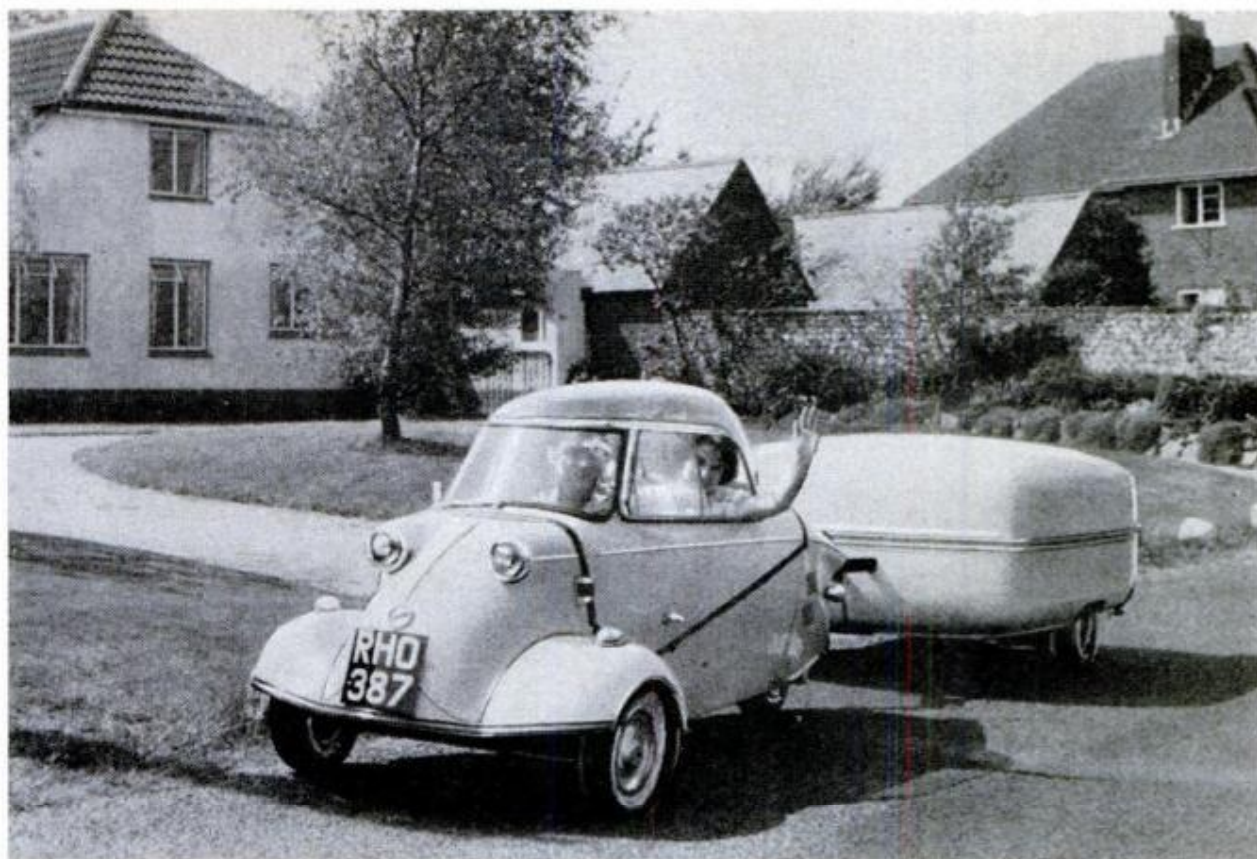

Bernsen's International Press Service, Ltd.

## Even a Motor Scooter Can Haul Collapsible Trailer

SOMETHING for the compact-car buyer—here's a compact traveling van that even can be transported by a motor scooter. The trailer neatly folds away into a flat box seven feet long and five feet wide. It stands just three and a half feet off the ground. Made of Fiberglas and equipped with independent wheel suspension, the trailer can be assembled into a nifty camping van in just 10 minutes. Hinged sides that fold inward when closed up are pulled out to form the walls, complete

with windows. The ends fold down from the roof. One end has a window and wash basin while at the other end there's a door with a window in it. There are two single beds which easily convert into a double bed. Storage cupboards are enclosed beneath the beds. During the daytime, a table folds down between the beds, turning the bedroom into a kitchen. To steady the caravan while it is being used, jacks at each corner lower to the ground. A towing bar attaches the van to the vehicle.





# **Look South For Your Future**

**By Frank J. Thomas**

**Y**OU CAN ESTABLISH a profitable business of your own in Latin America if you know where and how. In this article, you'll find helpful tips on existing business opportunities south of the border. But first, consider the stories of these Americans who have already gone south—and made money for themselves down there:

- Bernard Rosenberg left Brooklyn in 1952 with a good knowledge of electricity and established a fluorescent-lamp factory in Cali, Colombia. He started with borrowed capital. Now his annual sales run up to \$500,000, and he's planning to expand his operations.

- Frank Smith went to Mexico City a few years ago and established a small soda fountain. He specialized in making malts, and today his combination drugstore-

fountain-restaurant is known as one of the best in Mexico.

- Louis Chiurato settled in San Salvador in the Republic of El Salvador and started making hair dressing from imported ingredients. His product found immediate acceptance and has earned him thousands of dollars.

- Orlando Flye, a native of Maine, went to Santa Marta, Colombia, many years ago on a contract as an electrical engineer and soon found himself a prosperous farmer. One day, while working near a stream, he found some wild coffee plants whose berries he picked and sent off to New York for examination. The immediate reply that he got from New York was "Send us 10,000 bags of 100 pounds each of the same."



Coffee beans dry on William Flye's million-dollar plantation at Cincinnati, Colombia

That reply made Flye switch careers, and he soon invested his small earnings in a coffee plantation in the cool mountain area which he later called Cincinnati after his wife's home town. As time passed, Flye increased his coffee acreage, fought erosion, and improved his farming practices. When Flye died a few years ago, he left his son William a 1000-acre coffee plantation which today produces an average of 4000 bags of mild coffee beans a year. The plantation employs 500 workers during the harvest season and is now worth over a million dollars.

- Maxwell Cone arrived a few years ago in the Volcan area of



Rodolfo Castro (left), former Californian, displays product of his successful Ceramic Industries Ltd., San Jose, Costa Rica

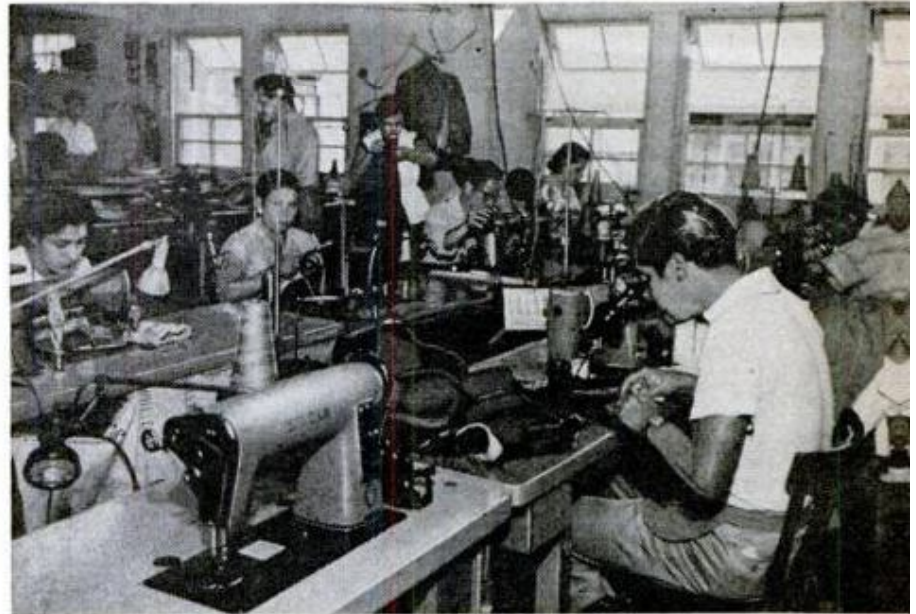

Demand for low-cost clothing is great in Latin America; ready-made clothing plant in Panama City sells all it can produce

Willie Brealey opened Costa Rica's first self-service food store—and customers soon preferred it to their old markets





United Fruit Company operates banana plantations, but also buys quality products from independent growers

the El General Valley in Costa Rica and now owns a first-class cattle ranch which brings him thousands of dollars annually. From the start, Cone wanted to own a cattle ranch but lacked the capital. So he went to El General Valley where land was still available at practically give-away prices. There he bought a couple of hundred acres, cleared the land and sold the logs to sawmills.

Inspected beef from Maxwell Cone's Costa Rica ranch helps feed the growing population of Latin America



Then he rented a small plane and sowed his pastures from the air. In time, he had hundreds of cattle grazing on his fine pastures, whereupon he built a slaughtering plant on his ranch. Today LACSA (a Costa Rica airline) cargo planes land on his ranch, wait a couple of hours while 47 steers are slaughtered and then take off loaded with 11,000 pounds of beef for meat-deficient Curacao, Puerto Rico and Venezuela.

When asked if he uses refrigeration in the planes to prevent the meat from spoiling, Cone replies, "No, there's no need for it. I simply tell the pilot to go high enough, and the cold air at 14,000 feet keeps the meat chilled until its arrival." Besides profiting from his beef-exporting business, Cone earns additional income from the hogs he produces on his farm. These are fed almost 100 percent from the waste obtained in his slaughterhouse.

Like these Americans, hundreds—if not thousands—of others are today working busily at their own profitable businesses in Latin America. They have found that business success, whether it be in a large city, a small town, or out in the country, comes from filling a need that exists or is created for a product or service. The way you manage the business will spell the difference between success and failure whether you are in Caracas, Panama or New York.

Starting a business is not easy, and it is getting more difficult every day to create a really profitable enterprise. Yet, I have discovered that everywhere throughout Latin America resourceful individuals are demonstrating that businesses similar

(Continued to page 224)

## Fuel Cells Power Tractor

Mixed fuel gases (largely propane) and oxygen react in an electrolyte within 1008 fuel cells to provide electricity to power an experimental tractor. Gases enter the cells through tubes. A catalyst coating the electrodes of each cell aids the reaction. Chemical reactions within cells cause direct current to flow through an external circuit, connected by bus bar to a controller. The driver regulates speed and reverses direction by the controller.



## Laboratory Highway Cuts Testing Time

Built in a circle only 12 inches wide, a test-tube highway may lead to multimillion dollar savings in road building. Four auto wheels, carrying the weight of anything from a bicycle to the largest truck at highway speeds, whirl around the track hour after hour. Electronic equipment produces cloudbursts, freezing, thawing and heat, enabling scientists to study in a few days what happens to a road in years.

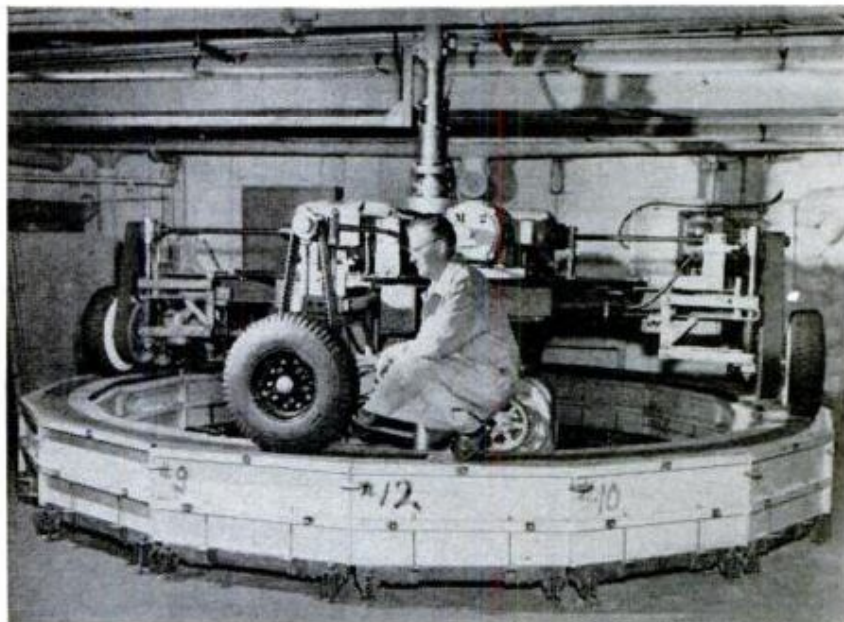

Standard Oil Company of Indiana photo

## Ballistic Missile To Carry TV Station

Shaped like a bomb, the U. S. Army's "flying TV station" is designed to be housed in a ballistic missile, which would eject it before diving to earth. The station would photograph the impact area and transmit pictures to screens behind the battle area, where commanders could quickly assess target damage. The device, mounted under an airplane wing, is being tested at the Air Proving Ground Center in Florida.



U. S. Army photo from UPI

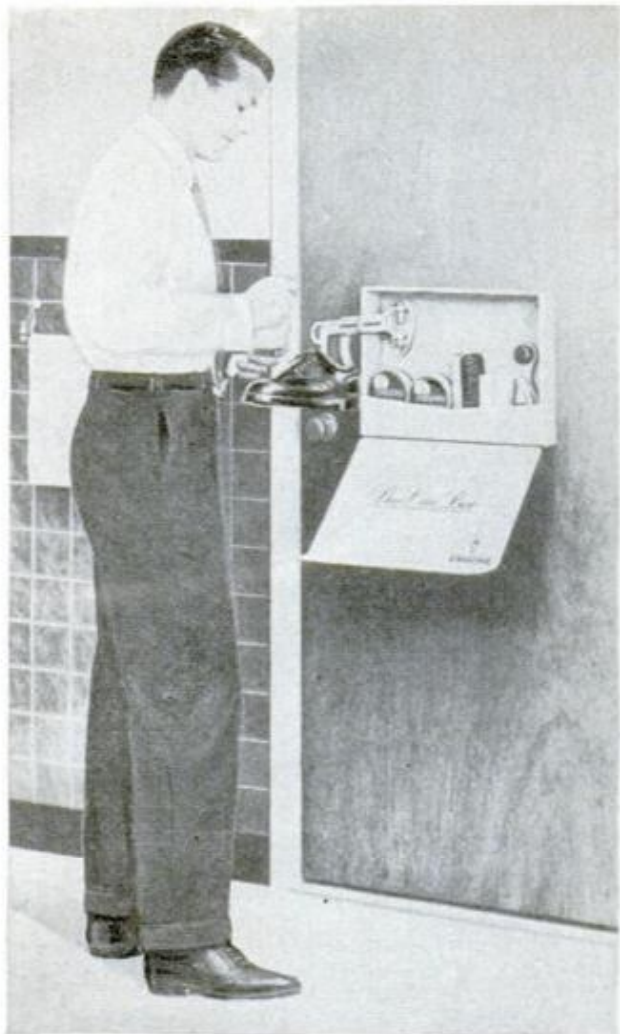

**SHOESHINE KIT** mounts on door or wall, providing storage for polish, daubers, cloths and brushes. Its swing-out, shoe-holding bracket locks into place, holds shoes of any size in polishing position  
Knomark, Inc., 330 Wythe Ave., Brooklyn, N. Y.

# WHAT'S NEW FOR Your Home



**UNDER-PILLOW ALARM** is attached to a clock that can be set in the usual manner to awaken everyone. If only one person wants to be awakened, however, a heart-shaped alarm is placed under his or her pillow  
The Sessions Clock Co., Forestville, Conn.



**UTILITY CART** made of aluminum and duck handles 10 times its 16½-pound weight, rolling on rubber-tired wheels. It holds six cubic feet of bulky items, yet folds to compact 10-inch thickness for storage  
Johnson Enterprises, 1818 Tenth Ave., North, Lake Worth, Fla.

**QUILT FRAME** which readily clamps to most tables also can be used for hooking rugs. Work material is held in tension in four directions by pins placed along the frame's sides. Pins can be removed quickly  
Sewing Products, Box 172, Cincinnati, Ohio





**HOSE HIDER** sits inside the house wall, allowing 150 feet of garden hose to be pulled from compartment either outside the house or into the floor above. The faucet is inside the 8 by 16-inch locked, aluminum compartment, preventing pipe freezing. Hose winds onto a reel which is flush against basement wall  
 Flinchbaugh Murray Corp., 66 N. Murray Place, York, Pa.

**GREASE TRAP** made of stainless steel can be used in homes where grease in sinks or dishwashers presents problems, although it was designed for commercial use. It works by taking advantage of the fact that grease rises to the top, and lets water flow out to drain. The cover may be removed to clean unit  
 Carrollton Mfg. Co., Carrollton, Ohio



MAY 1960

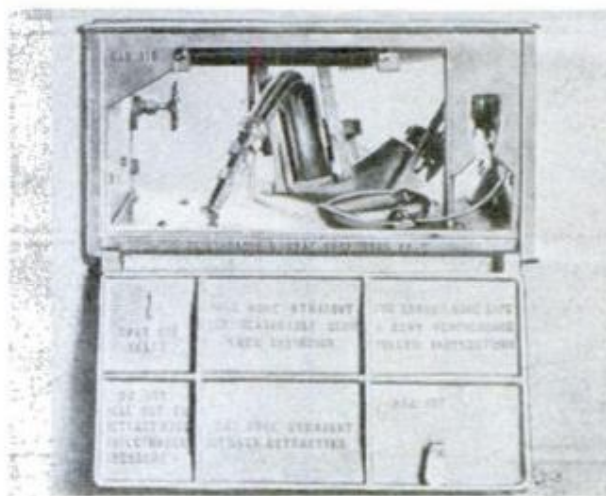
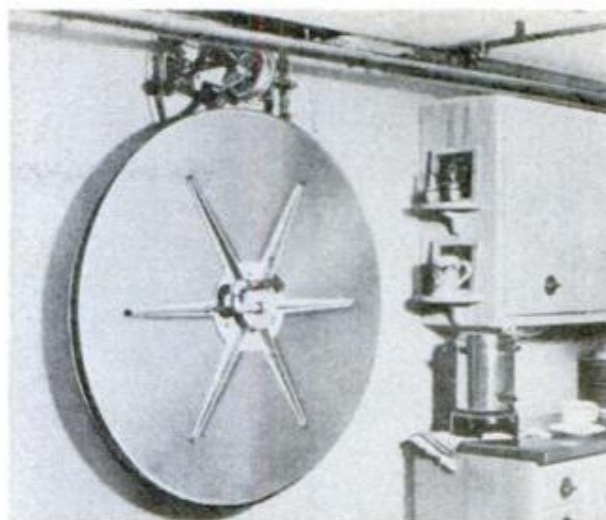

**UTILITY OVEN**, below, is only eight inches wide, but can roast, bake or broil after six minutes of preheating. Designed to supplement larger range ovens in preparation of frozen dinners, pies and snacks, it uses a 1500-watt element and operates on 110 volts. The oven slides from range for cleaning at the sink  
 The Philco Corp., Philadelphia, Pa.



139



### Tub-Side Television Shows Who's at Door

Tub-bound householders can monitor the front and back doors and watch TV programs with a communications panel designed by a British firm for the bathroom of the future. A pair of monitor screens gives pictures of front and back-door callers, whose images are picked up by closed-circuit cameras. A telephone amplifier permits the bather to converse (unseen) with the callers. The third screen enables the bathtub occupant to select regular television programs for viewing.



### Modeling Maché Serves as Roadbed

Papier-maché, applied to plywood or linoleum floors, makes a good roadbed for model railroad layouts. The manufacturers were trying the modeling material, consisting to a large degree of paper, for building mountain scenes for a toy railroad, when they decided to stick down track with it. They found it makes a well-insulated roadbed when dry. It can be broken up and cleaned away easily.

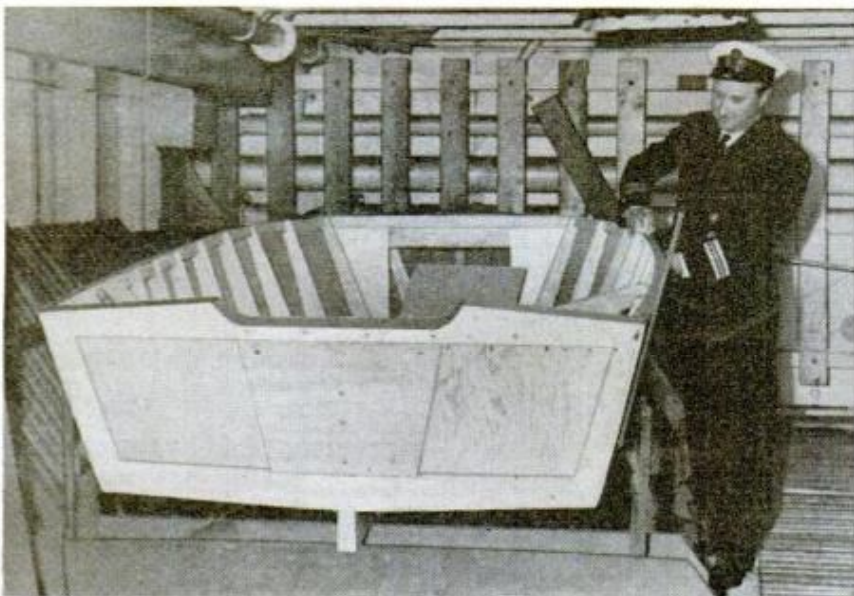

### He Builds Boats Aboard Ship

To pass his off-watch time while his ship is at sea, First Officer Robin Jones of the liner *Carinthia* builds boats in the ship's cargo hold. The Welsh officer is now working on a 14-foot runabout, the second boat he has built on the run between Liverpool and Montreal. He insists that this boat is Canadian, however, since he bought the fir lumber and plywood while his ship was docked in Montreal.



# RADIO TV HI-FI

## ELECTRONICS



## Fun and Thrills With Radio-Controlled Model Car and Boat

By Joe Stanton and Ralph Warner

3811 N. ALBANY  
CHICAGO 18

**E**VER HAD THE YEN to get behind the wheel of a racing car or powerboat—to go tearing down a course with a wide-open throttle and no speed limit? Well, few of us actually have the opportunity to satisfy this craving with the real thing, but everyone, young or old, can experience some of the same thrills—with radio-controlled models. And once you've been bitten by the bug you'll find that model racing is a sport or hobby which takes a back seat to nothing else.

Now you can buy or build radio-controlled equipment that'll duplicate every function of the real thing—with a few to spare. That kind of gear, however, is hardly the thing for beginners. It's complicated to build, install and operate—and it's expensive.

In contrast, the units described here can be built by just about anyone, and at the lowest possible cost consistent with reliable operation.

What's more, the electronic equipment and engine, the most expensive parts of any system, are completely interchangeable between car and boat. You can build either one—complete—for less than \$40, and you can have both for just a few dollars more.

Simplicity is the keynote for both of these projects. The efficient prop-drive engine eliminates the expense and problems of complicated gearing associated with electrically-driven units and reduces operating costs. It has only one speed—fast—but you can control the direction: forward, left turn, right turn, simply by

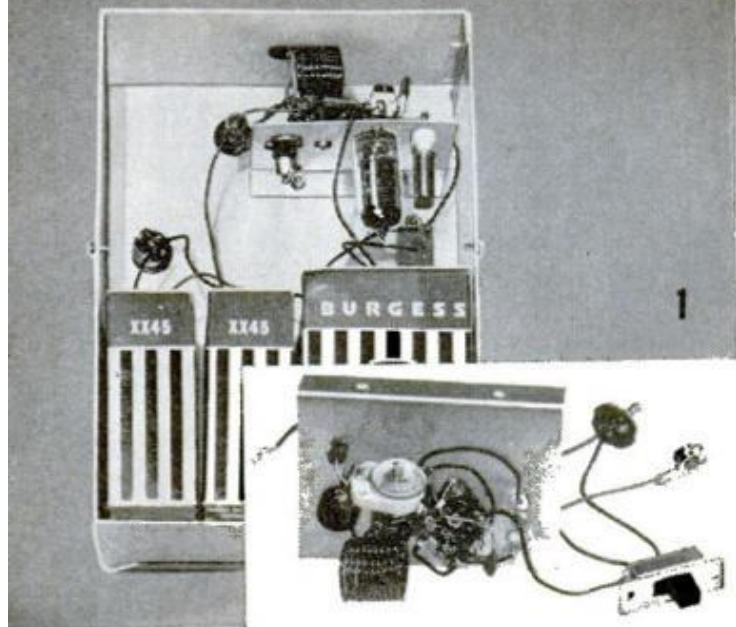

Easy-to-build transmitter chassis, inset, takes up little space in transmitter housing. Simple receiver, upper right, will present no construction problems

pressing the button on the transmitter. And right here, a few words concerning the electronic and electrical equipment are in order.

Operation of either car or boat requires only the simplest and least expensive type R/C transmitter and receiver. The units shown were assembled from commercially available kits for a combined cost of about \$18, but virtually any good make of equipment will do the job. You don't even have to build the units yourself since there are a variety of factory-wired jobs available from most hobby shops. But the construction of these kits is not difficult and can result in substantial savings.

Since the assembly and adjustment of the kits shown in Figs. 1 and 2 are thoroughly detailed in their accompanying instructions manuals, there is little point in duplicating them here. The photographs serve only to illustrate their relative simplicity. Precise adjustments can be made with a millimeter or inexpensive VOM.

In operation, the transmitter sends out a continuous, crystal-controlled signal as long as the "transmit" button is pressed. In the car or boat, the receiver picks up this signal and converts it into d.c. which actuates a set of relay contacts. As the contacts close, battery voltage is applied to the servo motor causing a 90-degree rotation of the servo gear. This rotation is translated into wheel-motion (or rudder action) through the crank pin, tiller and tie rod, see Fig. 3.

The crank pin remains in the offcenter position until the "transmit" button is released, after which the servo, by completing its rotation cycle, automatically returns to neutral. To cause the vehicle to turn in the opposite direction, the "trans-

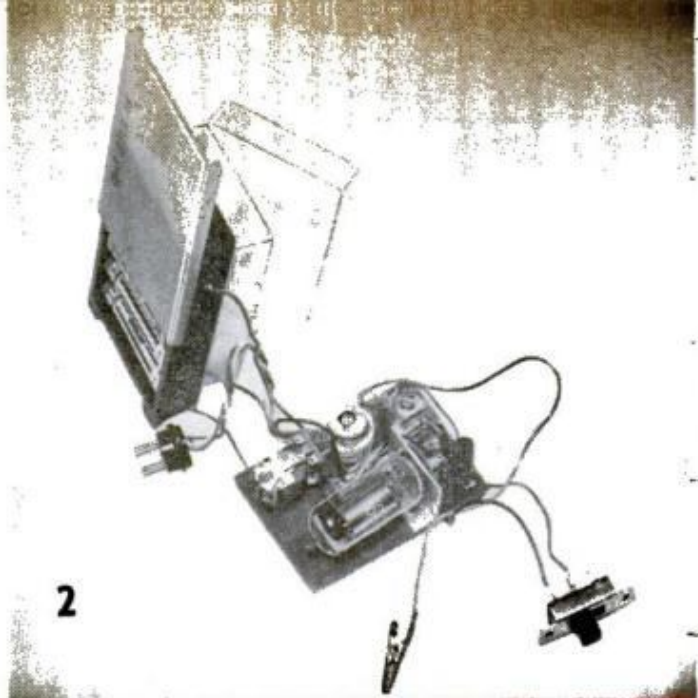

2

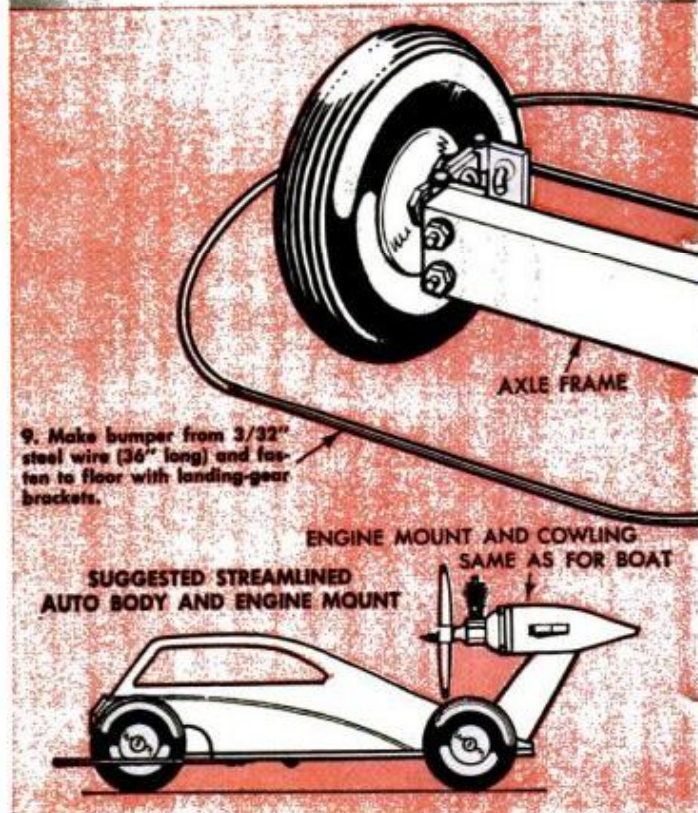

mit" button is pressed, released for an instant, and pressed again. This causes the crank pin to come to rest in the 270-degree position until the button is released for the second time, causing it to return to neutral. It takes only a short time of actual practice to get the hang of the operation.

Construction of the car, as detailed in Fig. 3, is a project of only a couple of hours, and all the parts can be obtained from a hobby shop and hardware store. The numbered assembly steps indicate the sequence of most convenient construction. Here are a few additional suggestions:

1. Cover all wood with several coats of "fuelproof" paint before mounting any of the parts.

2. Cement the bottom of the transparent receiver box (supplied with kit) to the bottom of the battery box. Use a sponge-

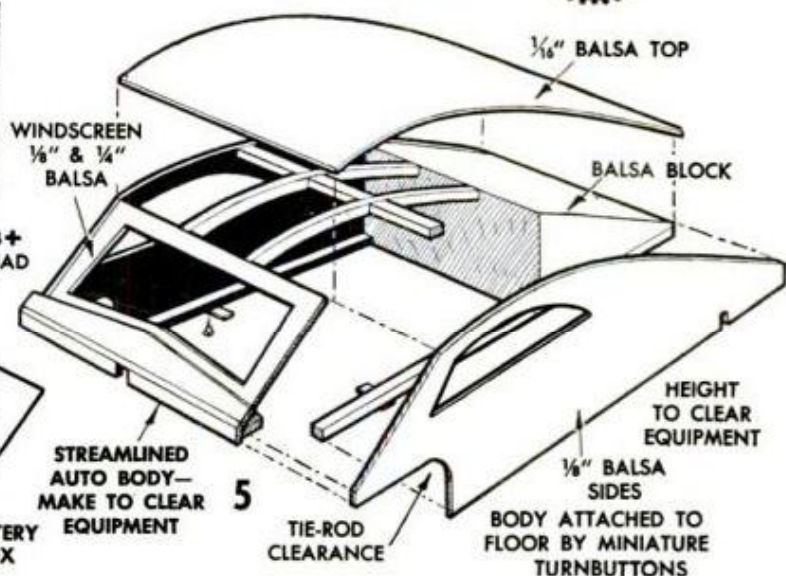
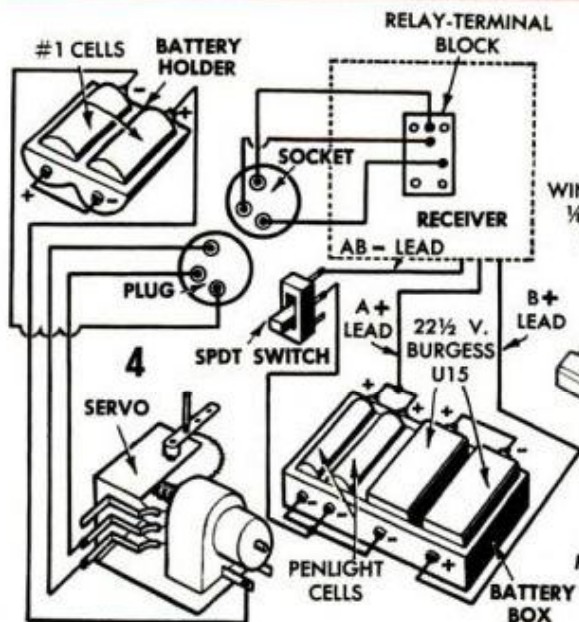
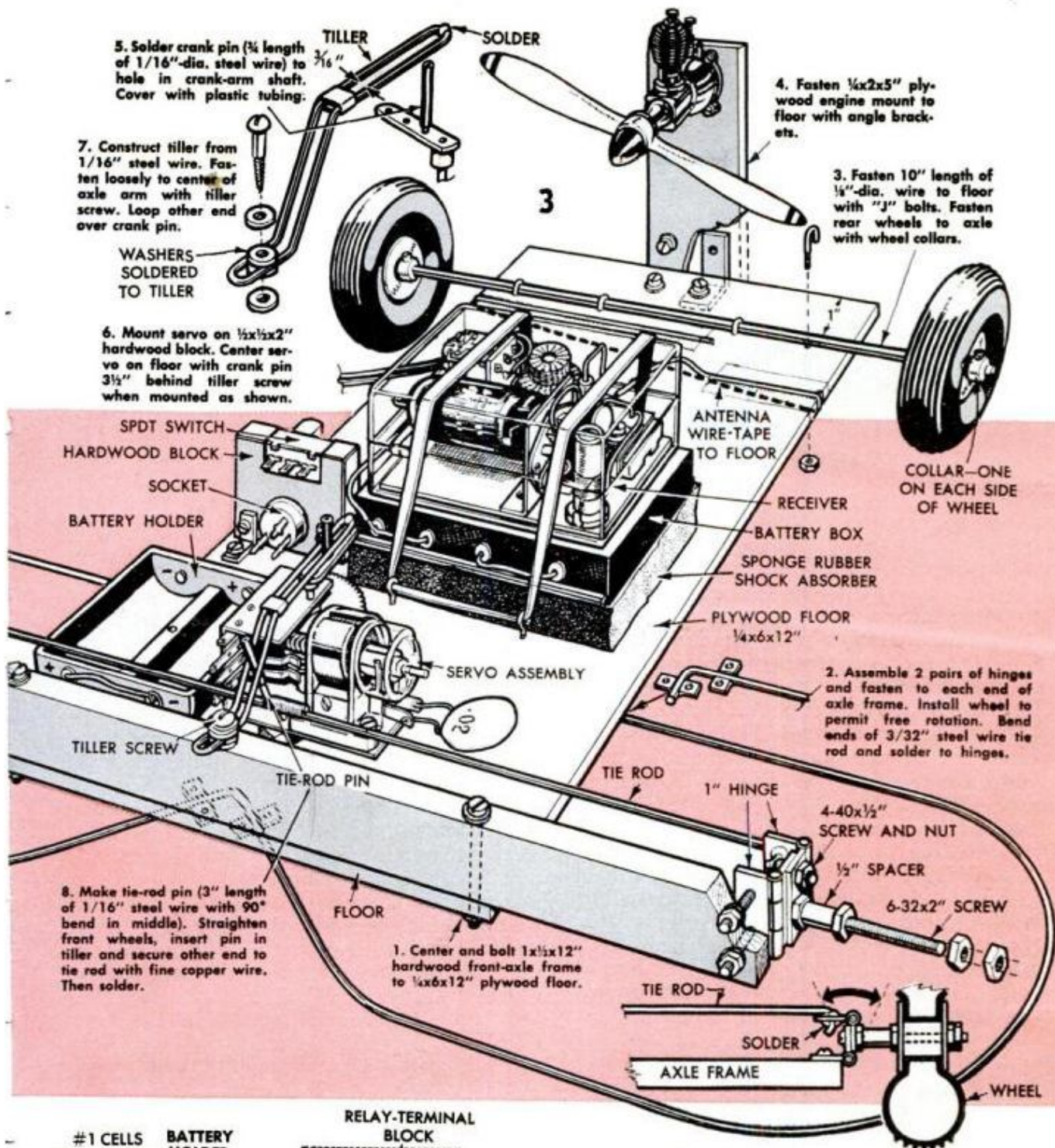

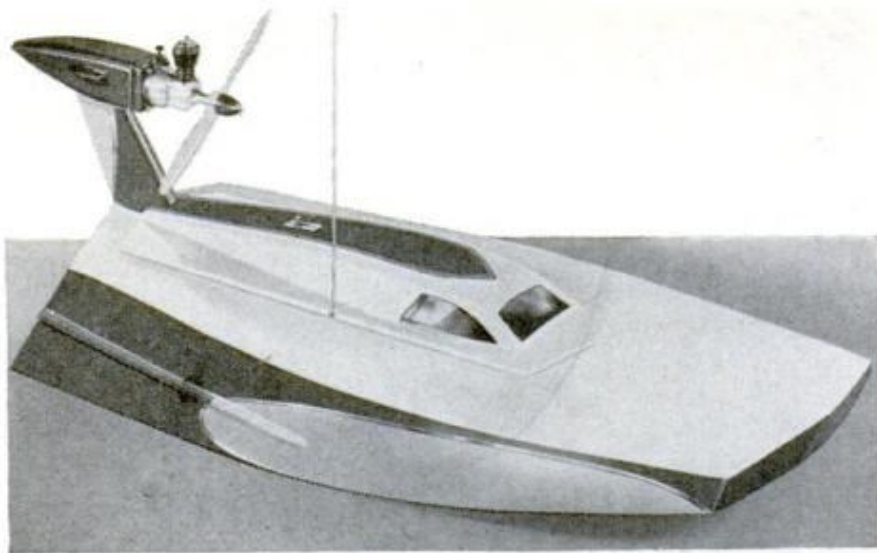

Prop-driven, radio-controlled model boat makes excellent construction project for hobbyists. Well-balanced model is extremely stable and highly maneuverable even in rough water. Radio control receiver and servo mechanism are mounted in cabin beneath removable cabin cover

rubber pad between battery box and car floor to act as shock absorber.

3. In following the wiring of Fig. 4, the plug and socket may be replaced with direct connections between the relay and servo. These parts merely facilitate transfer of the receiver from car to boat.

4. When mounting the engine, be sure to allow for adequate propeller clearance.

The streamlined cover, Fig. 5, is not required for proper operation of the car. It does, however, give the model a "finished" look.

Construction of the boat is much more involved than that of the car, but it's not particularly difficult.

The boat is built around a rectangular, closed-bottom box (see Fig. 6) which serves as the cabin and houses the R/C equipment. The bottom of the box has a slight ( $10^\circ$ ) upward taper, beginning about 8 in. from the rear edge. A notch cut in

the bottom of the front cabin-member permits insertion of the keel which is trimmed to extend the cabin-taper all the way to the front edge of the bow block.

Exact sizes and shapes of the bulkhead frames 1 through 7 can be obtained from the half-frame drawings of Fig. 7. The tinted screen over this drawing represents 1-in. squares and can be used for accurate sizing of these parts. Location of the frames is indicated in the half-top and cross section side-view drawings, Figs. 8 and 9. Small balsa-wood cleats serve to hold frames 4, 5 and 6 in position against the cabin sides. Frames 3 and 7 are cemented directly to the front and rear of the cabin box while frames 1 and 2 and the bow block straddle the keel with their bottom edges flush with the bottom of the keel. These determine the ultimate shape of the hull.

(Continued to page 242)

Boat is built around balsa-wood box detailed below

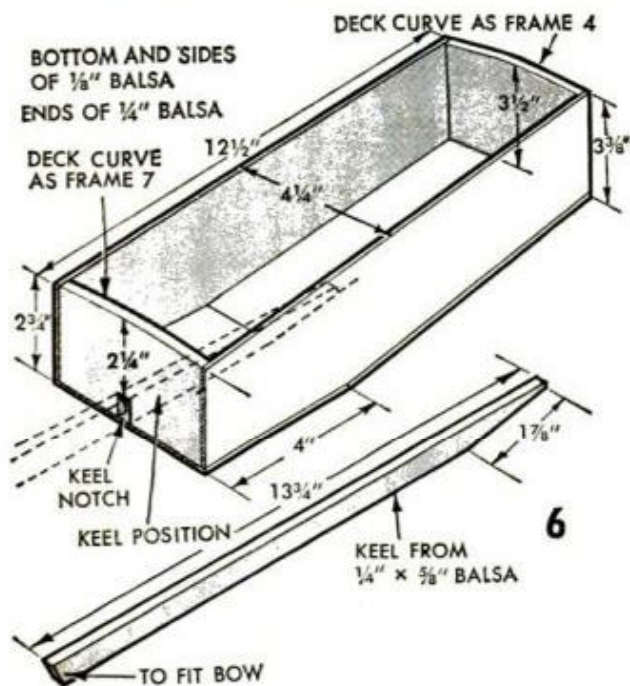

Bulkhead frames can be sized with 1"-square screen

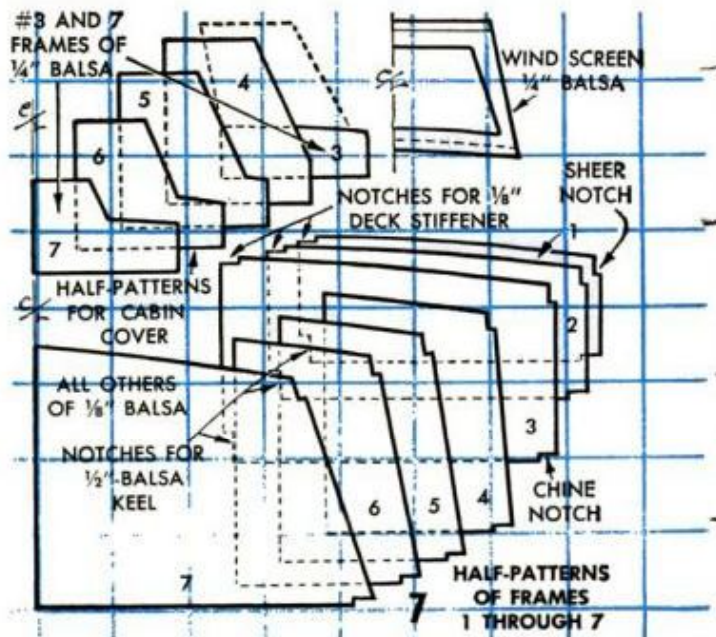

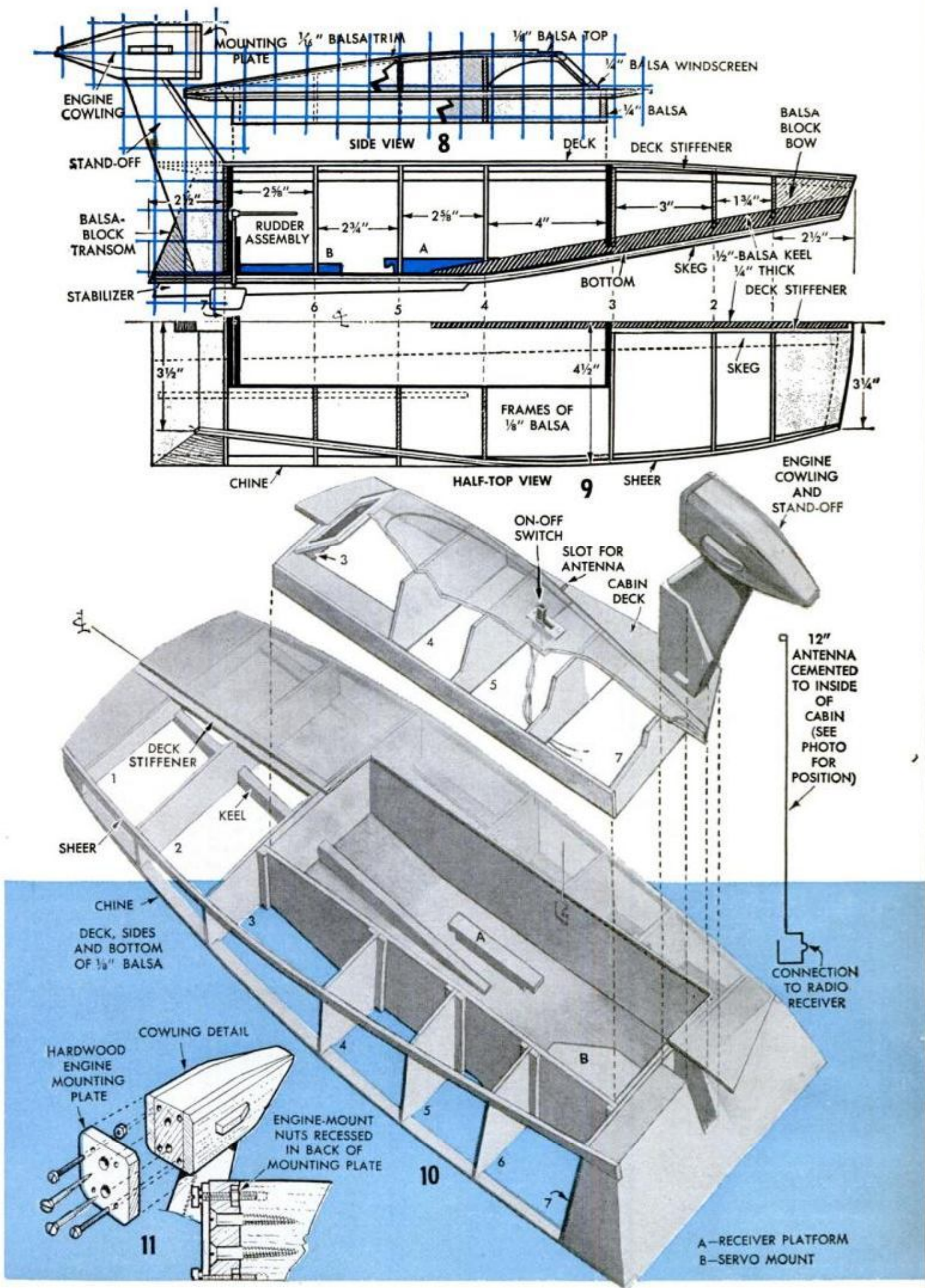

# Two-Tier

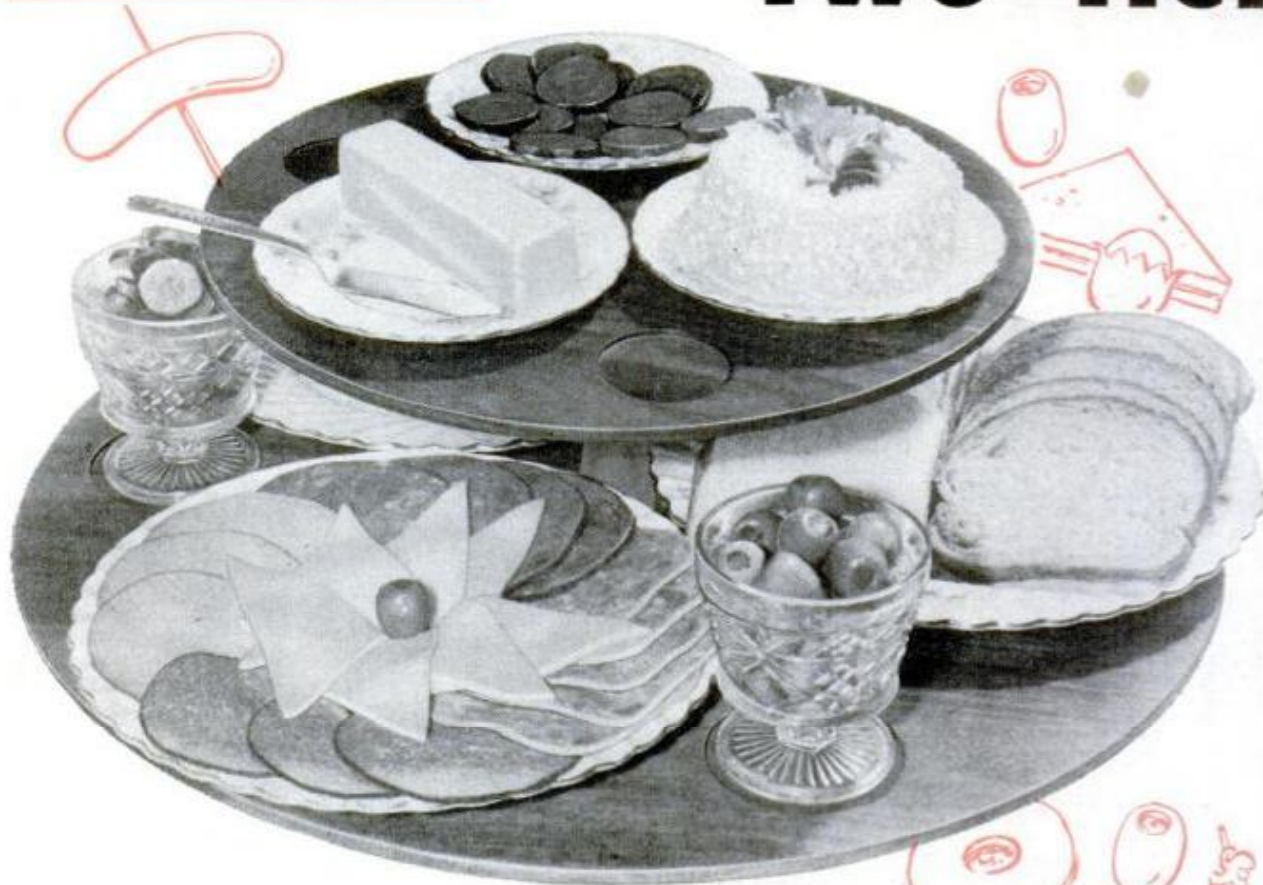

Food always seems to appear more appetizing when served from a Lazy Susan. Makes you hungry just to look at the photo above, doesn't it? Now, looking below at the left, you see the unit finished with the trays recessed as in Fig. 1. Arrangement of the recesses is optional. Directly below you see these recesses being cut freehand with a router. Although this calls for care, it's not as tricky as it looks



# LAZY-SUSAN SERVER

By John Jefchak

**W**ANT a conversation piece for your next social gathering? Bring out this stunning Lazy-Susan server. Loaded with cheese dips or the "makin's" for sandwiches, its two rotating trays will delight your guests and make selection quick and easy. Designed with classic simplicity to please the eye, it harmonizes with the traditional as well as contemporary.

Walnut was used in the original, but any one of the various hardwoods, such as mahogany, maple or birch, would do as well. All of the stock is  $\frac{3}{4}$  in. thick with the exception of the column. The top view, Fig. 1, illustrates the layout of the circular recess for dishes or bowls. Should you prefer, obtain dishes or bowls of your own choosing and dimension the recesses to suit the particular dishes.

Since solid wood is used, it is necessary to build up the base and the two trays from several pieces glued together edge to edge. Usually it is best to select three pieces  $\frac{3}{4}$  x  $5\frac{1}{2}$  x 13 in. for the base, three pieces  $\frac{3}{4}$  x  $5\frac{1}{2}$  x 15 in. for the upper tray and four pieces  $\frac{3}{4}$  x  $5\frac{1}{2}$  x 22 in. for the lower tray. These sizes allow 1 in. for waste in each case. The capital, Fig. 2, was turned out of a  $\frac{3}{4}$  x  $5\frac{1}{2}$  x  $5\frac{1}{2}$ -in. square.

In gluing up the pieces, first study the texture and figure of the wood grain, then decide on the most pleasing combinations. Mark the pieces selected and keep them in order. Check the edges to be joined since they must be smooth and straight in order to make good glue joints. Ripping out stock on a bench saw and jointing with a plane will give good results if carefully done.

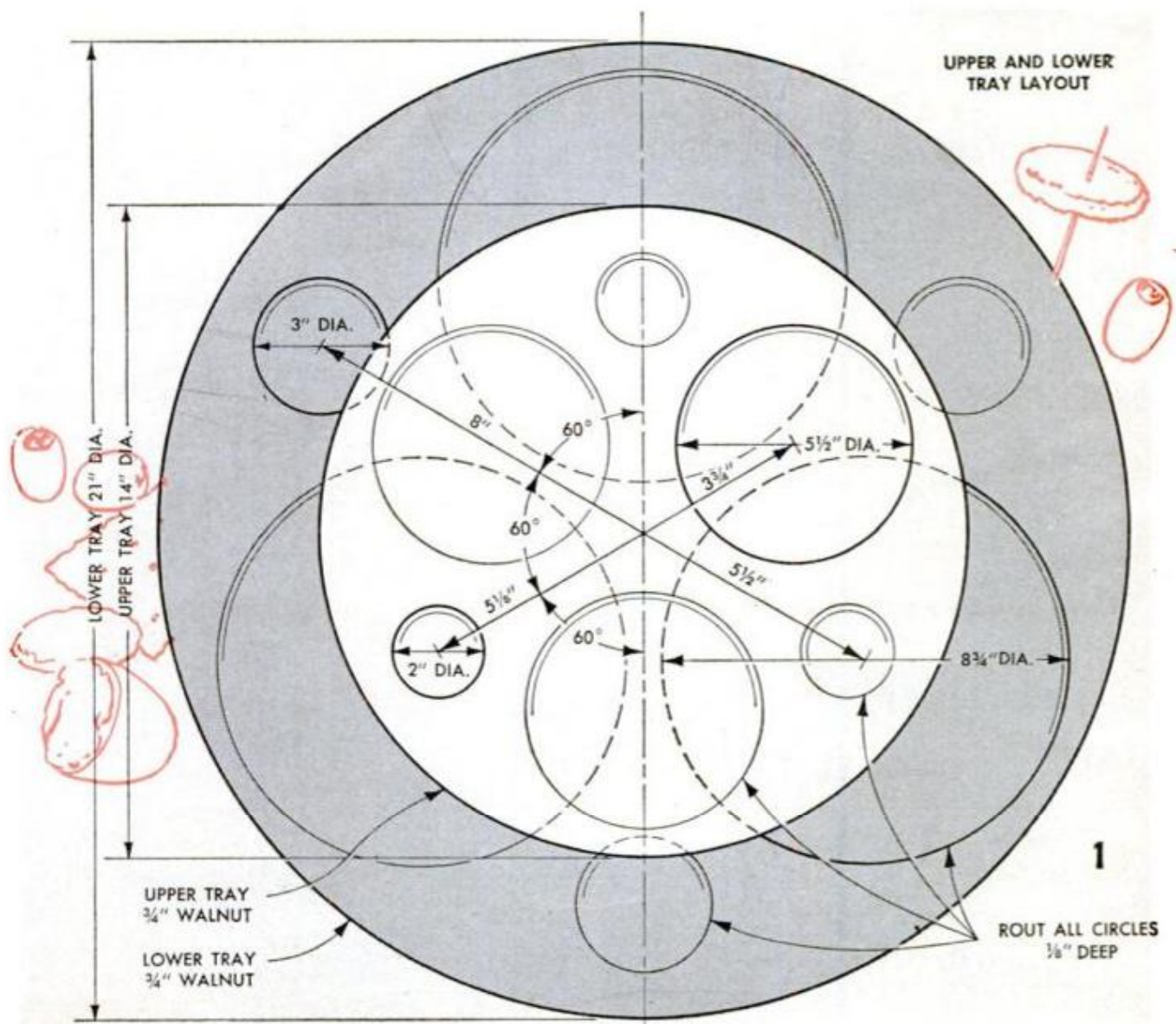

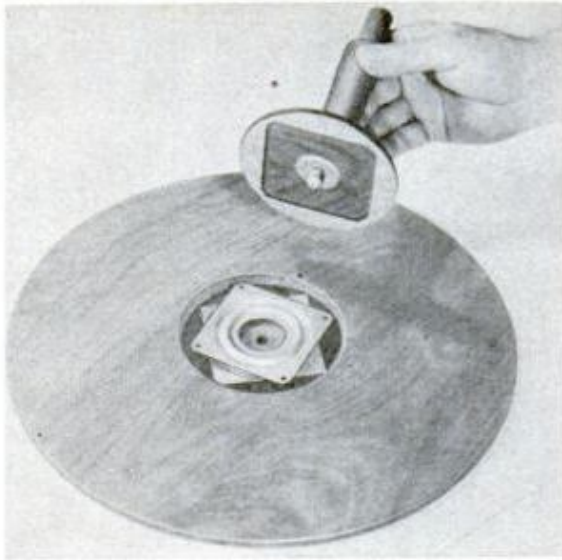

Underside of upper tray shows how Lazy-Susan bearing seats in recess. Note slight recess also in capital. Bearing is cemented in recesses with epoxy mastic

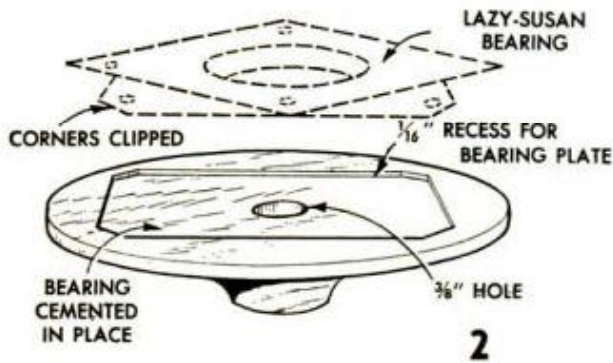

Bar clamps will provide the necessary sustained pressure for gluing. Three bar clamps, one above and two below, were used on the base. Likewise three were used for the upper tray. This method of placing the clamps will prevent buckling. Apply full-bodied glue to each joint spread to a uniform film. After drawing up the clamps, wipe off any excess glue with a damp cloth. Hardened glue is extremely difficult to remove. Allow the glue to cure overnight.

### Careful Sawing Required

Working from the diagrams, Fig. 1 and the detail, Fig. 4, lay out the three required circles, 12, 14 and 21 in., on the glued-up pieces. Mark the centers clearly and cut out the disks, using a bandsaw, portable sabre saw or a power jigsaw. Saw to the line but never beyond it, in order to retain a true circle. Sand all three disks on the top sides beginning with a coarse-grit sandpaper and working up to a finer grit. Smooth off the edges on either a belt or disk sander, or by hand with garnet paper.

Lay out all the circles for the recesses in the two trays, Fig. 1. A variation of individual recessing is to form one large recess in each tray, leaving a narrow lip around the outer edge to contain the various dishes or bowls. Another alternate method of tray construction is shown in Fig. 4. Here the individual recesses are formed by jigsawing them in a disk of 1/8-in. plywood and gluing it to the upper tray.

(Continued to page 210)

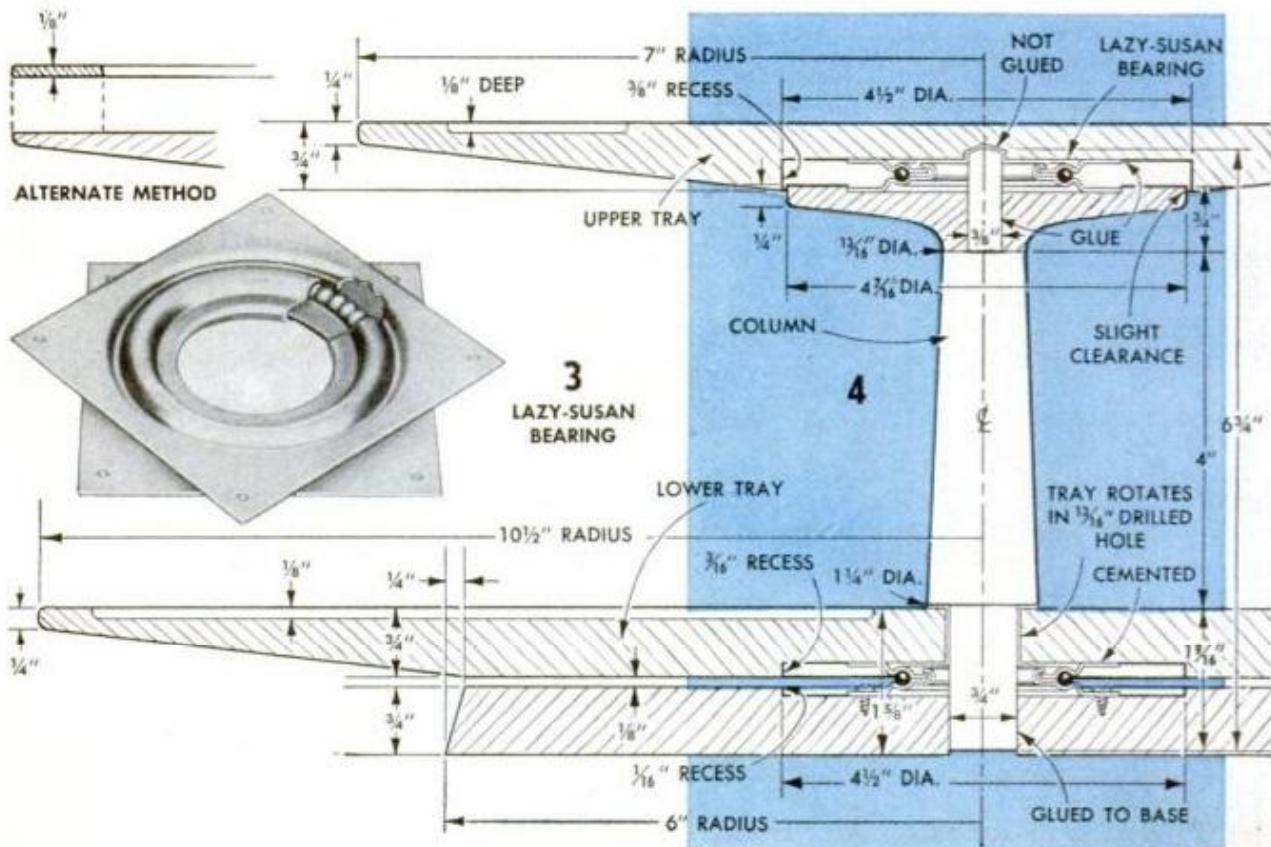



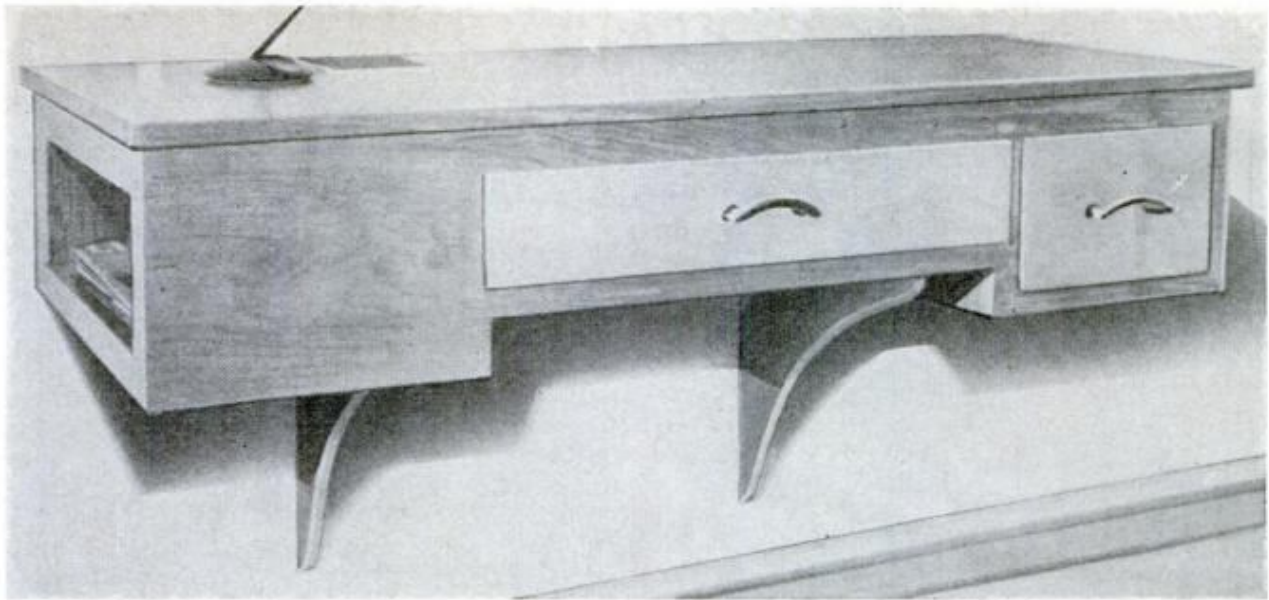

## Hanging Wall Desk Made of Plywood and Pine

Clean, simple lines make this desk an attractive yet useful addition to your home. The desk shown above measures  $8\frac{1}{2} \times 20 \times 48$  in. but these dimensions may be varied to suit individual needs. The top and front are  $\frac{3}{4}$ -in. fir plywood panels, while the ends, back and bottom are solid pine. The

front panel has sections cut out to accommodate a center and a side drawer, and one end has an opening for books and magazines. Partially supported by wooden brackets, the desk's main support is through bolts driven through the back and into the wall studs.

## Lock Nuts Cut From Coupling

While in the process of installing a stock-watering tank, one farmer found that he had no lock nuts with which to secure the inlet and outlet pipes. As an emergency substitute, two sections cut from the ends of a pipe coupling served perfectly for lock nuts which were drawn up tightly with a pipe wrench. Two rubber gaskets made the job leakproof.

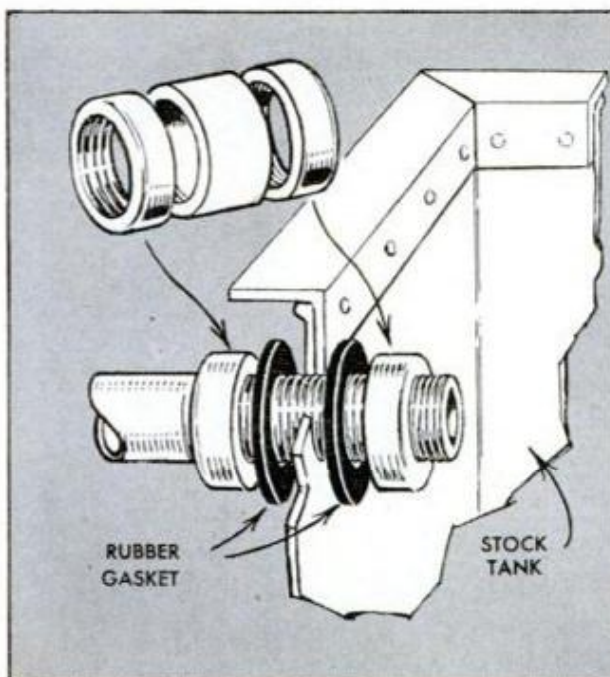

## Filter Fitted to Garden Sprayer

To keep the nozzle of a pump-type garden sprayer from clogging, install an automobile fuel filter in the line to trap coarse particles in the spray mixture. Drill out a 90-deg. brass fitting to receive the sprayer outlet tube to which the fitting is soldered. Clamp the hose to a straight, threaded union screwed into the outlet side of the filter.—L. G. Braunstein, Havertown, Pa.





**LADIES' HATS** are less likely to get crushed when stored on a wardrobe shelf if they are placed on small lamp shades that are covered with tissue paper as shown at left. Since the brim of a hat stored in this manner does not rest on the shelf, it will not become misshaped, particularly if the hat is heavy. Inexpensive shades may be purchased for this purpose, or shades that are to be discarded can be used

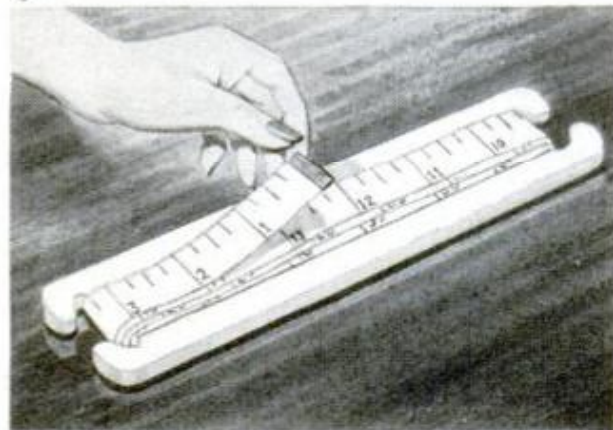

**CLOTH MEASURING TAPE** won't become tangled, frayed or creased when kept with other sewing paraphernalia if it is wound on a reel like the one shown in the drawing, left center. The reel is a piece of  $\frac{1}{8}$ -in. hardboard about 6 in. long and having undercut notches jigsawed at each end. Notches admit each turn of tape easily but prevent it from loosening or unwinding when stored in the sewing-cabinet drawer

**PLASTIC BAGS** used as dustproof wrapping for some wearing apparel sold in stores make good storage bags for woolen clothing that requires protection from moths. Treat the garment to be stored with a moth repellent, place it in a plastic bag of the right size and seal the open end with a warm iron as shown below, left. Place aluminum foil on each side of the plastic to prevent it from sticking to the iron

**HARDENED DROPS OF PAINT** on windows are easier to scrape off when the drops are dampened with turpentine shortly before removing them, below right. Turpentine softens the edges of the drops, making it easier for the scraper blade to get under the paint. It also serves as a lubricant, which allows the blade to glide over the glass without scratching it

## SOLVING HOME



**TO DEFROST A REFRIGERATOR** in a hurry, as when it is filled with perishable food but is long overdue for defrosting, try using a hair dryer to speed the job as illustrated at right. The warm air from the dryer can be directed completely around the freezer unit, insuring that no ice is left between the evaporator and cabinet interior

**WHEN FILLING** a hot-water bottle with boiling water, it is a good idea to place a spoon in the neck of the bottle to vent it as shown below left. This allows the steam to escape gradually on the side away from your hand, avoiding the danger of being burned

**TO BE SURE** of having the proper temperature setting for cooking certain foods (on top of the stove), fasten adhesive-tape tabs on the stove front to indicate the correct settings as in the photo below right. These settings, of course, must be determined previously when cooking each of the foods for which a temperature setting is desired



## PROBLEMS

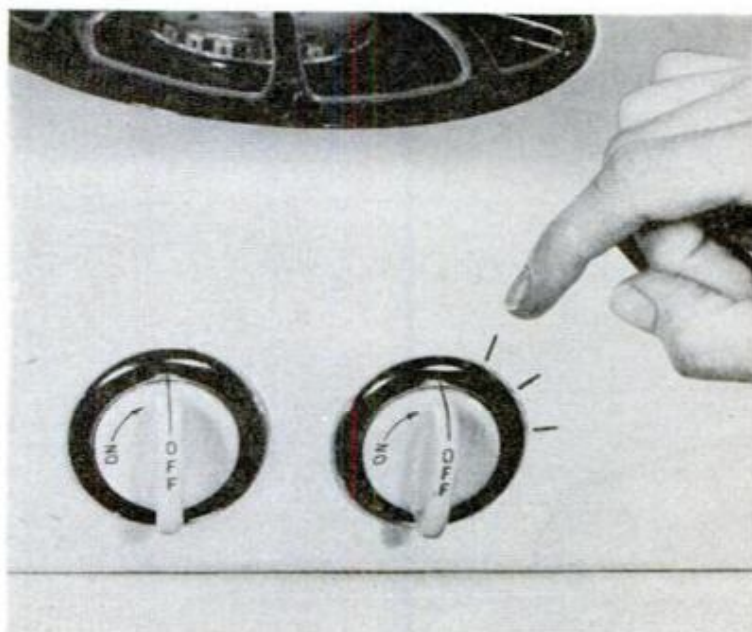



### Tote Box Set on Picket Legs

At berry-picking time, strawberry plants may be ruined and the berries crushed if a full tote box is set down on them. To avoid this, one fruit grower designed the tote box shown above. It is mounted on legs pointed like fence pickets. When the box is set on the ground, the legs, being pointed, will not crush the plants.

G. E. Hendrickson, Argyle, Wis.

### Drill Cranks Power Mower

Call it the lazy-man's way of starting a power mower but you can do it effortlessly with the sanding attachment of your portable electric drill. Simply chuck the flexible, rubber backing pad in the drill (without a sanding disk attached) and press it against the starting pulley, using two hands and bearing down firmly. Place one foot on the mower for safety, then trip the drill switch.—Phillip D. Bryant, Oxford, Miss.

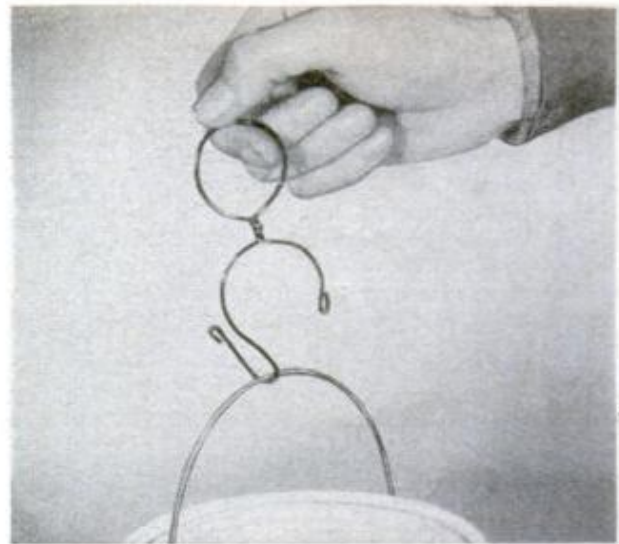

### Loop Improves Paint-Pail Hook

When painting from an extension ladder, some do-it-yourselfers use a wire hook to suspend the paint bucket from a rung at about waist level so that it is within convenient reach. To make it easier to grasp the hook and provide a sure grip on it when moving the bucket, one homeowner formed a finger-size loop on such a hook as shown.

R. Hanscom, Elmhurst, Ill.

### Disposable Wren House

House wrens are not fussy about interior-exterior decor of the home they occupy for a season. They'll be happy with anything you provide, even a milk carton. An entrance hole, a perch (not essential) and two wire hangers convert the carton to a wren house. If you don't like the looks of the thing, then dunk it in boiling water to remove the wax and paint it any color that suits your fancy.



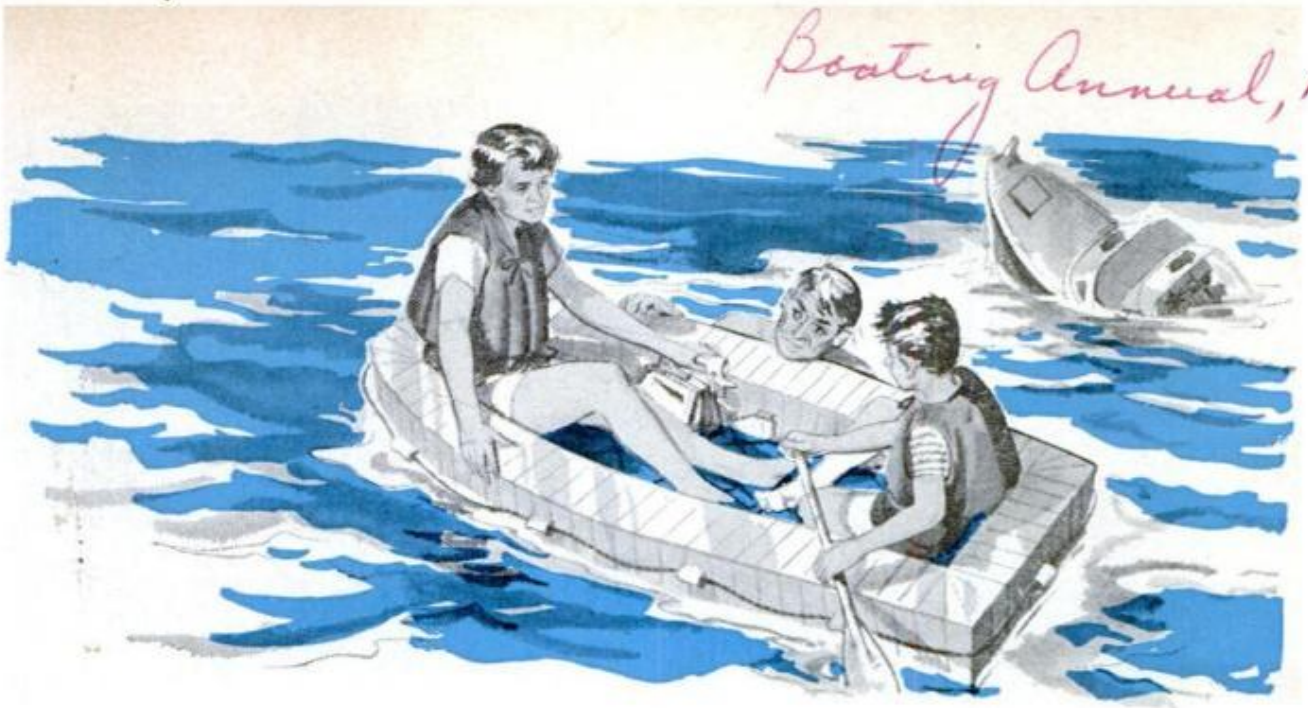

# Raft for Lifesaving and Play

DESIGNED for use as life-saving equipment to be carried on board a small cruiser, this life raft is as inexpensive and easy to make as it looks. It is made of a plywood core to which either foamed plastic or cork boards are laminated and wrapped with glass-fiber cloth as in Fig. 2, details A and B. The raft also serves as a "wet" dinghy that youngsters can have a lot of fun with when in port.

To build the raft, first cut the plywood core to shape as in Fig. 1. This should be dimensioned so that when completed the raft will fit the stowage place reserved for it on board. If stowed in a pram kept on board or towed, be sure the raft will nest in it as in Fig. 3. Canvas strips folded and stitched to form loops on the inboard and outboard sides of the float as in Figs. 1 and 4, provide a means of attaching the floor netting and life line.

Hi Sibley, Nuevo, Calif.

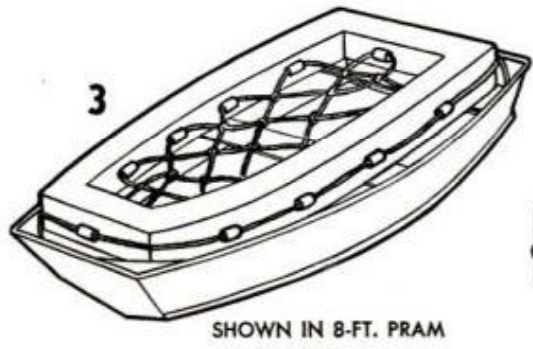
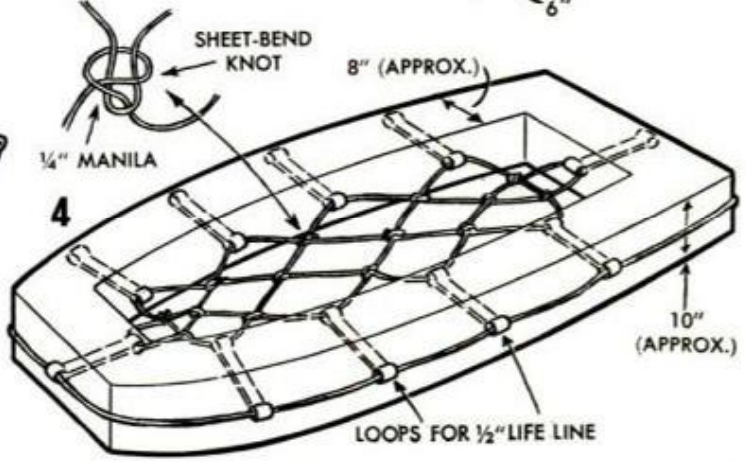
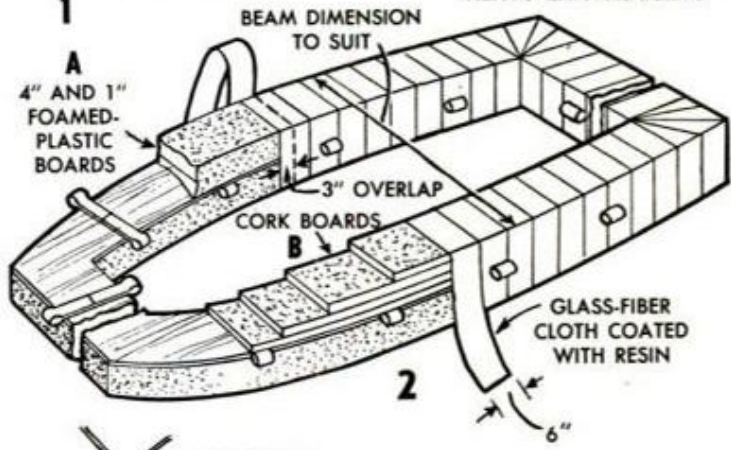
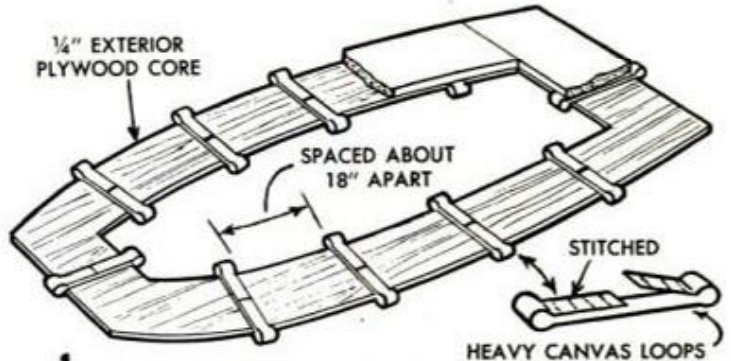

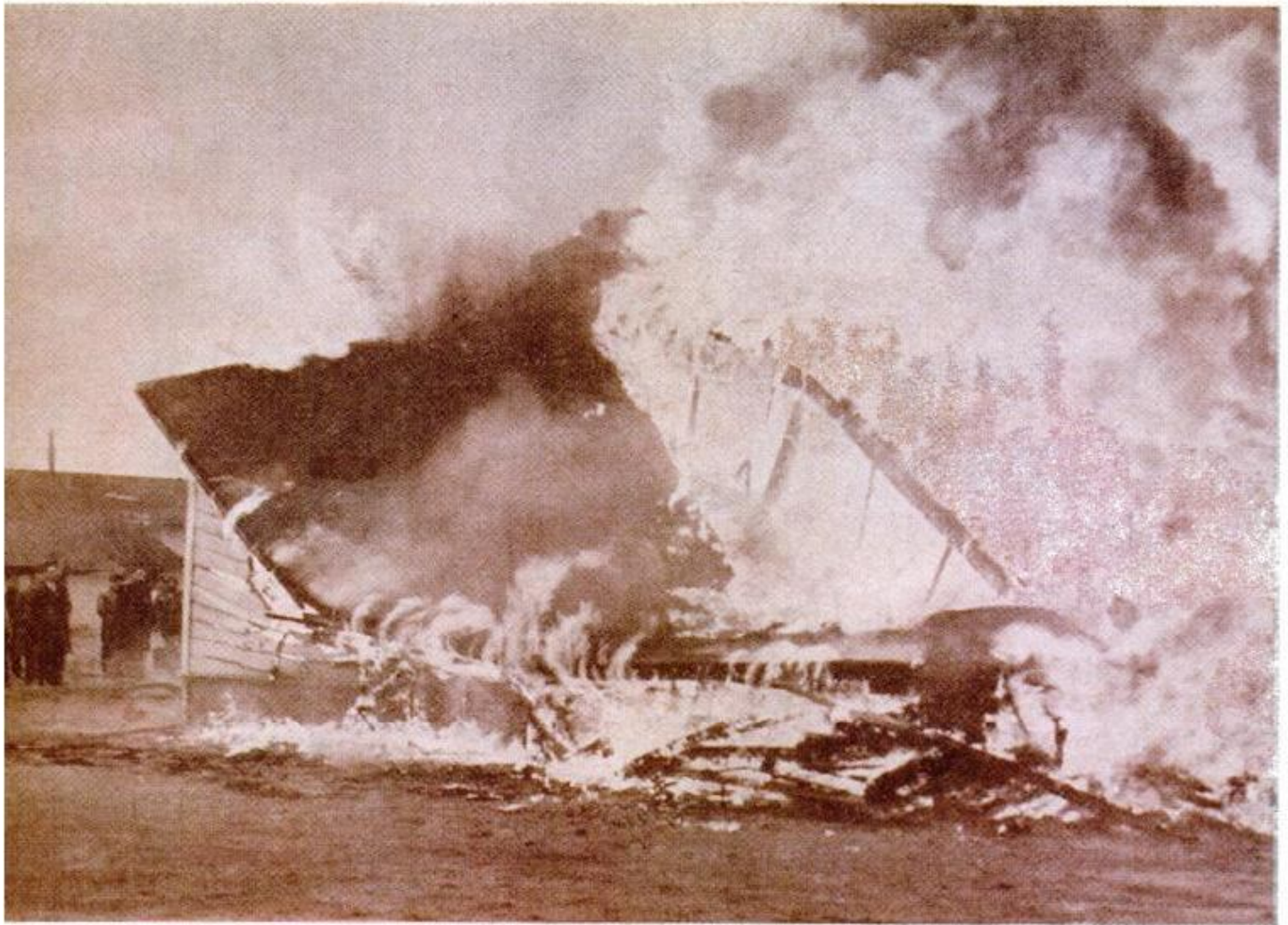

# HALTING FIRE

By Paul W. Kearney

Hon. Life Member, International Association of Fire Chiefs  
Author of "Disaster on Your Doorstep"; and "I Smell Smoke"

**L**AST DECEMBER in a Richmond, Va. residence a fire started in an overstuffed sofa some hours after a Christmas party had broken up. Once under way, the flames spread rapidly up an open stairwell, cutting off the exits at each end of the upper hall. Final toll: Five dead; the house a total loss.

In contrast to this tragedy, consider the incident in a Fresno, Calif. Veteran's Housing development where another live

cigarette butt fell out of an ashtray onto another sofa after the GI and his young wife had gone out to the movies. Fiberboard walls and ceilings had been extensively used in this project. While the blaze which spread from the sofa lasted an estimated 40 minutes, consuming every stick of furniture in the room, it never got out of the apartment to sweep through the rest of the building—it didn't even damage the electric wiring in the walls or ceiling. It

## *. . . but it could save your life*

The finest fire-retardant paint cannot prevent a fire, extinguish a fire or withstand a severe fire indefinitely. It cannot make anything "fireproof." But it can reduce the combustibility of the surface

to which it is applied for a reasonable time. This can be time enough to get out of a burning building or time enough to do something about the outbreak before the fire gets completely out of hand.



Fire-retardant paint is activated like a sprinkler system. When the temperature reaches 400 to 500 deg. F., the intumescent agents in paint start to swell and form a cellular barrier which insulates the wood and other combustible surfaces underneath. This insulating barrier reduces excessive heat penetration and retards the spread of flame

## WITH A PAINTBRUSH

simply died from lack of sufficient nourishment when all the available fuel in the room was exhausted.

The big difference between these two fires was no bigger than a paintbrush. For while an unprotected open stairwell spread the first outbreak with tornado velocity, it wouldn't have taken the second blaze long to eat its way out to an even more extensive stairwell if it hadn't been confined to its point of origin by an effective fire-retardant paint.

Most householders are unaware of the existence of such protection—and for a good reason. Most manufacturers sell all they can produce to industrial, commercial and government users, hence aren't too concerned about the retail market. Since early in World War II, the Army and Navy have been using a brand that has been listed by the Underwriters Laboratories for some 20 years. Now the current UL (Underwriters Laboratories) list includes eight other "surface coatings" which can be brushed or sprayed like ordinary paint and are available to the householder.

Describing these coatings in general, the Paint, Oil & Chemical Review says: "It is generally accepted that they fall into one of three general classes: Glazing agents that fuse to block oxygen from reaching the burning area; intumescent agents which puff up to insulate underlying

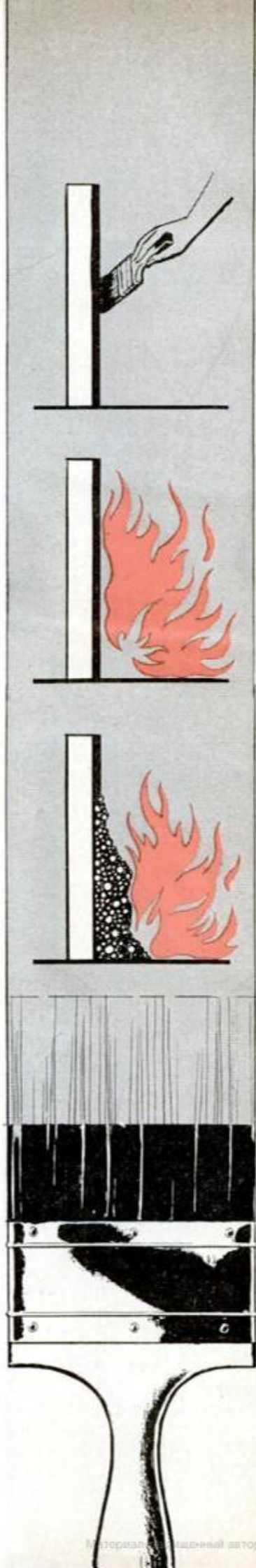

Manufacturer and Brand Name	No. of Coats	Total Coverage Sq. Ft. Per Gal.	Washable	Colors Available Plus White	Interior or Exterior Use	Underwriter's Laboratories Ratings for Interior Use on Unprimed Wood		
						Flame Spread	Fuel Contributed	Smoke Density
Albi Mfg. Co. Rockville, Conn. Also make two other grades not listed here (Ready mixed)	2 1	100 100	Yes Yes	10 Plus Black	Both Interior	15-20 15	25 15	0-5 5
Baltimore Paint & Chemical Co. Baltimore 30, Md. (Powder & liquid to be mixed)	1 1	150 500	Yes, when overcoated With SAF 202	8 8	Interior Interior	15 10	15 15	5 0
Builders Research & Chem. Co. 4990 East Asbury, Denver 22, Colo. (Ready mixed)	2 Plus Primer	100	Not scurrable	6 Plus Clear	Interior	10	10	40
Cheesman-Elliott Co. 647 Kent Ave., Brooklyn 11, N.Y. (Ready mixed)	2	87	Yes	8	Both	40-50	20-35	0
E. I. duPont de Nemours Wilmington 98, Del. (Ready mixed)	3	100	Yes	7	Interior	50-70	25-35	5-45
Flamort Chemical Co. 746 Natoma St., San Francisco 3, Calif. (Powder to mix with water for spray)	3	110	No	Clear Only	Interior	65-70	50-55	Same as bare wood
Glidden Co. Union Commerce Bldg. Cleveland 14, Ohio	3	70	Yes	White in stock Special colors on order	Interior	50-60	30-35	25-50
Benj. Moore & Co. Newark 5, N.J. (Ready mixed)	2	100	Yes	10	Interior	40	25	20
Morris Paint & Varnish Co. 27th & Douglas, Omaha 2, Nebr. (Ready mixed)	2	100	Yes	6	Interior	40	35	30

NOTE: The lower the number, the higher the rating. (These coatings also listed for cellulose wallboard.)



material from an adjacent fire; and chain-ending agents that smother a fire by releasing or by chemically combining to form nonflammable vapors, thereby excluding oxygen." None of these should be confused with incombustible paints which will not ignite, but which do nothing to halt flame-spread or heat penetration in the material underneath. As the Navy learned long ago, coat upon coat of ordinary paints applied to surfaces can add considerable fuel and fumes to a going blaze.

The majority of the protective paints now available are of the intumescent type, and many also generate oxygen-excluding vapors. Put a blowtorch flame on a piece of board coated with such a paint and the coating immediately blackens, then puffs out to a thick, insulating pod or blister resembling a scorched marshmallow. This blister will glow until the flame is removed, whereupon it "blacks out." The charred area can then be scraped clean and refinished.

In other words, the coating does not support flame nor add appreciable fuel to the fire. Equally vital, it checks the penetration of the heat so effectively that you can safely put your bare hand on the opposite side of the board while the blowtorch is still operating.

How important this factor is was shown in a test which I saw the Cleveland Fire Department make some ten years ago. A condemned, five-room dwelling was used for the experiment: The basement ceiling was painted with a fire retardant coating; the basement was stacked with old orange crates and packing boxes which were set ablaze and allowed to burn for 25 minutes. In this time the pyrometers showed a temperature of 1600° F. Yet not only were the ceiling beams and floor boards uncharred—but the temperature in the room directly above never exceeded a safe 205°. (It takes 325° to ignite a parlor match; 446° to touch off cotton batting.) Since then this particular paint has been greatly improved for less flamespread and much longer heat resistance.

It is important, of course, that a fire-retardant coating add no toxic fumes to a fire, and all of those listed by the UL are free from this hazard. The amount of smoke contributed also is very significant, since smoke kills far more fire victims than flame. This feature is rated in the UL listings and shows a wider variation than either flamespread or fuel contributed.

Since the function of a fire-retardant coating is to upgrade a free-burning material—or even a flash-burning one, such as cellulose wallboard, to the category of slow burning or fire retardant, a word

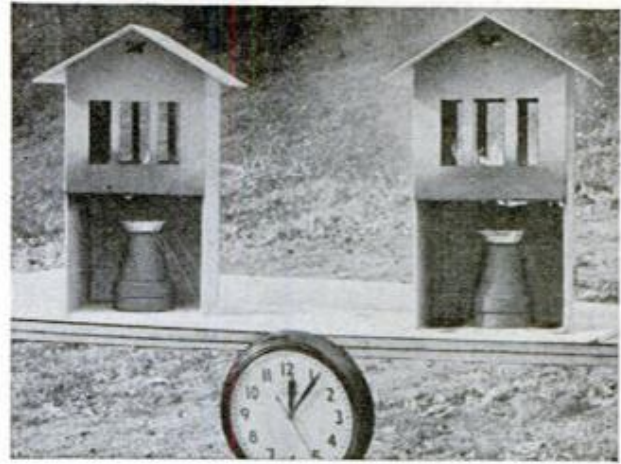

Above, after 6 min. exposure to an alcohol fire, flames are beginning to lick through the floor of the untreated plywood house at the right. House at left has been coated with fire-resistant paint

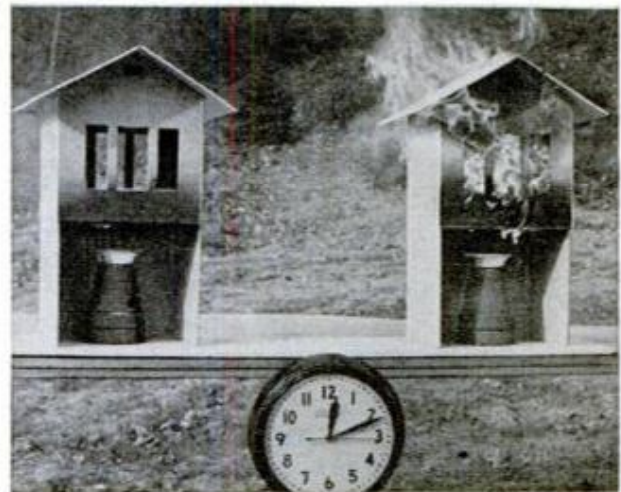

Above, after 12 min., the alcohol fire in both houses has burned out. As you can see, the untreated house at right is ablaze while there is no flame in this length of time in the treated plywood house

Below, after 20 min., the untreated house is completely consumed by flames. Treated house is scorched and has hole in floor where it was in direct contact with the fire but is otherwise intact and unharmed





Only damage done to interior by fire was puffing of fire-retardant paint although furnishings were destroyed. Swelling, spongelike insulating puff is easily scraped off with putty knife and surface repainted

about the standards employed is in order. The inherent rate of flamespread of a given material is measured at UL by inserting a 25-ft. sample in a tunnel; applying flame to one end for three minutes; then checking the time it takes for the flame to travel to the opposite end. With untreated red oak, which is the standard yardstick, this takes five to six minutes. This is considered normal for an average combustible, hence is so rated as 100 in the scale. On this basis, flamespread ratings given in the National Fire Protection Association Handbook classify noncombustible as 0-15; fire retardant, 16-30; slow burning, 31-75; combustible, 76-200; highly combustible, over 200.

The majority of fire-retardant coatings come ready-mixed and in a number of dec-

orator colors, mostly flat. (Some users apply a regular enamel top-coat for a gloss finish.) They are applied just as easily as a typical paint, by either brush or spray. In the early days there was an irritating odor during application, but that stage has long since passed among the better brands. Coverage per coat is roughly about half of that expected from a conventional enamel. If you want greater coverage with proportionately less protection, you can spread it thinner than specified in the UL listings. To be specific on this point, one leading brand has a flamespread rating of 10 for two coats at 200 square ft. per gal. per coat. A single coat of this same paint at the same coverage gets a flamespread rating of 25. This is still very good—but it is like going out in the rain with only one rubber.

Most fire-retardant coatings can be applied over an existing paint surface, but in this case two coats are required for the same rating obtained by one coat on unpainted wood. Some brands also protect any interior surface, including metal. Such paints are widely used to raise the protective rating of gypsum board by from 50 to 90 percent, and they are taking the notorious metal ceiling out of the fireman's nightmares. In one test, for example, an aluminum panel was melted in 2½ minutes by a 2200-deg. welding-torch flame. A similar panel coated with a top-grade fire-retardant paint remained intact after 25 minutes of the same temperature.

Some of these paints have a life expectancy of 10 to 12 years under normal indoor conditions. They also can be washed repeatedly, even scrubbed, which is rather important for home use. However, there are brands, which are acceptable fire retardants, but are water soluble, hence will not tolerate high humidity. This is a point to remember if you're looking for bargains.

★ ★ ★



## Nonslip Boating Gloves

Cheap cotton work gloves can be converted to handy boating gloves by coating the finger tips, thumbs and even the palms with plastic rubber. This is available in tubes at the dime store, dries in an hour or two and adds the nonslip properties of regular rubber gloves without the discomfort. It's a neat trick that will pay off when handling your outboard motor and in launching your boat.

Ken Murray, Colon, Mich.

A thin layer of coarse gravel spread over the top of the soil in a window box will prevent rain from splashing the dirt on the sill and window.

## You'll Find Many Extra Uses for Colorful Plastic Caps



Tipped with colorful plastic caps, exposed ends of bolts have a finished look and caps offer protection

Designed and marketed primarily to add color and protection to the exposed ends of perforated-hardboard hooks, the small plastic caps recently introduced can be put to many other practical uses either to improve the appearance or the function of the item. Two examples are shown in the photos above. One shows how the caps can

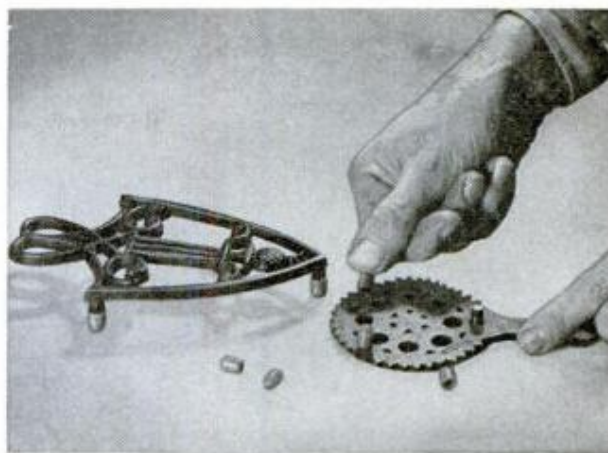

Made of rubberlike plastic (polyethylene), caps can be used to make feet of iron trivets nonmarring

be used to make trivets nonmarring, the other how they can be used to cap the projecting ends of exposed bolts. Other uses will come to mind in working with them. The caps come in two sizes,  $\frac{1}{8}$  and  $\frac{1}{4}$  in. I.D., and in white, black, red, yellow and turquoise. Being of polyethylene, the caps can be pressed in place and will stay put.

### Milk Carton Ignites Charcoal

When you are about to light your charcoal grill and find you are out of lighter fluid, a milk carton will prove a good substitute. Cut off the top of the carton and nest it in the center of the fuel bed. Then fill the carton with coal and ignite. The wax-coated carton will produce a hot flame around the center coals.



MAY 1960

### Pulling Stakes the Easy Way

Pulling stakes on sidewalk forms is easy on the back when you make use of a C-clamp and a pry bar. Clamped to the end of the stake, the C-clamp forms an eye for the end of a 2 x 4 which, when rested on a fulcrum block, will pry up the most stubborn stake with little effort.

Robert L. Sargisson, Berwyn, Ill.

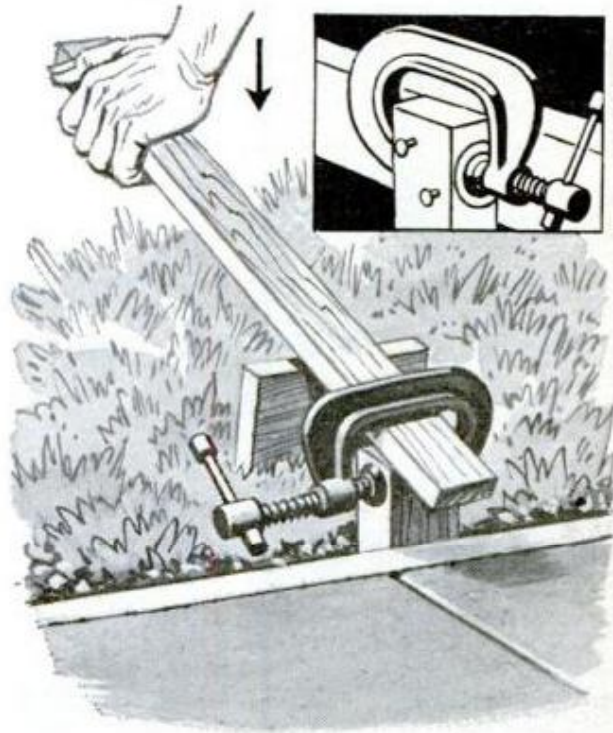

159

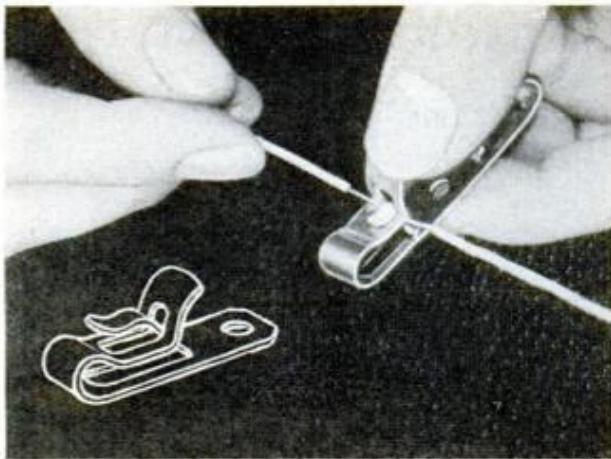

## Altered Fahnestock Clips Are Easier to Use

Spring clips called Fahnestocks can be made more versatile and easier to use by altering them as shown in the detail. Simply bend up the loop through which the wire is inserted so that when the clip is compressed the end of the loop extends above the spring blade. Now, not only can the wire be inserted from the front of the clip but a connection can be made in the middle of the wire by removing the insulation at the very point of contact.

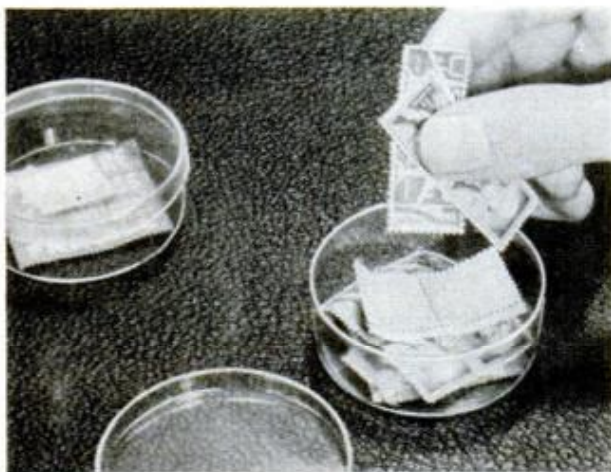

## Clear-Plastic Boxes Store Odds and Ends

Clear-plastic containers in which typewriter ribbons are sold can be used to store stamps, clips, labels and many other small items which may otherwise become lost or spilled among the contents of a desk drawer. The clear plastic allows the contents to be seen at a glance which is doubly helpful when making a quick inventory. The containers can be stored by stacking them in drawer compartments and are attractive enough to leave on the top of your desk.

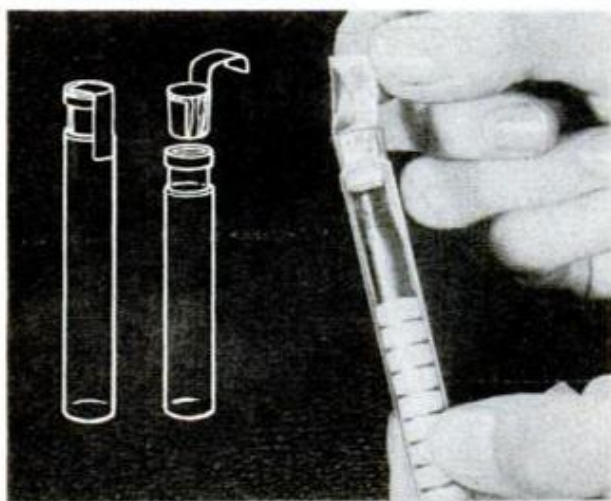

## Capsule Bottle Cap Removed By Cellophane-Tape Tab

Though compact and convenient to carry, the small narrow tubes used for pills and capsules often are difficult to open. However, the cork stoppers of such tubes are easily removed if a piece of cellophane tape is wrapped lengthwise around them so that the tape extends above the top to provide a tab. The tape in no way affects the sealing of the bottle since it is pressed into the cork. If the extending end is folded down along the side the bottle, the sticky tab will be out of the way.

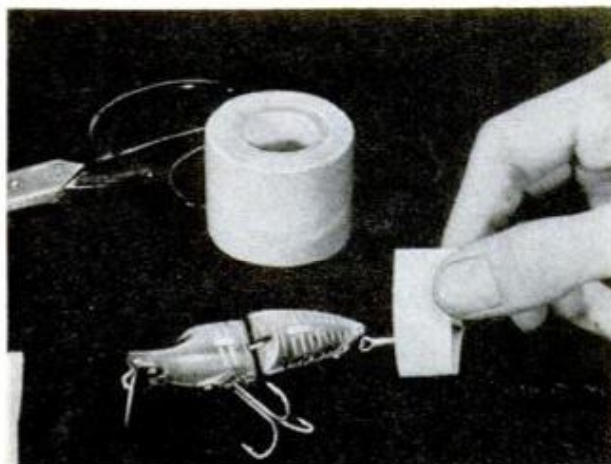

## Tape Around Lure Hooks Prevents Injury and Tangling

By wrapping a piece of masking or friction tape around the hooks of fishing lures, the fisherman can insure against accidents and also prevent the hooks from becoming entangled when they are stored in the tackle box. Another way to shield the lures is to stick them into a strip of balsa or cork cemented to the inside of the tackle-box lid. Stored in this manner, the desired lure also can be spotted at a glance.

H. Hanscom, Elmhurst, Ill.

## Pull-Out Leaf Houses Typewriter in Knee-Hole Desk



Here's a way that you not only can make it convenient to type on a high knee-hole desk, but you can store the machine in the desk as well. Usually there is sufficient knee room to permit a portable typewriter to be supported under the center drawer. So all you need do is to fasten two metal channels to the sides of the knee-hole opening at a height that will support the machine at a convenient typing position and then fit the channels with a plywood panel as long as the knee-hole is deep. The machine is fastened at one end of the panel to assure sufficient support when pulled out, flipped over and slid in place. When stored, the typewriter is suspended upside down at the back of the desk.

John E. Armstrong, Evanston, Ill.

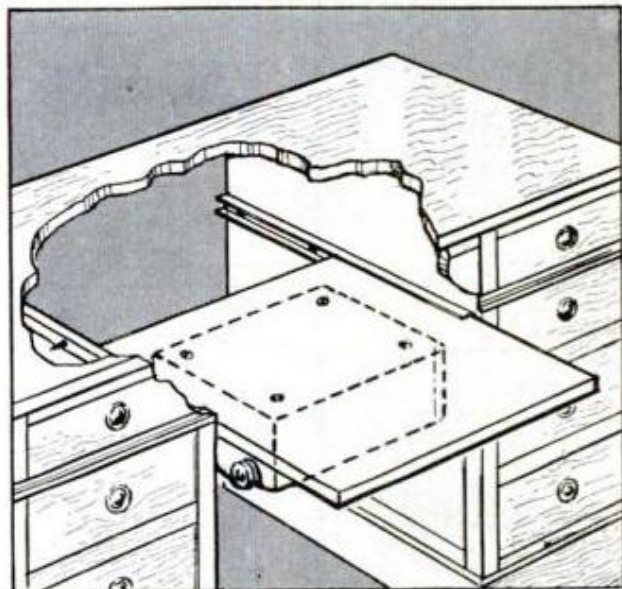

### Digging Tunnel Under Walk

When a pipe or electrical cable must be fished under a driveway or sidewalk you can dig a tunnel for it with hydraulic pressure. Dig a starting trench at one side of the walk, wire the nozzle of a garden hose to a steel rod and let the water pressure wash away the soil as the rod pokes a hole. As the soil washes back out of the tunnel, it is cleared away.

### Wooden Hangers Hold Moth Balls

An efficient way of mothproofing clothes is to attach several moth balls directly to each hanger. This is done by drilling three or four holes in the wooden hangers, large enough to seat a moth ball, and then stretching a strip of cellophane tape over each ball on both sides of the hanger so the ball will not fall out when it decreases in size.—M. Robert Beasley, Jackson, Mich.

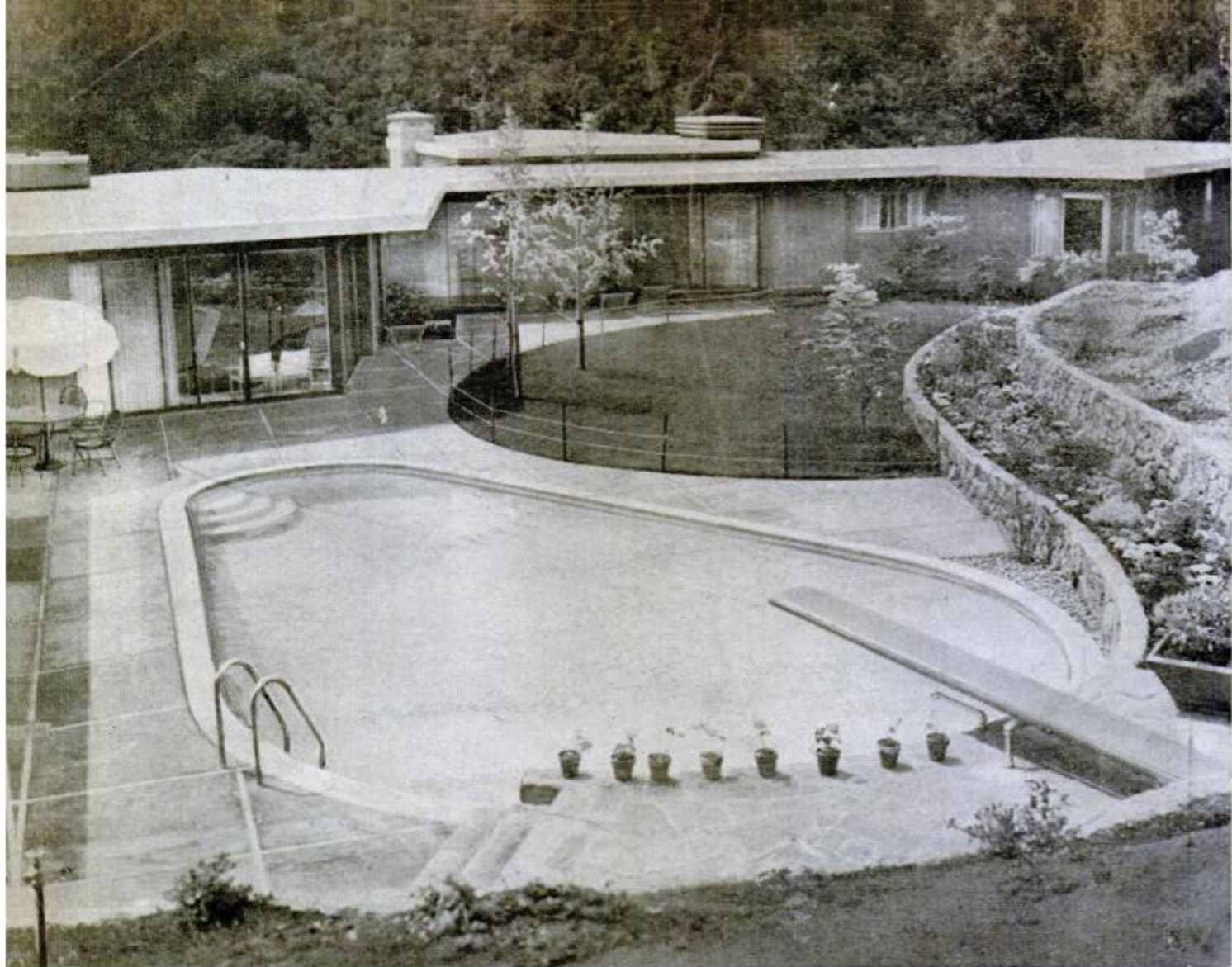

# GET IN THE SWIM

## BY BUILDING YOUR OWN POOL

### PART II

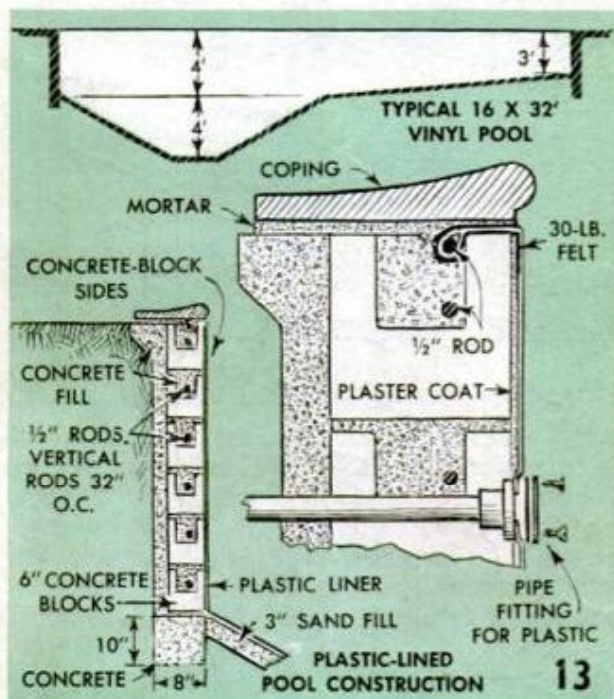

**I**F YOU ARE planning to build your own concrete pool, you will need to obtain a good set of plans locally. You need on-the-spot plans because each concrete pool is different, depending on its size, shape, the soil supporting it, the temperature extremes of the area and whether it is to be Gunited, poured or dry-packed. Today there are two good sources of concrete-pool plans. Many large cities now have engineering firms which specialize in designing home pools. They furnish the plans many pool builders use. One of these firms will inexpensively check your site and plan the pool you desire for it, including complete plumbing blueprints and also for the steel reinforcing of the shell. Or you can arrange with a pool-equipment dealer to buy all the necessary equipment from him. You have to buy it somewhere and in return most dealers today will similarly go over the site

and furnish plans for your particular pool.

Glass fiber and metal pools come with complete installation plans, as do the plastic-liner pool kits. Because they are quite flexible, the inexpensive plastic-lined pools with sand bottoms can be built by the same plans in warm and cold climates and in different soils. Concrete blocks are as practical as poured concrete when laid and reinforced as shown in Fig. 13. The block sides should be given a thin waterproof plaster coat to assure a smooth surface for the plastic lining. A plastic-lined pool shaped approximately as shown in Fig. 13 will give better swimming and diving features than one with a flat bottom. The detail also shows a good way to anchor the lining at the top of the pool. A 1/2-in. reinforcing rod is slipped inside the cuff of the plastic lining (or is rolled up in it, if no cuff) and then is embedded in the mortar joint under the coping. A strip of building felt will protect the plastic at this point from any sharp edges of the masonry. The mortar joint can be broken easily with a chisel and the coping removed if the lining should need replacing.

Digging the hole for the pool by hand is plain hard work and no saving today when a tractor-loader or small backhoe will dig it so quickly and inexpensively. About 24 man-hours with a flat shovel and a mattock is usually needed to smooth and finish the hole. Plan to dig the hole and lay the concrete or other shell in as short a time as possible, to eliminate the one big hazard of pool construction—a cave-in of the raw earth sides from a sudden rain.

With good plans, you can lay the plumbing and the reinforcing steel for a Gunited pool yourself without complications. Then the crew brings in its Gunite equipment

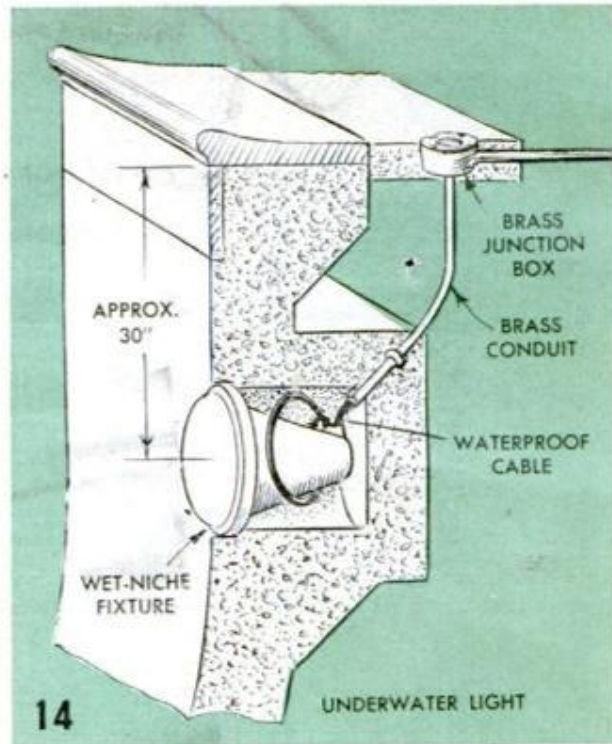

and sprays the shell, usually in one day, at an average cost of about \$700.

For a dry-pack concrete pool, be certain to use the extra thickness and the amount of reinforcing wire recommended by your plans. The sides are packed first, packing the stiff mix in a spiralling manner around the pool so that no great amount of fresh mix needs to be supported in any one place. Some of the mix will probably sag down but can be worked back up the sides with a trowel or spread on the bottom. At the top, the sides are completed by packing the mix behind leveled boards. The bottom is poured last. The secret of a good dry-pack job is to have several persons on hand to shovel, pack and smooth the pour.

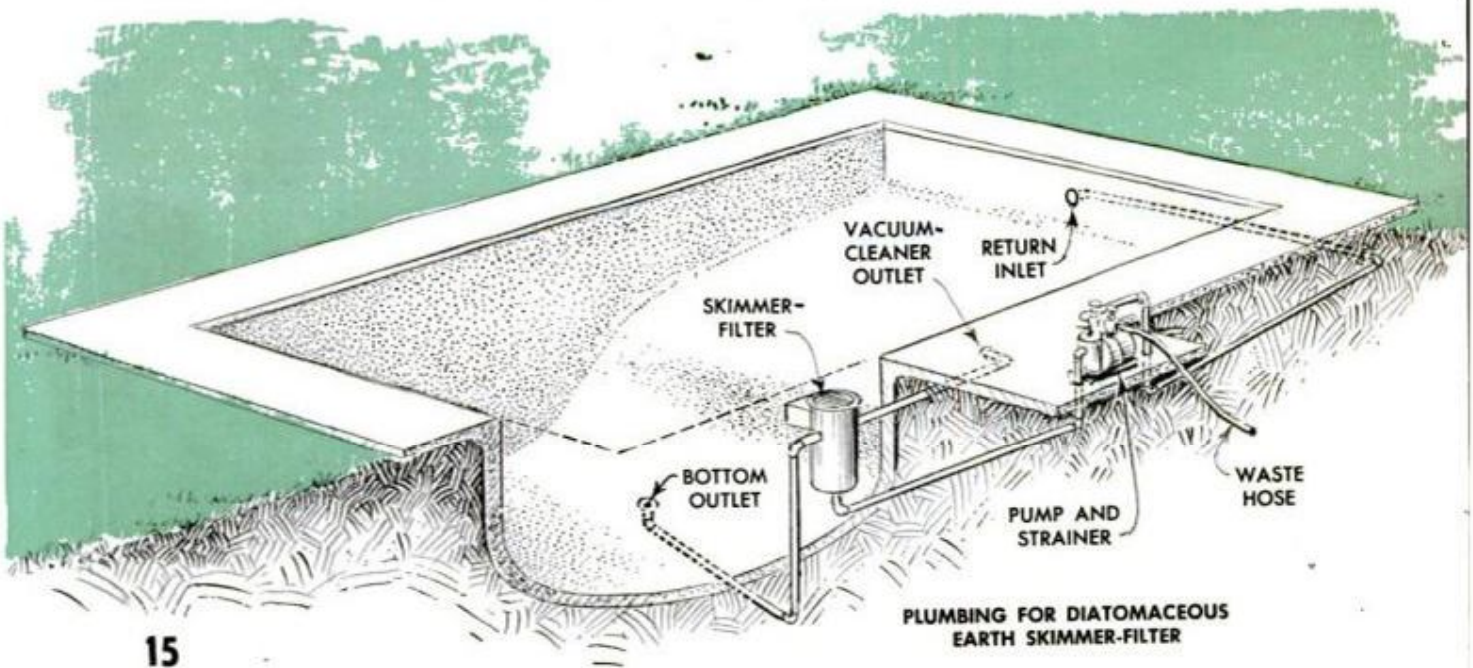

15

MAY 1960

163



Once the excavation has been made work can move rapidly through several stages to the finishing touches. Note coping form

If you plan to have an underwater light in your pool, a small niche to fit the light you obtain needs to be formed in the pool wall when the shell is built. Fig. 14 shows a typical installation. The waterproof light fixture usually is placed in the deep end directly under the diving board. It can be either 300 or 500 watts, is grounded and is surrounded by water for cooling. A length of waterproof cable looped inside the niche allows the fixture to be removed and lifted above water for replacing the bulb.

Usually, the finish coat of white calcareous-base plaster is laid on a concrete pool five to seven days after the shell is built. If the shell is rough, a thick coat of waterproof grout (sand and cement, plus

anti-hydril or tricisal) is plastered on first. If an expert is not available to apply the calcareous-base plaster it is probably best to apply a smooth coat of the waterproof grout and finish the pool with vinyl or chlorinated-rubber swimming-pool paint.

The water line of one or two rows of ceramic tile is cemented in place before the finish plaster is laid. Tile of light-blue color is the most popular, giving a blue reflection to the water, but warm colors, such as peach, orange, or maroon, are also good as their contrast intensifies the blue of the water. Because filtered water is a brilliant turquoise blue when it has a white background, the plaster or other finish of a pool shell is best a bright white. A blueshell gives a dark pool.

Most pools today are trimmed along their top edges with precast coping blocks, which are available from any pool dealer. They are slipproof and their bullnosed shape gives a good handhold and drainage away from the pool. Cut-flagstone and brick also give attractive pool copings, but their rough surfaces are not too practical for children. Scum gutters along the water line are obsolete today. A small skimmer does a much better job of removing floating material, and gutters are difficult to build and to keep clean. A deck or paved walkway 3-ft. wide around the pool is desirable, and it should slope away from the pool at a slant of 1 in. in 4 ft. for drainage. Grass up to the coping means clippings continually tracked into the pool and the splashing of chlorinated water will brown nearby grass. Most decks are of poured concrete, the surface being finished slightly rough so it will not be slippery. Flagstone, brick and wood blocks also are good.

Even if you do not plan at present to have a filter system or heater, it is advisable to stub in their piping when the pool shell is built. Copper pipe is best; galvanized pipe deteriorates in chlorinated water. Follow the pipe sizes specified in your plans, usually 1½ to 2-in. diameter, and if in doubt, use a larger size. Especially for a sand filter, use the recommended pipe, pump and strainer to have a strong backwash flow which is needed to clean the filter properly.

Fig. 15 shows the simple plumbing required for a diatomaceous earth skimmer-filter. The pump and its strainer usually are placed

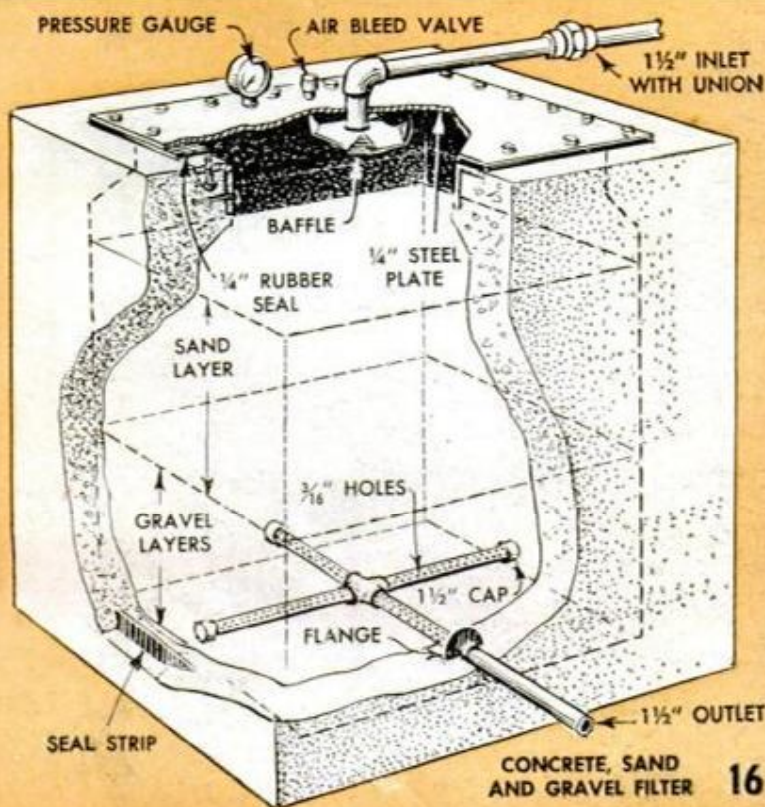

164



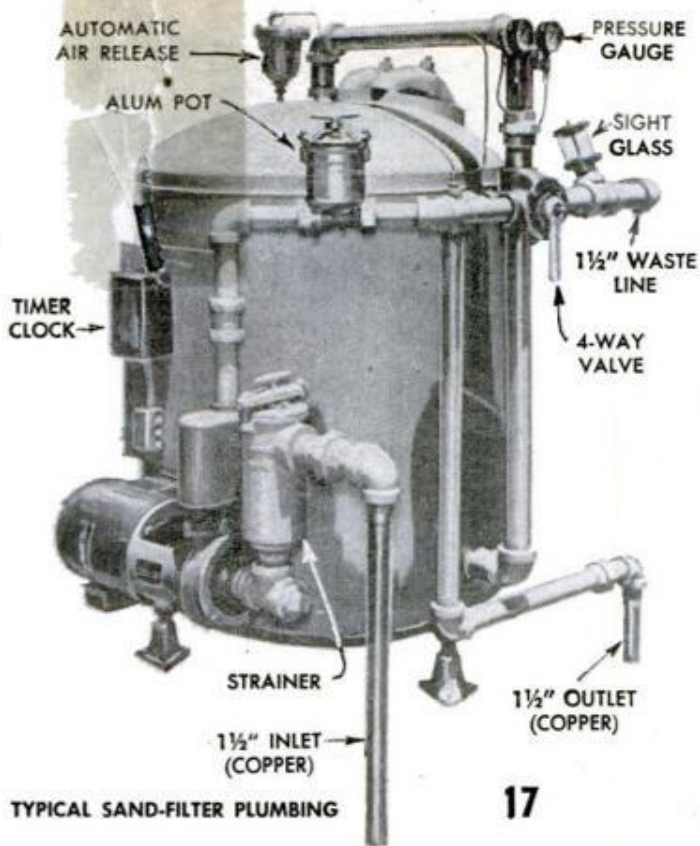

TYPICAL SAND-FILTER PLUMBING

17

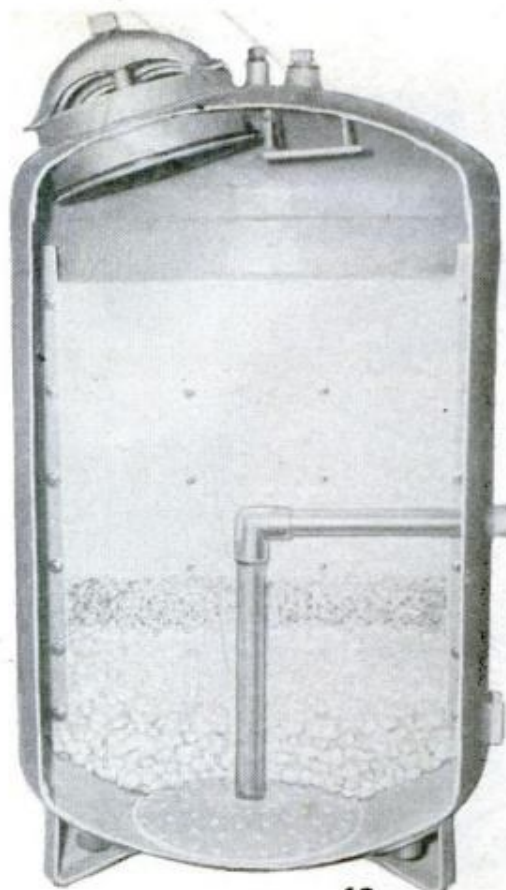

18

above ground near the pool and can be enclosed inside a small wooden bench. Back-washing this type of filter requires very little water and so the line to waste usually is just a plastic hose that is unrolled to drain the water somewhere into the ground.

You can build your own sand filter if you wish of concrete as shown in Fig. 16, or you can similarly adapt a heavy-metal tank by fashioning a removable lid on it of at least 10-in. diameter. For the average pool, the filter should have a 3-ft. inside diameter and 4 1/2-ft. depth. Cast the bottom of a concrete filter first, including a 2-in. strip of galvanized flashing around the edges as shown, to give an extra seal for the joint with the sides. Forms should be arranged to pour all four sides at once, with the outlet piping and top angle iron in place. Let the caps of the perforated pipes extend slightly into the concrete walls to keep the pipes from moving. Use one of the waterproofing additives in the concrete.

Where the outlet pipe extends through the concrete, a pipe flange or similar fitting is slipped over the pipe and welded in place to give a water seal. The inlet pipe is welded to the lid and has a union for removal in case the sand should ever need relaying. A simple baffle to spread the inlet flow is made by bending the corners of an 8-in. square of heavy plate and welding the corners to the lid as shown. A water pressure gauge is attached to the lid or

Filter and water-heating equipment generally can be installed in a cabana or other structure near pool. Fig. 17 shows the complete filtering unit with all fittings while Fig. 18 is a cutaway view of the sand filter showing how washed gravel in three gradations, is placed in the container and covered with sand

Diatomaceous earth skimmer-filter with cloth filter removed from drum, or container. Unit requires comparatively little water for back-washing filter periodically



19

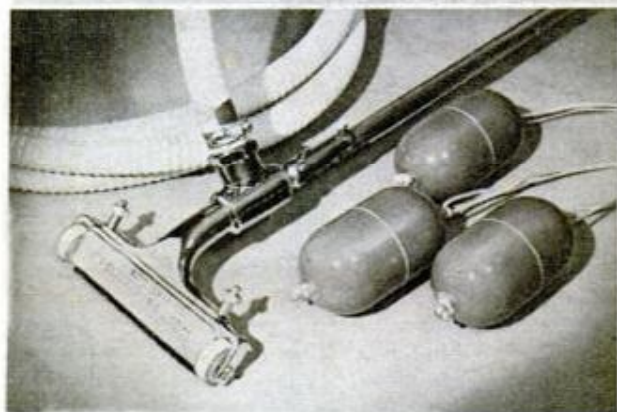
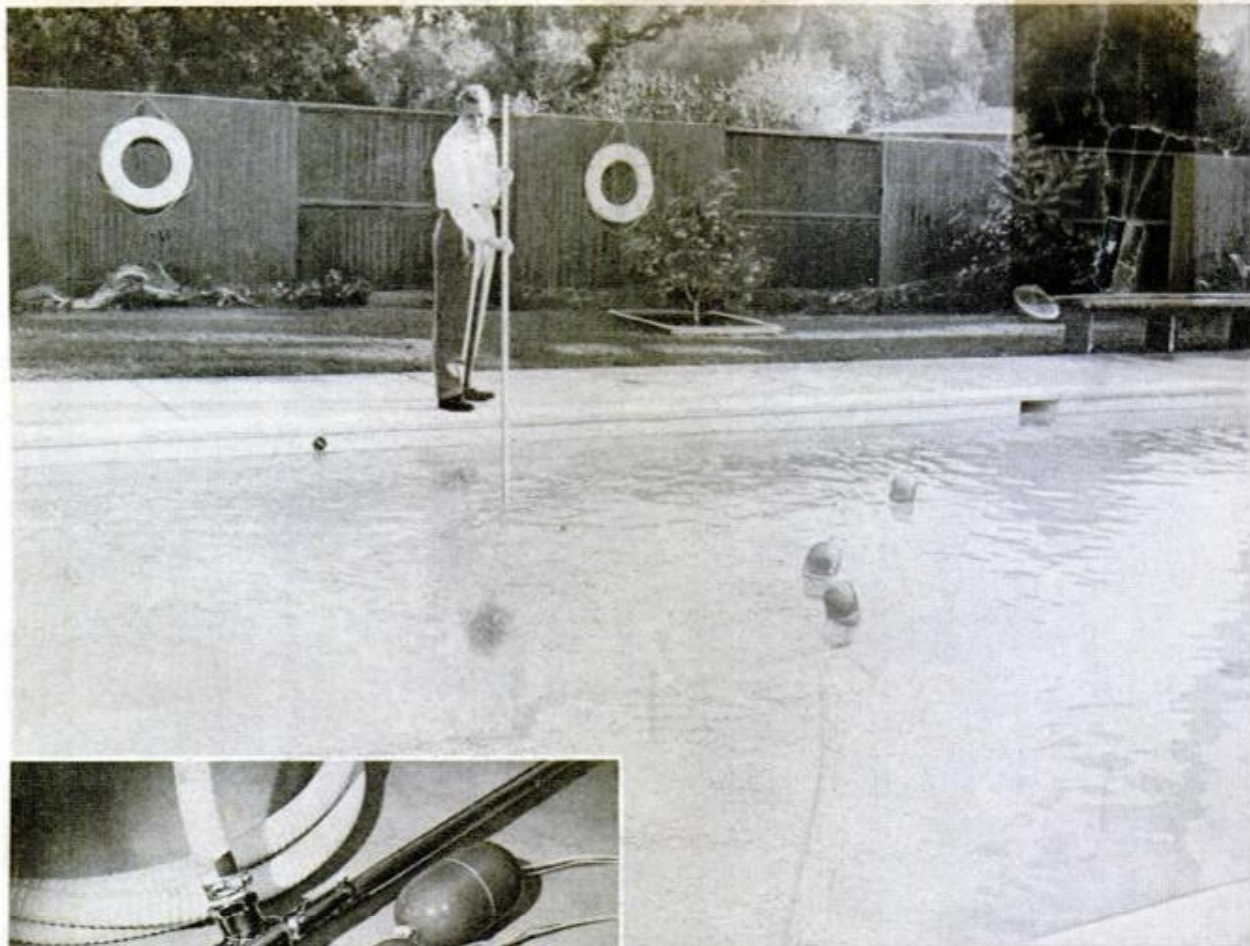

All large pools need a periodic vacuum cleaning to keep the bottom immaculate. Above you see the operation being carried out with regular vacuuming equipment. Plastic floats bobbing on the water above and shown with the vacuuming equipment at the left, keep the cleaner hose out of the way and prevent it from kinking. Note the leaf skimmer on bench at right above

inlet pipe to tell when the filter needs backwashing, and usually a second gauge is attached to the outlet pipe. The water pressure in a filter is not high, usually about 10 lbs., but the concrete should be reinforced with wire and the steel lid needs a thick rubber gasket and to be secured with  $\frac{3}{8}$ -in. bolts every 4 in.

The completed filter is filled 39 in. deep with level layers of sand and gravel. Fill the bottom 8 in. deep with 1 to  $1\frac{1}{2}$ -in. crushed gravel. Over that lay 3 in. of  $\frac{1}{2}$  to  $\frac{3}{4}$ -in. gravel, then 3 in. of  $\frac{1}{4}$  to  $\frac{1}{2}$ -in. gravel followed by 3 in. of  $\frac{1}{8}$  to  $\frac{1}{4}$ -in. gravel. The final layer is 22 in. of No. 16 filter sand. This is a coarse, heavy sand available from pool dealers.

A cabana or dressing room for the pool is an extra you can add later or do without if there is a bathroom available nearby in the house. The cabana can be of almost any design. Basic requirements are privacy, drainage, a place to sit down, a place for towels and a good-sized storage place for the face masks, fins, floating toys, etc., that gather around a pool. The filter and heater

equipment usually go in a "boiler room" in the cabana or in a small shed near the pool. In warm regions, cabanas are often built without roofs and the filter system is often left out in the open.

If you live near a small stream, the water supply problem usually is simple. Just install an intake box below normal stream level to house a submersible pump. Locate the pool so that its water level when full is well within the lift capacity of the pump. Fig. 21 suggests a method of installation, using natural stone laid in mortar for the pool sides and a layer of selected flat stones overlaid with concrete for the bottom.

### Maintenance

Throughout the swimming season the maintenance of the average pool is about the same as that for the average lawn—totaling approximately two hour's time for cleaning, plus a few minutes each evening for treating the water and emptying the skimmer. A poorly-planned pool can more than double the maintenance time.

The weekly cleaning is a matter of wip-

ing any "bathtub ring" from the water-line tile, scooping out any floating leaves the skimmer may have missed with a leaf skimmer (a long pole with a small flat net at the end), brushing down the pool sides with a brush on another long pole, and then vacuuming the pool bottom. The bottom of a small or seldom-littered pool often can be cleaned by just using the pool brush to sweep any sediment down to the bottom outlet where the filter pump will draw it away, but most pools will require a vacuum cleaner to keep the bottom immaculate. There are two types of cleaners. The standard heavy-duty version is simply a 1½-in. flexible hose with a vacuum-type nozzle that is plugged into the vacuum cleaner line of the filter system. The other is independent of the filter, operates by venturi effect from the water pressure supplied by a garden hose and has its own bag to collect the debris. It is handy for small pools.

The skimmer at the edge of the pool usually needs emptying every other day, or oftener if it gathers a clogging amount of floating material. The strainer at the pump needs emptying much less often. The pump is operated a sufficient number of hours each day to keep the water clear—the aver-

age being about twelve hours but varying with size of your filter and pool and with the season of the year. A timer clock usually is installed to turn the pump on and off automatically each day. If anything, it is best to over-filter your pool because the electricity used by the pump is insignificant and a clean pool requires less chemical treatment.

Most filters have two pressure gauges, one giving the water pressure at the top inlet, the other the pressure at the bottom outlet. As the filter loads up with dirt, the pressure differential will increase. When the top gauge reads 5 to 7 lbs. higher than the lower gauge, the filter should be backwashed by reversing its flow as described in Part I. The accumulated dirt is flushed away and the thick sand layer of the filter is lifted and scoured clean by the water flow. The piping to the sewer or dry well usually has a sight glass. You stop backwashing as soon as the water in the glass is clear.

After every backwashing, a small amount of alum is fed into the top of the filter via an alum pot on the inlet line or by dropping it into the pump strainer. In the

(Continued to page 214)

This rustic pool in its woodland setting is the nearest thing to the old swimmin' hole. It's completely informal in plan and design and of course it's a natural for a wooded yard. If there's a small stream nearby the water-supply problem can be solved by installing a submersible pump

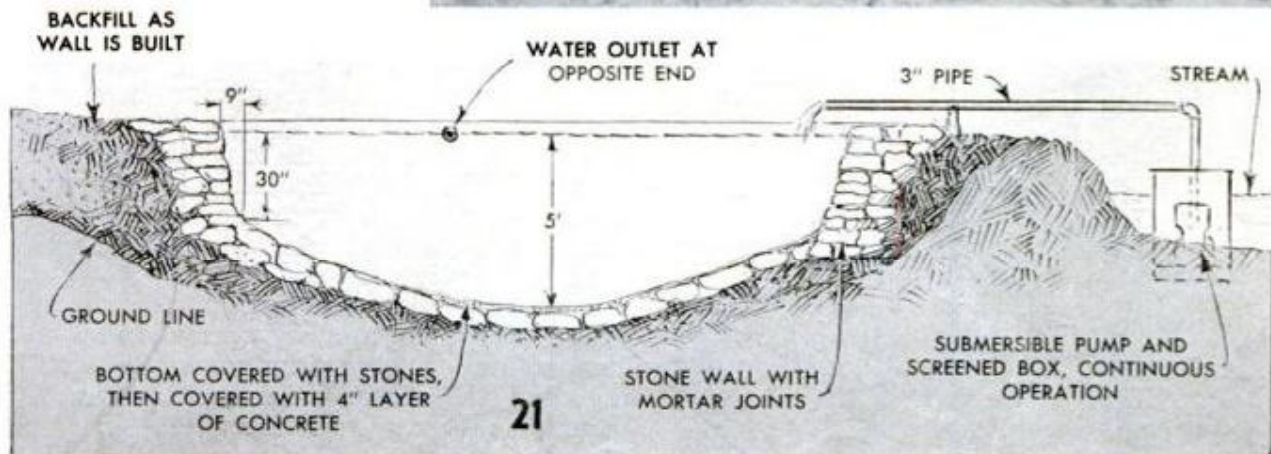
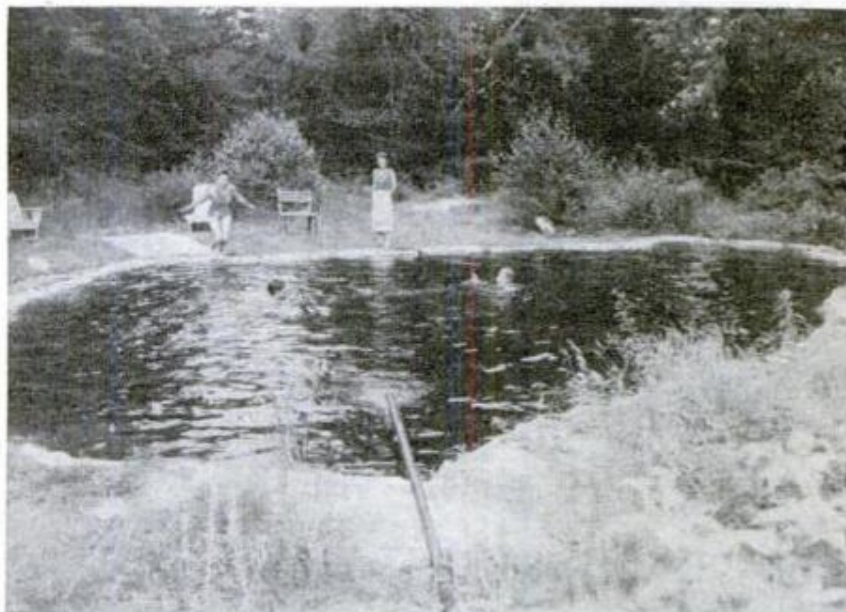

see Sept 60, 12



1. As the emulsion flows down the window a certain amount of overflow is unavoidable. To catch it, a trough of moistureproof butcher paper is used



2. To attain the proper viscosity for the "flow-on" process, the fluid is passed through a viscometer. Its rate of flow through the cup is carefully timed

## SUNGLASSES FOR YOUR WINDOWS

By James Joseph

**V**ISUALIZE, if you can, the interior of your living room bathed in a cool green or blue light even though the fierce summer sun is beating at the windows. Imagine being able to shut out 90 percent or more of the day's heat and glare. Comfort aside, this would mean money saved in faded furniture and drapes and in air conditioning costs. And all this is possible and within the reach of homeowners. The answer is a quick-drying, liquid-plastic emulsion,

3. Equipped with a suction nozzle, the pump dispenser makes it possible to retrieve all the overflow

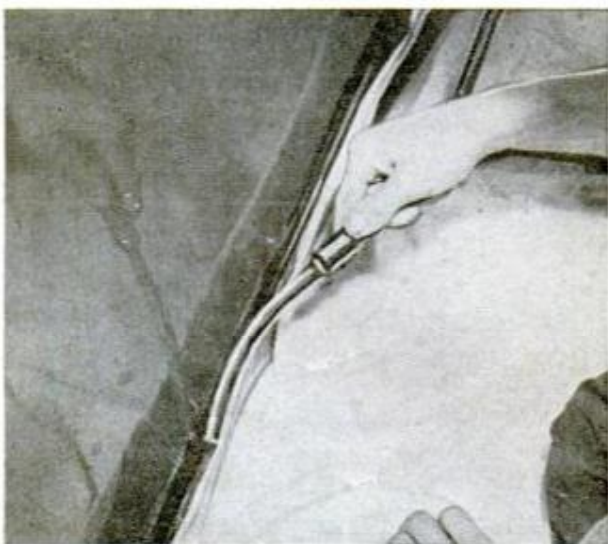

which when sprayed or "flowed" on windows, acts in much the same way as do the filters used on photographic lenses. Like the photo filters, the emulsion makes use of materials known as "photographic inhibitors," plus pigment and silicones. It is the addition of the silicones with their affinity for glass that bonds the emulsion to the window pane; the tint and the "inhibitors" shut out various lightwaves in the light spectrum, such as the ultraviolet and the infrared. Thus, in selecting one of the several available tinted emulsions, it is possible to "tailor" the light entering the room according to the light and heat conditions desired. Generally speaking, the clearer and more lightly tinted coatings have a lower "fade" percentage. That is, they allow more natural light and ultraviolet rays to enter, and with them more heat and glare. The darker coatings pass less light, but score highest in the way of heat and glare reduction, as indicated in the chart at the top of the following page. A comparison of tinted and untinted windows can be seen on the opposite page.

Preparatory to applying the emulsion, the window is thoroughly washed and then cleaned with a special window-conditioning chemical, applied with a tack cloth. A trough of heavy moistureproof paper is placed along the bottom edge of the win-

### Efficiency Percentages of Emulsion Tints

	Fade	Glare	Heat
Clear Transparent	70 %	1.4%	24.9%
Amber Transparent	82 %	7.0%	36.5%
Green Transparent	88 %	41.2%	44.6%
Blue Transparent	81 %	58.8%	43.7%
Green Frost	99.5%	96.2%	89.3%
Blue Frost	99.6%	90 %	90 %
Gray Frost	99.5%	95 %	90.5%

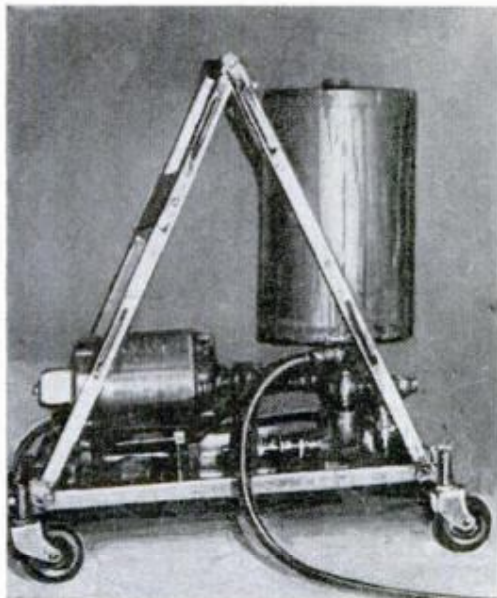

**4.** This electrically operated dual-pump dispenser furnishes the steady pressure which is necessary to attain an even flow of emulsion from the dispensing nozzle

dow, as shown in Fig. 1, to catch any overflow. Since it is of the utmost importance that the emulsion be of the proper viscosity, it is first tested with a viscometer cup, Fig. 2. When thinned enough so that a cupful flows from the hole in the cup in 17 to 18 sec., the fluid is ready to be applied.

Application is made by a special dual-pump dispenser, Fig. 4, equipped with dispenser and suction nozzles. The dispenser nozzle is moved steadily along the upper edge of the window from one corner to the other without backtracking, as shown in Fig. 6. As the emulsion flows down the pane of glass, it spreads itself out in an even coat about  $\frac{1}{1000}$  in. in thickness. The suction nozzle picks up the overflow in the trough, and returns it to the pump reservoir, Fig. 3.

Within 4 to 6 hours the coating is dry to the touch, and in 12 to 14 days it is completely dry and cured. Two weeks following its application and every six months thereafter it should be sponged with a cleaner-preservative. ★★ ★

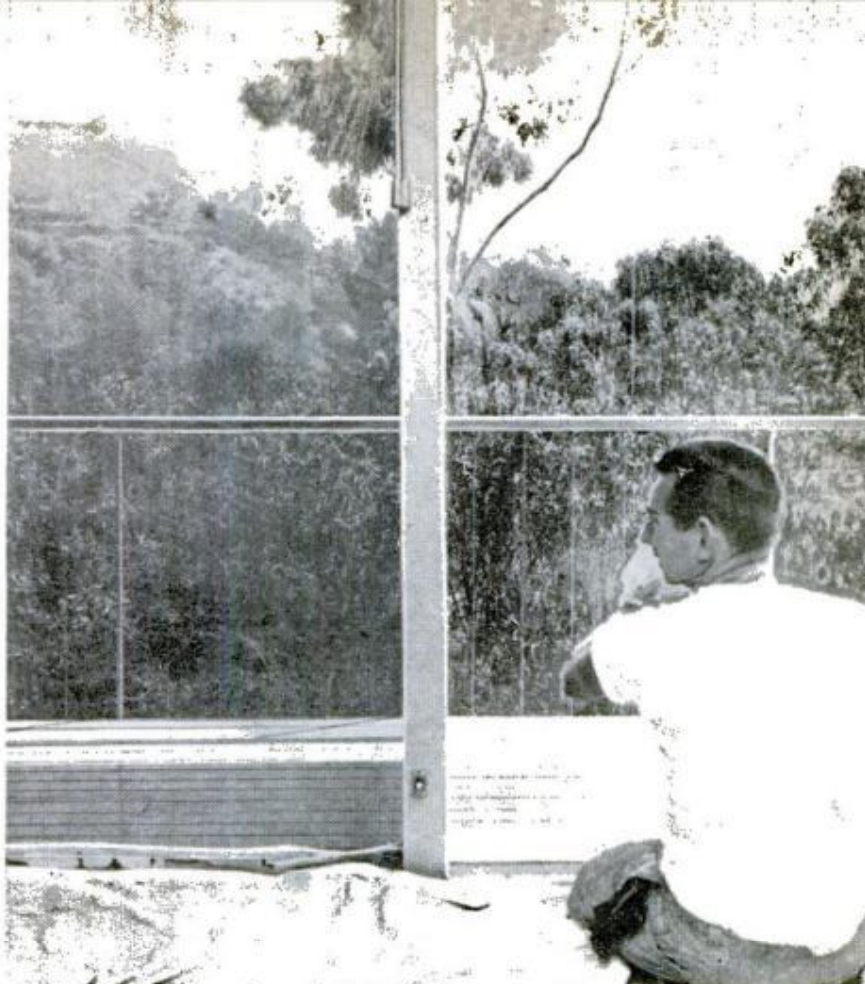

**5.** Effects of coating a window with tinted emulsion are immediately evident. There is practically no haze or glare coming through the window at the left, while the untinted window at the right offers no protection from the sun's light and heat

**6.** If the emulsion is properly applied, the pull of gravity, plus surface tension, will assure that its distribution is equal over every square inch of glass surface. Its viscosity will determine the thickness of the final 'plastic-emulsion coating



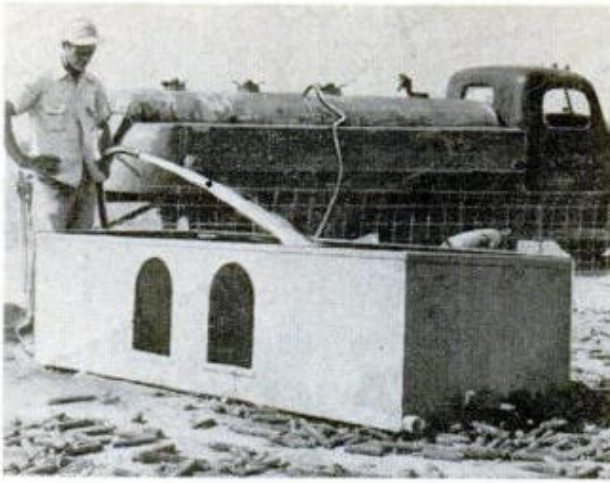

## Obsolete Fuel-Delivery Truck Serves as Farm Water Wagon

When buying stock water-carrying equipment, don't overlook a "junker" fuel-delivery truck. Already equipped with a motor-driven pump, the truck makes fast work of filling a stock tank as pictured, and it can be used as a fire truck in an emergency. After minor repair, the engine of such a truck usually will perform satisfactorily for this limited service. The tank, of course must be cleaned thoroughly before using it for drinking water

C. F. Marley, Nokomis, Ill.



## Tangleproof Dog-Chain Anchor

Here is a tangleproof dog-chain anchor you can make from a 3½-ft. length of ¼-in. mild-steel rod or heavy wire. After cutting the rod to length, bend it U-shape, spacing the legs about 5 in. apart. Then, push it into the ground like a croquet wicket and snap the end of the chain to it as illustrated. The chain will not only be held securely but it will not get wound around the anchor, since it will always ride over the top regardless of the number of times the dog runs around it.

G. E. Hendrickson, Argyle, Wis.

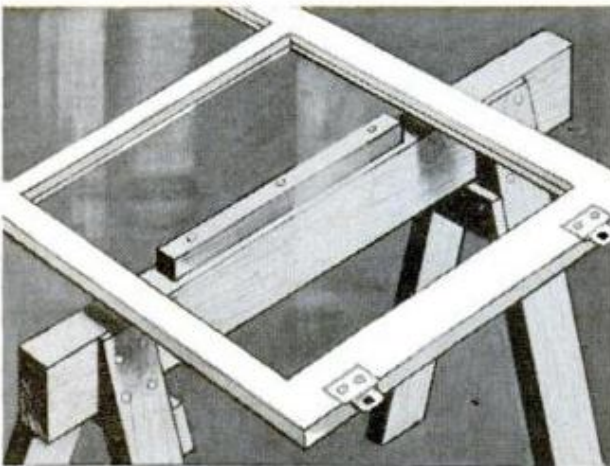

## Both Sides of Storm Sash Painted at One "Sitting"

Both sides of a screen or storm sash may be painted at one time by supporting the sash on a pair of sawhorses, to the tops of which wooden blocks are nailed as shown. The blocks, bearing against the glass only, provide clearance between the sash and sawhorses. Thus the side painted first doesn't contact the sawhorses when the sash is turned over to be completed. A brick centered under each pane or the wire of a painted screen, will do the trick too.

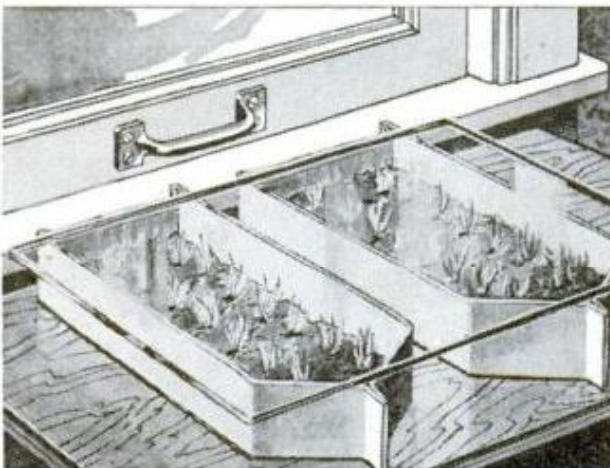

## Milk Cartons Cut in Half Serve as Seedling Flats

Half-gallon milk cartons make waterproof planting flats for starting seedlings when cut in half and filled with planting mix as illustrated at left. After sowing seeds in a firmly-tamped mix, the milk-carton flats are placed next to a window where they will be exposed to sunlight. The flats should be covered with a pane of glass to help keep the temperature and moisture constant within them.

Hi Sibley, Nuevo, Calif



## PLANT PROTECTORS

TO PROTECT newly germinated sweet corn from predatory birds, and to prevent frost damage to seedlings, cover them with fabricated plastic protectors as illustrated. Made in 6-ft. lengths, the lightweight units are easy to store and use since they nest when stacked and in use are simply placed on the ground over the row of plants. Each unit consists of two 6-ft. lengths of 1 x 1-in. wood strips drilled to take U-shaped frames formed from clothes-hanger wire. The stringers are spaced 5 in. apart, the wire frames about 6 in. Next, plastic-coated fabric or wire mesh, such as is used for covering a storm door, porch enclosure, or window openings, is stretched over the frames and tacked to the stringers. In a warm climate, where protection from only predatory birds is needed, window screening may be used instead.

Strips of aluminum foil do a good job of keeping birds away from ripening raspberries when hung on a line stretched over the bushes between stakes as shown at the right. Strips  $1\frac{1}{2}$  x 9 in. are cut from heavy-weight aluminum foil and are threaded on a length of heavy cord. Spaced about 1 ft. apart, the strips are kept apart by tying knots in the cord on both sides of them. They should be crimped so that the wind will make them flutter and sparkle in the sun.—Hi Sibley, Nuevo, Calif.



# WHICH BOAT FOR YOU?

By Earl F. Wobeck



Glasspar Co. photo

1. Boat to be used for offshore cruising should have well developed deep bow with fine entrance

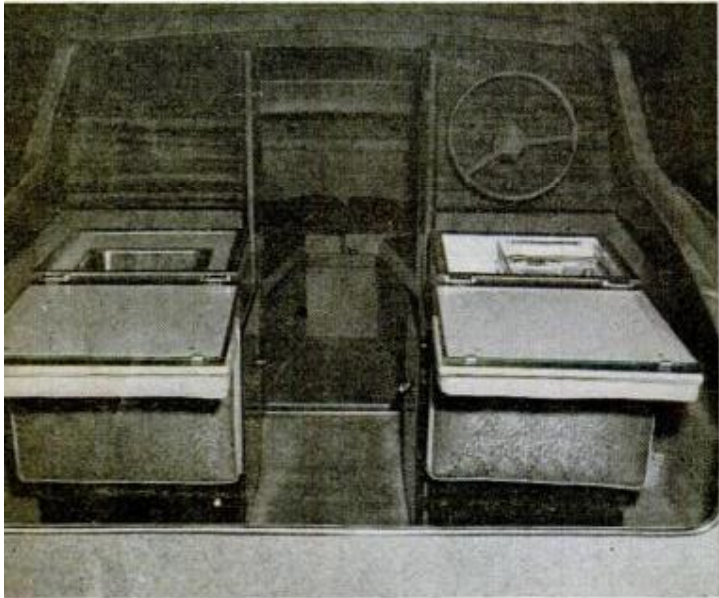

2. Extra cabin space is gained on small cruiser by locating galley under helmsman's seats in cockpit

WHETHER YOU ARE a seasoned skipper looking for a new "command" or a converted landlubber with dreams of enjoying the thrill of boating in a craft of your own, the information in this story is intended to help you make a wise choice in an outboard boat. Such major considerations as design, construction and performance characteristics should be given careful thought before you trade a bundle of cash for the boat of your choice. In addition, the number of persons to be accommodated regularly and their preference as to boating activity must be matched to the size and type of craft selected.

About the best place to shop for a new boat is at one of the annual boat shows held in most medium to large cities sometime between January and May. Here, gathered under one roof for your convenience, you are likely to find boats of most types and manufacture. And since an attempt usually is made to arrange exhibits according to broad categories, it is fairly easy to inspect and compare boats of the desired type, without having to drive miles from one dealer to the next. Of course, the great number of boats exhibited in even one category at the "national" boat shows may make selection of a particular model difficult—and hard

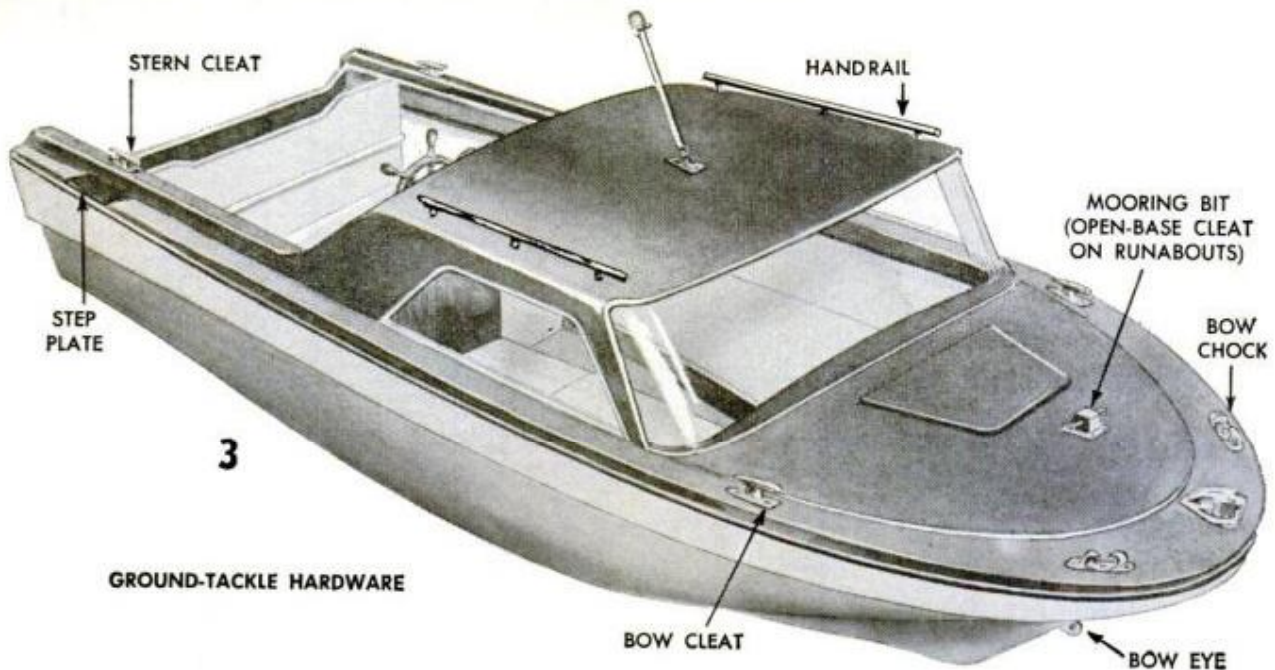





**3. Proper instruments and equipment help to make cruising safe and enjoyable. Good dealer takes it upon himself to instruct skipper and "mate" on correct use of equipment and how to operate and maintain boat**

on the feet, unless the answers to some rather important questions are known beforehand. This is particularly so if this "water dragon" you're going to buy is for the use of the entire family. While most boating families have one "like" in common—the water, Dad may prefer to fish or cruise, Mom likes to read and relax, while the younger set wants to be very active skiing, swimming, skin diving, or falling out of the boat. A good boat that will satisfy such diverse interests is a 17 to 20-ft. cruiser with the stern half of the boat open and the forward half an enclosed cabin, like the one shown in Fig. 6. In a craft of this type, there is ample room in the cockpit for water-sports equipment and elbow room to fish for large game fish, and a complete galley, head and bunks for three or more in the cabin. Most boats of this type also come with a canvas top and side curtains that can be installed quickly when bad weather threatens or extra sleeping space is needed in the cockpit. If you expect to do a lot of cruising, equip the boat with two medium-size motors instead of one large one for safety.

Boaters who prefer to spend most of their time on the water cruising, will want a boat with more space devoted to enclosed cabin, less cockpit area. Those who like the adventure of cruising large lakes, or to offshore islands, where the sea can get nasty in a hurry, should make sure that the cruiser of their choice handles well in rough water. The small cruiser in

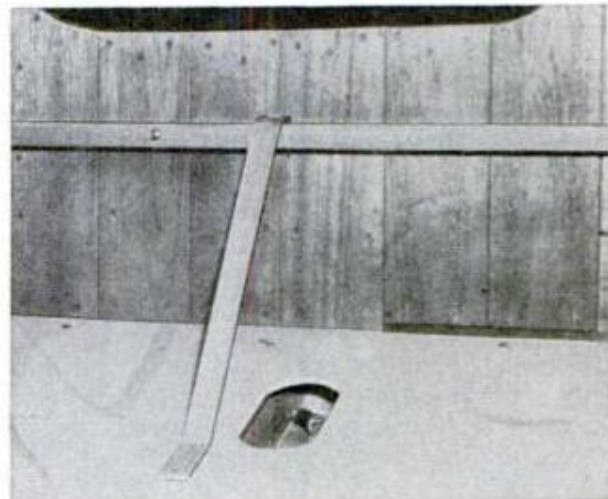

**4. Heavy metal brace bolted to keel and transom crossbeam is example of good wooden construction**

**5. Side-mounted fuel tanks help balance boat load, extend cruising range, yet take little usable space**

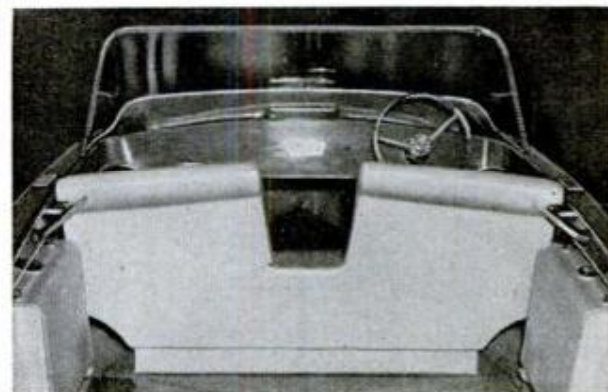



Lone Star Boat Co. photo

**6.** With extra space devoted to cockpit and less to cabin, this boat is fine for water sports, yet it can be used for cruising

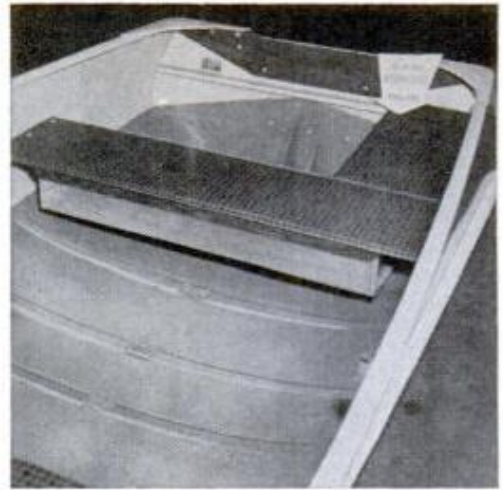

**7.** This aluminum boat has adequate transom bracing and transverse hull stiffeners

Fig. 1, is a good example of a fine rough-water boat. The fine entrance, V-bottom and deep, well-formed bow surfaces permit the boat to knife through the waves effortlessly, not pound and skid over them as is the case with flat-bottom boats having blunt bows.

Since space is at a premium on a small cruiser, it must be allotted to equipment niggardly, including only that which is definitely needed, and doubling up on some installations. A good example of the latter is shown on the cruiser in Fig. 2. Under the port helmsman's seat, which can be tipped aft to provide a counter surface, there is a sink and cabinet. The starb'd seat tips back in the same manner, exposing the galley stove, under which there is an ice box.

Those who take fishing, skiing, cruising and joy riding in afternoon doses need only a plain fishing boat to indulge in their favorite sport, although most will gravitate to a fancy upholstered runabout or sport boat soon after their first plain boat.

Runabouts are designed primarily for riding comfort. Sports boats are a compromise between a runabout and a cruiser. They are roomier and more versatile than runabouts, having movable or removable

stern seats that can be rearranged to make room for skiing and fishing equipment. Many models also are available with detachable hardtops, or canvas canopies, permitting them to be used as cruisers as well. As with boats of other types, select a size that will safely accommodate the number of passengers to be carried normally. For a good guide on this, see "Sink-proof Your Boat" in the March 1960 issue of *Popular Mechanics*.

The last important personal question to consider before shopping for a boat is, what can the budget stand as to initial investment, annual operating expenses and maintenance costs? If the boat you want is decked out with a lot of unnecessary frills that are not optional, and which may add up to a budget deficit, look around for one which lists the extras as optional, or select one of the many good plain boats. Big motors gulp prodigious amounts of fuel, so stay away from a boat that is designed for hefty power if operating expenses are to be kept to a minimum.

Outboard boats like other power boats, are classified usually by type (runabout, sport boat, cruiser, as explained already); by construction material (glass fiber, wood, aluminum); and by hull design

**8.** Section of glass-fiber boat bottom shows how stringers are used to support floor and make bottom rigid

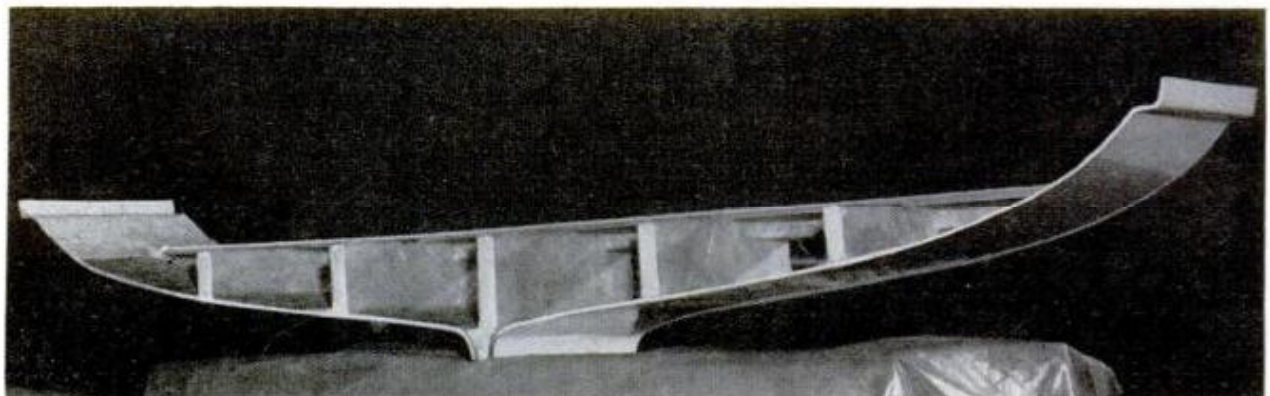

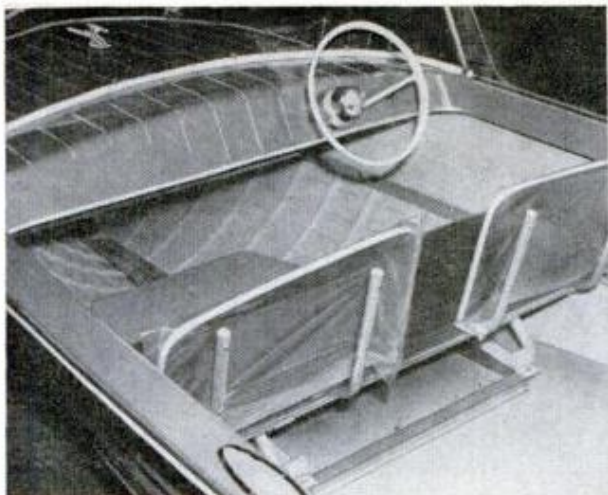

**9.** Molded glass-fiber hull, showing how "ribs" have been formed as part of the hull to help stiffen it

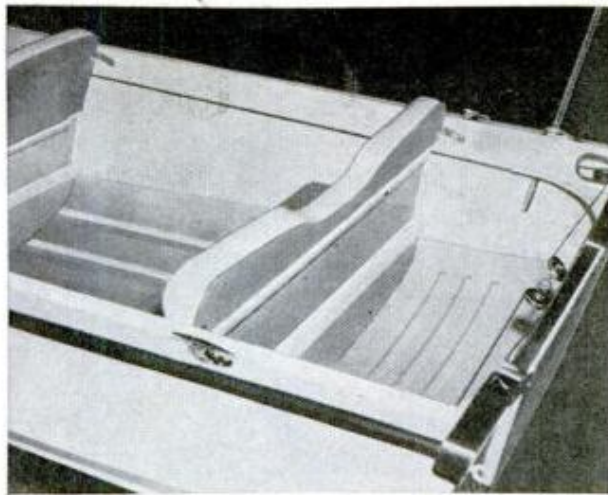

**10.** Longitudinal stiffeners are combined with transverse ones in this boat to counteract torque effects

(planing hull vs. displacement hull, lap-strake vs. smooth hull, soft vs. hard chine). Since design has a direct bearing on the performance of a boat according to its use, it is the first point to ponder when buying a boat. A design that is not suited to the purpose for which the boat is to be used will not perform well, regardless of the size, construction or material used.

A high-speed runabout should have a planing-type hull, one that rises above the water for most of its length when accelerated to cruising speed. The latter characteristic, in addition to shallow draft, makes such hulls ideal for water skiing and for fast riding on rivers, small lakes and sheltered bays. Most planing hulls have nearly flat bottom surfaces aft, which change gradually to a broad vee at the bow. On rough water this hull type will pound excessively, which is hard on the boat and passengers. Therefore, if most of your boating is expected to be done on large bodies of water where the surface frequently gets rough, a one-hundred-percent planing type of boat would be a poor choice.

Outboard boats seldom are built to displacement lines, wherein the bottom forms a broad vee at the stern and gradually changes to a sharp vee at the bow. When under way, the bottom of such a boat remains submerged for its entire length since there are no broad, flat surfaces angled upward toward the bow to lift it, as is the case with a planing hull. A displacement hull is essentially a deep-draft hull, making it comparatively slow moving but stable and comfortable riding, even when the water is very rough.

Modern outboard boats that are designed for use on exposed waters, such as large lakes and coastal waters, combine some of the features of planing hulls with

(Continued to page 220)

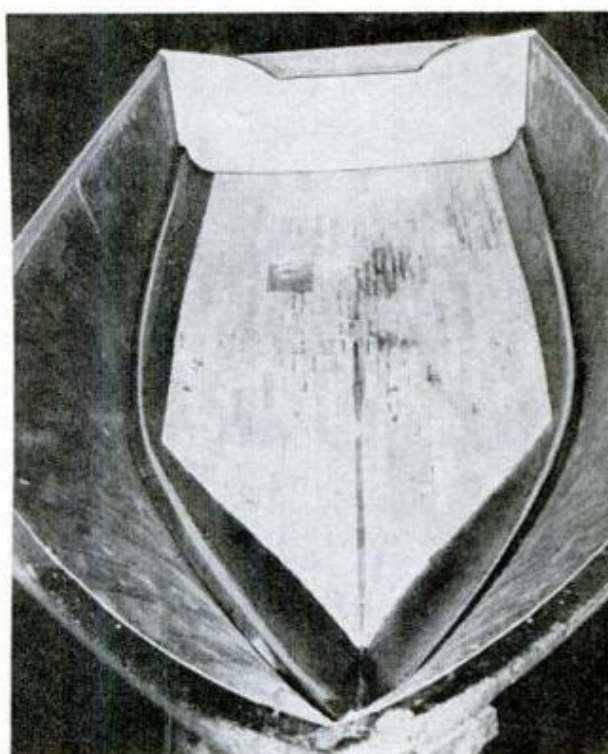

Crestliner, Inc. photo

**11.** Layer of balsa-wood blocks "glassed in" in this boat give it great strength and required buoyancy

**12.** Getting rid of bilge water is easy on boat having deep bilge sump fitted with through-transom drain

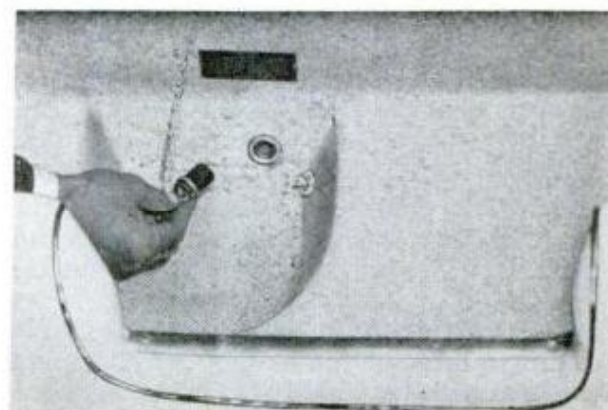

## Shear Pin in Post Saves Rural Mailbox From Damage



Although it offers greater convenience to the rural mail carrier, a mailbox extending outward on a pipe post, such as shown, is apt to be damaged by large trucks or road-working machinery. One rural resident suggests that the outward extending portion of the pipe be mounted on a pipe of smaller diameter which is driven into the ground. By drilling a hole through both, a wooden shear pin may be inserted. Should the box be struck accidentally, the pin will shear and allow the box to swing out of the way with little or no damage.

G. E. Hendrickson, Argyle, Wis.

## Chalked Line Measures Water Depth

In checking the water depth of unused wells to determine the periodic changes of the water level, one geologist uses a cotton line coated with blue carpenter's chalk. When the weighted line is lowered to the bottom of the well, the wetted chalk turns a darker blue in contrast to the dry portion of the line. By measuring this darker portion, the water depth is quickly determined.

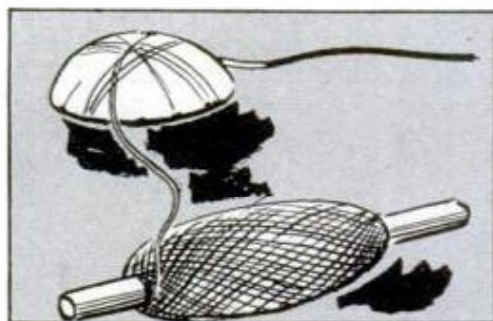

## Locators Help Align Decorative Laminate on Table Top



The use of contact cement to secure a sheet of plastic to a table or counter top requires the most accurate positioning. Once the table top and the plastic have been coated with cement and the two coated surfaces make contact, the plastic can not be shifted. Correct positioning is assured by taping two metal corners to the table top to serve as locators. They should project about  $\frac{1}{2}$  in. above the table surface. By directing the plastic sheet so that two corners engage the locators, as shown, the sheet may be lowered into place accurately.

## Staple Spaces Shingle Courses

Spacing of wood shingles becomes increasingly important when roofing large structures, such as barns, sheds and similar buildings, as the gain or loss in a long course will multiply the error considerably. A spacing gauge on the handle of your shingling hatchet will assure uniform spacing of each course and you can make a simple one by bending a large staple as shown and taping it to the handle at a point which will give the recommended spacing, or exposure, of the courses.

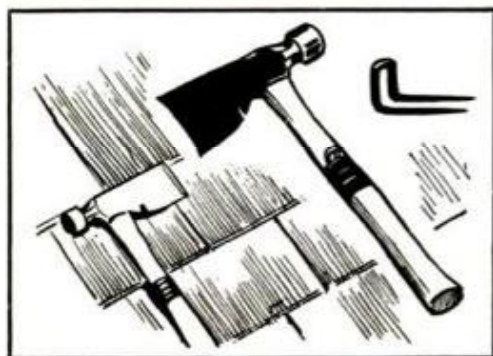

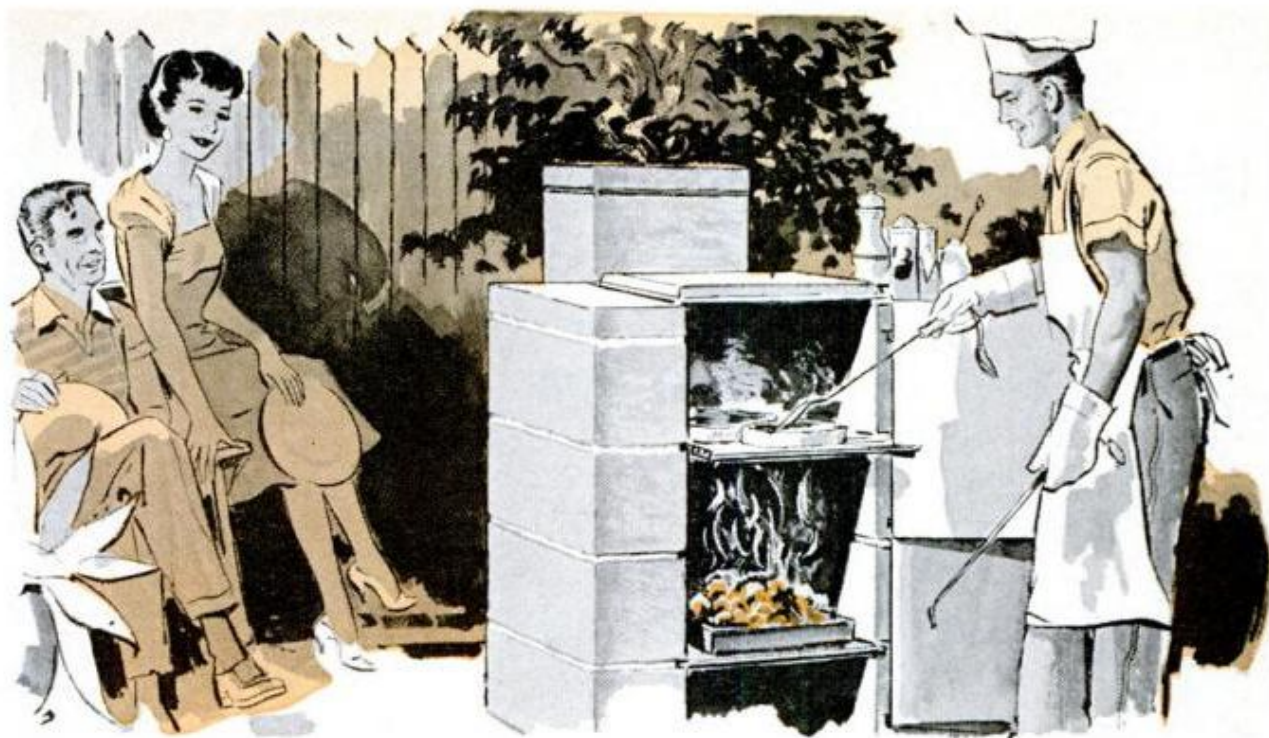

## OUTDOOR OVEN HAS UNDERGROUND SMOKE PIT

FOR THE MANY homeowners who have become cook-out enthusiasts, this outdoor barbecue oven affords a means of broiling steaks and fowl and in addition can be used to prepare casseroles, to smoke hams, small game or fish. With all these features, it occupies less than a square yard of space and can be built for only a few dollars.

The oven is simply a chamber built with concrete blocks. Over-all size is about 16 x 32 x 48 in. The uppermost block in the rear wall is a pilaster block which serves as a flue leading to a chimney formed by the openings in the fifth block set on top of the oven. The blocks are set  $\frac{5}{8}$  in. apart and mortar is cut from between them on the interior to allow grills to be moved various

distances from the fire. Thus food may be prepared in the many ways requiring fast or slow cooking. Two galvanized iron doors swing on hinges set in the blocks and another sheet of iron forms the top lid.

An underground pit measuring 15 x 17 x 36 in. is dug some 4 ft. from the oven and is lined with firebrick. Used for cold smoking, smoke is conducted to it through a 6-in. pipe and escapes either through a vent or by allowing the lid to remain open a crack. To use the entire oven as a smoke house, a similar pit is dug in the base of the oven. In this case the doors are kept closed and the smoke escapes out the chimney. A space at the bottom of the lower door keeps the fire alive.—W. A. Leak, Cupertino, Calif.

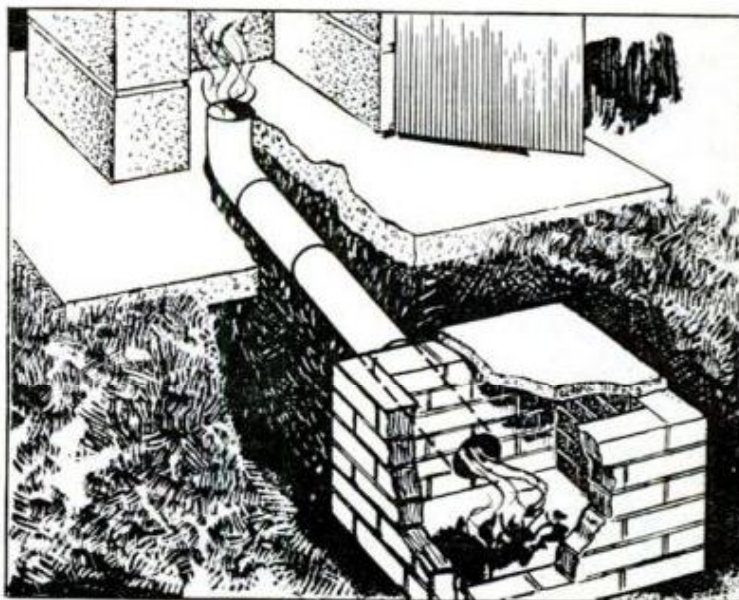
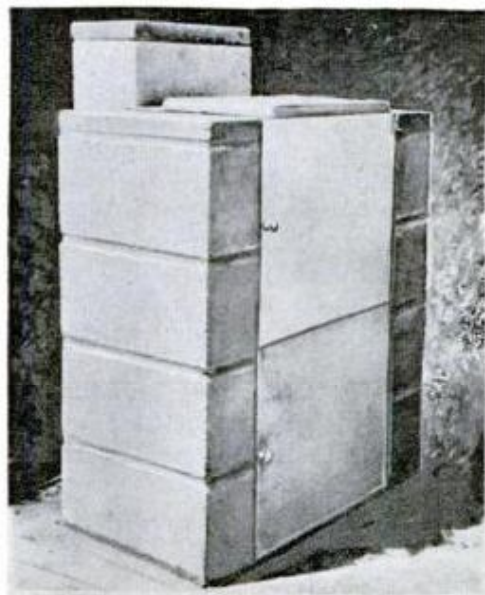

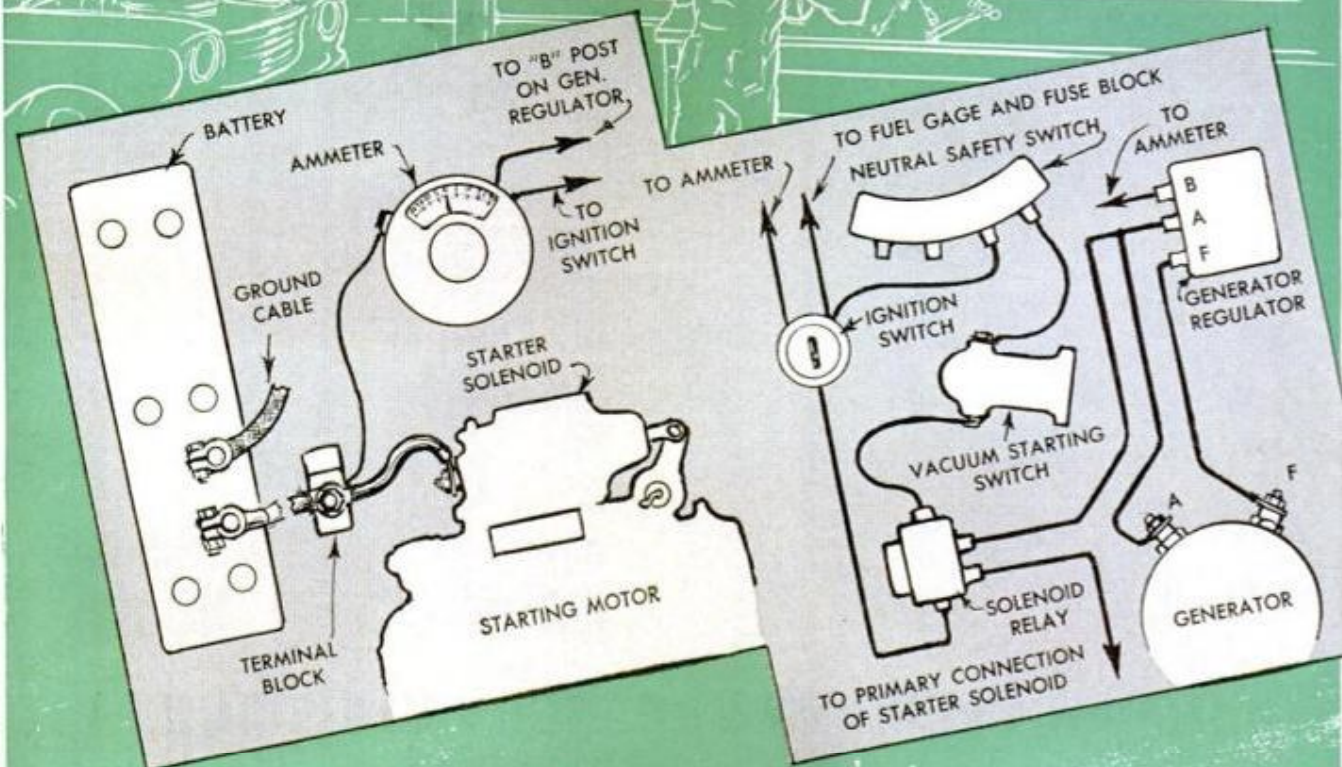

# Trouble Shooting THE TOUGH ONES

By Ben L. Davis

TOWED INTO THE SHOP because it couldn't start under its own power, a '53 Buick gave us a round of head-scratching. Quick, routine checks showed everything seemingly in order. But—the starter motor just wouldn't crank the engine.

Then I remembered the wiring charts for the '53 Buick. One long look at these showed that we overlooked something. The chart showed that starter solenoid action depended not only on a closed circuit for the vacuum and safety switches but also on a good ground through the generator via the field coils and brushes. If for example, the generator brushes made very poor contact, then the ground was not available and the starter would remain dead.

The two-panel diagram shows that from the battery the positive cable leads to an insulated terminal block, from which another cable leads to the starter solenoid. A wire connects the block to the ammeter. Two wires lead from the ammeter, one to the regulator post B and another to the ignition switch. Note that two wires come to the ignition switch, a feed wire from the

ammeter and another that energizes the fuel gauge when the switch is on. From the solenoid relay (don't confuse with the starter solenoid) a wire goes to the vacuum switch on the carburetor and from this switch another wire runs to the neutral safety switch.

Two more wires on the relay need accounting for, one leading to the regulator post A and the other to the primary stud of the starter solenoid. This is the wire that energizes the starter motor—if the circuiting is complete and the ground is through the generator. The heavy armature wire runs between the regulator terminal A and the generator armature post. The thin field wire ties in between the terminal F on the regulator and the post, F, on the generator.

In the case of the '53 Buick in our shop a close check of the generator showed that it was so badly worn that it was necessary to replace it. That cured the starting trouble immediately. In most instances, all that is necessary is a thorough overhaul of the generator to restore the circuiting to operating efficiency.

# Unusual Locations Where Trouble May Occur

## Loose Rivet

A loose rivet on the flex-plate that supports the Fordomatic transmission converter can produce a knock similar to that made by a worn water pump or a V-pulley that is slightly loose on a keyed shaft. Just one loose rivet will allow the plate to slacken its hold on the converter. This development is comparatively rare, but once the trouble is detected and localized it should be corrected without delay. Of course, it may be possible to make a satisfactory repair, but usually it is advisable to replace the defective plate with a new one.

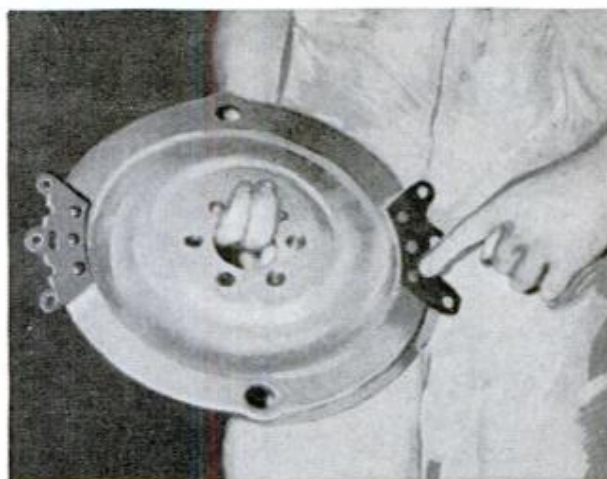

## Accelerator Lever

If a '59 Dodge develops a rough, erratic shift or if the shift mechanism seems to lack positive follow-through, check the accelerator lever for looseness. This lever is mounted on a bracket on the engine side of the firewall and it is necessary to make a close check to determine if any play is present. Shim stock fitted on the flat between lever and shaft (see arrow) will tighten the lever on its shaft and usually will smooth out the action of the shift mechanism. While you're at it check the whole linkage just to make sure there are no developing defects due to wear.

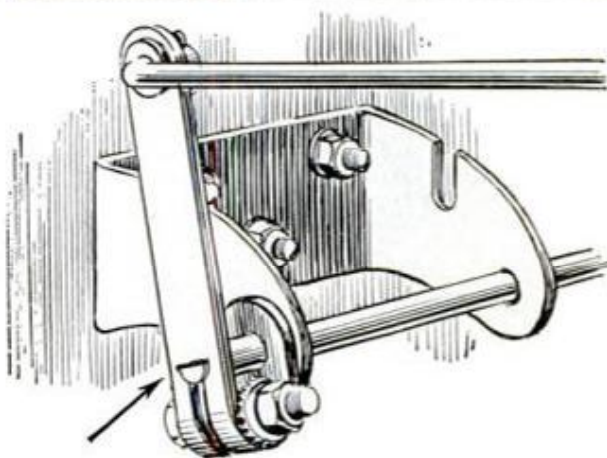

## Insufficient Clearance

For average owner-drivers clearance between the steering-wheel rim and the door control on '52 Studebakers is no problem. But in cold weather some drivers habitually wear lined, loose fitting gloves or heavy mittens and it is then that the minimum clearance between the wheel and the control handle can result in steering interference and possibly a bruised hand when swinging the car sharply to the left. As a serviceman you can warn your customers of this possibility.



## Fuel Gauge

Fuel gauges on some '56 Pontiacs indicate empty when the tank is still about one fourth full. Should this be objectionable to the owner, here's a way to make the gauge register more accurately: Remove the assembly and bend the float arm at a point near the float. Bending it down will cause the gauge to read higher and bending in the opposite direction will make it read lower. Although the gauge can be removed as a unit with little danger, it's best to take the precaution of disconnecting a battery cable before removing it from the fuel tank.

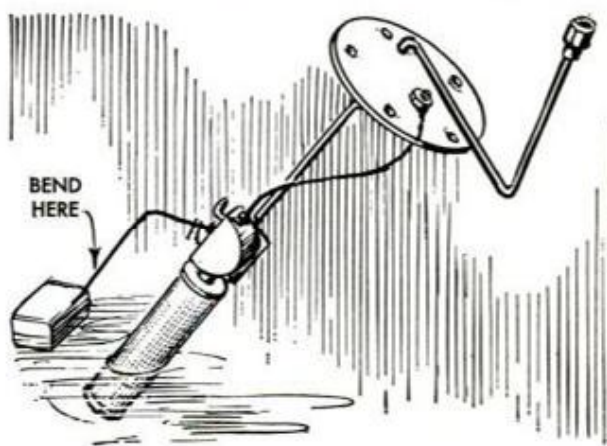



1



2



3



4



5



6

## On the MARKET for Do-It-Yourselfers

**1. WOOD SEALER** has been compounded for use on floors, especially floors of pine. Seals and conditions wood for any type of clear top finish, it also is ideal as a first coater under paint, shellac or enamels. Makes a good sanding base, primes fir plywoods and greatly increases top-coat coverage of any type of finish, especially when applied over soft woods.

The Parks Co., Fall River, Mass.

**2. TOP FINISHING MATERIAL** with a 100 percent oil base protects wood with a durable coating that defies stains, scratches and abrasions. Especially effective on fine work in cabinet hardwoods where a quality finishing material is essential. Can also be used inside on woods of all types. Not designed as an outdoor finish. Comes in gloss and semiflat.

Inseed Oil Products Corp.,  
1603 Talbert Ave., Santa Ana 33, Calif.

**3. MASONRY SEALER** locks out water pressures up to 1½ tons per sq. ft. in wet basements and swimming pools. Designed to coat all common porous masonry surfaces such as concrete, cinder and concrete blocks, cement stucco, stone and brick. Comes in a two-part container, contents of which must be mixed and applied according to detailed instructions included.

The Borden Co., 350 Madison Ave., New York 17, N. Y.

**4. SANITATION CHEMICAL** is designed to end the problems and dangers resulting from the clogging and overflow of septic tanks, also cesspools in older installations. Dissolves soap and detergent residues which are a main cause of trouble, kills roaches and eliminates objectionable odors. When using, care must be taken to follow instructions in all details.

Cloroben Chemical Corp., 115 Jacobus Ave., South Kearney, N. J.

**5. PRESSURIZED HAND SPRAYER** applies insecticides, paints, lacquers and varnishes. Gives either a fine mist or solid stream, the degree of atomization being controlled simply by squeezing the handles. Unit is reusable. Simply fill with spray material and inflate with air by means of a compressor or at local service station. Tested to 600-lb. pressure.

B. C. Moses, 3019 Prospect Ave., Houston 4, Texas





7

**6. DECORATIVE PLASTIC LAMINATE** comes with an exceptionally smooth finish which is deglossed by a special process so that it does not pick up reflections from bright surfaces. Laminate has warmth and appearance of woods that have been finished by hand  
Swedlow, Inc., 394 N. Meridian Rd., Youngstown, Ohio

**7. DAMP SURFACES** can be coated with this outside paint. It's blister and peel resistant under ordinary conditions producing dampness on surfaces ordinarily painted. Can be used on wood, brick, concrete, cinder blocks, asbestos shingles. It is not suitable for floors  
Magicolor Co., Ashland Ave. at 29th St., Chicago 8, Ill.

**8. PAIL HOLDER** for painters and window washers has a special locking arrangement which holds the pail securely, prevents it from tipping or swinging. Adjusts to all angles of ladder and attaches to either rail, locating pail in the handiest working position  
Lockhart Mfg. Corp., Detroit, Mich.

**9. REPAIR OF PORCELAIN FINISHES** is possible with this porcelain mender. Flows smoothly into nicks, scratches, chips and worn spots and levels easily with the built-in applicator in the cap. Withstands heat to 400 deg. and won't chip or peel  
Magic Iron Cement Co., 5403 Bower Ave., Cleveland 27, Ohio

**10. LOUVER RAILS** make it easy to build and install louvered shutters and small doors. The rails come in 4-ft. lengths and are made of extruded aluminum. Rails are slotted and flanged all ready for installation of slats and frames in your choice of woods  
Louvre Rails, 379 Cambridge St., Allston 34, Mass.



8



9

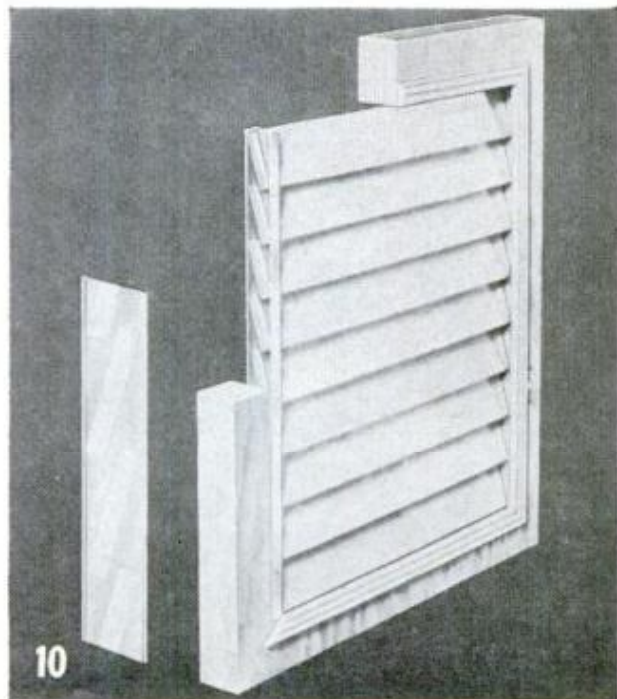

10

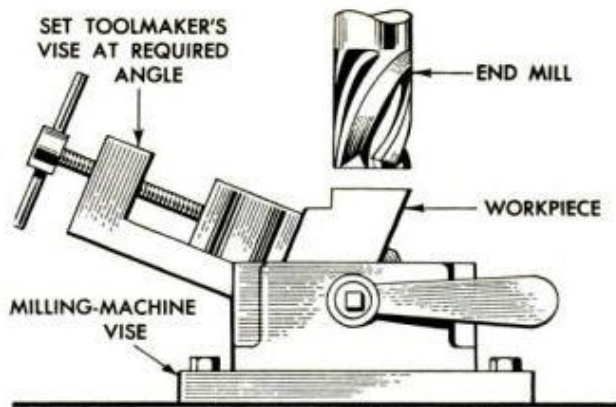

## Quick Double-Vise Setup Saves Milling Time

Having a small job that required milling 30 and 90-deg. angles, I saved machine setup time by using a toolmaker's vise. This was locked in the milling-machine vise to hold the work for milling the 30-deg. angle. Then the vise was removed and the work placed in the milling-machine vise to mill the 90-deg. angle.

Frank LaSaracina, New York, N. Y.

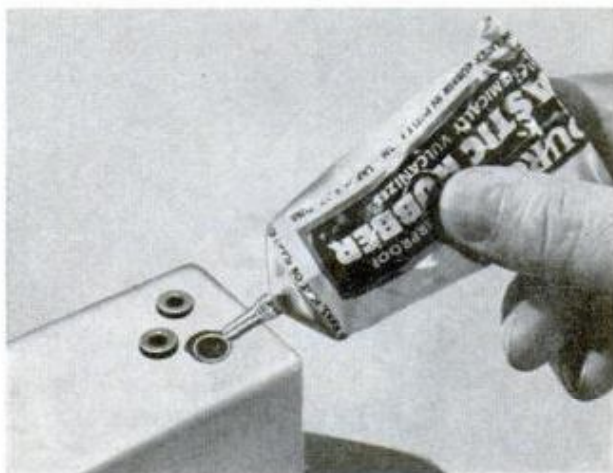

## Custom-Made Grommets Made of Liquid Rubber

When a rubber grommet is lost and you do not have one of the required size, it is not difficult to make one that is a perfect fit. Run a bead of liquid rubber around the hole through which the wire is to pass. Continue adding the liquid rubber around the sides and edges of the hole until the required thickness is reached. Warmed with a heat lamp, the rubber will set and vulcanize into a custom-made grommet.

Ken Murray, Colon, Mich.

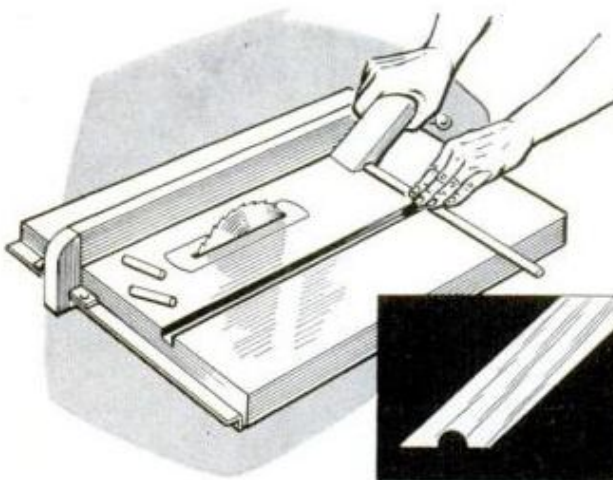

## Dowel Pins Cut in Quantity Using Wooden Safety "Paddle"

Cutting a quantity of dowel pins on a bench saw can be done quickly and safely with the use of a special paddle. Cut the paddle from  $\frac{3}{4}$ -in. stock. Its width should be equal to the length of the required pins. The wide end of the paddle is tapered and slotted to fit over the dowel stick. Set the fence paddle-width from the saw blade. By moving the paddle against the saw fence, the pins are cut to size quickly, without jamming or twisting between fence and blade.

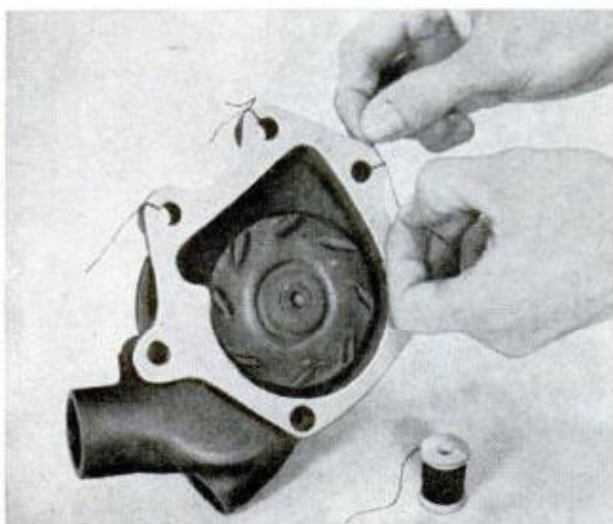

## Thread Helps Position Gasket

To keep a gasket from slipping out of position while a machine or automotive part is being mounted, apply gasket cement as usual and, in addition, tie the gasket on with fine sewing thread. Loop the thread through several of the part's mounting-bolt holes so that the gasket is held centered firmly in position. Once the part is mounted, the thread will be forced into the gasket material by the pressure of the bolts and need not be removed as it will offer no resistance to a good seal or seating.—R. Hanscom, Elmhurst, Ill.

## Dishpan Sink for Darkroom Beginner

What to use for a sink without spending a lot of money poses a problem for the amateur photographer interested in setting up a basement darkroom. The answer is a plastic dishpan. The plastic is soft and easy to cut, making it a simple job to cut a hole in the bottom for a standard bathtub-drain fitting. The flange around the edge of the pan permits it to rest neatly in an opening jigsawed in a plywood or hardboard counter covered with linoleum. In most cases, water can be piped to the darkroom by adding a line and faucet to the existing plumbing, and the sink can be drained with a length of 1½-in. plastic hose into a nearby floor drain. In the latter case, a trap isn't necessary on the sink fitting.

R. J. Phillips, Uncasville, Conn.



## Filter on Faucet Assures Clean Water at Darkroom Tap

Clean water, free of rust flakes and other foreign particles, is important when it comes to processing film. Unfortunately, commercial filters are expensive and for this reason most amateurs use unfiltered tap water in the darkroom. However, an inexpensive and fairly simple water filter can be made as shown in the pull-apart drawing and attached directly to the sink faucet. Made entirely of brass, the body is a 3-in. section of kitchen-sink drainpipe

which has a disk soldered at the bottom and a flange at the top. The bottom disk is drilled and tapped for a ¼-in. hose connection. The cover of the filter is held in place with eight capscrews turned into tapped holes in the flange. A gasket cut from an innertube goes between. A section of brass channel supports the filter screens and loosely packed cotton which filters the water.

Robert Michals, Freehold, N. J.

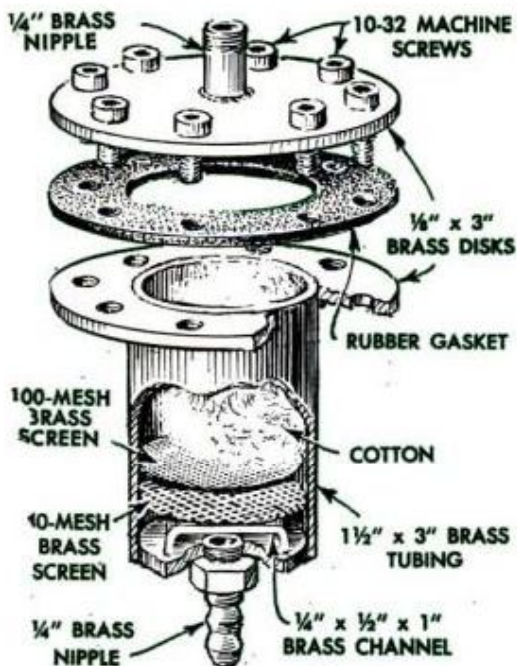

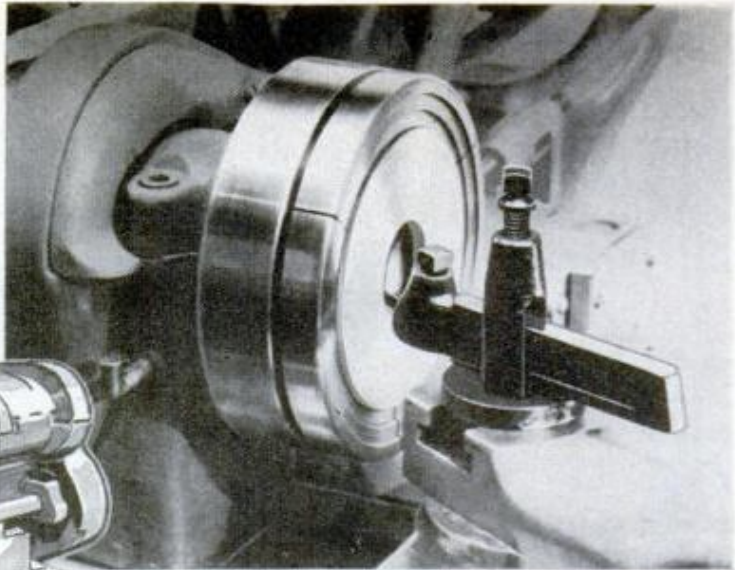

## STEP CHUCKS

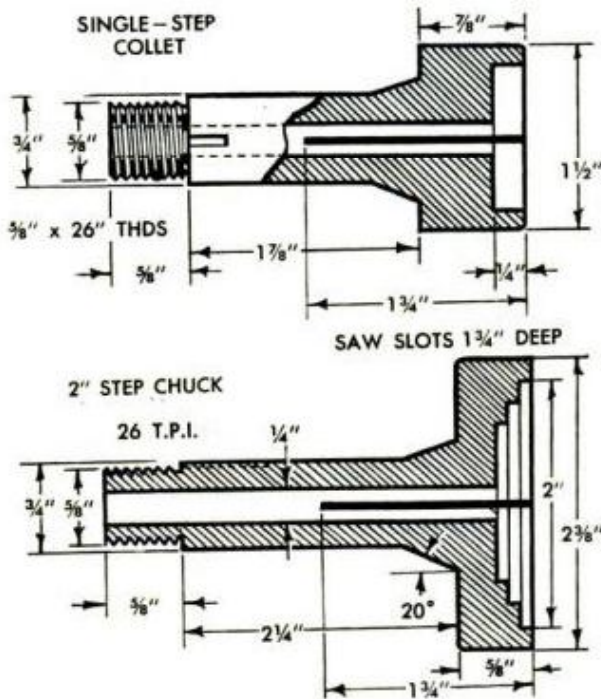

**F**INISHING OPERATIONS on semi-finished parts are often carried out by stepchucking the work piece by piece in a small lathe. Although somewhat slower than other methods, stepchucking the work results in the fine accuracy and uniformity so essential when finishing small parts within close limits. No other type of chuck in common use has greater accuracy than the step chuck, which takes over work beyond the capacity of the largest collet the lathe spindle will accommodate. Small disks which have been machined to finish diameter, precision gear blanks, any similar work which is difficult to hold, usually can be handled in a step chuck.

Step chucks made for use on small lathes usually are operated with a draw-in bar and a closing ring, or sleeve. Draw-in bars are available as accessories for almost all small lathes, also finished closers and chucks in various sizes, but many users prefer to purchase the bars and closers ready-made to fit the lathe and then machine chucks for their own requirements from step-chuck blanks. With these parts at hand, very accurate chucks can be machined on the lathe on which they are to be used. There are, of course, definite practical limits to the swing of a step chuck. As an

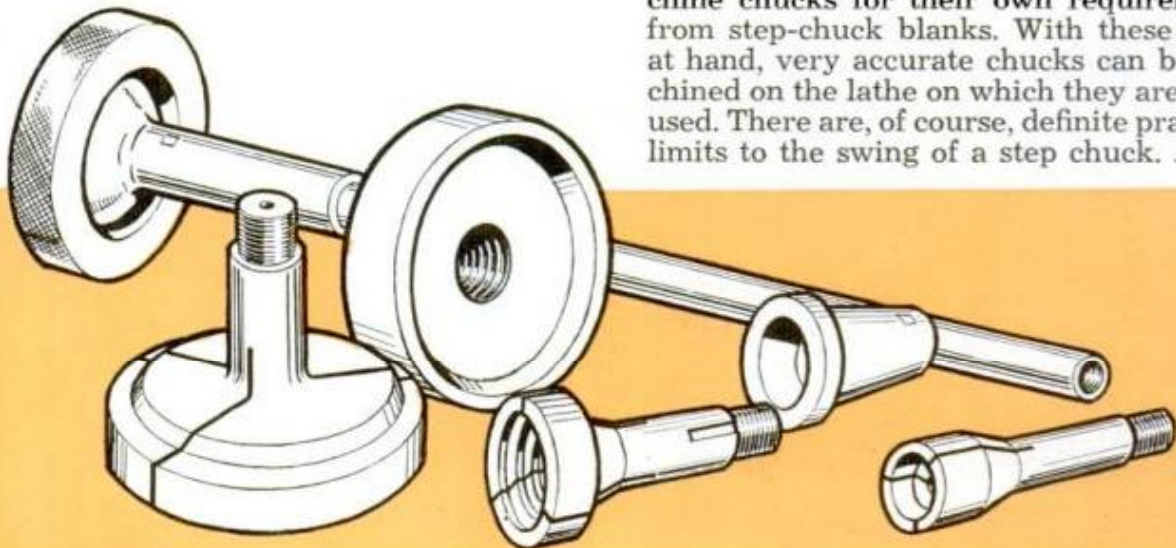

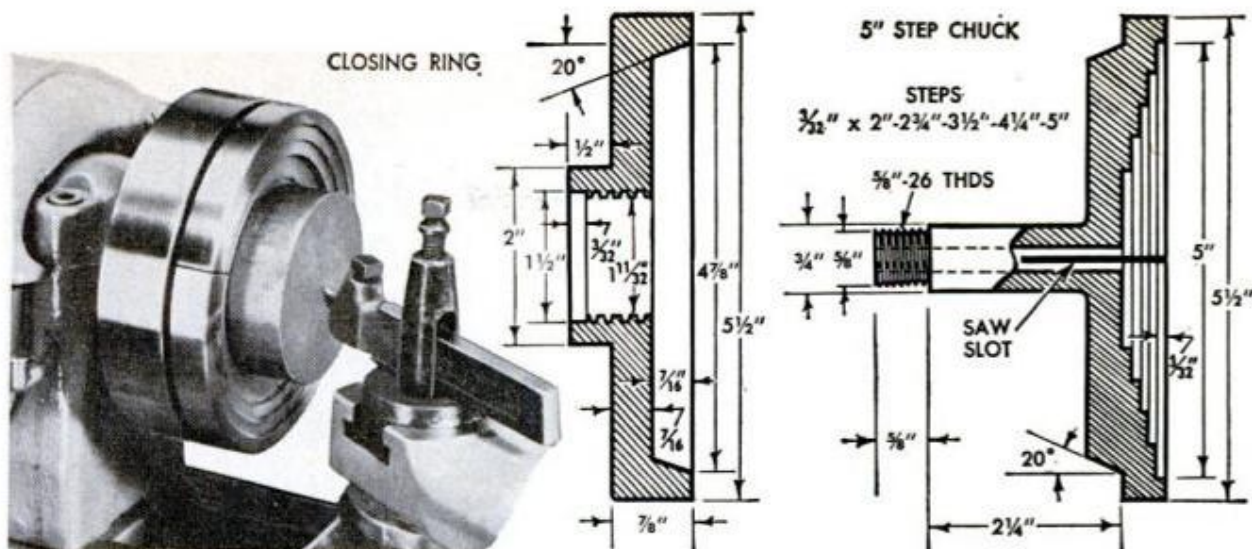

## SPEED FINISHING IN METAL LATHE

example, chucks taking work larger than 5 in. in outside diameter are seldom used on a 9-in. lathe. Some users consider 4 in. a maximum diameter when accuracy is a first consideration. Also, chucks are made with more than four steps only for jobs which may require special machining operations on both faces. A 5-in. capacity chuck is shown in detail above at the right.

Some users of step chucks purchase the blanks and machine them with only one step. In this way it is possible to attain the finest accuracy as the single step can be more easily machined to run dead true. When two or more steps are required, many lathe operators machine the second and succeeding steps with a work blank in place in the first step. By using this method extremely accurate concentricity is possible. Of course, in any operation the open and closed diameters of the step must be carefully calculated. Usually the requirements will call for a minimum movement of the parts when opening and closing the chuck. As a rule the steps are made  $\frac{1}{16}$  to  $\frac{3}{32}$  in. in depth but, of course, this can be varied to some extent to suit special jobs. As an example, the over-all depth of the chuck, including all steps, should not exceed  $\frac{5}{16}$  to  $\frac{3}{8}$  in., as otherwise there is

some risk of distortion of the segments when closing on the work.

The accompanying details give general dimensions of chucks and closers for small lathes. The dimensions given are not specific, but rather are intended to give a general idea of the size of small chucks, closers and draw-in bars.

When operating a lathe equipped with a step chuck, it's important that one acquire a sense of just the right amount of pressure to apply to hold the work securely for the machining operations. In repetitive work this uniformity of closure is especially necessary to avoid inaccuracies due to slight distortions of the work or chuck which may occur if too great a closing pressure is applied. Also, it is essential that the workpieces and all parts of the lathe and the chuck be scrupulously cleaned and kept clean throughout the entire work sequence. Tiny metal chips, heavy grease or oil, abrasive, or any other particles on any of the meeting surfaces of the work or the chuck can cause trouble. Make sure, by frequent close examination, that there are no metal chips in the slots between the segments of the chuck. A small metal chip in one of the slots can prevent uniform closure with resulting inaccuracy in the work. ★ ★ ★

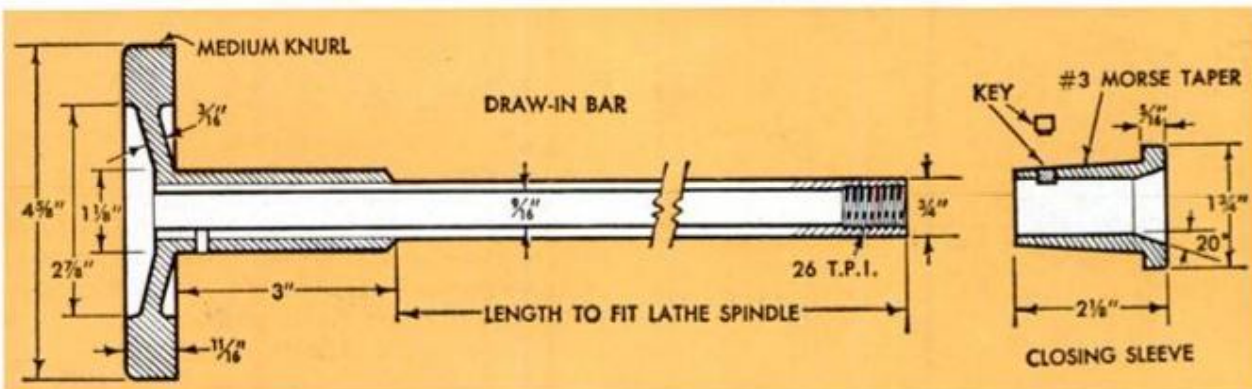

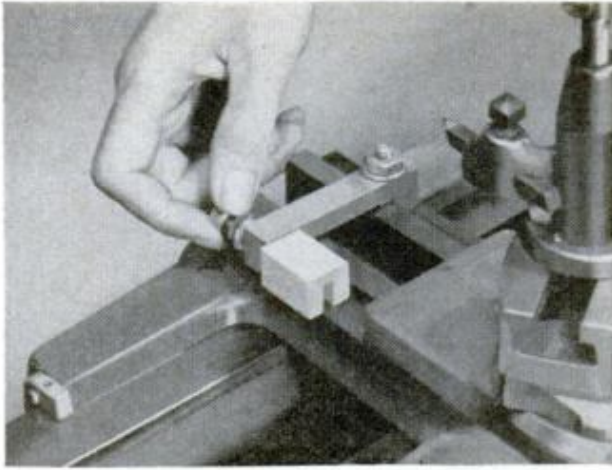

### Two-Position Cross-Feed Stop

An adapter that fits the cross-feed stop will permit turning of two diameters without disturbing the original setting of the conventional stop. The adapter can be of metal or hardwood, metal being best for durability while use of wood is permissible for special jobs where speed in making the setup is imperative. A stop about 1¼ in. long will have an adequate range for nearly all average work. It is grooved to fit over the cross-feed stop screw. In use, the cross-feed stop is positioned for the larger diameter to be turned.



### Four-Tier Rack for Used Tires

Racking 140 used tires side-by-side in four neat rows results in a display that is certain to catch the eye of every passing motorist. The wooden racks are a simple carpentry job. Retaining bars, made from 1-in. pipe, are counterbalanced by sash weights attached to cords running over awning pulleys. These bars keep the tires in the racks. Any individual tire can be removed by simply pulling down on the bar. When released the bar returns automatically to its original position. If desired the bar system could easily be arranged for padlocking as additional protection.

Grover Brinkman, Okawville, Ill.

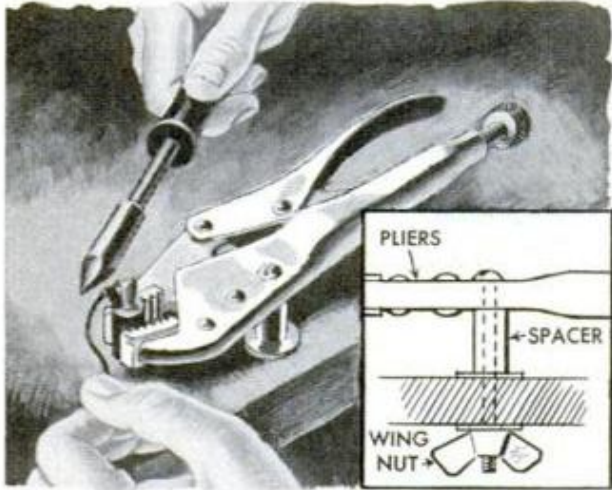

### Locking Pliers Serve as Vise

There are times when a conventional vise just won't hold things in the position you want them for some special operation. That's when you call on some other tool or fitting in the shop to do the job. The next time this problem comes up in your shop, think of your locking pliers. Drill one small hole through the fixed handle. Insert a screw, add a spacer, washers and wingnut and attach to the bench top as in the detail. The setup will swing in any desired direction and the locking pliers will hold any small item in a viselike grip.

Tom Raymond, Alamogordo, N.M.

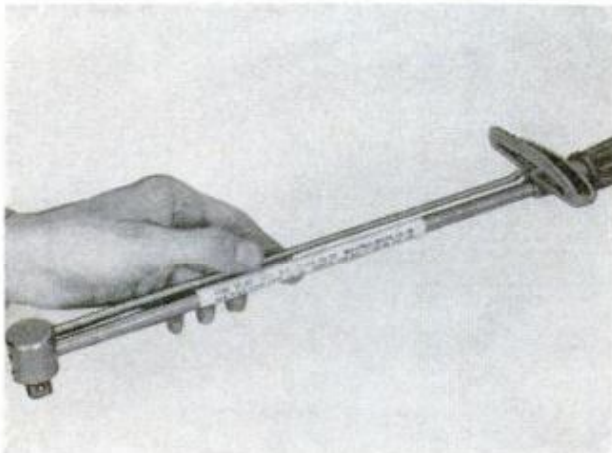

### Data Chart on Torque Wrench

This chart could be the means of avoiding a serious error when tightening bolts or screws to a uniform tension with a torque wrench. Often the tension limits of assemblies are quite definite and if you depend on memory alone, you may miss badly. To eliminate the guesswork for yourself, or someone else who is to use the wrench, type or letter a chart and tape it to the spindle of the wrench as indicated in the photo. Protect the chart from dirt and smudging with a wrap of cellulose tape.

R. Hanscom, Elmhurst, Ill.

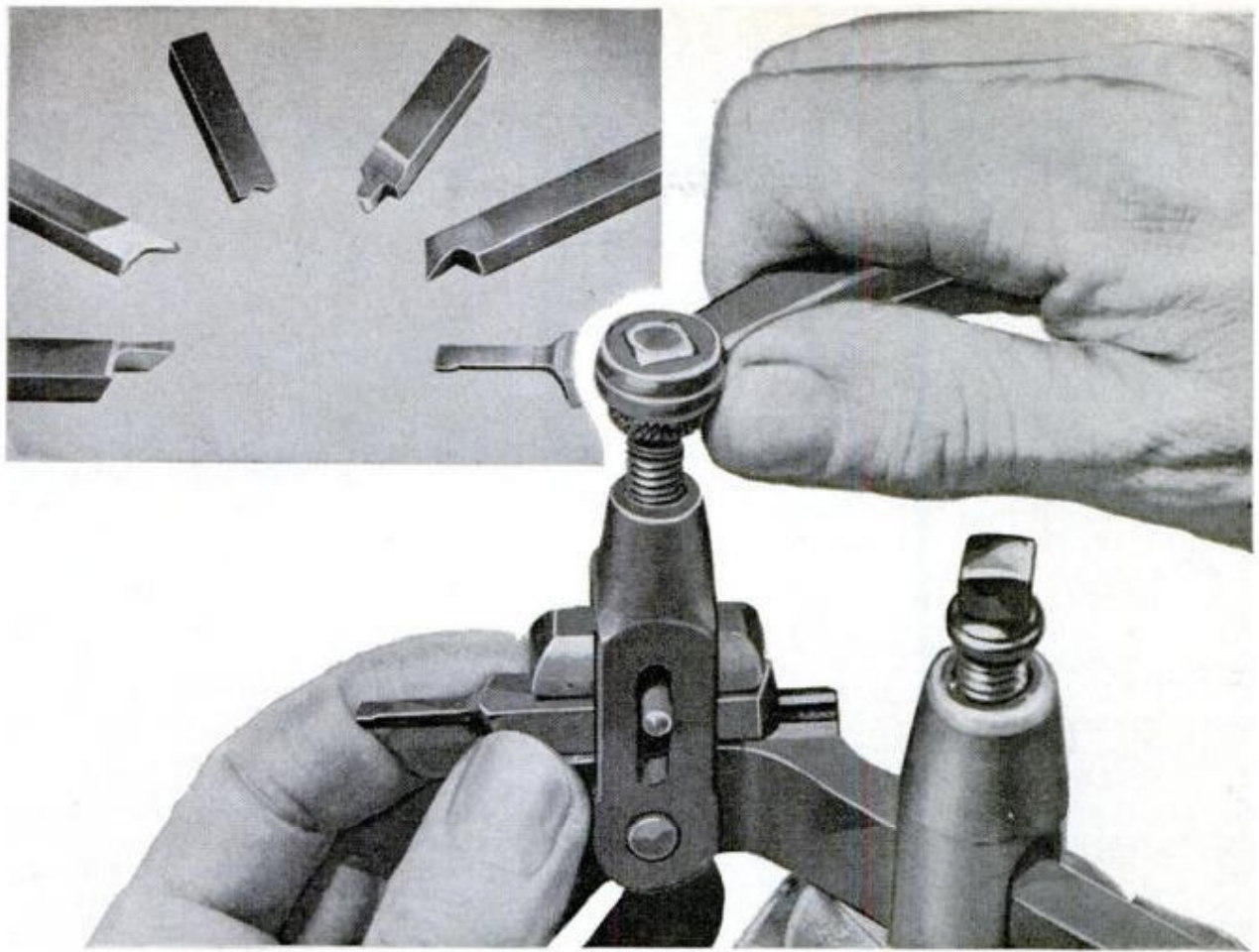

## ODD-JOB LATHE BITS

STANDARD lathe bits will handle all ordinary machining without altering the cutting edges, but some special jobs may require regrinding and reshaping the cutting edges and clearance angles. Figs. 1 to 6 inclusive show how bits can be altered to work in limited space, around corners, machine recesses, fillets and grooves. Figs. 2, 3, 5 and 6 show side and top views of altered bits, all the shapes shown being ground on  $\frac{3}{16}$ -in. high-speed-steel bit

stock. Within practical limits a cutting edge can be brought down to  $\frac{1}{32}$  in. as in Fig. 1. Of course, such a bit will take only very light cuts and it must be ground with side clearance to prevent binding, heating and scoring of the work when used for cutting off. The shape shown in Fig. 6 is useful for undercutting in bored work which is to be threaded internally. The maximum overhang should not be more than  $\frac{1}{2}$  in. or so.

Walter E. Burton, Akron, Ohio

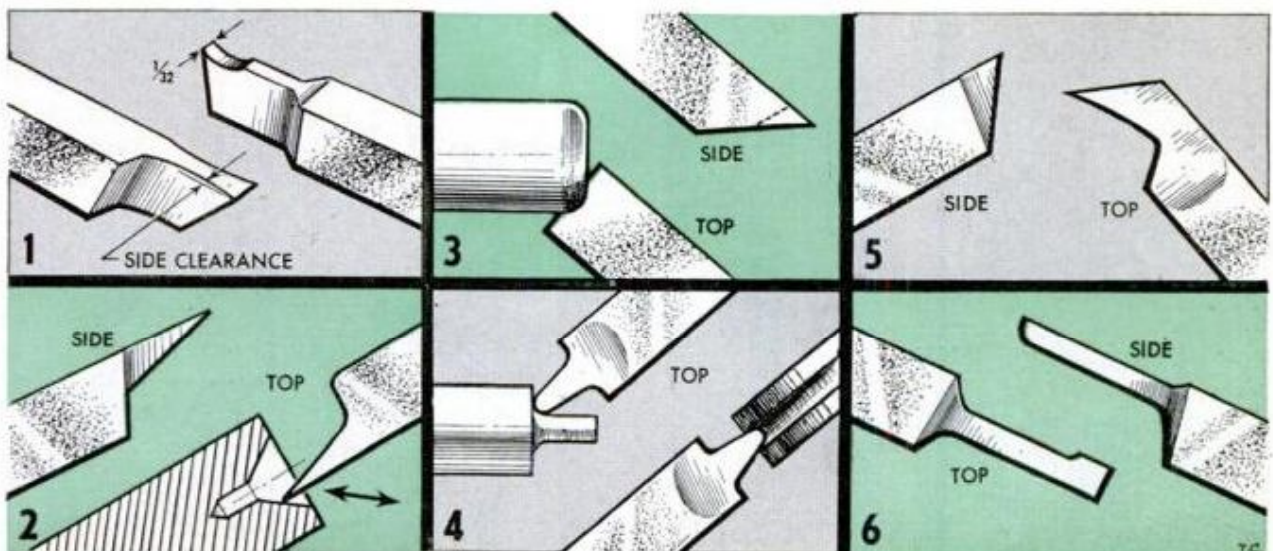

# Power Your Tools With a FLEXIBLE SHAFT

By C. W. Woodson

**F**LEXIBLE SHAFT applications cover a wide range of equipment from the most delicately manipulated hand tools, running at extremely high speeds for precision work, to the heavy-duty grinding or snagging wheel built for rough, hard use where the service is severe. For light work, with a suitable handpiece mounting a key-operated chuck, the flexible shaft will handle a variety of tools for drilling, grinding, carving, sanding and other operations, Figs. 1 and 5. With the proper combination of end fittings, on both the shaft and its casing, special equipment, such as the tool-post grinder, Fig. 2, can be driven at the required speed for internal grinding, making the tool an indispensable accessory to the metal lathe. A similar accessory, but for external grinding, is shown in Fig. 8.

## Flexible-Shaft Applications

Covering a wide field, flexible shafts are made in various sizes, for light work where extremely high speeds are needed, to shaft sizes transmitting power for the heaviest type of work that can be done with hand-held tools. Regular types of flexible shafts are built up of one or more superimposed layers of wire with a single wire, or mandrel, in the center. Fig. 7, details A, B and C, indicates how shafts of various sizes are made up and how the pitch direction of successive layers alternate.

Different characteristics of the flexible shaft are determined by varying the size and grade of the individual wires, the number of strands and number of layers, the

degree of pitch as well as the winding tension and in some cases, heat treatment after the shafts are wound. These features largely determine the transverse flexibility, or degree to which a shaft can be flexed, Fig. 3, while under load. Torsional stiffness, or twisting under load, is affected as well as the running torque of the shaft.

## "Lay" of Shaft

The "lay" of the shaft is either "right-lay" or "left-lay" as determined by the pitch direction of its outer layer of wires. A right-lay shaft is one in which the outer layer has the same pitch direction as a right-hand screw thread, while the outer layer of a left-lay shaft corresponds to a left-hand thread, Fig. 4. For maximum efficiency in transmitting power, the flexible shaft is wound for rotating in one direction only. The pitch direction of the outer layer of wires determines the direction of rotation for best results. Fig. 8 indicates how the direction of rotation is determined and the correct lay of shaft to use for each direction. For driving in a clockwise direction a left-lay shaft should be used. Direction of rotation is determined from the power-source end of the shaft, Fig. 6. Shafts of both right-lay and left-lay types are made in a wide range of sizes and care should be used in selecting one to correspond with the running direction of the motor and design of the tools to be used, Fig. 6. Clockwise direction of rotation is most frequently applied. The average small motor runs in a clockwise direction.

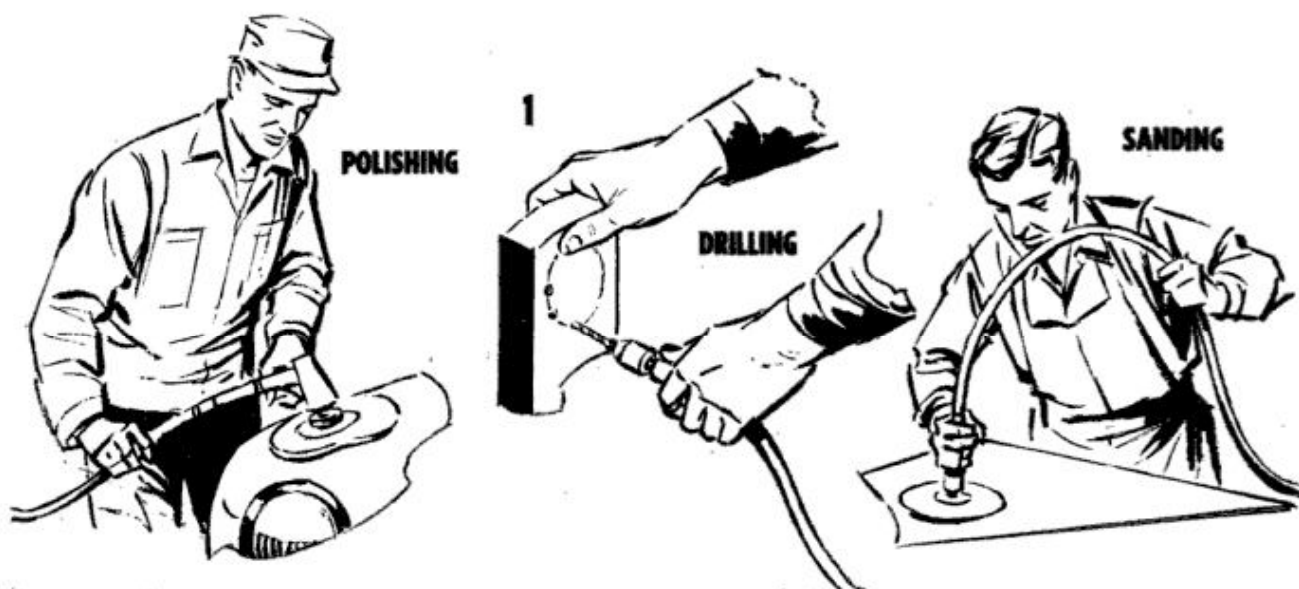



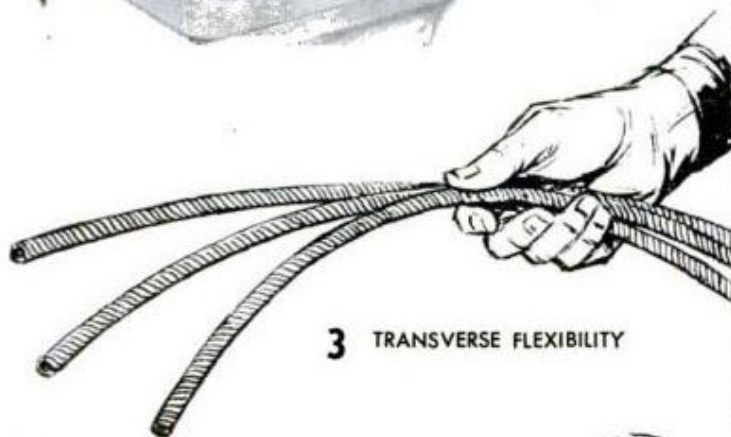
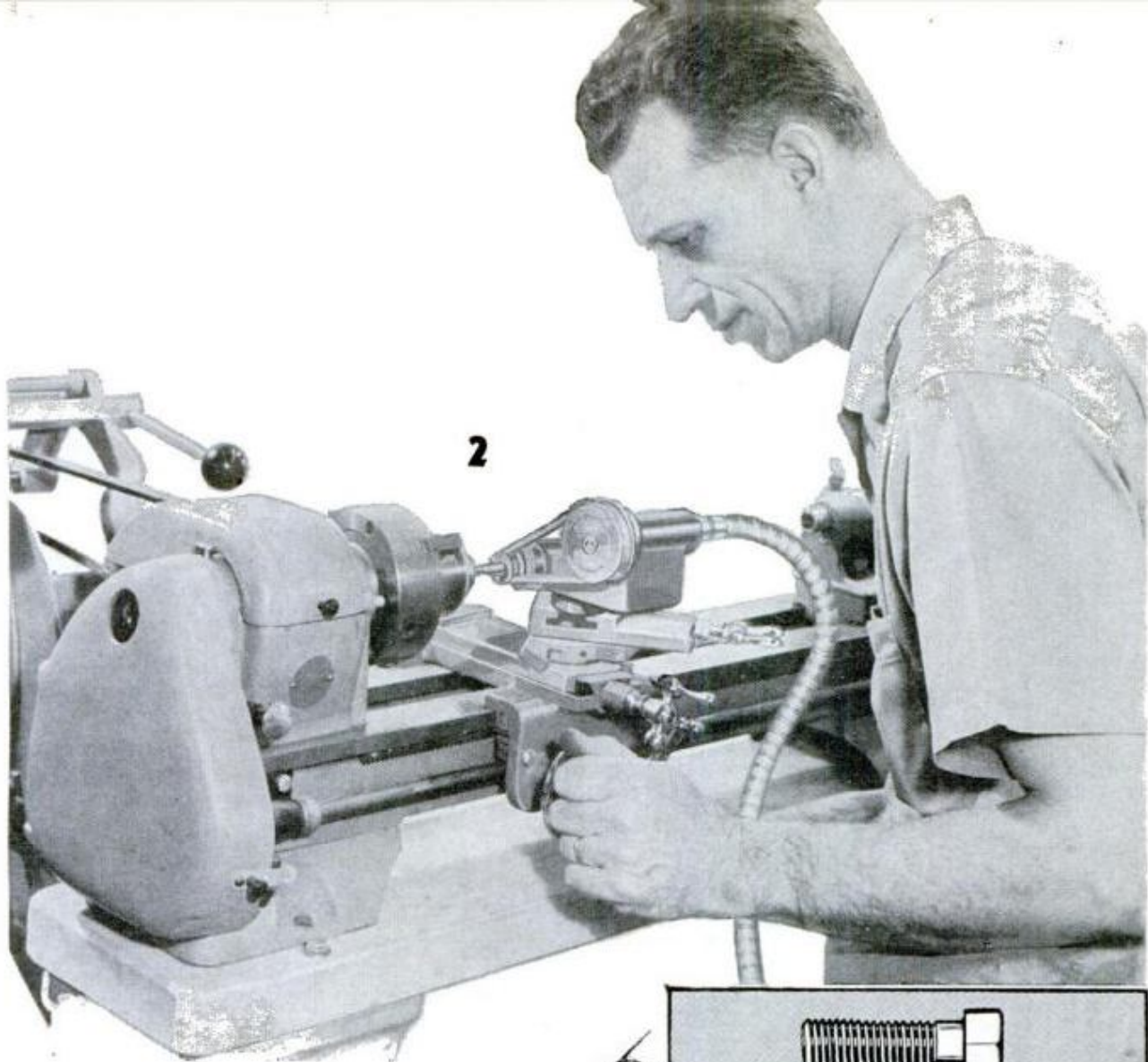

3 TRANSVERSE FLEXIBILITY

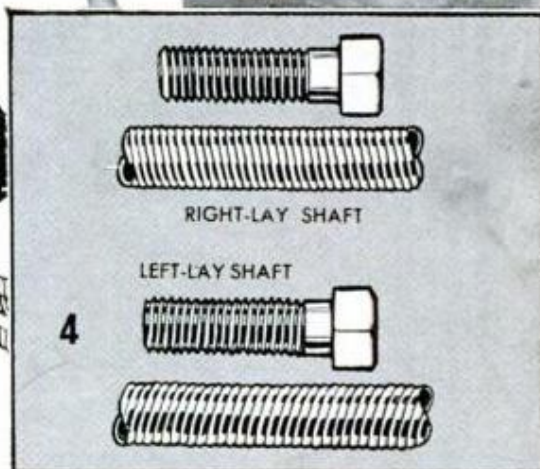

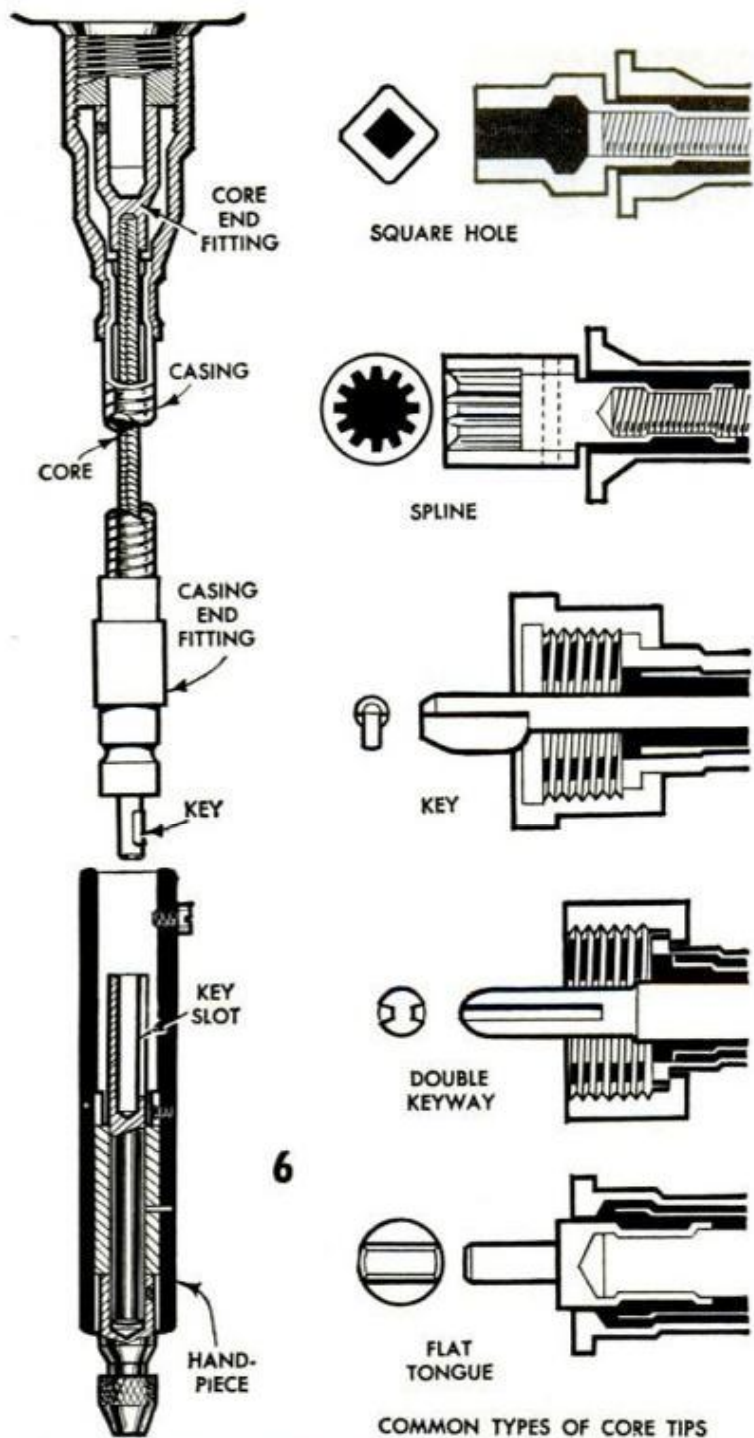

6

COMMON TYPES OF CORE TIPS

Torque, or twisting force which the shaft will be called on to transmit, is the principal factor in selecting a flexible shaft because each size has a definite torque-load capacity. A distinct advantage is to be gained by running a shaft at the highest speed which the job at hand will permit. Ordinarily, speeds of 1750 to 3600 r.p.m. are recommended as suitable for flexible-shaft operation. In many applications shafts operate from 600 to 12,000 r.p.m.

The use of gearing, where standard motors are used, is common practice where a decrease or increase of speed is desirable. In each case the flexible shaft is always run at highest practical speed. Fig. 9 illustrates how the gearing is located so that the shaft operates at the highest speed.

The flexible casing is made in three general types: metallic, fabric covered and rubber covered. The casing enables the shaft to run true and operate smoothly. It also prevents it from helixing, or looping, under torsional strain. The casing also protects the shaft from moisture, dust, grit and external injury and retains the lubricant.

Two and four-wire metallic casings meet requirements for the general use of power-driven flexible shaft applications, Fig. 7, detail D, E and F. The two-wire casings are made of two formed wires accurately machine-wound. The inner wire is half round in section and the outer wire triangular, its shape conforming to the inner-wire contour. This facilitates bending freely while maintaining the contact of adjacent wires. The two-wire casings are particularly suited

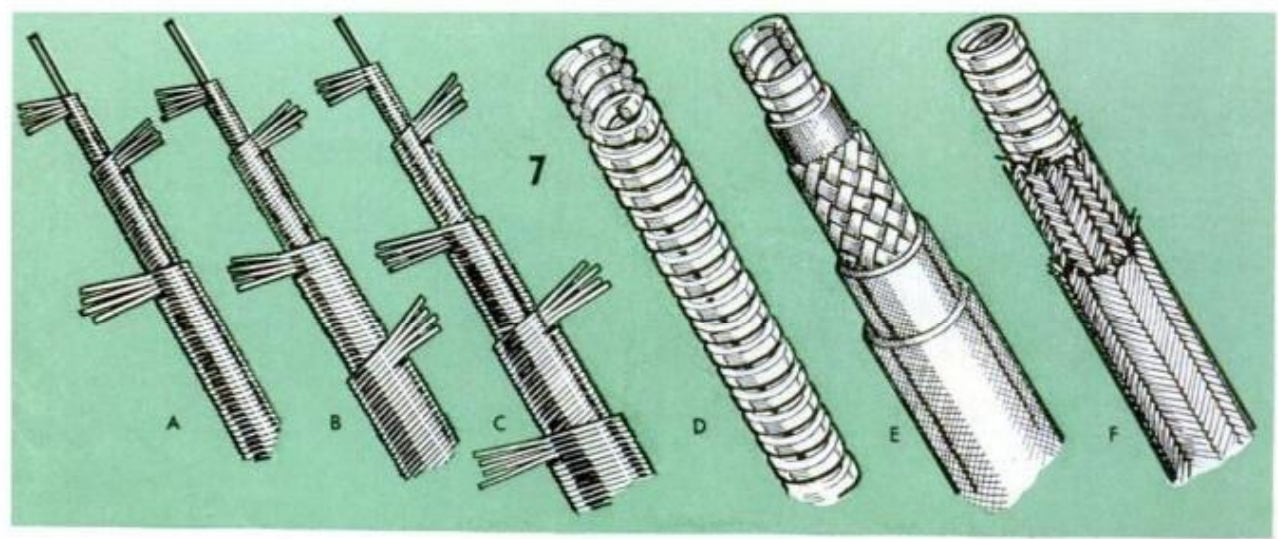

7

for portable tool applications where the shaft will be flexed more or less constantly. The four-wire casings are similar in construction but are wound four wires at a time instead of two. This makes a longer pitch, stiffening and strengthening the casing.

The interlocked type metallic casing is a single, continuous steel strip formed so that the adjacent turns are interlocked and when the interlocked joints are packed, usually with asbestos, the flexible casing is grease tight. Connecting end pieces of the shaft are press-fitted into the casing for direct connection to the motor at one end and the handpiece at the other. When the flexible shaft is operated in a straight position, the end of the core protrudes only slightly but when flexed the core protrudes considerably farther. To allow for this endwise movement the core is fixed on one end to the connector and is splined or keyed in the handpiece on the other, Fig. 6.

Fabric covered casing, Fig. 7, detail F, is very flexible in the smaller sizes. It is comparatively light in weight and is generally used on portable flexible-shaft machines. The rubber covered casing, Fig. 7, E, is generally a heavy-duty type on shafts designed for hard service. The casing is oil and watertight and offers maximum resistance to abrasion and stretching.

Always be sure the shaft rotates freely before starting. Also properly engage the end fittings and the core tips, Fig. 6, when setting up any special type of assembly. The flexible-shaft handpiece is made in different types for holding a large variety of tools. Suspended units, Fig. 8, consisting of motor, shaft and angle head, are widely used in industry.

Periodic lubrication of the shaft is necessary, the frequency of lubrication depending to some extent on the nature of the service. Where the shaft is operated for long periods with considerable flexing during operation it should be lubricated more often than for less service. ★ ★ ★

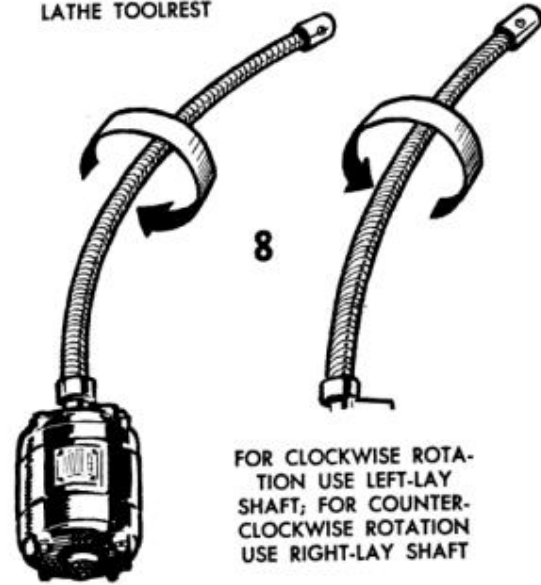
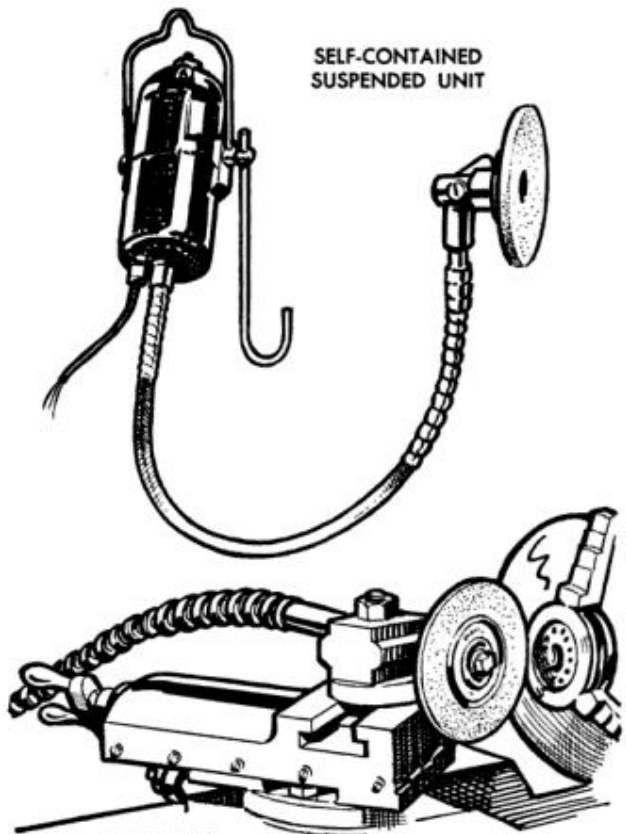

FOR CLOCKWISE ROTATION USE LEFT-LAY SHAFT; FOR COUNTER-CLOCKWISE ROTATION USE RIGHT-LAY SHAFT

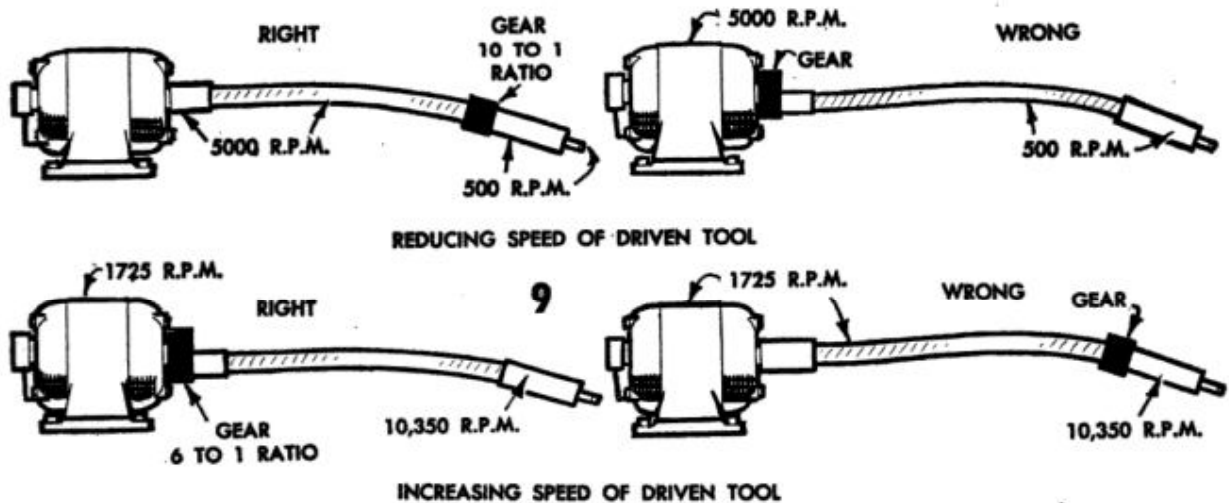

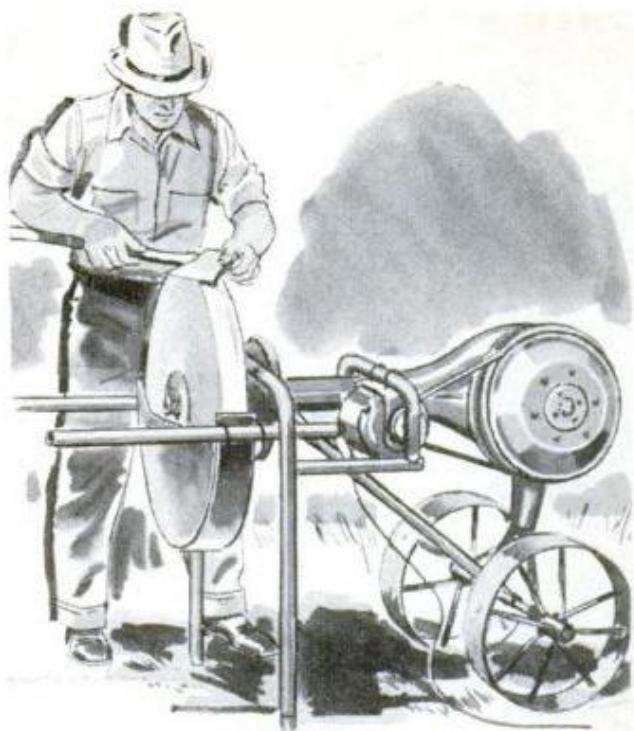

### Power-Drive Your Grindstone

Many farmers and others who must sharpen edge tools prefer slow, wet-grinding with the older grindstone which does not heat the work, as does a dry-grinding emery wheel. An electrified reduction drive for a large stone can be made by utilizing an auto rear end as pictured, a wheeled truck from a farm implement and odds and ends of pipe and rod stock.

F. Leland Elam, Sacramento, Calif.

### Large Work Dogged to Mandrel

Large diameter wheels sometimes tend to slip on the mandrel when machining must be done at or near the rim. This tendency usually can be prevented by dogging the wheel to the mandrel as pictured. Although an ordinary lathe dog can be used, a machinist's dog will give a more positive drive and a minimum of backlash.—H. J. Gerber, Stillwater, Okla.

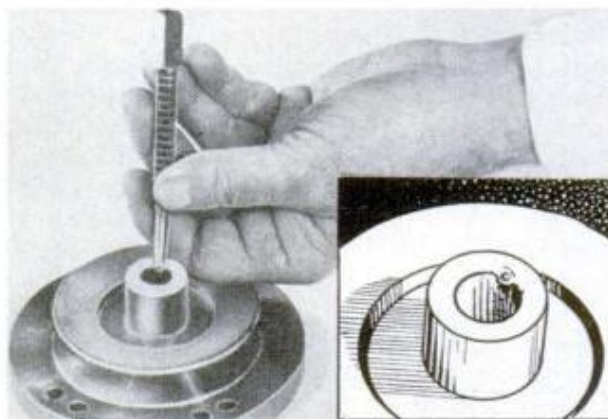
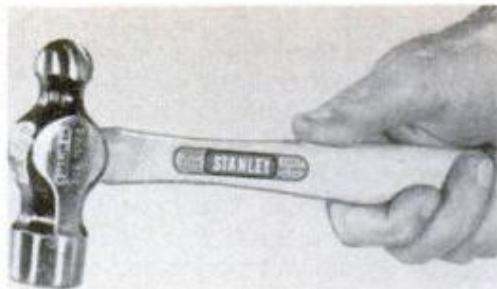
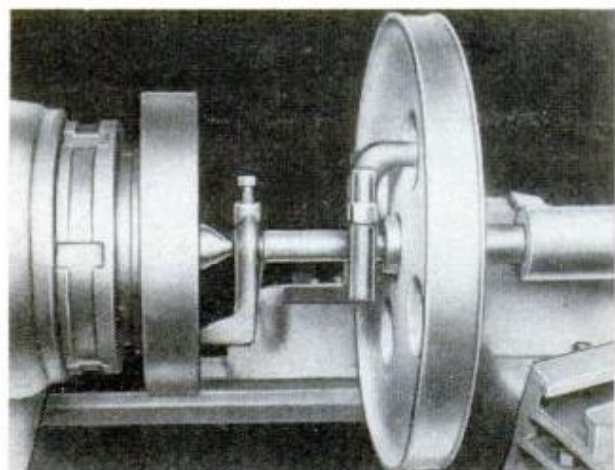

### Reducing Oversize Hole in Hub

If you listen closely, you can tell when a pulley is running slightly loose on the shaft. When the setscrew won't hold tightly enough to silence the rattle, remove the pulley and punch-mark the hub at the edge of the hole. Space the marks uniformly. Replace the pulley and check its performance. If still loose, make the punch marks a little deeper.

Robert L. Sargisson, Berwyn, Ill.

### Straddle Bar Holds Flanged Work

A flanged coupling like that pictured is difficult to set up on a drill-press table in an accurate and stable fashion. To correct any tendency to instability that may affect the accuracy of the work, many machinists make the setup on a straddle bar made especially for the job. The bar is attached to the machine table with a strap clamp as indicated.

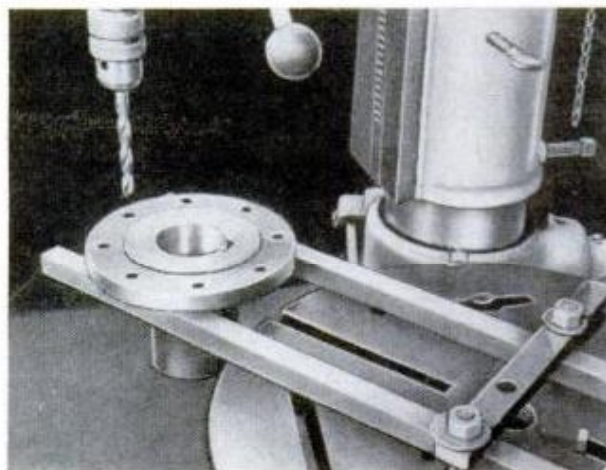

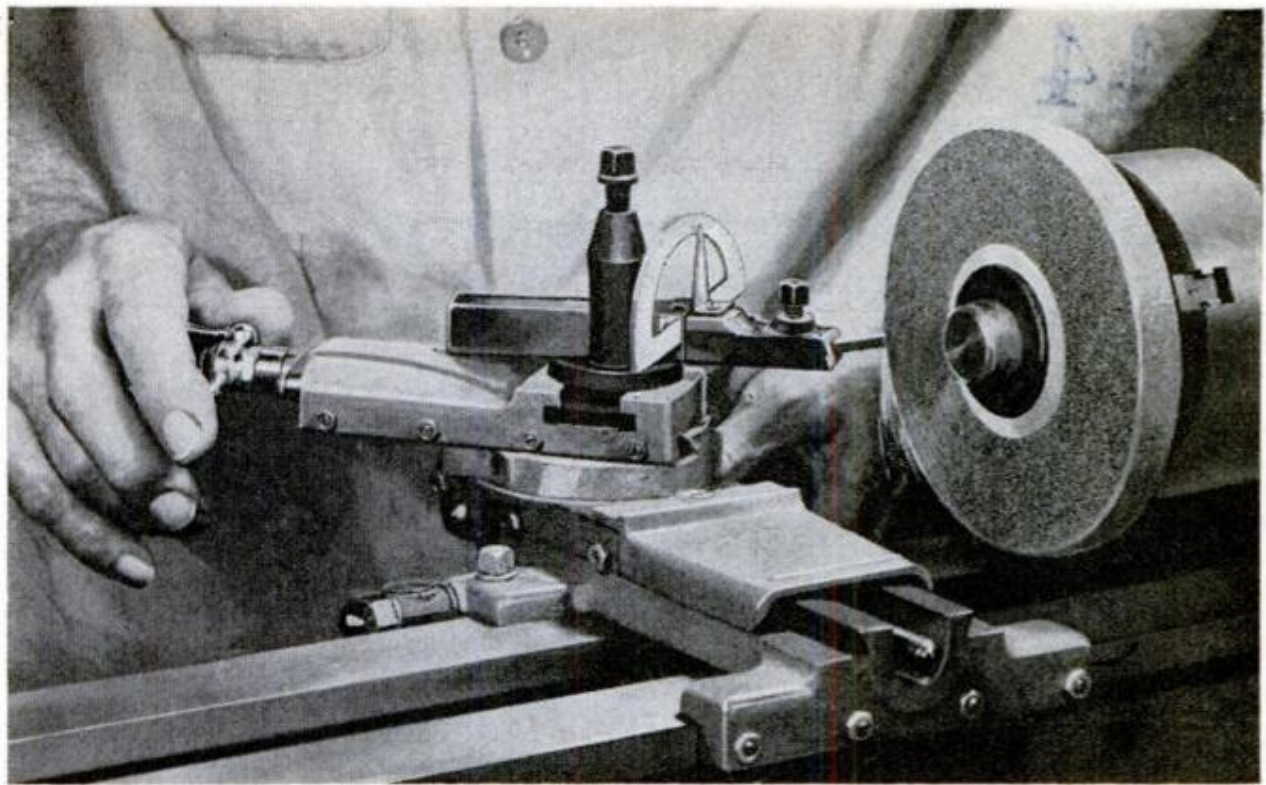

## Lathe-Bit Clearances Ground Accurately

Grinding a lathe bit by eye does not always produce the accuracy required for close work on the common metals. In some types of work the clearance angles are quite critical. Shops not equipped with special grinders will find use for this lathe accessory which is adapted from a straight tool-bit holder of the drop-head type. The shank of the holder is ground or milled flat on top, then is cut as indicated and fitted with a tenon so that the tool-holding end can be rotated and locked at any desired angle by means of a setscrew. Next, the parts are drilled and tapped and a pointer and protractor are fitted in the positions indicated. This arrangement, combined with the scale on the lathe compound, en-

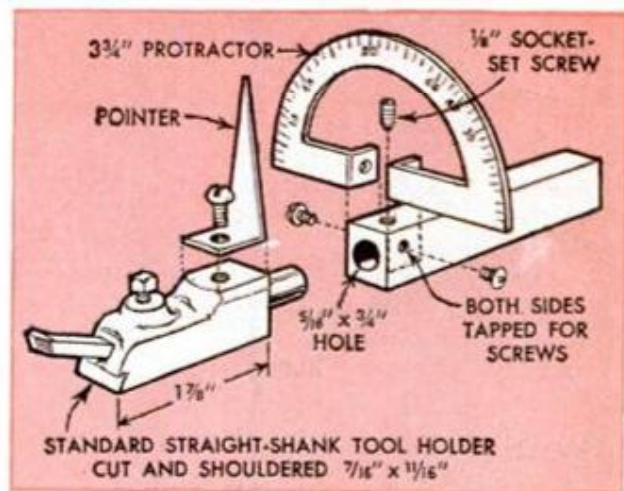

ables you to set the tool bit for grinding at any desired angle. Use a medium to fine grade wheel, mount in the lathe as pictured, and drive at the highest spindle speed.—Harland H. May, Toledo, Ohio.

## Steel Wool on Legs of Magnet Picks up Metal Filings

Removing tiny pieces of steel wool from work after rubbing down a finish can become rather trying to one's patience. It's almost impossible to brush away all the pieces, especially in the corners. Another job where a brush is only partially effective is removing metal filings from a bench top. Use a magnet for both jobs. It will pick up every particle of steel wool from a finished surface and if you press a wad of fine steel wool on each of the legs, you can use the magnet to clean up metal filings from the bench top. After using the magnet remove the wool and replace the keeper.



"61" Shopnotes Annual  
**X244**

# DRILL METAL SAFELY

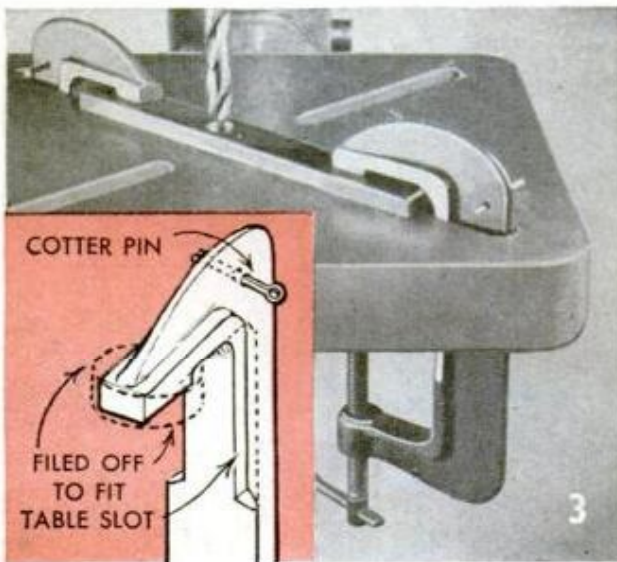
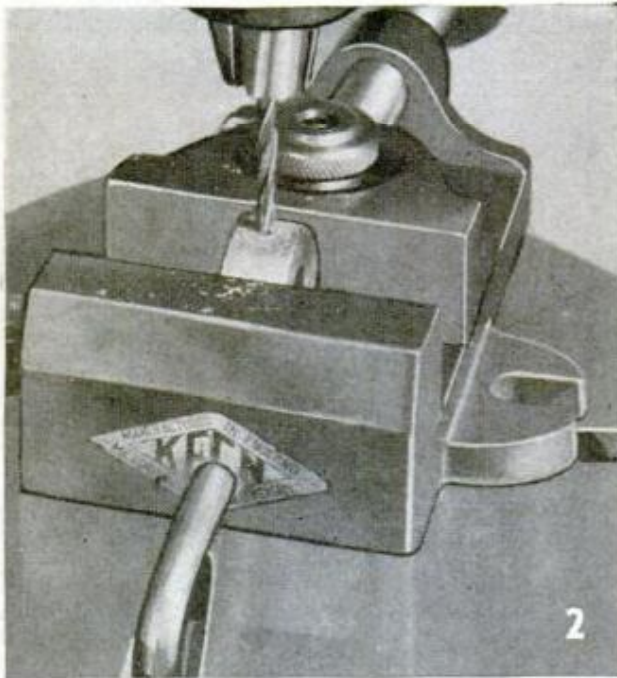
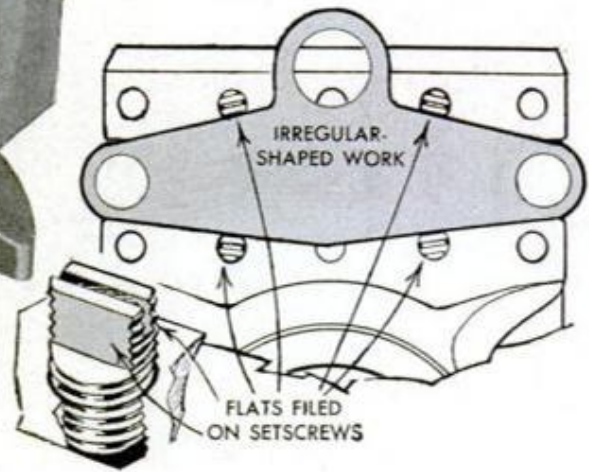
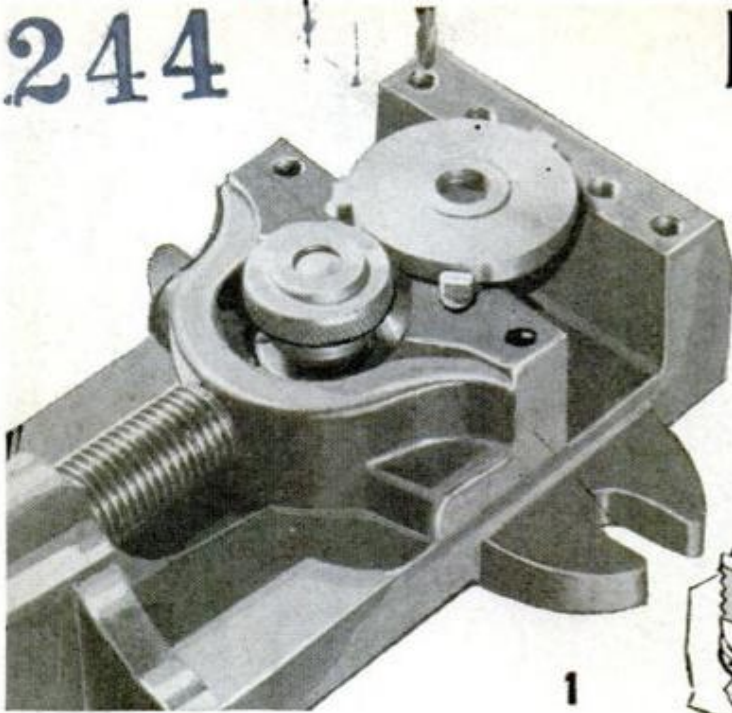

By Clifford T. Bower

**I**T IS never entirely safe to hold work by hand when drilling on a drill press, even when working small diameter holes in soft metals or hardwoods. Should the drill bit seize suddenly and spin the work, there's not only risk of a shattered drill bit but of a painful injury as well. Holding the work in a drill vise or by means of suitable clamps gets the job done safely and more accurately. Of course, it takes time to arrange clamps for holding individual workpieces that differ in size and drilling requirements, but the safety factor makes the extra time spent well worth while.

It is possible to increase greatly the use range of an ordinary drill vise. Figs. 1 and 2 picture examples of how this can be done easily and quickly. To adapt the vise to hold round work and also workpieces of irregular shape drill 5 holes in both the movable and fixed jaws. These are blind holes, bottom-tapped to take headless slotted setscrews. Flats are filed or ground on each setscrew as in the detail. For some types of work heat-treated, square-headed setscrews will serve equally well. By arranging the screws in the 10 holes provided, it is possible to hold almost any irregular shaped work and also any round workpieces within the capacity of the jaws.

In Fig. 2 note that the outer face of the fixed jaw of a drill vise has been drilled and tapped to take a threaded rod. The outer end of the rod is bent at a right angle so that when the vise is placed in position the bent end of the rod enters one of the slots in the drill-press table. When the vise

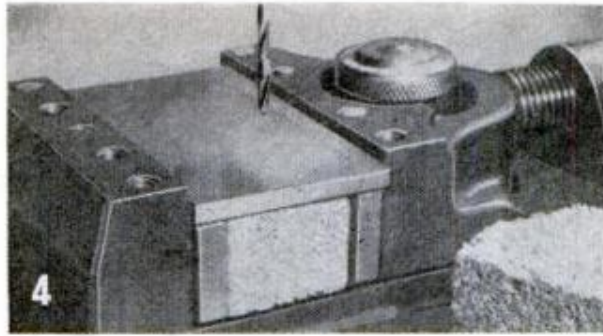

is used without bolting it to the machine table, the rod prevents it from accidentally falling to the floor, also prevents it from tilting or swinging out of position. The rod can be made to serve as a pivot when locating the work directly under the drill bit.

Ordinary C-clamps can be altered as in Fig. 3 for clamping work directly to the machine table. Simply grind or file off the web and the fixed pad to permit the clamp to slip through the table slot from below. The swiveling pad on the clamp screw will span the table slot. Drill the frame of each clamp to take a small cotter pin, which will

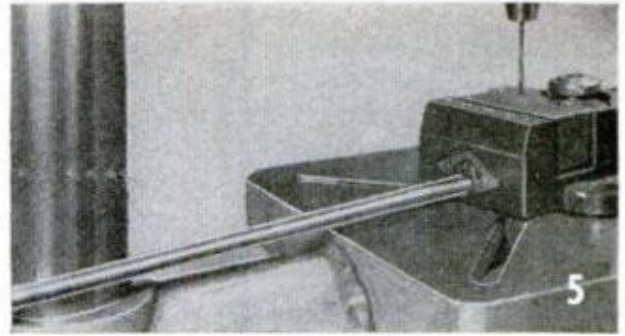

prevent it from falling through the slot.

A spacer cut from sponge rubber or an artificial sponge will hold parallels in place while the work is being set up in the drill vise as in Fig. 4. Cut that portion of the sponge to be used somewhat wider than the space between the parallels so that when it is in place it will hold the parallels securely.

Another use for the tapped hole in the outer face of the fixed jaw of the drill vise is shown in Fig. 5. Here a rod long enough to reach past the column when the work is centered, prevents the vise from tilting or spinning with the work. ★ ★ ★

## Ridge Saddle Is Safe On Steep Roof

When repairing a shingled roof at points between the eaves and the ridge it's common practice to rope a ladder over the ridge or trust two short lengths of 1 x 4 stock nailed or clamped to the ladder rails. On lower pitched roofs these methods can perhaps be considered safe enough. On a steep roof the method illustrated is safer and the ladder is more easily moved. Drive a large nail about half its length into a 2 x 4 near one end. Place the 2 x 4 and the ladder on the ridge as pictured. The length of the 2 x 4 should be more than half the length of the ladder for maximum safety.

Kenneth Murray, Colon, Mich.

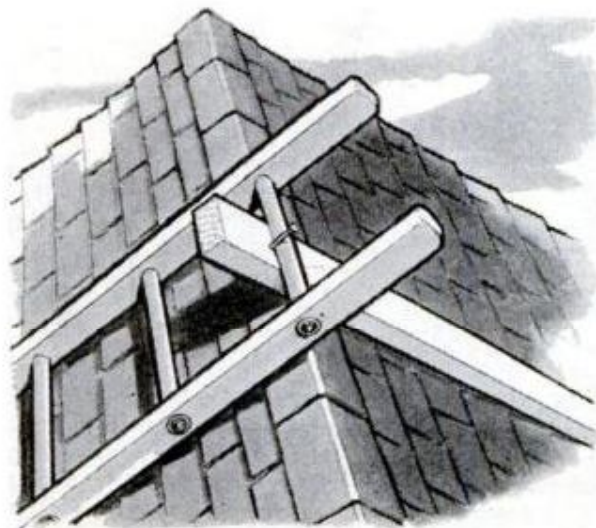

## Roof for Round Corncrib Hoisted With Elevator

How to lift the assembled sheet-metal roof of a round corncrib into position stopped one farmer until he thought of using his elevator as a hoist. The photo shows how the idea worked out. An implement wheel was placed inside the cone-shaped roof and a light chain was passed around the hub of the wheel and attached to the top end of the elevator. The latter was then raised by means of its own derrick, taking the roof with it as pictured. The elevator was backed into a position by tractor to bring the roof directly over the crib. Lowering the elevator dropped the roof neatly into place.—Wally E. Schultz, Elkhorn, Wis.



# Short Cuts That Help Solve Shop Problems

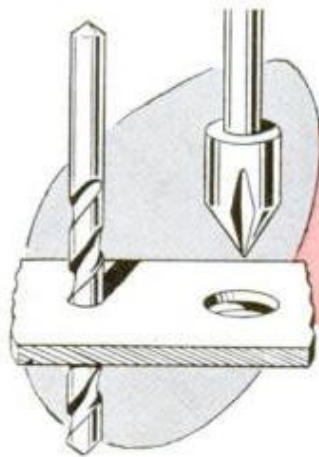

**1. TO DRILL** a larger hole when all you have at hand is a 1/4-in. drill, simply enlarge the 1/4-in. hole with a countersink to the required size. The remaining burr is removed with pin punch

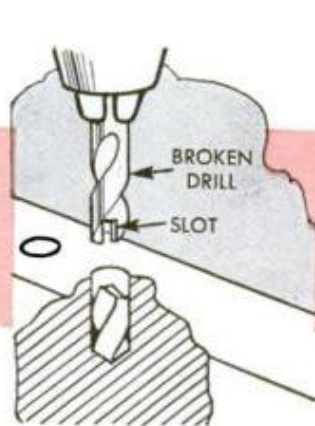

**2. A BROKEN TWIST DRILL** can be removed from work by slotting the end of the broken part. Chuck the part and rotate by hand. Slot will engage the broken part of drill in the work

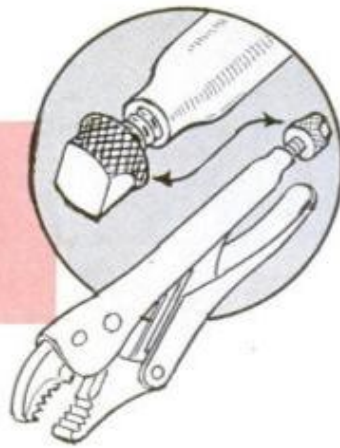

**3. CLAMPING PLIERS** are often difficult to unlock when worn. To remedy, grind two sides of the adjusting screw to take an open-end wrench. Pliers then can be loosened without damage

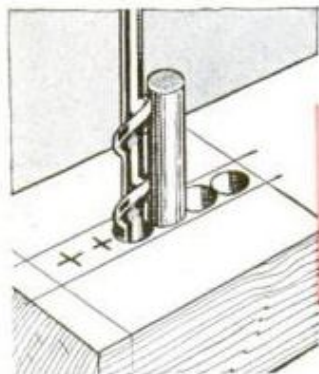

**4. WHEN BORING** a row of holes prevent the bit from running out by pressing a length of dowel into last hole bored. Dowel should fit fairly tight in order to serve as guide for bit

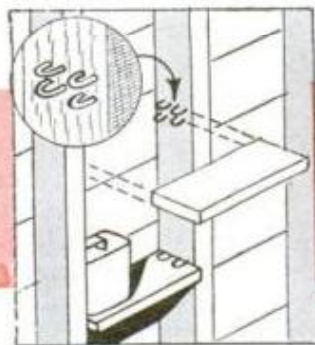

**5. FENCE STAPLES** can be substituted for supporting strips when placing shelving between studs. Simply drive two rows of staples in line to support shelf ends. Top row prevents tilting

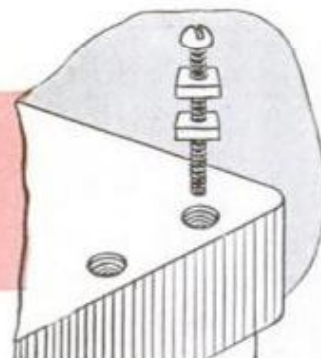

**6. A DEPTH GAUGE** for measuring blind holes can be made by turning two nuts onto a stove bolt. Place bolt in hole and run nuts down to touch surface. Tighten top nut to hold measurement

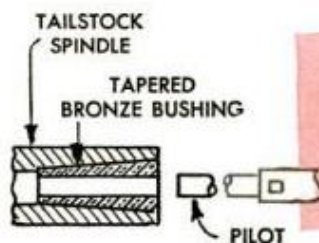

**7. LONG BORING BARS** are sometimes mounted with one end rotating in a special bushing turned to fit tailstock spindle. Bar is turned with pilot which fits straight bore of bushing

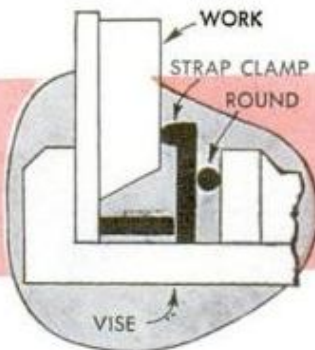

**8. IRREGULAR WORKPIECES** can be held vertically against the stationary jaw of the machine vise by a strap clamp which is pivoted between a steel round and a fulcrum block

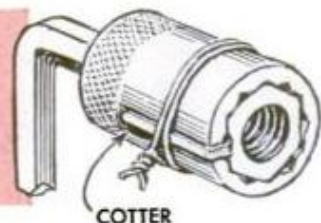

**9. A NUT** with badly rounded corners is removed easily if a cotter pin is first placed over rim of socket. Wire pin to the socket, then tap socket onto nut with light hammer blows



## Spillproof Container

This spillproof container was devised by a tree pruner to hold the sealer, or dope, with which fresh tree wounds are coated to prevent infection. It's made from an ordinary oil can which is placed inside a larger container fitted with a special bail. The bail can be hooked onto the user's belt while climbing and hooked over a tree limb when in use. The handle of the brush is shortened and forced into the oil-can spout which serves as a brush handle. When not in use, the spout, with the brush is screwed into the oil can.

**Before painting**, fill screw slots with putty. It keeps paint out of the slots, conceals countersunk screws effectively and you can always scrape the putty out of the slots when you need to remove or tighten the screws, as in the case of screw-fastened turnbuttons holding storm sash.



## Swamp Shoes for Tractor

Wide, hardwood treads bolted to the tracks of this small crawler tractor enable it to travel across swampy areas and through ditches without miring or stalling. Length of the wooden treads is determined, of course, by the clearance between the standard tread plates, or lugs, and the frame. This will vary with different makes of light crawlers. Ordinarily the treads should be cut from 2 x 3 or 2 x 4-in. hardwood such as elm, or red oak. Each tread should be held in place with two large-size carriage bolts.



## Portable Parts Cleaner

This parts cleaner is made easily portable by mounting on casters so that it can be moved to any part of the service shop where disassembly of car motors, transmissions and other parts makes thorough cleaning necessary. The tank is square, can be of any convenient size and consists of flat steel plates,  $\frac{1}{8}$  in. thick, welded to angle-steel legs. Square pads are welded to the lower ends of the legs for the attachment of plate casters. Inside the tank are welded two steel shelves in staggered positions for supporting the work while it is being cleaned by solvent. One shelf serves the dual purpose of protecting the motor from the liquid solvent and also supporting work. The shelves are tilted slightly so that solvent will drain back into the tank and the motor is protected from splashes by means of a baffle. The motor-driven pump supplies solvent under pressure.—Harry J. Miller, Sarasota, Fla.

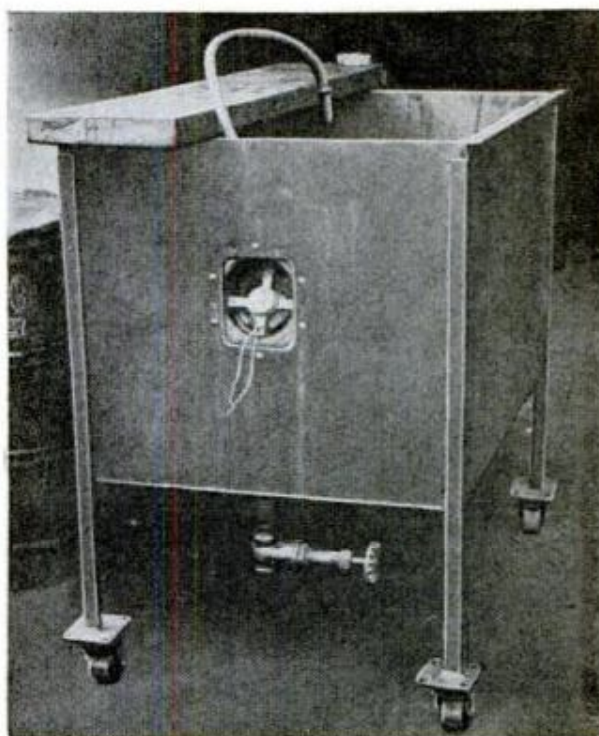

# SHOPPING



**1. ALL-METAL FIRESTOP** can be adjusted to fit between studs and is held in place with four nails. Gives positive firestopping; installs in fraction of time required to cut and place wooden firestops. Has knockouts for wiring and plumbing.  
Korky Firestops, Inc., 3515 N.W. 50th St., Miami, Fla.

**2. TILTING-ARBOR SAW** has been redesigned and precision engineered with additional safety features and precise rip and miter adjustments for more accurate work. Comes complete with all fittings and table extensions as pictured.  
Shopmaster, Div. Energy Mfg. Co., Monticello, Iowa

**3. RACK-AND-PINION STEERING UNIT** features a 3-to-1 gear reduction, giving more positive steering characteristics for small tractors, riding lawn mowers and sidewalk cars. Rack and pinion are housed in body of diecast aluminum.  
Dexon Mfg. Co., 4116 Cedar Ave., Minneapolis, Minn.

**4. PORTABLE PUNCH PRESS** has 10-in. throat for insertion of sheet metal to be worked. Punches  $\frac{1}{4}$ -in. round holes or shapes in sheet metals  $\frac{1}{8}$  in. in thickness, holes to  $\frac{3}{8}$  in. in dia. in thinner materials. Weighs 15 lb., runs on 115-230-V.  
Modern Mfg. Co., Inc., 680 Davisville Rd., Willow Grove, Pa.

**5. INTERNAL-EXPANDING BRAKE** has been designed for powered carts, is built for rugged usage. It comes complete with weld nuts for attaching to drive sprocket. Action of brake is smooth and in direct response to pedal pressure.  
Automatic Steel Products, Mercury Clutch Div., 1201 Camden Ave., S.W., Canton, Ohio

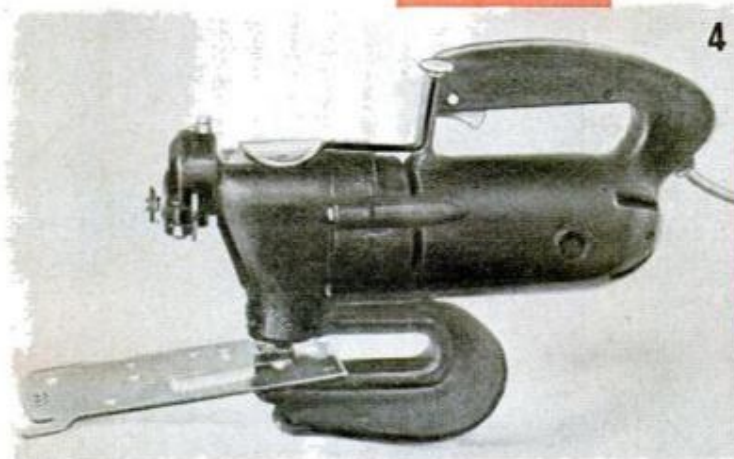
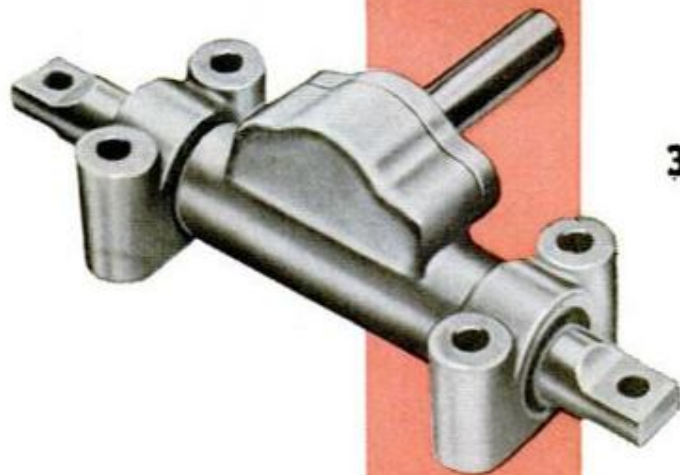

# FOR TOOLS

**6. PORTABLE ELECTRIC IMPACT WRENCH** takes accessories for drilling, tapping, reaming, wire brushing, sanding, polishing, driving screws, setting and removing bolts and nuts, hole-sawing and boring large-diameter holes in both hard and soft wood. Has forward and reverse speeds of 1900 r.p.m.

Thor Power Tool Co., La Grange Park, Ill.



**7. MAGNETIC WORKHOLDER** holds workpieces for assembly by welding or by other types of fasteners. The magnets are 1 x 1 x 2 in. and each pair is joined with steel links which are adjustable by means of wing nuts. Applications in sketches indicate wide range of uses of these work holders

General Hardware Mfg. Co., Inc., 80 White St., New York 13, N. Y.

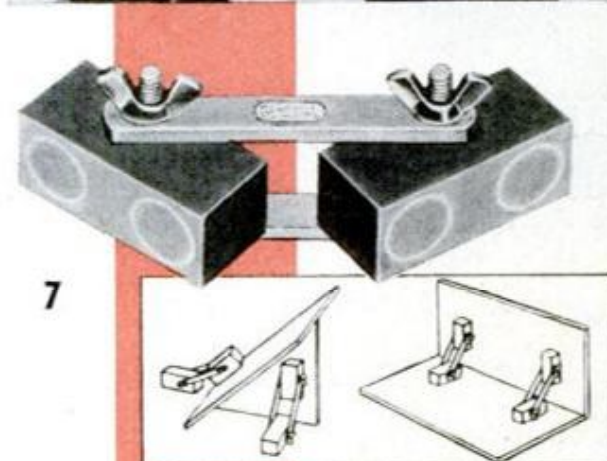

**8. DIAL-TYPE CALIPERS** are designed to take accurate internal measurements past a shoulder or flange and also in undercut bores up to 4 in. in dia. Dial is 2 1/8 in. in dia. for ease in reading. Feeler points can be adjusted and replaced when worn. Various types of feelers are available to suit requirements

Testing Machines, Inc., 72 Jericho Turnpike, Mineola, Long Island, N. Y.



**9. AUXILIARY DRILL CHUCK** for sensitive drilling operations with small drill bits comes with a telescoping spindle which is held in regular drill chuck or in a collet such as that used on milling machines and jig borers. Feed is by hand, thus making full use of the sensitivity of the operator's finger tips

Hunter Tools, 9851 Alburtils Ave., Santa Fe Springs, Calif.

**10. SPECIAL C-CLAMPS** are so shaped that they can be joined back to back, top to bottom, in parallel, and vertical and horizontal positions at angles of 45, 90 and 180 deg., giving as many as 40 different clamping combinations. Clamps have jaw openings of 2 to 4 in. are plated to resist spatter

Merrill Brothers, Artie St., Maspeth, N. Y.

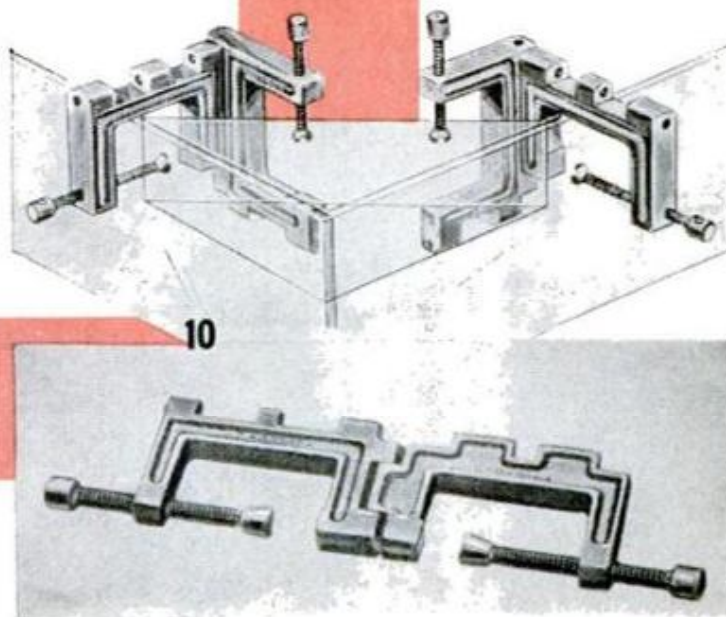



12



11

**11. DRIVING UNIT** is designed for quick attachment to such accessories as a circular saw, sander and a number of other similar units, making a portable power tool of each. Driving head is designed for attachment without the use of bolts or screws  
 Montgomery Ward & Co., 621 W. Chicago Ave.,  
 Chicago 10, Ill.

**12. CALIBRATED "BATTERBOARD"** can save builders hours of time over the old method of staking out excavations for foundations in residential and commercial construction. Uprights are of metal, drive easily. Has levels and retractable rules on each arm  
 Richey Mfg. Co., 2801 Rochester Rd., Springfield, Ill.

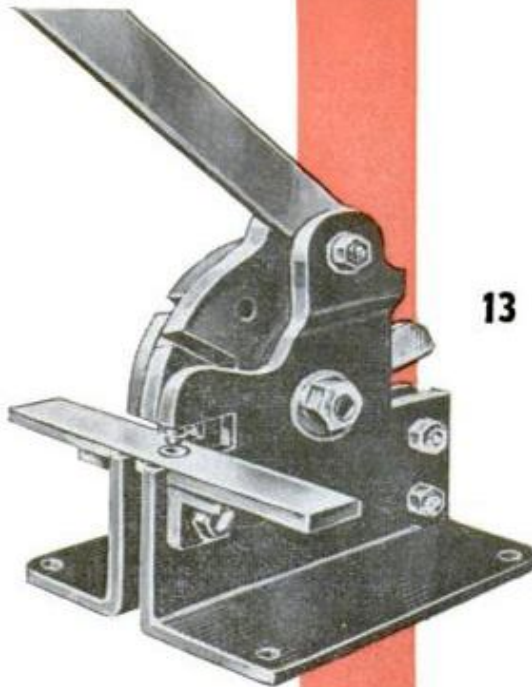

13

**13. MULTIPURPOSE BENCH PUNCH** also shears, forms and rivets metal. Shears sheet metals up to 16 ga., punches holes in five sizes from  $\frac{1}{8}$  to  $\frac{1}{4}$  in. in dia. Forms metal in bends up to 90 deg. Joins with any solid or hollow rivet up to 1 in. from edge  
 Albert J. Tatu, Inc., 5473 Main St., Williamsville 21, N. Y.

**14. LIQUID SPRING** utilizes the compressibility of a liquid to provide a yieldable member on overload applications in heavy construction equipment and also in certain heavy press operations. Mounting is stud 1 in. long but other mountings are available  
 Taylor Devices, Inc., 188 Main St., North Tonawanda, N. Y.

**15. 4-IN. JOINTER-PLANER** at an unusually low price has table adjustment for depth of cut and for rabbeting to  $\frac{3}{8}$  in., also adjustable tilting fence for planing bevels at any angle up to 50 deg. Fence is held in position with novel cam locking device  
 American Tool & Machine Co., Royersford, Pa.



14

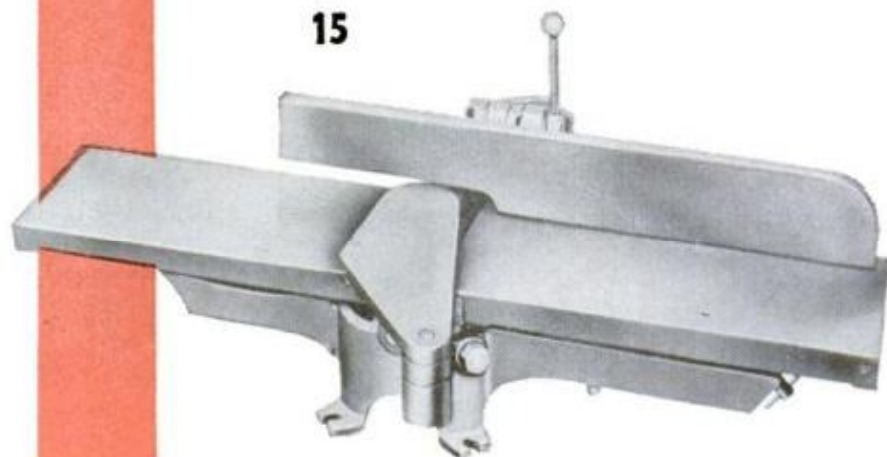

15

# ARMSTRONG SAFETY DISCS CAN SAVE YOUR LIFE!

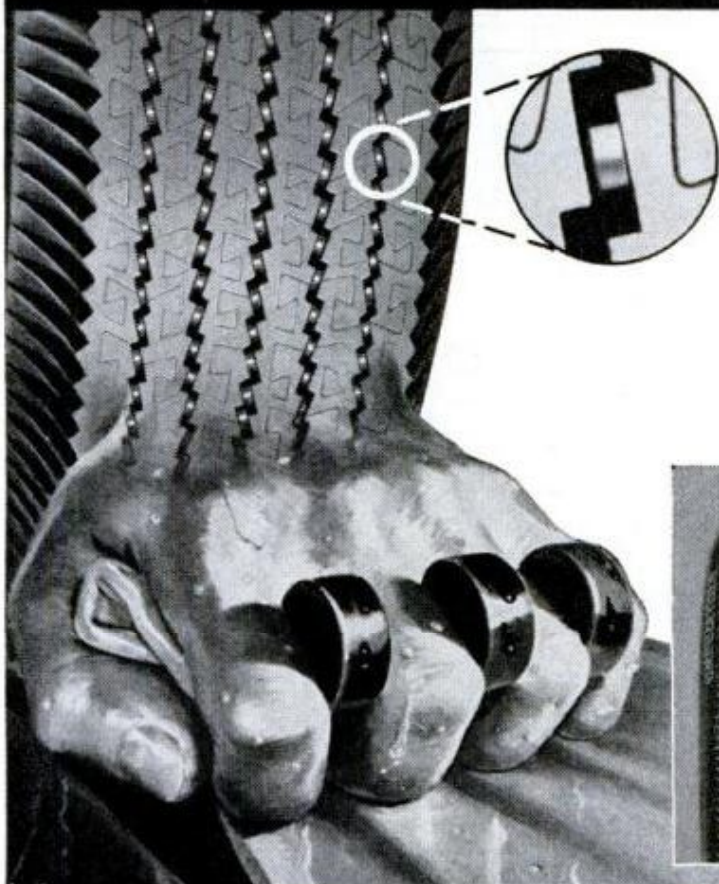

## ONLY ARMSTRONG TIRES HAVE THIS PATENTED SAFETY DISC TREAD

— Makes them grip the road to stop deadly skids as no other tires can.

When you hit your brakes, the weight of your car is thrown on the tires. Their tread can be squeezed together into a smooth, slippery surface. To overcome this danger, Armstrong engineers invented the famous Safety Disc tread design, which holds the tread ribs open, always ready to grip the road to stop deadly skids.

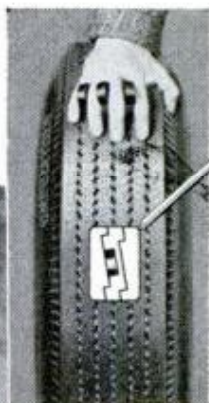

## OVER 1000 SAFETY DISCS

are *molded* between the tread ribs of the Armstrong tire. Just as the discs in hand at left keep the fingers apart, so Safety Discs keep the tire's gripping edges apart. They can't squeeze smooth, no matter how hard you brake. But the tread of ordinary tires, lacking discs, *can* squeeze together, go smooth . . . and you skid!

## Patented Interlocking Sipes ADD GRIP in ALL DIRECTIONS

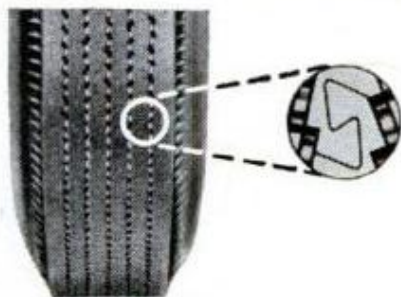

Sipes are slots put in tire tread to add gripping edges. Armstrong's S-shape *interlocking* siping gives sharply improved traction to protect against both forward and side skids.

## ARMSTRONG EXCLUSIVE UNI-CUSHION CONTOUR



Puts more rubber on the road — where it counts!  
Gives greater traction, more even wear.

Diagrams show Armstrong tread is flatter when inflated and rolling. Gives more road contact, greater stability and traction — vital for today's high-power cars and express highways. Armstrong Tires grip the road to stop deadly skids as no other tires can!

# GET EXTRA SAFETY AT NO EXTRA COST WITH ARMSTRONG TIRES!

Armstrong Rubber Company, Home Office, West Haven, Conn.

# New Ideas in Photography

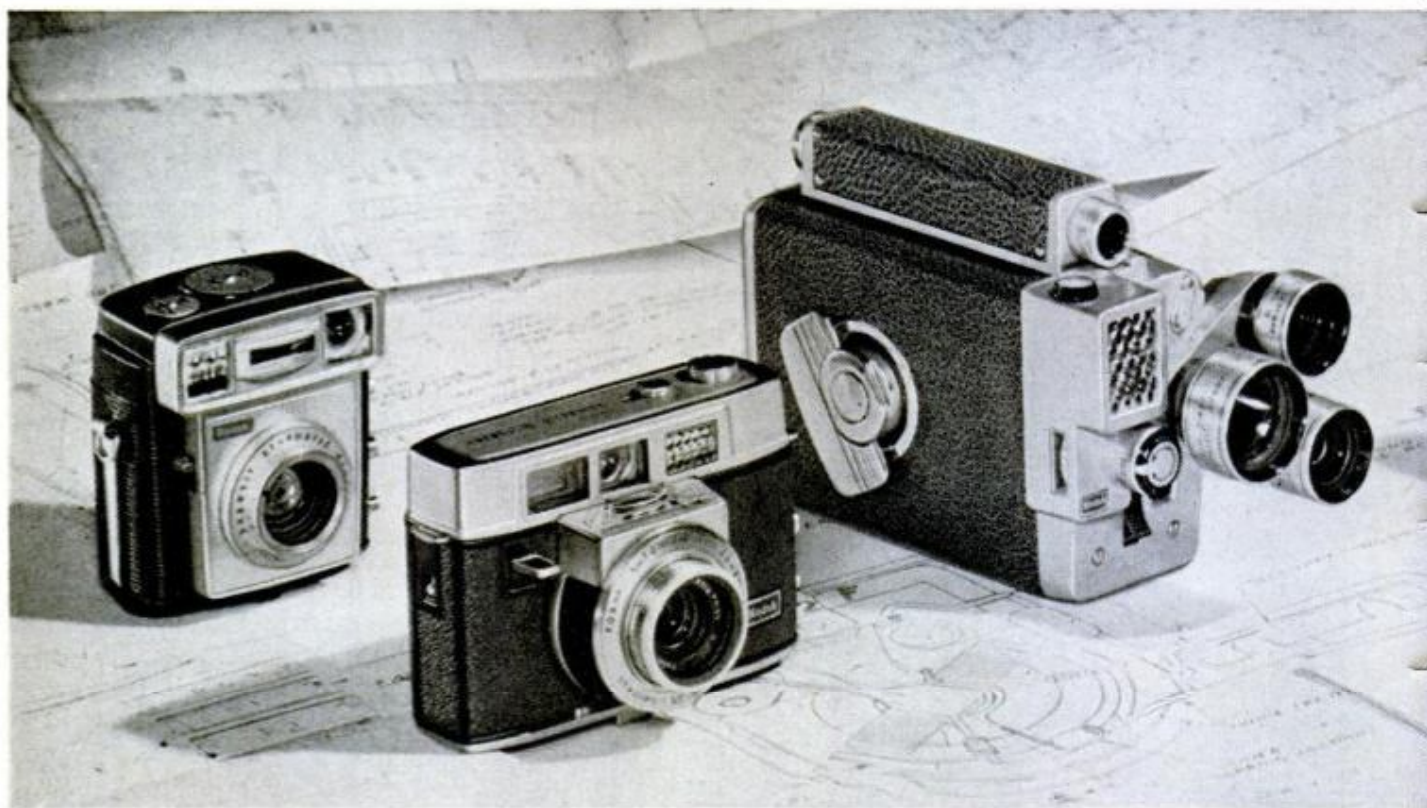

These cameras give you better pictures automatically: (from left) Brownie Staromatic, Kodak Automatic 35,

## How the Dependable New Electric-Eye

### Two different systems— same picture-perfect results!

Hottest still and movie cameras today are the new electric-eye models that read the light and set their own lens openings.

For dependability and trouble-free operation, Kodak engineers have created *two* control systems—one for still cameras, one for movie cameras. You need two, because still cameras have larger diaphragms. They demand more power than a photocell can supply.

**For still cameras: a control needle.** Kodak and Brownie automatic still camera diaphragm movements take *no* power from the photocell. Current from the cell simply positions an exposure-control needle! And the needle position decides how far the lens will open when you press the shutter release.

The simplest of the automatic cameras working this way is the Brownie Staromatic. Shoot in bright sunlight, the lens "squints" as your eyes do.

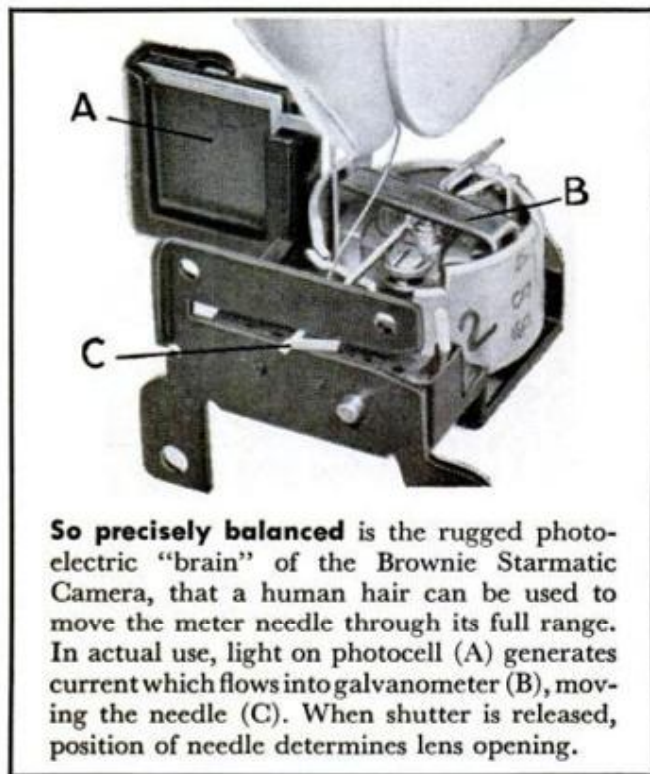

**So precisely balanced** is the rugged photoelectric "brain" of the Brownie Staromatic Camera, that a human hair can be used to move the meter needle through its full range. In actual use, light on photocell (A) generates current which flows into galvanometer (B), moving the needle (C). When shutter is released, position of needle determines lens opening.

# from Kodak

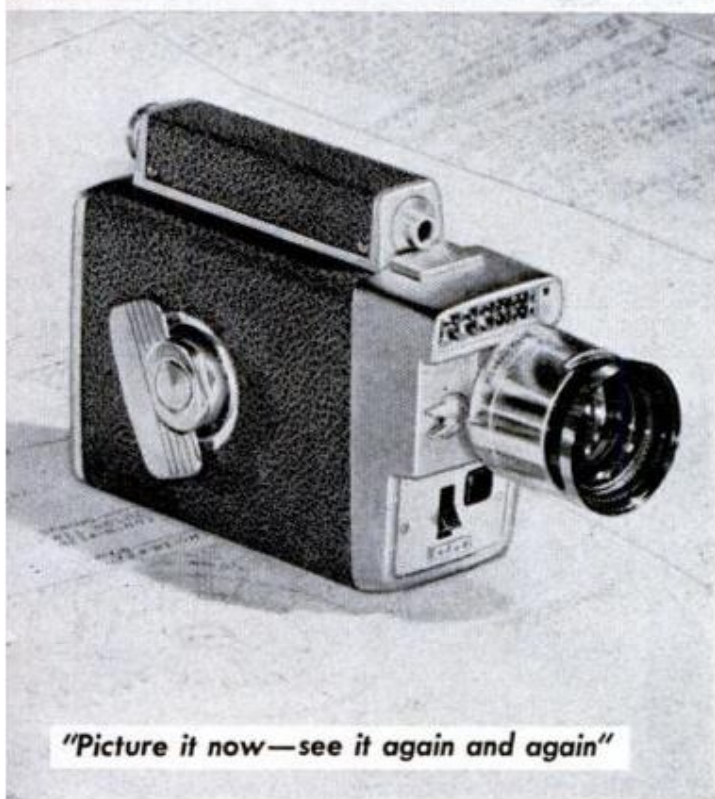

"Picture it now—see it again and again"

Kodak Cine Automatic Turret, Kodak Zoom 8.

## Cameras Work

Shoot on cloudy days, the lens opens up. And all automatically. No focusing. You get snapshots or slides, 12 pictures to a roll. Cost? Only \$36.50 at your Kodak dealer's.

The more advanced Kodak Automatic 35 Camera has an  $f/2.8$  lens, the fastest available on any automatic still camera. So it gives you more freedom in a wide range of light conditions, from dawn to sundown. For flash shots and special effects, set the camera on "manual" control and choose your own lens openings. Rapid film advance, easy loading. Costs only \$89.50.

**For movies: lightweight blades.** Movie cameras have a featherweight, counterbalanced diaphragm directly on the meter needle (see box, upper right). The lens opening then adjusts continuously, as you "pan" across a scene.

With the Kodak Cine Automatic Turret Camera,  $f/1.9$ , you can follow your subject from sun

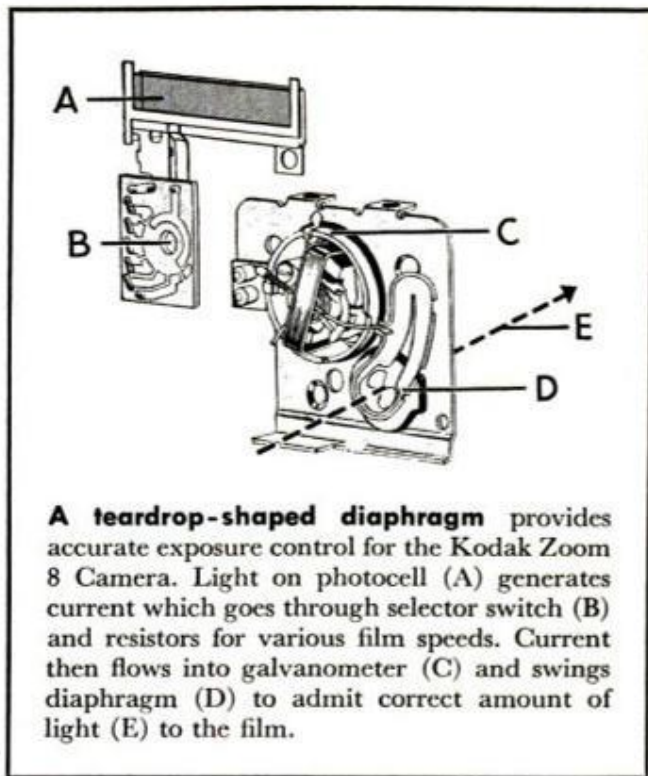

**A teardrop-shaped diaphragm** provides accurate exposure control for the Kodak Zoom 8 Camera. Light on photocell (A) generates current which goes through selector switch (B) and resistors for various film speeds. Current then flows into galvanometer (C) and swings diaphragm (D) to admit correct amount of light (E) to the film.

to shade without stopping to adjust the lens once. You can also use the meter independently, and lock the lens diaphragm at any setting. And it can be set for faster movie films than are now available. So it will be up-to-date for years to come. Three-lens turret gives you regular, wide-angle, and telephoto shots. Only \$124.50.

For the same dependable exposure control, with dramatic new zoom effects, choose the Kodak Zoom 8 Camera (Automatic  $f/1.9$ ). You can catch your subject in motion—then zoom in for a close-up without interrupting the action or changing your position. Zoom 8 lens also takes normal, wide-angle, and telephoto views—like a three-lens turret camera. \$139.50.

Ask your Kodak dealer for a demonstration.

*Prices are list, include Federal Tax, and are subject to change without notice*



**Only a billionth H.P.** operates Kodak electric-eye systems, because bearings and pins are made with "watch-jewel" precision. Bearing pins above have same .001-inch points as LP phono needle shown.

**EASTMAN KODAK COMPANY, Rochester 4, N. Y.**

SEE KODAK'S "THE ED SULLIVAN SHOW" AND "OZZIE AND HARRIET"

**Kodak**  
TRADEMARK

Paint  
it 4 to  
8 times  
faster  
with a  
**SPRAYIT**®



Do a week's worth of painting in a week-end, and do it better, with one of these professional-quality compressor paint sprayers! Made by the world's largest manufacturer of portable spray painting equipment.

### SPRAYIT 400 — \$39.95

- 1/4 h.p. motor-compressor
- adjustable nozzle
- 8 ft. hose
- unbreakable nylon gun
- sprays any type paint



Tough-hearted compressor keeps a steady 18 lbs. pressure in the spray gun. Sprays exterior and interior oil, latex paint, water-soluble, multi-color, stains, lacquers, enamels, varnishes, insecticides, etc. Precision made, guaranteed for a full year.

### SPRAYIT HOME-PAK — \$39.95

- extra-powerful compressor
- uses any 1/4 or 1/3 h.p. electric motor
- pulleys and belt included
- professional type spray gun
- 15 ft. hose



Best dollar-for-dollar buy in spray painting equipment! Powerful enough to spray your house. Compressor delivers 2.5 c.f.m. at 30 lbs. pressure—for faster spraying than outfits costing much more. Sprays any exterior or interior paint.



SEND for new "HOW TO SPRAY" book 10c brings you picture book of tips and techniques for professional-looking results every time. Shows how to paint a house in a week-end. Dozens of ideas.



**THOMAS INDUSTRIES INC.**, Dept. PM-3  
207 E. Broadway, Louisville, Ky.

Write your name and address in margin, and mail with ten cents.

## Clinic for Homemakers

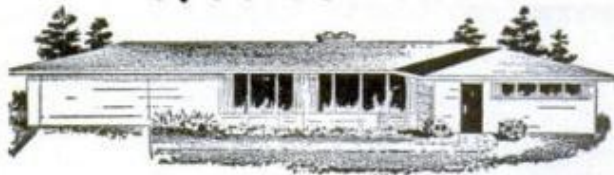

As a service to our readers in solving the hundreds of problems pertaining to a home—inside or out—the editors of *Popular Mechanics* invite you to present your problems to The Clinic Editor for help and advice. Address your questions to The Clinic Editor, *Popular Mechanics Magazine*, 200 East Ontario Street, Chicago 11, Ill.

### Low Grade

**Q**—My home is about 6 years old and was built on a level lot. All the way around three sides of the house, except in the front, the grade slopes toward the foundation from a point about 6 to 8 ft. from the walls. Water stands here for several hours after a heavy rain. What is best to do to correct this condition?

—O.W., Ia.



**A**—Obviously, the original grading has settled unduly. Also, it is equally obvious that the only repair

that can be considered at all permanent is to grade up the low areas to the original level. You do not say, but we assume that the height of the foundation will permit grading at least level if not slightly sloping upward to the top of the foundation. It is possible that after construction was completed the excavation was originally graded with top soil, which would settle much more than the clay or gravel that was excavated from the lower levels. Probably it would be best to grade with a mixture of clay and top soil rather than top soil only, if such a mixture is available. Usually if there is building construction going on nearby, suitable grading soil can be had for the hauling costs. If the area is now grassed over the sod can be lifted and piled and then replaced after grading. Lift the sod by cutting into squares of 10 or 12 in., and taking up about 3 in. of soil with each square. Pile in partial shade to a height of not more than 2 ft. and keep dampened until the squares can be replaced. A healthy and vigorous sod can be kept in this manner for several days. When the grading has been finished and the surface leveled by raking, apply a complete fertilizer, rake this into the top 1 in. or so of soil and replace the squares of sod, being careful to see that each square is pressed tightly against the one previously laid. When finished, scatter top soil lightly over the whole area and water thoroughly. Keep watering periodically until the sod has rerooted solidly.

### Paint Old Varnished Woodwork?

**Q**—My home has dark woodwork which appears to have been stained a very dark, reddish color. I have been told that if I paint over this finish it will discolor the paint. Is it necessary to remove this old finish to the bare wood before I can apply paint?—W.W., Conn.

**A**—No. Old finish which is still in good condi-

(Continued to page 206)



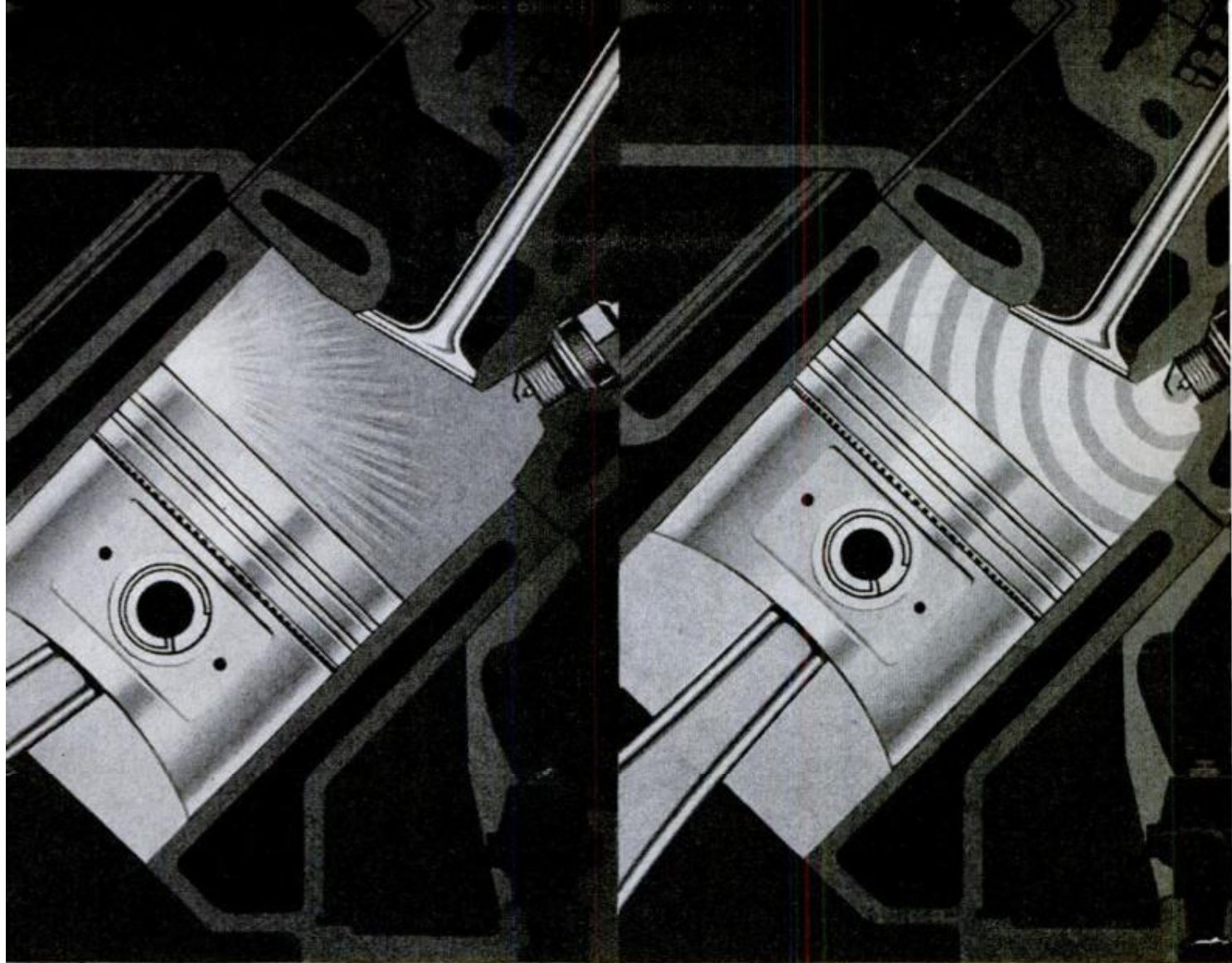

OCTANE'S TOO LOW when combustion takes place too soon, causing engine to "knock."

OCTANE'S JUST RIGHT when combustion takes place at right moment, giving quiet, powerful performance.

## What octane really means

"Octane" is a number which petroleum engineers use to rate a gasoline's freedom from "knock" or "ping" when it's burned in an engine.

Knocking occurs when the fuel-air mixture in the combustion chamber of a cylinder explodes prematurely or "detonates." It's usually caused by gasoline too low in octane, and it can result in loss of power and damage to expensive engine parts.

When the octane is just right, the gasoline burns smoothly and prevents knocking. Your engine gives you all the smooth, quiet, powerful performance it can deliver.

But octane is only one of the many properties of a good gasoline. For example, quick starting, smooth warmup, maximum

power, best performance, top economy and freedom from vapor lock are all affected by climate and altitude which vary in different areas.

Through selective blending, Texaco's gasolines are "100% climate controlled." This means that Texaco changes the blends not just seasonally, but every month of the year for 26 different climate and altitude areas throughout the country.

That's why, when you fill up with top-octane Sky Chief Super-premium with engine-saving Petrox, or famous *regular-price* Fire Chief gasoline, you can be sure you're getting the right blend for top performance and economy. You drive with more pleasure... and save for good measure!

**Buy the best... buy TEXACO**

TUNE IN: TEXACO HUNTLEY-BRINKLEY REPORT / MONDAY THROUGH FRIDAY / NBC-TV



for the  
man  
who has  
everything  
but...



**THE  
HANDIEST  
PLIER OF THEM ALL!**

**CHAN NEL LOCK**<sup>®</sup>

Your tool kit isn't complete until you own a CHANNELLOCK. Why? No other gripping tool does so many jobs so well . . . the reason why thousands of skilled mechanics—year in, year out—buy CHANNELLOCK in preference to any other plier. Available in three jaw capacities:  $\frac{3}{8}$ " ,  $1\frac{1}{2}$ " and 2". Ask your tool supplier for a genuine CHANNELLOCK Plier. If he's out of them, ask him to order one for you.

Write for Catalog of Complete Line of Pliers

**CHAMPION DEPARTMENT TOOL COMPANY**  
MEADVILLE 1, PENNSYLVANIA

tion usually is bonded solidly to the wood and provides an excellent base over which to apply paint. As the first step go over the surfaces with medium steel wool to cut the gloss and remove any dust flecks or bubbles which were in the original finish coats. Then apply a prepared undercoater, which is really a pigmented sealer. This will prevent any tendency of the old stain colors to bleed through the new paint. When the undercoater is thoroughly dry steel-wool it lightly and then apply the top coats in the color desired.

#### Trimming Hedge

**Q**—*There's a high hedge which has been planted on the lot line between my property and that of my neighbor. This hedge has been allowed to grow without trimming and is now about 8 ft. high. It shades my grass all along its length, making it difficult to grow a lawn or flower beds. I do not know who planted the hedge. Can I trim it to the lot line, or do you have some other suggestion?*

—T.W., Ind.



**A**—In most communities you would be permitted to trim the hedge to the lot line,

but the wisdom of this usually is questionable. Consider the appearance of a hedge of this height trimmed in this manner. It would be anything but attractive. Also, trimming away your half of the top growth would not solve your problem as the root system of the hedge plants would still compete with your lawn and any nearby flower beds for the available plant food. If any legal question is involved then we are not in a position to advise, but if not, then it would seem best to seek a mutual agreement with your neighbor on what seems best to do with the hedge. If it has grown to a height of 8 ft., then the hedge has been growing for several years, the time depending on the kind, of course. One plan would be to cut it to a height of about 4 ft. and reducing the width to about 2 ft. If the trunks of the individual plants are not too large, this procedure should stimulate new growth. Of course, the planting will have to be periodically trimmed in order to control height and width as otherwise the plants will spread and grow back to the original height. The other alternative is to remove the planting entirely.

#### Repair Old Sink

**Q**—*My kitchen sink is an older wall type and the enamel is chipped in several places, inside the bowl and on the rim. For several reasons I'd like to keep and use this sink for a year or more. It is quite large and has apron with rolled, or curved, edge. Is there any way to repair the chipped places?*—K.D., Mo.



**A**—There are several porcelain repair kits available but of course, these cannot be considered as durable as the original finish, which was fired onto the metal. Usually these repair materials are accompanied by detailed instructions and it is important that these be followed in all details. It's especially important that the entire area to be patched be thoroughly cleaned of all grease and soap residues. Scrub the area with a stiff-bristle brush and rinse with clean water. Allow to dry thoroughly before applying the patching material according to instructions for application.

# Paint blister problem 90% solved with new Du Pont LUCITE® house paint



*Resists paint peeling and blistering.* Moisture blistering, once the homeowner's most serious problem, has been solved. Research proves new "Lucite" Acrylic House Paint, used with Du Pont Blister-Resistant Primer over bare wood surfaces, effectively resists blistering, cracking and peeling in 90% of the cases tested . . . even over yellow pine! And new "Lucite" is equally good for masonry.

*Outlasts ordinary paints.* Tests also prove "Lucite", applied according to directions, can keep your home beautiful 50% longer than ordinary house paint. Consider today's painting costs and you'll see how it can save hundreds of dollars. Yet "Lucite" costs so little more!



*Serves as "Lucite" protective shield.* New "Lucite" is the only house paint made from "Lucite" acrylic resin. Because its surface is extra-hard, heavy rains wash dirt right off. The tough acrylic resins in the finish help resist rain, snow, baking sun, sea air, fumes, mildew and smog. **READY NOW . . .** in whitest white and 16 fade-proof colors.

Send for booklet, "How to Get Extra Years of Beauty from Your Next House Paint Job." Du Pont Finishes Div., Dept. PM-65, Wilmington 98, Del. Or ask your Du Pont Paint Dealer. He's in the Yellow Pages.



*Buy the paint that's worth  
the work...the beauty lasts*

**DU PONT**  
REG. U. S. PAT. OFF.

Better Things for Better Living  
*...through Chemistry*

**Porter-Cable**  
Quality Power Products



**CREATED FOR THE MOST PARTICULAR CRAFTSMAN  
... Porter-Cable 6½" CIRCULAR SAW**

Power tools are a long term investment. That is why you should consider every Porter-Cable feature . . . the Model 66's extra powerful motor that enables you to make every possible cut, including 45 degree angles for 2 x 4's, safety telescoping guard, instant depth and calibrated bevel adjustments, famous kick-proof clutch, self-lubricating bearings. And like every Porter-Cable tool, it has that custom quality look . . . and the built-in ability to deliver top performance year after year. See it at your local Porter-Cable dealer . . . only \$44.95.

**PORTER-CABLE MACHINE COMPANY**  
6145 Marcellus Street, Syracuse 4, N. Y.

Материал, защищенный авторским правом

## U. S. Military Services Need Help of Inventors

GOT ANY IDEAS for improving armed services chow? Or better yet, can you come up with something that will help a soldier turn inedibles into a meal?

The old problem of supplying military forces with food is still with us, even in the day of missiles and jets. And the armed forces are interested in any good ideas you might have about certain food matters as well as your solution for almost 300 other problems.

You can get a complete list of the problems from the National Inventors Council, U.S. Department of Commerce, Washington 25, D.C. When you solve them, send the answers back to the same group, which serves as a liaison between the armed services and the nation's civilian inventors. Here are some other items that are needed:

**A reliable parachute-opening system** to operate at altitudes from 250,000 down to 150,000 feet for the purpose of "exposing meteorological sensors to the measured elements for a sufficient period of time." The 'chutes are to be rocket-borne.

**Expendable cargo parachutes.** Those now in use are initially too expensive, and their recovery adds even more cost.

**High energy solid propellants** having a potential energy of some two million foot-pounds per pound without excessive erosion effect on gun barrels.

**Methods of producing food** from otherwise inedible natural materials—such as the use of micro-organisms (yeasts, molds, bacteria) to do this job so that a soldier can "live off the land" when cut off from his food supply.

**An insect repellent** that will protect personnel for at least 12 hours after a single application.

**Rapid warning device** that will give early warning of the presence of harmful contamination in the atmosphere.

**Flame protection** for individual soldiers that can be integrated into basic combat clothing.

**Cold-water laundry procedure.** Field laundries need a procedure and detergent to utilize water ranging from 35 to 80 degrees F.

**Turbojet engine noise suppression devices** that can be applied internally or externally to a jet engine without inhibiting its performance.

**For submarine cable repair,** a method that makes a damaged portion of cable rise to the surface by interaction of sea water with internal chemicals when damage occurs.

## What the POWERFUL Porter-Cable MODEL 66 SAW can do...



This portable power saw is the workhorse in any shop... built with professional features for top performance; converts to stationary saw with accessory saw table. Do a multitude of cutting tasks with wide variety of available blades.



**POCKET CUTS**—Cuts openings quickly and easily in existing walls for windows, medicine cabinets, heat ducts, etc.



**BEVEL CUTS**—Model 66 bevel cuts any angle from 0° to 45°—in 2" dressed lumber. Calibrated quadrant for accurate angles.



**KICKPROOF CLUTCH**—Automatically puts saw into "neutral" if it jams or pinches in the cut. Prevents kickback for all around safety.

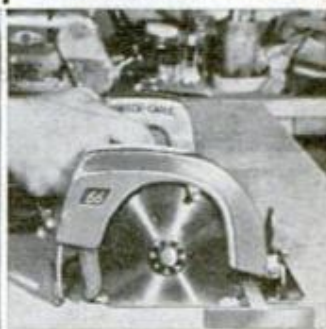

**TELESCOPING GUARD**—New design of telescoping guard eliminates jamming and "drag" at the start and during any type cut.



**FREE GUIDE...** send for complete Porter-Cable POWER TOOL Guide.

Porter-Cable Machine Co.  
6145 Marcellus Street, Syracuse 4, N. Y.  
Please send me FREE copy of your illustrated Power Tool Guide.

NAME \_\_\_\_\_

ADDRESS \_\_\_\_\_

CITY \_\_\_\_\_ ZONE \_\_\_\_\_ STATE \_\_\_\_\_



## SUPREME VERSAMATE

Versamate . . . a wonderful tool that fits any power drill —reduces speed to give seven times more power. Drives screws of all sizes. Inexpensive extras make it a nut and bolt driver, heavy-duty drilling unit. See your tool dealer today!



\$9.95

For Portable Drill Users...

**CHOOSE THE  
ATTACHMENTS  
THAT DO THE  
BIG JOBS!**

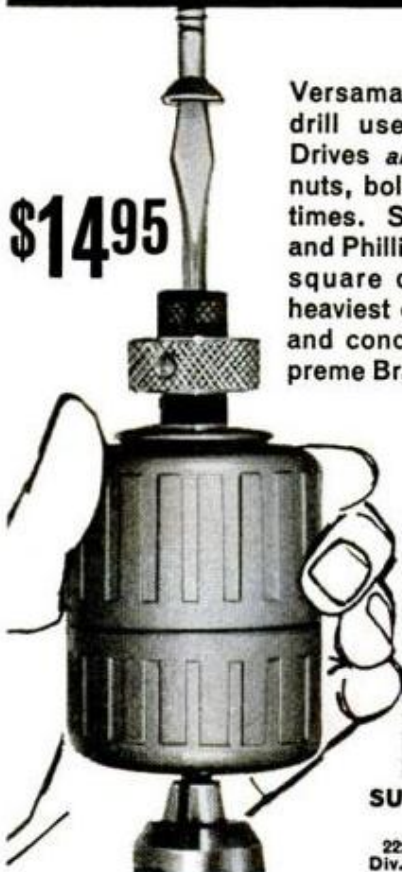

\$14.95

Versamatic triples portable drill usefulness. *Reverses!* Drives and removes screws, nuts, bolts. Boosts power 7 times. Set includes regular and Phillips-type bits, and 1/4" square drive adapter. For heaviest drilling jobs in steel and concrete, add a 1/2" Supreme Brand Chuck.

## SUPREME VERSAMATIC



**SUPREME PRODUCTS  
CORPORATION**  
2222 S. Calumet, Chicago 16  
Div. of A • S • R Products Corp.

## Lazy-Susan Server

(Continued from page 148)

Take care to allow for a possible variation in dimensions should you decide to follow either alternative.

When recessing with a portable router or a router bit in a drill press, proceed with caution along the penciled lines. A little experimenting will familiarize you with grain direction and its effect on a router bit rotating at high speed. If necessary, score each circle with a sharp knife, being careful to stay on the line, and clean up with a small chisel or gouge as soon as the routing is completed. Sand all routed surfaces smooth. A sanding disk of the flexible type designed for use in a portable electric drill will be convenient as well as time-saving. Shaped sanding blocks made from 3/4-in. scrap stock and notched to hold a garnet strip in place, will clean up the narrow edges of the recesses very well.

## Beveled With Hand Plane

The underneath sides of both trays are beveled flat, the bevels tapering off to 1/4 in. at the edges, Fig. 4. Check the drawing for accurate location of the inner edge of the bevel on each of the trays. On the original the beveling was done with a hand plane and the surface smoothed by sanding. The bevels also can be turned on the lathe before recessing with the router. Begin with the slowest speed and have your tools sharp. Work from the center to the edge. Note carefully the depth and diameter of the recess in each disk for the Lazy-Susan bearing, Fig. 3.

The capital was turned on the inboard lathe spindle, care being taken to assure a flush fit with the column, Fig. 4. When turning the column, note that the tenon extends 7/16 in. beyond the capital and that the 3/4-in. tenon is a little short of being flush with the bottom of the base. The bottom of the base should be checked for flatness and then felt or cork can be cemented in place, trimming off a little short of the edge for neatness.

It is best to apply a finish to the individual parts before assembling permanently. Varnish or lacquer can either be brushed or sprayed on over a suitable filler or sealer. Rub with fine steel wool (000) between coats and also rub the final coat to remove the gloss. Apply paste wax and rub to a glow. A soft, mellow finish can be obtained by applying a thinned coating of sealer (shellac cut by an equal amount of alcohol will do). Allow to dry and then steel-wool level with the surface of the wood. Apply lemon-oil polish generously and allow to

(Continued to page 212)

# NO DIP, NO SQUAT, NO SWAY

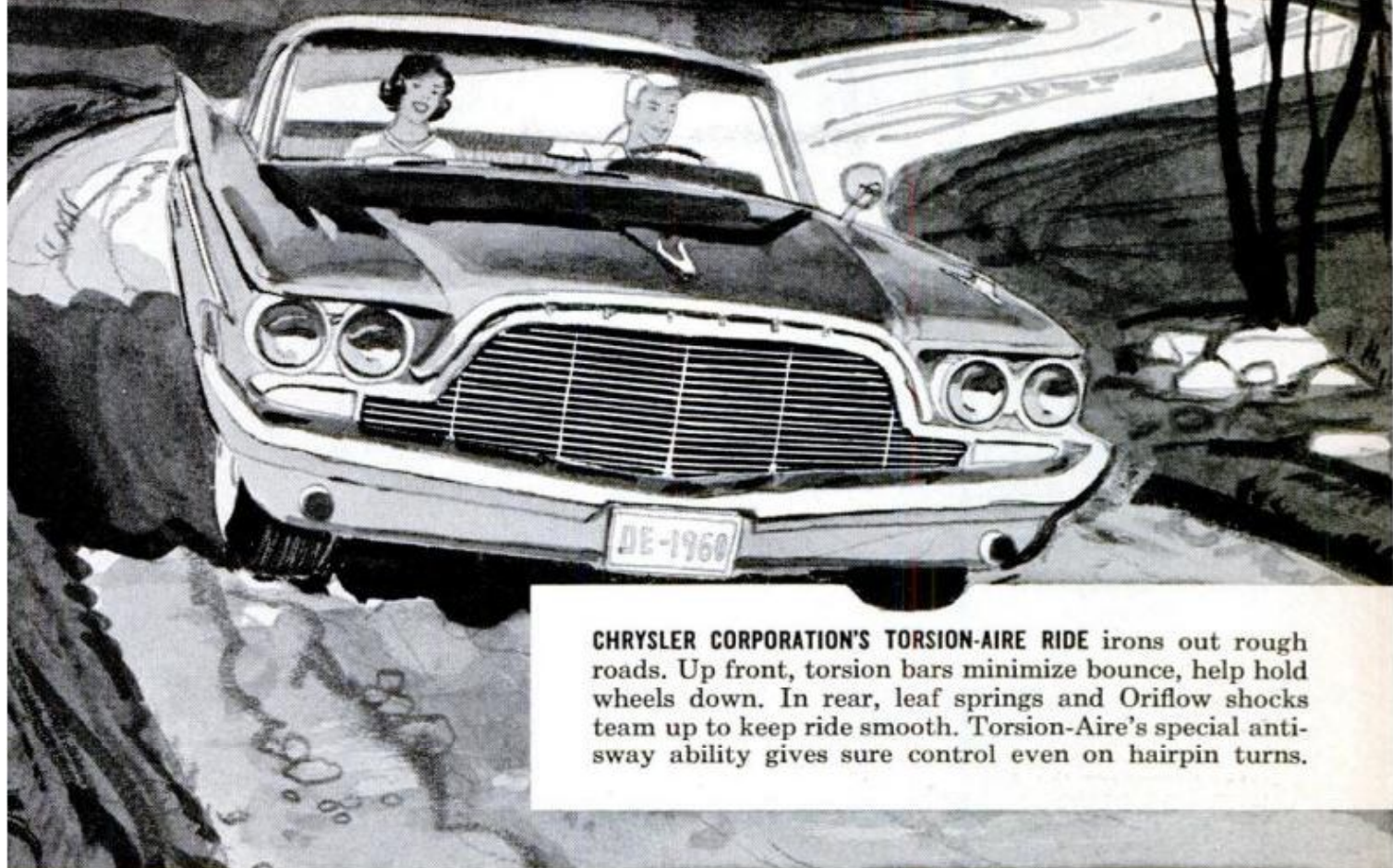

**CHRYSLER CORPORATION'S TORSION-AIRE RIDE** irons out rough roads. Up front, torsion bars minimize bounce, help hold wheels down. In rear, leaf springs and Oriflow shocks team up to keep ride smooth. Torsion-Aire's special anti-sway ability gives sure control even on hairpin turns.

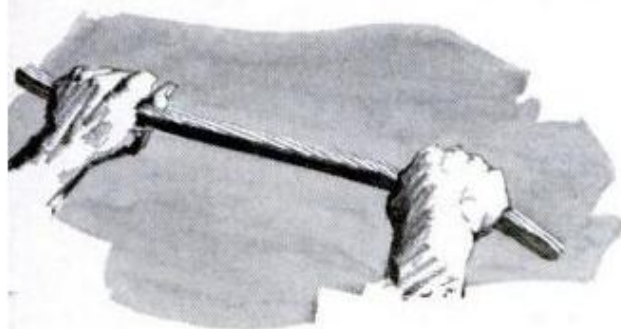

**PRECISELY POSITIONED** at front wheels, pre-stressed steel torsion bars give maximum control and comfort. Anchored at the rear but free to twist and unwind up front, they adjust to any variation in road surface that tires don't soak up first.

**HOW DO TORSION BARS WORK?** Twist a rubber hose in your hands. Feel it resist, twist back. Torsion bars work like this—help hold wheels on road, eliminate bouncy, squashy ride often found in cars with ordinary springing.

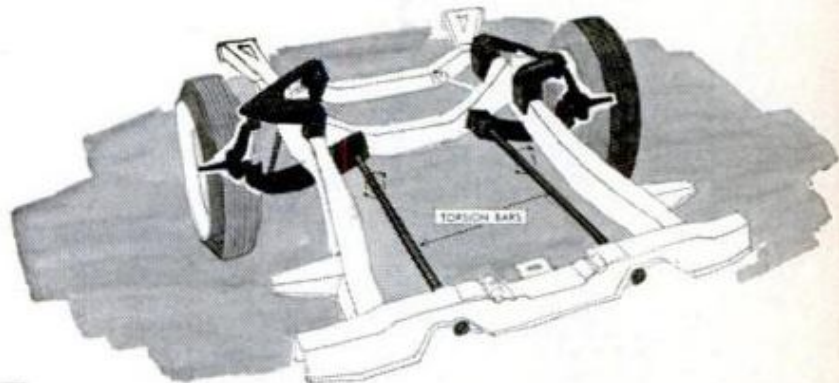

**NO MORE SQUAT, NO MORE DIP.** Some cars rear back when you start fast, nose-dive when you stop. In Chrysler Corporation cars, Torsion-Aire exerts a steady, equalizing force that works to keep the car "on the level" at all times.

*Only Chrysler Corporation cars offer Torsion-Aire. A drive will bring out the difference great engineering makes.*

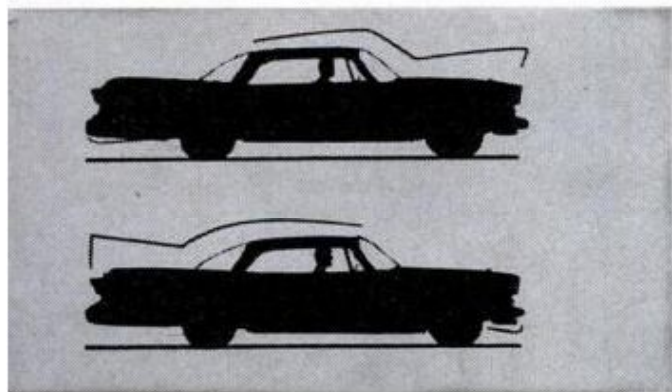

*The Quick, the Strong, and the Quiet from* **CHRYSLER CORPORATION**

**VALIANT • PLYMOUTH • DODGE DART • DODGE • DE SOTO • CHRYSLER • IMPERIAL**

Материал, защищенный авторским правом

# Stop ugly lawn weeds fast with **WEEDONE**

...the back saving chemical that can tell the weeds from the grass!



This strong, healthy (and ugly!) dandelion has been Weedone-treated—its days are numbered!

The dandelion is dead, from leaf top to root tip. The fast, selective action of Weedone did it!



**WEEDONE** actually *selects* dandelion, plantain and more than 100 lawn-scarring weeds, kills them—fast! Yet, **WEEDONE** won't kill fine lawn grasses.

**WEEDONE** enters the system of the weed, kills the whole plant! No chemical weed killer is more effective or safer to use. Get **WEEDONE**, it's been compounded specially for home lawns!



Easy to apply... Liquid or Dry (still at the same low price!)  
8-oz. can (liquid) for sprayer \$1.00  
5-lb. bag (dry) for spreader \$2.25  
Larger sizes available.

(Dry form slightly higher west of Rockies)



# WEEDONE

Amchem and Weedone are registered trademarks of **AMCHEM PRODUCTS, INC.** (Formerly American Chemical Paint Co.) **AMBLER, PA.** • St. Joseph, Mo. • Niles, Calif.

soak in. Wipe off dry, and rub down. Apply paste wax, wipe off immediately, and rub down. Repeat the process, continuing the rubbing. The result will be gratifying—especially so on a porous hardwood. There will be no “freshly varnished” look to your custom-built Lazy Susan. The finish will be in harmony with contemporary oil-finished furniture.

In assembling, join the column to the capital, using white glue for faster setting. A full  $\frac{7}{16}$  in. of the  $\frac{3}{8}$ -in. tenon should project beyond the recessed surface of the capital if dimensions have been followed. Allow at least  $\frac{1}{2}$  hour to set. Check the joint. Any error can be best corrected by recentering the work in the lathe and turning the joint with a very light cut. Check all the parts for fit before assembling.

Lubricate a 3-in. Lazy-Susan bearing with light grease. Use sheet-metal screws to fasten the bearing in the recessed top surface of the base, taking care to center it over the  $\frac{3}{4}$ -in. hole which will receive the  $\frac{3}{4}$ -in. tenon. In fastening the column to the base, place epoxy adhesive on the upper surface of the bearing; place white glue in the  $\frac{3}{4}$ -in. hole bored in the base, then slip the  $\frac{3}{4}$ -in. tenon through the slightly oversize hole bored through the exact center of the lower tray. Place a little glue on the tenon and force it into the base until the column shoulder bears against the top surface of the tray. Allow just enough play for the tray to rotate freely. This will result in a compact unit with the column fastened securely to the base.

Apply lubricant to the other bearing. Place a little furniture wax on the end of the  $\frac{3}{8}$ -in. tenon to eliminate any possible future squeak. Now place epoxy adhesive on the upper and lower surfaces of the bearing and set it into the squared recess of the capital. Slip the upper tray into place. Place a suitable weight on the upper tray and allow to set overnight. ★ ★ ★

## Seal Out That Condensation

**MOISTURE CONDENSATION** on the inner sash or the storm sash is due basically to a leakage of either warm or cold air. If the warm air leaks past the inner sash, condensate will form on the storm sash. If cold air leaks into the space between the sashes, condensate will form on the inner sash. Weather stripping the inner sash and sealing the storm sash with felt or a self-adhering rubber strip made for the purpose will usually prevent, or at least greatly minimize, the formation of condensate on either the inner or outer sashes.



# NOW, POSITIVE PROTECTION AGAINST RUST!

**PROOF!**

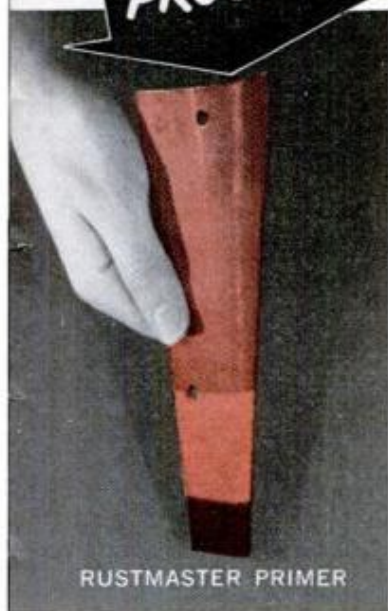

RUSTMASTER PRIMER

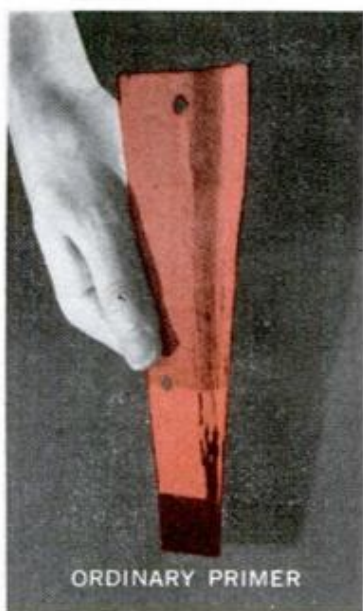

ORDINARY PRIMER

**PROOF OF BETTER ADHESION** — Rusted metal sheets were coated with primers and finish coats and exposed to weatherometer at 95 degrees and 95 per cent humidity for 300 hours. They were then subjected to severe bending. Ordinary Primer cracked and broke away from surface. RUSTMASTER showed little sign of stress, revealing far greater flexibility and adhesion.



RUSTMASTER PRIMER



ORDINARY PRIMER

**PROOF OF BETTER ENDURANCE** — In salt spray test, metal panels were coated with primers and finish coats and scratched through to bare metal. Panels were then subjected to continuous salt spray for 500 hours. Ordinary Primer had severe blistering and under-film corrosion. RUSTMASTER restricted corrosion to scratched area, proving higher corrosion-resistant qualities.

**New paint penetrates deep down into metal pores, forces out corrosive moisture and air**

**RUSTMASTER**, the paint developed to combat the \$6 million annual corrosion losses of industry, can now beautify and lengthen the life of metal surfaces in and around your home.

**RUSTMASTER** can be brushed right over rusted surfaces—penetrates deep down into metal pores, driving out corrosive moisture and air.

Secret to the remarkable protective action is a special surface wetting additive.\* Operating on a principle similar to modern detergents, RUSTMASTER forces right through rust layers to the metal beneath.

**RUSTMASTER PRIMER** is easy to apply by brush or with the convenient spray can. It dries overnight ready for finish coat.

Insist on the finest in metal protection. Ask your paint dealer for RUSTMASTER, the paint proved in industry. Primer and nine attractive finish coats are available plus RUSTMASTER GALVANIZED PRIMER for aluminum and galvanized metal.

\*Patent Pend.



**PACEMAKER IN PAINTS**

The Glidden Company • Cleveland 14, Ohio  
West Coast: The Glidden Co. • General Paint Co.,  
1000-16th Street, San Francisco 7, California  
In Canada: The Glidden Co., Ltd., Toronto, Ontario  
RUSTMASTER also sold by dealers for CLIMATIC  
HEATH & MILLIGAN • ROYAL • MOUND CITY



## Swimming Pools

(Continued from page 167)

slightly alkaline water of a pool, the alum coagulates into a soft floating mass on top of the filter bed. This soft floc, not the sand, catches the finer particles in the water and the used floc is flushed out with the backwash. One to three lbs. of alum per 10 sq. ft. of filter bed is ample; more should not be used.

Most diatomaceous earth filters are cleaned similarly. First, the built-in skimmer is emptied and then the water flow is reversed by a valve or other arrangement to backwash sediment and soiled diatomaceous earth to the waste line. When the water being flushed through the filter is clear, it is turned back to normal flow and a handful of diatomaceous earth is dropped into the top of the filter. The earth immediately recoats the cloth elements of the filter and it is back in operation. These filters have no pressure gauges to tell when to backwash. Smaller in capacity, they should be backwashed weekly or more often if experience dictates.

You become quite an amateur chemist when you own a pool. Besides treating the filter, the major item is proper chlorination of the water. Chlorinating does two important jobs—purifies the water and stops the growth of algae. Algae are microscopic one-celled plants which are everywhere in the air and in all water, even that drawn from deep wells. They multiply rapidly in the combination of sunlight and warm water and so are especially a factor with swimming pools. Most algae are green in color and can turn the water of an untreated pool a muddy green in three warm days. Some will turn the water brown and some stubborn black algae collect and multiply on a pool's sides and bottom. Other treatments—ultraviolet lights, ozone, silver ion and bromine—have been used with some success but chlorination has continually proved the simplest and best treatment for a residential pool.

You can chlorinate two ways, with calcium hypochlorite or liquid sodium hypochlorite. Calcium hypochlorite is a powdered chemical commonly available and it can be thrown directly into the pool but is better dissolved with water in a gallon jug and poured around the sides so the calcium solids will settle in the jug instead of on the bottom of the pool. Liquid sodium hypochlorite is simply poured out of its jug into the pool. Household bleaches, such as Chlorox and Purex, are sodium hypochlorite solutions and can be used in the pool but a mix of three times stronger chlorine content obtained from pool dealers usually

is less expensive. Inexpensive feeders are available today which will feed either of the above liquid mixes into the filter piping automatically. A third method of chlorinating, feeding chlorine gas from pressure cylinders into the filter lines, gives the cheapest chlorination of all but is usually practical only for large public pools. The equipment required is quite expensive and the poisonous gas requires constant attention.

Pool experts advise your maintaining a free chlorine residual of 0.2 to 0.5 parts per million parts of water during the swimming season. This may sound complicated but is easy to obtain by following the daily dosage recommended by the supplier of the chlorine you are using and then checking yourself with an inexpensive pool testing kit. You add a few drops of its ortho-tolidine solution to a test tube of water dipped from the pool (within two hours after chlorinating) and compare its color with the sample tube provided. More chlorine is needed if the color is paler than that of the sample, less if more yellow. Actually, few home pools are kept precisely at the above chlorine residual, especially 24 hours a day. The chlorine dissolved in the pool is a gas that sunlight burns away rapidly. Therefore, a small amount of chlorine is usually added each day, in the late afternoon or evening, to bring the water back to or near the recommended residual. The chlorine will stay in the water throughout the night. During the heat of the following day, especially if the pool is heavily used, the chlorine dissipates to where a test may show none at all in the afternoon. That is of no consequence, because the water will be rechlorinated in the evening and bacteria and algae will not have time to grow.

Some algae do become immune to the usual chlorination in time and therefore it is advisable to give your pool a "shock treatment" about every three weeks during the swimming season with a triple dose of chlorination to kill any stubborn algae in the water. The extra chlorine will dissipate in a few hours of sunlight and on a dull day within about 24 hours. The daily chlorination is the one treatment of significant cost. For a 16 x 34-ft. pool, the chlorinating averages about \$10 each summer month.

Most pool test kits also contain a PH test for the water's alkalinity-acid balance. Occasionally and after any special treatment, you should dip the other test tube into the pool, add a few drops as specified by the kit of its phenol-red solution and compare with the PH color sample provided. It is important that your pool water register slightly alkaline. If acid or highly

(Continued to page 216)



# THIS BABY'S GOT IT!

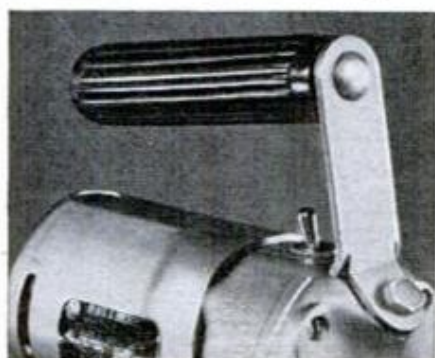

**B&D'S NEW JIG SAW HANDLE** is in a class by itself! Designed to "feel good," perfectly balanced for sure control, fast work. *Plus* three-wire cable. *Two extra blades free.*



**HEAVY-DUTY SAWS.** Famous B&D-built motors. Saws from \$49.95. Saw Attachment for Drill, \$14.95.

**Improved B&D Jig Saw gives 25% faster cutting, better control, greater value . . . only \$29.95.**

Just out—and rarin' to go through practically any material with the greatest of ease: that's Black & Decker's improved Jig Saw! Does the work of a jig saw, sabre saw, keyhole saw and most band saw operations. Cuts straight, curved and intricate designs. Handles like a dream. Feels like a feather. Packs power to spare . . . up to 25% faster sawing. Maneuvers like a sports car.

What more do you want? A new low price? You've got that, too! This Black & Decker-engineered Jig Saw costs *only* \$29.95. Jig Saw Attachment for B&D Drill, \$14.95.



For free power tool catalog, write: The Black & Decker Mfg. Co., Dept. D-050, Towson 4, Maryland.

See 'Tools-Electric' -Yellow Pages- for Service & Sales

# Black & Decker®

WORLD'S LARGEST MAKER OF PORTABLE ELECTRIC TOOLS



STAINLESS STEEL OIL RING, U.S. PAT. NO. 2,789,872

## Sealed Power has *Stainless Steel* ...the very best oil ring metal ever used!

Stainless steel oil rings deliver superior oil control—and for easily understood reasons. First, stainless steel resists the corroding and pitting effects of the gases of internal combustion engines. This means the oil ring surface stays clean. There is nothing for sludge or carbon to cling to. Thus the return oil vents stay open and you get the *long lasting* oil control you expect.

Second, stainless steel has no significant tension loss at engine operating temperature. This is unlike carbon steel oil rings. No tension loss assures proper tension of the side rails of the oil ring against the cylinder walls—even in tapered and out-of-round bores. Again, this proper tension is exerted for the entire life of the ring which means better oil control longer.

## Sealed Power

### KROMEX PISTON RING SETS Preferred Performance

Pistons • Pins • Sleeves and Sleeve Assemblies  
Valves and Valve Parts • Tappets • Water Pumps  
SEALED POWER CORPORATION • MUSKEGON, MICH.

alkaline, it may turn cloudy in the pool (resemble household ammonia). If the least acid, it will in time attack the plaster finish of a concrete pool, also the metal of the filter and plumbing and it will dissipate chlorine very rapidly. If too alkaline, the effectiveness of the chlorine in the water is greatly reduced. Most water has the correct balance, is slightly alkaline by nature and if off either way can easily be corrected. An acid condition is corrected by broadcasting a small amount of inexpensive soda ash in the water, about one lb. for each 5000 gallons. Repeat the dosage at two-hour intervals, if needed, to bring the water to proper PH balance. For high alkalinity, sodium bisulphite in the same dosages or equivalent amounts of muriatic acid is used. These amounts of chemicals are so minor the pool can be used for swimming immediately after treatment.

Occasionally, the fresh water used to fill a pool contains a high amount of iron, manganese or other metallic salt. Suspect this condition if your house sinks show a yellow or reddish-brown stain beneath their faucets. The water may be perfectly clear when drawn, but exposure to sunlight and chlorine can precipitate the metal to continually cloud the pool and deposit a yellow or reddish rust on the bottom. Also, a few hard waters will deposit a scale, usually calcium carbonate, on pool sides and bottom. The scale stains plastered pools and can give a surface as rough as coarse sandpaper. Either of these conditions can be remedied by refilling the pool with more suitable water, by treating it with chemicals or by using a water softener. Often a portable water softener can be rented from a pool dealer for a one-shot treatment to clear the pool. Carefully follow the advice of your local pool dealer when softening water with either chemicals or a water softener, because the treatment varies considerably with different waters. Test the water immediately after treatment for proper PH balance and correct if off.

#### Winter Care

As with a lawn, a pool's maintenance is much less in winter. The growth of algae and bacteria is greatly reduced in cold or cloudy weather and the pool is seldom used. Some owners in cold regions practically ignore their pools throughout the winter, just drain and scrub them thoroughly in the spring. Most owners give the pool a partial winter maintenance, clean out collections of leaves and give the water a triple dose of chlorine during stretches of warm weather or any time the water turns green. In warm climates full filtration and

(Continued to page 218)

Plain talk about  
power mowers



## How to pick a power mower

There is a big difference in power mowers that goes past the price tag, beyond the pretty paint. Certainly price is important. That's why some mowers are *made* to sell for less. But where *value* is concerned, even high price is no guarantee. How do you know you're getting your money's worth? Don't settle for sales talks. Find out for yourself fast, with the six-step test for power mower buyers.

Walk up to any mower, regardless of price or reputation. Look it over. Lift it. Start it. Listen to it. Then look at LAWN-BOY. Measured by any yardstick, this is the mower built for value! The nationally known, nationally serviced brand. The one that sets a standard others would like to live up to. This time, get more mower for your money! Go LAWN-BOY! Wide selection for every kind of lawn, starting at \$59.95.

Ask for a demonstration on your own lawn. Look in the "Yellow Pages" under Lawn Mowers for your nearest LAWN-BOY Dealer. Or write LAWN-BOY, Dept. LPM 560, Waukegan, Ill., for dealer name and colorful free booklet.

### SIX-STEP TEST OF A MODERN POWER MOWER

Standard to judge any power mower by—before you buy!

1. **TILT** the mower, as you would to clean it or to mow along a hillside. Oil should not leak out or spill. A drip-free LAWN-BOY mower keeps oil in the engine for full-time lubrication.
2. **FLEX** the blade. It should be pre-stressed, under tension. A long, whippy blade cuts unevenly, can cause crankshaft damage. LAWN-BOY uses a short, hard shaft, with bronze main bearings.
3. **TAP** blade housing. It should be solid as a rock . . . yet lightweight. Thin steel stamped housings will vibrate, can spring out of shape. LAWN-BOY light, strong, durable aluminum housings never do.
4. **LIFT** the mower. It should be light, easy to push or turn. Not too big, not too heavy. LAWN-BOY is aluminum-

light, nimble and comfortable to use. Even the handle is designed to fit you better.

5. **START** the engine. Several times. Starting should be easy, fast, sure. LAWN-BOY is famous for fast starting. Hottest ignition spark on any mower delivers years of easy one-pull starting.

6. **LISTEN** to it. Does it roar? Or spit fumes a step ahead of you? It shouldn't. LAWN-BOY has the biggest mufflers of any power mower. And exhaust is under the mower, away from you.

**AT LAST!** Complete lawn care in one modern mower! New LAWN-BOY Grass Catcher cleans and sweeps as it mows!



# LAWN-BOY



OMC ENGINES &  
EQUIPMENT DIVISION  
Outboard Marine Corporation,  
Waukegan, Illinois

You can do more with

**DELTA**



where every tool counts

## you'll want a DELTA

At \$117.50 this 14" Utility Drill Press\* is the biggest dollar value in its class! Versatile? In seconds you can convert it to do dozens of jobs (it has six interchangeable spindles). Rugged? A big 1 1/4" quill is just one of many features that stand out when you judge this tool against all others. Dependable? Its on-the-job performance in industry (big and little) has set production standards for years. Good tools are so basic to profitable work—why not start with the best? Call your Delta Distributor (listed under "TOOLS" or "MACHINERY" in the Yellow Pages). For fully illustrated details on the 14", other Drill Presses and Delta's complete line of tools, write: Rockwell Manufacturing Company, Delta Power Tool Division, 502 E N. Lexington Ave., Pittsburgh 8, Pa.

\*Model 14-008 (slightly higher in the West)

DELTA INDUSTRIAL TOOLS

another fine product by

**ROCKWELL**



chlorination is often continued (with considerable less chlorine treatment) for an occasional dip on sunny days or just to keep the pool attractive.

Almost all experts today recommend leaving your pool filled throughout the winter. A frozen-over pool will equalize the frost pressure of the surrounding ground, is much less likely to move or crack. In very cold areas, softwood logs of 10-in. diameter or more are often secured in the water around the perimeter of the pool by short ropes attached to stakes in the ground beyond. The logs weaken the pressure and break the expanding force of any heavy surface ice. Wherever freezing temperatures are expected, the level of the pool should be lowered in the fall to drain all inlet, outlet and vacuum lines above frost level and those are plugged to stay empty when the pool is refilled. Often, the pump and its motor are disconnected and stored elsewhere. The filter and heater and their piping also are drained.

A filled pool throughout wintertime eliminates the hazard of someone falling into an empty pool. Occasionally, an empty glass-fiber, metal or plastic-lined pool, sometimes even a concrete pool, will float up out of its bed from the pressure of ground water. If filled, it will not. Plastic covers are available today for pools which are simply spread over the surface, floating on top of the water. They will support a child should he fall in, will keep leaves and dust from entering and further reduce algae growth. The diving board, pool ladder and such are usually removed and stored elsewhere in winter.

Pool maintenance, especially the summer chemical treatment, does sound complicated to the newcomer but it is quite simple once you become familiar with the routine. In some localities pool companies offer to take complete care of the pool—weekly cleaning, chemical treatment, backwashing, etc. — for about \$35 a month. Doing it yourself requires about the same time but much less effort than maintaining a lawn. ★ ★ ★

### Keeping Gutters Free of Leaves

WHEN WET LEAVES accumulate in your roof gutters, getting them out can be a tedious and disagreeable job. Try using a 2-in. section cut from an old tire casing as a "dipper". The section of casing will take the contour of the gutter, gather the leaves from as far as you can reach in either direction, and serve as a dipper for removing them. A No. 2 can will serve the same purpose in half-round gutters.

# Combining business and pleasure



## on a new, lightweight **HARLEY-DAVIDSON Super-10\***

Deliveries, messenger service, whatever it may be, the Super-10 turns work into play. And what makes it doubly exciting is that you quickly pay for the economical Super-10 with the money you earn while you're having fun.

Easy to ride, easy to handle . . . great for traffic . . . single-unit engine and transmission with plenty of GO! Up to 80 miles to the gallon . . . that's money in your pocket!

Comfort? It's the most! The Super-10 features a form-fitting, bucket saddle. Looks? Just your dish. Two-tone finish: Birch White tank panel with Hi-Fi Red, Hi-Fi Blue, Hi-Fi Green or Skyline Blue.

Specially treated to resist rust and corrosion.

Ask your Harley-Davidson dealer for a demonstration ride. He'll also fill you in on his low down payment and easy-pay plans. Or mail the coupon for a colorful, detailed folder.

\*The Super-10 is also available in a 5-hp model to comply with various state laws.

**HARLEY-DAVIDSON MOTOR CO.**  
Dept. P. Milwaukee 1, Wisconsin

Please send me all the facts on the  
Harley-Davidson Super-10

Name.....Age.....

Address.....

## Which Boat for You?

(Continued from page 175)

that of displacement types, resulting in a modified V-bottom with a fairly sharp entrance (angle formed by the bottom planking in the area of the forward extremity of the keel and lower part of the stem). The boat in Fig. 1, is a good example of such a marriage of designs. Note that only the forward half of the boat clears the water at cruising speed and that no water is being pushed forward at the front of the hull, spray only being deflected at the chines. This makes for soft riding qualities, permitting the boat to be operated safely and comfortably at cruising speed. A planing boat would have had to travel at a much slower speed to avoid pounding.

Whether you buy a boat having a smooth-planked hull, or one of the lapstrake type is a matter of personal preference, general performance being about the same for both. Lapstrake is an old method of fastening the planks or boards to the hull frames by lapping the edge of one plank on the preceding one, similar to the way in which the exterior boards are fastened on a clapboard house.

The design of the chine (where the hull sides meet the bottom) has much to do with the handling qualities and performance of a boat. A rounded chine tends to allow a boat to skid on turns, while a sharp or "hard" chine on a boat having a flat bottom or shallow vee, tends to grip the water when turning, making it hazardous to make sharp turns at high speed. Carried to the extreme, a high-speed turn may cause the boat to flip. A sharp-cornered chine also makes it difficult to steer out of the wake of passing boats. It does help to give maximum lift though, which is why many racing craft have hard chines. The chines of the latest contender for a new world's water-speed record, the jet-powered "Tempo Alcoa," are sharp-cornered, with the sides meeting the bottom at or near a 90-deg. angle for most of its length.

Most folks, however, don't want a boat that will do a minimum of 200 mph. They are interested in a boat that will give them dependable service for a variety of water sports. To meet this demand, today's boat manufacturers are turning out hulls with chines ranging from medium-hard to medium soft. These boats take turns at high speed with little danger of overturning, yet skidding is negligible.

There is no "best" hull material. Good boats are made of wood, glass fiber, aluminum, plywood and various combinations of these materials. Although it is possible

to purchase a boat made of poor grade of material, it usually is difficult for the buyer to judge a boat from this standpoint. In this case, the reputation of the company must be relied on.

More important is the method and type of construction used, the design, size and location of the ground-tackle hardware, and the type of metal from which the latter are made. Non-ferrous metals should be used throughout, wherever metal fastenings and fittings are used. The hull planking, or shell in the case of aluminum and glass-fiber boats, should be thick enough to avoid hull damage when loaded properly on a trailer and resist easy puncture and buckling of the bottom in normal use. Joints must be fastened properly and stress points must be reinforced, especially at the transom, keel and stem. Examples of bracing are shown in Figs. 4 and 7.

There are many ways of making a hull rigid without adding weight unnecessarily by making the planking or shell overly thick. In wooden boats, of course, stringers and ribs, or frames, are used for this purpose. In small aluminum boats, transverse stiffeners of aluminum are fastened to the inside of the boat bottom, Fig. 7. To counteract the effects of motor torque (twisting action resulting from the rotation of the propeller) on a larger aluminum boat designed for a single motor, transverse stiffeners are used in the stern area, while longitudinal ones are installed from the stern seat forward, Fig. 10. The molded-in transverse stiffeners or "ribs" in the lapstrake glass-fiber boat shown in Fig. 9, is another means of achieving a strong, stiff boat while keeping the hull thickness to a minimum. Balsa-wood blocks fitted to conform to the bottom curves of the glass-fiber hull shown in Fig. 11, stiffen the bottom and provide a part of the required flotation. Heavy cruisers require bilge stringers spaced fairly close together to provide proper hull reinforcement. In the cross-section of a glass-fiber model shown in Fig. 8, the stringers not only stiffen the bottom but they divide the bilge into air chambers as well. The latter provide flotation for the boat, although air-chamber flotation is considered by the writer a poor second choice for meeting flotation requirements. Punctures, especially in the floors, could reduce the floatability of the boat beyond a safe point. Foamed plastic is the best available material to use for this purpose, because of its multicellular characteristics and resistance to deterioration.

The most important hardware on a boat is that which is used for handling of

(Continued to page 222)





**Don't start the season with a  
hard-starting, rough-running,  
lazy motor .....**



## **See what a difference new spark plugs can make!**

Don't let worn spark plugs spoil your fun. Give your motor new pep, power and performance—with a new set of Champion marine spark plugs. Remember — a motor can't be peppy with worn plugs. And last year's spark plugs have plenty of wear on them.

It's so inexpensive to get the sure spark you need for power-packed performance. Before you take to the water, replace those old plugs with new full-firing Champions. See what a difference new Champion marine spark plugs can make!



DEPENDABLE

**CHAMPION**

MARINE SPARK PLUGS

**EVERY MAJOR OUTBOARD MAKER USES CHAMPION SPARK PLUGS**

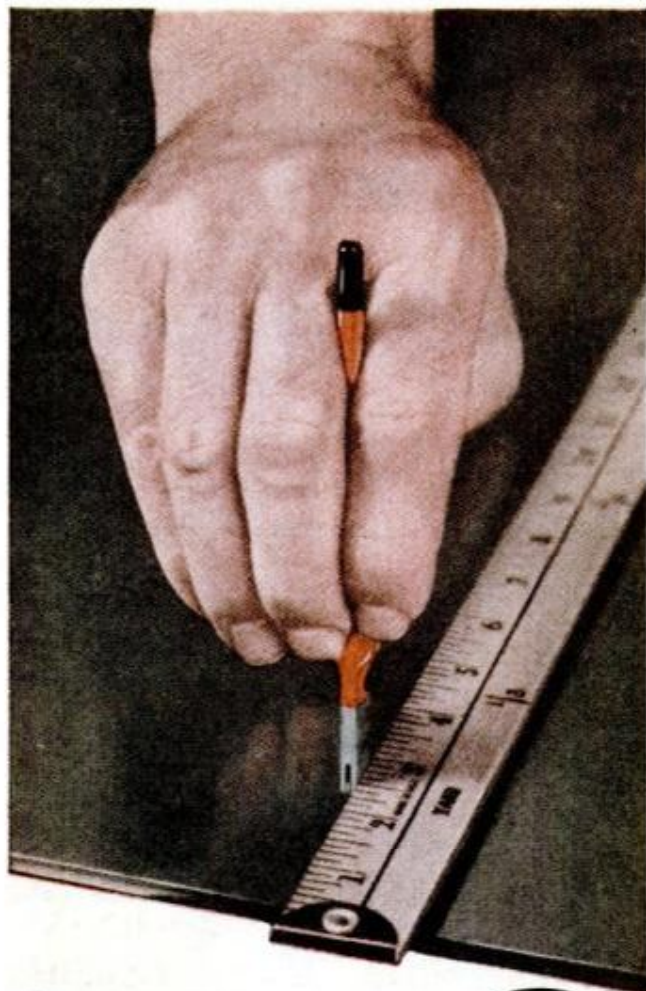

## Red Devil



### MAKES GLASS CUTTING EASY

Get to know how *easy* it is to cut glass like a "pro!" There are 15 kinds of Red Devil Glass Cutters, and all make the job easier than you ever thought. Send for our handy booklet, and see the most *helpful* dealer in your neighborhood—the one who sells Red Devil Tools:

Glass Cutters • Wall Scrapers • Glaziers' Tools  
Wood and Paint Scrapers • Hardware Specialties  
Putty Knives • Floor Polishers • Paint Conditioners

2903

### Red Devil Tools.

Dept. PM-5, UNION, N. J., U. S. A.

PLEASE SEND FREE BOOKLET  
"How To Cut Glass."



Name \_\_\_\_\_

Address \_\_\_\_\_

City \_\_\_\_\_ Zone \_\_\_\_\_ State \_\_\_\_\_

ground tackle—anchor and mooring ropes, p. 172. Many of the new streamlined designs look nice but make a bad showing when they must hold a line in a blow. Cruisers, especially, should have cleats big enough to take a minimum of  $\frac{3}{8}$ -in. rope,  $\frac{1}{2}$ -in. minimum for mooring bitts. All cleats and bitts should be bolted in place and have a backing block under the deck where they are fastened, otherwise a hard tug on the rope may pull them from the deck. A hatch on the fore-deck provides ventilation when in port on hot days and is a safe place from which to handle an anchor when the boat is tossing about. A minor point is the provision of a bilge drain. The example shown in Fig. 12 is ideal for two reasons. The drain plug is located in the transom at the bottom of a deep sump, making it easy to pull the plug when under way so that the water flows overboard. If you look closely at the sump, another plug fitted in a drain hole on the right side can be seen. This drain leads to the enclosed bilge compartments, permitting condensation to be drained as necessary.

On metal and glass-fiber boats, look for sharp edges on the gunwales and exposed structural members. This fault is difficult to correct, so avoid buying such a boat. Permanent fuel tanks are a valuable bonus feature, since they save the cost of cumbersome portable tanks. They also provide much more fuel capacity than the same number of units of the latter, while taking a minimum of usable space. The side-mounted tanks in Fig. 5, not only take very little space but help to maintain load balance in a boat that is designed for a twin-motor installation.

Before taking delivery on a new boat, it is wise to have the dealer give a run-down on the maintenance and operation of all the equipment, Fig. 3. The "mate" should be present at this briefing since some of the gadgets are in her department. Anyway, being second in command, she will be expected to see duty on the bridge, to spell the skipper on those long cruises in your "dreamboat." ★ ★ ★

### Painted Spouts Give Longer Service

WHEN YOU'RE PAINTING downspouts you can add years of service to the pipes by painting the inside as well as the outside. How? Form a roll of cotton batting or soft cloth large enough to fit the pipe snugly. Tie a long cord around the roll, dip the roll in paint and pull through the pipe with the cord.

POPULAR MECHANICS

**STANLEY HEAVY-DUTY BUILDERS SAWS**

**\$49.95 and up**

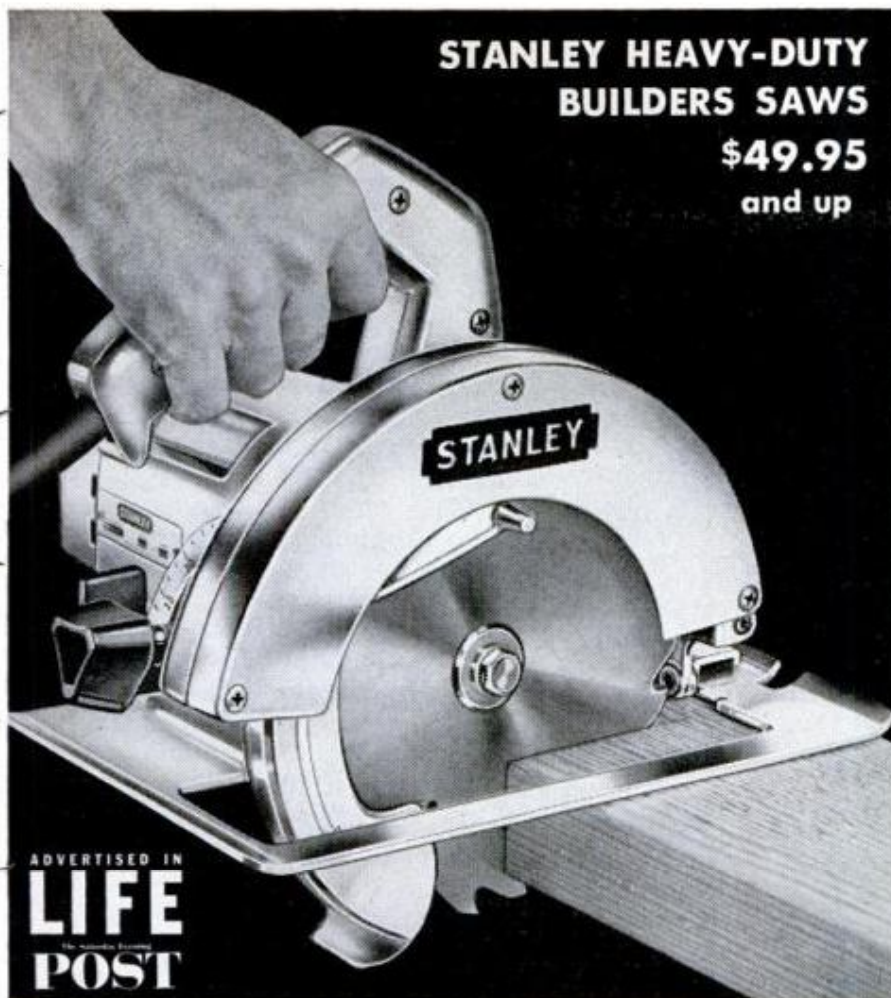

ADVERTISED IN  
**LIFE**  
The Illustrated Encyclopedia  
**POST**

**SPECIAL SPRING SAVINGS**

Offer ends July 31, 1960

H268 6 1/2" SAW

REGULAR..... \$54.95

NOW..... \$49.95

**YOU SAVE \$5.00**

H268K 6 1/2" SAW KIT

REGULAR..... \$69.95

(If items bought separately)

NOW..... \$56.95

**YOU SAVE \$13.00**

\*H269K 6 1/2" SAW KIT

REGULAR..... \$79.95

(If items bought separately)

NOW..... \$67.95

**YOU SAVE \$12.00**

\*H270 7" SAW KIT

REGULAR..... \$94.95

(If items bought separately)

NOW..... \$79.95

**YOU SAVE \$15.00**

\*All Ball and Needle Bearings

**SPRING SPECIAL! Save Up To \$15<sup>00</sup> On Complete Stanley Saw Kits**

Take advantage of the smartest buy you'll ever make for improvements around your home. If you're planning a new breezeway, bar, fence, porch, playroom . . . here's the tool that lets you tackle any big cutting job . . . faster, easier and with professional results. Just look at the features shown below!

Get ready for Spring fix-up now. See Stanley's builders saws and kits at your dealer's today.

Prices slightly higher in Canada • Prices subject to change without notice.

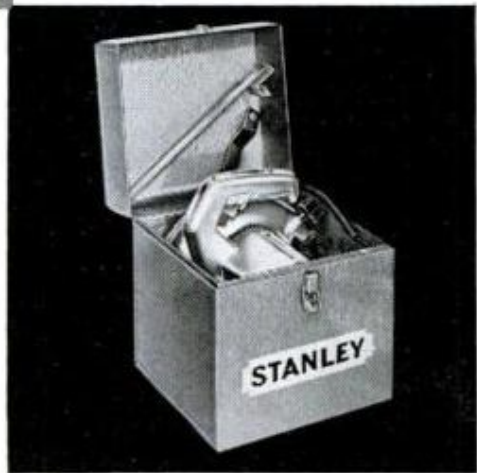

Kits include saw, rip guide, wrench and this sturdy steel carrying case.

**STANLEY**

*Electric tools built for the professional, priced for everyone!*

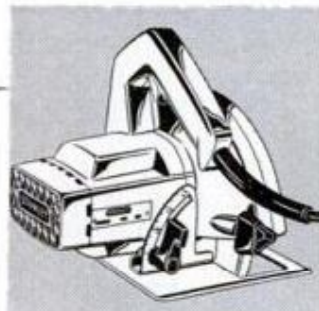

Rear position controls let you set depth or bevel adjustment from cutting position—fast!

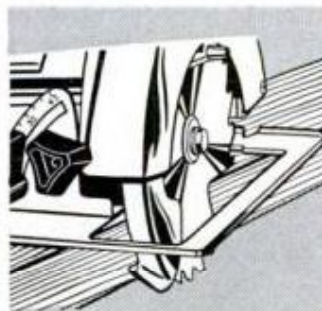

Ball-bearing\* and Free-start blade guards never stick. Blade enters cut smoothly. \*MODEL H270 ONLY



Spring steel beam, wrought aluminum base give saws extra strong structure.

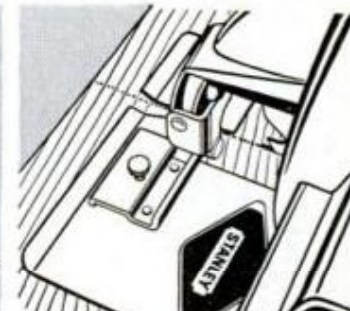

Big window lets you see line of cut clearly. One notch guides 45°, 90° cuts.

# "Why do I need an electric fuel pump?"

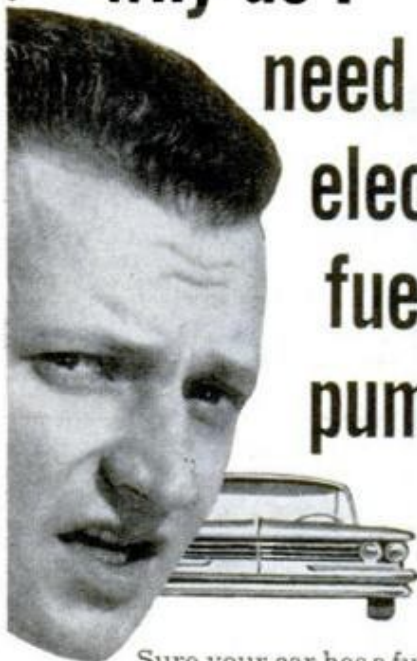

Sure your car has a fuel pump. But if you appreciate peak power and performance in a car, you'll want to install a Stewart-Warner Electric Fuel Pump. Here are three big reasons why:

1. Fuel is delivered to carburetor the instant switch is turned, to assure faster starts.
2. Pump operates independently of engine . . . eliminates vapor lock . . . assures quick starts all year long.
3. Adjustable pressure—no flooding . . . no starving . . . no surging.



MODEL 240-A

See the Stewart-Warner Electric Fuel Pump at your service station, garage, or automotive parts store. Ask about other Stewart-Warner automotive products . . . tachometers, "Twin Gauge" Panel, and Motor Minder.



1840 Diversey Parkway, Chicago 14, Illinois

## Look South for Your Future

(Continued from page 136)

to those existing in the U.S. can be established and operated successfully south of the border.

An example is young, enterprising Ruben Robles of San Jose, Costa Rica, who in 1955 established the country's first automatic laundry. At first, business was not too good. People were skeptical about the new type of service and were not sure their clothes would be washed separately. The reluctance of people to try something new and unknown posed a serious obstacle. It nearly broke Robles, but he didn't give up.

To solve the problem, he staged an extensive advertising campaign in which the main point stressed was that clothes were washed separately. That did the trick. People began to flood into his laundry in such great numbers that he decided to open three other similar establishments in other parts of town.

Still another proof that human nature is the same the world over was given by Willie Brealey, also of San Jose, when he established the city's first supermarket in 1955. At first, housewives who had never seen a self-service store hesitated to go inside and serve themselves. But this fright lasted only a few days. Before long, they had become so acquainted with the new system of buying and liked it so much that most of them never returned to the stores they formerly patronized.

In many cities in Latin America today there are no hot dogs or hamburgers available. Yet the Latins are great meat eaters, and in such areas as Panama and Puerto Rico people devour these two popular snacks. Many moving-picture houses still do not sell popcorn in many large towns in Latin America. Nor has anyone yet had the foresight to set up a popcorn stand at baseball games, boxing matches or other athletic contests in many places.

Last September when I traveled through the Central American countries, where there's a combined population of over 10 million, I didn't see a single telephone-answering service, a rat and roach-exterminating service, or a mailing service despite the fact that there's a need for these services and many others like them.

In many of the large cities in Latin America, drive-ins haven't been sampled yet. Good camera-repair shops are hard to find. And many of the large towns located in warm areas have no efficient air-conditioning and refrigeration-servicing firms.

(Continued to page 226)



# SPINSECT

NIGHT-FLYING INSECT TRAP

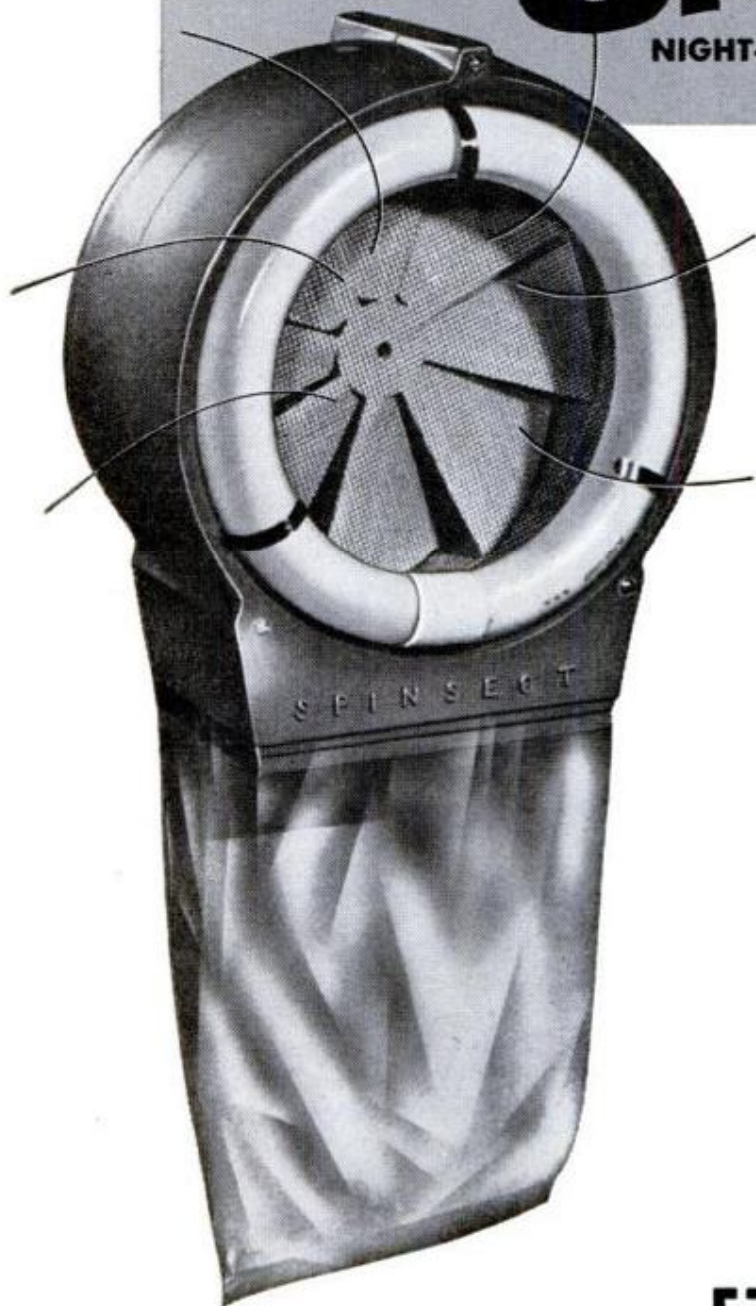

## TRAPS NIGHT-FLYING INSECTS AND PUTS THEM IN THE BAG!

*... lets you enjoy pest-free summer nights outdoors!*

Black light attracts them, powerful fan action sucks them in, whirls them into a plastic bag. You simply remove the bag after an evening's operation — twist the top, throw it in an incinerator or garbage can. Traps thousands of bugs per night, runs all night for 30 nights for less than \$1.00 electricity cost. Quiet, effective — lets you really enjoy your summer evenings outdoors where it's cool.

### Only a genuine Spinsect has these popular features!

- Operates on 115 Volt, 60 cycles
- Equipped with 10" grounding spike, 7 feet of rubber-covered, 3-wire cord
- Housing of long-lasting Cycholac plastic
- Motor, Black, Light, Ballast manufactured by General Electric
- 50 disposable plastic bags with each unit
- Sealed-in (permanently-oiled) motor
- Equipped with L-shaped hanger for wall, fence, post, or pipe mounting
- Needs little cleaning — bugs not mashed against unit
- Weighs only 6 pounds
- Guaranteed for one year against defects in material or workmanship.

### MAIL THIS COUPON FOR NAME OF YOUR NEAREST DEALER

**AMPSCO CORPORATION**  
1281 S. Front Street • Columbus 6, Ohio

Gentlemen: Please send me the name of a dealer near me that sells the amazing new Spinsect Night-flying Insect Trap.

Name \_\_\_\_\_

Address \_\_\_\_\_

City \_\_\_\_\_ Zone \_\_\_\_\_ State \_\_\_\_\_

*at your favorite hardware or garden supply store!*

**AMPSCO Corporation ac**

1281 S. FRONT STREET • COLUMBUS 6, OHIO

Although service industries offer excellent opportunities, I believe the greatest need right now is for small manufacturing industries such as plants for fruit and vegetable processing, candy making, furniture production and clothing manufacturing.

The reason for this is that as population increases (in Latin America it is increasing almost twice as fast as it is in the U.S.) the demand for food products, wearing apparel and housing will also rapidly increase. It is natural to expect, then, that it is in these fields that the alert individual will most likely be able to cash in if he becomes an efficient producer.

But don't plunge into establishing your business south of the border until you have first obtained more information on just what you would like to do and where you would like to do it.

Here are some practical tips on where to obtain the information you need:

Get a good geography book on Latin America and read the material presented for each country. By doing this, you get a broad picture of the whole. Don't limit yourself to travelogues and to what you see in the movies about those countries. Hollywood's version is usually distorted anyhow and will only help to confuse you.

Try to talk to people who are acquainted with those places. Most universities in the U.S. have professors, specialists in their fields, who have been in Latin America at one time or another on assignments as sociologists, anthropologists, technicians, geographers, geologists and diplomats. They can usually give you good, practical tips which may help you in your inquiry. Write the Pan American Union, Washington 6, D.C., for further information.

Now that you know what the whole is about, you may concentrate on a particular country that appeals to you. Go to your library and look up sources where more information is available about that particular country.

Then write to the U.S. Embassy in that country asking for advice on specific matters. The Embassy maintains a commercial attaché or economic advisor and other trained personnel who should know how things stack up in that locality. If they can't give you the information you seek, they can tell you where you can obtain it.

The Department of Commerce field office in your city can give you information obtained from the head office in Washington about specific business opportunities in certain countries. Every month the Department of Commerce publishes a little bulletin called *Investment Opportunities Abroad* (available in Washington) which

may contain something of interest to you.

Other sources of information are the Chambers of Industries in each of the capital cities of the 20 countries in Latin America. They are eager to attract potential businessmen to their areas and will give you all the assistance they can in making suitable contacts and furnishing additional data.

Be sure to write to the United States Operations Missions which operate in every Latin American country. They're carrying out what we know as the Point Four Technical Cooperation Program, and their job is to give technical assistance and to encourage more production. They will gladly guide you in your survey if you specify just what line of business you have in mind and give them complete information about yourself, your training and approximately how much capital you intend to put into the business. Their reports will be unbiased and entirely objective as they are not interested in recommending the establishment of just any type of business, but those which have a fair chance of survival and which would be beneficial to the country's economy.

When you have made your choice of where you want to go and what you want to do, the best thing to do is to take a leave of absence from your present job and go there to see for yourself. No need to take all your family along. That will only add to your expenses. See and speak to many people and, as you study each business opportunity, give it a rating on your check list. Only when you have weighed everything and studied every detail will you be justified in quitting your job at home and sending for your family.

Meanwhile, remember that the people in Latin America are eagerly looking to their neighbors of the north for tips on better living. They welcome brains and initiative. If you think you can supply these, here's an opportunity to build a future for yourself. ★ ★ ★

---

### **Lab Mice Recover From Cancer When Given Stimulating Agent**

Natural body defenses of laboratory mice can be stimulated to resist one form of cancer. The stimulation agent, bacillus calmette guerin, has been used commonly to stimulate resistance in children exposed to tuberculosis. The form of cancer, sarcoma 180, was implanted in the mice. In the tests, all mice recovered. Now in progress are animal studies to discover if body defenses can be stimulated against spontaneous cancers as well as implanted ones.

**MILLERS FALLS TOOLS**

SINCE 1868

# IT'S TOOLTIME!

**WHAT BARGAINS!**

**WHAT DEALS!**



## FREE Carrying Case and Rip Guide Worth \$15

Get both with any of these three heavy duty saws. Prices include FREE case and rip guide.

Saw	Capacity		Power	Price
	90°	45°		
No. 646-6 1/2"	2"	1-11/16"	1.5 HP	\$74.95
No. 747-7 1/4"	2 3/8"	2"	2.0 HP	\$84.50
No. 800-8 1/4"	2 7/8"	2-9/32"	2.0 HP	\$95.00

**\$5 SAVING** on No. 626 all-purpose 6 1/2" portable saw.  
Reg. ~~\$54.50~~ **TOOLTIME \$49.50**

**WOW!**

**SMOOTH!**



## \$5.95 Bonus Jig Saw Offer

Free bench stand and table with purchase of No. 360 Jig Saw.

Reg. ~~\$35.90~~

**TOOLTIME \$29.95**



## NEW! NEW! NEW! NEW! Heavy Duty Belt Sanders

Two new additions to the MF line. 16 special features!

No. 830 3" belt 3/4 HP  
**\$74.50**

No. 840 4" belt 1 HP  
**\$84.50**



**GREAT!**

**TERRIFIC!**

## Power Bit Set Slashed \$1.31



High speed steel blades packaged in handsome plastic carrying roll. Sizes 3/8", 1/2", 5/8", 3/4", 7/8", 1". (No. 8006)

**TOOLTIME \$6.49**

Reg. ~~\$7.80~~

## Prices Shaved on Planes

Save a buck! Fine bench plane with fast depth and side adjustments. Cutter is solid tool steel 2" wide. (No. 900)

Reg. ~~\$6.29~~

**TOOLTIME \$5.29**

59¢ off! Excellent quality block plane. Highly polished sides. Lever cam lock. Cutter depth screw adjusted. (No. 75)

Reg. ~~\$3.98~~

**TOOLTIME \$3.39**



**Offers good for limited time only!**

Hammer Knocked Down 80¢ (No. 692C)  
Reg. ~~\$4.99~~



**TOOLTIME \$4.19**

## Special Reduction

on this accurate square. (No. 1200)

Reg. ~~\$2.25~~

**TOOLTIME \$1.89**



## Hacksaw Frame Price Cut

Comfortable pistol grip. Back of frame is reinforced. Nickel finish. Blade is easily adjusted to face in 4 directions. (No. 1237)

Reg. ~~\$2.50~~

**TOOLTIME \$2.19**

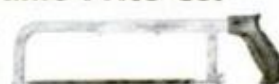

MILLER FALLS CO.  
Dept. PM-33  
Greenfield, Mass.



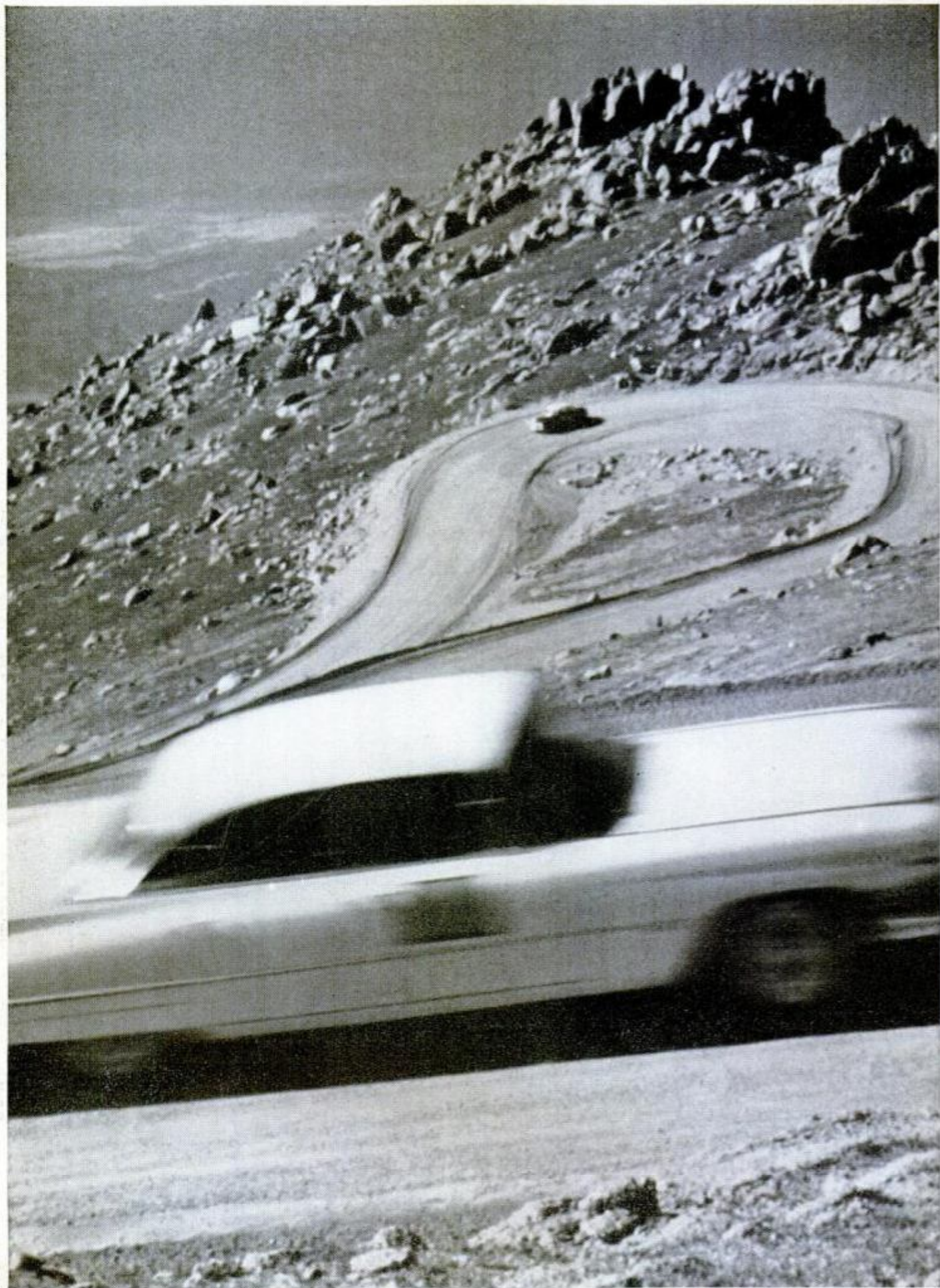

● FIRESTONE FIRST FOR 30TH CONSECUTIVE TIME IN GRUELING JULY 4TH PIKES PEAK RACE.



*At Pikes Peak, speedway-proved  
for your turnpike safety*

**Firestone**

**CHAMPION IN  
EVERY TEST OF  
TIRE SAFETY**

Winner for the 30th consecutive year of the famed Pikes Peak July 4th race—Firestone tires! Blazing a new racing car record of 13:36.5 over the tire-mauling 12.42 miles of dirt and gravel, Firestones swept sports and stock car competitions, too. No. 1 for road-gripping safety on all speedways and highways, Firestones are put through every conceivable tire "torture test" continuously—totaling 425 million miles yearly for *your* ever-improved tire safety on road and turnpike. And now, *another* Firestone first:

**FIRESTONE RUBBER-X-101**

It virtually eliminates tire squeal. And you can easily get 4,000 to 5,000 additional miles of motoring—all at regular tire prices. See them at your nearby Firestone Dealer or Store!



Copyright 1960, The Firestone  
Tire & Rubber Company

TEST-PROVED FIRESTONE  
TIRES ARE THE BEST PROVED  
TIRES ON THE ROAD!



PROVED in never-ending turnpike tests



PROVED on world's fastest test track



PROVED on all major speedways



PROVED on major city taxi fleets



PROVED on the steepest mountain turns



PROVED on abrasive stone and gravel



PROVED on burning desert roads

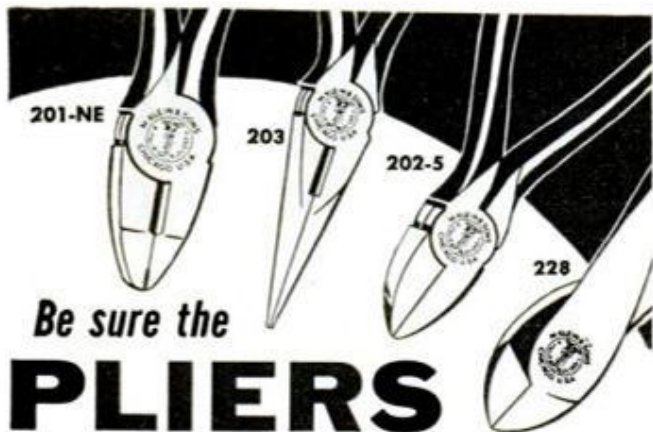

Be sure the  
**PLIERS**  
 you use are  
**KLEINS**

"Since 1857" the name Klein has stood for the finest in tools. Linemen, electricians and good workmen everywhere prefer Kleins because of the high standard of quality that is back of every pair. Now Klein Pliers are available in a wider selection of styles and sizes than ever before.

Ask your supplier for genuine Klein Pliers or write for a new Klein Plier Catalog.  
**FREE Klein Plier Catalog. On request.**

**Mathias KLEIN & Sons**  
 Established 1857 Chicago, Ill., U.S.A.  
 7200 McCORMICK ROAD • CHICAGO 45, ILLINOIS



**Today's way  
 to get there...GO  
 CUSHMAN**

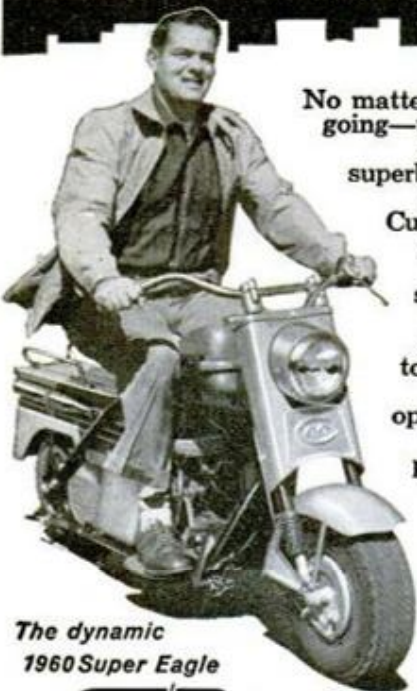

No matter where you're going—to work or just out for fun—a superbly engineered, sleekly styled Cushman scooter gets you there quickly and safely. It saves money, too—carries you up to 100 miles per gallon for an operating cost of less than a penny per mile

**NEW! Low cost  
 SCOOTER  
 INSURANCE**

Ask your dealer for **FREE demonstration** or write for colorful booklet

The dynamic  
 1960 Super Eagle

**CUSHMAN MOTORS**  
 1043 No. 21st, Lincoln, Nebraska

A subsidiary of Outboard Marine Corporation,  
 maker of Johnson and Evinrude outboard motors

**Tips for Tenting**

(Continued from page 121)



Worn plastic valves on air mattresses can be "built up" again by application of liquid plastic coating

Letting out the air from the mattresses should always be the first chore when you are breaking camp. The mattresses will be deflated when you are ready to take off. Incidentally, the mattresses make wonderful floats on a lake.

For additional recreation for the youngsters, carry along a spare inner tube and rope. Tie the rope to a tree limb, then attach it to the inflated tube. You have a swing which will attract playmates for your children from all over the camping area.

In national forests during fire seasons, you are required to have in your car a shovel, ax and pail. You might try picking up at an Army surplus store a folding shovel used by GIs for digging foxholes. Among other things, the shovel's sharp point is excellent for scratching a small rain-runoff around your tent—and for digging clams on a beach.

A hatchet will serve, but a small handled ax is much better. Some of the wood you will have to chop is on the knotty side. The blade of the ax is also the best tool I have found for prying tent spikes out of the ground.

You can keep the chopping down to a minimum by looking for "squaw wood"—bits of dead trees found on the ground. Squaw wood serves as good kindling, and its bark makes the hottest fire with a low flame. If the woods are wet with rain, snap off dried twigs from tree trunks to get a fire going.

Cook on an open fire if you will, but a camp stove will keep everybody happier.

(Continued to page 232)

# PEEL PAINT OFF



Furniture



Floors



Boats



Woodwork



## KLEAN-STRIP PAINT REMOVER

Fast • Clean • Non-inflammable

THE KLEAN-STRIP CO., INC.

2340 S. Lauderdale, Memphis 6, Tenn.

FREE THE HISTORY OF  
THE COMPASS  
SEND FOR YOUR COPY

### New DINSMORE Celebrity COMPASSES

in Beautiful GOLD OR SILVER

A jeweled, precision instrument—designed for modern cars. Full, indirect illumination. Sharp, clear letters. Silver or gold Celebrity models \$7.45, standard models \$5.95. Illuminated \$6.95

APPROVED BY AUTO MAKERS

Fine Quality Compasses for over 31 Years

DINSMORE INSTRUMENT CO.  
1802 Kelso St., Flint 1, Michigan



Write  
for Folder

## FREE 32-PAGE BOOKLET

... from your lumber, building material or hardware dealer ... with complete instructions for building, patching or repairing with Sakrete ready-to-use Cement Mixes — your assurance of smooth working, high strength concrete or mortar.

INSIST ON GENUINE

## SAKRETE

ADVERTISED AND SOLD NATIONALLY



## Jiffy SAWHORSE BRACKETS

NO NAILS NO SCREWS NO BOLTS

Now a sawhorse in a jiffy! Just use Jiffy Brackets and 2x4s. Sold by hdw. and bldg. supply stores everywhere, or order direct. \$1.95 A pair. Higher W. Coast

GRAND HAVEN STAMPED PRODUCTS CO.  
Grand Haven, Mich.



use the solder  
that most  
home owners  
use!

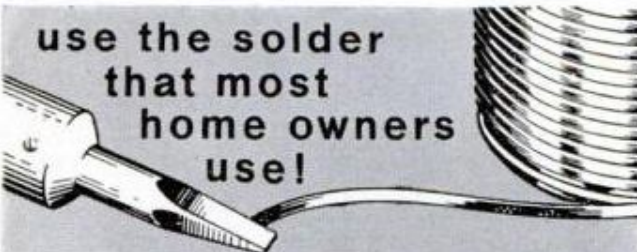

## KESTER SOLDER

For your electrical work, radio-TV, do-it-yourself projects ... always use the best ... KESTER SOLDER. Send for FREE 16-page book that tells you how!

KESTER SOLDER COMPANY

4251 Wrightwood Avenue • Chicago 39, Illinois

OVER 60 YEARS' EXPERIENCE IN SOLDER AND FLUX MANUFACTURING

# KNOW THESE ENGINE SYMPTOMS ... SAVE MONEY ON YOUR DRIVING

## LOOK FOR THESE WARNING SIGNS:

- Smoky exhaust
- Lack of power
- Low oil pressure
- Low gas mileage—loss of compression
- Sluggish performance
- Engine misfiring or knock

## HERE'S WHAT THEY MEAN:



Trouble: Pre-ignition knock and heavy oil consumption. Cause: Among other things, worn bearings! Note carbon deposits on piston head and clogged rings.

Warning signs like these may indicate that vital parts of your car engine, such as rings or bearings, are showing excessive wear. What has happened? Possibly worn main, connecting rod or camshaft bearings throw off excessive oil that piston rings can't handle. Oil slips into the combustion chamber—burns to heavy carbon and sludgy varnish, clogging ring grooves, oil control rings, and oil holes.

## SAVE MONEY ... GET A COMPLETE OVERHAUL

But do it right. An overhaul that doesn't include new engine bearings just postpones the day when you'll need the job done over. Even new piston rings can't cope with extra oil throw-off of worn bearings—throw-off as much as 25 times normal!

## FEDERAL-MOGUL MEANS PRECISION

Bearings are the heart of your engine. They control the lubrication of vital parts. Yet it costs no more to get the best—Federal-Mogul Engine Bearings. And no matter whether you drive a domestic car or an imported one, there are precision Federal-Mogul bearings to fit it.



# FEDERAL-MOGUL SERVICE



Division of Federal-Mogul-Bower Bearings, Inc. • Detroit 13, Michigan

You need a stationary light of some kind. It can be either gas or battery powered, but you should have a light to place on the camp table in the evening, and in the tent upon retiring.

Another indispensable item is a water jug. It is handy to have in the tent at night, but even handier to have in the car while traveling. Many stops at service stations are saved. If you take a boat out fishing, the jug should go along.

Keep dishes—and dish washing—to a minimum. For \$10, you can get a week's supply of paper service for a family of four.

Probably the biggest saving in dish washing comes in the use of paper cups. We carry them in assorted sizes. Eight-ounce hot-drink cups for coffee and tea, nine-ounce cold-drink cups for milk and heat-of-the-afternoon beverages, and five-ounce cold-drink cups for water and breakfast fruit juices.

We bring along our regular silverware, but disposable forks and spoons can be used if vacation dish washing is to be kept to an absolute minimum.

Many housewives today are using aluminum foil extensively in their cooking, but they too often forget it on vacation trips. Two or three rolls should be tucked in with the supplies.

My wife probably appreciates aluminum foil most when frying the day's catch of fish. She molds a large piece of foil over the frying pan, and cooks the fish on this superimposed surface. The frying pan comes through the cooking process clean enough to require only rinsing.

Selecting the best possible camp site is highly important. In improved federal and state parks, the problem is relatively simple. Just try to get near a water faucet and avoid being too close to rest rooms which are used at night.

Midwesterners, I have noticed, when they first come to the timbered mountains of the West, are inclined to pitch tents in the deepest woods. If the woods are deep enough, they don't warm up all day. And, if it has been raining, the tall timber can be downright uncomfortable. You want shade, but not too much.

Some camp sites in the mountains are of necessity in ravines, but avoid them if possible. The cool night air settles in the draws. And don't pitch your tent where there is danger from rock slides or falling rocks. I have a friend who got quite a hole in his tent. He adds that he was lucky "not to get one in my head."

Because you are camped in the mountains, you are not necessarily above the mosquito line. Last summer, one of my

sons and I camped at high-altitude Lake Louise in Canada's Banff National Park. As we ate our supper, the mosquitoes began dive bombing.

My son got an insect-killing bomb from the luggage compartment. Spraying this around the camp site and tent, he finished supper. By the time we were ready to hit the sleeping bags in the tent, there was not a mosquito in sight or sound. It was peaceful all night, although, once when I awoke, I heard a neighboring camper swatting desperately.

To help keep the floor of the tent free from ground moisture, place a piece of heavy plastic on the tent site before you erect the tent. If you carry gear on the top of your car, the plastic will do double duty as added protection against rain. The plastic is available at building-supply stores.

Then there is the matter of keeping the canvas floor of the tent clean. A big help is an old towel or throw rug placed at the entrance to the tent. Also handy is a "sawed-off" broom. Many campers use a child's play broom or a whisk broom for sweeping the floor of the tent, but a regular broom with handle sawed off to size is most effective. The shortened broom will fit under the front seat of most cars.

If you have extra space—and careful packing will usually allow some—take along a rake with sawed-off handle. It will come in handy for clearing a mountain camp site.

Finally, as a highly important "be sure" item, be sure always to put gear—from ax to air mattress pump—in the car in exactly the same place each time. If you have to make camp in the dark, you will be happy you did. Even in the daylight, it is good to know just where everything is. Makes you feel at home on the trail.

As an assurance that you're not forgetting anything, run through this check-off list before you leave on a camping trip:

### Shelter and Sleeping

- Tent (take a couple of extra tent spikes).
- Heavy plastic ground cloth.
- Throw-rug or towel for front of tent.
- Sleeping bags and pillows with cases.
- Air mattresses (include liquid plastic for repairs).
- Hand pump for mattresses.
- Broom with sawed-off handle.

### Eating and Cooking

- Knives, forks, spoons, cups, plates, cereal or soup bowls. Paper cups and plates will add to the vacation; at least, use paper cups.

(Continued to page 234)

first came Peg-Board...

now comes Panelok!



## Have this newest STORAGE WALL hang things anywhere...change 'em at will

You know how handy Masonite® Peg-Board® is for storing anything from pots and pans to heavy tools. Now comes Panelok®, a new concept in functional wall systems that serves equally well in utility or decorative areas. What smart, purposeful walls you can now have...

With the Panelok wall system there are shelves, racks, even cabinets that hook right into the wall itself. You can move accessories up or down, right or left—anywhere you want, any time you please. The drawing shows you how. Just hook the brackets into the hidden strips between the panels. They're hooked *solid*, well able to hold the heaviest things.

For your "dress-up" locations, Panelok comes finished in handsome color tones of walnut and cherry grains. See these exciting Peg-Board and new Panelok storage walls—and see how they work together for you—at your nearby lumber dealer's.



**MASONITE**   
CORPORATION

©Masonite Corporation—manufacturer of quality panel products for building and industry.

..... Free Brochure on Request .....

..... Masonite Corporation  
..... Dept. PM-5, Box 777, Chicago 90, Ill.  
..... In Canada: Masonite Corporation, Gatineau, Quebec  
..... Send free literature on Peg-Board and the Panelok wall  
..... system for storage and work areas.

Name.....  
Address.....  
City..... State.....  
Zone..... County.....

*Make way for power  
with  
a new thrill!*

## **Dream**



Model, HONDA DREAM  
(CE-71)  
Engine: O.H.C. Twin cylinder, 4-stroke  
Cylinder capacity: 247 c.c.  
Max. HP: 22HP/8,500  
r.p.m.  
Tire size: Front (3.25-18),  
Rear (3.50-18)  
Max. speed: 82 m.p.h.  
Fuel consumption: 106  
m.p.g. with electric  
starter.

  
**AMERICAN HONDA MOTOR CO., INC.**  
4077 W. Pico Blvd., Los Angeles 19, Calif.  
PHONES: REpublic-12598, 12597

**NOW!** a hi-compression  
**staple gun**  
for only  
**\$4.95**



With Exclusive  
Push-button Loading  
and Built-In  
Staple Extractor. 

Indispensable for home use...and never before priced so low! This compact, all steel, powerful SWINGLINE 101 staple gun is ideal for insulation, carpentry, upholstery, screening, wire fencing, plus thousands of other uses. Handle locks to fit pocket. Lightweight, maneuverable, jam-proof! Staple sizes  $\frac{1}{4}$ ",  $\frac{5}{16}$ ". Send for FREE book—"Tips for Tacking".

**Swingline® INC.**

Dept. PM-5-0, Long Island City 1, New York

Oilcloth table cover (wind may blow away a plastic tablecloth).  
Paring knife.  
Butcher knife.  
Large skillet. (Check to be sure it fits your camp stove.)  
Two saucepans and lids.  
Large kettle for heating water.  
Pancake turner.  
Mixing bowl.  
Measuring spoons and cup.  
Large unbreakable pitcher.  
Coffeepot.  
Toasting forks.  
Icebox (optional).  
Camp stove.  
Aluminum foil—regular and heavy.

#### Clean-Up Gear

Vegetable brush.  
Dishcloths and towels.  
Paper towels.  
Soap powder, kitchen cleanser, scouring pads.  
Two dishpans (that will nest together).

#### Convenience Kit

First-aid kit and medical supplies.  
Towels.  
Bath soap.  
Toilet tissue.

#### Tools

Small ax.  
Short-handled shovel.  
Bucket.  
Pliers, hammer, nails, screwdriver.

#### Miscellaneous

Clothespins.  
Rope.  
Flashlight.  
Lantern or stationary electric light.  
Insect repellent.  
Netting.  
Gasoline can.  
Gallon water jug.  
Canvas water bag if traveling in desert country.  
Folding chairs and table. (Optional, since tables and benches are provided in most improved state and national parks.)

★ ★ ★

#### QUOTE:

*"We must legislate into existence means by which all young people who have the urge and ability to inquire into nature's ways can be encouraged to do so—and will be respected for doing so."*

—DR. J. ALLEN HYNEK  
Smithsonian Astrophysical  
Observatory, Harvard

## RADAR SIGNAL BOUNCED OFF SUN

Scientists at Stanford University's Radio-science Laboratory report making man's first contact with the Sun by sending a radar signal to it and back.

Drs. Von R. Eshleman and Phillip B. Gallagher and Lt. Col. Robert C. Barthle said the Sun was difficult to reach by radar because it was 93,000,000 miles away and because of the "thunderous radio noise arising from its turbulent surface." The solar radar echo did not come from the Sun's visible surface, but from its outer corona, the pearly white upper atmosphere of the Sun

usually visible only at time of an eclipse.

The contacts were recorded on magnetic tape at daybreak, April 7, 10 and 12 of last year. Scientists have spent the past months analyzing the tapes, which store sounds of a crashing roar, with the aid of an electronic computer. They hope to use the radar probe to learn more about solar flares and violent eruptions on the Sun that hurl streams of particles into space. Some of these particles, trapped in the earth's magnetic field, are thought to form the radiation belts expected to hamper manned space travel.

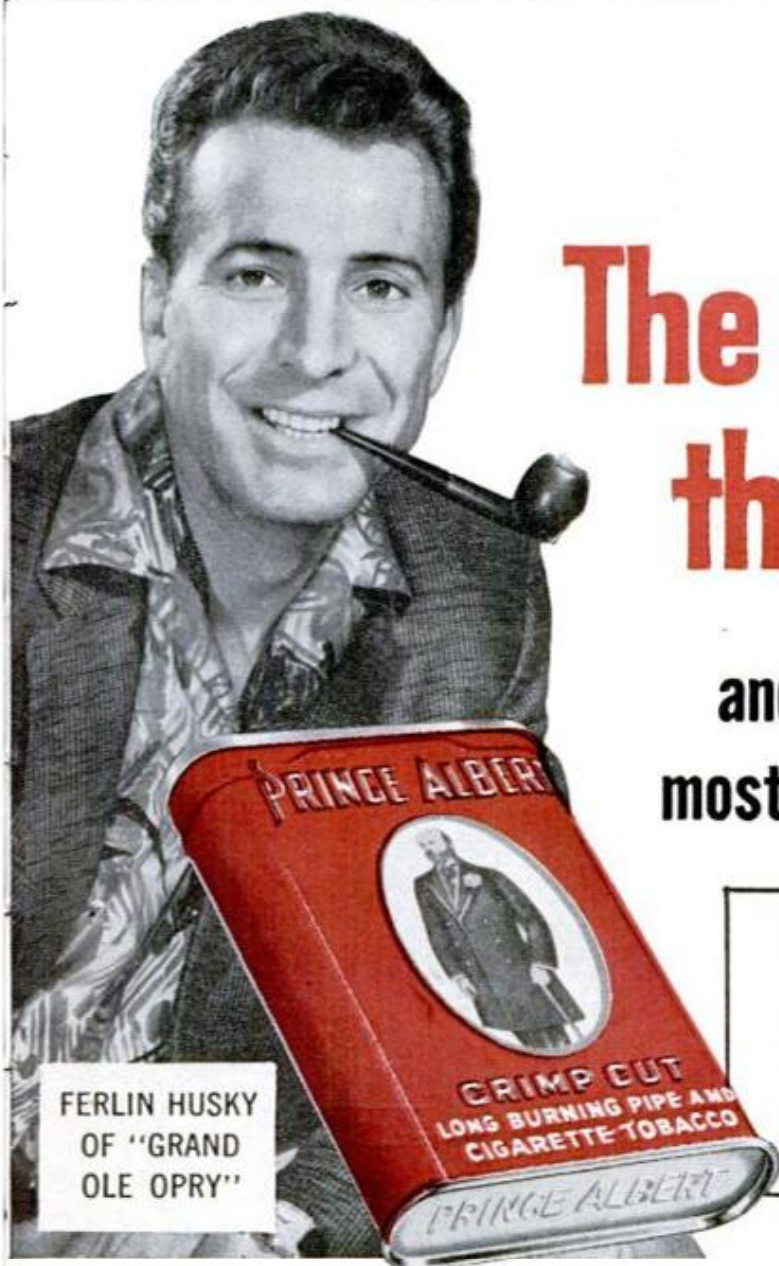

FERLIN HUSKY  
OF "GRAND  
OLE OPRY"

# The proof is in the puffing

and P. A. has the flavor  
most favored in the U. S. A.

- always tastes fresh
- mild, mellow flavor
- cool 'n' steady burning

R. J. Reynolds Tobacco Co., Winston-Salem, N. C.

**America's Largest-Selling Smoking Tobacco!**

# PRINCE ALBERT

## The "Big E" Dies With Her Boots On

(Continued from page 70)

cut down until there was nothing left in the water but a small chunk of center section. When that is gone the Big E will live among the great legends in our military annals. A few scraps of her will still be around, however. The rounded skirt of her fantail is destined to become a monument in center field on the diamond of Hoffman's favorite Little League ball team in River Vale, N. J. And the section of steel bulkhead containing her battle record was cut out intact for posterity. Few ships in history can boast the achievements emblazoned on that sheet of steel. Beside her impressive record of kills is the long row of battle stars, nine Navy Commendations and a Presidential Unit Citation—the first ever given to an aircraft carrier.

The *Enterprise* was one of those rare combinations—a rugged ship on which everything nearly always worked the way it was supposed to, and whose complement of officers and men always seemed to function with miraculous teamwork and spirit. B. J. Oglesby, a member of her crew through the great ship's early campaigns, wrote to *Popular Mechanics* and explained some of the factors that made her the number one fighting ship of her time.

## Outstanding Crew

"Her crew," says Oglesby, "was the cream of the crop, made up of highly trained enlisted men with high-school education or better, and officers who were nearly all Naval Academy graduates. Our chief petty officers were outstanding men in more ways than one. Bing Miller and Jelly Jones, two of the Navy's great baseball players were among them; so was Chief Sobeloff, the fleet boxing champ. Our aerographer, Chief Lindemann, was the navy's top enlisted weatherman, and no one in the fleet knew more about engines than our chief machinist's mate, Krup, who was later beheaded by the Japs on Guam. . . .

"But the number one reason for the spirit aboard was . . . Captain C. A. Pownall, who commanded her during the critical training period just before war broke out. He was a stern—but understanding—C.O. who demanded nothing less than perfection—and got it. As a result, we held many fleet honors. Our communications department won the coveted 'C' for excellence; we held three 'E's' on the five-inch gun mounts, an engineering 'E,' and boasted the top baseball, basketball, softball, and rowing teams in the fleet. Our rowing team won the International Battenberg Cup. This striving for the best extended through our air group

(Continued to page 238)



# JET POWER

Send for the facts now!

**BUEHLER** *Turbocraft* 

TURBOCRAFT DIVISION • INDIANA GEAR WORKS, INC.  
3115 ROOSEVELT AVENUE • INDIANAPOLIS, INDIANA

- Rush me complete information on the jet-powered Buehler Turbocraft.

NAME \_\_\_\_\_

STREET ADDRESS \_\_\_\_\_

CITY \_\_\_\_\_ ZONE \_\_\_\_\_ STATE \_\_\_\_\_





**"I think these guns are great!"**

...says **NELLIE FOX**, Chicago White Sox star and American League Most Valuable Player

"After a tense game, I like to 'unwind' with some casual target practice with my Crosman Pellguns. It's not only a lot of fun, but it keeps the eye sharp and coordination at a high level."

*Nelson Fox*

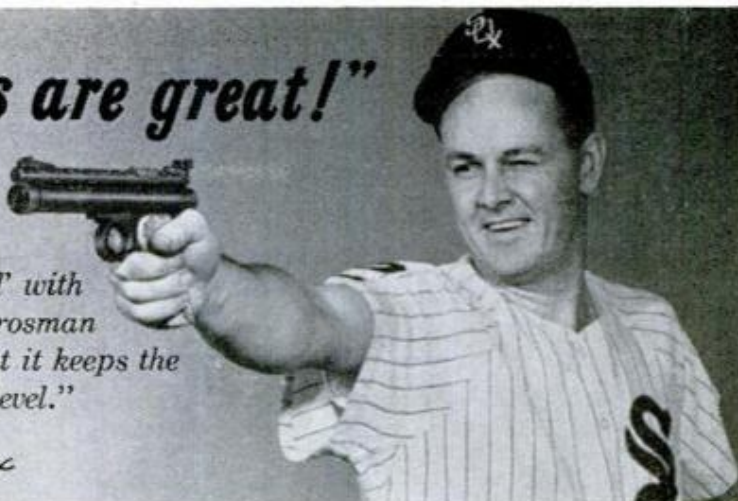

"400" GAS-POWERED REPEATER RIFLE

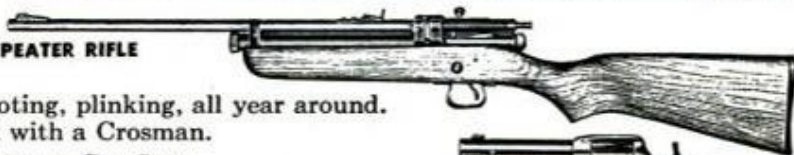

Try a Crosman Pellgun for target shooting, plinking, all year around. You'll have 3 times more shooting fun with a Crosman.

WRITE for colorful literature. Crosman Arms. Co., Inc., Dept. PM-41, Fairport, N. Y.

SINGLE ACTION 6 PELLGUN PISTOL



Ask your Crosman Select Dealer for FREE Demonstration

**Crosman** CO<sub>2</sub> GAS **HAHN**  
PELLGUNS BB GUNS

WORLD'S LARGEST MANUFACTURERS OF CO<sub>2</sub> GAS-POWERED RIFLES AND PISTOLS

**BUILD YOUR OWN POOL** Can You Drive a Nail?  
OUR PLANS, INSTRUCTION MANUAL & MATERIAL LIST ARE DESIGNED FOR THE AMATEUR  
**\$300** Check Size  
Prepaid 16' X 32'  20' X 40'

**DUTCHESS POOLS, INC., Staatsburg, N. Y.**

MAKE VACATION TIME ALL PLEASURE TIME

DRIVE WITH A HULL AUTO COMPASS  
No Lost Directions, Wasted Time and Miles

**Beaconlite** \$6.95 \$7.50  
**Streamline** \$5.95 \$6.50

At your dealer's or write for lit.  
FAMOUS AUTO AND BOAT COMPASSES

HULL MFG. CO. Box 246-D-5, Warren, Ohio



Works in seconds!



Loosens Rusted Bolts nuts, screws, "frozen" parts!

**LIQUID WRENCH**  
SUPER-PENETRANT

The super-penetrating rust solvent that quickly loosens rust and corrosion.

AT ALL HARDWARE AND AUTO STORES  
RADIATOR SPECIALTY COMPANY  
CHARLOTTE, N. C.



pull the trigger...

**spray paint**

7 times faster than brushing!



**Speedy Sprayer** ONLY \$32.00 less motor

Paints anything from a house to a toy. Saves its cost on the first major job! Speedy Sprayer does in minutes what brushing takes hours. Finish is smooth, flawless. Uses any 1/4 h.p. motor with 1/2" shaft. No. 780 Outfit—10 ft. air hose, tire chuck, quart gun, less motor, only \$32.00. Every workshop should have it. At leading stores.

Free! Write for "How To Spray" Booklet and folder.

**W. R. BROWN CORPORATION**  
Specialists in Portable Paint Sprayers for Over 37 Years  
2635 N. NORMANDY AVENUE, CHICAGO 35, ILL.



there's **MAN SIZE SPORT**  
when you're at the control of a

# Thimble-Drome

INTERNATIONALLY RECOGNIZED AS  
THE VERY FINEST IN POWERED MODELS

king  
size

## Comanche

Largest Plastic  
Model Plane on  
the Market!



Fully Assembled,  
Powerful Sportman .15 Engine,  
T-D Control Handle and  
Lines included.

An exciting challenge to fly—with more than 3 times the power of any previous ready-to-fly plane... yet completely controllable by anyone experienced in model flying! Almost yardstick broad, the 32" wingspan **COMANCHE** looms **BIG** on any flying field. Color striping and details are completely authentic from VHF antenna to landing gear covers! Even a king couldn't buy finer beauty, performance and dependability than this. **\$25.00** Sug. Ret.  
king-size aristocrat from Thimble-Drome craftsmen!

PT-19

## Flight Trainer

ALL NEW from Thimble-Drome!  
The finest flying plane in the  
.049 Ready-to-Fly class  
—bar none!



Wingspan 22"

Fully Formed  
Fuselage, Instant-  
Starting Babe Bee  
.049 engine, T-D Control  
Handle and Lines included.

For the seasoned flyers, here's flight performance they've never gotten before out of an .049... yet for the **beginner** it takes the roughest student landings without costly crack-ups! With T-D's **slip-together** rubber band assembly, its almost indestructible parts merely separate... reassemble in seconds to fly again! Unique engine-thrust adjustment gives you **time to think** about controls, brings instant flying confidence. Adjusts with experience right up through primary maneuvers. Get the Thimble-Drome PT-19 and join in the greatest sport of all—POWERED MODEL FLYING!



THIMBLE-DROME  
FUELS

Bring out the best  
performance from  
any engine.

Pint 95¢  
½ Pint 50¢

\$9.00 Sug. Ret.

Illustrated Catalog PM1  
on request.

At all hobby shops—most toy and dept. stores  
**L. M. COX MANUFACTURING CO., INC.**

World's Largest Manufacturer of Ready-to-Fly Planes and Engines  
P. O. BOX 476A • SANTA ANA, CALIF.

whose fighters always strafed closer, whose dive bombers waited just a little longer to release bombs, and whose torpedo planes pressed in to spitting distance before dropping their fish. This great competitive spirit was largely responsible for the fantastic record of enemy planes shot down, ships sunk, and shore installations destroyed during the real hostilities, and may explain why the Big E was able to continue fighting after suffering, on several occasions, what would have been mortal damage to a less efficiently run ship.

"Another factor was the personal conviction of every man aboard that it was our job to avenge Pearl Harbor. We had come into Pearl on December 8, 1941, to find ships still burning and the stench of the dead on the air. Every man was hopping mad to refuel, rearm, get back to sea and kill the enemy. That burning desire to kill the enemy was still in me when I left the Enterprise months later, and didn't disappear until long after I returned to the United States as an instructor in a training school in Florida. I have talked to many other shipmates who had the same experience."

And the hard fact is that no ship in the U.S. Pacific Fleet during World War II did more to "kill the enemy" than the far-famed fighting lady—Big E. ★★★

## This Month's "Great Pioneer in Science"

(Page 22)



**Benjamin Franklin (1706-1790)**

# Motor Trend Award: Corvair by Chevrolet named "Car of the Year"!

No other car even came close.

The editors of the world's largest general automotive magazine were unanimous in voting Corvair "the most significant car of 1960." Why? "For engineering advancement" . . . "four-wheel independent suspension totally unlike any other U.S.-built car" . . . a rear engine and transaxle "allowing a flatter floor and lower roofline." These are a few of the reasons given by the experts in announcing the industry's most coveted award in Motor Trend's April issue. But, unless you've personally driven a Corvair, you can't appreciate the happy combination of compact car economy and agility with big-car ride and room it all adds up to! Drop down to your dealer's . . . take a trial drive and judge the "Car of the Year" for yourself!

CHEVROLET DIVISION OF GENERAL MOTORS, DETROIT 2, MICHIGAN

for economical transportation ★

**corvair**

by CHEVROLET

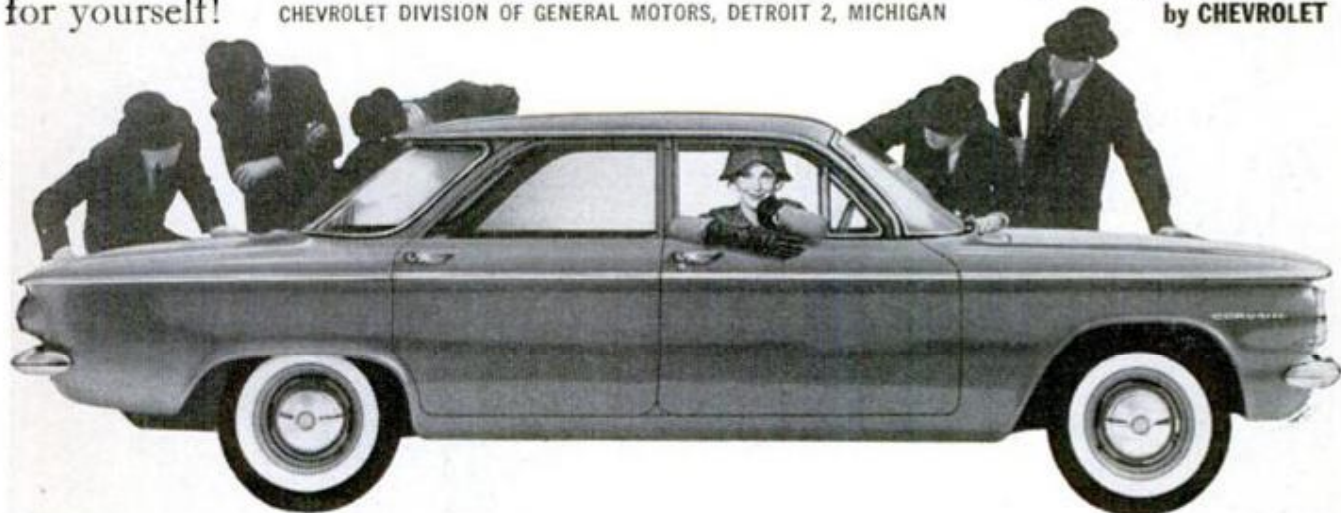

Corvair 700 4-Door Sedan

Your first pipeful tells you— you'll get along fine with AMPHORA

Make your next pipeful AMPHORA; the even-burning, longer lasting, gentle blend from The Netherlands, at tobacco counters everywhere.



# AMPHORA

U.S. Importer: Romick's International Tobacco Co., 11607 Vanowen St., North Hollywood, Calif.



## Wood Carvers!

"HERE'S THE NEWEST IN THE CARVING FIELD! \$10.95 PER SET! OVERALL LENGTH OF EACH TOOL 6 1/2". PLASTIC HANDLES



6 PIECE CARVING SET

Most Complete Line of Chisels and Gouges

CATALOG AVAILABLE!"

**BUCK BROS. INC.**  
RIVERLIN WORKS MILLBURY, MASS.



## Print Your Own

Cards, stationery, circulars, etc. Save money. Print for Others, Good Profit; easy rules sent. Raised Printing like engraving, too. Junior press \$15; Senior \$25 up. Sold direct from factory only. We furnish everything. Write for free details.

**KELSEY PRESSES, Y-37 Meriden, Connecticut**



## Get New 132 Page Catalog of WOOD AND WOODWORKING MATERIALS

**WORLD'S LARGEST SELECTION—Lowest Prices**  
Your buying guide for finest kiln dried domestic and rare imported woods, inlays, bandings, matched plywood, mouldings, ornaments, etc. Biggest selection of tools and hard-to-find hardware. Packed with scroll saw patterns, projects, wood facts and money making ideas. Enclose 25c (refunded on first order) to help pay mailing and handling costs. Write today to **CRAFTSMAN WOOD SERVICE COMPANY** 2729 S. Mary Street, Dept. A-5, Chicago 8, Ill.



TOM HENDERSON

"Then after it washes everything thoroughly, it automatically . . ."

FOR PANELING... BUILT-INS... CABINETS... FURNITURE

# The Complete Interior WOOD FINISH



*in One Can*

READY TO USE

A finer clear, semi-gloss for natural wood beauty. Non-darkening. ANYONE can use Deft... it's so easy.

Wherever paints are sold, or write Dept. SSPM Deft, 1526 W. 228th St., Torrance, Calif.

Free Shop Chart on Wood Finishing.

Write Dept. SSPM.



# AIR COMPRESSORS BY JOHNSON!

## 38

 ← QUALITY MODELS FROM 1/3 TO 3/4 HP FOR INDUSTRY, SHOP, GARAGE, FARM, HOME, HOBBIES

Now you can select a quality-built air compressor from the line that outperforms them all! There's a Johnson compressor for every purpose. What's more, Johnson, with 75 years of experience in building precision pneumatic equipment, knows how to combine really high quality with realistically low price!

Johnson compressors feature capacitor-type, ball-bearing motors, automatic controls, motor overload protection, patented safety system.

Send in the coupon below for your copy of the new Johnson catalog. Select the model best suited to your needs — air seal or piston type; electric, gasoline, or PTO power source. Catalog also shows complete line of accessories including spray guns, paint tanks, hoses, gauges.

## FIBERGLASS or PLYWOOD

\$41.95 Up: EASY TERMS

FREE CATALOG

50 Models 8-22 ft.

Cruisers, houseboats, runabouts, convertibles, fishing, sailing. Pre-assembled, pre-formed units anyone easily assembles. Equal factory-built. Save 1/2 to 2/3. Free catalog has all details, color photos, paint, accessories, Fiberglass supplies, trailers. WRITE TODAY.



Write Now

## LUGER BOAT KITS

Dept. B-5, 9200 Access Road, Minneapolis 20, Minn.

## A PM Editor Rides the Air Cars

and tells you about  
the flivvers and freighters  
of the future in the

### JUNE

## POPULAR MECHANICS



**THE "200" SERIES** — Sturdy, 1/3 HP piston-type compressors easily handle any job requiring up to 90 pounds pressure, up to 1.0 cfm of air volume. Units are available with or without storage tank.



**THE "400" SERIES** — Heavy duty piston compressors for jobs up to 125 pounds pressure, up to 2.8 cfm air volume. Available with horizontal or vertical tank. Can also be purchased without air storage tank.



### JOHNSON SERVICE COMPANY

Compressor Division, Dept. CD  
Milwaukee 1, Wisconsin

I'd like a copy of the new Johnson Air Compressor catalog and the name of nearest supplier.

Name.....

Address.....

City..... Zone..... State.....

C-144

# STOP using too much OIL and GAS



worn out piston rings mean waste oil and gas...power drop-off...costly repairs to come

You can prevent excessive oil and gas consumption . . . restore your engine's lost pep and power . . . with a Hastings re-ring job.

The sooner you act, the less it will cost. See your motor specialist the minute oil-pumping warns you there's trouble ahead. When he says you need new piston rings be sure you get Hastings. They're engineered exclusively for replacement service . . . to provide the additional lubrication worn engines need . . . to stop oil pumping, save gasoline, restore lost performance.

Get new car power and performance from your present car—with Hastings. Truly your best investment for many thousands of extra miles of trouble-free driving pleasure.

**TOUGH**  
on oil pumping  
**GENTLE**  
on cylinder walls



**HASTINGS**  
PISTON RINGS

HASTINGS MANUFACTURING COMPANY  
HASTINGS, MICHIGAN

Oil Filters, Piston Rings, Casite Additives,  
Spark Plugs

## Radio-Controlled Models

(Continued from page 144)

The transom block is shaped and slotted to receive the engine standoff before being cemented to frame 7.

Gluing the  $\frac{1}{4} \times \frac{1}{8}$ -in. balsa chine and sheer beams and the deck stiffener to the notched bulkhead frames, bow block and transom block completes the skeleton.

While the glue on the skeleton is drying, the engine standoff and cowling may be cut and shaped. There's nothing critical about the shape of these pieces except that the standoff should fit snugly into the transom slot and be high enough to allow adequate propeller clearance. Basically, the standoff and cowling are cut from a single  $\frac{3}{4}$ -in.-thick white-pine board. The cowling is widened with a layer of  $\frac{3}{8}$ -in. balsa glued to each side and shaped to fit. The engine mounting plate should be screwed to the hardwood core of the cowling, as detailed in Fig. 11.

Plank the bottom and sides of the skeleton with  $\frac{1}{16}$ -in.-thick balsa sheeting before gluing the engine standoff in place. Each joint should be given two coats of fuelproof glue to insure watertight compartments. In a similar manner, the top of the hull is planked after the standoff is in place.

### The Cabin Cover

The cabin cover is fashioned next. Details are given in Figs. 7, 8 and 10. Properly constructed, the frame of the cover will fit snugly into the cabin of the main hull so that it need not be fastened to the hull in any way. A cutout may be made in the top of the cover for the installation of the receiver on-off switch, if desired. Otherwise, the switch may be mounted inside the cabin.

Installation of the skag and stabilizers on the bottom of the hull completes the construction of the model.

"Finishing" the model is almost as time-consuming as the actual construction, but it must be done right if you expect a neat-appearing, watertight job. Carefully fill in all joints and crevices with a sealer such as balsa filler and sand the entire assembly smooth with fine sandpaper. Brush on a couple of coats of clear fuelproof lacquer, sanding lightly after each coat. Then cover the external parts of the hull and cabin cover with silk or model-airplane Silkspan. Don't try to cover these units with a single piece of material. Cut enough silk for the individual large surfaces, lay the material in place, and brush it down with a coat of clear lacquer. When the lacquer is dry, trim the silk with a razor

## CONSTRUCTION DETAILS FOR TILLER AND RUDDER

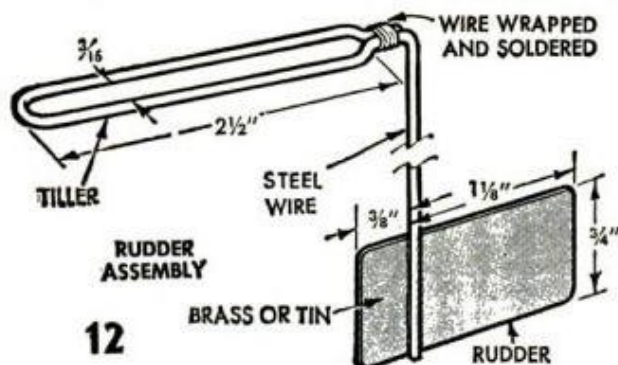

12

blade, allowing a  $\frac{1}{8}$ -in. overlap. This is then brushed into place with another coat of lacquer. Repeat this procedure for all exposed surfaces until the entire job is finished.

### Installing the Rudder

The rudder assembly, detailed in Fig. 12, is quite simple to construct and install. A small hole is drilled through the center of the cabin floor directly in front of frame 7. Push a  $2\frac{1}{4}$ -in.-length of  $\frac{1}{16}$ -in. i.d. brass tubing through the hole so that it extends  $\frac{1}{8}$  in. below the bottom of the boat. Cement the tubing to the center of the frame and apply a liberal amount of glue to the point where the tubing goes through the floor, both inside and outside the hull, to make a watertight seal. To strengthen this installation, a  $\frac{1}{4}$ -in.-thick piece of balsa is glued and screwed to frame 7 to hold the tubing firmly in place.

The tiller is made of  $\frac{1}{16}$ -in.-dia. steel wire, as in Fig. 12 and slipped through the previously installed brass tubing.

The rudder, a piece of .020 brass or tin is soldered to the end of the wire which protrudes through the bottom of the tubing. Before this is done, however, the rudder and tiller should be carefully aligned, as in Fig. 8.

Painting of the model can now be completed. The silk or Silkspan with which the boat is covered comes in several colors and can be used for your basic color scheme. Otherwise, you can follow up the coat of clear lacquer which fastens the silk to the boat with several coats of colored lacquer of your choice. The interior of the cabin and cabin cover should be painted at the same time and we strongly recommend that you use the same brand of paint throughout the entire project. When all painting is completed, strips of celluloid can be glued inside the cabin cover to serve as windows and to keep the cabin reasonably watertight.

(Continued to page 244)

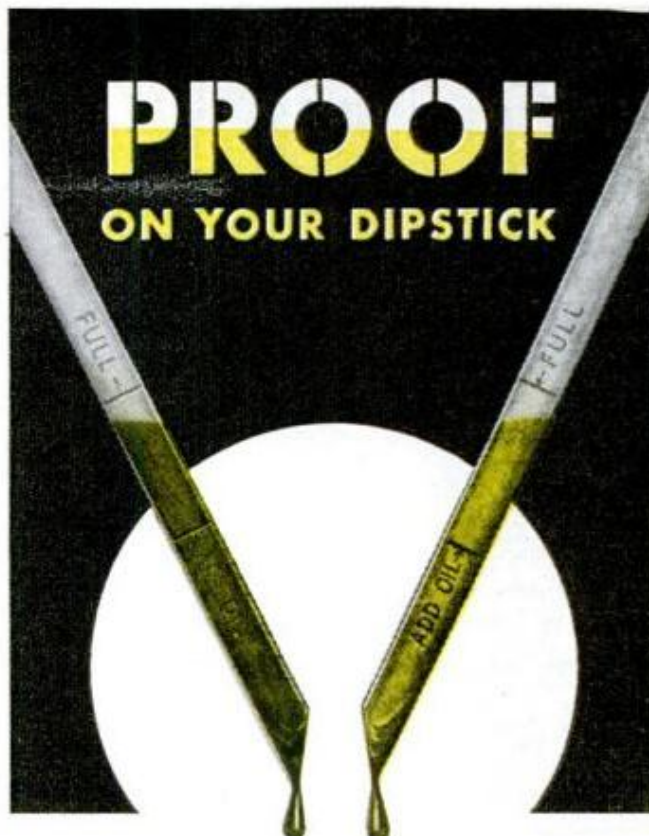

## Hastings keeps oil clean

Oil shows dirty? Dirt is abrasive and dirty oil causes wear. Get full-time protection—ask for Hastings Oil Filter Cartridges, and have *clean oil* from filter change to filter change.\*

The Hastings DENSITE filtering material traps and holds all the dirt, even the most microscopic size particles. And, *only* Hastings has Densite.

Hastings Cartridges assure clean oil—less engine wear and subsequent repair bills—as no other filter can. See for yourself . . . on your dipstick!

\*When replaced as normally recommended



U. S. Patent  
Nos. 2797811, 2584711

# HASTINGS

OIL FILTER CARTRIDGES

HASTINGS MANUFACTURING COMPANY  
HASTINGS, MICHIGAN

Oil Filters, Piston Rings, Casite Additives,  
Spark Plugs

# STOP WATER DAMAGE...



Wood  
Plywood  
Shingles  
Asbestos siding  
Concrete blocks  
Concrete  
Mortar  
Stucco  
Plaster  
Brick  
Paint  
Wallboard  
Tile  
Canvas  
Leather  
Linoleum  
Fabrics

**Prevents warping, swelling, mildew, mold, water stains, seepage, dampness, rot.**

**Keeps moisture out 5 years and longer.**

Use on all woodworking jobs, boats, patio furniture, planter boxes, shutters, screen doors, window sash, shingle roofs. Stops seepage in basement walls, concrete silos, foundations. Waterproofs canvas, tarps, tents, awnings, leather boots, shoes, outdoor clothing. Won't harden or crack leather or fabrics. Perfect underseal for oil base or alkyd paints. Deep penetrating, colorless. Apply by brush, spray or roller. At paint or hardware stores or order direct. 16 oz. spray can \$1.89, Qt. \$1.75, Gal. \$5.35, 5 Gal. \$25.25, ppd., tax incl. Send check or money order to **E. A. Thompson Co.** 1355 Market St., San Francisco 3, Calif. No COD's please. (Since 1929.)

## Send for your **FREE** 1960 **HEATHKIT** CATALOG

### HI-FI, HAM RADIO MARINE... TEST

Over 150 do-it-yourself electronic kits are illustrated and described in this complete Heathkit Catalog.



**DO-IT-YOURSELF... IT'S FUN**  
**IT'S EASY & YOU SAVE UP TO 1/2**

**HEATH COMPANY**/Benton Harbor 17, Mich.

a subsidiary of  
**DAYSTROM, INCORPORATED**

Please send the **FREE** Heathkit Catalog.

NAME \_\_\_\_\_

ADDRESS \_\_\_\_\_

CITY \_\_\_\_\_

ZONE \_\_\_\_\_

STATE \_\_\_\_\_

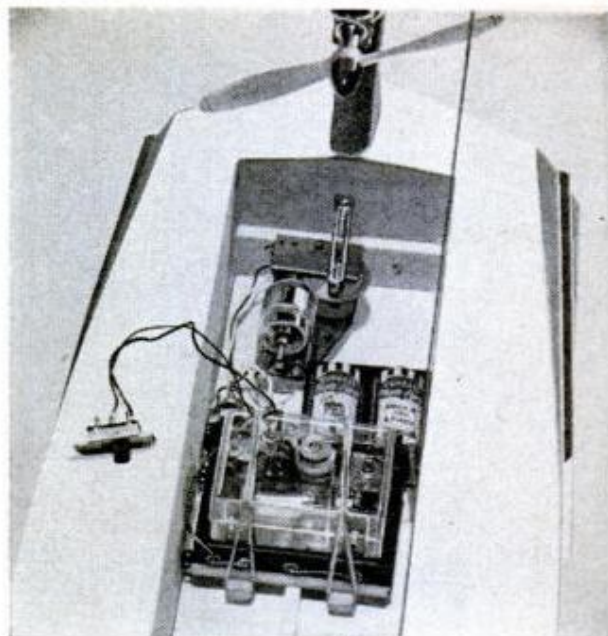

Roomy cabin easily houses required electrical gear

### Installing the Radio Equipment

Installation of the electrical equipment is illustrated in the photo. The equipment is identical to that in the car, and installation is very similar. The servo is first mounted on a piece of 1/4-in. white pine which is then glued to the bottom of the boat in a position which permits the crankshaft pin to engage the tiller. Careful positioning is essential so that the rudder is aligned straightforward when the servo is in "neutral."

The receiving antenna is a length of thin (.020) steel wire, bent as illustrated. It is cemented to the inside of the cabin, with cloth glued over it to hold it upright.

Two notched balsa-wood blocks glued to the floor serve as a receiver mounting platform and permit the receiver assembly to be fastened down with rubber bands. In the boat, the battery holder for the servo cells should be screwed to a block of 1/4-in. white pine glued to the bottom of the cabin. A small alligator clip attached to the end of the receiver antenna lead permits clipping this wire to the antenna without soldering. This facilitates interchange of the receiver between boat and car.

### Possible Substitutions

The simplicity of the radio-control functions, the stability of the models and the adequate mounting space available, make parts substitutions quite permissible. Virtually any receiver and transmitter and self-neutralizing servo you may already have will provide satisfactory results. Neither size nor weight is particularly

(Continued to page 246)



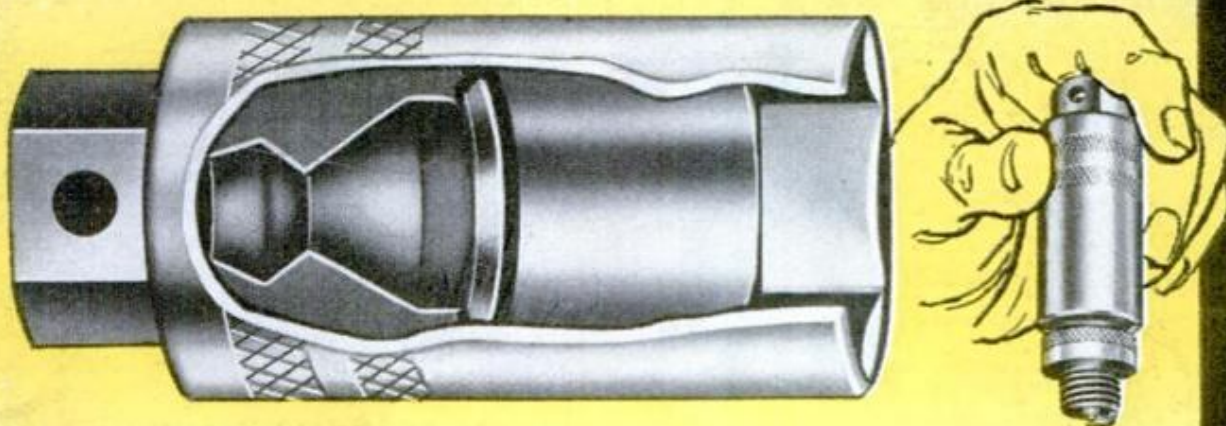

**PROTO'S SPARK PLUG HOLDING SOCKETS.** Revolutionary neoprene insert prevents burned hands, cracked porcelains, damaged electrodes. Available in  $\frac{3}{8}$ " (No. 5026HP) and  $\frac{1}{2}$ " drive (No. 5326HP). Both sockets fit all standard 14mm plugs in domestic and foreign cars. Turn with fingers, flat wrench, ratchet, torquer. Look for counter display-demonstrator. You'll find over 2,200 quality Proto tools at auto parts, hardware and industrial outlets. Professional performance guaranteed.

**PROTO TOOLS**  
PROFESSIONAL QUALITY TOOLS

Division of Pendleton Tool Industries, Inc.

2202 Santa Fe Avenue, Los Angeles, Calif. • 502 Allen Street, Jamestown, N. Y. • 1702 Oxford East, London, Ontario, Can.

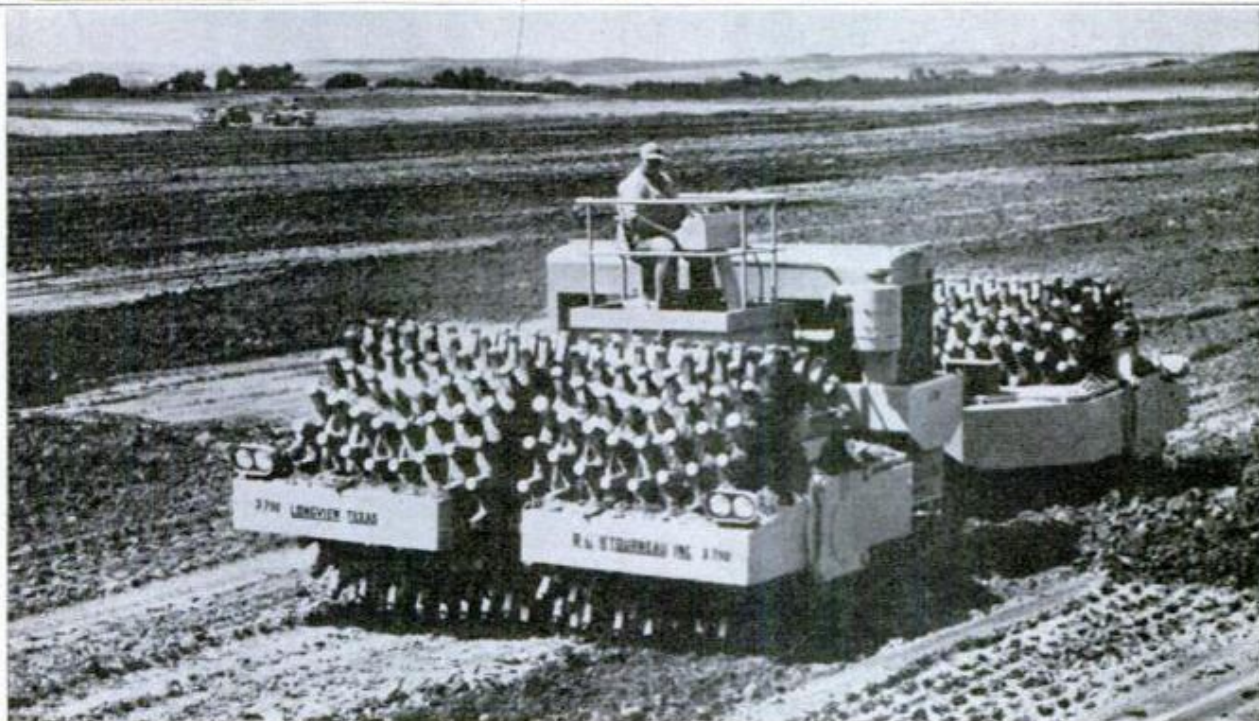

R. G. LeTourneau, Inc., 2399 South MacArthur, Longview, Tex.

## Electric Controls Drive Self-Propelled Sheepfoot Roller

Push-button electrical controls drive the self-propelled rollers on a new sheepfoot roller. The operator atop the machine can run the rollers backward or forward at 300 feet per minute under normal conditions. The manufacturer claims the new

machine saves money, since the rollers travel in either direction with identical power and speed, permitting any number of trips without turning the machine around. Two generators, coupled to a 420-horsepower diesel engine, supply power.

**1/2 PRICE OFFER!**



**S-200... the only motor oil additive made expressly for late model car engines!**

**only 75c**  
Regular price \$1.50

**millions of driving miles have dramatically proved its benefits!**

- A necessity with ALL types of motor oils. Keeps all the horsepower built into engines by the manufacturer.
- Cuts friction and wear. Assures immediate lubrication. Helps reduce fuel consumption.
- Keeps all moving engine parts clean. Cures and prevents noisy valves, lifters, sticking rings and pistons.
- Use one can of SHALER S-200 when changing oil and one can each 1,000 miles thereafter.

**CLIP THIS COUPON NOW**

**Save 75¢.** Fill in the make, year and license number of your car. Take this coupon to your SHALER S-200 dealer today—he has been authorized to allow you 75c off on a regular \$1.50 can of S-200. Offer good for 30 days only.

Make and Year of Car \_\_\_\_\_ License No. of Car \_\_\_\_\_

Redeemed By (Dealer's Name) \_\_\_\_\_ Dealer's Address \_\_\_\_\_

Dealer's Signature \_\_\_\_\_ 305  
Mr. Dealer: Your wholesaler is authorized to redeem this coupon.

critical so long as the equipment can be relied upon for dependable performance. In all cases, manufacturers' adjustment instructions for the radio equipment and servo should be carefully followed.

The engine recommended in the list of materials has an integral gas tank which holds enough fuel for a two or three-minute run. If a longer run is desired, a separate tank, such as a Kap Pak or Perfect #12, may be attached to the engine mount. (This may become necessary if an engine other than the one illustrated is used since many units are not supplied with a built-in tank.) The top of the auxiliary tank should be level with the engine crankshaft to avoid flooding or hard starting. A fuel line from the auxiliary tank to a hole drilled in the side of the Baby Bee engine's integral tank provides the necessary coupling for that particular engine. Your hobby shop dealer will be able to assist you in selecting the proper engine and tank combination for any reasonable length of running time.

**LIST OF MATERIALS**

- R/C Receiver kit—Ace "Commander"
- R/C Transmitter kit—Ace "Commander"
- Compound Servo—Babcock Electric #897
- Battery box—Hilcrest, type B
- Battery holder—Hilcrest, type 2C
- Engine—Baby Bee Thimble Drone
- Propeller—6" dia., 3" pitch
- Slide switch—SPDT
- Plug and socket—(optional)
- Wheels—3" dia. (for car only)

All above items and other materials, including wood, steel wire, silk, brass tubing and sheeting, celluloid, wheel collars, etc. (see illustrations and text) are available from most model shops.

\*\*\*

**Do You Know This Old-Timer?**

(Answer to quiz, page 24)



**1925 Jordan Six**

# WORLD'S LOWEST PRICED CAR New KING MIDGET

15 years continuous production—Thousands of proud, satisfied owners from Alaska to Ecuador. Many report 50 to 75 miles per gallon. Rear mounted air-cooled engine, smooth fully automatic transmission, four wheel hydraulic brakes. A safe and amazing small car you can own and drive at a fraction of the cost of any other. You owe it to yourself to get the surprising facts and prices. Buy it at the dealer price if no dealer near you. Rider Agents wanted. Send 25c for 32 page book, full details, dealers price, or \$1 (refunded first order) for this plus Service and Repair Manual and 16 5x7 photos of car and factory.

**MIDGET MOTORS CORPORATION**  
ATHENS 1, OHIO

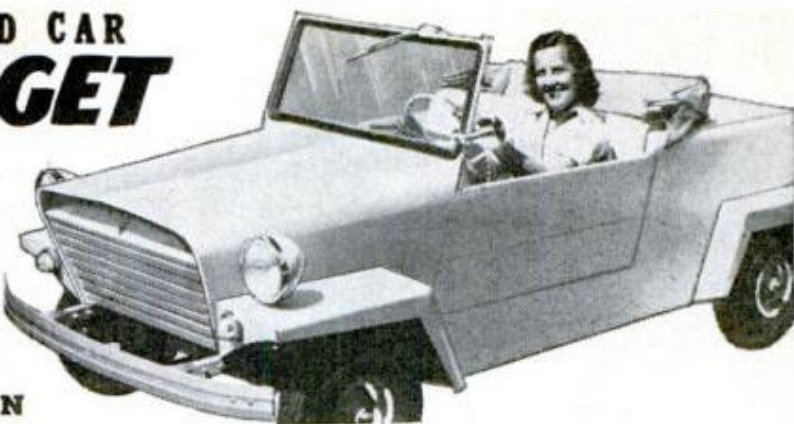

## Carry your tools in safe HUOT HIP-ROOF TOOL BOXES

You owe your tools a HUOT

For men who treat their tools with pride! The models shown here are made with heavy gauge steel and full length piano hinges that never get out of line. Heavy duty hasps and latches, welded double corners. Bright blue hammerlin boxes, red tote trays. Many models—write for free bulletin. Treat your tools to a Huot!

Model 503—20"—\$9  
Model 502—19"—\$7.10

**HUOT MFG. CO.**  
555 N. Wheeler St. St. Paul 4, Minn.



## The paint remover that licks the toughest finish



Send  
25c for  
illustrated  
Refinishing  
Manual

Next time you have to remove paint, don't ask for "a paint remover". Ask for Wonder-Paste. Softens up the thickest paint, enamel or varnish so it comes off clean. At paint and hardware stores.

Write for free Wonder-Paste folder  
Wilson-Imperial Co., 118 Chestnut St., Newark 5, N.J.

# EARN \$3 TO \$6 AN HOUR

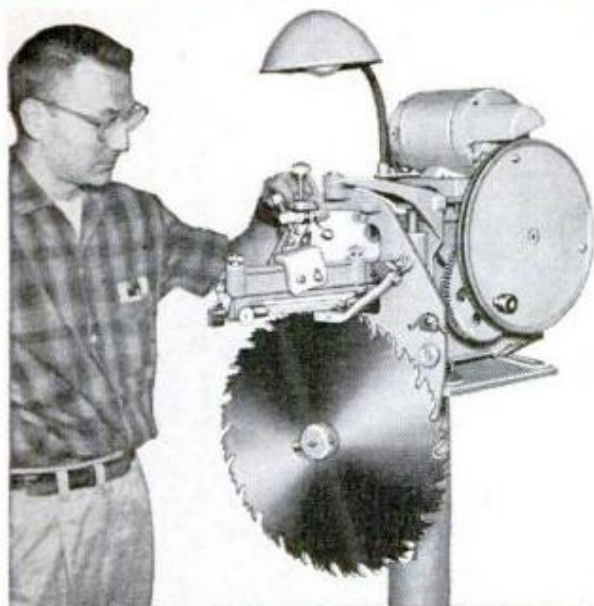

Here is a money-maker for you! In spare time and with little capital you can operate a profitable business of your own, built around essential service work—the sharpening of saws in your community. Amazing capacity range of Foley Automatic Saw Filer lets you restore to like-new condition all the types of hand and power saws commonly used in homes, farms, construction, schools, and manufacturing plants.

**The new model 200 Saw Filer is the one machine that files all these saws:**

1. Hand saws, rip and crosscut
2. Band saws
3. Crosscut circular saws.
4. Novelty combination rip and crosscut saws
5. Chisel-toothed combination rip and crosscut saws

It is easy to operate—no experience needed—no eyestrain.

Free Book "MONEY MAKING FACTS" shows you how to get into this CASH business that will pay you up to \$3 to \$6 an hour— with a small investment, no overhead, no stock of goods to carry. Time Payments if desired. Mail coupon now for free book. No salesman will call.



**THIS ONE MACHINE  
FILES ALL THESE SAWS**

**FOLEY MFG. CO.** 516-0 Foley Building  
Minneapolis 18, Minn.

Send me free book "MONEY MAKING FACTS"  
and Time Payment Plan.

NAME \_\_\_\_\_

ADDRESS \_\_\_\_\_

CITY \_\_\_\_\_ STATE \_\_\_\_\_

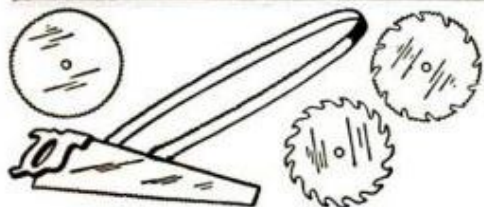



# First-rate builders buy Brand Name materials

Why do you buy Brand Names? Because you trust them. You know that they are consistently good, that they always meet the high standards of quality you've set for yourself and your family. You'll find Brand Name products wherever you go. No guesswork shopping. Like good friends, they're always there.

May 1-8 is Brand Names Week

Don't take a chance...take a NAME BRAND

LOOK FOR



## Gimmicks Add Realism To Your Home Movies

IF THE SCRIPT calls for snowflakes, the home-movie prop man can brew up a realistic snowstorm in a hurry with "snowstorm" tablets. Available at the joke counter of a novelty store, several tablets are placed in a can lid and heated. This makes the tablets vaporize, invisibly, and the condensing gas, falling from ceiling height in the form of white particles, photographs just like snow.

**TV MOVIE BACKGROUNDS.** Want something different in title backgrounds? Although it is not practical to shoot amateur movies off a TV screen, TV scenes do provide an excellent source for unusual title backgrounds. Pick the scene you like and take a still picture of it at a 25th of a second. Then make a blowup and use the enlargement as a background card to hold the letters of the title. Such TV backgrounds also can be used for animated puppet sequences.

**MYSTERY MOVIE TITLES.** Mystery titles that appear out of nowhere in black and white or color, are easy to produce if you write or print the title on a white card with a stick of paraffin. To make the lettering appear magically, support the card at an angle, start the camera rolling and sift fine, colored pigment over the lettering, letting the pigment slide from top to bottom.

**SMOKE FOR MOVIES.** Small clouds of fireless smoke can be produced with chemicals for outdoor movies. Pour several drops of hydrochloric acid into a plastic squeeze bottle and a few drops of ammonia into a second squeeze bottle. When ready, hold both spouts together and squeeze simultaneously. Dense clouds of chemically produced smoke will result. Caution: In handling hydrochloric acid, extreme precautions should be exercised. Wear rubber gloves to avoid direct contact with the skin, and avoid inhaling the fumes.

Ken Murray, Colon, Mich.

### Clean and Renew Your Window Screens

WELL BEFORE window-screen time go over each screen, both sides, with a lintless cloth moistened in a half and half solution of boiled linseed oil and turpentine. The accumulated dust will disappear like magic and the screen will look like brand new again. The oil coating also will protect the metal against rust and corrosion.

MAY 1960

Got a lot of  
**SANDING** to do?  
**BEAR** up!



*It'll make the job a lot easier!*

Mind you, it does pay to get good sandpaper, because it lasts longer and does more work. Rugged, sharp grits are bonded so firmly to the backing of BEAR brand sandpaper that they sand away so easy, lasting longer than you can imagine. Ask for BEAR brand ADALOX Paper sheets in racks or Handy Packs. Belts, discs and rolls are also available from your local hardware or paint dealer.

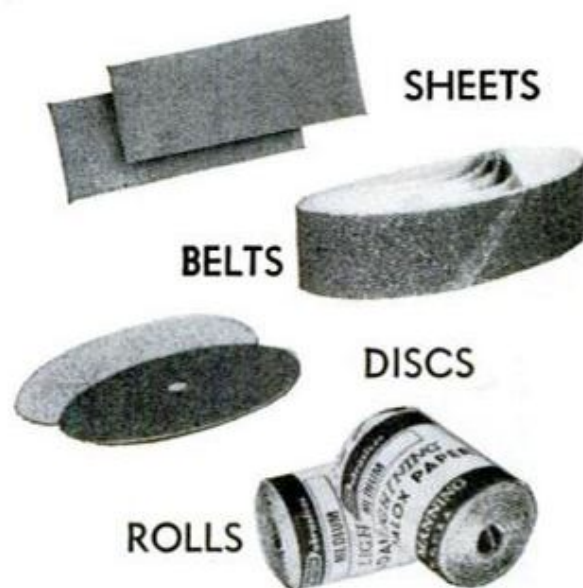

**BEAR**  
BRAND  
*Sandpapers*



**BEHR-MANNING CO.**

1901, NEW YORK

A DIVISION OF NORTON COMPANY 

BEHR-MANNING PRODUCTS: Coated Abrasives • Sharpening Stones • Pressure Sensitive Tapes • Floor Maintenance Products  
NORTON PRODUCTS: Abrasives • Grinding Wheels • Machine Tools • Belts • Belts • Electrochemicals  
In Canada: Behr-Manning (Canada) Ltd., Montreal • For Export: Norton International, Inc., Troy, New York, U.S.A.

249

Any man will enjoy new

**AIROGRATE**

**YELLO-BOLE**



**1. Smokes sweeter!**

Imported briar bowl lined with *real honey*. Starts caking the instant you light up. Hence, no break-in.

**2. Smokes drier and healthier!**

Metal grate condenses moisture, tars, nicotine. No wet heel.

**3. Smokes cooler!**

Air-vented chamber draws in fresh air. Aluminum fins and shank throw off heat, cool the smoke.

Famous honey-lining!

**\$295**

Extra interchangeable bowls — \$1.50 each

"Icepak" Set—Airograte Yello-Bole Pipe plus two extra bowls, \$5.95

Other Yello-Bole Pipes, also of imported briar \$1.95 to \$4.95

Send for FREE FOLDER, YELLO-BOLE PIPES, Inc., Dept. Y81, N. Y. 22

**EMERSON ELECTRIC**

**NEW POWER For Your Tools...**

There's an Emerson Electric Motor for every tool... sanders, saws, joiners, pumps, lathes, drills, buffers, etc... Home workshop or commercial. Operate in any position... exclusive dust-proof contact points. One year guarantee.



Write today for prices and FREE MOTOR SELECTOR GUIDE... tells you the exact motors you need for your tools.

**EMERSON ELECTRIC of St. Louis**  
8100 Florissant • St. Louis 36, Mo.

**Where to Write for More Details About 10 UNUSUAL VACATIONS**

ARE YOU INTERESTED in one of the 10 Unusual Vacations (page 112)? If you want more details about any of them, here's where to write:

**Vacation 1:** Cordova Airlines, Box 6203, International Airport, Anchorage, Alaska.

**Vacation 2:** United States Department of the Interior, National Park Service, Washington 25, D.C.

**Vacation 3:** District Passenger Agent, Canadian National Railways, Cor. Portage and Main Streets, Winnipeg, Man.

**Vacation 4:** Joseph C. Wampler, Wampler Trail Trips, Box 45, Berkeley 1, Calif.

**Vacation 5:** American Forestry Association, 919 17th Avenue N.W., Washington 6, D.C.

**Vacation 6:** Farm Vacations & Holidays, Inc., 500 Fifth Avenue, New York 36, N.Y.

**Vacation 7:** Inquiry Manager, State of Maine Publicity Bureau, Gateway Circle, Portland, Me.

**Vacation 8:** Greene Line Steamers, Inc., Foot of Main, Cincinnati 2, Ohio.

**Vacation 9:** Yacht the "Bahama Queen," 19160 North Bay Road, Miami Beach, Fla.

**Vacation 10:** Barachino Travel Service, Executive and Traffic Office, Calle 60, 488 Hotel Mérida, Mérida, Yucatán, México.

**Humidifier Removes Odors, Cleans Air Automatically**

Home odors are removed, and the humidity of the house kept constant, by a new home air purifier designed to work with air-conditioning systems. Resembling a drawerless filing cabinet, the unit gives the effect of airing out the home with clean, fresh air every half hour. Its manufacturer, the Carrier Corp., says the purifier not only removes new odors but also gradually will eliminate those absorbed over the years by walls and furnishings.

The unit's filtering element consists of many layers of aluminum mesh screen which is bathed every 20 seconds by a wave of water and a glycerinelike fluid. After absorbing odors, the fluid is heated and air is bubbled into it to carry away odor vapors through an outside vent.

Humidity is controlled by regulating the amount of water in the solution passing over the filtering element. A humidistat, once set, performs this chore by electrically opening and closing a water valve to maintain the desired rate of evaporation.

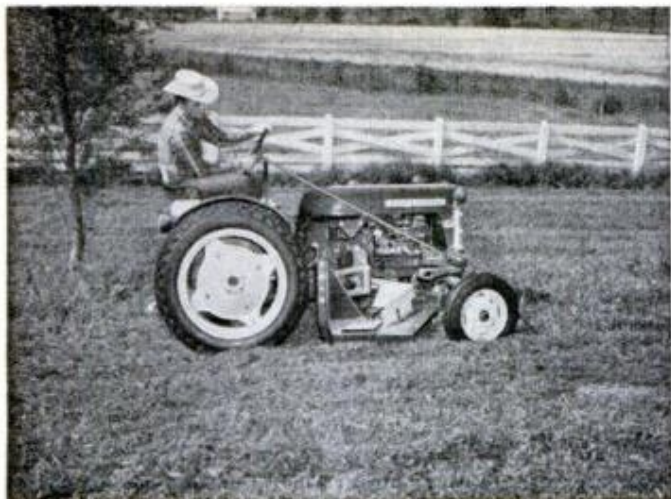

## CASH IN EXTRA EARNINGS NOW! with an International® Cub Lo-Boy®

Mow lawns... plow gardens... landscape grounds... clear snow. There are countless ways to earn extra income the year 'round with a low-cost 13.4 hp Cub Lo-Boy tractor. There are countless prospects near you: homeowners, businesses, and industrial plants. As little as \$250 down can start you in a business of your own. And you can earn more profit because of the Cub Lo-Boy's low operating expense.

Ask your IH dealer about the Cub Lo-Boy and matched equipment or write today for free catalog:



**INTERNATIONAL  
HARVESTER**

Dept. PM-5, Box 7333,  
Chicago 80, Illinois

RETAIL PRICE \$125.00  
FACTORY TO YOU \$79<sup>95</sup>

**SUPERSHOP** includes precision-built 8" tilting table saw, vertical and horizontal drill press, 30" lathe, sander, grinder. 100% BALL BEARING. Write for FREE catalog, full details, trial plan.

**UNITED INDUSTRIES, INC.**

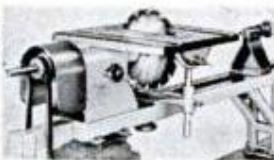

Power Tools Division  
131 YATES AVENUE  
BELOIT, WISCONSIN

Electric Model

\$64.95



### 5 GAL. PORTABLE MIXER

Not a toy—built for long hard use. Mixes cement plaster, paints, chemicals, plastic, feed, fertilizer. One man operation can mix 15 cubic feet per hour. Comes complete with 5 gal. removable pail, agitator, electric motor, switch and cord ready to plug in and go to work. Gasoline powered model with 10" wheels. \$89.95 FOB Pasadena.

Modern Mfg. Co. 160 N. Fair Oaks, Pasadena, Calif.



**REPLACE YOUR  
WORN-OUT  
WOODEN  
HATCHWAY...**

**with an  
all-steel  
BILCO  
basement  
door**



... and your basement entrance will be weathertight, good-looking — for a lifetime. A spring-balanced Bilco door floats open at a touch... locks securely... costs so little. And you can install it yourself — in just a few hours!



## TOP SPEED-

**better skiing - more fun!**

MICHIGAN AQUA-JET propellers win twice as often in the "National Stock Outboard Championships" as all other wheels, custom-built included. Inexpensive stock propellers, each specifically engineered for motor used (5 HP and larger). Send card for FREE 1960 catalog — the Outboarder's Bible. Shows how to get better performance from specific motor-boat-load combinations for racing, skiing, cruising, pleasure — also fine line of boat fittings. MICHIGAN WHEEL CO., Grand Rapids 2, Mich., Dept. PM

**Bilco**

**AMERICA'S FINEST  
BASEMENT DOOR**

The Bilco Co., Dept. R-95  
New Haven 5, Conn.

Please send me your free illustrated folder and name of local dealer.

NAME \_\_\_\_\_  
ADDRESS \_\_\_\_\_  
CITY \_\_\_\_\_ ZONE \_\_\_\_\_ STATE \_\_\_\_\_

For home handy-men everywhere!



Sturdy, Extruded Aluminum Track with Adjustable Pegs

Use anywhere! Keeps everything neat and handy. Simple to install. Fasten track in place. Insert pegs wherever needed. Packaged in complete sets.



Adjustable Shelf  
**STANDARDS & BRACKETS**

Quick, easy way for you to add shelves—anywhere! Sturdy, ornamental and practical. Just select shelf height—and hook in brackets!

At Leading Hardware & Lumber Dealers

**MACKLANBURG-DUNCAN CO.** OKLAHOMA CITY, OKLAHOMA



Gravelly does the jobs other tractors can't! The unmatched performance of the Gravelly Tractor gives you dependable **POWER** at your command to mechanize your lawn, garden and farm jobs.

**POWER** to mow the toughest rough or the finest lawn. Choose from 30 job-proved tools.

**NEW** full-flow Oil Filter, **NEW** Power—now 6.6 HP! All-Gear Drive, Optional Starter. Riding or Steering Sulkies.

Ask your authorized Gravelly Sales and Service Dealer for a **FREE DEMONSTRATION**. Or, write for **FREE** 24-page "Power vs Drudgery" Booklet today!



**GRAVELLY TRACTORS, INC.**  
P.O. BOX 601-E DUNBAR, W. VA.

## Flowers on the Production Line

(Continued from page 102)

transplanting when he goes to work with his fork or digger."

Another advantage of the freezing system is that it enables Wayside's shippers to fill orders from under one roof, which eliminates delays caused by inclement weather, the cause of many broken promises. Wayside uses the previous year's sales figure for perennial plants as a guide for the number of plants it stores in the freezing room in November. Two-thirds of the number of plants sold during the previous year are consigned to the freezer. In February, March and April, when plants are naturally dormant, orders are filled from the field. The first shipments go to the southern part of the country. Then, as spring's warmth sets in, Wayside begins shipping northward. In April, order fillers begin drawing from the freezing rooms.

A nurseryman of 100 years ago probably wouldn't have been very much surprised if he had visited a nursery of 50 years ago, because the process of growing seedlings and plants and cuttings—one of man's oldest occupations—hadn't really changed much. But a visit today to a large nursery like Wayside Gardens would produce wide-eyed astonishment in the time-traveler. He would never have dreamed that a planter could help nature—and improve the nursery business—in so many ways.

Meeting Winslow Grullemans, he might first be told about such innovations as the mechanical planter and weeder, and the freezer. Then Grullemans might explain that many nurserymen have their own planes to speed delivery of perishables.

The old-time nurseryman would be amazed to learn how Grullemans keeps track of his nursery business. One of the first nurseries to adopt an International Business Machines system, Wayside Gardens uses the machines for a daily sales inventory, the payroll, records, mailing lists, shipping labels and research. The cybernetic machines tell the Wayside office which plants are selling and which aren't, and even offer proof with comparative figures for other years. The machines keep a complete buying history for each customer, and if Grullemans wants to announce a special offer on a particular plant, the machines tell him which customers would be interested. If he wants to know how well a certain magazine advertisement "pulled" in a certain area of the nation, Grullemans can turn to his machines for the information.

(Continued to page 254)



## NEW FROM V-M



THE IDEAL AMPLIFIER FOR YOUR CUSTOM INSTALLATION! **\$89.95\*** List

## THE VOICE OF MUSIC DELUXE STEREO AMPLIFIER

Precision-built, this AC type amplifier has a built-in pre-amplifier and integral controls. Output sockets, Dual-channel, push-pull output of 28 watts (peak); 14 watts (peak) each channel. Jack panel with stereo inputs for *phono, tape, tuner* and a monophonic input for TV. Outputs to drive a stereo or monophonic tape recorder.

ASK YOUR DEALER ABOUT THE COMPLETE LINE OF EXCLUSIVE V-M 'STERE-O-MATIC'® 4-SPEED RECORD CHANGERS —THE WORLD'S FINEST! From \$50.00 List\*

\*Slightly higher West

the **Voice**  of **Music**®

V-M CORPORATION, BENTON HARBOR, MICHIGAN. WORLD FAMOUS FOR THE FINEST IN RECORD CHANGERS, PHONOGRAPHS AND TAPE RECORDERS

## ELECTRIC WELD - BRAZE & CUT

REPAIR MOST EVERYTHING MADE OF METAL

Home Appliances, Auto parts, Farm-garden equipment, toys. Make and repair playground equipment, lawn chairs, tables, ornamental iron work, gates, wagons, etc. Solder, heat, bend, and straighten, with terrific heat from arc torch.



Cut and weld up to 1/4" steel plate. A million uses for Home, auto, farm, inventors, factories, etc. Works from any home 110 volt plug-in. Complete with dark welder's mask, arc torch, supply of carbon welding and brazing rods and complete Welding Instruction Book. Efficient—durable—1 year guarantee. Wt. only 4 lbs. (cash, c.k. no) and pay postman \$9.95 plus COD

**SEND ONLY \$3** postage on arrival or send \$12.95 and we will send postpaid. Ideal gift for mechanically minded home owners, relatives, friends. Order now for early delivery. Available only from MIDWAY WELDER Dept. DPM-5 Kearney, Nebraska

It's Sharp... keep it that way with the right sharpening stone by



**CARBORUNDUM**®



Why **WOLVERINE** Leather gloves always **DRY SOFT!**

Wolverine's secret triple-tanning process tans naturally tough horsehide and pigskin super soft to stay soft—even dry soft after soaking.



WOLVERINE OFFERS THE MOST COMPLETE LINE OF HORSEHIDE, PIGSKIN AND BUCKSKIN GLOVES AVAILABLE... ALL LONG ON WEAR... LOW IN PRICE!

CHECK THESE FEATURES ↘

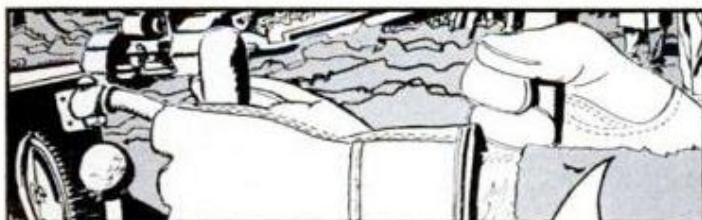

WRESTLING THE CONTROLS OF HEAVY EQUIPMENT REQUIRES A RUGGED, COMFORTABLE GLOVE. GET WOLVERINE HORSEHIDE OR PIGSKIN GLOVES AND ENJOY SURE GRIP PLUS LONGER WEAR!



EASY-WORKING SLIP-ON GLOVES FOR ASSEMBLERS LIGHTWEIGHT SUEDE PIGSKIN WITH ALL THE FREE FINGER AND WRIST ACTION YOU NEED.

Once you wear 'em, you won't be without 'em!  
At stores everywhere.

**WOLVERINE GLOVES**

Wolverine Shoe & Tanning Corp.  
Rockford, Michigan



If your wife is nagging  
you about shabby

## WOOD FLOORS

Refinish them yourself in  
just ONE DAY with



# FABULON

*the fabulous* FLOOR FINISH

Give your floors the armor-like protection of FABULON, the original "bowling-lane" finish for home use. Applies easily with brush or roller. Your wife will love her FABULON-ed floors. . . NO MORE WAXING OR SCRUBBING. At paint, hardware and lumber stores everywhere. For comprehensive manuals on all phases of wood finishing, send 25c in coin to . . .



**PIERCE & STEVENS CHEMICAL CORP.**  
710 OHIO STREET • BUFFALO 3, N. Y.  
Available in Canada—Le Page's, Toronto 18, Ont.

LOOK at its economy —  
LISTEN to its "whis-purr" —

## QUIET-TONE

HI-EFFICIENCY fiberglass-packed

## MUFFLER

GET GASOLINE ECONOMY . . . and FULL HORSEPOWER! Quiet-tone's straight-thru construction for unobstructed flow of gases gives you both! Plus the deep "acceptable" tone you admire, thanks to exclusive Turbo-Jet Diffuser. And, because Thermo-Dynamic Heat Flow produces faster evaporation of corrosive exhaust acids, QUIET-TONE mufflers last longer!

**FIT ALL CARS — EASY TO INSTALL**

See the complete line at your favorite dealer's today!  
. . . and ASK about the complete lines of Dual Exhaust Systems, too.

## GRAND AUTOMOTIVE PRODUCTS

2055 N. Ruby St.  
Melrose Park, Illinois

World's Largest Producer of Dual Exhaust Systems

Grullemans would take pride in telling about mist propagation, rose-waxing, jiffy pots, the use of sphagnum peat for growing purposes, and polyethylene packing.

Mist propagation, which was developed about four years ago, benefits young cuttings of shrubs, which have difficulty taking root. Mist propagation sprays water periodically on the cuttings' foliage, keeping it moist until the rooting action takes place. This means that the foliage will not deprive the cuttings of moisture, and they will have a better chance of surviving. Before mist propagation, cuttings had to be kept under shade, and even then many plants could not make their own roots; they had to be budded or grafted. Throughout the day, the spray comes on for five seconds in every 60-second interval. A timer can be set for any spraying period up to 60 seconds and the spray can be constant or scattered.

In Wayside Gardens' rosebush storage shed is a "wax heater." It is here that the dormant rose plants are dipped in melted paraffin wax to boost their development after replanting. The waxing process has been in the nursery industry for the past quarter century, but it was just a few years ago that a definitive study was made to prove its value. The study showed that waxing raised growth and flower production more than 50 percent, and that it reduced dieback and mold development in storage while increasing growth of shoots and roots. Moreover, the waxing of rose canes slowed moisture loss.

"We found, and still do, that some of our customers are suspicious of the idea of waxing roses, much as some are uncertain about freezing plants," Grullemans says. "But now we have scholarly proof that the waxing method helps nature, and we show the results of the study to anyone who's dubious. We still have unwaxed roses for customers who can't stand the idea of waxed roses—despite the proof."

About two years ago, the clay flower-pots familiar for scores of years to anyone who has ever planted were replaced by pots made of peat—called "jiffy pots." They got their name because plants grow faster in them than in the clay pots, and because people save time by planting pot and all in the ground. "Putting the pot in the ground also avoids the transplanting shock that a plant gets when you knock it out of a clay pot," says Grullemans. "And the roots will grow right through these peat pots." After the jiffy pot is in the ground awhile, the peat disintegrates.

Wayside Gardens grows many of its plants in sphagnum moss rather than in

(Continued to page 256)

**ARROW** T 50

**ALL-PURPOSE HEAVY DUTY STAPLE GUN**

**SHOOTS A STAPLE WHEREVER YOU'D DRIVE A NAIL!!!**

At Hardware, Building, Lumber and Stationery Dealers Everywhere.

ARROW FASTENER COMPANY, Inc. 1 Junius Street • Brooklyn 12, N. Y.

12.50

Uses 6 Staple sizes:  
 $\frac{1}{4}$ "  $\frac{3}{16}$ "  $\frac{7}{16}$ "  $\frac{1}{2}$ "  
 $\frac{5}{8}$ " and CEIL TILE



National Multiple Sclerosis Society

**FREE AMAZING NEW BOOK "HOW TO ANSWER ADS"**



Never before have you seen anything like this. Tells you in simple language the correct way to answer ads. Gets you quicker replies—better results, and greater satisfaction. Will save you time and money and it's ABSOLUTELY FREE. No obligation whatever. Every reader of advertising should have this booklet. Send a postcard for your copy NOW. F. W. JOHNSON, Popular Mechanics Magazine, Room 600-A, 204 East Ontario Street, Chicago 11, Ill.

**BASEMENT WET?**

**Having trouble with floods, seepage and condensation?**

Read how to

**WATERPROOF YOUR BASEMENT**

in the

**JUNE ISSUE**

**At Last, A New Amazingly Simple GAS TURBINE JET ENGINE YOU CAN BUILD FROM EASY TO FOLLOW PLANS**

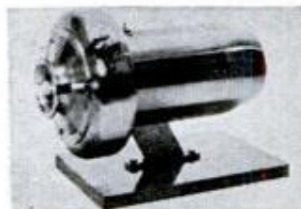

**SPECIFICATIONS**

Length—15"  
 Maximum Diameter—8 1/2"  
 Weight—14 lbs.  
 Compressor—Centrifugal  
 4.5" Dia. Impeller  
 Turbine—Impulse—Single stage  
 Rev. Per Min.—49,000  
 Fuel—Kerosene, Gasoline, Alcohol  
 Static Thrust—11 lbs.  
 Jet Velocity—700 ft. per Sec.  
 Jet Power Output—13.3 H.P.  
 Shaft Power Output—16.7 H.P.

The "Screamin' Demon" develops 30 H.P. (combined output of shaft and jet stream). An ideal project for the serious-minded hobbyist, student, and for scientific and industrial arts classes.

Can be made on any 9" metal cutting lathe with milling attachment. The "Screamin' Demon" can be used on small racing boats, midget cars, portable power plants, pumps, autogyros, etc.

Full size assembly drawing with complete list of materials, and containing critical dimensions, available for \$10.00. No C.O.D. Helpful, but not necessary detailed parts drawings, plus machined parts and castings may be procured at reasonable prices with each purchase of an assembly drawing.

**SAVOY LABORATORIES CORP.**

P.O. Box 1318

SANTA MONICA, CALIF.

**GUNK® degreases**

At better automotive supply and hardware retailers everywhere.



Cleans engines, garage floors, power mowers, greasy walls economically and safely. In aerosol or pour spout cans.



GUNK CHICAGO CO., River Forest, Illinois

servicing the Midwest and Southwest

RADIATOR SPECIALTY CO., Charlotte, No. Carolina

servicing the East, Southeast and far West

**SANDING BELTS**



	Doz.		Doz.
1x42 Mead, etc.	\$2.50	4x21 1/2 Skil, etc.	\$4.50
2x17 1/2 All Makes	2.50	4x27 Porter Cable, etc.	5.00
2x21 Porter Cables, etc.	2.75	4 1/2 x 26 Skil-Thor, etc.	5.00
2 1/4 x 21-5/16 Skil, etc.	3.00	4x36 Hammond, etc.	6.00
3x21 Porter Cable, etc.	3.50	4x37-13/16 Atlas, etc.	6.25
3x23 1/2 Skil, Thor, etc.	3.50	4x54 Porter Cable, etc.	9.00
3x24 Porter Cable, etc.	3.50	4x52 1/2 Walker Turner	9.00
3x25 American Floor, etc.	3.50	6x48 Delta-Sears, etc.	11.40
3x27 Porter Cable, etc.	3.50		

1—We have over 100,000 Sanding Belts in stock at all times.  
 2—All belts cloth backed—U.S. made. Brand New in original boxes.  
 3—Specify for wood, metal or plastic.  
 4—We will ship these belts assorted—Fine, medium, coarse, or with grit specification from 24 to 400 grit.  
 5—MONEY BACK GUARANTEE.  
 6—All other belt sizes available at lowest prices—Please inquire. Include 35c for postage and handling: Send check or money order. DEALERS INQUIRIES INVITED.

**H. S. R. SPECIALTIES CORP.**

28-09 Jackson Ave., Dept. PM3, L. I. City 1, New York

# Here are the reasons why you should kill weeds and grass with **NEW**

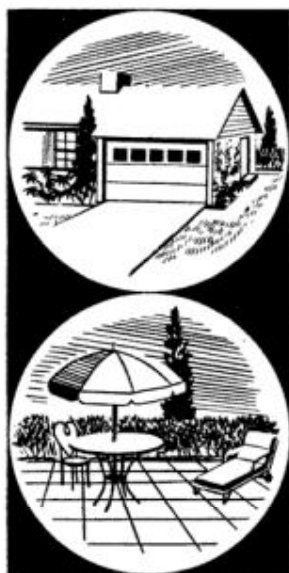

# X-All!

in driveways  
walks  
patios  
tennis-courts  
stone-walls  
ball-diamonds  
fence-lines

*wherever complete control of weeds and grass is desired!*

X-All kills . . . fast! Weeds and grass begin to die within a week.

One application of X-All controls weeds and grass for a whole season.

X-All contains no arsenic! Low toxicity makes it safer.

X-All will not stain patios, drives, walks.

X-All will not sterilize the soil.

X-All is easy to use—mix with water.

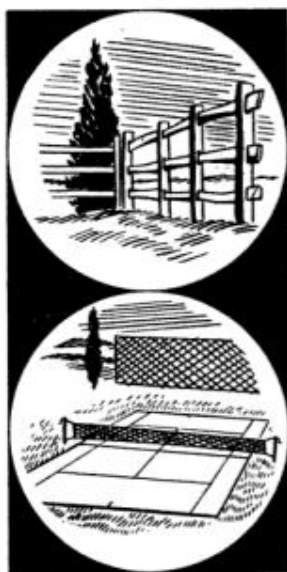

## LOOK FOR THE "SPRINKLING CAN" PACKAGE



2-ounce package . . . . . \$1.25  
(treats 75 sq. ft.)

8-ounce canister . . . . . \$3.50  
(treats 300 sq. ft.)



Amchem, X-All, Weedone are registered trademarks of AMCHEM PRODUCTS, INC.  
(Formerly American Chemical Paint Co.)  
AMBLER, PA. • Niles, Calif. • St. Joseph, Mo.

regular soil. It's been found that they do much better in the sphagnum, which is a genus of mosses that grows in boggy or swampy places. Once, as a test, Grullemans arranged for a shipment of sphagnum-grown chrysanthemums to be in the mails for a month. At the end of that time the mums were alive and healthy. "If those mums had been planted in regular soil," Grullemans says, "I don't think they would have lasted 10 days."

Wayside grows many difficult varieties in jiffy pots containing the nursery's own mixture of two-thirds sphagnum moss and one-third ground-plastic foam. The foam, mixed through the moss, keeps it from compacting. All of Wayside's plants are packed in polyethylene bags which let the plants breathe and retain their moisture, yet allow the harmful gases from the foliage to escape. Until three years ago, when Wayside adopted the polyethylene bags, the nursery used aluminum foil and wood-fiber cartons in packing. The trouble with this method was that the plants dried out too soon. It also produced a heavier and more expensive package to mail, and required much more labor in packing. Now a plant is dropped into a polyethylene bag and the top of the bag is tied. The customer merely unties the bag and places plant and jiffy pot in the ground.

For all their modern, mechanized look and the many changes that have come over them in the past 15 years, big nurseries like Wayside Gardens still depend on human hands for cutting, potting, budding and grafting. All perennial plants are hand-planted. Nurserymen still must gamble and take a certain number of risks, and hope for a warm spring, adequate rainfall and a not-too-severe winter. Experience and common sense haven't yet been outmoded by machines, and a nurseryman has to have much of both, plus patience. In propagating hydrangea plants, for example, Wayside's workers make hand cuts from maturing plants in the fields and haul the cuttings into sheds, where the foliage is trimmed, again by hand, and stems are dipped in hormone powder to induce rooting. Then the cuttings are planted in the cold frames and remain there six months. After that time they are removed and planted in the field, where they continue to grow for two years before they are harvested and sold. As they mature, of course, their cuttings are taken to the sheds to begin the three-year cycle over again.

It is unlikely that nurserymen will ever make nature conform to the Speed Age, but their machines have certainly gone a long way in giving nature a hand. ★ ★ ★

## FREE 16-PAGE BOOKLET

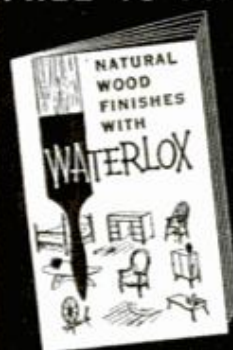

Want to give wood a hand-rubbed look?

Booklet tells how experts clear-finish antiques, floors, paneling, in soft lustre or gloss finishes.

**WATERLOX** Dept. PM  
2636 East 76th St.  
Cleveland 4, Ohio

**MASS PRODUCTION MAKES THESE PRICES POSSIBLE**  
**EASY TERMS**  
**SEND FOR FREE COLOR CATALOG**

**16 FT. RUNABOUT KIT**  
  
Complete with accessory package, low as \$17.57 per mo.

**TAFT MARINE WOODCRAFT**  
Dept. PM-560, 636 39th Ave. N.E., Minneapolis 21, Minn.



"Why do you think people would prefer handmade toothpicks?"

MEL MILLAR

## 1500-2000 P.S.I. CORNELIUS HIGH PRESSURE AIR COMPRESSOR

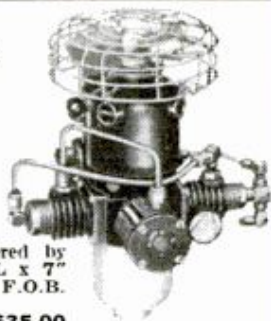

Excellent for filling Aqua Lungs, Air-Brush Work, Machine Shops, etc. 3 cylinder, 3 stage compressor, complete with 27 V. DC. 20 Amp. motor with fan. Rated 1500 P.S.I. continuous duty, 2000 P.S.I. Intermittent; includes Pressure Switch in Base. As released by Air Force in used, serviceable condition. Covered by our 30-day GUARANTEE. 11½" L x 7" H x 9" W. Shipping Wt. 12 lbs. F.O.B. Chicago. Limited Offer.

No. G-549 ..... \$35.00

### G-1 STAINLESS STEEL TANK



Capacity, 2100 Cu. In. (9 gals.) 450 PSI. ¼" port at each end. 24" length, 12" dia. Wt. 19 lbs F.O.B. Chicago.

No. G-63 ..... \$14.95 Each  
(2 for \$27.00)

**FREE CATALOG** ..... Tremendous Savings on Hydraulic Equipment, Diesel Parts, Electric Generator Sets, Electric Motors, Welding Equipment, Hand Tools, etc. Write for your **FREE COPY** today. Dept. G.

### D-2 AIR TANK



450 lbs. P.S.I. Aviators Breathing Oxygen bottles, type D-2, 500 cu. in. (approx. 2 gal.) int. vol. 6½" x 24". ¼" threaded openings at each end. Carbon Steel. New condition. Postpaid.

No. G-391 ..... \$4.95 Each  
(2 for \$8.50)

## GROBAN SUPPLY COMPANY

1139 South Wabash Ave., Dept. G Chicago 5, Ill., WEbster 9-3793

## MAKE HOME IMPROVEMENTS NOW



# great glue for every job you do

For Free copy of "Elmer's Guide to Good Gluing," send stamped, self-addressed envelope to The Borden Company, Dept. PM-50, 350 Madison Avenue, New York 17, N. Y.

**BORDEN'S PRODUCTS FOR THE HOME HANDYMAN**

**LICKITY LOG SPLITTER**  
  
**Ends Wood Splitting Drudgery**

Hydraulic power splits profits from waste wood • 7 HP trailer model • two speed • auto shift • auto stroke. Power "squats" to receive large diameter logs without "dead" lift—eighteen ton smooth hydraulic force cuts right through knots, 26" stroke handles up to 30" length, any diameter. Your name on a postal card will bring literature.

**THE WACO AIRCRAFT CO., Dept. D, Troy, Ohio**  
Dealer Inquiries Invited

# BUILD 'EM YOURSELF

with **DOT**

## TEENUTS®

and  
**EASI-BILD\* PATTERNS!**

TEENUTS . . . the flush-mounting, "can't-slip" nut that needs no washer . . . is now specified in 10 popular Easi-Bild patterns! Get them both at Hardware, Variety and Lumber stores!

\*T. M. Reg. U. S. Pat. Off.

*Columbia Fastener Company* Chicago 8, Illinois

**Exclusive Double-Bearing HEAVY-DUTY PUMPS**  
IRRIGATE • DRAIN • CIRCULATE • SPRAY  
Use 1/4 HP motor or larger . . . 1 HP for up to 7,500 GPH; 1,000 GPH 60' high; or 3,000 GPH from 25' well. 1 1/4" inlet; 1" outlet. Stainless shaft.  
**TYPE X**—2 oil-less bronze bearings. Won't rust. . . . \$10.95  
**TYPE XB**—Ball bearing model. . . . \$12.95  
Postpaid if cash with order. Rush your order today  
**MONEY BACK GUARANTEE**  
Centrifugal and Gear Pumps in All Sizes  
**LABAWCO PUMPS, Belle Mead 2, N. J.**

new **FORMICA®** table top?  
*Laminated Plastic*

It's easy when you use (1) Formica Safe-Bond, the new non-toxic, non-flammable adhesive that "tells" you when to contact . . . and (2) Formica laminated plastics in the smart new Raymond Loewy designs. Get Formica Safe-Bond and sheet stock at your local lumber dealer. Formica Corp., a subsidiary of American Cyanamid, Cincinnati.

a product of **CYANAMID**

MADE ONLY BY *Custom-Craft*

# THE ORIGINAL PACKAGED BOAT KITS

• World's Largest Line—New Fiberglass Hulls. Over 200 styles Boats-Kits, Formed-Hulls, Semi & Custom finished. All types: Prams, Cruisers, Racers, Inboards, Outboards. Easy to build. Professional results. Dealers - Agents Inquire.  
**Send 15c for 3-Colored Catalogs** 52 pg. Kit Catalog plus 20 pg. Hardware and 8 pg. Armor Glass books. (SPECIAL OFFER!)  
All 3-colored CATALOGS plus "Boating Handbook" . . . all for \$1.  
**CUSTOM • CRAFT** Buffalo 7L, N. Y.

**\* BOAT PLANS, PATTERNS FRAME PACS**

• Over 400 Plans-Patterns, Frame Pak Kits. Prams, Kayaks, Racers, Runabouts, Catamarans, Cruisers - In-Outboards (6' to 40') Wood, Plywood and Steel. **Send 35¢ for 120 pg. Plan Catalog.** Catalog plus "Boat Building Handbook" . . . Send \$1.00.

## BRAND NEW GOVT. SURPLUS AIRCRAFT STARTER MOTOR

(Acquisition cost of \$400)

OPERATES off BATTERY  
**DIRECT CURRENT—24 volt.**  
MANY USES for Hobbyists & Inventors:  
Boat Winches; Midget Cars; Delivery Carts; Small Welders. Ship. wt. Approx. 40 lbs. **ONLY 1000 LEFT—ACT FAST**  
Send check or Money Order.  
**WORTH HAVING JUST TO PLAY WITH!**

**AMERICAN BARREL COMPANY**  
49 South 5th West Salt Lake City, Utah

**\$4.95**  
Only **\$4.95** F.O.B. Salt Lake City



# CHIPPER CHARLIE

Never been sick a day in his life. But he knows it can happen to him—so he gets a health check-up every year—just in case. He also supports the American Cancer Society's Crusade. Send your contribution to "Cancer," in care of your local post office.  
**AMERICAN CANCER SOCIETY**



# WELD IN A JIFFY! IT'S DYNAMIC \$3850 F.O.B.



Now any one can weld, cut, braze or solder almost any metal quick, safe and easy with this professional type welder. Make repairs in home or shop and farm; repair auto bodies and fenders, build wrought iron furniture, railings, fences, etc. — 1001 metal items. No previous experience necessary. Designed to operate on any properly wired 110 V. A.C. line. Order today! Literature on larger industrial equipment on request.

**DYNAMIC WELDER COMPANY, 1808 S. Federal St., Dept. D2-E, Chicago 16, Ill.**

## EASY PAY PLAN

Low down payment. Pay as you USE. Money back guarantee. Act now!

SEND ONLY \$6.00

CHECK, CASH or M.O. PAY  
POSTMAN BALANCE  
PLUS CHARGES 1 YEAR  
GUARANTEE 10 DAY  
MONEY BACK TRIAL

## TOOLS WHOLESALE

Start your own business, sell tools to your friends and neighbors, or buy tools for your own use and **SAVE MONEY \$\$\$**

A MILLION DOLLAR INVENTORY AT YOUR FINGERTIPS. NO STOCK TO CARRY. ORDER AS YOU NEED IT.

**BUY AT WHOLESALE PRICES.** Extra \$25.00 profit on your accumulated purchases. \$1.00 refund on first purchase or refunded if you are not 100% satisfied.

**\$100 PUTS YOU IN BUSINESS**

THOUSANDS!! of Nationally Advertised items of Hand Tools, Power Tools, Machinist Tools, Tool Chests, Paint Sprayers, Light Fixtures, Appliances, Guns, Gifts, Toys and other items too numerous to mention.

**WE SHIP COAST TO COAST** Wholesale Disc. up to 50% off

Dept. PM-5 **SILVO HARDWARE CO., 107 Walnut St., Phila. 6, Pa.**



Hewitt-Robins, Inc., 666 Glenbrook Rd., Stamford, Conn.

## Around It Goes To Mix Up Ores

Standing as high as a three-story building, a giant wheel—the key element in a new blending and reclaiming machine — helps mix various grades of ore, cement and other bulk material to make them uniform and homogenous. The rotating wheel is fitted with two-ton-capacity buckets which can dig out 300 to 500 tons of stockpiled materials in an hour. It is mounted on a carriage which moves from side to side across the storage pile and forward into it. Buckets dump material into a hopper which, in turn, loads a conveyor belt to carry the bulk onto the next operation.

MAY 1960

## World's THRIFTIEST Light Plants



700 Watt, push button start, 115 v. 60 cyc. AC. 2.2 HP. easy starting Briggs eng. No wiring necessary; just plug in and operate. Plenty of current for any oil burner, freezer, brooder, emergency lights, etc. which require up to 700 watts. Ideal for television and radios. Complete with voltmeter and built-in winding to charge 6 v. auto batteries. (Item 24) Wt. 75 lbs. Easily fits in car trunk. Be prepared if storm knocks out power lines. Reg. \$275... **\$143.50**

1200 Watt Plant (Item 45) same as Item 24 but larger generator and engine with 50% greater output... **\$199.50**



**ELECTRONIC BRAIN** Now Available On All Our Plants—Write

**MASTER AIR COMPRESSOR**

**COMPARE!** This is the only compressor built with a **NO RUST** stainless steel tank. Safe up to 500 lbs. (Item 209) High pressure type (4 c.f.m.) Large volume of air for heavy duty spraying, inflating truck & auto tires, greasing, sand blasting, etc. Piston type 2" bore compressor with built-in air filter. Master built with high strength alloys and precision bearings. Tank, 12"x24", 2100 cu. in. cap. Equipped with automatic switch that starts and stops motor to maintain desired pressure (up to 150 lbs.) and check valve, safety valve, gauge, shut-off valve, 20 ft. air hose and tire chuck. lbs. per sq. in. Beautifully balanced on ball bearing wheels and rubber tires. Don't take chances with used or surplus equipment. Our compressors are factory new and are guaranteed **SAFE**. Low factory prices. 1/2 HP. Model Regularly \$175. (Item 209)..... **\$109.50**

1/2 HP. heavy duty model. Industrial motor motor and unloader switch. (Item 209a)..... **\$129.50**

**MASTER MECHANIC MFG. CO., Dept. A-56, Burlington, Wis.**  
Southern Customers Order from Dept. A-56, Box 65, Sarasota, Florida

## Design Your Own V-BELT DRIVES ... easily



...with this new **DRIVE DESIGNER** for light machines. Just turn dial for correct pulley and V-belt sizes.

Use this simplified **DRIVE DESIGNER** ...plus Gates Vulco V-Pulleys and highly flexible Gates Truflex V-Belts...to design a long lasting, trouble-free drive.

**Truflex V-Belts** are ideal for small pulley drives. At hardware and implement stores everywhere.



Send for **NEW V-Belt Drive Designer Today!**

The Gates Rubber Company, Sales Division, Inc. Dept. 15-999 So. Broadway, Denver 17, Colorado TPA-1102

Please send me the new Gates Truflex V-Belt **DRIVE DESIGNER** by return mail. I am enclosing 25c to cover cost of handling and mailing.

Name..... (please print)

Address.....

City.....Zone.....State.....

**Gates Truflex V-Belts**

259

Day after day  
a highly  
serviceable  
hammer



## STANLEY "JOBMASTER" ... \$3<sup>50</sup>

Here's a budget-priced, 16 oz. hammer designed for hard use and your comfort. Its super-heat-treated head has just the right hardness and temper. And its triple-wedged, straight-grained hickory handle is perfectly shaped. It's good-looking, too! You have your choice of a curved or ripping claw. Also available, "Jobmaster" Ball Pein hammers, 4 oz. to 48 oz.

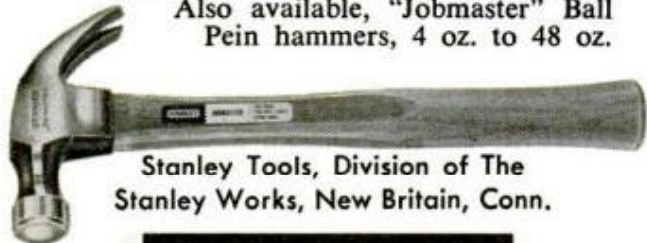

Stanley Tools, Division of The Stanley Works, New Britain, Conn.

# STANLEY®

## SUMMER COOLING For Your Entire Home At Amazingly Low Cost



If you have your own well or cold city water you can easily cool your entire home simply by adding a HASTINGS Coil Package Unit to your furnace.

No compressors or cooling towers and operating cost is negligible.

Be sure to get full information on Hastings Cooling before you make any decision.

Write for Free Bulletin P-5  
HASTINGS AIR CONTROL Inc., OMAHA 5, NEBR.



America is a Better  
America -  
thanks to Advertising!

## Two Cowbarns Become Clubhouse

Two 100-foot cowbarns, converted at a fraction of the cost of an original building, serve as a clubhouse for the Coldstream Country Club and Golf Course in Forestville, Ohio. Cutting and moving the barns onto a full basement foundation in which women's locker rooms and the pro shop were to be located, cost members of the club \$27,000. An original building would have cost between \$80,000 and \$100,000. Both barns were moved a quarter of a mile to the 188-acre golf-course location. The barns finally were joined by cutting one in half to form angle wings with the other structure.

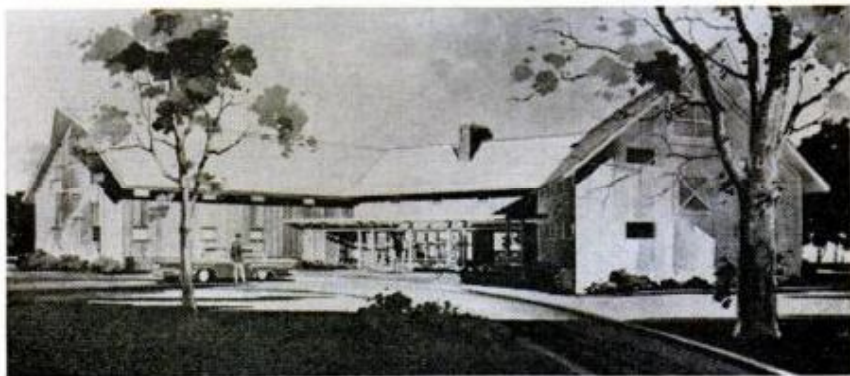
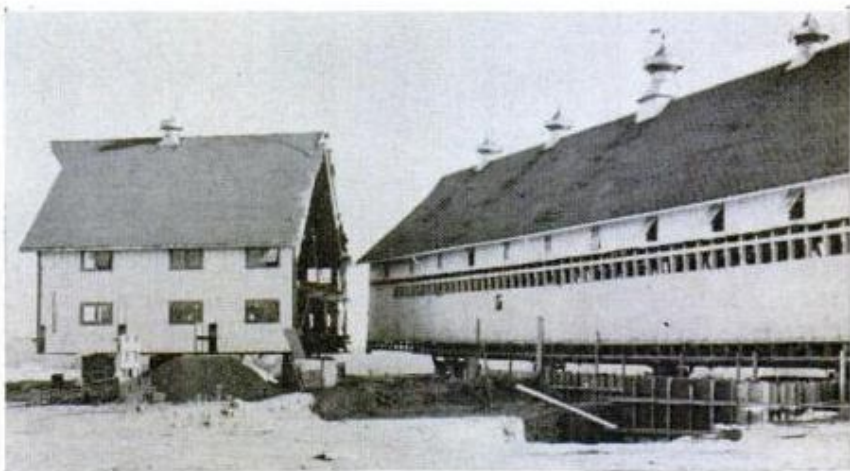



**Welding Cable 00' 50' \$12.50 100' \$24.00**  
 G-1 150-250 Amp New \$17.50 good C \$12.95  
 R-1 300 amp G.E. recond \$24.50 good \$15.50

**Accessories Kit For Arc Welder** for above generators has helmet, gloves, elect. holder, volt reg. rheostat, RC relay voltmeter, Gr. Clamp, including switch & 30' cable. . . . . \$19.95  
 With G-1 generator & 30' cable \$27.95

**Multi-Weld (R), D.C. Arc Welding Kit** Complete with G.E. R-1, 300-350 amp gen. incl. all items in accessories kit & reactor coil + 50' cable \$46.50 incl. solenoid control \$51.50

**AC-DC WELDER KIT** #511 G.E. Generator. Makes 1250 Watts AC light plant and 200 amp. DC welder and battery charger. Includes all items listed in accessories kit. AC-DC generator & instr. \$38.50

**New Reactor Coil Arc Stabilizer** for R-1, P-1, G-1 & ACDC. \$10.95. Incl. engine throttle solenoid control \$14.95

**3-V Belt Pulley Kit** fits R-1, P-1 & A.C.-D.C. gen., has 2 ball bearings blocks, high speed bearings, triple V-pulley, shaft 8" L & flex coupling \$17.50

**New Throttle Solenoid & Idling device** for all welder engine control 1" travel 6" L. Wt. 4 lbs. \$7.50

**NEW HYDRAULIC PUMP-MOTOR SYSTEM KIT**  
 Offers fluid drive of varying power, consist of 2 new Vickers p.d.s. pumps ea. .410 cu. in. rev. 3750 RPM 1000 PSI 375 GPH where one pump is belt driven as motor, 1 four way c. valve with variable speed control, reservoir, filter, gauge, hose & fittings. Value \$95.10. \$49.95

**Spectacular Bargain Electric pump** 400GPH complete with screen, 24-12VDC 5.2 Amp. motor off-on switch rheostat \$7.95

**Dual Power battery motors kit**  
 Excellent for golf cart, winch, etc., fully reversible, runs on 24-12VDC kit, includes 2 motors, Each 3 3/4 HP, 250 amp. 2300 RPM, 2 relays, switch, 2 flex couplings with speed reducers 10:1 & all connecting cable. Value \$70.65 save \$41.15. Kit price \$29.95

**Rotary Vane Vacuum pump**, Air or fluid, 15 C.F.M., 1500-4500 RPM 10" Hg Suction 24" HG pressure, reversible 3/4" ports wt. 9 lbs. gov't cost \$101.00 new \$22.50 good cond. \$14.50. Pump mount has ball bearings & Mt. bracket \$13.75

**Hydraulic Lift Kit** has stratopower hyd. pump rated 375 GPH 1400 PSI, reversible, 1D.A. Cylinder 2 3/8"x9 1/4" stroke, 1 four way c. valve, tank, filter, gauge, hose & fittings. \$79.40 value, kit price \$49.95

**NEW HYDRAULIC CYLINDERS**

Air or Oil	Bore	Stroke	Shaft D.A.	2000 PSI
#607	1 1/2"	4 1/2"	1 1/8"	\$4.95 2 / \$7.90
#300	2 3/8"	9 1/4"	1"	7 lbs. \$10.95
#511	3 1/2"	2 1/8"	1 1/4"	15 lbs. \$24.50
#311	3"	2 1/8"	1 1/4"	15 lbs. \$14.75
#600	4 7/8"	8"	2"	35 lbs. \$34.50

**NEW HYDRAULIC SYSTEM KIT**  
 #400 K heavy duty Power driven rated 16000 lbs lift Consists of 2 D.A. hyd cylinders 3 1/2" bore x 2 1/8" stroke ea. rated 8000 lbs with 1000 P.S.I. 1 four way hyd control valve with built in relief #821 1 Vickers hyd pump 400GPH 1000-1500PSI filter, gauge, hose & fittings. Value \$169.95 save \$90.00 \$79.95 Same kit with Two D.A. Cylinders 3 bore x 10 1/2" stroke \$63.50

**HYDRAULIC PUMP BARGAINS 1500 P.S.I.**

Type	RPM	GPH	Reversible
*Pesco Gear	4500RPM	270GPH	\$12.95
*Pesco Gear	3750RPM	198GPH	\$ 9.95
*Vickers PD	3750RPM	400GPH	\$19.50
*Stratopower PD	3750RPM	375GPH	\$15.50
Romec	900GPH pump & motor	1/4HPDC	\$ 9.95

**GENERAL SALVAGE CO** Check or Cash  
 2922 E. 27 St., Dept. 156, Kansas City 27, Mo.

# INCREASE HOME VALUE-MAKE NEEDED IMPROVEMENTS NOW

Send for your free Service File list of **Do-It-Yourself Materials**

**POPULAR SERVICE BUREAU MECHANICS** FREE REFERENCE KEY

SERVICE BUREAU Room 520E, POPULAR MECHANICS, 200 E. Ontario, CHICAGO 11, ILLINOIS  
 Include stamped self-addressed envelope.



Fairey Aviation Co. of Australasia Pty. Ltd., Salisbury, South Australia

## Midget Camera for Guided Missiles

Capable of taking a single photograph, a camera weighing eight ounces is being mounted in guided missiles at Woomera, Australia, to record details of target interceptions. Made of steel, it measures one and one-half inches in diameter and is one and one-quarter inches long. An ultrawide-angle lens gives a field of view of 186 degrees so that two cameras mounted back to back provide coverage through 360 degrees. The camera unit is mounted in the missile's nose and is triggered by a proximity fuse. Its main job will be to photograph the attitude of a missile relative to the target, but photographs may also show the attitude relative to the ground.

**NEW FIBERGLASS LAPSTRAKE & PLYWOOD BOAT KITS**

Most complete line. 8' to 23'. Prams, row-boats, outboards, cruisers.

MAIL 50c (coin) REFUNDABLE for BIG COLOR CATALOGS

**U-MAK-IT, DeLAND, FLORIDA • DEPT. 12**

The most popular motorcycle in the world



## BSA MOTORCYCLES

Suit yourself from the finest selection of motorcycles ranging from a 125 c.c. single cylinder to powerful 40 cubic inch o.h.v. twins - all designed for easy handling, famous for reliability and speed, and beautifully styled.

- |               |                    |                    |
|---------------|--------------------|--------------------|
| SUPER ROCKET  | SPITFIRE SCRAMBLER | 250 STAR           |
| ROYAL FOURIST | SHOOTING STAR      | STARFIRE SCRAMBLER |
|               | GOLD STAR          | BANTAM SUPER 175   |
|               | CATALINA SCRAMBLER | BANTAM 125         |

Send this coupon for free catalog showing complete new line of great models for racing or road touring.

**Western: HAP ALZINA** Dept. PM 5 3074 Broadway Oakland, Calif.  
**Eastern: BSA INCORPORATED** Dept. PM 5, 639 Passaic Ave Nutley, N. J.

Name \_\_\_\_\_  
 Address \_\_\_\_\_  
 City \_\_\_\_\_  
 State \_\_\_\_\_ Age \_\_\_\_\_

## Owners Report on the Valiant

(Continued from page 90)

**Foreign cars have their limitations. If you're not willing to live with these limits, you should not buy one. Accept the limits, adjust to them, and you'll be happy.** →

**Valiant's problem is the other way—its price is too low for it to be profitable. Present problem is how to cut costs so Chrysler can make money on the Valiants it builds.** →

**Somewhat heavy on the front end without power steering. After all, that engine is somebody's kid brother. It was designed for the Plymouth and adapted to the Valiant.** →

**He's reasonable. In winter, 18 miles per gallon is good for short trips. The big V8s get about 10 under such conditions. Even four-cylinder imports may drop to 20 miles per gallon in short-trip winter driving.** →

**A standout is its quietness at highway speeds. There's no air of austerity. You feel that you're going First Class all the way—and you are.** →

English Consul. This Valiant is far superior in performance, ride and design. Imports may be okay for Europe but too much 'pray to Almighty' in waiting to pass someone and continuous shifting."—Florida dentist.

"The main reason I changed from the Renault Dauphine to the Valiant was because it was difficult to get the Renault serviced. However, I am greatly disappointed in the economy. If they had told me the truth about this I would have bought another Dauphine."—New York housewife.

"To compete against foreign cars, the Valiant price needs to be lowered. I will not buy another Valiant nor any American compact at its present selling price."—California draftsman.

### Most Best-Liked Features

Sixth on the list of best-liked features is interior roominess, followed by parking ease, trunk size, and over-all size of the car. Here, in order of frequency of mention, are quotations describing the features that owners praise:

"This is a four-door small American car yet my six-foot-three-inch 225-pound size-48 husband fits in it better than in other small cars. It was selected for 'fit' and looks."—California teacher.

"Easy to park. Can get it in my garage."—Virginia retired colonel.

"Trunk space is probably the biggest surprise. The spare-tire placement really gives the room. I have gotten a full-size baby crib (with the exception of the mattress) in the trunk and still was able to close the lid."—Pennsylvania design engineer.

"It can fit in a two-car garage and leave space for bikes, mowers, etc. Yet it's not too small. Spacious trunk for golf clubs and sports gear."—Minnesota broker.

"Small size without giving up versatility of a big car. Ten inches have been taken off the body width outside, less inside due to slim doors."—Michigan stylist.

"I am satisfied with economy. I feel that the 18 miles per gallon is good for winter driving. I have no country driving so far."—Michigan executive.

"Its agility in traffic is wonderful."—New York owner.

"Surprisingly responsive."—Minnesota truck driver.

"Big-car sound when you close a door."—California foreman.

"I like the shift. I had never driven that type shift before and I'm so pleased with how smoothly the gears work in this car."—Pennsylvania teacher.

"Astonished by ease of shifting. No embarrassing orientation necessary on stick shift."—Virginia electrical engineer.

"Quietness through the car."—New York owner.

"Lack of wind noise at 60 miles per hour."—Michigan engineer.

### More Complaints

Seventh of the list of complaints was a strange one. Never before in the history of Owners Reports have owners complained that they didn't get an owner's manual with their new car! Other complaints include the hard-to-fill gas tank, engine and generator (alternator) troubles, necessity for high-test gas in an "economy" car, shortage of parts, poor quality interior and noisy shock absorbers. Here, in order of frequency of mention, are quotations describing these and other complaints:

(Continued to page 270)

LOOKING FOR LONGER WEAR IN SERVICE & SAFETY SHOES ?

# TRY *Knapp* SHOES

WITH **NEOPRENE SOLES!**



Neoprene soles give longer wear... resist oil, grease, chemicals and cold weather cracking. Neoprene soles are also available on Knapp boys' and men's casual styles.

*Ask for neoprene soles the next time you buy service shoes.*



BETTER THINGS FOR BETTER LIVING...THROUGH CHEMISTRY

**7 OUTBOARD PROPS IN 1**  
YOU VARY THE PITCH with "MULTI-PITCH"



With a flick of your wrist, change to any of SEVEN pitches, without tools. Select BEST pitches for your cruising, racing, skiing. Special "trolling pitch" cuts trolling speed IN HALF!

from \$27.75- Models for almost all 25-45 hp outboard motors. Ask your dealer or write manufacturer. **GUARANTEED - OVER 10,000 IN USE**

LESNOR-MAEHR MARINE CO., INC. • FLORAL PARK, L.I., N.Y.

**DO MORE PLANING JOBS WITH LOW COST BELSAW**



Exclusive MONEY-MAKING Features: Full 12 1/4" x 6" capacity • Power feeds at 14' to 34' a minute • Provides for Grinding Knives in the Cutter-head • Attachments for Jointing, Rabbeting, Tongue, Matching, Groove. Convert low cost rough lumber into high priced stock. Easy to make flooring and popular patterns. Send Today for FREE Literature and Prices.

**LOW DOWN PAYMENT EASY TERMS**

Belsaw Machinery Co, 2050 Field Bldg., K.C. 11, Mo.

**GENUINE ALNICO MAGNETS**



**AMAZING. PERMANENT. NON-ELECTRIC. HIGHLY PRACTICAL.** Conduct interesting experiments. Hundreds of uses. Retrieve valuable steel items such as guns, tackle from fresh or salt water; tools from tanks & drains. **GUARANTEED.** Try any magnet one week. Money back if you are not well-pleased.

No. M-710 (Wt. 53 oz.) Has pull of 225 lbs. on steel block	... \$18.00
No. M-625 (Wt. 70 oz.) Has pull of 125 lbs. on steel block	... \$10.00
No. M-575 (Wt. 18 oz.) Has pull of 75 lbs. on steel block	... \$ 7.00
No. M-500 (Wt. 13 oz.) Has pull of 50 lbs. on steel block	... \$ 5.00
No. M-90 (Wt. 5 oz.) Has pull of 15 lbs. on steel block	... \$ 3.50
No. M-300 Kit of Flat Bars 5 pairs 10 Magnets	... \$ 3.00
No. M-47 Hot Pad Magnets, 10 for \$1.00	... \$ 50 for \$ 4.87
No. M-35 Hobbyist assortment of 8 magnets	... \$ 2.00

Send M.O. or check. We pay postage. Sorry no C.O.D.'s.

MIAMI MAGNET COMPANY, 3240 N.W. 27th Ave., Miami 42, Fla.

*Wotta ride!* **MFG**



Smooth, soft, fast... because the hull is deep, wide, all-over-lapstrake. A beautiful, economical, maintenance-free boat. Extra-strong hull is molded in matched metal dies. Five sizes, 12 models. Write for literature.

**MOLDED FIBER GLASS BOAT COMPANY**  
71 Fourth Avenue, Union City, Pennsylvania

**EARN BIG MONEY**

**HAVE A PROFITABLE BUSINESS OF YOUR OWN**

**IT'S EASY TO OWN A LOW COST HOBART WELDER**



Build and repair anything made of metal. Turn out top-notch, professional work right away.

Cash in on the ever growing demand for construction and emergency repair welding.

**HOBART BROTHERS CO., BOX M-50, TROY, OHIO, Phone FE 2-1223**

WRITE FOR MORE DETAILS TODAY!

- NEW AC SHOP TYPE WELDER, the 180 amp. "Hustler" welds, cuts, burns holes, hardsurfaces and heats metal for bending and forming. Comes complete with accessories. Meets REA requirements.
- NEW WELDER/POWER COMBINATION, the 200 amp. "Power/Weld"; furnishes DC current for welding and 110/220 volts AC power for running lights, tools, etc. Can be invaluable in a power failure emergency.

# Dr. Grabow

## PRE-SMOKED PIPES

Cool, sweet  
and mild from  
the first puff.  
No breaking-in  
because they're  
mechanically  
pre-smoked with  
fine tobacco

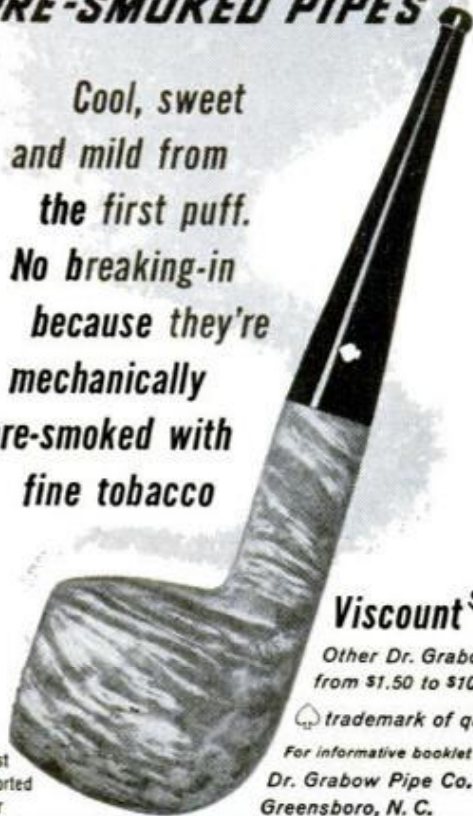

**Viscount \$5.**

Other Dr. Grabows  
from \$1.50 to \$10

trademark of quality

For informative booklet write  
Dr. Grabow Pipe Co.  
Greensboro, N. C.

finest  
imported  
briar

## FREE!

# BELT HOLSTER

NOW WITH EVERY

# EVANS TAPE

Sizes from 6 ft. to 12 ft.



CLIPS ON BELT!



YOURS FREE! — A fitted belt holster with each EVANS "White-Tape" that you buy! Metal-reinforced holster provides great on-the-job convenience — clips to the belt, for easy carrying and quick measuring.

On Evans Tapes only  
at your hardware dealer

## Evans RULE CO.

Factories at:  
Elizabeth, N. J. and Montreal, Que.

## The X-15 Points Into Space

(Continued from page 80)

full throttle. In that short time the craft accelerates from its drop speed of 500 m.p.h. to above 4000 m.p.h.

Research flights began last year and will continue into 1961. It is understood that specs on the X-15 call for a craft capable of sustained flight at Mach 6 at an altitude of 250,000 feet, roughly 50 miles above sea level. But North American designed the plane to fly higher. Eventually, climbs to 100 miles or more may be made unless it is found that the heat of re-entering the atmosphere would be too great. Even in a normal descent from 50 miles the leading edges of the nose and wing will glow bright red with heat.

The X-15s are painted black so they can radiate this heat away quickly. The pilot, however, wears a bright silvery suit. Its aluminized cloth is intended to reflect heat that might build up in the cockpit during re-entry or high-speed level flight.

No single pilot has been flying the X-15. Scott Crossfield, backed by Alvin S. White, has been doing the performance flights for North American. The Air Force's Maj. Robert M. White and NASA's Joseph A. Walker were assigned as pilots by the purchasers. Each will alternate and each is expected to fly the craft to maximum speed and to maximum altitude.

Never before has such a complex vehicle been built, for never before was it necessary to cram so much energy, in various forms, into such a small space. Seven different gases and liquids are required.

Liquid ammonia is the engine fuel, liquid oxygen is the oxidizer. The LOX tank is something like a spool that is built around a separate, inner tank and separated from it by an air space. Liquid nitrogen at minus 300 degrees is pumped through the air space at the start of servicing and helium gas is pumped into the inner tank. The nitrogen keeps the helium cold until subzero oxygen is loaded and takes over.

The surrounding structure frosts up at the start of this operation and so hot air is circulated through other parts of the craft to prevent freezing of the hydraulic and hydrogen peroxide lines.

The hydrogen peroxide provides a high-temperature gas that drives two auxiliary powerplants, known as APUs. These generate power for the 1300 pounds of instruments and for such odd jobs as defogging the windshield on the way to drop altitude.

The cockpit and the pilot's suit must be pressurized, and the pilot and instruments must be kept cool during portions of the flight. Liquid nitrogen (pressurized by he-

(Continued to page 266)

## Beauty...

backed by  
**SCIENTIFIC  
MARINE  
ENGINEERING**



Every Penn Yan is built to scientific principles of marine design. As a result, Penn Yans are superbly maneuverable,

fast, durable and safe. They are built—as they have been for nearly 40 years—to give greater satisfaction longer.



FREE catalog describes complete new line. Write Penn Yan Boats, Inc., 34th St., Penn Yan, N. Y.

**Penn Yan Boats**



You've read about  
the Compacts—

How do folks  
like the 1960

“BIG FORD”?



Read the Owners Report

in the

**JUNE ISSUE**

MAY 1960

## GIGANTIC SURPLUS SALE!

### FISH & WORM SHOCKER



• ITEM #670. Harvest worms, clear private ponds of coarse fish. Powerful 110-v AC hand geared generator creates powerful electric field in ground or water. Amazing results. Also fascinating for experimental use for fun at parties. Has Super-Alnico magnets. Govt. cost over \$12. SALE..... **\$3.89** Ppd.

### STANDARD DIAL PHONE



• ITEM #715. Modern hi-efficiency attractive dial phone. Use for extension to main line on private system. Use several for complete private system, etc. Complete. Work on any system. Govt. cost \$25. SALE..... **\$8.95** Ppd.

### 115-V AC WATER PUMP



• ITEM #246. Genuine Surplus. Rupp electric pump. Use for draining, circulating, empty tubs, fluid transfer. Rustproof housing. Cap. 500 gph. 1" outlet and inlet. 7" x 4" x 4". Wt. 5 lbs. SALE... **\$8.95** Ppd.

Write For

**FREE  
BIG 1960  
CATALOG**

SAVE TO 70% ON 1000's OF SURPLUS AND NEW EQUIP. BARGAINS

MONEY BACK GUARANTEE ON ALL ITEMS

### GOVT. GEARED BATTERY MOTOR

• ITEM #573. Powerful geared-down motor. Runs on 6 or 12-v. Use for golf cart, boat, farm winch, etc. Reversible. Speed 25-85 rpm. Wt. 35 lbs. Govt. cost \$250 .. **\$18.95** FOR



**SURPLUS CENTER**  
LINCOLN, NEBR. DEPT. 807

WELD

BRAZE

SOLDER

CUT

**4WAY**

ONLY  
**\$14.75**  
f.o.b. factory

**WELDER**

Complete with  
Twin Carbon Arc  
Torch and ac-  
cessories... to  
handle all metal-  
craft work.

Acclaimed by thousands of Homeowners, Mechanics and Hobbyists as the welder of 1001 uses. Easily operated from properly wired 110 volt AC or DC line. The ideal gift with a life-long use. Order today on 10 day money back guarantee. Send only \$3.00 to-day. Pay postman balance C.O.D. plus charges. Literature on larger equipment on request.

**FOUR-WAY WELDER CO., Dept. F2-E**  
1810 S. Federal St. Chicago 16, Ill.

America's "BEST BUY"  
Riding Mower!

**ROTO-HOE's 32"**



Enjoy lawn mowing!  
Ride on this comfortable spring seat away from motor heat and fumes. Cuts a full 32" swath, takes far less time to mow lawn; trims so closely that you have little left to trim. 5 1/2 h.p. engine, variable forward speeds and reverse;

exclusive outrigger wheels give maximum stability on side slopes. Only \$249.50 f.o.b. Write for free folder. ROTO-HOE, DEPT. P-19, NEWBURY, OHIO.

265

## ADJUSTABLE MITER BOX & CORNER CLAMP



Adjusts to any angle!

### No. 44—COMBINATION MITER BOX AND CORNER CLAMP

Holds the wood and holds your saw. Uses any handsaw for accurate cuts from 0° to 180°. Full 3" capacity. Sides of joints exposed for nailing, gluing. **\$2.75 PPD.**

No. 33 Works the same as No. 44, but without saw guide attachment. **\$1.75 ppd.**

## SAW SHARPENING IS EASY

Super Filer No. 11 joints and sharpens hand and circular saws 6" to 10" with all teeth correct in height, depth, pitch, bevel. When file hits steel roller, teeth are finished. Saw runs true with no side pull. Includes 8" file. **\$9.95 PPD.**



"TRU-CIRCLE" saw set automatically sets teeth at 10° or more. **\$2.95 PPD.**

MONEY BACK GUARANTEE

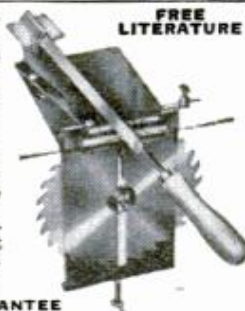

FREE LITERATURE

A. D. McBURNEY, 5908 Hollywood Blvd., Hollywood 28, Cal., Dept. A-50



### Drill and Countersink Holes for Wood Screws in ONE Operation.

4 Bits 24 Combinations

**\$1.70 PER SET**

**Parker**

**MANUFACTURING CO.**  
WORCESTER 1, MASS., U.S.A.

**FREE EICO CATALOG**  
Build Your Own Hi-Fi, Radios, Ham Gear, Test Inst., — Save 50%

Get started in ELECTRONICS the easy EICO way. No technical knowledge needed to build EICO kits. Simple, step-by-step "Beginner-Tested" pictorial instructions guide you all the way. LIFETIME service & calibration guarantee. Mail coupon now!

EICO, 33-00 Northern Blvd., L. I. C. 1, N. Y. Please send FREE catalog & name of local dealer. Dept. PM-5

Name .....  
Address .....  
City ..... Zone ..... State .....

lium) is used for this. It is converted into gas and is ducted to the instruments, to the cockpit, and to the pilot's suit. The pilot can't breathe nitrogen, of course, and so oxygen is piped to the mask.

Some of the LOX oxidizer would boil away during the time the X-15 is being carried to its 38,000-foot drop altitude, and the pilot would consume much of his oxygen supply. To avoid this the X-15 feeds off its mother plane during the climb. The LOX tank is topped off from a tank on the B-52, the pilot breathes B-52 oxygen and gets his suit nitrogen from the B-52 until just before the drop. Hot air from the B-52 is circulated through the X-15 until its APUs are started prior to the drop.

Readying such intricate equipment demands a long and exacting countdown. Nearly 100 people are involved. The "servicing pamphlet" is actually a book 1½ inches thick. There are 79 checkoff steps in preflighting the APUs alone.

Preparations begin five days ahead of time. Systems are inspected and operated. The rocket motor is fired. Movie cameras are installed on the mother plane. The closed-circuit TV by which the launch panel operator on the B-52 checks the X-15 during the climb is tested.

Other groups stand by. The pilots of the two F-104 chase planes, the F-100 photo plane and the photo helicopter are alerted, as are the crews of the back-up chase planes at Edwards and Palmdale.

A two-section convoy proceeds to the landing area on the dry lake bed. Included are fire fighting trucks, ambulance, a mobile crane, crash crew, purging crew, ground photographers and the radio control truck that takes over during landing.

Other crash and fire crews will be spotted at alternate landing areas. Telescopes that make space-positioning photographs of the flight are prepared. Radar and telemetry crews go to their high-range tracking stations at Ely and Beatty, in Nevada. Interested officials from throughout the country converge on Edwards.

The countdown begins 20 hours before the flight is scheduled to start. If takeoff is set for eight in the morning, the task of mounting the X-15 on the B-52 begins at noon the day before. Fueling starts at 3 a.m. and all the other gases and liquids go on board both planes on schedule.

It's possible to "hold" at any time. Once a countdown was held five days on account of weather. Strong surface winds are a bugaboo. The X-15 can land in a 25 or 30-knot wind but this would be too strong for the pilot in case of a bail-out.

More than an hour before takeoff the

(Continued to page 268)

# WAR SURPLUS AND OTHER **BAIGAINS** SAVE UP TO **90%**

**DC JET GENERATOR ARC WELDING KIT** Complete with GE Type CM-77 Generator (30 volts D.C., 400 Amp., 3000 RPM up; ampere rating is for continuous duty, intermittent amperage is 500 to 600 amps.), also 2 rheostats, 1 voltage regulator, 1 voltmeter, 1 electrode holder, 2 ea. 25 ft. lengths No. 0 welding cable, 1 welder's mask, 1 toggle switch, 10 lb. vacuum packed 1/8 in. welding rods, pair welder's gloves & spline coupling. All units guaranteed pre-tested. Wt. 110 lbs. Approx. GOVT. COST \$700. All items, now only **\$64.50**.

\*G.E. Generator noted above can be purchased separately. Makes deluxe heavy-duty welder comparable to the finest commercial welders available. Wt. 90 lbs. Approximate GOVT. COST \$600. Gen. alone—**\$49.50**.

**BUILD YOUR OWN ARC WELDER, LIGHT PLANT OR BATTERY CHARGER \$37.50**

Kit incl. 1 Navy NEA-5 Gen. combination AC-DC type. AC 115 V. DC 24 V., 200-300 Amps. 2 complete generators in 1, yet no larger than reg. gen. Ideal for home, shop and farm lighting plants. Delivers 1200 Watts AC. DC side for charging batteries, welding and operating war surplus motors. Also in kit: 2 Voltage Regs., AC & DC, Reverse Current Relay, 30' New Welding Cable, 1 Ammeter, Rheostat, Electrode Holder, Toggle Switch, Welder's Shield, Wiring Diagram for kit. Wt. under 100 lbs. Approx. GOVT. COST \$650. Kit—**\$37.50**. Navy NEA-5 Gen. as above, purchased separately, **\$23.50**.

**HOMELITE PORTABLE POWER PLANT** Ideal for battery charging, emergency lights for cabins, camps, aircraft, trailers or wherever power needed. Easy rope pull starting. Fully equipped, ready to start. 2000 W., 32 Volt D.C., 4 H.P. Like NEW. Tested. Shock-mounted. Deluxe type. Net wt. 115 lbs. Gross wt. cased 200 lbs. Approx. GOVT. COST \$700. Now—**\$65.00**. 2500 W.—**\$75.00**.

**ELECTRIC STORAGE BATTERY WINCH** Powerful reduction gear, fully reversible, ball bearing, safety locking device. Will handle from a 1000 to more than 2000 lbs. pull. Use on 6, 8, 12, 24, 32 V. battery. Holds 50' of 1/4" cable. For tractors, boats, tow trucks, etc. Complete with mounting bracket for mounting in any position. Wt. 44 lbs. Dim.: 10" W x 17" L x 12" H. Approx. GOVT. COST \$400. NEW, **\$46.50**.

**PORTABLE HAND TACHOMETER** Stewart-Warner. Hand held ideal instrument for checking speeds on saws, shafts, pulleys, engines, etc. Sturdily constructed, can be used clockwise or counter-clockwise. Will check speeds from 100 to 4,000 R.P.M. Two tips supplied. New in original factory cans. \$9.95 while they last.

**11 PIECE CROWFOOT WRENCH SETS** Wrenches snap onto T-bar in 3 different positions. The only wrenches for hard-to-get-to places. Mfd. by Plomb Tool Co. for U.S. Armed Forces. Finest case hardened tool steel. No shop mechanic should be without this set. Approx. GOVT. COST \$47. NEW. **\$5.95** ppd.

**BENDIX GEROTOR PUMP & MOTOR—NEW!** Use wherever fluid pumping required. Excellent for hydraulic installations and as crankcase drain pump for marine engines. Has 3/4" pipe connections, built-in relief valve adjustable up to 1500 lbs. Max. cap. 6 GPM. 1 1/2 H.P., 24 V. motor. Use on 12 to 32 V. Approx. GOVT COST \$350. **\$10.95**.

**DOUBLE-V SPLINE 3" PULLEY** For P-1, R-1, GE Gen. shown above. Heavy-duty machine-broached steel. Heavily constructed, will handle any job. Spline receptacle will fit most types of aircraft generators. Set screw locked. Shpg. Wt. 3 lbs. NEW. **\$5.95**. Triple-V Spline 3" Pulley—NEW—**\$6.95**.

**\$2940 NAVY AIR-COOLED POWER UNIT** Most compact engine ever assembled. Portable, net wt. 150 lbs. 200 Amp. Gen. self-starter capable of delivery of double overload or continuous service at 200 Amps. Mfd. by Ranger aircraft. 2 cylinder, 4 cycle, 10 HP, 3200 RPM. Fully governed for varying loads. This unit makes one of the finest arc welders obtainable. Also makes excellent boat engine. Shipped complete with rheostat & voltage reg. All units checked & pre-tested in our shop. Complete **\$185**. Engine same as above with deluxe welding accessories as follows: rheostat, voltage reg., dry charged 24 V. battery, 50' heavy duty welding cable, 1 electrode holder, 1 hood, pr. of gloves, voltmeter. All this only **\$225**.

**NEW 1960 CATALOG!** Tremendous catalog—our biggest ever—fully illustrated—1000s of bargains in war surplus & other items. Send 25c in coin for your copy today or free copy with order. Where ppd. indicated applies to US only. Other prices FOB Culver City, Cal. Send cash, check, money order. 50% dep. COD.

**AIRBORNE SALES CO., INC. DEPT. PM 560**  
8501 Stellar Drive, Culver City, Calif.

**Make your own Gems** **36.50** 105

The Gem Maker comes complete with all necessary equipment, including a super-charged diamond blade for sawing, and all the wheels for grinding, shaping and polishing; also complete instructions. The complete equipment as shown, less motor and belt for only \$36.50, f.o.b., Burlington, Wisconsin. Write today for information and literature.

**B & I MANUFACTURING CO.**  
Dept. P, Burlington, Wis.



**BUY DIRECT**  
**SAVE ON**  
**TILLERS • TRACTORS**

Full line of attachments for mowing, gardening, farming  
2-3-4 H.P. TILLERS 12"-16" CUT.  
**FREE CATALOG & PRICE LIST**

**RED-E TRACTOR CO.**  
4th Street  
RICHFIELD, WISCONSIN



**AConomize on Gasoline**

Get more miles per dollar—install an AC ACon-O-Mizer between your fuel pump and carburetor. Reduces flooding and stalling... tailors fuel pressure—precisely and instantly—to every driving condition from idle to full throttle. The best answer yet to real gasoline economy!

suggested retail price  
**\$7.95**

**AC**

**ACon-O-Mizer**

At Your Nearby Service Station, garage or General Motors Dealer

AC SPARK PLUG  THE ELECTRONICS DIVISION OF GENERAL MOTORS



**BOAT TRAILER KIT Only \$69.50**

Assemble and Own This High Quality Trailer—Save 1/3! Handles Boats to 16'. Other Models for Larger Craft. All parts furnished to assemble to a few pieces locally purchased pipe. Cuts freight costs. Trailer completely engineered—no special skills or tools required—assemble & tighten 13-Bolts. **CAMPING AND UTILITY TRAILER KITS ALSO AVAILABLE—ONLY \$52.50.**

Write today for illustrated catalog. Enclose 10c for postage and handling.  
Reference—First National Bank, Kingsport, Tenn.

**TRAILER PRODUCTS COMPANY, INC.**  
Dept. PM-5, P.O. Box 176, Kingsport, Tenn.



**LAZY**

**FAN?**

**QUICK! Lubricate with famous 3-IN-ONE. Nothing like it for speeding up sluggish parts. Penetrates fast. Prevents rust.**

**3-IN-ONE OIL**  
REGULAR • OIL SPRAY • ELECTRIC MOTOR



# FAVORITE "OLD RELIABLE"

## DELTA POWERlite

MILLIONS SOLD! Shoots a brilliant, 800-ft. spotlight from the side, widespread floodlight from the top. Sturdy — economical — so very handy. 6-Volts. Anyone can use it. Only \$6.15



### ASTROLite

A beauty! 800-ft. spotlight. Flashing red light visible for a mile. Fingertip switches. Uses twin-pack 6-V. battery. From.....\$7.95

### POWER-KING

Light to spare! Powerful 1/4-mile beam. Adjustable head. Unbreakable lens. 12-Volts. Uses two 6-Volt batteries. Only.....\$7.25

Prices are without batteries.



# Delta

LIGHTS THE WAY

DELTA ELECTRIC COMPANY, 323 W. 33rd St., Marion, Indiana

If it's worth painting  
it's worth sanding...  
with sandpaper by



## CARBORUNDUM®

## CURE THAT GAS EATER...

with triple-action

# MILESMASTER®

Mail Coupon for free pamphlet: "THE TRUTH about FUEL PRESSURE REGULATORS"

Authoritative engineering answers explain why over a MILLION installed in cars and fleets to save 15 ways including:

Save up to 20% on Gas • Stop Stalling, Vapor Lock, Flooding  
Stop Rough Idling • Stop Hard Starts, Jerky Acceleration  
Improve Filtration, Stop Fuel Clog • Reduce Carburetor Wear

Insist on Milesmaster—get up to 35 to 40 EXTRA miles in a tankful of gas! It's the "3-in-1" quality Leadership Fuel Pressure Regulator.

MONEY BACK  
\$6.95  
GUARANTEE

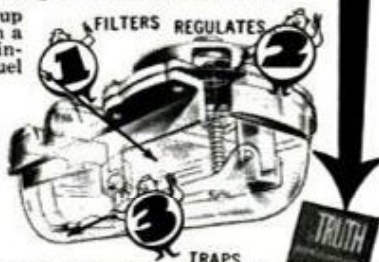

For free "TRUTH" Pamphlet, mail this coupon with your name and address in margin. No obligation. Sold only at retail through 40,000 auto service outlets on Money Back Guarantee.  
Milesmaster, Inc., Dept. 105, 1550 E. 74th Pl., Chicago 19, Ill.



pilot starts his personal countdown. He has a dressing room, an air-conditioned trailer, that delivers him to the plane and takes him from it. Two men dress him in the \$18,000 space suit and meanwhile the pilot goes on 100-percent oxygen, a prerequisite for an extremely high altitude flight. Before the dressing starts, however, there are other details. Sensing devices are taped to his body so that his rate of breathing, temperature and heartbeat can be monitored. At the last moment he is driven to the plane.

The chase planes take off, then the B-52 with the black X-15 under one wing. During the half-hour climb to the drop point and altitude, the X-15 pilot has more than 50 jobs to do. He checks his radio equipment, sends preliminary bursts of data by telemeter, operates the controls that start the aircraft's systems and reports his progress to P. C. Harvey. He finishes pressurizing the X-15 by the time the B-52 pilot gives him the one minute warning, and reports to the mother plane and test conductor that he is ready to be launched. The B-52 pilot starts a short countdown and at "one" presses the button that allows the X-15 to drop away.

Once free of the mother plane, the X-15 pilot fires his rocket motor and begins the flight scheduled for that day.

Each flight is made for different purposes. The idea is to obtain new information on such things as behavior of the vehicle at the speeds and altitudes achieved, the air pressure "Q" factors, the "G" forces, temperatures and the effects on the pilot himself.

Some knowledge from the X-15 program will be used in Project Mercury, the plan for orbiting a man around the earth in the nose cone of a rocket. The X-15 also is a forerunner to Dyna-Soar, the space glider that is intended to circle the earth in 80 minutes after being shot into orbit by a rocket. Like the X-15 pilot, the pilot of Dyna-Soar will control his craft as it re-enters the atmosphere and bring it to a safe landing at a selected spot.

Another vehicle under consideration is the X-15B, a larger version of the X-15. It would be shot into orbit as the third stage of a huge Saturn booster and would travel around the earth at 18,000 m.p.h. at 2000 miles altitude. It would carry two men, a pilot and an observer. It, too, would dive and glide back to a safe landing after using retro-rockets to decelerate.

But Mercury, Dyna-Soar and the X-15B are still in the future. Unless the Russians have put a man into orbit since this was written, the X-15 program is man's closest approach so far to true space flight. ★★



# LOOK! MORE DIVING FUN!

## NEW COMPACT DIVING BOARD

... by "Perma-D"



A real springboard in a compact design! Lively action—unique patented dual horizontal springs absorb vertical diving shock, adjust easily for children, adults, amateur divers. Just right for docks, floats, boat decks, swimming pools. Order now for summer fun.

Write for circular on "Perma-D" springboard, pontoon boat kit, dock and float brackets, boat mooring bars, boat canopy, etc. Dealer inquiries invited.

**"Perma-D" DIVISION**  
CENTRAL MACHINE WORKS CO.  
1235 Central Ave., Minneapolis 13, Minn.

your customer saves gas, and you save money.

## WHAT EXPERIENCED MECHANICS ARE DOING

Experienced mechanics are finding that, because MILEAGE MINDER assures a steady, constant fuel flow at manufacturers' recommended fuel pressures, they can take full advantage of minimum carburetor float level settings. For maximum economy and performance, mechanics now set float levels at minimum specifications. MILEAGE MINDER provides a steady, constant stabilized fuel flow.

See your distributor, or write:

**MILEAGE MINDER**  
537 TURK ST. SAN FRANCISCO 2, CALIF.

## POWER TOOLS MAKE YOUR WORK EASY

**FREE BOOK TELLS HOW**

## CLOGGED SEWERS

CLEANED INSTANTLY BY IMPACT  
SAVES PLUMBING BILLS—TIME



Anyone can trigger new Flush Gun shooting air & water impact on stubborn stoppages in Toilets, Sinks, Urinals, Bathtubs, & Sewers 200 ft in pipe 1/2" to 6". Rags, Grease, and Roots melt away INSTANTLY when struck by hammer blow. Amazingly effective! Worth many times its cost in Plumbing Bills or start your own Business. Tear out Ad now & write address beside it for FREE BOOKLET or phone Kildare 5-1702. Miller Sewer Rod, Dept. P4-M, 4642 N. Central Ave., Chicago 30, Ill.

## DO-IT-YOURSELFERS

# LOVE WD-40



Keep rust from tools and equipment . . . stop corrosion before it begins on mowers, clippers . . . loosen rust-stuck bolts . . . silence squeaky hinges.

**WD-40 PREVENTS RUSTING!**

Dealer inquiries invited.

**1.95**  
12 OZ. SPRAY CAN  
... money order (ppd.) to:

**ROCKET CHEMICAL CO., INC.**  
P. O. Box 20027 San Diego 20, Cal.

## BUILD-IT-YOURSELF AND SAVE 50%

# PALLEY 2-TANK DIVING KIT



Allows approximately 1 hour diving time. Has 2 22cu. ft. tested tanks, shut-off valves, air hoses, a dilutor-demand type air regulator, harness, safety belt and a weight belt. Equal to \$80.00 diving units. Complete kit only . . . **4595**

**SINGLE TANK PALLEY SKIN DIVING KIT** - Has 38 cubic ft. tested and dated Air Tank - allows approx. 45 minutes of diving time. Complete with shut-off valve, web cradle, and harness, air hoses, dilutor-demand air regulator, connector assembly, mouth piece, etc. Cat. No. PSD-11 **Now 3995**

## CORNELIUS AIR COMPRESSOR



A three stage Air Force Surplus Air Compressor. Ideal for filling underwater diving tanks (as shown above). Has built-in 1/3 HP, 27 V., DC electric motor. Develops 1500 PSI or may be reset to 2000 PSI. Delivers .04CFM. Used but good cond. **3250**

110 Volt TRANSFORMER to provide 24 volt AC current for the above air compressor. **2150**

## HYDRAULIC CYLINDERS



1500 PSI Double Action CYLINDER - Bore 1-1/2", Shaft 9/16", Stroke is adjustable 1-3/16" to 4-3/8", length 14-1/2". No. H-84. . . **395**

New 1500 PSI Dbl. Action Cylinder. Ideal for clutch or throttle control when used as a master & slave. Has 5/8" bore, 4-1/8" stroke, 7/16" shaft, 9-5/8" closed length. Parts are 1/4" tube (7/16-20thread). No. H-60 **375**

1500 PSI Dbl. Action HYD. CYLINDER Has 2-3/8" bore, 19" stroke, 1-1/4" shaft, 30 3/4" lgh. Gov't cost approx. \$75. **NEW LOW PRICES** No. H-53AU - USED . **1275** No. H-53AN - NEW . **1975**

1500 PSI Double Action Cylinder - Bore is 1-7/8", Shaft 7/8", Length 12", Stroke adjustable from 3-3/4" to 6-1/2".  
Cat. No. H-10U - USED . . . **675**  
Cat. No. H-10N - NEW . . . **1075**

World's largest stock of Hydraulics on our shelves. Send your requirements.

## 2000 PSI HYDRAULIC HAND PUMP

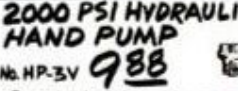

No. HP-3V **988**

Capacity is 1.5 cu. in. per cycle. Has operating pressure of 2000 PSI. Built-in diverter valve allows selection of suction and pressure ports for two independent systems. Regularly \$11.75.

## STRATO POWER HYD. PUMP



**39.95**

A variable displacement, piston type pump. Delivers 7 1/2 GPM at 1800 RPM. Max. output is 15 GPM at 3600 RPM. Full flow at 1275 PSI. The parts are 1" AN suction, 5/8" AN on pressure, 3/8" AN case drain. In new condition.

PUMP MOUNT for above with a 4-hole foot mount . . . . . **1695**

## 85 TO 1 GEAR BOX



Drives through a 6-gear train that rotates on self-lubricating, high speed roller bearings. Has 180° offset drive. Take-off shafts are 1-1/4" and 3/8" diam **995**

Overall size: 6" x 4" x 2 1/2"

## PARACHUTE CAR COVER



Large enough to cover any car. Made from 1/2 of a 28 ft. cargo parachute. Constructed of 100% NYLON throughout. . . . **488**

## palley's

2263 E. VERNON AVE., Dept. PM-50  
LOS ANGELES 58, CALIF.

TO ORDER - Send check or M.O. 1/2 deposit with C.O.D.s. All prices are F.O.B. Los Angeles Warehouse. All items sent postage or freight collect.

## BELL HELICOPTER SALE!

FULLY CERTIFIED!  
READY FOR DELIVERY NOW!

Bell Models 47G, 47G2, 47H-1, 47J and 47J-2800 Kit Installation.

Amazingly LOW PRICED! Write, Wire or Phone for detailed info on largest supply of fine "WHIRLYBIRDS" available anywhere. Stock limited!

## UNIVERSAL JOINT



Designed for drive take-off to winch. Takes 1-3/8" shaft on one side - 1-1/4" diam. shaft on other side. Heavy duty. Width 4", length 5-1/2". One take-off is key slotted. Body is Zerklubricated. . . **444**

## U.S. ARMY JEEP GASOLINE CANS

Top quality Army Surplus. 5 gal. size. Has screw type, self-seal cap. 3 for \$5.00 **198** EA.

GAS CANS as above. NEW \$4.95 ea.

Jeep WATER CANS - Newly manufactured. Parcelain lined. **595** EA. Never been used. NOW . . . **595** EA.

## SHOVEL PICKMATTACK

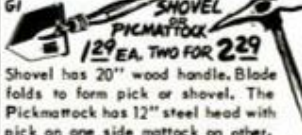

**129** EA. TWO FOR **229**

Shovel has 20" wood handle. Blade folds to form pick or shovel. The Pickmattack has 12" steel head with pick on one side mottack on other.

## AIR FORCE DROP TANKS



**BUILD-YOUR-OWN PONTOON RAFT, CATTAMARAN or BOAT!**

These ALL-ALUMINUM Air Force drop tanks make the finest pontoon raft, dock floats, marker buoys, etc. Being water-tight also ideal for use as canoe outrigger or to make a Cattamaran. 14 ft. tank holds up to 230 gallons of liquid.

14 ft. long with bright finish . . . **3750**  
16 ft. long with a black finish . . . **4900**

## JUNGLE HAMMOCK



Now **688**

Ideal for Hunter, Camper, Fisherman, etc. Body made of tough, waterproof raincoating. Tent type top fully waterproofed. Has built-in mosquito bar all around sides. Entrance has zipper. In good condition.

## 3 TO 1 SPEED REDUCER

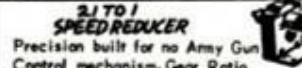

Precision built for no Army Gun Control mechanism. Gear Ratio gives approx. 90 RPM with direct drive 1750 RPM motor. Has ball bearings throughout. Will operate conveyors, timing devices, etc. SAVE! . . . **1475**

**He's no clown. The Valiant was such a crash program that there wasn't time, after everything was locked in, to get the book out. Nobody forgot. There's only 24 hours in every day—even in Detroit.** →

**Can't resist telling you that the British call rough idling "lumpy tickover."** →

**Here's a real switch.** →

**Word is that current production has a flocked glovebox. It's still cardboard (all gloveboxes are), but flocking makes it seem more luxurious.** →

**Miscellaneous:**

**An excellent car. The best of the three new compacts for over-all use as a family car. Workmanship troubles have been corrected in current production, says Chrysler. Ride and roadability are excellent. There's comfort galore. It's not nimble, not frisky. It is fast, it is responsive. It doesn't drive like, doesn't look like, a small car. This may be a plus feature to many, but to some it's a fault.**

"My main complaint is the stupidity of the clown in management who forgot to get the Owner's Manual printed in time. Also service stations have received no charts. I asked 10 different ones and all said No."—Massachusetts salesman.

"Fuel-fill location is miserable. Virtually impossible to fill tank completely. Also styrene packing around filler neck saturates with fuel and leaks into the trunk."—Georgia engineer.

"Rough idling."—Michigan salesman.

"Engine idled too fast. I filed down the fast-idle cam myself."—Connecticut tool and die maker.

"Fuse in voltage regulator line repeatedly blows due to sticky relay."—New York sales planner.

"Had alternator trouble. New alternator costs about \$95. This is certainly not an economy item."—Texas soldier.

"Cannot use regular gas without getting a ping in engine. Do not get good power and performance with regular gas."—Florida salesman.

"I think it is a crime to put a car on the market when replacement parts are not available. We have had to have gaskets made by a local garage for the ones ruined in this new car. I will never again buy a U.S.-made car until they can promise the same availability of parts that I have had on my Austin Healey and my MGA."—Connecticut retired shirt maker.

"Interior construction is very poor. Upholstery is not fitted neatly nor are the moldings. This is where the foreign car excels."—Ohio physician.

"Shock absorbers extremely noisy when cold."—Colorado commercial artist.

"Disappointed in the dash compartment which is made of cardboard. I feel this is false economy in a car that cost \$2366."—Massachusetts contractor.

"Can't open the door vent windows even a little bit in rain or water comes right in your face."—Illinois truck driver.

"Parking brake (foot pedal) requires too much effort. A woman couldn't use it."—New York heat treater.

"Turn-indicator lever broke twice in first 1500 miles."—California businessman.

"Dome light is too low. Hits the heads of children standing in rear."—New York photographer.

"Needs larger gas tank. I get more miles per gallon but a larger car has a 20-gallon tank so I make as many trips to the gas station as before."—California owner.

"There is high-powered advertising about rustproofing and yet there are many washers and brackets under the car which do not even have a coat of paint and were rusty when the car was purchased."—California geologist.

"Inside rear-view mirror too close to center passenger's head."—New York maintenance man.

"Too small rear window. Poor vision to rear."—Massachusetts executive.

That's it—the good and the bad about the new Valiant. As you can see, the owners are happy with the new concept of automobile design although some are not altogether happy with this specific rendition of it. Generally, the following quotation describes the feelings of the owners: "The Valiant is the kind of car we have needed for some time. It is fun to drive." This Michigan clerk describes what many, many Americans are finding out for the first time in years. These new compact cars are fun. If this spreads maybe we'll start calling automobiles pleasure cars again! ★ ★ ★

# ONLY A SPECIALIST CAN CLEAN A CARBURETOR THE WAY IT SHOULD BE CLEANED!

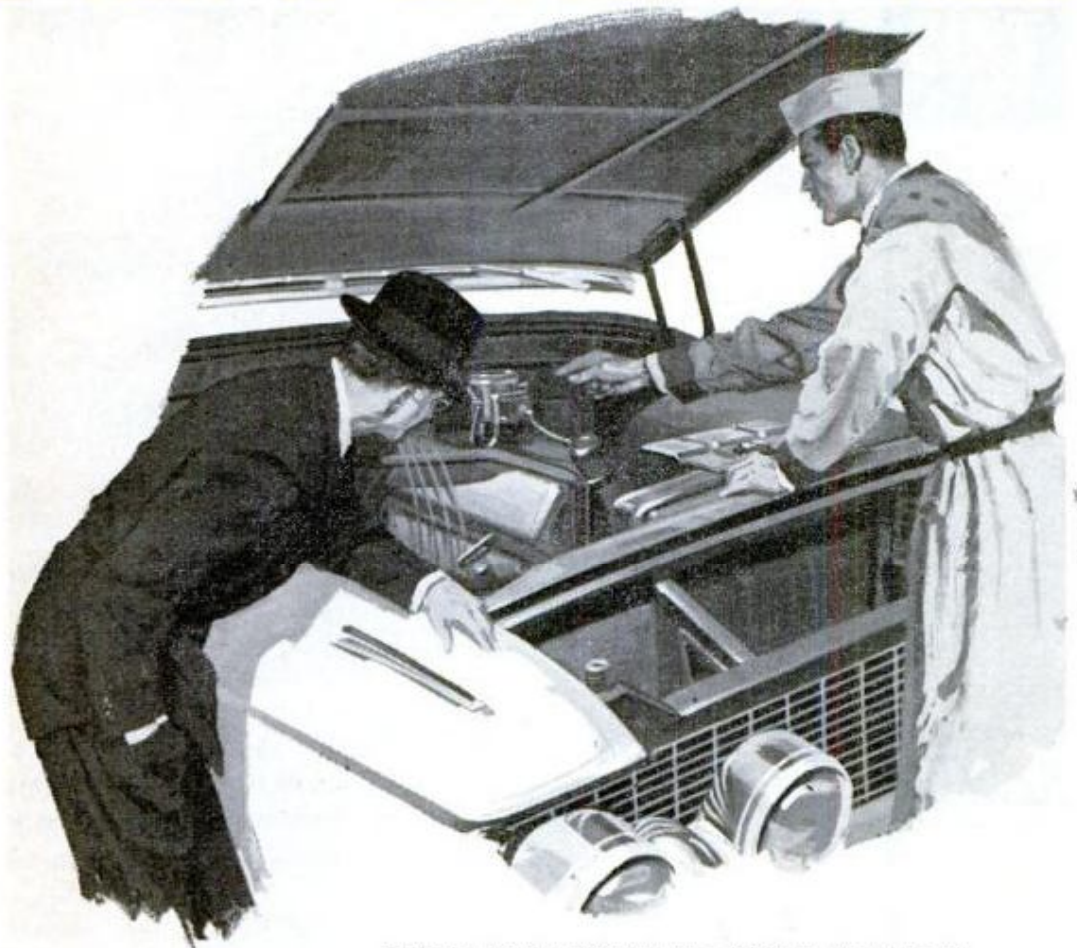

If top-quality service is your business, ask your local UMS Distributor about the Rochester-GM Service Line. It includes such top-quality service items as Kleanout Kits, Off Kar Kits and Master Kits.

## AVAILABLE NOW AT YOUR NEARBY ROCHESTER-GM CARBURETOR SPECIALIST'S!

The fast, economical way to keep your carburetor in perfect working condition is to have your nearby Rochester-GM Carburetor Specialist give your carburetor a clean-out . . . either on the car or off. This quick, simple operation chemically removes gum, sludge and other deposits that rob you of mileage. In addition, these clean-outs include replacement of vital parts *plus* a regular maintenance adjustment of your carburetor. These factory-approved procedures save you money in the long run. They're quick and easy, and they keep your car delivering top performance and economy. See your Rochester-GM Carburetor Specialist today. *Rochester Products Division of General Motors, Rochester, N. Y.*



America's  
number one  
original equipment  
carburetors

# ROCHESTER CARBURETORS

# PICK YOUR OWN SUCCESS STORY FROM THIS PAGE

These are the true stories of people who seemed trapped in routine, low-pay shaky jobs. Handicapped by lack of proper training, they couldn't get the things they wanted out of life—more money, a job they liked, security and happiness.

They are a small sample of the thousands of men and women—young and old—who turn to I. C. S. for help. Their will-to-learn plus I. C. S. training have changed the course of their lives.

Are you discouraged with your job and pay and feel you can't improve yourself because of lack of specialized education? Well, these men and women were in the same boat. With I. C. S. training, one of these success stories could be about you.

I. C. S. is the oldest and largest correspondence school. 258 courses. Business, industrial, engineering, academic, high school. One for you. Direct, job-related. Bedrock facts and theory plus practical application. Complete lesson and answer service. No skimping. Diploma to graduates.



**Wins \$3000 contest**—"After my I. C. S. courses I secured a new position," says Mr. Cecil Rhodes. "My income has more than doubled and I recently won a \$3000 sales contest."



**From clerk to Assistant Estimator, thanks to I.C.S.** "Any way you look at it," writes Mrs. Edna James, "the time and money one spends for I. C. S. Courses will be repaid a thousandfold."



**"As a college graduate, I found I.C.S. very valuable."** Robert Lee took the I. C. S. Course in Advertising, is now Promotion Manager for a large corporation. "I. C. S. got me started on the way up," he says.



**From \$152 to \$395 a month**—"I.C.S. made my engineering work more interesting," Frank Bachtik tells us. "I was a Jr. Draftsman making \$152 a month. My present income is \$395.25 a month."

**3 FREE BOOKS**—a 36-page pocket-size guide to advancement, a gold mine of tips on "How to Succeed." Also a big catalog outlining opportunities in your field of interest and a sample I.C.S. lesson (Math.).

**For Real Job Security—Get an I. C. S. Diploma! I. C. S., Scranton 15, Penna.**

Accredited Member,  
National Home Study Council

## INTERNATIONAL CORRESPONDENCE SCHOOLS



BOX 92953E, SCRANTON 15, PENNA.

In Hawaii reply P. O. Box 418, Honolulu

(Partial list of courses)

Without cost or obligation, send me "HOW TO SUCCEED" and the opportunity booklet about the field BEFORE which I have marked X (plus sample lesson):

### ARCHITECTURE and BUILDING CONSTRUCTION

- Air Conditioning
- Architecture
- Arch. Drawing and Designing
- Building Contractor
- Building Estimator
- Carpenter Builder
- Carpentry and Millwork
- Carpenter Foreman
- Heating
- Painting Contractor
- Plumbing
- Reading Arch. Blueprints

### ART

- Commercial Art
- Magazine Illus.
- Show Card and Sign Lettering
- Sketching and Painting

### AUTOMOTIVE

- Automobile
- Auto Body Rebuilding and Refinishing
- Auto Engine Tuneup
- Auto Technician

### AVIATION

- Aero-Engineering Technology
- Aircraft & Engine Mechanic

### BUSINESS

- Accounting
- Advertising
- Business Administration
- Business Management
- Cost Accounting
- Creative Salesmanship
- Managing a Small Business
- Professional Secretary
- Public Accounting
- Purchasing Agent
- Salesmanship
- Salesmanship and Management
- Traffic Management

### CHEMICAL

- Analytical Chemistry
- Chemical Engineering
- Chem. Lab. Technician
- Elements of Nuclear Energy
- General Chemistry
- Natural Gas Prod. and Trans.
- Petroleum Prod. and Engr.
- Professional Engineer (Chem)
- Pulp and Paper Making

### CIVIL ENGINEERING

- Civil Engineering
- Construction Engineering
- Highway Engineering
- Professional Engineer (Civil)
- Reading Struc. Blueprints
- Sanitary Engineer
- Structural Engineering
- Surveying and Mapping

### DRAFTING

- Aircraft Drafting
- Architectural Drafting
- Drafting & Machine Design
- Electrical Drafting
- Mechanical Drafting
- Sheet Metal Drafting
- Structural Drafting

### ELECTRICAL

- Electrical Engineering
- Elec. Engr. Technician
- Elec. Light and Power
- Practical Electrician
- Practical Lineman
- Professional Engineer (Elec)

### HIGH SCHOOL

- High School Diploma

- Good English
- High School Mathematics
- High School Science
- Short Story Writing

### LEADERSHIP

- Industrial Foremanship
- Industrial Supervision
- Personnel-Labor Relations
- Supervision

### MECHANICAL and SHOP

- Diesel Engines
- Gas-Elec. Welding
- Industrial Engineering
- Industrial Instrumentation
- Industrial Metallurgy
- Industrial Safety
- Industrial Supervision
- Machine Shop Practice
- Mechanical Engineering
- Professional Engineer (Mech)
- Quality Control
- Reading Shop Blueprints
- Refrigeration and Air Conditioning
- Tool Design
- Tool Making

### RADIO, TELEVISION

- General Electronics Tech.

- Industrial Electronics
- Practical Radio-TV Engr'g
- Practical Telephony
- Radio-TV Servicing

### RAILROAD

- Car Inspector and Air Brake
- Diesel Electrician
- Diesel Engr. and Fireman
- Diesel Locomotive

### STEAM and DIESEL POWER

- Combustion Engineering
- Power Plant Engineer
- Stationary Diesel Engr.
- Stationary Fireman

### TEXTILE

- Carding and Spinning
- Cotton Manufacture
- Cotton Winding and Weaving
- Loom Fixing Technician
- Textile Designing
- Textile Finishing & Dyeing
- Throwing
- Winding and Weaving
- Worsted Manufacturing

Name \_\_\_\_\_ Age \_\_\_\_\_ Home Address \_\_\_\_\_  
 City \_\_\_\_\_ Zone \_\_\_\_\_ State \_\_\_\_\_ Working Hours \_\_\_\_\_ A.M. to P.M. \_\_\_\_\_  
 Occupation \_\_\_\_\_

Canadian residents send coupon to International Correspondence Schools, Canadian, Ltd., Montreal, Canada. . . . Special low monthly tuition rates to members of the U. S. Armed Forces.

"SKIMOTORS" FROM GALE...

# outboards built for skiing fun!

Hard-charging thrust for deepwater take-offs. Deep-biting response for jump starts. Blazing speed for slalom runs, steady performance for jumping or stunts. Here's broad-shouldered stamina for day-in, day-out ski club use. All the action you want, you get with a completely new, completely restyled Gale outboard...*plus* trouble-free dependability that is built into every motor by craftsmen who are skiers, too.

Gale has a "skimotor" for every purse... there's one for you and your gang. From the mighty V Sovereign to the budget-priced 25 hp Buccaneer, Gale brings you "Tank-Tested" professional performance and satisfying reliability. See 'em now at your Gale dealer's. Or write for colorful brochure (including all Gale outboards from 3 to 60 hp) to: Gale Products, Dept. 350, Galesburg, Ill.



Get a Gale and GO...**ANYWHERE**



Sovereign 35 hp  
Prince of outboards! Electric starting. Full gearshift. Swift, smooth, spirited action.



**Gale**  
OUTBOARD MOTORS

NEW FROM DUPONT

# Special treatment shields the beauty of the new car finishes!

Now from Du Pont, makers of new LUCITE<sup>®</sup> acrylic lacquer and DULUX 100<sup>®</sup> enamel, comes Car Shield, a special treatment for shielding the beauty of all the latest car finishes.

Car Shield is an easy-to-use liquid. It sets up a hard "repellent shield" between the car finish and dulling dirt—grime can't get a grip. Improves scratch resistance, too.

At service stations, auto supply and hardware stores. Manufacturer's list price, only \$1.50.



BETTER THINGS FOR BETTER LIVING  
... THROUGH CHEMISTRY