

FEB. 1960

FASTEST BOAT IN THE WORLD

35 CENTS

POPULAR MECHANICS

WRITTEN SO YOU CAN UNDERSTAND IT

EXPLORING THE OCEAN DEEPS

What to Do Until the Firemen Come

OUR MISSILE-FIRING SUBMARINES

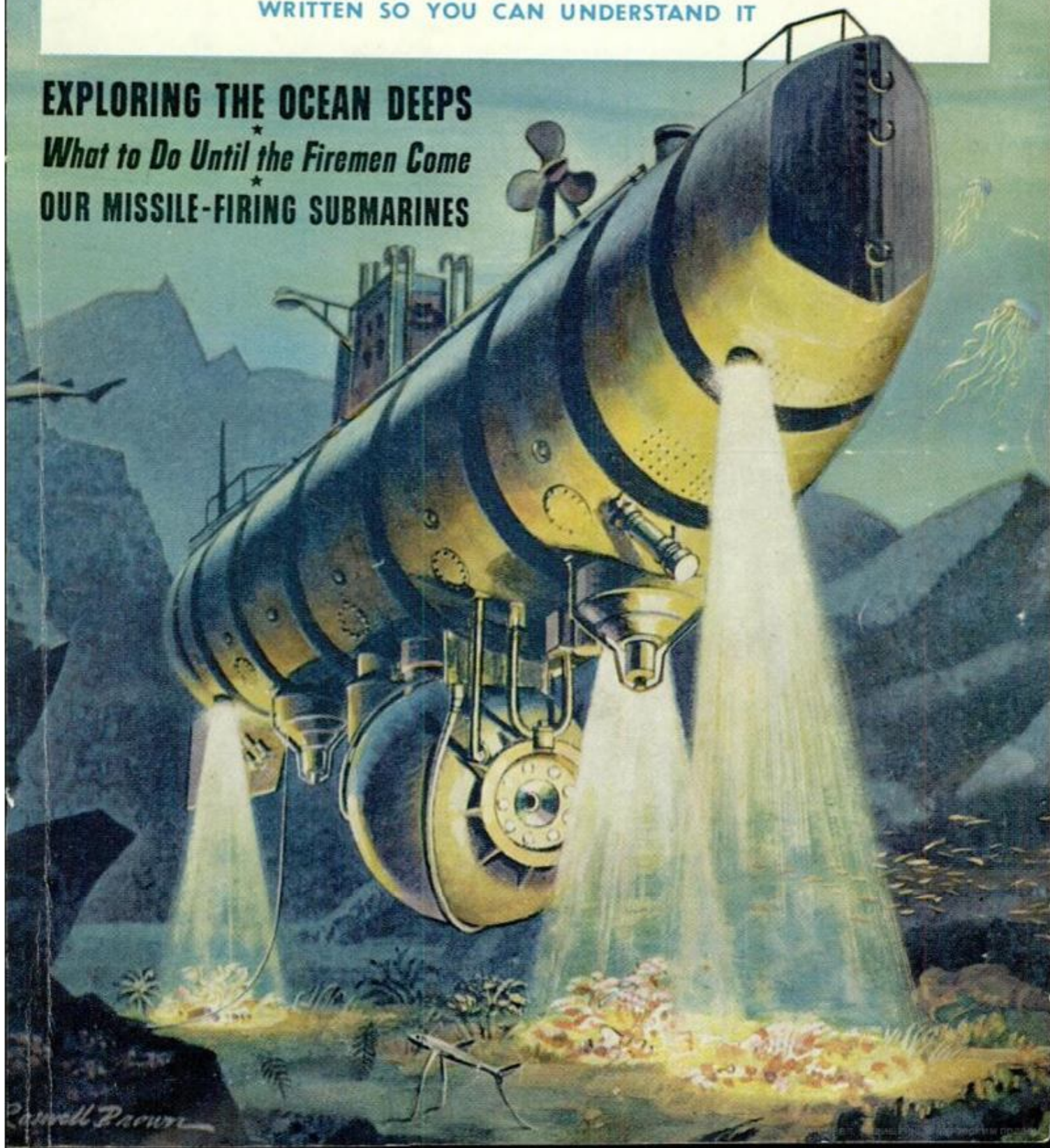

Raymond P. Brown



how to be a hero... on a budget!

Think what a hit you'll make with a fishing rig like this! Fishermen who love their families pick Evinrude's 40 hp Big Twin as the smart *big power economy buy of the year*. Power enough to take the family along for fishing, picnicking, camping... and plenty of power to ski your own kids and your neighbor's, too. Nothing can match it near its price!

Frankly, Big Twin is as fine a performer in every respect as Evinrude's luxury Lark II, except for electric starting and

automatic choke. And Big Twin starts easier by hand than other motors of lesser hp. It has the same magnificent Lark II engine under the hood... with advanced thermostatic temperature control. It's the most efficient, smoothest-running, longest-lasting engine money can buy. It'll give you the same silk-smooth trolling, crisp response, and commanding power as the Lark II.

Feature for feature... dollar for dollar... nothing can match Big Twin's genuine value! Be a hero to your family... see how little it costs to own, at your Evinrude dealer today!



A Div. of Outboard Marine Corp.
In Canada: Peterborough, Ont.

EVINRUDE

FIRST
IN
OUTBOARDS

CATALOG FREE!
EVINRUDE MOTORS
4196 N. 27th St., Milwaukee 16, Wis.

Send me catalog of 1960 Evinrude

Motors with details of today's most advanced features.

Name.....

Address.....

City.....Zone....State.....



**40hp
BIG TWIN**

Big power
economy buy
of the year!

CORVAIR'S A NEW SMOOTHIE

Behind Corvair's array of engineering innovations (*literally behind*) lies its engine: America's first and only rear-mounted air-cooled aluminum "pancake" six. The spec sheet reads like this: 140 cubic

like "pancake." Translated, it means that this is a horizontally opposed six, instead of the conventional in-line type. If you cut the engine crosswise, it would look like the picture.

There are three pairs of cylinders, of course, each working in unison. When one piston is at the top of its stroke, so is its mate. So? Well, Barney Navarro, who's engineering editor of Motor Life magazine and should know about these

is just what you're after.

As you might suspect, there's precious little of the commonplace in a Corvair engine. Yet there's nothing so radical that it hasn't been proved time and again for reliability. About the only question left now is whether we can build enough of these cuties to fill the demand. One thing you ought to do for sure is to try one out. After that, you'll probably be badgering us to build *you* one. This is a problem we're happy to have. . . . Chevrolet Division of General Motors, Detroit 2, Michigan.

That rear engine is just one of the engineering marvels in this new Corvair. Others include the silken smoothness of independent suspension at all 4 wheels . . . a practically flat floor, front and rear . . . briskly competent handling . . . and the ingenious unit combining the engine, transmission and rear axles. Be prepared to spend some time with these wonders when you check out the revolutionary Corvair at your dealer's.

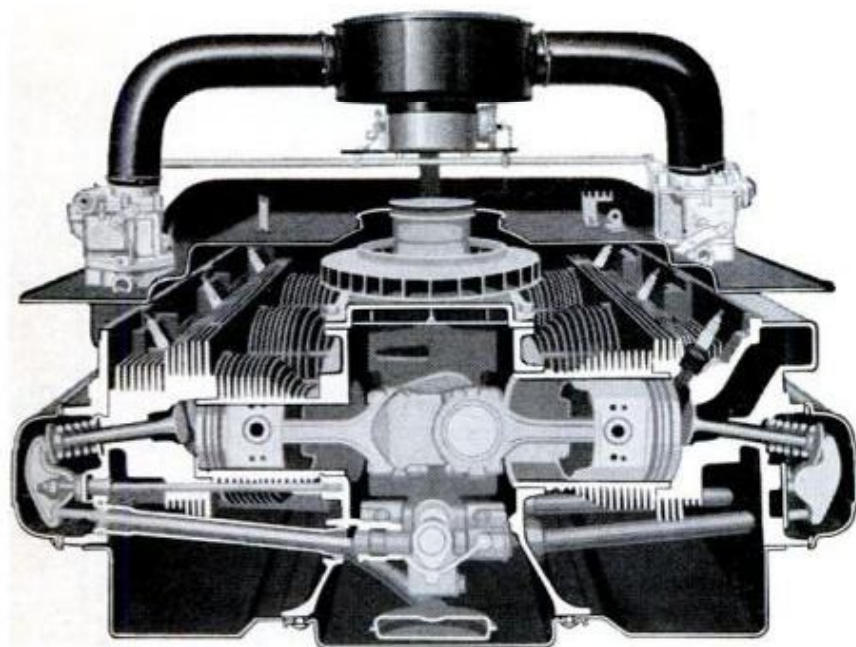

inches of displacement, bore 3.375 inches, stroke 2.60 inches, maximum horsepower 80 @ 4400 r.p.m., maximum torque 125 ft.-lb. @ 2400 r.p.m. (Hitch these figures to a car weighing only 2,375 pounds at the curb and you've got yourself a peppery package, if we do say so.)

Anyway, of the four adjectives, we particularly

things, writes "opposed engines (of Corvair's design) are inherently balanced." In other words, each pair of pistons, rods and crank throws balance each other, and there's no need for counterweights. Because this type of engine is inherently balanced, it's inherently smoother than an in-line six. And after all, ultra-smoothness

corvair
BY CHEVROLET

This One



HXFB-L4Q-LT7E

POPULAR MECHANICS®

Address communications to: 200 E. Ontario St., Chicago 11, Illinois. **SUBSCRIPTION SERVICE:** Mail all subscription orders, changes of address, correspondence concerning subscriptions, and Postmaster notices of undeliverable copies to Popular Mechanics, 250 West 55th St., New York 19, N. Y.

Editor

RODERICK M. GRANT

Executive Vice-President

RICHARD E. DEEMS

Publisher

G. HARRY CHAMBERLAINE

Managing Editor

WAYNE WHITTAKER

Assistant Managing Editor

CLIFFORD B. HICKS

Shop Notes and Crafts Editor

JAMES R. WARD

Associate Editors, General Features

ARTHUR R. RAILTON, Automotive

JOHN A. LINKLETTER

Associate Editors, Shop Notes and Crafts

WAYNE C. LECKEY W. CLYDE LAMMEY

Radio-Television, Electronics Editor

LOTHAR STERN

Assistant Editors, General Features

JAMES BIERY, ROBERT L. HULL, JR.

R. B. KIRKPATRICK

Assistant Editors, Shop Notes and Crafts

EARL WOBECK, GUERRINO F. AMATI

Assistant Editors, Makeup

WALLACE MYERS, JEAN KAVANAUGH

Art Staff

FRANK BEATTY, Director

HENRY NEHRBASS, Assistant Director

RICHARD A. POTTS, Art Editor

Eastern Editor

RICHARD F. DEMPEWOLFF

Room 4102, Empire State Bldg., New York City 1

Western Editor

THOMAS E. STIMSON, JR.

Suite 1003, 3400 Wilshire Blvd.
Los Angeles 5, Calif.

Advertising Manager

JOSEPH R. BUELL, JR.

Director, Bureau of Information

ALLAN CARPENTER

Advertising Offices

Chicago: 200 E. Ontario St., Whitehall 4-0100;
New York: Empire State Bldg., 350 Fifth Ave.,
LOngacre 5-7580; Detroit: General Motors
Bldg., TRinity 5-8711; Cleveland: Hanna
Bldg., 1422 Euclid Ave., PRospect 1-0456; Los
Angeles: 3460 Wilshire, DUmkirk 2-8458; San
Francisco: Russ Bldg., 235 Montgomery St.,
Yukon 2-0823.

Published monthly by Popular Mechanics Company,
200 E. Ontario St., Chicago 11, Ill. Richard E.
Berlin, President; Richard E. Deems, Executive
Vice-President; Fred Lewis, Vice-President and
General Manager; John R. Miller, Vice-President;
G. Harry Chamberlaine, Vice-President; G. O. Mar-
kuson, Treasurer; R. F. McCauley, Secretary. Single
copy in the United States and Canada, 35 cents;
subscription rates in the United States and pos-
sessions and Canada, 1 year \$3.50; 2 years,
\$6.00; 3 years, \$8.00. In countries of the Pan-
American Postal Union, 1 year \$4.50; 2 years
\$8.00; 3 years \$11.00. In all other countries 1
year \$5.50; 2 years \$10.00; 3 years \$14.00.
If you plan to move, notify us at least 30 days in
advance so you will not miss an issue. Give both
your old and new addresses. Second-class postage
paid at Chicago, Illinois, and at additional mail-
ing offices. Entered as Second Class Matter at
Post Office Dept., Canada. Registered as Second
Class Matter at the Post Office at Mexico, D.F.,
Mexico, June 20, 1950. © 1960 by Popular
Mechanics Company. All rights reserved. Printed
in the United States of America.

FOREIGN EDITIONS

SPANISH: Mexico-Caribbean, Southern Hemisphere

FRENCH, DANISH, SWEDISH, GERMAN, PORTUGUESE, DUTCH

Volume 113

FEBRUARY 1960

Number 2

In This Issue...

What to Do Until the Firemen Come	- -	97
Palmetto Polo	- - - - -	106
They're Rolling Steel From Powder	- -	111
Exploring the Ocean's Greatest Deep	- -	116
Fastest Boat in the World?	- - - - -	122
This Makes the Torpedo Child's Play	- -	128
The Weird and Wonderful World of Rowland Emmett	- - - - -	138
Museums Are for Doing Things	- -	148
Electronics Keeps the Gamblers Honest	- -	165

For the Craftsman...

Radio, TV and Electronics	- - - - -	173
Casting Plaster Gifts	- - - - -	182
The PM Houseboat—Part III	- - - - -	194
For Trumpet Players—Past and Present	- -	201
Home Plumbing Repairs	- - - - -	204
Liquid Rubber—Jack of All Trades	- - - - -	210
Surfacing Rough Lumber	- - - - -	218
The Corvair Car Heater	- - - - -	226

Regular Departments...

WHERE-TO-BUY-IT INDEX - - - 90

Know This Old Timer!	- - - 16	What's New for Your Home	- - - 154
Pentagon Sidelights	- - - 18	Solving Home Problems	- - - 190
Pioneer of Science	- - - 20	Car Trouble Shooting	- - - 216
An Eye on Space	- - - 103	Shopping for Tools	- - - 230
Detroit Listening Post	- - - 110	Clinic for Homemakers	- - - 236

Turn to detailed index on page 90. Sources of additional information on items in this issue are shown on the Where-to-Find-It List, available without charge by writing the Bureau of Information, Popular Mechanics, 200 E. Ontario St., Chicago 11, Ill.

Next Month...

HAVE YOU EVER wanted to ride a turbojet-powered runabout? . . . cruise the Florida Keys? . . . watch the bottom of your boat in action? . . . see a kolumaran? . . . learn more about flotation? (it could save your life) . . . take a 10-minute course in maritime law for small boats? . . . improve your boat trailering technique? PM's editors take you along and show you how in the big Annual Boating Section—28 pages of our best on boating for 1960

Exclusive Copper-Glass Seal Stays Gas-Tight Under 1400 Pounds Pressure

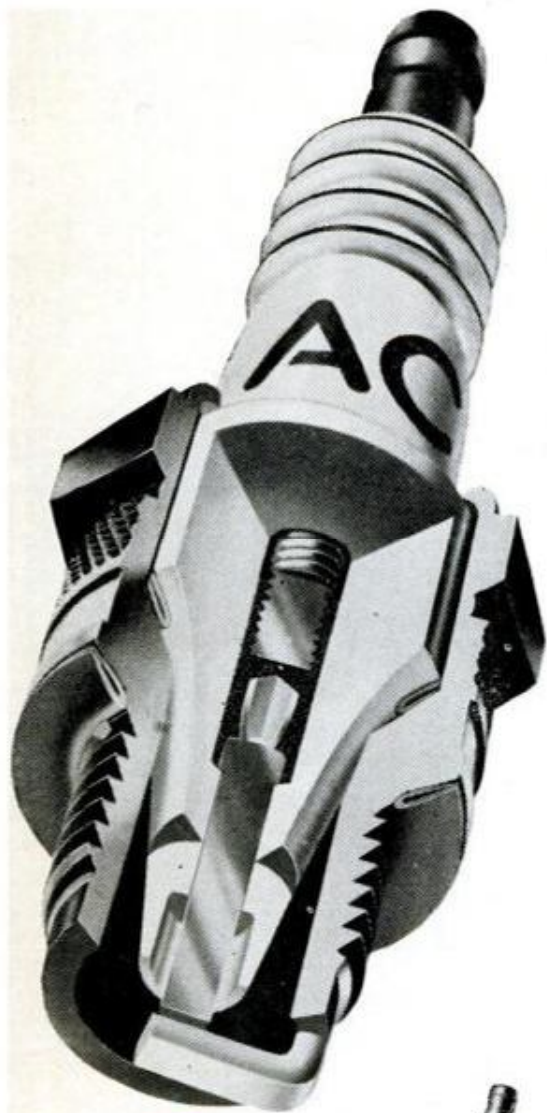

AC Fire-Ring Spark Plugs are your best buy in spark plugs for many reasons—but a big one is AC's exclusive Conductaseal that bonds the terminal screw and center electrode to the aluminum oxide insulator. This seal protects against leakage far better than ordinary seals. Leakage alters the spark plug heat range, which can damage the spark plug and, in turn, the engine. Conductaseal is a product of AC research. It is made of finely ground copper and glass, inserted into the center of the insulator and formed under terrific heat and pressure into an unyielding bond. It is tested under 1400 p.s.i. to give you trouble-free spark plug operation and long life.

The pictures on this page give graphic proof of Conductaseal superiority. Remember them the next time you buy spark plugs. For highest quality and greatest reliability, ask for AC Fire-Ring Spark Plugs.

AC SPARK PLUG  THE ELECTRONICS DIVISION OF GENERAL MOTORS

AC PRESENTS THE ART CARNEY SHOW, NBC-TV, FEB. 5



Skin-diver demonstrates how AC Conductaseal stays gas-tight under 1400 p.s.i., while ordinary spark plug leaks.



This X-ray check makes certain that the Conductaseal has bonded properly. It's one of 116 AC reliability tests.



Every AC Spark Plug features the exclusive Hot Tip that heats faster, cools faster to stay clean longer.



They must be the best!

AC Fire-Ring Spark Plugs

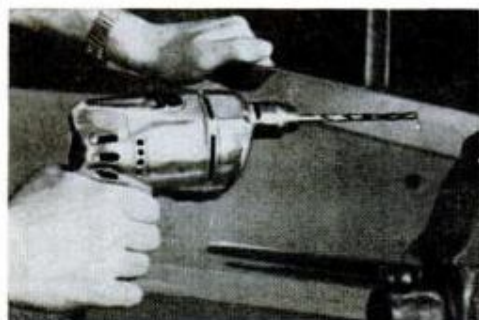
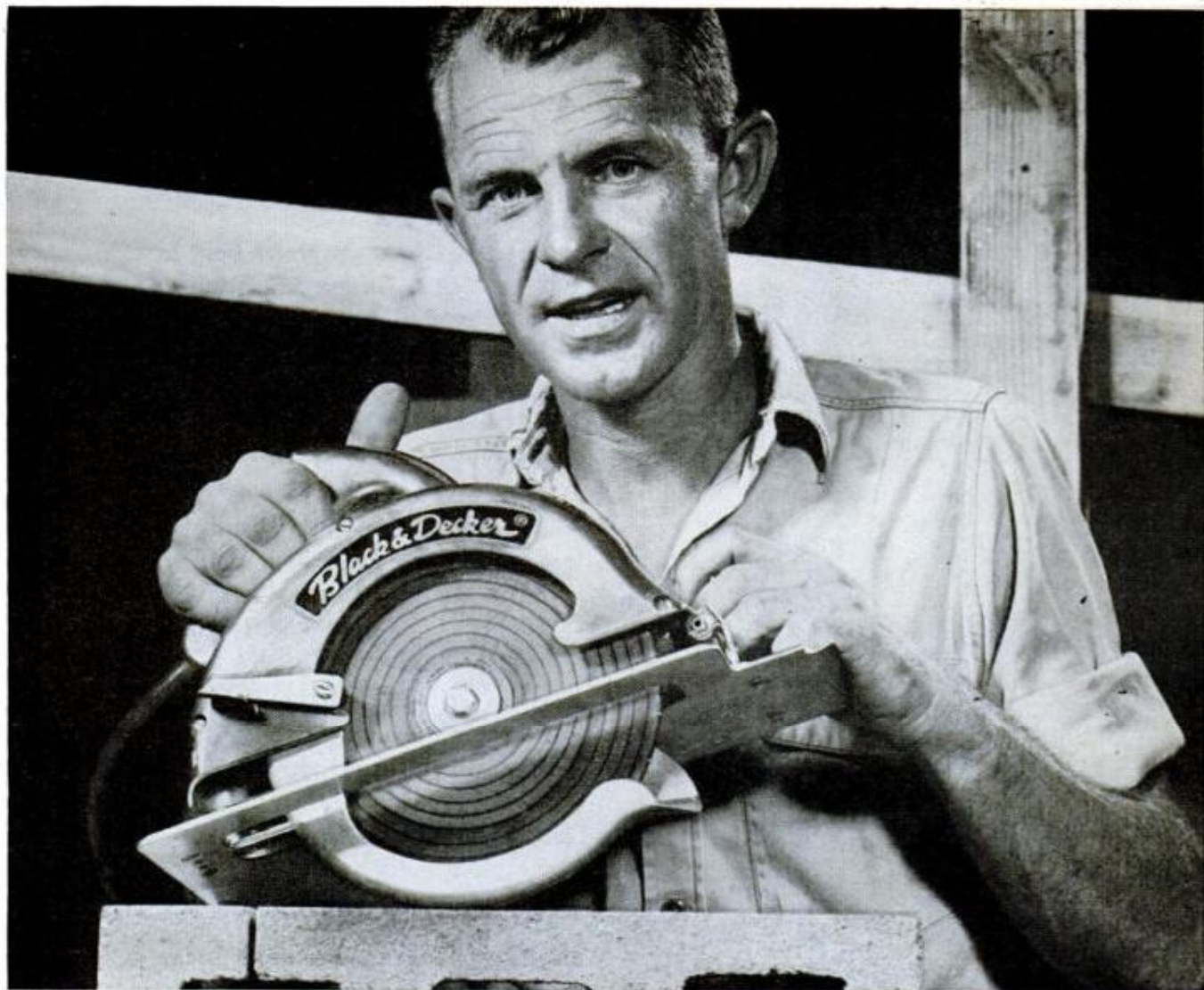

B&D 1/4" Deluxe Utility Drill. More power for drilling and driving attachments. Compact housing—fits your hand like a glove! B&D Drills from \$16.95. Attachments at \$14.95.



B&D's Dustless Finishing Sander is so dustless you can sand and paint side by side! Long on power—light on weight. Attach to any vacuum cleaner. B&D Sanders from \$29.95.

ASK THE EXPERTS!

Men who work on America's top construction jobs work with America's top saws—built by Black & Decker!

That same tough dependability, prized on big construction jobs, makes a Black & Decker Saw *your* best choice—whether you use it on the job or around your home.

There's extra built-in power, speed, accuracy and ease of handling for *more work with less maintenance*. Ask the experts, they'll tell you to put your money on B&D! Choose from five great models—from 6½" to 9¼" blade diameter. Priced from \$49.95. For free power tool catalog, write: THE BLACK & DECKER MFG. Co., Dept. D-020, Towson 4, Maryland.



WORLD'S LARGEST MAKER OF PORTABLE ELECTRIC TOOLS

Black & Decker®

POPULAR MECHANICS

TAIL DRAGGING?



scraping on driveways?

Load-Levelers* put an end to this common annoyance by increasing road clearance of even heavily loaded cars.



swaying on curves?

Without Load-Levelers*, loaded car sways and swings as it rounds curves; passengers are thrown from side to side. Stability is impaired. Tires wear faster.



"bottoming" on bumps?

Without Load-Levelers*, car scrapes bottom on impact of hitting bumps and ruts, with frightening noise and possible damage.

Keep your car on the level with Load-Levelers*—Monroe stabilizing units with built-in ride control for a level ride under all road and load conditions. With Load-Levelers*, your car will always ride on an even keel . . . without "tail drag" or side sway. You'll like the way your car will take rough bumps and steep driveways without "bottoming" on its axles. You'll appreciate the extra stability on tight curves. And you'll like the improved steering and longer tire life you'll get with Load-Levelers.*

Have Load-Levelers* installed today in less than 30 minutes at your car dealer's, repair shop or service station. You'll be amazed at the really big difference they make!

only
\$39.90
a set
for most cars



MONROE

Load-Leveler
STABILIZING UNIT



Listen to
BILL STERN'S "MONROE SPORTSREEL"
every morning, Monday through Friday, on the Mutual radio network. Check your local radio listings for time and station.

*Trademark

MONROE AUTO EQUIPMENT COMPANY • MONROE, MICHIGAN
In Canada, MONROE-ACME LTD., Toronto, Ontario • In Mexico, MEX-PAR, Box 21865, Mexico City
WORLD'S LARGEST MAKER OF RIDE CONTROL PRODUCTS, INCLUDING MONRO-MATIC® SHOCK ABSORBERS

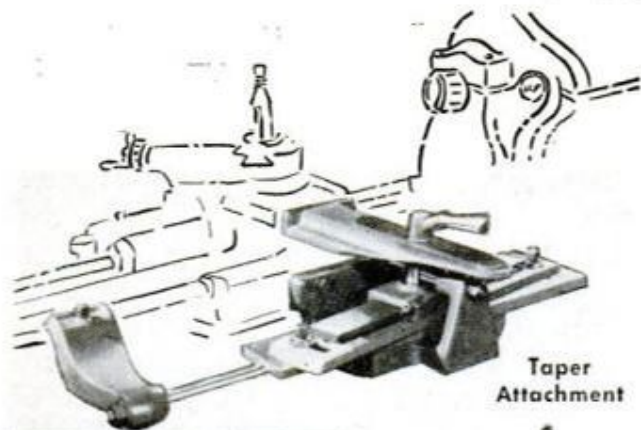

Taper Attachment

Get
More Work
out of
Your Lathe

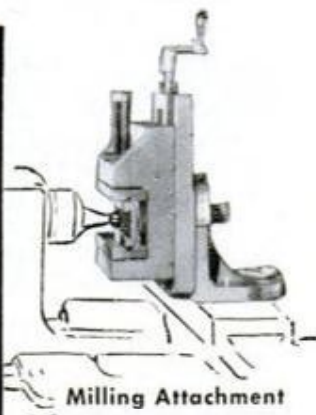

Milling Attachment



Steady Rest



External Grinder



Live Centers



Handlever Collet Attachment

Use South Bend Attachments to...

Cut Machining Time • Simplify Difficult Jobs
Speed up Tooling • Handle More Types
of Jobs • Perform Non-lathe Operations

Write for complete information
on the largest selection of lathe attachments,
tools and accessories made.

SOUTH BEND LATHE

South Bend Lathe, Inc., South Bend 22, Indiana

Builders of Lathes, Milling Machines,
Shapers, Drill Presses, Pedestal Grinders

Up to 24 months to pay



Over the Editor's Desk



A FAMILIAR NAME is missing from this issue. Wayne Whittaker, managing editor of *Popular Mechanics* for the last year and a member of the editorial staff since 1942, died recently after a long illness.

His name is well known to our readers as the author of many articles. When *PM* inaugurated its annual Home Section in the October issue of 1953 Mr. Whittaker was placed in charge of this popular feature and his writings and his ideas have sparked this every year since. He traveled widely each year in search of the best-designed homes in America and the architects who designed them, and thus became one of the nation's experts in knowledge of what Americans want in homes and home improvements. Prior to his editing the Home Section he had supervised *Popular Mechanics'* wide coverage of the automotive field.

Popular as a writer and as a man, his legion of friends throughout the country will mourn with us his passing.

☆☆☆

LOOKING FOR a pen pal overseas?

Often we are asked to publish letters from readers who would like to correspond with someone abroad. This we cannot do.

Instead we refer you, if you are so interested, to the International Friendship League, Inc., 40 Mt. Vernon St., Beacon Hill, Boston 8, Mass. The League, a member of President Eisenhower's People-to-People Program, in cooperation with American embassies throughout the world, is promoting the idea of exchanging information between adults or youths and pen pals in 139 free countries and territories.

Just send a stamped, self-addressed envelope to the League at the above address and ask for its brochure and application blanks. The League has thousands of letters from people abroad who would like to correspond with Americans.

☆☆☆

To the Editor:

Enclosed is a photograph of the Karlson sound chamber that you submitted plans for in the July 1958 issue of *Popular Mechanics*.

When I started construction, we needed some record storage also, so this was built onto the right side of the chamber with the whole unit having a design that was similar to the Hoffman console hi-fi that we already had. A good quality coaxial speaker was used with excellent results. It

(Continued to page 10)



To those who want to enjoy
an ACCOUNTING CAREER



FREE SAMPLE LESSON

IF you're that person, here's something that will interest you.

Not a magic formula—not a get-rich-quick scheme—but something more substantial, more practical.

Of course, you need something more than just the desire to be an accountant. You've got to pay the price—be willing to study earnestly, thoroughly.

Still, wouldn't it be worth your while to sacrifice some of your leisure in favor of interesting home study—over a comparatively brief period? Always provided that the rewards were good—a salary of \$5,000 to \$10,000 and up?

An accountant's duties are interesting, varied and of real worth to his employers. He has *standing!*

Do you feel that such things aren't for you? Well, don't be too sure. Very possibly they *can* be!

Why not, like so many before you, investigate LaSalle's modern Problem Method of training for an Accounting position?

Just suppose you were permitted to work in an accounting firm under the personal supervision of an expert accountant. Suppose, with his aid, you studied accounting principles and solved problems day by day—easy ones at first—then more difficult ones. If you could do this—and could turn to him for advice as the problems became complex—soon you'd master them all.

That's the training you follow in principle under the LaSalle Problem Method.

**Over 4,500 Certified
Public Accountants among
LaSalle alumni**

You cover accounting from Basic Accounting right through Principles and Cost Accounting. As you go along, you absorb the principles of Accounting Systems, Federal Income Tax, Certified Public Accountant Training, and prepare for the CPA examinations.

Your progress is as speedy as you care to make it—depending on your own eagerness to learn and the time you spend in study.

Will recognition come? The only answer, as you know, is that success *does* come to the man who is really *trained*. It's possible your employers will notice your improvement in a very few weeks or months. Indeed, many LaSalle graduates have paid for their training—with increased earnings—before they have completed it! For accountants, who are trained in organization and management, are the executives of the future.

**Get Free Sample Lesson—Also
"Opportunities in Accounting"**

For your own good get all the facts about this completely new and modern accounting training. Write for Free Sample Lesson—also latest book "Opportunities in Accounting." They will prove that Accounting offers brilliant futures to those who aren't afraid of serious home study, and will show the wide range of opportunities that exist today. No cost or obligation. If you want a position of higher income, greater prestige and professional standing . . . MAIL THE COUPON NOW!

Accredited Member, National Home Study Council

LASALLE EXTENSION UNIVERSITY
A CORRESPONDENCE INSTITUTION

417 S. Dearborn St. Dept. 264H Chicago 5, Ill.

I want to be an accountant. Send me without obligation, Free Sample Lesson—also "Opportunities in Accounting."

Name.....Age.....

Address.....

City, Zone & State.....

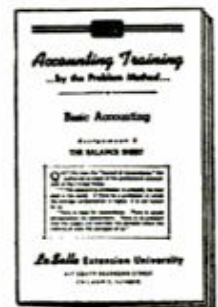

BURIED ALIVE!



SIX YEARS ON THE SAME JOB WITH NEVER AN ACCIDENT... AND THEN ONE MORNING...

2 A CAVE-IN PUT ME SIX FEET UNDER FOR SIX LONG MINUTES

QUICK! GET HIM OUT OF THERE!



3 IN THE HOSPITAL, I HAD PLENTY OF TIME TO THINK

SIX YEARS I'VE BEEN BURIED ALIVE IN THAT SAME OLD JOB, JANE!

WELL, NOW'S A GOOD TIME TO DO SOMETHING ABOUT IT



4 I'D PASSED OVER DOZENS OF I. C. S. ADS IN POPULAR MECHANICS. BUT I SAW THIS ONE IN A NEW LIGHT

I. C. S. SUCCESS PLAN... SPARE-TIME TRAINING... 256 COURSES TO CHOOSE FROM... THIS COULD BE THE ANSWER... WON'T HURT TO FIND OUT



FREE!

I.C.S. CAREER KIT

Send coupon now...
get all three books

INTERNATIONAL CORRESPONDENCE SCHOOLS
BOX 21953B SCRANTON 15, PA.



5 SIGNING UP FOR THAT I.C.S. COURSE WAS THE SMARTEST THING I EVER DID

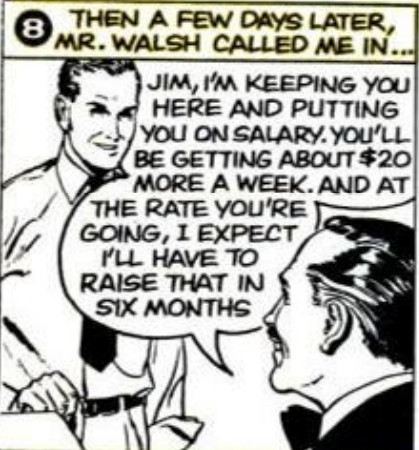

HERE'S WHERE YOU COME IN! LET I.C.S. SHOW YOU THE WAY TO MORE PAY, RAPID ADVANCEMENT, REAL JOB SECURITY! MAIL THIS COUPON TODAY!

- 1 "HOW TO SUCCEED" A 32-page gold mine of ideas
- 2 CAREER CATALOG Opportunities in the field that interests you most
- 3 SAMPLE LESSON (MATH) Shows the famous step-by-step I. C. S. teaching method



INTERNATIONAL CORRESPONDENCE SCHOOLS ICS

BOX 21953B, SCRANTON 15, PENNA.

Without cost or obligation, send me "HOW TO SUCCEED" and the opportunity booklet about the field BEFORE which I have marked X (plus sample lesson):

- | | | | | |
|--|---|--|---|---|
| <p>ARCHITECTURE and BUILDING CONSTRUCTION</p> <ul style="list-style-type: none"> <input type="checkbox"/> Air Conditioning <input type="checkbox"/> Architecture <input type="checkbox"/> Arch. Drawing and Designing <input type="checkbox"/> Building Contractor <input type="checkbox"/> Building Estimator <input type="checkbox"/> Carpenter Builder <input type="checkbox"/> Carpentry and Millwork <input type="checkbox"/> Carpenter Foreman <input type="checkbox"/> Heating <input type="checkbox"/> Painting Contractor <input type="checkbox"/> Plumbing <input type="checkbox"/> Reading Arch. Blueprints <p>ART</p> <ul style="list-style-type: none"> <input type="checkbox"/> Commercial Art <input type="checkbox"/> Magazine Illus. <input type="checkbox"/> Show Card and Sign Lettering <input type="checkbox"/> Sketching and Painting <p>AUTOMOTIVE</p> <ul style="list-style-type: none"> <input type="checkbox"/> Automobile <input type="checkbox"/> Auto Body Rebuilding and Refinishing <input type="checkbox"/> Auto Engine Tuneup <input type="checkbox"/> Auto Technician | <p>AVIATION</p> <ul style="list-style-type: none"> <input type="checkbox"/> Aero-Engineering Technology <input type="checkbox"/> Aircraft & Engine Mechanic <p>BUSINESS</p> <ul style="list-style-type: none"> <input type="checkbox"/> Accounting <input type="checkbox"/> Advertising <input type="checkbox"/> Business Administration <input type="checkbox"/> Business Management <input type="checkbox"/> Cost Accounting <input type="checkbox"/> Creative Salesmanship <input type="checkbox"/> Managing a Small Business <input type="checkbox"/> Professional Secretary <input type="checkbox"/> Public Accounting <input type="checkbox"/> Purchasing Agent <input type="checkbox"/> Salesmanship and Management <input type="checkbox"/> Traffic Management <p>CHEMICAL</p> <ul style="list-style-type: none"> <input type="checkbox"/> Analytical Chemistry <input type="checkbox"/> Chemical Engineering <input type="checkbox"/> Chem. Lab. Technician <input type="checkbox"/> Elements of Nuclear Energy <input type="checkbox"/> General Chemistry <input type="checkbox"/> Natural Gas Prod. and Trans. <input type="checkbox"/> Petroleum Prod. and Engr. <input type="checkbox"/> Professional Engineer (Chem) <input type="checkbox"/> Pulp and Paper Making | <p>CIVIL ENGINEERING</p> <ul style="list-style-type: none"> <input type="checkbox"/> Civil Engineering <input type="checkbox"/> Construction Engineering <input type="checkbox"/> Highway Engineering <input type="checkbox"/> Professional Engineer (Civil) <input type="checkbox"/> Reading Struc. Blueprints <input type="checkbox"/> Sanitary Engineer <input type="checkbox"/> Structural Engineering <input type="checkbox"/> Surveying and Mapping <p>DRAFTING</p> <ul style="list-style-type: none"> <input type="checkbox"/> Aircraft Drafting <input type="checkbox"/> Architectural Drafting <input type="checkbox"/> Drafting & Machine Design <input type="checkbox"/> Electrical Drafting <input type="checkbox"/> Mechanical Drafting <input type="checkbox"/> Sheet Metal Drafting <input type="checkbox"/> Structural Drafting <p>ELECTRICAL</p> <ul style="list-style-type: none"> <input type="checkbox"/> Electrical Engineering <input type="checkbox"/> Elec. Engr. Technician <input type="checkbox"/> Elec. Light and Power <input type="checkbox"/> Practical Electrician <input type="checkbox"/> Practical Lineman <input type="checkbox"/> Professional Engineer (Elec) <p>HIGH SCHOOL</p> <ul style="list-style-type: none"> <input type="checkbox"/> High School Diploma | <ul style="list-style-type: none"> <input type="checkbox"/> Good English <input type="checkbox"/> High School Mathematics <input type="checkbox"/> High School Science <input type="checkbox"/> Short Story Writing <p>LEADERSHIP</p> <ul style="list-style-type: none"> <input type="checkbox"/> Industrial Foremanship <input type="checkbox"/> Industrial Supervision <input type="checkbox"/> Personnel-Labor Relations <input type="checkbox"/> Supervision <p>MECHANICAL and SHOP</p> <ul style="list-style-type: none"> <input type="checkbox"/> Diesel Engines <input type="checkbox"/> Gas-Elec. Welding <input type="checkbox"/> Industrial Engineering <input type="checkbox"/> Industrial Instrumentation <input type="checkbox"/> Industrial Metallurgy <input type="checkbox"/> Industrial Safety <input type="checkbox"/> Machine Shop Practice <input type="checkbox"/> Mechanical Engineering <input type="checkbox"/> Professional Engineer (Mech) <input type="checkbox"/> Quality Control <input type="checkbox"/> Reading Shop Blueprints <input type="checkbox"/> Refrigeration and Air Conditioning <input type="checkbox"/> Tool Design <input type="checkbox"/> Tool Making <p>RADIO, TELEVISION</p> <ul style="list-style-type: none"> <input type="checkbox"/> General Electronics Tech. | <ul style="list-style-type: none"> <input type="checkbox"/> Industrial Electronics <input type="checkbox"/> Practical Radio-TV Eng'g <input type="checkbox"/> Practical Telephony <input type="checkbox"/> Radio-TV Servicing <p>RAILROAD</p> <ul style="list-style-type: none"> <input type="checkbox"/> Car Inspector and Air Brake <input type="checkbox"/> Diesel Electrician <input type="checkbox"/> Diesel Engr. and Fireman <input type="checkbox"/> Diesel Locomotive <p>STEAM and DIESEL POWER</p> <ul style="list-style-type: none"> <input type="checkbox"/> Combustion Engineering <input type="checkbox"/> Power Plant Engineer <input type="checkbox"/> Stationary Diesel Engr. <input type="checkbox"/> Stationary Fireman <p>TEXTILE</p> <ul style="list-style-type: none"> <input type="checkbox"/> Carding and Spinning <input type="checkbox"/> Cotton Manufacture <input type="checkbox"/> Cotton Warping and Weaving <input type="checkbox"/> Loom Fixing Technician <input type="checkbox"/> Textile Designing <input type="checkbox"/> Textile Finishing & Dyeing <input type="checkbox"/> Throwing <input type="checkbox"/> Warping and Weaving <input type="checkbox"/> Worsted Manufacturing |
|--|---|--|---|---|

Name _____ Age _____ Home Address _____
 City _____ Zone _____ State _____ Working Hours _____ A.M. to P.M. _____
 Occupation _____

Canadian residents send coupon to International Correspondence Schools, Canadian, Ltd., Montreal, Canada. Special low monthly tuition rates to members of the U. S. Armed Forces.

(Continued from page 6)



**I Can Make YOU a New Man, Too
In Only 15 Minutes a Day!**

PEOPLE once laughed at my skinny 97-lb. body. I was ashamed to strip for sports. Girls made fun of me behind my back. THEN I discovered "Dynamic Tension." It made me such a complete specimen of manhood that I hold the title, "The World's Most Perfectly Developed Man."

What's My Secret?

When you look in the mirror and see a healthy, husky, handsome, fellow smiling back at you—you'll be amazed at how fast "Dynamic Tension" GETS RESULTS. It's the easy, NATURAL method you can practice in your own room — JUST 15 MINUTES EACH DAY. No gadgets to fool with. You simply use the dormant muscle-power in your own body—watch it grow into solid LIVE MUSCLE. See your shoulders broaden . . . your scrawny chest swell with inches of new muscle . . . those spindly legs and arms bulge with new power . . . and your whole body starts to feel "alive," full of zip and go!

CHARLES ATLAS
Holder of title, "The World's Most Perfectly Developed Man"

FREE My 32-Page Illustrated Book
Not \$1.00—Not 10c—**BUT FREE!**

Send NOW for my famous book showing how "Dynamic Tension" can make you a new man. 32 pages, packed with photographs, valuable advice, answers many vital questions. This book is a real prize for any fellow. Yet I'll send you a copy absolutely FREE. Just glancing through it may change your life. Rush coupon to me personally: **CHARLES ATLAS, Dept. 82, 115 East 23rd St., New York 10, N. Y.**



**CHARLES ATLAS, Dept. 82,
115 East 23 St., New York 10, N. Y.**

Send me — absolutely FREE — a copy of your famous book, showing how "Dynamic Tension" can make me a new man. 32 pages, crammed with photos, valuable advice. This book is mine to keep, and sending for it does not obligate me in any way.

Name _____ Age _____
(Please print or write plainly)
Address _____
City _____ Zone _____ State _____



is constructed of solid maple with a satin provincial finish. Working time was about 45 hours. I want to thank you for the plans.

Don Webb,
Stigler, Okla.

☆☆☆

To the Editor:



Enclosed you will find a photo of a horse made from rubber tires, located in Brainerd, Minn., in an area of interest to the tourist. The photo clearly shows how the tires were cut and arranged to bring about the effect. To add realism a two-wheeled cart is hitched to it.

Elmer Vandrey,
Fairmont, Minn.

(Continued to page 12)

Make More Money Soon Fixing Electric Appliances



**Actual Lesson
FREE** Fast Growing
Field Offers
Good Pay, Security
Interesting Work

Learn at Home in Spare Time

Earn more money. Enjoy doing important, interesting work. Learn Electrical Appliance Servicing. This is a field of increasing opportunity. Today every wired home has many electrical appliances and millions and millions of new appliances are made and sold each year. Find out more about this great, growing field. Find out how NRI can train you, at home and in spare time to be an Appliance Service Technician. See how you can start soon to make extra money servicing appliances.

Add to Your Income Soon After Enrollment Opportunities Increasing for Service Technicians

NRI Training is practical, thorough. You get easy-to-understand lessons, and NRI supplies parts to build professional type Multi-Use Tester. Use it to get practical experience. Soon, you can add to your income by servicing appliances. Build a profitable *sideline* for your spare time—qualify for a good job—develop a business and be your own boss. As an Appliance Service Technician, your opportunities are broad—your services wanted, gladly paid for, highly regarded in your community.

Appliances are necessary to comfortable, convenient living. Owners pay well to keep them in repair. The field is amazingly big. In addition to major appliances such as electric ranges, air conditioners, refrigerators, there are over 40,000,000 electric irons, 5,000,000 electric blankets, 15,000,000 coffee makers, plus more millions of vacuum cleaners, fans, toasters, mixers, etc.



Learn and Earn With Tester Diploma When You Finish

Locate appliance troubles easily with Portable Appliance Tester you build. You use it to learn and do actual electric appliance repair jobs. For only \$3.00 with enrollment and \$6 per month, get training including Tester—a small price to pay for increased earnings. Mail coupon for Sample Lesson and Book—your first step toward more interesting work, bigger earnings. **NATIONAL RADIO INSTITUTE, Dept. ABO, Washington 16, D. C.**

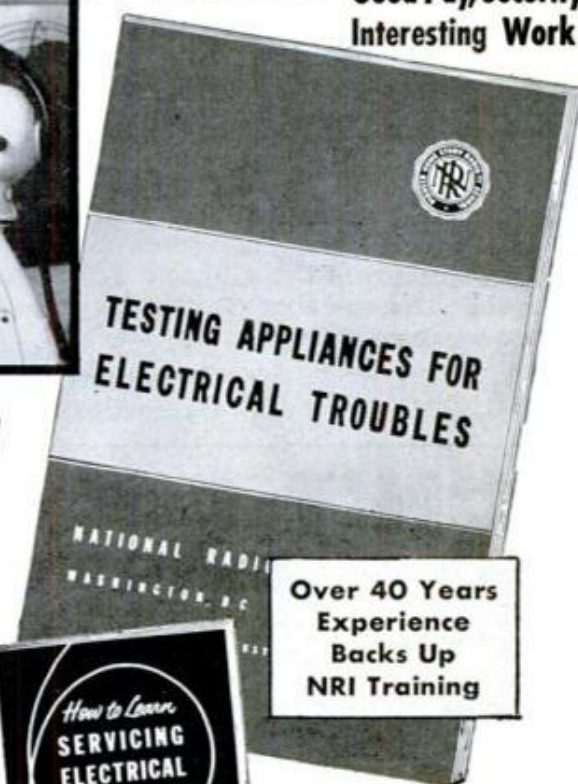

Over 40 Years
Experience
Backs Up
NRI Training

Find Out What
Appliance Repair
Offers You

Mail Coupon FOR LESSON AND BOOK FREE

National Radio Institute
Dept. ABO, Washington 16, D. C.

Please send me Electric Appliance Servicing Lesson and Book FREE. (I understand no salesman will call.)

Name _____ Age _____

Address _____

City _____ Zone _____ State _____

ACCREDITED MEMBER NATIONAL HOME STUDY COUNCIL

(Continued from page 10)

To the Editor:

Bob Arrol, pharmacist at the central Illinois town of Arcola, started this coffee bar in his drugstore back in 1949 with six cups. Today he has 162 cups in the stalls, and has



a waiting list. To join the club now, the prospective member must first drink five gallons of coffee. When some member dies, Arrol removes the cup and reassigns the space. To a member moving away, he gives the cup as a memento.

Grover Brinkman,
Okawville, Ill.

Shocking Meal for Squirrels

If it irritates you to watch squirrels dining on the expensive seed you bought to feed songbirds, here's one solution: a feeder that administers a mild electric shock to the squirrel. It's built on the see-



saw principle. The perch is counterbalanced and a squirrel weighing over eight ounces causes a microswitch to make contact and give the interloper a harmless but effective jolt.

(Continued to page 14)

DON'T DECIDE YOUR FUTURE UNTIL YOU HAVE READ



How To Make Big Money Fast in the Accident Investigation & Adjusting Field

A. J. Allen earned over \$2,000 in ten weeks. Gary Williams doubled his former salary. Jessie Hill says "Had I not learned of Universal Schools' Accident Investigator Course I would still be just another time card puncher; but today I have a wonderful position, and I receive \$3.00 an hour plus an expense allowance."

RIGHT NOW the Accident Investigation and Adjusting Field offers you a tremendous future. Here's why: *This vital business distributes more money than any other service industry.* Last year alone over 200 MILLION ACCIDENTS had to be investigated for Insurance Companies, Airlines, Railroads, Steamship Lines, and Government Offices — and the need for trained men is booming!

You can investigate full time for one company — or earn \$3 to \$10 an hour in *your own business*. No prior experience or higher education needed. And age is no barrier. Here is a field wide open to men 18 to 60.

NOW! FREE Book Gives You All the Facts

Send TODAY for new, illustrated Book mailed FREE. Learn how you can prepare at home in just a few weeks for excellent full time or spare time income. See for yourself how others have doubled and even tripled their earnings. Let us show you how Universal Schools has trained hundreds of men in their own homes spare time — and then helped them add thousands of dollars to their incomes. Absolutely no obligation on your part. No salesman will call. Write at once to me, M. O. Wilson, Universal Schools, 6801 Hillcrest Ave., Dallas 5, Texas.

Mr. M. O. Wilson, Dept. PM-2
Universal Schools, 6801 Hillcrest Ave.,
Dallas 5, Texas

Send me free book on Big Money in Accident Investigating & Adjusting Field. No salesman will call.

Name.....Age.....

Address.....

City.....Zone.....State.....





Your big opportunity to walk into Something Good!

Wouldn't you be happier with a job that not only is secure and highly paid, but also offers a splendid opportunity to go in business? The fast-growing refrigeration and air conditioning industry meets this requirement. It can use 20,000 newly-trained mechanics every year. *It needs you.* Refrigeration is so widely used in the home, in industry, and in transportation, that opportunities exist almost everywhere. You may become established right in your own community. For complete information on how to get into this lucrative field, fill out and mail coupon.

Enjoy the prestige of a service engineer

Few colleges offer courses in air conditioning. Therefore, industry chooses its service engineers from the ranks of well-trained technicians. What a wonderful way to gain professional status—and greater income—without benefit of a college degree!

ONLY CTI SENDS PARTS AND TOOLS TO BUILD A CONDENSING UNIT!



YOU PRACTICE WITH 25 BIG KITS

CTI has the practical way to train you for success in Refrigeration — Air Conditioning

As in anything else, there are short-cuts to getting ahead. In the refrigeration field, the short-cut is CTI Home Training. There is no other training like it. Only CTI home study is *practical*. Only CTI sends all parts and tools to build the condensing unit illustrated at right. You run many experiments—go through the trouble-shooting and repair techniques you'll encounter on the job.

How CTI students earn money as they train

Many students, after a few lessons, earn extra cash by installing and fixing refrigeration and air conditioning units. Some work evenings and weekends for local dealers; others establish service routes which include restaurants, motels, meat markets, supermarkets, etc. This is possible because CTI training is *practical*—equips the student to do field work. CTI training can pay its way—start you in business while you're still a student! Others have done it. You can too!



You gain experience as you train, because you learn by practicing. You get mechanic's tools and special equipment (left), as well as all parts to assemble a heavy-duty, commercial-type, 1/4 h.p. condensing unit (above). Then you can build a refrigerator, air conditioner, freezer or milk cooler.

PROOF! Read these letters from CTI men



"I'm in the refrigeration business for myself now. I earn nearly double what I used to. During my training, I made enough to pay my tuition."—*Allred Helm, Ky.* . . . "I've started a business and it's a success."—*Otto Degner, Canada* . . . "I am in business for myself. I am building a nice trade doing service work."—*Paulie Waters, Tex.* . . . "I applied for a job to install air conditioners in autos and got it."—*Richard Vinet, La.* . . . "Your refrigeration training helped me get repair jobs after only twelve of your lessons."—*Frank Green, W. Va.*

New auto air conditioning field is loaded with business opportunities

Each year over 500,000 autos are equipped with air conditioners. Experts say the figure should double in a few years. There's a severe shortage of technicians. Strong need in many areas for repair shops, too. Sell, install and service auto air conditioners for top profit! Go in business for yourself.



Invest a postage stamp in your future — Mail coupon

There are more refrigerators than autos, TV sets, radios or washing machines in America. The field is big and uncrowded, with less competition for the rewarding jobs. It offers a challenge to the younger man in search of a future . . . and dignified work to the older man who craves security. Let CTI send you its opportunity booklets. They contain vital information about the industry and CTI training. Then decide if the refrigeration and air conditioning industry meets your career needs. Mail coupon for catalog and lesson samples. No obligation whatever.

Expect the best—and get it!

Your career is in safe hands when you rely on CTI for a technical education. This progressive institute, which specializes in home study, was the first to offer kits to build a condenser. CTI lessons are kept up-to-date, well illustrated, understandable. You get better and more intensive training through CTI. Mail coupon and see for yourself!



FIRST GET THE FACTS—THEN DECIDE
Mail Coupon Today for 2 Free Booklets

COMMERCIAL TRADES INSTITUTE • CHICAGO 26, ILLINOIS
Accredited by National Home Study Council

COMMERCIAL TRADES INSTITUTE

1400 GREENLEAF AVENUE
CHICAGO 26, ILLINOIS DEPT. R-690

Send catalog, *Success in Air Conditioning & Refrigeration*, and Lesson Sample. Both FREE.

Name _____ Age _____
Address _____
City _____ Zone _____ State _____





Be Your Own MUSIC Teacher

PLAY ANY INSTRUMENT

**LEARN AT HOME THIS QUICK,
SIMPLE, MONEY-SAVING WAY**



SIMPLE as A-B-C. Your lessons consist of real selections, instead of tiresome exercises. You read real notes—no “numbers” or trick music. Some of our 1,000,000 students, such as Lawrence Welk, are band LEADERS. Everything is in print and pictures. First you are told what to do. Then a picture shows you how. Then you play it yourself and hear how it sounds. Soon you are playing popular tunes, hymns, classical and any other music. No special talent or previous training needed. Even if you don't know a single note of music now, you can soon play piano, guitar, accordion, organ, any instrument. Your friends will be amazed!

STOP CHEATING YOURSELF OF THESE JOYS!

Popularity! New friends. Gay parties. Good times. Career. Extra Money. Understand, appreciate and converse about music. Learn lives and compositions of modern and great masters . . . Relax! Banish worries and frustrations. Satisfy self-expression, creative urge. Gain self-confidence.

MAIL COUPON FOR FREE BOOK

See for yourself why our method has been successful for 61 years! Read the whole fascinating story of this wonderful course in 36-page illustrated book. For FREE copy, mail coupon. No obligation. No salesman will call.



**U. S. School of Music,
Studio 302,
Port Washington, N.Y.**



**U. S. SCHOOL OF MUSIC
Studio 302, Port Washington, N.Y.**

Please send me your 36-page illustrated Free Book. I'm interested in playing (name instrument) _____

I do I do NOT—have instrument now.

Name _____ Age _____
(please print)

Address _____

City _____ Zone _____ State _____

(Continued from page 12)

To the Editor:

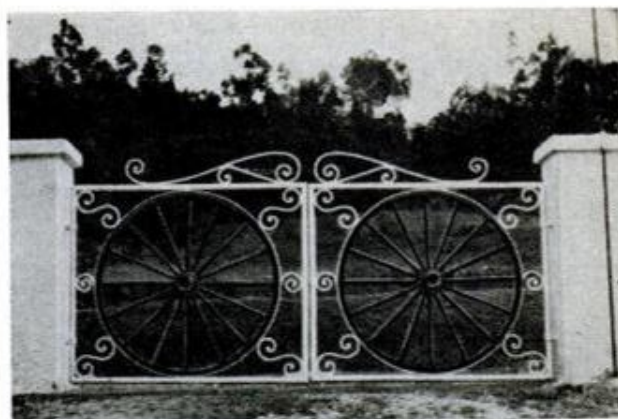

For more than 20 years I have been a constant reader of your publication. I am enclosing a photograph of the entrance to my house in this city in which I have used as decoration two wheels from an old English coach.

Major Alvaro Roldan S.,
Chief of Public Relations and Sales,
Hotel Tequendama,
Bogota, Colombia

☆☆☆

To the Editor:

With typical teen-age skepticism, Roger M. Woodbury, Jr., of Natick, Mass., decided to prove to himself that the sun's rays could be captured to cook a meal, heat a house, burn through steel, etc., as he had read so much about it in past issues of *Popular Mechanics*. After polishing up the



reflector bowl of a discarded bathroom heater, he replaced the heater coil with a wire spit. Next he loaded the spit with a frankfurter and aimed the bowl toward the sun. In 15 minutes the hotdog was sizzling with a mouth-watering aroma, ready to coat with mustard and pop into his mouth.

Roger M. Woodbury,
Natick, Mass.

NOW!
at a price
you can afford!

MAKE MORE MONEY in TELEVISION RADIO-ELECTRONICS

**BETTER...MORE COMPLETE...LOWER COST...
WITH NATIONAL SCHOOLS SHOP-METHOD
HOME TRAINING!**

BETTER... Training that is proved and tested in Resident School shops and laboratories, by a School that is the **OLDEST** and **LARGEST** of its kind in the world.

MORE COMPLETE... You learn **ALL PHASES** of *Television-Radio-Electronics*.

LOWER COST... Other schools make several courses out of the material in our **ONE MASTER COURSE . . .** and you pay more for less training than you get in *our course* at **ONE LOW TUITION!**

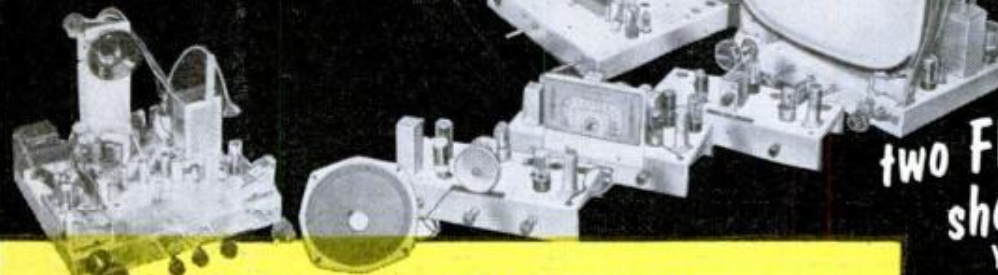

These
two FREE books will
show you how!

You get all information
by mail . . . You make
your own decision . . . at
home! **NO SALESMAN
WILL CALL**

TOP PAY... UNLIMITED OPPORTUNITIES LIFETIME SECURITY CAN BE YOURS!

You are needed in the Television, Radio, and Electronics industry! Trained technicians are in growing demand at excellent pay—in **ALL PHASES**, including Servicing, Manufacturing, Broadcasting and Communications, Automation, Radar, Government Missile Projects.

NATIONAL SCHOOLS SHOP-METHOD HOME TRAINING, with newly added lessons and equipment, trains you in your spare time at home, for these unlimited opportunities, including many technical jobs leading to supervisory positions.

YOU LEARN BY BUILDING EQUIPMENT WITH KITS AND PARTS WE SEND YOU. Your National Schools course includes thorough *Practical* training—**YOU LEARN BY DOING!** We send you complete standard equipment of professional quality for building various experimental and test units. You advance step by step, perform more than 100 experiments, and you build a complete TV set from the ground up, that is yours to keep! A big, new TV picture tube is included at no extra charge.

EARN AS YOU LEARN. We'll show you how to earn extra money right from the start. Many of our students pay for their course—and more—while studying. So can you!

LESSONS AND INSTRUCTION MATERIAL ARE UP-TO-DATE, PRACTICAL, INTERESTING. Every National Schools Shop-Method lesson is made easy to understand by numerous illustrations and diagrams. All instruction material has been developed and tested in our own Resident School Shops, Laboratories and Studios.

SEND FOR INFORMATION TODAY . . . it can mean the difference between **SUCCESS** and failure for you! Send for your **FREE BOOK "Your Future in Television-Radio-Electronics"** and **FREE Sample Lesson.** Do it **TODAY**, while you are thinking about your future. It doesn't cost you anything to investigate!

GET THE BENEFITS OF OUR OVER 50 YEARS EXPERIENCE

Approved for
GI Training



NATIONAL SCHOOLS
Los Angeles 37, Calif.

YOU GET...

- 19 Big Kits—**YOURS TO KEEP!**
- Friendly Instruction and Guidance
- Job Placement Service
- Unlimited Consultation
- Diploma—Recognized by Industry
- **EVERYTHING YOU NEED FOR SUCCESS!**

SHOP-METHOD HOME TRAINING COVERS ALL PHASES OF INDUSTRY

1. Television, including Color TV
2. Radio AM & FM
3. Electronics for Guided Missiles
4. Sound Recording and Hi-Fidelity
5. FCC License
6. Automation and Computers
7. Radar & Micro-Waves
8. Broadcasting and Communications

RESIDENT TRAINING AT LOS ANGELES

If you wish to take your training in our Resident School at Los Angeles, the world's TV capital, start **NOW** in our big, modern Shops, Labs and Radio-TV Studios. Here you work with latest Electronic equipment - - professionally installed - - finest, most complete facilities offered by any school. Expert, friendly instructors. Personal attention. Graduate Employment Service. Help in finding home near school - - and part time job while you learn. Check box in coupon for full information.

NATIONAL TECHNICAL SCHOOLS

WORLD-WIDE TRAINING SINCE 1905

MAIL NOW TO

NATIONAL SCHOOLS, Dept. RB-20
4000 S. FIGUEROA ST., LOS ANGELES 37, CALIF.
Rush free TV-Radio "Opportunity" Book and sample lesson. No salesman will call.

NAME _____ AGE _____

ADDRESS _____

CITY _____ ZONE _____ STATE _____

Check if interested **ONLY** in Resident School training at Los Angeles.

VETERANS: Give date of Discharge _____



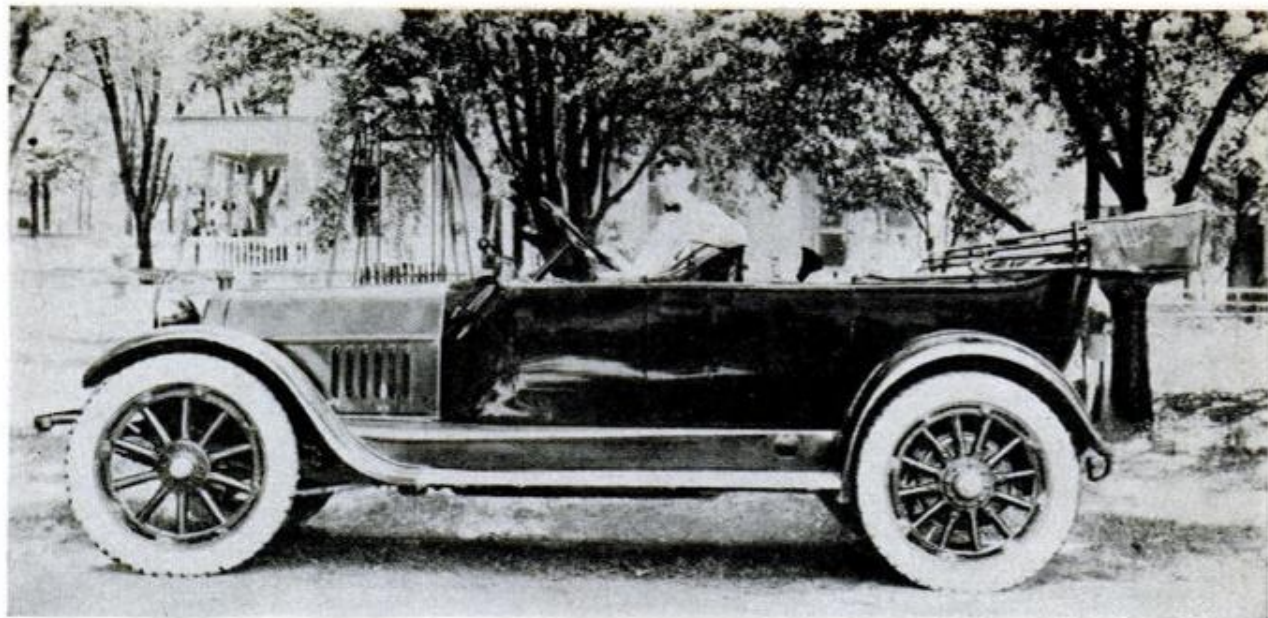

Do You Know This Old-Timer?

This old-timer was the "trophy" given to Eddie Collins of the Philadelphia Athletics when he was selected as the Most Valuable Player in the American League in 1914. The car, built on a 132-inch wheelbase, had a starter-generator combination that made stalling theoretically impossible. When the engine stopped, the starter

automatically would start it. The engine was a six-cylinder T-head and its exhaust manifold was finished in heavy baked enamel. Can you find the driver? He's Harry R. Johnson of Baltimore, Ohio, in a 1915 pose, and he's where he should be—behind the steering wheel. If you can't name the car, turn to page 242.

**95% PROFITS
YEAR 'ROUND**

Be your own boss. Operate a SIMPLEX lawnmower sharpening service in your community. One compact machine grinds all mowers, sharpens cutlery. Low investment, 95% profit. Pays for itself in average month.

SIMPLEX — 4 Machines in One!

Reel Grinder—sharpens any mower reel in or out of mower.

Bed Knife Grinder—grinds with either round or cup wheel.

Rotary Blade Grinder—hollow grinds any rotary mower blade.

Cutlery Knife Grinder—sharpens cutlery, tools, scissors.



Send for Simplex Brochure today!

THE FATE-ROOT-HEATH COMPANY

Dept. PM-2, Plymouth, Ohio

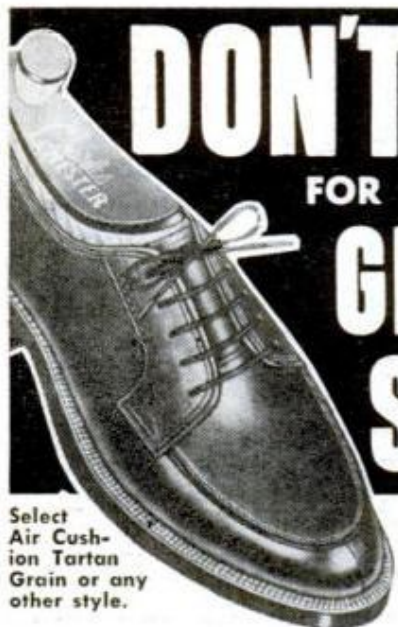

DON'T PAY FOR THESE GREAT SHOES

Select
Air Cushion
Tartan
Grain or any
other style.

GET THEM
WITHOUT COST
AS A REWARD
— PLUS —

THE CHANCE TO "BE BOSS" OF YOUR OWN \$10,000 A YEAR SHOE BUSINESS
Sell friends Work, Dress, Casual Shoes and Boots in spare time. No investment, no overhead, no stock to carry. Simple 2-finger demonstration of patented AIR CUSHION comfort makes shoe selling a snap! Actual shoe samples supplied.



Soft,
Light,
Double
Air
Cushion
Storm
Seal'd
Boot

New!
Swirl
Front Air
Cushioned Loafer—the
first adjustable Slip-on!

**WE BACK YOU WITH OVER
A QUARTER MILLION
PAIRS IN STOCK!**

Show America's greatest shoe values for men, women and children. Over 180 styles. Sizes 4 to 18, widths AAAA to EEEE. Sell full time if you wish, or spare time if now employed and have a "second" income! Advance commissions to \$5.00 a pair, plus big Bonus and "Vacation Checks." *Get your own shoes as "extras" at no cost!*

**SHOW MIRACLE VALUE
\$8.95 AND \$9.95
MEN'S DRESS SHOES!**

The most sensational group of under \$10 footwear folks have seen in 20 years! Our own new "jet age" equipment makes such values possible.

SEND FOR NEW SELLING OUTFIT!
Write NOW if you want the security and big steady income of a business of your own. You can't lose—so act today!

CHARLES CHESTER SHOE CO.
Dept. B-03, Brockton 64, Mass.

MAIL COUPON RIGHT THIS MINUTE!

CHARLES CHESTER SHOE CO.
Dept. B-03, Brockton 64, Mass.

I want to make spare time money. Send all equipment I need—without obligation—and tell me how I can get my own shoes or boots without cost.

Name _____

Address _____

City _____ Zone _____ State _____



Sidelights from the PENTAGON

By William R. Kreh

The Navy has laid aside a project it had been toying with for three years—training pigeons to steer guided missiles. It worked like this: The missile would be equipped with a cameralike device in its nose. It would pick up a picture of the target which would be shown on a screen inside the missile. A pigeon, a wire cemented to its back, would be trained to peck at the image everytime it moved from the center of the glass. The pecking would make contact with the gridded glass and relay a correction to the steering mechanism. The idea worked in the laboratory, but the project has been put on the shelf since the emergence of more practical electronic guidance systems.

Speaking of birds, the Navy's still trying to outsmart the "Gooney Birds" of Midway Island. Last year there were more than 500 bird collisions with Navy planes, causing \$156,000 worth of damage. The Navy has tried to smoke the birds away, steal their eggs, scare them with weird noises. Now the Seabees are building false airstrips to lure the 420,000 nesting albatrosses on the island away from the real airstrips. If *this* doesn't work, the Navy's going to clear away some of the dunes that flank the airstrips to eliminate air currents on which the birds soar.

The Army, along with private industry, has developed a new combat-surveillance radar which can spot and tell the difference between a walking man and a woman at from 5000 to 10,000 yards. The radar uses principles of the Doppler effect system, which has to do with the change in lengths of sound waves as an object moves in relationship to a fixed point. The radar can distinguish whether equipment, troops, or men or women are moving. The set is housed in a shelter which can be carried by helicopter, truck or a small two-wheel trailer. The Army will soon have 99 sets in use and industry is studying possible applications of the device.



Now! Work Over
300 PRACTICAL
PROJECTS with these
PARTS AT HOME!



to help You learn
ELECTRONICS
RADIO - TELEVISION - RADAR

NOW . . . at home in your spare time you can get the very kind of training and subsequent Employment Service you need to get started toward real earnings in one of today's brightest opportunity fields—TELEVISION-RADIO-ELECTRONICS. Now that Electronics is entering so many new fields, here is a chance of a lifetime to prepare to cash in on its remarkable growth.

DeVry Tech's amazingly practical home method enables you to set up your own HOME LABORATORY. You spend minimum time to get maximum knowledge from over 302 practical projects, using the same type of basic equipment used in our modern Chicago and Toronto Training Centers!

DeVry Tech Provides EVERYTHING YOU NEED . . .

—to help you master TV-ELECTRONICS. In addition to the home laboratory and easy-to-read lessons, you even use HOME MOVIES—an exclusive DeVry Tech advantage. You watch hidden actions . . . see electrons on the march. Movies help you to learn faster . . . easier . . . better.

LABORATORY TRAINING

Full time day and evening training programs in our modern Chicago and Toronto Laboratories are also available. MAIL COUPON TODAY for facts.

EARN WHILE YOU LEARN

DeVry Tech's practical training helps you toward spare time income servicing Radio and Television sets.

BUILD and KEEP Valuable TEST EQUIPMENT

As part of your training, you build and keep a fine Jewel-Bearing Vacuum Tube VOLTMETER and a 5-inch COLOR OSCILLOSCOPE—both high quality, needed test instruments.

EFFECTIVE EMPLOYMENT SERVICE

Get the same Employment Service that has helped so many DeVry Tech graduates get started in this fast-growing field.



"One of North America's Foremost Electronics Training Centers"

Accredited Member
of National Home
Study Council



DeVRY TECHNICAL INSTITUTE

CHICAGO 41, ILLINOIS



VACUUM
TUBE
VOLTMETER

5 INCH
COLOR
"SCOPE"

5-INCH
COLOR
OSCILLOSCOPE



21 INCH

Build and keep this BIG DeVry Engineered TV set—easily converted to U.H.F. (DeVry offers another home training, but without the TV set.)

✓ CHECK
*These Exciting
Job
Opportunities:*

- TV-Radio Broadcast Technician
- Color Television Specialist
- Radar Operator
- Laboratory Technician
- Airline Radio Man
- Computer Specialist
- Quality Control Manager
- Your Own Sales & Service Shop
- . . . PLUS MANY OTHERS

MAIL COUPON TODAY!

DeVRY TECHNICAL INSTITUTE
4141 Belmont Ave., Chicago 41, Ill., Dept. PM-2-Q

Please give me your FREE booklet, "Electronics in Space Travel," and tell me how I may prepare to enter one or more branches of Electronics.

Name _____ Age _____
PLEASE PRINT
Street _____ Apt. _____
City _____ Zone _____ State _____
2045 Canadian residents address DeVry Tech of Canada, Ltd.
626 Roselawn Ave., Toronto 12, Ontario

Would You Like to Make \$1,000⁰⁰ a Month?

That's what Stanley Hyman
has made selling the
amazing new PRESTO
Fire Extinguisher



STANLEY HYMAN

All over the United States, more and more men and women report large profits from introducing the new Presto Fire Extinguisher. And no wonder! 11,000 people died in fires last year! Over half were women and children! Civilian defense authorities have said that in the event of atomic attack regular fire-fighting forces will be fighting large fires and that the people must be equipped to take care instantly of the little fire that might so easily become a big one. So an eager public has been waiting for a handy new kind of fire extinguisher—one without the drawbacks of large, bulky, expensive models. Now it's here.



Over 3 Million Prestos Already Sold!

Presto salesman H. J. Kerr reported making \$20 a day. William F. Wydallis—\$15.20 an hour. Peter Zuccaro, a beginner—\$169 in one week. And this report from Stanley Hyman: "I have been selling the Presto Fire Extinguisher for well over a year and have found it to be the fastest money-maker and quickest-selling item ever produced. If a man demonstrates it intelligently, sales follow automatically. "I have made an excellent living with the Presto Fire Extinguisher, having made over \$1,000 a month. Presto is a 'natural.'"

How You Can Make Good Money Too

You can make good money in this way too! Just start introducing this new kind of fire extinguisher to civil defense workers, owners of homes, farms, cars, boats, filling stations, buses, trucks, factories, offices, in your locality and to stores for re-sale.

The Presto is so light—so small—so handy—even a child can put out a blaze with it. So inexpensive (\$4.95) anyone can afford it. Yet its contents (a new wonder chemical developed during the war) have been rated 1.5 to 6 times as effective as other extinguishing agents on an equal weight basis!

Nationally Advertised

And what sales advantages for you—as compared with large, bulky extinguishers that cost 4 times as much and are 8 times as heavy! Presto is easier to use. No pumping—no heavy tank or tangled tubes to struggle with. Just a twist of the knob . . . and flames disappear as fast as 2 seconds!

Mail Coupon to Get Started

We give you FREE printed sales aids. You are not required to invest a penny. Get started now. Every day you hesitate may cost you \$10, \$15, or even \$50 you could otherwise be making. Mail coupon NOW for everything you need.

MERLITE INDUSTRIES, Dept. P-15K
114 East 32nd St., N. Y. 16, N. Y.

- Ends fire fast as 2 seconds
- Contents 1.5 to 6 times more effective on an equal-weight basis
- Weighs less than 1 lb.
- Fits in palm of hand
- Never corrodes or deteriorates
- Costs only \$4.95
- Guaranteed for 20 years

MERLITE INDUSTRIES, Dept. P-15K, Presto Div.
114 East 32nd St., New York 16, N. Y.

Please send me illustrated sales literature, liberal profit plan, order blanks—everything I need to start making good money introducing Presto to my area.

Name
(Please print plainly)

Address

City Zone No. State

IN CANADA: Mopa Co., Ltd., 371 Dowd St., Montreal 1, P. Q.

Great Pioneers in Science Do You Know Them?

—By James S. Thistle—

THIS MONTH'S PERSONALITY may be called a pioneer in the science of economics. His experiments with "peanuts" brought the South an income of \$60,000,000 in a single year. His scientific research produced flour, shoe-blackening and candy. He produced synthetic marble from wood shavings, dyes from clay, gum and starch from cotton stalks.

What is equally remarkable about this man is that he and his slave mother were bought for a \$300 race horse.

While head of the agricultural department at Tuskegee Institute, he revolutionized farming in the South by showing the people how to diversify their crops: plant peanuts, sweet potatoes, and soybeans besides cotton. He was awarded the Roosevelt Medal and doctor's degrees from two universities and was in a position to become wealthy but, while still alive, gave his life's savings to further his research toward the economic freedom of his fellow men.

*These letters, unscrambled,
spell the name of this
month's Great Pioneer
in Science:*

REVERERAGGCO

(First and Last Names)

Write the correct name here:

Now turn to page 247 for the answer.



VIRGINIA
"My 10th year and business keeps growing. Have made as much as \$485 in one day"
E. Roddey, Hampton.



CALIFORNIA
"Made as much as \$347 on just one job. You can't miss with Duraclean" ...
C. W. Morris, Sacramento.



SOUTH DAKOTA
"Earned \$1571 in a single month. Homeowners here have great need for our services" ...
L. Canaday, Rapid City

These Men are Building Lifetime Businesses!

ILLINOIS
"Have averaged over \$50,000 my first 3 years. Hqtrs' help make it possible"
M. Lyons, Chicago.



MINNESOTA "Averaging over \$300 per month part-time. Nothing beats being your own boss" ...
T. Mason, Winona.

NEW YORK
"National advertising is tops. One lead from Hqtrs' got me 3 jobs totaling \$500" ...
T. Cook, Freeport.



ARKANSAS
"Every person thinks of owning a business. I know of no other which can offer a man so much" ...
E. Bailey, Hot Springs.



6 WAYS TO MAKE MONEY

You get exclusive use of unique absorption process which cleans carpets and upholstery without harmful scrubbing, soaking or shrinkage. It's acclaimed by housewives, mfrs and backed by McCalls and Parents' Seals. Five other profitable services are soil retarding, mothproofing, flame proofing, spotting and carpet repairing. Thus, on most jobs you multiply profits. "Headquarters say gross \$9.00 per hour. I gross up to \$12.00. Many dealers I know do even better," says Dan Chilcott of N. Platte, Neb.

You, too, can make BIG MONEY IN THIS Booming Industry

IN YOUR TOWN, there's a real opportunity right now for you to meet the growing demand for cleaning of costly carpets and upholstery . . . services for which homeowners are ready to pay good money. Mechanical methods have proved to be harmful to fabrics, so the field is wide open with our exclusive, safe, scientific absorption method of cleaning. Have you investigated this opportunity? Thousands like those above have, and are now enjoying the financial security of their own business. Many have started part-time and so can you!

This business is easy to learn, and quickly established. There's no shop needed . . . you operate from home and provide all services in your customer's homes.



Since 1930 We'll train you, show you the proved methods for operating and building your own business, and then back you with 25 continuous services.

By starting now, you will be getting in on the GROUND FLOOR of a \$750 million a year industry!

WE HELP YOU GROW
Under our unique cooperative program, you are fully trained through a nearby dealer and at our 50-hour

training school. You're kept up-to-date through monthly magazines, nat'l conventions, and at regional meetings where Hqtrs' staff come to you in your area. You're backed by nat'l advertising in consumer (McCalls, Parents', House & Garden, etc.) and trade magazines. Others of 25 services which help assure your success include: Individual counseling (staff of specialists give you prompt, expert counsel), ad kits, folders, product development, plus others.

EASY TERMS Moderate payment establishes your own business—pay balance from sales. We furnish machines, sales material and enough supplies to return your TOTAL investment.



What Manufacturers Say
". . . (Duraclean) standards in keeping with service to which . . . carpets and consumer are entitled."
—Avisco (American Viscose Corp)
". . . superior to any on-location process with which I'm familiar."
—President, Modern Tufting Co.
". . . we approve this process . . . in keeping with better service to Mrs. Housewife."
—Alden Rug Mills

Send for FREE booklets
Free 16-page booklets detail dealership program. No obligations, no salesmen will call. Clip and mail coupon today.

"OWN A BUSINESS" COUPON

DURACLEAN CO., 0-162 Duraclean Bldg., Deerfield, Ill.
Please rush FREE 16-page booklets which detail-how I may own my own business. I understand I am under no obligations and no salesman will call.

Name.....
Address..... (please print)..... County.....
City..... State.....

DURACLEAN CO., 0-162 Duraclean Bldg., Deerfield, Ill.

DRAFTSMEN



**CASH BIG
PAY CHECKS!**

**Train Now for
more success,
greater security**

**LEARN AT HOME IN SPARE TIME
(or at college in Chicago)**

Check the want ads in any newspaper—SEE the big-pay opportunities open to you as a draftsman. What's more, you can learn this well-paid, prestige profession at home — quickly, easily! No special talent needed. Get complete, step-by-step Chicago Tech lessons in the mail, spend a few pleasant hours studying each week. In a short time you'll be a well-trained draftsman, ready to take your pick of many good jobs. Act now!



Free Information—Mail Coupon Today!

Get FREE TRIAL LESSON plus information about C.T.C. practical training. Learn what successful Chicago Tech graduates say about high pay and opportunities in drafting. No charge, or obligation.

CHICAGO TECHNICAL COLLEGE

B-218 Tech Bldg., 2000 So. Michigan Ave.
Chicago 16, Illinois

Mail me FREE lesson with facts about big opportunities in DRAFTING.

Name _____ Age _____

Address _____

City _____ Zone _____ State _____

MAKE GARDENCRETE G-4

**A Spare-Time Activity Can
Lead to a Full-Time Business**

On one compact, low price, easy-to-operate machine you can make 24 different kinds or sizes of Gardencrete for patios, walks, planters, barbecues, terraces, etc. Easily set up in shed or garage. With small investment, you can turn idle hours into profit and build into a full-time operation. Gardencrete enables you to cash in on large, growing demand for garden masonry in color.



\$1.00 worth of materials can be turned into \$5.00 to \$8.00 worth of Gardencrete. A cash-and-carry business. We supply full instructions. Complete information in full-color brochure. Write today.

COLORCRETE INDUSTRIES, INC.
704 Ottawa Ave., Holland, Mich.

Patio Stones
Flag Stones
Solid Brick
Hollow Brick
Roman Brick
Slump Brick
Cap Stones
Curb Stone
etc., etc.

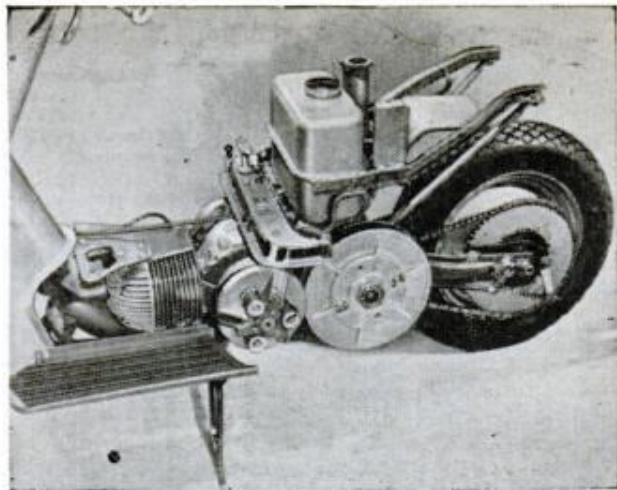

Harley-Davidson 1960 Line Features Lightweight Cycle

Harley-Davidson's 1960 line includes a new lightweight motorcycle, the Super-10, powered by a 10-cubic-inch engine, and an automatic transmission on its Topper motor scooter. The two-cycle engine on the Super-10, rated in excess of six horsepower, has a new intake and exhaust port designed for quick acceleration. The cycle is equipped with a waterproof ignition system and an alternating-current generator. The Super-10 features a three-speed transmission with constant-mesh gears. Each wheel has five-inch internal expanding brakes. The automatic transmission on the Topper scooter requires no shifting or clutching. Driving the rear wheel in the standard motorcycle manner is a roller chain that runs over a sprocket on the secondary sheave of the transmission and the sprocket at the rear wheel. The overall drive ratio varies from 18:1 in low to 6:1. The Topper also is powered by the 10-cubic-inch, two-cycle engine and delivers up to 100 miles per gallon. In the dual suspension system, the front wheel is suspended on a leading-link swinging arm. Rear suspension is by a pivoted rear fork, controlled by two adjustable extension springs. Among other features of the Topper is a parking brake lock located on the hand lever. Other vehicles in the line are Duo-Glides, Sportsters and Servi-Cars.

Harley-Davidson Motor Co., Milwaukee 1, Wisconsin



POPULAR MECHANICS

DON'T BE HALF-TRAINED! Be A Master Technician

NOW... ONE
modern master
home training course
IN ALL 3 PHASES



AIR CONDITIONING - REFRIGERATION ELECTRICAL APPLIANCES

**ALL AT ONE
LOW TUITION**
only National Schools gives
you this complete training
at no extra cost

YOU GET AND KEEP ALL THESE TOOLS AND INSTRUMENTS



Incomplete training limits your earning power, even disqualifies you for top-pay jobs. The big service companies require *complete*, all-phase training. If you open your own shop, you'll be called upon to service and repair *all* types of refrigerators, air conditioners and appliances. With *complete* training—as only National Technical Schools can give you—you can accept every job, make *big profits* all year round.

FUTURE BRIGHT FOR TRAINED MASTER TECHNICIANS

Over 30,000 new technicians must be trained annually. You are needed to help service and repair the 50 million air conditioners, refrigerators and electrical appliances that will need fixing this year alone. No wonder the Master Technician has steady work, at high pay, year after year. He can go places in his own business or with a manufacturer, dealer, distributor or department store. Armed with all-phase training, his earning power is unlimited.

JOB TRAINING AT HOME

You get Professional Tools, Precision Instruments, **PLUS** a Factory-Made **APPLIANCE TESTER!** A shop-full of **PRACTICAL**, professional equipment. Use them to conduct over 100 experiments... also in Spare Time Work and **ON THE JOB.** It is all yours to keep... no **EXTRA MONEY DEPOSITS**...no **EXTRA COST** on your equipment kits.

EARN AS YOU LEARN

We show you how. Many of our students pay for their entire course—and more—in Spare Time while learning. So can you. Graduate Advisory Service, too.



MEMBER



NATIONAL TECHNICAL SCHOOLS
WORLD-WIDE TRAINING SINCE 1905

4000 SO. FIGUEROA ST., LOS ANGELES 37, CALIF., U. S. A.

THE MOST FOR LESS

We give you illustrated Shop-Tested Lessons and Manuals...many other training aids...privilege of **CONSULTATION** with our instructors and engineers. Every lesson, every manual has been **SHOP** tested and approved.

**GET THE BENEFIT OF OUR OVER
50 YEARS EXPERIENCE**

**N.T.S. also offers training in
TV - RADIO - ELECTRONICS
and AUTO MECHANICS - DIESEL**

RESIDENT TRAINING AT LOS ANGELES

If you wish to take your training in our Resident School at Los Angeles, start **NOW** in our big modern Shops and Labs. Here you work with latest equipment...professionally installed... finest, most complete facilities offered by any school. Expert, friendly instructors. Personal attention. Graduate Advisory Service. Help in finding home near school...and part time job while you learn. Check box in coupon for full information.



**SEND FOR
FREE
BOOK AND
ACTUAL
LESSON NOW!**

We'll rush you our big, illustrated **OPPORTUNITY BOOK** and **ACTUAL LESSON**, show you how easily you can learn. **NO OBLIGATION**; no salesman will call. **Do it NOW!** It costs nothing to find out.

NATIONAL TECHNICAL SCHOOLS
WORLD-WIDE TRAINING SINCE 1905

MAIL NOW TO
National Technical Schools, Dept. CB-20
4000 S. Figueroa St., Los Angeles 37, Calif.
Rush **FREE** "Opportunity" Book and Actual Lesson. No Salesman will call.

NAME _____ AGE _____

ADDRESS _____

CITY _____ ZONE _____ STATE _____

Check here if interested **ONLY** in Resident Training at Los Angeles.

NEW-BRIAR PIPE DISCOVERY WILL YOU TEST SMOKE THIS DEMONSTRATOR AT OUR RISK?

Breaking in a new pipe is usually torture, but this "magic-cake" discovery will change all that. A nut sweet cake, specially built into the genuine imported briar bowl, makes this mellow beauty break in like a dream. You'll get dry, clean, sludge-free smoking, because the special construction of this wonderful pipe utilizes the 3 C's of Scientific Smoke Control — Combustion, Condensation and Capillary Attraction.

We've set aside a limited quantity of these imported briar beauties as Demonstrators. The bowls are "slight seconds" taken out of the regular production line before final smoothing and polishing, but they're guaranteed to smoke exactly like our regular top quality \$2.95 model.

Because we want to make new friends for this sensational new kind of briar pipe, we've written off the cost of these Demonstrators. Send us nothing for the pipe. Please send 25¢ to cover postage and handling.

All we ask in return is your good-will and word of mouth advertising if you like the pipe. Remember, the risk is ours, you can't lose. Sorry, only 1 Demonstrator to a family on this non-profit transaction. (Good in the U. S. A. only.)

PIPE 2/3 ACTUAL SIZE



WALLY FRANK Ltd. Dept. J110

132 Church Street, New York 7, N. Y.

I enclose 25¢. Send me the Demonstrator Pipe described above. Please Print Name and Address Below.

EARN \$125 A WEEK AND UP

BE AN AUTO-DIESEL EXPERT — LEARN A TRADE YOU LIKE

You learn fast in our shops because you learn with tools on real equipment. Students short of money may earn most of their expenses by doing part-time work. Experienced instructors explain WHY and show you HOW, then you DO IT YOURSELF. Forty years' experience training men. Successful graduates in 50 states and many foreign countries. Many of our graduates earn \$125 a week and up. Approved for veterans. Day and evening classes. Free bulletin-write today.
NASHVILLE AUTO-DIESEL COLLEGE
226 7th Ave., No., Dept. 86, Nashville, Tenn.

Air-Control System Could Track All Planes

Every airplane flying above the United States could be tracked—and thus warned of an impending mid-air collision or crash—by a new system devised by engineers of Lockheed Aircraft Corporation. It calls for installations in aircraft and on the ground. Each airplane would carry a small five-pound radio transmitter that would automatically and continuously send out, in all directions, coded pulses of altitude, identity and location information. On the ground, four receivers located in sectors which would be roughly 70 by 100-mile rectangles would pick up the signals and transmit them by microwave relay to a control center for that sector. The data—part of which is developed as the result of the receivers being located at widely separated points in the sectors—would be interpreted and then automatically and electronically displayed (radar displays similar information on screens).

Lockheed engineers say their system is comprehensive and fast. The controller can track more than 1000 aircraft in his sector, including those too small to be shown on radar screens today. Reports on position are obtained 10 times a second, and on altitude and identity 35 times a minute. A supersonic transport flying 3000 miles an hour, for example, would be positioned every 500 feet. Every aircraft equipped with a transmitter could be tracked at altitudes from 1200 to 100,000 feet. The system could also be used for intensive coverage down to almost zero altitudes on approaches to an air terminal. Transmitters would cost about \$200 each for private planes, \$500 for commercial and military aircraft. The system's developers say about 250 sectors would be enough to cover all major U.S. airways and that 700 would cover 48 states and provide high density coverage around major air terminals.

Launching Platforms to Moon May Be Built by Robots

Launching platforms for moon and planet expeditions may be built by robot men with television eyes and remote-controlled hands. Dr. Fred L. Whipple, of the Smithsonian Institution, says that such a robot would copy the motions of an operator. Its fingers would have feedback pressure so that the operator could feel objects being touched. Men in space suits will find it too dangerous to build the space platforms, according to Whipple.

ANOTHER WAY RCA
SERVES EDUCATION
THROUGH
ELECTRONICS

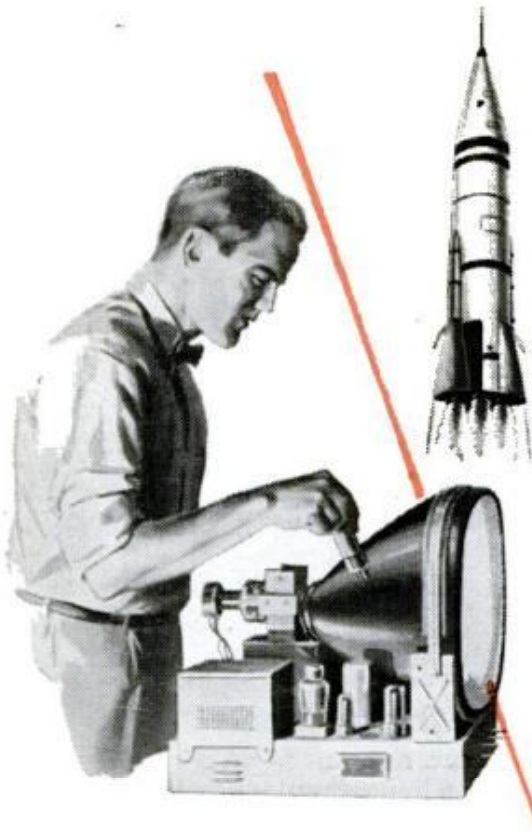

6 REASONS WHY RCA TRAINING IN ELECTRONICS can be the smartest investment you'll make in your *entire lifetime!*

1. You get the finest training-at-home under the supervision of the RCA INSTITUTES, experts in technical training for over 50 years. The very name "RCA" means dependability, integrity, and scientific advance.

2. You get comprehensive training in your choice of four complete, up-to-date Courses . . . from basic electronics theory to Color TV and Automation.

3. You get an evaluation of your aptitude for advanced training. RCA determines, for your benefit, whether you have the requirements for a career in the electronics field.

4. You get prime quality equipment as a regular part of your Course . . . equipment that you keep and use on the job. You never have to take apart one piece to build another.

5. You get each study group on a pay-as-you-go basis. Should you wish to interrupt your training at any time, you will not owe RCA Institutes a penny more, unless and until you decide to resume the Course.

6. You get top recognition — worldwide. Graduates of RCA Institutes now work for leaders in the electronics field; many have their own businesses. This record is true tribute to the high quality of RCA Institutes training.

Send for this
64-page Home
Study Catalog
FREE!

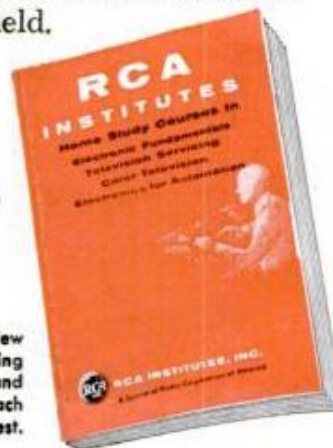

RESIDENT SCHOOL Courses in New York City offer comprehensive training in Television and Electronics. Day and Evening classes start four times each year. Detailed information on request.

RCA INSTITUTES, Inc. Home Study School PM-20

A Service of Radio Corporation of America
350 West Fourth Street, New York 14, N. Y.
Without obligation, send me FREE 64-page CATALOG on Home Study Courses. No salesman will call.

Name Age

please print

Address

City Zone State

Korean Vets! Enter discharge date

CANADIANS — Take advantage of these same RCA courses at no additional cost. No postage, no customs, no delay. Send coupon to: RCA Victor Company, Ltd., 5001 Cote de Liesse Rd., Montreal 9, Quebec
To save time, paste coupon on postcard.

NEW

way to train for BIG PAY!



The amazing new CTI Home Training Plan in Auto Mechanics is so practical it starts you earning spare-time money *in weeks*—makes you an expert mechanic *in months*! It is better written, more clearly illustrated, more understandable. It offers more up-to-date, usable knowledge. CTI also sends you Mechanic's Tools and Testing Instruments (Compression Tester, Ignition Timing Light, Vacuum Gauge & Fuel Pump Tester.) CTI offers you added training, free of extra cost, in Diesel Mechanics or Body & Fender Rebuilding. *Mail coupon for new booklet* which tells of America's need for 100,000 mechanics and 25,000 shops. Sample Lessons included. Act today!



COMMERCIAL TRADES INSTITUTE Dept. A1228
1400 Greenleaf Avenue • Chicago 26, Illinois
Send booklet, *Make Big Money in Auto Mechanics.*

Name _____ Age _____

Address _____

City _____ Zone _____ State _____

Accredited by National Home Study Council



General Electric Research Laboratory, Schenectady, New York

Manmade Diamonds

Diamonds are now made on a relatively large scale. The long-sought transformation of carbon to diamond became possible at the General Electric Research Laboratory by the use of a molten metal catalyst which acts as a thin film between the carbon and the growing diamond crystal. In the process, carbon and catalyst are placed in a pressure cell and subjected simultaneously to pressures ranging from 800,000 to 1,800,000 pounds per square inch and temperatures ranging from 2200 to 4400 degrees F.

ABSOLUTELY FREE!

Amazing 48-page
muscle-building
course, with
photos of
Champs! HOW
TO DEVELOP A



HE-MAN BODY!

TRADE IN that skinny, scrawny, milk toast body of yours for a jet-charged WEIDER physique — rippling with mountains of mighty muscle, oozing confidence and virility out of every pore! Now get my SENSATIONAL INTRODUCTORY MUSCLE-BUILDING COURSE — not for \$100, not for \$50 but **ABSOLUTELY FREE** if you act now!

Mail this coupon for your **FREE COPY**. See how easy it is to have a DYNAMIC HE-MAN BODY in just 15 minutes a day in your own home! Hurry, while offer lasts! Mail today!

JOE WEIDER, Dept. 38-20M
803 Palisade Ave., Union City, N. J.

Rush **FREE** Power-Packed Muscle Building Course. I enclose 10¢ for handling and postage. (offer limited to men over 16)

Name _____

Address _____

City _____ State _____ Age _____

In Canada: Write Joe Weider, 4466 Colonial Ave., Montreal, Que.



"Howard, you ought to see this blond stuff!"

POPULAR MECHANICS

LAW TRAINING for BUSINESS

[in spare time at home]

Earn LL.B. Degree



Thousands of men and women who never intend to practice are studying Law in spare time at home—not for a legal career but as an aid to business advancement.

Law today is involved in almost every major business decision. In many lines of work it is almost indispensable—credits and collections, accounting, traffic and transportation, employee relations, real estate, insurance, finance, taxation, etc. For all types of work, Law training develops keen, clear, quick, correct, and decisive thinking.

You can study LaSalle's American Law and Procedure right in the privacy of your own home—progressing as rapidly as your time and ability permit. LaSalle has, for over 50 years, helped more than 1,400,000 ambitious people get ahead in the business world. Thousands of letters in our files from grateful students and businessmen who have achieved greater success speak of—better jobs, more money and the satisfaction it brings, prestige and leadership.

A MOST UNUSUAL LAW LIBRARY

This training includes the fourteen-volume LaSalle Law library—AMERICAN LAW AND PROCEDURE, which is the basis of all the instruction service. This library has been compiled by leaders in the field of Law. It covers the whole basic field of Law in an orderly and simple manner that is easy to learn and understand. Collateral reading and printed lectures on legal problems which are furnished at regular intervals throughout the training, supplement the text. Law instructors personally supervise your program from the first assignment to the LL.B. degree or diploma. Under the LaSalle method you deal with legal problems—you learn by doing—actu-

ally solving legal problems—not just memorizing rules.

WRITE TODAY FOR TWO FREE BOOKS

You are determined to get ahead—to prepare for greater future possibilities—and to earn more money. Send the coupon below and find out how to qualify yourself for the many openings available to the Law-trained man. In our FREE books, "Law Training for Leadership" and "Evidence," you will find answers to all your questions about the study of Law and the LaSalle method.

No investment is likely to pay higher returns than an investment in yourself, by enrolling in the American Law and Procedure training. Send coupon today for full information—no obligation, of course.

ACCREDITED MEMBER, NATIONAL HOME STUDY COUNCIL

LaSalle Extension University

A Correspondence Institution

Dept. 264L 417 S. Dearborn St., Chicago 5, Ill.

Gentlemen: Please send me your two free booklets, "Law Training for Leadership" and "Evidence," which tell how I may study Law at home and qualify for the LL.B. degree.



Name.....Age.....

Street.....

City.....Zone.....State.....



It's GREAT to be TALLER

Why be Average?

ENJOY THE THRILL OF BEING TALL!

Now, at last, it's so easy to add all-important inches to your height! Just step into a pair of smart, comfortable "ELEVATORS" and instantly—you are almost 2 inches taller. You're a BIG MAN—with new poise and confidence—the kind of man she (and everyone else) is sure to look up to! "Big" men everywhere wear "ELEVATORS" with no one the wiser! "ELEVATORS" look just like other fine shoes—feel comfortable from the minute you put them on. Write TODAY for FREE booklet which tells what "ELEVATORS" height-increasing shoes can do for you. 34 handsome new styles illustrated. Give yourself a lift—mail coupon TODAY!



Styles for street, sport and dress

Mail Coupon Now

BE GREAT—BE TALLER

THE ORIGINAL AND GENUINE
ELEVATORS[®]
HEIGHT-INCREASING SHOES
"YOUR PERSONAL PEDestal"
© TRADE MARK OF STAN TAYLOR CO., INC.

BROCKTON FOOTWEAR, INC.,
Dept. 6-20 BROCKTON 68, MASS.

Please send Free Illustrated Booklet and name of nearest dealer. I understand that my inquiry will be held in strict confidence and that no salesman will call.

NAME _____ PLEASE PRINT

ADDRESS _____

CITY _____ STATE _____

LEARN TO EARN

HIGH WAGES

AS A HEAVY EQUIPMENT OPERATOR!



Secure a high paying future in the exciting construction industry today! Learn to operate bulldozers, draglines, cranes, back hoes, scrapers and motor graders on our actual construction projects!

- ONLY CONTRACTOR OWNED AND OPERATED SCHOOL IN WORLD
- ASSOCIATE MEMBER ASSOCIATED GENERAL CONTRACTORS
- MODERN EQUIPMENT
- V. A. APPROVED FOR G. I. TRAINING
- BUDGET PAY PLAN AVAILABLE

WESTERN NATIONAL
SCHOOL
OF HEAVY EQUIPMENT
OPERATION

WRITE TODAY
FOR FREE
SCHOOL
CATALOG

DEPT. B-1 BOX 510
WEISER, IDAHO PHONE 910



Hollis Company, 1133 Broadway, New York 10, N. Y.

Key-Chain Flashlight Weighs Less Than an Ounce

Weighing less than one ounce, a tiny flashlight that requires recharging once a month can be carried with you on a key chain. A small battery inside the flashlight is recharged by placing the light in an accompanying recharge box overnight. Shaped like a globe, the flashlight has an on-off switch that is connected to a chain and key ring.

"Hot" Waste Baked Into Bricks

Dangerous radioactive contamination around nuclear waste-disposal sites can be prevented by baking the "hot" residues into glasslike bricks. Scientists in the United States, Canada and Russia have reported good progress in perfecting the waste-disposal process.

Typical of the findings are those of Dr. James R. Oliver, chemistry professor at Southwestern Louisiana Institute. He said that he had mixed simulated reactor wastes containing cesium-137 and strontium-85 with sodium silicate or aluminosilicate powder and fused the mixtures into bricks. Samples containing nine percent or less of waste fused with aluminosilicate were un-leachable even with water at 190 degrees F. The process in which the dried, neutralized waste was mixed with powdered aluminosilicate and fused yielded the least leachable sample in the shortest time and at the lowest temperature. Mixing a neutralized solution of aluminum-containing waste with sodium silicate solution, then drying and fusing the mixture gave the easiest process to handle, but produced fused samples with slight surface activity which would have to be washed before storage.

Dr. Oliver said that the process still requires some long-term studies, though one sample containing 14.2 percent waste showed no leaching even after being subjected to water at room temperature for three months.

LET FACTORY EXPERTS GUIDE YOUR HANDS THRU ANY AUTO REPAIR QUICKLY-EASILY-RIGHT!

2,850
PICTURES
LIKE THESE SHOW
YOU HOW TO FIX
ANY PART OF
ANY CAR

Illustrated step-by-step manual is **GUARANTEED**
to make any auto fix-it job a breeze for you — or
you don't pay a single penny!

SUPPOSE you had an automobile factory engineer standing right beside you guiding your hands through every step of even the toughest car repair job!

That's what it's like when you use MOTOR'S famous AUTO REPAIR MANUAL, the "Bible" of auto mechanics from coast to coast. In detailed step-by-step instructions and crystal-clear "show-how" photos and drawings, the makers of 25 different automobiles give you their "tricks of the trade" for saving time, work, and money!

Eliminates Guesswork

You just can't go wrong because you are following the approved, recommended methods of the men who actually designed and built the cars. Nothing is left to the imagination. They tell you what tools to use, where to start, what parts to replace, how to finish the job fast.

Whether it's a simple carburetor adjustment or a complete overhaul, you just look up the problem in the giant Troubleshooter index, turn to the right page, and follow the easy instructions. Before you know it the job is done — and done right!

Turns Beginner Mechanics Into Experts Saves Experts Time, Trouble, Money

This big, new revised edition brings you the "meat" of 176 Official

Same FREE Offer on
MOTOR'S New Truck Manual
Brand new! Covers EVERY job on EVERY popular make gasoline and Diesel truck made 1952-1960. FREE 7-Day Trial.

shop manuals at your fingertips — engines, automatic transmissions, ignition systems, carburetors, fuel pumps, power steering, brakes, generators, distributors, dash gauges — practically every part of every popular American-made car, 1953 thru 1960.

Everything you need to know is simplified and illustrated in over 1100 double-size pages with 2,850 photographs and drawings. This huge book — almost a foot high — contains 225,000 service and repair instructions, plus 30,000 essential specifications and 195 "Quick-Check" charts for fast reference on the job!

**THIS GIANT 1,100-PAGE
MANUAL — ALMOST 1 FOOT
HIGH — SENT FREE
FOR 7 DAYS TRIAL**

Whether you're a beginner or expert mechanic, you'll find yourself breezing through jobs that you used to think were tough!

**SEND NO MONEY
— TRY BOOK FREE**

Enclose nothing with the coupon.

Pay nothing to the postman when he delivers your copy. Make the Manual prove what it can do for you by actually trying it for a week. Unless you agree that this is the greatest time and work saver that's ever come along, return it and owe nothing. Mail the coupon today! **MOTOR BOOK DEPT., DESK 012, 250 West 55th Street, New York 19, N. Y.** (Schools, Bookstores: Write for discounts.)

Covers All Models — 1953 thru 1960

Buick	Hudson
Cadillac	Imperial
Chevrolet	Jeep
Chrysler	Lincoln
Continental	Mercury
Corvair	Nash
Dart	Oldsmobile
De Soto	Plymouth
Dodge	Pontiac
Edsel	Rambler
Falcon	Studebaker
Ford	Thunderbird
	Valiant

3,000,000 USERS CAN'T BE WRONG!

Yes, three million copies sold. Used by
U.S. Army and Navy. Praised by beginners and experts.



"I amazed myself and my friends. Now do jobs that stumped me before," says beginner M. Baliczky, New Jersey.



"Paid for itself on the first two jobs and saved me valuable time by eliminating guesswork," says expert W. Schrop, Ohio.

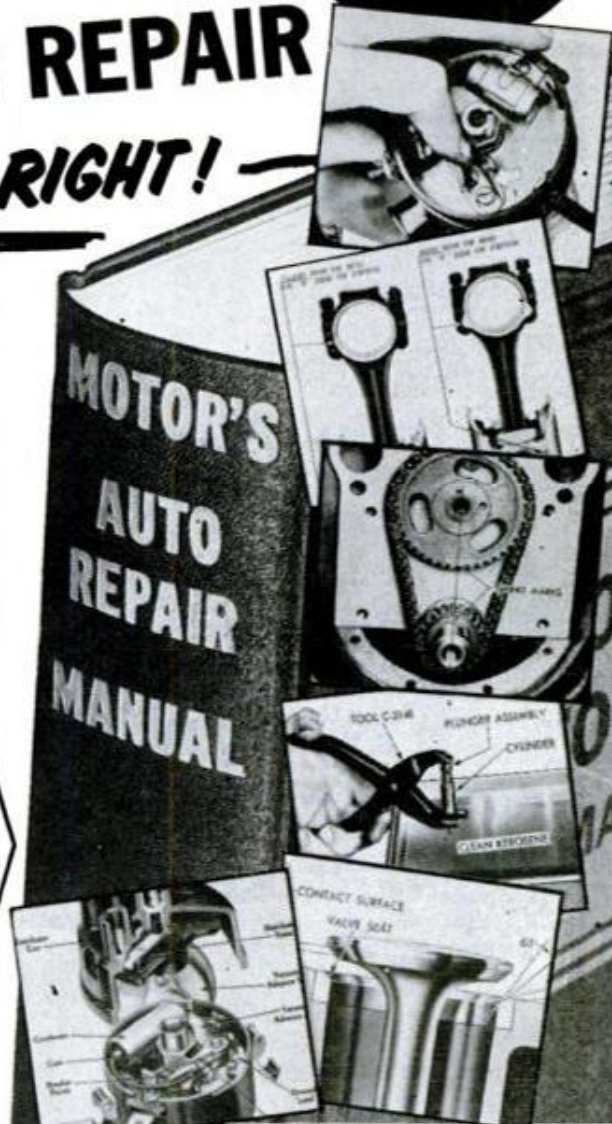

MAIL COUPON NOW FOR FREE TRIAL (Attach to postcard for fast action)

MOTOR BOOK DEPT.

Desk 012, 250 W. 55th St., New York 19, N. Y.

Rush to me at once (check box opposite book you want):

MOTOR'S New AUTO REPAIR MANUAL. If O.K., I will remit \$2 in 7 days, \$2 monthly for 2 months and a final payment of \$1.95 (plus 45¢ delivery charges) one month after that. Otherwise I will return the book postpaid in 7 days. (Foreign price, remit \$10 cash with order.)

MOTOR'S New TRUCK REPAIR MANUAL. If O.K., I will remit \$3 in 7 days and \$2 monthly for 3 months, plus 45¢ delivery charges, with final payment. Otherwise I will return book postpaid in 7 days. (Foreign price, remit \$11 cash with order.)

Print Name.....Age.....

Address.....

City.....Zone.....State.....

Check box and save 45¢ delivery charge by enclosing WITH coupon in envelope entire payment of \$7.00 for Auto Repair Manual or \$9 for Truck Repair Manual. Same return-refund privilege.

Pocket Transistor Radio

Mighty Midget
\$5.95



Low Price!
Smart Design!

Size of cigarette package, yet thrilling performance. Weighs only 3 ounces. Listen to music, news, sports, programs, etc. on your personal portable set. Modern plastic case, ivory and blue with gold metal grille. Complete broadcast band. On-off switch one end. Uses standard penlight cells (included). Guaranteed. Complete. ready for immediate playing.



\$5.95

JOHNSON SMITH COMPANY Dept. 873 Detroit 7, Michigan

Electronic Recorder

MAKE YOUR OWN RECORDS

Test your voice. Talk, Sing, Play. Immediate playback. Fun at home. Practical for office & school. Send records to friends. Make records from radio or TV. Play back favorites years later. Even conceal mike in another room! Makes 33, 45 or 78 rpm records (any speed). Set includes: Recording Unit (arm & electro-magnetic cutting stylus) which operates on any turntable, electric Studio Microphone, cutting needles & blank records. No wiring. Ready to use. Independent of phono circuit. Guaranteed.

\$14.95

Complete Set Postpaid Only . . . \$14.95
(Package of 5 Blank Discs \$1.98)

JOHNSON SMITH COMPANY Dept. 873 Detroit 7, Michigan



Portable Radio Transmitter \$198

NEW GOVERNMENT SURPLUS AT
FRACTION OF COST

Lightweight wireless transmitter. Broadcast from home, field, auto or boat. Use for remote control models, experimental electronics, etc. Weighs about 5 oz. Brand new. Portable. Completely wired. 2 tube (included). Adjustable frequency. With collapsible 14' aerial. Range up to 50 miles. Uses standard batteries (not included). With carrying case. 7x5x3". Limited quantity. Parts alone worth many times price.

2 for \$3.75. 4 for \$6.95.

EACH POSTPAID **\$1.98**

JOHNSON SMITH COMPANY
Dept. 873 Detroit 7, Michigan

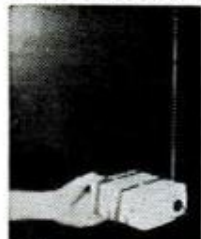

Catalog of 2900 Novelties 10c

New Send 10c for amazing catalog of novelties, live animals, scientific supplies, hobbies, funmakers, planes & boats, looms, magic tricks, joke articles, unusual seeds, gadget time-savers, cameras, optical goods, projectors, movies, lucky jewelry, religious novelties, disguises, musical instruments, stamps, coins, puzzles, fortune tellers, radios, auto & bike accessories, telescopes, magnifiers, compasses, banks, smokers' gadgets, artists' supplies, printing sets, engines, motors, shockers, knives, billfolds, guns, rifles, sports, books, games, plants, etc. Send 10c.

JOHNSON SMITH COMPANY Dept. 873 Detroit 7, Michigan

Starting Gear Aids Sprinters

Leaning over the starting line, ready to drop the handles and spring away at the starting signal, the white-clad sprinter on the left is using new starting equipment developed in Germany. Since the runner's feet remain behind the line, the device is within Olympic rules, and gives the user the advantage of about 2¾ inches over a runner starting from the traditional position demonstrated by the dark-shirted runner. In short-distance sprints that small advantage makes a big difference.

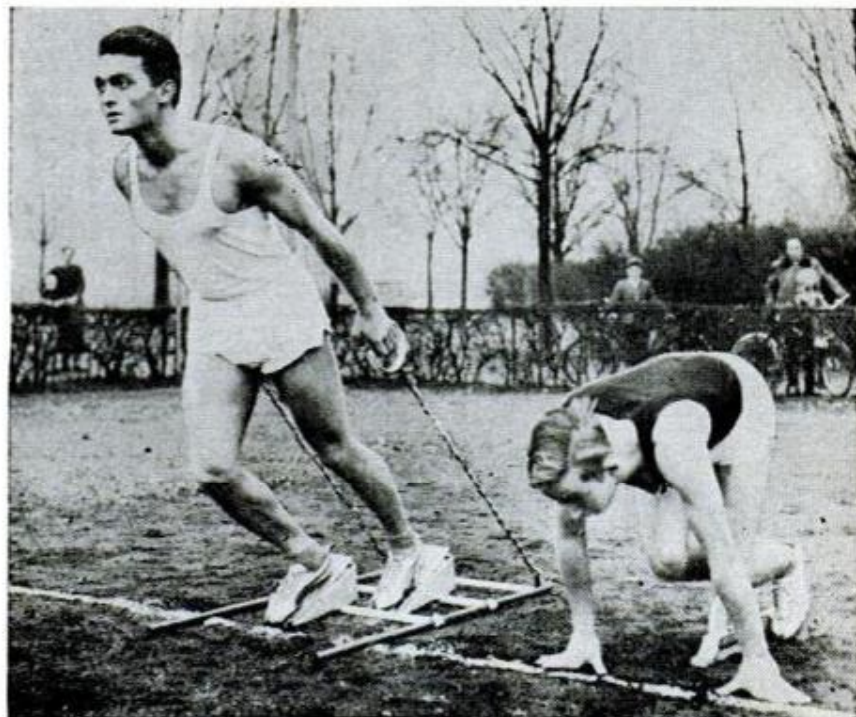



FREE

MUSCLE BUILDING INFORMATION

Sensational New Methods
Less Time—Less Effort—Better results
BODY-TONE, Box 638, North Miami 61, Fla.

FIND THE WOOD STUD IN YOUR WALL WITH A FORD DOWSER BALL



Indispensable when hanging pictures, mirrors, shelves; and when making alterations. The original Stud Finder. **YOU MAY NEED ONE TOMORROW!** The roll of the ball finds the actual STUD in the wall.

NO MAGNETS!

Only \$2.00 ppd. Money-back guarantee; no C.O.D.'s please. Usual trade discounts to dealers.



FORD PRODUCTS Dept. P-9 PORT CHESTER, N.Y.

\$2.00
POST PAID

Finish HIGH SCHOOL AT HOME

Complete 4 Yrs.  in 12 Months

Learn More! Earn More! Enter professional or technical schools. Advance Socially. Live a Happier, Fuller Life. Individual Courses or complete schedule. **WRITE FOR SCHOOL BULLETIN.**

ACADEMY FOR ADULTS
30 W. Washington, Dept. PM-260 Chicago, Ill.

POWER TOOLS MAKE YOUR WORK EASY

BECOME AN EXPERT IN TRAFFIC and TRANSPORTATION

Traffic men earn \$4,000 to \$10,000 and up. Thousands of firms need experts on rates, tariffs, regulations. We train you thoroughly in spare time at home for executive traffic jobs. Personal training under traffic authorities. Write for free book "Traffic and Transportation."

LASALLE Extension University, 417 So. Dearborn St.
A Correspondence Institution Dept. 264T Chicago 5, Ill.

Get into ... PLASTIC LAMINATING AT HOME!

Sensational New
**"ONE MAN
BUSINESS"**
..pays \$10 to \$20 profit
for each dollar of cost.

Make Up to \$5 an Hour by
our **MAGIC MAIL PLAN**... get
orders and cash from your mailman!



Here's the newest and most fascinating of all home-operated businesses. For the first time, a simplified machine brings the fabulous profits of Plastic Sealing and Plastic Laminating within the reach of the small operator. Can be

operated in a corner of the kitchen, basement, or garage. And any man or woman, regardless of age, education, or experience—can learn this interesting work in a few minutes of reading—can turn out professional jobs after one hour's practice.

TWO EXCITING FIELDS FOR BIG PROFITS!

No house-to-house canvassing. No face-to-face selling. We not only supply the equipment you need for the work, but also show you exactly how to cash in big daily profits from two big demand fields.

A FORTUNE IN PLASTIC SEALING

Millions of people want to protect valuable cards, photographs, documents and papers against wear, soil, and damage. By our MAGIC MAIL Plan you get this business through the mails. Open envelopes and take out money and orders. Details of this plan will amaze you. It will be sent free. Just mail coupon.

ENORMOUS PROFITS IN LAMINATING

A creative, artistic business. Gift shops sell your entire output. Just a few of thousands of giftwares illustrated on this page. Beautiful colors. Endless designs. Exclusive "one of a kind" appeal brings sales at ten to twenty times the cost of materials. Beautiful illustrations and instructions for making these artistic novelties sent free.

The opportunities in Plastic Laminating are so big that space here does not permit even skimming the surface. To get any idea

FREE at all of the size of these markets and your place in this sensational business you must read the details. See for yourself how easy it is to do the work—how you can put plastic sheets into your machine and take out a fortune—how money and orders come to you in the mail—how gift shops clamor to get more and more of your creations—how you can start with one machine and build up a big production plant with others doing the work—how you can get money and business from every State in the Union—how you can achieve independence without study or experience.

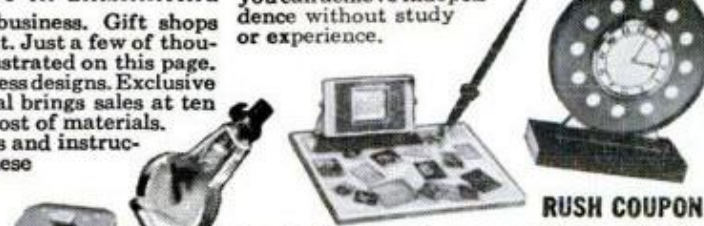

**NO MONEY—
Just Send Name!**



Never before has such an opportunity been offered the small, home-operator—an opportunity to gain complete personal independence in a big money business of your own. Don't lose a minute. Get the facts at once. All information, fully illustrated with pictures, is free. Send the coupon—or send your name and address on a postcard. There is no charge now, or at any other time. Send for the information on this exciting opportunity today.

Cash Money Comes to You in the Mail

By our MAGIC MAIL Plan you sit at home, send out mail, and get back money and orders. Additional profits in supplying lifetime protection for **SNAPSHOTS—IDENTIFICATION CARDS—DISCHARGE PAPERS—DRIVERS' LICENSES—SOCIAL SECURITY CARDS—VOTERS REG. CARDS—MENUS—BIRTH CERTIFICATES—CREDIT CARDS—BIRTH AND WEDDING ANNOUNCEMENTS—PASSES—DOCUMENTS.**

Lifetime protection. See how laminating prevents soiling, wear, and moisture damage with flexible, plastic covers.



WARNER ELECTRIC CO.
1512 Jarvis, Dept. L-2-B Chicago 26, Illinois

Thousands of Beautiful ART CREATIONS
Made by Laminating as explained in our Free information. Send coupon for list and pictures of **COSTUME JEWELRY—JEWELS—CIGARETTE BOXES—CUFF LINKS—NOVELTY BUTTONS—TRAYS—CANDLESTICKS—COASTERS—CLOCK CASES—LAMP BASES—PICTURE FRAMES—BOOK ENDS—CHARMS—ADVERTISING SIGNS—NAME PLATES—BELT BUCKLES—CHECKERS—PAPER KNIVES—CHESSMEN—BOOKMARKS—TIE RACKS—KEEPSAKES OF ALL KINDS.**

WARNER ELECTRIC CO., Dept. L-2-B
1512 Jarvis Avenue, Chicago 26, Illinois

Please mail, postage prepaid, complete information with illustrations showing the things I can make and the money possibilities in Plastic Laminating. All this is free. No Salesman is to call. Also, tell me how I get orders and money from my Postman by the MAGIC MAIL Plan.

NAME _____
ADDRESS _____
CITY _____ ZONE _____ STATE _____

Free! SCARCE TRIANGLE COLLECTION



Start TODAY to enjoy an exciting new hobby! Get this big, valuable collection of gorgeous, multi-colored triangle shaped postage stamps . . . brought to you from strange and mysterious lands in the wilds of Africa, enchanting Europe, exotic Latin America, etc. All genuine, all-different—picturing man-eating reptiles, jungle birds, action-packed sports, ancient clipper ships; PLUS scarce airmails, fabulous commemoratives, giant and midget-sized stamps. EXTRA! Bargain Catalog, "Collector's Manual" plus other exciting offers for your inspection. Enclose 10c for mailing costs. Supplies limited. ACT NOW!

JAMESTOWN STAMP CO. DEPT. H20PM JAMESTOWN, N.Y.

RUSH my Free "Triangle" Collection and other offers. I enclose 10c for mailing costs.

Name

Address

City & State

on any object **ELECTROPLATE**
ANY OBJECT IN HOME SHOP GARAGE.

NOW with our NEW ELECTROCHEMICAL Outfit. You can easily do your own plating with same LUSTER and DURABILITY as by more expensive equip. Outfit comes completely ready to start plating immediately. With instructions on plating metal & non-metal objects as Tools, Auto Parts, Silverware, Jewelry, Baby Shoes, 1001 other articles with COPPER, CHROME, NICKEL, GOLD, etc. SEND NO MONEY. Everything sent C.O.D. for low price of ONLY \$5.95 or send \$5.95 now and receive it postpaid. Money back in 7 days if not satisfied. M.Z. Sales Co., Dept. G-31, 113 W. 42nd St., N. Y. 36, N. Y.

GET THE HABIT OF READING OUR CLASSIFIED ADS.
Wonderful Opportunities Amazing Bargains

LEARN TO OPERATE or REBUILD EARTH MOVING EQUIPMENT

Complete Mechanics Course covering Diesel engine transmissions; torque converters; fuel injection systems; track assemblies; final drive assemblies; steering systems; idlers; rollers; power transfer systems; cable control systems; hydraulic control cylinders & welding pertaining to heavy equipment such as bulldozers, scrapers, loaders, off-highway trucks, etc. Course time—540 hours —10 weeks to 13 1/2 weeks. Convenient payment plan. Write for details. Approved for vets and civilians

OPERATORS COURSE
Learn to operate bulldozers, cranes, motor scrapers, crawler tractors, draglines, off-highway dump trucks, etc., on 1,700 acre Greer Training Area 60 miles S.W. of Chicago, Ill. on Route 66. Courses include operation, equipment care, preventive maint., stake reading, etc. Minimum classroom instruction. You learn by actually operating the equipment. 200 hour (5 week) complete course in the operation of bulldozers, loaders, scrapers, dump and off-highway trucks as low as \$375. Classes start every Monday. Reserve your space today. Approved for vets and civilians

Greer TECHNICAL INSTITUTE
ATT: P. N. Hutch, Box 278, Braidwood, Ill.

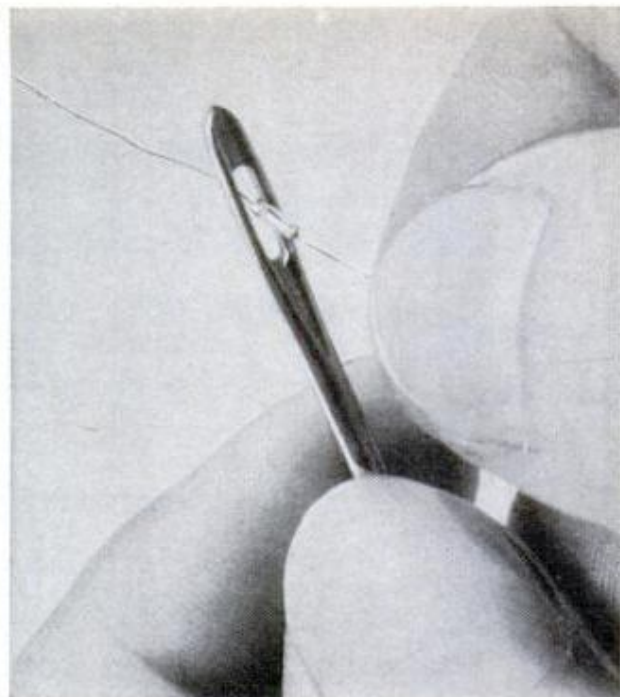

Sylvania Electric Products, Inc., Salem, Mass.

Incandescent Lamp Passes Through Needle

Small enough to pass through the eye of a darning needle, a new incandescent lamp has a filament less than one-tenth the diameter of a human hair, yet glows brightly enough to be seen in a well-lighted room. The body length of the microminiature Sylvania lamp is .125 inch, its diameter .040 inch. Now being produced in quantity, the lamp is expected to find application in transistorized circuits in missiles, computers and electronic systems. Requiring low current and voltage, it can be operated directly from the output of a transistor.

Insects Build Resistance To Modern Insecticides

Insects appear to be winning the battle to keep them in check, despite the \$500 million spent each year on their control. Resistance to insecticides is now virtually nationwide and only two states, Montana and Wyoming, are free of insecticide-resistant insects, according to Fairfield Chemical Division of Food Machinery and Chemical Corporation. Some chemicals introduced as recently as three years ago are already less effective in many parts of the country, the firm reports. Resistance can take many forms. Some are: slow rate of absorption which prevents the insect from getting a lethal dose of insecticide; enzymatic changes that render the insecticide harmless; storage of the insecticide in non-sensitive parts of the insect's body; or avoidance of the insecticide by change of normal habitat by the insects.

Uranium

"Let Him Down" to Success!

LIKE many another young American, Edward Walls was doing all right, in a moderate way, when the uranium bug bit him a couple of years ago.

And thereby hangs a mighty interesting tale.

Ed was a barber and hairdresser by trade. He operated a small shop in a Colorado city—and in his shop he heard glowing reports of overnight fortunes being made in uranium, the wonder-metal of the Atomic Age.

"If others can get rich fast in the uranium game, so can I," he thought. The more he pondered, the more alluring the Big Idea—uranium—seemed.

So he sold his little shop, packed up his belongings and, with his young family in tow, struck out for Utah—the new Golconda! Or, so he imagined it to be.

A few months later, his disillusionment was complete. He hadn't made his quick million. He hadn't even made an impressive start. Despite his hard work at a precarious job with a firm engaged in uranium reduction, the cold fact was that he was broke—and likely to stay broke.

Refused to Stay Beaten

But Ed Walls isn't the type of man who "chickens out" of life's problems. Discouragement had him down, but he was far from out!

His thoughts kept turning to an old friend of his, back in Colorado, who had bought a Rug Deterger machine some time before from the Von Schrader Manufacturing Company, 210 "R" PL., Racine, Wisconsin, long-established maker of high-quality rug-cleaning machines and equipment. This friend had grown tired of working for somebody else, and had set himself up—with no previous experience and with only a small financial stake—as an independent businessman.

"And," mused Ed, "he is doing all right for himself. He is no smarter than I am. Why can't I do the same thing? All over town there are homes with rugs just itching to be cleaned!"



Edward Walls

So enthused did he become over this idea that he telephoned the company to arrange for the purchase of a machine and supplies, and to discuss ways and means of making the most of his opportunities for money-making in the rug-cleaning business.

Small Loan Aids Fresh Start

Once his mind was made up Walls' next job was to borrow the small amount of money he needed to get started. "I found out that it's tough to borrow even a little dough when you're broke," he said. But, somehow, he *did* get the money and, with it, the machine.

"Believe it or not," Ed says, enthusiastically, "two weeks after I got my equipment and started using it, I was able to pay back the money I had borrowed—interest and all! And I was really amazed how easy it was to get work to do. One satisfied customer would tell a friend, and that friend would tell another friend. You'd think every rug in town needed cleaning—and that wouldn't be far wrong."

Ed has grossed as much as \$548 in a single week since he started his own business. Some months he takes in up to \$1400. Needless to say, the Walls family isn't going hungry these days.

Plans Larger Success

At latest report, Ed Walls is setting up a training program for young men in his town. He plans to add new machines to his equipment as fast as he can train these young men to operate them and represent him throughout the area.

"A year or two from now," he says, "I hope to have a *real* success story to tell. Things are better for me than they have ever been. My dreams of making a fast million in uranium never materialized—and actually I'm glad, for they forced me back to earth, where I can deal with real people and give them a real service that I'm proud of. And I'm happier that way, in addition to making a very, very good living out of my very own business."



Clubs, Banks, Hotels and Institutions of various kinds are regularly serviced by Mr. Walls.



Mr. Walls is shown here cleaning the carpets in the home of one of his many wealthy customers.

Turn your spare time into \$\$\$

WATCH REPAIRING



Learn this profitable trade at home the Sweazey Way

Opportunities now for full or part time earnings in watch repairing are the best in years. Unique Sweazey System teaches you at home step by step how to repair all types of American and Swiss watches. Professionally prepared training from recognized trade school, established 1908. You learn modern shop methods. Special tools provided for practice. No previous experience needed. Age is no barrier. Diploma awarded. Tuition is only \$5 a month. Send for **FREE SAMPLE LESSON** without obligation. No salesman will call.

CHICAGO SCHOOL OF WATCHMAKING

2330 N. Milwaukee Ave., Dept. 120, Chicago 47, Illinois

MAIL COUPON TODAY!

Chicago School of Watchmaking
2330 Milwaukee, Dept. 120, Chicago 47, Ill.
Rush **FREE** sample lesson and full information on home study training in watch repairing.

Name Age
Address
City Zone State

**FREE
SAMPLE
LESSON**

EAT ANYTHING WITH FALSE TEETH

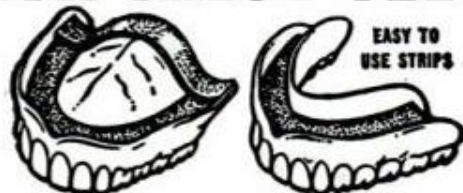

Trouble with loose plates that slip, rock or cause sore gums? Try **Brimms Plasti-Liner**. One application makes plates fit snugly without powder, paste or cushions. **Brimms Plasti-Liner** adheres permanently to your plate; ends the bother of temporary applications. With plates held firmly by **Plasti-Liner**, **YOU CAN EAT ANYTHING!** Simply lay soft strip of **Plasti-Liner** on troublesome upper or lower. Bite and it molds perfectly. *Easy to use*, tasteless, odorless, harmless to you and your plates. Removable as directed. Money-back guarantee. At your drug counter. \$1.50 reliner for one plate; \$2.50 for two plates. **Plasti-Liner, Inc.**, Dept. PM-6, 1075 Main Street, Buffalo 9, New York.

BRIMMS PLASTI-LINER
THE PERMANENT DENTURE RELINER

Exhaust Heat of Rocket Becomes Electric Power

Direct conversion of the heat of a rocket exhaust into electric power to run the vehicle's steering controls is the job of a new electronic generator which has no moving parts. The device, a developmental RCA tube of the type known as a thermionic generator, has already produced up to 270 watts of power directly from a high-temperature heat source—a Thiokol solid-fuel rocket motor. This is an output of nearly 80 watts per pound of its 3½-pound total weight. The generator could power the steering mechanism of the rocket as well as the guidance, telemetering and related electronic equipment throughout the operating life of the rocket motor.

The present experimental RCA tube has the form of a hollow cylinder that slips like a sleeve over the rocket-flame tube through which the burning fuel passes. A cathode is formed by the inner wall of the hollow cylinder, while a second electrode is formed by the outer wall. Between the walls is a narrow space filled with cesium vapor. When the cathode wall is heated, electrons "boil" out of the cathode material into the space between the walls. The cesium vapor becomes ionized upon contact with the hot cathode, and encourages the easy flow of electrons to the outer wall. The electric power that is generated is fed to the rocket steering apparatus by cables attached to the cathode and second electrode.

Irradiated Bones Preserved for Grafts

Radiation-sterilized bone from deceased persons is now being preserved in the first atomic age bone bank in western United States. The bone is kept in a freezer at the University of California at Los Angeles until needed to help repair the bones of the living.

Only relatively small pieces of bone are taken. Specimens are quick-frozen and air-expressed in dry ice to the Massachusetts Institute of Technology where they're irradiated under a three-million-volt Van de Graaf cathode-ray generator. This process sterilizes bone pieces without damaging their ability to function as grafts. Next, the bones are returned to UCLA and stored at subfreezing temperatures for a maximum of six months. Grafts of preserved bone promote union in fractures that have not healed, fill cavities in bones from which cysts and tumors have been removed, bridge and fuse weak joints and support the bones of children who have been born with deformities.

New PROFIT-PROVEN* Home-Business!

"I make \$400⁰⁰ a week!"



*Proves
Mr. J. T. Anderson,
Inglewood, Calif.

(Notarized statement on file in our office and open to inspection.)



and READ what others are saying about Screen Print

"My first attempt at Screen Printing netted me \$40.00."
J.R., Canada

"I would not take \$1,000 for it right now. Just what I have been searching the world over for" - C.S., Nevada

"Wonderful new method...made \$80.00 first week...swamped with orders."
R.T., Florida

"Screen Printing is nothing less than fascinating"
S.M.D., Mass.

MAKE BIG MONEY, TOO—printing without a printing press! Learn the secrets of this new MIRACLE PRINTING METHOD . . . build a Big-Pay Business, SPARE or FULL-TIME, right in your own home. Never before has there been such a golden opportunity to turn pennies into dollars in profit! — to build a successful, prosperous future easily, quickly, and enjoyably—AT HOME

WHAT IS SCREEN PRINT? It's a new, fascinating technique—so amazingly simple and economical it may soon revolutionize the printing industry! Imagine—after only a few short days, you may print many beautiful professional jobs for LESS THAN IT WOULD COST ON A \$5000 PRINTING PRESS!

SCREEN PRINTING IS FUN . . . EASY! If you like to work with your hands and make beautiful things, you'll find no Home Business that provides greater enjoyment, relaxation, and PROFIT. You'll enjoy every moment . . . creating beautiful printed material that may sell for really BIG MONEY!

NO EXPERIENCE OR COSTLY EQUIPMENT NEEDED! Few home businesses offer such BIG PROFITS for so little time, money, or training! You don't need art ability, expensive equipment, or previous experience! You start at home with little or NO OVERHEAD. Yet you can print—almost immediately—on PAPER, GLASS, LEATHER, CLOTH—ANYTHING! Work with all colors, even the vibrant new FLUORESCENT "Glow Colors" that are in such big demand in advertising circles! It's amazing—but true!

START SPARE TIME—ON A "SHOESTRING"! Use your spare time to earn up to \$12.50 per hour, right from the start. Earn 2 INCOMES INSTEAD OF ONE. Print in your garage, basement, spare room—anywhere! Screen Printing requires little space—won't interfere with your household set-up. Later, when you see the TREMENDOUS PROFITS to be made, you may wish to make Screen Printing your full-time occupation. Become your own boss—make BIG MONEY! Others are doing it—why can't you?



HELP FILL THE HUGE, GROWING DEMAND! Businesses in every city, every community have learned—almost "overnight"—of the amazing quality and economy of MIRACLE Screen Printing! You save them up to 50% on many jobs—yet you make up to 500% profit! When the word gets around people come to you—no selling necessary! Because this sensational printing discovery is so new, many Screen Printers sell exclusively by mail!

WE SUPPLY EVERYTHING YOU NEED! Every secret, enough materials to start making money almost immediately can be yours! Never before has such a wonderful "profitability" been offered to anyone desiring to start a profitable spare or full-time business of his own! We guide you every step of the way with our Personal Counseling Service & Home Business Plan . . . explain how we have helped others, and how we can help you, too! All the CONFIDENTIAL, money-making facts are yours if you MAIL COUPON today—while there's still time for you to get in on the ground floor!



PRINT WITHOUT A PRINTING PRESS!
OR ANY SPECIAL EQUIPMENT



Print Beautiful CLOTH, FABRICS, GLASS JARS, NOVELTIES, etc., at home!

MIRACLE Screen Print lets you print on all surfaces, all materials—a big advantage over regular print shops. You provide a service offered only by Screen Printers — may have the entire field to yourself!



PRINT expensive Posters, Banners, Labels, Signs, at home!

Realtors, Political Candidates, business firms, many are discovering that Screen Printing is the best answer to their needs. Be the first in your area to fill the huge demand!



PRINT Colorful ADVERTISING DISPLAYS at home!

Stores, markets, gas stations, theaters—all businesses need eye-catching displays. Ordinary printers simply can't compete, price-wise, with Screen Printers, on many jobs!

Free! COMPLETE REVEALING DETAILS, Authentic Samples, Proven Big-Money Opportunity Plan, Large Illustrated "How To" Booklet.



Screen Print, Dept. 22, 15127 So. Broadway, Los Angeles 61, Calif.

Learn the Secrets - RUSH COUPON TODAY!

SCREEN PRINT CO., Dept. 22
15127 S. Broadway, Los Angeles 61, Calif.

Gentlemen: Please mail me Free Revealing Details, samples, Opportunity Plan, etc.—All this is sent absolutely Free and sent to me by return mail, I am under no obligation now or ever.

Name _____

Address _____

City _____ Zone _____ State _____

make it with 60c worth of sand & cement!
SELL IT FOR \$2000
 every home a prospect for these "LIFETIME"

CONCRETE INCINERATORS

Make big profits manufacturing rust proof, fire proof, almost indestructible concrete incinerators in your own backyard or garage... full or part time. Sell to home-owners, hardware, department and garden supply stores. Phila. manufacturer doing big volume with Sears, Roebuck; large department stores. Easy to follow instructions and all needed equipment supplied. Exclusive protected franchise—No competition! Territories going fast. Write immediately for full details.



Dept. PM-260, T. C. TOR
 318 Rancocas Ave., Delanco, N. J.

Gentlemen:

Rush full information about your concrete incinerator protected franchise offer.

Name _____

Street No. or R.D. _____

City _____ Zone _____ State _____

GOVERNMENT OIL LEASES LOW AS \$1 PER ACRE

You do no drilling, pay no taxes, may realize a king-size profit without ever leaving home. Write for free map and literature.

AMERICAN OIL SCOUTS, Dept. PM
 8350 Santa Monica Blvd. Los Angeles 46, Calif.

BUILD YOUR OWN MIDGET ROADSTER \$25 BUILDS BODY & FRAME



IT'S EASY TO BUILD A PONY ROADSTER or Pick-Up in few spare hours. Uses 2 hp engine, 450 lb. loads, 70 m.p.gal., plenty of speed. Great for kids, sturdy utility car. Designed for VERY LOW COST assembly from PARTS BOUGHT IN YOUR NEIGHBORHOOD. Use home tools. COMPLETE step-by-step plans, 17 large-size pages, 30 "show-how" photos. Body templates, complete material. ORDER NOW. ONLY \$2.95 postpaid.

parts list and hood insignia. Satisfied or money back.

PONY PLANS, Dept. 32, 100 S. VERMONT, LOS ANGELES 4, CALIF.

engineering degree in 27 months

Share rewards awaiting college men... higher income... advancement. Important firms visit Tri-State campus to interview seniors. Bachelor of Science Degree in 27 Months in Electrical Engineering (Electronics or Power major), Mechanical, Civil, Aeronautical, Chemical Engineering. In 36 Months a B.S. in Business Administration (General Business, Accounting, Motor Transport Management majors). For earnest, capable students. Small classes. More professional class hours. Well-equipped, new and modernized, buildings, labs, dorms. Modest costs. Year-round operation. Enter Mar., July, Sept., Jan. Founded 1884. Write J. E. McCarthy, Director of Admissions, for Catalog and "Your Career in Engineering and Commerce" Book.



TRI-STATE COLLEGE

420 College Avenue

Angola, Indiana

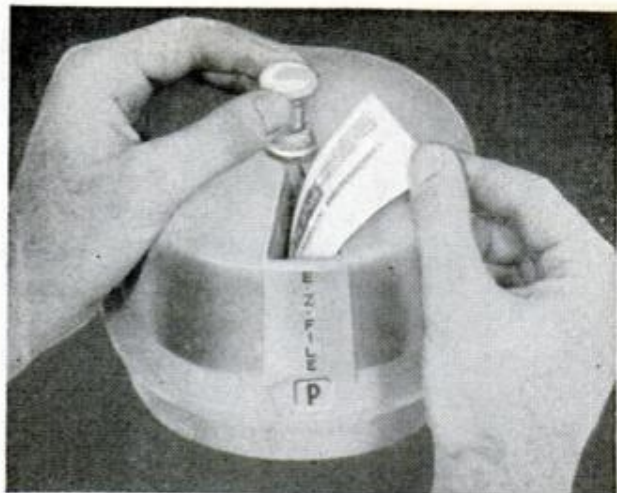

T & H Industries, 8328 Fishman Road, Pico Rivera, California

Plastic Container Files Business Cards

Time-consuming searches for business cards can be ended with a desktop file that alphabetically arranges as many as 500 cards. Cards slip into slots in the circular plastic holder and can be filed either by name or service rendered. When the card is needed, a selector knob is turned to the proper letter. A pull on the knob lifts the cards for easy access.

Carbon Dioxide Recovers More Oil

Carbon dioxide and carbonated water are superior tools in the secondary recovery of oil, according to L. W. Holm of the Pure Oil Company. An experimental investigation on oil-recovery efficiency of carbon dioxide has demonstrated this fact, he says. The use of relatively small quantities of carbon dioxide followed by carbonated water at pressures above 900 pounds per square inch resulted in oil recoveries that were from 50 to 150 percent greater than those obtained by conventional methods of operation.

Chromite Catalysts May Reduce Smog

Smog components have been reduced by using chromite catalysts at the Franklin Institute Laboratories. Nitrogen oxides, one of two main components of smog produced by automobile exhaust, have been reduced by more than 90 percent by counteracting the oxides with chromites and carbon monoxide. Under certain conditions, hydrocarbons, the second smog component, have been reduced by the same chromites. One present drawback to using the method to fight smog, says the Institute, is whether chromites can withstand lead poisoning in the exhaust, which would reduce their effectiveness.

HERE'S A READY-MADE FUTURE FOR YOU

MILLIONS OF HOMES IN U.S.
HAVE 6-12 SMALL APPLIANCES
MORE SOLD EVERY
YEAR - MILLIONS
NEED REPAIR NOW
WITH THE NEED
INCREASING
DAILY!

Start Your Own Business IN

ELECTRICAL APPLIANCE REPAIRING

EARN WHILE YOU LEARN

"Only had your course a few short weeks and have already made \$800.00."

J.D.S., St. Louis, Mo.

"I work day times at the shipyard and after 4:00 P.M. I operate from my cellar and garage. I average \$10.00 to \$15.00 clear every day."

W. H., Brookline, Mass.

"Make \$15.00 Saturdays and more. Am only able to operate in my spare time. It is just what a mechanically minded man needs." G.O.F., Thomasville, Ga.

3 EASY STEPS

- 1 We send you the "CHRISTY" Electronic Kit. A multi-purpose trouble tracer. Indicates current consumption, shorts, breaks, etc.
- 2 We teach you Electrical Appliance Repairing with cross indexed Illustrated Manuals. The Easy-to-Remember-Way.
- 3 We show you How to Get Business and Keep Business Coming to you.

IN YOUR OWN KITCHEN BASEMENT OR GARAGE

Learn at home in your spare time this fascinating, big paying profession.

If you are mechanically inclined, can hold and use tools, we can give you the training and time saving kits that will enable you to . . . Command

More Money At Work . . . A Better Paying Job Elsewhere . . . Or A Business Of Your Own! New Shop Method Home Training teaches you both the technical and practical side of Electricity by having you work with your hands Building, Testing, Repairing. All instruction manuals are written in easy-to-understand language, chock full of hundreds of detailed photos and drawings. We show you how to quickly locate the trouble, how to fix it and what to charge. ALSO, how to do House Wiring, Welding, Nickel Plating, Sharpen Lawn Mowers, Skates, etc. and how to build power tools you need from spare parts.

\$5.00 TO \$6.00 AN HOUR

Often charged for making ordinary repairs. We show you how to repair refrigerators, vacuum cleaners, washing machines, motors, irons, etc.

CHRISTY TRADES SCHOOL, Dept. A-8603
3214-16 W. LAWRENCE AVE. CHICAGO 25

SEND FOR FREE BOOK!

CHRISTY TRADES SCHOOL, Dept. A-8603
3214-16 W. Lawrence Ave., Chicago 25, Ill.

Please send me FREE Illustrated Book on Electrical Appliance Repairing and Special form for Paying Later from Earnings.

NAME _____ AGE _____

ADDRESS _____

CITY _____ ZONE _____ STATE _____





EARN BIG MONEY...

LEARN AT HOME IN SPARE TIME

You don't need previous training or art ability with the "Famous System of Manual Training!" With this modern streamlined method, you learn rapidly and easily...start to cartoon immediately, without tedious study or exercises.

Wide Demand for Cartoonists—Earn While You Learn... Magazines, newspapers, movies, television, ad agencies—all are searching for new cartoon ideas and talent. As a successful, Continental-trained Cartoonist, your earnings are not limited.

Many of our students start earning after first few lessons. A wonderful pastime, too.

We Supply Everything... As our student, you receive FREE of extra cost a big 15-piece Professional Kit containing all equipment and materials you need, and valuable Articulated Model that helps you draw any human pose.

Get All the Facts FREE... Big, colorful Free catalog gives all details plus pages of useful information. FREE for the asking. Use coupon.

*U.S. Pat. Applied For

Continental Schools, Inc.

4201 S. BROADWAY, LOS ANGELES 37, CALIF.

Continental Schools, Inc.
Dept. A-2, 4201 S. Broadway, Los Angeles 37, Calif.
Please rush me your Free Catalog and other information by return mail. No charge or obligation, no salesman will call.

NAME _____
ADDRESS _____
CITY _____ ZONE _____ STATE _____



SEND
COUPON FOR
FREE BOOK

START YOUR OWN MAIL ORDER HOME BUSINESS

**FREE
Publication
SHOWS
YOU
HOW**

Get your FREE COPY of "How to Make Money in Mail Order" revealing plans on how and where to get best products to sell by mail, how to pocket profits in advance, how to get free ads. Men, women, families, start your own big profit home mail order business without experience or product investment. New Mail Order Exchange Plan helps beginners start. Confidential bulletins show you products to sell by mail, show newest sure-fire mail order techniques. Write today for your Free Copy of "How to Make Money in Mail Order." There's no obligation, Airmail reaches us overnight. **MAIL ORDER EXCHANGE, 1717 Westwood, Dept. C252, Los Angeles 24, California**

TIMESTUDY

Cash in now on the fast growing demand for Timestudy Men. Thousands needed in modern automated companies. Quick route to promotions and better jobs. Be ready for an important job in just one year! Good starting pay. Save big money for your Co. with simple Methods improvements. Production Control. Plant Layout. BEGIN ANY TIME. Free Job Placement. Request 40 page Bulletin and THE PAY INCREASE YOU WANT.

**Address INDUSTRIAL ENGINEERING COLLEGE
3307 Washington Blvd., Chicago 24, Illinois**



SEND
FOR THIS
FREE!

Make money. Know how to break and train horses or ponies. Write today for this book FREE, together with special offer of a course in Animal Breeding. If you are interested in Gaiting and Riding the saddle horse, check here (). Do it today—now.

**BEERY SCHOOL OF HORSEMANSHIP
Dept. 1102 Pleasant Hill, Ohio**

First Terrain Map of Moon To Help Select Landing Sites

Depicting 60 percent of the lunar surface, the first terrain map of the moon will be used to select eventual landing sites. The current map study by the United States Geological Survey describes such surface features as slopes, texture and the likelihood of underground openings and caverns. The map is to be completed by October, 1960. The first Russian photos of the other side of the moon lacked sufficient detail to be useful in the mapping project.

Helicopter Speedometer Uses Sound Plus Radar

Pilots of helicopters now may learn how fast they are moving, even when their aircraft is hovering or moving at slow speeds. Turbulence from rotor blades—which sometimes throws air-speed indicators into error—does not affect a new system developed by Midwest Research Institute. The new system uses an acoustic wave projected from the helicopter and an electromagnetic wave (radar) which is also sent out and bounced off the sound wave. The frequency of the electromagnetic energy returned from the collision is interpreted by an instrument system to give the pilot an instantaneous reading of his air speed.

Leak Detector for Electronic Gear

Extremely small leaks in vacuum tubes, transistors and missile devices can be detected with a redesigned mass spectrometer leak detector. The detector has a filament that can be replaced in five minutes, compared to 30 minutes to an hour for previous models. Developed by International General Electric, the detector locates microscopic leaks through which less than one cubic inch of air would pass in 5000 years. Leaks are located by applying helium tracer gas to one side while the detector draws a sample of air from the other. If helium is present in the gas drawn out, an alarm is given.

Orange Blossom Perfume? That's a House You Smell!

If your house has the odor of citrus fruit the next time it's painted, don't be surprised. The Florida Citrus Mutual, in a unique paint-making experiment, is using citrus peel oil in place of conventional paint thinners. Twenty-five bushels of fruit make a gallon of peel oil and one gallon of peel oil makes 8½ gallons of paint. Mutual made up 150 gallons of the paint as an experiment. The paint smells like citrus blossoms only until it dries, which takes 24 hours. After that it's odorless.

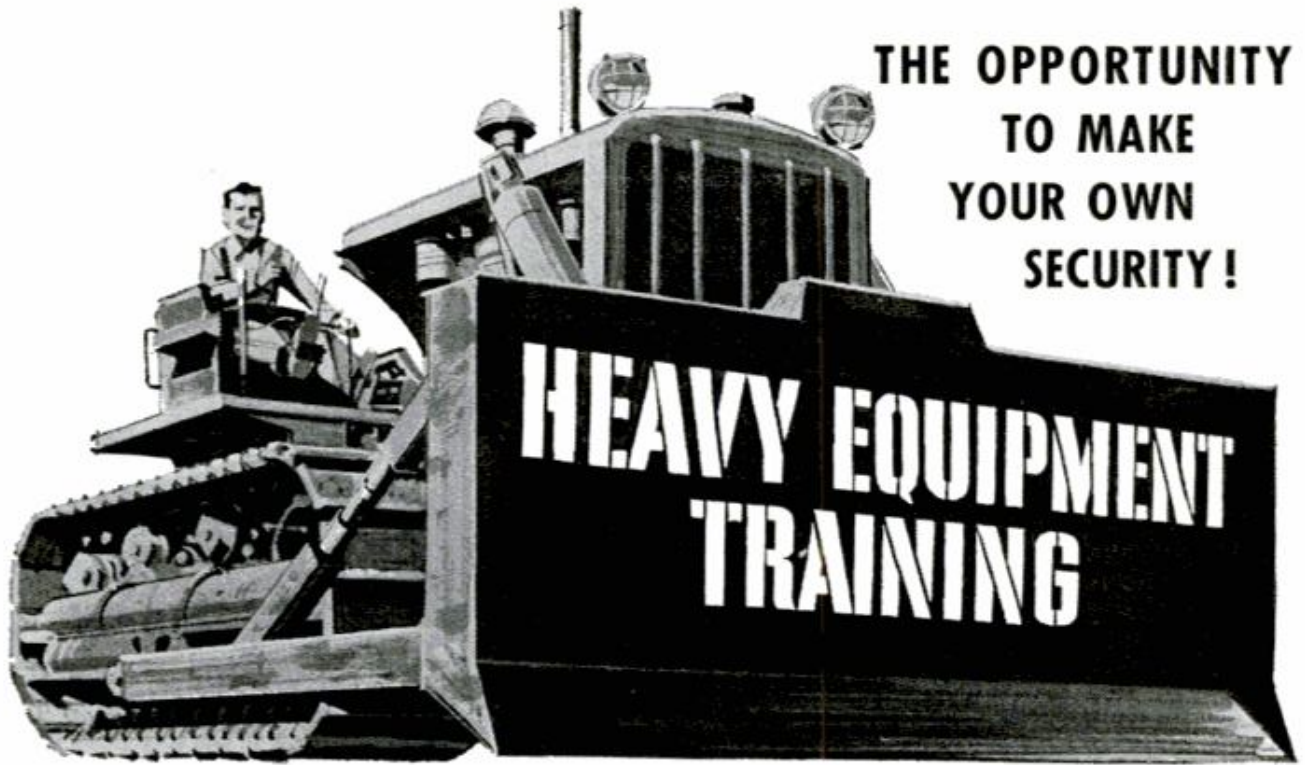

**THE OPPORTUNITY
TO MAKE
YOUR OWN
SECURITY!**

HEAVY EQUIPMENT TRAINING



With the increasing number of construction projects under way throughout the country—highways, dams, airports, bridges, factories; the need for trained men is also increasing and will continue to increase as newly planned projects get underway.

YOU CAN SHARE IN THE OPPORTUNITIES

TRAIN NOW to fill the demand for qualified heavy equipment operators . . . specialize in the construction field.

LEARN to operate the heavies: tractors, scrapers, graders, carry-alls, bulldozers. Learn field maintenance on modern equipment.

EQUIP YOURSELF as a specialist in the booming construction industry, with the proper training and background.

BROADEN your prospects to a better position, advancement, higher compensation, and security, by preparing today.

COMPLETE AND THOROUGH TRAINING PROGRAM INCLUDES COVERAGE OF:

- Blueprint Reading — Grade and Grade Stakes
- Operating Controls — Engineering Fundamentals
- Field Maintenance — Actual Work on Modern Equipment



START YOUR TRAINING IMMEDIATELY

You can learn without interference with present job or schooling. Placement assistance upon completion.

**IF AGE 17 TO 45
MAIL COUPON NOW**

HEAVY EQUIPMENT TRAINING, Northwest Schools, Inc. (Dept. M-6)
1221 N.W. 21st Avenue, Portland 9, Oregon

Rush information without delay

Name _____

Address _____

City _____ State _____

Phone _____ Age _____

Education _____ Hours Worked _____

I'll Send You This Handsome SAMPLE CASE-FREE



and Show You How to Make
Up to \$30.00 in a Day

Mail coupon for this Free Tailoring Sample Case packed with 100 beautiful, big-value suit and overcoat fabrics. Take orders from friends, fellow-workers, others, for fine quality, made-to-measure clothes. Pocket big cash profits in advance. Because wearing our suits and overcoats brings more orders, we make it easy for you to get your own clothes without 1c cost. No experience is needed. **SATISFACTION GUARANTEED, SEND NO MONEY.** Just fill out and mail coupon - today!

**PIONEER TAILORING COMPANY, Dept. B-1116
CONGRESS & THROOP STREETS - CHICAGO 7, ILLINOIS**

**PIONEER TAILORING CO., Dept. B-1116
Congress & Throop Sts., Chicago 7, Ill.**

Dear Sir: I WANT A MADE-TO-MEASURE SUIT TO WEAR
AND SHOW, without paying 1c for it. Rush details and Sample
Kit of actual fabrics, **ABSOLUTELY FREE.**

NAME..... AGE.....

ADDRESS.....

CITY..... STATE.....

AVIATION CAREER

**SPECIALIZED EDUCATION / PROFESSIONAL
TRAINING... only 16 months to 2 years**

Top-pay prestige positions, bright future in aviation. Job opportunities waiting for you as soon as you're ready. Air-frame and Powerplant Technician, Aeronautical Engineering Technologist, Business or Executive Pilot. Classes in Miami.

SEND FOR FREE 48-PAGE BOOK

Embry-Riddle Aeronautical Institute
Dept. B Miami, Florida (Founded 1926)

Name.....

Address.....

City..... Zone..... State.....



Become A --- BUILDING CONTRACTOR! MAIL COUPON for FREE BROCHURE

Simplified home study training program. Learn every phase of building, estimating, contracting. Fortunes are made in this line of work every year. Use spare hours—no interference with present work. Diploma awarded. Low tuition rates.

**AMERICAN TECHNICAL SOCIETY
Dept. BH-20, 850 E. 58th Street, Chicago 37, Ill.**

Please send me your FREE Brochure and full details of your building, estimating and contracting training program.

Name..... Age.....

Address.....

City..... State.....



Brody Manufacturing Co., 330 A. Higgins Rd., Park Ridge, Ill.

Bird Greens Grow in Four Days

Giving your bird an adequate diet of greens is made easy with a seed-filled pot that grows fresh greens in four days. The pot clips onto an accompanying drinking-fountain perch that attaches to the cage. Water from the fountain is absorbed by the dry seed through a cotton wick, and in four days greens appear. A protective grating permits greens to grow but prevents birds from uprooting them. Each pot supplies greens for 30 days.



Mr. "N" Made \$9,700 Last Year By Selling Just 20 KEEP/SAFES a Month!

Like Mr. "N" you can profit with KEEP/SAFE—the fine personal safe that undersells all others. Only safe sold direct. 95% of homes, farms and small businesses are prospects. \$30 to \$71 profit per sale, plus bonuses up to \$12 a safe. Choice territory, chance to become district agent. **FREE DEMONSTRATOR!** Get details, giving address including county.

JOHN D. BRUSH & CO., INC.
575 West Ave. Rochester 11, N. Y.

OWN CALIFORNIA LAND

STATE GOV'T LANDS. 500,000 Acres as low as \$2. per acre—min. offer 40 to 640 Acres. Ranch and Farm Tracts. Southern and Northern California Locations.

NO HOMESTEADING! NO IMPROVEMENTS! NO SALES TO ATTEND! You select, apply and **BUY DIRECT** through the mail. Lists & maps now available. **WRITE RESEARCH DIV.**

PIONEER RANCHES 8228 Sunset Blvd., Dept. 9
Hollywood 46, Calif.
LARGEST LAND CORPORATION OF ITS KIND IN THE WORLD

GIANT ITALIAN HUNTING KNIFE!

CLOSES WITH LIGHTNING SPEED! Imported direct from Italy, this is the same knife that is world famous for its effectiveness in life or death hunting or fishing emergencies. Blade is of durable high test carbon steel, guaranteed to stay razor sharp. Has genuine bone handle. Unlike a switch blade knife, there are no buttons to fool with, no springs to break.

SEAPORT TRADERS, INC., Dept. PM-2, 1221 S. Grand Ave., Los Angeles 15, California

LOCKS IN OPEN POSITION FASTER THAN THE EYE CAN SEE. Easy to handle, easy to carry. 4 sizes: 13 1/4" \$7.95, 11" \$7.50, 9" \$6.95, 5 1/2" \$4.50. **IMMEDIATE SHIPMENT GUARANTEED.** Send cash, check or M.O. 10-day money back guarantee. Calif. res. add 4% state tax.



POPULAR MECHANICS

BASS FISHERMEN WILL SAY I'M CRAZY - until they try my method!

JUST ONE TRIAL WILL PROVE THAT I MAKE EVERY FISHERMAN'S DREAM COME TRUE!

I have no fishing tackle to sell, I make a good living out of my profession. But fishing is my hobby. And because of this hobby, I discovered a way to get those giant bass—even in waters most fishermen say are "fished out."

I don't spin, troll, cast or use any other method you ever heard of. Yet, without live or prepared bait, I can come home with a string of 5 and 6 pound beauties while a man twenty feet away won't even get a strike. You can learn my method in a few minutes. It is legal in every state. All the equipment you need costs less than a dollar and you can get it in any local store.

The chances are no man who fishes your waters has ever used my method—or even heard of it. When you have tried it—just once—you'll realize what terrific bass fishing you've been missing.

Let me tell you about this method—and explain why I'm willing to let you try it for the whole fishing season without risking a single penny of your money. There is no charge for this information—now or any other time. But I guarantee that the facts I send you can get you started toward the greatest bass fishing you have ever known. Send me your name today—letter or postcard. You've got a real fishing thrill ahead of you. Eric W. Fare, Highland Park 19, Illinois.



BE A CLERK all my life? NOT ME!!

Of course you say you won't.

But you may be unless you do something about it.

Hoping and wishing won't get you a better job and more money.

You must prepare for that step ahead—be ready to make promotion come.

DON'T LIMIT YOURSELF TAKE OFF THE BRAKES

For over 50 years more than 1,400,000 ambitious men and women have turned to LaSalle training for greater job security, more money, and larger success in life.

At least you should investigate. It may be the turning point in your life to a better job and more money. So send the coupon without delay. Check the field of your choice and we'll send you without obligation the requirements and opportunities in that field.

Accredited Member, National Home Study Council

MAIL THIS COUPON TODAY

LASALLE Extension University A Correspondence Institution

417 S. Dearborn St., Dept. 264R Chicago 5, Ill.

Please send free book and full information about your home-study training and the opportunities in the field I have checked.

- | | |
|---|--|
| <input type="checkbox"/> Accounting | <input type="checkbox"/> Bookkeeping |
| <input type="checkbox"/> Law: LL.B. Degree | <input type="checkbox"/> Foremanship |
| <input type="checkbox"/> Business Management | <input type="checkbox"/> Stenotype-
(Machine Shorthand) |
| <input type="checkbox"/> Traffic and Transportation | <input type="checkbox"/> Sales Training |
| <input type="checkbox"/> Industrial Management | |

Name.....Age.....

Address.....

City.....Zone....State.....

KILLS • • NO CHEMICALS, GASES, ETC.

- MOSQUITOES
- FLIES, GNATS
- NOBLES, MILLERS
- FISH FLIES, ETC.

OVER 1/4 ACRE

No insect recovery. Harmless. Guaranteed. Built to last 25 years. Beautiful outdoor lighting. Plug into any 110 volt socket.

NO AREA CONTAMINATION

Uses up to 200 watt bulb. Grid cost 10¢ per month. Complete with fly attractor. Dead insect catcher. Cord. Directions. Etc. Very reasonable price - Write to -

SING SING BUG CHAIR, INC.
Box P 3708, Oak Park 37, Mich.



BOX SIZE - W.T. 151X131X - 14155



Print Your Own

Cards, Stationery, Advertising, Circulars, labels, photo and movie titles, church work, tags, etc. Save money. Sold direct from factory only. Raised printing like engraving, too.

Own a Printing Business

Print for Others, Good Profit. Have home shop. Junior press \$15; Senior \$29 up. We supply everything. Easy rules. Pays for self in short time. Write for free catalog of outfits and all details. **KELSEY PRESSES, C-37 Meriden, Conn.**

Shrinks Hemorrhoids

New Way Without Surgery Stops Itch - Relieves Pain

For the first time science has found a new healing substance with the astonishing ability to shrink hemorrhoids and to relieve pain - without surgery.

In case after case, while gently relieving pain, actual reduction (shrinkage) took place.

Most amazing of all - results were so thorough that sufferers made astonishing statements like "Piles have ceased to be a problem!"

The secret is a new healing substance (Bio-Dyne*) - discovery of a world-famous research institute.

This substance is now available in suppository or ointment form under the name Preparation H.* Ask for it at all drug counters - money back guarantee. *Reg. U.S. Pat. Off

"TOOK IN \$217 FIRST 10 DAYS"

Some make more, some less...

We help you to start Your Own All-Year Business

Make Big Money! With our easily operated, highly efficient Wall Washer, Charles Stelle took in \$217 in first ten days. E. L. Goss took in more than \$10,000 in one year. G. H. Jones wrote, "I made a net profit of \$1200 on one job." And no wonder—this machine washes walls 6 times faster and better than by hand and with no mess—no drop cloths needed.



Your Money Making Opportunity • We want more men to go into this profitable business for themselves and enjoy independence—freedom from layoffs and bosses. Customers everywhere—homes, offices, schools, churches, hotels, etc. How much you earn depends largely on you. What you take in is mostly profit. No need to rent shop or office; operate from home. Can start spare time until your full time is justified.

Lose No Time—Send Coupon Today for All the Facts

FREE BOOK! MAIL COUPON TODAY!

VON SCHRADER MFG. CO.
210 "W" Pl., Racine, Wisconsin

Send at once (no obligation) your FREE booklet containing information about your WALL WASHING MACHINE and how I can start my own permanent, profitable business.

Name _____

Address _____

City _____ Zone _____ State _____

LOOK for Rupture Help

Try a Brooks Patented Air Cushion appliance. This marvelous invention for most forms of reducible rupture is GUARANTEED to bring YOU heavenly comfort and security—day and night—at work and at play—or it costs you NOTHING! Thousands happy. Light, neat-fitting. No hard pads or springs. For men, women, and children. Durable, cheap. **Sent on trial** to prove it. Not sold in stores. Beware of imitations. Write for Free Book on Rupture, no-risk trial order plan, and Proof of Results. Ready for you NOW!



BROOKS APPLIANCE CO., 143-C State St., Marshall, Michigan

8 FT. SPECIALS — 80c



Mammoth, man, mammoth! These GIANT 8 FOOTERS (new, genuine neoprene govt. surplus) are terrific for fun or business. Great at parties, school proms, picnics, on the beach, etc. Just paint a message on 'em, inflate & fly, and they attract crowds to store or gas station openings, fairs, etc. Yours at a fraction of their original cost. Satisfaction guaranteed. Order several, they make wonderful gifts. Some sizes in limited supply.

8' dia.-80c ea. 2 for \$1.50

13' dia.-\$1.95 ea.—15' dia.-\$2.95 ea.

18' dia.-\$3.95 ea.—20' dia.-\$4.95 ea.

Postage pd. on ppd. orders.

Cal. res. add sales tax.

FRANK SALES, Dept. PM260, 3930 Sunset Blvd., Los Angeles 29, Calif.

NEW Improved Scope-Shot

Price Complete with 50 DISINTEGRATING PELLETS They crack like a rifle when they hit—leave mark—puff of smoke! \$1.95 P.P.

World's Finest Precision SLINGSHOT Scope-type sight!

ROUTS PESTS!

Price without pellets \$1.50 P.P.

Big Bag of 250 EXTRA Pellets 98c P.P.

Millions Sold! Patent No. D-178,837 Pure gum rubber slings. Beautifully polished cast aluminum stock.

Pistol grip. So powerful it kills small game. Fits pocket perfectly! Guaranteed. FREE shooting manual.

Order NOW from: GENERAL SPORTS

4184-M-B Apple Street, Cincinnati 23, Ohio

Secrets of VENTRILOQUISM Now Revealed!



Easy to learn in 60 to 90 days with our Home Study Course. RESULTS GUARANTEED. Make Money! Be Popular! Have Fun! Big Opportunity! Radio, Television, Stage Appearances! For FREE Information regarding price and terms WRITE. You must state your age. Dummy Catalog 25c. MAHER HOME COURSE OF VENTRILOQUISM Box 36, Studio PM-2, Kensington Station Detroit 24, Michigan

MONEY in WORMS

Sell 20,000 fishworms per week @ \$4 per 1000 from a bed 3 feet wide and 8 feet long. We teach you how to raise and where to sell fishworms and crickets. Write for free literature. CARTER WORM RANCH, PLAINS, GEORGIA

Learn LANDSCAPE GARDENING

AND GROWING OF PLANTS. Latest information on propagation, soil-testing, plant growth regulators, garden design. Start a profitable business or wonderful hobby. Unique and modern home study course—accredited. Earn your certificate at home. May I send FREE, and without obligation, my informative Booklet? NORM MORRIS NATIONAL LANDSCAPE INSTITUTE DEPT. M-20 11826 SAN VICENTE BLVD., LOS ANGELES 49, CALIF.

Learn ACCOUNTING Business Administration

Bookkeeping, secretarial and allied subjects at home in your spare time or attend nationally approved resident school. Write for FREE Success Book giving complete details on courses, plans, rates and employment opportunities. G.I. approved. Write Dept. A

Hills BUSINESS UNIVERSITY AND EXTENSION SCHOOL 619 W. MAIN ST. OKLAHOMA CITY 2, OKLAHOMA

TELEPHONE



HANDSETS

Use as inter-house phone, talk house to garage, as loud speaker system, etc. You receive transmitter, receiver, 3 conductor cord and simplified, illustrated installation diagrams. Handsets are guaranteed to be the same as used in our great National Telephone System. Price delivered \$2.95. Two for \$5.00!

TELEPHONE REPAIR AND SUPPLY CO. Dept. PM-124 1760 Lunt Ave., Chicago 26

Really Fast Communications!

Thirty million words a second can be handled by electronic devices which have been created to develop computers and communications systems capable of processing information 1000 times faster than the electronic computers in use today. At this rate, all the news material in 200 daily newspapers the size of *The New York Times* could be transmitted in less than one second, says Peter J. Isaacs, director of digital computer research for the Sperry Gyroscope Company, where the devices are in laboratory operation.

One device is a microwave diode switch capable of switching 700 million bits of information a second. It uses hollow pipes as conductors instead of conventional wires.

Another device is a microwave amplifier tube which can perform logic operations at the rate of one billion times a second. It employs a radio wave traveling down an electron beam to cause one microwave signal to control another microwave signal.

Isaacs predicts the earliest use of these devices will be in systems simpler than computers. "An immediate possibility," he says, "is development of a communications system in which a message, say of 30 words, such as a telegram, could be transmitted in a millionth of a second. This kind of system could transmit the message on a single radar impulse." He says they also could be used to reduce large amounts of data to more easily handled amounts in nuclear physics experiments where billions of events occur in a small space of time. The system would count and correlate these events.

Raw Rubber Mill Extrudes End Products

Hoses, tire treads and other rubber products can be formed continuously by an automatic machine that tears up raw rubber, blends it with chemicals and fillers and forces it through a slot. A simple machine capable of mixing a wide variety of rubber compositions on a continuous basis, the Rotomill is believed to be the first practical device for doing this type of job. The machine is a tapered, corrugated rotor that revolves inside a tapered, smooth shell. A short extruder screw and a "die" can be added at the output end. These permit simultaneous mixing and extruding. Feeding of the rubber and the many additional ingredients that go into modern elastic compositions can be done automatically. The rotor mixes them and the screw forcibly extrudes the product through the die, which shapes the desired end product.

FOR YOU BETTER PAY and a BRIGHTER FUTURE IN AUTO MECHANICS AND DIESEL



Your spare time pays off BIG with our world-famous **SHOP TESTED** Home Training



MAKE YOUR FUTURE AS BRIGHT AS THEIRS

In a matter of months, you can quit your no-future job for a big-pay, big-future career as an Auto-Diesel Mechanic. Free Illustrated Book gives you the facts. Send coupon below. No Obligation. No Salesman will call.

All Phase Training

N. T. S. students become skilled, all-around mechanics. Crystal-clear lessons, Shop-Tested manuals, real professional equipment, make it easy to learn. Big equipment kits, yours to keep. Earn as you learn...we show you how. Graduate Advisory Service.

N.T.S. Training is Better, More Complete, Lower Cost **BETTER...**

Because training is **SHOP-TESTED** in Resident School Shops & Labs. **MORE COMPLETE...** You learn all phases of Auto Mechanics & Diesel. **LOWER COST...** One low tuition covers entire cost of course and all equipment.

Unlimited Opportunities

Trained mechanics make top money...are in demand at dealer shops, garages, large bus and truck lines, construction projects, government labs, factories, and many others.

YOU GET AND KEEP ALL THIS PROFESSIONAL EQUIPMENT



NATIONAL TECHNICAL SCHOOLS

WORLD-WIDE TRAINING SINCE 1905
4000 S. FIGUEROA ST. LOS ANGELES 37, CALIF., U. S. A.



FREE!

Illustrated Fact Book & Actual Lesson
Mail coupon now.

Complete TV-Radio Electronics training also available.

RESIDENT TRAINING at Los Angeles!
If you wish to take Resident Training at Los Angeles, in our Big, Modern Shops & Labs, check special box in coupon for full information.

NATIONAL TECHNICAL SCHOOLS

WORLD-WIDE TRAINING SINCE 1905

MAIL NOW TO
NATIONAL TECHNICAL SCHOOLS, Dept. DB-20
4000 S. FIGUEROA ST., LOS ANGELES 37, CALIF.
Send for FREE Auto-Diesel Opportunity Book and actual Lesson.

NAME _____ AGE _____

ADDRESS _____

CITY _____ TOWN _____ STATE _____

Check if interested ONLY in Resident School training at Los Angeles.

VETERANS: Give date of Discharge _____



Member



FREE!
100
**WORLD-WIDE
STAMPS**
...just
released!

HURRY! SEND TODAY for colorful, valuable collection of 100 World-Wide stamps. Get new issues of past 12 months. From far corners of the world . . . Ghana, Togo, China, Polynesia, India, Australia, Honduras, Iceland and many others. Wonderful new additions to your collection. All different, all genuine, topicals, pictorials, bi-colors, mint and used. Limited supply. Only one to a collector. Plus free complete, helpful "Stamp Collector's Guide" and other offers for your FREE inspection. Send name, address, enclose 10¢ for handling and postage. Garcelon Stamp Company, Dept. 2PMX, Calais, Maine.

GARCELON STAMP CO., Dept. 2PMX
Calais, Maine — Rush FREE 100 Different Stamps, Collector's Guide, other offers. Enclosed 10¢ for handling. (PLEASE PRINT).

**... TURN CONCRETE
INTO GOLD!**

**MAKE UP TO \$75 A DAY
IN YOUR OWN BUSINESS**

If you want to have your own business — to start a business on your own — here's your big opportunity! New high speed, low cost General block machine produces up to 1,000 concrete blocks a day. Sell all you make to builders, supply houses, and others for homes, factories, buildings, garages. Cash in on the building boom! You can make profits of 100% to 150% — up to \$75. a day! General block machine equipped with 1/2 h.p. electric motor — or can be supplied with gasoline engine — works anywhere, in little space, indoors or out. Operates from ordinary house light socket. Simple, foolproof 3 step operation — so easy a child can do it. Makes superior 3 core blocks any size from 4" to 12" Also makes chimney, sash, corner and other types. Blocks meet any building code anywhere in the country. Materials — sand, water, cement, available anywhere. Simple illustrated operating instructions and mixing formulae for cement and cinder blocks supplied with each machine. Write for FREE folder with full information.

MOTOR DRIVEN

R.L.T. of New York City reports: "MY GENERAL BLOCK MACHINE PAID FOR ITSELF IN FIRST 2 WEEKS!" Hundreds now in use the world over! Write for FREE details today!

EXTRA Amazing illustrated book gives floor plans for 6 sensational concrete block bungalows. Tells how to lay blocks, lay out building lines, mix concrete, build steps, porch and concrete floors all at great savings. Written by experts. Can save many times the cost of the machine! Get it now! No strings attached. Send \$1.

BOOK SENT FREE IF YOU BUY MACHINE.
\$1 REFUNDED IF YOU BUY LATER.

GENERAL ENGINES CO.
DEPT. M-20, ROUTE 130, THOROFARE, N. J.

HOW TO BUILD YOUR OWN CONCRETE BLOCK HOME
Only \$1 Prepaid

BARBELLS

140-Pound, CHROME DELUXE Barbell-Dumbbell set only \$19.80. This is our feature set and is the finest ever manufactured.

Training with adjustable weight is the BEST way to keep fit; the ONLY way to develop great strength and a perfect body. As the oldest and best equipped barbell company, BUR gives value and prices no one can equal.

SEND FOR FREE CATALOG
BUR BARBELL CO.
Lyndhurst 9, New Jersey

100 POUND SET \$12.80

Extra Plates Only 12c Pound

**AIRLINES
NEED YOU**

Good paying positions with travel. Young men and women . . . Reservationists, Radio Communications, Passenger Agents, Hostesses. H. S. Grads, 17 to 38. See if you can qualify. For full information write today.

WEAVER AIRLINE PERSONNEL SCHOOL
2020 R GRAND KANSAS CITY 8, MISSOURI

Get Full Details

LEARN NOW! How to Become a
• GAME WARDEN
• GOVT. HUNTER
• Forest Ranger or Aid Positions

Let your love of field and forest guide you to real success! Be a career conservationist! — Protect resources. Arrest violators. Work with wildlife amid scenic surroundings, away from city pressures. Enjoy a "way of life" others can't even buy! Good pay, security, prestige. Full time and seasonal opportunities. men 17 to 45! Hunting, farming, military experience valuable. Prepare now, spare time. Write!

North American School of Conservation
DEPT. D172 1038 South La Brea, Los Angeles 19, California

FREE Colorful "CAREER BOOKLET"

If over 17 write NOW!

MAKE MONEY!
REPAIR HYDRAULIC JACKS

Earn While You Learn At Home
Make up to \$5 an hour, full or part-time, in the competition-free field of Hydraulic Jack Repair. Millions of jacks in auto service stations, truckers, body shops, riggers, farms, need servicing. We show you NOW. Easy step-by-step directions.

Get Folder PM-2 & free bonus offer

Institute of Hydraulic Jack Repair
P. O. BOX 50 • BLOOMFIELD, N. J.
A Correspondence School Licensed by N.J. Bd. of Ed.

POPULAR MECHANICS MAGAZINE now complete on
MICROFILM

VOLUMES ONE THROUGH NINETY-SIX

Early volumes of POPULAR MECHANICS have been eagerly sought as collector's items. Now the monumental new microfilm collection makes this wealth of reference material available to all libraries.

Begun in 1902 as a weekly, POPULAR MECHANICS was one of the first "picture" magazines. It also pioneered the do-it-yourself idea, and its files contain plans for almost any project desired.

Ninety-six volumes — \$750.00 for the set.

UNIVERSITY MICROFILMS, Inc.
313 North First Street Ann Arbor, Mich.



Cargo Plane Lifts Atlas Missile

Huge Atlas intercontinental ballistic missiles can now be flown from manufacturer to operational areas throughout the world aboard a new version of the Douglas C-133B. The 286,000-pound C-133B has rear-mounted doors that open in four directions to admit the 75-foot-long ICBM. Pow-

ered by four turboprop engines, the C-133B can carry more than 26 tons for a distance of 4000 miles at an average speed of 323 miles per hour. It carries missiles 20 to 30 times faster than present surface transportation. To speed loading, the missiles are guided to the doors on tracks.

These men are getting practical training in **NEW Shop-Labs of**

ELECTRICITY

ELECTRONICS

ON REAL

Motors—Generators
—Switchboards—
Controls—Modern
Appliances—
Automatic
Electronic
Control Units

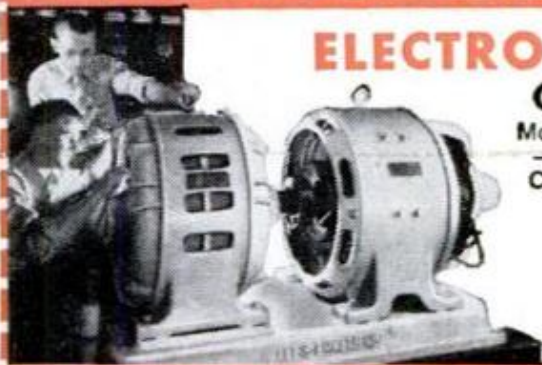

TELEVISION

RADIO ELECTRONICS

ON REAL

TV Receivers—
Black and White
and Color
AM-FM and
Auto Radios
Transistors
Printed Circuits
Test Equipment



COYNE

in Chicago—prepare for today's TOP OPPORTUNITY FIELD. Train on real full-size equipment at COYNE where thousands of successful men have trained for over 60 years—largest, oldest, best equipped school of its kind. Professional and experienced instructors show you how, then do practical jobs yourself. No previous experience or advanced education needed. Employment Service to Graduates.

START NOW—PAY LATER—Liberal Finance and Payment Plans. Part-time employment help for students.

GET FREE BOOK—"Guide to Careers" which describes all training offered in ELECTRICITY and TELEVISION-RADIO ELECTRONICS—no obligation; NO SALESMAN WILL CALL.

Coyne Electrical School, 1501 W. Congress Parkway
Chartered Not For Profit • Chicago 7, Dept. 20-3C

MAIL COUPON OR WRITE TO ADDRESS BELOW

COYNE ELECTRICAL SCHOOL
Dept. 20-3C—New Coyne Building
1501 W. Congress Pkwy., Chicago 7, Ill.

Send **BIG FREE** book and details of all the training you offer. However, I am especially interested in:

Electricity Television Both Fields

Name _____

Address _____

City _____ State _____



BUILD

and Save with
this Home
Plan Library

"Dream Home" Plans
You Can Build or
Contract

Over 700 plans custom designed to fulfill owner's cherished dreams, cost-saving, lasting construction, and to suit any site. You can save \$1000 or more whether you do the building or contract it. Complete working blueprint sets, materials lists, etc., at low-low cost.



SAVE!

Any 3 Illustrated
Plan Books

\$2

(Ordered Separately
Books - \$1 each)

- FAMILY ROOM HOMES 222 easy-living plans
- HILLSIDE & SPLIT-LEVEL 100 advantageous designs
- NEW TRENDS In Selected Homes... 260 special plans
- Block Masonry Homes 223 economical beauties
- WEEKEND PLANS Easy-to-build cabins, lodges
- DUPLEX HOMES 40 money-making plans

SEND TODAY! Postpaid in U.S. and Canada

HOME BUILDING PLAN SERVICE

Studio P, 2454 N. E. Sandy Blvd., Portland 12, Oregon

ENGINEERING DEGREE IN 27 MONTHS

Students given option of studying engineering under accelerated program leading to Bachelor of Science Degree in 27 months; or the standard four-year program leading to Bachelor of Engineering Degree in 36 months. The B.S. degree in Mathematics, Chemistry, or Physics (including Nuclear Physics) may be earned in 36 months. By attending classes year-round, students can graduate in 3 years and have one year of experience and income in the time usually needed to complete a four-year college course. Preparatory courses. Thorough, practical program. Individualized instruction.

Keeping pace with progress in science and engineering
Campus. Dorms, gym, playing fields. Superior faculty. 2,000 students. New Dana Science Building. Low tuition. Earn board. G.I. approved. Enter March, June, September, December. Students from 50 states, 40 foreign countries. Send coupon for free catalog, full information. Enroll now!

INDIANA TECHNICAL COLLEGE

520 E. Washington Boulevard, Fort Wayne 2, Indiana

Please send me free information on 27 mo. B.S. DEGREES in:

- Aeronautical Chemical Civil Electrical
- Mechanical Electronics

on 36 mo. B. E. DEGREES in:

- Aeronautical Chemical Civil
- Electrical (Power or Electronics) Mechanical Metallurgical

on 36 mo. B.S. DEGREES in:

- Mathematics Chemistry Physics

Name _____

Address _____

IT'S EASY TO ROLL OUT THIN LINES with

Master PAINT STRIPER

You can do professional striping on furniture, boats, autos, bikes, plywood, etc. Master Striper rolls out uniform lines on wood, glass, plastic, ceramics, almost any surface with paint, temperas, glue, textile-paint or underglaze; also used in industry



- TYPE M Tool with 1/16" roller tip..... \$1.25
- Other size Tools (1/64", 1/32", 3/64", 5/64", 3/32", 1/8")..... 1.75
- Extra Roller Tips, Sizes above, ea..... .90
- Extra Roller Tips, 1/4" ea..... 1.20
- Special complete set with 7 tips, only..... 3.00
- DOUBLE STRIPE KIT—5 combinations..... 3.25 (COD's, Postage Collect)

MAKES
CLEAN,
STRAIGHT OR
CURVED LINES;
VARIOUS WIDTHS
AVAILABLE.

WENDELL MFG. CO., 4234 LINCOLN AVE. DEPT. 44 CHICAGO 18, ILL.

Millions
have
done it
so
can
YOU!



Also
FREE Photo Book
of Strong Men

Stop being **SKINNY** like I was

Quickly **GAIN 25 LBS.** of

HANDSOME, POWER-PACKED MUSCLES like I did

Send for these 5 AMAZING PICTURE COURSES

All 5 FREE before \$1 price goes back

1. How to GAIN MIGHTY ARMS
2. How to GAIN A BIG CHEST
3. How to GAIN A MIGHTY BACK
4. How to GAIN POWERFUL LEGS
5. How to GAIN A GRIP OF STEEL

Send 10¢ for postage for all 6 items

Jowett Institute, Dept. PM-02, 220 Fifth Avenue, N. Y. 1, N. Y.

Finish HIGH SCHOOL AT HOME

Complete 4 Yrs. in 12 Months

Learn More! Earn More! Enter professional or technical schools. Advance Socially. Live a Happier, Fuller Life. Individual Courses or complete schedule. **WRITE FOR SCHOOL BULLETIN.**

ACADEMY FOR ADULTS

30 W. Washington, Dept. PM-260, Chicago, Ill.

\$3.25 OR 2 FOR \$6.00!

With 40 ft. of wire. Additional wire 3¢ ft. **TESTED AND GUARANTEED.** Write for free list of all types of telephones. Shipments FOB Simpson, Pa.

TELEPHONE ENGINEERING CO., Dept. 2 80, Simpson, Pa.

26 YEARS IN BUSINESS AT THE SAME ADDRESS.

Beat the high cost of new tires.

EXTRA MILEAGE TOP GRADE Tires.

(Written Insurance Guarantee). SEND AD

UP TO 15,000 MI.

Our entire stock of very slightly used

12 MOS. Written Guarantee, White Walls \$1.00 extra

600-16 \$5.22 670-15 \$5.22 700-15(6) \$8.92 750-20(8) \$12.22

800-16(6) 7.92 710-15 5.22 750-15(8) 10.72 825-20 18.92

650-16(6) 8.72 760-15 5.42 700-17 10.22 900-20 18.92

750-14 7.52 800-15 6.42 750-17 12.22 1000-20 19.92

800-14 7.52 820-15 6.72 650-20 10.02 1100-20 19.92

750-16(6) 9.82 700-16(6) 9.92 700-20 11.02 1000-22 20.92

"EXTRA SPECIAL" TOP QUALITY all size 4-ply pass. \$8.72

FREE TIRE with 2 or more of these.—W.W. \$1.00 Extra. EA.

Thousands of tires shipped all over the U.S.A. All tires shipped F.O.B. Phila. Send Check or M.O. with this ad. Dept. 2. No C.O.D.

STANDARD 834 N. Broad St., Philadelphia 30, Pa.



The Holz-All Co., 609 St. Joseph St., Rapid City, S.D.

Versatile Book Holder

Because its circular hinge permits the two sections of a reading, teaching and typing aid to revolve around each other, the holder can be put to a number of uses. It is primarily used to hold various sizes of books, papers to be copied and sheet music, but it has other applications, such as holding a sign, supporting a mirror, and even holding a football for kicking practice.

Take Up Slack Time — Make Extra Money FIX SMALL AIR COOLED ENGINES

New 4th Edition available—Contains 387 Makes & Models



Complete information on maintenance, servicing and repairing gas engines used on Chain Saws, Lawn Mowers and Go Karts. Edited by engineers and professional mechanics. Information on 24 major manufacturers engines. 2 New sections added—American Marc and Homelite. 387 Makes and Models in all including Lauson, Power Products, Briggs & Stratton, Clinton, Cushman etc. 121 New engine models added with total of 387 models listed. 529 magneto and 947 carburetor models listed. 320 pages of practical down-to-earth information on 2 and 4 cycle engines, 1, 2 and 4 cylinder models. Central parts distributors listed. Authoritative section on gas engine fundamentals. Trouble shooting and servicing of ignition and carburetor equipment. Section on trouble shooting for beginners. \$4.95 postpaid. Satisfaction guaranteed or your money back. Send check or money order. Order now. Clip this ad.

Small Engines Service Manual. Dept. 260,
1014 Wyandotte, Kansas City 5, Missouri

WANTED! New Products

We urge manufacturers with products requiring sales representation in the automotive or service-station field to write to us. Inventors, if you have patented items applying to the same sales field, let us know and we'll work out manufacturing and distribution problems for you. We have salesmen in every state.

JACK P. HENNESSY COMPANY, INC.

12 Depot Square Englewood, New Jersey

make your own Gems 36⁵⁰

The Gem Maker comes complete with all necessary equipment, including a super-charged diamond blade for sawing, and all the wheels for grinding, shaping and polishing; also complete instructions. The complete equipment as shown, less motor and belt for only \$36.50, f.o.b., Burlington, Wisconsin. Write today for information and literature.

B&I MANUFACTURING CO.
Dept. P, Burlington, Wis.

Learn MECHANICAL DENTISTRY

A profession offering unlimited opportunities. Most modern and complete course embracing every branch from Plate to Porcelain Work, which prepares you to work for Dentists or start your own business. Individual instruction — practical training in day or night school. No books — no classes. Catalog upon request.

McCARRIE SCHOOL OF MECHANICAL DENTISTRY
207 N. Broad Street Dept. 97 Philadelphia 7, Penna.

ELECTRIFY PLAYER PIANOS PUMP ORGANS

**YOU CAN QUICKLY END TIRESOME FOOT-PUMPING
With a Compact Low-Cost Lee Silent Suction Unit**

EASY TO INSTALL
FULLY GUARANTEED
1000'S IN USE

write to
LEE MUSIC MFG. CO.
Box 595, Tujunga, Calif.

TOOLS and HARDWARE WHOLESALE!

**HUGE PROFITS!
MORE MONEY!**

Start Your Own Business

Sell nationally advertised tools to your friends and neighbors. Also for your own industrial and institutional use. New giant wholesale catalog has room for only your name on it. You get all the orders and reorders. A MILLION DOLLAR INVENTORY AT YOUR FINGERTIPS. NO STOCK TO CARRY. ORDER AS YOU NEED IT! . . . Electric drills, saws, sanders, micrometers, snips, tool boxes, vises, motors, trowels, wrenches, socket sets, chisels, mitre boxes, squares and many others too numerous to mention. **WHOLESALE DISCOUNTS UP TO 50% off.** . . . Send \$1 deposit and get the new giant wholesale catalog. Your \$1 is credited to your first purchase or refunded if not 100% satisfied. Write NOW!

U. S. SUPPLY CORP., Dept. 284 149 Church St.,
N. Y. 7, N. Y.

MY SPARE TIME HOBBY MAKES ME

\$5⁰⁰ an hour
CASH PROFIT

— Grover Squires

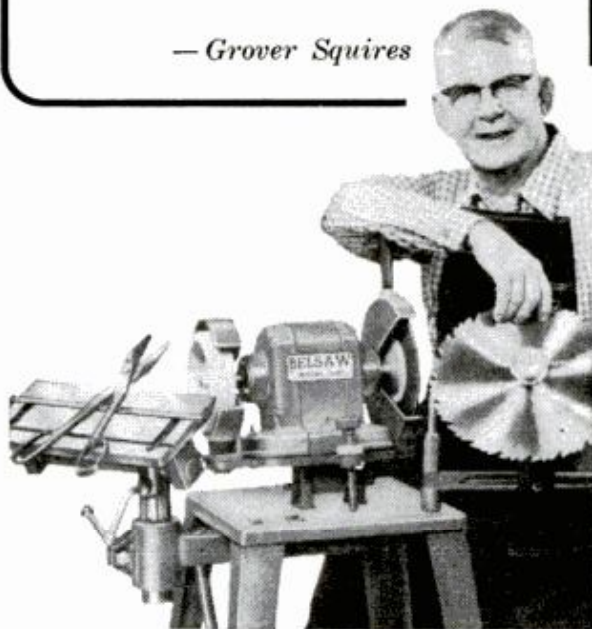

START YOUR OWN SPARE TIME BUSINESS



You can turn your spare time into Big Cash Profits with your own **COMPLETE SHARPENING SHOP**... Grind saws, knives, scissors, skates, lawn mower blades... all cutting edges. Your Own Cash Business with no inventory... right at home... no experience needed.

FREE BOOK tells how you can start your own spare time business while you are still working at your regular job. Low Cost—time payments only \$15.00 a month. **Send coupon today.**

FREE BOOK

BELSAW SHARP-ALL CO
710 Field Bldg.,
Kansas City 11, Mo.

Send Free Book "LIFETIME SECURITY". No obligation.

Name _____

Address _____

City _____ State _____



Do You Like Art?

DRAW FOR MONEY!

Our Simple Method Proves You Can Learn to Draw at Home in Spare Time for Only 20c a Day!

YOU can learn Commercial Art, Designing, Painting, Cartooning, etc. . . . right at home, in spare time. No previous art training necessary. Soon be your own boss — work at home, pick your own working hours. Or earn big money as staff artist for advertising agency, newspaper, magazine, dept. store, etc. Or make Art a profitable hobby. Earn while you learn. Two 22-piece art outfits given AT NO EXTRA CHARGE. (School est. 1914.)

FREE BOOK, "ART FOR PLEASURE AND PROFIT." Describes our methods.

Lists opportunities. Tells what our students say. No obligation. So mail coupon at once.



FREE BOOK

Washington School of Art
Studio 142, Port Washington, N. Y.

Send me—FREE—your valuable Illustrated Book, "Art for Pleasure and Profit." No obligation. No salesman will call.

Name.....Age.....

(PLEASE PRINT PLAINLY)

Street.....

City.....Zone.....State.....

NEVER AT THIS LOW PRICE! GENUINE 150-POWER ACHROMATIC TELESCOPE

with Achromatic Lens and
4-POWER FINDER attached

ONLY
\$18.95
PREPAID

EXTRA BONUS GIFTS:

- 273 page book, "Handbook of the Heavens"
- Magic Star Finder Dial
- 220X & 400X Eyepiece lenses

5 Magnifications 18X—35X—65X—85X—150X
Brings the Moon, Planets, Stars, Satellites, People
150 times Closer, Clearer, Sharper

Never before has an ACHROMATIC 150X telescope with range finder and tripod sold for anywhere near this amazing low price! Now you can not only explore the heavens and bring the moon, planets, stars, satellites 150 times closer, but you can observe all distant objects, people, ships too, because all pictures are erect, not upside down as in all astronomical telescopes. The kind of needle-sharp color-free viewing only a genuine achromatic lens can bring you. Ready for immediate use. 5 precision lenses bring you viewing at 18X—35X—65X—85X—150X. Tubes extend to 43" made of bakelite, finished in camera bellows black, trimmed with gleaming brass. 4 power finder scope (30mm Lens) mounted on main tube is feature usually found on more expensive telescopes—brings difficult objects on target before observing with main scope. For extra stability 5 ft. hardwood folding tripod is equipped with heavy cast iron head fitted with Criterion's famous 360 degree all aluminum mount that locks instantly in any position. Obtainable only from Criterion Co. shipped prepaid. 4 famous gifts—273 page book "Handbook of the Heavens," Magic star finder dial that aids in locating stars ANYWHERE at ANYTIME of the year. 220X & 400X eyepiece lenses included free for experiments. You must be completely satisfied with this super offer or your money back in full. Shipped Complete, nothing else to buy at amazingly low price of **\$18.95**. Without tripod **\$14.95**.

Send Cash, Check, or Money Order today

Dept. PMA-31, CRITERION CO., 331 Church St., Hartford, Conn.

FREE OUTFIT STARTS YOU IN BIG MONEY SHOE BUSINESS!



Run your own profitable 'shoe store' business from home! Represent fast growing million dollar firm in spare or full time. We give you—**FREE**—complete Starting Outfit that makes you **\$217.00 EXTRA** each month for just 2 easy orders a day. You feature 195

fast-selling dress, sport, work shoe styles for men and women. Air-cushion shoes, many other special features! Sizes 2½-15—widths AAAA to EEEE. Draw on 200,000 pair stock. Also horsehide jackets. Start now selling to friends, folks where you work. Rush postcard for FREE Outfit!

MASON SHOE, Dept. G-15, CHIPPEWA FALLS, WIS.

NO JOB WORRIES

PLASTEX INDUSTRY needs manufacturers on small scale for big production of Lamps, Clock Stands, Art Goods, Novelties in Plastic Marble imitation. No Experience necessary. 1/2¢ material makes regular 10¢ store sellers. Moulds furnished for fast production. Small investment brings good profit. Big wholesale orders now being placed. Ambitious men have chance for real prosperity and job security. Our NEW FREE booklet will interest and benefit you.

PLASTEX INDUSTRIES, Dept. A
3400 Third Ave. New York 56, N. Y.

Glass Motors Power Rockets

Vanguard III's third stage was made of glass fibers bound with a plastic substance. The 50-pound glass rocket motor burned 10 seconds longer than previous third stages and went into orbit with the 50-pound payload, according to the National Aeronautics and Space Administration (NASA). A simi glass rocket motor will form the third stage of the NASA's Thor-Delta rocket.

Phone Line Thwarts "Bugging"

Foil "petticoats" around a telephone line will stop eavesdropping by persons using either induction-type or direct line-tap equipment. The foil sheaths are connected to a highly sensitive relay which is activated when the electric current changes in the cable as little as two one-millionths of an ampere. The cable sounds an alarm to tip off the users that someone is tampering with the wire, and a noise generator "talks" into the cable, making such an unfilterable howl that it is impossible to listen in with induction equipment.

Wall of Trees to Hush Jets

People living near Dulles International Airport at Chantilly, Va., in a few years should not be bothered by the roar of jet engines. A barrier of trees was left standing around the airport when the site was excavated in 1958. This spring the Federal Aviation Agency will have 175,000 seedlings planted and hopes eventually to have a muffling ring of trees 1000 feet deep surrounding the 9800-acre airport.

\$1 BRINGS YOU \$18

Discover Flok-Kraft and Earn \$\$\$\$ AT HOME

Earn up to \$15.00 per hour spare time. Amazing new Velvet-fiber spray instantly makes any object (Lamps, Radio & TV Cabinets, Figurines, Signs, Auto dash boards, Toys, furniture, draperies — anything) worth expensive \$\$\$\$ Prices. . . like magic, you can spray anything with this beautiful new suede-like finish that feels like rich Velvet.

EARN UP TO \$300.00 PER WEEK SPARE TIME

Imagine, materials cost only 3c per square foot. (Average TV or radio cabinet can be beautifully sprayed with this startling new 3-dimensional Velvet finish in 15 minutes at a cost of only 34c in materials. Your charge for this job is at least \$10.00.)

REPRESENTATIVES IN YOUR AREA URGENTLY NEEDED

Own your own business. Work at home in your spare time. Help fill the huge growing demand for this amazing new beautiful Velvet-fiber finish. Orders come from stores, offices, homes, architects, auto dealers, — everywhere. Possible \$20,000,000.00 worth of jobs to be done. Investigate today—be first in your area! Actual samples in 16 Radiant Colors. Booklet of 50 Home Business Opportunities and Confidential Details all sent free! Send No Money. Write: Coast Industries, Los Angeles 61, Calif., Dept. B-2.



HOME-IMPORT BUSINESS . . .

Men, women. Make big profits buying low cost imports abroad (see examples at left) and selling to friends, stores or by mail order. Famous world trader guides you—shows you how to find thousands of exotic imports for full or spare time business, how to pocket profits in advance on foreign drop shipment plan. Full details FREE! Airmail reaches us overnight. Write Today! **MELLINGER CO., 1717 Westwood Dept. C252, LOS ANGELES 24, CALIFORNIA**

MAKE BIG MONEY—ALL PROFIT—AT HOME

INVISIBLE MENDING

Pays up to \$10 in an Hour!

Make moth holes, cigarette burns, tears, rips, disappear from all fabrics. Little-known craft pays extra spare-time profits at home. Write today for exciting details FREE! **FABRICON, 6238 Broadway DEPT. 322, CHICAGO 40, ILLINOIS**



Learn PHOTOGRAPHY at Home

Splendid opportunities. Prepare in spare time. Practical basic training. Long-established school. Send for free book, "Opportunities in Photography." No obligation.

American School of Photography, 835 Diversey Parkway, Dept. 1352, Chicago 14, Ill.

JEEP OWNERS

RE-POWER NOW WITH A V-8 OR 6 CYL. ENGINE — USE FORD—CHEV—MERCURY—GMC—PONT—STUDE—DODGE OR PLYMOUTH In Jeeps, Jeepsters, Sta-Wgn, trucks, Kaiser & H. J. cars. Conversion Kits \$45.35 to \$56.90. Want fast action? Give us full information, send \$15.00 Dep. and we will ship correct kit. Bal. COD. Send full amount for prepaid shipment. Wire, phone or write today. Details FREE

HOOSIER MACHINE PRODUCTS CO.
312 S. E. 6th St. Phone CR 6-3442 Pendleton, Oregon

STOP FRONT DRIVE DRAG ON YOUR Jeep



PROVEN IN OVER A BILLION MILES OF SERVICE!

Warn Hubs on your 4 w.d. give double-duty value — economical, free-wheeling 2 w.d. (with added pep!), normal 4 w.d. — automatically with Lock-O-Matics, manually with Warn Locking Hubs. See your 4 w.d. dealer!

WARN HUBS

WARN MFG. CO., Inc.
Riverton Box 6064-A
Seattle 88, Wash.

94.6% OF BAILEY GRADUATES ARE EMPLOYED AT TOP PAY IN THE FIELDS WHICH THEY WERE TRAINED!



DIESEL-AUTO MECHANICS DESPERATELY NEEDED!

We have a far greater demand for our students than we can fill!

We can show you an actual waiting list of leading companies throughout the world who have tried Bailey graduates — found them outstanding, and are coming back for more!

Bailey Graduates are Successful . . . RECEIVE BIG PAY — HAVE SECURE FUTURE!

The Famous Bailey Course prepares you for BOTH Diesel and Gasoline Mechanics.

This is a must—due to the advent of using Diesel principles, such as 'Fuel Injection' on passenger cars . . . use of gasoline engines for starting Diesel engines, etc. You learn all this at Bailey in the amount of time ordinarily required to learn just one of these subjects, ALL FOR THE PRICE OF ONE.

Don't be satisfied with a 'futureless', one-type job — learn how you can make big money now!

Write today for Free Booklet that takes you on a step-by-step camera tour through our spacious, modern shops — See Bailey students in action as they Learn-by-doing with the Famous Bailey Method of training!

We provide you with housing and part time jobs while in school, plus nation-wide placement service for graduates.

BAILEY Technical SCHOOLS

1634 S. GRAND ST. LOUIS 4, MO.

MAIL TODAY!

Please mail immediately this free booklet without obligation.

FREE BOOKLET



Name.....

Address.....

City..... State.....

APPROVED FOR VETERAN . . . NON-VETERAN

HOW TO MAKE THINGS OF PLASTICS

Complete
Low-Cost
Home Training
Course NOW
Available

There's exciting opportunities for you in Plastics Fabrication. Fun and relaxation as a hobby! Big money as a spare or full-

time business! Course teaches fibreglassing, model building and how to make molded, cast, internally carved colored plastic jewelry, toys, furniture, novelties, signs. Professionally prepared. Used by Industrial Arts Teachers. All materials furnished. For men and women.

Accredited Member National Home Study Council
SEND FOR FREE BOOKLET

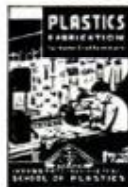

INTERSTATE TRAINING SERVICE
Dept. C-3, Portland 12, Oregon
Send Free Booklet on Plastics Home Training Course.

Name _____
Address _____
City _____ Zone _____ State _____

LIVING FENCE



Amazing Fast Growing Red Rose

See the sensational Red Robin Living Fence (Gloire Des Rosomanes) that's sweeping the country! Surround your property with beauty and protection for as little as 12c a foot. Plant this spring, have a vigorous Living Fence bursting with fragrant red roses this summer. Grows up to 6 feet. Not a multiflora. Keeps out intruders, noise. Available only from Ginden Nursery. Send name, address for free full-color landscape book, prices, guarantees, etc.

GINDEN NURSERY CO. Dept. 3112 San Bruno, Calif.

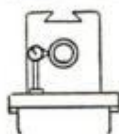

— TIPS & TECHNIQUES — MACHINE TOOL RECONDITIONING & THE ART OF HAND SCRAPING (4th printing)

SEND FOR FREE FOLDER DESCRIBING
ILLUSTRATED MANUAL FOR MACHINISTS
Machine Tool Publications, 382 Holly Ave., Saint Paul 2, Minn.



1000 NAME AND ADDRESS LABELS \$1
ANY 3 DIFFERENT ORDERS \$2 ppd. Sensational bargain! Your name and address printed on 1000 finest quality gummed labels. Padded! Packed with FREE Plastic GIFT BOX. Use them on stationery, books, cards, etc. 1000 only \$1 ppd. SPECIAL OFFER — ANY 3 DIFFERENT ORDERS \$2 Satisfaction guaranteed. **HANDY LABELS, 221 Jasperson Bldg., Culver City 1, California.**



Cushman's 1960 Scooters Feature Better, Longer-Lived Brakes

With minor styling changes, the 1960 Cushman Scooters have switched to a brake system in which the lining is on the shoes, as in a car, instead of on the drum.

Five scooters are produced, ranging from the deluxe Super Eagle down to the economy Highlander. All have four-cycle engines. Horsepowers are 4.8 and 7.95.

OWN A RESTAURANT
 START WITH LITTLE OR NO CAPITAL!

SENT FREE!
 HOW TO START A RESTAURANT ON A SHOESTRING

If you ever wanted to own your own profitable business—now is the time to investigate the food business that will soon boom with the coming U.S. population explosion. My amazing new plan shows you *how* to start and operate anything from a small hot dog stand to a super restaurant—*How to Get Cash Customers* rushing to you—*How to Make Big Money* from the first day you open. I'll share my unique revealing plan and mail you all Free Details. Write: NATIONAL RESTAURANT OWNERS TRAINING, DEPT. C-2, 15125 S. BROADWAY, LOS ANGELES 61, CALIF.

OUTER SPACE SHIP X15 **10^{ea.}**

Order any one of these official U.S. planes
 B-150 BOEING B-52 STRATOFORTRESS
 B-152 BOEING 707 JET STRATOLINER
 C-312 CONVAIR B-58 "HUSTLER"
 L-504 LOCKHEED F-104A STARFIGHTER
 R-824 REPUBLIC F-105 "THUNDERCHIEF"

AVIATION PHOTO EXCHANGE
 Box 75084PM, Los Angeles 5, Calif.

IS YOUR ENGLISH HOLDING YOU BACK?

I have helped thousands of men and women who have not had college training in English to become effective speakers, writers, and conversationalists. With my new C.I. METHOD you can stop making mistakes, build up your vocabulary, speed up your reading, develop writing skill, learn the "secrets" of conversation. Takes only 15 minutes a day at home. Costs little. 32-page booklet mailed FREE. Write TODAY! Don Bolander, Career Institute, Dept. E-1052, 30 E. Adams St., Chicago 3, Illinois

OWN THE WORLD'S FINEST POCKET PISTOL!
BERETTA PANTHER
 NEW 25 CAL. FEATHERWEIGHT—9 SHOT
 Sensational Beretta Panther carries more cartridges for its size and weight than other pocket pistols. Always dependable, reliable and accurate. Fits pocket or purse.



Std. Blue \$32.00
 Std. Blue, Pearl Nils. 37.50
 Chrome—Pearl Nils. 43.50
 25 Auto Cps (50) 3.85

FREE! Genuine Leather Holster
 ...Order by Mail Today!
 Send \$5.00 down, bal. C.O.D.
 GODFREY IMPORT CORP., Dept. PM2, 261 Broadway, N. Y. 7, N. Y.

POPULAR SERVICE BUREAU MECHANICS

HOME IMPROVEMENT LIBRARY
 12 AUTHORITY MANUALS FOR ONLY \$2.00

- ★ Now sold together in a service packet for the first time—a complete library of Popular Mechanics' home service, repair and improvement booklets—all 12 offered at one low group price. Listed below are only a few of the many topics covered:
- ★ Additions and Remodeling—How to modernize kitchens; how to work with concrete around the home; how to lay linoleum and tile; how to refinish floors and woodwork; how to remodel basements and attics; how to modernize walls and ceilings.
- ★ Basic Service and Repairs—House wiring and electrical repairs; plumbing repairs made simple; how to paint inside and out; how to cure your leaky basement; how to winterize your home; how to insulate your home.
- ★ The home owner who owns the HOME IMPROVEMENT LIBRARY will be prepared. Send your order in at once!

ONLY \$2.00

SERVICE BUREAU POPULAR MECHANICS, Room 517
 200 E. Ontario, Chicago 11, Ill.

Enclosed find remittance in the amount of \$2.00. Please rush the complete HOME IMPROVEMENT LIBRARY (12 booklets).

Name.....
 Address.....
 City..... State.....

Prepare for your career in

METALLURGY
AIR CONDITIONING
INDUSTRIAL TECHNOLOGY
MECHANICAL ENGINEERING



Missiles or machinery, rockets or refrigeration, MSOE equips you for a career in many fields:
 PRODUCT DESIGN • RESEARCH DEVELOPMENT • QUALITY CONTROL • TIME STUDY PURCHASING SALES ENGINEER

When you graduate from the Milwaukee School of Engineering, you are prepared for a dynamic career as a Mechanical Engineer or Engineering Technician. Under a faculty of specialists, you gain a sound technical education in modern, completely equipped laboratories and classrooms. As a result, MSOE graduates are in great demand and highly accepted by industries nationally.

AT MSOE you will meet men from all walks of life and all parts of the country—some fresh out of high school or prep school, others in their twenties—veterans and non-veterans.

You can start school in any one of four quarters and begin specializing immediately. Engineering technicians graduate in 2 years with an Associate in Applied Science degree. For a Bachelor of Science degree in Engineering, you attend 4 years. A 3-month preparatory course also is available.

Send for Free Career Booklet

MILWAUKEE SCHOOL OF ENGINEERING
 Dept. PM-260, 1025 N. Milwaukee St., Milwaukee, Wis.

Please send free Career Booklet. I'm interested in:
 Mechanical Engineering Air Conditioning
 Industrial Technology Metallurgy
 Electrical Engineering

Name..... Age.....
 Address.....
 City..... Zone..... State.....
 I'm eligible for veterans education benefits.

MS-147



FREE!
CANADIAN
STAMP
COLLECTION

RUSH reply. Big-value collection, historic Canadian Commemorative Stamps given free! Choice, scarce stamps issued over the years. Many large size, multi-colors including Royal Family, British Columbia Centennial, other colorful historic issues. All genuine, all different. Here's a rare chance to round out and increase the value of your collection. This offer never made before. Rush name, address for your FREE stamps and other valuable offers for FREE inspection. Include 10¢ for handling and postage. Williams Stamp Co., Dept. PM2M, St. Stephen, N.B., Canada.

WILLIAMS STAMP CO., Dept. PM2M, St. Stephen, N. B., Canada. Rush Free Canadian Commemoratives, other offers for inspection. Enclosed 10¢ for handling. PLEASE PRINT.



Carl H. Anderson, 655 North State, Preston, Idaho

One-Man Loader Also Steers Truck

Mounted behind the cab of a truck, a new one-man loader also has controls that allow its operator to drive the truck in reverse. Hand valves operate the boom loader, which is powered by a gasoline engine and can lift up to 600 pounds: a foot valve controls reverse steering. There also is a throttle, clutch, brake and gearshift on the loader platform. The unit is designed for industrial and agricultural chores.

STUDY TO BE A DOCTOR of Psychology or Metaphysics

Obtain a Ps.D., Ms.D., or Ph.D. Be a Teacher, Lecturer or Accredited Practitioner. Teach others how to achieve Health, Happiness and Contentment. Overcome problems. Correspondence Course only. Write for FREE book telling how.

THE NEOTARIAN FELLOWSHIP

Desk 8, Pickwick Building Kansas City 6, Missouri

FIND GOLD, SILVER BURIED TREASURE VALUABLE RELICS



Thousands of dollars worth of valuables have been found with DETECTRON instruments. Gold and Silver Ores and Nuggets, Other Precious Metals, Indian Artefacts, Battlefield Relics, Pirate Coins, Caches of Money buried or hidden in adobe walls. Six Models available including transistors. Have many features not found elsewhere. Light weight. Guaranteed to out perform Geiger Counters for Uranium. Ultra-Violet lamps for tungsten and oil. FREE INFORMATION. Write Dept. 3

Detectron SYLMAR, CALIFORNIA

*What Do the Owners
Think of the New
CORVAIR?*

Read the report of
the PM survey on this
compact rear-engine car

in the MARCH
**POPULAR
MECHANICS**

SAFETY PLUG LOCK

Locks plugs safely in wall outlets. Prevents shop eqpt., freezers, appliances, tools, from unplugging or from partial contact (which overburdens the motor). A great safety device. A must at home, in the office, factory, shop, everywhere. Helps protect children from electrical accidents. Installs in seconds, adjusts size to fit plug. Buy one for every outlet. Imm. Del. Fully Guar. Dealer Inquiries Invited.



Only 3 for
\$1.25
(6 for \$2)
Cash, check
or M.O.

LORD GEORGE LTD.

Dept. PM2, 1270 Broadway, New York 1, N. Y.

WORLD'S LOWEST PRICED CALCULATOR!

NEW! NEW! NEW!

TOM THUMB ADDING MACHINE

With beautiful Leatherette carrying case. **MADE IN AMERICA BY AMERICANS**. Beware of cheap imported imitations. Adds Up To One Billion—1,000,000,000. Subtracts—Multiplies—Divides.

Mistake Proof—Positively 100% Accurate—Lightning Fast—Shock Proof Solid Steel Mechanism

GUARANTEED FOR YOUR LIFETIME

Ideal for Housewives, Shoppers, Students, Engineers and Tax work. Take it to the Super Market—Save \$\$\$ every week. We pay postage if you send check, cash or money order—or just send your name & address and pay postman \$1.97 plus postage. Immediate Delivery—10 Day Free Trial—Satisfaction Guaranteed, money refunded by return mail. Special Gift Offer: 2 Machines for only \$3.49. Agents Wanted—Make easy money selling a Top Quality Calculator at our unbelievably low price.

TOM THUMB ADDING MACHINE

P.O. Box 5066, Dept. F-10, Philadelphia 11, Penna.

Not \$3.95 \$2.03 in

But Only **\$1.97** Penna. including 3% Tax.



REAL ESTATE

BE A BROKER

PAYS BIG! SEND FOR FREE, BIG, ILLUSTRATED CATALOG NOW! Graduates report making substantial incomes. Start and run your own business quickly. Men, women of all ages, learn easily. Course covers Sales, Property Management, Appraising, Loans, Mortgages, and related subjects. **STUDY AT HOME** or in classrooms in leading cities. Diploma awarded. Write **TODAY** for free book! No obligation. Approved for World War II and Korean Veterans

WEAVER SCHOOL OF REAL ESTATE (Est. 1936)
2020R Grand Avenue Kansas City, Mo.

FREE BOOK TELLS HOW

MAKE BIG MONEY

MAKING COSTUME JEWELRY AT HOME!

Thrilling spare-time, **MONEY-MAKING** hobby! Make newest, beautiful jeweled earrings, necklaces, bracelets, pins, pendants, cuff links, tie clips! Quick, easy to make—easier to sell to friends, neighbors, stores, at big profit! Details **FREE!**

DON-BAR CO., Dept. B-19

3511 W. Armitage Ave., Chicago 47, Ill.



MEN PAST 40

Afflicted With Bladder Trouble, Pains in Back, Hips, Legs, Nervousness, Tiredness.

If you have these troubles, particularly bladder trouble, then your condition may be traced to Glandular Inflammation . . . a constitutional disease. Neglect of this condition often leads to premature old age and sometimes incurable malignancy.

The Excelsior Medical Clinic has a **New Free Book** that tells how thousands of men have been successfully treated here at Excelsior Springs for Glandular Inflammation by **NON-SURGICAL Methods**. They found soothing relief and a new outlook in the future of life.

This **Free Book** may prove of utmost importance in your life. Write Today. There is no obligation. **Excelsior Medical Clinic, Dept. B6129, Excelsior Spgs., Mo.**

TRAIN AT HOME

in Your Spare Time or in the Great Allied School

1338-42 South Michigan Ave.
Chicago 5, Ill.

DRAFTING—All Branches
• Mech. • Structural • Aeronautical

ENGINEERING
• Industrial Engineering
• Tool Engin. & Designing

ELECTRONICS

AUTO MECHANICS

AIR CONDITIONING
Refrigeration — Heating & Cooling

TOOL & DIE MAKING
Machinist Trade

Choose the **Allied Way for Best Pay**

SEND FOR **FREE** BOOKS

Prepare for the best jobs in your spare time at home. With **ALLIED'S** practical home study program you can progress so rapidly that big new opportunities will soon be open to you. Students planning a career in engineering can begin their training in short courses at Home or at Allied Institute and continue progressively toward an Engineering Degree in 31 months. Allied is approved by Industry, National Home Study Council, Department of Education, Office of Public Instruction, State of Illinois, U. S. Department of Justice.

ALLIED INSTITUTE OF TECHNOLOGY,

1338-42 South Michigan Ave., Dept. PM-20, Chicago 5, Ill.

Send me without obligation information on your courses:

- | | |
|---|--|
| <input type="checkbox"/> MECHANICAL DRAFTING | <input type="checkbox"/> AUTO MECHANICS |
| <input type="checkbox"/> STRUCTURAL DRAFTING | <input type="checkbox"/> ELECTRONICS |
| <input type="checkbox"/> ELECTRONIC DRAFTING | <input type="checkbox"/> AIR CONDITIONING |
| <input type="checkbox"/> AERONAUTICAL DRAFTING | <input type="checkbox"/> REFRIGERATION |
| <input type="checkbox"/> INDUSTRIAL ENGINEERING | <input type="checkbox"/> TOOL & DIE MAKING |
| <input type="checkbox"/> TOOL & DIE DESIGNING | |
| <input type="checkbox"/> HOME STUDY | <input type="checkbox"/> RESIDENT |
| <input type="checkbox"/> VETERAN | <input type="checkbox"/> NON-VETERAN |

NAME AGE.....

ADDRESS

CITY..... COUNTY..... STATE.....

OWN • WEAR • ENJOY

Genuine DIAMONDS

YOUR credit is good at Kaskel's, America's Oldest Diamond Discount House serving over 1,000,000 satisfied customers since 1882. Select from hundreds of styles. Bargain prices defy competition. Only 10% down. Illustrated Guide explains Standard Diamond Grading System and Bonded Guarantee that protects you 100%. Send for FREE Buying Guide today. No obligation.

For As Little As
\$16⁰⁰
DOWN



SEND FOR FREE
DIAMOND BUYING
GUIDE

KASKEL'S • 41 W. 57th St., Dept. 7-B, New York 19, N. Y.
Send Free Buying Guide and advice about diamonds,
also details of easy payment plan.

Name.....
Address.....
City & State.....

Make \$4.00 An Hour EXTRA MONEY In Spare Time



Show Wonderful Paragon Shoes—up to \$4.00 cash commission per sale. Full or spare time. 160 styles. Big bonus. Easy selling helps. Magic Cushion. No investment. No experience. Write for FREE Kit.
PARAGON SHOE CO.
79 Sudbury St., Dept. 20
Boston 14, Mass.

Learn to **MOUNT BIRDS**

Tan SKINS, Make Up FURS
Be a Taxidermist. We teach you at Home. Mount Birds, Animals, Pets, Game Heads, Fish. Save your hunting trophies: decorate home and den. **MAKE MONEY.** Mount and Krometan for others. Big spare-time profits.

FREE BOOK 100 game pictures 48 pages - Hunters. get this wonderful book. It's Now Free. Send postcard TODAY. State AGE.
NORTHWEST TAXIDERMIST SCHOOL
Dept. 2502 Omaha, Nebraska

PROFIT IN YOUR SPARE TIME

FIX SMALL GASOLINE ENGINES
Outboard • Powermower • Chain Saw • Tractor



Harry F. Peters, Spokane, Wash., says:
"... your Course led me into a very profitable and enjoyable business."

MAKE EXTRA MONEY—or, repair your engines and SAVE. Illustrated, easy-to-understand, Home Study Course. FREE information. Write TODAY!

LINCOLN TECHNICAL INSTITUTE
Suite 2-E, 472 Market Street, Newark 5, New Jersey



Antlers Tell Rate of Fallout

Once good only for hatracks, Wyoming deer horns are being studied by scientists measuring radioactive strontium fallout, which is deposited in the calcium of the bones. Since the quick-growing antlers bud each spring and drop off each winter, they provide yearly measurements in an important study. In a previous measurement in Scotland, antlers collected in 1957 were found to contain more than 11 times the amount of strontium found in antlers collected in 1952.

CONCRETE BLOCK HOME PLANS

\$1600 RANCH HOME

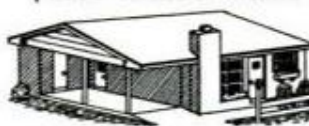

Build your own 24'x40' Ranch Home complete for \$1600. Liv. Room, Kit., two bedrooms, bath, Fireplace, slab or basement, carport or garage. Blueprints, instructions, and material list \$3.00 ppd. Money back guarantee. Other plans—\$1000 Cottage, \$1150 Garage Apt., \$1900 Duplex, \$2500 Ranch Home, \$3500 Cape Cod, \$3800 3 bedroom 2 bath family room Ranch Home. Illustrated Folder, "How To Build Your Own Block Home", plus Plan Folder 10c.

QUALITY PLANS SINCE 1953

BAILEY BUILDERS, 201-B Cherokee, Little Rock, Arkansas

DOLLS!

Learn to make, repair and sell dolls and accessories at home. Excellent money making opportunities. May we send FREE informative booklet? No obligation!

NORM & SUE'S DOLL HOSPITAL SCHOOL, Studio P-20
11826 San Vicente Blvd., Los Angeles 49, Calif.

MAKE \$5⁰⁰ AN HOUR IN SPARE TIME BIG, EASY "AT HOME" PROFITS—METALIZING

It's so easy to earn Big Money right at home in fascinating new spare time business. Little easy-to-run table-top machine returns Cash Dollars for a few cents cost. We furnish everything to put you in business for yourself, "eternalizing" baby shoes, and other keepsakes. Write TODAY for full facts FREE. No salesman will call on you. No obligation.

WARNER ELECTRIC, 1512 Jarvis, Dept. M-2-B, Chicago 26, Ill.

TERMITES?

GET RID OF THEM YOURSELF!

Don't pay up to \$300 and more to get rid of termites or prevent infestation. Do-it-yourself—Easily! Quickly! Inexpensively with "TERM-OUT" solution. Send 10¢ for fact-filled handbook.



COMPASS RESEARCH
701-A INVESTMENT BLDG., PITTSBURGH 22, PA.



LEARN MEAT CUTTING AT NATIONAL

Pay After Graduation



The steady dependable trade of Meat Cutting taught easily in 8 short weeks. YOU LEARN BY DOING under actual meat market conditions in big modern school at Toledo.

For beginners or men with experience. Get a profitable store of your own. Remember, PEOPLE MUST EAT! Big pay jobs. Free employment help. Thousands of successful graduates.

Buying, cutting, percentage, pricing, advertising, selling, etc. A complete retail meat education. National School established 37 years. Get National training NOW. Pay your tuition in easy weekly

payments after you graduate. Send coupon for FREE school catalog — TODAY. G.I. approved.

National School of Meat Cutting, Inc., Dept. 50-B, Toledo 4, Ohio

Send me your FREE school catalog on National Training at Toledo in Meat Cutting, Meat Merchandising and Self Service Meats. No obligation. No salesman will call.

Name _____ Age _____
 Address _____
 City _____ State _____
 Approved for Veterans

LEARN WHILE YOU SLEEP!



Experiment in this fascinating, educational new field. Use your phono, recorder or amazing new "Electronic Educator" endless tape recorder. Free catalog lists over 200 unusual tapes, records, equipment for sleep-learning & hypnosis experimenters. Sleep-Learning Research Ass'n., Box 24-A, Olympia, Wash.

GET INTO ELECTRONICS

V.T.I. training leads to success as technicians, field engineers, specialists in communications, guided missiles, computers, radar, automation. Basic & advanced courses in theory & laboratory. Assoc. degree in 29 mos. B.S. obtainable. ECPD accredited, G.I. approved. Graduates with major companies. Start Feb., Sept. Dorms, campus. H. S. graduate or equivalent. Catalog.

VALPARAISO TECHNICAL INSTITUTE
 DEPT. D VALPARAISO, INDIANA

BIG PROFITS- NO RISK!

LET SOLAR TWO-2-YEAR LIGHT BULBS

MAKE YOU \$10-\$70 A DAY

Supply trouble-free, SOLAR TWO-2-YEAR BULBS to factories, offices, homes. GUARANTEED in writing to burn 2 full years — last 4½ times longer than ordinary bulbs. Customers save 52¢ or more on every bulb. Send \$1.98 for 8 sample bulbs worth \$3.96 (money back if not satisfied). Or write for free facts.

SOLAR ELECTRIC PRODUCTS, INC.
 Dept. PM-20, 366 5th Ave., N. Y. 1, N. Y.

DRAINS cellars, cisterns, wash tubs; \$7.95
IRRIGATES - CIRCULATES - SPRAYS

1,001 uses. Stainless shaft. Won't rust or clog! Use 1/6 HP motor or larger... 3/4 HP for up to 3000 GPH; 450 GPH 80" high; or 1800 GPH from 25" well. 1" inlet; 3/4" outlet. Couplings included free. \$7.95. **HEAVY DUTY BALL-BEARING PUMP.** Up to 7,500 GPH; or 3,000 GPH from 25" well. 1 1/4" inlet; 1" outlet. \$12.95. Postpaid if cash with order. **MONEY BACK GUARANTEE** Centrifugal and Gear Pumps in All Sizes. LABAWCO PUMPS, Belle Mead 7, New Jersey



HOW TO WIN SUCCESS WITH YOUR VOICE

Special NEW experts' course!

PUT NEW STRENGTH AND MAGNETISM into your voice through this completely new, thoroughly-proven method. Win success as thousands of others have done — through our special course originally created for announcers, actors and other professionals — NOW AVAILABLE TO PUBLIC FOR FIRST TIME. Self-training in the privacy of your room. Requires only minutes a day — no other course like it! Includes 2 large LP Hi-Fi training records by top TV-radio network announcers, amazing TR-18 transistor microphone for self-testing, 10 illustrated, easy-to-follow lessons. Exclusive tape-recorded "final exam" assures maximum results. Money-back guarantee.

FREE BOOKLET — Write today for our fascinating free booklet and open a whole new world of business, financial and social success. No cost, no obligation. Just send name, address, age. Booklet will be sent immediately in sealed envelope. No salesman will call.

HOLLYWOOD VOICE-SPEECH INSTITUTE
 Studio #20 5504 Hollywood Boulevard, Hollywood 28, California



PAY 2 or 3¢ on the DOLLAR

for 1000's of Useful Items of

U.S. GOV'T SURPLUS

AT THE AMAZING PRICES PAID AT GOV'T SURPLUS SALES

Autos.....\$78	Tractors.....\$68
Trucks.....\$212	Motors.....99¢
Boats.....\$5.90	Typewriters..\$6.80
Compressors..\$9.69	Generators..\$8.78

You BUY DIRECT from U. S. Government at TREMENDOUS savings. Eliminate middlemen—Save BIG MONEY! Pay as LOW as 2¢ on the dollar. Our DIRECTORY Gov't Surplus Sales lists 100's Army, Navy, Air Force Surplus Depots all over the world. BUY JEEPS, sports equipment, hunting, fishing and photographic equipment and supplies, radio, electronic and electrical equipment, trucks, boats, airplanes. Plumbing, hardware, office equipment & supplies. Tools, machinery, furniture. This 1960 book tells how to buy Gov't Surplus DIRECT. No dealer profits to pay. Get on the gravy train NOW! Send \$1 TODAY for "Gov't Surplus DIRECTORY" to AVIATION SURPLUS, Dept. P.M.-2, Box 789, York, Pa.

High School at Home

MANY FINISH IN 2 YEARS

No classes. No time wasted going to and from school. Progress as fast as your time and abilities permit. Standard H.S. texts supplied. Thousands enroll each year in this 63-year-old school. Send for FREE descriptive booklet.

AMERICAN SCHOOL, Dept. H-245
Drexel at 58th St., Chicago 37, Ill.

Without obligation, please send FREE descriptive booklet.

Name _____

Address _____

Accredited Member National Home Study Council

new FROM HEATHKIT® transistor clock radio

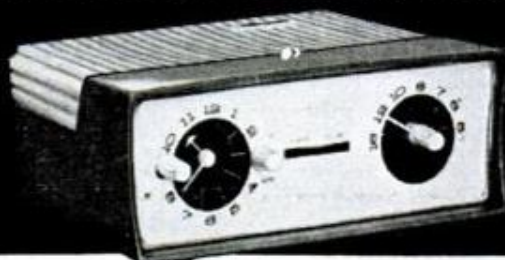

EASY TO ASSEMBLE... COMPLETELY PORTABLE
... UP TO 500 HOURS ON BATTERIES

Take it with you... on trips, to the beach, in a boat... Nothing to plug-in, just goes and goes on inexpensive batteries. Lulls you to sleep, wakes you up, tells time and plays all day long. Leather carrying case available. **ONLY \$45.95.**



HEATH COMPANY
Benton Harbor 17, Michigan
a subsidiary of Daystrom, Inc.

Send the latest Free Heathkit Catalog.

NAME _____

ADDRESS _____

CITY _____ ZONE _____ STATE _____

Note: Price subject to change without notice.

NEW! ISOTRONIC METHOD

LEARN TV REPAIR IN ONE SHORT WEEK!

Now, after 5 years research—a streamlined training system! Earn up to \$150 weekly, in just 7 days. No expensive training, equipment, or long study. Learn to service TV sets instead of building them! Most practical method yet—developed by leading scientists with cooperation of major TV mfg.'s! Send for details and FREE SAMPLE LESSON. Use it on your set—repair it!—convince yourself! Write: TV SERVICING SYSTEMS Dept. D-172, 1038 S. La Brea, Los Angeles 19, California

FREE! Sample Lesson



Eastman Kodak Company, Rochester 4, New York

Movie Camera Features Zoom Lens

In one motion, the home movie-maker can switch from a panoramic view of a scene to a close-up telephoto study of any part of it with Eastman's automatic 8-mm. movie camera, which features a zoom (variable focal length) lens. The camera also has a built-in exposure meter that automatically adjusts the f/1.9 lens for correct exposure. Under average daylight conditions, the wide-angle lens setting (9 mm.) can be used up to two feet from the subject; the normal lens setting (13 mm.) to 3½ feet, and the telephoto setting (24 mm.) up to 11 feet.

MEN NEEDED NOW—BIG PAY OPPORTUNITIES FOR JET ENGINE MECHANICS AND TECHNICIANS

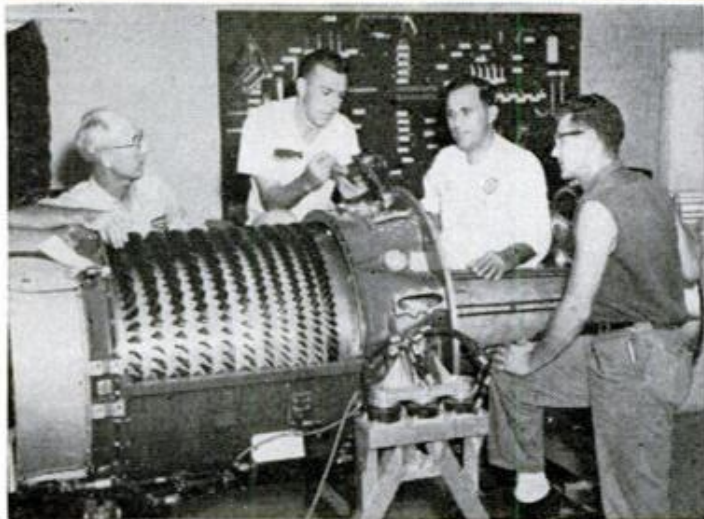

In our RESIDENT SCHOOL you get "live" practical JET ENGINE training in our own Airport Shop. Progress rapidly under guidance of FAA Licensed Instructor. Over 10 years experience behind A.J.T.'s training—school offers finest facilities of its kind. Lifetime employment service. Be part of the Jet Age—get the facts about good starting pay, great future opportunities. Write today for FREE BOOK.

ATLANTIC JET TRAINING, INC.
Dept. PM-20 ZEPHYRHILLS, FLORIDA

Learn at Home in Spare Time or in Atlantic Jet Training's Own Modern Airport Shop—Work on Jet Engine

Cash in on "Jet Age"—build successful future career in great, fast growing industry—prepare quickly for big pay opportunities, security, advancement. Act now, get in on ground floor, no advanced education or previous experience needed.

Practical training covers all phases for top pay jobs including—FLIGHT LINE MAINTENANCE, SHOP OVERHAUL MAINTENANCE, INSPECTORS WITH AIRLINES, AIR BASES, MANUFACTURERS, AND GOVERNMENT MISSILE PROJECTS.

SHOP METHOD HOME TRAINING is fully illustrated, thoroughly practical, easy to understand.

MAIL COUPON TODAY

ATLANTIC JET TRAINING, INC., Dept. PM-20
Municipal Airport Jet Engine Training Shop.
ZEPHYRHILLS, FLORIDA

Rush FREE Book, "YOU and the JET Industry" (No Salesman will call)

Name _____ Age _____

Address _____

City _____ Zone _____ State _____

Check preference: () Home Study () Resident

ARTHRITIS—RHEUMATISM VITAL FACTS EXPLAINED

FREE DESCRIPTIVE BOOK

How crippling deformities may be avoided. This amazing FREE BOOK explains why ordinary methods give only temporary relief—if that. Describes a drugless method of treatment successfully applied in thousands of cases. Write for this 36-page FREE BOOK today. No obligation.

BALL CLINIC, DEPT. 756, EXCELSIOR SPRINGS, MO.

You Can Have a HE-MAN VOICE

Send today for FREE booklet "Voice Power and Personal Power" by Eugene Feuchtinger. Just send your name, address and age. Mailed in plain sealed envelope. No obligation.

PREFECT VOICE INSTITUTE

210 S. Clinton, Studio BP-2, Chicago 6, Ill.



LAW FREE BOOK THE LAW TRAINED MAN

Write today for a FREE copy of illustrated law book, "THE LAW TRAINED MAN," which shows how to earn the professional Bachelor of Laws (LL.B.) degree through home study of the famous Blackstone Law Course. All necessary books and lessons provided. Moderate cost; convenient monthly terms. Write for FREE law training book today.

Blackstone School of Law, 307 N. Michigan Ave.

Founded 1890

Dept. 52 Chicago 1, Illinois

FREE AMAZING NEW BOOK "HOW TO ANSWER ADS"



Never before have you seen anything like this. Tells you in simple language the correct way to answer ads. Gets you quicker replies—better results, and greater satisfaction. Will save you time and money and it's ABSOLUTELY FREE. No obligation whatever. Every reader of advertising should have this booklet. Send a postcard for your copy NOW. F. W. JOHNSON, Popular Mechanics Magazine, Room 600-A, 204 East Ontario Street, Chicago 11, Ill.

Will You Trade 1 Hour a Week for BIG PAY—YOUR OWN BUSINESS?



Be a LOCKSMITH

You can quickly step into a well-paid job or start a big-profit business of your own. Shortage of locksmiths means opportunities everywhere, spare-time or full-time.

EARN EXTRA MONEY FROM THE START!
All Special Tools, Supplies Furnished Free

Age, education, minor physical handicaps don't matter in this growing, steady-income trade. You learn fast at home—gain practical experience through well-illustrated lessons. You do real jobs under the personal guidance of experts. Only school of its kind.

For a future as your own boss, or in a big pay job, send for FREE illustrated book. Mail coupon at once. No salesman will call. Licensed State of N. J.; Accredited National Home Study Council.

Approved for Veterans.

LOCKSMITHING INSTITUTE
Dept. 102, 150 Park Ave.
E. Rutherford, N. J.

Please send FREE and without obligation illustrated book.

Name.....

Address.....

City..... Zone.. State....

SEND FOR
FREE
BOOK
Professional
Tools
FREE
with Course



FOCUS YOUR  **on BENJAMIN**
AMAZING NEW
Line of REPEATERS
WITH THE LATEST IMPROVEMENT
IN FAST, SURE, GRAVITY
LOADING ACTION AND
PIGGY-BACK SHOT MAGAZINE

A Shot is placed in Firing Position each time Bolt is Pulled Back and Closed. Flash Ammo Count on Full View Magazine.

\$18.95

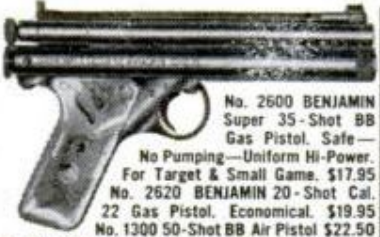

No. 3600 BENJAMIN Super 100 Shot BB Gas Rifle. Non-Toxic—Safe—Convenient—Uniform Hi-Velocity Power.
 No. 3620 BENJAMIN Super 85 Shot Cal. 22 Gas Rifle . . . \$20.95
 No. 3100 Super 100 Shot BB Air Rifle. Adj. Shooting Force \$23.95
 No. 3120 BENJAMIN Super 85 Shot Cal. 22 Air Rifle . . . \$25.95

FREE Catalog All Models Benjamin Single Shot & Repeaters—Cal. BB or 177 or 22. Also, Special Hunting & Fishing Knife Offer.
BENJAMIN AIR RIFLE CO., 896 MARION ST., ST. LOUIS 4, MO.



Mid-Century Tool & Products, Inc., 3328 E. Lake St., Minneapolis 6, Minn.

Car Desk Attaches to Dashboard

Installed in minutes without drilling holes, a plastic-coated wood table attaches to the dashboard of the car, serving as a writing desk or typewriter stand. Designed for businessmen and sales people, the desk, supported by a cast-aluminum frame, can be adjusted to several positions. It is connected to the dash with two thumb-screws. Rubber molding along the table edges prevents damage to the car. A clipboard spring holds paper in place and a tray keeps pencils handy.

SHORTHAND in 6 WEEKS

Famous **SPEEDWRITING** shorthand. 120 words per minute. No symbols; no machines; uses ABC's. Learn at home or through classroom instruction. Lowest cost. For business and Civil Service. 500,000 graduates. Typing available. 37th year. Write for **FREE** booklet.
 © 1959

Speedwriting
 Dept. 1502, 55 W. 42 St., New York 36

 **YOU NEED THIS**

FREE GIANT 1960 B-A CATALOG

A Complete Buying Guide for Everything in
RADIO 1960 TV ELECTRONICS
 ANNUAL CATALOG 601
BA
 SINCE 1927
 Guarantee

- 204 KING-SIZED PAGES**
- EVERYTHING IN RADIO TV AND ELECTRONICS**
- 100'S OF NEW ITEMS LISTED HERE FOR 1st TIME**
- 21 PAGES OF BARGAINS NOT IN ANY OTHER CATALOG**

BURSTEIN-APPLEBEE CO.
 Dept. PM, 1012 McGee St., Kansas City 6, Mo.
 Send Free 1960 B-A Catalog No. 601.
 Name.....
 Address.....
 City..... State.....

SEND FOR IT TODAY



Bolens Products Division, Food Machinery & Chemical Corp., Port Washington, Wis.

Rotary Mower Pulverizes Clippings

Grass clippings, retained in the "cyclone chamber" of this rotary mower, are pulverized to a superfine state and then blasted downward between the grass. The manufacturer, Bolens Products Division, says that the clippings need not be raked, as they're absorbed into the soil as fertilizer. The machine has a 22-inch cutting width.

Material, защищенный авторским правом

508 Different STAMPS

CATALOG VALUE \$15 *Yours* FOR ONLY 35¢



THIS fabulous offer is made to win new friends for Littleton. 508 different stamps — from all over the world — for only 35¢! Standard catalog value guaranteed to be at least \$15. Imagine the excitement of owning exotic stamps from Nationalist China, the United Arab Republic (shown here), Morocco, Indonesia, Pakistan, and many other legendary lands! Yes, you get a really generous assortment from every continent—for only 35¢ with approvals. (Offer open to adults only.) Simply rush your name and address, and only 35¢ to: **LITTLETON STAMP CO., Dept. PM-2, Littleton, N.H.**

ENGINEERING DEGREE IN 27 MONTHS

B. S. degree (27 mo.): Aero., Chem., Civil, Elec., Mech. & Electronics. B.E. (36 mo.): Aero., Chem., Civil, Electrical, Mechanical, Metallurgical. B.S. (36 mo.): Math., Chem., Physics. Prep courses. Demand for grads. Campus. 20 bldgs.; dorms, gym. Low rate. Earn board. G.I. appr. Enter March, June, Sept., Dec. **1620 E. Washington Boulevard Fort Wayne 2, Indiana**
Keeping pace with progress

INDIANA TECHNICAL COLLEGE

SIGN PAINTING

Home-Study Course — Only \$5.95

Teaches you commercial sign painting and sign building as it is being done TODAY in leading shops all over the country. Complete practical course for self-instruction. Shows latest methods of truck lettering, office doors, wood letters, reflecting signs, plastics, sprayed signs, gold leaf, silk screen process, up-to-date alphabets, money-making business information, etc. **SATISFACTION GUARANTEED OR REFUND!** Contains all the instruction of a high-priced correspondence course. Full price, only \$5.95, postpaid. Or C.O.D. plus postage. No risk—order today. Satisfaction or money back! Order "Sign Painting Course." **NELSON-HALL CO., 210 S. Clinton St., Dept. 2BP-2, Chicago 6, Ill.**



Now Many Wear FALSE TEETH With More Comfort

FASTEETH, a pleasant alkaline (non-acid) powder, holds false teeth more firmly. To eat and talk in more comfort, just sprinkle a little **FASTEETH** on your plates. No gummy, gooey, pasty taste or feeling. Checks "plate odor" (denture breath). Get **FASTEETH** at drug counters everywhere.

NEW WONDER AUTO GLAZE

with Miracle METHYL SILICONE Fluids



Dealers & Distributors Wanted for EXCLUSIVE FRANCHISES!

GUARANTEED to outshine, outlast and outperform ANY wax polish on the market today—or money back! **FAST, REPEAT SELLER!** Needed by 45,000,000 car owners. Demonstrates like magic. Just apply, wipe off. No hard rubbing. Keeps car and chrome like new for months! **OVER 175% PROFIT!** Retail \$2.00 pint (year's supply). Your profit can be over \$1.35 each pint. **SENT TO TRY** on your car. Rush name for **FREE** money-making details, **FREE** sample. No Obligation! **ROYALTONE PRODUCTS CORP. Dept. P-2 1035 E. 10th St., Brooklyn 30, N. Y.**



HIGH WAGES

for operators of heavy construction equipment

... here's your opportunity to be a part of the biggest booming industry in the U. S. A. and earn up to \$10,000 a year and more!

NOW is the time for you to learn to be an Operating Engineer for big diesel-engined bulldozers, draglines, cranes, back hoes, scrapers and motorgraders! Get in on the ground floor of this great industry. Cash in on the training you'll get at National for years to come. The construction field is going up, up, up... heavy equipment operators today are making as much as \$10,000 a year and more, and the really big boom years are still to come! You can make a career out of it... and the best part of all is that you need no experience to start. National School trains you right from the beginning in the operation and maintenance of all types of earth-moving equipment.



LEARN on the largest and finest machines... machines of major manufacturers are used to train you.

LEARN from experienced teachers... expert operators with years of practical on-the-job experience are your instructors. Contractors are on our advisory staff.

LEARN by doing... the outdoors is your classroom and actual operating machines are your tools. National is NOT a correspondence school, but a fully equipped educational institution located in the beautiful Piedmont area of North Carolina where you will live while you learn!

Five years ago, I founded National School of Heavy Equipment Operation, the first school of its kind in the world. I'm proud that hundreds of my graduates are now working in the construction field for higher wages than they ever made before!

Gilbert S. Shaw
President and Founder



Contractors need trained heavy equipment operators and pay high wages to our graduates. Begin TODAY to learn your way to better pay... mail the coupon NOW for FREE information. No obligation. Ages 18-55. Budget plan available. Approved for G.I. Benefits. Contractor affiliations.

NATIONAL SCHOOL of HEAVY EQUIPMENT OPERATION DEPT. D-4 P. O. Drawer 8415, Charlotte, N. C.

Please send me FREE illustrated school catalog and complete information without obligation about how I can become an operator.

Name _____ Age _____

Address _____

City _____ Zone _____ State _____

ENGINEERING

HOME
STUDY
COURSES

Courses written by world authorities in all branches of engineering and science. Step-by-step instructions using methods proved successful by thousands of our graduates. One hour each day in your spare time will start you off to higher pay, security and prestige. Fill in the coupon to-day and indicate the course of interest. We will send you a complete outline of the course with a booklet describing the Institute and our advanced teaching methods.

CIVIL ENG.
SURVEYING
ARCHITECTURE
FORESTRY
STRUCTURAL
MECHANICAL ENG.
INDUSTRIAL ENG.
REFRIGERATION
DRAFTING
ELECTRICAL ENG.
RADIO
ELECTRONICS
TELEVISION
AERONAUTICAL ENG.
HIGH SCHOOL
CHEMICAL
MATHEMATICS
ACCOUNTING

MAIL THE COUPON TODAY

Canadian Institute of Science & Technology Ltd.,
741 Century Bldg., 412, 5th St. N.W., Wash., D.C.

NAME.....

ADDRESS.....

CITY.....STATE.....

COURSE OF INTEREST.....

Canadians: Send to C.I.S.T., 741 Garden Bldg.,
263 Adelaide St. W., Toronto, Ont.



C. I. S. T.

Entertaining and Mystifying



LIT CIGARETTE VANISHES AND THEN REAPPEARS!

With sleeves rolled up, you make a lighted cigarette vanish! Not a trace remains! Then, like a magician, you reach into the air and presto! Cigarette reappears! Actually 2 tricks in one! You can also make bills, pencils disappear too! Easy to do! Astonish everyone! Be the Life of the Party! Order at once.

FREE WITH EACH ORDER YOU GET OUR GIANT SURPRISE CATALOG — 160 Pages of over 1000 other tricks.

Catalog alone 25¢ postpaid. Be sure to order your copy now!

HOUSE OF 1000 MYSTERIES • 202-37 PINWOOD • TRUMBULL, CONN.

\$6.95
.22 Cal.

The skilled hand of the German gunsmith is responsible for this .22 caliber, 6-shot repeater automatic with self-ejecting clip. Just 4" long, fits easily into pocket or purse. Ideal for sporting events, stage use. Not lethal weapon—ammunition available exclusively from us.
(Not available to California residents).

**Comes for \$6.95 p.p.d. from
BEST VALUES, Dept. A-371, 403 Market, Newark, New Jersey**

TOOLS WHOLESALE

**\$100
PUTS YOU IN
BUSINESS**

Start your own business, sell tools to your friends and neighbors, or buy tools for your own use and **SAVE MONEY \$\$\$**

A MILLION DOLLAR INVENTORY AT YOUR FINGERTIPS. NO STOCK TO CARRY. ORDER AS YOU NEED IT.

BUY AT WHOLESALE PRICES. Extra \$25.00 profit on your accumulated purchases. \$1.00 refund on first purchase or refunded if you are not 100% satisfied.

THOUSANDS!! of Nationally Advertised items of Hand Tools, Power Tools, Machinist Tools, Tool Chests, Paint Sprayers, Light Fixtures, Appliances, Guns, Gifts, Toys and other items too numerous to mention.

WE SHIP COAST TO COAST Wholesale Disc. up to 50% off

Dept. PM-2 107 Walnut St., Phila. 6, Pa.
SILVO HARDWARE CO.,



SUPER JU JITSU

Now get tough double quick!

A course of instruction in the art of practicing and using this method of applying **LIGHTNING-QUICK Super Ju Jitsu**. Be Dangerous! These amazing lessons show you how it's done... in a big illustrated home-study course. The weapons are just your **BARE HANDS**—they can be used effectively if you know how and practice the art. Easy to learn; quick. Full 16-lesson course only **\$5.95** postpaid—or COD, plus postage. Satisfaction or your money back guaranteed! Order "super Ju Jitsu Course."

NELSON-HALL CO., 210 S. Clinton St., Dept. 88P-2, Chicago 6, Ill.

"YOU ARE UNDER ARREST!"



Help Bring Crooks to Justice Through Scientific CRIME DETECTION!

We have taught thousands this exciting, profitable, pleasant profession. Let us teach you in your own home. Learn Finger Printing, Firearms Identification, Police Photography, Secret Service Methods thoroughly, quickly, at small cost. Over 800 of all American Bureaus of Identification employ I.A.S. students or graduates. Write for FREE "Blue Book of Crime."
(A Correspondence School Since 1916)

Institute of Applied Science, 1920 Sunnyside Ave., Dept. 1352, Chicago 40, Ill.

Atomic Waste Creates Problem

Disposing of radioactive wastes may become a great obstacle to the whole nuclear power program of the United States, warns Francis R. Bruce of the Oak Ridge National Laboratory. Bruce estimates that by 1970 the U. S. nuclear power industry will have produced 7,300,000 gallons of radioactive solution containing about three billion curies of radioactivity. By the year 2000, these figures will have risen to 300 million gallons of liquid with 60 billion curies of radioactivity. Mr. Bruce also calculates that in the year 2000, only 12 percent of all fission products obtained in atomic power stations will have found a practical or scientific application, while 88 percent will have gone into the waste disposal system.

Earth's Interior Is Cooler Than Formerly Believed

Temperatures inside the earth are probably somewhat lower than they were believed to be a few years ago, according to a University of California geologist. Dr. John Verhoogen reports that present observations indicate the bottom of the earth's crust to be about 900 degrees F., and the outer boundary of the core to be approximately 3600 degrees.

Imagine!

A NEW TYPE SHOE WITH SOLES GUARANTEED FOR A FULL TWO YEARS!

NOTHING LIKE IT EVER BEFORE! If you're looking For More Money We'll Set You Up For Life with America's Biggest and Most Sensational Shoe Line! **SERVE EVERY-ONE** from BABY to POP and MOM!

Imagine a material so tough it is almost impossible to wear it out! An amazing "first" in the shoe business that Ortho-Vent unconditionally guarantees to wear two years... or replaced free! Now offered in service shoes and oxfords—a shoe built for a man's kind of work. Stands up to grease, chemicals, foot-gripping mud, yet lighter, more flexible, more comfortable than any shoe ever made because of "built-in" Spring-Step Cushion Construction. This amazing shoe is only one of over 200 styles that make up America's biggest and most fabulous shoe line. Shoes for men, women, boys, girls, infants and babies... for work, dress, sports and play. Shoes for you to cash in with big!



WATERPROOF BOOTS, TOO!

New sole-vulcanizing process eliminates stitches. No way for water to enter ever! Guaranteed!

ORTHO-VENT GIVES LIFE and HEALTH INSURANCE...

Even to Spare Time Salesmen Life, Health and Accident Coverage without cost as extra bonus!

CASH & RETIREMENT INCOME FOR LIFE! lets you draw cash retirement income!



NO EXPERIENCE—NO INVESTMENT NEEDED

Can you use up to \$32.00 a day—up to \$150.00 a week—up to \$600.00 a month and more? Starting at once? Then get in on the shoe line that has revolutionized the entire industry, backed by an amazing Selling Plan that includes a Family Discount Plan as well—a combination that is making our salesmen the highest paid men in all the field. See below!

ORTHO-VENT SHOE CO., Inc.
1102 Brand Rd.
Salem, Va.



ORTHO-VENT SHOE CO.
1102 Brand Road, Salem, Virginia

I want to sell Spring Step Shoes and make BIG MONEY. Rush me the complete ORTHO-VENT LINE and special Salesman's Proposition.

Name _____ Age _____
Address _____
City _____ State _____

CUT OUT COUPON For FREE SELLING OUTFIT...

If you want lifetime big earnings mail the Coupon opposite or post card TODAY!

RUSH This Coupon Today for Free Selling Outfit!

'How to Make Money with Simple Cartoons'



A book everyone who likes to draw should have. It is free; no obligation. Simply address

FREE BOOK

CARTOONISTS' EXCHANGE
Dept. 92-D Pleasant Hill, Ohio

75 POWER TELESCOPE 25X-45X-75X \$3.98

NEW 3 in one telescopes, 3 variable 25X, 45X-75X magnification. Brass bound. 25 power for ultra bright images 45 & 75 power for long range. Guaranteed to bring distant stars, moons, objects, sports 75 times closer. Most powerful scope sold anywhere near this amazing low price. American made, 5 sections. Opens 36", closes 1 ft.; contains 4 ground & polished lenses. Can also be used as powerful compound microscope. Mass production enables us to offer telescope complete at \$3.98 postpaid. Money back guarantee.

CRITERION CO., Dept. PMB-78, 331 Church St., Hartford, Conn.

RUPTURED

BE FREE FROM TRUSS SLAVERY

Surely you want to **THROW AWAY TRUSSES FOREVER**, be rid of Rupture Worries. Then Why Do you put up with wearing a griping, chafing and unsanitary truss the balance of your life? If you do, it will NOT be through necessity but through choice on your part.

Now there is a new modern Non-Surgical treatment that is designed to permanently correct rupture. These Non-Surgical treatments are so certain, that a Lifetime Certificate of Assurance is given. Write today for our New FREE Book that gives facts that may save you painful, expensive surgery. Tells how non-surgically you may again work, live, play, love and enjoy life in the manner you desire. There is no obligation.

Excelsior Medical Clinic, Dept. H6124, Excelsior Springs, Mo.

LEARN UPHOLSTERY

in your spare time run your own business **AT HOME**



FREE BOOK with sample lessons

with course

YOU MAKE

SLIPPER CHAIR



CLUB CHAIR



OTTOMAN

PLUS SLIP COVERS Yours to Keep or Sell

BE YOUR OWN BOSS

Earn more from the start! Set up your own profitable business, in your own home, enjoy steady income, independence for life. You're in demand in the booming field of Custom Furniture Upholstery. Right off you start learning and earning with tools, complete frames, fabrics and materials, included FREE with N. Y. State-approved UTS course. You learn skilled professional custom upholstery, reupholstery, furniture finishing, repairs, how to make beautiful slip covers, cushions and draperies. **EARN WHILE YOU LEARN**, in your spare time AT HOME... the UTS easy way.

FREE ILLUSTRATED BOOK - FREE SAMPLE LESSON Get ready for well-paid job and big profits, from steady work, as your own boss, running your own business. Mail coupon NOW for FREE BOOK! Training in N. Y. School also available. **VET APPV'D. ACCREDITED BY N.H.S.C.**

UPHOLSTERY TRADES SCHOOL
Dept. MB-310, 721 B'way, N. Y. 3, N. Y.

Please send me FREE book, "Your New Way to a Successful Career," and FREE sample lesson. No obligation—no salesman will call.
 Home Study Training in N. Y. School

Name _____ Please Print Plainly
Address _____
City _____ Zone _____ State _____
 Check if Korean Veteran

MODEL CHANGEOVER SALE! 1959 MODEL—BELOW COST!

8" TILT ARBOR SAW

BLADE TILTS—TABLE REMAINS LEVEL

Heavy duty all cast iron and steel construction. Precision ground cast iron table. Price includes massive cast iron mitre gauge and patented motor drive that fits any motor. Cross cuts, rips, bevels, mitres, dadoes, cuts compound angles — everything expected of saws costing four times as much. Depth of cut adjustable; 0" to 2 1/4" — table always level. Send check or M.O. \$2.00 deposits on C.O.D.'s.



SPECIAL BARGAIN — This saw is our 1959 model. Each saw is brand new — sent to you in factory sealed cartons. Sold and guaranteed direct from the factory to you at a fantastic bargain.

FREE 10 DAY TRIAL — MONEY BACK GUARANTEE

Try this famous saw 10 days. If you are not satisfied that it does the work of any tilt arbor saw, regardless of price, return for immediate money back refund.

Sent Express Collect.

We reserve right to refund money if stock is exhausted

AMERICAN MACHINE & TOOL CO.
ROYERSFORD 10, PA.

49c

FIXES ANYTHING!

HERCULES PLASTIC ALUMINUM IN NEW HANDY 49c TUBE!

Repair metal, wood, glass, porcelain, masonry... almost anything! The amazing new formula Hercules Plastic Aluminum forms bonds so strong that an independent laboratory* test proved it superior in holding power to the other leading brand. Also available in Giant \$1.00 tube and cans.

*Name on request.



HERCULES CHEMICAL CO., INC. 416 Broadway, New York 13, N. Y.

Missiles of Mercy To Range the World

Guided missiles may be used to carry such items as thousands of pounds of medical supplies on mercy flights to any spot in the world within the next 10 years, says Robert P. Haviland, satellite engineer for the General Electric Company. He says improved guidance systems will enable a re-entry vehicle to "ride-in" on radio beams sent out by commercial or airport radio transmitters and land at a predetermined point. Problems connected with guiding military missile weapons will not apply to mercy missiles, for the people at the receiving end will be making every effort to provide a loud and clear signal to bring the vehicle in. Haviland says supply rockets will be used primarily in emergencies, where economy and efficiency are relatively unimportant.

Slick Varnish Frustrates Pigeons

Pigeons, whose "carelessness" is the bane of maintenance men, can find no footing on surfaces that have been painted with a slick varnish devised by a London scientist. The varnish is colorless and can be applied with a spray gun to buildings or statues that need protection. When a pigeon comes in for a landing, it skids right off the target.

Locksmithing AND KEY MAKING

Now Made Easy! Practical up-to-date course teaches you how to pick locks, de-code, make master keys, repair, install, service, etc. New self-instruction lessons for every handyman, homeowner, carpenter, mechanic, service station operator, fix-it shop, hardware dealer, gunsmith. 53 easy illustrated lessons. Full price only \$5.95 postpaid; or C.O.D. plus postage. Satisfaction or refund guaranteed.

NELSON-HALL CO., DEPT. BP-2
210 S. Clinton Chicago 6, Ill.

Complete course \$5.95
... now only \$3.95

LEARN UPHOLSTERY

EARN MORE MONEY

YOU'RE IN BUSINESS RIGHT OFF—Practical course, complete upholsterer's tools, materials, frames, all you need to earn while you learn **AT HOME**. N. Y. State-approved training in upholstery, slip covers, etc. **Big Opportunity Field.** FREE Illust. Catalog. **FREE Sample Lesson.** Write Today. **Approved for Vets. Accredited by N.H.S.C.**

Upholstery Trades School, Dept. MB-312, 721 Broadway, New York 3, N. Y.

\$3.00 post-paid
Special Factory Offer



NEW WESTERN HAIG USES 4.4 MG. POWDER CHARGE

This small bore gun shoots .12 cal. lead bullets fired by small 4.4 mg. powder charge. Not a CO₂ gun! You'll like the handsome lines, grip, and balance. Western in style, but patented ball and cap action allows this low price. 9 3/4" steel barrel cased in knurled styrene stock, overall 13 1/2". Develop pistol form, accuracy at a fraction of cost of large caliber pistols. Comes with 50 lead bullets. Satisfaction guaranteed. Send \$3 to:

HAIG MFG. CO., Box V-27, Alhambra, Calif.

221 STAMPS 25¢

plus 88 FLAGS OF THE WORLD
plus PLANET MAIL SOUVENIR SHEET

Poland Mushroom Triangle
Cayman Islands Cat Boat
Colombia Miss Universe

Look what you get for only 25¢! You get the stamps shown here — plus Indonesia "Wild Cow" Stamp, Germany "Sputnik", Transvaal King Edward (over 50 years old), French Antarctica bird set, St. Pierre, Grand Comoro, etc. Total 221 stamps — all different! You also get 88 Flags of the World in full color — plus unique Planet Mail Souvenir Sheet. All this for 25¢ to introduce our Bargain Approvals. Midget Encyclopedia of Stamps included FREE.

Send 25¢ Today. ASK FOR LOT FO-34
ZENITH CO., 81 Willoughby St., Bklyn 1, N.Y.

FREE GERMAN STEEL HUNTING KNIFE

4-INCH BLADE

We give you handiest hunting and fishing knife you've ever had! Has 4-INCH LONG highly tempered steel blade—VERY SHARP! Attractive handle. We send knife FREE to acquaint you with our below-wholesale bargains. Please send 25¢ for handling. NO LIMIT—but send 25¢ handling for each knife. Order TODAY! HUNTING KNIFE, Dept. K-462, Box 881, St. Louis, Mo.

BIG EARNINGS WAITING for TYPEWRITER REPAIRMEN

SEND FOR FREE BOOK Typewriter Supplied

Skilled men are in demand in the new, uncrowded field of typewriter repair. You'll quickly step into a big-pay job or business of your own, full or part time. EARN while learning easily at home under expert guidance. Materials, tools, typewriter supplied. Write TODAY for FREE book.

TYPEWRITER REPAIR SCHOOL, INC.
Dept. B-10, 150 Park Ave., E. Rutherford, N. J.
Lic. by New Jersey Dept. of Educ.

Better Than Your Own SHOE STORE AT HOME

Two-Eyelet Hit With Cushioned Comfort

No investment, no experience needed. Just show magic cushion comfort to friends, neighbors, co-workers. Advance commissions to \$4.00 a pair, plus Cash Bonus, Paid Vacation, \$25.00 Reward Offer. Outstanding values for men, women, children. Money back guarantee. Shoe samples supplied without cost. Write TODAY for FREE new 84 page catalog and full details.

TANNERS SHOE CO., 523 BROCKTON, MASS.

TECHNICAL DATA FOR ENGINEERS • TEACHERS STUDENTS • TECH. WORKERS

Loose Leaf Pocket Size \$1.25

Each book contains about 140 pages of essential technical data. A digest of many books and other sources condensed into one thin pocket size volume. Printed on 6-hole 63/4" 33/4" bond paper, in loose leaf binder.

Architecture	Survey Tables	Machinist's Data	Radio
Home Heating	Highway Eng'g.	Mech. of Materials	Television & FM
Illumination	General Math.	Pwr. Trans. Mach.	Electricity, AC
Electric Data	Math Tables	Thermo. Tbls.	Electricity, DC
Builder's Data	Physics	& Charts	AC Motors & Generators
Lumber Data	Trig-Log Tables	Phys. & Thermo-	Conversion Tabl.
Air-Conditioning	Gen'l. Chemistry	dynamic Data	Steel Forms
Building Constr.	Chemical Tables	Metallurgy	Welding Data
Reinf. Concrete	Analytic Chem.	Hydraulics	Transformers
Piping Data	Mech'l. Drawing	Metals	Relays & Meters
Survey Data	Machine Design		

Write for FREE Catalog (2000 listings). See how helpful Lefax can be to you. Send \$1.25 book, or \$6. for any 5 books to:

LEFAX PUBLISHERS Dept. PM-20 PHILADELPHIA 7, PA.

Superior's New Model 70 UTILITY TESTER®

FOR REPAIRING ALL ELECTRICAL APPLIANCES MOTORS • AUTOMOBILES • TV TUBES

As an electrical trouble shooter the Model 70:

- Will test Toasters, Irons, Broilers, Heating Pads, Clocks, Fans, Vacuum Cleaners, Refrigerators, Lamps, Fluorescents, Switches, Thermostats, etc.
- Will test all TV tubes for open filaments, inter-element shorts, burned out tubes, etc.
- Measures A.C. and D.C. Voltages, A.C. and D.C. Current, Resistances, Leakage, etc.
- Will measure current consumption while the appliance under test is in operation.
- Incorporates a sensitive direct-reading resistance range which will measure all resistances commonly used in electrical appliances, motors, etc.
- Leakage detecting circuit will indicate continuity from zero ohms to 5 megohms (5,000,000 ohms).

As an Automotive Tester the Model 70 will test:

- Both 6 Volt and 12 Volt Storage Batteries • Generators • Starters • Distributors • Ignition Coils • Regulators • Relays • Circuit Breakers • Cigarette Lighters • Stop Lights • Condensers • Directional Signal Systems • All Lamps and Bulbs • Fuses • Heating Systems • Horns • Also will locate poor grounds, breaks in wiring, poor connections, etc.

Model 70 comes complete including 64 page book, only... \$15.85

SHIPPED ON APPROVAL NO MONEY WITH ORDER — NO C. O. D.

Try it for 10 days before you buy. If completely satisfied then send \$3.85 and pay balance at rate of \$4.00 per month for 8 months — No Interest or Finance Charges Added! If not completely satisfied, return to us, no explanation necessary.

MOSS ELECTRONIC, INC., Dept. D-709
3849 Tenth Ave., New York 34, N.Y.

Please rush Model 70. If satisfactory, I will pay on terms specified. Otherwise I will return tester.

Name _____
Address _____
City _____ Zone _____ State _____
All prices net. F.O.B. N. Y. C.

ENGINEERING

Photo of Heald Students in Electrical Laboratory

American Industry Steps Up Its Demand for Trained Engineers. Train Now at Healds

BACHELOR OF SCIENCE DEGREE, 30 MONTHS

SAVE 2 YEARS' TIME

Degree Courses:

- Electronic Engineering
- Electrical Engineering
- Highway Engineering
- Mechanical Engineering
- Structural Engineering
- Civil Engineering
- Architecture

Diploma Courses:

- TELEVISION Color TV
- Electronic Technician
- Industrial Electronic Tech.
- Tool & Die Design
- Architectural Drafting
- Mechanical Drafting
- Structural Drafting

Approved for Veterans

Enroll Now for New Term
Heald College Ranks FIRST West of the Mississippi in "Who's Who in America"

Send for FREE Information

Heald Engineering College
Est. 1863
Van Ness at Post, Dept. P.M. San Francisco, California

NAME _____
STREET _____
CITY _____
STATE _____

GET READY FOR THE SPACE and SCIENCE ERA! SEE SATELLITES, MOON ROCKETS CLOSE-UP

AMAZING OPTICAL BUYS

and OTHER SCIENTIFIC BARGAINS



See the Stars, Moon, Planets Close Up!
3" ASTRONOMICAL REFLECTING TELESCOPE
 60 to 180 Power — Famous Mt. Palomar Type! An Unusual Buy!



Assembled—Ready to use! You'll see the Rings of Saturn, the fascinating planet Mars, huge craters on the Moon, Star Clusters, Moons of Jupiter in detail. Galaxies! Equatorial mount with lock on both axes. Aluminized and overcoated 3" diameter high-speed f/10 mirror. Telescope comes equipped with a 60X eyepiece and a mounted Barlow Lens, giving you 60 to 180 power. Low-cost accessory eyepiece available for higher powers. An Optical Finder Telescope, always so essential, is also included. Sturdy, hardwood, portable tripod. FREE

with Scope:—Valuable **STAR CHART** plus 272 page "**HANDBOOK OF HEAVENS**" plus "**HOW TO USE YOUR TELESCOPE**" BOOK. Stock No. 85.050-H.....\$29.95 postpaid

KNOW THE TRUTH ABOUT POWER. Telescope experts will confirm that an Astronomical Telescope will only give you practical powers to about 50 or 60 times per inch of objective diameter—powers above this only produce empty magnification — make viewing dim, difficult and unsatisfactory.

4 1/4" ASTRONOMICAL TELESCOPE! UP TO 255 POWER!



With this scope you can see everything as above but with greater power plus will split finer stars. Mirror has twice the light gathering power. Mirror guaranteed to give theoretical limit of resolution. Rack and pinion focusing, hardwood tripod, real equatorial mounting—only one adjustment follows stars! Aluminum tube. 6 power finder telescope. 2 standard size eyepieces and mounted Barlow lens give you powers of 40X, 90X, 120X, and 255X. Low-cost accessory eyepiece available for higher powers. FREE with Scope:—Valuable **STAR CHART** plus 272 page "**HANDBOOK OF HEAVENS**" plus "**HOW TO USE YOUR TELESCOPE**" BOOK. Shipping weight 25 lbs.

Stock No. 85.006-H.....\$74.50 f.o.b.

NEW BINOCULAR-TO-CAMERA HOLDER



For Exciting Telephoto Pictures Will Fit Any Camera Bring distant objects 7 times nearer with a 35 mm. camera, 7x50 binocular and our NEW BINOCULAR-TO-CAMERA HOLDER. Ideal for long-range shots of wild life, ships, planes, people, etc. Camera and binoculars attach easily. Use any binocular or monocular—any camera, still or movie. Take color or black and white.

Full directions for taking telephoto's. Stock No. 70.223-H.....\$11.50 postpaid

BUILD A SOLAR ENERGY FURNACE

A fascinating new field. Build your own Solar Furnace for experimentation—many practical uses. Easy! Inexpensive! Use scrapwood! We furnish instructions. This sun powered furnace will generate terrific heat—2000° to 3000°. Fuses enamel to metal. Sets paper aflame in seconds. Use our Fresnel Lens—14 3/4" diameter...f.l. 14". Stock No. 70.130-H...\$ 6.00 Postpd.

BEGINNER'S LENS KITS! FUN FOR ADULTS! FUN FOR CHILDREN!

Kits include plainly written, illustrated booklet showing how you can build lots of optical items. Stock No. 2-H—10 Lenses.....\$ 1.00 Postpaid Stock No. 5-H.....45 Lenses.....\$ 5.00 Postpaid Stock No. 10-H.....80 Lenses.....\$10.00 Postpaid

INSTRUCTION BOOKLETS

	Stock No.	Price Postpd.
How to Build Projectors.....	9014-H	30¢
Homebuilt Telescopes.....	9006-H	40¢
Photography With Your Telescope.....	9058-H	25¢
ALL ABOUT TELEPHOTO LENSES.....	9036-H	60¢
ULTRA CLOSE-UP Photography.....	9042-H	60¢
The Camera Lucida.....	9059-H	20¢
Infra-red Light and Its Uses.....	9040-H	75¢
Homemade Stereo-Adapters.....	9032-H	30¢
Homemade Stereo-Viewers.....	9034-H	30¢
"Building a Condenser Enlarger".....	9038-H	40¢
Time in Astronomy.....	9054-H	60¢
FUN WITH OPTICS.....	9050-H	50¢
HOW TO USE YOUR TELESCOPE.....	9055-H	60¢

(Includes directions on how to take photographs thru your telescope)

HAND SIGHTING LEVEL

Described in Popular Mechanics March 1958 issue, page 212

Sight it like a Telescope. Gives you a level line of sight, for laying out gardens, drives, new construction, ditches, etc. Complete instructions included.



Stock No. 105-H.....\$2.50 postpaid

'FISH' WITH A MAGNET

Go Treasure Hunting On The Bottom

Great Idea! Fascinating fun and sometimes tremendously profitable! Tie a line to our 5-lb. Magnet—drop it overboard in bay, river, lake or ocean. Trawl it along the bottom—your "treasure" haul can be outboard motors, anchors, fishing tackle, all kinds of metal valuables. 5-lb. Magnet is war surplus—Atrico V Type—a terrific bargain. Lifts over 125 lbs. on land—much greater weights under water. Order now and try this new sport.



Stock No. 70.183-H. 5-lb. Magnet.....\$8.50 Postpaid 15 3/4 lb. size. Will lift over 250 lbs. Stock No. 85.088-H. 15 3/4 lb. size.....\$22.50 F.O.B. Shipping weight 22 lbs. Barrington, N. J.

New! 2 in 1 Combination! Pocket-Size

50 Power MICROSCOPE and 10 Power TELESCOPE Useful Telescope and Microscope combined in one amazing, precision instrument. Imported! No larger than a fountain pen. Telescope is 10 Power. Microscope magnifies 50 Times Sharp focus at any range. Handy for sports, looking at small objects. Just plain snooping. Send Check or M.O. Satisfaction Guaranteed. Order Stock No. 30.059-H.....\$4.50 Postpd.



Terrific Buy! American Made! OPAQUE PROJECTOR

Projects illustrations up to 3" x 3 1/2" and enlarges them to 4 ft. wide. No film or negatives needed. Projects charts, diagrams, pictures, photos, lettering in full color or black-and-white. Operates on 115 volt, A.C. current. 6-ft. extension cord and plug included, operates on 60 watt bulb, not included. Size 12" x 8" x 4 1/2" wide. Weight 1 lb., 2 oz. Plastic case with built-in handle.

Stock No. 70.199-H.....\$7.95 Postpaid

Take Telephoto Shots Thru 7x50 MONOCULAR

This is fine quality, American made instrument—war surplus! Actually 1/2 of U. S. Govt. 7 x 50 Binocular. Used for general observation both day and night and to take fascinating telephoto shots with your camera. Brand new, \$95 value. Due to Japanese competition we close these out at a bargain price. Directions and mounting hints included.



Stock No. 50.003-H.....\$15.00 Postpaid

NOTICE: Edmund is now headquarters for Math Learning and Teaching Aids! See dozens of offerings in our FREE Catalog H.

NEW! CIRCULAR SLIDE RULE!

Pocket Size—Fast—Easy to Use!



Multiplies, divides, figures fractions, percentages, squares, cubes, roots, proportions, circumferences, areas, retail prices, fuel consumption. Faster, easier to learn and use. Directions included.

Stock No. 30.336-H.....\$4.95 postpaid

D-STIX CONSTRUCTION KITS for Science Fans, Hobbyists



Visualize your ideas. Crystallize your plans. Unique new D-STIX are ideal for "3-Dimensional thinking." Colored wood sticks 1/8" thick and "easy-on" rubber joints approx. 3/16" diam. fit together fast—help you work out molecular structures, geometric figures, structural members, shapes, models of all kinds. Ideal for interesting children in developing shapes, structures. Durable kits. Money-back guarantee.

Stock No. 70.209-H (230 pcs.).....\$3.00 ppd. Stock No. 70.210-H (370 pcs.).....\$5.00 ppd. Stock No. 70.211-H (452 pcs.).....\$7.00 ppd.

FREE CATALOG-H

128 Pages! Over 1000 Bargains!

Yours for the asking

America's No. 1 source of supply for experimenters, hobbyists. Complete line of Astronomical Telescope parts and assembled Telescope. Also huge selection of lenses, prisms, war surplus optical instruments, parts and accessories. Telescopes, microscopes, satellite scopes, binoculars, infrared sniperscopes, math, learning and teaching aids.

REQUEST CATALOG-H



ORDER BY STOCK NUMBER . SEND CHECK OR MONEY ORDER . SATISFACTION GUARANTEED!

EDMUND SCIENTIFIC CO., BARRINGTON, NEW JERSEY



CLASSIFIED ADVERTISEMENTS



Advertisements in this section \$1.30 per word, each insertion, minimum 10 words, payable in advance. To be inserted under proper classification, copy must be in our office the 18th of the second month preceding date of issue
 F. W. Johnson, Manager, Classified Advertising
 Popular Mechanics Magazine, 200 East Ontario Street, Chicago 11, Illinois

YOU'LL PROFIT

By reading and answering the classified ads in this section. Hundreds of opportunities for you to make and save money

AUTOMOBILES, MIDGET CARS

JEEP Headquarters. New and used jeeps, parts, snow plows. Winches. Every type of special equipment. Franklin Weber Pontiac. 6101 N. Clark St. Chicago 26, Ill.

1/4-MIDGET Plans and material list \$2.00. How to make 1/12-mile approved track and Go-Kart formula, 50¢. Build your own Kart from our parts list 25¢. Rocky, Galveston, Indiana.

SAVE—When buying new car. We show you how. Literature free. Price Research Bureau, Box 15, Tonawanda, N. Y.

NON-PROFIT Organization offers automobile literature — old, modern and foreign; dealer books, service manuals, glossy photographs; free motor magazines. Write immediately; get on free mailing list. Auto Maniacs, Stockbridge, Mich.

METROPOLITAN Owner's handbook, new, 320 pages \$3.00. Volkswagen handbook \$2.00. Souping the Volkswagen for more power, speed. Renault owner's handbook \$3.00. 1959 Indianapolis Race Yearbook \$2.00. Catalog 200 automobile books free. Clymer, Los Angeles 6, Calif.

CATALOG On parts kits for golf buggy or Jr. sports car. 25¢. Indus Corporation, 1815 Madison, Indianapolis.

AUTO SUPPLIES AND EQUIPMENT

HYDRAULIC Jack repair kits. Free catalog. Hydraulic Parts Supply, Box 4104, El Paso, Texas.

NEW And used parts at savings. Complete guaranteed parts service for all models cars and trucks, 1924 and later. Largest in the West. Jeep and army parts specialists. Newest type shifting hubs for all jeep and all military and latest production front end drive vehicles. \$27.50 and up. Also, foreign car parts. Write, Pioneer Auto and Truck Parts Co., 734 W. 13th Avenue, Denver 17, Colo.

GUARANTEED Starts! Unconditional? Information 10¢. Hass, 4624 Rhawn, Philadelphia 36, Penna.

AMAZING Discovery. Master Glaze, puts brilliant glass-like surface on cars. Free sample, information. Big commissions. Master Glaze, Dept. 919, 7720 Harwood, Milwaukee, Wis.

AUTO Keys by return mail. Send key number (on record and detach tag) year and make of car, with \$1.00 check to John Pyskaty Locksmith, 3458 West 62nd St., Chicago 29, Illinois.

JUST Out! New 388-page, illustrated catalog offering savings up to 50% on over 100,000 auto parts and accessories, many hard to get. All makes (1920 to 1960 models), trucks, foreign and sports cars. Also Hollywood accessories, custom styling, hi-speed equipment. Send 25¢ for postage, packing—refundable on first order. Whitney, 1919 PM-2 Archer, Chicago 16, Ill.

AUTO Shop welding repair training in world's largest non-profit welding school. Low tuition. Free booklet. Hobart Welders, Box M-201, Troy, Ohio.

WEASEL Parts and tracks, unused. Symington of Seattle, 4603 Union Bay Place, Seattle 5, Wash.

GIANT Auto parts catalog. Thousands special accessories, speed, power, performance. Mileage, custom equipment. Send 25¢ (refundable). Newhouse Automotive Industries, 5805-PM2 Beverly, Los Angeles 22, Calif.

PARTS, Model "A." List 25¢ (refundable). Matco, Box 135, San Pedro, Calif.

FOREIGN Speedometer Service, 1707 W. Clarendon Avenue, Phoenix, Arizona.

VOLKSWAGEN, Porsche. Fine mechanical accessories. State model. Lane Engineering, 70 King's Hwy., North, Darien, Conn.

RING-Valve job while driving, \$6.00 postpaid. (9th successful year.) Guaranteed! Yellow Cab test-proven. Motaloy, Grantham, Penna.

SAVE Money on Jeep and army truck parts. Large inventory. Catalogs for Jeep or G.M.C. owners only. American Auto Parts Co., 1830 Locust, Kansas City, Mo.

MAKE Old cars run like new. Inexpensive. Free details. Newco, Box 164-B, Hunlock Creek, Penna.

FREE! New catalog. Speed, power, mileage increasing equipment. Discounts! Almquist Engineering, Milford PM5, Penna.

1500 WATT 110 Volt a.c. power plant. Mounts on car, truck, tractor motors. Free literature. Kennell's Transit Power, Parsons, Kans.

EVERY Car owner needs our fast, efficient cleaning polishing cloths. New idea, no mess. Sample set prepaid \$1.00. Meyer Company, Box 868, Galesburg, Illinois.

TRANSMISSION And motor exchange. Buy wholesale. 5415 York Blvd., Los Angeles 42, California.

1909-1934 FORD Parts. Illustrated catalogue 50¢. Mark Auto, Layton, New Jersey.

JEEP Owners — V8 conversions. Read Jeep Owners ad, page 49.

CRANKSHAFT Grinder. Hand operated. Makes bearings fit without taking engine apart. \$4.00. Literature. L. D. McGee, 719 Cascade St., Wenatchee, Wash.

TIMER Controlled car starting system. For cold morning warmups. Simple installation instructions. \$1.00 postpaid. Wilbar Sales, New London, N. H.

TUNE-UP Tips. 1960 edition. Over sixty helpful hints, \$1.00 postpaid. Modern Automotive School, 323 W. Florence, Los Angeles 3, Calif.

AUTO TRAILERS

COMMERCIAL Style pickup coach. Plans \$1.00. Save 75% plus. Box 624, Moscow, Idaho.

TRAILER Building guide supply catalog, large floor plans, \$2.00. Booklet illustrating 5 models \$5.00. Kamcraft, Box 1153, Milwaukee 1, Wis.

A Natural for sporting goods, boat, hardware, auto dealers, service stations, ambitious individuals. Become dealer for nation's number one camping trailer. Sets up into complete camp in just one minute! Dealer details by return airmail. Hellite Trailers, 1505 South Sacramento, Lodi, California.

BUILD Expanding eight foot trailer. Accommodates five. Literature 10¢. Fra-Mar Company, Wilmington, Mass.

PICKUP Coach kits. Blueprints. Literature 10¢. Comstock Trailers, Parsons, Kansas.

MOTORCYCLES, BICYCLES, MOTORSCOOTERS AND SUPPLIES

BEST Deals on wheels. Economical Panther-made Leopards \$199.50; motor-scooter special: Tessa (List: \$415.50) only \$299.50 (139 available). Contessa (List: \$549.50) only \$399.50 (188 available). Hurry! Newest 8x10 catalog, 20 pages, 25¢. Motorcycle Import Corp., P.O.B. 1950-A, New York City 17.

HARLEY-Davidsons — Used bargains. New, used parts, accessories, all models. Bulletin 25¢. Knuth's (Factory Dealer), 1753 Muskego, Milwaukee, Wis.

MOTORCYCLE Parts. New, used. List 25¢. Ballak, 811 N. 9th, St. Louis 1, Mo.

RECONDITIONED Motorcycle motors. Chrome accessories. Complete stock Indian parts. Expert rebuilding. Fast service. Indian Motorcycle Sales, Kansas City 27, Missouri.

GOOD Doodlebug motorscooter \$35. Mo-Ped \$75, gasoline buggy \$60, boys midget car \$35. Briggs engine \$5, Whizzer \$10. (Mailorder only). Send 25¢ (35¢ for first class mailing) for Directory-Catalogue Number 93, listing these and hundreds of other bargains, homebuilders parts, plans, etc. Midget Motors Directory, Athens, Ohio.

AVIATION

BLUEPRINTS, Lightplanes, gliders, motors, etc. Illustrated circulars 50¢. Sport-plane building manual \$1.50. Kamcraft, Box 1153, Milwaukee 1, Wisconsin.

ANTI-GRAVITY Engine. Completely designed. Diagrams, details, physics, plus "Man in Flight." Send \$2.00 today. Knowledge, 2900-9th Street, Rock Island, Illinois.

AVIATION Surplus bargain catalogue. One dime. Box PM8, Thomasville, Penna.

TERRIFIC Bargains on Mattern computers and Telex headsets. Catalog 10¢. Carlson, Box 5536, Oklahoma City 10.

DUCTED Fan design. Used in air sleds and flying platforms. Specifications and six pages of drawings. \$2.00. Tyna-Turbine, Box 373, Chandler, Arizona.

BUY Gov't surplus: Aircrafts; engines; helicopters; boats; Jeeps; misc. Buy direct now from gov't. Send for "Depot Directory & Procedure" \$1.00. Gov't Surplus Sales, Box 425-PM, Nanuet, New York.

BARGAINS. Gov't surplus planes, electronic equip., trucks, boats, helicopters, etc. Send \$1.00 for listings, locations, and procedure to buy. P.O. Box 8356, Minneapolis 16, Minn.

"THE Bush Pilot," Alaska's Aviation Magazine features stories about bush flying. Published monthly. \$3.50 per year. Box 3535, Anchorage 5, Alaska.

CAPTIVE Helicopter, VTOL trainer uses 12 to 70 HP engines. Payloads 50 to 500 pounds. Complete plans, design parameters, illustrated instructions, detail and flight photographs. \$3.00. Flight Dynamics, Box 5443, Raleigh, N. C.

ELECTRICAL SUPPLIES

REPAIR Electric motors. Interesting, profitable. Free details. Modern, Box 8715, Kansas City 14, Mo.

BOOK Of 200 electrical stunts \$1.00. Kuttington, 875 Arastradero, Palo Alto, Calif.

FREE Bargain catalog. Fluorescent fixture kits, circlines, parts. Shoplite, 650-M Franklin, Nutley 10, New Jersey.

APPLIANCE Parts wholesale. Catalogue 25¢. Seco, 26 South 20th Street, Birmingham 3, Alabama.

LAMPS—Parts catalog containing wiring instructions, 25¢. Gyro Lamps, 5208P N.W. 35th Ave., Miami 42, Fla.

LAMP, Electrical parts, wholesale. Thousands of items for repairing, converting. Catalog 25¢. Brown Lamp, Box 305, Clayton 5, Mo.

WELDING, SOLDERING, PLATING

ACETYLENE Welding outfits. New, arc-welders. Eagle Welding, Dept. PM, 5085 Broadway, Chicago 40, Ill.

WELDERS, 110/220, \$39.50. Morris, 1070 Inner Drive, Schenectady 3, New York.

PLATING Equipment, supplies. Complete line of anodes, solutions. Home workshops, industrial sizes. Hollywood Bronze Supply, Dept. C, 1624 East First, Los Angeles 33, California.

FREE Catalog, welders, welder kits. Build 350-ampere welder using aircraft generator, plans 25¢. Agents wanted. Dunbar Manufacturing, Minneapolis 8, Minn.

BUILD Or buy efficient inexpensive 350 ampere welder. Guaranteed plans 25¢. Free welder kit catalog. LeJay Manufacturing, Minneapolis, Minnesota.

MACHINERY, TOOLS, SUPPLIES

PORTABLE Cement mixer. One man operation. \$29.95 less motor. Free literature. Quality, Box 112PM, White Bear Lake, Minn.

A Thousand and one uses fisherman, hobbyist, hunters, mechanics, photographers. Air tight kit has oneawl, 4 screwdrivers size .055-.070, .080-.100 jewelers quality. Rustproofed steel. Kit #SC5, \$1.50 p.paid. We specialize in tiny tools. Inquire. Molang Enterprises, Box 542, New Bedford, Mass.

"ULTRA-LOCK" Non-falling 1½" perforated board tool hooks. 42 for \$2.00 ppd. U.S.A. OK Engineering, Box 421, Barre, Vermont.

ENGINES, MOTORS, DYNAMOS

½ **HORSEPOWER** Electric motors, a.c. 110, used, good \$5.00 each f.o.b. Plant Machinery Corp., Richmond and Norris Sts., Philadelphia 25, Penna.

ELECTRIC Appliance repair and servicing \$3.00. Diesel engines and diesel electric power \$4.00. Battery repair manual \$3.00. Satisfaction guaranteed. Bayer Publications, 938F Betty Avenue, Neenah, Wisconsin.

DIESEL Injector parts and fuel pumps wanted. GM51-53-71-110. Bares, 7120 Carnegie, Cleveland 3, Ohio.

WINDING Data. 275 motors, single and three phase \$1.10. Data Company, 512 Kensington, Kansas City 24, Mo.

REWIND Motors yourself. Complete instructions \$1.00. Lewis Mfg., Howell, Michigan.

BOATS, OUTBOARD MOTORS

FIBERGLASS Fishin-Ski boat kits \$299.00. Finished with accessories \$495.00. Linden Marine, 1330 Linden, Dayton 10, Ohio.

SAILBOATS, Plastic, complete with mast, sails, centerboard, \$108.70. Photo and literature free. Telegraph Road Boat Sales, Monroe, Michigan.

WHOLESALE Direct from the factory. Fiberglass runabouts, fishing boats, pontoon boats, houseboats and boat trailers. Build it yourself: pontoons only—molded hulls only. Free catalog. Osage Mfg. Co., Box 117-M, Osage, Minn.

FULL Size, cut-to-shape boat patterns, blueprints, 7½-38 feet. Big new 88 pg. illustrated "Build a Boat" catalog of naval architect-designed Catamarans, cruisers, runabouts, skiffs, outboard boats, sailing, racing, houseboats, 50¢. "How to Build a Boat" booklet \$2.50. Equipment catalog \$2.00. Cleveland Boat Blueprint Co., Dept. A-66, Box 1651, Cleveland, Ohio.

BOATING Books! Keeping your outboard motor in shape, \$1.70; Basic Sailing, \$1.20; Plywood Boatbuilder, \$4.00; Piloting, Seamanship And Small Boat Handling by Chapman, \$4.00. Postpaid U.S.A. Outside U.S.A. add 50¢. No C.O.D. A. H. Lewis, Dept. P, Garrison, N. Y.

NOW, Fly your boat. Easily installed kit converts your boat to a flying boat. Send \$1.00 for photographs, flying instructions. Gyrocraft Inc., 1932 Nelson SE, Grand Rapids, Michigan.

MARINE Conversions, Willys to Cadillac, kits and parts. Catalog and conversion hints free. Barr Marine, 2706A Castor Avenue, Philadelphia 34, Penna.

BOAT Plans—Full size patterns, frame kits. Modern inboards and outboards for amateur builders. Complete new catalog 50¢ or specify requirements. Glen Designs, 9152 Rosecrans, Bellflower, California.

MARINE Conversions. Ford, Chevrolet, Jeep engines. Catalog 25¢. Lehman Manufacturing Company, 800 Elizabeth Avenue, Linden 4, N. J.

NEW, Used, rebuilt marine motors. Marine conversions, fittings. Free catalog. Stokes Marine Supply, Dept. 24, Coldwater, Michigan.

SAVE Money. New, used outboard motor parts. Send wants. Stamp appreciated. Outboard Motor Mart, 229-M State, Boston 9, Mass.

I Want to send you proof of the wonderful pulling power of Popular Mechanics classified pages. What's your proposition? Write me today. Include literature if possible. F. W. Johnson, Manager Classified Advertising, Popular Mechanics Magazine, 200 E. Ontario St., Chicago 11, Ill.

ATHLETIC EQUIPMENT, BODY BUILDING COURSES

DEADLY Karate, Kung-Fu fighting. Break planks barehanded. Using breath, sand, straw, pebbles. Illustrated manual \$3.98. Oriental Book Sales, P. O. Box 1183, Oakland 7, Calif.

BACKACHE Sufferers. Many helped. Free literature. Lou Stein, 311 Delsea Dr., Woodbury, N. J.

BARBELLS. Dumbbells. Courses. Booklet 10¢. Good Barbell Co., Siloam Springs, Arkansas.

FREE Muscle building information. Body-Tone, Box 638B, North Miami, Florida.

DEVELOP Powerful grip. Increase arm measurements. Amazing Grip-a-ciser \$2.98. Saxon, Freeburg, Ill.

SLOWING Down? Legs and feet muscles ache and cramp? Poor circulation and numbness? Active men know you are only as young as you feet and legs. If your answer to any one of these questions is yes, try the amazing Perrin Method. It activates, stimulates and intensifies circulation and energizes the nervous force. Perrin Method is a basic and organic force—a positive force. Deterioration of vigor leads to stagnation, resulting in incidence of painful and crippling disease. The Perrin Method is a progressive force, creating new cell activity thru acceleration and energizing nervous force and circulation. Contributing factors to the slowing down process such as weak kidneys, bladder irregularity and subnormal prostate glands can be brought to a higher degree of functioning. Perrin Method will enable you to control your energies and make them yield the desired result. Why lead an inferior existence? One fundamental requisite to good health is vital and vigorous nervous force. A dormant nervous force leads to premature age, frustration and despair. Perrin Method intensifies and elevates this force to the highest pinnacle. There is no expensive equipment or repeated cost connected with the Perrin Method. Write today for information. Orin Company, 1434-17th Street, Des Moines, Iowa.

SPORTING GOODS, GUNS, FISHING TACKLE, ARCHERY, TRAPPING

KITE Casting with the flying fisherman takes your fishing line 1,000 to 2,000 feet off shore and drops it where you choose. Full information free. Write Thomas Arnold Company, Dept. P2, 18 East Lanvale Street, Baltimore 2, Maryland.

154 PAGE Catalog—A real dream book for fishermen! It's free! Netecraft Company, Dept. B-2, Toledo 13, Ohio.

FISHERMEN: 45¢ Stamps brings you five beetle bug baits. Flycaster Products, 2149 Stanford, St. Paul 5, Minnesota.

DISCOUNTS Unlimited! Layman 4X \$39.95, Weaver K3 \$24.25, Bushnell 4X \$34.50! Guns, gun accessories below wholesale. Catalog 25¢. Discounts Unlimited, Box 38-A, Hastings-on-Hudson, N. Y.

HAVE Guns, will sell! Miniature pistols, rifles and accessories. G & S Mfg. Co., Nashville 3, Tenn.

BIZIBUG For spinning. New action! More bass! Free literature and introductory offer. Shaw Tackle Company, R. 2, Montevallo, Alabama.

ANTIQUE Guns, decorators to Patersons. Large photo illustrated catalog \$1.00. Jackson Arms, Box 8065-PM, Dallas 5, Texas.

ENJOY Camping: Make big profits while you play, with Hellite Camping Trailer dealer franchise. Set up into complete camp in just one minute; attracts crowds wherever shown! Write for dealer program. Hellite Trailers, 1500 South Sacramento, Lodi, California.

MOLDS For fisherman's sinkers, jigs, squids, casting and spinning lures. Free catalog. Sweet's Molds, Tonawanda 1, New York.

FREE Catalog America's first and finest guaranteed waterproof Sta-Dri Sportsman boots. The Sport Mart, Inc., Box 8047, Dallas 5, Texas.

GUNS, Swords, knives, daggers, flasks. Large list 25¢ coin. Ed Howe, Coopers Mills 52, Maine.

10,000 GUNS. Antiques, moderns, swords, armour. Every description. Giant catalog \$1.00. Agramonte's, Yonkers 2-G, N. Y.

MOLDS—For casting your own fishing sinkers. Free illustrated booklet. Reading Instrument Co., Box PM78, Reading, Penna.

CROSSBOWS! Hunting—Bows! Factory prices! Jayco, Box 1355, Wichita, Kansas.

BIG Money raising crickets and 12 inch African fishworms. Free literature. Carter Ranch, Plains, Georgia.

FREE—Wholesale catalog. Beads, Spinners. Lure parts. Sinker molds. Jigs. Reels. Finnyports (ME), Toledo 6, Ohio.

AMAZING Wholesale sporting catalog. Save 70%. Tremendous selections. Econ-O-Mart, Whippany 2, New Jersey.

KILL Submersed water weeds which foul up motor propellers, tangle fishing gear, with R-H Weed Rhap-20. Granular 2,4-D. Inexpensive, easy to use, sure results. For free information write Reasor-Hill Corporation, Box 36PM, Jacksonville, Arkansas.

KNIVES, Imported. Worldwide selection of rare daggers, gurrhas, stiletos, bowies, hunting, throwing knives. Terrific values. Free catalog. Clinton, Mt. Clemens 34, Michigan.

MINNOW Graders. Free circular. Crescent Mig., Box 3303, Ft. Worth, Texas.

SAVE! Gun & Tackle 100 page discount catalog. Unusual and famous brands. Send 25¢ to Klein's, Chicago 24.

FISHERMAN Catch up to 1,000 night-crawlers in the daytime. Guaranteed. No digging. No electricity. Harmless, fast, easy. And lots of fun to see them come out. Super "Wormout" kit \$5.00 ppd. Bishop's, 29 Main Street, Bangor, Maine.

WATERPROOF Triple thick polyethylene bags. Keep food, clothes, sleeping bag dry—carry home fish, game. 13" x 13" x 36". 2 for \$1. Trader Jim, 6715-A E. 25th, Tulsa, Okla.

5000 GUNS, Swords, war relics. Catalog 50¢. Smith Firearms, Runnemed, N. J.

HOW To catch fish with smell. Secret formulas, new recipes, \$1.00. Johnson's, 312-M Lake Avenue, Ithaca, New York.

EARTHWORMS, CRICKETS, FROGS

EARTHWORMS—Red hybrid. Breeding, bait, culture. Packed breeders, \$5.00-1.000. Instructions. Prepaid. George Pape, Jacob, Illinois.

WANTED, Men, women. Worm raisers. Sherwood, Dept. U-2A, Monmouth, Maine.

1,000 BROWN Or red hybrid bait size—\$4.50. Write for dealer quantity prices. Have steady supply all season! Sunnyside, Box 2326-PM, W. Gastonia, N. C.

OUR Famous Rocky Mountain hybrid worms. Mixed sizes. 10,000—\$19.95 postpaid. Dewey's Worm Ranch, Henderson, Colo.

FANTASTIC Profits raising redworms: Large breeders 1,000—\$3.50, 3,000—\$9.95. Medium 3,000—\$5.85, 10,000—\$16.75. Free instructions. Consultation service. Georgia Farms, Richland 18, Georgia.

RAISE Fishworms and rabbits on \$500 month plan. Free details. White's Rabbitry, Mt. Vernon, Ohio.

\$1,000 MONTHLY Possible, raising earthworms, African giants! Backyard, garage, basement. Complete illustrated booklet, explains raising, feeding, packing, marketing. Send 25¢! Ozark Worm Farm-J, Willow Springs, Missouri.

\$200.00 WEEKLY Possible, raising earthworms, basement, backyard, garage. Illustrated booklet \$2.00 explaining raising, feeding, marketing. Gay Worm Ranch, Box 13072, Dallas 20, Texas.

BIG Money raising fishworms and crickets. We teach you how to raise and where to sell. Free literature. Medium redworms, 3000, \$5.95; 10,000, \$16.95. Carter Redworms, Plains, Georgia.

FREE Picture folder, "How to Make \$3,000 Yearly, Sparetime, Backyard, Raising Earthworms!" Oakhaven-56, Cedar Hill, Texas.

BINOCULARS, TELESCOPES, MICROSCOPES, MAGNIFIERS

TELESCOPES, Binoculars, microscopes—all sizes. Complete telescope makers supplies. Free catalog. Suffolk Science, Matituck, New York.

TELESCOPES—Refractor, reflector, kits and accessories. Free illustrated booklet. Dell Optics Co., Limited, Dept. PM, 327 55th Street, West New York, New Jersey.

REFLECTOR Telescope kits direct from factory. From \$7.75. Other optical do-it-yourself kits. Free booklet. Hampton, P.O. Box 772, Sparta, N. J.

REFLECTING Telescope, 60X, completely assembled. Guaranteed observatory clearness. Free information. Skyscope, P.O. Box 55, Brooklyn 28, N. Y.

TELESCOPES, Mirrors, binoculars, microscopes, accessories. Free catalog. National Optical Company, 505 New York Avenue, Union City, New Jersey.

BUILD Your own reflector telescopes. Complete kits: Mirrors, eyepieces, tripods, all other accessories. Request free illustrated literature. Criterion Manufacturing, Dept. DPM-61, Hartford, Conn.

50 POWER Microscope \$3.95. 75 power \$4.95. DX Radio, Box 5938, Kansas City 11, Missouri.

DYNASCOPE. Amazing world-famous reflector telescope. Request free brochure. Criterion, Dept. DP-64, Hartford, Conn.

BINOCULARS, Telescopes, microscopes. Terrific values \$3.98 up. Request free money-saving catalogue. Criterion, Dept. P-87, Hartford, Conn.

BINOCULAR Specialists, all makes repaired. Authorized Bausch & Lomb, Zeiss, Hensoldt, Bushnell, Hertel-Reuss dealer. Tele-Optics, 5514 Lawrence, Chicago 30, Illinois.

STARGAZERS! Exciting new magazine! Sample 50¢. Monthly Evening Sky Map, Box 213-PM, St. Louis 5, Missouri.

AMAZING Prices precision binoculars. "Binocular Selecting," catalog free. Prentiss Importers, Mercury Bldg., West Los Angeles 25, Calif.

TELESCOPES, Microscopes. Illustrated catalog 25¢. Chambers Scientific, 124 West 23 Street, New York 11.

WAR Surplus bargains: Millions of lenses, instruments, telescopes, binoculars, components and complete line of astronomical telescope items. World's greatest optical market-place! Send only \$1.00 for beginner's 10-lens kit and big instruction booklet Stock 2-CH. Write for Catalog CH free! Edmund Scientific Co., Barrington, New Jersey.

PLANTS, SEEDS, BULBS, NURSERY AND GARDEN SUPPLIES

EVERGREEN Seedlings, ornamentals, flowering shrubs and roses. Free price list and planting guide. Flickingers' Nursery, Sagamore 11, Penna.

GROW Dwarf trees! Instructions & seeds, 35¢. Mail Order Specialties, 1439-BMD, Sabraton Ave., Morgantown, W. Va.

PETS—DOGS, BIRDS, RABBITS, HAMSTERS, ETC.

RAISE Rabbits successfully by knowing facts. 48 page illustrated book describing 25 breeds. Housing, feeding, breeding, marketing, etc. Plus bulletin. 25 cents. American Rabbit Association, 36 Arba Building, Pittsburgh, Penna.

FROGS, Wild jumbo proven best for breeders large supply. Oso Pier, 6124 Ocean Dr., Corpus Christi, Tex.

GOLDEN Hamsters—Pedigreed breeders \$3.85 pair. Albinos Whitebands. Literature. Moore's Hamster Ranch, Shepherdstown 25, West Virginia.

MAKE Money raising chinchillas, mink, rabbits, cavies for us. Free catalog. Keeney Brothers, New Freedom 2, Penna.

RAISE Rabbits on \$500 month plan. Free details. White's Rabbitry, Mt. Vernon, Ohio.

HAMSTERS—Ideal pets, \$2.95 pair. Free booklet. Jer-fre's Hamstery, 1447 Apple, Muskegon 13, Michigan.

SKINKS, Reptiles, hawks, raccoons. Illustrated catalogue, 25¢. Trails End Co., St. Stephen, S. C.

FLYING Squirrel. Live baby turtles. Ott's, 5505 Magazine, New Orleans 15, La.

RAISE Rabbits, make money. Information and prices sent free. Write: Johnson, 683, Kansas City 41, Missouri.

FUR BEARING ANIMALS

MINK Raising information free. Complete. Lake Superior Mink Farm, Superior, EEl, Wisconsin.

FARMS, FARM LANDS, REAL ESTATE

CENTRAL Florida developments. Trailer homesites; also lakefront and highway lots; acreage. No interest. From \$295.00. Terms. Victor Roepke, DeLand, Fla.

MR. Property Owner—Want a map of your property? Write Deed-Ettes, Mt. Pocono, Penna.

FREE Strout catalog! Farms, homes, businesses, resorts, retirement properties. Over 3000 values in 36 states. 58 years' service. World's largest! Write Strout Realty, 7-MF S. Dearborn, Chicago 3, Ill.

CANADIAN Vacation lands: Full price \$285.00, for 40 acres, \$10.00 month. Suitable cottage sites, hunting, fishing camps. Free information. Land Sales Corporation, 130C Shaftesbury, Downsview, Ontario, Canada.

FLORIDA. Nice homesites, \$345 at \$10 monthly. Folder free. Howard Vernor, DeLand, Florida.

OZARKS! America's best place. Ten lovely timbered acres \$195. \$5.00 monthly. descriptions mailed free. Write: Armstrongs, Shook, Missouri.

BUYING Real estate? Know correct mortgage payments. Handy 160 page book shows monthly payments necessary to pay off mortgage. All interest rates from 3% to 7% including intervening fractions. Used by bankers, brokers, appraisers. Now available to public. Send \$1.00 to D. Behrend, Box 8124, Pittsburgh 17, Penna.

CANADIAN Tax sale lands, average price five dollars an acre. Small monthly payments. Farms, timber, hunting and fishing camps, minerals. Limited number of properties. Write at once for free catalogue. Tax Sale Service, Room 105, 120 Bloor Street, West, Toronto 5, Canada.

FLORIDA Homesites in the booming Tampa Bay area are available now at Willow Shores for the low, introductory price of only \$895. These are large 80x100' plots only 21 miles south of Tampa on Route 301, near schools, churches and shopping. Enjoy boating, swimming, and fishing all year long. Only \$10 down and \$20 per month buys your Florida homesite. Beautiful 1/4-acre (or larger) waterfront lots on the Little Manatee River are only \$25 down and \$50 per month, full price \$2295. Send \$10 down payment to reserve your Florida homesite now (down payment refundable within 45 days for any reason) and Willow Shores will send you your contract, plat showing location reserved for you, and colorful descriptive literature. Send \$10 to: Gulf Coast Land and Title Company, Developers; Dept. PM; 632 South Tamiami Trail; Sarasota, Fla.

FLORIDA Homesites \$10 down, \$10 monthly buys your homesite in Central Florida's finest retirement and vacation community in the high ridge section near Sebring. On 84 square mile Highlands Lake. Free community parks and beaches. Get free color brochures, house plans; Learn how we help you plan, finance, build your low-cost, tax-exempt home. Write Florida Realty Bureau, Inc., Dept. EZM2, Lake Placid, Florida (AD58101).

FLORIDA 2 1/2-Acre estates. Choice premium properties only \$995 at \$15 monthly. Wendell Wood, Fountain, Florida.

FLORIDA'S Sunnyland Village. Pre-development sale. \$10.00 down, \$10.00 month. Water mains, paved streets, R.E.A. Electricity (under const.) Write: Box 768, Brooksville, Florida.

VALLEY Farm on stream. Only \$8,000 buys well-improved 200-acre southwestern Missouri stock farm! Attractive homesite overlooks beautiful pan-fish brook. Private hunting grounds. 40 acres tillable valley land, now in pasture and meadow grasses, balance abundantly-watered woodland pasture. See picture in catalog—large 5-room home, bath, fireplace, well with pressure system, nice oak and walnut shade. 30-ft. barn, small poultry house. On all-weather road, 5 miles town. Get your low-cost farming start here. Only \$8,000, less than half down. New free Spring catalog, bargains coast to coast! United Farm Agency, 2825-PM Main St., Kansas City 41, Mo.

FLORIDA—Silver Springs area. ¼ acre waterview homesites. \$795.00, \$10.00 month. Free color photos. Write: Smith Lake Estates, Box 5681, Belleview, Florida.

\$5.00 MONTHLY Buys 5 acres. Excellent fishing, near town, electricity. Price \$100.00. Free list, Box 425P, Carthage, Missouri.

FLORIDA Security homesites, \$120. \$5.00 monthly. Warranty deeds. Thompson, Lecanto, Fla.

OPPORTUNITIES! Government land, U. S., Alaska, Canada. Sledge Surveys, Macon, Mississippi.

MONEY in agriculture. Need no more than ¼ acre. Information on all phases—\$1.00. Agricultural Consultant; Walnut Hill, Amherst, New Hampshire.

FARM MACHINERY AND SUPPLIES

GARDEN Tractor—Nationally known—now sold at discount. Eliminates all hand hoeing, also tills. Nothing like it. Patent 2742840. Discount catalogue free. Autohoe, DePere 68, Wis.

PROFITABLE OCCUPATIONS

EARN Money using any camera. CPC shows you how, quick proved method. Experience not necessary. Make pictures at home, anywhere. Make money! Write today. CPC, Box 1066, Richmond, Calif.

RABBIT Journal—Angora magazine \$1.00 year. Hobby knitting machine \$6.50. Eugene Carpenter, Piqua, Ohio.

START A magazine subscription business. Earn generous commissions on Popular Mechanics, Good Housekeeping and all others. Best commissions, bonus, all materials sent free. No experience needed. Write Popular Mechanics, Room 2-P, 250 West 55th St., New York 19, N. Y.

INVESTIGATE Accidents—Earn \$750 to \$1,000 monthly. Thousands of insurance companies, airlines, steamship lines urgently need Accident Investigators. Make excellent full time or spare time income. Free book! No obligation. GI approved. Write: Universal Schools, CT-2, Box 8227, Dallas 5, Texas.

MAGAZINE Subscriptions. Highest commissions. Bonus. Qualified Agencies, 451HA Kingston, Brooklyn 25, N. Y.

BUILD A profitable business in your spare-time, for your future security. Send \$1.00 for instructions and kit. Money refundable. Oriental Arts, 9 Morrell Street, San Francisco 9, California.

FREE Book "990 Successful, Little-Known Businesses." Work home! Plymouth-7T, Brooklyn 4, New York.

RAISE Nightcrawlers, redworms. Easy, new, odorless, soilless method. Three Oaks Ranch, Dresden, Tenn.

ENJOY Camping: Make big profits while you play, with Heilite Camping Trailer dealer franchise. Sets up into complete camp in just one minute; attracts crowds wherever shown! Write for dealer program. Heilite Trailers, 1501 South Sacramento, Lodi, California.

MAKE Money making new greaseless doughnuts in kitchen. Sell stores. Free recipes. Michael, 3605 South 15th, Minneapolis 7, Minnesota.

BECOME Independent with your own franchise business. Thousands earning handsome incomes. Request interesting facts today. National Franchise Reports, PM-528, 333 North Michigan, Chicago 1.

BIG Money raising fishworms and crickets. Free literature. Carter Wormery, Plains, Georgia.

BUY Wholesale: 100,000 nationally advertised products. Appliances, cameras, sporting goods, housewares, watches, typewriters, tools, clothing, etc. Discounts to 60%. Buy-Rite, Box 258, Hawthorne 1, New Jersey.

\$200 WEEKLY Extra introducing buyers to sellers, weekends. Men, women enjoy learning real estate by listening to records. First lecture free. Lee Institute, Brookline, Mass.

MAILORDER Beginner's literature. Write Carnahan Bros., 9610 Acacia, Fontana, Calif.

AUCTIONEERING—Home study course. Diploma granted. Auction School, Ft. Smith, Ark.

RAISE Pheasants on \$100 week plan. Little capital and space can make you independent. Free details. Great Central System, Columbus 1, Kansas.

VENDING Machines. No selling. Operate a route of coin machines and earn amazing profits. 32-page catalogue free. Parkway Machine Corporation, Dept. #25, 715 Ensor Street, Baltimore 2, Maryland.

GROW Mushrooms. Cellar, shed and outdoors. Spare, full time, year round. We pay \$4.50 lb. dried. We have 29,000 customers. Free book. Mushrooms, Dept. 99, 2954 Admiral Way, Seattle, Wash.

EARN \$240.00 A month at home, spare time doing only two \$5.00 invisible mending jobs a day. Big money paid for service that makes cuts, tears disappear from fabrics. Steady demand. Details free. Fabricon, 6236 Broadway, Chicago 40, Ill.

MAKE Flexible molds. Cast plaques, figurines. Free sample. Tooker, 1045-M Fairview, Hamilton, Ohio.

BOOKS, PERIODICALS, PICTURES, POSTCARDS

TRADE In your books and pocket books at full price here! List free, all subjects, including science-fiction. Werewolf Bookshop, Verona, Penna.

EXPECT The unusual when you send card for details regarding "Gamblers Bible." Brooklyn Book Shop, 451 N. Western Ave., Los Angeles 4, Calif.

FREE. Unusual magazines. Over 900 illustrated brochure, many foreign. Rush quarter (postage). Friendship, Osprey 3, Florida.

BOOKFINDING Our specialty. Try us. Babcock, 412 Lulu, Wichita 11, Kansas.

OUT-Of-print books at lowest prices! You name it, we find it! Fast service. No obligation. International Bookfinders, Box 3003-PM, Beverly Hills, Calif.

BRITISH Book bargains—Any subject. Catalogues free. Transatbooks, Wantagh, N. Y.

FREE Catalog. Self-help books. Write: Wilshire, 8721 Sunset, Los Angeles 46P.

BOOKFINDERS! All subjects. Send wants! Jaher Book Service, 183 Hazelwood Drive, Westbury, N. Y.

"SCIENCE Milestones." Records march of science starting 400 years before Christ, right up to date. Amazing facts revealed. 312 pages packed with startling information that will thrill you. A real history of science. \$5.00. Literature free. Popular Mechanics Press, 200-SM East Ontario St., Chicago 11, Ill.

SELF-HELP Books all subjects. Free catalog. Box 102-A, Providence, R. I.

SPORTSMEN! Quickest way to become expert at your favorite activity! Send for catalog of books on hunting, fishing, self-defense, etc. Clinton Sportsmen's Books, Mt. Clemens 38, Mich.

NATIONAL Geographic magazines, 1888-1960, any issue. Periodical Service, Box 465-PM, Wilmington, Delaware.

GAMES, TOYS, NOVELTIES

"MAGIC Forest." Amazes children, adults. Grows overnight using household items. Instructions 25¢. McMullan, 1614 Kentucky, Lawrence, Kansas.

MAGIC TRICKS, PUZZLES, JOKER NOVELTIES

HILARIOUS "Rules and Regulations for Party Guests," 25¢. Free fun catalogue. House of Fun, Suite 216A, 6715 Hollywood, Hollywood 28, California.

THE House of 1000 Mysteries invites you to send for the World's Greatest Fun & Magic Catalog! 160 exciting pages containing 1000 thrilling tricks you can do! Rush name, address and 25¢ for this great book to Mystery House, 202-40 Pinewood, Trumbull, Conn.

ESCAPE Artist. Disappearing acts. Details 25¢. George Ropchan, 11823-58 St., Edmonton, Alberta.

MAGICIAN'S Cards, unbelievable tricks, \$1, 993 Wilmington Terrace, Raleigh, N. C.

EXCLUSIVE Tricks! \$2.50 precision made vanishing coin for \$1.00 plus "Top Hat Topics" booklets. Lou Tannen, 120 West 42nd Street, New York 36, N. Y.

BE A magician! Large professional catalog of latest tricks, 35¢. Ireland, C-109 North Dearborn, Chicago 2, Illinois.

500 TRICKS, Douglas famous 120-page catalog now available just 10¢. Fastest service to magicians everywhere with latest in magic or parlor, stage, pocket. Send 10¢ today. Douglas Magicland, Dept. 11, Dallas, Texas.

3100 NOVELTIES, Jokes, tricks, gadgets, funmakers, hobbies. Big catalog 10¢. Johnson-Smith, D-498, Detroit 7.

WORLD'S Finest professional magic. Joker novelties. Giant illustrated catalog 10¢. Top Hat, Evanston 12, Illinois.

PROFESSIONAL Catalog, 175 pages, 25¢. Williams, 900 Plymouth, Ellwood City, Penna.

CATALOG, Free trick, 25¢. (1,500,399 tricks, jokes). Magico, Box 4373-P, San Antonio 7, Texas.

COINS, TOKENS, CURRENCY

WOW! Indian cent, foreign coin, bargain lists. 10¢. Hutchinson's, Box 4747, Philadelphia 34, Penna.

HUGE Profit for coins from circulation. List, 10¢. Return our 35¢ Lincoln cent album with 60 different pennies from pocket change. Receive \$74.40 profit. P.O. Box 87, Santa Barbara, Calif.

NEW! Revised! 1960 coin bargain catalog 25¢! "Prices-paid" list, \$1.00! Sullivan, 50-TB East Sixth, St. Paul 1, Minn.

FLYING Eagle plus large cent, \$3.00. Rhode, 105 Windsor, Reading, Penna.

COINS From Formosa, Vatican, etc., plus foreign banknote. 10¢ with coin approvals. Littleton Coin Company, Littleton 51, New Hampshire.

BARGAIN Lots all different in Whitman folder. 10 Indian cents \$1.50; 10 Liberty nickels \$2.00; 10 Morgan dimes \$2.50; 10 Morgan quarters \$5.00; 10 Morgan halves \$9.50. Free list with orders. American Coin Company, 1921 Emerson North, Minneapolis, Minn.

FOR Sale 1913S, 1924S, 1931P, 1932D, 1938S, 1939D cents. All six for \$2. Gasser, Box 34615, Los Angeles 34, California.

BRILLIANT Uncirculated United States five dollar gold pieces, \$15.00. Twenty dollar, fine, \$45.00. Rare Coin Company, 31 North Clark St., Chicago 2, Ill.

LARGEST Coin magazine. 200 pages, 40¢. Scrapbook, 7320-J Milwaukee, Chicago 31.

EIGHT Different Indian cents \$1.00. Collector's Bargains, New Hope, Penna.

FREE List! U. S. coins. Lowest prices! Hugh's Coins, Hickory, N. C.

RAREST CC mint dollar, 1885 uncirculated \$7.50. Coin catalogue 50¢. Shultz, Salt Lake 10, Utah.

RARE Unc. 1899-P silver dollar, each \$5.00. Butts, Box 889, Torrington, Wyo.

NEW 1960 Giant U. S. coin catalogue 25¢. Ace, 107 N. Dearborn, Chicago 2.

COIN News Magazine, 35¢, subscription \$3.00 year. Dept. P, 231 North 18th, E. Orange, N. J.

NUMISMATICS Largest newspaper. Semi-monthly. Sample 25¢. \$2.00 yearly. Numismatic News, Box 42, Iola, Wis.

FREE Bonus offer! U. S. bargain list, 10¢ (refundable). Economy Sales Company, Mansfield, Massachusetts.

INDIAN Heads: 10 different dates \$1.00. Liberty nickels: 6 different dates \$1.00. Berry, Box 306, Westminster, Calif.

SIXTEEN Page 1960 retail price list of USA and Canadian coins for 10¢. Our selling prices on thousands of coins and coin collectors' supplies. Bryson Incorporated, 612A White, Toledo 5, Ohio.

U.S. Coin list 10¢. Contains over 100 illustrations; 5,000 delightful bargains. Stoney, 260 Washington, Boston 8, Mass.

40 GENUINE Foreign bills, \$1.00. Musser, Box 505, Dunbar, West Virginia.

LINCOLNS 50 Assorted dates, mints. Condition good to uncirculated. In coin folder. Send \$5.00 plus 35¢ toward postage. (No c.o.d.'s). New cleaning cloths for coins \$1.00 prepaid. Meyer Co., Box 868, Galesburg, Illinois.

THREE Brilliant guaranteed uncirculated Mexican silver dollars \$1.00. Universal Services, Box 675, San Antonio 6-D2, Texas.

THREE Different barber halves \$2.00. Bargain lists free. Sayers, 1000 Unaka, Johnson City, Tennessee.

SPECIAL Old Morgan dime, quarter, half dollar, 28 page coin catalogue, \$2.00. Hobby Sales, Box 4054, St. Paul 16, Minn.

MERCURY'S 1917S, 1918S, 1919S, 1920D, 1923S, 1930S. Complete \$3.00. Free Lincoln list. United, 101 Cranston, Providence, R. I.

\$4,000.00 FOR 1913 Liberty head nickel. Uncirculated dollars 1804-1939, 1893-S, 1895-P, 1903-O pay \$100.00-\$5,000.00. Certain dates—Lincoln cents before 1932, \$125.00; Flying Eagle cents, \$500.00; Indian cents, \$175.00; dimes before 1943, \$2,000.00; quarters before 1924, \$1,500.00; half dollars before 1929, \$3,000.00; 2¢ pieces, \$125.00; 3¢ pieces, \$150.00; half-dimes, \$1,500.00. Hundreds of others worth \$10.00, \$1,000.00. Canadian coins, 1921-50¢, \$750.00. Wanted—20¢ pieces, gold coins, paper money, etc. Our large illustrated guarantee buying-selling catalogue, giving complete alloy information—send \$1.00. Purchase catalogue before sending coins. Worthycoin Corporation (K-488-C), Boston 8, Mass.

SCARCE Uncirculated 1. ¢ cent with price list 50¢. Sda Landon, Box 836, Denver 1, Colorado.

FREE Bargain list! U.S. coins. Jeff's, Box 105, Newton, N. C.

CASH By return mail for large 1¢, 2¢, 3¢ Flying Eagle cents, shield nickels, U.S. gold. Send coins for quickest action. Centre Coin Co., 5B Centre St., Hempstead, N. Y.

STAMP COLLECTING

100 FOREIGN, 20 U.S. commemorative, 10¢. Approvals. Weckerling, 806C Orange, Westaco, Texas.

U.S. Mint #907-#928 face plus 2¢ each. #929-#1138 plus 1¢ each. Wilhelm, 16566 Mendota, Detroit 21, Michigan.

151 DIFFERENT U.S. commemoratives \$1.00. Free lists. M. Philpot, 1902 Losey, La Crosse, Wisconsin.

PICTORIALS — \$8.00 Catalogue, only \$1.00. Profit sharing approvals. Warden, 68, Sierra Madre, Calif.

FREE Mint set. Approvals accompany. Stampco, 5151 Princeton, Memphis 17, Tennessee.

FREE! Five different packets. Adult approval applicants. Norge, Ho-Ho-Kus, N. J.

FREE! Mint triangle set. Approvals. Skwarstamp, 730 Strawberry, Trenton 8, N. J.

FRANCE And colonies. 100 large pictorials, commemoratives, all different, \$1.00 bill. Prouteau, 1 Rue Verlaine, La Rochelle, France.

FREE! 5 Egypt, 5¢ handling, Approvals. Bellett, Mapledale, Hazel Park, Mich.

40,000 VARIETIES Available on approvals. 1/4¢ upwards. Keigwin, Box 933B, Daytona, Florida.

GERMANY, Russia, Argentina, Colombia, 15 different commemoratives! 25¢. Approvals. Jerry Conrad, Falmouth, Kentucky.

5 POUNDS U.S.A. mixture—\$2.50 plus postage. Utechts, 1143D North Keeler, Chicago 51.

FREE! Giant bargain catalog. New edition listing thousands of bargains including U.S. and B.N.A. stamps, packets, mixtures, albums, accessories and supplies; sent with beautiful approvals. Jamestown Stamp, Dept. E20PM, Jamestown, N. Y.

WOW! 110 All different Germany 10¢. Zeppelins, semi-postals, airmails, high values, etc. Giant catalog, bargain lists included with beautiful approvals. Jamestown Stamp, Dept. A20PM, Jamestown, N. Y.

21,000 ALL Different stamps, yours for only pennies a day on our systematic payment plan. Details free. Sjoquist, 1435 Cherrystone, San Jose 25, California.

FIRST UN set. Among world's prettiest. Only 10¢. Approvals. Welles, Box 1246-R, New York City 8.

FREE! 25 Different Turkey plus world's only octagonal stamp, plus Abyssinia Red Cross set; to those requesting approvals. C. J. Cleaveland, 806 North Humphrey, Oak Park, Illinois.

105 DIFFERENT U.S. stamps 25¢. Approvals included. Sheiron, Box 907K, New York 8, N. Y.

GIANT-Size issues collection: Laos elephant set, Brussels Fair, Olympic. Jet aircraft, Boy Scout, Somali animals complete. Romania flags. Togo set, diamond popes, UN set, etc., plus big stamp dictionary and approvals. Everything 10¢! Stampex, Box 47-KM, White Plains, N. Y.

FREE 66 Different to introduce approvals. McDonald, 3113 E. Mariposa, Phoenix, Ariz.

FREE! Three extra-special, superb sets, with fine low-cost foreign approvals. Bruns, 1709-PM Fremont, Madison 4, Wis.

FREE. 250 Peelable hinges and 20 different Brazil with approvals. Jaydee, 218 Dickinson S.W., Grand Rapids 7, Mich.

508 DIFFERENT Worldwide from Madagascar, Macao, Guinea, etc., cataloguing over \$15 only 35¢. Offer open to adults only. Approvals. Littleton Stamp Company, Littleton Q1, New Hampshire.

ROCKETS! Satellites! 10¢ with approvals. Schaefer, Californiastrasse 16, Wiesbaden, Germany.

FREE—1/2 Pound of United States mixture with approvals. Send 20¢ for postage. Wm. Rice, 87 Washington Avenue, Kingston 9, N. Y.

SURPRISE Collection exotic mint British Colonials absolutely free with approvals. Viking, Great Neck 8, N. Y.

GIGANTIC Collection free. Includes triangles, early United States, animals, commemoratives, British Colonies, high value pictorials, etc. Complete collection plus big illustrated magazine all free. Send 5¢ for postage. Gray Stamp Company, Dept. PM, Toronto, Canada.

QUEEN Elizabeth on stamps. A beautiful collection of 50 different stamps from 22 countries, all bearing the portrait of the Queen of England, 10¢ with approvals. Capital Stamp Co., Ferrysburg 2A, Mich.

GREATEST Premium! World-wide collection! Over 1000 different stamps from Angola, Nigeria, Ecuador, Macao, other exotic lands. Includes triangles, airmails, sport, animal, ship, map stamps. Catalog value over \$25.00. This exciting collection given to qualified customers. Request approvals, details, today. Odd Stamps Co., Dept. A6, Box 31, Redondo Beach, Calif.

\$5.00 STAMP Collection, only 25¢. Approvals. D. Cain, Selmer, Tennessee.

100 DIFFERENT U.S. commemoratives, including 19th Century, plus 100 different world-wide, including airm and mint, \$1.00. Stark, Box 47, La Quinta, Calif.

FREE! 50 Different Netherlands, Colorful, inexpensive approvals. Elkhart, Box 33, Elkhart, Indiana.

100 WORLD 10¢. Approvals accompany. Robert Arthur, 920 Third, Seattle 4, Wash.

ICELAND, Finland 333 stamps only \$1.00. Epaivio, Mantta, Finland.

115 UNUSUAL including 1 U. S., helicopter triangle, Pope diamond, Sputnik, jet, Ghana, Israel, U.A.R., Vatican, colorful stamps pictured in Life. 10¢ with approvals. Rosen, 238M 8 Ave., Paterson, N. J.

LIQUIDATING Collections. 2¢ approvals. Job lots. Moredan, X424, Boston 17, Mass.

FREE! \$1.00 Worth, your choice, from first selection. No strings! Adults only. Rush request now. Philatelics, Dept. RF, New Paltz, N. Y.

U.S. \$1, \$2, \$5. Special—10¢, with approvals. Stevens, Box 24, Bay Station, Brooklyn 35, New York.

15 MULTICOLORS From Life magazine! 10¢. Approvals. McDonald, 3113 E. Mariposa, Phoenix, Arizona.

FANTASTIC Ghana, Mozambique, Nyasaland collection. 10¢. Approvals. Erickson, 736 Cottage, St. Paul 6, Minnesota.

44 ALL Different, diamond, triangle, Timor, topicals, others, with approvals, 10¢. Carpenter, P.O. Box 310, Claremont, Calif.

EXTRAORDINARY! Free! 20 different Finland to those requesting approvals. Rosenbergh, Box 1303, Chicago 90.

FREE—Any volume Scott's International Albums, 1960 Scott's catalogues, even Master Global albums, free when you buy our sensational foreign approvals. Bargain Stamps, Redlands 2, Calif.

YEMEN UPU set free with approvals W-B Stamps, Wilkes-Barre, Penna.

FREE Collections—Canada, Philippines, world wide, many others, each over \$5.00 value. Many other attractive premiums free with purchase of sensational foreign approvals. Topval, Box 486B, Redlands, Calif.

25 TRIANGLES All are Scott listed. 50¢ with approvals. Fire Island Stamp Company, Box 37A, West Islip, New York.

OUR Specialty, 1000 worldwide stamps \$1.00, 3500, \$3.00. Guaranteed. Harrison's Stamps, 1435 First Ave., Oakland 6, Calif.

90,000 STAMPS Sale: bargain lot 31¢, \$1, extra special \$2. Giant assortment \$5. High value packet \$3. Free gifts with first order. Persile, 436 N.Y. Ave., Brooklyn 25, N. Y.

SPACEOPHOBIA? Monaco nudes 10¢ to approval applicants. BKJ, Astor, Boston 23, Mass.

U.S. 60 Different 20¢. 60 different commemoratives 40¢. Both 50¢. Jim's Stamps, Brocton, New York.

FREE! World-wide stamp exchangers' addresses. Send International Reply-Coupon. Lakshminarayan, 7/6 Daryaganj, Delhi 7, India.

UNITED States, 100 different commemoratives \$1.00 with foreign approvals. Jacobsen, Crompond, N. Y.

CLEARANCE: Your choice, 3¢, each, regardless of catalog! References: Cadet, Seiden, N. Y.

ITALY—10 Different 10¢ with approvals. DeRespinis, G.P.O. Box 771, New York City.

GIVEAWAY! Boy Scout First Day Cover only 10¢. Loral Stamps, Box 22-E, Cambria Heights 11, New York.

GREECE. 25 Different, free with approvals. Smith, 1028 Coteau, Moose Jaw, Saskatchewan.

6 COLIFUL Sets: Outer space, olympics, famous paintings, ships, orientals, 20 delightful works of art, 25¢. Mature approvals. Hills, 123 Pearl, Santa Cruz, Calif.

FREE Surprise packet with pictorial approvals. Dancer, 75-P7, Mansfield, Ohio.

SWEDEN—100 Different, 25¢! Inexpensive, worldwide approvals. Carling, Howard City, Michigan.

FREE. Mint Angola animals. Topical approvals. Wallace Grant, Graceville, Fla.

50 DIFFERENT Haiti. Catalog \$6.00-\$1.00. Approvals. Haiti-Herald, Port-au-Prince, Haiti.

50 DIFFERENT U.S. commemoratives 10¢. Approval bargains included. Edmark, 113 Madison, Fanwood, New Jersey.

SORT And save approvals, 1/2¢-up. Dimond, 3152 Cuthbert, Oakland 2, Calif.

FREE Sets \$1.00 value, discounted approvals, bonus! Francis Lemle, Box 5646, Norfolk 16, Va.

WANTED Stamps, coins, cash paid. Harris, 1457 Moreno, Oceanside 5, Calif.

PARTICULAR? Want unusual stamps on approval. Try Bayou Stamps, Box 4126, Pensacola, Florida.

BEAUTIFUL—2¢ approvals! Thousands varieties! Marshall, Box 451-PA, Long Beach, Calif.

FREE—Laos elephants with approvals. Bacon, 405 Main, Rolla, Missouri.

50 DIFFERENT British Colonials 10¢. Approvals. Robert Searjeant, Mendon, New York.

150 DIFFERENT United States stamps, fabulous value only \$1.00. Free United States price list. Universal, Box 6, Kenosha 5-C, Wisconsin.

200 DIFFERENT Canada, \$3.00! Superb condition. Satisfaction guaranteed. Nierkerk, Tottenham, Ontario, Canada.

CONGO, Latest bicolored "Jungle Animals" free! Approvals. William Deems, 226p Race, Ravenswood, West Virginia.

135 DIFFERENT Canada \$1.00. 150 different U.S. \$1.00. Joseph Myers, Route 5, Coldwater, Michigan.

AIRMAIL Collection: Many countries, complete sets. Approvals. Rush dime. Each different. Boger, Box 152, North Wales, Penna.

25 DIFFERENT Russia 5¢ to applicants for our bargain approvals. Somith Stamp Co., Box 83-MR (Rugby), Brooklyn 3, New York.

500 DIFFERENT Germany, valued over \$10.00. Only \$1.00 with unique approvals. Universal, Box 6, Kenosha 5-A, Wisconsin.

TERRIFIC Triangles! Sports, volcanoes, mushrooms, African flowers, flags, Angola map, 26 others, 4¢ to approval buyers. Potomac Stamps, Washington 15, D. C.

U.S. Or foreign grabs 50¢ Three for \$1.00. Lore Company, Dedham, Mass.

100 DIFFERENT Belgium 25¢ with mounted approvals. Return postage paid. Frogness, Box 3008, Glendale 1, Calif.

50 FREE With approvals. Adults. Patton's Stamps, 660 California, Boulder City, Nevada.

ADULTS! Like stamps? Then start your own mail-order business. Our free guidance program shows you exactly what to do, makes it easy, profitable for you. Details free! Columbia, 9268-MP, Piney Branch Road, Silver Spring, Md.

500 DIFFERENT Hungary, valued over \$10.00. Only \$1.00 with unique approvals. Universal, Box 6, Kenosha 5-B, Wis.

ROOSEVELT 1¢ Plate block and list 10¢. Prins, 1325 Broadway, Watervliet, N. Y.

JUNGLE And Space Age. Fascinating wildlife selection and original spudnik stamp all free with terrific approvals. 5¢ handling. Stamp Imports, Peterborough, Ontario.

SURPRISE Set, fifty British Commonwealth, free with terrific approvals. Kawartha Stamps, Box 513, Peterborough, Canada.

BARGAIN—55 Different U.S., 10¢, with fine U.S. approvals. Stamps, Kennebunk, Maine.

ENJOY Stamp collecting! Write for "Penny-provals." Penny-proval Service, New York Building, Saint Paul 1, Minn.

FREE, Surprise assortment, 50 different world wide. With attractive approvals. Banner, M-3, 2861 So. Yates, Denver 19, Colorado.

BEAUTIES! Pictorials from Sudan, Monaco, Honk Kong, Iceland, Toga, New Caledonia, San Marino, Singapore, etc. Only 10¢. Approvals. Champlain, Isle La Motte, Vt.

INTRODUCING Our better United States approvals we offer 15 United States stamps including Columbian, Bi-Centennials, famous American, airs, others; only 10¢. Ocean Stamps, Box 64-PM, Brooklyn 29, New York.

FREE Packet! Five different foreign countries. Request fascinating approvals. Coral, Box 7095 (Ludlam), Miami 55, Fla.

50 DIFFERENT Large U.S. commemoratives 10¢ with approvals. Jack Clancy, Box 2187, Portland 14, Oregon.

10 BEAUTIFUL Mint British Colonies 10¢ wth approvals. Bennett, Candor 3, N. Y.

FREE! Fifty different stamps. Adult approval applicants. Norge, Ho-Ho-Kus, N. J.

PENNY Approvals. Thousands. Bargains for pennies. Gifts with purchases. Penny Stamps, Orange, California.

UNITED Nations. Five different 10¢. Approvals. Anderson, 1112 Harrison, San Francisco 3, Calif.

TERRIFIC Value. Eight complete mint sets 10¢ with approvals. Beatties, 58 Glenagar, Islington, Ontario, Canada.

25 DIFFERENT Commemoratives 1893 up 10¢. U. S. approvals. K&B, Box 70, Brooklyn 23, N. Y.

FREE Sample! Interesting, informative, illustrated. National Stamp News, Anderson, South Carolina.

FREE 50 Worldwide, mailed with inexpensive approvals. University Stamps, P.O. Box 95, Tamiami Station, Miami 44, Florida.

TRADE Your duplicates toward our approvals! (Foreign only.) Complete information, 10¢. Variety Stamps, Box 98-P, Newton Highlands 61, Mass.

307 WORLDWIDE Different stamps only 25¢. Approvals. Niagastamp, St. Catharines 671, Ontario.

MINT U.S. at face! Older commemoratives only. Send 25¢ for all different packet with first selection mint U.S. approvals. Western, Box 1689P, Salinas, California.

1000 DIFFERENT Worldwide stamps \$1.00. Valued over \$20.00. Universal, Box 6, Kenosha 5, Wisconsin.

60 DIFFERENT U. S. (30 commemoratives) 25¢. No approvals. Seidenberg, Appleton, Wisconsin.

GIANT Approvals, thousands different, 1¢ and 2¢ each. Wahl's Stamp Exchange, 7008P Farragut, Chicago 31, Ill.

ALBUM Only 10¢! Hundreds of spaces! Stampart Company, Hartford 1, Conn.

UNITED States commemorative collection containing 33 different—10¢. Approvals. White, 516-A Avenue L, Brooklyn 30, New York.

SELL Your surplus good grade stamps. Write, describing fully what you have. Vanroy Shirk, Lebanon, Pennsylvania.

AMAZING OFFER! 200 United States stamps — including commemoratives, airmails, high denominations to \$1.00. Only 10¢ to approval applicants! Illustrated bargain lists free. Mystic Stamp Co., Dept. 80, Camden, New York.

100 STAMPS, 10¢ With approvals. Smith, 508A Brooks, College Station, Texas.

OLD Scarce U.S. seconds on approvals. Slight imperfections, lowest prices. Hernefield, Clintonhill Sta., Newark 8, N. J.

100 OLD United States between 1861 and 1935, \$1.00. Roush Stamps, 51 Chestnut, Mansfield, Ohio.

225 STAMPS For only 10¢! This mammoth value includes airmails, pictorials; stamps from strange countries cataloging up to 25¢ each! Also approvals. Mystic Stamp Company, Camden 80, New York.

UNITED States price list, 116 pages, price 25¢. Mark Hanna, 335 Fifth Ave., Pittsburgh 22, Penna.

SELL Stamps to our readers. Your ad in this space will be read by thousands of stamp buyers. I'll prove that to you. Write now for Folder "S." F. W. Johnson, Classified Advertising Manager, Popular Mechanics, 200 E. Ontario St., Chicago 11, Ill.

14,000 DIFFERENT! Amazing new plan builds your collection systematically, country by country. Only 50¢ weekly. Free details. L. G. Ware, Stepney 75, Conn.

U. S. Mint flag set, complete, \$1.00. Free list. Brooks, 2323 Avenue X, Brooklyn 35, New York.

103 DIVERSIFIED British colony stamps only 10¢. Approvals. Niagastamp, St. Catharines 671-A, Ontario.

102 DIVERSIFIED Worldwide stamps 10¢. Approvals. Linstamp, St. Catharines 618, Ontario.

PENNY Approvals! Regardless catalogue! Kloster, 4164—52nd St., San Diego 5, Calif.

25 DIFFERENT Large American commemoratives 10¢. With approvals. Linstamp, St. Catharines 618-A, Ontario.

INTERESTING Worldwide animal stamp collection 10¢. With approvals. Niagastamp, St. Catharines 671-B, Ontario.

ECONOMICAL, 1/2¢-3¢ Approvals, 33,000 varieties. Dresel, Box 128-N, West Englewood, New Jersey.

105 BRITISH Colony stamps, all different 10¢. Approvals. Crown Stamp Company, 901, Virgil, Ontario.

A System that brings you 100 to 400 different new stamps of your own choice, each and every week. What every collector has dreamed about. Nothing else like it. This is entirely different. Complete details sent by return mail, merely by sending \$1.00 for one full year's membership or \$1.50 for two years. Las Vegas Stamp Service, 558 Oakley Blvd., Las Vegas, Nev.

50 DIFFERENT Stamps free! Approvals. Marford, Box 48, Queens Village 29, New York.

FREE! Liberia airmail triangle, diamond, midget, mammoth to approval buyers. Plymouth, Dept. A-8, Bell, California.

STAMP Collecting outfit, includes packet worldwide stamps, package hinges, watermark detector, millimeter gauge. Everything 10¢ with approvals. Loraine Brown, Marion, Michigan.

FREE! Wonderful, new 84 page U. S. catalog. Handling 10¢. Norrisco, Milwaukee 7, Wis.

SUPERIOR Worldwide mission mixture. Amazing variety! Six ounces \$1.65. Pound \$3.95. Bay Nielsen, 4545B Harvard, Montreal 28, Canada.

100 DIFFERENT Belgium free. UPU. Brussels Fair, railroad stamps free. Approval applicants only. Tylon, Box 31-P, Brooklyn 30, N. Y.

ZOUNDS! Amazing "Strange Countries" packet. Free with approvals! Saxon, Orange, California.

65 DIFF. U. S. commemoratives 50¢. No approvals sent. K. Plascyk, 4 Pasture Lane, Massapequa, Long Island, N. Y.

DAMAGED Old U.S. 1/2 catalog, on approval. K. Swartz, Maiden Bridge, N. Y.

15 AUSTRALIAN Commemoratives 5¢. Approvals. Van, Box 981, Columbus, Miss.

FREE. U. S. pricelist plus foreign packet list. Thom, 4808—15th Avenue, Minneapolis 17, Minnesota.

FREE! China collection, approvals. Send 10¢ postage. Coast, P.O. 2187AB, Santa Ana, California.

LOOK! 150 Diff. U.S. commemoratives \$1.00! Ewing, 2133 Lunt, Chicago 45.

U.S. Illustrated list free. Big irresistible discounts. National, Box 60, Boston 1, Mass.

LOOK! Six Queen Elizabeth mint sets from Singapore, Tristan, Malacca, Malta, Antigua, Caymans! 21 brilliant pictorials, 25¢. Attractive approvals. Gannon Stamps, Box 931, Canton 1, Ohio.

12,000 PENNY Approvals waiting for you! Many from exotic countries, pictorials, airmails, new issues. Tilbury, Box 862, Newark 1, N. J.

MOONE Rocket including 111 different stamps, 10¢ with approvals. Finney, Box 89, El Monte, Calif.

U. S. Commemoratives: 202 different \$2. Moseley, 6 Hanley Downs, St. Louis 17, Missouri.

1075 DIFFERENT \$1.00 with approvals. Klondike, 682 Jefferson, Elgin, Illinois.

300 DIFFERENT Given free with approvals. Particulars. Windsor Stamps, 8834 Cornell Avenue, Chicago 17.

HUNDREDS Of free commemoratives and bi-colored stamps to buyers from our 1/2¢, 1¢ and 2¢ approvals. Orana, 704 S. Main, Santa Ana, Calif.

25 AUSTRALIAN Commemoratives 10¢. Approvals. Binkowski, 944 Park, Schenectady, New York.

FINE U.S. stamps. \$5.00 Coolidge of the 1938 Presidential series, and the \$5.00 Hamilton of the 1954 series. Both for only \$1.00. Fine U.S. approvals included. Willett Co., P.O. Box 338, Dept. 45, Yorktown Heights, N. Y.

ANTIQUES, RELICS, INDIAN GOODS, CURIOS

ANCIENT Grooved stone tomahawk \$3.00. Indian relic list free. Lear's, Glenwood, Arkansas.

4 ARROWHEADS \$1.00. List. Smith, 841 N. Tacoma, Indianapolis 1, Indiana.

ILLINOIS: Selling hundreds — Confederate, Civil War, Indian War, western muskets, Kentuckies, Springfield, rifles, pistols, flasks, blunderbusses, flintlocks, frontiers, dueling, pepperboxes, Confederate-Union swords, bayonets, bullet molds, 12,000 collectors cartridges, \$20,000.00 Confederate bills. Gold coins, Indian cents. Agates, minerals, fossils. 50,000 Stonegate Indian relics, arrowheads, spearpoints, discoidals, gold nuggets, stagecoach guns. Mounted birds, daguerrotypes, holsters, military insignias. Send 35¢ (refundable) for large listing. Heikerson, Wenona, Ill.

PRECIOUS STONES, MINERALS

THE Collectors Shop, 95 Camino Espanol, Tucson, Arizona. 10 beautiful colorful Arizona minerals \$2.00.

20 DIFFERENT Beautiful polished gem stones \$2.50. David Wilson, 1865 Poplar, Memphis, Tenn.

"TREASURE Map of Mojave Desert," gems, minerals, recreation, 21"x33" \$1.00 postpaid. Gemac, 808A, Mentone, Calif.

TWELVE New Mexico minerals \$2.00, six fluorescents \$1.06, five crystallized minerals \$1.06, fools gold 35¢. Minerals, Winston, New Mexico.

PROSPECTORS! Learn from experienced geologists how to locate and identify rocks and minerals. A comprehensive home study course designed for anyone interested in exploring for valuable ore deposits. Write now for free literature. Pacific School of Mines, Dept. B-1, Box 2538, Palm Springs, California.

FREE Bargain gem list. Lapidary and silversmith catalog, 56 pages, 25¢. O'Brien's, 1116M Wilcox, Hollywood 38, Calif.

"GEMS & Minerals Magazine," largest rock hobby monthly. Field trips, "how" articles, pictures, ads. \$3.00 year. Sample 25¢. Box 687A, Mentone, California.

SEMI-Precious uncut gems. Ten different for \$1.00. Request list 26. Prospectors Shop, 201 San Francisco, Santa Fe, New Mexico.

EARTH Science, the rockhounds national magazine. Subscription \$2.00. Sample 35¢. Box 1357-PM, Chicago 90, Ill.

DIAMOND \$1.00! Genuine small stone, not a chip, uncut, just as it comes from the mines in Africa. Wonderful curio. Educational. P. O. Box 566, Ardsley, N. Y.

ROCKHOUNDS, Gem cutters, jewelry makers. New free catalog, just off the press! Biggest suppliers to hobbyists and craftsmen offers you tools, materials, equipment, introductory bargains and know-how. Free catalog. Write Grieger's, Dept. C-12, 1633 E. Walnut, Pasadena, California.

18 COLORFUL And basic U.S. mineral specimens attractively boxed with descriptive folder \$1.00 prepaid. Included free dinosaur bone pocket piece. Rock Haven Mineral Co., Dept. 203, Whitefield, N. H.

HOBBIES AND COLLECTIONS

WANTED Cigarette, tobacco cards. Write Charles Bray, East Bangor, Penna.

25 COLORFUL Selected seashells plus genuine sea horse and starfish \$1.00 postpaid. Includes free shell card in color with names and free tropical catalog. Treasure Highland, Airgate Branch PM, Sarasota, Fla.

COLLECTORS Matchbook covers, 100 different unused, \$1.00. Catalog 25¢. Album \$3.00. Charles Edelman, 1311-C East 84, Cleveland 3, Ohio.

COLLECT Foreign medals, daggers, helmets. Iron Cross with ribbon, \$1.50; Swastika emblem 25¢; catalog 25¢. Hobbies, Box 71-B, Rockaway 94, N. Y.

NAZI Insignia book, 600 illustrations, and 6 Nazi emblems, \$1.00. Hobbyland,

PHOTOGRAPHY, CAMERAS, PHOTO SUPPLIES

PHOTOGRAPHY For pleasure or profit. Learn at home. Practical basic training. Long established school. Free booklet. American School of Photography, 835 Diversey Parkway, Dept. 3441, Chicago 14.

164 PAGE Photographic bargain catalog, listing thousands of photographic bargains. Send 25¢ for your copy, credited on first order. Dept. 1-C2, Central Camera Company, 230 So. Wabash Ave., Chicago 4, Ill.

PHOTO FINISHING

FREE! Kodak film for life. New Kodak film for every roll you send to develop. Jumbo size. Black and white: 8 exp. 80¢; 12 exp. \$1.05. Kodachrome: 8 exp. \$3.50, 12 exp. \$4.50. Send for price catalog for more savings. Satisfaction guaranteed. Yankee Photo Service, Box 1820-PM, Bridgeport 1, Conn.

A Triple value. Quality, price, service. Color or black and white, 12 exp. (black and white) 59¢. 20 gift photos \$1.00. Holiday Photos, Dept. 16, Box 666, Denver, Colo.

A 3-In-1 value. Price, quality, service. 20 gift photos, \$1.00. 12 exposure rolls (black and white), 59¢. Color or black and white. Interstate Photos, Dept. 11, Box 15, Aurora, Ill.

KODACHROME Processing by Kodak. 8mm. roll or 35mm., 20 exp., \$1.40. Prompt service. Write for mailers and prices. Color Pix, Dept. P, CPO Box 30, Kingston, N. Y.

TWELVE Exposure rolls 49¢. Wallets 20 for \$1.00. Lincoln Studios, Dept. K, Box 13, Lincoln, Nebr.

TWO 5"x7" Natural color enlargements only \$1.00! Made from Kodachrome negatives or 35 mm color slides. Limited. Thrifty Dan, Box 68, Dept. A, Grand Rapids, Mich.

ENLARGEMENTS, Heavyweight, six 5x7's or three 8x10's \$1.00. Jack Koons, Huntington Mills, Penna.

FILMS—Developed and printed 50¢—127, 620, 120 film. Color film developed and printed, save 25 to 33½ discount on all color work. World's finest quality. Send for mailers-price list. Apex Photo, Box 511, Paoli, Penna.

100 PHOTOSTAMPS. Send any photo. \$1. Refundable. Stadri, Whitestone, N. Y.

SAVE 20-50% On custom grade photo finishing. Send for brochure. Dura Color Lab, 742 N. Highland, Los Angeles 38, California.

MOST Beautifully colored 8x10 enlargement. Send favorite photo, \$1.00. Fully guaranteed. Dick's Studio, Louisville 12, Ky.

MOTION PICTURES AND SOUND EQUIPMENT

SAVE Dollars. 16mm sound movies 25¢. Giant listings. Gaines, Box 3243-PM, Van Nuys, California.

8MM Movies, 50', comedies, cartoons, travel, airplanes, hunting, fishing. Limited offer. Send \$1.00 each. Movieland, Box 10-M, Van Nuys, Calif.

WILL Pay cash or trade 16mm sound for 35mm, 28mm, 16mm silent films. Lists free. Johnny Allen, Park Ridge, N. J.

ROSE Parade color movies. 8mm 50' \$4.95. Complete parade 200' \$17.50. 12 35mm color slides \$2.75. Movieland, Box 10-M, Van Nuys, Calif.

16MM. Sound films and equipment. Write, phone Entertainment Films Company, 2621 Broadway, New York 23.

16MM. Sound films. Bargain bulletin. Duquette, 97-T Snow, Fitchburg, Mass.

MOVIE Film! Free catalog! ESO-R, 47th Holly, Kansas City 12, Missouri.

16MM. Sound, projectors, films. Sale, rental, exchange. Visit store or write for catalog. National Cinema, 71 Dey St., New York City.

FREE! Blackhawk's big sale catalog 8mm., 16mm. movies, 2"x2" color slides. Biggest selection anywhere! Projectors, cameras, supplies. Big discounts! Get free, every three weeks, 12-page newspaper size bargain list! Blackhawk Films, Davenport 14, Iowa.

5,000 8-16MM. Movie films. Free catalogues. International, Greenvale, N. Y.

MOVIE Camera film: 8mm. roll \$1.50. 16mm. 100' \$3.00. Free processing. Better Films, 742 New Lots, Brooklyn, N. Y.

16MM. Sound shorts. Tremendous assortment features, \$16.50 up. Used 16 mm. sound projectors, \$79.50 up. Catalog. Abbe Films, 417 West 44th Street, New York City 36.

10¢ BRINGS Big new cine manual for the 8mm.-16mm. movie maker. Save money on fresh b&w and color movie film, all home processing equipment. Superior, 448 N. Wells, Chicago 10.

16MM. Sound films, also 8mm. subjects. Bedner, 5300 So. Talman, Chicago.

COLOR SLIDES

MISS America slides. Twenty 2x2 color slides \$5.00. Free brochure. Box 117, Atlantic City, N. J.

WESTERN Scenery. Best combination quality, price and individual selection service. Free lists. Slides, 711 Columbia Road, Colorado Spring, Colo.

MUSIC & MUSICAL INSTRUMENTS

ACCORDIONS — 1960 Models. Lowest discount prices. Save up to 50%. Free home trial. Trades accepted. Big color catalog free. Accordion Manufacturers, Dept. 20-R, 2003 Chicago, Chicago 22.

RECORDS Stereo monaural big discounts. Write: Records, Box 211, New York 5, N. Y.

BONGOS, 6" and 7½" heads two-tone wood \$18.00 value \$10.00 postpaid. Instructions free. Arfin Music, 1712 Nostrand, Brooklyn 26, New York.

WOOD Pipes. Send for description and prices. C. A. Sevigny, P.O. 195, Chester, Conn.

ELECTRIC Guitars, amplifiers, wholesale. Free catalog. Carvin, PMM, Covina, Calif.

SONGWRITERS, With publisher contacts, want song ideas. Share royalties. No fees. Send poems: Songwriters' Associates, 1650 Broadway, New York City 19-G.

ACCORDIONS, Italy's best, guaranteed. 60% discount. Importers, 7445 East Seven Mile, Detroit 34, Mich.

GUITAR Making books, plans, imported woods, tools. List 10¢. Store, 510 East 11th Street, New York 9, N. Y.

SONGPOEMS And lyrics wanted. Mail to: TinPan Alley, Inc., 1650 Broadway, New York 19, N. Y.

POEMS Wanted for musical setting and recording. Send poems. Free examination. Crown Music Company, 49-C West 32 Street, New York 1.

SONGS Into dollars. Share \$33 million dollars yearly for new songwriters, song poets. Any subject, songs composed, published, promoted by largest firm. Information, appraisal free. Send Nordyke Music Publishers, 6000 Sunset, Hollywood 28 PM, California.

POEMS Wanted for musical setting and recording by America's largest song studio. Send poems. Free examination. Five Star Music Masters, 630 Beacon Building, Boston.

LEARN To play guitar, accordion, piano. 10 lessons on records with instruction book, \$4.98. 24 lessons, \$9.95. U. S. Gov't. approved. Vavro Institute, So. St. Paul, Minn.

POEMS Wanted! Best songs recorded free with 7-piece orchestra. Melodies written. Songmakers, 1472-M Broadway, New York 36.

POEMS Needed immediately for new songs and records. Free examination and appraisal. Send poems: Songcrafters, Acklen Station, Nashville, Tenn.

SONGWRITERS—Arranging by specialists. Music set to poems, religious and popular. Offset printing. Free information. Music Printing Company, Dept. PO-2, 732 South Sherman, Chicago 5, Ill.

POEMS, Songs serviced. New plan. Sequoia Songwriters, 6419 Primrose, Hollywood 28, Calif.

GUITAR For beginners—easy! Quality professional guitar, plus famous "Play-at-once" course, case, music stand. Easy time payments. Free details. Sale, Bradley Beach 20, N. J.

EXCELLENT New songs from author, 3 best copies, \$1.00. 3 song poems 50¢. J. F. Jacobson, 2118 Capitol, East Palo Alto, Calif.

WANTED! Poems, lyrics, songs. Free rhyming dictionary. Bengol, 93 Jefferson, Chelsea 50, Massachusetts.

SONGWRITERS! Free, detailed information. Iris Music, Box 192, Sun Valley, California.

PORTABLE Chord organs from distributor. Save. Sixty chords only. Free information. Libro Music Center, 591-593 Chapel St., New Haven, Conn.

RADIO, TELEVISION AND ELECTRONICS

TELEVISION Interference filter \$1.00 ppd. Electro-Mechanical Co., Springboro, Ohio.

FREE Flyer monthly, electronic surplus. Kurtz, 702 Bay, Staten Island, N. Y.

15 DISTANCE One-tube plans with transistor experiments, 25¢. Laboratories, 1131-C Valota, Redwood City, California.

LEARN Television servicing. Beginners course 4 lessons \$1.00. Scientific-Technical Studies, Box 4016, Brighton Station, Rochester 10, N. Y.

AMPEX Tape recorders. Components. Boynton Studio, 10-PM Pennsylvania, Tuckahoe, N. Y.

FIX Your own TV. Save 80%! Send for free illustrated chart showing how! We'll include giant electronics catalog. Zalytron, 220-M West 42 St., New York City.

TUBES — TV, radio, transmitting, special purpose types. Bought, sold, exchanged. Unused only. Send details to Barry Electronics Corp., 512 Broadway, Dept. PM, New York 12, N. Y.

RECHARGEABLE Battery and plug-in 110-120V charger for 9-volt pocket transistor radios \$4.25. Also 6-transistor radios w/case complete \$20. 8-transistor 2-band \$40. Rotoken Corporation, Roppongi Bldg., Mikawadai-machi Minato-ku, Tokyo.

DIAL Inter-com telephone system you can build for few dollars. Plans \$3.00. Gerry Miller Electronics, Maquoketa, Ia.

CASH For used short-wave ham receivers, transmitters and accessories. Treger, W91VJ, 2023 N. Harlem Ave., Chicago 35, Tuxedo 9-6429.

RECORDERS, Hi-Fi. Free wholesale catalogue. Carston, 215-PM East 88, New York City 28.

FREE! Giant wholesale catalog on electronics, hi-fi, transistor, scientific, hobby, optics, photographic, housewares, jewelry, tools, novelties, toys. Write: Lektron, 131M Everett Ave., Chelsea 50, Mass.

TAPE Recorders, Hi-Fi components, sleep learning equipment, tapes. Unusual values. Free catalog. Dressner, 69-02M, 174 St., Flushing 65, N. Y.

LEARN While asleep with amazing "Electronic Educator" endless tape recorder. Details free. Research Association, Box 24-N, Olympia, Washington.

GOVERNMENT Surplus radios, parts. Picture catalog 10¢. Meshna, Malden 48, Mass.

ELECTRIC Guitars, amplifiers, wholesale. Free catalog. Carvin, PMR, Covina, Calif.

RADIO And TV tubes at manufacturers' prices! 100% guaranteed! Brand new! No re-brands or pulls! United Radio, Box 1000, Newark, N. J.

BUSINESS OPPORTUNITIES

OPERATE Home mail-order business. Vosacek Printing, 4444A1 Ute, San Diego 17, Calif.

MAKE Extra money—Big cash commissions plus premiums for you and your customers. Sell advertising book matches. Sensational new tenor sax, glamour girls, hillbillies; dozens others. All sizes. Quick daily sales; big repeat business. Free master kit makes selling easy. No experience necessary. Superior Match, Dept. MX-260, 7530 Greenwood, Chicago 19.

PEST Control pays big money full or spare time. Homes, offices, stores, factories, pay big fees for insect, rodent control. \$50 job requires 50¢ in material, 50 minutes time. Quick, easy to learn. Complete course teaches everything in weeks; pays big for a lifetime. Write for free details. Pestrol, Dept. A-1, 6238 N. Broadway, Chicago 40, Illinois.

IMPORT-Export opportunity, profitable, world-wide, mail-order business from home, without capital; or travel abroad. Established world trader ships instructions for no-risk examination. Experience unnecessary. Free details. Mellinger, C702, Los Angeles 24.

BIG Money—Operate own fix-it shop. Service household appliances, motors, mowers, saws, skates, etc. Free book. Christy Trades School, A-8703, 3214 Lawrence, Chicago 25.

BRUSH Plating outfits for plating articles in the home and shop. No tanks necessary, silvering mirrors, spare or full time. Free particulars. Gunmetal Co., Ave. H, Decatur, Ill.

COLORGLAZED Concrete pottery made without molds. Patented method. Cemetery products, novelties, tiles. Basement leak-sealing. Money-making projects. Booklet, details free. Men only. National Potteries Company, Grand Rapids, Minnesota.

MAIL-Order home business. Get free copy, "Make Money in Mail-Order." Mail-co, 1717 Westwood, Dept. C702, Los Angeles 24.

LEARN Professional TV servicing in one week! Fabulous new simplified system. No big expense. No studying. No tools or equipment. Spare, full time. Own your own big profit business! Save! Amazing but true! Free! Write, TV Systems, Dept. DC-172, 1038 So. LaBrea, Los Angeles 19, Calif.

OPERATE Home mail order folio business. Details free. Whitaker's Service, Box 368-B, Lake Village, Arkansas.

PATENTED Portable power spray car washer and supply of super detergent. Wash car in 5 minutes. Money back guarantee. \$12.95 complete. No C.O.D. Detergent Engineering Corp., Box 364-B2, Tulsa, Okla.

WILL You test new items in your home? Surprisingly big pay. Latest conveniences for home, car. Send no money. Just your name. Kristee 115, Akron, Ohio.

MARKETS Everywhere. Make artistic concrete birdbaths, pottery. Best coloring. Home workshop. Hundred varieties. Hollywood Cementcraft, 8527-S Wonderland, Hollywood 46, California.

\$250.00 WEEK Profit possible. Earn at home spare time with fascinating printing method. \$5 start you. Send no money now. Free confidential facts and valuable samples. Screen-Print FY, Los Angeles 61.

START Your own business on credit (U.S. and Canada). Your own boss. 1383 dealers sold \$5,000 to \$33,500 in 1958. We supply stocks, equipment on credit. 200 home necessities. Sales experience unnecessary. Pleasant profitable business backed by world-wide industry. Write Rawleigh's, Dept. B-U-PPM, Freeport, Ill.

PROFIT With Popular Mechanics' subscription plan. No investment, no experience needed. Earnings begin immediately when you obtain subscriptions for Popular Mechanics, Good Housekeeping and others. High commissions, bonus. No experience needed. Deal directly with the publisher. Write Popular Mechanics, Room 2B, 250 West 55th St., New York 19, N. Y.

GAME Warden, government hunter, forestry, park and wildlife services announce job openings. All states. Enjoy outdoor work, good pay, real security. Complete information free! Write North American School of Conservation, Dept. DC-172, 1038 S. La Brea, Los Angeles 19, Calif.

GROW Living miniature forest (only inches high) or orchard that bears tasty tiny fruit. Learn amazing dwarfing secrets! Fascinating hobby! Profitable home-business opportunity! Free seeds and plan. (State your age.) Miniature Nurseries, Dept. FY, Gardena, California.

BUSINESS Kit free! Postcard puts you in business! Complete line 230 shoe styles, jackets! New discoveries pay big commissions. No investment. Send for free kit. Mason, Chippewa Falls KB-303, Wisconsin.

NEW Home-import mail order profitability! Your mailbox stuffed with money! No selling. No experience. No investment. We supply everything. Free details. Mail Order Distributors (Import Division), 15201 South Broadway, Los Angeles B52C, Calif.

"50 NEW Home-Business Ideas" booklet, sample free. Spray exotic Velvet-Suede on anything. Flokcraft-FY, Los Angeles 61.

PRACTICAL Mailorder. Start small. Money-maker (260), 722 East Silver Spring, Milwaukee 17, Wisconsin.

CAN You qualify? Selected men. We help establish floor refinishing business. Complete program. Tool Rental, 3602 California, St. Louis 18, Missouri.

HIGHER Income! Facts-fallacies. Details: Grentius, 182-25 Wexford, Jamaica 32, N. Y.

HIGHEST Quality liquid rubber, \$10.00 gallon, prepaid. Free details. Steece Bros. Box 177-M, Sioux Falls, So. Dak.

FREE List needed inventions. Protection form. Inventors Sales and Engineering Bureau, Dept. 462-D, Box 4973, Washington 8, D. C.

ATTENTION Big mailers. Proven list \$6.50 per 1,000. Hartford, Box 127, Highland Station, Denver 11, Colo.

YOUR Own spare time home-operated business. Take over your area as our service distributor keeping retail stores supplied. Nationally advertised 30-year-old line pays up to \$20.00 hour. Under \$100.00 for merchandise gets you started. For samples, highly successful plan, write Novo, 3855 Lincoln, Desk M-85, Chicago 13.

WANTED, Men, women. Raise bait for us at home. Full, spare time. Doesn't take up space. We furnish everything. Sherwood, Dept. U-2, Monmouth, Maine.

CO-PUBLISH "Home Business Digest." Free details! GPO, Box 972-po, New York 1.

BIG Money in novelties. New easy method. Write Breeden-Cooke, 3209 Marvin, Overland 14, Mo.

FREE Imports from overseas. Particulars free. Bassens Imports, 828 Fullerton, Chicago 14, Ill.

TERRITORIES Open for Auto-Moly lubricant (doubles engine life). Small investment. Build future state franchise. Pacific Lubricants, 5807-PM2 Beverly, Los Angeles 22, Calif.

FREE Brochure. My own story of "Success in Home Mail Order" by: Hamilton's, Hatch, New Mexico.

COLOSSAL Earthworm reproduction means big profits. Will explain method and buy crop. Earthworm book 35¢ and enjoyable moneymaking proposition. Crestwood Gardens, Box 162, Mantua, Ohio.

AGENTS. Penny and nickel counter and packager, accurate, fast. Sample \$1.00. Details. Sterling, Box 626, Dania, Florida.

CASH From sawdust, tin-cans, newspapers. Over 200 methods. Instructions \$1.00. Charles Company, 42-GPD, Norwood, Ohio.

PROFITABILITY. "Turning Ideas Into Cash" tells how. \$1.00 per copy. Satisfaction guaranteed. Robey House, Dept. 1613, 2042 W. Chicago Ave., Chicago 22, Ill.

12 SPINNING Lures. None better. \$11.00 value. All different. Send \$3.00. Quaker, 438 Sedgley, Philadelphia 40, Penna.

DON'T Waste money on worthless schemes! 30¢ brings a letter opener pen and valuable opportunities. Modern Merchandise, Box 77531 PB, Los Angeles 7, Calif.

IMPORT. Mail-order, plastics offered in new three-in-one money making opportunities. Free details. Trialpha, 7950 Mammoth, Dept. F20, Van Nuys, Calif.

INTERNATIONAL Mailorder business made easy. Individual setup service. Not just instructions. Hermes, 152 West 42, New York City 36.

MAILORDER To motels, churches, institutions. Complete individual set-up, not just instructions. Hermes Advertising, 152 West 42, New York City 36.

QUICK Money! Repairing car batteries. At home! Easy too! Free details! Batteryman, Penrose, Colo.

LEARN Sewing machine repairing. To \$125 weekly. Sparetime. Supplies. Add to present business. Write today! Taylor Service, Box 2126, San Bernardino, Calif.

OPERATE Your own bookkeeping and collection service installation. Earn up to \$25,000 or more. Details. Allison, 295 Hamilton Blvd., Kenmore 17, N. Y.

EARN \$10,000 Yearly raising Angora rabbit wool for us. Information 25¢ coin. American Angora Company, Malta 77, Montana.

WHAT Is this mail order business? Get the one true answer. John Bishop, Box 153B, Ojai, California.

MAIL Trade magazine has moneymaking opportunities galore. Sample 25¢. Donovan, 79-PM Greenbelt, Levittown, New York.

100% PROFIT Selling reconditioned spark plugs. Free sample. Lee, 1608-H Roberts, Houston 3, Texas.

FRANCHISES Make profits! Operate your own independent franchised business as distributor, dealer or agency owner. Nationwide opportunities. National Franchise Reports is the recognized source for information regarding the booming franchise field. Write today for interesting free details of this helpful service. National Franchise Reports, W-528, 333 North Michigan, Chicago 1.

FREE Picture folder, "How to Make \$3,000 Yearly, Sparetime, Backyard, Raising Earthworms!" Oakhaven-38, Cedar Hill, Texas.

VENDING Machines. No selling. Operate a route of coin machines and earn amazing profits. 32-page catalogue free. Parkway Machine Corporation, Dept. #27, 715 Ensor Street, Baltimore 2, Maryland.

SELL Books by mail. 400% profit. Royal, Box 368-X, Cleveland 27, Ohio.

PLASTERCRAFT Molds, liquid rubber, plasters, flocks, candle supplies. Catalog and manual free. Blue Rapids Supply, Blue Rapids, Kansas.

I Got rich in the dry cleaning business with no investment, so can you. Free details. Write: Imperial School of Dry Cleaning, Dept. PMC, 1700 Touhy Avenue, Chicago 26, Illinois.

STRIKE It rich on small home repairs by using set prices. Details free. House Clinic, Dept. P, 7307 Fenton, Dallas 31, Texas.

FREE! Name brands catalog! Your own high profit business. Sell name brands, full or part time. No inventory, no investment. More than 2,000 name brand items; lowest wholesale prices. Watches, jewelry, cameras, hi-fi, stereo radios-phonos, appliances, housewares, hardware, power tools, luggage, musical instruments, garden equipment, sporting goods, toys, many others. 8 floors of name brands. Million dollar inventory. Orders shipped complete in 24 hours! Send for free, beautifully illustrated catalog now! Separate wholesale price list. H. B. Davis Corp., Dept. 11, 145 W. 15 St., New York 11, N. Y.

PLATE Baby shoes, jewelry, gifts. Bronze and colored pearl. We finance home businesses. Booklet free. Platex, 11029 South Vermont, Los Angeles 44.

IF You like motorcycles and money then send for Harley-Davidson dealership book on how to become a franchised dealer of motorcycles and a new line of motor-scooters. Here's a chance to own your own business with a very modest investment. The youth market is beginning to explode and the next few years promise a chance to cash in on it. Write for free illustrated dealership book today. Harley-Davidson Motor Company, Dept. P, Milwaukee 1, Wisconsin.

BUSINESSES, Resorts, motels, investment property, ranches. Our special service dept. at your disposal. No obligation. World's largest. 58 years' service. Strout Realty, 7-MB S. Dearborn, Chicago 3, Ill.

BIG Money raising fishworms and crickets. Free literature. Carter Farms, Plains, Georgia.

OPERATE Mailorder folio business. Free details. Ballard's, 1834 Edgeland, Louisville 4, Ky.

\$34.70 **TWO** Hours. Manufacturing concrete products. No selling. Carlayne Castings, 1803 Fremont, Rapid City, South Dakota.

TO \$100.00 Weekly. Sparetime, home operated mailorder business. Successful beginner's plan. Everything supplied. Lynn, 10420-M National, Los Angeles 34.

PIANO Tuning learned quickly at home. Tremendous field! Musical knowledge unnecessary. Information free. Empire School of Piano Tuning, Champaign, Ill. (Founded 1935).

WANT To make big money at home? \$10.00 profit in an hour possible with invisible mending. Make tears, holes, disappear from clothing, fabrics. Steady year-round demand from cleaners, laundries, homes. Details free. Fabricon, 6234 Broadway, Chicago 40, Illinois.

\$70 **WEEKLY**—Home, spare time. Simplified mail bookkeeping. Immediate income—easy! Auditax, 34757A, Los Angeles 34.

I Want to send you proof of the wonderful pulling power of Popular Mechanics classified pages. What's your proposition? Write me today. Include literature if possible. F. W. Johnson, Manager Classified Advertising, Popular Mechanics Magazine, 200 E. Ontario St., Chicago 11, Ill.

COPUBLISH Mail Sale Advertiser, leading mail order paper. Details, latest copy, dime. Vanroy Shirk, Lebanon, Penna.

11,000 **NEW** Prospects daily. Baby record books, shoes, albums. Sell mailorder. Use our literature. Write: No-Co-Ro, Capitola, California.

BRONZE Baby shoes: Instructions, equipment and mountings for genuine electroplating process. Largest supplier of all plating equipment, supplies. Free catalog. Hollywood Bronze Supply, Dept. B-3, 1624 East First, Los Angeles 33, Calif.

MAKE \$46 From square foot plywood; jigsaw necessary. Free details. Woodart, Bridgewater, Mass.

FIX Typewriters. Free repair course. Home operated. Remit 25¢ for book explaining free course and agency appointment. Athey, Tarentum, Penna.

OPERATE Profitable mail order business. Write Walter Service, 4159A East 112th, Cleveland 5, Ohio.

EARN Good money sharpening chain saws, scissors, cutters, knives. Free manual. Treyco, North Tonawanda, N. Y.

RE-Cast junk batteries into new. Latest achievements. Battery Laboratories, Bayou LaBatre, Alabama.

BAKE New greaseless doughnuts in kitchen. Sell stores. Free recipes. Montgomery, 3605 South 15th, Minneapolis 7, Minnesota.

\$3.00 **HOUR**—Home, sparetime, assembling pump lamps. Easy. Free details. Ougor, Caldwell, Arkansas.

PLAQUES-Figurines-molds. Free details. Russo, 1196 Brooklyn, Bklyn 3, N. Y.

"**MAIL** Order World of Opportunities." Free subscription, details. GPO, Box 972-P, New York 1.

FOURTEEN Magic methods for extra home income. Free illustrated catalog. Dorco, Box 494, Muncie, Indiana.

\$400.00 **MONTHLY** Raising giant worms. Odorless soilless method. Charlie Morgan, Bushnell, Florida.

BE A notary. Information: Stationers, 515 East 33rd, Kansas City 9, Missouri.

QUICK Profits, with no capital! Take orders for magazines your neighbors like, want. Make cash on the spot! We show how with free kit. Get yours now. Write McGregor Magazine Agency, Dept. 312, Mount Morris, Ill.

"**MAILORDER** And the Law." Know about required licenses, federal and state regulations, taxes, etc. Only \$1.00. Included free: "Starting a Mailorder Business." Dorf, 186-M Covington Lane, Woodbury, New Jersey.

MAKE Flexible molds. Cast plaques, figurines. Free sample. Tooker, 1045-R Fairview, Hamilton, Ohio.

ENJOY A profitable business of your own selling the "World's Most Useable Bible." Profit from our 26 years experience. International Book Company, Dept. M., Box 118, Wichita 1, Kansas.

CAN The boss! Make strange building plastic from waste. Economical. Bays Laboratory, Chinle, Arizona.

CANDIED Popcorn and potato chip equipment. Eakins, Box 933-AO, Springfield, Ohio.

LEARN Appliance service and repair. Motors, washers, refrigeration, cleaners, everything. Free booklet. Appliance, 11027 South Vermont, Los Angeles 44.

RAISE Rabbits on \$500 month plan. Free details. White's Rabbitry, Mt. Vernon, Ohio.

PROFITABLE Home mail order business! Particulars free. Progressive, Box 422-B, Raymond, N. H.

MUSHROOMS Easier, quicker, cheaper. Magic preplanted trays. Newest facts free. "Mushroom Growing Handbook," illustrated, 96 pages, \$1.85, Spawm \$1.00, both \$2.00. Luxur, 641 South 19th St., Newark 3, N. J.

FABULOUS Profits in exterminating! Easy. Information. F. Breeden, 3209 Marvin, Overland 14, Mo.

OPERATE Your own home mail order business. It's profitable. Write: Webb Imports, Pico Rivera, Calif.

OPERATE Profitable mailorder dealership. Names, circulars everything supplied. Free details. Bernard, 112-Pf West 44th, New York 36.

500% **PROFIT** New easy home mail order setup. Write: Factory Agents Bureau, 135-D Liberty, New York 6, N. Y.

SELL Books by mail without stock. Big profits. Taliaferro, 832-A Monroe, Fort Worth 2, Texas.

BOSS Your own home business. Profits 1200% to 3000%! Make, distribute stunning Shellcraft jewelry. Sells itself wherever displayed. Big repeat demand. Details free; Shellcraft, Dept. A, Box 804, Panama City, Florida.

WANTED: Home producers, to be sub-contractors. Cast plastic products for manufacturers in our clearing house service. Thousands of easily made items required. Cash in at home, without previous experience. Plastic Service Associates, Dept. 2-PM East Boston 28, Massachusetts.

\$200.00 **MONTHLY**, Spare time. With table saw, bandsaw or jigsaw. Write. Holiday House, 7228 4th Plain, Vancouver, Washington.

MANUFACTURE, Import toys, vinyl dolls, plush animals, dollhouses. Directory. Benko, Box 188, New York City 21.

PACKAGE Bulk merchandise at home. High profits! Valuable franchises now available for contract packaging, gift wrapping and rack merchandising. No selling required! Free details, HPC, 807 Sunset, Los Angeles 12.

JAPAN Directory. 145 Japanese manufacturing exporters, Japan and Hong Kong trade journal information. Asia opportunities. \$1.00 today. Nippon Annai, Box 6266, Spokane 28, Washington.

BUY Direct from factories. Appliances, cameras, watches! Free details! Cam Co., 6810PM-20th Ave., Brooklyn 4, N. Y.

EASY Handwork makes fast-selling useful articles. Sample free. Sunmade Company, Brockton 64, Massachusetts.

A Natural for sporting goods, boat, hardware, auto dealers, service stations, ambitious individuals. Become dealer for nation's number one camping trailer. Sets up into complete camp in just one minute! Dealer details by return airmail. Heilite Trailers, 1503 South Sacramento, Lodi, California.

SELL Popular-priced planters, plastic foliage; arrangements to householders, stores, nightclubs, institutions. In demand everywhere. Franchise available. Cleve-Imports, 4500M52B Lorain, Cleveland 2, Ohio.

I Can make you rich with some honest effort and a little cash. This is no get rich quick fancy. It's a proven fact. Information free. Write: No U-Mix Buffet Balas, Box 6923, Houston 5, Texas.

INCREASE Your income. Free information. Excello, Box 500, Shreveport, La.

SHEET Metal bending machines. 36", \$37.00; 61", \$80.00. Also made to order. Vyke Mfg. Co., P4158 Jason, Denver 11, Colo.

OPERATE Profitable low cost mailorder business! Liberty, 210-PMF6 Fifth Avenue, New York 10, N. Y.

CALIFORNIA Restaurants, bars, resorts, drive-ins. Free brochures. Donoho Realty Company, 493 East Eighth Street, Chico, California.

MONEYMAKING OPPORTUNITIES

MAKE \$5,000 Yearly sparetime raising mink, chinchillas, nutria, etc. Free booklet reveals proved plans. Write: Furs, 588 Mt. Pleasant Road, Toronto 1, Canada.

START A profitable subscription business in spare time! We need men and women (young or old) as representatives for all leading national magazines. Liberal commissions on all subscriptions. Supplies free. No experience needed. Send this ad with your name and address to: Popular Mechanics, Room 2-O, 250 W. 55th St., New York 10, N. Y.

BUSINESS Kit free! Postcard puts you in business! Complete line 230 shoe styles, jackets! New discoveries pay big commissions. No investment. Send for free kit. Mason, Chippewa Falls KM-303, Wis.

MAKE Big easy profits making costume jewelry at home in spare time! Quick, easy to make, easier to sell! Details free! Don-Bar, 3511 W. Armitage, Dept. B-192, Chicago 47, Illinois.

INVISIBLE Reweaving: \$5 in one hour possible reweaving burns, tears, moth-holes. Spare-full time. Free details. Skill-Weave, Dept. WC-162, 335 W. Madison, Chicago 6.

BIG Mail service 10¢ per month. Hartford, 2704 W. 32, Denver 11, Colo.

YOUR Name on our giant mailing list, brings you moneymaking and other mail offers galore! Send 25¢ today! Direct Mail Service, Dept. PM, Box 581, Bakersfield, California.

HUSBANDS & Housewives wanted! Big money. Spare or full time cake decorating and candy making. Turn your kitchen into a gold mine. No age, education limits. Complete instruction, learn and earn at home. Write for free facts: Candy And Cake, Dept. 629, Fallbrook, California.

\$200.00 WEEKLY buying gold. D'Amico, 1506 W. Erie St., Chicago 22.

BOOMING Southland opportunities. Jobs, businesses, real estate, investments, retirement. Free literature. Shorelands, 20 W. Jackson, Suite 1412, Chicago.

OPERATE Home mail-order business. Vosacek Printing, 4444A Ute, San Diego 17, Calif.

GET Money for newspaper clippings. Free details. Write: Whitted-20A, 2815 Nicholson, Dallas 24, Texas.

GREATEST Do-it-yourself book ever printed. 10,000 money-making formulas. Free literature. Ranslow, 51A W. 32 St., Hialeah, Fla.

MINNOWS Make money in your backyard or farm pond—if you start right. Send for illustrated booklet "Minnow Raising Hits and Misses" \$1.00 postpaid. Daniel Minnow Ranch, Box 9247-B, Fort Worth, Texas.

BIG Money. No selling. Free details. Delcoa, 5812 Warrington, Philadelphia 43.

PROFITABLE Homework! Guaranteed earnings. No selling. Everything supplied. Elvee, 556 Beacon, Manchester, N. H.

MINK Raising information free. Complete. Lake Superior Mink Farm, Superior, EE1, Wisconsin.

VENDING Machines. No selling. Operate a route of coin machines and earn amazing profits. 32-page catalogue free. Parkway Machine Corporation, Dept. #26, 715 Ensor Street, Baltimore 2, Maryland.

GROW Mushrooms. Cellar, shed and outdoors. Spare, full time, year round. We pay \$4.50 lb. dried. We have 29,000 customers. Free book. Mushrooms Dept.: 173, 2954 Admiral Way, Seattle, Wash.

CIGARETTES: Make 20 plain or filter-tips for 9¢. Facts free. Moberly, Box 821, Owensboro, Kentucky.

EARN Money evenings copying and duplicating comic cartoons for advertisers. Adservice, Argyle 1, Wisconsin.

YOUR Own, easy-to-start, home mail-order business, sparetime. Fascinating; profitable! Information free. Alfano, 19-PM Pine, Closter, N. J.

BIG Money raising fishworms and crickets. Free literature. Carter Hatchery, Plains, Georgia.

READ "Progressive Mailtrade," the magazine that tells how to make money by mail. Quarter brings sample and special offer. Progressive Mailtrade, Box 357, Sheboygan, Wisconsin.

WIN Contest money. General Contest Bulletin gives hundreds of tips. Lists current contests, rules. Sample magazine 25¢. General Contests, 1609½ East 5th, Duluth 12, Minnesota.

AMAZING Successes through franchises! Become exclusive franchise holder your territory. Information rushed. National Franchise Reports, MP-528, 333 North Michigan, Chicago 1.

START Big-pay business at home in spare time. No experience needed to operate little table-top machine for bronzing baby shoes. Make \$5.46 profit on every pair. Full particulars free. Send postcard to Mason, 1512 Jarvis, Room CM-2-A, Chicago 26, Ill.

MEN — Women! Start money-making plastic laminating business at home in spare time. Material that costs 11¢ brings back \$2.50. No canvassing or selling but mail orders bring in \$20 a day. Write for full particulars free. Rush name on postcard to Warner, Room CL-2-A, 1512 Jarvis, Chicago 26, Ill.

EASY To start rubber stamp business at home in spare time. Make up to \$9.80 an hour without experience. Facts free. Write to Roberts, 1512 Jarvis, Room CR-2-A, Chicago 26.

SELL Diamonite gems; more brilliant than diamonds. Credit arranged. Catalog 10¢. Diamonite, 2420-M 77th, Oakland 5, California.

MAKE Money writing short paragraphs! No tedious study. I tell you what to write, where and how to sell; and supply list of editors buying from beginners. Many small checks add up quickly. Write to sell, right away. Send for free facts. Benson Barrett, Dept. C-27-N, 7464 Clark, Chicago 26.

IN 1952 I was unemployed, broke. Today own \$18,000 home, drive Cadillac, have bank account. Anyone can do this. Write Norris Cole, 217 West 49th, Bradenton, Florida.

BIG Mail kit contains "Cream of Crop" plans, ideas, special offers, for starting successful home moneymaking business! Details rushed free! Direct Mail Service, Box 581-PM, Bakersfield, California.

OPERATE Profitable home import business! Details free. Direct Mail Service Company, Box 581, Bakersfield 10, Calif.

\$340.00 MONTHLY With jigsaw. Details. Ekman, 346F North Summit, Sioux Falls, So. Dak.

LEARN Appliance service and repair. Motors, washers, refrigeration, cleaners, everything. Free booklet. Appliance, 11027 South Vermont, Los Angeles 44.

SHELLCRAFT Brings high profits! Instructions \$1. Write for details. You'll be surprised! Tropical Shellcraft, Montverde, Florida.

"HOW To Make More Money"—Jobs, businesses, investments. Free literature. Shorelands, 20 W. Jackson, Suite 1412-K, Chicago 4.

\$50,000 YEARLY Possible. Distribute sales literature your territory. Write Afja, Box 33-D, Southfield, Michigan.

MAKE This product at home. Good demand, high profit, can be sold by mail. Tested plan \$1.00. Travis, 140 E. Nevada, Detroit 3, Michigan.

START Your own profitable mailorder business with step-by-step instruction folio, continued personal assistance, and twelve fact-filled monthly bulletins. \$5.00 complete, \$2.00 folio only. Free details. Clark, Box 2513 Nat Sta., Springfield, Missouri.

72 MONEY Making opportunities. Folio \$2.00. Details free. Cappazoli, 237 Fourth, Jersey City, New Jersey.

BUILD Dutch windmill and wishing well dog houses. Two plans \$1.00. Craft Shop, Peotone, Illinois.

\$20 DAILY Spare time plating baby shoes, novelties, jewelry. Start with \$3.00 refundable investment. Free details. JO-CA Electroplater, 7840-D Northwest Sixth Court, Miami 50, Florida.

A Natural for sporting goods, boat, hardware, auto dealers, service stations, ambitious individuals. Become dealer for nation's number one camping trailer. Sets up into complete camp in just one minute! Dealer details by return airmail. Hellite Trailers, 1504 South Sacramento, Lodi, California.

EXPORT — IMPORT

DIRECTORY Listing over 300 selected firms in 50 foreign countries exporting gifts, novelties, amazing money making offers, \$1.00. Imports Unlimited, 5916 California Street, San Francisco 21.

PROFITABLE Imports, Japan contacts, \$1.00. Barnards, 1081 Gilwood, La Puente, California.

FORMULAS, PLANS, ETC.

RESILVER Mirrors—make one-way mirrors. Both \$1.00. Kem-Mir, Park Ridge, Illinois.

OPPORTUNITIES. Unlimited! World's finest formulas. Product development. Analysis. Monthly product report. Exciting details, free. Alpha-Midwest, LaPorte, Indiana.

LATE. Modern manufacturing formulas. List free. Moon Chemical, Martville, New York.

FORMULAS For latest money-making discoveries. New! Good! Valuable literature free! Miller, Chemist, 1517-D, Tampa, Florida.

FORMULAS; All kinds, latest, best. Literature free. Kemixal, Park Ridge, Ill.

PLASTICS

NEW Liquid casting plastic, clear, colors. Embed real flowers, butterflies, photos, coins. Send 25¢ for two handbooks "How to Cast Liquid Plastics" and "How to Make Extra Money at Home." Castolite, Dept. B-101, Woodstock, Illinois.

LAMINATING Supplies. Price list free. Solomson, 4 Beacham, Everett 49, Mass.

SIMPLIFIED Plastic molding, repairing, trial unit \$2.00. Hallmark Dental Co., Box 1924, Detroit 31, Mich.

LEARN Plastics fabrication for spare time income. Low cost home training now available. Write for free booklet. Interstate Training Service, Dept. D-3, Portland 12, Oregon.

BOXES, Plastic. Free list. Althor, 170 Bay 23 Street, Brooklyn, N. Y.

PLASTIC And supplies for laminating. Colamco, 12 Center, New Haven, Conn.

DO-It-yourself casting, molding, modeling plastics. Clear colors, accessories. No experience or machinery necessary. 64 page catalog 25¢. Castacraft Corp., Dept. A-23, P.O. Box 555, Palo Alto, California.

PLASTICS—Plexiglas, polyester, fiberglass, acetate, vinylite, supplies. Manufacturers' distributor, sheets, rods, tubes, liquids, coatings, films, boat plastics. Large, small quantities. Complete instructive catalog. 25¢. Gem-O-Lite, 5529-A Cahuenga Blvd., North Hollywood, Calif.

ELECTRIC Laminating kit. Pleasure. Profitable. Details. Burr, 330 East Center, Kalamazoo, Mich.

CELLULOID Scrap. Sheets, state thickness, colors. Celluloid, Box 333, Kearney, New Jersey.

REPAIR False teeth yourself. Special, new professional plastic. \$2.00 postpaid. Guaranteed. Grant Dental Laboratory, 219 W. 7th St., Los Angeles, Calif.

PLEXIGLAS— $\frac{1}{8}$ " \$1.25; $\frac{1}{4}$ " \$1.73 sq. ft. Sheets, rods, tubings, fabricating. Catalog 15¢. Plastic Shop, 2025 Nevada, Butte, Montana.

EVERYTHING In plastics. Catalog 25¢. Gel, Box 261, Union, N. J.

CHEMISTRY

RADIOACTIVE Isotope experiments—New. 16 for 60¢. Atomic Researchlab, 10717 Venice, Los Angeles 34, Calif.

AMAZING New book of science experiments, formulas, and catalogue of laboratory supplies. Only 35¢. National Scientific Co., 13 S. Park Avenue, Dept. PM-2, Lombard, Illinois.

SMALL Quantity chemicals. Apparatus, glassware, biology supplies. Illustrated catalog 25¢. Bio Chemical Products, Sumerset, Belmont, Massachusetts.

ROCKET Supplies for amateur rocketry. Catalog 25¢. Mervin Hill Company, Bolts Pennsylvania.

MICROSCOPE Slides, anatomical. Free list. Bay, 409 Roosevelt, San Francisco 14, California.

CHEMICALS And apparatus for industrial, analytical, and private laboratories. Catalog 25¢. Dept. M-50, Biological Supply Co., 1176 Mt. Hope Ave., Rochester 20, N. Y.

ILLUSTRATED Catalog: Chemistry, mineralogy, biology 25¢. Tracey Laboratories, Evanston, Illinois.

CHEMISTRY, Microscopic. Insect, butterflies, rocks, minerals. Sets complete. Literature. Amateur Chemist and Microbiologist, 208 East Eleventh, Kansas City, Mo.

NEW 52 Page science catalog. Prices reduced 30%. Catalog 25¢. Winn Chemicals, 124M West 23 St., New York 11.

"EXPERIMENTS In Pyrotechny." Book of fireworks-type experiments, plus electrical detonator plans. \$1.00. Debro Co., Dept. PM, Box 216, Northfield, Minn.

EXPERIMENTERS: — "Terrific Bargains" scientific catalog, 25¢. Hagenow Laboratories, Manitowoc, Wisconsin.

AGENTS WANTED

MAKE \$1,000 Extra this year! Over 800 best-selling items! Gifts for men, women, children, the home! Distinctive greeting cards, stationery, jewelry, cosmetics, mechanical gadgets, novelties, household helps, toys, games. No minimum order. Samples on approval. Make up to 92% profit! Write for free catalog. Greetings Unlimited, 6-146 Park Square, St. Paul 1, Minn.

BIG Profits. Sell proven family medication. Low wholesale prices. Free sample. Porter's, Box P-907, Piqua, Ohio.

TERRIFIC Money-maker. Lumar floor finish ends waxing forever. Details. Lumar, 25 Clifton, West Hartford 7, Conn.

AGENTS—300% Profit selling genuine gold window letters; stores and offices. Free samples. Metallic Sign Letter Co., 1217-D West Newport, Chicago.

FREE Sales kit, fire extinguisher-burglar alarms. Nieman Safety Products, 250 South 3rd St., Brooklyn 11, N. Y.

EARN \$3.00 Per hour writing orders. Steele, 2322 St. Albans, Philadelphia 46, Penna.

CLEANS Windows without mess. Strange dry cleaning-cloth. Replaces liquids. Windows gleam. Samples sent on trial. Kristee 70, Akron, Ohio.

MEN! Women! 60% profit on cosmetics. Famous nationally advertised Hollywood cosmetics pay 60%. Make \$25 day up. Hire others. For free samples, details, write Studio Girl, Glendale, California, Dept. 1202J.

BIG Earnings selling amazing floor treatments, business firms, factories, institutions. Exclusive territory. Free sales kit offer. Sheridan Chemicals, 1417 Sheridan Street, Camden 4, N. J.

BE The Popular Mechanics representative in your neighborhood and earn big profits in your spare time. Write Popular Mechanics, Room 2-A, 250 West 55th St., New York 19, N. Y.

BUSINESS Kit free! Postcard puts you in business! Complete line 230 shoe styles. Jackets! New discoveries pay big commissions. No investment. Send for free kit. Mason, Chippewa Falls KA-303, Wisconsin.

NEW Baby bib. Delights parents! Faster! Safer! Slips on! No strings to tie! Sample \$1.00. Excellent profits. Details free. Buddy Bib Co., Box 477-E, Sidney, Ohio.

START Your own International Shopping Service. Offer unique foreign imports at amazing discounts. Capital unnecessary. Free details. Bennett, 956-C, 52nd, Brooklyn 19, N. Y.

GOLD Or silver letters, numbers. Windows, doors, trucks. 1" to 6". 500% profit. Free samples. Atlas, Box 543-T, Oak Lawn, Ill.

EVERY Man a prospect. Request refundable sales kit offer showing line of belt buckles, tie clasps, money clips, cuff links, lapels, individualized with customer's name and emblems, also cap badges for trucking, bus, taxi, police, firemen. Choice 3,000 emblems. Hook-Past, Box 1425PM, Providence, R. I.

RUN A spare-time greeting card and gift shop at home. Show friends samples of our wonderful new 1960 all-occasion greeting cards and gifts. Take their orders and earn up to 100% profit. No experience necessary. Costs nothing to try. Write today for samples on approval. Regal Greetings, Dept. 58, Ferndale, Mich.

BIG Profits. Stamp security plates, key protectors. Sample 50¢. Catalog free. General Products, 188-PM State, Albany 10, N. Y.

MEXICAN Art goods! Free sample! Send 14¢ stamps mailing. Sylviak, Apartado 9036, Mexico City.

PRINTING, Advertising salesmen—Excellent moneymaking sideline selling decalcomania name plates, small quantities. Automobile initials, sign letters. Free samples. Ralco, XL, Boston 19, Mass.

YOUR Ad in this space will get some good agents for you. Yes, I'll prove it. Write for Folder "A" right now. F. W. Johnson, Classified Advertising Manager, Popular Mechanics Magazine, 200 E. Ontario St., Chicago 11, Ill.

SELL Champion, AC, Autolite spark plugs. Reconditioned, electroplated, guaranteed 10,000 miles. 100% profit. Free sample. Lee Plugs, 1608-E Roberts, Houston 3, Texas.

YOUR Own business—Used suits \$1.50; overcoats 65¢; mackinaws 35¢; shoes 12½¢; ladies' coats 30¢; dresses 15¢. Enormous profits. Catalog free. National Mail Order, 2111-AA Roosevelt Road, Chicago 8, Ill.

"AGENTS Wanted: We will set you up in business. Well-known company with over thirty years experience will supply valuable made-up sample line to responsible men. Sell from our huge stocks of blankets, hosiery, sweaters, underwear, trousers, shirts, jackets, slacks, etc. Liberal commission. Steady repeat business. Quality guaranteed. Territory open in north central and north west states only. Write: Star Woolen Company, Fergus Falls, Minn.

\$1,000.00 A Month for making dramatic 3-second demonstration of amazing lightweight Presto Fire Extinguisher. New chemical used by airforce snuffs out fires instantly. Only \$4.95. Terrific commissions. Millions want it. Free kit. Merlite, 114 E. 32nd, Dept. P-66K, New York 16.

SEEKING New products? Get my outfit 47 moneymaking specialties. Latest conveniences for home, car. Send no money. Just your name. Kristee 71, Akron, Ohio.

SPARE Time booksellers earn money—without investment! Countrywide, 129-M Bella Vista, Tuckahoe, New York.

DON'T Miss our ad under "Salesmen Wanted" in this magazine. National Press.

SELL To doctors, clinics, hospitals. Exclusive new device for removing orthopedic casts quickly, painlessly. Liberal commission. Automatic repeat business. Protected territories open. Kastoff, Inc., 4924 Greenville, Dallas 6, Texas.

AGENTS Make big profits on new automotive soldering tool. Sell car owners, mechanics. Free details. C. Hobbs, 59 Tower Lane, Dayton 3, Ohio.

ENJOY Camping: Make big profits while you play, with Heilite Camping Trailer dealer franchise. Sets up into complete camp in just one minute; attracts crowds wherever shown! Write for dealer program. Heilite Trailers, 1502 South Sacramento, Lodi, California.

WANTED. Fire extinguisher salesman. Huge profits. Out-O-Matic, 1737L E. 31st Ave., Denver, Colo.

BUY IT WHOLESALE

JUST Out! New 388-page, illustrated catalog offering savings up to 50% on over 100,000 auto parts and accessories, many hard to get. All makes (1920 to 1960 models), trucks, foreign and sports cars. Also Hollywood accessories, custom styling, hi-speed equipment. Send 25¢ for postage, packing. Refundable on first order. Whitney, 1919-PA Archer, Chicago 16, Ill.

NEW Multicolor wholesale catalog, automobile catalog, and others. Housewares, appliances, refrigerators, freezers, washers, dryers, television, radios, furniture, clothing, luggage, binoculars, photographs, recorders, cameras, projectors, typewriters, sewing machines, power tools, toys, sporting goods, watches, jewelry. Name brands. Huge discounts. Postcard: Selbyco, Decatur, 153, Illinois.

HANDMADE Western boots. Free catalog. Ysleta Boots, Box 815M, Ysleta Station, El Paso, Texas.

SAVE During 1960. 1960 wholesale catalog \$1.00 postpaid. Ben-Art Specialties, 2231 Vicky Avenue, Columbus, Georgia.

WALLETS — Quality leather! Black, brown. \$1.25. LoBrillo, 3548 Central, Chicago 34, Illinois.

MACHINELESS Laminating kits, wholesale. 2 kits \$1.00, 10 for \$3.50. William Panek, 2280 Wyandotte, Detroit 12, Mich.

FOUR Different wholesale catalogs plus \$1.00 merchandise certificate. \$1.00. Hanks, Weott, California.

FREE Wholesale catalog! Appliances, housewares, 25¢. Refundable. French's, 1804 So. 23rd St., Louisville 10, Kentucky.

LOWEST Priced catalog on market today. Nationally advertised brands. Catalog \$1.00. Smith Sales Co., R-3 Meadow Dr., Clay, N. Y.

LESS Than wholesale. Humorous studio greeting cards, western, etc. Fifteen assorted \$1.00. McLean's, 2703 E. Third, Denver 6, Colorado.

CLOTHING, Appliances etc.! Free catalog offer! United Wholesalers, 1265-M Broadway, New York 1, N. Y.

WHOLESALE! World's largest supply. Buy from 257 American, European, Japanese wholesalers. Tailormade suits from Hongkong. Free details. International Buyers, 216-MM Jackson, Chicago 6, Ill.

WHOLESALE Catalogs; classified directory listing 115 firms, \$1.00. Ozco, Canaan, Connecticut.

BUY At discount prices. Huge savings tools, jewelry, toys, games. Catalog 10c. Macleif, 105-AB, Canal, New York City 2.

WHOLESALE: 850,000 Items. Supply source directory 25¢. Idealer, Park Ridge, Illinois.

ELECTRIC Guitars, amplifiers, wholesale. Free catalog. Carvin, PMW, Covina, Calif.

BUY Wholesale; 100,000 nationally advertised products. Appliances, cameras, sporting goods, housewares, watches, typewriters, tools, clothing, etc. Discounts to 60%. Buy-Rite, Box 258, Hawthorne 2, New Jersey.

USED And new watches \$2 up. Free list. Southern Watches, 5-PM So. Wabash, Chicago 3.

LARGEST Wholesale supply source in U.S.! Furniture, clothing, appliances, housewares, automobiles and accessories, tools, sporting goods, hobby supplies, farm equipment, imports, new products, bargain merchandise. Free details. Associated Wholesalers, Box 2068-DD, Sioux City 4, Iowa.

BUY Nationally advertised products at discounts to 60%. Appliances, watches, cameras, clothing, housewares, jewelry, toys, typewriters, tools, etc. Stephens Distributing Co., Box 1434, Atlanta 1, Ga.

SALESMEN—DISTRIBUTORS

MAKE Up to \$50.00 a day soliciting delinquent accounts. Terrific commissions. Write today. General Finance, 304V Pickwick Bldg., Kansas City 6, Mo.

MAKE Extra money—Big cash commissions plus premiums for you and your customers. Sell advertising book matches. Sensational new tenor, glamour girls, hillbillies; dozens others. All sizes. Quick daily sales; big repeat business. Free master kit makes selling easy. No experience necessary. Superior Match, Dept. M-260, 7530 Greenwood, Chicago 19.

MAKE Extra money selling advertising matchbooks. Free catalog and sales outfit. Matchcorp., Dept. PM-20, Chicago 32.

GET New shirt outfit free; make \$90.00 weekly on 5 average orders a day. Famous quality made-to-measure dress and sport shirts at \$3.95 up sell fast to all men. No experience needed. Full or part time. Write: Packard Shirt Co., Dept. 129, Terre Haute, Ind.

OWN Franchised import business without any capital. Make good profit and many friends by handling our custom-tailored suits for women and men. British and Italian fabrics, superb tailoring, American or French fashions at unbelievable low export prices. Dept. RB-2 Transpacific Enterprises, P.O. Box 3067, Hongkong.

WILL You wear new suits and topcoats without one penny cost and agree to show them to friends? You can make up to \$30.00 in a day even in spare time, without canvassing. Pioneer Tailoring Co., Congress & Throop Sts., Dept. C-1226, Chicago 7, Ill.

MAKE Money selling sensational dwarf trees—Bear giant-size apples, peaches, pears. Ornamental. Also Stark-Burbank standard trees, roses, shrubs, vines, etc. Outfit free. Stark, Dept. 30120, Louisiana, Missouri.

BUSINESS Kit free! Postcard puts you in business! Complete line 230 shoe styles, jackets! New discoveries pay big commissions. No investment. Send for free kit. Mason, Chippewa Falls KS-303, Wisconsin.

I'LL Send you free stocking sample newest advancement in hosiery since nylon. Patented, full-length. Stays up over-the-knee without supporters, without girdle! Nationally advertised price \$1.95. Make money introducing to friends at \$1.00 pair. American Mills, Dept. 351, Indianapolis, Ind.

POCKET Knives, pistols, novelties. Catalog available. Jones Import Co., 931 Gervais, Columbia, S. C.

MAKE Up to \$50.00 a day soliciting delinquent accounts. Terrific commissions. Write today. National Credit, 304Y Pickwick Bldg., Kansas City 6, Mo.

SALESMEN. Big money showing nationally advertised Down-Spout-O-Matic sensation wherever shown. Attaches to all down spouts, uncoils when it rains, recoils after it rains. Once in a lifetime item. Dry basements guaranteed. Commissions advanced. Special sample offer. Campbell Co., Rochelle 63, Illinois.

SERVICE Your area. Agents, dealers, farmers make \$125 up weekly distributing nationally advertised Campbell's Gro-Green Liquid and 100% soluble crystal fertilizer concentrates. No investment. Demonstration kit furnished. Campbell Co., (Est. 1928), Rochelle 5, Ill.

YOUR Free copy of world's biggest sales magazine tells you how and where to make more money on your own in selling. Write Specialty Salesman Magazine, Desk 5B, 307 North Michigan, Chicago 1.

IF You're interested in making money in selling, see the hundreds of exceptional opportunities in Salesmen's Opportunity Magazine. Send name for your copy, absolutely free. Tell us what you're selling now. Opportunity, 848 N. Dearborn, Dept. 17, Chicago 10, Illinois.

SELL The hottest line of fishing tackle in 1960. Over 40 items. Free details. Samples \$3.50 value, \$2.00. Pat's Fishing Tackle, Box 164-P, Sheboygan, Wisconsin.

JOBBERs, Distributors, salespeople. Buy direct from manufacturer. Finest Austrian Aurora Borealis crystal jewelry. Sample necklace and earrings \$3.00. Borucki Jewelry Manufacturers, Box 2016-Noble, Bridgeport, Conn.

ANYONE Can sell famous Hoover uni-forms for beauty shops, waitresses, nurses, doctors, others. Miracle fabrics—nylon, dacron, wash 'n wear cottons. Exclusive styles, top quality. Big income, real future. Equipment free. Hoover, Dept. B-100, New York 11, N. Y.

\$1,000.00 A Month for making dramatic 3-second demonstration of amazing light-weight Presto fire extinguisher. New chemical used by airforce snuffs out fires instantly. Only \$4.95. Terrific commissions. Millions want it. Free kit, Merlite, 114 E. 32nd, Dept. P-66K, New York 16.

DO You sell from your car or truck. Big profits in selling cleaning polishing cloths sets. Sample prepaid \$1.00. Refunded on first wholesale order. Meyer Company, Box 868, Galesburg, Ill.

\$5,000.00 SALES Talk now available on LP record. Elmer Wheeler, America's #1 salesman, reveals selling secrets that made him a millionaire. Free information. Master Productions, Box 7067, Long Beach, California.

EARN Big commission full or part time. Build profitable business of your own selling America's largest line low priced business printing. 360 page catalog, samples, hundreds of items used daily by business people. Imprinted ball pens low as \$8.95 for 100. Calendars low as \$5.95 for 100. Free sales kit. National Press, Dept. 8, North Chicago, Illinois.

NEW Exclusive opportunity. 30 natural foods in each tablet! 360 tablets \$4.50. Your cost \$2.70. Mason Formula Company, Los Angeles 36, California.

SALESMEN And distributors, full or part time, sell outdoor advertising pennants. Write: Radder Products, Box 31, Colvin Station, Syracuse 5, New York.

EMPLOYMENT INFORMATION

HOTEL Employment in Florida. Details free. Fairbrother, 710 Dora Street, Jacksonville 4, Florida.

DETROIT Classifieds, \$1.00. Airmail, \$2.00. J. Brown, Box 772, Mt. Clemens, Mich.

WANT A good overseas or stateside job with higher pay? Transportation paid. Men-women. Free information. Employment Headquarters, 79 Wall Street, Dept. B-5, New York 5.

EXECUTIVE Recruiting companies seek personnel. Send them your qualifications for free consideration. Exclusive, nationwide list, over 85 recruiting organizations, only \$3.00. Execaid, Box 2647, New York 17, N. Y.

U. S. A., Foreign jobs, up to \$1500.00 monthly. Construction, clerical, supervisory, etc. Skilled, unskilled. Free transportation. Unusual opportunities. Complete information plus worldwide project listings. Only \$2.00 (\$2.25 airmail). Satisfaction guaranteed. International Reports, Dept. H, P.O. Box 621, San Jose 6, California.

CALIFORNIA Employment and business opportunities, \$1.00. Barnard, 1081 Gilwood, La Puente, California.

LATEST Foreign jobs. Highest wages. Unlimited opportunities. Laborers, clerical, construction electronics, oilfields, Civil Service. \$2.00. (C.O.D.'s accepted). America's leading overseas employment researcher. Plus: newest South American, Alaskan, Venezuelan listings. Universal Research, Box 4912, Baltimore 20, Md.

CHICAGO Jobs, classifieds, over 1000 openings. Send \$1.25, McCarthy, P.O. Box 8536, Chicago 80, Ill.

RICHES Can be yours! Are you rich? If not, send immediately for that new nationally advertised book "How to Get a Good Job": hundreds of fact-packed pages. Only \$4.00, money back guarantee. Winter & Wiechels, Dept. 10-A, College House, Harvard Square, Cambridge 38, Mass.

EXCLUSIVE Job information. U.S.A.- world-wide. Up to \$1500 monthly. Free information. Elsinger, Box 12, Detroit 13, Mich.

CALIFORNIA Job opportunities. Jim Smith, Box 6356, Los Angeles 55, Calif.

BOOMING Latin America! Prosperous Brazil, Venezuela. Only hours from the States. New data regarding jobs, opportunities, conditions. American companies employing, etc. All skills required. Salaries to \$1,650.00 monthly; U.S. tax exempt. Bonuses, living allowances, travel expenses, exciting vacations, and more! First-hand information direct: \$2.00 (\$2.35 airmail) checks or money orders. Latin American Opportunities, Sabana Grande, Apartado 10212, Caracas, Venezuela.

JOBS On ships. \$100 weekly. beginners. Travel, adventure. Write: Seaman's Service, Box 17-M, Brooklyn 8, N. Y.

FOREIGN Jobs—Latin America, Alaska, Canada, up to \$1500 monthly. Up-to-date 1960 foreign service directory gives complete information; hot list of firms hiring for military and civilian construction, aircraft, oil, exporters-importers, mining. How-when-where to apply. 12th successful year. \$1.00. Global Reports, Box 8873-S, Los Angeles 8, Calif.

JOBS On ships and yachts traveling foreign countries. Davenport's, 1354-K, G.P.O. New York 1, N. Y.

COPYRIGHTED Reports. Best paying companies, travel, adventure, promotions. Construction, aviation, shipping, oil fields, laborers, clerical, trades, supervisory, factory, unusual opportunities. Skilled, unskilled. Foreign, stateside. Only \$2.00 (\$2.25 airmail) (C.O.D.'s accepted). Satisfaction guaranteed. Included free: Special reports on Alaska, Venezuela, South America. Research Services, Meramec Building, St. Louis 5-PM, Missouri.

FREE Information—U.S.A., overseas jobs. High pay, transportation. Futures, Dept. M, 215 West 34th Street, New York City 1.

SPECIAL SERVICES

FLORIDA'S 37 Colleges have space! Directory \$1.00. Florida Education Service, P.O. Box 5825, Tampa 5, Florida.

BENSON'S, 152 West 42, New York 36, \$3.00 month no remailing charge.

BIRTH Certificates. Any state. Results guaranteed. Millers Service, Inverness, Florida.

INFORMATION On anything. Ferguson Research Specialists, 116-14 141 St., South Ozone Park 36, N. Y.

EDUCATIONAL AND INSTRUCTION

COMPLETE Your high school at home in spare time with 63-year-old school. Texts furnished. No classes. Diploma. Information booklet free. American School, Dept. X245, Drexel at 58th, Chicago 37, Illinois.

FINISH High School at home, spare- time. No classes. Diploma awarded. Write for free catalog. Wayne School, Catalog HF-102, 2527 Sheffield, Chicago 14.

MASTER Watchmaking at home. Free sample lesson. Chicago School, 2328-YB Milwaukee, Chicago 47.

DIESEL! Learn to operate, maintain and overhaul all type engines—spare time. Write for free book. Utilities Diesel Training, Dept. DC-71, 2521 Sheffield, Chicago 14.

PROFITABLE Welding training available Hobart Trade School, Box M-202, Troy, Ohio, GI approved. Finest equipment in U.S.A. Reasonable prices. Request catalog.

STUDY Mathematics at home. Algebra, Trigonometry, Calculus. Write for free test. Mathematics Institute, Essex, 14F, Mass.

AUTOSUGGESTION. Home study courses with phonograph recordings. Free brochure. Write Clark R. Bellows, 200 West 57th St., New York 19A, N. Y.

BECOME Tax consultant. Graduates earn \$1,000-\$3,000 every tax season preparing returns evenings. State approved. Union Institute, Lakewood 2H, N. J.

OIL Coloring photographs—a fascinat- ing hobby or profitable sideline for those with artistic talent. Learn at home. Easy simplified method. Free booklet. National Photo Coloring School, 835 Diversey Parkway, Dept. 3432, Chicago 14.

"HOW To Train Horses"—A book every- one who likes horses or ponies should have. Free. No obligation. Simply address, Beery School of Horsemanship, Dept. 1102-C, Pleasant Hill, Ohio.

BLUEPRINT Reading. Homestudy. Write Belton, 1059K North Lawndale, Chicago 51.

INTERESTED In sales career? Write: The Spaulding Co., Box 122, Fond Du Lac, Wis.

LEARN Tile setting at home. Free details. American Institute of Tile Setting, Box #217, Oakland 4, California.

TECHNICIANS Learn speedy scientific method for manipulating screwdriver, 50¢. Veejay, Box 69, Old Saybrook, Conn.

LEARN Asleep or awake. Self-help books, tapes, recordings. Free catalog. Drawer PM-697, Ruidoso, New Mexico.

SECRET Investigations. Experience unnecessary. Investigators particulars free. George Wagner, M125 West 86th, New York City 24.

PROFESSIONAL Investigators. Home study. Badge, certificate, future. Box 41197-F, Los Angeles 41, California.

HIGH School diploma at home. Licensed teachers. Approved materials. Southern States Academy, Station E-16, Atlanta, Ga.

BE A real estate broker. Study at home. Write for free book today. GI approved. Weaver School of Real Estate, 2018P Grand, Kansas City, Missouri.

WANT A diesel job? Higher pay? Advan- cement? We can help you qualify! Complete diesel, tractor and heavy equipment and Cummins Diesel Engine Shop-method home-training courses available. Write today. Interstate Training Service, Dept. B-3, Portland 12, Ore.

DEVELOP Mind power, personality while asleep. Use your phonograph, recorder. Amazing psychological tapes, records now available. Details free. Sleep-Learning Association, Box 24-N, Olympia, Washington.

STUDY For doctor's degree of psychol- ogy, metaphysics and divinity. Correspondence courses only. College of Divine Metaphysics, Dept. P-M, 2811 North Illinois, Indianapolis 8, Indiana.

SING. Speak with power. Self-training records. Amazing! Canfield, 2018-A Fifth Avenue South, Minneapolis 4, Minnesota.

EARN While you learn. Auto and diesel mechanics master this top paying trade. Many graduates earn \$100 a week and up. Approved for Korean veterans. For free information write Dept. No. 256, Nashville Auto-Diesel College, Nashville 3, Tenn.

PHYSICAL Therapy and massage. Home training. Practice privately or work with doctors and hospitals. Free catalogue. National Institute, Desk 4, 159 E. Ontario, Chicago, Ill.

BOOKS. Free general catalog, 100 pages. Text, vocational, educational, instructional subjects. Millions of volumes, new and used. Bargain prices. Books bought. Est. 1902. Long's College Book Co., Dept. PM, Columbus 1, Ohio.

PIANO Tuning pays. Big money in spare time. Learn at home in 30 days. No musical knowledge necessary. Phonograph, records, tools and instructions furnished. Personal instructions available. Free catalog. Capital Piano Tuning School, 3160 S.W. 16th Court, Fort Lauderdale, Fla.

STUDY To be a doctor of psychology, metaphysics, divinity or philosophy. Correspondence courses only. The Neotarian Fellowship, Desk 9, Kansas City 6, Mo.

INVESTIGATOR Training—Robert B. Phillips Sr., Founder, former U.S. Government Special Agent. Write to 1917-K North Kenneth, Chicago 39, Ill.

PROFESSION, 2 Yrs. college correspondence course physical therapy, massage. Complete 6 mo. Practice privately. Diploma. Write. Northwestern Institute, Box 368, Rock Falls, Ill.

DISK Jockeys in demand. Radio stations eager for men and women trained to do and sell own programs. Big money in salary, fees and commissions, plus personal appearances. Successful N.Y. disk jockey has trained thousands, will show you how. Free information. No salesman will call. Darwin, Studio B, 1639 Broadway, N.Y. 19, N.Y.

USED Correspondence courses and books sold and rented. Money back guarantee. Catalog free. (Courses bought.) Lee Mountain, Pisgah, Alabama.

ENGINEERING And art degrees earned through home study. Electronics, electrical, mechanical, civil, physics, business administration, liberal arts. When writing, specify course desired. Pacific International College of Arts & Sciences, primarily a correspondence school. Resident classes also carried. 5719-B Santa Monica Boulevard, Hollywood 38, California.

INVESTIGATORS Course. Credentials, diploma. Free information. Southwestern Institute Criminology, Box 2117-A, Lawton, Oklahoma.

BOOKKEEPERS. Operate your own "Dollar-A-Week" system. Ellis, Box 200, Cedar Grove, North Carolina.

LEARN Appliance service and repair. Motors, washers, refrigeration, cleaners, everything. Free booklet. Appliance, 11027 South Vermont, Los Angeles 44.

MIDWEST Engineering School. Electro-Mechanical. Correspondence, 10923 Hillcrest, Hickman Mills, Missouri.

SWEDISH Massage. Home study. Diploma. Illinois Licensed School, 3809 Alta Vista, Chicago 13.

OPERATE Collection agency. "Gold Mine" opportunity. Lifetime business. Be respected. Franklin Credit, Raonoke, Va.

LEARN To work a slide rule! Increase your earning power. Offer includes easy-to-understand instructions and a slide rule with plastic case. Only \$3.95! Allen's, 1236 Sierra Bonita, Pasadena, Calif.

LEARN By ear with Dormiphone. While you slumber, the amazing new scientific invention works for you. Revolutionary Dormiphonic tools give you a shortcut to learning languages, correct speech; memorizing facts, figures; relaxation, habit training. Saves you time, effort. So simple to use, children benefit. Used by educators, psychologists. Write today for fascinating free book. No obligation. Modernophone, Inc., 320-020 Radio City, New York 20.

INEXPENSIVE Correspondence courses. Theology, Philosophy, Psychology. Earn degree. Institutes abroad. Representatives: Aureba, Central Valley, New York.

CHINESE, Simplified home study. Doctor degree. Chinese Language Institute, P.O. Box 270, Taipei, Formosa.

OPERATE Restaurant or diner. Free booklet reveals plan. Write School of Restaurant Business, Dept. RC-352, 335 W. Madison, Chicago 6, Illinois.

LEARN Civil and criminal investigation at home. Earn steady, good pay. Institute Applied Science, 1920 Sunnyside, Dept. 162, Chicago 40, Illinois.

POWER Thoughts: Inspiring ideas of great thinkers and doers. Sharpen thinking. Increase cultural background. Sparkle conversation. \$1. Satisfaction guaranteed. Ries, 533 W. 112, New York City.

CIVIL Service. Training for U. S. tests. Get full information about this field; home study preparation for high rating. Free booklet. Private organization. No obligation. Franklin Institute, Dept. V10, Rochester 4, N. Y.

SHOP Math. Trig formulas—sine bar theory. Short cuts \$2.00. K. M. Allison, 601 Lemon, Vista, Calif.

LEARN Another language at home, easily, quickly, naturally with Linguaphone, the World's Standard Conversational Method. You learn to speak French, Spanish, German, Russian, Modern Greek, any of 34 modern languages available on life-like conversational recordings. It's like living in another country. Complete language course available on free trial. Send for free book and details of free trial. No obligation. Linguaphone Institute, T-83-020 Radio City, New York City 20.

USED Educational filmstrips, slide sets, correspondence courses, books—bought, sold, traded, rented. Send 25¢ for information. Inter National Educational Services, P.O. Box 823, Nashville 3, Tennessee.

SHORTHAND In 15 days. Learn at home. Simplest, most legible and rapid system. Uses ABC's. \$1.98 ppd. Arco Distributors, Dept. S, Box 20, New York 25, N. Y.

LEARN Real estate business fast. Unlimited opportunities. Economical home-study course. Particulars free. Gordon-Howard Institute, 320 Glover Building, Kansas City 5, Missouri.

PLAYS, STORIES, MANUSCRIPTS

WANT Your book published? Learn how we publish, advertise, promote, distribute. Many successes. Free booklet PM. Vantage, 120 West 31, New York City. Midwest office: 220 S. Michigan Ave., Chicago, Ill.

ADVERTISING AGENCIES, LETTER WRITERS, FOR ADVERTISERS

MAILING Lists most any classification \$5.00 1000. Your circulars mailed with ours \$4.00 1000. Write for our literature. Dixie Mailers, King, N. C.

ADVERTISING. Result-getting ads prepared, placed newspapers, magazines, radio, anywhere! Lowest rates. Catalogue free. Baker Advertising Agency, 189 W. Madison, Chicago 2.

CREATIVE Advertising. Magnetic copy. Dramatic layouts. Moran Agency, Shoemakersville, Pennsylvania.

BEFORE Advertising—Get instructive Ad-Guide and newspaper-magazine rate-book, free. Chicago Advertising Agency, Chicago 4.

FREE! Red-hot book, "More Profit From Your Advertising." Lists—best mail order magazines, newspapers. Adservice, 516 Cornelia, Chicago 13.

NOW Ready: New, amazing Classified Advertising Record Book—prepared especially for classified advertisers. Here is a book that tells you instantly whether or not your advertising in any publication is paying you real results. You can tell immediately how many inquiries each publication produced—how much cash received from every ad. Spaces are provided for the name and address of the publication, date of issue, space used, rate, cost of ad, key number, etc. You have a complete record of each publication right before your eyes. Plenty of space to keep accurate record of 28 separate publications. You can have a copy by sending only 10¢ for cover postage and handling. Send for your copy now. W. F. Johnson, Classified Adv. Mgr., Popular Mechanics Magazine, 204 E. Ontario Street, Chicago 11, Illinois.

"AMAZING New Book"—"Profits From Classified Advertising." Tells how and what to advertise. Be sure to read this book before you invest one cent in advertising. Write for your copy now. Just send 10¢ for postage and handling. W. Johnson, Classified Advertising Manager, 202 East Ontario Street, Chicago 11, Illinois.

CARTOONING, COMMERCIAL ART, SHOWCARD & SIGN PAINTING, TATTOOING

CARTOON Your way to success! Internationally known instructor, Raye Burns, will personally teach you to create original, salable cartoons at home. Cost of course is very low. Write for free details. Raye Burns School, Box 3583-P, Cleveland 18, Ohio.

YOU Can entertain with chalk talks. Catalog 10¢. Balda The Cartoonist, Oshkosh, Wis.

LEARN Sign painting at home. Free talent test. Ben Kerns, Box 812-PM, Greenville, S.C.

LEARN Profitable, fascinating tattooing. Illustrated information \$1. Zeis, 728-C Leslie, Rockford, Illinois.

LEARN Sign painting with fascinating system. Straley, 410 S. Western, Springfield, Ohio.

PAINT Signs! Use patterns! Alphabet \$1.00. Harwall, PM-260, Byrdstown, Tenn.

"HOW To Make Money With Simple Cartoons." A book everyone who likes to draw should have. It is free; no obligation. Simply address Cartoonists' Exchange, Dept. 92-C, Pleasant Hill, Ohio.

GUARANTEED 152 Lesson course in sign painting. Details free. Stewart Sign Co., Box 287M, Pasadena, California.

RUBBER STAMPS AND OFFICE SUPPLIES

INDEXED, Cushioned, 3 lines \$1.00, 4 or 5 lines, \$1.50. Signature stamps, \$3.50. (Script, print, or old English.) Free stock stamp literature. Youngers Stamp Shop, Princeton 4, Iowa.

POCKET, 3 Lines \$1.00. Guaranteed. W. J. Specialty, 8464 Manhattan, Detroit 11, Michigan.

FREE! Rubber stamp catalog. Many items. Campfield, Box 798, Springfield 1, Mass.

THREE Line rubber stamp, 1,000 embossed cards, \$3.95. Reed Press, Mishawaka, Indiana.

4 LINES \$1.00. Agents wanted. Sailors, 537 Conn., Gary, Indiana.

FREE—Rubber stamp catalog. Martin, 1425 Major Drive, Jefferson City, Missouri.

TYPEWRITERS, DUPLICATORS, OFFICE DEVICES

RECONDITIONED Typewriters, duplicating, printing devices. \$25.00 up. Supplies. Appliances. DixieGraph, King, N. C.

IBM Electric typewriters \$49.95. Continental Distributing Company, Box 71, Temple City, California.

PRINTING, MULTIGRAPHING, MIMEOGRAPHING, GUMMED LABELS

250 8½x11 Hammermill letterheads \$2.95. 250 envelopes \$2.95. Samples! Davis, 7609 Spruce Road, Baltimore 22, Maryland.

OFFSET Printing, 1000 8½x11 \$4.95. Alpine, Box 676-E, Cupertino, California.

FREE Business printing catalog. Samples. Howprint, 723-C Eunice, Webster Groves 19, Missouri.

MIMEOGRAPHING—Letters, pricelists, formulas, instructions. Lowest prices. Lem's Letter Shop, 5710 Stanton, Detroit 8.

FREE Catalog postpaid printing, rubber stamps. DM Press, Sebastopol, Calif.

ADS Running under this heading sell printing. Ask me for proof. I'll gladly send you amazing facts. Ask for Folder "P." F. W. Johnson, 200 E. Ontario St., Chicago 11, Ill.

FREE Unusual catalog—business, personal printing, rubber stamps. Lowest prices. Barriskill, 1715 Julian, El Cerrito, California.

100 6 $\frac{3}{4}$ ENVELOPES, 100 5 $\frac{1}{2}$ x8 $\frac{1}{2}$ letterheads printed, \$2.35. M. Fortney, R3, Dillsburg 4, Penna.

QUALITY Business printing. Free samples. Rayborg, 810 West 18th, Erie, Penna.

1,000 BUSINESS Cards. Raised letters. \$3.95. Samples. Pioneer, PM-2 Island Park, N. Y.

1000 EMBOSSED Business cards, \$4.00—Name and address rubber stamp, \$1.00. Illustrated folder free! Price Brothers, 406-PM, South Main, Los Angeles 13, California.

EMBOSS Business cards \$3.49 1000. Diamond, 534 State, Hammond, Indiana.

PRINTING—Bumper strips (Velva-Glo), posters. News Press, Mounds, Illinois.

1,000 BUSINESS Cards, "Raised Letters" \$3.50 postpaid, samples. Ellis, 5909 Highlandview, Sylvania, Ohio.

POST-PAID, Low priced printing and mimeographing. Samples. Press, Weaubleau, Missouri.

100 EACH 8 $\frac{1}{2}$ x11 Letterheads, 6 $\frac{3}{4}$ envelopes, carefully printed \$2.35 postpaid. Race Printers, Hudson, New York.

PRINTING—All kinds. Best quality, stock, workmanship. Reasonable. Free samples. Hilltop, Box 2253, Oakland 21, California.

NEED Printing? Write for samples, prices. Mayfield, Box 8011, Chattanooga 11, Tenn.

1500 NAME & address labels in plastic box \$1.00. George, PM2, G. P. O. Box 1547, New York 1.

BUSINESS Cards (raised letters) 500—\$2.50, C.O.D. Samples free. Picha, 27600M Joy, Livonia, Michigan.

QUALITY Printing, lowest prices. Stone, 203 West Allegheny, Philadelphia 33, Penna.

1000 BUSINESS Cards, raised letters. \$3.95 postpaid. Samples. John H. Taylor, R.D.2, Box 215, West Middlesex, Penna.

PRINTING OUTFITS AND SUPPLIES

MAKE Your own self-molding rubber stamps and printing cuts. Plexirubber, Argyle 1, Wisconsin.

DO Your own printing. Save money. Simple rules. We supply everything. Print for others; good profit. Raised printing like engraving too. Have home shop. Details free. Kelsey Presses, V-11, Meriden, Connecticut.

PRINTING Presses, type, supplies. Lists 4¢. Turnbaugh Service, Mechanicsburg, Penna.

RUBBER Stamp presses, supplies. Kiewiet, 2025 Barney Road, Kalamazoo, Mich.

RUBBER Stamp presses, hydraulic operated, electrically heated. Sizes 5"x8", 8"x12", 10"x15". Starting outfits, supplies. Printing presses, supplies. Custom Manufacturing, 507-P N. Jefferson, Springfield, Missouri.

TYPE For rubber stamp making and printing made from hard foundry metal. Send for free 20% discount catalog. Barco Type Founders, 64 Wagner Dr., Northlake, Ill.

FOR INVENTORS

INVENTIONS Wanted immediately for promoting on cash or royalty. Patented, unpatented. Free booklet outlines royalty rates, requirements. Write Kessler Corporation, C-52-FI, Fremont, Ohio.

INVENTIONS. Don't sell your invention patented or unpatented until you receive our offer. Write Cowgill, Box 298-A, Marion, Ohio.

INVENTORS—Get the best offer first! Patented or unpatented. Write Carl Sommer, Director, Industrial Invention Sales, 3136-A Sylvania Ave., Toledo 13, Ohio.

INVENTORS—Save high fees! Apply for your patent yourself. New do-it-yourself patent kit now makes it easy. Free "Registration Form." Miss Claire Arden, 806 Wm. Penn Annex, Philadelphia 5, Penna.

INVENTORS! Determine patentability of your invention. Searches of the Patent Office Records administered professionally—\$6.00. For free invention protection forms, dependable service write Washington Patent Office Search Bureau, 1426 G Street, N. W., Washington 5, D. C.

PATENTS Skillfully prepared and filed for total service charge of \$200.00 for U. S. and Canada for simple invention, with valuable development and market service. Accurate receipt for any data sent me. Patent search and valuable report \$15.00. 30 years' experience as patent and development engineer. Foreign patents obtained. Joseph O'Brien, 132 Nassau St., New York, N. Y.

YOU Can easily apply for patents. Save with complete professional kit. Free registration certificate. Patent Associates, Suite 1214, Commonwealth Bldg., Philadelphia 7, Penna.

INVENTORS' Complete service. Cash-royalties sales. Inventions researched. Patent development engineering. Free invention certificate. George Spector, Licensed Invention Engineer, 3615 Woolworth Building, New York.

SEARCHES \$6.00. Including copies of related patents. Original "World-Wide" service to inventors, patent attorneys, manufacturers. Free "Record Form." Write Miss Jean Hayward, 310 Realty Building, Washington 5, D. C.

INVENTIONS Wanted now by my manufacturer clients. Patented. Unpatented. Write Gilbert Adams, Patent Broker, 80 Wall St., Financial District, New York City.

PATENT Searches, including copies of nearest patents, \$6.00. Reports airmailed within 48 hours. More than 200 registered patent attorneys have used my service. For free invention protection forms, write Miss Ann Hastings, P. O. Box 176, Washington 4, D. C.

PATENT Searchers \$6.00. 48-hour service. Free invention protection forms. Formerly with U. S. Patent Office. Write Raymond L. Smith, Patent Searcher, 620 Sheraton Building, Washington 5, D. C.

PATENT Searchers \$6.00. 48-hour airmail service. Invention protection forms free. Write patent Engineering Service, 711 14th Street, N. W., Washington 5, D. C.

WE Have the markets if you have the ideas. Harvey Engineers, Cambridge 1, Maryland.

INVENTORS: Test the commercial value of your patented or unpatented inventions, quickly and inexpensively. Write for free information. Institute of American Inventors, Dept. 40-B, 635-F St., N.W., Washington 4, D. C.

INVENTORS! Consider our offer first before selling or licensing your invention on a cash or royalty basis. Patented. Unpatented. Inventions on Demand, 79 Wall Street, New York 5, N. Y.

SEARCH Details free. Patent Searching Service, 437 Washington Building, Washington 5, D. C.

INVENTORS—New lowest easy to apply for patent kit. Free "Protection and Registration form." Patent Research, 2106 Hamilton, Pultneyville, N. Y.

INVENTIONS WANTED

INVENTORS—Do you want to sell or license your invention on cash or royalty basis? Write Kessler Corporation, C-52, Fremont, Ohio.

INVENTORS. Don't sell your invention patented or unpatented until you receive our offer. Write Cowgill, Box 298-B, Marion, Ohio.

INVENTORS—Get the best offer first! Patented or unpatented. Write Carl Sommer, Director, Industrial Invention Sales, 3136-A Sylvania Ave., Toledo 13, Ohio.

FREE List needed inventions. Protection form. Inventors Sales and Engineering Bureau, Dept. 162-D, Box 4973, Washington, D. C.

PATENT For sale? Items in production? We sell rights to manufacturers or arrange national marketing. No fees. Commission basis. Seaboard Corporation, Mewshaw Building, Glen Burnie, Maryland.

INVENTIONS Wanted: patented, patent pending. 29 years experience promoting inventions. National Service Bureau, 3120 Meramec, St. Louis 18, Mo.

INVENTORS' Complete service. Cash-royalties sales. Inventions researched. Patent development engineering. Free invention certificate. George Spector, Licensed Invention Engineer, 3615 Woolworth Building, New York.

INVENTIONS Wanted now by my manufacturer clients. Patented. Unpatented. Write Gilbert Adams, Patent Broker, 80 Wall St., Financial District, New York City.

INVENTORS! Outright cash sale or royalties for your inventions. Patented. Unpatented. Constant demand from our client manufacturers. Write United States Invention Brokerage, 15 Park Row, New York 36, N. Y.

INVENTIONS Wanted. Patented; unpatented. Tremendous manufacturers lists. Global Marketing Service, 2420 77th, Oakland 5, California.

INVENTORS: Hundreds of manufacturers have requested our assistance in locating marketable new products. Complete information free. Institute of American Inventors, Dept. 40-D, 635-F St. N.W., Washington 4, D. C.

INVENTORS! Consider our offer first before selling or licensing your invention on a cash or royalty basis. Patented. Unpatented. Inventions on Demand, 79 Wall Street, New York 5, N. Y.

ARE You interested in offers from reliable manufacturers for your invention? Patented, unpatented. Harvey Engineers, Cambridge, Maryland.

CASH, Royalty, obtainable for good ideas, inventions. Ketchum's Advertising, B-1058A, Springfield, Illinois.

IDEAS For new products make money. Free details. Inventors Creative Service, 354 South Spring, Los Angeles 13, Calif.

MANUFACTURING

ACTIVE Retired maintenance engineer. Have large basement workshop, etc. Looking for something small to manufacture. Will consider any proposition. G. C. Howell, 3606 Perry, Mt. Rainier, Md.

MODELS—Small lot manufacturing. Metals, plastics, etc. Milburn, Burlington, Kentucky.

MODELS, MODEL SUPPLIES

MODEL Cars, electrified roadways. Electromat Company, Box 13742, Dallas, Texas.

MODEL Case traction engine kit 9" long, 5" high, 3 $\frac{3}{4}$ " wide. Cast aluminum-painted. Instructions for easy assembly. \$4.85 ppd. Assembled \$5.35 ppd. No C.O.D. White's Model Shoppe, Felton 2, Penna.

SHIP Models and yacht supplies complete. Large 68 page catalogue 50¢. Bill Wild's, 510 East 11 St., New York City 9.

"POWER Drives Handbook"—36 pages illustrating many types motor drives for model autos, boats, displays, turntables, etc. Mail 25 cents cash, returnable first order \$3.00 or more. Wilson's of Cleveland, Dept. PM, P.O. Box 8995, Ft. Lauderdale, Fla.

LIONEL Trains. Big discounts. Catalog 25¢. Mack Bros., 2043-P Chicago Ave., Chicago 22.

SHIP Models. Most complete line in New England, kits, fittings, plans, books, tools, engines, motors. Illustrated catalog 35¢. James Bliss & Co., Inc., Dept. SM, 342 Atlantic Ave., Boston 10, Mass.

ROCKET Supplies—Nozzles, cones, tubes. Specials also made. Catalog 10¢. Sky Mfg., Mineral Point, Penna.

SHIP Model kits and fittings: Fishermen, clippers, frigates, schooners, brigs, tugboats. Also half-hull models for interior decoration. Send 25¢ for 1960 catalog and booklist. Model Shipways, Box 85, Bogota, N. J.

ROCKETS—Powerful fuels: plans, construction, ignition. 75¢. Rocketry, Box 1655, Marysville, California.

ROCKET Plans: Two-stage rocket, 6 mile altitude, instrumented payload, parachute recovery. Send \$2.00 to Missile Research and Development Centre, Box 1124, Orlando, Florida.

ROCKETEERS: Supplies, chemicals. Catalog, plans 25¢. Central Rocket Company, Waupaca, Wis.

SHIP And yacht model fittings; blueprints. Send 40¢ for illustrated catalog listing hundreds of items. A. J. Fisher, Inc., 1002-1 Etowah Ave., Royal Oak, Mich.

POWER Models. Unusual steam, gasoline and traction engines, fittings, metals. "O" rings, Teflon, Molykote. Comprehensive, 92 page catalog \$1.00. Chas. Cole, Ventura, Calif.

COMPLETE Plans flying platform. Easy to build. Amazing performance, \$1.00. C&S, Box 911, Shawnee, Okla.

HOME CRAFTSMEN

FREE. New plans catalog. Make 2400 things. Fun. Profit. Craftplans, 1322-A Wabash, Chicago 5.

KNOCKDOWN Cedar chests, also over fifty kits. Catalog 25¢. Giles Kendall Co., Huntsville 2, Alabama.

FREE Leathercraft catalog—quality kits, leather, tools. Handicrafters, Dept. P, Box 427, Montrose, Calif.

LEARN Art metalcraft and jewelry making. Complete, inexpensive, home training course now available. Special tools and materials furnished. Write for free booklet. Interstate Training Service, Dept. L-3, Portland 12, Oregon.

WOODWORKING And cabinetmaking course for beginning and advanced home craftsmen. Only complete low-cost home training program available. Write for free booklet. Interstate Training Service, Dept. G-3, Portland 13, Ore.

KNOCKDOWN Cedar chests and lumber. Free price list. Bedford Lumber Company, Shelbyville, Tennessee.

REMODEL Your own home. Save hundreds of dollars. New, amazing book shows you how. Written so you can understand it. Step by step instructions make it easy. Fully illustrated, 400 photographs, hundreds of diagrams, 160 pages. \$3.50. Literature 10¢. Popular Mechanics Press, 200-RH East Ontario St., Chicago 11, Ill.

PATTERNS. Full size. It's easy to make tables, chairs, beds, chests, shelves, workbench, toys, Santa Claus lawn designs, and many others. Illustrated circular free. Popular Mechanics Press, 200PL East Ontario St., Chicago 11, Ill.

LEATHERCRAFT. Send 10¢ for catalog. Saxcrafts, Inc., 1101 N. 3rd, Milwaukee, Wisconsin.

136 PAGE Supply catalog: enameling, ceramics, mosaics, jewelry. 50¢ (refundable). Bergen, 300B S.W. 17th Ave., Miami, Fla.

LEATHERCRAFT. Superior leather, tools, kits. Catalog 30¢. Midas, Box 1255, Huntington Park, California.

FREE Do-it-yourself leathercraft catalog. Tandy Leather Company, Box 791-K34, Fort Worth, Texas.

OREGON Myrtlewood. A rare, beautiful wood for the lathe. Ken Dorman, Oakland, Oregon.

NEW Big illustrated catalog. Supplies for leathercraft, metalcraft and numerous small inexpensive crafts. Prompt shipments. Top values. Latest ideas. Send 10¢ today to J. C. Larson Co., Dept. 9527, 820 S. Tripp, Chicago 24.

BUY Picture frame moldings at wholesale, actually less than cost of raw lumber. All styles and widths. Free delivery. Write for price list. Chesapeake Picture Frame Co., 511 N. Charles St., Baltimore 1, Maryland.

REPAIR False teeth yourself. Special, new professional plastic. \$2.00 postpaid. Guaranteed. Grant Dental Laboratory, 219 W. 7th St., Los Angeles, Cal.

BELT Sander. Low cost. Easily made from plans. Free literature. Gipple, 121-A School, Buffalo 13, N. Y.

FILL In dents, cracks, nail holes with Amco-100 Wax. Send \$1 for yours now. American Wax & Supply Co., 2425 W. Hutchinson, Chicago 18, Ill.

GRANDFATHER Clock movements, kits, case plans. Wholesale catalog 25¢. Mason-Sullivan, Noroton 7, Conn.

WRITE For free catalogue of craft supplies. New lower than discount prices. Apache Leather Co., 2804 East Washington St., Phoenix, Arizona.

PROFITS To 3,000% making Shellcraft jewelry. We show you how to cash it! Details, illustrated booklet, wholesale catalog 25¢. Shellcraft, Dept. AA, Box 804, Panama City, Florida.

101 PATTERNS Of smart gifts, novelties, shelves, action windmills plus "Make Money Jig Sawing." \$1.00. Mastercraft, 25M, 7041 Olcott, Chicago 31.

CACTUS Wood. Description, prices free. 214B East Yavapai, Tucson, Arizona.

KILN Dried walnut, cherry, etc. Hardwoods, blocks, lumber and squares. Midland Lumber Company, P.O. Box 262, Savannah, Missouri.

CRAFT Catalog free. Mosaics, leathercraft, enameling, plastic casting, metal tooling, floralcraft, shellcraft. Many more. Kit Kraft, 202, Studio City, Calif.

FREE! Leathercraft catalog. Hundreds of new items. Write MacPherson Bros. Leather Company, Dept. E, 730 Mission St., San Francisco 3, Calif.

DO IT YOURSELF

FREE Sample. Permapel. New Silicone waterproofer for use on block, brick, stucco, stone and all above-ground masonry surfaces. Less than 1¢ per square ft. applied. Eliminates dampness. Protects and preserves for 10 years or more. Perma-Stone Company, Desk 8, Columbus, Ohio.

FREE Do-it-yourself leathercraft catalog. Tandy Leather Company, Box 791-K34, Fort Worth, Texas.

ELECTRIC Laminating kit. Fun or profit. \$14.95. Therm Appliance, St. Charles, Ill.

FREE Check-list covering 340 classifications of projects, plans, instructions, service and repair information detailed in Popular Mechanics famous series of instructional booklets. These easy to follow booklets cover an extremely wide variety of do-it-yourself data on home remodeling, repair and improvement, hobbies, crafts, boating, games, lawn and garden, and hundreds of others. For your free copy of this helpful list of booklets, write: Service Bureau, Popular Mechanics, Room 517A, 200 East Ontario, Chicago 11, Ill.

ALUMINUM Combination window kits, \$11.95. Pre-cut. Top quality. Literature. Gould's Hardware, Woodstock, Ontario, Canada.

SWIMMING Pool. Complete blueprints, instructions to build your own inexpensively. \$2.00. Pools, 10235 Elmhurst, Genoa, Texas.

HOW To harden steel. \$1.00. PSI, 1342-A East 58th Street, Kansas City 10, Mo.

WATCHES, OLD GOLD, JEWELRY

WATCH And clock repairing books. Free catalog. North American, 2320-AP Milwaukee, Chicago 47, Illinois.

HIGHEST Cash paid for old gold, jewelry, gold teeth, diamonds, watches, silver. Mail articles today. Information free. Chicago Gold Refining Co., 6 E. Monroe, Dept. 1958, Chicago 3.

WANTED Old gold jewelry, spectacles, watches, teeth, silverware, platinum for cash. Electro Company, Ref. Dept., 1042 Highland Ave. Buffalo 23, N. Y.

COSTUME Jewelry supplies, settings, rhinestones, etc. 88 page illustrated catalog. 30¢. Milady, Box 1328, G.P.O., New York City.

FREE Catalog. Costume jewelry parts. Supplies. Reasonable prices. Fast service. Guaranteed quality. Unique merchandise. Folsom's, Box 52, Medford 55, Mass.

HIGHEST Cash for old gold, jewelry, gold teeth, watches, diamonds, silverware, spectacles, platinum, mercury. Free information. Rose Refiners, Heyworth Building, Chicago 2.

RAZORS, BLADES, SHARPENING

100 RAZOR Blades \$1.00, single, double edged. John Davis, Box 486, Clearwater, Florida.

TOBACCO, SMOKERS' SUPPLIES

TOBACCO! Grow your own natural, pure tobacco for your cigarettes, pipe, and chewing. Year's supply easily, quickly grown in small space yard or garden. It's amazingly easy to prepare for smoking, chewing. Generous package of certified seeds with simple instructions only \$2 postpaid. Guaranteed to please or your money back. Seavy's, Box 4223, Pasadena, California.

OF INTEREST TO WOMEN

STAMPED Linens for embroidery or painting. Buy direct from manufacturer and save. Send for free catalog. Merribee, 16 West 19th St., Dept. 706, New York 11, N. Y.

DRESSES 24¢; Shoes, 39¢; men's suits, \$4.95; trousers, \$1.20. Better used clothing. Free catalog. Transworld, 164-G Christopher, Brooklyn 12, N. Y.

HOUSEWIVES. Teachers, students, office workers, if you need extra cash each week but household or other duties prevent you from taking a part-time job, learn how you can earn by accepting orders to Popular Mechanics, Good Housekeeping and all other magazines. No experience needed. Write Popular Mechanics, Room 2W, 250 West 55th St., New York 19, N. Y.

MAKE Money weaving rugs at home for neighbors on \$79.50 Union loom. Thousands doing it. Booklet free. Union Loom Works, Dept. 3, Boonville, N. Y.

SELL Fine fabrics. Get yours wholesale. Box 863, Norwalk, Conn.

"8 MISTAKES Parents Make." Every parent should have this new book about child training. It is free; no obligation. Simply address Parents Association, Dept. 672, Pleasant Hill, Ohio.

MAKE, Sell, inexpensive Easter corsets, flowers; woodfibre, plastic, etc. Big supplies catalog 10¢. Cleveimports, 4500 M52W Lorain, Cleveland 2, Ohio.

PERSONAL

LODGE Emblem neckties \$1.60. Uniform neckties \$1.00. All colors. Barnett, Box 723, San Bernardino, California.

BORROW By mail. \$100-\$600. Anywhere. Air mail service. Postal Finance, 200 Keeline Building, Dept. 17-B, Omaha 2, Nebraska.

BORROW \$100 To \$600 by mail. Quick, easy, private. No co-signers. Repay in 24 small monthly payments. For the amount you want write today to Dial Finance Co., 410 Kilpatrick Bldg., Dept. B-1, Omaha 2, Nebraska.

BIBLE Questions answered. Stamped envelope. Bylon, 17167 Bentler, Detroit 19, Michigan

LOANS By mail. \$50 to \$600 for any purpose. Employed men and women eligible. Confidential, 2 years to repay. Write for free loan application. American Loan Plan, City National Bldg., Dept. PM-2010, Omaha 2, Nebraska.

FIREMENS Greeting cards, party, convention supplies. Free brochure. Hobby Mats, Balsam Lake, Wisconsin.

REMAILING SERVICE

CONFIDENTIAL New York City, mailing, receiving, forwarding, address. \$3.00 month. Birnhan, 109 W. 42, New York 36, N. Y.

REMAILS — Salem, Dallas, Independence, Portland, \$50. A. Hanks, 244 Water, Sheridan, Oregon.

BOSTON Remails 25¢. William Reaves, 44 Chandler St., Boston 16, Mass.

RENT Confidential postal mailing, receiving-forwarding address. Details free. Agent since 1950. William McLaughlin, 800 Stewart, Columbus 6, Ohio.

REMAILING Letters from this snazy spot 25¢. Anderson, Box 13412, Phoenix, Arizona.

SALT Lake City, 16. Box FG44. Remails 25¢. Complete confidential mail service \$3.00 monthly.

SECRET Mail receiving-forwarding system. Hedgpeh, Box 830, Alhambra 23, California.

REMAILS. Replies forwarded, 25¢; monthly \$3.00. Sunday classifieds \$1.00; souvenirs, etc. Strictly confidential. Box 694, Saint Louis 88, Missouri.

URUGUAY Reairmails or classifieds \$1.00. Bazzano, P.O. Box 1242, Montevideo.

REMAILS Postmarked anywhere in U.S. 25¢. Hartford, Box 127, Denver 11, Colo.

LETTERS Remailed 25¢. Monthly rates. Sunset, Box 45, Hutchinson, Minnesota.

REMAILS 25¢. Monthly \$3.00. Campbell, 130 E. Dorothy Lane, Dayton 19, Ohio.

FOUR Postcard views of historical Charleston's famous gardens \$1.00 remailed free. Wessinger, 1815 Carlton St., Charleston 51, South Carolina.

REMAILS 25¢. Monthly \$3.00. Prompt receiving-forwarding. Lillian's, Box VC-3011A, No. Hollywood, Calif.

REMAIL Receiving-forwarding. Details. Fred's, 3910 University Avenue, Madison, Wisconsin.

CONFIDENTIAL. Las Vegas, Nevada, remails 25¢, forwarding 30¢. Ked Riding, 1038 Palm St.

EUROPEAN Confidential, remailing, receiving, forwarding from any European city. Complete mailing service, \$3.00 monthly. Trans-World Mailer, P.O.B. 3973, Frankfurt /M, Germany.

TREASURE FINDERS

TREASURE! Map, handbook, 25¢. Locators. Howe, 811 Kansas, Atchison, Kansas.

TREASURE! Buried coins, gold, silverware, relics. Transistorized M-scope locates them! From \$59.50. Easy terms. Free catalog. Fisher Research, Dept. C-1, Palo Alto, Calif.

GOLD-Silver detectors. Geiger counters. Violites for tungsten, etc. Best available. Guaranteed. Information free. Delectron, Dept. 4, Sylmar, California.

ROCKHOUNDS, Amateur, professional, or adventurous vacationers. Dig diamonds, gold, rubies. Mines open to public, 25¢. Diggins, 1848 Oakland, Ft. Worth, Texas.

\$25.00 INFORMATION Folder. "Metal Locating Kinks" 25¢. IGWTP, Williamsburg, New Mexico.

TREASURE Locators, "Screen." Special model. Batteries V. last 1000 hrs. \$185.00. Literature in English and Spanish. Free catalog. Adolfo Vicente, 659, Escobar St., Havana, Cuba.

FOR SALE—MISCELLANEOUS

BALL Pens \$22.00 per thousand. Assemble yourself. Large users only. Permarite, 712 Broadway, New York 3, N. Y.

HEARING Aid batteries, wholesale. Free list. Habs, Box 51, York, Penna.

WANTED—MISCELLANEOUS

QUICKSILVER, Platinum, silver, gold. Ores analyzed. Wholesale Terminal, Norwood, Mass.

MISCELLANEOUS

INCOME Taxes. Short forms completed \$2.00. Avoid errors. Any individual long form checked for accuracy \$2.00. All business forms checked. Reasonable rates. Audiproof, 3525 Crestaire, Baton Rouge, Louisiana.

BIG Interesting mails, three months 25¢, year \$1.00. Harvey Teeple, Dept. PM, Decatur, Indiana.

MIRROR—Transparent back. Watch, photograph people, secretly! 8"x10", \$2.00; 16"x20", \$5.00. One-Way Mirror, PM-260, Box 625, Mt. Vernon, N. Y.

REWARD Yourself! How-to-Fix-It book, 600 pages; home repairs, \$2.95, guaranteed. North Star Products, Box 112-FM, Cedar Grove, New Jersey.

JAPAN: Buy direct. Gifts, novelties, dolls, kimonos, 26 page catalogue, manufacturers' names, addresses, business information. Send \$1.00. Clarence Yamagata, 202 Naka 7 Bldg., Marunouchi, Tokyo.

FREE Listings. Buy or sell through Southwestern, 1306 South Darlington, Tulsa 12, Oklahoma.

LET Us tell you how to turn the reading habits of your friends into profit for you. \$10.00, \$25.00 or \$50.00 can easily and quickly be made under our Popular Mechanics subscription plan. No experience needed. Write Popular Mechanics, Room 2M, 250 West 55th St., New York 19, N. Y.

POST Card Calendar computes day of week for any date, 1800 through 2000, fast, simple. 25¢ each. Novelty Calendars, P.O. Box 626, Norfolk 1, Va.

BOOKS On antique and their prices. Free circular! P. Warman Publishers, Uniontown, Penna.

EPOXY Adhesive kit \$1.50. Sunset Research Laboratories, Box 6117, Seattle 88, Washington.

SEPTIC Tanks, cesspools, outdoor toilets. Keep clean and odorless with Northel Septic Tank Reactivator. Bacterial concentrate breaks up solids and grease—prevents overflow, back-up, odors. Regular use saves costly pumping or digging. Simply mix dry powder in water, flush down toilet. Non-poisonous, non-caustic. Six months supply only \$2.95, postpaid (money-back guarantee of satisfaction), or rush postcard for free details. Northel, PM-2, Box 1103, Minneapolis 40, Minn.

GREY Hair recolored beautiful natural shade. Lanolized pomade, \$2.25. Guaranteed! Dealers wanted. Marion Pharmacal, Long Island City 4, N. Y.

GLAMOROUS Feather picture 5½x8½ with glassed frame \$1.45. Artistic catalog, greeting folder, and papaya seeds 35¢. Mexicana, 1104 Calexico, Calif.

RECEIVE Magazine samples. Mails. Catalogues. Bargains from everywhere. Get listed 25¢. Rorick, Cincinnati 26, Ohio.

GET Samples, opportunities, magazines, catalogs, offers galore! Your name in 5000 big mail directories, 25¢. Results guaranteed. King's, Moorestown, Ontario, Can.

LEARN To relax. Reduce nervous tension. 27 minute LP record, \$3.98 ppd. Write: Records, 1919 Ridgeland Road, Rockford, Illinois.

BIBLE As literature inspires, helps, leads. Ask for your marker with selected passages. Publications, 620 W. Big Bend, Kirkwood 22, Mo.

WESTERN Bolo ties with hand polished gem stones, \$3.00 each. Cash or M.O. Satisfaction guaranteed. Import Service Co., Box 877, Karnes City, Texas.

ELECTRIC Home barber kit. Complete. Guaranteed. \$7.98 postpaid. Falco, 1024 Eureka, Lansing 12, Mich.

ORNAMENTAL Iron designs. Book of 1600 beautiful, practical designs for railings, columns, etc. Free literature. Cunningham, 3881 South 3200 West, Salt Lake City 4, Utah.

FALLOUT Shelter you can build. Plans \$1.00. Wiman, Box 1005A, Douglas, Alaska.

CIGARETTES: Make 20 plain or filter-tips for 9¢. Facts free. Moberly, Box 915, Owensboro, Kentucky.

100,000 PRODUCTS Wholesale—Free catalog! Send postcard: Econ-O-Mart, Whippany 15, New Jersey.

YOUR Name wanted. We'll send 1000 publishers, mailers, wholesalers your name, on our list one year 25¢. Dixie Mailers, King, N. C.

MONEY Making and saving catalogue. Write: Adams, PM 210 5th Avenue, New York 10, New York.

SUPER Memory overnight! Success guaranteed! Bijou, Box 1727-M, Hollywood 28, California.

Learn BAKING At Home

Baking is one of America's high industries in wages. Nearly depression-proof. Thorough basic home course lays sound foundation. If you have aptitude, write for FREE BOOKLET, "Opportunities in Commercial Baking." National Baking School, 835 Diversey Pkwy., Dept. 1352 Chicago 14, Illinois



JOB OPPORTUNITIES FOR TRAINED MEN



Operate big construction machinery—draglines, shovels, graders, scrapers and dozers. One hundred hours actual operating time. Plenty of machinery and acres of work projects. Graduates quickly employed by contractors. Limited enrollment in February and April classes. Rush coupon for details and the opportunity of a lifetime.

ENGINEERING EXTENSION SERVICE
Texas A&M College System
Box 236FE, Dept. PM-5
College Station, Texas



Name _____
Address _____
City _____ State _____



119 JIG SAW PATTERNS

FULL-SIZE . . . trace on wood and saw out. Clever, ORIGINAL designs, things you can make to SELL. Wall shelves, lawn signs, planters, book ends, others. **\$1** postpaid

BURGESS VIBROCRRAFTERS, INC.

Rush \$1 today. DEPT. C-138, Grayslake, Illinois

GIVE AMERICAN CANCER SOCIETY

POPULAR MECHANICS

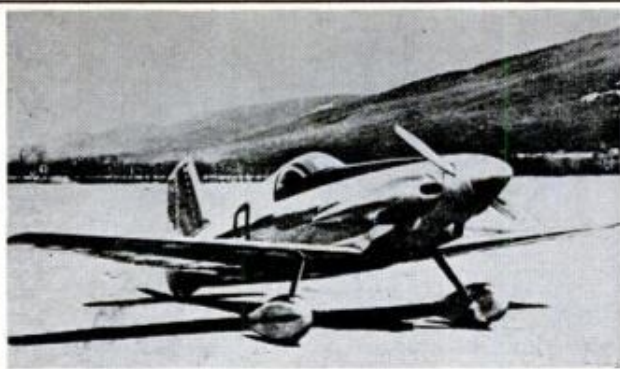

MIDGET MUSTANG—(D. Long Racer)

Highest Proven Performance
All Metal Available Now As **HOME BUILT KIT**
11 Long Racers Built and Flying.
With 85 HP Cont.—175 MPH Cruise—5 GPH Fuel
300 MPH Max. Fully Aerobatic Stressed Skin 9G's.

— **SPECIAL OFFER!** —

PHOTOGRAPHS — CAA REQUIREMENTS
CONSTRUCTION DETAILS — COST BREAKDOWN
— **MAIL \$2.00** —

MUSTANG AIRCRAFT CO.

10438 Santa Monica Blvd., West Los Angeles, Calif.

MEN WANTED

Earn \$100 Per
Week and up
**AUTO DIESEL
MECHANICS**

Master a trade with a future—learn Auto-Diesel mechanics in our shops. You learn with tools on real equipment. Earn while you learn. Many of our graduates earn \$100 per week and up. No previous experience necessary. Day and night courses. Approved for veterans. Write for free bulletin.

NASHVILLE AUTO-DIESEL COLLEGE

226 7th Ave., N., Dept. 73

Nashville 3, Tenn.

Shop PM Ads for Exciting
Direct-Mail Offers

WOULD YOU
DO THIS
IF
ATTACKED?



**80 MODERN
INDIVIDUAL
LESSONS ON
LETHAL JUDO**

Defend or attack with scientific "know how". Lessons packed with pictures, charts, etc. Armed & unarmed attack & defense. Nerve center pressure points, unbreakable holds. 80 lesson professional course by return mail. **ONLY \$3**

(MONEY BACK GUARANTEE)
OXFORD STUDIO 44 Bromfield St., Boston, Mass.

**FREE AUTO
BOOK**

Tells how to lengthen your car's life—increase trade-in value. Spot trouble areas for noises, clutch, oil leaks, bad brakes, poor starts. The most complete guide for the "Care of Your Car" yours Absolutely **FREE!** Please include 10c to cover cost of postage and handling.

CONSUMERS AUTOMOTIVE RESEARCH BUREAU
Dept. 101, 516 Fifth Ave., New York, N. Y.

**FREE! LAFAYETTE'S
1960
CATALOG**



304 GIANT-SIZED PAGES

CONTAINS

HUNDREDS OF EXCLUSIVE LAFAYETTE ITEMS NOT IN ANY OTHER CATALOG OR AVAILABLE FROM ANY OTHER SOURCE—SEND FOR YOUR COPY NOW!

Everything In Electronics

See the newest and finest in Stereo Tuners, Amplifiers, Cartridges and Music Systems

The Complete Catalog
Featuring The Best Values
Obtainable

- TAPE RECORDERS • PUBLIC ADDRESS SYSTEMS • AMATEUR EQUIPMENT
- INDUSTRIAL SUPPLIES • RADIO & TV TUBES AND PARTS • INSTRUMENTS
- TELESCOPES, BINOCULARS, MICROSCOPES & CAMERAS

LEADERS IN HI-FI

The most complete electronic supply catalog crammed full of everything electronic at our customary down-to-earth money-saving prices.

OUR

39th

The largest selection of hi-fi components and systems; greatest savings on Lafayette endorsed "best-buy" complete systems.

YEAR

EASY PAY TERMS AVAILABLE —
10% DOWN — UP TO 18 MONTHS TO PAY

CUT OUT
AND PASTE
ON POST
CARD

Lafayette Radio P.O. BOX 222
JAMAICA 31, N. Y.
DEPT. LB-6

Send **FREE LAFAYETTE Catalog 600**

Name.....

Address.....

City..... Zone..... State.....

**PREPARE FOR BETTER JOB, BIGGER PAY
IN SPARE TIME AT HOME**

Today, choose the job you want—and prepare for it in time you might otherwise waste. Or if you are already in the work you like best, start training now for quicker promotion and increased pay. During the past 63 years AMERICAN SCHOOL has helped ambitious people to reach higher goals. Check subject that interests you and mail coupon for full information.

AMERICAN SCHOOL, Dept. G245, Drexel at 58th, Chicago 37, Ill.

Without obligation, please send **FREE** and postpaid, full particulars about the subject checked below.

- | | | |
|--|---|---|
| <input type="checkbox"/> Accounting | <input type="checkbox"/> Diesel Technician | <input type="checkbox"/> Machinists |
| <input type="checkbox"/> Apprenticeship Courses | <input type="checkbox"/> Drafting—Building | <input type="checkbox"/> Mechanical Engineering |
| <input type="checkbox"/> Architecture & Building | <input type="checkbox"/> Drafting—Machine | <input type="checkbox"/> Mechanical Technology |
| <input type="checkbox"/> Automotive Technician | <input type="checkbox"/> Electrical Engineering | <input type="checkbox"/> Metalworking Courses |
| <input type="checkbox"/> Better Foremanship | <input type="checkbox"/> Electricity—Practical | <input type="checkbox"/> Plumbing—Practical |
| <input type="checkbox"/> Bookkeeping | <input type="checkbox"/> Electronics—Industrial | <input type="checkbox"/> Private Secretary |
| <input type="checkbox"/> Business Management | <input type="checkbox"/> HIGH SCHOOL COURSES | <input type="checkbox"/> Retail Merchandising |
| <input type="checkbox"/> Civil Engineering | <input type="checkbox"/> Human Relations | <input type="checkbox"/> Sheet Metal Work |
| <input type="checkbox"/> Contracting | <input type="checkbox"/> Instrumentations | <input type="checkbox"/> Tool Making |

NAME.....
HOME ADDRESS.....
CITY..... STATE.....
OCCUPATION..... AGE.....

Accredited Member NATIONAL HOME STUDY COUNCIL

MAIL COUPON NOW



HELP US KEEP THE THINGS WORTH KEEPING

A boy keeps days like these all his life. Some day he'll trundle his own sons in a barrow too—remembering the jolly, peaceful man-to-man times spent with his father.

So many precious things like this depend on peace. And *peace* depends upon so many things. For instance: peace costs money.

Money for strength to keep the peace. Money for science and education to help make peace lasting. And money saved by individuals to keep our economy sound.

Every U. S. Savings Bond you buy helps provide money for our country's Peace Power—the power that helps us keep the things worth keeping.

Are you buying as many Bonds as you might?



Photograph by Harold Halma

HELP STRENGTHEN AMERICA'S PEACE POWER BUY U. S. SAVINGS BONDS

The U.S. Government does not pay for this advertising. The Treasury Department thanks The Advertising Council and this magazine for their patriotic donation.



FACTORY OVER STOCK SALE!

Must MOVE OUT Merchandise—Including Items BELOW COST!

CIGARETS—8½ A PACK!



Enjoy cigarettes as good or **BETTER** than the brand you now smoke, yet pay—**NOT 29c—but only 8½c** a pack! The Korum Cigarette-Maker is a little "home factory" that cranks out **THOUSANDS** of cigarettes. Precision-made. Follows, in essence, same principles as \$100,000 machines used in Va., N. Car., etc. Remember, you can't smoke taxes—so why pay for them. Join the thousands of Americans—bankers, clerks, housewives, etc.—who now manufacture their own custom-blend cigarettes and **save 6¢ per TWO-THIRDS** on every pack! Try the Korum Cigarette-Maker 10 days—see how its exclusive Conveyor Belt hands you a cigarette every 2 seconds! Comes complete—ready to use. Thousands sold at \$4.98—**NOW ONLY \$1.25.** Order by No. 851.

No. 851
Orig. \$4.98
1.25

THORESEN, Inc., Dept. 6-B, 585 Water St., New York 2, N.Y.



HEAVY-DUTY SLINGSHOT

Built-in Range Finder **1.25**

Extra-thick Quadrangular slings with 44 lb. pull! Kills small game, roats pests. Use for target practice. Packs w/loop! Special cross-bar range finder assures greater accuracy. Same type used on cameras, rifles. Thick leather pouch. Brass riveted slings. Ebony finish wood. Super silent. Hits like a rifle!

FREE! 100 Killer Steel Pellets. No. 943 Slingshot & 100 pellets \$1.25. Extra Pellets: 400 for \$1.

STORM WINDOWS



ORIG. 49c **19½c**

Transparent like glass yet can't shatter, chip, peel or rattle. Non-porous. Won't crack even at 53 below! Install in minutes. No nails, screws or tools. No installation costs. Cut to fit window, press on with Adheso Border Tape. That's all. When winter's over, fold away for next year. 5 million used in U.S., Canada, Alaska. Shipped flat in rolls measuring 36"x43 1/2" for 10 windows. 90-foot Adheso Border Tape **FREE**. No. 74 Kit of 10 Plastic Storm Windows \$1.98 plus 22c mailing. Total: \$2.20. 2 kits (20 windows) \$3.99.

Pumps 300 Gals. Per Hour

2.98



Needs No Electric Motor! Can't Break Down **WORKS ON WATER PRESSURE!** This is one of the most ingenious low-cost pumps we've ever seen. Pumps up to 300 gallons per hour—**WITHOUT electricity! Without a Motor!** And it can't break down! Merely attach to any faucet and turn on—water pressure does the rest. You spent not a penny for electricity or gasoline. Use it in cellar, backyard, pool, sinks, excavations, fish tanks—whenever you want to drain water **FAST!** No. 491 Drain Pump—\$2.98.

Human Skeleton Model WALKS!

In scale to **6-FT. MAN!** **1.98**

- ★ Unbreakable Materials
- ★ Each Part Interlocks and Snaps Together! No Glueing!
- ★ 100% Accurate Anatomically

This human skeleton model is completely authentic—each bone is built in perfect scale to a 6' man. Easy to assemble... each part interlocks and snaps together. Unbreakable. Praised by medical schools, doctors, scientists. Large anatomical charts included **FREE**. Helps you locate and identify every bone in human body. No. 194.....\$1.98



Cigaret Case and Lighter

Pull Trigger—It Hands You a Cigarette →



Pull Trigger—Again—Gives You a Light →

The rage of Germany, England, France and Italy. Press trigger and out pops a cigarette—press trigger again and barrel lights your cigarette with real flame! It's the most unusual, most different lighter we've yet seen. Precision made by skilled German craftsmen. It never needs repairs or adjustments. Compact—fits pocket or purse. Great party stopper—conversation starter—house gift! Looks like a \$10.00 item—yet Thoresen's price is just \$2.98. No. 422.

Talk or Sing on Radio or TV with this Hi-Modality Microphone!

1.93



Be the life of the party... talk, sing, act thru any radio or T.V. with this new Hi-Modality Microphone. This you can do unseen from another room. Create dramatic effects by cutting in on programs with special news announcements. Educational for children too! Ideal for voice development, correction of speech defects. No. 187.....\$1.93

8-Pc. Wrench Set

1.00

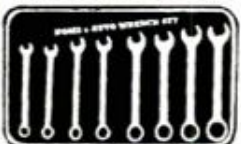

8-piece set in handy plastic kit. Contains 8 drop forged chrome plated wrenches. No. 701. 99c.

THORESEN Holesaw



Saws any shaped hole for 1/4" electric drills. Bores thru wood, plastics, aluminum, plaster, etc. No. 42.....95c



Dacron Insulated Vest

Orig. \$9.95 **3.98**

Dacron Insulated Vest. Large Zipper. Two huge roomy pockets within side elastic shell loops. It's washable. Dries fast. **SHRINK-PROOF!** Keeps shape. Dust-proof. Mothproof. This same Insulated Vest sold for \$9.95—now only \$3.98. Sizes: SMALL, MEDIUM, LARGE, EXTRA LARGE. No. 53 Insulated Vest \$3.98. For man who prefers the best, we recommend our TRIPLE GARD Model. Order by No. 53-D. \$4.98 complete.

Car Owner's HANDBOOK

11c 1001 tips, how-to info that may save you hundreds! Used by 250,000 car owners. Orig. \$2.00—now 11c (one to customer). No. 999



STOP TV & RADIO NOISE

New electronic Filter stops hum & static caused by motors, plane trains, electrical appliances. Enjoy TV & radio without interference. Thousands sold! No. 438 Noise Filter. \$1

TV REMOTE CONTROL



Guests Will Think You're Using a **RADAR BEAM!**



2.98

CLICK . . . CLICK . . . turn TV Set on or off Any Distance up to 25 FEET!

Now—operate your TV or Radio Set from chair or bed. Use your **REMOTE CONTROL Switch**. Click . . . click! Your set goes on or off like magic! Works automatically from any distance—up to 25 feet. No. 443 Remote Control \$2.98

THORESEN, Inc., Dept. 6-B, 585 Water Street, New York 2, N.Y.

RUSH Items below on 10 day trial. Money back guarantee.

- Check or money order enclosed. (Minimum order \$1.)
- Send C.O.D., plus postage and C.O.D. fee (enclose \$1 deposit).

NO.	QUANTITY	ARTICLE	PRICE

PRINT NAME _____

ADDRESS _____
Canadians THORESEN, LTD., 439 King Street, W. Tor. 2, B. Ont.

EARN MORE - LEARN **AUTO** DIESEL MECHANICS

OR TRAIN WITH OTHER GREER DIPLOMA COURSES

- | | |
|--|---|
| <input type="checkbox"/> AUTO MECHANICS | <input type="checkbox"/> REFRIGERATION |
| <input type="checkbox"/> DIESEL MECHANICS | <input type="checkbox"/> AIR CONDITIONING |
| <input type="checkbox"/> BODY & FENDER REPAIR | <input type="checkbox"/> MACHINIST TRADE |
| <input type="checkbox"/> GAS-ARC WELDING | <input type="checkbox"/> ADVANCED MACHINIST |
| <input type="checkbox"/> CONSTRUCTION EQUIPMENT OPERATORS TRAINING | |
| <input type="checkbox"/> CONSTRUCTION EQUIPMENT MECHANICS TRAINING | |

Skilled men are needed in every part of the country. Earn top pay in established shops or start your own business. Greer's expert instruction and actual shop training teaches you how. You learn by doing—quick, easy courses using the latest tools and equipment. Day, evening and part time instructions available.

Job placement and convenient living accommodations are yours while training. Contact GREER'S FREE JOB PLACEMENT ASSISTANCE when you enroll if you wish part time or full time employment.

All Courses Approved Civ. or G. I.

Please rush me free literature on the trade indicated.

NAME _____ AGE _____

STREET _____

TOWN _____ ZONE _____ STATE _____

GREER SHOP TRAINING

Box B, 2236 S. Michigan Ave.
Chicago 16, Illinois

FORTUNES IN DIVING

Train at Home in Spare Time

Write Today for Amazing Free Booklet

Here is one of the greatest opportunities of our time. Make big money fast in Skin and Lung Diving. Trained divers needed in hundreds of industries and by government. Build a successful business of your own. Hourly rates among highest paid in any field. Training program by E. R. Cross, world famous master diver. Get the facts now. Mail coupon for FREE BOOKLET TODAY!

DIVEMASTER, Dept. PM-20

5637 W. 63rd Place, Chicago 38, Ill.

Send me free information about Diving.

Name _____ Age _____

Address _____

City _____ State _____

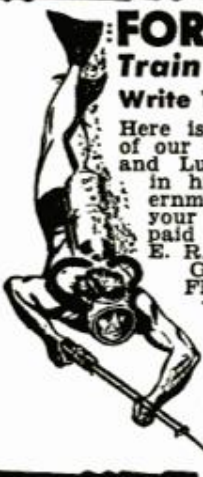

NEW FIBERGLASS LAPSTRAKE & PLYWOOD **BOAT KITS**

Most complete line. 8' to 23'. Prams, row-boats, outboards, cruisers.

MAIL 50c (coin)
REFUNDABLE
for BIG COLOR
CATALOGS



U-MAK-IT, DeLAND, FLORIDA • DEPT. 12

Why Don't You Invent It?

By Paul Brock

You must have heard this phrase scores of times:

"Why on earth don't they think up some gadget that will...?" The plaintive question is completed in a hundred different ways.

It is uttered usually at times when the inefficiency of some trivial article becomes particularly annoying.

"Why don't they...?" It's always the same cry. Well why don't *you* think up a gadget before *they* do? Good ideas bring high prices in any market, and we all get bright ideas at one time or another. The trouble is that we seldom recognize ideas when they come along. We fail to give them a second thought and the germ of what could be a fortune-making idea dies.

Many years ago an Irishman named O'Sullivan was working at a bench in a factory. The vibration from the machines upset his stomach, so he brought a rubber mat to work. He found that by standing on it the shaking was eliminated.

Two days later the mat disappeared, removed by some light-fingered gentleman who approved of O'Sullivan's idea. So the Irishman bought himself another mat, which also disappeared. Finally, O'Sullivan bought a third mat, but this time he cut out two pieces of rubber and nailed them to the heels of his boots.

The idea worked, and the unpleasant effects of the vibration virtually were banished. O'Sullivan had the good sense to realize the value of his inspiration, and so it was that rubber heels came on the market and netted a fortune for their inventor.

Simple ideas like O'Sullivan's are within the scope of all of us, but so often we just have our gripe and leave it at that. A good idea is marketable, even if you haven't the money to launch a commercial venture of your own.

It is foolish to be stopped because you are not an electronics specialist or a nuclear scientist, for frequently the expert is blinded by his own knowledge. His point of view is so cramped by technicalities that he would never dream of experimenting along novel lines. The outsider, unhampered by technical knowledge, can make a success of an idea that the expert would reject as impractical.

Elias Howe, son of an American farmer, conceived the idea that resulted in the lock-stitch sewing machine. Nobody thought of

(Continued to page 96)

**WE'RE GOING
TO WORK
MIRACLES!**



Next Month

DR. EDWARD TELLER

**famed scientist
and head of the
University of Cali-
fornia Radiation
Laboratory**

**tells how we'll put
the atom to work
peacefully in dig-
ging harbors and
generating power
from underground
explosions**

**Save 1/2 on New
ACCORDIONS**



**Over 40 Exciting 1960
Models From Italy...
Buy on Easy Terms!**

**5-DAY FREE
TRIAL**

**BUY
DIRECT
FROM
IMPORTER**

•Professionals
•Students
•Teachers

...all over the
U. S. A. agree
"you get more
for your money
at A. M. W. O."

FREE BONUS GIFTS

- Free Lessons
- DeLuxe Case
- Music Stand
- Music Portfolio
- Year's Music Supply
- Your Name in Chrome

MANY OTHER GIFTS FOR PROMPTNESS

Now — amazing savings on the world's finest Italian-made accordions! Play the most popular instrument of all — for FUN, LEADERSHIP and PROFIT! We're offering your choice of over 40 exciting brand-new imported models of glorious tone and startling beauty at LOWER PRICES! You save 50% off mfr's list prices! Buy direct from world's largest exclusive accordion dealer. Valuable extra Bonus Gifts Free if you buy during this sale. Big allowance for your trade-in. Your satisfaction guaranteed or your money back! Try and examine before you buy on our FREE 5-DAY NO-RISK PLAN. Double guarantee.

TRADE-IN

your old accordion
on brand-new model
—top allowance.
Free Appraisal.

MONEY BACK GUARANTEE

Find out what the accordion can do for you! Find out how easily you can own the accordion you've dreamed about. See and read about all the wonderful new features of these famous-make accordions manufactured by Italy's master craftsmen. Rush coupon now for big new COLOR CATALOGS and low discount prices—FREE! No obligation. No salesman will call. Write today—

Accordion Manufacturers and Wholesalers Outlet
Dept. R-20, 2003 West Chicago Avenue, Chicago 22, Illinois

FREE

**COLOR
CATALOGS
•
DISCOUNT
PRICES**

Mail Coupon

Accordion Manufacturers & Wholesalers Outlet
Dept. R-20, 2003 W. Chicago Ave., Chicago 22, Ill.
Rush color catalogs and low discount prices—FREE!

Name _____

Address _____

City _____ Zone _____ State _____



THE FINE ART OF BEING THERE

IN STEREOPHONIC HIGH FIDELITY



by David Tardy

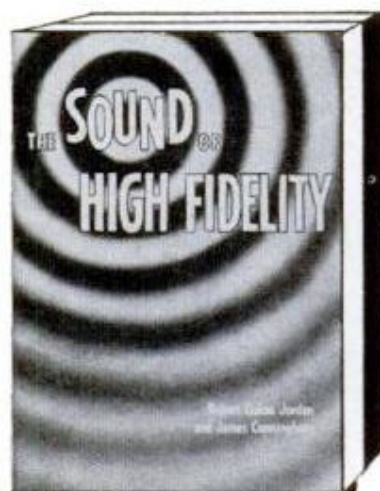

by Robert Oakes Jordan
and
James Cunningham

a stereophonic test record
available free with every
copy



For those who want the true realism, A GUIDE TO STEREO SOUND offers ways and means of bringing an orchestra into your living room. Latest information on stereophonic tape and disc recording and broadcasting. Distinguish between stereophonics and stereo-phonies. \$4.95.

A basic handbook and guide to the operation and maintenance of high-fidelity audio equipment, THE SOUND OF HIGH FIDELITY covers the field of audio reproduction from propagator to loudspeaker, from Pythagoras to Klipsch. Sound information for sound enthusiasts. \$4.95.

at bookdealers, or write:

**POPULAR MECHANICS PRESS
200 EAST ONTARIO STREET, CHICAGO 11, ILLINOIS**

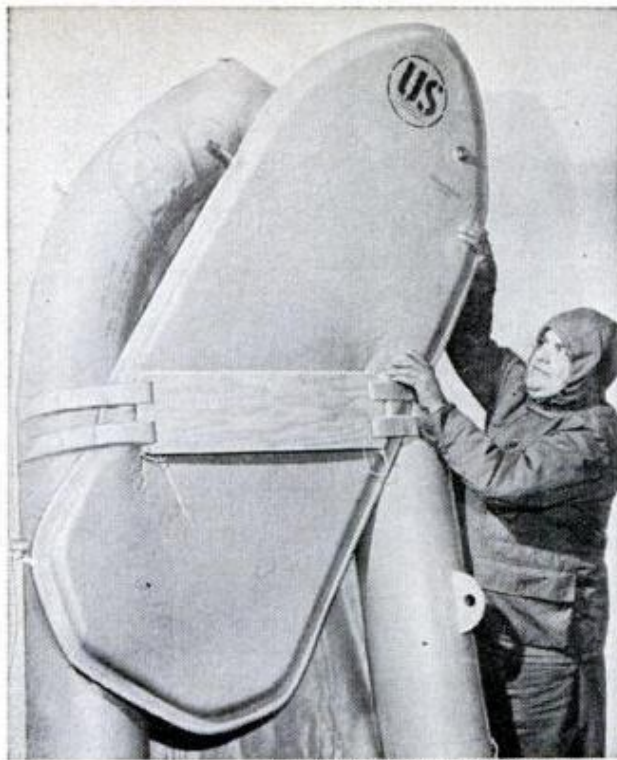

U. S. Rubber Co., Providence, R. I.

Inflatable Two-Man Dinghy Features Separate Floor

For yachtsmen, campers, hunters and fishermen, an inflatable two-man dinghy provides a reliable boat when needed, but deflates and folds into duffel-bag size. It can be stored in a small space aboard a large boat, in a closet, or carried in a car trunk. Made of neoprene-coated nylon, the 48-pound boat is 8½ feet long and 3½ feet wide, and comes with seats, oars, motor mount, pump and carrying case. The separate floor adds rigidity, stability, and insulation in cold water; it can be taken out and used as a mattress or life raft.



"FIRE UP"

YOUR ENGINE AT ALL SPEEDS WITH AUTOLITE RESISTOR SPARK PLUGS WITH

POWER TIP

LOOK FOR THE PROTRUDING TIP!

FIX YOUR OWN TV

PICTURE TUBE in SECONDS!
(NO TOOLS — NO SOLDERING)

Many picture tubes thought bad when only a loose soldered connection an element to pin was at fault! Slip BERN'S PERFECT PIN CRIMPER on pin, squeeze, you have a solid electrical connection. Crimp all pins when you're in doubt! Use blade as screwdriver, wrench for Channel Selector . . . (3 in 1 Tool)

**TV
PICTURE TUBE
REPAIR
TOOL**

SAVE \$50
USED BY THOUSANDS OF PROFESSIONAL SERVICEMEN!



PAT. 2,878,658

Only \$1.95

C. O. D.'s. plus postage ppd.

AMERICAN RADIO & TELEVISION CO.
Dept. PM — 9853 Chalmers, Detroit 13, Mich.

MANUFACTURE THIS BEAUTIFUL CONCRETE OUTDOOR FIREPLACE

Right In Your Own Backyard

\$4.00 Worth of Sand & Cement produces this Attractive Fireplace.



Sells on Sight from \$60. to \$80. Easy to start your own Profitable Business.

The General Fireplace Molds and Process are the most amazing and foolproof ever invented. Simple to operate. Two men can produce five fireplaces a day.

BIG DEMAND!!

Sell all you produce to Department Stores, Homeowners, Parks, Nurseries and Picnic Groves. Fireplaces sell on sight. No experience necessary. We supply full operating instructions and equipment plus the know-how that spells **BIG PROFITS**. This is an outstanding opportunity for men of vision and small capital to get into a busy rich paying field. Don't delay, be the only exclusive manufacturer in your own home town. Mail coupon at once for full details as to how you can reserve your territory. **Molds sold only on exclusive franchise.**

GENERAL ENGINES CO., Inc., Dept. MF-20
ROUTE 130, THOROFARE, N. J.

Mr. Tor of Philadelphia writes: Sold 250 in first 4 months. Selling to Sears Roebuck, John Wanamaker, and Gimbel Bros. in Philadelphia area.

Name
Address
City Zone
State

PROTECT YOUR CAR WITH

Latest and best automotive products —you'll find them advertised in PM.

BSA MOTORCYCLES

The most popular motorcycle in the world



Hitch your wagon to a STAR

Here's a sweet handling lightweight—the BSA STAR 250. Plenty of snap and power from a clean ultra-modern design 250 c.c. o.h.v. engine with built-in unit of clutch, primary drive and four speed gearbox. Safety, comfort, and the best riding pleasure come with the powerful brakes, full width hubs, and comfortable dualseat on this handsomely styled lightweight, the BSA STAR 250—"Star of the Road."

Send this coupon for a colorfully illustrated free catalog of the new 1960 BSA models.

Name
Address
City State
Age Dept. PM-2

Western:
HAP ALZINA
3074 Broadway
Oakland, Calif.
Eastern:
BSA INCORPORATED
639 Passaic Ave.
Nutley, N. J.

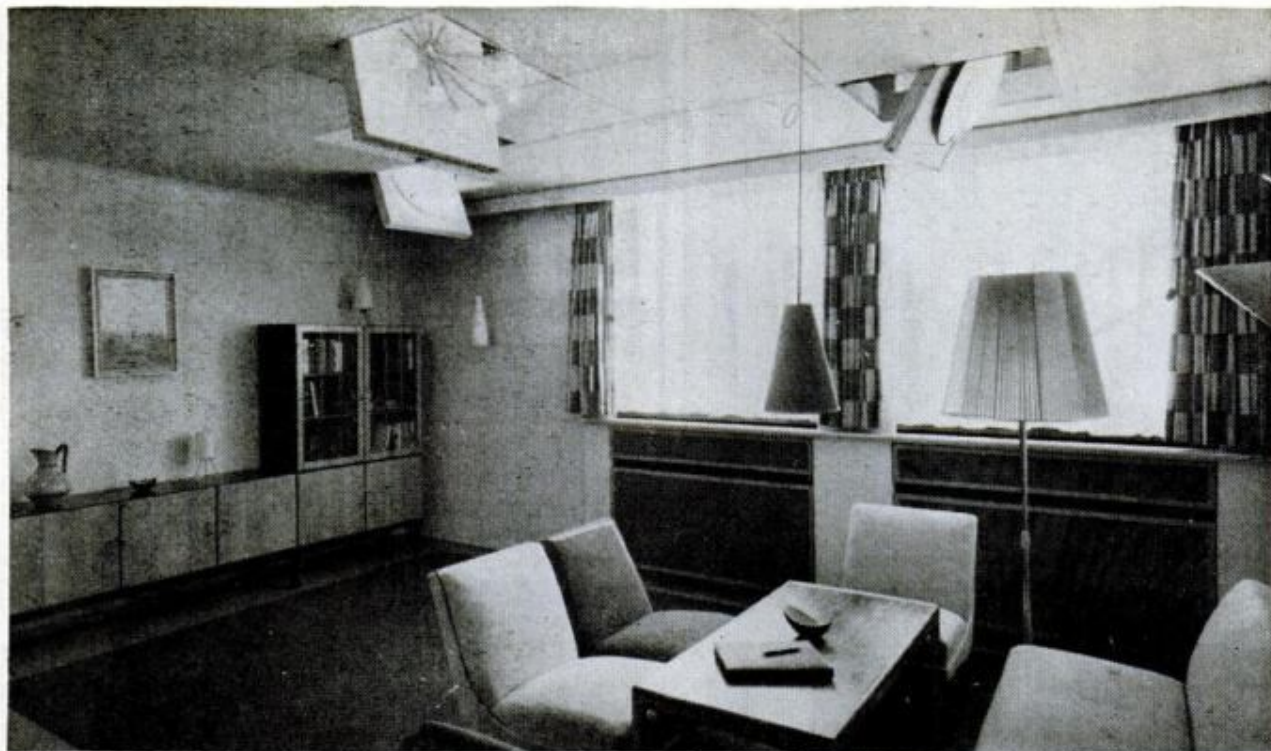

Osram, G.m.b.H., 522 Postbox, Munich (Bavaria) West Germany

Overhead Light Fixtures Disappear Into Ceiling

One of the highlights of the recent Light Show in Stuttgart, Germany, was a demonstration of overhead lights that are mounted on ceiling panels which can be rotated by a remote switch so that the lights are

exposed or concealed. Both fluorescent and incandescent lamps were shown in the ceiling fixtures. Any number of fixtures can be arranged this way to provide whatever degree of illumination is necessary.



TOM
HENDERSON

"G'morning, Mr. Carter—say, your clocks are way off!"

cabana marrone



**PLAN YOUR FUTURE NOW...
have a business of your own**

Luxurious, high-fashion fur now being ranch-raised in U.S.A. and Canada. All select, pedigreed, registered stock. Easy and economical to raise in any climate. One pair should produce 10 to 15 young per year. Warranty assures life and production. You may qualify for membership in CNBA (Cabana Nutria Breeders Association), the largest and strongest Nutria association. Free ranch training program. Cabana Marrone Nutria garments nationally advertised.

Cabana Marrone available only through authorized distributors. Write for complete information. Distributor inquiries invited.



CABANA NUTRIA INC.
Dept. 71 636 West Lemon Arcadia, Calif.

**"\$7,108⁵⁰ First Year
SERVICING RADIATORS!"**



— Hank Konter, Newcastle, Wyo.
Make good money servicing auto-truck-tractor radiators with new Inland 1-Piece Radiator Shop. Easy to test, clean and repair radiators. Inland, world's largest radiator equipment mfr., trains you free. Small down payment starts you. Proved merchandising assures volume. Profitable dept. for garage or service station. Write
INLAND MFG. CO., PM-2, 1108 Jackson St., Omaha 2, Nebraska

MASS PRODUCTION MAKES THESE PRICES POSSIBLE

EASY TERMS

SEND FOR FREE COLOR CATALOG

TAFT MARINE WOODCRAFT
Dept. PM-260, 636 39th Ave. N.E., Minneapolis 21, Minn.

16 FT. RUNABOUT KIT



Complete with accessory package, low as \$17.57 per mo.

SAVE 75% ON HIGH SPEED CUTTING TOOLS

HIGH SPEED STRAIGHT OR TAPER SHANK CHUCKING REAMERS

SET. 20 DIFFERENT H.S. STRAIGHT 12C SHANK CHUCKING REAMERS. Size to 1/2". New & Used. Only. **995 Ppd.**



SET. 20 DIFFERENT H.S. TAPER 13C SHANK CHUCKING REAMERS. Size to 1/2". #1 & #2 Tapers. New & Used. **995 Ppd.**



SLITTING SAWS WITH MANDREL

SET. 6 DIFFERENT H.S. SLITTING SAWS 2C 2 3/4 dia. X 1" Arbor. Thickness from .040 to .071. Cuts wood, aluminum, brass, steel etc., plus special mandrel which enables use of saws in 1/4" & 1/2" elec. drill. \$25 Value. **495 Ppd.**



HIGH SPEED MORSE TAPER LATHE CENTERS

#2 Morse Taper, 98c. #3 Morse Taper, \$1.59. **SAVE 65%!**



HIGH SPEED WOODRUFF TAPER SEAT CUTTER

SET. 5 DIFFERENT SIZE CUTTERS, can be used 1C as mounted milling cutter or circular saw. All with 3/8" or 1/2" shank, widths to 1/4". New & Used. **395 Ppd.**



ALL MERCHANDISE SHIPPED POST PAID

WHOLESALE TOOL COMPANY
10248 GRAND RIVER
DETROIT, MICH.

SEND NO MONEY NOW! We will ship you a complete set of tools for only \$1.00. If you are not satisfied, we will refund your money. All orders shipped by air. No handling charges. All orders shipped by air. No handling charges. All orders shipped by air. No handling charges.

DAN LURIE
America's
Champion
Muscle Builder



BUILD YOUR MUSCLES FAST WITH DAN LURIE BARBELLS

Get results as no other method can. See your arms, chest, legs grow like magic. no other method compares. Get \$10.00 BODY MOLD COURSE FREE with order. Results guaranteed. Buy direct and save. **as low as 948**

50 lb. set \$ 9.48 • 100 lb. set \$15.98
150 lb. set \$23.48 • 200 lb. set \$29.98

Semi-steel sets approx. 10% higher. Extra wts. 15c per lb. Send 50% cash, balance COD., F.O.B. Plant. Order today.
DAN LURIE BARBELL CO., 52-M2 Bristol St., Dept. 59B, Bklyn. 12, N. Y.

KEEP CAR PERFORMANCE LIKE NEW—REPLACE WORN PARTS



American families are
better housed —
thanks to Advertising!

CHORD ORGANS SAVE UP TO 1/2

Importer-to-You Prices

5 Day FREE Home Trial

Startling value and performance! Buy direct from importer—amazing savings. Hand-crafted in Italy. Anyone can play. E-Z Terms. Bonus Gifts. Free Home Trial. Money Back Guarantee. Piano-keyboard models. New! Send for color catalogs, low discount prices.



**Play at Sight—
No Lessons Needed!**

FREE
Color
Catalog
Rush
Coupon

PHILHARMONIC ORGAN CORP., Dept. R-20
2003 W. Chicago Ave., Chicago 22, Illinois
Rush color Catalogs and Discount Price List.

NAME

ADDRESS

CITY & ZONE STATE



ARC WELDING WILL PAY YOU big profits

COMES COMPLETE—ready to weld. This potent package of performance welds, cuts, burns holes, hard surfaces, solders, brazes and heats metal. It's an ideal all-around shop welder. The Power/Weld gives you DC for

welding AND FURNISHES AC POWER simultaneously. It can also be used to provide emergency AC power. These two welders are bound to help you earn big profits—write for more details today!

HOBART BROS. CO., BOX M-20, Troy, Ohio, Phone FE 21223

LOW COST combination welder and power unit, welds or runs tools, lights, motors. Easy to use . . . handles all types of electrodes.

ac dc
POWER—WELD



The MOST in Modern Boating

**GLASS
MAGIC '60**

Tortuous destruction tests prove Glass Magic boats are built better to last longer . . . with extra speed and higher performance for more fun afloat. See your Glass Magic dealer.

GLASS MAGIC, INC.
2730 Ludelle St.
Fort Worth 5, Texas



Beautiful FREE
Glass Magic
'60 catalogue
of your marine
dealer . . . or
write factory.

FIND BURIED TREASURE

GOLD, silver, coins, jewelry, strong-boxes, battle relics! M-SCOPE transistorized electronic Treasure-Metal Locators detect them all. Used world-wide. Exciting! Rewarding! Guaranteed. Lightweight, super-sensitive. Indestructible fiberglass cases. From \$59.50. Easy Terms. FREE catalog.

FISHER RESEARCH LAB., INC.
Dept. PM-3, Palo Alto, Calif.



**YOU'D NEVER KNOW I HAD
PSORIASIS**

For 26 years psoriasis sufferers have learned that Siroil tends to remove unsightly external crusts and scales. If lesions recur, light applications of Siroil help control them. Siroil won't stain clothing or bed linens. Offered on 2-weeks-satisfaction-or-money-refunded basis.

SIROIL
AT ALL
DRUG STORES

Write for new FREE
BOOKLET, written by
Registered Physician.



SIROIL LABORATORIES, INC.
Dept. PM-14 Santa Monica, Calif.

Please send me your new FREE booklet on PSORIASIS.

NAME _____ Please Print
ADDRESS _____
CITY _____ STATE _____

Where-to-Buy-It Index

Automotive

Tire has replaceable treads (Martial International Corp., 29 E. 61st Street, New York 21, N. Y.).....102
Adult view for kiddies (DaVee Mfg. Co., Frewsburg, N. Y.)...102
Trailer train dumps to either side while moving (Differential Co., Findlay, Ohio).....115
Tilted racks double parking lot capacity (All American Engr. Co., Box 1247, Dupont Airport, Wilmington 3, Delaware)....133
Cars that live in glass houses (Metropolitan Greenhouse Mfg. Corp., Brooklyn, N. Y.).....146
Bus for sightseers recalls yesteryear.....156
Mobile theater fills small van.....160
Rear axle assembly guides long trailers (Pollack Industries Inc., South Keim St., Pottstown, Pa.).....160
Variable-pitch truck fan.....172

Aviation

Remotely-controlled helicopter fires torpedo.....104
Army's flying platform is jeep of the air.....114
Lightweight Beryllium latest metal for industry (Lyle M. Christensen, Northrop Corp., Norair Div., 1001 E. Broadway, Hawthorne, California).....143
Airborne nurses train in water.....144
"Hound Dog" hangs under wing of huge air force bomber (North American Aviation).....152
No confusion here when crews "scramble".....161

Construction

80-foot light poles made of concrete (Concrete Technology, Inc., 1123 Port of Tacoma Rd., Tacoma, Wash.).....120
Revolving hotel.....121
Form simplifies concrete pouring (Bobform Corp., 5679 W. Flagler St., Miami, Fla.).....142
Armor-like visors to regulate flow of Dutch river.....145
School's circular library stands on stilts.....147
One man operates gold dredge.....159

Miscellaneous

Aluminum pipe welded quickly by machine.....109
Assembly line packs herring in soviet ship.....109
Vinyl molds produce inexpensive stone (Precast Building Sections Inc., of New Hyde Park, N. Y.).....120
Transistor radio-phonograph.....121
Rod rest for angler (Dayton Bait Co., 2701 S. Dixie Drive, Dayton 9, Ohio).....121
Push-pull train has extra cabs.....126
Electric dial switch locks cars and power tools (Electric Dial, Inc., 7039 Sunset Blvd., Hollywood 28, Calif.).....126
Youngsters must earn long slide (Miracle Equipment Co., Grinnell, Ia.).....127
Flash unit is rechargeable (Allied Impex Corp., 300 Fourth Ave., New York 10, N. Y.).....127
Mouthpiece flashlight, Hand-I-Like, Kenco Plastics, Walker, Minn.127
Gloves give swimmers "webbed" hands (Pioneer Rubber Co., Willard, Ohio).....133
Kit molds plastic night crawlers.....134
Model steam engine operates threshing machine.....134
Clown dispenses oxygen (National Cylinder Gas, Div. of Chemetron Corp., 840 N. Michigan Ave., Chicago 11, Ill.)...135
Point on scaler holds fish (I.M.D. Inc., 319 Prospect St., Beloit, Wis.).....135
Snap-on letters make lighted sign (Versatile Display Co., 3512 Ross Ave., Dallas 1, Texas).....135
Tokyo policeman wired for sound.....135
Packing down Squaw Valley's snow.....137
Babies can breathe through this pillow (Roland Ward Datchet, Buckinghamshire, Great Britain).....142
Nail holder is finger saver (Max Bailly, Rue Henri Maubel 104, Forest-Bruxelles 19, Belgium).....142
Ten-ton tractor pulls huge plow.....146
Trackboard is covered with vinyl (A. B. Boyd Co., 763 14th St., Los Angeles, Calif.).....147
Boneless fish.....153
Model village made of bricks.....156
T.V. spies on lobster, Annan Photo Features, 25 W. 45th St., New York 36, N. Y.).....157
Kids shift weight to operate "space trainer".....158

(Continued to page 92)

Future Space Vehicles May Sport "Bumpers"

Future space vehicles may have bumpers for protection against meteors. Dr. Fred L. Whipple of the Smithsonian Institution suggests placing a "skin" layer one-tenth the thickness of the original metal a few centimeters from the "outside skin" of the space craft. Striking the outer skin, the meteor would explode there and only gas vapor would strike the heart of the craft. The vapor would not cause punctures, according to Dr. Whipple.

Electrical Current "Sews" Wound

Bleeding wounds that are difficult to seal off can be "sewn" closed by a small direct electrical current. Three surgeons from the State University of New York tested the technique on blood vessels, spleen and liver incisions on animals. Currents from 2 to 100 milliamperes were used on hemorrhaging tissues, effectively controlling the bleeding.

Gas-Charged Steam Kills Soil Organisms

Steam, charged with gas at a temperature of 140 degrees F., can be used to kill plant-disease organisms in the soil. The new treatment, developed by Dr. Kenneth F. Baker of the University of California, does not destroy harmless organisms. Previous methods, involving 212-degree temperatures, killed all organisms, rendering the soil sterile.

**After the city,
Before the state
The ZONE keeps your mail
From being late**

★ ★ ★

The Post Office has divided 106 cities into postal delivery zones to speed mail delivery. Be sure to include zone number when writing to these cities; be sure to include *your* zone number in *your* return address — after the city, before the state.

FEBRUARY 1960

LOOK!
New!
Improved!



**POCKET-SIZE
BLOW TORCH**
only \$2²⁵

Now—solder, braze, fix leaks. Do wiring, plumbing, loosen frozen nuts and bolts, 1001 odd jobs. Butane gas blow torch gives intense 3500° pin point flame that lasts ½ hour, turns on or off. Extra "chargers" 49¢ for two. Send \$2.25, check or money order for Jet King Blow Torch with one charger, or send \$2.95 for complete soldering kit: Blow Torch, two chargers, soldering tip, roll of solder. Send coupon now!
Money back guarantee!

Kidde Manufacturing Co., Inc., 204 Farrand St., Bloomfield, N. J.

Send me _____ JET KING BLOW TORCHES @ 2.25 ea.*

Send me _____ JET KING SOLDER KITS @ 2.95 ea.*

Send me _____ Boxes of Extra Chargers @ .49 per box.

My check, _____ money order _____ for \$ _____ is enclosed
(*Add \$1.00 Extra per unit for Canada)

NAME _____

STREET _____

CITY _____ STATE _____

MAKE HOME IMPROVEMENTS NOW



DELTA ASTROLite

Styled for the space age! Quality built to take hard knocks! Adjustable Sealed-Beam unit. Brilliant 800-foot spotlight. Fresnel-type red lens magnifies flashing light visible for a mile. Dual fingertip switches with signaling facility. Uses twin-pack 6-Volt battery.

With conventional bulb unit \$7.95

With Sealed-Beam unit \$9.25

Prices are list without batteries.



Delta LIGHTS THE WAY

Delta Electric Company, 323 West 33rd Street, Marion, Indiana

REVOLUTIONARY NEW
DESIGN SAVES YOU \$20 TO \$40

4 1/8" JOINTER PLANER

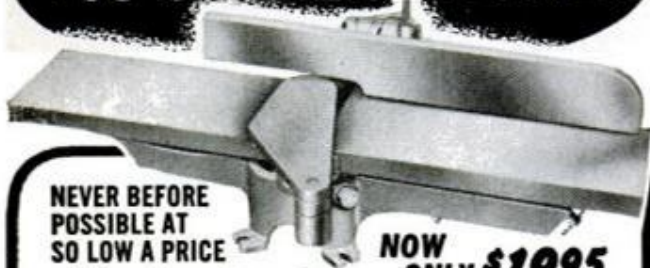

NEVER BEFORE
POSSIBLE AT
SO LOW A PRICE

NOW
ONLY \$19.95

(shipped complete as shown)

SOLD DIRECT FROM FACTORY

Patents pending on revolutionary new engineering developments make this bargain possible. This is a power plane with all the features of machine tools costing 3 times OUR PRICE. It planes, rabbets, bevels, aids beveling and glueing joints; is so rugged and durable we guarantee it unconditionally for ten years.

SEE THESE QUALITY FEATURES

All cast iron and steel construction • Balanced steel cutter head • Hardened and ground knives • Precision ground cast iron tables • Rugged cast iron base • Table depth adjustable 0" to 3/8" • Cast fence with single action cam lock • Pat. lift-off aluminum guard • Big, full size—22" long • Shp. wt. 25 lbs.

Order By Mail — Sold Direct From Factory to You

OUR 30TH YEAR SEND \$19.95 CHECK OR M.O.
SENT C.O.D. WITH \$3.00 DEPOSIT

(If not completely satisfied after ten days return for full refund.) Shipped express collect.

AMERICAN MACHINE & TOOL CO., INC.
ROYERSFORD 11, PENNSYLVANIA

you can always

BE SURE OF A JOB

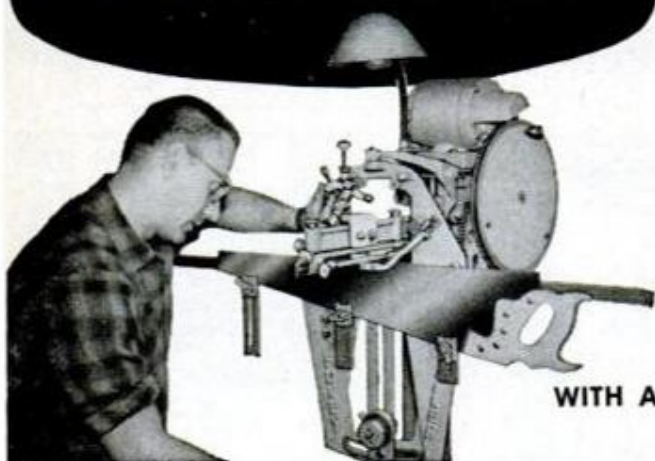

WITH A

FOLEY SAW FILER

Have you been laid off—or afraid you may be? If you want security, plus a bigger income too—don't look for a job—start your own spare time business. In his first 2 months J. P. Robitaille earned \$300 with his Foley Saw Filer. From his starting day R. T. Hart made \$600 in 4 months. Frank P. Layne wrote—"In our town of 2,800 instead of 200 to 300 saws I did over 1,500 the first year, averaging about \$1.50 each.

FREE booklet "MONEY MAKING FACTS" shows you how to get business. The new Foley "200" sharpens hand, band and both "combination" and crosscut circular saws. Use our Time Payment Plan—pay for the machine out of your CASH profits. Send coupon today—no obligation, and no salesman will call.

FOLEY MFG. CO., 243-0 Foley Bldg., Minneapolis 18, Minn.

Send Free Booklet and Time Payment Plan on Foley Saw Filer.

Name _____

Address _____

City _____

State _____



(Continued from page 90)

"Plastic" school	158
Giant blower seeds embankments.....	159
Antenna to catch signals bounced off satellites.....	164
Farm tractors drafted by army.....	164
Wire-mesh panels display paintings.....	164
Catamaran rig aids fishermen.....	170
T.V. records passing train.....	170
Tractor on screws slithers across mud flats (Ahlman Landmaschinen, Hildesheim, W. Germany).....	171
Transmitter in nightstick triggers alarm.....	171
Hair dryer for pampered pup (Beauty Equipment Mfg. Corp., 15 River St., Norwalk, Conn.).....	172

Photography

Electric motor in camera (L. M. Harvey and Co., 365 East Ave., Rochester 4, N. Y.).....	115
Gym steadies binoculars or camera (Gordon Enterprises, 5362 N. Cahuenga Blvd., North Hollywood, Calif.).....	134
This is a camera accessory (Minneapolis-Honeywell, Helland Div., 5200 E. Evans Ave., Denver, Colo.).....	161

Science

Surgical stapler	21
Noiseless air conditioner for nuclear subs.....	96
Underwater metal detector (Goldak Co. Inc., 1544 W. Glendale Blvd., Glendale 1, Calif.).....	102
Hot-air engine	104
Tiny radio fits on bar.....	114
Reactor may power space generator (U. S. Atomic Energy Commission, Washington 25, D. C.).....	120
Smudge pots help meteorologists (News Bureau, Lockheed, Georgia Div., Marietta, Ga.).....	134
Huge plastic balloon will become satellite.....	143
Spinning aluminum disks wind electric cable.....	144
Thin hi-fi speaker forms "sound wall" (Firma Max Braun, Frankfurt-Main, W. Germany).....	144
Valuable seeds stored in vault.....	156
85-foot radio-telescope will listen to sun.....	252
Stills use solar energy to convert sea water.....	260
Interchangeable type symbols snap into place (Remington Rand, 315 Fourth Ave., New York 10, N. Y.).....	264

Radio, T.V., Electronics

Personalized stereo fidelity.....	173
Selecting your speaker system.....	173

What's New for Your Home

Electronic chlorinator	154
Puff iron	154
Knife sharpener	154
Cutter server	154
Electronic air cleaner.....	154
Metal basket	155
Baby-food warmer	155
Hair dryer	155
Portable radio control.....	155

Craftsman and Shop Notes Index

Automotive

New lease on life for rubber suction cups.....	185
--	-----

Farm Shop Ideas

Reels in electric-fence wire with auto starting motor.....	188
Heavy anvil for repair jobs.....	208
Heavy oil cans for storage of bolts and nails.....	208
Rack for "filing" welding rods.....	208
Table saw	208
Avoid finger bruises from glancing hammer.....	208

House and Home

Tricky trinket chest.....	178
Hints on repair and care of masonry around the home.....	181
Fireplace set has aluminum handles.....	181

(Continued to page 94)

Two Easily Melted Elements Make High-Temperature Parts

Gallium and phosphorus—two chemical elements whose outstanding quality is that they melt at low temperatures—have been fused into a highly heat-resistant material which the Army Signal Corps says may be ideal for the electronic parts of missile nose cones. The nose cones are subject to blast-furnace temperatures when returning from outer space.

Resembling yellow ground glass, the material, gallium phosphide, will withstand temperatures up to 1500 degrees F. From it, the Signal Corps has built an electronic diode—a transistorlike version of the radio tube diode that detects radio signals—which has withstood temperatures seven times higher than silicon and germanium, previously used in electronic diodes.

"The material may also be used in building solar-cell power plants for space stations," says Brig. Gen. J. C. Monahan, Chief of the Corps' Research and Development Division. "As a rugged core of tiny electrical devices, it may be used in making electronic parts for missiles, satellites and space probes of the future."

Gallium, a rare silvery metal that costs about \$1500 a pound in pure form, will melt when held in the hand; phosphorus, used in matches, melts in summer sunlight.

Doses of Sulfate Counteract Strontium

Poisonous strontium in radioactive fallout from atomic bombs can be counteracted by doses of sulfates, if man responds as dogs do in experiments at Johns Hopkins Medical School. Research reported by Drs. Mackenzie Walser, John W. Payne and Ann A. Browder shows that sulfates cause animals injected with strontium to excrete 5 to 20 times as much radioactive strontium as they normally would. The sulfate infusions might be used therapeutically in the case of a laboratory accident or massive amounts of strontium in radioactive ash such as befell Japanese fishermen a few years ago, but they would not be useful in the gradual piling up of strontium in bones in normal fallout.

QUOTE:

"In my judgment the missile, because of the need for a dependable but still mobile base of operation, and the large space vehicle, because of its requirement for a powerful engine, and for a source of enduring power for transmission of data to earth, will find in the atom a solution for their now forbidding problems."

—JOHN A. McCONE, Chairman
Atomic Energy Commission

WOOD
PLIOBOND
CANVAS
SYNTHETIC RUBBER
"BONDS"
PLASTIC
GLASS
ANYTHING
LEATHER
COMPOSITION BOARD
TO
ANYTHING!
STAINLESS STEEL

EASY TO APPLY. PLIOBOND requires no mixing, brushes on, dries rapidly.

EXCELLENT ADHESION. PLIOBOND exhibits exceptional strength—up to 1600 lbs./sq. in. in shear tests.

EXTREMELY DURABLE. PLIOBOND resists age, heat, cold, water, chemicals, oils.

Pliobond
BY
GOOD YEAR

Pliobond—T. M. The Goodyear Tire & Rubber Company, Akron, Ohio

FEBRUARY 1960

93

FREE

it's value-packed...
SEND FOR IT!

ALLIED'S MONEY-SAVING 1960 ELECTRONIC SUPPLY CATALOG

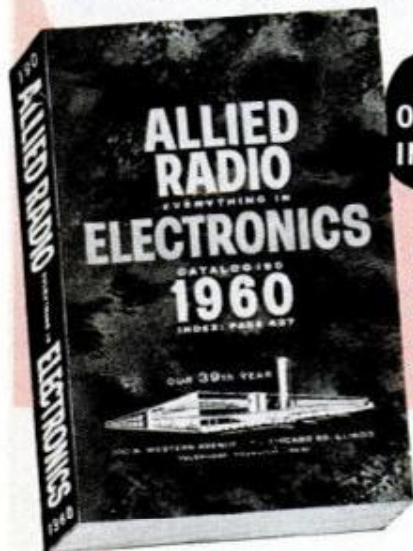

**SAVE
ON EVERYTHING
IN ELECTRONICS**

ONLY \$2 DOWN
on orders up to \$50;
only \$5 down on
orders up to \$200;
\$10 down over \$200.



Largest Selection—Lowest Prices

Send for the most widely used buying guide to everything in Electronics for Builders, Experimenters, Hi-Fi fans, Amateurs, Servicemen and Engineers. Save on:

- **KNIGHT-KITS®**—Best in Build-Your-Own
- Everything in Stereo Hi-Fi
- Hi-Fi Music Systems and Components
- Tape Recorders & Phono Equipment
- TV Tubes, Antennas, Accessories
- Parts, Tubes, Transistors
- Everything in Tools & Technical Books
- Amateur Station Equipment
- Public Address & Paging Systems
- Latest Test & Lab Instruments

SAVE on everything in Electronics at ALLIED—get fastest service, expert personal help, guaranteed satisfaction. Send today for your FREE 1960 ALLIED Catalog.

our 39th year



ALLIED RADIO CORP., Dept. 5-B
100 N. Western Ave., Chicago 80, Ill.

Rush FREE 1960 ALLIED Catalog.

Name _____

Address _____

City _____ Zone _____ State _____

SEND FOR
FREE
CATALOG



(Continued from page 92)

Floor and wax wisdom.....	185
Hats stored and protected in hanging closet shelf.....	188
Unit controls room lights for home-movie projection.....	189
Western book ends for den or library.....	192
Spray adjustment won't work when shower is blocked.....	203
Home plumbing repairs.....	204

Miscellaneous

Shut-off switch for power mower made from wooden block and cord.....	104
Photo speedlight charger powers battery toys.....	180
Belt-and-pocket hints for wandering pencils.....	188
Heavy asphalt building paper cut without grab on binding.....	188
Lightweight ice-fishing shelter.....	193

Photography

Knitting needle keeps tongs out of photo developer.....	104
Refinishing camera parts to original black finish.....	185
Copy-camera mount.....	215

Solving Home Problems

Sputtering of candles eliminated.....	190
Wooden knobs.....	190
Skeleton keys.....	190
Prevent floor mops from falling.....	190
Airing your clothes.....	190
Upright piano kept from sliding on floor.....	190
Cutting tile.....	190
Loose needles and pins easy to locate.....	191
Empty milk cartons make handy frozen-food containers.....	191

Shopping for Tools

Hand-operated shear.....	230
Spherical caster.....	230
Tree-tying machine.....	230
Electrically driven chain saw.....	230
Angle indicator.....	230
Locking pliers.....	231
Machine-tool clamping set.....	231
Composite plastic screw.....	231
Integral metal form.....	231
Hollow-ground blade.....	231
Sander-polisher.....	232
Stone-cutting saw.....	232
Pencil-type concrete vibrator.....	232
Magnifying viewer.....	232
Flame-cutting.....	232

Workshop Hints

Small parts storage cabinet.....	104
Clothespin used to start screws in hard-to-reach places.....	104
String helps mount heating coil.....	180
Storage jars hang on L-hooks.....	180
Socket-head screws driven with nail clipper.....	185
Oil burner chamber relined.....	187
Small stock clamped on holder can't spin when drilled.....	203
Use paste wax on rubbing job.....	209
Wooden block resets snap ring.....	209
Double-decker nail tray.....	209
Cutting accurate miters.....	214
Battery clip improves extension cord.....	214
Scoring with a sharp chisel makes clean cut in hardboard.....	214
Dowels held for end-drilling by improvised V-block.....	221
Dovetail joints.....	222
Restore chuck-jaw faces with cylindrical lap.....	224
Pre-cut disk-cement tube for convenient application.....	224
Drill reground for wood working.....	224
Extension on rip-fence guide table for cross cuts.....	224
Counterbalanced safety sticks.....	225
Increase capacity of your lathe with these chuck-jaw extensions.....	229

NOTICE—It is the intention of this magazine to provide its readers with information regarding the latest developments in the mechanical arts. Except where otherwise indicated, this magazine has no information as to any unexpired patents in respect of the developments reported herein. In the event that commercial use is to be made of any of the developments reported herein, it is suggested that legal counsel be consulted to avoid liability for patent infringement. It is not the purpose of this magazine to encourage patent infringement but, as indicated, it is the intention of this magazine to report on the latest developments in the mechanical arts.

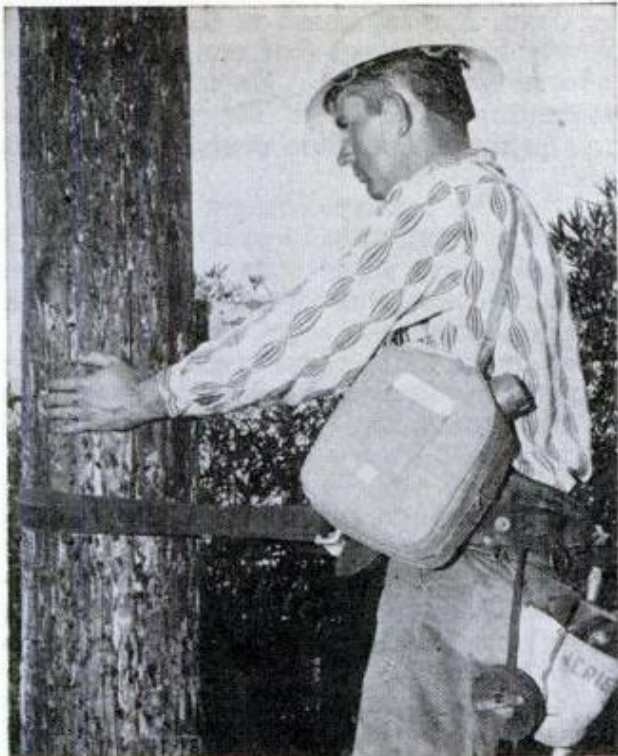

T. A. Ford Co., Inc., 320 S. San Marino Ave., San Gabriel, Calif.

Unbreakable Canteen

For the outdoor sportsman or worker, an unbreakable plastic canteen maintains the temperature of hot or cold liquids for six or more hours. The canteen holds a full gallon, and will not corrode or cause water to have taste or odor. A water-repellent fabric cover has a pocket for paper cups.

Will Man Create Life?

Man may be able to create living cells in a test tube within the next 1000 years, according to an authority on evolution, Dr. Hans Gaffron of the University of Chicago. He says the Darwin theory that living things evolved from less complex ancestors also supposes that there must have been a first primitive living cell or group of cells, and that laboratory experiments have indicated how lifeless compounds on earth evolved into those living cells. Dr. Gaffron estimates it took three billion years to make this change in nature and predicts that within 1000 years scientists may duplicate its four major stages in the laboratory. Those stages that occurred in nature were:

1. A layer of water vapor-methane-hydrogen-ammonia covering the earth provided for the accumulation of important organic compounds.

2. Oxygen began to replace hydrogen in the earth's atmosphere.

3. Organisms capable of living in an oxygenless atmosphere gave way to cells deriving their energy from visible light.

4. Green plants which produce oxygen became dominant.

Big Ones won't get away

WITH **FISH-SAVING**
LEVEL-WIND
AND **MICRO-DRAG**



"This one didn't", says Marinus DeJong. "My push-button outfit stopped him cold on Campbell lake in Michigan."



EASY CASTS—QUICK AS A FLASH
WITH PUSH-BUTTON MAGIC!

Just a push of the button, s-w-i-s-h of the rod—PRESTO—PUSH-BUTTON FISHING! Long, easy casts every time. Backlash impossible! Smooth, powerful level-wind retrieve—plus fish saver MICRO DRAG—brings the big ones under control—quickly. No. 1797 Beautiful bronze finish heavy-duty push-button WonderCast filled with approx. 100 yds. 12-lb. line \$24.95 (Other push-button reels from \$14.95)

DOUBLE-BILT® WONDEROD®



(1) A reinforcing glass fiber cylindrical wall inside (2) thousands of parallel glass fibers outside—it's this patented process that leaves the famous spiral markings—visible trademark of genuine Wonderod quality. No. 1579 Bronze and white push-button Wonderod 6' & 6' 6" L, XL or M action or 7' model.....\$17.95

FREE FISHING CATALOG—SEND TODAY!



All fishermen will enjoy this big new 32 page catalog, "Techniques and Tackle to Catch Big Fish." Newest in reels, rods and lines. Plus pocket fishing calendar showing best days to fish, all free!



SHAKESPEARE CO., Dept. PM-2, KALAMAZOO, MICH.
Please send me, absolutely free, your big new fishing catalog and 1960 pocket fishing calendar.

Name _____

Address _____

City _____ Zone _____ State _____

(Continued from page 84)

making an eye in the point of a needle. It was all wrong, unnatural and absurd. But it worked.

Ideas do not usually arrive ready-made and cut to fit. The mind must be alert and prepared to fasten upon the inspiration of the moment.

In the days when a woman was proud if she could sit on her combed-out hair, a husband sat watching his wife at work with a fresh packet of hairpins. His curiosity was aroused because she had to put a little kink into each prong before inserting the pin.

Idly he asked why.

"To keep the things from slipping out," he was told.

The husband immediately came up with the idea of a hairpin with kinks in it, and some time later he marketed a hairpin with three or four kinks in each prong. Result: a fortune, yet one could hardly say that he was an inventive genius.

There are three steps in obtaining ideas and making them profitable: observation, appreciation and commercialization. Observation is easy. We see inefficiency many times a day—paper clips that tear paper, buttons that have been sewn on a dozen times and still come off, mirrors that get covered with steam so that a man has to hold his breath while shaving.

It is in the matter of appreciation, of learning from our observation, that most of us come to a full stop. We seldom think about such matters long enough to understand the problem involved.

Edison once declared:

"You have only to state a problem accurately and you have, in general, stated the solution."

Let's take the safety pin as an example. This little item made a huge fortune for the man who put it on the market. The inventor was faced with the problem of finding a pin that was safe. To make a safe pin the point had to be covered in a sheath. Obviously, the sheath could not be a separate item, and it was essential that it maintain its position over the point.

So the inventor attached the sheath to the other end of the pin, and then bent that end around until it reached the point. One extra coil at the bend provided the necessary resilience to hold the sheath in place.

A first-class idea, if developed the right way, can prove more profitable than complicated invention. The farmer who invented barbed wire became a millionaire in no time at all.

An idea doesn't even need to be inventive in order to be salable. In the days before safety matches were invented, matchboxes had a strip of sandpaper fixed on either side

of them. A man, about to throw away an empty box, noticed that one striking side was as good as new. He made inquiries regarding the cost of sandpaper in the match trade, and then decided to sell his idea.

When he managed to get an interview with a top executive, he said his idea would save the firm some quarter of a million dollars a year. But he would sell it only if guaranteed \$15,000 a year for life.

It simply had not occurred to company experts to put sandpaper on only one side of each matchbox. The idea was adopted and the author received his salary.

The third step in making money from ideas is through commercialization. Here you must be wary. It is foolish to indulge in wildcat schemes that may involve financial loss. If you cannot afford to promote your own idea, then sell it outright on a royalty basis.

When you have an invention, procure a patent and avoid the grim experience of seeing somebody else reap a fortune from your idea. An invention patent gives the inventor the privilege, for a limited time, to exclude others from making, using or selling his article. However, he cannot have patent rights if his idea is merely an improvement on some unexpired patent.

Patents are not granted for methods of doing business or for claims contrary to natural law. Hundreds of applications have been received for a perpetual motion machine, but until a working model is presented that actually fulfills the claim, no patent will be issued.

But it is the inspiration that is of primary importance. Hundreds of ideas must have been lost for want of a few minutes' thought.

So the next time you hear somebody say, "Why on earth don't they think up a gadget...?" just turn the matter over in your own mind. There could be a fortune in it for you. ★ ★ ★

Noiseless Air Conditioner For Nuclear Subs

All new nuclear submarines will be equipped with noiseless air-conditioning equipment which uses liquid lithium bromide to absorb heat and cool the air. The atomic sub *Thresher*, now under construction, will be the first craft to have the new air conditioner. The unit, which has a 140-ton capacity, will be used along with conventional cooling equipment. A 170-ton-capacity unit will also be installed in the *Ethan Allen* class of fleet ballistic-missile atomic subs.



Things really jump when you start with a Delco Dry Charge battery. It's got reliable power plus stamina. You need both—for today's high compression cars, loaded with accessories, demand an awful lot from a battery. In fact, the electrical load has *tripled* in the past 10 years! That's why you're wise to replace with Delco DC-12, the battery that's designed for modern car requirements. More new cars come factory equipped with this power-packed Delco. It's a dry charge battery, too—your assurance of

100%
FRESH
STARTS



DELCO DC-12
 DRY CHARGE BATTERY

6- AND 12-VOLT MODELS Quality built by Delco-Remy, first in automotive electrical equipment

... distributed nationally through



No. 1 in POWER
No. 1 in PERFORMANCE
No. 1 in RELIABILITY
No. 1 in FUEL ECONOMY
No. 1 in ENGINEERING
No. 1 in STYLING
No. 1 in FEATURES
No. 1 in SAFETY
and No. 1 in SALES

MERCURY.

**Featuring the World's Most Powerful
Family Outboard...80 hp**

merc 800

See the 1960
Mercury line...
6 to 80 hp...at
this sign of
friendly service.



Write for Free catalog.
© 1960 KIEKHAEFER CORP.,
FOND DU LAC, WISCONSIN

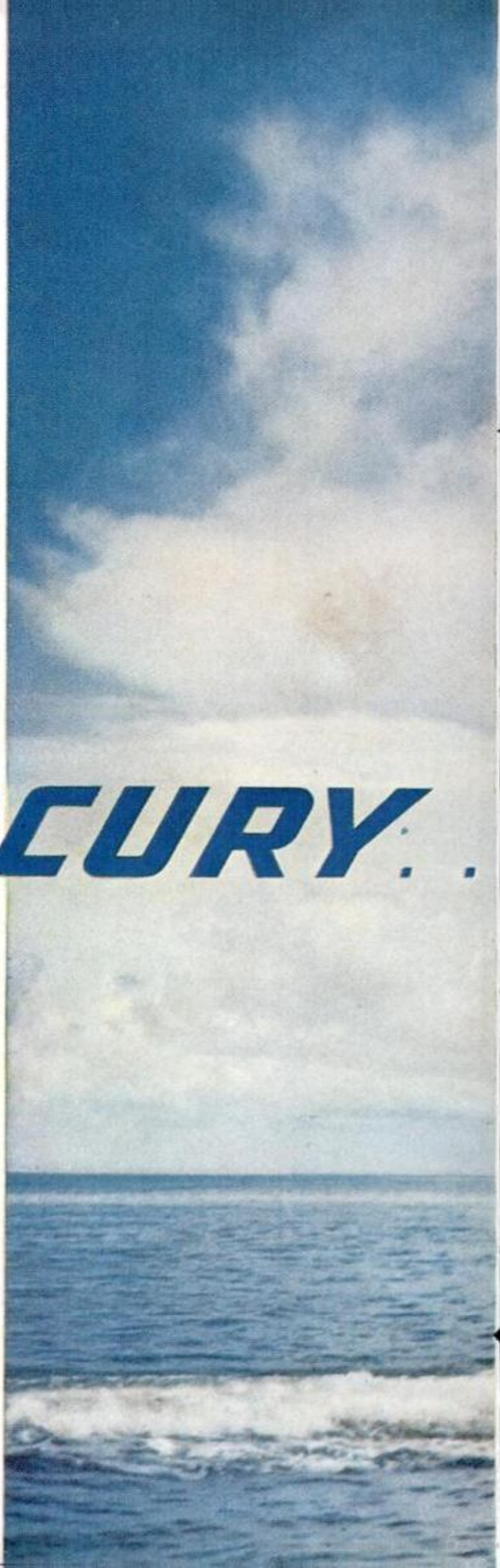

IS THE WORLD'S NO. 1 OUTBOARD!

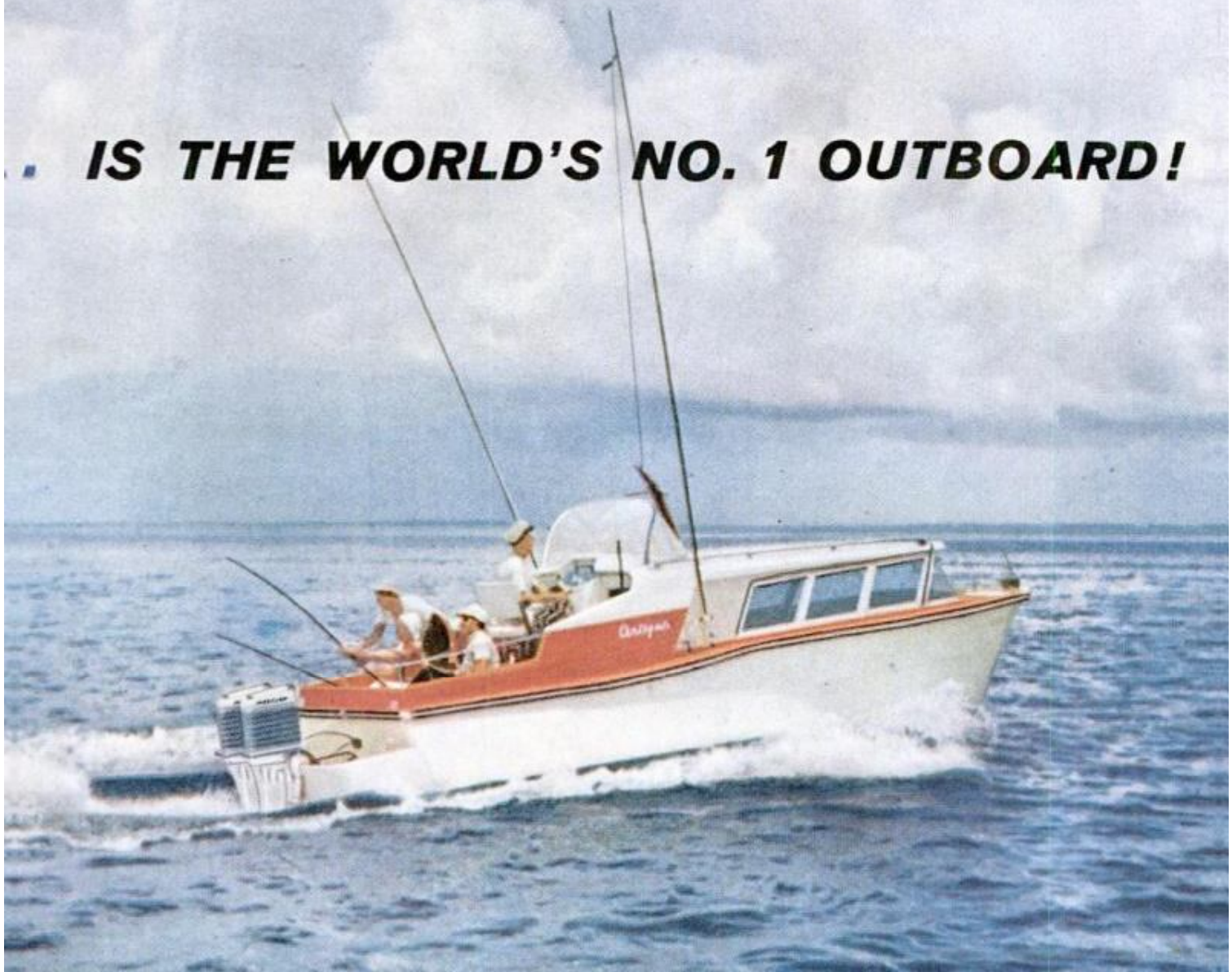

Get satisfying flavor...so friendly to your taste!

NO FLAT "FILTERED-OUT" FLAVOR!

NO DRY "SMOKED-OUT" TASTE!



Never too strong.
Never too weak.
Always just right!

You can light either end!

See how Pall Mall's famous length of fine, rich-tasting tobacco travels and gentles the smoke—makes it mild—but does not filter out that satisfying flavor!

HERE'S WHY SMOKE "TRAVELED" THROUGH FINE TOBACCO TASTES BEST



1 You get Pall Mall's famous length of the finest tobaccos money can buy.



2 Pall Mall's famous length travels and gentles the smoke naturally . . .



3 Travels it over, under, around and through Pall Mall's fine tobaccos . . . and makes it mild!

OUTSTANDING...and they are MILD!

© A. T. Co. Product of *The American Tobacco Company* — "Tobacco is our middle name"



If you smell smoke, don't throw open the door. Feel it. If it's hot, leave it closed and head for a window. If it's cool, open it a crack (bracing it with your body) and test the incoming air with your hand

POPULAR FEBRUARY 1960 MECHANICS

WRITTEN SO YOU CAN UNDERSTAND IT
VOL. 113 NO. 2

The information in this article may save your home — or your life.

What to Do Until The Firemen Come

By Paul W. Kearney

AT ABOUT 11 O'CLOCK one night last June, a man in California discovered a small fire burning in a closet of the bedroom where his five children were sleeping. While his wife routed the kids, he rushed outside for the garden hose. Pulling it through the window, he knocked down the blaze, put the children back to bed and closed the door.

Several hours later the house began to feel so warm that the father got up to investigate. Opening the door to the children's room, he was driven back by a blast of flame. He

Call the firemen as soon as a blaze is discovered —then try to put it out while they're on the way

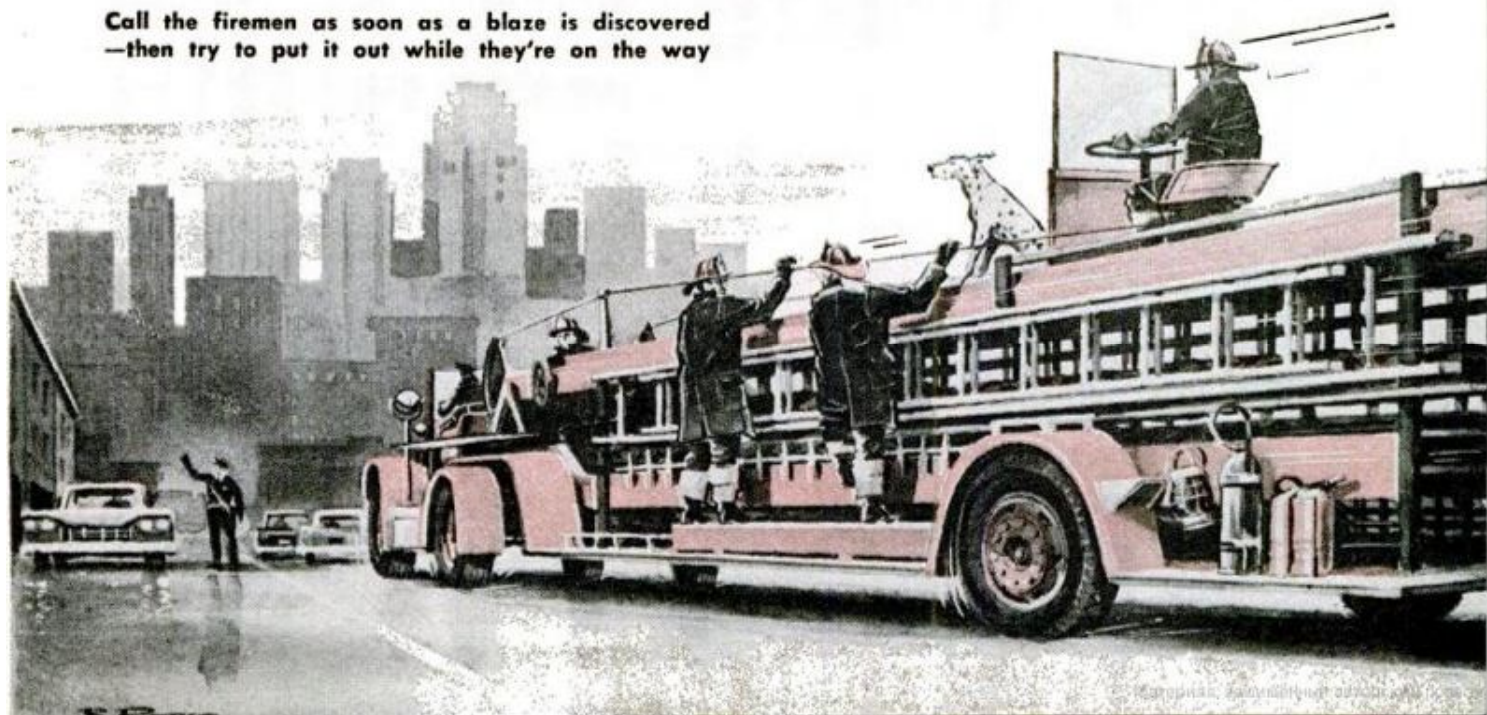



Many shapes and sizes of CO₂ extinguishers are available; carbon dioxide is good for fighting blazing fat and electrical fires

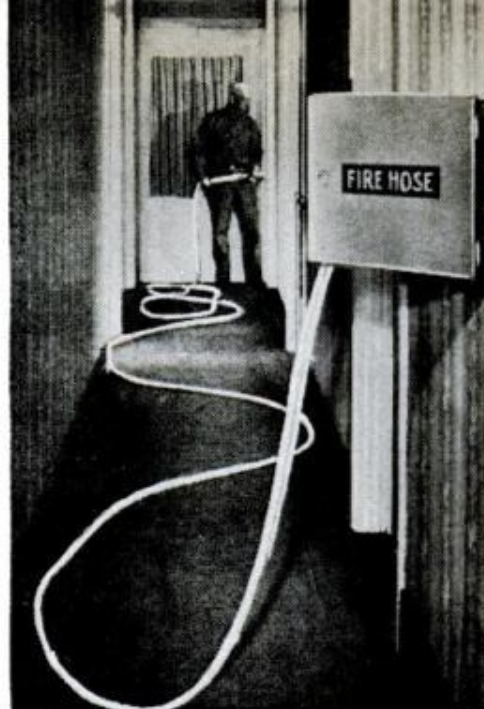

Homes with municipal water supply can be protected by a special fire-hose station

could neither enter the room nor get near the window on the outside. By the time firemen were summoned, all five children had been cremated in the ruins.

This tragic episode is an eloquent demonstration of an age-old fact familiar to trained firefighters: putting out a fire is only half the job; *keeping it out is the important second phase.* Under the trade name, "overhaul," this dreary chore takes more time and labor than extinguishing the flames in the first place.

While it is not the intent of this article to make firefighters out of civilians in one installment, some elementary advice about self defense for the householder seems

warranted by our morbid record of over 1500 dwelling fires a day in this country. The action of that California father was perfect so far as it went, but he lost five children and a home because it wasn't far enough.

His initial mistake was in failing to *call the fire department first* — or having his wife do it while he worked on the outbreak. This is the most universal error in "do-it-yourself" firefighting. No matter how much you know, you're a sucker not to call for reinforcements just in case you've bitten off more than you can chew. Firemen don't mind a dry run nearly as much as one where it's too late to do anything.

Wire-connected sensory and alarm panel in bedroom gives fire warning audible through house

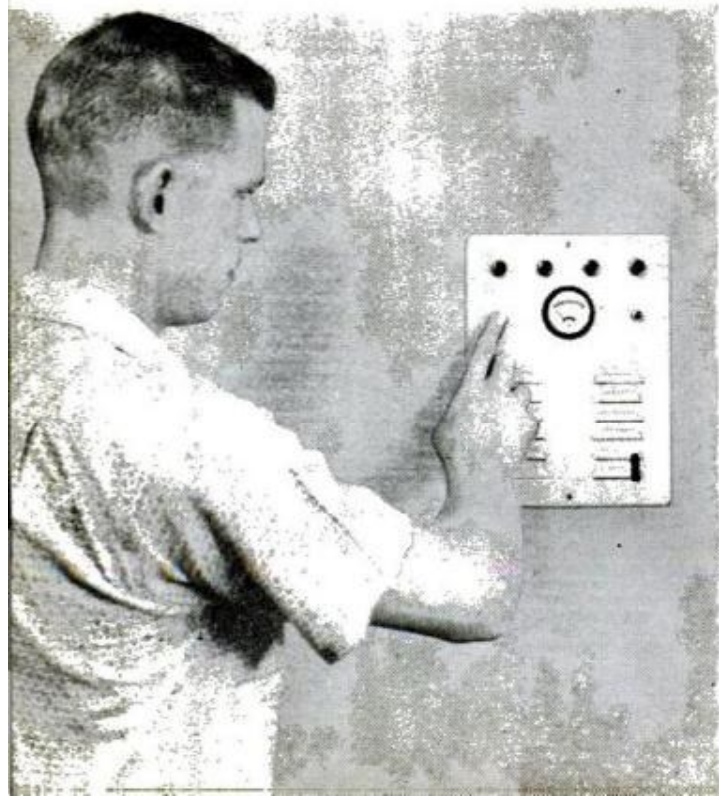

Installation of detector unit is done with screws. Wire leading to central panel (left) is stapled into place



The Californian's second mistake was in quitting too soon. True, he used the best "extinguisher" there is for that type of fire—a garden hose. Official manuals recommend water above everything else for this so-called Class A outbreak in ordinary combustibles—the typical dwelling fire. Usually in abundant supply, water cools the burning fuel—brings its temperature below the ignition point—and quenches the fuel by seeping below the surface if you give it a chance. This man didn't give it a chance.

By way of contrast, a New Jersey insurance man came down for an early Sunday breakfast to find the overstuffed divan in his living room smoking furiously. Evidently one of the previous night's cigarette butts had fallen on the upholstery and burrowed in. He knew that if he ripped open the upholstery, he would stimulate the fire by admitting more oxygen. Yet if he threw water on it, used the garden hose, or even resorted to a chemical extinguisher, he would not get the required *quenching* effect because most of the water or chemical would bounce off instead of penetrating the smoldering mass.

So he did a smart thing. Hustling outside for a water can, he *sprinkled* the water slowly over the smoking area so it could soak in. As the water penetrated, he opened up the cushion and kept sprinkling. When he felt that he had caught up with the fire, he threw the remains of the offending cushion out in the yard.

This last is exactly what the ill-fated father should have done. Everything in that closet should have been "overhauled"—pulled out and examined. Every charred piece should have been opened and doused, then heaved outside. There would have been no "rekindle," the sin of firemanship.

Insurance companies have always advised calling the firemen, period, rather than calling the firemen first. "Insurance can replace your house but not your life," is their irrefutable logic. Yet there are probably few insurance men who themselves won't tangle with an outbreak in their own homes if they think they have a chance to



Lives can be saved by a folding metal ladder and by an automatic heat-actuated extinguisher over a potential trouble spot

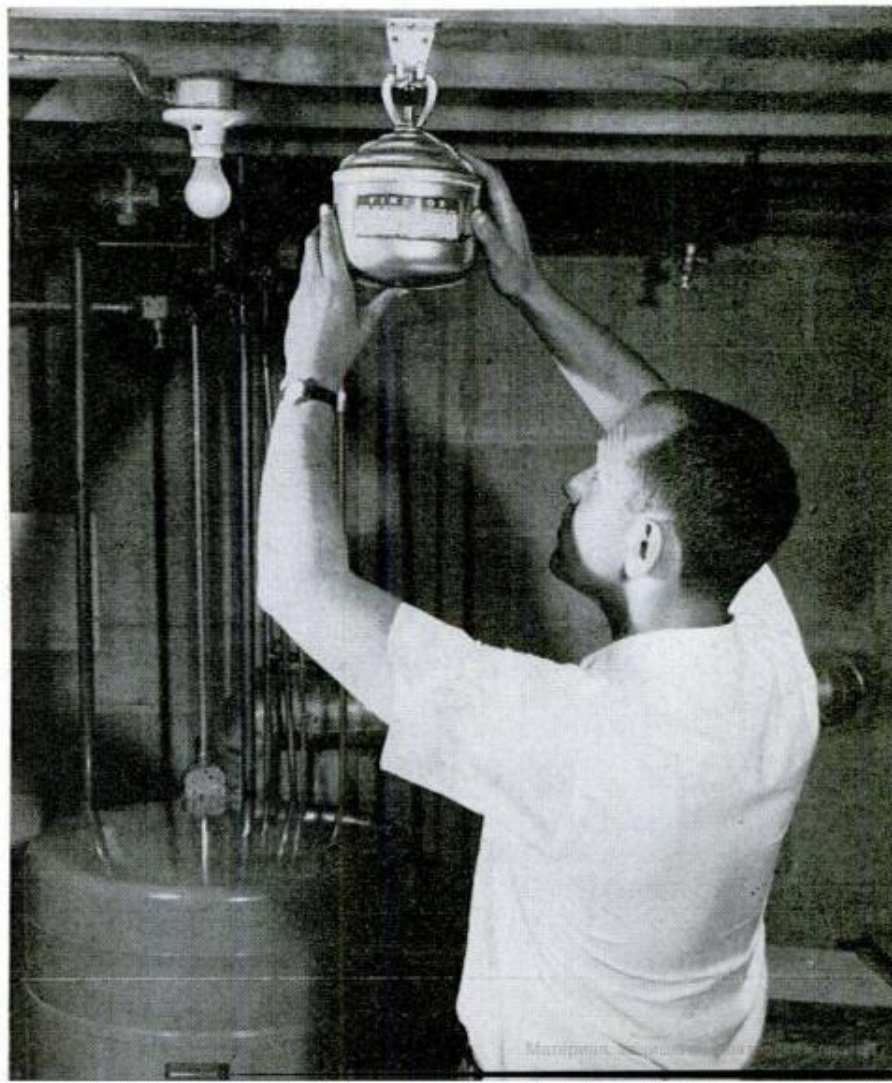



Individual pressurized horns can be mounted anywhere in the house. Heat sets off loud blast of horn

stop it. And since this is the most human reaction in the world, some basic facts can help minimize the calculated risk.

The first secret of safe and effective home fire fighting is *early discovery*. You can line your halls with hose and put an extinguisher under every pillow. But if you're going to snore blissfully while a young outbreak is taking possession of the premises, you and the firemen are both licked.

There are a dozen or more inexpensive automatic fire alarms on the market which may—or may not—be better than nothing. But at least three unit-type automatic detectors, bearing the coveted Underwriters' Laboratories label, give reasonable assurance that you won't be caught napping. Some require no electrical connections, but are actuated by Freon gas which blows a loud, shrill horn when the temperature of the surrounding air reaches a hostile level. For about \$100 you can have such an automatic watchman in your basement, upstairs hall, and attic—providing top-heavy odds that you'll discover your fire in ample time to do something effective without undue risk. Yet the sad fact is that the typical housewife would rather spend the money on a cedar-lined clothes closet to fight moths—which have never yet killed a child!

Given a reasonably prompt discovery, even a garden hose on a going blaze requires some technique. As indicated by

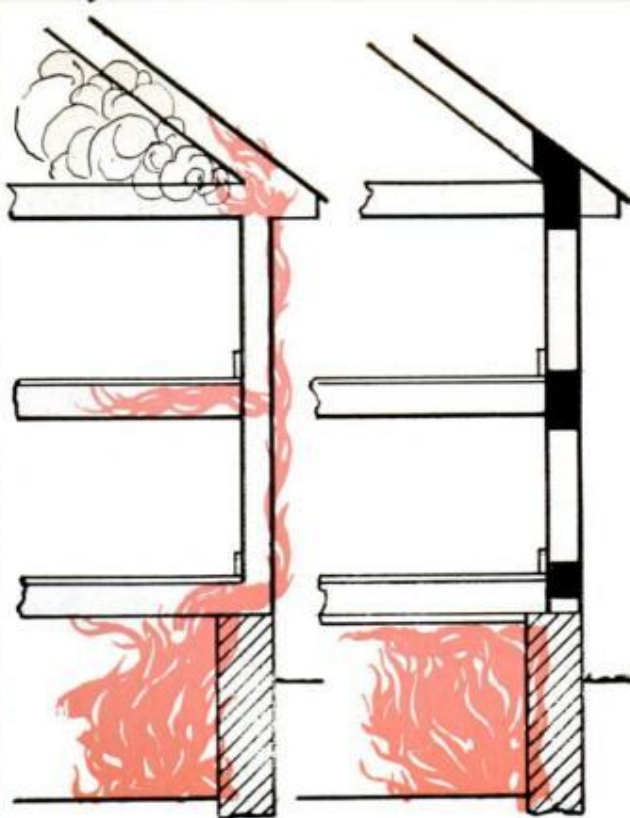

Noncombustible material (shaded blocks at right) prevents the spread of fire through hollow walls

the watering-can incident, it is important that the water soak into the fuel. In his effort to deliver the most water in the shortest time, the average householder usually adjusts the nozzle to give a straight, solid stream. But because of the force of this stream at close range, about 80 percent of the water splashes off the burning fuel and accomplishes nothing.

It is more effective to adjust the nozzle for a *coarse spray*, which will do two things to compensate for its shorter range: (1) It substantially reduces the run-off or splash, and (2) provides a "broken stream" of thousands of individual drops, exposing more water *surface* to the heat, hence, absorbing more heat.

This is a crude approximation of the advantages firemen obtain with fog nozzles—that sprinkler on a large scale. It kills more fire with less water.

Since most residential fires involve ordinary combustibles (even though many originate as grease or electrical fires), and since water is the best extinguishing agent for such Class A outbreaks, the smart householder will have enough hose and connections to reach any room in the house with a substantial stream of water. This means he should have an upstairs line and connection for an upstairs fire.

Two factors operate against this ideal. First, any given length of hose may be somewhere else when needed. Second, outside hose connections are shut off in the

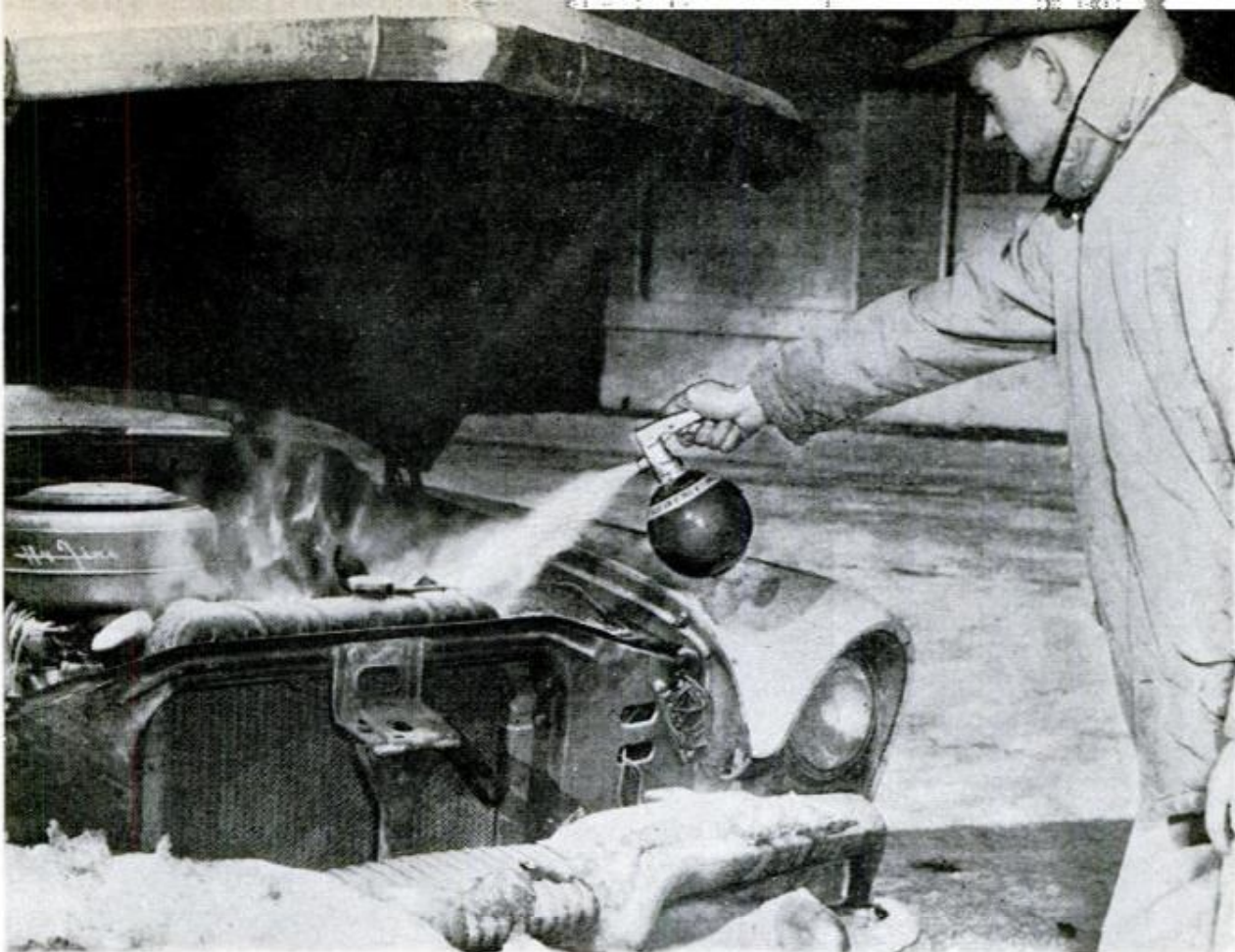

New dry chemical extinguishers resemble anything from shotguns to bombs. This one, for gasoline, grease, oil and electrical fires, resembles a globular bomb with a pistol grip and trigger. The shell is disposable

winter. Since storing garden hose inside is awkward, the perfect solution is a fire-hose station for homes. Such units, now on the market, use $\frac{3}{4}$ -inch linen hose, compactly stored in a steel wall cabinet and permanently attached to the regular house water supply. The fire line is equipped with a nondetachable nozzle which can be adjusted to the desired spray for close work, or to a solid stream for a longer range of 25 to 30 feet if necessary. Prices range from about \$35 for a 30-foot length to around \$52.50 for 75 feet.

While ideal for homes served by a municipal water supply, the country resident who pumps his own water should back up this protection with hand extinguishers. A fire of electrical origin may knock out the pump; wind or sleet storms often paralyze the public power supply. In either case, he is left with an unloaded gun.

Unfortunately, the choice of the "right" extinguisher for the home has been made complicated by the manufacturers of approved extinguishers who must cater to industrial needs—and far too simple by the high-pressure gyps with their

(Continued to page 278)

Pushing a button on this compact unit causes a dry chemical to be discharged onto a home blaze, attacking the fire with a smothering action. The gauge on the side indicates the amount of pressure and quantity of chemical in the container





Tire Has Replaceable Treads

Three separate tread bands that can be interchanged or replaced quickly without tools are featured on a revolutionary tire introduced by Pirelli of Milan, Italy. The treads fit over the tire casing, and as the tire is inflated, pressure secures them firmly. When one tread band is worn, it can either be interchanged to equalize wear or it can be replaced by a new band without the need of buying a new tire. Two types of bands, one for fine weather driving and the other for winter roads, can be alternated as the weather warrants. And the winter treads (above) can be supplemented with steel ice spikes, eliminating the need for chains. Each casing normally outlasts two sets of tread bands.



Adult View for Kiddies

It's no longer necessary for your child to become restless on trips because he can't see out of the front car window. A new portable seat brings the child up where he can see from both the front and rear seats. Weighing only four pounds, the seat is equipped with a safety belt and torsion bars to hold it in position. A cotton-backed vinyl cover makes it comfortable and easy to clean.



Underwater Metal Detector

Skin-diving prospectors or treasure hunters will find many uses for a new underwater metal detector developed by a California manufacturer. Fully transistorized, the detector locates iron, steel, brass, aluminum, copper, gold, and silver in fresh or salt water and through mud, sand, rock, concrete, wood, or other non-conductive materials. The detector can be carried ahead of the diver, who can swim, watch the dial, and make tuning adjustments without taking his hands from the grips. The clear-plastic disc is non-conductive and strong enough to stand rough handling or pressures down to a depth of 100 feet.

Asahi, Tokyo newspaper, is reproducing its daily edition 600 miles away by transmitting full pages on facsimile machines.

AN EYE ON SPACE

By Dr. Dan Q. Posin

PROFESSOR OF PHYSICS, DE PAUL UNIVERSITY
SCIENTIFIC CONSULTANT AND ADVISOR, COLUMBIA BROADCASTING SYSTEM

THE FLYING SAUCER stories refuse to stay down. Month after month, sightings are reported. And you may be sure that's the way it will always be.

Many people *have* seen hair-raising sights in the sky. I must admit that I am one of these. It happened at the university in Panama City, Panama. On a bright Earth-day at about 5 p.m., I stepped outside into the courtyard and suddenly noticed an object in the sky. It was round, silvery and silent. Then it was gone, lost on the horizon. I knew something about meteors and weather balloons. It did not seem to be either. This was more than 20 years ago, but the experience has stayed with me.

Are there flying saucers? The Earthlings wonder. "Have we been visited by beings from other worlds?" they ask. Could such mechanisms exist somewhere in the universe, swift, silent, streaming mechanisms, spanning great oceans of vacuum between planets, spanning vaster oceans of vacuum between solar systems, guided by intelligent beings, daring, wondrous?

Actually, I do believe such mechanisms and such beings may exist!

The concern with flying saucers got started on the planet Earth in June, 1947, when an airplane pilot reported seeing nine dazzling saucer-shaped objects buzzing around Mount Rainier. After that a rash of saucer reports broke out over the entire country.

Not all reports could be laughed off easily by skeptical Earthlings. On Aug. 25, 1951, three professors at the Texas Technological College saw several groups of lights dash silently across the sky. One evening in 1949 in Las Cruces, N. M., Clyde Tombaugh, the Earth-man who discovered the planet Pluto, saw a "strange" solid "ship" whip across the sky. It appeared oval and "seemed to trail off at the rear into a shapeless luminescence." The object glowed a blue-green, and about six "windows" were visible at the front as well as at the side.

As saucer reports multiplied, they grew less reliable. One man reported finding the wreckage of a flying object with dead midgets about. Another told of conversing with visitors from outer space. A third claimed to have films of saucers.

What *are* flying saucers? Opinions among Earthlings vary. Aime Michel, an amateur scientist, believes some are from outer space. Dr. Donald Menzel, eminent astronomer, believes that all "objects" seen are reflections of lights, balloons, missiles or atmospheric effects. The flying saucers, many Earthlings believe, are not all missiles, atmospheric disturbances or meteors. But some are merely meteors. "And these, of course, are really out of this world," the Earthlings say. "They may even bring some tiny visitors with them—spores, slumbering bacteria—but no little green men."

Can flying saucers even be built? Yes. In fact, they *are* being built right now by the little men of earth. To travel in outer space, they have made huge rockets, and are designing space ships, space sailboats and gigantic cosmic butterflies to flit between planets.

Have any *genuine* saucers come to us from outer space? The answer our foremost scientists give is: "Probably not. But they *can* come and they might come—any day!"

(Dr. Posin is author of a new Popular Mechanics Press book, *Out of This World*.)



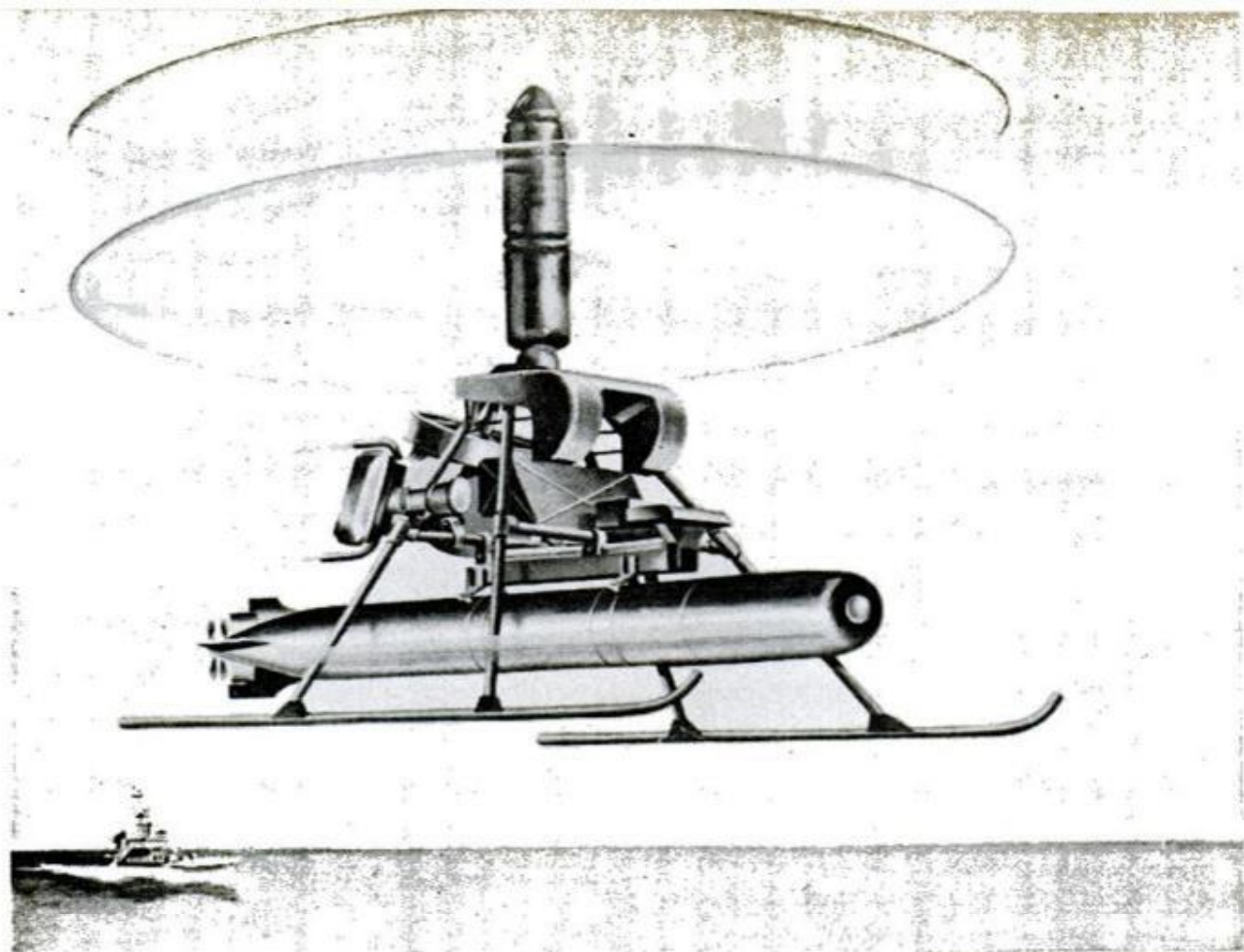

Gyrodyne Company of America, Inc.

Remotely-Controlled Helicopter Fires Torpedo

Whirring up from decks of U.S. Navy destroyers, remotely-controlled helicopters called DSN-1 Drones can dart off to lairs of enemy submarines and release torpedoes which automatically seek out and destroy

underwater targets. This combination of DSN-1 and destroyer forms the Navy's DASH (Destroyer Anti-Submarine Helicopter) weapon system. The helicopter's blades rotate in opposite directions.

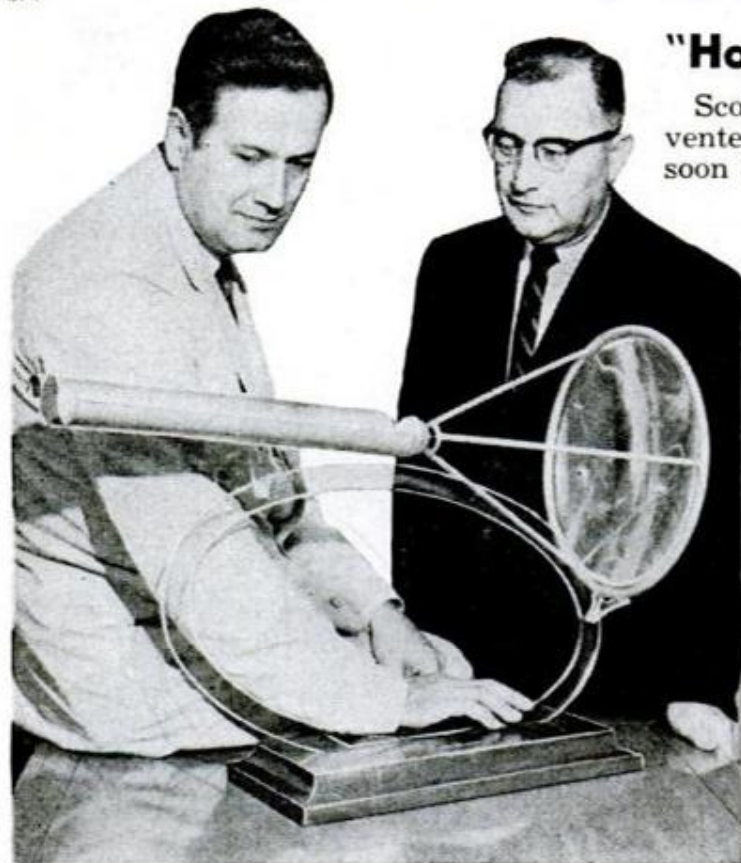

"Hot Air" Engine

Scottish clergyman Robert Stirling invented the air engine in 1816, but it was soon dropped as inefficient. Now, in the laboratories of Allison Division of General Motors, engineers have used the same principle to build a reliable power source for space research vehicles. The Stirling-cycle engine works by driving a piston with the expansion and contraction of a gas when heated and cooled. The mechanics are much like a steam engine, with the expanded gas shunted out of the cylinder after the power stroke, then cooled and returned to be used again. Heat from any source can be used, and the closed-cycle engine can work in airless space, so its uses in satellites are obvious. It should run for two years unattended. At left, Allison research men H. H. Dice and T. F. Nagey inspect scale model of satellite using the engine.

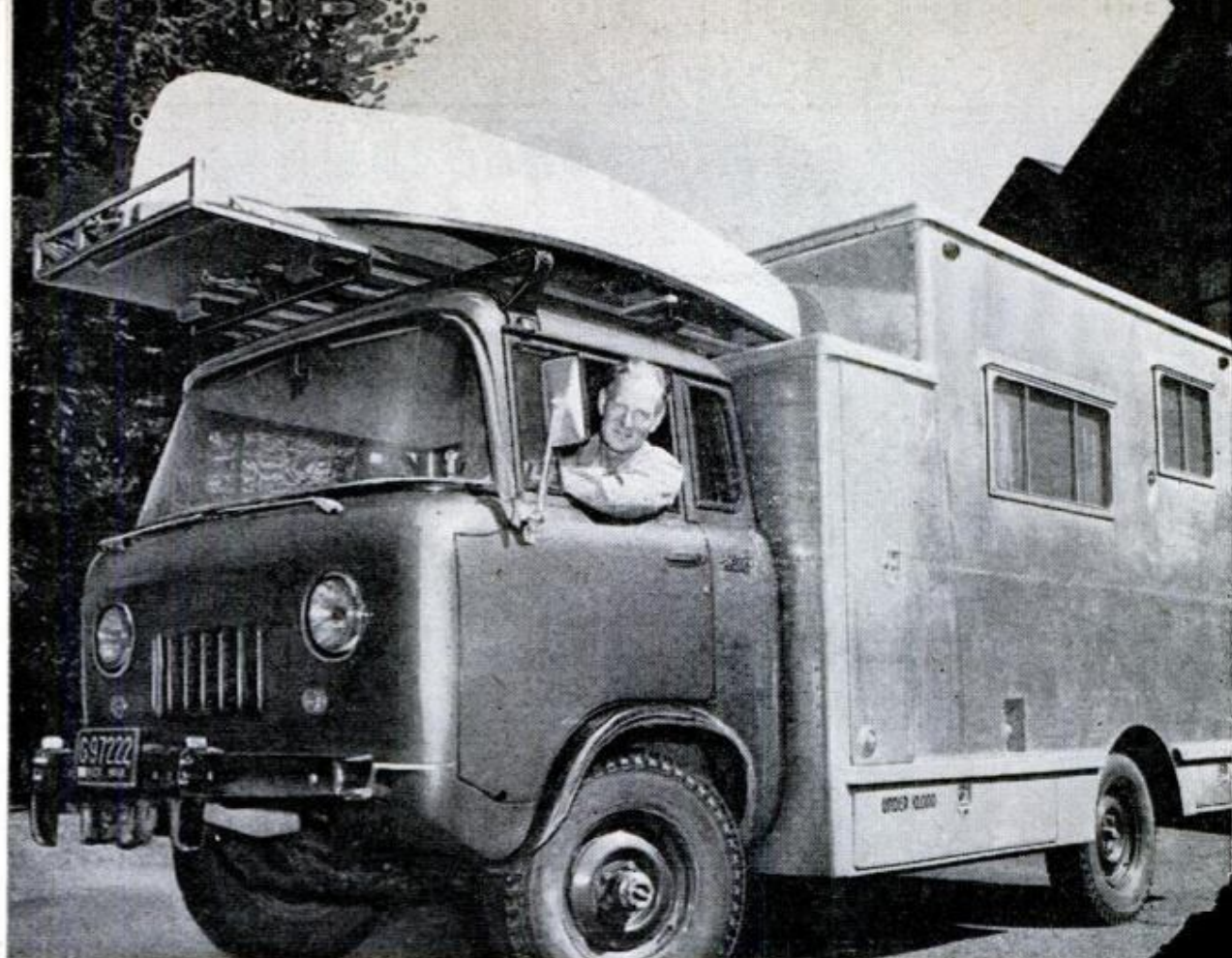

Camp Cruiser Built on Truck

Camping trailers and truck conversions didn't suit the needs of C. F. Johnson of Seattle, Wash., so he had an aluminum body built over a Willys Jeep four-wheel-drive truck chassis. The 18-foot rig has 11½ feet of living space with butane stove and refrigerator-freezer, a full galley, and laminated plastic surfaces throughout for easy maintenance. Tanks in front carry a supply of water and 50 gallons of gas, with a spigot to draw off gas for the outboard motor. The motor rides upright in its own compartment. Up front, there's a bed for an eight-foot boat with a winch for loading and a power winch for pulling out of mudholes. There's even a special built-in riding shelf for the dog.



Palmetto Polo

By
Max Hunn



Two players in New Smyrna Beach go for the town's own game—polo with a 12-inch rubber ball and king-
mallets. The game has grown from a local horsemen's pastime in 1953 to a nationally organized
sport. This 13-year-old youngster, practicing with the adults, will soon be ready for competition

ALTHOUGH the little town of New Smyrna Beach, Fla., is far more famous for beaches and tourists than for cowhands, it's the birthplace of the equestrian world's newest and most unusual sport—palmetto polo.

And in the short space of seven years, this unique game has spread from the little Atlantic coastal community to the ranges of Texas, New Mexico, Colorado and Oklahoma, to California and the Pacific Northwest, and even aroused interest of the sedate horsemen of England.

Starting as a strictly local sport, it's developed regional and national interest, and since 1953 annual national championship competitions have been held, first in the sport's Florida birthplace, later in Texas, where the American Association of Sheriffs' Posses and riding clubs eagerly adopted the game, and in 1959 in Colorado Springs, Colo.

To a first-time viewer, palmetto polo can be a confusing sport, but obviously one that demands top-flight horsemanship, and the players are experts or they don't last in this game. It's fun for both the contestants and the spectators, and each club always has its own routin' section, either

perched on the field's fence—corral style—or lounging in western saddles. It's a horseman's game, first, last and always.

Basically the game was developed to enable riding clubs to have team rather than individual competitions, and to provide sport for horsemen who aren't in the "polo string" financial category. And today, it's just that—poor man's polo.

Its kinship to society polo is scant. Any group of riders can play at a minimum expense. The essentials are a field 40 by 80 yards, an inflatable rubber ball, and some polo sticks—which originally were carved from the stems of palmetto fronds, giving the game its Florida name. Today, however, the polo sticks have gone from the happy-go-lucky palmetto frond to the manufactured stage, but the game's name hangs on.

Where in regular polo the players speed the length and breadth of the field, in the palmetto sport each is limited to his particular zone, placing the emphasis upon quick starting, dextrous pivoting and complete coordination between horse and rider. The game consists of four 15-minute chukkers, and it'll tire any horse and rider just as much as the regulation game.

The playing field is divided into five

zones—the middle one, 20 yards in depth, the others 15 yards deep. Not much room for long runs; a slow starter won't make the grade as a palmetto polo pony. The players must maneuver to hit the ball without riding or reaching over their respective boundary lines.

Each team has five players. Occupying the largest zone is the center. The middle forward plays in the first 15-yard zone adjoining the center zone, opposed by the defensive middle guard, and nearest the goal is the forward, opposed by the defensive goalie. Each player maneuvers offensively and defensively as the situation requires.

Unlike regular polo, player and mount are substituted as a unit, and no rider may have more than one mount unless his horse is injured. This enables the one-horse owner to compete on equal terms with a horseman with a string of ponies.

Thoroughbreds are rare in palmetto polo, although when properly trained they can perform as well as other horses. Most of the mounts are quarter horses, noted for their speed over short distances and

Early referees worked on foot, but the job proved both tiring and dangerous. Now they ride, with a pickup net to retrieve the ball without dismounting

Close action at a zone line—two riders chase the ball while a third waits across the line in his zone, ready to move in if the ball comes his way

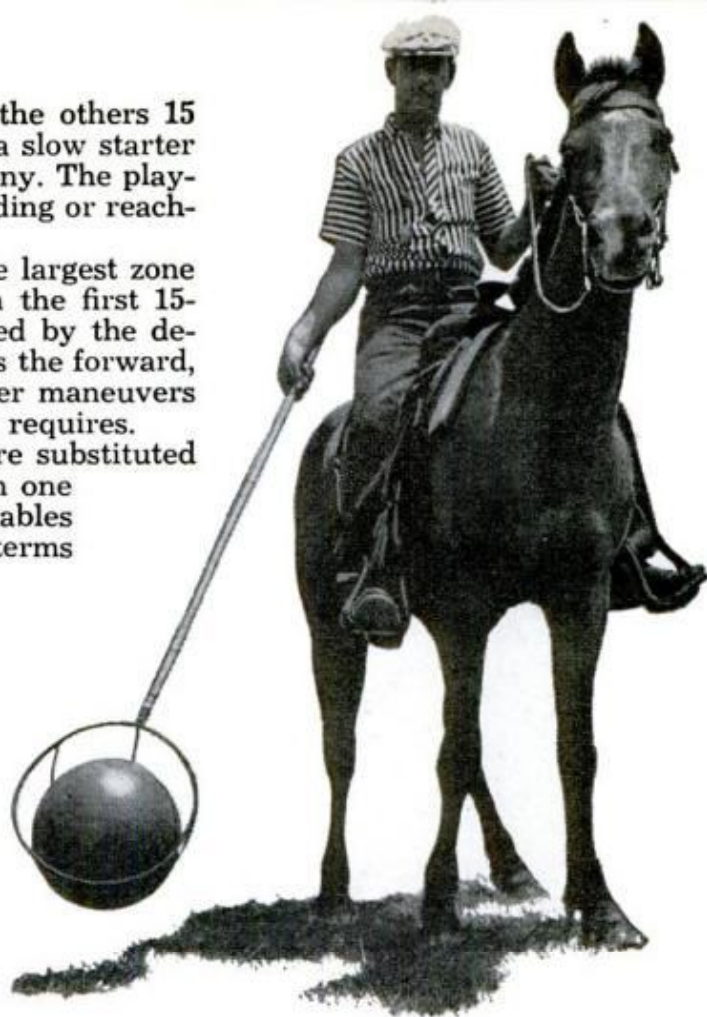



Game begins with a center charge as opposing centers race for the ball. Fast-starting horses pay off here

fast starting and stopping. This requirement makes the game suited to hard-riding cowboys whose horses wheel and pivot all day under normal working conditions.

The original field developed by the New

Smyrna Beach Riding Club was slightly smaller than today's, measuring 25 yards wide and 60 yards long. But as the sport grew, the playing field expanded to the

(Continued to page 262)

Jack Sapp demonstrates the old method of making palmetto polo sticks while Ed Eslinger watches. At right they compare the old and new sticks. Both are polo players and members of the New Smyrna Beach Riding Club

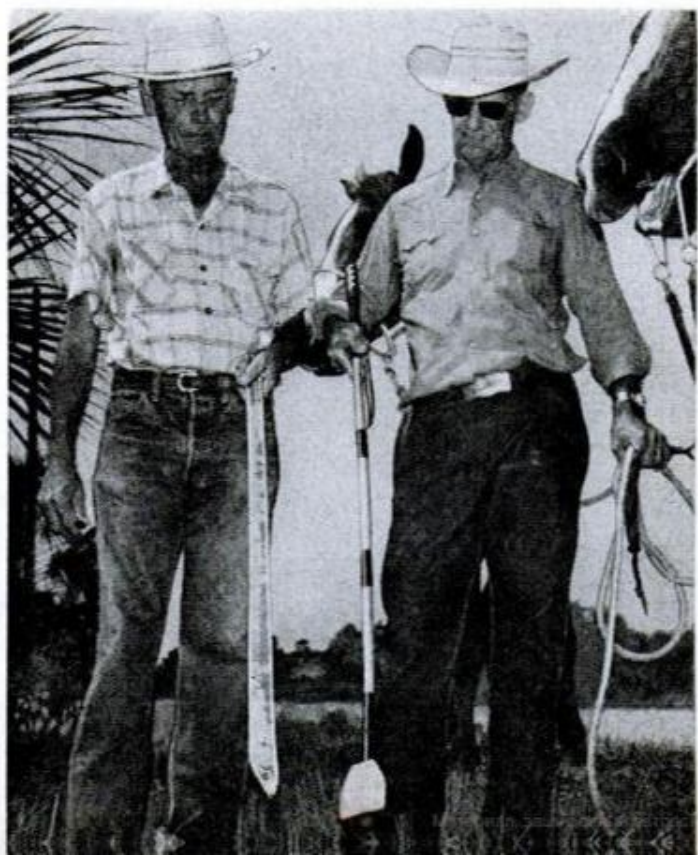

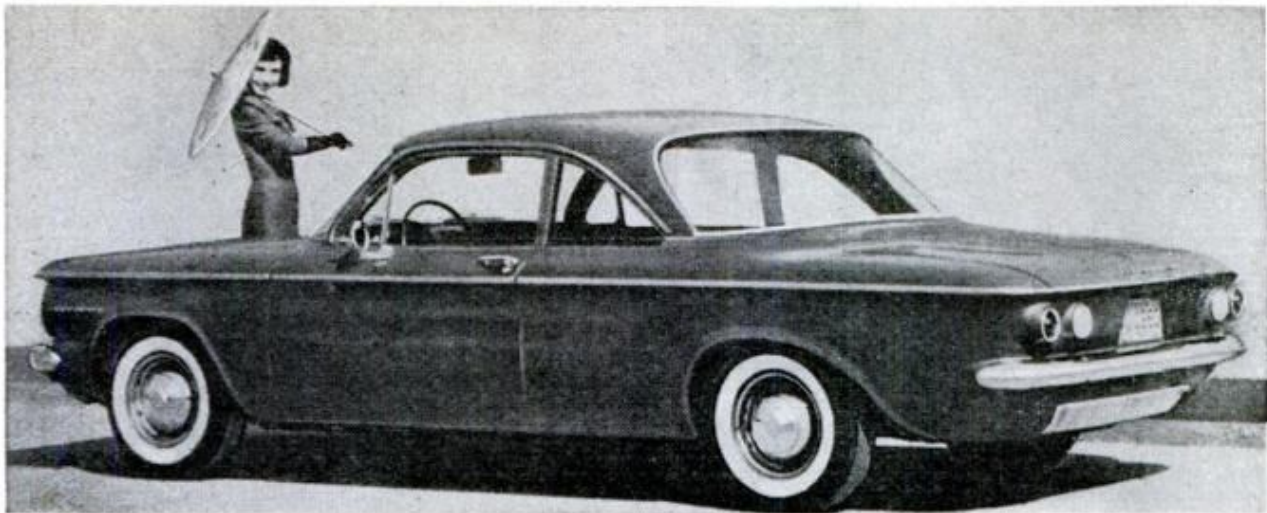

CORVAIR SPORT COUPE Corvair enters the two-door field with its Sport Coupe. To be introduced shortly, its list prices start at \$1984

Assembly Line Packs Herring

Thousands of herring an hour flow along the assembly line of cutting machines and canners aboard the *Lamut*, a packing ship built at Osaka, Japan for the Ship Import Corporation of the Soviet Union. The 4982-ton vessel is equipped with modern devices usually found only in shore-bound plants for the automatic processing of up to 120 tons of herring a day. One device shakes piles of herring from a table onto a conveyor belt in a neat row.

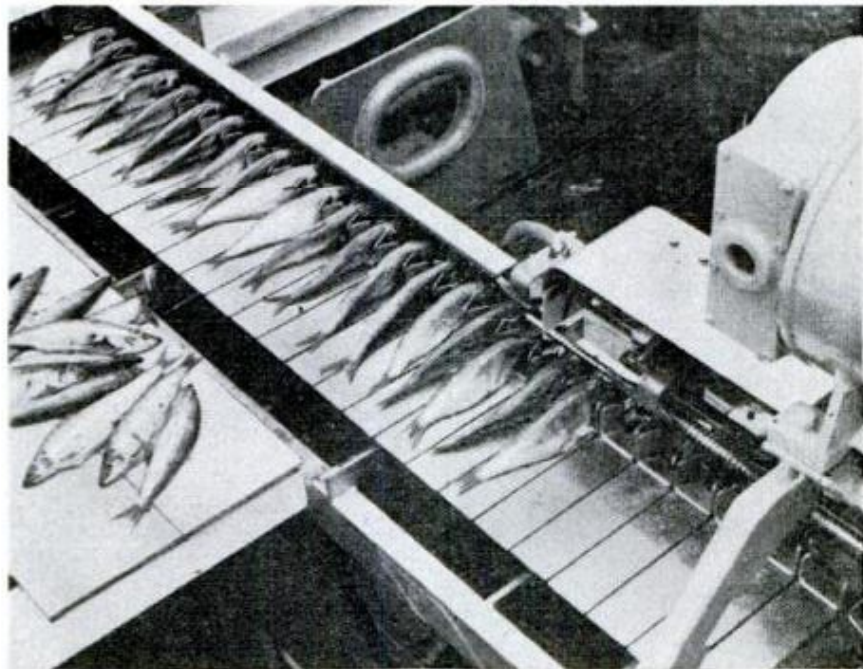

UPI Photo

Aluminum Pipe Welded Quickly

Aluminum pipe can be welded automatically while passing through a new machine designed and developed by Aluminum Company of America. The high-speed unit completes a weld on four-inch pipe in 11 seconds, and it can weld pipes with diameters up to 11 inches. To insure complete filling of welds, the torch can be set to move automatically back and forth across the joint, and it can be raised for servicing.

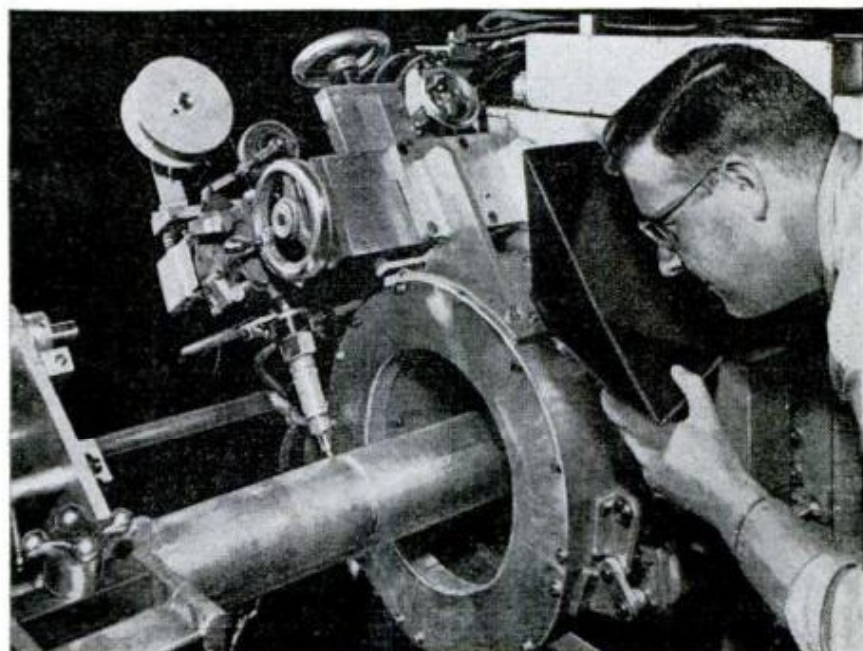



DETROIT LISTENING POST

By Art Railton

LIKE THE BIG-car feel? Detroit thinks you do and builds cars accordingly.

As a result, even the new small compacts feel bigger than they are. To the people who tell the engineers what kind of a car you want (the product planners), this is an important selling advantage.

These planners, the town scryers of Detroit, are convinced that to be successful a car must feel big—the bigger the better, in the good old American way.

Yet the revolution (the Big Turn that American Motors brags about) was started by small, nimble, frisky and certainly not-big-feeling imported cars. What made the public buy them? Certainly not any big-car feel.

It's more obvious daily that the new compacts don't compete with volume imports as much as with Rambler and Lark. Obviously, the Big Three chose not to fight the world champions in this round, but settled for the American champs. Maybe the next round will be for the world title?

As of now, however, it appears that the nimble, alert imports will continue to sell over here. Once titillated by the aliveness of a good small car, an owner may hesitate to go back to the more stodgy big-car feel that Detroit worships. (Not to mention, of course, the \$500 price differential and actual 30 miles to the gallon.)

Incidentally, the car to watch at American Motors is the American, not the bigger Ramblers. It is leading the industry into the 100-inch-wheelbase field. Right now, it is heavier and bulkier than it should be (after all it is about 10 years old) and its engine is less efficient than it should be (it's even older), but things will change—soon.

Reports are that the overhead-valve six may become available in the American early this spring. There may even be a new American body in 1961, certainly by 1962. Here is the car that AM will use to call the "Even Bigger Turn" into the small-car field.

Like the rooster that thought its crowing brought up the sun, AM seems to be thinking that it brought the small cars into the

world. There's no doubt, though, that AM is (and will continue to be) standing there crowing when the "sun" does come up.

The Big Three are all working on cars of under 100-inch wheelbases. Of course, none will admit it. It's the old "The public will never settle for anything less" routine.

Perhaps these upcoming smaller cars will be nimbler, more alert, more small-car-feeling than the present compacts. And surely more economical. But the product planners once again may get in the engineers' way and if so the little cars will feel and look big.

Before these small cars come out, however, there will be a rash of bigger compacts. Cars like the Comet, from Lincoln-Mercury, will be brought out to satisfy the dealers' demands. Actually, the Comet was rushed out earlier than planned as a result of tremendous dealer pressure for something to compete with the new compacts. Lincoln-Mercury dealers suddenly discovered that their Ford brothers had all the gravy: The Falcon, Ford and T-Bird.

Consequently, the Comet is expected to come out different from the original plan and different from what it may shortly become. Engineering time ran out. As a result it may share the same engine as the Falcon without the expected increase in displacement. Original plans were to lengthen the stroke by a half inch for more power, but that will have to wait a year now. More time is also required to get a three-speed automatic transmission ready for production, something both the Falcon and the Comet could use.

The industry is pleased with how quickly you have accepted the facts of life about compact cars. It knew that wasn't going to give you what you expected and it was worried. But you have apparently adjusted to reality fast. The myths are dispelled.

First, there was initial price. Somehow you expected the compacts to sell for about \$1500. It took a few weeks for the \$2000-and-up shock to wear off. Second, there was the size and comfort. You expected small cars and they were not so small. You expected bumpy, austere cars and they were comfortable, more luxurious than you anticipated (this was a pleasant surprise). Third, (this will take longer but you'll get used to it) you expected more miles per gallon than these compacts give. The hoped-for 30 miles per gallon over-all was a dream. These cars are not miracle-makers—they get only the same amount of work out of a gallon of gas as a bigger car. Being a little lighter, a little smaller, they go a little farther on a given amount of gas. But they won't go twice as far, or three times as far, as some people seem to have expected. Such are the facts of life.

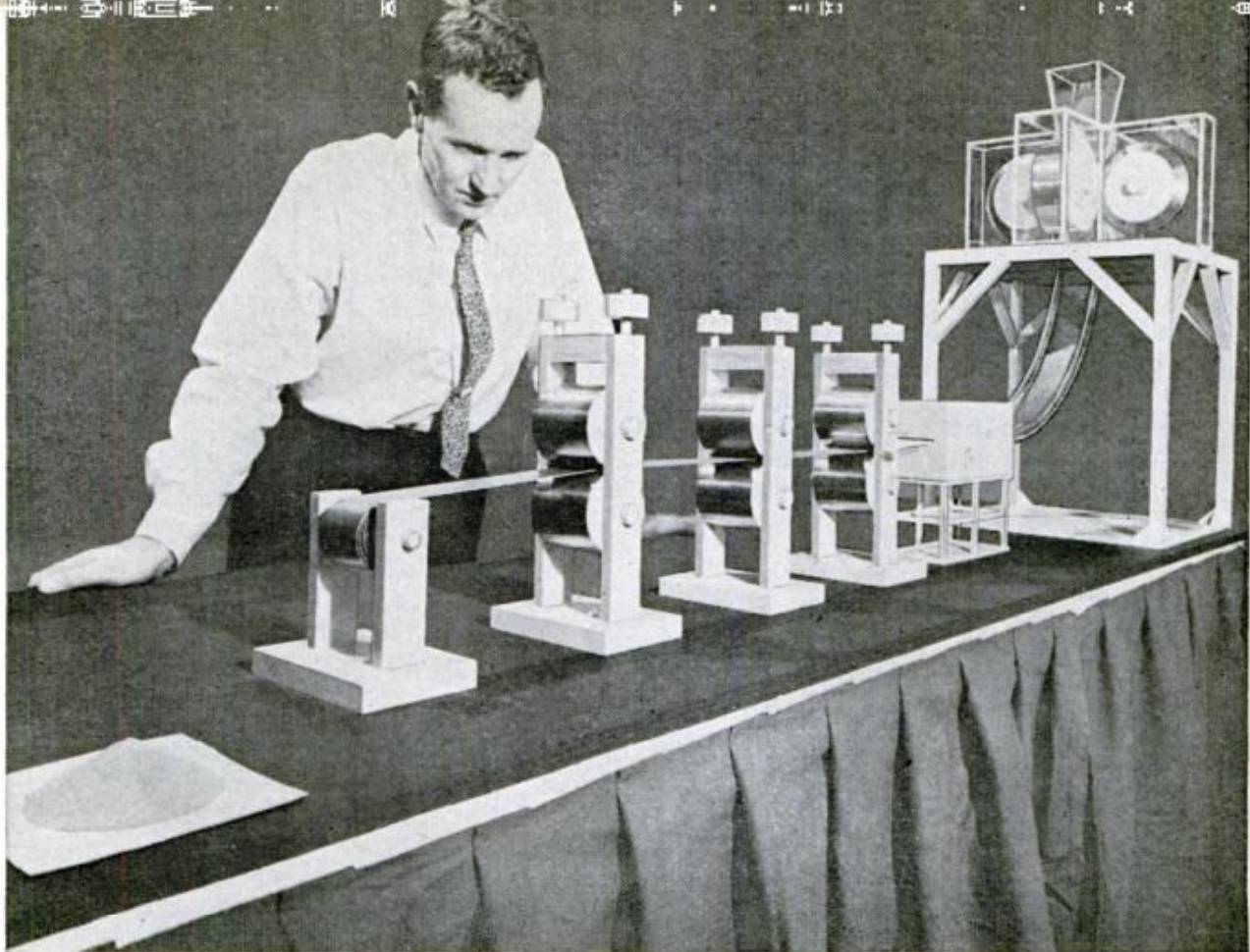

These are models of machines that turn iron powder into sheet steel at Republic Steel's Research Center

They're Rolling Steel From Powder

By Sheldon A. Mix

IN THE LONG history of steelmaking, blast furnaces have been as necessary to a steel mill as a desk is to an executive's office. Yet a process has now been developed that can make strip steel without the help of the 100-foot-high furnaces. It also bypasses other conventional steelmaking operations such as coke ovens, open hearths and blooming mills.

Developed in the research laboratories of Republic Steel Corporation, Independence, Ohio, the new process rolls out steel directly from powdered iron ore. While considerably more research needs to be done on the process, and Republic estimates that commercial production will not be realized for five or six years, the nation's steel industry is keenly interested in Republic's steel-from-powder experiment because it has already proved that it can produce a quality steel.

These are the steps in the new process: The iron ore is first put through a machine

which removes the impurities by magnetically drawing off the iron. Then a powerful ball mill grinds the ore into powder, which is cleaned with hot hydrogen. The purification of the powder is vitally important, because with as little as one-half of one percent impurities, the strip steel produced from the powder would tear or crack.

In the next step, the highly purified metallic iron powder is funneled between four rolls that press it into a semi-solid strip. The strip passes through a furnace, where it is heated at 2200 degrees F. so it can be rolled, then glides through a series of three hot-strip rolling stands, where it is squeezed between rollers. (Most existing hot-strip mills have 12 stands.) Each of the stands has two working rolls. The stands reduce the product to full density and the desired thickness. The strip is at 75 percent density when it enters the first stand.

The hot-rolled steel emerges from the final stand and is coiled. Then the steel is

pickled, cold-rolled and annealed in the conventional ways before being re-coiled or cut into sheets.

To test the steel made from the new process, Republic has made stampings of it in a die-forming machine — one of the severest tests possible. The result was that the new strip steel completely resisted tearing and cracking.

Now that Republic has solved the mechanical problem of rolling the iron ore powder into strip steel, the company is concentrating on long-range plans including a pilot-plant operation and an evaluation of the cost of making commercial quantities of steel by the new process. One

matter under consideration is the iron ore powder: It has to be abundant, pure and inexpensive. In price, it will have to compete with the ingot.

In simplifying steel production by making iron without melting, the new process would reduce labor and equipment costs. Republic estimates that a plant designed to house the direct-reduction process would cost only 40 to 50 percent as much as plants used today in the conventional melting process. Part of that saving might come from elimination of the familiar blast furnace, which costs about \$75,000,000 to build and uses enough bricks in its lining to erect 80 five-room brick houses. ★ ★ ★

OLD: HOT STRIP ROLLING MILL

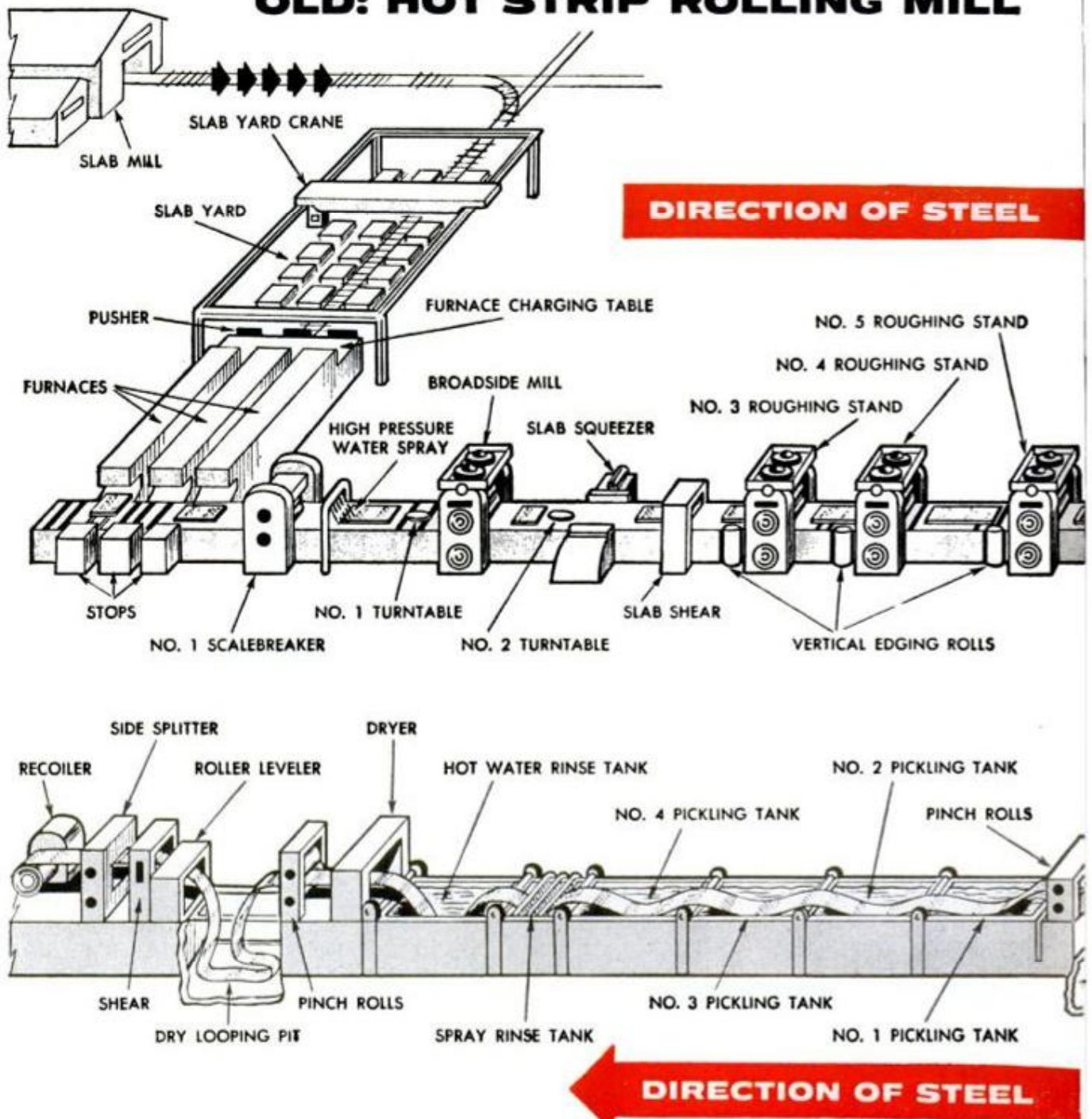

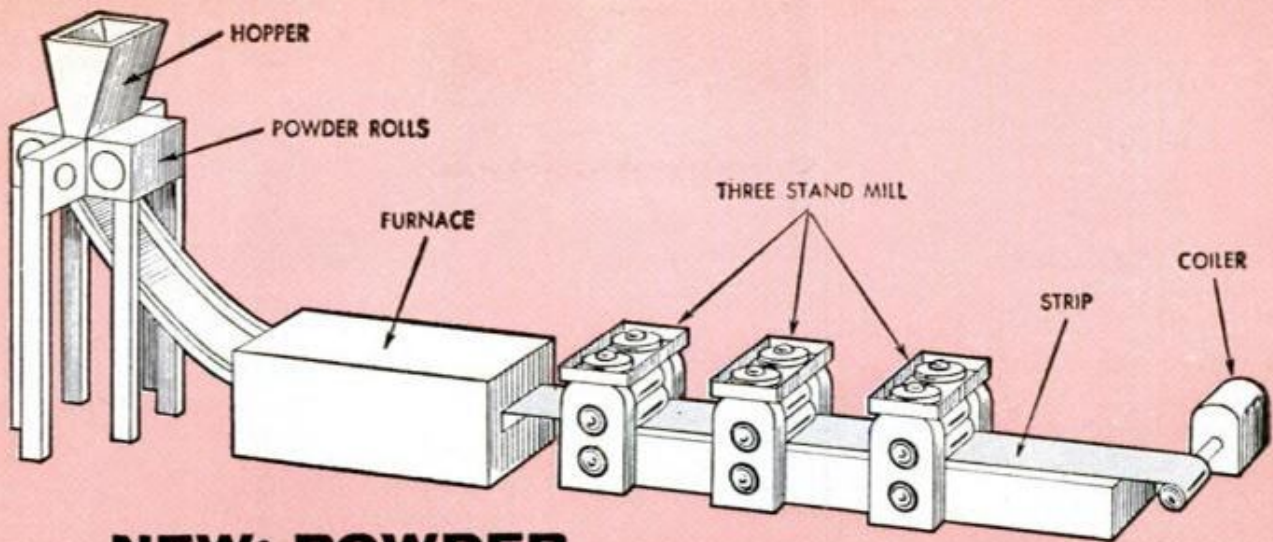

NEW: POWDER STRIP ROLLING MILL

TRAVEL THROUGH CONTINUOUS HOT MILL

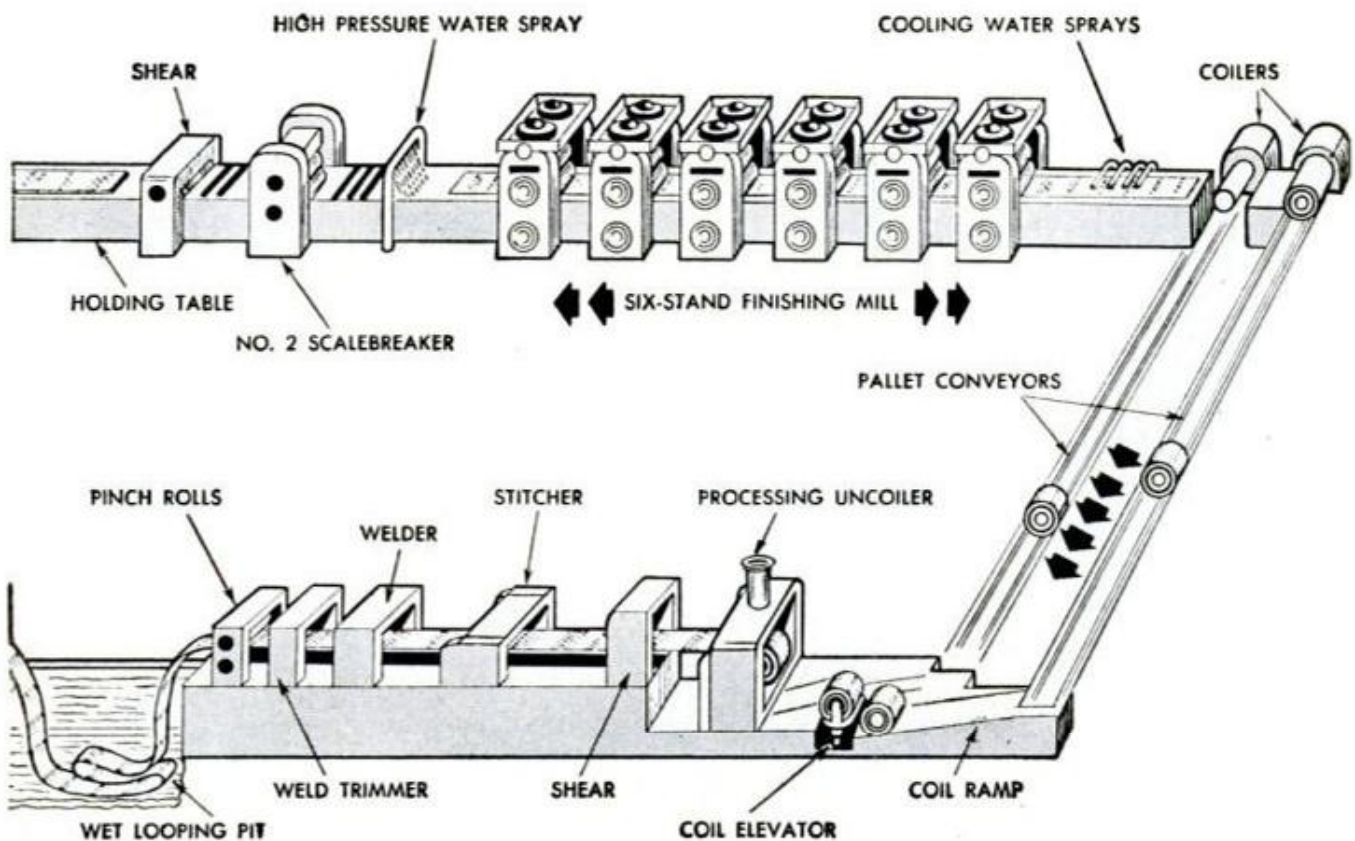

TRAVEL THROUGH PICKLER

FEBRUARY 1960



Army's Flying Platform Is Jeep of the Air

Combining characteristics of a Jeep and a helicopter, an "aerial platform" has been developed by Curtiss-Wright Corporation for the U. S. Army Transportation Research and Engineering Command. The vehicle is 17 feet long and 16 feet wide. Exhaust from the 425-horsepower gas-tur-

UPI photo



bine engine, which powers four two-bladed propellers, is directed backward to give a large part of the thrust required to propel the vehicle. The platform's small size, low silhouette and flat cargo deck may make it suitable for transport and reconnaissance, and for use as a transporter and ground-firing platform for a recoilless rifle, rockets or other weapons. The power plant requires no warmup, making immediate takeoff possible. The pilot controls direction of flight by simply moving a conventional pilot's stick, a collective pitch lever and foot pedals. Although actual speed of the VTOL aerial platform is restricted information, it has been demonstrated at 20 miles per hour and is expected to go considerably faster.

Tiny Radio Fits on Ear

Wearing a tiny transistron radio on her ear, this pretty resident of Frankfurt, Germany, tunes in on a local radio program. She's holding another miniature receiver in her hand. Powered by a tiny battery that keeps it running for 150 hours, the "ear" radio can pick up stations within 15 miles without an antenna. The radio can be converted to other frequencies and could be utilized by patrolling policemen to pick up police broadcasts.

☐ Lichen plants can survive either in the steaming tropics or on Antarctic mountains where they are frozen nearly all year.



Trailer Train Dumps to Either Side While Moving

Dumping to either side, a giant trailer train, made up of a truck and one or more trailers, dumps clear of the roadway in 30 seconds while it keeps moving. Multiple trailers with 15 and 25-ton capacities for highway and off-highway use can double and triple the normal load hauled. The number of trailers is limited only by the steepness of the grade. From inside his cab, the driver can tilt each trailer to a 55-degree dumping angle to clear sticky loads. Developed by Differential Company, the highway trains are powered by 256-horsepower V8 gas engines. The larger off-highway trains are powered by diesel engines of 300 and 385 horsepower.

Electric Motor in Camera

No larger than a nickel, a battery-powered electric motor winds film, cocks the shutter and allows sequence or single exposures on a new 35-mm. camera made by Graflex, Inc. The camera features complete interchangeability of bayonet-mounted lenses. Billed as the first self-contained electric-motor-driven camera, it is the same size as a regular 35. The motor is in the film takeup spool.

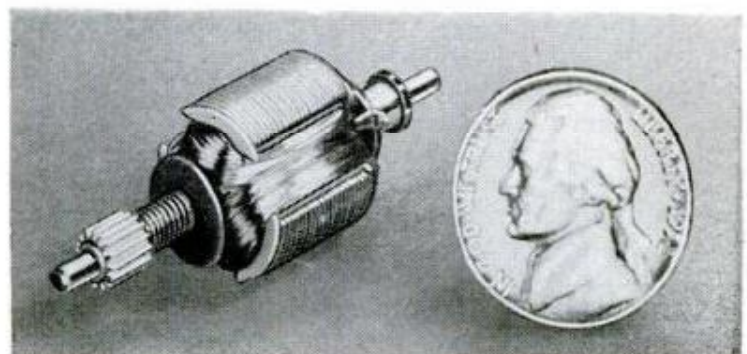

IN MID-NOVEMBER, two scientists sank 18,600 feet into the Pacific near Guam to peer into a never-before-seen world of perpetual darkness where strange creatures exist in an "atmosphere" that presses with a force of more than four tons on every square inch.

Their descent into the ocean was far deeper than man had ever gone before—and by the time you read this, they may have set another world record of almost twice the depth of that November mark.

The scientists are Dr. Andreas B. Rechnitzer, Navy Electronics Laboratory oceanographer, and Jacques Piccard, who helped his famed father, Auguste, develop the craft in which the record was made.

The vessel that carried the explorers under water is an awkward blimplike craft, the bathyscaph, *Trieste*. And, despite the world-record performance, the *Trieste* is only beginning its work, for there are many more journeys planned into "inner space" as oceanographers seek to learn about the deep sea. The scientists will also test equipment and lay the groundwork for more specialized or advanced types of deep-submergent craft.

The bathyscaph is one of only two of its kind in the world—both built by famed Swiss physicist Auguste Piccard. The craft was delivered to the U. S. Navy Electronics Laboratory in 1958. It made a number of preliminary dives and was partly rebuilt before the descent to 18,600 feet.

Among the gains to be made by prowling around where pressures are measured by tons rather than by pounds is further contribution to the vast knowledge about deep scattering layers and thermoclines which frequently are used by submarines to avoid detection by surface craft. Scientists, too, can see for themselves the fantastic creatures of hitherto inaccessible depths and examine visually the geology of the bottom.

This craft that can carry human cargo miles below the ocean's surface is, in reality, an undersea analogue of another of Professor Piccard's inventions—the early stratospheric balloon. The bathyscaph operates free of any surface connections, just as the balloon does. A float full of gasoline provides buoyancy, and disposable ballast gives control of ascent and descent. The scientists ride below the float in a gondola—a 14-ton ball of steel that protects them from the crushing water outside. It is capable of withstanding the greatest pressures to be encountered in the sea with an adequate safety factor.

The main structure of the bathyscaph is a partitioned steel float, approximately 60 feet long and 11 feet wide. The float holds 26,000 gallons of gasoline in its 11 compart-

EXPLORING THE OCEAN'S GREATEST DEEPS

One of gondola's two "windows"—each a truncated cone that allows 90-degree visibility from inside—appears here. The bin is one of two magnetically operated tanks which hold the iron pellet ballast

U. S. Navy photos

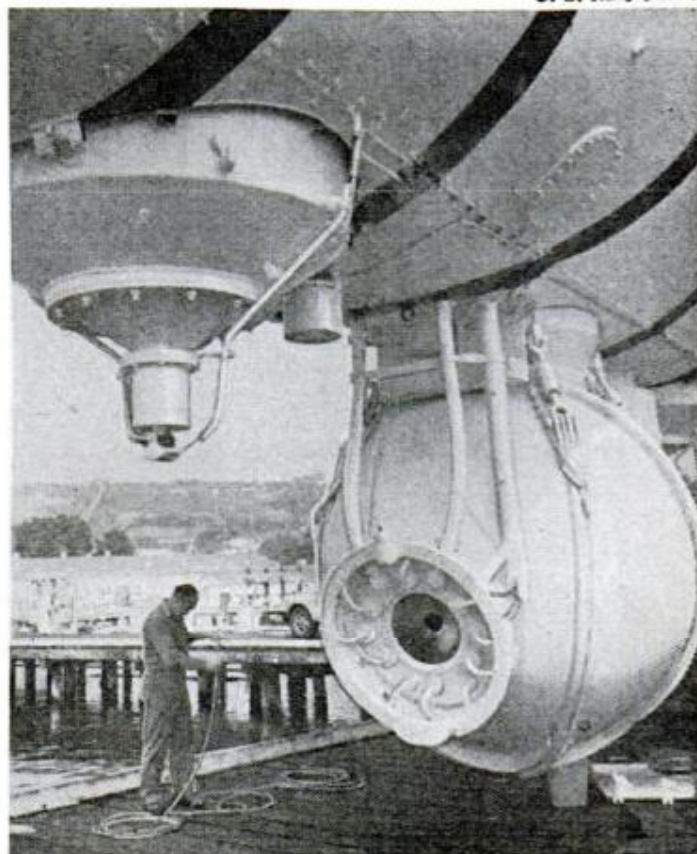

POPULAR MECHANICS

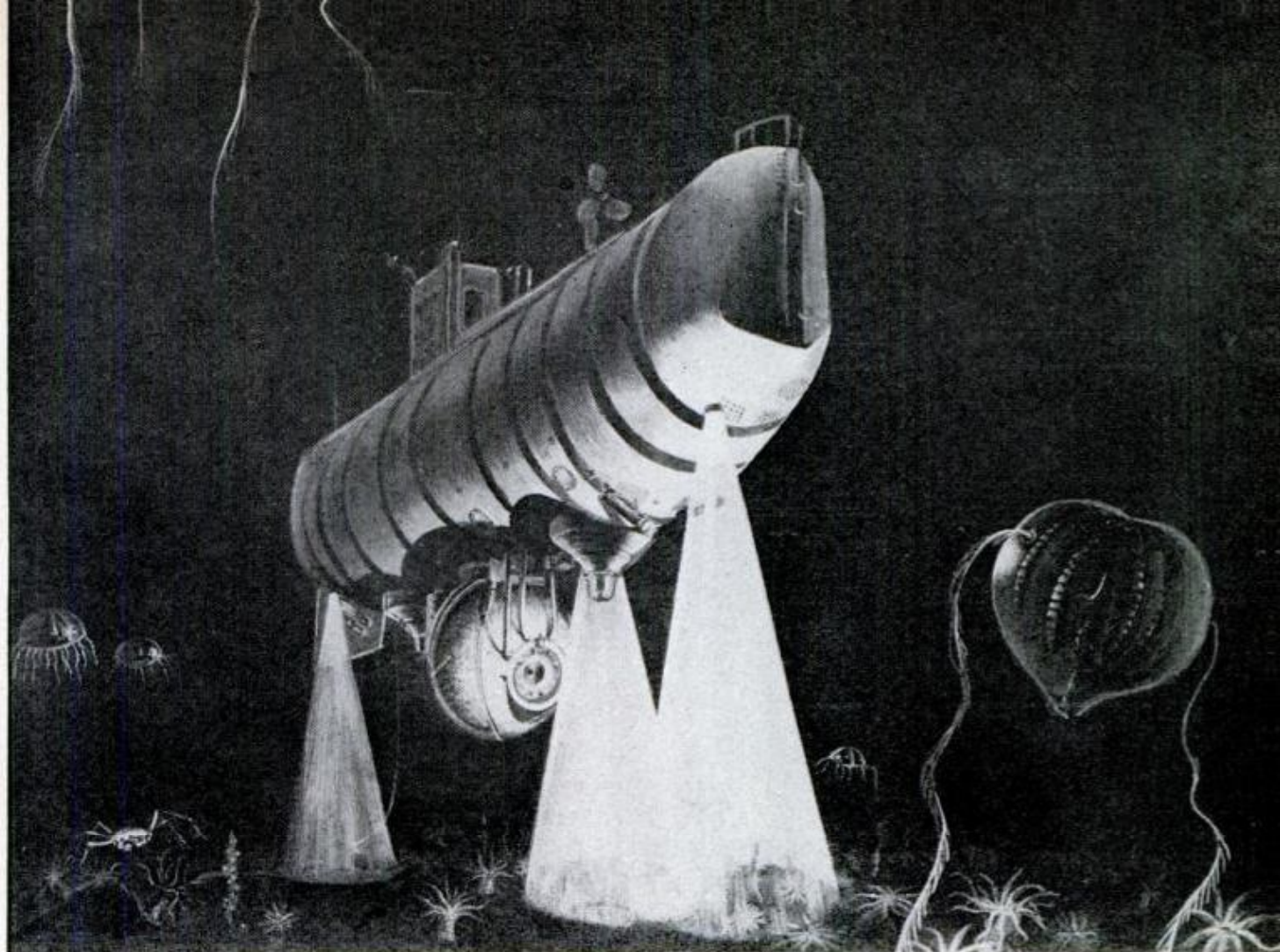

U. S. Navy Electronics Laboratory drawing

Probing with powerful lamps in the inky blackness thousands of feet below the surface, the bathyscaphe can roam about a mile horizontally. Its two passengers ride in the gondola suspended below the hull, entering it through a tube that leads down from the structure topside labeled "Trieste." The hull, when lifted from the water, clearly shows the stripes that define the 11 gasoline-filled flotation compartments inside

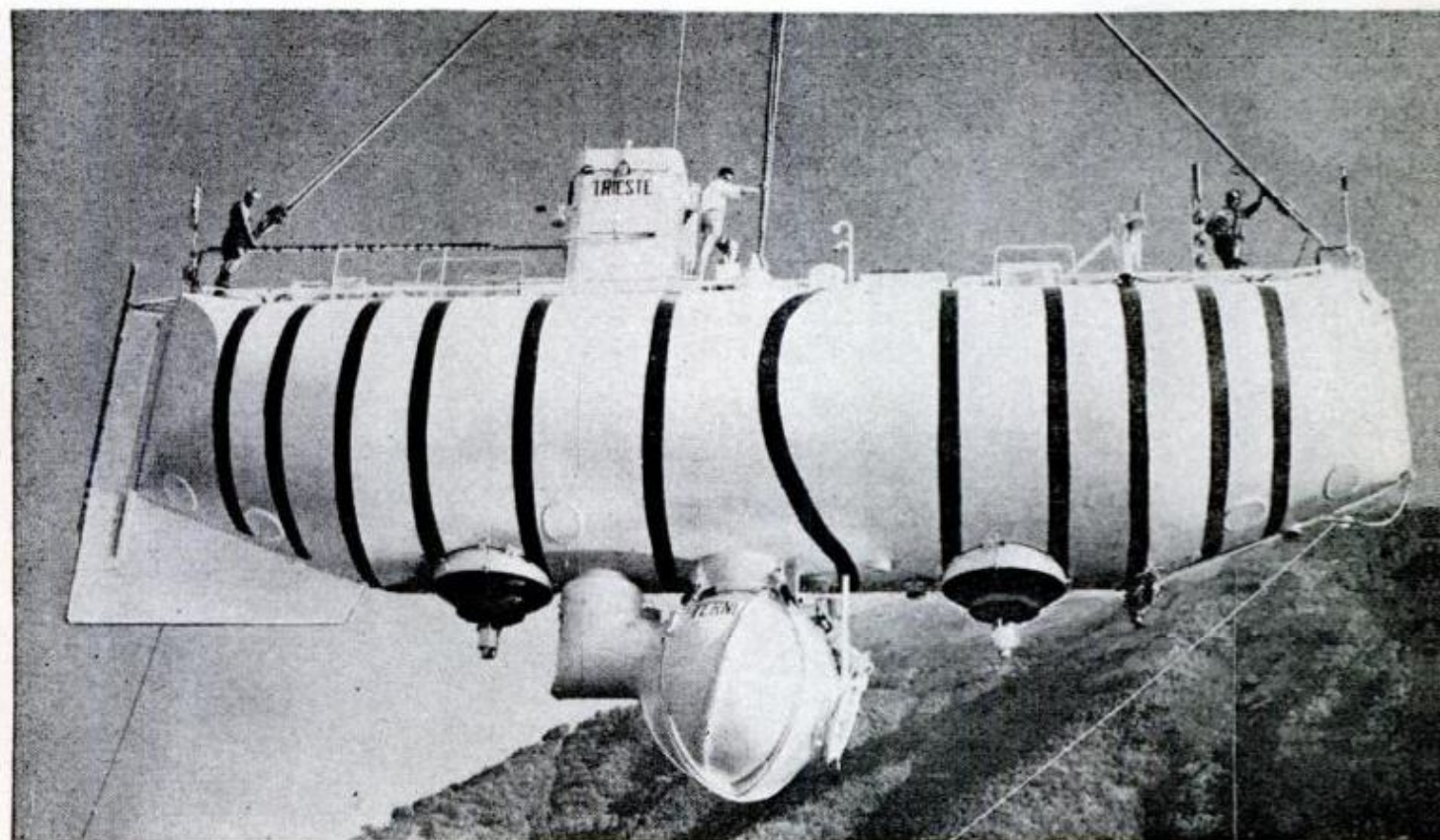

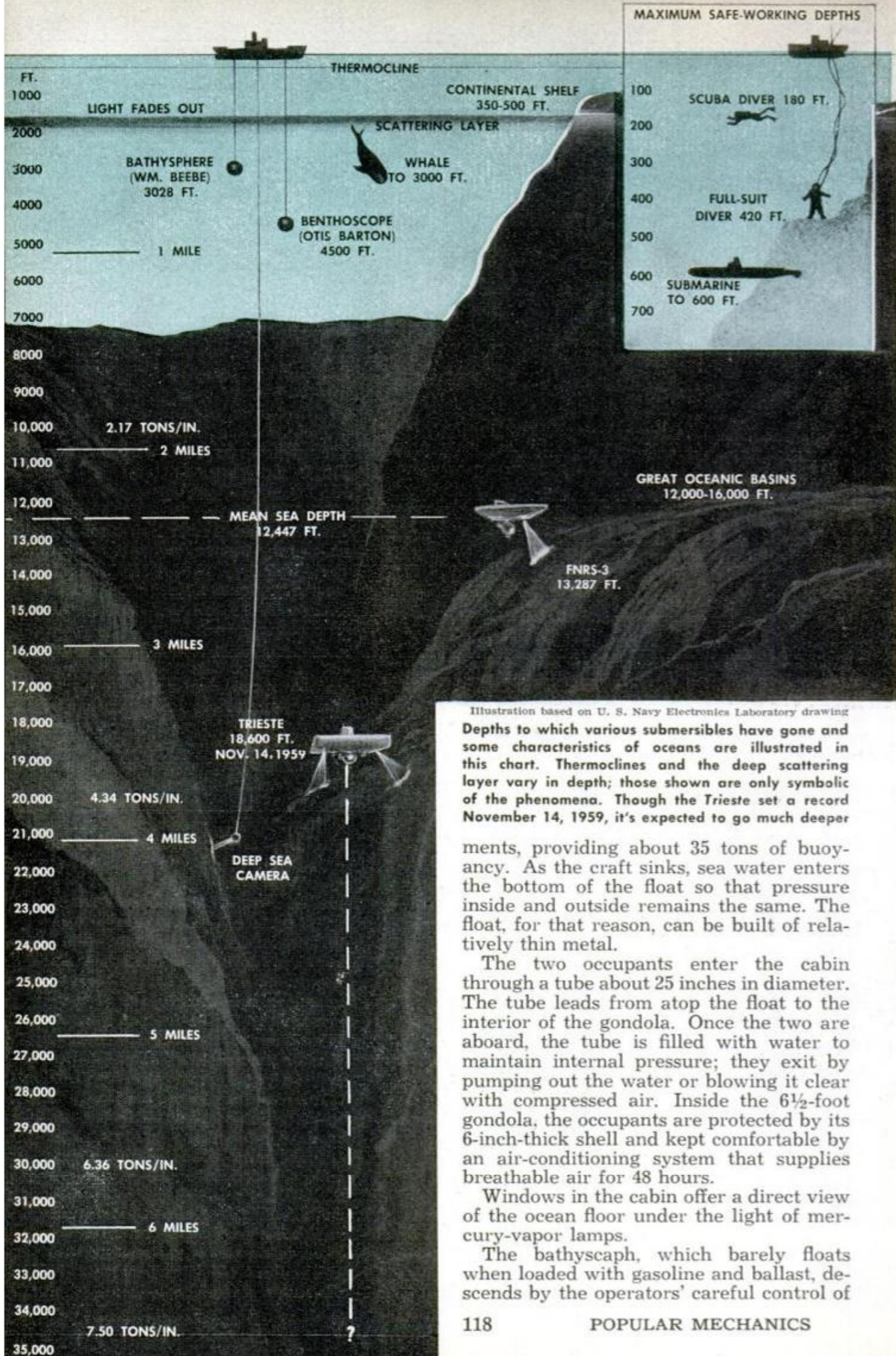

Illustration based on U. S. Navy Electronics Laboratory drawing
 Depths to which various submersibles have gone and some characteristics of oceans are illustrated in this chart. Thermoclines and the deep scattering layer vary in depth; those shown are only symbolic of the phenomena. Though the Trieste set a record November 14, 1959, it's expected to go much deeper

ments, providing about 35 tons of buoyancy. As the craft sinks, sea water enters the bottom of the float so that pressure inside and outside remains the same. The float, for that reason, can be built of relatively thin metal.

The two occupants enter the cabin through a tube about 25 inches in diameter. The tube leads from atop the float to the interior of the gondola. Once the two are aboard, the tube is filled with water to maintain internal pressure; they exit by pumping out the water or blowing it clear with compressed air. Inside the 6½-foot gondola, the occupants are protected by its 6-inch-thick shell and kept comfortable by an air-conditioning system that supplies breathable air for 48 hours.

Windows in the cabin offer a direct view of the ocean floor under the light of mercury-vapor lamps.

The bathyscaph, which barely floats when loaded with gasoline and ballast, descends by the operators' careful control of

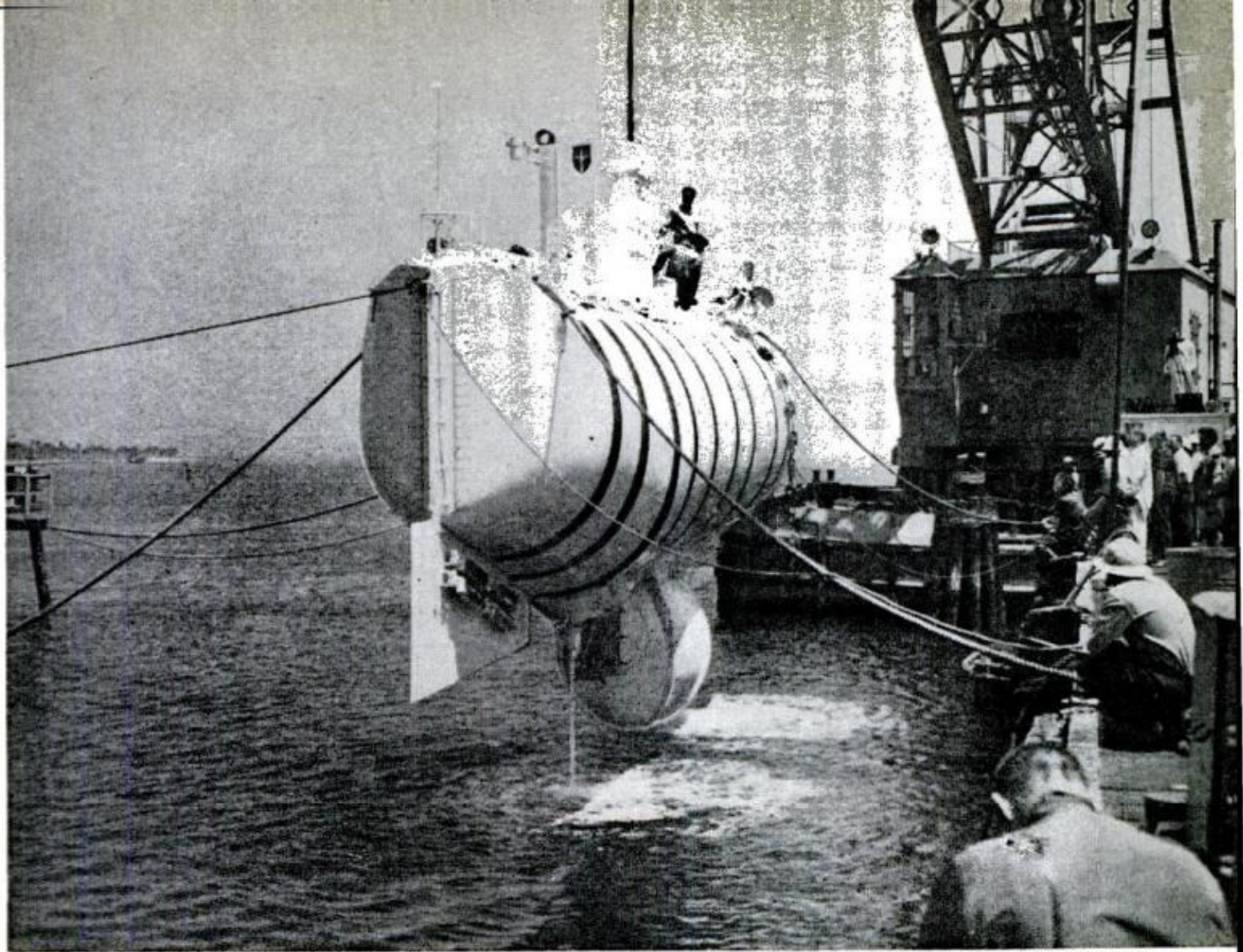

U. S. Navy photo

water and ballast. Sea water fills two water-ballast tanks, and, as the craft sinks, automatically enters the hull through an opening in its underside, compressing the buoyant gasoline and equalizing the pressure inside and out. The craft's rate of descent—60 feet per minute—is controlled by the release of a portion of the 13 tons of iron pellets which are carried in fore and aft containers. Variation in the rate of descent is encountered as the gasoline, which is 30 percent lighter than water, loses a little of its buoyancy because it is compressed by increasing water pressure and cooled by lower temperatures.

At the bottom, the vessel is held down by the remaining ballast; balance is so fine that a thin wire suspended beneath the vessel will cushion the final few yards of descent as the weight of the wire is taken up by the sea floor.

Moving about under the power of its own battery-driven motors, the *Trieste* has a horizontal range of about one mile.

Designing equipment to work in sea water at great pressures is a difficult and time-consuming task for oceanographers. But despite the difficulties, the *Trieste* carries specially designed equipment, such as an electronic sound velocity meter that meas-

(Continued to page 254)

Rectangular magnesium anodes fixed to the rudder provide cathodic corrosion protection for the bathyscaphe. The *Trieste* is towed to sea for its deep dives

Rare photo of publicity-shy Auguste Piccard, builder of the *Trieste*, shows him with son, Jacques, who made record November dive with Dr. A. B. Rechnitzer

James Joseph photo





Vinyl Molds Produce Inexpensive Stone

Mass-produced duplications of hand-carved stone work now can be made at low cost from molds of vinyl plastisol. After the stone work pattern is designed, an aluminum master mold is cast and the plastisol poured into it to jell. When the

plastisol cools, it is stripped from the mold, forming a durable vinyl mold. Concrete is then poured into this mold for mass-production work. The cost is considerably less than wood molds and the vinyl is flexible, making it easy to manipulate.



80-Foot Light Poles Made of Concrete

Towering 80 feet over a Tacoma, Wash., baseball park are 10 lighting standards made of pre-stressed concrete, the first poles of this size made with that material. The poles are anchored on their concrete bases by welding the reinforcing rods at the base; all wiring is located inside the hollow poles. The 10 poles support a total of 144 floodlamps of 1500 watts each.

Reactor May Power Space Generator

Electric power for future space vehicles may be provided by a high temperature nuclear reactor that weighs only 220 pounds and generates three kilowatts of power, according to John A. McCone, chairman of the Atomic Energy Commission, who recently reported that a prototype of the reactor has been test operated.



UPI photo

Transistor Radio-Phonograph

Seven-inch (45 r.p.m.) records may be played on a portable, German-made radio-phonograph that also picks up short-wave broadcasts. Four flashlight batteries power the radio, four others spin up to 1000 records against a needle that is shielded inside the unit.

Surgical Stapler

Inserting vitallium staples in the human body as a substitute for hand suturing is the job of this Russian-made surgical stapler. It can even stitch sections of the heart.



FEBRUARY 1960

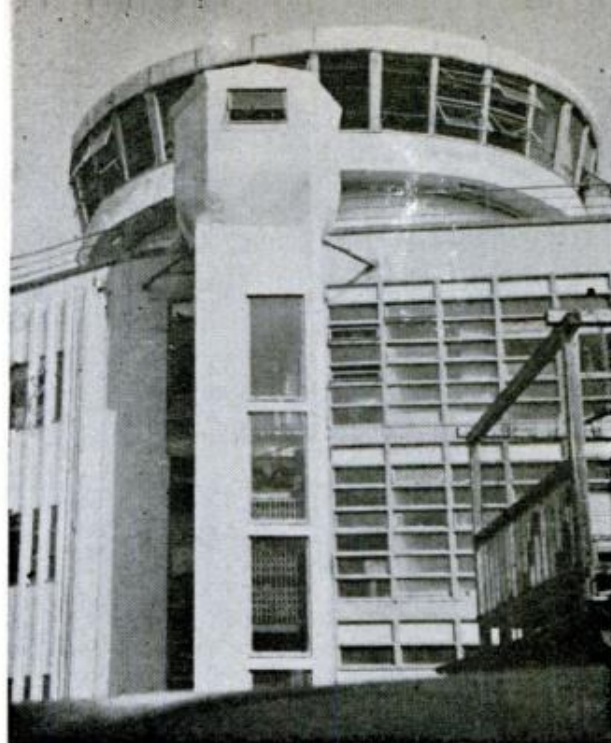

Revolving Hotel

Guests in the eight rooms on the top floor of the Kan Ichi Hotel, Atami, Japan, have a panoramic view of mountains and Pacific Ocean coastline. The floor, riding on a track, rotates in a complete circle once each hour. It is turned by a 7.5 horsepower motor operating a chain-drive.

Rod Rest for Angler

Fishermen never seem to have enough hands, but a new neck-slung rod rest holds the most delicate rod and reel securely while you change lures or carry tackle.



121

FASTEST BOAT IN THE WORLD?

By Les Staudacher

As told to Dick Kirkpatrick

PM photos by Tom Stimson



I THINK she's the fastest. I designed her and built her and was driving last November 23 when the water-speed meter went up over 260 miles per hour on a test run. The current world's water speed record is 260.35.

We were testing the *Tempo Alcoa* that day, getting her ready for an attempt on that record, when we were put out of action by a strange collection of the things that can



EDITOR'S NOTE . . .

The gentleman at left builds church pews. In his spare time he builds fast boats. And drives them. He's Les Staudacher, owner of Kawkawlin Wood Products Company of Kawkawlin, Mich., and he has earned a reputation as the nation's finest builder of unlimited-class hydroplanes. He has built 34; one of them, Jack Regas' *Hawaii Kai III*, holds the world's speed record for propeller-driven boats at 194 miles an hour. And you've probably heard of the others, even if you don't follow boat racing . . . *Tempo*, *Miss Pepsi*, *Miss Thriftway*, *Maverick*, *Gale*, *Shanty*, *My Sweetie*—and now *Tempo Alcoa*.

In 1958, Staudacher-built boats swept the first five places in Gold Cup Competition for unlimited hydros. His boats have won the other big awards, too—The Silver Cup, the President's Cup, the Governor's Cup, the Harmsworth Trophy and the national powerboat championship.

In 1955, Les built *Tempo VII* for orchestra leader and hydro racer Guy Lombardo. *Tempo VII* cleaned up that year, winning the national championship. And that's where Guy comes in. Now the two are partners and co-owners of a new boat—maybe the fastest thing on water. Les tells about it in this exclusive article.

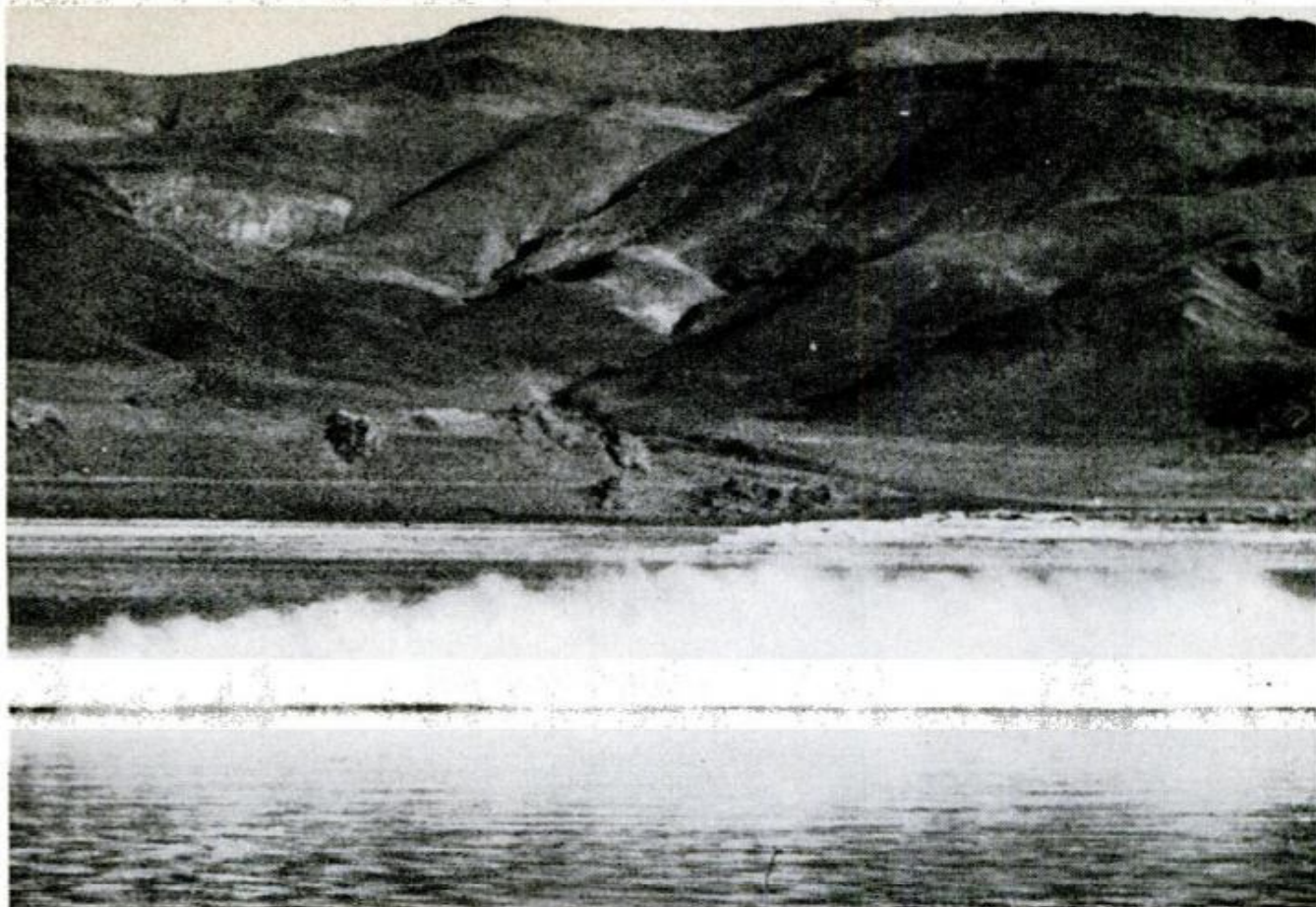

Tempo Alcoa, on high speed test run, streaks across Nevada's Pyramid Lake at around 250 miles an hour. Boat and engine combination is thought to be capable of over 400 miles per hour; safe up to around 320

happen at over 200 miles an hour on the water. But we'll get another chance sometime this year, and we'll break the record.

Let's begin at the beginning. Ten years ago the world's water speed record was held by the late Sir Malcolm Campbell, the great British speed merchant, at 141.74 miles an hour. In June, 1950, the late Stanley S. Sayres brought the record to the United States when his *Slo-Mo-Shun*

IV was clocked at 160.323 on Lake Washington near Seattle. Two years later he raised his own mark to 178.497, the last world's water speed mark to be set by a propeller-driven boat.

In September, 1952, Englishmen John R. Cobb, holder of the world's *land* speed record, drove his jet speedboat *Crusader* at Loch Ness in Scotland at 206.89 through one official measured mile, but on the

Moving away from the pits, the jet boat crouches low in the water and idles along at 10 to 15 miles an hour. The hull stays "wet" up to 90, then leaps up onto its three riding points and gains speed very fast





Staudacher buzzes the pits on his final speed run at a "leisurely" 180 miles an hour. This was the last photograph taken before the now-famous flight over Pelican Point; the boat had tested at over 260 miles an hour and was ready for an official speed run. The engine cowling was not used during the speed trials

Special truck and trailer carries *Tempo Alcoa*, spare engine and parts for highway travel

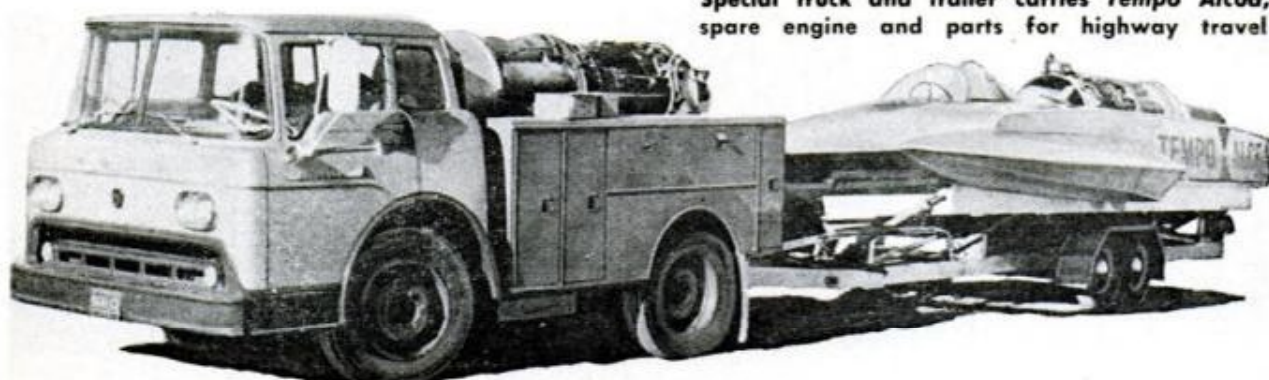

same run *Crusader* disintegrated and Cobb was killed. Since only one timed run was made, the record could not be certified as an official one.

After the death of Malcolm Campbell in 1948, his son Donald had sworn to hold the water speed record for England. In July, 1955, his jet hydroplane *Bluebird* was clocked at 202.32 on Ullswater Lake, England, to win the record for Campbell

and England. He became the first man to drive a boat at more than 200 miles an hour and live.

Every year since then, Donald Campbell has raised his record, and has remained unchallenged in the jet field. In 1956 he set the single-run record at 286, though a slow second run cut that year's record to 225.36. (For an official record run, the boat must pass once in each direction

Crane eases *Tempo Alcoa* into Pyramid Lake for test runs. Note the clean underwater lines; at high speed the boat rides on the after ends of the sponsons and the small skeg just forward of the rudder

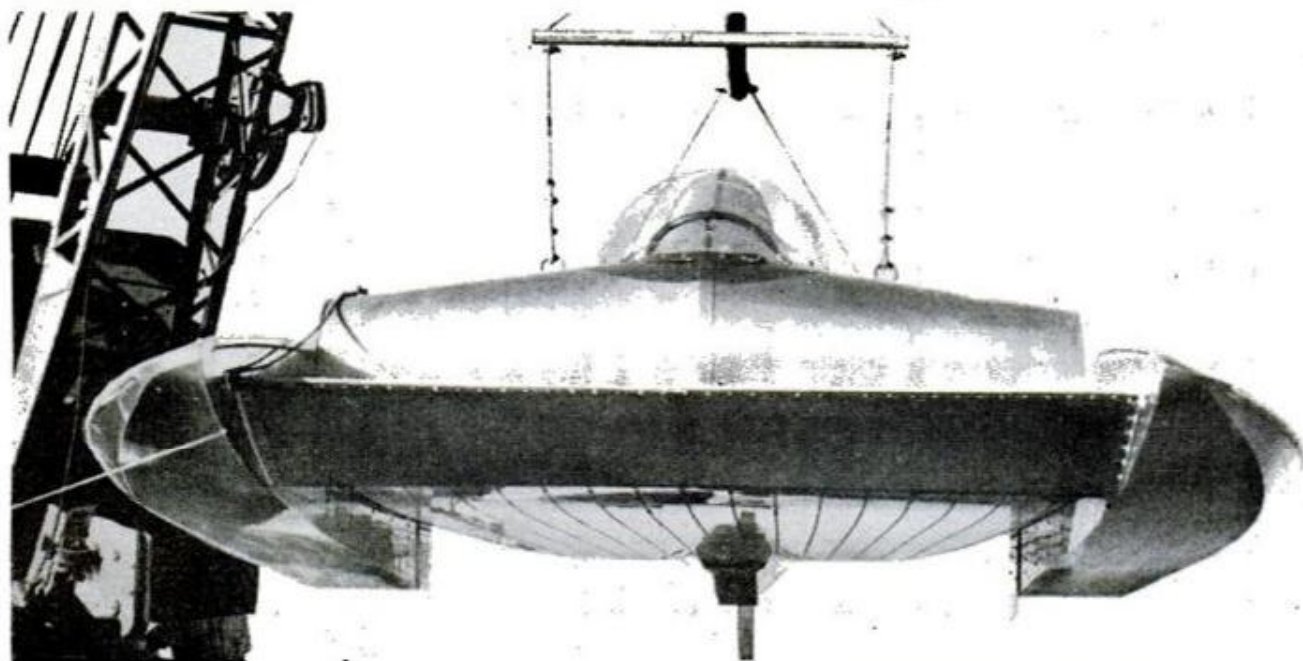



After flight across promontory, boat stopped at the water's edge after traveling 100 feet in the air and another 60 across the sand. Staudacher emerged unhurt, said "She runs much better on water." At right, left to right, W. S. McChesney of Alcoa, Guy Lombardo, and Staudacher discuss model

through a measured mile course within one hour. The speeds are averaged for the time.) By 1959 he had raised the record to 260.35, a mark which still stands.

Determined to stay ahead in the speed race, Campbell is planning to shoot for 300 miles an hour in 1960, but has interrupted his boat work to try for a *land* speed record with a jet-powered car also named *Bluebird* and thought to be capable of 400 miles an hour. Campbell says he'll retire when he holds both records; five years ago he could have done it. But now Guy Lombardo and I are after his world water speed mark.

During the New York Boat Show early in 1959, Guy talked speedboats with some of Alcoa's boating experts, and they decided they'd like to try an aluminum hydroplane. I had built an experimental prototype of a jet boat in 1958, mostly to test design ideas and powerplants. Guy

(Continued to page 270)

Staudacher, in racing gear, inspects the hydraulic booster controls that operate the rudder. Booster is necessary to turn the rudder even at fairly low speeds; it's never used above about 90 miles an hour



Alcoa photo

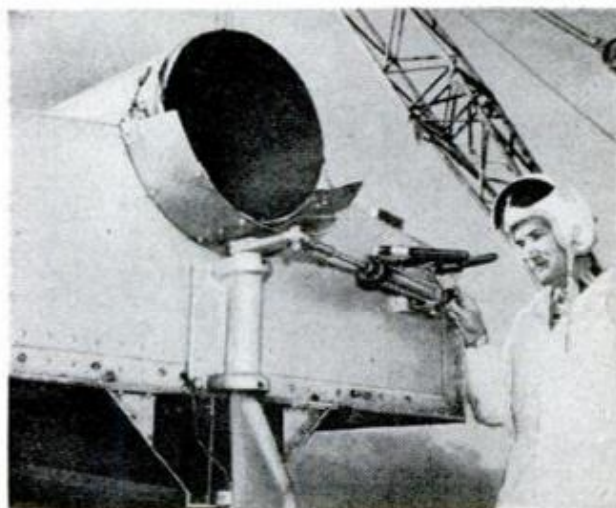

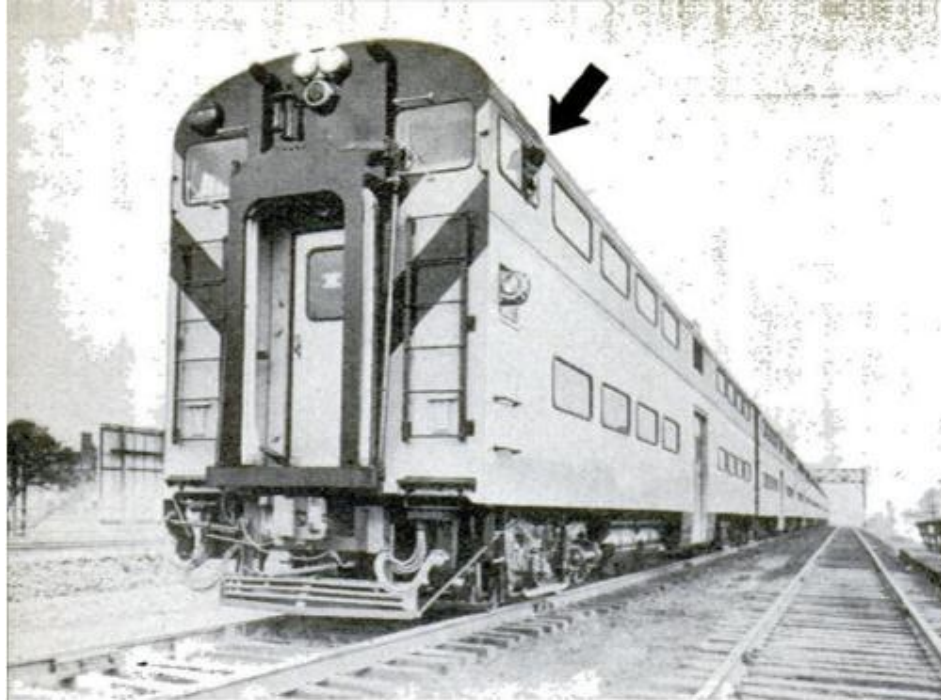

Push-Pull Train Has Extra Cabs

Going into service on Chicago and North Western Railway's suburban lines is a new train that, for ease of operation to and from the Chicago terminal, will have its diesel engine located permanently at one end of its double-decker coaches. Thus the engine will always *push* the train into the terminal and *pull* it out. When the engine is pushing, the engineer will control the train from a cab in the leading coach: It and several other coaches have full controls — air brakes, headlights, bells, rail sanders for braking and automatic signal and stopping devices. The train will never have to be switched around; the engineer will merely walk from coach cab to engine cab to run the train back to the suburbs. Having controls in other coaches allows some coaches to be removed, while still retaining a coach with a cab at the end opposite the engine.



Electric Dial Switch Locks Cars and Power Tools

Dialed like a combination lock, an electric locking switch lets you lock any electrically or pneumatically operated mechanism, from a motor vehicle to an elevator. A pair of lead wires coming from the hand-size switch connect into any a.c. or d.c. locking circuit. To open, four numbers are

dialed, each closing the contact points on four plastic gears. Installed on a car, the switch lets you lock doors, windows, hood and ignition by pressing a button on the dashboard. It can easily be installed on power tools, burglar alarms or doors of buildings, too.

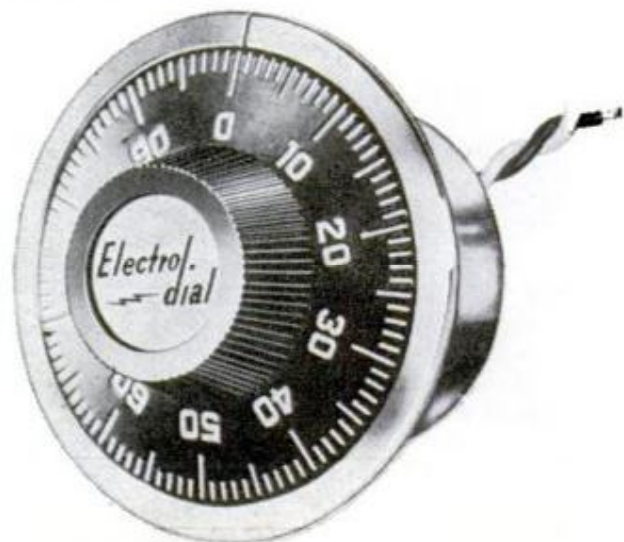
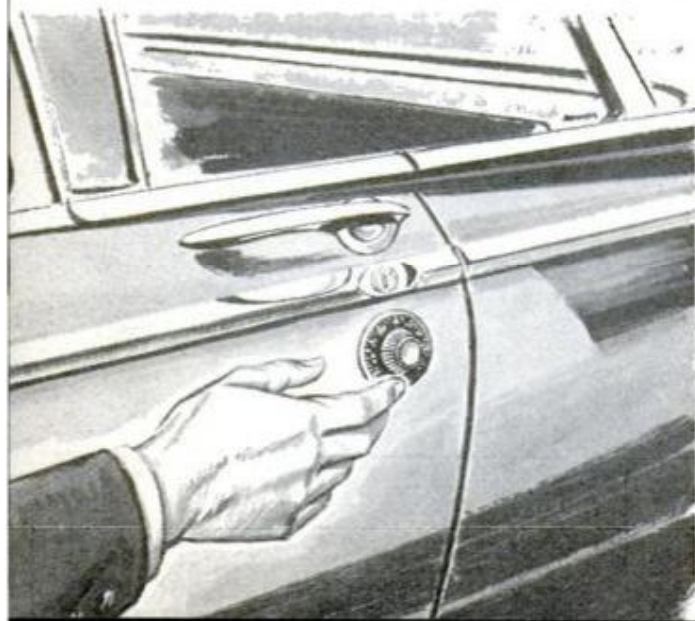



Miracle Equipment Company

Youngsters Must Earn Long Slide

To get a long slide, a youngster must earn it by climbing hand over hand along the angled upper edge of a new playground slide. Once he reaches the highest point, he's rewarded with a 12-foot slide. The stainless steel slide is 16 feet across, and is edged with 1½-inch tubular steel. The entire structure is supported by sturdy steel posts.

Flash Unit Is Rechargeable

There's never need for battery replacement in a new electronic flash unit; it has a sealed-in nickel-cadmium battery and charger that recharges from ordinary household current. Each charge yields 50 flashes of 1/2000-second duration. It has a light-color guide of 52 and recycling time of nine seconds. Monitored relay transistor circuits give a constant light output and uniform edge-to-edge coverage. The self-contained unit weighs less than two pounds.

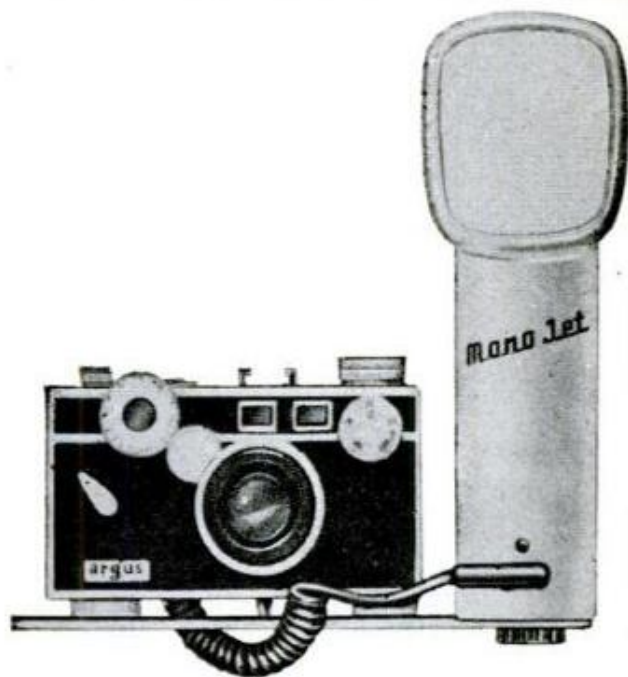

Mouthpiece Flashlight

Designed by a fisherman for fishermen, but also of use to mechanics, electricians, TV repairmen, or anyone who must work with his hands in the dark, a lightweight plastic flashlight features a built-in mouthpiece. It hangs from a neck cord when not in use, easy to reach and switch on when needed. The light, directed away from the eyes, doesn't leave the user blinded afterwards.

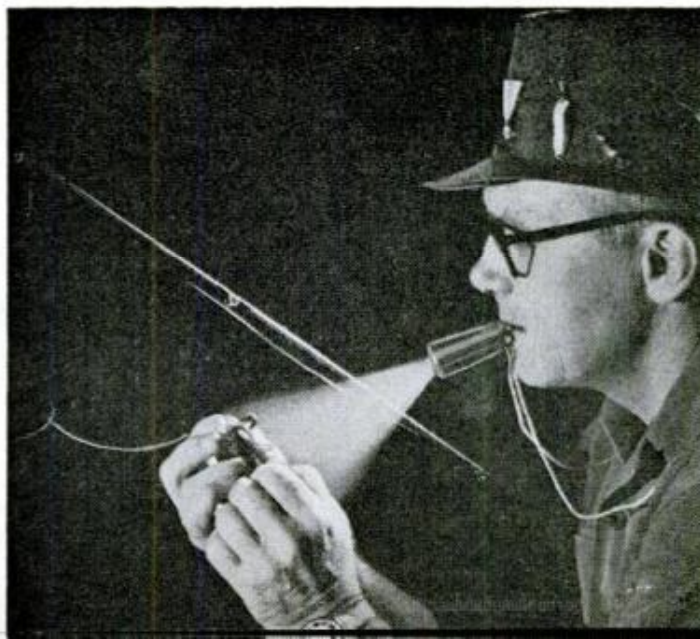

THIS MAKES THE TORPEDO CHILD'S PLAY

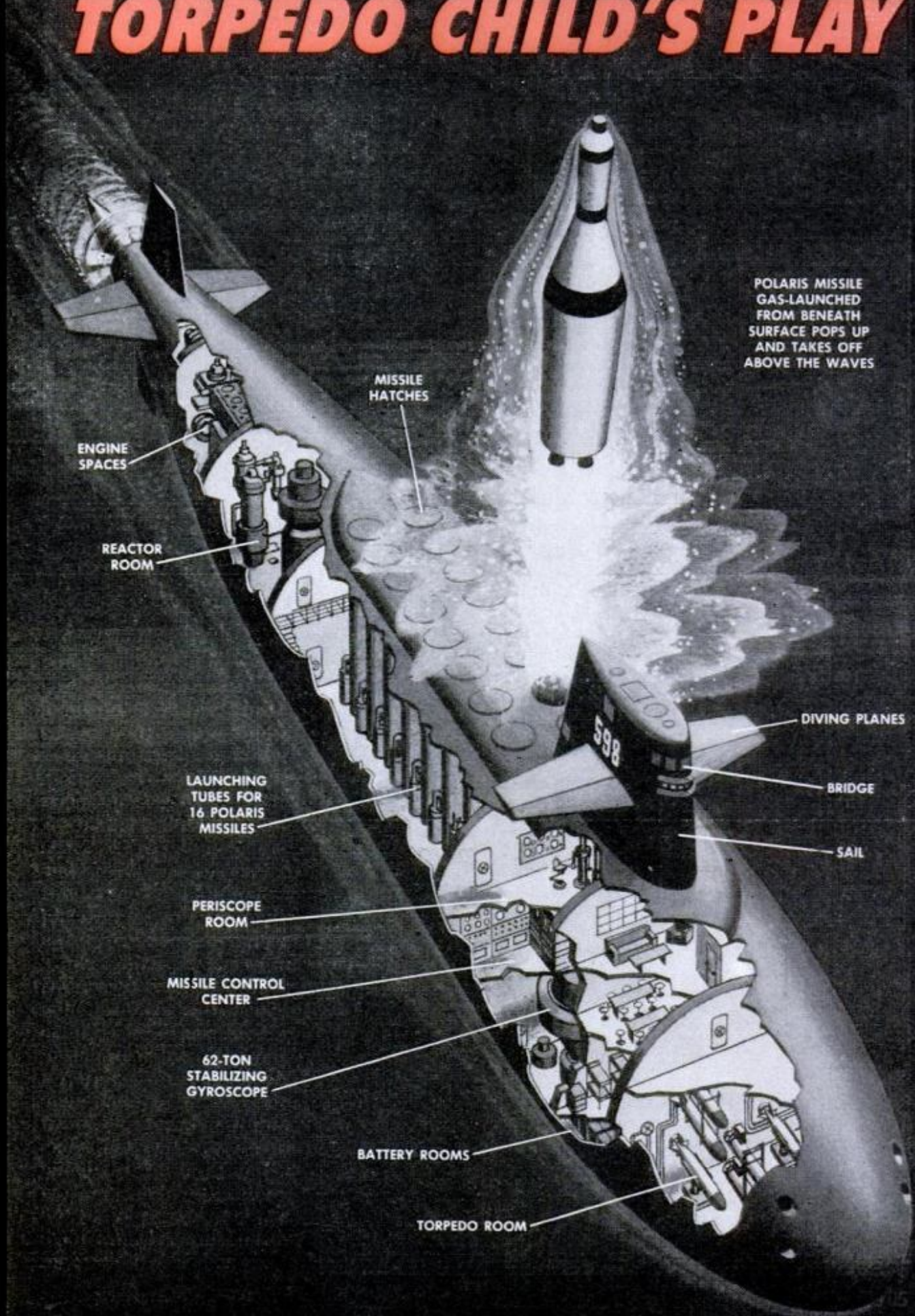

POLARIS MISSILE
GAS-LAUNCHED
FROM BENEATH
SURFACE POPS UP
AND TAKES OFF
ABOVE THE WAVES

ENGINE
SPACES

REACTOR
ROOM

MISSILE
HATCHES

LAUNCHING
TUBES FOR
16 POLARIS
MISSILES

PERISCOPE
ROOM

MISSILE CONTROL
CENTER

62-TON
STABILIZING
GYROSCOPE

BATTERY ROOMS

TORPEDO ROOM

DIVING PLANES

BRIDGE

SAIL

598

The first missile-carrying sub soon will put to sea. And, to perfect the technique of firing the Polaris from beneath the surface, a strange ship already is spitting A-missiles into the sky

By Richard F. Dempewolff

WITHIN THE next few months, one of the most formidable vessels ever to sail the seas — the atom-powered and atom-armed submarine *George Washington* — will glide out the channel from Port Canaveral, Florida, and dive beneath the waves. The 380-foot monster, shaped like a slim blimp, is the first in a planned force of some 50 Fleet Ballistic Missile submarines. Five more now building are scheduled to join the Navy during the next two years. All will be fighting arms of a new U.S. Navy defense strategy. All will have lethal fists cocked and ready to explode with knockout power from depths of oceans throughout the world.

Marching down the broad back of the *George Washington* (SSBN 598), are eight pairs of hatches, like two rows of giant steel blisters about five feet in diameter. Beneath them, in an arrangement reminiscent of an old-fashioned candle mold, are nested 16 vertical steel tubes that rise from the ship's rounded bottom. Each tube contains a nuclear-tipped Polaris missile. The 30-foot, solid-fueled two-stage navy rocket can hurl a thermonuclear warhead 1500 miles, and the navy's rocket experts hint that later models will do even better.

But the neatest trick in this wedding of nuclear sub and nuclear missile is that even while the ship ghosts along under the surface, it can fire its destructive birds. At his control panel deep in the forward part of the hull, the fire-control officer presses a button. High-powered pumps force compressed gas into the tubes. When a certain pressure is reached, there's an ear-splitting crack, and, topside, a firing tube lid flies open. The missile, driven upward by the tremendous pressure of the hammering gas beneath it, pops from the tube like a cork from an agitated champagne bottle. Blasting upward through the sea's surface, under its own momentum, it leaps vertically into the air to a height several times its length. Near the peak of its free climb, a timing device touches off the first stage rocket engine with a mighty roar, and the great missile soars off toward outer space

Fifty cameras and TV monitors, such as the two above, record each missile launching on the *Observation Island*. They are controlled by a technician below decks who views a screen and moves a lever

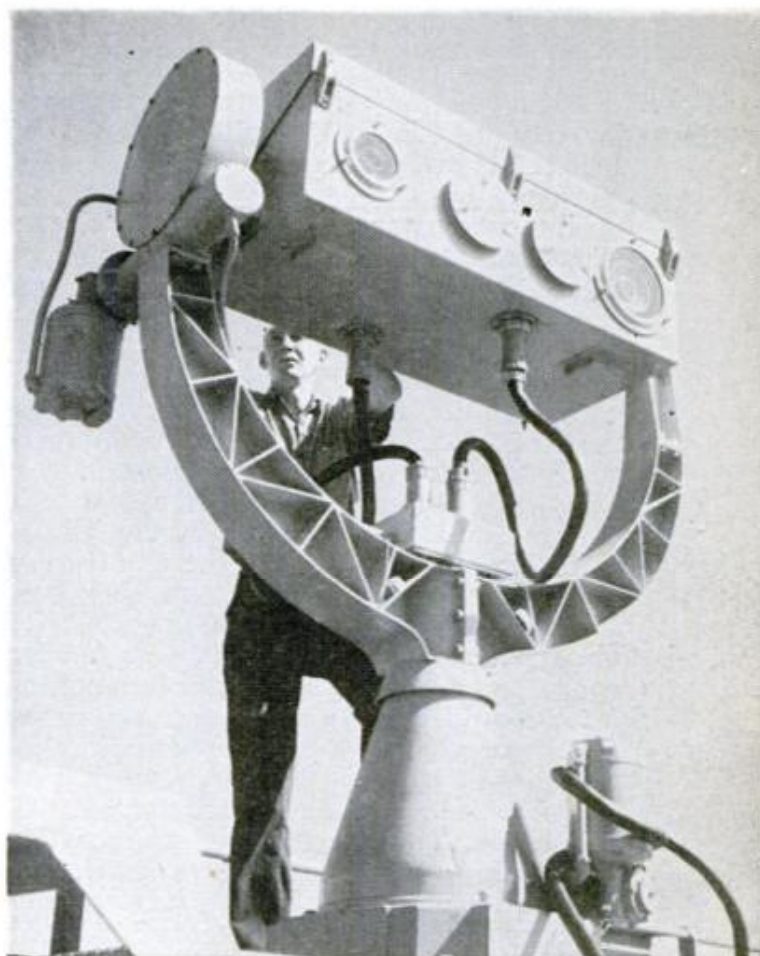

on a preset course. A built-in inertial guidance system that senses the slightest deviation from course feeds any such data to a computer that promptly calculates course corrections and triggers a device that changes the burning pattern in the rocket engine, deflecting the missile back to proper trajectory. At the end of powered flight, the nuclear nose cone separates from the rocket and soars ballistically to its target at a top speed of about 12,000 m.p.h.

When you know that virtually every major city in the Soviet Union lies within 1500 miles of open sea; and that those 16 warheads in the *George Washington* alone pack more destructive wallop than *all* the U.S. bombs dropped during the whole of World War II, you begin to appreciate the strength and agility of this counter punching weapon.

Admiral William F. Raborn, Jr., director of the Polaris program, points out that a fleet of FBM nuclear subs, poised and ready, are able to prowl for months at a time, hide beneath Arctic ice, move tens of thousands of miles without thought of refueling. No one except the Pentagon's highest brass will know where they are. Even an enemy's sonar would tell him little about the kind of target he was facing; every "ping" in the sea might be another missile sub. Should an enemy power be foolish enough to launch an atomic war, says the admiral, this fleet alone, when fully deployed, will insure instant and incredible retaliation. The rapid firing rate possible with Polaris will allow the submarine to launch its entire cargo in a remarkably short space of time. The hypersonic speed



1 Phases of experimental launching of dummy missile are shown in pictures at right. Above, loading

of the missiles will deliver total destruction to target cities more than 1000 miles away in a matter of minutes. Once developed to its maximum, Polaris' range will enable it to reach almost any point on earth from positions at sea.

When an FBM submarine has shot its last missile, it is far from defenseless. Up forward, rides a battery of Mark 37 anti-sub homing torpedoes that can be fired when the ship is submerged or surfaced, and will seek out targets by themselves.

High-speed cameras shooting four pictures a second made picture of live Polaris missile emerging from tube. In actual operation, it would fire rockets and take off for target. The cloud was caused by compressed air

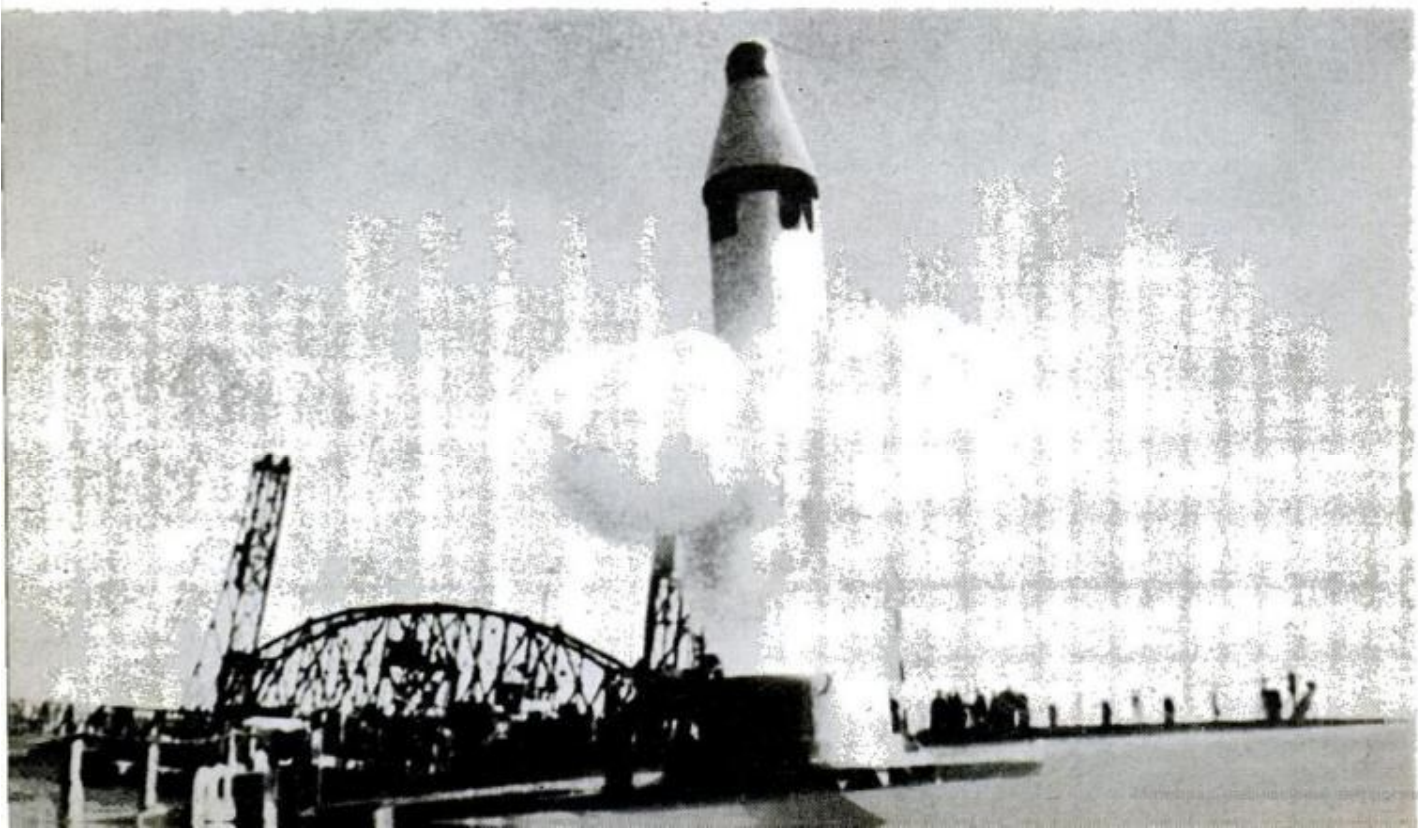



2 Kicked up by a jet of compressed air, the dummy missile will fall away from ship, which has heeled over to provide the trajectory

3 Polaris dummy soars to more than 100 feet

What's more, with its capability of stealth, maneuverability and high speed underwater endurance, the FBM sub will make a tricky target. The *George Washington* was rushed to completion by inserting a missile section in the middle of a 260-foot "teardrop" Skipjack Class atomic sub hull. While the stretched out version probably won't come up to Skipjack's rumored 40 knots underwater, it's no slouch. "She still goes fast and deep," according to her designer. "She has clean lines."

Officer at launching operations station below decks controls firing sequence after an involved countdown



FBM sub 608, now on the ways, will be heavier, larger and faster than the first five—"enabling it to take fullest advantage of the many millions of cubic miles of ocean which still offer the greatest hiding place on the face of the globe," according to Raborn. "Polaris," he says, "has just one mission. That is to help *prevent* the need for its use from ever occurring. It is a weapon in our arsenal of deterrants to aggression."

Since the new missile subs are crammed with the navy's latest top secret devices and systems, it will be a long time before anyone but their own highly trained crews will ride one. Recently, however, a gray and massive navy surface ship, the *USS Observation Island*, has been operating quietly out of Port Canaveral. Known as an "EAG" (for Experimental Auxiliary, General) the ship is a converted military cargo transport—563 feet long and 76 feet abeam. From the broad sweep of her flat stern weather deck, to her high antenna-studded bow, she is a complete, floating Polaris missile "complex"—the sea-going test bed for all components of the complicated firing and guidance systems that soon will be installed in the FBM subs.

Some 265 officers and men under a square-jawed navy captain, Leslie M. Slack, operate this portable missile base, and a more concentrated crew of technical wizards probably never sailed the main together. "It's about the only ship in the navy where chief petty officers swab decks and polish brass," says Commander Kenneth

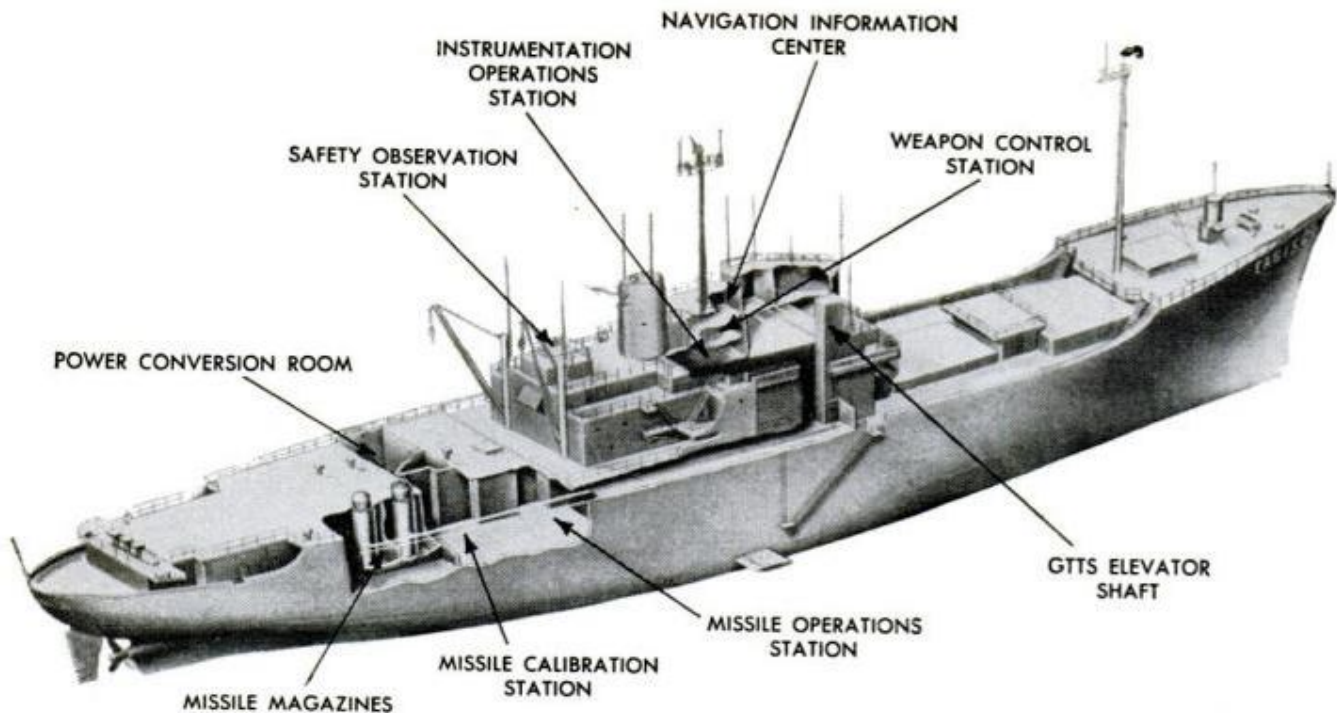

USS *Observation Island*, the test ship, is steadied by a gyroscope indicated by abbreviations GTTS, right

Wallace, the weapons officer. "Since every man is an expert, an unusual percentage of the crew consists of chiefs. There just aren't enough lower rates to handle all the housekeeping chores alone."

Tip-off to the *Observation Island's* unusual mission is her flat launching deck with its two great domed hatches covering the launch tubes. These thick-walled steel wells plunge vertically through the lower decks—just as they will on a submarine. Hatches in each tube's wall, at various deck levels, allow for check-off of the missile. Even slugs must have umbilical cords leading out to instrumentation at all of the ship's centers, for complete missile simulation.

Thirty-foot Polaris nestles deep in launching tube. Submarines will each carry 16 such live missiles

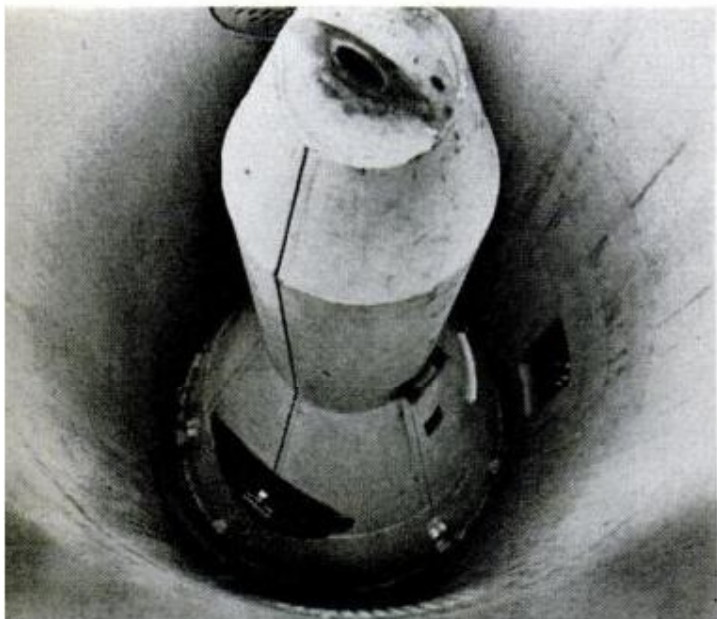

On the port side of the deck, Polaris missiles rest in giant racks—looking for all the world like the big propane bottles in your local fuel supply yard. Most early "shoots" at sea from this test pad involved concrete-weighted dummy missiles, or "slugs," which lack the typical Polaris "bottle-neck" nose cone. These are the only kind you're likely to see lying in the open on deck. Hoisted by cranes, each is lowered into a yawning tube, which it fits like a piston in a cylinder, and the dome-shaped cover is swung shut and dogged down. Small wooden blocks, or "shoes," fastened to the outer wall of the missile at intervals, prevent the rocket shell from scoring the walls of the tube when launched.

Firing a slug, or a live missile, from one of these vertical gun barrels is done, actually, by blowing it out with a gigantic puff of compressed air let in at the base of the tube. You hear a *whoosh* of rushing air as the missile rises from the tube and climbs majestically about 100 feet into the air. "The dense cloud of 'smoke' you see billowing from the tube, is actually a cloud of ice crystals, formed from the water vapor in the compressed air," says Lt. Comdr. Ernest J. King, the ship's operations officer.

The virtue of having a 15-ton slug fall in the water, instead of dropping back and plunging through several layers of deck on the ship, is achieved in two ways on the *Observation Island*. The launchers can be tilted to shoot its monsters at a gentle angle that carries them over the side, or the ship takes on ballast and heels over far enough to "throw" the slug seaward. "We ran one

(Continued to page 248)

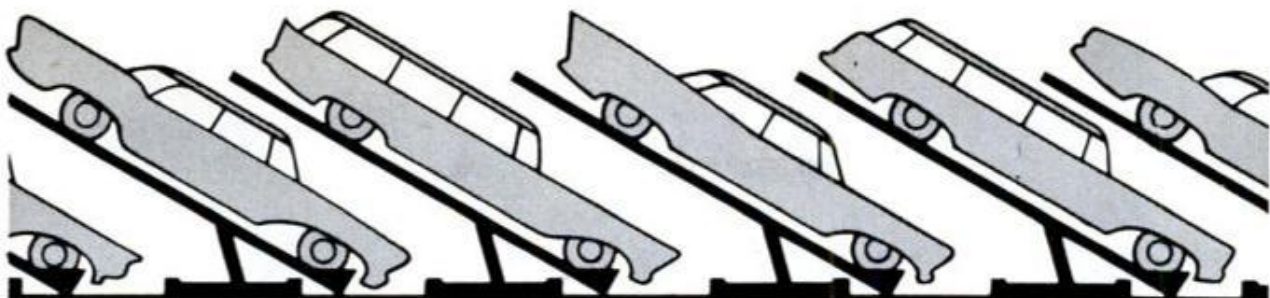

Tilted Racks Double Parking Lot Capacity

Offering a solution to overcrowded parking lots, a new system doubles the capacity of lots and garages while making them virtually accident-free. Cars, resting on racks, are tilted under each other at 30-degree angles, thus allowing two cars to park in nearly the same amount of space normally used by one car. The units can be installed in any size parking area. As shown in the three photos at the right, the motorist drives his car onto a rack parallel to an empty parking space. The attendant then takes over. He turns off the engine, gets out and switches on a 110-volt electric motor. This activates a hydraulic jack that tilts the car to a 30-degree position. After it is tilted, the attendant then manually shoves the rack with the car on it into position beneath another car. The entire operation is completed in 40 seconds. When the motorist returns to claim his car, the attendant pulls the rack from the storage slot into the access lane, lowers the ramp, backs the car off and the motorist is on his way. Accidents are greatly reduced, since no car can come into accidental contact with another, once it is on the rack and out of the access lane. Called the Auto-Pack system, it was developed after two years of study.

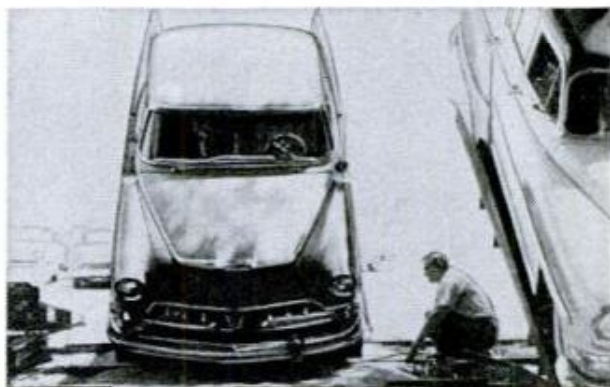
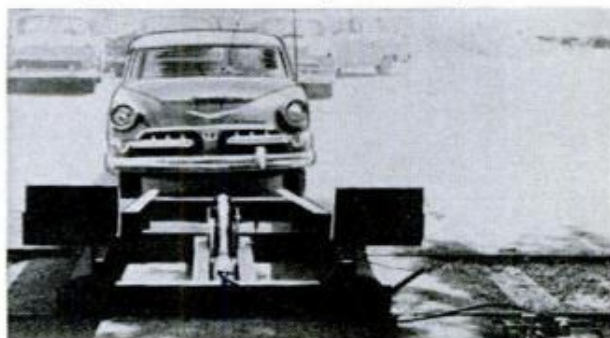

ⓂRussian mining engineers say they have a method that allows them to sink shafts 10 feet in diameter at the rate of about three feet every four minutes, or 10 times faster than by conventional methods; liquid explosives are piped through an opening in a big drill bit and then detonated.

Gloves Give Swimmers "Webbed" Hands

Webbed hands can add greatly to a swimmer's speed and power, but most types of swimming gloves interfere with the use of the hands. A new rubber "Swim Mitt" has full finger webs, but is made of a soft material that doesn't interfere with manual dexterity any more than a pair of household rubber gloves. They'll be sold in six sizes, including models for youngsters.

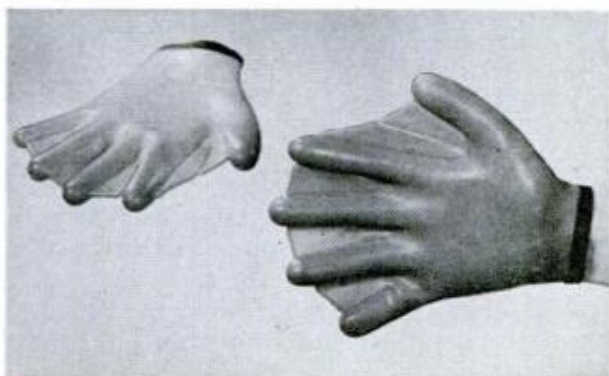

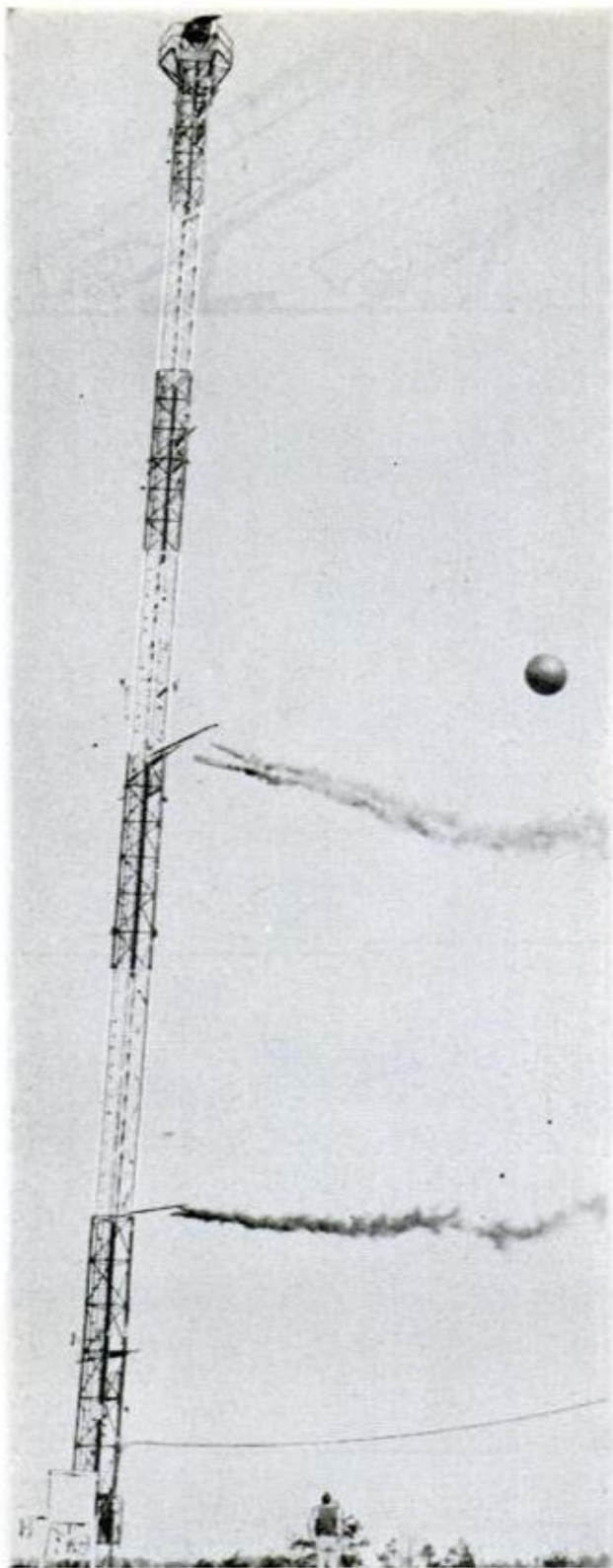

Smudge Pots Help Meteorologists

Smoke trails help meteorologists study the intensity and direction of low-level temperature inversions at Lockheed's Georgia Nuclear Laboratory. Spotting these climatic nuisances 24 hours in advance enables meteorologists to determine the advisability of operating the main reactor. Such studies help predict weather variables affecting a variety of industries and military programs.

134

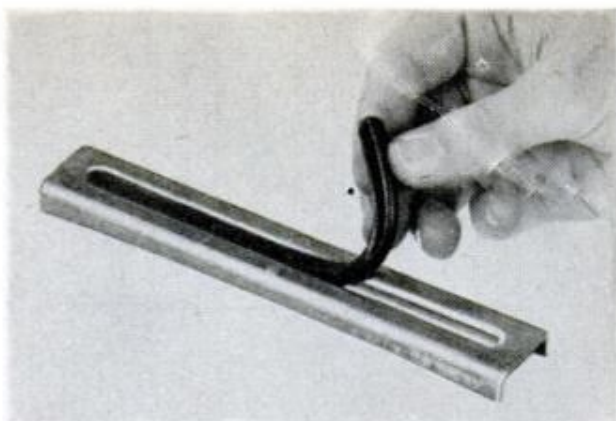

Kit Molds Plastic Night Crawlers

Fishermen can mold their own plastic night crawlers with a kit consisting of a bottle of liquid plastic and three molds. The plastic lures are oven-cured, then fitted with hooks.



Gyro Steadies Binoculars or Camera

For use with most hand cameras, binoculars and optical instruments, a battery-operated gyro stabilizer steadies hand movements, providing crisp, sharp pictures even from moving vehicles. Two gyro motors perform the function of a tripod, holding the camera on a given axis. For use with cameras weighing 10 pounds or less, the stabilizer is effective in an auto, boat or plane.

POPULAR MECHANICS

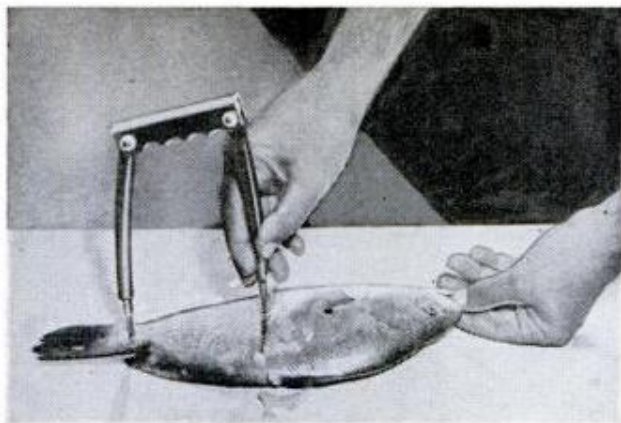

Point on Scaler Holds Fish

Pinning his fish to the cleaning board with one end of a new fish scaler, a fisherman scales it with the other end. The tool can also be used as a fishing rod holder or an ice pick.

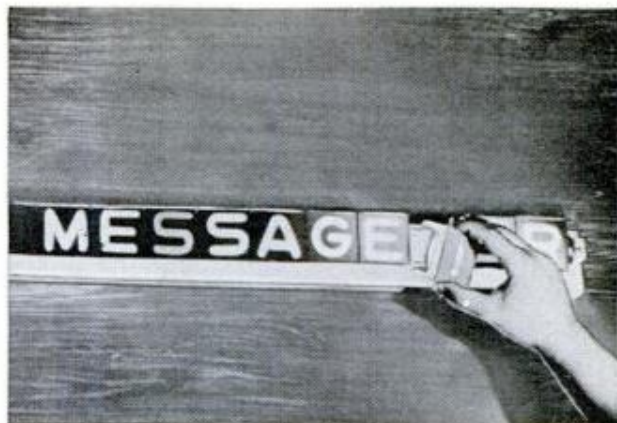

Snap-On Letters Make Lighted Sign

Translucent plastic letters that snap over a standard fluorescent tube make an attractive, inexpensive sign. Color and letter plates are interchangeable so that messages can be composed with variety.



Clown Dispenses Oxygen

Oxygen equipment in the guise of a clown eases the fears of youngsters who are frightened by therapy devices. Each breath through the candy-striped hose causes the clown's left eye (a pressure gauge) to roll. The red nose is an emergency button which starts artificial respiration if breathing stops. The device is manufactured by the National Cylinder Gas Division of Chemtron Corporation.

FEBRUARY 1960



Tokyo Policemen Wired for Sound

Eighty select Tokyo policemen are constantly in touch with police headquarters as they patrol crowded streets of the city carrying miniature portable radio receivers. Each receiver has nine transistors and weighs only 28 ounces. The radio unit is carried in a black leather case at the policeman's side while the antenna is concealed inside the leather strap over his right shoulder.

135

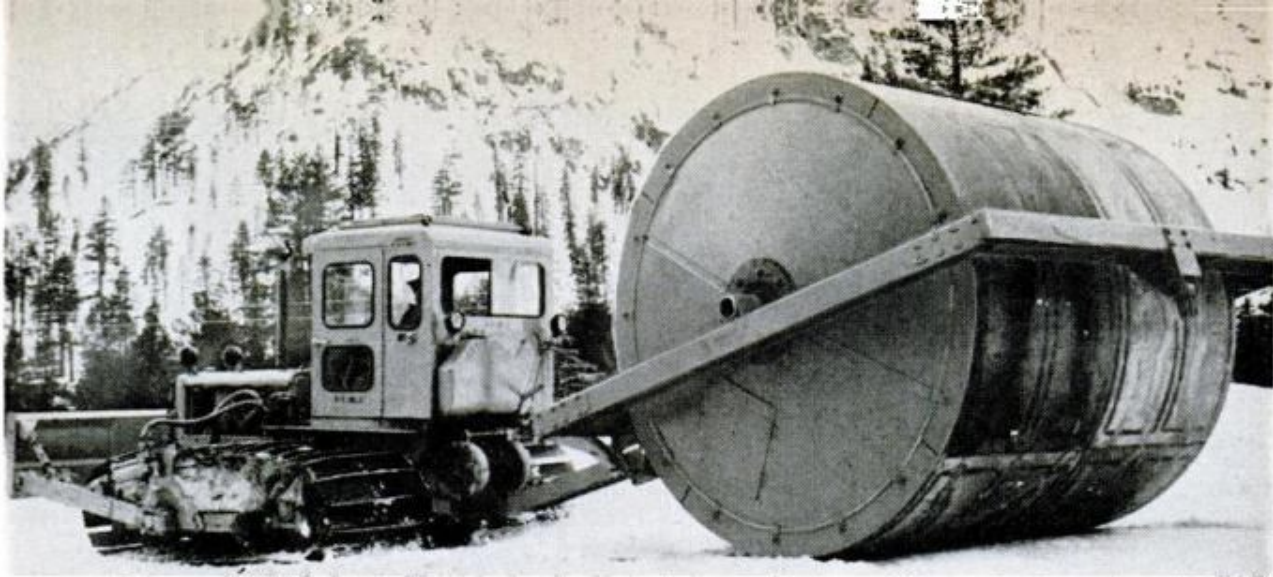

Giant snow roller weighs five tons empty, compacts snow in first step to allow other vehicles to operate. Snow planer, below, levels the rolled surface. Sawdust toppings varied from one to three inches in tests



Pulvi-Mixer, below, grinds sawdust into the top six inches of snow. The surface is allowed to set for about 40 hours before testing. Test pad successfully bears a load of 200 vehicular tons at one time



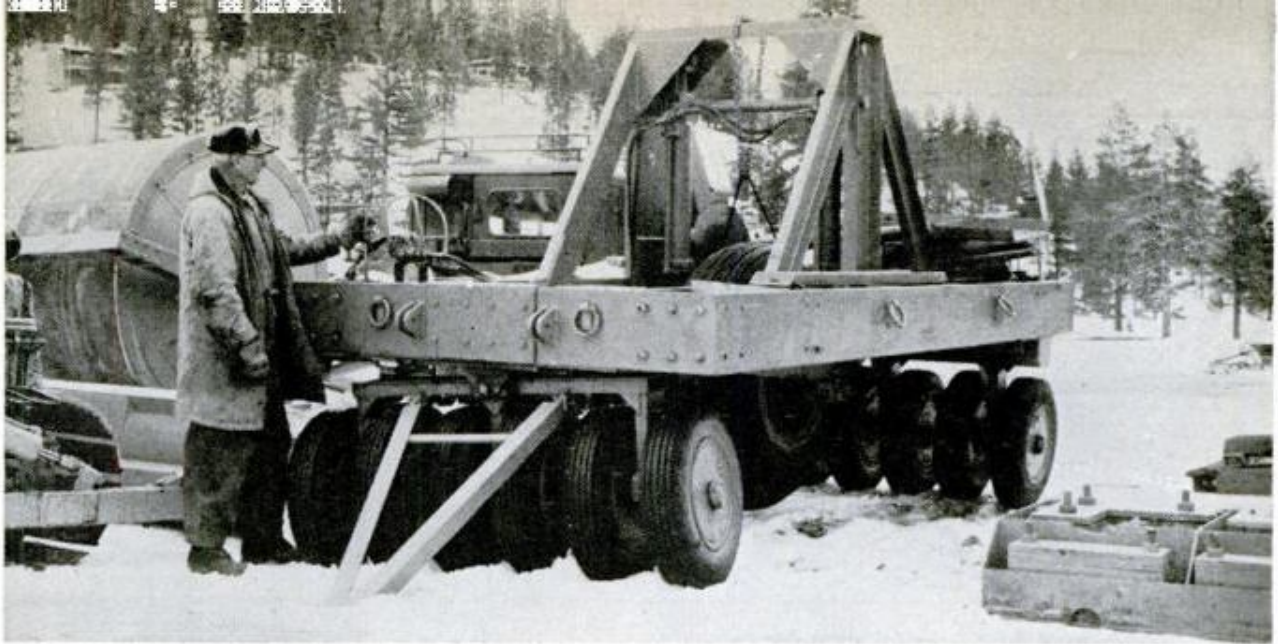

Wobble-wheel roller, above, tests compacted snow by simulating the load of an aircraft wheel landing. Below, heavy truck tests the finished "pad"; engineers put the test strip through seven weeks of tests

Packing Down Squaw Valley's Snow

By C. Robert Lee

AS IF THERE weren't enough problems involved in holding the 1960 Winter Olympics in California's remote Squaw Valley, Olympic committeemen are faced with the prospect of parking 12,000 cars, trucks and buses in the middle of winter in the 6000-foot valley, where temperatures leap from zero to 50 degrees and they measure snowfall in feet instead of inches. The possibility of having 40,000 people stranded in the half-mile by three-mile valley by a snowstorm or sudden thaw

would keep even Squaw Valley's promoters awake nights. Navy engineers, however, came up with an idea from their arctic experience that may save the day—and \$700,000 for the State of California. They plan to pack the snow on the valley floor, then roll down a thick layer of sawdust to insulate it from traffic and the sun's warmth. A 200-square-yard test pad has proved a success, so plans are going ahead for a 130-acre parking lot, which authorities say has a 90-percent chance of working. ★ ★ ★



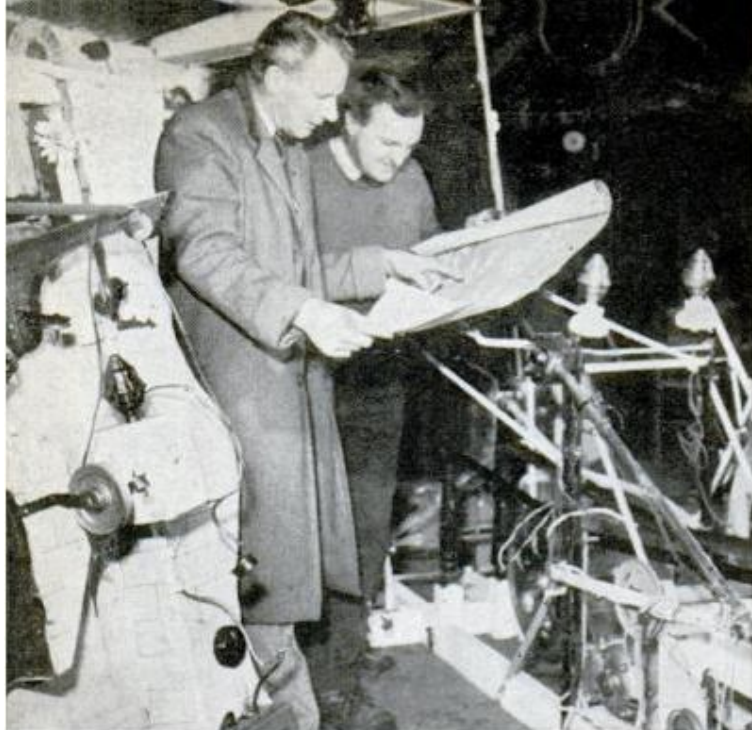

In an old blacksmith's forge, Emett discusses a new plan with his right-hand man, Arthur Depree



Emett-land has over 50 favorite Edwardian-Victorian characters—and, of course, a moth sanctuary on top

The Weird and Wonderful



MODEL YEARS, tail fins and all that are in a world apart from Rowland Emett who invents and builds mechanical things that should have appeared during the reign of Queen Victoria.

Even such a modern concept as his sputnik launcher (as yet unrecognized by the world's scientific groups) has the appearance of a fairly orderly 19th century junk heap. The fact that its secrets have not yet been copied by any major power is a good indication of the degree of sophistication Emett has achieved.

His airplane, too, stands in a class by itself, and some may marvel that it stands at all. But everyone knows that an aircraft—at best—is a fragile thing on the ground, and they await the day it conquers its element. Others fear that someone will try.

Rowland Emett, whose fertile brain and affection for Edwardian and Victorian ages have fostered a whole new brand of technology, is a pleasant-faced man with fair hair and dreamy blue eyes. He

For Emett's air force, an assault on the sound barrier is probably a few years off



Oswald, close-mouthed hero of the Ideal Home machine, sits with his creator for an informal portrait

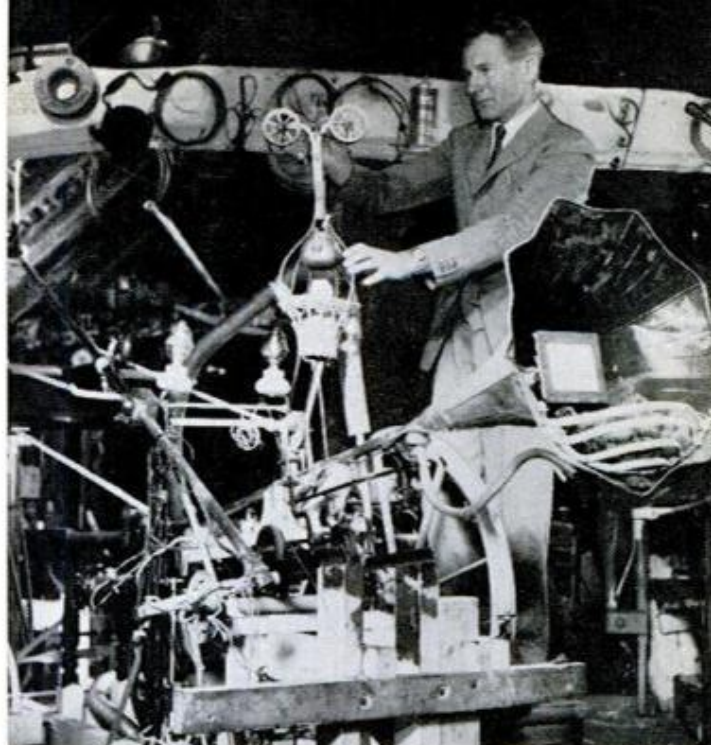

Is this Emmett's idea of a television set? At any rate, it'd be a conversation piece in the parlor

World of Rowland Emmett

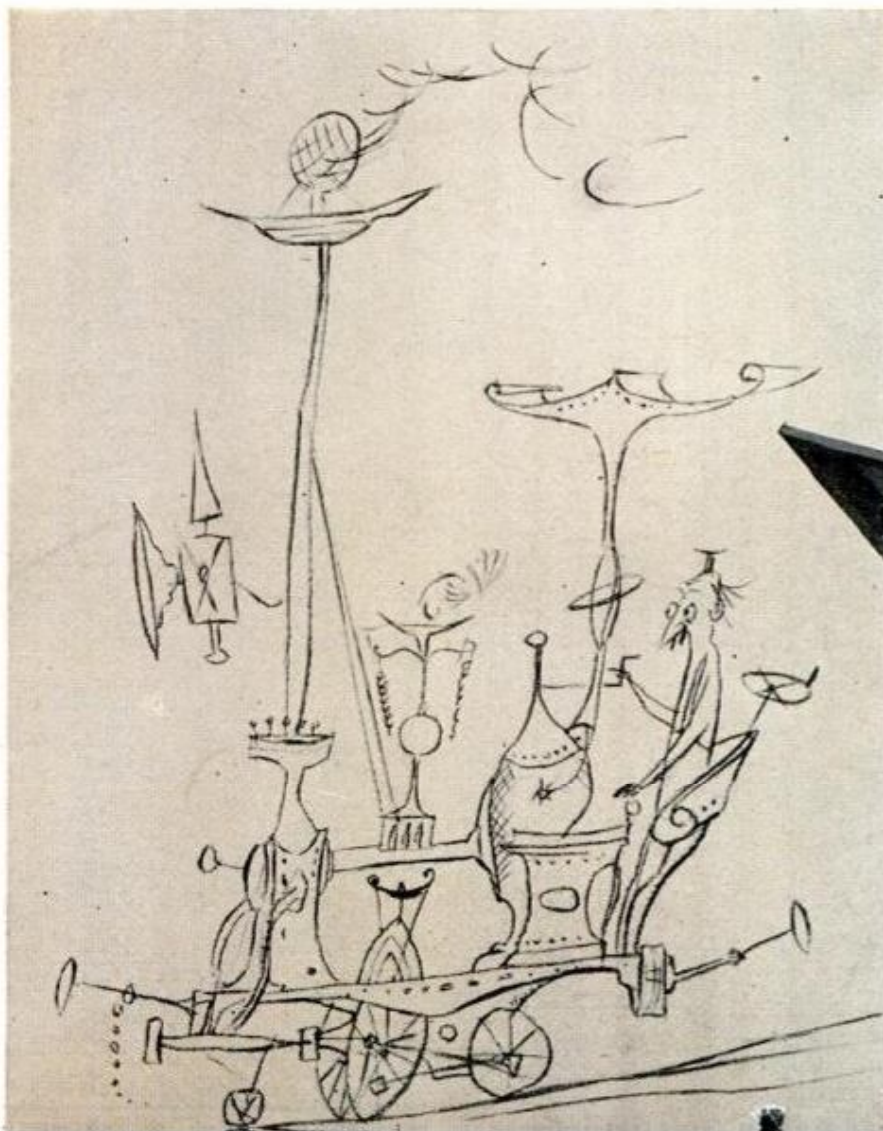

Youthful appearing at 50, Emmett looks like any artist seated at his drawing board—but the pictures on the board look like nothing ever seen before. He first gained fame for drawings





As much at home with tools as with drawing pencil, Emett takes his turn at the forge

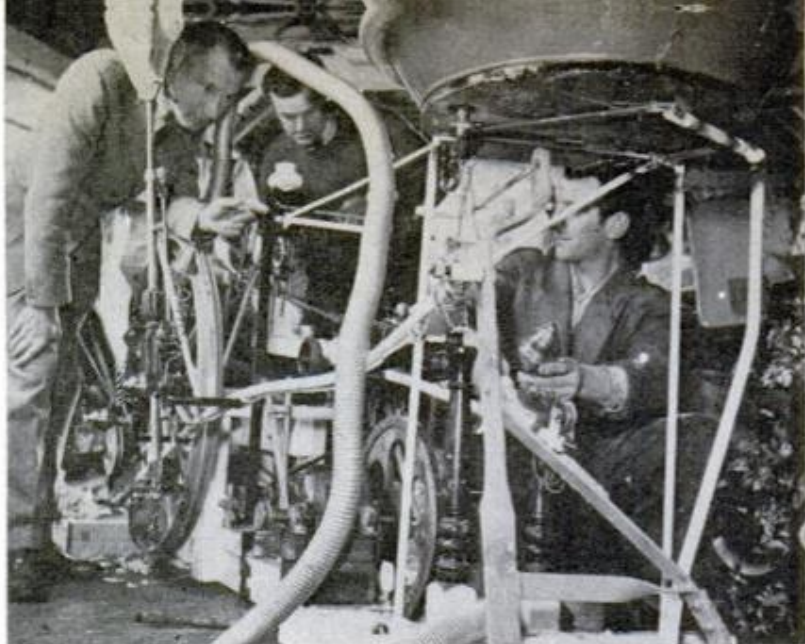

Few people realize how close the tolerance is for placing a brass bed knob under a hipbath. It takes careful sighting

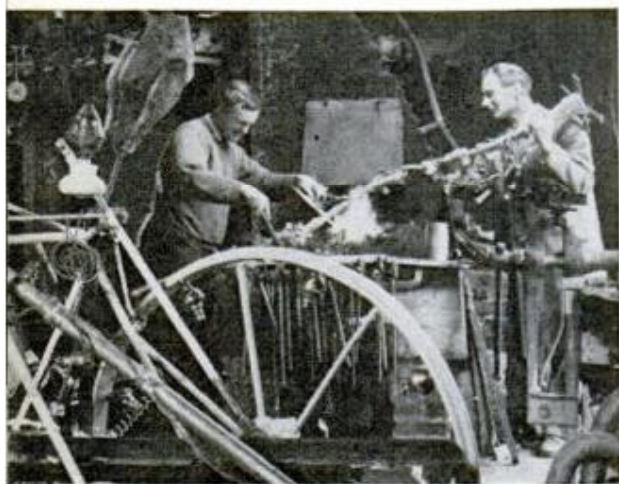

Well-equipped forge includes an artificial chicken, springs, bells and curtain rods

divides his time between his pleasant home in Sussex, England, a blacksmith's forge in the neighboring village of Streat, and strange little curio shops and forgotten junk heaps in weed-covered yards of tumbledown warehouses and factories.

It's a red letter day, indeed, for Emett when he runs across a sack of ornate Victorian bed knobs or some other such treasure. Ordinarily, the items he seeks in shops haven't been moving at too brisk a pace since the turn of the century, and it some-

(Continued to page 256)

Emett believes he shouldn't get lost in the past; here he's about to orbit a modern satellite





Emett adds a new dimension to farm and home living. Among the countless features of the agricultural machine are an egg inducer, a mangelwurze-digger which scrubs and polishes and a carrot fuddler. Oswald, whom Emmett calls "bone idle," appears below in the Ideal Home. Oswald likes everything done for him. Even flowers and grass of the garden are whisked to him through a pipe, held under his nose and then whisked back

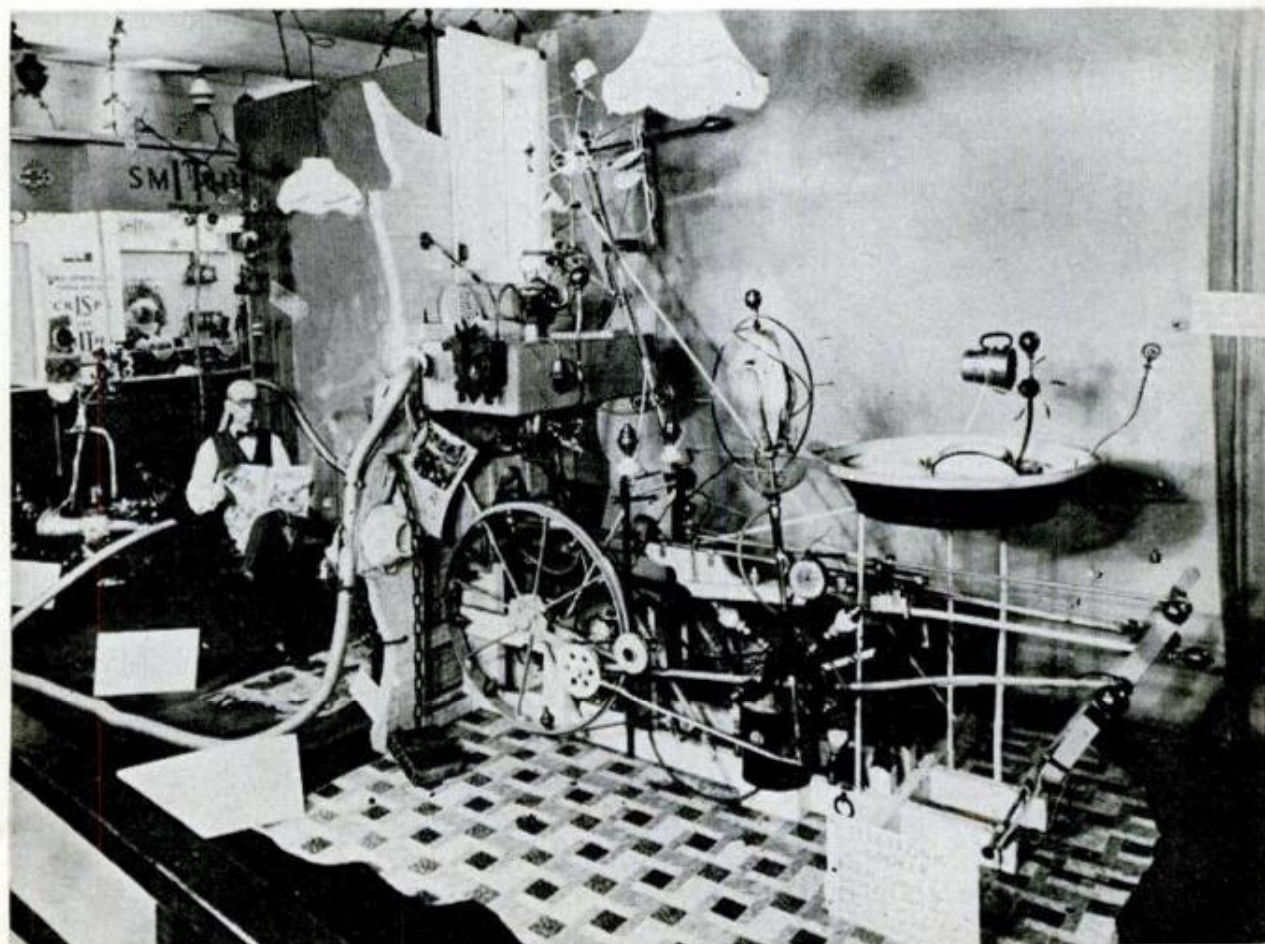



Babies Can Breathe Through This Pillow

Infants who sleep on pillows are no longer in danger of suffocation with this perforated head support that allows a child to breathe when he's lying face down. The

pillow, a British invention, is covered with washable wide-meshed material that allows free passage of air. Wood supports hold it at a comfortable angle.

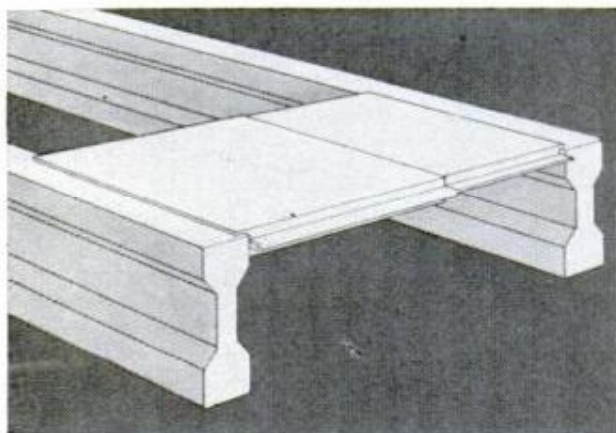

Form Simplifies Concrete Pouring

Adjustable to fit between joists or beams for pouring concrete floors or ceilings, a new steel form is easy to install and re-

move, makes a smooth bottom surface on the slab, and is strong enough to form a safe working surface during the pour.

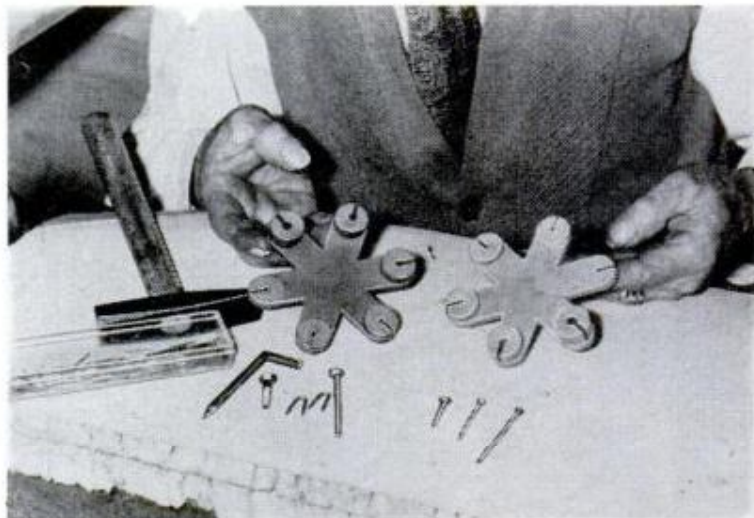

Nail Holder Is Finger Saver

Swollen fingers needn't be the trademark of home carpenters. Here's a six-armed nail holder that keeps hands well out of the

range of a swinging hammer. Each arm of the rubber device has a different size slot to take care of a great range of nail sizes.

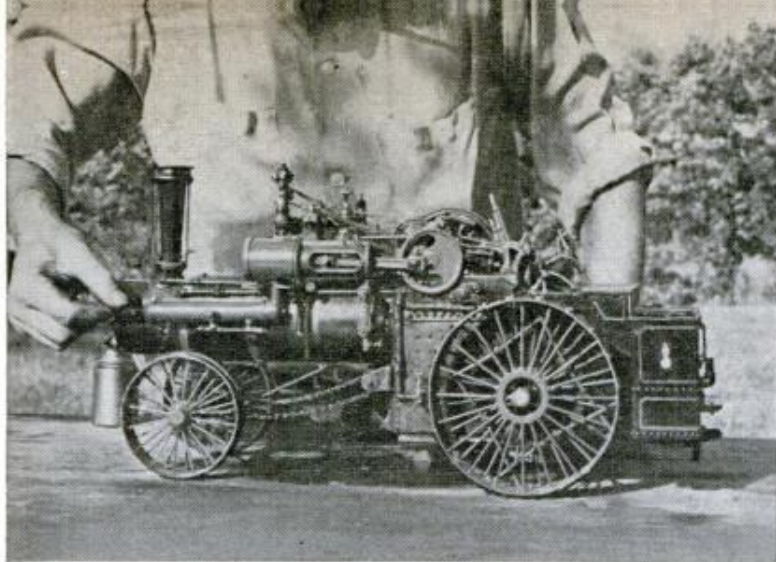

Model Steam Engine Operates Threshing Machine

Some kinds of work remain in a person's blood forever. This old saying certainly applies to E. J. Earles, of Milwaukee, Wis. After 10 years of spare-time work, he has completed an exact model of a 1916 steam engine he ran as a youth in North Dakota. The steam engine actually operates a scale-model threshing machine (middle right) that Earles also built. Earles made all of the tiny gears and the casting, based on a scale of one inch to one foot. The engine runs on 75 pounds of steam generated through the use of bottled gas or charcoal as fuel.

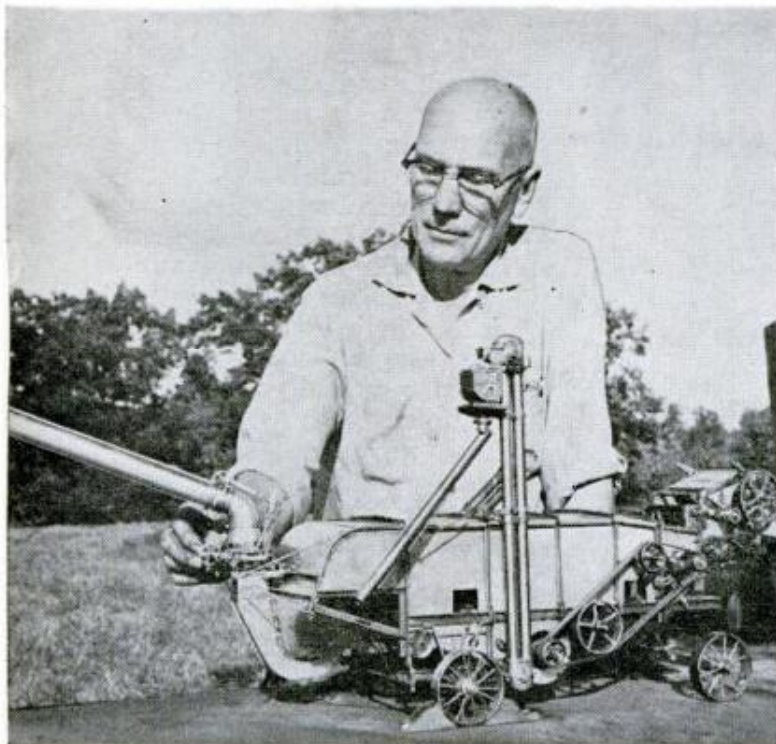

Lightweight Beryllium— Latest Metal for Industry

Beryllium, a lightweight metal that could cut the weight of a transport airplane in half if used instead of aluminum, is expected to see extensive use in industry within two years. Northrop Corporation's Norair Division reveals that beryllium metal bars costing \$100 a pound, have been extruded into U-shapes after early failures. Aircraft channels have not been built yet, but will eventually be made. Cost of the metal would be reduced drastically if it were to be used freely in the aircraft industry.

NASA photo from United Press

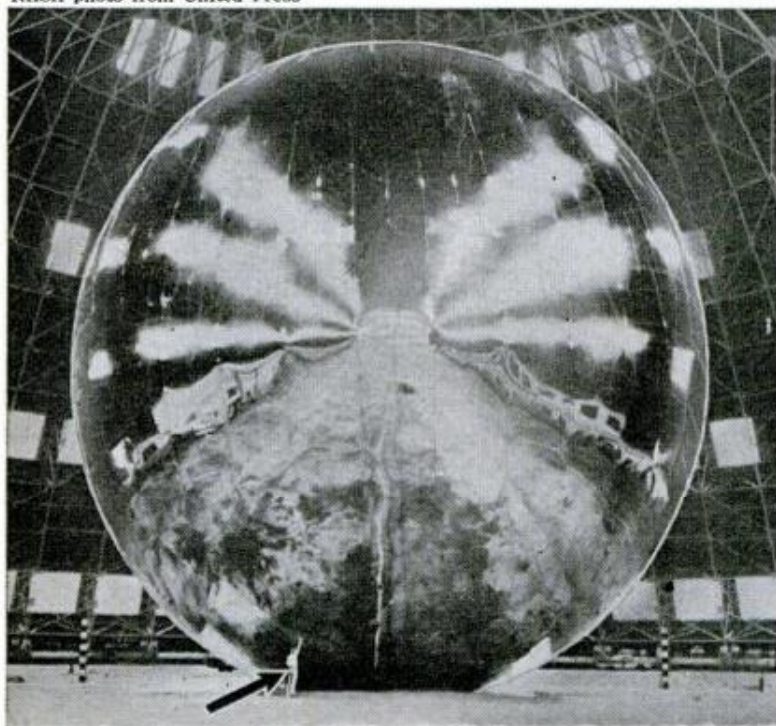

Huge Plastic Balloon Will Become Satellite

One hundred feet in diameter, a satellite developed by the National Aeronautics and Space Administration, can be folded into a metal container 30 inches in diameter and sent aloft at the head of a rocket booster to be inflated in space. It is made of micro-thin plastic and coated on the outside with a film of aluminum. Although it takes 40,000 pounds of air to inflate the sphere on the ground, only a few pounds of gas will inflate it in space. To keep it inflated, despite possible meteorite punctures of the skin, the sphere will carry crystals of a solid that, like dry ice, change to gas. The sphere is proposed as a reflector for radio and radar signals, for around-the-world communication and for signals bounced from the moon in lunar probe experiments.

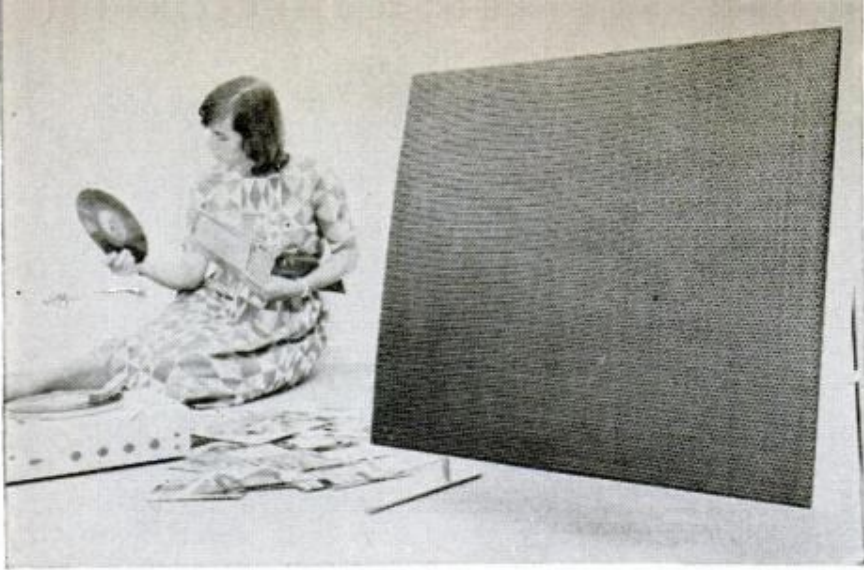

Thin Hi-Fi Speaker Forms "Sound Wall"

Effectively reproducing high-pitched sounds, a large, thin loudspeaker provides a veritable wall of sound. The entire front membrane oscillates to provide the tone. German-made, the unique speaker sells for \$150.

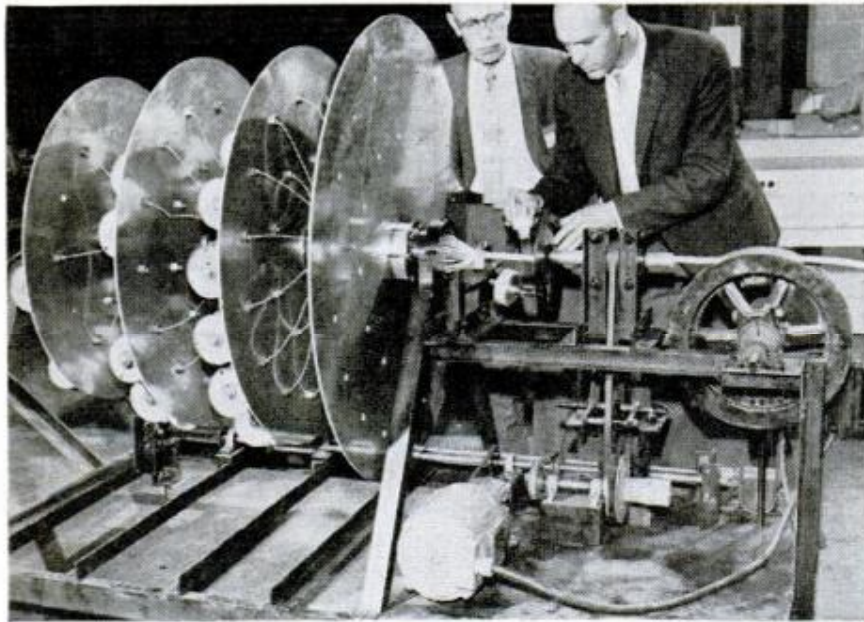

Spinning Disks Wind Electric Cable

Four-layer cables containing 84 No. 16-gauge wires, plus core, can be spun out of a new cable-winding machine at the rate of 15 feet per minute. The machine, developed by Boeing Airplane Company, consists of four aluminum disks mounted on varying sizes of steel tubing and driven in opposite directions by chains and sprockets. The disks carry a number of wire spools which retain their position during the spinning, and spiral each layer of the cable in a different direction from the layer below. The cable is taped automatically.



Airborne Nurses Train in Water

English nurses who accompany sick and injured men home from far-flung naval and air bases are being trained to keep their helpless charges from drowning, should their air ambulance go down at sea. They study at the Royal Air Force Aero-medical Training Center in England, practicing putting on life vests in the water, righting overturned life rafts and other rescue procedures.

☐ Ninety million meteors bright enough to be seen under good viewing conditions enter the earth's atmosphere each day.

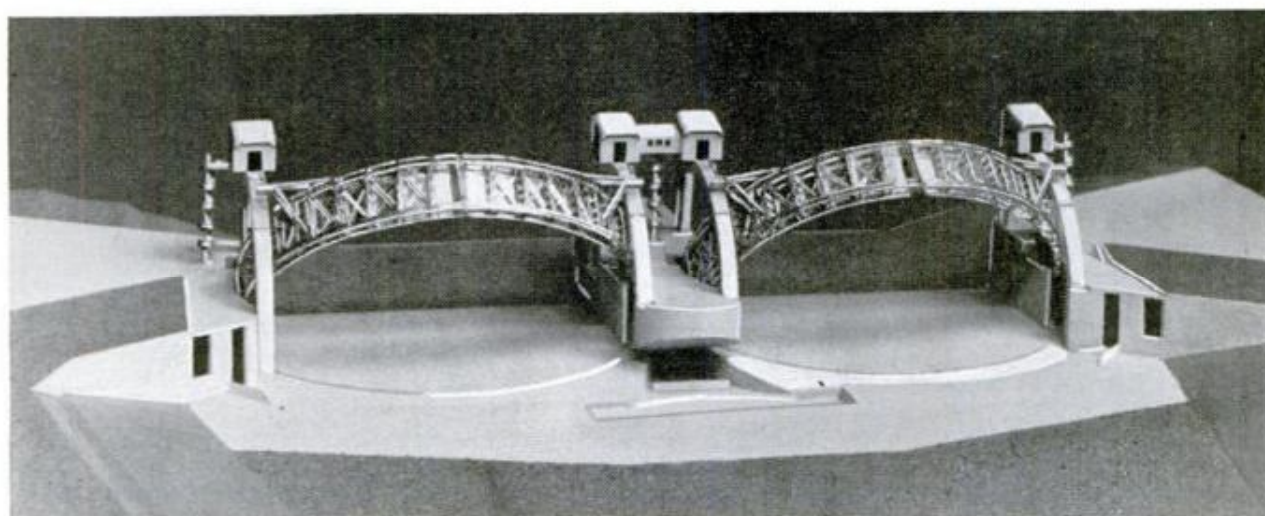
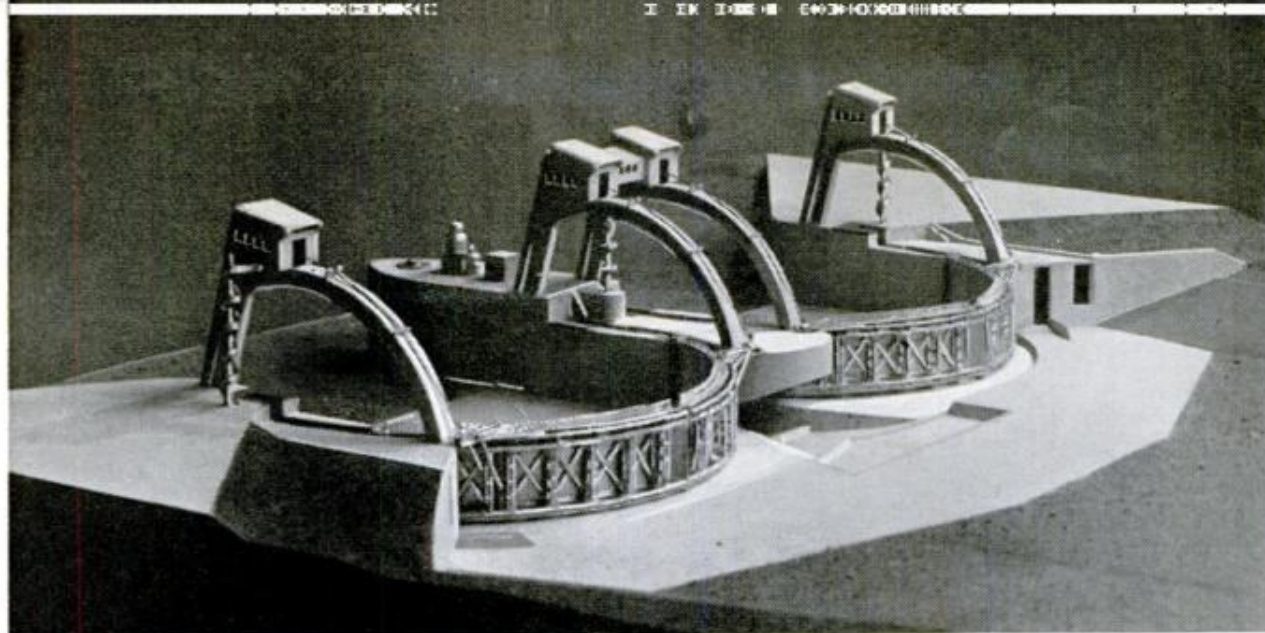

Armor-Like Visors to Regulate Flow of Dutch River

Dutch dam-builders, well experienced in regulating waterways, are employing an engineering technique never before used in the construction of a dam. Visors, resembling those that slipped down over faces of ancient knights, will rotate around an axle in a half circle to control the watercourse of the Lek River near Hagestein, Holland. The traditional turn-doors or lift-doors are eliminated in this project. The slides, which are 174 feet wide, are raised or lowered on their axles.

Besides being considerably less expensive than other dam-building principles, the slides need no lift-towers since they are guided by the axle. Each visor slide weighs about 200 tons. Turn or lift-doors are tons heavier, and greater electric output is required to operate them. Present plans indicate that by 1968, the Lek will have three new sluiceways.

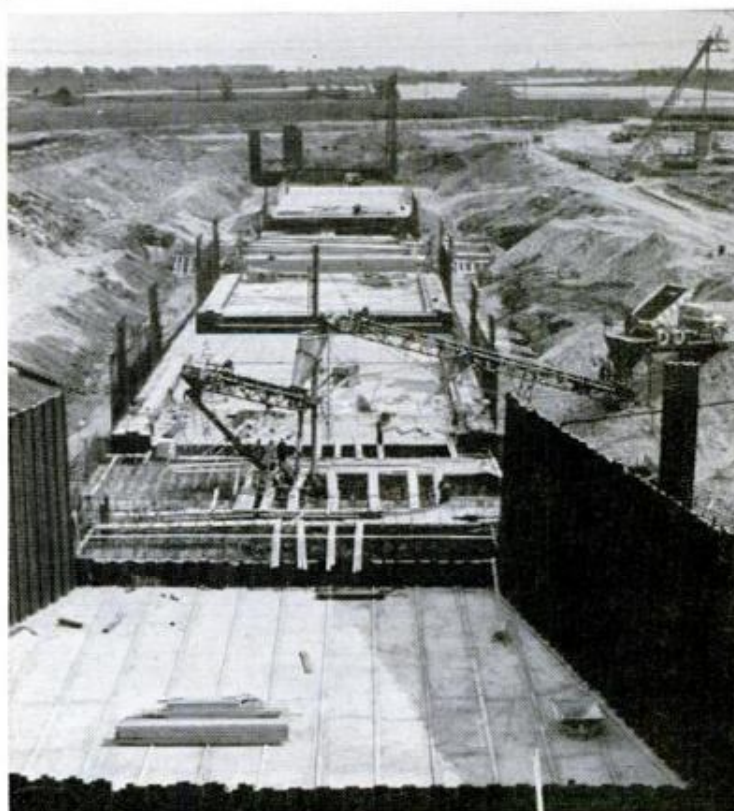

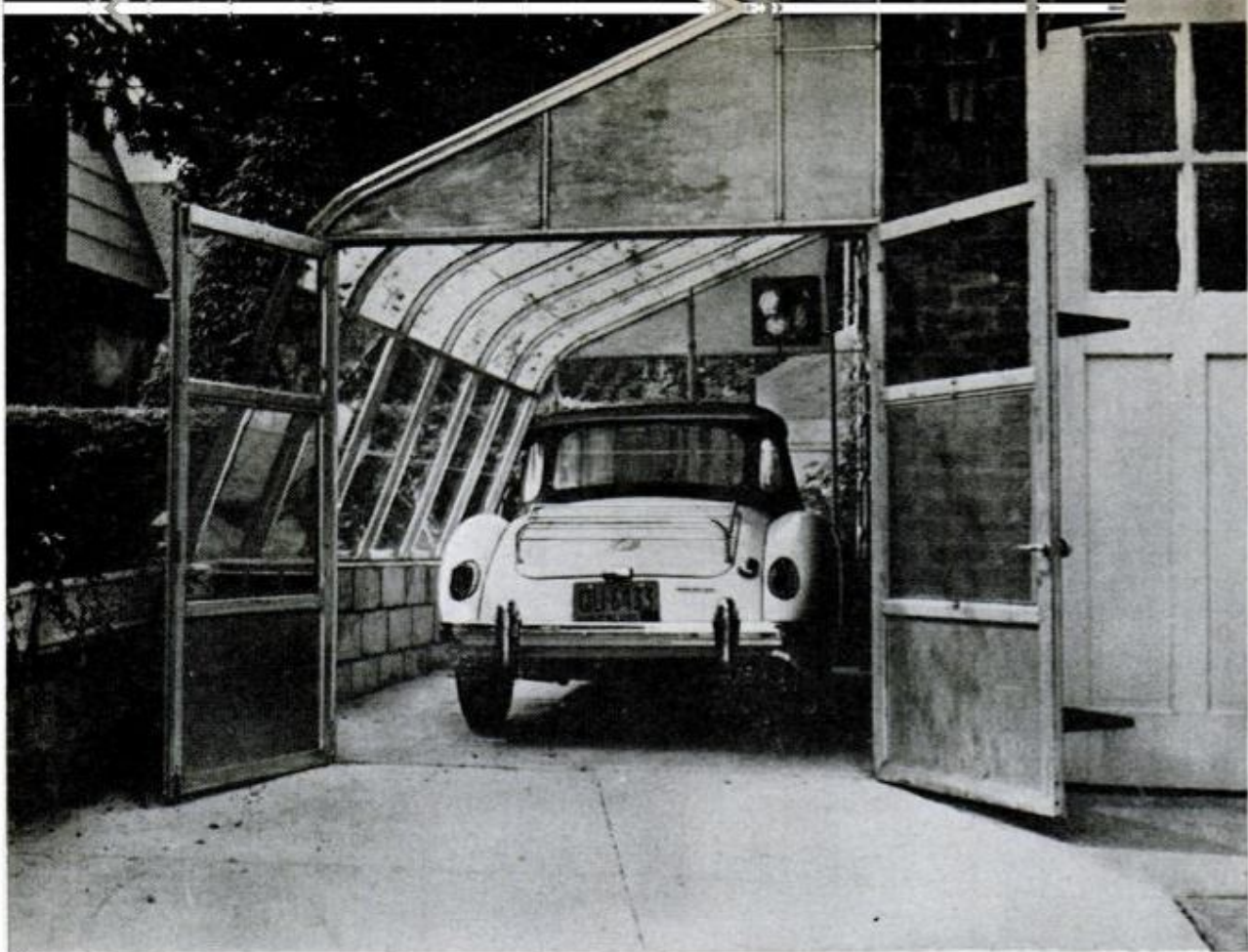

Cars That Live in Glass Houses...

Needing a shelter for his sports car, P. J. Amico of Flushing, N. Y., bought himself a prefabricated greenhouse and set it up beside his garage. The glass walls give plenty

of light for working on the car during the day, and at night it's protected from the elements. It took him only a weekend to complete the project.

Ten-Ton Tractor Pulls Huge Plow

Two and a half tons of plow—an eight-bottom “pickup” model—is integral equipment on the new John Deere 10-ton tractor for large-acreage farms. Powered by a 218-horsepower two-cycle diesel engine, the

giant tractor is the biggest to make use of integral equipment. Front and rear wheel units are mounted separately allowing operation over almost any terrain. Power brakes and steering make driving easy.

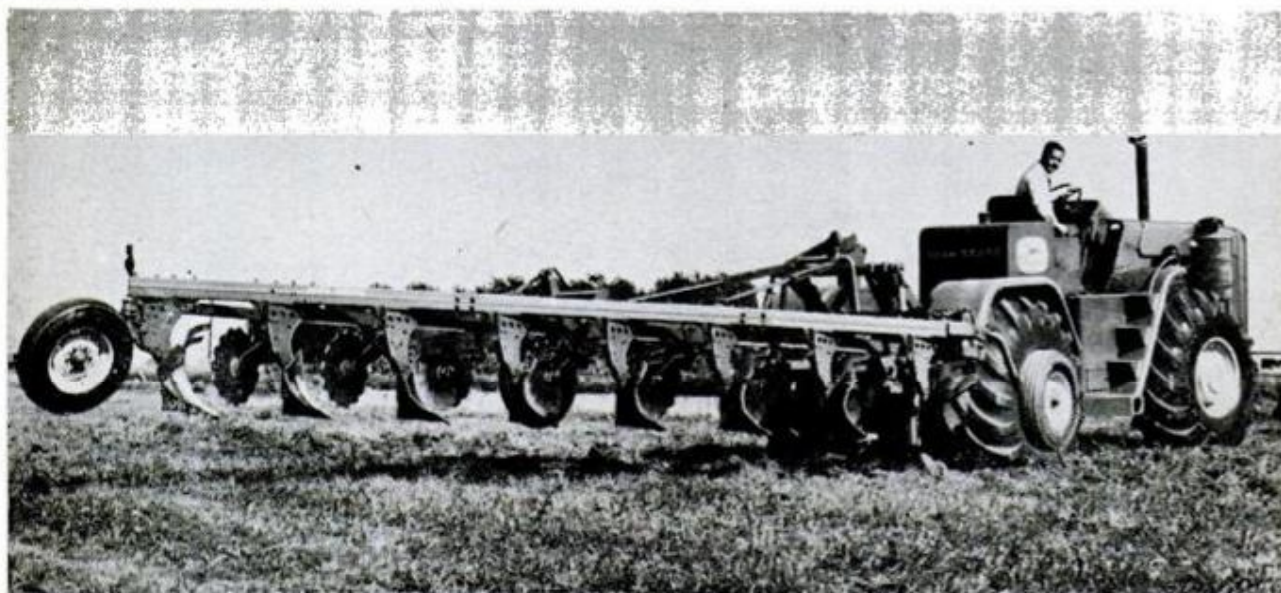

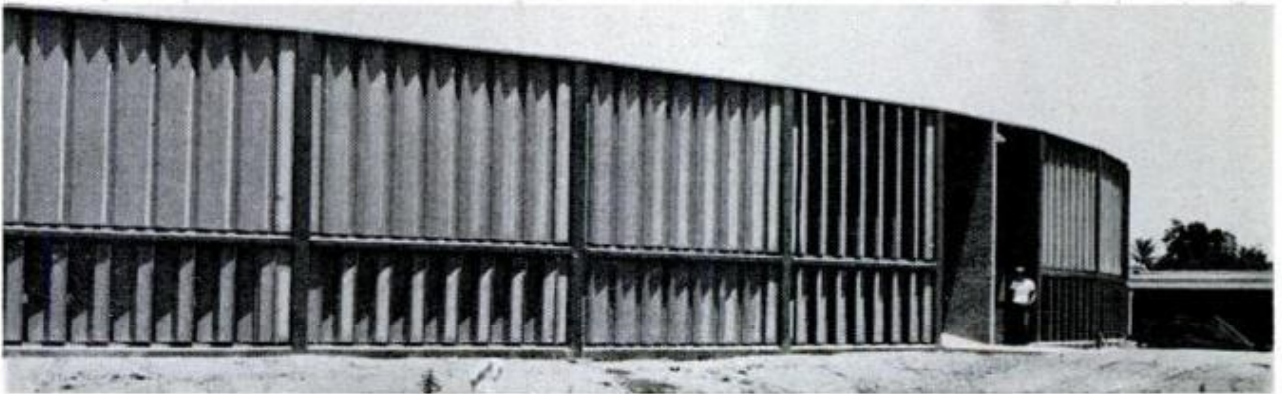
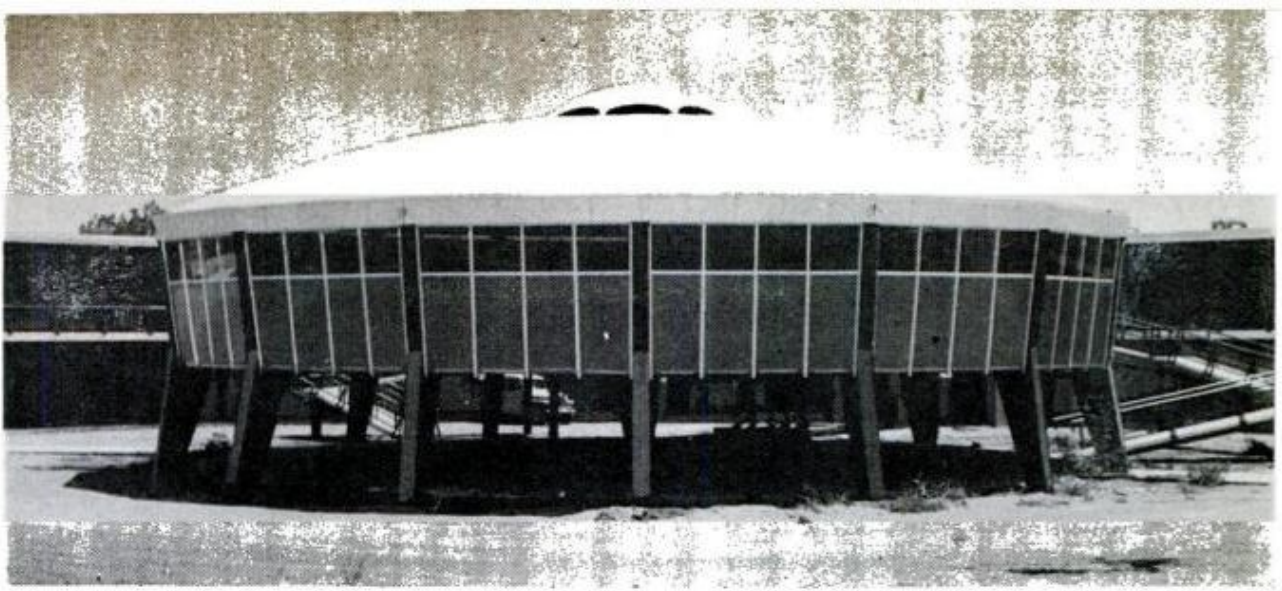

School's Circular Library Stands on Stilts

Standing on 10-foot stilts inside a semi-circle of classrooms, the library of Arcadia High School in Phoenix, Ariz., forms the focal point of the entire structure. It is the

same distance from all the classrooms. Architect Mel Ensign designed the vertical louvers in the classrooms to allow each room to have individual sunlight control.

Tackboard Is Covered With Vinyl

Laminating vinyl wall covering with quarter-inch sheet cork, a California manufacturer has developed a tackboard material that's easy to maintain, yet is as easy to use as cork board. Called Vinyl-cork Tackboard, it is available in 12 colors; is non-fading and glare-free; and tends to close over old tack holes to prevent damage from heavy use. In schools and museums it can be used as a full wall covering for displays.

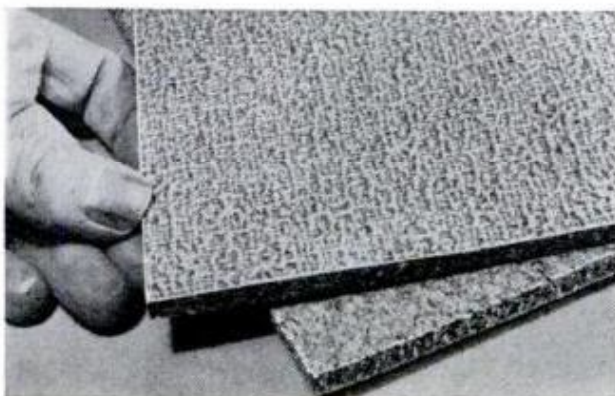

Museums Are for Doing Things

Children's museums pick up where school leaves off

By Charles V. Mathis



IBM's exhibit of Da Vinci's inventions gets a lot of attention in Charlotte, N. C., Nature Museum



Student and instructor inspect a find during a fossil hunt sponsored by the Charlotte Children's Nature Museum

A MUSEUM is as individual as a thumbprint. It may specialize in art or science or natural history; it may have its own ideas of public service and its own techniques of exhibition. But most museums do much the same job—they display specimens, carry on research programs and ask of the visitor only that he use his eyes.

Within the museum world, however, there is one entirely different breed. It is called the children's museum, and there are now nearly a hundred of them, sprinkled happily across the nation.

These new museums are completely dedicated to and guided by the needs of children. They are places not only to see things, but to do things, and combine museum, workshop, zoo, school and community center. The young visitors can even help build simple exhibits, such as displays of Indian folk art or models of the planetary system.

The youngsters play with live animals of types not usually classified as household pets. They join clubs for science and nature study, participate in pet and puppet shows,

and attend organized classes which may range from ceramics and carpentry to taxidermy and telescope making.

The concept of the children's museum is not much older than the twentieth century. The first was the Brooklyn Children's Museum in New York City, founded in 1899. Today there are 92, with the largest numbers in California, New York, Massachusetts, Connecticut and North Carolina.

Most children's museums work closely with the public school system. Their self-appointed task is to bring to life what the children are learning in class. To do so, they send periodic bulletins to the local schools listing current exhibits and coming attractions.

The special flavor that distinguishes children's museums is satisfying the child's yen to get his hands dirty; the flavor of participation. The junior museum program is dynamic, not static, and provides a community with a popular cultural center for young and old. The children who flock in tens of thousands through the doors of the



Class group examines a target drone plane loaned by Lowry Air Force Base to the Denver Children's Museum

junior museums learn to think of our native flora and fauna as living things to be cherished. This leads to a genuine desire to protect and conserve our invaluable natural resources.

The junior museum program is built on the belief that curiosity is the beginning of wisdom; that a child's natural curiosity and love of living things should be encouraged and cultivated in order that his life may be enriched by greater knowledge of the world he lives in.

A child may read about the stars in school, but he can't see them; at a zoo he sees animals, but he can't touch them. But in the planetaria maintained by many junior museums, he sees the heavens close and bright, and his face shows awe.

Or a deodorized skunk takes a complacent stroll across the floor and the child strokes its bushy tail and squirms with de-



Sacramento's Junior Museum loans pets as a library loans books. Shirley Taylor checks out a snake



Keith Hacker, sick at home, is cheered by a skunk and a fox loaned by the Sacramento Junior Museum



Sacramento's museum has a long waiting list for animals like skunk and coon above; squirrel below



light. In a museum science workshop, he welds together a challenge—a model of the solar system or a satellite. The preschooler discovers textures—sand or clay—and his fingers transmit their contentment to his face.

A children's museum is a breezy sort of school, where boys and girls may come and go as they like, eat and chew when they please, study just what strikes their fancy and even bring their pet turtles along for company.

They respond to everything—to sounds, to smells, sights, touch—to skunks and stars and all the majestic mysteries which lie between in the wide, wonderful world of the child. And behind every response lies a new little nugget of learning.

Recently the space and satellite activity has given new impetus to the junior museum field. If larger numbers of our youngsters are to become interested in science, the country cannot wait until high school and college and then hope they will select a scientific career.

Scientific thinking must begin with children in the elementary grades. That is the proper time to start a trend which can and should greatly increase the number of young people entering high school and college with a genuine interest and dedication in the field of science.

Junior museums can serve as the science center for a community and through their progressive programs capture the imagination and enthusiasm of even the smallest children. Science is no longer the misunderstood and sometimes, boring oddity with which children occasionally make contact. Through colorful exhibits, especially the popular "touch me" action displays, games and demonstrations, science can be popu-

Satisfied customer headed home from another animal lending agency, the Children's Museum in Boston



Sacramento's museum animals are out where the kids can see them—this is Pogey, the popular porcupine

larized and accepted as part of youngsters' daily lives.

The guiding light behind the junior museum idea is John Ripley Forbes, who for 29 years has worked to repay his debt of gratitude to one of America's great scientists. In doing so, he has built a coast to coast chain of free children's museums and has revolutionized museum practice. Now no hamlet is too small and no slum is too dense to echo a child's happy squeals as he holds a live opossum or sits entranced by nature or science movies.

All this started when Johnny Forbes, then a 14-year-old Boy Scout, went on a hike through the woods near Stamford, Connecticut. He discovered a frog that had just swallowed a firefly. The insect glowed through the membranes of the frog's stomach. John took the spectacular exhibit to his neighbor, Dr. William T. Hornaday, director of the New York Zoological Park and world-famous naturalist. As one scientist to another, the boy and the elderly zoologist exchanged their views. The gentleness and keen interest of the distinguished man inspired the boy to make natural history his career. A year later Forbes opened a museum in his father's attic and invited his new friend to inspect it. Dr. Hornaday spent an hour examining the exhibits; when he came downstairs, he said, "Mrs. Forbes, I came to see a boy's collection, but I have seen a scientific museum. Your son is a born curator."

Forbes has since worked diligently to help establish the national chain of junior museums in paying off his debt to Dr. William Hornaday.

The junior museums pick up where school leaves off. For school is a necessity, dealing in textbooks. The museum is a luxury, dealing in objects. Each is important to the other, as important as the knowledge of arithmetic is to a dedicated junior astronomer.

But if the youngster treats his telescope somewhat more tenderly than his multiplication tables, he can hardly be blamed. For a child's favorite world is composed of objects, not ideas; and it is the sole and gratifying job of a children's museum to hand him the world on his happiest terms.

★ ★ ★

Douglas Aircraft's early "Bumper Wac" rocket is another popular exhibit in the Charlotte Museum

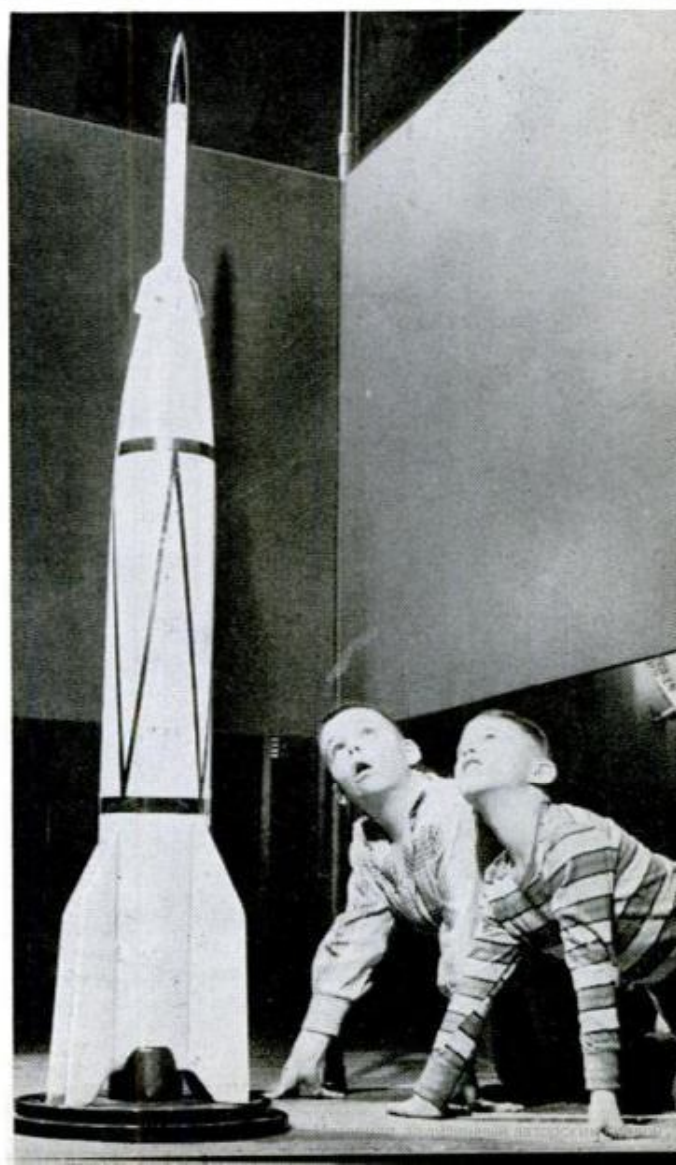

"Hound Dog" Hangs Under Wing Of Huge Air Force Bomber

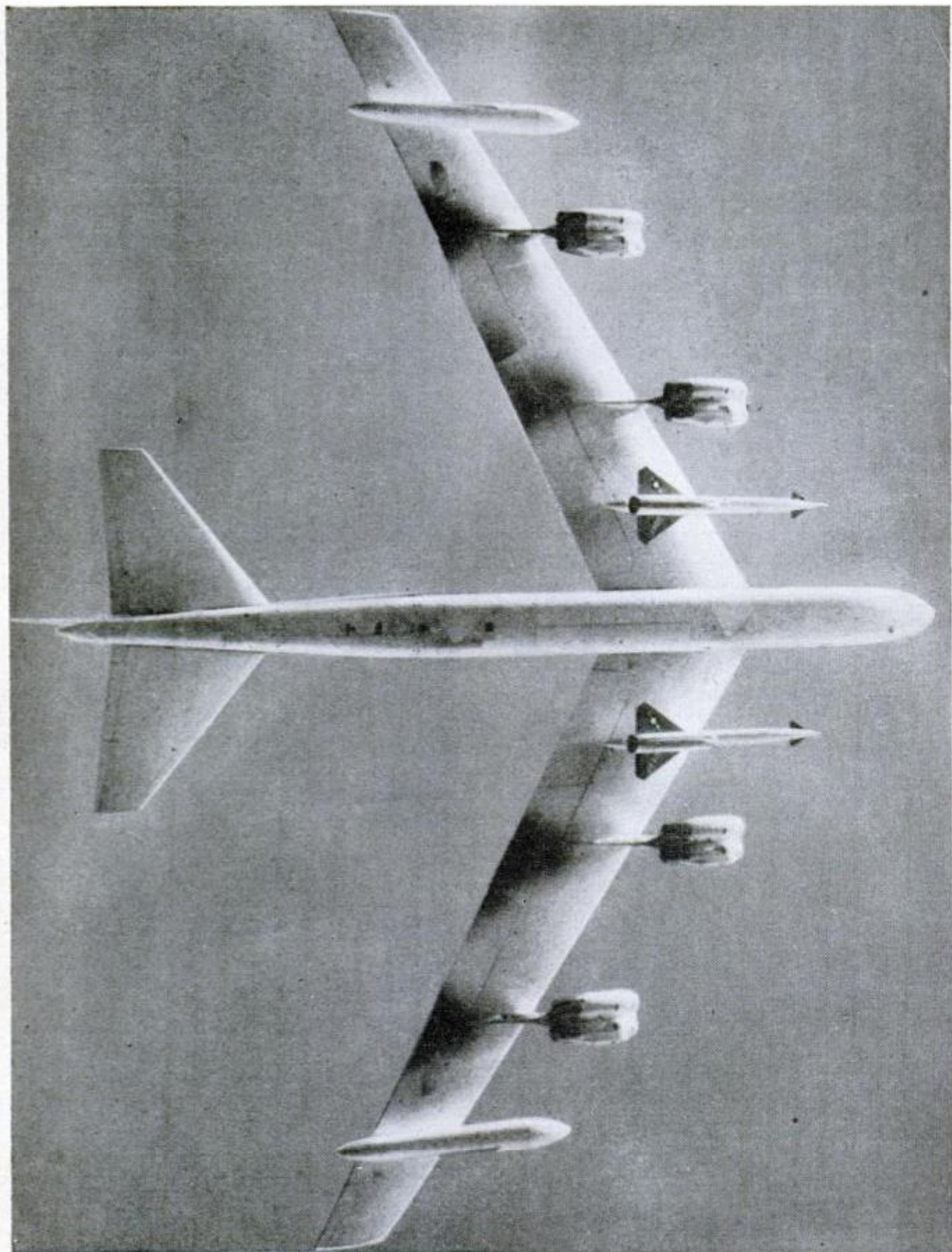

Suspended under the wing between the inboard engines and the fuselage of this giant Air Force B-52G are two GAM-77 "Hound Dog" missiles. The air-to-ground missiles are manufactured by North American Aviation

BONELESS FISH!

By Hurley L. Campbell

FISHERMEN'S wives and kids often dislike helping Dad eat his catch because of the inconvenience of eating around the small bones. But you can have boneless fillets if you'll follow these step-by-step instructions next time you clean your fish. It takes only a little more time, and you'll end up with nothing but edible meat. All it takes is a bit of practice and a sharp knife with a flexible blade—and, of course, a fish . . .

2. Cut along the dorsal fin down to the rib cage, but don't cut the ribs. Extend the cut back along the length of the fin, then clear through the body behind the ribs

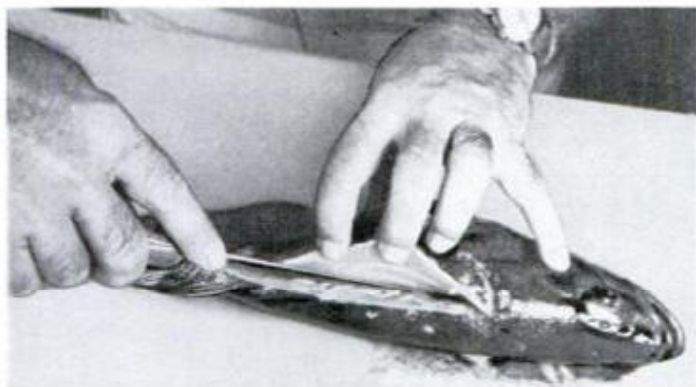

4. Discard the knife momentarily and use the finger tips to peel the flesh away from the rib cage; it pulls away easily, but be careful not to bruise the flesh. When that's done, the fillet will be freed except for the belly skin and the skin "hinge" left at the tail in step 3

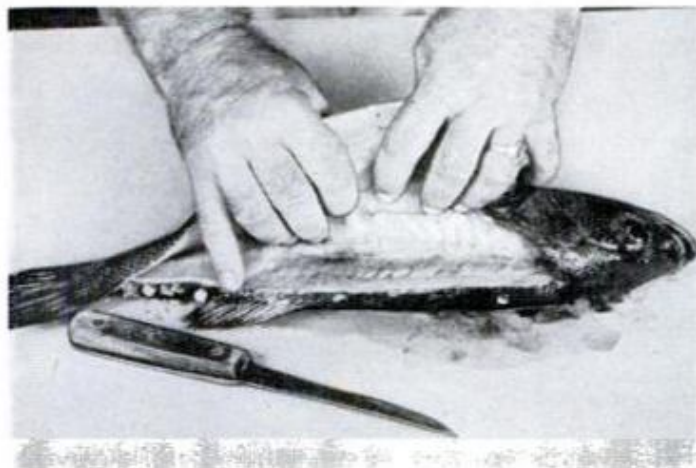

6. Flip the fillet over and insert the knife blade where the skin was left attached at the tail. Work the knife along, pressing down against the skin with a slight sawing motion until the fillet is freed. The only bones left in the skinned fillet are the small tip bones from the ribs



1. Start with a forward-slanting cut from behind the pectoral fin and gill cover, working down to (but not through) the backbone

3. Slide the blade back along the tail bones with a slight sawing motion to within a half inch of the tail. Stop here, leaving a "hinge"

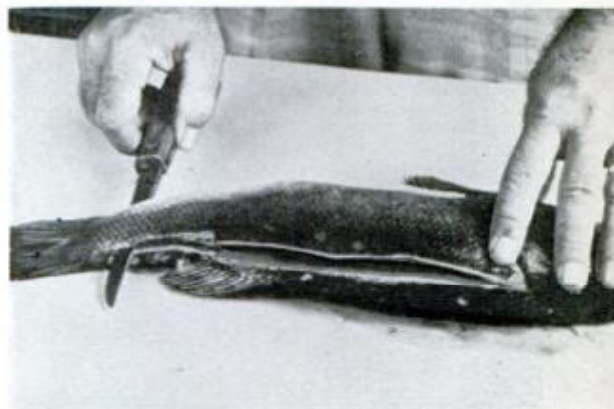

5. Cut along the center of the belly to join the cuts made in steps 1 and 3. This frees the fillet at the forward end, leaving the bones and viscera with the head. (There is no need to scale or draw the fish first.)



7. Easiest way to cut out the rib tips is to remove a quarter-inch strip of meat from the inside of the fillet. The finished fillets can be cooked whole or cut into bite-sized chunks which are quicker and easier to cook

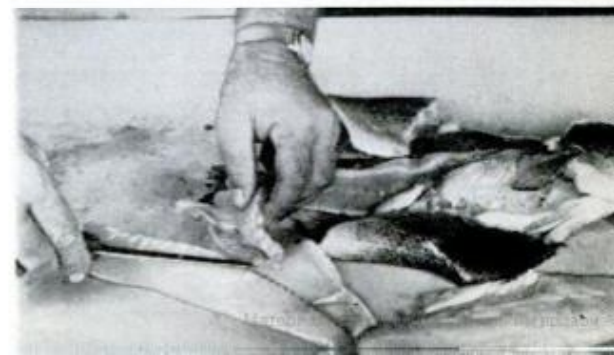



WHAT'S NEW FOR

ELECTRONIC CHLORINATOR, using ordinary household bleach, treats up to 75,000 gallons of water a day for home, farm or commercial use. Normally located between pump and water-storage tank, the unit is cased in cast aluminum finished in white and gold. Chlorination rate is adjusted by finger-tip control and proper strength is determined by simple test
 Clayton Mark & Co., 1900 Dempster St., Evanston, Ill.

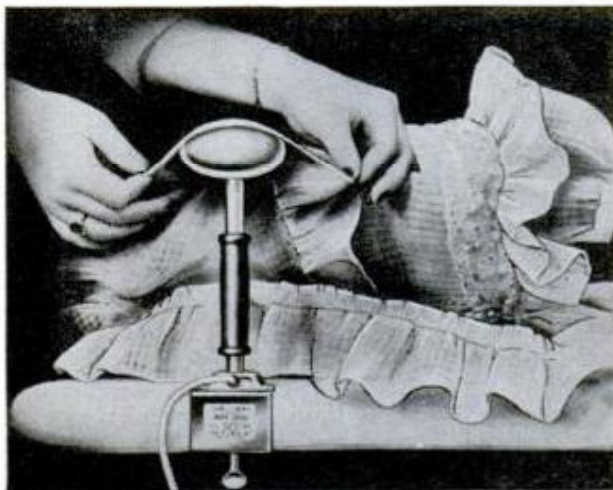

PUFF IRON that clamps onto the back side of an ironing board and is ideal for ironing ruffles and puffed sleeves can also be used for sealing cellophane packages, such as those put in freezers. It has a special heating unit in the head that adjusts automatically to correct temperature for all fabrics. The fittings are chromium plated for longer wear
 Vin-Max Co., 631-85th Ave., Oakland 21, Calif.

KNIFE SHARPENER provides a separation between blade and holding hand for safety. It has self-adjusting, revolving grinding wheels inside a slotted aluminum tube. The mechanism, completely enclosed, sharpens knife evenly, end-to-end. Seven inches long, it fits in drawer and has hole for hanging
 Robot Mfg. Co., 5803 Kearny Villa Rd., San Diego, Calif.

CUTTER-SERVER makes neat work of handling such foods as cake, pie, meat-loaf and pizza. One stainless steel blade resembling a pancake turner is slid under food; knife cuts as handles are squeezed
 Kitchen-Quip, Inc., Waterloo, Ind.

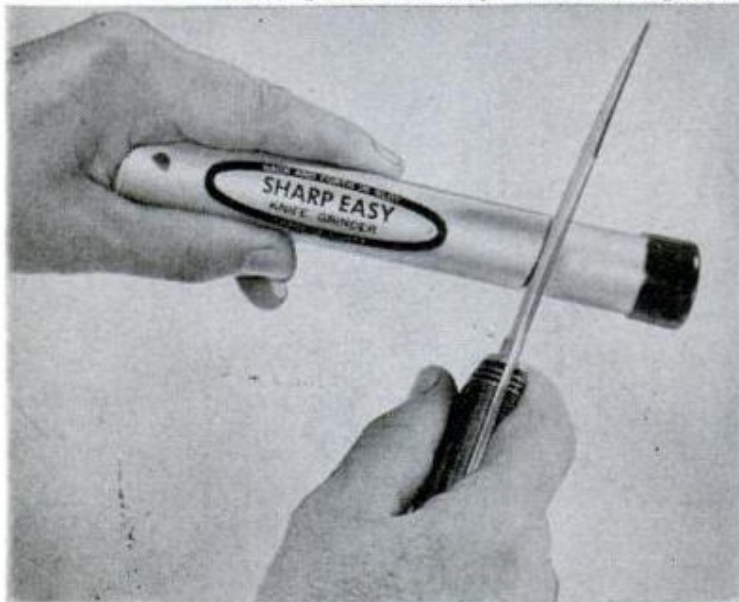



ELECTRONIC AIR CLEANER weighing just under 50 pounds can be moved from room to room. Its patented ionizer is claimed to remove 85 to 90 percent of all smoke, pollen, dust and airborne dirt in a room. To clean, cell plates are flushed with water
 Electro-Air Cleaner Co., Inc., Olivia & Sproul Streets,
 McKees Rocks, Penn.

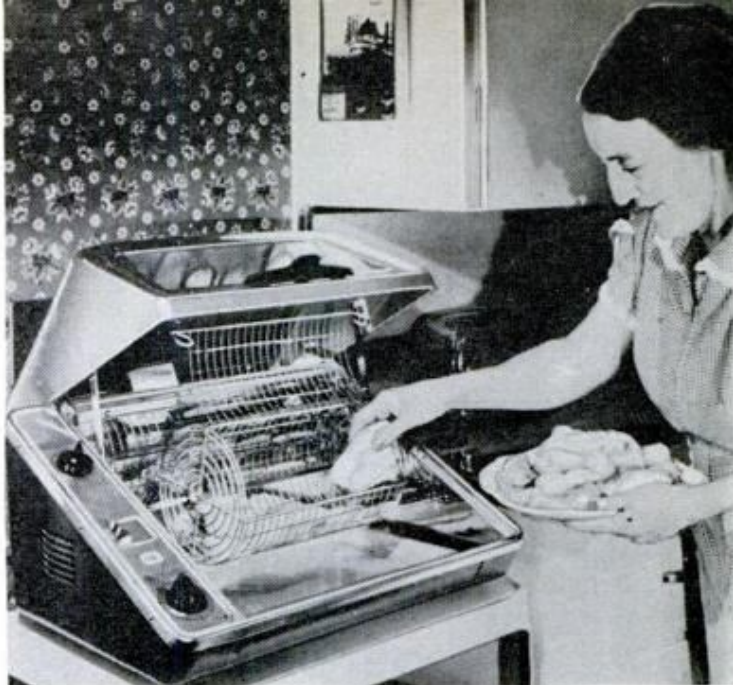

METAL BASKET fits on rotisserie spit and through its tumbling action evenly cooks, and uniformly browns, food items too small to be barbecued on the spit itself. It is self-basting, and the manufacturer recommends it for cut-up chicken, ribs, chopped wieners. Available in a number of sizes, the basket can be cleaned by rinsing in detergent and water
 Hewitt Brothers Mfg. Co., 2207 Cleveland, National City, Calif.

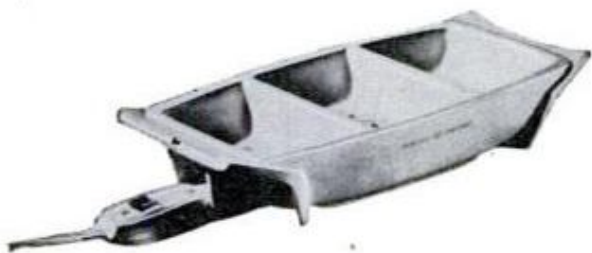

BABY-FOOD WARMER, electrically operated, heats food in seven to ten minutes, keeps it warm for half an hour. Each of three compartments holds a jar of food
 International General Electric, New York, N. Y.



HAIR DRYER is ready for use when door of case is raised. Cap and tube are stored in the unit, which has a permanent Fiberglas filter. There are no electric wires in the cap itself. The compact dryer has settings for four air temperatures, including cool
 Sunbeam Co., 5600 Roosevelt Rd., Chicago, Ill.

PORTABLE RADIO CONTROL for electronic garage door openers is a nine-ounce transmitter that operates for more than a year from a single battery. It can be geared to a receiver to operate with any one of 25 signal combinations, and requires no wires
 The Alliance Mfg. Co., Alliance, Ohio.



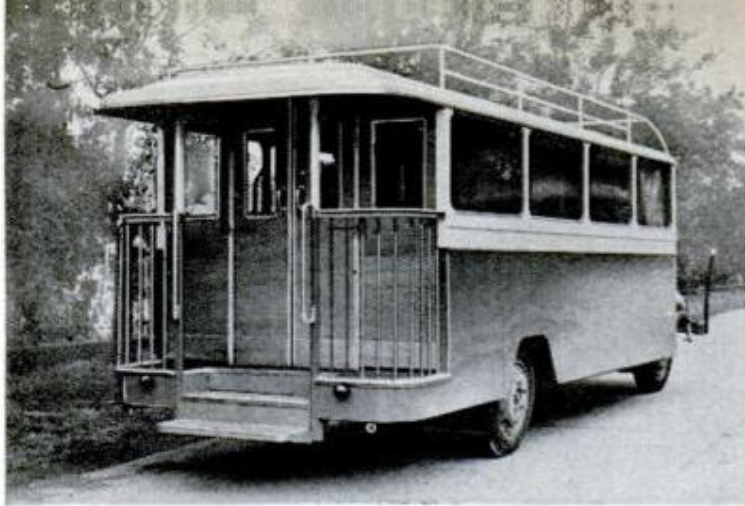

Bus for Sightseers Recalls Yesteryear

When a horse-drawn bus became too small and too slow, a West German sightseeing company demanded a bus for their visitors that resembled the old one. That's what they got, only it's not horse-drawn. It's equipped with a 48-horsepower Austin engine. If you saw it from the back, you'd believe it was the former bus, since it even has the entrance in the rear. The unique vehicle has adequate room for 35 passengers.



Model Village Made of Bricks

Thousands of tiny concrete bricks, formed in the trays of matchboxes, have been assembled to make a model village in Shawford, England. L. R. Abrahams and his wife spent 10 years building the village now displayed in their front garden. It contains shops, factories, roads, bridges, a church, a movie house, a railway station and a model train. Like all builders, the Abrahams are making plans for expanding their project: They also display a container where their many visitors may drop matchboxes.



Valuable Seeds Stored in Vault

To make sure the United States will continue to have vigorous strains of corn, cotton, wheat, rice and other plants, the Department of Agriculture has opened a National Seed Storage Laboratory at Colorado State University. Some 300,000 quarts of seeds—the best types remaining from 60 years of plant exploration as well as possible breeding stocks—will be stored in nine vaultlike rooms that automatically are maintained at proper temperature and humidity levels for the various types. Seeds from wild plants and primitive varieties also will be kept, and all seeds will be available, free of charge, to scientists in this country and its possessions.

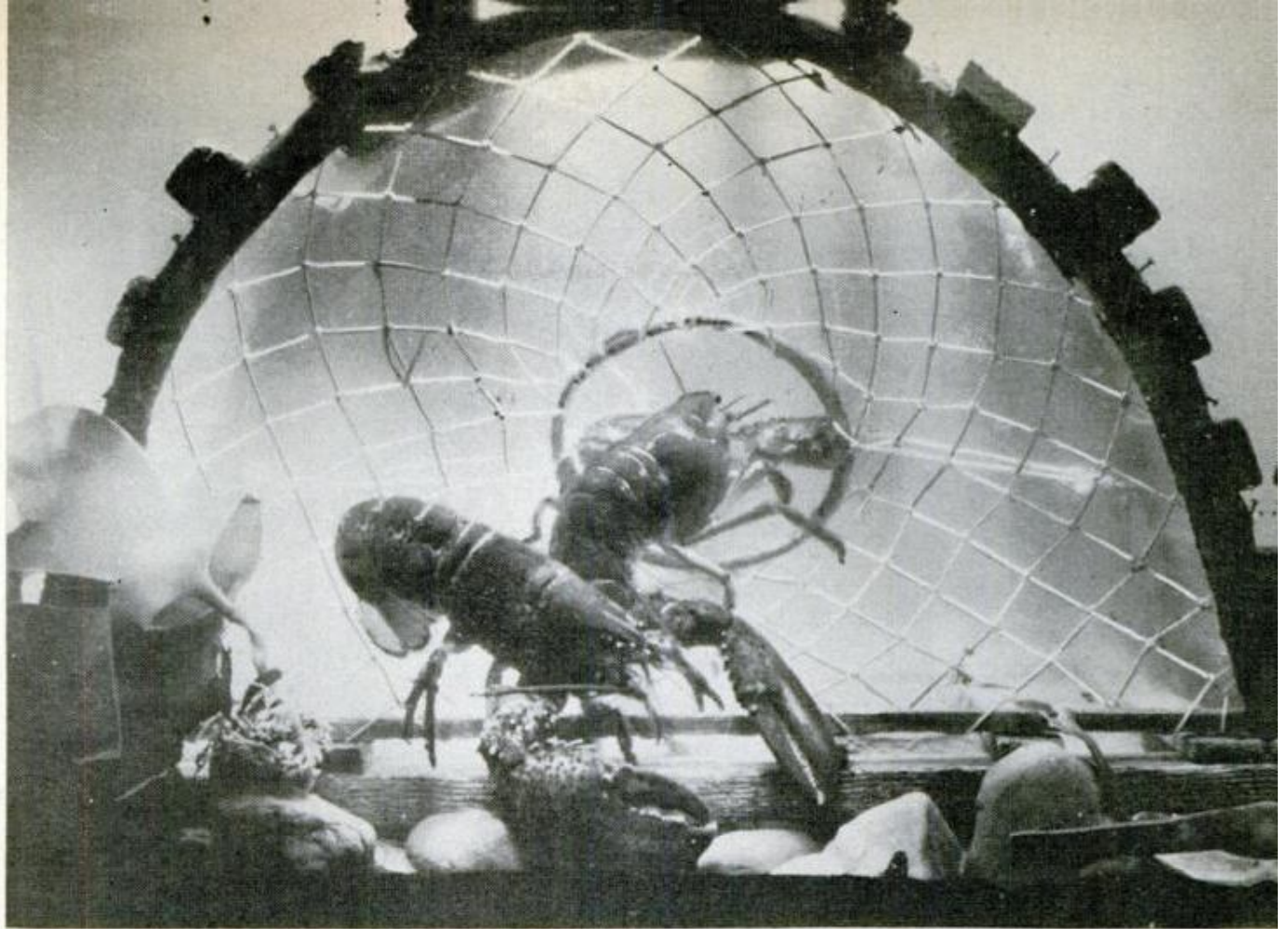

Underwater television cameras watch as lobsters enter a wooden trap on the ocean floor. Below right, a frogman prepares to carry an aluminum trap to the bottom. TV studies show lobsters prefer wooden traps

TV Spies on Lobsters

TELEVISION CAMERAS that spy on ocean-bottom lobster colonies are solving a dilemma that recently has puzzled the lobster industry. While providing closeup views of lobster feeding habits, the cameras can tell lobstermen whether old-fashioned wooden traps or new metal ones are more attractive to lobsters. Light metal traps outlast wooden ones by 12 years, but lobsters prefer the old ones in certain weather. The television cameras show that, when water is cold, lobsters shun metal traps and fight for the same type of bait in wooden traps.

Pictures of lobsters' activities are recorded by movie cameras. Right, each television camera is installed in a water-tight bell, then lowered



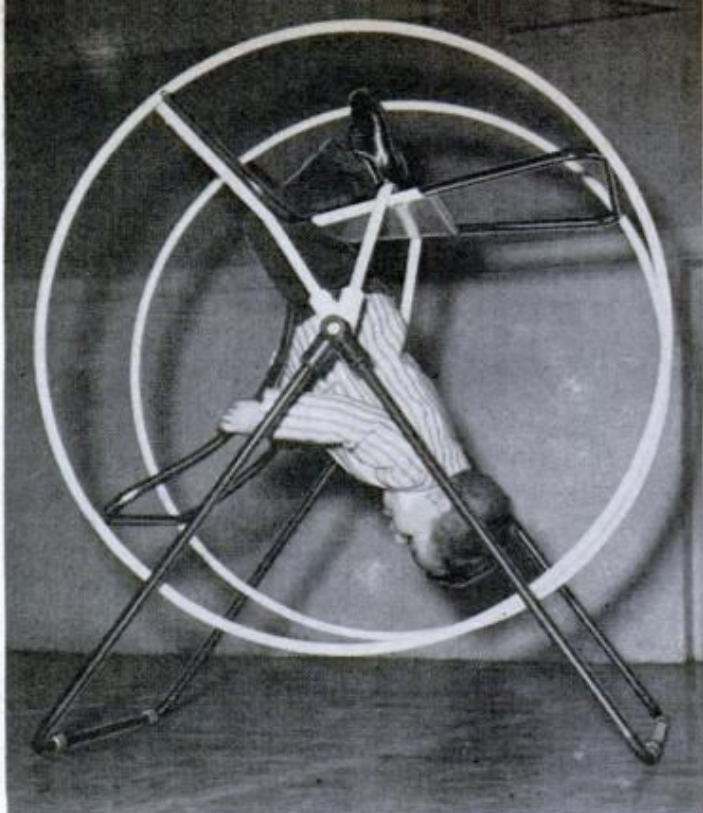

Kids Shift Weight to Operate "Space Trainer"

Kids can rock, spin, or roll as fast or slow as they want simply by shifting their weight inside a new toy. The lightweight wheel and

frame can be set up indoors or out, and the wheel can be used with the frame or taken out and rolled along the ground alone.



"Plastic" School

Economy, flexibility and strength are the leading features of a "plastic" school designed by the Department of Architecture at M.I.T. Built of 16-foot-square "tree" units and load-bearing plastic sandwich panels, the school can be expanded, altered to fit new requirements, or even taken apart, moved to a new site and quickly reassembled. The panels have plastic outer skins bonded to a plastic-foam core.

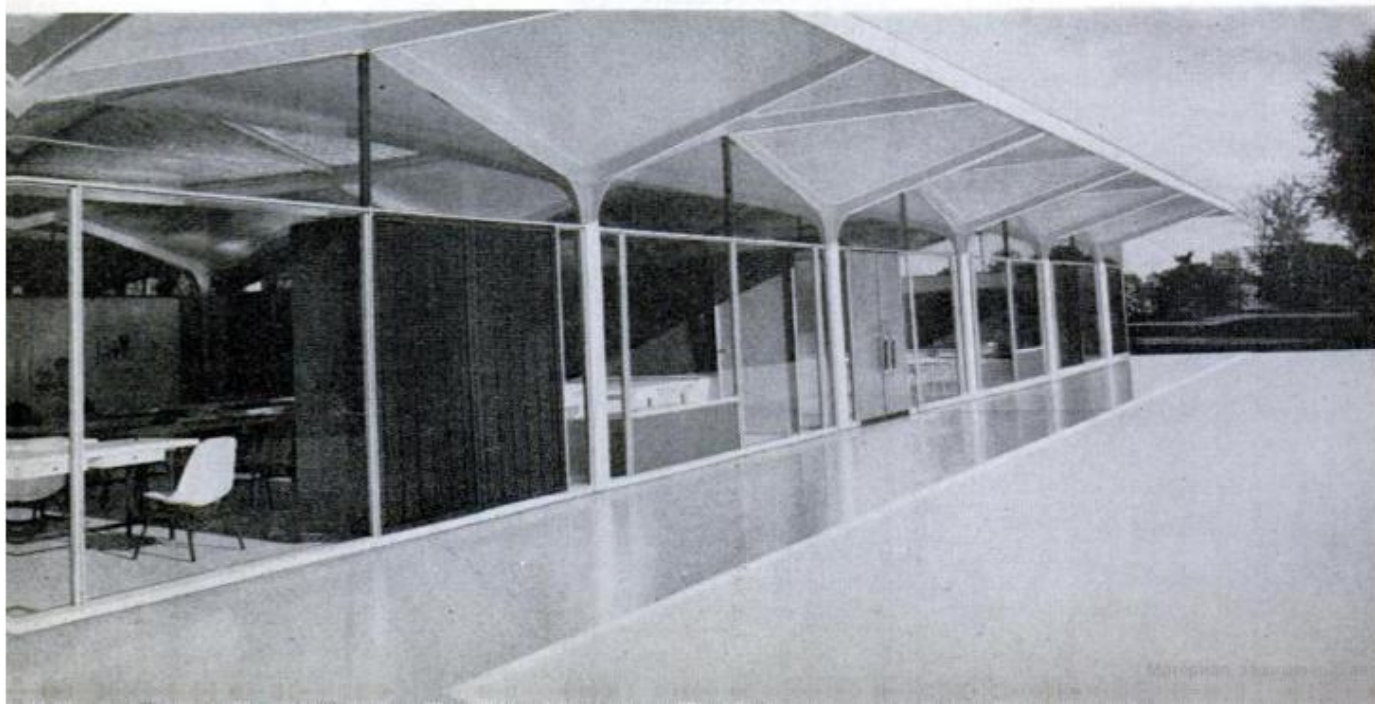



Giant Blower Seeds Embankments

Modified to spray a mixture of wood pulp, fertilizer and grass seed, a big commercial sprayer enables a two-man crew to plant grass on new embankments at a rate of over six acres per day. Developed by International Paper Co., the sprayer applies the mixture in a sweeping motion as the truck moves along the bank. It throws 150 gallons of seeding mixture a minute to a range of about 125 feet. The mixture dries quickly to form a coating much like papier-mache, which protects the seed and raw earth from erosion.



One Man Operates Gold Dredge

Fifteen yards of sand and gravel per hour can be pumped through a one-man, home-

built gold dredge. Mounted on pontoons, the dredge is propelled by an auto engine.

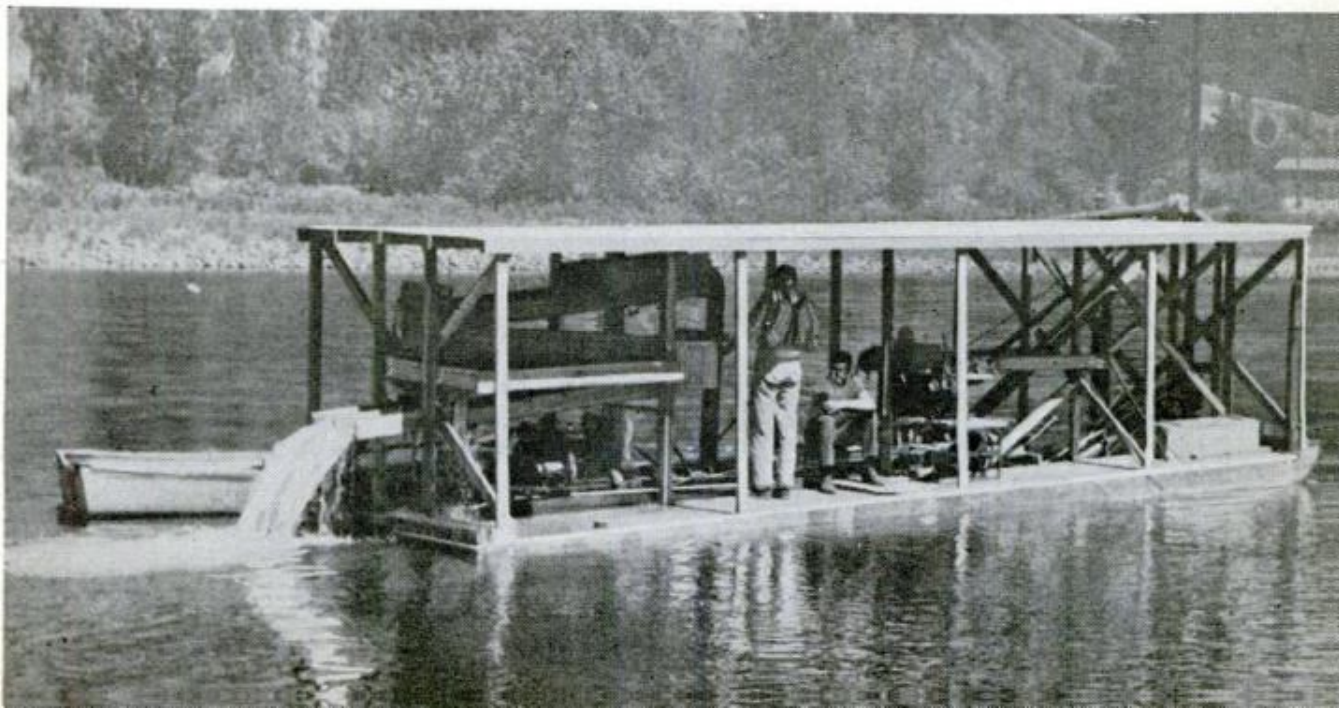

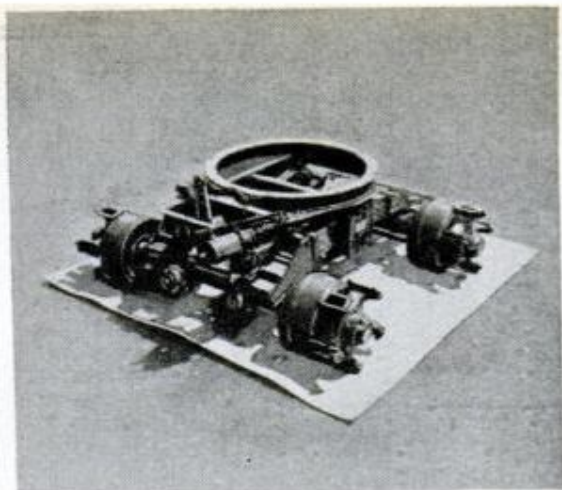
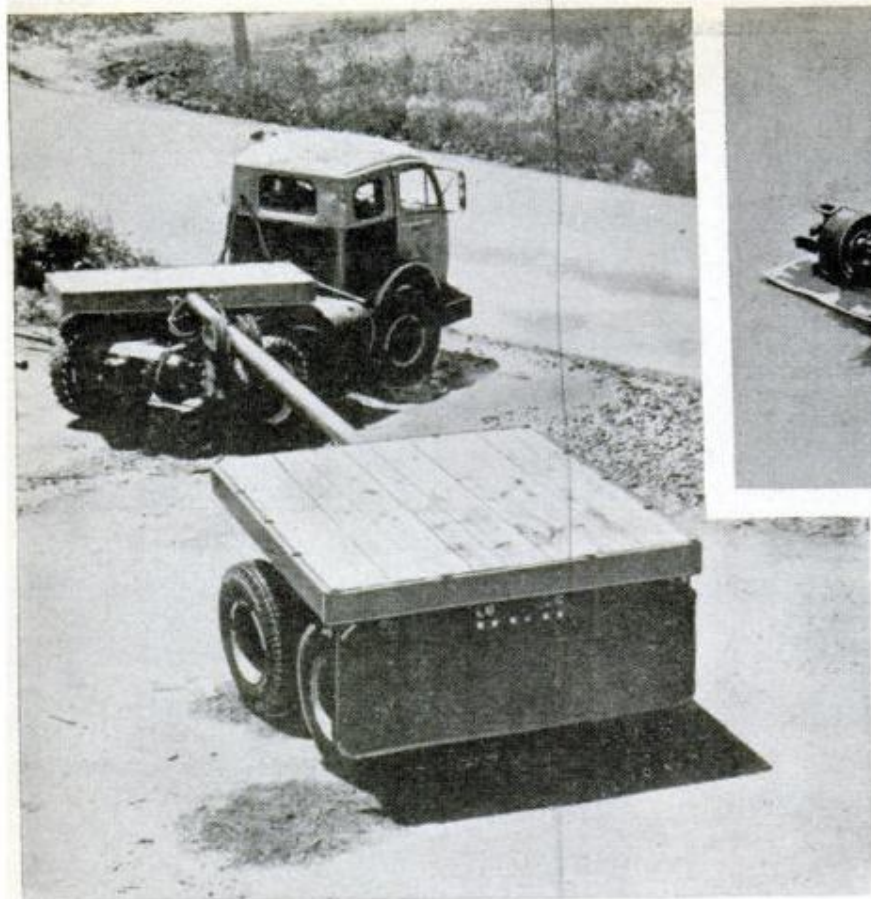

Rear Axle Assembly Guides Long Trailers

Extra-long trailers, such as used by telephone companies and pipeline contractors, can be equipped with an assembly that automatically steers the trailer's dual wheels. Mechanically operated, the unit keeps the trailer in its lane on sharp turns and increases tire life up to 50 percent.

☐ Typical 1960 passenger cars have 27 lights, five more than the average home uses for general lighting.



Mobile Theater Fills Small Van

One busy traveling salesman has set up an office and movie studio, all inside a small imported Goliath bus wagon. He is Fred E. Magel, of Erie, Pa., who sells film for United Film Service, Inc. To provide himself with proper facilities for showing movies as he travels, he has equipped the inside of his van with a mobile screening room that has a 30-inch-square screen, 35-mm. and 16-mm. projectors, an editing machine and 1000 feet of film. There's also a traveling office, complete with typewriter. Magel has added a dash of comfort by providing wall-to-wall carpeting.



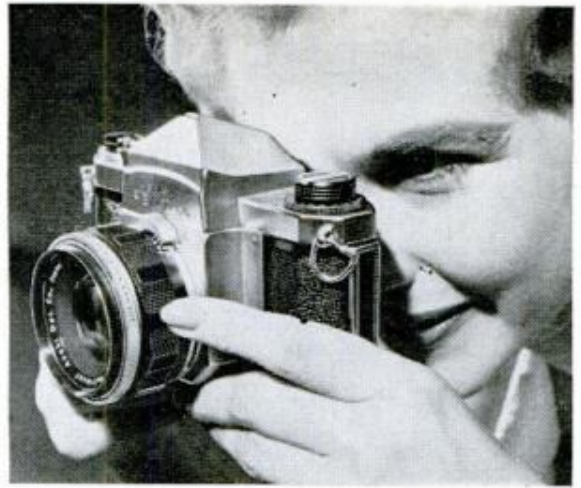

This Is a Camera Accessory!

It's not standard equipment, but this giant 1000-mm. lens is available with the 35-mm., single-lens reflex camera (right)

made by the Asahi Optical Company of Japan. The camera's U.S. distributors say it is the lightest, smallest in its field.

No Confusion Here When Crews "Scramble"

Alert crews of the Strategic Air Command won't be confused when they're told to "scramble" at Griffiss Air Force Base. Metal tubes from the sides of their readi-

ness building guide them straight to vehicles that will speed them to their aircraft. The building houses 75 men on 'round-the-clock duty.

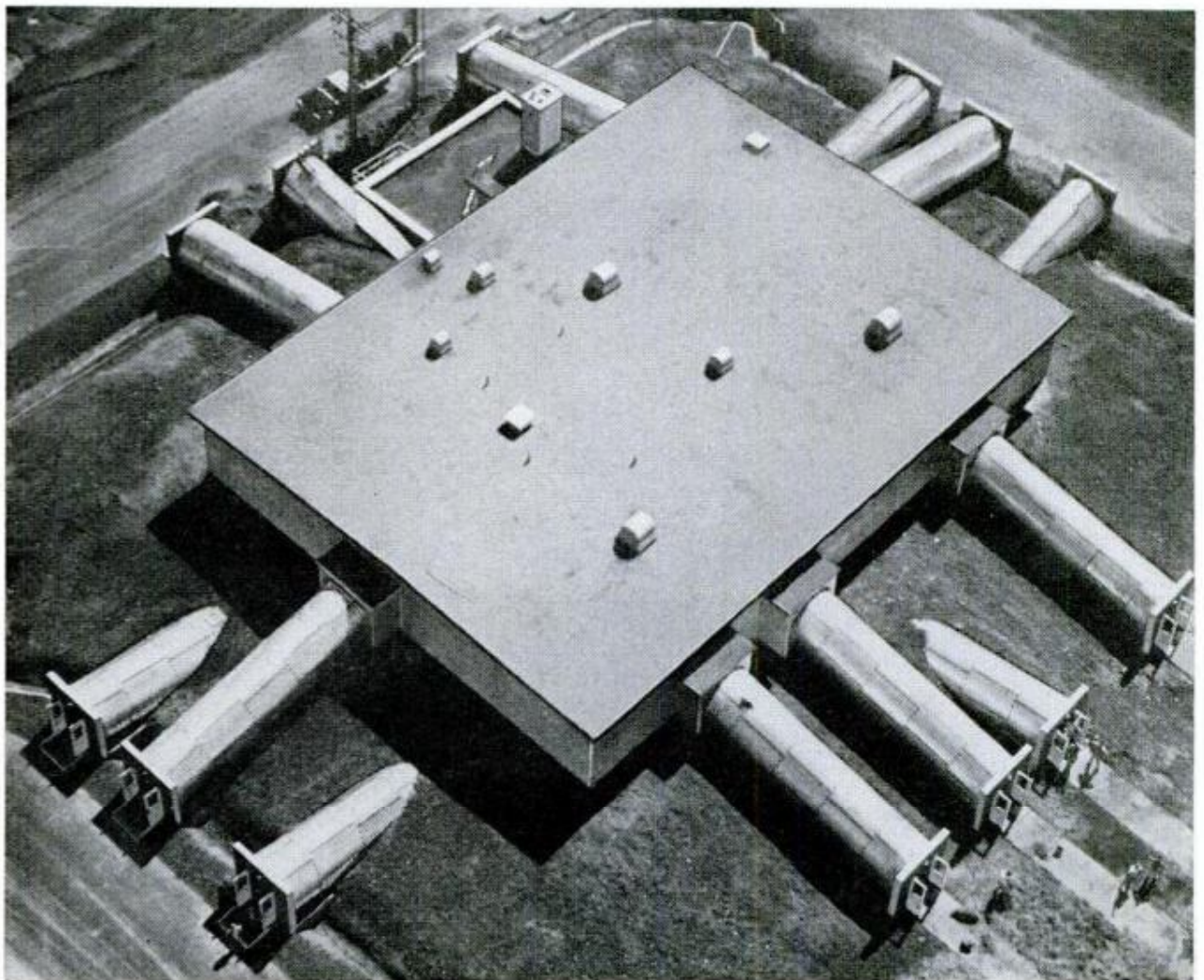

Sap's Running

And look how science and automation have invaded the sugar bush



Eagle-Morgan photos

Plastic bags on maple trees, a billow of steam from the evaporating shed are sugar camp symbols of progress

IN LATE MARCH and early April — when snow is still on the ground, but mostly in patches that are quickly making way for spring—it's an American custom, dating from the Indians, to go maple sugaring. As might be expected, there are great differences between the methods the Indians used and the methods used today to

turn the clear, watery sap of the maple tree into sweet syrup or crunchy, brown sugar.

When Indians slashed a sugar maple and collected the flowing sap in birch bark containers, they dumped the contents into a hollowed-out log. Rocks heated in a nearby fire were dumped sizzling into the sap. The air would steam with water evaporating from the sap and the sticky, brown fluid left over was America's first maple syrup. Even in those days, children got to lick the log for the candy-like residue left behind after the syrup had been scooped out and stored—a great treat after a long winter in the north woods.

Today, from Minnesota east to Maine, sugar camp operators such as Ned Finnell of Hayward, Wisconsin, are using modern methods and materials to do basically the same job the Indians did. Because it takes 40 gallons of raw sap to produce one gallon of high-grade

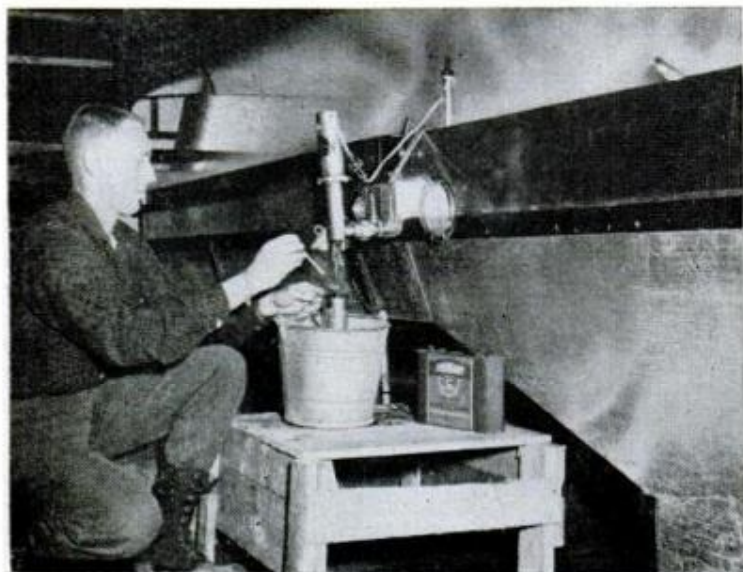

When syrup is boiled from sap, a thermostat opens valve to let it flow from tank



Plastic tubing carries sap from 60 trees to 300-gallon barrel in background, filling it every two days

maple syrup, it is important that they employ the automation and quality control modern science and invention can bring to bear on production problems.

Finnell (lower left) uses plastic bags, plastic tubing, and a battery-operated draw-off and so needs the help of only two men to process 32,000 gallons of sap. Many producers using modern equipment operate alone for lower overhead. Once the sap starts running, the processing is swift and easy. The plastic tubing is tapped into trees, and as many as 60 of the tubes are connected to spew their collection into 300-gallon tanks, which, in turn, are carried to an evaporator house, where the sap is heated in huge evaporator pans. It is drawn off through a valve that opens automatically, when it reaches the correct density.

Using modern methods, Finnell and his two helpers get 800 gallons of syrup from his bush of 12,000 maple trees. ★★★

Modern operator Ned Finnell also uses plastic bags for collecting: They let in the sun's sterilizing, ultraviolet rays





Farm Tractors Drafted by Army

Reversing the old idea of beating their swords into plowshares, a Norwegian infantry battalion is turning farm tractors into tools of war. Shown during recent maneuvers in southern Norway, the half-track-equipped farm machines are being used in place of trucks to haul equipment over rough terrain. The light, hard-pulling tractors proved superior to trucks for many prime-moving jobs.

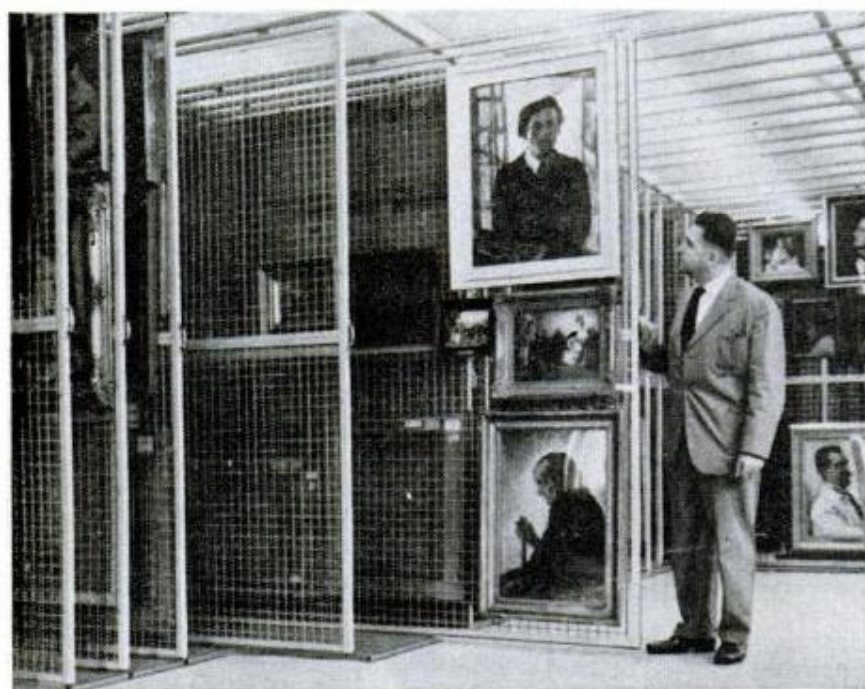

Wire-Mesh Panels Display Paintings

Paintings on display at the Wuppertal, West Germany, Museum are stored for protection while being readily available for viewing. The paintings are mounted on wire-mesh screen panels that can be pulled out easily for inspection by visitors to the museum. The panels also hold more paintings than normally could be placed on the walls of the museum. Paintings are easily attached to the screens, and just as readily detached.

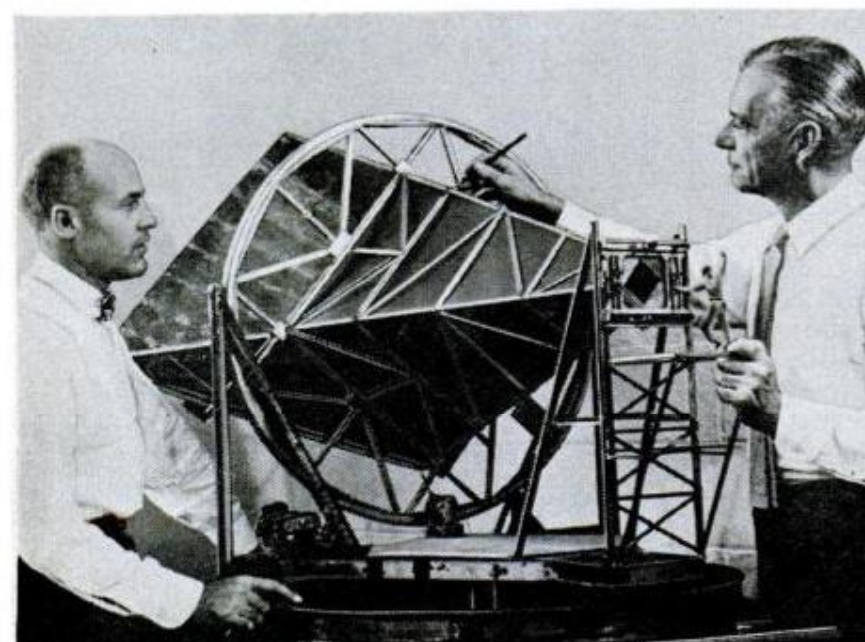

Antenna to Catch Signals Bounced off Satellites

With a huge horn-shaped antenna, Bell Telephone engineers hope to learn if signals can be bounced off man-made satellites and sent to all corners of the earth. The 50-foot antenna now under construction (a model was built first) will receive radio energy from specific directions, enabling it to pick up signals reflected from the moon or man-made satellites. Its first test will be to catch a signal bounced off moon from an earth station 2300 miles away.



Electronics Keeps The Gamblers Honest

Stage shows at the Stardust Hotel are given electronic glamour from this lighting and sound-effects booth

By James Joseph

THE MANAGER of a Las Vegas, Nevada gambling casino sat at the control board of the closed-circuit TV system, flipping switches to operate 10 cameras which were set in ceiling ports and focused on the gaming tables. On the television screen before him, pictures of people tossing dice and betting on the spin of the roulette wheel flickered and changed. Suddenly, he hunched forward. He spotted trouble. The screen pictured a crap table, where one player was stealthily palming another's \$100 chip.

The alert manager quickly snapped on his intercom.

"Joe," he told a casino detective, "go to table four. White sports shirt just swiped a chip from plaid shirt at his right."

The thief, picked up a minute later, could hardly argue he was innocent. He had been caught in the act by one of the electronic devices that are as common, and as welcome, as tourists in Las Vegas today.

Las Vegas not only relies on electronics to give the suckers (last year, they dropped about \$40 million on its gaming

tables) an even break. The casino owners use electronics to guard their vaults, protect patrons from cheaters, give glamorous effects to the glittering stage shows, and keep tabs on dealers, a few of whom might be tempted to larceny were it not for the ever-watchful electronic eyes.

"In the old days, we trusted to luck and to the odds," says a casino manager.

Television cameras are focused on blackjack tables to catch dealers or players in the act of cheating

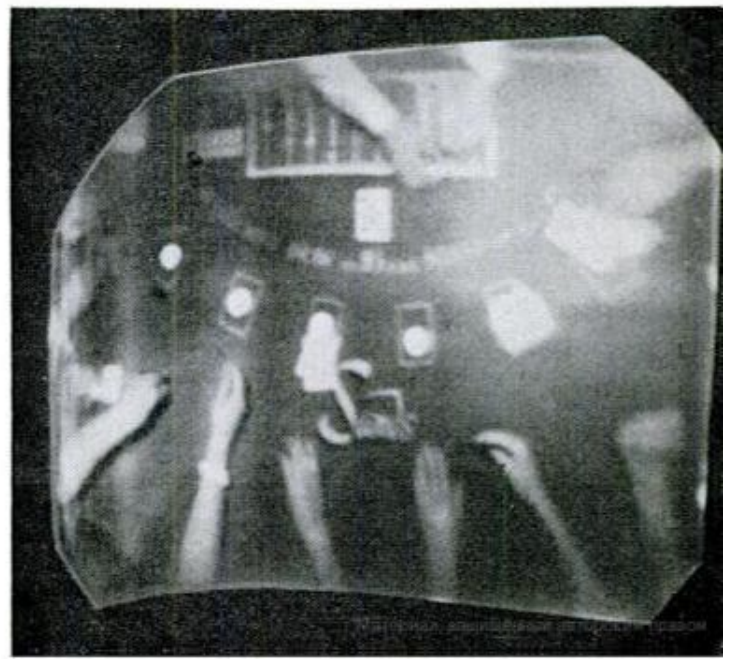



"Nowadays, we put as much faith, sometimes more, in electronics to keep things straight, the odds right." In honest play, the odds heavily favor the house, but let dishonesty from any source plague a casino, and it's usually the house that pays. Electronics helps keep play honest and is used to nab the dishonest dealer (who can flip a winning card to a confederate) as well as the quick-handed cheater who drops a chip on a winning roulette number after the wheel has stopped spinning.

Electronics is used most spectacularly to actuate the gaudiest electric signs in all America that lure the lucky and luckless into the casinos. Cam-actuated brass fingers, tipped with silver alloy, make and break circuits which flick thousands of bulbs on and off every $\frac{7}{8}$ second on one sign that advertises the Mint, a downtown gambling palace. All told, 11,000 winking bulbs and 13,600 feet of fluorescent tubing comprise the \$125,000 sign which was judged the nation's best in 1958.

Electronics has even turned credit manager in many of the plush hotels. Transistorized robots shuffle through credit references approving—or turning down—personal checks offered by luckless bettors.

Electronics at the Hotel Tropicana is put dramatically to work in the lake-size swimming pool. A submergence speaker (with a response up to 10,000 cycles per second), driven by a 30-watt amplifier, booms music to underwater swimmers. Above water, the music is inaudible.

At the Desert Inn Hotel, a musician nightly plays an electronic console, which also sprays water. Called "Dancing Waters," the electronic aqua-spectacle orchestrates 4000 jets of water which plume into the air in time with the music. Pushbutton-controlled magnetic contacts feed high voltage to 19 pumps which, with less than a second's delay, send water 50 feet skyward.

But it is as a silent, ever-present policeman that electronics fills the biggest role in Las Vegas. In one casino, where rows of 400 slot machines cough up nickels, dimes and silver dollars, three



Top, antenna-shaped plastic bowl and tubes hold Keno balls. A blast of air pops ball into tube; a casino employe punches button, flashing its number on huge board

Above, ports in ceiling conceal lights and television cameras. Ten cameras, placed strategically above gaming tables monitor each flick of cards and bet on roulette

Right, electronic microfilm machine films Keno cards, recording numbers they possess, assuring that a player cannot freely play cards of his own manufacture

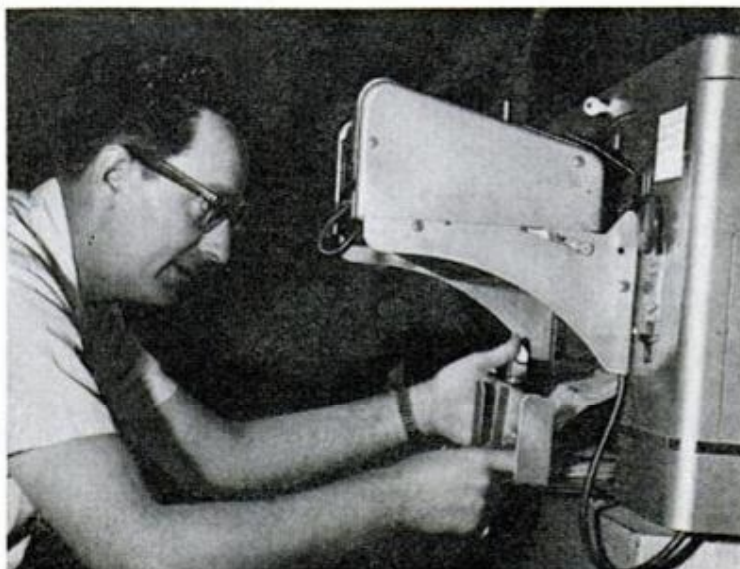



Keno players, before each game, buy cards that are electronically stamped with purchase time and number

long-play tape recorders (located in the attic) keep track of every jackpot—both to double-check the honesty of cashiers and to ride herd on the generosity of each machine. If a machine pays out too much too often, expert mechanics quickly curb its generosity.

"The system works in this way," explains the casino manager. "Every time a jackpot is hit, a complex circuit lights up the machine, telling the player exactly how much he won. In our operation, the coins don't come tumbling out of the machine. When you hit a jackpot, a buzzer rings, the machine spells out what you've

won in lights, its number is flashed on a big board, the cashier announces 'Machine number eight, a \$10 jackpot,' and somebody brings you your winnings.

"The girl's voice, announcing the jackpot, is automatically recorded on tape. Once a day we put on earphones and run through the tapes, figuring what every machine paid out. This keeps the cashiers honest and the machines profitable."

The manager is also proud of an electronic microfilm machine that photographs every Keno card before the game's begun.

"First, though," he explains, "another electronic machine stamps each card with



Casino managers in Las Vegas monitor their gaming rooms' activities without leaving their desks. Closed-circuit television screen will picture scenes, taken by 10 cameras, at flick of buttons on desk panel

Electronic circuit on slot machine lights Mint sign for jackpot, signals cashier, flashes win on board



a serial number and time-clocks its purchase. Then all the cards are fed to the microfilmer—as many as 500 cards a minute. We film some 20,000 cards a day. Once filmed, a card's tamperproof. There's no chance that a losing card can be turned into a winning one with the flick of the eraser."

The same casino—which each month grosses nearly \$1,000,000 from slot machines, crap tables and roulette wheels—is also installing elaborate electronic cops to guard the take from slot machines. Vaults beneath each row of slot machines are being rigged with electronic timers. Electronic locks will seal them against pilfering. They'll open only for a 15-minute period every 24 hours when guards trundle the heavyweight loot to the casino's big vault.

"In this place alone," says the manager, "if you count the \$100,000 sign that beckons customers, we've got maybe a quarter-million-dollar investment in electronic devices. Most are calculated to keep patrons and dealers honest."

To maintain honesty in another gambling palace, three detectives peer through one-way mirrors installed in the ceiling, watching every gaming table and slot machine. When they spot a cheater, they flick a switch, turning on remotely-controlled movie cameras. The cameras, their



Interior of Stardust Hotel's show booth discloses an array of hi-fi controls, right, and lighting controls

wide-angle lenses focused at table level, not only film cheaters in the act, but time-clock the cheating. When the cheater is apprehended, his name and often, his picture are added to the Las Vegas rogue's gallery, a list which circulates the casinos.

"Once a guy's on our list," says a detective, "he finds his welcome limited here."

While electronics produces intense, dramatic scenes with cheaters—in its role as policeman—it also is responsible for the success of some of Las Vegas' more light-hearted dramatic scenes. It is the unseen producer behind such spectacular stage shows as those given at the Hotel Stardust's huge supper theater. Packed into the theater's control booth are \$250,000 worth of audio, lighting and special-effects consoles.

"These consoles," says chief projectionist Gordon L. Hayes, "coordinate 36 microphones, raise and lower the stage's six big hydraulic-electric elevators (two weigh 15 tons each), and mix super hi-fi."

Packed along one wall are two five-channel selective program repeaters whose endless tapes are recorded with dialogue, sound effects and music. Pushbutton-controlled from the main audio console, tapes are "cued" automatically when a spot of aluminum paint on the tape actuates a selenium photocell.

Typically, one console—its 166-switch

keyboard is more complex than a cathedral organ's—mixes audio through 18, 40-watt stereo speakers. A locomotive's whistle, or a full-throated C note, can be swept from one side of the vast theater to the other, giving an exciting sound effect.

Special effects are mixed—and microphone pickups blended—in a room-size reverberation chamber (38 feet long, 12 feet high and 16 feet wide) that has Fiberglas walls. As a result technicians can make the Stardust's 18-piece orchestra sound like 40 musicians at work. What's more, the reverberation chamber can pan sound, or a performer's voice, entirely around the listeners.

Just as electrically complex is the theater's mechanics. One bank of console switches raises and lowers hidden microphones and actuates motor-driven mike doors (high in the ceiling) which slide shut to conceal microphone ports.

A vacationing electronics engineer was so caught up in the gambling capital's maze of equipment that he scarcely found time to place a bet.

"You can't shove a nickel into a slot machine without tripping an electronic circuit," he said. "You can't toss the dice, without some electronic gadget, concealed in the ceiling, drawing a bead on you."

He had discovered that Las Vegas always bets to win—and that electronic devices are its blue chips. ★ ★ ★

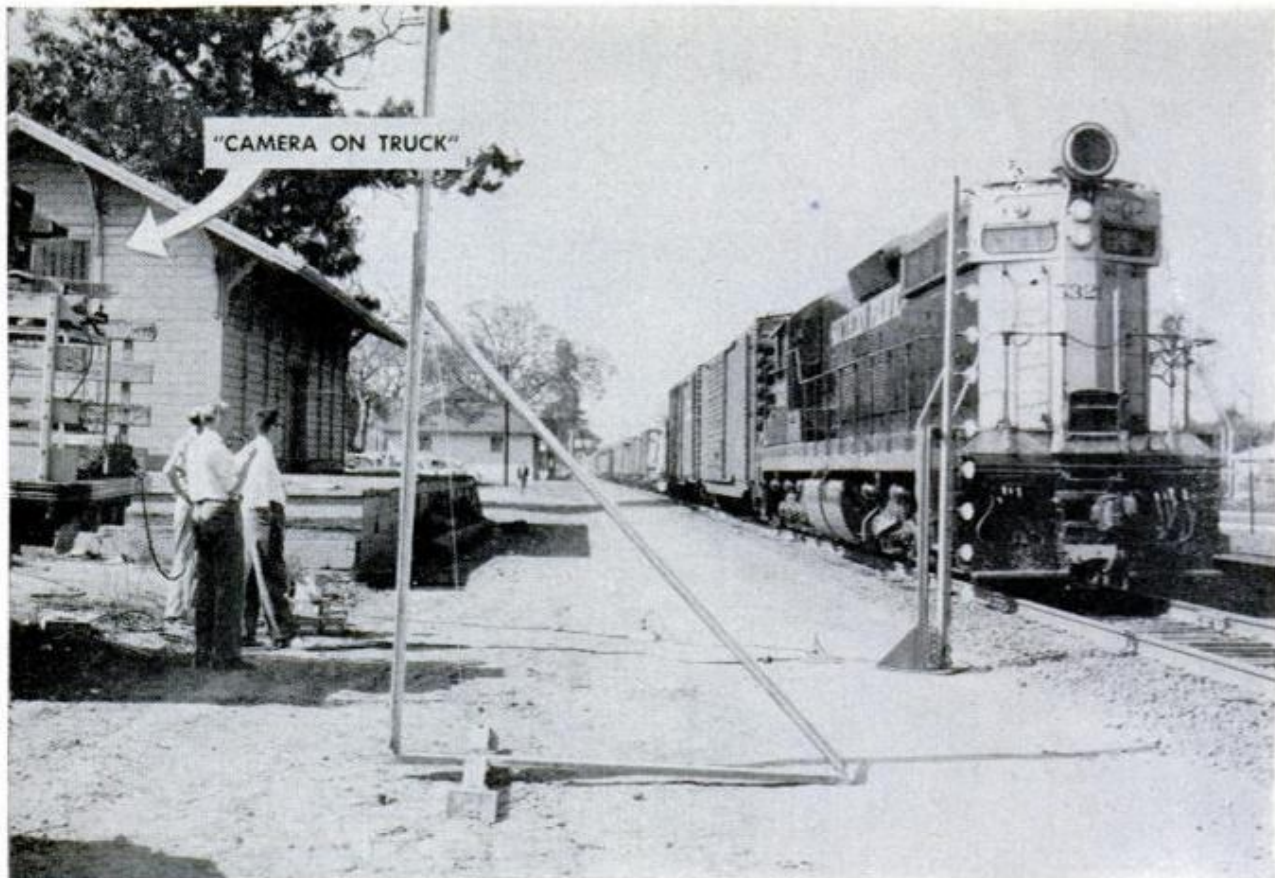

TV Records Passing Train

Speeding through an outlying station at 60 miles an hour, this freight train is "sitting" for a portrait. A television camera mounted on the truck at left records the train's passing, and the picture is relayed by coaxial cable or microwave relays to its destination. The yardmaster, with a picture of the car numbers and their sequence in the train, can plan accordingly to keep each car heading for its destination and to make up new trains from the arriving cars.

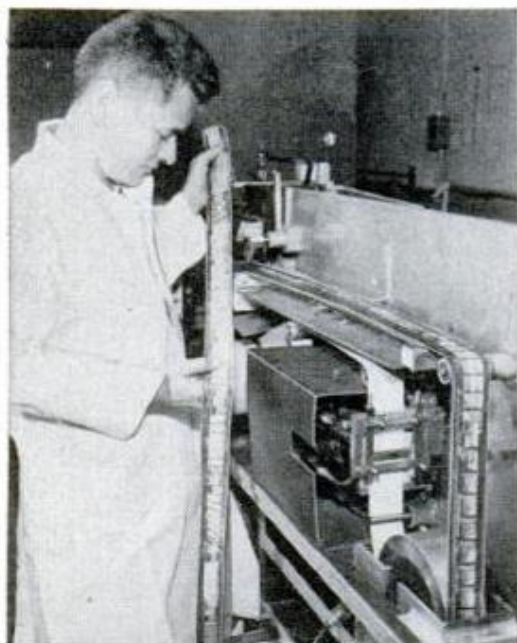

Catamaran Rig Aids Fishermen

Using native canoes, small outboard motors, old bicycle wheels and angle iron, a British fisheries officer at Lake Victoria in Africa has helped native fishermen speed up their work by 96 percent. Combining two canoes to make a catamaran, Maurice Atkinson added net reels across the hulls. The new boat, with two five-horsepower motors, can lay 1200 feet of net in five minutes and retrieve the same net in half an hour. The job takes half a day from an ordinary canoe.



□ About 42 billion steel "tin" cans are produced annually in the U. S.



Tractor on Screws Slithers Across Mud Flats

Land reclaimers working along Germany's North Sea coast are faced at low tide with mud that's too thin for land

vehicles and too thick for boats. Their answer is a prime mover that slithers easily through the mud on rotating screws.

Transmitter in Nightstick Triggers Alarm

Night watchmen armed with an English-made nightstick are equipped to sound alarms, call the police, and defend themselves at the same time; a transistorized transmitter in the stick sets off the alarm system when a button on the handle is pressed. A similar unit is built into the handle of a watchman's flashlight.



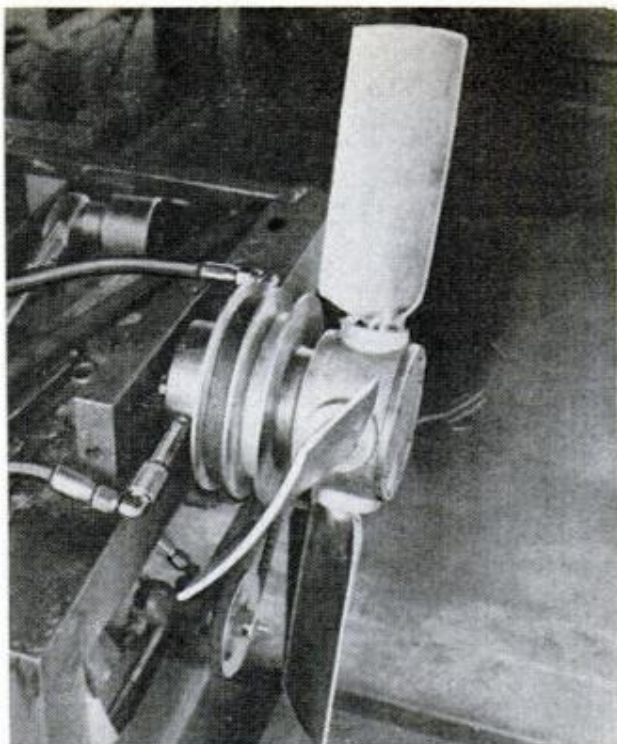
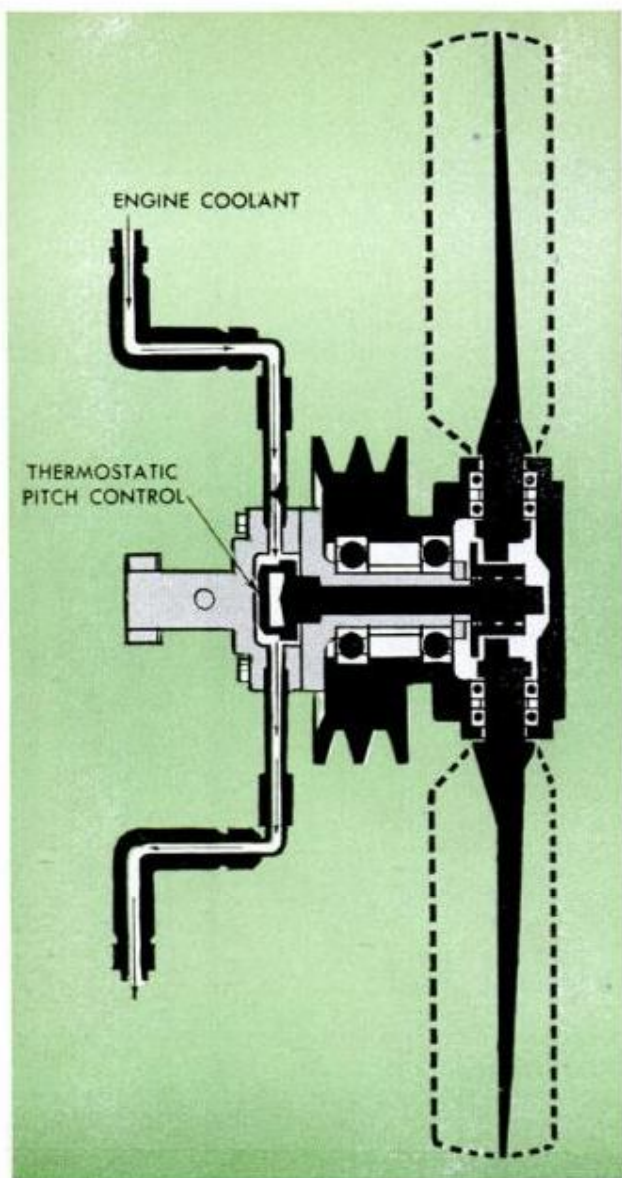

Variable-Pitch Truck Fan

Switching pitch like the blades on an aircraft propeller, an automatically operated truck fan saves as much as \$100 a month fuel costs. Cooling water from the engine operates a thermostatic control which increases or decreases the blade pitch, depending upon engine temperature. On high speed, level operation, the fan runs flat, thereby reducing engine load and fuel consumption.



Hair Drier for Pampered Pup

Every canine lassie may soon enjoy all of the comforts of the beauty parlor. A new hair drier can be hung on any cage after the dog is washed. It sends an even flow of air, adjustable from warm to hot, that soothes as it dries. Males like it, too!

Number, Please!

Whenever you write us to

- Renew your subscription
- Change your address
- Order your own or a gift subscription

. . . In fact, whenever you write us,

PLEASE INCLUDE YOUR CITY POSTAL ZONE NUMBER IN YOUR ADDRESS

*This insures better delivery.
It helps you and it helps the postman.*

RADIO TV HI-FI**ELECTRONICS**

Courtesy Allied Radio Corp.

Partial view of a well-stocked demonstration room for evaluation of high-fidelity loud speaker systems

PERSONALIZED STEREO FIDELITY—PART IIBy
Lothar Stern**Selecting Your
Speaker System**

FROM 10 TO 250! No, it's not the frequency response specification of a low-frequency woofer—it's the approximate price range of "hi-fi" speakers shown in the catalog of a leading distributor.

Going a bit farther in the same catalog, you'll find complete speaker systems (speakers mounted in appropriate enclosures) ranging from less than 50 to almost 1000 dollars, and just to make matters worse (or better) there are literally dozens of speakers in every price category.

Read the catalog copy carefully. Compare the information given for speakers in the various price ranges. You'll find low-priced units that "outperform speakers costing up to three times as much," medium-priced ones that are "guaranteed to outperform all others—regardless of price," and virtually every speaker has "smooth, flat response over the audible range."

Fantastic? Yes—but that's the situation

which makes the selection of this vital part one of the toughest hurdles in the assembly of your custom-built music system.

In choosing all other components you have plenty of valid data to guide your selection; but this fails when applied to loudspeakers. Specifications are usually meaningless since few manufacturers use the same standards and test setups. Recommendations of friends, even those of experts, should be used only as a possible starting point. The fact is that no two speakers of different design sound alike, and what sounds best to one expert may be only a poor second or third choice in the opinion of another. In selecting a speaker, your own ears are the final authority.

To select the best possible speaker within your budget, a listening-comparison test is advisable and, fortunately, there are hi-fi demonstration centers in most cities where such comparisons can be made. But even

before you begin the actual comparison you should have a pretty good idea of what you want. To make tentative selections from catalogs and advertisements, here are some of the things you'll have to consider:

PRICE VS. PERFORMANCE. That old adage "You get what you pay for" may not hold true for everything, but it does apply to speakers—particularly in the low and medium price ranges. While you might find it hard to choose between two speakers costing 150 and 200 dollars, respectively, the difference between a 20-dollar unit and one costing 50 dollars is usually unmistakable.

How much should you spend for your speaker? The answer to this depends on the total amount you expect to invest for a basic hi-fi system. If you start with a modestly priced monophonic system—say between 150 and 250 dollars—about one third of this should be allocated for the speaker system. For more expensive systems, or for stereo, the percentage allotted for the speaker should be higher. One reason for this is that the price range is much greater for speakers than for any other single component. Another is the fact that a stereo speaker system can cost up to twice as much as a monophonic one while the price difference between other stereo and monophonic components is often negligible.

SPEAKERS AND ENCLOSURES. No speaker can give high-fidelity sound unless it is housed in a properly designed enclosure. To prove this to yourself you need only remove the cabinet from an inexpensive table radio and notice the deterioration of the resulting sound quality. And if this is true even in the cheapest of music reproducers, it is accentuated in a hi-fi instrument. The speaker enclosure, therefore, plays an important part in the reproduction of high-fidelity sound.

Acoustically designed enclosures are available in a wide variety of styles and types. They go under such exotic names as infinite baffles, bass reflex, folded horns, and perhaps a dozen more. Carefully built, all are capable of excellent sound reproduction, yet a given speaker may sound far better in one particular enclosure design than in any other. To be absolutely certain that you're getting the best possible speaker system, you'd have to listen to every speaker in every type of enclosure, and that's a job that would take the better part of a lifetime. But this monumental task can be reduced to the vanishing point if we make one permissible assumption.

Virtually every speaker manufacturer makes not only a number of speakers, but also some complete systems. The latter contain the same speakers which are sold separately. The assumption we'll make is that the manufacturer, in selecting a par-

ticular enclosure, has picked the design which shows up the characteristics of his speakers to the best advantage. This being true, it is merely necessary to compare the systems in your predetermined price range and select the one that sounds best.

STYLING. There was a time, not too long ago, when physical size was a good yardstick of speaker performance. "The larger the better" was the slogan, and no audiophile would have dared boast about his speaker system unless it was of mammoth proportions.

But times have changed. Today, manufacturers have designed special speakers which give outstanding performance in small, bookshelf-type enclosures—systems which operate as well as their giant-sized counterparts. Size, therefore, is no longer a limiting factor.

BUILD YOUR OWN AND SAVE. You can't build a loudspeaker, but you can make your own speaker enclosure at substantial savings. A number of manufacturers now supply their enclosures in kit form at savings of 30 percent or more.

Enclosure kits are relatively easy to build. They are supplied with precisely cut panels, mitered and predrilled for simplified assembly. In many cases, a screwdriver is the only required tool and, usually, an evening or two is all that's needed for the actual assembly.

You can save even more if you have facilities for building your enclosure from scratch. Despite the great care involved in the design of a good enclosure, its eventual construction is relatively simple. If you already own a good hi-fi speaker, or if you have selected one on the strength of a listening-comparison test, the manufacturer usually can supply plans for a recommended cabinet.

But what if there are no facilities for a listening test in your area? In this event you may never have the satisfaction of knowing that your actual selection represents the best possible choice. But the point is a moot one since, in the absence of a comparison standard, your ears quickly adapt themselves to the resulting sound and any good system will be satisfactory. The only suggestions we can make are: Select from a catalog the most expensive speaker system (two for stereo) your budget permits; or, duplicate a system with which you are familiar; or—build one of the units described on the following pages.

The systems to be described differ from one another both in design and application. They are not represented as being the *very best* of anything. They are neither the cheapest, nor the most expensive. They do, however, provide excellent sound, and they merit your serious consideration.

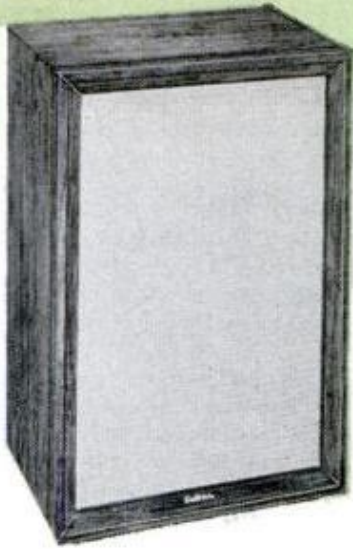

THE ELECTRO-VOICE MARQUIS

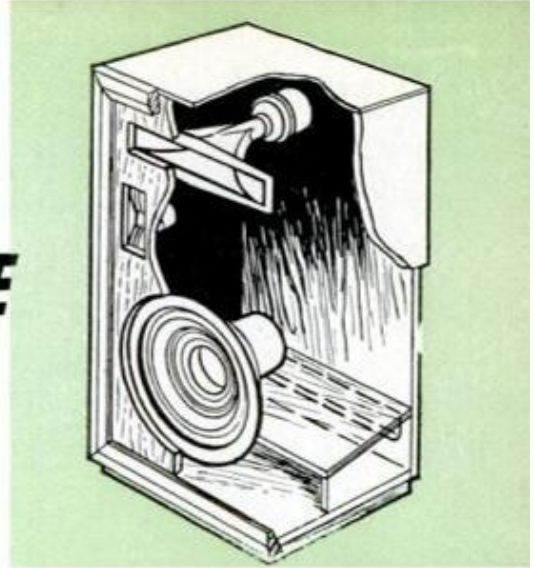

THE MARQUIS is a carefully designed enclosure which gives a good account of itself with any high-quality 12 or 15-in. speaker or with multiple-speaker installations. Commercially assembled you can buy it for \$60 or \$70 (depending on the type of finish); in kit form it's available for about \$35. Or you can build it from 3/4-in.-thick veneer plywood of your choice in accordance with the exploded-view diagram on the following page. Construction is quite simple, and satisfactory performance is assured if all pieces are properly cut so that a rigid, airtight cabinet results.

The Marquis is billed as a rear-loaded, folded horn enclosure designed for along-the-wall placement. While simple in appearance, the operating theory of the enclosure is quite involved. In essence, the enclosure is so constructed that the sound wave generated by the front of the speaker cone radiates directly into the listening area. The rear wave, however, is loaded by a folded horn, part of which is built into the cabinet itself with the remainder being furnished by the wall directly behind the

enclosure. At low bass frequencies, where the horn becomes effective, most of the audible sound is produced by the rear wave which, by virtue of its tighter coupling to the surrounding air, offers much greater efficiency for bass frequencies than could be obtained with equivalent flat baffles or bass-reflex enclosures.

SPEAKER CONSIDERATIONS. Considering the fact that a loudspeaker must duplicate the sounds of strings, reeds and percussions without actually containing any of these in its makeup, it is truly amazing that we have any sort of fidelity at all. It is all the more astounding that some speaker systems can mimic not only the individual instruments, but an entire orchestra, so faithfully that even the experts, at times, are unable to tell whether they are listening to the real thing or a reproduction. Small wonder, then, that the speakers are perhaps the most critical components of a hi-fi system.

Probably the greatest stumbling block in the way of an ultimate-fidelity speaker system is m-o-n-e-y—that is, the lack of it.

Starting with a modestly priced all-range speaker, A, you can improve performance with add-on building blocks. Tweeter addition, B, increases brilliance by increasing high-frequency response. Squawker kit, C, takes over mid-range reproduction in a three-way speaker system offering highest order of fidelity

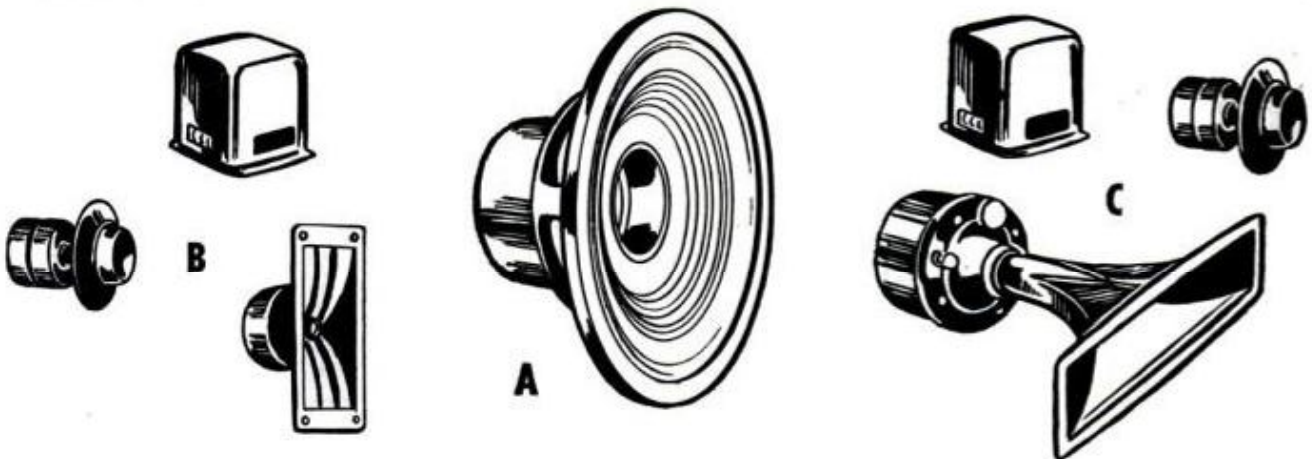

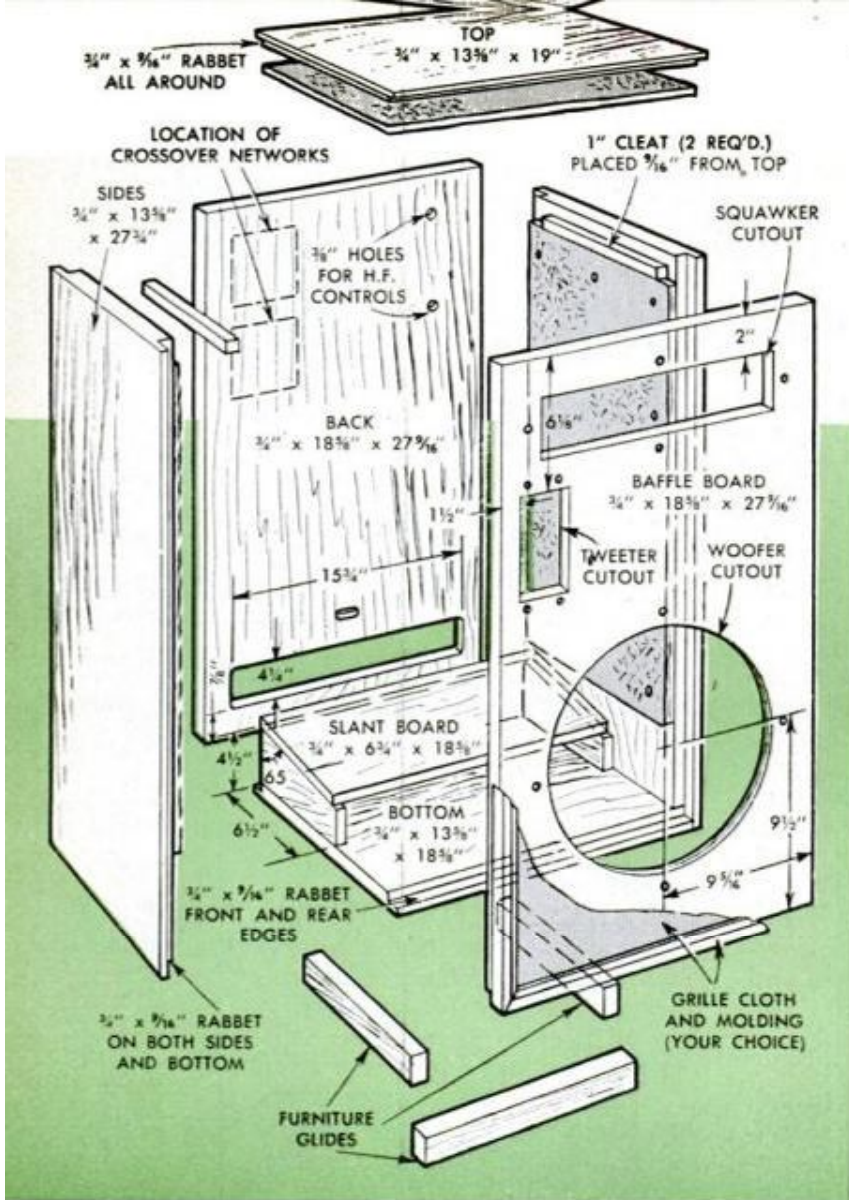

CONSTRUCTION HINTS

Solid, air-tight construction, except for specially prepared openings, is prerequisite in any high quality enclosure. All parts, except back, should be joined with a good wood glue. Glue rubber stripping to all inside edges which contact back cover when the latter is screwed in place. Screws may be used to hold parts together while glue is setting where screws do not show from the outside.

Dimensions of baffle-board cutouts depend on sizes of speakers employed. Countersink speaker-mounting holes so that screw heads do not interfere with application of grille cloth to front of baffle board. Anticipate eventual addition of tweeter and squawker by making the necessary cutouts and mounting holes, and covering any unused cutouts with wood blocks before grille cloth is installed.

Inside surfaces of top and both sides should be covered with 1-in.-thick acoustical insulating material, as shown.

Cover front surface of baffle board with black stain to prevent accentuated outline of speaker cutouts from showing through grille cloth.

Height of enclosure may be made to correspond with that of the equipment cabinet described last month by proper choice of dimensions for furniture glides.

Wiring details for speakers and crossover networks are supplied with building-block kits discussed below.

Often, this limitation brings up the question, "Should I buy two good but low-priced speakers for stereo, or should I start with a superior monophonic system?" That's largely a matter of opinion. My own is that you'll get more listening pleasure from a low-cost stereo system—providing you select the speakers with an eye towards eventual improvement.

Going on this premise, a good initial choice for the Marquis enclosure is the Electro-Voice SP12B dual-cone, all-range speaker. Available from most hi-fi distributors at about \$35, this popular 12" unit reaches way down into the bass register. For monophonic operation or in pairs, for stereo, the Marquis-SP12B combination gives excellent results at low cost.

If you want even greater fidelity, you can improve this initial system by adding the Electro-Voice BB1 building-block kit (cost—\$36). The kit includes a T35B tweeter with the necessary crossover network and wiring harness, and extends the high-frequency response of the system close to the very limits of human hearing. The crossover network divides the electrical signals

from the amplifier into two parts, sending the low frequencies to the large speaker and the highs to the tweeter. A level control permits precise balancing of the two portions of the audio spectrum for smooth response over the entire range.

Still another improvement is possible. A second building-block kit (type BB3—\$84) further splits the audio spectrum so that it is divided between three separate speakers for optimum efficiency and flexibility. Whether or not the cost of this final addition is justified by improved sound quality is something only your own ears can tell you. Certainly you are now in an area governed by the law of diminishing returns—a region where any improvement in quality can be achieved only at a relatively high cost. But that is the nature of high-fidelity.

SPEAKER PLACEMENT. No matter what speakers you use in the Marquis, the system must be tuned to the room for optimum results. The tuning, however, is quite simple, involving merely the moving of the enclosure a few inches out from the wall so that the latter can function effectively as a portion of the folded horn.

THE JENSEN GALAXY II

ESPECIALLY DESIGNED for stereo, the Galaxy II system offers a measure of performance which, a few short years ago, could have been achieved only by a much larger and more expensive set of components. As a space-saving, money-saving stereo system it joins several units by other manufacturers in a compromise design which is rapidly setting a new trend in the stereo industry. The compromise is in the way that stereo is reproduced—not in the resulting sound.

The illusion of stereo depends upon two slightly different audio signals, each independently reproduced through individual speakers. Ideally, this requires two separate full-range speaker systems which can play havoc with your pocketbook. But continued audio research has confirmed the fact that very low sound frequencies, though vitally important for the reproduction of high-fidelity sound, contribute virtually nothing to the directional effect of stereo. It is possible, therefore, to combine the bass frequencies of the two stereo channels, and reproduce them through a single low-frequency speaker, without affecting

the apparent orchestral spread. This saves not only the cost of one "woofer" (low-frequency reproducer) but also the space required for its installation.

The Galaxy II system consists of a center bass unit, a crossover network and two "satellites," each containing a mid-range "squawker" and a high-frequency "tweeter." The frequency spectrum of each stereo channel, therefore, is divided between three speakers each designed to provide optimum performance over its specified range.

Housed in a tube-vented reflex enclosure, Jensen calls it BASS-SUPERFLEX, an 8-

(Continued to page 244)

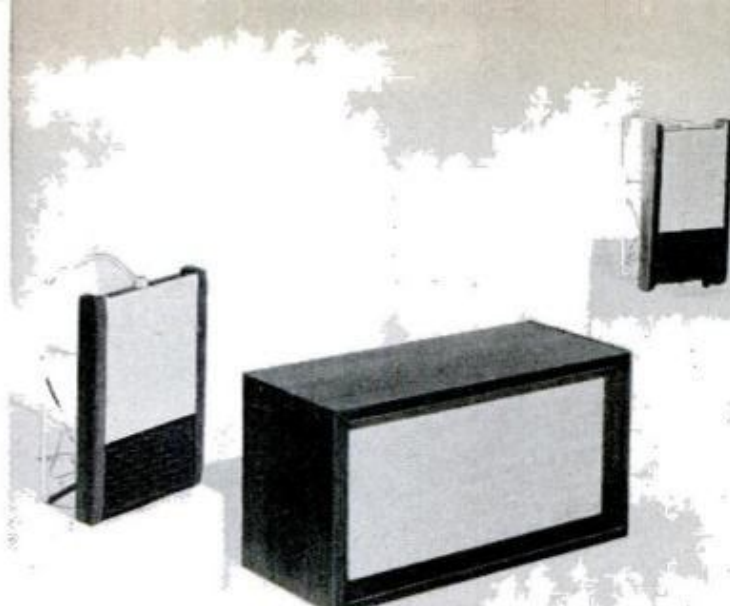

Construction details for center BASS-SUPERFLEX enclosure suggested for Jensen Galaxy II speaker kit. Use 1-in.-thick acoustical insulating material to cover inside surfaces of top, bottom and both sides

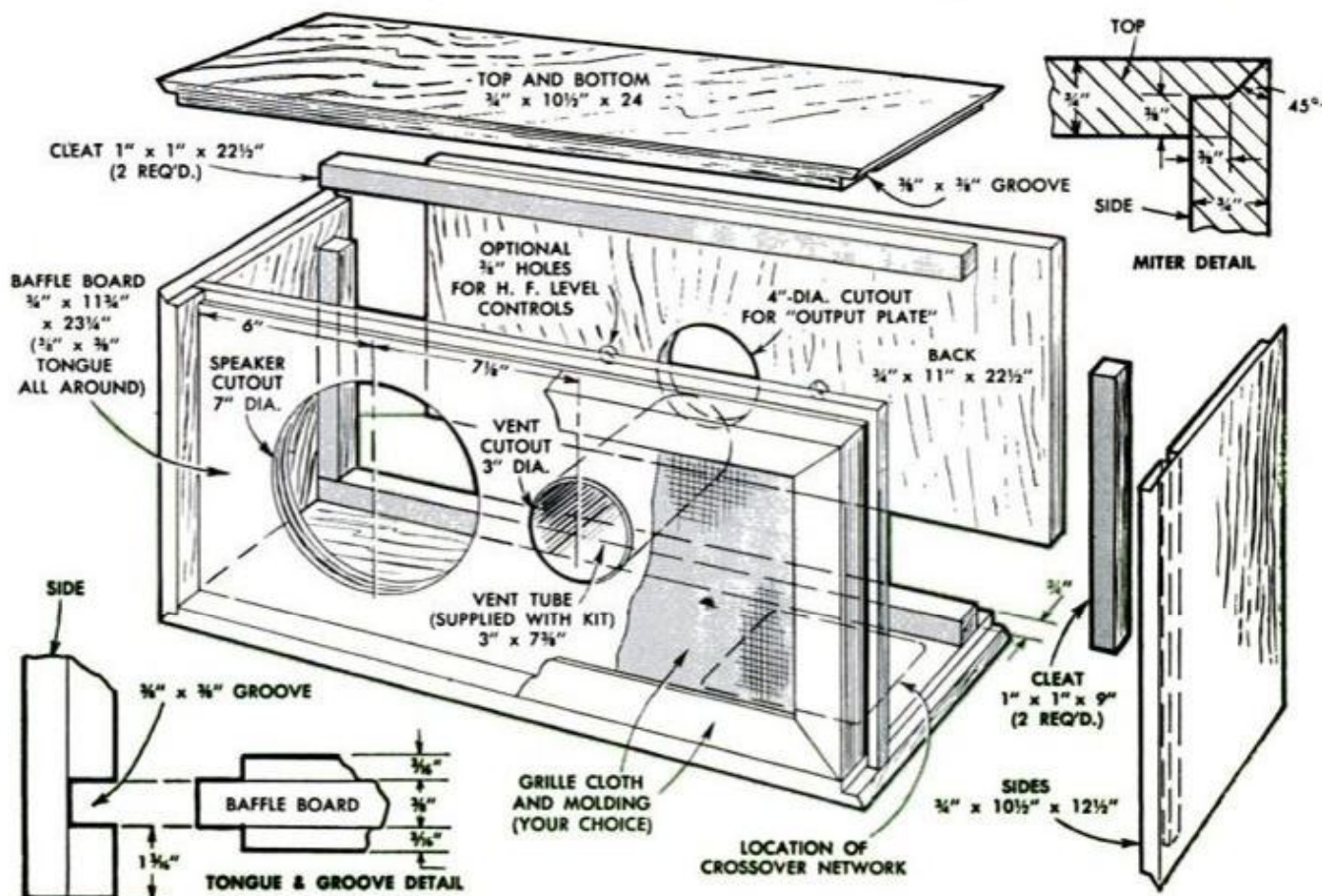



TRICKY TRINKET CHEST

By Walter E. Burton

NOT ONLY does this small chest provide compact storage for jewelry, writing supplies and sewing materials, but the unique arrangement of drawers lends an element of mystery. Out of what appears to be 16 drawers, only four are real, one on each side as indicated in the photo above. While the chest illustrated consists of two units or tiers of drawers, additional ones can be added easily since each unit is of identical construction. Drawer units can be added even after the chest is completed and placed in use, providing the top is attached with nails only, omitting the glue until you are sure no more units are to be added. The drawers in each unit extend the entire depth of the chest. In the chest shown, tiers are

combined so that the drawers of one unit slide at right angles to the other. If desired, drawers may be positioned so that all the operable ones open on the same side, or they can be arranged to open from two opposite sides.

The parts of the chest may be cut from white pine and walnut as suggested in the drawing on the next page, or any other combination of cabinet woods may be used. To cut costs, veneer stock can be used for all parts but the top and corner posts. Drawer bottoms are $\frac{1}{8}$ -in. hardboard. All joints are glued and nailed. The handle shown was formed from a 6-in. length of brass tubing, although a suitable cabinet door or window pull may be used in its place. ★ ★ ★

Posts and inlay piece on sides having fake drawers are glued in place before chest parts are assembled

Side piece and end piece are glued and nailed to border of solid walnut glued to edges of pine bottom

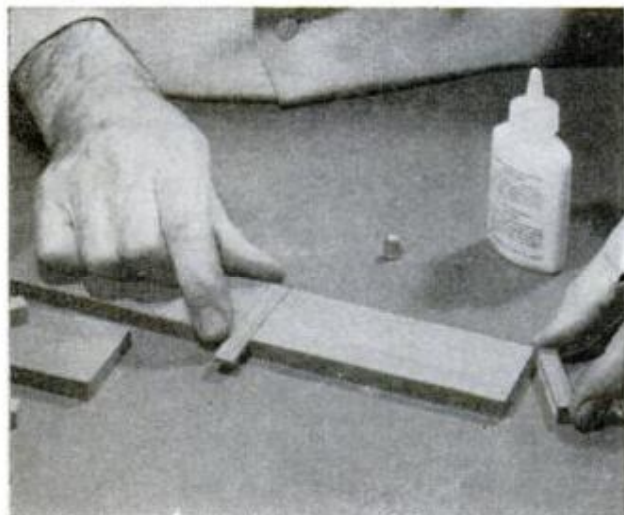

Except to someone who is familiar with a trinket chest such as this, it is difficult to determine which of the four drawers on each side is the real one

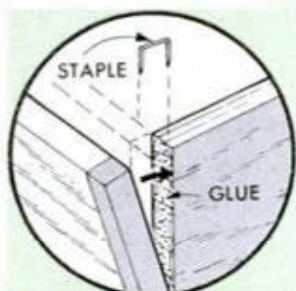

CORNER DETAIL

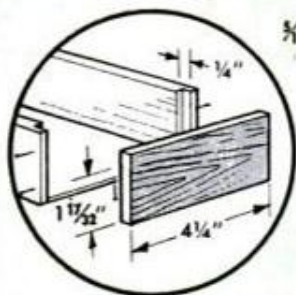

DRAWER BACK DETAIL

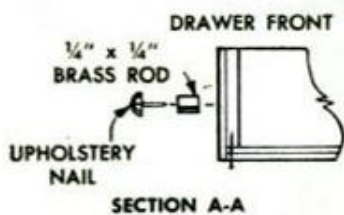

SECTION A-A

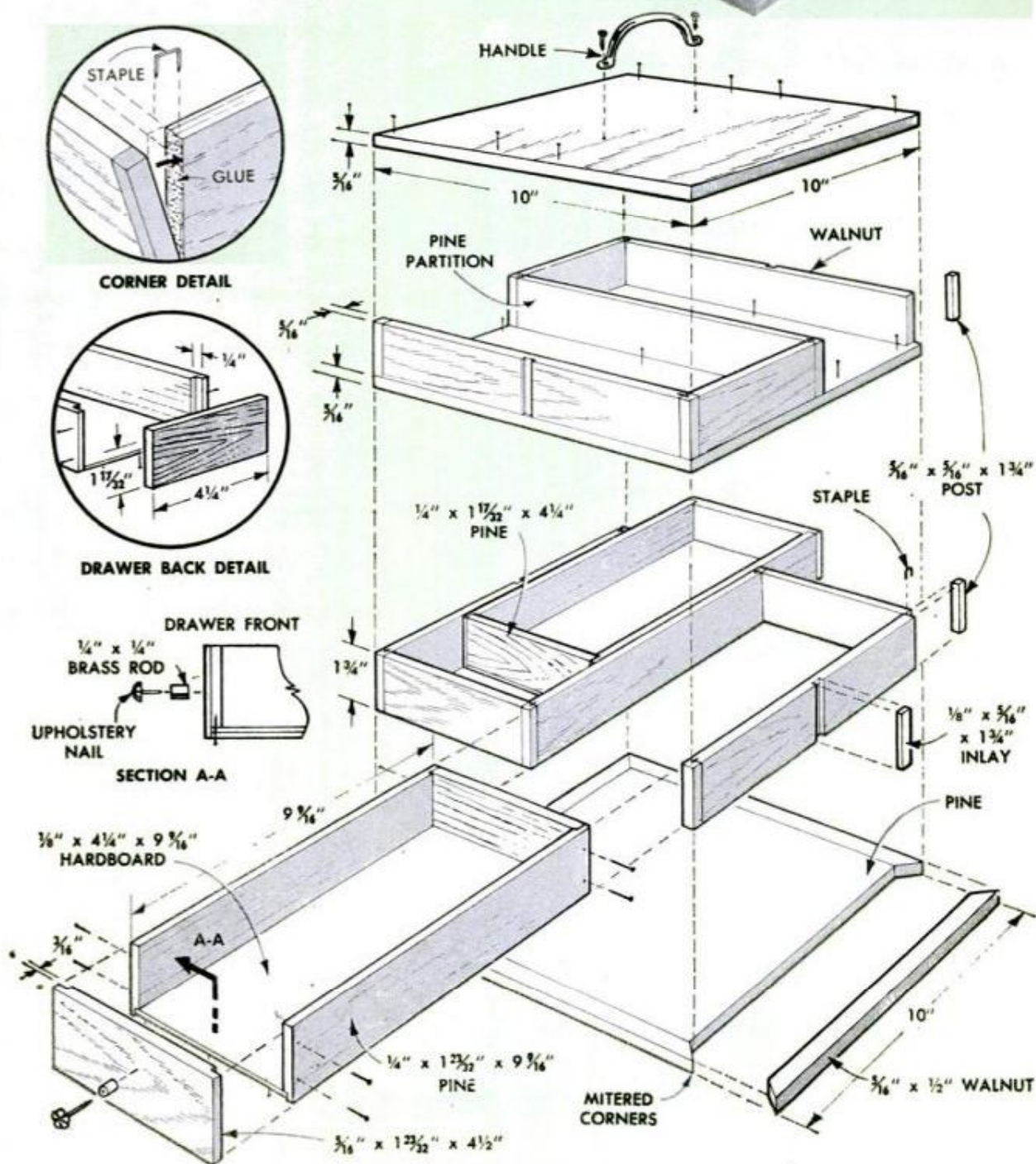
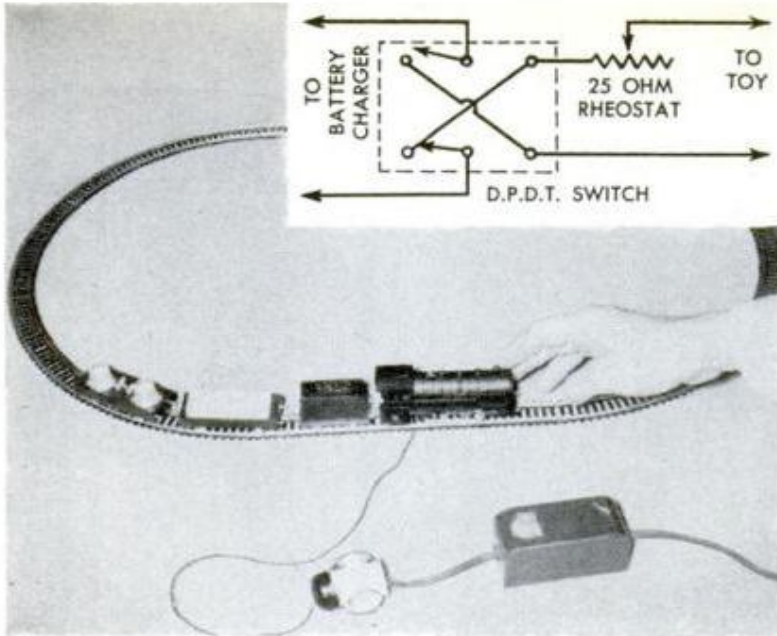

Photo Speedlight Charger Powers Battery Toys

A photographic speedlight charger can be used as a d.c. power supply for battery-operated toys. Chargers producing up to 6 volts at fractional amperage can be connected directly. Larger-capacity chargers, connected in series with a 25-ohm rheostat, will reduce the voltage and serve as a speed control. A DPDT toggle switch permits forward, reverse and stop control. Mount the rheostat and switch in a box for quick hook-up when needed.

M. C. Anderson, Arlington, Va.



Storage Jars Hang On L-Hooks

Here is a new twist for storing light hardware and small parts. Fasten a lug bolt to a jar cover with two small nuts. Screw an L-hook into the wall and the jar is easily hung. Try it. You will find it easier to pull the jar off the hook than to unscrew it from a cover, which has been fastened to the bottom of a shelf. Larger parts can be stored in cardboard "cabinets" of the type from which typewriter ribbon is sold. These cabinets usually have three drawers mounted vertically and are fine for storing radio tubes and electronic parts.

A. P. Zanelli, Tampa, Fla.

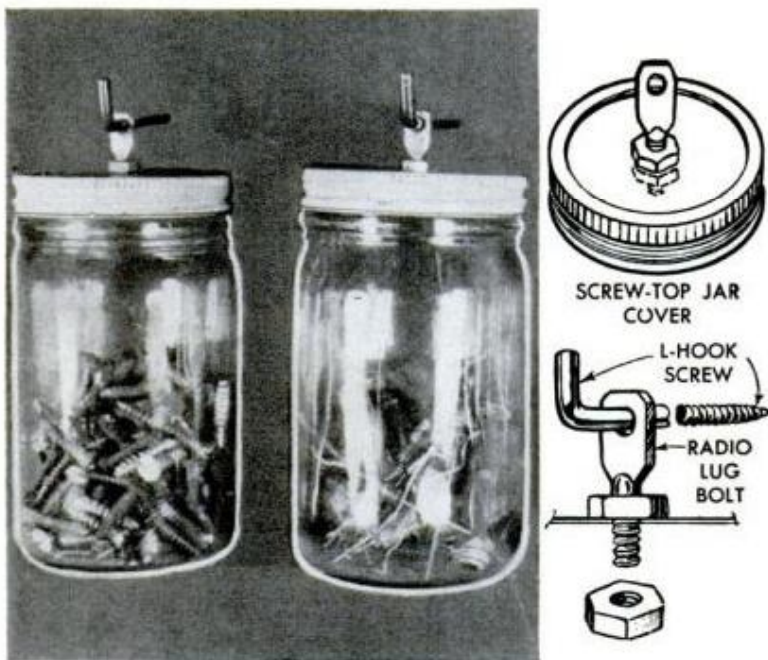

String Helps Mount Heating Coil

You can determine the length of new heating coil you need by threading a piece of string through the path of the old coil. Then remove the string from the assembly and stretch the new coil until it is one to three inches shorter than the string. This will give the coil the proper tension when mounted. Starting from the center of the assembly, thread the coil in. Tighten the terminal screws and complete the reassembly.

Robert A. Brown,
Shelbyville, Tenn.

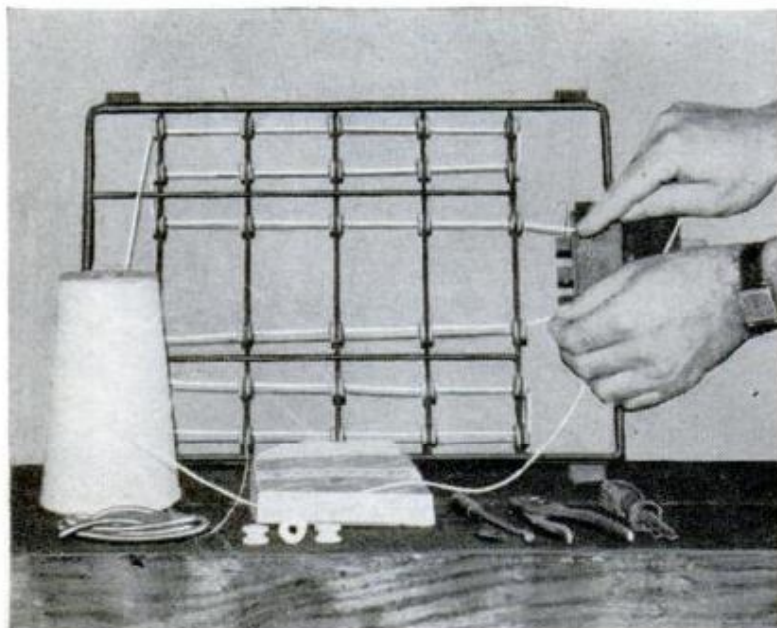

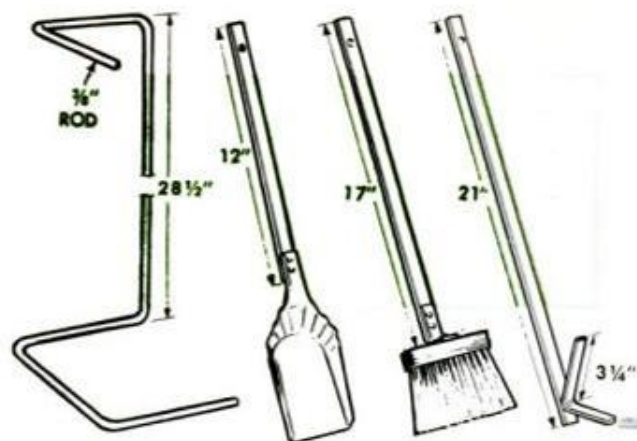

Fireplace Set Has Aluminum Handles



The sleek, distinctive and expensive look of stainless-steel fireplace accessories can be matched at low cost by making your own out of aluminum. This fireplace stand was made by bending a 6-ft.-length of $\frac{3}{8}$ -in. aluminum rod around a steel post to the desired curve. The shovel is an ordinary coal shovel. Cut the handle off and attach the shovel end to a piece of aluminum bar stock measuring $1 \times 1\frac{1}{4} \times 12$ in. From the same stock cut a piece about 6 in. long and bend it in a vise to form the

V-shaped blade for the poker. Make the broom in the same way, by sawing the handle off a wallpaper brush. Attach the brush to an aluminum handle with an angle cut from $\frac{1}{8} \times \frac{3}{4}$ -in. stock. Approximately $1\frac{1}{2}$ in. from the top of each handle drill a hole about $\frac{1}{2}$ in. in diameter by which the finished tools may be hung. Given an occasional light coat of plastic spray, the accessories will remain bright and decorative.

Edward L. Fisher, Milwaukee, Wis.

Hints on Repair and Care of Masonry Around the Home

If you have brick surfaces in and around your home, here are a few tips to help you keep them looking bright and in good repair. Red fireplace brick, for instance, will in time become white and chalky in appearance. To restore the bricks to their original color, rub them occasionally with a mixture of olive oil and vinegar and wipe them with a dry cloth. Those same indoor bricks will be protected against stains if they are given a coat of thinned shellac. New brick surfaces and ceramic-tile walls that have been finished with

white finishing cement will lose that new look if the cement is allowed to yellow. To keep the cement spotlessly white, rub it with an old toothbrush dipped in ammonia. If you wish to do a quick repair job or to make a fairly small object of concrete without the use of forms, try this: Make a rich mixture of concrete, using just enough water to wet all the material. Dampen the area to be covered and set the concrete in place. Shape it as desired and in two hours it can be troweled smooth.

61 Shopnotes Annual X483

CASTING PLASTER

By Howell M. Burke

BALLOON LAMP BASE

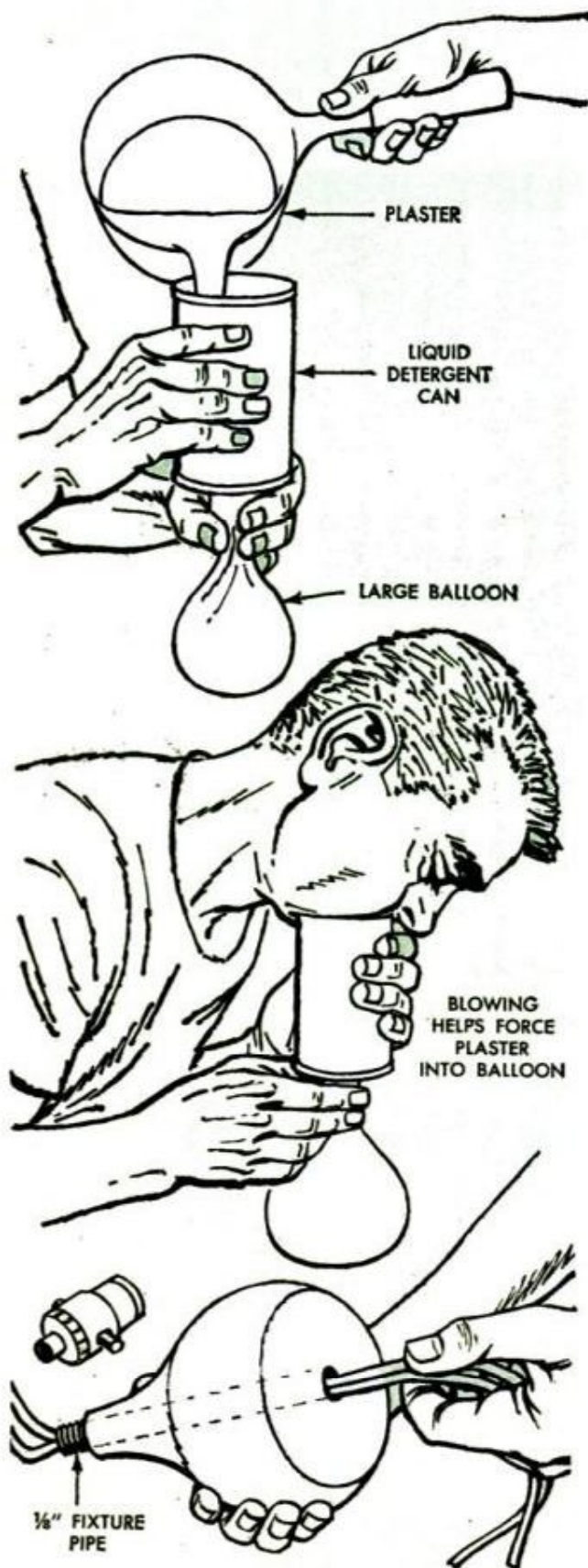

SPECIAL-OCCASION gifts must be simple, useful and decorator styled. These requirements immediately suggest a lamp, planter or perhaps ash trays, all designed and handcrafted with just a touch of flair. The lamp bases and planters pictured below and on the opposite page are selected examples of what you can do with the simplest equipment, most of which you may already have at hand.

All the items pictured are plaster castings, made with what is known to the trade as molding plaster. The lamp base below is made with plaster, a detergent container and a large toy balloon. The essential three steps in the casting procedure are shown in the details at the left. First, cut the bottom out of the detergent can and unscrew the cap. Then attach the balloon to the neck of the can, using a length of fine wire, or better still, a pipe cleaner, which can be twisted tightly, yet is easily loosened quickly. Fill the balloon with water, then empty into a container. The amount of water contained in the balloon will give a measure of the amount of plaster you will need to mix.

With everything in readiness at the kitchen sink or laundry tubs, including a length of 1/8-in. threaded fixture pipe, mix the plaster in a large shallow pan with a pouring lip. For best results the mix should be about the consistency of heavy cream so that it will pour easily. At this point it will facilitate the procedure if you have



POPULAR MECHANICS

GIFTS



Use care when working casting out of plastic mold. Plaster should be fully hardened before removal



Above, planters of various sizes make useful gifts. Below, mixed plaster should be poured into mold without delay. Right, after casting has been removed from mold, smooth by rubbing on coarse sandpaper



someone to help you. Molding plaster sets quickly and once mixed to a uniform consistency without any lumps, it must be used immediately. Squeeze the balloon lightly with one hand to force out the air it may contain and have your helper pour about one third of the plaster into the can. Without delay, blow lightly into the can as in the center detail on the opposite page. This will force the plaster into the balloon. Repeat this procedure as rapidly as possible until the balloon is full.

Now remove the filled balloon from the detergent can and place it on a flat surface. Allow the casting to spread somewhat so that it takes the bulbous form pictured. The bottom will flatten and for this reason it's important to hold the cast in the perpendicular position. Next, working quickly, open the balloon carefully and insert the threaded pipe, one end of which has been plugged with a dowel, into the neck of the cast and push down to the bottom. Make sure that the pipe stands perpendicular to the surface on which the cast is placed. Now, working lightly with the tips of the





Rectangular lamp bases and ash trays are easily made by using cardboard boxes or utensils as molds



Above, "hand-trowel" the plaster into cardboard-box mold. Below, when plaster has set, strip off box. Right, smooth top of casting with file and sandpaper

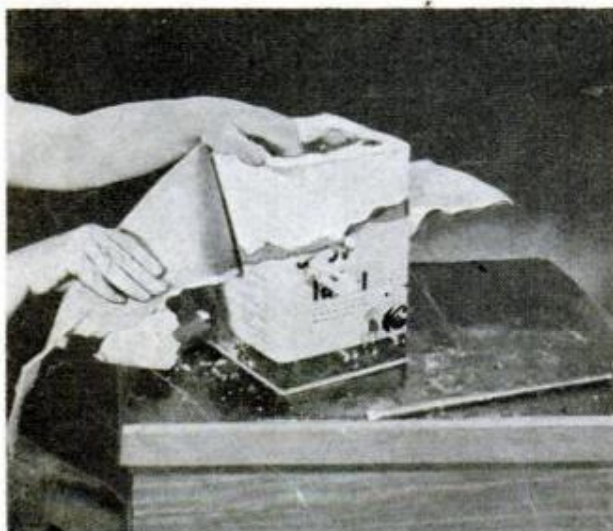

fingers, form the neck of the cast around the threaded pipe, shaping to a true curve and uniform diameter.

As soon as the pouring is finished, have your helper wash the utensils and the sink or laundry tubs thoroughly. Do not permit even a small quantity of mixed plaster to enter the drain from the sink or tubs, as a residue may be left to harden in the trap, even though the drain is flushed with a quantity of water.

When the plaster cast has set, tear off the balloon and force the dowel plug out of the threaded pipe. Form a groove in the plaster casting from the outer edge of the flat bottom to the threaded pipe, using a round file. This groove permits the lamp cord to be led out at the side of the base. To finish up the job, wire a socket, slip a brass spacing neck over the threaded pipe, fit a harp and the socket, add a shade of your choice and there you are. By sizing the plaster casting you can decorate it with colored cutouts, or paint it in any color and pattern that suits your fancy. Cement $\frac{1}{8}$ -in. felt to the bottom of the base.

Using various types of plastic containers, bread tins, even a cardboard box which originally contained grass seed, you can make the lamp and planters pictured on page 183 and also the lamp base at the left. In making these the procedure differs somewhat from that used in making the balloon lamp base. You use a somewhat heavier and thicker plaster mix and press it onto the sides of the container with your hand, building up, by successive stages where necessary, until you have a thickness of $\frac{3}{4}$ in. or more. Wait until the plaster has hardened, then tear off the container and smooth the top edges of the casting with a file or by inverting and rubbing on a sheet of coarse sandpaper as in one of the illustrations.

An attractive planter can be made by using two bread tins, one small and one large one. Pour a creamy mix of plaster in the



larger and then press the smaller tin inside the larger one until the plaster is forced up to the top edge. Center the smaller tin and hold in position until the plaster sets. Then carefully remove the smaller tin and work the casting out of the larger one. Using the same procedure you can make round planters by using a child's plastic sand pail and a plastic juice container. Mix and pour the plaster in the large container as before and place the smaller one inside, pressing it down until the plaster is forced to the top of the pail. Hold in place until the plaster sets, then remove the juice container and pail and smooth the edges of the casting. Finally, note the base of the lamp in the upper right-hand photo on page 183. This is made by using two separate containers of the type used to store leftovers in the refrigerator. Two separate castings are made and when the plaster has hardened a hole is centered through both to take the threaded pipe. Smooth the meeting faces of the two parts, then join tightly by running seating rings and nuts on the threaded pipe. By using containers of different sizes you get the attractive offset base pictured. ★ ★ ★

Socket-Head Screws Driven With Nail Clipper

In an emergency, such as an automobile breakdown, if a socket-head screwdriver is needed and there is not one at hand, try using the blade of a fingernail clipper instead. The blade is usually about the right size to fit one of the slots of the screw.



Refinishing Camera Parts To Original Black Finish

After a period of long, hard service brass parts on a camera will lose their black oxidized finish. To restore the finish add copper sulphate, $\frac{1}{2}$ tsp., to water, 4 oz., and allow it to dissolve. Add sodium carbonate, or washing soda gradually until the precipitate stops forming. A small amount of household ammonia will dissolve the precipitate and turn the solution a deep blue. Now clean the parts to be oxidized and dip them in the solution for about one minute. Wash them with clean water and dry them. The brass should turn black in a few minutes.

Floor and Wax Wisdom



The hard work involved in caring for tile or linoleum floors is eliminated by a wise choice and use of cleaning and polishing products. According to the Johnson's Wax Company, there are two basic types of floor wax—polishing and liquid self-polishing. The self-polishing type is best applied with a fleece applicator, as shown above. It dries to a hard shiny finish and requires no buffing. Polishing wax, which comes in liquid and paste form, requires buffing but affords longer lasting protection and a higher luster. In applying liquid polishing wax, a cloth mop is preferable to a sponge mop as the cloth releases the wax more evenly for a smoother, glossier coat. Most liquid polishing waxes clean as they are applied requiring no preparatory scrubbing. A solvent in the liquid loosens the soil which is then picked up by the cloth. However, this solvent has a softening effect on plastic and asphalt floor tile. Any good self-polishing wax is preferable on these surfaces. For linoleum which has become old and porous, two thin and even coats are recommended with at least four hours of drying time allowed between coats.

New Lease on Life For Rubber Suction Cups

With much use and exposure to sun and weather, the inner surfaces of rubber suction cups, such as are used on auto-top carriers, may lose their smoothness, become checked and dry and refuse to stick. Their restoration is a simple process. Rub the inner surfaces with fine sandpaper and then brush on a thin coating of plastic rubber, available in any hardware store. Allow the cups to dry over night before attempting to use them. This treatment will give the suction cups a new, live-rubber finish.

5 SHOP SHORT CUTS



When sawing plastic or hardwood, a jigsaw blade will cut with less friction, and therefore remain sharp longer, if it is lubricated with candle or beeswax. Unlike oil, the wax will not soil the work.



Mitered edges of craft work can be protected from nicks while awaiting assembly by covering them with masking tape creased down the center. Tape is peeled off just prior to assembly.



One C-clamp often may be made to serve as two clamps by using short lengths of steel angle under both jaws of the clamp. These steel "pads" will distribute the clamping pressure over a greater area.

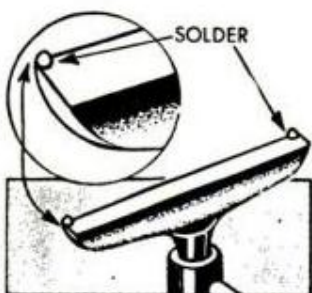

Tool stops at the ends of a lathe tool rest will prevent the chisel from accidentally sliding off the end and gouging the work. Stops can be formed by upsetting the metal, or with solder.

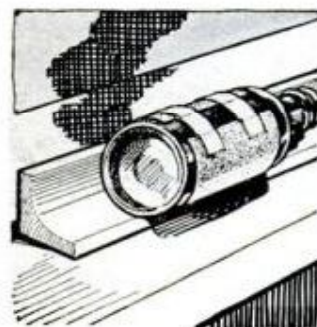

Round bottles of varying diameters make perfect ready-made sanding blocks for smoothing contours and concave molding. Abrasive paper is wrapped around bottle and held with adhesive tape.

OIL BURNER CHAMBER RELINED WITH "CERAMIC" FELT

DAMAGED CERAMIC linings in oil-burning home furnaces can now be relined with "ceramic felt" at a fraction of the cost involved when the customary firebrick-relining job is made, according to Socony Mobil Laboratories. Reason for the smaller cost is a drastic reduction in installation time; ½ hr. for ceramic felt and about 6 hrs. for removal and replacement of a brick lining. The latter must be installed by a competent repairman, but a felt lining can be installed by the homeowner at a considerable saving.

Originally developed for insulating aviation jet engines, the new material is made of alumina and silica fibers bonded together to form a flexible blanket-like substance. Manufacturers of two of these products now on the market report that as a combustion-chamber lining, it weighs much less than a brick lining, permits the furnace to develop maximum temperature faster and reduces noise.

Ceramic felt may be purchased in mat form, or as a kit that consists of a stainless steel outer liner and enough felt material for most any installation. The outer liner helps to keep the felt in place and provides a rigid backing. Mat thickness of ½ in. and a density of 10 to 12 lb. is recommended. The material may be installed in any damaged brick, precast or steel combustion chamber that has enough strength to serve as a retainer for the new

Socony Mobil Oil Co., Inc.

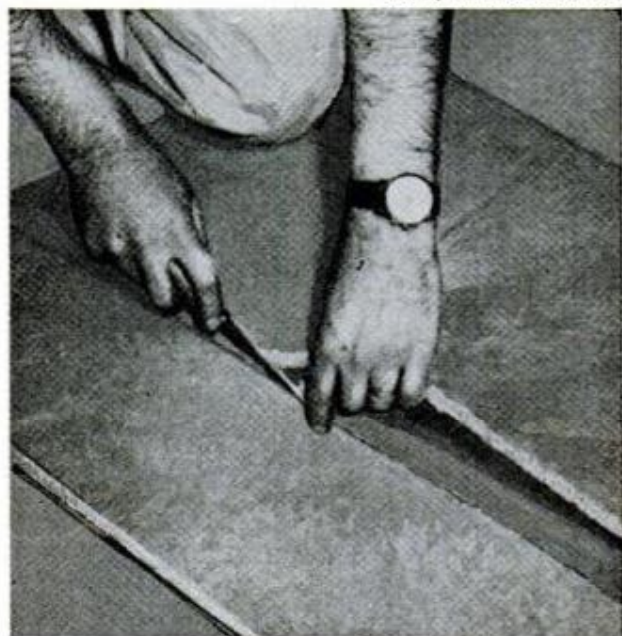

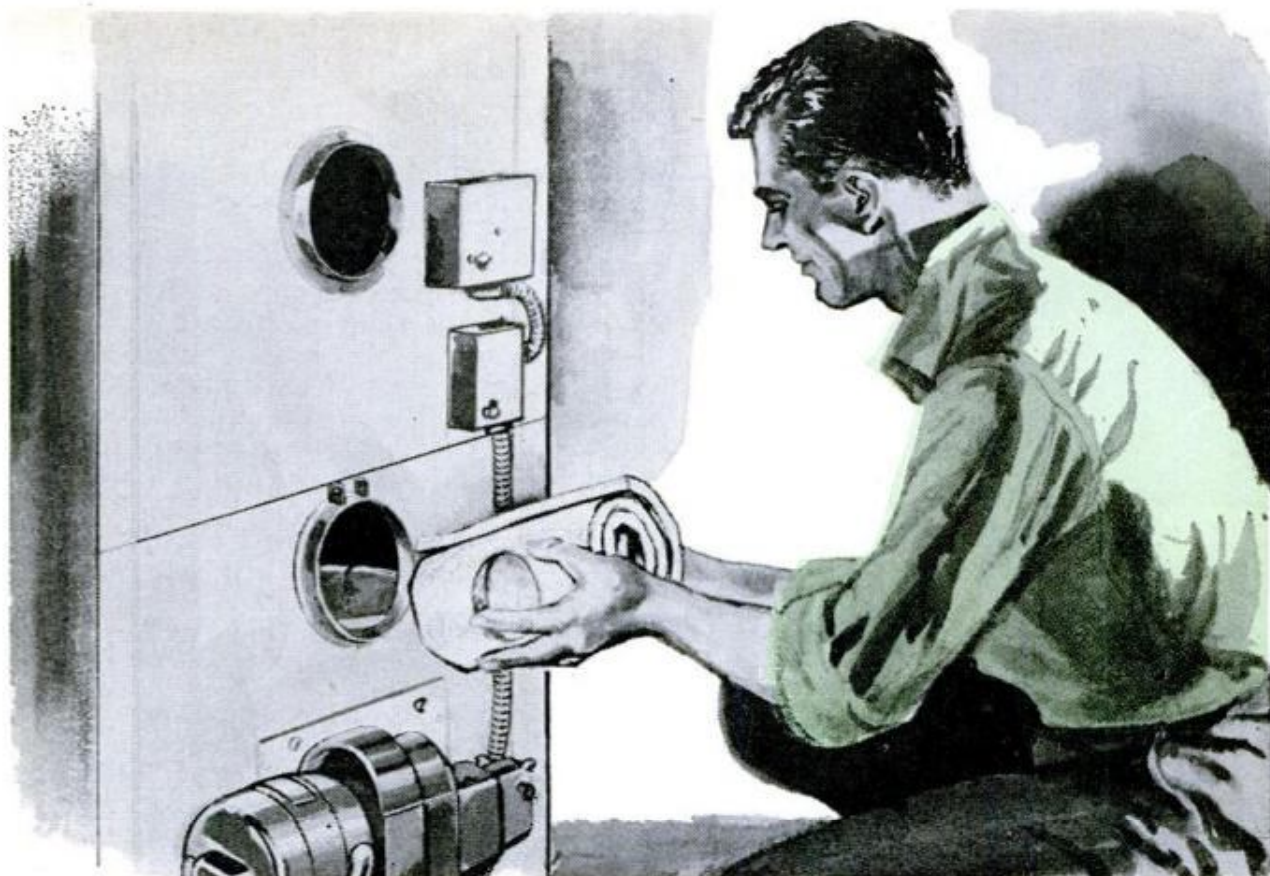

liner. It should not be used when the bricks in an existing chamber are oil-soaked due to a misfire, in which case a new brick lining is needed.

The usual repair procedure is to first remove the access plate of the furnace and obtain the following measurements: diameter of the chamber, chamber height, distance of blast tube from chamber floor and diameter of blast tube. Then place the mat on a flat surface, outline the liner to be cut from the above dimensions, and cut it to fit as shown in the drawing below left. To find the liner length, multiply the

diameter of the chamber by 3.14 and add 6 in. for overlap at the ends. Allow 1/2-in. clearance around the blast tube, and locate the hole for the latter about 6 in. from one end so that the lap occurs close to the tube. Use a pair of heavy scissors or a knife to cut the felt. Installation of the liner is easy. Simply roll it up as in the illustration above and place it in the chamber so that the end with the hole can be slipped over the blast tube. Then push the liner into position against the old chamber wall as shown below and the furnace is ready to go again. ★ ★ ★

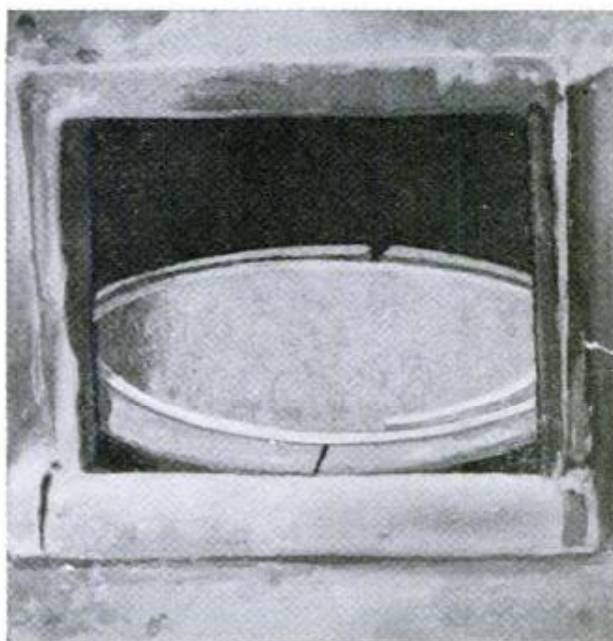
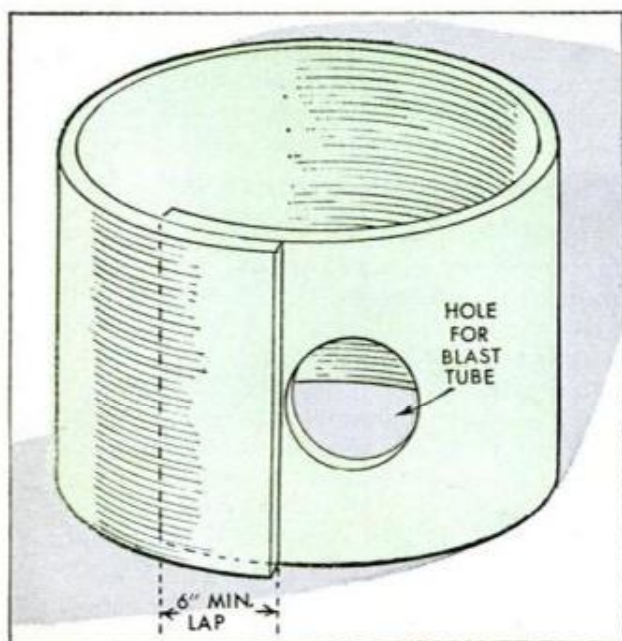



Reels in Electric-Fence Wire With Auto Starting Motor

The hard work involved in winding up electric-fence wire is entirely eliminated with this simple device. An automobile starting motor is used to drive a shaft by means of a V-belt. The shaft is mounted between two water-pump bearings, and the original spool is fitted on one end. By using a reduction pulley, the shaft turns at about $\frac{1}{3}$ the speed of the motor, furnishing enough power to reel the wire in at a safe handling speed. Mounted on the front of a truck on an A-frame, the device reels in $\frac{1}{2}$ mi. of wire in a few minutes.



Heavy Asphalt Building Paper Cut Without Grab or Binding

Small difficulties in routine jobs can slow progress considerably. For example, it is hard to make a clean cut in asphalt or other heavy building paper because the edge of the paper will often pull and gather in front of the knife blade. The job can be simplified if the roll is placed face down, as illustrated, and the cut is started about 2 in. in from the edge. With a sharp linoleum knife, cut across the paper and then cut the remaining 2-in. margin.

Daniel Bousha, Jackson, Mich.

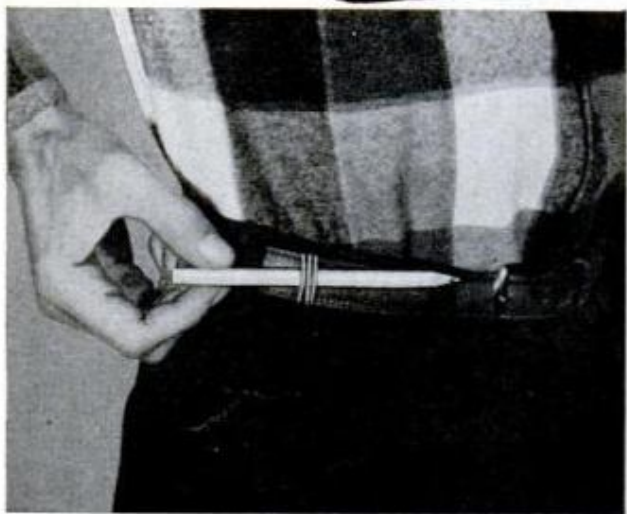

Belt-and-Pocket Hints For Wandering Pencils

A rubber band looped several times around your belt makes a convenient pencil holder. The pencil will always be in reach and won't be broken when you bend over, as it often is when carried in a trousers pocket. If you carry several clip-on pens and pencils, a shirt breast pocket is a good place to keep them. However, they may be hard to clip on and remove from a shirt made of heavy material. In this case, fold a piece of celluloid over the edge of the pocket. This saves much tugging and prevents frayed pocket edges.

R. Hanscom, Elmhurst, Ill.

Hats Stored and Protected In Hanging Closet Shelf

A convenient place in which to store hats is made by cutting away the top and one end of a cardboard box and tacking it to the underside of a closet shelf, as illustrated. In cutting away the top, leave a strip about 2 in. wide on each side. The strips are then bent outward and the tacks inserted through them. If desired, a box of greater length may be used. Cut away one side instead of an end and attach the box in the same manner. This will allow you to store several hats safe from crushing or soiling.

G. E. Hendrickson, Argyle, Wis.

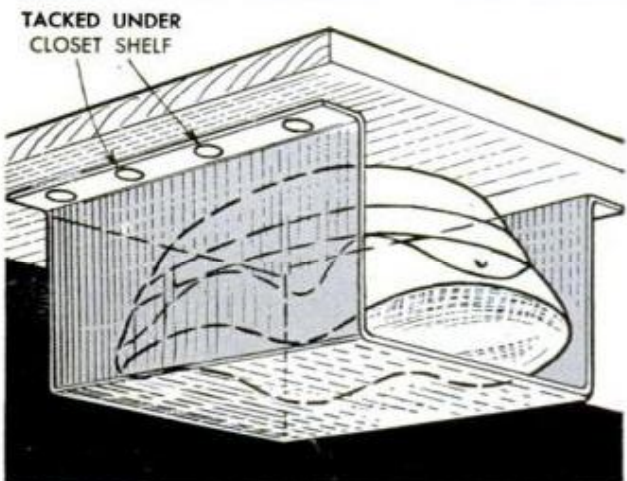

Unit Controls Room Lights for Home-Movie Projection

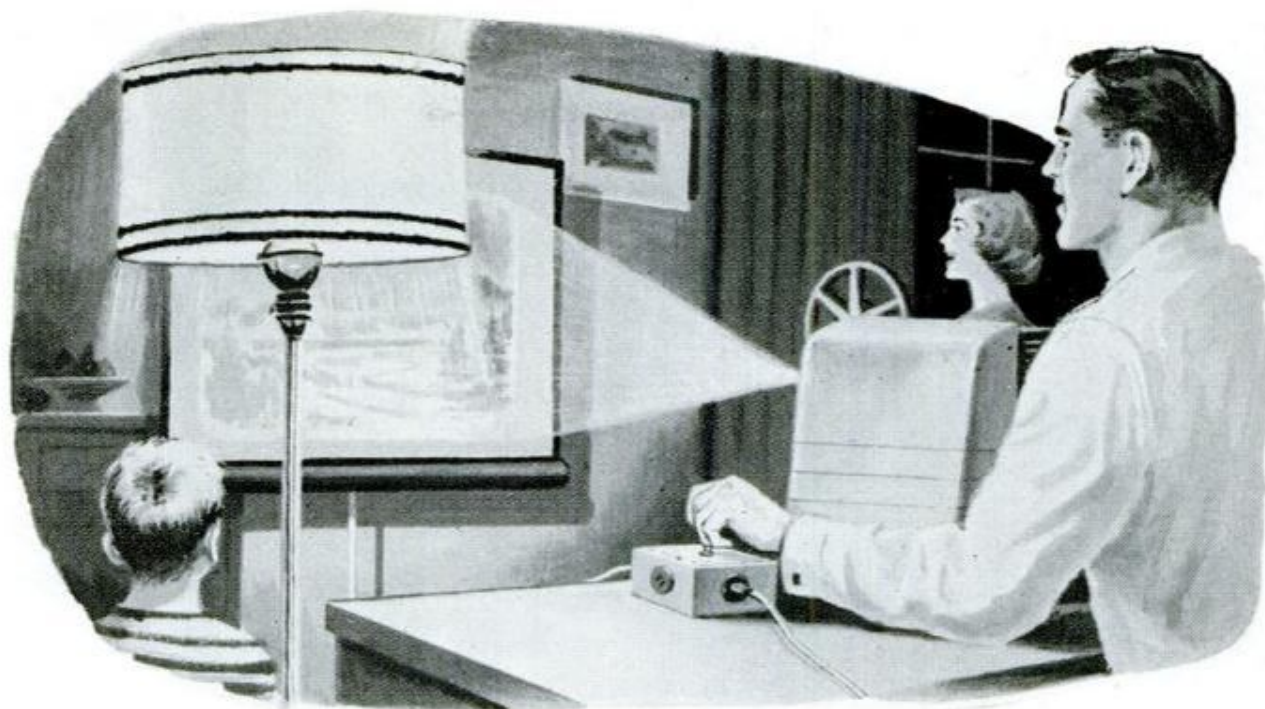

THIS LIGHT-CONTROL UNIT places complete control of the floor lamp or other room lights at the home-movie or slide projectionist's finger tips, making it unnecessary to grope in the dark for the light switch. The unit consists of two 61 Amphenol female receptacles (with removable mounting plates), a toggle switch and a 61 Amphenol male plug, all mounted in a small metal box. The male plug, leading to the current source, is wired directly to the projector receptacle. This in turn is wired to the lamp receptacle with the "hot" wire running through the switch as illustrated. If desired, a tape recorder or phonograph may be used with the projector. In this case, an additional female receptacle is wired directly to the male plug and to one of the light leads, as shown in the illustration at the right. The additional receptacle is also "hot" and current is controlled at the phonograph.

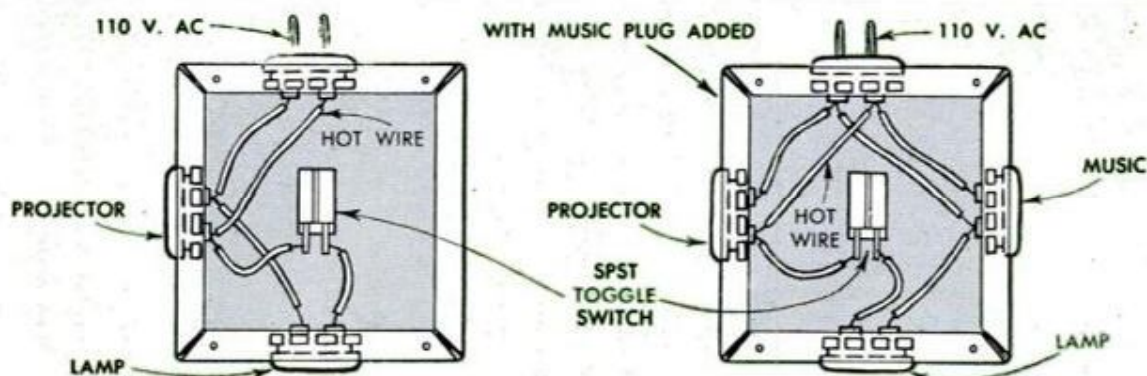
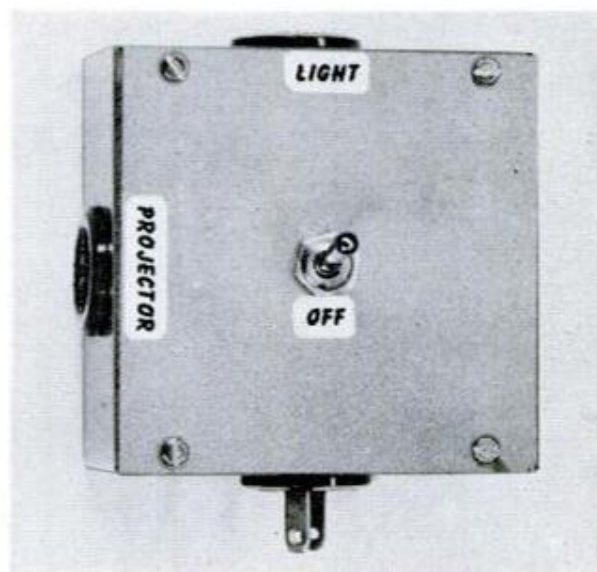

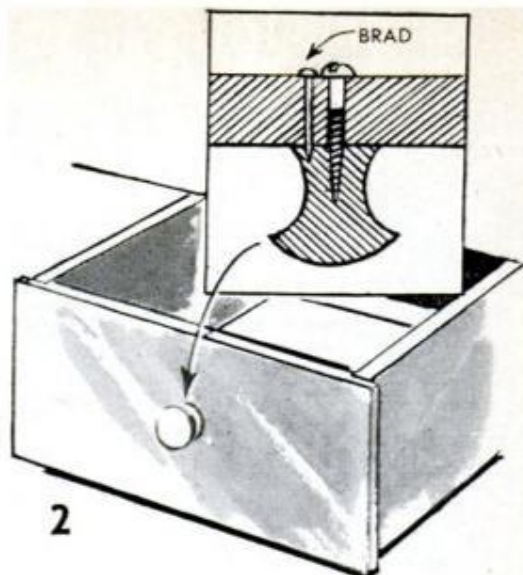

Solving HOME PROBLEMS

1. THE SPUTTERING OF CANDLES can be disturbing during candlelight dinners or on other occasions where a hushed atmosphere is desired. To avoid this annoyance, first dip the candles in a can of thinned shellac. The candles will burn quietly and evenly all through the dinner or ceremony

2. WOODEN KNOBS on doors and drawers often persist in coming loose no matter how many times you tighten them. The problem is permanently solved by tightening the mounting screw and then driving a wire brad into the knob from inside the drawer or door. On hardwood knobs, a dab of glue will do

3. SKELETON KEYS often are left in the door purposely for the sake of convenience and are just as often lost. To keep them from falling out or to prevent children from taking them, place a strip of adhesive tape across the vertical slot of the keyhole, or tie them to the doorknob with a string

4. FLOOR MOPS that are stored in corners or between a wall and an appliance, have a way of falling into inaccessible places. Prevent this by taping a shoehorn to the handle so that it hooks over the edge of the bucket. This keeps the mop standing upright while it is in storage or when it is in use

5. CLOTHES HUNG OUT TO AIR are often carried down the clothes line before a good stiff breeze and may fall off and become soiled. No need to repeat the experience. They can be made to stay put with the use of a common fruit-jar rubber. Double the rubber over the clothes line and slip the hanger through the fold. No breeze can move them now

6. UPRIGHT PIANOS and spinets that see hard and frequent use will invariably creep along the surface of a polished floor. To keep them the recommended distance from the wall, screw two wooden doorstops of the required length to the baseboard so that they strike the piano in back at each end

7. DON'T SURROUND YOURSELF with a pile of chewed-up ceramic tile. Cutting the tile to fit around fixtures and into corners need not be exasperating nor expensive. Use an ordinary glass cutter to score the glazed surface. Then crack the tile by placing it on a drill bit and applying pressure evenly



LIGHTWEIGHT ICE-FISHING SHELTER

LIGHTWEIGHT AND COMPACT, this portable ice-fishing shelter can be set up in a matter of minutes and offers maximum protection against wind and weather. The upright sections of the frame are 1-in. aluminum tubing, 72 in. high. The cross members are $\frac{3}{4}$ -in. aluminum tubing, 48 in. long. The ends of the cross members are closed with wooden plugs into which are inserted $\frac{3}{16}$ -in. machine screws. Two $\frac{1}{4}$ x $\frac{1}{2}$ -in. slots which receive the screw heads are cut in one end of the uprights. The canvas is a piece of water-repellent khaki drill measuring 75 x 156 in. A $1\frac{1}{2}$ -in. seam is sewn along the top and 2-in. seams along the tent wall as indicated in the diagram. The roof is a triangular section of canvas measuring 50 in. on each side, one side being stitched to the back tent wall. A grommet and rope placed opposite this sewn edge will allow you to secure the roof tightly. To set the tent up, measure off and mark three points on the ice at the proper intervals and drill holes here 2 in. deep. Slip the canvas over the uprights and place the uprights in the holes. Now install the cross members and pull the roof down. The 5-in. overlap at the bottom can be pulled in and weighted down to keep the wind out.

Anchored to the ice, and set facing prevailing winds, the tent offers sturdy and comfortable shelter for one or two-man fishing expeditions. Ventilation is through top joint openings

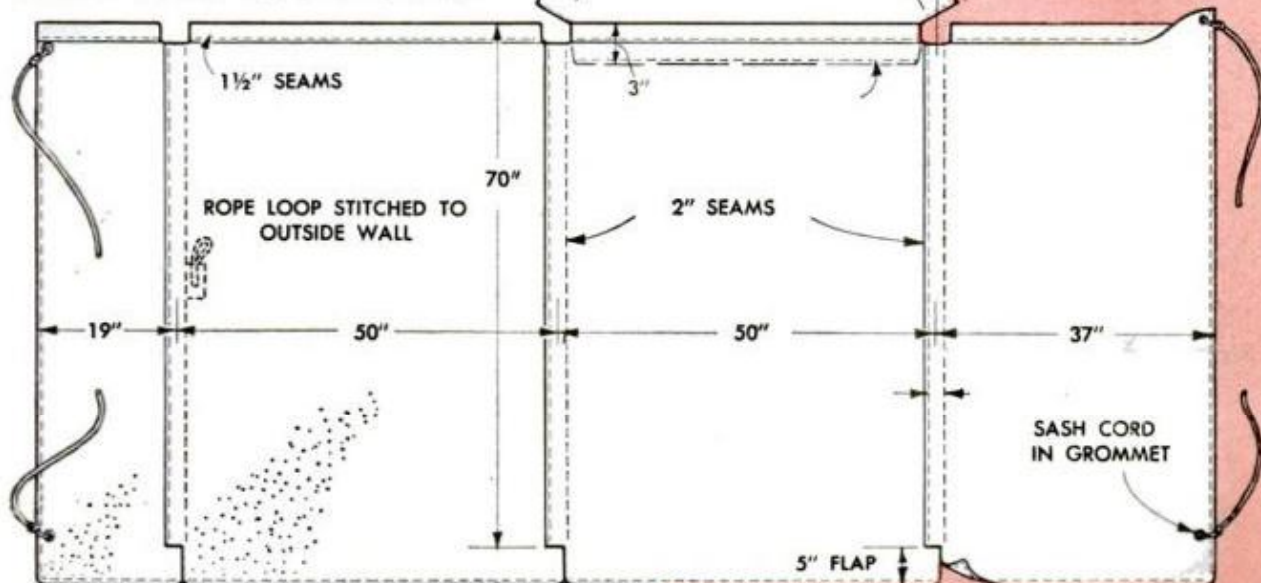
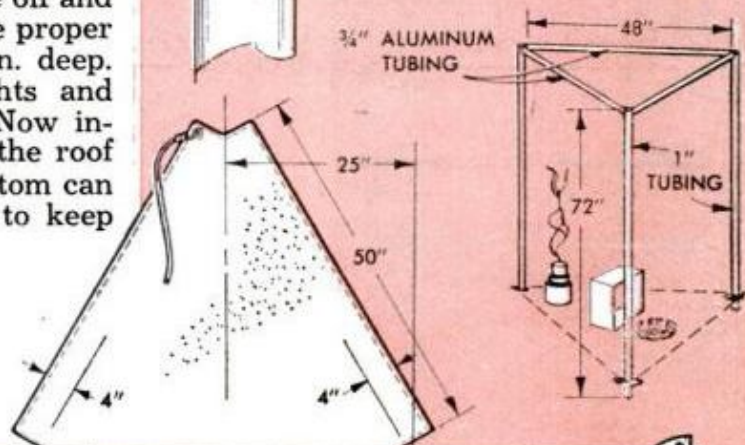
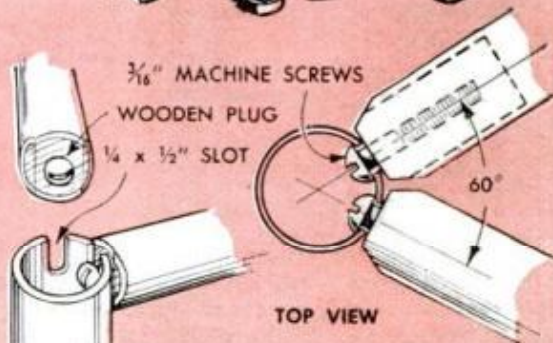
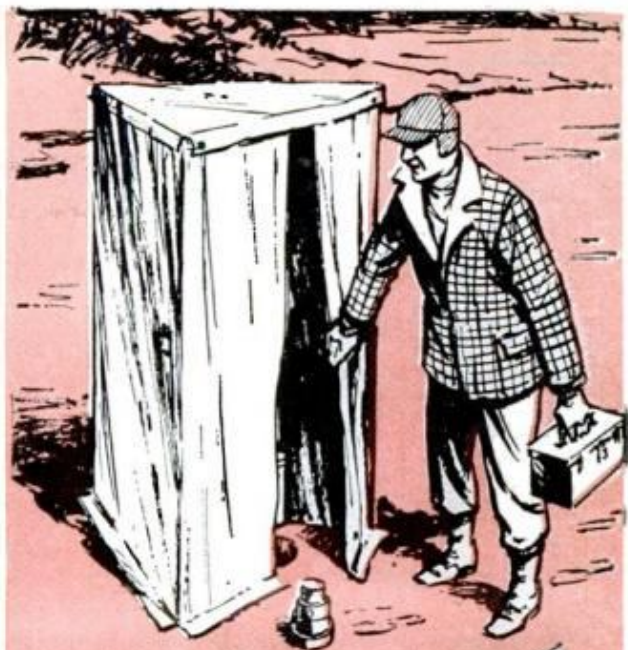

BUILDING THE 24-FT. PM HOUSEBOAT

PART III

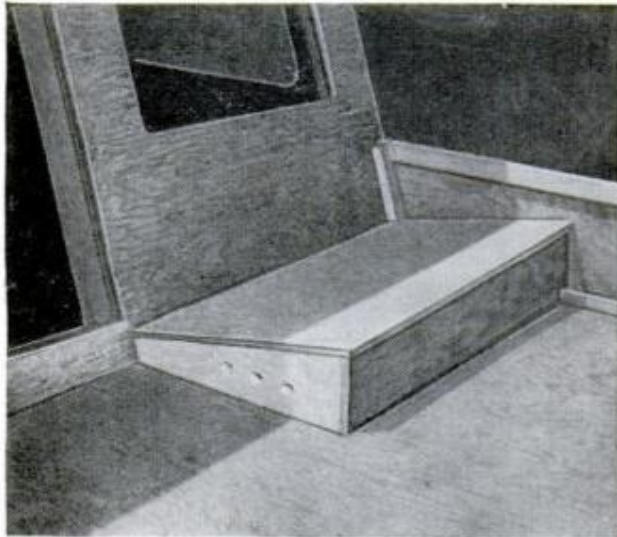

Twin seats on forward deck also serve for storing gear. Inclined for comfort, seats have loose cushions and lift-out lids to give access to stored fenders and mooring lines. Holes in the ends ventilate interior

LAST MONTH we explained how to plank the fore and after decks, trim the cabin "cockpit" and erect the cabin itself. This included the framing of the after deck and companionway hatches, as well as covering the cabin roof and hatch covers with glass fiber.

The plywood coaming around the forward deck is added next. In studying Fig. 30 you will see that the coaming appears to be a continuation of the cabin sides in that it is of the same thickness, maintains the same 5 deg. inward rake and is located in line. Across the front, the coaming slants inward 70 deg. Beveled cleats screwed and glued to the deck planking provide a base for gluing and screwing the coaming. A rabbeted molding trims and stiffens the upper edges of the coaming and a strip of 1-in. half-round molding, which extends the length of the cabin, is used to cover the rabbet joint. A knee brace adds rigidity to

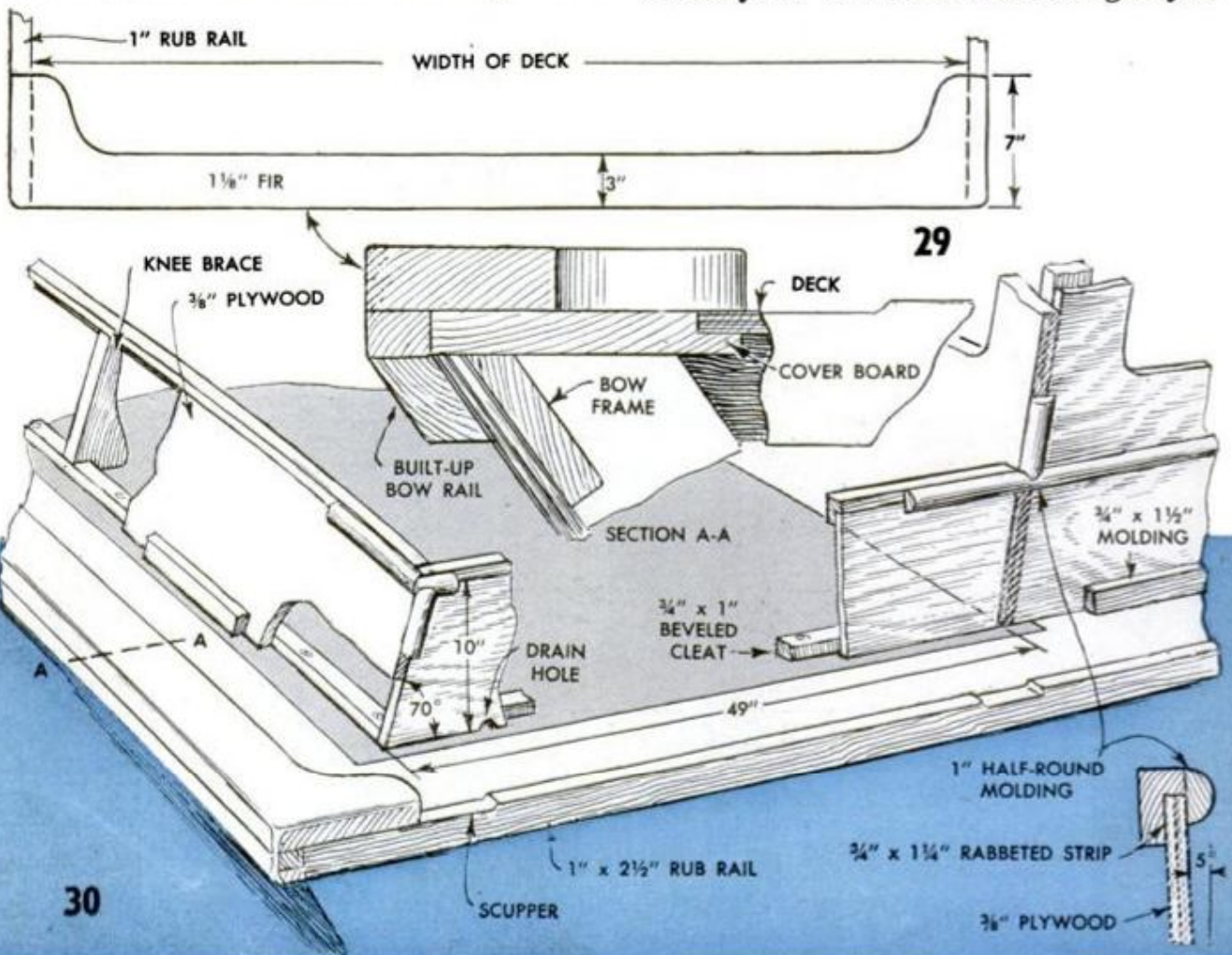



4

8. EVER LOOK FOR A NEEDLE in a haystack? How about at the bottom of a sewing basket? Those loose needles and pins are hard to find and they can prove dangerous. A simple way to store them is to stuff a small wad of cotton into a thread spool. Be sure to pack the cotton loosely so that little pressure is needed to insert or remove the needles and pins

9. IN AN EMERGENCY, a frozen-food container is yours for the making if you have an empty milk carton handy. Remove the staples from the carton and cut away a band $\frac{3}{4}$ in. wide from the top. Fold the top closed so that the triangular flap ends fold down along the sides. The edges of the top will now join snugly against one another and the cut-away band can be used to secure the container closed. Its size and shape make it ideal for freezer storage

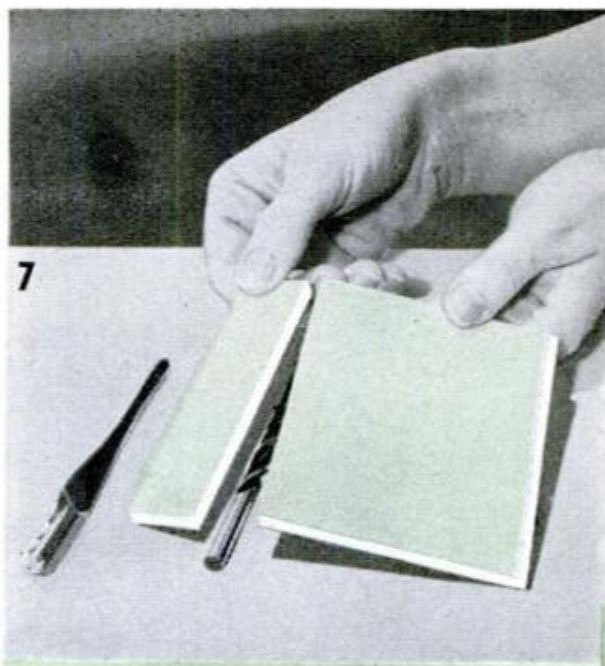

7

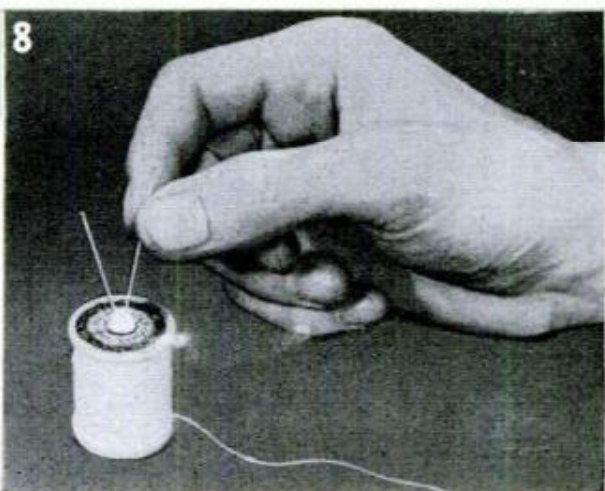

8

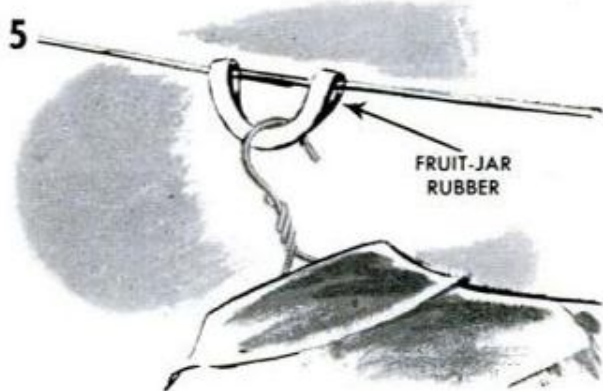

5

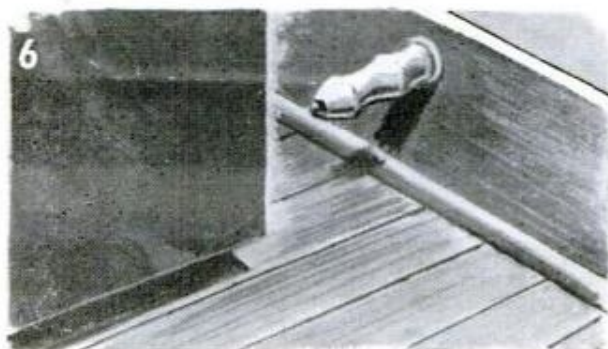

6

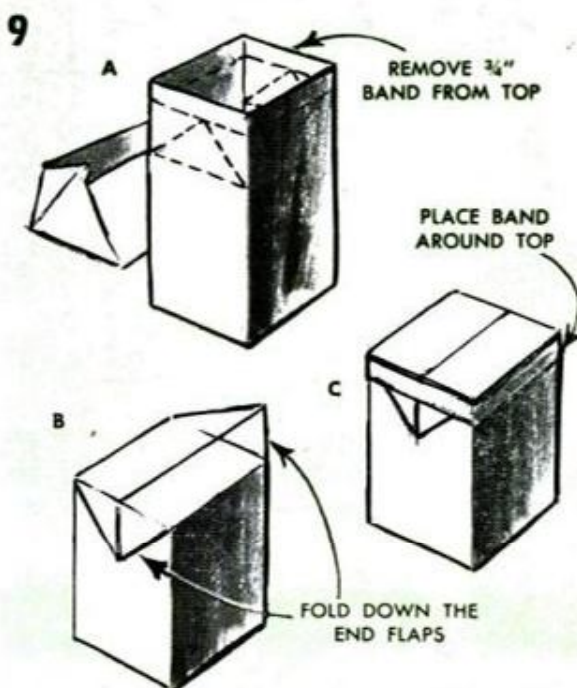

9

Western Book Ends for Den or Library

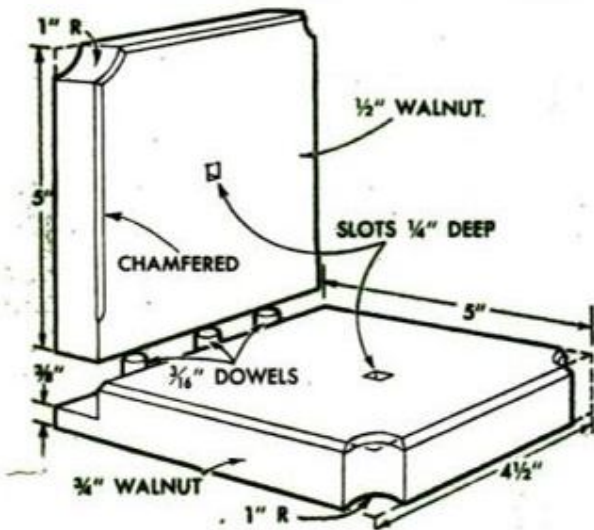

YOU WILL FIND this eye-catching set of book ends for the western section of your library appropriate for the living room or den. The back is cut from $\frac{1}{2}$ -in. walnut and measures $5 \times 4\frac{1}{2}$ in. Trim and chamfer the edges and drill the bottom end with three $\frac{3}{16}$ -in. holes. The base is $\frac{3}{4}$ -in. walnut and measures $4\frac{1}{2} \times 5$ in. It is trimmed and chamfered like the back. Along its back edge cut out a section measuring $\frac{1}{2}$ in. wide and $\frac{3}{8}$ in. deep. Set the remaining strip with $\frac{3}{16}$ -in. dowels. Dowel and glue the two sections together and allow to dry. Cut the figures from $\frac{3}{16}$ -in. birch and mount and glue them into $\frac{1}{4}$ -in. slots cut into the base and back. Now finish the book ends with clear varnish and wax.

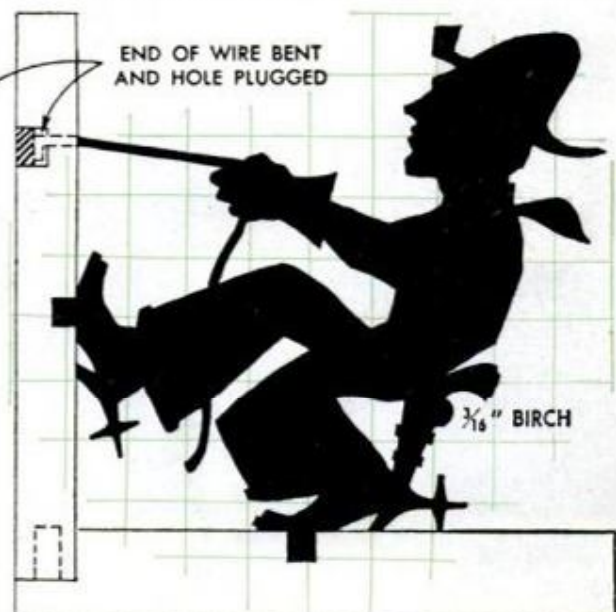
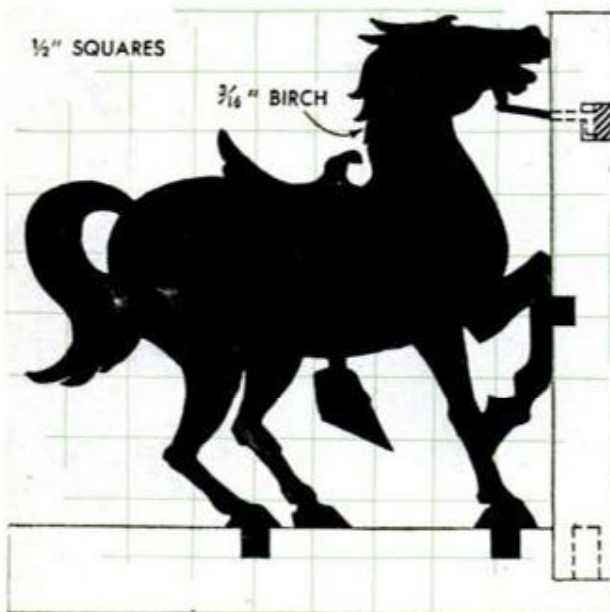

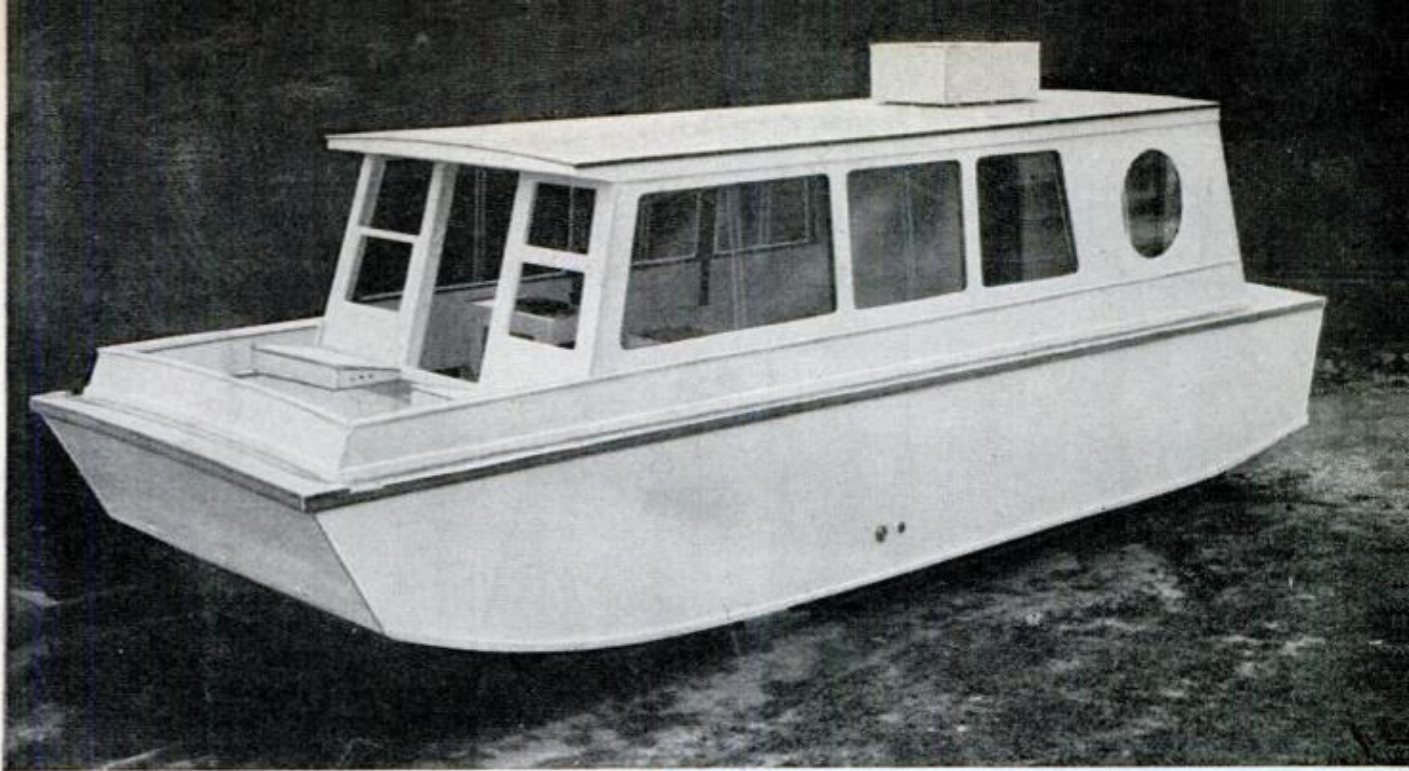

the coaming across the bow. This is placed on the centerline of the hull and screwed securely into the deck king plank. Drain holes are necessary at the base of the coaming to permit water awash to drain from the deck. These are formed through both the cleats and the coaming at the deck line. A couple of such holes on each side will be adequate. Rub rails at the sheer are made of oak and are glued and screwed in place so they project $\frac{1}{4}$ in. above the covering boards. Drain notches, called scuppers, are made in the rails about 4 ft. apart. These can be formed after the rails are in place, making them about 3 in. wide and chiseling them even with the top surface of the covering boards. The rub rail across the bow is built up in the manner shown in the section view A-A, Fig. 30. Consisting of three separate pieces which extend to the outside faces of the sheer rub rails, the top piece, called a toe rail, is shaped according to Fig. 29. Although it is cut from $1\frac{1}{8}$ -in.-thick stock, it is easily sprung to the curved deck with clamps. Bed it in bedding compound

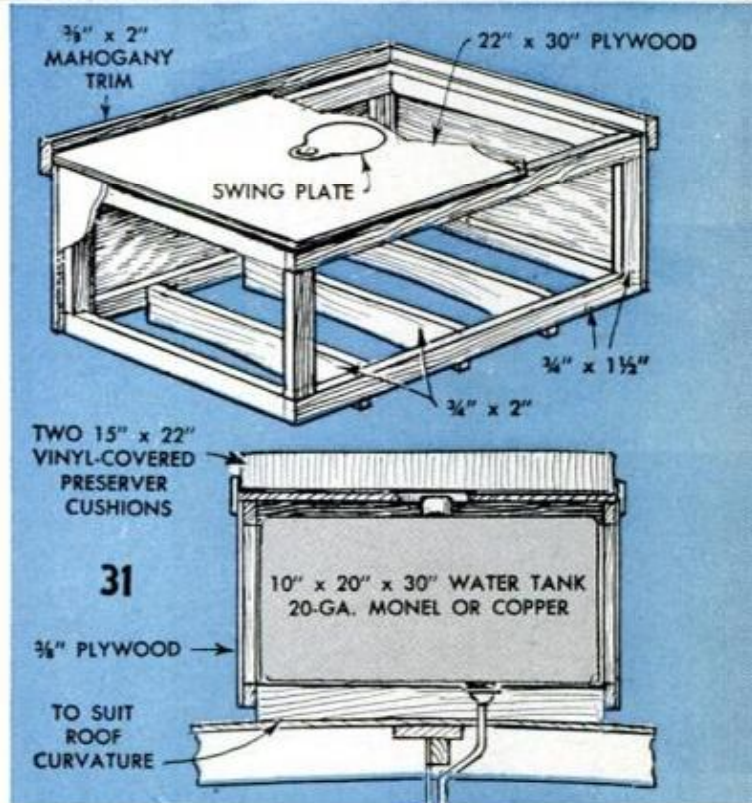

Below, water for drinking and washing is stored in tank housed in padded seat perched atop cabin roof

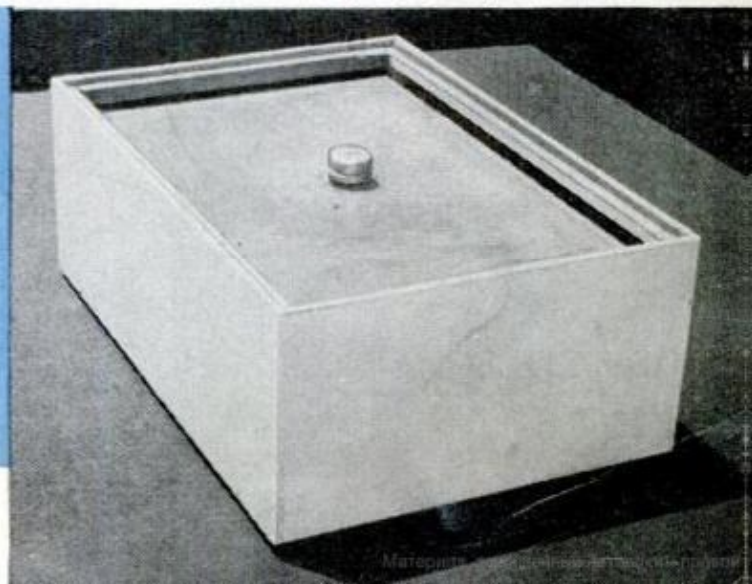
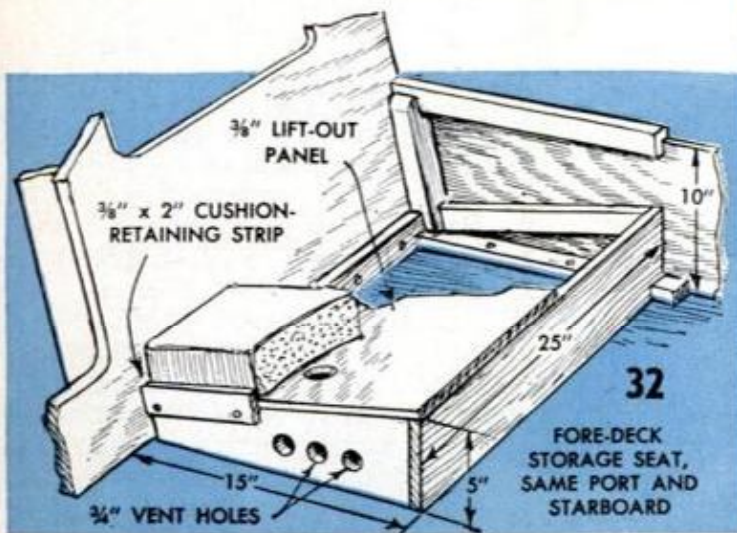

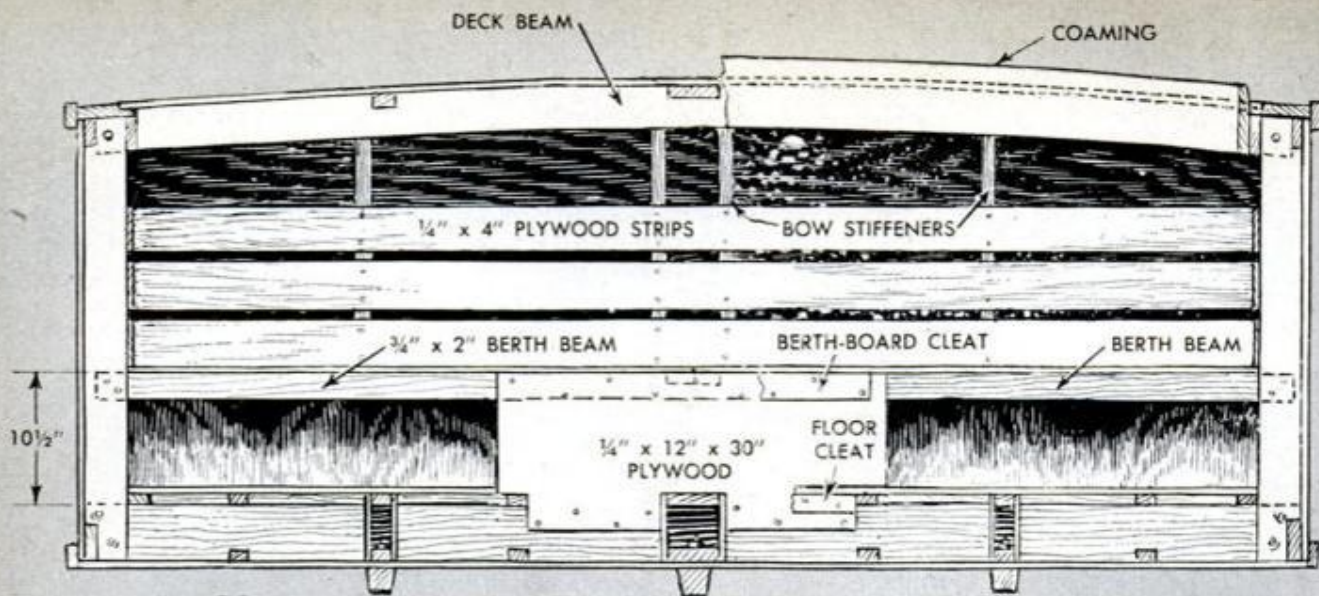

33 SECTION AT FRAME 2 LOOKING FORWARD

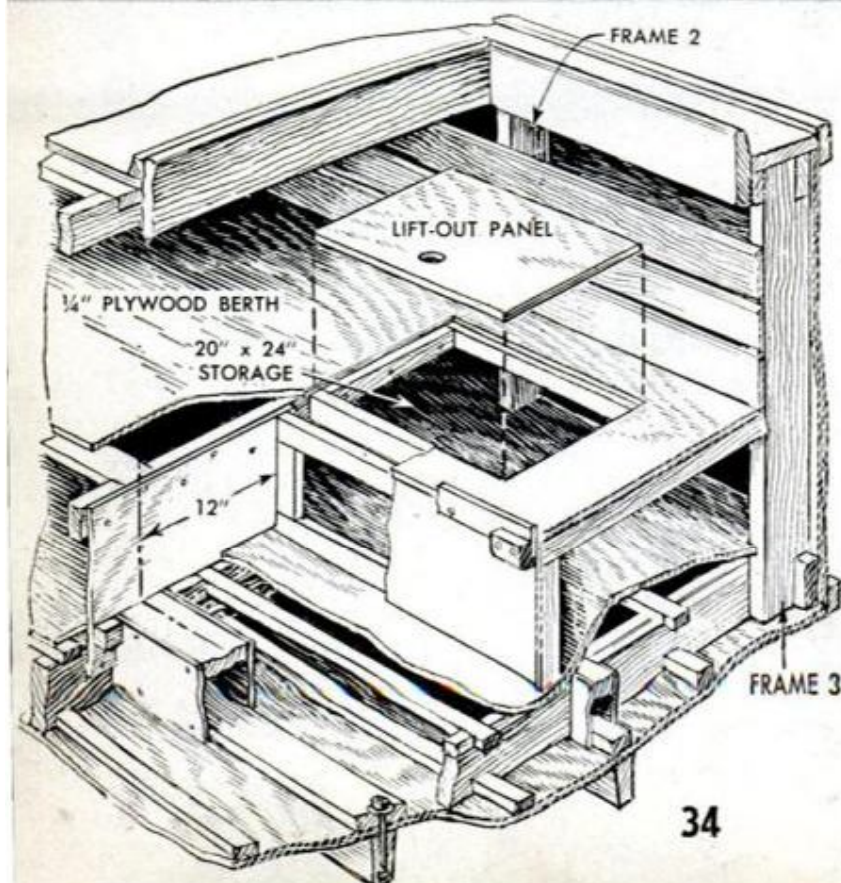
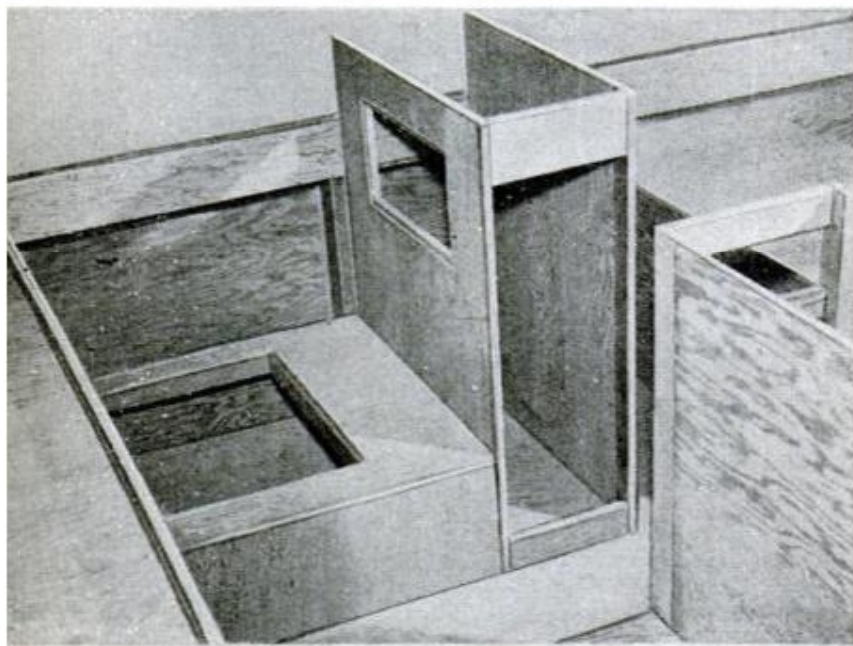

34

and anchor it securely with flat-headed wood screws placed 6 to 8 in. apart. The edges of the toe rail should be rounded and sanded smooth. Finally, a flat molding, beveled on the bottom, is applied at the base of the coaming and along the cabin sides. Half-round molding is used to conceal the plys of the wood at the front corners of the cabin and also at the front corners of the coaming.

Two stowage seats fitted with loose cushions are added to the forward deck, but you should first waterproof the deck by laying glass-fiber cloth in a wet coat of polyester resin, followed by a second coat, as was done in the case of the cabin roof. Fig. 32 shows clearly how the seats are framed, both being alike, with lift-out panels being provided to give access to space below for stowing fenders and mooring lines. The cushions are tailored to fit from foam rubber and plastic fabric and are kept in place by mahogany trim pieces.

The combination seat and freshwater tank, which mounts on the cabin roof, can be made now. Built like a box, it is framed around a custom-made metal tank in the manner shown in Fig. 31. Three cross members cut to conform to the roof curvature, support the tank 1/2 in. off the roof so that water will drain under it. Actual fastening of the tank to the roof is done later. The seat cushions are standard life-preserver cushions. The tank, of course, is fitted with a filler tube and cap located under a hole covered by a swing plate.

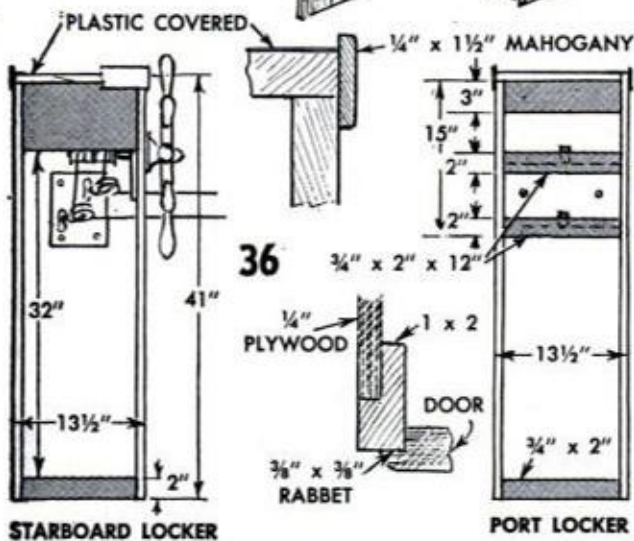
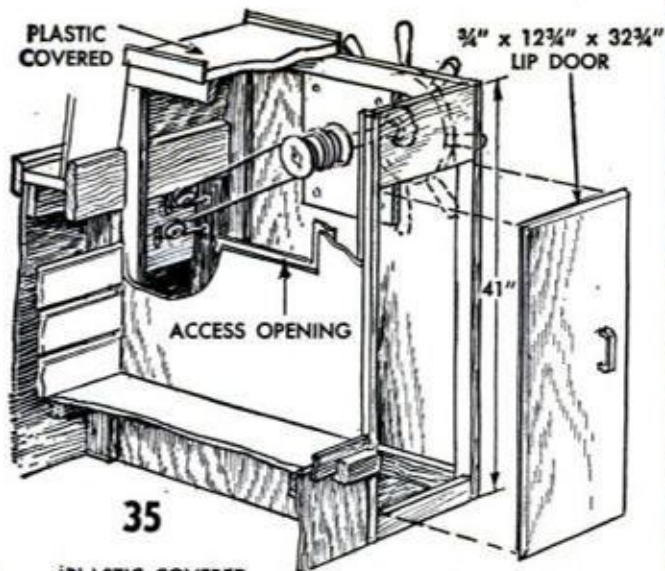

The twin forward berths make use of the space under the deck for leg room and the plan and sectional profile views in Part I show their arrangement. Cross beams fastened to frames 1 and 2 support the part of the berth that extends under the deck and you will see in Fig. 33 that the beam at frame 2 is placed 10 1/2 in. from the top of the bottom frame member. The beam at frame 1 is placed at a point which will make the berth level (parallel) with the water line. A batten, set in notches in the beams, supports the berth plywood at the center.

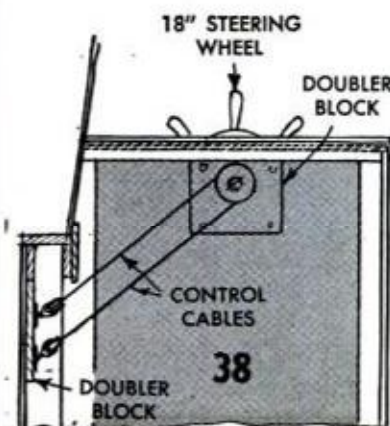
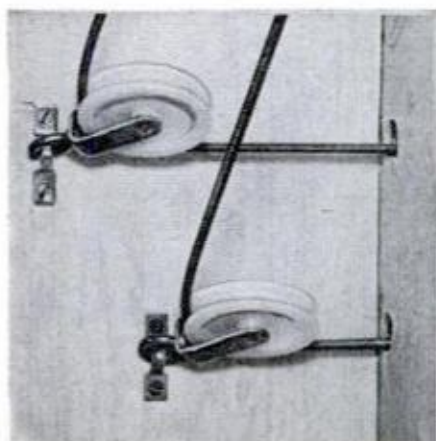
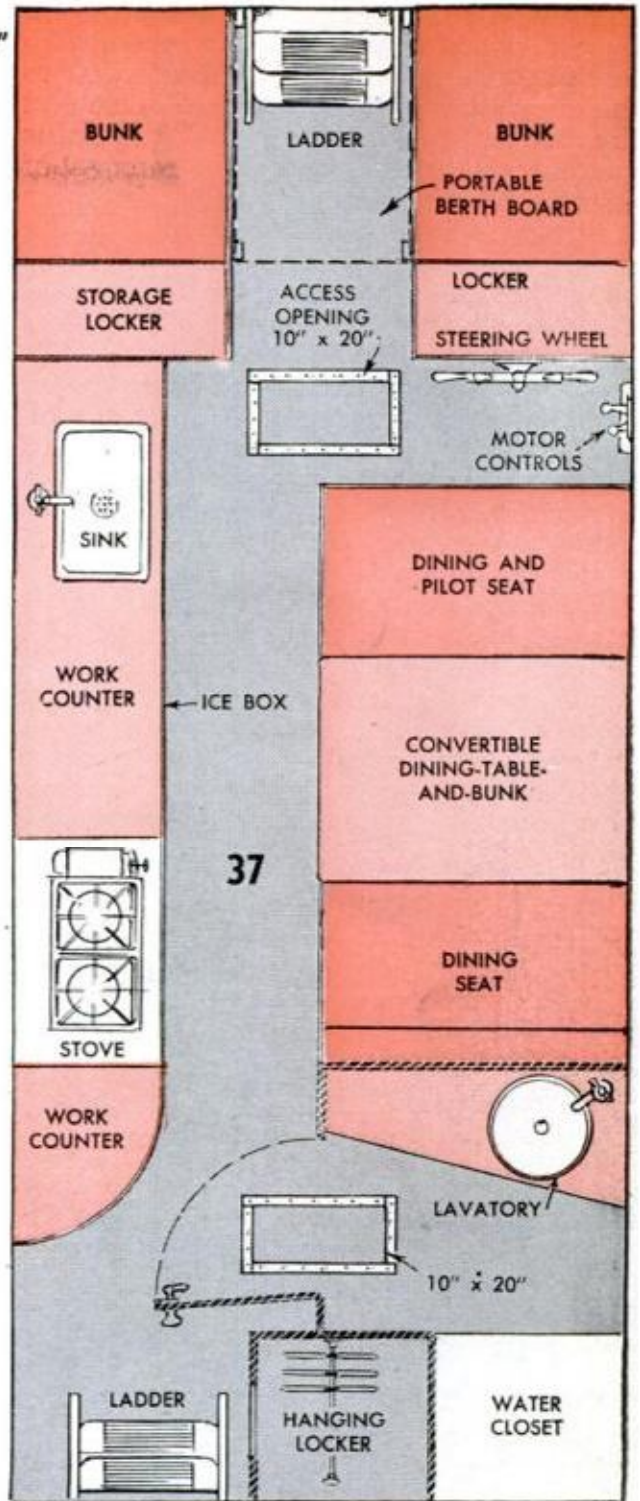

Additional support at frame 2 is provided by a plywood gusset which is notched to fit over the floor battens and screwed to the after faces of both the berth beam and the bottom frame member. Fitting this gusset in place will require the removal of a section of the temporary floor. But after it is installed and cleats are applied to the gusset to support the floor, the latter can be permanently fastened to the battens. Fig. 33 also shows a support cleat across the top of the plywood gusset. This supports one end of a separate berth board which is used to provide sleeping accommodations for another person. The board is merely a panel of plywood that bridges the area between the twin berths after the ladder is removed. The board stores back under the forward deck.

Each berth extends aft to frame 3 and is framed in the manner shown in Fig. 34. A lift-out panel provides access to the space under each berth and rests in a rabbet formed around the openings with cleats. Side walls are formed by nailing 4-in. strips of 1/4-in. plywood to the frame side members and to the stiffeners at the bow. These

strips terminate at frame 3 and are spaced 1/2 in. apart. Loose cushions of foam rubber and plastic fabric are tailored to fit the berths. Here, again, trim strips of mahogany are added along the edges to retain the cushions. Small blocks are screwed and glued at the ends of the trim strips to support the removable berth board.

Twin storage lockers stand at the ends of the berths, Fig. 37. While identical in overall size, the portside locker is fitted with drawers for storing dishware, whereas the starboard locker houses the drum and tiller cables for the steering wheel. Details of the two lockers are given in Figs. 35 and 36. Both lockers also have lip-type cabinet doors of mahogany, and plastic covered tops. The starboard locker has an optional access opening in the forward side which makes it more convenient to reach and service the tiller cables if and when necessary. Both lockers are custom fitted right against the side planking and the cabin sides and are notched to fit over the coaming members. Doubler blocks are used to backup the plywood for attaching the cable pulleys and the steering wheel hub in the

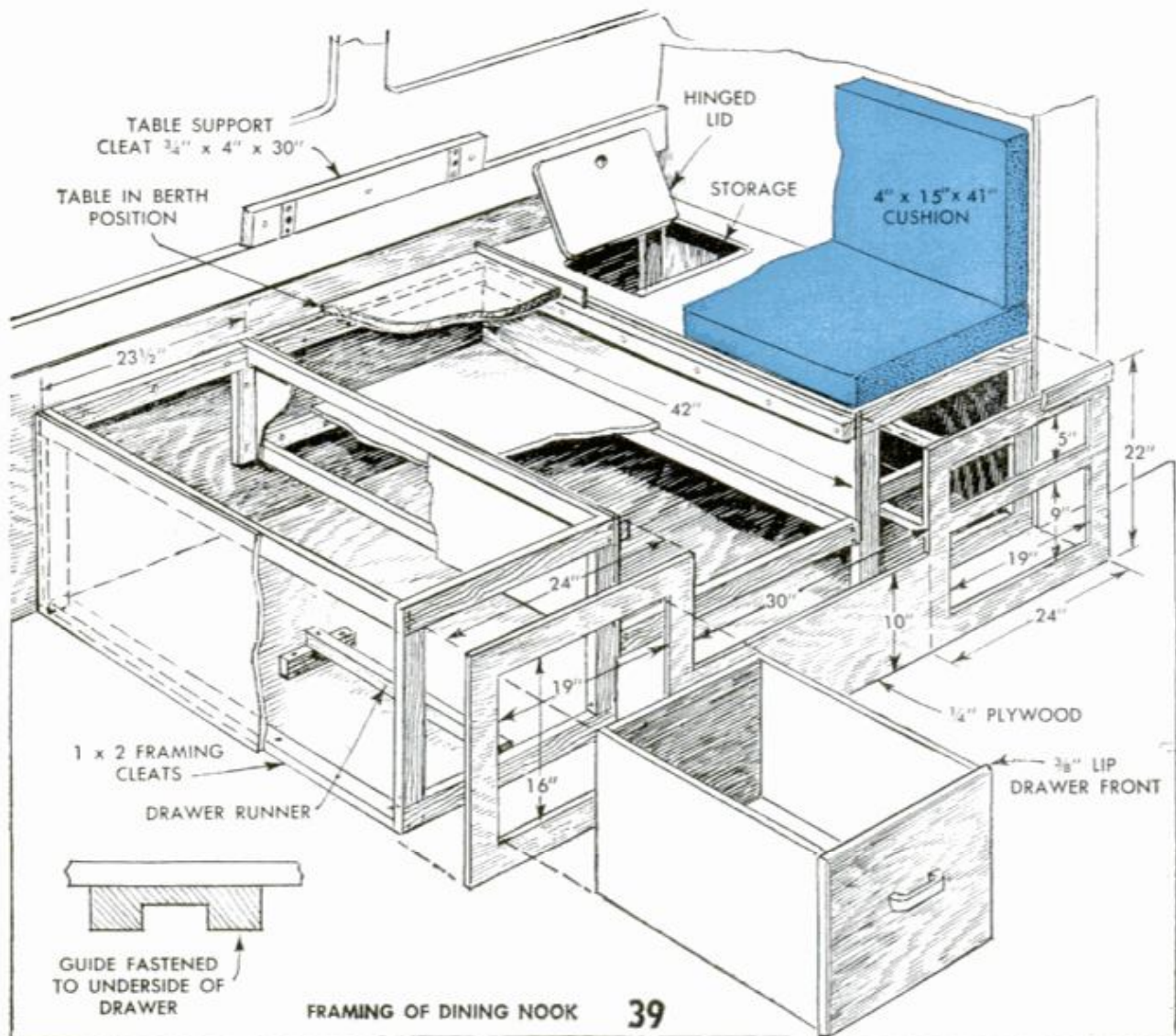

manner shown in Fig. 38. The latter is centered and mounted about 4 in. down from the top of the locker. Regular nylon pulleys are purchased for the tiller cables, and to save wear, metal sleeves are pressed in the cable holes previously made in the hull frames.

Before the bench-table-bed unit is framed in place, a 1/4-in. plywood wall must be applied between the starboard locker and frame 6. This is fitted between the floor and the clamp members and screwed to the side members of the hull frames. Openings should be provided at strategic places in the wall to permit the cables to be reached in an emergency. Such openings would be closed with lift-out panels held with a couple of screws.

The table-and-bed unit detailed in Figs. 39 and 41 contains storage space galore. To convert the unit to a full-size bed, the table is unhooked and lowered to fill the gap between the twin benches. Supporting cleats let the table top rest flush with the benches and a separate tailored cushion brings the center section up level with the others. When the table is used for dining, the extra fill-in cushion is stored up under the forward deck along with bedding. The unit, which also provides a seat for the helmsman, is built amidships right in place

(Continued to page 242)

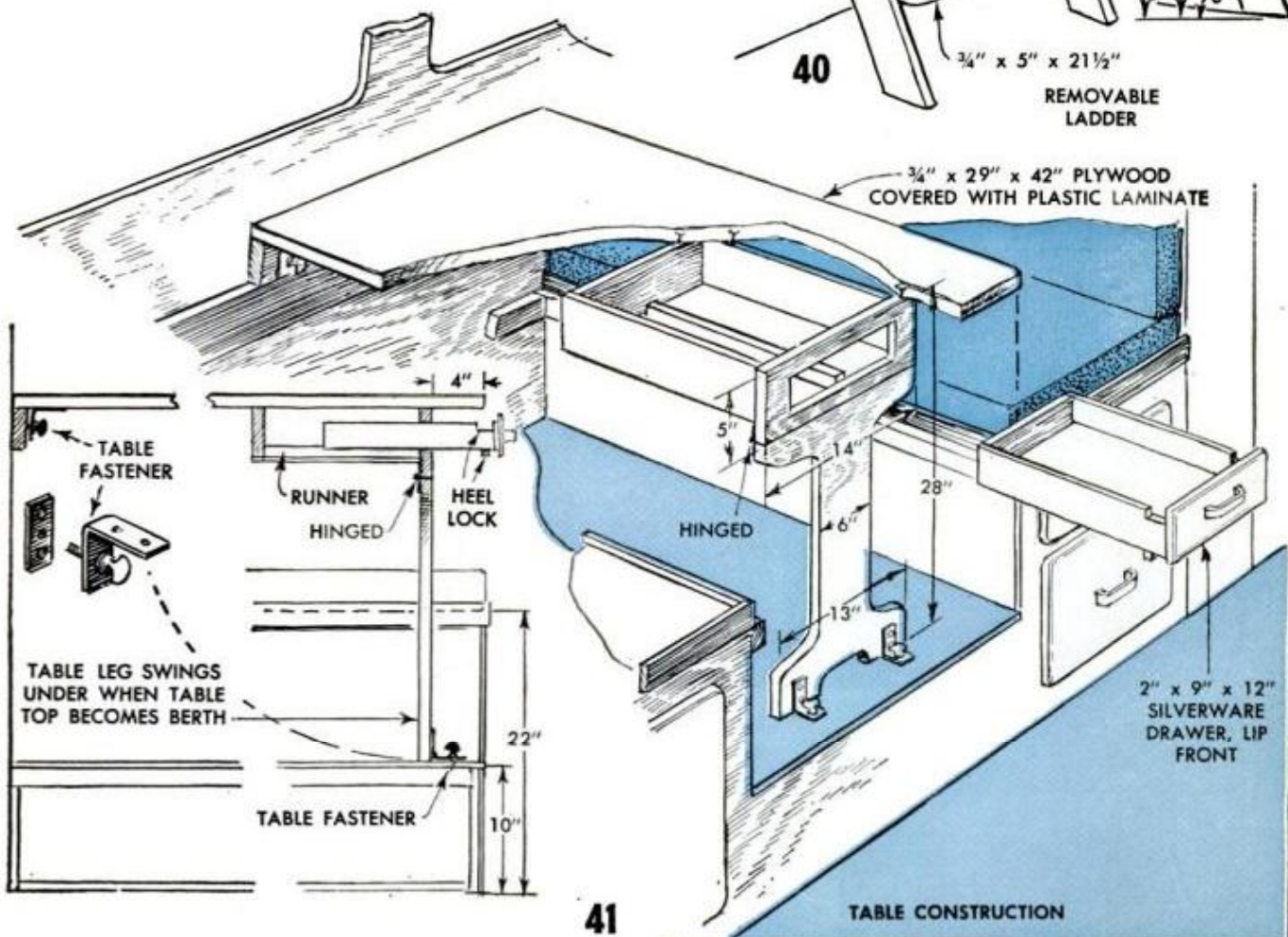
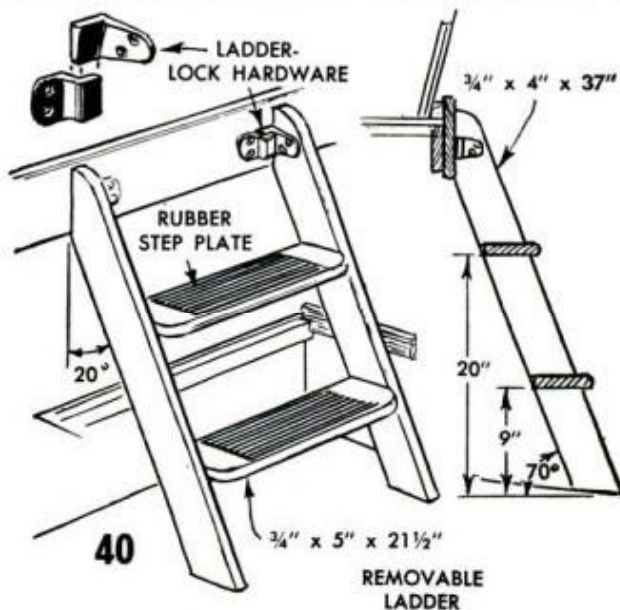
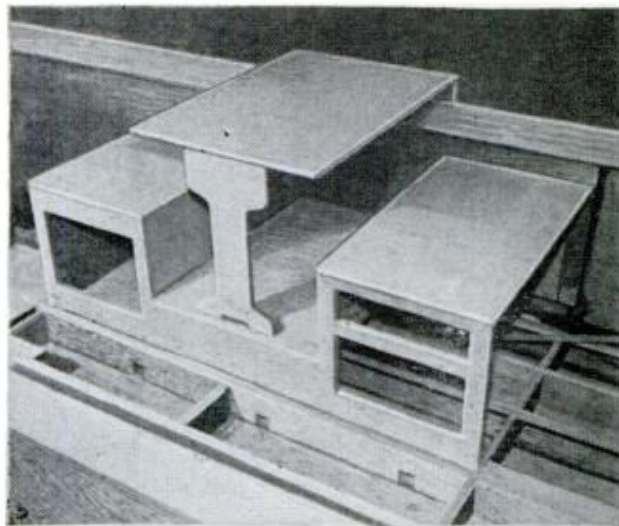

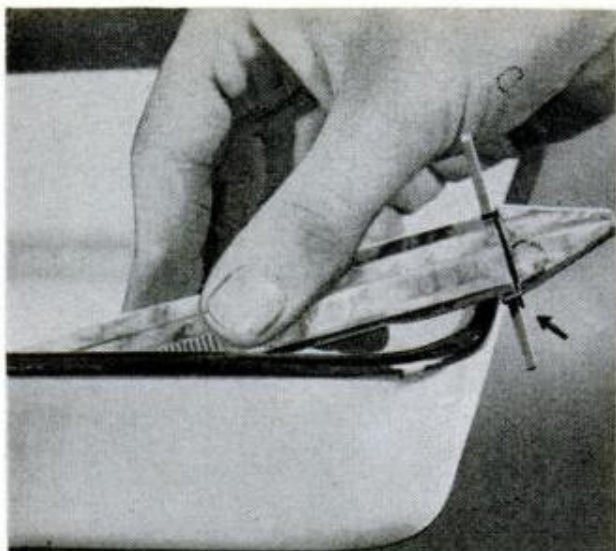

Knitting Needle Keeps Tongs Out of Photo Developer

When developing photo prints, tongs for handling the wet prints usually are placed with the handle resting on the tray edge where frequently they slide into the solution. To prevent this, so that the fingers don't become contaminated with developer chemicals, one photo hobbyist secured a 3-in. length of plastic knitting needle to each of his tongs as shown in the photo at left. A short rubber band looped over the handle of the tongs and the ends of the length of needle holds it in place.

Ken Patterson, Sask., Canada

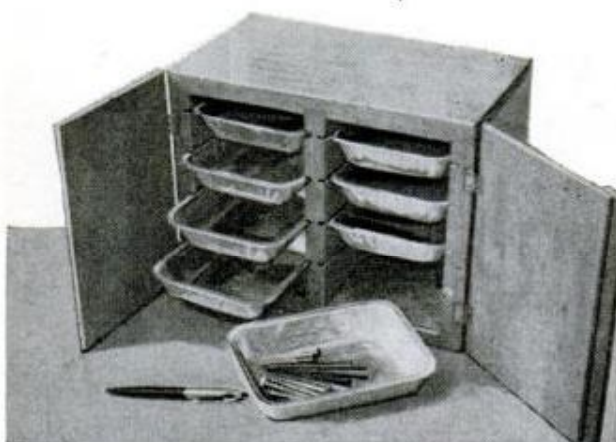

Small Parts Storage Cabinet

Here is an excellent storage cabinet for screws, bolts, washers and other small parts used around the shop. Made of 1-in. white pine and fitted with plywood doors, the unique feature of the cabinet is the use of aluminum trays or pans in which frozen dinners are sold. The tray lips slide in $\frac{1}{8}$ -in.-wide by $\frac{1}{4}$ -in.-deep grooves cut in the cabinet walls and partition. The grooves are spaced to provide $\frac{1}{2}$ in. clearance between trays.

B. Pedersen, Lake Charles, La.



Clothespin Used to Start Screws In Hard-to-Reach Places

When starting a screw in a place that cannot be reached with the fingers, one home craftsman grips it with a spring-type clothespin to which a screwdriver is taped as in the photo at left. After the screw has been started, the clothespin is removed and the screw is driven in the usual manner.

Harry Miller, Sarasota, Fla.

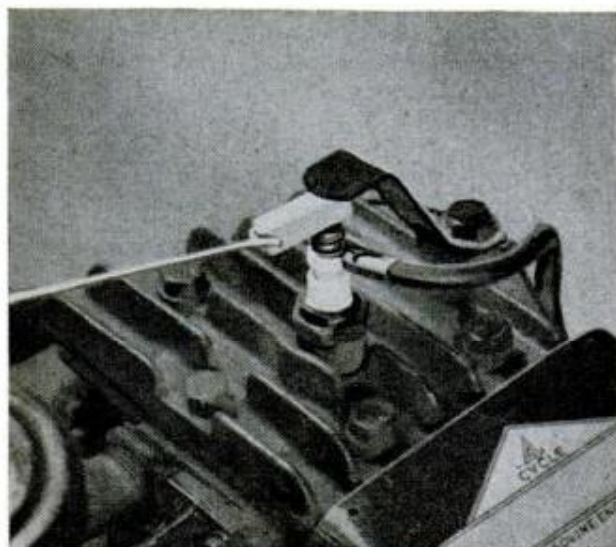

Shutoff Switch for Power Mower Made From Wooden Block and Cord

For safety a gasoline engine-powered lawn mower should have a shutoff switch within convenient reach of the operator. Such a switch can easily be rigged by attaching a length of cord to a small wooden block and inserting it between the shut-off blade and spark plug as shown in the photo at left. First it is necessary to bend the blade so that it contacts the plug when the block is removed. The other end of the cord is tied to the mower handle where it can be reached quickly in an emergency. Other engine-driven equipment can be equipped with the same type of switch.

H. Hanscom, Elmhurst, Ill.

FOR TRUMPET PLAYERS

PAST AND PRESENT

By Robert Gannon

THAT OLD beat up trumpet long stored away with musical memories of high-school days, can be put into first-class shape again for your teen-age son. Spend a few hours taking out dents, cleaning, oiling and polishing it and very likely you will have the old horn in like-new condition again. About all it will cost is a few dollars for replacement springs and washers.

Begin the repair job by disassembling the trumpet so that you can give it a thorough cleaning and note what parts are defective. The most common wind-instrument ailment is sticking parts. Slides corrode in place, the mouthpiece won't come loose and valves become sluggish.

When removing the parts that slide into one another, keep in mind that you are working with metal that is fairly soft and thin. Use force with caution. First saturate the joint with penetrating oil, allowing at least one hour for it to dissolve gummy residue formed between the telescoped surfaces, before trying to separate the parts. Then, in the case of a stuck mouthpiece, hold the instrument as shown in the photo below and tap the receiver with a rawhide or wooden mallet, working around it once or twice. If this fails to loosen the part, hold the receiver against a softwood block and strike it slightly harder than before. As a last resort, wrap the mouthpiece in several layers of cloth and clamp it in a vise. Then tap the receiver while pulling on the trumpet.

A good way to loosen a valve slide is to apply penetrating oil to the joint, loop a rope through the

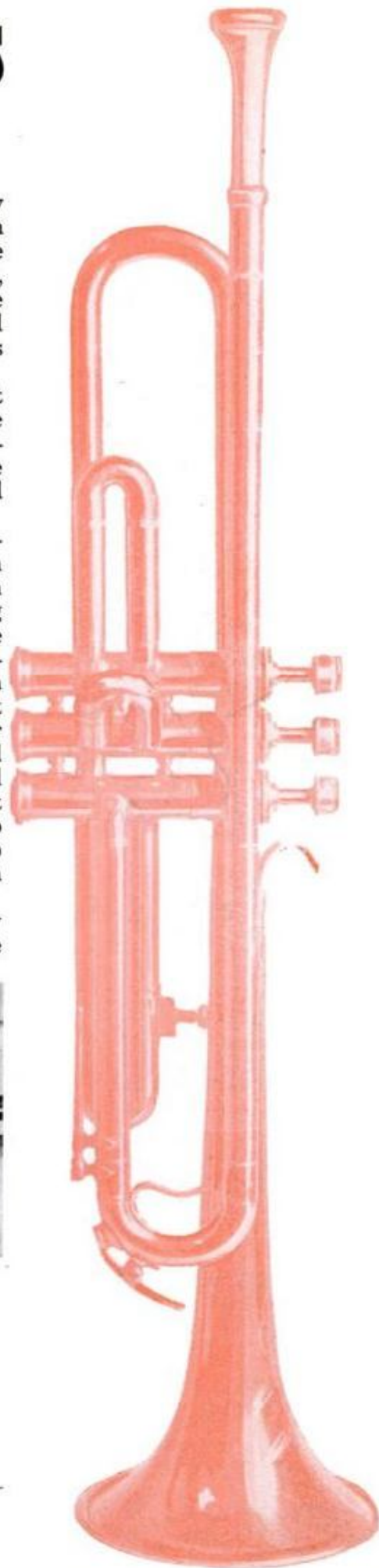
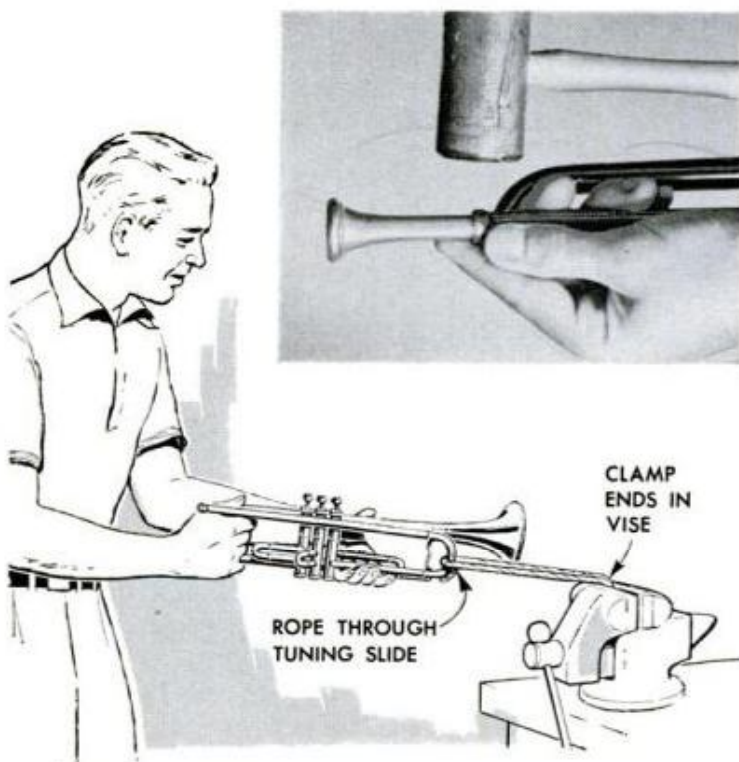

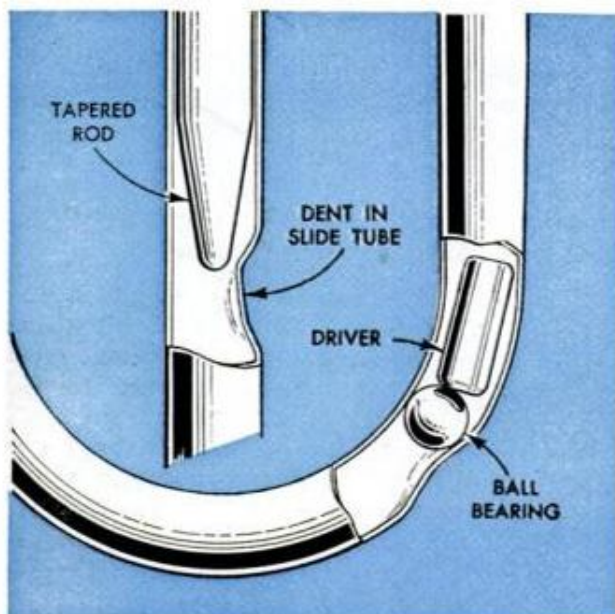
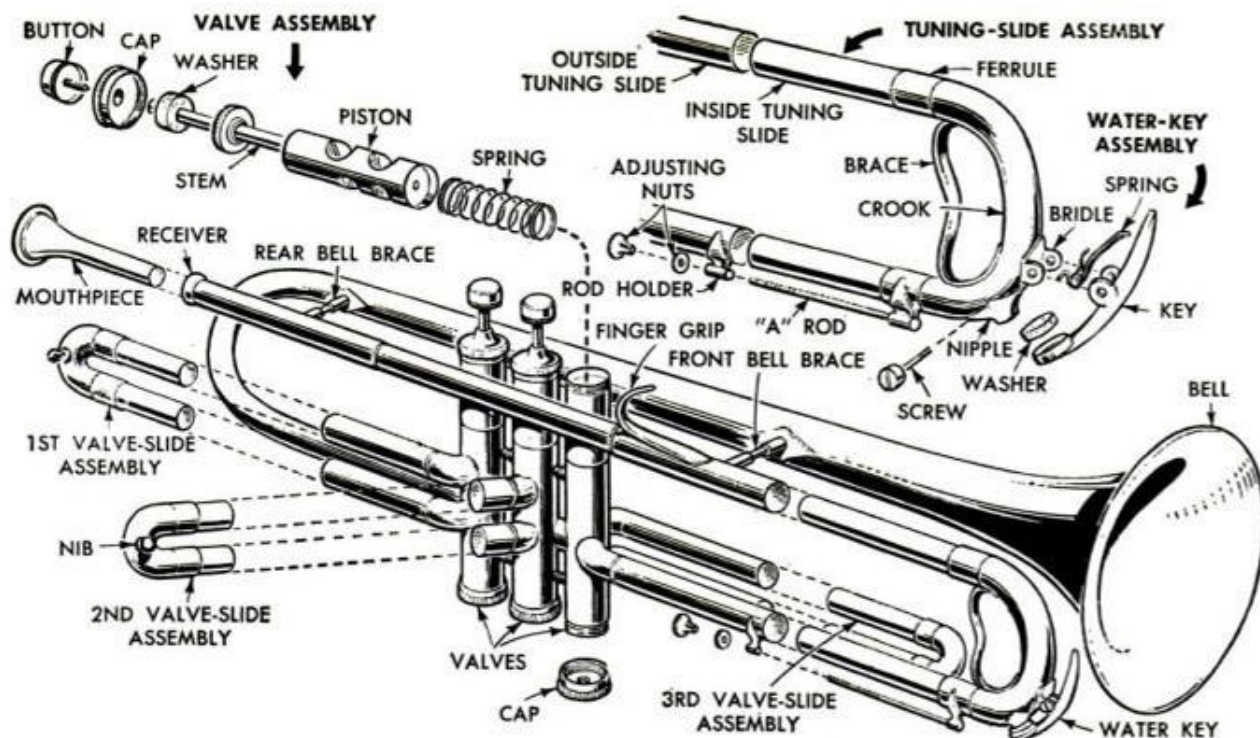

crook and then clamp the ends in a vise, so that the part can be jerked free as in the drawing on page 201. If it fails to come loose, apply heat to the telescoped portion and try again, being careful not to melt the solder on attached parts.

When disassembling the three valves, you may find that the top and bottom caps can't be budged by hand. Don't use a pair of pliers to remove them, but follow the penetrating-oil mallet-tapping routine described. A piston that is stuck in its lowest position, making it impossible to get a good grip on it, can be removed by unscrewing the button from the stem and connecting a bolt or nut to it, depending upon the construction of the stem. If the piston cannot be removed by hand, apply oil from both sides and tap the stem, driving the piston out of the casing.

After the instrument has been disassembled, soak all the metal parts for two hours in a strong solution of water and detergent. Then work a soapy cloth through the tubular parts, rinse all parts with clean water and dry them with a chamois. Wrap cloth around a pencil or toothpick to clean small slots and orifices. When reassembling the valves, coat the pistons with a grade of oil recommended by the manufacturer and be sure to install them in the right casings. If the pistons still stick after cleaning and oiling them, the following should be done. Coat the pistons with a thin film of Lava soap, lathered and applied with a shaving brush. Then work each one into its respective casing until the action feels smooth. Add a few drops of water as needed to keep the soap fluid. Clean, rinse and oil the pistons again before reassembling. Valve

springs and worn leather or felt valve washers should be replaced. New ones can be purchased at most large musical-instrument stores. The portions of parts that are fitted together when reassembled, also should be coated lightly with oil. The cork washer on the water key must close tight against the nipple on the tuning slide. If the cork is worn, dig it out and replace it with a new one, using shellac for cement. When doing this, hold a dime between the nipple and cork and press down on the key to seat the cork properly.

Although most dents are not likely to be deep enough to affect the tone quality of a trumpet, they do detract from its appearance. To remove a dent in a tube that is straight from the open end to the dent, a tapered metal rod is used as indicated in the drawing, page 202, left center. The rod should be of solid stock $\frac{1}{2}$ in. less in diameter than the tube. After grinding the rod to a blunt, tapered point, it is inserted in the tube and tapped through the dent area gently, being careful not to tear or batter the metal.

If the dent is in a crook of a tuning or valve slide, you will have to use a ball bearing and a driver to straighten it as shown in the drawing. The driver, cut from the unthreaded portion of a bolt, is of a length and diameter that will just pass the curved section of the tube. The edges are ground round to avoid scratching the tube. The ball used should be of a size that will permit it to lodge between the dented and undented walls of the tube when dropped into the open end. After the ball has been lodged in place, the driver is dropped into the tube and it is swung in an arc so as to cause the driver to strike the ball. The ball and driver are greased with petroleum jelly to reduce abrasion and prevent them from becoming stuck unintentionally. For deep dents it may be necessary to use several sizes of balls, starting with one that is slightly larger than the passage at the dent and changing to larger ones as the dent is worked out.

A bent mouthpiece can be straightened without much difficulty. Simply block it up in a vise to apply leverage at the desired places as shown in the photo at the bottom of page 202. Use softwood blocks for this purpose to avoid marring the metal. Softwood also forms easily to the contours of the mouthpiece when pressure is applied, providing a better grip.

A first-class trumpet restoration also includes a polishing job. This should be done with a 6-in. buffing wheel turning at 3500 to 4000 rpm. Red or black rouge may be used for a buffing compound. Buffing, of course, cannot remove scratches. ★★

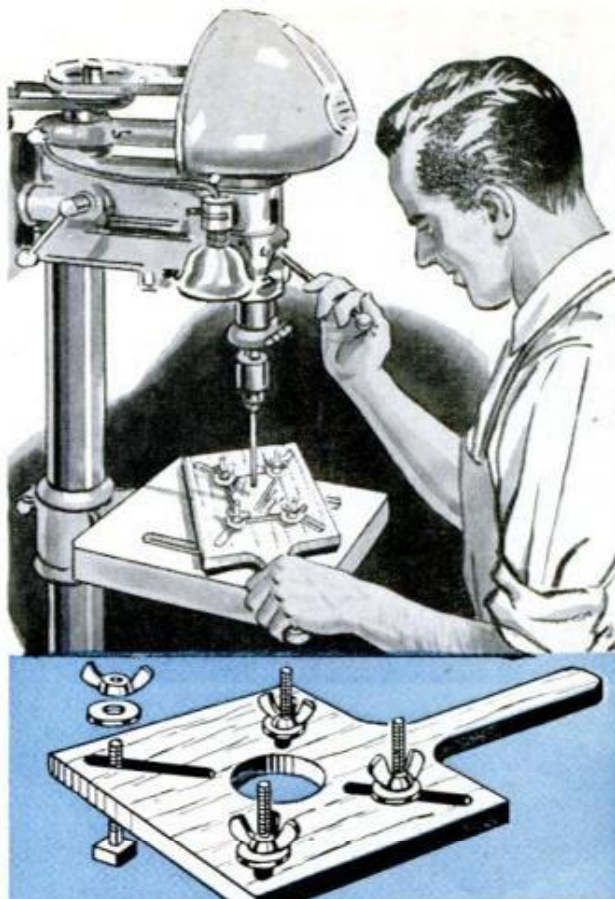

Small Stock Clamped on Holder Can't Spin When Drilled

To avoid the danger of having thin stock spin suddenly when the drill bit breaks through it, one safety-minded home craftsman uses a paddle-shaped holder to which the stock is clamped as shown above. The clamping feature is provided by four bolts with washers and wing nuts fitted in slots cut diagonally in the holder. These permit stock of various sizes to be clamped quickly in place. Plywood $\frac{1}{4}$ in. thick is ideal for this purpose but other thicknesses may be used as well.

M. Robert Beasley, Jackson, Mich.

Spray Adjustment Won't Work When Shower Head Is Blocked

When the head of a shower pours forth a thick stream of water regardless of how the spray is regulated, it is quite likely that the holes are stopped up. To correct this, remove the head and scour the inside surface with steel wool. This will dislodge the hardened material from all but a few holes. To clean the latter and remove remaining particles from the other holes, thread a darning needle having a maximum diameter slightly less than the holes and pass it through each one. The needle does a good job of removing loosened material when threaded with coarse yarn or string.

HOME PLUMBING REPAIRS

WHEN YOUR KITCHEN SINK gets stopped up, or the toilet threatens to flood the bathroom floor, what do you do? These and other plumbing breakdowns require prompt attention, immediate in some cases, if water damage and a hazard to health are to be avoided. Since it is not always possible to obtain the services of a plumber right away, especially on weekends, every householder should know how to go about correcting common plumbing failures. Or, at the very least, know how to make emergency repairs.

When a sink drainage line is allowed to become blocked with debris, the quickest

relief usually is obtained by clearing the line mechanically with a drain-trap auger, Fig. 1, detail A. This should be 15 to 20 ft. long and have a crank similar to the one shown. The usual procedure for cleaning an obstruction is to remove the trap below the sink and work the auger down the drain pipe as in Fig. 3. A good technique to use when forcing the flexible part through a tightly clogged pipe, is to make short thrusts, pulling it outward an equal distance each time. The crank permits rotating the auger to help pass turns in the line and to "drill" through troublesome obstructions.

If the obstruction cannot be reached from the sink location, the auger is inserted through entry points at various locations in the line as indicated in Fig. 1. At each of these entry points there is a cleanout fitting, detail B, from which the plug must

2 Toilet-tank ball is pressed into drain seat to prevent flush water from overflowing stopped bowl

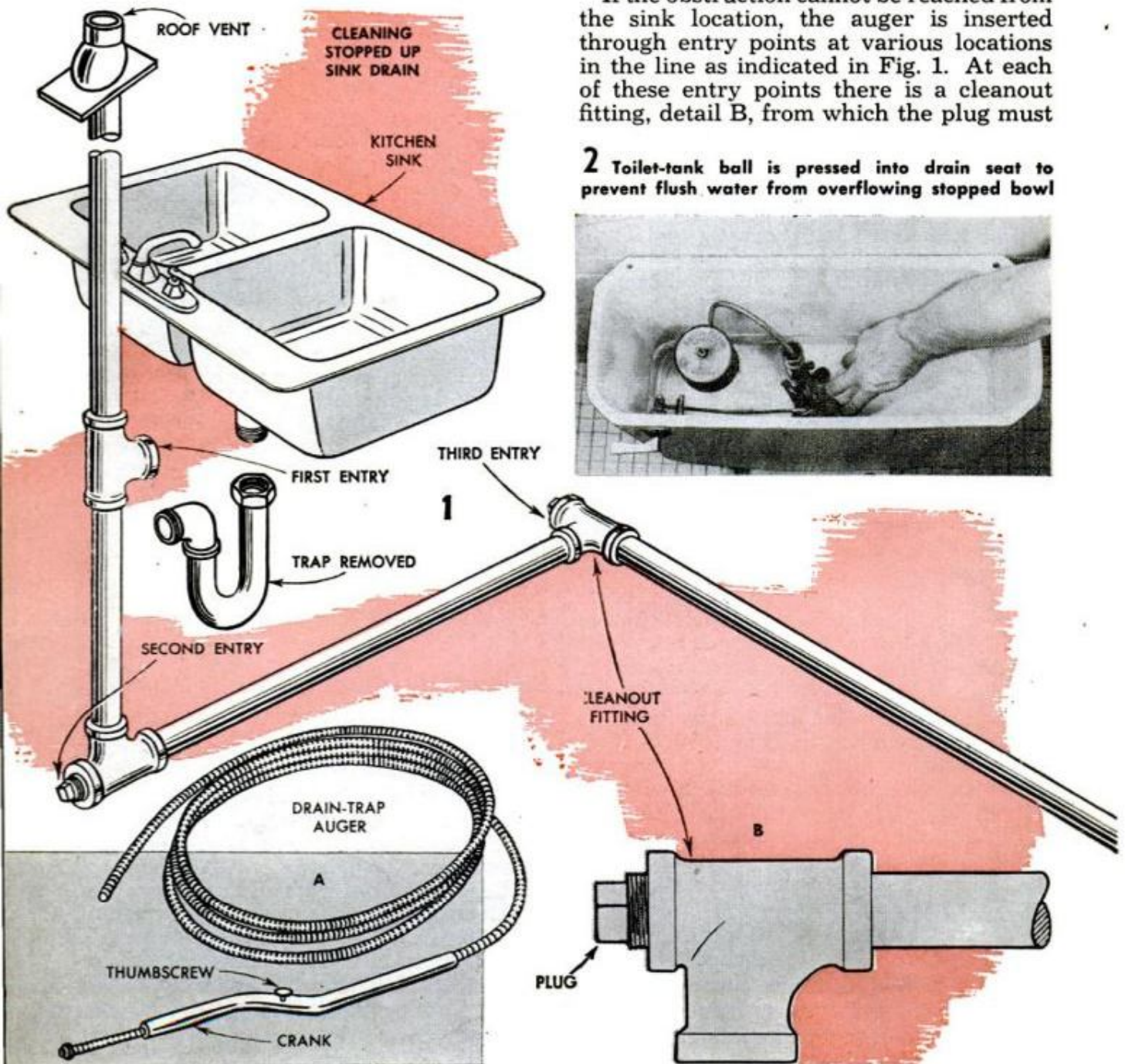

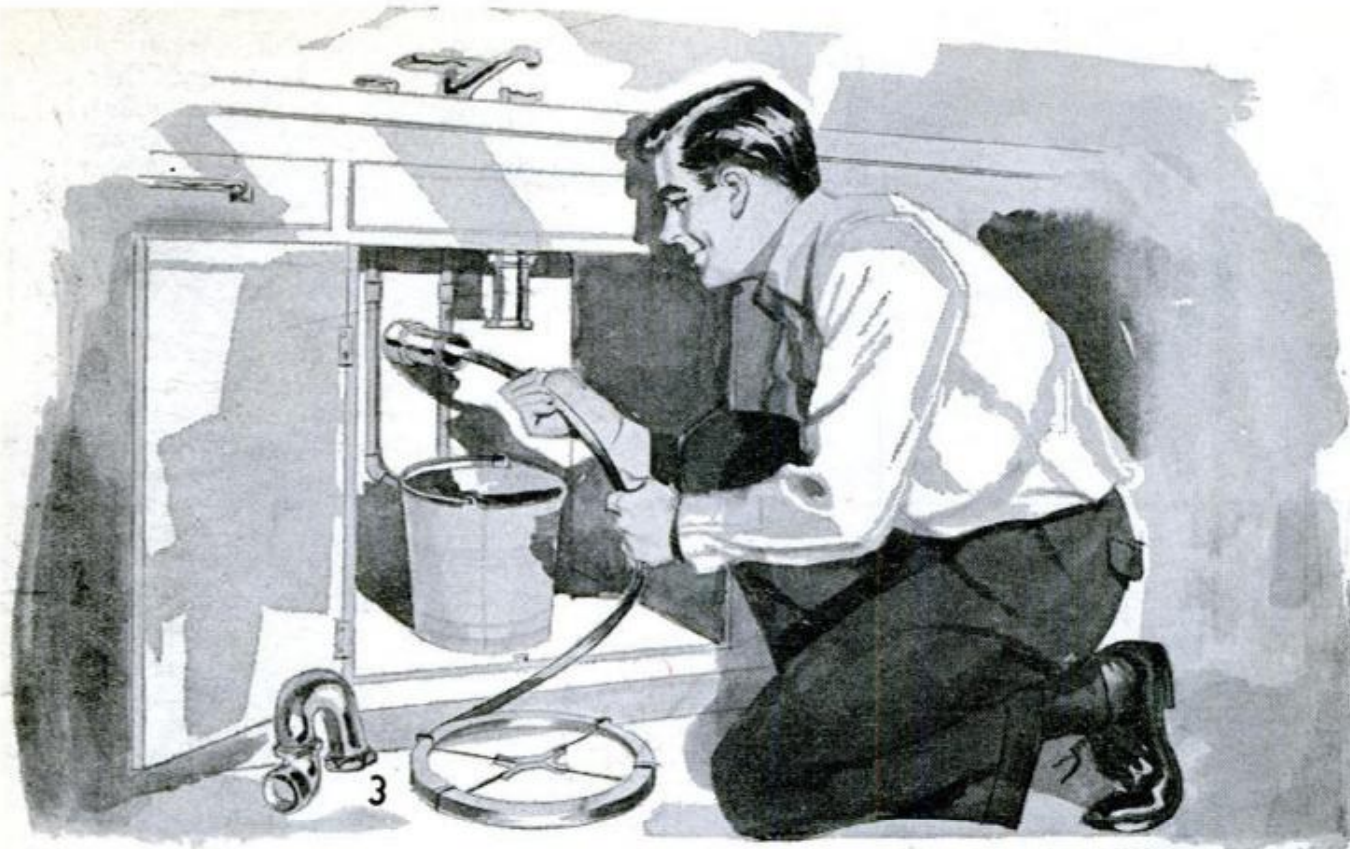

be removed so that the auger can be inserted. Such plugs often rust tight, requiring a large pipe wrench to start them. When replacing a plug, clean the threads and apply cup grease to prevent rust seizure.

When a toilet trap becomes clogged, water in the bowl may overflow to the floor. If this happens, the flow can be stopped as follows: Quickly remove the tank lid and press down the tank ball, which seats in the drain opening at the bottom as indicated in Fig. 2. Then let the tank fill again.

A closet auger, Fig. 6, detail C, is used to clear such obstructions. Paper obstructions usually can be shredded by an auger. When you think that the material has been broken up, flush the toilet but be on guard to stop the tank discharge again if necessary. Sometimes solid obstructions become wedged so tightly that the bowl must be removed to dislodge them, involving the services of a plumber. A basement toilet may also overflow due to backflow from the sewer.

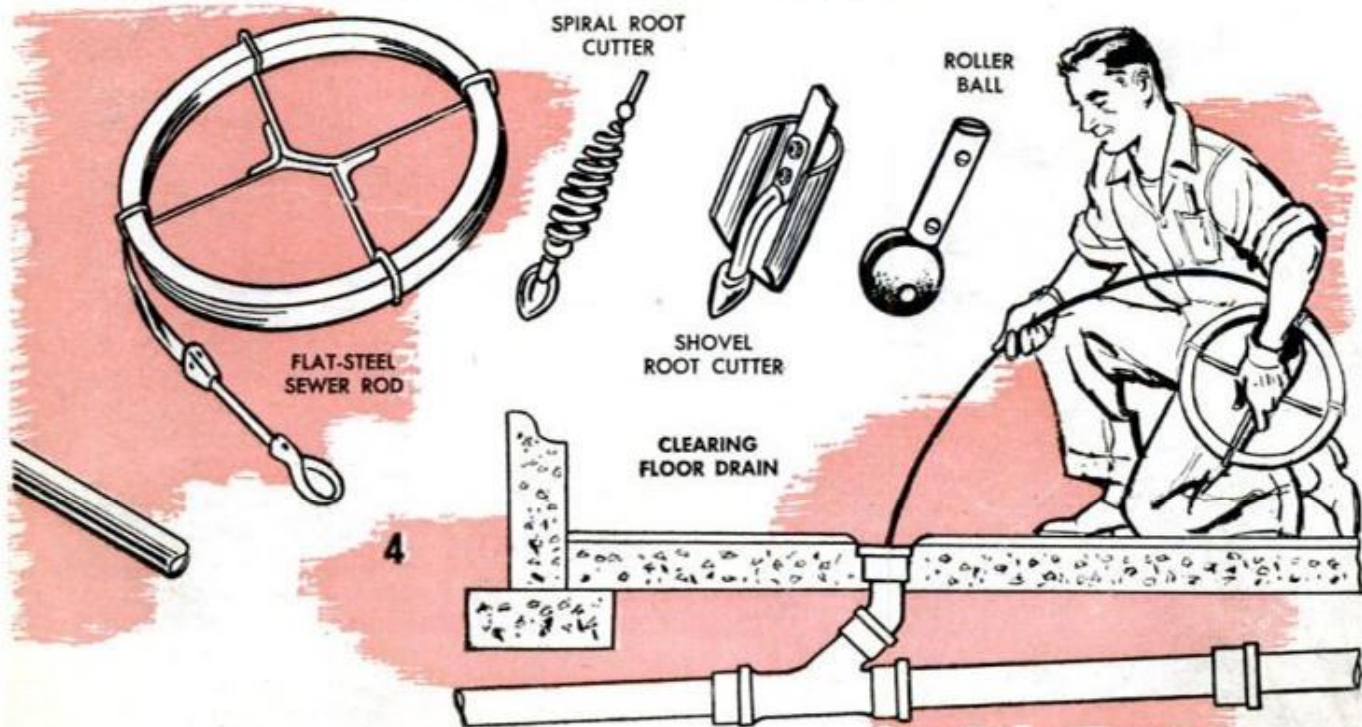

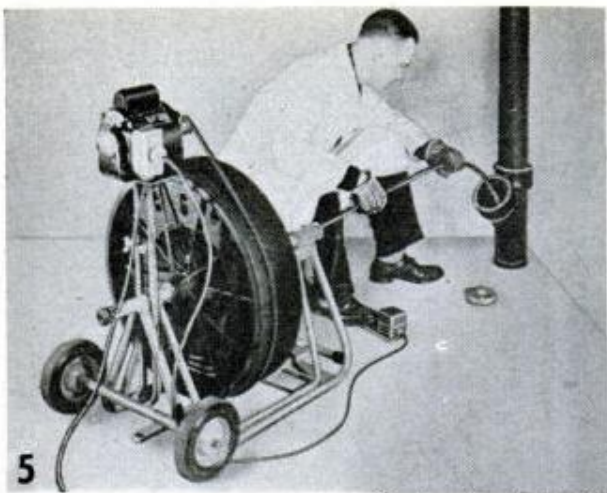

Courtesy Spartan Tool Co.

Pinpointing Stoppages

Often you can save time on a cleanout job by pinpointing a stoppage and then reaching it through the closest entry point. For example, if a dishwasher doesn't drain and water from the sink backs into it, the stoppage lies beyond the sink. Similarly, if water draining from a lavatory causes water in a toilet bowl to rise, there is an unrestricted passage between the two, and the obstruction lies farther away. If the discharge from all taps in the house causes water to rise from the lowest drain, it is evident that the house drain or house sewer is obstructed beyond this point.

The most common cause of stoppage in a house sewer (the line from the house to the city sewer or to a septic tank), is invasion of tree roots that sometimes get through cracks in pipe joints. Such obstructions can be drilled out as a temporary relief measure. This is done with a power auger fitted with a root cutter, such as are used by plumbers, Fig. 5. A flat spring-steel sewer rod fitted with one of the root cutter attachments shown in Fig. 4, often is effective. The roller ball is used for moving debris through the sewer.

Backflow from sewers often occurs during heavy rainstorms when sewers become overloaded. A temporary measure to stop or retard backflow through a basement floor drain, or toilet, is shown in Fig. 6 and detail D. The best permanent remedy is to install a backflow valve as indicated in Fig. 7, installed so it can be serviced later.

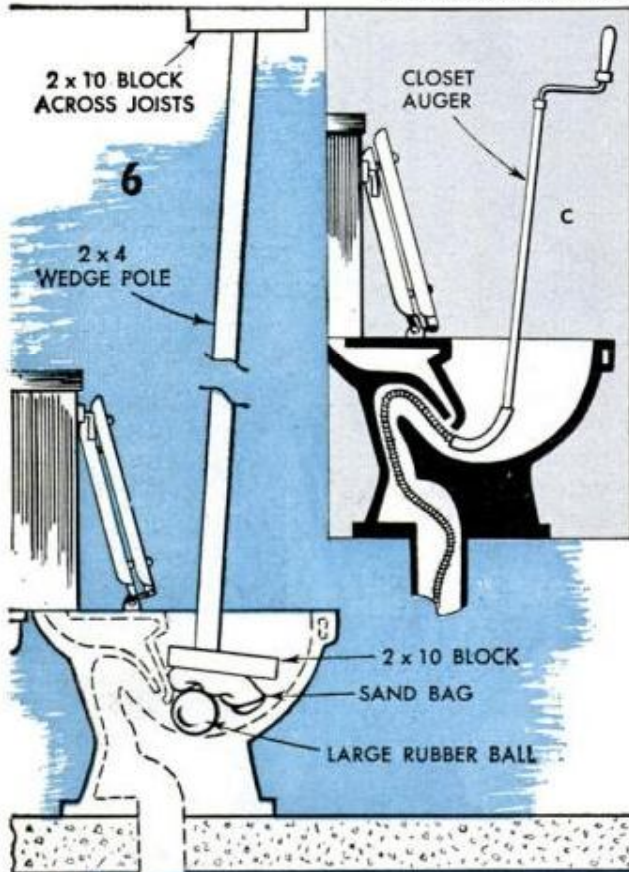

EMERGENCY METHOD OF STOPPING BACKFLOW FROM SEWER

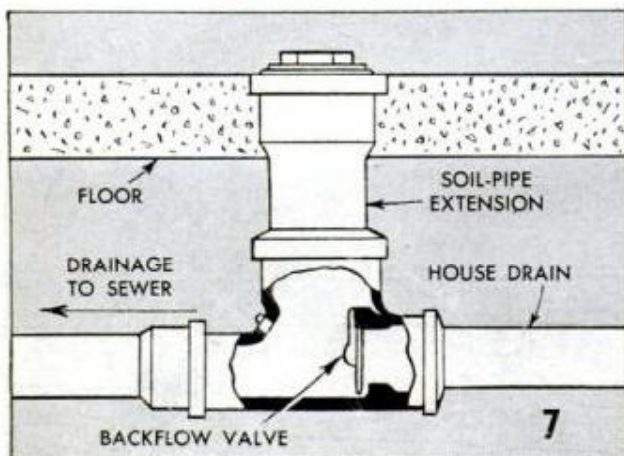
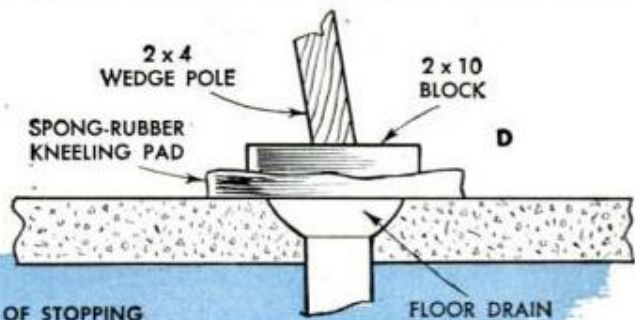

Water-Heater Leaks

A steady stream of water coming from a water heater drain cock, or safety valve also constitutes a plumbing emergency. Likewise, water dripping from the bottom of the heater, which usually indicates a defective tank, needs immediate attention. In all such cases the first thing to do is to turn off the heat source and cold-water supply at the heater, then drain the tank.

The safety valve usually is located at the top of the tank on the hot-water line where it is shown being removed in Fig. 8. There are two common types of valves, combination pressure-and-temperature, and pres-

sure alone. The former type has a fusible plug that melts when subjected to excessive water temperature, opening the valve to relieve pressure. Only the plug need be replaced. The pressure type simply opens a valve when tank pressure exceeds the safe limit. The valve itself may develop a slight leak as a result of solid particles getting on the seat, preventing it from closing completely. This can be remedied by removing the valve and cleaning the seat. After restoring the valve to operation, check the operation of the thermostat, which turns the heat source on and off as necessary to maintain the desired water temperature. If it is overheating, try a lower setting. If the water temperature again becomes excessive, the thermostat must be checked by a service man. Never use a water heater without a safety valve. When not regulated, it can develop enough power to blow itself through the roof! A leaky drain cock may simply be in need of a new washer.

Water pipes seldom develop leaks, except when subjected to unusual strain. Fractures from strain usually occur at the threaded ends where the wall thickness has been reduced. Constant vibration from excessive water hammer may cause a leak. Pipes also may burst from freezing. To make a temporary repair for a leaking pipe, first close the main valve near the meter. Then allow the remaining water to drain from the system. Saw off the defective portion of pipe and install a length of hose as shown in Fig. 9, detail E. A permanent repair can be made later.

Water and drainage lines that freeze shut can be cleared by several different methods, if they are accessible. Cloths may be



8 Safety valve at top of heater tank is disassembled so that destroyed fusible plug can be replaced

wrapped around the frozen section and constantly soaked with hot water. An electric iron placed in contact with the pipe can be used for thawing a short section of frozen pipe. A more direct approach, involves disconnecting the pipe from the line at one end and pouring hot water into it as shown in detail F. On a water line, thawing should be done from the faucet side of a frozen pipe, after the faucet has been opened to relieve pressure and permit the water to run when the ice melts. ★ ★ ★

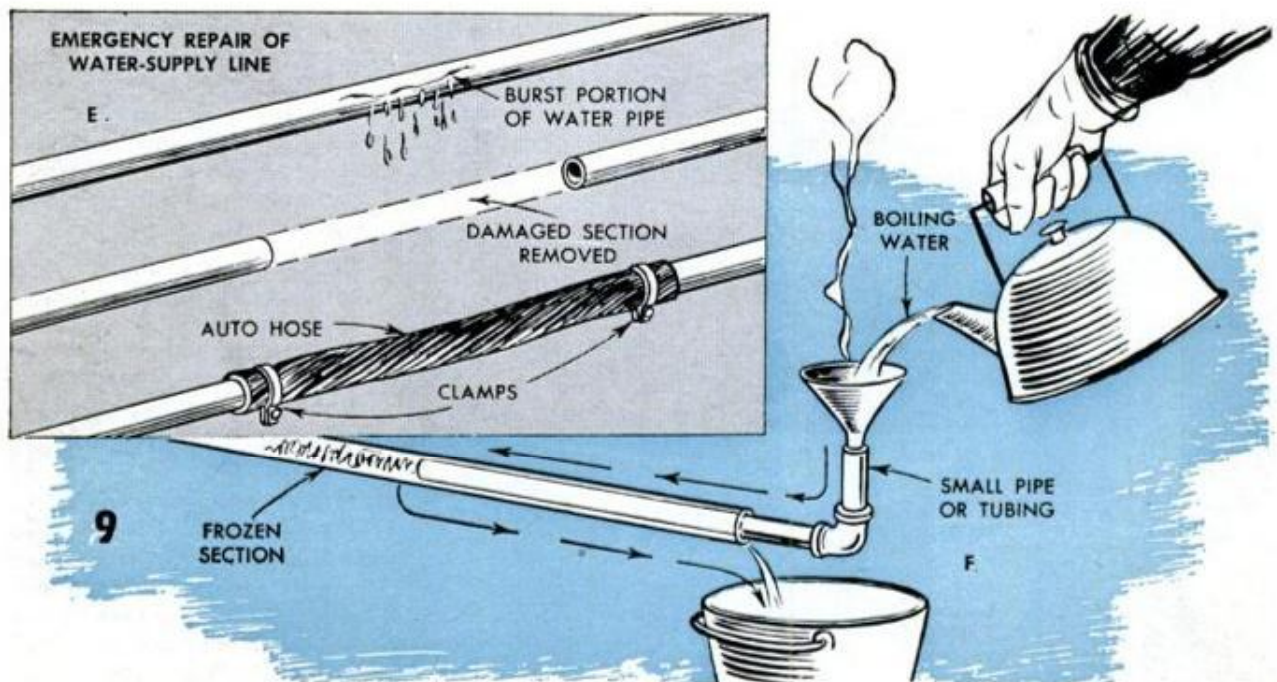



NEEDING A rather heavy anvil for many of his repair jobs, a farmer made the one shown from a short length of railroad rail and a few other odds and ends. A tapered piece of shafting welded on one end of the rail serves as a horn. For a base, the anvil is welded to one end of a length of pipe that is welded to a car brake drum at the other end. The drum provides a sturdy base and permits the anvil to be rolled easily from job to job

FARM SHOP IDEAS

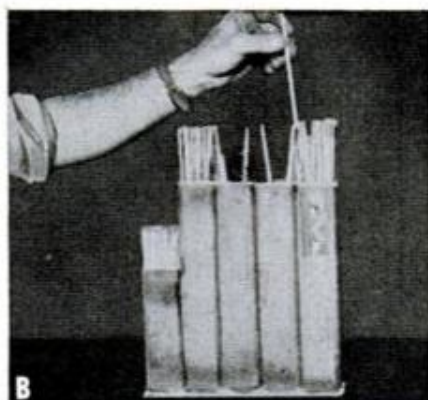
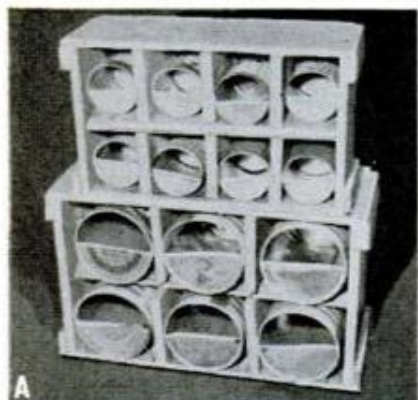

EMPTY OIL CANS on which the tops have been opened halfway and crimped on the inside, provide convenient storage for bolts and nails. Cans are placed in partitioned crates as in the photo A at far left

SEVERAL LENGTHS of square pipe welded on end to a flat-steel base, photo B, make a rack for "filing" welding rods according to type and size. Saves trips too, when repairing machinery away from shop

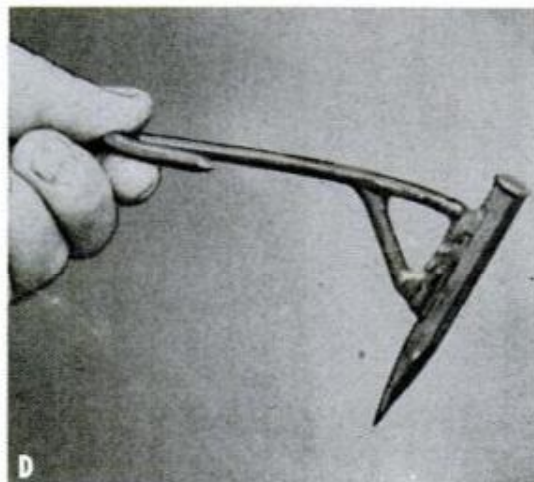

FOR EASY handling of long work on a table saw, make the rest shown in the photo far left. A setscrew on the upper, telescoping pipe section permits raising the roller and locking it at the height desired

TO AVOID finger bruises from glancing hammer blows when nailing sheet-metal roofing, use a prick punch to make pilot holes. A handle welded to the punch as shown at left, further protects the fingers

Double-Decker Nail Tray

WHEN LOOKING FOR a particular size nail or screw, you won't have to dig through a mixed assortment of light hardware if you use this double-decker nail tray. With two levels and seven sections, the tray offers a convenient means of sorting different kinds of nails, screws, nuts, bolts etc. The top tray is the smaller of the two, measuring 3 x 9 x 12 in. The sides and partitions are of $\frac{3}{4}$ -in. pine and are secured with small nails and wood screws. The bottom may be cut from the same weight stock or a lighter $\frac{1}{4}$ -in. stock may be used. The bottom tray measures 5 x 6 x 12 in. and its parts are similarly secured. Two $3\frac{1}{2}$ x 12-in. uprights are screwed to the trays. A $\frac{3}{4}$ x $13\frac{1}{2}$ -in. dowel connects the uprights and serves as a handle. Designed for easy storage the tray does not sacrifice carrying capacity. Sand and finish all parts with stain or light varnish.

Sam Fenn. Skokie, Ill.

Nail trays like this one can be made for storing small radio and electronic parts. Vary the sizes and shapes of the tray partitions to accommodate the different parts

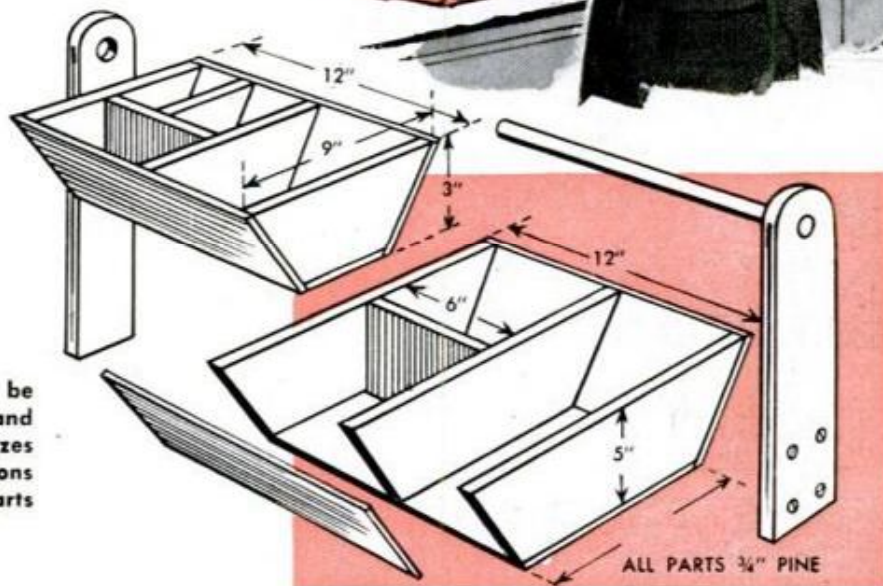

Wooden Block Resets Snap Ring

To replace a snap ring, bore a shallow hole in one end of a piece of wood. Its diameter should be slightly smaller than that of the ring. Place it over the ring and give the wood a sharp rap with a hammer.

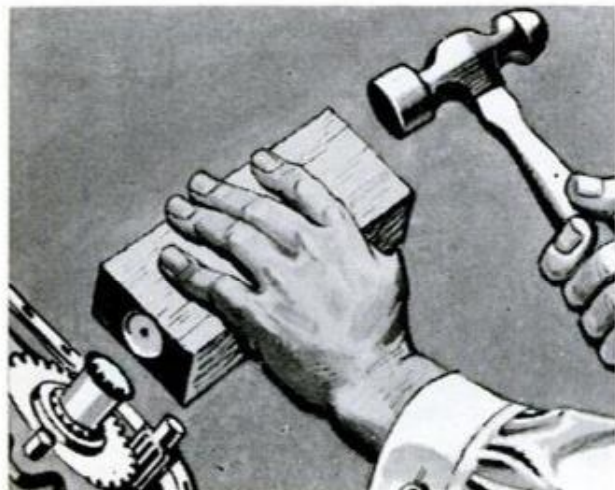

Use Paste Wax on Rubbing Job

Don't ruin a piece of work in the last stages. Heat generated in rubbing a shellac or lacquer finish with steel wool can ruin the finish. You can avoid this by using paste wax as a lubricant.



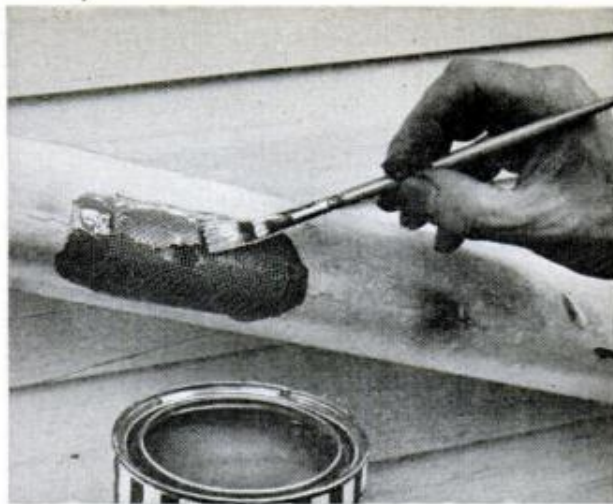

Liquid rubber brushed on boat floor boards provides non-skid, hard-wearing surface. To patch down-spout, coat repair area with liquid rubber, cover with screening when tacky and fill mesh with more coats

LIQUID RUBBER Jack of All Trades

By Walter E. Burton

NEW ON THE MARKET is a type of rubber-surfacing and repair compound that permits the home craftsman to apply a rubber coating of the desired thickness on most any object, a process that could formerly be done only in a factory. Whether it's a tear in a rubber girdle or a punctured tire that needs repairing, a coat or two of this wonderful fluid will extend the useful life of the damaged item. While the preparations of different brands vary somewhat, their application procedures and long list of uses, some of which are pictured in this story, are quite similar.

Primary uses of liquid rubber compounds are to stop corrosion, waterproof fibrous materials, provide a non-skid, resilient surface on boat decks and floors and mend al-

most anything. One brand, Pro-Chem, is available in 1 pt. to 5-gal.-size containers in black, gray and aluminum. The product may be applied from the container with brush or roller, or it may be thinned for spraying. Small items, such as tool handles that are to be given a more comfortable gripping surface, or insulated for electrical use, may be dipped directly into the can.

Another brand comes in tubes from which the material is applied directly to the repair area, or it may be squeezed into a container and mixed with water to the consistency desired for a particular application. The number and variety of uses for this product, called Flex-O-Fix, is about the same as for Pro-Chem, except that the small-size container of the former precludes

Bead of liquid rubber applied along seam between shoe sole and upper serves as waterproofing seal



Coat of liquid rubber brushed on floor mat fills small cracks and cuts, giving it like-new appearance





Wooden planter is made watertight by brushing three coats of liquid rubber on inside surfaces. Corners of large boxes should be reinforced, using screening strips laminated between first and second coats

Right, camera-lens board having numerous scratches on inner face is coated with black liquid rubber to prevent reflections from shiny exposed metal

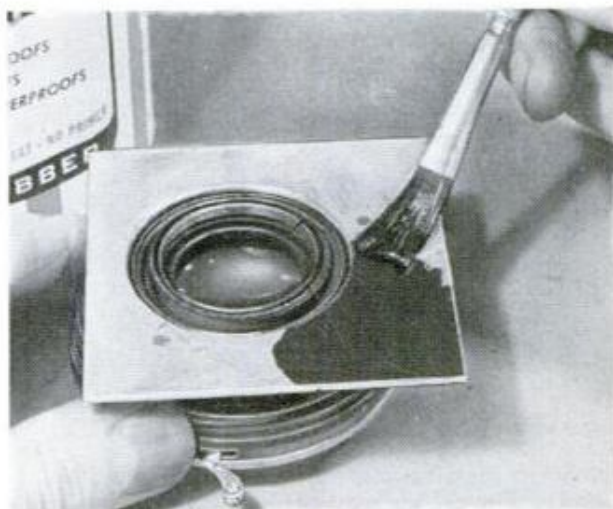

Below right, liquid rubber brushed on worn areas of rubberized canvas gloves prevents them from leaking

Below, dip-coating handles of chain pliers with liquid rubber produces a more comfortable grip, prevents corrosion and insulates them electrically

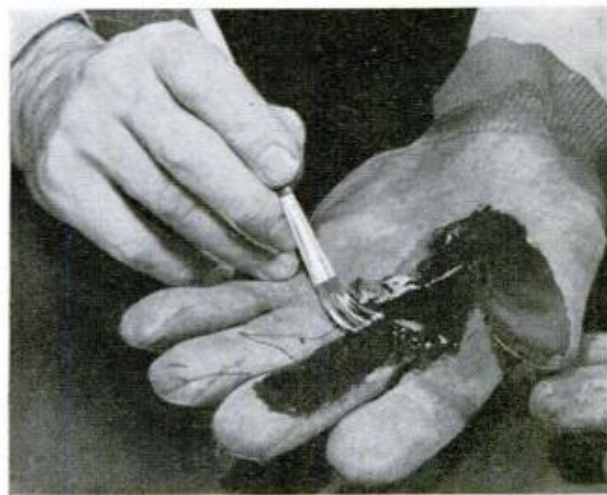

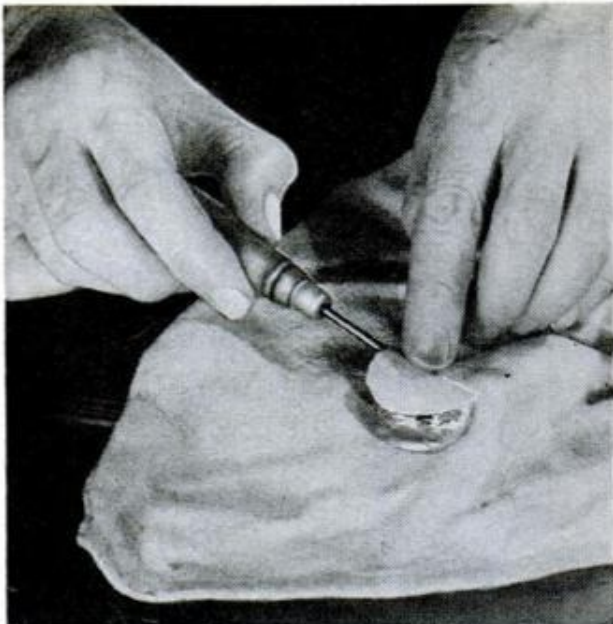

Hole in canvas shop apron is repaired by coating cloth patch and area around hole with rubber compound, then pressing them together. For good bond, patch and repair area should be water-dampened first



Bead of liquid rubber applied along cut edge of rug prevents fiber "fallout," serves as neat binding

Chipped spots on enameled photo-darkroom tray are coated with rubber compound to prevent rust damage

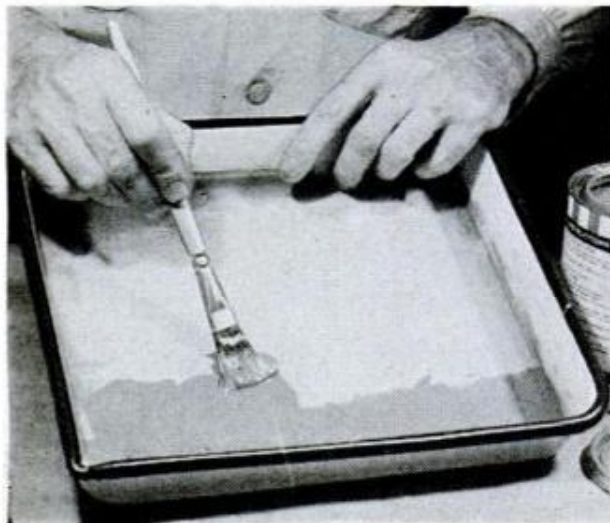

using it for anything but small jobs. Because of the many uses for this versatile repair and surfacing material, other brands may be available by the time this is read.

Application Procedures

As with the application of any coating material or cement, the surfaces to receive liquid rubber must be free of dirt, oils and loose material. Otherwise it will be impossible to obtain a good bond. Sand smooth surfaces, such as rubber, leather, plastic and metal, using coarse-grit sandpaper. Be especially thorough about these first two steps. Regardless of what is used to apply the compound, flow it on in one direction. Do not scrub it on. Since newly cured liquid rubber tends to adhere to smooth surfaces if pressed hard against them, dust the rubber with talcum powder to prevent this.

When filling holes and cracks, taper the edges of the rubber fill to a thin edge before it sets. Holes in material where there is access to both sides, such as a car tire, should be filled from both sides of the casing to form a dumb-bell shaped patch.

When repairing a large hole, such as the rusted-out spot on the downspout shown in one of the photos, it is necessary to provide a patch of some sort to bridge the gap. In this case a piece of window screening was used. First the repair area is cleaned and given a coat of liquid rubber. When the surface becomes tacky, the screen patch is pressed into it and a second and third coat is applied, allowing about 1 hr. drying time between coats. For repair of holes in other materials, cut a patch from tape, gauze, canvas or other material as best suits the repair situation. Where extra strength is required and it is possible to reach both sides of the repair area, apply a patch on

Broken cloth hinge on sheet-film holder is repaired by laminating cloth strip between multiple coats of liquid rubber applied on holder and strip. Latter is pressed in place on the second, tacky coat, following which two additional coats are applied



each side. Follow the same procedure and overlap the hole by about one-half its diameter. With all liquid-rubber products it is important to remove unwanted material before it sets. Brushes should be cleaned immediately after using. Use solvents recommended by the manufacturer.

When using liquid rubber to skid-proof a boat deck or any other surface, the following 2-coat application procedure is recommended by one of the manufacturers: Flow on the compound after preparing the surface to be coated. Next sprinkle foundry grit or fine, dry sand evenly over the first coat while it is still wet. When the latter is dry, brush off loose grit and add a top coat to seal in the imbedded grit.

Make Rubberized Items

With liquid rubber you can convert objects for other than their designed use, or even make new ones. Canvas work gloves and aprons can be changed to rubberized ones simply by brushing on a coat or two of one of these products. Processing trays to accommodate extra-large prints can be made by coating cardboard cartons of the desired dimensions. To replace broken parts that are unrepairable, new ones can be fabricated from corrugated cardboard and other materials assembled and coated as shown in the photo and drawing at the bottom of this page. Play pools for children and flower ponds are made by applying two coats of liquid rubber to a frame or form shaped as desired. Above ground the form must be a rigid enclosure. Below the ground surface no lateral support is necessary so that fabric, construction paper or any other flexible material may be used as a liner after excavating to the desired shape. Or, for a waterproof, rubber-coated work area in a darkroom, greenhouse, studio, or work shop, clean the surface to be set aside for this purpose and apply liquid rubber. ★ ★ ★

Floating lid for film-processing tank is made from corrugated cardboard disk covered with four coats of liquid rubber, after edges are taped. Cork handle is laminated in place during application of last three coats

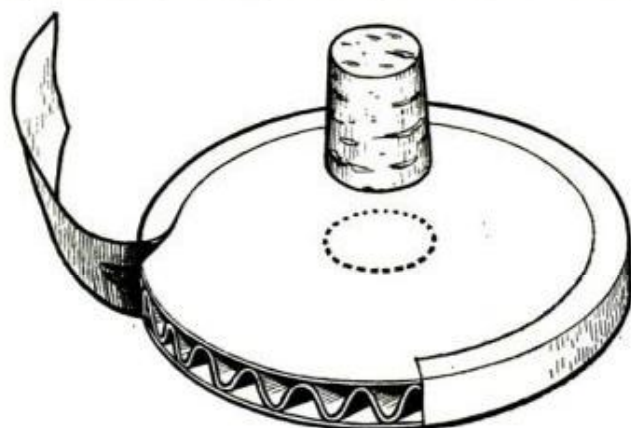

Three coats of liquid rubber on vase bottom prevent it from marring table. Rubber must cure completely before placing item in use. Porous vases can be made watertight by coating insides with liquid rubber

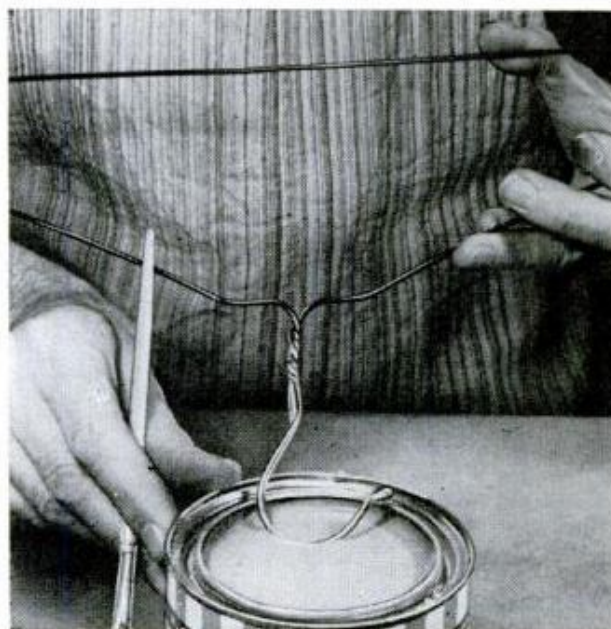

Hook portion of wire clothes hanger dipped in rubber compound prevents it from scratching wardrobe rod





Overlapped Molding Strips Insure Accurate Miter Cut

Accurate miters can be cut in light molding by overlapping the molding strips. Cut the stock $\frac{1}{2}$ in. longer than the measurements require. Overlap the strips at right angles and fasten each of them down with a tack. Saw through both strips as indicated in the illustration and secure the joints with brads or glue. Cut in this manner, the miters will fit perfectly, regardless of the angle of the cut.

After sanding a piece of wood, the remaining sawdust can be used to make a good patching paste for filling holes and cracks in wood. Mix the sawdust with a little white resin glue. If the sawdust used is from a neutral-colored wood, such as pine, the patched area can be stained or varnished to match any other kind of wood.

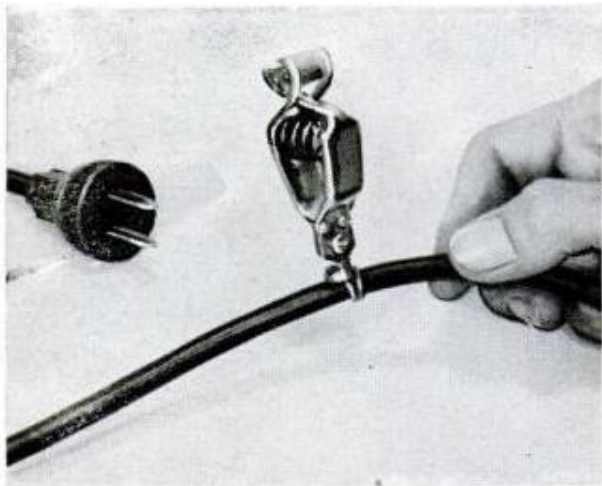

Cords Kept From Underfoot With Large Battery Clips

With a large battery clip the excess length of an extension cord is held out of the way by doubling part of the cord back upon itself. Attached to the wall or ceiling, several of these clips will lead and position a cord where it is needed. One or more clips can be set to travel the length of a brass or steel rod set overhead above the workbench. The cords from hand power tools and trouble lights are then easily moved where needed and will never be underfoot.



Scoring With a Sharp Chisel Makes Clean Cut in Hardboard

For a sharp clean cut in a piece of tempered hardboard, score both sides with the edge of a sharp chisel. Repeat the scoring process several times on each side, place the scored line along the edge of the workbench and apply pressure. The result is a faster, cleaner separation than can be had using a saw.

Small cracks in concrete walks and steps should be repaired quickly to prevent them from spreading. Sweep the crack, wet it down and brush in a flowing mixture of portland cement and water. For a medium-sized crack, undercut the edges and fill it with a mixture of sand, cement and water. For large breaks, add gravel to the mixture.

COPY-CAMERA MOUNT

ONE IMPORTANT REQUIREMENT for photographic copy work is a firm camera support. You can convert a drill press into a copying stand by adding this easily built attachment. For vertical copying, subject-to-camera distance is adjusted by sliding the table up and down the column. Finer adjustments within a range of 7 in. are made with a handwheel and screw arrangement. The mount is cut from $\frac{3}{4}$ -in. plywood, the base fitting into horizontal grooves cut into the sides and secured with glue blocks and wood screws. The adjustable camera platform, detail A, operates by means of a $\frac{3}{8}$ x 16-in. threaded rod running vertically through two cross braces. These are secured horizontally to the front top and bottom of the mount. The rod is turned by means of a hand wheel and screws through a $\frac{3}{8}$ -in. hex nut soldered to an angle iron fitted to the bottom brace. The brass guides on either side of the platform move in $\frac{1}{4}$ x $\frac{3}{4}$ -in. grooves cut into the sides of the mount, and the camera is secured to the platform with a bolt screwed into the camera's tripod attachment. Any play in the platform is taken up by the four metal guides which are adjusted for a good sliding fit.

Howard R. Clark, Springdale, Ark.

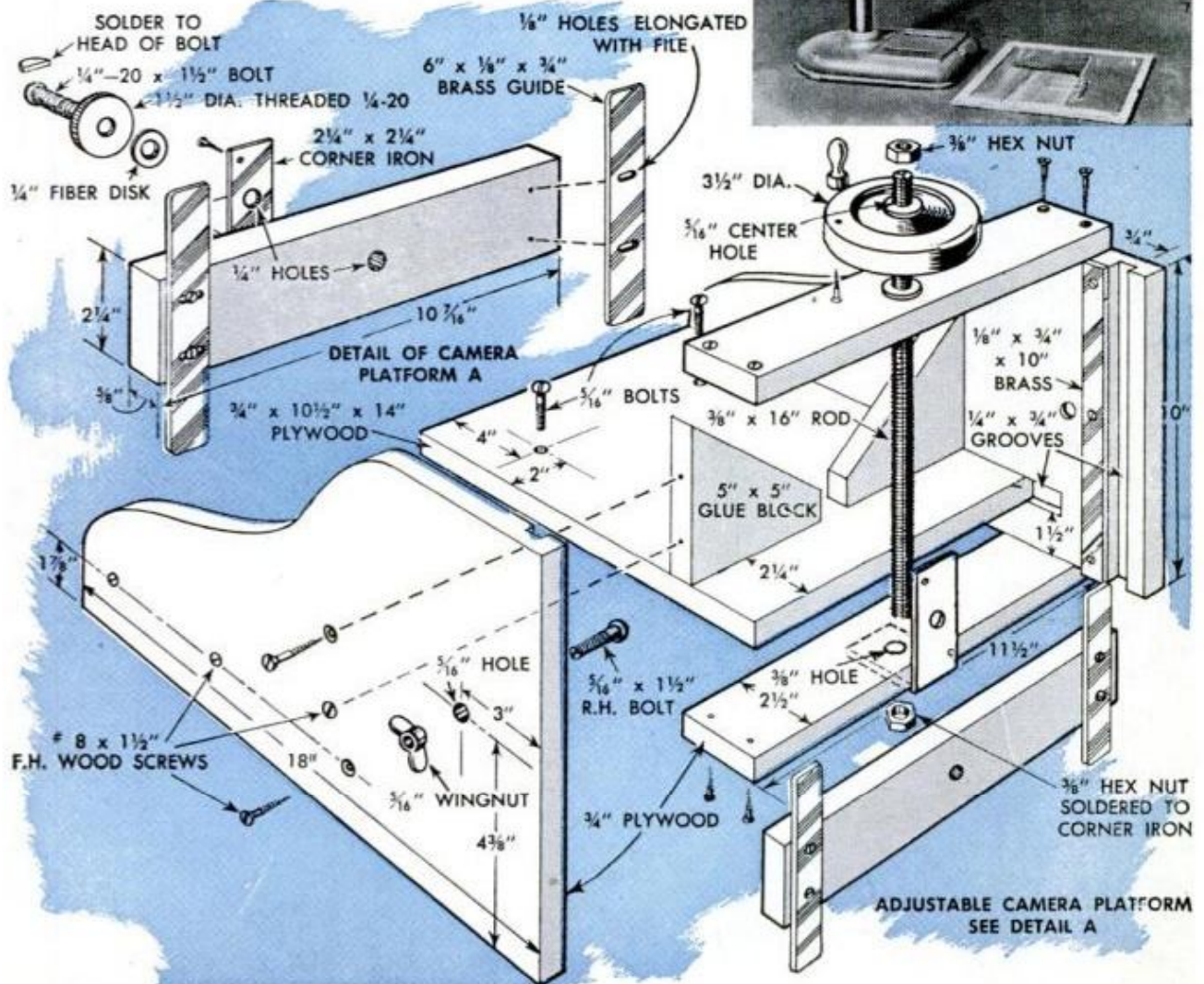
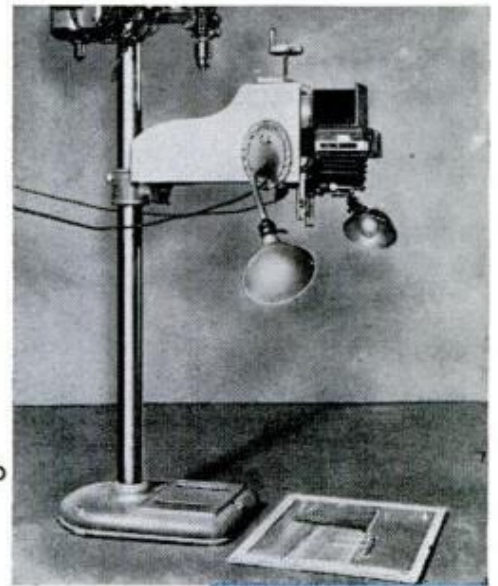
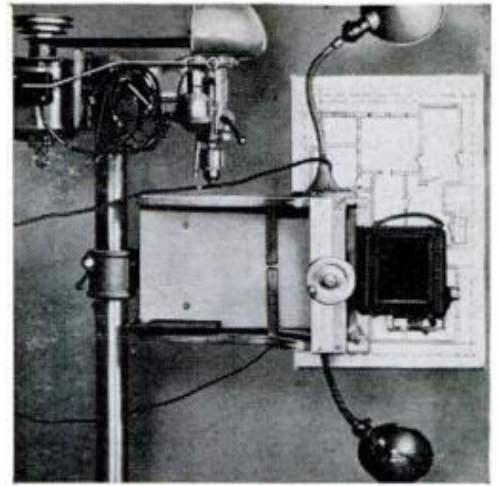

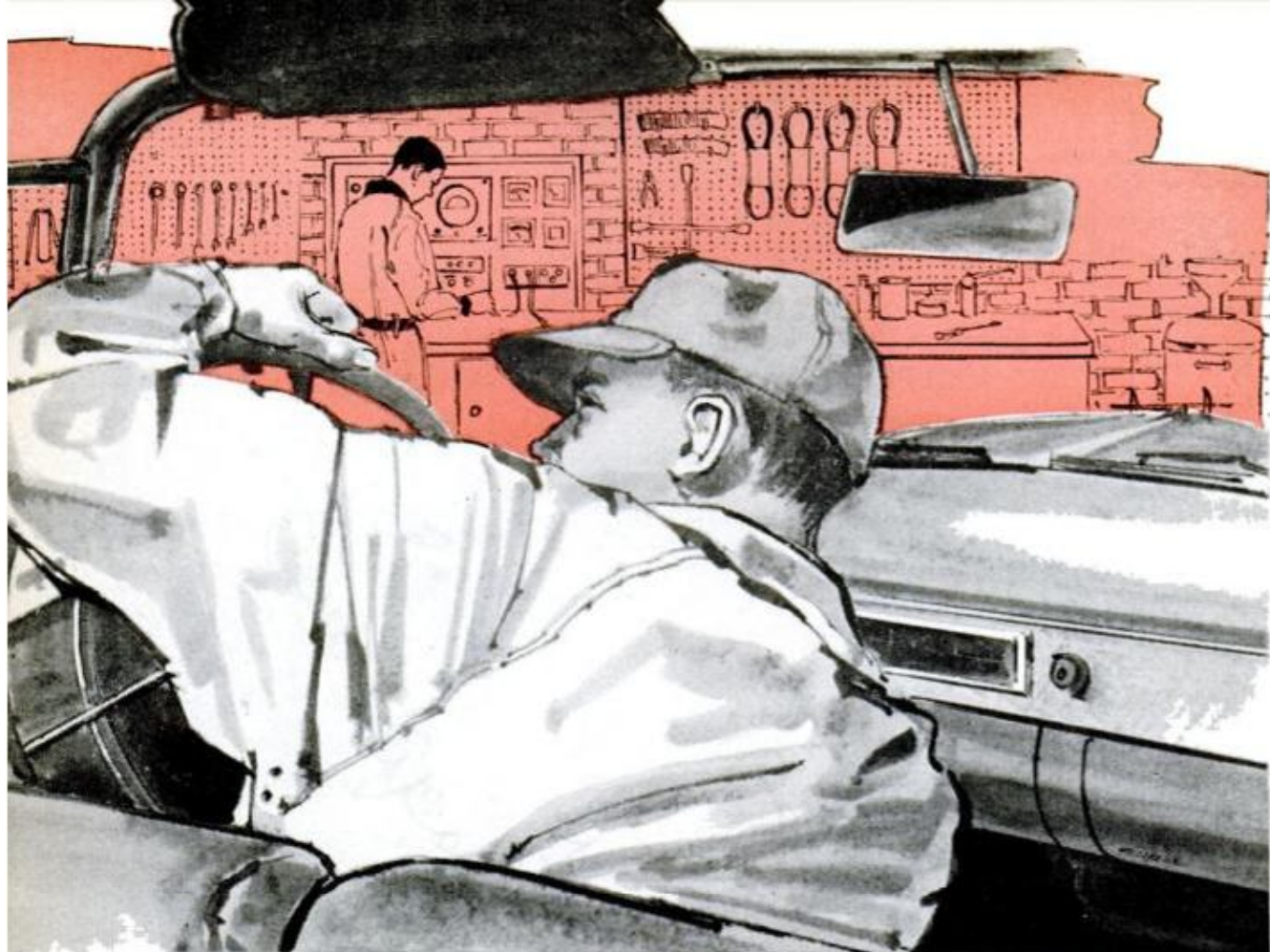

Trouble Shooting

THE TOUGH ONES

By Ben Davis

OCCASIONALLY a repair job will come to the troubleshooter as the result of a previous do-it-yourself repair job. An example was a '57 Ford that was driven into the shop with the complaint of no oil pressure and no generator charging. This might have been an ordinary case of several malfunctions but for the fact that the trouble occurred only at night. Right then and there I decided that the trouble must be in the electrical system, a supposition which turned out only half-right.

The red tell-tale lights that told of generator or engine-lubrication troubles went out normally as the motor was speeded up—until the light-switch was pulled out. Then the two lights glowed. Despite this, checking by a meter proved the generating system and oil pressure were O.K.

Now, suspicion swung to the wiring. Maybe some of the bulb sockets had been placed in the wrong dash panel openings. Certainly it wasn't too difficult to switch two lamps, like an instrument light and a generator tell-tale. Yet, checking the wiring colors proved everything proper in this respect. At about this time it was learned that the owner had taken out the speedometer for repair. Evidently, then, something had been altered in the earlier repair job. And so it was. The shielding around the speedometer had been misplaced. Therefore, when the lights were turned on, the reflection of the instrument lamps through the speedometer housing holes made it appear that the oil pressure and generator lights were also lit. Setting the shielding properly stopped the trouble.

Unusual Locations Where Trouble May Occur

Rambler Hood Latch

If you haven't already experienced trouble with the hood latch on the '59 Rambler failing to release, be prepared, for it may do so. Push in on the latch post through the grille. It is best to use a blunt tool, such as a screwdriver. After opening the hood, the latch plate should be adjusted by means of the two $\frac{7}{16}$ -in. (wrench size) screws. Generally the latch needs to be moved back.



Plymouth Driveshaft

More than one driveshaft has already been replaced on the '57 Plymouth due to its snapping and tearing away from the weld near the rear universal joint. This is especially true of the V8 car with automatic transmission. Whenever you have one of these cars on the lift, why not inspect the joint for signs of a fracture? You may save a customer an embarrassing experience. Failure of the joint will mean a new propeller shaft.



Chrysler Handbrake

If the handbrake on a '58 Chrysler pulls all the way back but does not hold the car, even after adjustment has been made, check the firmness of the brake-lever support. The lever bracket is welded to the fire-wall on the driver's side and sometimes breaks loose. The photo shows a similar arrangement on the '57 model where the cable passes through the cowl. Reinforce the weld joint with a bolt and nut.

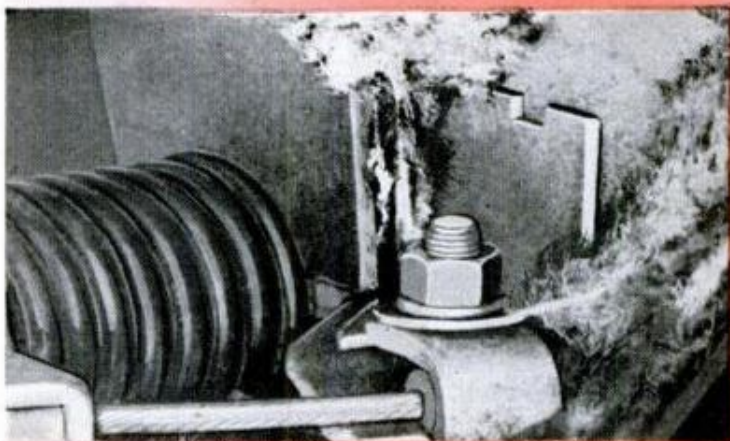

Air Filter Lock Washer

Under the air filter supporting stud of many '56 and '57 Ford V8s there should be a lock washer. However, over tightening of the filter nut on this stud may result in the stud screwing out of the base with the result that the washer may drop into the carburetor unnoticed. This, of course could result in expensive engine damage. You should check this washer carefully, or even remove it.



SHOP NOTES

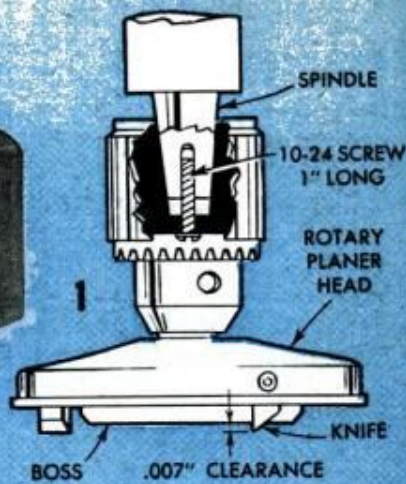
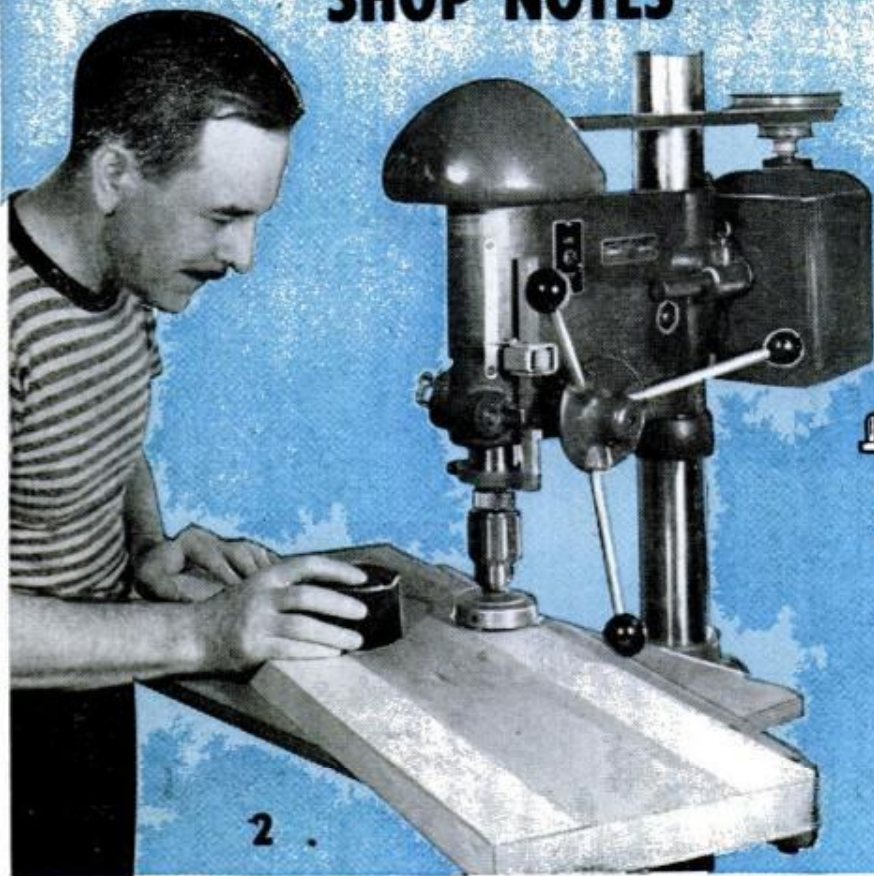

CAUTION: BE SURE DRILL CHUCK IS SOLIDLY ATTACHED TO TAPER SPINDLE BEFORE USING PLANER HEAD. CHUCK CAN BE ATTACHED TO TAPER SPINDLE WITH SCREW AS INDICATED

SURFACING ROUGH LUMBER

By Sam Brown

NOT MANY HOME SHOPS and small woodworking shops are equipped with a single surfacer, or thickness planer, for finishing rough-sawed lumber or reducing finished stock to a required thickness. Where only an occasional piece requires finish planing from the rough, or when a few small pieces of stock must be reduced to a given thickness, the outlay for a small surfacer is hardly justified.

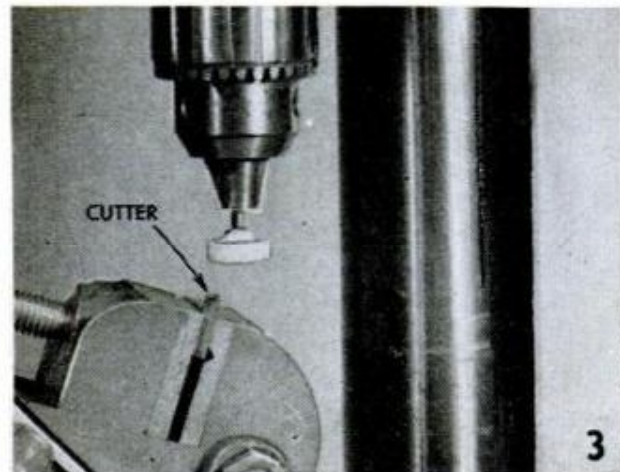

Lacking a conventional thickness planer, you still can turn out good surfacing and thickness planing jobs with accessories available for use on a drill press or circular saw. Even a small jointer can be made to serve when drill-press and table saw accessories are not at hand. A planer head, Figs. 1, 2 and 4 is perhaps the most commonly used for both rough planing and surfacing stock to thickness. A molding cutter head fitted with square-edged cutters and mounted on the saw arbor also is an efficient tool for planing rough stock and reducing stock to thickness. The setup is shown in Figs. 12, 13 and 14.

The planer head: Although the planer head, Figs. 1 and 2, can work in a speed range from 3000 to 9000 r.p.m., it generally does its best work at a speed of about 5000 r.p.m. The vertically-mounted knives are positioned in the head to combine a shearing and scraping action and cut exceptionally smooth and clean when they are sharp. Knives should be honed with a hand stone about every 20 minutes of actual cutting time and should be reground

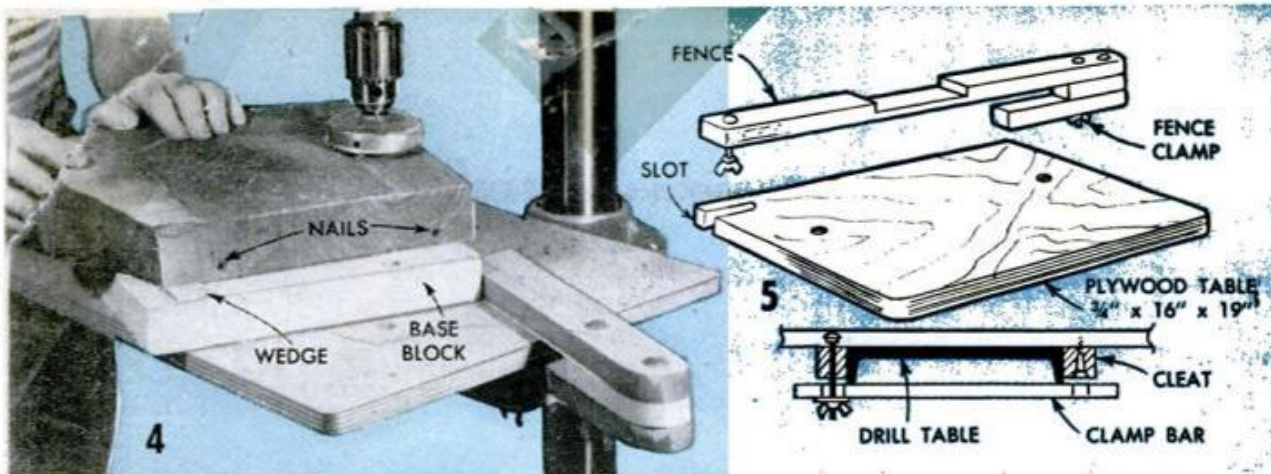

An auxiliary table is necessary to assure adequate support for large pieces of work when surfacing with a planer head on the drill press. Note construction of the pivoted fence to permit quick, easy adjustment

after three or four honings. A simple setup for grinding can be made with an angle vise, Fig. 3. When using a planer head an auxiliary table made of plywood, Figs. 2, 4 and 5, is needed to provide a solid support for average-size work. If the work is warped or the rough sawing is irregular, it may require nailing to a base block having a flat surface, Fig. 4. Actual cutting is simply a matter of pushing the work under the cutterhead, feeding from left to right as in Figs. 2 and 4. Down pressure needed to keep the work flat on the table may be obtained with a weight as in Fig. 2. Each pass of the work will surface a strip 2 to 2½ in. wide and work up to 12 in. or more in width can be handled by making successive cuts. If you use a planer head on the drill press, Fig. 2, make sure the chuck is tight on the taper

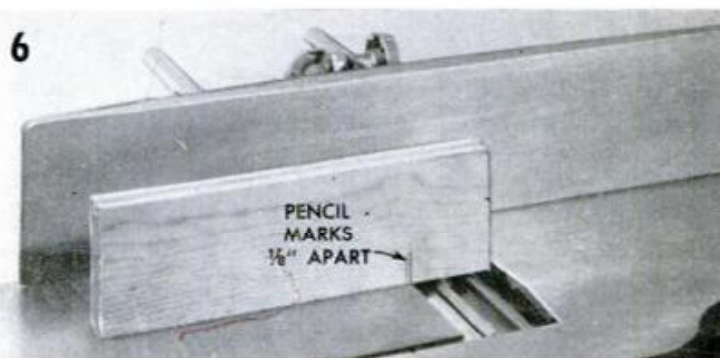

Above, set rear jointer table so that knives move test block about 1/8 in., no more. Below, adjust the front table for depth of cut with piece of thin sheet metal, about .025 in. thick

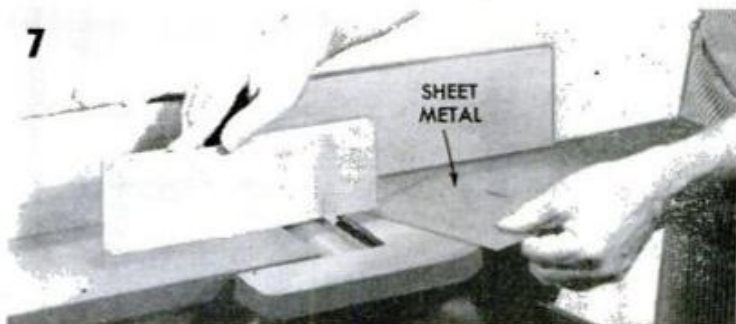

When surfacing on a jointer it's always best and safest to use a pusher. Either type detailed enables you to hold the stock firmly and at the same time feed uniformly throughout length of cut. Metal weights can be used

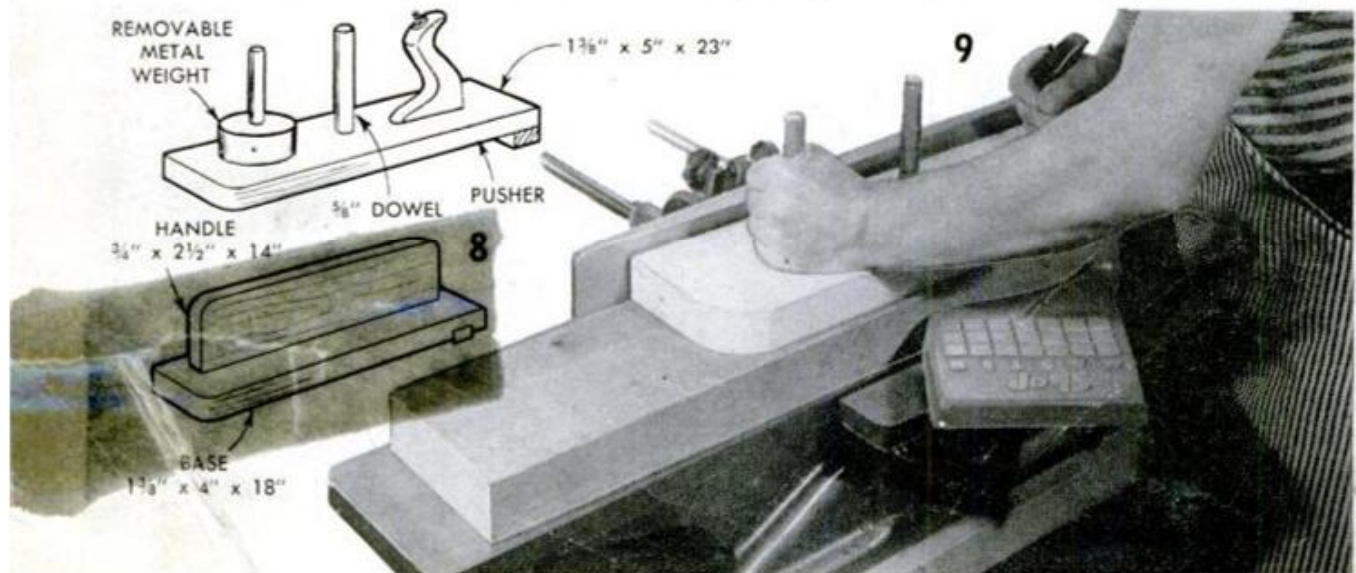

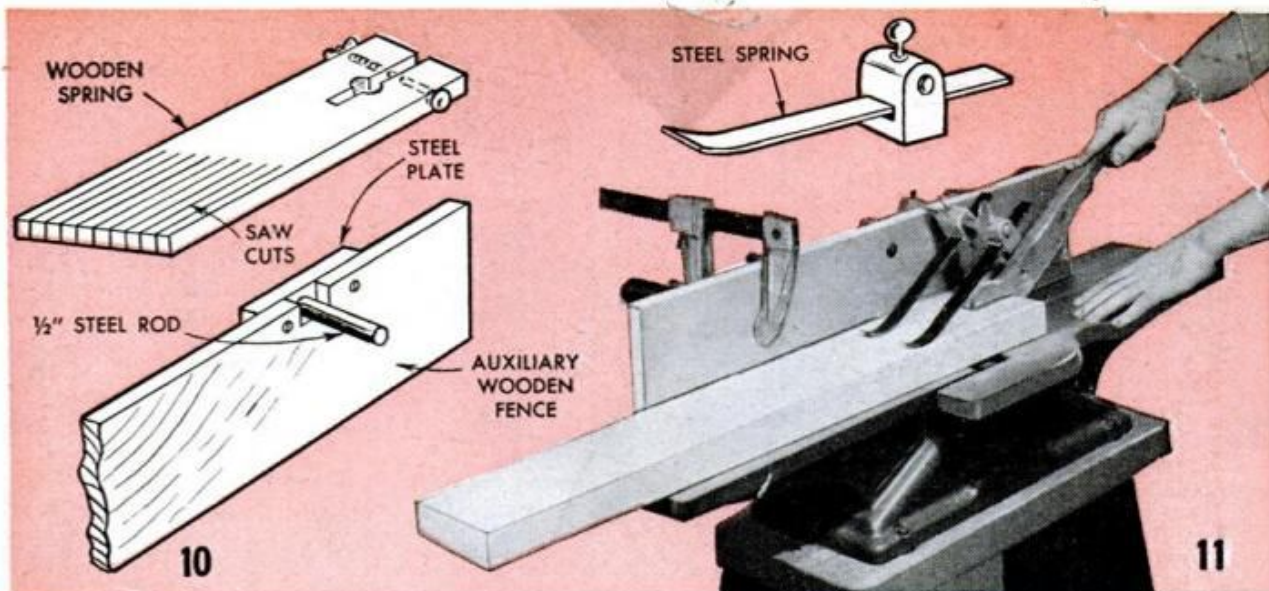

spindle so that it won't loosen when side pressure is applied. Some chucks permit attachment to the spindle with a machine screw as in Fig. 1.

The jointer: A 6-in. jointer will surface a board 6 in. wide in one pass, and work up to 12 in. wide can be surfaced by making two passes of the stock. Unless you make careful adjustments of the jointer you may not get good results. The rear table should be slightly lower than the cutting circle of the knives, just enough so that the knives, when turned by hand, will move a test block forward not more than $\frac{1}{8}$ in., as shown in Fig. 6. The depth of cut on a full 6-in. board should not be more than $\frac{1}{32}$ in. and preferably a little less. Use a piece of sheet metal about .025 in. thick to set the depth of cut as in Fig. 7. Jointer knives hold a keen edge for about 1 hr. of actual cutting time. They should

be honed regularly and systematically, and should be reground after four or five honings. Applying the right amount of pressure to hold a uniform depth of cut when surfacing on a jointer requires some practice. Use of a pusher, Figs. 8 and 9, or holddowns and an auxiliary fence, Figs. 10 and 11, make the job a lot easier and safer.

The operator should stand alongside the machine where he can use his body weight to best advantage, Fig. 9. Down pressure is applied mainly with the left hand, the right hand being used for feeding the material. The pressure should be over the front table at the start of the cut. The hand then moves over the cutterhead and becomes stationary over the forward part of the rear table. Unless you are experienced in this, you'll do better using a pusher and you'll also feel safer. The pusher should be ample in all dimensions as in Fig. 8.

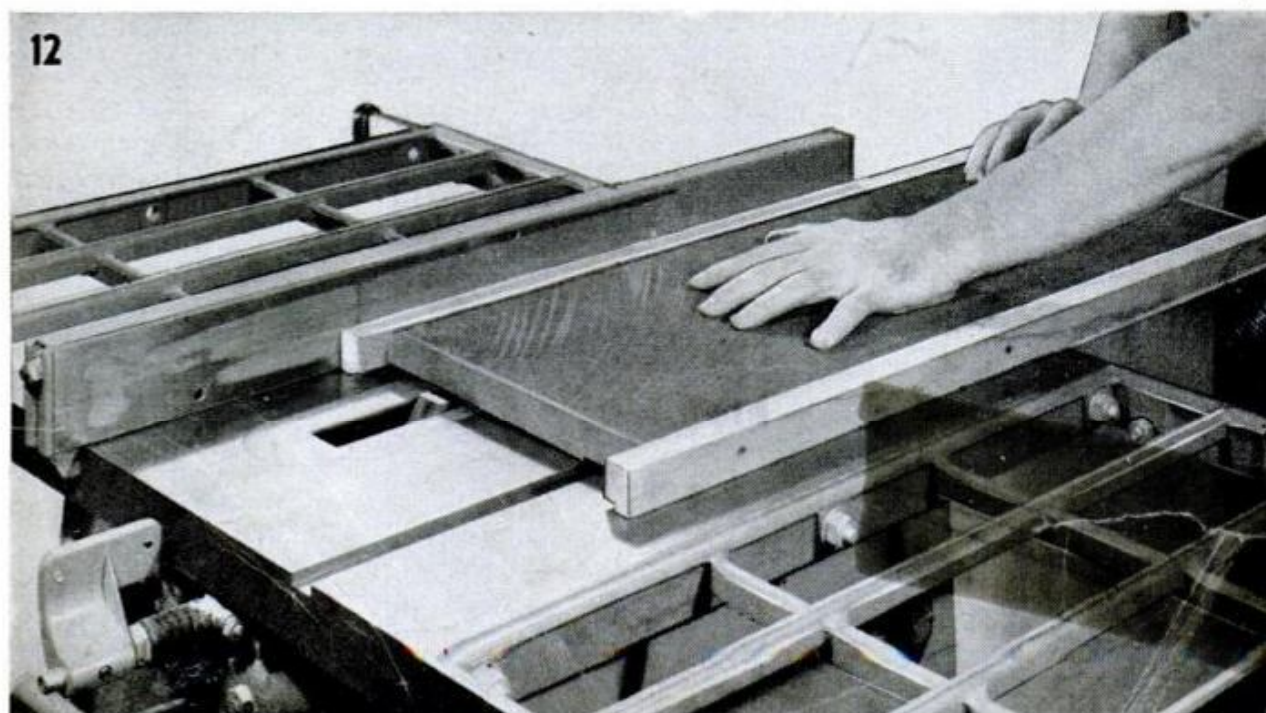

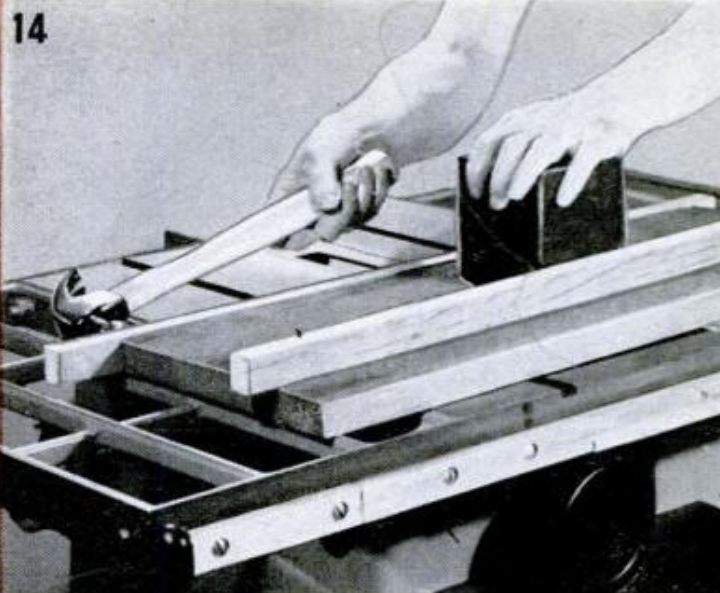
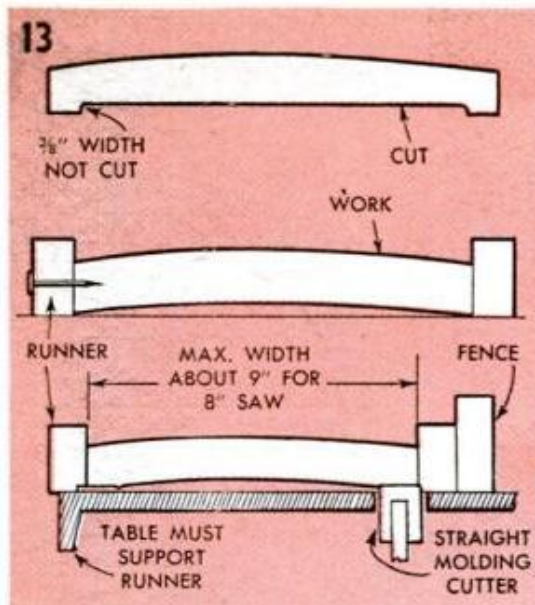

The type having dowel handles can be loaded with one or two metal weights to steady the work and lessen the amount of hand pressure required. The feed should be very slow, and, of course, should be continuous. If you have to shift your pressure hand, stop feeding as even the slightest amount of feed without down pressure will cause you to lose the "bite" and the cut will tend to taper off.

Both manufactured and shopmade hold-down devices in a wide variety of styles can be used on a jointer to eliminate the need of hand pressure. One simple setup is made as shown in Figs. 10 and 11, using either the wooden spring hold-down or the flat-steel spring. With the springs supplying the needed down pressure, all you have to do is maintain a uniform rate of feed, running the last few inches safely by using

a push stick in the manner shown in Fig. 11.

Molding head: Successive cuts with straight knives fitted in the circular saw molding head will quickly surface a rough piece of lumber. Most work will be sufficiently flat so that it will ride without rocking, but uncut strips must be left along the edges to provide runners, Fig. 13. If the work is warped it should be leveled on a flat surface and runner strips nailed in place as in Figs. 13 and 14. Cuts to $\frac{3}{16}$ in. deep can be taken. The maximum width of work which can be handled depends on the size of the main saw table. Open-type extensions do not provide adequate support. In running adjacent cuts by this method, the ripping fence is moved after each pass. You'll do better work if you adjust the fence so that the cuts overlap about $\frac{1}{16}$ in. ★ ★ ★

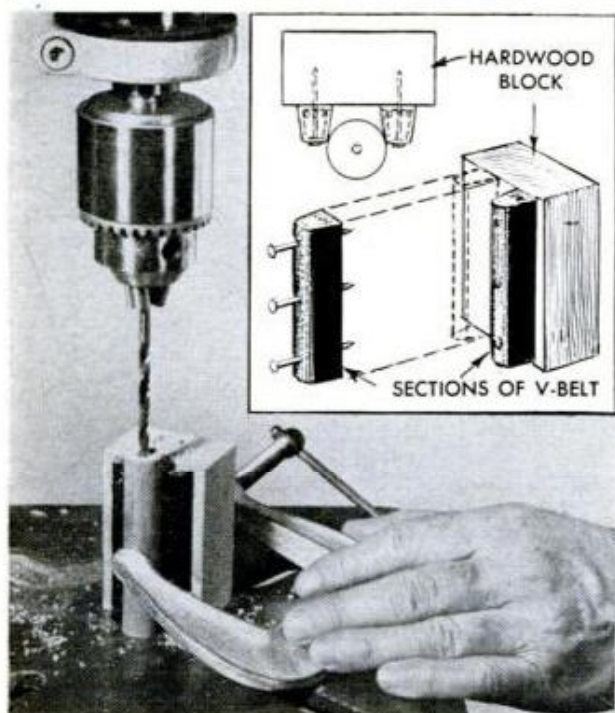

Dowels Held for End-Drilling By Improved V-Block

Did you ever try to drill an accurate hole in the end of a short length of dowel in the drill press? It's a neat trick if you can do it without having the dowel tilt sidewise or spin and burn your fingers unexpectedly. Here's a way to eliminate all the chances of trouble: Square a block of hardwood of a length slightly less than that of the dowel. Then cut two sections from an old V-belt and tack these to one face of the block as in the detail. Space the pieces so that they support the dowel as in the top view.

Clamp them in place and nail to the block, making sure that the two are in line. Then make the setup as pictured, clamping the dowel lightly in place with a C-clamp. Just make sure that the block bears squarely on the table.

G. E. Hendrickson, Argyle, Wis.

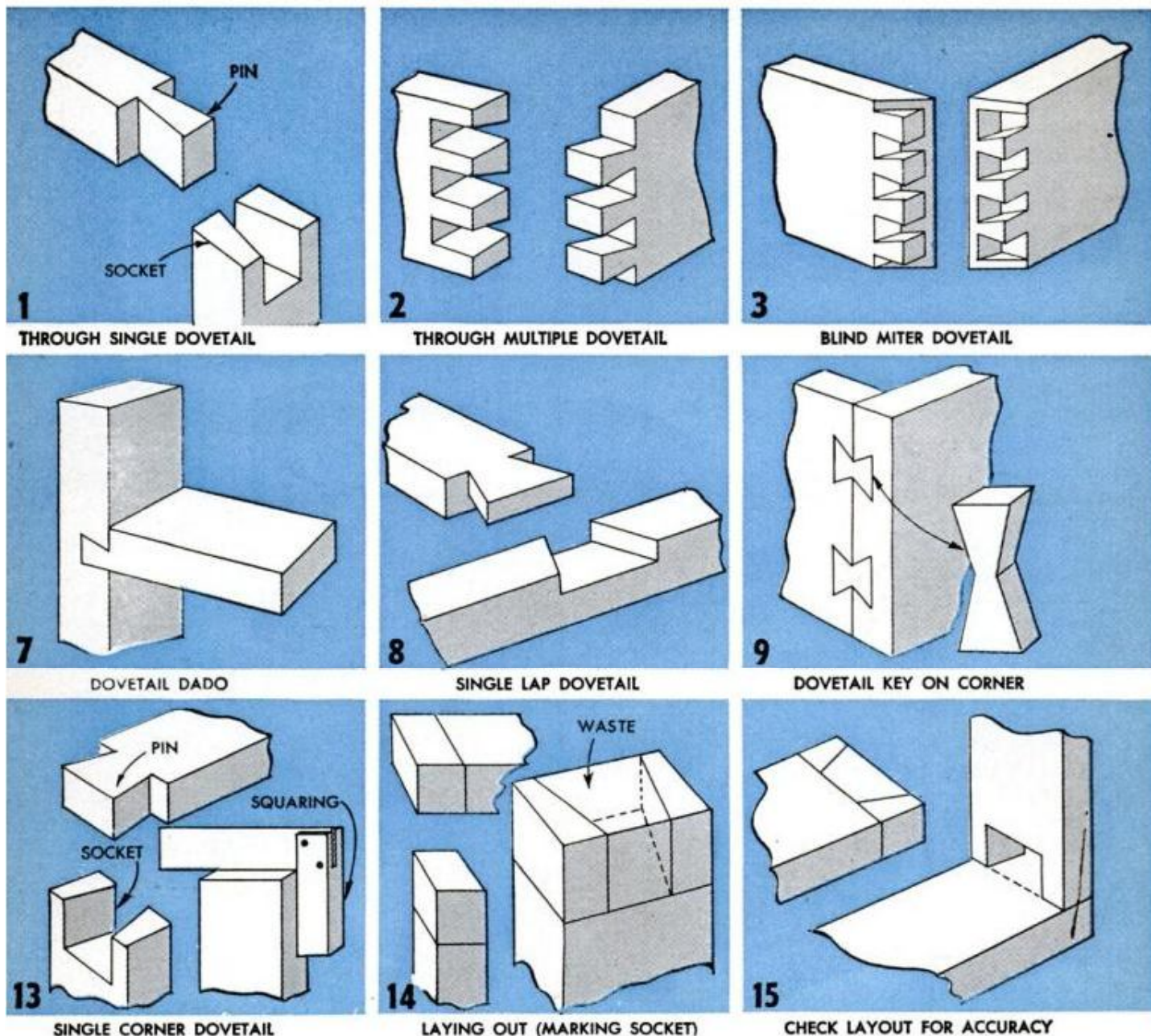

DOVETAIL JOINTS

By
C. W. Woodson

ONLY A FEW of the many forms of the dovetail joint are considered practical for cutting by modern machining methods. Originally, all types were designed, laid out and cut by hand. You will find nearly all types in old work. On old chests the rails were often joined to the side or end panels by means of a single lap dovetail, Fig. 8. Tops of early chests were sometimes joined to the side panels by multiple dovetails, Fig. 2. The old type corner dovetail in which the pins, or tails, are relatively wide, Fig. 10, was quite commonly used in corner-joining wide stock for blanket chests and deep drawers. Sometimes the beveled dovetail joint, Figs. 11 and 12, will be noted in old dough trays, also cutlery trays. Other variations such as the dovetail key, Fig. 9,

blind miter dovetail, Fig. 3, and the dovetail dado, Fig. 7, will be found. The blind miter dovetail is rather difficult to cut as the full miter cut cannot be made at the outset on either of the joining pieces. The miters are formed when cutting the sockets and pins. Such a joint was used only in the most painstaking work. The multiple dovetail joint, Fig. 2, the lap dovetail, Fig. 4 and the box joint, a related form, Fig. 6, are commonly used in modern joinery. The single exposed dovetail is sometimes found in modern work as an ornamental feature. Figs. 13 to 18 inclusive show hand methods of laying out and cutting sockets and pins. In present-day joinery sockets and pins are made a uniform size, unless, of course, older types of work are being duplicated.

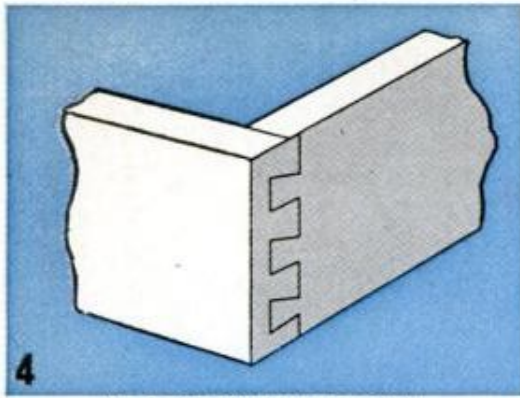

4 LAP DOVETAIL (DRAWER JOINT)

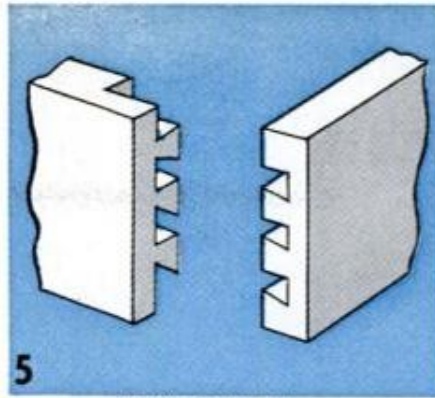

5 BLIND DOVETAIL

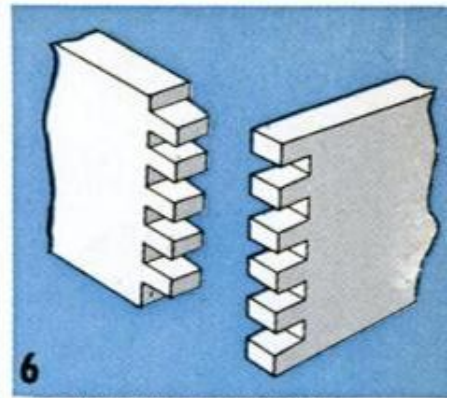

6 LOCK JOINT OR BOX JOINT

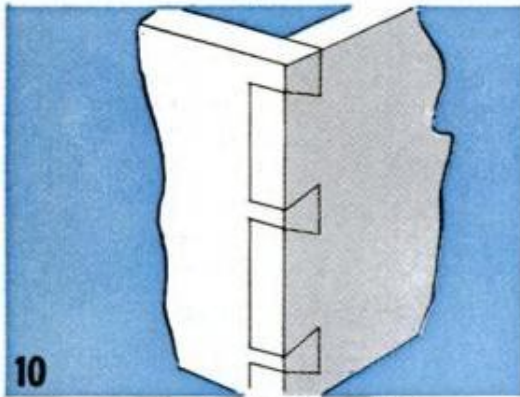

10 CORNER DOVETAIL (OLD TYPE)

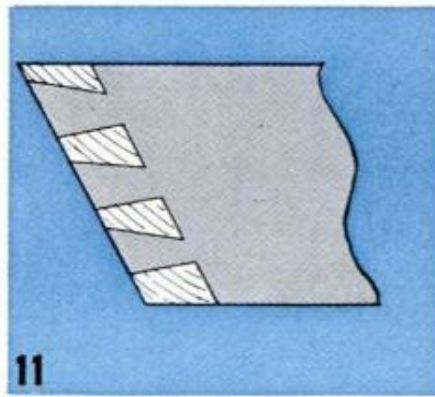

11 BEVELED DOVETAIL

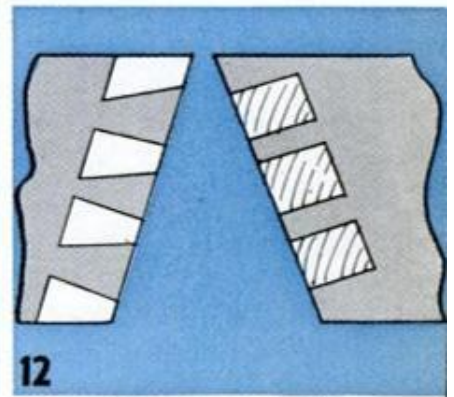

12 CORRECT SOCKET ANGLE

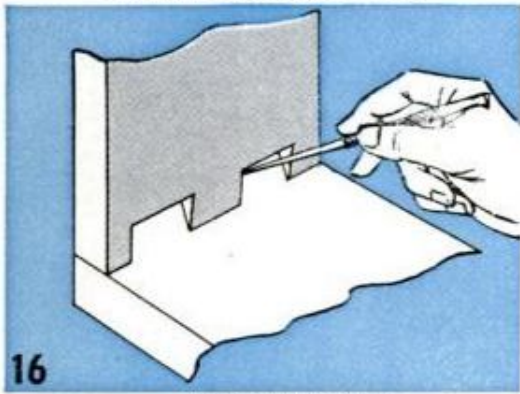

16 SCRIBING SOCKETS

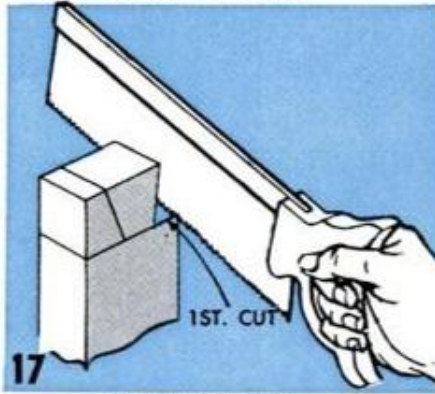

17 SAWING THE PIN

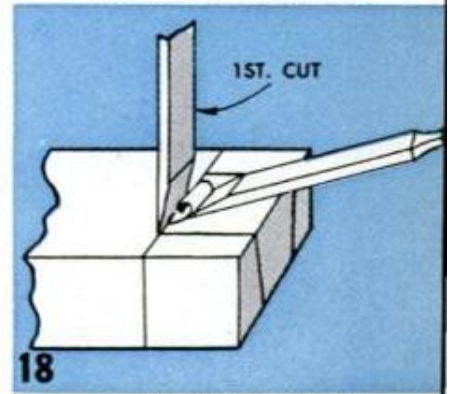

18 CUTTING THE SOCKET

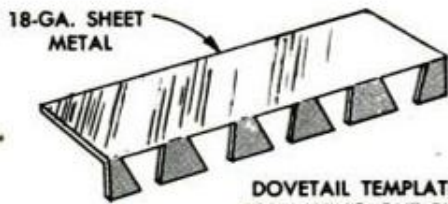

DOVETAIL TEMPLATE, FOR LAYING OUT PINS

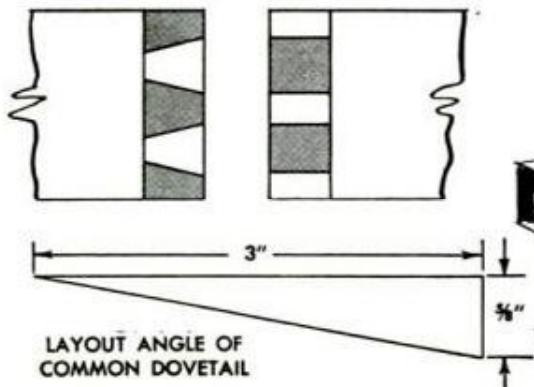

LAYOUT ANGLE OF COMMON DOVETAIL



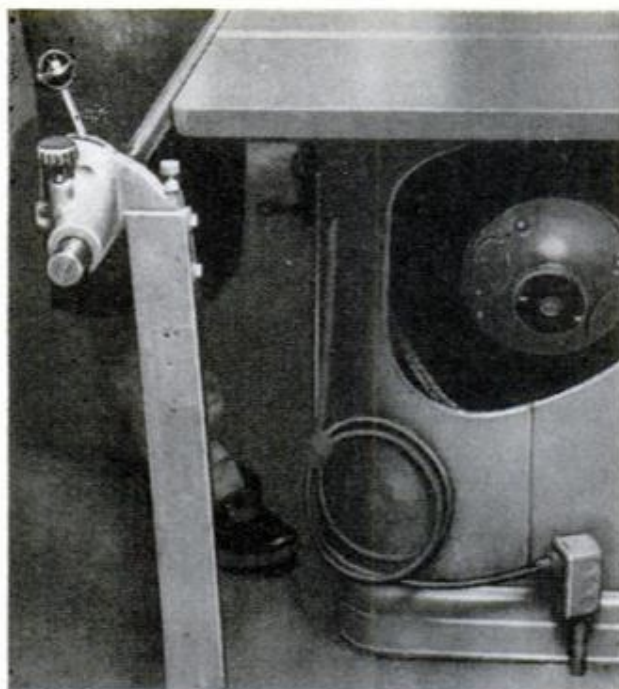

Extension on Rip-Fence Guide Clears Table for Cross Cuts

When frequent removal of the ripping fence is necessary to clear the saw table for cross cuts on long, narrow stock, an extension welded onto the front fence guide will save time by permitting the fence to tilt downward out of the way. On table saws having round fence guides, an 8-in. length of steel tubing welded to the guide will permit you to slide the fence out far enough to allow the rear end to drop down as pictured at the left.

Wayne Judy, International Falls, Minn.

☐ An open-end wrench can be used to turn a small pipe. Insert a wood screw between the work and the lower jaw of the wrench. The threads will provide the grip necessary to turn the pipe.

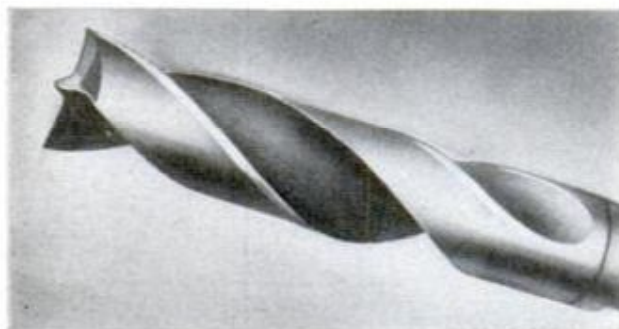

Drill Reground for Wood Working

A twist drill can be reground to drill a clean, true hole in wood. Just grind the point of the drill square across and re-sharpen the two cutting lips with a relief angle of about 30 deg. back of the cutting edge. Do not grind the flat lips all the way to the center. Leave a sharp pointed spur at the center to act as a pilot.

H. J. Gerber, Stillwater, Okla.

Precut Disk-Cement Tube For Convenient Application

Application of sanding-disk cement is made easier and more convenient if you cut the tube into sections about $\frac{1}{8}$ or $\frac{1}{4}$ in. in thickness. The sections are always ready for use and the cardboard is easily peeled off with a knife. In addition, you will have no uncovered adhesive lying about.



Restore Chuck-Jaw Faces With Cylindrical Lap

To restore the gripping faces of a universal lathe chuck, insert a cylindrical lap through the chuck. Hold the lap down with a lathe dog and smear it with coarse-grit lapping compound. Rotating the chuck jaws around the lap will restore the faces to trueness.—H. J. Gerber, Stillwater, Okla.

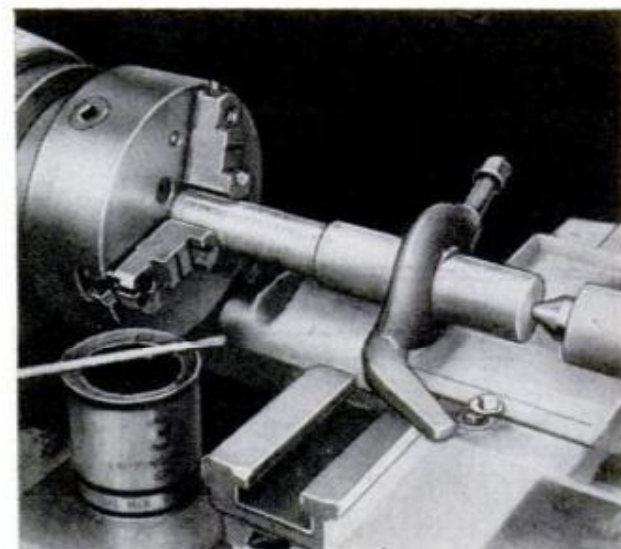

Counterbalanced Safety Sticks

SOME YEARS AGO I made a safety survey of high-school Industrial Art Shops and found that jointers caused many more accidents than other machines. I also found that nearly every shop had a push stick, but it was not in use when an accident occurred. This indicated that lack of use of the stick resulted in the accidents. To assure that a safety stick would be close at hand at all times, which should help prevent accidents, I designed the unit shown here.

A unit consists of two lengths of tubing, one to telescope inside the other. A collar was used on the upper tube to form a stop for adjusting the height of the unit. Inside the tube assembly a chain and counterweight were suspended as indicated. Push sticks of the desired type were attached to the upper end of the chain. In this way, the stick could be pulled down for use and would return to the top of the tube when released. A unit was placed beside each machine with which a push stick should be used.

Another way of accomplishing practically the same results if the machines remain in the same place, is to run the chain or small rope over pulleys attached to the ceiling above. Then use a counterweight of the right size to pull up the stick when it is released. To keep the counterweights out of the way, it may be necessary to locate pulleys to let the counterweights lower near a wall so that they will not interfere with working space.

Wayne Judy, International Falls, Minn.

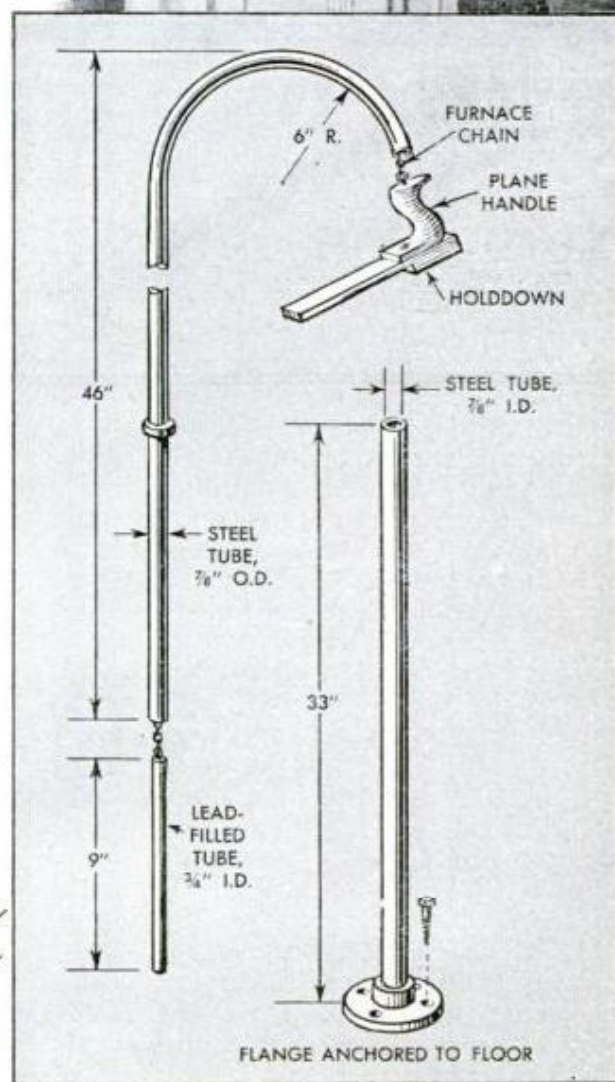
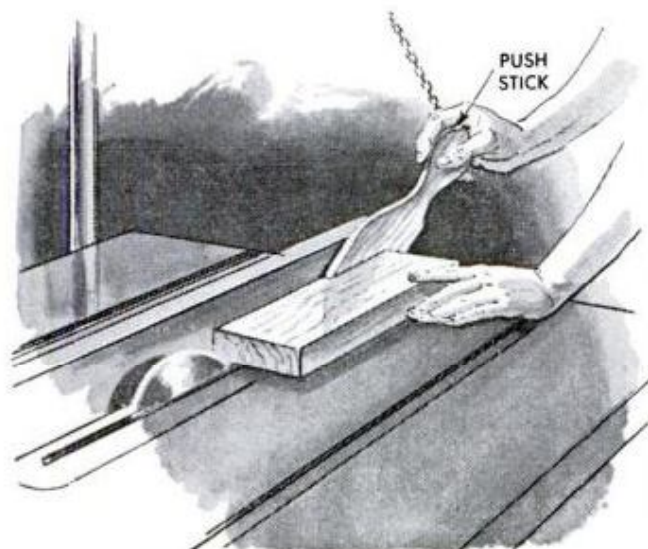

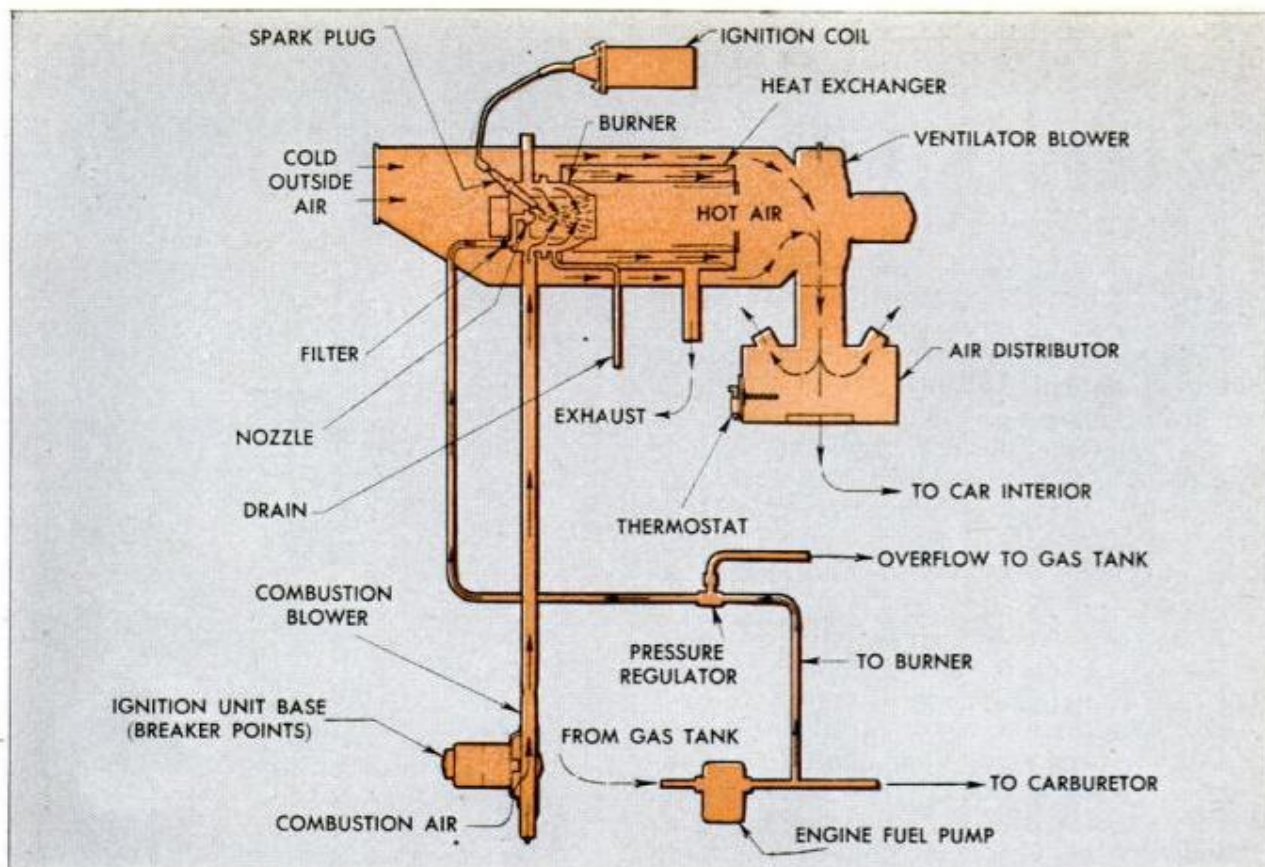

Maintaining and Repairing THE CORVAIRE CAR HEATER

By John Krill

WITH ITS NEW air-cooled engine, the Corvaire car has left water-cooling systems behind, and with them the conventional hot-water heaters familiar to motorists for the past decade or more. Instead, the Corvaire uses a highly efficient gas-fired heater which delivers heat to the interior of the car almost instantly. But, like any other piece of gas-fired equipment, it must have a means of mixing air and fuel and an ignition unit to fire the mixture. It is therefore more complex than its hot-water counterparts and may require more attention.

The schematic detail above shows the parts of the heater system and the photograph on the following page shows it mounted on the car. Essentially, this unit is a miniature form of the oil-burning hot-air furnaces used to heat homes. But instead of oil, this one burns gasoline. As in the home unit, fuel is sprayed into a burner cup in the form of a fine mist. Here it mixes with air from the combustion blower. The spark plug immediately fires the mixture and the resulting flame heats the heat-exchanger walls. Air pulled in by the ventilating air blower is then warmed in the heat exchanger and blown inside the

car through the air distributor. Hot combustion gases escape through a slot located in the top of the inner cylinder of the exchanger and are forced through the outside wrap before being discharged through the exhaust tube thus transferring some of their heat to the ventilating air stream.

Up to this point, though the heater has been operating, the thermostatic switch remains closed until the warmed air heats it to a temperature of predetermined setting. Then it opens and shuts off the ignition and the flow of fuel. However, both the combustion blower and the ventilating blower continue to operate. As soon as the air temperature drops in the air distributor, the thermostatic switch closes, the solenoid switch opens to admit fuel, the plug fires, and combustion begins again. This off-again on-again process is so swift and quiet that variations in temperature inside the car are kept to a minimum and are not noticeable to driver or riders. In extremely cold weather and at high driving speeds, the heater may burn continuously. When the fan switch or the car ignition is turned off, heat in the exchanger will activate a purge switch. This turns on the combustion blow-

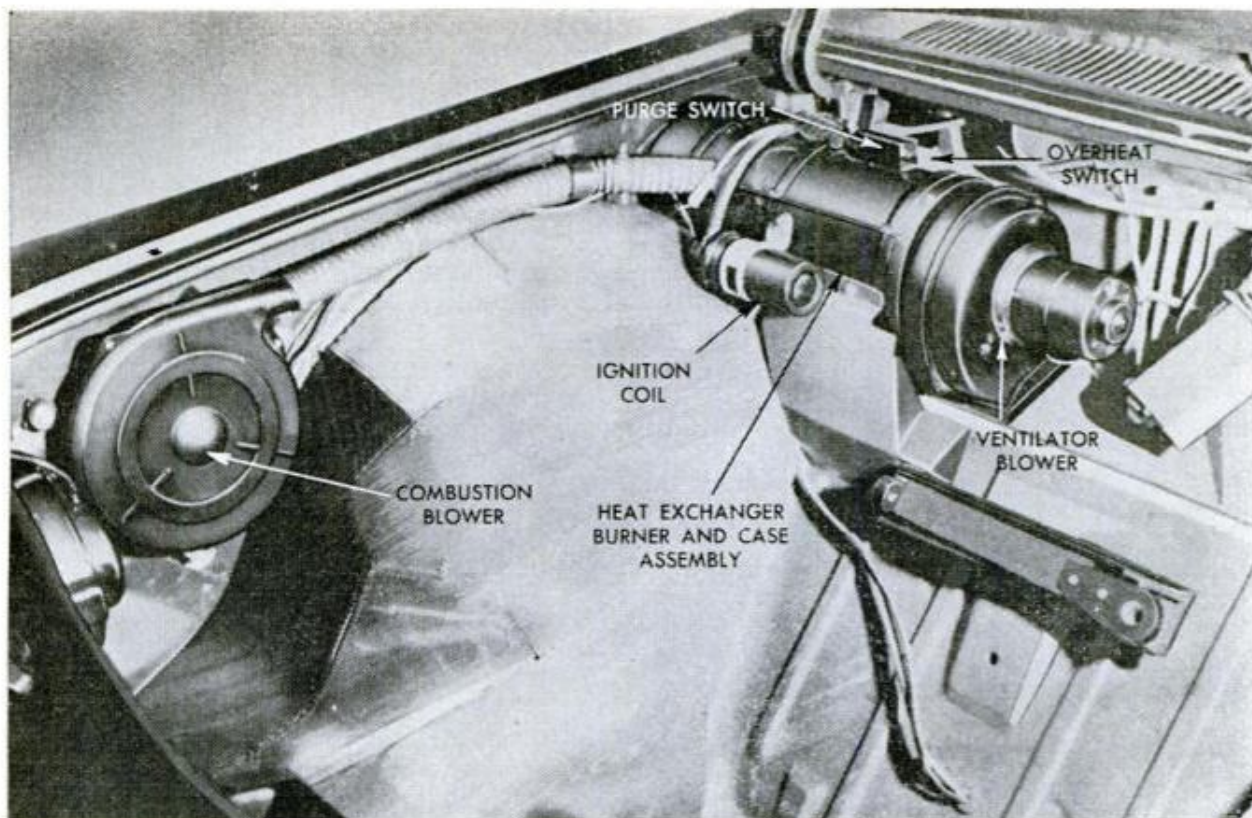

Photo above shows the components of the Corvair gas-fired heater, mounted in the front luggage compartment of the car. Their location offers plenty of elbow room and makes them easy to reach

er for a short time so that the combustion chamber is cleared of fuel fumes. When the temperature of the exchanger drops, the purge switch cools, and the blower automatically stops.

Once acquainted with the general construction and operating principles of the heater, it should not be difficult for you to spot the cause and cure of malfunctions which may occur. Following are a few of the parts and some of the more common ailments which may require attention.

If the heater fails to start, check for a blown fuse. Located under the left side of the car instrument panel, this 15-amp fuse

protects the entire heater system. In case the combustion blower does not run, check for broken wiring, motor failure, or a defective purge switch. There is also a separate ground lead attached to the heater motor which should be grounded tightly to the car body. If it is loose, the motor will run only at a reduced speed, if at all. Normal speed is 3000 r.p.m. at 12 volts.

If the preceding investigations reveal nothing, the heater's overheat switch may bear looking into. Mounted on top of the heater case, it is connected in series with the solenoid coil. Its bimetal blade opens the circuit to the coil if the air temperature

The spark plug's ground electrode must be given the proper ground if the plug is to fire with an adequate arc. A poorly grounded plug will allow a heavy deposit of carbon to form on the electrodes

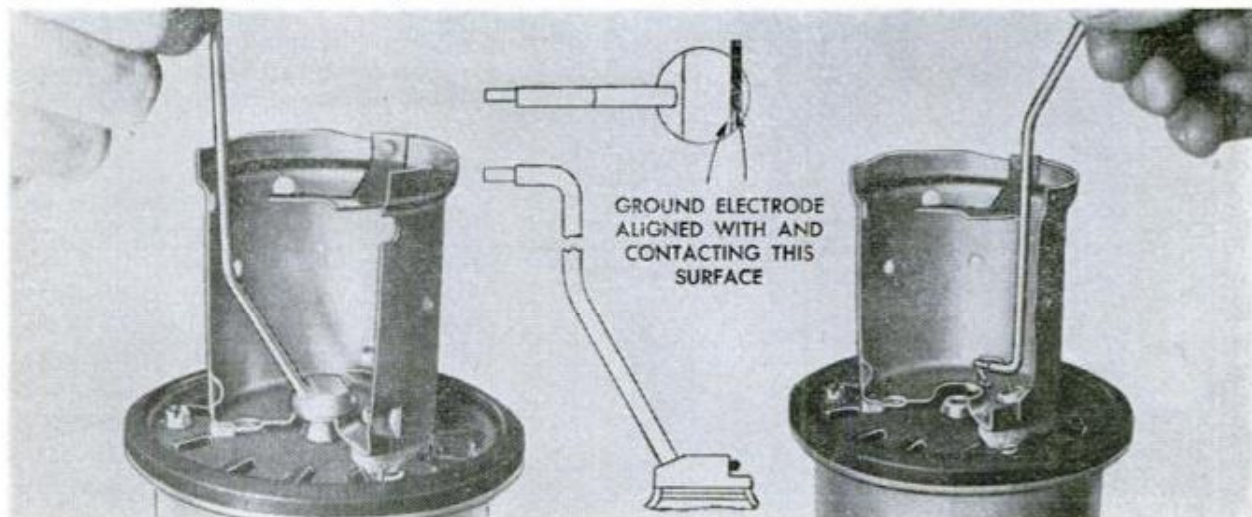

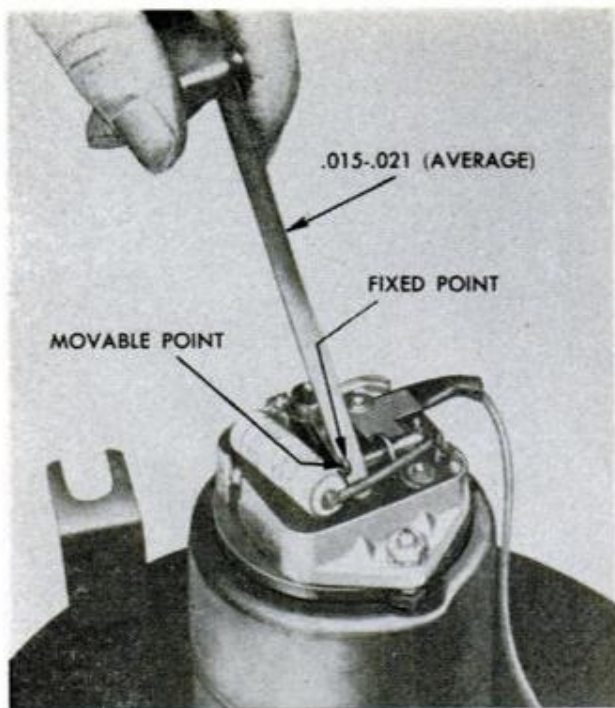

Proper setting of the breaker points in the heater ignition unit averages between .015 and .021 in.

risers excessively. This switch turns the heater off if the thermostat fails to do so and it may get stuck.

Backfiring or "popping" in the combustion chamber is a sure sign that there is something wrong with the ignition system. Check for burned or pitted breaker points or for a weak coil. The points should be set at .015 to .021 in. If the trouble does not seem to be electrical, the solenoid fuel valve may be stuck to its seat, in which case it should be cleaned, or replaced.

Notice that the heater spark plug is made with a single electrode. Its ground elec-

Here is an exploded view of the burner, heat exchanger, and other component parts of the heater

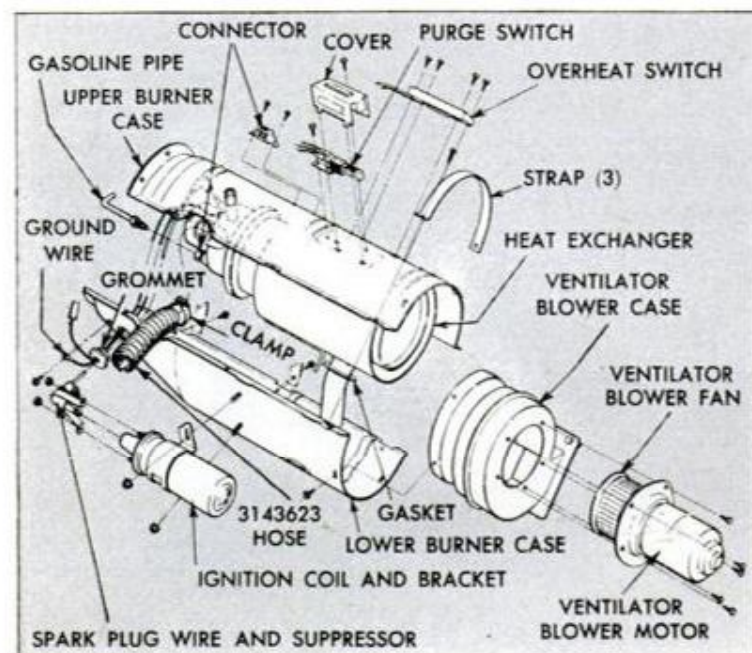

trode is welded to the fuel-mixer cup. It is most important that the welded ground electrode be correctly positioned or heavy carbon deposits will build up and foul the plug. Once the plug is cleaned, check its arc before reinstalling it. Gapped at .085 in. and properly grounded, a good plug will test with a steady, bluish arc.

If the heater fails to ignite but the combustion blower runs normally, check to see that the fan control lever is at High or Low position. Serious malfunctions are usually due to a defective thermostat or to the accumulation of carbon deposits in the combustion chamber. If this is not the cause, the hose connecting the blower to the combustion chamber may be loose, or there may be a leak in the fuel line where it connects to the heater. Since the heater is wholly dependent on the engine's fuel pump for its fuel pressure, a defective fuel pump will have an adverse effect on the operation and efficiency of the heater.

Burned gasoline odor is usually due to a loose burner clamp or a loose exhaust gasket. The gasket should be tightly seated between the flange of the heater case and the heat exchanger. In case of a clogged fuel system you will find that the fuel nozzle has a built-in screen which cannot be removed or replaced. If either should give you trouble, replace the entire nozzle unit.

If the combustion blower starts and then stops, something may be wrong with the purge switch. If no current is evident from the black terminal, replace the switch. But, lack of current from the blue and red terminals will require a complete check of the heater circuit. Erratic operation of the combustion blower is almost always the fault of the purge switch. When properly running, this switch will run the blower for up to two minutes after the ignition or the heater switch is turned off.

If no warm air is delivered, yet the rest of the heater seems to be working properly, check the air blower by turning on the fan and ignition switches. Air should be forced from the outlet. If it is not, check for a blown fuse, loose wiring, bad switch or a defective motor.

If the heat output is low, the thermostat unit may not be functioning correctly or a fuel line may be defective, or the engine fuel pump may not be delivering enough pressure. If the heater blows smoke, the air blower hose may be pinched or leaking, or the combustion blower may be running too slow. If not, check the purge switch again. ★ ★ ★

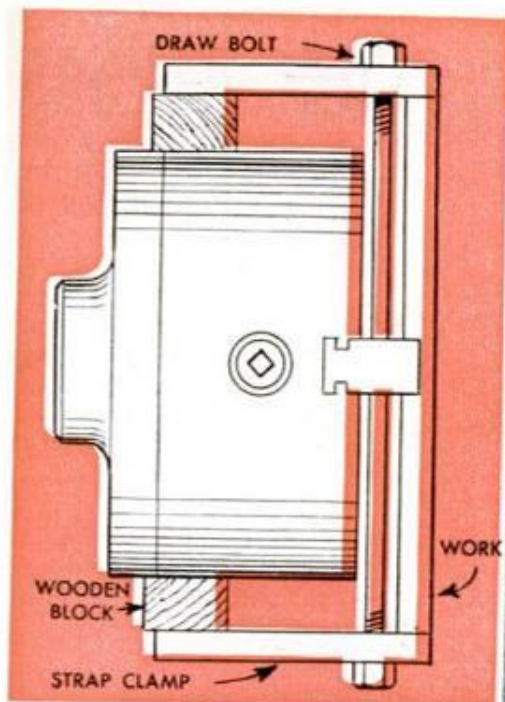

Increase Capacity Of Your Lathe With These **CHUCK-JAW EXTENSIONS**

By C. W. Woodson

WHAT TO DO when that rush job comes into the shop and the largest chuck in the place won't quite take it? One solution is to use a set of chuck-jaw extensions. Or, if the work is irregular in shape, you generally can utilize the chuck as a base on which to set up a strap-clamping arrangement something like that suggested in the detail above. In some cases one pair of chuck jaws can be removed and one pair and a clamp like that shown, or one similar in assembly, can be utilized to hold those outsized jobs. When the job has been set up it must be carefully checked for running balance and for clearance over the lathe carriage before starting the lathe and before machining. Jaw extensions A and B are designed to be slipped onto the standard jaws of a three or four-jaw chuck and can be bandsawed or milled to the general shapes indicated. They should fit the jaws snugly so that they will stay in place. Extension C has a squared opening to fit over the top projection of the jaw and is held in place with a screw as in detail D. In some instances drilling and tapping the chuck jaws may not be desirable or permissible. In this case the extension can be milled with a step, or offset, which locks over the jaw step.

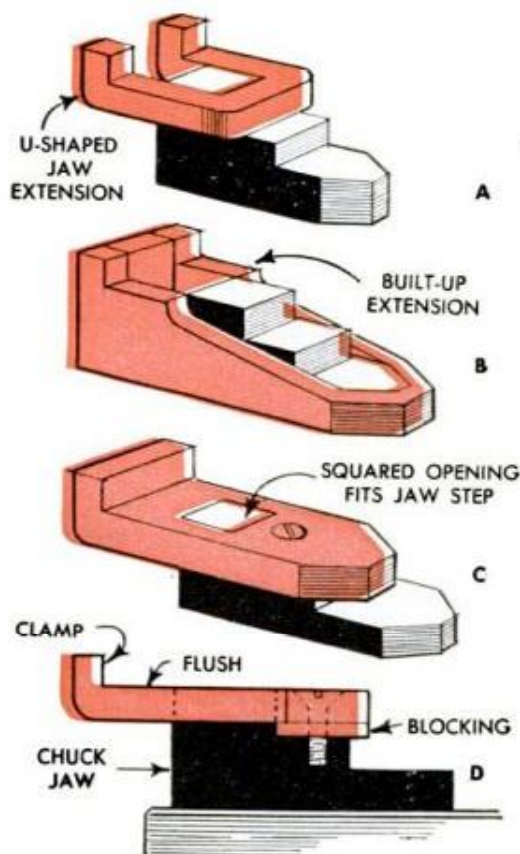

SHOPPING FOR TOOLS



1

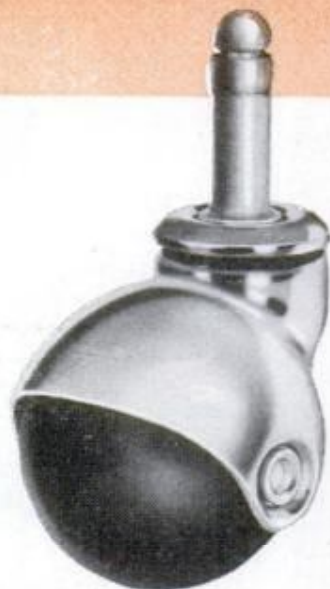

2

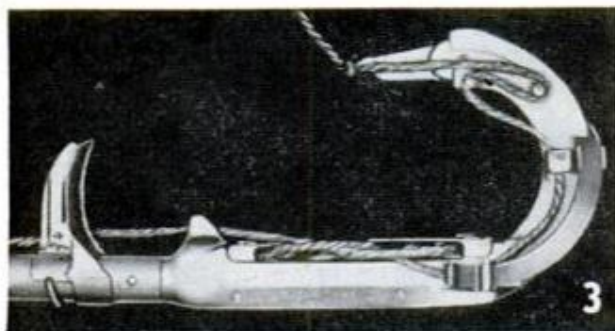

3



4

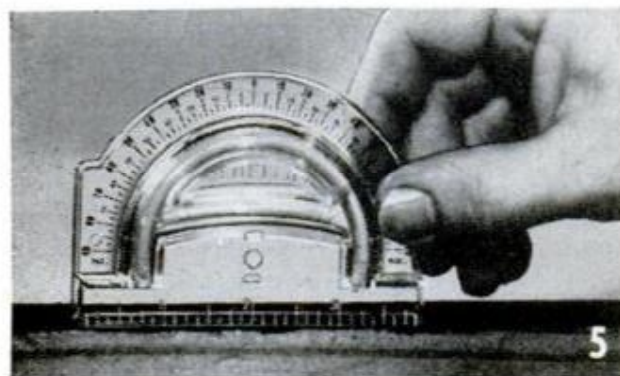

5

1. HAND-OPERATED SHEAR has a capacity of 16-ga. mild steel and takes a sheet 36 in. wide. Inclined ram combines eccentric-leverage action which greatly increases mechanical advantage and reduces shearing pressure. One-piece bed is a ribbed casting for maximum rigidity. Steel ram, housings resist deflection.
O'Neil-Irwin Mfg. Co., 779 Eighth Ave. Lake City, Minn.

2. SPHERICAL CASTER has wheel of non-marking, stain-resistant rubber. Wheel is 2 in. in diameter and is mounted in a wooden yoke which forms a guard for wheel and an offset mounting for stem which swivels on ball bearings. Caster is for office and home furniture and is available in brass and nicked finish.
Faultless Caster Corp., Evansville 7, Ind.

3. TREE-TYING MACHINE is widely used by orchardists to tie fruit-laden tree limbs so that they are self-supporting and do not require props to prevent breakage. Unit consists of a tying mechanism attached to an aluminum rod, or pole, which comes in lengths up to 25 ft. Unit is designed for one-man operation.
A-S-K Corp., 2200 4th St., Berkeley, Calif.

4. ELECTRICALLY DRIVEN CHAIN SAW weighs only 17½ lb., making it easy and safe to maneuver in dense undergrowth and treetops. Unit has 16-in. reach and a chain speed of over 2000 ft. per min. Motor delivers full 2 hp. at the chain, operates on 115-volt a.c. or d.c. or from portable generator.
Milwaukee Electric Tool Corp., West State St., Milwaukee 8, Wis.

5. ANGLE INDICATOR combines with spirit level. Place on inclined surface and read angle on semi-circular scale which houses a bubble traveling in a curved path. Use it for leveling picture frames, shelves, posts or tape it to a straightedge and use for leveling concrete forms. Use lower bubble for leveling.
Stegeman Specialty Mfg. Co., 18 E. Sixth St., Newport, Ky.

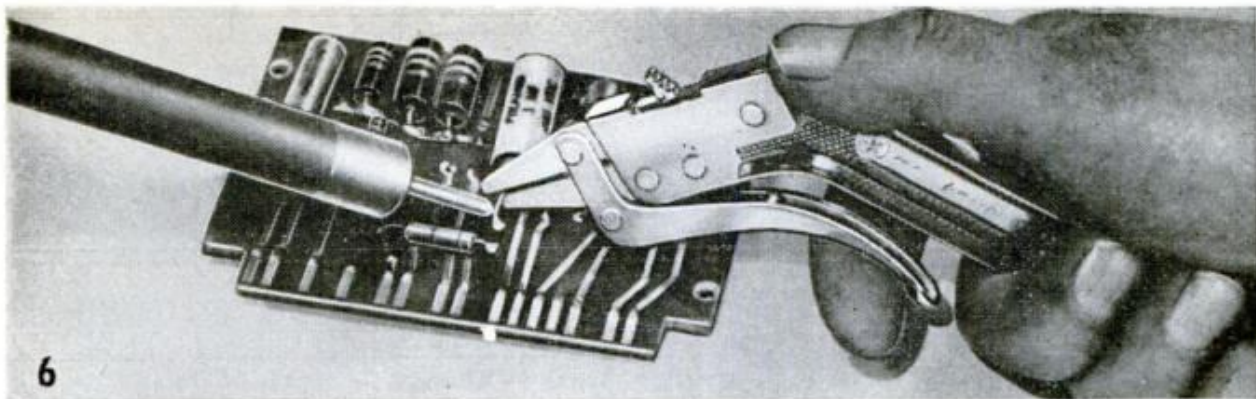

6. LOCKING PLIERS have cam-actuated jaws and pistol grip with lever-type trigger which gives delicate control when placing and holding small parts. Jaws are long and narrow to reach into hard-to-get-at places. Although designed primarily for electronics servicemen, pliers are useful to modelmakers

Handicraft Tools, Inc., Div. of X-ACTO Inc.,
48 Van Dam St., Long Island City 1, N.Y.

7. MACHINE-TOOL CLAMPING SET has a clamping range of $\frac{3}{8}$ to 11 in. Set includes U-clamps in two adjustable ranges, also extensions and a gooseneck adapter. Both the bolt and the heel-block assemblies are adjustable. The U-clamps can be used individually and with the extensions or gooseneck adapter

Hi-Lo Products Co., 8817 Lyndon Ave., Detroit 38, Mich.

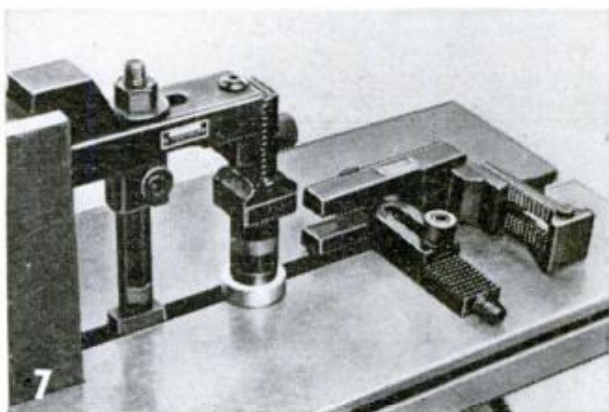

8. COMPOSITE PLASTIC SCREW with metal core has the insulating properties of plastic combined with the strength of metal. Use of screws of this type often permits elimination of costly parts from electrical assemblies. The screw consists of a serrated metal core carried in a threaded plastic body, or sleeve

Austin Screw Products Co., 4873 W. Armitage Ave.,
Chicago 39, Ill.

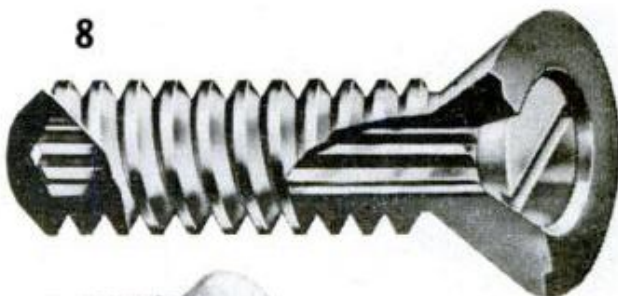

9. INTEGRAL METAL FORM speeds stair building. Form is nailed to wooden stringers and treads to complete a stair from basement to first floor, from first to second floor. Adaptable for use in building either open or closed-riser stairs. Provides 8-in. rise, 9-in. run

The Bilco Co., 37 Water St., New Haven 5, Conn.



10. HOLLOW-GROUND BLADE is specially toothed for cutting plywoods without splintering. The teeth are chromeplated to stay sharp. High backs of individual teeth reduce vibration which results in a rough-cut, splintered lower edge on stock. Available in standard sizes

H. K. Porter Co., Inc., Disston Div.,
Philadelphia 35, Pa.

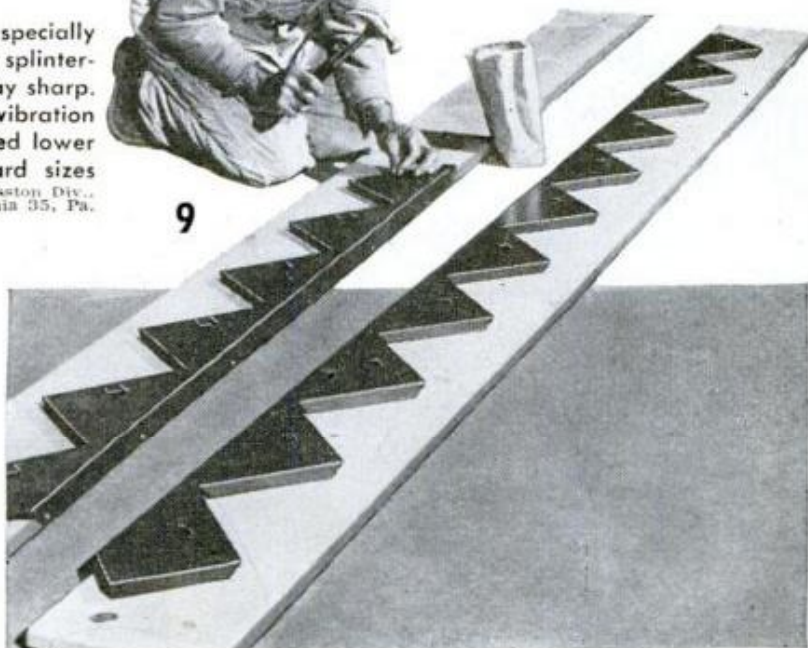

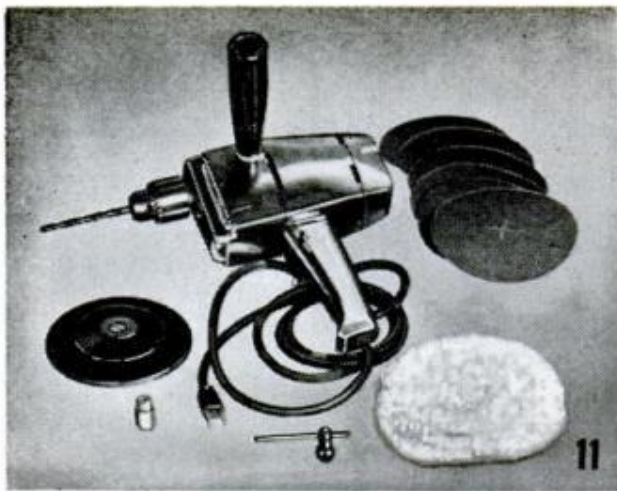

11

11. SANDER-POLISHER has two speeds, 2400 r.p.m. for fast, smooth sanding and 750 r.p.m. for high-grade polishing of finished surfaces. Unit also can be supplied with an accessory $\frac{3}{8}$ -in. drill chuck converting it into a high-low-speed drill for metal and wood. Changes in speeds are made by removing and inserting the driving head, or spindle, in either of two recesses in the gear housing. Unit is supplied as kit
Sears, Roebuck & Co., 925 S. Homan Ave., Chicago 7, Ill.



12

12. STONE-CUTTING SAW is powered by a 2-hp. totally enclosed motor, will make cuts up to 6 ft. long on material 3 in. thick. Uses 14-in. diamond blade or a 14-in. abrasive disk, depending on type of material to be cut. Rugged, precision built track carries rolling motor mount. Blade is entirely housed, except at cutting point, by a rigid guard. Fitted with water-feed control for wet cutting with abrasive
Cardinal Engineering Corp., Philadelphia 27, Pa.

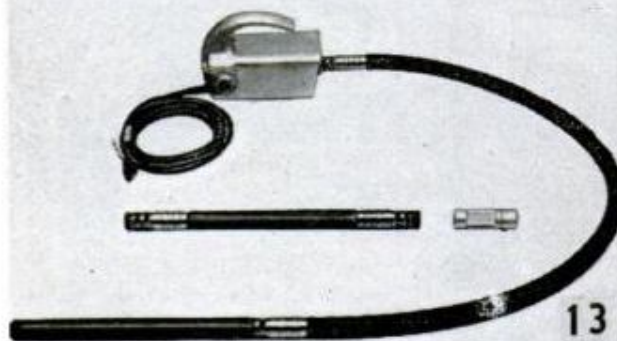

13

13. PENCIL-TYPE CONCRETE VIBRATOR has a vibrating head only $1\frac{1}{4}$ in. in diameter to get into narrow forms and also to work between closely spaced reinforcement. Head is driven by flexible shaft and is powered by 1-hp. universal motor which operates on either a.c. or d.c., 115 volt. Unit weighs only $23\frac{1}{2}$ lb. with 6-ft. shaft. Both 6 and 12-ft. shafts are available. Unit operates at 10,000 v.p.m. in low-slump concrete
Master Vibrator Co., 168 Stanley Ave., Dayton, Ohio



14

14. MAGNIFYING VIEWER features a multi-lens achromatic optical system for true-color inspection or assembly of tiny parts. Lens is 5 in. in diameter and provides 2X magnification. Can be used for long periods for binocular viewing without eye fatigue. Field of view is 14 in. in diameter and is lighted by 22-watt fluorescent lamp. Unit tilts, swings side to side and can be adjusted for most convenient height
EdnaLite Optical Co., Inc., Peekskill, N.Y.

15. FLAME-CUTTING duplicate parts of any ordinary length, width, or thickness is accomplished with this automatically controlled flame-cutting machine. Intricate parts are produced in duplicate simply by feeding pencil drawings of the part into a photoelectric tracing system. Width of kerf made by cutting jets is automatically compensated for, which results in duplicated parts that have exceptional uniformity
The Linde Co., Div. of Union Carbide Corp., 30 E. 42nd St., New York 17, N.Y.



15

Low-Priced Dodge Dart Features Revolutionary New Engine
**New Economy Slant "6" Uses
 Exclusive Semi-Ram Intake Manifold!**

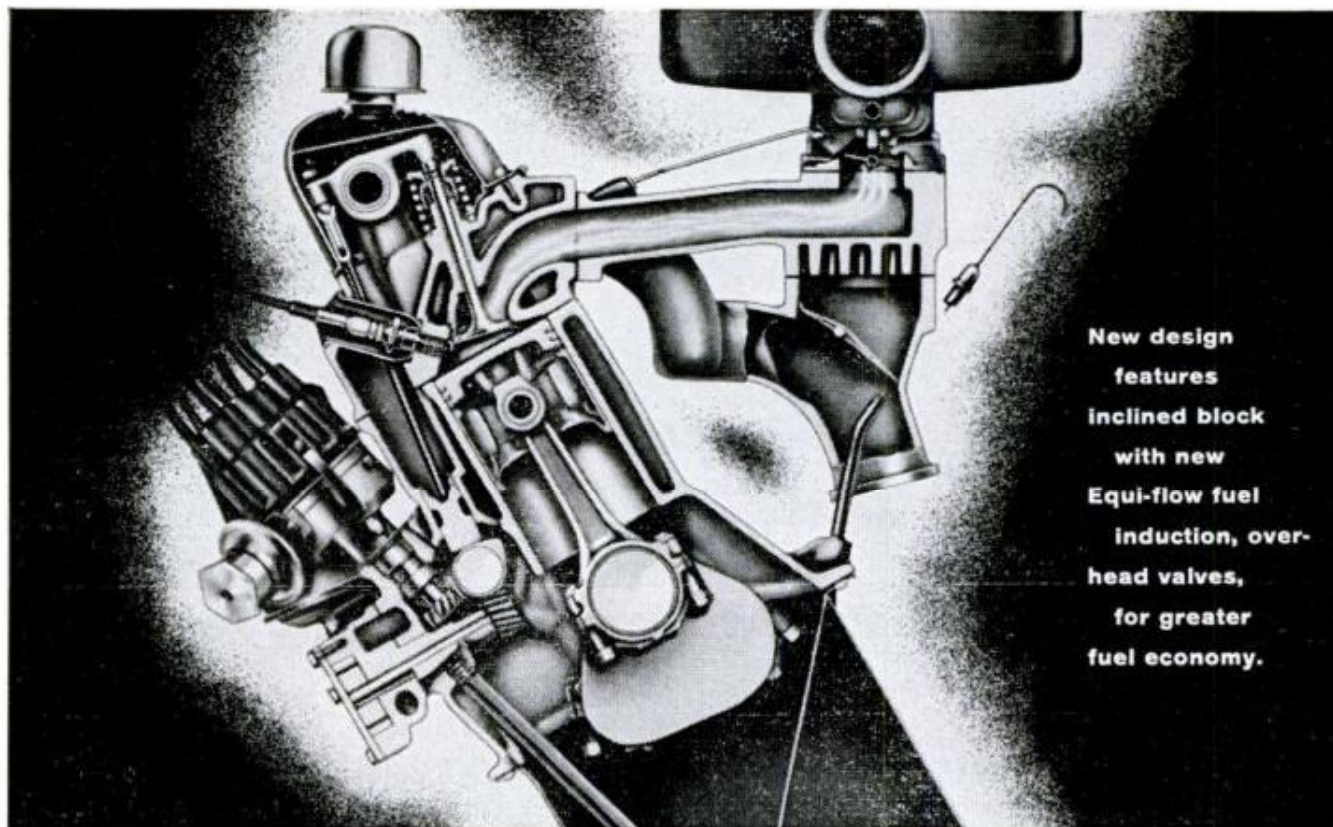

New design features inclined block with new Equi-flow fuel induction, overhead valves, for greater fuel economy.

Packing surprising performance with the kind of gas mileage usually found only in much smaller cars, this new Economy Slant "6" represents a major breakthrough in engine design. The 225 cu. in. block is angled 30° to the side to allow for special free-breathing intake and exhaust manifolds. High-turbulence

wedge-shaped combustion chamber and carefully selected 8.5 to 1 compression ratio deliver 145 h.p. at 4000 r.p.m., using regular gas. Special high-efficiency camshaft puts top torque right down in useful driving ranges. Output: 215 lb.-ft. at 2800 r.p.m. Uses new velvet-smooth Free-Flight Power engine mounting.

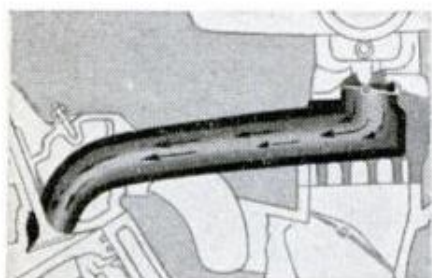

Special slant-block makes room for this new semi-ram intake manifold. Exclusive Equi-flow design provides more efficient, evenly balanced distribution of fuel to all cylinders.

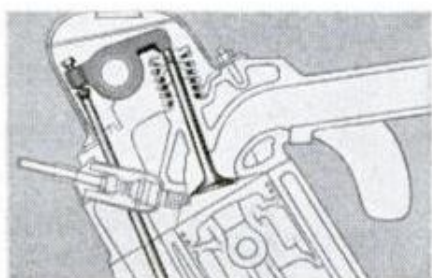

Big, overhead valves mean better breathing, better distribution of fuel mixture inside cylinders. More even burning means extra power and mileage from every gallon of gas.

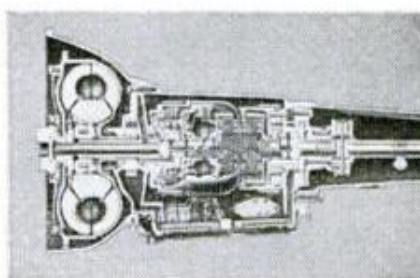

Special TorqueFlite Six is the first automatic transmission designed specifically to match the power-torque curve of a six-cylinder engine. (Optional at extra cost.)

AMERICA'S FIRST FINE ECONOMY CAR

DODGE DART



NOW DODGE BUILDS TWO GREAT CARS: DODGE DART • '60 DODGE

New Ideas in Photography

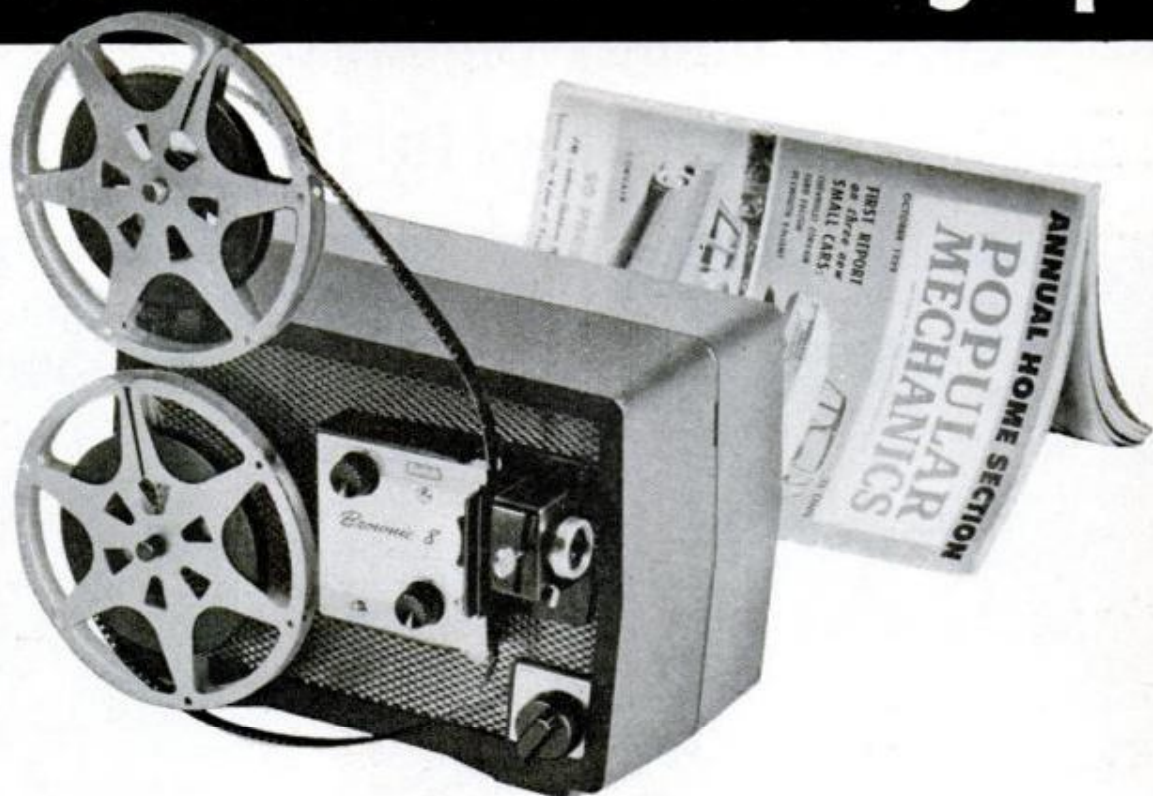

Now a Movie Projector as Small as This Page

—yet it shows beautiful movies a yard wide

Here's the latest word in compactness for 8mm home movies. The Brownie 8 Movie Projector stands only 9" by 6½" (this page size) by 6", and weighs only 5½ pounds.

But don't let its small size fool you. It performs big in every way.

At just 12 feet from your screen, this projector shows movies three feet across. The secret is a new-type lamp with its own non-

tarnishing, electronically prefocused reflector to assure maximum brilliance.

Loading is simple because there are no sprockets. You can actually thread the film while the projector is running. The projector accepts big 200-foot reels for full 15-minute shows. And it is blower-cooled.

It's worth a trip to your dealer to see the Brownie 8 Movie Projector in action. The price: only \$44.50, or as little as \$4.50 down.

Lens Automatically "Squints" in Sun, Opens in Shade Like Human Eye

Now Kodak has built an automatic 35mm camera that works much like your eye. It sees light and sets its own lens opening.

The "brain" in the Kodak Automatic 35 Camera is a photoelectric meter. Light reflected from your subject moves a control needle which determines the lens opening. The result: correctly exposed pictures time after time!

Change shutter speed, and an automatic switch adjusts the meter and lens response. If light is too dim even for the $f/2.8$ lens, an automatic signal

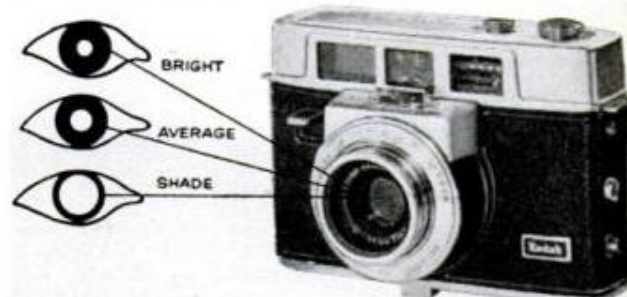

tells you to use flash. You don't even thread film—just drop it in!

Try for yourself all the swift, easy operating features of this camera . . . the single-stroke film advance . . . the click-stop "zone" focusing. Only \$84.50, or \$8.50 down.

from Kodak

Spots on Sun Filmed for Clues To Radio Disturbances on Earth

Film—in a giant 35mm tele-camera—is bringing astronomers new facts about how happenings on the sun affect us here on earth.

Sunspots cause interference in long-range radio communications. They are being studied through thousands of 35mm photographs of the surface of the sun—taken by a telescope-TV camera system. Kodak films designed for astronomical and professional movie work are being used.

To get the pictures, the radio-controlled photographic equipment was carried by balloon to an altitude of 80,000 feet. This eliminated the shimmer and poor visibility caused by the earth's atmosphere. As a result, the pictures are far more detailed than any ever obtained by even the most powerful ground telescopes.

And the most searching pictures were taken on Eastman Background-X Film, a close relative of the famous fine-grain Kodak Panatomic-X Film used by amateur and professional photographers.

Versatile Slide Projector Lets You Use Any of 3 Changer Systems

Mount and store your slides any way you want . . . choose any of three kinds of slide changers. This Kodak 300 Projector lets you build your color-slide collection without restrictions.

And it gives you great performance. The efficient lamp and condenser show both 35mm and super-slides brilliantly. The four-inch lens permits big-screen images even in small rooms.

A quiet, turbine-type blower pulls cool air in over your slides and around the lamp. Carrying handle is on the projector, not the cover, for extra safety. Cover snaps on—no extra carrying case to buy.

With Readymatic Changer and 4-inch lens, Kodak 300 Projector, \$64.50; Kodak 500 Projector with extra margin of brightness, \$74.50. Look at both before you choose.

Prices are list, include Federal Tax, and are subject to change without notice.

EASTMAN KODAK COMPANY, Rochester 4, N. Y.

SEE KODAK'S "THE ED SULLIVAN SHOW" AND "OZZIE AND HARRIET."

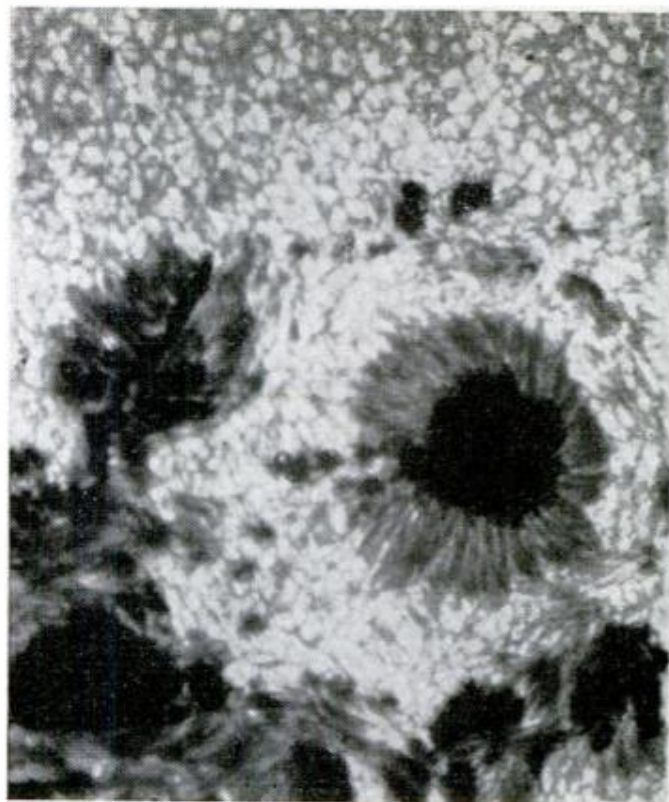

Pictures of sunspots reveal dark cores of relatively cool gases embedded in strong magnetic fields. Surrounding the cores are wispy filaments of outward-moving warmer gases. The sunspots shown here produced a magnetic storm on earth the day before the picture-taking flight.

Kodak 300 Projector

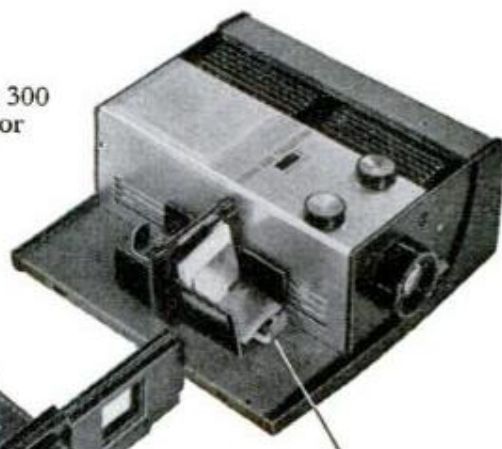

Kodak Readymatic Changer for cardboard mounts. Easy editing, stacking.

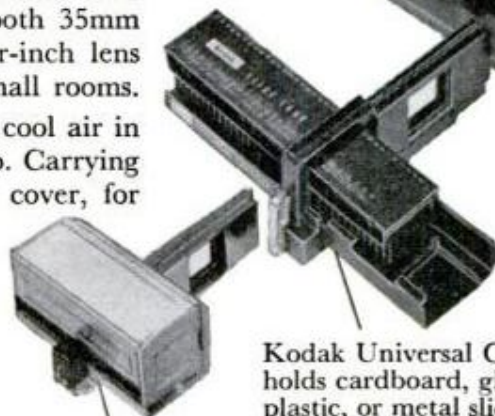

Kodak Universal Changer holds cardboard, glass, plastic, or metal slide mounts.

Automatic Magazine Changer. Metal frame. Takes cardboard mounts only. Allows indexing.

Kodak
TRADEMARK

New Dexall Wood Bleach

- Effective, fast-acting on wood-work, furniture, floors.
- Will not harm wood or natural grain.
- Nonflammable. Eliminates hours of sanding!

Modernize old-style wood finishes in easy minutes!



DESHLER PRODUCTS, INC.
Deshler, Ohio



"Wood in a tube"

New Dexall Wood Patch

- 6 popular wood colors. Ready to use.
- Fills holes, cracks, other defects in furniture and woodwork.
- Can be nailed, sanded, sawed, planed.

At paint and hardware stores everywhere.

Clinic for Homemakers

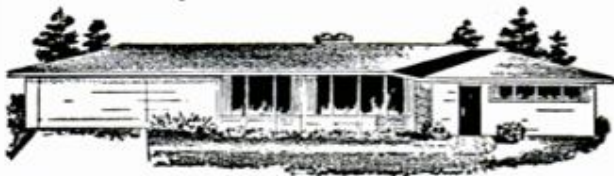

As a service to our readers in solving the hundreds of problems pertaining to a home—inside or out—the editors of *Popular Mechanics* invite you to present your problems to The Clinic Editor for help and advice. Address your questions to The Clinic Editor, *Popular Mechanics Magazine*, 200 East Ontario Street, Chicago 11, Ill.

Warped Table Leaf

Q—I have a drop-leaf table and one of the leaves is warped rather badly. I've been told to take the finish off and sponge water on the bare wood on the concave side, which is the top side. I tried this but it didn't work; the leaf is just as bad as ever, now the wood has dried out. I also tried cleats, but these bent to the curve of the leaf. Can the leaf be straightened? How?—H.R., Mich

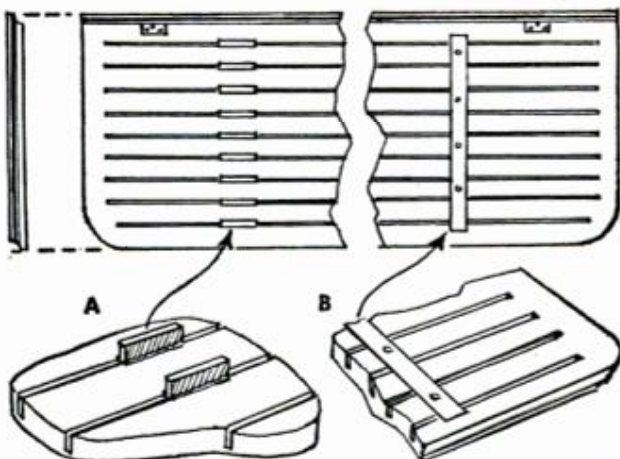

A—You are not likely to succeed with either of the methods you describe, although in some rare instances the first method you outline does prove successful if the concavity of the wood is only slight. However, success depends so largely on the grain characteristics of the individual piece of wood from which the leaf was made that the method is never reliable. Generally it is best to make a new leaf by gluing together several narrow strips of matching wood of selected grain and color. If you do not have equipment for this type of work have the job done by a cabinetmaker. But if for some reason you wish to utilize the original leaf the detail shows a method of straightening which is nearly always successful and permanent. Stopped saw kerfs are run on the back face of the leaf to approximately the depth indicated. The kerfs should be made to a uniform depth and spaced not more than 1 in. apart. Run the kerfs as close to the ends as possible but be careful not to cut through, especially if the ends are molded. Again, if you do not have equipment for this work it can be done by a cabinet shop. Once the piece has been kerfed as detailed, clamp it face down on a flat surface such as a bench or table top. Then cut a number of thin pieces, making them slightly wedge shaped so that they will fit easily into the saw kerfs, detail A. Glue the pieces in the kerfs in line as indicated, being careful not to press them in tightly to wedge the kerfs open. The purpose of these pieces is to hold the leaf in the flat position. Do not loosen the clamps until the glue is dry. Another method, detail B, is to cut a groove across the width to take a strip of hardwood. This is glued and screwed in place. The first method, detail A, generally is best on a narrow leaf.

(Continued to page 238)

POPULAR MECHANICS



REACH FOR THE
RED END

MADE ONLY BY

LUFKIN



Only the best wood rules merit this seal

If a carpenter catches you measuring something, he'll think you're a fellow professional (if you're using a Lufkin RED END rule).

This Lufkin X46, for example. It looks quality, with its natural finish and crisp, black graduations; or the 6" brass extension that makes inside

measuring so simple. It even *speaks* with authority . . . a decisive "snap" from gleaming joints and strike plates.

The X46 is only one of *four* Red Ends you'll find on the Lufkin Turnover Target—where you can select the exact rule that suits your needs. Reach for one at *your* hardware store.



always look for the
"LUFKIN" TARGET
where your hardware man
displays his finest
measuring tools.

Make Your Own Aluminum-Glass

SHOWER DOORS FOR UNDER \$35



with Reynolds DO-IT-YOURSELF ALUMINUM

Make your own attractive aluminum and glass shower doors. Pay under \$35 for materials. Same high quality doors that cost \$70 to \$80 (installed) in most retail outlets. Easy to make in hours with ordinary woodworking tools.



Write for free plans,
how-to literature
and check-list of over
40 fascinating
Reynolds Do-It-Yourself
Aluminum Projects.

Look for the Reynolds
DIYA display rack at
most hardware and build-
ing supply stores.

Reynolds Metals Co. • Richmond 18, Va.

Please send Reynolds Do-It-Yourself Alu-
minum How-To kit with FREE shower door
plans.

Name

Address

City Zone State

Dept. PM

(Continued from page 236)



Decorating Problem

Q—My home has 10-ft. ceilings in all downstairs rooms. The windows are tall and the sashes are narrow and curved at the top. The rooms are not large and the smaller rooms seem like a box, the same dimension in all directions. I've thought of installing a wainscot of horizontal boards or panels and covering the windows with half shutters instead of full-length shutters or drapes. Above the

wainscot the walls would be covered with a figured wallpaper. What is your opinion?—F.H., Wis.

A—Basically, you have the right idea. The refinements in the decorative scheme you have outlined would have to be determined by someone, possibly yourself, who could study the problem firsthand and outline a complete procedure. This we could not do at such long range, of course. If we can visualize the problem correctly from your brief description, we'd be rather doubtful about using a figured wallpaper above the wainscoting. It could be that some types of patterned wallpaper would work out satisfactorily, but it would seem that use of such a paper on all four walls of a room would tend to "bring the walls in", or possibly give a kind of two-dimensional effect which might be objectionable in some rooms. Also, we'd be inclined to favor drapes with wide valances rather than half-length shutters, especially in a rectangular room with tall windows at one end. Also, we would rather favor painted walls above the wainscot, at least as a trial in working out the final scheme. You can always paper over the paint, if paper seems more desirable. Much depends on the color used in the rooms. As a rule the lighter pastel shades work out better than the heavier solid colors on walls in rooms having high ceilings. If the exposed woodwork is in a dark natural wood, it usually is best to lighten it by refinishing or painting. By painting woodwork in the wall color, or only a few shades darker, the room generally can be made to appear larger. Sometimes use of a darker color on the ceiling will have the effect of lowering it.

Slab Floor

Q—This spring or summer I plan to build a summer home with a slab floor. The soil at the location is very sandy, but I'm told that there is a layer of heavy clay about 4 ft. below the surface. The slab will be about 20 x 28 ft. and there will be a separate footing for a fireplace at one end. I have been advised not to pour a slab floor but to support the structure on a conventional foundation with footings on



the clay. What do you advise?—L.A., Minn.

A—You can use slab-floor construction by supporting the slab on piers which extend down to the clay. Or you can pour foundation walls with footings on the clay, as you have been advised. However, this assumes that the clay is entirely stable. It's best to find out beforehand by taking borings, or samples, to determine the kind of clay and the thickness of the layer, or deposit. These samples should be taken by your contractor and evaluated before deciding whether to pour a slab floor or to erect the structure on foundation walls. Ordinarily such a procedure is not necessary but your letter implies that there has been some question about the stability of the top soil and subsoils at the building site and that is the reason the procedure has been recommended.



New

**HARLEY-DAVIDSON
DUO-GLIDE**

We've put this "show" on the road—the world's finest motorcycle made better than ever by the world's finest craftsmen.

Spectacular styling with gleaming new headlight nacelle of aluminum alloy. Flowing back from the nacelle, new twin-flare tank paneling adds dash to the famous Duo-Glide look. Spectacular new performance is the result of a host of new mechanical improvements . . . quieter engine, longer bearing life and faster starts.

Harley-Davidson

MOTOR CO.

MILWAUKEE 1, WISCONSIN

Perfect Mating of Man and Machine.

Your Harley-Davidson dealer is *pre-viewing* the new Duo-Glide now. He will show you the many other new features that make the Duo-Glide for '60 the greatest "road show" ever. Or mail the coupon for free, colorful folder.

HARLEY-DAVIDSON MOTOR CO.
DEPT. P, MILWAUKEE 1, WISCONSIN

Please send me new folder
on the Duo-Glide for '60

Name.....Age.....

Address.....

You can do more with

DELTA

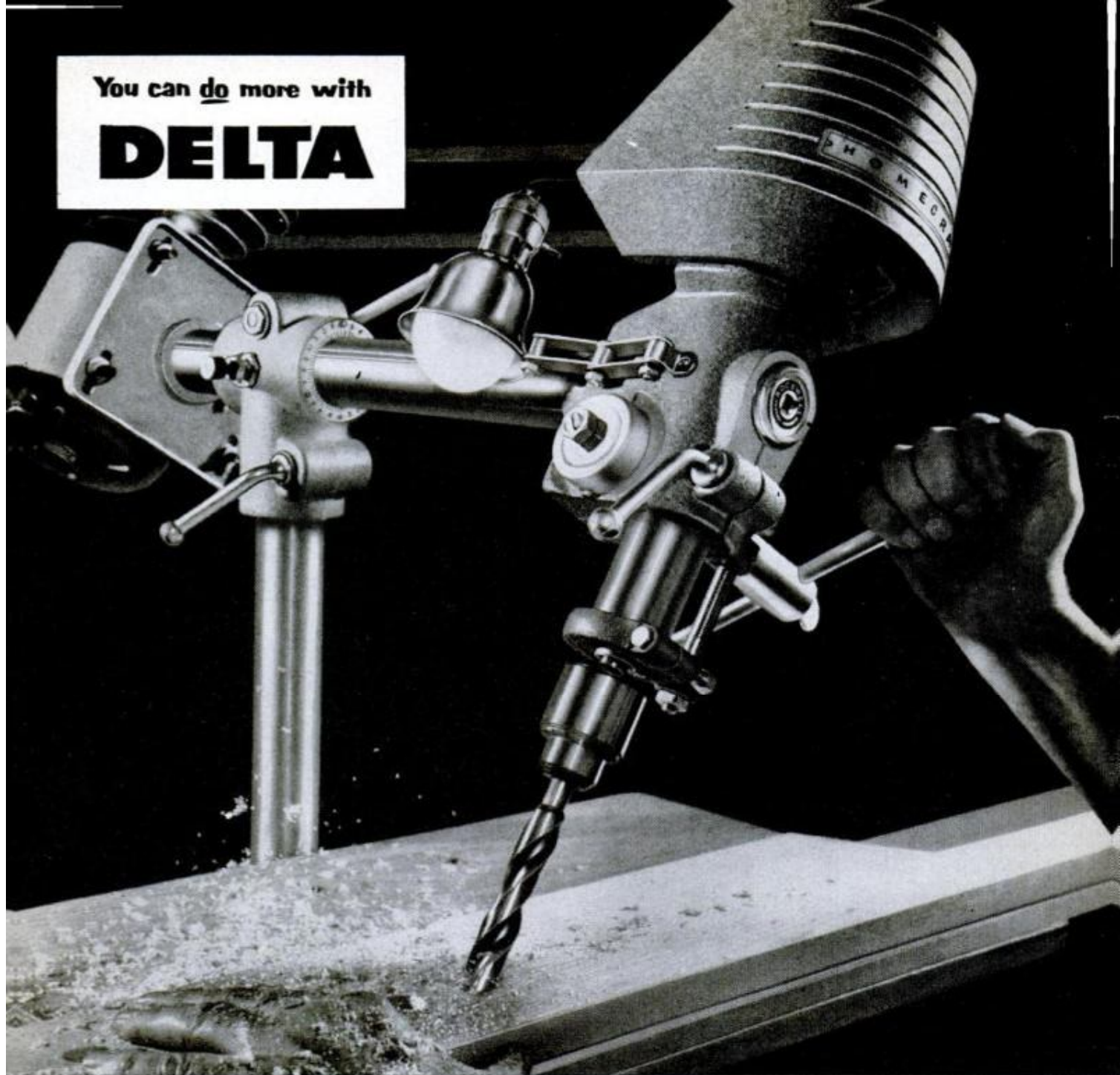

Angular drilling for the splayed legs on a coffee table is no problem with this tool because the angle of right or left tilt can be set by a calibrated scale and locked into position. Resetting head to vertical position is simplified by setting of the automatic stop into a milled groove.



Inlay routing in the center of a 30" x 40" project is possible because there is 16 $\frac{3}{8}$ " capacity between the column and the router bit. Use of the fastest of the four speeds available makes this a smooth operation. Controls are conveniently grouped "up front" for safe, positive action.



Spindle drilling on an extra long hand rail *does not* require a special fixture or jig because the head tilts. Big $\frac{3}{4}$ " x 23 $\frac{3}{4}$ " x 15 $\frac{1}{8}$ " table gives adequate support while remaining parallel to the base. Laminated wood work surface is mounted to a fully machined 8 $\frac{1}{2}$ " x 9" cast iron table.

New radial drill press

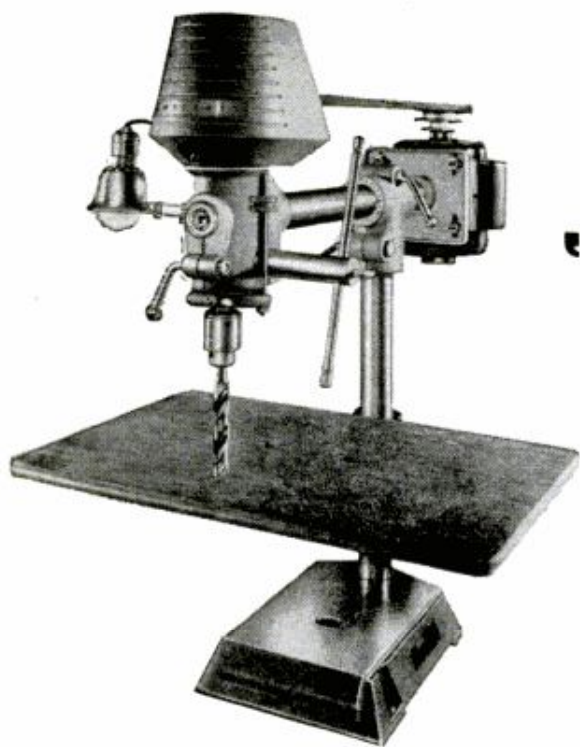

makes
"impossible" drilling
easy

DELTA 32" RADIAL DRILL—basic machine complete with $\frac{1}{2}$ " capacity geared chuck, belt and motor pulley.

Weight 85 lbs—only **\$89.50** (slightly higher in the West).

Here's just what you'd expect from Delta—a brand new radial drill—specifically designed to handle drilling jobs you *can't* do on a conventional drill press. There is almost no limit to the flexibility this tool puts at your fingertips—and you'll really appreciate the big capacity. The head swivels 360° around the column, tilts more than 90° left and right, travels almost a foot forward and back—yet the work always remains parallel with the base. You can drill to the center of a 32" circle, rout, sand, mortise, do dozens of operations at your choice of four speeds (700,1250,2400,4700 r.p.m.) on a wide variety of materials.

You can count on this tool to extend your skill, broaden your range of projects. And because you know tools, you know you can count on the precision, ruggedness and safety that Delta's 31 years of experience build into tools used throughout industry and in home workshops.

Consider the many ways you can do more jobs better, quicker and easier with the *newest* Delta tool—you'll want to see the Radial Drill in action! Visit your Delta Dealer (he's listed under "TOOLS" in the Yellow Pages) or your leading Department, Hardware or Building Supply Store. Do it soon!



See the world's most complete line of home workshop power tools and accessories—pictured and described in this colorful, FREE Homecraft catalog. Write to: Rockwell Manufacturing Company, Delta Power Tool Division, 502B N. Lexington Ave., Pittsburgh 8, Pa. In Canada: Rockwell Manufacturing Company of Canada, Ltd., Guelph, Ontario.

DELTA POWER TOOLS

another fine product by

ROCKWELL



You can...

PICK UP A HUMAN HAIR

with these
precision-machined points



Specially
Designed

CHANNEL LOCK
®

No. 738 Long-reach Round-Nose Plier

A precision gripping tool for precision work . . . the CHANNELLOCK No. 738 Round-Nose Plier. Gives you a long slim, firm grip in tight places you can't reach with other pliers. Hundreds of uses on electrical, radio, TV, Hi-Fi and all other types of electronic work. Comfortable, blue-plastic grips. Top quality, polished forged steel. Ask your tool supplier for a CHANNELLOCK No. 738 Round-Nose Plier. If he's out of them, ask him to order one for you.



Write for Catalog of
Complete Line of Pliers

CHAMPION DEARMENT TOOL COMPANY
Meadville 1, Pennsylvania

PM Houseboat

(Continued from page 199)

and extends from frame 4 to frame 6. In studying Fig. 39, you will see that it consists of a framework screwed to the floor and wall, after which it is covered with 1/4-in. plywood. Lip-front drawers, 20 in. deep, are fitted in each bench to ride on regular drawer runners, and hinged access lids installed in each bench top make full use of the storage area under the benches. As with the other cushions, 3/8-in. mahogany retaining strips keep them in place. Only the after bench is fitted with a back cushion. The latter, incidentally, rests against a plywood bulkhead which is later erected and butted against the bench.

The table part of the unit is detailed in Fig. 41. Table fasteners, consisting of L-brackets fitted with thumb screws, are used to anchor the table and its hinged leg. A cleat fastened to the cabin side at the top of the coaming member, provides a screwing surface for the fastener hardware for the table top, where, as in the case of the leg, they are screwed directly to the raised floor between the benches. The leg is hinged to a drawer compartment attached to the underside of the table top. Note that a heel lock on the underside of the drawer keeps the latter from working out. To open the drawer, wide notches in the drawer sides permit it to be lifted up and over the rail. The top surface of the table is covered with plastic laminate.

Fig. 40 shows how the two companion-way ladders are made. Special locking hardware screwed to the ladder rails and to the coaming members, allows the ladders to be unhooked and removed. This is necessary in the case of the forward ladder when the berth board is used to increase sleeping facilities. The ladder treads are fitted with rubber step plates.

(Continued next month)

Do You Know This Old-Timer?

(answer to quiz, page 16)

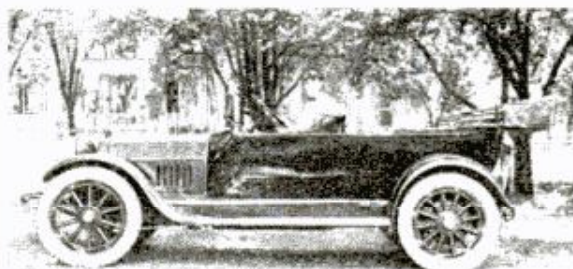

1914 Chalmers



THESE ARE SOME OF THE NUTS AND BOLTS AND SCREWS THAT WERE NOT PUT INTO THE BODY AND FRAME OF THE 1960 PLYMOUTH.

They just can't loosen and rattle because they're not there. The Solid 1960 Plymouth's new Dura-Quiet Unibody is welded around 5400 times.

Ordinary unit body construction isn't particularly new. But *this* kind is!

Chrysler Corporation pioneered unit building in 1934 and turned out the first welded-unit American passenger cars. Later, the method was adapted by other manufacturers. But there were problems, in the way of noise and vibration, and chance of rust and corrosion.

Chrysler engineers kept the idea under study. To it, they applied the biggest digital electronic computer program in the auto business. They used methods developed in the building of space missiles. They built an "electronic highway" to simulate all kinds of road conditions.

The outcome is a new kind of car body—quieter, tighter, more solid than any you have known. With more room inside. Doors and windows that fit tightly. And a noticeably steadier ride, combined with easier, brisker handling.

Unibody Plymouth is made to *stay* quiet and solid for an unusually long time. Corrosion is licked for years to come by the greatest protective treatment ever given an American car. This Plymouth is, we believe, the best-built, best-performing car in the low-price class. Try it!



Body and frame are welded as one unit with Dura-Quiet Unibody construction.

SOLID PLYMOUTH 1960

A Chrysler-engineered product, built a new solid way to give you solid satisfaction.

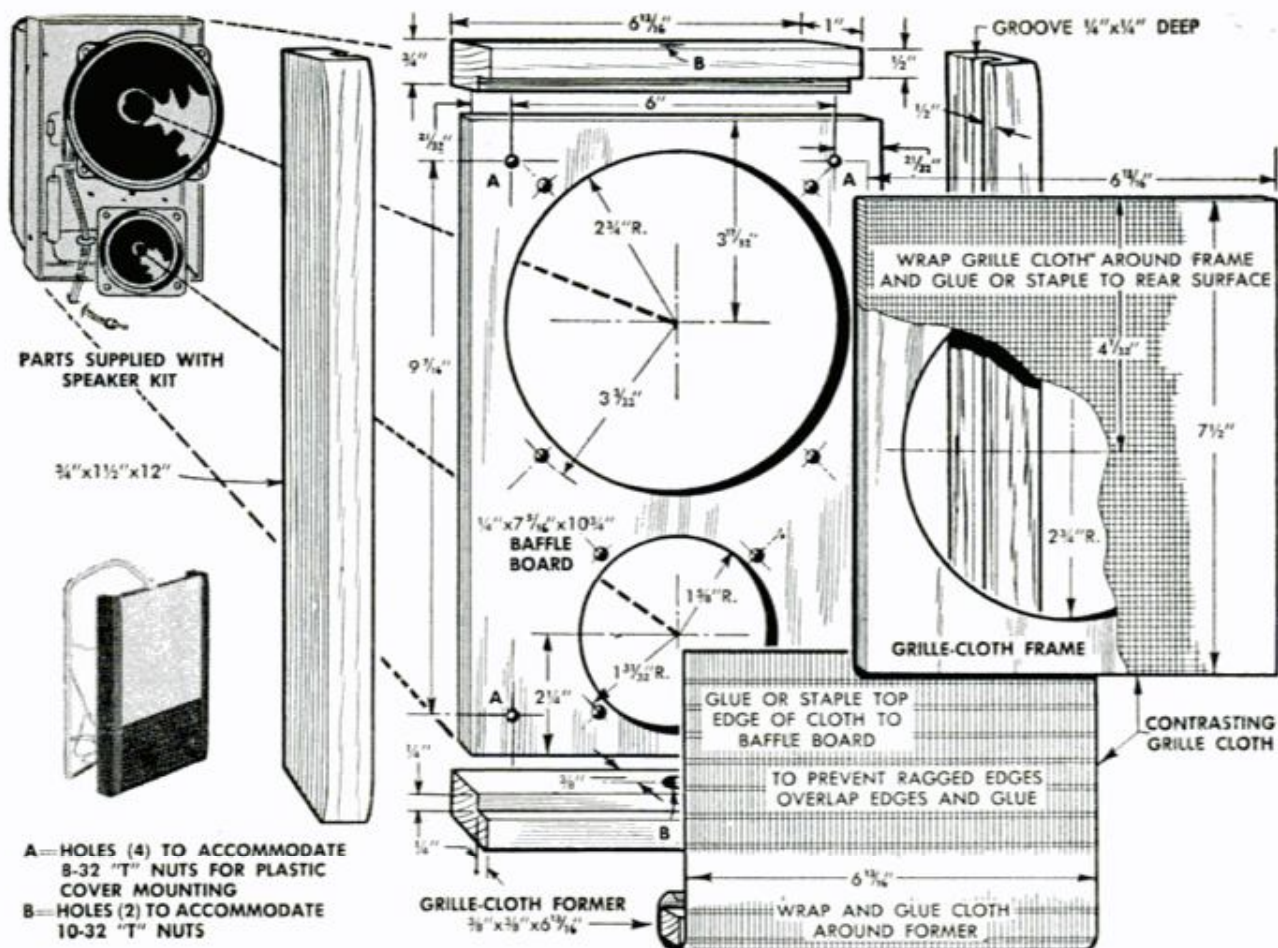

Construction details for Jensen Galaxy II "satellite" enclosures. All parts other than lumber and grille cloth are supplied with Galaxy II stereo speaker kit which also includes wiring instructions of "crossovers"

(Continued from page 177)

in. dual voice-coil woofer handles the bass tones from both stereo channels, up to 1000 cycles. Frequencies from 350 to about 14,000 cycles from each stereo-amplifier channel are handled separately by the left and right satellites. As a result of the overlap in the 350 to 1000-cycle region, the bass speaker provides a degree of center-channel fill which greatly increases stereo flexibility. Even with the satellites separated by as much as 20 feet, there is little evidence of "the hole in the middle" or the "ping-pong effect" so often associated with widely spaced conventional speakers.

The Galaxy II is not inexpensive. Commercially assembled and ready to play, it costs \$170, though you can shave this price by about one-third by buying the KTG-2 speaker kit (price, \$92.50) and building the cabinets yourself. The kit is supplied with all speakers, plus the necessary electrical parts and hard-to-make items of hardware, for duplicating the factory-made unit. The only extras you need are the lumber, grille cloth, acoustical padding, and the time required for building the housings. And, due to the small size of even the center cabinet, construction as shown in the diagrams is relatively simple.

The electrical crossover network supplied with the Jensen kit is essentially pre-wired. The only wiring left for the builder are four leads from the network to the two voice coils of the woofer, and a couple of small parts and wires in each of the satellites. But there is one optional addition which may, in some cases, improve the performance of the system. This addition consists of a separate level control for each of the two satellites.

Although the speaker complement of the Galaxy II is well matched, some listeners may find the resultant sound a bit too "brilliant" for their personal taste—particularly in a very "live" listening area. Tone controls could be used to compensate for this effect, but only at the expense of some of the higher frequencies. The addition of the level controls would permit individual adjustment of the satellite outputs for the most pleasing balance under virtually any condition.

(The wiring diagram supplied with the Jensen speaker kit clearly shows all the necessary connections, but does not provide for the addition of level controls. Anyone building this kit who wishes to make these optional additions can obtain a revised dia-

(Continued to page 246)

Build a Liberty Home Yourself WITH NO FINANCING PROBLEMS

SAVE AS MUCH AS
\$5000

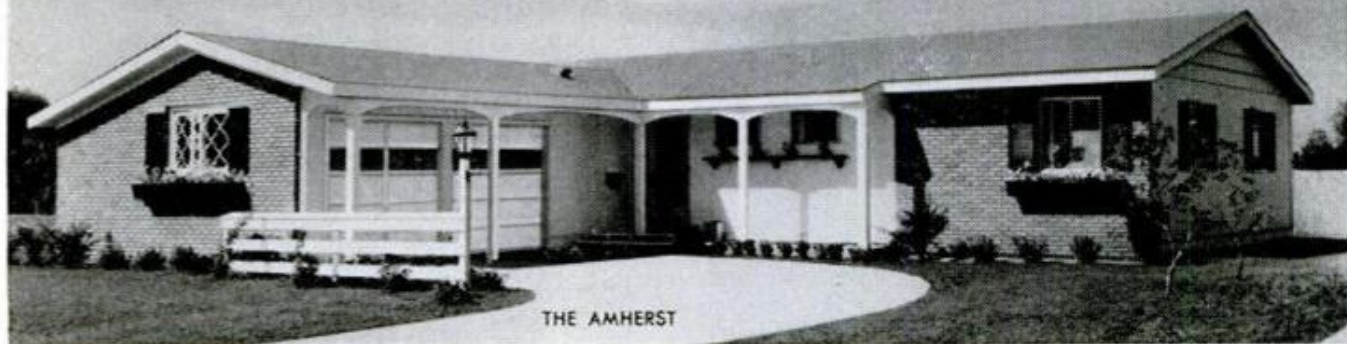

THE AMHERST

IF YOU CAN DRIVE A NAIL, YOU CAN BUILD A Liberty HOME!

Beat high building costs . . . and have an outstanding home, too. The revolutionary, new Liberty Ready-Cut method gives you a beautifully designed home . . . EASY TO ASSEMBLE . . . at unbelievably low cost. Everything is precision cut for exact fit . . . saving days of costly labor. You receive all framing and finish lumber, assembled windows, pre-fit mortised doors, oak flooring, insulation, self-sealing roof shingles, nails, paints, hardware, plus complete building plans and instructions.



THE MANCHESTER

ONLY WITH A Liberty Ready-Cut Home CAN YOU GET ALL THESE EXCLUSIVE BUILDING SERVICES

UNCONDITIONAL GUARANTEE—Your Liberty Home is covered by an unconditional guarantee for quality, quantity and soundness of construction.

FINANCING NO PROBLEM—Liberty Homes are approved by Banks and Savings and Loan Associations everywhere. Acceptable for FHA and VA financing.

SOLD DIRECT TO YOU—Liberty has no salesmen. You buy direct and save sales commissions. You make your own decision without high pressure tactics of any kind.

78 DESIGNS—For 1960 Liberty offers the most beautifully designed homes in America today with unlimited floor plan variations to fit your specific needs.

LIKE TO VISIT A LIBERTY HOME?

Over 25,000 Liberty owners are thrilled with their homes—and there is one near you . . . just ask us for the address.

- **SAVE \$5000**—You save on material cost, labor cost, contracting fees. You eliminate all middleman's profits, architect's fees and costly material waste.

- **100% QUALITY**—Only materials of unquestioned quality are used. All lumber is kiln-dried. Your home will last a lifetime.

- **FREE CONSULTATION**—The Liberty way is the foolproof way. However, if a problem of any kind arises during construction, Liberty's building consultants are ready to help you day or night without obligation.

Priced from \$3700 . . . Freight Prepaid



FIND OUT ABOUT THE MOST SENSATIONAL HOME BUILDING OPPORTUNITY IN AMERICA TODAY

Clip this coupon. Mail it with 25c for your **BIG** full-color catalog.

Mail to LIBERTY HOMES
1202 Lafayette Avenue, Bay City, Michigan

NAME _____
ADDRESS or RFD _____
CITY _____ ZONE _____ STATE _____

CRESCENT ADJUSTABLE WRENCHES



Crescent offers unequalled value, performance and selection in Adjustable Wrenches. Choose CRESTOLOY for greatest strength and finest finish in 4" to 24" sizes, single and double end patterns; CRESCENT for toughness and durability at lesser cost in 4" to 18" sizes. Also insulated handles on the 12" CRESTOLOY. See CRESTOLOCK, the new locking adjustable wrench.

Sold by hardware dealers everywhere.

CRESCENT TOOLS

Give Wings to Work



Crescent is our trade-mark, registered in the United States and abroad, for wrenches and other tools. Sold by leading distributors and retailers everywhere and made only by

CRESCENT TOOL COMPANY, JAMESTOWN, N. Y.

Selecting Your Speaker System

(Continued from page 244)

gram by sending a stamped, self-addressed envelope to the Popular Mechanics Radio Dept.)

The woofer of the Galaxy II may be installed in a compartment of the equipment cabinet described in last month's article without changing the external appearance of the cabinet itself. In this application, holes for the speaker and vent tube are made in the bottom of the cabinet so that these units face the floor. The openings should be covered with grille cloth for protective purposes.

Rigidity is the keynote for any well-constructed speaker enclosure. If the speaker is mounted in the equipment cabinet, the original compartment drop-door must be permanently fastened to the front of the cabinet, backed up by 3/4-in. wood cleats. Similar cleats should be glued and screwed to all inside corners of the enclosure.

The original 1/4-in. plywood back no longer serves as the back panel of the speaker enclosure. For the rear of this compartment, a 3/4-in. plywood back should be used. The back should be cut to fit snugly inside the compartment and screwed to carefully installed wood cleats in a manner similar to that shown for the BASS-SUPERFLEX enclosure on page 177.

To compensate for the difference in volume between this compartment and the separate enclosure, the vent tube supplied with the Galaxy kit must be shortened. Jensen engineers have calculated that best results will be achieved with a tube length of 2 1/2 inches.

Mounting of the speaker in the same cabinet with the record player and other electronic components is recommended only where space problems prevent the use of a separate enclosure. Vibrations, even in a well-built speaker enclosure, could adversely affect the performance of other components in the same cabinet at very high volume levels. Should this occur, some extra care in shock-mounting the record player and preamplifier will usually correct the difficulty.

Summary

There's no such thing as an absolute criterion for true high fidelity. Loud-speakers, even the very best of them, can have entirely different "voices," and only a listening-comparison test can tell you which one is best for you. But price is usually a fair indication of speaker quality and, if a listening test is impractical, a generous portion of your total hi-fi budget should be apportioned to the speaker system.

The enclosure is an integral part of any

speaker system. Unless you have facilities for comparing a given speaker in a number of different enclosure designs, you'd be wise in following the speaker manufacturer's suggestions in buying or building a suitable speaker cabinet.

Size is no longer a good indication of quality, but a small enclosure requires special, high-compliance speakers capable of large, linear cone excursions, and the enclosure design may be quite critical. Don't try to place a conventional speaker in a miniature enclosure and expect good bass response.

If your budget is limited, remember that the performance of many systems can be improved with add-on components. Select an enclosure which will permit eventual mounting of additional speakers and pick your original speaker on the basis of good low-frequency response rather than extended highs. It'll make a good deal of difference in the long run.

Finally, whatever speaker system you buy, try it out in various locations in your listening room. Often the placement of a speaker against a different wall, or in a corner, can make the difference between just good sound and superb high fidelity.

Next Month: *How to Select Your Stereo Amplifier.*

This Month's "Great Pioneer in Science"

(Page 20)

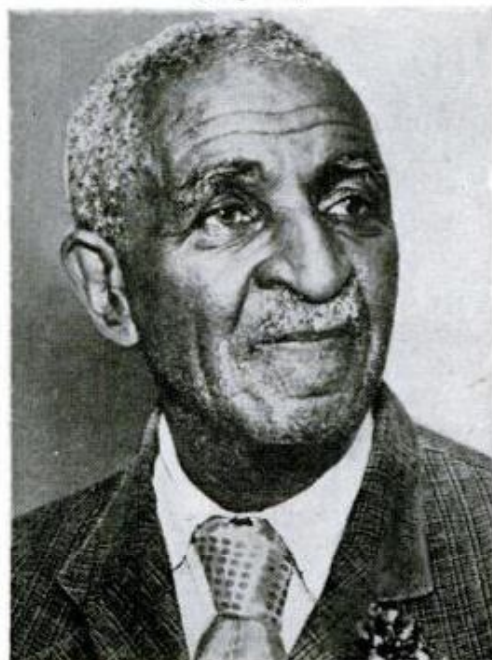

George Carver (1864-1943)



BUILD THE BEST!

build quality money-saving

knight-kits®

A PRODUCT OF ALLIED RADIO

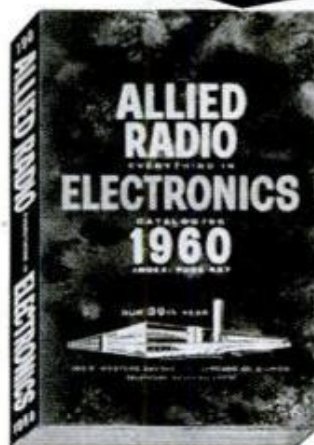

see them all in
ALLIED'S
1960 ELECTRONIC
SUPPLY CATALOG

FREE

build your own...
it's easy...it's fun!
SAVE UP TO 50%



world's
largest
stocks



EASIEST TERMS
only \$2 down on
orders up to \$50

FREE
catalog

See the 1960 KNIGHT-KIT line—available only from ALLIED. KNIGHT-KITS are lowest in cost, convenience-engineered for easiest assembly—the only kits with money-back guaranteed specifications. Send today for the 1960 ALLIED Catalog—select your KNIGHT-KITS—and...

**SAVE ON EVERYTHING
IN ELECTRONICS**

Get more for your money in Stereo hi-fi systems and components; save on recorders and tape; Amateur station equipment; TV tubes, antennas, accessories; test instruments; electronic parts, tubes, transistors, tools, books. Send today for your **FREE 1960 ALLIED Catalog!**

ALLIED RADIO

100 N. Western Ave., Dept. 24-B, Chicago 80, Ill.

Rush **FREE** 1960 ALLIED Catalog

Name _____

Address _____

City _____ Zone _____ State _____



SUPREME VERSAMATE

Versamate . . . a wonderful tool that fits any power drill —reduces speed to give seven times more power. Drives screws of all sizes. Inexpensive extras make it a nut and bolt driver, heavy-duty drilling unit. See your tool dealer today!



\$9.95

For Portable Drill Users...

CHOOSE THE ATTACHMENTS THAT DO THE BIG JOBS!



\$14.95

Versamatic triples portable drill usefulness. *Reverses!* Drives and removes screws, nuts, bolts. Boosts power 7 times. Set includes regular and Phillips-type bits, and 1/4" square drive adapter. For heaviest drilling jobs in steel and concrete, add a 1/2" Supreme Brand Chuck.

SUPREME VERSAMATIC

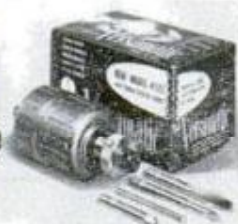

SUPREME PRODUCTS
CORPORATION
2222 S. Calumet, Chicago 16
Div. of A • S • R Products Corp.

This Makes the Torpedo Child's Play

(Continued from page 132)

experimental shot like that right beside a dock," Comdr. Wallace recalls. "A local reporter heard the launching explosion, turned and saw the ship listing, and clouds of 'smoke' pouring from the hole in the deck. So he promptly turned in an alarm and told the yard we had exploded and were sinking. There was great confusion around here for a while."

What would happen if a live missile malfunctioned or did accidentally fire in the tube? It would probably just launch itself, even with the lid dogged down, King points out. "The tube hatch covers are of soft iron that will blow out at 25 pounds pressure," he reveals. "So the missile can be 'dumped' right through them if anything goes wrong."

Fifty Cameras

In some ways, the maze of systems for testing and evaluating this tricky missile, are more complex on the *Observation Island* than they will be on the A-subs. For one thing, her decks are studded with grotesque mounts for more than 50 cameras that take still and motion pictures of every instant of every launch. One 16 mm. movie camera shoots 1600 frames per second to pin down the velocity of the slug as it leaves the tube! Batteries of TV cameras are remotely controlled from below at the instrumentation operations station, by technicians who point them this way or that by means of joy-sticks adjacent to monitor screens. "Those TV cameras have embarrassed people," says Wallace. "Several times, before a shoot, we've caught sailors sleeping on the launching deck. You can even read the numbers on their shirts."

Down in the spaces below decks, more than 70 seven-foot-high racks of electronic and electro-mechanical equipment perform in seconds the staggering number of calculations necessary to launch one Polaris.

One of the big problems facing an FBM submarine skipper will be to know, with pinpoint precision, exactly where he is before he can fire one of his birds with any hope of accuracy.

The systems that do this job would curl your hair. A Sperry navigational device called SINS (Ship Inertial Navigation System), involving an array of gyroscopes and accelerometers, records every movement of the ship as it slips through the water. This information pours into an electronic brain, called a navigational data computer (NAVDAC), where the assem-

(Continued to page 250)

BUY **GRAVELY** FOR

MORE PERFORMANCE

MORE POWER

MORE FOR YOUR MONEY



Why plow with equipment you have to push, pull and help? Gravelly and its Rotary Plow attachment tills a perfect seedbed in *one operation*—all you do is guide it!

Gravelly does the tough jobs other tractors can't . . . because Gravelly has *reserve power*—now 6.6 Horsepower! Improvements in design and quality make the new Gravelly an even better buy than ever!

INVEST in the
BEST!

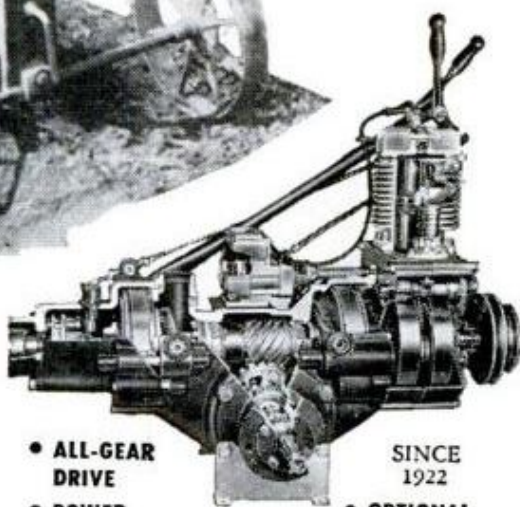

- ALL-GEAR DRIVE
- POWER REVERSE

- SINCE 1922
- OPTIONAL STARTER

Power attachments *securely* mounted by only four bolts. Balance, easy handling, simple controls. Cutaway view shows Gravelly's clean, compact, power-engineered design—the reason for its remarkable performance. Make the wise choice—*choose Gravelly!*

EASY PAY PLAN

GRAVELLY TRACTORS, INC.
P.O. BOX 601-B DUNBAR, W. VA.

Please send "Power vs Drudgery" Booklet and dealer's name to:

Name _____
Address _____
Town _____ State _____



30 TOOLS

UNMATCHED PERFORMANCE

Choose the tools that fit your jobs from 30 year-round attachments. All powered by one Gravelly tractor!

Do the job *better* because power attachments are driven direct from the engine by splined steel shafts and gears. No belts or chains to slip, wear or break. More power *at the working tool!*

A FREE demonstration by your local sales and service representative will show you, beyond doubt, that the Gravelly and its attachments will do your jobs *better, faster, easier*. Compare. You will see that you get *more power, more performance, more for your money!*

FREE 24-PAGE BOOKLET!

Big, 24-page illustrated booklet, "Power vs Drudgery", shows how the Gravelly solves your lawn and garden problems . . . Write for it today!



FREE! MAIL NOW

bled data hums through batteries of electronic tubes. Out comes position references. These are fed continuously to a bank of 16 electronic brains known as the "Geo-ballistic Computer." This monster digests the position facts. Then data about the location, altitude and other specifics of certain special targets like a Russian missile base, or airfield, is fed into the computer's maw. Instantly, the brain makes a comparison of the relative positions of the FBM submarine and the target—and out comes the precise firing information which is automatically preset in the missile's guidance package. All in a matter of seconds!

As the missile-launcher moves through the sea during countdown, constant course corrections must be fed to the navigating brains. A device called a Joglog, streamed aft of the ship, provides reading on ocean cross currents. Another log provides the speed through the water.

A launching from the big missile ship begins at dockside, where huge traveling cranes load the shooting cargo. Dummy missiles swing skyward, and are eased into the launching tubes. The weighted slugs have a domed nosepiece entrapping just enough air to keep the great cylinders afloat so that skin divers can retrieve them after the shoot. By reversing the cap and making the nose concave—like the bottom of a wine bottle—the slug becomes sinkable.

Missiles Are Packaged

Live missiles come packaged in massive steel cylinders with self-contained cranes. Positioned vertically atop the launch tube, the towering container lowers the rocket down through itself and into the tube by means of steel cables and pulleys—like an elevator descending through a shaft.

Below decks, throughout the ship, check-outs are in full swing as the ship heads seaward. A pair of huge underwater fins hinge outward from recesses in the hull, to counteract rolling motion in much the same way that ailerons keep an airplane on an even keel.

Trying to aim a 1500-mile missile from a moving platform requires tricks, and the *Observation Island* has several. "The ship's inclinometer (which measures degree of roll) is 'educated,'" King explains. "It's tied in with the fire control mechanism and won't allow the launching gear to operate until the ship has assumed precise firing attitude in the water."

Missile submarines will use similar tricks. But instead of anti-roll fins, which only work when a vessel is under way, they'll be steadied on the surface by king-

size Sperry gyroscopes. Deep under the submarine's "sail," the 62-ton devices, with massive rotors resembling steel doors for bank vaults, will spin the stability of an island into the sub whether it is moving or sitting dead in the water. Such giant gyros, capable of diminishing a 40-degree roll to two degrees by means of their muscular torque, had a brief heyday on a few luxury yachts and one big liner right after World War I. Their comeback on the A-sub's will be their first appearance in about 30 years.

As firing time approaches, the missile ship hums with activity. In a confusion of lights, dials and switches in the Instrumentation Operations Station below decks, the instrumentation officer scans a display console providing constant read-outs on all navigational data for firing. Across the way at the launching complex, the launch officer watches another bank of dials and lights that will give him the word to start firing sequence. The telemetry officer reads his radar and radio equipment for tracking the big rocket from the instant it moves upward in the tube. Enlisted men stand at the joystick controls for the TV cameras on deck, panning this way and that, while the picture is checked by other men at slave screens scattered around the room. Other complexes for weapons control, missile calibration, missile observation, weapons navigation and launching operations make last minute circuit checks in an aura of tense excitement. Up on the bridge, in the pilot house, Captain Slack stands at a bridge console containing rows of buttons and lights that will permit him to destroy the missile in flight, if necessary, or to hold the countdown at any point.

Launching Spectacular

Man with the best view of the proceedings is the ship's executive officer, Comdr. James O. House. With him is a range safety man from Canaveral. Standing in the Range Safety Observation Station, these men look down on the launching deck through slotted windows of three-inch shockproof glass. Similar ports in the roof provide a skyward view. The walls of the shack are of three-inch plate steel, and a trap door leads down to lower decks in case the men have to leave in a hurry. At T-minus-zero, the tremendous crack of the air valve rings through the ship. Fifty cameras automatically begin to record the surging missile as it lifts ponderously from the tube and hurtles skyward in a billowing veil of icy mist. A live Polaris, kicked to an altitude of about 100 feet by the mighty air gun, lights off with a spectac-

(Continued to page 252)



DOES A HILLHOLDER HOLD HILLS?

No, but with it you can hold The Lark on a steep hill without ever touching the brake pedal. It's a simple optional device of convenience, but one that you won't find on other cars. ➤ With Lark synchromesh transmission, braking action on hills is maintained simply by flooring the clutch pedal. Prevents rollback and is particularly pleasant on icy slippery hills. ➤ Why do we make such a "thing" over a mere hillholder? Simply to point out that Studebaker engineers and design people are a very thorough lot. ➤ You'll find a very high degree of skillful detailing and ingenious design in The Lark plus a variety of features other new dimension cars don't even have available: headrests, reclining seats, limited slip differential, choice of axle ratios, 4-barrel carburetor for the V-8 (0-60 in 9.5 seconds) ... even air conditioning. ➤ The Lark is a car of delightful surprises... particularly when you drive it. Tell your Studebaker Dealer to demonstrate on a twisty road. You'll "get the message" and you'll —

LOVE THAT **LARK** *BY STUDEBAKER*

*It's like employing
your own personal mechanic
to keep your engine
always at its best*



The superior lubricating qualities of Kendall SuperB mean less wear, less need of repair. Oil and gas mileage go up. Noise level goes down. Driving is more economical, more enjoyable with this All-Weather SAE 10W-30 oil refined from the choicest 100% Pennsylvania Crude Oil—richest in the world.

Ask your favorite dealer
for it now

KENDALL REFINING COMPANY
BRADFORD, PENNA.

ular roar, engulfing the launching deck and tube in a Niagara of white flame. Within moments, it is lost in the sky—a pinpoint of light on a 1500-mile ride.

The reverberating BANG! of one of those launch valves letting go is an impressive thing. "Below decks," says Comdr. Wallace, "it sounds something like being in a submarine that's sustained a close hit by a depth charge. Once when we were setting up for a firing at Norfolk, an underwater demolition team on a research job near the ship set off a charge without warning. The crack below decks sent everyone racing for the hatches in a mad scramble to get out. Everyone was sure that the launch tube plumbing had let go under the strain and blown up the ship."

A blast of that air, even through an empty tube, can create a colossal wind. Wallace enjoys recalling the first dry run, or "air shot" at Norfolk, when the launching gear was being tested right after work crews had finished the last of their work in the base of the big guns. "Everything worked fine," he says. "We blew a regular volcano of welding rods, coke bottles and Dixie cups all over the shipyard."

Though primarily built as a testing vehicle for the Polaris submarines, the *Observation Island* has worked out so well as a missile launcher that we may wind up with surface Polaris ships of a somewhat different type. "The launch tubes," Joe King points out, "could be hung on the quarters of aircraft carriers, for instance. Such a carrier task force could launch their missiles to soften a target, then send in their planes to mop up."

Meanwhile, the *Observation Island* carries the distinction of being probably the most uniquely armed ship in the Navy. "Our weapons department's first-line armament is a 1500-mile nuclear warhead Polaris," Wallace points out, "—backed up by a secondary battery of .45 automatic pistols. That's all." ★★★

85-Foot Radio-Telescope Will Listen to Sun

When the sun flares up from now on, shooting out bursts of mysterious radio noises, scientists at the University of Michigan can tune in on them with a huge radio-telescope. The 85-foot-long electronic ear, designed to study the sun's radio emissions, has a 155-ton parabolic antenna that can track the sun from sunrise to sunset, as well as pick up radio noise coming from galaxies millions of miles away.

GRASS-BAGGING TORO MOWER

...why it outmows all other rotaries

YOU'RE LOOKING THROUGH the housing of the Whirlwind* 19—the power mower with a built-in vacuum cleaner. You're looking at the full-circle "Wind Tunnel" design you get only in this Toro machine. This wind tunnel builds up a super-powerful vacuum that freezes blades of grass upright for a cleaner cut than any other rotary. And it snatches up clippings the instant they're cut, blasts them into the bag for easy disposal.

No more raking! You can use this mower 3 seasons of the year to vacuum your lawn clean of leaves, seeds and other lawn litter.

Prove it on your own lawn! Your Toro dealer, in the classified section of the phone book, offers a selection of models from \$89.95 (only \$8.95 down!) complete with grass-catching bag. See him *now*—while the selection's complete!

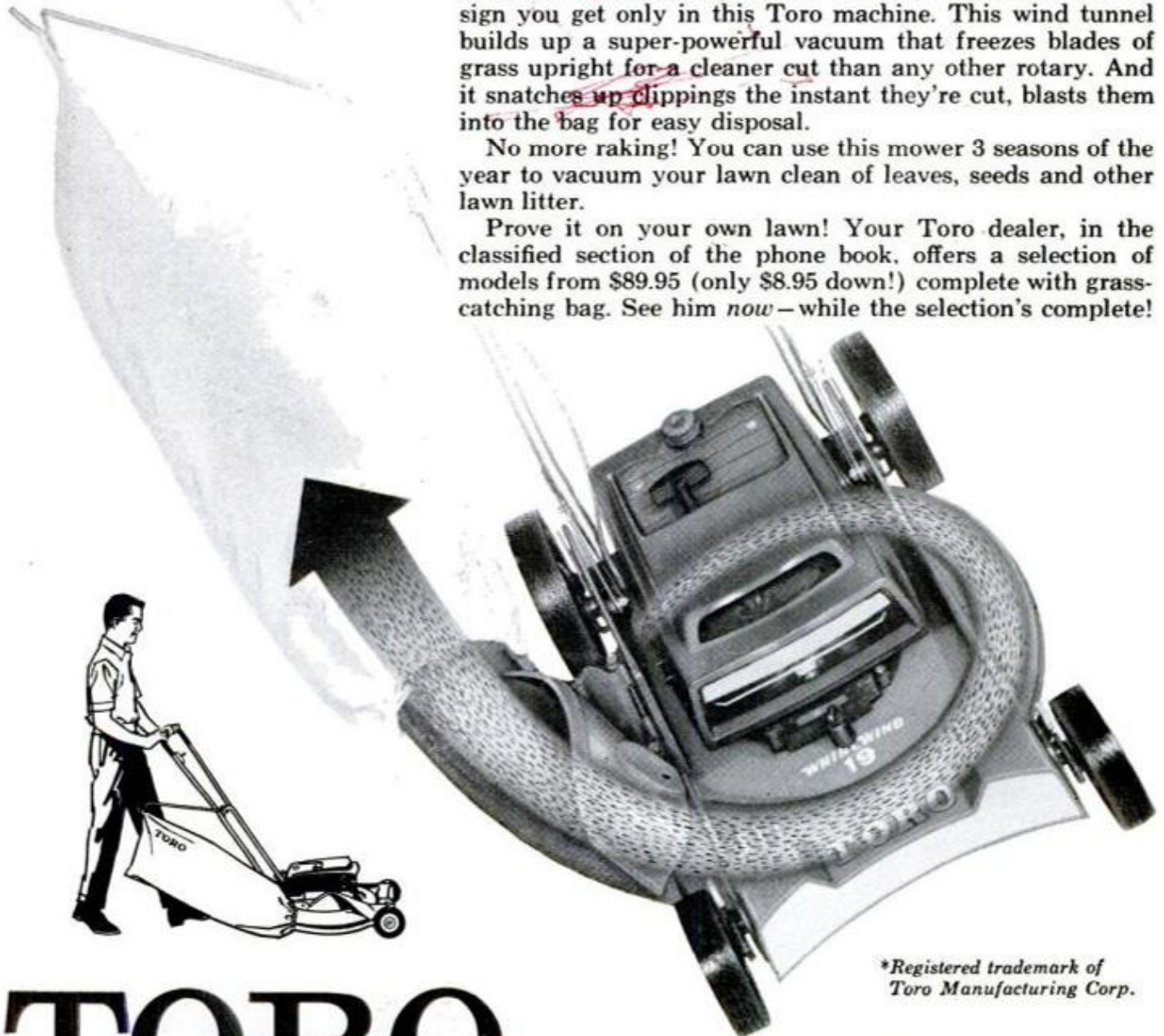

**Registered trademark of
Toro Manufacturing Corp.*

TORO

TORO MANUFACTURING CORPORATION
3006 SNELLING AVE., MINNEAPOLIS 6, MINNESOTA, U.S.A.

FEBRUARY 1960

253

Exploring the Ocean's Greatest Deep

(Continued from page 119)

ures the varying speeds of sound through the water; depth-sensing devices such as the vibrotron with its resonating tungsten wire chronicling telltale pressures, and a remote-controlled solenoid-actuated plankton collector (designed and built by Dr. Rechnitzer) set to sample the minute sea plants and animals which hover in the water like a living cloud.

At intervals during a typical descent, a scientist triggers a solenoid which trips one of a dozen water-sampling Nansen bottles. Simultaneously, a thermometer records the temperature of the sea-water sample. Overhead, an electronic flash winks, turning a cone-shape area of the depths into daylight as a camera records the contents of the water. Periodically, the velocity meter determines the speed of sound through the water—a velocity which varies with temperature, density and depth. Another button actuates the sampler which obtains a sample of animal and plant life. Another automatic instrument riding outside the bathyscaph's sphere clocks currents, recording their speed and direction. Another measures sea pressure.

Automated by electronics, this deep-sea research vehicle gathers and compiles data that will yield a profile of information about currents, pressures, temperatures and sea life in a more complete manner than ever before.

Will Map Deep Scattering Layer

One of the important phenomena the *Trieste* will be mapping is the great blanket of animal life—dubbed the deep scattering layer—which spans the world's oceans. Other ocean oddities are the great masses of varying-temperatured water, called thermoclines, which are stacked atop one another.

"Analysis of sonic probings and vertical profiles of such phenomena has revealed odd current flows and extended distribution of animal life," says the wiry Dr. Rechnitzer, 34, who heads up the Navy's "Project Bathyscaph."

"All have been around as long as the oceans themselves," he continues. "Now for the first time—and with an assist from the bathyscaph—we intend to expand our knowledge about these and other features of the deep sea. The deep ocean has long fascinated man and discussion about its contents has yielded tales that have not been refuted for lack of accurate observa-

tion. For years, animal distribution in the deep sea has confused sonar and fooled fathometers, registering shallow 'false bottoms' in areas where the ocean was known to be hundreds (and sometimes thousands) of feet deeper."

Only last year Rear Admiral John S. Thach, who commands the Navy's sub-hunting Atlantic Task Force ALFA, dispatched a frantic S-O-S to the American electronics industry.

"The black boxes are not good enough," complained Admiral Thach, referring to sub-hunting electronic gear.

Sonar, he said, is often bothered and bewildered by "deep-lying inconsistencies"—thermoclines. Sub-searching sound waves, ricocheting from fathoms-deep layers of varying temperature water, are bent, reflected and distorted. Maverick temperature changes can cut sonar's range from a hefty 25 miles to a handful of yards. Safe and unsounded are subs that cannily hide beneath a protective thermocline.

Adding to the problem of future detection of deep craft are the animals which oftentimes form a 200-foot-thick cloudlike scattering layer. The layer's depth is not fixed; it rises like a living elevator from its daytime depths of perhaps 1000 to 1500 feet to just a few feet below the surface at nightfall. Confusing to sonar and its harried operators are a myriad of deep-sea noises . . . the hoots of whales, the snapping of shrimp and whistling cries of porpoise.

But Dr. Rechnitzer, the project's scientific chief who's a lieutenant commander in the Naval reserve and a marine biologist (he earned his doctorate at famed Scripps Institution of Oceanography), pigeonholes as "beyond the bounds of military security" any speculation on application of the *Trieste's* findings to use of modern nuclear submarines.

Assembly of Top Scientists

Lieutenant Don Walsh, the bathyscaph's skipper, says, "We've assembled some of the world's leading oceanographic experts . . . including Auguste Piccard and his son, Jacques."

The deep-diving assignment of the bathyscaph is closely watched by oceanographers, for not until the bathyscaph, which physically drops researchers to the depths, was a really detailed study of midwater and ocean floor research possible.

"Certainly," agrees Dr. Rechnitzer, "you can drop plankton nets from the surface—and dredge up a fair sample of the scattering layer's minute sea life. You can track the deep scattering layer with echo sound-

(Continued to page 266)

MODERNIZE YOUR CAR'S **PERFORMANCE** WITH AN ORIGINAL EQUIPMENT CARBURETOR REPLACEMENT!

Available Now at Your Nearby Rochester-GM Carburetor Specialist's AT A NEW LOW PRICE!

When you need a replacement carburetor—see that it's a new Rochester-GM Carburetor . . . number one for original equipment. These replacement carburetors have the very latest engineering advances, giving your GM car up-to-the-minute performance. And they're at a new low price! They're engineered, manufactured and tested to the highest standards.

Rochester-GM Carburetors are original equipment on the new GM cars, including the new Corvair. Get a Rochester-GM Carburetor replacement for your GM car . . . update your performance and get new-car economy. Ask about it at your factory-trained Rochester-GM Carburetor Specialist's. *Rochester Products Division of General Motors, Rochester, New York.*

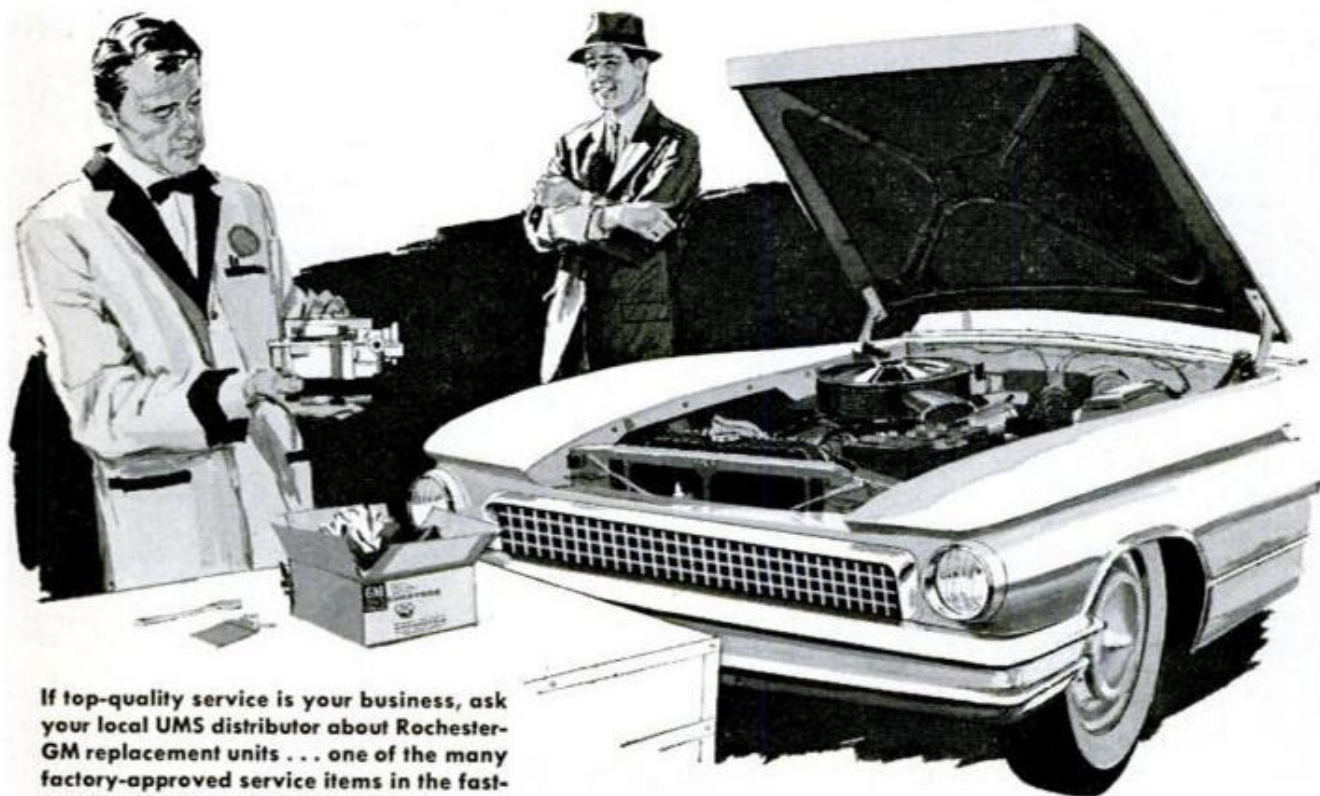

If top-quality service is your business, ask your local UMS distributor about Rochester-GM replacement units . . . one of the many factory-approved service items in the fast-moving Rochester-GM Service Line.



America's
number one
original equipment
carburetors

ROCHESTER **CARBURETORS**

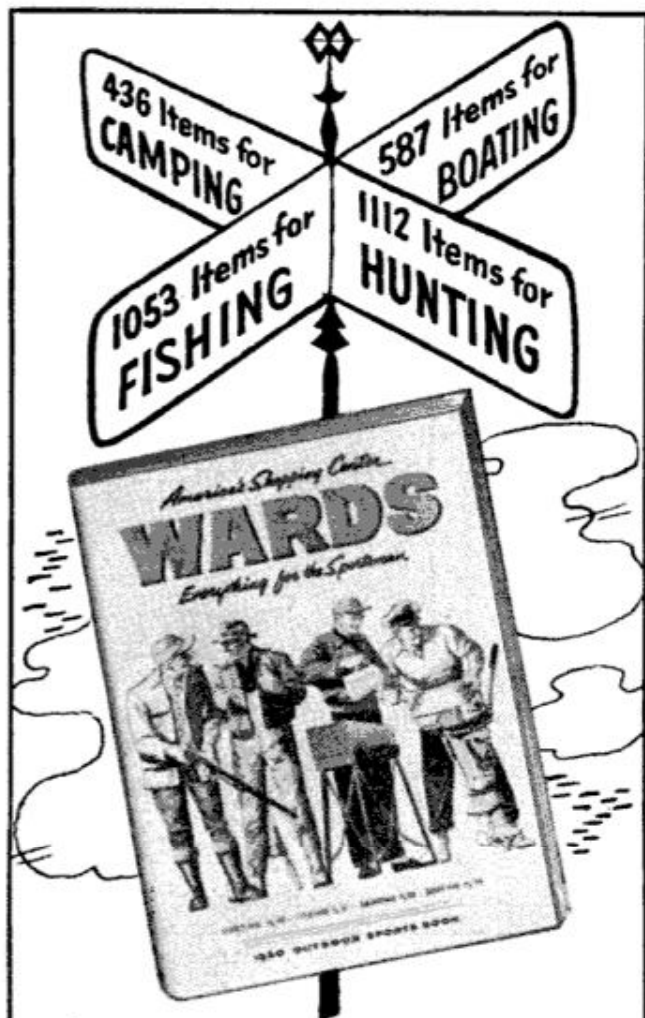

Over 3000 wonderful and exciting items for the sportsman in Ward's FREE 1960 Outdoor Sports Book. 128 pages filled with everything for hunting, fishing, camping, and boating. See these NEW items: Electronic Fish Finder, All-in-one Camp Kitchen, Seascope, Surf Sailors . . . and many more.

Make your selections the easy way . . . from Ward's new catalog. Everything guaranteed. Use your credit . . . charge it or pay by the month. Mail coupon below or see nearest Ward Retail or Catalog Store.

SEND NOW...IT'S FREE!

Mail to: Montgomery Ward, Dept. PM6-2
in city nearest you.

Chicago 7, Ill.; Baltimore 32, Md.; Albany 1, N. Y.; St. Paul 1,
Minn.; Denver 17, Colo.; Kansas City 23, Mo.; Portland 10,
Ore.; Oakland 16, Calif.; Fort Worth 1, Tex.

Please send, without obligation, my FREE copy of
Wards big exciting 128-page 1960 Outdoor Sports
Book, ready about Feb. 15.

NAME _____
(Please PRINT Name and Address Plainly)

Street Address or Route and Box No. _____

POSTOFFICE _____ ZONE _____

STATE _____ PHONE _____

The Weird and Wonderful World of Rowland Emmet

(Continued from page 140)

times takes digging in back rooms to locate the things that delight him.

Rowland Emmet is as famed today for the crazy machines and contrivances he puts together from collected oddities as he is for his cartoons of equally crazy railway trains which burst upon the delighted readers of the British humor magazine *Punch* in 1942. You don't have to be a railroad enthusiast to enjoy Emmet's trains, although to share some of his affection for the Edwardian and Victorian ages and the myriad small branch railway lines in the backwaters of Britain helps more than somewhat.

Settled at the drawing board in an armchair at his home in Ditchling, Sussex, Emmet creates his big-funneled, flower-bedecked, rickety engines pulling incredibly narrow, uncomfortable-looking carriages across a spidery landscape and peopled by bewildered ladies and moustached gentlemen dressed in an outrageous parody of the fashions of the 19th and early 20th centuries.

And in the smoky, noisy blacksmith's forge, Emmet and his carefully chosen staff bring to life his drawings of trains and fantastic apparatus—the latter adorned with anything from a Victorian hipbath to an up-to-the-minute plastic salad shaker.

Among the many cobwebby contributions Emmet has made to the modern world are the Oyster and Far Tottering Railway; Nellie, the gallant little steam engine and heroine of his book, "Nellie Goes to America"; the Hush-A-Bye Bed and the Hogmuddle Rotatory Niggler and Fidgeter.

It was back in 1942 that he became a regular contributor to *Punch* after a series of drawings he submitted impressed the editor. Hunting for new subjects, Emmet came up with his idea of an Edwardian train. To his amazement, he received shoals of letters begging him to draw more of the same type.

"From then on, it was trains, trains and still more trains," he said. "I was kept pretty busy. But I didn't go to quiet places for thought and inspiration. I got my ideas in a noisy London cafe. (These days I fancy the almost equally noisy sea end of Brighton Pier.) When I started on the trains I didn't want to get typed, but people seemed so interested that I just had to keep going on the same lines—if you see what I mean. When they built my Far Tottering and Oyster Creek Railway for

(Continued to page 258)

PEEL PAINT OFF



Furniture



Floors



Boats



Woodwork



KLEAN-STRIP PAINT REMOVER

Fast • Clean • Non-inflammable
THE KLEAN-STRIP CO., INC.
 2340 S. Lauderdale, Memphis 6, Tenn.



Tom McCahill Reports on: *The Killer—Carbon Monoxide*

Any grammar school kid with an IQ of 2 knows that a typical automobile engine produces poisonous carbon monoxide fumes. This deadly gas is odorless and invisible and packs enough wallop to kill the entire population of Rhode Island on a tankful of fuel—if conditions are just right.

Yet few people worry about carbon monoxide dangers, figuring it's out the rear stack, which makes it a problem for the daisies, not them. Even an audibly leaky muffler doesn't excite the average driver too much because you rarely hear of a guy dying from leaking exhaust fumes. However, carbon monoxide can cause you to kill yourself. In the end you're just as dead either way.

The F.B.I. felt strongly enough about it to make an extensive search some years ago into the part carbon monoxide played in many unexplained accidents. They found that truck drivers on long hauls frequently fell asleep and went off the road—probably from drowsiness caused by carbon monoxide from a muffler or manifold leak.

Carbon monoxide can make you kill yourself by slowing up your reaction time to a point where stepping on the brake to avoid running over Aunt Nell, becomes a major chore.

To ignore a faulty exhaust system is like playing catch with a bottle of nitroglycerine. My advice is to check your muffler and exhaust system regularly—and if you find any signs of corrosion or leakage, have the faulty part replaced right away. AP mufflers and pipes are the endurance champs in their field, because they have thicker, coated steel. AP is the world's largest manufacturer of replacement mufflers and pipes with over 100,000 dealers. Look for the red and white AP "Free Muffler Check" sign at stations everywhere. They sell mink coat mufflers and pipes at muskrat prices.

Sharpen All Circular Saws with QUICK-WAY

Model PG12
 \$19.95
 Postage-Paid



IDEAL for home-workshops; carpenters, contractors, QUICK-WAY unit precision sharpens, joints, gums and retools all circular saws to 12" diameter. Fits all bench, table and radial saws. Thousands of satisfied users. Send for Circular Make money sharpening saws. Order today \$19.95 postage-paid. Complete Unit with Grinder Wheel. No Extras to Buy. Patented.

FREE Saw Set with Initial Order
QUICK WAY SAW CO., 136 Tompkins Street, Cortland, N.Y.



STOP WASTING MONEY
 on worn-out piston rings
 Get **HASTINGS**
STEEL-VENT

Tremendous Savings on Hundreds of Surplus and Newly Manufactured Items!

Equipment for farm, home, work-shop, factory. Hydraulic equipment, pumps, motors, construction and diesel equipment and parts, etc. Write for FREE Catalog today!

GROBAN SUPPLY CO.

1139 S. Wabash Ave., Dept. PM2, Chicago 5, Ill. WE 9-3793

KING MIDGET

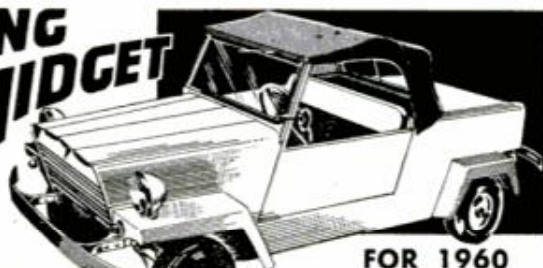

FOR 1960

More aluminum, lighter weight, better performance, beautiful styling. Still Worlds Lowest Priced Car. Drive it for 75c a week. Rider Agents Wanted. If no dealer near you send 25c for 32 page picture book, full details, dealer price. Or send \$1 (refunded first order) for this and Service Manual plus Repair Manual and 15 5 x 7 photos of car and factory.

MIDGET MOTORS CORPORATION, ATHENS 1, OHIO



AP PARTS CORPORATION

14-0 AP BUILDING, TOLEDO 1, OHIO

**BEFORE
YOU
PAINT...**



Caulk with DAP®



DAP Caulking Compounds—in cartridges, cans or collapsible tubes—do a fast, long lasting sealing job around windows, door frames, flashings... at joints in masonry or wood and metal siding. Make sure your paint job lasts. Get DAP Caulk and other nationally advertised DAP products at hardware, paint or building supply dealers. Write for do-it-yourself folder.

DAP

CAULKING COMPOUNDS
GLAZING COMPOUNDS
TUB AND TILE SEALER
SPACKLING COMPOUND

• DICKS-ARMSTRONG-PONTIUS, inc. • Dayton, Ohio •

4 SIMPLE, EASY-TO-USE **only 14.75**
WAY WELDER F.O.B.

ANYONE CAN WELD, BRAZE, SOLDER, CUT,
HEAT MOST ANY METAL WITHOUT EXPERIENCE



Over 200,000 in use in homes, garages, firms, shops, factories everywhere. Save money—earn money, making and repairing auto bodies and parts, fenders, furniture and railings, farm equipment, machinery, lawn mowers, toys. Does 1001 jobs on iron, steel, bronze, brass, aluminum, etc. Operates on any properly wired 110 AC or DC line.

SEND ONLY \$3 Pay postman \$11.75 plus C.O.D. charges. Simple instructions included. Ideal lifetime gift for hobbyist, mechanic, hot rodder, homeowner. Order direct on 10-day money back guarantee or write for literature FREE.
FOUR WAY WELDER CO., Dept. F2-B
1810 S. Federal St., Chicago 16, Ill.

Sent complete with twin carbon arc torch, welder's shield, carbon, welding and brazing rods. Ready to use.

the Festival of Britain, the interest was greater than ever.

"When I went to America for six months I realized there were wide possibilities. After leaving Punch I designed a crazy aeroplane for an oil company and followed it with an agricultural machine which was a skit on all agricultural machines, which went down surprisingly well with the farmers."

After all these came the Hush-A-Bye Bed, the Ideal Home, and finally Emmet-land, his latest and most ambitious creation.

The Hush-A-Bye Bed quite reasonably floats delicately among the topmost branches of a small synthetic tree. It has provision for early morning tea at all times of the day and built-in dawn chorus of warblers in lieu of an alarm clock. If you can accept all this, then you'll understand the logic of the bed's having a pair of dog-powered, ostrich-feathered lateral oars.

The Ideal Home—Emmet calls it a boon for the "bone idle"—was the first machine to be built in Emmet's own home. He agreed to try to make it himself because of the prohibitive manufacturing costs. It took shape in his drawing room in seven months, and because it was 23 feet long, nine feet high and eight feet broad, the fact that it did only minor damage to the room when taken out was considered remarkable—as well as being a lucky omen.

The machine was intended only for three exhibitions, but when it had served its purpose Emmet had the idea of offering it for display in large stores. Today, like the other machines, it is traveling Britain, and—again like the others—it never fails to be in perfect working order.

Emmet-land, by far the largest of his creations, defies description. There are over 50 characters, ranging from the usual bewildered Edwardians waiting on the usual fantastic station for the usual fantastic train (which fails to stop there), to the gentleman in bathing trunks who dives into a small pool every few seconds and the personage hanging for dear life on a rope dangling from an airplane which constantly circles the moth sanctuary at the summit of the landscape. This machine, too, was built in Emmet's home and is the result of over six months' work in which Emmet's right-hand man Arthur Depree kept activity at fever pitch, sometimes working around the clock to get the machine completed on time.

Emmet hopes that soon he'll be off to Australia with his machines. "But I'm not going to churn things out one after the other," he said. "I'm afraid the public will

(Continued to page 260)

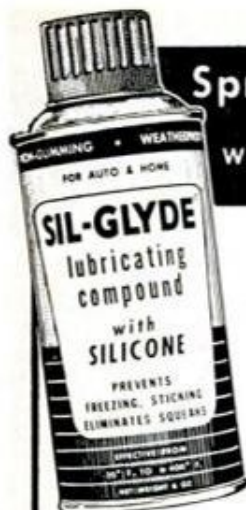

Spray Away Squeaks WITH SIL-GLYDE®

The new miracle push-button lubricant for aluminum screens, windows, drawer guides and all metal, rubber, plastic and wood friction surfaces that stick or squeak. For car — use on weatherstripping, trunk seals, etc. Lubricates, silences, protects. Water-repellent, freeze-proof. Effective from -20° F to +400° F.

6-oz. aerosol \$1.49
1 1/2-oz. tube — 89¢

American Grease Stick Co.,
Muskegon, Mich.

5-251

Model K312

**CHARGES 12-VOLT CAR
BATTERY OVERNIGHT**

ONLY \$14.95
POSTPAID

Avoid run-down battery troubles—own this high-grade SCHAUER Charger. Has automatic circuit breaker. Pays for itself many times over in longer battery life; sure, quick starts. Get yours now. If your dealer can't supply, send check or money order. Money-back guarantee. The best made, most beautiful charger you can own is a SCHAUER. Other 6 and 12 volt models available. Send for free catalog.

4532 Alpine Avenue
SCHAUER MFG. CORP. Cincinnati 42, Ohio

FREE AMAZING NEW BOOK "HOW TO ANSWER ADS"

how to
answer
ads

Never before have you seen anything like this. Tells you in simple language the correct way to answer ads. Gets you quicker replies—better results, and greater satisfaction. Will save you time and money and it's ABSOLUTELY FREE. No obligation whatever. Every reader of advertising should have this booklet. Send a postcard for your copy NOW. F. W. JOHNSON, Popular Mechanics Magazine, Room 600-A, 204 East Ontario Street, Chicago 11, Ill.

MAKE EXTRA CASH

SHARPENING LAWN MOWERS THE MODERN WAY



\$275.00
F.O.B. Pasadena

Start your own shop! Full or spare time. Earn many dollars in a short time... average \$5.00 per hour. Many mowers need sharpening. With MODERN'S Extra Heavy Duty LAWN MOWER SHARPENER AND BED KNIFE GRINDER you have 6 machines in one. All operations are done quickly and easily. You make money from the start. Write for free details.

MODERN MFG. CO.
160 N. Fair Oaks Ave. Dept.
Pasadena, California 10-4

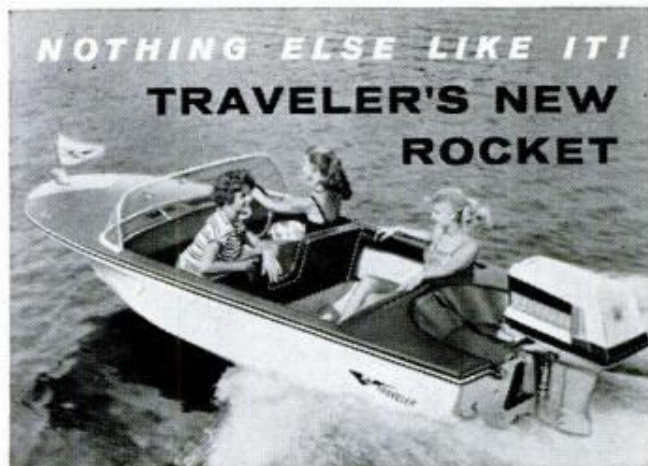

14 ft. Fiber Glass ROCKET Runabout (RKC 14-G)

Terrific pick-up... beautiful lines... deluxe finishes all make the 1960 Traveler Rocket the prize of the waterways. Full 62" beam for stability and roominess. Rated for 40 hp. Ideal ski boat. Luxurious upholstery and appointments. A boat you'll be proud to own. See it at your Traveler Dealer's.

FREE: Write today for full-color catalog on the exciting new 1960 models — both aluminum and fiber glass.

ARKANSAS TRAVELER BOATS
2006 E. 14th Street, Little Rock, Arkansas

You Get **MORE** with
Arkansas-TRAVELER

**Drill and
Countersink
Holes for
Wood Screws
in ONE
Operation!**

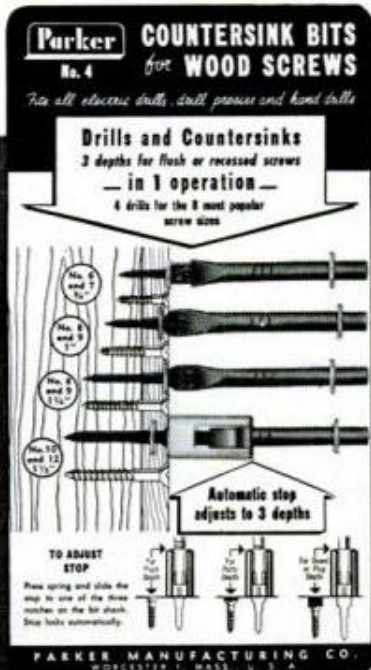

4 Bits —
24 Combinations

\$1.70
per set

Manufacturers of World-Famous Trojan Saw Blades and Frames

Buy the **Parker** Line
PARKER MANUFACTURING CO.
WORCESTER 1, MASS., U. S. A.

BELSAW
MULTI-DUTY
POWER TOOL

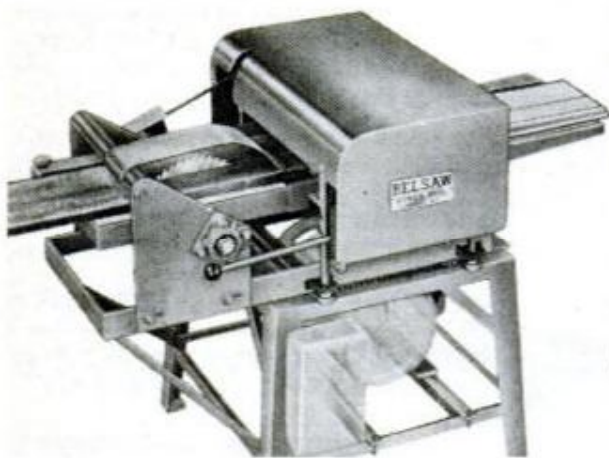

Now you can use this **ONE power feed** shop to turn rough lumber into high-value moldings, trim, flooring, furniture... **ALL** popular patterns.

RIP... PLANE... MOLD... separately or all at once by power feed... with a one horse-power motor. Use 3 to 5 HP for high speed commercial output.

LOW COST... You can own this **MONEY MAKING POWER TOOL** for only... **\$30⁰⁰** down payment

Send coupon today

BELSAW POWER TOOLS

900 Field Bldg., Kansas City 11, Missouri

Send me complete facts on the **MULTI-DUTY Power Tool**. No obligation.

Name _____

Address _____

City _____

State _____



get tired of me if I overdo things. And I want time for humorous drawings and illustrations. It will be a year at least before I start another machine, although I have orders galore from various concerns all over the world and I have formed a company, Fluffy Mechanisms Ltd., to exploit the models.

"Anyway, making a machine is a major operation. The difficulties of finding things like hipbaths and gramophone horns these days you just can't imagine."

British royalty are great Emett fans. Prince Philip recently bought the original of a drawing which showed a balloon with a basket crammed in a narrow liftshaft of a Victorian mansion. The hostess is saying to a caller, "We hesitated a long time before putting in a lift. Fortunately, it's period." Soon afterwards there was news that Philip was complaining about the "antiquated" lifts at Buckingham Palace and asking for modern ones to be installed.

"I wonder," mused the genius of Fluffy Mechanisms, Ltd., "if there's any connection. . . ." **★★★**



Stills Use Solar Energy To Convert Sea Water

Conversion of sea water to fresh water by means of solar distillation is taking place on a research site at Port Orange, Fla. Three stills, each with black-bottomed basins and transparent covers, are expected to produce 500 gallons of fresh water a day. Vapor, produced during distillation from sea water in the bottom of the basins, condenses on the inside of the transparent covers and runs down to channels at the edges of the basins where it is collected. Principle objectives of the solar method are reduction of equipment cost and greater efficiency.

SQUEAKY



HINGES?



QUICK! Hush 'em up with handy 3-IN-ONE OIL. Just a drop or two and away go squeaks. Dozens of other uses.

3-IN-ONE OIL

REGULAR · OIL SPRAY · ELECTRIC MOTOR

SAVE MILES · DOLLARS
HULL AUTO COMPASS

One wrong turn means wasted hours and mileage, lost dollars, lost appointments. Eliminate guesswork with a famous, dependable HULL AUTO COMPASS. \$5.95 to \$7.50. At your dealer's or write for literature.

BOAT OWNERS NEED 'EM, TOO!

HULL MFG. CO. · P.O. Box 246-D-2 · Warren, O.



WANT TO CRUISE THE OCEAN WITH AN OUTBOARD?

In the March issue
a *PM* editor writes
of his experiences in

"Offshore Cruising by Outboard"

Here it is...

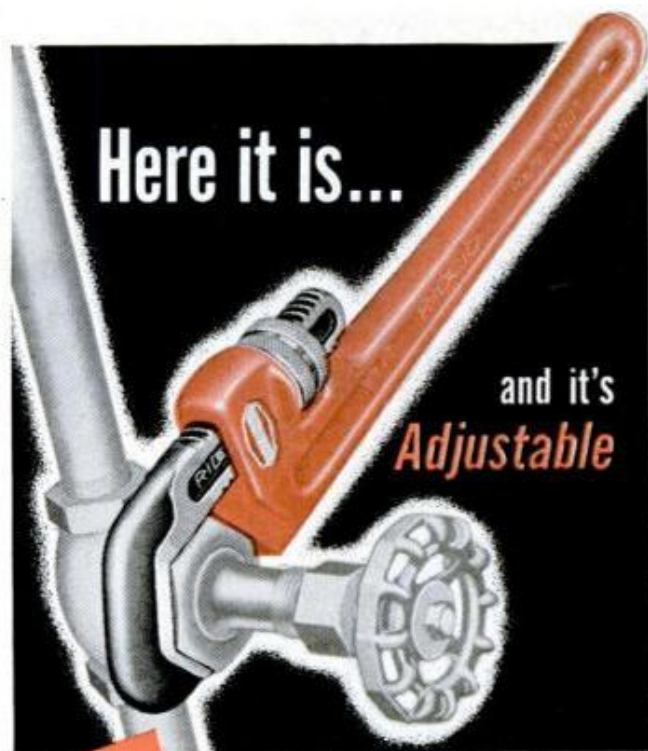

and it's
Adjustable

New

Pat. Applied For

RIGID

Hex Wrench

**gives you Time-Saving, Positive, 4-Sided
Grip on Hex Nuts, Square Nuts, Valve
Packing Nuts, Unions, Gas Cocks**

Here's the adjustable wrench you've always needed for hexes, squares and flatheads. Ideal for toy, mower, tractor and implement, car and home repairs. No more barked knuckles or rounded nut shoulders. New wide-open jaw goes on easy . . . won't slip off. 4-sided grip gives extra leverage.

Famous **RIGID** heavy-duty construction with guaranteed housing. Narrow jaw design makes work easy in tight places. Comfort grip I-beam handle has handy hang-up-hole.

Most Wrench For Your Money!

The new **RIGID** Hex Wrench gives you more for your money than wrenches costing twice as much. See, try and buy it at your Hardware Dealer's.



Available in 3 Sizes
3/8" to 3/4", 5/8" to 1 1/4" and 1" to 2".

The Ridge Tool Company · Elyria, Ohio, U. S. A.

YOUR OWN 2-WAY RADIO FOR BUSINESS OR PLEASURE!



Messenger

FROM
\$129.75



Anyone can operate
—license issued by
the FCC on request!

- Complete 23 channel Citizens' Band coverage—choose any 5 channels by the flip of a switch!
- Excellent receiver sensitivity and selectivity—full fidelity voice reproduction!

"More than just 2-way Citizens' Radio equipment"—the Viking "Messenger" offers the finest performance of any equipment available. Meets all FCC requirements. Maximum legal power. Designed for high reliability and easy installation in your home, business location, car, truck, or boat. Built-in Squelch, Automatic Volume Control, and Automatic Noise Limiter. Compact, modern styling—only 5 $\frac{3}{8}$ " high, 7" wide, and 11 $\frac{3}{8}$ " deep. Complete with tubes, push-to-talk microphone, and crystals for one channel.

WRITE TODAY FOR FULLY ILLUSTRATED BROCHURE



E. F. JOHNSON COMPANY

161 SECOND AVE. S. W. • WASECA, MINNESOTA

For peak performance . . .

TRIUMPH

**BACKED BY
COAST-TO-COAST
DEALER SERVICE**



Take a new lease on life! Ride the hottest motorcycles ever built — the "sizzling '60" Triumphs. Whatever you want in a 'cycle, you'll

find in a Triumph — speed, power, peak performance and operating economy.

There isn't a 'cycle *anywhere* to keep pace with the exciting 1960 Triumphs.

FREE OFFER

DEPT. P

Mail this coupon today for FREE 1960 full-color catalog showing the complete Triumph line and the name and address of your nearest Triumph dealer. Send coupon to nearest address:

In the West:
Johnson Motors, Inc.
267 W. Colorado Street
Pasadena 1, Calif.

In the East:
The Triumph Corporation
Towson, Baltimore 4
Maryland

PLEASE PRINT

Name _____

Street _____

City or Town _____ State _____

Telephone Number _____

Palmetto Polo

(Continued from page 108)

present size, which allows maximum speed and action.

The original ball was small—six inches in diameter—but the inventive players soon found it had the annoying habit of sticking in the turf holes made by their pivoting mounts. The present 12-inch ball overcomes this difficulty, and at the same time makes the shots trickier because it twists erratically when hit offcenter.

Points are scored by driving the ball through 20-foot-wide goals at each end of the field. A goal made from the goal zone counts one point. Goals made from the second zone, if unaided by a player in the goal zone, count two points, and a successful, unaided, hefty belt from the middle zone counts three. Penalty shots count one point.

When the game was invented, neutral zones flanked the playing field but the players soon discovered time was wasted returning the ball from out-of-bounds. Now the standard field has wood or wire fence boundaries on the long sides, and the experts bank the ball off the boundary walls in a variety of trick shots. There's a short out-of-bounds zone behind the goals.

Referees Now Mounted

The game has two mounted referees to keep it moving. The first contests were supervised by referees on foot, but this required officials with unlimited stamina and sprinting ability, and with a marked shortage of officials who could outrun quarter horses, the result was that the referees were mounted.

But while this saved the officials it created a new problem—retrieving the ball in the event of a foul or a shot out of bounds. Dismounting to pick up the ball wasted time, so the inventors devised the long-handled pickup "net" which is now standard equipment.

The original palmetto-frond sticks were found to be useless after drying and losing weight, so the modern manufactured, rubber-headed stick was developed. No metal or weighting is permitted; maximum size is four inches long, three inches wide and two inches thick, mounted on a cane or rattan handle 48 to 54 inches long.

It's a hell-for-leather game from the moment of the center charge. The referee places the ball in the middle of the center zone on a white stripe, and the two centers send their horses charging at the ball from boxes ten yards away, sticks swinging. The quickest starter gets in the first lick, driv-

(Continued to page 264)

SUPER GLUE

FOR
PLASTIC TABLE
AND
COUNTER TOPS

Elmer's Contact Cement. Non-flammable. No mixing. Spreads easily. What a glue! "Elmer's Guide To Gluing" tells all about it and other great Borden glues. Send stamped, self-addressed envelope for free copy. The Borden Company, 350 Madison Ave., New York 17, N.Y.



REPAIR

FOR YOUR B&D TOOLS



Check the Yellow Pages under "Tools-Electric" for the location of the nearest Black & Decker factory service branch or authorized service station.

Free tool inspection when requested • Genuine B&D parts used • Factory-trained technicians • Standard B&D Guarantee at completion of recommended repairs • Fast service, reasonable cost, always.

Or write for address of nearest of the more than 50 branches and service stations to: THE BLACK & DECKER MFG. CO., Dept. 8002-S, Towson 4, Md.



Black & Decker



Quality Tool Service



Exclusive Double-Bearing HEAVY-DUTY PUMPS

IRRIGATE • DRAIN • CIRCULATE • SPRAY
Use 1/4 HP motor or larger . . . 1 HP for up to 7,500 GPH; 1,000 GPH 60' high; or 3,000 GPH from 25' well.
1 1/4" inlet; 1" outlet. Stainless shaft.

TYPE X—2 oil-less bronze bearings. Won't rust. . . . \$10.95

TYPE XB—Ball bearing model. . . . \$12.95

Postpaid if cash with order. Rush your order today

MONEY BACK GUARANTEE

Centrifugal and Gear Pumps in All Sizes

LABAWCO PUMPS, Belle Mead 2, N. J.

GET BOTH HOME PROJECT BOOKS—FREE!



1. "101 HOME IDEAS"—24 pages, many in full color, feature home-building, remodeling and decorating ideas using wood paneling. For living rooms, dens, playrooms, dining and kitchen areas, storage and utility rooms, bathrooms, bedrooms . . . traditional and contemporary. Tips on choosing grades, species, patterns to fit your way of living. Section on built-ins, finishes and effects.



2. **HOW TO COLOR-FINISH WOOD PANELING** in bright or pastel shades. "Nature Makes News" features full-color photos of wood-paneled interiors. Ideas on unusual colors, textures, ways of installing paneling for exciting effects. How-to-do-it instructions cover sanding, sealing, choosing, mixing and applying colors, highlighting grain and knots, finish coats, maintenance and care.

Mail coupon to **WESTERN PINE ASSOCIATION**

DEPT. 429-N, YEON BLDG., PORTLAND 4, OREGON

YOUR NAME _____ STREET ADDRESS _____

CITY _____ ZONE _____ STATE _____

THE BIGGEST PLIER MADE!

DIAMALLOY[®]



*"There is
nothing finer than
a DIAMOND"*

Now a 16-inch size with jaws that open to 4 1/4". Will handle up to 2" pipe fittings or conduit. Reaches places impossible for a pipe wrench, yet weighs only 1/3 as much. Ask your dealer for the Diamond HL116P, \$4.80, nickel chrome plated with soft bonded plastic handles. For long time satisfactory service, be sure of the DIAMOND trade mark used for years on Diamalloy adjustable wrenches. Made in the USA and only by

DIAMOND TOOL
and Horseshoe Co.

DULUTH, MINNESOTA  TORONTO, ONTARIO
EST. 1908

For free tool booklet, write your name and address on margin below, clip ad and mail to manufacturer

ing the ball towards his scoring goal. Sometimes it's a tie, with the ball spurting off into the center zone for more scrambling and hitting.

From then on the ball shuttles back and forth, in and out of zones, with riders tearing after it full tilt, swinging mightily and pulling their mounts into tight turns to take another swing or to avoid fouling. It's amazing how they manage to ride full speed, yet check their mounts just before going over the foul line.

Few Accidents

Accidents among these expert horsemen are few, although collisions are frequent as they rush each other for the ball, and a loose cinch or some other equipment flaw can spill the best rider. And once he's down, he's in trouble.

Palmetto polo has come a long way from the days when you would cut another stick in a few minutes, but it remains—now on a national scale—poor man's polo, one of the most unusual sports of the equestrian world. ★ ★ ★



Remington Rand, 315 Fourth Ave., New York 10, N. Y.

Interchangeable Type Symbols Snap Into Place

Special symbols for the fields of electronics and electricity can now be reproduced on a regular typewriter by use of electronics symbol slugs that fit right over ordinary type. Developed by Remington Rand, type is snapped into place at the end of each type bar with a pair of special pincers. When not being used, the symbols are stored in a clear plastic case.

MADE ONLY BY *Custom-Craft*

THE ORIGINAL PACKAGED BOAT KITS



• World's Largest Line—New Fiberglass Hulls. Over 200 styles Boats-Kits, Formed-Hulls, Semi & Custom finished. All types: Prams, Cruisers, Racers, Inboards, Outboards. Easy to build. Professional results. Dealers - Agents Inquire.

Send 15c for 3-Colored Catalogs 52 pg. Kit Catalog plus 20 pg. Hardware and 8 pg. Armor Glass books. (SPECIAL OFFER!)

All 3-colored CATALOGS plus "Boating Handbook"...all for \$1.

CUSTOM • CRAFT Buffalo 7L, N. Y.

★ BOAT PLANS, PATTERNS FRAME PACS

• Over 400 Plans-Patterns, Frame Pak Kits Prams, Kayaks, Racers, Runabouts, Catamarans, Cruisers-In-Outboards (6' to 40') Wood, Plywood and Steel. **Send 35¢ for 120 pg. Plan Catalog.** Catalog plus "Boat Building Handbook"... Send \$1.00.

SMALL! POWERFUL!

ECONOMY TRACTOR



Unequaled value! Low price! America's finest tractor. Ruggedly built. Easy to operate. 790 lbs. Borg-Warner clutch, trans. and diff 140 to 1 reduction. 40% more drawbar pull than ordinary tractors 8-1/4 H. P. engine. 20 quick change implements. HOOD, FENDERS.

Thousands In Use Write for complete details.

Engineering Products Co. 1005-K-2 Anoka Ave. Waukesha, Wis.

ONE-MAN SAWMILL LOW \$50.00 AS... DOWN



Take BELSAW Portable Sawmill right to the trees—turn out valuable lumber for home and farm — sell to local yards — make up to \$50 a day custom sawing for neighbors. BELSAW lasts a lifetime. No crew needed. Power with tractor or auto engine. Beginners get excellent results. Send today for FREE BOOK.

BELSAW MACHINERY CO 3450 Field Bldg. Kansas City 11, Missouri

BRONZE FOUNDRY

Schools • Home Workshops • Inventors



Make your own castings of aluminum, copper, bronze, silver. Foundry sets are available in four sizes, capacity 1 1/2 lb. to 36 lb. of red brass. 2400 Deg. F. blast furnace included with each. Write for Free Circular.

KANSAS CITY SPECIALTIES CO. DEPT. P-2, P.O. BOX 6022, MARYSVILLE, KANSAS

The Modern PLASTIC for lasting Home Repairs



DURHAM'S Rock Hard WATER PUTTY WILL NOT SHRINK STICKS AND STAYS PUT

PERMANENTLY mends cracks or holes in wood, tile, stone or plaster. Sticks and stays put—Does not chip, shrink or fall out. Easy to use. Economical. Mold it, chisel it, polish or paint it. The big 4-lb. can is obtainable from your lumber, paint or hardware dealer at \$1.40; or will be shipped direct postpaid (in U. S.) for \$1.75. Complete satisfaction guaranteed or your money refunded.

DONALD DURHAM CO. Box 805-T Des Moines, Iowa

The modern little cigar with **BIG** cigar taste



Humidor pack of 20 **35c**

NOW MILDER THAN EVER!

Right size—long enough for complete satisfaction . . . short enough to enjoy no matter how busy you are. Perfect blend of the most expensive tobaccos in any cigar like it—100% cigar tobaccos clear through.



TREND-AIR CONDITIONED FOR MAXIMUM MILDNESS

Scientifically placed, microscopic air-inlets "breathe" just the right amount of cool air into the smoke stream to give you the mildest, freshest smoke you've ever tasted in a cigar, large or small.

STEPHANO BROTHERS (Cigar Division) Phila. 7, Pa.

YOU NEED NOT INHALE TO ENJOY THEM

DREMEL MOTO-TOOL THE "POCKET SIZE MACHINE SHOP"

Handiest tool you'll ever own. Its high speed is ideal for precision grinding, polishing, carving, drilling, engraving, de-burring, sharpening, and hundreds of other household and workshop uses. Eliminates time-consuming hand work — gives the finished job a professional look.

Weighs only 13 oz.—handles easily as a pencil. Does fine detail work with pin point accuracy. Fastest, most powerful tool of its kind — develops 27,000 RPM. Widely used by tool and die makers, model builders, craftsmen, lab technicians, repair men, gun smiths, schools, etc.

SEE YOUR DEALER or write for FREE catalog on the complete Dremel line of power tools.



MOTO-TOOL KIT No. 2 (as shown) Incl. Model No. 2 Moto-Tool, 23 accessories (high-speed steel cutters, grinding wheels, etc.) in a sturdy storage case.....\$27.50

MODEL No. 1.....\$14.85
MOTO-TOOL MODEL No. 2.....\$19.95
MOTO-TOOL KIT No. 1.....\$23.50

QUALITY POWER TOOLS SINCE 1934

DREMEL MFG. CO. Dept. 110B, RACINE, WIS.

Rare, Fancy & Imported Woods... Veneers... Plywoods
Mouldings... Patterns... Hardware... Mosaic Tile
Ornaments... Tools... Archery and Skiing Supplies

Everything You Need in Craftsman's New **WOOD** and Home Workshop CATALOG

Get Yours! Rush Coupon Today!

132 pages



NEW—MOSAIC TILE PROJECTS!

World's Largest Selection of Finest Domestic and Imported Woods... Mouldings, Hardware, Tools—ALL AT LOW MONEY-SAVING PRICES!

Your complete wood buying guide and project book. Craftsman is your best, most complete source of finest kiln-dried domestic and imported woods, beautiful wood inlays, colorful bandings, matched plywoods, embossed mouldings, carved ornaments, newest wood-working tools, "hard-to-find" cabinet hardware; more than 1,500 items! Packed with newest scroll saw patterns, project ideas and money making plans. Enclose 25c (refunded with first order) to help pay mailing and handling cost. Write TODAY to

CRAFTSMAN WOOD SERVICE CO.,
Dept. A-2 2729 S. Mary St., Chicago 8

OVER
1,500
ITEMS

NEW TOOLS:
Upholstery Materials; Lamp Parts;
Metal and Wood Legs; Cabinet
Hardware; Music Box Movements;
Archery and Water Ski Kits.

CRAFTSMAN WOOD SERVICE CO., Dept. A-2
2729 S. Mary Street, Chicago 8, Ill.
Enclosed find 25c. Rush new CRAFTSMAN WOOD CATALOG.

NAME _____
ADDRESS _____
CITY _____ ZONE _____ STATE _____

(Continued from page 254)

ers and come up with a gross idea of bottom topography. You can—and researchers do—collect sea water samples from great depths. But to coordinate all this, together with visual observation, photographs and accurate measurements, you need more than surface craft. You need a deep-water research platform like the bathyscaph."

Questions yet to be answered are, for example: How continuous is the deep scattering layer (abbreviated D.S.L. by researchers)? Surface research shows the phenomenon to exist in all world oceans, including the strategic Arctic and Antarctic. Soundings have indicated more than one layer in places at different depths.

Moreover, when ocean waters warm, the sea life which most experts believe compose the layers seems to multiply. Its living composition may account for the layer's depth variations in clear water (off Bermuda, down to 2100 feet) and in murky water (as off California's coast where the layer has been recorded at shallower depths, between 900 and 1500 feet). Since light penetrates far deeper in clear tropical waters, it may nurture the layer's creatures at these greater depths.

Layer Changes Depth

Harder to explain is the layer's behavior. As long ago as 1945, oceanographers located the D.S.L. off California at 900 feet. During the day, it remained at that depth, but suddenly, when darkness fell, the layer mysteriously began to rise at a rate of some 6 to 18 feet a minute. In less than three hours, it reached the surface.

Nor is the layer's thickness consistent. It has been recorded as 300 feet thick at times. And at other times and other places, a third that thick.

One clue as to the size and kind of sea life which makes up the D.S.L. comes from nettings. Dredged from the depths have been mollusks, shrimp, sea worms and crustaceans such as copepods. Working on the theory that the layer's creatures must approximate in size the wavelengths they affect, one Woods Hole Oceanographic Institute scientist declared that few, if any, of the critters could be longer than 12 inches.

Another interesting sea phenomenon which the *Trieste* may explore is that of deep sound channels—watery sea "tunnels" through which sound travels fantastic distances at five times the speed it travels through the air.

Dr. Rechnitzer, writing in a scientific journal, recently defined sound channels as "layers in the water, set apart by spe-

(Continued to page 268)

Tractor with the "Most"

SPEEDEX



9 h.p. B. & S. powered model S-23 shown is today's "MOST" Tractor. Compare with anything on the market at its \$475 price. Two other riding models (4 h.p. & 5 3/4 h.p.) and 3 h.p. walking model

also use complete line of "unit-design" tools. Full year guarantee; sold on 10 day money-back guarantee. Color FOLDER gives complete information and dealer's name. Send 10c for it today.

SPEEDEX TRACTOR 367 No. Freedom St. RAVENNA, OHIO
COMPANY,

ELECTRIC WELD - BRAZE & CUT

REPAIR MOST EVERYTHING MADE OF METAL

Home Appliances, Auto parts, Farm-garden equipment, toys. Make and repair playground equipment, lawn chairs, tables, ornamental iron work, gates, wagons, etc. Solder, heat, bend, and straighten, with terrific heat from arc torch.



Cut and weld up to 1/4" steel plate. A million uses for Home, auto, farm, inventors, factories, etc. Works from any home 110 volt plug-in. Complete with dark welder's mask, arc torch, supply of carbon welding and brazing rods and complete Welding Instruction Book. Efficient—durable—1 year guarantee. Wt. only 4 lbs.

SEND ONLY \$3 (cash, ck, mo) and pay postman \$9.95 plus COD postage on arrival or send \$12.95 and we will send postpaid. Ideal gift for mechanically minded home owners, relatives, friends. Order now for early delivery. Available only from:
MIDWAY WELDER Dept. DPM-2 Kearney, Nebraska

WHAT DO YOU KNOW ABOUT

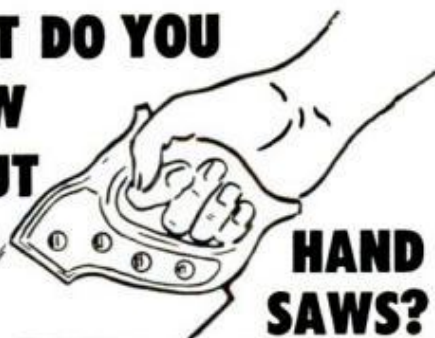

HAND SAWS?

HIGH CROWN

... means that the tooth line is curved or arched. This arched tooth arrangement gets fewer teeth engaged in the wood at a time ... reducing friction, making cutting easier ... faster.

SANDVIK Swedish Charcoal Steel Hand Saws feature this high crown. This is only one of SANDVIK'S many exclusive advantages. Before you buy any hand saw, ask your dealer to show you a SANDVIK.



Want to know more? Write today for the new 16 page booklet that tells all. "Things You Should Know About Hand Saws." It's free!

Sandvik STEEL INC.

Saw & Tool Division

1702 NEVINS ROAD, FAIR LAWN, N. J.

\$ POPULAR MECHANICS MEANS MORE MONEY IN YOUR POCKETS

POPULAR MECHANICS, the magazine that brings you money-saving ideas now brings you a perfect money-making opportunity.

We are looking for more men and women to introduce our magazines in their neighborhood, to accept orders for Popular Mechanics and other leading publications. If you have been looking for a way to earn a little extra each week—here's the answer!

No waiting for payday, you pocket your earnings right away! No experience necessary, you work when you please, as much as you please, your home is your office, and you are your own boss!

YOU CAN EARN \$10.00, \$25.00, \$50.00 right away with our new Popular Mechanics Subscription Plan. **SEND NOW!**

Popular Mechanics Dept. 260-B
250 West 55th St., N. Y. 19, N. Y.

Please send me your subscription plan!

Name _____

Address _____

City _____ Zone _____ State _____

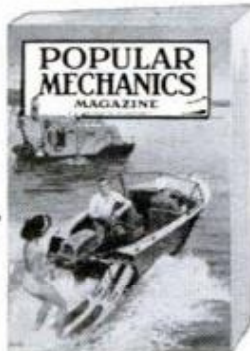

CABINETS

FURNITURE

WOOD PANELLING

NOW! LUXURIOUS HAND-RUBBED NATURAL WOOD FINISH WITHOUT THE RUBBING

WOOD LORE

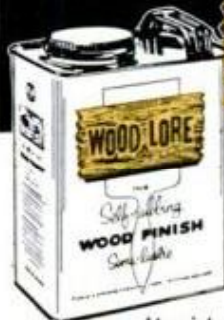

Needs no primer; applies so easy anyone can use it with excellent results.

Use over any wood interior—new or old—natural or painted—for luxurious "hand-rubbed" effect.

At paint, hardware and lumber dealers coast-to-coast



PIERCE & STEVENS CHEMICAL CORP.
710 OHIO STREET, BUFFALO 3, N. Y.

Makers of FABULON the fabulous floor finish

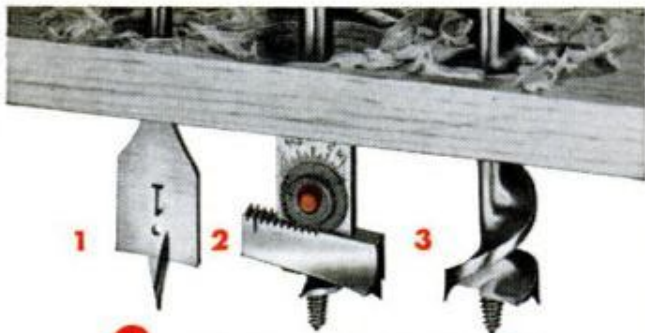

3 easy ways to bore holes faster

1. **Irwin Speedbor "88"** for all electric drills. Bores up to 5 times faster in any wood, at any angle. Sizes $\frac{1}{4}$ " to 1", \$.75 each. Sizes $1\frac{1}{8}$ " to $1\frac{1}{2}$ ", \$1.25 each.

2. **Irwin No. 22 Micro-Dial** expansive bit. Fits all hand braces. Just dial your size. Bores 35 standard holes, $\frac{7}{8}$ " to 3". Only \$3.80. No. 21 small size bores 19 standard holes, $\frac{3}{8}$ " to $1\frac{1}{4}$ ". Only \$3.40.

3. **Irwin 62T Solid Center** hand brace type. Only 16 turns to bore 1" holes through 1" wood. Double-cutter boring action. Sizes $\frac{1}{4}$ " to $1\frac{1}{2}$ ". As low as \$1.00 each.

Made to last for years. Every Irwin wood bit is made of high analysis steel, machine-sharpened, and heat-tempered full length for longest life. Highly polished, too. Irwin is the wood bit independent hardware dealers recommend for faster, cleaner boring action. Write Irwin, Dept. 20PM, Wilmington, Ohio, today for free booklet on how to select, use, and care for wood auger bits.

IRWIN every bit as good as the name
at Wilmington, Ohio, since 1885



cial conditions of temperature, salinity and pressure, which trap sound . . . and transmit it considerable distances . . . sometimes even thousands of miles."

Some sound-transmission channels are transitory. Others seem permanently rooted—and fixed—in the depths.

A mere four pounds of dynamite could be heard from Pearl Harbor to San Diego when detonated at a depth of about 900 feet, the Pacific "tunnel's" region of greatest transmitting efficiency. In the Atlantic, the best transmittal zone lies about twice as deep—down around 1800 feet.

There's another depth problem that the *Trieste* can explore; the varying speed of sound through water of different temperature, density and pressure.

"Temperature," explains Kenneth V. Mackenzie, who heads the Navy Electronics Laboratory's Underwater Sound Propagation section, "causes probably the greatest range errors in electronic gear." The error can be upwards of one-half percent, he points out.

These are a few of the many strange characteristics of the sea which will be explored and analyzed as the *Trieste* roams about in the black depths of "inner space" with its many instruments and recording devices gathering in the ocean's secrets.

Not only will scientists have records and samples of strange underwater phenomena, but they'll also have firsthand observations of sea creatures which have never before been observed in their environment.

★ ★ ★

Ring of Hydrogen Around Milky Way

One of the latest additions to our Milky Way galaxy is an expanding ring of hydrogen gas whose source is unknown, reports Dr. J. H. Oort of the Leiden Observatory. The ring of gas is moving outward from the dish-shaped galaxy in large quantities; in fact, the quantities of gas are so large that, at the rate the gas is moving, it would be exhausted in 10 million to 15 million years if it were not being constantly replenished. The source of the hydrogen gas is one of the current puzzles facing radio astronomers. One possible solution suggested by Dr. Oort is the corona of gas that surrounds the Milky Way. However, astronomers then face the problem of where this coronal gas comes from. Another contribution to knowledge of our galaxy is the discovery, reported by Dr. Oort, of a flat central disk of hydrogen gas some 3000 light-years in diameter that is rotating in a swirl close to the center of the Milky Way.

POPULAR MECHANICS

NOW! a hi-compression staple gun
for only
\$4.95



With Exclusive Push-button Loading and Built-In Staple Extractor.

Indispensable for home use . . . and never before priced so low! This compact, all steel, powerful SWINGLINE 101 staple gun is ideal for insulation, carpentry, upholstery, screening, wire fencing, plus thousands of other uses. Handle locks to fit pocket. Lightweight, maneuverable, jam-proof! Staple sizes $\frac{1}{4}$ ", $\frac{3}{16}$ ". Send for FREE book—"Tips for Tacking".

Swingline® INC.

Dept. PM-2-0 Long Island City 1, New York

5 Borden's GREAT GLUES



There's an Elmer glue for every job you do! "Elmer's Guide to Good Gluing" tells you all about them with hints, tips and what to use where. Send stamped, self-addressed envelope for your free copy of this 16-page illustrated guide book. The Borden Company, 350 Madison Ave., New York 17, New York.

ADVANCED DESIGN — REMARKABLE PERFORMANCE

BOAT TRAILER KIT Only \$59.50

Assemble and Own This High Quality Trailer—for 1/3 the Cost! Handles Boats up to 16' Long. Other Model Capacities to 2000 lbs.—Boats to 21 ft.

All parts furnished to assemble to a few pieces locally purchased pipe. Cuts freight costs. Trailer completely engineered—no drilling or cutting—assemble and tighten U-Bolts. "Easy Launcher" tilting bed available.

EASY FACTORY FINANCING.

Write today for free catalog showing other sizes, models, and prices.

TRAILER PRODUCTS COMPANY, INC.
Dept. PM-2, P.O. Box 176, Kingsport, Tenn.



with sockets, *QUALITY* counts

P&C SOCKETS

Last longer, let you work faster, easier



When you need sockets, buy good ones... P&C. Buy from the colorful P&C Merchandisers, 12,000 stores. Send 10c for tool catalog.



P&C TOOL COMPANY

Box 5926, Portland 22, Oregon
Warehouse: Schiller Park, Ill.

Subsidiary of Pendleton Tool Industries, Inc.

Free Boat Selector shows ultra-new designs



Model "Tangler"

Rakish, jaunty, streamlined... smart as tomorrow's sport cars, the new fiber glass and aluminum runabouts in the Yacht Club Fleet bring dashing appearance and flashing performance to Aluma Craft's accepted fine quality.

See these new beauties in the 1960 Boat Selector which also shows the Cottage Fleet of family boats as well as the popular Fishing and Wilderness Fleets. Each model pictured and described with full specifications, capacities, recommended horsepower, to guide your selection. Write for your free copy today.



Packed with factual information helpful to everyone interested in boating.

ALUMA Craft

America's Best Built Boats

ALUMA CRAFT BOAT COMPANY

1519 N.E. Central Avenue
Minneapolis, Minnesota

Gentlemen without obligation send me free 1960 Boat Selector Catalog.

NAME _____

ADDRESS _____

CITY _____ STATE _____

Fastest Boat in the World?

(Continued from page 125)

and I talked with the Alcoa people in Pittsburgh in the spring of 1959, and from there the project snowballed into *Tempo Alcoa*.

Once under way, the job went fast. We knew that the boat would have to be metal—no wood or wood fastening could stand the strains of traveling 300 miles an hour over water—and we knew that it would take 300-plus to beat Campbell. Alcoa provided the materials to my specifications; $\frac{1}{10}$ -inch sheet aluminum for the skin; aluminum channels for the framework; tapered sheet ($\frac{3}{16}$ to $\frac{1}{10}$ inch) for the sponsons, to give maximum strength at the rear but minimum weight at the front.

We named the boat *Tempo* (for Guy's boats) and *Alcoa* (for that company). Her racing number is J-13; J for jet hydroplane, 13 for Guy's lucky boat number. She took 2½ months to build in my shop in Kawkawlin, and we launched her into Saginaw Bay on Lake Erie on August 27, 1959.

Tempo Alcoa is 31½ feet long and 11½ feet across the beam, and weighs 5800 pounds dry. The power plant is a surplus Allison J-35 turbojet engine, the same as that in the Air Force F-84 jet, which develops 5600 pounds of thrust at 8000 revolutions per minute. The tanks hold 165 gallons of kerosene jet fuel, enough for about 20 minutes of high speed operation.

During construction, Guy met the Air Force's "Blue Angels" precision flying team and told them about the boat. They urged him to build in an aircraft ejection seat, and recommended that we confer with the engineering department of North American Aviation in Columbus, Ohio.

After some discussion, we decided not to use the ejection seat—if something goes wrong in a boat at over 200 miles an hour, there's no time or opportunity to hit a panic button anyway. But while we were working with North American, we met Dr. Robert Laidlaw, chief of dynamics, who suggested that we let him wind-tunnel a model of the boat. We built a model, which he tested at airspeeds up to 320. He made us all very happy when he reported that he could suggest no design improvements, and that *Tempo Alcoa* should be stable at least up to 320. We believe that this design and power combination could go as fast as 400 or 500 miles an hour, but almost nothing is known about boat performance above 200, and stability over that speed is a tremendous problem. (At 300 miles an hour, water is as hard as a plank, and at that speed you need 3000

pounds of thrust per square inch of hull going through the water. That's 1½ tons of thrust to shove a quarter along.)

Greatly encouraged by the wind-tunnel tests, we launched the boat and started power tests on Saginaw Bay, learning as we went along.

We use a heavy starting battery to crank up the big jet engine, setting the throttle at about 20 percent until she "lights up." At 1000 revolutions per minute the engine is on its own and we unplug the batteries and run on the 24-volt battery aboard. Idling, she eases out onto the test course at 10 to 15 miles per hour with more than half the hull in the water. In position on the end of the course, I run the engine up to 3000 revolutions per minute, then throw the high speed switch that feeds the engine its full quota of fuel.

She accelerates to about 90 with the hull still "wet"—mostly in the water. At about 90, with two-thirds throttle, she comes up out of the water very fast, and within a second she's doing over 100, up on three points and accelerating fast. During that second I have to get her aimed at a target, for there's no steering over 100 miles an hour. To move the rudder would spin or flip the boat, so if I'm off course I have to ease her back into the water and start all over again.

Breaking the suction on the bottom of the hull and getting the boat up onto its three points is the trickiest part of driving her—and the most dangerous. That engine has enough thrust to shove the boat at 500 miles an hour, but must be pushed to full power at 90 to get her out of the water. The boat and its resistance are balanced on that tremendous thrust until she breaks loose and comes up; on one run it took a two-mile, full-power run to do it. If anything should happen to throw the boat off balance during that time, she would spin like a Fourth of July pinwheel. The spin would break the resisting suction, so she'd whip faster and faster, like a missile out of control. I don't want to try that ride. Strangely, on rough water like Saginaw Bay, she bounces up nicely, but on smooth water the suction gives me a lot of trouble.

Once she's on her feet and aimed straight I can let her run; acceleration from 100 to 200 only takes six or seven seconds. At 100, the sound of the jet engine begins to drop away, and at 150 there is no engine noise at all—just the whistle of the wind over the cockpit and the banging of the water on the sponsons. She ran smooth and steady as a rock on the test runs, and I took her up to about 225,

(Continued to page 272)

Should be "NAVY'S" (see May 60, p. 16)

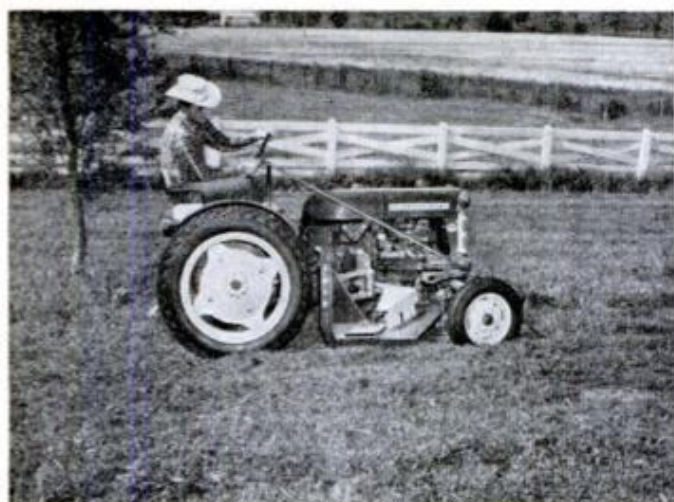

CASH IN EXTRA EARNINGS NOW! with an International® Cub Lo-Boy®

Mow lawns... plow gardens... landscape grounds... clear snow. There are countless ways to earn extra income the year 'round with a low-cost 13.4 hp Cub Lo-Boy tractor. There are countless prospects near you: homeowners, businesses, and industrial plants. As little as \$250 down can start you in a business of your own. And you can earn more profit because of the Cub Lo-Boy's low operating expense.

Ask your IH dealer about the Cub Lo-Boy and matched equipment or write today for free catalog:



**INTERNATIONAL
HARVESTER**

Dept. PM-2, Box 7333,
Chicago 80, Illinois

NEW SPEED PROPELLERS

for JOHNSON AND EVINRUDE 18, 40, 75 HP Outboards, SCOTT-ATWATER 25, 40, 60 HP. If you own one of these great motors by all means investigate MICHIGAN'S new, style SMC, 3-blade propellers engineered specifically for them, to provide more speed, better skiing, more fun. Send postcard for FREE 1960 catalog—the Outboarder's Bible. Also contains outstanding bargains in skis, speedometers, boat accessories. MICHIGAN WHEEL CO., Grand Rapids 2, Mich., Dept. PM



**SURPLUS! 5000 WATT A.C.
Electric GENERATOR**

115 Volt 60-Cycle A.C.
1800 RPM Single Phase

Gov't. Cost \$525.00

BRAND NEW!

FULLY GUARANTEED Only **\$189⁰⁰** fob

Ideal as a permanent or stand-by unit for electricity IDENTICAL to your house current. Handles an entire house, farm, camp, aboard ship, oil fields, mines, etc. Easily handles lights, refrigerator, deep freeze, oil burner, radio; power for saws, floodlights, drills, pumps, etc. **ALL BALL BEARING!** Operates at 1800 RPM. Drive with 10 HP or larger engine—or use power take-off. Voltage self regulating. Standard base mfg. 1 1/4" Shaft 2 1/2" Long. Size: 23" L., 17" W., 14" H., wgt. 300 lbs. Separately self-excited! Operates either direction. Mfg. by Louis Allis. Delivers 5000 Watts CONTINUOUSLY! Complete with service manual.

SUPPLY LIMITED! .. ORDER FROM AD! .. TAYLOR 9-1365
Free Catalog of other Surplus & Hydraulics

ROBERTS ELECTRIC CO., 849 W. Grand, Dept. PM 983, Chicago 22

Special Offer 25¢

Hear these authentic recordings of dramatic events from

"The Amazing World of Short Wave Listening"

narrated by Alex Dreier, Radio-TV "Man on the Go"

- President's voice from outer space!
- Actual capture of a desperate criminal!
- Radio amateur at Little America!
- Ships at sea . . . aircraft in action!

SX-110
receiver
\$159.95

Standard broadcast plus short wave coverage from 1550 kc. to 34 mc. Cal. electrical bandsread.

MAIL COUPON TODAY!

hallicrafters...
DEPT. 14, CHICAGO 11, ILL.

Gentlemen: Please rush by return mail my recording, "The Amazing World of Short Wave Listening." I enclose 25¢.

NAME _____

ADDRESS _____

CITY _____ STATE _____

Dr. Grabow

PRE-SMOKED PIPES

Cool, sweet
and mild from
the first puff.
No breaking-in
because they're
mechanically
pre-smoked with
fine tobacco

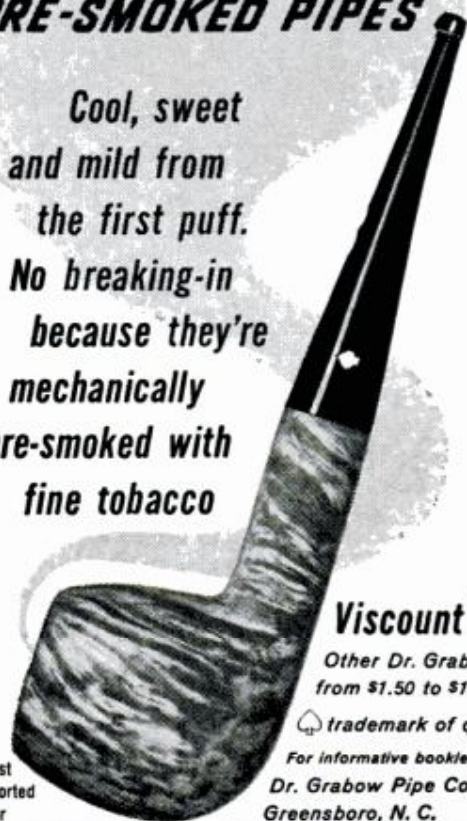

Viscount^s 5.

Other Dr. Grabows
from \$1.50 to \$10

trademark of quality

For informative booklet write:
Dr. Grabow Pipe Co.
Greensboro, N. C.

finest
imported
briar



SEAL YOUR DOORS AND WINDOWS
AGAINST COLD, RAIN, WIND AND
DIRT WITH

Bridgeport

INNER-SEAL
WEATHERSTRIPPING
and Cut Your
Fuel Bills, Too!

Made of flexible sponge rubber,
reinforced with spring wire and
neoprene coated for extra tough-
ness, long-wearing Inner-Seal is
easy to put on—you can do-it-
yourself with hammer, scissors
and tacks. Get INNER-SEAL at
your hardware store today! Only
10c a foot.



Write for
FREE FOLDER
"How to
Weatherstrip
Your Home!"
Dept. PM-2



BRIDGEPORT FABRICS, INC.
BRIDGEPORT 9, CONN.

winning the big battle by simply traveling that fast and staying alive.

Driving at that speed is much like driving a very fast car down a railroad road-bed—over the ties. In choppy water she jumps up and down from six to ten inches, hard and fast, and pulls up to 9 G's on the bounces. For that reason we had to put in a foot throttle—I couldn't have reached or operated a hand throttle under those conditions. The wheel, above 100, is just something to hang onto; all I'm concerned with is keeping the throttle setting steady and going as fast as possible.

During the tests we added the bow plane between the sponsons; it adds lift to help get the boat up out of the water, but adds none when she's up on a plane. Aerodynamic lift is something we *don't* want, which accounts for the blunt nose. The hull is much shorter than the sponsons to avoid air leverage, which could flip the boat up and over at high speed. We designed the boat for about 1800 pounds of lift at 300 miles an hour. That's all we want or need.

Surprisingly, it's almost as hard to stop the jet as it is to start. In the first place, even with the throttle chopped it can take up to 2½ miles to slow down—more than it takes for a freight train — and she doesn't settle back into the water until she's down to 80 or 90. As she begins to settle, we go through the same critical transition period that we do in coming up onto a plane, only without the overpower problem. She must come down perfectly flat, or a sponson could hook the water and spin or flip the boat. About all I can do is watch the direction she's heading; if she begins to veer, I know she's low on that side and can steer accordingly. It's a very touchy period, and takes fast steering reactions. As we learn more about design and performance at high speed, I hope we can stretch those critical planing and settling periods and make control easier.

The water surface makes a big difference in speed. In dead calm the boat is fast, but if we hit a patch of water ruffled a bit by the wind I can feel her accelerate without a throttle change, then slow down again when we're back on smooth water. Water that's ruffled just enough to produce that effect but not enough to bounce the boat is called "fast" water by boat racers.

It was a combination of those three characteristics of high speed boats—slow deceleration, inability to steer at speed, and the "fast" water effect—that caused the accident at Pyramid Lake and kept us

(Continued to page 274)

CUT-TO-FIT HOMES CUT COSTS UP TO 40%

Save labor cost up to 100%, reducing completed home cost up to 40%. You can assemble any of 57 designs from easy-to-follow plans. No measuring or cutting . . . every piece precision machine pre-cut and marked. **BUY DIRECT FROM MILL.** Eliminate all between overhead, profit and labor

costs. Nothing to plan or figure. Complete with all lumber, hardware, paint, nails, glass, roofing, etc. Sterling Home quality material throughout. Freight paid most areas. Write today. Send 25c for illustrated, color catalog, floor plans and details.



PRICED FROM \$2150 UP

CHOICE OF 57 DESIGNS

FIVE EASY-PAYMENT PLANS

INTERNATIONAL MILL & TIMBER CO. Bay City, Michigan, DEPT. PM 20



America is a Better America - thanks to Advertising!



GENUINE ALNICO MAGNETS

AMAZING, PERMANENT, NON-ELECTRIC, HIGHLY PRACTICAL. Conduct interesting experiments. Hundreds of uses. Retrieve valuable steel items such as guns, tackle from fresh or salt water; tools from tanks & drains. **GUARANTEED.** Try any magnet one week.

MONEY BACK IF YOU ARE NOT WELL-PLEASED
 M-710 (Wt. 53 oz.) Has pull of 225 lbs. on steel block . . . \$18.00
 M-625 (Wt. 70 oz.) Has pull of 125 lbs. on steel block . . . \$10.00
 M-575 (Wt. 18 oz.) Has pull of 75 lbs. on steel block . . . \$ 7.00
 M-500 (Wt. 13 oz.) Has pull of 50 lbs. on steel block . . . \$ 5.00
 M- 90 (Wt. 5 oz.) Has pull of 15 lbs. on steel block . . . \$ 3.50
 M-102 Pocket Magnet, 5 lb. pull, 2 for . . . \$ 1.50
 M- 47 Hot Pad Magnets, 10 for \$1.00 . . . 50 for \$ 4.87
 M- 35 Hobbyist assortment of 8 magnets . . . \$ 2.00

Send M.O. or check. We pay postage. Sorry no C.O.D.'s.

MIAMI MAGNET COMPANY, 3240 N. W. 27TH AVE. MIAMI 42, FLORIDA

"I Built a Full-Time Business in six weeks"

says Jack Philip Paynton, Saskatchewan

"MY JOHN DEERE BACKHOE was first bought for working after hours and on holidays. Within four to six weeks I had enough work lined up that I quit my job and am now working full time with the unit. With a lot of farms now being equipped with water systems and sewers, I believe I'll always have plenty of work. I would recommend this unit to anyone who wants to be independent and be his own boss."

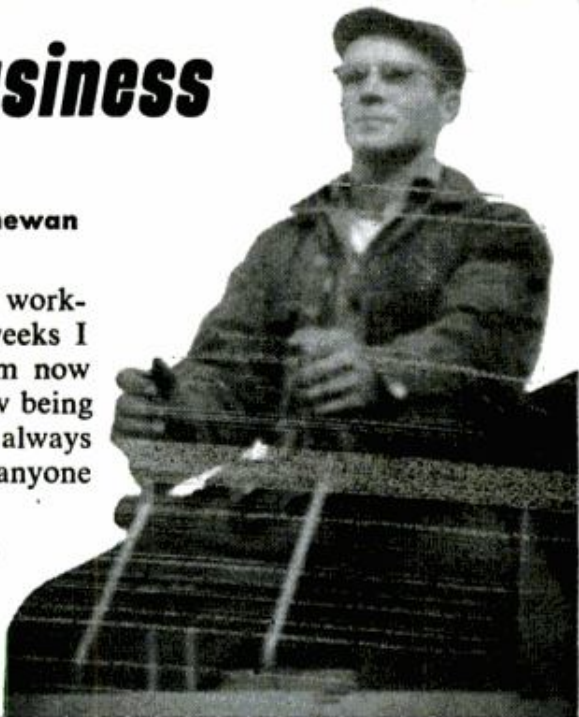

JOHN DEERE INDUSTRIAL DIVISION MOLINE, ILLINOIS



Without obligation or cost to me, please rush information on John Deere Earthmoving Equipment, plus details of the John Deere Credit Plan.

Name.....

Occupation.....

Address.....

Dept. 2408



PLUMB F-57 HAMMER Non-Breakable Fiber-Glass Handle

- Stronger Than Steel—
with the Hickory Feel
- Will not bend,
collapse, rust, rot or
corrode
- Guaranteed
non-breakable in
normal use
- Non-Slip Neoprene
Covered Grip

PERMABOND®

KEEPS HANDLES
TIGHT
permanently



PLUMB®

HAMMERS • HATCHETS • AXES • FILES

from setting a new world speed record.

Choosing the spot for a speed run is a tricky business. Any fresh water will do if there's room for a straight run of about eight miles, but the surface and wind conditions must be just right—not too much wind, not too smooth, and not too rough. And the weather should be as consistent and predictable as possible. Some lakes are much better than others—favorites are Loch Ness in Scotland, Lake Coniston and Lake Ullswater in England, Lake Mead and Lake Washington (near Seattle) in this country; but they all have drawbacks.

Bill Stead of Reno, an official of the American Power Boat Association and one of the great names in speedboat racing, suggested trying Pyramid Lake, near Reno. It has high banks, good weather, 15-mile straightaways, a good shoreline, a lot of open country around it, and it's good water for high-speed boating. The only trouble with Pyramid is that it's inside the Pyramid Lake Indian Reservation, so permission had to be obtained from the local Piute Indians.

Fortunately for us, Bill Harrah, owner and operator of Harrah's Club in Reno and a friend of Guy's, stepped in at that point and handled all the local arrangements. He appeared before the council of chiefs and got permission to use the lake for 30 days, then went on to take over the entire local operation, doing a tremendous job and smoothing the way for our whole project.

On November 14, we loaded the *Tempo Alcoa* on a special aluminum trailer (equipped with jacks to tilt her to within highway width restrictions) and left Kawkawlin in two trucks and a pickup truck with three mechanics, a truck driver, a load of accessory gear and two J-35 engines. When we pulled into Reno, we showed the boat to the local population, then started the final test runs.

On the 22nd, during a test run, I came back down from 200 through a patch of rough water. Bouncing around in the cockpit at about 140, I couldn't control the throttle with the delicate touch that's necessary to control the decelerating engine. My foot bounced on the throttle and fed great gobs of raw fuel into the engine, which was white-hot after the run. The extra fuel burned out the turbine blades and tailpipe cone in seconds, and as I looked back I could see chunks of steel coming out the tailpipe like popcorn. That was all for that engine. We put in the spare and made plans for more trials on the 22nd.

The engine tested all right, so on the

(Continued to page 276)

**ALL
NEW!**

**1960 Edition of Constantine's
WOODWORKING
CATALOG & MANUAL**



Get the biggest Constantine Catalog & Manual—2000 items! World's largest source since 1812 for rare imported and domestic woods in veneers, lumber, plywoods, bandings, inlays, mouldings, carvings . . . hard-to-find hardware, new solid brass hardware, wood finishing and upholstery supplies, patterns, tools, wood-working materials—at bargain prices! Also exclusive Inlaid-Wood-Picture Kits . . . Identification Chart of 60 rare woods in color . . . Inspiring projects, plans, etc. For all-new 1960 Catalog & Manual, send 25c (refunded on first order). Write today!

FREE—Year's subscription to "Chips & Chats" . . . brings news of exciting woodworking ideas and latest offerings . . . Free with Catalog!

ALBERT CONSTANTINE & SON, INC.
2050 Eastchester Rd., Dept. B-5
New York 61, N. Y.

**CUT ANY SIZE — ANY SHAPE
WITH Spearhead Cutter**



Handy pocket size — cuts leather, asbestos, rubber, cork, etc. — round 1/4" to 6" — any size straight and odd shapes.

Send Check or Money Order!

935
POSTPAID

ZIMMERMAN PACKING — NORWOOD 12, OHIO

CHANGE SPARK PLUGS REGULARLY

UNIMAT

complete machine shop-in-miniature

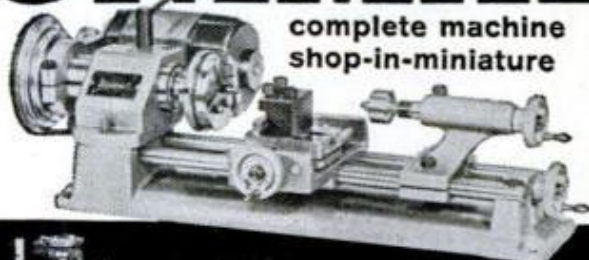

Converts from lathe to drill press, tool and surface grinding machine, vertical milling machine, or polisher/grinder—in seconds! **\$12950**

THIS is that jewel of a machine tool you've been looking for—if you're the kind of craftsman, hobbyist, model builder or inventor who demands all-out precision. It's hard to believe that such versatility, such high-level performance could be built into a rugged instrument that measures only 16" from headstock to tail wheel! The basic UNIMAT includes a powerful 3500 RPM motor and everything you need for fundamental machining operations. Advanced workers, of course, will want many of the accessories that make UNIMAT the most practical, all-purpose tool available anywhere in the world! Whether you're a perfectionist or putterer, you'll really enjoy working with UNIMAT. Available at better hardware stores and hobby shops, or WRITE FOR FREE CATALOG AND BUDGET PLAN INFORMATION.

AMERICAN EDELSTAAL, INC. DEPT. GB
850 BROADWAY ■ NEW YORK 13, N. Y.

**HERE'S A MONEYMAKER
FOR YOU!**

**make from \$3 to \$6 an hour
with the FOLEY SAW FILER**

Ask yourself these three questions: 1. Do I really want to get ahead *faster*? 2. How can I do it? 3. Am I willing to use my spare time? If you answer "Yes" to questions 1 and 3—then we have a positive answer for you on No. 2. Men make from \$3 to \$6 an hour sharpening hand, band and circular saws with Foley Saw Filers. No experience needed, to turn out sharp, smooth-cutting saws with this automatic machine. Start in spare time—no canvassing.

HERE'S THE WAY TO START

Read "Money Making Facts"—shows you how others have added hundreds or thousands of dollars to their incomes in this steady, repeat, CASH business. Start your own business in your basement or garage, no overhead, small investment. With *Time Payment Plan* the Foley can more than pay for itself out of profits. Send for "Money Making Facts"—mail coupon now. No salesman will call.

HERE'S PROOF

"When Mr. Patrick got his Foley Saw Filer in March 1946 he made a good and wonderful investment. He has done so well that we bought a house and paid for it; bought a new car, built an addition to our house. Nicest of all, it's all paid for." Mrs. Leslie Patrick.

"I made \$765 last year filing saws, and it sure comes in handy. I do this work in my spare time." —James B. Williams

"Last year's profit amounted to \$3,000. Not so bad for a one-man outfit." —Charles C. Hough.

"I have done 4 or 5 thousand saws in my spare time in the 4½ years since I got the outfit, and they are all coming back with repeat orders." —Len Crego.

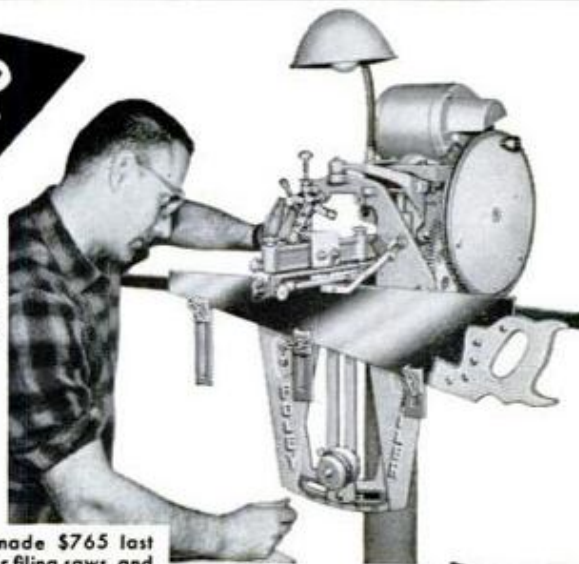

FOLEY MFG. CO., 216-0 Foley Bldg., Minneapolis 18, Minn.

Send me free book "MONEY MAKING FACTS" and Time Payment Plan.

NAME _____

ADDRESS _____

23rd we started trials again. That afternoon I fired up the jet normally and moved slowly out onto the lake, accelerating slowly and making a long run toward the south end of our course. I slowed, turned, and made a high-speed pass, then turned around and ran to the south end. The water speed indicator went up over 260 and everything worked beautifully. As I turned in toward the pits, satisfied that we were ready to try an official run, I spotted a photographer on the shore and remembered that I'd promised one close run for pictures. I opened her up and passed the pits about 200 yards offshore. The water was smooth but we ran easily up over 180 before I cut the throttle. We were headed toward a low, rocky promontory called Pelican Point. On earlier runs, all over 200 miles an hour, the jet had stopped in less than a mile on the smooth water, but a sudden breeze kicked the surface in front of me into "fast" water. Even with the power off, the boat took off so fast that the rudder was useless—it was like skidding on glare ice. I tried to make a shallow turn, but it was soon obvious that we were going to hit the point, and turning the boat wouldn't stop its forward motion. If we hit sideways we'd really break up, so I straightened her out and hit the beach headon at about 150 miles an hour.

I expected a sudden stop—but the next thing I knew the boat was airborne and I was feeling mighty relieved. They tell me I missed a rock outcrop by 18 inches, shot up over a 12-foot bank, then flew 100 feet at an altitude of about 20 feet. We landed on sand, slid another 60 feet, and stopped on the other side of the point with the starboard sponson hanging over the water. Another 30 feet and we'd have made it back into the lake.

As soon as I'd convinced myself that I'd survived the flight I climbed out and walked back to the high point to wave to the crew that I was all right. They were pouring toward the point in cars, boats, and on foot, expecting to see a crumpled boat and a driver to match. As it was, the only injury sustained was when Guy fell among the rocks and cut his leg as he rushed to the scene.

Tempo Alcoa lived through the flight pretty well, too. The major damage was to the starboard sponson and around the jet tailpipe, which was beyond repair. The rest of the boat surpassed our expectations and came through with fairly minor damage. The aluminum was tougher than even we thought. Repair on the spot was out of the question, though, so we loaded up and drove back to Michigan. When we've finished the repairs the jet goes on a tour of the boat shows—New York, Chicago, Dal-

las and Oakland—and then we'll go back and try again. We'll break the record if I can keep her on the water.

A lot of great guys helped out on the *Tempo Alcoa* project—Dr. Robert Laidlaw at North American Aviation's Columbus Division; Jay Sharp of Alcoa; George Maxwell of the Mobil Oil Company; Bill Stead and Bill Harrah and his staff in Reno. And my own crew of boat builders in Kawkawlin—Don Morin, Jack Chosay, and Lawrence Fouchea — took my life in their hands and built the boat. I was never in any danger; they're the finest group of speedboat craftsmen in the business. When we set a new record, a lot of the credit will have to go to them.

There's a big future for jet power in speedboat racing, even on the closed-course races like the Gold Cup. In the first place, the stocks of big Rolls-Royce and Allison piston engines are being used up fast and they've been out of production since aircraft went to jets. (I have three Allisons in my shop and they may be the only ones left in the country; I'd sure like to hear of any that are still around and available.)

Jets are cheaper and simpler to run, too, and even require fewer mechanics. What's more, they don't need gear boxes, shafts or propellers, and those three things fail as often as the engine in racing.

But there are disadvantages. The jet loses thrust if you slow down for a corner, and doesn't accelerate as fast as the prop jobs. We're trying to figure out a way to slow them down without cutting the engine speed, and to find a way to steer by deflecting the jet blast. The heat from the tailpipe is dissipated so soon that it won't be a problem to other boats, but the jet blast digs a three foot hole for about 20 feet behind the boat, which is even tougher on the other drivers than the "rooster tails" they're throwing now. But I think we'll all be using them before too long.

What about Campbell? The water-speed record is a big thing with England, a national endeavor involving support running into hundreds of thousands of dollars. (Guy and I plan to keep *Tempo Alcoa* a private thing between us and Alcoa.) If we break that record, Campbell will try to get it back, and he could do it, though we think we've got the best boat—at least for now.

I hope to start work on another jet boat soon—a twin-jet job with smaller engines placed well forward on sponsons and the driver seated aft. With the power forward and the increased beam, we should get a faster, safer, more stable boat that's easier to drive, and it should go over 400 miles an hour. I sure want to try it. ★ ★ ★

WELD, BRAZE, HEAT
DYNAMIC

SAFE, EASY, QUICK...

No experience needed!
Use on iron, steel, bronze,
brass, aluminum, other metals



SOLDER, CUT
**TRANSFORMER
ARC WELDER**

SEND ONLY \$6.00
Cash, Check or M.O.
Pay postman balance
plus charges.
Complete with
all accessories
only \$38.50 F.O.B.
direct factory-to-you

EASY PAY PLAN
Low down payment. Pay-
as-you-weld. Write for de-
tails. Literature on larger
welders on request.

Professional type welder for home, shop, farm, industrial use. Build, straighten, bend, repair auto bodies, fenders, lawn mowers, wrought iron furniture, railings, fences, farm equipment. Anything metal. Save money—earn money in spare time. Operates on properly wired 110 AC line. Simple instructions included. Complete with helmet, electrode holders, arc torch, flux, solder, rods, cables. Act now! Order from this ad on 10 day money-back trial. 1 year guarantee.

DYNAMIC WELDER CO. 1808 SOUTH FEDERAL STREET
Dept. D2-B, CHICAGO 16, ILL.

PAGE FOR TILLING
PLOWING
MOWING

A FULL LINE — 2 to 9 HP with complete
gear drive and reverse

FREE CATALOG—LOW PRICES—EASY TERMS

Over 40 years experience

OVER 60 ATTACHMENTS AVAILABLE!

PAGE 1904 S. 81 St.
Milw., Wisc.



Don't Miss the
**ANNUAL
BOAT SECTION**

in the

**MARCH
POPULAR
MECHANICS**

FEBRUARY 1960

Atlas 12" LATHE

Greatest value
in its Field!



**Greater capacity . . . greater work
range for production,
service and hobby work.**

Atlas 12" precision lathes handle every job faster and better, and, for sound reasons. They give you greater capacity, versatility and performance than has ever before been available at or near their low cost. Compare their features:

- (1) 12 1/4" swing over bed, 12" swing over saddle wings, 8" over cross slide, up to 36" between centers.
- (2) Timken tapered roller bearings.
- (3) 16 spindle speeds, reversible power cross feed and longitudinal feed.
- (4) Wide thread cutting range.
- (5) Complete V-Belt drive for full power transmission.
- (6) Heavy beds with ways precision ground to within .001" in all planes.

These and other big lathe features are standard equipment on *all* Atlas 12" lathes. Available in bench models with standard change gears or quick-change gears, and in two underneath drive models with pedestal base, as illustrated. See them at your Atlas dealer's, or write for NEW CATALOG.

PRICES START AT \$340
F.O.B. FACTORY



Atlas Press Company
2-24 N. Pitcher St., Kalamazoo, Mich.

QUALITY MACHINE TOOLS SINCE 1911

277

TOYS BROKEN?

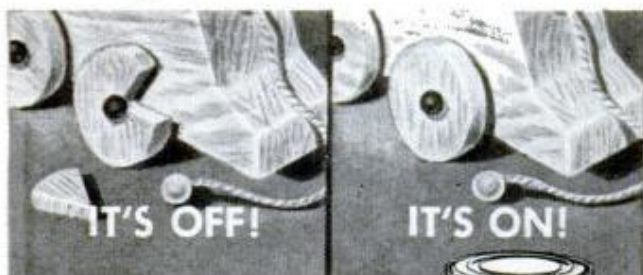

Fix 'em quick with the one and only Plastic Wood. It can be sanded, planed, painted!



For surest results always use GENUINE

PLASTIC WOOD

Handles like putty—hardens into wood!

Not an "ACHE in an ACRE"

MOWING WITH
ARIENS
Imperial

RIDING MOWER

Turn electric starter key
... shift gears ...
away you go! 26"
Rotary or 30"
Reel Mower!



New Flex-N-Float mowing keeps lawns carpet-smooth! 4½ or 5½ h.p. IMPERIAL has fingertip controls, 4 forward speeds; reverse. Many year 'round attachments. Unequaled for performance, value!

Ariens / SOLD & SERVICED
BY SELECTED
INDEPENDENT DEALERS

Mail to: ARIENS COMPANY
161 Calumet St., Brillion, Wisconsin
Send free IMPERIAL literature

Name _____
Address _____
City and State _____

What to Do Until the Firemen Come

(Continued from page 101)

inadequate appliances and phony demonstrations. So, here are some practical suggestions:

1. DON'T buy any extinguisher which does not bear a UL label, no matter what the man says.
2. Base your choice on rated fire killing power, not price.
3. Rely on your hose line for the common Class A fire in ordinary combustibles—but don't forget the watering can.
4. Back this up with *dry chemical extinguishers* which are excellent for Class B outbreaks in grease, oil or flammable liquids and are by no means useless on Class A fires if you remember about the overhaul.
5. Forget about electrical fires; the home doesn't have high-voltage electrical equipment. If a domestic appliance or even a TV set takes off, it either blows a fuse or you pull the plug. Then it is no longer an electrical fire.

All the other types of approved extinguishers are effective in the job they're designed to do. But why burden your wife with a "first aid appliance" that is too heavy to transport, unwieldy to handle, or so tricky to operate that she'll have to study the manual first? It's the housewife who's most likely to need the extinguisher. The dry chemical type is simple, foolproof, nontoxic, a nonconductor, lightweight and kills far more fire per pound (or per dollar) than any other type. This makes it a "best buy" for the home—and all leading manufacturers make them.

A promising new fire-fighting chemical was recently approved by the Army for its use—and engineers say it is also safe for the home. It's a brominated chemical which carries the tongue-twisting name, monobromotrifluoromethane—though you may prefer the shorter term, Freon-13B1. The material is excellent for electrical and flammable-liquid blazes.

The thing to remember about all hand extinguishers except those employing plain water is that they are most effective on *surface fires* where their smothering action is at its best. They can't achieve the penetration of water on ordinary combustibles. But they can do wonders on flash fires in lightweight materials which are so common in the home and so frequently the springboard from which the fatal fire takes off. Once you've seen a small handgun black out a blazing, dried-out Christmas tree, you get the point. Few

(Continued to page 280)

SURPLUS SALE

GOVT. SURPLUS
EXCESS INVENTORY
BANKRUPT STOCK

SURVEYING-LEVELING INSTRUMENTS

- Leading make, latest models, brand new guaranteed levels—transits at big saving. Wonderful values, all prepaid to you. Complete with tripod, case, etc.
- Professional Level-Transit..... **\$196.50**
- Professional Dumpy Level..... **155.00**
- Contractor-Farmer Level..... **\$3.99**
- Grading Hand Level..... **2.95**



ARMY PLANT

- Item #669. 3000-4000-w. 115-v. 60-c plant. 4 cyl. water cooled engine. Finest Hobart generator—Instrument panel—push button start. Army's finest plant. When power fails, generate your own. Wt. 600 lbs. Govt. cost \$1248. **SALE..... \$349.50 FOB**



STORAGE BATTERY WINCH

- Item #331. Powerful fully reversible ball-bearing gear reduction winch. 600-2000 lb. pull. Use on 6' or 12-v battery. Holds 40' of 1/4" cable. For trucks, docks, boats. Govt. cost \$280. **SALE..... \$46.75 FOB**



HI-VOLTAGE SPARK COIL

- Item #2260. Powerful laboratory expensive vibrating type spark coil. 10,000 volt spark from 12-volt AC or DC. Jumps gap. Use for ignition booster, burglar protection, practical joke (wired door knobs), etc. Govt. cost \$13.50. **SALE..... \$4.39 Ppd.**



AC POWER SOLENOID

- Item #2271. Wonderful very powerful 115-v 60-c solenoid. Tremendous pull. Use to operate latches, levers, etc. Has 1" stroke. Easy to mount and use. Size 2"x3". Wt. 1 lb. List \$8.25. **SALE..... \$3.49 Ppd.**



115-V WATER HEATING UNIT

- Item #127. Expensive finest Westinghouse water heating elements. Use for heating water, oil, etc. Makes ideal stock tank heater. Totally enclosed. 1 1/4" pipe threads. 3 heats—800, 400, 200 watts. Very rugged. Real buy. Govt. cost \$17.90. **SALE..... \$3.95 Ppd.**

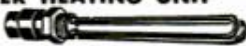

STANDARD DIAL PHONE

- Item #715. Modern hi-efficiency attractive dial phone. Use for extension to main line on private system. Use several for complete private system, etc. Complete. Work on any system. Govt. cost \$25. **SALE..... \$9.95 Ppd.**



SPECIAL OF THE MONTH!



SELF PRIMING PUMP

- Item #280. New leading make Govt. unit. Self priming. High capacity. Fine for basement sumps. Ideal bilge (boat) pump, fuel transfer, contractor use, etc. Capacity 12-40 gpm.
- Bronze fitted, self adjusting vanes. 1 3/4" (o.d.) inlet and outlet. Wt. 51 lbs.
- Kit of spare parts free. **\$24.91 FOB**
- List \$93.50. **SALE.....** (Note—only 81 units available.)

FISH-WORM AC SHOCKER

- Item #670. Harvest worms, clear private ponds of coarse fish. Powerful 110-v AC hand geared generator creates powerful electric field in ground or water. Amazing results.
- Also fascinating for experimental—use for fun at parties. Has Super-Alnico magnets. Govt. cost over \$12. **SALE..... \$3.89 Ppd.**



HYDRAULIC EQUIPMENT BARGAINS

- Savings to 80%. Build loaders, diggers, presses, etc. All brand new.
- Hand Pump (1000 psi)..... **\$10.95 Ppd.**
 - Control Valve (2-way)..... **18.00 Ppd.**
 - DA-16" Stroke Cyl..... **17.41 FOB**
 - Hyd. Press-Gauge (1500 lb.)... **3.45 Ppd.**
 - SA-144" Stroke Cyl..... **79.50 FOB**
 - DA-Servo Cyl 6" Stroke..... **5.79 Ppd.**
 - 12 GPM Pump (400 RPM)..... **45.50 Ppd.**
- Save 30% on finest winches, hoists, etc. For trucks, boats, farms, etc.
- 1000-lb. Hand Winch..... **\$ 8.95 Ppd.**
 - Boat dock, utility hand winch.
 - 1-4 gear ratio. 1500 lb. **19.95**
 - 2000-lb. Hand Winch..... **30.95 FOB**
 - 2000-lb. Worm Winch..... **36.95 FOB**
 - 2000-lb. Hand Hoist..... **19.71 FOB**
 - 3000-lb. Snatch Block..... **6.95 FOB**



FREE CATALOG Electronics, Power Tools, Binoculars, Hydraulics, Power Plants, Air Compressors and thousands of other items.

SURPLUS CENTER
LINCOLN, NEBR DEPT 804

OUTBOARDERS

FOR THE BEST
SKIING... RACING... CRUISING... TROLLING
"MULTI-PITCH" Variable Pitch OUTBOARD PROPS
OVER 10,000 IN USE • Simple, Rugged, Guaranteed
For most 25-45 hp motors • Ask your dealer, or write
LESNOR-MAEHR MARINE CO., INC. • Floral Park, L.I., N.Y.

7 PROPS
IN ONE
from
\$27.75

Take Correspondence Courses
For a Better Education

AConomize on Gasoline

Get more miles per dollar—install an AC ACon-O-Mizer between your fuel pump and carburetor. Reduces flooding and stalling... tailors fuel pressure—precisely and instantly—to every driving condition from idle to full throttle. The best answer yet to real gasoline economy!



suggested retail price
\$7.95



ACon-O-Mizer

At Your Nearby Service Station, garage or General Motors Dealer

AC SPARK PLUG THE ELECTRONICS DIVISION OF GENERAL MOTORS

ever work with hard woods?



SURFORM tools work 'em easier

Working hard woods—getting the exact contour, the smooth shape, or the delicate curve—is a lot easier with SURFORM tools. Pocket tool, new drum tool, all SURFORM tools—work quickly and easily on all kinds of wood, asphalt tile, composition boards, sheet rock, aluminum and other non-ferrous metals.



Making rabbet cut with SURFORM Drum

For free folder on miracle speed SURFORM® tools, write Stanley Tools, Dep't. 6202, New Britain, Conn.

STANLEY

domestic fires are as awe inspiring as this.

One valid exception to this rule of thumb is an automatic sprinkler type extinguisher which has a definite place in any home using an oil-burning furnace or a pump motor which runs frequently. This device, which carries UL approval, is a metal container suspended on a hook from the ceiling and containing carbon tetrachloride and ammonium hydroxide. The latter not only renders the former nontoxic, but it also generates the discharge pressure when the release of a fusible link allows the two to mix. A typical sprinkler distributor spreads the discharge in an umbrella-shaped spray over considerable floor area.

This is hardly fire fighting, but it is compelling the fire to commit suicide by having its own heat turn on the extinguisher! This device, listing at around \$29.50, must not be confused with the cheap glass balls or bombs employing straight carbon tet, which are not approved by any recognized inspection agency.

In any "do-it-yourself" project, how you use your tools is as important as what tools you use. Home fire fighting is no exception. Whether you have a hose line or a chemical extinguisher, the cardinal principles are:

1. Always aim the stream at the base of the flames.

2. Keep the stream moving from side to side across the fire.

3. Don't throw the stream at the smoke, but at the burning fuel which is causing the smoke.

Water absorbs the maximum heat at the instant it is converted into steam—which is the way it cools a fire—and the best place for this conversion is at the seat of the fire. Carried upward by convection, the steam also exerts a certain smothering effect. Similarly, a chemical agent releases an inert gas which smothers the flame by excluding oxygen, and you want this gas to be carried upward in the rising column of heat. So always aim at the base of the flames.

The volume of this gas, incidentally, is many, many times greater than the volume of chemical from which it came. Consequently, the approved hand extinguisher, correctly used, will kill far more fire than the uninitiated layman would believe possible.

In a combat with fire, flame is the least of your worries. Being an amateur, you're going to get out if the blaze gets painfully hot—as you should. But if it isn't punishing, you're going to face a far more stealthy adversary: smoke. Smoke contains toxic

(Continued to page 282)



ONCE A DRAFTY PORCH... NOW A SPACIOUS YEAR 'ROUND FAMILY ROOM

Need extra space? You, too, can transform that back porch into a weathertight room, comfortable for every season. With Andersen Flexivent® Window Units, it's easy to create extra all-weather living space. Andersen Windows are crafted in wood, a natural insulator... 21.5% more effective than aluminum sash in blocking outside cold. For do-it-yourself planning help see your lumber or millwork dealer.



CLIP AND MAIL TODAY!

PM-20

FREE Remodeling Book plus 19 Steps for enclosing a porch

Andersen Corporation, Bayport, Minn.
Please send me a FREE copy of "19 Steps
For Enclosing A Porch"

Name _____

Address _____

City, Zone, State _____

Andersen Windowalls



POPULAR MECHANICS

ADJUSTABLE MITER BOX & CORNER CLAMP



No. 44—COMBINATION MITER BOX AND CORNER CLAMP

Holds the wood and holds your saw. Uses any handsaw for accurate cuts from 0° to 180°. Full 3" capacity. Sides of joints exposed \$2.75 PPD.

No. 33 Works the same as No. 44, but without saw guide attachment. \$1.75 ppd.

FREE LITERATURE

SAW SHARPENING IS EASY

Super Filer No. 11 joints and sharpens hand and circular saws 6" to 10" with all teeth correct in height, depth, pitch, bevel. When file hits steel roller, teeth are finished. Saw runs true with no side pull. Includes 8" file. \$9.95 PPD.



"TRU-CIRCLE" saw set automatically sets teeth at 10° or more. \$2.95 PPD.

MONEY BACK GUARANTEE

A. D. McBURNEY, 5908 Hollywood Blvd., Hollywood 28, Cal., Dept. A-20

OUTWORKS THEM ALL

Prepares the toughest soils in one operation. All-purpose tiller-tractor tills to 12" deep—12" to 40" wide. 3 models; 7 rotor styles including mulchers. 40 attachments include all tractor tools, mowers, snow plow. Tough chain-gear drive. Send for details.



Pat'd. Also Pats. Pend.

MERRY TILLER

Northern Life Building, Box 1829, Seattle 11, Wash.

Works in seconds!



Loosens Rusted Bolts nuts, screws, "frozen" parts!

LIQUID WRENCH®

SUPER-PENETRANT

The super-penetrating rust solvent that quickly loosens rust and corrosion.

AT ALL HARDWARE AND AUTO STORES

RADIATOR SPECIALTY COMPANY CHARLOTTE, N. C.



HOW TO PROTECT YOUR INCOME!

Earn Extra Money With A Rapid

SHEAR SHARPENER AND KNIFE SERRATOR



Easy to operate—professional-type sharpener does a perfect job in just 2 minutes on all types scissors and shears, including pinking shears. Knife guide puts proper edge on any blade. Knife serrating attachment puts saw-tooth edge on hard or soft steel blades. Quick profits from homes, dressmakers, barbers, restaurants, hotels, butchers, etc. No experience needed. Big opportunities with this precision ball bearing machine. Has ¼ h.p. motor. A money-making investment—write for FREE FOLDER PM-8

BEAVER MFG. CO P.O. BOX 434, 800 So. Isis Ave. Inglewood, Calif.

RADIO SHACK flash!

Send Coupon for Latest

FREE

ELECTRONICS Catalog

plus every new issue for 1960



Act today! See the newest, the best, the most complete lines of electronic equipment in America—stereo, hi-fi, ham radio, LP records, tapes, optical goods and scores of others. Over 100,000 items—everything for the amateur, the pro, the devotee or just the interested.

Mail the coupon now! We will send you immediately, Free and Postpaid, not only our latest 312 page Electronic Catalog but every new issue for next 12 months—a full year's Free subscription to the finest in electronics and associated products all at famous money-saving Radio Shack prices. Satisfaction guaranteed on every order or your money back.

RADIO SHACK CORPORATION Dept. 60B3
730 Commonwealth Ave.
Boston 17, Massachusetts

Just one of thousands of RADIO SHACK buys

Transistor Battery Radio
19.95 Value
only
\$9.95



Exclusive Radio Shack transistor battery radio. Only 2¼x4x1¼ inches in size. Weighs less than 10 ounces. Built-in speaker and ferrite antenna. Conelrad markings, handsome molded case.

Radio Shack Corporation
730 Commonwealth Ave.
Boston 17, Massachusetts

Dept. 60B3

Please send me, FREE and POSTPAID, your latest Electronic Catalog. Also send me every new issue for the next 12 months—a full year's subscription FREE.

Name _____

Address _____

Postoffice or City _____ Zone _____ State _____

NEW GORMAN-RUPP

All-Purpose Portable

HANDY PUMP



Self-priming centrifugal with motor. Weighs only 13 lbs. Pumps up to 950 GPH. Uses garden hose. Sturdy aluminum body. Series motor, 7800 RPM, 115 volts. High-gloss metallic finish. Supplied with hose adapter, suction strainer, motor protector, 3-wire connector, ground adapter. A portable pump with 1000 uses, now only... **\$74⁹⁵**

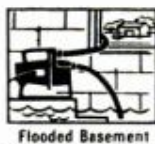

Flooded Basement

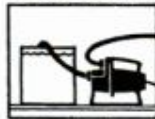

Standby Use



Around the Farm



Bilge Pumping



Spray or Wash*

THE GORMAN-RUPP COMPANY, MANSFIELD, OHIO

Send Free Handy Pump Folder and name of nearest dealer.

NAME.....

ADDRESS.....

CITY.....ZONE.....STATE.....

Most valuable use to me:

Farm Home Boating Business

FIBERGLASS

or PLYWOOD

FACTORY-DIRECT
PRICES

FREIGHT
Paid to You

18 FT. CRUISERS, 8 Models: from \$379



50 Models
8-18 Ft.



12, 14, 16, 18 ft. runabouts, ski-models, convertibles, utilities: \$114 up. 8, 10, 12, 14, 16, 18 ft. racing, fishing, utilities: \$41.95 up.

FIBERGLASS 14 & 16 ft.
From \$299 (at right)

Interlocking units (lower right photo) snap together, bond into 1-piece boat easily assembled in one evening.

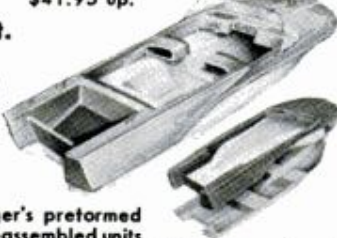

Luger's preformed preassembled units are easily assembled by anyone. Equal factory-built yet save 1/2 to 3/4. FREE catalog has all details, trailers, accessories, paint, Fiberglass supplies.

FIBERGLASS
14 ft. Sail Boat
\$299 with sail



SEND FOR FREE
COLOR CATALOG

MONEY-BACK GUARANTEE
EASY TERMS 1/4 DOWN

LUGER BOAT KITS

Dept. B-2, 9200 Access Rd., Minneapolis 20, Minn.

combustion gases, some of which are more lethal than carbon monoxide, which is always present. And smoke has killed many more victims than live flame.

Unfortunately, the color or shade of the smoke is not a reliable clue to its toxicity, but there is one cue you'd better follow. If the smoke is thick, dark and "lazy" (slow moving), you'd better get out without delay. Not only is it loaded with lethal gases, but its sluggishness implies a dangerous depletion of oxygen. Never forget that a going fire can survive in an oxygen concentration which won't support life, and this is a condition common to the pent-up cellar or attic outbreaks which are best left for trained men to handle.

About three-quarters of all dwelling fire victims die *upstairs* from *downstairs* fires. This is because heat rises. In the home it floods up the open stairwell to the topmost hall — where the bedrooms usually are — then mushrooms under increasing pressure as more superheated air (at 1600 to 1800 degrees Fahrenheit) pours up from the blaze below. One gulp of this withering air is as lethal as a rifle bullet, and escape through it via a main stairway is almost always impossible.

One Brooklynite, aroused at 3 a.m. by the strong odor of smoke, jumped out of bed, grabbed the hall door knob, then dropped it because it was too hot to hold. Undaunted, he wrapped a towel around his hand, opened the door and was felled in his tracks. Firemen found him sprawled dead across the sill without a burn on him. What got him? Superheated air and combustion gases flooding up the stairwell. The hot doorknob was a sure danger signal that the hallway was deadly—if only he'd known it.

The basic rule is NEVER OPEN A HOT DOOR. First, put your hand on the panel above your head. If the wood is hot, *don't open the door*; it's too late. Instead, go to a window and holler for help. Or get out by some secondary exit, such as a porch roof, a back stairway or any other course which does not bring you into the main hall.

If the door is not hot when you feel it, open it carefully. Brace your hip against it; put one hand over the crack between the door and jamb higher than your head; open the door an inch. If there's any pressure against it, slam it shut. If the incoming air on your hand is hot, slam the door shut, for you'll never make the stairway.

Drill every family member in this procedure. Figure out a secondary means of egress for each individual which avoids the upper hall and the main stairway—or any

(Continued to page 284)



700 Watt Light Plant PUSH BUTTON START

115 v. 60 cyc. AC Powered by a rugged 2.2 HP, easy starting Briggs engine. No wiring necessary: just plug in and operate. Plenty of current for any oil burner, freezer, brooder, emergency lights, etc. which require up to 700 watts. Ideal for television and radios. Complete with voltmeter and built-in winding to charge 6 v. auto batteries. (Item 24) Wt. 75 lbs. Easily fits in car trunk. Be prepared if storm knocks out power lines. Reg. \$275.

\$143.50
1200 Watt Plant (Item 45) same as Item 24 but larger generator and engine with 50% greater output. \$199.50

ELECTRONIC BRAIN Now Available On All Our Plants Up To 100,000 Watts!

Allows plant to saunter along at a thrifty idle till electricity is called for. Then instantly . . . automatically, plant comes up to full speed with a steady 115 volts of power. When demand stops, the BRAIN returns plant back to that same thrifty idle. Saves gas, doubles engine life! If BRAIN desired, specify & add 3 lb. and \$35 to plant price.



HEAVY DUTY D-C ARC WELDER

Use as portable or shop welder. Up to 300 amps. Senior model. Made for years of trouble-free, continuous service. Will handle light or heavy jobs. Easily welds up to 3/4" plate using 1/4" rods. Built-in air cooling system. Arc is easy to strike and hold, because of specially designed arc stabilizer. Hi-lo switch and dial control gives wide range of welding heats. Run welder at 2600 rpm. with tractor, jeep or 15 hp. gas engine, or 7 hp. elec. motor and triple V belt or flat pulley. You can pay more, but you can't buy a better welder.

\$119.50
WELDING KIT. Two 10 ft. leads, welding helmet, electrode holder, ground clamp. Sold only with welder at. \$10.50

Send 10c for 100 page Catalog-FREE with order. Prices f.o.b. factory—Send check or M. O.

MASTER MECHANIC MFG. CO., Dept. A-26 Burlington, Wis.

Southern Customers Order from Dept. A-26, Box 65, Sarasota, Florida

BATTERY BARGAINS

We're liquidating our stock of new 12-volt dry-charge batteries at cost: 10 amp @ \$8.70; 20 amp @ \$9.06. Ideal for boating and camping equipment. Dimensions: 10 amp: 8 1/16" x 4 5/16" x 5 3/4". 20 amp: 7 3/4" x 5 3/16" x 7 3/8". Famous-brand batteries are still in original cartons. Separate containers of electrolyte furnished. Send check or money order. State quantity and amperage. We'll ship express, collect.

Fairbanks, Morse & Co., Magneto and Engine Accessories Division, Beloit, Wisconsin.



WATERBURY FOR TILLING PLOWING MOWING

A FULL LINE 3 to 9 HP
 2 WHEEL • 4 WHEEL
 FREE CATALOG • LOW PRICES • DEALERS WANTED
 Many attachments available

WATERBURY
 Box 2734-D, Milwaukee, Wis.



use the solder that most home owners use!



KESTER SOLDER

For your electrical work, radio-TV, do-it-yourself projects . . . always use the best . . . KESTER SOLDER. Send for FREE 16-page book that tells you how!

KESTER SOLDER COMPANY
 4251 Wrightwood Avenue • Chicago 39, Illinois
 OVER 60 YEARS' EXPERIENCE IN SOLDER AND FLUX MANUFACTURING

Now! It's easy to have Beautiful Oak Floors

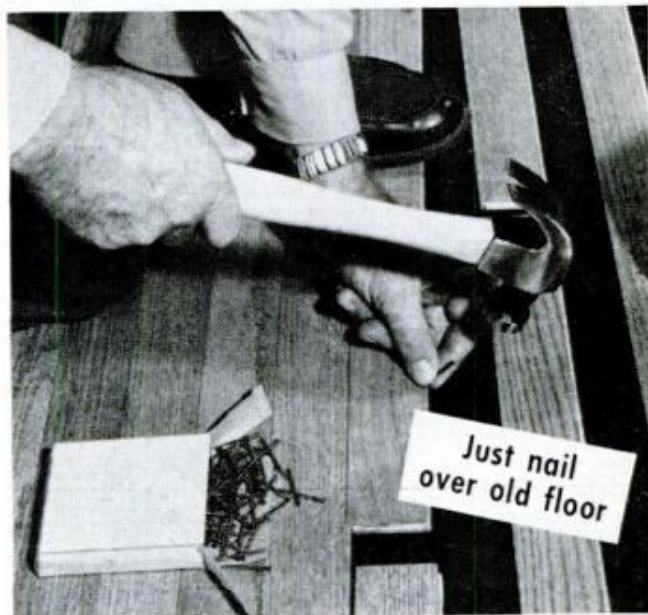

PRE-finished Bruce Crestwood Flooring

Now you can have beautiful new oak floors in less than a day. Crestwood is a modern pre-finished flooring in a special size (2" wide by only 3/8" thick) designed to be laid over your old wood floor or subfloor. It's packaged in handy cartons complete with nails.

Completely finished—even waxed—at the factory, Crestwood requires no sanding or finishing. It's ready for use as soon as laid! Strips have tongues and grooves for blind nailing as shown in the photo above.

A new Bruce Crestwood Floor will cost you less than a good rug or carpet . . . and will last the life of your home. Sold by leading lumber dealers. Mail coupon for colorful literature.

SEND FOR COLOR FOLDER

E. L. BRUCE CO.
 Box 397-X, Memphis 1, Tenn.
 Send literature on Bruce Crestwood Floors to:



Name _____
 Address _____

BRUCE CRESTWOOD FLOOR

Product of world's largest hardwood flooring maker

Schupack's Amazing Tool Bargains! Save up to 100%!

75 Mounted Wheels & Miniature Cutters. Regular \$11.00 value **\$4.50** P.P.
 For cutting and grinding on paid wood, metal or plastic. Includes 26 mtd. wheels and points on 3/32" shanks; 24 miniature cutters on 3/32" shanks; 25 short shank min. cutters. Will fit all electric drills and hand grinders.

FLEXIBLE SHAFT—ONLY \$6.50 P.P.
 Fits all electric drills & hand power tools 3 3/4" long. Oilite bearings. Core of specially wound, high carbon steel wire in flexible steel casing. Will accommodate tool shafts up to 1/8" dia. For lathes, electric drills, etc.

2 DRUM SANDERS With 12 bands in Assorted Grits. 1/2" dia. x 1" long on 1/4" arbor with 12 hands. **\$1.50** P.P.
 One drum, 1" dia. x 1" long on 1/4" arbor with 6 extra sleeves **\$1.00** P.P.

8 Carbon Steel Wood Bits for Brace. Assorted sizes, 3/32" to 3/8", for drilling on wood or metal. **\$1.75** P.P.

10 HIGH SPEED STEEL REAMERS—Straight and Taper Shanks— all brand new and in excellent condition. Reg. \$25.00 value. 10 for **\$4.50** P.P.

12 Miniature Cutters. For cutting wood, plastic or metal. Assorted shapes on 3/32" shank. **\$1.50** P.P.

2 Circular saws. On 2 Mandrels—all at one low price. 1" diameter saws on 1/4" Mandrels. For cutting wood, plastic or soft metals. **\$1.50** P.P.

20 Piece Set Wire Gauge Drills from 61 to 80. **\$2.50** P.P. No C.O.D.'s. Catalog 10 cents

SPECIAL—101 PIECES for ELECTRIC GRINDERS
 Grinding Wheels, Cut-off wheels, Sanding Discs, Mounted Stones, Honing Stones, Rotary Cutting Burrs, Mandrels and other items **\$4.50** P.P.

12 MOUNTED WHEELS and points on 1/4" Shank **\$2.95** P.P.
 For grinding on plastic, wood, soft & hard metals. Regular Value \$8.40. 18 Mounted points on 3/32" shank **\$2.50**; 12 mtd. wheels on 1/4" shank **\$3.60**.

ADAPTER CHUCK With 2 interchangeable collets, opening from 3/32" to 6, on 1/8" mandrel. Price each only **\$1.50** P.P.
 Adapter Chuck, From 60 to 80 on 3/32" Mandrel **\$1.00** P.P.

7 H.S. and carbon drills from 6" to 12" in length. Assorted sizes up to 1/4" diam. for drilling in hard to reach places. A reg. \$10.00 val. for only **\$1.95** P.P.

12 India Silicon Carbide and Arkansas Stones— Squares, Rounds, Triangles. An assortment from 3/4" long to 6" long. Fine, medium and coarse. A real **\$9.00** value. 12 for **\$4.25** P.P.

32 H.S. steel drills, threaded shanks from 3/32" to 1/4". Reg. \$9.50 value, only **\$2.00** P.P.

18 Rotary Cutters **\$5.85** P.P.
 \$13.50 Value. Assorted size cutters on 1/4" or 3/32" shank. Will fit all hand grinders. Ideal for cutting wood, metal, or plastic.

SCHUPACK SUPPLY CO. 7331 COTTAGE GROVE AVE. DEPT. PM-22 CHICAGO 12, ILL.

other stairway that might be flooded with heat.

It is smart to have a ladder outside the house so the first one to get clear can raise it to bedroom windows. The modern lightweight aluminum types are excellent.

It is smarter yet to equip sleeping rooms which have no secondary exit with an ingenious escape ladder now available. Fastened to baseboard or under the window sill, this ladder stows in a box on the floor and is always available for emergencies.

All this suggests another basic rule: always bottle up the blaze, if possible. If you can shut a hall or bedroom door and keep the heat from flooding through the house, you've at least put a curb on the extension of the fire by convection—its fastest means of advance. In Jersey City recently four people died on the third floor of an apartment because those who discovered the blaze on the first floor fled in panic and left the door to the hall open.

If your home is situated where a fire department response is fairly prompt, there isn't much for you to do beyond the elementary first-aid operations if you've had the wit to call the firemen first. But if you are in a more isolated location, there are other things to worry about. Two very common types of fire which often break out in concealed spaces are those started by overheated or defective flues in chimneys and those originating in defective wiring. Both require opening up the wall or ceiling with an axe or hatchet so that you can get water or chemicals into the hidden void. And while this is a large order for the untrained layman, he'll have to do it if help isn't readily available. (See the diagram on page 100 for an idea of how fire spreads through hollow spaces—and how to guard against it.)

If you succeed in dousing the fire this way, then the aforementioned task of overhaul becomes vital. This involves following the natural upward course of the heat all through that part of the house, feeling walls and looking for paint blisters or drooping wall paper in all the rooms directly above the outbreak. Such signs mean you must open up that wall and get water in there, else the blaze you thought was out will be coming through the roof presently. The presence of cobwebs in such a void is good evidence that no dangerous heat has passed that point.

The same procedure should be followed when any substantial volume of fire has burned inside a room close to the hollow wall. Heat can go through a crack which a cockroach couldn't negotiate, and this vertical spread through concealed voids is

(Continued to page 286)

For QUALITY Results STANDARDIZE on *Southern Screws*



Wood Screws
Stove Bolts
Hanger Bolts
Dowel Screws
Tapping Screws
Machine Screws
Carriage Bolts
Drive Screws

**THIS LABEL IS YOUR
GUARANTEE OF
QUALITY SCREWS**

● SPECIFY SOUTHERN!

Buy 'em by the box and save!

Only a screw holds like a screw!!



SOLD THROUGH LEADING HARDWARE AND BUILDING SUPPLY DEALERS

WAR SURPLUS AND OTHER BARGAINS SAVE UP TO 90%

200 AMP D.C. WELDER 24-32 volts D.C., 200 amp gen. Extra heavy duty. Internal fan cooling. Brand new 9 H.P., ball bearing, Briggs & Stratton engine. 200 amp generator (direct coupling to engine). Portable wheeled frame mount. Voltage reg. Rheostat. Reactor coil. Welds 1/8" rod to SAE standard, any thickness metal. Complete. Wt. 200 lbs. NEW. A \$750 value. **\$199.50.**

AIRBORNE ALL-PURPOSE ELECTRIC WINCH Fully bearinged 3 HP motor with a reduction of 240 to 1. Will operate on 6, 8, 12, 24 or 32 V. Will lift up to 2 tons. Safety clutch set at 3 tons. Fully reversible. Adjustable hand brake and lock. Drum will handle over 500' of 1/4" steel cable or 5/8" rope. A terrific, compact power takeoff for beaching boats, etc. Will work off any battery within the range from 6 to 32 V. Cost of this unit is less than an installation for a competitive brand. Shpg. Wt. 150 lbs. Complete, ready to run (less cable). NEW. **\$99.50.**

SENSITIVE ALTIMETER in 20 ft. increments. 0 to 35,000 ft. (inches of Mercury). Famous Pioneer. Tested & inspected in our own instrument lab. Guaranteed perfect. Approx. GOVT. COST \$150. Wt. 2 lbs. **\$13.95**

"SUPER 9" 200 AMP WELDING KIT With Deluxe accessories consisting of one 200 AMP. Gen., adjustable helmet, electrode holder, 30' welding cable, rheostat, giant toggle switch, voltmeter, voltage reg., 1 pr. heavy-duty welder's gloves. All units guaranteed pre-tested. Approx. GOVT. COST — \$500. Most items new — all perfect. **\$26.00.**

"DELUXE 11" ARC WELDING KIT Consists of 160-250 AMP Gen., voltage reg., ammeter, shunt, adjustable helmet, electrode holder, pr. welder's gloves, 30' welding cable, reactor coil, giant toggle switch, rheostat. Approx. GOVT. COST \$650. All units guaranteed pre-tested. **\$34.95** complete.

ELECTRIC PUMP WITH CONTROL UNIT

Runs on 12 or 24 V. Centrifugal type. Draws 5.2 AMPS. Has built-in removable filtering screen. Great for bilge, circulating or sump pump... bait tanks, etc. Pumps 500 GPH. Complete with on and off switch rheostat, explosion-proof motor, 2 speeds (hi & lo). Mfd. by Ingersoll-Rand. Shpg. Wt. 7 lbs. Approx. GOVT. COST \$195. NEW—**\$8.95.**

SOUTH WIND HEATER & ACCESSORIES

Mfg. for govt. antarctic expeditions for jeeps and half-tracks. Heating unit puts out over 20,000 B.T.U.'s. Burns any type gas, 6 volt system. Dim: 8 1/4" W x 18 1/2" L x 9 3/4" H. Fuel consumption extremely low, 1 gal. per 8 hrs. Terrific for trucks, boats, tractors... farms, warehouses, ranches, boat houses, cabins, etc. Complete with service & installation manuals and over 360 components. Approx. GOVT. COST \$550. Shpg. wt. 120 lbs. gross. NEW **\$39.95.**

BUILD YOUR OWN ARC WELDER, LIGHT PLANT OR BATTERY CHARGER \$37.50

Kit incl. 1 Navy NEA-5 Gen. combination AC-DC type. AC 115 V. DC 24 V., 200-300 Amps. 2 complete generators in 1, yet no larger than reg. gen. Ideal for home, shop and farm lighting plants. Delivers 1200 Watts AC, DC side for charging batteries, welding and operating war surplus motors. Also in kit: 2 Voltage Regs., AC & DC, Reverse Current Relay, 30' New Welding Cable, 1 Ammeter, Rheostat, Electrode Holder, Toggle Switch, Welder's Shield, Wiring Diagram for kit. Wt. under 100 lbs. Approx. GOVT. COST \$650. Kit—**\$37.50.** Navy NEA-5 Gen. as above, purchased separately, **\$23.50.**

NEW 1960 CATALOG! Tremendous catalog—our biggest ever—fully illustrated—1000s of bargains in war surplus & other items. Send 25c in coin for your copy today or free copy with order. Where ppd. indicated applies to US only. Other prices FOB Culver City, Cal. Send cash, check, money order. 50% dep. COD.

AIRBORNE SALES CO., INC. DEPT. PM 260
8501 Stellar Drive, Culver City, Calif.

BUY GREAT NECK HAND TOOLS
... for long-lasting performance



GREAT NECK SAW MFRS., Inc.
MINEOLA, N. Y. — SEE YOUR LOCAL STORE

GEARS
In Stock — Immediate Delivery
Gears, speed reducers, sprockets, thrust bearings, flexible couplings, pulleys, etc. A complete line is carried in our Chicago stock. Can also quote on special gears of any kind. Send in your blueprints and inquires.
Send for Complete Catalog No. 10 CHICAGO GEAR WORKS
440-50 N. Oakley Blvd., CHICAGO 12, ILL.

GUNK-it-yourself!

Gunk® G.P. removes grease from engines or concrete floors; cleans paint brushes, power mowers, or machinery completely, economically, safely. It's ready-to-use, rinses off with water, won't clog drains. Quart size with handy "Squirt Spout" top speeds application. Insist on the best degreaser — the original "GUNK" at better automotive supply and hardware retailers everywhere. ® REG. TRADE MARK.



GUNK CHICAGO CO., River Forest, Illinois
serving the Midwest and Southwest
RADIATOR SPECIALTY CO., Charlotte, No. Carolina
serving the East, Southeast and far West

LONGER LASTING

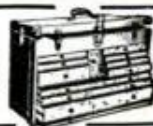

Built to serve over the years. Free catalog to toolmakers and machinists.
GERSTNER TOOL CHESTS
460 Columbia St. Dayton 7. O.

\$500 in 4 months spare time

IS WHAT I MADE WITH

the FOLEY LAWN MOWER SHARPENER

"No one can go wrong with the Foley machine"—V. J. Patterson wrote us. Get in this CASH business where 99c of every dollar is YOUR profit! The Foley Lawn Mower Sharpener handles up to 3 or 4 mowers per hour. Hand mowers run \$2.00 to \$3.00—power mowers \$5.00 to \$8.00.

FREE PLAN shows how to start. Foley prices are low—easy payments available. Send coupon today—no salesman will call.

"In my home town of 5,000 I paid for the Foley 4 or 5 times over the first season. I also put a \$1035 oil furnace in my new home."
—B. Mathews.

"We sharpened nearly 1000 mowers our first season and gained a reputation for the best work."
—J. W. Kemper.

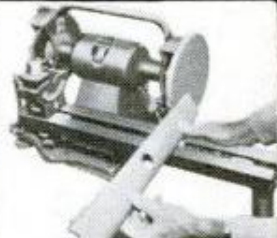
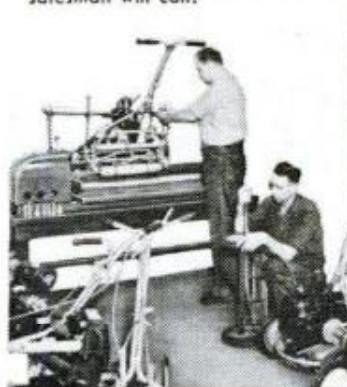

Sharpen Rotary Mower Blades

with the Foley Grinder, also circular saws, ice skates, scissors, planer knives, all sharp edged tools.

FOLEY MFG. CO., 207-0 Foley Bldg., Minneapolis 18, Minn.
Send **FREE PLAN** on lawn mower business and Special Combination Offer.

Name _____
Address _____

A NEW DELUXE MODEL

Deluxe Model with external sights

\$9.95



Optional leatherette carrying case \$3.95

SPLIT IMAGE TRANSIT

the finest, low cost level and incline measure built.

The deluxe model "Hoppy" Split Image Transit features external sights for faster operation . . . Precision-engineered metal mirror holder . . . New prism-like optical system and a simplified calibration system.

One man alone, using the Split Image Transit, can perform any leveling or incline measuring job quickly, easily, and accurately within a fraction of an inch.

Over 50,000 "Hoppy" Split Image Transits are now in use by contractors, carpenters, engineers and do-it-yourselfers.

Standard Model \$7.95 (without sights)

Available at leading hardware, builders and engineers supply stores . . . if not, send check or money order to:

HOPKINS MANUFACTURING CORP.
Dept. P-1 Emporia, Kansas

BUILD 'EM YOURSELF



with **DOT**
TEENUTS®

and **EASI-BILD® PATTERNS!**

TEENUTS . . . the flush-mounting, "can't-slip" nut that needs no washer . . . is now specified in 10 popular Easi-Bild patterns! Get them both at Hardware, Variety and Lumber stores!

*T. M. Reg. U. S. Pat. Off.

Columbia Fastener Company

Chicago 8, Illinois

the bane of the fireman's existence. You've often heard how they "wantonly chop up" a place, doing more damage than the fire did. This foolish gripe stems from ignorance of the fact that they are making certain that a second fire, worse than the first, doesn't break out later.

In modern living, the Class B fire is assuming increasing importance. This ranges all the way from grease in the oven to oil drippings or gasoline spills around the car or power mower in the attached garage. The dry chemical extinguisher will be a stalwart ally here if handled properly; water will just make matters worse by spreading the flame. Sweep the surface of the burning material from side to side, being very wary of the treacherous re-flash from some overlooked hot spot, especially metal. If the fire is on the floor, start at the point nearest to you and mop it up *thoroughly* as you advance. Don't overlook the italics, for the sudden flashback has trapped many an unsuspecting man in an ankle-deep pool of unburned vapor.

All of this counsel is based on the assumption that you or someone will get an early start on your fire. Fortunately, this is the case in a remarkable number of home blazes. Professional firemen take care of one-third of their alarms with hand extinguishers and handle most of the rest with a small "jump line."

With an early warning, there is a good chance that you can do likewise. But you'll need something more than a flyswatter with which to work—and a little more know-how that the ill-fated father in California had! ★ ★ ★

Body's Electrical Energy Is Clue to Emotions

One of these days scientists may be telling you what job is best for you or what your state of mind will be the week after next—all according to the electricity in your body. Three Yale scientists, Drs. H. S. Burr, F. S. C. Northrop and Henry Margenau, have found that basic electrical energy ebbs and flows in all living things, producing predictable changes in human personality and behavior. Tests on more than 500 humans over a period of 11 years, the scientists said, suggest that the performance of soldiers or astronauts under severe stress could be gauged in advance by study of their changing force field patterns. The emotional state of the individual is inseparably related to the ups and downs of the voltage of his electrical field, Dr. Burr said, and each human's field varies with a measurable rhythm.

IS THIS OFFER TOO GOOD TO BE TRUE?

We Pay All Freight For Your FREE Home Trial!



It's true. We pay all freight for your FREE home trial. Factory to you only \$79.95. Handles big jobs. 100% ball bearing. Think of the fun you'll have and the money you'll save with your own workshop. Only \$10 down delivers \$79.95 Supershop prepaid to your home. Write for full details, color brochures, FREE home trial plan. Mail postcard now.

Power Tools Division
UNITED INDUSTRIES, Inc.
128 Yates Ave., Beloit, Wis.

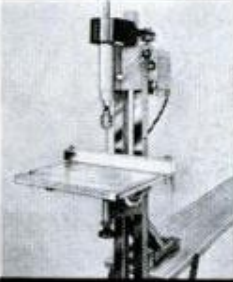

VERT. DRILL PRESS

TINY CRYSTAL SET RADIO PLAYS FOR 10 YEARS!

NO TUBES—TRANSISTORS—BATTERIES OR "PLUG-INS" NEEDED

Smaller than a pack of cigarettes. 1960 model never runs down or burns out. Guaranteed to receive local radio stations most anytime, anywhere—without EXTRA ANTENNA WIRES. Easy thumb station tuner. Chrome black plastic case. BUILT IN SPEAKERPHONE—NO SEPARATE DANGLING EARPHONE. American made and service guaranteed.

SEND ONLY \$2.00 (cash, ch., mo) and pay postman \$4.99 C.O.D. on arrival or send \$6.99 for postpaid delivery. Sent complete—Ready to listen. No extras to buy. Free long distance antenna enclosed if you order at once.

Midway Co., Dept. TPM-2, Kearney, Nebr.

INVEST IN

U.S. SAVINGS BONDS

SAFE AS AMERICA

EMERSON ELECTRIC

PORTARC 180c
PORTABLE WELDER
High Capacity ... Low Price

Ideal for farm, home workshop. Cuts, brazes, solders, welds. One man can carry ... only 68 lbs. 6 welding heats up to 180 amps ... 3/32" to 3/16" rod sizes. Write today for prices and receive FREE WELDING SELECTOR GUIDE ... gives working data you need in seconds!



EMERSON ELECTRIC of St. Louis
8100 Florissant • St. Louis 36, Mo.

SAVE 85% 2000 WATT HOMELITE POWER PLANT NOW 89.00

An efficient and dependable power plant for use as a power supply up to 2000 watts. Easily portable. Generator is rated at 28 volts DC, at 70 Amps with 3000 RPM. Equipped with voltage regulator and volt meter. Rope start or push button start with 24 V battery. Engine is single cylinder, air cooled 2-cycle type and is direct coupled to the generator. Size: 21-1/4" x 8-1/2" x 18-1/2".

SAVE

HYDRAULIC CYLINDERS

1500 PSI Double Action CYLINDER - Bore 1-1/2", Shaft 9/16", Stroke is adjustable 1-3/16" to 4-3/8", length 11-1/2". No. H-84... **395**

1500 PSI Hydraulic Cylinder with 11" long, 19 tooth rack. Double action type. Bore 1 1/2", Stroke 7 1/2", Shaft 1 1/8", Length with rack 23". Catalog No. H-98... **775**

1500 PSI - Double Action CYLINDER Bore 2-3/8", Stroke adjustable from 7-3/8" to 9-5/8", Shaft 7/8", eye-to-eye length is 20". No. H-17USU - Used... **788**
No. H-17NSU - New... **\$14.88**

1500 PSI Double Action CYLINDER - Bore 2", Shaft 7/8", Stroke 9", eye-to-eye length 14-1/2". Catalog No. H-48... **595**

Special 1500 PSI HYDRAULIC CYL. Designed for use in multiple banks or in series. Bore 1-1/2", Shaft 1-1/8", Stroke 4-7/8", Length 10". Catalog No. H-56... **295**

25 GPM PESCO PUMP

A positive displacement, 25 GPM pump at 3450 RPM. Has a pressure limit of 1000 PSI continuous or 1500 PSI intermittent. SAVE NOW at... **2795**

Catalog No. H-P25SU

PUMP MOUNT for above - Will adapt pump to key slot drive shaft. Has sealed-in bearings and 4-hole foot mount... **\$15.95**

ACME TRAILER HITCH

Insures you of a comfortable, non-sway tow. Has an automatic safety lock. Made of certified malleable iron. Has design reinforced ball. Easy to install and hitch... **288**

BOSTON 10 TO 1 GEAR REDUCER NOW 2249

When used with a 1/3HP motor at 1800 RPM this unit will deliver an output torque of 90 inch lbs. at 180 RPM. Has 1.2" dia. output and input shafts, 4-hole foot mount. Sold elsewhere up to \$50.00. Save at our Surplus Price.

WINCH TAKE-OFF UNIVERSAL ONLY 444

Designed for drive take-off to a winch. Takes 1-3/8" shaft on one side, 1 1/4" shaft on the other side. Heavy duty. 4" wide, 5 1/2" long. Body is Zerk lubricated. Worth \$25.00. Stock limited.

2000 PSI HYDRAULIC HAND PUMP

Regularly \$11.75 **988**

Cat. No. HP-3VSU

Has capacity of 1.5 cubic inches per cycle. Operating pressure is 2000 PSI. Includes built-in diverter valve to select suction and pressure ports for two independent systems.

WRITE FOR INFORMATION ON... New WEBSTER HYDRAULIC POWER DRIVE with 5 HP motor and a 7 GPM Vickers Variable Displacement Pump. Cost approx. \$2000. NOW Only... \$195. Send for information on our special TEST STAND BARGAINS!

SPECIAL GOV'T SURPLUS BARGAINS

- A - British combination PICK-HOE tool - \$1.29 ea. 2 for \$2.29
- B - Army BAYONET with scabbard. Has 17" blade... \$2.29
- C - Army MACHETE w/Vanadium steel 22" blade & sheath... \$1.98
- D - Special Swedish folding BAYONET. 7" blade... \$1.98
- E - Navy fighting KNIFE. 6 1/2" blade, dbl. edged at point... \$2.98
- F - Army FIELD SHOES - Natural cowhide. Treated & waterproof. Sizes: 10 B, 10 1/2 B, 11 1/2 B - \$4.44. All other sizes... \$5.95

SPECIAL U.S. ARMY COVERALLS \$5.95 VALUE

Of heavy duty herringbone twill. Has belted waist and luffan front. Four large pockets. Cleaned and reconditioned like new, O.D. color. Sizes: small and large... **3.88**

NEW AIRPORT LIGHTING CONTROL PANEL 1288

Wt. 34 lbs. Has nine 15 Amp and one 25 Amp circuit breaker switches. One 8-position and two 5-position, 10 Amp, 125V. AC heavy duty rotary switches. All contained in metal case. Ideal for experimenter.

AIR SPECIAL SALE OXYGEN

10,000 STAINLESS STEEL GI TANKS

Used - **1195 EA.**

EXCELLENT Condition!

AVAILABLE in NEW condition! Write for special quantity prices and SAVE!

palley's
2263 E VERNON AVE., DEPT. PM-20
LOS ANGELES 58, CALIFORNIA

TO ORDER - Send check or M.O. 1/2 deposit with C.O.D.s. All prices are F.O.B. Los Angeles Warehouse. All items sent postage or freight collect.

Are you a guy who didn't MARRY THE BOSS'S DAUGHTER?



They tell us it's a good way to get ahead. The tough part is... there aren't enough bosses' daughters to go around. But there's another way to call your shots.

How? Look at the want ads! Business and industry are crying for men with special training. 60,000 Engineers—Industrial Supervisors, Communications and Traffic Specialists are urgently needed. Demand has never been greater—or salaries higher—for trained people.

With the right kind of training you can step into one of these jobs — write your own ticket. Without it you must compete with a few million other guys who are in the same boat. And, if times get tough, it's not going to be a good boat to be in.

So act now! Choose the education for men who want to get ahead fast. Pick your future from success-proven I.C.S. courses. Whichever field you choose it will be *right* because all I.C.S. courses are developed by business and industry leaders who know what *you* need to know to go places.

You get *personalized* guidance. Earn as you learn. Study in your spare time — at your own pace. And when you get the coveted I.C.S. diploma, it's the frosting on the cake. Chances are by that time you've already been snapped up for a bigger job with a bigger price tag.

Don't wait another day! Choose your course and send for the free career booklets offered below.

For Real Job Security—Get an I. C. S. Diploma!

I. C. S., Scranton 15, Penna.

Accredited Member,
National Home Study Council

INTERNATIONAL CORRESPONDENCE SCHOOLS



BOX 67953X, SCRANTON 15, PENNA.

Without cost or obligation, send me "HOW TO SUCCEED" and the opportunity booklet about the field BEFORE which I have marked X (plus sample lesson):

- ARCHITECTURE and BUILDING CONSTRUCTION**
- Air Conditioning
 - Architecture
 - Arch. Drawing and Designing
 - Building Contractor
 - Building Estimator
 - Carpenter Builder
 - Carpentry and Millwork
 - Carpenter Foreman
 - Heating
 - Painting Contractor
 - Plumbing
 - Reading Arch. Blueprints
- ART**
- Commercial Art
 - Magazine Illus.
 - Show Card and Sign Lettering
 - Sketching and Painting
- AUTOMOTIVE**
- Automobile
 - Auto Body Rebuilding and Refinishing
 - Auto Engine Tuneup
 - Auto Technician

- AVIATION**
- Aero-Engineering Technology
 - Aircraft & Engine Mechanic
- BUSINESS**
- Accounting
 - Advertising
 - Business Administration
 - Business Management
 - Cost Accounting
 - Creative Salesmanship
 - Managing a Small Business
 - Professional Secretary
 - Public Accounting
 - Purchasing Agent
 - Salesmanship
 - Salesmanship and Management
 - Traffic Management
- CHEMICAL**
- Analytical Chemistry
 - Chemical Engineering
 - Chem. Lab. Technician
 - Elements of Nuclear Energy
 - General Chemistry
 - Natural Gas Prod. and Trans.
 - Petroleum Prod. and Engr.
 - Professional Engineer (Chem)
 - Pulp and Paper Making

- CIVIL ENGINEERING**
- Civil Engineering
 - Construction Engineering
 - Highway Engineering
 - Professional Engineer (Civil)
 - Reading Struc. Blueprints
 - Sanitary Engineer
 - Structural Engineering
 - Surveying and Mapping
- DRAFTING**
- Aircraft Drafting
 - Architectural Drafting
 - Drafting & Machine Design
 - Electrical Drafting
 - Mechanical Drafting
 - Sheet Metal Drafting
 - Structural Drafting
- ELECTRICAL**
- Electrical Engineering
 - Elec. Engr. Technician
 - Elec. Light and Power
 - Practical Electrician
 - Practical Lineman
 - Professional Engineer (Elec)
- HIGH SCHOOL**
- High School Diploma

- Good English
 - High School Mathematics
 - High School Science
 - Short Story Writing
- LEADERSHIP**
- Industrial Foremanship
 - Industrial Supervision
 - Personnel-Labor Relations
 - Supervision
- MECHANICAL and SHOP**
- Diesel Engines
 - Gas-Elec. Welding
 - Industrial Engineering
 - Industrial Instrumentation
 - Industrial Metallurgy
 - Industrial Safety
 - Machine Shop Practice
 - Mechanical Engineering
 - Professional Engineer (Mech)
 - Quality Control
 - Reading Shop Blueprints
 - Refrigeration and Air Conditioning
 - Tool Design
 - Tool Making
- RADIO, TELEVISION**
- General Electronics Tech.

- Industrial Electronics
 - Practical Radio-TV Eng'g
 - Practical Telephony
 - Radio-TV Servicing
- RAILROAD**
- Car Inspector and Air Brake
 - Diesel Electrician
 - Diesel Engr. and Fireman
 - Diesel Locomotive
- STEAM and DIESEL POWER**
- Combustion Engineering
 - Power Plant Engineer
 - Stationary Diesel Engr.
 - Stationary Fireman
- TEXTILE**
- Carding and Spinning
 - Cotton Manufacture
 - Cotton Warping and Weaving
 - Loom Fixing Technician
 - Textile Designing
 - Textile Finishing & Dyeing
 - Throwing
 - Warping and Weaving
 - Worsted Manufacturing

Name _____ Age _____ Home Address _____
 City _____ Zone _____ State _____ Employed by _____
 Occupation _____

Canadian residents send coupon to International Correspondence Schools, Canadian, Ltd., Montreal, Canada. . . . Special low monthly tuition rates to members of the U. S. Armed Forces.

Special Offer! TO Popular Me

Take 4

12" Long Play



High Fidelity

ALBUMS

RETAIL VALUE UP TO \$19.92—PAY C

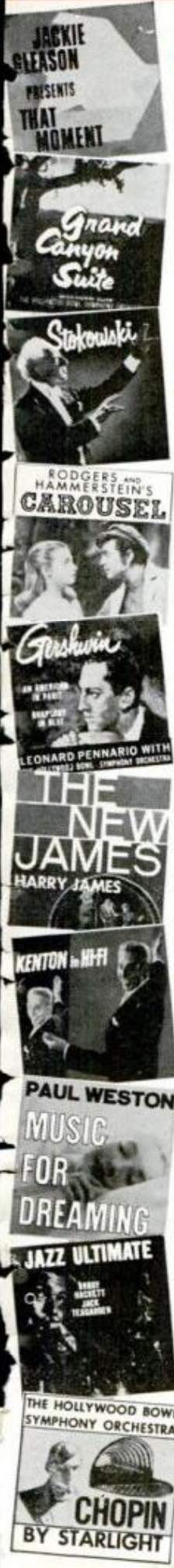

JACKIE GLEASON
147. Mood magic —with strings and Bobby Hackett's trumpet. \$4.98

FERDE GROFÉ
122. Slatkin conducting The Grand Canyon and Mississippi Suites. \$4.98

LEOPOLD STOKOWSKI
2. Landmarks of his career. Works by Bach, Debussy, Strauss, etc. \$4.98

RODGERS and HAMMERSTEIN
102. Movie sound track with Gordon MacRae and Shirley Jones. \$4.98

GEORGE GERSHWIN
1. His famous compositions — American in Paris, Rhapsody in Blue. \$4.98

HARRY JAMES
117. A new collection of ballads and songs to listen and dance to. \$3.98

Stan Kenton
6. Lover, Painted Rhythm, Southern Scandal, Peanut Vendor, etc. \$4.98

PAUL WESTON
142. A brand new album of "Music for Dreaming". 12 songs. \$3.98

Bobby Hackett Jack Teagarden
121. Baby Won't You Please Come Home, 'S Wonderful, 8 more. \$3.98

HOLLYWOOD BOWL SYMPHONY
118. Chopin's greatest music in superb orchestral performance. \$4.98



KINGSTON TRIO
98. Tom Dooley, Three Jolly Coachmen and many others. \$3.98

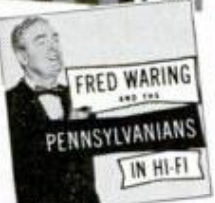

FRED WARING
99. Fred directs the Pennsylvanians in 17 of your all-time favorites. \$4.98



GEORGE SHEARING
101. What Is There to Say, Black Satin, Starlight Souvenirs, others. \$3.98



Gaité Parisienne
110. Offenbach's exuberant ballet music. Conductor: Felix Slatkin. \$4.98



Glen Gray
115. He recreates the sounds of Krupa, Dorsey, Miller, others. \$4.98



Guy LOMBARDO
100. Say It Isn't So, Be Careful, It's My Heart, 38 more Berlin hits. \$3.98



Keely Smith
116. 12 tender tunes. S'posin', All the Way, Sweet and Lovely, etc. \$3.98



CARMEN DRAGON
112. Great Music of France: Faust Waltz, La Marseillaise, etc. \$4.98



NAT KING COLE
104. Who's Sorry Now, Just One of Those Things, 10 more. \$4.98



JUNE CHRISTY
107. June sings When Lights Are Low, Easy Living, 9 others. \$3.98



Ray Anthony
139. Ray and the orchestra at their light, danceable best. \$3.98



FELIX SLATKIN
119. Stars and Stripes Forever, Anchors Aweigh, 11 others. \$4.98



JONAH JONES
103. The f Jones comb swingin' n of 12 tunes

HOW TO SAVE MONEY on the Albums you from the greatest of classics, to the biggest

YOU GET FOUR ALBUMS—WORTH UP TO \$19.92 (retail value) as a member of the Capitol Record Club and pay only \$4.98 per album. As a member you agree to buy six additional records the next 12 months from over 200 to be offered! Then resign, or retain membership by buying only three annually with full bonus credit. For the records you pay only the usual retail price plus a small charge for packing and mailing.

MORE FREE ALBUMS! Each time you buy two more records you agreed upon six future selections, you may choose long-play BONUS ALBUM worth \$3.98 or \$4.98, free of current Capitol best sellers... FREE!

UNLIMITED CHOICE! Each month you receive the Record Review, describing the month's selections. If you select in the division you joined (Classical... Hits and Show Music... or Hi-Fi Jazz), do not come automatically. If you wish any of the other or no record that month—simply notify the Club always provided.

BUT HURRY to get your FOUR ALBUMS—and pay only \$4.98! The first three are Bonus Albums which will be free if you buy your second, fourth and sixth additional (the rate of at least one every other month), but which you now in advance.

SEND NO MONEY—RISK NOTHING! If not delighted, your four albums within 7 days and your membership charges will be cancelled without further obligation. Send coupon to: Capitol Record Club, Dept. 5067, Sec 2, Philadelphia, Pennsylvania.

Smoking more now...but enjoying it less?

Have a real cigarette— CAMEL

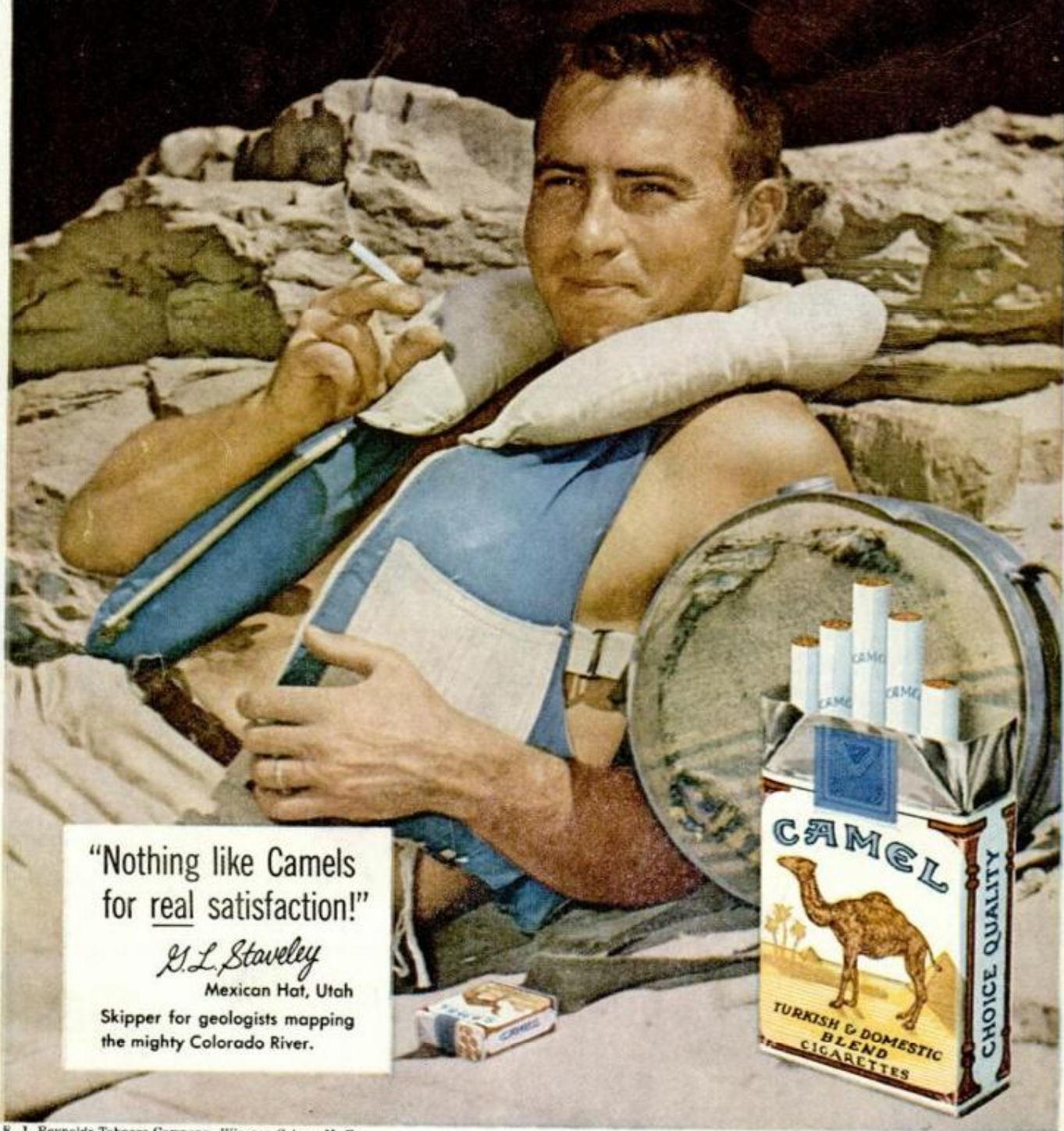

"Nothing like Camels
for real satisfaction!"

G.L. Staveley

Mexican Hat, Utah

Skipper for geologists mapping
the mighty Colorado River.

R. J. Reynolds Tobacco Company, Winston-Salem, N. C.

The best tobacco makes the best smoke