

POPULAR MECHANICS

WRITTEN SO YOU CAN UNDERSTAND IT



WE BUILT THIS HOUSEBOAT TO SHOW YOU HOW—
Start Building It Now From Plans in This Issue

Fishing man's motor...

...THE EVINRUDE FISHERMAN

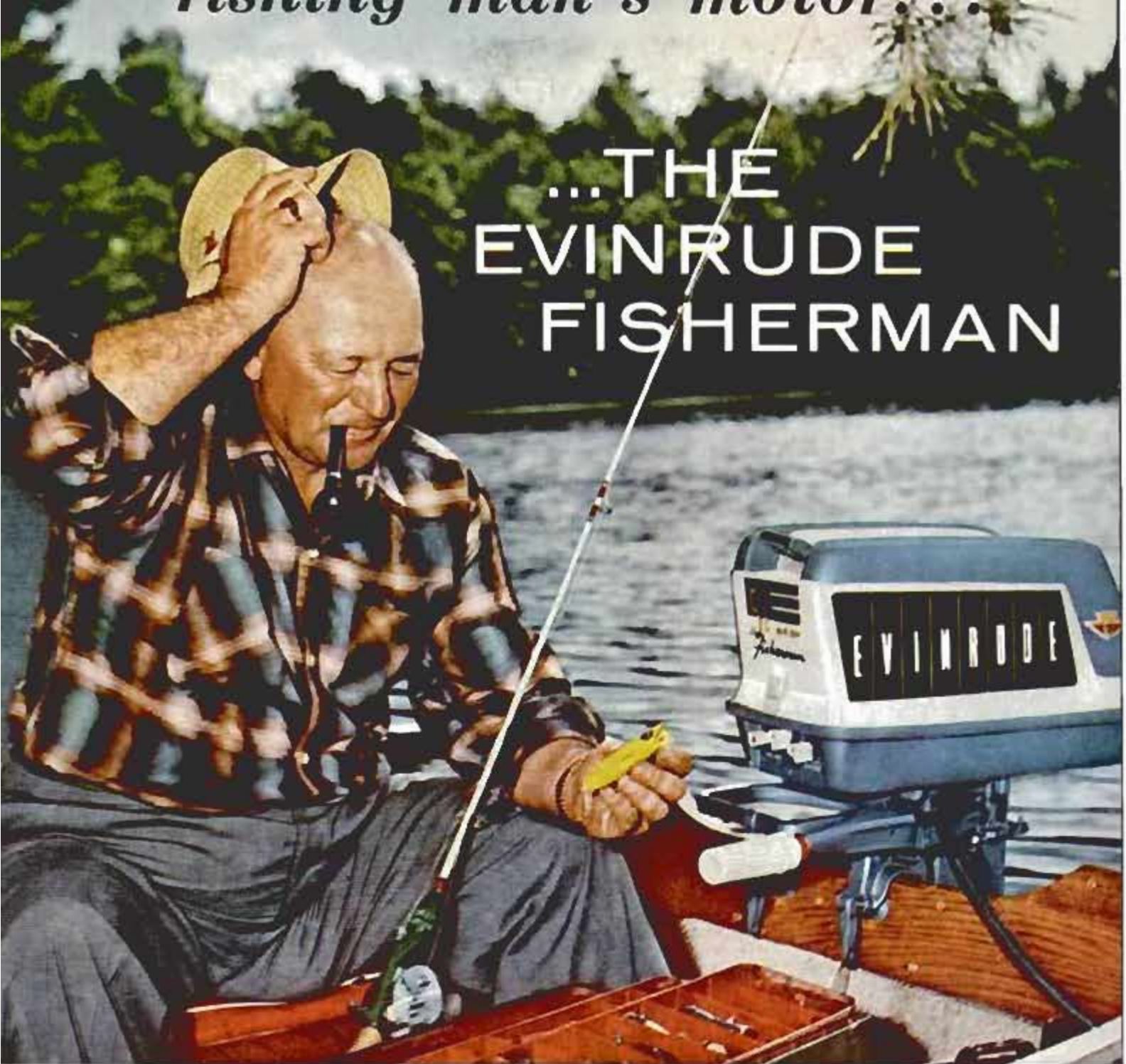

THIS IS THE ONE...preferred by serious anglers above all others.

5½ horsepower . . . power enough to hustle a good boat to good fishing ahead of the crowd. Small enough to use on rental skiffs. Light enough to be truly portable, without compromising an ounce of ruggedness or strength. *Smooth and quiet* beyond compare from slow troll to full throttle. Powerhead floats on live-rubber mounts. Fiberglass hood seals in sound. *Gearshift?* You bet! No one who has known its convenience would settle for less. *Easy starting* . . . next to effortless!

What else? Thermostat-controlled cooling for silk-smooth trolling, faster warm-up, fewer

spark plug changes and longer engine life . . . one-hand Roto-Matic control . . . separate Cruis-A-Day tank . . . slip clutch which ends shear pin problems . . . even remote control if you like. This is the small motor with *all* the big motor features!

As a Christmas gift . . . you couldn't do better than to give yourself a Fisherman . . . or a new Evinrude in any power range. See the new 1960 models now at your Evinrude dealer. *Colorful 1960 Catalog Free.* Write: EVINRUDE MOTORS, 4250 N. 27th St., Milwaukee 16, Wisconsin.

A Division of Outboard Marine Corporation
In Canada: Mfd. by Evinrude Motors, Peterborough

Ask your Evinrude dealer about 16 mm color movies

Downloaded and transformed by the Michael, UB3ABZ

EVINRUDE

FIRST
IN

OLD LOW BEAM

25 feet beyond those approaching headlamps there's a barrel in the road. It's not yet within the range of the low beam of any previous 2-headlamp cars.



**You'll see better
in spite of the
other car's lights!**

NEW G-E LOW BEAM

There's the barrel—225 feet away! This is how the low beam of G-E SUBURBAN Headlamps (made only for 2-headlamp cars) helps you see in spite of oncoming lights.



*Three-fourths of all night driving
is now done with the low beam!*

**New G-E SUBURBAN
Headlamps
have a "spotlight" effect
...in the low beam!**

Since nighttime traffic has increased tremendously, motorists find they must use the low beam more and more. So, General Electric now puts the *low beam* filament on focus to give maximum beam control where it's needed most—to provide a "spotlight" effect which directs more light down the right side of the road. That's why the low beam of new General Electric SUBURBAN Headlamps lets you see past the oncoming car when you're 75 to 200 feet apart.

Only General Electric SUBURBAN Headlamps have this feature for 2-headlamp cars. General Electric Co., Miniature Lamp Dept. M-913, Nela Park, Cleveland 12, Ohio.



**ATTENTION ALL OWNERS
OF 2-HEADLAMP CARS!**

For approximately the same results as the four-headlamp systems in brand new cars (whose low beam filaments are also on focus) . . . have a pair of new G-E SUBURBAN Headlamps installed and aimed today. Tonight you'll see better in spite of other cars' lights.

Progress Is Our Most Important Product

GENERAL  ELECTRIC

This One



YV60 0ND 1670

POPULAR MECHANICS®

Address communications to: 200 E. Ontario St., Chicago 11, Illinois. **SUBSCRIPTION SERVICE:** Mail all subscription orders, changes of address, correspondence concerning subscriptions, and Postmaster notices of undeliverable copies to Popular Mechanics, 250 West 55th St., New York 19, N. Y.

Editor
RODERICK M. GRANT

Executive Vice-President
RICHARD E. DEEMS

Publisher
G. HARRY CHAMBERLAINE

Managing Editor
WAYNE WHITTAKER

Assistant Managing Editor
CLIFFORD B. HICKS

Shop Notes and Crafts Editor
JAMES R. WARD

Associate Editors, General Features
ARTHUR R. RAILTON, *Automotive*
JOHN A. LINKLETTER

Associate Editors, Shop Notes and Crafts
WAYNE C. LECKEY W. CLYDE LAMMEY

Radio-Television, Electronics Editor
LOTHAR STERN

Assistant Editors, General Features
JAMES BIERY, ROBERT L. HULL, JR.,
R. B. KIRKPATRICK

Assistant Editors, Shop Notes and Crafts
EARL WOBECK, GUERRINO F. AMATI

Assistant Editors, Makeup
WALLACE MYERS, JEAN KAVANAUGH

Art Staff
FRANK BEATTY, *Director*
HENRY NEHRBASS, *Assistant Director*
RICHARD A. POTTS, *Art Editor*

Eastern Editor
RICHARD F. DEMPWOLFF
Room 4102, Empire State Bldg., New York City 1

Western Editor
THOMAS E. STIMSON, JR.
Suite 1001, 2100 Wilshire Blvd.,
Los Angeles 5, Calif.

Advertising Manager
JOSEPH R. BUELL, JR.

Director, Bureau of Information
ALLAN CARPENTER

Advertising Offices
Chicago: 200 E. Ontario St., Whitehall 4-0100;
New York: Empire State Bldg., 350 Fifth Ave.,
LONgacre 5-7580; Detroit: General Motors
Bldg., TRIMbly 5-8711; Cleveland: Hanna
Bldg., 1422 Euclid Ave., PRospect 1-0456; Los
Angeles: 3460 Wilshire, DUmkirk 2-8458; San
Francisco: Russ Bldg., 255 Montgomery St.,
YUKon 2-0824.

Published monthly by Popular Mechanics Company, 200 E. Ontario St., Chicago 11, Ill. Richard E. Berlin, President; Richard E. Deems, Executive Vice-President; Fred Lewis, Vice-President and General Manager; John R. Miller, Vice-President; G. Harry Chamberlaine, Vice-President; G. O. Markeson, Treasurer; H. J. McArthur, Secretary. Single copy in the United States and Canada, 35 cents; subscription rates in the United States and possessions, Canada and countries of the Pan American Postal Union, 1 year \$3.50; 2 years, \$6.00; 3 years, \$8.00. For other countries add \$1.00 a year over United States rates for overseas postage. If you plan to move, notify us at least 30 days in advance so you will not miss an issue. Give both your old and new addresses. Second-class postage paid at Chicago, Illinois, and at additional mailing offices. Entered as Second Class Matter at Post Office Dept., Canada. Registered as second class matter at the Post office at Mexico, D.F., Mexico, June 20, 1950. ©1959 by Popular Mechanics Company. All rights reserved. Printed in the United States of America.

FOREIGN EDITIONS:	MECANIQUE POPULAIRE (French)	MECANICA POPULAR (Spanish)	POPULAER MEKANIK (Danish)	POPULAR MEKANIK (Swedish)	POPULARE MECHANIK (German)
Volume 112	DECEMBER 1959			Number 6	

In This Issue...

Hollywood Spricht Deutsch	-	-	-	-	65
I Lived With the Astronauts—Part I	-	-	-	-	74
Skiing Is for Everyone	-	-	-	-	86
He Fishes for Sharks—With Balloons!	-	-	-	-	93
"Cat Eye" Turns Night Into Day	-	-	-	-	100
Cows on the Belt Line	-	-	-	-	106
Oil Hunters With Aqualungs	-	-	-	-	110
The Big Round Sound	-	-	-	-	117
The Pastor Is a Sculptor	-	-	-	-	126
Pearls From Fresh-Water Mussels	-	-	-	-	137

For the Craftsman...

Radio, TV and Electronics	-	-	-	-	141
Decorate Your Mailbox for Christmas	-	-	-	-	150
Early American Clock—Part I	-	-	-	-	154
The PM Houseboat—Part I	-	-	-	-	160
Make Your Own Christmas Candles	-	-	-	-	176
Home Repair of Electric Motors	-	-	-	-	190
Cutting the Miter Joint	-	-	-	-	197

Regular Departments...

WHERE-TO-BUY-IT INDEX	-	-	-	60	
Know This Old-Timer!	-	14	What's New for Your Home	-	134
Pioneer of Science	-	18	Solving Home Problems	-	180
An Eye on Space	-	70	On the Market	-	202
Detroit Listening Post	-	85	Clinic For Homemakers	-	208

Turn to detailed index on page 60. Sources of additional information on items in this issue are shown on the Where-to-Find-It List, available without charge by writing the Bureau of Information, Popular Mechanics, 200 E. Ontario St., Chicago 11, Ill.

Next Month...

THE FAMOUS Auto Issue of Popular Mechanics is on its way. The 50-page section in January includes a six-page pictorial history of the auto industry in color; pictures and specifications of all the 1960 cars including many foreign models; road tests of the new American small cars, with an engineering analysis of their engines; a report on the world's largest auto show. . . . Plus regular features, including an account of an exciting "5000-Mile Game of Catch" and the spectacular story of "Masters of Explosives"

INDIAN TERRITORY



AND WE MEAN CIGAR STORE INDIAN TERRITORY...
A LAND THAT'S BEEN INVADED BY A WONDERFUL NEW CIGAR

PHILLIES. CHERROOTS



The smoke signal you get from Gheroots is

MIRACLE MILD

Whoop it up with a cigar that's new in size and shape

*Slick on the draw
and big as your trigger finger!*



Scout around for 28 cents and buy the handy fresh pack of 5

FOR '60, A NEW SOUND DOMINATES THE ROAD...THE OVERWHELMING PLYMOUTH SONORAMIC COMMANDO V-8.

THE FIRST RAM INDUCTION ENGINE IN A PRODUCTION CAR! GIVES SUPERCHARGED RESULTS WITHOUT STEALING POWER... AND PUTS OUT GREATER TORQUE THAN 400 CU. IN. MILLS!

Here's **authority!** Chrysler Corporation's top engine men worked with test cars in the Brickyard at Indy . . . spent months with chattering electronic computers in the labs . . . and finally turned a "custom competition" dream into a production model!

Plymouth **SonoRamic** uses long, curving intake manifolds to provide the results of a positive displacement supercharger. The air-fuel mixture moves through the manifold tubes until the intake valve closes. This sets up a compression wave which travels back and forth at high frequency, building enormous pressure and ramming home a super charge at the optimum time.

Once you **hear SonoRamic** you'll have to try it! You'll find it handles marvelously in the '60 Plymouth because the new welded Plymouth Unibody, with Torsion-Aire suspension, has the solid rigidity and strength high performance demands. Available (extra cost) in two versions—in ANY body model!

Note: There's more big Plymouth engine news at the other end of the scale for '60—the 30-D Economy Six, first American production car with engine slanted at a 30-degree angle. Aluminum intake manifold, many other advances. Slanting of engine lowers center of gravity, makes car easier to handle, simplifies servicing and many adjustments. An economy engine which still gives brisk performance.

A Chrysler-engineered product built a new solid way to give you solid satisfaction.

SOLID PLYMOUTH 1960

383 cu. in. **SonoRamic Commando V-8:** HP., 330 at 4800 RPM. Torque, 460 lbs.-ft. at 2800 RPM. Comp. ratio, 10:1. Dual 4 bbl. carbs. Or choose the 361 cu. in. **SonoRamic V-8:** HP., 310 at 4800 RPM. Torque, 460 lbs.-ft. at 2800 RPM. Comp. ratio, 10:1. Dual 4 bbl. carbs.



Merry Christmas

(with a big \$21⁰⁰ saving)

from **DELTA**
to **YOU!**

Take advantage of Delta's holiday gift to you—a \$21.00 saving on the most popular home workshop power tool made! And whether you plan to play Santa for yourself, or just be plain surprised when your Christmas "wish" comes true, you'll start with the finest when you get this famous Delta 9" Tilting Arbor Circular Saw.

Now—just in time for gift giving (or getting)—your Delta Dealer will give you a \$21.00 trade-in allowance for your old hand saw (any kind, regardless of condition) toward the purchase of a new Delta 9" Circular Saw. You'll get a lifetime of safe, accurate, dependable performance (along with lots of fun and satisfaction) when you own a Delta Saw—it's backed by over 30 years of engineering skill and experience. Why be satisfied with anything less?

Visit your Delta Dealer (he's listed under "TOOLS" in the Yellow Pages) or take your saw to leading Department, Hardware or Building Supply Stores. Go alone, or with your own "Santa," but don't miss this opportunity! Rockwell Manufacturing Co., Delta Power Tool Division, 502M N. Lexington Ave., Pittsburgh 8, Pa.

Cat. No. 34-004
Delta Homecraft 9" Tilting
Arbor Circular Saw

Own the finest right from the start—
and at a big **\$21⁰⁰ SAVING**
(slightly higher in the West)

DECEMBER 1959

DELTA POWER TOOLS

another fine product by

ROCKWELL





DICTATING MACHINES



typewriters, movers, toys, tires,
caterers, cleaners & dyers
whatever you need —



Advertisers displaying this emblem
make your shopping easy.

Over the Editor's Desk



Attention, Space Candidates

Apparently one prerequisite for piloting a space capsule is reading *Popular Mechanics*! The editorial team that lived with the Astronauts (page 74) discovered that all seven of the men, without exception, have been enthusiastic readers of *PM* for years —and still read it whenever they can find time in their crowded training program.

☆☆☆

To the Editor:

For at least 30 years I have read your magazine with great profit and interest. It must be a tremendous job to find new material each month, and I compliment you on your success.

In the September issue, however, you touch on a subject about which I know something — the German pipe organ, page 129. One gathers that this horizontal positioning of pipes is something new. There

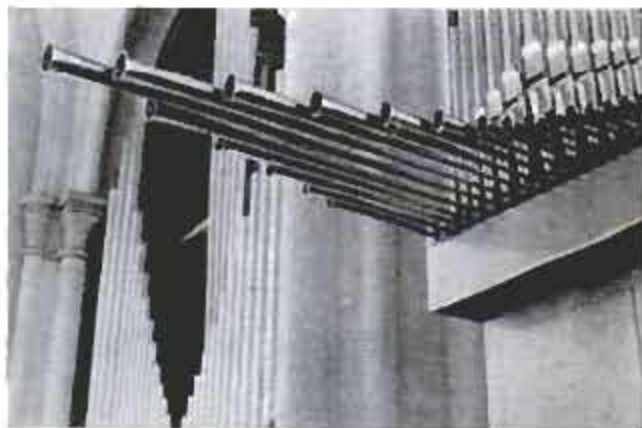

is, however, in Leon, Spain, a set dating back to 1750, and perhaps others older. The resonator of pipes whose tone is produced in the "boot" by the beating of a metal "reed" against a "shallot"—much like the mouthpiece of a clarinet—gives direction to the sound. This is not so of other types of pipe. The Spanish go in strongly for this type of pipe and also that arrangement, hence the name. There are many examples in this country (e.g. St. Thomas, New York City).

As one who views you as writing "gospel," I hate to see even the most infinitesimal chink in your "armor."

Joseph G. Bradley, Jr.,
1165 Fifth Ave.,
New York, N. Y.

(Continued to page 10)

THIS FREE SAMPLE LESSON

will prove that you can become an expert

ACCOUNTANT...AUDITOR

OR CPA

FREE SAMPLE LESSON

We offer you this free sample lesson so that you can prove to yourself that you CAN master Accounting—quickly, thoroughly—in spare time at home.

You will see exactly how LaSalle's famous "Problem Method" works...how you are led step-by-step through actual accounting work—learning by doing and not by study of theory alone. First you tackle easy problems, then more difficult ones—until soon you master them all. And at every step you have the close personal guidance of LaSalle's large staff of expert accountants and CPA instructors.

One out of every 13 of all CPAs in the U.S. has been trained by the LaSalle Problem Method

GOOD-PAY JOBS IN MANY FIELDS

If you were an expert accountant right now, chances are you would find yourself in one of the best paid fields of business.

There are several big fields of opportunity open to men and women trained in accounting...opportunities that are wide open and highly inviting, offering maximum income and job security in good times or bad. And under LaSalle's "Problem Method" you can start earning while still learning—either in spare-time or full-time employment...or in business for yourself with no capital required.

Get the latest information by sending for our illustrated booklet, "Opportunities in Accounting"—plus free sample lesson. The coupon at right will bring both to you without cost or obligation. LaSalle Extension University, 417 S. Dearborn St., Chicago 5, Illinois.

This well-paid LaSalle-trained Accountant's success could be yours.



THIS SAME LESSON HAS STARTED HUNDREDS OF THOUSANDS toward well-paid accounting careers—in business, government, and public practice as CPAs. Even without previous knowledge, progress is rapid—earning power climbs fast. This sample lesson will show you why.

IF you have been envying the high incomes and good jobs enjoyed by thousands of men and women Accountants today...incomes ranging from \$5,000 to \$10,000 and more per year...why not launch such a career for yourself?

Do you doubt that you can?

Then let us send you—without cost or obligation—the same Lesson Number One with which LaSalle has started several hundred thousand men and women toward successful accounting careers. We want you to see for yourself how this remarkable method, originated by LaSalle, makes Accounting simple, interesting, practical, and certain...how it leads you step-by-step to a complete mastery of Accounting—and on up to the Certified Public Accountant Certificate if you so aspire. It doesn't matter

whether you've had previous bookkeeping experience, or whether you don't know a debit from a credit. Whether you wish to qualify as an expert accountant, advanced accountant, cost accountant, auditor, government accountant, income tax specialist, or public accountant...you'll find in LaSalle's Problem Method the exact plan to prepare you rapidly and inexpensively—in spare hours at home—without losing a day from your present job.

So right now, today...if you are an adult, employed, and earnestly ambitious for rapid advancement in one of the highest paying fields of business...send your name and address on the coupon below. We'll send you the free sample lesson—plus our illustrated book outlining today's career opportunities and how you can qualify for them. A coupon like this has started many thousands toward greater success. It can do the same for you. Mail it today!

Accredited Member, National Home Study Council

Clip Coupon...Mail TODAY!

LaSalle Extension University...A Correspondence Institution

Dept. T264H, 417 S. Dearborn Street, Chicago 5, Illinois

YES, I want to see how LaSalle's "Problem Method" works... Send me free sample lesson—also your book, "Opportunities in Accounting"...without cost or obligation.

Name.....Age.....

Street Address.....

City, Zone & State.....



BURIED ALIVE!



SIX YEARS ON THE SAME JOB WITH NEVER AN ACCIDENT... AND THEN ONE MORNING...

2 A CAVE-IN PUT ME SIX FEET UNDER FOR SIX LONG MINUTES



3 IN THE HOSPITAL, I HAD PLENTY OF TIME TO THINK



4 I'D PASSED OVER DOZENS OF I.C.S. ADS IN POPULAR MECHANICS. BUT I SAW THIS ONE IN A NEW LIGHT



FREE!

I.C.S. CAREER KIT
Send coupon now...
get all three books

INTERNATIONAL CORRESPONDENCE SCHOOLS
BOX 21626M SCRANTON 15, PA.



HERE'S WHERE YOU COME IN! LET I.C.S. SHOW YOU THE WAY TO MORE PAY, RAPID ADVANCEMENT, REAL JOB SECURITY! MAIL THIS COUPON TODAY!



- 1 "HOW TO SUCCEED" A 32-page gold mine of ideas
- 2 CAREER CATALOG Opportunities in the field that interests you most
- 3 SAMPLE LESSON (MATH) Shows the famous step-by-step I. C. S. teaching method



INTERNATIONAL CORRESPONDENCE SCHOOLS



BOX 21626M, SCRANTON 15, PENNA.

(Partial list of 258 courses)

- Without cost or obligation, send me "HOW TO SUCCEED" and the opportunity booklet about the field BEFORE which I have marked X (plus sample lesson):
- | | | | | |
|--|--|--|---|---|
| <p>ARCHITECTURE and BUILDING CONSTRUCTION</p> <ul style="list-style-type: none"> <input type="checkbox"/> Air Conditioning <input type="checkbox"/> Architecture <input type="checkbox"/> Arch. Drawing and Designing <input type="checkbox"/> Building Contractor <input type="checkbox"/> Building Estimator <input type="checkbox"/> Carpenter Builder <input type="checkbox"/> Carpentry and Millwork <input type="checkbox"/> Carpenter Foreman <input type="checkbox"/> Heating <input type="checkbox"/> Painting Contractor <input type="checkbox"/> Plumbing <input type="checkbox"/> Reading Arch. Blueprints <p>ART</p> <ul style="list-style-type: none"> <input type="checkbox"/> Commercial Art <input type="checkbox"/> Magazine illus. <input type="checkbox"/> Show Card and Sign Lettering <input type="checkbox"/> Sketching and Painting <p>AUTOMOTIVE</p> <ul style="list-style-type: none"> <input type="checkbox"/> Automobile <input type="checkbox"/> Auto Body Rebuilding and Refinishing <input type="checkbox"/> Auto Engine Tuneup <input type="checkbox"/> Auto Technician | <p>AVIATION</p> <ul style="list-style-type: none"> <input type="checkbox"/> Aero-Engineering Technology <input type="checkbox"/> Aircraft & Engine Mechanic <p>BUSINESS</p> <ul style="list-style-type: none"> <input type="checkbox"/> Accounting <input type="checkbox"/> Advertising <input type="checkbox"/> Business Administration <input type="checkbox"/> Business Management <input type="checkbox"/> Cost Accounting <input type="checkbox"/> Creative Salesmanship <input type="checkbox"/> Managing a Small Business <input type="checkbox"/> Professional Secretary <input type="checkbox"/> Public Accounting <input type="checkbox"/> Purchasing Agent <input type="checkbox"/> Salesmanship <input type="checkbox"/> Salesmanship and Management <input type="checkbox"/> Traffic Management <p>CHEMICAL</p> <ul style="list-style-type: none"> <input type="checkbox"/> Analytical Chemistry <input type="checkbox"/> Chemical Engineering <input type="checkbox"/> Chem. Lab. Technician <input type="checkbox"/> Elements of Nuclear Energy <input type="checkbox"/> General Chemistry <input type="checkbox"/> Natural Gas Prod. and Trans. <input type="checkbox"/> Petroleum Prod. and Engr. <input type="checkbox"/> Professional Engineer (Chem) <input type="checkbox"/> Pulp and Paper Making | <p>CIVIL ENGINEERING</p> <ul style="list-style-type: none"> <input type="checkbox"/> Civil Engineering <input type="checkbox"/> Construction Engineering <input type="checkbox"/> Highway Engineering <input type="checkbox"/> Professional Engineer (Civil) <input type="checkbox"/> Reading Struc. Blueprints <input type="checkbox"/> Sanitary Engineer <input type="checkbox"/> Structural Engineering <input type="checkbox"/> Surveying and Mapping <p>DRAFTING</p> <ul style="list-style-type: none"> <input type="checkbox"/> Aircraft Drafting <input type="checkbox"/> Architectural Drafting <input type="checkbox"/> Drafting & Machine Design <input type="checkbox"/> Electrical Drafting <input type="checkbox"/> Mechanical Drafting <input type="checkbox"/> Sheet Metal Drafting <input type="checkbox"/> Structural Drafting <p>ELECTRICAL</p> <ul style="list-style-type: none"> <input type="checkbox"/> Electrical Engineering <input type="checkbox"/> Elec. Engr. Technician <input type="checkbox"/> Elec. Light and Power <input type="checkbox"/> Practical Electrician <input type="checkbox"/> Practical Lineman <input type="checkbox"/> Professional Engineer (Elec) <p>HIGH SCHOOL</p> <ul style="list-style-type: none"> <input type="checkbox"/> High School Diploma | <ul style="list-style-type: none"> <input type="checkbox"/> Good English <input type="checkbox"/> High School Mathematics <input type="checkbox"/> High School Science <input type="checkbox"/> Short Story Writing <p>LEADERSHIP</p> <ul style="list-style-type: none"> <input type="checkbox"/> Industrial Foremanship <input type="checkbox"/> Industrial Supervision <input type="checkbox"/> Personnel-Labor Relations <input type="checkbox"/> Supervision <p>MECHANICAL and SHOP</p> <ul style="list-style-type: none"> <input type="checkbox"/> Diesel Engines <input type="checkbox"/> Gas-Elec. Welding <input type="checkbox"/> Industrial Engineering <input type="checkbox"/> Industrial Instrumentation <input type="checkbox"/> Industrial Metallurgy <input type="checkbox"/> Industrial Safety <input type="checkbox"/> Machine Shop Practice <input type="checkbox"/> Mechanical Engineering <input type="checkbox"/> Professional Engineer (Mech) <input type="checkbox"/> Quality Control <input type="checkbox"/> Reading Shop Blueprints <input type="checkbox"/> Refrigeration and Air Conditioning <input type="checkbox"/> Tool Design <input type="checkbox"/> Tool Making <p>RADIO, TELEVISION</p> <ul style="list-style-type: none"> <input type="checkbox"/> General Electronics Tech. | <ul style="list-style-type: none"> <input type="checkbox"/> Industrial Electronics <input type="checkbox"/> Practical Radio-TV Eng'g <input type="checkbox"/> Practical Telephony <input type="checkbox"/> Radio-TV Servicing <p>RAILROAD</p> <ul style="list-style-type: none"> <input type="checkbox"/> Car Inspector and Air Brake <input type="checkbox"/> Diesel Electrician <input type="checkbox"/> Diesel Engr. and Fireman <input type="checkbox"/> Diesel Locomotive <p>STEAM and DIESEL POWER</p> <ul style="list-style-type: none"> <input type="checkbox"/> Combustion Engineering <input type="checkbox"/> Power Plant Engineer <input type="checkbox"/> Stationary Diesel Engr. <input type="checkbox"/> Stationary Fireman <p>TEXTILE</p> <ul style="list-style-type: none"> <input type="checkbox"/> Carding and Spinning <input type="checkbox"/> Cotton Manufacture <input type="checkbox"/> Cotton Warping and Weaving <input type="checkbox"/> Loom Fixing Technician <input type="checkbox"/> Textile Designing <input type="checkbox"/> Textile Finishing & Dyeing <input type="checkbox"/> Throwing <input type="checkbox"/> Warping and Weaving <input type="checkbox"/> Worsted Manufacturing |
|--|--|--|---|---|

Name _____ Age _____ Home Address _____
 City _____ Zone _____ State _____ Working Hours _____ A.M. to P.M. _____

Canadian residents send coupon to International Correspondence Schools, Canadian, Ltd., Montreal, Canada. . . . Special low monthly tuition rates to members of the U. S. Armed Forces.

To the Editor:

On page 136 of your magazine of July 1959 you have announced a note "Hey Detroit, Look at Poland." The note is not wrong and the photo is very witty.

Nevertheless I should like to complete your knowledge about our country. Poland has lost 6,000,000 of its people during the second world war; that is about 20 percent of the population of our country. We have lost many thousands of scholars, teachers, professors, engineers and technologists. Our towns, factories and mines have been spoiled in about 80 percentages.

I don't lay claim to you but I think it would be good that you as an editor of this excellent magazine would be acquainted with any information about our country. Perhaps you would change your look at our country.

If that would be interesting for you, ask, please, the opinion about Polish turning



lathes which were lately imported to your country.
Warsaw, Poland

EDITOR'S NOTE: No affront to Poland was intended. The "horse-before-the-coupe" was an amusing adaptation but it does demonstrate the will of the Polish to make do with what they have while fighting their way back from the ravages of a war that struck from both sides, engulfing Poland first of all. Poland may have lost professors and engineers, but not her spirit.

(Continued to page 12)

Enjoy
Velvet-Smooth Smoking
-the whole bowl
through!



No wonder Velvet stays smooth and mellow from first puff to last. Velvet's aged burley tobaccos are selected and cut to burn slower and cooler in any pipe, for truly Velvet-smooth smoking.

IN POCKET TINS . . . REGULAR
AND LARGE SIZE HUMIDORS

Spend the rest of your life on Velvet!

For a Successful Career in Radio-Television Electronics

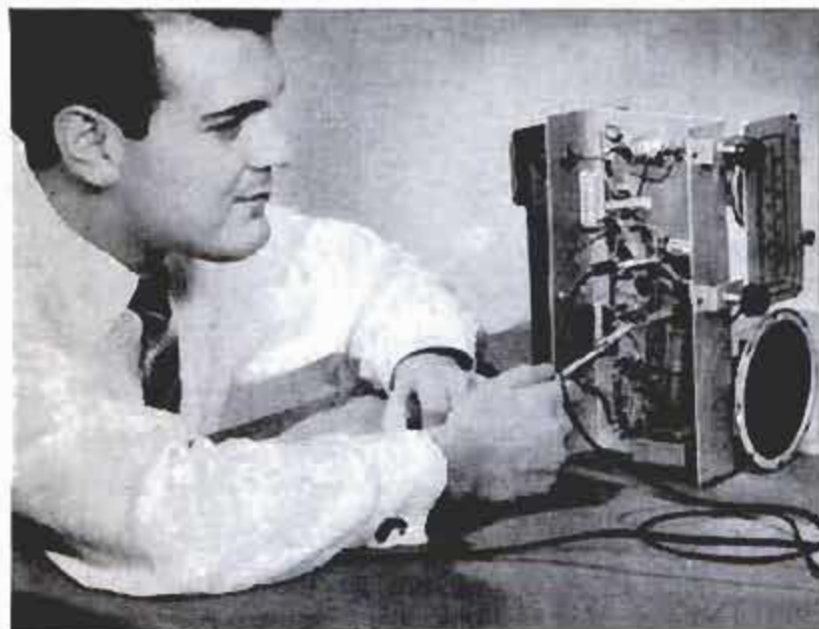

Train at Home
in Spare Time
with N. R. I.
**OLDEST and
LARGEST**
Home Study Radio-Television School

N.R.I. Trained These Men

Prosperous Fast Growing Industry Offers You GOOD PAY-BRIGHT FUTURE-SUCCESS

ENGINEER STATION WHPE
"Thanks to NRI, I operated a successful Radio repair shop. Now I am an engineer for WHPE."
VAN W. WORKMAN, HIGH POINT, NORTH CAROLINA



It's the trained man who gets ahead—gets the better job, drives a better car, lives in a better home, is respected for what he knows and can do. For a job with a future—find out how you can train at home for Radio-Television.

at home in spare time for Radio-TV. With NRI 50-50 method, you study basic principles AND learn by practicing with actual equipment NRI furnishes. You learn with your hands and your head. You get dependable training, backed up by the reputation of the oldest and largest home study Radio-TV school.

QUICK SPARE TIME CASH
"Knew nothing about Radio-TV when I enrolled. After 15 lessons started repairing sets. My future looks bright."
DONALD B. ACKERMAN, MINNEAPOLIS, MINNESOTA



TODAY'S OPPORTUNITY FIELD
Training PLUS OPPORTUNITY is the ideal combination for success. And today's OPPORTUNITY field is Radio-Television. Over 125 million home Radios plus 30 million sets in cars, plus 40 million TV sets mean big money for trained Technicians. More than 4,000 Radio and TV broadcasting stations offer interesting and important positions. Color television, portable TV sets, Hi-Fi, assure future growth. Find out about NRI. Since 1914—for more than 40 years—NRI has been training ambitious men

**ADD TO YOUR INCOME SOON
\$10-\$15 A WEEK IN SPARE TIME**

Soon after enrolling many start earning extra money fixing sets. Many open their own full time Radio-TV shops after getting NRI Diploma. **MAIL COUPON.** Get FREE Sample Lesson and 64-page Catalog showing equipment supplied, outlines of courses, opportunities in Radio-TV. Price is low—terms easy. Address: **NATIONAL RADIO INSTITUTE, Dept. 9NA, Washington 16, D. C.**

HAS OWN TV BUSINESS
"Quit my job to do Television work full time. I love it and do all right financially."
WILLIAM F. KLINE, CINCINNATI, OHIO



You Learn Servicing—Broadcasting at Home—By Practicing with Kits N.R.I. Sends



Nothing takes the place of practical experience. That's why NRI training is Learning-by-Doing. With Servicing Course you build Radio shown at top and other equipment. With Communications Course you build Transmitters at left and other equipment. Catalog shows all equipment you get.

Available To
VETERANS
Under G.I. Bills



SAMPLE LESSON AND CATALOG FREE

MAIL COUPON TODAY

National Radio Institute
Dept. 9NA, Washington 16, D. C.

Mail me Sample Lesson and 64-Page Catalog FREE. (No salesman will call. Please write plainly.)

Name _____ Age _____

Address _____

City _____ Zone _____ State _____

ACCREDITED MEMBER, NATIONAL HOME STUDY COUNCIL

KLEIN PLIERS

make electronic wiring easier



In the complete Klein line are pliers exactly designed to assure quicker, faster assemblies, to provide greater comfort and less fatigue. Pliers below all carry the Klein trademark famous for quality "Since 1857."

MIDGET LONG NOSE NO. 321-4½

A small plier only 4½ in. long for use in confined space. Points may be had plain or knurled. Available with coil spring.



MIDGET END CUTTING PLIER NO. 224-4½

A small plier only 4½ in. long with transverse cutters at end. Available with coil spring.



MIDGET OBLIQUE CUTTING PLIER NO. 257-4

A small oblique cutter only 4 3/16 in. long for cutting in confined space. Available with coil spring.



POINTED NOSE OBLIQUE CUTTING PLIER NO. 209-5

A lightweight cutter 5 in. long with pointed nose to reach into narrow space. Available with coil spring. Also available in 4 in. size.

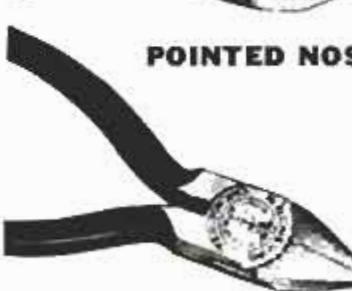

NEEDLE NOSE ELECTRONIC PLIER NO. 261-6

Shear cutting blade cuts flush...jaws hold clipped end. Useful in testing and repair work. 6½ in. long. Available with coil spring.



FREE CATALOG 101A illustrating and describing the complete Klein line of pliers for every purpose, is available on request. Write for your copy.



Mathias **KLEIN** & Sons
Established 1857 Chicago, Ill. U.S.A.
7200 McCORMICK ROAD • CHICAGO 45, ILLINOIS



(Continued from page 10)

A bound copy of the September issue of *Popular Mechanics*, which featured the story of Igor Sikorsky's 50 years in aviation, was presented to Mr. Sikorsky by distributors of the magazine in the Bridgeport, Conn., area. The presentation took place in Mr. Sikorsky's office at the Sikorsky plant in Stratford, where he is engineering



consultant. From left: Milton C. Rottman, owner, and Salvatore D. Grosso, manager, Fairfield County News Company; George Geils, Hearst Publications, and Mr. Sikorsky. Following the presentation Frank J. Delear, public relations manager of this division of United Aircraft, observed that Mr. Sikorsky was delighted particularly because he has been "practically a lifelong reader of *Popular Mechanics*."

☆☆☆

To the Editor:

Back in '28 or '29, while I was still building boats of wood, I read a small article in *Popular Mechanics* which included a drawing of a model boat made of one piece of metal. I made one of these models from a piece of light metal, and it was so slick that a small acorn was planted in my mind: Some day I would build boats of metal—but not as long as rivets were required, for I couldn't see myself punching holes and driving hot rivets to build a boat. But in 1933, when arc welding was getting out of three-cornered pants, I started building steel boats. I'm now getting ready to apply the basic principle I got out of *PM* 30 years ago to a superspeed boat for transoceanic service. . . . Just thought you might be interested in knowing that *PM* planted the little acorn that may grow into a giant oak.

Jack Casey,
Casey Craft,
Mermentau, La.

(Continued to page 24)

I WAS STANDING STILL IN A FAST-MOVING WORLD!



1
MANY OF MY NEIGHBORS WERE MAKING BIG MONEY... AND BUYING NICE HOMES IN THE SUBURBS...



2
... BUT I STILL WORKED ON AN ASSEMBLY LINE... EARNING THE SAME PAY... AFRAID OF A LAYOFF

I TRIED LOOKING FOR A BETTER JOB... BUT NO EMPLOYER WANTED AN UNTRAINED MAN



3
I SWALLOWED MY PRIDE WHEN MY WIFE RETURNED TO HER OLD JOB BECAUSE WE NEEDED MONEY

4
ONE DAY A PAL DROPPED IN... HE LOOKED PROSPEROUS

I OWN A REFRIGERATION AND AIR CONDITIONING BUSINESS. WHAT'S YOUR LINE?



5
IT WASN'T EASY FOR ME TO ADMIT I WAS IN A RUT

GET INTO REFRIGERATION!
OVER 20,000 NEW MECHANICS ARE NEEDED EACH YEAR. THERE'S AN EASY WAY TO TRAIN!



THE NEXT DAY MY FRIEND SHOWED ME HOW HE LEARNED THIS SECURE, HIGH-PAY CRAFT...

YES, I LEARNED QUICKLY BY PRACTICING AT HOME... C.T.I. SENT ME 25 KITS TO BUILD THIS REAL CONDENSING UNIT... TOOLS TOO!



I ALSO MADE MONEY AS I TRAINED!

7
THAT NIGHT I MAILED A COUPON FROM A C.T.I. AD FOR FULL INFORMATION



8
SOON I WAS TRAINING WITH REAL OPERATING EQUIPMENT DOING FIELD-TYPE PROJECTS



9
IN A FEW MONTHS I WAS READY FOR A GOOD JOB WITH A BRIGHT FUTURE



10
MY BIG PAY LETS US LIVE A LOT BETTER... MY FAMILY IS MORE SECURE... THANKS TO C.T.I.!

LET'S LOOK AT THE NEW CARS!



WHY DON'T YOU MAIL COUPON FOR VALUABLE SUCCESS BOOKLETS? BOTH ARE FREE!
COMMERCIAL TRADES INSTITUTE CHICAGO 26, ILLINOIS

COMMERCIAL TRADES INSTITUTE

1400 GREENLEAF AVENUE DEPT. R-667
CHICAGO 26, ILLINOIS
Rush me your booklet, Success in Air Conditioning & Refrigeration, and Sample lesson. Both FREE.

Name _____ Age _____

Address _____

City _____ Zone _____ State _____





Do You Know This Old-Timer?

Proud? You bet they are. And with reason. For more than a generation, this car's name was pronounced with pride. Unhappily, it is gone today. On this very early one-cylinder model the under-the-floor radiator was nothing more than a ventilated water tank. See page 228 for the name and year.

DON'T DECIDE YOUR FUTURE UNTIL YOU HAVE READ



How To Make Big Money Fast in the Accident Investigation & Adjusting Field

A. J. Allen earned over \$2,000 in ten weeks. Gary Williams doubled his former salary. Jessie Hill says "Had I not learned of Universal Schools' Accident Investigator Course I would still be just another time card puncher; but today I have a wonderful position, and I receive \$3.00 an hour plus an expense allowance."

RIGHT NOW the Accident Investigation and Adjusting Field offers you a tremendous future. Here's why: *This vital business distributes more money than any other service industry.* Last year alone over 200 MILLION ACCIDENTS had to be investigated for Insurance Companies, Airlines, Railroads, Steamship Lines, and Government Offices — and the need for trained men is booming!

You can investigate full time for one company — or earn \$3 to \$10 an hour in *your own business*. No prior experience or higher education needed. And age is no barrier. Here is a field wide open to men 18 to 60.

NOW! FREE Book Gives You All the Facts

Send TODAY for new, illustrated Book mailed FREE. Learn how you can prepare at home in just a few weeks for excellent full time or spare time income. See for yourself how others have doubled and even tripled their earnings. Let us show you how Universal Schools has trained hundreds of men in their own homes spare time — and then helped them add thousands of dollars to their incomes. Absolutely no obligation on your part. No salesman will call. Write at once to me, M. O. Wilson, Universal Schools, 6801 Hillcrest Ave., Dallas 5, Texas.

Mr. M. O. Wilson, Dept. PM-12
Universal Schools, 6801 Hillcrest Ave.,
Dallas 5, Texas

Send me free book on Big Money in Accident
Investigating & Adjusting Field. No salesman will call.

Name.....Age.....

Address.....

City.....Zone.....State.....



NOW!
at a price
you can afford!

MAKE MORE MONEY in TELEVISION RADIO-ELECTRONICS

**BETTER...MORE COMPLETE...LOWER COST...
WITH NATIONAL SCHOOLS SHOP-METHOD
HOME TRAINING!**

BETTER... Training that is proved and tested in Resident School shops and laboratories, by a School that is the **OLDEST** and **LARGEST** of its kind in the world.

MORE COMPLETE... You learn **ALL PHASES** of *Television-Radio-Electronics*.

LOWER COST... Other schools make several courses out of the material in our **ONE MASTER COURSE** and you pay more for less training than you get in our course at **ONE LOW TUITION!**



These
two FREE books will
show you how!

You get all information
by mail... You make
your own decision... at
home! **NO SALESMAN
WILL CALL**

TOP PAY... UNLIMITED OPPORTUNITIES LIFETIME SECURITY CAN BE YOURS!

You are needed in the Television, Radio, and Electronics industry! Trained technicians are in growing demand at excellent pay—in **ALL PHASES**, including Servicing, Manufacturing, Broadcasting and Communications, Automation, Radar, Government Missile Projects.

NATIONAL SCHOOLS SHOP-METHOD HOME TRAINING, with newly added lessons and equipment, trains you in your spare time at home, for these unlimited opportunities, including many technical jobs leading to supervisory positions.

YOU LEARN BY BUILDING EQUIPMENT WITH KITS AND PARTS WE SEND YOU. Your National Schools course includes thorough *Practical* training—**YOU LEARN BY DOING!** We send you complete standard equipment of professional quality for building various experimental and test units. You advance step by step, perform more than 100 experiments, and you build a complete TV set from the ground up, that is yours to keep! A big, new TV picture tube is included at no extra charge.

EARN AS YOU LEARN. We'll show you how to earn extra money right from the start. Many of our students pay for their course—and more—while studying. So can you!

RESIDENT TRAINING AT LOS ANGELES

If you wish to take your training in our Resident School at Los Angeles, the world's TV capital, start **NOW** in our big, modern Shops, Labs and Radio-TV Studios. Here you work with latest Electronic equipment - - professionally installed - - finest, most complete facilities offered by any school. Expert, friendly instructors. Personal attention. Graduate Employment Service. Help in finding home near school - - and part time job while you learn. Check box in coupon for full information

LESSONS AND INSTRUCTION MATERIAL ARE UP-TO-DATE, PRACTICAL, INTERESTING. Every National Schools Shop-Method lesson is made easy to understand by numerous illustrations and diagrams. All instruction material has been developed and tested in our own Resident School Shops, Laboratories and Studios.

SEND FOR INFORMATION TODAY... it can mean the difference between **SUCCESS** and failure for you! Send for your **FREE BOOK** "Your Future in Television-Radio-Electronics" and **FREE Sample Lesson**. Do it **TODAY**, while you are thinking about your future. It doesn't cost you anything to investigate!

GET THE BENEFITS OF OUR OVER 50 YEARS EXPERIENCE

Approved for
GI Training



NATIONAL SCHOOLS

Los Angeles 37, Calif.

YOU GET...

- 19 Big Kits—**YOURS TO KEEP!**
- Friendly Instruction and Guidance
- Job Placement Service
- Unlimited Consultation
- Diploma—Recognized by Industry
- **EVERYTHING YOU NEED FOR SUCCESS!**

SHOP-METHOD HOME TRAINING COVERS ALL PHASES OF INDUSTRY

1. Television, including Color TV
2. Radio AM & FM
3. Electronics for Guided Missiles
4. Sound Recording and Hi-Fidelity
5. FCC License
6. Automation and Computers
7. Radar & Micro-Waves
8. Broadcasting and Communications

NATIONAL TECHNICAL SCHOOLS
WORLD-WIDE TRAINING SINCE 1905

MAIL NOW TO
NATIONAL SCHOOLS, Dept. RB-129
4000 S. FIGUEROA ST., LOS ANGELES 37, CALIF.
Rush free TV-Radio "Opportunity" Book and sample lesson. No salesman will call.

NAME _____ AGE _____

ADDRESS _____

CITY _____ ZONE _____ STATE _____

Check if interested **ONLY** in Resident School training at Los Angeles.
VETERAN'S Give date of Discharge _____



**A HIGHLY
RESPECTED TRADE—
START SOON TO
EARN EXTRA MONEY
IN SPARE TIME**

Learn at Home IN YOUR SPARE TIME to Fix Electrical Appliances

To build a better future, get into a field where there's much important work and the security that comes from knowing a good trade. Servicing electrical appliances offers that OPPORTUNITY. Every wired home has many electrical appliances and millions and millions of new appliances are sold every year. Owners pay well to keep them in repair. That's making a fast-growing need for trained men.

Add To Your Income Starting Soon Need For Service Technicians Increasing

Make extra money in your spare time. Start soon to fix electric toasters, fans, clocks, vacuum cleaners, and other electric appliances for your neighbors and friends. Work in your basement, garage or spare room. It's easy to increase your earning power—to pay for your training many times over—to have extra money to buy things you need.

Learn and Earn with Multi-Use Tester Built with Parts We Send

This course includes the parts to build a portable, sturdy Appliance Tester that helps you locate electrical defects quickly and easily. You use it to learn and do actual electrical appliance repair jobs. If you want better pay learn this good trade. No need to give up your present

job. You can train at home in your spare time for only \$3.00 down and \$6.00 a month. A small price to pay for increased earnings, a more secure future. Paste coupon below on a postal or mail in envelope for free book and sample lesson. Address **National Radio Institute, Dept. AN9, Washington 16, D. C.**

**MAILING THIS
COUPON MAY START
YOU TO SUCCESS
LESSON AND BOOK
FREE**



NATIONAL RADIO INSTITUTE, Dept. AN9, Washington 16, D. C.

Please send me Electric Appliance Training lesson and book free. (No salesman will call.)

Name Age

Address

City Zone State

ACCREDITED MEMBER NATIONAL HOME STUDY COUNCIL

Train NOW as **HEAVY EQUIPMENT OPERATORS**

PUT YOURSELF IN THE DRIVER'S SEAT!

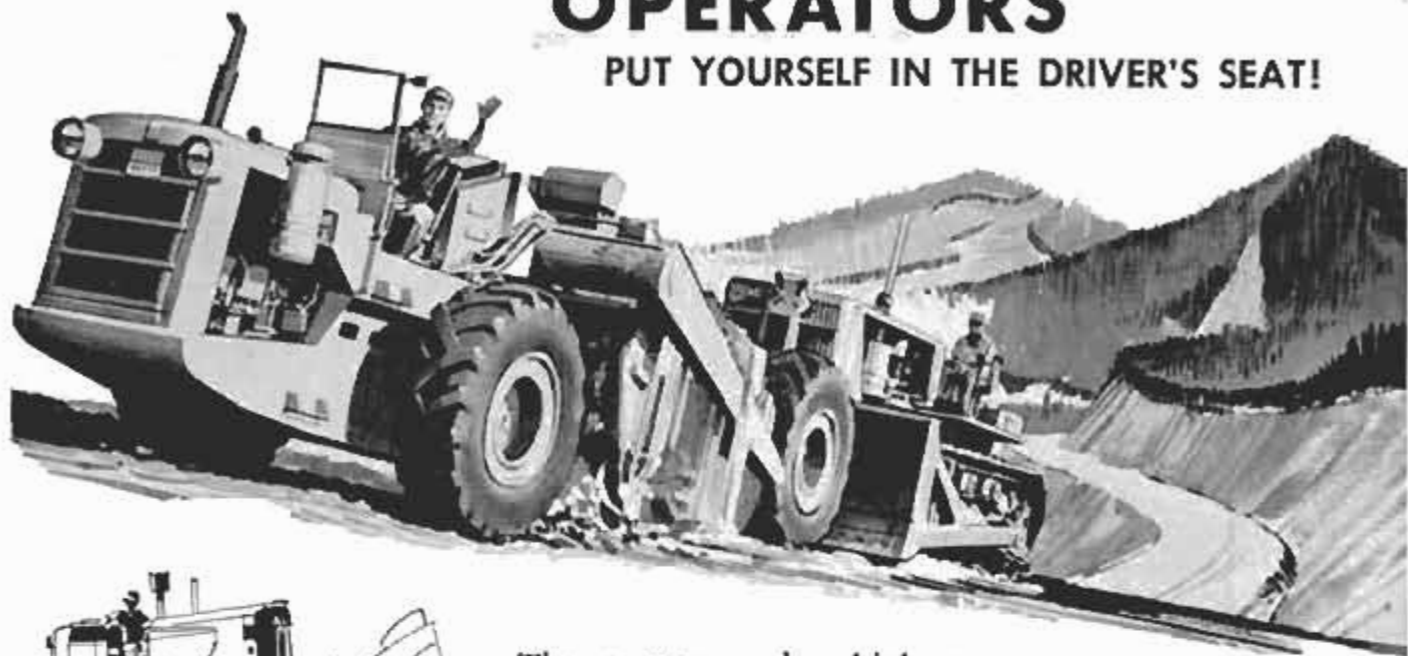

The most tremendous highway building program in history is under way... bridges, dams, houses, factories, are springing up all across the nation... The construction industry is booming as never before. And *You* can have a box seat for this greatest show on earth!

EXPERIENCE UNNECESSARY — APPLY NOW

You will be trained thoroughly for modern heavy equipment operation. Learn to master heavy equipment such as: tractors, scrapers, graders, carry-alls. Engineering fundamentals... blueprint reading... operating controls... diesel engine operation... highway construction, etc.

If you are between 17 and 45, you can get into Heavy Equipment NOW — regardless of your present position, training or income. Nationwide placement service available upon completion. We help you with financing.



SEND FOR FREE INFORMATION

HEAVY EQUIPMENT TRAINING

Northwest Schools, Inc. (Dept. M-5)
1221 N. W. 21st Avenue • Portland 9, Oregon
Rush information without obligation.

Name _____

Address _____

City _____ State _____

Phone _____ Age _____

Education _____ Hours Worked _____



DRAFTSMEN



CASH BIG PAY CHECKS!

Train Now for more success, greater security

LEARN AT HOME IN SPARE TIME (or at college in Chicago)

Check the want ads in any newspaper—SEE the big-pay opportunities open to you as a draftsman. What's more, you can learn this well-paid, prestige profession at home—quickly, easily! No special talent needed. Get complete, step-by-step Chicago Tech lessons in the mail, spend a few pleasant hours studying each week. In a short time you'll be a well-trained draftsman, ready to take your pick of many good jobs. Act now!



Free Information—Mail Coupon Today!

Get FREE TRIAL LESSON plus information about C.T.C. practical training. Learn what successful Chicago Tech graduates say about high pay and opportunities in drafting. No charge, or obligation.

CHICAGO TECHNICAL COLLEGE

5-217 Tech Bldg., 2000 So. Michigan Ave. Chicago 16, Illinois

Mail me FREE lesson with facts about big opportunities in DRAFTING.

Name _____ Age _____

Address _____

City _____ Zone _____ State _____

CONVERT THAT MILITARY RIFLE



NEW BOOK

Shows You How



'03 Springfield—Before



After

Step by Step Instructions

Shows How To Convert:

- Springfield
- Enfield
- Mauser
- A. Krag
- N. Krag
- 6.5 Jap
- 7.7 Jap
- 6.5 Carcano
- 7.35 Carcano
- 7.62 Russian
- S.M.I.E.
- Others

The complete "How To" booklet for amateur or expert. Makes custom "sporterizing" of military rifles easy. Tells what the average shooter will require, what accessories are available and how to install them. More than 150 illustrations take you from disassembling through the final finishing. Gives sight combinations, height chart, ammunition to use, etc. Only 50c per copy. If your dealer can't supply, order direct OR send \$1.00 and we will send above booklet plus complete 144 page Shooter's Catalog.

WILLIAMS GUN SIGHT CO. "On the Range"

7212 Lapeer Road Davison 23, Michigan

Great Pioneers in Science Do You Know Them?

—By James S. Thistle—

DO YOU KNOW this member of the most notable husband-and-wife team in the history of science? Together with her marital partner, she succeeded in isolating an element 900 times as "radioactive" as uranium. They called it "radium."

To obtain radium in purer form, they labored over a ton of pitchblende in an old shed. After a good deal of hardship they managed to extract a tenth of a gram (less than four thousandths of an ounce) of radium, pure enough to determine its atomic weight.

In 1911 this renowned woman scientist won the Nobel Prize for a second time, the only woman to do so. American women presented her a gram of radium worth \$100,000. In 1934 the world grieved on learning that the "radioactive bodies" she and her husband had discovered for the benefit of others had taken her own life.

These letters, unscrambled, spell the name of this month's Great Pioneer in Science:

ICEARUMIRE

(First and Last Names)

Write the correct name here:

Now turn to page 226 for the answer.

Superior's New Model 70 UTILITY TESTER®

FOR REPAIRING ALL ELECTRICAL APPLIANCES MOTORS • AUTOMOBILES • TV TUBES



As an electrical trouble shooter the Model 70:

- Will test Toasters, Irons, Broilers, Heating Pads, Clocks, Fans, Vacuum Cleaners, Refrigerators, Lamps, Fluorescents, Switches, Thermostats, etc.
- Will test all TV tubes for open filaments, inter-element shorts, burned out tubes, etc.
- Measures A.C. and D.C. Voltages, A.C. and D.C. Current, Resistances, Leakage, etc.
- Will measure current consumption while the appliance under test is in operation.
- Incorporates a sensitive direct-reading resistance range which will measure all resistances commonly used in electrical appliances, motors, etc.
- Leakage detecting circuit will indicate continuity from zero ohms to 5 megohms (5,000,000 ohms).

As an Automotive Tester the Model 70 will test:

- Both 6 Volt and 12 Volt Storage Batteries • Generators • Starters • Distributors • Ignition Coils • Regulators • Relays • Circuit Breakers • Cigarette Lighters • Stop Lights • Condensers • Directional Signal Systems • All Lamps and Bulbs • Fuses • Heating Systems • Horns • Also will locate poor grounds, breaks in wiring, poor connections, etc.

IT'S SO EASY!!



With tester's cord in outlet, current consumption of appliance is read direct on meter when line cord is connected to receptacle on panel. This typical iron takes 7 amperes (Good).



Small electric fan motor indicates 50 ohms (normal resistance).



Control circuits of most furnaces use 24 volts obtained from step-down transformer. Here's how to check room thermostat to see if wire to it are live.



Manual supplied with Model 70 shows meter needle moves to right when test leads are connected to pins 3 and 4 of this 6AU6 tube. Procedure for testing all tubes used in TV are detailed in manual.

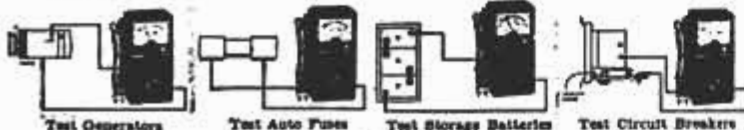

READ THIS!

READ THIS!

READ THIS!



INCLUDED FREE!!

This 64-page book—practically a condensed course in electricity. Learn by doing.

Just read the following partial list of contents:

- What is electricity? • Simplified version of Ohms Law • What is wattage? • Simplified wattage charts • How to measure voltage, current, resistance and leakage • How to test all electrical appliances and motors using a simplified trouble-shooting technique.
- How to test all TV tubes; also simple procedure for determining which specific tube (or tubes) is causing the trouble.
- How to trace trouble in the electrical circuits and parts in automobiles and trucks.

Model 70 comes complete with above book and test leads. Only...

15⁸⁵

You don't pay for the Model 70 until AFTER you have examined it in the privacy of your home! Model 70 is

SHIPPED ON APPROVAL NO MONEY WITH ORDER — NO C.O.D.

Try it for 10 days before you buy. If completely satisfied then send \$3.85 and pay balance at rate of \$4.00 per month for 3 months—No Interest or Finance Charges Added! If not completely satisfied, return to us, no explanation necessary.

MOSS ELECTRONIC, INC.

Dept. D-690 3849 Tenth Ave., New York 34, N. Y.

Please rush me one Model 70. If satisfactory I agree to pay \$3.85 within 10 days and balance at rate of \$4 per month until total price of \$15.85 plus postage is paid. If not satisfactory, I may return for cancellation of account.

Name _____

Address _____

City _____ Zone _____ State _____

**"MADE \$1200
ON ONE JOB"**

Some make more, some less.

We help you start Your Own All-Year Business

Make BIG Money! With our easily operated, highly efficient wall washer, G. H. Jones made \$1200 on one school job. E. L. Goss took in more than \$10,000 in one year.



E. C. Taber wrote, "I made \$400 gross in two weeks." And no wonder... this machine washes walls 6 times faster and better than by hand — with no mess... no drop cloths.

Your Money-Making Opportunity • We want more men to go into this profitable business for themselves and enjoy independence—freedom from layoffs and bosses. Customers everywhere—homes, offices, schools, churches, hotels, etc. How much you earn depends largely on you. What you take in is mostly profit. No need to rent shop or office; operate from home. Start spare time until full time is justified.

Lose No Time — Send Coupon Today for All the Facts

FREE BOOK! MAIL COUPON TODAY!

VON SCHRADER MFG. CO.
W10 "W" Pl., Racine, Wisconsin

Send at once (no obligation) your **FREE** booklet containing information about your **WALL WASHING MACHINE** and how I can start my own permanent, profitable business.

Name _____

Address _____

City _____ Zone _____ State _____

**New Table Top Invention Puts You In...
PROFITABLE RUBBER
STAMP BUSINESS**

Home Operators now make \$9.40 AN HOUR in business once monopolized by a few big companies

Special rubber stamps bring high prices—cost only pennies to make on new, low-cost table top machine. Take 27 cents worth of material, make perfect stamps, the kind businesses and offices now buy by the dozen at \$1.80 each. Make up to \$9.40 an hour. Start in spare time in your own home. Run machine on kitchen table using ordinary electrical outlet. Make any kind of stamp. We'll send you free information without obligation about this established, highly profitable business, now open to individuals for the first time. For free information send name today on a post card to **Rubber Stamp Div., 1512 Jarvis Ave., Dept. R-2-P, Chicago 26, Ill.**

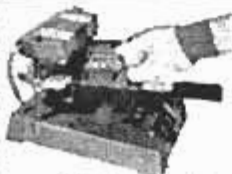

8 FT. SPECIALS — 80c



Mammoth, man, mammoth! These **GIANT 8 FOOTERS** (new, genuine neoprene gut, surplus) are terrific for fun or business. Great at parties, school proms, picnics, on the beach, etc. Just paint a message on 'em, inflate & fly, and they attract crowds to store or gas station openings, fairs, etc. Yours at a fraction of their original cost. Satisfaction guaranteed. Order several, they make wonderful gifts. Some sizes in limited supply.

8' dia.—80c ea. 2 for \$1.50
13' dia.—\$1.95 ea.—20' dia.—\$4.95 ea.

Postage pd. on ppd. orders.
Cal. res. add sales tax.

FRANK SALES, Dept. PM1259, 3930 Sunset Blvd., Los Angeles 29, Calif.

75 POWER TELESCOPE \$3.98
25X-45X-75X

NEW 3 in one telescopes, 3 variable 25X-45X-75X magnification. Brass bound, 25 power for ultra bright images 45 & 75 power for long range. Guaranteed to bring distant stars, moons, objects, sports 75 times closer.

Most powerful scope sold anywhere near this amazing low price. American made, 3 sections. Opens 36" closes 1 ft.; contains 4 ground & polished lenses. Can also be used as powerful compound microscope. Mass production enables us to offer telescope complete at \$3.98 postpaid. Money back guarantee.

CRITERION CO., Dept. PMB-76, 331 Church St., Hartford, Conn.

make your own Gems 36⁵⁰

The Gem Maker comes complete with all necessary equipment, including a super-charged diamond blade for sawing, and all the wheels for grinding, shaping and polishing; also complete instructions. The complete equipment as shown, less motor and belt for only \$36.50, f.o.b. Burlington, Wisconsin. Write today for information and literature.

B&I MANUFACTURING CO.
Dept. P, Burlington, Wis.

**High School Course
at Home Many Finish in 2 Years**

Go as rapidly as your time and abilities permit. Course equivalent to resident school work — prepares for college entrance exams. Standard H. S. texts supplied. Diploma, Credit for H. S. subjects already completed. Single subjects if desired. High school education is very important for advancement in business and industry and socially. Don't be handicapped all your life. Be a High School graduate. Start your training now. Free Bulletin on request. No obligation.

American School, Dept. H945, Drexel at 58th, Chicago 37



1000 NAME AND ADDRESS LABELS \$1
ANY 3 DIFFERENT ORDERS \$2 ppd. Sensational bargain! Your name and address printed on 1000 finest quality gummed labels. Padded! Packed with **FREE Plastic GIFT BOX**. Use them on stationery, books, cards, etc. 1000 only \$1 ppd. **SPECIAL OFFER — ANY 3 DIFFERENT ORDERS \$2.** Satisfaction guaranteed. **HANDY LABELS, 1221 Jasperson Bldg., Culver City 1, California.**

**Helps You Overcome
FALSE TEETH
Looseness and Worry**

No longer be annoyed or feel ill-at-ease because of loose, wobbly false teeth. **FASTEETH**, an improved alkaline (non-acid) powder, sprinkled on your plates holds them firmer so they feel more comfortable. Avoid embarrassment caused by loose plates. Get **FASTEETH** at drug counters everywhere.

POPULAR MECHANICS

DON'T BE HALF-TRAINED! Be A Master Technician

NOW... ONE
modern master
home training course
IN ALL 3 PHASES



AIR CONDITIONING - REFRIGERATION ELECTRICAL APPLIANCES

ALL AT ONE
LOW TUITION
only National Schools gives
you this complete training
at no extra cost

YOU GET AND KEEP ALL THESE TOOLS AND INSTRUMENTS



Incomplete training limits your earning power, even disqualifies you for top-pay jobs. The big service companies require complete, all-phase training. If you open your own shop, you'll be called upon to service and repair all types of refrigerators, air conditioners and appliances. With complete training—as only National Technical Schools can give you—you can accept every job, make big profits all year round.

FUTURE BRIGHT FOR TRAINED MASTER TECHNICIANS

Over 30,000 new technicians must be trained annually. You are needed to help service and repair the 50 million air conditioners, refrigerators and electrical appliances that will need fixing this year alone. No wonder the Master Technician has steady work, at high pay, year after year. He can go places in his own business or with a manufacturer, dealer, distributor or department store. Armed with all-phase training, his earning power is unlimited.

THE MOST FOR LESS

We give you illustrated Shop-Tested Lessons and Manuals...many other training aids...privilege of CONSULTATION with our instructors and engineers. Every lesson, every manual has been SHOP tested and approved.

JOB TRAINING AT HOME

You get Professional Tools, Precision Instruments, PLUS a Factory-Made APPLIANCE TESTER! A shop-full of PRACTICAL, professional equipment. Use them to conduct over 100 experiments...also in Spare Time Work and ON THE JOB. It is all yours to keep...no EXTRA MONEY DEPOSITS...no EXTRA COST on your equipment kits.

EARN AS YOU LEARN

We show you how. Many of our students pay for their entire course—and more—in Spare Time while learning. So can you. Graduate Advisory Service, too.

**GET THE BENEFIT OF OUR OVER
50 YEARS EXPERIENCE**

**N.T.S. also offers training in
TV - RADIO - ELECTRONICS
and AUTO MECHANICS - DIESEL**



NATIONAL TECHNICAL SCHOOLS

WORLD-WIDE TRAINING SINCE 1905

4000 SO. FIGUEROA ST., LOS ANGELES 37, CALIF., U. S. A.

RESIDENT TRAINING AT LOS ANGELES

If you wish to take your training in our Resident School at Los Angeles, start NOW in our big modern Shops and Labs. Here you work with latest equipment...professionally installed...finest, most complete facilities offered by any school. Expert, friendly instructors. Personal attention. Graduate Advisory Service. Help in finding home near school...and part time job while you learn. Check box in coupon for full information.



**SEND FOR
FREE
BOOK AND
ACTUAL
LESSON NOW!**

We'll rush you our big, illustrated OPPORTUNITY BOOK and ACTUAL LESSON, show you how easily you can learn. NO OBLIGATION; no salesman will call. Do it NOW! It costs nothing to find out.

NATIONAL TECHNICAL SCHOOLS

WORLD-WIDE TRAINING SINCE 1905

MAIL NOW TO
National Technical Schools, Dept. C8-129
4000 S. Figueroa St., Los Angeles 37, Calif.
Rush FREE "Opportunity" Book and Actual Lesson. No Salesman will call.

NAME _____ AGE _____

ADDRESS _____

CITY _____ ZONE _____ STATE _____

Check here if interested ONLY in Resident Training at Los Angeles.

"Something Is Missing Here"

FOR MORE THAN fifty years the pages of *Popular Mechanics* have brought you the advertising of patent attorneys . . . the business cards of men who are the links between inventive Americans and the United States Patent Office.

Suddenly they are gone.

Suddenly a small group of experts, honorable men specially trained to perform a special service to you, has been declared guilty of "unprofessional conduct" if they advertise this service. They can write you as patent attorneys on their letterheads. They can hand you their business cards. They can advertise by listing in the pages of the classified telephone directory or a city directory. But to advertise such service to the inventors and craftsmen and industrialists and shop operators who read *Popular Mechanics* and similar magazines is suddenly "unprofessional."

Not by law. Congress has never declared it bad conduct for a patent attorney to advertise. No, this ruling comes by government decree, the sort of thing you look for in some other country than America.

The decree comes from the Commissioner of Patents with the approval of his superior, the Secretary of Commerce. It bars an advertising attorney from appearing before the Patent Office and threatens him with disbarment.

Read it:

"The use of advertising, circulars, letters, cards and similar material to solicit patent business, directly or indirectly, is forbidden as unprofessional conduct, and any person engaging in such solicitation, or associated with or employed by others who so solicit, shall be refused recognition to practice before the Patent Office or may be suspended, excluded or disbarred from further practice. . . ."

And so you have lost something that we honestly feel is your right, the right to find in our pages the names of patent attorneys of unquestioned integrity who may represent an inventor seeking advice and service.

If you live in a large city, you may find a patent attorney listed in the classified telephone book, where anyone may advertise. If you happen to live in a small town or rural area of Ohio or Utah, Mississippi or Maine, no such directory may be available. We screen all our advertisers carefully. We know of their integrity and honest service. Yet, if they advertise with us, these patent attorneys are branded "unprofessional."

So you have lost this link. We feel you are entitled to it; we feel that the patent attorneys themselves are deprived of a right given them by the Constitution, a right of freedom of speech and of the press.

A letter to your Congressman protesting against the restrictive rule of the Commissioner of Patents might be of substantial value in restoring to patent attorneys their right to advise you of their availability to assist you before the Patent Office.

THE EDITORS

GET FULL FACTS
FREE!

Prepare for a
Profitable, Exciting Future

as an **Electronics Technician!**

No Previous Technical Experience Required!

Opportunities were never greater for the man who wants to get someplace and be somebody than they are today in the fast-expanding, profitable field of Electronics.

Let us tell you without cost or obligation how you may prepare for a real career in one or more branches of Electronics, either in our well-equipped Chicago or Toronto laboratories—or at home without interfering with your present job. Send coupon for **FREE** facts today!

AN EXCELLENT OPPORTUNITY FOR MEN 17-55!

Even if you haven't an advanced education, find out how you may prepare in your spare time at home, to enter the **BIG OPPORTUNITY** field of Electronics. Mail coupon **TODAY!**

Sample Booklet FREE!

We'll give you a free copy of an interesting booklet, "Electronics and YOU." See for yourself how you may take advantage of the opportunities in this growing field.



MAIL COUPON TODAY!

DeVRY TECHNICAL INSTITUTE
4141 Belmont Ave., Chicago 41, Ill., Dept. PM-12P

Please give me your **FREE** booklet, "Electronics and YOU," and tell me how I may prepare to enter one or more branches of Electronics as listed above.

Name _____ Age _____
PLEASE PRINT

Street _____ Apt. _____

City _____ Zone _____ State _____

Check here if subject to Military Training.
DeVry Tech's Canadian Training Center is located at
2032 626 Roselawn Avenue, Toronto 12, Ontario

NO ADVANCED EDUCATION NEEDED!

Prepare now for Electronic job opportunities in —

- | | |
|----------------|----------------|
| Radar | Remote Control |
| Guided Missile | Systems |
| Control | Automation |
| Computers | Electronics |
| Radio | Industrial |
| Television | Electronics |
| Broadcasting | Your Own |
| Communications | Service Shop |

Free Employment Service

DeVry Tech's Placement Department is in contact with some of the best-known employers in the Electronics field. The service is free to all graduates—and DeVry Tech's record in helping to place men has been outstanding.

Draft Age?

We have valuable information for every man of draft age; so if you are subject to military service, be sure to check the coupon.

Accredited Member of National Home Study Council



"One of North America's Foremost Electronics Training Centers"

DeVRY TECHNICAL INSTITUTE

CHICAGO 41, ILLINOIS

formerly DeFOREST'S TRAINING, INC.



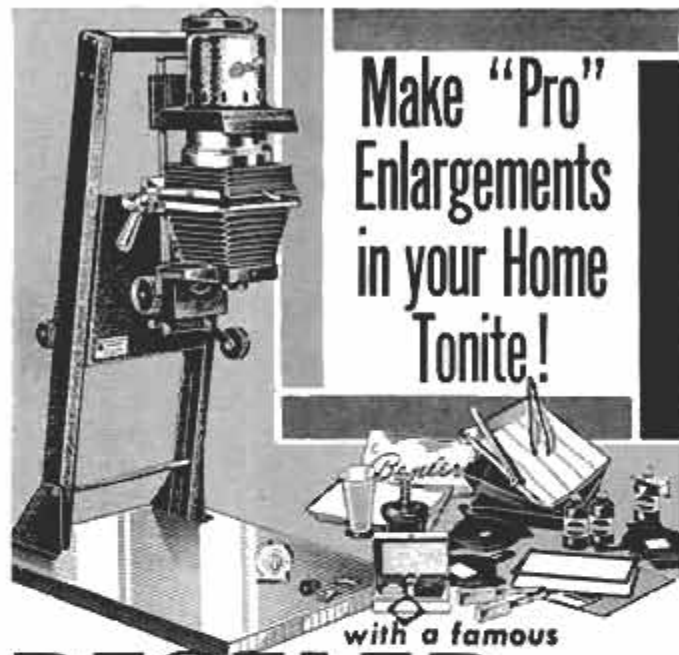

Make "Pro"
Enlargements
in your Home
Tonite!

with a famous

BESELER DARKROOM

... in your own basement, bathroom,
kitchen, closet or clubhouse!

Taking pictures is twice the fun when
you make them into giant enlargements.
Outfit with lens, chemicals, paper, trays,
easel, timer. Beseler 23C Enlarger... if
purchased individually, would cost \$287!

\$195

Colorado West \$199

Complete Outfit

MAIL THIS COUPON TONITE!

CHARLES BESELER CO.
206M S. 18th St., East Orange, N.J.

Please rush my FREE booklet,
"Fun in the Darkroom."

NAME _____

ADDRESS _____

CITY _____ ZONE _____ STATE _____

©1954, Charles Beseler Company



Exclusive Double-Bearing HEAVY-DUTY PUMPS
IRRIGATE • DRAIN • CIRCULATE • SPRAY
Use 1/4 HP motor or larger . . . 1 HP for up to 7,500
GPH; 1,000 GPH 60" high; or 3,000 GPH from 25' well.
1 1/2" inlet; 1" outlet. Stainless shaft.
TYPE X—2 oil-less bronze bearings. Won't rust. . . . **\$10.95**
TYPE XB—Ball bearing model. . . . **\$12.95**
Postpaid if cash with order. Rush your order today
MONEY BACK GUARANTEE
Centrifugal and Gear Pumps in All Sizes
LABAWCO PUMPS, Belle Mead 2, N. J.

NEW LAPSTRAKE KITS
U-MAK-IT FIRST AND OLDEST
KIT BOAT
MANUFACTURER
Most complete line of PRAMS,
ROWBOATS, OUTBOARDS, CABIN
CRUISERS and new Lapstrake kits.
MAIL 50c (coin) REFUNDABLE
for **BIG COLOR CATALOG**
Showing all models 8' to 23'
including accessories, paints, etc.
All you need to build
your own.
U-MAK-IT PRODUCTS
DELAND, FLA.—Dept. 12

and FRAME
KITS

To the Editor:

For a long time I have wondered why, now that we know about carrier-current transmission on power wires, nobody has seen fit to consider using this as a means to provide synchronization for electric clocks. Anything that will cause a break in the power to a clock for a time will cause it to be in error. In order to keep clocks running accurately I propose that utility companies put a pulse on their lines at, say, midnight. In the clock itself, a remarkably simple cold-cathode glow-discharge tube tied up to a resonant circuit could actuate a mechanism to cause the thing to set itself at midnight.

By adopting this scheme we could always be considerably more certain that when we looked at a clock, it would be set at the proper time, for it would, in the normal course of events, have corrected its setting at midnight the previous night.

James A. Davis,
Philadelphia, Pa.

☆☆☆

Now it's official. The American Rocket Society is in favor of rockets, but opposed to experiments by amateurs. Reporting 162 injuries to experimenters in a sample six-week period, the society points out that this rate is relatively higher than the automobile accident rate and concludes: "The development of the science of rocketry is not served by amateur experimentation. The somewhat debatable loss in opportunity for intellectual development which might be suffered by foregoing experimentation is small compared with apparently unavoidable and appalling losses of eyes, fingers and lives. . . ."

"All practical means must be taken to prevent the manufacture of propellants or rockets by amateurs. The launching of rockets by amateurs must be prohibited."

☆☆☆

Wearing Your Safety Shoes Today?

Some 128 persons per week are joining a new club. No meetings, no dues, just a club. Membership, which gives you the privilege of wearing a Golden Shoe pin and receiving a certificate, is for those involved in a foot accident where injury was averted or lessened by wearing safety shoes. It can happen at your factory, home workshop, when using a lawnmower, or dropping a flatiron. International Shoe Company, one of the makers of safety shoes, started the club and reports that 128 new members—saved by safety shoes—are joining the roster every week!



LET RCA TRAIN YOU IN ELECTRONICS

RCA Institutes celebrates Fifty Years of Electronic Training by introducing its newest Home Study Course . . .

ELECTRONICS FOR AUTOMATION

. . . Now you have *four* comprehensive courses for your electronic training . . . from basic electronic theory to the more advanced principles of color TV and Automation.

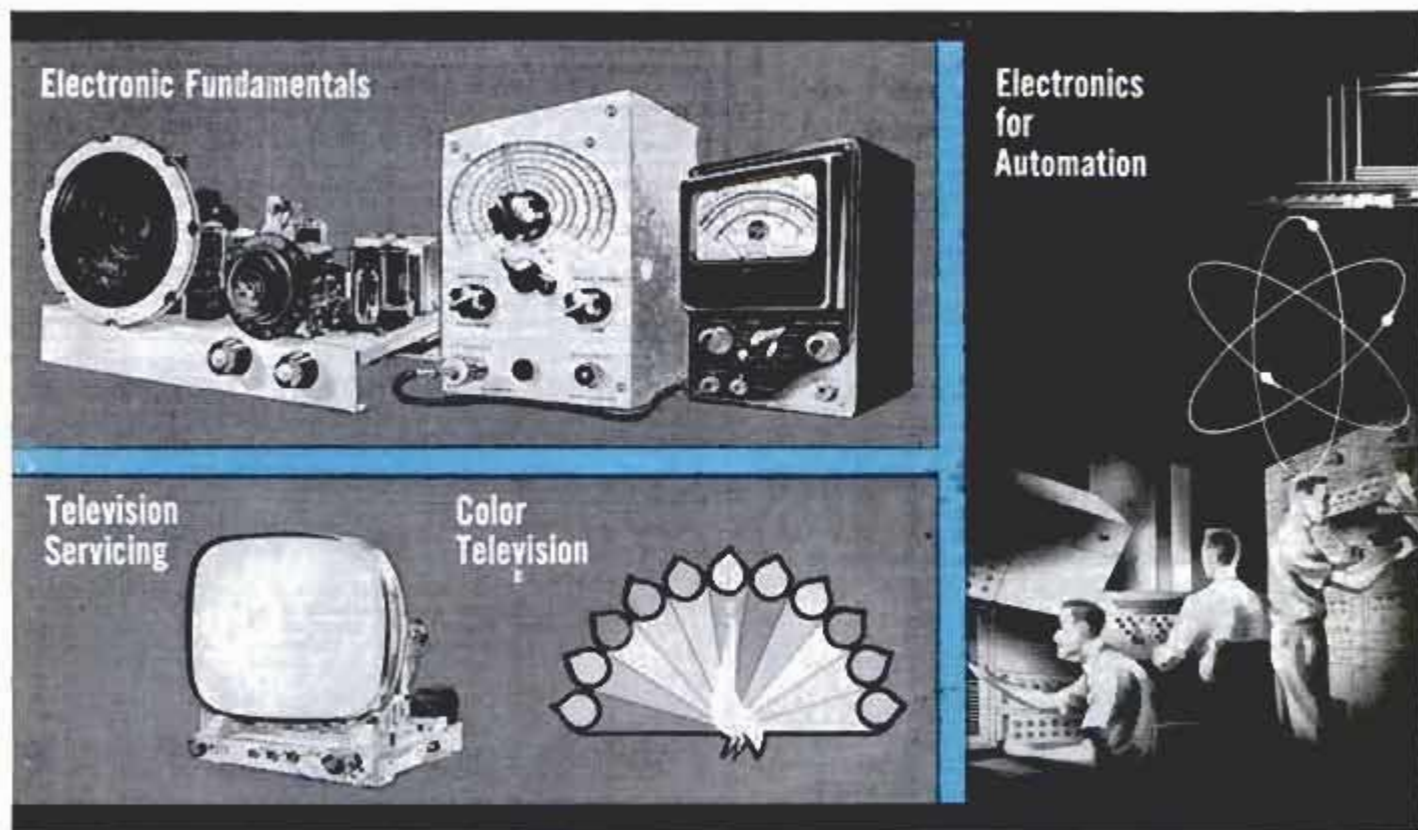

Send for our 64 page Home Study Catalog **FREE!**



RESIDENT SCHOOL offers Technical Institute and Vocational School Courses in Electronics. Day and Evening classes start 4 times each year. Resident School Catalog sent free on request.

Practical work with the very first lesson. Pay-as-you-learn. You need pay for only one study group at a time

RCA INSTITUTES, Inc. Home Study School, Dept. PM-129

A Service of Radio Corporation of America
350 West Fourth Street, New York 14, N. Y.

Without obligation, send me the FREE catalog of Home Study Courses. No salesman will call.

Name Please print

Address

City Zone State

Korean Vets? Enter Discharge Date

CANADIANS — Take advantage of these same RCA courses at no additional cost. No postage, no customs, no delay. Send coupon to: RCA Victor Company, Ltd., 5001 Cote de Liesse Rd., Montreal 9, Quebec
To save time, paste coupon on postcard.

ANOTHER WAY RCA SERVES EDUCATION THROUGH ELECTRONICS

My name is Charles Atlas. I can't promise you'll win the title of "World's Most Perfectly Developed Man" as I did. But I do believe I can make a powerful He-Man of you -- in a very short time. You can prove it to yourself -- at my risk. My big free book tells how to do it.



FREE BOOK Mail coupon now for free 32-page book. Tells how I can give you "Stand-Out" muscles -- how "Dynamic Tension" can make you a new man -- confident, popular, successful. Rush coupon to me personally: **CHARLES ATLAS, Dept. 8M, 115 E. 23 St., N.Y. 10.**

CHARLES ATLAS, Dept. 8M,
115 East 23rd St., New York 10, N. Y.

Dear Charles Atlas -- Here's the Kind of Body I Want:
(Check as many as you like)

- Slimmer Waist, Hips
 Broader Chest, Shoulders
 More Powerful Arms, Grip
 More Powerful Legs
 Better Energy, Sleep

Send me, absolutely FREE, a copy of your famous book showing how "Dynamic Tension" can make me a new man. 32 pages, crammed with photographs, answers to vital questions, and valuable advice. No obligation.

Name..... Age.....
(Please Print or Write Plainly)

Address.....

City..... Zone... State.....

LEARN TO MOUNT BIRDS



ANIMALS, FISH, PETS

Be a Taxidermist. Save your hunting TROPHIES. Have a fine home-museum. Hunters, save and MOUNT your beautiful DUCKS, QUAIL, DEER, TAN skins, FURS. Great Fun, Spare-time PROFITS. **FREE BOOK** Tells ALL about it. 100 fine wild-game pictures, 48 pages. SEND TODAY, don't delay. Get this WONDERFUL FREE BOOK, MEN AND BOYS. Learn Taxidermy. Double your hunting pleasure. Rush letter or POSTAL today. STATE YOUR AGE. **N. W. SCHOOL OF TAXIDERMISTRY, Dept. 2512 Omaha, Neb.**

FOCUS YOUR EYE OF BENJAMIN

SMOOTH BORE BB OR RIFLED 22 -- AIR OR GAS GUNS -- ROUND LEAD AMMO EFFECTIVE UP TO 100 FT. **AMAZING NEW Line of REPEATERS** WITH THE LATEST IMPROVEMENT IN FAST, SURE, GRAVITY LOADING ACTION AND **PIGGY-BACK SHOT MAGAZINE**

A Shot is placed in Firing Position each time Bolt is Pulled Back and Closed. Flash Ammo Count on Full View Magazine.



- No. 3600 BENJAMIN Super 100 Shot BB Gas Rifle. Non-Toxic -- Safe -- Convenient -- Uniform Hi-Velocity Power. -- \$18.95
- No. 2600 BENJAMIN Super 35 Shot BB Gas Pistol. Safe -- No Pumping -- Uniform Hi-Power. For Target & Small Game. \$17.95
- No. 2620 BENJAMIN 20 Shot Cal. 22 Gas Pistol. Economical. \$19.95
- No. 1300 50-Shot BB Air Pistol \$22.50
- No. 1320 BENJAMIN 35-Shot Cal. 22 Air Pistol \$24.50
- No. 3600 BENJAMIN Super 100 Shot BB Gas Rifle. Non-Toxic -- Safe -- Convenient -- Uniform Hi-Velocity Power. -- \$18.95
- No. 3620 BENJAMIN Super 85 Shot Cal. 22 Gas Rifle. . . . \$20.95
- No. 3100 Super 100 Shot BB Air Rifle. Adj. Shooting Force \$23.95
- No. 3120 BENJAMIN Super 85 Shot Cal. 22 Air Rifle. . . . \$25.95

FREE Catalog All Models Benjamin Single Shot & Repeaters -- Cal. BB or 177 or 22. Also, Special Hunting & Fishing Knife Offer.

BENJAMIN AIR RIFLE CO., 876 MARION ST., ST. LOUIS 4, MO.

26 YEARS IN BUSINESS AT THE SAME ADDRESS.
Beat the high cost of new tires.
EXTRA MILEAGE TOP GRADE Tires,
(Written Insurance Guarantee). SEND AD
WHY PAY MORE? UP TO 15,000 MI.
Our entire stock of very slightly used
12 MOS. Written Guarantee. White Walls \$1.00 extra

600-16	\$5.22	670-15	\$5.22	700-15(6)	\$8.92	750-20(8)	\$12.22
600-16(6)	7.92	710-15	5.22	750-16(8)	10.72	825-20	18.92
650-16(6)	8.72	780-15	5.42	700-17	10.22	900-20	18.92
750-14	7.52	800-15	6.42	750-17	12.22	1000-20	19.92
800-14	7.52	820-15	6.72	850-20	10.02	1100-20	19.92
750-16(6)	8.82	700-16(6)	9.92	700-20	11.02	1000-22	20.92

"EXTRA SPECIAL" TOP QUALITY all size 4-ply pass. **FREE TIRE** with 2 or more of these. --W.W. \$1.00 Extra. **\$8.72 EA.**
Factory Tube given -- **GIANT TIRE SALE**

Thousands of tires shipped all over the U.S.A. All tires shipped F.O.B. Phila. Send Check or M.O. with this ad. Dept. 2. No C.O.D.
STANDARD 834 N. Broad St., Philadelphia 30, Pa.

GOVERNMENT OIL LEASES LOW AS \$1 PER ACRE

You do no drilling, pay no taxes, may realize a king-size profit without ever leaving home. Write for free map and literature.

AMERICAN OIL SCOUTS, Dept. PM
8350 Santa Monica Blvd. Los Angeles 46, Calif.

TRAINED AND SKILLED MEN IN CLOCK AND WATCH REPAIR

Are Needed in Watchmaking, Electronics, Defense, Aviation, and other technical and precision instrument fields. NOW IS THE TIME TO LEARN THIS VALUABLE TRADE. But, Before You Enroll in Any HOME STUDY Course in Watchmaking, Write for Your Copy of "LEARN THE FACTS."

KANSAS CITY SCHOOL OF WATCHMAKING
1226 Admiral Blvd. Kansas City 6, Missouri

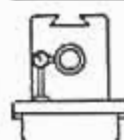

TIPS & TECHNIQUES MACHINE TOOL RECONDITIONING & THE ART OF HAND SCRAPING (3rd printing)

SEND FOR FREE FOLDER DESCRIBING ILLUSTRATED MANUAL FOR MACHINISTS
Machine Tool Publications, 382 Holly Ave., Saint Paul 2, Minn.

GIVES You \$100.00 Every Year



Get Perpetual Date & Amount Banks. 25c a day automatically keeps Date up to date. Also totals amount saved. Forces you to save daily, or Calendar Bank won't change date. Automatic mechanism with key. Use year after year. Pays for itself in 8 days. Reg. \$3.50. Now only \$1.99 each; 3 for \$5.75; 6 for \$11.00. Add 25c per bank postage. Mail check, cash or M.O. to LEECRAFT, Dept. PM, 300 Albany Ave., Brooklyn, 13, N. Y. Sold by mail only. Prompt delivery.

INVENTORS NEEDED AT ONCE

If you have an invention you wish to sell outright or license on royalty, write us at once. We are seeking inventions of household items, games, toys, sports items, tools, and mechanical and technical devices. Patented or unpatented. For further information and free brochure outlining manufacturers' requirements, royalty rates, send name (no drawings, please) on letter or postcard at once.
KESSLER CORPORATION, Dept. D-512, Fremont, Ohio

LEARN WHILE YOU SLEEP!



Experiment in this fascinating, educational new field. Use your phono, recorder or amazing new "Electronic Educator" endless tape recorder. Free catalog lists over 200 unusual tapes, records, equipment for sleep-learning & hypnosis experimenters. Sleep-Learning Research Ass'n., Box 24-A, Olympia, Wash.

LOCATE HIDDEN TREASURE

JEWELRY, COINS, METALS, MINERALS,
WIRES, PIPE, ETC.

AUTHENTIC U.S. ARMY PORTABLE

MINE DETECTOR

ORIG. \$233.00 **\$19.50** BATTERIES \$3.00 EXT.
EXP. CHGS. COLLECT

Model SCR625. Detects objects up to 24" depth. Comes complete in fitted chest with bulbs and instructions. Chest is 28 1/4" long, 15" wide, 8 1/4" deep. Instrument is ideal for electricians, plumbers, utility companies, mineralogists, beach combers, scouts, etc. Like-new condition. No C.O.D.

A.M. AIRCRAFT PARTS CO.

307-309 West Broadway, New York 13, N. Y.



It's FUN
to do

MAGIC TRICKS

Amaze—mystify—entertain! 500 TRICKS, 1959 Edition now ready. Contains latest, best magic for pocket, club, stage. Only 10¢.

DOUGLAS MAGICLAND, Dept. M. DALLAS TEXAS

KILLS

• • NO CHEMICALS, GASES,
ETC.

• MOSQUITOES • MOTHS, MILLERS
• FLIES, GNATS • FISH FLIES, ETC.

OVER 1/2 ACRE

HANG IT
ANYWHERE

No insect recovery. Harmless. Guaranteed. Built to last 25 years. Beautiful outdoor lighting. Plug into any 110 volt socket.

NO AREA CONTAMINATION

Uses up to 200 watt bulb. Grid cost 10¢ per month. Complete with fly attractor. Dead insect catcher, Cord, Directions, Etc. Very reasonable price — Write to —

SING SING BUG CHAIR, INC.

Box P 3781, Oak Park 37, Mich.



SOLE SIZE - WT.
12 1/2" x 18" x 18" - 12 LB.

Make \$500 an Hour CASH PROFIT THE DAY YOU START!



START YOUR OWN BUSINESS AT HOME... SHARPEN HOUSEHOLD, GARDEN AND SHOP TOOLS IN SPARE TIME

Now you can turn spare time into Big Cash Profits with new Belsaw Sharp-All. Sharpen knives, scissors, shears, snips, ice skates, mower blades, hedge trimmers, grass whips, axes, chisels, screw drivers, scrapers and saws... just about any household, garden and shop tool. Your own CASH business with no inventory. No calls to make. No experience needed.

Learn how easily you can start your own spare time business. Amazing low cost easy-payment plan. Send postcard for FREE BOOK.

BELSAW SHARP-ALL CO
710 Field Bldg. • Kansas City 11, Missouri

FREE
BOOK

These men are getting practical training in **NEW Shop-Labs of**

ELECTRICITY

ELECTRONICS ON REAL

Motors—Generators
—Switchboards—
Controls—Modern
Appliances—
Automatic
Electronic
Control Units

COYNE

in Chicago—prepare for today's TOP OPPORTUNITY FIELD. Train on real full-size equipment at COYNE where thousands of successful men have trained for over 60 years—largest, oldest, best equipped school of its kind. Professional and experienced instructors show you how, then do practical jobs yourself. No previous experience or advanced education needed. Employment Service to Graduates.

START NOW—PAY LATER—Liberal Finance and Payment Plans. Part-time employment help for students.

GET FREE BOOK—"Guide to Careers" which describes all training offered in **ELECTRICITY** and **TELEVISION-RADIO ELECTRONICS**—no obligation; NO SALESMAN WILL CALL.

Coyne Electrical School, 1501 W. Congress Parkway
Chartered Not For Profit • Chicago 7, Dept. 99-3C

MAIL COUPON OR WRITE TO
ADDRESS BELOW

COYNE ELECTRICAL SCHOOL
Dept. 99-3C—New Coyne Building
1501 W. Congress Pkwy., Chicago 7, Ill.

Send **BIG FREE** book and details of all the training you offer. However, I am especially interested in:

Electricity Television Both Fields

Name _____

Address _____

City _____ State _____



TELEVISION

RADIO ELECTRONICS ON REAL

TV Receivers—
Black and White
and Color
AM-FM and
Auto Radios
Transistors
Printed Circuits
Test Equipment

LEARN WOODWORKING AT HOME

Complete Home Training Course in Woodworking and Cabinetmaking Now Available

Today—it's easy to acquire the skills and craftsmanship of fine woodworking and cabinetmaking with Interstate's complete "shop method" course. Prepared by expert instructors, the course consists of 22 profusely illustrated training manuals containing more than 1100 pages of instruction. Covers all phases of woodworking, including selection of woods, planning and laying out projects, correct use and care of all hand and power tools, joint making, cutting, assembling, finishing, simple upholstery, etc. Over 75 learn-by-doing instruction projects give work bench training and experience in actual construction. Course is approved for beginners and professionals alike.

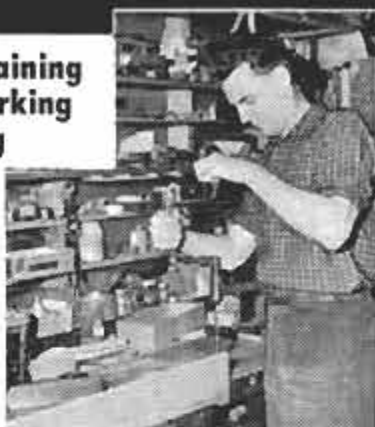

SEND FOR FREE BOOKLET TODAY

INTERSTATE TRAINING SERVICE

Dept. F-3, Portland 12, Oregon

Please send free booklet and information on your complete course in Woodworking and Cabinetmaking.

Name _____
 Address _____
 City _____ Zone _____ State _____

MONEY in WORMS

Sell 20,000 fishworms per week @ \$4 per 1000 from a bed 3 feet wide and 8 feet long. We teach you how to raise and where to sell fishworms and crickets. Write for free literature.
CARTER WORM RANCH, PLAINS, GEORGIA

WILL YOUR CAR START TOMORROW MORNING?



Get push button starting instead of a push . . .

Cold and Damp weather makes engines hard to start. Save time and temper with New Pyroil Push-Button Starting Fluid. Just spray into air cleaner. The high potency vapors are drawn into the engine when you press the starter. Your engine starts fast and sure. Saves wear on starter and batteries. Don't wait for cold weather. Get a can today for "Easy Starting Insurance" only \$1.75 per can. **THE PYROIL COMPANY, INC., LA CROSSE, WISCONSIN • TORONTO, CANADA**

PAINT STRAIGHT or CURVED LINES with Sensational PAINT PEN

DECORATE Furniture, Interiors, Autos, Bikes, Model Planes, Boats, Toys, Linoleums, Wall Board, etc.

PAINTS on wood, glass, plastic, ceramics, metals, fabrics and paper. Use any color paint, glue, tempera, textile paint or underglaze; secure clean, professional decorative lines. No clog or smear.

(MASTER) Single 1/16" Stripe Model, From Your Dealer Only \$125

Other single stripe models:
 1/64" 1/32" 3/64" 5/64"
 3/32" 1/8" only \$1.75 ea. Extra tips
 90c each. Extra 1/4" tip \$1.20.

SPECIAL: Complete Set \$500
 (Pen and all 7 tips) Only Single Line.



MFRS. ask about heavy duty, precision industrial and production stripping tools.

FOR DEALERS: Fast profitable seller; attractive display, write for money-making details. **PAINTERS, CRAFTSMEN!** "Professional" results every time with this time-saver.

Double Stripe Model—w/5 combination \$3.25 C.O.D. Postage Collect.
WENDELL MFG. CO., 4234 LINCOLN AVE., DEPT. 352 CHICAGO 18, ILL.

Catalog of 2900 Novelties 10c

New Send 10c for amazing catalog of novelties, live animals, scientific supplies, hobbies, funmakers, plates & boxes, looms, magic tricks, joke articles, unusual seeds, gadget timesavers, cameras, optical goods, projectors, movies, lucky jewelry, religious novelties, disguises, musical instruments, stamps, coins, puzzles, fortune tellers, radios, auto & bike accessories, telescopes, magnifiers, compasses, motors, shockers, knives, billfolds, guns, rifles, sports, books, games, plants, etc. Send 10c.
JOHNSON SMITH & CO. Dept. 468 Detroit 7, Michigan



FREE

MUSCLE BUILDING INFORMATION

Sensational New Methods
 Less Time—Less Effort—Better results
BODY-TONE, Box 638, North Miami 61, Fla.

REAL ESTATE BE A BROKER

PAYS BIG! SEND FOR FREE, BIG, ILLUSTRATED CATALOG NOW! Graduates report making substantial incomes. Start and run your own business quickly. Men, women of all ages, learn easily. Course covers Sales, Property Management, Appraising, Loans, Mortgages, and related subjects. **STUDY AT HOME** or in classrooms in leading cities. Diploma awarded. Write **TODAY** for free book! No obligation. Approved for World War II and Korean Veterans.
WEAVER SCHOOL OF REAL ESTATE (Est. 1936)
 2020R Grand Avenue Kansas City, Mo.



BUILD FINE GRANDFATHER CLOCK NOW

The simple sensible **SPEEDE** Red-I-Kut way as thousands have — **FOR YOURSELF OR SELL AT A GOOD PROFIT. SAVE HUNDREDS OF DOLLARS. SHOP TESTED PLANS "SPIRIT OF THE CENTURY"** Narrow waist 63" tall or stately straight side **"SPIRIT OF AMERICA"** **EASY-TO-FOLLOW** photopack **PLANS & LIFE SIZE PATTERNS** tell all—plus **MOVEMENT BROCHURE \$40** up, of heavy brass weight (Kuempel original) Westminster, tube BELL chime, movements, gorgeous bronze-silver **MOVING MOON** dials, 3/4" solid-mahogany Jiffy Joint-Kwik-Bilt case kits. Send \$1.00 today — Both plans **RUSH \$1.50** as folks have for over forty years.
Kuempel Chime Clock Works. #2 Kuempel Bldg., Minneapolis 16, Minn.

INVEST IN—



SAFE AS AMERICA

LAW TRAINING FOR BUSINESS

(In spare time at home)

Earn LL. B. Degree

Thousands of men and women who never intend to practice Law are studying it in spare time at home as an aid to business advancement.

Today Law is involved in practically every business decision. In many lines of work it is almost indispensable. Law training develops keen, clear, quick, correct and decisive thinking.

You can study LaSalle's American Law and Procedure right in the privacy of your own home—progressing as rapidly as your time and ability permit. For more than 50 years we have helped over 1,400,000 ambitious people get ahead in the business world.

A MOST UNUSUAL LAW LIBRARY

This training includes the 14-volume LaSalle Law Library—AMERICAN LAW AND PROCEDURE—that is the basis of all our instruction service. This library has been compiled by leaders in the field of Law. It covers the whole field in an orderly and simple manner that is easy to learn and understand. Collateral reading and printed lectures, furnished at regular intervals, supplement the texts. Law instructors personally supervise your program. Under the LaSalle method you learn by actually solving legal problems—not just memorizing rules.

WRITE FOR TWO FREE BOOKS

Send the coupon TODAY and find out how you can qualify

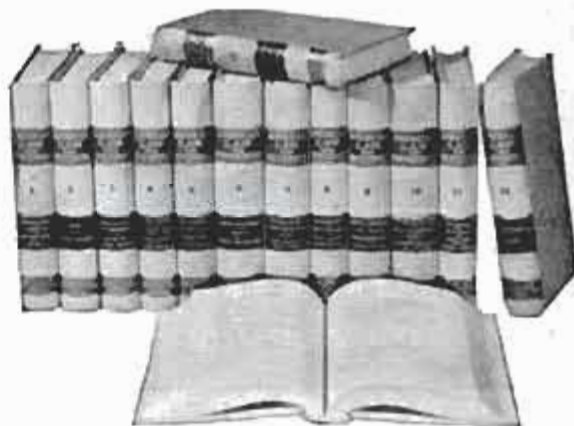

for the many fine openings available to the law-trained man. In our FREE books "Law Training for Leadership" and "Evidence" you will find answers to your questions about the study of Law and the LaSalle method, and how you can earn the LL. B. Degree.

Accredited Member, National Home Study Council

MAIL COUPON TODAY

LA SALLE EXTENSION UNIVERSITY

A Correspondence Institution

417 S. Dearborn St. Dept. 1264L Chicago 5, ILL.
Please send me, FREE, "Law Training for Leadership" and "Evidence."

Name.....Age.....

Address.....

City.....Zone.....State.....

100% All Wool U.S. Navy TOQUE DICKEY



NOW ONLY \$1 Post paid **A real \$3.50 Value**
GUARANTEED NEW NEVER USED

A real comfort in Cold and Damp weather Fits everyone; Men, Women and Children. Keeps Ears, Neck and Chest warm. Soft, Durable, Flexible, Comfortable. Converts any jacket to a parka.

SEND \$1 TODAY (Sorry no C.O.D.)
SPECIAL 6 for \$5 Postpaid

A. L. ROBBINS

36 BOWERY, Dept. PM, NEW YORK 13, N. Y.

Shrinks Hemorrhoids New Way Without Surgery Stops Itch—Relieves Pain

For the first time science has found a new healing substance with the astonishing ability to shrink hemorrhoids and to relieve pain—without surgery.

In case after case, while gently relieving pain, actual reduction (shrinkage) took place.

Most amazing of all—results were so thorough that sufferers made astonishing statements like "Piles have ceased to be a problem!"

The secret is a new healing substance (Bio-Dyne*)—discovery of a world-famous research institute.

This substance is now available in suppository or ointment form under the name Preparation H.* Ask for it at all drug counters—money back guarantee. *Reg. U.S. Pat. Off.

ENGINEERING



Photo of Heald Students in Electrical Laboratory

Enroll Now for New Term

Heald College Ranks **FIRST** West of the Mississippi in "Who's Who in America"

Send for FREE Information

Heald Engineering College
Est. 1867

Van Ness at Post, Dept. P.M.
San Francisco, California

American Industry Steps Up Its Demand for Trained Engineers. Train Now at Healds

BACHELOR OF SCIENCE DEGREE, 30 MONTHS

SAVE 2 YEARS' TIME

Degree Courses:

- Electronic Engineering
- Electrical Engineering
- Highway Engineering
- Mechanical Engineering
- Structural Engineering
- Civil Engineering
- Architecture

Diploma Courses:

- TELEVISION Color TV
- Electronic Technician
- Industrial Electronic Tech.
- Tool & Die Design
- Architectural Drafting
- Mechanical Drafting
- Structural Drafting

Approved for Veterans

NAME _____
STREET _____
CITY _____
STATE _____

Some make more, some less;

F.E. DORAN reports:

\$1050
gross in single
MONTH
in my own business



Start your own business!

Here's YOUR chance to start a money-making, year 'round business of your own and make the success you've dreamed about.

G. R. Adcock took in \$102 in one day. O. W. Hare landed a \$750 hotel job. J. S. Corbit grossed \$279.50 his first month. Homes, hotels, offices, clubs, offer you big profit possibilities. Auto upholstery cleaning also.

NO SHOP OR OFFICE NECESSARY • You clean furniture on customers' premises. No hauling, no high rents. Supplies inexpensive; you operate from your own home. What you take in is mostly profit.

If you want to be your own boss—free from lay-offs and strikes, we will help you to start and succeed. **This is not a lease proposition.** You own the machine, you work when and where you please and all the money you take in is your own.

Mail
Coupon
Today
for
FREE
Book

VON SCHRADER MFG. CO.
W10 "D" Pl., Racine, Wisconsin
Without obligation rush your **FREE** booklet about how I can start my own permanent, profitable electric Upholstery Cleaning business.

Name _____
Address _____
City _____ Zone _____ State _____

EARN \$125
A WEEK AND UP

**BE AN AUTO-DIESEL
EXPERT—LEARN
A TRADE YOU LIKE**

You learn fast in our shops because you learn with tools on real equipment. Students short of money may earn most of their expenses by doing part-time work. Experienced instructors explain WHY and show you HOW, then you DO IT YOURSELF. Forty years' experience training men. Successful graduates in 50 states and many foreign countries. Many of our graduates earn \$125 a week and up. Approved for veterans. Day and evening classes. Free bulletin-write today. **NASHVILLE AUTO-DIESEL COLLEGE**
226 7th Ave., No., Dept. 86, Nashville, Tenn.

**only 27 months for
engineering degree**

Realize your dream of becoming a graduate engineer. Then promotion will not pass you by. Share rewards awaiting college men . . . higher income . . . rapid advancement. Important firms visit Tri-State campus to interview seniors. Approved for veterans. *Bachelor of Science Degree in 27 months* in Electrical Engineering with either Electronics or Power major . . . also in Mechanical, Civil, Chemical, Aeronautical Engineering. *In 36 months* a B. S. in Business Administration (General Business, Accounting, Motor Transport Management majors). For earnest, capable students. Small classes. More professional class hours. Well-equipped, new and modernized buildings and labs. Modest costs. Year-round operation. Enter Jan., Mar., June, Sept.

Write J. E. McCarthy, Director of Admissions, for Catalog and Career Book.

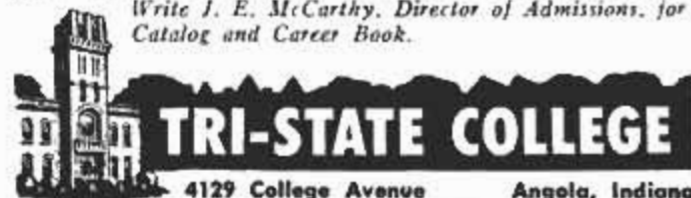

**'How to Make Money with
Simple Cartoons'**



A book everyone who likes to draw should have. It is free; no obligation. Simply address

FREE BOOK

CARTOONISTS' EXCHANGE
Dept. 912-D Pleasant Hill, Ohio

ALL TRANSISTOR RADIO

Tiny as a Cigarette Package!



Amazing bargain! Full performance from unbelievably small new Transette radio, made in U.S.A. Built-in antenna. Powered by long-life Mercury battery. Complete with stereophonic adapter and personal earphone. *Fully guaranteed.* Have fun with this radio sensation. Order today, cash or C.O.D.

Price **\$12.75** including postage
Transette Radio Corp., Dept. 10
7334 No. Lawndale Ave., Skokie, Ill.



Print Your Own

Cards, Stationery, Advertising, Circulars, labels, photo and movie titles, church work, tags, etc. Save money. Sold direct from factory only. Raised printing like engraving, too.

Own a Printing Business

Print for Others, Good Profit. Have home shop. Junior press \$15; Senior \$29 up. We supply everything. Easy rules. Pays for self in short time. Write for free catalog of outfits and all details.
KELSEY PRESSES, C-37 Meriden, Conn.

MEN PAST 40

**Afflicted With Bladder Trouble,
Pains in Back, Hips, Legs,
Nervousness, Tiredness.**

If you have these troubles, particularly bladder trouble, then your condition may be traced to Glandular Inflammation . . . a constitutional disease. Neglect of this condition often leads to premature old age and sometimes incurable malignancy.

The Excelsior Medical Clinic has a **New Free Book** that tells how thousands of men have been successfully treated here at Excelsior Springs for Glandular Inflammation by **NON-SURGICAL** Methods. They found soothing relief and a new outlook in the future of life.

This Free Book may prove of utmost importance in your life. Write Today. There is no obligation.
Excelsior Medical Clinic, Dept. B6129, Excelsior Spgs., Mo.

WHAT ALL AUTO MECHANICS WANT TO KNOW



This Big Practical Book gives full information, with working diagrams, covering the principles, construction, ignition, service and repair of modern cars, trucks and buses.

Diesel Engines, Hydraulic and Fluid Drives Fully Explained.

A complete guide of 1696 Pages, with over 1500 Illustrations showing inside views of working parts, with instructions for service jobs. Completely up-to-the-minute. Priced at only \$6.

CIRCLE No. 1 IN COUPON

HOW TO FIX HOME APPLIANCES

REFRIGERATORS WASHERS TOASTERS DRYERS IRONERS RANGES VACUUMS FREEZERS

Many other GAS AND ELECTRIC APPLIANCES. Handy Reference for Electric & Gas Servicemen, Mechanics, Dealers and Homeowners. Explains clearly and simply how to locate troubles, how to test, assemble and connect. Wiring diagrams, 1000 Facts. Easy to read. Answers ALL your questions. 864 Pages. Illustrated. Only \$6.

CIRCLE No. 2 IN COUPON



TV TELLS HOW TO ANSWER RADIO RADIO TV QUESTIONS SERVICE LIBRARY

HERE IS LATEST INFORMATION IN A HANDY FORM FOR RADIO AND TELEVISION REPAIRMEN, SERVICEMEN AND STUDENTS. TWO COMPLETE VOLUMES - 1568 Pages - 1085 Illustrations and Diagrams. 1001 Important Facts and Figures on Modern T.V. Radio. Electronic Devices. INCLUDES TRANSISTORS & Transistor Circuits, Rectifiers, Record Changers, P.M. Systems, Phonograph Pick-ups, P.M. Auto Radio, Short Wave.

Basic principles, Construction, Installation, Operation, Shooting. How to get Sharp, Clear T.V. Pictures. Install Antennas. How to Test. Explains COLOR SYSTEMS, Methods of Conversion, Terms, etc. Includes Ultra High Frequency. Quick ready reference or use as a home study course. Only \$8 for BOTH volumes.

CIRCLE No. 3 IN COUPON

KNOW YOUR TRUCK

The TRUCK & TRACTOR GUIDE for Mechanics & Drivers, Foremen, Garagemen, Helpers, Owners, Trouble Shooters, Farmers, etc. Covering Gas & Diesel Motor Principles - Construction - Operation - Maintenance - Repair - Brakes - Service of all Parts. 1376 Pages. FULLY ILLUSTRATED. Index. Only \$5.

CIRCLE No. 5 IN COUPON

PLUMBERS AND STEAMFITTERS GUIDES

Practical Trade Assistant & Reference Set. Explains in plain language and by clear illustrations, diagrams, charts, graphs and pictures the principles of modern plumbing practice including Pipe Fitting and Air Conditioning. 4 Vols. - 2024 Pages - 3642 Diagrams & Illustrations. Only \$8 for the complete set of 4 vols.

CIRCLE No. 6 IN COUPON

PAINTING & DECORATING MANUAL

Inside Trade information on outside and inside work; how to mix paints, preparation of surfaces, paper hanging, wood finishes, tools, synthetic paints, color (with color chart), spray equipment, costs, estimating, etc. A COMPLETE guide to easier, better painting and decorating. 464 Pages. Fully Illustrated. Only \$2.

CIRCLE No. 7 IN COUPON

7-DAY FREE EXAMINATION

SEND NO MONEY - Pay the postman nothing! We are glad to send you any of the Audel Guides for absolutely FREE examination in your own home. We take all the risks and leave all the decisions up to YOU. There is no obligation! If you decide to keep the books of your choice you may pay for them under our astounding easy-pay plan of only \$2 a month.

HERE IS ALL YOU DO

IT'S EASY TO ORDER: In the No-Risk Mail Order Coupon at the right just draw a circle around the number of Audel Guides you want us to send you for FREE EXAMINATION. We will send them to you at once to help you build a brighter future by increasing your SKILL. If for any reason at all you are not COMPLETELY satisfied, return the books to us, and that will end the matter! NO STRINGS OR CATCHES TO THIS OFFER.

THEO. AUDEL & CO.
49 West 23rd Street, New York 10, N.Y.

CARPENTERS AND BUILDERS GUIDES



PRACTICAL STOREHOUSE OF MODERN CONSTRUCTION INFORMATION (4 vol. set) for carpenters and all woodworkers. Explains in easy language and by profuse illustration principles, advances, short cuts, trade secrets, all based on the NEWEST information. Vol. 1 - Tools, steel square, saw filing, joinery, furniture, etc.; Vol. 2 - Builders' mathematics, drawing plans, specifications, estimates, etc.; Vol. 3 - House and roof framing, laying out foundations, etc.; Vol. 4 - Doors, windows, stair building, millwork, painting, etc. 4 vols. 1904 Pages. 3760 Illustrations. Whole set only \$8.

CIRCLE No. 8 IN COUPON

PRACTICAL ELECTRICITY

A COMPLETE HANDBOOK - Quick, simplified, ready reference. Complete instruction and practical information on the rules and laws of electricity - Maintenance of Machinery - A.C. and D.C. Motors - Armatures - Wiring Diagrams - House Lighting - Power Wiring - Meters - Batteries - Transformers - etc. Simple to understand. 1520 Pages. 2600 Illustrations. Priced at \$5.

CIRCLE No. 4 IN COUPON

DIESEL

ALL THERE IS TO KNOW ABOUT MODERN DIESEL ENGINES - Basic principles, starting valves, timing, fuel pumps, fuel injection compressor, air compressor, pistons, cylinders, lubrication, cooling systems, etc. Answers on operation, calculations. 640 Pages. Fully Illustrated. Priced \$3.

CIRCLE No. 9 IN COUPON

WELDERS GUIDE

Covers Electric, Oxy-acetylene, Thermit, Unionmet welding for sheet metal, spot and pipe welds, pressure vessels and aluminum, copper, brass, bronze and other metals. Airplane work, surface hardening, hard facing, cutting, brazing, etc. 608 Pages. Fully Illustrated. Only \$3.

CIRCLE No. 10 IN COUPON

MATHEMATICS MADE EASY

A COMPLETE HOME STUDY COURSE - Starting with the first principles of arithmetic, advancing step by step through the various stages of mathematics, including the rules and calculations for mechanical and electrical problems. New EASY correct methods. Includes plane and solid geometry, trigonometry, algebra, calculus, etc. Practical tests, reference tables and data. How to use slide rule. 732 Pages. \$50 Illustrations. Priced at only \$3.

CIRCLE No. 11 IN COUPON

NEW MACHINISTS AND TOOLMAKERS HANDBOOK

MODERN MACHINE SHOP PRACTICE - 5 PRACTICAL BOOKS IN ONE. New from cover to cover. Tells how to set up and operate lathes, screw and milling machines, shapers, drill presses and all other machine tools. A COMPLETE INSTRUCTOR AND REFERENCE BOOK. 1728 Pages. Fully Illustrated. Priced at only \$6.

CIRCLE No. 12 IN COUPON

WIRING DIAGRAMS

This book gives the practical facts on wiring of electrical apparatus. It explains clearly and SIMPLY how to wire apparatus for all fields of electricity. Each diagram is complete and self-explaining. Know your HOOK-UPS! 304 Pages. Illustrated. Only \$2.

CIRCLE No. 13 IN COUPON

REFRIGERATION & AIR CONDITIONING

FOUR BOOKS IN ONE - basic principles, servicing, operation, repair of: 1. Household Refrigeration. 2. Special Refrigeration Units. 3. Commercial & Industrial Refrigeration. 4. Air Conditioning Systems. A GOLD MINE of essential information. Completely up-to-date. 1360 Pages. Fully Illustrated and Indexed. Priced at only \$6.

CIRCLE No. 14 IN COUPON

THE NEW ELECTRIC LIBRARY

A COMPLETE ENCYCLOPEDIA explaining in the simplest terms the fundamental principles, rules and applications of applied electricity.

A COMPLETE COLLEGE EDUCATION! Fully illustrated with diagrams and sketches, calculations and tables for ready reference. Questions and answers. Trial tests for practice study and review. All based on the most modern theory.

- Vol. 1 - Principles and rules of electricity, magnetism, armatures, repairs. No. 15
- Vol. 2 - Dynamos, DC Motors, construction, installation, maintenance, etc. No. 16
- Vol. 3 - Testing instruments and tests, storage battery const. and repairs. No. 17
- Vol. 4 - Alternating current, power factor, alternators, transformers. No. 18
- Vol. 5 - A.C. Motors, winding, maintenance, converters, switches, fuses, etc. No. 19
- Vol. 6 - Relays, condensers, regulators, rectifiers, meters, switchboards, etc. No. 20
- Vol. 7 - Wiring, house light and power, circuits, high tension, plans, code, etc. No. 21
- Vol. 8 - Railways, signals, elevators, ignition, etc. No. 22
- Vol. 9 - Radio, telephone, telegraph, television, motion pictures. No. 23
- Vol. 10 - Refrigeration, illumination, welding, x-ray, electrical appliances, Index. No. 24

7,000 fully illustrated pages, Priced at only \$20 for the ENTIRE SET. Also sold individually for \$2 each.



ALL TYPES OF BLUEPRINT READING

How to read scales, the standard symbols, detail and assembly prints, working drawings, short cuts, hints and suggestions. THE MAN WHO CAN READ BLUEPRINTS IS IN LINE FOR A BETTER JOB. This book gives you the secret language, step by step in easy stages. 448 Pages, Very Fully Illustrated. Priced at \$3.

CIRCLE No. 25 IN COUPON

MASONS & BUILDERS GUIDES

A PRACTICAL ILLUSTRATED 4 VOL. SET - Explaining in clear, simple language and profuse illustration, principles, advances, short cuts, trade secrets, based on modern practice - including how to figure and calculate various jobs. Vol. 1 - Brick work, bricklaying, bonding, designs. Vol. 2 - Brick foundations, arches, tile setting, estimating. Vol. 3 - Concrete mixing, placing forms, reinforced concrete. Vol. 4 - Plastering, masonry, steel construction, blueprints. 4 Vols. 1440 Pages. 2987 Illustrations. Complete Set only \$8.

CIRCLE No. 26 IN COUPON

ELECTRIC MOTORS

THIS GUIDE covers the construction, hook-up, control, maintenance and trouble shooting of all types of motors. Includes armature winding. Explains entire subject in great detail in simple language. Over 1056 Pages of information. 617 Diagrams. All types of motors fully illustrated and indexed for ready reference. Priced at only \$5.

CIRCLE No. 27 IN COUPON

OIL BURNERS

New, complete, explaining in detail both domestic and industrial oil burners. Includes electrical hook-ups and wiring diagram. Fully covering the theory, construction, installation, operation, testing, servicing and repair of all equipment. Indexed for ready reference. Over 416 Pages. 320 Illustrations and Diagrams. Only \$2.

CIRCLE No. 28 IN COUPON

ADDITIONAL IMPORTANT TITLES

- The following Audel Guides are all the best in their fields, written in clear simple fashion, all lavishly illustrated. Circle the numbers wanted in the MAIL ORDER COUPON below. All books are sent for FREE EXAMINATION.
- No. 29 SHEET METAL PATTERN LAYOUTS. 1132 Pages. \$7.50
 - No. 30 SHEET METAL WORKERS HANDBOOK. 448 Pages. 2.00
 - No. 31 MECHANICAL DRAWING GUIDE. 192 Pages. 2.00
 - No. 32 MECHANICAL DRAWING AND DESIGN. 480 Pages. 3.00
 - No. 33 ELECTRONIC DEVICES. 304 Pages. 2.00
 - No. 34 ELECTRICIANS EXAMINATIONS. 272 Pages. 2.00
 - No. 35 ELECTRIC POWER CALCULATIONS. 480 Pages. 3.00
 - No. 36 ELECTRIC DICTIONARY. 9000 Terms. 2.00
 - No. 37 POWER PLANT ENGINEERS GUIDE. 1568 Pages. 5.00
 - No. 38 ENGINEERS AND FIREMANS EXAMS. 544 Pages. 2.00
 - No. 39 OPERATING ENGINEERS LIBRARY. 3 Book Set. 12.00
 - No. 40 PUMPS, HYDRAULICS AND AIR COMPRESSORS. 1760 Pages. 6.00
 - No. 41 HOUSE HEATING GUIDE. 1008 Pages. 3.00

MAIL THIS NO-RISK COUPON TODAY!

THEO. AUDEL & CO - Self Improvement Publishers Since 1879 - P-12 1 2 3 4 5 6
49 W. 23rd Street, New York 10, N.Y.

Please mail me for 7 days' FREE EXAMINATION the books I have circled at right. I agree to mail \$2 in 7 days on each book or set ordered, and to further mail \$2 a month on each book or set ordered until I have paid the purchase price, plus shipping costs. If I am not completely satisfied with my Audel Guides I may return them.

NAME _____

ADDRESS _____

OCCUPATION _____

SAVE SHIPPING COSTS! Check here if you enclose complete payment with order. We pay postage charges. You have same return privilege.

7	8	9	10	11	12	13	14	15	16	17	18	19	20	21	22	23	24	25	26	27	28	29	30	31	32	33	34	35	36	37	38	39	40	41
---	---	---	----	----	----	----	----	----	----	----	----	----	----	----	----	----	----	----	----	----	----	----	----	----	----	----	----	----	----	----	----	----	----	----



PLAY RIGHT AWAY

ANY INSTRUMENT

— even if you don't know a single note now!

NOW it's EASY to learn ANY instrument. No boring exercises. Even if you don't know a single note now you can play delightful pieces — from your FIRST lesson! BY NOTE. Make amazing progress. No special "talent" needed. Learn at home in spare time. Without a teacher. Low cost! Soon you can play popular music, hymns, classical and any other music. Over 1,000,000 students, including Lawrence Welk.



FREE BOOK. Send this ad with your name and address filled in below, to: U. S. SCHOOL OF MUSIC, Studio A3012, PORT WASHINGTON, N. Y. (No obligation, no salesman will call.)

Name _____
Address _____
Be Sure to Include Zone No., if any



"I'M MAKING MORE THAN \$1000 a Month

Haven't Touched Bottom Yet!"

—reports Charles Kama, Texas, one of many who are "cleaning up" with orders for PRESTO. Science's New Midget Miracle Fire Extinguisher. So can YOU!



Amazing new kind of fire extinguisher. Tiny "Presto" does job of bulky extinguishers that cost 4 times as much, are 8 times as heavy. Ends fires fast as 2 seconds. Never corrodes.

Guaranteed for 20 years! Over 3 million sold! Sells for only \$4.95.

Show it to civil defense workers, owners of homes, cars, boats, farms, etc., and to stores for resale — make good income. H. J. Kerr reports \$20 a day. Wm. Wvdallis \$15.20 an hour. **FREE Sales Kit.** No obligation.

MERLITE INDUSTRIES, Dept. P-15G
PRESTO DIV., 114 E. 32 St., New York 16, N.Y.
Canada: Mopa Co., Ltd., 371 Dowd St., Montreal 1, P.Q.

CHRONOGRAPH WATCH



tells the time, measures the distance and the speed of moving objects. It's also a stop-watch — all for only **\$9.95**. Precision-made with rugged, shock-resistant case, radium hands and numerals, sweep hand. One-year guarantee (excl. parts). Instructions and band included for **\$9.95** ppd.

Cryder Sales Corporation, Box 79-C-716, Whitestone 57, N.Y.



ADD UP TO 25 POUNDS of SOLID MUSCLES

\$10 BODY MOLD course included **FREE** with DAN LURIE BARBELLS. Only DAN LURIE BARBELLS and "Body Mold" courses produce such amazing results. 15 minutes a day can make you a bigger man. Send today for details. Order now at lowest factory price.
50 lb. set \$8.98 • 100 lb. set \$14.98
150 lb. set \$21.98 • 200 lb. set \$27.98
Semi-steel sets approx. 10% higher. Extra wts. 1 lb. per lb. Send 50¢ cash, balance C.O.D. F.O.B. Plant

DAN LURIE BARBELL CO., 52-M12 Bristol St., Dept. 959M, Bklyn. 12, N.Y.



BIG EARNINGS WAITING for TYPEWRITER REPAIRMEN

Skilled men are in demand in the new, uncrowded field of typewriter repair. You'll quickly step into a big-pay job or business of your own, full or part time. EARN while learning easily at home under expert guidance. Materials, tools, typewriter supplied. Write TODAY for FREE book.

TYPEWRITER REPAIR SCHOOL, INC.
Dept. M-19, 150 Park Ave., E. Rutherford, N. J.
Lic. by New Jersey Dept. of Educ.

SCIENTIFIC DOUBLE PUZZLE • 2 in 1

The new Double Puzzle—2 ways of assembling. Complete instructions with puzzle. Get one for yourself. Makes a wonderful Gift. See how these 6 different colored pieces are cleverly assembled through each other. Amusing and interesting. Made of strong birch wood—3 inches long. Send to:

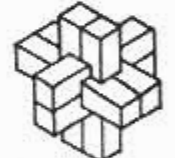

BALDWIN PATTERNS, Dept. 2
8365 Sunset Rd., Minneapolis 21, Minn.
Only \$2.00 Postpaid. Send cash with order. No COD's.

JEEP OWNERS

RE-POWER NOW WITH A V-8 OR 6 CYL. ENGINE — USE FORD—CHEV—MERCURY—GMC—PONT—STUDE—DODGE OR PLYMOUTH In Jeeps, Jeepsters, Sta-Wgn, trucks, Kaiser & H. J. cars. Conversion Kits \$45.35 to \$56.90. Want fast action? Give us full information, send \$15.00 Dep. and we will ship correct kit. Bal. COD. Send full amount for prepaid shipment. Wire, phone or write today. Details **FREE**

HOOSIER MACHINE PRODUCTS CO.
312 S. E. 6th St. Phone CR 6-3442 Pendleton, Oregon

STOP FRONT DRIVE DRAG ON YOUR Jeep



PROVEN IN OVER A BILLION MILES OF SERVICE!

Warn Hubs on your 4 w.d. give double-duty value — economical, free-wheeling 2 w.d. (with added pep!), normal 4 w.d. — automatically with Lock-O-Matics, manually with Warn Locking Hubs. See your 4 w.d. dealer!

WARN HUBS WARN MFG. CO., Inc.
Riverton Box 6064-A
Seattle 88, Wash.

95% PROFITS YEAR 'ROUND

Be your own boss, Operate a SIMPLEX lawn-mower sharpening service in your community. One compact machine grinds all mowers, sharpens cutlery. Low investment, 95% profit. Pays for itself in average month.

SIMPLEX

—4 Machines in One!
Reel Grinder—sharpens any mower reel in or out of mower.
Bed Knife Grinder—grinds with either round or cup wheel.

Rotary Blade Grinder—hollow grinds any rotary mower blade.
Cutlery Knife Grinder—sharpens cutlery, tools, scissors.

Send for free, money-making details!

The FATE-ROOT-HEATH Company • Dept. PM-12, Plymouth, Ohio



prepare for your career in

ELECTRONICS ELECTRICAL ENGINEERING RADIO-TV COMPUTERS

At MSOE, you can equip yourself for a career in many exciting, growing fields:
MISSILES • RADAR • AVIONICS
AUTOMATION • RESEARCH
DEVELOPMENT • ELECTRICAL
POWER • ROCKETRY

When you graduate from the Milwaukee School of Engineering, you are prepared for a dynamic career as an Electrical Engineer or Engineering Technician. Under a faculty of specialists, you gain a sound technical education in modern, completely equipped laboratories and classrooms. As a result, MSOE graduates are in great demand and highly accepted by industries nationally.

At MSOE, you will meet men from all walks of life and all parts of the country — some fresh out of high school or prep school, others in their twenties — veterans and non-veterans.

You can start school in any one of four quarters and begin specializing immediately. Engineering technicians graduate in 2 years with an Associate in Applied Science degree. For a Bachelor of Science degree in Engineering, you attend 4 years. A 3-month preparatory course also is available.

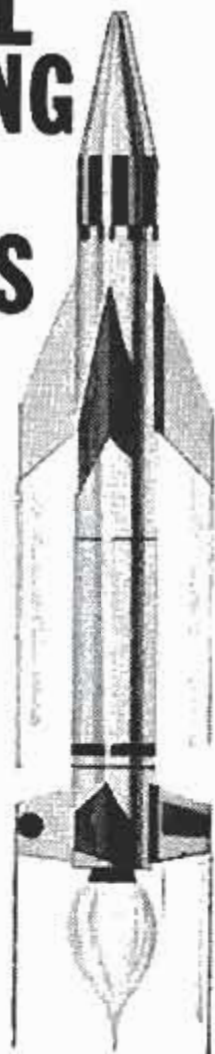

WANT MORE MONEY? GET INTO PHOTOGRAPHY

Coast to coast, high-paying jobs in photography are waiting for people with that "know-how" to fill them. You can quickly, easily qualify at home with the world-famous NYI Learn-by-Doing Method. Write today for free catalog. Also resident training in N. Y. Our 50th Year. Approved for Veterans.

NEW YORK INSTITUTE OF PHOTOGRAPHY

Dept. 49 10 West 33 St. New York 1, N. Y.



LEARN MEAT CUTTING

Train quickly in 8 short weeks at Toledo for a bright future with security in the vital meat business. Big pay, full-time jobs—HAVE A PROFITABLE MARKET OF YOUR OWN! Pay after graduation. Diploma given. Job help. Thousands of successful graduates. Our 36th year! Send NOW for FREE catalog. No obligation. GI approved.

NATIONAL SCHOOL OF MEAT CUTTING, Dept. 50-2, Toledo 4, Ohio

IMPORT Men - Women! BOOM

Big import craze now sweeping the country means BIG PROFITS at home for you now!

Famous world trader guides beginners. Ships plan for no-risk examination. Send for FREE DETAILS while this boom is at fever pitch.

MELLINGER, 1717 Westwood, Dept. X25C, Los Angeles 24, Calif.

YOU ARE UNDER ARREST!

Help Bring Crooks to Justice Through Scientific CRIME DETECTION!

We have taught thousands this exciting, profitable, pleasant profession. Let us teach you in your own home. Learn Fingerprinting, Firearms Identification, Police Photography, Secret Service Methods thoroughly, quickly, at small cost. Over 800 of all American Bureaus of Identification employ I.A.S. students or graduates. Write for FREE "Blue Book of Crime."

(A Correspondence School Since 1916)

Institute of Applied Science, 1920 Sunnyside Ave., Dept. 1359, Chicago 40, Ill.

Probe Unseen Wonders

with this 750 power MICROSCOPE complete with 6 slides, 5 pc. dissecting set and wooden carrying case; self illuminated; battery operated. 4 Turret 7 power adjustment 100 - 150 - 200 to 750x. \$20 value. Only \$9.95

Complete plug in conversion kit to 110v AC \$2.95. Add \$1 for prepaid guaranteed delivery.

BUILDERS HARDWARE AGENCY
25 Stuart St. Boston, Mass.

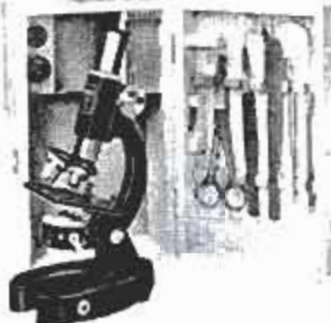

FREE CAREER BOOKLET!

If you're interested in any phase of electronics, radio or television, be sure to look into the programs of study offered by the Milwaukee School of Engineering. Just mail the coupon.

MILWAUKEE SCHOOL OF ENGINEERING

Dept. PM-1259, 1025 N. Milwaukee St.
Milwaukee, Wisconsin

Please send FREE Career Booklet. I'm interested in
 Electronics Electrical Power Television
 Mechanical Engineering Radio Computers
 Electrical Engineering Industrial Electronics

PLEASE PRINT

Name _____ Age _____

Address _____

City _____ Zone _____ State _____

I'm eligible for veterans education benefits

MS-125

OWN a BUSINESS

Be a Specialist in a Booming Industry



Get in on the ground floor of a booming \$750 million a year industry. Fill the need in your area for safe, effective "on location" cleaning of carpets and upholstery. Every home houses a customer! We'll train and establish you in your OWN lifetime business. Start part-time if employed. You'll be trained by a nearby dealer and at 60-hour school. You provide 6 services to multiply profits. You get exclusive use of process which cleans without harmful scrubbing, soaking, shrinkage. It's acclaimed by housewives, manufacturers and backed by famous McCalls and Parents Seals. No shop needed. Just 2 jobs a day nets \$8,750.00 first year.

WE HELP YOU GROW Our whole program is cooperative; thus, your training is only the beginning of a continuous assistance program designed to build your business. You receive continuous counseling from specialists at Hdqtrs. You're backed by *National Advertising in Parents'*, *House & Gardens*, *McCalls*, others; ads in national trade magazines target retailers in your town to refer customers to you. Others among 25 regular services you receive are conventions, regional conferences, product development, sales letters, advertising kits, monthly magazines. Free booklets explain everything. No obligation. No salesman will call. So write for *Free Booklets* today!

DURACLEAN CO., 9-16D Duraclean Bldg., Deerfield, Ill.

OWN A BUSINESS COUPON

DURACLEAN CO., 9-16D Duraclean Bldg., Deerfield, Illinois
Without obligation, rush me FREE 16-page booklets giving full details on a dealership in my town.

Name _____
Address _____
City _____ State _____

MECHANICAL DENTISTRY

A profession offering unlimited opportunities. Most modern and complete course embracing every branch from Plate to Porcelain Work, which prepares you to work for Dentists or start your own business. Individual instruction—practical training in day or night school. No books—no classes. Catalog upon request.

McCARRIE SCHOOL OF MECHANICAL DENTISTRY
207 N. Broad Street Dept. 05 Philadelphia 7, Penna.

LEARN TO EARN

HIGH WAGES

AS A HEAVY EQUIPMENT OPERATOR!



Secure a high paying future in the exciting construction industry today! Learn to operate bulldozers, draglines, cranes, back hoes, scrapers and motor graders on our actual construction projects!

- ONLY CONTRACTOR OWNED AND OPERATED SCHOOL IN WORLD
- ASSOCIATE MEMBER ASSOCIATED GENERAL CONTRACTORS
- MODERN EQUIPMENT
- V. A. APPROVED FOR G. I. TRAINING
- BUDGET PAY PLAN AVAILABLE

WESTERN NATIONAL
SCHOOL
OF HEAVY EQUIPMENT
OPERATION

WRITE TODAY
FOR FREE
SCHOOL
CATALOG

DEPT. 2 BOX 310
WEISER, IDAHO PHONE 970



AMAZING MINIATURE BROADCAST TRANSMITTER

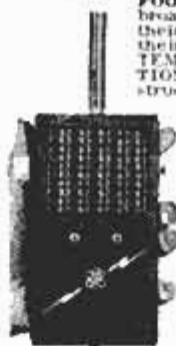

FOOL YOUR FRIENDS with this transmitter . . . by broadcasting on to any radio or car radio and watch their startled faces when they hear YOUR voice on their radio. Can be used as FUN MAKER, P.A. SYSTEM, WALKIE TALKIE, CAR TO CAR COMMUNICATIONS and MANY OTHER USES described with instructions. Use on HUNTING and FISHING TRIPS. Completely portable (5 1/2"x3 1/2"x1 1/2"); with self contained batteries and equipped with TELESCOPING ANTENNA. **ABSOLUTELY WIRELESS** . . . no wires to run to your radio . . . NO GROUND WIRES or HOOKUPS to make on transmitter . . . Works up to ONE BLOCK OR MORE . . . NO LICENSE REQUIRED, if used within legal FCC limits. The "SPACE-CASTER" transmits THROUGH WALLS! SIMPLY push the button and talk!

The "SPACECASTER" has a built-in station selector so you can tune in on any station you desire!

Three models: M27—\$9.95; higher powered M37—\$10.95; super power de luxe M47—\$12.95 post paid. Or send just 1.00 & pay postman balance. Batteries 2.50 extra. Kits now available; all models, two dollars less than above prices. Soon available! Citizens' Band Walkie-Talkie. Write for information.

Available only from **HALCO ELECTRONICS, DEPT. C**
5211 Venice Blvd., Los Angeles 34, California

LAW FREE BOOK THE LAW TRAINED MAN

Write today for a FREE copy of illustrated law book, "THE LAW-TRAINED MAN," which shows how to earn the professional Bachelor of Laws (LL.B.) degree through home study of the famous Blackstone Law Course. All necessary books and lessons provided. Moderate cost; convenient monthly terms. Write for FREE law training book today.

Blackstone School of Law, 307 N. Michigan Ave.
Founded 1890 Dept. 59, Chicago 1, Illinois



"\$7,108.50 FIRST YEAR SERVICING RADIATORS!"

— Hank Konter, Newcastle, Wyo.

Make good money servicing auto-truck-tractor radiators. Easy to learn. Inland, world's largest radiator equipment mfr., offers complete package — equipment, merchandising, "pays-for-itself" financing, free training. Small down payment on equipment starts you. Profitable dept. for garage or service station. Write

INLAND MFG. CO., Dept. PM-12, 1108 Jackson St., Omaha 2, Nebr.

LEARN LANDSCAPE GARDENING

A thorough, interesting home study course for those who wish to become LANDSCAPEERS, GARDENERS, DESIGNERS, etc.; for profit or pleasure. Write today for FREE INFORMATION to:

NATIONAL LANDSCAPE INSTITUTE
Dept. M-129 11826 San Vicente Blvd. Los Angeles 49, Calif.

GET INTO ELECTRONICS

V.T.I. training leads to success as technicians, field engineers, specialists in communications, guided missiles, computers, radar, automation. Basic & advanced courses in theory & laboratory. Assoc. degree in 29 mos. B.S. obtainable. ECPD accredited. G.I. approved. Graduates with major companies. Start Feb., Sept. Dorms, campus. H. S. graduate or equivalent. Catalog.

VALPARAISO TECHNICAL INSTITUTE
DEPT. D VALPARAISO, INDIANA

RUPTURED

BE FREE FROM TRUSS SLAVERY

Surely you want to THROW AWAY TRUSSES FOREVER, be rid of Rupture Worries. Then Why Do you put up with wearing a griping, chafing and unsanitary truss the balance of your life? If you do, it will NOT be through necessity but through choice on your part.

Now there is a new modern Non-Surgical treatment that is designed to permanently correct rupture. These Non-Surgical treatments are so certain, that a Lifetime Certificate of Assurance is given. Write today for our New FREE Book that gives facts that may save you painful, expensive surgery. Tells how non-surgically you may again work, live, play, love and enjoy life in the manner you desire. There is no obligation.

Excelsior Medical Clinic, Dept. H6124, Excelsior Springs, Mo.



Sidelights from the PENTAGON

By William R. Kreh

The Navy's looking for ways to shoo seagulls off air station runways, and is about to try the Army's secret weapon—Elvis Presley.

It's reported that an English airfield, beset with the gull problem, played a tape recording of gulls' panic signals to try to drive them away. The gulls left, but were back almost immediately. On the same tape was a recording of a teen-agers' party. . . . Out came the voice of Elvis and off went the birds, not to return for 24 hours.

The gulls are no fun for flyers. Mid-air collisions between the birds and planes have been recorded as high as 400 feet, although most accidents happen closer to the ground during take-offs and landings. The Navy's present method is to drive a Jeep down the runway to scare them off temporarily. They've tried sprinkling runways with moth crystals and other devices, to no avail.

They have found out one thing, though—it's not the distress call of the gull that scares others away, it's the odor emitted by the frightened gulls that warns the others.

A home-made cigarette dispenser, dreamed up by a sailor aboard the submarine tender *USS Nereus* to discourage moochers, sells lighted cigarettes for a penny. The customer, after dropping a penny in the slot, selects the size cigarette he wants and then watches his smoke pass under an ultraviolet light for sterilization, through a humidifier, onto a heating coil for a light, and then into an ashtray, ready for smoking . . . It's the brainchild of Fireman Robert W. Packard.

An airborne mechanical ditch-digger, designed to give quick protection for Army troops, and able to dig a four-foot-deep trench, 24 inches wide, at the rate of 12 feet a minute, is being tested at Fort Belvoir, Va. . . . Mounted on tires, the ditcher is highly mobile and capable for road speeds of 35 mph . . . the digging mechanism is retractable for travel.

YOU BRIGHTER FUTURE IN AUTO MECHANICS AND DIESEL



Your spare time pays off BIG with our world-famous **SHOP TESTED Home Training**



MAKE YOUR FUTURE AS BRIGHT AS THEIRS

In a matter of months, you can quit your no-future job for a big-pay, big-future career as an Auto-Diesel Mechanic. Free Illustrated Book gives you the facts. Send coupon below. No Obligation. No Salesman will call.

All Phase Training

N. T. S. students become skilled, all-around mechanics. Crystal-clear lessons, Shop-Tested manuals, real professional equipment, make it easy to learn. Big equipment kits, yours to keep. Earn as you learn...we show you how. Graduate Advisory Service.

N.T.S. Training is Better. More Complete, Lower Cost BETTER...

Because training is SHOP-TESTED in Resident School Shops & Labs. **MORE COMPLETE...** You learn all phases of Auto Mechanics & Diesel. **LOWER COST...** One low tuition covers entire cost of course and all equipment.

Unlimited Opportunities

Trained mechanics make top money...are in demand at dealer shops, garages, large bus and truck lines, construction projects, government labs, factories, and many others.

YOU GET AND KEEP ALL THIS PROFESSIONAL EQUIPMENT



Motor Analyzing Set



Socket Wrench Set

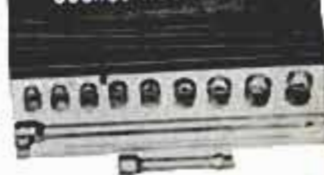

NATIONAL TECHNICAL SCHOOLS

WORLD-WIDE TRAINING SINCE 1905
4000 S. FIGUEROA ST., LOS ANGELES 37, CALIF., U.S.A.



FREE!

Illustrated Fact Book & Actual Lesson

Mail coupon now.

Complete TV-Radio Electronics training also available.

RESIDENT TRAINING at Los Angeles!

If you wish to take Resident Training at Los Angeles, in our Big, Modern Shops & Labs, check special box in coupon for full information.

NATIONAL TECHNICAL SCHOOLS

WORLD-WIDE TRAINING SINCE 1905

MAIL NOW TO
NATIONAL TECHNICAL SCHOOLS, Dept. DB-129
4000 S. FIGUEROA ST., LOS ANGELES 37, CALIF.
Send for FREE Auto-Diesel Opportunity Book and actual Lesson.

NAME _____ AGE _____

ADDRESS _____

CITY _____ STATE _____

Check if interested ONLY in Resident School training at Los Angeles.



Member



ENGINEERING

**DEGREE IN
27 MONTHS**

Students given option of studying engineering under accelerated program leading to Bachelor of Science Degree in 27 months; or the standard four-year program leading to Bachelor of Engineering Degree in 36 months. The B.S. degree in Mathematics, Chemistry, or Physics (Including Nuclear Physics) may be earned in 36 months. By attending classes year-round, students can graduate in 3 years and have one year of experience and income in the time usually needed to complete a four-year college course. Preparatory courses. Thorough, practical program. Individualized instruction.

Keeping pace with progress in science and engineering
Campus. Dorms, gym, playing fields. Superior faculty. 2,000 students. New Dana Science Building. Low tuition. Earn board. G.I. approved. Enter December, March, June, September. Students from 50 states, 40 foreign countries. Send coupon for free catalog, full information. Enroll now!

INDIANA TECHNICAL COLLEGE

5129 E. Washington Boulevard, Fort Wayne 2, Indiana

Please send me free information on 27 mo. B.S. DEGREES in:

Aeronautical Chemical Civil Electrical
 Mechanical Electronics

on 36 mo. B. E. DEGREES in:

Aeronautical Chemical Civil
 Electrical (Power or Electronics) Mechanical Metallurgical

on 36 mo. B.S. DEGREES in:

Mathematics Chemistry Physics

Name _____

Address _____

250 POWER



Telescope Lens Kit only \$3.49 postpaid

Conquer Space. Explore the Universe. Planets. Moon Craters. New Stars, etc. Complete Lens Kit consists of 80 inch focal length ground and polished objective lens, eyepiece lenses for 50 POWER, 100 POWER, 150 POWER, 200 POWER, 250 POWER, and all necessary lens fittings. Easy to make from simple step by step instructions. (Tripod and mount not included.) Money back guarantee.

BUSSE SALES CO., Hartford, Conn., Dept. PM-82



Draw
CARTOONS

EARN BIG MONEY...

LEARN AT HOME IN SPARE TIME

You don't need previous training or art ability with the "Famous System of Manual Training!" With this modern streamlined method, you learn rapidly and easily...start to cartoon immediately, without tedious study or exercises.

Wide Demand for Cartoonists—Earn While You Learn... Magazines, newspapers, movies, television, ad agencies—all are searching for new cartoon ideas and talent. As a successful, Continental-trained Cartoonist, your earnings are not limited.

Many of our students start earning after first few lessons. A wonderful pastime, too.

We Supply Everything... As our student, you receive FREE of extra cost a big 15-piece Professional Kit containing all equipment and materials you need, and valuable Articulated Model that helps you draw any human pose.

Get All the Facts FREE... Big, colorful Free catalog gives all details plus pages of useful information. FREE for the asking. Use coupon.

U.S. Pat. Applied For

Continental Schools, Inc.

4201 S. BROADWAY, LOS ANGELES 37, CALIF.

Continental Schools, Inc.
Dept. A-12, 4201 S. Broadway, Los Angeles 37, Calif.
Please rush me your Free Catalog and other information by return mail. No charge or obligation, no salesman will call.

NAME _____
ADDRESS _____
CITY _____ ZONE _____ STATE _____

SEND
COUPON FOR
FREE BOOK

SHORTHAND in

**6
WEEKS**

Famous SPEEDWRITING shorthand. 120 words per minute. No symbols; no machines; uses ABC's. Learn at home or through classroom instruction. Lowest cost. For business and Civil Service. 500,000 graduates. Typing available. 37th year. Write for FREE booklet.

© 1959

Speedwriting
Dept. 1512-9, 55 W. 42 St., New York 36



YOUR OWN BUSINESS
with BIG EARNINGS in..

ELECTRIC APPLIANCE REPAIRING

SEND FOR
FREE
BOOK!

50,000,000 Families... Repair electrical appliances for friends and neighbors. Service electrical equipment in stores, etc. Earn up to \$5.00-\$8.00 an hour or more! New shop method home study training. Electronic Kit makes it now possible. Rush name for FREE Book, and Special PAY LATER form. **CHRISTY TRADES SCHOOL, 3214 W. Lawrence Ave., Dept. A-9803, Chicago 25.**

MAKE MONEY! REPAIR HYDRAULIC JACKS



Earn While You Learn At Home
Make up to \$5 an hour, full or part time, in the competition-free field of Hydraulic Jack Repair. Millions of jacks in auto service stations, truckers, body shops, riggers, farms, need servicing. We show you HOW. Easy step-by-step directions.

Get Folder PM-12 & free bonus offer

Institute of Hydraulic Jack Repair

P.O. BOX 50 • BLOOMFIELD, N. J.

A Correspondence School Licensed by N.J. Bd. of Ed.



WHOLESALE Electric Guitars - Parts - Factory to You

Professional electric solid body Spanish guitars, amplifiers, electric bass, double-necks, triple-necks, tone changers, double-neck Spanish, electric mandolin, pickups. Parts to outfit your own. 1960 Models wholesale — Free catalog.

CARVIN CO., Box 287, PM-12, Covina, Calif.



HIGH WAGES

Heavy Equipment Operators earn up to \$10,000.00 per year. Train NOW. Write for FREE details. No obligation.

NATIONAL SCHOOLS of HEAVY EQUIPMENT OPERATION

Dept. D-2, P.O. Drawer 8415, Charlotte 8, N. C.

STATEMENT REQUIRED BY THE ACT OF AUGUST 24, 1912, AS AMENDED BY THE ACTS OF MARCH 3, 1933, AND JULY 2, 1946 (Title 39, United States Code, Section 233) SHOWING THE OWNERSHIP, MANAGEMENT, AND CIRCULATION OF Popular Mechanics published monthly at Chicago, Illinois, for October 1, 1959. 1. The names and addresses of the publisher, editor, managing editor, and business managers are: Publisher, Popular Mechanics Company, 200 E. Ontario St., Chicago 11, Ill.; Editor, Roderick M. Grant, 200 E. Ontario St., Chicago 11, Ill.; Managing editor, Wayne Whittaker, 200 E. Ontario St., Chicago 11, Ill.; Business manager, G. Harry Chamberlaine, 200 E. Ontario St., Chicago 11, Ill. 2. The owner is: Popular Mechanics Company, sole stockholder, The Hearst Corporation, 100 West Tenth Street, Wilmington, Delaware. All of the stock of The Hearst Corporation is held by the following Voting Trustees, namely: Martin F. Huberth, 959 Eighth Avenue, New York, New York; Richard E. Berlin, 959 Eighth Avenue, New York, New York; Richard A. Carrington, Jr., 530 West Sixth Street, Los Angeles, California; Harold G. Kern, 5 Winthrop Square, Boston, Massachusetts; G. O. Markuson, 959 Eighth Avenue, New York, New York; Charles Mayer, Third and Market Streets, San Francisco, California; William Randolph Hearst, Jr., 959 Eighth Avenue, New York, New York; Randolph A. Hearst, 1108 South Hill Street, Los Angeles, California; and David W. Hearst, 1111 South Broadway, Los Angeles, California, under Voting Trust Agreement dated as of February 28, 1958; the beneficial owners of the stock deposited under the aforesaid Voting Trust are The Hearst Foundation, Inc., The William Randolph Hearst Foundation, William Randolph Hearst, Jr., Randolph Apperson Hearst, David Whitmire Hearst, George Hearst, John Randolph Hearst, Jr., Joanne Hearst Herndon, William Randolph Hearst II and Deborah Hearst. 3. The known bondholders, mortgagees, and other security holders owning or holding 1 percent or more of total amount of bonds, mortgages, or other securities are: None. 4. Paragraphs 2 and 3 include, in cases where the stockholder or security holder appears upon the books of the company as trustee or in any other fiduciary relation, the name of the person or corporation for whom such trustee is acting; also the statements in the two paragraphs show the affiant's full knowledge and belief as to the circumstances and conditions under which stockholders and security holders who do not appear upon the books of the company as trustees, hold stock and securities in a capacity other than that of a bona fide owner. G. Harry Chamberlaine (Signature of business manager), sworn to and subscribed before me this 26th day of September, 1959, Harry P. Cera (My commission expires March 7, 1960).



Thousands now find it a cinch to FIX ANY PART OF ANY CAR

THREE MILLION
COPIES SOLD!
USED BY U.S.
ARMED FORCES

Now — Whether You're a Beginner or Expert Mechanic
You, too, Can "Lick" ANY Auto Repair Job —
With 2,850 "This-Is-How" Pictures, 225,000 Service and
Repair FACTS, ABC Factory-Expert Methods

YES, this famous "Auto Repair Man's Bible" has turned thousands of beginner mechanics into experts. Helped thousands of experts save time, trouble and money "brezing thru" the toughest jobs. Now, the new edition can put YOU right on "top" of practically ANY job on ANY car listed — 1952 thru 1959!

No guess work! No false start! This giant illustrated guide tells you, then shows you, with crystal-clear pictures and step-by-step directions — how to find the trouble fast — where to start — what tools to use — how to "wrap up" the job "in double-quick time!"

"Never knew anything about repairing cars until I got this book. I've paid for it—half three and time again!"



—P. Pempfer, Wis.

So Simple You CAN'T Go Wrong!

Here's everything you need to know to repair over 1967 car models. Over 1,100 giant pages, 2,850 "this-is-how" pictures, 291 "Quick-Check" charts, 30,000 essential repair specifications, 225,000 service and repair facts.

All the instructions and pictures are so complete, so clear that you can't go wrong. That's because

your hands are guided by the men who actually build the cars. For this book brings you the time and work-saving methods from 178 Official Shop Manuals!

Everything You Need to Know

Here's complete ILLUSTRATED guidance on Automatic Transmissions, Air Suspensions, Ignition, Carburetors, Fuel Pumps, Steering Gears, Brakes, Generators, Distributors, Power Brakes, Power Steering, Dash Gauges, Voltage Regulators, Starter Switches, etc., etc. Plus a big Trouble-Shooting Section that shows how to spot any one of 2300 car troubles.

"Have been a mechanic 25 yrs. Manual still takes me out of tight spots. It's a 100% enough to be understood by average person."



—V. Laurin, Nev.

No wonder this guide is used by the U.S. Armed Forces and hundreds of thousands of repair men. It's guaranteed to help even a beginner mechanic do a good job. And top-notch mechanics are amazed by the time-saving methods it brings them.

Try It FREE 7 Days

SEND NO MONEY! Just mail coupon (Paste it to a postcard for fast action.) Use Manual for a whole week, free. If you don't agree it's the greatest time and work-saver you've ever seen — return book in 7 days and pay nothing. Mail coupon today! MOTOR Book Dept., Desk 91Y, 250 West 55th St., New York 19, N. Y. (Schools, Bookstores: Write for discounts.)

MOTOR'S
AUTO
REPAIR
MANUAL

MOTOR'S
AUTO REPAIR
MANUAL

COVERS ALL THESE MAKES 1952 Thru 1959

- | | | |
|-------------|----------|-------------|
| Buick | Edsel | Oldsmobile |
| Cadillac | Ford | Packard |
| Chevrolet | Hudson | Plymouth |
| Chrysler | Imperial | Pontiac |
| Clipper | Jeep | Rambler |
| Continental | Lincoln | Studebaker |
| De Soto | Mercury | Thunderbird |
| Dodge | Nash | Willys |

TRY BOOK
FREE
FOR A WHOLE WEEK

Same FREE 7-Day Trial on TRUCK REPAIR MANUAL

Covers every job on every popular make truck made since 1952, including GM, Mack and Cummins Diesels. Engines, fuel systems, ignition systems, starters, generators, transmissions, axles, brakes, steering, etc., etc. For FREE TRIAL, check box in coupon.



MAIL COUPON NOW FOR 7-DAY FREE TRIAL
(Attach to postcard if more convenient)

MOTOR BOOK DEPT.
Desk 91Y, 250 W. 55th St., New York 19, N. Y.

Rush to me at once (check box opposite book you want):

MOTOR'S New AUTO REPAIR MANUAL. If O.K., I will remit \$2 in 7 days, \$2 monthly for 3 months and a final payment of \$1.95 (plus 45¢ delivery charges) one month after that. Otherwise I will return the book postpaid in 7 days. (Foreign price, remit \$10 cash with order.)

MOTOR'S New TRUCK REPAIR MANUAL. If O.K., I will remit \$2 in 7 days and \$2 monthly for 3 months, plus 45¢ delivery charges with final payment. Otherwise I will return book postpaid in 7 days. (Foreign price, remit \$11 cash with order.)

Print Name.....Age.....

Address.....

City.....Zone.....State.....

Check box and save 45¢ shipping charge by enclosing WITH coupon in envelope entire payment of \$1.95 for Auto Repair Manual (or \$9 for Truck Repair Manual.) Same 7-day return refund privilege applies.



You can make money in

WATCH REPAIR

Learn at home the low cost Sweazey Way

Watch repairing pays up to \$6 an hour, part time watch makers report on survey. Unique and modern Sweazey home study System starts you making repairs right away on Swiss and American watches. Professionally prepared training. No previous experience needed. Special tools provided for practice. Tuition only \$5 a month. Diploma Awarded. Free sample lesson and opportunity book give all facts. Write today. No obligation.

CHICAGO SCHOOL OF WATCHMAKING
2330 N. Milwaukee Avenue, Dept. 1129, Chicago 47, Illinois

FREE BOOK and SAMPLE LESSON

CHICAGO SCHOOL OF WATCHMAKING
2330 N. Milwaukee Ave., Dept. 1129, Chicago 47, Illinois
Please rush FREE BOOK and Sample Home Study Lesson.

Name _____ Age _____
Address _____
City _____ Zone _____ State _____



Become A --- BUILDING CONTRACTOR!

MAIL COUPON for FREE BROCHURE

Simplified home study training program. Learn every phase of building, estimating, contracting. Fortunes are made in this line of work every year. Use spare hours—no interference with present work. Diploma awarded. Low tuition rates.

AMERICAN TECHNICAL SOCIETY
Dept. BH-129, 850 E. 58th Street, Chicago 37, Ill.

Please send me your FREE Brochure and full details of your building, estimating and contracting training program.

Name _____ Age _____
Address _____
City _____ State _____



I'll Send You This Handsome SAMPLE CASE—FREE

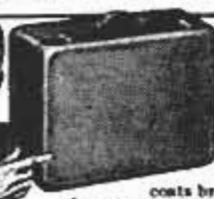

and Show You How to Make Up to \$30.00 in a Day

Mail coupon for this Free Tailoring Sample Case packed with 100 beautiful, big-value suit and overcoat fabrics. Take orders from friends, fellow-workers, others, for fine quality, made-to-measure clothes. Pocket big cash profits in advance. Because wearing our suits and overcoats brings more orders, we make it easy for you to get your own clothes without 1c cost. No experience in needed. **SATISFACTION GUARANTEED.** SEND NO MONEY. Just fill out and mail coupon—today!

J. C. FIELD & SON, Harrison & Throop Streets
DEPT. Y-1716 - CHICAGO 7, ILLINOIS

J. C. FIELD & SON, Dept. Y-1716
Harrison & Throop Sts., Chicago 7, Ill.

Dear Sir: I WANT A MADE-TO-MEASURE SUIT TO WEAR AND SHOW, without paying 1c for it. Rush details and Sample Kit of actual fabrics, ABSOLUTELY FREE.

NAME _____ AGE _____
ADDRESS _____
CITY _____ STATE _____

NOW THE WORLD'S FINEST POCKET PISTOL CAN BE YOURS!

BRAND NEW .25 AUTOMATIC



Compact! Accurate! Always Dependable! Powerful ammunition available everywhere. A pocket pistol of excellence. Ideal for the Plainclothesman or Home Protection. Reduced from \$32.50. ORDER NOW! Send \$10.00—Balance C.O.D.

\$22.50

KENT'S SPORTING GOODS
Dept. P-12 114 E. Roosevelt, Phoenix, Arizona

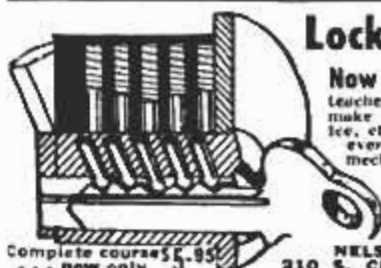

Locksmithing AND KEY MAKING

Now Made Easy! Practical up-to-date course teaches you how to pick locks, de-code, make master keys, repair, install, service, etc. New self-instruction lessons for every handyman, homeowner, carpenter, mechanic, service station operator, fix-it shop, hardware dealer, gunsmith. 53 easy illustrated lessons. Full price only \$5.95 postpaid; or C.O.D. plus postage. Satisfaction or refund guaranteed.

Complete course \$5.95
... Now only \$3.95
NELSON-HALL CO., DEPT. MR-2
210 S. Clinton Chicago 6, Ill.



BARBELLS

100 POUND SET \$12.80

140-Pound, CHROME DELUXE Barbell-Dumbbell set only \$59.80. This is our feature set and is the finest ever manufactured.

Training with adjustable weight is the BEST way to keep fit; the ONLY way to develop great strength and a perfect body. As the oldest and best equipped barbell company, BUR gives value and prices no one can equal.

SEND FOR FREE CATALOG
BUR BARBELL CO.
Lyndhurst 9, New Jersey

Extra Plates Only 12c Pound

Read
5,000-MILE GAME OF CATCH
Next Month
and join the crew of a little ship in the Caribbean as they play hide-and-seek with nose cones

Make \$20 to \$30 a Day
with this new **ONE MAN**

MAIL ORDER BUSINESS

DO PLASTIC LAMINATING AT HOME!



Would you like to get orders and cash from your mailman—then in space of hours make and ship the things people ordered from you? If you have spare time and a little spare room in kitchen, garage, or basement, get the facts about the newest and most fascinating of all home operated businesses. For the first time a simplified machine brings the fabulous profit of **Plastic Sealing and Plastic Laminating** within the reach of the small operator. Any one can learn to operate the machine with a few minutes practice—then

with our **Magic Mail Plan** can get mail orders pouring in daily with cash in every envelope. No canvassing—no selling. We even supply the circulars you mail to bring back cash and orders. Don't waste a minute. Rush your name. We'll send you, **FREE** and postpaid, pictures, prices, details, all the facts you need to start. Mail coupon or send name on postcard. No charge.

**WARNER ELECTRIC CO., 1512 Jarvis Av.
DEPT. L-2-P CHICAGO 26, ILLINOIS**

Make Thousands of Beautiful Art Creations

**COSTUME JEWELRY • CIGARETTE BOXES
TRAYS • CANDLESTICKS • COASTERS
LAMP BASES • BOOK ENDS...ALL IN
SPARKLING COLORED PLASTIC**



THIS MAN . . .

is taking out of the machine a Plastic Sealing Job—ordered by mail—only 11c in material cost brings back \$2.58 in cash by mail. Capacity of machine: \$25.00 profit per hour of operation.

**WARNER ELECTRIC CO., 1512 Jarvis Av.
Dept. L-2-P, Chicago 26, Ill.**

At no cost to me, please rush complete details postage prepaid. I am under no obligation.

Name _____

Address _____

City _____ Zone _____ State _____

WHAM-O BLOWGUN SET for target and hunting

This amazing gun has accuracy like a rifle. Compression of breath in barrel gives terrific air power. You won't believe your eyes!



SPECIAL \$1.98 postpaid

Can shoot over 150 ft. Average person can hit a 2" bullseye at 30 ft. Excellent for shooting small game. For target fun with friends, set up in patio or den. Set includes four 5" steel darts, 4 suction-cup target darts, range target. Extra set 10 darts \$2. Satisfaction guaranteed. At sports dealers or send 1.98 to: **WHAM-O MFG. CO., Box T-10, San Gabriel, Calif.**

WORLD'S LOWEST PRICED CALCULATOR!

TOM THUMB ADDING MACHINE

Not \$3.95 \$2.03 in
Penna. including 3%
Tax.
But Only **\$1.97**

With beautiful Leatherette carrying case. **MADE IN AMERICA BY AMERICANS** Beware of cheap imported imitations. Adds Up To One Billion—1,000,000,000 Subtracts—Multiplies—Divides

Mistake Proof—Positively 100% Accurate—Lightning Fast—Shock Proof Solid Steel Mechanism **GUARANTEED FOR YOUR LIFETIME** Ideal for Housewives, Shoppers, Students, Engineers and Tax work. Take it to the Super Market—Save \$3 every week. We pay postage if you send check, cash or money order—or just send your name & address and pay postman \$1.97 plus postage. Immediate Delivery—10 Day Free Trial—Satisfaction Guaranteed money refunded by return mail. **Special Gift Offer: 2 Machines for only \$3.49.** Agents Wanted—Make easy money selling a Top Quality Calculator at our unbelievably low price.



TOM THUMB ADDING MACHINE
P.O. Box 5066, Dept. D-19, Philadelphia 11, Penna.



119 JIG SAW PATTERNS

FULL-SIZE . . . trace on wood and saw out. Clever, ORIGINAL designs, things you can make to SELL. Wall shelves, lawn signs, planters, book ends, others. **postpaid**

BURGESS VIBROCRAFTERS, INC.

Rush \$1 today. **DEPT. C-118, Grayslake, Illinois**

Learn ACCOUNTING Business Administration

Bookkeeping, secretarial and allied subjects at home in your spare time or attend nationally approved resident school. Write for **FREE Success Book** giving complete details on courses, plans, rates and employment opportunities. G.I. approved. Write Dept. A



Hills BUSINESS UNIVERSITY AND EXTENSION SCHOOL
519 W. MAIN ST. OKLAHOMA CITY 2, OKLAHOMA

\$1 BRINGS YOU \$18

Discover Flok-Kraft and Earn \$\$\$\$\$ AT HOME

Earn up to \$15.00 per hour spare time. Amazing new Velvet-fiber spray instantly makes any object (Lamps, Radio & TV Cabinets, Figurines, Signs, Auto dash leavies, toys, furniture, draperies—anything) worth expensive \$\$\$\$ Prices . . . like magic, you can spray anything with this beautiful new suede-like finish that feels like rich Velvet.

EARN UP TO \$300.00 PER WEEK SPARE TIME

Imagine, materials cost only 3c per square foot. (Average TV or radio cabinet can be beautifully sprayed with this startling new 3-dimensional Velvet finish in 15 minutes at a cost of only 34c in materials. Your charge for this job is at least \$10.00.)

REPRESENTATIVES IN YOUR AREA URGENTLY NEEDED

Own your own business. Work at home in your spare time. Help fill the huge growing demand for this amazing new beautiful Velvet-fiber finish. Orders come from stores, offices, homes, architects, auto dealers, everywhere. Possible \$10,000,000.00 worth of jobs to be done. Investigate today—be first in your area! Actual samples to 16 Radiant Colors, Booklet of 50 Home Business Opportunities and Confidential Details all sent free! Send No Money. Write: **Coast Industries, Los Angeles 61, Calif., Dept. B-12.**

Lift the Hood to a Bright Future

Be a Top Pay Auto Mechanic—Learn at Home in Spare Time

Tie this for opportunity: America needs 100,000 newly-trained mechanics—and 25,000 more repair shops! Skilled men earn up to \$3 an hour and more. Learn this well-paid, interesting, secure trade at home. CTI shop-method is easy, fast, sure. Diesel Mechanics or Body & Fender Rebuilding included at no extra cost. **Mail coupon.**



Tools & Tune-Up Kit Sent

CTI sends you professional Mechanic's Tools and valuable instruments, including a Compression Tester, Vacuum Gauge & Fuel Pump Tester, Ignition Timing Light; and a handy portable steel case.

MANY STUDENTS EARN CASH as they train. They fix cars on their own, or work in local shops. All facts free. **Mail coupon now for Catalog and Sample Lessons.**

COMMERCIAL TRADES INSTITUTE Dept. A1193
1400 Greenleaf Avenue • Chicago 26, Illinois
Send booklet, Make Big Money in Auto Mechanics

Name _____ Age _____

Address _____

City _____ Zone _____ State _____

Accredited by National Home Study Council





AMAZING OPTICAL BUYS

and OTHER SCIENTIFIC BARGAINS

See the Stars, Moon, Planets Close Up! 3" ASTRONOMICAL REFLECTING TELESCOPE

60 to 180 Power — Famous Mt. Palomar Type! An Unusual Buy!



Assembled—Ready to use! You'll see the Rings of Saturn, the fascinating planet Mars, huge craters on the Moon, Star Clusters, Moons of Jupiter in detail. Galaxies! Equatorial mount with lock on both axes. Aluminized and overcoated 3" diameter high-speed f/10 mirror. Telescope comes equipped with a 60X eyepiece and a mounted Barlow Lens, giving you 60 to 180 power. Low-cost accessory eyepiece available for higher powers. An Optical Finder Telescope, always so essential, is also included. Sturdy, hardwood, portable tripod. FREE

with Scope:—Valuable **STAR CHART** plus 272 page "**HANDBOOK OF HEAVENS**" plus "**HOW TO USE YOUR TELESCOPE**" BOOK. Stock No. 85,050-M.....\$29.95 postpaid

KNOW THE TRUTH ABOUT POWER. Telescope experts will confirm that an Astronomical Telescope will only give you practical powers to about 50 or 60 times per inch of objective diameter—powers above this only produce empty magnification — make viewing dim, difficult and unsatisfactory.

4 1/4" ASTRONOMICAL TELESCOPE! UP TO 270 POWER!



With this scope you can see everything as above but with greater power plus will split finer stars. Mirror has twice the light gathering power. Mirror guaranteed to give theoretical limit of resolution. Rack and pinion focusing, hardwood tripod, real equatorial mounting—only one adjustment follows stars! Aluminum tube. 6 power finder telescope. 2 standard size eyepieces and mounted Barlow lens give you powers of 40X, 90X, 120X, and 270X. Low-cost accessory eyepiece available for higher powers. FREE with Scope:—Valuable **STAR CHART** plus 272 page "**HANDBOOK OF HEAVENS**" plus "**HOW TO USE YOUR TELESCOPE**" BOOK. Shipping weight 25 lbs.

Stock No. 85,006-M.....\$74.50 f.o.b.

Same Telescope as above but equipped with Electric Clock Drive— Stock No. 85-094-M.....\$111.50 F.O.B. Barrington, N. J.

9-PIECE DRAWING-COMPUTING SET

For students, engineers, designers, teachers and technicians. A true \$10.00 value! Includes ruler, T-Square calibrated in inches and centimeters, 6" protractor calibrated in 1/2 degrees, a French curve, a 10" 30° 60° triangle, a 45° 90° triangle, an Engineer's Scalemaster 6" and Architect's Scalemaster 6" and a 6" slide rule for pocket and desk use.

Stock No. 70,242-M.....\$5.00 Postpaid

NEW BINOCULAR-TO-CAMERA HOLDER

For Exciting Telephoto Pictures



Bring distant objects 7 times nearer with a 35 mm. camera, 7x50 binocular and our NEW BINOCULAR-TO-CAMERA HOLDER. Ideal for long-range shots of wild life, ships, planes, people, etc. Camera and binoculars attach easily. Use any binocular or monocular—any camera, still or movie. Take color or black and white.

Full directions for taking telephoto's. Stock No. 70,223-M.....\$11.50 postpaid

Play This New Game—MATH MAGIC . . . The Fun-Way to Math Skills!



Educator-approved! 3 fascinating games in one! Great fun for the whole family. Increases skill at addition, subtraction, multiplication, division. Includes Dial and Spinner, Numbered Cards, Plastic Tokens, etc.—also rules and directions. Stock No. 70,204-M.....\$3.00 Postpaid

D-STIX CONSTRUCTION KITS for Science Fans, Hobbyists



Visualize your ideas. Crystallize your plans. Unique new D-STIX are ideal for "3-dimensional thinking." Colored wood sticks 1/8" thick and "easy-on" rubber joints approx. 3/16" diam. fit together fast—help you work out molecular structures, geometric figures, structural members, shapes, models of all kinds. Ideal for interesting children in developing shapes, structures. Durable kits. Money-back guarantee.

Stock No. 70,209-M (230 pcs).....\$3.00 ppd.
Stock No. 70,210-M (370 pcs).....\$5.00 ppd.
Stock No. 70,211-M (452 pcs).....\$7.00 ppd.



50-150-300 POWER MICROSCOPE

Amazing Value—Equal of a \$75.00 instrument! 3 Achromatic Objective Lenses on Revolving Turret! Imported! The color-corrected, cemented achromatic lenses in the objectives give you far superior results to the single lenses found in the microscopes selling in this range. Results are worth the difference! Fine rack and pinion focusing. Stock No. 70,008-M.....\$14.95 Postpd.

MOUNTED 500 POWER OBJECTIVE

Threaded for easy attachment on above microscope. Achromatic lenses for fine viewing, 3 mm. focal length. Stock = 30,197-M.....\$5.00 Postpd.

MAKE YOUR OWN ASTRONOMICAL TELESCOPE

See December, 1957 issue of **POPULAR MECHANICS**—Pages 188-192. 4 1/4" MIRROR KIT—Contains ready-to-use 4 1/4" diameter concave, aluminized objective mirror, lenses for 1" focal length eyepiece, and aluminized first surface diagonal mirror.

Order Stock No. 50,074-M.....\$16.25 postpaid

'FISH' WITH A MAGNET

Go Treasure Hunting On The Bottom



Great Ideal! Fascinating fun and sometimes tremendously profitable! Tie a line to our 5-lb. Magnet—drop it overboard in bay, river, lake or ocean. Trawl it along the bottom—your "treasure" haul can be outboard motors, anchors, fishing tackle, all kinds of metal valuables. 5-lb. Magnet is war surplus—Alnico V Type—a terrific bargain. Lifts over 125 lbs. on land—much greater weights under water. Order now and try this new sport. Stock No. 70,183-M. 5-lb. Magnet.....\$8.50 Postpaid

15 3/4 lb. size. Will lift over 250 lbs. Stock No. 85,088-M. 15 3/4 lb. size.....\$22.50 F.O.B. Shipping weight 22 lbs. Barrington, N. J.

New! 2 in 1 Combination! Pocket-Size

50 Power TELESCOPE and 10 Power TELESCOPE

Useful Telescope and Microscope combined in one amazing, precision instrument. Imported! No larger than a fountain pen. Telescope is 10 Power. Microscope magnifies 50 Times Sharp focus at any range. Handy for sports, looking at small objects, just plain snooping. Send Check or M.O. Satisfaction Guaranteed. Order Stock No. 30,059-M.....\$4.50 Postpd.

Terrific Buy! American Made! OPAQUE PROJECTOR



Projects illustrations up to 3" x 3 1/2" and enlarges them to 4 ft. wide. No film or negatives needed. Projects charts, diagrams, pictures, photos, lettering in full color or black-and-white. Operates on 115 volt, A.C. current. 6-ft. extension cord and plug included, operates on 60 watt bulb, not included. Size 12" x 8" x 4 1/2" wide. Weight 1 lb., 2 oz. Plastic case with built-in handle. Stock No. 70,199-M.....\$7.95 Postpaid

NEW! STATIC ELECTRICITY GENERATOR



EDUCATIONAL AND LOTS OF FUN! See a thrilling spark display as you set off a miniature bolt of lightning. Absolutely safe and harmless. Stands 14" high. Turn the handle and two 9" plastic discs rotate in opposite directions. Metal collector brushes pick up the static electricity, store it in the Leyden jar type condenser until discharged by the jumping spark. Countless tricks and experiments. 24 page Instruction booklet included. Stock No. 70,070-M.....\$12.95 Postpaid

BARGAIN! WAR SURPLUS! 7 x 50 MONOCULAR

This is fine quality, American-made instrument—war surplus! Actually 1/2 of U. S. Govt. 7 x 50 Binocular. Used for general observation both day and night and to take fascinating telephoto shots with your camera. Brand new, \$95 value. Due to Japanese competition we close these out at a bargain price. Directions and mounting hints included. Stock No. 50,003-M.....\$15.00 Postpaid

FREE CATALOG-H

128 Pages! Over 1000 Bargains!

Yours for the asking

America's No. 1 source of supply for experimenters, hobbyists. Complete line of Astronomical Telescope parts and assembled Telescope. Also huge selection of lenses, prisms, war surplus optical instruments, parts and accessories. Telescopes, microscopes, satellite scopes, binoculars, infrared sniper scopes, math, learning and teaching aids.

REQUEST CATALOG-H



ORDER BY STOCK NUMBER . SEND CHECK OR MONEY ORDER . SATISFACTION GUARANTEED!

EDMUND SCIENTIFIC CO., BARRINGTON, NEW JERSEY

**WORLD'S
BEST
WANT-AD
MEDIUM**

CLASSIFIED ADVERTISEMENTS



Advertisements in this section \$1.30 per word, each insertion, minimum 10 words, payable in advance.

To be inserted under proper classification, copy must be in our office the

20th of the second month preceding date of issue

F. W. Johnson, Manager, Classified Advertising

Popular Mechanics Magazine, 200 East Ontario Street, Chicago 11, Illinois

YOU'LL PROFIT

By reading and answering the classified ads in this section. Hundreds of opportunities for you to make and save money

AUTOMOBILES, MIDGET CARS

GO-Kart, Plans, information. Unique suspension design. Kart sticks to track like on rails. \$1.00. Wasp Engineering, 2731 Hawcreek Blvd., Columbus, Indiana.

NON-PROFIT Organization offers automobile literature—old, modern and foreign; dealer books, service manuals, glossy photographs; free motor magazines. Write immediately; get on free mailing list. Auto Maniacs, Stockbridge, Mich.

OLD Car magazine. Free sample. Fran-son's Motor News, Box 1568, San Diego 12, California.

ASSEMBLED Axles, steering, for karts, midgets. Literature 10¢. The Manning Company, 436 Magnolia Street, Atlanta 3, Georgia.

START Any car in coldest weather. Instructions \$1.00. Consulting, Box 55403, Indianapolis 5, Indiana.

1959 CATALOG On parts kits for golf buggy or Jr. sports car 25¢. Indus Corporation, 1815 Madison, Indianapolis.

AUTO SUPPLIES AND EQUIPMENT

TUNE-Up Tips. 1959 edition. Over fifty helpful hints. \$1.00 postpaid. Modern Automotive School, 323 W. Florence, Los Angeles 3, Calif.

GIANT Auto parts catalog. Thousands special accessories, speed, power, performance. Mileage, custom equipment. Send 25¢ (refundable). Newhouse Automotive Industries, 5805-PM12 Beverly, Los Angeles 22, Calif.

IDLETACH—New tachometer for setting idling speed of automobiles. One unit for 6 or 12 volt and 6 or 8 cylinder. Delivered \$9.95. Bob Salisbury, Box 17, Grossmont, Calif.

1960 EDITION. It's new! It's different! Get world's largest auto accessories and parts catalog, save up to 50%. 388 pages, over 100,000 items, earliest to 1960 models, including Hollywood accessories, custom styling and hi-speed equipment. All parts and accessories for all cars, trucks, foreign and sports cars. We have that hard-to-get part. Jam-packed with bargains. Completely illustrated. Send 25¢ (refundable). J. C. Whitney, 1919 PM-12 Archer, Chicago 16, Ill.

PARTS, Model "A." List 25¢ (refundable). Matco, Box 135, San Pedro, Calif.

AUTO Shop welding repair training in world's largest non-profit welding school. Low tuition. Free booklet. Hobart Welders, Box M-1291, Troy, Ohio.

NEW Gasoline additive gives more power, quicker starting. Formula, directions. \$3.00. G. Gale, RD#1, Lakewood, N. J.

INCREASED Volume makes possible price reduction on build yourself battery charger. 15 amp. output. Plans 50¢. Hughes Electronics, Farwell, Texas.

AUTOMATIC Door operators new famous make. Only \$59.95. Buy direct. Save! Free literature. Demco, Inc., Sebring 5, Ohio.

AUTO Thieves stopped! Protecto anti-theft device. Engine cannot be started even with ignition switch jumped. Installed 15 minutes. Guaranteed. \$2.98 postpaid. Moji Products, 5539 S. May, Chicago 21.

CRANKSHAFT Grinder. Hand operated. Makes bearings fit without taking engine apart. \$4.00. Literature. L. D. McGee, 719 Cascade St., Wenatchee, Wash.

RING-Valve job while driving. \$6.00 postpaid. (9th successful year.) Guaranteed! Yellow Cab test-proven. Motaloy, Grantham, Penna.

JEEP Owners—V3 conversions. Read Jeep Owners ad, page 32.

ELECTRIC Fuel pumps. New six or twelve volts. Guaranteed. Only \$13.95 tax and postage paid. Sunshine Auto Parts, P.O. Box 4754 Fairview Park, Ohio.

SAVE Money on Jeep and army truck parts. Large inventory. Catalogs for Jeep or G.M.C. owners only. American Auto Parts Co., 1830 Locust, Kansas City, Mo.

WARNING System designed and engineered to give lifetime protection to your car battery. Guards against your leaving car with park or headlights on. Price \$3.50. P-S Products Co., Box 364, West Covina, California.

JEEP Tops. Free catalogue. Mor-Nan, Box 141, Beverly, Mass.

FORD T and A parts? Try best source old model parts, all makes. Wisneski Auto, Milwaukee 4.

1909-1934 FORD Parts. Illustrated catalogue 50¢. Mark Auto, Layton, New Jersey.

SIRENS. Air-horns, lights! Catalog 10¢. McCanna Company, Tarrytown, N. Y.

TOILET Paper oil filter adapter \$3.50. Zepco, Box 2461, Los Angeles 54, Calif.

MAKE Old cars run like new. Inexpensive. Free details. Newco, Box 164-B, Hunlock Creek, Penna.

NEW And used parts at savings. Complete guaranteed parts service for all models cars and trucks, 1924 and later. Largest in the West. Jeep and army parts specialists. Newest type shifting hubs for all jeep and all military and latest production front end drive vehicles. \$27.50 and up. Write. Pioneer Auto and Truck Parts Co., 734 W. 13th Avenue, Denver 17, Colo.

FREE! New catalog. Speed, power, mileage increasing equipment. Discounts! Almqvist Engineering, Milford PM5, Penna.

SILENCE Hydraulic valve lifter click. Micro-moly guaranteed. \$3.00 pint. Postpaid. Literature. Micro-Moly Products, Garrison 1, Kentucky.

AUTO TRAILERS

BUILD Expanding eight foot trailer. Accommodates five. Literature 10¢. Fram-Com Company, Wilmington, Mass.

ALUMINUM Pickup coach kits. Trailer blueprints. Literature 10¢. Comstock Trailers, Parsons, Kansas.

MOTORCYCLES, BICYCLES, MOTORSCOOTERS AND SUPPLIES

EUROPEAN Motorscooters from \$285. Motorcycles from \$375; Newest 1960 Catalog 25¢. Motorcycle Import Corp., 505-A Fifth Ave., New York City 17.

WHERE To buy, sell midget cars, engines, wheels, plans, motorcycles, motorscooters, motorbikes. Bulletin, 30¢ (coin). Sportcraft, Bx. 395, Pillmore, Illinois.

MIDGET Racer \$12, motorscooter \$6, less engines. Go cart engine \$6. Chek motorcycle \$25, James \$45. Four wheel drive Crosley truck \$195. (Mailorder only). Send 25¢ (35¢ for first class mailing) for Directory-Catalogue Number 92 listing these and hundreds of other bargains, homebuilders parts, plans, etc. Midget Motors Directory, Athens, Ohio.

HARLEY-Davidsons—Used bargains. New, used parts, accessories, all models. Bulletin 25¢. Knuth's (Factory Dealer), 1753 Muskego, Milwaukee, Wis.

MOTORCYCLE Parts. New, used. List 25¢. Ballak, 811 N. 9th, St. Louis 1, Mo.

RECONDITIONED Motorcycle motors. Chrome accessories. Complete stock Indian parts. Expert rebuilding. Fast service. Indian Motorcycle Sales, Kansas City 27, Missouri.

AVIATION

RAMJET Helicopter. Build inexpensively. Plans only \$1.00. Wooster Engineering, Box 259-L, Wooster, Ohio.

CAPTIVE Helicopter, VTOL trainer uses 12 to 70 HP engines. Payloads 50 to 500 pounds. Complete plans, design parameters, photographically illustrated instructions. \$3.00. Flight Dynamics, Box 5443, Raleigh, N. C.

AVIATION Surplus bargain catalogue. One dime. Box 22PM, Thomasville, Penna.

BUILDING Your own high performance sport plane is easy with our new simplified blueprints and detailed instructions. No experience required. Four economical models, one, two passenger, aerobatics. For complete details, brochures, photographs, 3-views. F.A.A. regulations on homebuilt airplanes, mail \$1.00 (postal, packaging expense) to Stits Aircraft, Box 3084M, Riverside, California.

PROPELLERS. Plans, supplies for airboats and snowplanes. Latest designs, prompt delivery. Catalog 25¢. Banks-Maxwell, Box 3301E, Ft. Worth 5, Texas.

BUY Gov't surplus: Aircrafts; engines; helicopters; boats; Jeeps; misc. Buy direct now from gov't. Send for "Depot Directory & Procedure" \$1.00. Gov't Surplus Sales, Box 425-PM, Nanuet, New York.

ELECTRO-SCRIBE! Engraves all metals, \$2.00. Beyer Mfg., 10511-H Springfield, Chicago 43.

LAMP. Electrical parts, wholesale. Thousands of items for repairing, converting. Catalog 25¢. Brown Lamp, Box 305, Clayton 5, Mo.

BOOK 200 Electric stunts \$1.00. Kuttington, 875 Arastradero, Palo Alto, Calif.

LAMPS—Parts catalog containing wiring instructions, 25¢. Gyro Lamps, 5208P N.W. 35th Ave., Miami 42, Fla.

WELDING, SOLDERING, PLATING

WELDERS, 110/220, \$39.50. Morris, 1070 Inner Drive, Schenectady 3, New York.

PLATING Equipment, supplies. Complete line of anodes, solutions. Home workshops, industrial sizes. Hollywood Bronze Supply, Dept. C, 1624 East First, Los Angeles 33, California.

ACETYLENE Welding outfit, new, \$64.50. Arcwelders, \$56.50. Eagle Welding, Dept. PM, 5085 Broadway, Chicago 40, Ill.

MACHINERY, TOOLS, SUPPLIES

SCREW—Nail gauge tells screw number, nail size, length. Measures rods and drill diameter. \$1.00. Free Homeshop Notes. Lee, Box 8122M, Rochester 17, New York.

SHEET Metal machines. Brakes: 36", \$37.00. Box: \$95.00; 5' floor, \$80.00. Shears: 7", \$18.50; 24", \$42.00. Free folder. Vyke Mfg. Co., P4158 Jason, Denver 11, Colo.

PRECISION Milling machine. Castings, machine parts available. Plans \$1.00. McKim Manufacturing Co., 4223 Lincoln Blvd., Venice, Calif.

TOOL Bargains. Save to 90%. H. S. Cutters, \$3.50 dozen. Sample and catalog, \$1.00. List 10¢. Salme, 40 Greendale Avenue, Worcester 6, Mass.

DRILLS, Reamers, taps, High speed. Used, like new, jumbo assortment 20 pounds for only \$15.00. Free catalogue. Plant Surveyors, 710 N. Wells, Chicago 10, Illinois.

ENGINES, MOTORS, DYNAMOS

REWIND, Repair motors. Profitable. Easy. Free details. Lincoln, Box 52P, Hempstead, N. Y.

BUILD Friction motor bike \$10.00 up. Plans \$1.00. Jenks Rides, Audubon, Iowa.

FREE Catalog. Motor rewinding supplies, instructions, diagrams. Modern, Box 8715, Kansas City 14, Mo.

DIESEL Injector parts and fuel pumps wanted. GM51-53-71-110. Bares, 7120 Carnegie, Cleveland 3, Ohio.

WINDING Data. 275 motors, single and three phase \$1.10. Data Company, 512 Kensington, Kansas City 24, Mo.

REWIND Motors yourself. Complete instructions \$1.00. Lewis Mfg., Howell, Michigan.

BOATS, OUTBOARD MOTORS

LIFETIME Fiberglass boat coating kits. Write: Viking Fiberglass, Box 5273, Minneapolis 7, Minnesota.

CHEAP In Honolulu. Buda, Commando, Invader, Packard marine engines. Goin's Gen. Eng., Niland, California.

MARINE Conversions, Willys to Cadillac, kits and parts. Catalog and conversion hints free. Barr Marine, 2706A Castor Avenue, Philadelphia 34, Penna.

BOAT Plans—Full size patterns, frame kits. Modern inboards and outboards for amateur builders. Complete new catalog 50¢ or specify requirements. Glen Designs, 9152 Rosecrans, Bellflower, California.

FULL Size, cut-to-shape boat patterns, blueprints, 7½-38 feet. Big new 88 pg. illustrated "Build a Boat" catalog of naval architect-designed cruisers, runabouts, skiffs, outboard boats, sailing, racing, houseboats, 50¢. "How to Build a Boat" booklet, \$2.50. Hardware and Equipment Catalog, \$2.00. Cleveland Boat Blueprint Co., Dept. A-66, Box 1651, Cleveland, Ohio.

MARINE Conversions, Ford, Chevrolet, Jeep engines. Catalog 25¢. Lehman Manufacturing Company, 800 Elizabeth Avenue, Linden 4, N. J.

PROPELLERS, Plans, supplies for airboats, snowplanes. Catalog 25¢. Banks-Maxwell, Box 3301P, Ft. Worth 5, Texas.

NEW. Used, rebuilt marine motors. Marine conversions, fittings. Free catalog. Stokes Marine Supply, Dept. 24, Coldwater, Michigan.

SAVE Money. New, used outboard motor parts. Send wants. Stamp appreciated. Outboard Motor Mart, 229-M State, Boston 9, Mass.

I Want to send you proof of the wonderful pulling power of Popular Mechanics classified pages. What's your proposition? Write me today. Include literature if possible. F. W. Johnson Manager Classified Advertising, Popular Mechanics Magazine, 200 E. Ontario St., Chicago 11, Ill.

FREE Catalog! Boat kits, trailers, fiberglass, marine hardware, Luger Industries, Dept. M-12, 9200 Access Rd., Minneapolis 20, Minnesota.

WATER Proof, cast aluminum tail light with stop and directional control wiring. \$5.45 factory c.o.d. P.O. Box 555, Hawthorne, California.

PRIVATE Boat operators. Get your boat for hire license. Course gets you through examination. Boat Operators School, Box 2601-G, San Francisco 26, California.

FIBERGLAS Boat covering, wholesale prices, free literature and samples. Seifert's, Box 31M, DePere, Wis.

300 BOAT Plans, patterns, catalog 50¢. Modern trailer kits! Marinecraft, Box 161-M, Brighton, Mass.

ATHLETIC EQUIPMENT, BODY BUILDING COURSES

FREE Muscle building information. Body-Tone, Box 638B, North Miami, Florida.

BARBELLS, Dumbbells. Courses. Booklet 10¢. Good Barbell Co., Siloam Springs, Arkansas.

DEADLY Oriental fighting arts. Elemental Karate, Kung-fu. Illustrated manual \$3.98. Oriental Book Sales, P.O. Box 1183, Oakland 7, Calif.

BIG Strong healthy muscles. 4 courses only 25¢. 12 courses \$3.00. Health wisdom courses \$1.00. Personal supervision. Agents wanted. Results fully guaranteed. Sid's System, PM-2, Southgate, California.

BOXERS, Heavy canvas striking bag, 12x36 inches! Tremendous buy, complete \$7.00 P.P. Heff, Box 236, Williamsport, Penna.

SPORTING GOODS, GUNS, FISHING TACKLE, ARCHERY, TRAPPING

154 PAGE Catalog—A real dream book for fishermen! It's free! Netcraft Company, Dept. B-12, Toledo 13, Ohio.

JAP Rifle altering to 30-06, \$6.00. Japshells, \$3.95. Catalog 10¢. T. P. Shop, West Branch 11, Mich.

FISHERMEN! Double your catch with Lurezem oil. Guaranteed. \$2. McGregor Sportsman, McGregor 1, Texas.

ARCHERY Equipment, supplies. Catalog 25¢. Jones, Box 343, Mineola, New York.

FREE Catalog America's first and finest guaranteed waterproof Sta-Dri Sportsman boots. The Sport Mart, Inc., Box 8047, Dallas 5, Texas.

MAKE Your own tents, sleeping bags, packs. Free catalog, materials, plans. Umakit, Dept. 140, Ward, Colorado.

GUNS, Swords, knives, daggers, flasks. Large list 25¢ coin. Ed Howe, Coopers Mills 52, Maine.

CLEAN 2000 Fish \$2.00! Nylon scaling attachment fits any electric drill, cleans in seconds. No mess. Jaco, 106 First Avenue, Berea, Ohio.

DISCOUNTS Unlimited! Lyman 4X \$39.95. Weaver K3 \$24.25. Bushnell 4X \$34.50! Guns, gun accessories below wholesale. Catalog 25¢. Discounts Unlimited, Box 38-A, Hastings-on-Hudson, N. Y.

10,000 GUNS. Antiques, moderns, words, armour. Every description. Giant catalog \$1.00. Agramonte's, Yonkers 2 G. N. Y.

MOLDS—For casting your own fishing sinkers. Free illustrated booklet. Reading Instrument Co., Box PM78, Reading, Penna.

CROSSBOWS! Hunting—Bows! Factory prices! Jayco, Box 1355, Wichita, Kansas.

BIG Money raising crickets and 12 inch African fishworms. Free literature. Carter Ranch, Plains, Georgia.

FREE—Wholesale catalog. Beads. Spinners. Lure parts. Sinker molds. Jigs. Reels. Finnyports (ME), Toledo 6, Ohio.

MOLDS For fisherman's sinkers, jigs, squids, casting and spinning lures. Free catalog. Sweet's Molds, Tonawanda 1, New York.

5000 BARGAINS, Firearms, binoculars, war relics. Catalog 50¢. Smith Firearms, Runnede, N. J.

AMAZING Wholesale sporting catalog. Save 70%. Tremendous selections. Econ-O-Mart, Whippany 2, New Jersey.

KILL Submersed water weeds which foul up motor propellers, tangle fishing gear, with R-H Weed Rhap-20, Granular 2,4-D. Inexpensive, easy to use, sure results. For free information write Reesor-Hill Corporation, Box 36PM, Jacksonville, Arkansas.

KNIVES, Imported. Worldwide selection of rare daggers, gurrhas, stiletos, bowies, hunting, throwing knives. Terrific values. Free catalog. Clinton, Mt. Clemens 34, Michigan.

MONOGRAMMED Nylon golf tee. Guaranteed unbreakable. Packaged in transparent reusable jewelry box, 50 cents. Specify initial. Jaco, 106 St., Berea, Ohio.

NEW Vest pocket pellet gun. All steel. Powerful. \$2.65 post paid. B. Sypher Co., Station P, Toledo, Ohio.

MINNOW Graders. Free circular. Crescent Mfg., Box 3303, Ft. Worth, Texas.

AMERICA'S Largest monthly trapper's magazine, also excellent hunting, fishing, camping material. \$2.50 year. 25¢ copy. Special—8 months, \$1.00. Fur-Fish-Game, Dept. 190, Columbus 9, Ohio.

SAVE! Gun & Tackle 100 page discount catalog. Unusual and famous brands. Send 25¢ to Klein's, Chicago 24.

EARTHWORMS, CRICKETS, FROGS

WANTED, Men, women worm raisers. Sherwood, Dept. S-2A, Monmouth, Maine.

FREE Picture folder, "How to Make \$3,000 Yearly. Sparetime, Backyard, Raising Earthworms!" Oakhaven-56, Cedar Hill, Texas.

BIG Money raising fishworms and crickets. We teach you how to raise and where to sell. Free literature. Medium redworms, 3000, \$5.95; 10,000, \$16.95. Carter Redworms, Plains, Georgia.

RAISE Fishworms and rabbits on \$500 month plan. Free details. White's Rabbitry, Delaware 2, Ohio.

BINOCULARS, TELESCOPES, MICROSCOPES, MAGNIFIERS

TELESCOPES—Refractor, reflector, kits and accessories. Free illustrated booklet. Dell Optics Co., Limited, Dept. PM, 327 55th Street, West New York, New Jersey.

DYNASCOPE—Amazing world-famous reflector telescope. Request free brochure. Criterion; Dept. DP-62, Hartford, Conn.

REFLECTOR Telescope kits direct from factory. From \$7.75. Other optical do-it-yourself kits. Free booklet. Esco Products, Oakridge, New Jersey.

BINOCULARS, Telescopes, microscopes. Terrific values \$3.98 up. Request free money-saving catalog. Criterion, Dept. P-85, Hartford, Conn.

REFLECTOR And refractor telescopes, binoculars, microscopes, all sizes. Complete telescope kits, parts, accessories. Free illustrated catalog. Suffolk Science, Mattituck, New York.

BUILD Your own reflector telescopes. Complete kits: mirrors, eyepieces, tripods, all other accessories. Request free illustrated literature. Criterion Manufacturing, Dept. DPM-59, Hartford, Conn.

REFLECTING Telescope, 60X. completely assembled. Guaranteed observatory clearness. Free information. Skyscope, P.O. Box 55, Brooklyn 28, N. Y.

AMAZING Prices precision binoculars. Folder, "Binocular Selecting," catalog free. Prentiss Importers, Mercury Bldg., West Los Angeles 25, Calif.

WAR Surplus bargains: millions of lenses, instruments, telescopes, binoculars, components and complete line of astronomical telescope items. World's greatest optical market-place! Send only \$1.00 for beginner's 10-lens kit and big instruction booklet stock 2-CH. Write for catalog CH. Free! Edmund Scientific Co., Barrington, New Jersey.

TELESCOPES, Mirrors, binoculars, microscopes, accessories. Free catalog. National Optical Company, 505 New York Avenue, Union City, New Jersey.

MICROSCOPES. Educational research surveying, instruments, electronics, optical, everything Japanese. Importers prices. Catalogs 25¢. Magnification Instrument, 2 E. 45th, New York 17.

PLANTS, SEEDS, BULBS, NURSERY AND GARDEN SUPPLIES

WORLD'S Greatest cash crop. Free information. Write Ginseng Gardens, Asheville, N. C.

GROW Dwarf trees! Instructions and seeds 35¢. Mail Order Specialties, 1439-PMC Sabraton Ave., Morgantown, W. Va.

PETS—DOGS, BIRDS, RABBITS, HAMSTERS, ETC.

EARN \$10,000 Yearly raising Angora rabbit wool for us. Information 25¢ coin. American Angora Company, Malta 12, Montana.

HUNTERS. Sale price on fine Coon hounds, Fox and Rabbit hounds. Write, Okaw River Kennel, Cowden, Illinois.

GOLDEN Hamsters—Pedigreed breeders \$3.85 pair. Albinos Whitebands. Literature. Moore's Hamster Ranch, Shepherdstown 25, West Virginia.

MAKE Money raising chinchillas, mink, rabbits, cavies for us. Free catalog. Keeney Brothers, New Freedom 2, Penna.

STRAIGHT Cooners! World's oldest kennel. Combination hounds, rabbit, fox, beagles, deerhounds, bird dogs. Puppies of all breeds. Prices reasonable. Trial. Free catalogue. Raccoon Mountain Kennels, Box 464, Boaz, Alabama.

RAISE Rabbits successfully by knowing facts. 48 page illustrated book describing 25 breeds. Housing, feeding, breeding, marketing, etc. Plus bulletin. 25 cents. American Rabbit Association, 36 Arba Building, Pittsburgh, Penna.

HAMSTERS—Ideal pets, \$2.95 pair. Free booklet. Jer-fre's Hamstery, 1447 Apple, Muskegon 13, Michigan.

SKUNKS, Reptiles, hawks, raccoons. Illustrated catalogue, 25¢. Trails End Co., St. Stephen, S. C.

RAISE Rabbits, make money. Information and prices sent free. Write: Johnson, 683, Kansas City, Missouri.

HAMSTERS. Golden \$1.25; Whitebands, Albinos, Creams \$2.00; Amber gold \$2.50. Prompt service. Winch's Hamstery, Box 582, Fort Wayne, Ind.

RAISE Rabbits on \$500 month plan. Free details. White's Rabbitry, Delaware, Ohio.

GERMAN Shepherd puppies by Rin Tin Tin's son. Lookout Kennels, Jacksonville, Texas.

BEAUTIFUL Pure white pedigreed police puppies. Right for Christmas. Ansonia Kennels, McHenry, N. Dak.

FUR BEARING ANIMALS

MINK Raising information free. Complete. Lake Superior Mink Farm, Superior, EE1, Wisconsin.

FARMS, FARM LANDS, REAL ESTATE

FLORIDA—Silver Springs, Ocala. Beautiful improved homesites over 1/4 acre ready to build on. Large lake, park, beach, boat facilities on property. \$795.00, \$10.00 month. Write Box 568-1, Belleview, Florida.

VALLEY Farm on stream. Only \$8,000 buys well-improved 200-acre Ozarks stock farm! Attractive homesite overlooks beautiful pan-fish brook. Good private hunting grounds. 40 acres tillable valley land, now in pasture and meadow grasses, balance abundantly-watered woodland pasture. Large 5-room home with bath, fireplace, well with pressure system, nice oak and walnut shade. 30-ft. barn, small poultry house. On all-weather road, 5 miles town, 60 city of 40,000. Get your low-cost farming start here, only \$8,000, \$3,000 down. New free winter catalog, bargains coast to coast! United Farm Agency, 2825-PM Main St., Kansas City 41, Mo.

HOW To retire on real estate profits. Big book \$2.00. Free literature. Shoreland, Box 215, Wheeling, Illinois.

FLORIDA. Beautifully wooded homesites, \$290, \$10 monthly. Popular beach-resort area. Free literature. Wendell Wood, Fountain, Florida.

CENTRAL Florida developments. Trailer homesites; also lakefront and highway lots; acreage. No interest. From \$295.00. Terms. Victor Roepke, DeLand, Fla.

OPPORTUNITIES! Government land. U. S., Alaska, Canada. Sledge Surveys, Macon, Mississippi.

MR. Property Owner—Want a map of your property? Write Deed-Ettes, Mt. Pocono, Penna.

FREE Strout catalog! Farms, homes, businesses, resorts, retirement properties. Over 3000 values in 36 states. 58 years' service. World's largest! Write Strout Realty, 7-MF S. Dearborn, Chicago 3, Ill.

CANADIAN Vacation lands: Full price \$285.00, for 40 acres, \$10.00 month. Suitable cottage sites, hunting, fishing camps. Free information. Land Sales Corporation, 130C Shaftesbury, Downsview, Ontario, Canada.

FLORIDA. Nice homesites, \$345 at \$10 monthly. Folder free. Howard Vernor, DeLand, Florida.

OZARKS! America's best place. Ten lovely timbered acres \$195. \$5.00 monthly. Descriptions mailed free. Write: Armstrongs, Shook, Missouri.

PROFITABLE OCCUPATIONS

PIANO Tuning learned at home. Musical knowledge unnecessary. American School Piano Tuning, Box 707, Gilroy, California.

WASHING Machine repair book. Details free. Kay, 5704 Third Ave., Brooklyn 20, N. Y.

FREE Book "990 Successful, Little-Known Businesses." Work home! Plymouth-7N, Brooklyn 4, New York.

NEW Soilless method raising night-crawlers. Brownnose worms. Three Oaks Ranch, Dresden, Tenn.

START A magazine subscription business. Earn generous commissions on Popular Mechanics. Good Housekeeping and all others. Best commissions, bonus, all materials sent free. No experience needed. Write Popular Mechanics, Room 12-P, 250 West 55th St., New York 19, N. Y.

MAGAZINE Subscriptions. Highest commissions. Bonus. Qualified Agencies, 451-FA, Kingston, Brooklyn 25, N. Y.

MAKE Money making new greaseless doughnuts in kitchen. Sell stores. Free recipes. Michael, 3605 South 15th, Minneapolis 7, Minnesota.

BECOME Independent with your own franchise business. Thousands earning handsome incomes. Request interesting facts today. National Franchise Reports, PM-528, 333 North Michigan, Chicago 1.

BIG Money raising fishworms and crickets. Free literature. Carter Wormery, Plains, Georgia.

AUCTIONEERING—Home study course. Diploma granted. Auction School, Ft. Smith, Ark.

RAISE Pheasants on \$100 week plan. Little capital and space can make you independent. Free details. Great Central System, Columbus 1, Kansas.

VENDING Machines. No selling. Operate a route of coin machines and earn amazing profits. 32-page catalogue free. Parkway Machine Corporation, Dept. #25, 715 Ensor Street, Baltimore 2, Maryland.

GROW Mushrooms. Cellar, shed and outdoors. Spare, full time, year round. We pay \$4.50 lb. dried. We have 29,000 customers. Free book. Mushrooms, Dept. 99, 2954 Admiral Way, Seattle, Wash.

INDEPENDENT Opportunities. Jobs unlimited. Self improvement. William Dunihue, 224 Beach Drive North, St. Petersburg 1, Florida.

\$200 WEEKLY Extra introducing buyers to sellers, weekends. Men, women enjoy learning real estate by listening to records. First lecture free. Lee Institute, Brookline, Mass.

MAILORDER Beginner's literature. Write Carnahan Bros., 9610 Acacia, Fontana, Calif.

SHARPEN—Scissors, pinking shears. Inexpensive outfit. Supplies. Blackhaws, Sheldahl, Iowa.

BUY Wholesale: 100,000 nationally advertised products. Appliances, cameras, sporting goods, housewares, watches, typewriters, tools, clothing, etc. Discounts to 60%. Buy-Rite, Box 258, Hawthorne 1, New Jersey.

BOOKS, PERIODICALS, PICTURES, POSTCARDS

BRITISH Book bargains—Any subject. Catalogues free. Transatbooks, Wantagh, N. Y.

FREE Catalog. Self-help books. Write: Wilshire, 8721 Sunset, Los Angeles 46P.

BOOKFINDERS! All subjects. Send wants! Jaher Book Service, 183 Hazelwood Drive, Westbury, N. Y.

"SCIENCE Milestones." Records march of science starting 400 years before Christ, right up to date. Amazing facts revealed. 312 pages packed with startling information that will thrill you. A real history of science. \$5.00. Literature free. Popular Mechanics Press, 200-SM East Ontario St., Chicago 11, Ill.

EXCITING Catalog packed with books covering most everything. Think of it—From cover to cover you will find described and illustrated hundreds of books telling how to fix and how to build almost anything. How to remodel your home; do your own decorating, plumbing, electrical work, carpentry, painting, furniture making and refinishing. How to build your own home workshop tools. Best books on welding, hobbies, homecraft. Send now for 1958 book catalog—only 10¢. Popular Mechanics Press, 200-BC E. Ontario St., Chicago 11, Ill.

SCIENCE-Fiction book bargains. List 10¢. Werewolf Bookshop, Verona, Penna.

FREE Catalog! 10,000 books, records! Treasure-Site, 6990 Aberdeen, Upper Darby, Penna.

BOOK Traders Bargain Magazine 15¢. Periodicals. 6376-M Windsor Lane, San Jose 29, California.

SPARETIME Repeat profits taking magazine subscriptions. Special offers. Cassell Agency, Boynton Beach, Florida.

SELF-HELP Books all subjects. Free catalog. Box 102-A, Providence, R. I.

SPORTSMEN! Quickest way to become expert at your favorite activity! Send for catalog of books on hunting, fishing, self-defense, etc. Clinton Sportsmen's Books, Mt. Clemens 38, Mich.

NATIONAL Geographic magazines, 1888-1960, any issue. Periodical Service, Box 465-PM, Wilmington, Delaware.

EXTRA Income. Sell books by mail, free literature. Dacco, Box 781 H, Ridgecrest, California.

GAMES, TOYS, NOVELTIES

MODEL Auto racing. Four cars free literature. Distinctive, Room 121, 1613 Wisconsin, Washington 7, D. C.

AGENTS To sell litterbugs. 4 inch injection molded dashboard riding magnetized in five gay colors. Retail \$1.00. Agents price 60¢, 12 or more. Free catalogue and sample, 60¢. Anti-Litterbug Company, 1914 E. 18 St., Tucson, Arizona.

THE Next president of the U.S.A. \$1.00. The cleverest novelties come from Harding & Co., Box 111, N.Y.C. 28.

WINNING Table tennis tips 10¢. Goebel, 3140 Alpine, Wichita, Kansas.

MAGIC TRICKS, PUZZLES, JOKER NOVELTIES

3100 NOVELTIES, Jokes, tricks, gadgets, funmakers, hobbies. Big catalog 10¢. Johnson-Smith, D-498, Detroit 7.

WORLD'S Finest professional magic. Joker novelties. Giant illustrated catalog 10¢. Top Hat, Evanston 12, Illinois.

3000 TRICKS, Pocket, parlor, stage. World's finest magic catalog (408 pages), \$2.50. Kanter's, M-1311 Walnut, Philadelphia 7.

PROFESSIONAL Catalog, 175 pages, 25¢. Williams, 900 Plymouth, Ellwood City, Penna.

CATALOG, Free trick, 25¢. (1,500,399 tricks, jokes). Magico, Box 4373-P, San Antonio 7, Texas.

IF Interested in original mechanical puzzles, write L. D. Whitaker, Farmville, Va.

EXCLUSIVE Tricks! \$2.50 precision made vanishing coin for \$1.00 plus "Top Hat Topics" booklets, Lou Tannen, 120 West 42nd Street, New York 36, N. Y.

VENTRILOQUISM, Easiest method. Details free. Smith, 2125 N. Bigelow, Peoria, Ill.

BE A magician! Large professional catalog of latest tricks, 35¢. Ireland, C-109 North Dearborn, Chicago 2, Illinois.

ONE Thousand tricks, jokers, stunts, magic, illusions, puzzles! Jumbo catalog (160 pages). Rush 25¢! Free trick given! House of 1000 Mysteries, 202-91 Pinewood, Trumbull, Conn.

500 TRICKS, Douglas famous 120-page catalog now available just 10¢. Fastest service to magicians everywhere with latest in magic or parlor, stage, pocket. Send 10¢ today. Douglas Magician, Dept. 11, Dallas, Texas.

"VENTRILOQUISM Selftaught"—Complete book 25¢. Greenview, Box 61-BY, Whitestone 57, New York.

COINS, TOKENS, CURRENCY

GOLD Plated Lincoln penny, looped for pendant and Rare Coin Guide \$1.00. Campbell's, Box 115, Mattoon, Ill.

FINE Gold coins, \$20, \$43.50; \$10, \$25.00; \$3, \$90.00; \$1, \$21.00. John Ziegler, R. 2, Fremont, Ohio.

BRILLIANT Mexican silver dollars 50¢ each, three for \$1.00. Box 445, Fabens, Texas.

GENUINE Confederate notes only \$1.00 each. Fine condition. Heflin, 1501 Grandview, Nashville, Tennessee.

9 DIFF. Indian cents \$1.00. 7 diff. Liberty nickels \$1.00. I. Doktor, P.O. Box 35151, Los Angeles 35, Calif.

COINS From Formosa, Vatican, etc., plus foreign banknote, 10¢ with coin approvals. Littleton Coin Company, Littleton 51, New Hampshire.

INDIAN Cent, foreign coin, bargain lists. All 15¢. Hutchinson's, Box 4747, Philadelphia 34, Penna.

LINCOLNS. Good, fine 1910S, 1913S, 1914S, 1915S, 1926S, 1931D, \$1.10 each. All \$6.00. Free list. United, 101 Cranston, Providence, R. I.

120 DIFFERENT Lincoln-head cents, only \$4.99 postpaid! Prices paid send 25¢. France, P.O. Box 63, Evansville, Indiana.

\$6,500.00 WE Paid for 1794 dollar. Wanted certain others before 1904. \$4,000.00 for 1913 Liberty Head nickel. Certain 1955 cents \$20.00. Certain Lincoln cents before 1932, \$175.00; Indian cents \$275.00; dimes before 1943, \$3,000.00; quarters before 1924, \$1,500.00; half dollars before 1929, \$3,000.00; \$3.00 gold pieces \$2,500.00. Wanted all gold coins, rare coins, etc. Canadian coins, 1921 5¢ silver, \$100.00. 1889-10¢, \$100.00. 1921-50¢, \$750.00. Hundreds of others worth \$10.00 to \$3,000.00 each. For complete alloy information, before sending coins, purchase our large illustrated guaranteed buying-selling catalogue, \$1.00. Catalogue dollar refunded \$20.00 sale. Worthycoin Corporation (K-488-C), Boston 8, Massachusetts.

WANTED—Rolls, uncirculated coins. Give year, mint price. Lowman, Box 904, Fairbanks, Alaska.

SILVER Dollar bonus free. Sample album, details 50¢. Laurelbilt, 555 Long Beach, New York.

EUROPEAN Coin collectors paying fabulous prices for rare U.S. coins. Send \$1.00 for detailed catalogue. Tricontinental, 40 Blvd., Helvetique, Geneva, Switzerland.

MEXICAN Coins—all types. Gold and silver, 6 coins and price list \$1.00. Crown, Box 8236, Fort Worth, Texas.

CHRISTMAS Bargain—Lincoln cent beginner collection. 50 different, 1909-1940, only \$2.50! Earl Kammerzell, 207 Cleveland, Pullman, Washington.

BRILLIANT Uncirculated United States five dollar gold pieces, \$15.00. Twenty dollar, fine, \$45.00. Rare Coin Company, 31 North Clark St., Chicago 2, Ill.

LARGEST Coin magazine, 200 pages, 40¢. Scrapbook, 7320-J Milwaukee, Chicago 31.

SIXTEEN Page price list of U.S.A. and Canadian coins free. Selling prices on thousands of coins and supply items. Bryson Inc., 612A White, Toledo 5, Ohio.

COMPLETE U.S. coin list, 10¢ (refundable). Bonus offer included! Economy Sales, 156-C Dean, Mansfield, Mass.

SPECIAL \$1.00, 20 page bargain list, 7 different Indian cents, album. Hobby Sales, Box 4054, St. Paul, Minnesota.

EIGHT Different Indian cents \$1.00. Collector's Bargains, New Hope, Penna.

DELUXE 32 Page U.S. catalog 10¢. Contains almost 100 illustrations; over 5,000 delightful bargains. Stonie, 260 Washington, Boston 8, Mass.

FREE List! U. S. coins. Lowest prices! Hugh's Coins, Hickory, N. C.

STARTER Collections, 12 Liberty nickels, \$2.50; 18 Barbour dimes, \$5.00; 15 Barbour quarters, \$8.00; 15 Barbour halves, \$15.00. All different, in folders, postpaid. Prager, 470 27th Avenue, San Francisco, California.

FOR Sale 1913S, 1924S, 1931P, 1932D, 1938S, 1939D cents. All six for \$2. Gasser, Box 34615, Los Angeles 34, California.

RAREST CC mint dollar, 1885 uncirculated \$7.50. Coin catalogue 50¢. Shultz, Salt Lake 10, Utah.

TWELVE Different barber dimes \$2.00. Bargain lists free. Sayers, 1000 Unaka, Johnson City, Tennessee.

RARE Unc. 1899-P silver dollar, each \$5.00. Butts, Box 889, Torrington, Wyo.

NEW 1960 Giant U. S. coin catalogue 25¢. Ace, 107 N. Dearborn, Chicago 2.

NEW! 1960 Buying Guide Canadian coins, 20 pages, 15¢. Marles, Box 833, Calgary, Canada.

VATICAN Set, 4 new coins in holder, \$1.00; 1957 U.S. proof set, \$3.00; large lists, curious coin, 10¢. Elliott, 235 Juniper, Coraopolis, Penna.

COIN News Magazine, 35¢, subscription \$3.00 year. Dept. P, 231 North 18th, E. Orange, N. J.

LINCOLNS, 25 Different, 1909-1934, \$1.50. DeWolf, 2041 Manchester, Cardiff, California.

FREE Gift! Free catalogue! Bargains! With 30 different worldwide coins, \$1.00. Packard, 61-23 Palmetto, Ridgewood 27, New York.

JEFFERSON Keys: 1939-S-D, 1938-S-D, 1942-D, 1950-P, 1951-S, 1948-S, 1949-S. Complete lot \$4.50. Berry, Box 306, Westminster, Calif.

GLITTERING Lucite cube paper weight with encased 1957 (or 1959) proof set \$9.75. \$20.00 gold \$43.95; \$10.00 gold \$22.95. Books: world coins \$4.00; Canadian \$1.50; U.S. Guidebook \$1.75. Bebee's, 4514 North 30th, Omaha 11, Nebraska.

NUMISMATICS Largest newspaper. Semi-monthly. Sample 25¢. \$2.00 yearly. Numismatic News, Box 452, Iola, Wis.

OBSOLETE U. S. coins, 6 different Indian cents after 1899 with album for all Indian cents, \$1.00; 12 different Indian cents before 1900 \$3.00; 10 different Liberty head nickels \$2.00; Large cent and Two Cent piece before 1866, \$2.00; 1883 Liberty Nickel, 1863 copper Nickel Indian cent and 1865 Three Cent Nickel, \$2.00; Bust type half dollar before 1838, \$3.50. Dates clear. Empire State Coin & Stamp Co., Empire State Building, New York.

STAMP COLLECTING

U.S. Columbian free. Approvals. Dolinco, 31 Park Row, New York City 38.

SET-List, list of approvals free. Deschl, Box 482, DeBary, Fla.

MONACO Nudes (3) 5¢. Approvals. Hannay's, 186 W. Lawrence, Albany 3, N. Y.

FREE, Surprise assortment, 50 different world wide. With attractive approvals. Banner, M-3, 2861 So. Yates, Denver 19, Colorado.

EXCHANGE Your duplicates with other members, Scott basis. Write for particulars. E. McMillan, 916 No. Sierra Bonita, Hollywood 46, Calif.

1960 ILLUSTRATED U. S. catalog—30¢. Refundable. Gama, 93 Nassau, 38, New York City.

BEAUTIES! Pictorials from Sudan, Monaco, Honk Kong, Iceland, Toga, New Caledonia, San Marino, Singapore, etc. Only 10¢. Approvals. Champlain, Isle La Motte, Vt.

142 DIFFERENT U. S. commemoratives \$1.00. 71 for 50¢. M. Philpot, 1902 Losey, La Crosse, Wisconsin.

MIXTURES—1000 Foreign or United States, \$1.00 each prepaid. 21st year. Missions Warehouse, Box 386, St. Petersburg, Florida.

VERY Special offers. Two international reply coupons. Langheinrich, Muenchen 23, Germany.

40 STAMPS 40 Countries 10¢ handling. Approvals. Hollandco, Box 142, St. Johns, Michigan.

BRAZIL: Commemoratives and airmails! 100 diff. \$2.50. Israel: 100 diff. \$4.95. No approvals. Cork, Box 4934, Midland, Texas.

FREE Stamps weekly with half cent approvals. Superioex Grafton, Ohio.

FIFTEEN Famous men. Statesmen, patriots, pioneers, artists and explorers. Send dime today. Approvals. Robert Butler, 2810 Enoch, Zion, Illinois.

BONANZA Packet 10¢, with approvals. Wokasien, Aronica Trailer Court, Hamburg, N. Y.

50 FREE With approvals. Adults. Patton's Stamps, 660 California, Boulder City, Nev.

FREE Packet! Five different foreign countries. Request fascinating approvals. Coral, Box 7095 (Ludlam), Miami 55, Fla.

WOW! 110 all different Germany 10¢. Zeppelins, semi-postals, airmails, high values, etc. Giant catalog, bargain lists included with beautiful approvals. Jamestown Stamp, Dept. A129PM, Jamestown, N. Y.

GIGANTIC Collection free. Includes triangles, early United States, animals, commemoratives, British Colonies, high value pictorials, etc. Complete collection plus big illustrated magazine all free. Send 5¢ for postage. Gray Stamp Company, Dept. PM, Toronto, Canada.

10 POUNDS U. S. mixture \$3.75 plus postage. Utechts, 1143D North Keeler, Chicago 51.

8 DIFFERENT U. S. airmails free! Approvals accompany. Dec. Box 926, Ormond Beach, Florida.

ILLUSTRATED Price list and stamp packet 30¢. Lippert, 16958 East Warren, Detroit 24, Mich.

U. S. Bureau precancels. A 32-page, illustrated booklet. Price 25¢. George Klein, Box 461, Vincennes, Indiana.

100 CANADA Stamps 10¢. Joseph Myers, Route 5, Coldwater, Michigan.

FREE 55 different Americas (worldwide). Kelemen, Airbox 4810, Cali, Colombia.

INTRODUCING Our better United States approvals we offer 15 United States stamps including Columbian, Bi-Centennials, famous American, airs, others; only 10¢. Ocean Stamps, Box 64-PM, Brooklyn 29, New York.

105 DIFFERENT U. S. stamps 25¢. Approvals included. Shelton, Box 907-K, New York 8, N. Y.

MILLION Stamps on approval! 2¢ each! Send for thrilling, giant selection! ABC Stamp Company, San Francisco 1-AC, California.

10 DIFFERENT Beautiful topical color- ful sets for 10 cents. Approvals. Filatella Francar, Box 386, Aguadilla, P. R.

350 DIFFERENT. Includes Korea, Laos, Ifni, 100 United States. 25¢ with approvals. Bob's Approvals, Box 3045, Saint Louis 30, Missouri.

FREE! Giant bargain catalog—New edition listing thousands of bargains including U. S. and B. N. A. stamps, packets, mixtures, albums, accessories and supplies; sent with beautiful approvals. Jamestown Stamp, Dept. E129PM, Jamestown, N. Y.

JAMAICA—20 Different 15¢. Approvals. Edwin Morr, 1204 Sandusky, Ashland, Ohio.

210 DIFFERENT U.S. stamps \$2.00. Grassi, 515 Carr, Augusta, Georgia.

FREE Stamps equal the value of your first purchase from our U.S. approvals. White Mountain Stamps, Bethlehem, N. H.

BONANZA! 100 Different pictorials, mostly large, 20¢. Approvals. Curran Stamps, 16 Curran, Whitesboro, N. Y.

100 DIFFERENT World free with 15¢ upwards British Commonwealth. Approvals. Bush, 53, Newlyn Way, Poole, Dorset, England.

\$1.00 VALUE in free sets, approvals. Francis Lemle, Box 5646, Norfolk 16, Va.

FREE United States illustrated catalog. Simmy, Inc., 45-PM Bromfield, Boston, Mass.

WANTED Stamps, coins, cash paid. Harris, 1457 Moreno, Oceanside 5, Calif.

HUNGARY, Soviet Moon Rocket commemoratives—free! Approvals. William Deems, 226m Race, Ravenswood, West Virginia.

FREE! 2 Sets with approvals. Dodds, 618 Magnolia, Saint Paul, Minnesota.

90 DIFFERENT U.S. (45 commemoratives) 25¢. Grassi, 515 Carr St., Augusta, Georgia.

FREE! Colorful 215-different stamp collection! Cataloguing \$5.00! With adult, bargain approvals. Rush 10¢ postage. Philatelics, Dept. RE, New Paltz, N. Y.

10 BEAUTIFUL Mint British Colonies 10¢ with approvals. Bennett, Candor 3, N. Y.

BEAUTIFUL! Big pictorials! 2¢ approvals! Marshall, Box 451-PL, Long Beach, Calif.

HALF Pound mixed U.S. stamps, 50¢, postpaid. Kensington Stamps, Buffalo 15, N. Y.

U.S. Commemoratives, 100 mixed 25¢. Rayworth, 321 So. Cicero, Chicago 44.

1000 WORLDWIDE Stamps, many commemoratives, \$1.00. Approvals upon request only. Harrison's Stamps, 1435 First Ave., Oakland 6, Calif.

PINE Foreign stamps. Many at 1¢, 2¢, 3¢ each. Send for a selection with details of premiums. Lakewood Stamps, Box 6008A, Lakewood, Calif.

100 DIFFERENT World Wide—10¢. Request foreign approvals. Dunning, 1634 Chippendale, Houston 18, Texas.

ITALY—10 Different 10¢ with approvals. DeRespinis, G.P.O. Box 771, New York City.

WORLD-WIDE Commemorative and pictorials on approval. Priced right. Attractive premiums. Allegheny Stamp Agency, 705 Fourth Avenue, Altoona, Penna.

50 DIFFERENT Orient, 10¢. Approvals. These, 9320-M San Juan, South Gate, California.

SURPRISE Set, fifty British Commonwealth, free with terrific approvals. Kawartha Stamps, Box 513, Peterborough, Canada.

2000 U.S. Mission mixture. Absolutely unpicked \$1.00. Wesley Road, Box 285, Cedar Rapids, Iowa.

90,000 STAMPS Sale! Grab bag 31 cts. Bargain lot \$1.00. Extra special \$2.00. Giant assortment \$5.00. High value packet \$3.00. Persile, 436 N. Y. Ave., Brooklyn 25, N. Y.

FREE. 250 Peelable hinges and 20 different Brazil with approvals. Jaydee, 218 Dickinson S.W., Grand Rapids 7, Mich.

FIRST Day cover approvals! Aircraft, Artmaster. Included free: valuable airmail flight cover. Myers, Coopersburg, Penna.

FRANCE 125 Different highgrade commemoratives (\$2.00 bill). Lamy, Domats (Yonne), France.

50 DIFFERENT Large U.S. commemoratives 10¢ with approvals. Jack Clancy, Box 2187, Portland 14, Oregon.

BRITISH Honduras. Used mint approvals. William Williamson, Belize, Br. Honduras.

SURPRISE Collection exotic mint British Colonials absolutely free with approvals. Viking, Great Neck 8, N. Y.

25 U. S. Commemoratives 10¢ with approvals. Colonial Stamp Mart, 280 Main, Kingston 13, N. Y.

FREE U.S. singles and P & B pricelist. Schiff, 536P West 111 St., New York City 25.

FREE! Giant flowers, helicopters, bird triangles, 25 others different. Approvals. Stamps-A-Plenty, Viola, Kansas.

WEIRD Diamond shape coffee stamps. Lovely flower triangle! First American big commemorative. Greenland. Idol Dancer, etc. 10¢ with approvals. Capital Stamp Co., Ferrysburg 2, Michigan.

A Real bargain! Washington bicentennial, complete set 25¢ with interesting approvals. Superior Stamp, Dept. 412, Box 53, Cathedral Station, New York 25, N. Y.

NOTHING Free. Just imagine stamps at fair prices to dignify your album. Postage paid both ways. Laclede Stamps, 4973A Columbia, St. Louis 9, Mo.

U.S. Army-Navy set 25¢. Approvals if requested. O'Galey, 3753 Highland Park, Memphis 11, Tennessee.

ENJOY Stamp collecting! Write for "Penny-provals." Penny-proval Service, New York Building, Saint Paul 1, Minn.

145 DIFFERENT U.S. commemoratives \$1.00. Carstamps, 719 Ordway, Freeport, Illinois.

1000 DIFFERENT Worldwide for approval buyers. Jacobsen, Crompond, N. Y.

SPORTS Stamps, 10¢ with approvals. Blue Hill, Box 6, Milton, Massachusetts.

BRITISH Empire. All different. 500, \$2.00; 1000, \$6.50. Large pictorials. 100, 75¢; 200, \$1.65. Packet pricelist free. West Stamp, Box 392P, Great Neck, N. Y.

ADULTS! Like stamps? Then start your own mail-order business. Our free guidance program shows you exactly what to do, makes it easy, profitable for you. Details free! Columbia, 9268-MP Piney Branch Road, Silver Spring, Maryland.

UNITED States approval collections. Enclose 10¢. Peterson, 405 Northwestern Bank, St. Paul 1, Minn.

ICELAND 10 Different beautiful stamps for only 10 cents to applicants for our good old fashioned approvals. Old Colony Stamp Co., Dept. A, Milford, Connecticut.

1000 DIFFERENT, \$1.00 With approvals. Louis Golden, 6721 Eastwood, Philadelphia 49, Pennsylvania.

WHOLESALE Lots! Specify all different or duplication. Sample \$2.00 (also, wholesale mail auctions). Cadet, Selden, N. Y.

FREE! Fifty different stamps. Adult approval applicants. Norge, Ho-Ho-Kus, N. J.

NATIONAL Parks; Jets; Mother's Day; U.S.; U.N.; Free when purchasing approvals. Details! Stamp Farm, M2-18, Oxford, Wis.

FREE! Over 100 different, \$2.50 value, including space satellite, Israel, British, U.S., first U.N., Siberia. Approvals. Send 25¢ for mailing. Horace Gatewood, Winston-Salem, N. C.

CHRISTMAS Issues. Four complete sets free with fine approvals. Stamp Imports, Peterborough, Ontario.

LIQUIDATING Collections, 2¢ approvals. Job lots. Moredan Stamps, Wellesley 81, Mass.

NEW 1960 Catalogue! Send two dimes. New-Way Stamp, Lawrence (2), Mass.

JAPAN 100 Different plus 200 commemoratives only \$1.00 by air. T. Yonehara, 248 Eifuku-cho, Suginami-ku, Tokyo, Japan.

508 DIFFERENT Worldwide from Madagascar, Macao, Guinea, etc., cataloguing over \$15 only 35¢. Approvals. Littleton Stamp Company, Littleton Q1, New Hampshire.

GIANT Issues collection: Laos elephant set, Brussels Fair, Olympics, jet aircraft, Boy Scout, Somali animals complete, Romania flags, Togo set, diamond popes, United Nations set, etc., plus big stamp dictionary and approvals. Everything 10¢! Stampex, Box 47-KM, White Plains, N. Y.

PENNY Approvals. Thousands. Bargains for pennies. Gifts with purchases. Penny Stamps, Orange, California.

FREE! 25 Egypt, 5¢ handling. Approvals. Bellet, Mapledale, Hazel Park, Mich.

U.S. Stamps. Giant bargain catalogue, 15¢. Raymax, 35-VZ Maiden Lane, N.Y.C. 38.

UNITED Nations. Five different 10¢. Approvals. Anderson, 1112 Harrison, San Francisco 3, Calif.

MEXICO 25 Beautiful 10¢. Approvals. Salsman, Box 702, Berkeley, Calif.

TERRIFIC Value. Eight complete mint sets 10¢ with approvals. Beatties, 58 Glenagar, Islington, Ontario, Canada.

25 DIFFERENT Commemoratives 1893 up 10¢. U. S. approvals. K&B, Box 70, Brooklyn 23, N. Y.

BARGAIN US—101 different 25¢, with US. approvals. Stamps, Kennebunk, Maine.

FREE Sample! Interesting, informative, illustrated. National Stamp News, Anderson, South Carolina.

FREE 50 Worldwide, mailed with inexpensive approvals. University Stamps, P.O. Box 95, Tamiami Station, Miami 44, Florida.

TRADE Your duplicates toward our approvals! (Foreign only.) Complete information, 10¢. Variety Stamps, Box 98-P, Newton Highlands 61, Mass.

307 WORLDWIDE Different stamps only 25¢. Approvals. Niagastamp, St. Catharines 671, Ontario.

MINT U.S. at face! Older commemoratives only. Send 25¢ for all different packet with first selection mint U.S. approvals. Western, Box 1689P, Salinas, California.

1000 DIFFERENT Worldwide stamps \$1.00. Valued over \$20.00. Universal, Box 6, Kenosha 5, Wisconsin.

60 DIFFERENT U. S. (30 commemoratives) 25¢. No approvals. Seidenberg, Appleton, Wisconsin.

FREE! Eight sided stamp, triangle, diamond, midget, mammoth, to approval buyers. Plymouth, Dept. A-9, Bell, Calif.

GIANT Approvals, thousands different, 1¢ and 2¢ each. Wahl's Stamp Exchange, 7008P Farragut, Chicago 31, Ill.

ALBUM Only 10¢! Hundreds of spaces! Stampmart Company, Hartford 1, Conn.

UNITED States commemorative collection containing 33 different—10¢. Approvals. White, 516-A Avenue L, Brooklyn 30, New York.

SELL Your surplus good grade stamps. Write, describing fully what you have. Vanroy Shirk, Lebanon, Pennsylvania.

AMAZING OFFER! 200 United States stamps— including commemoratives, airmails, high denominations to \$1.00. Only 10¢ to approval applicants! Illustrated bargain lists free. Mystic Stamp Co., Dept. 80, Camden, New York.

100 STAMPS, 10¢ With approvals. Smith, 508A Brooks, College Station, Texas.

OLD Scarce U.S. seconds on approvals. Slight imperfections, lowest prices. Hernefield, Clintonhill Sta., Newark 8, N. J.

100 OLD United States between 1861 and 1935, \$1.00. Roush Stamps, 51 Chestnut, Mansfield, Ohio.

225 STAMPS For only 10¢! This mammoth value includes airmails, pictorials; stamps from strange countries cataloguing up to 25¢ each! Also approvals. Mystic Stamp Company, Camden 80, New York.

UNITED States price list, 116 pages, price 25¢. Mark Hanna, 335 Fifth Ave., Pittsburgh 22, Penna.

SELL Stamps to our readers. Your ad in this space will be read by thousands of stamp buyers. I'll prove that to you. Write now for Folder "S." P. W. Johnson, Classified Advertising Manager, Popular Mechanics, 200 E. Ontario St., Chicago 11, Ill.

14,000 DIFFERENT! Amazing new plan builds your collection systematically, country by country. Only 50¢ weekly. Free details. L. G. Ware, Stepney 75, Conn.

U. S. Mint flag set, complete, \$1.00. Free list. Brooks, 2323 Avenue X, Brooklyn 35, New York.

103 DIVERSIFIED British colony stamps only 10¢. Approvals. Niagastamp, St. Catharines 671-A, Ontario.

80 DIFFERENT U. S. stamps, includes 19th century, commemoratives, high values. Plus 1943 flag stamp of occupied nations. All for only 25¢. Approvals included. Willett Co., Box 338-C, Yorktown Heights, N. Y.

102 DIVERSIFIED Worldwide stamps 10¢. Approvals. Linstamp, St. Catharines 618, Ontario.

logue! Kloster, 4164—52nd St., San Diego 5, Calif.

25 DIFFERENT Large American commemoratives 10¢. With approvals. Linstamp. St. Catharines 618-A, Ontario.

INTERESTING Worldwide animal stamp collection 10¢. With approvals. Niagastamp. St. Catharines 671-B, Ontario.

ECONOMIC! 1/2¢-3¢ Approvals. 33,000 varieties. Dresel, Box 128-N, West Englewood, New Jersey.

U.S. Catalog free. Contains almost 1,000 illustrations; over 10,000 delightful bargains. Stone, 260 Washington, Boston 8, Mass.

105 BRITISH Colony stamps, all different 10¢. Approvals. Crown Stamp Company, 901, Virgil, Ontario.

FREE United States price list of singles, plate blocks, FDC's. Introductory discount. Bailey, 45-G Bromfield, Boston, Mass.

135 DIFFERENT U.S. commemoratives \$1.00; 50, 25¢. Approvals. Harold Holub, 18 East 198 Street, New York 68, N. Y.

50 DIFFERENT Stamps free! Approvals. Marford, Box 48, Queens Village 29, New York.

1958 LAOS Unesco unused complete, 10¢, or six Greek wind airmails 5¢ to applicants for our progressive approvals. Mark II Stamps, Shop 1517, 6671 Sunset Blvd., Hollywood 28, Calif.

50 CHINA 10¢. Approvals, gifts. Coast, P.O. 2187A, Santa Ana, California.

200 MIXED World famous stamp mixture \$1.25. Stroskey, 223 Market St., Perth-Amboy, New Jersey.

1000 FINE Mixed United States stamps 25¢. Wright's, Box 1122, Hagerstown, Maryland.

DISCOUNT Approvals. Send 10¢. Surprise packet. McIntyre, 231 Stanford, Berea, Ohio.

FREE Giant collection, including U.S.A., British, foreign, to collectors requesting approvals. Stanley Zajac, 159 Emerson Ave., Toronto, Canada.

FREE. Valuable collections, each collection over \$5.00 catalog value, plus many other terrific gifts free when you buy our sensational foreign approvals. Topval, Box 486B, Redlands, Calif.

LET Us preserve your stamps for life. Samples 25¢. Merchandise Service, 3211 Martin Ave., Evansville 12, Ind.

1053 DIFFERENT \$1.00 with approvals. Klondike. 682 Jefferson, Elgin, Illinois.

50 DIFFERENT British Colonials 10¢. Approvals. Robert Searjeant, Mendon, New York.

SOUVENIR Sheets Czechoslovakia 1937 plus Japan 1947, 10¢ with approvals. Kingman, 30 Empire, Yonkers 4, N. Y.

PACIFIC Islands, Australasia. 500 attractive mixed, \$1.50. Lang, Box 2, Hornsby, Australia.

BARGAIN Surprises! Beautiful colonials, topicals, American commemoratives, small country collection 5¢. Approvals. Bristols, Canton Center, Connecticut.

FREE! 40 Different Portuguese; colorful inexpensive approvals. Elkhart, Box 33, Elkhart, Indiana.

100 STAMPS 25¢. Joseph Gaidar, 6615 South Ashland Ave., Chicago 36.

THREE Beautiful, unusual sets free, with worldwide approvals. Post-Age, Box 218-C, Brazil, Indiana.

LOOK! Six Queen Elizabeth mint sets! Antigua, Caymans, Singapore, etc. Total 21 different brilliant pictorials! Only 25¢ now with approvals! Gannon Stamps, Box 931, Canton 1, Ohio.

HONG KONG, 25 Different, 25¢. Foreign approvals. Spicka, 518 No. 85th, Omaha 14, Nebraska.

ANTIQUES, RELICS, INDIAN GOODS, CURIOS

ANCIENT Grooved stone tomahawk \$3.00. Indian relic list free. Lear's, Glenwood, Arkansas.

SPECIAL: 10 Genuine arrowheads, \$2.00. Stan's, 1054 Lilley, Columbus 6, Ohio.

SCALPING Knife, spearhead, thunderbird \$4.00. Catalog free. Arrowhead, Glenwood, Arkansas.

catalog 10¢. Al's, Box 393, Bellmore, New York.

FOUR Arrowheads of three warpoints \$1.00. Birdpoint, hatchet head, scraper \$2.00. 70 beads \$5.00. Fifteen relics \$3.50. Palmer, 435 Washington Road, McKeesport, Penna.

ILLINOIS: Selling hundreds—Confederate, Civil War, Indian War, western muskets, Kentuckies, Springfields, rifles, pistols, flasks, blunderbusses, flintlocks, frontiers, dueling, pepperboxes, Confederate-Union swords, bayonets, bullet molds, 12,000 collectors cartridges. \$20,000.00 Confederate bills. Gold coins, Indian cents. Agates, minerals, fossils, 50,000 Stonegate Indian relics, arrowheads, spearpoints, discoids, gold nuggets, stagecoach guns. Mounted birds, dagger-rotypes, holsters, military insignias. Send 35¢ (refundable) for large listing. Heidke, Wenona, Ill.

PRECIOUS STONES, MINERALS

GET Free catalog no serious rockhound, gem cutter, jewelry maker, hobbyist or craftsman can be without. Full of bargains, exclusive items, low prices from largest suppliers and authorities in the field. Free, new catalog just off the press, yours for the asking! Write Grieger's, Dept. C-11, 1633 E. Walnut, Pasadena, California.

JERSEY Fluorescents 75¢ lb. postpaid. Blacklight kits. Tom, 174 Willow, East Brunswick, N. J.

PROSPECTORS! Learn from experienced geologists how to locate and identify rocks and minerals. A comprehensive home study course designed for anyone interested in exploring for valuable ore deposits. Write now for free literature. Pacific School of Mines, Dept. B12, Box 2538, Palm Springs, California.

"GEMS & Minerals Magazine," largest rock hobby monthly. Field trips, "how" articles, pictures, ads. \$3.00 year. Sample 25¢. Box 687A, Mentone, California.

SAPPHIRE And four more uncut gems, \$1.00. Ten polished gems, baroque-shaped, \$1.00. Free gem list. Lapidary catalogue, 25¢. O'Brien's, 1116M Wilcox, Hollywood 38, Calif.

SEMI-Precious uncut gems. Ten different for \$1.00. Request list 26. Prospectors Shop, 201 San Francisco, Santa Fe, New Mexico.

EARTH Science, the rockhounds national magazine. Subscription \$2.00. Sample 35¢. Box 1357-PM, Chicago 90, Ill.

GOLD, Silver, copper ore with catalog 50¢. Gemco, Eisner Av., Sheboygan, Wis.

GOLD Ore! Large beautiful specimen from world's greatest gold camp. \$1.00. The Old Prospector, Box 396, Cripple Creek, Colorado.

18 COLORFUL And basic U.S. mineral specimens attractively boxed with descriptive folder \$1.00 prepaid. Included free dinosaur bone pocket piece. Rock Haven Mineral Co., Dept. 201, Whitefield, N. H.

HOBBIES AND COLLECTIONS

WANTED Cigarette, tobacco cards. Write Charles Bray, East Bangor, Penna.

FASCINATING Catalog, hobby kits, 10¢; Craft kit, absolutely free, your choice, when joining Hobbyguild, 550C Fifth Ave., New York City.

CHRISTMAS Present collection. 20 arrowheads \$5.00. Smith, 841 N. Tacoma, Indianapolis 1, Indiana.

THREE Brilliant uncirculated Mexican silver dollars \$1.00. Universal Services, Box 675, San Antonio 6—D12, Texas.

100 SEA Shells \$1.00 postpaid. World Wide Service, 1505 North Parkwood, Harlingen, Texas.

FOSSIL Shark teeth, 20 million years old. 2 for 25¢. Joe Larned, Box 111, Bradley, Fla.

25 COLORFUL Selected seashells plus genuine sea horse and starfish \$1.00 postpaid. Includes free shell card in color with names and free tropical catalog. Treasure Highland, Airgate Branch PM, Sarasota, Fla.

COLLECTORS Matchbook covers. 100 different unused, \$1.00. Catalog 25¢. Album \$3.00. Charles Edelman, 1311-C East 84, Cleveland 3, Ohio.

profitable hobby. Write for particulars. Institute of American Inventors, Dept. 40-E, 635-F St., N.W., Washington 4, D. C.

NAZI Insignia book. 600 illustrations, \$1.00. 12 Nazi insignia, \$1.00. Hobbyland, Calgary, Canada.

COLLECT Foreign medals, daggers, helmets. Iron Cross with ribbon, \$1.50; Swastika emblem 25¢; catalog 25¢. Hobbies, Box 71-B, Rockaway 94, N. Y.

HARTLAND Horses, riders, gunfighters, ballplayers. Complete line and parts. Mission Supply, Floral City, Florida.

MILITARY Miniatures. Catalog 85¢. Bussler Miniatures, Box 107-Z, Wollaston 70, Mass.

ANTIQUE Handcuffs, leg-irons represent great new collecting field. 25¢ brings illustrated catalog, history, information how to start. Patterson Smith, 269-P Shepard Ave., E. Orange, N. J.

PHOTOGRAPHY, CAMERAS, PHOTO SUPPLIES

AVAILABLE Franchises to established photographers. Sell hand painted oil portraits on canvas. Not painted photographs. Exclusive. Territorial reorganization planned. World Wide Artists, Box 9032, North Station, Newark, New Jersey.

164 PAGE Photographic bargain catalog, listing thousands of photographic bargains. Send 25¢ for your copy, credited on first order. Dept. 1-C12, Central Camera Company, 230 So. Wabash Ave., Chicago 4, Illinois.

CAMERAS, Film, projectors—discounts to 40%. Catalog free. Photo Distributors, Box 4203, San Diego 4, Calif.

CAMERA Owners! Earn \$50.00 weekends! Instructions \$1.00 information free! Kline, 935-PM North Austin, Chicago 51, Illinois.

PHOTO FINISHING

A Triple value. Quality, price, service. Color or black and white, 12 exp. (black and white) 59¢. 20 gift photos \$1.00. Holiday Photos, Dept. 16, Box 666, Denver, Colo.

A 3-in-1 value. Price, quality, service. 20 gift photos, \$1.00. 12 exposure rolls (black and white), 59¢. Color or black and white. Interstate Photos, Dept. 11, Box 15, Aurora, Ill.

KODACHROME Processing by Kodak. 8mm. roll or 35mm., 20 exp., \$1.40. Prompt service. Write for mailers and prices. Color Pix, Dept. P, CPO Box 30, Kingston, N. Y.

TWELVE Exposure rolls 49¢. Wallets 20 for \$1.00. Lincoln Studios, Dept. K, Box 13, Lincoln, Nebr.

ENLARGEMENTS, Heavyweight, six 5x7's or three 8x10's \$1.00. Jack Koons, Huntington Mills, Penna.

COLOR Processing! Anscochrome, ektachrome \$1.00, 35mm. 20-exposure roll mounted. Kodachrome 20-exposure or 8mm. movie \$1.25. U.S. Color Mart, Box 191, Hartford 1, Conn.

SAVE! Photographic Christmas cards. Free mailers. Mail-A-Way, Box 375-A, Fitchburg, Mass.

25 WALLET Size silk finish photos from any picture \$1.00. Original returned unharmed. Studio, Drawer 701M, Springfield, Missouri.

YOUR Photo on your Christmas cards, stationary. Real miniature photographs reproduced from your photo. 100 Photo-stamps \$1.50. Chesley Distributors, 2339-A University Avenue, San Diego 4, California.

3-DAY Service on beautiful personalized Christmas cards from your photo or negative. Write for free sample and information. Lincoln Studios, Dept. K, Box 13, Lincoln, Nebraska.

GIVE Your friends the thrill of receiving personalized Christmas cards from your negative or photo. Information, samples from Interstate Photos, Dept. 11, Box 15, Aurora, Illinois.

HAVING Trouble finding those just right Christmas cards? Thoughtful, personal cards from your photo or negative. Samples, information from Holiday Photos, Dept. 16, Box 666, Denver, Colorado.

MOTION PICTURES AND SOUND EQUIPMENT

RARE Air movies World War I. 8mm.-16mm. Free lists. Jarrett, RD#1, Aberdeen, Maryland.

TITLES Custom-made to your order in color. Dress up your home movies. Write for free information and order blank. No obligation. 8 mm. only. Acme Titles, Box 2568, Hollywood 28, Calif.

MOVIES Sound-silent. Rented-sold, equipment. Huntoon Rentals, Bellows Falls, Vermont.

16MM. Sound films and equipment. Write, phone Entertainment Films Company, 2021 Broadway, New York 23.

SPECIAL Entertainment. 8mm. B&W, \$12.00. 16mm. B&W, \$20.00. Tex, Box 368, Terminal A, Toronto, Ont., Canada.

16MM And 35mm sound film, projectors. Savarese, Woodcliff Lake, N. J.

16 M.M. Sound features \$30.00. Shorts \$5.00. Bedner, 5300 So. Talman, Chicago.

COLOR 8MM.-16mm. movies of Pikes Peak region and Colorado. Free catalogue. Scenic Associates, Box 547, Dept. P, Colorado Springs, Colorado.

16MM. Sound films, Bargain bulletin, Duquette, 97-T Snow, Fitchburg, Mass.

MOVIE Film! Free catalog! ESO-R. 47th Holly, Kansas City 12, Missouri.

16MM. Sound, projectors, films. Sale, rental, exchange. Visit store or write for catalog. National Cinema, 71 Dey St., New York City.

FREE! Blackhawk's big sale catalog 8mm., 16mm. movies, 2"x2" color slides. Biggest selection anywhere! Projectors, cameras, supplies. Big discounts! Get free, every three weeks, 12-page newspaper size bargain list! Blackhawk Films, Davenport 14, Iowa.

5,000 8-16MM. Movie films. Free catalogues. International, Greenvale, N. Y.

MOVIE Camera film: 8mm. roll \$1.50. 16mm. 100' \$3.00. Free processing. Better Films, 742 New Lots, Brooklyn, N. Y.

16MM. Sound shorts. Tremendous assortment features, \$16.50 up. Used 16 mm. sound projectors, \$79.50 up. Catalog. Abbe Films, 417 West 44th Street, New York City 36.

10¢ BRINGS Big new cine manual for the 8mm.-16mm. movie maker. Save money on fresh b&w and color movie film, all home processing equipment. Superior, 448 N. Wells, Chicago 10.

COLOR SLIDES

500 COLOR Slides tell complete Lincoln story from birthplace in Kentucky to tomb in Springfield. Send 35¢ for catalogue and sample slide. Willems, Box 1515-A, Chicago 90.

BEAUTIFUL Color slides, package of four, 98¢. Big catalog, 17,000 subjects, with free title slide, 35¢. Weston's Travels, 38015 North Piedras, El Paso, Texas.

TRANSPARENCIES Wanted. Up to \$500.00 each. For information write: American Color, Box 38391, Hollywood 38, California.

MUSIC & MUSICAL INSTRUMENTS

SONG Poems wanted. Don't sign contracts 'til you learn the truth. Johnny Mack's Melody Mart, Dept. A, 1094 1/2, West 39 Street, Los Angeles 37, California.

SONGWRITERS—Arranging by specialists. Music set to poems, religious and popular. Offset printing. Free information. Music Printing Company, Dept. PO-12, 732 South Sherman, Chicago 5, Ill.

POEMS Wanted for new songs and recording artists. Send: Successful Songs, 6 North Street, Danbury, Conn.

ACCORDIONS—1960 Models. Lowest discount prices. Save up to 50%. Free home trial. Trades accepted. Big color catalog free. Accordion Manufacturers, Dept. 129-R, 2003 Chicago, Chicago 22.

SWISS Musical movements. Mechanical-electrical. Spielman, 131 West 42nd, New York City 36.

WOOD Pipes. Send for description and prices. C. A. Sevigny, P.O. 195, Chester, Conn.

ACCORDIONS. Wholesale to everyone. Save up to 60%. All national known brands. Free catalogue. Del Principe, 29 South Cicero, Chicago 44.

ELECTRIC Guitars, amplifiers, wholesale. Free catalog. Carvin, PMM, Covina, Calif.

VIOLIN Bowhair replacements. Synthetic. Easily applied without damaging bow. \$1.00 each. Bowman, 1007 Pineheights Avenue, Baltimore 29, Md.

SONGWRITERS, With publisher contacts, want song ideas. Share royalties. No fees. Send poems: Songwriters' Associates, 1650 Broadway, New York City 19-G.

ACCORDIONS. Italy's best, guaranteed. 60% discount. Importers, 7445 East Seven Mile, Detroit 34, Mich.

POEMS Wanted immediately for musical setting and recording. Free examination. Rush poems. Songcrafters, Acklen Station, Nashville, Tennessee.

GUITAR Making books, plans, imported woods, tools. List 10¢. Store, 510 East 11th Street, New York 9, N. Y.

SONGPOEMS And lyrics wanted. Mail to: TinPan Alley, Inc. 1650 Broadway, New York 19, N. Y.

POEMS Wanted for musical setting and recording. Send poems. Free examination. Crown Music Company, 49-C West 32 Street, New York 1.

SONGS Into dollars. Share \$33 million dollars yearly for new songwriters, song poets. Any subject, songs composed, published, promoted by largest firm. Information, appraisal free. Send Nordyke Music Publishers, 6000 Sunset, Hollywood 28 PM, California.

POEMS Wanted for musical setting and recording by America's largest song studio. Send poems. Free examination. Five Star Music Masters, 630 Beacon Building, Boston.

SWISS Musical movements. \$1.90. Helax, 218 W. 72nd St., New York City 23.

REED Organ. Electrify and make vibrata inexpensively. Plans \$1.00. Paul R. Grove, Huntingdon, Penna.

WILL Place your song with publisher for \$10. Berthold Phillips, Chuckey, Tenn.

CHORD Organs—Save 1/3. Italian craftsmanship. Play without lessons! Terms. Free trial! Free catalogs. Philharmonic Importers, Department 119-R, 2003 Chicago, Chicago 22.

RECORDERS—Lowest import price \$3.99. Free case. Schier, 21 Russell, Edgewater, New Jersey.

PLAY Guitar first lesson! Nationally advertised phonograph record method shows how. Free LP Album. Write Radiant, 1697 Broadway, New York City 19-M.

LEARN To play guitar, accordion, piano. 10 lessons on records with instruction book. \$4.98. 24 lessons, \$9.95. U. S. Gov't. approved. Vavro Institute, So. St. Paul, Minn.

ACCORDION Repair guide \$3. How to build accordions \$5. Satisfaction guaranteed. Parts Fischer, Box 402, Bellingham, Wash.

RADIO, TELEVISION AND ELECTRONICS

EXPERIMENTERS. Long range transistor radios. Particulars free. Elmer Block, Sarcoxie, Mo.

STEREOPHONIC Phonographs, Radios, Recorders. Free catalogues. Tower Distributors, Norristown, Penna.

DON'T Buy hi-fi components, kits, tape recorders, until you get our low low quotes return mail. Catalog free. Hi-Fidelity Centre, 1799M 1st Ave. New York 28, N. Y.

BRAND Transistor 6 tube pocket radio. Mail \$22.95. Jemco, 141-25 25 Road, Flushing 54, N. Y.

CASH For used short-wave ham receivers, transmitters and accessories. Treger, W91VJ, 2023 N. Harlem Ave., Chicago 35, Tuxedo 9-6429.

RECORDERS, Hi-Fi. Free wholesale catalogue. Carston, 215-PM East 88, New York City 28.

CRYSTAL Radio kit \$1.00; preassembled \$1.25; phone \$1.75; catalogue. Clearco Crystal Co., 2966 N. 4th, Milwaukee 12, Wisconsin.

FREE! Giant wholesale catalog on electronics, hi-fi, transistor, scientific, hobby, optics, photographic, housewares, jewelry, tools, novelties, toys. Write: Lektron, 131M Everett Ave., Chelsea 50, Mass.

TAPE Recorders, Hi-Fi components, sleep learning equipment, tapes. Unusual values. Free catalog. Dressner, 69-02M, 174 St., Flushing 65, N. Y.

AMPEX Tape recorders, components. Boynton Studio, 10-PM Pennsylvania, Tuckahoe, N. Y.

LEARN While asleep with amazing "Electronic Educator" endless tape recorder. Details free. Research Association, Box 24-N, Olympia, Washington.

TUBES—TV, radio, transmitting, special purpose types. Bought, sold, exchanged. Unused only. Send details to Barry Electronics Corp., 512 Broadway, New York 12, N. Y.

GOVERNMENT Surplus radios, parts. Picture catalog 10¢. Meshna, Malden 48, Mass.

ELECTRIC Guitars, amplifiers, wholesale. Free catalog. Carvin, PMR, Covina, Calif.

RADIO And TV tubes at manufacturers' prices! 100% guaranteed! Brand new! No re-brands or pulls! United Radio, Box 1000, Newark, N. J.

BUSINESS OPPORTUNITIES

\$200.00 MONTHLY. Spare time. With table saw, bandsaw or jigsaw. Write, Holiday House, 7228 4th Plain, Vancouver, Washington.

MOTEL-Resort management. Qualify for hundreds fascinating, leisurely, well-paid executive openings. Learn at home. Free booklet. Motel Managers Training School, PM129, 612 S. Serrano, Los Angeles 5.

SWIMMING Pool franchise. Small investment, partial financing. Write for brochure. Box PM 1262, 125 W. 41 St., New York City, U.S.A.

HOME Earnings unlimited. Intelligent, responsible person; \$200 capital; populated community necessary. Own business. New. Free literature. Box 1005, Topeka, Kansas.

OPERATE Profitable mailorder dealership. Names, circulars everything supplied. Free details. Bernard, 112-PJ West 44th, New York 36.

YOUR Own successful business can bring \$1,000 monthly by mail at home. Free details. DeLang Research, Box 52-D, Burlington, Iowa.

EARN \$150.00 Or more per week selling the only Bible that answers all questions. Beautiful pictures. Proven selling plan free. International Book Company, Dept. M., Box 118, Wichita 1, Kansas.

ENJOY Second income by mail. New book tells how. Literature free. Cox, 84 Chestnut, Saugus, Massachusetts.

QUICK Money! Repairing car batteries. At home! Easy too! Free details! Batteryman, Penrose, Colo.

GAME Warden, government hunter, forestry, park and wildlife services announce job openings. All states. Enjoy outdoor work, good pay, real security. Complete information free! Write North American School of Conservation, Dept. CC-17C, 1038 S. La Brea, Los Angeles 19, Calif.

UNLIMITED Earnings in a sparetime business of your own. One dollar for full particulars. Fox, Elgin, Nebraska.

CASH From sawdust, tin-cans, newspapers. Over 200 methods. Instructions \$1.00. Charles Company, 42-GPR, Norwood, Ohio.

PROFIT With Popular Mechanics' subscription plan. No investment, no experience needed. Earnings begin immediately when you obtain subscriptions for Popular Mechanics. Good Housekeeping and others. High commissions, bonus. No experience needed. Deal directly with the publisher. Write Popular Mechanics, Room 12B, 250 West 55th St., New York 19, N. Y.

WILL You test new items in your home? Surprisingly big pay. Latest conveniences for home, car. Send no money. Just your name. Kristee, 113, Akron, Ohio.

GROW Living miniature forest (only inches high) or orchard that bears tasty tiny fruit. Learn amazing dwarfing secrets! Fascinating hobby! Profitable home-business opportunity! Free seeds and plan. (State your age.) Miniature Nurseries, Dept. DR, Gardena, California.

START Your own business on credit (U.S. and Canada). Your own boss. 1383 dealers sold \$5,000 to \$33,500 in 1958. We supply stocks, equipment on credit. 200 home necessities. Sales experience unnecessary. Pleasant profitable business backed by world-wide industry. Write Rawleigh's, Dept. L-U-PPM, Freeport, Ill.

\$250.00 WEEK Profit possible. Earn at home spare time with fascinating printing method, \$5 starts you. Send no money now. Free confidential facts and valuable samples. Screen-Print DR, Los Angeles 61.

"50 NEW Home-business ideas" booklet, sample free. Spray exotic Velvet-Suede on anything. Flokcraft-DR, Los Angeles 61.

IMPORT-Export opportunity, profitable, world-wide, mail-order business from home, without capital; or travel abroad. Established world trader ships instructions for no-risk examination. Experience unnecessary. Free details. Mellinger, X70C, Los Angeles 24.

IMPORT. Mail-order, plastics businesses offered in new streamlined three-in-one money-making opportunities. Free details. Trialalpha, Dept. P12, 7950 Mammoth, Van Nuys, California.

DROPSHIP Buyers' Guide reveals 151 manufacturers mailing single orders using your label. Large profits; no inventory, delivery, packaging headaches. Complete operating instructions. Complete guide \$2.00 postpaid. Rutward, 112 Bryant, Columbia Station, Ohio.

SELL. By mail. Mail order specialist shows how to start on low capital. Modern merchandising methods, not crackpot schemes. Free details. Griffin, 322 West State Street, Ithaca, New York.

LEARN Sewing machine repairing. To \$125 weekly. Sparetime. Supplies. Add to present business. Write today! Taylor Service, Box 2126, San Bernardino, Calif.

OPERATE Your own bookkeeping and collection service installation. Earn up to \$25,000 or more. Details. Allison, 293 Hamilton Blvd., Kenmore 17, N. Y.

MAKE Extra money—Big cash commissions plus premiums for you and your customers. Sell advertising book matches. Sensational new tenorams, glamour girls, hillbillies; dozens others. All sizes. Quick daily sales; big repeat business. Free master kit makes selling easy. No experience necessary. Superior Match, Dept. MX-1259, 7530 Greenwood, Chicago 19.

EARN \$10,000 Yearly raising Angora rabbit wool for us. Information 25¢ coin. American Angora Company, Malta 77, Montana.

WANTED: Home producers, to be subcontractors. Cast plastic products for manufacturers in our clearing house service. Thousands of easily made items required. Cash in at home, without previous experience. Plastic Service Associates, Dept. 12PM East Boston 28, Massachusetts.

HIGHER Income! Facts-fallacies. Details: Grentius, 182-25 Wexford, Jamaica 32, N. Y.

\$3 HOURLY. Addressing, mailing. Material supplied. Instructions 50¢, refundable. Interstate, Del Station, Albany 9, N. Y.

MECHANICALLY Inclined men earn \$5.00-\$6.00 hourly while learning household appliance service repair. New shop method home study plan. Christy Trades School, A-8203, 3214 Lawrence, Chicago 25.

PRACTICAL Mailorder. Start small. Money-maker (129), 722 East Silver Spring, Milwaukee 17, Wisconsin.

EUROPE Offers sensational coin operated footmassage machine. Low investments make a fortune. Free literature. Nieuwenhuis, 128 Stadhouderskade, Amsterdam/Netherlands.

SIX Mailorder magazines, opportunities, 25¢. Thompson, Box 94-PM, Salinas, California.

WHAT Is this mail order business? Get the one true answer. John Bishop, Box 153B, Ojai, California.

MAKE \$5,000-\$15,000 Yearly at home in respectable field. Future growth unlimited! No experience necessary! No public contact! Nothing to grow or make! Free expert guidance helps you achieve financial success! Rush \$1.00 today for complete details! Satisfaction or refund. Columbia Enterprises, 9268-PM Piney Branch Road, Silver Spring, Maryland.

MUSHROOMS Quicker, easier, cheaper. Magic preplanted trays. Newest facts free. Spawn \$1.00. Luxur, 641 South 19th, Newark 3, N. J.

RAISE Rabbits on \$500 month plan. Free details. White's Rabbitry, Delaware, Ohio.

OPERATE Profitable low cost mailorder business! Write! Liberty, 210-PMD9 Fifth Avenue, New York 10, New York.

EARN Money at home. Be your own manufacturer of high quality woven rugs. Big market, big profits. Write for catalogue of weaving supplies. Newcomb Loom Co., Davenport, Iowa.

MAIL Trade magazine has moneymaking opportunities galore. Sample 25¢. Donovan, 79-PM Greenbelt, Levittown, New York.

HELP Yourself mailorder! Know the facts: laws, trends, secrets! Everything! 99¢. Customers only! Free advice, product analysis. Ads written professionally, 10¢ word. Minter Enterprises, Box 244PM, Cedarburg, Wisconsin.

MONEY From your mailbox daily. Free details. Wayne's Service, 3016-MP Channing N.E., Washington 18, D. C.

EARN \$100.00 Weekly part time from your arm-chair and in one year you'll receive a free trip to Europe for two. No selling. No mailorder. Pan Pacific, TDF, Box 595, Laguna Beach, Calif.

WANTED. Men, women. Raise bait for us at home. Full, spare time. Doesn't take up space. We furnish everything. Sherwood, Dept. S-2, Monmouth, Maine.

FREE Imports from overseas. Particulars free. Bassens Imports, 828 Fullerton, Chicago 14, Ill.

LOVERS' Knots! Unusual charming creations! Priced for resale! No competition! Jewelry manufacturer sends free folder. Fredericks, 1223 National Newark Building, Newark, New Jersey.

CANDIED Popcorn and potato chip equipment. Eakins, Box 933-A9, Springfield, Ohio.

TERRITORIES Open for "Auto-Moly" lubricant (doubles engine life). Small investment. Build future state franchise. Pacific Lubricants, 5807-PM Beverly, Los Angeles 22, Calif.

NEW Home-import mail order profitability! Your mailbox stuffed with money! No selling. No experience. No investment. We supply everything. Free details. Mail Order Distributors (Import Division), 15201 South Broadway, Los Angeles A5CC, Calif.

PUNCHBOARDS. Catalog 10¢. D'Lux Sales, Blue Earth, Minn.

COLORGLAZED Concrete pottery made without molds. Patented method. Cemetery products, novelties, tiles. Basement leak-sealing. Money-making projects. Booklet, details free. Men only. National Potteries Company, Grand Rapids, Minnesota.

HOBBIES, Collections, antiques: world-wide contacts. 25¢. Rainone Publications, Middle Village 79, New York.

AMAZING Profits selling books by mail. Everything furnished. Roe, 2317P Marshall, Chicago 23.

BEGINNERS Mail Order Guide. Rules, laws, regulations. Listing 15 mail order publications, 50¢. Curtis Publications, 312 Olive, Porterville, Calif.

PLAN And personal help. Retired mail order operator will show you how to start profitable home business. Norris Cole, 217 West 49th, Bradenton, Florida.

100% PROFIT Selling reconditioned spark plugs. Free sample. Lee, 1608-H Roberts, Houston 3, Texas.

"MAILORDER Laws and Regulations" and "Mailorder Rules for Beginners," \$2.00. Explains mailorder licenses, mail-order taxes, etc. Tasker, Box 3131, Alexandria, Virginia.

FRANCHISES Make profits! Operate your own independent franchised business as distributor, dealer or agency owner. Nationwide opportunities. National Franchise Reports is the recognized source for information regarding the booming franchise field. Write today for interesting free details of this helpful service. National Franchise Reports, W-528, 333 North Michigan, Chicago 1.

FREE Picture folder, "How to Make \$3,000 Yearly, Sparetime, Backyard, Raising Earthworms!" Oakhaven-38, Cedar Hill, Texas.

MONEY From your mailbox daily. Details free. Jacks House of Values, 3057 Brighton 4th Street, Brooklyn 35, New York.

32-PAGE Mailorder "Homework Bulletin," 10¢. Tasker, Box 3131, Alexandria, Virginia.

SELL By mail. High income! Everything furnished. Irvin, Box 1052, Oklahoma City 1, Oklahoma.

NORTHERN California business opportunities. Donoho Realty, 493 Eighth Street, Chico.

VENDING Machines. No selling. Operate a route of coin machines and earn amazing profits. 32-page catalogue free. Parkway Machine Corporation, Dept. #27, 715 Ensor Street, Baltimore 2, Maryland.

SELL Books by mail. 400% profit. Royal, Box 368-X, Cleveland 27, Ohio.

PLASTERCRAFT Molds, liquid rubber, plasters, floccs, candle supplies. Catalog and manual free. Blue Rapids Supply, Blue Rapids, Kansas.

MAILORDER To churches, motels, restaurants, institutions. Complete, individual set-up, not just instructions. Hermes Advertising, 152-C West 42, New York City 36.

I Got rich in the dry cleaning business with no investment, so can you. Free details. Write: Imperial School of Dry Cleaning, Dept. PMC, 1700 Touhy Avenue, Chicago 26, Illinois.

MAILORDER. America's most unique no cost plan for beginners. Armstrong's, 154A Darrington St. S.W., Washington 24, D. C.

STRIKE It rich on small home repairs by using set prices. Details free. House Clinic, Dept. P, 7307 Fenton, Dallas 31, Texas.

FREE! Name brands catalog! Your own high profit business. Sell name brands, full or part time. No inventory, no investment. More than 2,000 name brand items; lowest wholesale prices. Watches, jewelry, cameras, hi-fi, stereo radios-phonos, appliances, housewares, hardware, power tools, luggage, musical instruments, garden equipment, sporting goods, toys, many others. 8 floors of name brands. Million dollar inventory. Orders shipped complete in 24 hours! Send for free, beautifully illustrated catalog now! Separate wholesale price list. H. B. Davis Corp., Dept. 11, 145 W. 15 St., New York 11, N. Y.

PLATE Baby shoes, jewelry, gifts. Bronze and colored pearl. We finance home businesses. Booklet free. Platex, 11029 South Vermont, Los Angeles 44.

IF You like motorcycles and money then send for Harley-Davidson dealership book on how to become a franchised dealer of motorcycles and a new line of motor-scooters. Here's a chance to own your own business with a very modest investment. The youth market is beginning to explode and the next few years promise a chance to cash in on it. Write for free illustrated dealership book today. Harley-Davidson Motor Company, Dept. P, Milwaukee 1, Wisconsin.

BUY Direct from factories. Appliances, cameras, watches! Free details! Cam Company, 6810PM-20th Ave., Brooklyn 4, N. Y.

BUSINESSES, Resorts, motels, investment property, ranches. Our special service dept. at your disposal. No obligation. World's largest. 58 years' service. Strout Realty, 7-MB S. Dearborn, Chicago 3, Ill.

BIG Money raising fishworms and crickets. Free literature. Carter Farms, Plains, Georgia.

QUICK Profits, with no capital! Take orders for magazines your neighbors like, want. Make cash on the spot! We show how with free kit. Get yours now. Write McGregor Magazine Agency, Dept. 311, Mount Morris, Ill.

OPERATE Mailorder folio business. Free details. Ballard's, 1834 Edgeland, Louisville 4, Ky.

\$34.70 TWO Hours. Manufacturing concrete products. No selling. Carlayne Castings, 1803 Fremont, Rapid City, South Dakota.

TO \$100.00 Weekly. Sparetime, home operated mailorder business. Successful beginner's plan. Everything supplied. Lynn, 10420-M National, Los Angeles 34.

PIANO Tuning learned quickly at home. Tremendous field! Musical knowledge unnecessary. Information free. Empire School of Piano Tuning, Champaign, Ill. (Founded 1935).

WANT To make big money at home? \$10.00 profit in an hour possible with invisible mending. Make tears, holes, disappear from clothing, fabrics. Steady year-round demand from cleaners, laundries, homes. Details free. Fabricon, 6234 Broadway, Chicago 40, Illinois.

\$70 WEEKLY—Home, spare time. Simplified mail bookkeeping. Immediate income—easy! Auditax, 34757A, Los Angeles 34.

I Want to send you proof of the wonderful pulling power of Popular Mechanics classified pages. What's your proposition? Write me today. Include literature if possible. F. W. Johnson, Manager Classified Advertising, Popular Mechanics Magazine, 200 E. Ontario St., Chicago 11, Ill.

11,000 NEW Prospects daily. Baby record books, shoes, albums. Sell mailorder. Use our literature. Write: No-Co-Ro, Capitola, California.

COPUBLISH Mail Sale Advertiser. leading mail order paper. Details, latest copy, dime. Vanroy Shirk, Lebanon, Penna.

FREE Catalog. Contains hundreds of businesses, farms and income properties throughout U.S., Canada. Specify type and location desired. Deal direct with owners. U. I. Buyers Digest, 1608 Hillhurst, Dept. FM-3, Los Angeles 27, Calif.

BRONZE Baby shoes: Instructions, equipment and mountings for genuine electroplating process. Largest supplier of all plating equipment, supplies. Free catalog. Hollywood Bronze Supply, Dept. B-3, 1624 East First, Los Angeles 33, Calif.

MAKE \$46 From square foot plywood;igsaw necessary. Free details. Woodart, Bridgewater, Mass.

MARKETS Everywhere. Make artistic concrete birdbaths, pottery. Best coloring. Home workshop. Hundred varieties. Hollywood Cementcraft, 8527-S Wonderland, Hollywood 46, California.

LIQUID Molding rubber, free sample. Shellcraft supplies. Chaney's, 1907-A East Road, Jacksonville 11, Fla.

FIX Typewriters. Free repair course. Home operated. Remit 25¢ for book explaining free course and agency appointment. Athey, Tarentum, Penna.

MANUFACTURER Fishing lures, plastic, none better. 20 models pennies. Free circular. Quaker, 3514-24 N. Lawrence, Philadelphia 40, Penna.

OPERATE Profitable mail order business. Write Walter Service, 4159A East 112th, Cleveland 5, Ohio.

EARN Good money sharpening chain saws, scissors, cutters, knives. Free manual. Treyco, North Tonawanda, N. Y.

RE-Cast junk batteries into new. Latest achievements. Battery Laboratories, Bayou LaBatre, Alabama.

\$100 WEEKLY! Men, women! Work home! Sparetime! Free "Confidential Plan." Scott Sales, Box 388, Great Neck, New York.

IMPORT-Export business made easy. Individual setup service. Not just instructions. Hermes, 152 West 42, New York City 36.

BAKE New greaseless doughnuts in kitchen. Sell stores. Free recipes. Montgomery, 3605 South 15th, Minneapolis 7, Minnesota.

\$3.00 HOUR—Home, sparetime, assembling pump lamps. Easy. Free details. Ougor, Caldwell, Arkansas.

PLAQUES-Figurines-molds. Free details. Russo, 1196 Brooklyn, Bklyn 3, N. Y.

"MAIL Order World of Opportunities." Free subscription, details. GPO, Box 972-P, New York 1.

"BOOKKEEPING System for Mailorder Beginners," \$1.00. Tasker, Box 3131, Alexandria, Virginia.

MONEY In chemicals. Make own products! Pocket all profits! Others work for you! Valuable starting information, \$1.00. Satisfaction guaranteed. Ranslow Reporters, 51 W. 32nd St., Hialeah, Florida.

FREE—Exciting details. New. Complete, profitable home-operated mail order business setup. Eastern, Box 142, Boston 24, Massachusetts.

DISTRIBUTE Wholesale catalogs, \$1.00 each. Plus 5% commission. Instructions 25¢. Wilson Specialties, 621P North Fancher, Mt. Pleasant, Mich.

MONEYMAKING OPPORTUNITIES

AMAZING Mail plan. Booklet 50¢. Satisfaction guaranteed. Douglas, PM. Box 1691, Milwaukee 1, Wisconsin.

700% PROFIT! Learn how a \$1 investment returns \$8 at once plus continued steady income. No selling. No experience necessary. Rush \$1 to Emersell Company, P.O. Box 125, Lincoln 1, Nebraska, for complete plan and free wholesale catalog.

EARN Up to \$200 weekly making purchases from local merchants. Cockrell Enterprises, Plant City, Florida.

FREE! Mailorder at its best. Beatty's, Box 4754P, Baltimore 11, Md.

SELL By mail! Make money from beginning. No losses. Start small, grow big. Home, spare time. "How To Build Your Own Mail Order Business" idea book for beginners. Tells how—other pointers. 50¢. Satisfaction guaranteed. Ed Sweigert, 30201 Fern, Willowick, Ohio.

STEADY Home income stenciling simple monograms. We start you. Co-art, 111 Cronkhite, Danville, Ill.

SQIGGLES! Spaghetti shaped, donut tasting confection! Easily made. Wildfire seller! Instructions and sample \$1.00. HHP, Route 3, 456-B, San Jose, Calif.

CASH For writing short, simple items! Walsh, Talbotville, Ontario, Canada.

FREE Details! Respectable mail-order money making opportunity. Experience unnecessary! Columbia, 9268-M Piney Branch Road, Silver Spring, Maryland.

COLLEGE—High school students, junior, senior interested in making extra money. Send us your name, address, college or high school you attend on 4¢ postcard for information. Gerard Rivard, Box 437, Claremont, N. H.

SEND \$1.00 For beautiful sample assortment. Details included. Hildebrand, Box 988, Vallejo, California.

900% PROFIT Possible! Sell books by mail! Valuable details free. Northwest, Medina 1, Washington.

START Home mailorder! Interesting, profitable! Ideas galore! Guarprod, 2036-PB 66th, Brooklyn 4, N. Y.

PROFITABLE Homework! Guaranteed earnings. No selling. Everything supplied. Elvee, 556 Beacon, Manchester, N. H.

MINK Raising information free. Complete. Lake Superior Mink Farm, Superior, Eel, Wisconsin.

PROFITABLE Mailorder business! Magazine 25¢. Post, 1425-W 32nd, Indianapolis 23, Indiana.

START A profitable subscription business in spare time! We need men and women (young or old) as representatives for all leading national magazines. Liberal commissions on all subscriptions. Supplies free. No experience needed. Send this ad with your name and address to: Popular Mechanics, Room 12-0, 250 West 55th St., New York 10, N. Y.

\$1,000 MONTHLY For life. Complete details \$2.00. Wambaugh, 7316 Lawndale, Philadelphia, Penna.

UNUSUAL "12 Ways Make Money at Home by Mail" plan. Details stamp. Graham, Box 657, Watsonville, California.

MAKE \$5,000 Yearly sparetime raising mink, chinchillas, nutria, etc. Free booklet reveals proved plans. Write: Furs, 588 Mt. Pleasant Road, Toronto 1, Canada.

REPLACING Diamonds! MexTexte I. White. Brilliant. Hard! \$2.00 carat. Wholesale dealers wanted! Full information free! MexTex, El Paso 9, Texas.

EASY To start rubber stamp business at home in spare time. Make up to \$9.80 an hour without experience. Facts free. Write to Roberts, 1512 Jarvis, Room CR-2-L, Chicago 26.

MONEY! Money! Make and save it. Try our guaranteed books. Hurry! Get free information. U. S. Soldiers Home, Box 11-W, Washington 25, D. C.

VENDING Machines. No selling. Operate a route of coin machines and earn amazing profits. 32-page catalogue free. Parkway Machine Corporation, Dept. #26, 715 Ensor Street, Baltimore 2, Maryland.

GROW Mushrooms. Cellar, shed and outdoors. Spare, full time, year round. We pay \$4.50 lb. dried. We have 29,000 customers. Free book. Mushroom Dept.: 173, 2954 Admiral Way, Seattle, Wash.

CIGARETTES: Make 20 plain or filter-tips for 9¢. Facts free. Moberly, Box 821, Owensboro, Kentucky.

EARN Money evenings copying and duplicating comic cartoons for advertisers. Adservice, Argyle 1, Wisconsin.

YOUR Own, easy-to-start, home mail-order business, sparetime. Fascinating, profitable! Information free. Alfano, 19-PM Pine, Closter, N. J.

BIG Money raising fishworms and crickets. Free literature. Carter Hatchery, Plains, Georgia.

SELL Titania gems. Far more brilliant than diamonds. Catalog 10¢. Diamonite, 2420-M 77th, Oakland 5, California.

BOOKS: Hundreds of subjects. Big 1958 book catalog—10¢. Popular Mechanics Press, 200-BC East Ontario St., Chicago 11.

WIN Contest money. General Contest Bulletin gives hundreds of tips. Lists current contests, rules. Sample magazine 25¢. General Contests, 1609½ East 5th, Duluth 12, Minnesota.

MAKE Money writing short paragraphs. Information free. Barrett, Dept. C-27-D, 7464 No. Clark, Chicago 26.

READ "Progressive Mailtrade," the magazine that tells how to make money by mail. Quarter brings sample and special offer. Progressive Mailtrade, Box 357, Sheboygan, Wisconsin.

OPERATE Home mail-order business. Vosacek Printing, 4444A Ute, San Diego 17, Calif.

START Big-pay business at home in spare time. No experience needed to operate little table-top machine for bronzing baby shoes. Make \$5.46 profit on every pair. Full particulars free. Send postcard to Mason, 1512 Jarvis, Room CM-2-L, Chicago 26, Ill.

NOW! A second income in part time mail order business. It's terrific! Free informative literature. Wagner, 110 Calodine, Buffalo 26, N. Y.

MEN — Women! Start money-making plastic laminating business at home in spare time. Material that costs 11¢ brings back \$2.50. No canvassing or selling but mail orders bring in \$20 a day. Write for full particulars free. Rush name on postcard to Warner, Room CL-2-L, 1512 Jarvis, Chicago 26, Ill.

MAKE Humorous signs. Easy, profitable. Free information. Stanmore Sales, Listowel, Ont., Canada.

SELL Information by mail. 10-to-1 profit ratio. Valuable suggestions free. Rawson Wood, 2753-F Fullerton, Chicago 47.

AMAZING Successes through franchises! Become exclusive franchise holder your territory. Information rushed. National Franchise Reports, MP-528, 333 North Michigan, Chicago 1.

PLEASANT Moneymaking opportunities. All ages. Full time. Part time. Bill Dunihue, 224 Beach Drive North, St. Petersburg 1, Florida.

DISC Jockey. Home study course Weidner, 423 E. 7th St. Boston 27, Mass.

START Home business spare time. Experience unnecessary. Literature free. Arthur Tracy, 4 Cherokee Road, Pinehurst, North Carolina.

EXPORT — IMPORT

MANUFACTURE, Import toys, vinyl dolls, plus animals, dollhouses. Huge profits. Benko, Box 188, New York City 21.

FORMULAS, PLANS, ETC.

LATE, Modern manufacturing formulas. List free. Moon Chemical, Martville, New York.

FORMULAS For latest money-making discoveries. New! Good! Valuable literature free! Miller, Chemist, 1517-D, Tampa, Florida.

FORMULAS; All kinds, latest, best. Literature free. Kemixal, Park Ridge, Ill.

OPPORTUNITIES, Unlimited! Latest specialty formulas, analyses, development, consultation. Monthly report of newest products. Exciting details, free. Alpha-Midwest, LaPorte, Indiana.

FORMULAS. Good ones. List free. Top Laboratories, Box 43631, Hyde Park Station, Los Angeles, Calif.

FORMULAS For 10,000 products \$4.95. Ervin Sales, Box 370, Roseburg, Ore.

PLASTICS

LAMINATE-It yourself kit \$1.00. Plastics, Acetate, Mylar, manufactured products. Agents wanted. Major's, 1740-A Columbia, Chicago 26.

NEW Liquid casting plastic, clear, colors. Embed real flowers, butterflies, photos, coins. Send 25¢ for two handbooks "How to Cast Liquid Plastics" and "How to Make Extra Money at Home." Castolite, Dept. P-101, Woodstock, Illinois.

PLEXIGLAS: 1/8" \$1.25; 1/4" \$1.73 sq. ft. Sheets, rods, tubings, fabricating. Catalog 15¢. Plastic Shop, 2025 Nevada, Butte, Montana.

LAMINATING Supplies. Price list free. Solomson, 4 Beacham, Everett 49, Mass.

NEW Do-it-yourself casting and molding plastics! No experience or machinery necessary. Send 25¢ for big 64 page catalog. Castcraft Corp., Dept. T-22, P. O. Box 555, Palo Alto, California.

CELLULOID Scrap. Sheets, state thickness, colors. Celluloid, Box 8096, Newark 8, New Jersey.

MANUFACTURE Flowers, gems, toys, lures, novelties, statuettes. Instructive catalog 25¢. Gel, Box 261, Union, N. J.

SIMPLIFIED Plastic molding, repairing, trial unit \$2.00. Hallmark Dental Co., Box 1924, Detroit 31, Mich.

PLEXIGLAS. Square foot cost. 1/16" \$1.20; 1/8" \$1.52; 3/16" \$1.86; 1/4" \$2.21; 3/8" \$3.23; 1/2" \$4.36. Colors add 10%. Send 15¢ for postage. Aristocrat Plastics, 23 Sussex Avenue, Newark, N.J.

BOXES, Plastic. Free list. Althor, 170 Bay 23 Street, Brooklyn, N.Y.

LEARN Plastics fabrication for spare time income. Low cost home training now available. Write for free booklet. Interstate Training Service, Dept. D-3, Portland 12, Oregon.

PLASTICS—Plexiglas, Polyester, fiberglass, Acetate, supplies. Manufacturers distributor, sheets, rods, tubes, liquids, coatings, films. Large, small quantities. Complete instructive catalog, 50¢. Details free. Gem-O-Lite, 5529-X Cahuenga Blvd., North Hollywood, California.

CHEMISTRY

EXPERIMENTERS—"Bargains Galore" catalogue 25¢ (refundable). Hagenow Laboratories, Manitowoc, Wisconsin.

AMAZING New book of science experiments, formulas, and catalogue of laboratory supplies. Only 35¢. National Scientific Co., 13 S. Park Avenue, Dept. PM-12, Lombard, Illinois.

FREE Offer. Students chemicals, apparatus, biology supplies. Catalog 25¢. Bio Chemical Products, 30 Somerset, Belmont 78, Massachusetts.

NEW 52 page catalog: chemicals, microscopes, telescopes, lab equipment. Catalog 25¢. Winn Chemicals, 124M West 23 St., New York 11.

ROCKET Chemicals, supplies. New Catalog and plans sent with sample kit of tubes, fuse, chemicals, zinc and sulfur. \$1.00. Central Rocket Company, Waupaca, Wis.

ROCKET Supplies for amateur rocketry. Catalog 25¢. Mervin Hill Company, Bolts Pennsylvania.

LABORATORY Catalog, 25¢ Experiment Book 25¢; Used list. Laboratory Sales, Box 161-A, Brighton, Mass.

"SCIENTIFIC Oddities," 60 page booklet, 10¢. Franks, 3121 South Racine, Chicago, 8.

MICROSCOPE Slides, anatomical. Free list. Bay, 409 Roosevelt, San Francisco 14, California.

CHEMICALS And apparatus for industrial, analytical, and private laboratories. Catalog 25¢. Dept. M-50, Biological Supply Co., 1176 Mt. Hope Ave., Rochester 20, N. Y.

ILLUSTRATED Catalog: Chemistry, mineralogy, biology 35¢. Tracey Laboratories, Evanston, Illinois.

CHEMISTRY, Microscopic. Insect, butterflies, rocks, minerals. Sets complete. Literature. Amateur Chemist and Microbiologist, 208 East Eleventh, Kansas City, Mo.

AGENTS WANTED

AGENTS—Plastic coinwrap, counts and wraps pennies, nickels. Free details. Sterling Discount House, Box 626A, Dania, Florida.

BIG Profits. Stamp social security plates, key protectors. Sample 50¢. Catalog free. General Products, 188-PM State, Albany 10, N. Y.

MEXICAN Art goods! Free sample! Send 14¢ stamps mailing. Sylviak, Apartado 9036, Mexico City.

EASY Handwork makes fast-selling useful articles. Sample free. Sunmade Company, Brockton 64, Massachusetts.

PRINTING, Advertising salesmen—Excellent moneymaking sideline selling decalcomania name plates, small quantities. Automobile initials, sign letters. Free samples. Ralco, XL, Boston 19, Mass.

AGENTS — 300% Profit selling genuine gold window letters; stores and offices. Free samples. Metallic Sign Letter Co., 1217-D West Newport, Chicago.

YOUR Ad in this space will get some good agents for you. Yes, I'll prove it. Write for Folder "A" right now. F. W. Johnson, Classified Advertising Manager, Popular Mechanics Magazine, 200 E. Ontario St., Chicago 11, Ill.

SELL Champion, AC, Autolite spark plugs. Reconditioned, electroplated, guaranteed 10,000 miles, 100% profit. Free sample. Lee Plugs, 1608-E Roberts, Houston 3, Texas.

YOUR own business—Used suits \$1.50; overcoats 65¢; mackinaws 35¢; shoes 12 1/2¢; ladies' coats 30¢; dresses 15¢. Enormous profits. Catalog free. National Mail Order, 211-AA Roosevelt Road, Chicago 8, Ill.

FOG-STOP Windshield cloth. Instantly removes blurry mist, frost, sleet, snow. Stops windshield fogging. Samples sent on trial. Kristee 65, Akron, Ohio.

GOLD Or silver letters, numbers. Windows, doors, trucks. 1" to 6". 500% profit. Free samples. Atlas-T, Box 543, Oak Lawn, Ill.

WEAR False teeth? Sell new miracle denture retainer. Guaranteed repeat profit. Get dollar size for special 50¢ postpaid. Prosthodont, Box 682, Glendale, California.

BE The Popular Mechanics representative in your neighborhood and earn big profits in your spare time. Write Popular Mechanics, Room 12-A, 250 West 55th St., New York 19, N. Y.

SELL New 2-year light bulbs to homes, offices, factories. Burns 450% longer than ordinary bulbs or replaced free! "Guaranteed Profit Plan." Details free. Solar Electric Products, 366 Fifth Ave., Dept. 9123, New York.

MEN! Women! 60% profit on cosmetics. Famous nationally advertised Hollywood cosmetics pay 60%. Make \$25 day up. Hire others. For free samples, details, write Studio Girl, Glendale, California. Dept. 12912J.

\$1,000.00 A Month for making dramatic 3-second demonstration of amazing lightweight Presto Fire Extinguisher. New chemical used by Airforce snuffs out fires instantly. Only \$4.95. Terrific commissions. Millions want it. Free kit. Merlite, 114 E. 32nd, Dept. P-66Q, New York 16.

BIG Profits selling ties. \$2.00 value. \$6.50 dozen. Free catalog. Empire Cravats, 656-PM Broadway, New York City 12.

SEEKING New products? Get my outfit 47 money-making specialties. Latest conveniences for home, car. Send no money. Just your name. Kristee 68, Akron, Ohio.

AUTOMATIC Needle threader. Sells for \$1.00. You make tremendous profits. Ideal for fund raising. Details free. Moore's Wholesale, Dept. 7, Ionia, Mo.

MAKE Money selling ties. Free catalog. Write to Philip's Neckwear, 24 West 22nd, New York City.

MEN! Women! Earn extra money. Free details. Ralph Wall, 1071 Linden, Zanesville, Ohio.

BUY It wholesale. \$2 brings information on 70 wholesalers selling to individuals, also mail order and franchise information. Guaranteed. Franks's, Box 547, Paducah, Kentucky.

65 MILLION Potential customers assure you \$85 a week part time, \$250 week full time selling new Swami car polishing cloth with famous General Electric silicone oil. Over 1 million sold in U.S. Big repeat business. Write: Mill River Automotive Products Corp., PM-12, Great Neck, N. Y.

\$5.00 HOURLY Distributing nameplates for desk door uniform. Gardner, 507 West Hildebrand, San Antonio, Texas.

DAMASCENE Earrings! Exotic Orientalism. Huge profit. OHGA, PM-170, Sigakenkusatu, Japan.

RUBBER Stamps made to order. 50% discount to agents. Universal Rubber Stamp Co., 4718M-18th Avenue, Brooklyn 4, N. Y.

WE Start you free in big profit business of your own. Take orders for exclusive cabinet-concealed safe. \$19-\$84 per sale. Free kit. Free safe offer. Exclusive opportunity. Write today. John Brush Co., 558M West Ave., Rochester 11, New York.

BUY IT WHOLESALE

CHRISTMAS Bargains! General gift catalogs \$1.00, toys 50¢. Hawn, Box 178, Ballwin, Missouri.

ELECTRIC Guitars, amplifiers, wholesale. Free catalog. Carvin, PMW, Covina, Calif.

BUY Wholesale: 100,000 nationally advertised products. Appliances, cameras, sporting goods, housewares, watches, typewriters, tools, clothing, etc. Discounts to 60%. Buy-Rite, Box 258, Hawthorne 2, New Jersey.

FABULOUS, Wholesale gift catalogue 25¢. Osterhoudt's, Red Oaks Mill Road, Poughkeepsie, N. Y.

USED And new watches \$2 up. Free list. Southern Watches, 5-PM So. Wabash, Chicago 2.

LARGEST Wholesale supply source in U.S.! Furniture, clothing, appliances, housewares, automobiles and accessories, tools, sporting goods, hobby supplies, farm equipment, imports, new products, bargain merchandise. Free details. Associated Wholesalers, Box 2068-DD, Sioux City 4, Iowa.

HANDMADE Western boots. Free catalog. Ysleta Boots, Box 815M, Ysleta Station, El Paso, Texas.

OLD Wall telephones, working order. Oak cabinets, hand crank for ringing. \$7 each. FOB, Telephone Co., Turtle Lake, Wis.

DISCOUNT Prices appliances, silverware, watches, housewares, tools, toys, etc. Free catalog. Buehler's Bargains, Millersville 1, Ohio.

NEW Multicolor wholesale catalog, automobile catalog, and others. Housewares, appliances, refrigerators, freezers, washers, dryers, television, radios, furniture, clothing, luggage, binoculars, phonographs, recorders, cameras, projectors, typewriters, sewing machines, power tools, toys, sporting goods, watches, jewelry. Name brands. Huge discounts. Postcard: Selbyco, Decatur 163, Illinois.

FAMOUS Weighing label \$1.00 post paid. Wholesale catalog 10¢ refunded. Newton's Sales Outlet, Dept. 1, 285 High St., Athol, Mass.

WHOLESALE Catalog 25¢. Refunded. Russell Morris, 3501 Root N.E., Canton 5, Ohio.

2,000 PAGES Wholesale catalogs. Write: Mopam, Box 47, Newark, Ohio.

BUY Nationally advertised products at discounts to 60%. Appliances, watches, cameras, clothing, housewares, jewelry, toys, typewriters, tools, etc. Stephens Distributing Co., Box 1434, Atlanta 1, Ga.

SAVE 65%! Appliances, clothing, etc. United Wholesalers, 1265-M Broadway, New York 1, N. Y.

BOOTS, Handsome western styles. Free catalog. Austin Boot Co., Box 5303J, El Paso, Tex.

GOLF Equipment wholesale. Free price list. Crystal Golf Sales, Crystal, Mich.

SALESMEN—DISTRIBUTORS

71,000 ADVERTISING Novelties. Fifteen samples, \$1.00. (Refundable). Adelpia Specialty, 212 Yellowstone Rd., Plymouth Meeting, Penna.

WILL You wear new suits and topcoats without one penny cost and agree to show them to friends? You can make up to \$30.00 in a day even in spare time, without canvassing. W. Z. Gibson, Inc., 500 S. Throop St., Dept. A-626, Chicago 7, Ill.

\$1,000.00 A Month for making dramatic 3-second demonstration of amazing light-weight Presto Fire Extinguisher. New chemical used by Airforce snuffs out fires instantly. Only \$4.95. Terrific commissions. Millions want it. Free kit. Merlite, 114 E. 32nd, Dept. P-66G, New York 16.

MAKE Extra money selling advertising matchbooks. Free catalog and sales outfit. Matchcorp., Dept. PM-129, Chicago 32.

MAKE Extra money—Big cash commissions plus premiums for you and your customers. Sell advertising book matches. Sensational new tenor, glamour girls, hillbillies; dozens others. All sizes. Quick daily sales; big repeat business. Free master kit makes selling easy. No experience necessary. Superior Match, Dept. M-1259, 7530 Greenwood, Chicago 19.

MAKE Money selling sensational dwarf trees—Bear giant-size apples, peaches, pears. Ornamental. Also Stark-Burbank standard trees, roses, shrubs, vines, etc. Outfit free. Stark, Dept. 30160, Louisiana, Missouri.

LIVEWIRES: One salesman makes \$56.60 selling individuals and firms \$139.00 daily, 4 nationally advertised, fast demonstrating order producers. \$222.60 weekly; \$1,668.00 monthly; \$19,415.00 yearly which repeats pyramids galore providing distributors \$2,877.00 monthly; \$34,531.20 yearly potential plus repeats. Opportunity, only to those mailing \$5.00 for \$10.25 salable kit (to avoid sample and curiosity hounds) to sell, use or return for money back. Selling muscles with advertising helps launch your own business practically overnight. Seize franchise while available. Service Industries, 2105-F (Dun Rating B-1) Philadelphia 34, Penna.

MONEY! Your picture on dollar bills. Send photo, business card, \$10 for \$1,000. Moneymakers, 1225 East Broadway, Phoenix, Ariz. (Free samples.)

SELL Beautiful stainless steel tableware. Up to \$22 single order. Theodore Fountain, P.O. Box 287, New York 30, N. Y.

DISTRIBUTORS Wanted. New product. Free details. Helms, Leonard Co., Bristol, Tennessee.

ATTENTION! Wagon jobbers and auto parts salesmen! Hottest automotive item to hit the market in years! Small investment! Big profit! Full particulars! Rocket Nickel-Silver Spark Plug Co., Corona, California.

YOUR Free copy of world's biggest sales magazine tells you how and where to make more money on your own in selling. Write Specialty Salesman Magazine, Desk 5B, 307 North Michigan, Chicago 1.

IF You're interested in making money in selling, see the hundreds of exceptional opportunities in Salesmen's Opportunity Magazine. Send name for your copy, absolutely free. Tell us what you're selling now. Opportunity, 848 N. Dearborn, Dept. 17, Chicago 10, Illinois.

MAKE Up to \$50.00 a day soliciting delinquent accounts. Terrific commissions. Write today. General Finance, 304V Pickwick Bldg., Kansas City 6, Mo.

SALESMEN Needed for the finest watch and clock oil on earth. D. C. Stull, Box 176, Marion, Mass.

EPOXY Coatings and other advanced building materials pay top commissions. Paramount, Box 1956, Cleveland 6, Ohio.

POPNIK! Perfect give-away. Novelty action rocket. \$25M, 15 samples \$1.00. A&M Sales, 3241-P North Hoyne, Chicago 18, Ill.

EMPLOYMENT INFORMATION

JOBS On ships. Travel, adventure, good pay. Details free. P. Kain, 1593-P-G.P.O., New York 1, N. Y.

LOOKING For a job? Higher pay? Read: "Things You Should Know." It's free. Write Career Counselor, Box 7, Adams, Massachusetts.

"BEATING Job Tests!" \$2.00. Psychologist, POB-12, Port Laysa 7, Texas.

JOBS On ships. \$100 weekly, beginners. Travel, adventure. Write: Seamans Service, Box 17-M, Brooklyn 8, N. Y.

COMING To Florida? Send for complete report, jobs, salaries, cost of living. Information you need. \$2.00. Survey, 904 Chamber of Commerce Bld., Miami 32, Fla.

WANT A good overseas or stateside job with higher pay? Act now! All occupations. Transportation paid. Free information. Employment Headquarters, 79 Wall Street, Dept. B-3, New York 5.

FLORIDA — Cape Canaveral employment information. \$1.00. Jobs, P.O. Box 6, Lacross, Fla.

FOREIGN Jobs—Latin America, Alaska, Canada, up to \$1500 monthly. Up-to-date 1960 foreign service directory gives complete information; hot list of firms hiring for military and civilian construction, aircraft, oil, exporters-importers, mining. How-when-where to apply. 12th successful year. \$1.00. Global Reports, Box 8873-S, Los Angeles 8, Calif.

LOS ANGELES Classified Examiner and Times airmailed \$2.00. "Explore Southern California" beautiful photocolored booklet included. Jim Smith, Box 6356, Los Angeles 55, California.

JOBS On ships and yachts traveling foreign countries. Davenport's, 1354-K, G.P.O. New York 1, N. Y.

COPYRIGHTED Reports. Best paying companies, travel, adventure, promotions. Construction, aviation, shipping, oil fields, laborers, clerical, trades, supervisory, factory, unusual opportunities. Skilled, unskilled. Foreign, stateside. Only \$2.00 (\$2.25 airmail) (COD's accepted). Satisfaction guaranteed. Included free: Special reports on Alaska, Venezuela, South America. Research Services, Meramec Building, St. Louis 5-PM, Missouri.

FREE Information—U.S.A., overseas jobs. High pay, transportation. Futures, Dept. M, 215 West 34th Street, New York City 1.

"VALLEY of the Sun" opportunities, Phoenix classifieds \$1.00. Herrick, Rt. #1, Box 1327, Apache Junction, Arizona.

JOBS Detroit classifieds \$1.00. J. Marriage, Box 62, Gaylord, Mich.

LATEST Foreign jobs. Highest wages, unlimited opportunities. Laborers, clerical, construction, electronics, oilfields, civil service. \$2.00 airmailed. America's leading overseas employment researcher. Plus: newest South America, Alaska, Venezuela listings. Universal Research, Box 4912, Baltimore 20, Maryland.

SPECIAL SERVICES

INFORMATION On anything. Ferguson Research Specialists, 116-14 141 St., South Ozone Park 36, N. Y.

BIRTH Certificates. Necessary for social security. Millers Service, Inverness, Florida.

EDUCATIONAL AND INSTRUCTION

SPEND Less. Have more! Valuable suggestions, free! Better Living Program, 605-E West Lake, Minneapolis 8, Minn.

TRIGONOMETRY In six easy lessons. Arithmetic is the only prerequisite. Used by industry in company sponsored training programs. Only \$2.95 ppd. Key-Trig, 8706 Buckles St., Downer, Calif.

PROFITABLE Welding training available Hobart Trade School, Box M-1292, Troy, Ohio. GI approved. Finest equipment in U.S.A. Reasonable prices. Request catalog.

MILLIONS Of sewing machines need repair. Train at home for this high paying trade. For information write: Sincere Training Schools, Box 10014, Phoenix, Arizona.

LEARN How to make artificial parts of the body. Free literature. Adele Laboratories, 45-236, Miami, Florida.

EARN College degrees all subjects \$195; terms. Trinity College, 325 Bankers Trust Building, Indianapolis 4, Indiana.

BIG Money in drafting. I made \$1275 per month. Free information. Drafting Service, 3849 Applegate, Cincinnati 11, Ohio.

INEXPENSIVE Correspondence courses: Science, Arts, Psychology, Engineering. Earn diplomas, degrees, colleges abroad. Aurecas, Central Valley, New York.

STUDY Elementary science. Membership \$6.00. 334-P Kings Court, West Palm Beach, Florida.

LEARN To sing beautifully. Unlimited opportunities. Inexpensive course. Sunland, 3362 Romero Rd., Tucson, Arizona.

MANY Earn \$1,500.00 per month operating collection agency. Franklin Credit, Roanoke, Virginia.

TELEVISION, Journalism, electronics, import, law, etc. Late correspondence courses. (Buy or sell.) Gem., Dept. 12-M, Linwood, N. J.

HIGHER Salaries for architectural draftsmen thru further professional self-education. Join: Architectural Draftsman's World Book Club, 7456 Collins, Miami Beach, Florida.

LEARN By ear with Dormiphone. While you slumber, the amazing new scientific invention works for you. Revolutionary Dormiphonic tools give you a shortcut to learning languages, correct speech; memorizing facts, figures; relaxation, habit training. Saves your time, effort. So simple to use, children benefit. Used by educators, psychologists. Write today for fascinating free book. No obligation. Modernophone, Inc., 320-129 Radio City, New York 20.

BUILD A solid future for yourself through Mechanical Drafting. Thousands of trained draftsmen needed for huge construction program all over the country. Learn the "trade secrets" of Mechanical Drafting and take advantage of the opportunities which exist. Quick, easy-to-learn methods learned at home in your spare time. Send for free information "How to Get into Mechanical Drafting". No salesman will call. No obligation. Greer Extension Training, Dept. 4, 20 East Huron St., Chicago 11, Ill.

HAMMOND'S Raised relief map of United States, 27 1/2 x 21". Elevations by color. Fade-proof. Many features. Complete, wooden frame, mounting unit. Great for school children. Only \$12.50 PP. No COD's. Offer limited. Loeber, 224PM Wyatt Ave., Lincoln, Ill.

COMPLETE Your high school at home in spare time with 62-year-old school. Texts furnished. No classes. Diploma. Information booklet free. American School, Dept. X945, Drexel at 58th, Chicago 37, Illinois.

"HOW To Train Horses"—A book everyone who likes horses or ponies should have. Free. No obligation. Simply address. Beery School of Horsemanship, Dept. 11012-C, Pleasant Hill, Ohio.

HELP Yourself! Solve personal problems by self-mastery. Free information. Leavitt Science, Clinton, Illinois.

BECOME! Tax consultant. Graduates earn \$1,000-\$3,000 every tax season preparing returns evenings. State approved. Union Institute, Lakewood 2F, N. J.

SENSATIONAL Discovery. I can teach you to perform tasks done by electronic equipment, for profit and pleasure. Nothing required except Mystic Antenna which I supply. Complete details \$2.00. Unconditionally guaranteed. Stillwater, Box 337M, Morris Plains, New Jersey.

MASTER Watchmaking at home. Free sample lesson. Chicago School, 2328-YY Milwaukee, Chicago 47.

FINISH High School at home, spare-time. No classes. Diploma awarded. Write HF-100, 2527 Sheffield, Chicago 14.

LEARN Civil and criminal investigation at home. Earn steady, good pay. Institute Applied Science, 1920 Sunnyside, Dept. 169, Chicago 40, Illinois.

INTERESTED In sales career? Write: The Spaulding Co., Box 122, Fond Du Lac, Wis.

LEARN Tile setting at home. Free details. American Institute of Tile Setting, Box #217, Oakland 4, California.

PIANO Tuning pays. Learned easily at home. GI approved. 59th year. Free booklet. Niles Bryant School, Dept. P, 3731 Stockton, Sacramento 20, Calif.

INVESTIGATE The collection agency business. Highly profitable. Easily learned. Cole Associates, SAK Bldg., Syracuse, N.Y.

TECHNICIANS Learn speedy scientific method for manipulating screwdriver, 50¢. Veejay, Box 69, Old Saybrook, Conn.

USED Books, courses. List free. Hutch, 2409 Spiller, Fort Worth, Texas.

TIME Study. Key to positive personal profits! Associated Techniques, Box 426, Cedar Rapids, Iowa.

LEARN Asleep or awake. Self-help books, tapes, recordings. Free catalog. Drawer PM-697, Ruidoso, New Mexico.

INVESTIGATORS Trained, men-women. Fascinating, profitable profession, spare time study. Big pay. Details to open own agency any state. Free booklet. Investigator, Box 490, Times Square Station, New York 36, N. Y.

SECRET Investigations. Experience unnecessary. Investigators particulars free. George Wagner, M125 West 86th, New York City 24.

LEARN Piano tuning at home! Only \$32.95 including tools. Write Tunecraft, Box 5074-M, St. Paul, Minnesota.

PROFESSIONAL Investigators. Home study. Badge, certificate, future. Box 41197-F, Los Angeles 41, California.

LEARN Real estate business fast. Unlimited opportunities. Economical home-study course. Particulars free. Gordon-Howard Institute, 320 Glover Building, Kansas City 5, Missouri.

COLLEGE Correspondence courses, for Doctor of Psychology, Metaphysics, Divinity. Catalogue. Dr. Dorothy B. Arnheiter, Forest Park, Greenwood Lake, New York.

USED Correspondence courses and books sold and rented. Money back guarantee. Catalog free. Courses bought. Lee Mountain, Pisgah, Alabama.

HIGH School diploma at home. Licensed teachers. Approved materials. Southern States Academy, Station E-16, Atlanta, Ga.

BE A real estate broker. Study at home. Write for free book today. GI approved. Weaver School of Real Estate, 2018P Grand, Kansas City, Missouri.

WANT A diesel job? Higher pay? Advancement? We can help you qualify! Complete diesel, tractor and heavy equipment and Cummins Diesel Engine Shop-method home-training courses available. Write today. Interstate Training Service, Dept. B-3, Portland 12, Ore.

DEVELOP Mind power, personality while asleep. Use your phonograph, recorder. Amazing psychological tapes, records now available. Details free. Sleep-Learning Association, Box 24-N, Olympia, Washington.

INVESTIGATORS Course. Free information. Southwestern Institute Criminology, Dept. 1, Box 2117, Lawton, Oklahoma.

STUDY For doctor's degree of psychology, metaphysics and divinity. Correspondence courses only. College of Divine Metaphysics, Dept. P-M, 2811 North Illinois, Indianapolis 8, Indiana.

WIN Business success by writing letters that sell. New manual by expert gives you this money-making power. \$3.95 postpaid. Free literature. Christopher Helinger, Court St., East Syracuse, New York.

CAKE Decorating. Amazing new method. Details free. Decorating Institute, Box 648, Wantagh, N. Y.

SING. Speak with power. Self-training records. Amazing! Canfield, 2018-A Fifth Avenue South, Minneapolis 4, Minnesota.

EARN Degree. Free bulletin. Home-study only. Midwestern Bible School, 1060 Broadripple, Indianapolis.

BOOKKEEPERS! Increase your earnings! Operate your own simplified "Dollar-A-Week" bookkeeping and tax service. Full or spare time. Details free. No obligation. Ellis, Box 200, Cedar Grove, North Carolina.

EARN While you learn. Auto and diesel mechanics master this top paying trade. Many graduates earn \$100 a week and up. Approved for Korean veterans. For free information write Dept. No. 256, Nashville Auto-Diesel College, Nashville 3, Tenn.

PHYSICAL Therapy and massage. Home training. Practice privately or work with doctors and hospitals. Free catalogue. National Institute, Desk 4, 159 E. Ontario, Chicago, Ill.

INVESTIGATOR Training. Phillips Secret Service System, 1917-B North Kenneth, Chicago 39.

BOOKS. Free general catalog, 100 pages. Text, vocational, educational, instructional subjects. Millions of volumes, new and used. Bargain prices. Books bought. Est. 1902. Long's College Book Co., Dept. PM, Columbus 1, Ohio.

PIANO Tuning pays. Big money in spare time. Learn at home in 30 days. No musical knowledge necessary. Phonograph, records, tools and instructions furnished. Personal instructions available. Free catalog. Capital Piano Tuning School, 3160 S.W. 16th Court, Fort Lauderdale, Fla.

STUDY To be a doctor of psychology, metaphysics, divinity or philosophy. Correspondence courses only. The Neotarian Fellowship, Desk 9, Kansas City 6, Mo.

PLAYS, STORIES, MANUSCRIPTS

WANTED: Book manuscripts, all subjects considered. Greenwich Book Pub., Attn. Mr. Zealand, 489 Fifth Ave., New York City.

FREE 32 Page brochure to writers seeking a book published (fiction, poetry, non-fiction). Learn how to become a published author in five months, get 40% royalties, publicity and recognition. Write Perry Matson, Exposition Press, 386 Fourth Ave., New York 16, N.Y.

WANT Your book published? Learn how we publish, advertise, promote, distribute. Many successes. Free booklet PM. Vantage, 120 West 31, New York City. Midwest office: 320 S. Michigan Ave., Chicago, Ill.

ADVERTISING AGENCIES, LETTER WRITERS, FOR ADVERTISERS

ADVERTISE: 24 Words, 100 Canadian newspapers, \$5.50. Lists free. Advertising Bureau, 10511-C Springfield, Chicago 43.

"AMAZING New Book"—"Profits From Classified Advertising." Tells how and what to advertise. Be sure to read this book before you invest one cent in advertising. Write for your copy now. Just send 10¢ for postage and handling. W. Johnson, Classified Advertising Manager, 202 East Ontario Street, Chicago 11, Illinois.

MAILING Lists most any classification \$5.00 1000. Your circulars mailed with ours \$4.00 1000. Write for our literature. Dixie Mailers, King, N. C.

ADVERTISING. Result-getting ads prepared, placed newspapers, magazines, radio, anywhere! Lowest rates. Catalogue free. Baker Advertising Agency, 189 W. Madison, Chicago 2.

CREATIVE Advertising. Magnetic copy. Dramatic layouts. Moran Agency, Shoemakersville, Pennsylvania.

NOW Ready: New, amazing Classified Advertising Record Book—prepared especially for classified advertisers. Here is a book that tells you instantly whether or not your advertising in any publication is paying you real results. You can tell immediately how many inquiries each publication produced—how much cash received from every ad. Spaces are provided for the name and address of the publication, date of issue, space used, rate, cost of ad, key number, etc. You have a complete record of each publication right before your eyes. Plenty of space to keep accurate record of 28 separate publications. You can have a copy by sending only 10¢ to cover postage and handling. Send for your copy now. W. F. Johnson, Classified Adv. Mgr., Popular Mechanics Magazine, 204 E. Ontario Street, Chicago 11, Illinois.

CARTOONING, COMMERCIAL ART, SHOWCARD & SIGN PAINTING, TATTOOING

CARTOON Your way to success! Internationally known instructor, Raye Burns, will personally teach you to create original, salable cartoons at home. Cost of course is very low. Write for free details. Raye Burns School, Box 3583-P, Cleveland 18, Ohio.

YOU Can entertain with chalk talks. Catalog 10¢. Balda The Cartoonist, Oshkosh, Wis.

LEARN Sign painting at home. Free talent test. Ben Kerns, Box 812-PM, Greenville, S.C.

LEARN Profitable, fascinating tattooing. Illustrated information \$1. Zeis, 728-C Leslie, Rockford, Illinois

LEARN Sign painting with fascinating system. Straley, 410 S. Western, Springfield, Ohio.

BEAUTIFUL Multi-ring lifetime sketch book. Sketching, class room. Designed by professional illustrator. 50 replaceable quality sheets. Ideal gift. Free sample sheet, literature. Donahue Products, 5010 Underwood, Omaha, Nebr.

CAN'T Draw? "Cartoonizer," talentless method 50¢. Surprise included! Haphol, Route 3, 456-B, San Jose, California.

"HOW To Make Money With Simple Cartoons." A book everyone who likes to draw should have. It is free; no obligation. Simply address Cartoonists' Exchange, Dept. 912-C, Pleasant Hill, Ohio.

RUBBER STAMPS AND OFFICE SUPPLIES

RUBBER Stamps, address labels. Free catalog. Martin, 1425 Major Drive, Jefferson City, Missouri.

RUBBER Stamps, 3 lines \$1.00. Jones, Box 4244, Memphis 1, Tenn.

DELUXE Model metal pocket stamp. Your name, address, 3 lines \$2.00. J. R. Walfish Stamps-Seals, 160-30 Cross Island Parkway, Whitestone 57, New York.

INDEXED, Cushioned, 3 lines \$1.00. Franklin Printing, 4913 W. Minnesota Ave., Hales Corners, Wisconsin.

YOUR Signature—exact facsimile—hand stamp or pocket stamp \$3.00. No C. O. D. Marco Rubber Stamp, 1188 Broadway, New York 1, N. Y.

INDEXED, Cushioned, 3 lines \$1.00, 4 or 5 lines, \$1.50. Signature stamps, \$3.50. (Script, print, or old English.) Free stock stamp literature. Youngers Stamp Shop, Princeton 4, Iowa.

THREE Line rubber stamp, 1000 embossed business cards, both \$3.75. Reed Press, Mishawaka, Indiana.

POCKET, 3 Lines \$1.00. Guaranteed. W. J. Specialty, 8464 Manhattan, Detroit 11, Michigan.

FREE! Rubber stamp catalog. Many items. Campfeld, Box 798, Springfield 1, Mass.

3 LINE Handle stamp \$1.00. Free list. Stamps, Box 711, Denver, Colorado.

TYPEWRITERS, DUPLICATORS, OFFICE DEVICES

RECONDITIONED Typewriters, duplicating, printing devices, \$25.00 up. Supplies. Appliances. DixieGraph, King, N. C.

IBM Electric typewriters \$49.95. Smith-Corona electric portables \$149.95. Continental Distributing Co., Box 71, Temple City, California.

NEW, Used, electric, hand, adding machines. Miller, 505, Poteau, Okla.

RECONDITIONED Typewriters, Adding machines. List free. Woods Typewriters, Bedford, Penna.

PRINTING, MULTIGRAPHING, MIMEOGRAPHING, GUMMED LABELS

OFFSET Printing, 1000 8½x11 \$4.95. Alpine, Box 676-E, Cupertino, California.

MIMEOGRAPHING — Offset. Complete lettershop services. Samples. Pennway Drawer 1470, Scranton, Pa.

OFFSET Printing Guide, shows paste-up printing method. Make folio covers, trademarks. Has ready to use art work, designs. Contains Will Fern. \$2.00. Curtis Publications, 312 Olive, Porterville, Calif.

SEND Postcard for free samples, prices. Mayfield, Box 8011, Chattanooga 11, Tenn.

BUSINESS Cards 500—\$2.00. Randolph Press, Box 3406-A, Detroit 3, Mich.

1000 BUSINESS Cards. Raised letters, \$3.95 samples. John H. Taylor, R.D. 2, West Middlesex, Pa.

OFFSET; Mimeographing; samples, prices, free. Litho, 53 Laurie, Ft. Walton Beach, Florida.

ATTRACTIVE; Stickers, labels, circulars, cards. Samples, Fame, 291 Ellis, San Francisco 2, Calif.

FREE Business printing catalog. Samples. Howprint, 723-C Eunice, Webster Groves 19, Missouri.

1000 PRINTED 6 3/4 Envelopes, \$5.95, #10, \$7.95, postpaid. Free price list, other sizes, quantities. Karstan's, 151-39 26 Ave., Flushing 54, New York.

MIMEOGRAPHING—Letters, pricelists, formulas, instructions. Lowest prices. Lem's Letter Shop, 5710 Stanton, Detroit 8.

FREE Catalog postpaid printing, rubber stamps. DM Press, Sebastopol, Calif.

1,000 **EMBOSS** Business cards \$3.50 postpaid. Samples, Ellis, 5909 Highlandview, Sylvania, Ohio.

ADS Running under this heading sell printing. Ask me for proof. I'll gladly send you amazing facts. Ask for Folder "P." F. W. Johnson, 200 E. Ontario St., Chicago 11, Ill.

MULTILITHED Sales letters, business forms, low prices, get facts, samples. Perkins Printing Service, Fremont, Nebr.

5,000 **COLORED** Circulars \$39. Complete. Samples. Promotion, 385-MM12 Broadway, New York City 13.

COLORED Or white 8 1/2 x 11 offset, 1,000, \$5.50, \$17. Fast! Promotion, 385-MM12 Broadway, New York City 13.

1000 **NAME** And address labels, \$1.00. Variety. Box 864-M, Brooklyn 1, N. Y.

POSTPAID, Low priced printing and mimeographing. Samples. Press, Weaubleau, Missouri.

150 8 1/2 x 11 **BOND** Letterheads and envelopes \$2.95. T. D., 187 Austin, Old Bridge, N. J.

SPECIAL 1000 Calendar business cards \$3.99 prepaid, Rayborg, 810 West 18th, Erie, Penna.

BUSINESS Cards (raised letters) 500—\$2.50, C.O.D. Samples free. Picha, 27600M Joy, Livonia, Michigan.

USEFUL Surprise gifts. Social business printing. Catalog 254. S. Smith, 1938 Pine Street, Beaumont, Texas.

1500 **NAME** & address labels in plastic box \$1.00. George, PM12, G. P. O. Box 1547, New York 1.

1,000 **BUSINESS** Cards. Raised letters. \$3.95. Samples. Pioneer, PM-12 Island Park, N. Y.

250 8 1/2 x 11 **Hammermill** letterheads \$2.95. 250 6 3/4 Envelopes \$2.95. Guaranteed! Samples. Davis, 7600 Spruce Road, Baltimore 22, Md.

FREE Unusual catalog—business, personal printing, rubber stamps. Lowest prices. Barriskill, 1715 Julian, El Cerrito, California.

PRINTING OUTFITS AND SUPPLIES

FONTS For Vari-Typer \$5.00. 11x14 camera \$390.00. Murelco, 11 St. Marys, Dayton 2, Ohio.

RUBBER Stamp presses, supplies. Kiewit, 2025 Barney Road, Kalamazoo, Mich.

SAVE 40% on type cases. Manufacturer. Catalog. King McKay Company, 23179 Telegraph Road, Southfield, Michigan.

RUBBER Stamp presses, hydraulic operated, electrically heated. Sizes 5"x8", 8"x12", 10"x15". Starting outfits, supplies. Printing presses, supplies. Custom Manufacturing, 507-P N. Jefferson, Springfield, Missouri.

TYPE For rubber stamp making and printing made from hard foundry metal. Send for free 20% discount catalog. Barco Type Founders, 64 Wagner Dr., Northlake, Ill.

MAKE Your own self-molding rubber stamps and printing cuts. Plexirubber, Argyle 1, Wisconsin.

DO Your own printing. Save money. Simple rules. We supply everything. Print for others; good profit. Raised printing like engraving too. Have home shop. Details free. Kelsey Presses, V-11, Meriden, Connecticut.

PRINTING Presses, type, supplies. Lists 44. Turnbaugh Service, Mechanicsburg, Penna.

FOR INVENTORS

PROTECT Your invention. Apply for U.S. Patent. Free "Registration Form." Adren, 806 Wm. Penn Annex, Philadelphia 5, Penna.

WRITE For information regarding our dignified manner of selling your patent. Reasonable. New Products Development Company, 414 Benson Building, Sioux City, Iowa.

INVENTIONS Sold on percentage basis, searches. Model Prod., 201 W. Maple, Independence, Mo.

FREE New patent vigilance and 24-hr. patent copy ordering. Patent Searching Service, 437 Washington Building, Washington 5, D. C.

CASH Buyers waiting for good ideas, inventions. Write: Inventors Creative Service, 354 South Spring, Los Angeles 13, Calif.

SAVE Half patent expense. Free details. Product Research, Box 181, Arlington 10, Virginia.

FUN For all! Order your copy of "Inventing the Invention," today. \$4.95 post paid. Eaton Roller & Manufacturing Company, 300 North Meridian, Eaton, Indiana.

INVENTORS! Determine the patentability of your invention. Searches of the Patent Office records administered professionally for only \$8.00. For free invention protection forms and dependable service write Washington Patent Office Search Bureau, 1426 G. Street, N. W., Washington 5, D. C.

PATENT Searches, including copies of nearest patents, \$6.00. Reports airmailed within 48 hours. More than 200 registered patent attorneys have used my service. For free invention protection forms, write Miss Ann Hastings, P. O. Box 176, Washington 4, D. C.

PATENT Searchers \$6.00. 48-hour service. Free invention protection forms. Formerly with U. S. Patent Office. Write Raymond L. Smith, Patent Searcher, 620 Sheraton Building, Washington 5, D. C.

PATENT Searchers \$6.00. 48-hour airmail service. Invention protection forms free. Write patent Engineering Service, 711 14th Street, N. W., Washington 5, D. C.

OUR Sales drawings in color sell your invention. Inexpensive. Free sample. Write Starck, Wells Bldg. Milwaukee, Wis.

INVENTIONS, Ideas, patents wanted! By manufacturers. Cash, royalties. Sales promotion, invention development. George Spector, Licensed professional engineer, 3615 Woolworth Building, New York.

INVENTIONS Wanted for immediate promotion! Patented; unpatented. Casco, 703 Bernley Building, Philadelphia 7, Penna.

INVENTORS—Get the best offer first! Patented or unpatented. Write Carl Sommer, Director, Industrial Invention Sales, 3136-A Sylvania Ave., Toledo 13, Ohio.

INVENTIONS Wanted now by my manufacturer-clients. Patented, unpatented. Write Gilbert Adams, Patent Broker, 80-A Wall Street, Financial District, New York City.

WE Have the markets if you have the ideas. Harvey Engineers, Cambridge 1, Maryland.

INVENTORS: Test the commercial value of your patented or unpatented inventions, quickly and inexpensively. Write for free information. Institute of American Inventors, Dept. 40-B, 835-F St., N.W., Washington 4, D. C.

INVENTORS, Don't sell your invention patented or unpatented until you receive our offer. Write Cowgill, Box 298-A, Marion, Ohio.

INVENTORS! Consider our offer first before selling or licensing your invention on a cash or royalty basis. Patented. Unpatented. Inventions on Demand, 79 Wall Street, New York 5, N. Y.

INVENTIONS Pay inventors when profitable sales are certain from constructions soundly patented, and wise steps taken to reach the best markets. I help inventors to make the most profit with low definite fees for all services. Searches \$15. 30 years experience as patent-development engineer. U. S. and foreign patents secured. Joseph O'Brien, 132 Nassau Street, New York 38, N. Y.

INVENTIONS WANTED

INVENTIONS Needed immediately for manufacturers. For additional information write Kessler Corporation, 512-1W, Fremont, Ohio.

CASH, Royalty, obtainable for good ideas, inventions. Ketchum's Advertising, B-1058A, Springfield, Illinois.

INVENTORS, Don't sell your invention patented or unpatented until you receive our offer. Write Cowgill, Box 298-B, Marion, Ohio.

INVENTORS: Hundreds of manufacturers have requested our assistance in locating marketable new products. Complete information free. Institute of American Inventors, Dept. 40-D, 635-F St. N.W., Washington 4, D. C.

INVENTIONS Wanted. Patented; unpatented. Tremendous manufacturers lists. Global Marketing Service, 2420 77th, Oakland 5, California.

INVENTIONS Wanted: Patented, patent pending. 28 years experience promoting inventions. National Service Bureau, 3120 Meramec, St. Louis 18, Mo.

INVENTORS! Consider our offer first before selling or licensing your invention on a cash or royalty basis. Patented. Unpatented. Inventions on Demand, 79 Wall Street, New York 5, N. Y.

ARE You interested in offers from reliable manufacturers for your invention? Patented, unpatented. Harvey Engineers, Cambridge, Maryland.

INVENTIONS Wanted now by my manufacturer-clients. Patented, unpatented. Write Gilbert Adams, Patent Broker, 80-A Wall Street, Financial District, New York City.

CASH Buyers for inventions. Write National Inventors Institute, Box 4125, Washington 15, D. C.

INVENTIONS Wanted for immediate promotion! Patented; unpatented. Casco, 703 Bernley Building, Philadelphia 7, Penna.

NEW Product for sale? Patented or unpatented. Let us submit an effective presentation to national manufacturers. No fees. Commission basis. Seaboard Research and Development Corporation, Inc., Mewshaw Building, Glen Burnie, Maryland.

INVENTORS—Get the best offer first! Patented or unpatented. Write Carl Sommer, Director, Industrial Invention Sales, 3136-A Sylvania Ave., Toledo 13, Ohio.

INVENTIONS, Ideas, patents wanted! By manufacturer. Cash, royalties. Sales promotion, invention development. George Spector, licensed professional engineer, 3615 Woolworth Building, New York.

MANUFACTURING

SMALL Parts, product manufacturing, precision machining. Econo-Matic, 614E Edna Place, Covina, California.

MODELS—Small lot manufacturing. Metals, plastics, etc. Milburn, Burlington, Kentucky.

MODELS, MODEL SUPPLIES

POWER Models. Unusual steam, gasoline and traction engines, fittings, metals. Accessories as miniature Escutcheon, Cotter, Taper pins. Comprehensive, 92 page catalog \$1.00. Chas. Cole, Ventura, Calif.

ROCKET Supplies. Kits, Parts, Catalog with plans, formulas, 25¢. Central Rocket Company, Waupaca, Wis.

"POWER Drives Handbook"—36 pages illustrating many types motor drives for model autos, boats, displays, turntables, etc. Mail 25 cents cash, returnable first order \$3.00 or more. Wilson's of Cleveland, Dept. PM, P.O. Box 8995, Ft. Lauderdale, Fla.

MODEL Railroad made easy. Six month trial subscription \$2.00. Sample copy 50¢. Railroad Model Craftsman, Ramsey, New Jersey.

LIONEL Trains. Big discounts. Catalog 25¢. Mack Bros., 2043-P Chicago Ave., Chicago 22.

SHIP Models. Most complete line in New England, kits, fittings, plans, books, tools, engines, motors. Illustrated catalog 35¢. James Bliss & Co., Inc., Dept. SM, 342 Atlantic Ave., Boston 10, Mass.

ROCKET Supplies—Nozzles, cones, tubes. Specials also made. Catalog 10¢. Sky Mfg., Mineral Point, Penna.

SHIP And yacht model fittings; blueprints. Send 35¢ for illustrated catalog listing hundreds of items. A. J. Fisher, 1002-1 Etowah Ave., Royal Oak, Mich.

STAGECOACH—Accurate working drawings for authentic eighth-scale model Wells Fargo coach. Two large sheets, completely detailed, \$8.50. Ivan L. Collins, 10385 McKenzie Highway, Springfield, Oregon.

MODEL Cars run on electrified roadways. Sets, roadways, cars, motors, controls, power packs, supplies. Details free. Electromat Company, Box 13742, Dallas, Texas.

SHIP Model kits and fittings: Fishermen, clippers, frigates, schooners, brigs, tugboats. Also half-hull models for interior decoration. Send 25¢ for 1960 catalog and booklist. Model Shipways, Box 85, Bogota, N. J.

SAVE Money on model supplies. Miniature gas engine \$2.49; jet engine 49¢; 99 pc. HO train set \$10.95. Send 4¢ unused stamp for free 32 page bargain book "PM5." America's Hobby Center, 148 West 22nd Street, New York 11, N. Y.

HOME CRAFTSMEN

MOSAICS—New. Exciting display. Instructions. 1960 Catalog 25¢ (refunded). Mosaic-Arts Co., 7197-P9, Pittsburgh 13, Penna.

NEW Big illustrated catalog. Supplies for leathercraft, metalcraft and numerous small inexpensive crafts. Prompt shipments. Top values. Latest ideas. Send 10¢ today to J. C. Larson Co., Dept. 9327, 820 S. Tripp, Chicago 24.

LEATHERCRAFT. Send 25¢ for new 160-page catalog of tools, supplies, kits, including metalcrafts, enameling, ceramics, all other crafts. Complete stock Reasonable. Since 1910. Sax Bros., Dept. PM-12, 1111 N. 3rd, Milwaukee, Wis.

BUY Picture frame moldings at wholesale, actually less than cost of raw lumber. All styles and widths. Free delivery. Write for price list. Chesapeake Picture Frame Co., 511 N. Charles St., Baltimore 1, Maryland.

PLYCRAFT Makes 3-D Bird, Animal models. Sample kit 25¢. Zenith, Queens Village, N. Y.

105 **JIGSAW Patterns** plus alphabets \$1.00. Jigsaw, O'Fallon 512, Missouri.

100 **DESIGNS.** Transferable to ceramics, wood, anything! Includes Pennsylvania Dutch, modern, floral, Mexican, oriental, children's. \$1.00. Goode Knight, 4900 Madison, Chicago 44, Illinois.

GRANDFATHER Clock movements, kits, hardware, case plans \$1.50. Raymond Heckert, Box 131A Lemoyne, Penna.

CRAFTS. Free catalog. Leathercraft, mosaics, enameling, metal tooling, stamp engraving, shellcraft, floralcraft, many more. Kit Kraft 2912, Studio City, Calif.

BELT Sander. Low cost. Easily made from plans. Free literature. Gipple, 121-A Saint Petersburg 33, Florida.

101 **PATTERNS** of smart gifts, novelties, shelves, action windmills plus "Make Money Jig Sawing." \$1.00. Mastercraft, 125M, 7041 Olcott, Chicago 31.

GOLDPLATED Findings, imported rhinestones, all colors, including Aurora Borealis, free catalog. Sextons, 416 Potomac, Buffalo 13, N. Y.

EASY Plans: Spice racks, wall holders for bookmatches, stick matches, cigarettes, plates. \$1.00. H. A. Robinson, 3366 Columbia Road, Westlake, Ohio.

WOODWORKERS. Buy direct tapered legs, table kits. Send self-addressed envelope for folder. Orr's Woodcraft, Columbiana, Ohio.

KILN Dried walnut, cherry, etc., hardwoods, blocks, boards and squares. Midland Lumber Company, P.O. Box 262, Savannah, Missouri.

SKIL-CRAFTS—World's finest and largest selection of leathercraft, hobby craft, art & craft supplies. Free billfold or leathercraft kit with first purchase. Send 25¢ latest catalog. Skil-Crafts, Box 167-P, Joplin, Missouri.

FREE. New plans catalog. Make 2400 things. Fun. Profit. Craftplans, 1322-A Wabash, Chicago 5.

KNOCKDOWN Cedar chests, also over fifty kits. Catalog 25¢. Gilles Kendall Co., Huntsville 2, Alabama.

FREE Leathercraft catalog—quality kits, leather, tools. Handicrafters, Dept. P, Box 427, Montrose, Calif.

STYLECRAFT "Pretraced" leather kits. Handbags, billfolds, illigree belts. Patterns on leather. Just carve, assemble and lace. "Pre-carved" kits also available. Send 25¢ for catalog, free folder. Refunded first order. Apache Leather Company, 2804 E. Washington St., Phoenix, Arizona.

LEARN Art metalcraft and jewelry making. Complete, inexpensive, home training course now available. Special tools and materials furnished. Write for free booklet. Interstate Training Service, Dept. L-3, Portland 12, Oregon.

FREE "Do-It-Yourself" leathercraft catalog. Tandy Leather Company, Box 791-M30, Fort Worth, Texas.

WOODWORKING And cabinetmaking course for beginning and advanced home craftsmen. Only complete low-cost home training program available. Write for free booklet. Interstate Training Service, Dept. G-3, Portland 13, Ore.

FREE! Leathercraft catalog. Hundreds of new items. Write MacPherson Bros. Leather Company, Dept. E, 730 Mission St., San Francisco 3, Calif.

KNOCKDOWN Cedar chests and lumber. Free price list. Bedford Lumber Company, Shelbyville, Tennessee.

REMODEL Your own home. Save hundreds of dollars. New, amazing book shows you how. Written so you can understand it. Step by step instructions make it easy. Fully illustrated, 400 photographs, hundreds of diagrams. 160 pages. \$3.50. Literature 10¢. Popular Mechanics Press, 200-RH East Ontario St., Chicago 11, Ill.

PATTERNS. Full size. It's easy to make tables, chairs, beds, chests, shelves, workbench, toys. Santa Claus lawn designs, and many others. Illustrated circular free. Popular Mechanics Press, 200PL East Ontario St., Chicago 11, Ill.

DO IT YOURSELF

UPHOLSTERING Simplified. Instructions, samples, supply list. 25¢. Hart Company, Payne, Ohio.

MOSAICS—New. Exciting display. Instructions. 1960 catalog 25¢ (refunded). Mosaic-Arts Co., 7197-P9, Pittsburgh 13, Penna.

BUILD Genuine Black Forest cuckoo clock from do-it-yourself kit. Details, price. Pimoco, PM1407 Woodland, Pittsburgh 12, Penna.

FREE Check-list covering 340 classifications of projects, plans, instructions, service and repair information detailed in Popular Mechanics famous series of instructional booklets. These easy to follow booklets cover an extremely wide variety of do-it-yourself data on home remodeling, repair and improvement, hobbies, crafts, boating, games, lawn and garden, and hundreds of others. For your free copy of this helpful list of booklets, write: Service Bureau, Popular Mechanics, Room 517A, 200 East Ontario, Chicago 11, Ill.

BUILD Your own hydraulic ram. Irrigate free from creek. Spring water runs uphill. Booklet on rams \$2.00. Do-it-yourself blueprints \$5.00. Both \$6.00. Rams, 2258 W. Holden, Seattle 6, Wash.

TERMITES Easily controlled with my method at low cost. Inf. Swan, 211 E. 1st St., Clifton, N. J.

ELECTRIC Laminating kit. Fun or profit. \$14.95. Therm Appliance, St. Charles, Ill.

FREE "Do-It-Yourself" leathercraft catalog. Tandy Leather Company, Box 791-V32, Fort Worth, Texas.

WATCHES, OLD GOLD, JEWELRY

ELGIN Stop watches 1/5 second \$11.95. Tax and postage included. Navy surplus. Timed on watch master. Dealers prices on quantity. Mitchell's Jewelry, 705 Broadway, Oakland, California. TW 3-6062.

WATCH And clock repairing books. Free catalog. North American, 2320-AN, Milwaukee, Chicago 47, Illinois.

SUPPLIES To make costume and sea shell jewelry. Free catalog, designs, instructions. Modern Craft, Box 11088-JK, Saint Petersburg 33, Florida.

LADIES', Men's new 17 jewel Swiss wrist watches \$9.99. Precise, Box 6164, Seattle.

50% DISCOUNT On 10,000 jewelry gift items. Send for our 140-page full-color "encyclopedia." Only 50¢ deductible from first order in any amount. Regent Lapidary, Dept. PMC-1, 511 East 12 Street, NYC 9, N. Y.

COSTUME Jewelry supplies, settings, rhinestones, etc. 88 page illustrated catalog. 30¢. Milady, Box 1328, G.P.O., New York City.

10 SWISS Watches \$18.00. Catalog 25¢. Berkowitz, 1150 Castle Hill, New York City 62.

FREE Catalog. Costume jewelry parts. Supplies. Reasonable prices. Fast service. Guaranteed quality. Unique merchandise. Polson's, Box 52, Medford 55, Mass.

GOLD, Silver, platinum, diamonds, jewelry, watches, silverwear, gold teeth, coins. Highest cash immediately, free information. Wilmot's, 1067A Bridge, Grand Rapids 4, Michigan.

SWISS Watches from importer, \$2.95 up. Catalog. Transworld, 565 5 Ave., New York City.

WATCHMAKERS Journal contains watch repairing instructions. Sample copy 25¢. Box 3218-M, Daytona Beach, Fla.

RAZORS, BLADES, SHARPENING

SAVE On good razor blades! Free details. North Star Products, Box 112-DM, Cedar Grove, New Jersey.

TOBACCO, SMOKERS' SUPPLIES

CIGAR Smokers! Factory-fresh cigars at savings! Same quality as top-selling 10¢ cigars. Millions sold since 1918! Send 25¢ for 3 samplers; \$3 for box of 50; \$5.50 for two boxes factory-fresh cigars, post-paid. Money back if not completely satisfied. Order now! Dept. E, Menendez Cigars, 6416 Michigan, St. Louis 11, Mo.

FOR THE HOME

LIFEGUARD Fire alarm automatically sounds siren at fire temperature. \$3.95. Particulars free. Cappozzoli, 237 Fourth, Jersey City 2, New Jersey.

FOAM Rubber furniture cushions. Factory seconds. 50% discount. Free catalog. Perma-Foam, 390-C Nye Avenue, Irvington, N. J.

OF INTEREST TO WOMEN

SELL Fine fabrics. Get yours wholesale. Box 863, Norwalk, Conn.

\$100.00 PRIZE. Doll dressing contest. Box 333 Staten Island 1, N. Y.

50 VALENTINES Only 25¢. Make biggest money showing friends best greeting card sellers for every occasion all year—Mothers, Fathers Day, Easter, birthday, everyday assortments. Gifts, stationery. Samples on approval. Send 25¢ for valentine special. Midwest, 1113 Washington, Dept. 650-R, St. Louis 1, Mo.

HOUSEWIVES, Teachers, students, office workers, if you need extra cash each week but household or other duties prevent you from taking a part-time job, learn how you can earn by accepting orders to Popular Mechanics. Good Housekeeping and all other magazines. No experience needed. Write Popular Mechanics, Room 12W, 250 West 55th St., New York 19, N. Y.

DISTINCTIVE Gifts—household items. Catalog free. Rayborg's, 810 West 18th, Erie, Penna.

"8 MISTAKES Parents Make." Every parent should have this new book about child training. It is free; no obligation. Simply address Parents Association, Dept. 6712, Pleasant Hill, Ohio.

PERSONAL

LOANS By mail. \$50 to \$600 for any purpose. Employed men and women eligible. Confidential. 2 years to repay. Write for free loan application. American Loan Plan, City National Bldg., Dept. PM-12019, Omaha 2, Nebraska.

YOUR Handwriting reveals you! Handwriting analyzed by Certified Grapho Analyst plus illustrations of how. \$1.00. Marvin Wilson, Jamestown, Alabama.

PIRE Department greeting cards. 25 assorted \$2.50. Hobby Mats, Balsam Lake, Wis.

"BORROW By Mail" \$100-\$600. Anywhere. Air mail service. Postal Finance, Dept. 17-X, 200 Keeline Building, Omaha 2, Nebraska.

HEALTHY Nutrition. A diet of fresh juices will supply vitamins and minerals. Learn how. Kenco, 1720 N. California, Chicago 47, Illinois.

KNOW Exact day of week of your birth, marriage or other events. New copyrighted fascinating system, covers all ages. Send \$1.00 to Calendar, Box 5401, Corpus Christi, Texas.

YOU'RE Never too young to make your will. Save attorney's fees now, protect loved ones later! Mail \$1.00 (two for \$1.50) for "Last Will & Testament" form. No better protection available when witnessed. Lewisco, 144C Roberts, Glenside, Penna.

MYSTIFYING! Tell day of week, any date, in seconds, mentally. Self-addressed stamped envelope and \$1. Winsett, Box 269, Key Largo, Florida.

REMAILS 25¢, Monthly \$3.00. Secret, prompt receiving-forwarding. Steelmaster, Box 524, Findlay, Ohio.

BIBLE Questions answered. Stamped envelope. Bylon, 17167 Bentler, Detroit 19, Michigan

VITAMINS—Send \$1.00 for special introductory 90 day supply Multi-Vites. Similar formulas cost \$3.00 retail. Free catalogue guide-book included. Vitamins, Box 4435-A, Philadelphia 40, Penna.

REMAILING SERVICE

JUAREZ, Mexico, remails \$1.00. L. H. Batton, Box 445, Fabens, Texas.

REMAIL From aviation birth-place 25¢ letter. \$3.00 monthly. Campbell, 130 E. Dorothy Lane, Dayton 19, Ohio.

COLORADO Springs remails 25¢. Monthly service \$3.00. John Green, Box 2353.

CAPE Canaveral remails. Letters 25¢. Port Canaveral postmark. P.M. 661 Brevard Ave., Cocoa, Fla.

RENT A confidential remailing, receiving-forwarding address. Details free. William McLaughlin, 800 Stewart, Columbus 6, Ohio.

REMAILS Lafayette, La., 25¢. Mary's, 205 Downing St., Lafayette, La.

HOLLYWOOD Remails 25¢, \$2.50 month. Econo-matic, 614E Edna Place, Covina, California.

MIAMI Remails 25¢. Monthly \$2.00. Classified \$1.00. Webco, Box 42-629, Miami 42, Fla.

CONFIDENTIAL Remailing, 25¢. Monthly, \$2.00. A. Bursleson, Box 5464, Dallas, Texas.

REMAIL 25¢. Receiving and forwarding monthly \$3. Pronto, P.O. Box 118, Miami Beach 39, Fla.

MEXICO Re-airmails \$1.00. Write: Traveler, Sto. Domingo 13, San Miguel Allende, Gto., Mexico.

HONOLULU Remails, \$1.00. Replies forwarded. Dennis, Box 1581, Waipahu, Hawaii.

FLORIDA Remails 25¢. Souvenirs, etc. William Bennett, 14040 N.E. 12 Ave., Miami, Florida.

FABENS, Texas, remails 25¢, receiving, forwarding system. Complete mailing service \$3.00 monthly. L. H. Batton, Box 445, Fabens, Texas.

SECRET Mail receiving-forwarding system. \$4 month. Hedgpath, Box 830, Alhambra 23, California.

MEXICO Re-airmails \$1.00. Replies forwarded free. Apartado 2042, Guadalajara, Mexico.

LETTERS Mailed 25¢; forwarded 30¢. Stella M. Lumsden, East 11 Pacific Ave., Spokane 3, Wash.

REMAILS Forwarding 25¢, monthly \$3.00. Lee, Box 6186, Corpus Christi, Tex.

REMAILS—From North Pole, Alaska, 25¢. H. Daniel, P.O. Box 1412, Fairbanks, Alaska.

CANADIAN Confidential mail forwarding receiving system. Two plans. Details free. Thomas Wanless, 852 Seven Oaks, Victoria, B. C.

TREASURE FINDERS

METAL Locator kits and assembled models from \$39.90. Transistorized and underwater models available. Free catalog. Electronic Applications, Dept. M, Box 8, Arlington 10, Virginia.

MONEY For you in buried treasure. Coins, gold, silver can be found with Goldak transistorized locators. Five models including underwater locator, priced from \$79.50. Free literature. Authentic books of known treasures available. Goldak Company, 1541 West Glenoaks Blvd., Glendale, California.

TREASURE! Map, handbook 25¢. Locators. Howe, 811 Kansas, Atchison, Kansas.

445 TREASURES, United States map 2x3 feet, plus catalogue. \$1.00. Foul Anchor, Rye 2, N. Y.

TREASURE! Buried coins, gold, silverware, relics. Transistorized M-scope locates them! From \$59.50. Easy terms. Free catalog. Fisher Research, Dept. C-1, Palo Alto, Calif.

GOLD-Silver detectors. Geiger counters. Violites for tungsten, etc. Best available. Guaranteed. Information free. Detectron, Dept. 24, Sylmar, Calif.

FOR SALE—MISCELLANEOUS

HEARING Aid batteries, wholesale. Free list. Habs, Box 51, York, Penna.

CLOSE-OUT Imported alarms. New merchandise. Fire or burglar, battery operated, very loud. Useful pocket, purse items. Adding machine, also subtracts. Check protector, protects names, amount. Alarm scares off boldest thief, molester. Binoculars. Any item mentioned \$1.00 postpaid. Harold Balaity, 401 Durfor, Philadelphia 48, Penna.

MIRROR—Transparent back. Watch, photograph people, secretly! 8"x10", \$2.00; 16"x20", \$5.00. One-Way Mirror, PM1259, Box 625, Mt. Vernon, N. Y.

FOR Sale. Portable, patented burglar alarm and door or window stops. F. E. Mitchell, 1403 Ruth Ave., Walla Walla, Wash.

WANTED—MISCELLANEOUS

QUICKSILVER, Platinum, silver, gold. Ores analyzed. Wholesale Terminal, Norwood, Mass.

MISCELLANEOUS

FREE Listings—Buy or sell through Southwestern, 1306 South Darlington, Tulsa 12, Oklahoma.

CIGARETTES: Make 20 plain or filter-tips for 9¢. Facts free. Moberly, Box 915, Owensboro, Kentucky.

BOOKS On antiques and their prices. Free circular! P. Warman Publishers, Uniontown, Penna.

100,000 PRODUCTS Wholesale—Free catalog! Send postcard: Econ-O-Mart, Whippany 15, New Jersey.

YOUR Name wanted. We'll send 1000 publishers, mailers, wholesalers your name, on our list one year 25¢. Dixie Mailers, King, N. C.

MONEY Making and saving catalogue. Write: Adams, PM 210 5th Avenue, New York 10, New York.

SUPER Memory overnight! Success guaranteed! Bijou, Box 1727-M, Hollywood 28, California.

ORNAMENTAL Iron designs. Book of 1700 beautiful, practical designs for railings, columns, etc. Free literature. Cunningham, 3881 South 3200 West, Salt Lake City 4, Utah.

OLD Original 1903 desk telephones. Working order, oak crank ringer, box included. \$5 each, f.o.b. Telephone Company, Turtle Lake, Wis.

WOOL Caps. Colorful; handknitted. S-M-L-sizes. \$1.50 each. 3/\$4.00. Woolens, Box 9, Atchison, Kansas.

ENGRAVED Name plates 5 x 1 1/4 white letters on black glossy Bakelite ready for mounting \$1.00 postpaid. Maximum 15 letters. Art-Ray, Box 618, Riviera Beach, Fla.

RECEIVE Interesting world-wide mailings. Listing, 25¢. Malloservice, PMM, Bronxville, New York.

FABULOUS Feather Christmas and greeting folders! Dozen assorted \$1.95. Sample folder, artistic catalog and papaya seeds 35¢. Mexicana, 1104, Calexico, Calif.

GET Samples, opportunities, magazines, catalogs, offers galore! Your name in 500 big mail directories, 25¢. Results guaranteed. King's Moorestown, Ontario, Can.

BE A clown. Profitable. Fun. Free details. Wheeler, Box 7755, Washington 4, D. C.

SEND For your booklet of imported gifts. Treasure Caravan, 1647 So. Beverly Glen Blvd., Los Angeles 24, Calif. Studio one.

AMAZING Beverage cooler for picnics, fishing, traveling. Keeps six cans of beverage cool up to 10 hours without ice. Postpaid \$2.98. Cooler, Box 125, Reseda, California.

PIONEER Covered wagon lamps. Natural wood finish replicas. Red, green, brown or yellow cloth tops. 15" long, \$14.95, or two \$25.00. No c.o.d.'s. Ed's Shopping Service, 1505 1/2 Chestnut St., Paso Robles, Calif.

RECEIVE—Magazine samples, mail offers, bargains from everywhere. Get listed 25¢. Rorick, Cincinnati 26, Ohio.

FIFTY Personalized iron-on clothing labels. Send dollar. Sly's, 4381-PM Lake, Rochester 12, N. Y.

NEW 2-Part Epoxy chemically bonds anything permanently, even glass and metal. Small amount of "2-weld" goes a long way. Amaze yourself with what you can repair. Complete kit, \$3.00, postpaid. Money-back guarantee. Send cash, check or money order to Department K, Rowell Products, 752 Vandavia, St. Paul 14, Minnesota.

MEN! Perfect Christmas gift for your wife! Driving tips from qualified instructor. No more bent fenders! \$1.00 to Bolen, Box 1824, St. Louis 12, Mo.

HOW To become successful in selling. Send \$1.00. Marsan, 520 Patton, San Jose, Calif.

EXTRA Sensory perception, divining rod, pendulum, earth radiation. Concern you. Startling information free. Radiesthetic Research, Dept. B, P.O. Box 41222, Los Angeles, California.

NAME-Brand bargains. Free catalogue. Falco, 1024 Eureka, Lansing 12, Mich.

GROUND Effect vehicle plans 7 views, photos \$5.00. Aeromobile, Neponset, Illinois.

EPOXY Adhesive kit \$1.50. Sunset Research Laboratories, Box 6117, Seattle 88, Washington.

RECEIVE Mails, magazines, samples. Your name in numerous mailing lists 25¢. Greenwood, Box 1116-KE, New York City 8.

WILD Animal trophy heads. Ready for hanging, \$2.98. Layne's, 6950 Gage-6, Bell-Gardens, Calif.

2,500 GUARANTEED Mails, offers, 25¢. Mails, 4158 Calhoun, Gary, Indiana.

LATEST Information bulletin, literature free. Leaver, 1216 1/2 Scott, LaPorte, Indiana.

PATTERNED Hawaiian styles! 100 pictured designs, 50¢, applicable first purchase. Thrifty Tutu, Box 417-M, Kaneohe, Hawaii.

JAPAN: Buy direct-mail order. kimonoes, dolls, etc. 24 page catalogue, manufacturers' names, addresses. Send \$1.00. Clarence Yamagata, 202 Naka 7, Bldg., Marunouchi, Tokyo.

VOICE Caster. Transform phone into intercom. Costs pennies to operate. Literature free. Lewis, 113 1/2 A East Alondra, Compton, California.

FREE Christmas gift catalog. Klemm's, 411 E. Thomas, Seattle 2, Wash.

70 BIBLE Lessons, 25¢. Bulletin, Box 87, Cathedral Station, New York City 25.

LET Us tell you how to turn the reading habits of your friends into profit for you. \$10.00, \$25.00 or \$50.00 can easily and quickly be made under our Popular Mechanics subscription plan. No experience needed. Write Popular Mechanics, Room 12M, 250 West 55th St., New York 19, N. Y.

DATE Finder & calendar for any day, week, month. 200 years 1800-2000. 25¢ each. Novelty Calendars, P.O. Box 626, Norfolk 1, Virginia.

SKYSCRAPER-Heel shoes! Photo catalog, \$1.00. Pincraft, Box 442-R, Hollywood 28, Calif.

Want **BIG PAY**—
Your Own Business?

Be a LOCKSMITH



You can quickly step into a well-paid job or start a big-profit business of your own. Shortage of locksmiths means opportunities everywhere, spare-time or full-time.

EARN EXTRA MONEY FROM THE START!
All Special Tools, Supplies Furnished Free

Age, education, minor physical handicaps don't matter in this growing, steady-income trade. You learn fast at home—gain practical experience through well-illustrated lessons. You do real jobs under the personal guidance of experts. Only school of its kind. Licensed State of N. J.; Accredited Nat'l. Home Study Council.

For a future as your own boss, or in a big pay job, send for FREE illustrated book. Mail coupon at once. No salesman will call. **Approved for Veterans.**

Locksmithing Institute, Dept. 112-9,
180 Park Ave., E. Rutherford, N. J.



Please send **FREE** and without obligation illustrated book.

Name _____

Address _____

City _____ Zone _____ State _____

AMAZING NEW TOOL MAKES YOU AN EXPERT!!!

Turn, Carve Wood. Engrave Metals, Plastic, Etc.



PROFESSIONAL WORK VERY FIRST TRY. So simple a child can operate it. All this from easy to make templates with the Amazing **TURN-O-CARVE TOOL**. It's FUN, PROFITABLE, FASCINATING. Send \$5.50 deposit for 8mm color, ACTION packed demonstration movie film. Deposit refundable, 50c for handling. SEEING IS BELIEVING. Send TODAY for FREE folder and Price List.

TURN-O-CARVE TOOL, INC., Dept. A-1259
3227 Fairmount Ave., San Diego 5, Calif.

\$24.95 Dacron Insulated Undersuit

★ Keeps you warmer in 67° Below!

★ For Hunters, Outdoor Workers, Policemen, Farmers, Men Over 35!

888



Mr. needed cash to pay back bills. Thoresen's came thru with gigantic order at far below usual wholesale. Result? You get \$24.95 Dacron Insulated 2-pc. undersuit for only \$8.88. Featherweight—yet keeps you warmer than bulky, itchy wool underwear. Shrinkproof. Washable. Won't mat or bunch. Moth-proof. Can be worn in normal room temperature. 500,000 undersuits sold! Small, Medium, Large, Extra Large. No. 333 Thoresen Undersuit \$8.88 plus 67c postage. TOTAL: \$9.55. Prompt delivery. COD's \$1 deposit. Money back guarantee.

Super Special! Deluxe Triple Gard Model only \$1.39 more. Multi-Cellular, tripler layer insulation. Order by No. 333-D \$10.94 complete.

THORESEN, Inc., Dept. 6-N-333
585 Water Street, New York 2, N.Y.

Finish HIGH SCHOOL AT HOME

Complete 4 Yrs. in 12 Months

Learn More! Earn More! Enter professional or technical schools. Advance Socially. Live a Happier, Fuller Life. Individual Courses or complete schedule. **WRITE FOR SCHOOL BULLETIN.**

ACADEMY FOR ADULTS

30 W. Washington, Dept. PM-129, Chicago, Ill.

STUDY TO BE A DOCTOR

of Psychology or Metaphysics

Obtain a Ph.D., Ms.D., or Pl.D. Be a Teacher, Lecturer or Accredited Practitioner. Teach others how to achieve Health, Happiness and Contentment. Chartered by State. Correspondence Courses only. Write for FREE book telling how.

THE NEOTARIAN FELLOWSHIP

Desk B, Pickwick Building Kansas City 6, Missouri

YOU NEED THIS

FREE GIANT 1960 B-A CATALOG

A Complete Buying Guide for Everything in

RADIO 1960 TV ELECTRONICS

BA
ANNUAL CATALOG 601
SINCE 1937

204 KING-SIZED PAGES

EVERYTHING IN RADIO TV AND ELECTRONICS

100'S OF NEW ITEMS LISTED HERE FOR 1st TIME

21 PAGES OF BARGAINS NOT IN ANY OTHER CATALOG

BURSTEIN-APPLEBEE CO.

Dept. PM, 1012 McGee St., Kansas City 6, Mo.

Send Free 1960 B-A Catalog No. 601.

Name _____

Address _____

City _____ State _____

SEND FOR IT TODAY



Rome Plow Company, Cedartown, Georgia.

Disk Plowing Harrow Irons Out Rough Roads

Oil roads in need of repair are inexpensively resurfaced with a disk plowing harrow that cuts up road material into easily blended small pieces. Successfully applied to a street in Springfield, Ill., a motor grader scarifier first ripped the oil road. One or two passes by the plowing harrow reduced the surface to small pieces, which were then bladed with the grader and rolled to specified smoothness. When the temperature is above 70 degrees, an oil road can be cut directly with the harrow.



OFFICIAL SPREAD EAGLE SHIELDS Silver or Gold

Finest quality with reinforced backs and pins for heavy duty. A quick flash of one of these gleaming, official-looking badges instantly shows who has the power! Your choice: Special Officer, Deputy Sheriff, Constable, Watchman, Sheriff, Police, Special Police, Private Detective, Civilian Defense, Special Investigator. Standard Size: \$1.98. Miniature: \$1.25.

SPECIAL OFFER! FREE! — Authentic Badge Carrying Case FREE with each badge.



REGULATION POLICE HANDCUFFS

With New, Exclusive CUFF-STOP

Latest type—features exclusive Cuff-Stop that locks handcuffs automatically. Made of hard-tempered steel with jewelry polished nickel surface. Fitted with 2 tamper-proof locks that only matching key will open. Used internationally by Law Enforcement and Private Detective Agencies. \$7.95. Deluxe Leather Cuff Case: \$2.75.

All prices postpaid. SATISFACTION GUARANTEED. Send cash, check or money order and save C.O.D. charges. \$1.00 deposit with all C.O.D. orders.

BIG THREE ENT., INC.

1109 Sixth Ave., N. Y. 36, N. Y.

Dept. **PM-12**

40x-360x5 inch portable telescope. 8950

Carries like a briefcase.

A precision instrument for professional and amateur alike.

Full axis mounts.

Azimuth calibrated circles.

7X finderscope.

Combination rack and pinion.

No stamped parts.

Approximately 27 lbs.

Starlight Instrument Co., 1128 Madison Ave., Paterson, N. J.



HOW to
BREAK
and
TRAIN
HORSES

SEND FOR THIS **FREE!**

Make money. Know how to break and train horses or ponies. Write today for this book FREE, together with special offer of a course in Animal Breeding. If you are interested in Gaiting and Riding the saddle horse, check here (). Do it today—now.

BERRY SCHOOL OF HORSEMANSHIP
Dept. 11012 Pleasant Hill, Ohio

SIGN PAINTING

Home-Study Course — Only \$5.95

Teaches you commercial sign painting and sign building as it is being done TODAY in leading shops all over the country. Complete practical course for self-instruction. Shows latest methods of truck lettering, office doors, wood letters, reflecting signs, plastic, sprayed signs, gold leaf, silk screen process, up-to-date alphabets, money-making business information, etc.

SATISFACTION GUARANTEED OR REFUND!
Contains all the instruction of a high-priced correspondence course. Full price, only \$5.95, postpaid. Or C.O.D. plus postage. No risk—order today. Satisfaction or money back! Order "Sign Painting Course." NELSON-HALL CO., 210 S. Clinton St., Dept. 2 MR-2, Chicago 6, Ill.



Secrets of VENTRILOQUISM Now Revealed!



Easy to learn in 60 to 90 days with our Home Study Course. **RESULTS GUARANTEED.** Make Money! Be Popular! Have Fun! Big Opportunity! Radio, Television, Stage Appearances! For FREE information regarding price and terms WRITE. You must state your age. Dummy Catalog 25c.
MAKER HOME COURSE OF VENTRILOQUISM
Box 36, Studio PM-12, Kensington Station
Detroit 24, Michigan

TRAIN AT HOME

in Your Spare Time or in the Great Allied School

1338-42 South Michigan Ave.
Chicago 5, Ill.

DRAFTING—All Branches
• Mech. • Structural • Aeronautical

ENGINEERING
• Industrial Engineering
• Tool Engin. & Designing

ELECTRONICS

AUTO MECHANICS

AIR CONDITIONING
Refrigeration — Heating & Cooling

TOOL & DIE MAKING
Machinist Trade

Choose the Allied Way for Best Pay

SEND FOR **FREE** BOOKS

Prepare for the best jobs in your spare time at home. With ALLIED'S practical home study program you can progress so rapidly that big new opportunities will soon be open to you. Students planning a career in engineering can begin their training in short courses at Home or at Allied Institute and continue progressively toward an Engineering Degree in 31 months. Allied is approved by Industry, National Home Study Council, Department of Education, Office of Public Instruction, State of Illinois, U. S. Department of Justice.

ALLIED INSTITUTE OF TECHNOLOGY,
1338-42 South Michigan Ave., Dept. PM-129, Chicago 5, Ill.
Send me without obligation information on your courses:

- | | |
|---|--|
| <input type="checkbox"/> MECHANICAL DRAFTING | <input type="checkbox"/> AUTO MECHANICS |
| <input type="checkbox"/> STRUCTURAL DRAFTING | <input type="checkbox"/> ELECTRONICS |
| <input type="checkbox"/> ELECTRONIC DRAFTING | <input type="checkbox"/> AIR CONDITIONING |
| <input type="checkbox"/> AERONAUTICAL DRAFTING | <input type="checkbox"/> REFRIGERATION |
| <input type="checkbox"/> INDUSTRIAL ENGINEERING | <input type="checkbox"/> TOOL & DIE MAKING |
| <input type="checkbox"/> TOOL & DIE DESIGNING | |
| <input type="checkbox"/> HOME STUDY | <input type="checkbox"/> RESIDENT |
| <input type="checkbox"/> VETERAN | <input type="checkbox"/> NON-VETERAN |

NAME AGE.....

ADDRESS

CITY..... COUNTY..... STATE.....

Join the jets WITH HUMBOLDT'S RADIO AND CONTROL TOWER TRAINING!



Picture yourself in the airport control tower—guiding the pilot to his safe landing! Today there is an urgent need for well-paid, trained control tower radio operators—and in just 16 weeks of training at the new Humboldt Institute, you can be ready for this key job in the country's fastest-growing industry.

JOIN THE JETS—FREE NATION-WIDE EMPLOYMENT SERVICE. Mail coupon for facts—no obligation. (Please print)



HUMBOLDT INSTITUTE 2201-P. Blaisdell Ave., Minneapolis 4, Minn.

NAME _____ AGE _____
ADDRESS _____ PHONE _____
CITY _____ STATE _____

GOV'T SURPLUS BARGAINS for 2 or 3¢ on the \$1.



You BUY DIRECT from U. S. GOV'T at AMAZING savings. Our DIRECTORY lists 100's Surplus Depots. Buy JEEPS, trucks, cars, boats, planes, tools, mach., tents, furniture, pumps, generators, compressors, motors, typewriters, etc.

Send \$1.00 TODAY for list and instructions to: AVIATION SURPLUS, Dept PM-12, Box 789, York, Penna.

FINANCIAL HELP TO START YOUR OWN HOME BUSINESS!



Tired of being squeezed between rising prices and a stationary salary? Could you use a nice little home-business to bring in extra income from your spare time, evenings and week-ends? I can show you how—will even help finance you, if you're short of cash. Sound unreasonable? Wondering how I can afford to do it? Well, it's simple. The business I'm talking about uses supplies. I make and distribute those supplies. So do other firms—but I'm willing to gamble that when your business gets rolling you'll rather do business with a friend than with strangers who did not show up until you were in the money. I've gambled the same way with hundreds of others, and it has paid off by helping me build the biggest business of its kind in the world! The Golden Rule of "do unto others..." always works for those who give it a fair trial.

What is this business? It's printing without a press, an amazing process I call "Screen Print." With it, you can turn out printing in gorgeous coloring that many big shops cannot duplicate, even with presses costing thousands of dollars! Yet my equipment (supplied to you with my instructions) weighs only a few pounds, can be set up on a small table in the corner of your garage, basement, attic, or even a bedroom. You can earn in a few hours to print on paper, metal, glass, plastic, leather, cloth, and about anything you can name—even on curved or round surfaces that ordinary printing presses cannot handle at all! And I show you how to get big-profit orders from stores, factories, theatres, schools, and practically every type of business or organization for miles around—even by MAIL ORDER coast to coast.

JUST SEND ME YOUR NAME & ADDRESS—NO MONEY

Remember, I'll help finance you, so don't worry about the money—whether you are employed or not. I'm sure I can help you get set in a home business that may settle your money problems forever. Just send name and address for FREE information, without obligation. TODAY SURE.

Mr. C. J. Nowak, President, Screen Print Co., Dept. 212, 15127 S. Broadway, Los Angeles 61, California

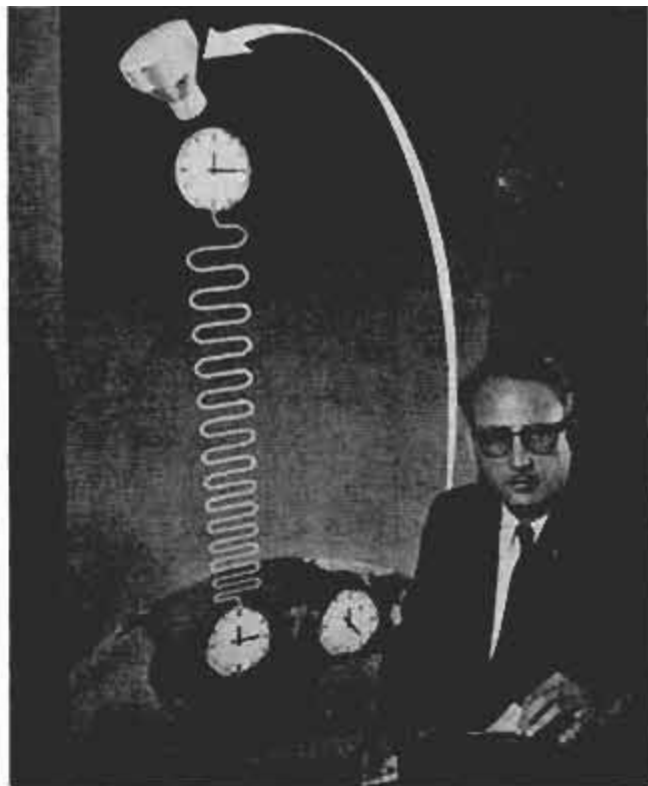

Will Atomic Clock Gain Time Ticking Through Outer Space?

Hughes Aircraft Company is building a 30-pound atomic clock—it looks like a foot-long electron tube—to test Einstein's theory of relativity by ticking an astounding 24-billion times a second through space. Accurate to one second in 1000 years, the clock, orbiting in a satellite, should prove Einstein's proposition that a clock running in a different gravitational field above Earth would apparently run fast, relative to a clock on the ground.

According to theory, the satellite clock should run slow compared to a ground clock, for orbits below 2000 miles, and fast for orbits above. At a height of 8000 miles, for example, the orbiting clock should be a second faster after 60 years. Dr. Harold Lyons, director of the Hughes' project, explains that the clock works by housing ammonia molecules. These contain nitrogen atoms that bob up and down, or "tick," emitting radio waves at a frequency of 24 billion times a second. The "ticks" are counted by a frequency divider, just as the hands on a wristwatch count and translate the ticks of its balance wheel in seconds and minutes. These slower units then would be radioed to earth and times compared with a duplicate atomic clock. Because accurate measurements of the relativity predictions can be made during a satellite flight of three weeks, the clock is being built with a lifespan of 500 hours. It can also be used to measure the geometric shape of Earth, and to measure velocity of light or radio waves.

40 TO 640 ACRE TRACTS STATE GOVERNMENT LANDS

LOW AS **\$2.** ACRE **NO BUILDING REQUIRED**

NO HOMESTEADING NECESSARY

MIN. OFFER

PIONEER RANCH SITES LOW AS **\$10. \$10. DOWN MONTHLY**

California & Oregon Farm, Ranch Timber Tracts, Creek & Lake Front Hunting-Fishing Lands. Easy Terms Some with Cabins, Old Houses, etc.

WRITE FOR **FREE BOOKLET** on available lists & maps of other U. S. & So. American lands

Pioneer Ranches Inc.

6228 Sunset Blvd., Dept. 9
Hollywood 48, Calif.
OL 4-2315 or WG 4-2611



Sorry no COD Full Money Back Guarantee

Genuine Postage Stamps

Permanently Laminated in Plastic
Your Choice of U. S. or Foreign

Cuff Links\$3.00
Earrings\$3.00
Brooch\$3.00
Tie Bar or Tack\$3.00
Pendant and Chain\$4.00
Charm Bracelet (3 Stamps)\$4.00
Anklette\$2.50
Sterling Silver\$2.50

EDWARD'S, P.O. BOX 167PM, BROOKLYN 15, N. Y.

\$3.25 OR 2 FOR \$6.00!

With 40 ft. of wire. Additional wire 3c ft. **TESTED AND GUARANTEED.** Write for free list of all types of telephones. Shipments FOB Simpson, Pa.

TELEPHONE ENGINEERING CO., Dept. 1289, Simpson, Pa.

WOULD YOU DO THIS IF ATTACKED?

80 MODERN INDIVIDUAL LESSONS ON LETHAL JUDO

Defend or attack with scientific "know how". Lessons packed with pictures, charts, etc. Armed & unarmed attack & defense. Nerve center pressure points, unbreakable holds. 80 lesson professional course by return mail. **ONLY \$3**

(MONEY BACK GUARANTEE)

OXFORD STUDIO 44 Bromfield St., Boston, Mass.



START NOW — EARN TOP PAY

Graduates in Auto Mech., Diesel Mech., Welding, Body & Fender, Refrig., Air-Conditioning, and Mach. Tool & Die earn highest pay. Train in the largest trade school in the world. Day—evenings—part time. Free Placement assistance while training and after graduation. Veteran Approved.

GREER shop training

Write for details. Box L

2236 S. Michigan Ave., Chicago 16, Ill.

HOME STUDY can open the door to a **BETTER JOB** at **BIGGER PAY** for YOU

TODAY, CHOOSE YOUR CAREER! Then take the first easy step toward preparing for the goal you can reach *in spare time at home.* Or, if you are in work you like, learn how you can earn quicker promotions and bigger pay. For 62 years AMERICAN SCHOOL has helped many thousands of ambitious people succeed. Think seriously about the subjects listed. Fill in and mail coupon today.

AMERICAN SCHOOL, Dept. G945, Drexel at 58th, Chicago 37, Ill.

Without obligation, send FREE information on the subjects I have checked.

<input type="checkbox"/> Accounting	<input type="checkbox"/> Contracting	<input type="checkbox"/> Mechanical Engineering
<input type="checkbox"/> Apprenticeship Courses	<input type="checkbox"/> Diesel Technician	<input type="checkbox"/> Mechanical Technology
<input type="checkbox"/> Architecture & Building	<input type="checkbox"/> Drafting—Building Trades	<input type="checkbox"/> Metalworking Courses
<input type="checkbox"/> Automotive Technician	<input type="checkbox"/> Drafting—Machine Trades	<input type="checkbox"/> Plumbing—Practical
<input type="checkbox"/> Better Foremanship	<input type="checkbox"/> Electrical Engineering	<input type="checkbox"/> Private Secretary
<input type="checkbox"/> Blueprint Reading	<input type="checkbox"/> Electricity—Practical	<input type="checkbox"/> Retail Merchandising
<input type="checkbox"/> Bookkeeping	<input type="checkbox"/> Electronics—Industrial	<input type="checkbox"/> Salesmanship—Outside
<input type="checkbox"/> Business Management	<input type="checkbox"/> HIGH SCHOOL COURSES	<input type="checkbox"/> Sheet Metal Work
<input type="checkbox"/> Civil Engineering	<input type="checkbox"/> Machinist	<input type="checkbox"/> Tool Making

NAME _____ OCCUPATION _____ AGE _____

HOME ADDRESS _____ CITY _____ STATE _____

Accredited Member NATIONAL HOME STUDY COUNCIL

FORTUNES IN DIVING

Train at Home in Spare Time

Write Today for Amazing Free Booklet

Here is one of the greatest opportunities of our time. Make big money fast in Skin and Lung Diving. Trained divers needed in hundreds of industries and by government. Build a successful business of your own. Hourly rates among highest paid in any field. Training program by E. R. Cross, world famous master diver. Get the facts now. Mail coupon for **FREE BOOKLET TODAY!**

DIVEMASTER, Dept. PM-129
5637 W. 63rd Place, Chicago 38, Ill.

Send me free information about Diving.

Name _____ Age _____

Address _____

City _____ State _____



\$3.00 post-paid **Special Offer** **Factory**

NEW WESTERN HAIG

USES 4.4 MG. POWDER CHARGE

This small bore gun shoots .12 cal. lead bullets fired by small 4.4 mg. powder charge. Not a CO₂ gun! You'll like the handsome lines, grip, and balance. Western in style, but patented ball and cap action allows this low price. 9 3/4" steel barrel cased in knurled styrene stock, overall 13 1/2". Develop pistol form, accuracy at a fraction of cost of large caliber pistols. Comes with 50 lead bullets. Satisfaction guaranteed. Send \$3 to:

HAIG MFG. CO., Box B-27, Alhambra, California

Long Barrel .12 CALIBER



94.6% OF BAILEY GRADUATES ARE EMPLOYED AT TOP PAY IN THE FIELDS WHICH THEY WERE TRAINED!



DIESEL-AUTO MECHANICS DESPERATELY NEEDED!

We have a far greater demand for our students than we can fill!
We can show you an actual waiting list of leading companies throughout the world who have tried Bailey graduates — found them outstanding, and are coming back for more!
Bailey Graduates are Successful . . . RECEIVE BIG PAY — HAVE SECURE FUTURE!

The Famous Bailey Course prepares you for BOTH Diesel and Gasoline Mechanics.

This is a must—due to the advent of using Diesel principles, such as 'Fuel Injection' on passenger cars . . . use of gasoline engines for starting Diesel engines, etc. You learn all this at Bailey in the amount of time ordinarily required to learn just one of these subjects. ALL FOR THE PRICE OF ONE.

Don't be satisfied with a 'futureless', one-type job — learn how you can make big money now! Write today for Free Booklet that takes you on a step-by-step camera tour through our spacious, modern shops — See Bailey students in action as they Learn-by-doing with the Famous Bailey Method of training!

We provide you with housing and part time jobs while in school, plus nation-wide placement service for graduates.

BAILEY Technical SCHOOLS

1634 S. GRAND ST. LOUIS 4, MO.

MAIL TODAY!

Please mail immediately this free booklet without obligation.

FREE BOOKLET



Name _____

Address _____

City _____ State _____

APPROVED FOR VETERAN . . . NON-VETERAN

Where-to-Buy-It Index

Automotive

Do you know this old-timer?	14
Dual front wheel assembly increases truck's payload	71
Experimental outboard motor tests unique features	91
Chrysler's Valiant offers two and three-seat station wagon	99
Table and stools fit station wagon	124
Safe car TV works in "park"	128

Construction

Fiberglass sections form small buildings (Carroll Co., Erie, Pa.)	83
World's longest bridge	97
Yale's unique hockey rink doubles as campus center	98
Compactor speeds construction (Ray Wills, Baldwin-Lima-Hamilton Corp., Construction Equipment Div., Lima, Ohio)	99
Snooper with an elbow	105
Rotterdam restaurant is hoisted to top of 350-foot mast	113
Hobbyist creates town on quarter-inch scale	114

Miscellaneous

Pedestrian power scooter	71
Toy incubator hatches eggs (Fleet-O-Mfg. Co., Inc.)	71
Ancient sport of chariot racing invades the west	72
Single powerhead operates lawnmower and outboard motor	73
Right out of the barn	80
Doglift ends stairway problem	82
Tire inflated in cage	83
Steel troop shelter	84
Stand holds crooked trees (5th Ave. Metal products, 567 Van Dyke, Detroit 14 Mich.)	84
Railroad ferries carry 40 autos	91
Sea-going truck "flies" on water	92
Tape recorder runs projector (Chicasawa International Trading Co., 1117, 3 Chrome, Sogi, Siginami-Ku, Tokyo, Japan)	92
Electric candlelight for table makes attractive display (Osram Works, Munich, W. Germany)	97
Christmas tree "plugs" into simple conical stand (Capital Die Tool and Machine Co., 446 East 5th Ave., Columbus 3, Ohio)	99
Lifter aids panel installation (Rocko Panel Lifter Refugio Mfg. Co., P.O. Box 4, Refugio, Tex.)	104
Cows on the belt line	106
"Dialed" sign describes road conditions ahead (Marshall Electric Co., San Carlos, Calif.)	108
He paints with nails	109
Time-saving egg carrier holds seven containers	113
Jointed metal pipe speeds loading of tankers	115
Outboard operator has "car control"	115
Chain follows dog's movements (C. W. Barnes Co., 31630 Lake Rd., Bay Village, Ohio)	116
Gas appliance plugs into outlet	116
Bag purifies water (Hydronics Corp., 29 Bala Ave., Bala-Cynwyd, Pa.)	122
Fishermen carry boat between plane's pontoons	123
Stomping feet launch rocket (Rempel Mfg. Inc., 396 Morgan Ave., Akron 11, Ohio)	123
Tree treatment	124
Electric pry bar moves seven tons (Western Gear Corp., Industrial Products, Div., Belmont, Calif.)	124
Firefighting float	125
The Pastor is a sculptor	126
Swiss chalet comes in "kit" (Global Traders, 240 Columbia Ave., Berkeley 8, Calif.)	128
Versatile room dividers permit quick-change decor (Sold only by Montgomery Ward and Co.)	129
Playground rocket ride creates sensation of flight	130
Portable TV set doubles as serving table	132
Tubes prevent clogging of gutters (E. I. DuPont de Nemours and Co., Public Relations Dept., Wilmington, Delaware)	133
Marines move heavy tank from ship to shore in 63-ton carry-all	133
Log unloader empties truck in one big bite	136
Chute from rocket ship brings kids back to earth	140
Propeller drives car over Siberian snow	140

Rockets, Missiles and Space

Built-in steel cables support spaceman's suit	80
Globe shows satellite movement	96
Heat-absorbing shield forged for space capsule	96
Satellites may find craft lost at sea or in air	98
Good scarecrow needed by air force	109
Periscope system to guide astronaut	116
Soldier fires guided missile (Convair, General Dynamics Corp., San Diego 12, Calif.)	172
Mail delivery by missile	262

Science

Ball separates oil products (Shell Oil Co.)	84
Arrow poison ingredients relax patients in surgery	84
Strong ceramic is translucent	92
Single Xenon lamp bulb lights Europe's largest hall	104
Braille translator	122
Welded sphere	122
Fuel cell produces electricity directly from gas	128
"Zoomar" lens for microscope (Production Information Bureau, Bausch & Lomb Optical Co., Rochester 2, N. Y.)	132
"Thermostat" controls room lights (The Superior Electric Co., Communications Counselors, Inc., 750 Third Ave., New York 17, New York)	133
First protonic microscope	140
Monitor warns surgeon of heartbeat deviations (National Cylinder Gas, Div. of Chemetron Corp., 840 N. Michigan Ave., Chicago 11, Ill.)	140
Compound makes fabrics immune to insects	218
Skim milk halts plant virus	218

(Continued to page 69)

49c

FIXES ANYTHING!

HERCULES PLASTIC ALUMINUM IN NEW HANDY 49c TUBE!

Repair metal, wood, glass, porcelain, masonry... almost anything! The amazing new formula Hercules Plastic Aluminum forms bonds so strong that an independent laboratory* test proved it superior in holding power to the other leading brand. Also available in Giant \$1.00 tube and cans.

*Name on request.



HERCULES CHEMICAL CO., INC. 416 Broadway, New York 13, N. Y.

MINIATURE ELECTRICAL TESTER (2 1/2" x 3 1/2" x 1 3/8")

For testing all appliances, radio, TV, auto circuits, etc. Measures AC and DC voltages, resistance and milliamps. Instructions and leads included. Slightly larger than the size of a pack of cigarettes, easily carried in your pocket. Ideal Xmas gift.

ONLY \$10.95, postage prepaid U.S.A.

B & B PRODUCTS CO. P. O. Box 925 - Dept. 129 SAN FRANCISCO 1, CALIF.

MASS PRODUCTION MAKES THESE PRICES POSSIBLE!

Only world's largest boat kit maker can deliver such quality at such prices! Kits from \$42, freight paid. EASY PAYMENT PLAN



12 ft. runabout \$99.50 FREE COLOR CATALOG!

TAFT MARINE WOODCRAFT

Dept. PM-1259, 636 39th Ave. N.E., Minneapolis 21, Minn.



SUPER JU JITSU

Now get tough double quick!

A course of instruction in the art of practicing and using this method of applying LIGHTNING-QUICK Super Ju Jitsu. Be Dangerous! These amazing lessons show you how it's done... in a big illustrated home-study course. The weapons are just your BARE HANDS—they can be used effectively if you know how and practice the art. Easy to learn; quick. Full 70-lesson course only \$5.95 postpaid—or COD, plus postage. Satisfaction or your money back guaranteed! Order "super Ju Jitsu Course."

NELSON-HALL CO., 210 S. Clinton St., Dept. B MR-2, Chicago 6, Ill.

MONEY FOR YOU... in hidden treasures

Locate buried treasure... coins, gold and silver. New transistorized instruments for greater locating depth, less weight, operates on flashlight batteries. Complete line priced from \$79.50. FREE literature... authentic books of known treasures available. WRITE today.

GOLDAK COMPANY

1542-12 W. Glenoaks Blvd., Glendale, Calif.



HOW TO GROW

ORCHIDS AT HOME

Learn Special Conditions of Light, Temperature & Humidity Needed!

WORLD'S MOST THRILLING HOBBY - PROFITABLE HOME BUSINESS. SUCCESSFUL HOME GROWER offers COMPLETE illustrated instructions. Tells HOW TO START. Explains every thing you need to know about growing Cattleyas, Cymbidiums, Dendrobiums, and many others. Mary Orbach GROW WITHOUT SOIL, get food from the air! Instructions include rear BLOOMING-SIZE ORCHID PLANT. FREE - full details and 3 months Subscription to the "Orchidist," the "how-to" publication for home orchid growers. WRITE TODAY! Airmail reaches us overnight. TROPICAL FLOWERLAND, Dept. 31C, 100 S. Vermont, Los Angeles 4, Cal.



NO SOONER SEEN THAN PLAYED



Discover your musical talent with the HOHNER MELODICA, the musical instrument you play right away. Two full chromatic octaves and a tone that's great, group or solo. Available at your local store at \$14.95. For free illustrated leaflet send coupon below to M. HOHNER INC., 351-4th Ave., N.Y. 10, N.Y.

M. HOHNER INC., 351-4th Ave., New York 10, N. Y.

Gentlemen: Dept. PM-12
Please send me the HOHNER MELODICA leaflet

Name.....
Address.....
City/State.....

... TURN CONCRETE INTO GOLD!



MAKE UP TO \$75 A DAY IN YOUR OWN BUSINESS

If you want to have your own business - to start a business on your own - here's your big opportunity! New high speed, low cost General block machine produces up to 1,000 concrete blocks a day. Sell all you make to builders, supply houses, and others for homes, factories, buildings, garages. Cash in on the building boom! You can make profits of 100% to 150% - up to \$75 a day! General block machine equipped with 1/2 h.p. electric motor - or can be supplied with gasoline engine - works anywhere, in little space, indoors or out. Operates from ordinary house light socket. Simple, foolproof 3 step operation - so easy a child can do it. Makes superior 3 core blocks any size from 4" to 12". Also makes chimney, sash, corner and other types. Blocks meet any building code anywhere in the country. Materials - sand, water, cement, available anywhere. Simple illustrated operating instructions and mixing formulae for cement and cinder blocks supplied with each machine. Write for FREE folder with full information.

R.L.T. of New York City reports: "MY GENERAL BLOCK MACHINE PAID FOR ITSELF IN FIRST 2 WEEKS!" Hundreds now in use the world over! Write for FREE details today!

EXTRA

Amazing illustrated book gives floor plans for 6 sensational concrete block bungalows. Tells how to lay blocks, lay out building lines, mix concrete, build steps, porch and concrete floors all at great savings. Written by experts. Can save many times the cost of the machine! Get it now! No strings attached. Send \$1.

BOOK SENT FREE IF YOU BUY MACHINE. \$1 REFUNDED IF YOU BUY LATER.

GENERAL ENGINES CO.
DEPT M-129, ROUTE 130, THOROFARE, N. J.



FREE ALLIED'S MONEY-SAVING 1960 ELECTRONIC SUPPLY CATALOG

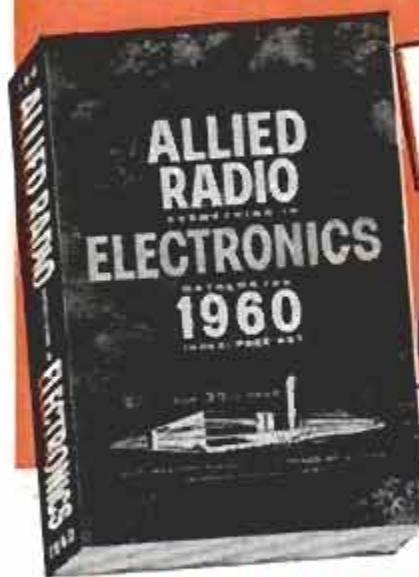

value-packed
SEND FOR IT!

SAVE
ON EVERYTHING
IN ELECTRONICS

EASIEST TERMS
only \$2 down on
orders up to \$50

WORLD'S LARGEST STOCKS

Send for the most widely used buying guide to everything in Electronics for Experimenters, Builders, Amateurs, Servicemen, Engineers and Hi-Fi enthusiasts. Save on:

- KNIGHT-KITS®—Best in Build-Your-Own
- Everything in STEREO HI-FI
- Hi-Fi Music Systems and Components
- Tape Recorders & Phono Equipment
- Public Address & Paging Systems
- TV Tubes, Antennas, Accessories
- Amateur Station Equipment
- Latest Test & Lab Instruments
- Parts, Tubes, Transistors
- Everything in Tools & Technical Books

SAVE on everything in Electronics at ALLIED—get fastest service, expert personal help, guaranteed satisfaction. Send today for your FREE 1960 ALLIED Catalog.

Everything in Electronics
from One Reliable Source

our 39th year



ALLIED RADIO

ALLIED RADIO CORP., Dept. 5-M9
100 N. Western Ave., Chicago 80, Ill.

Rush FREE 1960 ALLIED Catalog.

Name _____

Address _____

City _____ Zone _____ State _____



SEND FOR
FREE
CATALOG



(Continued from page 60)

What's New for Your Home

Back-pack vacuum cleaner.....	134
Portable heater.....	134
Bench-picnic table.....	134
Spring catches.....	134
Dated package.....	135
Interlocking floor.....	135
Automatic insect spray.....	135
Slip-cover anchors.....	135

Craftsman and Shop Notes Index

Farming

Low-load milk cart minimizes lifting.....	182
Hitch pin for tractor drawbar has locking feature.....	182
Wooden tilt board turns hatchery eggs.....	201

House and Home

Stairway clothes hamper.....	149
Decorate your mailbox for Christmas.....	150
Preventing breakage of lamp pull chains.....	153
Giant footprints cast in concrete make novel flagstone walk.....	173
Storage closet on a door.....	184
Built-in family wall for all.....	186

Household Hints

Outlet for breakfast table in center of kitchen.....	148
Novel hardware caddy made from cigar boxes.....	149
Replacing lost buttons in upholstered furniture.....	173
Make your own Christmas candles.....	176
Christmas-tree shaped mobile from hardboard and ornaments.....	178
Novel dinner bell made from tumbler.....	189
Remember these problem solvers for your home chores.....	189
Make these candle trees for your holiday decor.....	196

Miscellaneous

Suet feeder for songbirds made from milk carton.....	152
Part of paint-can cover cut away to provide edge for wiping brush.....	153
All-metal weather vane.....	171
Artist's palette covered with foil for easy mixing of colors.....	172
Auxiliary carrying strap for binocular case.....	172
Milk cartons collect sap at maple-sugaring time.....	172
Blocks elevate scaffold plank for short plasterer.....	178
Sand in mailing tube provides traction in snow.....	196

On the Market

Masking tape for do-it-yourself painters.....	202
Furniture legs in color.....	202
Soft-water kit.....	202
Automatic drain valve.....	202
Home bricklaying jobs.....	203
Metal polishing without drudgery.....	203
Snow for Christmas decorations.....	203
Hydraulic closer.....	203
Self-adhesive weather stripping.....	203

Office Shop and Store

Improvised bulletin "board" on plastered or tiled wall.....	146
Hints and facts for the use and storage of glue.....	174
Crease oilcloth on V-strip for straight-line cutting.....	188

Photography

Coated developing reel loads without sticking.....	152
Paper clip holds film slide.....	174
Disk corrects flash exposure.....	188
False bottom in photo kit bag stores tripod and accessories.....	188
Marking extension cords.....	193

Solving Home Problems

Freshly ironed garments hung out of way.....	180
Substitute turnbutton for small cabinet.....	180
Freshen wallpaper.....	180
Table-tennis balls readily found.....	180
Basement clothesline kept from sagging.....	181
Wax paper used to press ribbon badges.....	181
Pictures that slide can be made to hang straight.....	181
Lawn basket.....	191

Workshop Hints

Flask lamp.....	146
Cross handle for allen wrench gives additional leverage.....	148
Quick way to make rounded wood buttons.....	148
Sanding "drum" expands to hole diameter.....	152
Holder for calking gum tips.....	174
Make this simple crimper for wire and sheet metal.....	175
Workshop cabinet pulls made from copper tubing.....	178
Elapsed time indicator.....	179
Special thread gauge made from bolt.....	182
Starter for standby generator.....	183
Plastic cap on oil-can spout prevents spillage in toolbox.....	188
Good way to cover nail holes in wood joints.....	189
Pointing fence pickets fast.....	193
Mortising table fits your drill.....	194
Rubber-bonded abrasive gives controlled polishing action.....	196
Small setscrew and nut hold stock in V-block.....	201
Versatile combination tool is depth gauge and caliper.....	201
Centering a scribed circle.....	204
Prevent rust on shop tools.....	204
Stop hinged to ripping fence.....	204
Waxed bit drills clean hole.....	204

Radio, TV, Electronics

Those little things counts in the sound of your hi-fi system.....	141
Bulls-eye tuning with your radio.....	144

NOTICE—It is the intention of this magazine to provide its readers with information regarding the latest developments in the mechanical arts. Except where otherwise indicated, this magazine has no information as to any unexpired patents in respect of the developments reported herein. In the event that commercial use is to be made of any of the developments reported herein, it is suggested that legal counsel be consulted to avoid liability for patent infringement. It is not the purpose of this magazine to encourage patent infringement but, as indicated, it is the intention of this magazine to report on the latest developments in the mechanical arts.

**New -
FANTASTIC -
BUSINESS or
HOBBY**

PLASTIC VACUUM FORMING MACHINE "HOBBY-VAC"

A rugged production vacuum-forming machine at a fraction of usual industrial machine cost. No skill required to operate efficiently, only a few minutes of practice.

**HOBBY-VAC FORMS, BUBBLE AND BLISTER PACKS,
DRAWS UP TO 3" DEEP**

HOBBY-VAC will reproduce from natural objects, such as flowers, shells, letters, etc., or dies, in seconds, for as little as 10¢ each. No pumps required. Each machine fully equipped and ready to operate on 110 V. outlet and your regular hose-type vacuum cleaner.

Forms one of a kind or thousands of items in plain or brilliant metallic plastic up to 1/4" thick.

**PICTURED ON RIGHT IS THE SMALLEST SIZE HOBBY-VAC
HOBBY-VAC MACHINES AVAILABLE IN THESE SIZES**

7"x7"	Picture size	6"x6" x up to 3" deep	\$ 39.50
7"x14"	"	6"x13" x up to 3" deep	79.00
10"x14"	"	9"x13" x up to 3" deep	97.00
14"x14"	"	13"x13" x up to 3" deep	160.00

LARGER MACHINES AVAILABLE

Possibilities are practically unlimited for commercial and industrial purposes. Excellent for producing rugged 3-dimensional parts.

Literature on request.
Distributors wanted.

ORBIT of CALIFORNIA 211 Los Molinos, San Clemente, California

**ONLY
39.50**



You Can Have a HE-MAN VOICE

STRENGTHEN your voice this tested, scientific way. Yes—you may now be able to improve the POWER of your speaking and singing voice . . . in the privacy of your room! Self-training lessons, mostly silent. No music required.

FREE BOOKLET

Write today for Eugene Vouchtinger's great booklet "How to Develop a Successful Voice." It's absolutely FREE! You must state your age. Booklet mailed postpaid in plain sealed envelope. No salesman will bother you. Send your name and age RIGHT NOW!

Perfect Voice Institute, 210 S. Clinton St., Studio MR-2, Chicago 6, Ill.



ENGINEERING DEGREE IN 27 MONTHS

B. S. degree (27 mo.): Aero., Chem., Civil, Elec., Mech. & Electronics.
B. E. (36 mo.): Aero., Chem., Civil, Elec., Mechanical, Metallurgical, B.S. (36 mo.): Math., Chem., Physics.
Prep courses. Demand for trade. Campus. 20 bldgs.; dorms, gym. Low rate. Earn board. G.I. appr. Enter Dec., March, June, Sept.

1612 E. Washington Blvd.,
Fort Wayne 2, Ind.
Keeping pace with progress

INDIANA TECHNICAL COLLEGE

BE A MAGICIAN!

Get started today! Become a popular man of mystery. Earn and learn in spare time. Magic is fun and profitable too. Be the life of the party. Astonish your friends!

RUSH 25¢ now for

PROFESSIONAL MAGIC CATALOG

160 pages thick • 800 illus. • 1000 Mysteries
Also Jokes, Puzzles, Secrets, Illusions.
FREE MAGIC TRICK INCLUDED

HOUSE OF 1000 MYSTERIES • 202-63 PINEWOOD • TRUMBULL, CONN.



MEN WANTED

Earn \$100 Per
Week and up
AUTO DIESEL
MECHANICS

Master a trade with a future—learn Auto-Diesel mechanics in our shops. You learn with tools on real equipment. Earn while you learn. Many of our graduates earn \$100 per week and up. No previous experience necessary. Day and night courses. Approved for veterans. Write for free bulletin.

NASHVILLE AUTO-DIESEL COLLEGE

226 7th Ave., N., Dept. 75

Nashville 3, Tenn.

LEARN UPHOLSTERY

in your spare time
run your own
business AT HOME

BE YOUR OWN BOSS



Earn more from the start while learning AT HOME. Set up your own profitable business at home, enjoy steady income, independence. You're in demand in the booming field of Custom Furniture Upholstery.

EARN WHILE YOU EARN . . . the easy UTS way. Right off, you start with tools, complete frames, fabrics, materials, included FREE with your N. Y. State approved UTS course. You earn as you learn skilled professional custom upholstery, reupholstery, furniture finishing, repairs; to make slip covers, window cornices, cushions, draperies in your spare time at home.

Send for FREE Illustrated Book, Sample Lesson. Get ready for well-paid job, steady work and big profits as your own boss. Also Training in N.Y. School. Acc. by N.H.S.C. APPROVED FOR VETERANS.

MAIL COUPON TODAY. No obligation.

UPHOLSTERY TRADES SCHOOL, Dept. HX-310
721 Broadway, New York 3, New York

Please send me FREE book with FREE Sample Lesson. No obligation—no salesman will call.

Home Study Training in N.Y. School

Name

(Please print plainly)

Address

City Zone... State.....

Check if Korean Veteran



The skilled hand of the German gunsmith is responsible for this .22 caliber, 6-shot repeater automatic with self-ejecting clip. Just 4" long, fits easily into pocket or purse. Ideal for sporting events, stage use. Not lethal weapon—ammunition available exclusively from us. (Not available to California residents).

Comes for \$6.95 ppd. from

BEST VALUES, Dept. A230, 403 Market, Newark, New Jersey

**SAVE
50%
AND MORE
DURING
THIS GREAT
SALE**



ACCORDIONS 1/2 OFF!

FIVE DAY FREE TRIAL—Easy Terms

Buy direct from world's largest exclusive accordion dealer. Save 50% or more. Finest imported Italian makes; over 30 models. 5 DAY FREE TRIAL. Lifetime guarantee. Trade-ins accepted. Bonus gifts. Easy terms, low as \$10 monthly. Write today for Big Catalog and Low Wholesale Prices—FREE!

ACCORDION MANUFACTURERS & WHOLESALE OUTLET, 2003 West Chicago Avenue, Dept. R-129
Chicago 22, Illinois

Please rush color catalog, wholesale price list.

**FREE
Color
Catalog**

Name

Address

City State

DIE MAKER or

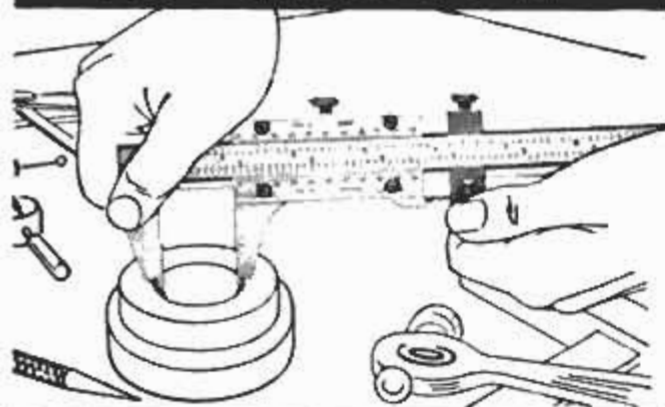

DO-IT-YOURSELFER



You'll work better with

Starrett TOOLS

Whatever your job or hobby, you'll find tools in the big Starrett catalog that will help you work faster, easier and more accurately. Write today for your *free* copy.

Use the coupon.



THE L. S. STARRETT COMPANY
Dept. AP, Athol, Massachusetts

Please send my free copy of Catalog 27 describing over 3,000 Starrett Tools for professional and amateur craftsmen.

Name.....

Occupation.....

Address.....

City.....Zone.....State.....

Sun's Cosmic-Ray Outbursts Could Harm Space Travelers

Future space travelers may encounter greater radiation hazards than have been suspected, say two University of California physicists. They sent balloons carrying Geiger counters to an altitude of 90,000 feet above College, Alaska, and discovered that the amount of radiation in the atmosphere increased sharply when there were disturbances on the sun. The number of protons entering the atmosphere on those occasions was 10,000 to 100,000 times normal intensity, said Dr. Robert R. Brown, one of the investigators.

The physicists found no radiation caused by sun activity at heights below 50,000 feet. Brown said this indicates that solar outbursts of sizeable proportion are occurring more frequently than scientists have imagined, for only a sun disturbance—a flaring or boiling—of stupendous size will increase radiation at ground levels.

Space scientists recently have been concerned with the Van Allen radiation belts, discovered by satellites, surrounding the earth. A high-speed rocket would pass through these narrow belts in a few hours so exposure would be minimal. The danger to space travelers from solar particles may be more difficult to contend with however. It is quite possible, Brown says, that a manned moon rocket, for example, would run into a proton storm of deadly proportions if a solar outburst occurred at the right moment. (He found radiation from such outbursts could last as long as four days.) He explains that while the protons are mostly of the low-energy variety, they would interact with atoms in the hull of the spaceship to create lethal gamma rays, half of which would spray the ship's occupants.

Pacific Ocean Current Is 3500 Miles Long

A current that flows in an eastward direction along the equator beneath the surface of the Pacific has been found to be at least 3500 miles long. Direct measurements taken during the International Geophysical Year show that the current follows the equator from a longitude of 150 degrees West, near the Christmas Islands, to 92 degrees West, near the Galapagos Islands. The current is about 190 miles wide and 650 feet thick, sandwiched between shallower and deeper flows which both move westward. Velocities of up to five feet per second (three knots) were recorded. The flow was first described in 1954 and is called the Cromwell Current.

BIG REASON WHY AC "MUST BE THE BEST"!

NEW EXTRUDED SHELL GIVES 50% GREATER STRENGTH



AC Engineers have done it again!

First for 51 years in pioneering spark plug advancements, AC now introduces the process of cold extrusion for producing superior spark plug shells.

A giant 200-ton press forces blanks of steel through a die. Shells emerge ready for machining, threading and assembly into quality spark plugs.

What's the point? Metal has "flow lines" just like grain in wood. No longer do bar-stock machines cut across longitudinal flow lines and "shave against the grain" of the metal. No longer is metal weakened because of a flow line cut.

Cold extrusion by mighty presses bends the steel's flow lines to the shape of the die. Original strength of the steel is preserved.

That means AC spark plug shells are 50% stronger: still another reason why AC Fire-Ring Spark Plugs **MUST BE THE BEST!**

Excellent flow lines, clearly shown in this cut-away of a spark plug shell, account for 50% greater strength in AC Spark Plugs.



Every AC features the exclusive Hot Tip that heats faster, cools faster to stay clean longer.

AC SPARK PLUG  THE ELECTRONICS DIVISION OF GENERAL MOTORS

AC PRESENTS THE ART CARNEY SHOW, NBC-TV, JANUARY 8

AC Fire-Ring Spark Plugs

"MEN INTO SPACE," Lucky Strike's authentic new series (Wed. nights on CBS-TV), captures the drama, the excitement, the suspense of man's struggle to conquer outer space.



Never before has a film TV series attempted to tell the true and thrilling story of man's plunge into outer space. Every episode is a dramatic portrayal of adventures and experiments actually taking place today and planned for tomorrow. Lucky Strike is proud to bring this amazing and compelling show into your home.



© CHEVLEY BONEWELL

BILL LUNDIGAN
star of
"MEN INTO SPACE"

A MAN'S HORIZONS may change overnight. His tastes don't. The man who wants the honest taste of fine tobacco finds it in a Lucky Strike—and he always will. This is the cigarette that made fine tobacco famous . . . the one with the taste no other cigarette can touch. Remember how great cigarettes used to taste? Luckies still do!

**Get the honest taste
of a LUCKY STRIKE**

© A. T. Co.

Product of *The American Tobacco Company* — "Tobacco is our middle name"

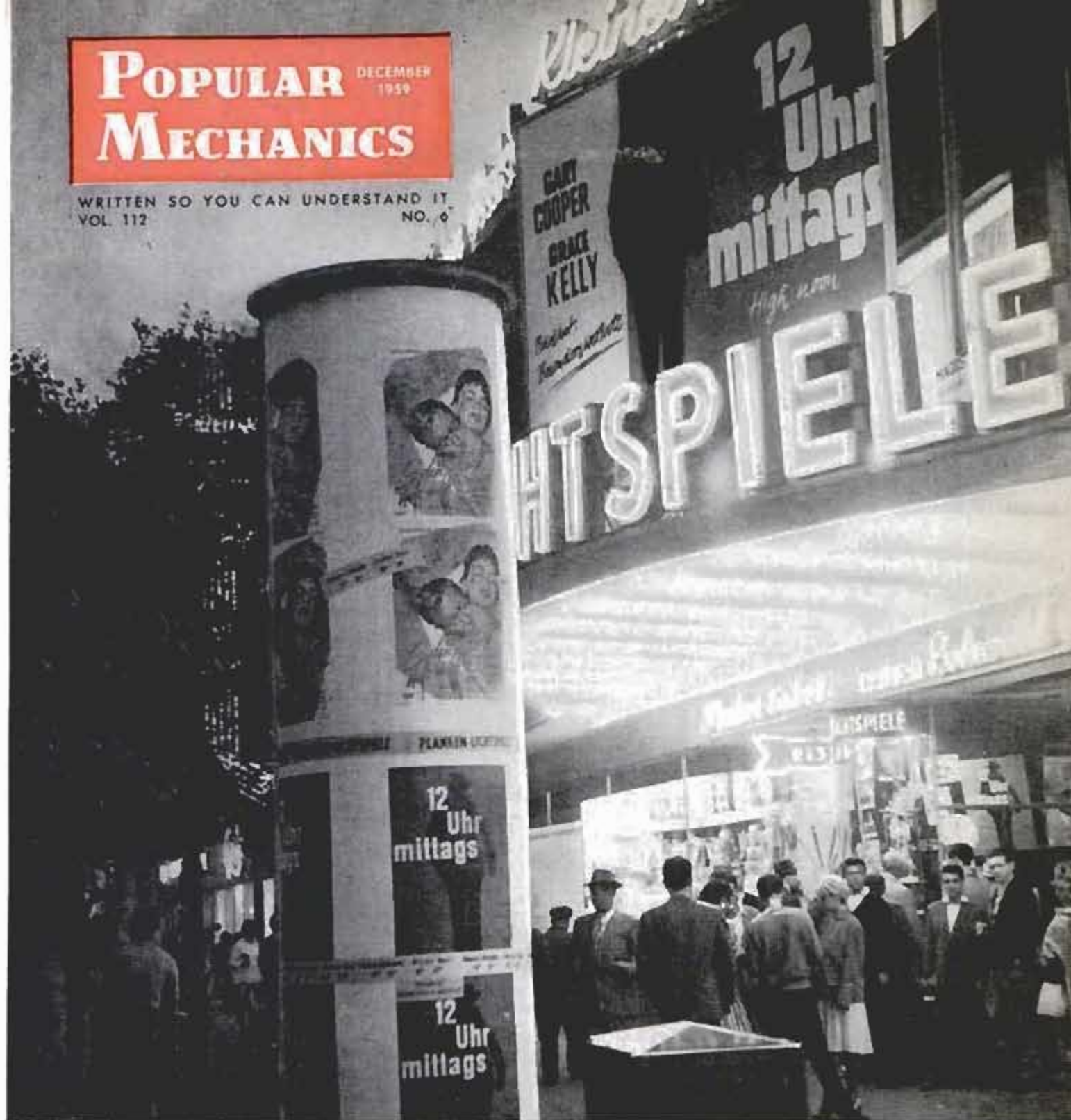

Hollywood Spricht Deutsch

By
Sam Iker

THE ENTHRALLED AUDIENCE watched a lean-jawed U. S. marshal face the "heavy" in the streets of old Tucson, Arizona Territory. As the bad man's hands hovered over his sixguns, he snarled, "Schluss jetzt Brazos, oder ich drucke beide Lanfe auf Sie ab!"

This sparkling bit of German "wild west" dialogue, literally translated to, "Hold it, Brazos, or ah'll let ya have both barrels," was nothing out of the ordinary for the lederhosen-clad movie fans in the Bavarian town of Bad Reichenhall.



Through the control-room window, actors can be seen watching screen as they dub in German-language "take"

Yes, Hollywood spricht Deutsch — Hollywood speaks German and many other languages as its American-made films entertain around the world. All over Germany—and France, Italy and Spain—audiences take it for granted that their favorite Hollywood film stars emote fluently in their respective native tongues. Through the technical miracle of sight and sound synchronization, avid European moviegoers can enjoy America's top motion pictures

Magnetic sound film is adjusted in preparation for final blending of dialogue, sound effects and picture



without struggling with subtitles. Almost all of the nearly 300 feature films Hollywood exports overseas yearly—from multimillion dollar extravaganzas like "Ten Commandments" to low-budget westerns—are dubbed in with foreign dialogue.

The voices are amazingly well-matched with those of their Hollywood counterparts. Jimmy Stewart in German has the same hesitating, slightly nasal twang; Marlon Brando still mumbles; Cary Grant retains his clipped, deep tones; and even Marilyn Monroe manages to come through with her kittenish seductiveness.

But the faces behind the voices would sometimes jolt European movie fans. Tall, rugged Burt Lancaster's "voice" is a rather short, thick-set West Berlin actor named Horst Niendorf. On the other hand, actress Gisella Trowe who speaks Anne Baxter, Yvonne DeCarlo and June Allyson could easily hold her own with her Hollywood "faces." And young actor Ditmar Schonharr who dubbed for the late James Dean bears a striking likeness to the teen idol. The great majority of voices who speak for the stars in Germany, for instance, are prominent in their own right on the German stage and in the film industry. Many of them, furthermore, physically resemble their Hollywood alter-egos.

One of the largest of the German dubbing studios is Berliner Synkron. With over



This trio is dubbing in German dialogue for Thelma Ritter, Burt Lancaster, Audrey Hepburn and Sophia Loren

1000 actors in its voice file, the West Berlin studio turns out about 80 foreign films a year, including all features from Paramount, Universal-International and Allied Artists, as well as independent productions from Hollywood.

Essentials of synchronization are the same in all studios, though technical methods sometimes differ. When an American movie arrives, the first step is to do a raw translation of the script or "continuity."

At Berliner Synkron, there are two full-time writers plus a number of freelancers. While the writer (sometimes two working as a team) turns out a literal translation, the picture itself goes into the cutting room. Here, the film is run through a "moviola"—an apparatus that the technician can operate either automatically or manually at varying speeds. The picture shows on a small screen and the technician can run it frame by frame as he listens to the dialogue.

The film is marked at every natural pause in conversation and later cut into individual segments. Every one of these segments or "takes" makes up a speech. The cutter marks these takes on a copy of the original English-language script.

The takes are numbered and the English script goes to the writers. They divide their rough German translation into the same segments, and then the fun begins. . . .

The writers hibernate to the "check

room" for the next step in the process. The check room is simply a projection room where each take is run off separately while the writers wrack their brains to produce German dialogue in which lip movements approximate and at the same time retain the basic sense of the original English.

Berliner Synkron writer-director Klaus von Wahl explains that "the most difficult problem is that thoughts are expressed in fewer words in English than they are in German. English tends to be more abrupt. And so we have to jam more German words in and still make the speech look natural."

Some speaking habits of American actors drive the writers to distraction. "Jane Wyman has a tendency to start sentences with 'well,'" says writer Gerda von Ruxleben. In German, the closest approximation is "wissen Sie," and the repetition becomes murderous. Actors like Marlon Brando or Elvis Presley, who stop and start, sometimes mumble and come up with abrupt pauses, are also tough, comments Frau von Ruxleben. The corresponding Deutsch also has to stop and start and pause.

According to von Wahl and other writers, the easiest actors to "synch" are the best actors. Tall, lean von Wahl, himself an actor who dubs Danny Kaye's German voice, declares that "Gary Cooper, Bill Holden, Spencer Tracy, and others act not only with their voices but also with their



Cameraman in mixing room gets directions from tone-meister (sound director) before rolling finished film

faces and bodies. It's possible to follow the action and understand meanings without sound. This makes our job simpler."

On the other hand, actors who enunciate clearly with pronounced lip movements present problems. The German dialogue must produce exactly the same lip movements or the result looks unreal on the screen. Consequently, every writer has to be a walking wealth of synonyms in order to find the right words.

Actors like Rock Hudson and Alan Ladd who tend to speak with tight lips make the job easy for von Wahl and his associates. Because of the slight lip movements, the writers have much more latitude in picking out German equivalents.

Declares von Wahl, "The saddest thing is that many wonderful American accents are lost in translation. In a Civil War picture, for instance, we can't use a southern Bavarian accent and a northern Hanoverian-type speech. We always have to use the 'high German' that's understood all over the country. Consequently we sometimes lose the flavor and some of the fine shades of meaning in a film. In westerns and in other movies with foreign locales, we substitute broken German for the Indians and other characters who speak broken English."

Because of the German censors, the actual content of an American film is sometimes re-written. War pictures, westerns and mysteries come in for the greatest alterations. In war movies, slurring refer-

ences to Germans are softened to spare the sensibilities of local audiences. When the hero in a western or Civil War picture mows down a dozen adversaries, he'd better have good reason because the German censor board frowns on "useless, unprovoked killing." Thus, the "bad guy" sometimes has to be cleaned up. And the "hero" might assume a different character.

Writer Peter Kup of Munich's Riva Films recalls such an instance. In a recent "Alfred Hitchcock Presents" TV program, a mother whose son was murdered slipped poison into the killer's lemonade. This poetic bit of justice was softened in the German version, says Kup. "Instead of the woman adding poison to the drink, we had her using a powerful sleeping drug."

Writers Like Action

Depending on the length of a picture and amount and complexity of dialogue, the synonym-straining writing job takes anywhere from eight days to two weeks. A film with plenty of "ottos" puts smiles on the writers' faces. An "otto" in the jargon of the trade refers to points in the film where there's no speech — only action. A prime example, according to Kup, occurred recently with the TV mystery, "The Silent Stranger." Remarks Kup, "The usual TV show consists of about 140 takes. This one had only 70 because the silent stranger was really silent."

After the German-language script is completed, the scene changes to the studio. Here, the faces on the screen take on their new German-speaking identities. The typical studio is rather small, with a movie screen covering one wall, a podium with microphone in the center and a glassed-in control room at the back.

The director and "tone-meister" or sound director, sit in the control booth. The actors working a particular "take" cluster around the podium and keep their eyes glued on the screen. They have a script in front of them. But every speech has to be learned thoroughly since it's impossible to watch the script and the screen at the same time.

Here's how an average session runs. The particular film stars Carlos Thompson, Jeff Chandler and Esther Williams. In this case, Argentinean actor Thompson is doing his own dubbing. The studio is dark. A red light flashes. "Achtung" — attention — crosses the screen. Then rapidly, "1, 2, 3, 4," and immediately following, the actual scene. The actors are tensed, and, as Carlos Thompson on the screen speaks in English (the English sound is cut off), Thompson in the studio rattles off his new German dialogue. As Esther Williams answers, Inge Landgut matches her counterpart perfectly.

In a few seconds, it's all over. The take

A technician in the cutting room synchronizes final film and dialogue sound track by seeing and hearing the "pips" or "beeps" which occur at the start of every take in both sound and picture films. She matches the two



runs only four or five lines. But the director isn't satisfied. He explains from the control booth just what he wants in the way of expression and emphasis. Again the "Achtung" and "1, 2, 3, 4" flash up, and again the actors speak their parts—concentrating fiercely on both the acting job and also on matching the German dialogue with the lips on the screen.

This time Thompson fumbles his lines. He disgustedly tosses his head and repeats the German words over and over. A minute later, the process is repeated. Now the sound director is dissatisfied. The synchronization wasn't perfect. His trained eye and ear can spot immediately any variation of the dialogue in the studio from the lip movements in the film.

Finally, after the fifth try, all goes well. The take is run through once more, this time with its new German dialogue, to make sure everything is perfect. It looks and sounds real and everyone breathes a little sigh of relief. Several minutes later, the next take flashes up on the screen and the nerve-wracking business is repeated.

The 600 to 800 takes in an average picture

are dubbed in four to eight days. Most takes must be run through three or four times. But the final result creates a near-perfect illusion. According to actress Landgut, "It almost becomes automatic after a while. We don't hear the original voices in the English sound track. That way, we don't try consciously to imitate and our voices stay the same for every role in any picture we're doing."

Producer Gunter Kulakowski explains that, "The voice is vital. We don't try to find a perfect match. It's almost impossible. But we audition actors and actresses and classify them by which Hollywood voices they most closely resemble. Their acting ability makes up for any lack of similarity." He adds that many German actors and actresses speak two or three different screen personalities.

Once classified, they dub for the same Hollywood stars in every picture in which the particular stars appear. To German audiences, Marion Degler's voice is always that of Audrey Hepburn and Sophia Loren; Harold Juhnke is always Marlon Brando,

(Continued to page 232)

Making adjustments in lighting arrangement, a technician prepares to photograph a new German title for an American film



AN EYE ON SPACE



By Dr. Dan Q. Posin

PROFESSOR OF PHYSICS, DE PAUL UNIVERSITY
SCIENTIFIC CONSULTANT AND ADVISOR, COLUMBIA BROADCASTING SYSTEM

THERE WILL BE many shots at the moon. Our nearest neighbor in the heavens patiently revolves around the earth, waiting for us to learn its secrets. What kind of moon shots can we use to find the answers to those secrets?

In some of the shots the traveling object—let's call it the "payload"—will miss the moon and continue out beyond, to go into orbit around the sun, as did Lunik I (Mecha) and Pioneer IV. The payloads which go into orbit around the sun become, in effect, little planets, and will continue in their orbital travels as long as the planets do.

Another moon shot might miss, but does not have enough speed to orbit the sun, and is "recaptured" by earth—that is, it becomes an earth satellite with a long orbit, requiring perhaps several weeks for one complete circuit. Whether or not this payload has also gone around the moon depends, of course, on the timing. If the speed of the payload is excessive, it may arrive at the moon orbit region too soon, make its loop because of the earth's pull-back, and that's that. Of course, some day, when the moon returns (in a month, two months, three months), the payload may be out there again on one of its swings and might go around the moon. But this is relying too much on chance.

The payload which is too slow, or is fired too late, may also miss the moon on the first try, and not go around it; but it, too, may be successful by pure chance on a future swing.

A payload which does make a tour around the moon may execute a distorted egg-shaped orbit around it, or may make a kind of S or inverted S, or a figure 8 around the moon, all, of course, depending upon the angle of approach.

A payload could, in principle, pass very close to the moon in such a way as to be yanked completely away from earth's control and flung out into space, soon to go orbiting around the sun. Such a "yanking away" is one method of space travel, utilizing the moon and the planets as "sling shots." This can only be achieved through careful guidance and speed.

There is also the moon shot in which the payload goes into orbit around the moon alone. This can be achieved by having the payload fire a braking charge so that it loses speed and allows the moon to keep it for its own satellite—a moon for the moon.

Or, the payload can go around the moon, return to the region of the earth and fire a braking rocket to become a modest earth satellite. Still other possibilities are "hard" and "soft" landings on the moon.

The difficulty of a moon shot can be stated in this way: What is the chance of coming close to the moon, which is almost a quarter of a million miles away and is traveling at a speed of more than 2000 miles per hour? Such a shot is difficult or easy (relatively speaking, of course!) depending upon whether it is a *free ballistic* shot or a *guided* shot. A free shot has only a slight chance of success, as an error of four degrees in pointing the rocket will result in a 16,000-mile miss. A guided shot, however, can afford to be a little contemptuous of timing and speed, since corrections can be made anywhere along the trajectory. The guidance can be from the ground by radio signal, or by a homing instrument in the payload.

Guidance-equipped devices are heavy, and therefore require much launching power. Some countries have more launching power than others. The latter can catch up. But it isn't easy.



Pedestrian Power Scooter

Louis Richards, graduate design student at Illinois Institute of Technology in Chicago, demonstrates his "Skeeter," a lightweight motor scooter for pedestrians. Powered by a 1.32 horsepower model-aircraft engine, the Skeeter has an 18-inch platform wide enough for both feet and an aluminum handle for balance and steering. It will carry an average person at 12 miles per hour, but weighs only 12 pounds and can be picked up and folded into a small canvas carrying bag.



Toy Incubator Hatches Eggs

Which comes first—the beak or the feet? This small incubator, billed as an educational toy, can actually hatch one egg at a time before a child's eyes, letting him answer the question for himself. It is called a "Chick-u-Bator," and has a clear plastic cover through which the hatching process—from cracking of the shell to the first shaking of wings—can be watched. The toy, which fascinated children at a Chicago fair, comes complete with electric cord and bulb.

Dual Front Wheel Assembly Increases Truck's Payload

Front axle loadings of 18,000 pounds or more are possible with a dual front wheel assembly that has four tires mounted individually. All four tires are mounted on standard wheel bearings and each wheel rolls independently. Tire mileage is increased better than 50 percent, according to the manufacturer. Developed by the Truck Equipment Company, of Denver, Colo., the twin front wheels give 100 percent more road contact and allow increased payload, larger capacity and greater front end stability. A 30 percent greater turning angle makes long vehicles easier to maneuver. The front tires and wheels can be interchanged with the rear ones and the parts are interchangeable with standard units that are now in service.



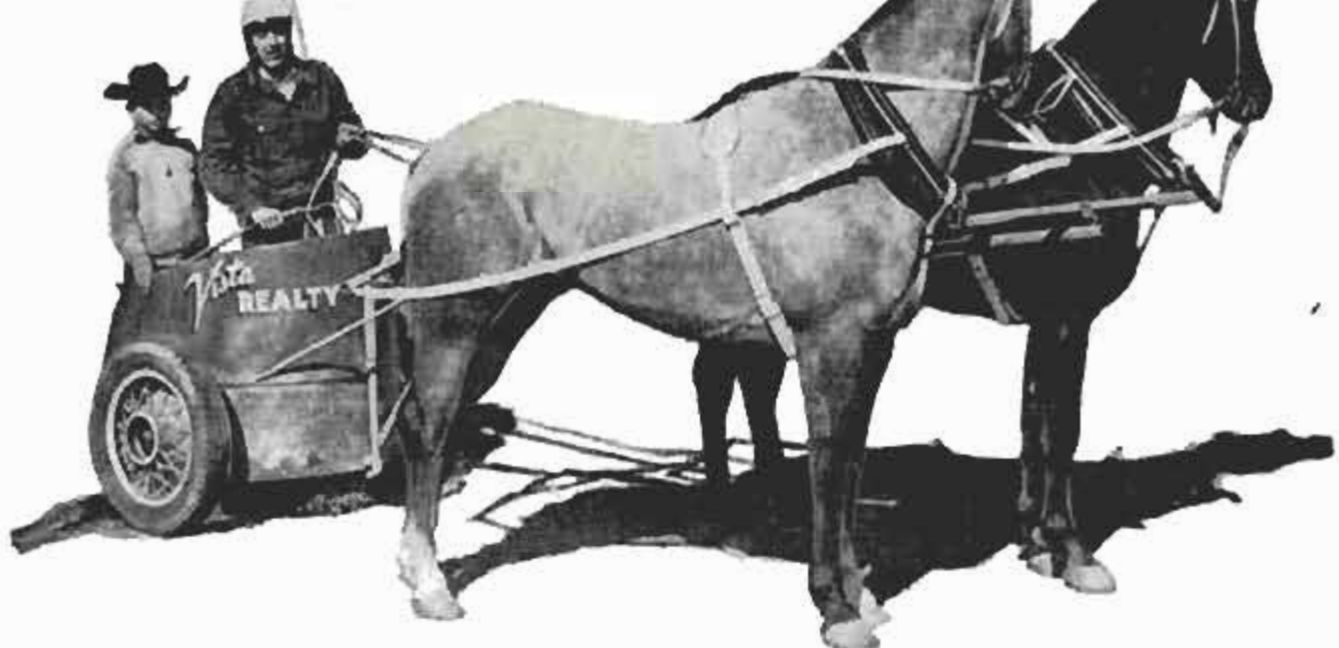

His chariot is a 50-gallon oil can cut to size. Cost of chariot and harness combined seldom exceeds \$150

Ancient Sport of Chariot Racing Invades the West

WHEN 36 AVID HORSEMEN get together for weekend races in the Boise, Idaho, area, the sound of their rumbling chariots now almost drowns out the thundering of their horses' hooves. The group took up the ancient Roman sport of chariot racing last

January, when not enough snow fell to support cutter racing, and members now race in two-team, quarter-mile sprints before thrilled spectators. No sport for sissies, charioteering takes a toll in broken arms and ribs among the drivers, ages 18 to 57.



Races are between two teams only—unlike Roman scrambles of 10 or more teams—but a swerve can lock wheels, sending drivers and chariots tumbling



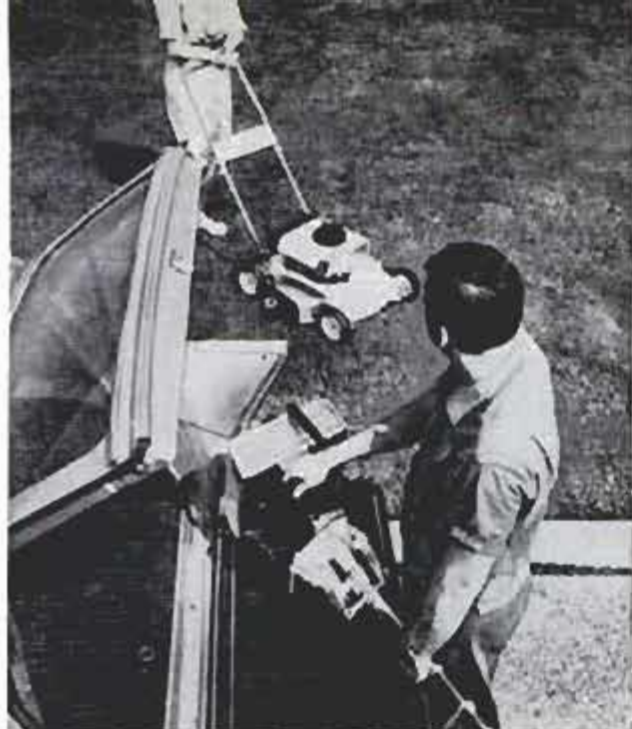

Single Powerhead Operates Lawnmower and Outboard Motor

Ever have trouble deciding whether to do the yard work or go fishing? Here's a portable power unit that goes along in either case. If you're fortunate enough to get away to the lake, it fits on a light low-

er unit to make a small outboard motor; otherwise it'll stay home on another unit and mow the lawn. One four-cycle, air-cooled engine operates both. A wind-up starter works on both. It is sold as a set.

Seaplane Takes off From Dolly

How do you take a seaplane off a dry runway? At the de Havilland Aircraft Company's airport, located eight miles from the Toronto seaplane base, the planes roll down the runway atop a rubber-tired dolly. When floats lift from the cradle, the dolly brakes to a stop. This technique allows a plane to be built to customer specification and flown, as a seaplane, to his base.



Air Compressor Starts Jets

At London Airport, a Boeing 707 gets all four engines started in 70 seconds by a new Swedish air compressor. The unit also serves as an air-conditioner, warming or cooling the plane's interior within one hour, and functions as a de-icer when the hose delivering hot air is fitted with a wide mouthpiece. It has no wearing parts and runs 10,000 hours without overhauling.





Author discusses the training program with Astronauts Schirra, left, and Carpenter. All of the Astronauts are dedicated pilots, eager to keep their flying proficiency at peak level, even though they'll be cruising the heavens in a craft far different from the plane shown in the background

I LIVED WITH THE ASTRONAUTS

By Joseph N. Bell

Popular Mechanics photos by Joe Fletcher

PART I

Unnoticed by other NASA workers, four of the Astronauts discuss problems over a quick lunch at NASA cafeteria





Seven Astronauts and project director Gilruth examine tailor-made couches on which men will ride into space

I JUST SPENT a week with the Mercury Astronauts—the seven young Americans who were selected, after long and rigorous tests, for training as the first pilots to be blasted into space in a manned vehicle.

I found them a little bewildered at the attention they're receiving, slightly impatient to get the Mercury capsule into space, much more convinced of the probability of Project Mercury's success than the possibility of failure, and giving scarcely a passing thought to that much-posed question in the nation's press: Who is going to be the first man in space?

Although distinct individuals, the Astronauts share to a high degree earnestness of purpose, broad technical knowledge and skill, and a patient and understanding grasp of the necessity of explaining their work and problems over and over again to a world with little background for assimilating this new dimension in exploration.

The Astronauts definitely don't consider themselves in imminent danger of death, and they tend to scoff at the perils predicted for them. This isn't intemperate whistling past the graveyard; no one is in a better position than the Astronauts, themselves, to assess the chances of completing a successful manned space flight. They not only hope to go soon—they also expect to come back. And they have good reasons for feeling this way.

The oldest Astronaut, 38-year-old Marine Col. John Glenn—blond, crew-cutted, amiable and easy-going—told me: "Space travel is going to be accomplished, and we want to be in on it. We have all the faith in the world in the people running this program."

To the seven Mercury Astronauts, it's as simple as that.

Who are these first space adventurers? Here's a quick rundown:

Lt. Col. John Glenn, 38, of New Concord,

The editors of *Popular Mechanics* feel that the story of the Mercury Astronauts is one of the most exciting events in many generations. We have exerted every effort, since the program was first announced, to get a firsthand, factual, on-the-spot account of what's going on in Project Mercury. This two-part article is the result. It was written and photographed by a *PM* editorial team which lived with the Astronauts for a week in October. Over the past few months a strong impression has been given the public that the Astronauts are the exclusive property of a big weekly magazine. *PM* has proved that this is not the case—by going to the source and getting the story from the Astronauts themselves. The Astronauts belong to themselves, and their work belongs to the entire American public. We are proud that *PM* is the first monthly magazine to "live with the Astronauts."

Ohio, veteran of 150 combat missions for the Marine Corps in World War II and the Korean War, holder of a transcontinental speed record in the F8U, 5000 air hours, father of a boy and girl;

Lt. Comdr. Walter Schirra, 36, son of a team of barnstorming pilots, native of New Jersey, with 90 Korean combat missions and 3000 air hours, also the father of a boy and girl;

Lt. Comdr. Alan Shepard, 36, from East Derry, N.H., Navy deck officer in World War II who took flight training immediately after and became a longtime test pilot, 3600 air hours, father of two daughters;

Capt. Donald (Deke) Slayton, 35, native of Sparta, Wis., veteran of seven missions over Japan at end of World War II, 3400 air hours, father of one son;

Lt. Scott Carpenter, 34-year-old Coloradoan, primarily a multi-engine pilot who flew "big boats" during the Korean War and later served in Air Intelligence, 2800 air hours, father of two boys and two girls;

Capt. Virgil (Gus) Grissom, 33, from Mitchell, Ind., veteran of 100 combat missions in Korea in Sabre jets, 3000 air hours, father of two sons;

Capt. Gordon Cooper, 32, from Carbondale, Col., raised in a flying family where he soloed when he was 16, no combat experience, 2300 air hours (more than half in jets), father of two daughters.

These are the bare bones of the Mercury

Astronauts. Now, let's put their program into perspective before we move on to what the Astronauts are doing and why they're doing it.

Project Mercury is the name given to the manned satellite program of the National Aeronautics and Space Administration. A Space Task Group was set up in October, 1958, under Robert R. Gilruth, headquartered at Langley Field, Va. Its objectives: to put a manned space capsule into orbital flight around the earth, recover the capsule and its occupant successfully, and investigate the capabilities of man in space.

Selection Program

To bring this off, there obviously had to be men able and willing to attempt the flight. Accordingly, a massive selection program was undertaken to find the men best qualified. There were three primary considerations: physical, psychological and technical. The first two have been emphasized in the press out of all proportion to the third. As one of the psychologists attached to the Astronauts told me:

"We were looking for a professional group that could best fulfill the most requirements to achieve space flight at the earliest time. This brought us inevitably to military test pilots. Others could undoubtedly have been trained, but these men had a tremendous head start—and because they

Astronaut Shepard, clad in a pressure suit, "flies" a training problem on the flight simulator. The instrument, with problems fed through a computer, is designed to give men the feel of the three-dimensional control

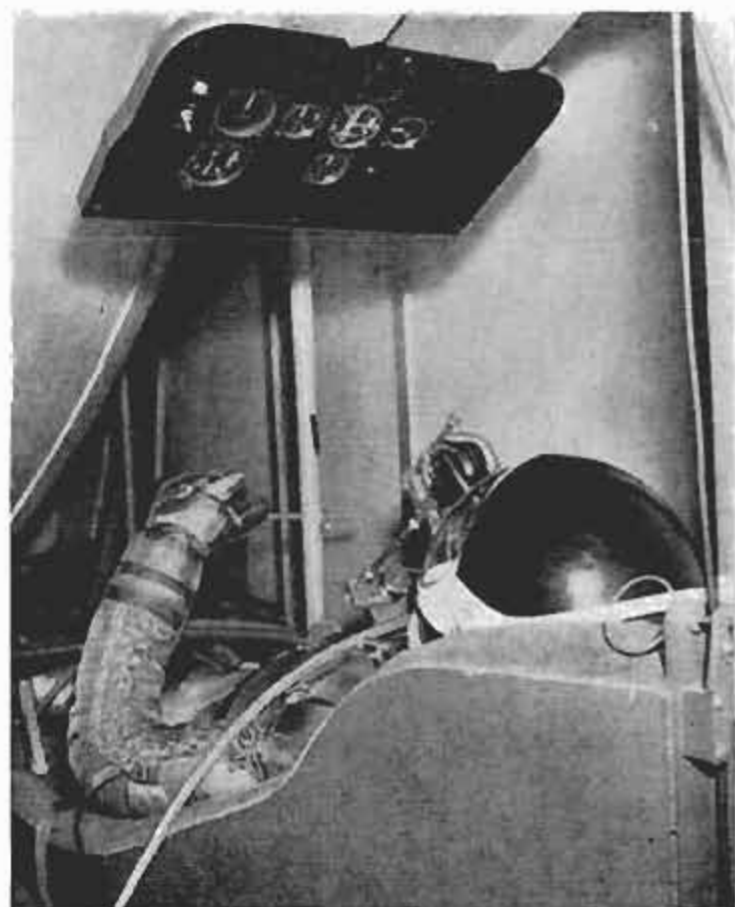



Astronauts make periodic trips to Wright Field to experience brief periods of weightlessness in a plane equipped for zero-G flights. Weightlessness is the most difficult factor to simulate during training

Grissom practices reactions in attitude simulator. He lies on couch, looking at projection of earth in mirror, and operates air jets to correct position of "capsule." Right, camera looks into periscope from outside

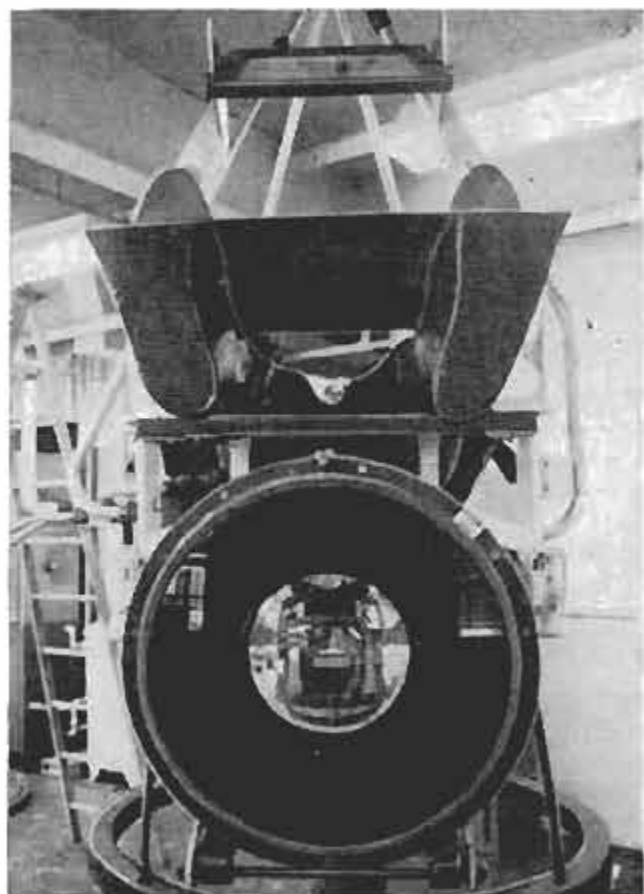
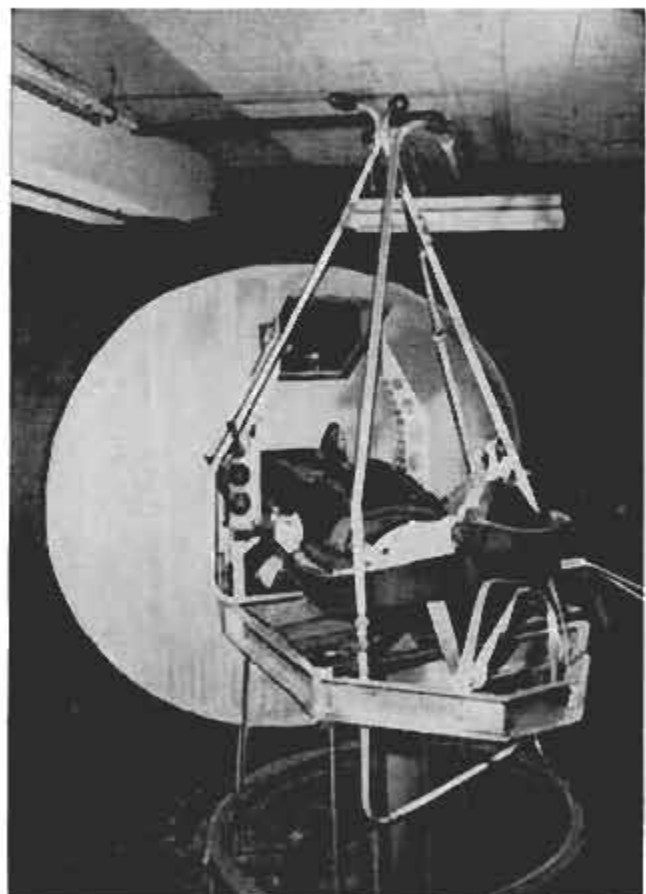

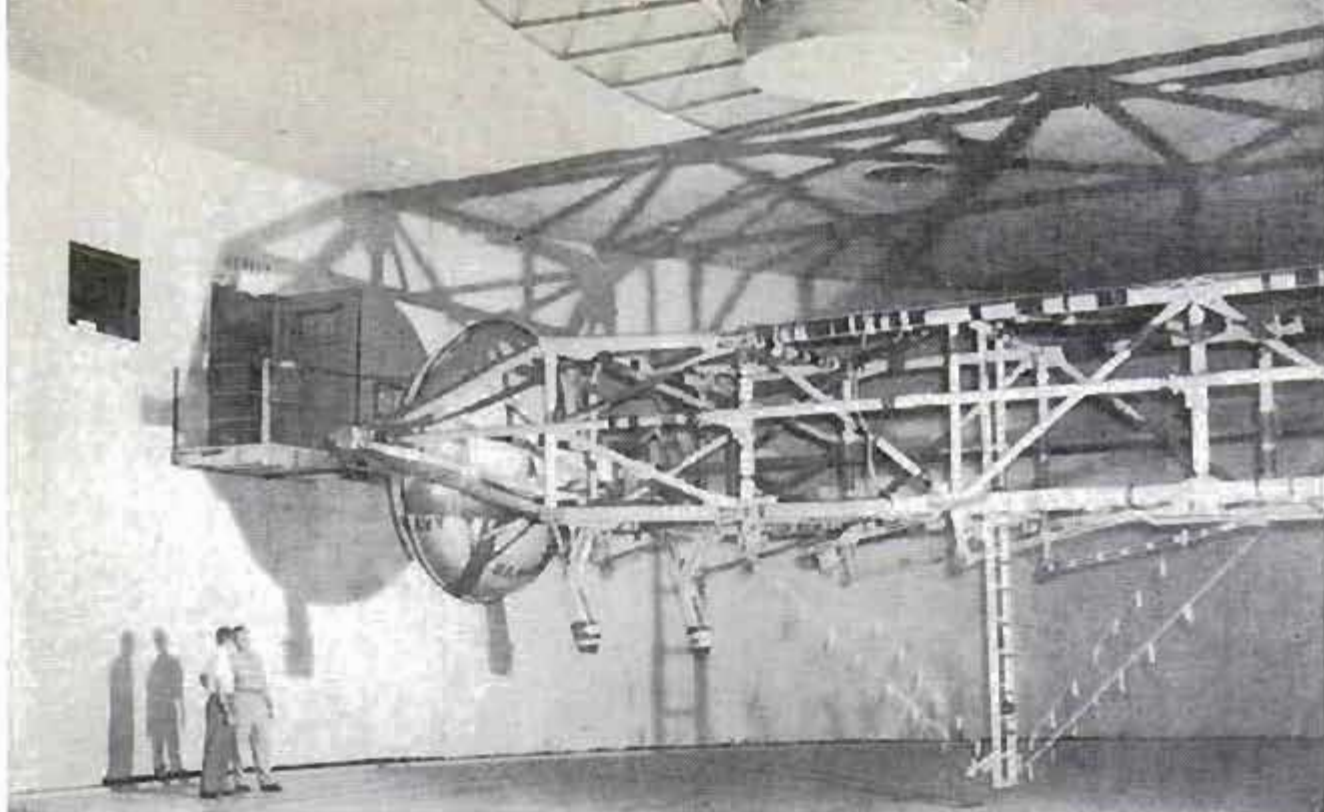

Cooper and Schirra inspect human centrifuge, which will whirl them around in simulation of space flight

were in the military they were also available to us. But it should be emphasized that throughout our search, the most important factor was technical skill."

Because these men were to be engineering consultants as well as pilots, the technical requirements dictated older men. The original list of 110 military test pilots invited to volunteer for the program was first winnowed to 32, and finally to the seven men selected as Astronauts. Seven

was considered the most workable number for the specialized training necessary; the seven men chosen also embodied special skills in particular areas which had to be explored as the Astronauts were being trained.

The Astronauts were released by their various service branches (three Air Force, three Navy, and Col. Glenn, the lone Marine) and reported to Langley Field for training last April. Since that time

Much of the Astronauts' time is spent listening to technical lectures and briefings given by scientists





Two F-102's are assigned for Astronauts' exclusive use. Men complain they don't get enough time in the air

the program has been moving steadily—but sometimes rather painfully—forward toward the day when the Mercury capsule will be secured atop an Atlas rocket and fired out of the Earth's atmosphere into space with one of these seven men strapped securely in the contour couch inside.

How do you train an Astronaut? There were no precedents to guide the directors of Project Mercury, and training devices had to be created almost from scratch. Here the technical skill of the Astronauts themselves proved of great help.

Astronauts Help Design Capsule

Wally Schirra told me: "One of our most important jobs is to put the pilot's ideas into the cockpit of the capsule. The engineers won't be going up into space with us. There's always a certain amount of conflict between the designers and the men who fly the machines, but we've worked it out well with the technical people here."

The Astronauts are stationed (and their families live in and around) Langley Field, near the southeastern tip of Virginia. They spend from half to two-thirds of their time at Langley; the rest is spent at various installations around the country where they personally consult on the building of equipment to go into the capsule or take training tests not available at Langley.

When I met with the Astronauts, they had just returned from a three-week trip to the West Coast which included extended visits at McDonnell Aircraft in St. Louis, manufacturers of the space capsule; Convair in San Diego, builders of the Atlas

rocket; and North American Aviation, which is building and testing the X-15. The week I followed them through their activities at Langley was typical of their fluid training program. Here are the essential elements of that program:

Technical lectures on basic astronautics, physics, astronomy, propulsion, biophysics,
(Continued to page 252)

Full-size model of capsule has retro rockets at bottom. Bags will float capsule if it lands in water





Right Out of the Barn!

Both a jet fighter and a missile shoot out of a simulated ground shelter and streak away toward their targets. A self-contained "inertial" system, a form of memory navigation, makes the Air Force MACE missile invulnerable to enemy jamming. The system eliminates the need for ground control and guides the missile over any route, including water.



Built-in Steel Cables Support Spaceman's Suit

Though it looks like a suit of long-legged underwear, a new seat-suit design offers maximum protection and mobility for the future spaceman. Steel cables sewn into the seams of the nylon-net suit fasten the

suit to the spaceship's cabin, producing a hammock effect. The system permits the pilot to operate controls without tumbling around in gravity-free situations and protects his body from acceleration pressure.

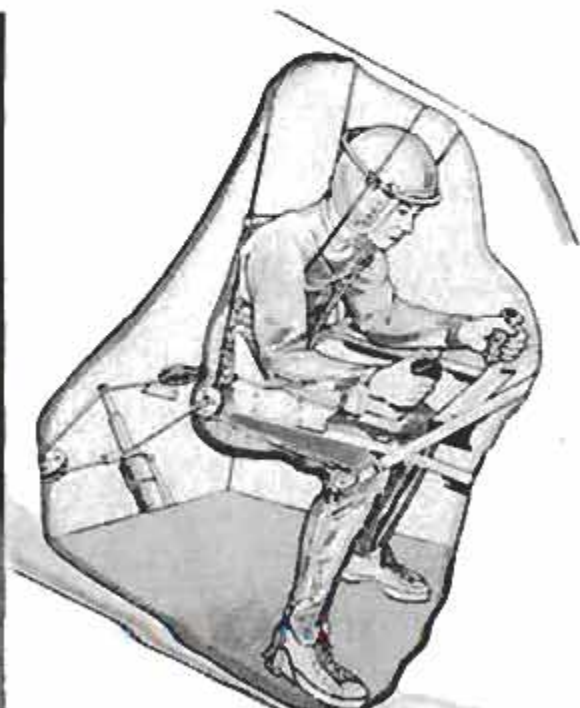

NEXT MONTH--

PM's 8th Annual

AUTO ISSUE

Featuring--

PICTORIAL HISTORY OF THE AUTO INDUSTRY IN FULL COLOR

A six-page pullout that traces each present-day auto company back to its origin. The suitable-for-framing chart includes scores of drawings of old and new cars, chassis and engine diagrams covering six decades of automobiles.

Also:

- Pictures and specs on all the 1960 cars, including many foreign makes
- Road tests on the new American small cars
- Engineering analysis of the Corvair, Falcon and Valiant engines
- Illustrated report on the World's Largest Auto Show
- Troubleshooting tips from a mechanic
- Plus all regular features

It's your yearbook of the auto industry:

PM's JANUARY AUTO SECTION

On the newsstand December 29

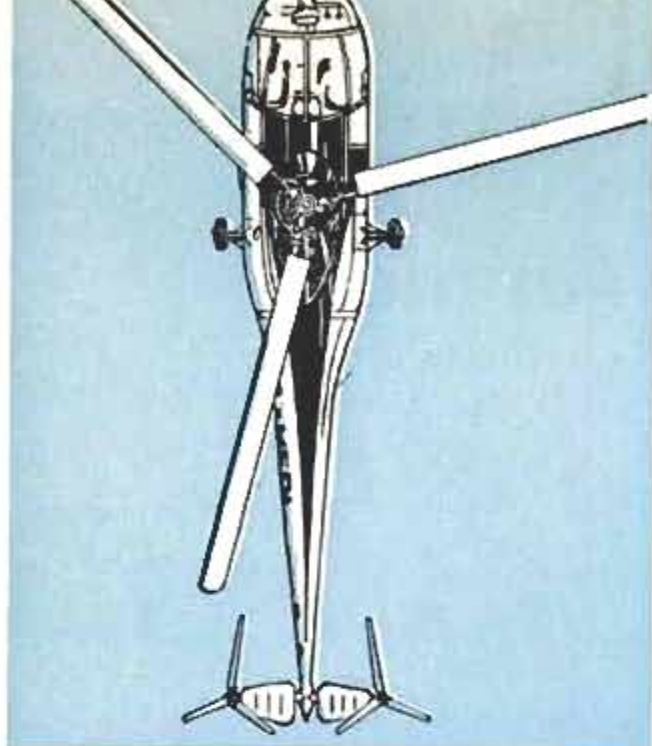

Three Rotors Operate First Postwar West German Helicopter

West Germany's first postwar helicopter, Kolibri I, operates with three rotors. In addition to its central rotor, it has two smaller ones on the tail that sit at 45-degree angles from the center line to provide greater stability and better control. Both the main rotor and the rear ones are three-bladed and all controls are operated by means of hydraulic pressure. While the helicopter underwent testing, its fuselage was kept uncovered. Tests have shown

that the craft flies at a vertical speed of 99 miles an hour and a horizontal speed of 87 miles an hour. Its maximum altitude is 13,133 feet and it carries a pilot and two passengers. Designed by Professor Heinrich Focke, the helicopters are built by Carl F. Borgward GmbH of Bremen, Germany, the company that manufactures automobiles of the same name. The helicopters will be priced somewhere between \$37,500 and \$50,000.



Doglift Ends Stairway Problem

Actress Lynn Tracey is one of the few second-story pet owners who doesn't have a dog-walking problem, and her dachshund "Shortie" may be the only dog with a private elevator as a result. A friend rigged a basket lift which allows Miss Tracey to lower the dog to the garden from her second-floor apartment window. When he wants to come back upstairs, he climbs in the basket and rings a bell. The only trouble so far has been with a neighbor's big boxer; the big dog crams his bulk in the basket, pushes the button, and waits hopefully for a ride.



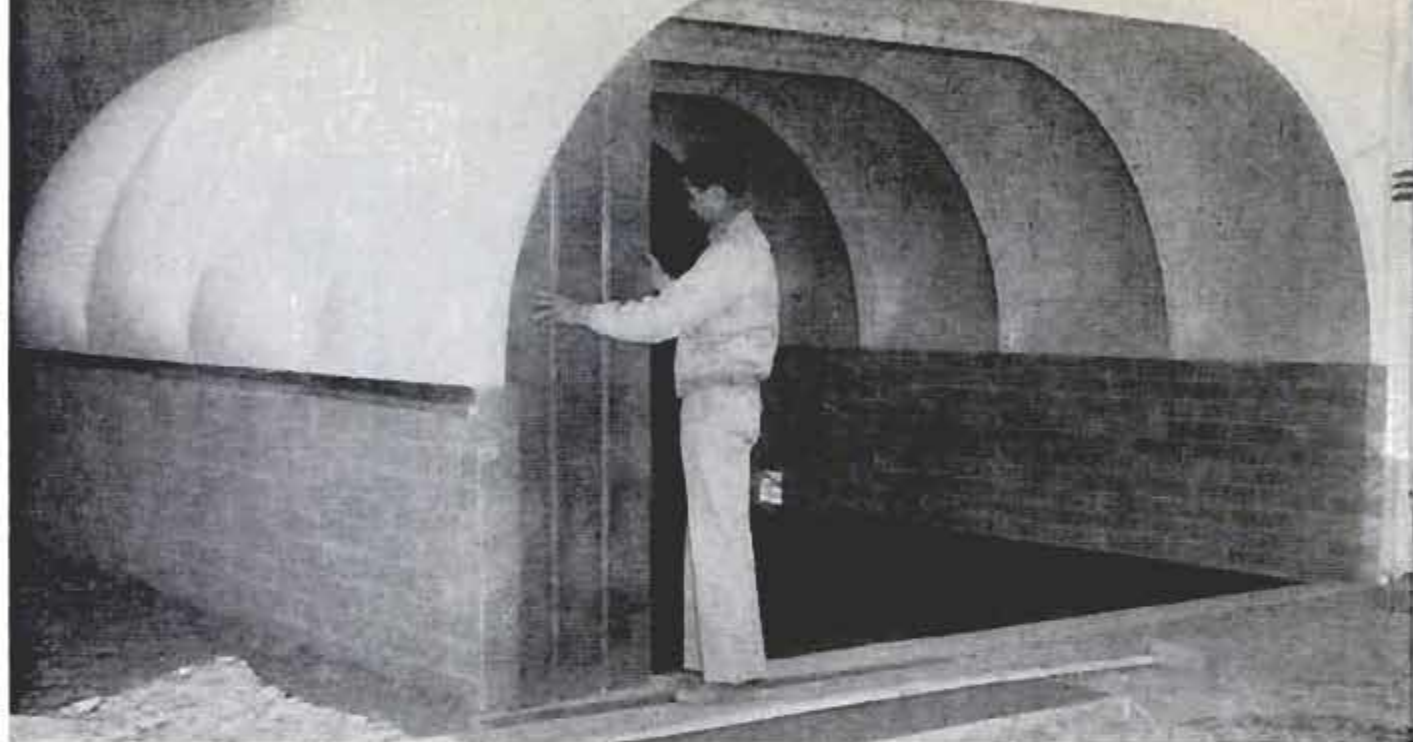

Fibreglas Sections Form Small Buildings

Curved Fibreglas sections in four-foot widths are joined to form a greenhouse, garage, storage building or other utility structure. The sections can be assembled by a handyman, and once they're erected, they're virtually maintenance free. The Fibreglas pieces rest on a masonry base. The greenhouse is sold as a complete package which includes doors, windows, screens and a heating and ventilating unit with thermostatic controls. The greenhouse canopy diffuses sunlight and prevents the burning of young plants.

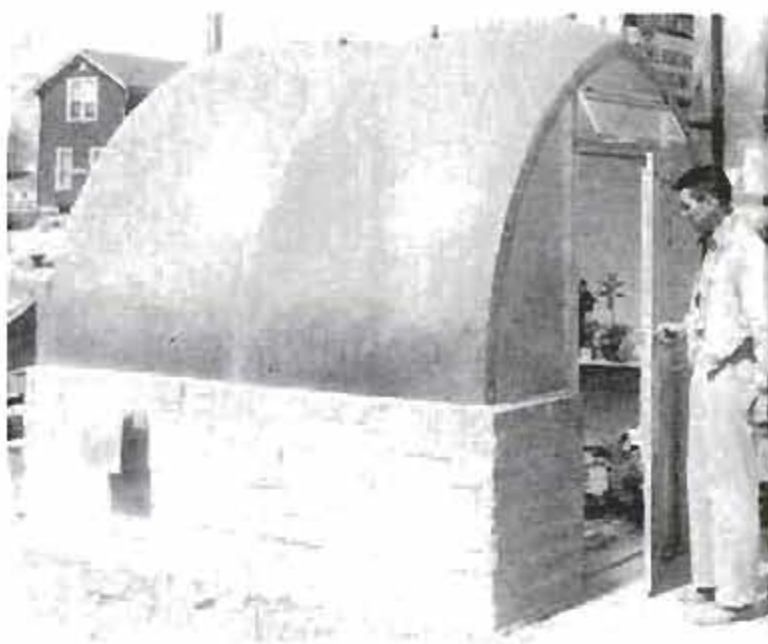

Tire Inflated in Cage

Steel pipes and a steel plate make up a safety cage for inflating giant tires. Orders for building the safety device were given by Brigadier General George W. Power, commanding general of the First Guided Missile Brigade at Fort Bliss, Texas. The tire is placed in the cage so that it stands upright and is inflated through the bars. Pipe for the cage is one and a half inches thick, and is considered nearly foolproof in case the tire should blow up.



☐ There are 1.3 fatalities for each 100 million miles of travel on U. S. turnpikes — about half the fatality rate of 2.3 on other highways, reports the National Safety Council.



Ball Separates Oil Products

Inserted into a petroleum-products pipeline, a water-filled ball helps reduce by 50 percent the mixing that occurs when different oil products are pumped one after another through the same line. Shell Oil Company reports that as many as 10 of the balls may be used at the same time to separate various products that are moving through the pipeline.



Stand Holds Crooked Trees

Crooked-stump Christmas trees are no problem with a new tree stand that serves as a brace as well as a holder for any shape of tree. The tree holder allows you to take the tree as purchased, insert its trunk in the cup on the stand and then clip the trunk to a sturdy pipe, supported by circular tubing. It's not necessary to trim attractive bushy bottom branches.

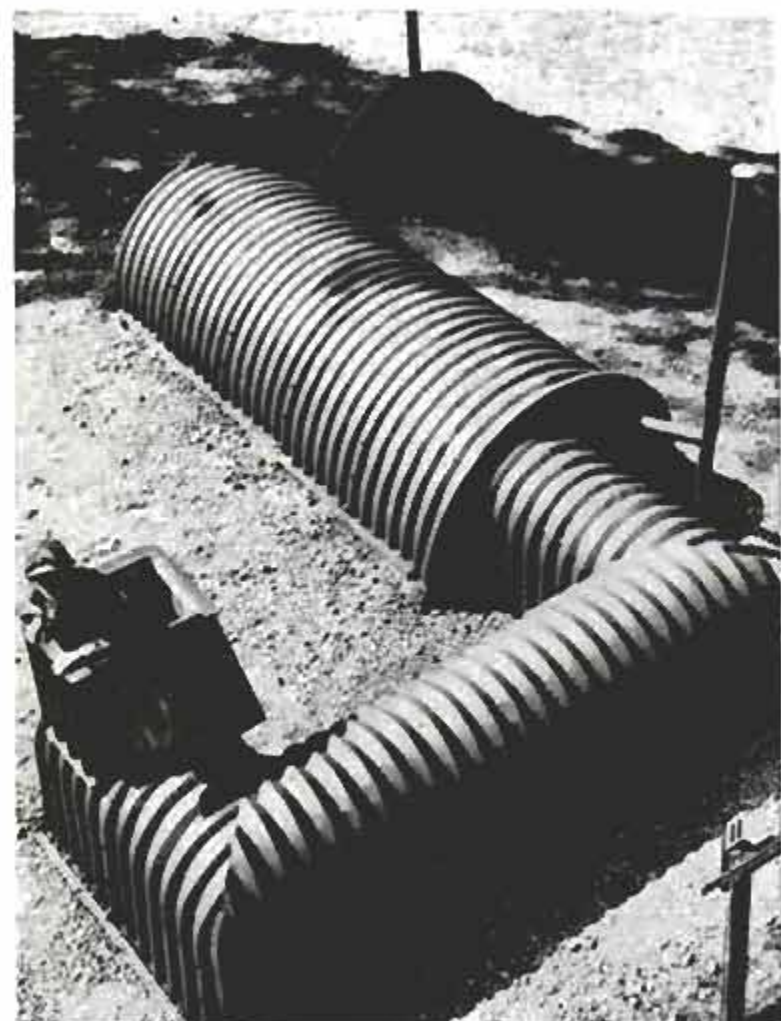

Steel Troop Shelter

Replacing individual foxholes as a means of shelter for soldiers, a corrugated steel covering, called a "group helmet," has been demonstrated in Sweden. Instead of each man digging his own foxhole, a large pit is dug and the steel covering is placed over it. The "group helmet" is then covered with earth to help protect against possible radioactive danger. Here a soldier emerges from the exit of the protective cover. The apparatus, relatively light for its size, weighs about 2800 pounds.

Arrow Poison Ingredients Relax Patients in Surgery

Dr. Paul Karrar of the University of Zurich, Switzerland, has synthesized two of the 63 alkaloids (saltlike substances) found in the poison, calabash curare, and they are being used in Swiss hospitals to relax muscles of patients in major surgery. For centuries, Orinoco natives of the Amazon have used arrowheads poisoned with curare to paralyze prey.

YOU DID IT—you brought on the revolution. Are you happy? Did you get what you wanted?

After all, Detroit was shooting in the dark. It knew you wanted more economy, but how much more? It knew you wanted smaller cars, but how much smaller? It knew you wanted less opulence, but how much less? Are the new small cars what you wanted?

Small-car sales look good. Even better than expected. Chevrolet, for example, set up production to sell five big Chevys for each Corvair. After the cars came out, the ratio was lowered to four to one. Now, it looks as though it may come down to three to one.

Most 1960 models are out, but there's still excitement ahead. Ford Motor Company has announced it will bring out another "small" car, the Comet, to be sold by Mercury dealers this spring.

It will share much Falcon structure and machinery. Wheelbase will be 114 inches (the Falcon's is 109.5). The added length will be mostly in the trunk. The engine is expected to be the same as Falcon's except for more displacement.

Like the Falcon it will come as a two-door, a four-door plus a two-door wagon. The Falcon wagon is to be available by January and will sell for about the same as the Rambler American wagon.

Buick and Dodge will get into the big-small-car act, but probably not until next fall. Buick's will be all new. It won't be able to borrow from Corvair. You can't put a flat six between the front wheels. This just doesn't leave enough room for steering. Dodge's version may be a stretched Valiant.

Still to come is the Chrysler 300F. As before, it is the Chrysler shell with a distinctive grille, ornamentation and running gear plus plenty of power. The interior is emphatically "sports car" with four individual bucket seats. The driveshaft hump between the seats is covered by a panel containing such items as a tachometer, a sweep-second-hand clock and radio controls. It may offer an optional four-speed handshift transmission with a short, stubby lever coming up from the floor. The transmission that may be used is European and synchromesh in all gears. (If this keeps up, we'll be calling automobiles "pleasure cars" again!)

Is the industry going back into racing? There is evidence that it may. Top stock-car drivers are being signed up sub rosa by at least one company. Another company is working out a fuel-injection system obviously aimed at the race course. Items such as super-large-capacity radiators are being added to parts lists, ostensibly for



DETROIT LISTENING POST

By Art Railton

the taxicab trade. Watch for something to break soon. Involved could be Ford, Chevy, Pontiac, Plymouth and even Buick.

What's ahead for 1961? Is there anything exciting left? You bet there is. It will be as big a year for surprises as 1960. General Motors' transaxle is set for the 1961 models, from Cadillac down to Chevrolet. This will make the front seat a three-passenger seat once more. Bodies will be quieter in their styling, more sane in design (but lower, of course).

There will be less of the complex sheet-metal work, less crispness. Cars will look more like a cake of soap that's been used once. Even the big cars will occupy less geography, you'll be glad to know.

The Thunderbird will get some competition. The other companies are going out after some of that profitable business. One story is that this is to be De Soto's role in the Chrysler Corporation—to put out a distinctive car for the luxury class to compete with the T-Bird. Chevrolet is thinking along similar lines with a beautifully finished, jewellike version of the two-door Corvair. The only question is how big is the market? Do all people with lots of money insist on big cars? The Thunderbird seems to prove otherwise. Maybe even the rich like their automobile pleasures small?

Some 1961 cars may offer front-mounted mufflers. There are some legal hurdles to jump, but these have not stopped the industry before. By running the muffler crosswise under the front end, expensive, meandering exhaust pipes are eliminated. Exhaust gas is dumped into the front-wheel turbulence where it is dissipated harmlessly. The problem is to get the exhaust pipe far enough from the heater air intake to meet legal restrictions.

Big news also will be a heater-air-conditioner combination that operates on the heat-pump principle. Using engine heat to cool as well as to heat, it is cheap, small and solves the problem of air conditioning low-horsepower cars. With the help of a compressor, it gives hot air in winter, cool air in summer. ★ ★ ★

Skiing Is for Everyone:

By Stan Tomlinson

Chief Instructor, Squaw Valley Ski School

WITH A FEW hours practice of what you are reading here you can learn the rudiments of modern downhill skiing.

For best results you should practice these lessons in the sequence in which they are given. They are the same lessons that I give my beginners' classes at Squaw Valley, Calif.

First of all, your equipment: In selecting the length of ski you need, a rough rule is that when you stand a ski on end you should be able to reach up and catch its tip in the palm of your hand. A shorter ski will do if you are lighter than normal. Short skis are more maneuverable, long skis are fastest and track best. All good modern skis have steel edges that allow you to bite into the snow on side slopes. Modern ski techniques are based on this feature, and this is the kind of ski you want. The bottoms need waxing once a day. Use a paraffin wax for wet snow, a "silver" wax containing graphite for drier snows. Most modern skis have plastic bottoms that take the wax very well. Inexpensive skis that have varnished bottoms can be improved a great deal by removing the varnish and applying a coat of lacquer.

Your ski boots should fit snugly, more so than walking shoes, and should attach to the skis with safety bindings that release you in a spill. You'll want sun glasses, snug warm clothing and gloves or mitts. The two ski poles should come up to your armpits. The safe way to hold a pole is to run your hand up through the leather loop so that the leather rests in your palm, then grasp the pole as shown. This grip will allow your hands to slip free in case of a spill without losing the poles.

Always try a new outfit on at home where you have time to become familiar with it. This saves possibly an hour of making adjustments when you are out on the snow.

First I ask new skiers to walk around on their skis on level snow for 10 minutes or so, to help them become accustomed to the skis. They learn how easily the skis slide through the snow, how to propel themselves with the poles and how to turn around by taking a series of short steps.

Making a Kick Turn

This method of turning won't work on a side slope, so the first actual lesson is how to make a kick turn. This always is done while standing still.

With part of your weight resting on the poles, kick one foot up until the heel of that ski rests in the snow. Now pivot on that ski, turning your foot outward and around and bringing it down beside your other foot, at the same time bringing one pole around to help keep your balance. Now pick up your other foot and bring it around into place. The turn is now complete. Some people find it easier to do a reverse kick turn, first drawing one foot back and around and then kicking up the other foot and pivoting it into place.

Your next lesson is how to walk up a small hill. It's done sideways. Stand at the bottom with your skis parallel and sideways to the slope. Step sideways up the hill with one foot, bring up the other, and take another sidestep. It's

First, get "feel" of your skis. Here, author demonstrates proper form



Start Here

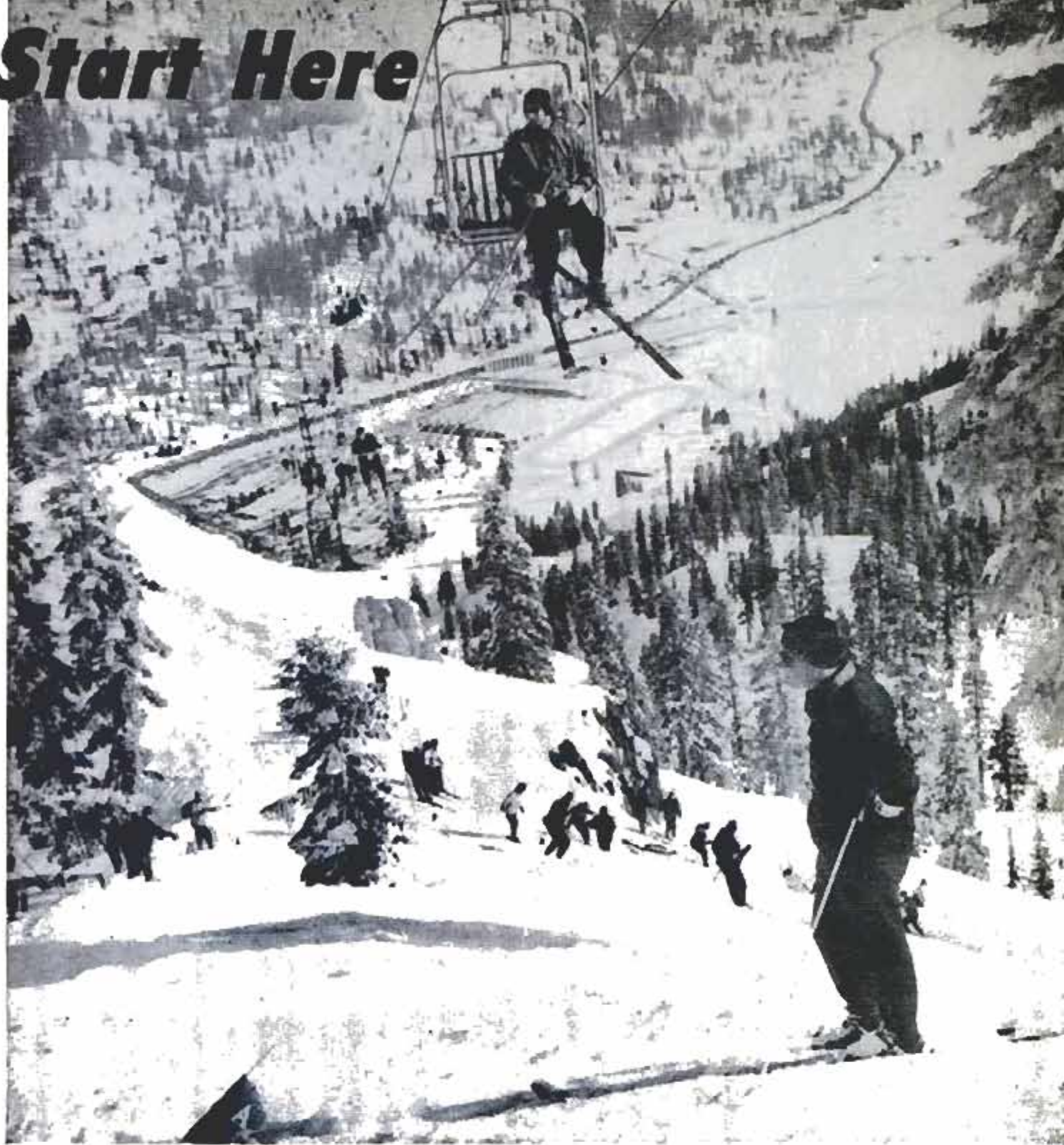

necessary to dig in with the uphill edges of the skis to prevent slipping back; in fact part of the reason for this lesson is to teach you the importance of the edges and how to use them. After a few such climbs you can try the half sidestep, stepping up and forward at the same time and always digging in with the edges. This is somewhat less tiring and carries you diagonally up the slope.

Now practice the herringbone climb, named for the pattern the skis leave in the snow. Face straight uphill with the tails of the skis close together and with their tips about three feet apart. Plant each foot firmly in the snow as you walk ahead, using the inside edges to prevent skidding, and using your poles to prevent slipping back.

By now you are ready for the first downhill runs.

Spectacular Squaw Valley will be the scene of the 1960 Winter Olympics. Chair lift is one of several for the skiers. Below, ski pole is held with loop of leather across the palm. This grip permits hand to let go without injury and without losing pole





Don't try this if you are a beginner! At Squaw Valley, championship skiers deliberately make long jumps in a downhill race to gain speed. Championship skiing requires split-second timing and keen balance



Use a very gentle practice slope, 50 to 100 feet long, preferably level at the top and with a long flat runout or even a slight rise at the bottom. Keep your skis parallel and no more than four inches apart. Lean forward a bit with bent knees almost as if you were preparing to kneel on your skis. This attitude helps maintain your balance.

After pushing off with your poles at the top of the slope, reach forward slightly with the arms and hold your poles pointed toward the rear. This, too, helps you keep your balance and that's principally what you are learning at this point. Don't look

SNOWPLOW STOP:

Feet are spread and tips of the skis are brought close together. Note how skis are riding on their inside edges. Friction on these edges stops skier

KICK TURN:

Part of weight is rested on poles to balance yourself. Then kick up left foot until tail of ski rests on ground. Pivot foot outward and around until feet are again parallel but pointing in opposite directions. Remaining ski then is swung around and into place, completing turn

down at the skis. Keep looking some distance ahead and continue to coast along until you glide to a stop. After you've made a dozen or more easy runs and have gained confidence, you may stand straighter if you wish, and even push yourself along with your poles to go faster. Bending and extending the legs will usually help you relax.

Snowplow Stop for Beginners

Learning how to stop is the next step, and the snowplow stop is the easiest for a beginner. It's done at slow speed in easy snow. While you are coasting down the practice slope, apply the brakes by spreading your feet and pointing the tips of the skis toward each other. Press your heels out so that the skis ride on their inside edges. The friction produced by the edges will bring you to a stop in 15 or 20 feet if you are not traveling too fast.

This snowplow maneuver may be used for making slight changes of direction and also for complete turns. With the ski tips close together and riding on the inside edges, shift some of your weight away from the direction in which you wish to turn by leaning your shoulders to that side. This puts more weight on the outside ski and tends to make it track in the direction it is pointed.

The skating turn is another way for changing direction on easy slopes. It's the same kind of turn you make on ice skates, a series of short steps that gradually lead you around.

When you can handle yourself in these maneuvers you are ready to traverse a steeper slope. Traversing allows a skier to select his own downhill grade, no matter how steep the hill happens to be. He travels downhill in a series of tacks, moving first in one direction across the slope and then in the other. With knees slightly bent and with the skis resting mainly





Running a slalom course, a skier demonstrates how edges of skis dig into snow while turn is made downhill

on the uphill edges, keep the uphill ski about half a bootlength ahead of the other. This allows both knees to bend the same amount and lets you place more weight on the downhill ski, preventing it from slipping away.

When you reach the end of the traverse there are several ways in which you can stop and turn, preparatory to the next traverse. One is to use the skating step to turn uphill. Or you can snowplow to a stop. Now you make a kickturn to change direction, then shove off on the next traverse. Or, you may make a snowplow turn downhill

and then continue traversing without stopping at all.

Incidentally, one of the mountains that rims Squaw Valley and on which some of the Olympic events will be run in February, is known as KT-22. The mountain is named for the fact that the first woman to negotiate its steep slopes required 22 kickturns to reach the bottom.

Don't point your skis at too steep a downhill angle when making your first traverses. It's safest and gives you more confidence to pick a flat angle that allows you to slide

(Continued to page 236)

HERRINGBONE CLIMB:

Inside edges of the skis help prevent skier from slipping backward. Poles also provide leverage



UPHILL SIDESTEP:

Easiest way for the beginner to go uphill, and it teaches you to dig in with uphill edges to prevent sliding down





Railroad Ferries Carry 40 Autos

Two railroad ferries, capable of transporting 40 automobiles and 10 freight cars each, connect their respective ports in Switzerland and Germany. The Swiss ferry, *Romanshorn* and the German ferry *Schussen* are each 180 feet long and 39.3 feet wide. The two ships have twin 600-horsepower diesel engines and are capable of attaining speeds of about 15 miles an hour. Both of the vessels are equipped with radar.



Experimental Outboard Motor Tests Unique Features

Following the lead of the automobile industry in building experimental models to explore new design ideas, the McCulloch Corporation has built the Scott R-120, a high-performance outboard power unit which incorporates many new features. The four-cylinder radial engine develops 125 horsepower from 90 cubic inches of displacement, but is smaller in every dimension than current outboards of half the power. A turbo-supercharger improves fuel economy while increasing performance, and gives automatic altitude compensation and better sound control. An oil-lubricated crankcase eliminates fuel mixing and cuts oil consumption; the engine has direct cylinder fuel injection. All engine controls are remote and electric. The motor is hung from the transom on a mount that lets it tilt forward *behind* the transom and keeps the powerhead out of the boat at all times. Steering is done by moving the lower unit only; the powerhead does not turn. Tilt and trim of the motor are also remotely controlled. The propeller pitch is variable and reversible. The experimental model is not intended for production and sale, but its features may eventually be incorporated in Scott production motors.

Unique features of the experimental Scott R-120 will be displayed at the major 1960 boat shows





Sea-Going Truck "Flies" on Water

Suspended on three hydrofoil water wings, this 26,000-pound "Flying Duck" can travel 50 miles an hour with its hull four feet above the water. The converted amphibious landing craft, developed for the Army, uses a Lycoming T53 gas-turbine engine. It rises from the water at 13 miles an hour and can maintain high speed over a long, rough-water haul.

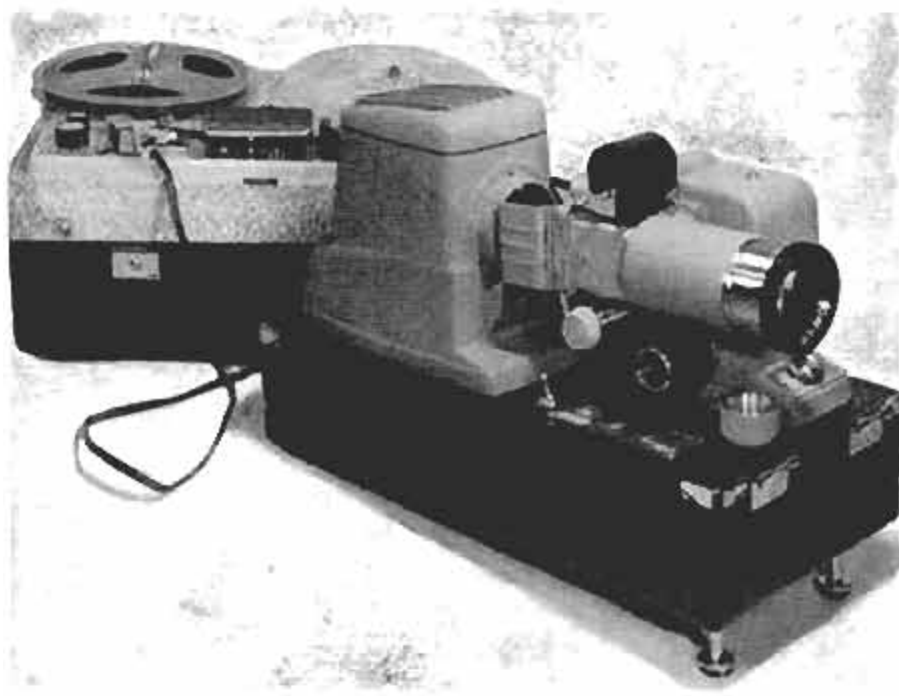

Tape Recorder Runs Projector

Home color transparencies and a "sound track" can be presented in unison while the operator sits back and enjoys the show. The tape recorder is attached to the projector, and, once adjusted and set in motion, the recorder changes pictures in synchronization with the narration. The tape can be re-used for new sound as often as desired, and the recorder can be adjusted so that it will change transparencies to suit the new narration.

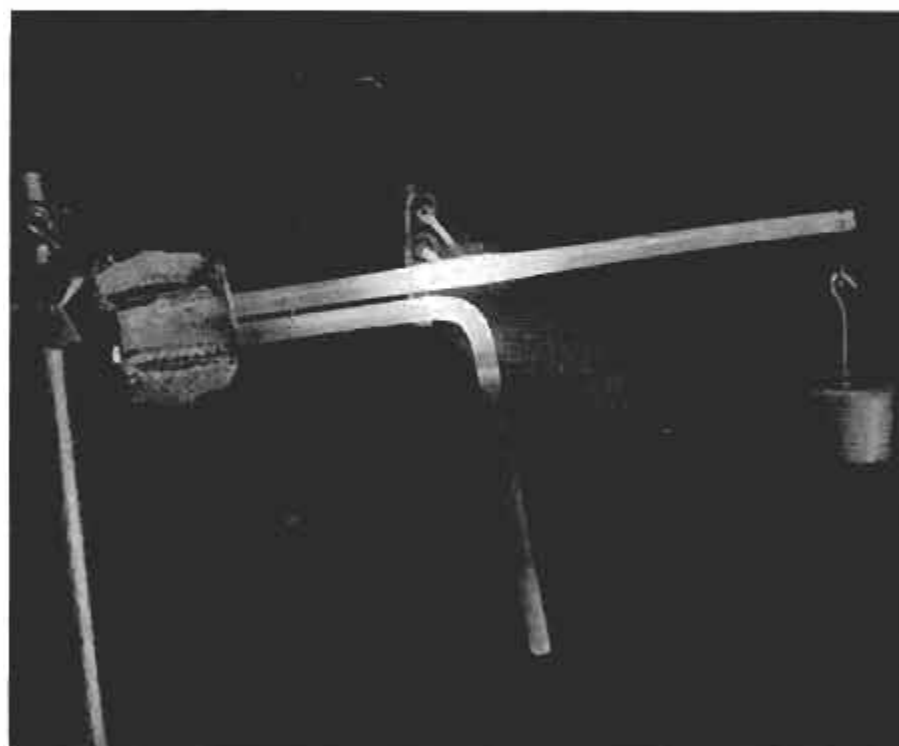

Strong Ceramic Is Translucent

Lucalox, a polycrystalline ceramic developed by General Electric Company, has in its unique combination of properties high strength, heat resistance, ease of fabrication and the ability to transmit light. It is made from powdered aluminum oxide and is closely related to sapphire and ruby gem stones. In tests, a bar of Lucalox and another of fused quartz were heated; the quartz bent under its own weight at 2350 degrees while the Lucalox supported 50 grams.

He Fishes for Sharks — With Balloons!

By
George X. Sand

Louis ("Herb") Goodman heaves mightily to cast bait and balloon floats into the outgoing tide. The current carries his bait out to where the big sharks feed

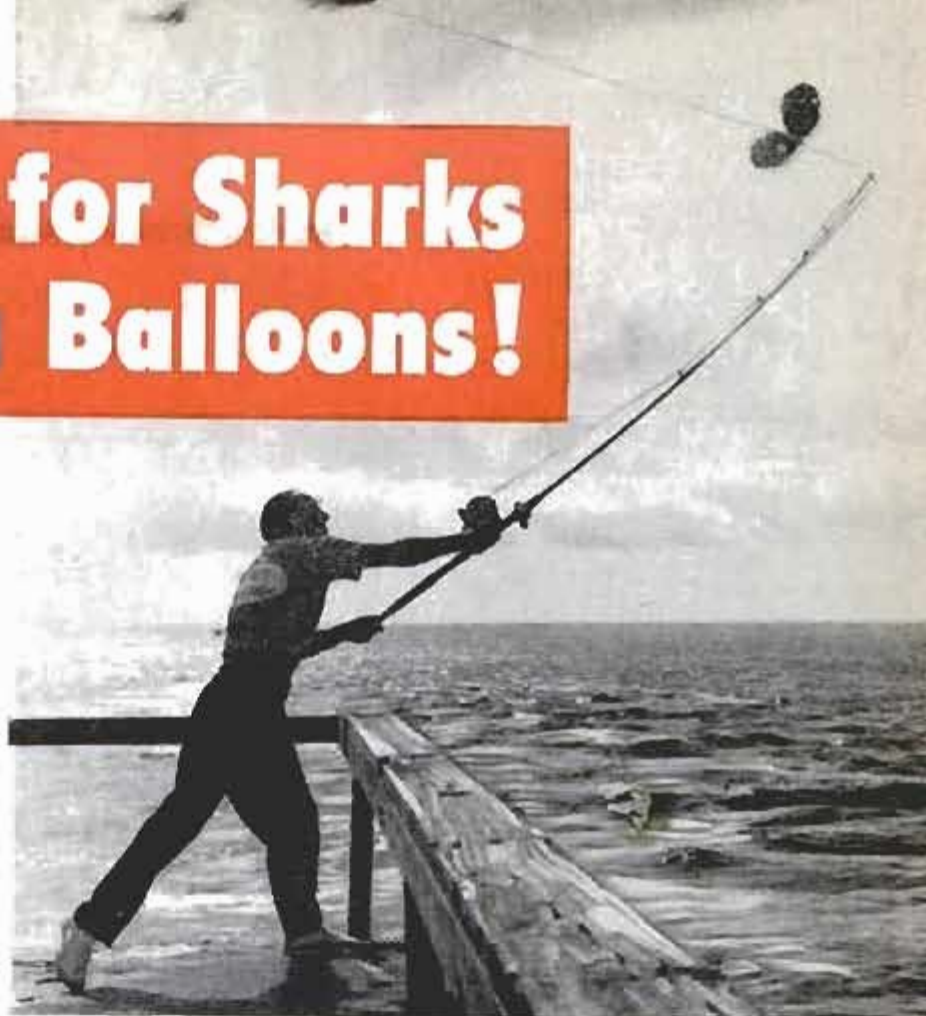

Down in Lake Worth, Florida, a wiry 130-pound fisherman passes up the popular salt-water fish and slugs it out from a jetty with sharks four times his weight . . .

Toughest part of the fight—Goodman wades into waist-deep surf to gaff a still-dangerous blue shark





Typical bait—a keeping-size bonito laced with two hooks. Third hook carries “teaser”

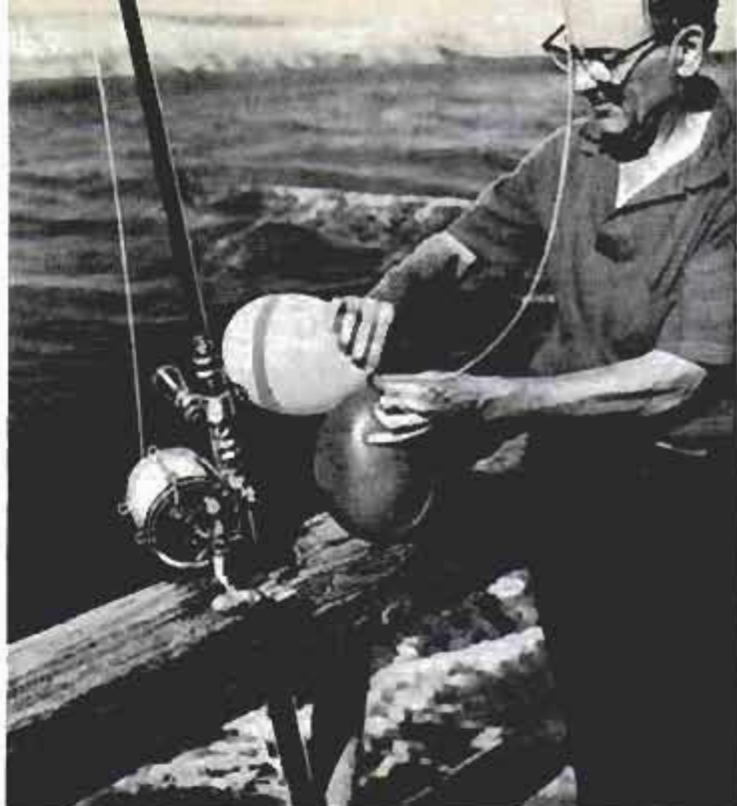

Bright-colored toy balloons keep the bait moving off the bottom, act as a bobber, and mark its position as it goes

HERB GOODMAN lives within rock-throwing distance of Florida's finest salt-water game fishing. His tackle shop in Lake Worth serves fishermen and charter-boat outfits that work offshore into the fabulous Gulf Stream grounds for sailfish, marlin, tuna, and other big game species.

Pesky little (four foot!) barracuda interferes with an outgoing bait. Herb once hooked a six-foot sailfish this way



But he passes up the glamor fish and does his fishing from shore, and for only one kind of fish—sharks, and the bigger the better.

In six years of strenuous fishing, Herb has landed 65 big sharks weighing up to 600 pounds, and hundreds more under 100 pounds, which he doesn't count. His biggest catch was an 11-foot 4-inch hammerhead. He's lost count of the number of fish and rigs he's lost (he uses 10/0 Scobey hooks at 25 cents apiece, and 130-pound test line at \$13 per thousand-foot spool, and often loses the whole works when a big shark strips his reel).

Herb has worked out a unique method for getting to his sharks—he stands on the north jetty of the Boynton Beach inlet, which is noted for its fierce outgoing tides, and lets the outrushing current carry his bait out to sea. The bait is a big chunk of bloody fish; bonito or kingfish or dolphin, and he lets the tide carry it out a thousand feet or more. A couple of balloons, in bright colors for easy visibility, serve as a combination of float, bobber, and spotting device.

Goodman uses a homemade nine-foot glass boat rod with an



Goodman beaches a nine-foot, 350-pound blue shark while a bystander holds the rod. Like most shark fishermen, he always inspects the stomach contents of his fish, but says he "never finds anything interesting"

auxiliary handle bolted above the reel seat for heaving against the big fish, and a big game reel of a size more often associated with marlin and tuna. Bait is easy—the sport fishing captains who pass through the inlet encourage Herb to rid the waters of all the sharks he can, and provide him with bait fish. They also speed his fishing occasionally by carrying his bait offshore on their way out.

Usually Herb manages to persuade a bystander to carry his bait and balloons to a bridge over the tidal rip and drop it in for him. When no one is around, the huge

bait requires a heroic casting technique shown in the photograph on page 93.

The long, hard job of wearing down the powerful sharks attracts a lot of attention along the waterfront. The day he beached the 11-foot hammerhead a crowd of over a thousand crowded the area, blocking traffic a mile down the highway. The bystanders help, though—when the shark is whipped down and ready to beach, Herb must hand the rod to someone while he wades into the surf to gaff his fish as with the nine-foot, 350-pound blue shark that he caught "to order" for these *PM* photographs. ★★

Big shark puts a good arc in Herb's rod as he plays it back through the tidal currents toward the beach



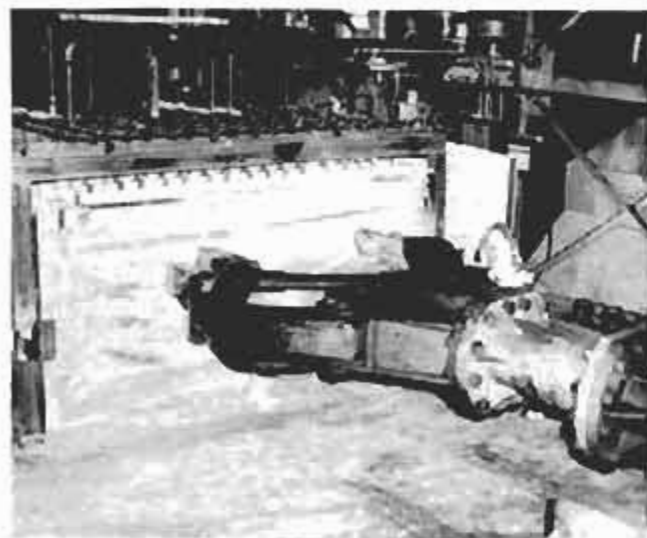

Heat-Absorbing Shield Forged for Space Capsule

America's manned capsule designed to circle the globe in just 90 minutes will have a huge, heat-absorbing shield made of beryllium. The dish-shaped piece has been forged by Alcoa from a record-size billet supplied by Brush Beryllium Company. The workers shown above in aluminized suits are guiding the die set's top half into the bottom half. At the left, a beryllium billet in steel jacket is removed from the furnace after being heated at about 2000 degrees Fahrenheit. During the rocket ride, the beryllium shield will form the outside covering of the space capsule's "floor."



Globe Shows Satellite Movement

Two scientists at the Sohio Research Center in Cleveland, Ohio, have invented a globe that can illustrate, in proper scale, a satellite's orbital movement about a celestial body at any desired time. Made from a bowling ball, the device also enables scientists to calculate the position of a satellite when viewed from any position on the celestial body. The globe has two rotatable hemispheres. The upper one represents a terrestrial hemisphere; the lower, the celestial sphere. The terrestrial hemisphere is inscribed with meridian and latitude lines, and the celestial sphere graduates in declination and right ascension.

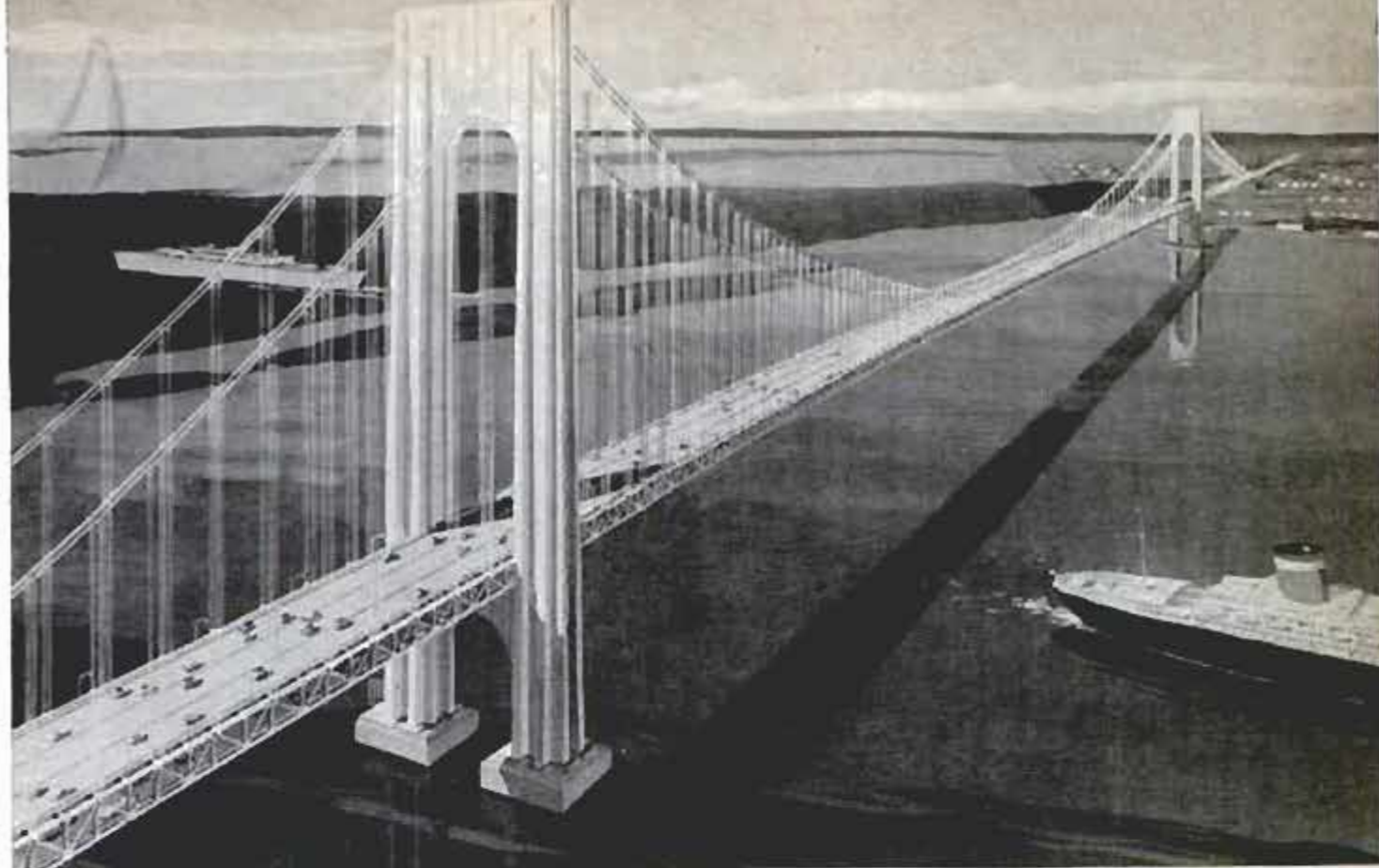

World's Longest Bridge Under Construction

Ground was broken recently on Staten Island as construction began on the \$320,000,000 Verrazano-Narrows Bridge that will link Brooklyn and Staten Island when completed in 1965. The suspended center span of 4260 feet will exceed the 4200-foot center span of the Golden Gate Bridge in San Francisco, currently the world's largest. From anchorage to anchorage, the bridge will be 6690 feet long, supported by 690-foot steel towers at either end. Including the immediate approaches, the new structure will be nearly three miles long. It will have a double deck with six traffic lanes on each level.



Electric Candlelight for Table Makes Attractive Display

Thanks to a German manufacturer, hostesses can now have the beauty of candlelight at their tables without the concern about wax drippings on the tablecloth. The manufacturer has marketed a seven-arm candelabrum that holds electric bulbs shaped like candles.

□ A Norwegian scientist has computed that the Gulf Stream gives off as much heat to the Norwegian shores as would be produced by burning the oil required to fill a 100,000-ton tanker every other minute.





Yale's Unique Hockey Rink Doubles as Campus Center

Looking like some prehistoric monster, Yale University's hockey rink serves as a unique activity center for the campus. When the skating area is not in use, the structure will seat 5000, and can be used for lectures, concerts and dances. The unique

feature of the rink, designed by Eero Saarinen, is a central concrete arch that forms the backbone of the building. The ceiling of planks, covered with black plastic neoprene, is suspended on cables like those used in a suspension bridge.

Satellites May Find Craft Lost at Sea or in Air

Satellites, orbiting far above the earth, may soon be able to help search out and locate to within one mile any type of craft in distress. Lost craft in the air or at sea, including nose cones and space capsules, would be equipped with subminiature radio

transmitters so that they could send out distress signals. Satellites, receiving the signals, would measure their frequency and transmit them to ground stations. Analysis of the signals by ground crews would locate the lost craft.

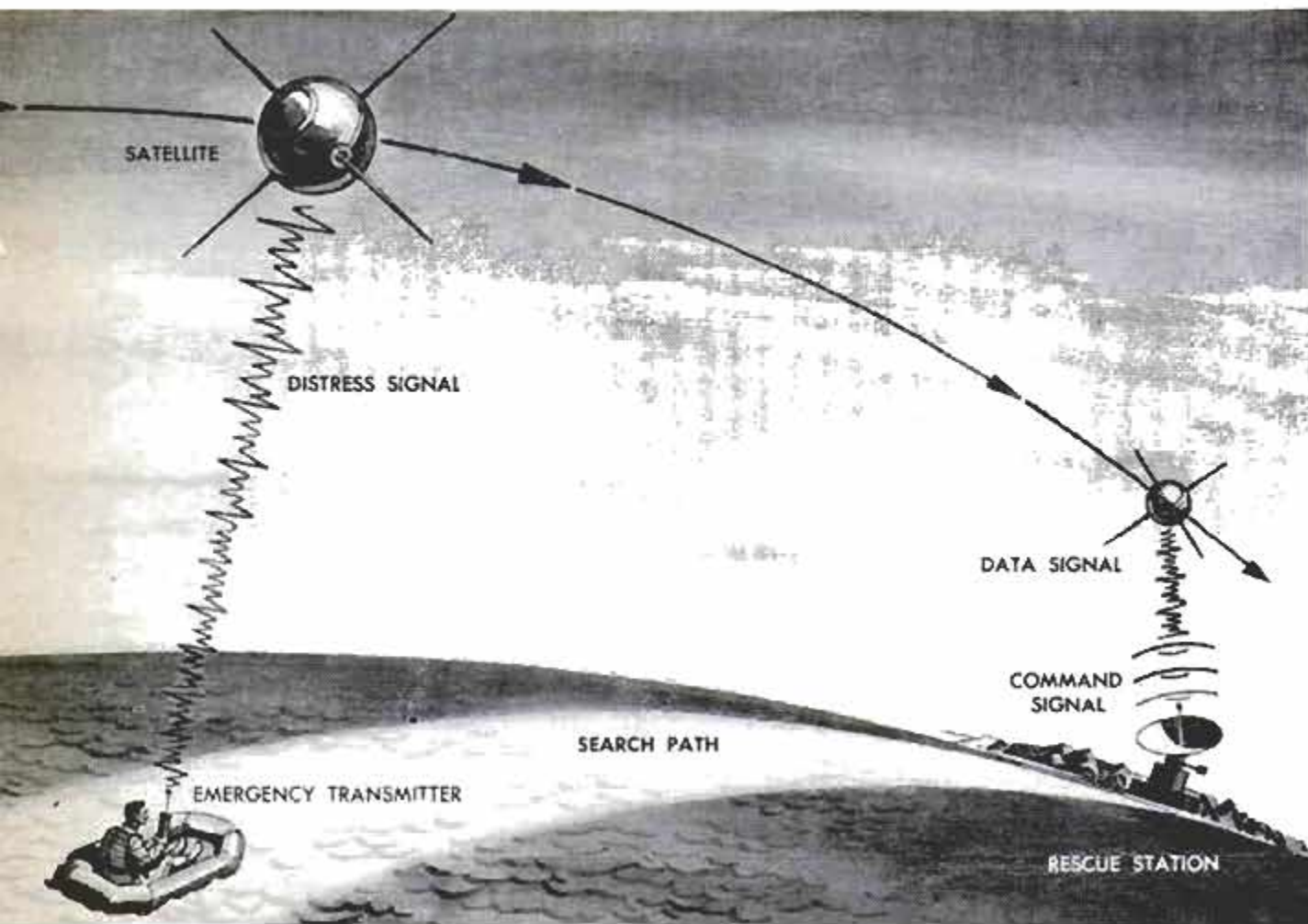



Chrysler's Valiant Offers Two and Three-Seat Station Wagons

First of the Big Three's compact station wagons is the Chrysler Corporation's Valiant Suburban. Available in two and three-seat versions, the wagons continue the continental styling of the sedans. The wagons feature a cantilever roof post structure. Side windows wrap around into the rear end. Captive-Air tires are standard on the rear-facing third seat wagon

and can be obtained as an option on the two-seater, providing locked luggage space under the floor usually taken up by the spare. The rear window rolls into the tailgate, which opens as a single piece, similar to other Chrysler wagons. The two-seat wagons are the same length as sedans, three-seaters 1.1 inches longer. Both are unit-constructed on a 106.5 wheelbase.

Compactor Speeds Construction

Two 15-foot rows of vibrating shoes do the job on a giant road-building machine that compacts granular material into pavement foundations in half the usual time. Hydraulically operated and controlled, the shoes will compact up to 1500 tons of rock and sand screenings an hour. One engine drives the hydraulic pumps and another the roadpacker.



Christmas Tree "Plugs" Into Simple Conical Stand

Just two simple operations are necessary to erect a Christmas tree on a new stand. First, a plastic plug is screwed to the bottom of the tree trunk; second, the plug with the tree attached is inserted into a recess in the conical base of the stand. It

isn't necessary to cut off low branches of the tree or tighten pressure screws to get the tree up. The base, 19½ inches in diameter, has leveling screws on the underside and a cup around the base of the tree to hold water.



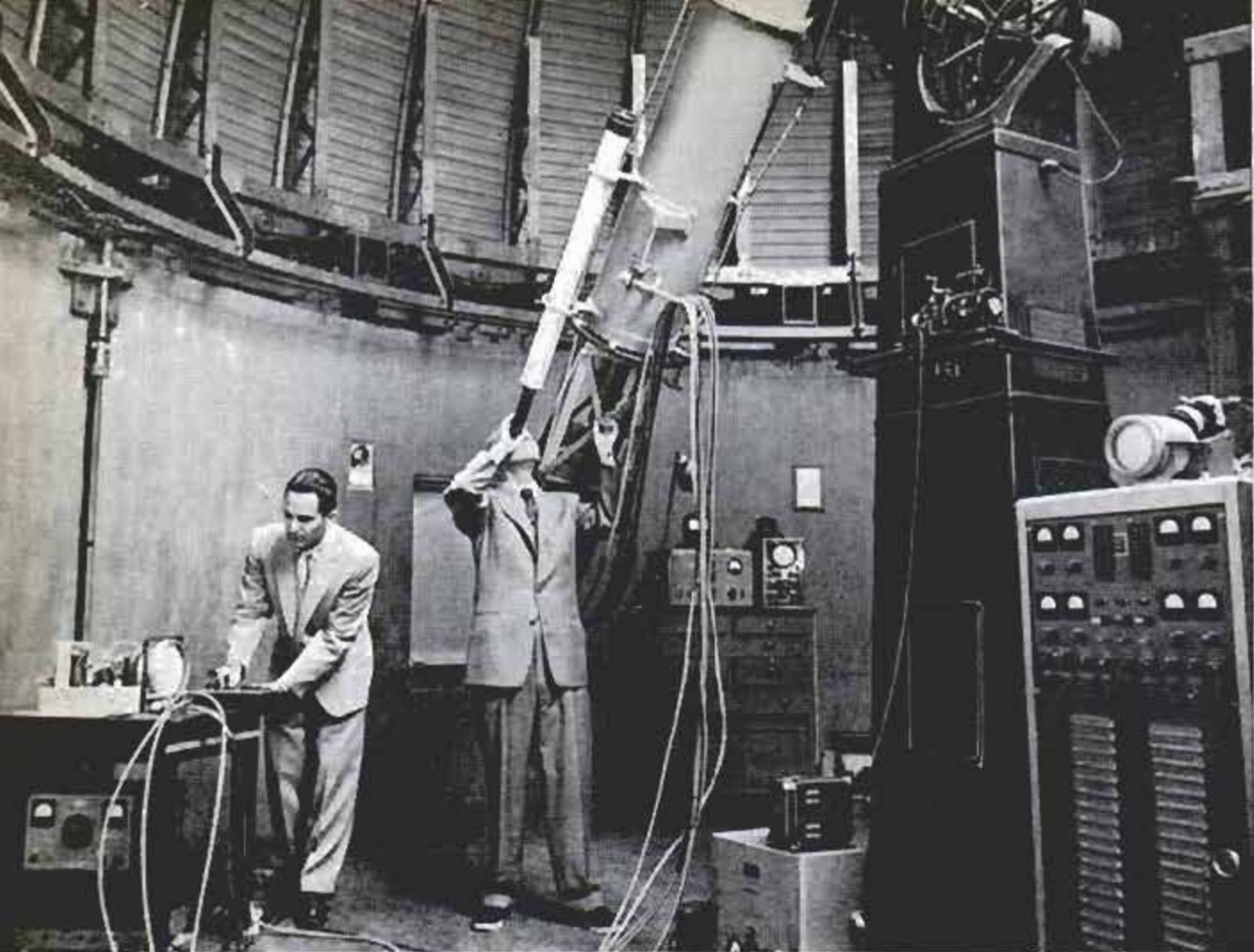

Light-intensifying system connected to 10-inch telescope permits stars to be photographed in broad daylight

"CAT EYE" TURNS NIGHT

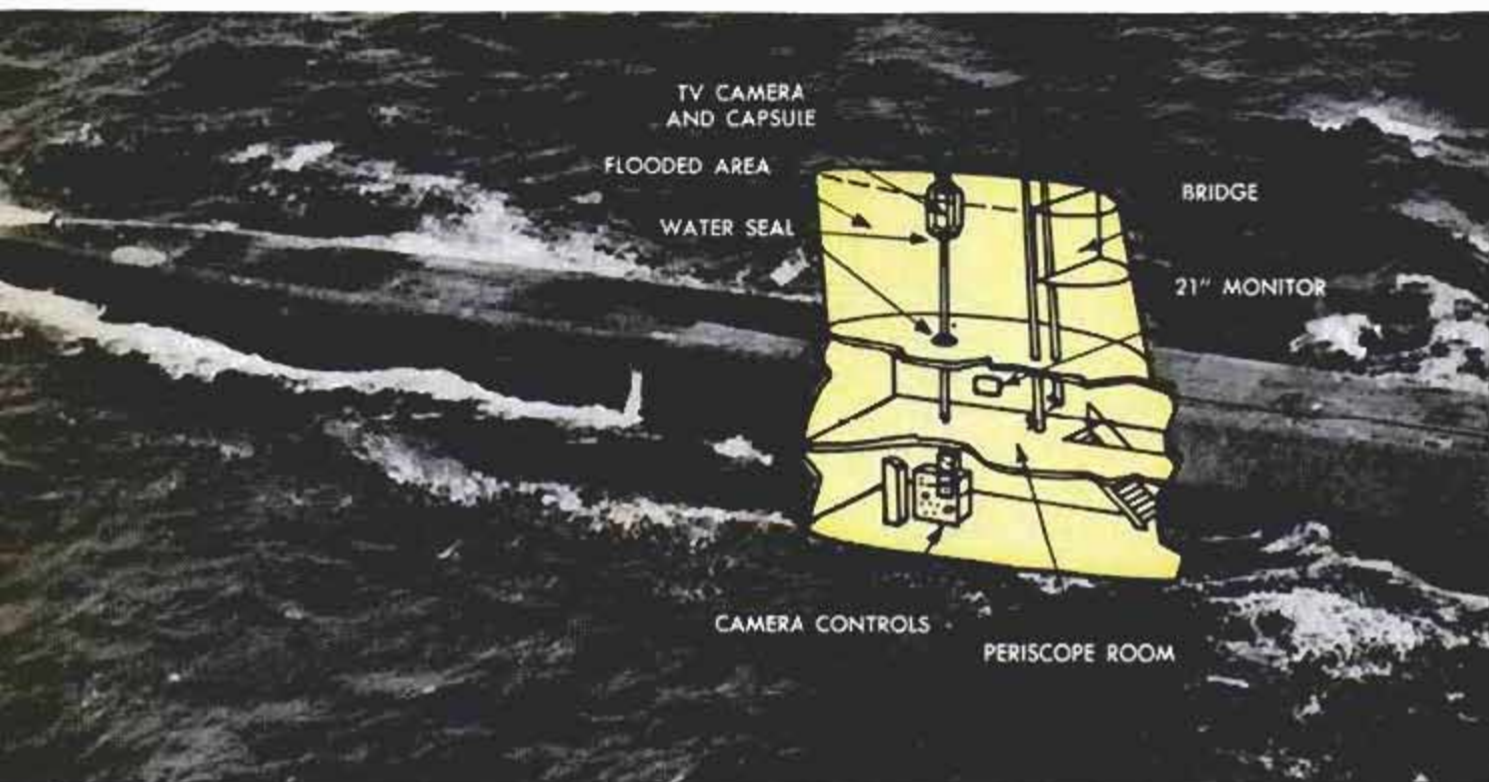

By
Art Zuckerman

AN ATOMIC SUBMARINE glides cautiously under the polar ice cap, its skipper intently watching a 21-inch television screen set into the bulkhead of the control room. On the screen he sees the ice cap itself gliding ominously overhead. He can make out details of its structure.

Suddenly a huge break in the ice comes into view on the screen. Just what the skipper has been waiting for. He orders the ship trimmed for surfacing. Soon he stands on the bridge, watching a "shore party" of his men at work collecting specimens from the floes that make up the polar cap.

The television rig that enabled the submarine commander to see where he was going under water is no ordinary TV setup. It is a unit that actually amplifies light. It provides a picture in the underwater darkness where ordinary television equipment would draw a complete blank.

Submarine exploration is but one of many applications being found these days for the electronic amplification of light.

Near the Wright Air Development Center, at Wittenberg College in Springfield, Ohio, the Air Force is working on television gadgetry coupled to a 10-inch refracting telescope that makes it possible to photograph a star in broad daylight. More important by far is the fact that the device shows details of heavenly bodies never before visible with such a small telescope, and it permits the taking of astronomical pictures with a sharpness never before possible with any telescope.

Light Amplification for X Rays

Another light-amplifying device promises to give the Army new long-range night vision. And unlike present Army night-seeing devices, it won't need an infrared light source to function. Still another light-amplifying device has successfully been adapted to a medical fluoroscope to reduce the amount of harmful X rays needed. This special fluoroscope actually permits viewing in a lighted room—and viewing after the subject has left the scene!

To industry, closed-circuit television with light-amplifying properties will provide observation where poor light conditions have in the past made such observation impossible.

Probably the first time light amplification figured in the news in a really big way was when the Navy's famed *USS Nautilus* made the first underwater penetration of the

Commander of *Nautilus* could view underside of polar ice cap thanks to light-amplifying TV system with camera mounted in a capsule in the conning tower

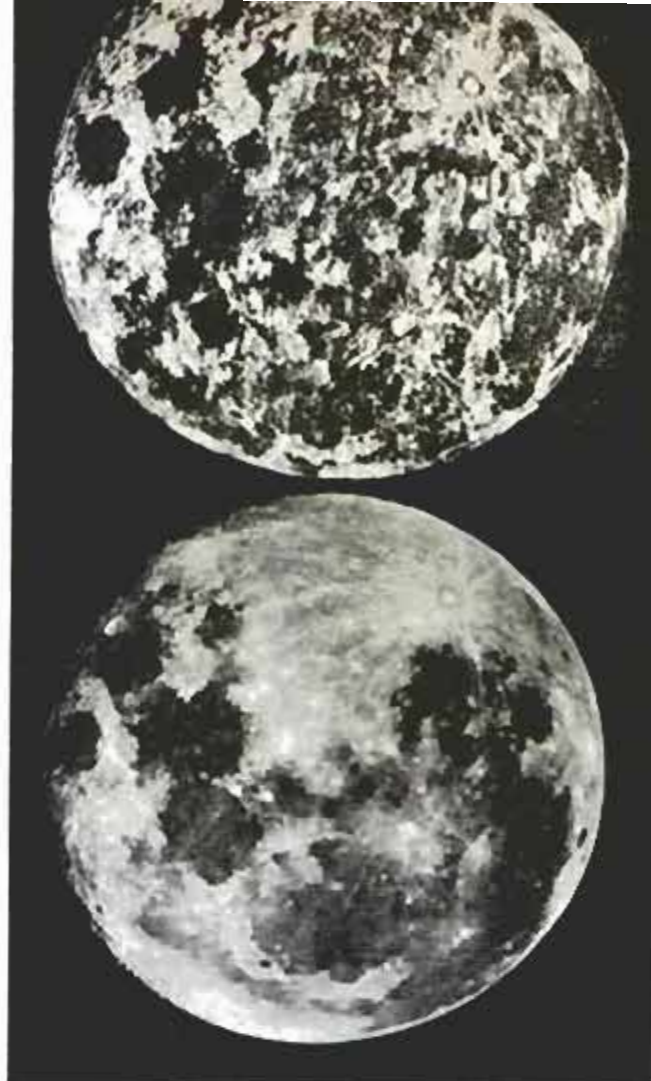

Top, "Cat Eye" moon photo; bottom, ordinary photo

INTO DAY





Early experiments by General Electric established that certain phosphors will amplify light when current is passed through them. Here, screen barely shows test pattern projected by ultraviolet light



When an electric current is passed through the screen of the phosphor, the image brightness increases at least 10 times. This phenomenon, known as electroluminescence, is basis of light-amplifying projects

polar ice cap in the summer of 1958. A special light-amplifying, closed-circuit TV system supplied by General Electric provided the *Nautilus*' crew with man's first fish-eye view of the North Pole's underside. The camera for this system was encased in a one-ton pressurized steel capsule mounted in the sail, or conning tower, of the atomic sub. This camera fed a 21-inch monitor screen, much like your own television set, that was located in the control room.

Cigarette Produces Picture

GE has since developed a TV camera so sensitive that it makes the *Nautilus* equipment look as light-hungry as the world's first video camera. The new version, which was designed with military needs in mind, is built around a cylindrical, 30-pound cam-

era that requires only a lighted cigarette to produce a clear picture in an otherwise completely dark room. A supersensitive image orthicon tube—the same kind of pickup used in commercial broadcast cameras—and a high-powered preamplifier give the system its superkick.

A key to the GE system's sensitivity is the fact that it provides 800-line resolution under top conditions and 200 lines at its lowest usable light level. Standard home television under normal lighting conditions delivers 300 lines. In addition to military uses, the company has fond hopes that the equipment will win favor as a night surveillance device in railroad yards, on highways and in dark factory areas.

General Electric is loath to reveal the exact means by which its image orthicon

"Cat Eye" photo of Jupiter reveals three moons, with a fourth at right causing planet's irregular shape

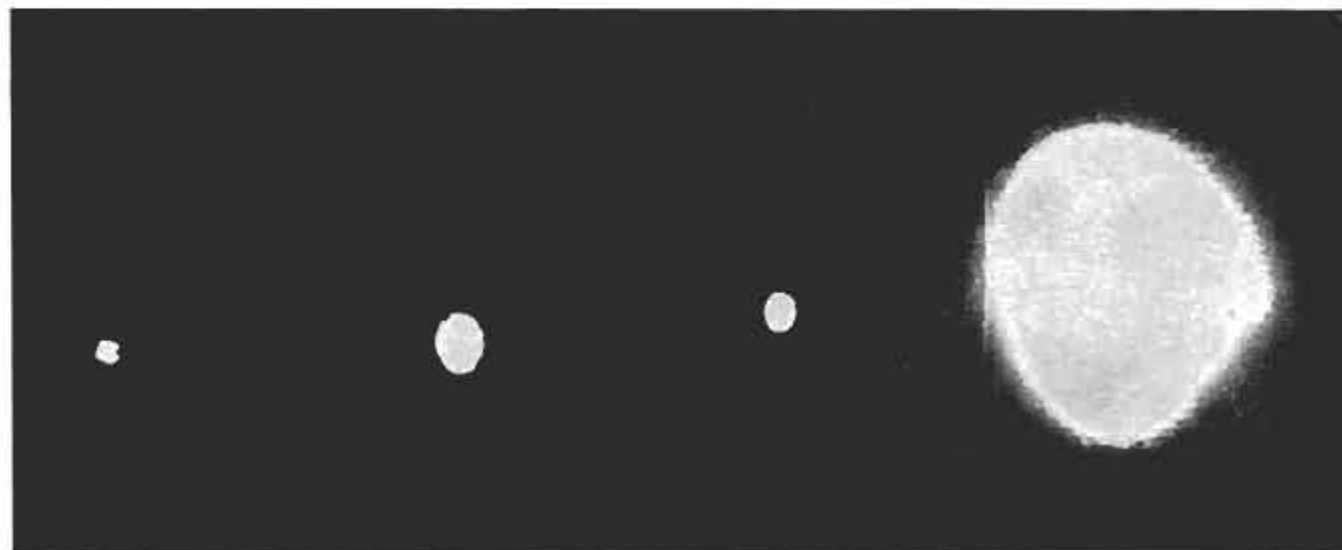



Set-up at right shows a normal TV photo with standard room lighting. Above, screen shows clear picture when room is lighted only with match

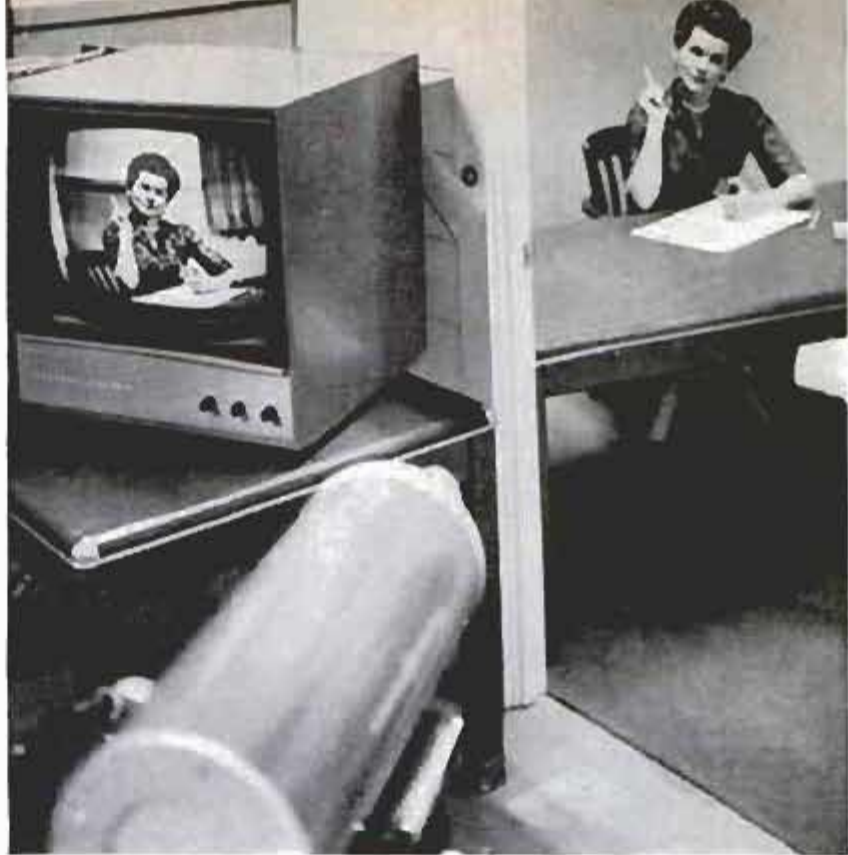

goes about amplifying light. But similar devices form the heart of the Air Force's experimental "Cat Eye" project at Wittenberg College. The RCA Tubes Division, and Westinghouse, have both developed special image-orthicon pickups for the project, which was brainstormed by a civilian scientist, Radames K. H. Gebel, at Wright Air Development Center. To understand how these special image orthicons work, let's take a look at a conventional model.

An image-orthicon tube has a photosensitive surface. When light hits this surface, it gives off electrons in quantity varying directly with the intensity of the light. This

creates a negative charge on a nearby target screen, which in turn induces a corresponding but opposite positive charge on an adjacent target plate. A scanning beam moves across this target plate, dropping off electrons to restore the plate to its original negative charge. The number of electrons dropped off by the beam at each point of its scan is translated into a video signal.

In a Cat Eye image orthicon, two inten-

(Continued to page 218)

Left, "Cat Eye" tube is much more sensitive than conventional tube. Below, night-spying instrument developed for Army has two tubes to boost weak light

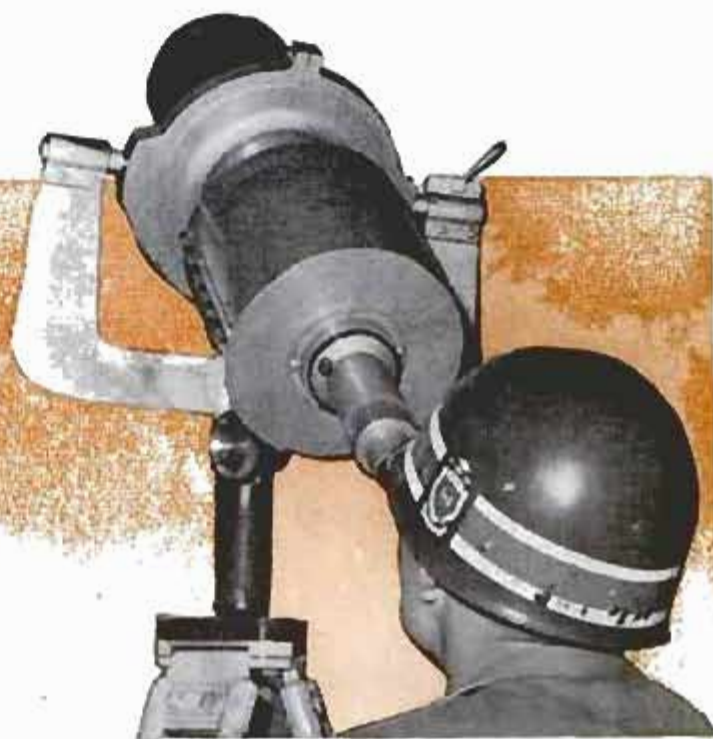



Single Xenon Lamp Bulb Lights Europe's Largest Hall

Deutschland Halle, the largest hall in Europe, and the officers and stockholders of Berlin's light and power company, pose for a photograph in the light of a single bulb — a 65,000-watt xenon tube produced by the Osram Works of Berlin. The occasion was the 75th anniversary of electrical illumination in the city.

Lifter Aids Panel Installation

Solving an old problem for handymen and professionals alike, a new on-the-shoe panel lifter lets a single installer lift and fit the biggest sheets of wallboard or plywood while remaining erect and with both hands free for guiding and nailing. The one-piece aluminum lifter will raise 200 pounds two inches with little effort, and works equally well on doors. It's designed to roll upright from any position to save bending over to slip it on.



SNOOPER WITH AN ELBOW



With three engineers in the palm of its hand, this articulated bridge inspection machine reaches under a stone bridge arch in northern England while the passengers check the condition of the ancient masonry. Self-powered and mounted on a flatcar, the arm-and-platform device saves days on each inspection job by eliminating the scaffolding that once was necessary for a thorough check-up or a minor repair job

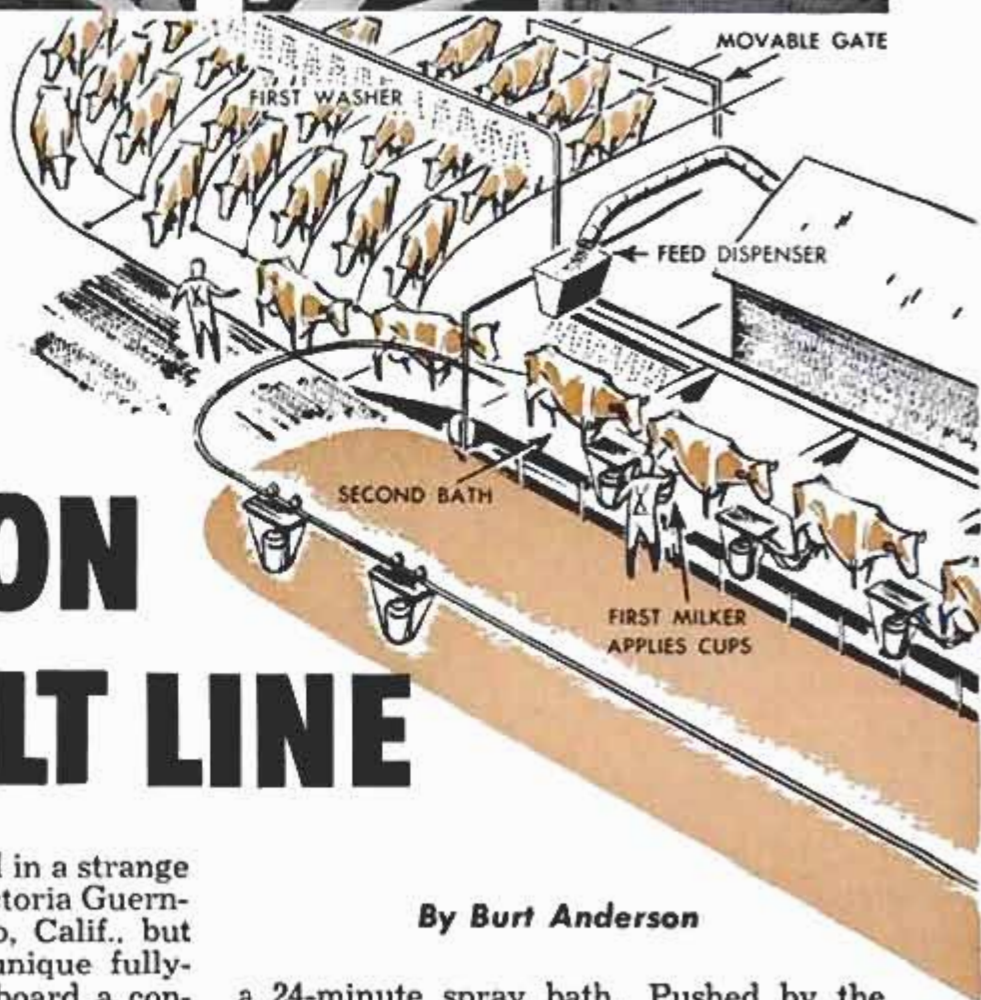

COWS ON THE BELT LINE

COWS ARE BEING milked in a strange way these days at the Victoria Guernsey Dairy in San Bernardino, Calif., but it's paying off. There, at a unique fully-mechanized dairy, 300 cows board a conveyor belt and in three hours are automatically washed, fed and milked.

Designed and built by Harry C. Cain at a cost of \$30,000, the belt is now milking the 300 Guernsey cows three times as fast as the conventional stall method with an estimated saving of \$5000 a year.

Twice a day, at 1:30 in the morning and afternoon, herdsmen drive groups of 60 cows from nearby corrals into a milking line where they are automatically divided into eight columns. A chain-driven gate drops down and nudges them forward into

By Burt Anderson

a 24-minute spray bath. Pushed by the gate, they board the conveyor belt.

Feeder troughs drop before them. Spying their food they push ahead and are washed again. Then the first milker wipes the udders and applies the cups. For the next 107 feet the cows do nothing but eat and give their all into 12 milking machines. At the end of the line they step off and go back to the corral. The advantage? Speed, say Robert and Harold Willis who own the dairy—the system reduces milking time from nine hours to three and it's all done automatically. ★ ★ ★

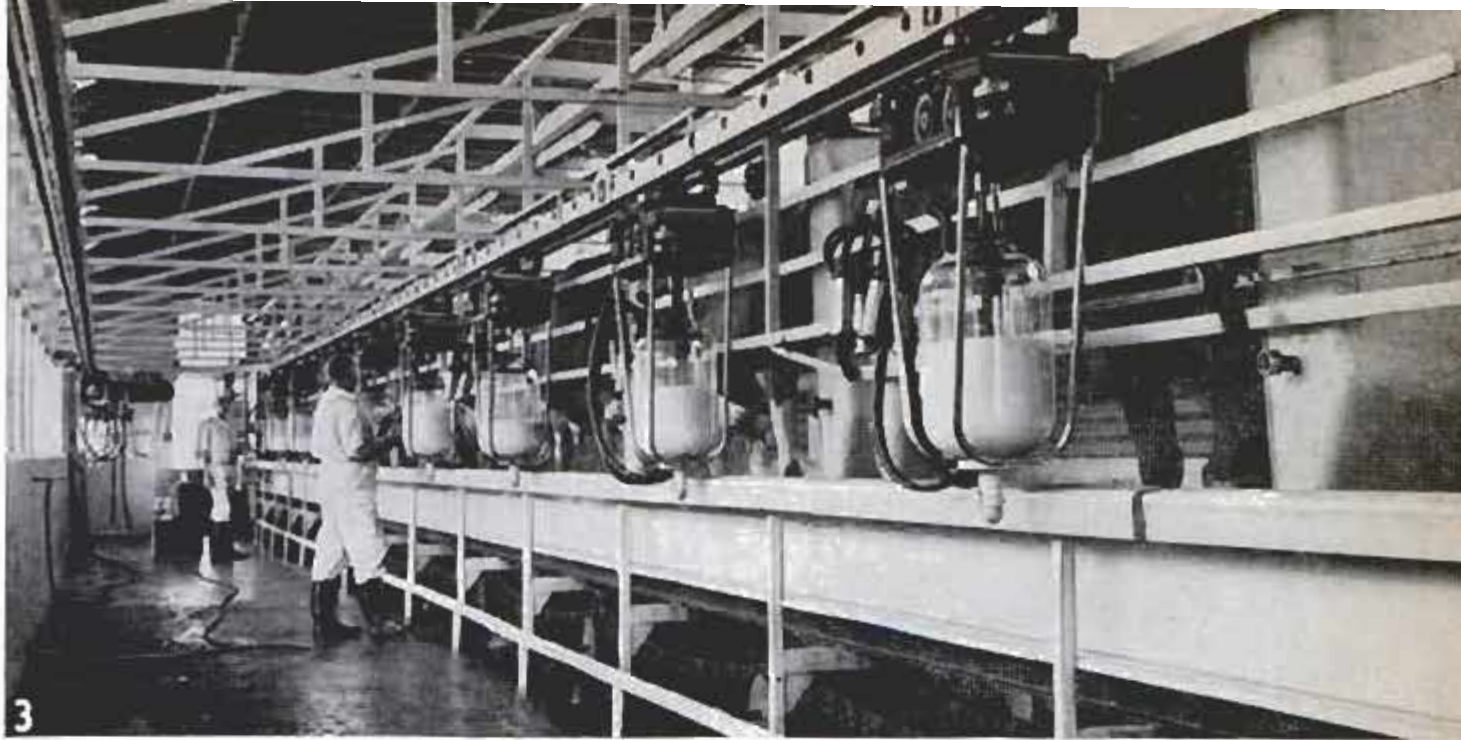

Nudged by moving gate at rear (1), a group of 60 cows moves forward to be milked. Lanes converge into one long path that leads cows onto conveyor belt (2). Once on the belt (3), cows eat as they are milked automatically. At the end of the line (4), suction cups are removed and cows leave. Milking time is reduced from a total of nine to just three hours

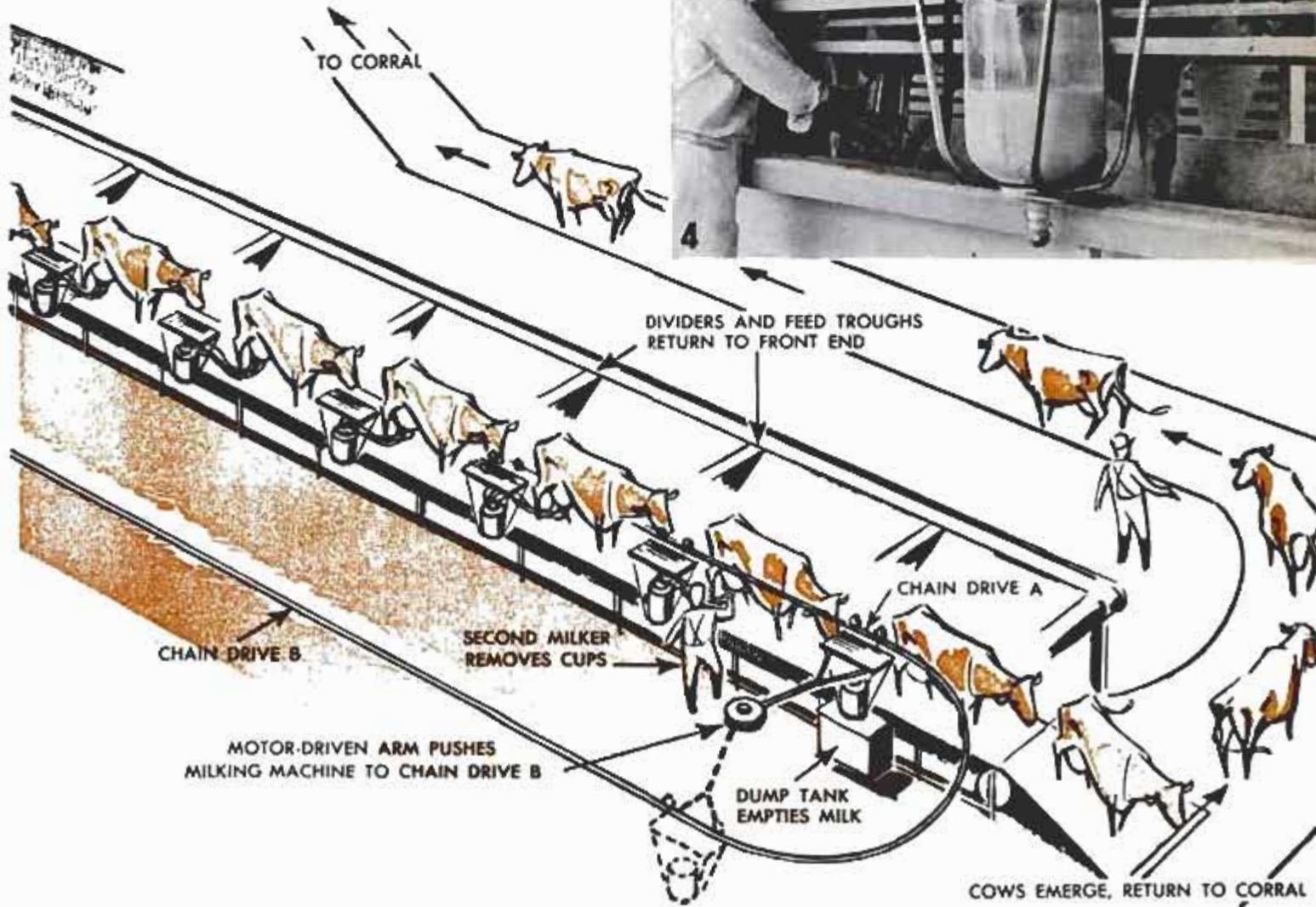
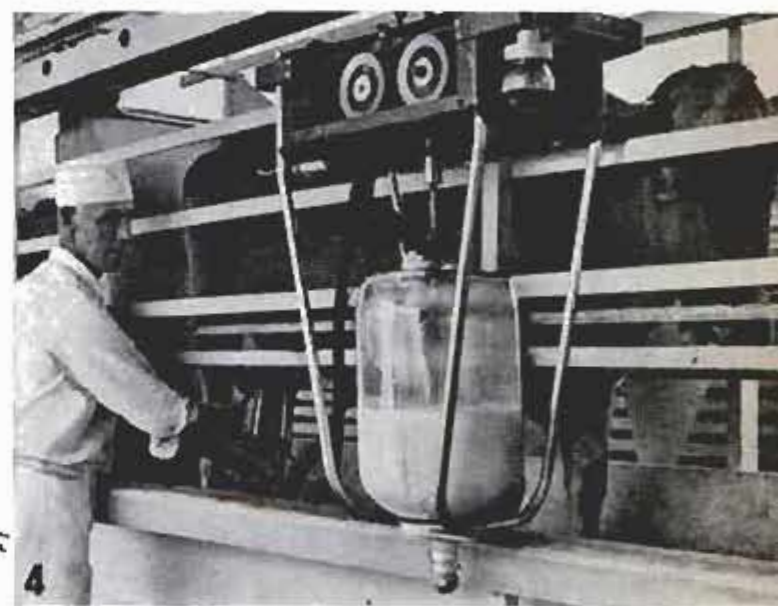



"Dialed" Sign Describes Road Conditions Ahead

ROAD CONDITIONS along California's Sierra Summit route on U. S. Highway 40 are now being flashed to motorists by two electronic signs that give up-to-the-minute information on highway hazards ahead. Placed in heavy snow country, the signs flash such messages as "Chains Required Over Summit" and "Road Closed Over Summit." Radio controlled, the signs are activated at a mountain maintenance sta-

tion or at a communication center in Sacramento. Radio signals are transmitted to the signs by an operator dialing a special telephone. The words in each line of the three-line signs can be changed by the radio signal, and each sign can be operated independently of the other. Nine messages are possible. They are produced on glass faces, and lights inside the units illuminate the messages to be read by night drivers.





He Paints With Nails

Britain's champion cobbler since 1952, George Brockwell is an artist in leather—the kind that goes on the bottom of shoes. Spending as much as six months on one pair of shoes, Brockwell uses thousands of tiny chrome nails to outline pictures on soles and heels and then fills them in with colored paints. Collectors pay high prices for his shoes, but not to wear as most are too heavy. Some of the paintings are composed of as many as 12,000 rivets. Brockwell has been called the “Da Vinci of the leather industry.”



Good Scarecrow Needed by Air Force

Recordings of machine-gun blasts, and thunder and hawk cries are being used to scare birds away from the missile sled track at Holloman Air Force Base in New Mexico. Birds, perched atop the monorails, cannot hear the sleds coming at faster-than-sound speeds of 1000 to 3000 miles an hour and cause considerable damage when they are hit by the sleds. The impact rips holes in the steel nose cones, tears apart sheeting and even wrenches the sleds.





Geological conference studies rock specimens—in 60 feet of water on the bottom of the Gulf of Mexico

Oil Hunters With Aqualungs

By Rafe Gibbs

Timing his ascent by his own bubbles, a diver brings up a sack full of specimens



WITH HIS EYES on the piece of crustaceous rock in his hand, the geologist jotted down notes on a pad—just as geologists have been doing for many years in many odd corners of the world. What made this jotting unusual was that it was being done at the bottom of the Gulf of Mexico—about 50 feet below the surface.

An aqualung attached to his back, the geologist was breathing easily. He was writing easily, too—with a wax pencil on a plastic slate.

Oil men have a reputation for going to great lengths in their quests for black gold, but skin-diving operations are in a class of their own. In fact, the oil industry claims a first in using skin-diving techniques for industrial development.

Thirty-five petroleum companies, which have already spent more than \$1,250,000,000 in probing for drilling sites in the Gulf, are continually seeking ways to cut down the number of "dry" holes in the water. A series of wells drilled in a new field from a single platform can quickly run up a bill of more than a million dollars.

There's oil in the gulf—plenty of it. About 120,000 barrels are being sucked up through the water daily. But the cost of exploration and development is heavy. That is why the skin-diving geologists have been put on the job to seek new scientific short cuts.

Pioneering in the new search technique have been six Socony Mobil men—four geologists and two geological technicians. They were selected because they knew their diving as well as geology. After additional diving training in the San Marcos River of Texas, they were put through the U.S. Navy test for frogmen, and were ready for the Gulf.

When first working out of Galveston in their 65-foot converted shrimp boat, the scientists took a bit of kidding:

"Going after shrimp—the hard way?"

"Not unless they're oil-bearing."

They began plying waters far from the coast—up to 45 miles—and when the divers went overboard they sank as much as 65 feet before touching bottom.

Sixty-five feet is considered deep water for oil wells in the Gulf, although Continental Oil last year set a new record by sinking a wildcat through 137 feet of water about 25 miles off the coast of Louisiana. Near the California coast, wells have been sunk in much deeper water.

The underwater work of the geologists in the Gulf is pleasant, because the water there is eight to nine degrees warmer than in the ocean. And it is quiet. Commented one scientist:

"I could even hear the clams clicking their shells shut when I approached."

Every now and then, however, the quiet is shattered, and there is a stirring of fish—and geologists. The cause of the disturbance? Dynamite.

A common way of conducting hunts for oil in the Gulf is by setting off blasts of



Rocks, shells and samples of bottom sand—all are trail markers for underwater oil explorers

dynamite in seismographic surveys. Crews operating 10 or more miles away can be heard—under water.

"First time I heard the sound below I thought someone had knocked on my air tank with a metal tool," said one diver. "I looked around, thinking one of the other divers was trying to signal me. Except for some scurrying fish, there wasn't a living thing near me."

The principal tool used by the diving

Offshore oil drilling costs big money; diving geologists cut costs by cutting the number of "dry" holes





You can't make notes "on the cuff" when you're not wearing a shirt, so the divers use plastic slates strapped to one leg

geologists can be found in many a garden shed—a dandelion digger. With it, the geologists loosen specimens of rock and shell from the sand and coral bottom.

To pry out larger specimens, some of the divers carry regular geologic picks. The specimens are tucked into gunnysacks, and wriggled to the surface with the same care—and effort—afforded possible pearl-bearing shells.

For taking photographs of the Gulf floor, the divers carry watertight still cameras. Movie cameras are being considered—they have been successfully used by a Union Oil crew off the coast of California in another phase of oil development.

The crew was core drilling in waters 1500 feet deep, and had a problem: Landing conductor pipe—without bending or breaking it—on the ocean floor. The depth was too great for a diver to follow the pipe to its destination, and this made the task a precarious one.

Almost before you could say "I Love Lucy," however, somebody came up with the idea of adapting closed-circuit TV to the job. A TV camera in a watertight case was lowered to the ocean bottom and operated from the drilling platform. The drillers on the platform could see on a TV screen just what was happening below.

The only trouble came from scene-stealing fish. Light for the camera was supplied by two 357-watt diver's bulbs, and these attracted great numbers of curious fish.

How do you get rid of fish 1500 feet below you? Turn off the lights. A diver operating a movie camera, however, would not have this problem. He would merely have to wave his arms or tap his tank with a dandelion digger.

(Continued to page 214)

Offshore operations involve every modern development. Here a helicopter lands on a special heliport built on an oil barge

Socony Mobil photos

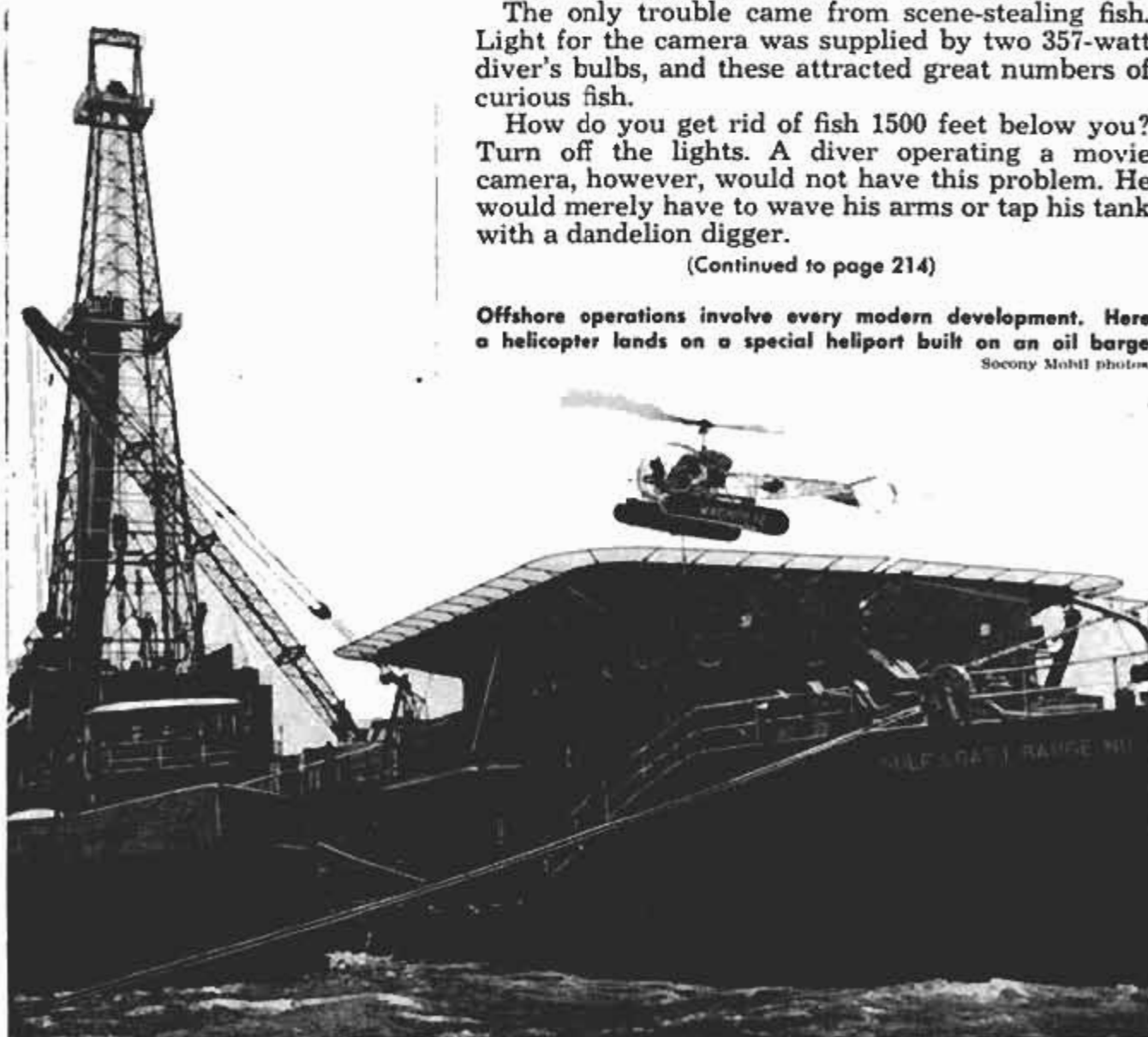

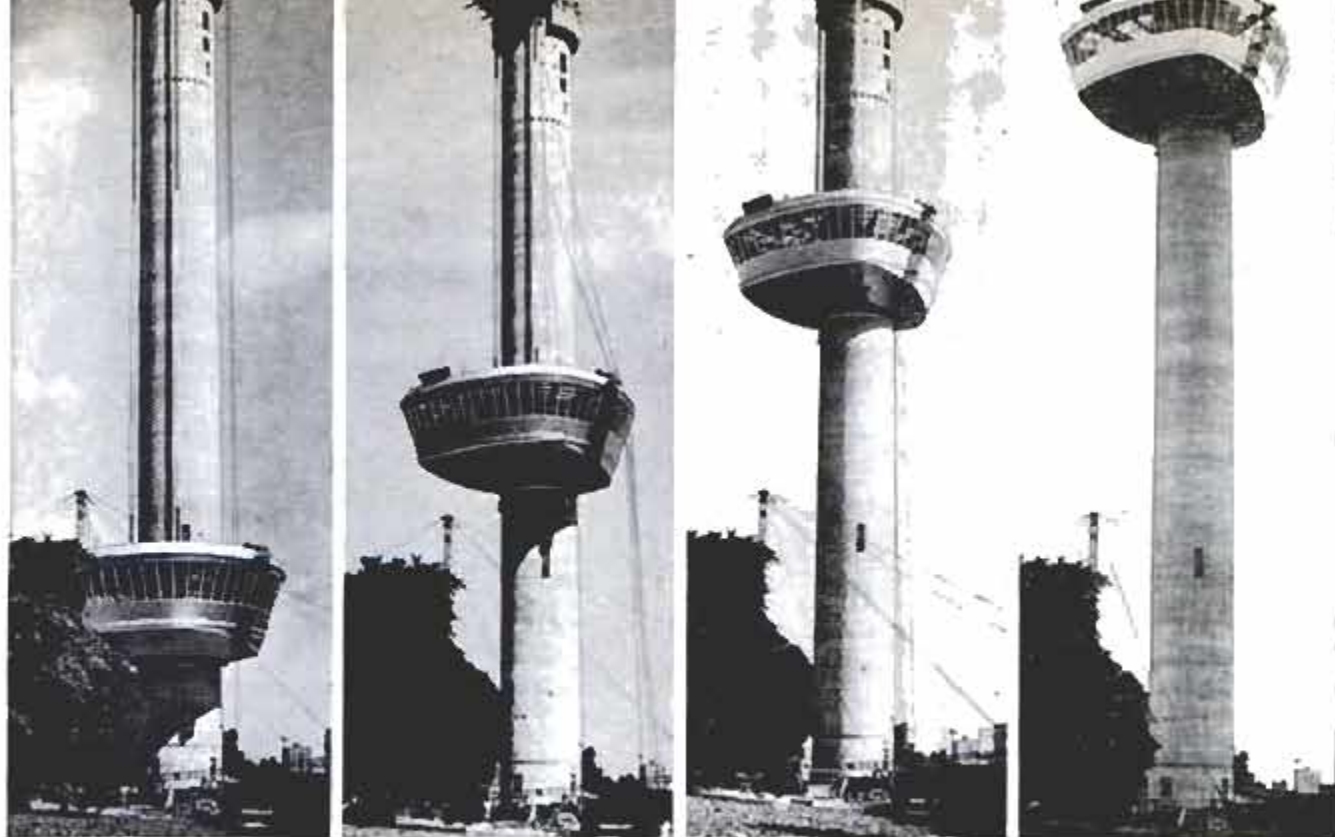

Rotterdam Restaurant Is Hoisted to Top of 350-Foot Mast

In less than five days, a crew of 60 men working in shifts around the clock hoisted a 240-ton restaurant to its permanent position atop a 350-foot mast. Diners will be able to see 60 miles in every direction. The eating place, which will seat 800 per-

sons, is scheduled to open next March in Rotterdam when that port city becomes host to the Floriade, a giant international horticultural show. The Euromast, as the structure is called, will remain a permanent feature of the city.

Time-Saving Egg Carrier Holds Seven Containers

Seven egg containers can be stacked on a carrier invented by a California poultryman. The containers, or flats, rest on two prongs that fit in the ridges of the bottom flat. The malleable iron rods are coursed vertically, then curved forward to form a carrying handle. A cross bar provides a carrying grip. Golf-club tape wrapped around the handle keeps the hand from slipping. Empty flats are carried on hooks welded on the vertical part of the shaft near the top and pointed upward. Two downward-pointing hooks enable the carrier to be hooked onto the side of the nest.

☐ Developed for supersonic fighter planes flying at speeds up to Mach 3 (1950 miles per hour), a plastic laminate for the pilot's canopy, will withstand the impact of a .45-cal. bullet and temperatures up to 400 degrees. The plastic bubble over the pilot is optically clear.



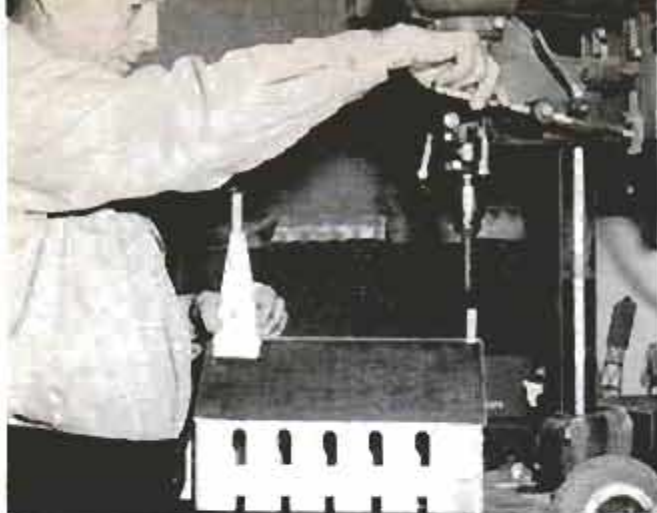

Rheingans puts the finishing touches on a church that will soon take its place in the miniature town



Lifelike animals inhabit the neat farm at the edge of town. This scene is a favorite of young visitors



With his wife, the Wisconsin carpenter watches a team of horses pull a load of logs onto a sled hitched to another team. The team is one of nine moving objects in north-woods sawmill scene

HOBBYIST CREATES TOWN ON QUARTER-INCH SCALE

By Wally E. Schulz

IN 17 years of spare-time building, a Wisconsin carpenter has created a miniature animated village which features everything from a stream rushing down a mountainside to an operating sawmill. The builder, Melvin Rheingans, has even constructed a full-size house to display the tiny town, which he enjoys showing to young visitors. Among the 60 buildings, built on a quarter-inch scale, are many replicas of larger ones, including the homes of friends. Typical of the detailed work is the sawmill on which Rheingans spent 12 to 14 hours a day for four months.

Details, such as streetlights, sidewalks, shrubbery and pedestrians, add realism to the miniature village





Jointed Metal Pipe Speeds Loading of Tankers

Long, robotlike arms that move by hydraulic power are adding speed and safety to tanker loading and unloading operations. The arms are two-section swivel-jointed metal pipes that swing out from a dock structure to the tanker's manifold to take on or discharge petroleum products. There may be as many as 11 of the 54-foot arms—8, 10 or 12 inches in diameter—on a single structure; all are powered

from a single source and manipulated from a single control point. This tanker-loading system, built by Chiksan Company, eliminates the need for manhandling heavy rubber hoses, as has been the practice at marine terminals. The smooth bore of the metal pipes offers a faster rate of flow than rubber hoses. The 12-inch-diameter arms are capable of moving 15,000 to 20,000 barrels per hour.

Outboard Operator Has "Car Control"

Pivoting at its center, this foot throttle for operating outboard motors causes acceleration when the toe is depressed and deceleration when the heel is pushed down. The treadle remains in one position while the boat is under way, making control in rough water easier. The foot throttle employs standard control cables. Adjustable pads allow it to be mounted level on any interior boat contour. Mounting is accomplished with strong epoxy paste.



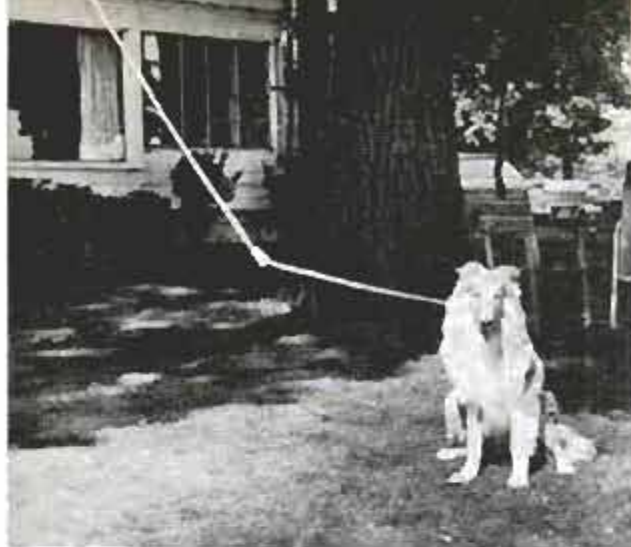

Chain Follows Dog's Movements

Rover won't get tangled in his chain anymore with a retractable chain that feeds out and returns as the dog runs back and forth. The chain, giving the dog a feeling of freedom since he never feels the chain tugging, doesn't touch the ground and stays above the dog's collar. Easily attached on an overhead line, the chain is rust resistant.

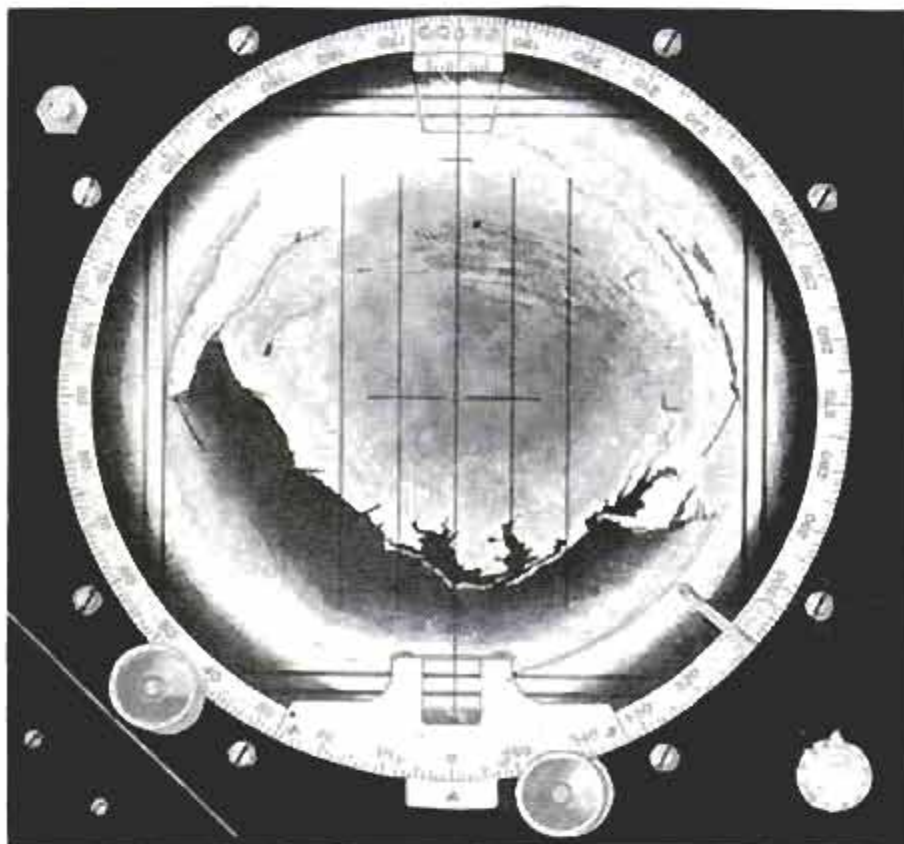

Periscope System To Guide Astronaut

On an eight-inch diameter screen, an astronaut will be able to view the earth below him and, should his re-entry system fail, "navigate" his own re-entry. The screen, part of a unique periscope system being developed for a manned space capsule, will enable the space man to view the earth and make measurements of his altitude, direction and position in space, and thereby fire the retrograde rockets that make re-entry possible. The artist's drawing shows how the East will appear, with Florida at the left and Connecticut at the right.



Gas Appliance Plugs Into Outlet

If you've ever thought it would be convenient to plug in a gas appliance like an electric one, a new system will appeal to you. German engineers have developed a white hose similar to an electric cord that connects by a union to the appliance. At the opposite end is a plug that fits into a gas outlet. A quarter turn of the plug to the left opens the outlet. It turns off to the right and then easily disconnects.



C. G. Conn, Ltd. painstakingly makes more than 50,000 musical instruments a year

The Big Round Sound

By Kenneth Anderson

Photos by Joseph Fletcher

THERE'S A ROOM in a building at Elkhart, Ind., where the walls literally close in on a busy musician known as "Hot Lips Harry." Harry can't read a note of music and he doesn't get a nickel for his long hours of trumpet and cornet playing. But he can produce tones with measured precision and he can hold a note longer than any professional player.

Hot Lips Harry actually is a robot in the research laboratories of C. G. Conn, Ltd., a company that manufactures more than 50,000 band instruments a year. It's one of many devices employed in a scientific search for the elusive thing musicians call the "big round sound."

The "fat sound," the full clear tone for which the music man strives, is a bit difficult for scientists to capture because

it's subjective. Whether it's good or bad depends to a certain extent upon the judgment of the listener. The people who study musical acoustics can make a "picture" of a sound by playing a trumpet, or any other instrument, and recording the sound's wave pattern on an oscillograph.

In a similar manner, scientists can contrive a shade of color and measure its wave length. But the artist who works with the color must decide, subjectively, whether the color is pleasing to the eye. And the musician who plays the trumpet must determine whether the tone is pleasing to the ear. In fact, juries of musicians convene regularly to vote on the tones they think an instrument should produce.

After the juries decide how a horn should perform, the scientists try to design



This unconventional instrument, called a Connosax, was introduced to music in the roaring twenties but failed to meet with public approval. It is now consigned to Conn museum

Dr. Jody Hall, chief acoustical engineer for Conn, plays the first Sousaphone, below, ever made. It is now a museum piece, together with the "snorklephone" at the right, built as an experiment. The snorklephone is like a Sousaphone with part of the curve straightened out

the instrument that will give the desired performance.

"We only try to produce the most acceptable instrument," says Dr. Earle Kent, director of research at Conn. "Nobody has made a 'perfect' instrument. And probably never will."

Designing a nearly perfect cornet, trumpet, trombone or saxophone isn't as simple as it may seem to a person browsing among the merchandise in a music store. The mathematical formula for the effective length of a horn at a single frequency fills a piece of paper five feet six inches long. Before the days of digital computers, it took a researcher two days to solve the formula and check the answer. An electronic brain can handle three of the giant problems per minute.

All Things Are Interdependent

But there are many other factors besides the length of the horn to be considered. And a number of these variable factors are interdependent—if one changes, the others change. Changing the diameter of a horn bell, for example, can upset the measurements for a dozen other parts of the instrument.

Even the player's lips and oral cavity can affect his performance. Dr. Jody Hall, chief acoustical engineer at Conn, discovered that after a dentist had worked on his teeth, his playing of some of the low notes was off by $\frac{1}{100}$ of a semitone.

A factor not immediately apparent, even to the musician, is the relation of the mouthpiece to the horn. Each instrument is designed to be





Each instrument is tested by a musician, who checks tones with an electronic device called a Stroboconn

used with a certain mouthpiece, and custom fitting is needed. An error of only $\frac{1}{16}$ of an inch in the placing of the mouthpiece in the tone chamber, or mouthpipe, can make a good instrument sound bad on some notes.

Almost everything, including people, in the room will have some effect on the sound of a musical instrument. For this reason, Hot Lips Harry sometimes works by remote control. A transducer can be attached to the mouthpiece, as well as a rubber disk, to produce controlled sounds through a horn. And levers can be set up as fingers to push the valves of a cornet or trumpet.

The strange room in which the robot trumpet player performs is referred to as "Bulgy." The walls and ceiling bulge toward the center to provide as much asymmetry as possible. The method in this apparent madness is the elimination of parallel surfaces that might reflect or "build up" sounds of the instruments being tested. Patches of felt cloth have been attached to the walls and ceiling where

necessary to remove the last effects of sound reflections. The temperature in the room is controlled to within $\frac{1}{10}$ of a degree Fahrenheit.

The usual approach, according to Dr. Kent, would be to construct an anechoic chamber, or "dead room." However, it was discovered that professional musicians find it extremely difficult to make music in such a room. The asymmetrical room permits a bit of "liveness" for the player's benefit without emphasizing or detracting from any part of the tone.

Wet Plaster Affects Tone

To illustrate what a difference a room makes, when the acoustical plaster on the walls of "Bulgy" was still wet, musicians using the chamber found they could play a half-octave higher than usual. The tones returned to normal after the plaster dried.

One of the carpenters who worked on "Bulgy" commented, "It's the only room I've seen like it and I hope I never see another." The three-dimensional blue-



Electroformed tone chamber and bell unit of horn is yanked out of chemical vat, where copper was deposited on mandrel

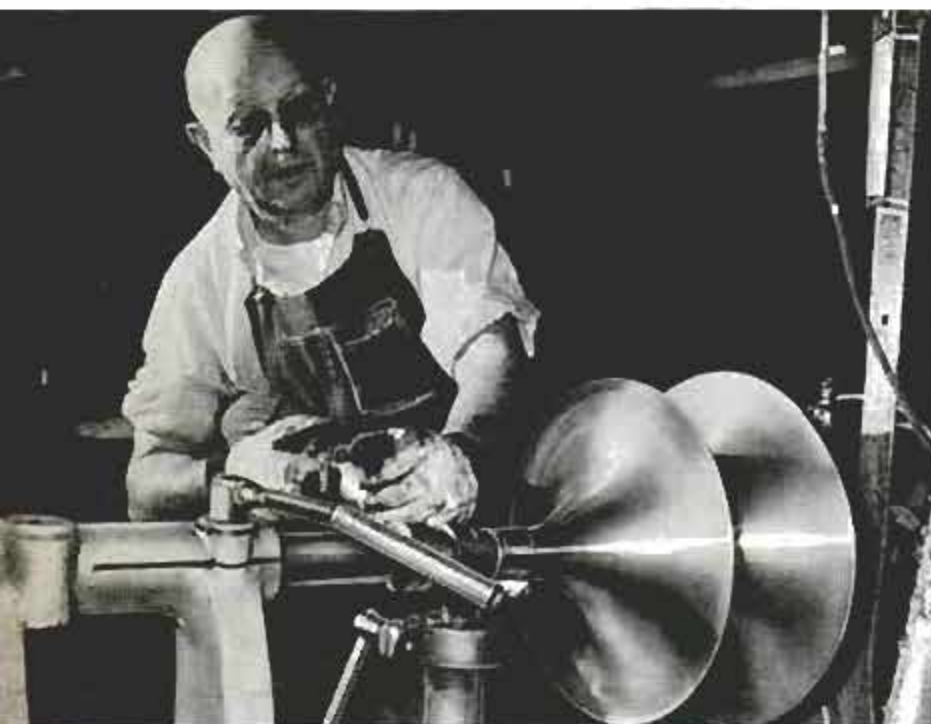

French horn's bell is created by mounting brass disk against mandrel on lathe. Below, holes in saxophone chamber are drawn out by machine that pulls metal dies through brass from outside

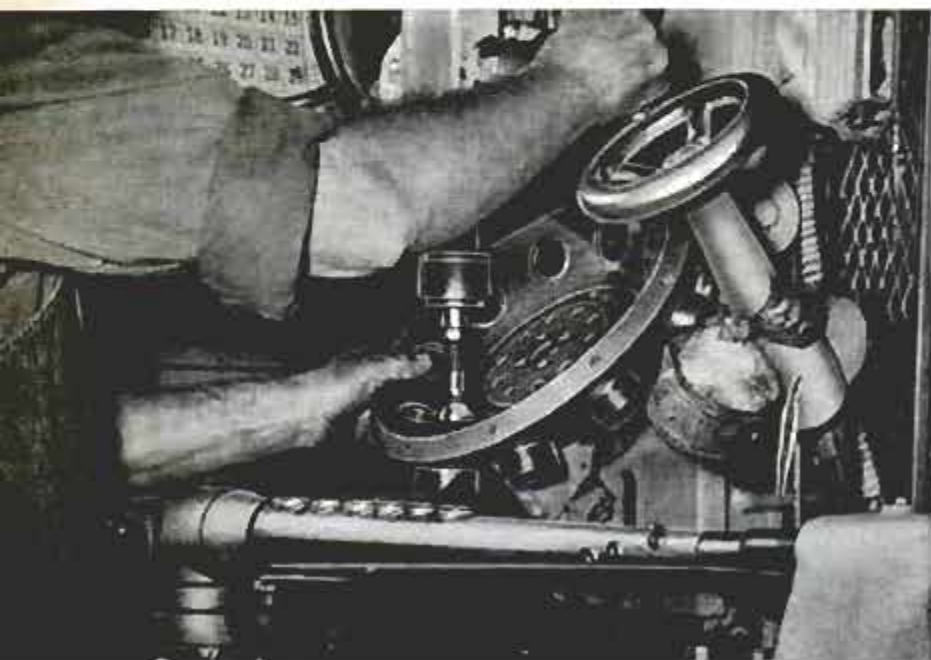

prints, which the builders probably will never see again, were prepared from mathematical formulae that plotted quadrants of different ellipses.

Most people don't realize that it takes longer to build a cornet or trombone than it does to produce an automobile. Although the music men probably could turn out a playable horn on short notice, the usual length of time required to shape a fine instrument from a sheet of brass is three to four months.

Production of the horn with the "big round sound" usually starts under a microscope in the materials-testing laboratory. Here the researchers study samples of metals that will be used in the various parts of an instrument. Each part requires an optimum grain size that is a key to the strength and ductility of the metal. If the ductility is poor, the metal may tear while it is being shaped or bent. If the grain size is too large, the metal may develop a rough, "orange peel" surface.

The metal parts also are tested for optimum thickness, which has a measurable effect on the tone of the instrument. One of the electronic devices used in such research can detect variations in the thickness of metal plating with the accuracy of a microscope. Called a non-destructive thickness tester, the device generates eddy currents in the metal and senses variations in thickness by measuring the eddy currents.

Use Copper Ions for Bells

Conn's research workers have experimented with silver, copper, brass, bronze and many other metals in a search for better ways to make a more perfect horn. Out of their research has come a method of producing one-piece seamless horn bells from copper ions.

Electroforming a horn bell is similar to electroplating, except the microscopic bits of copper are allowed to build up in a thick layer. The copper ions are deposited electrolytically on the surface of a stainless-steel mandrel that has been machined to tolerances measured in millionths of an inch. Stainless steel is used



On a revolving drum, pens attached to valves record degree of bounce, which may cause slurring of notes.

for the mandrel, or form, because the pure copper bell can be separated easily from stainless steel. Brass cannot be used in the electroforming process.

Electroformed horn parts reportedly cut intonation errors in half, permitting a more even balance of tone in all ranges. Mouthpipe tolerances are 10 times as close as in instrument parts produced by the more conventional methods of drawing and soldering.

The bulk of the brass instruments, however, are still made by hammering, drawing, soldering and swaging—starting with a thin sheet of brass. If the ultimate product is a trumpet, the piece of brass is held on a tubular metal form and whacked with a wooden mallet until it has the shape of the form. The seam is soldered and smoothed under pressure. The bell is spun from a flat disk and fastened to the rest of the horn with silver solder. The disk is attached to a flared mandrel on a lathe. As the disk spins on the lathe, a craftsman forces a long pole against the piece of brass. The pressure exerted through the pole makes the brass disk bend along the surface of the mandrel until it has the same flared shape.

After the brass disk has been shaped into a bell, it is burnished by pressing a metal tool against the bell as it spins on the lathe. A bell for a French horn goes through a series of six spins and five anneals. Each anneal requires 15 minutes of baking in an oven heated to 1050 degrees

Long straight horn without valves, another Conn experiment, has same tone as conventional trumpet



Dr. Earle Kent, Conn's research director, checks trumpet tone by attaching transducer to mouthpiece

Fahrenheit. The annealing is handled on a critical schedule because the bell can crack if the process isn't stopped at the right time.

Jigs Used for Bending

Specially designed machines bore valves, shape tone holes, test valve bounce and make the inside of a curved column as smooth as the polished outside surface. The curves are added to the horn columns by bending them in jigs. The curved sec-

(Continued to page 220)



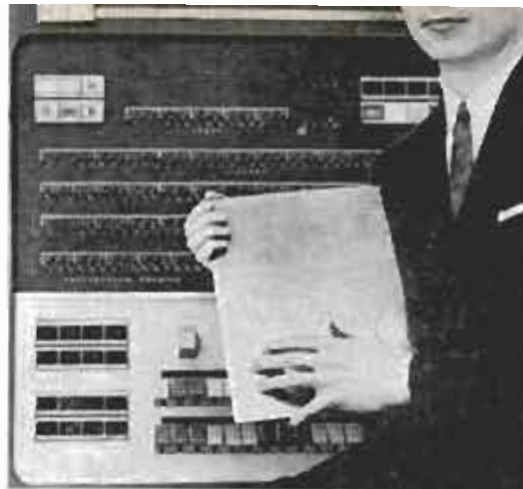

Braille Translator

Printed text can now be translated into braille at electronic speeds. A braille embossing machine, shown above left, is linked to a punched-card reading device, making it possible to produce automatically the metal plates, right, used to print braille books. The punched cards with the braille language are translated directly from English by an IBM computer at the rate of 4000 words per minute. The new method was developed by mathematicians of the International Business Machines Corporation for an IBM 704 data-processing system.

← Bag Purifies Water

Campers don't have to take a chance with questionable drinking water. They can purify the water in five minutes by pouring it into a pocket-size plastic bag containing a supply of filter material mixed with disinfecting ingredients. The bag holds a quart of water. The cleared and purified water is drawn from a spout at the bottom. A plug is used to stop the flow. The bag, which weighs less than eight ounces, is good for about 200 fillings, or 50 gallons of water.

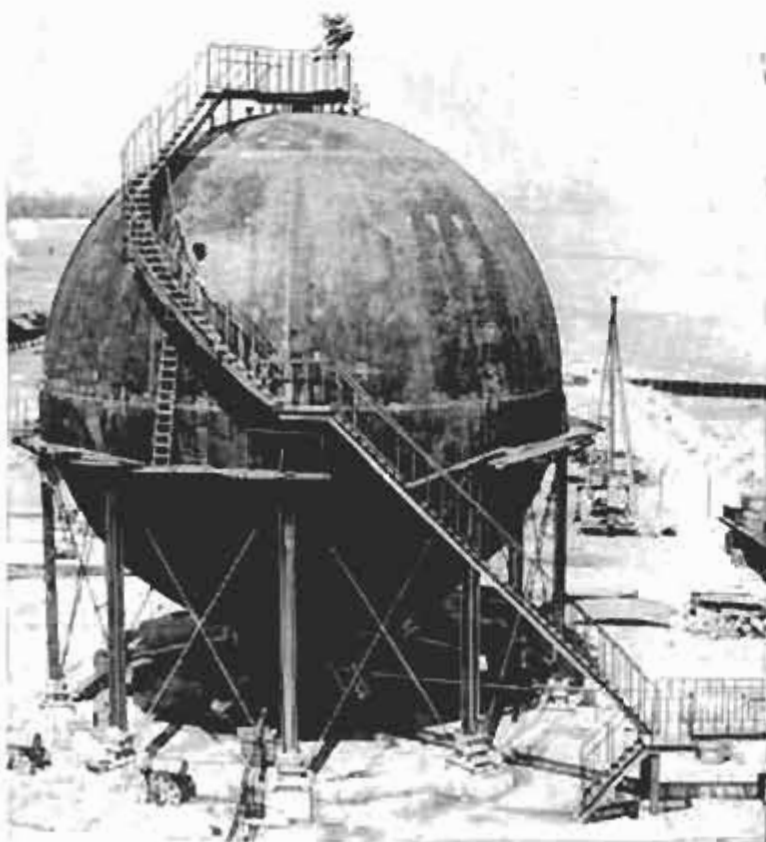

Welded Sphere

In Copenhagen, Denmark, is a spherical gas tank that is entirely welded. Built by a German firm, it is the first of its kind to go up in Europe. Spherical gas tanks usually are riveted. The "Gasometer" at Copenhagen has a volume of 1500 cubic meters. Its diameter is 47½ feet. A much larger spherical gas tank is now under construction at Wuppertal, Germany.



Fishermen Carry Boat Between Plane's Pontoons

Anglers flying to the remote lakes of Florida, Alaska and Canada are now taking their boats with them. Most of these air-minded fishermen tuck the craft between the spars of the plane's pontoons. The sportsmen in the picture above con-

structed their own flat-bottomed ketch and equipped it with a small motor. The ketch fits snugly along the spars of the single-engine seaplane. This plane-boat combination enables the men to visit many different Florida waters in one outing.

Stomping Feet Launch Rocket

Toy rockets go soaring high into the sky with nothing powering them but the two stomping feet of a youngster. The rocket toy consists of a 40-inch launching tube attached to a big rubber bulb. An eight-inch tubular rocket, with a soft-rubber nose cone and plastic guiding fins, slips on the end of the thin tube. When the child jumps on the bulb, the rocket takes off. One person can work it, but when one holds the launching tube and the other jumps with both feet, the rocket goes a lot higher!

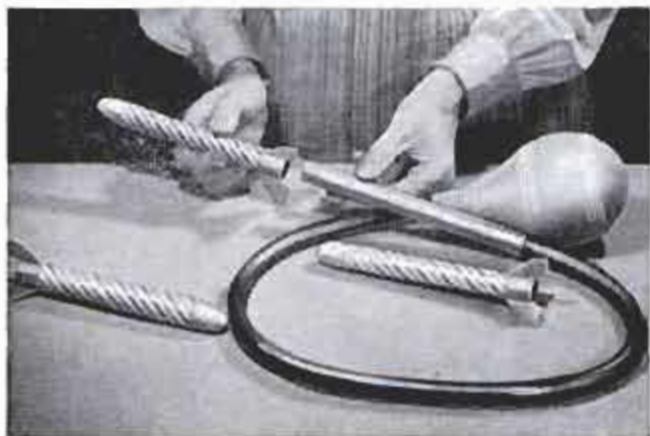



Table and Stools Fit Station Wagon

For the field worker, camper or picnicker, an engineer in Portugal has designed a table and stool combination that fits into a station wagon. The table stands on the floor deck at window height. Small stools make the outfit handy as a desk or dining table during travel, or the furniture can be removed from the car for picnicking. Even with the table in the loading space, there is still ample room for a spare tire and other luggage beneath the table.



Tree Treatment

By adding a fungus-killing chemical to the asphalt varnish used for painting tree wounds, growth of decay-producing fungi can be prevented. The U. S. Department of Agriculture says a formula including .25 percent phenyl mercury nitrate is ready to market, but warns against the public mixing its own antiseptic varnish because the mercury compound is highly toxic.

Electric Pry Bar Moves Seven Tons

Able to maneuver in close quarters, an electric pry bar can move as much as seven tons of weight. The machine, which weighs 110 pounds, can be handled by one man since it does all of the work, pushing cargo in planes, ships and plants.

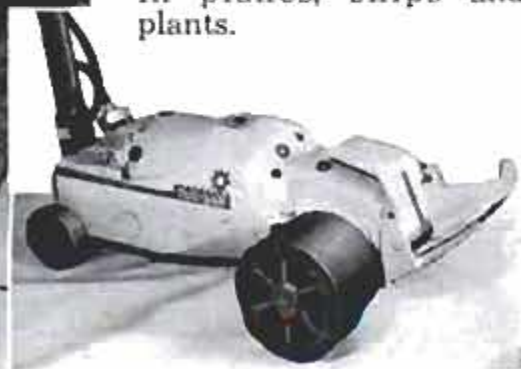

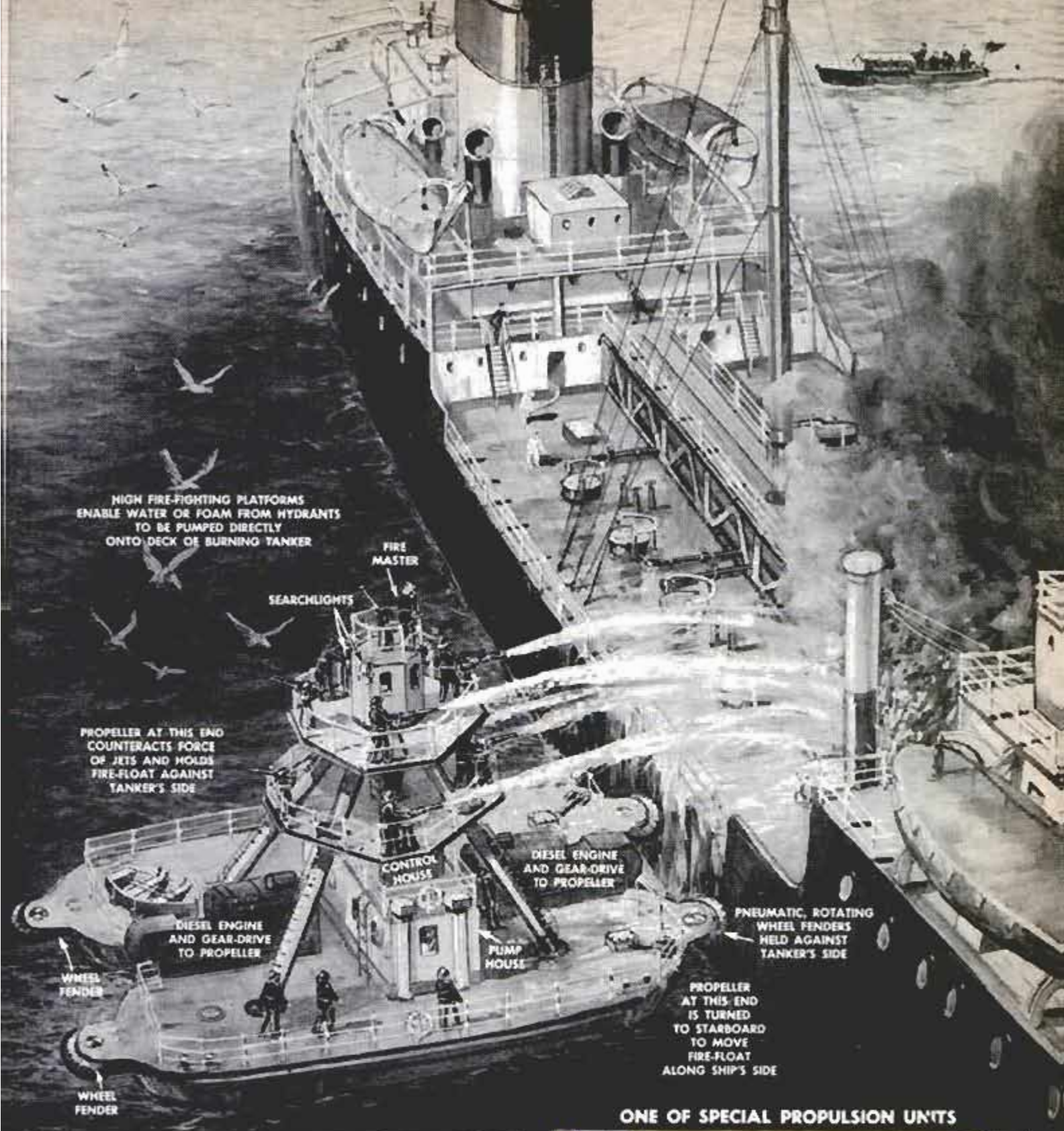

HIGH FIRE-FIGHTING PLATFORMS
ENABLE WATER OR FOAM FROM HYDRANTS
TO BE PUMPED DIRECTLY
ONTO DECK OF BURNING TANKER

FIRE
MASTER

SEARCHLIGHTS

PROPELLER AT THIS END
COUNTERACTS FORCE
OF JETS AND HOLDS
FIRE-FLOAT AGAINST
TANKER'S SIDE

CONTROL
HOUSE

DIESEL ENGINE
AND GEAR-DRIVE
TO PROPELLER

PNEUMATIC, ROTATING
WHEEL FENDERS
HELD AGAINST
TANKER'S SIDE

DIESEL ENGINE
AND GEAR-DRIVE
TO PROPELLER

PUMP
HOUSE

WHEEL
FENDER

PROPELLER
AT THIS END
IS TURNED
TO STARBOARD
TO MOVE
FIRE-FLOAT
ALONG SHIP'S SIDE

WHEEL
FENDER

ONE OF SPECIAL PROPULSION UNITS



Firefighting Float

BRITAIN has introduced a firefighting craft that has two diesel-driven propulsion units to counteract the force of water jets against a burning ship. The new catamaran-type craft can keep its position even though all nine of its hydrants are shooting at full force. The float's propellers can be turned 360 degrees, and two wheels fore and aft aid in moving it along the side of a burning ship. The firefighting capacity of the craft is 3100 gallons of water a minute or 12,500 gallons of foam a minute



The Rev. Carl Eberhard at the lectern he carved when his church couldn't afford the one he wanted



Under Pastor Eberhard's skilled knife, a figure of Moses emerges from a block of aged white oak

THE PASTOR

By John Fetterman

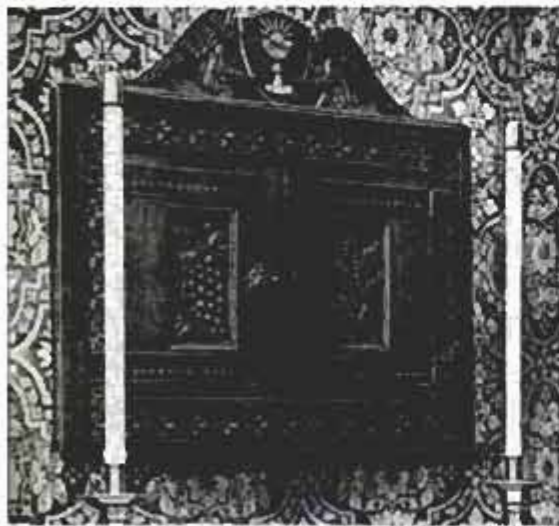

Intricately carved doors of the ambry, above, conceal the church's wall safe for safekeeping of sacramental equipment. Below, the notice board which hangs just inside the entrance



CONCORDIA LUTHERAN CHURCH, in Louisville, Ky., was built during the depression of the 30's. When the building was finished, so was the building fund; the congregation and its pastor, the Reverend Carl Eberhard, were broke. But despite his pride in the new church, Pastor Eberhard felt that something was lacking. There were no works of art to add to the beauty of the interior—and no money to buy them. The architect had designed an ornate lectern, but professional artisans estimated its cost at \$3500. They might as well have said a million, but the pastor set out to find a way.

Pastor Eberhard decided finally that he'd have to do it himself, so he bought a book on wood carving and a few simple tools. Today, the pastor is an accomplished wood carver, and his church is full of beautiful carvings which he has created with his own hands.

The first project was a small crucifix. The work progressed slowly, but the basic steps were soon mastered, and finally the crucifix materialized—a textured walnut figure of Christ on a cross of aged oak. Then came the lectern, put together piece by piece over 14 years. Meanwhile he added figures of David, Moses, and the angels, a notice board and a gleaming ambry. With growing confidence the pastor met new problems, often returning to his reading on the art of wood carving. He studied woods and went to great lengths to get fine pieces (a piece from the White House, salvaged from the last re-



Figure of King David which decorates the front of Pastor Eberhard's reading stand



Walnut and oak crucifix was the pastor's first carving project



Carved angel forms the back corner of the lectern rail

IS A SCULPTOR

modeling, is part of the lectern). Most of the carvings are done in sugar maple, white oak, and walnut.

Would Pastor Eberhard recommend wood carving as a hobby? "It takes patience," he says, "but you can start with a couple of dollars' worth of tools. It's all in your head and hands. And it's satisfying."

It's especially satisfying each Sunday when he steps up to his pulpit and places his hand on the polished wood of the lectern his church couldn't afford. ★ ★ ★



Above right, shields of the signers of the Augsburg Confession. Below, detail of the pastor's reading stand

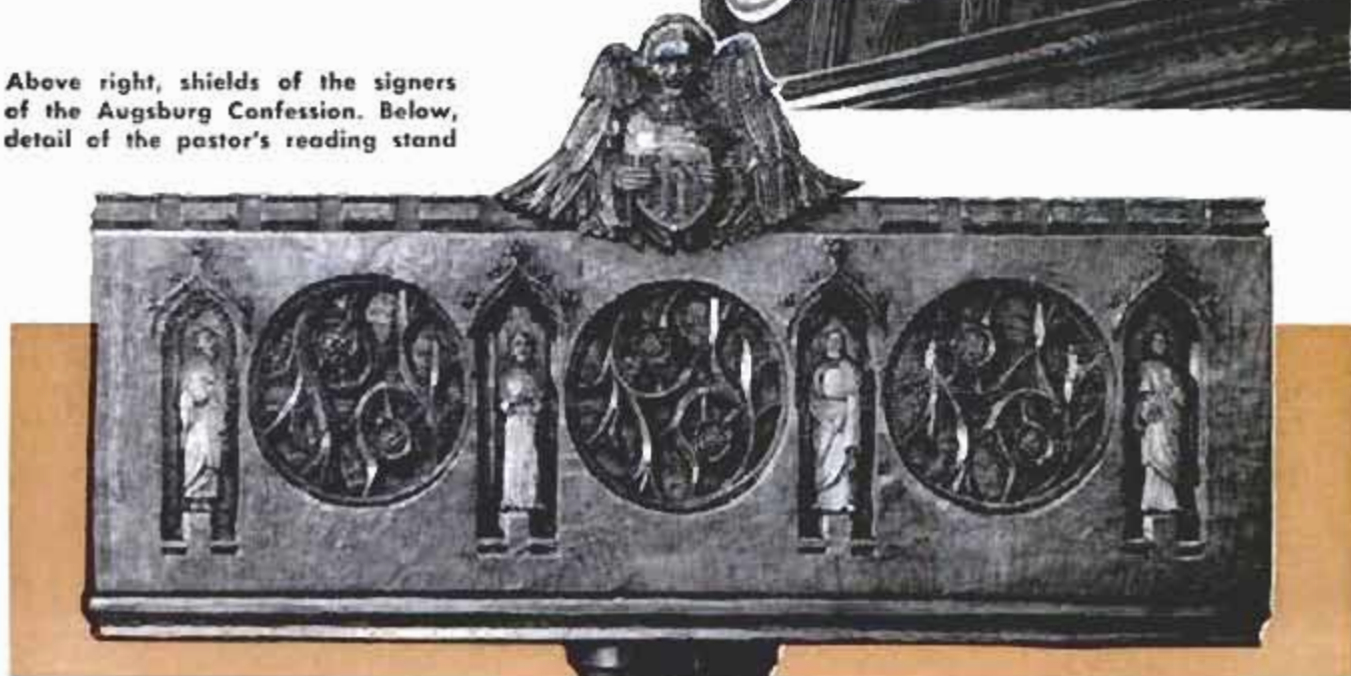



Safe Car TV Works in "Park"

One Cleveland man has a television set in the glove compartment of his car, but he doesn't worry about criticism. It's installed so that it will turn on only when the automatic gearshift is in "park." Dorse R. Johnson says he installed the 8½-inch portable to use at the beach and on picnics.



Swiss Chalet Comes in "Kit"

You can now order prefabricated Swiss chalets built exactly to your plans. Imported from Switzerland, wood parts for the chalet are numbered according to your design to assure simple and accurate assembly. Each house is made of four-inch-thick lumber held together by joints and oak pegs. Interior walls are similar, but three inches thick. No nails are used anywhere in the walls.

Fuel Cell Produces Electricity Directly From Gas

Electricity generated in a small plastic cell spins a miniature propeller in a demonstration by General Electric Research Laboratory scientists, Drs. Leonard W.

Niedrach and W. Thomas Grubb. The fuel is hydrogen, contained in the balloon. The hydrogen reacts with oxygen in the air, producing electricity.

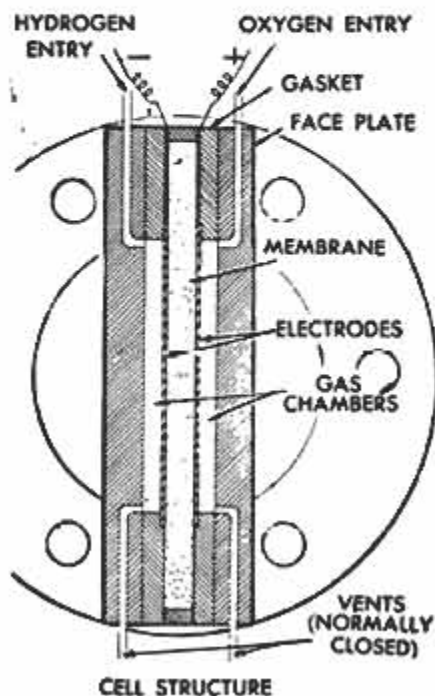
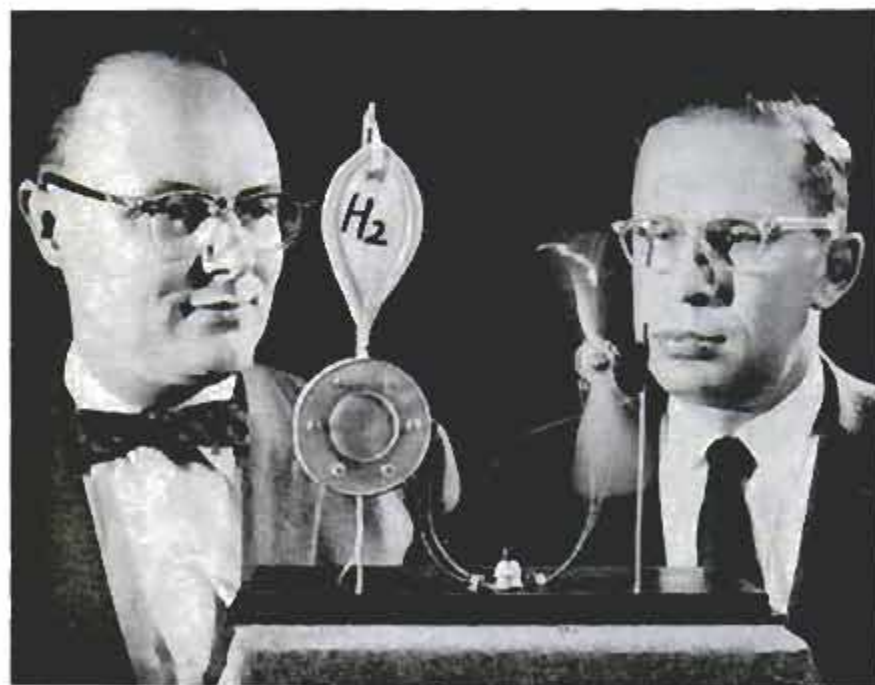

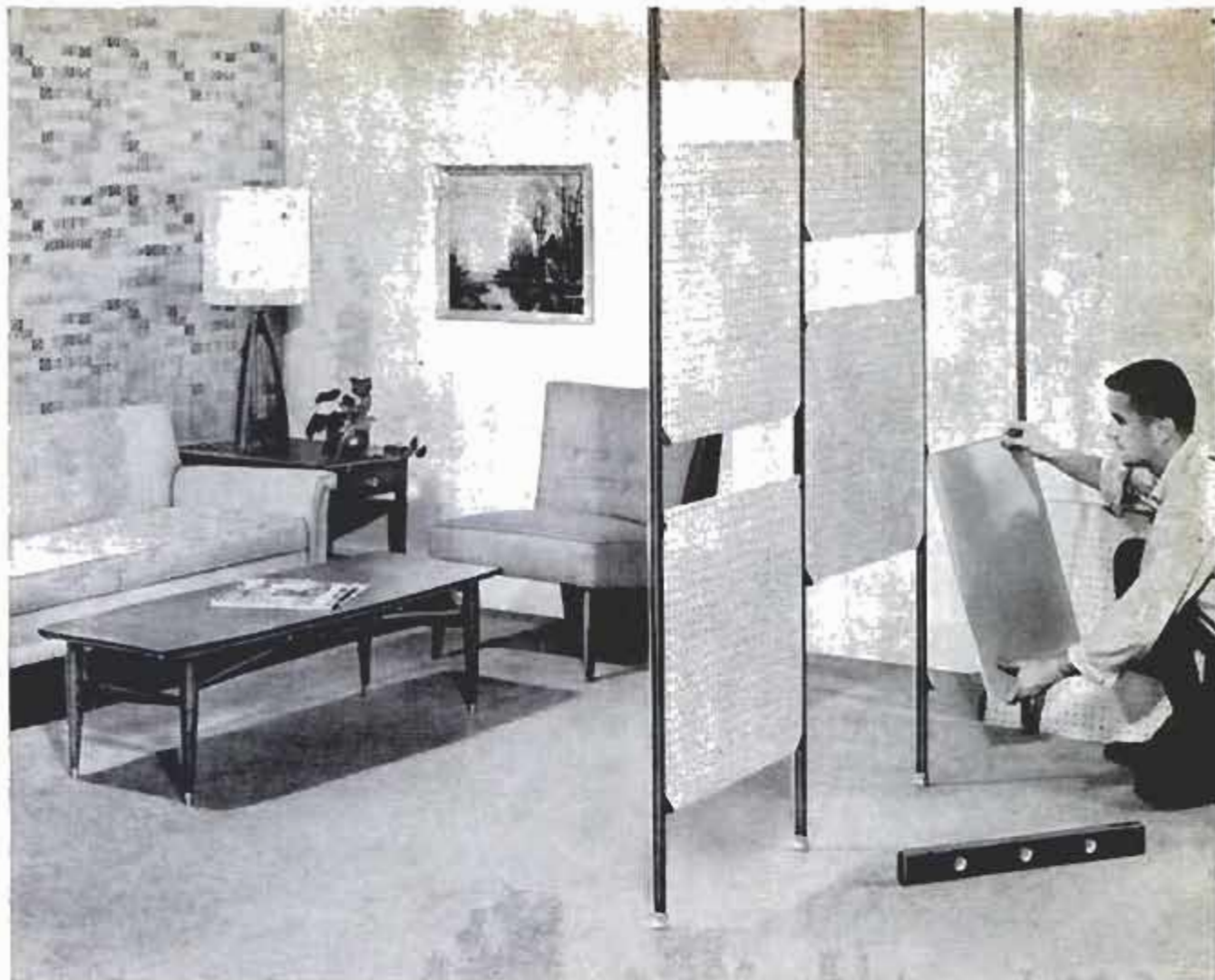

Carpenter's level is used to make sure poles are vertical. Wooden or metal panels are mounted with clips

Versatile Room Dividers Permit Quick-Change Decor

YOU CAN give the interior of your house a "quick change" by setting up room dividers that take just a few minutes to install. Spring-loaded, slotted-steel poles are placed vertically between the floor and ceiling. Then metal or wooden panels are mounted on the poles with clips. The poles have rubber tips and feet, and can be adjusted to fit any ceiling between seven feet four inches and nine feet one inch in height. Shelves can be installed on the dividers by inserting brackets in the poles, which are a slate-gray color.

Top of pole is placed at desired point on ceiling. Pole then is lifted up against spring pressure. Shelf, left, can be adjusted to one-inch intervals





Visitors to the Peralta playground in Oakland, Calif., prepare for their first flight into outer space

Playground Rocket Ride Creates Sensation of Flight

Thirty-three passengers board an aluminum spaceship, fasten their seat belts and travel to the moon and back in a rocket that never leaves the ground. They're riding the Star Flyer, a carnival ride owned and invented by two former Oakland, Calif., policemen, John G. Taggart and

Samuel Daugherty, Jr. The rocket's nose tilts to a 23-degree angle 35 feet above ground. At blastoff, motors thunder and seats thrust forward. A film takes riders into space, bringing the moon into view. Minutes later, the ship "returns" to earth with all of the sensation of landing.

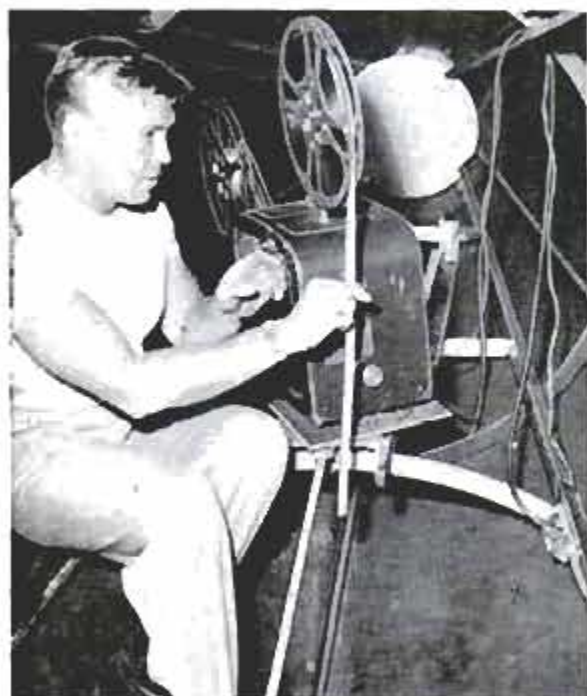

Flight sensations are created by film that shows the heavens sweeping by on a front-end screen



Passengers sit tensely as they near the moon. Later, film brings earth gradually closer creating feeling of return

There's a Name for It . . .

Next year the census taker will be around to see you. When he asks your occupation—can you give him a straightforward answer? Are you a knocker or a wrinkle chaser or a vinegar man?

Try on some of these strange-sounding occupations and see if they fit. Everyone knows a carpenter is a carpenter and a painter is a painter. But some aren't so familiar. The out-of-the-ordinary names below appear in the U. S. Department of Labor's Dictionary of Occupational Titles:

By H. P. Behnke

BOOSTER: Circulates among patrons of night club or gambling den to encourage spending.

TURTLE-BACK MAN: Assembles airplane parts to bottom of plane to give rounded appearance.

DIMPLER: Forms dimple around rivet holes in airplane sheet-metal parts.

HORSE PUSHER: Takes care of horse in transit.

KNOCKER: Harvests fruit or nuts from trees by knocking them down with a long pole.

CORN SNAPPER: Corn picker.

WRINKLE CHASER: Worker in shoe factory who takes wrinkles out of shoes by hand or with hot iron.

FIDDLER: Scrapes rough edges from shoe left by edge trimming operation.

PRETZEL STRINGER: Uses wire mechanism to loosen pretzels from board before they go into oven.

BACK SPIKER: Railroad term for man who spikes rails to ties after track has been laid.

BOOTMAN: Works mechanism for spreading oil or bituminous liquid on highway from truck.

BRICKMAKER: Molds codfish cakes in fish cannery.

DREAMER: Sells lucky numbers.

FLYMAN: Raises and lowers scenery.

BELLY SELECTOR: Grades hog bellies in slaughterhouse.

CABIN MAN: Sorts bobbins of yarn and stores in boxes or cabins.

DOPE RUNNER: Worker who moves raw material in textile mill, such as glue, starch, etc.

CHEESE FORMER: Forms tobacco into cakes called "cheeses."

FINE-SCRAP SEARCHER: Picks out foreign material from tobacco.

BANANA MESSENGER: Accompanies shipment of bananas to make sure of safe arrival.

FUR PLUCKER: Picks coarse hairs from flat skins for better appearance.

NECK FELLER: Sews in blind stitches in garment industry.

TEASER: Feeds raw material to glass melting tank in glass industry.

SMOKE CHASER: Fire lookout.

PONY PACKER: Fills sacks of grain.

SCALPER MAN: Cleans foreign objects from grain.

LURER: Worker who gives luster to felt hat crowns with heated pad.

HOOKEE: Couples up mine cars.

YEAST MAN: Mixer in iron and steel industry.
BOSOM PRESSER: Laundry worker who presses shirt bosoms.

SHORT GIRL: Locates lost articles in laundry.

PICKLE HOUSE LUMPER: Hide picker in leather working.

SAMMY MAN: Uses water to dampen hides.

EYE-LASH PASTER: In manikin making, one who affixes lashes to forms.

GREENSMAN: Worker in motion-picture industry who decorates sets with flowers, shrubs, etc.

BELLYMAN: Assembles and mounts sounding board to back of piano.

VINEGAR MAN: Mixer in paint factory.

PONY-ROLL MAN: Paper-factory worker who wraps and seals small rolls of paper.

SAND SMELLER: Geologist in petroleum industry who collects core samples for analysis.

JIGGERMAN: Pottery worker who forms ware.

SHUFFLEDOWNER: Shingle stacker for binding in bundles.

TICKET CHOPPER: Railway ticket taker.

BOARD DUSTER: Bakery man who sprinkles flour on boards, pans, etc.

OUTPEELER: Removes baked crackers from oven.

RUSTLER: Looks after haulage system in coal mining.

DRIFTER: A rock-drill operator.

SPECIAL-NOISE MAN: In dairy industry, a man who checks for unnecessary noises.

STAR LOADER: Loads and assembles ship signal lights.

SPIKE PITCHER: Farm worker who uses pitchfork to move grain from ground to wagon or reverse.

RED MUD THICKENER: Works with red mud in smelting and refining.

DUBBER: Ship-frame trimmer.

COTTON PICKER: Machine operator in mattress factory.

NECKER: Neckline stitcher on neckties.

CAT DOCTOR: Tractor mechanic.

DONKEY DOCTOR: Donkey-engine mechanic.

BULLY OR TWISTER: Boss in logging camp.

BUCKWHEATER: Tenderfoot lumberman.

BALL HOOTER: Rolls logs down slopes.

HIGH CLIMBER: Removes limbs from tree tops.

PIGMAN: Greases logging skids.

ROAD MONKEY: Works on logging roads.

BUSH MONKEY: Tanbark piler.



Soldier Fires Guided Missile

Guided missiles as ground-troop weapons are forecast by Red-Eye, an anti-aircraft guided missile that can be transported by troops and is shoulder-fired. The bazooka-type launching tube contains propellant, electronic guidance, and a high-explosive warhead. It weighs 20 pounds.



"Zoomar" Lens for Microscope

By turning a power-selector dial, continuous zoom-type magnification is available on a three-dimension research microscope. It eliminates the step-by-step increase on regular microscopes and allows study of the specimen through all magnification stages without shifting eyepieces.



Portable TV Set Doubles as Serving Table

Resembling a tea cart, a portable television set can be rolled on rubber wheels to any location desired. Slim and lightweight, the unit, with its wooden top, can double as a utility service table in the living room, dining room, or patio. If desired, attractive floral arrangements might also be placed atop this versatile all-purpose unit.

Number, Please!

Whenever you write us to

- Renew your subscription
- Change your address
- Order your own or a gift subscription

. . . In fact, whenever you write us,

PLEASE INCLUDE YOUR CITY POSTAL ZONE NUMBER IN YOUR ADDRESS

*This insures better delivery.
It helps you and it helps the postman.*



"Thermostat" Controls Room Lights

In the home of the future you may never have to worry about adjusting the proper amount of lighting. A thermostat-like instrument that can be preset to any lighting level, just like the heating thermostat, will do it for you. A photoelectric scanner located in the ceiling measures the amount of daylight in a room and automatically dims or brightens lights to the level of natural light in the room, at electricity-cost savings of 50 percent. Such lighting controls are presently designed for offices and schools, but can be expected for homes of the future.



Tubes Prevent Clogging of Gutters

Clogging of roof gutters by falling twigs and leaves can be eliminated by placing plastic tubes lengthwise in your gutter. The tubes, made of polyethylene resin, form a tunnel, and arch high enough above the gutter edges to provide a natural slope, shedding airborne litter in the same way as a peaked roof. Water flows down over the guard and enters through a scallop-edged open side, while litter passes on. The guard is lightweight and rustproof, and its sections are laid end to end. It also provides the same type of protection from ice and snow.

Marines Move Heavy Tank From Ship to Shore in 63-Ton Carry-All

U. S. Marines have a new 62-ton heavy-gun tank in their amphibious arsenal. It is carried from ship to shore by a 63-ton

tracked vehicle. The tank mounts a 120-mm. cannon that fires a 50-pound projectile more than 18 miles.



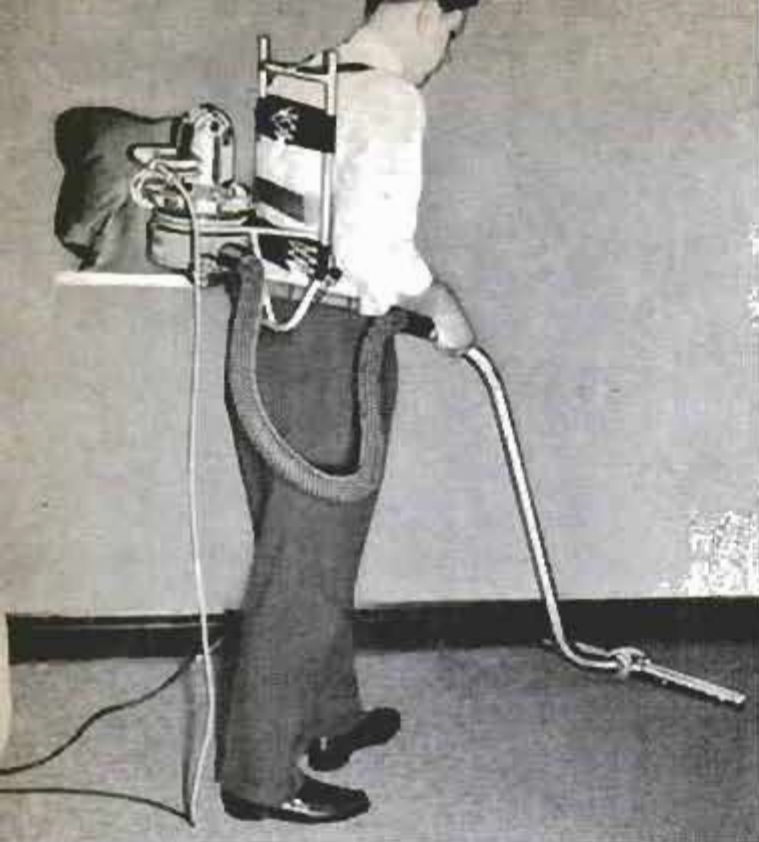

BACK-PACK VACUUM CLEANER is fully portable, making it easy for the operator to reach out-of-the-way spots. The machine draws dirt into an attached bag, or, with the air flow reversed, operates as a sweeper to blow debris forward and out from under hard-to-clean places. The electric cleaner can be detached from the shoulder straps and pulled along on its sled-like frame. Many attachments are available

Brewer Electric Manufacturing Company,
5100 N. Ravenswood Avenue, Chicago 40, Ill.

WHAT'S NEW FOR Your Home



PORTABLE HEATER has thin, ribbon-like heating elements which glow and give off warmth the moment the user pushes a button. The heater is mounted on a U-shaped frame so that it can be tilted to direct heat upward or downward; it also swivels to face any direction. The unit has a combination high and low wattage (1,320 and 1,650 watts) and operates as a radiant heater or a fan-forced convection heater

Cory Corporation,
3200 West Peterson Avenue, Chicago 45, Ill.

BENCH-PICNIC TABLE combination solves the problem of outdoor seating and eating. The back of the bench is hinged so that it flips forward to become a table top. Two benches set together form a table top 32 inches wide. The kit for each bench contains all necessary metal parts, bolts and screws—no lumber is included. Benches up to six feet in length can be built from one kit; for an eight-foot bench, an extra set of legs should be used in the center to provide additional strength

Leavenworth Steel, Inc.
First and Walker, Kansas City 15, Kansas

SPRING CATCHES that hold this lens frame to the recessed ceiling-light fixture are released with just a quarter turn of a screwdriver. It takes only ten seconds to remove or replace the frame—cutting substantially the time that is ordinarily spent in an awkward over-the-head position to remove long screws in such ceiling fixtures

The Simes Company, 114-15th Avenue,
College Point 50, N. Y.

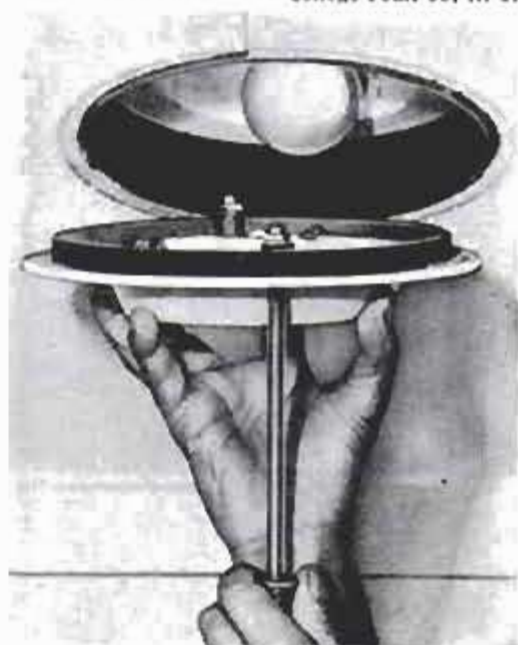



DATED PACKAGE (above) tells the housewife how long the food inside has been in the freezer. The lock-on cover of this handy flexible container has a dial which can be set to show either the week and month of freezing or the latest date for using the frozen food. Each carton also includes a chart showing maximum safe storage period for all foods. The container is available in 14, 24 and 32-ounce sizes.

Plastomatic Corporation, Malvern, Pa.



INTERLOCKING FLOOR TILES go into place and stay there without adhesive or tools of any kind. Edges of each tile dovetail into adjacent tiles. The pattern may be changed at any time by rearranging the tiles—or the entire tile floor can be removed and used in another room. Composed of a composite rubber material, the tile can be installed over any relatively smooth subfloor, including below-grade concrete.

Sears Roebuck and Company,
925 S. Homan Avenue, Chicago 7, Ill.

AUTOMATIC INSECT SPRAY keeps the house free of flies, mosquitoes and gnats 24 hours a day. The electrically-operated unit releases measured amounts of non-toxic insecticide spray into the air at regular 15-minute intervals. The dispenser, weighing five and a half pounds, may be carried from room to room and installed high enough on a wall to disperse its spray effectively. It is both odorless and harmless to humans.

Synco-Mist Controls, Inc., 270 Madison Avenue, New York, N. Y.

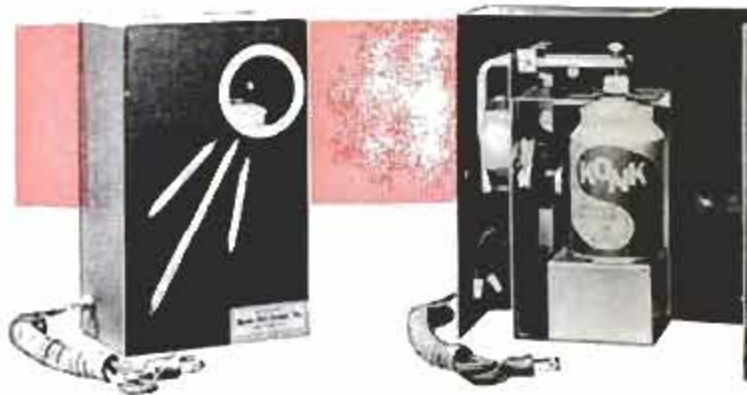

SLIP-COVER ANCHORS are simply fiber tubes that act as wedges to hold ready-made or custom-tailored slip covers in place. The tubes are tucked into the furniture at the same time the slip cover is put in place, where they remain, holding the cover material tight. Housewives can also insert moth balls or flakes, wrapped in gauze or cloth, in the open-end tubes to protect the furniture from damage by moths.

National Fibre Can and Tube Association, 274 Madison Avenue, New York 16, N. Y.



Log Unloader Empties Truck in One Big Bite



Two giant prongs of a log unloader reach down and lift the entire load from a truck in one grasp. It can do the same with a railroad car—empty it with one bite. Used by the Pacific Lumber Com-

pany of Scotia, Calif., the unloader provides quick unloading for convenient sorting of the logs before they go to pond storage or to the debarker for additional processing.



In a lily pool outside his home in Japan, Teizo Yokomizo and his son grow pearls from fresh-water mussels

Pearls From Fresh-Water Mussels

By Albion T. Sawyer

WADING IN HIS lily pool one day, a Japanese school teacher named Teizo Yokomizo stubbed his toe on something hard in the mud. Reaching down with a stick, he poked out a large black mussel.

Unknown to him, the mussel had become attached to a wild lily he had transplanted in the pool some years earlier. Curious, Yokomizo got some cutting instruments and started dissecting. While he was thus engaged, the village letter carrier came by and, after learning what Yokomizo was doing, told him that a farmer nearby had tried to use mussels for food but had given up in disgust. They were too tough and ill smelling. However, said the mailman, the farmer had found pearls in one of the mussels.

So Yokomizo delved into the cool wet tissues of his mussel with heightened interest. But he found no pearls. Next day he bicycled to the village where the farmer lived. There, on a piece of white cloth in the farmer's house, Yokomizo saw mussel shells and several pearls. All the farmer was able to tell Yokomizo about his dis-

coveries was that mussels occasionally contain beautiful pearls.

The sight of those pearls on the farmer's shelf was enough to start Teizo Yokomizo searching for a way to make mussels grow good cultured pearls. The search was to last 17 years.

In that time, Yokomizo experimented with six different ways to operate surgically on mussels before he found a successful one. Each of the operations, which involve insertion of mother-of-pearl nuclei in the mussel's flesh, required at least three years to evaluate. Finally the sixth experiment produced what Yokomizo was looking for—pearls with large spheres and good luster.

There is a ready market for the cultured pearls that Yokomizo gets from his fresh-water mussels. Japan's pearl-export business has increased more than four times in the past nine years. In 1950 the country exported \$4,022,783 worth of cultured pearls. By 1958 the figure had jumped to \$16,751,000. The U. S., Italy, France and Switzerland are the biggest buyers.

Yokomizo finds that mussels can produce



Using instruments he designed, Yokomizo inserts an American mother-of-pearl nucleus in a live mussel

pearls better and less expensively than oysters can. This, he says, is because mussels grow larger than oysters and have thicker shells, which means they can accept—without injury—larger mother-of-pearl nuclei than the small oysters used in the pearl industry.

Also, mussels are not subject to the hazards of cold currents and sudden storms, nor to the depredations of salt-water enemies like starfish and red microbes.

In general, fresh-water mussels thrive over a wide range of climate where food is plentiful and where water chemistry is favorable. They live widely over the United States, and have been a source of industry in the Mississippi River's tributaries.

In fresh-water mussels you may find one or more natural pearls loose on top of the mantle that lines the shells. You may also find one embedded in the mantle or even under the mantle. A natural pearl, whether in oyster or mussel, is begun by accident. The cultivated pearl, on the other hand, is begun by cutting a small mother-of-pearl nucleus — about the size of a ball bearing—and inserting it into the flesh of the mussel by surgery.

This operation requires speed and skill. Speed is important because the mussel weakens while out of water and is not fit to undergo a severe or prolonged operation. Many mussels die when the mother-of-pearl sphere is placed in their bodies.

Anyone interested in growing his own pearls can construct a large lily pool in his back yard, hunt up a half dozen mussels from streams or lakes, insert the nuclei and lay the mussels in the bottom of a pool. The pool should have masonry walls and be at least six feet wide and eight to ten feet long. It should have four to six inches of clean gravel or pebbles on the bottom, covered with about eight inches of earth. Duck weed, pond lilies and other varieties of fresh-water plants can be added to the pool. The mussels prefer cool water and can stand ice water, but they can't tolerate acids. Dead tree leaves should be kept out of the pool.

You also will need special surgical instruments. Yokomizo designed his own and contracted an expert machinist to make them. Basically, his set includes the following four instruments:

1. Reverse forceps with thin, wide jaws for prying open and holding apart the shells of the mussel. A sliding metal band holds the jaws apart at the desired spread.

2. A long, slender cutting instrument that has one small end flattened and sharpened to a razor's edge for making tiny incisions. The other end has a tiny spear-point for picking up fragments of live tissue for transplanting.

3. This instrument, also long and slender, has tiny cups at each end, one a trifle larger than the other. The cups are moistened in

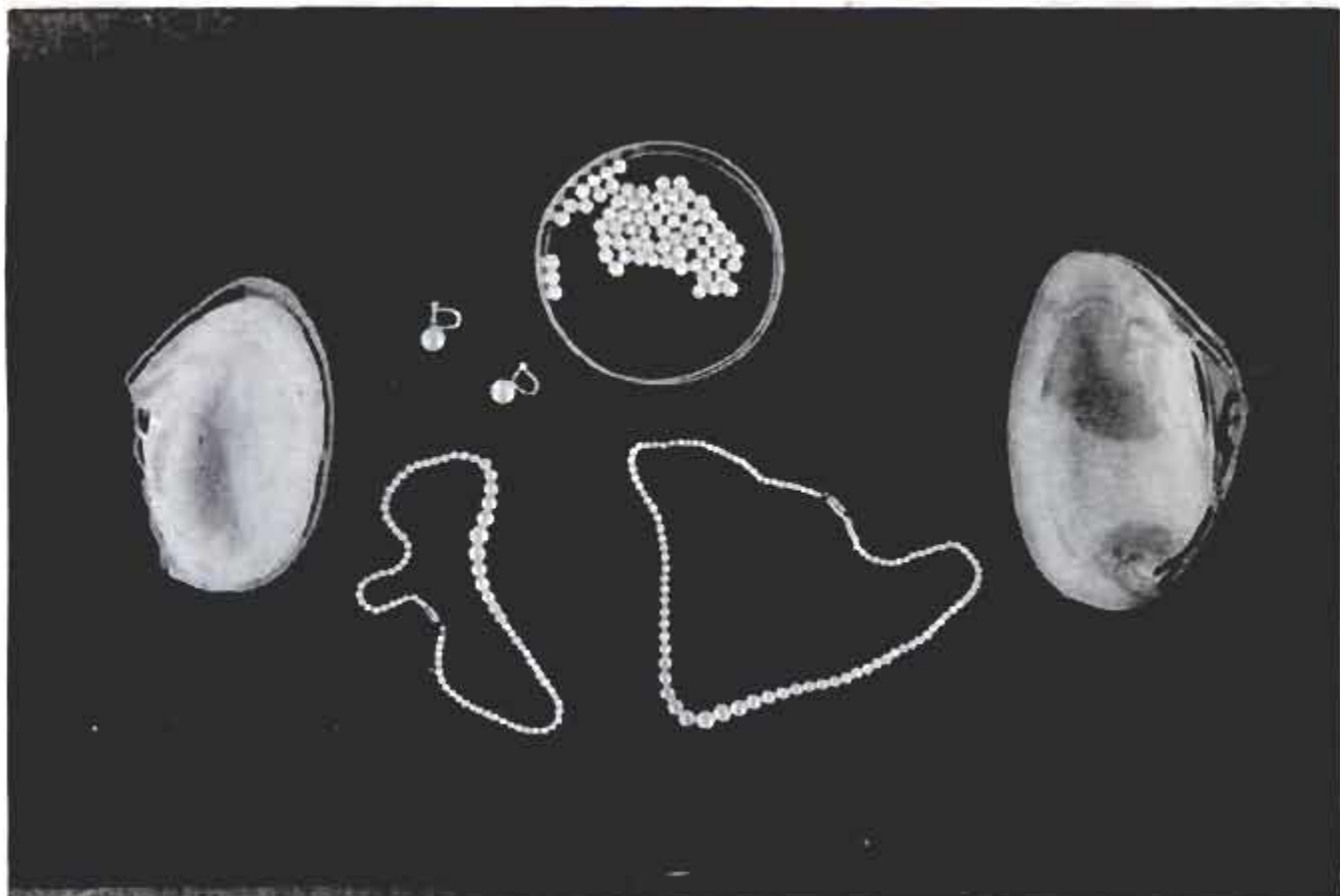

This jewelry was made from fresh-water pearls taken from mussel shells like these. Unset pearls are in the box

water and serve to pick up the nuclei beads for insertion in the tissue. Molecular attraction holds the beads in the cup.

4. A slender tool, ending in a small, rigid wire loop, that is necessary for the looping operation in which the nucleus is enfolded in a section of the mantle. The loop, pressed gently down over the bulge in the mantle, assists in tying of thread to hold the pearl nucleus in place.

All of these instruments are made of stainless steel.

Here's how you can insert the nucleus in the mussel's flesh: Using extremely small simulated pearls for nuclei, make a

slit in the surface of the membrane. It should be large enough to admit just one bead. Push the bead inside and away from the slit. The slit will heal. Then lift the membrane and tie under the bulge with a nylon thread. Don't tie too tightly.

When you return the mussel to the water, it probably will dig into the bottom of the pool and stay put. This method will produce a pearl—but it may have a slight bump on one side. Don't be discouraged, though, for perfectly round pearls of gem color are the exception, even in mass production. And don't be impatient. You won't see any results for at least three years. ★ ★ ★

Radar Tracks Copper Chaff To Chart High Winds

Smoother rides on high-flying jet airplanes and greater accuracy for missiles are two of the benefits from a unique method of charting high-altitude winds. Using a method developed during World War II to confuse enemy radar, Navy scientists are now charting winds as high as 100,000 feet. They eject fast-falling copper chaff from a sounding rocket, then track its descent by radar. Wind velocities are computed from the chaff's drift rate during the 33 minutes it takes to fall from 100,000 feet. The new method lets meteorologists determine wind direction and velocity eight times faster than possible by any other means.

Plastic Foam Glue Permits Quick Use of Broken Bones

Bone glue that allows you to walk out of a hospital on a fractured leg in three days is being tested by scientists in medical schools and hospitals. Developed by Dr. Michael P. Mandarino, the glue, a plastic polyurethane foam, becomes tougher than bone when it dries. During treatment, the glue is poured on the end of small pieces of bone removed from each of the broken ends. The pieces are replaced so that the two ends of the bone dovetail, and within a few hours the fractured member can be moved. Normal bone eventually grows through the glue and in about a year the bone joins solidly.

Chute From Rocket Ship Brings Kids Back to Earth

Getting into this spaceship means a quick trip back to earth for youngsters in Hanover, West Germany. They whiz down a graceful, curved slide from the starting point inside the rocket ship. The slide is located in a modernistic play area on the spacious grounds of the German Flower Show.

First Protonic Microscope

Capable of probing much deeper into the unknown than ever before, a protonic microscope, the first of its kind, has been built by French scientists. Unique because it uses protons rather than electrons, it has been used so far only to study the structure of certain crystals. Using the new microscope, scientists expect to see six times deeper into the microcosm than has thus far been possible with the most powerful electron microscopes.

Propeller Drives Car Over Siberian Snow

There's no worry about chains or deep drifts when the driver of this Russian vehicle takes off for a midwinter jaunt. Wheels of the car have been replaced with wide skids which ride over the snow. The vehicle, now being used in Siberia, is powered by a 260-horsepower engine which drives an airplane propeller.

Monitor Warns Surgeon Of Heartbeat Deviations

Strapped to a patient's arm during surgery, a tiny, self-contained instrument translates the electric-wave activity of the patient's heart into audible "beeps" to warn the surgeon of cardiac arrest or other disturbance. By monitoring the electrical currents produced by each heartbeat, it can give instantaneous warning of deviations with greater accuracy than pulse or blood-pressure counters. An electrode strapped to the other arm accomplishes the completion of the circuit.



UPI photo

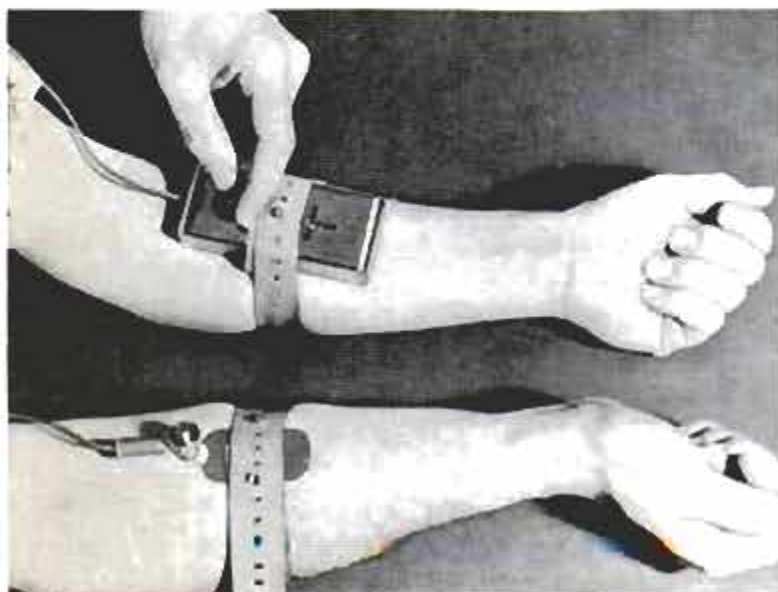

Those Little Things Count..

In the Sound of Your Hi-Fi System

By John Gayner

YOU PROBABLY recall the day you first flipped the switch of your spanking-new hi-fi system and listened with delight to the clarity and realism of the music coming from the loudspeaker.

Does it sound as good now? Are the trumpets as saucily brassy and the voices as crisp and clear as they were? Or do the records sound scratchy? Fuzzy? Do they crackle and pop? Does Como seem to "tremolo" when he didn't before, and does your favorite piano piece seem to w-a-a-w-a-a-w-a-a-w?

If your system has lost some of its original brilliance you are no longer getting a good return from your investment. And,

when you uncover and cure certain maladies by the simple means described here, you may find that the original sparkle and clarity have wilted away so gradually that you may not even have noticed the change. The improvement, therefore, will be all the more startling.

Like an automobile, a hi-fi system requires periodic checks and some special care to remain in top-notch condition. Elec-

Worn stylus can cause as much distortion and more damage than a defective electronic component. Periodic stylus inspection with inexpensive microscope, above, lets you know when it's time for a change

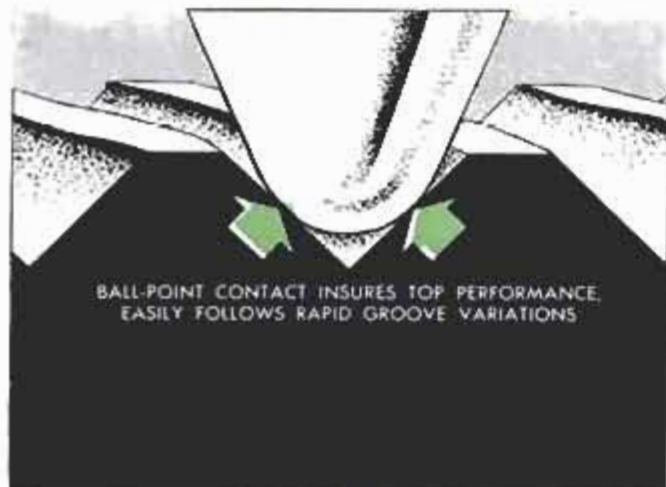

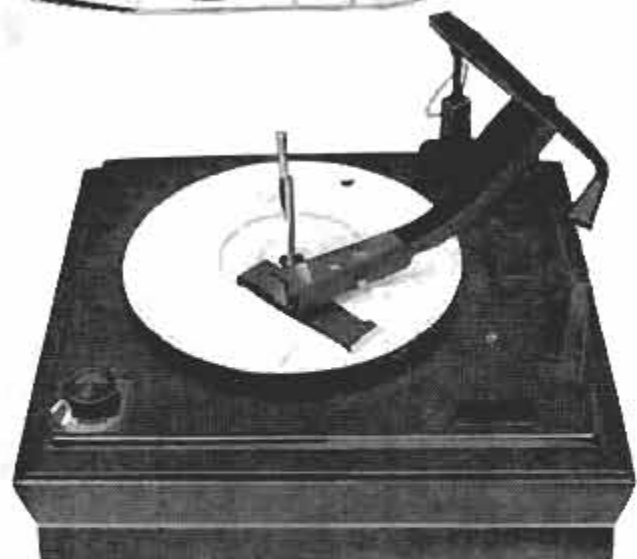

Stylus pressure, too much or too little, is detrimental to high fidelity. Most hi-fi record players have accessible pressure adjustment in tone arm, as above. Inexpensive pressure gauge placed on turntable permits accurate adjustment for optimum results

Level that turntable. It may cure those sticking or groove-jumping habits of your pickup arm. Simple bubble levels are available from hi-fi dealers to make this an easy job. You may find that it will also improve stereo balance and overall fidelity

tronic parts age, components change in performance and, even in the absence of major troubles, after a year or so of use the characteristics of the system may no longer be the same as they were originally. Such gradual deterioration, if it becomes noticeable, can be localized and corrected only by a qualified audio technician.

But there are a number of routine checks that you, yourself, can and should make at regular intervals. They take only a few minutes of your time and require a very small outlay, but they can prolong the life of your equipment and eliminate some rather expensive service calls. Here are some of them:

STYLUS WEAR—The stylus (needle) of your record player does not come to a point. It's rounded so that it contacts both walls of the V-shaped record groove. After some use that rounded tip wears down and develops chisel-like edges. Instead of accurately tracing the delicate patterns of sound impressed into the groove it chops and hacks its way through the wave peaks and valleys.

Result is distortion: Fuzzy, hard-to-listen-to sound, with the high flutes and piccolos going or gone.

And, it murders your records!

To avoid this, check the stylus tip regularly with a microscope. Your audio dealer sells a little, inexpensive pocket unit that lets you inspect without removing the stylus. If it shows signs of wear, don't play another record with it! Replace it!

The styli of most phono cartridges can easily be changed according to directions

given in your instructions manual. If you don't have the manual, ask your dealer for it or write directly to the factory. They'll be happy to send you one.

And, even if the cartridge originally came with a sapphire stylus, replace it with a diamond. These cost more, but they last 10 to 20 times as long and represent a worthwhile investment. It's a good idea to inspect a sapphire stylus for wear after every 10-hour period of use—a diamond at 100-hour intervals.

STYLUS PRESSURE—If your phono cartridge bears down too hard it will permanently distort the relatively soft plastic material of the record. If it rides too lightly it will climb the walls of the groove and may even jump out. Either condition causes serious distortion.

Answer: Buy a stylus pressure gauge (cost—about \$1-\$4) and adjust for the correct tracking pressure called for in the manual. On most record players or changers, such as the Glaser-Steers unit shown here, the adjustment is easily made.

Note this: On some changers, stylus pressure may rise above the recommended maximum as the record stack on the turntable rises. Make sure that it remains within permissible limits from one record to the top of the stack. If it doesn't, don't load the changer with its full complement of records.

TURNTABLE LEVEL—If your record player—changer or manual—rests on an incline, the stylus bears more heavily on one wall of the record groove than on the other. Again, distortion and excess wear

for Keeping the HI in the FI



Dirt, dust and grime are archenemies of both records and stylus. Lightweight "atomic jewel" attached to tone arm neutralizes static electrical charge which causes dust to cling to record grooves



Wipe away "crackle, snap, pop" with swish of chemically impregnated cloth before playing any record. Below: plastic cover, available for most record changers, is useful accessory for uncased instruments

are the results. In stereo, balance may be affected. An inexpensive bubble level, made for the job, will show any turntable tilt and permit you to compensate for it by raising one side of the unit. **DUST, DIRT, GRIME**—Those fine, spiraling grooves in your records are as attractive to dirt as a mud puddle is to a 4-year-old. Dirt not only causes annoying crackle and pop, it can also cause serious wear. Every time the stylus crashes into a microscopic "rock" of dirt it imbeds it deeper into the soft vinyl plastic. What should be a zig in the shape of the groove becomes a zag and the sound suffers. It takes its toll of the stylus too, acting like a fine abrasive and prematurely wearing the tip to a dangerous chisel shape.

One way to help keep dust off the record is to neutralize its static electrical charge. That way the record won't attract and hold the tiny dust particles. You can do it with a silicone anti-static spray, with an impregnated "Jockey" cloth that cleans the record at the same time, or with an "atomic jewel" that attaches to the pickup arm. Another low-cost and useful item is a small brush which attaches to the tone arm and sweeps the record ahead of the stylus.

If your record changer sits out in the open, a plastic cover is a handy item to shield against all forms of dirt. And a little common sense in handling your precious records—such as always replacing them in their original jackets as soon as possible and handling them by their edges to prevent dirt-attracting grease and moisture from getting into the grooves—will greatly increase their useful life.

TURNTABLE WOW—The word "wow" tells the story. That annoying repetitive waver in pitch is caused by an alternate slow-down and speedup of the turntable. If it stems from a defective or badly-

(Continued to page 226)



Removal of "C" washer from changer spindle lets you lift off turntable to expose driving mechanism. Careful cleaning and lubrication may eliminate "wow" and "flutter" which has marred your listening pleasure and save costly service call

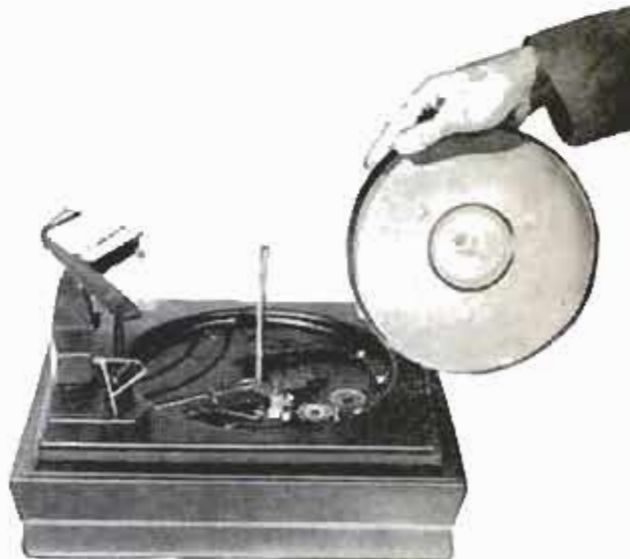

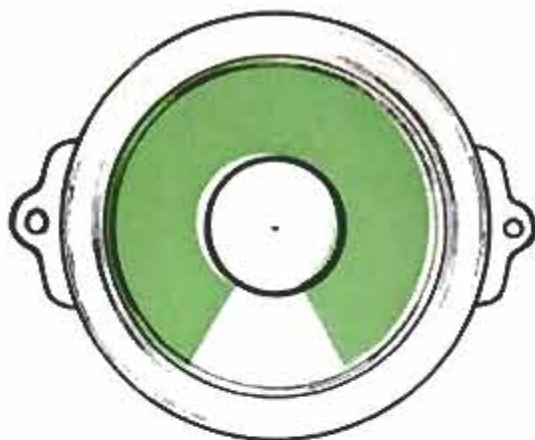

BULLS-EYE TUNING WITH YOUR RADIO

By Rudolf F. Graf

FOR HIGHEST QUALITY reception of AM and FM radio broadcasts the receiver must be tuned exactly to the carrier frequency of the desired station. Some of the more expensive radio sets incorporate some sort of tuning indicator which permits easy, on-the-nose tuning, but a good many receivers are not so equipped. As a result, such sets are difficult to adjust and are often left in a detuned position which causes a great deal of distortion and listener fatigue. The addition of a tuning indicator will greatly improve their performance.

The easily constructed tuning indicator shown here employs the popular and inexpensive 6E5 electron-ray tube illustrated below. The cut-away illustration of Fig. 1 shows the essential parts of the tube. Here's how it works.

The target, a funnel-shaped piece of metal at the head of the tube, is coated

with a fluorescent chemical which gives off a green glow when bombarded with a stream of electrons. It is connected to a positive d.c. voltage in a receiver and thus attracts the electrons emitted from the heated cathode. In the absence of a control voltage the electrons strike all parts of the target, giving it the appearance of a green ring of light.

Located between the target and the cathode is a small piece of wire which serves as a ray-control electrode. When this electrode is at the same potential as the target it has no effect on the electron stream. If, however, the electrode is negative with respect to the target it will repel the electrons in its vicinity, effectively keeping them from reaching the target. As a result, the target area directly behind the electrode does not glow, causing the familiar pie-shaped shadow.

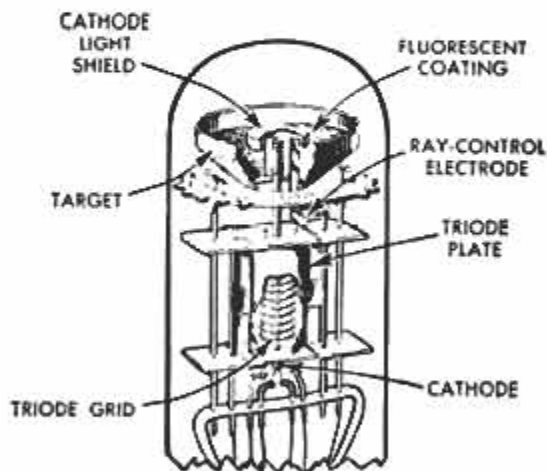
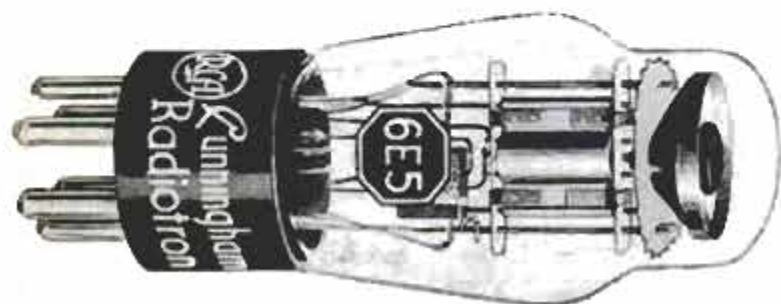
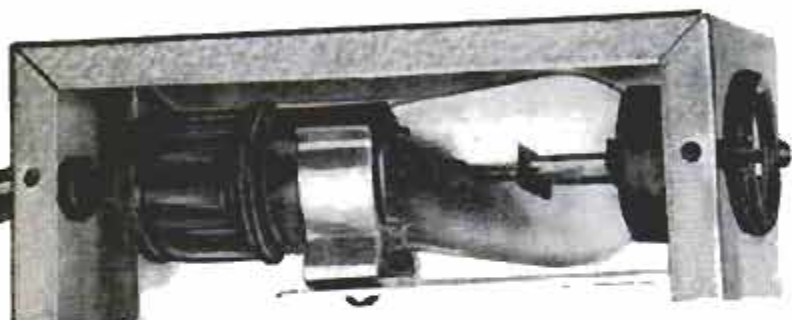

1

The size of the shadow is proportional to the voltage difference between the target and the ray-control electrode. For the tube to act as a tuning indicator, therefore, it is merely necessary to connect its control grid to a point in the receiver where the voltage varies in accordance with the signal strength. Such a point exists in all modern AM and FM radios.

Construction of the tuning indicator is simplicity itself. The required parts—the 6E5 tube, the Amphenol 58-MEA-6 Tuning Eye Mounting Assembly and a small aluminum box (Bud, CU2106A) are inexpensive and are available from most large radio parts distributors or dealers. The mounting assembly is supplied with bracket, escutcheon, light shield and socket. Five color-coded wires emanating from the back of the socket are sufficiently long to reach the back of most any receiver when the completed tuning indicator is placed on top. It is merely necessary to mount the tube and assembly inside the box (this requires the drilling and punching of 4 holes in the box) and to connect the 5 wires to the appropriate points within the receiver. If desired, the receiver can be outfitted with an appropriately wired 5-prong socket, and a matching plug wired to the tuning-eye wires, so the two units can easily be interconnected or separated.

Making the proper connections within the receiver requires some knowledge of radio circuitry—at least the ability to read and follow schematic diagrams. These connections, for various types of sets, are shown in Figs. 2 through 5. It will be noted that the green and blue filament leads of the 6E5 require 6.3 volts of a.c. This restricts the use of the tuning indicator to

(Continued to page 230)

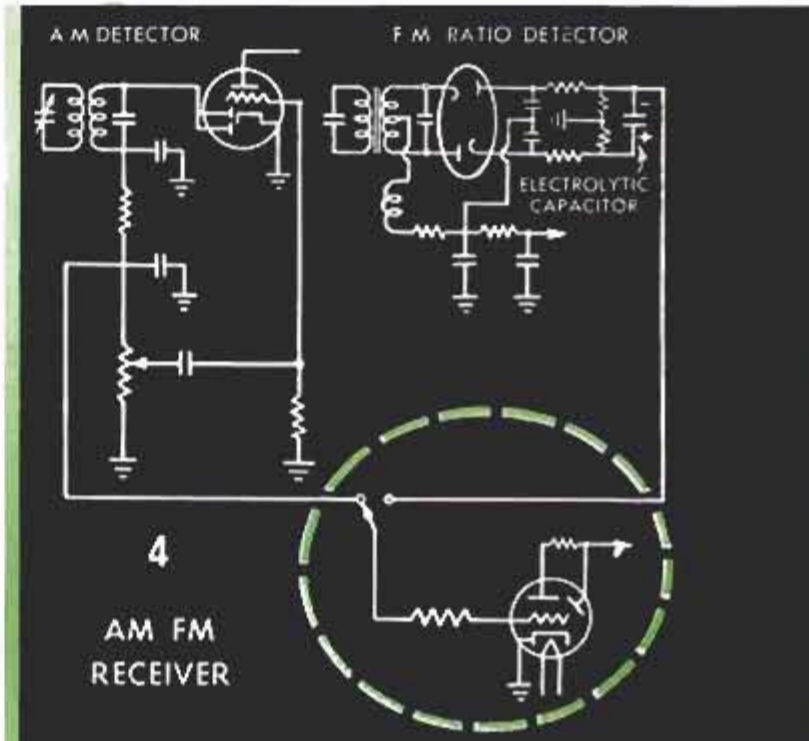
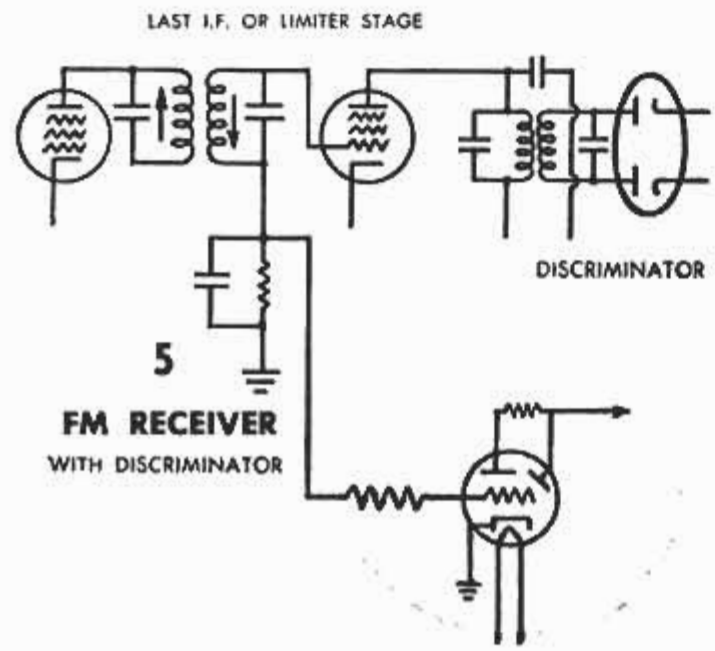
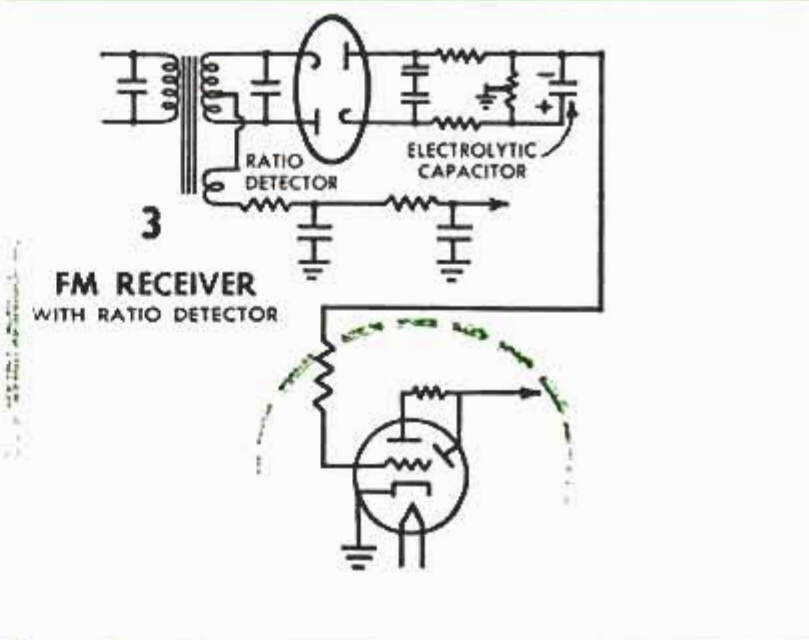
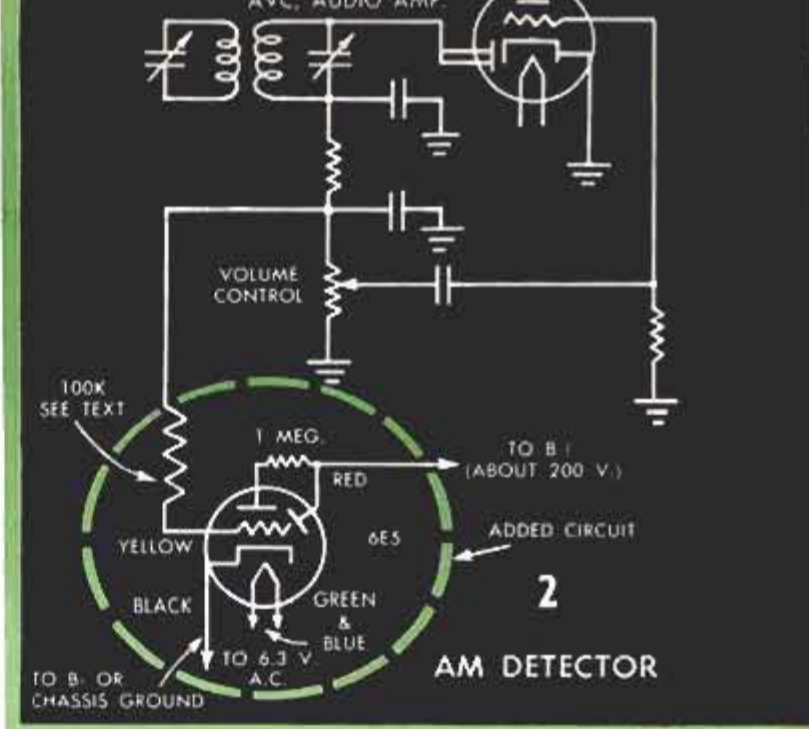

FLASK

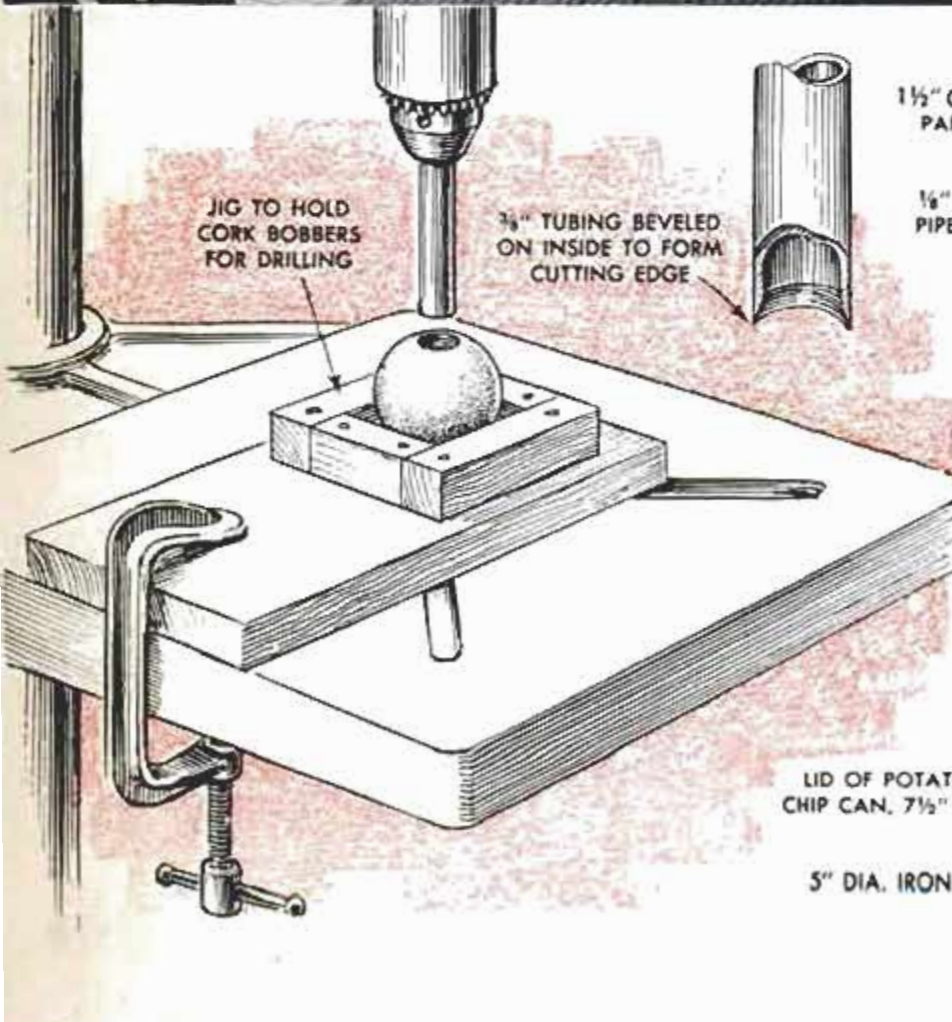
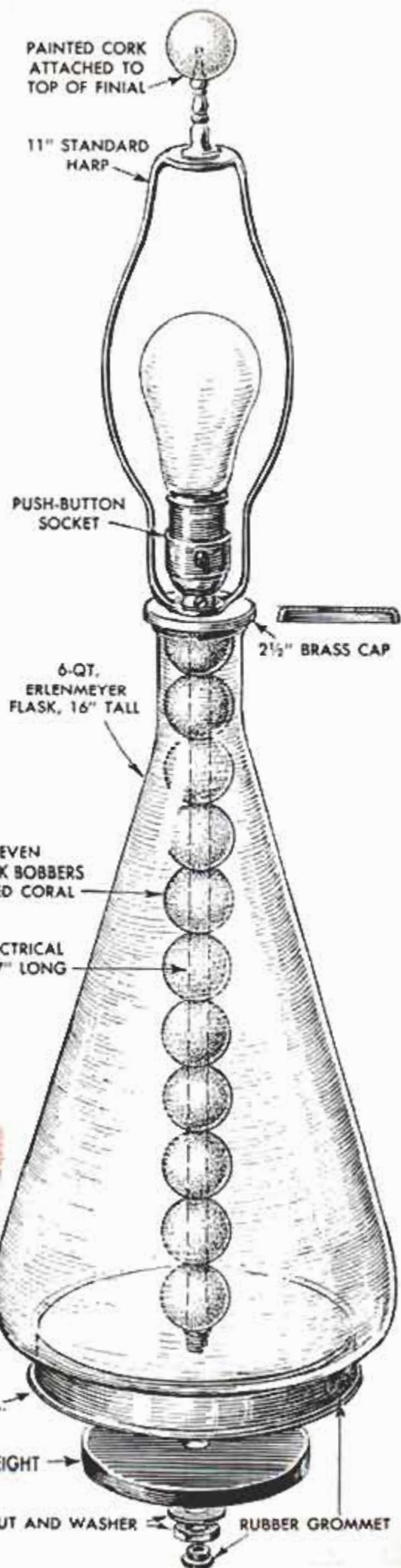

LAMP

The CRAFTSMAN

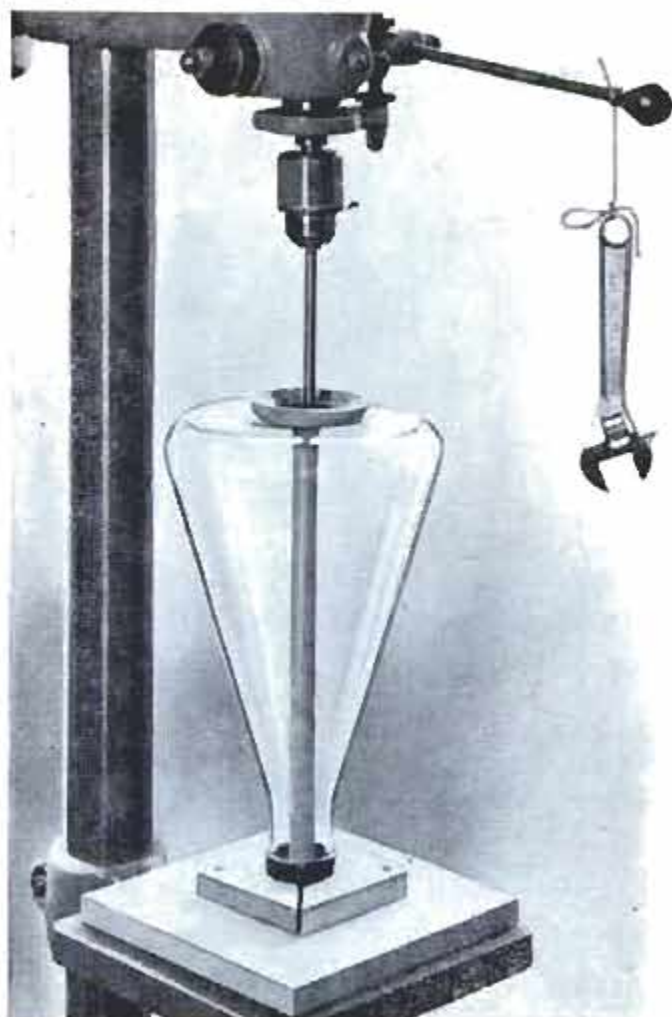

Wrench of sufficient weight to apply right amount of pressure for drilling glass is tied to handle of drill, so it can be run with minimum of attention

Here is a novelty-type lamp that is suitable for a bedroom, nursery, or den. Using a large flask as the basic unit on which standard lamp parts are assembled as shown, you can make a pair of the lamps in a few hours. A unique feature of the lamp is the column of painted cork fishing bobbers that are stacked on threaded electrical pipe fastened in the center of the flask. Not only do the bobbers conceal the lamp cord but they can be repainted any number of times to fit into the decor of any room. In most cases the same shade could be used.

Begin the lamp by drilling a $\frac{3}{8}$ -in. hole in each of the bobbers, using a jig and an improvised bit as shown in the detail on the opposite page. Next drill a $\frac{3}{8}$ -in. hole in the bottom of the flask to take one end of a 17-in. length of electrical pipe. A workable procedure for drilling glass is explained below. Since this job is the most time consuming of the project, make a jig to hold the flask in position on your drill-press table as shown in the photo. Meanwhile the rest of the assembly can be completed as shown in the drawing.

When painting the bobbers, string them on a taut wire and use a hat pin to hold and turn each one as paint is being brushed on them. The potato-chip can lid used for the base is painted flat black. If a 5-in. dia. iron disk base weight is unavailable, melt some lead and pour one directly in the lid.
Bob Joselyn, Chicago

HOW TO DRILL GLASS

About the easiest way of drilling a hole in glass is to chuck a length of brass tubing in a drill press and use a jig to hold the object while the relatively slow process of drilling or grinding is in progress. A weight, such as a wrench, is tied to the drill handle to apply sufficient pressure to grind away the glass without overheating or breaking it as in the photo above.

An oil-and-emery dust mixture confined to the drilling area by a putty dam as detailed at right, provides the abrasive. Slots cut in the end of the improvised bit help to circulate the mixture. This cools the glass and brings a constant supply of abrasive to the grinding surfaces of the bit. The drill must be run at slow speed to avoid overheating the glass, which might crack it.

When drilling a hole in the bottom of a thin-wall bottle or flask, the flat surface must be supported at a point directly under the bit to counter-balance pressure exerted by the drill. In the case of the flask illustrated, a prop consisting of a length of dowel with a rubber disk glued on each end

serves this purpose. The lower end of the dowel is fitted in a hole drilled in the bottom of the jig. The latter is made up of two squares of 1-in. lumber, the lower one of which is one piece. The upper square is sawed in half diagonally and notched at the center to clamp the neck of the flask when screwed to the bottom square. A portable power drill may be used for drilling glass in this manner but it is a tiresome job since the weight of the drill must be balanced carefully.

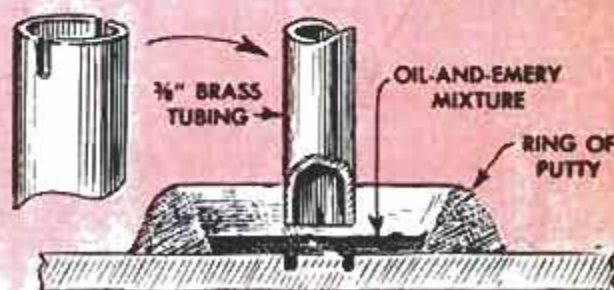



Quick Way To Make Rounded Wood Buttons

Decorative wooden buttons for surface gluing can be made by first rounding the end of a dowel freehand on a sander and then sawing partway through with your circular saw. Finish cutting off with a jigsaw to avoid damaging the completed button.

Outlet for Breakfast Table In Center of Kitchen

Do away once and for all with that electrical appliance cord reaching from a wall outlet to the coffeemaker on a table in the center of the kitchen. Install a floor outlet close to the table leg, then drill holes in the latter and pull the cord through and connect to a cord outlet as shown in detail below.

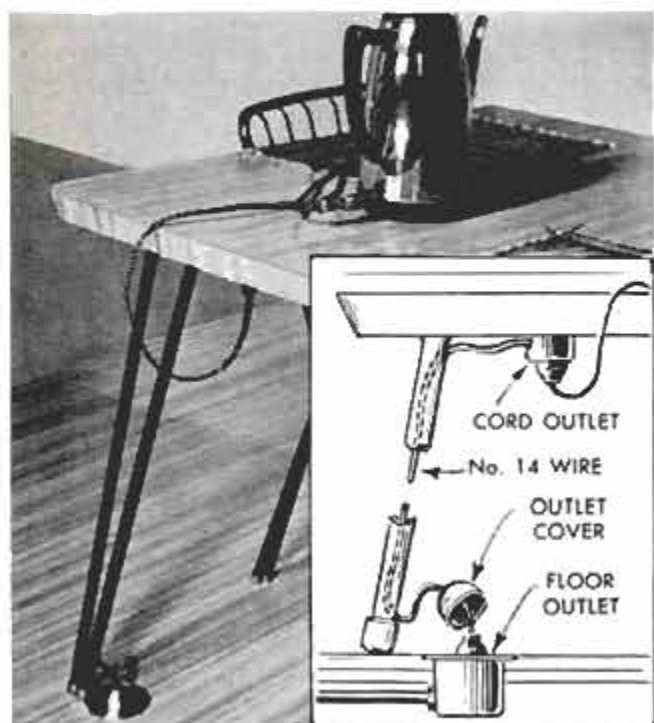

Improved Bulletin "Board" On Plastered or Tiled Wall

Office bulletins or shop plans and blueprints can be thumbtacked to any wall simply by drilling two holes in the wall material and pressing a cork into each hole. Corks should fit tightly and should be spaced to suit the width of the sheet.

Cross Handle for Allen Wrench Gives Additional Leverage

When you have to use the long leg of an Allen wrench a cross handle gives you the extra "torque" needed to seat a screw properly. Make a handle by grooving a piece of hardwood about 2½ in. long and ½ in. square. Drive an escutcheon pin a little offcenter through the groove and insert short leg of wrench as shown.



STAIRWAY CLOTHES HAMPER

If your home is without a built-in laundry chute, here is a device which will save the lady of the house many steps to and from the basement. The top basement-step tread, planed flush with the riser, becomes the laundry-hamper lid. It is hinged to the riser and is opened with a simple string-and-pulley combination, which runs up the wall. A stop screwed to the wall prevents the lid from falling too far open, and elastic cords serve to close it. The hamper is as wide as the step case and about 6 in. deeper so that it extends under the landing. From the lid, the hamper falls vertically to within 3 or 4 ft. of the basement floor. It is made of $\frac{3}{8}$ -in. plywood mounted on a frame of 2x2-in. stock. Clothes are easily removed through a trap door flush mounted in the bottom.

Novel Hardware Caddy Made From Cigar Boxes

A household hardware caddy can be made from two cigar boxes, a dowel and paper cups. The cups are set in openings cut in one box, and its lid is sealed. The sides, cut from the second box, are fastened with screws and the handle is attached. The caddy carries light hardware or serves beverages.



DECEMBER 1959

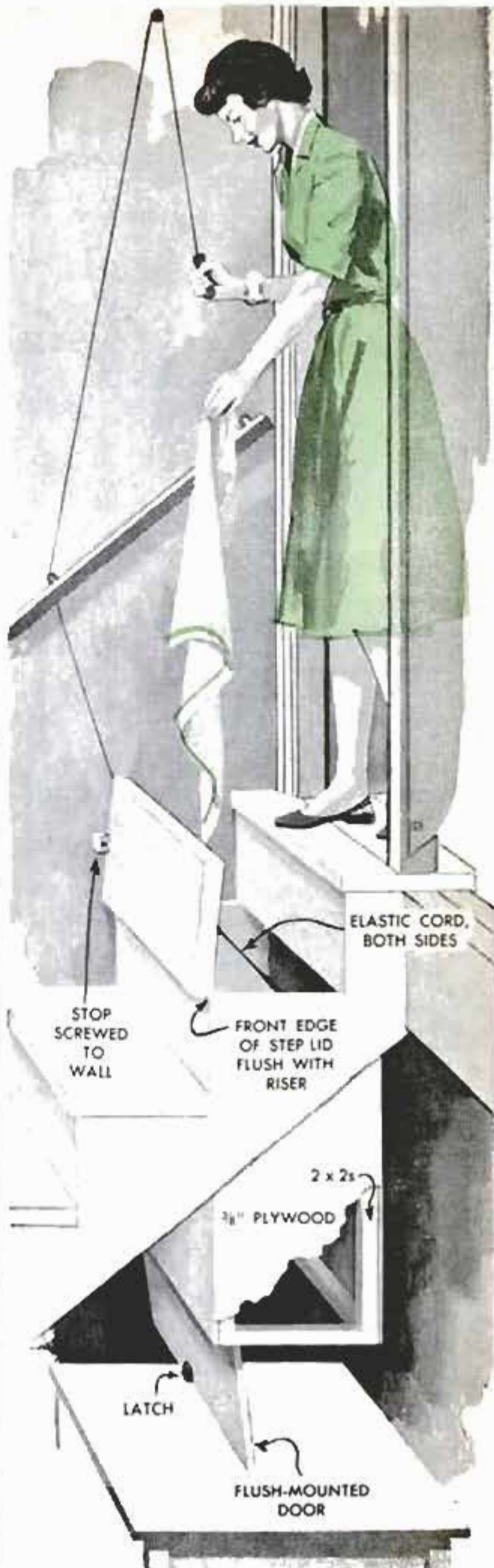



In warm, dry climates where snow is a rarity, this type of decoration can appeal strongly to homeowners

DECORATE YOUR MAILBOX FOR CHRISTMAS

By Ted Lau

COME CHRISTMASTIME why not change the plain, year-'round look of your rural mailbox by including it in your outdoor decorating plans? It's no problem to fit the mailbox into the general plan and it takes only a little extra time. Working with bright ribbon, a candy cane or two, or a few pieces of foil and artificial snow, you can make box and post symbolize a gaily wrapped gift package, a church with an open door, a post festooned with new snow—decorations that bring a warm thought of Christmas to the passerby.

But while you're planning the box decorations remember your mail carrier. He'll have bundles of cards, letters and small packages for you every day of the week before the holiday and the chances are he'll deliver your mail on Christmas day. Make it as easy for him as possible. Arrange the decorations so that they do not interfere in any way with opening and closing the box. If you're a newcomer to the neighbor-

Snow, Santa and reindeer go together. Here's happy combination



Church with open door, cross of foam plastic, are in keeping



This decoration can only mean that Santa Claus comes for mail on time



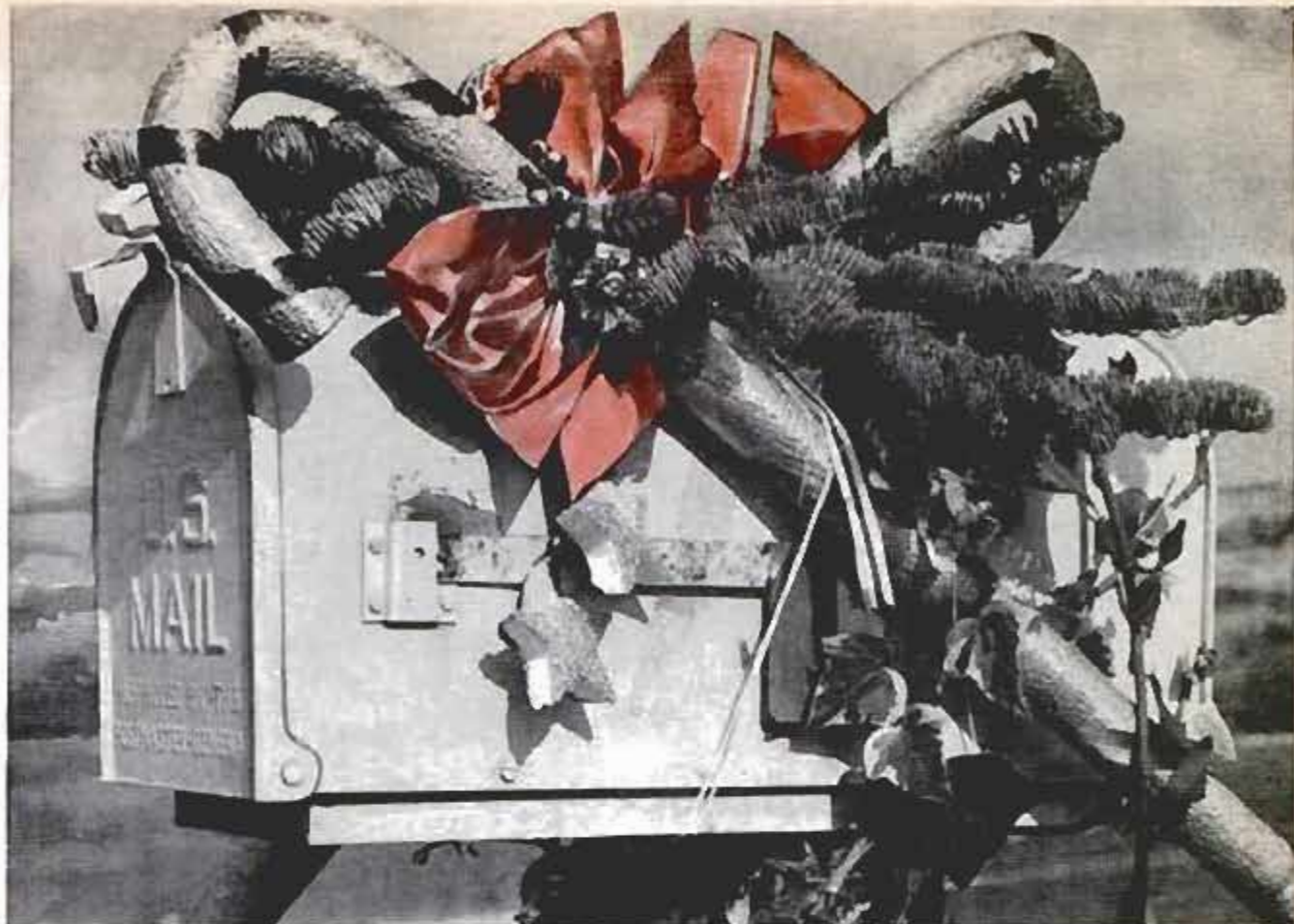

From a distance you can easily imagine this to be a specially wrapped gift package, anything but a plain mailbox on a post. It very well expresses the owner's wish of a "Merry Christmas" to all who pass by

hood and the decorations cover your name lettered on the box, then it's a good idea to letter name and address on a card and tape it to the front of the box where it is easily read by your carrier.

Boxes unduly exposed to wind and weather should be decorated with materials which are easy to fasten securely in place and which will withstand the elements for the week or so they are in use. Many suitable materials are readily available and easily utilized to get the desired effect. ★ ★ ★

Below and at right are boxes similarly decorated with foil and ribbon cut from brightly colored plastic





Suet Feeder for Songbirds Made From Milk Carton

Winter birds, whose main problem is a constant food supply, will soon spot this novel feeder. It's made from a 1-qt. milk carton having openings about 2 by 2 in. cut in the four sides. The flaps are bent upward to form awnings which protect the openings from entrance of snow or rain. Two $\frac{1}{4}$ -in. dowels, each about 10 in. long, are forced through undersized holes punched in the sides of the carton just below the openings. The dowels project equally on both sides to form perches for the convenience of the customers. Hang the feeder with two wire hooks to a tree branch at least 5 ft. above ground and tie a cake of suet to the dowels as indicated. Although altered to serve primarily as a suet feeder, the carton can also serve usefully as a small seed feeder.



Sanding "Drum" Expands To Hole Diameter

There are times when you need to smooth the inside of a large-diameter through hole for the sake of appearance or to obtain a tight fit of some joining part such as a round tenon. The only sanding drum you have won't enter the hole. But before you go to a half-round file or a piece of sandpaper wrapped around a dowel, grab a magazine, roll it up tightly and wrap the piece of sandpaper around the roll. Then pass the whole thing through the hole, release the rolled magazine, allowing it to expand, and there you are. Sand with a back and forth stroke, turning the roll simultaneously and you'll do very nearly as good a job as you could do with an oscillating-spindle sander.



Coated Developing Reel Loads Without Sticking

When roll film sticks in the groove of the developing reel you're in trouble. Once it sticks it's difficult to move it in either direction without the chance of damaging the film itself or getting it smudged with fingerprints. But if you wish to save the film, there's nothing to do but keep trying until you finally get it safely in place. You can avoid this trouble simply by rubbing the groove with silicone-coated tissues of the type used for cleaning eyeglass lenses. Wad several tissues and press into the groove tightly so that all surfaces take a light coating. The trace of silicone, which is chemically inert, forms a smooth surface that prevents the film from sticking.

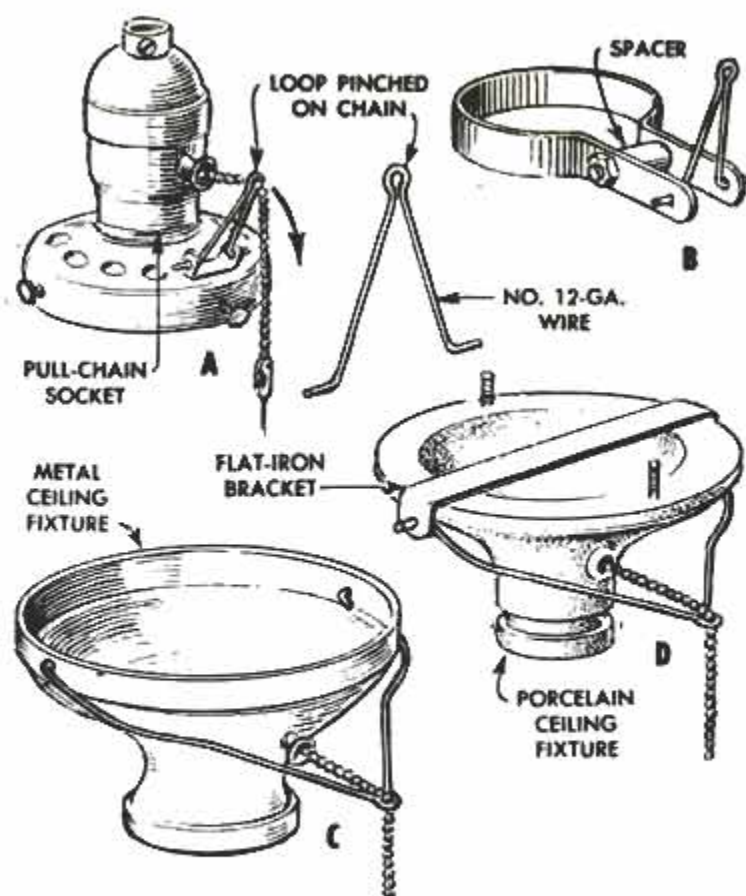

Preventing Breakage of Lamp Pull Chains

Repeated breakage of pull chains on overhead lighting sockets or ceiling fixtures, caused by binding of the chain on the bell-shaped bushing, can be avoided with a simple swinging arm shown in detail A. This exerts a horizontal pull on the chain and thus prevents binding. The pivoted arm, formed from a length of No. 12-ga. wire has a loop, which is pinched on the chain after the arm is set at a 45-deg. angle. It pivots in tabs formed by cutting the shade holder and turning the cut ends up, or, if desired, a U-shaped piece of brass

may be soldered into place on the holder.

For porcelain sockets and some types of ceiling fixtures, the arm is pivoted to the ends of a band tightened around the socket shell or fixture body as shown in detail B. For other porcelain ceiling fixtures on which a band cannot be fitted, a flat-iron or sheet-metal bracket can be inserted between the ceiling and the fixture base as in detail D. For spun-metal fixtures the pivot holes can be drilled in the sides of the base, and the ends of the arm bent over inside as in detail C.

Part of Paint-Can Cover Cut Away to Provide Edge for Wiping Brush

Altering the cover of a paint can as shown not only keeps the groove on the can free of paint, but also acts as a straight-edge for wiping the brush. Since most can covers are interchangeable with other cans, several of different sizes can be kept on hand for any need. The cover is altered by cutting away just a little less than half the top, leaving the rim intact. Then the sharp edge is bent back on itself to form a wiping strip as indicated.

Richard Hanscom, Elmhurst, Ill.

☐ When using a ruler or straightedge as a guide for cutting glass, make heavy crayon marks on the glass. The wax will provide friction to help keep the rule from slipping.



Early American Clock Has

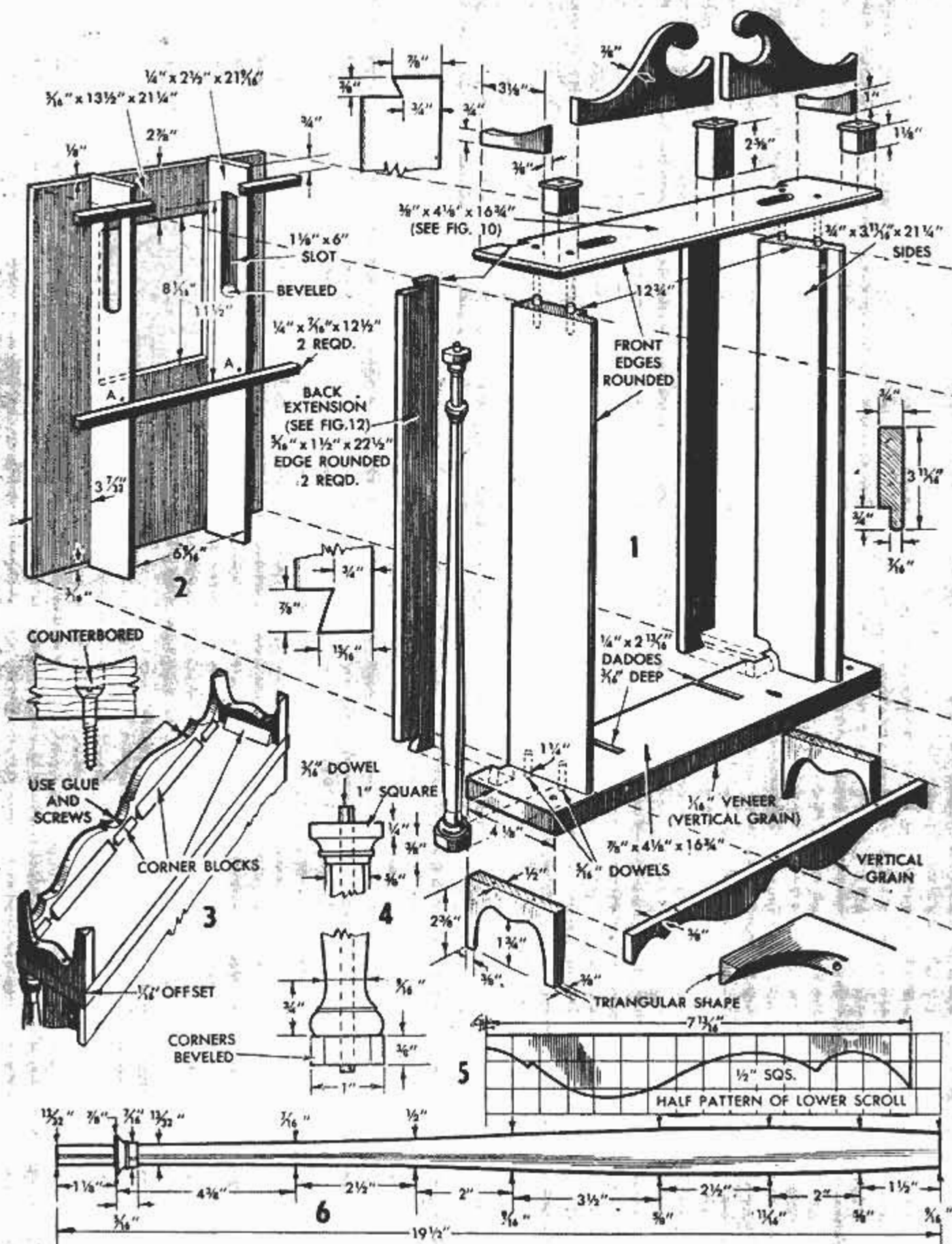

7

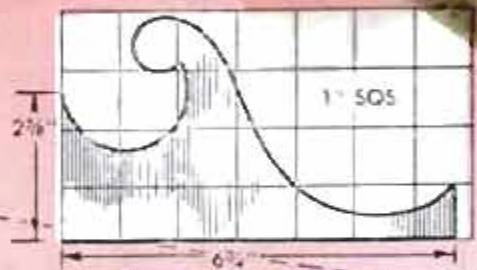

8

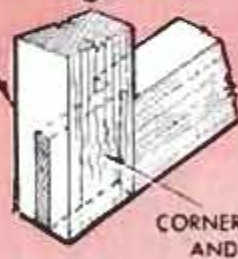
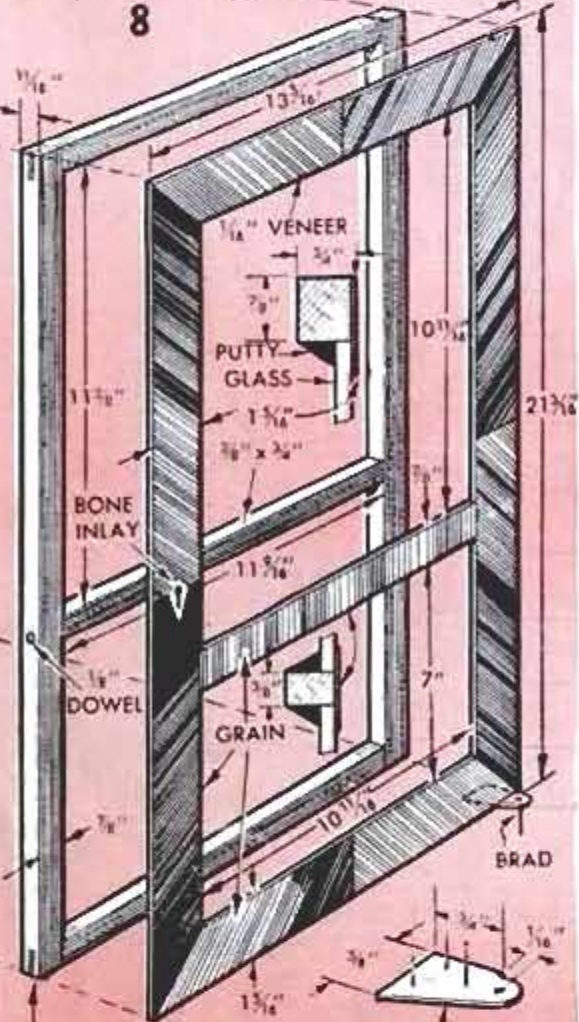

9

No. 20-GA. BRASS HINGE



PART I

CASE AND MOVEMENT MOUNTING

By E. R. Haan

SHELF CLOCKS of the pillar-and-scroll type were made by several American clockmakers in the early 1800's. Most of these early clocks were fitted with 30-hour wooden movements housed in handsome mahogany cases. Pictured above is one of them, at least 130 years old and still in running condition. It was loaned to *Popular Mechanics* by courtesy of The Museum of Science and Industry, Chicago, for the purpose of making the accompanying measured drawings of its construction. From these you can build a

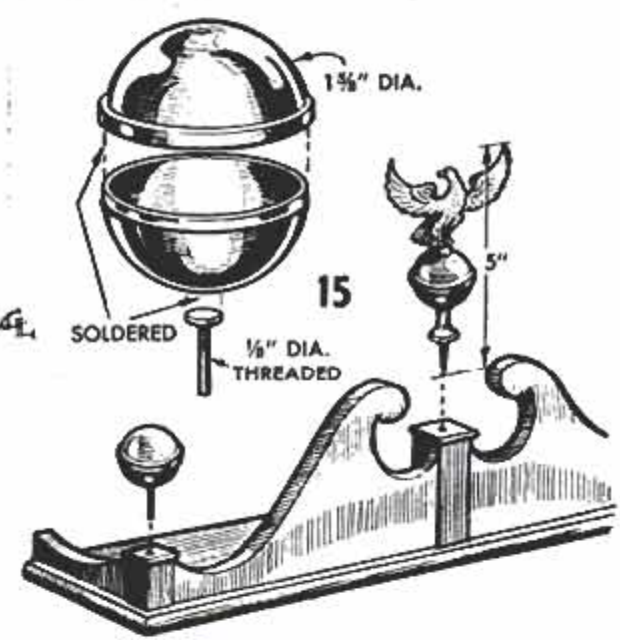
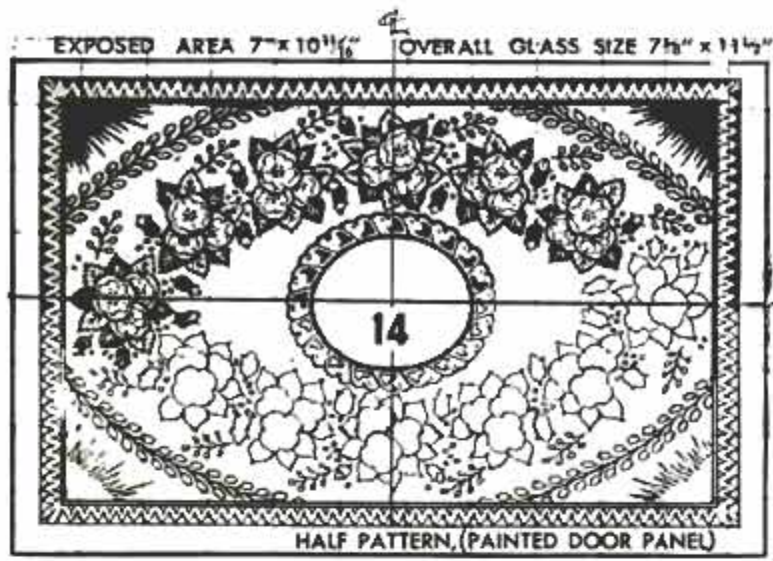
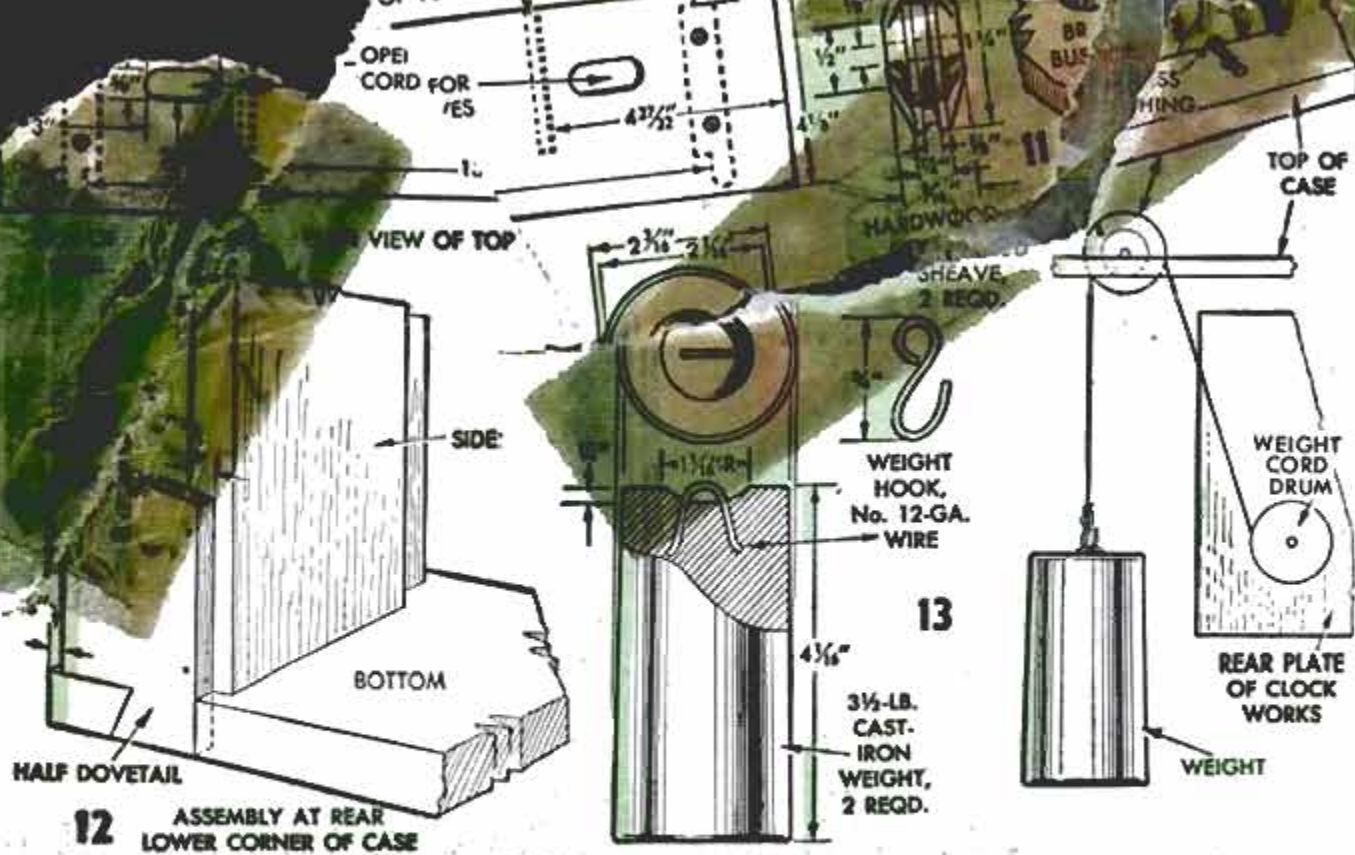

copy of the clock, now a comparatively rare American antique.

You have a choice of procedures. You can build the case alone and fit it with an electric movement, time only, or a spring-driven movement with strike. Or you can go all the way and build case and weight-driven movement complete. If you build the case only simply omit the movement opening in the back panel. Fig. 2, the vertical mounting strips, Fig. 2, and the tell-tale opening in the lower glass door panel, or tablet, Fig. 14. The case alone is quite simple to build. Building the wooden

movement is, of course, a painstaking job.

The case, without ornamentation, consists of the side members, the top and bottom and the back extensions, or wings, Fig. 1. These parts should be made and joined first. The top is detailed in Fig. 10 and the half dovetail joint made at the lower ends of the wings is shown in Fig. 12. Joinery of the wings at the top is the same except that the half dovetails are shorter. Note that the wings lap onto the back edges of the side members to form rabbets into which the back panel fits.

Next, cut and fit the movement supports

$\frac{1}{4}$ " x $11\frac{1}{2}$ " x $11\frac{1}{2}$ "
WOODEN DIAL (PINE
PLYWOOD CAN BE USED)

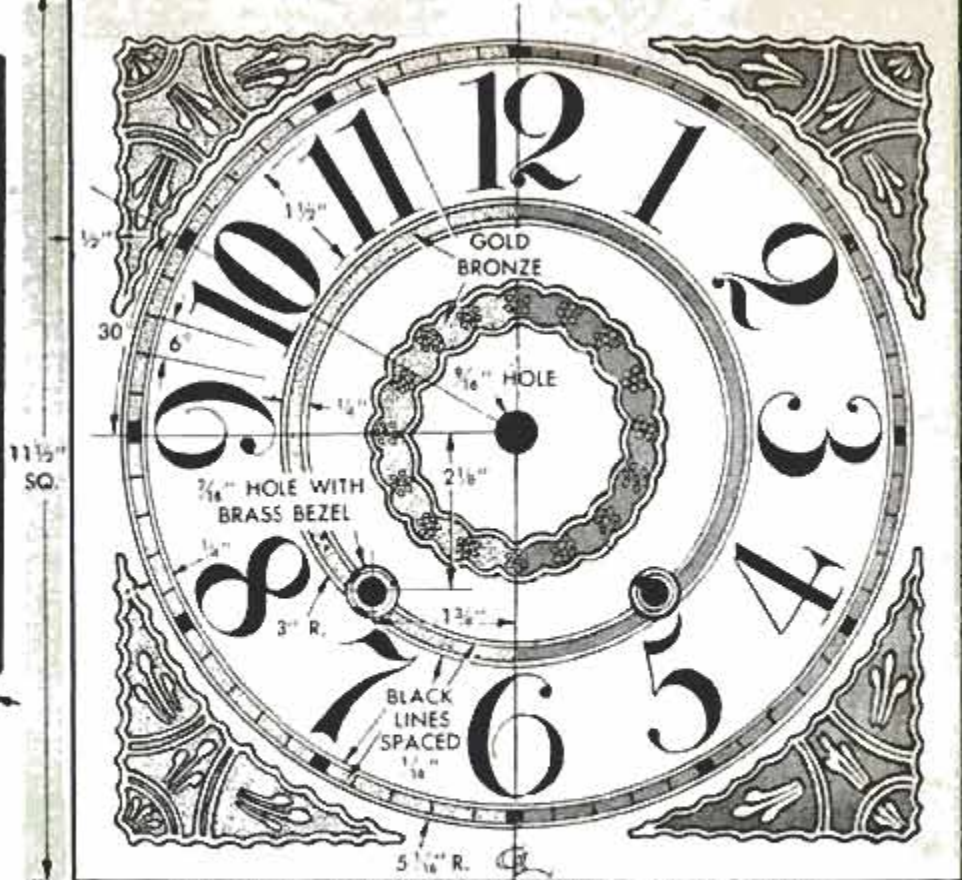
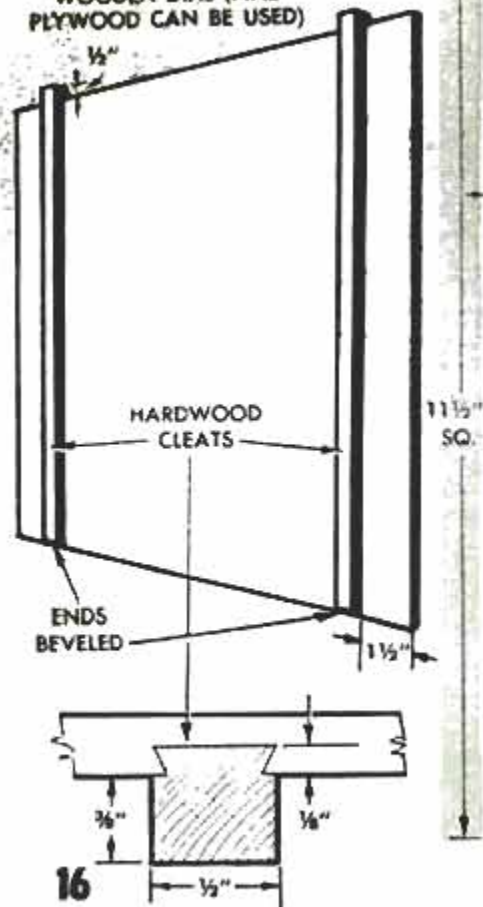

WHITE DIAL. GOLD BRONZE IN CIRCLES AND SPANDRELS.
BLACK NUMERALS, MINUTE DIVISIONS.

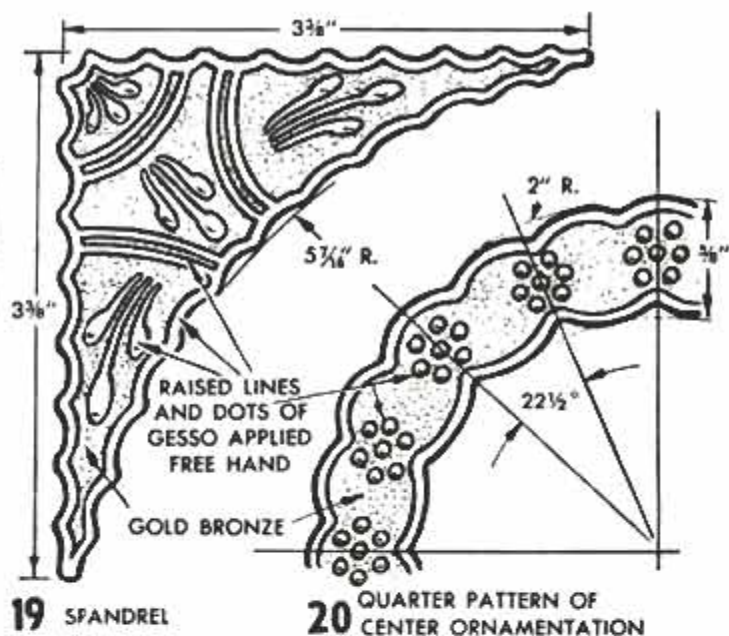
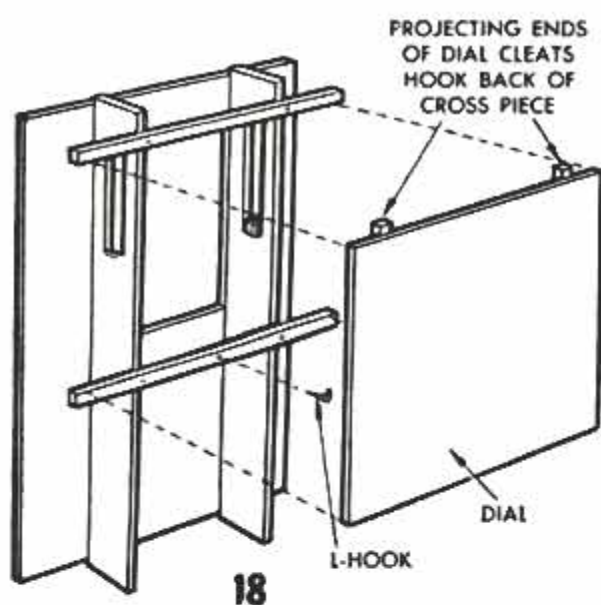

and the back panel, Fig. 2. The slotted movement supports fit into dados cut in the top and bottom members and need not be glued in. If you use an electric time movement or spring-driven striking movement, these supports can be omitted and the dial can be attached to cleats screwed to the sides of the case. The original pillars, Figs. 1, 4, and 6, were made in three parts, the long column, Fig. 6, and the top and bottom caps, Fig. 4. The pillars are doweled in place after test-fitting. Although not so indicated in Fig. 1, the dowels at the top can be made to project

1 in. to serve as anchors for the ornament base blocks, Fig. 7. The pillars are turned from maple or birch. All other exposed parts of the case are selected mahogany.

Cut the top and bottom scrolls, Figs. 5 and 8, slightly longer than the dimensions given to allow for fitting. Although the originals consisted of veneers laid on solid stock, top and bottom scrolls can be cut from plywood faced with figured mahogany. End pieces of the lower scroll form the legs, Fig. 1. Leg pieces and the lower scroll are glued, screw-fastened and corner-blocked in place as in Fig. 3.

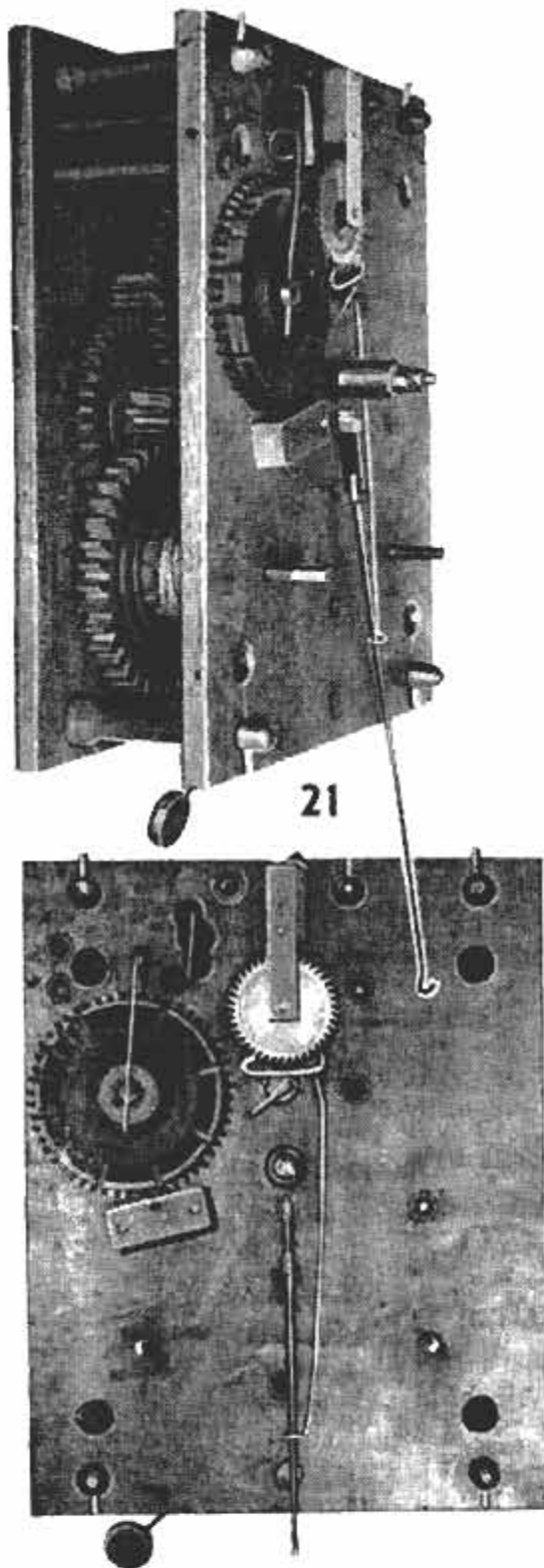

Dots and solid-line circles of template at right indicate the holes to be drilled through both plates while clamped together. Round dots are No. 52 drill holes. Holes Marked B are $\frac{1}{8}$ in. diameter to take brass bushings having No. 52 center holes. Dotted circles indicate added or enlarged holes in the front plate only. The $\frac{1}{8}$ -in. holes for spindles carrying the winding drums and drive wheels are not bushed. As noted on template, these holes are drilled $\frac{1}{8}$ in. dia. in the back plate and $\frac{5}{32}$ in. dia. in the front plate. Dotted lines to $\frac{7}{16}$ -in. holes in front plate indicate holes taking pins holding movement in place between supports

The door frame, Fig. 9, is made from selected straight-grained white pine and is faced with $\frac{1}{16}$ -in. sawed mahogany veneer, the grain running in the directions indicated. Note in the sectional views, Fig 9, that the facing veneer forms the glass rabbets when glued in place on the door frame. This construction is necessary in order to provide ample clearance for the hand post, or hand spindle, of the wooden movement. The door swings on two simple hinges, one located at the top, the other at the bottom corner. Brads driven into the top and bottom members of the case form the hinge pivots. A replica of the door latch originally used is no longer available, but you can use a very small chest lock. Or, simply mortise the door for a small skeleton key of the type supplied with small chest locks and then use a friction catch or magnetic latch. Fit the inlaid escutcheon as indicated.

The addition of the dial, Figs. 16 to 20, the tablet, Fig. 14, and the top ornaments, Fig. 15, complete the case for either an electric or spring movement. Ornaments like those in Fig. 15 are no longer made, of course, but similar ornaments are available and are authentic for the pillar-and-scroll case. If you don't feel equal to making the dial you can have it custom made at a nominal cost. It can be made with Arabic numerals as pictured, or with Roman numerals as both types were used by makers of the original pillar-and-scroll clocks. Likewise the tablet designs varied. That in Fig. 14 was taken from an original and it will be noted that

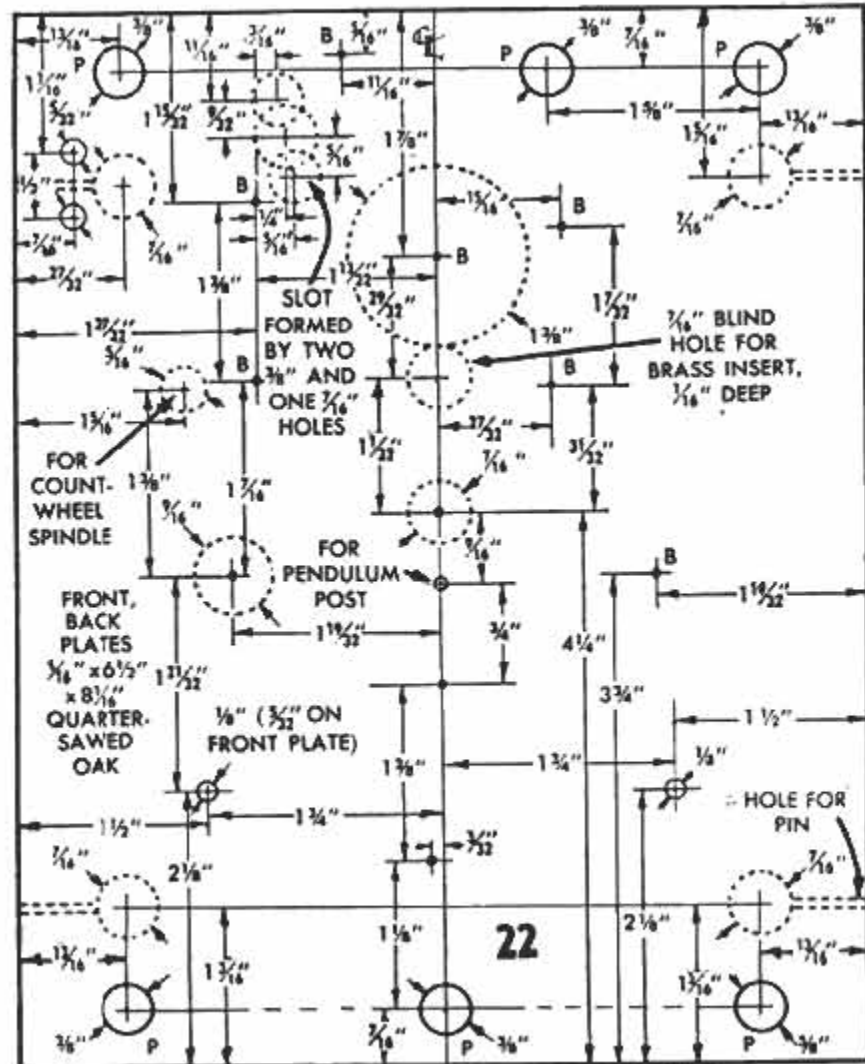



UNDERSIDE OF FRONT PLATE

23 HOUR-WHEEL HOLDDOWN

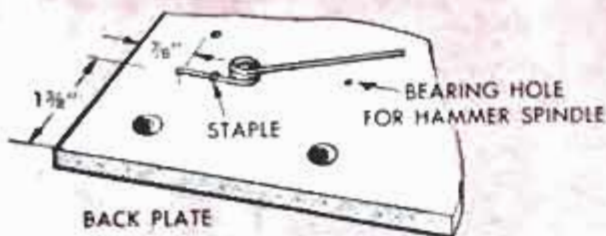

BACK PLATE

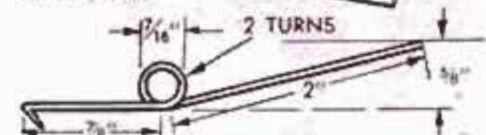

24 BELL-HAMMER SPRING

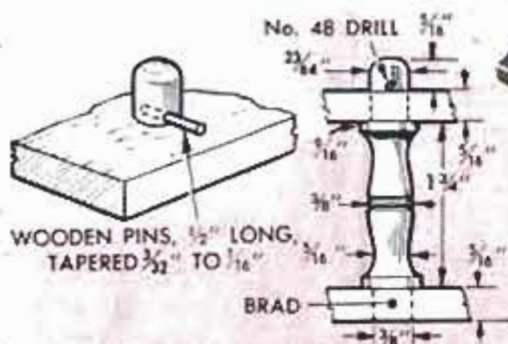

25 PLATE SPACERS (SEE FIG. 21)
6 REQD.

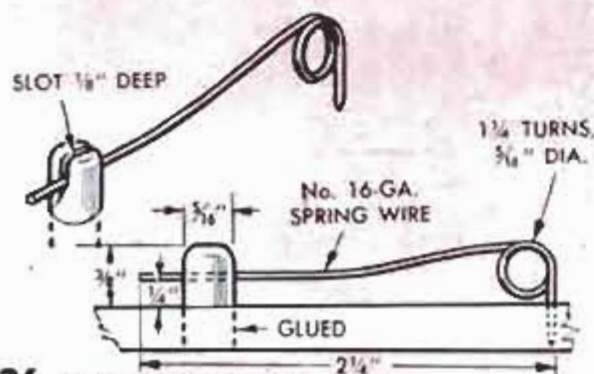

26 COUNT-WHEEL KEEPER

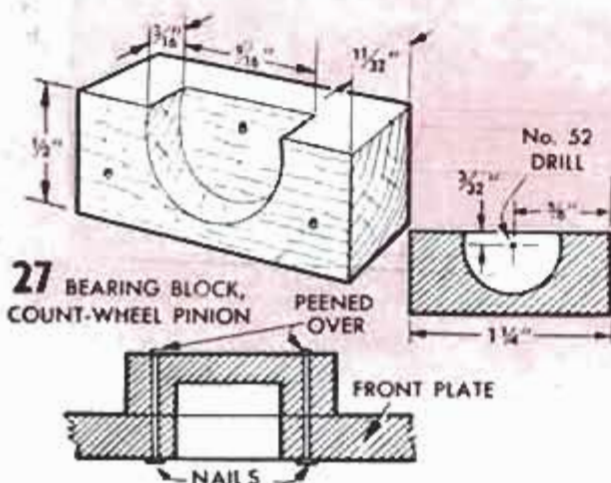

27 BEARING BLOCK,
COUNT-WHEEL PINION



FRONT PLATE

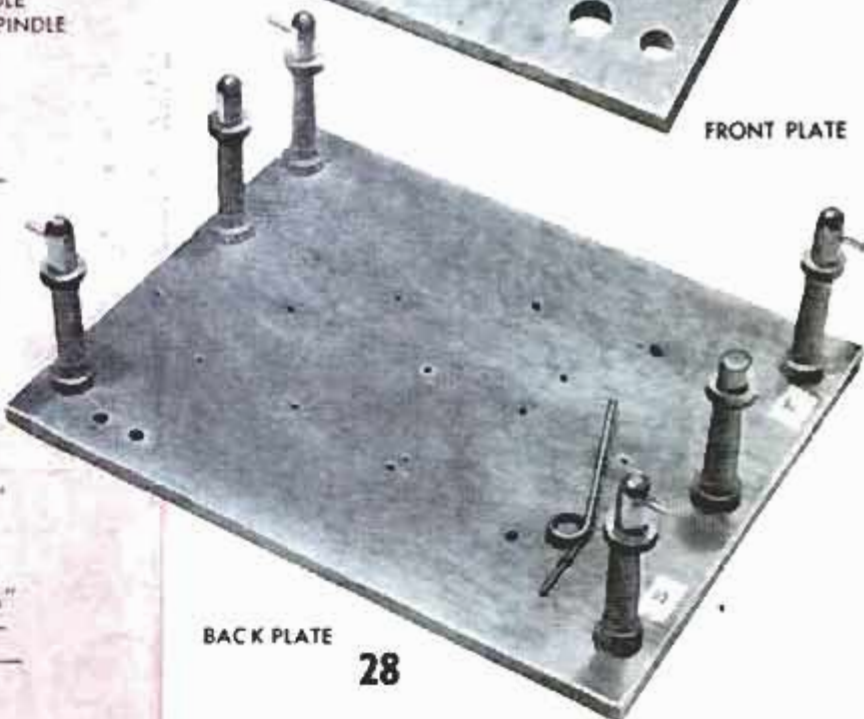

BACK PLATE

28

the overall pattern is slightly wider than the exposed area of the glass opening in the door, Fig. 9. When the pattern is laid out on the glass panel this correction should be made. The design is painted in reverse on the back of the glass panel, using gold and black in the border design, bright colors in the floral design and ivory for the background. In the original the area within the center oval was left clear so that swing of the pendulum could be observed. The tablet pictured in the clock on page 155 is not the original.

If you're following through with construction of a replica of the original wooden movement, you continue with the addition of the cord sheaves, Fig. 11, and then take up layout and drilling of the movement plates, Figs. 22 and 28. Two views of the original movement with all fittings are shown in Fig. 21, and parts that are attached to the movement plates are detailed in Figs. 23 to 27 inclusive. These include the plate spacers, or posts, Fig. 25. Note that in Fig. 22 the holes indicated by dotted lines are drilled in the front plate only. Those marked with the letter P are

(Continued to page 212)

THE P M HOUSEBOAT

PART I

Length: 24 ft.
Beam: 8 ft.
Cabin: Approx. 7 x 16 ft.
Construction: Plywood
Sleeps five plus
Enclosed head
Running water to sink
and lavatory
Spacious galley
Hanging locker
Fuel: 36 gallons

Aware of the growing interest in houseboating, the editors of Popular Mechanics had this trim little houseboat designed and built for you and your family. The straight lines make it comparatively easy to build by anyone handy with tools, and its size permits trailering it to almost any waters desired. The interior of the cabin has virtually all the comforts of home. The roof provides a sun-deck, and inside are sleeping accommodations for five, three forward and two amidships; a galley to delight any "chef," consisting of a stove, sink, 100-lb. icebox, and storage cabinets and work surfaces galore. There is a dining booth for four which converts to a large bed for two. The enclosed head, or toilet, contains a lavatory, mirror and storage space, and there is a full-length closet for clothes. Lights over galley sink, dining booth and in head provide plenty of illumination.





A table by day and a bed by night—
double-duty dining table has folding leg
table top drop down to form full-size bu
Foam cushions provide comfortable seati
Silverware drawer pulls out from und

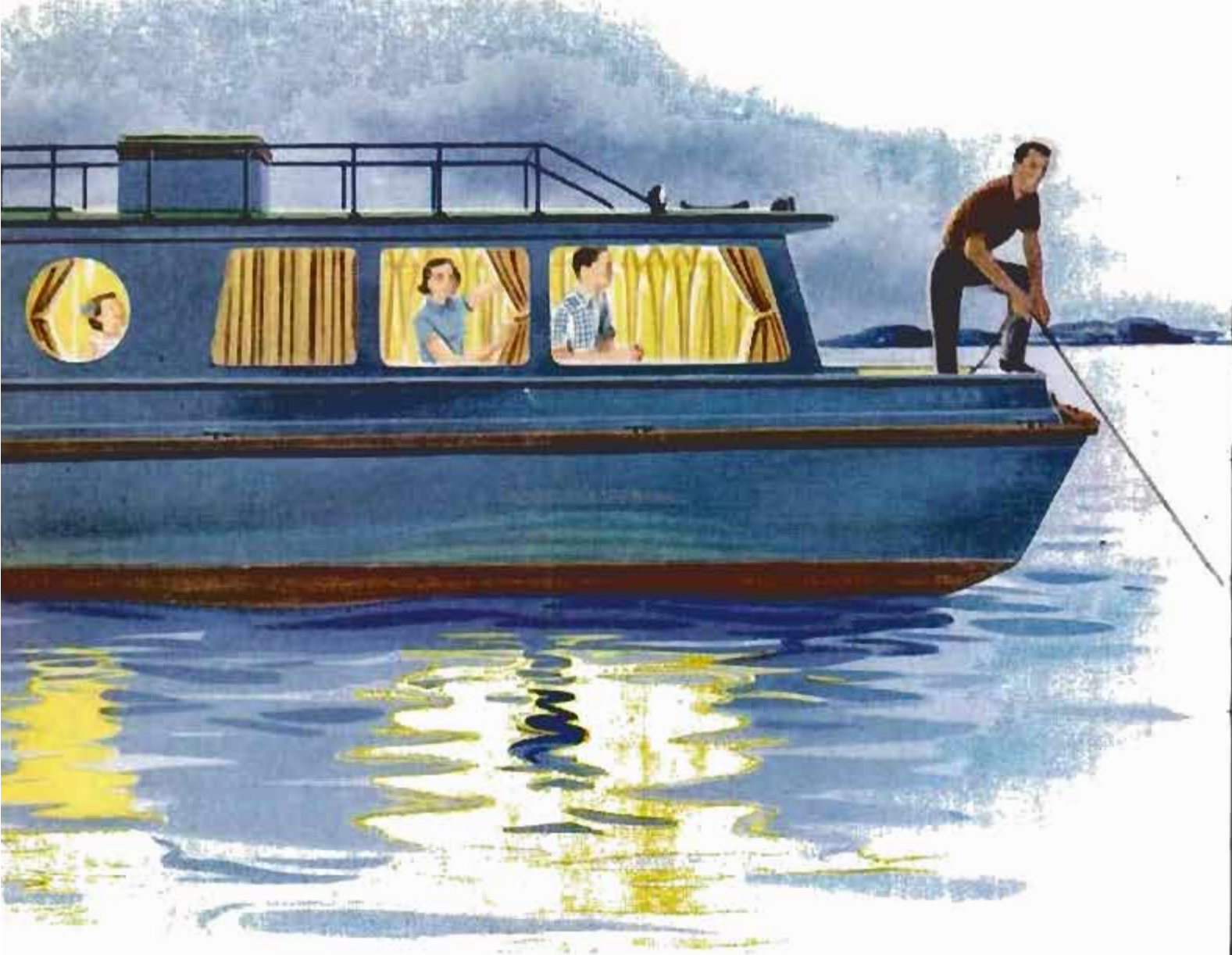

Recess, housing two-burner alcohol stove, is fitted with two-section hinged cover to provide unbroken counter surface when stove is not being used. Cover folds back against window when stove is used

Fresh water for washing and drinking is piped to galley sink and lavatory from combination storage tank and seat on cabin roof. Both sink and lavatory drain overboard through fittings just above waterline



1. Follow instructions on the other side

Back

0018-backsip-0018



Inverted Back

1. Follow instructions on the other side

Folded edge of the page

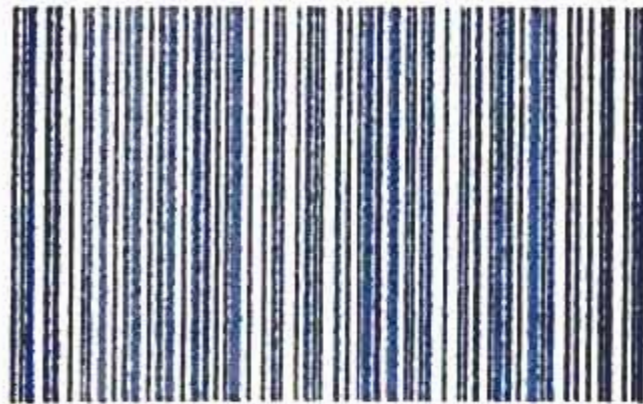

GbslipSheet-001

Foldout slip-sheet

1. Open the foldout page
2. Insert this sheet with
 1. Front side touching the free page
 2. Arrow pointing to the fold
 3. Slice the folded edge
 4. Close the page and slip-sheet



Inverted Foldout slip-sheet

1. Open the foldout page
2. Insert this sheet with
 1. Front side touching the free page
 2. Arrow pointing to the fold
 3. Slice the folded edge
 4. Close the page and slip-sheet

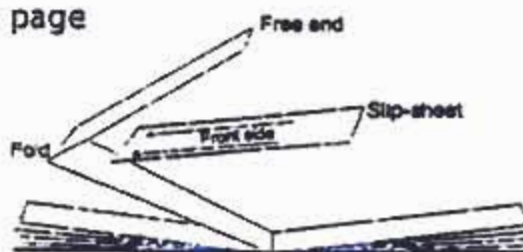

CHANCES ARE most builders will build their houseboat outdoors since a sizeable building is required to complete it under cover. So until such time as the cabin is in place and enclosed, tarps will have to be used to protect the work during early stages of construction. However, parts such as the hull frames, for example, can be prefabricated inside. All eight frames, plus bow and transom members, are ripped from standard 1 1/8-in. fir stair-tread material. Each one measures 95 in. wide and Fig. 2 gives the height of each one, plus the widths of the bottom and side frame members and the location of the various notches for the battens, keel, chines and sheer parts. The latter are cut 1 1/8 x 3 1/2 in. Although not shown, limber notches should also be made in the frames. These form openings for the bilge water to pass through the frames to points where it can be removed through openings in the floor. The limber notches should be about 1/2 in. square and located in the bottom members of the frames at points midway between the batten and keel notches.

The side members lap the ends of the bottom members and are both glued and bolted to hold the parts at right angles. In drilling the holes for the bolts, keep in mind that the corners of the frames are later notched for the chines, and, therefore, should be spaced to clear the notches. You may find it best to drill the holes after gluing and clamping the corners. You also may find it more convenient to cut

Twin forward bunks, port and starboard, make use of space under forward deck. Additional center bunk is provided by removing ladder and filling gap between with lift-out panel and covering with extra cushion



Johnson twin 18s were used to power the PM houseboat and provide greater maneuverability in cross winds, but one 35-hp. outboard motor will do. Motors clamp to mounting board bolted to transom brackets





In lowered position, table fills gap between dining benches and when fitted with extra cushion, beds down two. Bunks extending under fore deck accommodate three persons. In each case, center section of mattress, plus bedding, stows away under fore deck



aving
ch lets
two.
four.
top

1. Open the foldout page
2. Insert this sheet with
 1. Front side touching the free page
 2. Arrow pointing to the fold
3. Slice the folded edge
4. Close the page and slip-sheet

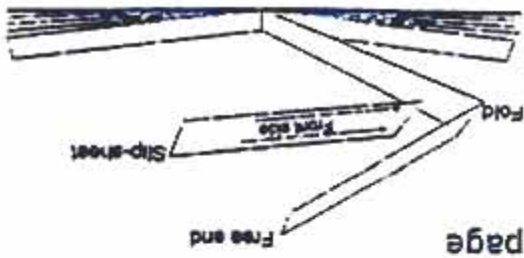

Inverted Foldout slip-sheet

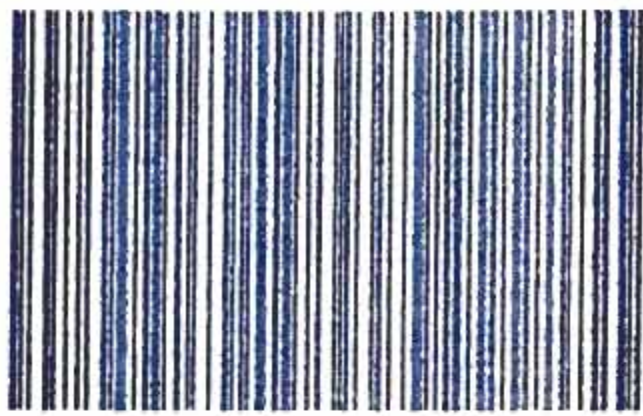

GbsSlipSheet-001



Foldout slip-sheet

Folded edge of the page

1. Open the foldout page
2. Insert this sheet with
 1. Front side touching the free page
 2. Arrow pointing to the fold
3. Slice the folded edge
4. Close the page and slip-sheet

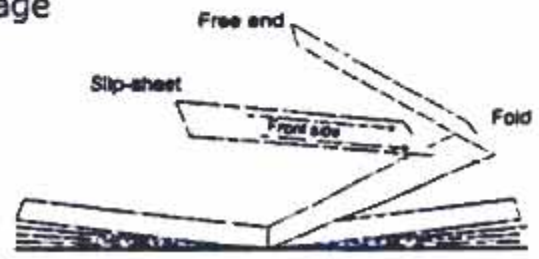

1. Follow instructions on the other side

Inverted Back



GbsSlpBack-0018

Back

1. Follow instructions on the other side

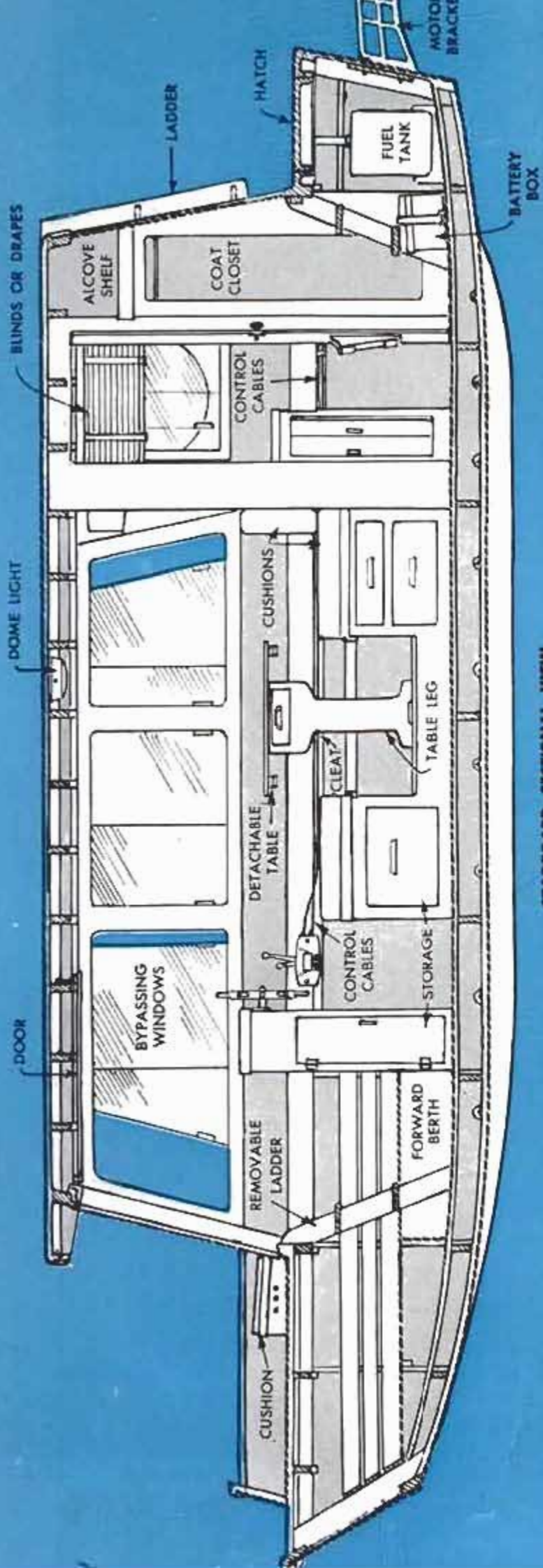

STARBOARD SECTIONAL VIEW

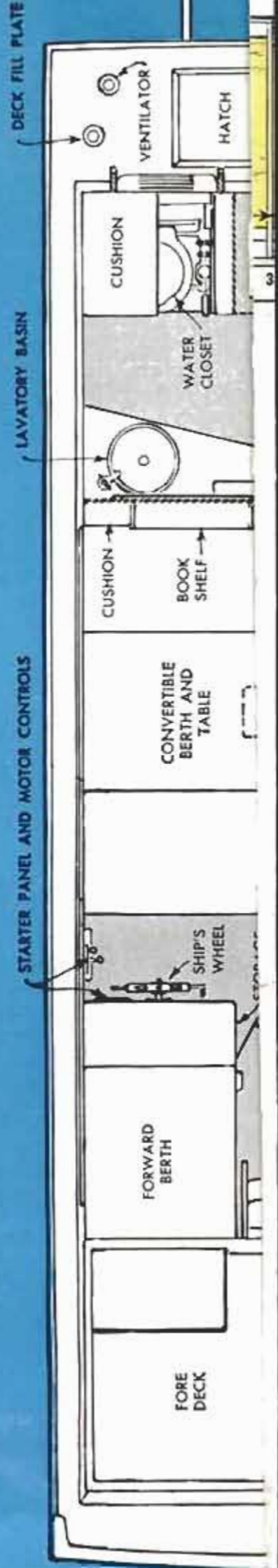

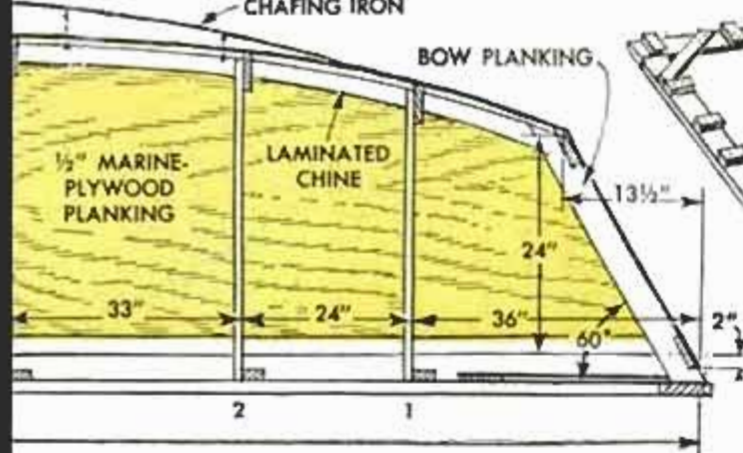

frames are set up on a building board, or platform. Although it serves only as a temporary part of the hull, the building form plays an important part in providing a solid foundation on which to fabricate the hull. Fig. 3 shows what the building form looks like. It consists of 2 x 8 planks placed end to end and flat on the ground to which they are staked. It is made the same width as the frames, 95 in., square at the corners and blocked up where necessary to make it perfectly level both transversely and longitudinally. It should be a few inches longer than 24 ft., which is the overall length of the hull framework. Since it is unlikely that you would be able to obtain planks 24 ft. long, the length of the building form will have to be equaled with two or more planks. You will find this true in purchasing material for the keel, battens, chines and other long hull members. The 2 x 4 blocks which are spiked to the building form and to which the waste ends of the frames are nailed, are spaced according to the dimensions given in Fig. 1. Those placed across the ends are omitted until later.

The frames are erected in an upside down position to stand plumb and even with the outer edges of the building form. Keep in mind when placing the frames that the bottom members of frames 6, 7 and 8 are positioned to face aft as compared to the others which face forward. The frames will have to be braced to keep them standing plumb until they are held so by the keel and other longitudinal members. Before going further you should paint the frames with a clear liquid preservative to prevent wood rot.

The bow and transom differ from the others in that they are assembled flatwise and half-lapped at the corners as shown in Fig. 6. Brass screws are used here instead of bolts and are kept clear of the 1 1/8 x 3-in. chine notches which are cut after assembly. In studying Fig. 1 you'll note that the bow frame is placed at a 60-deg. angle and the transom, a 78-deg.

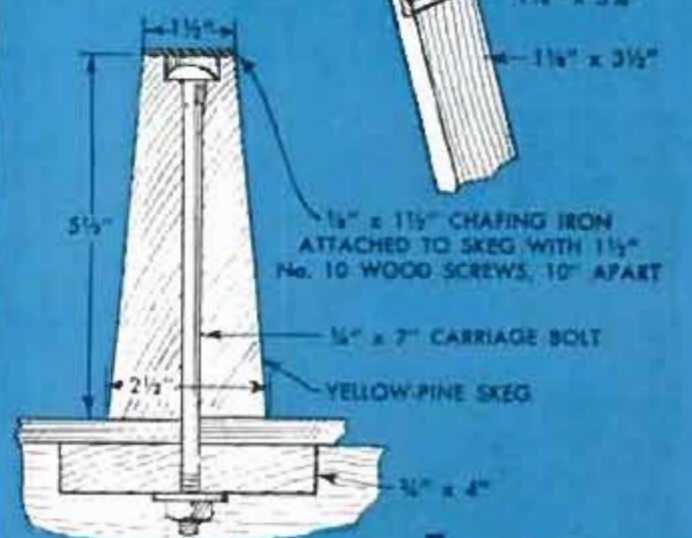
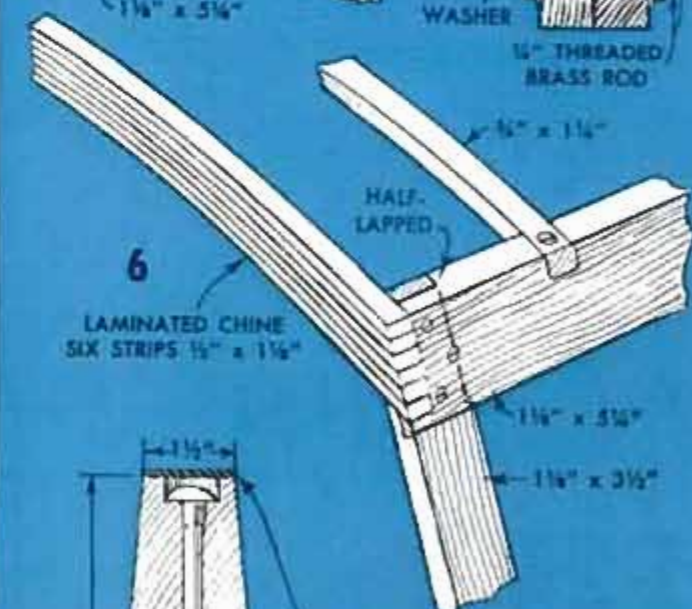
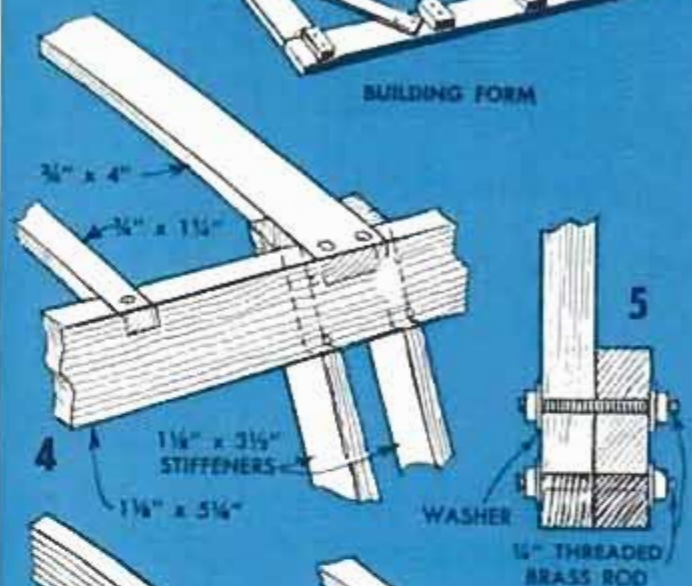
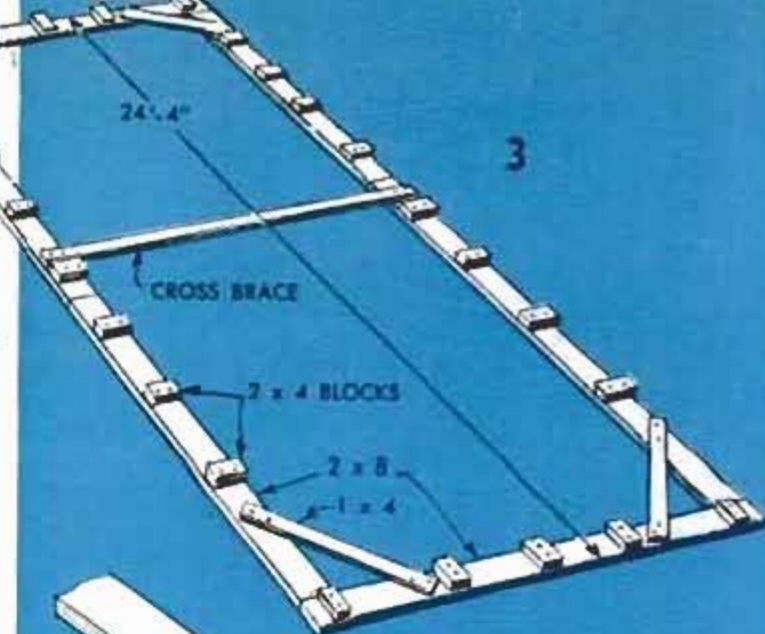

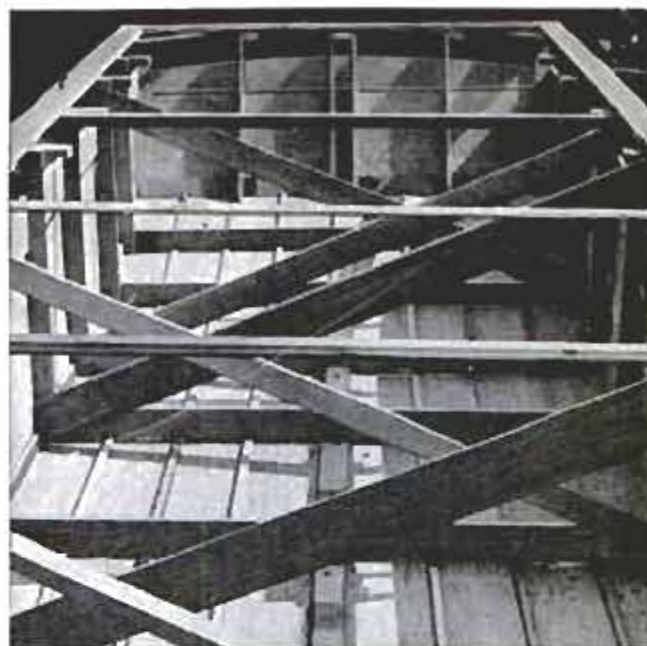
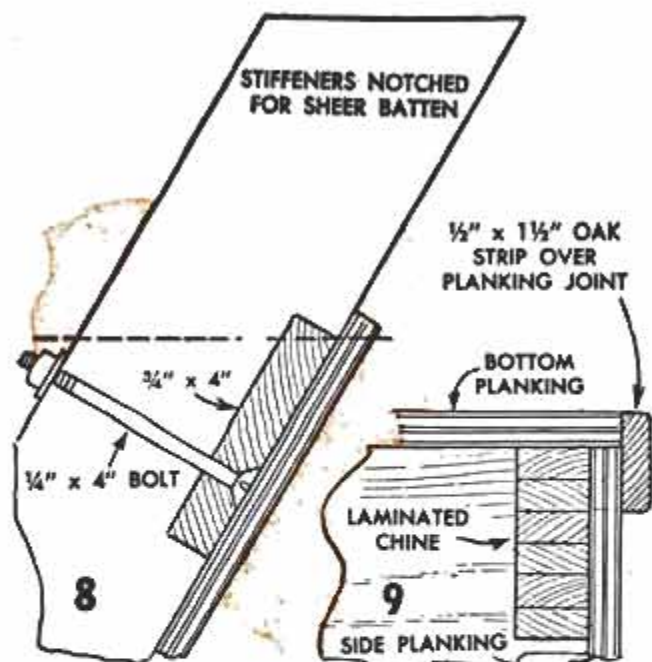

How hull must be cross-braced prior to rolling it over to add rigidity to otherwise unsupported frames

angle, which is $13\frac{1}{2}$ and 6 in. respectively from the vertical. Like the others, these frames are positioned even with the edges of the building form, braced and toenailed to blocks placed $3\frac{3}{4}$ in. in from the corners.

The most practical way to make the long curved chines is to laminate each one from six strips of $\frac{1}{2} \times 1\frac{1}{8}$ -in. fir. This is done right in the chine notches, letting the first strip assume a natural curve in following the notches. One by one the rest of the strips are coated with glue and clamped to the first one until the full width is built up. Where single-length strips cannot be obtained, shorter ones are spliced into the layers as you go. A number of C-clamps will be needed to hold the sandwiched strips until the glue dries. Finally, holes are made in the chines at each frame for fastening to the latter with two flat-headed brass screws. Prior to forming the chines, the bottom of the chine notches in frames 1, 2 and 8 should be

faired to make the chine strips lay properly. The six battens, plus the keel, which fit flush in the frame notches, are set in bedding compound. One flat-headed, $2\frac{1}{2}$ -in. No. 10 brass wood screw is used to fasten each batten to each frame, whereas two screws are used to fasten the keel. The bottom of the notches in the bow and transom frames, as well as frames 1, 2 and 8, must be faired before the batten and keel members are fitted. Here, again, where full-length pieces are not being used, separate lengths are joined by half-lapping the ends and centering the lap over a frame. Four $1\frac{1}{8}$ -in. members, called stiffeners, are installed at both the bow and transom and Fig. 4 shows how two of them are positioned alongside the keel and notched to fit over the bottom frame member. The other stiffeners are installed alongside battens as in Fig. 2. As before, the stiffeners are bedded in

Once right side up, hull cross bracing, plus the building form which still remains attached, is removed

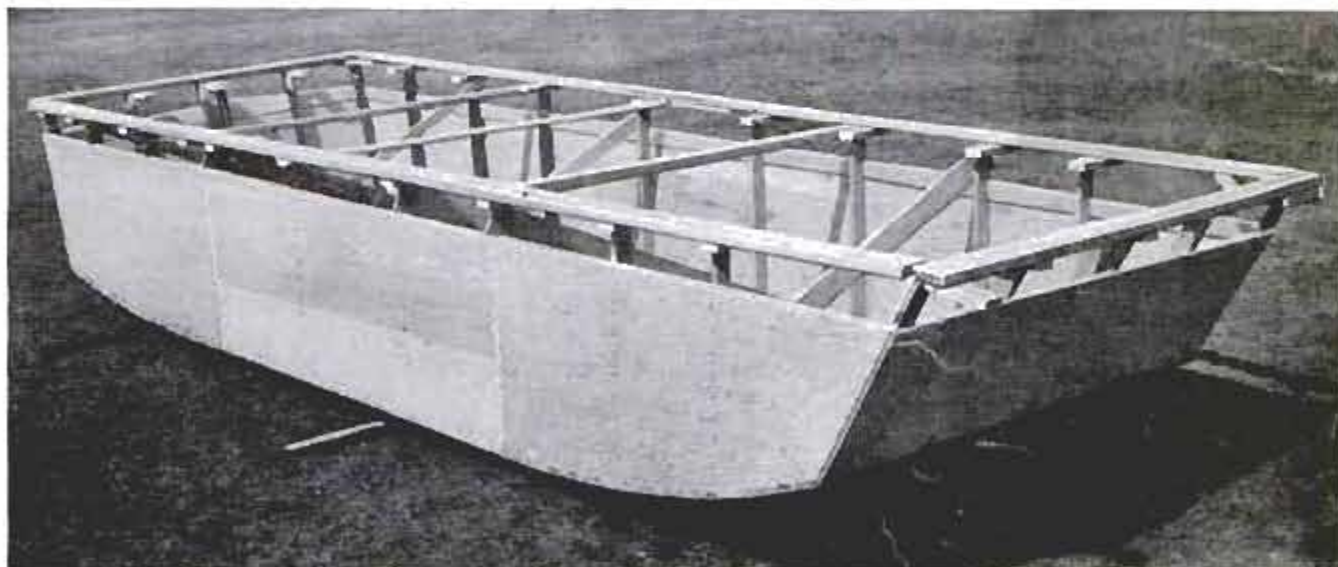

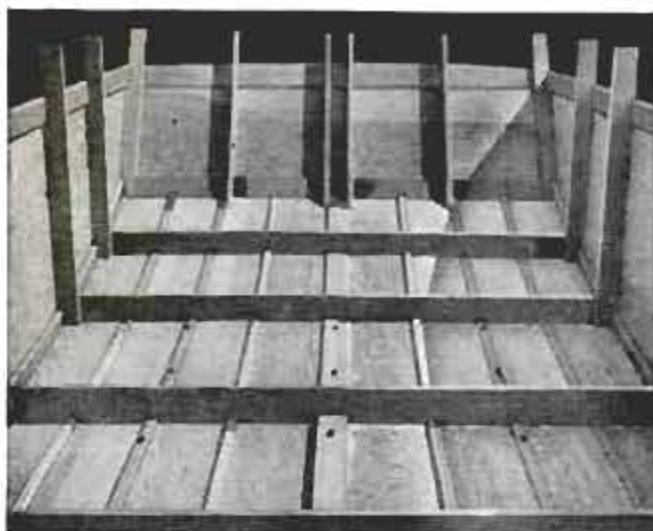

Waste ends of frames above sheer are sawed off flush

HULL MATERIAL LIST

(All dimensions net or approx.)

FIR LUMBER (1 1/8" stair-tread stock)

FRAMES

- 2 pcs.—1 1/8" x 4 1/2" x 95"—Bottom frame members
- 6 pcs.—1 1/8" x 5 1/4" x 95"—Bottom frame members
- 2 pcs.—1 1/8" x 5 1/4" x 95"—Bow and transom members
- 2 pcs.—1 1/8" x 3 3/4" x 37 1/2"—Side members, frame #1
- 2 pcs.—1 1/8" x 3 3/4" x 42"—Side members, frame #2
- 2 pcs.—1 1/8" x 3 3/4" x 44"—Side members, frame #3
- 2 pcs.—1 1/8" x 3 3/4" x 43 1/2"—Side members, frame #4
- 2 pcs.—1 1/8" x 3 3/4" x 43"—Side members, frame #5
- 2 pcs.—1 1/8" x 3 3/4" x 42 1/2"—Side members, frame #6
- 2 pcs.—1 1/8" x 3 3/4" x 42"—Side members, frame #7
- 2 pcs.—1 1/8" x 3 3/4" x 39 1/2"—Side members, frame #8
- 2 pcs.—1 1/8" x 3 1/2" x 42"—Bow side members
- 2 pcs.—1 1/8" x 3 1/2" x 39"—Transom side members
- 4 pcs.—1 1/8" x 3 1/2" x 42"—Bow stiffeners
- 4 pcs.—1 1/8" x 3 1/2" x 39"—Transom stiffeners
- 12 pcs.—1/2" x 1 1/8" x 22'-9"—Laminated chines
- 1 pc.—3/4" x 4" x 22'-9"—Keel
- 6 pcs.—3/4" x 1 1/4" x 22'-9"—Bottom battens
- 2 pcs.—1 1/8" x 3 1/2" x 24"—Sheer members
- 2 pcs.—1 1/8" x 3 1/2" x 24"—Sheer-clamp members
- 1 pc.—3/4" x 14" x 56"—Transom doubler board (plywood)
- 2 pcs.—1 1/8" x 5 1/2" x 95"—Bow and transom top frame members

PLANKING (1/2" marine-grade plywood)

- 2 pcs.—1/2" x 48" x 9"—Side planking
- 2 pcs.—1/2" x 48" x 8"—Bow and transom planking
- 4 pcs.—1/2" x 48" x 8"—Side planking
- 2 pcs.—1/2" x 48" x 8"—Bottom planking
- 4 pcs.—1/2" x 48" x 10"—Bottom planking

SKEGS (Yellow pine)

- 3 pcs.—2 1/2" x 5 1/2" x 11"—Center sections
- 3 pcs.—2 1/2" x 5 1/2" x 45"—Aft sections
- 3 pcs.—2 1/2" x 5 1/2" x 66"—Fore sections
- 3 pcs.—1/8" x 1 1/2" x 23"—Skeg chafing irons

BUILDING FORM

- 2 pcs.—2 x 8 x 14"—Side members
- 2 pcs.—2 x 8 x 10"—Side members
- 2 pcs.—2 x 8 x 8"—End members
- 1 pc.—2 x 4 x 84"—Scrap for nailing blocks
- 4 pcs.—1 x 4 x 36"—Corner braces
- 1 pc.—1 x 4 x 8"—Cross brace

bedding compound and fastened with brass screws. The blocks which hold the stiffeners to the building form are positioned to hold them plumb. Frame notches must be cut in the stiffeners before the plywood planking is applied to the bow and transom, Fig. 8. Since there is a 2-in. deck crown to the hull, the location of the notches are found by holding a fairing stick at the sheer notches in the side members and bending it accordingly. Removal of the waste from the notches is simplified by making a series of saw cuts 1 1/8 in. deep and then chiseling away. The frame member itself is bandsawed to a 2-in. crown and half-lapped into the side members. Brass screws and bedding compound are used to hold the bow and transom frame members in place. Except for the frames which have already been treated, all the other members are painted with wood preservative.

Before the planking can be applied, the bottom members of the bow and transom frames, plus frames 1, 2 and 8, must be faired (planed) to the designed lines so they are even with the battens, chines and keel.

In the case of the side planking, a 9-ft. length of 1/2-in. marine-grade plywood will center midway on frames 3 and 6 without trimming since the distance center to center equals just 108 in. However, in the case of the bottom planking, 10-ft. sheets are required so the joints can be staggered. You'll have some waste here that can't be helped. Since the side planking laps the bow and transom planking, the latter two should be planked first. A full 8-ft. length will cover each nicely without cutting. Rip the panels lengthwise so they project a little beyond the top and bottom members of the bow or transom frame as the case may be. This will allow for later planing when fairing the planking. Apply glue to the edges of the stiffeners and end members and tack the planking in position to let you get a screw or two started. All planking is fastened with 1 1/4-in. No. 8 flat-headed brass screws which are spaced 3 in. apart at the frames and 2 1/2 in. apart at the sheer and chines. In the case of the transom planking, a 3/4-in. plywood doubler board, 14 x 56 in., must be notched into the stiffeners before applying the planking. The board adds additional rigidity to the planking at this point for the motor-mounting brackets which are later bolted to it. While the board is shown located at a point 21 in. from the sheer, it is better to increase this to 23 in. Both port and starboard sides are planked alike. The 9-ft. side panel is glued and screwed in place first, then the panels fore

(Continued to page 228)

All-Metal Weather Vane

THIS CROWING ROOSTER on his lofty perch indicates the direction of the wind, and does it silently, as it is mounted on a column that rotates in an oil reservoir and never needs lubrication. Cut the bird from galvanized sheet steel and rivet it to a length of $\frac{3}{8}$ -in.-steel square stock. After the arrowhead and feather have been attached to this member, weld it to a $\frac{3}{4}$ or 1-in. pipe cap as indicated. The pipe cap now is welded to the upper end of a length of $\frac{1}{2}$ -in. steel rod, the lower end of which is ground to a point. This assembly is fitted inside a 20-in. length of $\frac{1}{2}$ -in. pipe, the lower end of which is sealed by welding a plug in it. The pipe column now is welded to a sheet-metal saddle that is shaped to fit the angle of a particular roof. The saddle is fastened to the roof with screws driven into pilot holes drilled through the shingles into the wood. Paint the entire weather vane a flat black so it makes a sharp outline against the sky.

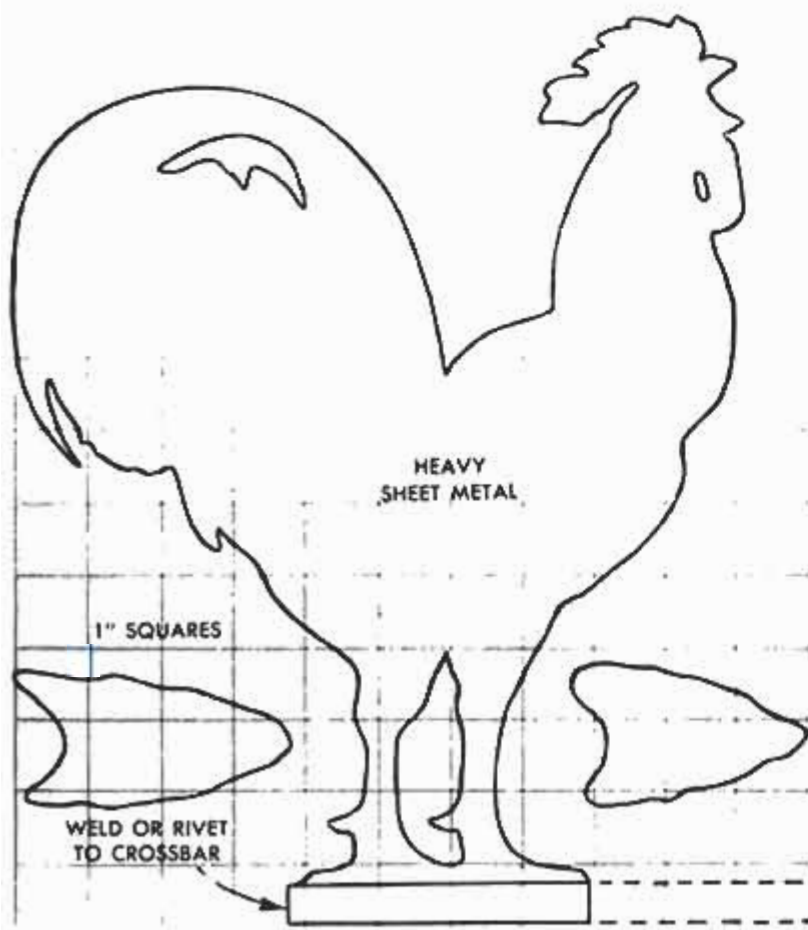

Above is squared pattern for rooster, arrowhead and feathers. Below are patterns for letters used to indicate directions. These letters are fastened to lengths of $\frac{1}{4}$ -in. steel rod, threaded and turned in holes drilled in the pipe column of the weather vane

SE
NW

DECEMBER 1959

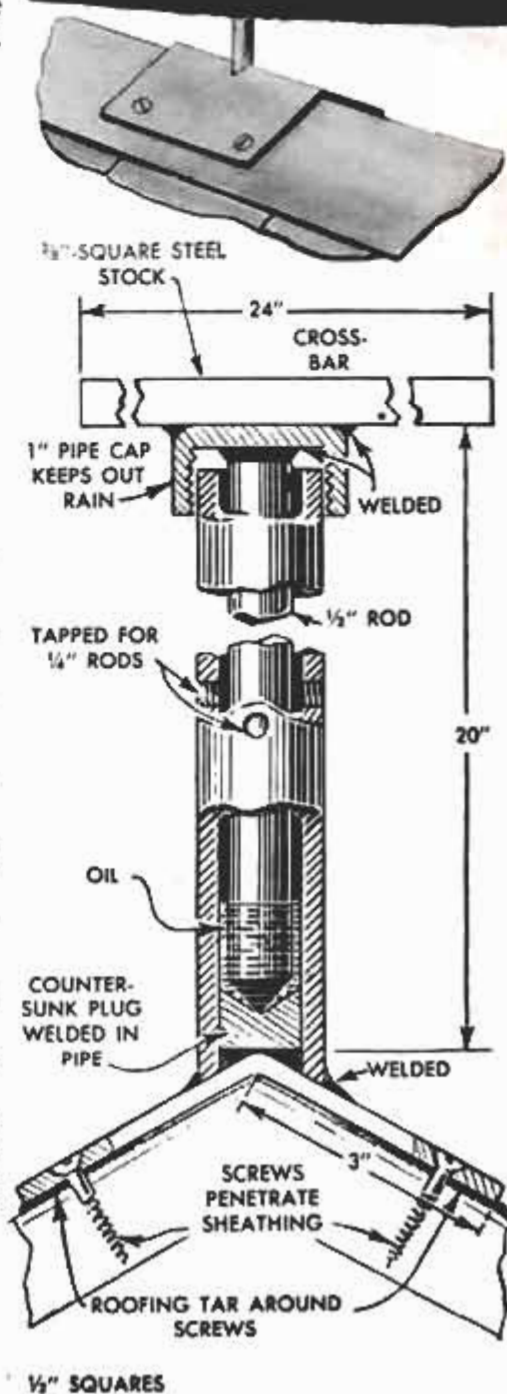

$\frac{1}{2}$ " SQUARES

Milk Cartons Collect Sap At Maple-Sugaring Time

When sap begins to flow in the sugar maples there's no time to waste. It's then you may discover, at the last minute, that there are not enough sap buckets to go around. Ordinary milk cartons, either the 1 qt. or the 1/2-gal. size, can fill in for the missing buckets. Cut a hole in one side of the carton near the top, the hole being just large enough to fit over the spile. Notch the spile lightly to hold the carton in place. Closed cartons have the additional advantage of keeping the sap clean.

A roller-type window shade sprayed with aluminum paint makes a reasonably good screen for home movies. When applying the paint care should be taken to obtain a uniform coating. The shade must be in good condition with no tears, wrinkles or worn spots.

Artist's Palette Covered With Foil for Easy Mixing of Colors



Artists using oil colors have found that covering the wooden palette with aluminum foil not only makes the heavy oils easier to mix, the foil-faced surface of the palette also is much easier to clean when the work period is finished. When the foil facing finally becomes coated with hardened traces of the paints it is simply replaced with a fresh sheet. The foil sheet is cut to the shape of the palette and slightly oversize so that the edges of the foil can be folded down over the edges of the palette to hold the facing securely in place. The foil does not absorb oils or pigments.

Auxiliary Carrying Strap For Binocular Case

Not all binocular cases are equipped with a short strap to serve as a carrying handle. Although the shoulder strap makes it easy to carry the heaviest case and instrument, there are times when a carrying handle, or strap, is a convenience well worthwhile. Nearly all shoulder straps are provided with buckles for adjusting the length and usually it is possible to rivet a short strap in place below the buckles to serve as a carrying handle. Placed at just the right point this will in no way interfere with the normal use of the shoulder strap or opening and closing the case. The carrying strap should be cut from the same leather and to the same width as the shoulder strap.



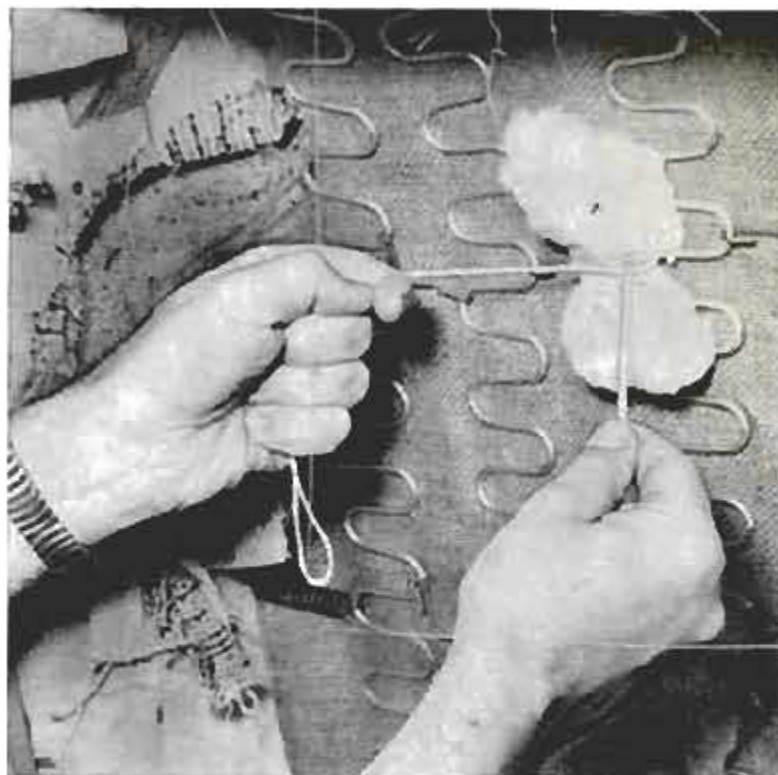
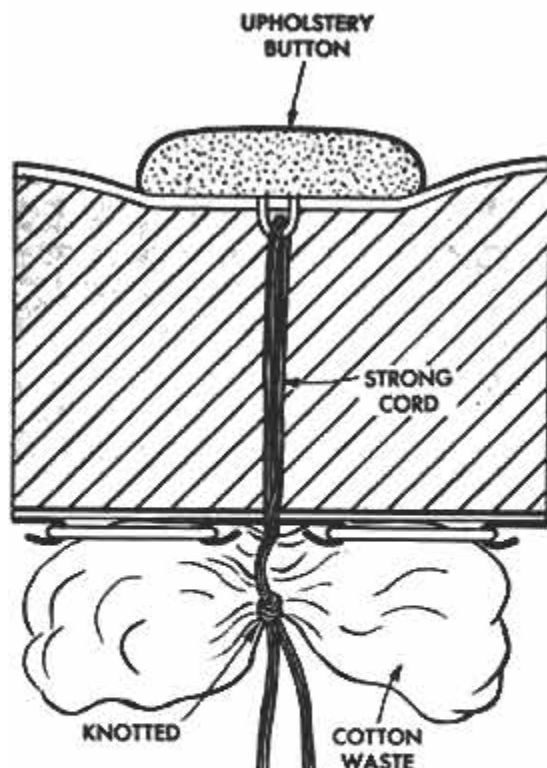

Replacing Lost Buttons In Upholstered Furniture

When an attractively upholstered and buttoned chair seat or chair back loses a button or two there's nothing about the house more unsightly. But replacing the button is simple when you know the trick. Obtain a matching button and an upholsterer's mattress needle from a local dealer in upholsterer's supplies. Loop a length of strong cord through the eye of the button

and thread through the needle. Then remove just enough of the dust cover from the bottom or back of the chair to enable you to reach the point on the cushion where the button is to be placed. Press the needle through the cushion at this point and pull the cord through. Then knot the cord securely over a pledget of cotton batting or cotton waste as in the photo.

Giant Footprints Cast in Concrete Make Novel Flagstone Walk

At first sight of these huge footprints leading to your door passers-by may well conclude that Paul Bunyan once called and left his tracks in your lawn. But you'll know better because you mixed and poured the concrete of which they are made. They're about 30 in. long and are spaced about 15 to 20 in. apart edge to edge so that you can walk on them comfortably without stepping on the grass. As the first step, make a cardboard pattern for laying out the excavations. Turn it over to make right and left footprints. Excavations should be about 6 in. deep with vertical sides. Pour fine gravel to a depth of 3 in. in each excavation and tamp firmly. Apply a grouting of concrete 1 in. thick and from coarse-mesh hardware cloth cut a shape slightly smaller than the excavation. Lay this over the grouting, pour concrete to grade level and trowel smooth. Round the edges to a radius. If the soil is sandy, use a sheet metal form when pouring. This is easily bent to the contours desired and held in place with small stakes.





Car-Door Weather Stripping Repaired With Tape

If you have forced a frozen car door open and torn or loosened the weather stripping, try this temporary repair. It may save you total replacement of the weather stripping later. With a piece of cloth, dry an area on both sides of the car door and around the weather stripping. Place a piece of tape on the outside surface of the door and run it over the weather stripping to the door's end section. A piece of masking, adhesive, or plastic tape will usually hold the loose end in place. Later at a more convenient time, when the car door and the weather stripping are dry, remove the tape and permanently replace the loose section with rubber adhesive, sold in any automobile supply store.

Robert V. Thompson, Clinton, Iowa

Holder for Calking Gun Tips

Calking gun tips will always be at hand if kept in a holder fitted to the gun barrel. The holder is made from a piece of springy sheet metal about $\frac{3}{4}$ in. wide. Bend the strip around the gun barrel. Then bend the extending ends to fit around the calking tips so that the tension of the metal holds them tightly. Holder and tips will stay firmly in place if a nut and bolt are inserted in the holder between the gun barrel and the loops holding the calking tips.

R. Hanscom, Elmhurst, Ill.

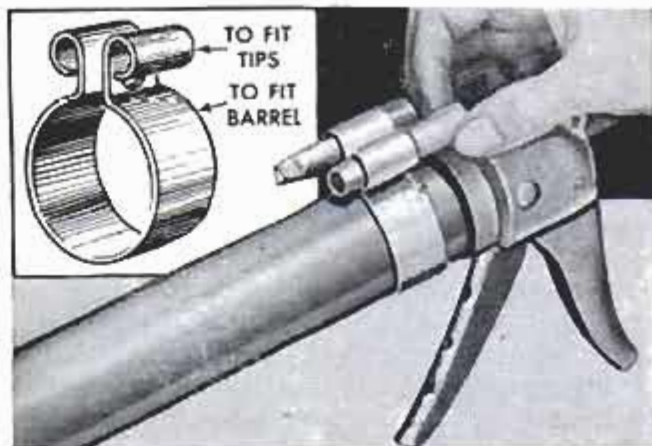

Hints and Facts for the Use and Storage of Glue

Never thin liquid glue when it is cold. When warmed to room temperature (70 deg. or warmer) it will be thinner and have the proper consistency for use. Should a thin glue be needed, pour some into a separate container before adding warm water. Caps on glue bottles, shellac and other adhesives will unscrew easily if the threads

are coated with a film of petroleum jelly the first time they are opened. Use a bead headed pin as a stopper in the end of a tube of glue. It is easy to remove and helps keep the glue free flowing. When gluing dowels in holes, ridges filed in the dowels will keep the glue from being forced out when the dowel is inserted.

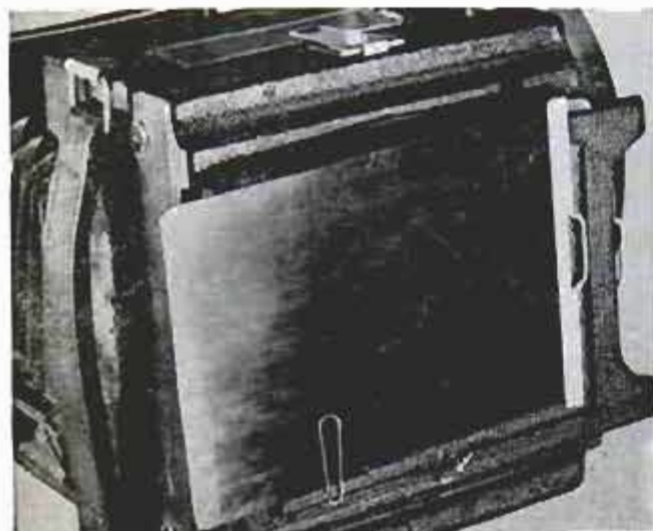

Paper Clip Holds Film Slide

The busy photographer who finds himself working against time, or surrounded by general shop confusion, will agree that a film slide can be a very elusive piece of equipment. For a quick solution to this problem, try using a wire paper clip fastened to the hood on the back of the camera. The clip will provide a simple yet effective slide holder. A stiff paper envelope, of the kind used to store light-sensitive paper, taped to the hood, will provide a holder for several film slides. The envelope will prevent the slides from getting lost and will keep them free from dust and damage.

Bil Toman, Palatine, Ill.



MAKE THIS SIMPLE CRIMPER FOR WIRE AND SHEET METAL

USING TWO SMALL BLOCKS of hardwood, 7 finishing nails, a coil spring and a piece of leather you can make a sheet-metal crimper that will turn out work such as you see in the photo above. Bandsaw the blocks to the shape detailed and hinge together with leather. Drill a hole in each to take the spring, then space and drill holes in each block to take the metal crimpers. These are made from 10d finishing nails by cutting off the heads and bending to form a staple as in the left-hand photo below and the lower right-hand detail. Drive the crimpers into the blocks, 3 in one, 4 in the other. Be careful not to bend the crimpers as you drive them home. When crimping curved work as in the lower right-hand photo use a C-clamp to apply the necessary pressure.

Walter E. Burton

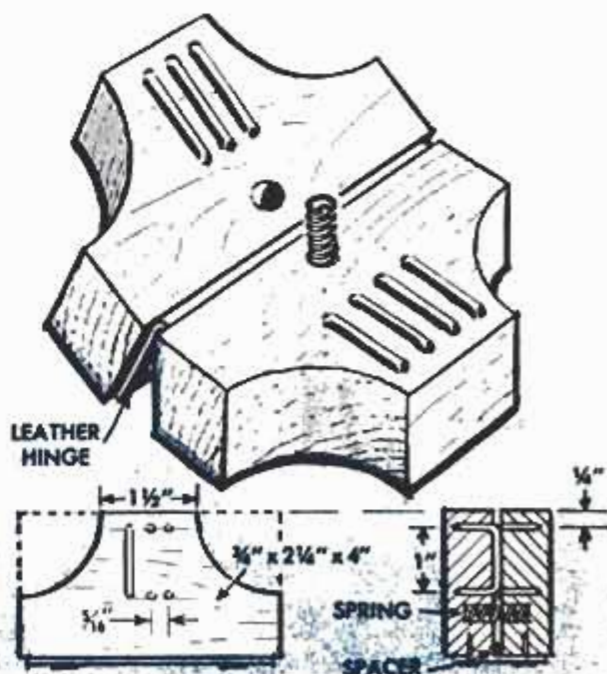

Crimpers are made from 10d finishing nails by cutting off heads and bending to the form of a staple

In crimping curved work such as the edges of stove-pipe or furnace pipe, use a C-clamp to apply pressure

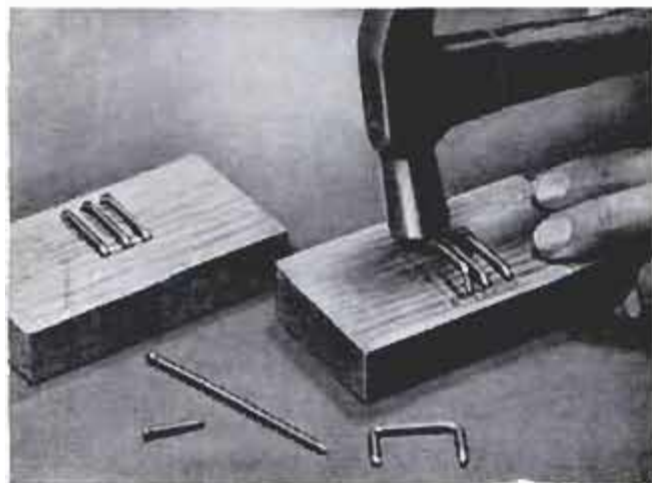

MAKE YOUR OWN

CANDLE-DIPPING

A candle's but a simple thing
 It starts with just a bit of string
 Yet dipped and dipped with patient hand
 It gathers wax upon the strand
 Until, complete and snowy white,
 It gives at last a lovely light.

By Ellen Bell Thurston,
 reprinted from *Daily World* magazine

WORD

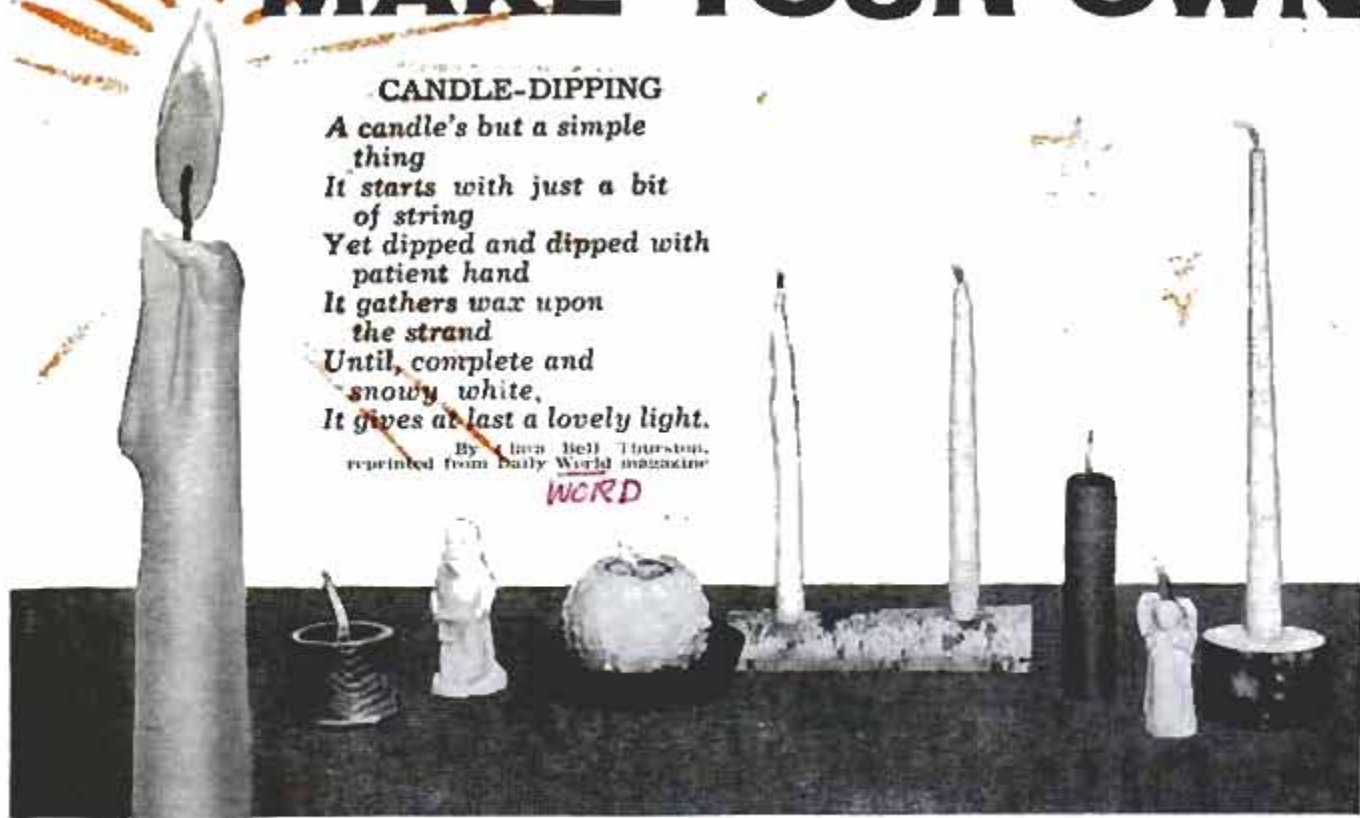

CANDLEMAKING can be a lot of fun, especially when all members of the family join in, each one trying to create the most unusual candle of them all. A pre-holiday project such as this also is a good one to plan for that last sewing or bridge club meeting just before Christmas. Each member is asked to bring a part of the needed materials. At the end of the candlemaking session, prizes may be awarded to the creators of the most unusual candles.

The basic ingredients needed for making candles consist of paraffin, beeswax, stearin (a wax) and wicking. Decorating materials such as color tints, glitter and sequins, may be used to obtain special effects. Combined in the proportions shown in the photo below, the waxes provide sufficient stock to make 20 hand-dipped candles 8 in. long, or about 25 small figurine candles. Stearin, also called stearic acid, is a hard type wax that, when combined with the softer paraffin and beeswax, helps to prevent the candles from

Formula for wax dip to make 20 medium-size candles consists of stearin, 1 lb., paraffin, 2 lbs., and beeswax, 1 oz.



CHRISTMAS CANDLES

dripping and bending. For some candles the dripping feature is desired, so as to produce certain effects as the candle burns, in which case the stearin is omitted.

While paraffin and beeswax are quite easy to obtain locally, it may be necessary to have your druggist order the stearin since there is little call for it. If braided wicking is unavailable, use 4 to 6 strands of cotton string twisted together. Or, you can avoid having to assemble individual items by buying a candle-making kit from a hobby shop.

Most candles are made either by the dipping process, or by molding. In either case, the wax stock must be melted and kept a few degrees hotter than the temperature required to liquify it. The best way to do this is to use the double-boiler method as shown above. Any tall can will do for a dipping can.

Actual candle dipping is done as follows: Cut a length of wicking that is long enough to permit dipping two candles at once as above. The candles being formed must be kept apart when dipping. If the wicks tend to become wavy, pull them straight while the wax from the first dip is hardening. Then dip the candles quickly, allowing the wax to harden between dips. When the candles reach the desired diameter ($\frac{3}{4}$ -in. base is standard), trim the base and cut the wicks to the correct length.

For a frothy appearance, dip a half-completed candle in wax that has been foamed with an egg beater, detail A. If you want colored candles, add powdered tinting color to a small amount of liquid wax in a slender beaker. Dip the candles

By Ivan H. Crowell



individually 3 times as in detail B. Candles can be hand painted by tinting the liquid wax as above and applying it with an artist's brush. Wax crayons also may be melted and used for coloring purposes as above. Glitter and sequins add sparkle to candles. To apply them, dip the candle in hot wax and roll it in the colored granules scattered on a sheet of paper as in detail C.

Unusual shapes are produced by pouring candles in rubber molds made for this purpose, and in any other molds that ingenuity can dream up. Some examples are shown in the photo on the opposite page. The wicks for these must be held in place until "frozen" in place by hardening wax. Wash rubber molds with soapy water before using for easy removal. Candles are released from rigid-type molds by heating them slightly.

Attractive holders can be made by drilling candle holes in birch "logs," or disks as shown on the opposite page. Other holders can be devised from jar lids, bottles, saucers and various discards. ★★★



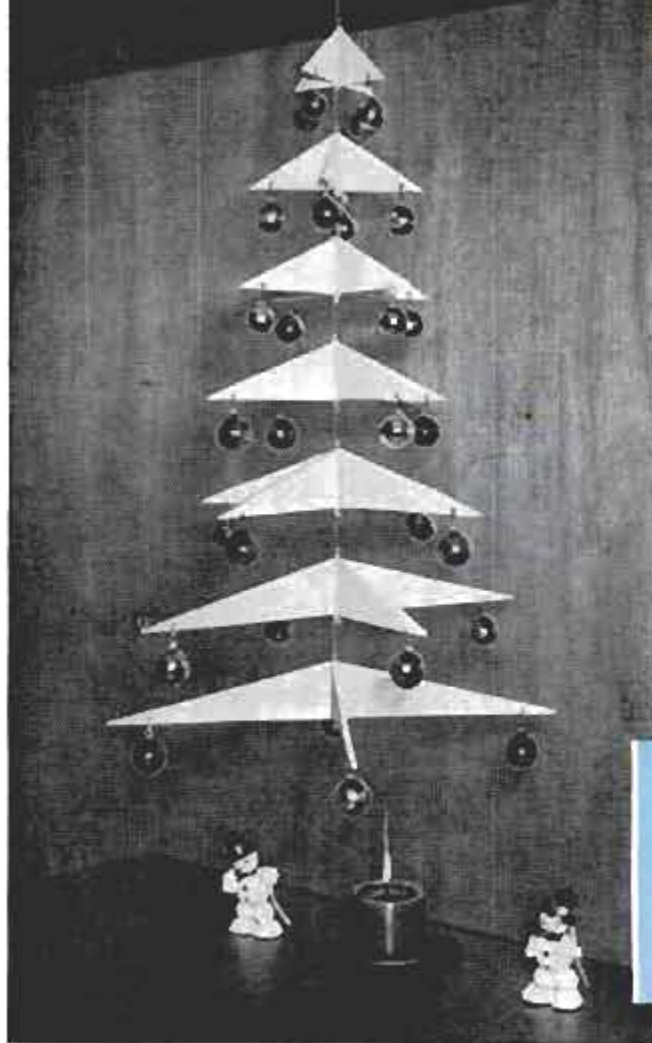

Christmas-Tree Shaped Mobile From Hardboard and Ornaments

Seven pairs of hardboard triangles in graduated sizes are joined together to form the interesting mobile shown in the photo at left. Cut from $\frac{1}{8}$ -in. hardboard smooth on both sides, paired triangles are slotted at the center and glued together to form a four-point "star" as detailed below. Triangle lengths are 4, 6, 8, 10, 14, and 16 in. Height of 4 in., peak to base, is the same for all triangles. Lengths of fine wire glued in the joint of each triangle pair at top and bottom permit tying them together, spaced 2-in. apart. The mobile may be painted white, gold or silver and decorated with tree ornaments hung from holes drilled in the ends of the triangles.

Photo and information courtesy Masonite Corp.

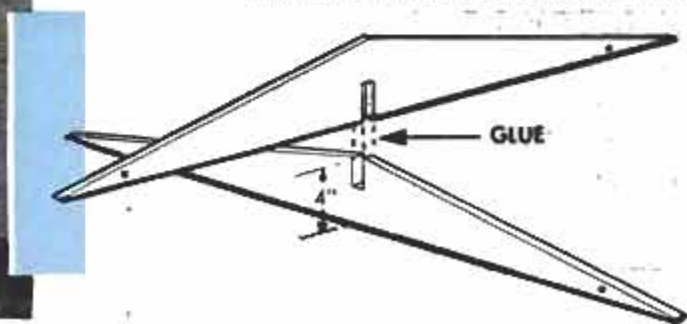

Workshop Cabinet Pulls Made From Copper Tubing

Sturdy pulls for workshop drawers and cabinet doors can be made easily from lengths of copper tubing as detailed at left. A pull is made by cutting $\frac{1}{4}$ or $\frac{3}{8}$ -in. tubing to the desired length, after which the ends are flattened and the corners are rounded with a file. Holes to take screws are then drilled and the piece is shaped as indicated. To predetermine the length of the drawer pulls make the desired shape and size of pull from wire solder and then straighten it for use as a pattern.

G. E. Hendrickson, Argyle, Wis.

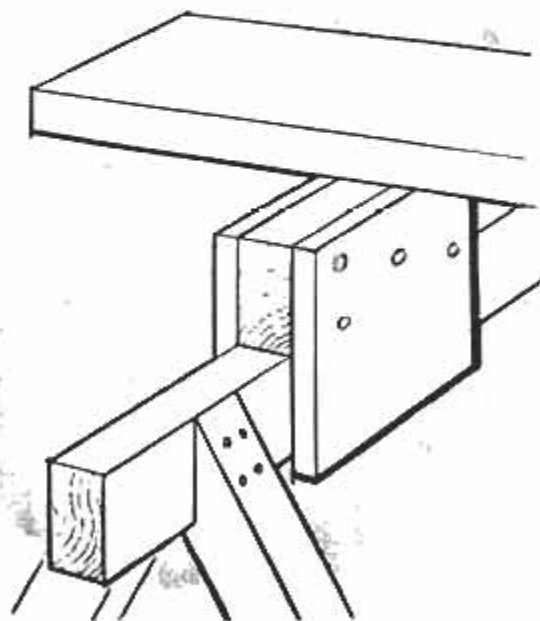
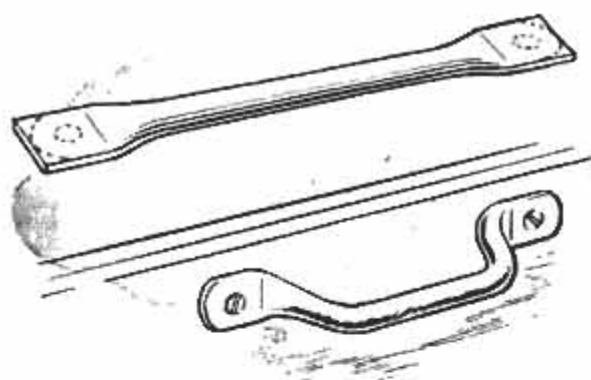

Blocks Elevate Scaffold Plank For Short Plasterer

To gain a few additional inches of height on a scaffold plank supported by sawhorses, one plasterer of short stature used two saddle blocks in the manner shown in the drawing at left. Each of the blocks is made of a short length of 2 x 4 sandwiched between pieces of scrap material as shown. Since the blocks slide freely on the horses, it is important that the outer pieces overlap the member on which they are placed. For safety, it's a good idea to make the saddle blocks wider than the plank to be used on them.—G. E. Hendrickson, Argyle, Wis.

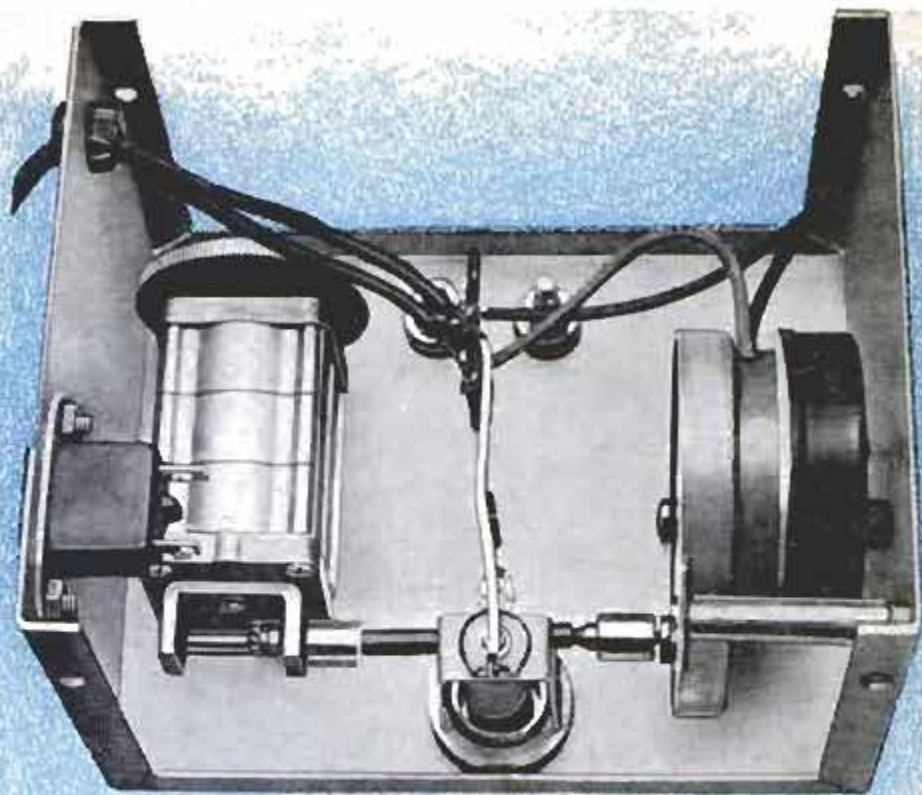

ELAPSED-TIME INDICATOR

KEEPING TRACK of the length of time a piece of electronic equipment has been in actual use, makes good sense and can save you costly replacements and repairs. For your more sensitive components, here is an elapsed-time indicator you can build for only a few dollars. The indicator uses a self-starting motor from an electric clock with an output shaft turning at 1 rph; and the counter from an antenna-reel control box, available from almost any mail-order supplier of electronic parts.

Remove the counter and the flexible shaft from the antenna-reel control box. Mount them at the front of an aluminum box measuring 3 x 4 x 5 in. Mount the

clock motor at the rear of the box, aligning the two so that the two shafts may be coupled. If you use the pilot-light assembly that comes with the control box, then use an NE51 bulb in series with a 56,000-ohm, 1/2-watt resistor across the 117-volt line. However, you may find it more convenient to use a regular neon-bulb socket with a built-in resistor.

When you have assembled and wired your time indicator, you will be ready to connect it to a piece of equipment. If, for example, you use it to measure the length of time a phonograph stylus is used, connect the indicator to the phonograph through the A.C. receptacle or jack with which your phonograph is equipped. Thus, each time the phonograph motor is turned on, the indicator will run and count the cumulative number of hours your turntable operates.

The elapsed-time indicator may also be adapted for use by remote control. A transformer, mounted on the equipment to be timed, steps the current down so that it may be carried the desired distance unshielded. A second transformer, mounted in the housing, restores the voltage to 117 volts and operates the time indicator.

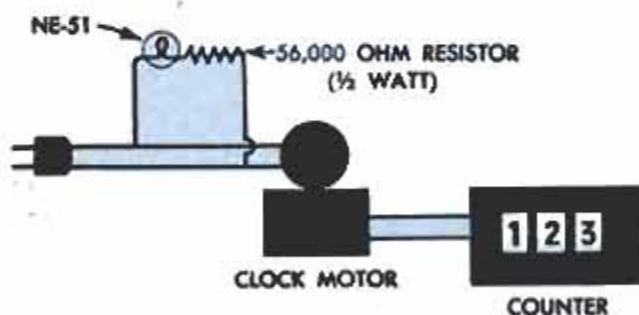

BASIC CIRCUIT DIAGRAM

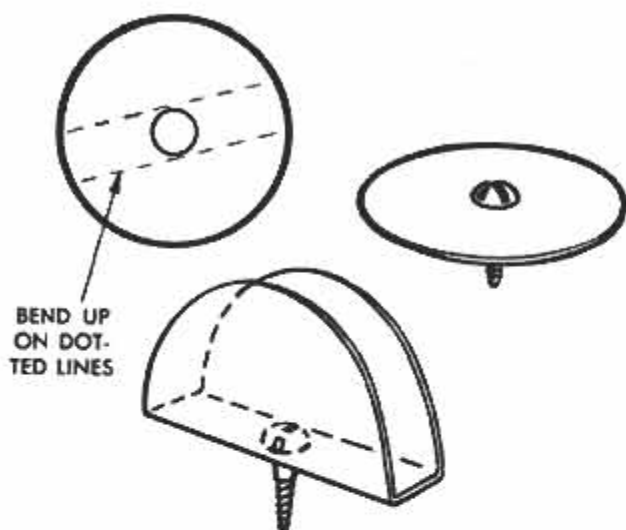
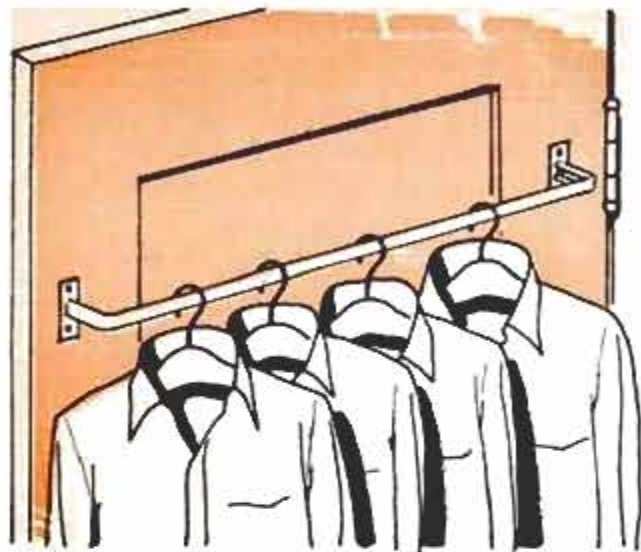

BEND UP
ON DOT-
TED LINES

Solving Home Problems

Above, freshly ironed shirts and similar lightweight garments may be hung prior to putting them away on an ordinary flat-type curtain rod attached to the back of a kitchen or utility-room door. The rod will support a number of wire hangers holding light apparel and may be removed and stored away in a convenient place when the day's ironing is completed

Above, when a turnbutton is needed for a small cabinet a neat one can be formed quickly from a scrap of sheet metal. First cut a disk about 2 in. in dia. and drill a hole in the center for a screw. Then bend up the edges on the dotted lines to form wings for turning the button. Sharp edges on the metal can be smoothed with a file to avoid cuts on the fingers

Below, before you try more drastic methods of cleaning wallpaper that has lost its fresh look and yet is not really bad enough to replace, borax may save the day. First wipe the soiled places with a clean cloth dipped in dry powdered borax. Follow this by dusting with a second clean cloth. You'll be surprised how the powder will freshen faded and soiled wallpaper

Below, you will find your table-tennis balls readily available and in good condition if you keep them in this handy tube dispenser. To make it cut notches in the ends of a length of mailing tube to take a rubber band and cut out an oval section in one end for your thumb. The rubber band holds the balls in place yet allows them to be removed as they feed down the tube

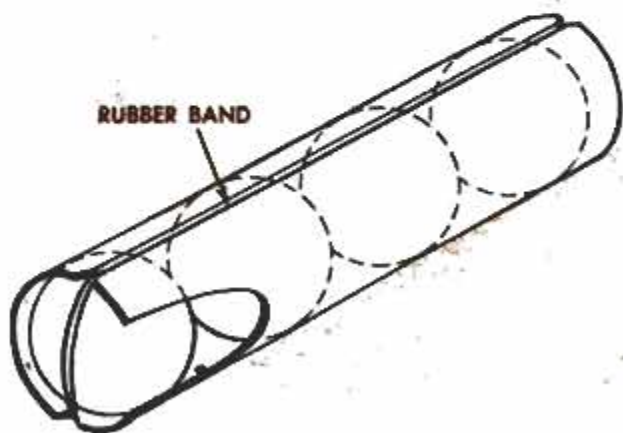



Above, basement clotheslines stretched wall to wall can be kept from sagging by attaching hooks to the center supporting I-beam. Regular clothesline hooks are soldered to square pieces of sheet metal and the edges crimped up over the beam. Right, a pressing "cloth" of waxed paper will take the wrinkles out of a ribbon badge.

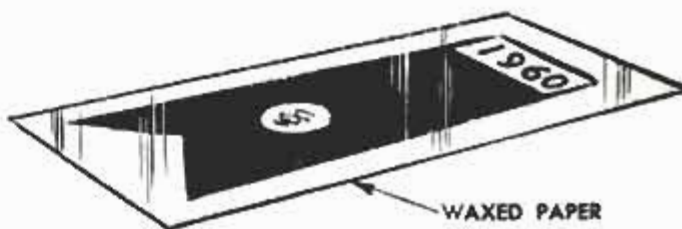

Lower right, pictures can be made to hang straight if a strip of ordinary sandpaper is glued to each of the bottom corners of the picture frame. Below, for a unique lawn basket, cut away 3-in. strips from the sidewalls of a discarded tire. Loop the freed treads under to form a base and join the beads for a handle.





Low-Load Milk Cart Minimizes Lifting

Loading full cans of milk and carting them from the barn driveway to the milk-house is an easy job for this farmer who made the low-bed cart, illustrated at left, especially for the job. The all-steel push cart is made of angles, flats and pipe welded together to form a strong unit that can accommodate three cans of the type shown. Small diameter, 200-lb. capacity utility wheels, mounted on an axle that is welded directly to the underside of the frame at the center, help to reduce the loading height of the cart. A caster at each end gives rolling support when the ends contact the pavement.

John Krill, North Lima, Ohio

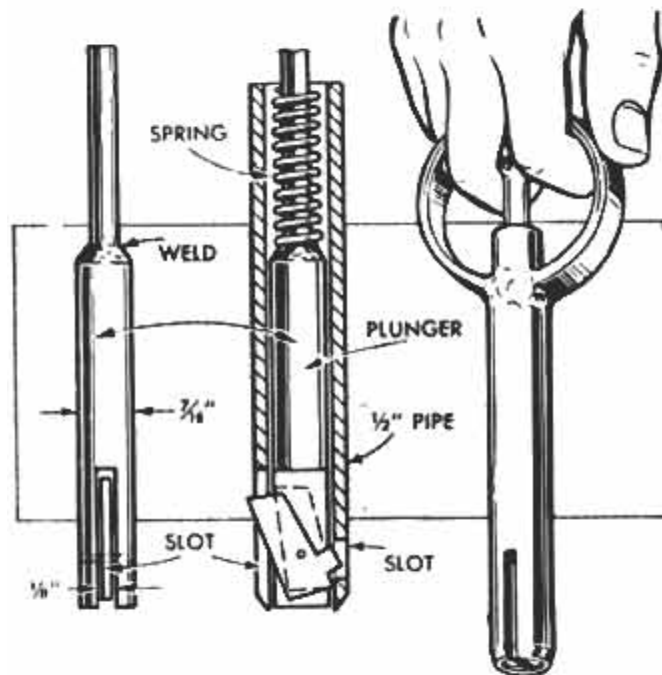

Hitch Pin for Tractor Drawbar Has Locking Feature

Needing a hitch pin that would not work free of the tractor drawbar, yet be easy to insert or remove when necessary, one farmer made the locking pin detailed at left. The locking feature is provided by a dog shaped as shown and mounted on a pin that permits it to pivot in slots cut in the lower end of the plunger and pin housing as shown in the cross-sectional view. A small ear at the lower end of the dog engages a short slot in the housing, so that when the plunger is released a compression spring mounted on it forces the dog into locked position. When the plunger handle is pulled up, the dog is withdrawn, permitting the pin to be removed.

A. M. Wettach, Mt. Pleasant, Iowa

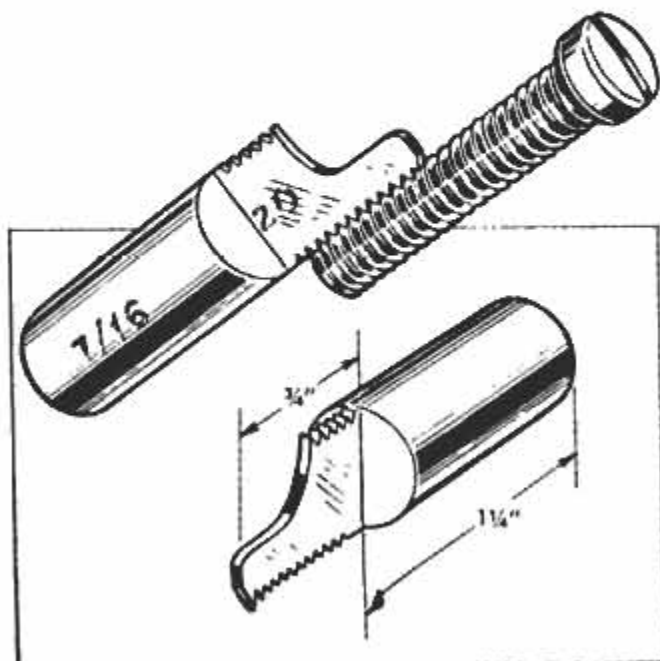

Special Thread Gauge Made From Bolt

When a special thread gauge is needed for checking bolt and nut sizes, make it from a bolt or threaded rod of the desired diameter and number of threads per inch as indicated in the drawing at left. The first step is to file or grind a $\frac{3}{4}$ -in.-long flat tongue on the threaded end as shown. The tongue should be about $\frac{1}{16}$ -in. thick and made with an offset approximately as shown to permit easy checking of internal threads. About $1\frac{1}{4}$ in. of the whole portion of the bolt is left for a handle. The bolt diameter and thread-gauge numbers are die stamped on the completed tool for quick, positive identification.

Walter E. Burton, Akron, Ohio

STARTER FOR STANDBY GENERATOR

By Ray B. Dorward

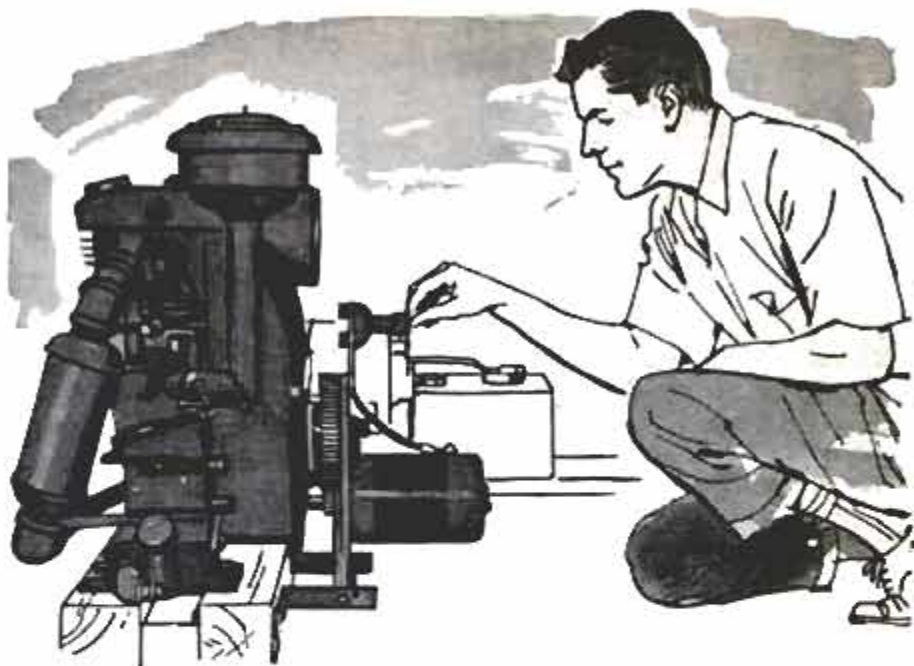

HAND-STARTING a large air-cooled engine that operates a standby electric generator is not the easiest job, especially during cold weather. This problem was solved on one farm by making an electric-starting device from a car-starting motor and other objects found around the workshop. The parts are assembled and bolted on the engine base as detailed. In use, the driving

studs on the large gear wheel engage the starter-rope notches when the starting unit is pushed forward as shown above. Thumb pressure required to depress the starter button is sufficient to hold the driving studs in engagement with the rope-starter wheel. When released, the starting unit disengages automatically and remains in the position shown in the photo.

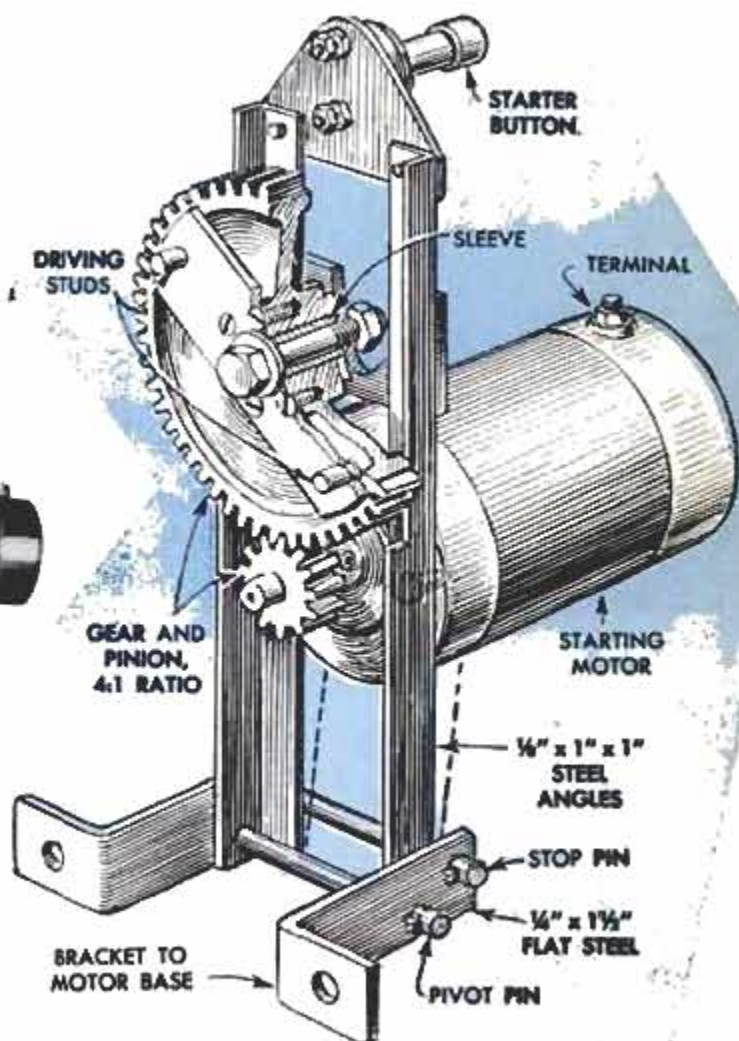
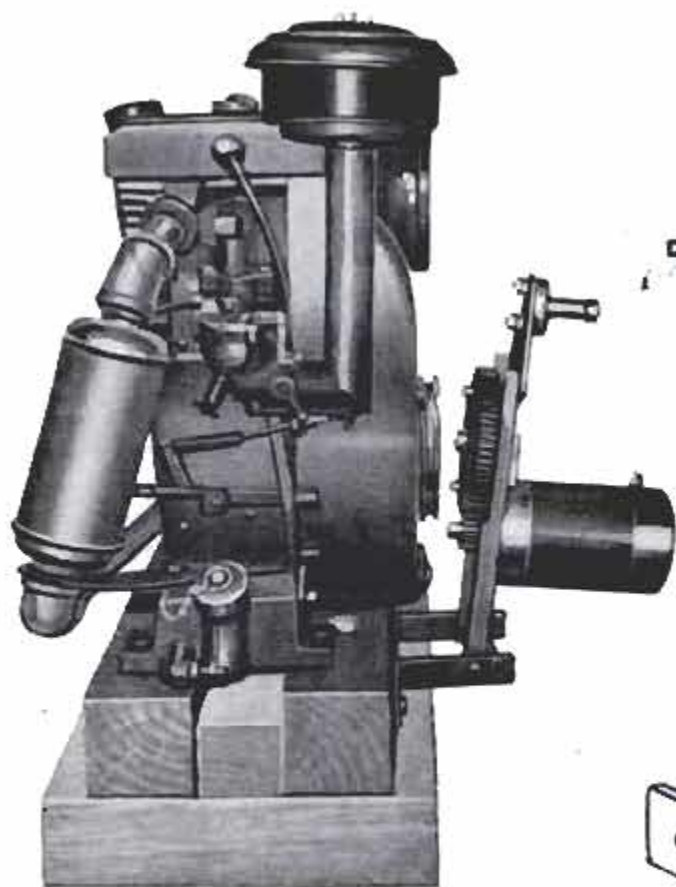

STORAGE CLOSET

1 BROOM CABINET

By Ron and
Marion Anderson

TAKE A TIP from the current trend in refrigerator-door design and add new storage cabinets in most any room of your house having an inside door. The idea is called the "storage door," the added cabinet of which occupies wholly unused spaces in most cases.

On the back of a kitchen door you can have a broom cabinet; on a bedroom door, a tie and shoe cabinet, or an "auxiliary" clothes closet; a hat and glove cabinet on a guest-closet door; and a bookcase, or gun cabinet on a door to the family room. And don't forget miniature versions on the backs of kitchen cabinet doors. They are fine for spice containers.

Illustrated are four ideas with tips on how to build such cabinets. Simple box construction is used for all of them. Dimensions are determined by available space, cabinet use and door clearance. Joints are fastened with glue and screws. The door on which a cabinet is mounted serves as the back. Cabinets are mounted on steel brackets as in Fig. 1. Screw anchors fasten the

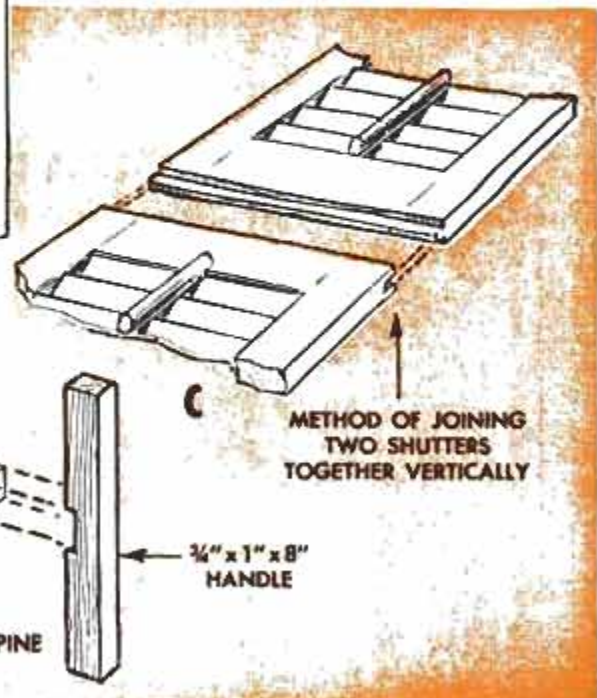
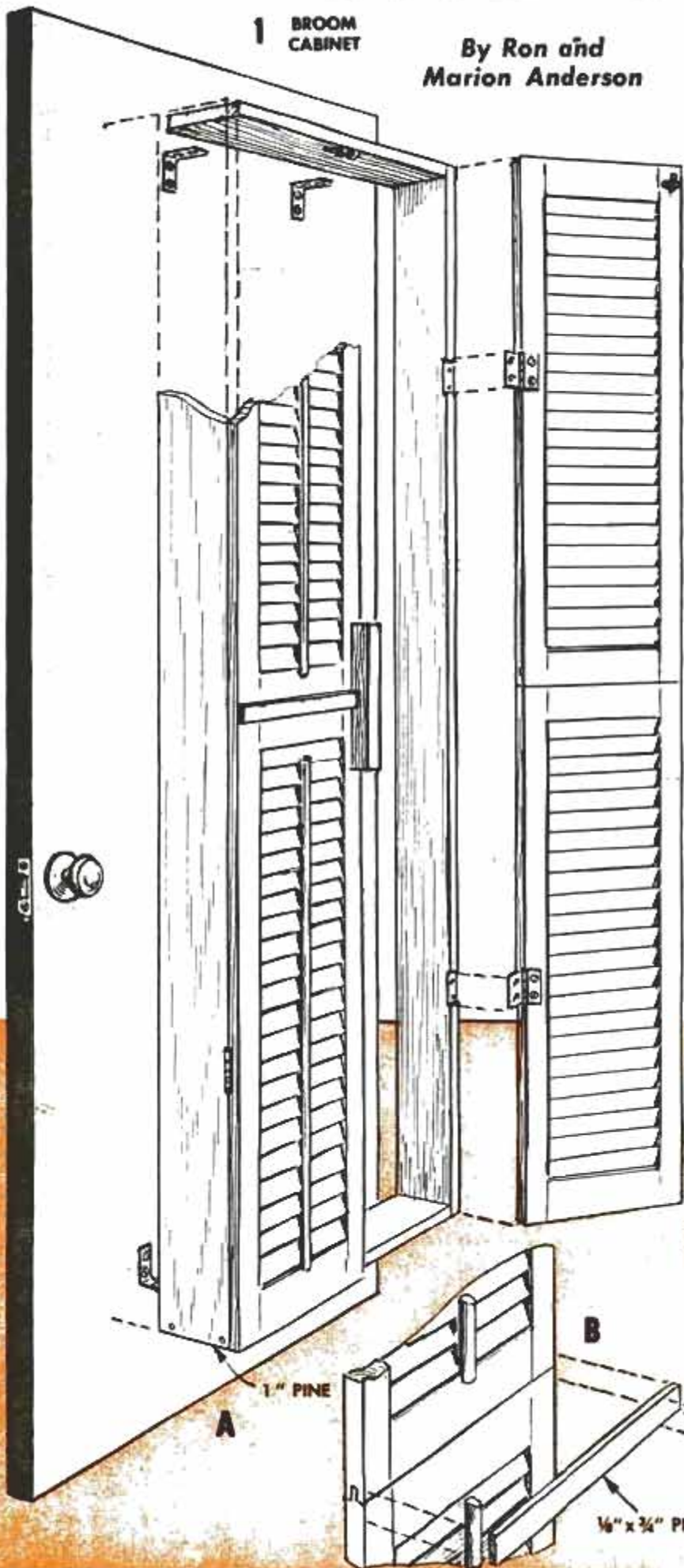

ON A DOOR

latter to hollow-core doors, standard screws for solid ones.

Any style of door may be used for the cabinets. To obtain a shutter-style door that cannot be purchased in the required length, piece two short ones together as shown in details A, B and C. It's a good idea to check on sizes of available shutters before starting construction. It may save time and possible embarrassment.

Since these on-a-door cabinets are subject to frequent movement, it is necessary to make provision for holding the contents in place. Available hardware and fixtures may be used for this purpose as is, or they can be adapted to accommodate the item.

Retaining strips on bookcase shelves as suggested in Fig. 2, hold books in place. A clothes-hanger fixture of the type shown in Fig. 3, is ideal for the closet illustrated since it can be folded flat when not in use. Brooms and mops are hung in the broom cabinet by means of a screw eye driven in each handle and slipped on a hook screwed in the underside of the top as shown in the photo at right. A hanger formed from a length of wire and mounted as shown, permits hanging a sponge mop sponge-end up to avoid crowding at the bottom. Slots cut in a cross member near the top of the gun cabinet help to keep guns in place, Fig. 4. Furniture-caster cups screwed to the bottom prevent the butt ends from sliding out.

Care must be taken not to overload a door, or it may sag. Completed cabinets may be painted or varnished as desired.

★ ★ ★

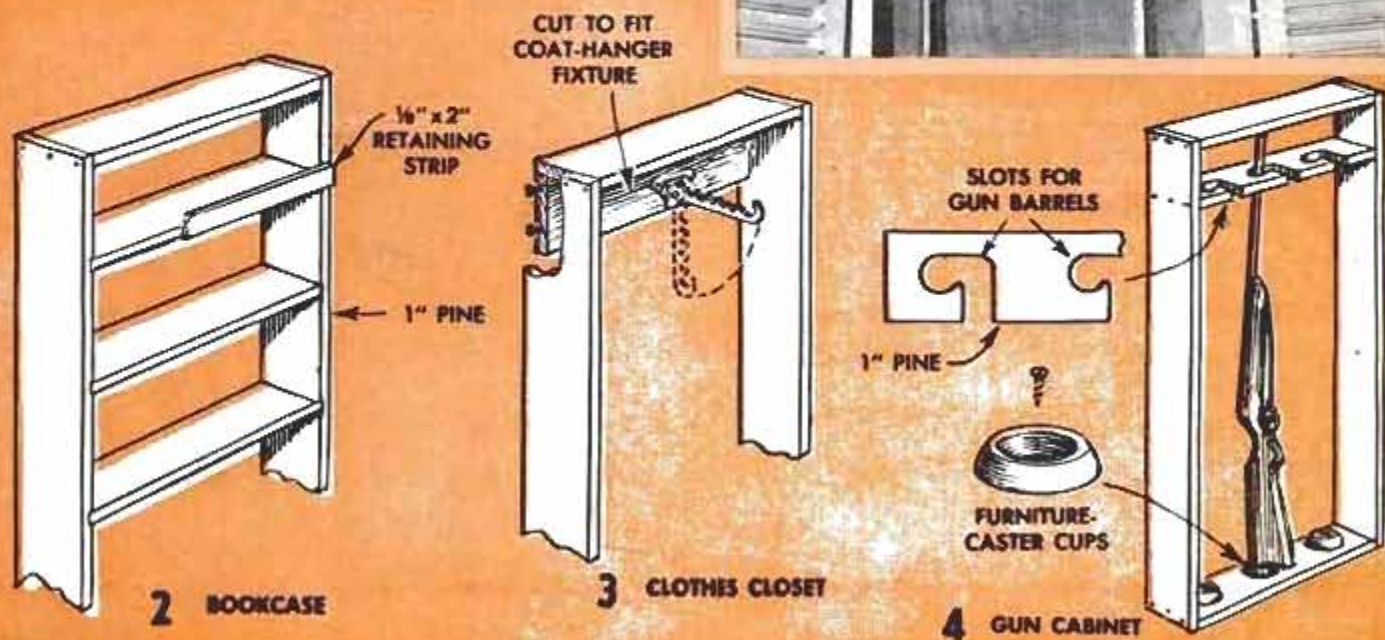



Built-In

FAMILY WALL FOR ALL

THERE IS NOTHING quite as effective for getting a lot of living into a small space as the modern storage wall or living center where one or both sides of the wall are utilized. Just about the ultimate in such walls has been attained by the noted craftsman and designer, Bill Baker who created this living center. Sponsored by AMF DeWalt Power Tools and United States Plywood Corp., this family wall or living center offers many suggestions that may be adapted to a wall in the average home. Or, in some cases, such as in a basement playroom or modern family room, it may be possible to use the wall in its entirety.

Among the many functional space savers incorporated in the wall is a music center, which contains a lazy susan for record storage, Fig. 1, with a speaker underneath, a television set, and a radio and stereo hi fi components, Fig. 3. There also are record storage compartments under the TV set. At one end of the wall is a home workshop, Figs. 2, 4 and 5, complete with a hideaway radial-arm saw, vise, storage cabinets, hand-tool rack and a work-

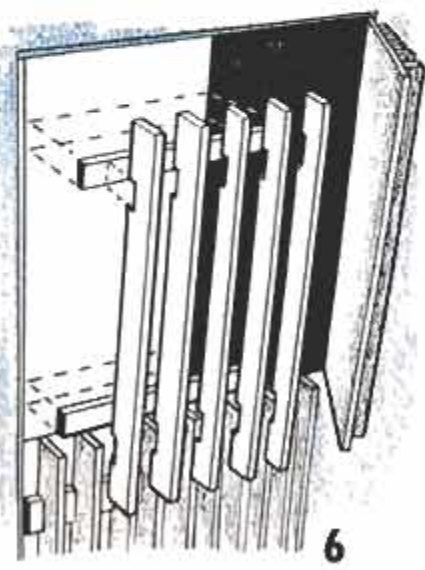
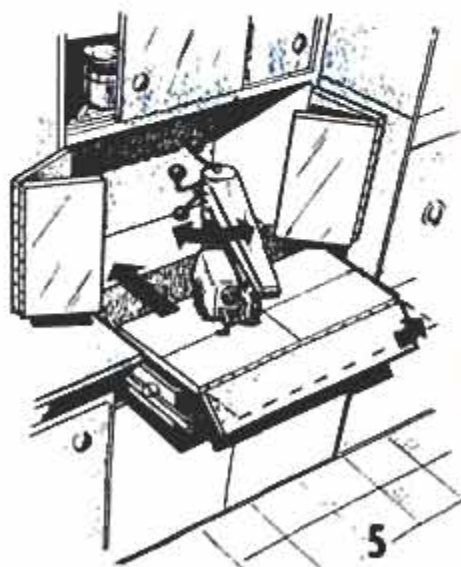

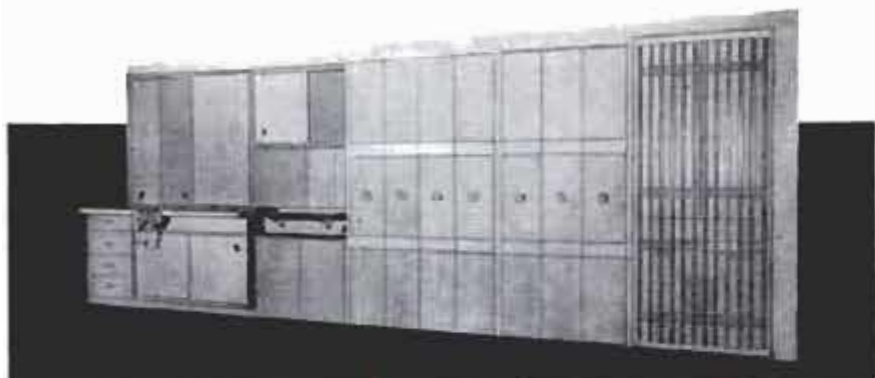

bench. In the center of the wall is a sewing center which is divided into two sections. One section contains drawers and storage space, a fold-out ironing board, Figs. 8 and 9, a fold-out work table and a cabinet for scrap materials. The other section contains a slide-out sewing machine table, Fig. 7, racks of patterns, spools of thread, measuring tape, etc. Not shown on the opposite side of the wall are a fold-away bed, beverage center and storage closets.

All centers or compartments are covered by foldaway doors, and each center may be used independently. Fig. 6 shows how the unusual effect on the surface of the doors over part of the music center is produced. ★ ★ ★

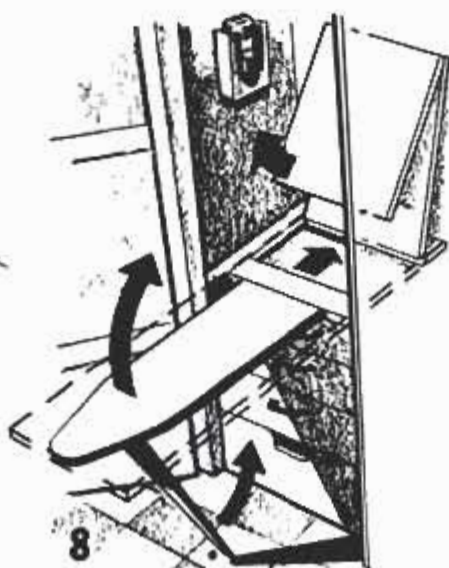

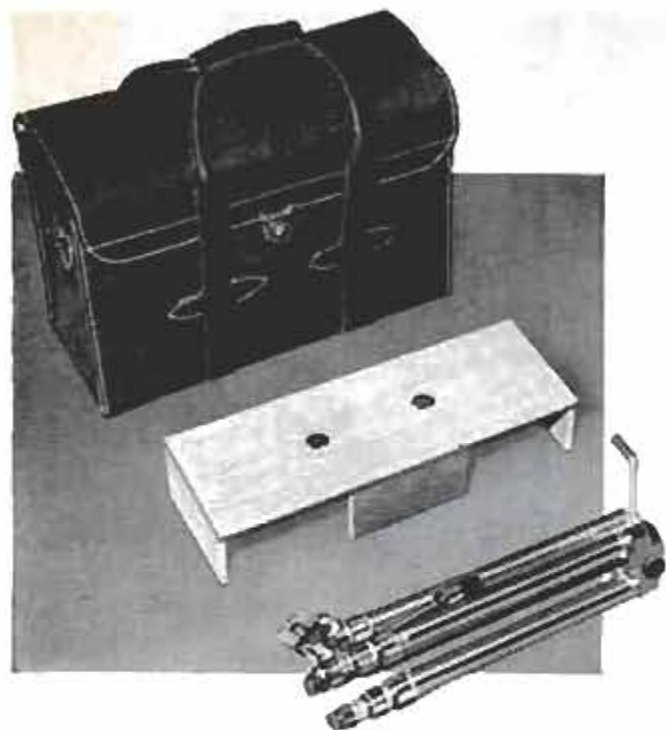

False Bottom in Photo Kit Bag Stores Tripod and Accessories

For the photographer who prefers to carry a tripod in a press or kit bag but dislikes the clutter it creates, here is a good way of providing out-of-the-way storage for the tripod. Tripod, cable release, straps and seldom used accessories are simply packed under a removable false bottom as indicated in the photo. For the model shown, $\frac{1}{8}$ -in. hardboard was used for the top and $\frac{1}{4}$ -in. pine stock for the two end pieces and two side members. Joints are fastened with glue and screws. Finger holes cut in the top, permit easy removal of the false bottom. The depth of the latter is equal to the minimum vertical clearance required for the tripod. Clearance of $\frac{1}{16}$ in. is provided at sides and ends. The completed unit weighs only a few ounces.

M. Rosko, Jr., Rahway, N. J.

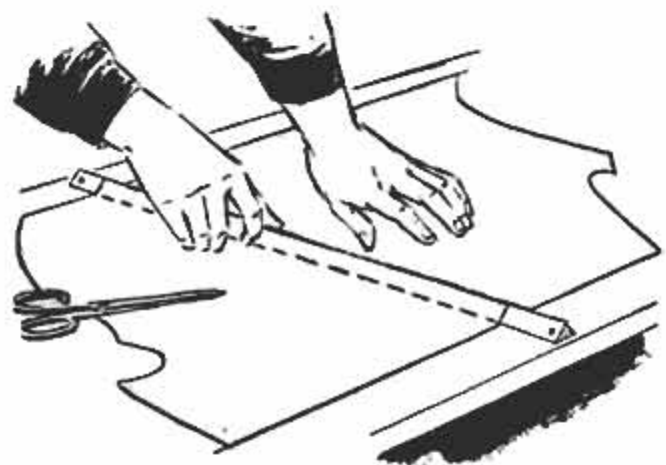

Crease Oilcloth on V-Strip For Straight-Line Cutting

General store owners, here is a way of quickly marking oilcloth for cutting with a scissors when it has no straight-line pattern oriented at right angles to the sides. First a strip of wood having a V-shaped cross section is tacked on the store counter where oilcloth from rolls is sold. The length of cloth desired by the customer is then pulled over the strip and creased at the cut-off point by pressing the cloth against it with the thumb and forefinger as shown in the drawing at left.

G. E. Hendrickson, Argyle, Wis.



Plastic Cap on Oil-Can Spout Prevents Spillage in Toolbox

When carrying a small oil can in a toolbox it is wise to provide some kind of stopper for the spout, to guard against oil spillage should the can tip over. A plastic cap from an empty lighter-fluid can or other container is ideal for this purpose. Simply slip the cap on the end of the spout when the can is not in use as shown in the photo at left.

Disk Corrects Flash Exposure

To avoid overly-exposed closeup photos when using M-2 flash bulbs at the recommended shutter speeds, one amateur photographer uses a 3-in. disk of black paper cemented to an extra M-2 adapter. To arrive at new guide numbers for film, reduce the given number for each type by 30 percent and take a few test pictures.

Ken Patterson, Tribune, Sask.



Good Way to Cover Nail Holes in Wood Joints

Raising a chip at the point where a nail is to be driven, and then gluing the chip in place over the nailhead is one of the best ways of hiding it, especially on fine cabinet work. To do this, drill a blind pilot hole for the nail to within about $\frac{1}{16}$ in. of the surface. This can be done easily by positioning the drill as in Fig. 2 and then setting

the stop at this point. After drilling the hole, cut off a nail and drive it through the hole to break out the chip as in Fig. 1. Then drive a regular nail into place, Fig. 3, and glue the chip down over it. A little sanding will smooth any roughness and make the spot almost impossible to detect after the finish is applied.

Remember These Problem Solvers for Your Home Chores

Most vexing problems that arise during your daily work around the home often have relatively simple solutions. For example, a rug that curls at the corners usually can be straightened by placing a dampened bath towel over the curled spot overnight. And those hooked rugs you thought useless because of worn edges may be renewed by edging them with regular carpet binding. If dad or the children have tracked in some road tar on your linoleum, cover

the spot with petroleum jelly for a few minutes, and then wipe it away with a paper towel. Rubber-heel marks usually can be removed in the same way. When your do-it-yourself husband heads toward that beautifully chrome-plated plumbing with his pipe wrench, be sure he wraps some electrician's tape around it before applying the wrench. The tape will prevent marring the plated fixture, and even help prevent his wrench from slipping.

Novel Dinner Bell Made From Tumbler

This little bell is not only practical for use in the home, but it also may be used as an unusual what-not item. To make it, select a glass tumbler that sounds a pleasing note when struck lightly. To the bottom of the glass cement a wooden drawer knob, and inside cement a large button to which has been "sewed" a clapper made as indicated at the right.

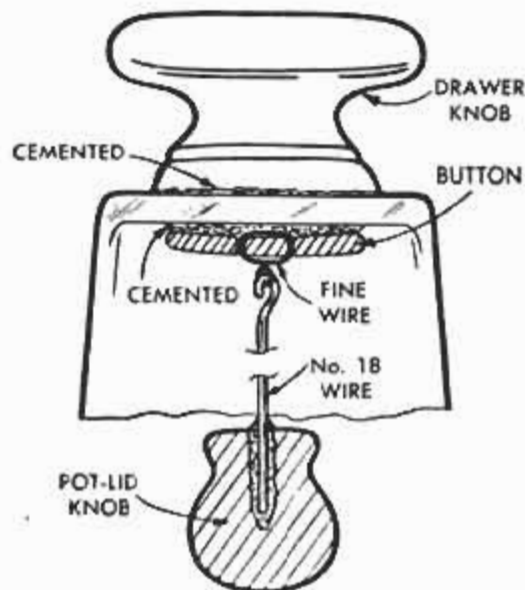

HOME REPAIR

By H. D. Eckerson

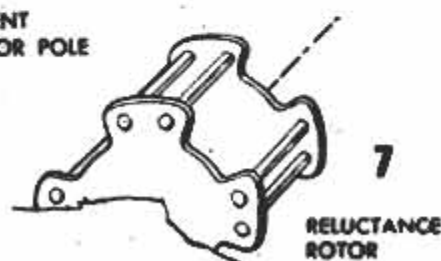
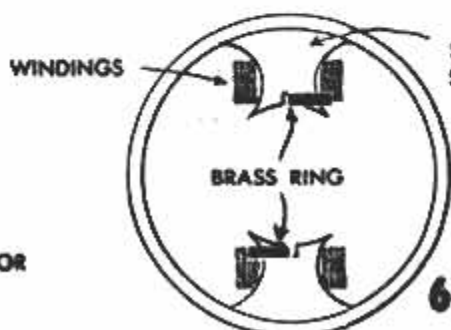
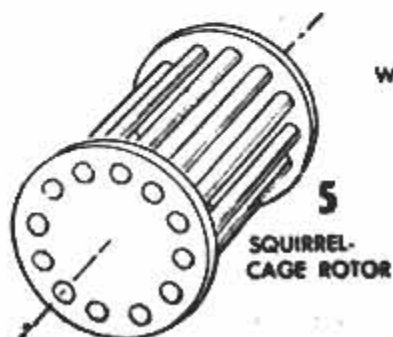
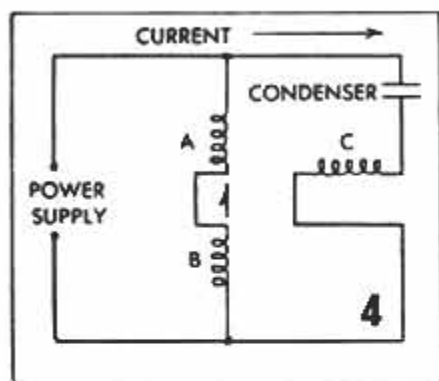
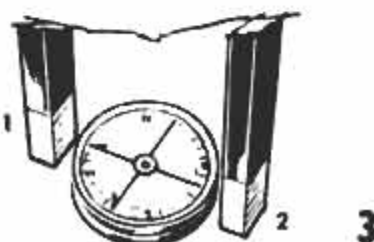
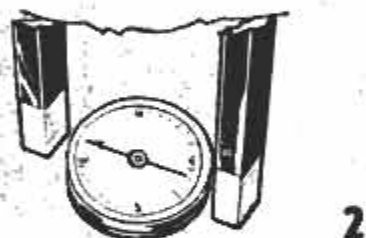
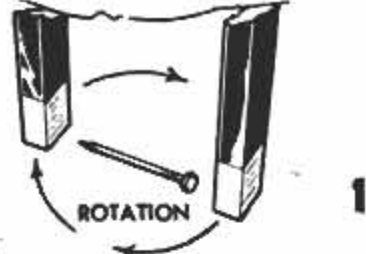

FAILURE of a home appliance motor can upset the daily schedule of any modern household. Everything must be put aside until the motor is fixed and running again. Electric motors powering home appliances and shop tools are extremely durable and long-lasting units, and under normal conditions they keep running for many years without attention. But occasionally they fail due to worn parts, hardened lubricant or some other abnormality that may have developed unobserved. It's then that you can save yourself money and time by knowing how the various types of motors work and how to make simple motor repairs.

Action, or power, of an electric motor results from interaction of the magnetic field of a stationary winding, usually called the stator, and a rotating member generally referred to as the rotor. Note the nail between the poles of the horseshoe magnet in Fig. 1. If you rotate the magnet very slowly the nail will turn with it, following the magnetic field rather jerkily due to inertia. If rotation of the magnet is started quickly the nail will not follow, as it cannot respond quickly enough to stay within the field of the magnet. This "motor" is not self starting.

Now note Fig. 2 and think first of the compass needle and then the body of the compass as being the components of the rotor. When the magnet is rotated, fast or slow, the needle will follow quite precisely. But think of the body of the compass being pulled around with the needle, making a slower start and following at its own pace. Several conclusions can now be drawn: The magnetic field still must rotate and, although the rotor is self starting it will not turn as fast as the magnet. It will lag, or "slip," a little.

Finally, think of the compass as having two needles fixed at right angles so they will rotate as one, Fig. 3. It will be noted that the needles start to turn when the magnet is placed in position. When the leading needle passes pole No. 1 it will be pulled in the opposite direction from the second needle which is approaching pole No. 1. The result will be a kind of pulsating movement. But suppose that polarity of the first

of ELECTRIC MOTORS

needle is reversed the instant it passes pole No. 1. It then will continue to rotate toward pole No. 2. This action will set up a continuous rotation of the fixed needles and you have in effect, a d.c. motor, still assuming, of course, that the body of the compass is being pulled along with the needles and is rotating about a center. From this action it can be concluded that the stator field need not rotate, that the fields must switch, or reverse, polarity each time they pass a stator pole and, finally, that this type of motor also is self starting.

Fig. 4 shows how the stator fields of an induction motor are connected. Windings A and B are main field windings and the auxiliary winding C is connected into the circuit through a condenser. Operating on a.c. the condenser in effect keeps current in the auxiliary winding out of step with that in the main windings with the result that the stator field is oriented in the direction

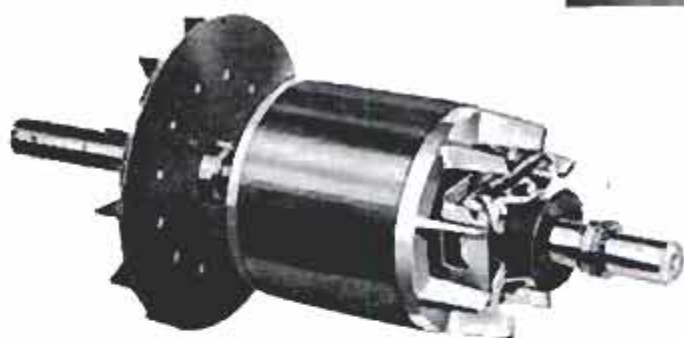
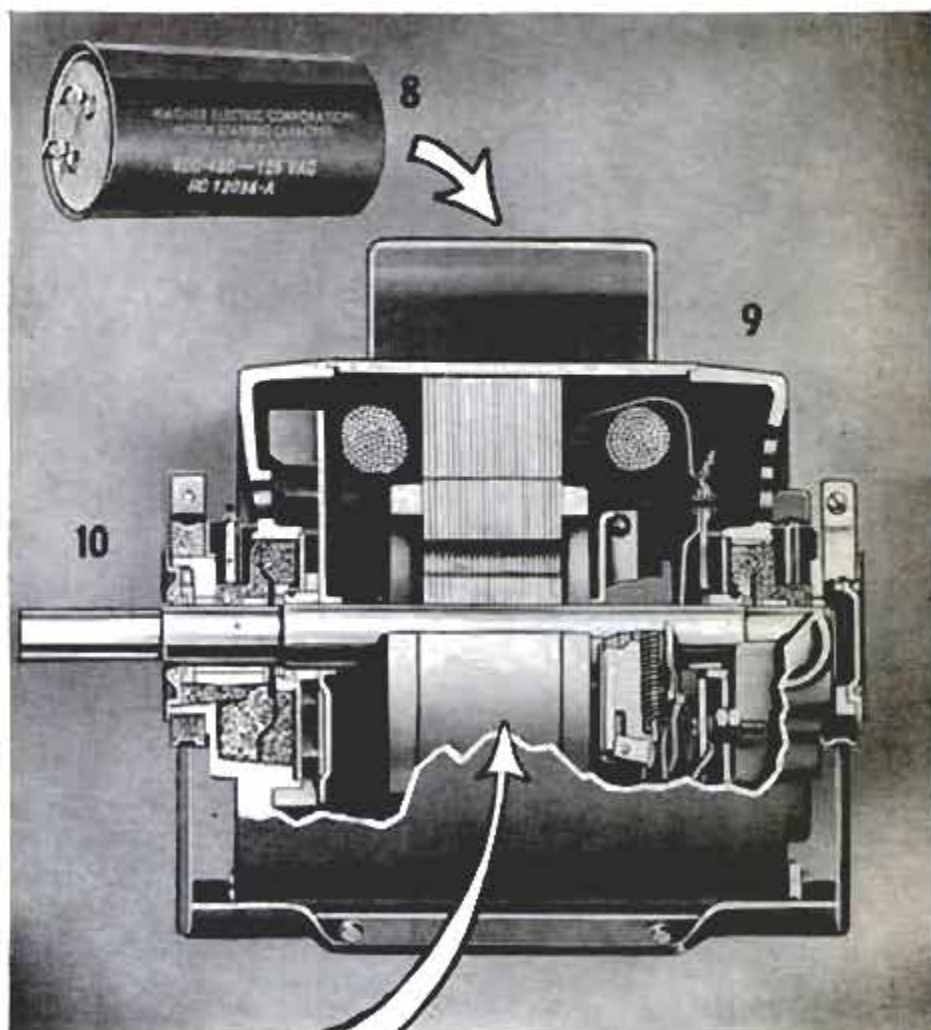

11

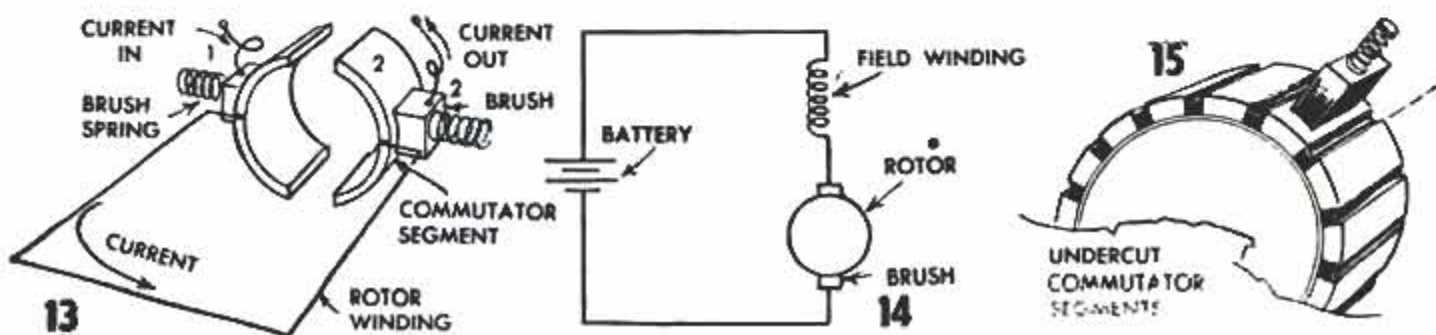
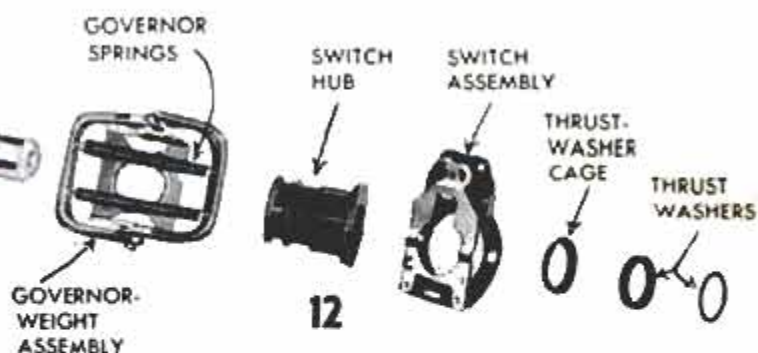

13

14

15

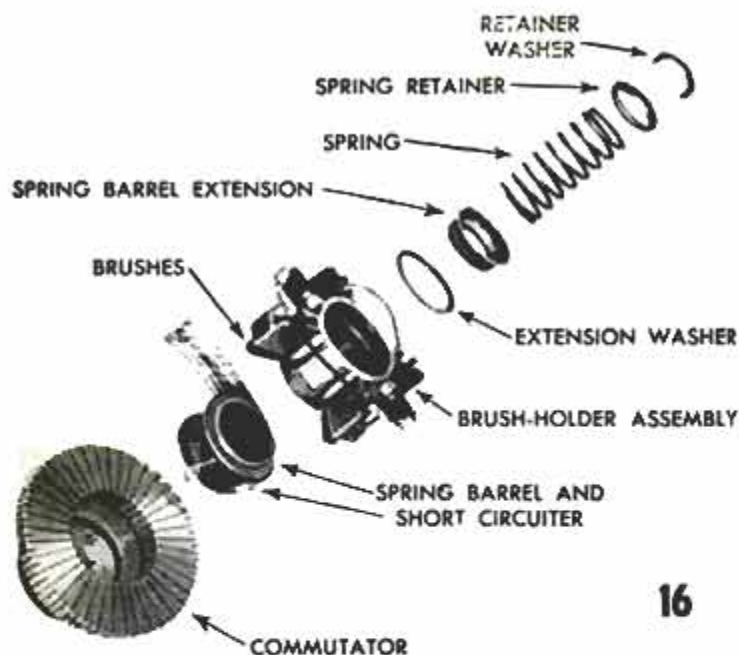

16

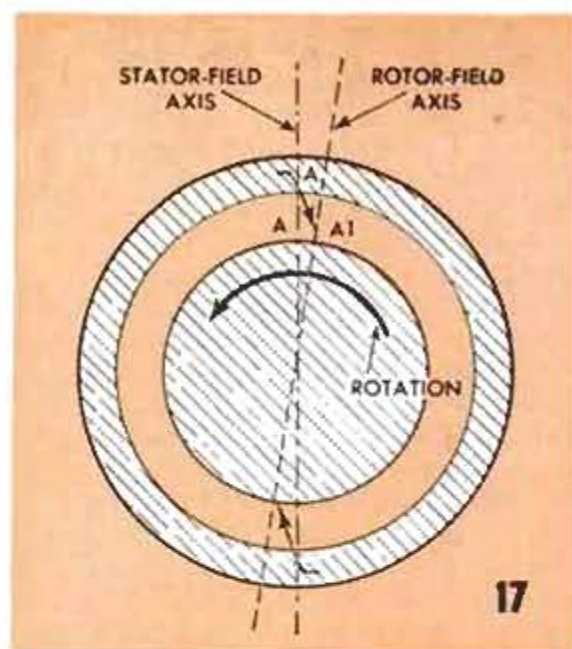

17

of the arrow, Fig. 4, at one instant and in the direction of the secondary winding at a different instant. In effect, the rotor "follows" a magnetic field which rotates around the air gap.

The rotor's magnetic field, not shown in Fig. 4, is set up by induced currents, there being no connection between the main windings and the rotor. Fig. 5 shows a typical induction rotor of the squirrel-cage type, found in nearly all appliance motors of fractional hp. In this connection, refer also to the cutaway view of a typical appliance motor, Fig. 10, and the rotor in Fig. 11. These views show the finished parts. In these motors the condenser, Fig. 8, is mounted in a housing, Fig. 9, which is attached to the frame of the motor. Also, in this type of motor, the condenser is

used only for starting and is then automatically switched out of the circuit by the centrifugal switching device. This switch is shown in a pulled-apart view in Fig. 12 and assembled in Figs. 10 and 11.

After the rotor attains full speed and the condenser has been switched out of the circuit (this occurs when the rotor attains about half its normal speed) the rotor continues to spin by what might be termed straight induction. When the motor switch is turned off, the governor, Fig. 12, returns the centrifugal switch assembly to the starting position just before the rotor stops. This usually results in an audible click.

These motors are of the capacitor-start, induction-run type (see the table below) and the condenser and centrifugal switch

TYPE	IDENTIFYING FEATURES	CHARACTERISTICS	APPLICATIONS	REPAIR
Induction (capacitance & "split phase")	None of the features used below	Fair all around operating qualities	Common household uses: fans, vac. cleaners, pumps	Check condenser and all terminals for good contact
Induction capacitance-start	Centrifugal switch	Good starting torque & good running qualities (especially if combined with permanent capacitor)		Check switch, change condenser
Induction shaded-pole	Salient-stator poles with brass ring	Low torque, low efficiency	Very small fans, etc.	If cleaning & checking contacts doesn't help, you're stuck for a rewinding job at the repair shop
Reluctance	Salient-rotor poles	Synchronous, large for HP rating	Very rare	Check condenser & switch
Hysteresis	Usually a smooth rotor identified best by application	Low torque, synchronous speed, quiet	Clocks, phonographs	Cleanliness essential & also check condenser. Try setting motor on its side for several hours
Universal	Brushes "AC or DC" on nameplate	Small, light wt., high speed	High-speed applications, hand tools, etc.	Check brushes & spring tension. Clean commutator segments & governor contacts
Repulsion-induction	Brushes, brush-lifting device, shorting ring	Good starting torque, but large & expensive for its horsepower rating	Only older motors are likely to be this type	Check brushes, commutators, springs, shorting clamp, brush-lifting device

are the parts most likely to fail. A burned-out condenser is easily replaced and careful use of a solvent generally restores the switch to efficient operation.

Variations of the induction motor include those with two condensers, one for starting and one for continuous running. These are sometimes called capacitor-start, capacitor-run motors, and are not commonly used to power home appliances. Other types have a brass ring around one half of each pole, Fig. 6, to change the magnetic properties of the halves and simulate the effect of an auxiliary winding. This motor is limited in application because of a very low starting torque.

Recall that in Fig. 3 it was noted that a change in polarity can cause the needles to rotate continuously in one direction and that the magnetic field does not rotate. Basically, this is the principle on which the universal, or d.c.-a.c., motor operates. The device for changing current direction in these motors is the brush and commutator, Figs. 13, 14 and 15. The rotor of such a motor consists of a group of current-carrying coils. Fig. 13 shows an elementary rotor winding, the latter terminating on the brass (or copper) segments which are called commutators. Current is fed through the brushes to the commutator segments and around the coil, thus setting up a rotor field. When the rotor turns, commutator segment No. 1 will eventually contact brush No. 2 and commutator No. 2 will contact brush No. 1 and thus the direction of the current around the coil will be reversed. Fig. 14 shows a series connection of such a motor with a battery as the power source. If the battery is replaced by an a.c. power source, the stator magnetic field will reverse its polarity periodically with the alternating current, but because of the series connection the rotor field will change its direction in step with the stator and the rotor will continue to turn.

This is the universal motor you find in nearly all portable power tools and about the only servicing it requires is a periodic cleaning to remove thrown lubricant and dust, and replacement of worn brushes.

In the repulsion-start, induction-run motor (see table on the opposite page) a centrifugal switch short circuits the commutator and in some motors lifts the brushes after the rotor has attained about half its normal speed. Fig. 16 is a pulled-apart view of the short-circuiting, brush-lifting mechanism showing the various parts. Other motors sometimes used on light equipment and in special applications are the "reluctance" motor, Fig. 7, and the "hysteresis" motor, Fig. 17, the latter used in clocks and phonographs. ★ ★ ★

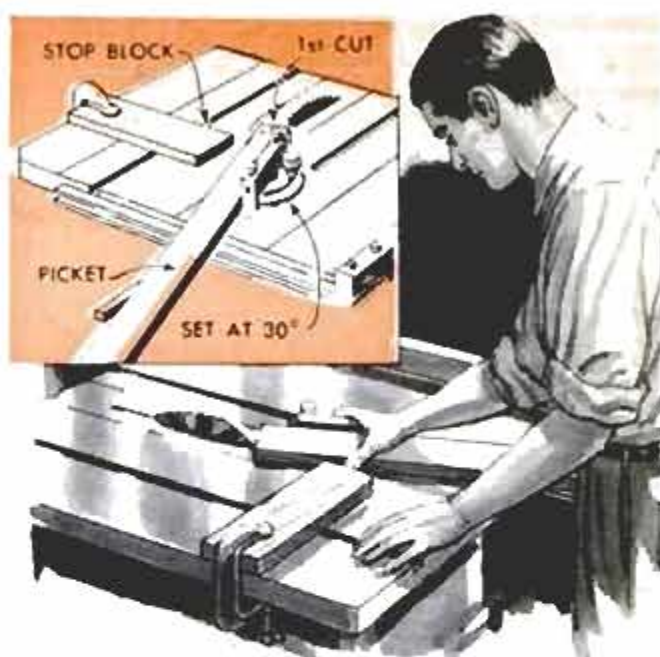

Pointing Fence Pickets Fast

With a stop block clamped to the table of your bench saw to automatically position the work, you can point fence pickets as fast as you can feed them through the saw. Place the crosscut guide in a reverse position in the right-hand table slot and set it at 30 deg. Hold the picket against the guide so it touches the stop block and push it through the saw. Make the second cut in the same manner by flipping the work over. The width of the picket, of course, determines the position of the stop block. A 30-deg. setting will produce a 60-deg. point.

Marking Extension Cords

When several extension cords of different lengths are used from time to time, picking the right one for length when packed in a camera case can be a waste of time. I found a good way to clearly mark them for quick selection by painting the footage of each one on both the plug and the socket with a small brush and quick-drying enamel. With both ends marked it's easy to spot the desired cord at a glance.

Don Honick, Bartlett, Ill.



SHOP NOTES

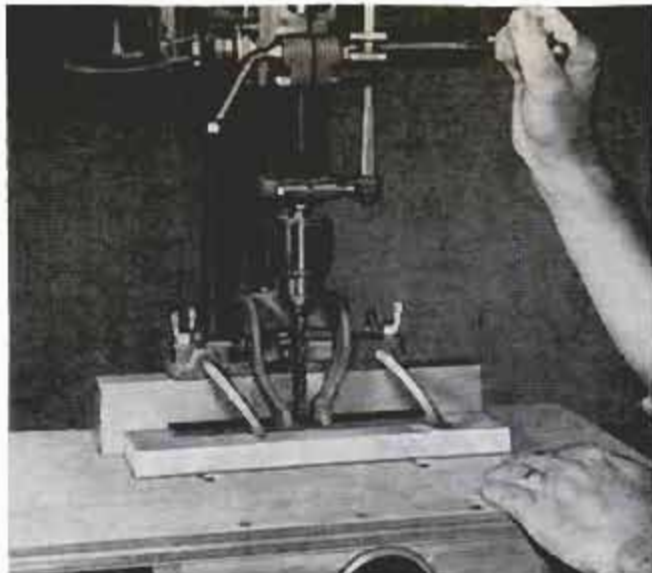
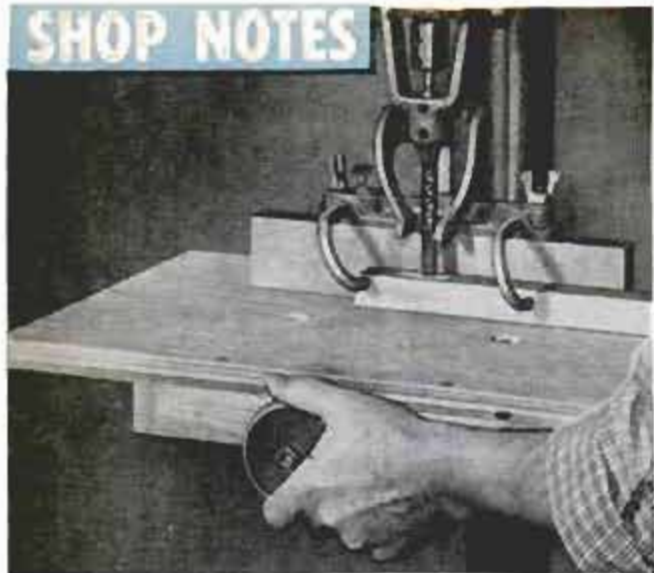

When setting up for mortising with the hollow chisel the handwheel provides a means of positioning the work accurately. Table can be made any desired size

Table and fence of mortising attachment also can be used for holding and drilling flat steel with twist drill. Always use backing piece when drilling through

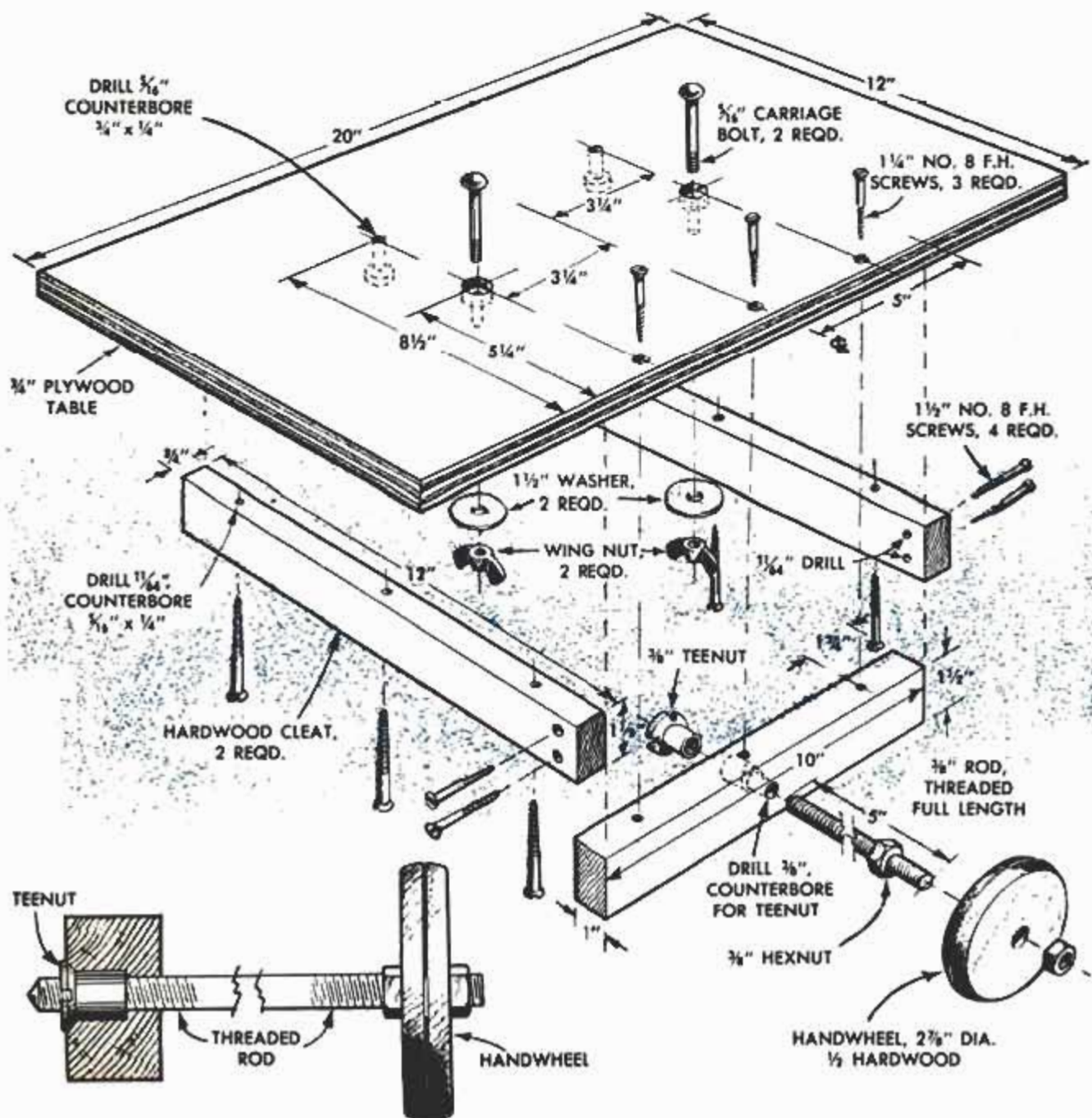

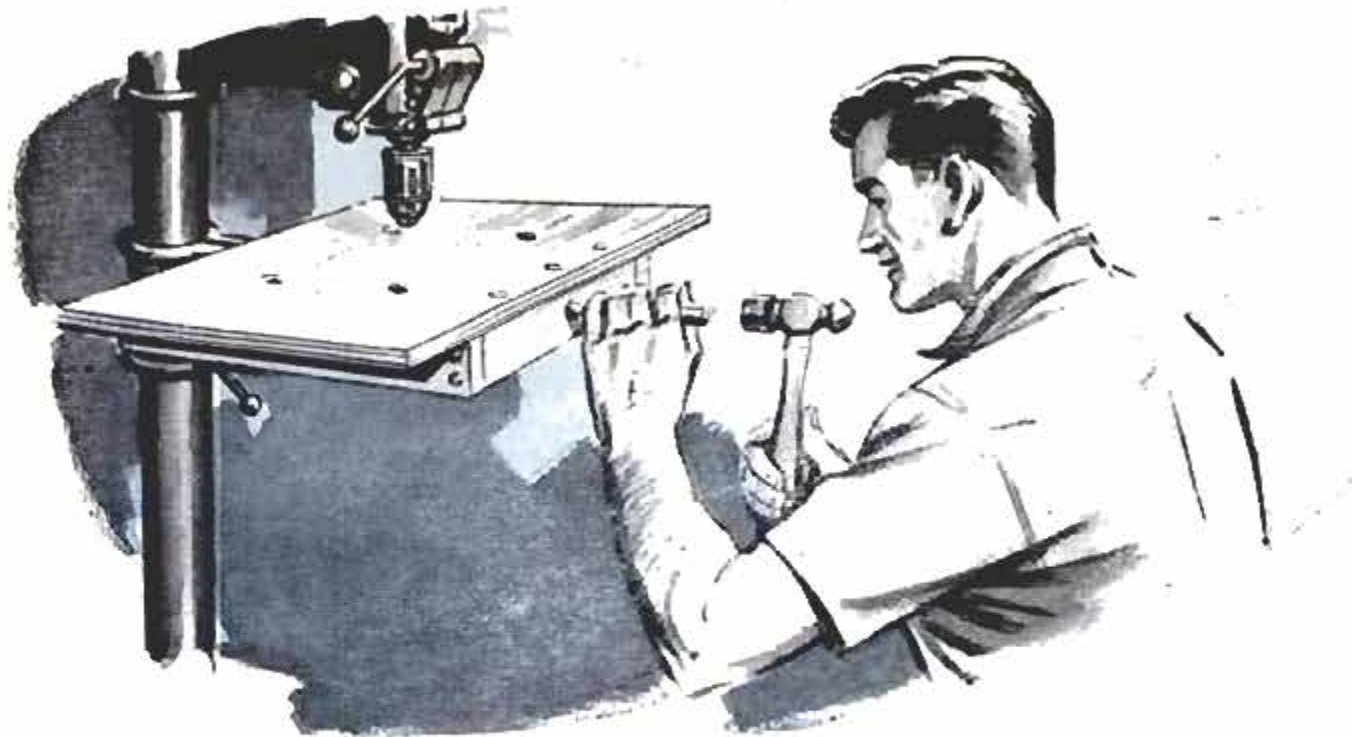

MORTISING TABLE

FITS YOUR DRILL PRESS

By Howard R. Clark

ALTHOUGH the standard drill-press table is adequate for all ordinary work with twist drills and wood-boring bits, it's helpful to have an auxiliary sliding table for the special jobs such as mortising. A screw-actuated table enables you to position work with much greater accuracy when mortising and routing. Nearly all mortising attachments for the drill press can be bolted to the auxiliary table and thus will travel with it, making positioning of the work under the bit easy and precise.

As detailed on the preceding page the table is made from $\frac{3}{4}$ -in. plywood and is 12 in. wide and 20 in. long, a good average size. Before you drill any holes in the auxiliary table, be sure to check the size of your drill-press table, the location of the slots and the distance from the bit to the column. These measurements may differ from those given in the detail.

When the auxiliary table has been positioned on the drill-press table and bolted in place, measure and cut the two crosswise cleats and clamp in place, one on each side of the machine table. These cleats serve as guides and must fit against the sides of the table rather tightly and yet allow it to be moved back and forth by hand. Test and adjust for fit before attaching permanently in place with screws.

The front piece, which serves both as a closure and as a support for the handwheel,

fits between the two cleats and is held in place with screws. The piece is center-drilled and counterbored to take either a regular hex nut or a flanged nut of the type shown. The handwheel consists of a turned disk of hardwood and a length of threaded rod ground to a point at one end. The handwheel disk is attached to the rod with two hex nuts as indicated.

With the auxiliary table in position and before you turn the handwheel screw in place, insert a center punch in the hole in the front piece as in the illustration above and punch mark the front lip of the machine table. Then remove the auxiliary table and spot-drill on the punch mark to a depth of about $\frac{1}{8}$ in. to form a seat for the pointed end of the handwheel screw. At this point you can, if desired, drill and tap a hole for the handwheel screw in the front lip of the machine table. Then omit the nut in the counterbore in the front piece of the table. Run two nuts on the screw and lock them at the handwheel, insert the screw in the hole in the front piece and run on a second pair of nuts, locking them in a position that will permit the handwheel to turn freely. Installed in this way the handwheel will run the table in and out, rather than in one direction only. Installed either way it gives a very close final adjustment for positioning work under the mortising chisel, router bit, or twist drill. ★ ★ ★

Sand in Mailing Tube Provides Traction in Snow

Should your car stall unexpectedly on a treacherous ice patch or in heavy snow, a mailing tube filled with dry sand will help you get going again. The tube serves not only as a reliable container but is a handy dispenser as well. It enables you to place sand just where it's needed most and in just the right amount. Use a good sized tube, one of the heavier types that is exceptionally rigid. Fill with dry sand and close the ends with tight-fitting corks.

Running two or more nuts onto a threaded rod or bolt will prevent damage to the threads when clamping in the vise for hacksawing to length. When you finish the cut, running the nuts off the ends will straighten the threads cut through at an angle by the hacksaw. For a clean, square cut with minimum damage to the threads, use a hacksaw blade with fine teeth, about 24 to the inch.



Rubber-Bonded Abrasive Gives Controlled Polishing Action

Polishing in the lathe with a flexible, rubber-bonded abrasive stick reduces the possibility of distortion in concentricity to the minimum. At the same time pressures are more easily equalized and controlled, there is less tendency to heat the work and there is no danger of scoring. The stick is notched as in the illustration and mounted in the tool post on a solid support that extends to the working end. The lathe is operated at its highest speed with the back gears out and the carriage is slowly traversed right and left as the work rotates.

H. J. Gerber, Stillwater, Okla.

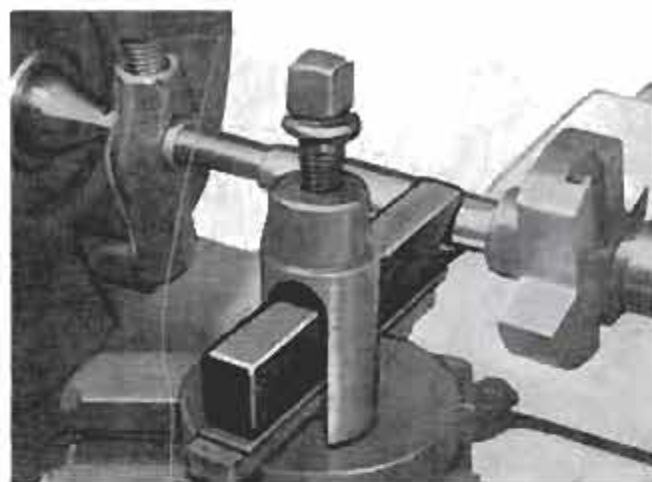

Make These Candle Trees For Your Holiday Decor

These candle trees could well be the novel touch you are looking for to top off the holiday decorative scheme. Using a small plastic funnel as a mold it takes only a few minutes to make each tree. Place the funnel in a glass tumbler and wedge a short candle into the funnel. Then melt candle wax (not paraffine) and pour slowly into the funnel until it is filled. A light tap will release the tree from the funnel, after which it may be tinted or otherwise decorated with liquid food colors. Support the tree in a short candle holder as pictured.



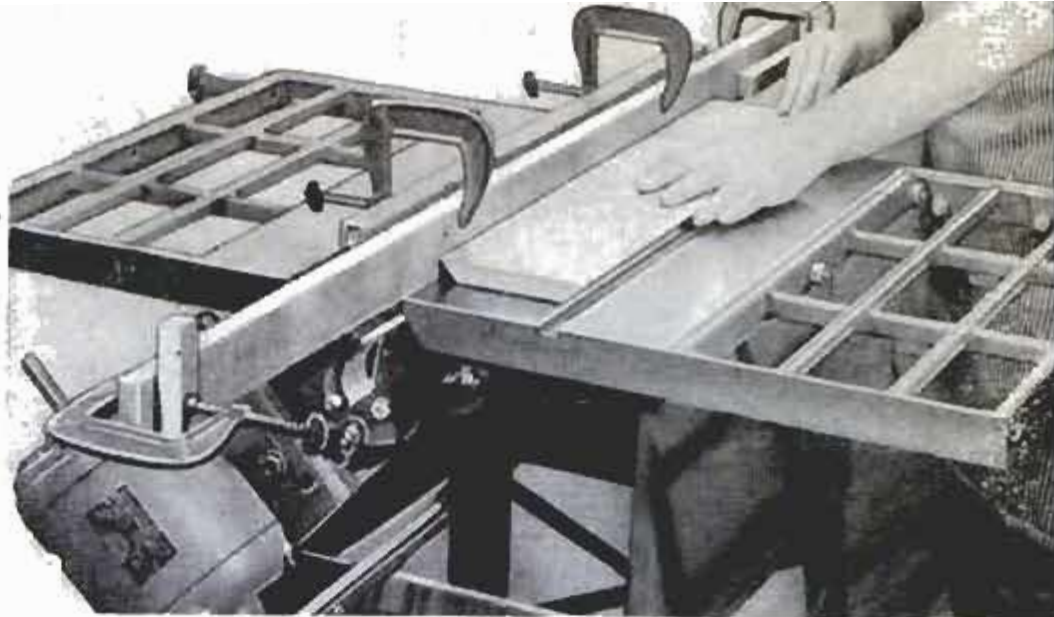
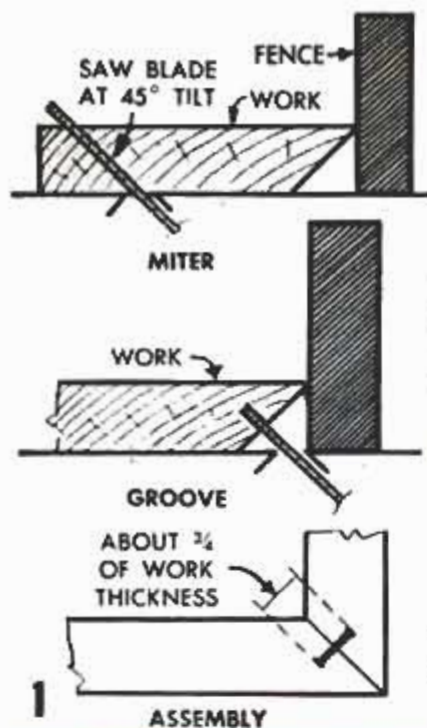

When the stock is joined along the edge, the miter cut is run with the saw blade tilted to 45 deg. Then the cut faces are grooved for splines

Cutting the MITER JOINT

By Sam Brown

NOTHING PLEASES the eye of the craftsman more than a neatly worked miter joint which leaves the grain of the wood unbroken at the corner and shows nothing more on the surface than the fine line indicating where the parts were joined. A good, tight-fitting miter joint is quite easy to produce, either by hand with a simple miter box or with a power saw. About all it takes is careful attention to setups and procedures.

When mitering the corners of a boxlike structure, the 45-deg. cuts are made along the edges of the stock as in Figs. 1 and 2, and to add strength and rigidity the joint is splined, Fig. 1. The joint can be made complete on the circular saw with the blade tilted to 45 deg.

The crosscut miter is perhaps the most common type of miter joint. It is worked with the saw blade set at 90 deg. and the miter gauge set at 45 deg. Two work positions are possible in each table groove, as shown in Figs. 3 and 4. The open position, Fig. 3, is preferred by most craftsmen as it tends to keep the hands away from the saw blade. The closed position offers somewhat better support but is not as safe because the feed hand is behind the blade—the area where most saw accidents happen.

There is seldom any need to use the closed miter-gauge position. If the work can be turned over, face to back, both ends can be cut without disturbing the position of the miter gauge, Fig. 7. It can be seen that the same edge is toward the miter

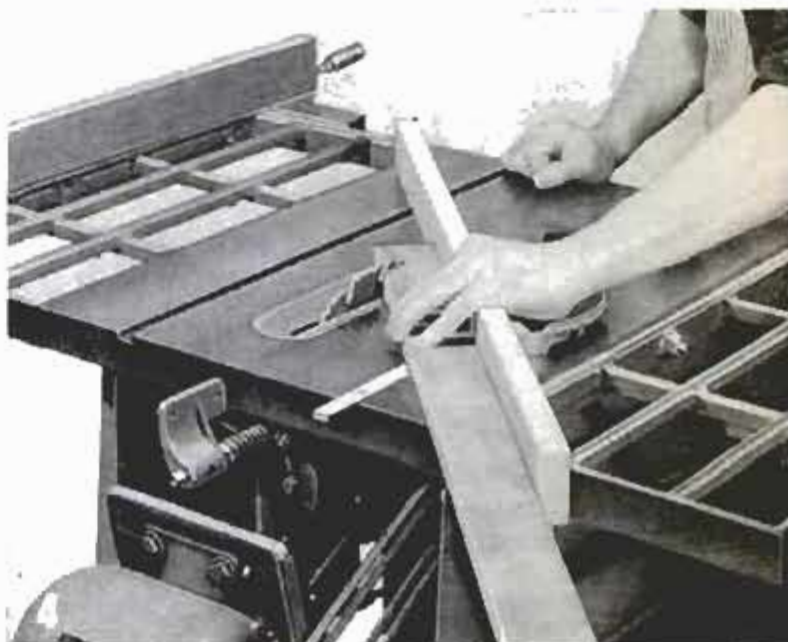
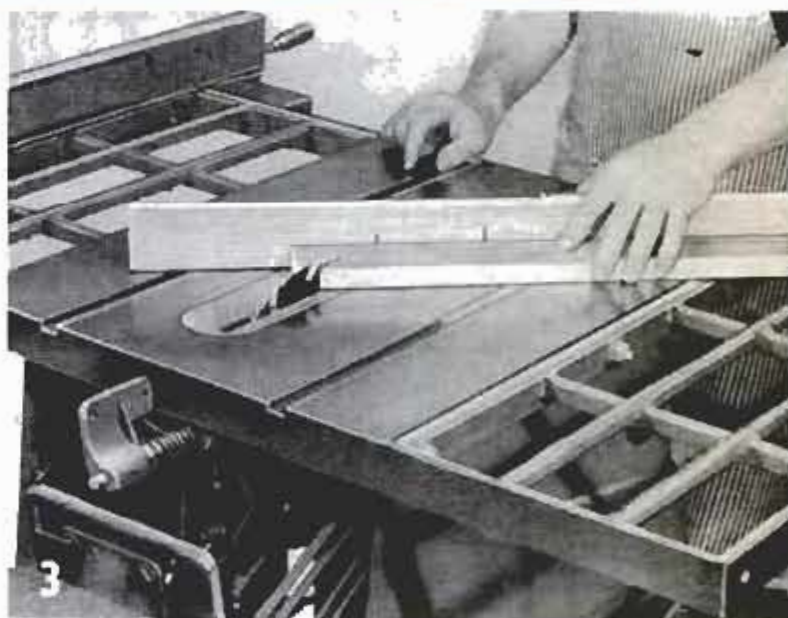

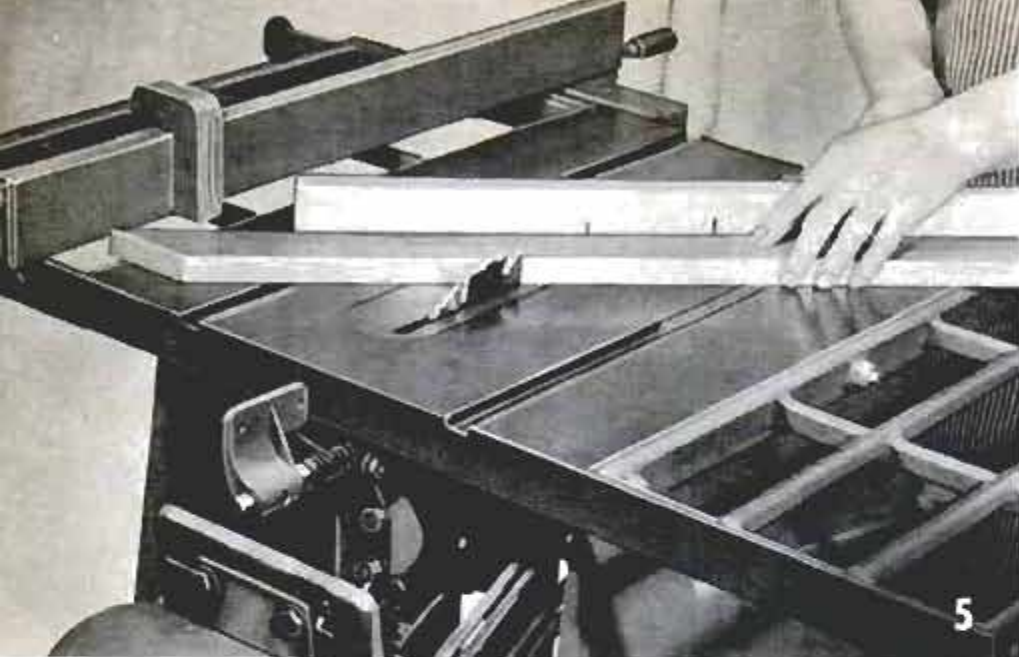

WOODEN STRIPS ON UNDERSIDE
FIT IN SAW-TABLE GROOVES

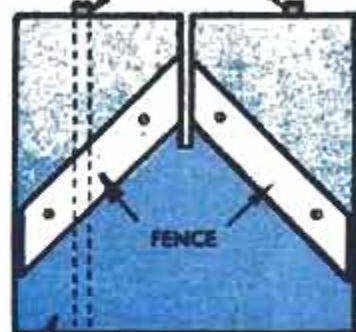

3/8" PLYWOOD

MITER TABLE

6

When making crosscut miter cuts on strips of equal length, use a stop on ripping fence for accuracy

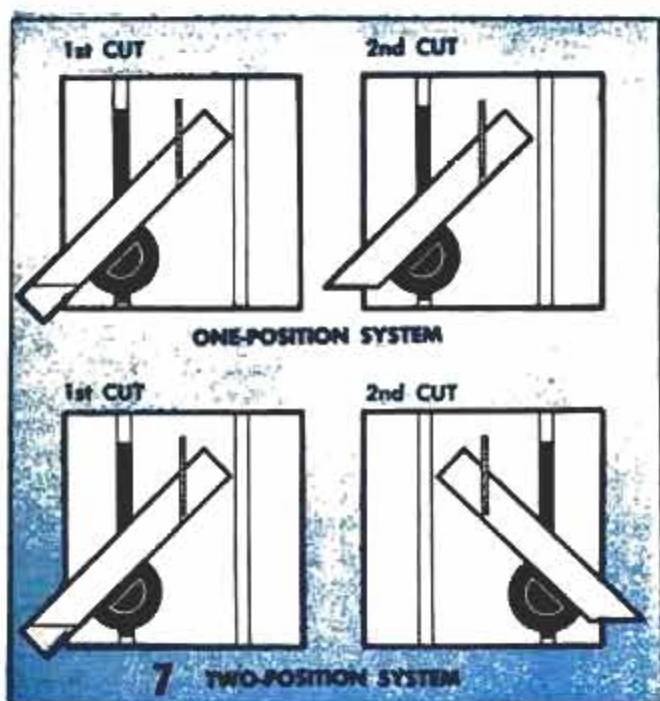

gauge for both cuts, but the work must be face up for one cut and face down for the other. This, of course, can't be done with moldings and various jobs where the work must remain face up. In this case, the open position is used for both cuts but the miter gauge must be turned to the opposite 45-deg. position and used in the opposite table groove, as shown in Fig. 7. If you are doing a lot of molding work, the auxiliary miter table shown in Fig. 6 is useful as it permits right and left-hand cuts at will. The simplest type of miter cut occurs when pieces are cut from a long work strip. Both right and left cuts can be made by simply turning the work alternately edge-for-edge and face-to-back, Fig. 5, using the same miter-gauge position throughout, and without reversing the work end-for-end.

Grooving for splines on crosscut miters can be done freehand with the aid of a

First splining groove is run with stock in this position. Note use of hold-in to keep stock against fence

Opposite end of stock is spline-grooved with piece in this position. Use special care in making cut



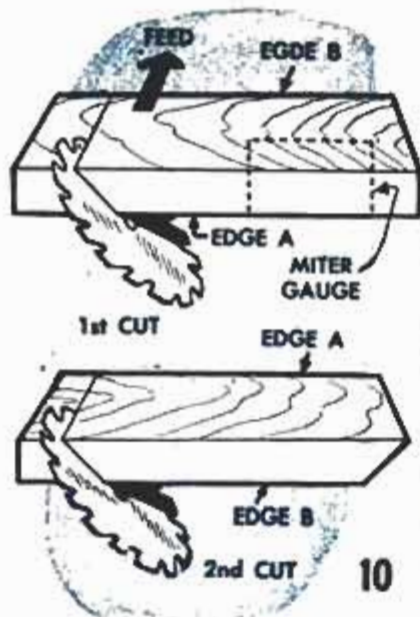

When crosscut mitering as in Fig. 11, use a stop to assure accuracy. For second cut turn stock, Fig. 10

spring hold-in. One end of each work piece can be cut in an open position, Fig. 8, but the other end must be worked in the objectionable closed position, Fig. 9. Only the shallow depth of the cut, rarely exceeding $\frac{3}{8}$ in., makes this kind of freehand sawing practical and reasonably safe. Splines of $\frac{1}{8}$ -in. plywood will usually fit the saw kerf if sanded lightly on both sides. For exact control of the saw kerf width, the well-known trick of slipping a piece of paper between the arbor flange and saw blade is worth keeping in mind; the slight wedging action of the paper will make the saw wobble slightly and cut a slightly wider groove than normal. The spline stock is usually cut square and is fitted slightly beyond the inside corner of the joint, as in the right-hand detail, Fig. 9.

A second type of common crosscut miter is done with the work flat on the table but with blade tilted, Figs. 10 and 11. In work

of this kind the miter gauge is in the 90-degree position and can be used in either table groove as desired, with a slight preference for the right-hand position because this puts cut-off waste pieces under the blade. Both ends of the work can be cut with the same miter gauge position; the face side of the work is up for both cuts but the edges reverse, Fig. 10. It is necessary that the stock be of uniform width, since non-parallel edges would cause inaccuracy in cutting.

Other than the conventional wood fastenings (splines and dowels), there are mechanical fasteners for several types of miter joints. One in common use is known as the clamp nail, which draws the members of the miter joint firmly together, Fig. 13. A special thin blade cutting a 22-gauge kerf is required to cut the spline groove. For narrow work, one method is to cut the kerfs with a band saw, Fig. 12. This is worked with the miter gauge and with end

Miters on narrow stock are often joined with clamp nails. Bandsaw blade cuts a kerf of the right width

Clamp nails have flanges shaped to draw the mitered faces tightly together to form strong, rigid joint

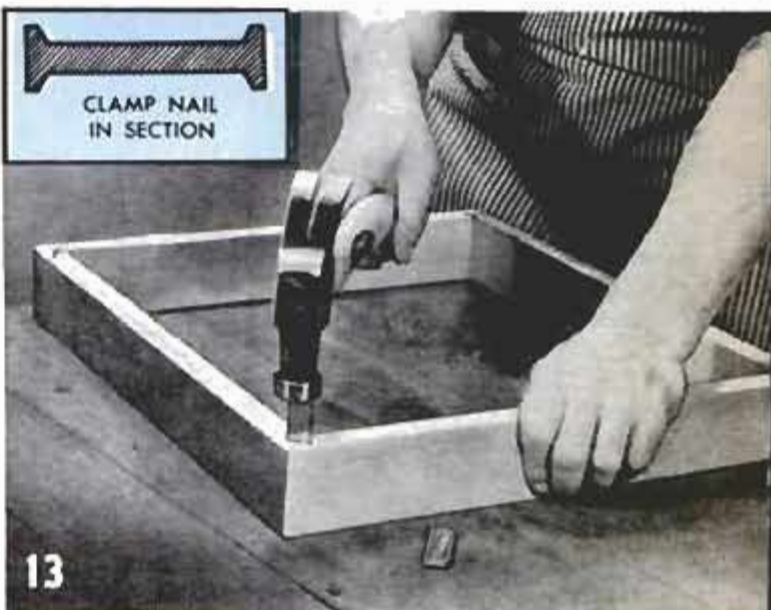
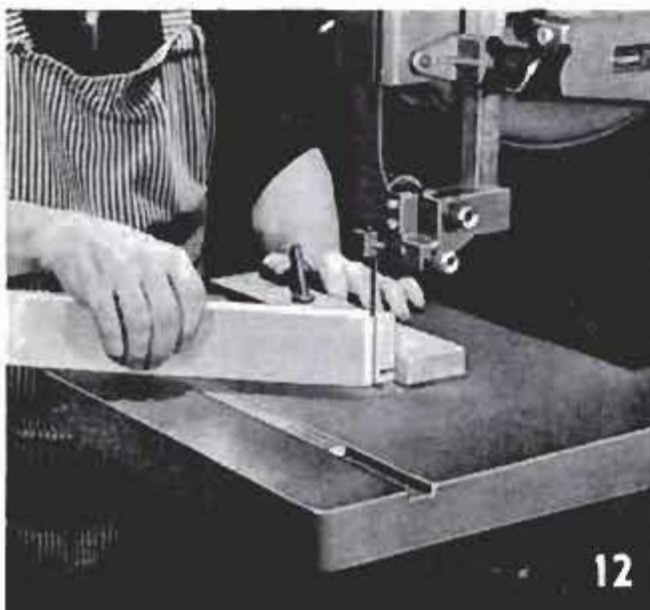

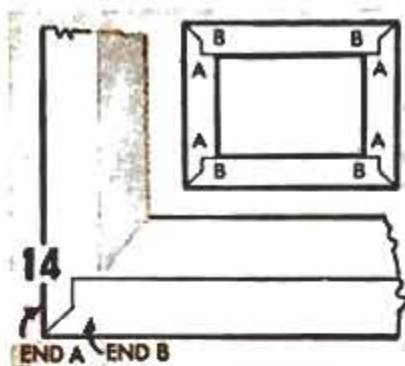

14
In making a rabbeted miter joint cut all parts square to net length



15
Run a test piece with shoulder $\frac{1}{2}$ the work thickness. Use miter blade

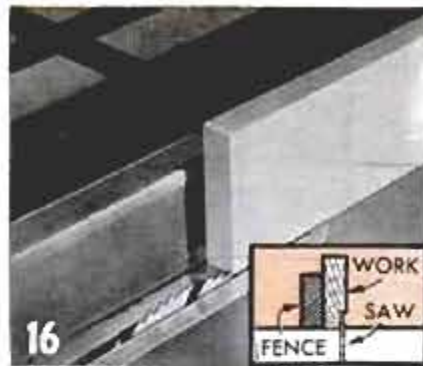

16
Set rippling fence to locate saw blade exactly flush with work face



17
Beginning with end A, Fig. 14, make a shoulder cut with blade in waste



18
Follow with successive cuts to clear waste just beyond miter line

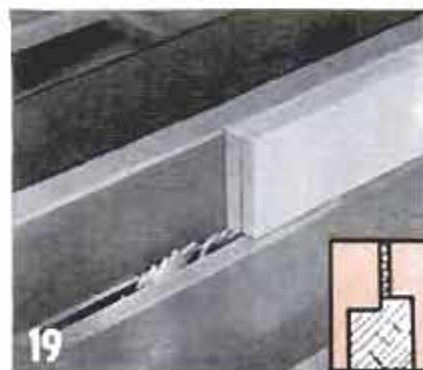

19
Using the test piece set the rippling fence at $\frac{1}{2}$ work thickness



20
Make shoulder cut on end B, Fig. 14. Repeat on all ends marked B



21
Tilt blade to 45 deg. and miter corners on all ends marked B

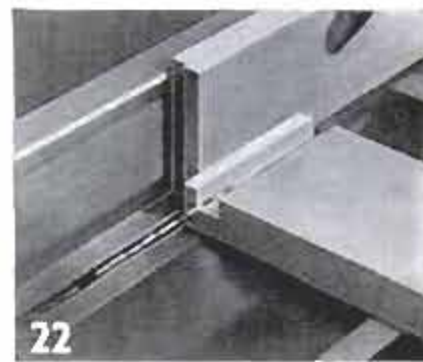

22
Make same mitering cut on all ends marked A. Note use of test piece

and depth stops as shown. The average bandsaw blade produces a kerf of just the right width. The width of the average clamp nail is $\frac{9}{16}$ in.; a saw kerf $\frac{7}{16}$ -in. deep will accommodate and also will allow just the right clearance.

There are many special types of miter joints but the extra work in cutting them tends to limit their use to choice pieces of cabinet work. One such joint, excellent for cabinet bases and similar work, is the rabbeted miter, Fig. 14. Its main feature is the rabbet which provides a square butting corner easily assembled with glue or nails. In an average assembly with four work pieces, the A and B ends of each work piece go together as shown in Fig. 14. Cutting this or any other fancy cabinet joint requires care in making exact saw settings. Follow the step-by-step procedure shown in Figs. 14 to 22.

In all miter work done on the circular saw it is very important to have the miter gauge and saw set at 45 deg. This is simply a matter of checking. Before you start work on the actual job, run cuts on scrap stock and test with a square. If the cuts check true, you are all set to begin work. If not, adjust the miter gauge setscrews or change the settings of the tilt stop.

In all types of miter work it also is important to use a sharp saw blade to give a clean, true cut. If you use a circular saw to make the cuts, it is best to use a hollow-ground blade which runs without set in the teeth. The hollow-ground blade does not chip the lower edge of the stock, which is important when the piece must be reversed or turned over to make a second miter cut. Never crowd the blade. Run all cuts slowly. Hold the stock firmly to prevent creeping.

★ ★ ★

Versatile Combination Tool Is Depth Gauge and Caliper

This combination tool can be used as a depth gauge and as a caliper. Cut a piece of tool steel to $5\frac{3}{4} \times \frac{7}{8} \times \frac{3}{8}$ in. The hole for the lock rod is drilled through lengthwise and each end is tapped $\frac{1}{4}$ -28. The hole for the depth rod is then cross drilled. Harden the stock by uniformly heating it to 1800 deg. F. and cooling it in still air. The depth and lock rods are made of $\frac{5}{32}$ in. drill rod. Heat one end of the depth rod to a bright red, bend it to a right angle and file it to shape. The thumb screw is turned, shaped and threaded on the end of a $\frac{5}{8}$ in. steel bar chucked in the three-jaw chuck. To assemble the tool, insert the depth rod in the stock, and force the compression spring against it with a headless setscrew. Insert the lock rod in the opposite end and turn the thumbscrew in place. The usefulness of the tool will be greatly increased if the depth rod is graduated with marks set at $1/16$ -in. increments.

C. W. Woodson, Chicago, Ill.

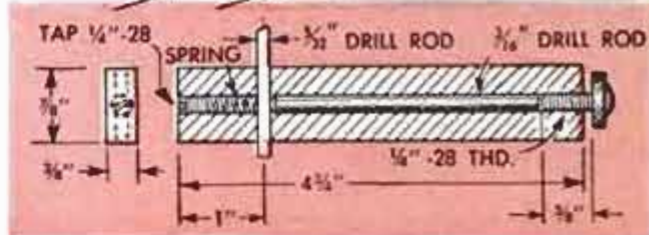
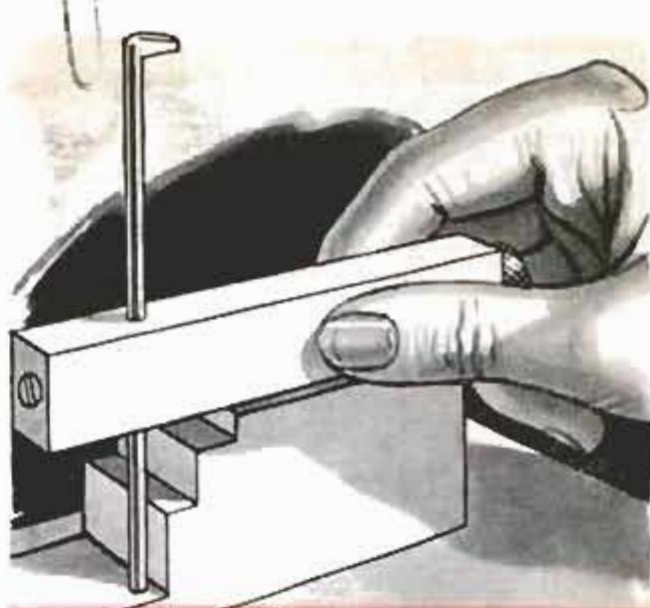

Wooden Tilt Board Turns Hatchery Eggs

With this tilt board, you don't need to lift the egg case to turn the eggs—just tip the board the other way. The case rests on a 1 x 12 x 28-in. board. Cleats across both ends keep the egg case from sliding off. Two 1-in. cleats are screwed to the center on the underside an inch apart. Their inside edges are mitered to allow the board to tilt on the stand at about 40 deg. The stand itself measures 1 x 6 x 16 in. and is braced on both sides by pieces 4-in. high.

A. M. Wettach, Mt. Pleasant, Ia.



Small Setscrew and Nut Hold Stock in V-Block

When you are drilling a hole in round stock, the knurled screwhead of the V-block clamp may interfere with the chuck. Here is a tip which may save you a case of frayed nerves the next time a similar job comes up. Remove the screw from the clamp and in its place use a setscrew of a smaller diameter which will slip-fit into the hole. Run a nut up the setscrew but position it under the clamp. The tension exerted by the nut against the clamp will force the screw down onto the piece being drilled and hold it in place. When clamping a piece in the V-block, simply lift the screw and turn it. The nut, forced against the underside of the clamp, will not turn but will allow the screw to tighten.

Frank LaSaracina, New York, N. Y.

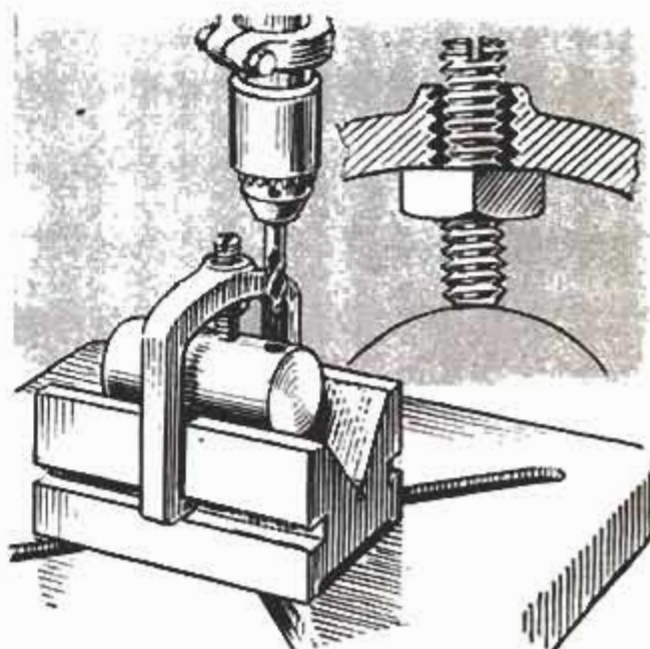

On the
MARKET
for Do-It-Yourselfers

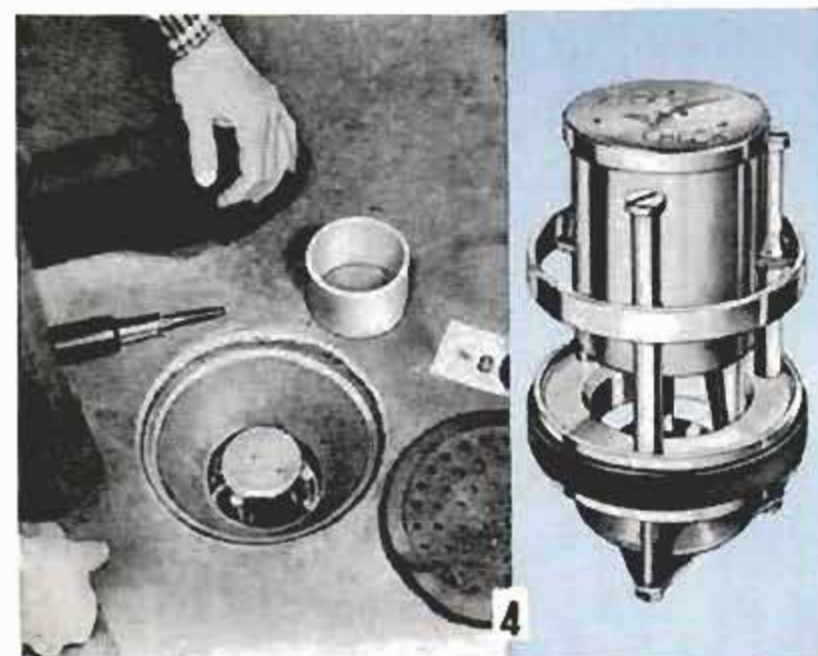
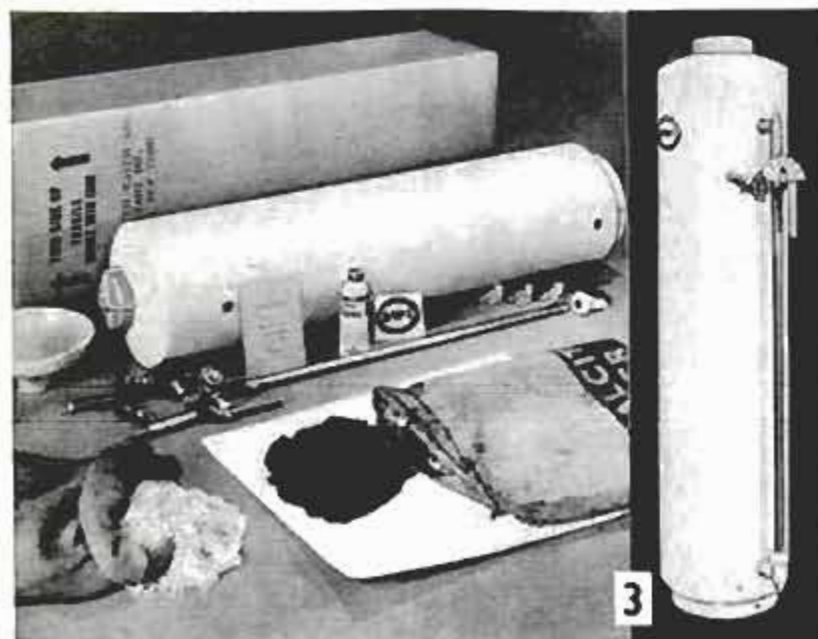

1. MASKING TAPE and a specially developed paper are combined in one large sheet for masking while paint is rolled, brushed, or sprayed. Strip-gummed edges allow use as drop cloth or application to walls, windows, moldings or furniture with light thumb pressure. Do-it-yourself painters and decorators can get professional results
J. E. Fricke Co., Philadelphia 6, Pa.

2. FURNITURE LEGS of molded and colored plastic are made especially for upholstered furniture, coffee tables and phonograph cabinets. In simulated wood and twelve solid colors, legs come in 4, 5, and 6-in. lengths. Extra rigidity, strength and endurance are provided by a metal bolt extending vertically through center of leg
Hassick-Sack, Div. of Stewart-Warner Corp., Winston-Salem, N. C.

3. A SOFT-WATER UNIT and all its benefits are available in an easily assembled softener kit. Unit has epoxy coated 12-ga. steel tank, automatic backwash and regeneration control. Softening is done by a special permanent-type mineral agent. Provides 48,000 grain softening capacity. Entire unit can be installed in 3 hours
Associated Water Industries, 277 Military Rd., Buffalo 7, N. Y.

4. AUTOMATIC DRAIN VALVE "senses" trouble long before it arrives. Sensitive float mechanism actuates a powerful spring which closes the drain. Made of stainless steel and neoprene, valve needs no lubrication or electric power and is clog proof. Installed with three screws in any standard 4-in. drain
Hally Manufacturing, Inc., 427 Lake Ave., Racine, Wis.

POPULAR MECHANICS

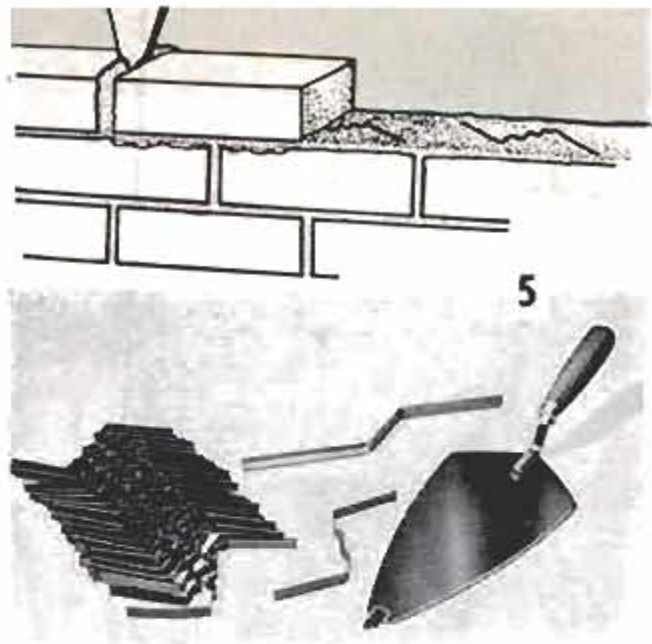

5. HOME BRICKLAYING JOBS take on that professional look when you use this do-it-yourself kit. Supplied in the kit are flat steel spacers which are laid in the mortar under each brick to space the horizontal joints uniformly. Tip on trowel spaces vertical joints and jointing tool supplied finishes both

Lemco Products, 1207 Boyce Ave., Ruxton, Md.

6. METAL POLISHING without drudgery is made possible with a new polish. Originally developed to give a protective coating to earth satellites, this product acts as a polish on all common metals, glass, jewelry. Gives a high luster. Nontoxic and non-flammable, it can be applied easily with a cloth

Certified Mfg. Co., Inc., Ge-Haltin Div.,
41 E. 11th St., New York 2

7. SNOW for Christmas decorations comes in a bag with a "flocking" gun which utilizes air blast from vacuum cleaner. Cost of kit with 1-lb. bag of snow is less than \$5.00. Bag coats 5-ft. tree adequately. White coating really looks like snow, can be colored, is fire-retardant, prevents needle drop indefinitely

General Mills, Inc., 9200 Wayzata Blvd., Minneapolis 26, Minn.

8. HYDRAULIC CLOSER controls door movement even against strong wind. A piston and rod moving through an oil-filled cylinder make the device self adjusting and insure smooth, quiet and positive closing. Barrel fastened to the jamb bracket holds door against sudden gusts and prevents bent rods

The Illinois Lock Co., 800 S. Ada St., Chicago, Ill.

9. SELF-ADHESIVE weather stripping can be used in many different ways. Pressed into place, it reduces vibrations of household appliances and rattles around car doors. Taped around garden tools it prevents blistered hands. Thermal insulating qualities make this foamed tape ideal for refrigerator doors

Little Falls Import Co., 55 Jacobus Ave., Little Falls, N. J.

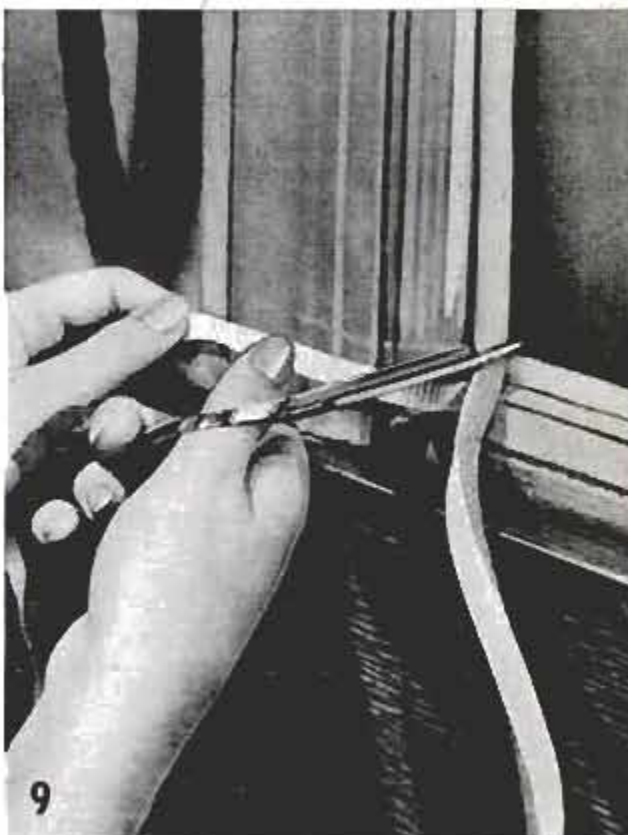



Waxed Bit Drills Clean Hole

If you've had trouble drilling soft metals with a twist drill, try running the bit into a cake of paraffin or beeswax beforehand. The heavy wax fills the flutes and prevents chips from sticking to the cutting edges. This kink works equally well when cutting soft metal on a circular saw. Just push the cake of wax into the blade while it is running. The wax will fill the gullets and prevent clogging and heating. When drilling or sawing soft metals feed slowly and uniformly for a smooth cut.

Centering A Scribed Circle

Locating a layout center on cored castings can pose a rather baffling problem unless you remember this procedure. Cut a piece of hardwood to fit snugly in the bore. Then locate the center of the crosspiece, or "bridge." Center a punch lark on the head of a thumb tack and seat the tack on the center previously located, making sure the tack is driven straight. Then set one leg of the dividers on the punch mark.

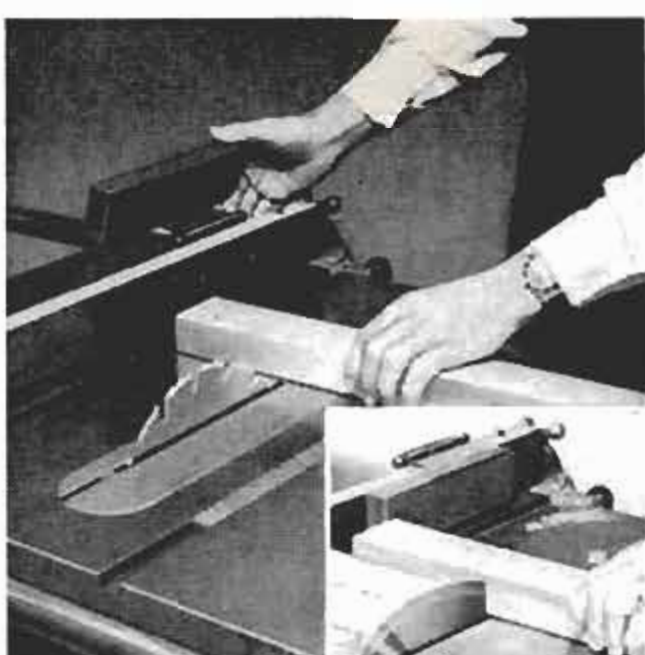
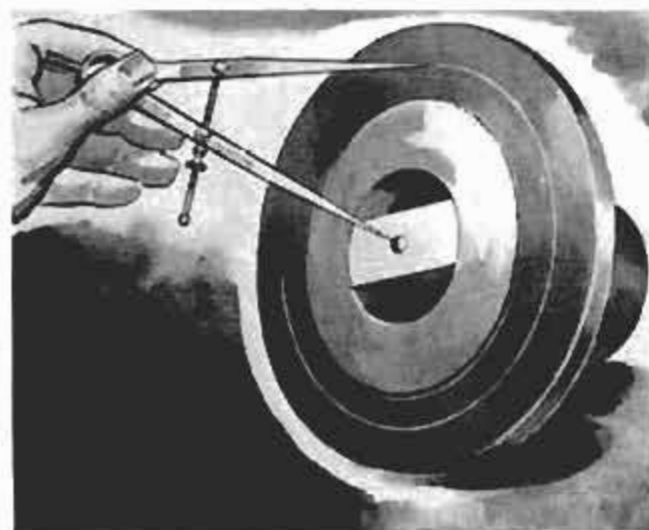

Stop Hinged To Ripping Fence

Instead of clamping a stop block to the ripping fence for use when cutting duplicate lengths, hinge the block to the fence as pictured. Use a $\frac{3}{4}$ x 2 x 6-in. block. Extend one leaf of a butt hinge by welding a strip of $\frac{1}{16}$ -in. flat steel to the outer edge. Drill holes in the extension piece for wood screws. Attach the block to the hinge. Then drill and tap the fence for cap screws which hold the hinge in place. Adjust with shims if necessary so that the block fits snugly against fence when in the down position.

Prevent Rust On Shop Tools

Coating machine tables, hand saws, wide chisels—any machined or polished surface—with ordinary paste wax will prevent rusting of the exposed metal where dampness is present, especially in a basement. On machine tables such as that of the circular saw, the wax serves a twofold purpose, prevents rusting and permits the work to slide easily over the surface. The wax coating should be renewed periodically.



come
try the car with
so much that's

new

so much
that's

different!

THE SUPERLATIVE 1960 CHEVROLET



*There's nothing like a new car—
and no new car like a '60 Chevrolet.
The Bel Air 2-Door Sedan.*

Every tasteful line of this superlative '60 Chevrolet seems to tell the luxury cars to move over—from the proud jut of its prow to the saucy cut of its rear deck. ■ And the hushed elegance of its roomier new Body by Fisher repeats the refrain—with finely tailored fabrics, sofa-wide seats and a lower-than-ever transmission tunnel that'll please you right down to your toes. You'll luxuriate, too, in the way this new Chevy's Full Coil ride—insulated from road shock and noise by thicker, newly designed body mounts—rivals the poise of even the costliest cars. ■ Yet, sumptuous as this '60 Chevy is, it remains more dedicated than ever to those proved Chevrolet virtues—economy and dependability. There's a choice of two standard engines that do marvelous things with mileage—the famed Hi-Thrift 6 and a new Economy Turbo-Fire V8 that gets up to 10% more miles on a gallon of regular. Your dealer's the man to see for the facts. Chevrolet Division of General Motors, Detroit 2, Michigan. ■ **nearest to perfection a low-priced car ever came!**

CHEVROLET



The superb new Kodak Retina Reflex S— makes you master of every picture-taking situation. Built-in light meter. Automatic

exposure control. View *and* focus through the lens. Accepts full family of lenses, 28mm to 135mm. With *f*/2.8 lens, \$199.50.

Kodak suggests a "Give

Give Kodak gifts for a happy Christmas!



Brownie Starflash Outfit—For snapshots *and* color slides! Includes built-in flashholder, bulbs, batteries, film. Only \$10.35.

Brownie Starmatic Outfit—Electric eye sets the lens! Camera, field case, flashholder, bulbs, batteries, film. \$45.95.



Kodak Signet 80 Camera—Fine 35mm, easy to use. Light meter, rangefinder, *f*/2.8 lens. Accepts interchangeable lenses. \$129.50.

Kodak Cavalcade Projector—Changes slides *by itself!* Turn it on, it does the rest. Model 510, with brightness control, \$159.50.



Many photo dealers offer terms as low as 10% down. Prices are list, include Federal Tax, and are subject to change without notice.

See Kodak's "The Ed Sullivan Show" and "The Adventures of Ozzie and Harriet"



The Kodak Cine Scopemeter Camera, Turret f/1.9, shows correct lens setting automatically. Built-in exposure meter, filters,

three-lens range. Only \$99.50. 8mm Kodak Cine Showtime Projector threads itself all the way—automatically. Model A20, \$137.50.

and Take Christmas

Take pictures to save and share the fun!



Brownie Movie Camera Kit, f/2.3—Color movies easy as snapshots. Complete with camera, light bar, lamps, titler board. \$39.95.



Brownie 8 Movie Outfit—Includes Brownie Movie Camera, f/2.3, Brownie 8 Projector, plus 200-foot reel and can. \$78.25.

Brownie Movie Camera, Turret f/1.9—Three-lens range at a 1-lens price. Takes normal, wide-angle, telephoto shots. \$67.50.

Brownie 500 Movie Projector—Most brilliant of Brownie projectors gives half-hour shows, reverses action, shows stills. \$79.50.

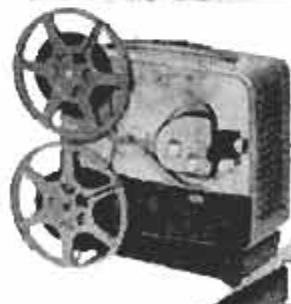
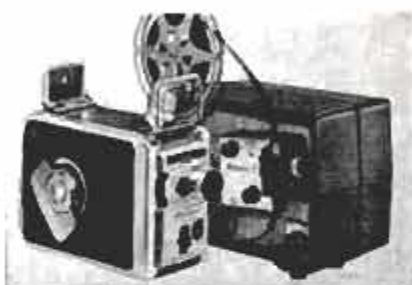

EASTMAN KODAK COMPANY, Rochester 4, N. Y.

Kodak
TRADEMARK

SOUTH BEND

for
PROFITS.....
PRECISION..
PRODUCTION

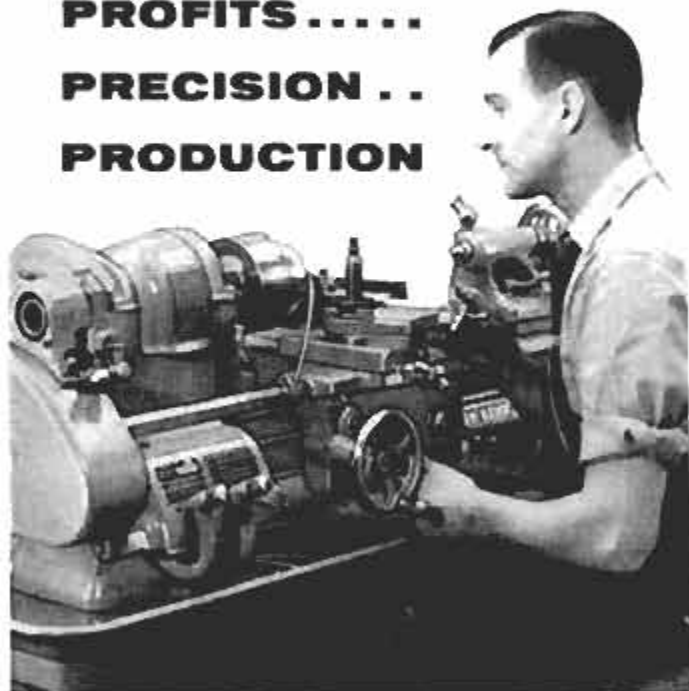

BENCH LATHES-9", 10-K and 10" sizes in independent change gear, quick change gear and toolroom models.

FLOOR LATHES-9", 10-K, 10", 13", 14½", 16" and 16-24" sizes in quick change gear and toolroom models—129" maximum between centers on 16" lathes.

TURREY LATHES-10", 13" and 16" sizes with 1-1/16" collet capacities.

MILLING MACHINE-Vertical spindle type with universal 360° swivel head.

BENCH SHAPER-7" stroke. Only shaper of this size with pressure lubrication system.

DRILL PRESSES-14" precision type in bench, floor and multiple spindle models.

PEDESTAL GRINDERS-8" and 10" wheel sizes. More room for work and for hands.



WRITE FOR CATALOG

Fully describes and illustrates all the features of the above machines plus many tools, attachments and accessories.

SOUTH BEND LATHE
SOUTH BEND 22, INDIANA
Building Better Tools Since 1906



Up to 24
months to pay.

Clinic for Homemakers



As a service to our readers in solving the hundreds of problems pertaining to a home—inside or out—the editors of *Popular Mechanics* invite you to present your problems to The Clinic Editor for help and advice. Address your questions to The Clinic Editor, *Popular Mechanics Magazine*, 200 East Ontario Street, Chicago 11, Ill.



Repairing Sink Top

Q—My sink top is quite old and was made by cementing linoleum to plywood. Although worn it still is in good condition over the whole area except near the sink rim where two small cracks are opening. I'm told on the one hand that the thing to do is replace the linoleum top entirely and on the other that the cracks are easily

patched. Which, in your opinion, is the best procedure?—P.T., La.

A—It's rather hard to say with certainty at such long range. Ordinarily we would think of patching, especially if the sink top is large, extending, say, across the end of the room. But if, on the other hand, the top is relatively small, then it might be best to replace it entirely with a plastic-faced countertop. Patching a linoleum top is quite simple to do but requires painstaking care in order to finish with a neat, tight fitting patch. Of course, a matching linoleum must be used, and it should be of the same weight and quality as the original. Begin by marking out an area about the crack which is large enough to include all damaged linoleum in the waste to be removed. Mark approximately the same area on the patching material, cut out a section somewhat larger than the marked area and then place this over marked waste that is to be removed. Tape the piece down securely and then, with a sharp knife cut through both thicknesses, the knife being canted outward at a slight angle. Lift off the patch thus cut and remove the waste from the original top, making sure that all the old cement is removed and the bare wood exposed. Coat the bared area with linoleum cement and immediately press the patch in place.



Condensation in Walls

Q—I have an older home with blow-in insulation in the north and west walls, none in the south and east walls. Recently I removed plaster from a west and south wall when making a repair. I found that the insulation and framing in the west wall was damp with moisture, but that in the south wall was perfectly dry.

What causes this condition in one and not in the other?—W.H., Minn.

(Continued to page 210)

(Write your name here)

of Stanley Tools I want for Christmas

Dear _____

(Write your Stanley Claus' name here)

I'd like a Stanley Tool from this list if you want to give me something I really need and will use. I've numbered my choices in order of preference. It won't

just be a surprise. It will be a Christmas gift I'll use and appreciate all year long and many years to come.



"YANKEE" Push Drill. Has eight drill points in magazine handle. Perfect for small holes, lead holes in wood, plastic and plaster. **\$6.95**



"BIG 6" Folding Rule has extra thick sticks, bigger joints and big, clear, black markings protected by tough plastic coating. **\$1.98**



STEELMASTER Camp Axe. The ideal gift for outdoor man or boy. All steel with Neoprene grip. Sewed leather sheath for convenience and safety. **\$7.50**



STEELMASTER Hammer. The finest hammer ever made. Tempered rim minimizes chipping. All steel with comfortable cushioned grip. **\$4.99**



SURFORM File. The exciting new tool for cutting and shaping wood and many other materials. Replaceable blade. **\$2.69**



SWIRLAWAY flexible ball-joint sander and polisher fits any electric drill. Complete kit with 3 sanding discs and polishing bonnet was \$5.95, now only **\$3.69**

Special Note to the Men of the House

Here's your chance. Reduce the possibilities of too many ties for Christmas. Cut out this part of the page and leave it where it will do the most good. You know Stanley Tools.

You know what you want. Many times the ladies and youngsters don't. Help them out. They won't mind and you'll be glad you did.

Stanley Tools—The Tool Box of the World
A Division of The Stanley Works, New Britain, Conn.

STANLEY



MOSSBERG**K**
MODEL**SHOTGUNS****bring
home
the
game****195K**
12 gauge
3-shot
repeater**Here's why:****RIGHT PATTERN**—instantly, with Mossberg's factory-installed C-LECT-CHOKE. Settings are positive and clearly visible.**ON TARGET BETTER and FASTER**—because of correct balance—and safety is behind the barrel at your right thumb. No hand shifting, no fumbling.**COMFORTABLE SHOOTING**—cushion rubber recoil pads. Barrel vents behind choke where they're most effective.**SURE OPERATION**—Mossbergs are factory guaranteed. Yet less than 1 in 1,000 comes back for repair.

195K (12 ga.)	185K (20ga.)
\$41.95	\$37.95
190K (16 ga.)	183K* (410 ga.)
\$40.95	\$35.95

*No recoil pad. No barrel vents.
Prices \$1.00 higher west of Rockies.

Ask your dealer to show you Mossberg's K Model shotguns. They bring home the game.

FREE: For Mossberg's new, fully illustrated catalog, tear off the bottom of this ad, write your name, street address and town in the margin, and mail to**O. F. MOSSBERG & SONS, INC.**
99712 St. John St., New Haven 5, Conn.**Mossberg**
for accuracy

(Continued from page 208)

A—Condensation. Space does not permit a lengthy discussion of why and how this variation is brought about, but stated simply moisture-laden warm air passes rather quickly through the uninsulated wall to the drier air outside. The air passing through is not cooled to the dew point within the wall and for this reason the moisture it carries does not condense. Insulation in the west and north walls, which are not faced with a vapor barrier on the room side, slows the passage of warm air and at some point within the wall the dewpoint is reached and the moisture condenses. It is this condensate that causes the condition of dampness you describe. Had the west and north walls been protected with a barrier which prevents moisture entering the wall from the room side, you would not find the framing and insulation damp. Curing this trouble in a home already built is not simple, as all component parts of the wall are permanently in place. One rather makeshift procedure that does help to some extent is to paint the affected outside walls on the room side with two coats of oil-base paint. The only fully effective step is to remove the plaster on the room side of the uninsulated walls, apply a vapor barrier, and finish with plasterboard, or with conventional lath and plaster.

**Removing
Water Stains**

Q—I have a drop-leaf table, some years old, and there are several discolorations on the top which look to me like water stains, the areas affected being a whitish-gray color with the grain of the wood showing. Otherwise the finish is still in quite good condition. Can these discolorations be concealed without removing the old finish and refinishing with new materials?—O.E., Tex.

A—We assume that the wood has been stained under the original finish and that the water-stained areas will have to be darkened to match as nearly as possible. No procedure can be said to be entirely reliable under such conditions but we would suggest that you try an old method which almost invariably gives good results. Pour olive oil into a shallow container and add scrapings from a white candle (if the wood is a reddish color add scrapings from a red candle). Heat this mixture until the wax melts and apply to the water-stained area with a piece of soft cloth folded into a pad. Rub lightly with an easy circular motion until the oil from the first application is absorbed. Wait a few minutes and then polish with a linen cloth. If the spot is still lighter in color than the adjacent finish, apply again and polish in same manner.

Painting Brick

Q—My home is old and the walls are brick and natural stone. Mortar joints in both the brick and stonework need pointing up with new mortar. This done this coming spring I want to paint the masonry but I'm at a loss to know what kind of paint to use. I'm told to use a masonry paint, as this will not peel. Also I'm advised to apply only an oil-base exterior paint. The reason seems to be rather vague. What is your opinion?—W.D., Pa.

A—Why paint the masonry? It would seem to us that a house having masonry walls of brick and stone would be quite attractive just as it stands, especially after the mortar joints have been cleaned and repointed in a professional manner. In our opinion paint will add little if anything, except possibly color, to the brick work and it certainly will not enhance the stonework, especially natural stone or field stone. There are two other points to be considered. Once masonry has been painted one must accept the painted finish with little possibility of change except the color. Painting a home built of masonry and brickwork may change its general appearance appreciably. Also, certain stones in the wall may be of much greater density than others and neither a masonry paint nor an oil-base paint will bond solidly to these. We do think that it would be advisable to coat the walls of brick after pointing with a clear masonry sealer.

**Kookie,
lend me
your
TOPPER**

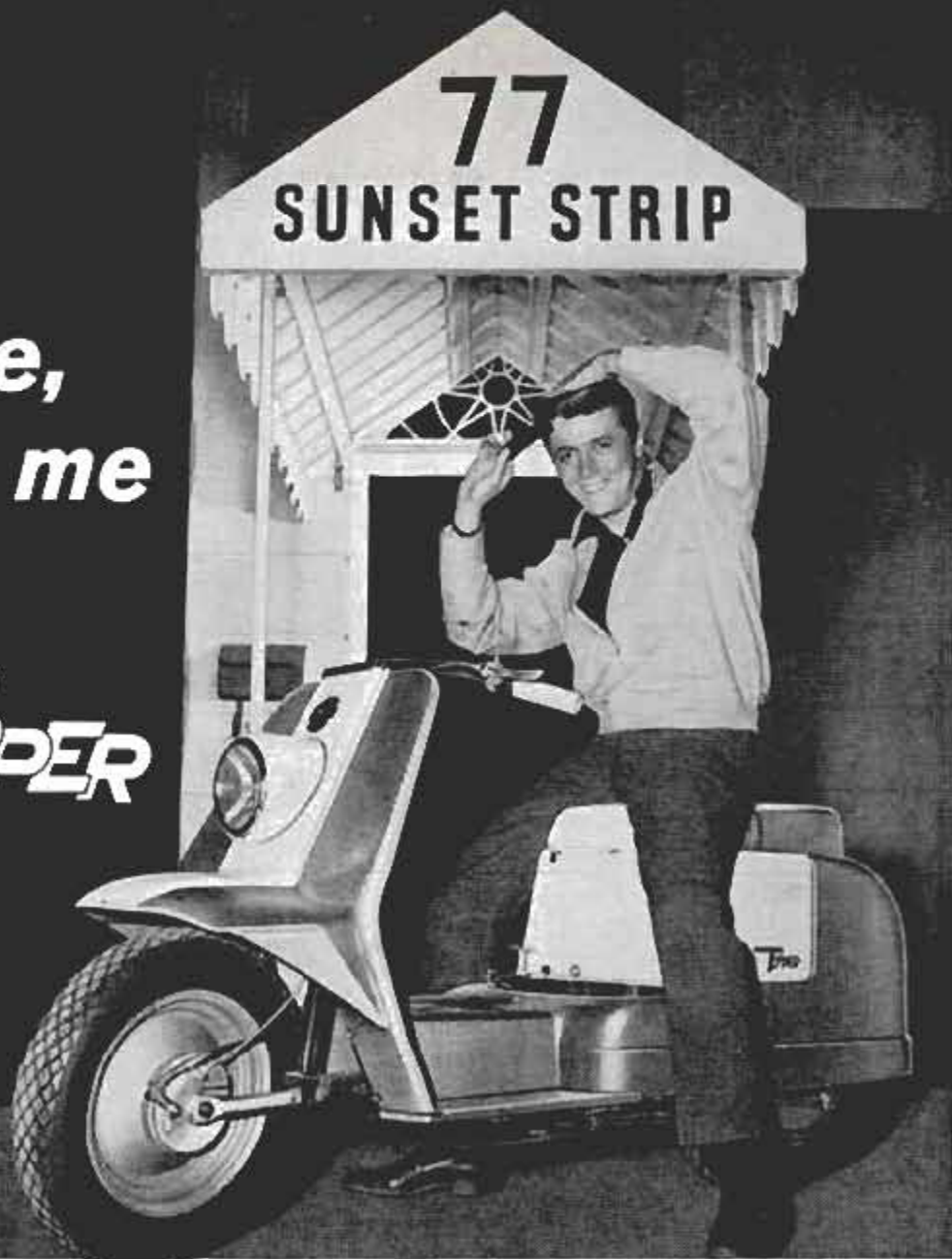

See EDD "KOOKIE" BYRNES

starring in "77 SUNSET STRIP" a WARNER BROS. TV production.

Tops under the Christmas tree this year...

because it's tops in appearance . . . tops in performance. There's so much new about the sensational Topper that we can only touch on the highlights. Things like automatic *Scot-away* transmission . . . finger-tip handling . . . silky-soft ride . . . sleek lines moulded in fiberglass . . . stop-on-a-dime brakes . . . 100 miles to the gallon economy.

Advice to Teenagers: When it comes to combs and scooters, never a borrower or a lender be. Instead, start dropping hints to Mom and

Harley-Davidson
MOTOR CO.
MILWAUKEE 1, WISCONSIN

Dad about the new exciting Harley-Davidson Topper.

Advice to Parents: Go see your Harley-Davidson dealer and learn more about young America's safest, most responsible transportation . . . or mail the coupon for free folder.

HARLEY-DAVIDSON MOTOR CO.
Dept. P Milwaukee 1, Wisconsin

Send me more information on the
Harley-Davidson Topper.

Name.....Age.....

Address.....

GIFT SUGGESTION FOR CIGAR SMOKERS



Give a carton of TREND—200 wonderfully mild, satisfying little cigars. He'll like the modern TREND size . . . short enough for busy people to enjoy anytime. A superior blend of Havana cigar tobaccos with big cigar taste and aroma. Free Trend cigar holder with each carton.

Humidor Pack of 20—35¢ Carton of 200—\$3.25

(Plus applicable state and local tax)



GET THIS GIFT CARTON

at leading tobacco counters everywhere

Stephano Brothers, Cigar Division
Philadelphia 7, Pa.

PIONEER IN MODERN LITTLE CIGARS

Early American Clock

(Continued from page 159)

drilled in both plates and take the spacers. The holes marked B are brass-bushed on both plates, are drilled $\frac{1}{8}$ in. through and counterbored about $\frac{1}{16}$ by $\frac{1}{4}$ in. to take the bushings, which are disks cut from $\frac{1}{4}$ in. round brass. The disks are $\frac{1}{16}$ in. thick and are center-drilled with a No. 52 twist drill. Nylon bushings are available, but if you use these have them at hand so that you can determine the counterbores.

Note the hole B at the center of the larger $1\frac{3}{8}$ -in. hole drilled in the front plate. The large hole forms the opening for the escape wheel. The hole B is drilled in the back plate and is bushed for one end of the spindle carrying the escapement. The other end of this spindle is carried in an outboard bearing as in Fig. 21. Making and installing this bearing will be covered in Part II. The hole taking the rear end of the hand post is bushed in the back plate in the same manner as that taking the rear end of the escapement spindle. In the original movement the holes taking the winding drum spindles were drilled $\frac{1}{8}$ in. diameter in the back plate and $\frac{5}{32}$ in. in the front plate. These holes are not bushed.

Note the four $\frac{7}{16}$ -in. holes drilled near the corners of the top plate. Holes for $\frac{1}{16}$ in. pins are drilled into these holes from the edges of the plate as indicated by the dotted lines. The small holes take pins which hold the movement in place. The pins pass through holes drilled in the movement supports as at A in Fig. 2. The holes in the supports should not be drilled until the movement has been completed.

The count-wheel keeper, shown in position in Figs. 21 and 28, is detailed in Fig. 26. The count-wheel spindle also is shown in Fig. 26. This is made from a short length of dowel and the location of the hole into which it is fitted and glued is shown in Fig. 22. The bearing block for the count-wheel pinion is detailed in Fig. 27 and shown in place on the front plate in Fig. 28. It is made from oak to the size given and when in position forms the outboard bearing for the count-wheel pinion. Note that the blind hole which forms a recess in the block for the pinion is fitted directly over the $\frac{9}{16}$ -in. hole in the front plate. The bearing block is glued and bradded in place and note from Fig. 21 that it is set at an angle of about 15 deg. The plate spacers, Fig. 25, are turned from hard maple or birch and care must be taken to turn them all to the same length between the shoulders. They are bradded and glued in the holes drilled in the back plate.

(To be continued)



TIPS FROM TEXACO

Seven ways to save the life of your battery this Winter

Cold weather is rough on your battery. At 32°F. even a fully-charged battery delivers only 50% of its power! At 0°F. only 40%.

- 1** Starting causes the most drastic drain. So, before you start, be sure all electrical units — lights, radio, heater, etc. — are *off*.
- 2** If your car has a manual shift, be sure it is in neutral *and* depress clutch. Avoid flooding engine by pressing accelerator clear to floor *once*, then engage starter.
- 3** If engine doesn't start, check gas supply. In damp weather, wipe off spark plug porcelains with a *dry* rag. Then try it.
- 4** Cold garage? Not using your car often during extreme cold weather? It will pay you to buy an inexpensive trickle charger. Hook in overnight as required.

5 Best plan for cold weather: have your battery looked at, at least every 2 weeks, by your Texaco Dealer. He will check water level, test, and re-charge if necessary. This may save the life of your battery.

6 Keep terminal clamps *clean*. (Every time you have a Texaco Fall Safe-T check-up, your Texaco Dealer will remove corrosion and protect with coating of Marfak.)

7 Take the cold-weather load off your battery and engine by keeping crankcase filled with Havoline Special 10W-30. This is the *all-temperature* motor oil that stays free-flowing, prevents cold-starting wear (with less drag on your battery) — prevents harmful varnish, sludge and deposits.

Buy the best . . . buy TEXACO

TUNE IN: TEXACO HUNTLEY-BRINKLEY REPORT / MONDAY THRU FRIDAY / NBC-TV



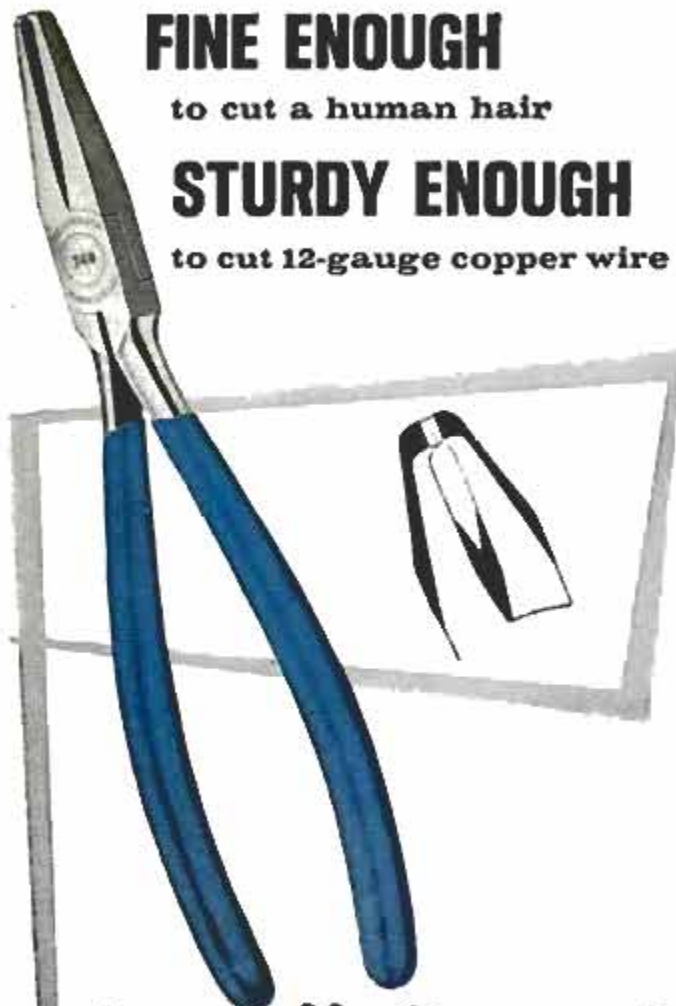

FINE ENOUGH

to cut a human hair

STURDY ENOUGH

to cut 12-gauge copper wire

Specially Designed

CHANNEL LOCK[®]

No. 748 Long-reach

End Cutter

Here's the answer to your hard-to-get-at wire cutting jobs . . . the CHANNELLOCK Long-Reach End Cutter. Gets into tight places you can't reach with any other cutter. Especially handy for electrical, radio, TV, Hi-Fi and electronics work. Precision-honed, specially hardened cutting edges. Long, blue-plastic coated handles. Top quality polished forged steel. Ask your tool supplier for a CHANNELLOCK No. 748 End Cutter. If he doesn't have one, ask him to order it for you.



Write for Catalog of
Complete Line of Pliers

CHAMPION DEARMENT TOOL COMPANY

Meadville 1, Pennsylvania

Oil Hunters With Aqualungs

(Continued from page 112)

Frequently the divers in the Gulf see eye to eye with tropical fish—technicolor at its best. Swimming up to peer into face masks are red snapper, angelfish, sheepshead, triggerfish. One species, unscientifically identified as "ostrichfish," doesn't go for close-ups. As soon as a diver approaches, this fish sticks head—and tail—into the sand until the disturbance stops.

The divers have raised several questions for oceanographers, such as:

After the death of shell-plated marine life such as oysters, clams, snails and echenoids, what happens to the shells? Do they remain where death occurred or are they tumbled about by wave and current pressure? If so, how far?

Sands of beaches usually grade into finer-grained sediments seaward, and those of barrier islands and offshore bars may grade into finer sediments both shoreward and seaward, but how gradual is this transition and what is its cause?

Most of the big oil fields are in what is known as "structural traps"—subsurface closures formed by the subterranean folding and fracturing of rock layers. But some of the very biggest oil finds, including the great East Texas strike, have been in stratigraphic traps. These are sandstone bars of limestone reefs formed in ancient seas by the gradual deposition of sediments over a period of many centuries.

Finding stratigraphic traps by conventional exploratory methods is about as difficult as locating a diamond lost in a newly spaded garden. Luck is an important factor. Many of the big oil fields in stratigraphic traps, such as the Pembina field in Alberta, were discovered while drilling for structural traps.

What the divers in the Gulf of Mexico hope to accomplish is to lessen the importance of the luck factor. And they may be like the Texan who was drilling for water in his back yard and complained that all he could get was oil.

A report issued in February this year by Dr. Roger T. Revelle, Director of the Scripps Institution of Oceanography at San Diego, states that the ocean bottoms are "strewn with deposits of manganese and cobalt so rich they probably could break the world market in those metals if they were mined on even a modest scale."

All of which leads to this conclusion:

Man today is pretty busy investigating the stratosphere, but there is still plenty to be learned in the ocean depths. ★ ★ ★

READY FOR A FLYING START

AS A U.S. AIR FORCE PILOT

The Air Force pilot is a man of many talents. He is, first of all, a master of the air—and no finer exists. In addition, he has a background in navigation, airborne electronics and engineering. Then, too, he must show outstanding qualities of leadership, initiative and self-reliance. In short, he is a man eminently prepared for an important technological future in the new Age of Space.

Find out if you can qualify for training as an Air Force pilot. Paste the coupon below on a postal card and mail it now.



GRADUATE THEN FLY

U.S. AIR FORCE
AVIATION CADET PROGRAM

MAIL THIS COUPON TODAY

Aviation Cadet Information, Dept. MM-912
Box 7608, Washington 4, D. C.

Please send me details on my opportunities as an Aviation Cadet in the U. S. Air Force. I am a U. S. citizen, between the ages of 19 and 28½ and a resident of the U. S. or possessions.

Name _____ College _____
Street _____
City _____ Zone _____ State _____



STANLEY

**Perfect Christmas
Gifts at Perfect
Christmas Savings**

MODEL 1475

Heavy-duty sabre saw — only \$44.50, plus 7 blades worth \$4.90—FREE! Lowest-priced heavy-duty sabre saw you can buy. Cuts scrolls, curves, wood, metal. Special blades cut flush up to a wall and to $\frac{5}{8}$ of an inch along a wall.

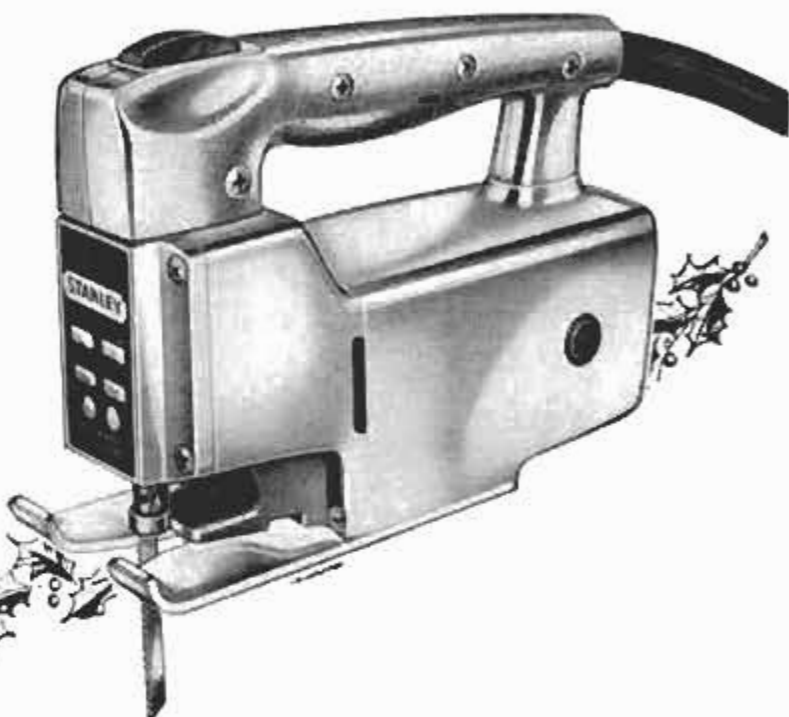

MODEL H131

\$6.00 Off on 3-amp $\frac{1}{4}$ " drill. Reg. \$24.95 Stanley Christmas special price — \$18.95 Most powerful $\frac{1}{4}$ " drill for the price on the market. *Plus* rugged bearing construction, non-slip pistol grip, 3-jawed geared chuck, 3-wire cord.



Electric tools built for the professional,

Christmas Specials



MODEL H36

Heavy-duty orbital sander — \$49.95
Get 2 permanent abrasives . . . FREE!
You save \$4.00 and lots of work, too. Powerful, rugged, the H36 gives satin-smooth finishes, fast!

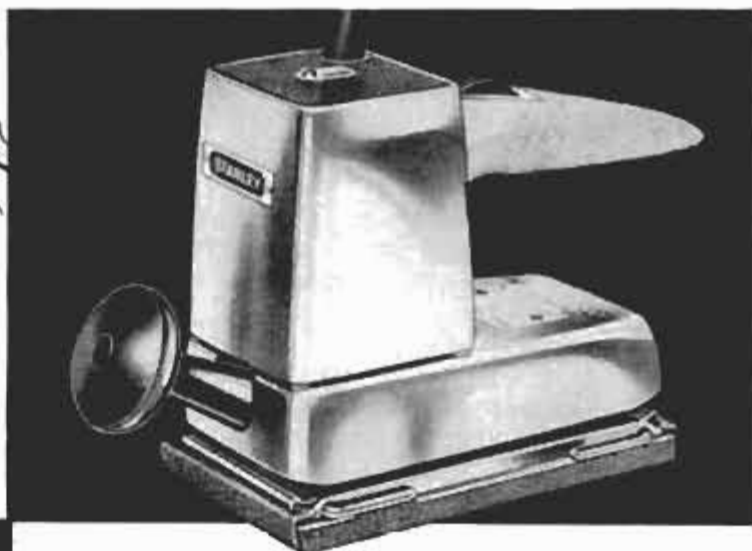

MODEL H81

Save \$4.30 on new power drill kit.
A \$43.25 value, now only \$38.95.
Complete with 3-amp 1/4" drill, steel case, and 19 extras, including famous SWIRLAWAY sander/polisher.

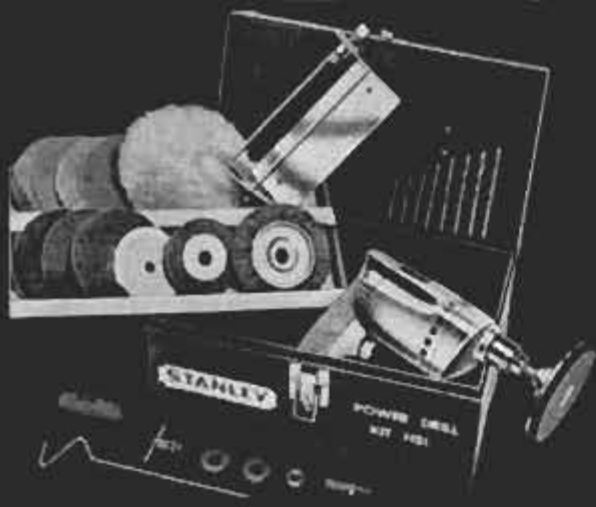

MODEL H28H

\$15.00 Off on complete builders saw kit. \$67.95 value . . . now — **\$52.95**
Powerful 6 1/2" saw has rear controls, Free-start guard, ball-bearings. And you get case, etc.—*free!*

Stanley Electric Tools, Div. of The Stanley Works, New Britain, Conn.

*Prices slightly higher in Canada
Canadian office: Hamilton, Ont.*

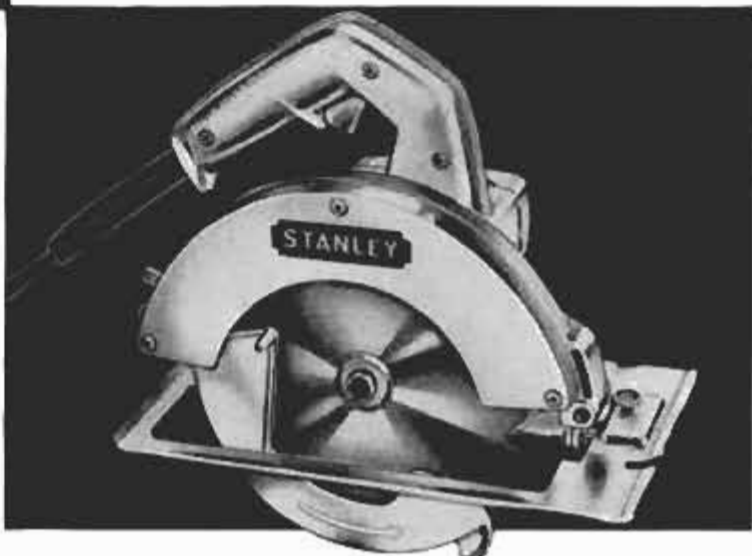

priced for everyone

STANLEY

®

"Cat Eye" Turns Night Into Day

(Continued from page 103)

sifier layers are placed between the photosensitive surface and the target screen. For every electron given off by the photosensitive surface, the first intensifier gives off 10 to 20. This process of electron multiplication is repeated by the second intensifier, with a resultant 100-to-1 ratio between the photosensitive layer and the target plate.

The result is that light levels 1000 times below the needs of a standard pickup will provide a usable picture. The tube, in short, is 10,000 times more light-sensitive than the fastest photographic film.

This special Cat Eye pickup is coupled directly to the 10-inch telescope at Wittenberg College's Weaver Observatory. Because of its speed, photographs can be made from a monitor screen at less than 1/25 of a second. This eliminates the jitters that plague normal photographic exposures as a result of fluctuations in the earth's atmosphere. Even more important, it provides vast new ranges of contrast that reveal hitherto-unseen detail.

Night Vision for the Army

A similar but less complicated device has been developed by RCA for use by the Army as a night-vision aid. Resembling a rather stubby telescope with a dangling electric cable, this unit also combines optics with electronics. A double-image tube, the first stage serving as a preamplifier for the second stage, picks up and amplifies the weak light gathered by the lens. A system of transformers and transistors takes power from a six-volt battery and converts it into a 25,000-volt kick to power the tube.

The Army and RCA don't say just how the tube works, but chances are it's a relative of the Cat Eye image orthicon.

In the long run, however, the development with the most far-reaching possibilities is the discovery of electroluminescence. General Electric researchers several years ago demonstrated that certain phosphors, when electric current is passed through them, will actually amplify light directly.

They proved this by making a special screen of the phosphor and attaching two electrodes to it. A lantern slide was projected onto this phosphor screen with a projector, using ultraviolet light. The resulting image was extremely dim until current was passed through the screen. The image then showed a 10 times increase in brightness.

Normal light, X rays and other types of radiation have the same effect on the phosphor screen as does ultraviolet light.

Since this initial demonstration, the de-

vice has been improved by General Electric and RCA researchers through the addition of a photoemissive material that gives off electricity when light strikes it.

Persistent Image

So far the unit has not proved applicable to television because it tends to retain an image, thus ruling out the rapid building up and breaking down of individual pictures that is the heart of the television illusion. But RCA has turned this problem to good advantage by adapting electroluminescence to the X ray fluoroscope.

The company took a medical fluoroscope and replaced the conventional viewing screen with an electroluminescent panel equipped with its own power supply. The electroluminescent viewing screen yields normal image intensity at a fraction of normal X-ray exposure. With normal power the unit gives an image 100 times brighter than that supplied by a standard fluoroscope screen, making it possible to view the image in moderate room light. Since the image can be made to persist up to 30 seconds, the screen can be inspected after the X rays have been turned off and the subject has walked away from the machine.

Researchers are now hard on the trail of the image-persistence phenomenon. When they lick the problem, they will be opening new vistas not only for television but a host of other applications. ★ ★ ★

Compound Makes Fabrics Immune to Insects

Fabrics can now be impregnated with an antimetabolite compound that makes them immune to insect attack. The compound makes the material indigestible to carpet beetles, clothes moths and other insects for the fabric's lifetime. Structurally similar to essential nutrients, the compound has slight differences that eventually lead to the death of young insects. Mature insects recognize the antimetabolite quickly and leave the impregnated material.

Skim Milk Halts Plant Virus

Scientists are recommending that tobacco growers spray their crops with a skim-milk solution to inhibit tobacco mosaic virus. Tests have shown that skim milk not only protects tobacco plants, but peppers and tomatoes as well; when tomato and pepper pickers dip their hands in skim milk, the incidence of mosaic virus is greatly reduced. Dr. G. B. Lucas, North Carolina State College plant pathologist, reported that an unknown globulin in milk causes this disease inhibition.

YOU'RE MONEY AHEAD

WITH U.S. ROYAL  LOW PROFILE TIRES

Radically New U.S. Royals Give You All These Premium Features—Yet Cost No More Than Ordinary Tires!

1. MILEAGE—upped as much as 35%!



2. HIGH-SPEED ENDURANCE—3 times better!



3. TURNPIKE GAS ECONOMY—6 to 12 extra miles per tankful!



4. TURNING EFFORT—20% more stability on curves!



5. SKID RESISTANCE AND TRACTION—raised 5 to 10%!

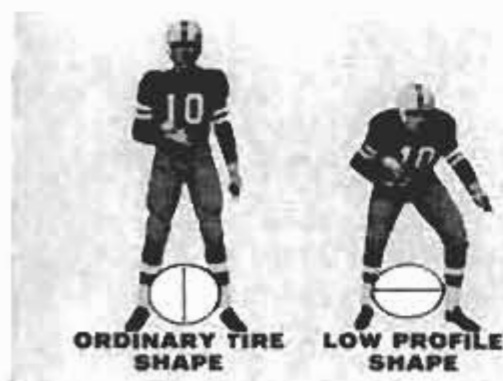

Low profile tires are as different from ordinary tires as the two football players shown at the left. Notice that one fellow is lower, wider, harder to knock off his feet. In the same way, new U.S. Royals are lower, wider, more stable. Built to roll easier, run cooler, give you greater safety and longer mileage

on today's tire-killing superhighways. There's a *Low Profile* tire to match your budget...at your U.S. Royal Dealer's!



Latest in the Low Profile Line!
**NEW U.S. ROYAL
WINTERIDE
TIRES**

Now at the lowest price in years

U.S. ROYAL TIRES



United States Rubber

Rockefeller Center, New York 20, N. Y. In Canada: Dominion Rubber Company, Ltd.
See things you never saw before. Visit U. S. Rubber's new Exhibit Hall, Rockefeller Center, N. Y.

WANT A PRACTICAL GIFT THIS CHRISTMAS?

CLIP THIS AS A SUGGESTION FOR YOUR WIFE



...an ideal
man's gift

Cordomatic

MODEL 500

HANDY-LITE REEL

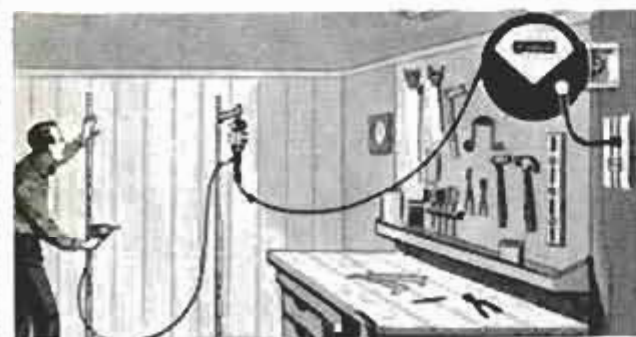

It's just what you need for all kinds of jobs from attic to basement... around the yard, too. Wherever you want light and power, they're at your fingertips. Best of all, they're on the job without the inconvenience and hazards of tangled cords. 20 feet of cord locks at any desired length...retracts automatically into case. Handle has built-in outlet for electric tools and appliances. Mounts easily on wall or ceiling. Guaranteed. Only \$8.95 at hardware and department stores.

Cordomatic®

17th and Indiana Ave., Philadelphia 32, Pa.

The Big Round Sound

(Continued from page 121)



High-speed polishing wheel puts lustrous finish on band instrument, which goes next to lacquer room

tions are placed in precision dies, and water is forced through under pressure of 2800 pounds per square inch. The water pressure not only smooths the inside surface but puts the proper acoustical measurements in the column.

The calibration of the instrument's bore, from mouthpiece to bell, must be accurate within millionths of an inch. Conn researchers use the term "cali-bore" to describe the accurate calibration of the tone column that is necessary if the horn is to produce the "big round sound." The curves in the trumpet, trombone or French horn are of minor importance compared to the calibration of the bore.

Valve bounce may seem a minor problem in designing a trumpet or cornet. But it's one of the gremlins that makes one note run into the next when the instrument is played. The exact amount of note slurring can be determined by taking high-speed movies at the rate of 2000 frames per second. Research personnel tested thousands of ideas and materials over a period of two years in order to reduce valve bounce 75 percent.

When each horn finally is assembled, polished and lacquered, it is passed along to a professional musician who tests it in one of several soundproof rooms. And the musician doesn't depend on his ears

(Continued to page 222)

*"I'm the only one in the family that can't use the **Dremel!**"*



It's a dog's life when you're left out of things — but not so with a Dremel Moto-Shop. Here's an exciting way the whole family can enjoy a woodworking hobby together. Teaches children to be creative and helps cut down the TV habit.

Not a cumbersome cast iron model, but sturdy, lightweight, portable — and safe. Unique blade guard protects even the littlest hands. Simple operation — make gifts, toys, furniture, practical items for the home.

Treat your whole family to a Dremel Moto-Shop. America's most popular and useful multi-purpose tool.

- Large capacity — Has 15" throat — cuts 1 1/4" wood, light metal, tile, plastics.
- Powerful ball bearing motor — not a vibrator, 3,450 strokes per minute.
- 4-way blade holder — saws in any direction.
- Lightweight, sturdy — easy to carry or store away.
- Tilting table — Tilts 45° for angle and bevel cuts.
- Adjustable table — Raises or lowers to new blade area.
- Economical — Self contained — no extra motor — no belts or pulleys.

A complete power workshop in 1 compact portable unit. Two models to meet any family's need.

Model 571 Moto-Shop. Includes 15" Jig Saw with disc sander attachment only as shown above. . . \$33.95

Model 572 Deluxe Moto-Shop. Includes 15" Jig Saw with disc sander, grinding wheel and guard, wire and cloth buffing wheels, a 12 piece accessory set, and 30" flexible shaft (grinds, drills, carves, polishes, engraves, sands, sharpens) . . . \$49.95

Ask your Power Tool Dealer for a Demonstration

WRITE FOR FREE LITERATURE

DREMEL MFG. CO. Dept. 119M Racine, Wis.



DREMEL POWER SANDERS — All Dremel Sanders have it — *Straight-Line Action!* Means you sand with-the-grain, get the smoothest finish. No swirl marks, no scratches. Three models — from \$14.85 to \$37.50.

DREMEL MOTO-TOOL KITS — A compact, pocket-size machine shop. Grinds, polishes, carves, sharpens, drills, engraves. For fine detail work at home or shop. Speed range from 25,000-27,000 rpm. Prices, \$14.85 to \$27.50.

DREMEL MOTO-SAW — The scroll saw everyone can use skillfully. Cuts the most intricate designs accurately at 7200 strokes per minute. Saws 3/4" wood, light metal, plastics, floor and wall tile. Model 203 . . . \$6.85.

Any man will enjoy new

AIRGRATE YELLO-BOLE

1. Smokes sweeter!

Imported briar bowl lined with real honey. Starts caking the instant you light up. Hence, no break-in.



2. Smokes drier and healthier!

Metal grate condenses moisture, tars, nicotine. No wet heel.



3. Smokes cooler!

Air-vented chamber draws in fresh air. Aluminum fins and shank throw off heat, cool the smoke.

Famous honey-lining!

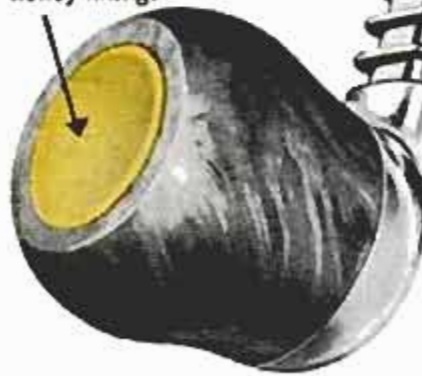

\$295

Extra interchangeable bowls - \$1.50 each

"Icepak" Set—Airograte Yello-Bole Pipe plus two extra bowls, \$5.95

Other Yello-Bole Pipes, also of imported briar \$1.50 to \$4.95

Send for FREE FOLDER, YELLO-BOLE PIPES, Inc., Dept. Y65, N.Y. 22

Everything for the Craftsman!



WRITE FOR NEW 132 PAGE

WOOD AND HOME WORKSHOP CATALOG

Finest Domestic and Imported Woods
... Mouldings, Hardware, Tools
ALL AT LOW MONEY-SAVING PRICES!

Your complete wood buying guide and project book. Craftsman is your best, most complete source of finest kiln-dried domestic and rare imported woods, beautiful wood inlays, colorful bandings, matched plywoods, embossed mouldings, carved ornaments, newest woodworking tools, "hard to find" cabinet hardware and fittings... more than 1500 items! Packed with newest scroll saw patterns, project ideas and money making plans. Enclose 25c (refunded with first order) to help pay mailing, handling cost. Write:

NEW!!

- Mosaic Tile Kits
- Period Clock Kits
- New Line of Metal Legs
- Over 1,500 Items!

CRAFTSMAN WOOD SERVICE COMPANY, Dept. A-12
2720 SOUTH MARY STREET - CHICAGO 8, ILLINOIS



Engraving intricate, fancy lines on surface of instrument is one of jobs that still must be done by hand

alone to tell him whether the instrument is in tune. Each room contains an electronic frequency-measuring unit, accurate to within $\frac{1}{100}$ of a semitone. If a trumpet tester sounds an "A" and the instrument is in tune, a pattern in the window of the device will remain stationary. If the tone is flat, the pattern moves to the left. If it is sharp, the pattern moves to the right. Turning a knob to stop the left or right drift of the pattern automatically tells the tester how flat or sharp the tone is, in hundredths of a semitone.

With their knowledge of musical acoustics, Conn researchers have assembled trumpets, Sousaphones and other instruments that do not look like anything you would find in a music store. One of the instruments, called a snorklephone, is a Sousaphone with part of the curve removed. Another is a trumpet that has neither curves nor valves. Dr. Kent, using the algebra and geometry of horns, has even tried to design musical instruments that have never existed. But the work so far has been strictly experimental. Although these scientists and engineers can make a trumpet that doesn't look like a trumpet, it might be hard to market such an instrument. It might be equally hard to convince the public that a "straightened out" Sousaphone can have the same quality of tone as a Sousaphone with all the curves in it.

(Continued to page 224)



Prevent bumping on driveways and all the other problems caused by overloading today's longer, lower cars.

Tail dragging?

*your car needs Load-Levelers**

Keep your car on the level with Load-Levelers*—Monroe stabilizing units with built-in ride control for a level ride under all road and load conditions. With Load-Levelers*, your car will always ride on an even keel . . . without "tail drag" or side sway. You'll like the way your car will take rough bumps and steep driveways without "bottoming" on its axles. You'll appreciate the extra stability on tight curves. And you'll like the improved steering and longer tire life you'll get with Load-Levelers.*

Have Load-Levelers* installed today in less than 30 minutes at your car dealer's, repair shop or service station. You'll be amazed at the big difference they make!

Only
\$39⁹⁰
a set
for most cars



*Trademark

**Load-
Leveler**



Mail this coupon for free literature

MONROE AUTO EQUIPMENT CO.

Monroe, Michigan

Dept. ST-8

Name _____

Address _____

City _____ Zone _____ State _____

MONROE AUTO EQUIPMENT COMPANY • World's largest maker of Ride Control Products, including famous Monro-Matic Shock Absorbers • In Canada, **MONROE-ACME LTD.**, Toronto, Ont.

CRESTOLOY MINIATURE PLIERS

with BOX
JOINTS

No. 21

ROUND
NOSE

No. 622

CHAIN NOSE
SIDE CUTTER

No. 22

SHORT
CHAIN NOSE

No. 942

DIAGONAL CUTTER

Forged from CRESTOLOY Steel, these fine pliers have precision-fitted box joints that assure perfect jaw alignment and smooth operation under long, hard usage. Excellent balance, combined with broader handles reduces worker fatigue. All are electronically hardened. Cutting pliers have tested edges. Finished with polished heads and gun metal handles.

Sold by hardware dealers everywhere

CRESCENT TOOLS

Give Wings to Work

®

Crescent is our trade-mark, registered in the United States and abroad, for wrenches and other tools. Sold by leading distributors and retailers everywhere and made only by

CRESCENT TOOL COMPANY, JAMESTOWN, N. Y.

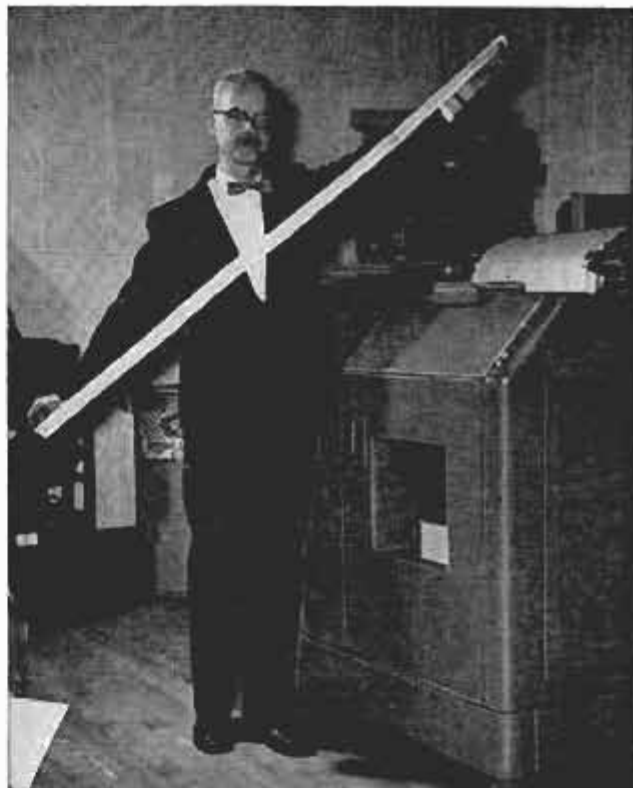

Design for horn starts with formula $5\frac{1}{2}$ feet long. Computers solve and check its problems within seconds

But the time will come, Dr. Kent believes, when band instruments will be even more unconventional. Some day in the hazy future you may be sitting in a football stadium between halves listening to a rendition of *The Stars and Stripes Forever* played on portable electronic instruments. Dr. Kent already has some ideas along this line. ★ ★ ★

Telephone Cable to Europe Carries 36 Voices at Once

Voices of 36 persons are carried at the same time over the first telephone cable system to link North America directly to Europe. Two deep-sea cables span the 2200-mile distance from Clarendville, Newfoundland, to Penmarch, France. One carries the speech of 36 persons to Europe and the other the same number from Europe. The system links U. S. telephone networks to France, Germany, Belgium, The Netherlands, Switzerland and Italy. Thirty-six other areas can be reached through the European points. The system is owned by American Telephone and Telegraph Company and the French and German telecommunication ministries.

☞ To find paths of ocean currents, men of the Coast and Geodetic Survey, U. S. Department of Commerce, are tossing 2000 soda-pop bottles into the Atlantic off the New England coast; each bottle holds a card for the finder to send to Washington.

BOOST PERFORMANCE AND ECONOMY WITH **ON-THE-CAR** CARBURETOR CLEAN-OUT!



If top-quality service is your business, ask your local UMS distributor about the Rochester-GM Kleanout Kit. It's one of the many factory-approved service items in the fast-moving Rochester-GM Service Line.

AVAILABLE NOW AT YOUR NEARBY ROCHESTER-GM CARBURETOR SPECIALIST'S!

Here's the fast, economical way to keep your carburetor in perfect working condition. Have your nearby Rochester-GM Carburetor Specialist give your carburetor an *on-the-car* clean-out. This quick, simple operation removes gum, sludge and other deposits that rob you of mileage. In addition, this on-the-car clean-out includes replacement of vital parts *plus* a regular maintenance adjustment of your carburetor. This in-between-tune-ups procedure will save you money in the long run. It's quick and easy, and it keeps your car delivering top performance and economy. See your Rochester-GM Carburetor Specialist today.

Rochester Products Division of General Motors, Rochester, N. Y.



America's
number one
original equipment
carburetors

ROCHESTER **CARBURETORS**

GENERAL MOTORS

Those Little Things Count

(Continued from page 143)

designed unit, a major repair—or even replacement—is called for. But before you resign yourself to such an expense, try the following quick cure: Using carbon tetrachloride, clean the inner rim of the record player's turntable and the rubber idler and drive wheels. Use a bit of elbow grease, if necessary, to rub off any shiny areas on the rubber drive parts and carefully check these for flat spots. Unless they are perfectly round, replace them with parts obtainable from your dealer or from the factory. If the record player uses small drive belts, inspect these for deterioration or cracking. Consult the manual for proper lubrication.

Barring some major defect, these measures will usually correct any speed-variation tendencies.

Though some of the above troubles may seem minor compared with the more spectacular electronic gremlins that sometimes infest hi-fi systems, they are just as often responsible for the loss of quality. The occasional few minutes of time spent, and the almost negligible cost of pampering your records and record player will be well repaid in greater listening enjoyment and longer life for your equipment and record collection. ★ ★ ★

This Month's "Great Pioneer in Science"

(Page 18)



Marie Curie (1867-1934)

Buy this Tape and get a present for HER at no extra cost!

SAVE 99¢! BUY THE LUFKIN Banner 50' tape and get a 6' tape rule for your lady at no extra cost!

Both are packed in a handsome gift box. Both cost only \$5.49.

And now the Banner has improved markings . . . a 16" marking for setting studding and quickly marking off any combination of 16" spacings. Bold black against pure white makes reading easy.

And that companion steel tape rule will be a treasure to any woman. No bigger than a compact, so it fits in handbag or sewing kit. And there's a handy calorie counter on back of blade!

Pick up a set next time you're in a hardware store.



THE **LUFKIN** RULE COMPANY
TAPES • RULES • PRECISION TOOLS
BAGINAW MICH • MIDDLETOWN N.Y. • BARRIE ONT

LIONEL TRAINS

THE LEADER IN MODEL RAILROADING

FROM
SUPER "O"...TO "O27"...TO HO



Get your free Lionel catalog
at your Lionel dealer today!

Only Lionel offers so much newness with such complete authenticity! From the "General" to modern steamers and diesels to missile launchers with exploding targets, here's a whole era of model railroading.



NEW! No. 470 IRBM Missile Launching Platform with Exploding Target Car—Press the firing lever and the launching mechanism tilts upward. The missile fires and "explodes" the target car. Set includes platform, missile, car. \$10.95

NEW! No. 3512 Operating Fireman-and-Ladder Car—As train moves, fireman swivels with nozzle, light rotates. Ladder can be extended, raised, pivoted. Operates anywhere on track. \$9.95

NEW! No. 3435 Operating Aquarium Car—Within the illuminated interior rare tropical fish appear to be swimming. Off-on switch on car controls the swimming action. Operates anywhere on track. \$12.95

NEW! No. 3419 Operating Helicopter Launching Car—Wind the spring in the launching platform and set the 'copter in position. By remote control, the "whirlybird" soars into the air. \$7.95



ALL THIS
PLUS...

HO BY LIONEL

THE LIONEL CORPORATION, 15 EAST 26th STREET, NEW YORK 10. N. Y.

Lionel-designed, engineered and built...here are the best motor, drive system and freight trucks in the HO field. With every outfit having its own power pack, Lionel HO offers the newest in locomotives, rolling stock and accessories.

We're Still Looking
for a **Craftsman**
Who Doesn't
Prefer



RIDGID



"Of Course,
I said

RIDGID

... It's the only
pipe wrench for my money.
I've got work to do!"



At your Dealer's



The Ridge Tool Company • Elyria, Ohio, U.S.A.

The PM Houseboat

(Continued from page 170)

and aft. Stagger the screws where the panels butt so they are not in line. Apply a double row of screws along the chine and across the bottom and up the sides of the bow and transom frames. In planking the starboard half of the hull bottom, cover frames 3 to 6 first, then frames 4 to 7 inclusive on the port side, allowing the panels to center midway on the frames as well as the keel. After this cover the remaining areas, gluing and screwing the plywood to the frames. An oak strip, Fig. 9, covers the planking joint along the sides at the chines. Bed this member in compound before attaching with brass screws.

As a final step to turning the boat right side up and removing the building form, three members, called skegs, are bolted to the bottom planking. One bolts through the keel, the other two through battens as shown in Fig. 7. You will note in Fig. 1 that each skag is formed from three pieces of 3 x 6 yellow pine and spliced together. The center section is a straight member 11 ft. long, whereas the outer sections are bandsawed to match the curvature of the hull. While shown tapered, Fig. 7, the skegs can be left straight to save considerable work. Carriage bolts spaced 20 to 24 in. apart anchor the skegs in place, after which a 1/8-in. steel band, called a chafing iron, is screwed to the edge of each skag and allowed to extend across the planking and up the bow and transom for about 2 in.

Before you turn the hull right side up it should be cross-braced inside to provide additional rigidity during the flip-over operation. Once right side up, the bracing is removed with the building form.

(To be continued next month)

Do You Know This Old-Timer?

(Answer to quiz, page 14)



1901 or 1902 Packard



great glue for every job you do

For Free Gluing Booklet send stamped, self-addressed envelope to Elmer, The Borden Company, Dept. 126, 350 Madison Avenue, New York 17, N.Y.

BORDEN'S PRODUCTS FOR THE HOME HANDYMAN



10" TILT/ARBOR SAW

Wood, steel, and aluminum construction. ball bearing arbor. Big machine capacity & performance. Simplified Plans, full size patterns, build easily with hand tools only. Kit with 10" comb. blade \$27.40. Enclose this ad for **FREE DELIVERY**. Money back guarantee. Order NOW. Or Send \$1.00 for Plans refundable with Order NEW DRILL PRESS-LATHE KIT. FREE CATALOG. Gilliom Power Tools Mfg. Co. Dept. PM-12, 1109 N. 2nd Street, St. Charles, Missouri

~~\$45.00~~
BUILD IT YOURSELF
\$23.95
 COMPLETE PLANS Only \$1.00 Each POSTPAID

BUY GREAT NECK HAND TOOLS . . . for long-lasting performance



One-piece, forged steel, rubber-cushioned, no-slip grip

PRECISION BALANCED NAIL HAMMER
GREAT NECK SAW MFRS., Inc.
 MINEOLA, N. Y. — SEE YOUR LOCAL STORE

KING MIDGET

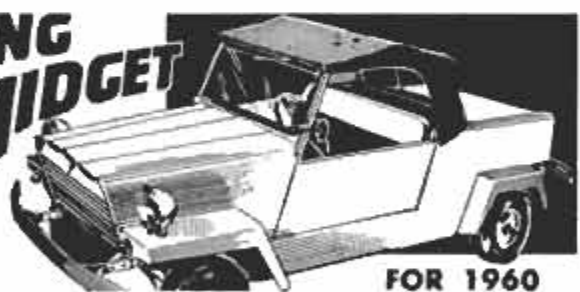

FOR 1960

More aluminum, lighter weight, better performance, beautiful styling. Still Worlds Lowest Priced Car. Drive it for 75c a week. Rider Agents Wanted. If no dealer near you send 25c for 32 page picture book, full details, dealer price. Or send \$1 (refunded first order) for this and Service Manual plus Repair Manual and 15 5 x 7 photos of car and factory.

MIDGET MOTORS CORPORATION, ATHENS 1, OHIO



There's a right gun for everyone!
THIS CHRISTMAS

GIVE CROSMAN CO₂ GAS PELLGUNS

Mother, Dad, Sis and Bill . . . all can enjoy shooting fun the safer, Crosman power-without-powder way. Crosman's controlled range and power and top target accuracy lets them shoot anytime, anywhere, all year long . . . in the family room, basement or backyard. A wide selection of single-shot rifles and pistols, repeating rifle, and western style single action six provides the right gift gun for everyone.

GIVE HAHN CO₂ GAS BB GUNS

Give the wholly new BB guns with higher BB power and accuracy. Feel, look and handle like the famous rifles and pistols of the Old West. True fast draw single action in the revolver . . . authentic lever action in the rifle.

Look for Crosman-Hahn Sales Center at your Crosman Select Dealer. See for yourself what fun it is to shoot the Crosman power-without-powder, CO₂ gas Powerlet way.

WRITE for free, colorful shooting fun literature. Crosman Arms Co., Inc., Dept. PM-36 Fairport, New York.



WORLD'S LARGEST MANUFACTURERS OF CO₂ GAS-POWERED RIFLES AND PISTOLS



BUILD THE BEST!

build quality money-saving

knight-kits®

A PRODUCT OF ALLIED RADIO



see them all in
ALLIED'S
1960 ELECTRONIC
SUPPLY CATALOG

FREE

build your own...
it's easy...it's fun!
SAVE UP TO 50%



HI-FI
KITS



INSTRUMENT
KITS



HOBBY KITS



HAM
KITS

world's
largest
stocks



See the 1960 KNIGHT-KIT line—available only from ALLIED. KNIGHT-KITS are lowest in cost, convenience-engineered for easiest assembly—the only kits with money-back guaranteed specifications. Send today for the 1960 ALLIED Catalog—select your KNIGHT-KITS—and...

**SAVE ON EVERYTHING
IN ELECTRONICS**

Get more for your money in Stereo hi-fi systems and components; save on recorders and tape; Amateur station equipment; TV tubes, antennas, accessories; test instruments; electronic parts, tubes, transistors, tools, books. Send today for your **FREE 1960 ALLIED Catalog!**

EASIEST TERMS
only \$2 down on
orders up to \$50

FREE
catalog

ALLIED RADIO

100 N. Western Ave., Dept. 24-M9, Chicago 80, Ill.

Rush **FREE** 1960 ALLIED Catalog

Name _____

Address _____

City _____ Zone _____ State _____

Bulls-Eye Tuning

(Continued from page 145)

transformer-operated receivers where this voltage is available from the filament winding of the power transformer. For AC-DC sets, an inexpensive 6.3-volt filament transformer can be separately installed.

No modifications or changes in the receiver circuit are required. It is merely necessary that the tuning-indicator leads be connected to the correct points within the set. The red wire, from the target of the 6E5, goes to B-plus (any value of filtered d.c. voltage between 150 and 250 volts will do) and the black cathode wire goes to ground (the chassis in transformer-powered sets—the negative lead of the filter capacitor in AC-DC receivers).

The yellow wire from the grid of the 6E5 triode section must be connected to a point in the receiver which provides a negative d.c. voltage, varying in accordance with the strength of the received signal. In AM receivers, Fig. 2, this is the top (ungrounded end) of the volume control; in FM sets with ratio detectors it is the negative terminal of the electrolytic capacitor shunting the detector load resistor, Fig. 3.

Fig. 4 shows the use of a s.p.d.t. switch to connect the tuning indicator to either the AM or FM section of a combination FM-AM receiver. The switch may be mounted directly on the receiver chassis.

Some of the more expensive FM receivers use a discriminator circuit rather than a ratio detector. Such a circuit is always preceded by one or more limiter stages. In such sets the yellow wire is connected to the R-C filter network in the grid circuit of the last limiter stage, Fig. 5. If in doubt as to the kind of detector used in your FM set, consult a schematic diagram.

Normally, the yellow lead from the tuning indicator can be directly connected to the proper point in the receiver. In some cases however, the addition of a 100K, 1/2-watt isolation resistor, as shown, will give a sharper indication, though it is not absolutely essential. The 1-megohm resistor shown between triode plate and target of the 6E5 is already wired in place in the Amphenol mounting assembly. This resistor need not be installed separately.

Properly wired, a pie-shaped shadow of about 100 deg. will appear on the indicator tube when the receiver is turned on but not tuned to a station. As a station is tuned in, the "eye" will close. Correct setting is indicated by maximum closing of the "eye."

By providing a visual indication of signal strength, the tuning indicator greatly simplifies tuning and makes radio listening far more enjoyable. ★ ★ ★

HUOT ROLLING TOOL CHEST

PROTECTS YOUR VALUABLE TOOLS



Goes where your work is! It's a handsome professional piece of equipment!

This complete rolling cabinet is ruggedly built of heavy formed and welded steel for permanent service on the job or in your home workshop. Three top drawers are cork-lined for precision tools—two heavy duty bottom drawers are extra deep for power tools. Complete with built-in lock.

MODEL 250 HUOT Rhymes With Do-It!

Write for free bulletin showing this and 12 other models!
HUOT MFG. CO., 555 N. Wheeler St., St. Paul 4, Minn.

8 MIDGET WRENCHES IN PLASTIC KIT

\$1 ppd



sizes:
open end—13/64" to 3/8"
box end—7/32" to 7/16"
Nickel plated wrenches ideal for hobbyists, TV, car and boat repairs.

Graduated lengths from 3" to 3 5/8" - returnable.

STERLING Distributing Co. Dept. M-1
P. O. Box 511, Columbia, S. C.

SMALL! POWERFUL!

ECONOMY TRACTOR



Thousands in Use Write for complete details.
Engineering Products Co.
1005-K12 Anoka Ave.
Waukesha, Wis.

Unequaled value! Low price! America's finest tractor. Ruggedly built. Easy to operate. 700 lbs. Borg-Warner clutch, trans. and diff 140 to 1 reduction. 40% more drawbar pull than ordinary tractors 6-3/4 H.P. engine. 20 quick change implements. HOOD, FENDERS.

Constantine's Catalog & Manual for WOODWORKERS



ALL-NEW! 1960 Edition. More than a catalog—a manual, tool 120 pages—exciting new items! Since 1912, world's most complete source for rare imported & domestic woods at rock-bottom prices. Inlays, bandings, carvings. Hard-to-find hardware, inlaid wood picture kits, new brass hardware, etc. Plus tools, plans, projects. Enclose 25c (refunded on 1st order). Get FREE year's subscription to "Chips & Chats" too. Write NOW!

ALBERT CONSTANTINE and SON, INC.
2050 Eastchester Rd., Dept. T-5, New York 61, N. Y.

GENUINE ALNICO MAGNETS

AMAZING, PERMANENT, NON-ELECTRIC, HIGHLY PRACTICAL. Conduct interesting experiments. Hundreds of uses. Retrieve valuable steel items such as guns, tackle from fresh or salt water; tools from tanks & drains. GUARANTEED. Try any magnet one week.

MONEY BACK IF YOU ARE NOT WELL-PLEASED
M-710 (Wt. 53 oz.) Has pull of 225 lbs. on steel block. \$18.00
M-625 (Wt. 70 oz.) Has pull of 125 lbs. on steel block. \$10.00
M-575 (Wt. 18 oz.) Has pull of 75 lbs. on steel block. \$ 7.00
M-500 (Wt. 13 oz.) Has pull of 50 lbs. on steel block. \$ 5.00
M- 90 (Wt. 5 oz.) Has pull of 15 lbs. on steel block. \$ 3.50
M-102 Pocket Magnet, 5 lb. pull, 2 for \$ 1.50
M- 47 Hot Pad Magnets, 10 for \$1.00. 50 for \$ 4.87
M- 35 Hobbyist assortment of 8 magnets. \$ 2.00
Send M.O. or check. We pay postage. Sorry no C.O.D.'s.

MIAMI MAGNET COMPANY, 3240 N. W. 27TH AVE. MIAMI 42, FLORIDA

"Pays Off" In your workshop. . .

Cummins "Circle of Power"

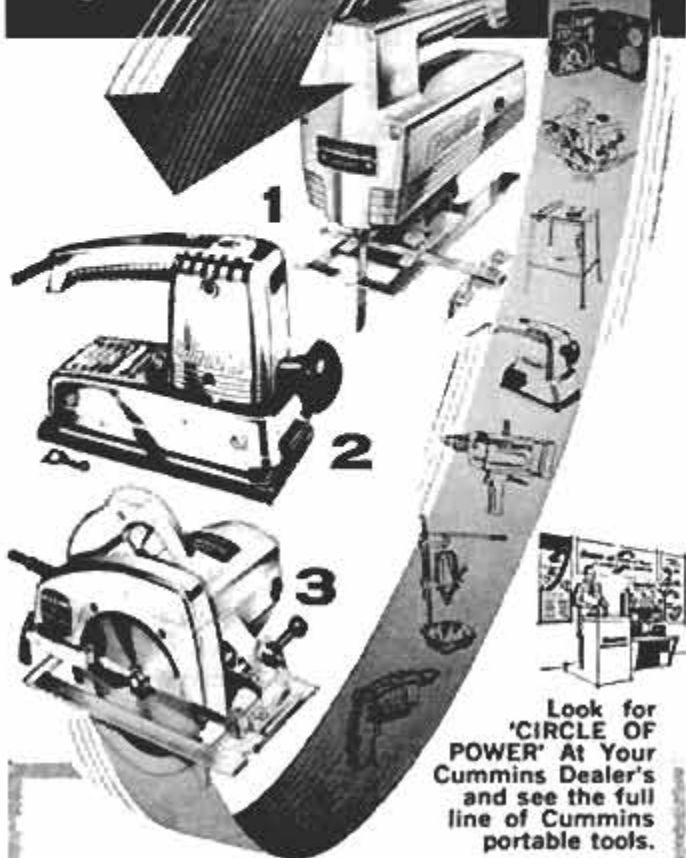

Look for 'CIRCLE OF POWER' At Your Cummins Dealer's and see the full line of Cummins portable tools.

A Complete Line of Portable Electric Tools . . . With Pay-Off Power for Everyone!

King-size performance — budget-size cost! Quality-built Cummins "Circle of Power" Tools mean versatility for most home workshop, maintenance and repair jobs . . . reliability with rugged Cummins-built motors. See the "Circle of Power" display at your Cummins dealer's now!

- 1 Cummins Sabre-Jig Saw\$44.95
NO VIBRATION! Seven saws in one — cuts 2" dressed lumber at 45°, cuts plywood, plastics, leather, even metal. Accurate control.
- 2 Cummins Double-Action Sander \$49.95
TWO SANDERS IN ONE! Get orbital and straight-line sanding at the turn of a key for beautiful professional-quality finishes.
- 3 Cummins 727-01 MAXAW\$49.95
7 INCH CUTTING CAPACITY! Magic-pivot for deeper angle cuts with blade to spare; makes all cuts in 2" dressed lumber.

Cummins Portable Tools

5055 N. Lydell Ave., Milwaukee 17, Wis.

Prices slightly higher in Canada

Division of *John Deere* MANUFACTURING CO.



**STOP
THOSE
LEAKS!**



Caulk with DAP



DAP Caulking Compounds stop air and water leaks fast. You pay pennies to save dollars in heat loss, water damage, repair work. Easy to apply. Best you can buy to keep your home snug and comfortable. Get DAP Caulk at hardware, paint or building supply dealers. Write for do-it-yourself folder.

DAP

CAULKING COMPOUNDS
GLAZING COMPOUNDS
TUB AND TILE SEALER
SPACKLING COMPOUND

DICKS-ARMSTRONG-PONTIUS, Inc. • Dayton, Ohio.

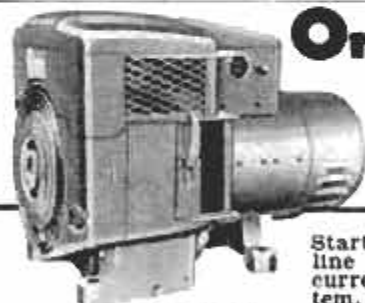

Onan Emergency Electric Plants

Start automatically when high-line power is cut off, supply current for lights, heating system, freezer, water pump, stove, all appliances and machines. Prevents losses and hardships. Plant stops automatically when power is restored. Compact, easy to install. 500 to 200,000 watts A.C. Priced from \$319.00.

PORTABLE
MODELS

500 to 10,000
watts. Supply
plug-in power
anywhere!

Write for Free Folder

D. W. ONAN & SONS INC.
3319 UNIVERSITY AVE. S.E. • MINNEAPOLIS 14, MINN.

Hollywood Spricht Deutsch

(Continued from page 69)

and Margot Leonard, Marilyn Monroe, Clark Gable, for the past 20 years, has been Siegfried Schuremberg.

While the actors are doing their stuff in the studio, technicians are hard at work behind the scenes. Every take is first spliced into a "start strip"—the 1, 2, 3, 4 that alerts the actors. It's also spliced into a blank strip of film so that it forms a circular piece and can be run again and again through the projector without rethreading.

Two sound systems are used. In the more widely adopted system, all dialogue is recorded on a tape recorder. The voices can be erased repeatedly, and only the perfect take is allowed to remain.

After all takes are completed, both the pictures and the sound (now on a sprocketed half-film) go back to the cutting room. Here, a technician uses a cutting table to do the actual synchronizing. The apparatus resembles the moviola in that the film is seen on a small screen and can be run through at any speed. But it also can accommodate the separate sound track.

The picture and sound track are "synched" by means of "pipes"—small V-shaped marks contained in every start strip. The little pipes also show up in the recorded sound track immediately before the dialogue. It's a simple matter to match the marks so that the actors in the picture and the German voices speak as one.

When the sound track is perfectly synchronized, it's re-recorded on a continuous strip of sprocketed magnetic film. The picture film is likewise respliced into one film and copied.

Final Step Is in Mixing Room

Now comes the last step. Both sound and picture go to the "mixing room," a room filled with assorted projectors and sound equipment. The picture film, a working copy without sound, is put on a special projector. The German sound track goes on an amplifying apparatus. And the ME—music and effects shipped from the United States with the original film—is set on a large tape recorder.

The whole works is fed into a small projection room where the sound director, sitting at a control board, views the picture and proceeds to "mix." Here, picture, German-language dialogue, music and effects are all blended into the final product.

Another sound system, used in Paris and in Munich's Riva and Mondial studios, follows the same principles. But there's one great difference. Instead of recording all

(Continued to page 234)



Porter-Cable
CIRCULAR SAWS
 have
Power-Plus
Accuracy!

This 6½" Saw is loaded with many of the exclusive features found on Porter-Cable professional models. You can make every possible cut, including 45° angles on 2 x 4's! Has instant depth and bevel adjustments... self-lubricating bearings... weighs only 8½ lbs.

A 3-STAR TOOL

Safety Kickproof Clutch
 "No-Drag" Telescoping Guard
 Cuts 2 x 4's at 45°

MODEL 66 Only **\$39⁹⁵**

MODEL
 146A
\$74⁹⁵



6½" Heavy-Duty Porter-Cable Saw. Here is a professional saw at a low price. It's light in weight yet a powerhouse. Carpenters pick this model every time for speed and accuracy of cut!

**A
 5-STAR
 TOOL**

- ★ Ball bearings throughout
- ★ Exclusive gear lubricator
- ★ Safety Kickproof Clutch
- ★ Blower Clears Line as Cut
- ★ Calibrated Depth, Bevel Sets

Limited offer! Order your saw now!
Send no money! Take 6 months to pay!

Porter-Cable Machine Co., 914B Marcellus Street
 Syracuse 4, N. Y.

I wish to order the tools checked below. I agree to pay my Porter-Cable Dealer full price or down payment indicated upon receipt of tool, and the balance in monthly installments shown below.

	Price	Down Payment	Balance Monthly for 6 months
Model 66 Saw	\$39.95	\$9.00	\$5.50*
Model 146A Saw	\$74.95	\$18.75	\$9.95*

*includes service charge

Name _____

Address _____

City & State _____

Porter-Cable
Quality Power Tools

PORTER-CABLE MACHINE COMPANY
 914B Marcellus Street, Syracuse 4, N. Y.

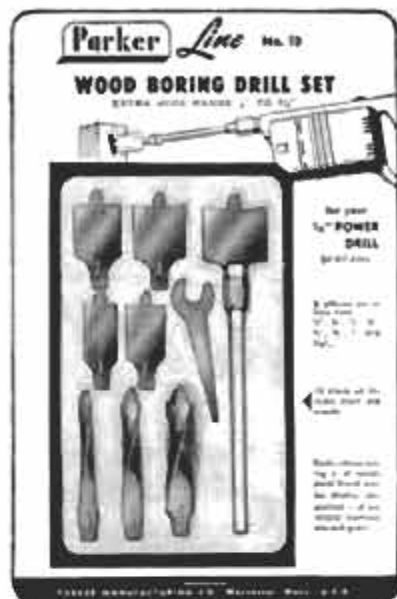

Now!
**A Wood Boring
 Drill Set**
 with an
 extra wide range
 from 1/4" to 1 1/4"
**Yours for
 only \$2.75**

New 10 piece set fits all 1/4" electric drills and drill presses. Bore faster, cleaner, truer holes in wood, plastics, panelboard, plaster, compositions. New plastic case gives you permanent, moisture resistant container for your bits. Hardened tool steel — rugged construction. Sold at leading hardware stores.

Set includes universal shank and wrench.

Buy the **Parker Line**

PARKER MANUFACTURING CO.
WORCESTER 1, MASS., U. S. A.

NOW! a hi-compression
staple gun
 for only
\$4.95



With Exclusive
 Push-button Loading
 and Built-In
 Staple Extractor.

Indispensable for home use... and never before priced so low! This compact, all steel, powerful SWINGLINE 101 staple gun is ideal for insulation, carpentry, upholstery, screening, wire fencing, plus thousands of other uses. Handle locks to fit pocket. Lightweight, maneuverable, jam-proof! Staple sizes 1/4", 3/8". Send for FREE book—"Tips for Tacking"

Swingline® INC.

Dept. M-12-9 Long Island City 1, New York

dialogue on a single tape, each take is recorded on a regular piece of magnetic film that's exactly the same length as the corresponding picture strip.

Each piece of magnetic film is spliced onto blank film just as the individual picture takes are. They run simultaneously so that when all takes are finished, it's a simple matter to cut out the blank film strips and splice both the pictures and the sound track together. The result is an exact matching of sight and sound that does away with the necessity of re-recording and further cutting. With this latter system, though, every take has to be absolutely perfect. In the former process, there's some latitude for correction in the cutting room and the original recording doesn't have to be so exact.

The entire dubbing operation, from start to finish, costs about 25,000 deutsch marks (\$5950) an average film. About one quarter of the cost is taken up by actors' salaries, another quarter by the writers and directors, and the rest by technical costs. Expenses in the United States would be multiplied many-fold—the main reason why foreign movies in America often still appear with subtitles.

Officials of the various synchronization firms look on subtitled films with a dim view. They say that it's difficult for the average viewer to read subtitles, watch the picture at the same time and still enjoy the movie. Consequently, practically all foreign pictures in Germany are dubbed.

Synchronized Films Are Popular

Crowded theatres all over Germany attest to the popularity of synchronized films—especially American films. Attendance figures not only from Germany but from throughout the world warm the hearts of Hollywood executives. Since television started cutting deeply into attendance receipts in the United States, the export market has become more and more vital.

The 275 to 300 U. S. feature films sent overseas yearly are estimated to earn approximately \$200 million annually for the American motion-picture industry. Adding to this healthy total is the booming export of filmed U. S. television programs, dubbed in with foreign-language dialogue exactly as the major films are. It's expected that syndicated, half-hour TV movies will generate another \$125 million for Hollywood studios this year.

Even more important, the foreign voices who speak for the stars enable many millions all over the world to enjoy the products of America's entertainment industry, and in a small way bringing us all closer together.

★ ★ ★

Good advice to Car Owners...

Casite's 3-Zone Engine Protection

adds new power and performance!

Now three new Casite products reduce friction, keep your car's engine and automatic transmission clean and at peak operating efficiency.

Developed by the technical staffs of Casite and its parent organization, Hastings Manufacturing Company, these products are the results of years of specialized research in the field of automotive maintenance.

You probably are aware of the damaging effects of modern stop-and-start driving on high compression engines and automatic transmissions. In our own engine testing laboratories, we've seen how acids, rust and corrosion—from condensation caused by fluctuating extremes in operating temperatures—cause poor performance and deterioration of engine parts.

Utilizing the latest proved chemical discoveries, Casite technicians have developed and perfected scientific correction *and* protection for the three vital areas of car performance—the firing zone, the friction zone, the transmission zone. Each requires specific treatment to keep your car's "power plant" clean, at top operating efficiency, with minimum friction.



The three Casite products perform these specific functions. Each is a liquid concentrate additive—for gasoline, for crankcase oil, for transmission fluid.

You can use them without mechanical labor costs or expensive parts dismantling or replacement. In a few minutes you're on your way, with noticeable results.



This is the Improved Casite Tune-Up, for the firing zone. It's the nation's favorite "tune-up in a can," now greatly improved with spark plug and carburetor cleaner and acid inhibitor.

It is recommended for use in the gas tank or carburetor air intake to free valves and rings, and clean carburetor and spark plugs.



Also, for use in the crankcase oil for quicker starting, less start-up wear, and to break in new or rebuilt engines. The price is only \$1.25.

For a quiet smooth engine, you'll want Casite 3-C, with Barimen. This is a new heavy duty crankcase concentrate developed for the friction zone. Added to motor oil, it gives you a tougher oil that won't thin out—oil that cushions the load on every working part, cuts friction and wear, reduces oil consumption, too! Casite 3-C stops hydraulic lifter noises, quiets and smooths the engine. Cleans the engine, and keeps it clean—protects against acid, rust and corrosion. Costs only \$1.50.

Casite "Smooth-Seal" is the latest scientific development for automatic transmissions. It reduces jerks and roughness, assures smooth, quiet operation.

It stops and prevents leaks due to hardening or shrinking of transmission seals. Also reduces shock and wear, enables parts to last longer. Only \$1.95.

Most service stations have a supply of Casite products to protect your engine—or can get them in a hurry.

Just ask for Casite Tune-Up, 3-C and "Smooth-Seal." Use them with confidence. If you're not entirely satisfied with the results, let us know. We'll promptly send you double-your-money-back. That's how strongly we feel (and millions of car owners do, too) that Casite products will solve many of your engine problems, reduce repair bills—and keep your car rolling for many thousands of carefree extra miles!



HASTINGS MANUFACTURING CO. • HASTINGS, MICH.

Casite, Piston Rings, Oil Filters, Spark Plugs

Skiing Is for Everyone

(Continued from page 90)

along without too much speed. You have better control while traveling slowly. Later, much later, you can try making high-speed runs straight down the hill. The unofficial world speed record on skis is 109 miles per hour, made in Chile several years ago by Ralph Miller. Miller wore special clothing that couldn't be torn off by the wind and he crouched as low as possible on his skis to reduce wind resistance.

If you are an average beginner you will have had a few spills by now. If a fall is inevitable, do your best to land on one side and on your hips. Keep your arms up so you won't land on your hands, and keep your legs straight to avoid falling on your knees. If you remember these points you'll avoid most of the sprains and twisted muscles that some people seem to collect.

Once you have fallen you have the problem of getting up again, and skis are slippery on the snow. The best way is to bring the skis parallel and close together, then draw up your knees to get your feet close to your hips. Now you can use your poles to push yourself up onto your feet again. If you lost a ski in the spill, get up first and put it on afterward.

Always tramp over the hole you made in

the snow by sidestepping on it, removing a hazard that might trip other skiers. It's a standard rule, too, never to walk on ski slopes without skis. Otherwise your feet can leave dangerous holes.

Varying Snow Conditions

Snow conditions can vary from an almost icy crust to fresh, deep, powder snow. I don't advise beginners to take their first lessons when conditions are icy; the crust is just too slippery. Later on you'll find that you have best control on icy snow if you lean farther forward than usual and apply more edge than normal. In deep fresh snow it's best to do the opposite: Lean back a bit, keeping your weight equal on the skis and keeping them fairly flat to prevent their diving deeper.

By the time you have progressed to this point you'll have seen more experienced skiers descending the slopes in a series of linked turns, their feet always held tightly together. This is the modern parallel downhill turn and is a controlled curving skid. This turn is now your goal.

First, you must become familiar with a plain skid or sideslip; that is you move sideways down the slope by releasing the edges instead of digging them in. This develops lateral balance and control of the edges.

(Continued to page 238)

LOOK!
New!
Improved!



**POCKET-SIZE
BLOW TORCH**
only \$2.25

Now—solder, braze, fix leaks. Do wiring, plumbing, loosen frozen nuts and bolts, 1001 odd jobs. Butane gas blow torch gives intense 3500° pin point flame that lasts ½ hour, turns on or off. Extra "chargers" 49¢ for two. Send \$2.25, check or money order for Jet King Blow Torch with one charger, or send \$2.95 for complete soldering kit: Blow Torch, two chargers, soldering tip, roll of solder. Send coupon now! Money back guarantee!

Kidde Manufacturing Co., Inc., 1204 Farrand St., Bloomfield, N. J.

Send me _____ JET KING BLOW TORCHES @ 2.25 ea.*

Send me _____ JET KING SOLDER KITS @ 2.95 ea.*

Send me _____ Boxes of Extra Chargers @ .49 per box.

My check _____ money order _____ for \$ _____ is enclosed
(*Add \$1.00 Extra per unit for Canada)

NAME _____

STREET _____

CITY _____

STATE _____



TRANSEAL®
PREVENTS AND
STOPS LEAKS
IN AUTOMATIC TRANSMISSIONS

Prevents and stops leaks due to drying, hardening or shrinking of transmission seals. Reduces gear and bearing noise... makes shifting quieter... faster... smoother.

AT SERVICE STATIONS, GARAGES,
AUTO ACCESSORY STORES

RADIATOR SPECIALTY CO., Charlotte, N. C.



**HANDY, BIG
PLASTIC
BOX**

24 compartments,
13 1/8 x 9 x 2 1/4.

Beautiful,
crystal clear,
rigid plastic.
Ideal for fish

lures, nuts, bolts, washers,
buttons, jewelry, office supplies.

Sturdy cover and hinges. At hardware,
automotive, sports goods stores.

The **Victek** Tool Co. Dep't. P
Cleveland 4, Ohio



THIS "ONE-TOOL" WORKSHOP FOR DAD MEANS A FAMILY MERRY CHRISTMAS

Home improvement projects come easy . . . are finished faster with this all-purpose, power cutting tool. A Disston "Dagger" handles every cutting job needed to finish a game room or an attic. With a "Dagger" you can build kitchen cabinets, bookshelves, dividers, fix the stairs or do any one of a hundred fix-up jobs. It's fast, easy and convenient.

Disston's "Dagger" cuts wood (45° through a 2 x 4), plywood, pipe, plastic, formica and sheet metal. It'll cut through heavy house wiring and conduit . . . even frozen meats, bone and all.

"Dagger" is a rip saw, crosscut saw, hack saw, coping saw, hole saw, back saw and more . . . all rolled into one, with power added. You carry the lightweight Disston "Dagger" anywhere, to do any job, conveniently. And even an "all thumbs" beginner is right at home with the "Dagger." See a Disston "Dagger" at your hardware dealers', now, while stocks are still on hand. Disston Division, H. K. Porter Company, Inc., Philadelphia 35, Pa.

DISSTON PORTER DIVISION
H. K. PORTER COMPANY, INC.

PORTER SERVES INDUSTRY: with Rubber and Friction Products—**THERMOID DIVISION:** Electrical Equipment—**DELTA-STAR ELECTRIC DIVISION, NATIONAL ELECTRIC DIVISION, PEERLESS ELECTRIC DIVISION;** Specialty Alloys—**RIVERSIDE-ALLOY METAL DIVISION;** Refractories—**REFRACTORIES DIVISION;** Electric Furnace Steel—**CONNORS STEEL DIVISION, VULCAN-KIDD STEEL DIVISION;** Fabricated Products—**DISSTON DIVISION, FORGE AND FITTINGS DIVISION, LESCHEN WIRE ROPE DIVISION, MOULDINGS DIVISION, H. K. PORTER COMPANY de MEXICO, S. A.;** and in Canada, Refractories, "Disston" Tools, "Federal" Wires and Cables, "Nepcoduct" Systems—**H. K. PORTER COMPANY (CANADA) LTD.**

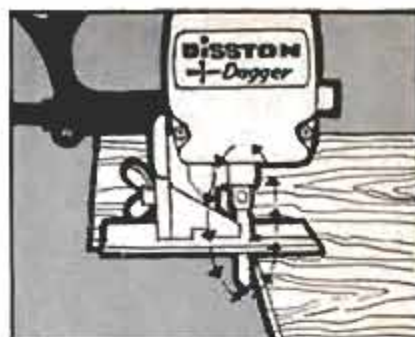

"ORBITE" ACTION Exclusive Disston Orbite blade action cuts up, then backs away going down. Eliminates splintering of wood and plywood. 3600 strokes per minute mean smooth, fine cutting action. Blade replacement costs pennies not dollars.

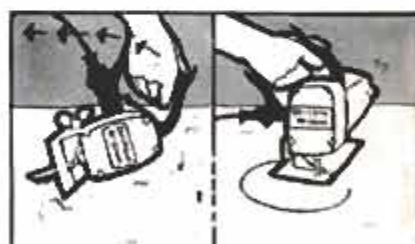

PLUNGE CUTS Makes inside cuts without drilling starter holes. Works fast and easy for plumbing and electrical outlets and cutouts.

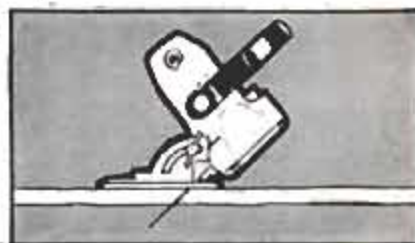

CUTS 2 x 4's Plenty of power and blade length to cut through 2" lumber, even at a 45° angle. Adjustable shoe readily set at any angle from 0° to 45° for bevel cuts.



MAKES INTRICATE CUTS Cuts scrolls, curves, angles and figures. Takes the place of coping saw or jigsaw on most jobs.

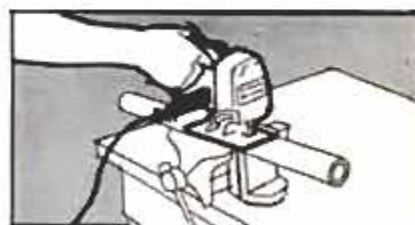

CUTS VARIETY OF MATERIALS Cuts metal tubing, sheet metal, pipe, wood and plastics with ease. 5 basic blades for wide range of materials.

**Bore 35 standard holes
with just one tool**

**New IRWIN
Expansive Bit**

lets you dial your size

Just turn the dial and you're set to go with this new Irwin Expansive bit. No hunting for the size you need. Fits all hand bit braces. Clean, fast, accurate boring action from $\frac{7}{8}$ " to 3"—35 standard hole sizes in all!

And what a really fine precision tool to own. It's drop-forged from special bit steel, heat treated full length, machined for accuracy and sharpness, highly polished, too. Two cutters supplied with each bit. Model No. 21 with $\frac{5}{8}$ " to 1 $\frac{3}{4}$ " boring range also available. Ideal for home handyman, professional woodworker, or farm. See your independent hardware dealer soon.



IRWIN

Wilmington, Ohio

the original solid
center auger bit
•
screw drivers
screw driver bits

**COAST
TO
COAST**



MONARCH ROAD MACHINERY COMPANY



**POWER
HYDRAULIC
CONTROLS**

*lift and lower
snow plows
automatically!*

Snow removal is easier, faster, more economical. See your dealer or write for illustrated folder.

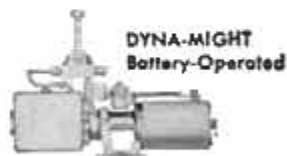

DYNAMIGHT
Battery-Operated

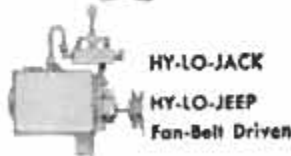

HY-LO-JACK

HY-LO-JEEP
Fan-Belt Driven

1331 Michigan St., N. E.
Grand Rapids 3, Michigan

Once this skid is mastered it must be converted into a curving diagonal skid. This is done by applying a small amount of edging and leaning forward at the same time. The edging causes a diagonal slip and the forward lean helps the front of the skis to grip while just the tails slip. The combination produces a simple uphill turn. You can facilitate the turn by a down-up "unweighting" movement. Start across the slope in a traverse, crouch down and then quickly raise your body at the same time that you partly release the edges to start the skid. Then lean forward to complete the turn with just the tails skidding.

Now you are ready for the downhill turn itself. While traversing a slope, "unweight" the skis with the down-up motion of your body and at the same time change to the downhill edges and start the skid by twisting the legs and feet in the desired direction. Once the skid is started, the rest of the turn is similar to the technique of an uphill turn, with tips gripping and tails slipping. Planting the inside pole momentarily at the time you make the "unweighting" movement is a big help. If you make a wide turn you will pick up speed, while a short turn starts you on the next traverse at a slower pace. In fact, you can come to a complete stop easily enough by remaining in the turn until your skis are pointed somewhat uphill.

Jump Over Bumps

When moving across bumpy terrain you can try jumping over the worst bumps. There's nothing tricky about this; you simply crouch, spring up, and tuck up your feet to clear the bump, landing on smooth snow. You must keep the skis parallel while in the air, of course.

What you have read so far is the equivalent of a week of instruction at the rate of two lessons per day. With practice you should soon be able to handle yourself safely on most slopes and enjoy yourself as well. Then you will be ready for more advanced instruction.

I suggest you take lessons from an instructor even though you become fairly proficient. You can't see your own mistakes, while an instructor can spot them, correct you, and teach you additional technique as well. The better you become, the more fun you'll have. ★ ★ ★

☞ The new band shell in a Tampa, Fla., park is hurricane proof. When winds reach a specified force, double doors open and release the pressure, preventing the roof from being ripped off.

MAKE EXTRA CASH

SHARPENING LAWN MOWERS THE MODERN WAY



\$275.00
F.O.B. Pasadena

Start your own shop! Full or spare time. Earn many dollars in a short time... average \$5.00 per hour. Many mowers need sharpening. With MODERN'S Extra Heavy Duty LAWN MOWER SHARPENER AND BED KNIFE GRINDER you have 6 machines in one. All operations are done quickly and easily. You make money from the start. Write for free details.

MODERN MFG. CO.
160 N. Fair Oaks Ave. Dept.
Pasadena, California 10-4



Handles for Glass, yet!



Unless in the glass business, you probably won't pay \$11.50 for this Red Devil Vacuum Grip Glass Holder that makes it easy to lift and place sheets of glass, steel, marble or anything smooth and heavy. But now you know how they do it.



It's Practically Impossible to burn fingers, bark knuckles if you use a Red Devil Burn-Off Knife with I-o-n-g handle, and good stiff blade. The largest of 4 sizes costs but \$1.80, so why do it the hard way? Good for scraping floors under radiators, too.



Why Didn't They Think Of It Before? Polyurathane pad attached to a good handle makes a Red Devil SP2 Screen Painter. You dip it in a shallow paint pan, wipe the screen with it, and presto!—job's done. The cost? Just 29¢.



Sign Of A Good Paint Store. Buy paint only where you see one of these red machines. It's a Red Devil Paint Conditioner and for it the dealer paid about \$150 so he can shake your paint into factory-fresh suspension to save you stirring—or blend colors to your taste. It's always best to buy where Red Devil Tools are sold, for wider choice, top quality, and correct "how-to" advice.

Free booklet
"How To Fix Broken Windows."

Address Dep't. B-12

4572



Red Devil Tools.

Union, N. J., U. S. A.

World's largest manufacturer of painters' and glaziers' tools.



G E A R S

In Stock — Immediate Delivery
Gears, speed reducers, sprockets, thrust bearings, flexible couplings, pulleys, etc. A complete line is carried in our Chicago stock. Can also quote on special gears of any kind. Send in your blueprints and inquires.

Send for Complete Catalog No. 10
CHICAGO GEAR WORKS
440-50 N. Oakley Blvd., CHICAGO 12, ILL.

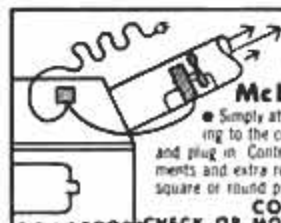

NOW! HEAT THAT COLD ROOM WITH A...

McLarty Automatic Booster Fan

Simply attach the McLarty Automatic Booster Fan in the pipe leading to the cold room. Screw control to dome or lay on top of furnace and plug in. Control runs fan when furnace is warm. Wonderful for basements and extra rooms or to assist your present blower. For 8 to 12 inch square or round pipe. Quality fans since 1936.

COMPLETE \$17.95 POSTPAID FAN ONLY \$11.95

CHECK OR MONEY ORDER

McLARTY SYSTEMS

DICKMAN RD. AT 35TH ST.
BATTLE CREEK, MICHIGAN

Works in seconds!



Loosens Rusted Bolts
nuts, screws, "frozen" parts!

LIQUID WRENCH

SUPER-PENETRANT

The super-penetrating rust solvent that quickly loosens rust and corrosion.

AT ALL HARDWARE
AND AUTO STORES

RADIATOR SPECIALTY COMPANY
LANSING, MICH.



A FINE CHRISTMAS GIFT FOR YEAR ROUND ENJOYMENT



NOW! HOME CRAFTSMEN CAN OWN THIS PROFESSIONAL ARC WELDER

EASY TERMS
ONLY \$98.50
F. O. B.

Now you can own a Trindl full 125 amp Industrial Welder at a price far less than smaller machines. With a Trindl 125A you can weld metals up to 1/2 inch thick. Operates off either 110 or 220 volt line, properly wired. 16 heat stages from 20 to 125 amps. Make and repair anything of metal around the home, garage, farm or shop, like a professional. No previous experience or training needed. Full "do-it-yourself" instructions with each machine. Complete only \$98.50 f.o.b. factory, or write for details. Trindl manufactures a complete line of heavy duty welding machines. Dealer inquiries invited.

TRINDL PRODUCTS Ltd., Dept. T2-N
1807 So. Clark St., Chicago 16, Ill.



Guaranteed

12 MONTHS
IN
CONTINUOUS
OPERATION

FREE

WRITE FOR
COMPLETE
DETAILS AND
EASY PAY PLAN



6.6 HP

Now!
NEW
EASE IN

SNOW REMOVAL

With Steering Sulky and Self Starter

- Powerful Gravelly Tractor—with *push-button Starter, New Steering Sulky* and *Snowblower*—make snow removal almost child's play!
- You can blow snow—deep or light, wet or dry—wherever you want it, with fingertip maneuverability. 48" Snow Plow also available. 30 year round attachments... *All on Easy Pay Plan.*

Write today for FREE 24-page
"Power vs Drudgery" Booklet!

GRAVELLY TRACTORS, INC.
BOX 601-M DUNBAR, W. VA.

FIELD-TESTED SINCE 1922



Now! You can keep your circular-saw blades in "new" condition by using the "Sharp-Set." This tool was designed to set teeth precisely and keep the blade under proper tension regardless of size for filing. Available direct from factory. \$19.95

Prepayment saves C.O.D. and postage charges. California residents add 4% sales tax.

Calgo Manufacturing

89 N. Santa Anita Av.—Pasadena, Cal.

GUNK-it-yourself!

Gunk® G.P. removes grease from engines or concrete floors; cleans paint brushes, power mowers, or machinery completely, economically, safely. It's ready-to-use, rinses off with water, won't clog drains. Quart size with handy "Squirt Spout" top speeds application. Insist on the *best degreaser*—the original "GUNK" at better automotive supply and hardware retailers everywhere. © REG. TRADE MARK.



GUNK CHICAGO CO., River Forest, Illinois
serving the Midwest and Southwest
RADIATOR SPECIALTY CO., Charlotte, No. Carolina
serving the East, Southeast and far West

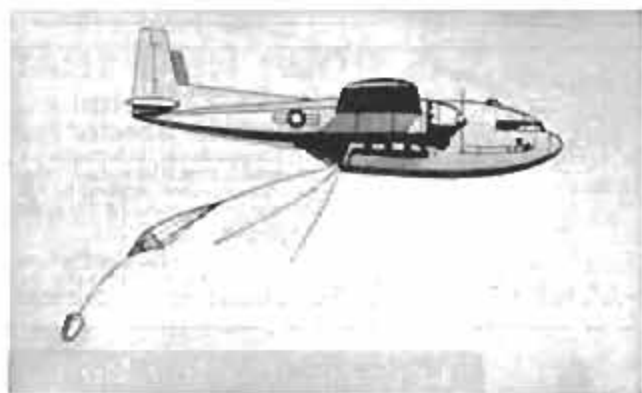
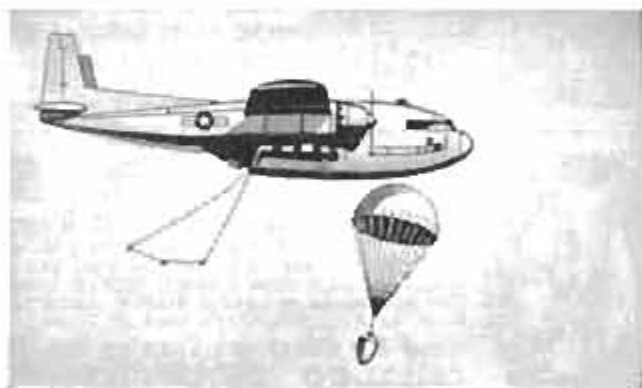
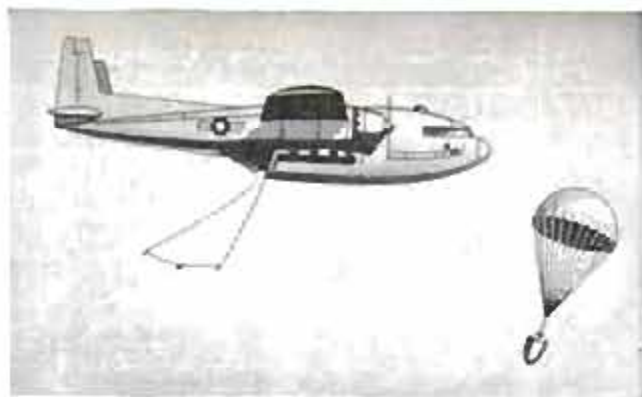

"Trapeze" Beneath Aircraft Snatches Returning Satellite

Air Force artist's drawings show the air-snatch technique for recovering satellite payloads returning from orbit. When the capsule falls to 55,000 feet, a parachute opens and a built-in radio beacon broadcasts a homing signal. The pickup aircraft follows the signal until visual contact is made, then makes a recovery run with "trapeze" recovery gear as shown. Surface recovery units retrieve misses.

READY CUT HOMES

\$2150 AND UP DIRECT FROM MILL

YOU SAVE the items which help make today's building cost expensive: high labor cost, contractor's profit and overhead, insurance, architect's fees. Cut-to-Fit eliminates usual lumber and material waste, also costly mistakes. Anyone can assemble. Simple, easy-to-follow plans furnished and each part numbered. Complete with all lumber, roofing, nails, glass, hardware, paint, doors, windows. Freight paid. Low-cost building plans sold separately if desired. 57 Homes and Floor Plans.

5 EASY PAY PLANS
COLOR CATALOG

Send
25c



INTERNATIONAL MILL & TIMBER CO.
Dept. PM129 Bay City, Mich.

Tremendous
Savings on
Hundreds of
Surplus and Newly
Manufactured
Items!

Equipment for farm, home, work-shop, factory. Hydraulic equipment, pumps, motors, construction and diesel equipment and parts, etc. Write for FREE Catalog today!

GROBAN SUPPLY CO.

1130 S. Wabash Ave., Dept. PM Chicago 5, Ill. WE 9-3793

Don't Miss
PART II
of Joe Bell's
"I LIVED WITH
THE ASTRONAUTS"
in the
JANUARY ISSUE

FEATURE FOR FEATURE

... dollar for dollar

Atlas LATHES

LEAD THE LOW-PRICED FIELD



For experimental, development, production and hobby work, Atlas precision lathes give you many more important features that increase accuracy, speed production and cut costs than any other lathes in the low-priced field.

NEW Atlas 12" LATHE

A big capacity lathe with these important features standard equipment: Timken tapered roller bearings, 16 speeds, reversible power cross and longitudinal feeds, wide thread cutting range, V-belt drive. Available in bench models, and in underneath drive models with pedestal base. Investigate before you buy any lathe.

PRICES START AT \$340 F.O.B. FACTORY

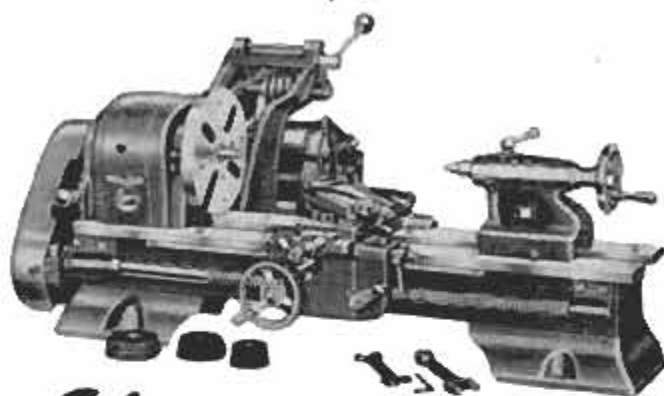

Atlas 6" (screw-cutting) LATHE

For a small investment you can own a back-geared, screw-cutting lathe that, within its capacity, will do everything a high-priced lathe will do . . . and do it fast, efficiently and accurately. It is Timken bearing equipped for precision jobs. Has precision ground bed, 16 spindle speeds, complete V-belt drive, power longitudinal feeds. A most exceptional value.

PRICES START AT \$175

F.O.B. FACTORY

Write for NEW CATALOG

Atlas Press Company



12-24 NORTH PITCHER ST., KALAMAZOO, MICH.



GIFT CHOICE FOR EVERYONE
America's Hardest Working Tool
For Home, Farm, Industry

Look for this Vise-Grip display in your favorite hardware store. On it you will find the world's most popular hand tool in 3 models - 2 sizes. Each Vise-Grip model packs a whole workshop of uses. Locks on to the work...tight! Press new "Easy Release" and jaws spring open. Use it as a pliers, locking wrench, wire cutter, etc. Manufactured exclusively by Petersen Mfg. Co., DeWitt, Nebraska.

Vise-Grip Does More Jobs Easier Than Any Other Tool!

New Self-locking
 perforated board fixtures
DOUBLE YOUR
STORAGE SPACE
 without remodeling!



Just insert Easy Hang fixtures into perforated board. They automatically lock into position. Ideal way to double your storage space in closets, playroom, kitchen, workshop. Fast! Low cost!

Dozens of styles and sizes.

Free, new idea folder tells all!

Turnbuckles, Inc.

Turnbuckles Inc., Dept. PM, Box 333, Michigan City, Ind.
 Rush free folder showing how to double my storage space.

Name _____

Address _____

City _____

State _____



Off-Road Army Transport
Rolls or Swims Anywhere

Another specialized tool for the fast-moving, widely dispersed units of today's ground forces, the "Goer" offroad transport vehicle is an outgrowth of heavy-duty commercial earthmoving machines. The two-wheeled prime mover and trailers ride on six-foot doughnut tires, carrying 15 tons or 5000 gallons of cargo through sand, mud, snow, water or the roughest terrain without dependance on roads or bridges. The builder, LeTourneau-Westinghouse, has delivered four of the carriers to the Army for further testing under combat conditions in various climates.



Corrosion-Proof Reel and Rod
Made With New Polymer Plastic

Use of DuPont's new Delrin polymer plastic has enabled the Zebco Company to market two reel-and-rod combinations that are 100 percent corrosionproof without any sacrifice in size, price, or efficiency. The new plastic, nearly as strong and stable as the non-ferrous metals, is not only non-corrosive even in salt water, but is also not affected by solvents such as oil, gasoline, and carbon tetrachloride, and resists abrasion by dirt and sand. The non-plastic parts of the outfit are of stainless steel; the rod is tubular glass. Two balanced combinations are available—Model 88, shown above, for medium and heavy-duty fishing, and Model 99 for regular fresh water fishing. The matched package includes rod, built-in reel, and line.

**Thrills
Excitement
Perhaps
a career!**

**Send
young minds
soaring into
the amazing
realm of
science...**

*The sparkling adventures of
Randy and Sam Morrow in the
breathtaking world of science:*

**POPULAR
MECHANICS** each-
\$2.95

***There's
Adventure***
BOOKS

DECEMBER 1959



**NOW! SPRAY ANYTHING
IN MINUTES**
↓ **SPRAYIT 400.**

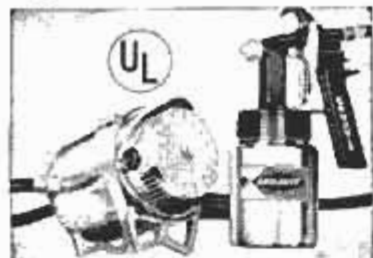

NO FINER GIFT
FOR THE
HOBBYIST OR THE
PROFESSIONAL
PAINTER

\$39.95

(\$40.95 in
7 Western States)

LOW COST! EASY TO USE!

At last! A "do-it-yourself" sprayer that gives professional results. The rugged, rotary vane Sprayit 400 is a truly professional type, integral 1/4 h.p. motor-compressor paint spraying outfit. So simple to use it makes you an expert right from the start. Even beginners get beautiful results the very first time.

Sprays all paint, varnish, lacquer, enamel—even liquid fertilizers and insecticides—anything. It's perfect for multi-color painting. You've never seen anything like the lightweight Sprayit 400—it's ideal for spray painting brick and siding, wicker and lawn furniture, shutters, toys and auto touch-up, too. Use it everywhere, indoors and out.

WRITE TODAY for FREE Sprayit full-line catalog and "How to choose the right paint spray outfit."



THOMAS INDUSTRIES INC.
ELECTRIC SPRAYIT DIVISION
410 S. 3rd St., Dept. PM-12, Louisville, Kentucky

The second most important tool...
for every
woodworking shop

A VERSATILE
W&H
MOLDER-PLANER

is second only
to a saw... it
molds, planes and rabbets.
"Your savings pile up as your
shavings pile up."

SEND FOR
FREE BROCHURE

WILLIAMS & HUSSEY MACHINE CORP.
CLINTON ST., MILFORD, NEW HAMPSHIRE



America is a Better
America -
thanks to Advertising!

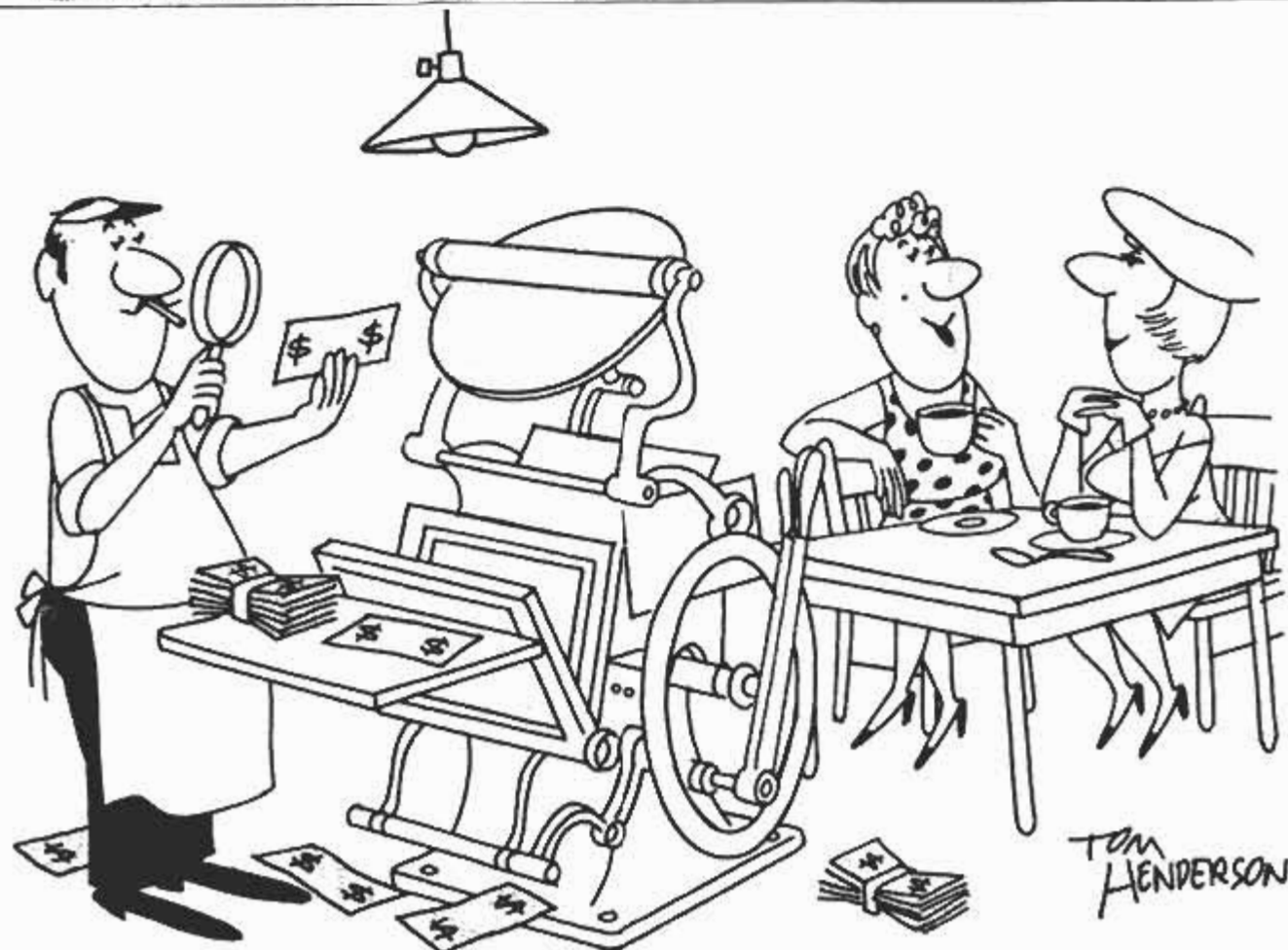

"This year we're thinking of making our own Christmas cards."

SANDING BELTS



	Doz.		Doz.
1x42 Mead, etc.	\$2.50	4x21 1/2 Skil, etc.	4.50
2x17 1/2 All Makes	2.50	4x27 Porter Cable, etc.	5.00
2x21 Porter Cables, etc.	2.75	4 1/2 x 26 Skil-Thor, etc.	5.00
2 1/2 x 21-5/16 Skil, etc.	3.00	4x36 Hammond, etc.	6.00
3x21 Porter Cable, etc.	3.50	4x37-13/16 Atlas, etc.	6.25
3x23 1/2 Skil, Thor, etc.	3.50	4x54 Porter Cable, etc.	9.00
3x24 Porter Cable, etc.	3.50	4x52 1/2 Walker Turner	9.00
3x25 American Floor, etc.	3.50	6x48 Delta-Sears, etc.	10.00
3x27 Porter Cable, etc.	3.50		

1—We have over 100,000 Sanding Belts in stock at all times.
 2—All belts cloth backed—U. S. made. Brand New in original boxes.
 3—Specify for wood, metal or plastic.
 4—We will ship these belts assorted—Fine, medium, coarse, or with grit specification from 24 to 400 grit.
 5—**MONEY BACK GUARANTEE.**
 6—All other belt sizes available at lowest prices—Please inquire.
 Include 35c for postage and handling; Send check or money order. **DEALERS INQUIRIES INVITED.**
H. S. R. SPECIALTIES CORP.
 28-09 Jackson Ave., Dept. PM2, L. I. City 1, New York

KITBOATS Boat Plans Patterns Frame Kits



CREDIT TERMS
FREE FREIGHT—SAVE 2/3
CRAIG-CRAFT, Tonawanda 1L, N. Y.

KIT CATALOGS—Over 50 Models—Pre-assembled. Runabouts, Cruisers, Fishing (8' to 19'). Anyone can assemble. Complete Marine Accessories, Fiberglass plastics, Trailers, Paint, etc. Also Catalog on 50 Modern Plans and Patterns. Prefab Frame Kits—SEND 10c FOR 2-COLORED CATALOGS

BRONZE FOUNDRY



Schools • Home Workshops • Inventors

Make your own castings of aluminum, copper, bronze, silver. Foundry sets are available in four sizes, capacity 1 1/2 lb. to 36 lb. of red brass. 2400 Deg. F. blast furnace included with each. Write for Free Circular.

KANSAS CITY SPECIALTIES CO. DEPT. P-12, P.O. BOX 8022, MARYSVILLE, KANSAS

CUT ANY SIZE — ANY SHAPE WITH Spearhead Cutter

Handy pocket size — cuts leather, asbestos, rubber, cork, etc. — round 1/4" to 6" — any size straight and odd shapes.



Send Check or Money Order!

935 POSTPAID

ZIMMERMAN PACKING — NORWOOD 12, OHIO

use the solder that most home owners use!



KESTER SOLDER

For your electrical work, radio-TV, do-it-yourself projects always use the best... **KESTER SOLDER.** Send for FREE 16-page book that tells you how!

KESTER SOLDER COMPANY

4251 Wrightwood Avenue • Chicago 39, Illinois
 OVER 60 YEARS' EXPERIENCE IN SOLDER AND FLUX MANUFACTURING

FUEL BILLS GET FAT

when insulation goes flat!



Get It up to the proper fuel-saving level

INSULATE with ZONOLITE®

Fuel bills zoom if attic is uninsulated or if old insulation's played out... shrunk... skimpy! Zonolite vermiculite pours easily between joists; fills uniformly to plug heat leaks and cut fuel bills as much as 40%! It's fireproof, rotproof and verminproof; never settles or loses efficiency. Guaranteed for the life of the building. Send for FREE booklet.



ZONOLITE COMPANY, Dept. PM-129
 135 S. La Salle Street, Chicago 3, Illinois
 Send me free booklet HI-110, "Homeowners' Guide to Insulation." No obligation.

Name _____
 Address _____
 City & Zone _____ State _____

AT LUMBER OR BUILDING SUPPLY DEALERS

Make \$20 to \$30 a Week EXTRA MONEY!

With the high prices of food, clothing and everything else, just think what you could do with extra money every week! Turn your spare time into CASH—sharpening saws with a Foley Automatic

Saw Filer pays from \$3 to \$6 an hour. Start in your basement or garage—no experience necessary. "The first saw I sharpened with my Foley Filer came out 100%"—writes Clarence E. Parsons. No canvassing—"I advertised in our local paper and got in 93 saws"—says M. L. Thompson. With a new model 200 Foley you can file all hand saws, also band and both combination and crosscut circular saws.



FREE BOOK Shows How to Start

It explains how you can get business from home owners, farmers, carpenters, schools, factories, etc. "I got work from 20 and 30 miles away"—says Charles H. Smith. Free Book, "Money Making Facts," tells how to start. **Time Payment Plan.** Send coupon today—no salesman will call.

Send Coupon for **FREE BOOK**

FOLEY MFG. CO.
 1243-9 Foley Bldg., Minneapolis 18, Minn.
 Send **FREE BOOK**—"Money Making Facts," and Time Payment Plan.

Name _____
 Address _____





Vanguard Air and Marine Corporation, Paoli, Pennsylvania

VTOL Craft Has Features of Airplane and Helicopter

Combining a helicopter's versatility with an airplane's speed, a vertical take-off aircraft built by Vanguard Air and Marine Corporation is undergoing Air Force-sponsored tests. A section in the top of each wing lifts hydraulically to allow rotors inside to raise the craft vertically. At 50 miles

per hour, the fixed wing's normal lift takes over, and the cap is lowered on the rotors. A 265-horsepower Lycoming engine drives the rotors and pusher propeller. Now planned are a four-passenger executive plane and a 40-passenger transport with a cruising speed of 275 miles per hour.



Proto makes more than 80 different Pliers and Snips...and more than 2,100 other fine tools...each one guaranteed.

PROTO TOOL COMPANY

2202 Santa Fe Ave., Los Angeles 54, California
502 Allen St., Jamestown, N. Y.
1702 Oxford East, London, Ontario, Canada

Help Fight TB



Use Christmas Seals

FIBERGLASS or PLYWOOD

\$41.95 Up, Frt. Pd.

EASY
TERMS
FREE 1960
CATALOG

Cruisers, runabouts, convertibles, fishing. Pre-assembled, pre-formed units. Perfect assembly by anyone. Equal factory-built. Save you 1/2 to 3/4. Catalog has natural color photos, details; paint, trailers, accessories, Fiberglass supplies. WRITE TODAY.

LUGER BOAT KITS

Dept. B-12, 9200 Access Rd., Minneapolis 20, Minn.

VACO®

You'll Want This Nut Driver Kit!



Nothing Finer!

- Five New Design VACO nut drivers (most popular hex sizes).
- Beautifully polished chrome shafts with new super hard sockets.
- Beautifully colored, extra comfortable, plastic handles (a different color for each size).
- "Jewel Case" packaging in two-tone plastic storage box with clear plastic, hinged cover.

No. SP 500
\$4.95
Complete

At Better Stores Everywhere or Write.
Four Color Catalog Available

VACO PRODUCTS COMPANY, 323 E. Ontario St., Chicago 11, Illinois



Wash or scrape
old paint off
with

HEAVY-BODIED KLEAN-STRIP



AUTOMATIC CLUTCH and sheave
for gasoline engine drives

Add a low-cost F-M centrifugal clutch to your conveyors, elevators, go-carts, cultivators, pumps, etc. Get faster, easier starts in any weather. Gives automatic engagement, high torque — fits shaft on 1 - 10 hp engines, up to 3 hp motors. Six models, engagement speeds 1450-3100 rpm. See your dealer or write to:

FAIRBANKS, MORSE & CO.
Magneto Division • Beloit, Wisc.

A PICTORIAL HISTORY

OF THE

AUTO INDUSTRY

—a six-page color feature

in the

JANUARY ISSUE

is a highlight of the

ANNUAL AUTO SECTION

UNIMAT

complete machine shop-in-miniature



Converts from lathe to drill press, tool and surface grinding machine, vertical milling machine, or polisher/grinder—in seconds! **\$129.50**

THIS is that jewel of a machine tool you've been looking for—if you're the kind of craftsman, hobbyist, model builder or inventor who demands all-out precision. It's hard to believe that such versatility, such high-level performance could be built into a rugged instrument that measures only 16" from headstock to tail wheel! The basic UNIMAT includes a powerful 3500 RPM motor and everything you need for fundamental machining operations. Advanced workers, of course, will want many of the accessories that make UNIMAT the most practical, all-purpose tool available anywhere in the world! Whether you're a perfectionist or putterer, you'll really enjoy working with UNIMAT. Available at better hardware stores and hobby shops, or WRITE FOR FREE CATALOG AND BUDGET PLAN INFORMATION.

AMERICAN EDELSTAAL, INC. DEPT. 61
350 BROADWAY ■ NEW YORK 13, N. Y.

FREE! LAFAYETTE'S 1960 CATALOG



304 GIANT-SIZED PAGES

CONTAINS

MUNDREDS OF EXCLUSIVE LAFAYETTE ITEMS NOT IN ANY OTHER CATALOG OR AVAILABLE FROM ANY OTHER SOURCE - SEND FOR YOUR COPY NOW!

See the newest and finest in Stereo Tuners, Amplifiers, Cartridges and Music Systems

Everything In Electronics

• TAPE RECORDERS • PUBLIC ADDRESS SYSTEMS • AMATEUR EQUIPMENT • INDUSTRIAL SUPPLIES • RADIO & TV TUBES AND PARTS • INSTRUMENTS • TELESCOPES, BINOCULARS, MICROSCOPES & CAMERAS

The most complete electronic supply catalog crammed full of everything electronic at our customary down-to-earth money-saving prices.

The largest selection of hi-fi components and systems; greatest savings on Lafayette endorsed "best-buy" complete systems.

EASY PAY TERMS AVAILABLE — 10% DOWN — UP TO 18 MONTHS TO PAY

Lafayette Radio P.O. BOX 222
JAMAICA 31, N. Y.
DEPT. LL-9

Send FREE LAFAYETTE Catalog 600

Name.....
Address.....
City..... Zone..... State.....

CUT OUT AND PASTE ON POST CARD



Plane That Looks Like a Bird

Swan I, an airplane invented by Walther Filter of Hannover, W. Germany, is designed to swing through the air like a bird, on wings that are "feathered." Fitted with

a four-horsepower gasoline motor to drive a piston which in turn will flap the wings, Swan I is expected to soar at speeds up to 50 miles per hour.

HIGH SPEED SHANK DRILLS



- SET 30 SELECT H.S. STRAIGHT DRILLS TO 1/4 IN.
4B ALL SHARP, MOSTLY NEW. 4" TO 12" LENGTH.
\$15.00 VALUE **Red \$3.29**
- SET 12 DIFFERENT SIZE H.S. STRAIGHT SHANK
5B DRILLS 1/4" TO 1/2" LENGTHS TO 7"
Red \$3.98
- SET 5 DIFFERENT SIZE H.S. DRILLS 1/2" TO 1 3/16"
7B 1/2" SHANK
5 DRILLS FOR THE PRICE OF 1 NEW DRILL **Red \$9.95**
- SET 10 DIFFERENT H.S. DRILLS 1/2" TO 1 3/16"
8B NEW AND RECONDITIONED H.S. PRECISION DRILLS
WITH 1/2" SHANK. MAY BE USED IN 1/2" REC. DRILL OR
A 1/2" CAP. LATHE OR DRILL PRESS. **Red \$17.95**

TRUCK or CAR HEATER

7"X4 3/4" BRASS RADIATOR,
6 or 12 VOLT, CONTINUOUS DUTY
FROM 1/2" TUBE CONNECTIONS. BRAND
NEW. SUITABLE FOR CARS, TRUCKS, BULL
DOZERS OR FARM MACHINERY.

MAKE THIS WINTER
COMFORTABLE!
at only **\$4 95**



Wholesale Tool Co.

10248 GRAND RIVER
DETROIT 4, MICHIGAN

YOUR MONEY BACK on receipt of merchandise
if you are not satisfied. All merchandise
sold in this ad. has been tested and
found to be of the highest quality.
We will replace or refund your money.
Deduct one shipped cost plus, being 10% to
20% in labor delivered cost.

DO MORE PLANING JOBS WITH LOW COST BELSAW



Exclusive MONEY-MAKING Features: Full
12 3/4" x 6" capacity • Power feeds at 14'
to 34' a minute • Provides for Grinding Knives in the Cutter-
head • Attachments for Jointing, Rabbeting, Tongue, Matching,
Groove, Convert low cost rough lumber into high priced stock.
Easy to make flooring and popular patterns. Send Today
for FREE Literature and Prices.

LOW DOWN
PAYMENT
EASY TERMS

Belsaw Machinery Co., 2050 Field Bldg., K.C. 11, Mo.

FOR SPORTS, FUN OR FOR SELF-PROTECTION!

World's Finest Blank Pistol .22 Cal.
6 Shot Automatic NOW ONLY \$5.95

Looks, feels and sounds like a fine
"real" pistol. But it's safe...
can't hold regular cartridges. Ideal for all
sports, theatrical events, dog training and
home protection. Fits easily into pocket
or purse. Outstanding in appearance, action and price.



ORDER by MAIL TODAY

Godfrey Import Corp., Dept. M12, 261 Broadway, N.Y. 7, N.Y.

NO JOB WORRIES

PLASTEX INDUSTRY needs manufacturers on small
scale for big production of Lamps, Clock Stands, Art
Goods, Novelties in Plastic Marble imitation. No Ex-
perience necessary. 1/2c material makes regular 10c
store sellers. Moulds furnished for fast production.
Small investment brings good profit. Big wholesale
orders now being placed. Ambitious men have chance
for real prosperity and job security. Our NEW FREE
booklet will interest and benefit you.

PLASTEX INDUSTRIES, Dept. A
3400 Third Ave. New York 56, N.Y.

**GIVE
AMERICAN
CANCER
SOCIETY**

DECEMBER 1959

V-M RECORD CHANGERS



STIRRING STEREO SOUND!

An incomparable combination! Functional beauty is perfectly matched with audio engineering perfection in V-M record changers. They've rewarded millions with pure musical pleasure since the advent of High-Fidelity Model 1201 — V-M 'Stere-O-Matic'® 4-speed changer. Plays all stereo records. Plays all sizes, speeds of mono-
phonic records and plays them better! Model 1202 — with 4-pole motor and plug-in head for magnetic cartridges. Both available on style-pleasing bases (shown) as Models 1227 or 1229. V-M Corporation, Benton Harbor, Michigan.

the Voice  of Music®

Christmas Treat
for
THE-MAN-OF-THE-HOUSE
Deluxe
CUSHION GRIP
SCREWDRIVERS by
Bridgeport



A pleasure to give or receive
... and a pleasure to use! Four
most-needed CUSHION GRIP
Screwdrivers in handsome red and
gold gift package.

Only \$5.50 retail at Hardware
stores.

Tested and Approved by Mechanics.

- 50% greater Turning Power.
- Blistertproof, resilient neoprene handle.
- Super Comfortable.
- Alloy tool steel blades
- Fully guaranteed.

Bridgeport Hardware Manufacturing Corporation

Bridgeport 5, Conn.



Chemical Slows Seepage from Ponds and Canals

"SS-13," a mayonnaise-thick liquid, is being pumped into soil-bottomed ponds and canals in the Southwest to control the seepage of precious water in sandy soil. Pumped into a pond or canal, the chemical diffuses through the water, then is carried to the

soil, where it reacts to increase the soil's resistance to seepage. Harmless to plants or animals, the chemical is known to last at least two years and has reduced seepage up to 75 percent in the field. Lab tests indicate a potential effectiveness up to 94%.

you can always

BE SURE OF A JOB

WITH A

FOLEY SAW FILER

Have you been laid off—or afraid you may be? If you want security, plus a bigger income too—don't look for a job—start your own spare time business. In his first 2 months J. P. Hobbitt earned \$300 with his Foley Saw Filer. From his starting day R. T. Hart made \$600 in 4 months. Frank P. Layne wrote—"In our town of 2,800 instead of 200 to 300 saws I did over 1,500 the first year, averaging about \$1.50 each.

FREE booklet "MONEY MAKING FACTS" shows you how to get business. The new Foley "200" sharpens hand, band and both "combination" and crosscut circular saws. Use our Time Payment Plan—pay for the machine out of your CASH profits. Send coupon today—no obligation, and no salesman will call.

FOLEY MFG. CO., 1216-9 Foley Bldg., Minneapolis 18, Minn.
Send Free Booklet and Time Payment Plan on Foley Saw Filer.

Name _____
Address _____
City _____ State _____



ELECTRIC WELD - BRAZE & CUT

REPAIR MOST EVERYTHING MADE OF METAL

Home Appliances, Auto parts, Farm-garden equipment, toys. Make and repair playground equipment, lawn chairs, tables, ornamental iron work, gates, wagons, etc. Solder, heat, bend, and straighten, with terrific heat from arc torch.

Cut and weld up to 1/4" steel plate. A million uses for Home, auto, farm, inventors, factories, etc. Works from any home 110 volt plug-in. Complete with dark welder's mask, arc torch, supply of carbon welding and brazing rods and complete Welding Instruction Book. Efficient—durable—1 year guarantee. Wt. only 4 lbs.

SEND ONLY \$3 (cash, r.k., m.o.) and pay postman \$2.95 plus COD postage on arrival or send \$13.95 and we will send postpaid. Ideal gift for mechanically minded home owners, relatives, friends. Order now for early delivery. Available only from:

MIDWAY WELDER Dept. DPM-12 Kearney, Nebraska

TOP QUALITY

The finest materials and expert craftsmanship make Gerstner Chests first choice everywhere.

GERSTNER TOOL CHESTS
459 Columbia St., Dayton 7, Ohio

TOOLS WHOLESALE

\$100 PUTS YOU IN BUSINESS

Start your own business, sell tools to your friends and neighbors, or buy tools for your own use and **SAVE MONEY \$\$\$**

A MILLION DOLLAR INVENTORY AT YOUR FINGERTIPS. NO STOCK TO CARRY, ORDER AS YOU NEED IT.

BUY AT WHOLESALE PRICES. Extra \$25.00 profit on your accumulated purchases. \$1.00 refund on first purchase or refunded if you are not 100% satisfied.

THOUSANDS!! of Nationally Advertised items of Hand Tools, Power Tools, Machine Tools, Tool Chests, Paint Sprayers, Light Fixtures, Appliances, Guns, Gifts, Toys and other items too numerous to mention.

WE SHIP COAST TO COAST Wholes. Disc. up to 50% off

Dept. **SILVO HARDWARE CO., PM-12107 Walnut St., Phila. 6, Pa.**



HALF PRICE SALE

ON DISCONTINUED

BLUEPRINTS AND PLANS

Have the things you want and need the easy way using Popular Mechanics famous blueprints and plans. Because we're clearing out our stocks of titles where we have only a limited number of copies left, you save half the cost.

Just check off your order on the list below. Total the amount and

CUT THE PRICE IN HALF
before you send us your remittance.

WHILE THE SUPPLIES LAST

FULL-SIZE PATTERNS

Trundle Bed	\$1.50
Cocktail Table	.50
Step Table	.50
Toys for Children	.50
Juvenile Clothes Chest	1.00
Cupola & Weathervane	.50
Workbench	1.00
Valances & Trim	.50
Wall Shelves	.50
TV Chair	1.00
Tub Chair	1.00
Sofa Bed	1.00
Love Seat	1.00
Corner Table	.50
Palette Coffee Table	.50
Traditional Magazine Rack	.50
Lamps & Planter	1.00
Twin Head Boards	.50
Night Stand	.50
Santa Claus	.50
Sleigh & Reindeers	1.00
Child's Dinette Set	.50
Shoe Shine Box	.50

FURNITURE SETS

Bedroom Furniture Plans	\$2.00
Dining Room Furniture	2.00
Occasional	2.00
Lawn Furniture	2.00
Living Room	4.50
Kitchen	2.00

SINGLE FURNITURE PLANS

40c Each

Revolving Book Stand
Built-in Telephone Cabinet
Puritan Candle Stand
Duncan Phyfe Console Table
Queen Ann Footstool
Three Hanging Shelves
Bent Iron Flower-Magazine Stand
Child's Rabbit Bookcase
Writing Case
End Table
End Table
Vanity Table
Hanging Shelves & Brackets
Nevel Elec. Clock Cases
12 Point Star Lamp
Play Seat & Dutch Gulana Stool
70" Elec. Hall Clock
Dutch Type Breakfast Set
Chest on Chest of Drawers
Sawyer Chair for garden
Cape Cod Cupboard
Ladder-back Chair
Combination Beverage & Teacart
Folding Muffin Stand
Duncan Phyfe Drop Leaf Table
Duncan Phyfe Lyre Back Chair
Two Tray Tier Table
Two Spindle Shelves
Coffee Table & Tray
Twin Deck Beds
Console Table
Occasional Table
Chippendale Bookcase
Colonial Footstool
Six Towel Racks
Colonial Mirror Frames
Colonial Writing Desk
Two Smoking Stands
Cape Cod Cricket Chair
Chair Side Magazine Case
Swedish Supper Cart
Corner Dish Shelf
Sturdy Bookcase
Modern Desk

HOUSE PLANS

Your Home & How to Build It	\$12.50
Concrete Block House	12.00
Ranch House Plans	13.50
Pre-Cut House	12.50
Young Family Home	12.50
Big Family Home	12.50
P.M. California Home	15.00

GARAGE PLANS

2 car 20x20 ft. Frame	\$2.00
1 car 12x20 ft. frame hip roof	2.00
2 car 20x20 ft. frame gable roof	2.00
1 1/2 car 14x20 frame gable roof	2.00
2 car 20x21 ft. brick gable roof	2.00
1 car 20x20 cone blk stge area	2.00
1 1/2 car brick 14x20 hip roof	2.00
2 car 20x20 frame gable roof	2.00
1 1/2 car 15x20 frame gable roof	2.00
2 car frame 20x26 gable roof	2.00
Garage Floor Plans	2.00

MODEL PLANS

Henry Hudson Half Moon	\$1.60
Flying Cloud	2.40
De Witt Clinton Train	4.00
Sovereign of Seas	2.80
32" Model Roamer	2.40
Atlantic Grasshopper Locomotive	1.20
Grecian Trireme—480 B.C.	1.60
Gas Powered Model Airplane	.80
S. S. United States	1.50
Midway Carrier	2.50
12" Model Yacht	.40
Jeanne D'Arc	7.50
Marie Jeanne	5.00
La Sabizise	5.00
Le Terrible	5.00

BOAT PLANS

Roamer Outboard Boat	\$2.40
Air Propelled Ice Boat	.40
12 Foot Sectional Rowboat	.40
Whizz Class E Ice Yacht	1.60
Falcon	4.00
Sea Craft Cabin Cruiser	10.00
Sea Knight Cruiser	10.00
Swish Sports Runabout	9.00

HARDBOARD PLANS

40c Each

Dog Bed
Bird Feeder & Bird House
Garden Windmill
Parkway Numbers
Noah's Ark
Lawn Ornaments

Kitchen Utensils
Photo Frames
Mirror Frames
Magazine Racks
Scrollwork Waste Basket
Snack & Beverage Tray
Tea Cart
Bed Tray
Bird House
Clothes Hanger
Clothes Hamper
Child's Rocker
Baby Sleigh
Bric-a-Brac Cabinets
Sewing Box & Spool Tray
Waste Basket
Magazine Baskets
Bird & Animal Designs
Toy Chest
Vegetable Bin
Ski Jump Toss Game
Doll House (204A)
Doll House (204B)
Chariot Scooter
Window Valances
Novel Shoe Racks
Warm Dog House
Record Cabinet
Tool Chest
Child's Clothes Hamper
Modern Desk

27 Other Interesting Blueprints

40c Each

Electric Banjo Clock
Boys Hand Car
Kicking Mule Toy
Feeding Chicken Toy
Infant Bowls
Flat Roof Arbor Gate
Scroll Sawed Waste Basket
Coasting Toboggan
Sand Box & Wading Pool
Treasure Box with Secret Lock
Sensitive Drill Press—Small Work
Lathe Post Tool Grinder
Electric Spot Welder
Box Kites
Large Cabinet Bench
Midget Auto
Half-Pint Sea Sled
Speedy Bobbed
Photo Printer
Homemade Farm Tractor
Workshop Electromagnet
Electric Weathervane
Linear Conversion Table
Color Mixing Chart
Flower Boxes
Martin Houses
5 Wren Houses

SERVICE BUREAU, POPULAR MECHANICS, ROOM 519
200 East Ontario, Chicago 11, Illinois

Enclosed is remittance in the amount of \$_____ for blueprints at half price as listed above. (Minimum order \$1.00)

Name _____

Street _____

City _____ Zone _____ State _____



HEAVY DUTY D-C ARC WELDER

Use as portable or shop welder. Up to 300 amps, Senior model. Made for years of trouble-free, continuous service. Will handle light or heavy jobs. Easily welds up to 3/4" plate using 1/4" rods. Built-in air cooling system. Arc is easy to strike and hold, because of specially designed arc stabilizer. Hi-to switch and dial control gives wide range of welding heats. Run welder at 2600 rpm, with tractor, jeep or 15 hp. gas engine, or 7 hp. and triple V belt or flat pulley. You can pay more, but you can't buy a better welder. **\$119.50**
Wt. 110 lbs., \$400.00 value. **\$10.50**

with mounting flange (item 38)

WELDING KIT. Two 10 ft. leads, welding helmet, electrode holder, ground clamp. Sold only with welder at **\$10.50**

HEATING AND VENTILATING FAN

(Item 10) Easily installed in furnace pipes. Forces even heat to all rooms. Over range removes kitchen smoke and odors. Powerful, continuous duty motor. 110-120 v. AC. Mount in wall or ceiling to ventilate any area. Quiet, super-efficient fan moves huge volume of air. (400 to 600 CFM).

8" Pipe, wt. 5 lb. **\$6.85**
9" Pipe, wt. 6 lb. **\$7.85**
10" Pipe, wt. 7 lb. **\$8.85**
12" Pipe, wt. 8 lb. **\$9.85**

HEAVY DUTY FAN. Semi-enclosed motor, suitable for spray booths, restaurant exhausts, poultry houses, etc.
10" Fan, wt. 8 lbs. (Item 10E) **\$11.95**
12" Fan, wt. 10 lbs. (Item 10F) **\$12.95**

HIGH SPEED BARN FAN similar to above, but larger, high speed motor moves huge volume of air.
12" Fan (Item 10G) **\$14.95**
14" Fan (Item 10H) **\$17.95**



700 Watt Light Plant

115 v. 60 cycle, AC Powered by a rugged 2.2 HP, easy starting Briggs engine. No wiring necessary; just plug in and operate. Plenty of current for any oil burner, freezer, brooder, emergency lights, etc. which require up to 700 watts. Ideal for television and radios. Complete with voltmeter and built-in winding to charge 6 v. auto batteries. (Item 24) Wt. 75 lbs. Easily fits in car trunk. Be prepared if storm knocks out power lines. Reg. \$275. **\$143.50**

1200 Watt Plant (Item 45) same as Item 24 but larger generator and engine with 50% greater output. **\$199.50**

We make all sizes up to 100,000 watts — write for details.

Heats instantly anything from a cup of water to a wash tub full. . . much faster than any stove or coaly heater. Indispensable for laundry, dishes, baths, etc. Terrific for coffee, tea, soups. Made of unbreakable shock proof "Nyalite." Simple and cheap to operate . . . just plug it in. 1200 watts, 115 v. A.C. Money back guarantee. Item 856. *Shipped prepaid. **\$3.95** only.



Send 10c for 100 page Catalog — FREE with order. Prices f.o.b. factory — Send check or M.O.

MASTER MECHANIC MFG. CO., Dept. A-129 Burlington, Wis.
Southern Customers Order from Dept. A-129, Box 65, Sarasota, Fla.

I Lived With the Astronauts

(Continued from page 79)

gyroscopic theory and similar highly technical subjects delivered by specialists from the Langley Research Center. These are usually scheduled every Monday morning.

Briefings on activities in areas where they are concerned . . . e.g., Atlas firings.

Lectures on specific problems of Project Mercury. There were several of these a day when the program started, but they have largely been completed and are now reduced to a few each month.

Practice flights on equipment at Langley which simulate some of the conditions they will encounter in space.

Flying jet aircraft from Langley Field. Two F-102's have been assigned for the exclusive use of Astronauts, and they strive to put in at least 20 air hours a month per man to maintain their flying proficiency. Later, this flying will be done in pressure suits to help them adapt to long periods in this encumbering type of equipment. All of the Astronauts complain they don't get enough time in the air—which they don't. Above all, these men are dedicated pilots. They love to fly, and look forward eagerly to leaving the classroom for the flight line.

Not Much Leisure

Individual study of technical reports. More and more, lectures are being superseded by technical reports which the men can read and assimilate during leisure moments—of which there are far too few.

Free time for athletics and recreation.

And finally field trips to (1) make test flights in equipment not available at Langley and (2) consult with manufacturers on the equipment the Astronauts will be using in their space flights.

The two most important training facilities away from Langley are the weightlessness tests at Wright Field in Dayton, Ohio, and the centrifuge at Johnsville, Pa. To familiarize the Astronauts with the sensation of weightlessness, they are tumbled in the cargo compartment of a C-130 transport which pulls abruptly out of a steep power dive and provides about 15 seconds of weightlessness for its occupants at the top of the climb. This is the most difficult element of space flight to simulate—particularly for a period long enough to give the Astronauts any real feel of the problems involved in exerting hand controls in a weightless state.

A new effort to breach this gap is underway at Langley now. Still in the development stage, it will consist of a barrel-shaped device filled with water. The Astronaut will be inside the barrel, completely sub-

(Continued to page 254)

SAVE YOUR FINGERS STOP YOUR POWER TOOLS INSTANTLY

with a

SELENIBRAKE JR.

The Electric Brake for Motors up to 3/4 HP



Avoid serious accidents . . . STOP your power tool or lathe INSTANTLY. The SELENIBRAKE, JR. — a complete electric braking unit. Requires NO wiring. Female plug connects directly to motor, male plug to 110 volt single phase. Heavy-duty 3-position switch for "START", "OFF" and "BRAKE". Junior model of famous SELENIBRAKE used over 7 years in industry, provides hundreds of thousands stops. No Maintenance. No moving parts, tubes, relays. Guaranteed. Hammer-tone metal cabinet, wall or bench mounting. Max. Size: 8" x 8" x 10". Wt. 15 lbs. PRICE: up to 1/4 Hp. \$44.50; 1/3 to 1/2 Hp. \$53.75; 3/4 Hp. \$69.50 F.O.B. New York. Send cash with order. Shipped collect. 100% satisfaction or money refunded. Write for literature.

AMERICAN RECTIFIER CORPORATION Dept. JSB1
95 Lafayette St. — New York 13, N. Y.

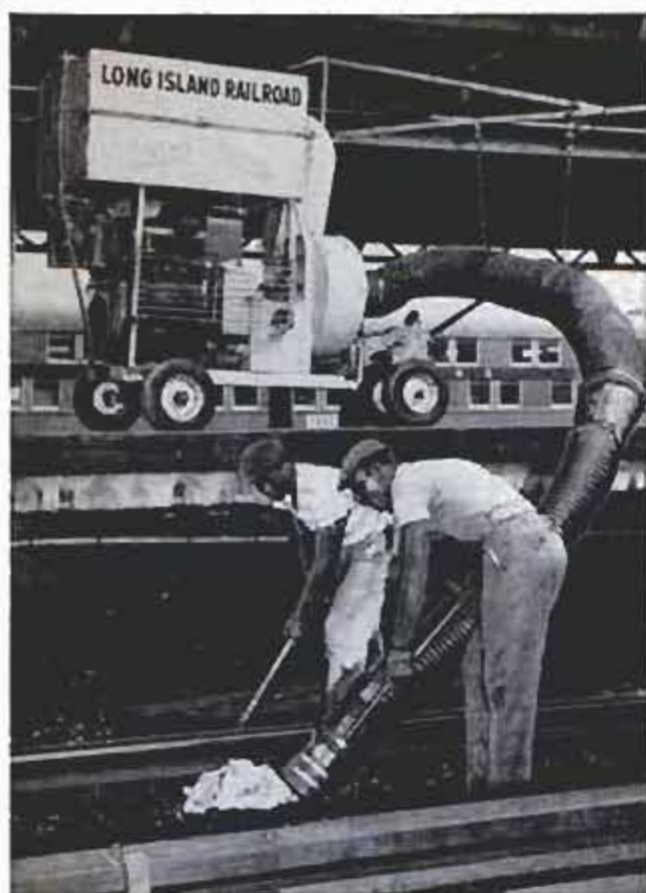

Giant Vacuum Cleaner Tidies Up Railroad Yard

It's a big job to keep a railroad yard clean, but the job is considerably easier with a unique industrial vacuum cleaner. Currently being used in the Long Island Railroad's housecleaning program, the gigantic sweeper has a 10-inch diameter suction hose. Its pull is so powerful that along with debris it even sucks up the grease drippings that collect on the track beds.

POPULAR MECHANICS
MAGAZINE

now complete on
MICROFILM

VOLUMES ONE THROUGH NINETY-SIX

Early volumes of POPULAR MECHANICS have been eagerly sought as collector's items. Now the monumental new microfilm collection makes this wealth of reference material available to all libraries.

Begun in 1902 as a weekly, POPULAR MECHANICS was one of the first "picture" magazines. It also pioneered the do-it-yourself idea, and its files contain plans for almost any project desired.

Ninety-six volumes — \$750.00 for the set.

UNIVERSITY MICROFILMS, Inc.

313 North First Street

Ann Arbor, Mich.

"My New Homelite Cuts Like a Dream"



Another User Testimonial for **HOMELITE**



**IT'S NEW!
ONLY**

\$153⁵⁰

complete, f.o.b. factory

As low as
\$290
Weekly
after small down
payment

- direct drive
- 19 pounds, less bar and chain
- cuts trees up to 3 feet in diameter
- famous Homelite short stroke engine design
- perfect for cutting firewood, clearing campsites, cutting logs for cabins

PROOF — Robert C. Giltz of Toledo, Ohio writes: "My new Homelite cuts like a dream. I really am sold on it." See a free demonstration at your Homelite dealer's. Send 10¢ for your copy of a new 16-page booklet — "A Man's Guide to Chain Saws."



HOMELITE

A DIVISION OF **TEXTRON INC.**
612 RIVERDALE AVENUE
PORT CHESTER, N. Y.

THINK FIRST OF QUALITY . . . THINK FIRST OF HOMELITE

Get out and
GO



CUSHMAN!

The road ahead leads to new fun and adventure when you're in the saddle of a distinctively styled Cushman scooter...a showpiece wherever it goes. It's ruggedly built for safe roadability, precision engineered for dynamic performance. The dependable Cushman Husky 4-cycle engine delivers up to 100 miles per gallon, for an operating cost of less than a penny per mile.

Sold and serviced nationally—Full accessory line at all dealers

Ask your dealer for a **FREE** demonstration or write for colorful booklet



CUSHMAN MOTORS

1039 No. 21st, Lincoln, Nebraska

A subsidiary of Outboard Marine Corporation, maker of Johnson and Evinrude outboard motors

Radio Shack
transistor
portable
**PRICE
SMASH!!**



\$9.95 Plays like \$19.95!

Give 2 of these radios for the usual cost of 1

BUILT-IN 2 1/2" SPEAKER, phone jack for "private" earphone listening, powerful antenna that pulls in all major stations, Conelrad markings — all this in the gift bargain of the year! For students, youngsters, shut-ins, office. Handsome molded case. Ship. wt. 2 lbs. Accessory earphone, battery extra (see coupon).

**NEW
ELECTRONIC
GUIDE 35c**



50,000 sold already! Newly published Radio Shack 1960 Buying Guide. 312 book-size 8 1/2 x 11 rotogravure pages. Handsome illustrations, articles, charts, complete "specs" for over 40,000 items.

**FREE
BARGAIN
CATALOGS**



12-month subscription. Famous Radio Shack "exclusives" in hi-fi, electronics, "ham" radio, tools, records.

RADIO SHACK Corporation, Dept. 12M
730 Commonwealth Avenue, Boston 17, Mass.

- FREE Bargain Catalogs
- New 1960 Electronic Buying Guide @ 35c
- Transistor Portable, 90L601 @ \$9.95
- Earphone, 91L166 @ 69c
- Battery, 95L030 @ 59c

Name _____
Address _____
City _____ Zone _____ State _____
() Cash () Check () M.O. () C.O.D.

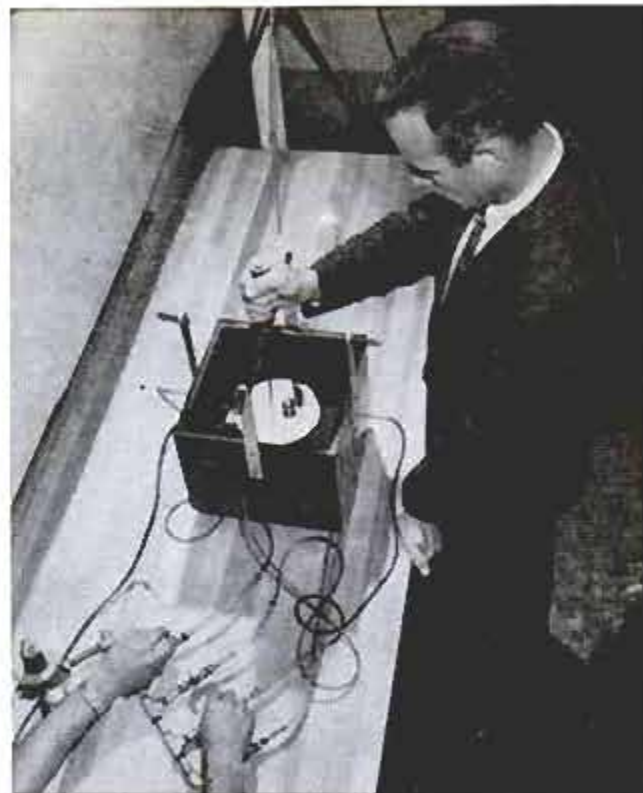

Carpenter attempts to keep ball bearing on plate while operator tilts the plate with jets of air

merged. In this state, he will have to operate controls similar to those in the space capsule.

This device illustrates the extreme efforts being made to develop training machines to simulate conditions man has never experienced. The trainers will probably be modified drastically once a trip into space has actually been made and the pilot can report accurately what he encountered. But lacking this information, the ingenuity of the NASA engineers and scientists must substitute as effectively as possible for exact knowledge. So far it has been impossible to develop any one training device which duplicates all of the problems—atmospheric and mechanical—that the Astronaut will face. Probably the closest thing is the centrifuge at Johnsville, Pa.

Here, the Astronauts are strapped into a cockpit, faced with a battery of complicated instruments, and whirled about to give them a taste of the tremendous forces that will be exerted on them. During the launch trajectory, the Astronaut will have to take about 8.6 Gs, and again during the re-entry. The time at these peak Gs will be only a fraction of a second, but he will probably be above 5 Gs for a half-minute to a minute. The Johnsville centrifuge can duplicate and greatly exceed these pressures.

Because space travel opens an entirely new frontier, the production of the "hardware"—as the Astronauts call their capsule

(Continued to page 256)

Welding Cable 00" 50' \$12.50 100' \$24.00
 G-1 150-250 amp 30V Good condition \$12.95
 G.E. 200 amp 30 Volt Good Cond. \$15.50
 R-1 300 amp G.E. new \$24.50 Good C. \$16.50

Accessories Kit For Arc Welder for above generators has helmet, gloves, elect. holder, volt reg. rheostat, RC relay volt-meter, Gr. Clamp, & switch \$19.50.
 With G-1 160-250 am gen. \$27.95

Multi-Weld D.C. Arc Welding Kit Complete with G.E. R-1, 300-350 amp gen. incl. all items in accessories kit plus 2 (25 ft) cables & reactor coil with solenoid throttle control all pretested \$56.50

AC-DC WELDER KIT - 511 G.E. Generator. Makes 1250 Watts AC light plant and 200 amp. DC welder and battery charger. Includes all items listed in accessories kit. AC-DC generator & instr. \$38.50

New Reactor Coil Arc Stabilizer with 4 S Copper for R-1, P-1, G-1 & ACDC type generators, \$10.95. Incl. engine throttle solenoid control \$14.95

V Belt Pulley Kit fits R-1, P-1 & A.C.-D.C. gen., has 2 ball bearings blocks, high speed bearings, triple V-pulley, shaft 8" L. & flex coupling \$17.50

New Throttle Solenoid & Idling device for all welder engine control 1" travel 6 7/8" wt. 4 lbs. \$7.50

NEW HYDRAULIC PUMP-MOTOR SYSTEM KIT Offers fluid drive of varying power, consist of 2 new Vickers p.d.s. pumps ea. 410 cu. in. rev. 3750 RPM 1000 PSI 375 GPH where one pump is belt driven as motor, 1 four way c. valve with variable speed control, reservoir, filter, gauge, hose & fittings. Value \$98.10. \$49.95

HYDRAULIC SNOW PLOW LIFT KIT. Consists of stratopower Hyd. pump rated 450 cu. in. 1400 P.S.I. 375GPH with relief, 1 D.A. cylinder 2 3/4"x1 1/4" stroke, 1 four way control valve #821, tank, filter, hose and fittings \$75.40 value, special price \$49.95

Now 4 way open center control valve with built in adj. relief for 1 to 4 D.A. cyl. 3/4" ports. #1006C \$12.95. #3W357, 3 Way, for 1 cyl. 3/4" b. \$6.95

SAVE ON SURPLUS MOTORS

H.P. 24-12VDC (+15% port.)
 Delco 1 1/2 6.5 amp 7/32"x2" \$5.50 2/89.95
 Delco 1 1/4 8.4 amp 5/16"x1" \$5.95 2/10.50
 Bendix 3/4 8 amp 5/16"x1" 4000 RPM \$6.50
 Gear Red mtr 2711 or 511 1 1/2 HP 3800 RPM \$4.85
 *Pescos 3 1/2 HP 2300 RPM 1 1/2"x2" \$9.95 2/ \$7.50
 * with 10:1 speed red. & flex coupling \$16.50

Spectacular Bargains. Electric pump 400GPH runs on 24-12VDC with 1/4HP 8.4amp motor complete with screen & on-off rheostat \$7.95. Speed reducer 5:1 or 10:1 2HP \$6.45

NEW HYDRAULIC CYLINDERS
 Air or Oil Bore Stroke Shaft D.A. 2000 PSI
 #007 1 1/2" 4 1/2" 1 1/4" \$4.95 2/\$7.90
 #300 2 1/2" 0 1/4" 1" 7 lbs. \$10.95
 #511 3 1/2" 2 1/4" 1 1/4" 15 lbs. \$24.50

NEW HYDRAULIC SYSTEM KIT
 #400 K. Heavy duty Power Driven, rated 14,000 lbs. lift. Consists of 2 D.A. hyd. cylinders, 3" bore x 24" stroke, each rated 7000 lbs. with 1000 P.S.I., 1 four way hyd. control valve with built in relief #821, 1 Vickers hyd. pump, 400 G.P.H., 1 1/2" P.S.I., 3750 RPM, 1 hyd. 2 gal. reservoir, 1 Purolator hyd. filter, 1 gauge 0-2000 P.S.I. all hose, & fittings. Value \$184.10, save \$90.00. Kit price \$94.10. Kit with two #511 cyl. \$79.95
 Kit with two #300 cylinders \$59.95

HYDRAULIC PUMP BARGAINS 1500 P.S.I.

Type	RPM	GPH	Reversible
Vickers PP	3750	375	\$17.50
*Pescos gear	3750	198	\$9.95
*Pescos gear	4500	270	\$12.95
*Stratopower	450 cu. in.	375GPH	\$15.50
Weaver Hand P&P	relief 20"	handle	\$9.95
Rotace	900GPH & motor	1/4HPDC	\$9.95

GENERAL SALVAGE CO. Check or Cash
 2922 E. 27 St., Dept. 112, Kansas City 27, Mo.

JOINT AND SHARPEN ALL SAWS

SUPER FILER NO. 9
 SO EASY to joint and file saws like new Two hardened steel rollers keep teeth same height All teeth cut, saw runs true and smooth \$2.95 ppd
 "TRU-CIRCLE" SAW SET
 Automatically sets teeth at 10 or more \$2.95 ppd

SUPER FILER NO. 11
 For both hand and circular saws. Steel rollers give all teeth correct height, pitch and bevel. \$9.95 ppd.

SUPER DRILL GRINDER
 Sharpens round shank drills like new, using hand or power grinders \$2.95 ppd

send for **FREE CATALOG**
 A. D. McBURNEY, 5908 Hollywood Blvd., Hollywood 28, Calif., Dept. A-129

CHANGE SPARK PLUGS REGULARLY

Comparable with radios listing at \$75 without batteries!
8 TRANSISTOR "Jewel" POCKET RADIO
 MADE IN U.S.A. \$29.95 INCLUDING BATTERIES
 JEWEL 8 transistor radio — never before available at this low, low price! Has unbreakable Styrene plastic case — earphone attachment outlet — 3 position metal stand-up easel and carrying handle. Built-in antenna is OMNI-DIRECTIONAL... radio plays equally well regardless of position. Powerful 8 transistor superheterodyne circuit. Has full tuning range of 540 to 1620 kilocycles. Brings in distant stations without station overlap. Clear, full distortion-free tones that can be turned up to amazingly big volume. Plays in train, plane, car, steel construction buildings — anywhere! Each complete with warranty registration card for factory service and repair in New York City. Limited quantities... order NOW for prompt delivery!
 LEATHER CARRYING CASE—with snap lock and sturdy leather strap—\$2.49 ppd.
 PRECISION PRIVATE EARPHONE ATTACHMENT—\$1.95 ppd.
 Send check or money order. If C.O.D. fees extra. Money-back guarantee.

SCOTT MITCHELL HOUSE, INC. Dept. HC-20, 415 S. Broadway
 Yonkers, New York



The Salvation Army
 with YOUR help
 can make
 Christmas Happy for All



"It was there yesterday!"

SERVICE FOR YOUR B&D TOOLS



Check the Yellow Pages under "Tools-Electric" for the location of the nearest Black & Decker factory service branch or authorized service station.

Free tool inspection when requested • Genuine B&D parts used • Factory-trained technicians • Standard B&D Guarantee at completion of recommended repairs • Fast service, reasonable cost, always.

Or write for address of nearest of the more than 50 branches and service stations to: THE BLACK & DECKER MFG. CO., Dept. 8312-S, Towson 4, Md.



Quality Tool Service

Special Offer 25¢

Hear these authentic recordings of dramatic events from

"The Amazing World of Short Wave Listening"

narrated by Alex Dreier, Radio-TV "Man on the Go"

- President's voice from outer space!
- Actual capture of a desperate criminal!
- Radio amateur at Little America!
- Ships at sea . . . aircraft in action!

S-107
receiver
\$94.95

4 short wave bands plus standard broadcast. Phono and headset jacks, built-in speaker.



MAIL COUPON TODAY!



hallicrafters...

DEPT. 14, CHICAGO 11, ILL.

Gentlemen: Please rush by return mail my recording, "The Amazing World of Short Wave Listening." I enclose 25¢.

NAME _____

ADDRESS _____

CITY _____

STATE _____

and its attendant equipment—limits the speed at which the program can progress. The size of the capsule is dictated by the size of the Atlas on which it will hitch a ride; presently it is about 10 feet high, 6 feet in diameter at its broadest point, and shaped very much like an oversized TV tube. Since at this stage the Astronauts can't make test flights in the capsule itself, NASA engineers have had to substitute various simulators to reproduce partial problems the Astronauts will have to meet. Two in particular at Langley merit special mention. One—just now being completed—simulates orbital flight dynamics in a frictionless system for tracking and navigation control. The Astronaut reclines on a couch and must make altitude and navigational corrections on his controls through visual reference to a projected picture of the earth which he can see through the periscope in front of him. The machine "floats" on a powerful air jet, and smaller jets—controlled by the Astronaut—will change the attitude of the trainer. The other simulator combines the Mercury control panel with a stationary F-100 trainer in the Langley Research Center to provide the Astronauts control problems which are fed into the simulator through a computer.

Simulators Very Important

Other simulators have been considered and abandoned. Among them was a proposal to take a capsule aloft to 100,000 feet under a balloon. Now most efforts are channeled toward combining as many space conditions as possible in a single simulator. Most of the men helping to train the Astronauts (particularly the medical people) submit to the same tests—as far as their physical equipment will permit—so they can better understand the problems of the Astronauts.

In general, throughout the time I spent with the Astronauts, their mornings were taken up with lectures and briefings, and their afternoons with work on the flight simulators, proficiency flying, conferences with engineers and scientists on problems in each man's specialty area, and some exercise to keep in shape. Beyond the normal working day, their time is their own, and they live a reasonably normal sort of life with their families. Two of the Astronauts—Cooper and Carpenter—live on the base at Langley. Glenn still maintains a home in Washington, D.C.; Shepard lives about an hour's drive away at Virginia Beach, and the other three Astronauts live in a new subdivision near Langley.

A number of rather widely held misconceptions have grown out of the avalanche

(Continued to page 258)



Foremost Optical Products Corp., 36-12 34th St., Long Island City, N. Y.

Glasses for Reading Have Small Lenses

People who have good vision for distance, but poor close vision may now wear spectacles with a small reading segment fitted below the pupil of the eye. The lenses are large enough for all normal reading or work, yet they permit unobstructed vision above and to the sides.

**After the city,
Before the state
The ZONE keeps your mail
From being late**



The Post Office has divided 106 cities into postal delivery zones to speed mail delivery. Be sure to include zone number when writing to these cities; be sure to include *your* zone number in *your* return address — after the city, before the state.

REVOLUTIONARY NEW DESIGN SAVES YOU \$20 TO \$40

4 1/8" JOINTER PLANER

NEVER BEFORE POSSIBLE AT SO LOW A PRICE **NOW ONLY \$19.95**
(shipped complete as shown)

SOLD DIRECT FROM FACTORY
Patents pending on revolutionary new engineering developments make this bargain possible. This is a power plane with all the features of machine tools costing 3 times OUR PRICE. It planes, rabbets, bevels, aids beveling and glueing joints; is so rugged and durable we guarantee it unconditionally for ten years.

SEE THESE QUALITY FEATURES
All cast iron and steel construction • Balanced steel cutter head • Hardened and ground knives • Precision ground cast iron tables • Rugged cast iron base • Table depth adjustable 0" to 3/8" • Cast fence with single action cam lock • Pat. lift-off aluminum guard • Big, full size—22" long • Shp. wt. 25 lbs.
Order By Mail — Sold Direct From Factory to You

OUR 30TH YEAR SEND \$19.95 CHECK OR M.O.
SENT C.O.D. WITH \$3.00 DEPOSIT
(If not completely satisfied after ten days return for full refund.) Shipped express collect.

AMERICAN MACHINE & TOOL CO., INC.
ROYERSFORD 30, PENNSYLVANIA

DRAINS cellars, cisterns, wash tubs; **\$7.95**
IRRIGATES - CIRCULATES - SPRAYS

1,001 uses. Stainless shaft. Won't rust or clog! Use 1/8 HP motor or larger... 3/4 HP for up to 3000 GPH; 450 GPH 80" high; or 1800 GPH from 25' well. 1" inlet; 3/4" outlet. Coupling included free. \$7.95.
HEAVY DUTY BALL-BEARING PUMP. Up to 7,500 GPH; or 3,000 GPH from 25' well. 1 1/4" inlet; 1" outlet. \$12.95
Postpaid if cash with order. **MONEY BACK GUARANTEE**
Centrifugal and Gear Pumps in All Sizes
LABAWCO PUMPS, Belle Mead 7, New Jersey

EARN GOOD MONEY IN SPARE OR FULL TIME.

UP TO \$30 A DAY WITH A UNIVERSAL GRINDER
Have a business of your own in your garage or basement, sharpening lawn mowers. Be your own boss. Small investment. We furnish everything you need to start. Write **FREE** Dept. M-129 today for complete details

ROGERS MANUFACTURING CO.
LINDSEY, OHIO

IDEAL CHRISTMAS GIFT FOR ANY MAN

4 SIMPLE, EASY-TO-USE **only 14.75**
WAY WELDER F.O.B.

ANYONE CAN WELD, BRAZE, SOLDER, CUT, HEAT MOST ANY METAL WITHOUT EXPERIENCE

Over 200,000 in use in homes, garages, farms, shops, factories everywhere. Save money—earn money, making and repairing auto bodies and parts, fenders, furniture and railings, farm equipment, machinery, lawn mowers, toys. Does 1001 jobs on iron, steel, bronze, brass, aluminum, etc. Operates on any properly wired 110 AC or DC line.

SEND ONLY \$3 Pay postman \$11.75 plus C.O.D. charges. Simple instructions included. Ideal lifetime gift for hobbyist, mechanic, hot rodder, homeowner. Order direct on 10-day money back guarantee or write for literature **FREE.**

FOUR WAY WELDER CO., Dept. F2-N
1810 S. Federal St., Chicago 16, Ill.

your **THIRD HAND** for
SMALL ASSEMBLY WORK

x-acto®
LOCK-GRIPLIER®



LOCKING KEY:

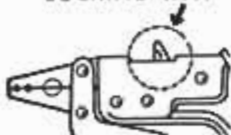

LOCKING KEY:
Pushing locking
key forward locks
jaws. Release by
pulling back
locking key.

Specifically designed as a multiple-service tool for small assembly jobs; to pick up and firmly grasp small parts for soldering or other operations; as a vise to free both hands; to strip insulation; as a brad or staple setter.

Pat. No. 2,766,646

\$4.50 at hardware stores
or order direct. We'll pay the postage.

x-acto, INC.

48-75 Van Dam Street
Long Island City 1, N.Y.



KEEP
WINTER
WEATHER
OUTSIDE

SEAL YOUR DOORS AND WINDOWS
AGAINST COLD, RAIN, WIND AND
DIRT WITH

Bridgeport

INNER-SEAL
WEATHERSTRIPPING
and Cut Your
Fuel Bills, Too!

Made of flexible sponge rubber, reinforced with spring wire and neoprene coated for extra toughness, long-wearing Inner-Seal is easy to put on—you can do-it-yourself with hammer, scissors and tacks. Get INNER-SEAL at your hardware store today! Only 10c a foot.



Write for
FREE FOLDER
"How to
Weatherstrip
Your Home!"
Dept. PM 12

BRIDGEPORT FABRICS, INC.
BRIDGEPORT 9, CONN.

of publicity around the Astronauts. Here are a few of the most common:

1. *The Astronauts are the world's greatest physical specimens.* John Glenn told me: "Sometimes I think people expect us to sprout wings and take off. This business of us being the greatest physical specimens in captivity is badly overstated. We're as healthy as any group you could find, but we aren't supermen. There are plenty of other people just as healthy."

Being a test pilot is a rigorous profession. The Astronauts had to be in top physical condition to ply their trade, and they still are. But there are probably thousands of other men—the Navy's frogmen for example—in other rigorous pursuits who would have been physically qualified for the space program. Again, the primary qualifications of the Astronauts were technical. Along with the technical background, they of course had to have the intellect (all of them have IQ's in excess of 130) to grasp the engineering problems implicit in flying the Mercury capsule.

Not a Suicide Mission

2. *There's an odds-on chance that Mercury will be a suicide mission.* Quite the contrary is true. Every possible caution and precaution is being taken to insure the safe return of the Astronauts. These young men have no vainglorious desire to kill themselves in the interests of space travel. But as experienced test pilots, they are familiar with the dangers of unknown and untested aircraft. They regard the Mercury capsule simply as an extension of the work they were engaged in before Mercury existed.

3. *Once the first man is put into space, the Mercury program will be over.* Obviously this program is not aimed at putting a man into space once and then quitting. Eventually all of the Astronauts will go, and quite likely many more men whom they will train. For this reason, the Astronauts are impatient with all the emphasis being put on the first man into space. Several of the Astronauts—and possibly all of them—will take the short ride on a ballistic missile into space before the first man is orbited.

On this point, John Glenn said. "This business of being first is badly overdone. The individual isn't all-important here; it's the big job that's important. People have dreamed about this for thousands of years, and it's so much bigger than individual names. This program opens up whole new worlds, and we're just lucky—as individuals—to be part of it. Sure we all want to be first. Any guy who didn't really want to go first shouldn't be in this program. But

(Continued to page 260)

WAR SURPLUS AS COMING BARGAINS **SAVE UP TO 90%**



SPECIAL ON \$4770 NAVY AIR-COOLED POWER UNITS

Tremendous power package. Can be used as a portable or stationary unit. Makes terrific welder. Great engine for 1/4 midget racers. 30D-1A Lawrence. 24V. 2 Cylinder opposed 4 cycle 10 1/2 H.P. Complete with various generators. Net wt. 180 lbs. Gross wt. 250 lbs. Like NEW. With 24 to 32 V. D.C. Gen., 160 to 200 amps, 2500 RPM \$149.50. With 24 to 32 V. D.C. Gen., 175 to 250 amps, 2500 RPM \$155.75. With 24 to 32 V. D.C. Gen., 200 to 300 amps, 2500 RPM \$162.75. With NEA-5 AC-DC Gen., 24-32 V. D.C. 175 to 220 amps, 110 V. A.C. 10.5 amps, 800 cycle, 1250 watts \$167.50. Engine only \$137.50.

DC JET GENERATOR ARC WELDING KIT Complete with GE Type CM-77 Generator (30 volts D.C., 400 Amp., 3000 RPM up; ampere rating is for continuous duty, intermittent amperage is 500 to 600 amps.), also 2 rheostats, 1 voltage regulator, 1 voltmeter, 1 electrode holder, 2 ea. 25 ft. lengths No. 0 welding cable, 1 welder's mask, 1 toggle switch, 10 lb. vacuum packed 1/8 in. welding rods, pair welder's gloves & splicing coupling. All units guaranteed pre-tested. Wt. 110 lbs. Approx. GOVT. COST \$700. All items, now only \$64.50.

*G.E. Generator noted above can be purchased separately. Makes deluxe heavy-duty welder comparable to the finest commercial welders available. Wt. 90 lbs. Approximate GOVT. COST \$600. Gen. alone—\$49.50.



BUILD YOUR OWN ARC WELDER, LIGHT PLANT OR BATTERY CHARGER \$37.50

Kit incl. 1 Navy NEA-5 Gen. combination AC-DC type. AC 115 V. DC 24 V., 200-300 Amps. 2 complete generators in 1, yet no larger than reg. gen. Ideal for home, shop and farm lighting plants. Delivers 1200 Watts AC, DC side for charging batteries, welding and operating war surplus motors. Also in kit: 2 Voltage Regs., AC & DC, Reverse Current Relay, 30' New Welding Cable, 1 Ammeter, Rheostat, Electrode Holder, Toggle Switch, Welder's Shield, Wiring Diagram for kit. Wt. under 100 lbs. Approx. GOVT. COST \$650. Kit—\$37.50. Navy NEA-5 Gen. as above, purchased separately, \$23.50.

SHIP'S BELL Solid polished brass. Stationary bracket with removable clapper and bell housing. High, resonant tone. Decorative for boat or home or patio. Brand new, great gift. 5' bell—4 lbs.—\$6.75. 6' bell—6 lbs.—\$12.95. 7' bell—8 lbs.—\$18.95.



SOUTH WIND HEATER & ACCESSORIES

Mid. for gov't. antarctic expeditions for jeeps and half-tracks. Heating unit puts out over 20,000 B.T.U.'s. Burns any type gas. 6 volt system. Fuel consumption extremely low, 1 gal. per 8 hrs. Terrific for trucks, boats, tractors... farms, warehouses, ranches, boat houses, cabins, etc. Complete with service & installation manuals and over 360 components. Approx. GOVT. COST \$550. Shpg. wt. 120 lbs. gross. NEW. \$39.95. Limited quantity.

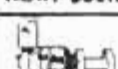

ELECTRIC STORAGE BATTERY WINCH

Powerful reduction gear, fully reversible, ball bearing, safety locking device. Will handle from a 1000 to more than 2000 lbs. pull. Use on 6, 8, 12, 24, 32 V. battery. Holds 50' of 1/4" cable. For tractors, boats, tow trucks, etc. Complete with mounting bracket for mounting in any position. Approx. GOVT. COST \$400. NEW. \$48.50.

ELECTRIC PUMP WITH CONTROL UNIT

Runs on 12 or 24 V. Centrifugal type. Draws 5.2 AMPS. Has built-in removable filtering screen. Great for bilge, circulating or sump pump... ball tanks, etc. Pumps 500 GPH. Complete with on and off switch rheostat, 2 speeds (hi & lo). Mfd. by Ingersoll-Rand. Shpg. Wt. 7 lbs. Approx. GOVT. COST \$195. NEW \$8.95.

140-1 REDUCTION GEAR

For beaching boats, winches, hoists. Ideal for motor in golf or boy's electric car. DC motor & clutch. Easily reversible wiring diagram furnished. Hi torque, 105 RPM. Runs on 6-12 or 24 V. Wt. 65 lbs. gross. Approx. GOVT. COST \$300. Like NEW. \$12.00. Matched splined gear for above—\$3.00 ea. *225-1 Reduction Gear—\$13.50

SENSITIVE ALTIMETER

In 20 ft. increments. 0 to 35,000 ft. (inches of Mercury). Famous Pioneer. Tested & inspected in our own instrument lab. Guaranteed perfect. Approx. GOVT. COST \$150. Wt. 2 lbs. \$13.95

NEW 1960 CATALOG!

Tremendous catalog—our biggest ever—fully illustrated—1000s of bargains in war surplus & other items. Send 23c in coin for your copy today or free copy with order. Where ppd. indicated applies to US only. Other prices FOB Culver City, Cal. Send cash, check, money order. 50% dep. COD.

AIRBORNE SALES CO., INC. DEPT. PM 1259
8501 Steller Drive, Culver City, Calif

Ever Watch

A Mountain

Blasted Apart?

Read

MASTERS of EXPLOSIVES

in the

JANUARY ISSUE



.22 Cal NEW 7 SHOT REPEATER AUTOMATIC. The skilled hands of the German gunsmith is responsible for this .22 Caliber 7 shot repeater automatic with self-ejecting empty shells. Just 1 inches long, fits easily into pocket or purse. Ideal for sporting events, stage use. Not available to Calif. residents. Not a lethal weapon—ammunition available exclusively from us. Money back guarantee. Comes for \$6.95 from Best Values Co., Dept. F-51, 403 Market St., Newark, New Jersey.

CONCRETE BIRD BATHS AND OVER 250 OTHER MONEY MAKING ITEMS

You've seen them all over the country... concrete bird baths, garden seats, flower boxes, appealing statuary, and many other items that add charm around the house and lawn. They're made by enterprising people, just like you, from our **COPYRIGHTED ALUMINUM MOLDS**. It's easy. It's fun. It's profitable.

Send \$2.00 today for this 32-page "How to" book. 20 pages of clear instructions. Valuable trade secrets. Over 250 items beautifully pictured (with description, dimensions, and prices of molds). Rushed to you by first class mail.

CONCRETE MACHINERY CO., INC.
HICKORY 2, NORTH CAROLINA

Name _____
Address _____

HOW TO TURN CONCRETE INTO GOLD



for power tools
to your liking

SAY WEN



PHOTO COURTESY OF WEN

**2-SPEED 3/8"
LOW COST
DRILL**

**ONLY
\$29.95**

Lets you change from 1000 to 3000 rpm and back to get just the right speed for different jobs. 3/8" Jacobs geared chuck, AC/DC motor delivers maximum torque under load.

35 PIECE ACCESSORY AND TOTE KIT

\$9.95

Say WEN for Sabre Saws, Solder Guns, Sanders
5810 NORTHWEST HIGHWAY, CHICAGO 31

**Never Again . . . a dropped Nut
or Bolt with MAGGIE'S BUTTONS**

TM



MAGNETIC SOCKET INSERTS

Save up to an hour on one repair job. Maggie's Buttons hold nuts and bolts firmly in your Socket Set to eliminate dropping, to make starting them easier in hard-to-get-at places.

- Alnico Magnets last a lifetime.
- Fit your present socket set, making it more efficient.
- 6 most-used sizes—3/8", 9/16", 1/2", 7/16", 5/8", & 5/16".
- Easily installed in minutes, seat firmly.

You'll find Maggie's Buttons the best time and temper-saving tool you ever bought. You'll be repaid the low \$2.98 price time and again through faster work. Money-Back Guarantee.

Appreciated Gift for the Do-it-yourself man or for the professional mechanic who has everything. Order right away for yourself and your Christmas list.

Dealer Inquiries Welcome!

Please send me _____ Mag- Send to:
gie's Buttons Sets for _____
which I enclose \$ _____
\$2.98 per set. _____

L & M Mfg. Co., Box 314 P Spirit Lake, Iowa

we also realize that the second and third guys up will probably be much more important from the standpoint of information obtained."

4. *Project Mercury is a crash program geared to a race with the Russians to put the first man in space.* If Mercury is a crash program, it's doing a lot of creaking at its financial joints. A few weeks ago, the Astronauts spent the better part of a day sitting around airports waiting for commercial flights. They've traveled in buses and creeping trains on field trips because there is no provision in the Mercury program for government air transportation for them. The space budget was pared some \$68 million last year, and every activity has to be carefully considered in the light of hard budgetary facts. Even the Astronauts are acutely conscious of budgets; Alan Shepard told me that lack of sufficient funds was holding up the production of equipment for tracking stations for the space capsule. As for racing with the Russians, the Astronauts are divided on this point; the majority of them emphasize that under no circumstances are we cutting any corners to beat the Russians at getting a man into space—that not even a minute safety element will be sacrificed to attain this objective. But while granting this, several of the Astronauts feel that the competitive challenge can hardly be avoided—budget or no. One of them told me: "Sure we're in a race with Russia. That's no way to run a technological program, but that's the way it is and we can't change it."

Don't Know When

5. *Space flights will be made on a schedule already established but not released.* Probably no comparable program in history has ever had more scheduling fluidity than Project Mercury. Each step in putting a man into space depends entirely upon the successful completion of the previous step as well as production of the necessary "hardware." As a result, it's impossible to set any sort of rigid schedule. When officials say they don't know when the first space flight will be attempted, they're stating a simple and irrevocable fact.

6. *The Astronauts are kept on a rigid program of diet and exercise.* Quite the opposite is true. The Astronauts have no formal program of either diet or exercise. When Project Mercury started, the Astronauts were asked if they wanted regular calisthenics. Being experienced military men, they said "No" emphatically, and that was that. The Astronauts' only group physical training has been a course with Navy frogmen, which ended with them

(Continued to page 262)



Bausch & Lomb Optical Co., 635 St. Paul St., Rochester 2, N. Y.

Ear Protector Banishes Noise

Lightweight, sanitary and inexpensive, a close-fitting ear protector has been designed for use at jet airfields, on carrier flight decks, at missile launching sites and in industry.

AVOID DRIVING FATIGUE!

Foot-Ease LEFT FOOT THROTTLE CONTROL

Now you can relieve your right foot and rest your leg while driving. Leaves your brake foot free for quicker, safer brake action. Positive control. You'll be amazed! Heavy, durable... fits all cars. No installation necessary. Lies flat on floor when not in use. Satisfaction guaranteed. Send \$2.98 (postpaid) to:

WHOLESALE DIE CO., Box 19-A, San Gabriel, Calif.



Special
Factory Offer
\$2.98

out of the way with
a flick of the foot
when not in use.

SAVE UP TO 85% ON GOVT SURPLUS

PRECISION 21 to 1 SPEED REDUCER
Precision built for Army Gun Control mechanism. Gear ratio gives approx. 90 RPM with direct drive 1750 RPM motor. Can be belt driven with up to 1/10HP motor. Has ball bearings throughout. Will operate conveyors, timing devices, etc. Many other gear drive bargains in stock. **\$4.75**

180° - 85 TO 1 GEAR BOX
For use where tremendous power at low take-off speed is desired. Drives through a train of 6 gears that rotate on self-lubricating, high speed roller bearings. Take-off shafts are 1-1/4" and 3/8" in diameter. Overall size 6" x 4" x 2-1/2". Has a 180° off-set drive. **ONLY 8.95**

SAVE ON AIR TANKS

STAINLESS STEEL G-1 TANKS
Pressure tested to 400 PSI. Ideal for air, acids, chemicals, experimental uses, etc. Has 1/4" pipe ports. Size: 12-1/2" x 24". 2100 cu. in. No G-1U - Used **\$12.95**
No. G-1N - NEW ... \$16.95

F-1 Stainless Steel TANKS - 500 cu. in. capacity. Size: 10" x 18" ... \$10.95

J-1 Large Volume AIR or CHEMICAL STORAGE TANKS
Has 18,000 cu. in. capacity (77 gallons). All stainless steel. Size: 24" x 45" lgh. Worth \$150. No. J-1 ONLY **\$99.50**

D-2 Steel AIR TANKS - Tested to 400 PSI. Capacity 500 cu. inches. Size: 6-1/2" x 24".
D-2-C Carbon Steel - NEW **\$5.95**
D-2-CU Carbon Steel - USED \$4.95
D-2-S Stainless Steel ... \$9.95
F-2 TANKS - Same as D-2 with a 1000 cu. in. cap. Size: 6" x 45".
F-2-C Carbon Steel ... \$6.95
F-2-S Stainless Steel ... \$10.95

TO ORDER - Send check or M.O. 1/2 deposit with C.O.D.s. All prices are F.O.B. Los Angeles Warehouse. All items sent postage or freight collect.

25 GPM HYD PUMP
A positive displacement, 25 GPM pump at 3450 RPM. Pressure limit is 1000 PSI continuous or 1500 PSI intermittent. Pesco type. No. H-P25SU. ... **\$27.95**
Pump MOUNT for above with sealed-in bearings and spline adapter, \$16.95

palley's
2263 E VERNON AVE., DEPT. PM-129
LOS ANGELES 58, CALIFORNIA

IS THIS OFFER TOO GOOD TO BE TRUE?

We Pay All Freight For Your FREE Home Trial!

GRINDER
SANDER
30" LATHE
TILTING TABLE SAW
HORIZONTAL DRILL PRESS

It's true. We pay all freight for your FREE home trial. Factory to you only \$79.95. Handles big jobs. 100% ball bearing. Think of the fun you'll have and the money you'll save with your own workshop. Only \$10 down delivers \$79.95 Super shop prepaid to your home. Write for full details, color brochures. FREE home trial plan. Mail postcard now.

Power Tools Division
UNITED INDUSTRIES, Inc.
124 Yates Ave., Beloit, Wisc.



MAKE BIG MONEY WITH THESE LOW COST WELDERS

AC shop type welder
Build and repair anything made of metal. This low cost, easy to use AC shop type welder is a real money maker for home, garage, farm, plumbing, autobody and repair shops. You can weld, cut metal, burn holes, hard surface, etc. Requires no experience or special training.

Combination AC power, DC welder
This combination welder and power unit supplies DC current for welding and 110/220 volt AC power for running lights, tools, sprays, etc. Can be invaluable in a power failure emergency. Ideal on farms to run brooders, freezers, milking machines, etc.

HOBART BROTHERS CO., BOX M-129, TROY, OHIO, Phone FE 2-1223

HANDEE

GRINDS • POLISHES • CUTS • SAWS • CLEANS
ROUTS • ENGRAVES AND BURNISHES



HANDEE...
THE MOST
PRACTICAL
GIFT EVER!



HANDEE, all-purpose craftsman's hand power tool. Only 14 oz. Does 1,001 jobs: wood carving, jewelry making, plastics work, model building, ceramics, initialing, etc.

PRECISION - ENGINEERED

Perfectly balanced, cool running HANDEE fits your hand for delicate or rough work. Allows 360° rotation, 25,000 r.p.m.; 110 or 220-volt (please specify), 25 to 60 cycles. AC or DC. Guaranteed.

No. 6010—HANDEE Grinder, 45 accessories, metal case, 110-volt. Only... **\$32.95**

No. 6008—HANDEE Grinder, 6 accessories. Only... **\$23.95**

—Send your order today!—

Chicago Wheel & Mfg. Co., 1101 W. Monroe St., Chicago

Enclosed is money order for set No. _____ **PM-12**

Please send me HANDEE Catalog.

Name _____

Address _____

City _____ Zone _____ State _____

new FROM HEATHKIT® transistor clock radio



**EASY TO ASSEMBLE... COMPLETELY PORTABLE
... UP TO 500 HOURS ON BATTERIES**

Take it with you... on trips, to the beach, in a boat... Nothing to plug-in, just goes and goes on inexpensive batteries. Lulls you to sleep, wakes you up, tells time and plays all day long. Leather carrying case available. **ONLY \$45.95.**



HEATH COMPANY
Benton Harbor 17, Michigan
a subsidiary of Daystrom, Inc.

Send the latest Free Heathkit Catalog.

NAME _____

ADDRESS _____

CITY _____ ZONE _____ STATE _____

Note: Price subject to change without notice.

swimming a thousand yards under water using an aqualung and flippers. This is not to say that they don't keep in good physical condition. But as Scott Carpenter pointed out: "We don't need any formal health or physical conditioning program. We're big boys now, and know how to take care of ourselves. Besides, this thing is important to us, and we're not going to let ourselves get out of shape."

All of the Astronauts enjoy water sports and indulge in them whenever possible. Only Glenn played college football—at Muskingum College in Ohio. Glenn tries earnestly to run two miles every morning before breakfast—and does most of the time. At the start of the program, three of the Astronauts didn't smoke. Now all of them have quit—but strictly on their own and under no duress. The Astronauts office at Langley has a hand-lettered sign stuck to the door which reads: "No Smoking in This Room Please." and it's signed "Three Ex-Smokers."

But the Astronauts are in superb physical condition. One of the NASA engineers stumbled on Gordon Cooper the other day playing with a group of 50-pound weights; he lifted four of them rather easily. Another saw Scott Carpenter climb a 40-foot rope hand-over-hand in a friend's back yard, just for exercise.

The Astronauts are all highly motivated young men going about a logical extension of their business which is test piloting. For many years they've worked at a hazardous occupation, and they have no personal fear. Their main concern is with getting the job done.

John Glenn said: "This project is comparable to the Wright brothers at Kitty Hawk, with Orville and Wilbur pitching a coin to see who was going to shove the other one off the hill. I think we stand on the verge of something as big and expansive as that was 50 years ago."

(Continued next month)

Mail Delivery by Missile

Europe may soon claim the first "missile mail" operating on a regular schedule. A project to deliver letters by means of guided missiles between Genoa, Italy, and Hamburg, West Germany, has been proposed with the support of the Italian post-ministry. Rocket delivery over the 700-mile distance would take about 23 minutes. The proposed mail missile is started with the aid of a booster rocket and then it continues its flight on the ram-jet principle. For landing, it is slowed down by braking rockets. Weighing 200 pounds, the missile can deliver a cargo of 750 letters and cards weighing 12 pounds.

SURPLUS SALE

GOVT SURPLUS
EXCESS INVENTORY
BANKRUPT STOCK

GOLF and FACTORY CAR MOTOR

● Item #573. Amazing buy! Use for golf cars, factory run-a-bouts, electric carts.
● Powerful, expensive ball-bearing gear reduction motor runs on any 12-v storage battery. Powerful high torque. Shaft speed 150-300 rpm. Full Instr. Easily reversible. Wt. 34 lbs. Size 7 1/2" x 9" x 14". Est. Govt. cost \$250. SALE..... **\$19.46 FOB**

MISCELLANEOUS SURPLUS

- Door Bell Transformer..... \$.98
- Deluxe Door Bell..... .98
- DPDT-Toggle Switches..... .32
- 20-to-1 Gear Reducers..... 7.61
- DC-Ammeter-0-300 amps..... 6.97
- Army Folding Wire Reel..... 9.91
- Private 12-Line Switchboard..... 97.50
- Vickers Hydraulic Pump Unit..... 49.50
- 110-v AC-Centrifugal Pump..... 8.95
- Fish and Worm Shocker..... 3.49
- Home Laboratory Experimental Kit..... 6.71
- 200-Amp. Welding Generator..... 18.95
- Pressure Air Tank-6"x13"..... 3.49
- AC Warm Gear Motor..... 8.69
- 80-to-1 Gear Reducer..... 8.98
- Send for Free Catalog.

CONTRACTOR PUMP

● Item #200. 2 1/2" size. 16,500 gph. New ball-bearing centrifugal irrigation-contractor pump. 280 rpm. 6 1/2 ft. head. 6" bulley. 2 1/2" intake. 2" discharge. Wt. 37 lbs. Govt. cost \$95. SALE..... **\$49.50 FOB**

AIR COMPRESSOR BARGAINS

- For painting, cleaning, tires, termites. Assemble own outfit.
- Item #450. DeLuxe Kit. Compressor, tank, gauge, regulator, paint can, relief valve, fittings, hose, instructions. List \$52. SALE **\$43.91 FOB**
- Air Components. Compressor 1-cyl. **\$19.35**. Air tank. **\$14.95**. Regulator **\$3.95**. Pop-off **\$1.95**. Press. Gauge **\$1.89**. Finest Paint Gun **\$11.90**. Auto Switch **\$4.75**.

POWER PLANTS

● Amazing buys in DeLuxe plants. Govt. 115-v 60-c. Large selection. Write for descriptive catalog. All F.O.B.
● 1000-W **\$169.75**
● 3000-W **289.50**
● 5000-W **497.50**
● 7500-W **549.50**
● 3000-W (DC-115-v) **169.50**
Get Free Catalog.

6 or 12-V Storage Battery Winch

● Item #311. Powerful fully reversible ball-bearing gear reduction winch. 1000-2000 lb. pull. Use on 6 or 12-v battery. Holds 40' of 1/4" cable. For trucks docks, boats. Govt. cost \$280. SALE..... **\$46.71 FOB**

PORTABLE AIR PRESSURE UNIT

● Item #462. Consists of tank, valve, gauge, fire check, spray nozzle, hose, etc. Spray equipment and valve not shown. Wt. 8 lbs. Cost \$26.50. SALE..... **\$8.89 FOB**
(Note-Pressure Tank only **\$4.95 FOB**)

CONTRACTORS LEVEL-TRANSITS

● Item #804. Leading make, brand new latest model level-transit with tripod and case. Used by leading builders, schools, etc. 12-X scope. High accuracy. Use as level or transit. Limited time offer..... **\$69.95 Ppd.**

STANDARD DIAL PHONE

● Item #715. Modern hi-efficiency attractive dial phone. Use for extension to main line on private system. Use several for complete private system, etc. Complete. Work on any system. Govt. cost \$25. SALE..... **\$9.95 Ppd.**

SPECIAL OF THE MONTH!

SPEED REDUCER

● Item #1315. Deluxe ball and needle bearings heavy duty gear reducer. Ratio 86-to-1. Protective Clutch, etc. Input Shaft 3/4" diam., Dual Output Shaft 1" diam.
● Hundreds of farm and Industry uses. A four Star Buy. Size 6"x9". Wt. 14 lbs. Govt. Cost \$137.50. SALE..... **\$19.69**

HI-SPEED VACUUM-BLOWER UNIT

● Item #1604. Industrial hi-speed 110-v AC motor driven vacuum-blower unit. Useful sucking dirt, sawdust from power tools such as bench saws, shapers, etc.
● Solenoid permits selection of either of two tubes. Size 6"x18"x9". Wt. 10 lbs. Original cost \$60.50. SALE..... **\$18.95 FOB**

Hydraulic Equipment Bargains

Savings to 80%. Build loaders, dumpers, presses, etc. All brand new.
● Hydraulic Hand Pump & Cyl. **\$29.87 FOB**
● Control Valve, 1 or 2 way..... **18.00 Ppd**
● Tractor Pump 1000 psi..... **45.50 Ppd**
● 12-v Motor & Pump 1000 psi..... **16.95 FOB**
● 2-Way Cyl. 1 1/4" bore, 11" stroke **9.87 FOB**
Get catalog, many items.

12-V DC ROBOT CONTROL MOTOR

● Item #522. Powerful DC unit. Geared reversible motor operates lever. Use to operate remote valves, throttles, levers, steering, doors, switches, open-close drapes, etc. Govt. cost \$47.50. SALE..... **\$5.95 FOB**

FREE CAT-ALOG Electronics, Power Tools, Binoculars, Hydraulics, Power Plants, Air Compressors and thousands of other items.

SURPLUS CENTER
LINCOLN, NEBR DEPT. 814



"FIRE UP"

YOUR ENGINE AT ALL SPEEDS WITH
AUTO-LITE RESISTOR SPARK PLUGS WITH

POWER TIP

LOOK FOR THE PROTRUDING TIP!

FREE AMAZING NEW BOOK "HOW TO ANSWER ADS"



Never before have you seen anything like this. Tells you in simple language the correct way to answer ads. Gets you quicker replies—better results, and greater satisfaction. Will save you time and money and it's ABSOLUTELY FREE. No obligation whatever. Every reader of advertising should have this booklet. Send a postcard for your copy NOW. F. W. JOHNSON, Popular Mechanics Magazine, Room 600-A, 204 East Ontario Street, Chicago 11, Ill.

Automatic Saw Set...



MAKE EXTRA PROFITS!
Set 400 teeth per minute on hand or band saws, 4 to 16 point, with the BeMaCo Automatic Saw Set. Fast, accurate, true hammer-anvil action sets teeth uniformly, eliminates tooth breakage. Used profitably by saw shops and manufacturers everywhere. Every machine positively guaranteed!
Write for details—today!

BEAVER MFG. CO.
Saw Machine Division 40-C
PO Box 434
800 ISIS AVENUE • INGLEWOOD, CALIF.

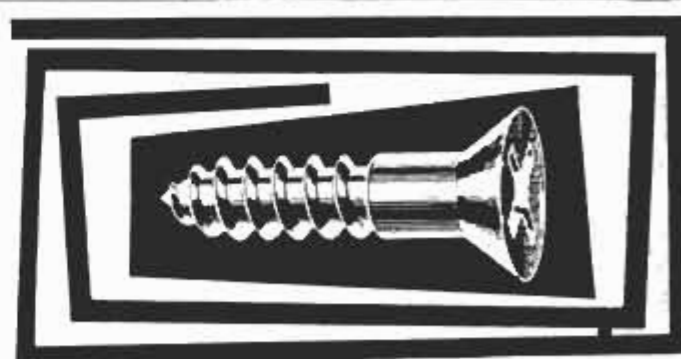

For every job you do
Only a Screw
Holds like a Screw

And only SOUTHERN quality screws are identified with the EZ to C® label.

Sold Through Leading Hardware and Building Supply Dealers

Buy 'em by name . . .
Buy 'em by box
and save!



Wood Screws
Tapping Screws
Machine Screws
Dowel Screws
Drive Screws
Stove Bolts
Carriage Bolts
Hanger Bolts



HOW TO MAKE YOUR BOSS SIT UP AND TAKE NOTICE



Best way we know of is to come up with the right answers on the job. Show him you have the drive and ambition it takes to get ahead.

How? By getting the right kind of training... training that enables you to come up with the right answers. Nowadays the crying need in business and industry is for men with special knowledge—skilled technicians, plant and office workers who have more to offer than on-the-job experience.

Without the right training you're just another one of the millions competing for the same, dull routine jobs, the same low salary.

But—when you have the right kind of training your boss can't help but sit up and take notice of you. He can see you're a man who is prepared to move ahead.

Now is the time to act! Choose the kind of training you need to get ahead from success-proven I.C.S. Courses—259 in all. Each I.C.S. Course was developed

by business and industry leaders who know—who can tell you—what you need to go places.

The instruction is practical, down-to-earth. What you learn has immediate "cash value." No waiting to see results. Students report increased earnings within as little as three months.

You get personalized guidance. Study in your spare time—at your own pace. Chances are by the time you get your coveted I.C.S. diploma you're already on your way to a better job, bigger pay.

Don't wait another day. Start this minute to make your boss sit up and take notice of you. Mark and mail the coupon.

For Real Job Security—Get an I. C. S. Diploma!

I. C. S., Scranton 15, Penna.

Accredited Member,
National Home Study Council

INTERNATIONAL CORRESPONDENCE SCHOOLS



BOX 16626M, SCRANTON 15, PENNA.

Without cost or obligation, send me "HOW to SUCCEED" and the opportunity booklet about the field BEFORE which I have marked X (plus sample lesson):

ARCHITECTURE and BUILDING CONSTRUCTION

- Air Conditioning
- Architecture
- Arch. Drawing and Designing
- Building Contractor
- Building Estimator
- Carpenter Builder
- Carpentry and Millwork
- Carpenter Foreman
- Heating
- Painting Contractor
- Plumbing
- Reading Arch. Blueprints

ART

- Commercial Art
- Magazine Illus.
- Show Card and Sign Lettering
- Sketching and Painting

AUTOMOTIVE

- Automobile
- Auto Body Rebuilding and Refinishing
- Auto Engine Tuneup
- Auto Technician

AVIATION

- Aero-Engineering Technology
- Aircraft & Engine Mechanic

BUSINESS

- Accounting
- Advertising
- Business Administration
- Business Management
- Cost Accounting
- Creative Salesmanship
- Managing a Small Business
- Professional Secretary
- Public Accounting
- Purchasing Agent
- Salesmanship
- Salesmanship and Management
- Traffic Management

CHEMICAL

- Analytical Chemistry
- Chemical Engineering
- Chem. Lab. Technician
- Elements of Nuclear Energy
- General Chemistry
- Natural Gas Prod. and Trans.
- Petroleum Prod. and Engr.
- Professional Engineer (Chem)
- Pulp and Paper Making

CIVIL ENGINEERING

- Civil Engineering
- Construction Engineering
- Highway Engineering
- Professional Engineer (Civil)
- Reading Struc. Blueprints
- Sanitary Engineer
- Structural Engineering
- Surveying and Mapping

DRAFTING

- Aircraft Drafting
- Architectural Drafting
- Drafting & Machine Design
- Electrical Drafting
- Mechanical Drafting
- Sheet Metal Drafting
- Structural Drafting

ELECTRICAL

- Electrical Engineering
- Elec. Engr. Technician
- Elec. Light and Power
- Practical Electrician
- Practical Lineman
- Professional Engineer (Elec)

HIGH SCHOOL

- High School Diploma

(Partial list of 258 courses)

- Good English
- High School Mathematics
- High School Science
- Short Story Writing

LEADERSHIP

- Industrial Foremanship
- Industrial Supervision
- Personnel-Labor Relations
- Supervision

MECHANICAL and SHOP

- Diesel Engines
- Gas-Elec. Welding
- Industrial Engineering
- Industrial Instrumentation
- Industrial Metallurgy
- Industrial Safety
- Machine Shop Practice
- Mechanical Engineering
- Professional Engineer (Mach)
- Quality Control
- Reading Shop Blueprints
- Refrigeration and Air Conditioning
- Tool Design
- Tool Making

RADIO, TELEVISION

- General Electronics Tech.

- Industrial Electronics
- Practical Radio-TV Eng'g
- Practical Telephony
- Radio-TV Servicing

RAILROAD

- Car Inspector and Air Brake
- Diesel Electrician
- Diesel Engr. and Fireman
- Diesel Locomotive

STEAM and DIESEL POWER

- Combustion Engineering
- Power Plant Engineer
- Stationary Diesel Engr.
- Stationary Fireman

TEXTILE

- Carding and Spinning
- Cotton Manufacture
- Cotton Winding and Weaving
- Loom Fixing Technician
- Textile Designing
- Textile Finishing & Dyeing
- Throwing
- Winding and Weaving
- Worsted Manufacturing

Name _____ Age _____ Home Address _____

City _____ Zone _____ State _____ Working Hours _____ A.M. to P.M. _____

Occupation _____

Canadian residents send coupon to International Correspondence Schools, Canadian, Ltd., Montreal, Canada. . . . Special low monthly tuition rates to members of the U. S. Armed Forces.



BUSY—that's what the modern battery is! In fact, it's three times as busy as it was just ten years ago. The cars have changed, so have their electrical requirements. And, you're just kidding yourself if the battery you buy hasn't changed, too. Delco has! The DC-12 was specially designed to meet modern car requirements. That's why it's factory installed on almost half of the new cars built. Moreover, it's a dry charge battery—the kind that can give you

100% FRESH **DELCO DC-12 NEW STARTS**



6- and 12-volt models for most cars. Quality-built by Delco-Remy, first in automotive electrical equipment . . . distributed nationally through

See "The Art Carney Show" on NBC-TV



Whether you give 'em
or get 'em this Christmas

...there's real
gift
excitement in



Weller® POWER TOOLS

It's a wise choice to give work-saving power tools at Christmas because any man will appreciate them. And it's a wiser choice to give Weller Tools because their fine quality and advanced features mean dependable performance.



POWER SANDER

Makes sanding easy. Fast, too with big 25 sq. in. sanding surface and 14,400 strokes a minute. Straight line action—never bucks, twists or scars wood—gets into corners. Low design—gets under low places. Fingertip "on-off" control. Easy sandpaper replacement. Assorted sandpaper and polishing cloth included.

MODEL 700 **\$16⁹⁵**

Also available in Metal Kit Model 700K, **\$18.95**



SABRE SAW

Makes every kind of cut through plywood, composition board, aluminum, etc. Even makes its own starting hole for inside cuts. And it's portable—use it anywhere. Exclusive strain-relief design eliminates blade breakage. Hammer-tone finish aluminum housing. Two wood cutting blades and metal cutting blade included.

MODEL 800 **\$19⁹⁵**

All Weller Power Tools are guaranteed for 1 year.



Dual Heat SOLDERING KIT

Features the new Weller Dual Heat Gun. Not only does heat and spotlight come on instantly when you pull the trigger—but 2 trigger positions give 2 temperatures at tip for more accurate soldering. First position gives low 90-watt heat. Second gives high 125-watt heat. Soldering aid, cleaning brush and solder included.

MODEL 8200K **\$7⁹⁵**

Heavy Duty Soldering Kit Model 8250AK, **\$14.95**

AT YOUR HARDWARE OR HOBBY DEALER • Weller Electric Corp. Easton, Pa.