

POPULAR MECHANICS

WRITTEN SO YOU CAN UNDERSTAND IT

NOVEMBER 1959
35 CENTS

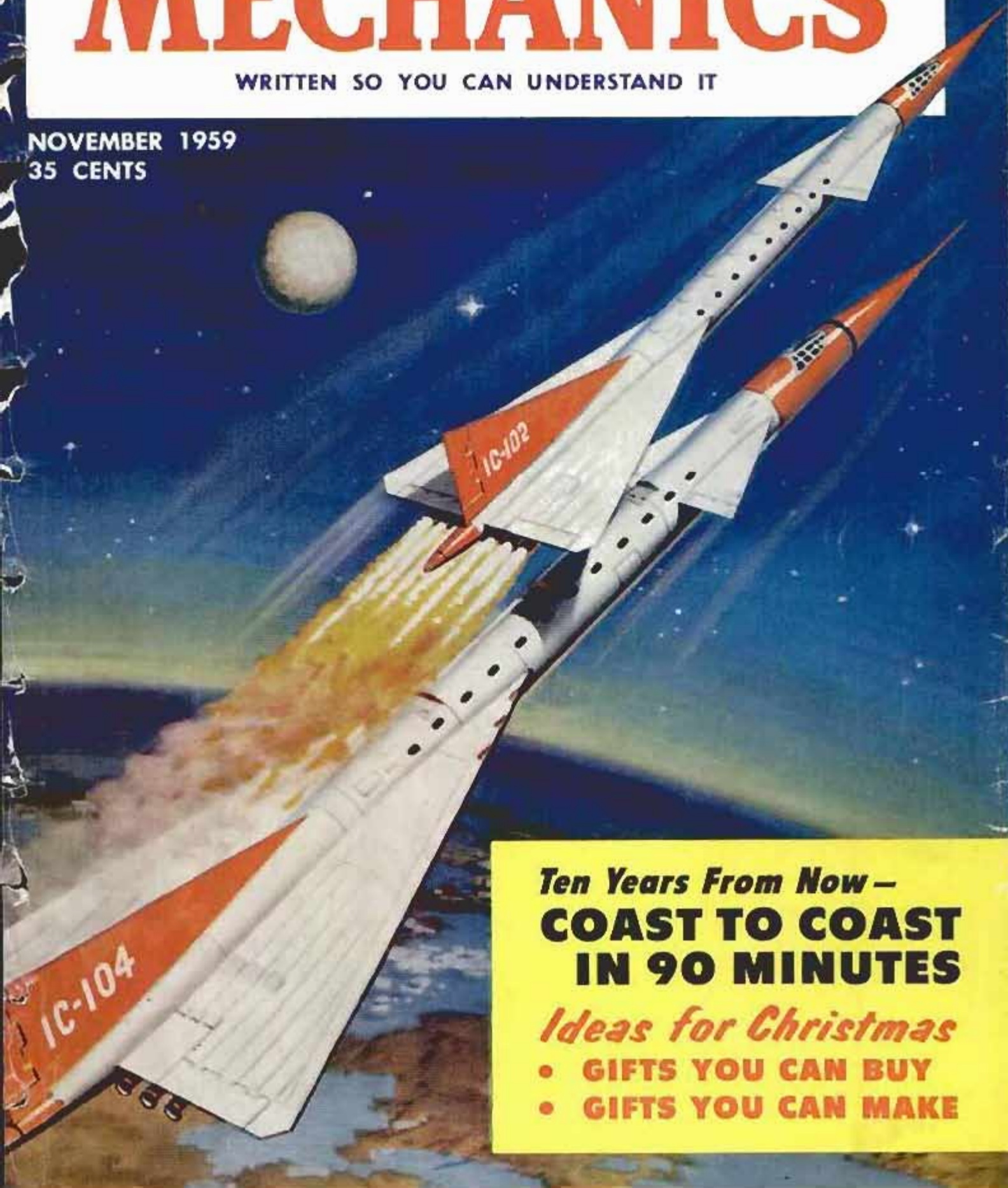

Ten Years From Now—
**COAST TO COAST
IN 90 MINUTES**

Ideas for Christmas

- GIFTS YOU CAN BUY
- GIFTS YOU CAN MAKE



great to get . . .



A POPULAR GIFT with plenty of practical appeal. Rugged construction. Unbreakable Tenite head and handle. All exposed metal parts nickel plated. Forged steel jaws.

1950 Ratchet Brace \$7.35



MAKE A MAN A CRAFTSMAN with these fine chisels. Four sizes: 1/4", 1/2", 3/4" and 1". Plastic pouch. Forged blades and balsters.

1434 Wood Chisel Set \$6.95



4 TOP QUALITY SCREWDRIVERS — 4" and 6" standard, 3" cabinet and 4" Phillips. Convenient plastic pouch. Tempered chrome steel blades. Shock-proof Tenite handles.

8514 Screwdriver Set \$3.95



YOU CAN'T GO WRONG with this accurate 9" pocket level. V-grooved bottom for use on round material. Extra tough magnesium frame will not warp or rust. Perfect for handymen, electricians, plumbers.

290 Torpedo Level \$2.95



NEW! 6 SAWS IN 1 — jig saw, hacksaw, coping saw, ripsaw, crosscut and keyhole saw! Straight lines, curves, circles and intricate shapes are sawed easily in woods, metals, plastics.

360 Jig Saw \$29.95

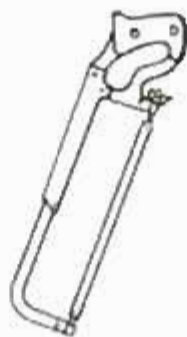

EVERY HANDYMAN NEEDS A HACKSAW. Finest quality frame of nicked and buffed steel with unbreakable Tenite pistol-grip handle. Adjustable for 8" to 12" blades. Furnished with 10" blade for all 'round use.

48 Hacksaw Frame \$4.25



ACCURATE ANGLES ARE EASY with this rugged mitre box. Select hardwood bottom and solid steel back. Quick-adjusting clamp locks saw at any angle. For use with regular hand saw or back saw.

816 Mitre Box \$7.50

WITH A BAG-FULL OF CHRISTMAS BARGAINS!

\$20 Tool Certificate FREE!

A REAL CHRISTMAS BONUS! With the purchase of either the 888 or 1114 Power Units, you'll get a special Tool Certificate that can save you up to \$20. It entitles you to \$2 off the regular price of any one of the ten attachments that convert these power units into complete power workshops. Act now! Limited time only — offer expires January 31, 1960.



888 Power Unit
\$39.95



1114 Power Drill
\$22.95

SAVE \$20 — GET ALL TEN ATTACHMENTS

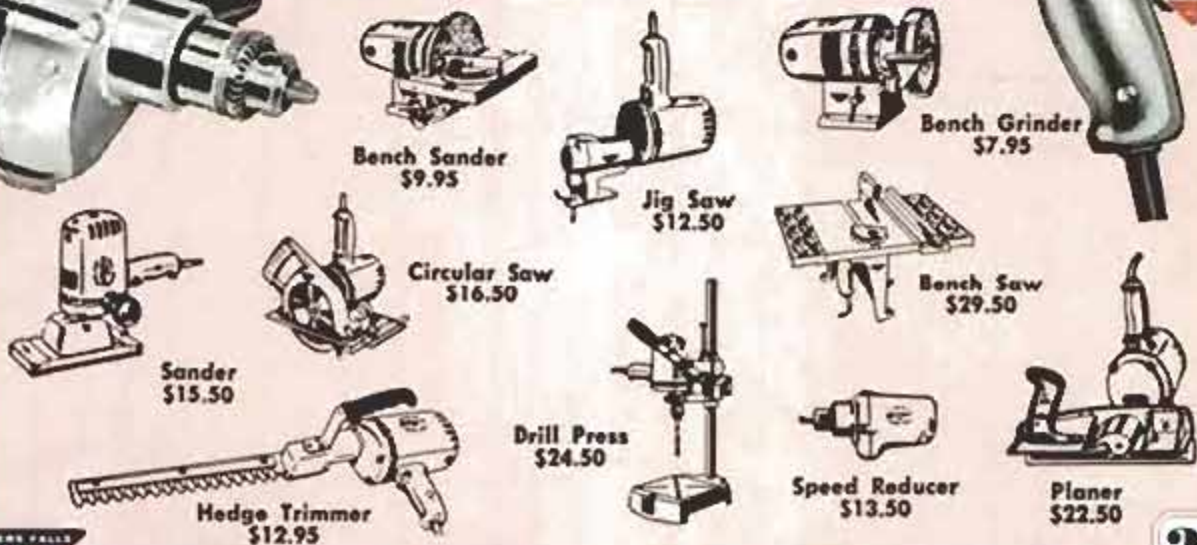

Bench Sander
\$9.95

Jig Saw
\$12.50

Bench Grinder
\$7.95

Circular Saw
\$16.50

Bench Saw
\$29.50

Sander
\$15.50

Drill Press
\$24.50

Speed Reducer
\$13.50

Hedge Trimmer
\$12.95

Planer
\$22.50

GOOD FOR \$2 OFF REGULAR PRICE ON EACH ATTACHMENT SHOWN

20

FREE Plane-'R-File worth \$3.49

Millers Falls will give a handy Plane-'R-File to the lucky guy who gets any one of these 3 fine tools for Christmas. There's a card with each — and when it's sent to Millers Falls, a free Plane-'R-File is mailed immediately. Good way to say Merry Christmas twice! Offer expires January 31, 1960.

IT'S A PLANE!



IT'S A FILE!

THIS CAN SAVE YOU MONEY, HONEY!

BARGAIN REMINDER

THIS COUPON MEANS BIG SAVINGS!

Keep it to remind yourself of the Christmas specials now featured at leading tool centers. For name of Millers Falls dealer nearest you, simply write Dept. PM-32, Millers Falls Company, Greenfield, Mass.

FREE \$20 CERTIFICATE

Savings of \$2 on any one of 10 attachments for the 888 or 1114.

FREE PLANE-'R-FILE

A bonus worth \$3.49 when you buy a 360 Jig Saw, 580 Sander or 626 Saw

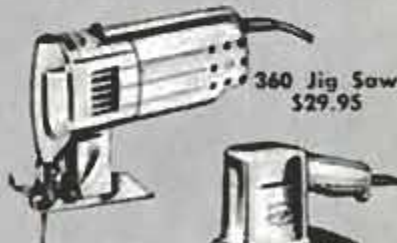

360 Jig Saw
\$29.95



580 Orbital Sander
\$39.95





Give the 1



JOY ALL YEAR LONG to the man who receives this rugged 1/4" drill. Full 2.7 amp. rating gives it all the power needed to drive 14 different quick-change accessories and attachments.

1114 Power Drill \$22.95



GOOD GIVING 'N' GETTING, TOO! Contains everything needed for drilling, sanding, polishing, and sawing: 1114 1/4" Drill, Jig Saw attachment with 4 Blades, 3-piece Drill Set, 5" Rubber Pad, 5" Polishing Bonnet, two 5" Sanding Discs, in steel carrying case.

**1118 Deluxe Drill Kit
Regular \$44.50 — Special \$39.95**



A REALLY WANTED GIFT for men and boys. This kit contains the same items as the 1118 Deluxe Kit with the exception of the Jig Saw Attachment.

**1117 Basic Drill Kit
Regular \$34.50 — Special \$29.95**



ANY FELLA WOULD APPRECIATE this precision-made plane. Excellent for hardwoods and end grain. Adjusts to cut a nickel plated screw and locking lever. long, 1 3/8" wide.

1455 Block Plane



3 TOOLS IN ONE! A powerful 3/4" 6-inch portable disc sander, and 6-inch orbital sander. Becomes complete, 17 tool, power shop with wide assortment of attachments.

888 Power Unit

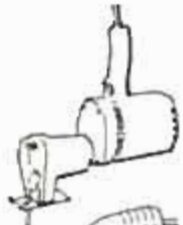

CUTS ANY SHAPE in wood or metal. Fits to the 888 Power Unit or 1114. Cuts own starting hole in wood. Complete with 4 blades.

886 Jig Saw Attachment



S-M-O-O-T-H-I! This speedy finishing attachment puts the professional touch on any project. 12 times faster than hand sanding. Fits both the 888 and 1114.

882 Orbital Sander Attachment



Tools that are



• **MAKES LIGHT WORK** of heavy jobs. Whether cross-cutting or ripping, this 6" saw attachment for the 888 slices through 2" dressed lumber. Quick, easy adjustments for depth and angle. **8811 Portable Saw Attachment \$16.50**



• **CUT AWAY** hours from those big time projects with this rugged 6 1/2" power saw. Packed with quality features. 1 H.P. motor. **626 Circular Saw Regular \$54.50 — Special \$49.50**



• **A SURE HIT** for any man. Precision hardened and tempered alloy steel head. Octagon shaped hickory handle. Beautifully balanced and finished. Weight 16-ozs., 13" long. **716 Claw Hammer \$4.50**



• **HOBBYIST'S DELIGHT!** Automatic drill with quick-action chuck locks or releases drill points instantly. Unbreakable Tenite handle holds up to 12 drill points. **170 Automatic Drill \$4.00**



• **TRY SQUARE, MITRE SQUARE,** level, depth and marking gauge all in one. Accurate. Easy to read. 12" x 1" steel blade. Cat's-eye level and scribe make it really versatile.

1200 Combination Square . . . \$2.95

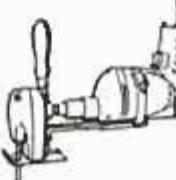

• **ANY DRILL IS A JIG SAW** with this versatile attachment. Saws all sorts of decorative and odd shapes in wood or metal. Equipped with 4 blades.

2140 Universal Jig Saw Attachment . . . Regular \$11.95 — Special \$9.95



• **FINE FINISHING** made fast and easy with this professional sander. A real Santa special too, with **2 FREE tungsten carbide sanding sheets.**

580 Finishing Sander \$39.95



• **HAPPY HOBBY DAYS** are his with this high quality bench plane. 9 inches long with 2" cutter. Quick, easy depth and side adjustments provide precise control of cut.

90 Bench Plane \$6.95

Give 'a Tool

FOR CHRISTMAS

MILLERS FALLS
TOOLS

SINCE
1868





Miller's Falls



A GOOD RULE FOR GIVING is to give the best with this fine 50' tape rule. Easy, one-finger winding. Extra strong, rustproof case. Clear foot and inch markings.

2050 Tape Rule \$3.29



FITS ANY 1/4" DRILL. 5" circular saw attachment rips, crosscuts, trims, bevels, and mitres. Adjustable rip guide. Telescoping guard.

2170 Circular Saw Attachment . . .
Regular \$14.95 — Special \$12.95



SPECIALLY DESIGNED for the 1114 Drill, this 5 1/2" saw crosscuts and rips finished 2 x 4's with speed and ease. Rip guide included.

1170 Circular Saw Attachment . . .
Regular \$13.50 — Special \$11.95

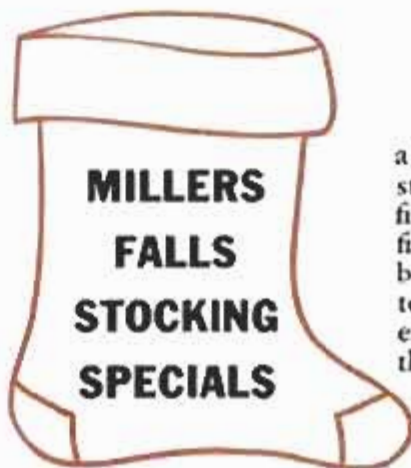

Look for this Bin of Bargains

at your favorite hardware store. It's filled with gifts just fine for stocking fillers. It's filled with gifts just fine for budget givers. Your pick of ten popular tools at only 99¢ each. You're bound to win at this bargain bin!

MILLERS FALLS COMPANY, DEPT. PM-32, GREENFIELD, MASS.



★ See special offer on cover.

POPULAR MECHANICS®

Address communications to: 200 E. Ontario St., Chicago 11, Illinois. SUBSCRIPTION SERVICE: Mail all subscription orders, changes of address, correspondence concerning subscriptions, and Postmaster notices of undeliverable copies to Popular Mechanics, 250 West 55th St., New York 19, N. Y.

Editor

RODERICK M. GRANT

Executive Vice-President

RICHARD E. DEEMS

Publisher

G. HARRY CHAMBERLAINE

Managing Editor

WAYNE WHITTAKER

Assistant Managing Editor

CLIFFORD B. HICKS

Shop Notes and Crafts Editor

JAMES R. WARD

Associate Editors, General Features

ARTHUR R. RAILTON, Automotive

JOHN A. LINKLETTER

Associate Editors, Shop Notes and Crafts

WAYNE C. LECKEY **W. CLYDE LAMMEY**

Radio-Television, Electronics Editor

LOTHAR STERN

Assistant Editors

R. B. KIRKPATRICK, ROBERT I. HULL, JR.

General Features

WALLACE MYERS, JEAN KAVANAUGH

Makeup

Art Staff

FRANK BEATTY, Director

HENRY NEHRBASS, Assistant Director

RICHARD A. POTTS, Art Editor

Eastern Editor

RICHARD F. DEMPEWOLFF

Room 4104, Empire State Bldg., New York City 1

Western Editor

THOMAS E. STIMSON, JR.

Suite 1007, 3100 Wilshire Blvd.

Los Angeles 5, Calif.

Advertising Manager

JOSEPH R. BUELL, JR.

Director, Bureau of Information

ALLAN CARPENTER

Advertising Offices

Chicago: 200 E. Ontario St., WHitehall 4-0100; New York: Empire State Bldg., 350 Fifth Ave., LOngacre 5-7580; Detroit: General Motors Bldg., TRinity 5-8711; Cleveland: Hanna Bldg., 1422 Euclid Ave., PRospect 1-0456; Los Angeles: 3460 Wilshire, DUnkirk 2-8458; San Francisco: Russ Bldg., 235 Montgomery St., YUKon 2-0823.

Published monthly by Popular Mechanics Company, 200 E. Ontario St., Chicago 11, Ill. Richard E. Deems, President; Richard E. Deems, Executive Vice-President; Fred Lewis, Vice-President and General Manager; John R. Miller, Vice-President; G. Harry Chamberlaine, Vice-President; G. O. Markon, Treasurer; H. F. McCauley, Secretary. Single copy in the United States and Canada, 35 cents; subscription rates in the United States and possessions, Canada and countries of the Pan American Postal Union, 1 year \$3.50; 2 years, \$6.00; 3 years, \$8.00. To all other countries add \$1.00 a year over United States prices for overseas postage. If you plan to move, notify us at least 30 days in advance so you will not miss an issue. Give both your old and new addresses. Second-class postage paid at Chicago, Illinois, and at additional mailing offices. Entered as Second Class Matter at Post Office Dept., Canada. Registered as Second Class Matter at the Post Office at Mexico, D.F., Mexico, June 20, 1950. ©1959 by Popular Mechanics Company. All rights reserved. Printed in the United States of America.

FOREIGN EDITIONS: MECANIQUE POPULAIRE (French) MECANICA POPULAR (Spanish) POPULAER MEKANIK (Danish) POPULAR MEKANIK (Swedish) POPULARE MECHANIK (German)

Volume 112

NOVEMBER 1959

Number 5

In This Issue...

All the 1960 Cars in Full Color	- - -	81
More Details on the New Cars	- - -	89
Valiant, page 89; Ford, Mercury, Edsel, page 92; Rambler, page 95; Studebaker, page 96; Chrysler, Plymouth, Dodge, DeSoto, page 98; Cadillac, Buick, page 100.		
Your Toy Construction Grew Up	- - -	108
Toughest Railroad You Taxpayers Own	- - -	117
The Shortest Route May Be the Longest	- - -	124
Coast to Coast in 90 Minutes	- - -	128
Bulldozer? An Elephant Will Do	- - -	140
TV's Tiny Spectaculars	- - -	146
A Scientist Blows Square Bubbles	- - -	150
Christmas Shopping Section	- - -	166

For the Craftsman...

Christmas Gifts You Can Make	- - -	176
The Vacuum-Booster Pump	- - -	186
You Can Finish Furniture	- - -	194
Three One-Evening Projects	- - -	206
Workshop Cleaner	- - -	210
Radio, TV and Electronics	- - -	220

Regular Departments...

WHERE-TO-BUY-IT INDEX - - - 76

Know This Old-Timer!	- - - 12	An Eye on Space	- - - 116
Pioneer of Science	- - - 16	Shopping for Tools	- - - 172
Detroit Listening Post	- - - 101	Solving Home Problems	- - - 190

Clinic for Homemakers - - - 228

Turn to detailed index on page 76. Sources of additional information on items in this issue are shown on the Where-to-Find-It List, available without charge by writing the Bureau of Information, Popular Mechanics, 200 E. Ontario St., Chicago 11, Ill.

Next Month...

YEARNING FOR A HOUSEBOAT? You can build it yourself. Next month we present the first of a series of articles telling you in construction detail how to build a 24 by 8 foot boat—just right for a family summer afloat. A leading marine architect drew the plans, Popular Mechanics built the houseboat and launched it to prove every step of the construction before we offered it to you. Don't miss the December issue!

ROUNDUP

Hitch up your horse, pick up the boys, and head for the nearest store to git a pack of **PHILLIES. CHERROOTS**



WHY HERE'S A CIGAR AS FRESH AS A NEW BORN COLT.

A spankin' new size and shape and it's

MIRACLE MILD

*Slick on the draw
and big as your trigger finger!*



Rustle up 28 cents and buy yourself a pack of 5. If you gotta wait in line and your horse starts chompin' at the bit- tell him "whoa"- you ain't getting back in the saddle 'til you get your CHERROOTS!



The low beam of G-E SUBURBAN Headlamps



OLD LOW BEAM

25 feet beyond those approaching headlamps there's a barrel in the road. It's not yet within the range of the low beam of any previous 2-headlamp cars.

has a "spotlight" effect, so . . .



NEW G-E LOW BEAM

There's the barrel—225 feet away! This is how the low beam of G-E SUBURBAN Headlamps (made only for 2-headlamp cars) helps you see in spite of oncoming lights.

you see better in spite of other cars' lights

Three-fourths of all night driving is now done with the low beam!

When there wasn't a great deal of nighttime traffic, you used the *upper* beam most often because it pushed a lot more light farther down the road. So, headlamp manufacturers put the upper beam filament on focus for maximum beam control.

Since nighttime traffic has increased tremendously, motorists find they must use the *low beam* more and more. So, General Electric now puts the *low beam* filament on focus to give maximum beam control where it's needed most—to provide a "spotlight" effect which directs more light down the right side of the road. That's why the low beam of new General Electric SUBURBAN Headlamps lets you see past the oncoming car when you're 75 to 200 feet apart. Only General Electric SUBURBAN Headlamps have this feature for 2-headlamp cars. General Electric Company, Miniature Lamp Department M-912, Nela Park, Cleveland 12, Ohio.



ATTENTION ALL OWNERS OF 2-HEADLAMP CARS!

For approximately the same results as the four-headlamp systems in brand new cars (whose low beam filaments are also on focus) . . . have a pair of new G-E SUBURBAN Headlamps installed and aimed today. Tonight you'll see better in spite of the other cars' lights.

Progress Is Our Most Important Product

GENERAL  ELECTRIC



How we retired in 15 years with \$300 a month

We're having a wonderful time, Betty and I. We're doing all the things we've always dreamed of doing. We enjoy our home. Summers, we pack the car and take trips. And it's all thanks to a check for \$300 that comes by mail, as regular as clockwork, every month!

Luckily for me, I was only forty when Betty began to worry about our future. "You're going to want to slow up in a few years," she'd say. And I'd laugh. Because I felt fine. "But you won't always want to work," she'd say. "Well, I still have fifteen good earning years ahead of me," I'd answer.

But one day she stopped me. She asked me how much I'd earn in the next fifteen years—not counting raises. I did some quick arithmetic, multi-

plying my salary by fifteen. It ran up into *six figures!* I grinned.

Betty wasn't impressed. "How much of that do you think we'll save?" she asked. I had to be honest. We were always paying off on a new car or a radio, or going places. "A thousand or two," I admitted.

"That's just our trouble," she said. "We can't seem to save. You ought to take out one of those retirement income plans right now."

So I looked into the subject and discovered the Phoenix Mutual Retirement Income Plan. It was a way I could make part of my salary *now* buy me a retirement income *later*. All I needed was to start in time. With a Phoenix Mutual Plan, I could get a check for \$300 a month for life, start-

ing in fifteen years, when I reached fifty-five. I applied immediately and qualified.

The big day came fifteen years later, when our first Phoenix Mutual monthly check for \$300 arrived in the mail. *I retired*. Now Betty and I are having the time of our lives—with no money worries.

Send for Free Booklet

This story is typical. Assuming you start at a young enough age, you can plan to have an income of from \$50 to \$300 a month or more—starting at age 55, 60, 65 or older. Send the coupon and receive, by mail and without charge, a booklet which tells about Phoenix Mutual Plans. Similar plans are available for women. Don't delay. Send for your copy now.

PHOENIX MUTUAL

Retirement Income Plan

GUARANTEES YOUR FUTURE

OVER 100 YEARS

OF LIFE INSURANCE PROTECTION

FOR FAMILIES AND BUSINESS

PHOENIX MUTUAL LIFE INSURANCE CO.
314 Elm Street, Hartford 15, Conn.

Please send me, without obligation, your free 28-page book showing new retirement income plans.

Plan for Men Plan for Women

Name _____

Date of Birth _____

Business Address _____

Home Address _____

Over the Editor's Desk



Auto Show in Color

In this, the most exciting automotive year in a generation, *PM* presents color photographs of all the new cars. It's the first time we have done it and, as far as we know, it's the first time any magazine has done it.

To make it possible, *PM* photographer Don Honick spent days locked inside Detroit proving grounds—often on weekends. One such weekend was the Fourth of July.

But Don didn't mind—it was safer than last year's Fourth when he burned his shutter hand lighting a sparkler for his son, Scott. ☆ ☆ ☆

Casting around for Christmas ideas? For the head man, the lady of all work, the youngsters? Turn to pages 166-181 for some suggestions. And we'd like to tell you about a new book your 8 to 12 year olds would read with fascination. Written by our own Assistant Managing Editor, Clifford B. Hicks, "First Boy on the Moon" is not only good reading but will teach a "space world" of facts about astronautics to those youngsters who'll grow up in an outgrown world. Wait till you read how a stowaway frog saved our first mission to the moon and its stowaway boys! Publisher: John C. Winston Co.

To the Editor:

I've just read the excellent article [July, 1959] by Mr. H. F. Unger, "Karate—'Gentle Art' of Self Defense" and enjoyed it thoroughly. As a Judo-ka (student of Judo) however, I have noticed an item which seems to run contrary to my own training: I think that Mr. Unger has given the name "Gentle Art" to the wrong sport. To clarify my point and give my reasons, it might be appropriate to investigate a little of the history of Japanese sports.

Karate, as Mr. Unger has pointed out, is a very lethal martial art. Jujitsu, on the other hand, is not. While the two are frequently confused, Jujitsu actually makes use of, and in fact was the origin of, the throwing techniques that we associate with much Japanese combat. The word "jujitsu" when translated means "gentle art," and refers not to the severity or ease of defeating an opponent but to the principle upon which jujitsu throwing techniques are based.

Judo, the sport which I practice, is a modern-day derivative of jujitsu, devel-

(Continued to page 8)

NOW!

no spindle deflection

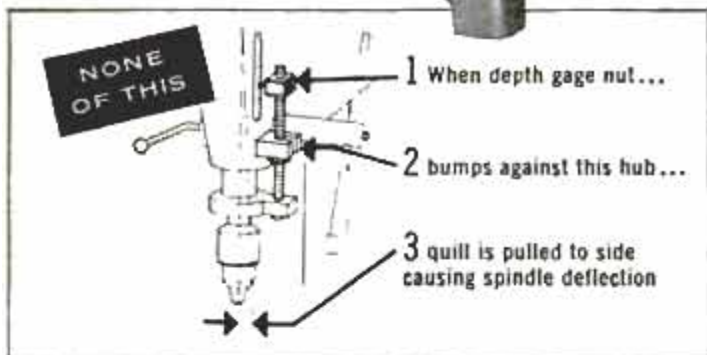

South Bend's design eliminates the major cause of inaccuracies common to all drill presses—spindle deflection resulting from depth gage pressure. *There is no depth gage collar on the quill.* Travel of the quill is controlled by an exclusive Rack Type Depth Gage that limits the rotation of the quill feed shaft. Write for more details about South Bend's exclusive features.

Prices of South Bend 14" Precision Drill Presses start at \$128 f.o.b. factory

SOUTH BEND

LATHE

South Bend Lathe, Inc., South Bend 22, Indiana

Builders of Lathes, Milling Machines,
Shapers, Drill Presses, Pedestal Grinders
Up to 24 months to pay



Satisfied with my PRESENT PAYCHECK?

NOT ME!!

TODAY, you are probably earning enough to get by—enough to provide your family with life's necessities, and perhaps you are depositing a few extra dollars in the bank.

BUT are you content with just earning a living wage? Do you say "Someday I'll really get a break and go right on to the top." THAT'S WISHFUL THINKING!

You know that the "breaks" go to the man or woman who is *prepared* to take advantage of them—to the person who can fill the better job and who is worth more money. He makes the "breaks" instead of waiting for them.

DO YOU QUESTION YOUR OWN ABILITY?

There is a field of business which has never been overcrowded—it's the ACCOUNTING FIELD. And the demand for skilled accountants—men and women who really know their business—is increasing. State and Federal legislation requires much more efficient accounting from business. Corporations are in constant need of expert counsel in matters relating to Auditing, Cost Accounting, Business Law, and Federal Income Tax. Men who prove their qualifications in this important branch of business are promoted to responsible executive positions—given an opportunity to earn real salaries. The range is \$5,000 to \$10,000 a year—even to higher income figures.

WHY BE SATISFIED WITH YOUR PRESENT JOB?

Why accept mediocre pay when right in your own home you can acquire the necessary training to advance rapidly in the profitable, growing field of Accounting.

Under the LaSalle Problem Method you can acquire a thorough knowledge of Accounting, master its fundamental principles, become expert in the practical application of those



principles—without losing an hour from work or a dollar of pay.

Your training will be under the supervision of organization and management specialists, Attorneys and Certified Public Accountants. Preliminary knowledge of bookkeeping is not necessary. We train you from the ground up—Basic Accounting right on up through the Certified Public Accountant training.

SO RIGHT NOW—TODAY

If you are ambitious—if you are interested in a high-paying career—investigate the opportunities in this profitable field.

FREE SAMPLE LESSON

Decide today to send for LaSalle's Accounting Lesson Number One, also FREE book, "Opportunities in Accounting." In it you will find complete information on the opportunities which are open to those qualified, and you will learn how you can prepare yourself for a better job and more money. NO OBLIGATION. MAIL THE COUPON TODAY.

ACCREDITED MEMBER, NATIONAL HOME STUDY COUNCIL

FIFTY YEARS OF QUALITY TRAINING

MAIL THE
COUPON
TODAY!

OVER 4,500 CPAs
HAVE BEEN TRAINED
BY THE LA SALLE
PROBLEM METHOD

-----SEND FOR FREE BOOKS-----



LaSalle Extension University

— A Correspondence Institution —

Dept. 1164H, 417 S. Dearborn St., Chicago 5, Ill.
Please send me, free of all cost or obligation, Free sample lesson, and your illustrated book, "Opportunities in Accounting."

Name.....Age.....

Address.....

City, Zone, State.....

oped by Jigoro Kano in the 1800s. Mr. Kano succeeded in refining and making safe the old jujitsu, as well as giving it a high moral purpose. The resultant sport, known as Judo or more correctly, the Kodokan Judo, utilizes throwing, choking, holding and arm-bending techniques in individual competition between friendly opponents all over the world. This is the sport that the world knows as the "gentle art." Its influence is such that the uniforms the Karate students wear in the article are known as Judogi, or Judo-cloths. Mr. Kano himself explained the idea of gentleness best with the following illustration:

Suppose we measure the strength of men in units of ten. If, then, my strength is 7 units, and I attempt to push a man who has 10 units, I shall be pushed back. However, if I yield to his force, and at the same time pull him slightly off-balance, I shall be able to throw him to the ground.

Because of the reasons I have given, and because striking techniques, while taught to Judoka, are never used in competition for fear of injury, I submit that Judo and jujitsu are the actual gentle arts, while Karate deserves the reputation for deadliness that Japanese sports have attained.

Gordon S. Kirkpatrick,
Centralia, Wash.

Rocket "Lighthouse"

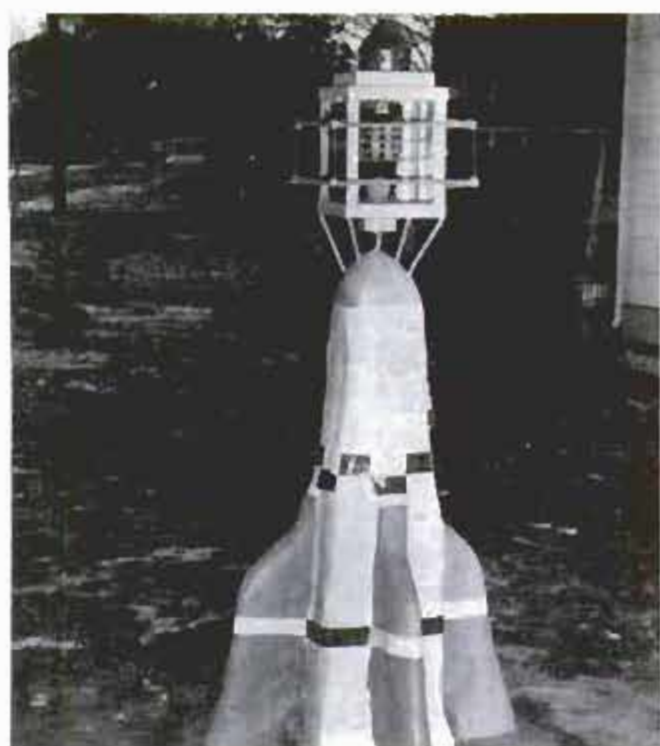

Solomon B. Meserve built a lamp for his yard in Framingham, Mass., with a home-made "rocket" for the base. The frame is of wood covered with hardware cloth, then Portland cement, and painted over. The lamp itself was made of scrap metal.

(Continued to page 10)

"EARNED OVER \$2,000.00 IN TEN WEEKS"



You can investigate full time for one company — or earn \$3 to \$10 an hour in *your own business*. No prior experience or higher education needed. And age is no barrier. Here is a field wide open to men 18 to 60.

NOW! FREE Book Gives You All the Facts

Send TODAY for new, illustrated Book mailed FREE. Learn how you can prepare at home in just a few weeks for excellent full time or spare time income. See for yourself how others have doubled and even tripled their earnings. Let us show you how Universal Schools has trained hundreds of men in their own homes spare time — and then helped them add thousands of dollars to their incomes. Absolutely no obligation on your part. No salesman will call. Write at once to me, M. O. Wilson, Universal Schools, 6801 Hillcrest Ave., Dallas 5, Texas.

INVESTIGATE ACCIDENTS. We train you. Then we assist you to step into an excellent position — or to develop your own lifetime business.

A. J. Allen earned over \$2,000 in ten weeks. Gary Williams doubled his former salary. Jessie Hill says "Had I not learned of Universal Schools' Accident Investigator Course I would still be just another time card puncher; but today I have a wonderful position, and I receive \$3.00 an hour plus an expense allowance."

RIGHT NOW the Accident Investigation and Adjusting Field offers you a tremendous future. Here's why: *This vital business distributes more money than any other service industry.* Last year alone over 200 MILLION ACCIDENTS had to be investigated for Insurance Companies, Airlines, Railroads, Steamship Lines, and Government Offices — and the need for trained men is booming!



Mr. M. O. Wilson, Dept. PM-11
Universal Schools, 6801 Hillcrest Ave.,
Dallas 5, Texas

Send me free book on Big Money in Accident Investigating & Adjusting Field. No salesman will call.

Name.....Age.....

Address.....

City.....Zone.....State.....

YOU BUILD Broadcasting Transmitter

As part of N.R.I. Communications Course you build this low power Transmitter; use it to learn methods required of commercial broadcasting operators, train for FCC license.



YOU BUILD Signal Generator

N.R.I. sends kits of parts to build this Signal Generator. You get practical experience, conduct tests to compensate Radio frequency amplifiers, practice aligning a typical I.F. video amplifier in TV circuit, many other experiments.



YOU BUILD Vacuum Tube Voltmeter

Use it to get practical experience, earn extra cash fixing neighbors' sets in spare time, gain knowledge to help you work in Radio, Television, Color TV. With N.R.I. training you work on circuits common to both Radio and TV. Equipment you build "brings to life" things you learn in N.R.I.'s easy-to-understand lessons. 64 page Catalog FREE, shows all equipment you get.



YOU BUILD AC-DC Superhet Receiver

N.R.I. servicing training supplies all parts, everything is yours to keep. Nothing takes the place of practical experience. You get actual servicing experience by practicing with this modern receiver; you learn-by-doing.



Learn RADIO TELEVISION ELECTRONICS

by Practicing at Home



WHAT GRADUATES DO AND SAY

Chief Engineer

"I am Chief Engineer of Station KGCU in Mandan, N. D. I also have my own spare time business servicing high frequency two-way communications systems."

R. BARNETT, Bismarck, North Dakota.



Paid for Instruments

"I am doing very well in spare time TV and Radio. Sometimes have three TV jobs waiting and also fix car Radios for garages. I paid for instruments out of earnings."

G. F. SEAMAN, New York, N. Y.



Has Own TV Business

"We have an appliance store with our Radio and TV servicing, and get TV repairs. During my Army service, NRI training helped get me a top rated job."

W. M. WEIDNER, Fairfax, South Dakota.



NEED FOR TECHNICIANS INCREASING Fast Growing Field Offers Good Pay, Bright Future

Today's OPPORTUNITY field is Radio-Television. Over 125 million home Radios plus 30 million sets in cars and 40,000,000 Television sets mean big money for trained Radio-TV Technicians. More than 4,000 Radio and TV Broadcasting stations offer interesting and important positions for technicians, operators. Color television, portable TV sets, Hi-Fi, other developments assure future growth.

It's the trained man who gets ahead. The fellow who uses his spare time to develop knowledge and skill gets the better job, drives a better car, lives in a better home, is respected for what he knows

and can do. So plan now to get into Radio-TV.

Keep your job while training with N.R.I. You learn at home in your spare time. N.R.I. is oldest and largest home study Radio-TV School. Our methods have proved successful for more than 40 years, provide practical experience.

Soon after enrolling, many N.R.I. students start to earn \$10, \$15 a week extra in spare time fixing sets. Many open their own full time Radio-TV shops after getting N.R.I. Diploma. Find out more. Mail Coupon. Cost is low, terms easy; includes all equipment. Address: National Radio Institute, Dept. 9MA, Washington 16, D. C.

Send for
LESSON
and **CATALOG**
FREE

VETERANS
Available under
G.I. Bills



MAIL COUPON NOW

NATIONAL RADIO INSTITUTE
Dept. 9MA, Washington 16, D. C.
Mail me Sample Lesson and 64-Page Catalog,
FREE. (No Salesman will call. Please write plainly.)

Name _____ Age _____

Address _____

City _____ Zone _____ State _____

ACCREDITED MEMBER, NATIONAL HOME STUDY COUNCIL

AUTO-LITE[®]

RESISTOR SPARK PLUGS WITH

POWER TIP



AT LOW SPEEDS
Power Tip is hot to burn
fouling deposits away clean.

AT HIGH SPEEDS
Power Tip is cool to check
costly pre-ignition.

**"FIRE UP" AT
ALL SPEEDS
WITH
AUTO-LITE[®]
POWER TIP**



*— the spark plug that cleans
itself while you drive!*

To the Editor:

(Continued from page 6)

A famous old ship which has outlived almost all of the men who sailed her will soon begin a new career in North Atlantic waters.

The 85-year-old former Coast Guard cutter *Bear* is at Halifax, N.S., where the Shaw Steamship Co. plans to re-engine her for work as a sealer and Arctic trader. The company says the *Bear* has been found as sound of hull as ships one third her age.

Built at Dundee, Scotland, in 1873, the *Bear* sailed with the Newfoundland sealing



fleet before being purchased by the U.S. government in 1884 to head an expedition looking for Lt. A. W. Greely of the U.S. Army. Greely had led an expedition to Lady Franklin Bay in the Arctic and had been unheard from for almost two years.

Teaming up with the sealers *Thetis* and *Alert*, the *Bear* sailed along the northwest coast of Greenland and helped locate the last few ragged and starving survivors of the Greely party.

Famous for her many rescue missions in the Arctic and the Bering Sea, the *Bear* sailed the Far North for almost 40 years!

(Continued to page 18)

You'll soon be happy in a great new job...

...earning **BIG** money...

...if you start training **NOW** for success in

AIR CONDITIONING AND REFRIGERATION

You could be earning top pay in months. It's mostly a matter of getting your training now. Your best bet is to be a mechanic in the air conditioning and refrigeration field. This industry is growing so fast that *20,000 newly trained mechanics are needed each year*. Over 150 million units are in use; over 5 million new air conditioners, freezers and refrigerators are sold annually. Skilled men are desperately needed for installation and repair work. Be a mechanic! *Mail coupon for free success booklets on CTI's amazing new Home Training Plan.*



You can earn cash during your training

Because CTI training is so *practical*, you'll soon be making profitable service calls. Perhaps you'll work on your own. Or, you may prefer to get a part-time job with a local appliance dealer or air conditioning contractor. You can add to your present income this way. With extra cash, you can buy additional shop equipment, pay your tuition, even bank money.



You could go in business and be independent

Own a business—and enjoy independence! Thrill to the satisfaction of being the boss. Give orders—not take them! The refrigeration field is ideal for getting started on your own. You can make friends as you make service calls. In time, you'll have a list of potential customers. You can also sign service contracts with food stores, taverns, restaurants, etc. Ever so many CTI graduates have their own successful shops. Most of them began with nothing more than their new training and pluck. You, too, can start small and grow big. Be a business man!

You could get into the profitable new auto air conditioning field

Hundreds of thousands of new cars are being equipped with air conditioners. Auto dealers are advertising for skilled refrigeration mechanics, offering premium pay, to set up service departments. Or, you can go in business for yourself, and contract with auto agencies to do this type of installation and repair. You can make big profits either way.



This is the home of CTI, one of the world's great home study schools. Through this Institute you receive "training you can trust." Over 40,000 career graduates from coast to coast.

COMMERCIAL TRADES INSTITUTE
1400 Greenleaf Avenue • Chicago 26, Illinois

FIRST GET THE FACTS—THEN DECIDE
Mail Coupon Today for 2 Free Booklets

ONLY CTI SENDS PARTS
AND TOOLS TO BUILD A
CONDENSING UNIT!

25
BIG KITS



You learn fast because you practice with real equipment—Get experience

You train at home in spare time. No need to give up your present job; no need to leave home to attend a resident school. *CTI sends 25 kits of parts and tools to build a heavy-duty, commercial-type, 1/4 h.p. refrigeration high-side (illustrated above.)* You do 10 troubleshooting and service jobs—it's almost like field training!

After assembling and working projects with your unit, you may build an air conditioner, refrigerator, freezer, or milk cooler. *All parts and tools are sent without extra charge—they are yours to use and keep.*

You get all these quality mechanic's tools



You get special "tools of the trade" as part of your training. Included is a pressure gauge, vacuum gauge and testing manifold. You'll use these tools to assemble and test the condensing unit. Thus, you get not just tools—but *equipment to practice with.* (Why settle for one without the other?)

You must look into your opportunities

Thousands of CTI graduates (and students) tell us they are getting better jobs, earning more money, working steady. Many are going in business. It is surprising how many report the best benefit of all is that they gained self-confidence. With so much at stake, can you afford to neglect your opportunities? Isn't it worth a few minutes of your time to *find out?* Just fill out and mail the handy coupon! Be sure to act today.

COMMERCIAL TRADES INSTITUTE

1400 GREENLEAF AVENUE
CHICAGO 26, ILLINOIS

DEPT. R-659

Send me your two opportunity booklets, *Success in Air Conditioning & Refrigeration*, and Lesson Sample. Both FREE.

Name _____ Age _____

Address _____

City _____ Zone _____ State _____



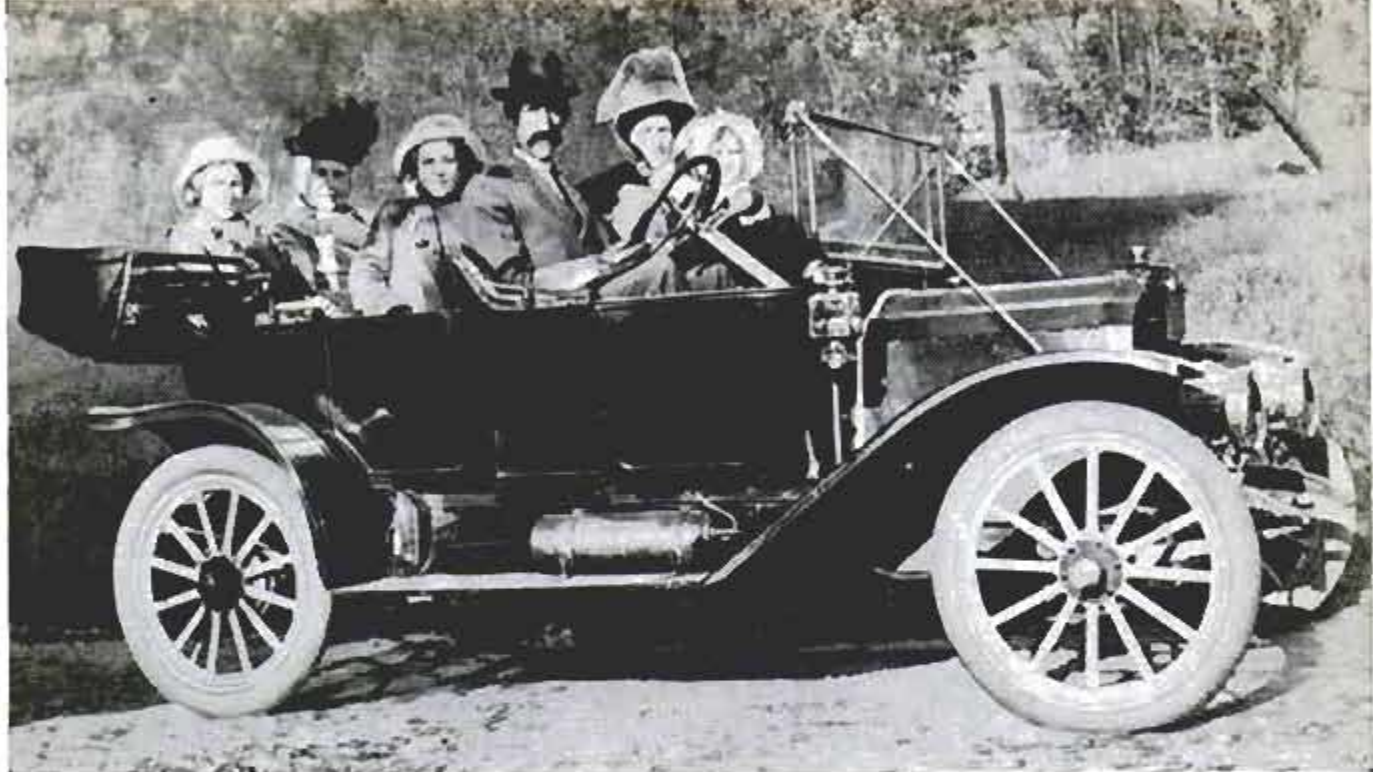

Do You Know This Old-Timer?

When grandfather sat behind the wheel of this stylish, four-door touring car, he was the man about town. If you can't place it at first glance, note such details as a removable tonneau that converted the car

into a truck, smooth tires, Presto-Lite head lamps, a four-cylinder engine with a dry-cell battery for starting spark and a bulb horn that could be heard 50 feet away on a still day. Answer on page 252.

*Comforting Facts
about*
**WOLVERINE
WORK SHOES**



PLUS THESE COMFORT FEATURES—



- FOAM RUBBER CUSHION
- INSOLE WITH SWEAT-PROOF
- LEATHER COVER • RIBBED
- STEEL SHANK • CHOICE OF
- SOLES TO FIT YOUR JOB

WOLVERINE
ROCKFORD, MICHIGAN

Service Oxfords
Work Shoes • Boots
Safety Shoes

NOW!
at a price
you can afford!

MAKE MORE MONEY in TELEVISION RADIO-ELECTRONICS

**BETTER...MORE COMPLETE...LOWER COST...
WITH NATIONAL SCHOOLS SHOP-METHOD
HOME TRAINING!**

BETTER... Training that is proved and tested in Resident School shops and laboratories, by a School that is the **OLDEST** and **LARGEST** of its kind in the world.

MORE COMPLETE... You learn **ALL PHASES** of *Television-Radio-Electronics*.

LOWER COST... Other schools make several courses out of the material in our **ONE-MASTER COURSE** - and you pay more for less training than you get in our course at **ONE LOW TUITION!**



These
two FREE books will
show you how!

You get all information
by mail... You make
your own decision... at
home! **NO SALESMAN
WILL CALL**

**TOP PAY... UNLIMITED OPPORTUNITIES
LIFETIME SECURITY CAN BE YOURS!**

You are needed in the Television, Radio, and Electronics industry! Trained technicians are in growing demand at excellent pay—in **ALL PHASES**, including Servicing, Manufacturing, Broadcasting and Communications, Automation, Radar, Government Missile Projects.

NATIONAL SCHOOLS SHOP-METHOD HOME TRAINING, with newly added lessons and equipment, trains you in your spare time at home, for these unlimited opportunities, including many technical jobs leading to supervisory positions.

YOU LEARN BY BUILDING EQUIPMENT WITH KITS AND PARTS WE SEND YOU. Your National Schools course includes thorough *Practical* training—**YOU LEARN BY DOING!** We send you complete standard equipment of professional quality for building various experimental and test units. You advance step by step, perform more than 100 experiments, and you build a complete TV set from the ground up, that is yours to keep! A big, new TV picture tube is included at no extra charge.

EARN AS YOU LEARN. We'll show you how to earn extra money right from the start. Many of our students pay for their course—and more—while studying. So can you!

LESSONS AND INSTRUCTION MATERIAL ARE UP-TO-DATE, PRACTICAL, INTERESTING. Every National Schools Shop-Method lesson is made easy to understand by numerous illustrations and diagrams. All instruction material has been developed and tested in our own Resident School Shops, Laboratories and Studios.

SEND FOR INFORMATION TODAY... it can mean the difference between **SUCCESS** and failure for you! Send for your **FREE BOOK** "Your Future in Television-Radio-Electronics" and **FREE Sample Lesson.** Do it **TODAY**, while you are thinking about your future. It doesn't cost you anything to investigate!

**GET THE BENEFITS OF OUR OVER
50 YEARS EXPERIENCE**

Approved for
GI Training



NATIONAL SCHOOLS
Los Angeles 37, Calif.

YOU GET...

- 19 Big Kits—**YOURS TO KEEP!**
- Friendly, Instruction and Guidance
- Job Placement Service
- Unlimited Consultation
- Diploma—Recognized by Industry
- **EVERYTHING YOU NEED FOR SUCCESS!**

**SHOP-METHOD HOME TRAINING
COVERS ALL PHASES OF INDUSTRY**

1. Television, including Color TV
2. Radio AM & FM
3. Electronics for Guided Missiles
4. Sound Recording and Hi-Fidelity
5. FCC License
6. Automation and Computers
7. Radar & Micro-Waves
8. Broadcasting and Communications

NATIONAL TECHNICAL SCHOOLS
WORLD-WIDE TRAINING SINCE 1905

MAIL NOW TO
NATIONAL SCHOOLS, Dept. RB-119
4000 S. FIGUEROA ST., LOS ANGELES 37, CALIF.
Rush free TV-Radio "Opportunity" Book and sample
lesson. No salesman will call.

NAME _____ AGE _____

ADDRESS _____

CITY _____ ZONE _____ STATE _____

Check if interested **ONLY** in Resident School training at Los Angeles.
VETERANS Give date of Discharge _____

RESIDENT TRAINING AT LOS ANGELES

If you wish to take your training in our Resident School at Los Angeles, the world's TV capital, start **NOW** in our big, modern Shops, Labs and Radio-TV Studios. Here you work with latest Electronic equipment - - professionally installed - - finest, most complete facilities offered by any school. Expert, friendly instructors. Personal attention. Graduate Employment Service. Help in finding home near school - - and part time job while you learn. Check box in coupon for full information.

Make More Money Soon Fixing Electric Appliances



**Actual Lesson
FREE**

Fast Growing
Field Offers
Good Pay, Security
Interesting Work

Learn at Home in Spare Time

Earn more money. Enjoy doing important, interesting work. Learn Electrical Appliance Servicing. This is a field of increasing opportunity. Today every wired home has many electrical appliances and millions and millions of new appliances are made and sold each year. Find out more about this great, growing field. Find out how NRI can train you, at home and in spare time to be an Appliance Service Technician. See how you can start soon to make extra money servicing appliances.

Add to Your Income Soon After Enrollment Opportunities Increasing for Service Technicians

NRI Training is practical, thorough. You get easy-to-understand lessons, and NRI supplies parts to build professional type Multi-Use Tester. Use it to get practical experience. Soon, you can add to your income by servicing appliances. Build a profitable *sideline* for your spare time—qualify for a good job—develop a business and be your own boss. As an Appliance Service Technician, your opportunities are broad—your services wanted, gladly paid for, highly regarded in your community.

Appliances are necessary to comfortable, convenient living. Owners pay well to keep them in repair. The field is amazingly big. In addition to major appliances such as electric ranges, air conditioners, refrigerators, there are over 40,000,000 electric irons, 5,000,000 electric blankets, 15,000,000 coffee makers, plus more millions of vacuum cleaners, fans, toasters, mixers, etc.

Learn and Earn With Tester Diploma When You Finish



Locate appliance troubles easily with Portable Appliance Tester you build. You use it to learn and do actual electric appliance repair jobs. For only \$3.00 with enrollment and \$6 per month, get training including Tester—a small price to pay for increased earnings. Mail coupon for Sample Lesson and Book—your first step toward more interesting work, bigger earnings. **NATIONAL RADIO INSTITUTE, Dept. AM9, Washington 16, D. C.**



Over 40 Years
Experience
Backs Up
NRI Training



Find Out What
Appliance Repair
Offers You

Mail Coupon FOR LESSON AND BOOK **FREE**

National Radio Institute
Dept. AM9, Washington 16, D. C.

Please send me Electric Appliance Servicing Lesson and Book FREE. (I understand no salesman will call.)

Name _____ Age _____

Address _____

City _____ Zone _____ State _____

ACCREDITED MEMBER NATIONAL HOME STUDY COUNCIL

Men 17-55

READ THESE AMAZING FACTS ABOUT A MAN WHO COULD BE YOU!

Are **YOU** One of
the men who could
prepare for a job that
PAYS REAL MONEY in

**TELEVISION
RADIO**

Electronics

EMPLOYMENT
SERVICE

NOTHING
ELSE
LIKE IT

NO
PREVIOUS
TECHNICAL
EXPERIENCE
NEEDED

NO
ADVANCED
EDUCATION
NEEDED

LEARN
AT HOME
OR ...

... IN OUR
CHICAGO
OR TORONTO
LABORATORIES

ONLY DeVRY OFFERS ALL THESE FEATURES!

Only DeVry Tech provides Training Movies to make the basic principles of Electronics crystal clear! DeVry's explanations and illustrations are a pleasure to follow. Over 300 practical experiments with actual Electronic parts are included to give you on-the-job type know-how. You even build your own test equipment.

EMPLOYMENT SERVICE

The Industry knows the quality of DeVry training. That's why our Employment Service usually has more demands for graduates than we can fill. We can also help you get started in your own shop.

ARE YOU PASSING UP THE PAYCHECK—THE SOLID FUTURE —THE REAL BREAK—YOU'VE ALWAYS DREAMED OF?

You meet them almost every day . . . the men who want to advance out of humdrum, low-pay, or no-future jobs. Some are men who had to quit school too soon; men just out of school with no idea of what to do; or men looking for help in planning a better future. Yet, many of them could—can, if they're 17-55—train at home, in their spare time, for an exciting career with real money and an inspiring future in the field of Electronics. And the tragedy of it is: they don't know it! They think they need an advanced education, or some special experience, or a lot of money, to start—but what they need most is the will to win. Maybe you're a man like that. Well, here's great news! It's not too late! Electronics offers men like you, when trained, dozens of different job opportunities—from guided missile control to running your own radio-television service shop. Get the full story of the jobs you may prepare for . . . NOW . . . BEFORE the years and responsibilities close in on you. Send coupon today—no obligation.

2 MODERN TRAINING CENTERS

Large modern training centers in Chicago and Toronto offer DeVry students day and evening classes. The staffs, facilities and experience of these centers stand back of the home training programs. Whether you train at home or in residence, you're a DeVry Tech man. Look into it now!

Be A Standout in Electronics . . . Be A DeVry Tech Man!

Accredited Member of National Home Study Council

"One of North America's Foremost
Electronic Training Centers"



DEVRY TECHNICAL INSTITUTE
4141 Belmont Avenue • Chicago 41, Illinois
Formerly DeForest's Training, Inc.



DON'T DELAY!

MAIL COUPON TODAY

DEVRY TECHNICAL INSTITUTE

4141 Belmont Ave., Chicago 41, Ill., Dept. PM-11-P

Please give me your FREE booklets, "Pocket Guide to Real Earnings" and "Electronics in Space Travel," and tell me how to prepare to enter one or more branches of Electronics.

NAME _____ AGE _____

PLEASE PRINT

STREET _____ APT. _____

CITY _____ ZONE _____ STATE _____

Check here if subject to military training.

DeVry Tech's Canadian Training Center is located at
626 Roselawn Avenue, Toronto 12, Ontario.

2060



Easy as A-B-C



Be Your Own MUSIC Teacher

PLAY ANY INSTRUMENT

**LEARN AT HOME THIS QUICK,
SIMPLE, MONEY-SAVING WAY**



SIMPLE as A-B-C. Your lessons consist of real selections, instead of tiresome exercises. You read real notes—no "numbers" or trick music. Some of our 1,000,000 students, such as Lawrence Welk, are band LEADERS. Everything is in print and pictures. First you are told what to do. Then a picture shows you how. Then you play it yourself and hear how it sounds. Soon you are playing popular tunes, hymns, classical and any other music.

No special talent or previous training needed. Even if you don't know a single note of music now, you can soon play piano, guitar, accordion, organ, any instrument. Your friends will be amazed!

STOP CHEATING YOURSELF OF THESE JOYS!

Popularity! New friends, Gay parties, Good times, Career, Extra Money, Understand, appreciate and converse about music. Learn lives and compositions of modern and great masters . . . Relax! Banish worries and frustrations. Satisfy self-expression, creative urge. Gain self-confidence.

MAIL COUPON FOR FREE BOOK

See for yourself why our method has been successful for 61 years! Read the whole fascinating story of this wonderful method in 36-page illustrated book. For FREE copy, mail coupon. No obligation. No salesman will call.



U. S. School of Music,
Studio A3011,
Port Washington, N.Y.



U. S. SCHOOL OF MUSIC
Studio A3011, Port Washington, N.Y.

Please send me your 36-page illustrated Free Book. I'm interested in playing (name instrument) _____

I do I do NOT—have instrument now.

Name _____
(please print)

Address _____

City _____ Zone _____ State _____

Great Pioneers in Science Do You Know Them?

By James S. Thistle

THIS PIONEER discovered dynamite in 1867. He later combined nitroglycerin with guncotton, and produced a substance called "blasting gelatine," a still more powerful explosive. He also perfected the detonator without which it would not be possible to set off the explosive at a designated time.

Although he became one of the world's richest men, he never felt right about making money from a substance that was capable of destroying human life, so in his will he set up a fund of \$9,000,000, the interest of which he directed to be used annually for world prizes.

These prizes are awarded for noteworthy achievements in physics, chemistry, medicine, literature and the advancement of world peace. Each award consists of a gold medal, a citation and about \$30,000 to \$40,000. The prizes do much to stimulate original research and unusual talent.

*These letters, unscrambled,
spell the name of this
month's Great Pioneer
in Science:*

FONDLEBLEA

(First and Last Names)

Write the correct name here:

Now turn to page 265 for the answer.



ARE YOU GIVING YOUR CHILDREN MORE THAN YOU HAD?

A THOUGHTFUL DISCUSSION by Dr. D. Alan Walter

"When you look around your home with its comforts and conveniences, you will undoubtedly answer an unhesitating 'yes . . . my children have much more than I had.' But a moment's reflection may lead you to wonder—'am I giving my children more of the *important things*?"

"There is a distinction to be made between a *standard of living* and a *standard of life*. It is natural to want to give one's children more of the material things. But no material standard of living is adequate preparation for the years to come. Your children must have a standard of life—to guide their conduct, to direct their thinking, to give them strength and wisdom.

"The first step in developing a high standard of life is knowledge. That is why the Encyclopaedia Britannica is an essential possession. Children who develop the habit of 'looking it up in Britannica' develop a habit that will help to sustain them throughout life."

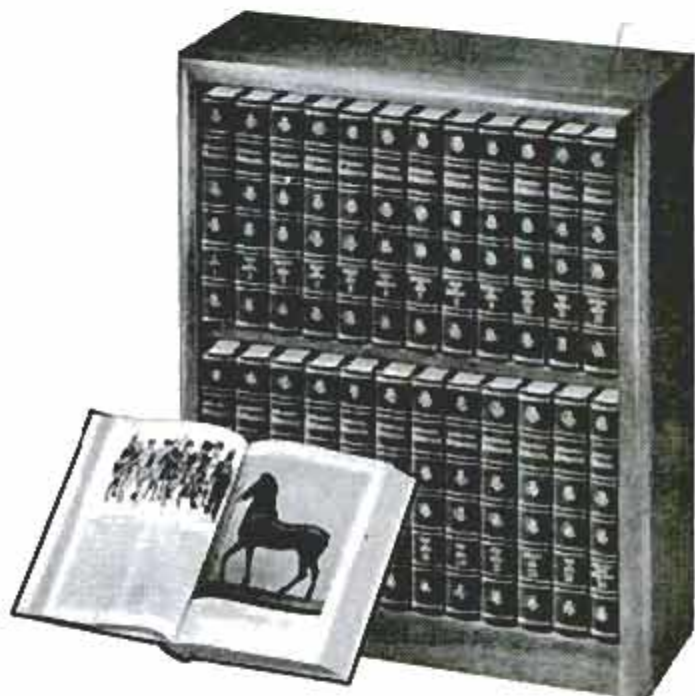

Brand new edition

ENCYCLOPAEDIA BRITANNICA

now available direct from the publisher on

Book a Month Payment Plan

you get all 24 volumes now—pay later!

The latest edition of Britannica—the most respected treasure of knowledge ever published—is the biggest and greatest in our almost 200-year publishing history. An enormous printing materially reduces our costs and under an unusual direct-from-the-publisher plan, we pass these savings on to you. All 24 handsome volumes will be delivered to your home NOW direct from the publisher. You pay later at a cost so low it is as easy as buying a book a month!

Equivalent to a library of 1,000 books

The Encyclopaedia Britannica is the most valuable gift you can give yourself and your family—the priceless gift of knowledge. Contained in its pages is information on every subject significant to mankind. It is equivalent to a library of 1,000 books, bringing you the knowledge and authority of world-recognized leaders in every field.

The new Britannica almost "televises" information to you, with 25,042 magnificent photographs,

maps and drawings. In every respect, Britannica is the most complete reference set published in America, containing 27,357 pages, and over 38,000,000 words.

Symbol of a good home

Benjamin Franklin said: "An investment in knowledge pays the best interest," and Britannica gives you the accumulated knowledge of the world in clear, easy-to-read language and superb illustrations. It is essential in every home where edu-

cation is valued and respected.

Preview Booklet Offered FREE

Simply fill in and mail the coupon today, and we will send you . . . without cost or obligation . . . a copy of our new booklet which contains an exciting preview of the latest edition of Encyclopaedia Britannica. Send no money—not even for postage. It's yours, absolutely free! However, since this offer is necessarily limited, please mail the coupon today before it slips your mind.

Mail Coupon Now for
FREE BOOKLET



ENCYCLOPAEDIA BRITANNICA, DEPT. 41-J
425 N. Michigan Avenue, Chicago 11, Illinois

Please send me, free and without obligation, your colorful Preview Booklet which pictures and describes the latest edition of ENCYCLOPAEDIA BRITANNICA. Also include complete information on how I may obtain this magnificent set, direct from the publisher, on the Book a Month Payment Plan.

Name _____ Please Print

Address _____

City _____ Zone _____ State _____

In Canada, write E. B. Ltd., Terminal Bld., Toronto, Ont.

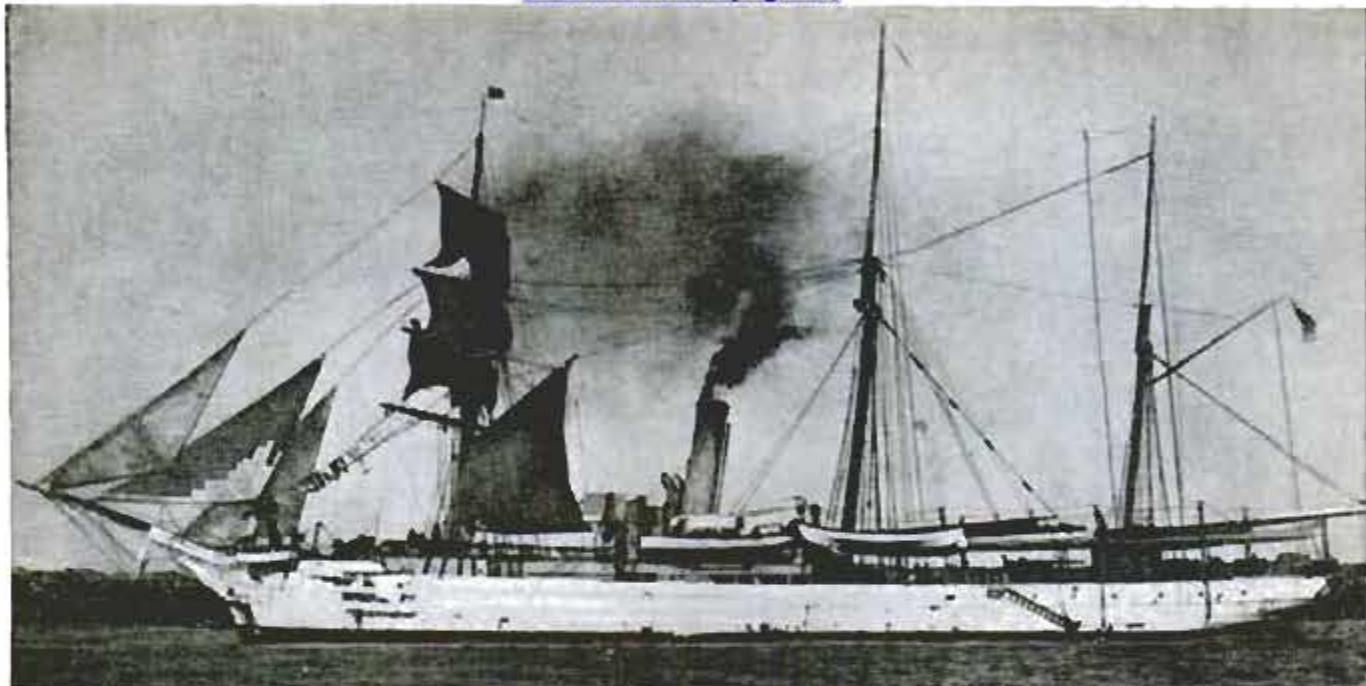

She took the first reindeer to Alaska, once saved a village of 500 Eskimos from starving to death, doctored countless sick and injured natives, married Eskimos on her quarterdeck, and quelled more than one mutiny on whaling barks in the Bering and Beaufort Seas.

During World War II, the *Bear* served briefly on the Greenland Ice Patrol.

It's no wonder this rugged ship has lasted

so long. Her hull is of six-inch oaken plank-ing bolted with Swedish iron and sheathed with tough Australian iron bark.

For all of her active career the *Bear* was a barkentine with a steam engine for auxiliary power. When she goes back to sea again, she will be powered by a diesel engine.

John Bunker,
San Diego, Calif.

(Continued to page 31)

A tree for his future!



No. 18 - Bulldozer



No. 1 - Allchin Steam Engine



No. 24 - Mechanical Shovel

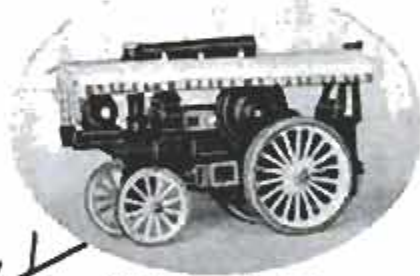

No. 9 - Showman's Engine

"MATCHBOX" SERIES

65 modern models to choose from - each packed in multicolor matchbox - from sleek sport cars to detachable trailer trucks. So detailed and perfect they were chosen by Lionel Trains as part of their HO sets! Only 49¢ each.

"MODELS OF YESTERYEAR"

Oldtime sports cars, steam engines, double-decker buses - and more! 12 yesteryear models, each a history lesson in itself! On the back of each colorful matchbox there is an authentic story of the vehicle. Only 59¢ to \$1.00.

What he plays today will help shape the man of tomorrow! These masterpieces of engineering in miniature will provoke his imagination - gladden the heart of every boy and girl (and Dad, too!) and stimulate them to creative play. In pressure die-cast metal, brilliantly enameled, with moving parts, they are priced so low any family can afford this joyous, educational collecting hobby.



No. 52 - Maserati 4 Cylinder - 1948

IMPORTED FROM ENGLAND

Engineered by Old World craftsmen, both series are sold in most toy and hobby shops. For complete catalogue - write: Fred Bronner Corp., 251 Fourth Avenue, New York 10, N. Y.



TOY IMPORTS



LET RCA TRAIN YOU IN ELECTRONICS

RCA Institutes celebrates Fifty Years of Electronic Training by introducing its newest Home Study Course . . .

ELECTRONICS FOR AUTOMATION

. . . Now you have *four* comprehensive courses for your electronic training . . . from basic electronic theory to the more advanced principles of color TV and Automation.

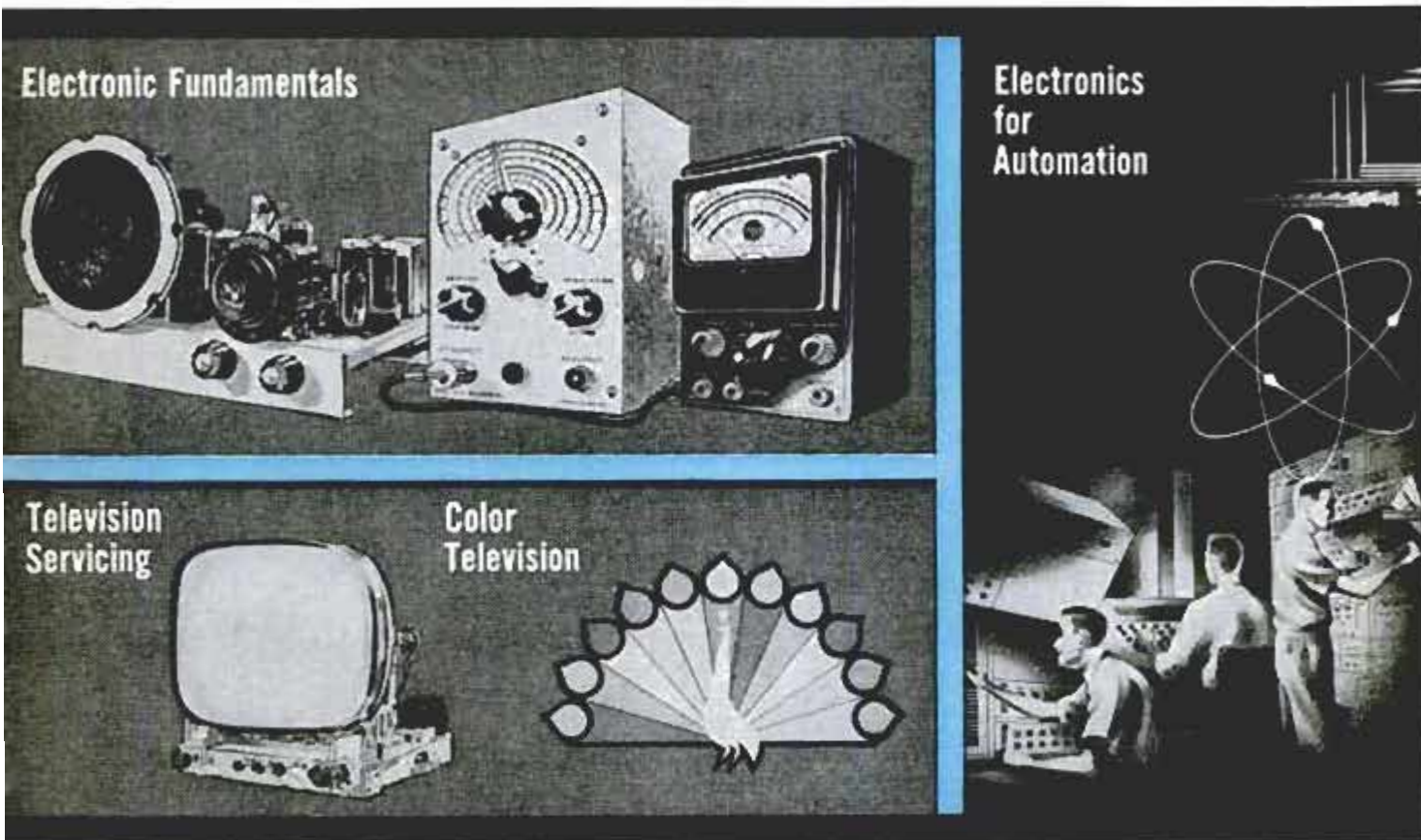

Electronic Fundamentals

Electronics for Automation

Television Servicing

Color Television

Practical work with the very first lesson. Pay-as-you-learn. You need pay for only one study group at a time.

Send for our 4 page Home Study Catalog

Home Study Courses in
Electronic Fundamentals
Television Servicing
Color Television
Automation for Automation

RESIDENT SCHOOL offers Technical Institute and Vocational School Courses in Electronics. Day and Evening classes start 4 times each year. Resident School Catalog sent free on request.

ANOTHER WAY RCA SERVES EDUCATION THROUGH ELECTRONICS

RCA INSTITUTES, Inc. Home Study School, Dept. PM-119
A Service of Radio Corporation of America
350 West Fourth Street, New York 14, N. Y.

Without obligation, send me the FREE catalog of Home Study Courses. No salesman will call.

Name Please print

Address

City..... Zone..... State.....

Korean Vetal Enter Discharge Date.....

— Take advantage of these same RCA courses at no additional cost. No postage, no customs, no delay. Send coupon to: RCA Victor Company, Ltd., 5001 Cote de Liesse Rd., Montreal 9, Quebec
To save time, paste coupon on postcard.



**MEN! Make up to
\$1,000⁰⁰
IN A MONTH!**

without "SELLING"

Sensational Demand for Low-Priced Fire Alarm PLUS Sure-Fire "No-Selling" Plan Offers Ambitious Men Huge Profit Opportunities

AMAZING NEW INVENTION



Even beginners who never sold anything in their lives are cleaning up unbelievable profits with the first practical effective, low priced Fire Alarm ever invented . . . needed, wanted in homes, factories, offices, stores, on farms, for boats, everywhere. Professional salesmen are making biggest profits in years! Later in this ad I'll tell you about the plan that's producing orders for 1 to 12 Fire Alarms per sale from 8 out of 10 prospects . . . without selling. Here are the facts about the Fire Alarm. It hangs on the wall like a picture—no wiring, no installation. It's always on guard . . . It "smells" a fire before danger point. When temperature rises, Fire Alarm goes off automatically, howls loud warning that can be heard 1/5 mile, wakes up soundest sleeper, give precious time to put out fire, call fire department, or escape. And it sells for only \$4.95 with profit up to \$2.70 on each one.

**Nearest Thing to
AUTOMATION SELLING**

With our field-tested plan customers sell themselves. No cold canvassing. No hard selling. It's the nearest thing to 'Automation Selling.' Imagine a sales plan even a child can use successfully because the sales tools we give you (and which you leave with your prospects) do all your selling even while you sleep! No room here to give you all the details but if you want big money fast rush the coupon now.

**Make This
Lighted-Match
Demonstration**

Sensitive! Lighted match triggers Alarms in 3 seconds.

you \$1,080.00 profit in a month. No competition anywhere. Get in on the ground floor now. Rush this coupon.

Free Sales Kit

Send no money. Just rush coupon below for all the exciting moneymaking facts, complete illustrated Sales Kit, everything you need to make money your first day. Learn how selling only 20 Fire Alarms a day pays

Made \$26.52

in 3 Hours!

"Received first shipment about noon. Worked 3 hours and made \$26.52 profit. It's a terrific seller!"

—Stanley



MERLITE INDUSTRIES, Inc.

(ALARM DIVISION)

114 E. 32nd St., Dept. F-15F

New York 16, N. Y.

ALVIN WESLEY, Sales Manager
Merlite Industries, Inc. (Alarm Division)
114 E. 32nd St., Dept. F-15-F New York 16, N. Y.

Rush FREE SALES KIT and full details about your "No-Selling" plan which gives me opportunity to make up to \$1,000.00 in a month without cold canvassing and hard selling—automatically. I am not obligated.

Name _____

Address _____

City _____ Zone _____ State _____

In Canada: Mopa Co., Ltd., 371 Dowd St., Montreal 1, P.Q.

**OPERATE or REBUILD
EARTH MOVING EQUIPMENT**



Complete Mechanics Course covering Diesel engine transmissions; torque converters; fuel injection systems; track assemblies; final drive assemblies; steering systems; idlers; rollers; power transfer systems; cable control systems; hydraulic control cylinders & welding pertaining to heavy equipment such as bulldozers, scrapers, loaders, off-highway trucks, etc. Course time—540 hours —10 weeks to 13 1/2 weeks. Convenient payment plan. Write for details. Approved for vets and civilians

OPERATORS COURSE
Learn to operate bulldozers, cranes, motor scrapers, crawler tractors, draglines, off-highway dump trucks, etc., on 1,700 acre Greer Training Area 60 miles S.W. of Chicago, Ill. on Route 66. Courses include operation, equipment care, preventive maint., stake reading, etc. Minimum classroom instruction. You learn by actually operating the equipment. 200 hour (5 week) complete course in the operation of bulldozers, loaders, scrapers, dump and off-highway trucks as low as \$375. Classes start every Monday. Reserve your space today. Approved for vets and civilians



Greer TECHNICAL INSTITUTE
ATT: M. K. Hutch, Box 278, Braidwood, Ill.

Double Shot, Silver-Tipped, All Brass

REFILLS 20 for \$1

Retractable

PENS

15 for \$1

100 for \$6.60

Fits Every Retractable Pen Made, including "Scripto" "Eversharp" "Paper Mate" "Waterman." Over 200 others (except Parker). One make per \$1 order. Choice of Red, Blue, Black, Green, Brown, Lavender or Go Ink.



Choice of Red, Blue, Black or Green Ink! Add 10c shipping charge. Money back guarantee. Quantity and imprint prices on request.

**REFILLS, VISUAL INK SUPPLY—30 FOR \$1
BARCLAY DISTRIBUTORS**

DEPT. 59-M 86-24 PARSONS BLVD. JAMAICA, N. Y.

STUDY TO BE A DOCTOR

of Psychology or Metaphysics

Obtain a Pa.D., Ms.D., or Ph.D. Be a Teacher, Lecturer or Accredited Practitioner. Teach others how to achieve Health, Happiness and Contentment. Chartered by State. Correspondence Courses only. Write for FREE book telling how.

THE NEOTARIAN FELLOWSHIP

Desk B, Pickwick Building Kansas City 6, Missouri



Mrs. Arthur H. Robinson
1025 Thormal Avenue
Bophtler, New York

1000 NAME AND ADDRESS LABELS \$1

ANY 3 DIFFERENT ORDERS \$2 ppd. Sensational bargain! Your name and address printed on 1000 finest quality gummed labels. Padded! Packed with FREE Plastic GIFT BOX. Use them on stationery, books, cards, etc. 1000 only \$1 ppd. SPECIAL OFFER — ANY 3 DIFFERENT ORDERS \$2. Satisfaction guaranteed. HANDY LABELS, 1121 Jasperson Bldg., Culver City 1, California.

**Shrinks Hemorrhoids
New Way Without Surgery
Stops Itch—Relieves Pain**

For the first time science has found a new healing substance with the astonishing ability to shrink hemorrhoids and to relieve pain — without surgery.

In case after case, while gently relieving pain, actual reduction (shrinkage) took place.

Most amazing of all — results were so thorough that sufferers made astonishing statements like "Piles have ceased to be a problem!"

The secret is a new healing substance (Bio-Dyne*)—discovery of a world-famous research institute.

This substance is now available in suppository or ointment form under the name Preparation H.* Ask for it at all drug counters—money back guarantee. *Reg. U.S. Pat. Off

LAW TRAINING *for* BUSINESS

[in spare time at home]

Earn LL.B. Degree



Thousands of men and women who never intend to practice are studying Law in spare time at home—not for a legal career but as an aid to business advancement.

Law today is involved in almost every major business decision. In many lines of work it is almost indispensable—credits and collections, accounting, traffic and transportation, employee relations, real estate, insurance, finance, taxation, etc. For all types of work, Law training develops keen, clear, quick, correct, and decisive thinking.

You can study LaSalle's American Law and Procedure right in the privacy of your own home—progressing as rapidly as your time and ability permit. LaSalle has, for over 50 years, helped more than 1,400,000 ambitious people get ahead in the business world. Thousands of letters in our files from grateful students and businessmen who have achieved greater success speak of—better jobs, more money and the satisfaction it brings, prestige and leadership.

A MOST UNUSUAL LAW LIBRARY

This training includes the fourteen-volume LaSalle Law library—AMERICAN LAW AND PROCEDURE, which is the basis of all the instruction service. This library has been compiled by leaders in the field of Law. It covers the whole basic field of Law in an orderly and simple manner that is easy to learn and understand. Collateral reading and printed lectures on legal problems which are furnished at regular intervals throughout the training, supplement the text. Law instructors personally supervise your program from the first assignment to the LL.B. degree or diploma. Under the LaSalle method you deal with legal problems—you learn by doing—actu-

ally solving legal problems—not just memorizing rules.

WRITE TODAY FOR TWO FREE BOOKS

You are determined to get ahead—to prepare for greater future possibilities—and to earn more money. Send the coupon below and find out how to qualify yourself for the many openings available to the Law-trained man. In our FREE books, "Law Training for Leadership" and "Evidence," you will find answers to all your questions about the study of Law and the LaSalle method.

No investment is likely to pay higher returns than an investment in yourself, by enrolling in the American Law and Procedure training. Send coupon today for full information—no obligation, of course.

ACCREDITED MEMBER, NATIONAL HOME STUDY COUNCIL

LaSalle Extension University

A Correspondence Institution

Dept. 1164L 417 S. Dearborn St., Chicago 5, Ill.

Gentlemen: Please send me your two free booklets, "Law Training for Leadership" and "Evidence," which tell how I may study Law at home and qualify for the LL.B. degree.



Name.....Age.....

Street.....

City.....Zone.....State.....

DRAFTSMEN



**CASH BIG
PAY CHECKS!**

Train Now for
more success,
greater security

**LEARN AT HOME IN SPARE TIME
(or at college in Chicago)**

Check the want ads in any newspaper—SEE the big-pay opportunities open to you as a draftsman. What's more, you can learn this well-paid, prestige profession at home — quickly, easily! No special talent needed. Get complete, step-by-step Chicago Tech lessons in the mail, spend a few pleasant hours studying each week. In a short time you'll be a well-trained draftsman, ready to take your pick of many good jobs. Act now!



Free Information—Mail Coupon Today!

Get FREE TRIAL LESSON plus information about C.T.C. practical training. Learn what successful Chicago Tech graduates say about high pay and opportunities in drafting. No charge, or obligation.

CHICAGO TECHNICAL COLLEGE

P-217 Tech Bldg., 2000 So. Michigan Ave.
Chicago 16, Illinois

Mail me FREE lesson with facts about big opportunities in DRAFTING.

Name _____ Age _____
Address _____
City _____ Zone _____ State _____



MUSICAL CHURCH KIT

(Plays Silent Night.) Beautiful all wood 11 inches high. Many lovely features. Regular Retailer \$7.95. Complete Kit \$3.95 P.P. Sell Them!

PILTZECKER IMPORTS, Wood-Ridge, N. J.

FOCUS YOUR EYE ON BENJAMIN

SMOOTH BORE BB OR RIFLED 22—AIR OR GAS GUNS—ROUND LEAD AMMO EFFECTIVE UP TO 100 FT.

AMAZING NEW
Line of REPEATERS

WITH THE LATEST IMPROVEMENT
IN FAST, SURE, GRAVITY
LOADING ACTION AND
PIGGY-BACK SHOT MAGAZINE

A Shot is placed in Firing Position each time Bolt is Pulled Back and Closed. Flash Ammo Count on Full View Magazine.



No. 1320 BENJAMIN 35-Shot Cal. 22 Air Pistol \$24.50

No. 3600 BENJAMIN Super 100 Shot BB Gas Rifle. Non-Toxic—Safe—Convenient—Uniform Hi-Velocity Power. —
No. 2600 BENJAMIN Super 35-Shot BB Gas Pistol. Safe—No Pumping—Uniform Hi-Power. For Target & Small Game. \$17.95
No. 2620 BENJAMIN 20-Shot Cal. 22 Gas Pistol. Economical. \$19.95
No. 1300 50-Shot BB Air Pistol \$22.50



FREE Catalog All Models Benjamin Single Shot & Repeaters—Cal. BB or 177 or 22. Also, Special Hunting & Fishing Knife Offer.

BENJAMIN AIR RIFLE CO., 896 MARION ST., ST. LOUIS 4, MO.

95% PROFITS YEAR 'ROUND

Be your own boss, Operate a SIMPLEX lawn-mower sharpening service in your community. One compact machine grinds all mowers, sharpens cutlery. Low investment, 95% profit. Pays for itself in average month.

SIMPLEX
—4 Machines in One!
Reel Grinder—sharpens any mower reel in or out of mower.
Bed Knife Grinder—grinds with either round or cup wheel.



Rotary Blade Grinder—hollow grinds any rotary mower blade.
Cutlery Knife Grinder—sharpens cutlery, tools, scissors.

Send for free, money-making details!
The FATE-ROOT-HEATH Company • Dept. PM-11, Plymouth, Ohio

I'll Send You This Handsome SAMPLE CASE—FREE



and Show You How to Make
Up to \$30.00 in a Day

WRITE for this FREE Tailoring Sample Case packed with 100 beautiful, big-value suit and overcoat fabrics. Take orders from friends, fellow-workers, others, for fine quality, made-to-measure clothes. Pocket big cash profits in advance. Because wearing our suits and overcoats brings more orders, we make it easy for you to get your own clothes without the cost. No experience is needed. **SATISFACTION GUARANTEED.** SEND NO MONEY. Rush your name, address, and age—today!

**W. Z. GIBSON, INC., 500 South Throop Street
DEPT. W-516 CHICAGO 7, ILLINOIS**



WANT MORE MONEY? GET INTO PHOTOGRAPHY

Coast to coast, high-paying jobs in photography are waiting for people with the "know-how" to fill them. You can quickly, easily qualify at home with the world-famous NYI Learn-by-Doing Method. Write today for free catalog. Also resident training in N. Y. 50th Year. Approved for Veterans.

NEW YORK INSTITUTE OF PHOTOGRAPHY
Dept. 49 10 West 33 St. New York 1, N. Y.

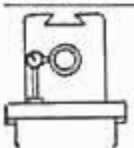

— TIPS & TECHNIQUES — MACHINE TOOL RECONDITIONING & THE ART OF HAND SCRAPING (3rd printing)

SEND FOR FREE FOLDER DESCRIBING
ILLUSTRATED MANUAL FOR MACHINISTS
Machine Tool Publications, 382 Holly Ave., Saint Paul 2, Minn.

JEEP OWNERS

RE-POWER NOW WITH A V-8 OR 6 CYL. ENGINE — USE FORD—CHEV—MERCURY—GMC—PONT—STUDE—DODGE OR PLYMOUTH in Jeeps, Jeepsters, Sta-Wgn, trucks, Kaiser & M. J. cars. Conversion Kits \$45.35 to \$56.90. Want fast action? Give us full information, send \$15.00 Dep. and we will ship correct kit. Bal. COD. Send full amount for prepaid shipment. Wire, phone or write today. Details FREE

HOOSIER MACHINE PRODUCTS CO.
312 S. E. 6th St. Phone CR 6-3442 Pendleton, Oregon

STOP FRONT DRIVE DRAG ON YOUR Jeep



PROVEN IN OVER A BILLION
MILES OF SERVICE!

Warn Hubs on your 4 w.d. give double-duty value — economical, free-wheeling 2 w.d. (with added pep!), normal 4 w.d. — automatically with Lock-O-Matics, manually with Warn Locking Hubs. See your 4 w.d. dealer!

WARN HUBS
WARN MFG. CO., Inc.
Riverton Box 6064-A
Seattle 88, Wash.

DON'T BE HALF-TRAINED! Be A Master Technician

NOW... ONE
modern master
home training course
IN ALL 3 PHASES



AIR CONDITIONING - REFRIGERATION ELECTRICAL APPLIANCES

**ALL AT ONE
LOW TUITION**
only National Schools gives
you this complete training
at no extra cost

YOU GET AND KEEP ALL THESE TOOLS AND INSTRUMENTS

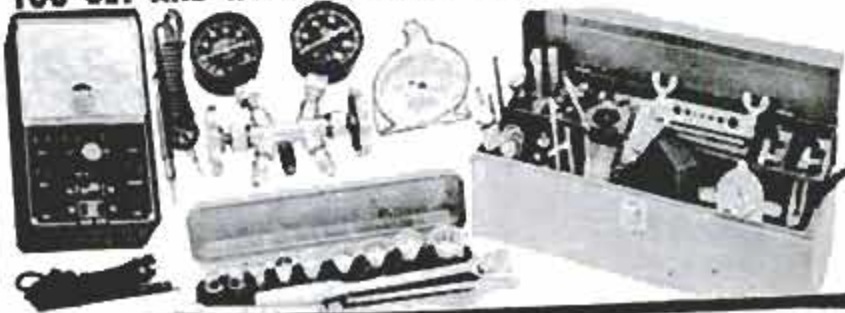

Incomplete training limits your earning power, even disqualifies you for top-pay jobs. The big service companies require complete, all-phase training. If you open your own shop, you'll be called upon to service and repair all types of refrigerators, air conditioners and appliances. With complete training—as only National Technical Schools can give you—you can accept every job, make big profits all year round.

FUTURE BRIGHT FOR TRAINED MASTER TECHNICIANS

Over 30,000 new technicians must be trained annually. You are needed to help service and repair the 50 million air conditioners, refrigerators and electrical appliances that will need fixing this year alone. No wonder the Master Technician has steady work, at high pay, year after year. He can go places in his own business or with a manufacturer, dealer, distributor or department store. Armed with all-phase training, his earning power is unlimited.

JOB TRAINING AT HOME

You get Professional Tools, Precision Instruments, PLUS a Factory-Made APPLIANCE TESTER! A shop-full of PRACTICAL, professional equipment. Use them to conduct over 100 experiments...also in Spare Time Work and ON THE JOB. It is all yours to keep...no EXTRA MONEY DEPOSITS...no EXTRA COST on your equipment kits.

EARN AS YOU LEARN

We show you how. Many of our students pay for their entire course—and more—in Spare Time while learning. So can you. Graduate Advisory Service, too.

THE MOST FOR LESS

We give you illustrated Shop-Tested Lessons and Manuals...many other training aids...privilege of CONSULTATION with our instructors and engineers. Every lesson, every manual has been SHOP tested and approved.

**GET THE BENEFIT OF OUR OVER
50 YEARS EXPERIENCE**

**N.T.S. also offers training in
TV - RADIO - ELECTRONICS
and AUTO MECHANICS - DIESEL**



MEMBER



NATIONAL TECHNICAL SCHOOLS

WORLD-WIDE TRAINING SINCE 1905

4000 SO. FIGUEROA ST., LOS ANGELES 37, CALIF., U. S. A.

ACTUAL LESSON



**SEND FOR
FREE
BOOK AND
ACTUAL
LESSON NOW!**

We'll rush you our big, illustrated OPPORTUNITY BOOK and ACTUAL LESSON, show you how easily you can learn. NO OBLIGATION; no salesman will call. Do it NOW! It costs nothing to find out.

NATIONAL TECHNICAL SCHOOLS

WORLD-WIDE TRAINING SINCE 1905

MAIL NOW TO
National Technical Schools, Dept. CB-119
4000 S. Figueroa St., Los Angeles 37, Calif.
Rush FREE "Opportunity" Book and Actual
Lesson. No Salesman will call.

NAME _____ AGE _____

ADDRESS _____

CITY _____ ZONE _____ STATE _____

Check Here if interested ONLY in Resident Training at Los Angeles.

RESIDENT TRAINING AT LOS ANGELES

If you wish to take your training in our Resident School at Los Angeles, start NOW in our big modern Shops and Labs. Here you work with latest equipment...professionally installed...finest, most complete facilities offered by any school. Expert, friendly instructors. Personal attention. Graduate Advisory Service. Help in finding home near school...and part time job while you learn. Check box in coupon for full information.

\$5,000,000 CHRISTMAS SALE!



This '24.95 Dacron Insulated Undersuit Keeps You Warmer at 67° Below Freezing!

This is the very same insulated suit selling from coast-to-coast for \$24.95. The same thick, warm DACRON insulation by DuPont—the same rugged NYLON shell! The same quality tailoring made by the same manufacturer and bearing the very same label! Incredible but true! Because the manufacturer was hungry for cash, Thoresen came through with a giant order at far below regular wholesale price. Now you reap the benefits—you save over \$15 on every garment you buy. You don't pay \$24.95—you pay only \$8.88 plus mailing costs. The good news is spreading fast—thousands of men . . . hunters, salesmen, policemen, truckers, farmers, postal workers, construction workers, milkmen, state troopers, etc., gladly pay dollars more for their insulated suits! Even at 67 degrees below freezing these wonderful garments keep you much

BIG PRICE REDUCTION!
8.88

warmer, much more comfortable than other thick fibres, including wool! You get cozy warmth without bulk, without weight, without restricting your movements. And don't let Thoresen's low price confuse you. This is a quality-made garment in every way—won't shrink, stretch or lose weight even when washed scores of times. Never mats or bunches. No special care needed. Just pop into washing machine and hang to dry fast! Dacron is odorless, non-toxic, mothproof. No rubber or sealing chemicals used. Can be worn in normal room temperatures because it "breathes with your body." No wonder over 300,000 men have bought one or more!
Mention size: Small, Medium, Large or Extra Large. No. 333—Dacron & Nylon Insulated Suit (2-pc.) \$8.88. Add 67c postage—9.55



LOOK FOR THIS LABEL
10.94

EXTRA SPECIAL for men who demand the very best in fit and cold weather comfort—the Deluxe Quality **TRIPLE-GARD** model—yours for only \$1.39 more. Expertly tailored with world famous Multi-Cellular insulation. All 3 layers—inner, middle and outer—are perma-bonded to withstand countless washings. Triple-Gord never mats—never bunches. Gives long wear, wonderful protection even in coldest weather.

The Triple-Gord jacket is so well tailored it can be worn as an outer garment, too! Has sold for much higher prices—yet you pay only 1.39 more than for our Dacron model. When ordering, be sure to mention "TRIPLE-GARD" and Order No. 333-D. Also state size desired—Small, Medium, Large or Extra Large. Quantity on the deluxe model limited. No. 333-D . . . 10.94 complete.

7x35 BINOCULARS



CUT PRICE!

8.98
Plus Tax

ORIG. ADV. AT 24.95

Pigskin Case, Shoulder Straps, 4 Slide-on Protective Lens Covers

We've sold more than ONE MILLION binoculars in recent years, but this is our most fabulous value. Precision-made 7x35 binoculars—advertised at \$24.95—now SLASHED to only \$8.98 plus Federal tax. Highest optical craftsmanship. Meticulously ground COATED lenses. Full power without distortion or color breakdown. Made of cast METAL with pebble grain, jet black covering. Smooth center focusing. Rugged yet surprisingly light-

weight—ideal for hours WITHOUT ARM FATIGUE. Excellent light transmission permits viewing even in moonlight. Pigskin case, shoulder straps, four slide-on protective lens covers included at NO extra cost. SEEING IS BELIEVING! Try them for 10 days without risk. Use them at football games, hockey matches, sight-seeing tours. No. 171 7x35 Binoculars 8.98 plus 90c Fed. tax. TOTAL 9.88

CENTRIFUGAL AIR POWER RIFLE KILLS GAME!



NOT \$19.95
REDUCED PRICE

8.88

SAVE ON AMMUNITION
No. 177 1,000 Pellets \$3.49
No. C-13 72 MULTICOLOR DARTS . . . \$2.69

A masterpiece! You get 1. Contoured stock of hand rubbed Russian wood. 2. Barrel is of heavy duty high carbon steel, with interior swirl rifling. Mandsuety Blued. 3. Sights are precision made and adjustable for elevation. 4. High capacity air compression chamber. 5. Positive action easy flow trigger—don't "pull" the trigger, merely slide it back easily, smoothly to fire. 6. Balanced weight distribution, and many other starting features. Not shipped to N.Y. & residents. Add \$1 for shipping cost for this heavy shipment (Approx. 7 lbs.) Remotely \$8.88 plus \$1 postage, total: \$9.88. No. 940

.22 CAL. GERMAN AUTOMATIC!



NOT \$9.95
NOT \$7.95
4.99
NOT SOLD TO MINORS

Genuine .22 Cal. German AUTOMATIC. Exact dimension, finish and design of the death-dealing automatic. Not total—but NOT SOLD TO MINORS! Solid blue carbon steel. Ideal for track and swim meets, football games, training cadets, for theatre and stage work. 6-shot FULLY AUTOMATIC! Self-act-

ing clip. Safety Catch. Deluxe jerdoven handle. Comes with cleaning brush. No permit needed but not shipped to NYC residents. Safe elsewhere for \$6.95 and \$7.95—Thoresen's imports direct from West Germany and you SAVE MONEY! Our cut price only \$4.99 while supply lasts. Sorry, no COD's on this item, No. 11 \$4.99

THORESEN, 585 Water St. NEW YORK 2, N.Y.

POCKET WATCH



\$4.98
VALUE **1.77**

No fancy diamond dial or water thin case. No alligator or golden band. No plush velvet gift box—and NO FANCY PRICE TAG EITHER! In fact, only \$1.77—YES, ONLY \$1.77—buy this rugged, old-fashioned railroad-type watch sold for so low a price. And it's guaranteed for 3 years! If you want an old-timer that evokes interest—and keeps darn good time—buy this old "shoo shoe" watch. (Limit: one to a customer.) Pocket Watch—now reduced to \$1.77 plus 18¢ Federal Tax. TOTAL: \$1.95. No. 231

FAMOUS GERMAN POCKET ADDING MACHINE

1.00

NOT 3.98 **NOT 2.98**



Others pay \$3.98 for machines that calculate to 999,999. Wizard Calculator goes to ONE BILLION—yet costs only \$1 plus 25¢ postage. Karim steel mechanism. Sleek, slim. Fits pocket. Unbreakable in normal use. Never makes a mistake. Press numbers! see numbers pop into view like cash register. Tally scores, statements—use at market to add up purchases as you take them off shelves. Know your bill before you reach tally-out counter. West German import. Free styling given. No. 118. \$1 plus 25¢ postage, \$1.25 total.

HEAVY-DUTY SLINGSHOT



with Built-in RANGE FINDER
NOT 1.00
1.98

Extra powerful slingshot gives longer range, greater accuracy! Extra thick Quadrangular slings with amazing pull! Kills small game, rabbit pests. Ideal for target practice. Cross-bar range finder assures greater accuracy. Thick leather pouch, Brass-riveted slings. Ebony finish wood. Super silent—hits like rifle!
FREE: 100 Killer Steel Pellets. Extra pellets only 75¢ for 400. Send only \$1 plus 25¢ mailing costs. No. 928

5,000,000 CHRISTMAS SALE!

once again is Thoresen's big annual Christmas sale—giving you top quality merchandise at bargain prices. As you can't match them anywhere! Millions of satisfied customers already know the reason Thoresen's is able to sell its competitors: we buy by the carload and boat—we get lower prices as a result—and WE PASS SAVINGS ON TO YOU! Many of the items shown here two pages are exclusive with us and many are priced from all over the world... but all are offered at bottom prices! And this year we are going even fur-

ther in offering our customers the utmost in value: ON ALL PREPAID ORDERS THAT TOTAL \$3.00 AND UP WE ARE SENDING A SURPRISE CHRISTMAS GIFT ALONG WITH THE ORDER! This absolutely free bonus includes some items that retail for as much as \$10.00! So don't delay! Use the coupon below and mail it today! All merchandise is offered on a 10-day money back guarantee. You don't risk a penny! Be sure and mail the coupon to: THORESEN, Inc., Dept. 585 Water St., New York 2, N. Y.

AMAZING INSULATED VEST FEELS WARMER THAN 5 SWEATERS

Insulated with DuPont DACRON Washable! Dries Fast! Shrinkproof! Weighs Ounces Yet Gives More Warmth! "light-as-a-feather" Insulated Vest feels warmer than five—yes FIVE—bulky, woolen sweaters. That's the claim we make. Best of all, it can move freely. Your body doesn't feel constricted by cumbersome, tight-fitting sweaters. It's why this Dacron Insulated Vest is such a favorite among hunters, rugged sportsmen, ice fishermen. That's why it's worn by Salesmen, Bus Drivers, Construction Engineers, Milkmen, Letter Carriers, Telephone Linemen, State Troopers, etc. Men who work outdoors appreciate the comfort and the warmth of this amazing insulated vest, and an extra-large zipper that can't freeze. Two large pockets with inside elastic shell loops. Washable. Dries fast. SHRINKPROOF! Keeps shape. Dustproof. Mathproof. This same Insulated Vest sold for \$9.95—now only \$4.98 to our customers. No. 53 Insulated Vest \$4.98

ORIG. SOLD FOR \$9.95

4⁹⁸

SIZES: SMALL (36-38) MEDIUM (40-42) LARGE (44-46) EX. LG. (48-50)



CUT PRICE

TRIPLE CARD DELUXE MODEL—ONLY 98c MORE

For the man who prefers the BEST we recommend our Deluxe TRIPLE CARD model. It costs you only 98c more. Only a garment of the finest workmanship can bear the famous TRIPLE CARD label. Yet you pay only \$5.96. Brown or neutral gray. No. 53-D.

INSULATED BOOTIES

Fabulous foot warmers for all outdoor action. Durable knit trim top, quilted insulated boot. Keeps feet nice and warm even in BELOW ZERO weather. Wear 'em with your insulated undersuit. Order several pair at our special Thoresen-to-you price of \$1.94 per pair. Neutral color. State your shoe size. No. 54E

REG. 2.98
1⁹⁴



Almost Half a YARD Long

GIANT 5-CELL FLASHLIGHT

The complete new Powerhouse flashlight contains engineering features never before produced. Tremendously powerful 5 cells—with all this big power concentrated into a spot beam that shatters distance, provides wondrous lumi-

nosity! Special new Opti-View reflector and gleaming metallic case that's over 15 inches long! It will illuminate targets heretofore only reached by giant searchlights! An ideal flashlight. No. 706—

COMP. VALUE 4.98
\$1⁰⁰ PLUS 25c POST.

9 x 12 FOOT PLASTIC TARPULIN
ORIG. 1.25 PLUS POST. **47c**
9 x 12 ft. Protects carpets, floors, upholstery—yet you still see beauty of fabrics! Protects outdoor furniture, garden tools, bikes, cars, boats, air conditioners. WATERPROOF, dust-proof, tear-resistant. Use as drop cloth when painting, to make TRANSPARENT auto seat covers, furniture, slip covers, etc. This is original Trans-Kleer brand—the best! Order by No. 4. 47c per giant cloth.

Insulate Your Home with Plastic STORM WINDOWS

ORIG. 49c EA. **19 1/2c**
Transparent like glass yet Trans-Kleer won't shatter, rattle, break or peel. Install in minutes. No nails. Just cut and fit window, press an Adhesa border tape—that's all! Shipped in rolls measuring 35" by 32"—enough for 10 windows. Reduced from \$4.95 to only \$1.98. 2 kits \$3.93. No. 74.



100 Power Projector Flashes Comics, Photos, Even Live Insects on Wall to Giant Size... in Colors!

PRICE REDUCED on the amazing X-500 Power Vision Electric Projector—needs no films, no negatives, no strips, no dyes. Picks up the image DIRECT from the object, snapshot, book, sketch, etc. and it shoots it out thru a powerful convex lens, flashes it onto your wall giant size—and in full color! It transmits LIVE MOTION—showing machinery, animals, insects IN ACTION. Thousands of projectors originally sold at prices of \$7.00 to \$14.95. NOW SELLING OUT entire stock at the rock-bottom price of only \$4.98 complete. Ideal for students of every age—from elementary school collage. Helps pupils learn better & faster. Same machine used in schools, colleges, universities everywhere! Get your Power Vision Projector now at the "giveaway" price of only \$4.98 plus 27c to defray heavy postage. TOTAL \$5.25. Order by No. 370

ORIG. 14.95
4⁹⁸

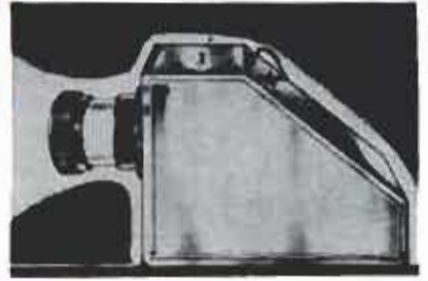

\$1 ANY ITEM HERE VALUES TO 2.99 \$1

20 MAGNETS

These permanently magnetized Magnets (112 gr. weight) And you get not 5 or 10 but 20 Powerful Magnets for only \$1. Use 'em in different ways—new into got holders—magnet holds them to stove, sink, refrigerator! No. 428

Holds 30 Belts

Belts Click On... Click Off! Rotating action allows you to remove belt you select without having to remove any others. Weighs an ounce and a half. Belts click on... click off. Holds up to 30 belts easily. Simple instruction. No groping for the "right" belt. No more removing 3 or 4 belts to get the one you want. Now you get the belt you want in 1 second—No. 544

Collar Stays—\$1 36 Stainless Steel

STAINLESS STEEL beautiful that can't RUST, BREAK, or BEND! They won't fade to color when ironed or twist in shirt if washed—in case you forget to remove them. Look! You get 36 for \$1—assorted sizes. Order by No. 732

Seals Cards & Papers in Clear Plastic in 1 Minute

With this do-it-yourself "Seal-in-Plastic" Kit you can seal wallet-size cards or photos—even birth certificates, discharge papers, marriage announcements, blueprints, memoranda, etc., fast and easy. Simple No-pain pressure seals plastic in 1 minute! Each GIANT kit includes 12 4"x4" plastic sheets PLUS a bonus of 6 additional 5"x7" sheets. No. 246

Thoresen Hole Saw

Saws Any Shaped Hole for 1/2" Drill! Insert this hole saw into chuck of your 1/2" electric drill. Bore thru material in any pressure. No large hole by moving "Hole Saw" in winding circles. You stop ANY shaped hole with full saw stroke and light pressure. Easily cuts thru wood, plastic, plaster, plywood, etc. No. 62

4 BRISTLE BRUSHES

One each: 1 1/2", 2", 3", 4". All have 100% bristle Vulp. sealed in rubber. Ideal for touch-up trim, wash, moulding, etc. for furniture refinishing, etc. Comparative Value \$2.98. No. 570. 4 Paint Brushes.

8-Pc. WRENCH SET

8 piece set in heavy plastic kit contains 8 drop-forged chrome-plated wrenches. One side hex-end, sizes 7/16", 7/8", 1", other side open end, sizes 1/2", 3/4", 1", 1 1/4". Ideal for repairs around the house or for car repairs. Order by No. 701. 8-Pc. Wrench Set, \$1.

Korium 9-in-1 Knife

Can Opener, Small Knife, Screwdriver, File, Bottle Opener, Corkscrew, Nailers, Awl, Jackknife—3 inches long. Genuine Korium steel. Bone handle. Fits pocket. Thousands sold at \$1.95 now yours for \$1. No. 314

Electric Magnifier

Lights Up as It Magnifies Magnifier five times larger, Brilliant light illuminates objects viewed. Makes smallest speck stand out. Examines stamps, coins, currency, signatures, fingerprints, stamps, machine parts, jewelry, etc. Ideal for reading fine print in contracts, leases, wills, etc. Uses standard flashlight battery (not incl.) NOT \$1.25 No. 610.

BLACK FOREST Hunting Knife

World's most famous hunting knife! Over 100,000 sold for \$2.95. Now this genuine Black Forest Knife yours for \$1.95. 4 1/2" thick, high carbon tempered Korium Steel—can cut thru materials. Sharp enough to shave with. No. 70

COMBI-MATIC

SAVE \$2.00! 8 instruments in 1. Pocket binoculars, magnifying glass, reading glass, telescope, stereoscope and even a lun dial watch. 8 Instruments in 1 No. 53

50x Pocket Microscope from Germany

Metal design, optically ground lenses, Easy eyepiece focusing. (Ag. Made by famous West German optical plant.) See nature's wonders. Examine jewelry, watches, insects, fossils, tissues, etc. We've sold thousands originally for \$1.95. No. 12*

THORESEN, Inc., Dept. 6-M 585 Water St., N.Y. 2, N.Y.

Rush items listed below. My money back if I'm not satisfied.
 Check, cash or money order enclosed Send postage-paid.
 Send COD plus COD fee & postage

FREE GIFT
If your prepaid order totals \$9.99 and up, we will include a surprise FREE GIFT. Gifts include appliances, tools, pens, lighters, etc. (Original values to \$10 each.) But hurry! Best gifts go first!

No.	Quantity	Name of Article	Price

PRINT NAME & ADDRESS _____

I took the quick easy way to top pay in AUTO MECHANICS

I TRAINED AT HOME—
MADE MONEY FIXING CARS

FIFTY THOUSAND MECHANICS are needed! One-third of America's 60 million vehicles are in the heavy-repair class. These facts spell opportunity for a good job, big pay, lifetime security!

CTI TRAINS YOU AT HOME in spare time. You learn every phase of repair. Our practical, Shop-Proved training makes each step easy. After a few lessons, earn to \$15 a week and more by fixing cars for friends. Some students open shops before graduating!

DIESEL OR BODY-FENDER TRAINING is also yours at no extra cost. Only CTI offers this extra choice. Mail coupon for FREE BOOKS which tell how you, too, can succeed!

YOU PRACTICE WITH TUNE-UP KIT AND MECHANIC'S TOOLS



Tune-Up Kit (left) includes a Compression Tester, Vacuum Gauge and Fuel Pump Tester, Ignition Timing Light, portable steel case. Tools (right) are fine quality. No extra charge for kits!



MAIL TODAY FOR 2 FREE BOOKS

COMMERCIAL TRADES INSTITUTE

1400 Greenleaf Ave. • Chicago 26, Ill. Dept. A-1175
Send FREE Auto Mechanics book and Sample Lesson.

Name _____ Age _____

Address _____

City _____ Zone _____ State _____

Accredited by National Home Study Council

Exclusive Double-Bearing HEAVY-DUTY PUMPS
IRRIGATE • DRAIN • CIRCULATE • SPRAY
Use 1/4 HP motor or larger . . . 1 HP for up to 7,500
GPH; 1,000 GPH 60' high; or 3,000 GPH from 25' well.
1 1/4" inlet; 1" outlet. Stainless shaft.
TYPE X—2 oil-less bronze bearings. Won't rust. . . . \$10.95
TYPE XB—Ball bearing model. . . . \$12.95
*not paid if cash with order. Rush your order today
MONEY BACK GUARANTEE
Centrifugal and Gear Pumps in All Sizes
LABAWCO PUMPS, Belle Mead 2, N. J.

OWN a BUSINESS

Be a Specialist in Booming Industry



Get in on the ground floor of a booming \$750 million a year industry. Fill the need in your area for safe, effective "on location" cleaning of carpets and upholstery. Every home houses a customer! We'll train and establish you in YOUR OWN lifetime business! Start part-time if employed. You'll be trained by a nearby dealer and at 50-hr. school to get you quickly established. You provide 6 services to multiply profits. No shop needed. Just 2 jobs a day nets \$8,750.00 first year. We back you with 27 services: counseling, nat'l advg. . . . McCalls, Parents, etc., conventions, advg. kits, others. Booklets explain everything—no obligation, no salesman will call. Send for Free Booklets.

DURACLEAN COMPANY
9-16N Duraclean Bldg., Deerfield, Ill.

make your own *Gems* 36⁵⁰

The Gem Maker comes complete with all necessary equipment, including a super-charged diamond blade for sawing, and all the wheels for grinding, shaping and polishing; also complete instructions. The complete equipment as shown, less motor and belt for only \$36.50, f.o.b. Burlington, Wisconsin. Write today for information and literature.

B&I MANUFACTURING CO.
Dept. P. Burlington, Wis.

TRAINED AND SKILLED MEN IN CLOCK AND WATCH REPAIR

Are Needed in Watchmaking, Electronics, Defense, Aviation, and other technical and precision instrument fields. NOW IS THE TIME TO LEARN THIS VALUABLE TRADE. But, Before You Enroll in Any HOME STUDY Course in Watchmaking, Write for Your Copy of "LEARN THE FACTS."

KANSAS CITY SCHOOL OF WATCHMAKING
1226 Admiral Blvd. Kansas City 6, Missouri

Secrets of **VENTRILOQUISM**
Now Revealed!

Easy to learn in 60 to 90 days with our Home Study Course. RESULTS GUARANTEED. Make Money! Be Popular! Have Fun! BIG Opportunity! Radio, Television, Stage Appearance! For FREE information regarding price and terms WRITE. You must state your age. Dummy Catalog 25c.
MAKER HOME COURSE OF VENTRILOQUISM
Box 36, Studio PM-11, Kensington Station
Detroit 24, Michigan

Plaza de Toros de **BARCELONA**

SENSACIONAL CORRIDA DE TOROS
SEIS MAGNIFICOS TOROS D. JOSE ESCOBAR

MARCEL RODRIGUEZ MANOLETE
JOE SMITH
v. ANTONIO BIENVENIDA

YOUR NAME HERE

Now! . . . Show All Your Friends
You, Too, Have Lived Dangerously!

Your Name On A Genuine Bullfight Poster

Impress and puzzle your friends, with this large 17" x 28" bullfight poster, featuring your name among those of other famous matadors. This authentic poster, using the original art work and printing plates in full color, makes a dramatic eye-catching decoration for home or office . . . or a truly personalized gift for your bull-throwing friends. Poster imprinted with your full name or any other name you specify—only \$2.98 ppd. 2 posters, with 2 different names—\$5.75 ppd.

Mailed in a round mailing tube, not folded. Ready to frame or hang on wall.

Be the first matador in your set. Order now.
Send check or money order • Available by mail only from

SPENCER GIFTS EZ-1 Spencer Bldg., Atlantic City, N. J.

Copyright 1959 Spencer Gifts, Atlantic City, N. J.



I'd like to give this to my fellow men... while I am still able to help!

I was young once, as you may be—today I am older. Not too old to enjoy the fruits of my work, but older in the sense of being wiser. And once I was poor, desperately poor. Today almost any man can stretch his income to make ends meet. Today, there are few who hunger for bread and shelter. But in my youth I knew the pinch of poverty; the emptiness of hunger; the cold stare of the creditor who would not take excuses for money. Today, all that is past. And behind my city house, my

summer home, my Cadillacs, my Winter-long vacations and my sense of independence—behind all the wealth of cash and deep inner satisfaction that I enjoy—there is one simple secret. It is this secret that I would like to impart to you. If you are satisfied with a humdrum life of service to another master, turn this page now—read no more. If you are interested in a fuller life, free from bosses, free from worries, free from fears, read further. This message may be meant for you.

By Victor B. Mason

I am printing my message in a magazine. It may come to the attention of thousands of eyes. But of all those thousands, only a few will have the vision to understand. Many may read; out of a thousand only you may have the intuition, the sensitivity, to understand that what I am writing may be intended for you—may be the tide that shapes your destiny, which, taken at the crest, carries you to levels of independence beyond the dreams of avarice.

Don't misunderstand me. There is no mysticism in this. I am not speaking of occult things; of innumerable laws of nature that will sweep you to success without effort on your part. That sort of talk is *rubbish!* And anyone who tries to tell you that you can *think* your way to riches without effort is a false friend. I am too much of a realist for that. And I hope you are.

I hope you are the kind of man—if you have read this far—who knows that anything worthwhile has to be *earned!* I hope you have learned that there is no reward without effort. If you have learned this, then you may be ready to take the next step in the development of your karma—you may be ready to learn and use the secret I have to impart.

I Have All The Money I Need

In my own life I have gone beyond the need of money. I have it. I have gone beyond the need of gain. I have two businesses that pay me an income well above any amount I have need for. And, in addition, I have the satisfaction—the deep satisfaction—of knowing that I have put more than three hundred other men in businesses of their own. Since I have no need for money, the greatest satisfaction I get from life, is sharing my secret of personal independence with others—seeing them achieve the same heights of happiness that have come into my own life.

Please don't misunderstand this statement. I am not a philanthropist. I believe that charity is something that no proud man will accept. I have never seen a man who was worth his salt who would accept

something for nothing. I have never met a highly successful man whom the world respected who did not sacrifice something to gain his position. And, unless you are willing to make at least half the effort, I'm not interested in giving you a "leg up" to the achievement of your goal. Frankly, I'm going to charge you something for the secret I give you. Not a lot—but enough to make me believe that you are a little above the fellows who merely "wish" for success and are not willing to sacrifice something to get it.

A Fascinating and Peculiar Business

I have a business that is peculiar—one of my businesses. The unusual thing about it is that it is needed in every little community throughout this country. But it is a business that will never be invaded by the "big fellows". It has to be handled on a local basis. No giant octopus can ever gobble up the whole thing. No big combine is ever going to destroy it. It is essentially a "one man" business that can be operated without outside help. It is a business that is good summer and winter. It is a business that is growing each year. And, it is a business that can be started on an investment so small that it is within the reach of anyone who has a television set. But it has nothing to do with television.

This business has another peculiarity. It can be started at home in spare time. No risk to present job. No risk to present income. And no need to let anyone else know you are "on your own". It can be run as a spare time business for extra money. Or, as it grows to the point where it is paying more than your present salary, it can be expanded into a full time business—overnight. It can give you a sense of personal independence that will free you forever from the fear of lay-off, loss of job, depressions, or economic reverses.

Are You Mechanically Inclined?

While the operation of this business is partly automatic, it won't run itself. If you are to use it as a stepping stone to independence, you must be able to work with your hands, use such tools as hammer and screw driver, and enjoy getting into a pair of blue jeans and rolling up your sleeves. But two hours a day of manual work will keep your "factory" running 24 hours turn-

ing out a product that has a steady and ready sale in every community. A half dollar spent for raw materials can bring you six dollars in cash—six times a day.

In this message I'm not going to try to tell you the entire story. There is not enough space on this page. And, I am not going to ask you to spend a penny now to learn the secret. I'll send you all the information, free. If you are interested in becoming independent, in becoming your own boss, in knowing the sweet fruits of success as I know them, send me your name. That's all. Just your name. I won't ask you for a penny. I'll send you all the information about one of the most fascinating businesses you can imagine. With these facts, you will make your own investigation. You will check up on conditions in your neighborhood. You will weigh and analyze the whole proposition. Then, and then only, if you decide to take the next step, I'll allow you to invest \$15.00. And even then, if you decide that your fifteen dollars has been badly invested I'll return it to you. Don't hesitate to send your name. I have no salesmen. I will merely write you a long letter and send you complete facts about the business I have found to be so successful. After that, you make the decisions.

Does Happiness Hang on Your Decision?

Don't put this off. It may be a coincidence that you are reading these words right now. Or, it may be a matter that is more deeply connected with your destiny than either of us can say. There is only one thing certain: If you have read this far you are interested in the kind of independence I enjoy. And if that is true, then you must take the next step. No coupon on this advertisement. If you don't think enough of your future happiness and prosperity to write your name on a postcard and mail it to me, forget the whole thing. But if you think there is a destiny that shapes men's lives, send your name now. What I send you may convince you of the truth of this proverb. And what I send you will not cost a penny, now or at any other time.

VICTOR B. MASON

1512 Jarvis Ave., Suite M-2-M

CHICAGO 26, ILLINOIS

"TOOK IN \$217 FIRST 10 DAYS"

Some make more, some less...

We help you to start Your
Own All-Year Business

Make Big Money! With our easily operated, highly efficient Wall Washer, Charles Stelle took in \$217 in first ten days. E. L. Goss took in more than \$10,000 in one year. G. H. Jones wrote, "I made a net profit of \$1200 on one job." And no wonder—this machine washes walls 6 times faster and better than by hand and with no mess—no drop cloths needed.



Your Money Making Opportunity • We want more men to go into this profitable business for themselves and enjoy independence—freedom from layoffs and bosses. Customers everywhere—homes, offices, schools, churches, hotels, etc. How much you earn depends largely on you. What you take in is mostly profit. No need to rent shop or office; operate from home. Can start spare time until your full time is justified.

LOSE NO TIME—SEND COUPON TODAY FOR ALL THE FACTS

FREE BOOK! MAIL COUPON TODAY!

VON SCHRADER MFG. CO.
E10 "W" Pl., Racine, Wisconsin

Send at once (no obligation) your FREE booklet containing information about your WALL WASHING MACHINE and how I can start my own permanent, profitable business.

Name _____

Address _____

City _____ Zone _____ State _____

High School at Home

MANY FINISH IN 2 YEARS

No classes. No time wasted going to and from school. Progress as fast as your time and abilities permit. Standard H.S. texts supplied. Thousands enroll each year in this 62-year-old school. Send for FREE descriptive booklet.

AMERICAN SCHOOL, Dept. H845
Drexel at 58th St., Chicago 37, Ill.

Without obligation, please send FREE descriptive booklet.

Name _____

Address _____

Accredited Member National Home Study Council

realize your dream

Become a graduate engineer. Then promotion will not pass you by. Share rewards awaiting college men . . . higher income, rapid advancement. Important firms interview seniors here regularly. Approved for veterans.

Graduate Engineer in 27 months

B. S. degree in Electrical Engineering (with either Electronics or Power major), also in Mechanical, Civil, Chemical, Aeronautical Engineering. In 36 Months a B. S. in Business Administration (General Business, Accounting, Motor Transport Management majors). For earnest, capable students. Small classes. More professional class hours. Mature students. Well-equipped labs. Modest costs. Year-round operation. Enter Jan., Mar., June, Sept. Write J. E. McCarthy, Director Admissions, for Catalog and "Your Career" Book.



TRI-STATE COLLEGE

4119 College Avenue

Angola, Indiana

KILLS

• NO CHEMICALS, GASES, ETC.

• MOSQUITOES • MOTHS, MILLERS
• FLIES, GNATS • FISH FLIES, ETC.

OVER 1/4 ACRE ANYWHERE

No insect recovery. Harmless. Guaranteed. Built to last 25 years. Beautiful outdoor lighting. Plug into any 110 volt socket.

NO AREA CONTAMINATION
Uses up to 200 watt bulb. Grid cost 10¢ per month. Complete with fly attractor.

Dead insect catcher. Cord, Directions, Etc. Very reasonable price — Write to —

SING SING BUG CHAIR, INC.
Box P 3781, Oak Park 37, Mich.



BOX SIZE - 9 1/2" x 11 1/2" x 9 1/2"

75 POWER TELESCOPE \$398

NEW 3 in one telescopes, 3 variable 25X, 45X-75X magnification. Brass bound. 25 power for ultra bright images 45 & 75 power for long range. Guaranteed to bring distant stars, moons, objects, sports 75 times closer.

Most powerful scope sold anywhere near this amazing low price. American made, 3 sections. Opens 36", closes 1 ft.; contains 4 ground & polished lenses. Can also be used as powerful compound microscope. Mass production enables us to offer telescope complete at \$3.98 postpaid. Money back guarantee.

CRITERION CO., Dept. PMB-75, 331 Church St., Hartford, Conn.

HYDRAULIC JACK REPAIRS

Earn While You Learn at Home

Millions of jacks in gas & auto-service stations, truckers, body-shops, riggers, factories, farms need servicing. We show you HOW—easy step by step directions—what tools to use. EARN UP TO \$5 an hour, in spare time, in your own basement or garage. Start your own business NOW.

Write for folder No. PM-11 & free bonus offer.



Institute of Hydraulic Jack Repair
P.O. Box 50, Bloomfield, N. J.

RUPTURED

BE FREE FROM TRUSS SLAVERY

Surely you want to THROW AWAY TRUSSES FOREVER, be rid of Rupture Worries. Then Why Do you put up with wearing a griping, chafing and unsanitary truss the balance of your life? If you do, it will NOT be through necessity but through choice on your part.

Now there is a new modern Non-Surgical treatment that is designed to permanently correct rupture. These Non-Surgical treatments are so certain, that a Lifetime Certificate of Assurance is given. Write today for our New FREE Book that gives facts that may save you painful, expensive surgery. Tells how non-surgically you may again work, live, play, love and enjoy life in the manner you desire. There is no obligation. Excelsior Medical Clinic, Dept. H6124, Excelsior Springs, Mo.

WHAT ALL AUTO MECHANICS WANT TO KNOW



This Big Practical Book gives full information, with working diagrams, covering the principles, construction, ignition, service and repair of modern cars, trucks and buses.

Diesel Engines, Hydramatic and Fluid Drives Fully Explained.

A complete guide of 1696 Pages, with over 1500 Illustrations showing inside views of working parts, with instructions for service jobs. Completely up-to-the-minute! Priced at only \$6.

CIRCLE No. 1 IN COUPON

HOW TO FIX HOME APPLIANCES

REFRIGERATORS TOASTERS IRONERS VACUUMS
WASHERS DRYERS RANGES FREEZERS

Many other GAS AND ELECTRIC APPLIANCES

Handy Reference for Electric & Gas Servicemen, Mechanics, Dealers and Home-owners. Explains clearly and simply how to locate troubles, how to test, reassemble and connect. Wiring diagrams, 1000 Facts, Easy to read. Answers ALL your questions. 864 Pages. Illustrated. Only \$6.

CIRCLE No. 2 IN COUPON



TV TELLS HOW TO ANSWER RADIO RADIO TV QUESTIONS SERVICE LIBRARY

HERE IS LATEST INFORMATION IN A HANDY FORM FOR RADIO AND TELEVISION REPAIRMEN, SERVICEMEN AND STUDENTS

TWO COMPLETE VOLUMES - 1508 Pages - 1085 Illustrations and Diagrams. 1001 Important Facts and Figures on Modern T.V. Radio, Electronic Devices, INCLUDES TRANSISTORS & Transistors Circuits, Rectifiers, Record Changers, P.A. Systems, Phonograph Pick-ups, F.M., Auto Radio, Short Wave.

Basic principles, Construction, Installation, Operation, Shooting, How to get Sharp, Clear T.V. Pictures. Install service flow to test. Explains CULOM SYSTEMS, Methods of Conversion, Terms, etc. Includes Ultra High Frequency. Quick ready reference or use as a home study course. Only \$8 for BOTH volumes.

CIRCLE No. 3 IN COUPON

KNOW YOUR TRUCK

The TRUCK & TRACTOR GUIDE for Mechanics & Drivers, Foremen, Garagemen, Helpers, Owners, Trouble Shooters, Farmers, etc. Covering Gas & Diesel Motor Principles - Construction - Operation - Maintenance - Repair - Brakes - Service of all Parts. 1376 Pages. FULLY ILLUSTRATED. Index. Only \$5.

CIRCLE No. 5 IN COUPON

PLUMBERS AND STEAMFITTERS GUIDES

Practical Trade Assistant & Reference Set. Explains in plain language and by clear illustrations, diagrams, charts, graphs and pictures the principles of modern plumbing practice including Pipe Fitting and Air Conditioning. 4 Vols. - 2624 Pages - 3642 Diagrams & Illustrations. Only \$8 for the complete set of 4 vols.

CIRCLE No. 6 IN COUPON

PAINTING & DECORATING MANUAL

Inside Trade information on outside and inside work, how to mix paints, preparation of surfaces, paper hanging, wood finishes, tools, synthetic paints, color (with color chart), spray equipment, costs, estimating, etc. A COMPLETE guide to easier, better painting and decorating. 464 Pages. Fully Illustrated. Only \$2.

CIRCLE No. 7 IN COUPON

7-DAY FREE EXAMINATION

SEND NO MONEY - Pay the postman nothing! We are glad to send you any of the Audel Guides for absolutely FREE examination in your own home. We take all the risks and leave all the decisions up to YOU. There is no obligation! If you decide to keep the books of your choice you may pay for them under our astounding easy-pay plan of only \$2 a month.

HERE IS ALL YOU DO

IT'S EASY TO ORDER: In the No-Risk Mail Order Coupon at the right just draw a circle around the number of Audel Guides you want us to send you for FREE EXAMINATION. We will send them to you at once to help you build a brighter future by increasing your SKILL. If for any reason at all you are not COMPLETELY satisfied, return the books to us, and that will end the matter! NO STRINGS OR CATCHES TO THIS OFFER.

THEO. AUDEL & CO.
49 West 23rd Street, New York 10, N.Y.
NOVEMBER 1959

CARPENTERS AND BUILDERS GUIDES



PRACTICAL STOREHOUSE OF MODERN CONSTRUCTION INFORMATION (4 vol. set) for carpenters and all woodworkers. Explains in easy language and by profuse illustration principles, advances, short cuts, trade secrets, all based on the NEWEST information.

Vol. 1 - Tools, steel square, saw filing, joinery, furniture, etc.; Vol. 2 - Builders' mathematics, drawing plans, specifications, estimates, etc.; Vol. 3 - House and roof framing, laying out, foundations, etc.; Vol. 4 - Doors, windows, stair building, millwork, painting, etc. 4 vols. 1900 Pages. 3700 Illustrations. Whole set only \$8.

CIRCLE No. 8 IN COUPON

PRACTICAL ELECTRICITY

A COMPLETE HANDBOOK - Quick, simplified, ready reference. Complete instruction and practical information on the rules and laws of electricity - Maintenance of Machinery - A.C. and D.C. Motors - Armatures - Wiring Diagrams - House Lighting - Power Wiring - Meters - Batteries - Transformers - etc. Simple to understand. 1520 Pages. 2600 Illustrations. Priced at \$5.

CIRCLE No. 4 IN COUPON

DIESEL

ALL THERE IS TO KNOW ABOUT MODERN DIESEL ENGINES - Basic principles, starting valves, timing, fuel pumps, fuel injection compressor, air compressors, pistons, cylinders, lubrication, cooling systems, etc. Answers on operation, calculations. 640 Pages. Fully Illustrated. Priced \$3.

CIRCLE No. 9 IN COUPON

WELDERS GUIDE

Covers Electric, Oxy-acetylene, Thermit, Unionmelt welding for sheet metal, spot and pipe welds, pressure vessels and aluminum, copper, brass, bronze and other metals. Airplane work, surface hardening, hard facing, cutting, brazing, etc. 608 Pages. Fully Illustrated. Only \$5.

CIRCLE No. 10 IN COUPON

MATHEMATICS MADE EASY

A COMPLETE HOME STUDY COURSE - Starting with the first principles of arithmetic, advancing step by step through the various stages of mathematics, including the rules and calculations for mechanical and electrical problems. New EASY correct methods. Includes plane and solid geometry, trigonometry, algebra, calculus, etc. Practical tests, reference tables and data. How to use slide rule. 752 Pages. 550 Illustrations. Priced at only \$3.

CIRCLE No. 11 IN COUPON

NEW MACHINISTS AND TOOLMAKERS HANDBOOK

MODERN MACHINE SHOP PRACTICE - 5 PRACTICAL BOOKS IN ONE. New from cover to cover. Tells how to set up and operate lathe, screw and milling machines, shapers, drill presses and all other machine tools. A COMPLETE INSTRUCTOR AND REFERENCE BOOK. 1728 Pages. Fully Illustrated. Priced at only \$6.

CIRCLE No. 12 IN COUPON

WIRING DIAGRAMS

This book gives the practical facts on wiring of electrical apparatus. It explains clearly and SIMPLY how to wire apparatus for all fields of electricity. Each diagram is complete and self-explaining. Know your HOOK-UPS! 304 Pages. Illustrated. Only \$2.

CIRCLE No. 13 IN COUPON

REFRIGERATION & AIR CONDITIONING

FOUR BOOKS IN ONE - basic principles, servicing, operation, repair of: 1. Household Refrigeration. 2. Special Refrigeration Units. 3. Commercial & Industrial Refrigeration. 4. Air Conditioning Systems. A GOLD MINE of essential information. Completely up-to-date. 1360 Pages. Fully Illustrated and Indexed. Priced at only \$6.

CIRCLE No. 14 IN COUPON

THE NEW ELECTRIC LIBRARY

A COMPLETE ENCYCLOPEDIA explaining in the simplest terms the fundamental principles, rules and applications of applied electricity.

A COMPLETE COLLEGE EDUCATION!

Fully illustrated with diagrams and sketches, calculations and tables for ready reference. Questions and answers. Trial tests for practice study and review. All based on the most modern theory.

Vol. 1 - Principles and rules of electricity, magnetism, armatures, repairs, No. 15
Vol. 2 - Dynamos, DC Motors, construction, installation, maintenance, etc. No. 16
Vol. 3 - Testing instruments and tests, storage battery constr. and repairs. No. 17
Vol. 4 - Alternating current, power factor, alternators, transformers, No. 18
Vol. 5 - A.C. Motors, windings, maintenance, converters, switches, fuses, etc. No. 19
Vol. 6 - Relays, condensers, regulators, rectifiers, meters, switchboards, etc. No. 20
Vol. 7 - Wiring, house light and power, circuits, high tension, plans, code, etc. No. 21
Vol. 8 - Railways, signals, elevators, ignition, etc. No. 22
Vol. 9 - Radio, telephone, telegraph, television, motion pictures, No. 23
Vol. 10 - Refrigeration, illumination, welding, x-ray, electrical appliances, Index. No. 24

7,000 fully illustrated pages. Priced at only \$20 for the ENTIRE SET. Also sold individually for \$2 each.



ALL TYPES OF BLUEPRINT READING

How to read scales, the standard symbols, detail and assembly prints, working drawings, short cuts, helps, hints and suggestions. THE MAN WHO CAN READ BLUEPRINTS IS IN LINE FOR A BETTER JOB. This book gives you the secret language, step by step in easy stages. 448 Pages, Very Fully Illustrated. Priced at \$3.

CIRCLE No. 23 IN COUPON

MASONS & BUILDERS GUIDES

A PRACTICAL ILLUSTRATED 4 VOL. SET - Explaining in clear, simple language and profuse illustration, principles, advances, short cuts, trade secrets, based on modern practice - including how to figure and calculate various jobs.

Vol. 1 - Brick work, bricklaying, bonding, designs, Vol. 2 - Brick foundations, arches, tile setting, estimating, Vol. 3 - Concrete mixing, placing forms, reinforced stucco, Vol. 4 - Plastering, stone masonry, steel construction, blueprints. 4 Vols. 1440 Pages. 2067 Illustrations. Complete Set only \$8.

CIRCLE No. 26 IN COUPON

ELECTRIC MOTORS

THIS GUIDE covers the construction, hook-ups, control, maintenance and trouble shooting of all types of motors. Includes armature winding. Explains entire subject in great detail in simple language. Over 1056 Pages of information. 617 Diagrams. All types of motors fully illustrated and indexed for ready reference. Priced at only \$5.

CIRCLE No. 27 IN COUPON

OIL BURNERS

New, complete, explaining in detail both domestic and industrial oil burners. Includes electrical hook-ups and wiring diagrams. Fully covering the theory, construction, installation, operation, testing, servicing and repair of all equipment. Indexed for ready reference. Over 416 Pages. 320 Illustrations and Diagrams. Only \$2.

CIRCLE No. 28 IN COUPON

ADDITIONAL IMPORTANT TITLES

- The following Audel Guides are all the best in their fields, written in clear simple fashion, all lavishly illustrated. Circle the numbers wanted in the MAIL ORDER COUPON below. All books are sent for FREE EXAMINATION.
- No. 29 SHEET METAL PATTERN LAYOUTS. 1132 Pages. \$7.50
 - No. 30 SHEET METAL WORKERS HANDY BOOK. 448 Pages. 2.00
 - No. 31 MECHANICAL DRAWING GUIDE. 192 Pages. 2.00
 - No. 32 MECHANICAL DRAWING AND DESIGN. 480 Pages. 3.00
 - No. 33 ELECTRONIC DEVICES. 304 Pages. 2.00
 - No. 34 ELECTRICIANS EXAMINATIONS. 272 Pages. 2.00
 - No. 35 ELECTRIC POWER CALCULATIONS. Page 480. 3.00
 - No. 36 ELECTRIC DICTIONARY. 5000 Terms. 3.00
 - No. 37 POWER PLANT ENGINEERS GUIDE. 1588 Pages. 5.00
 - No. 38 ENGINEERS AND FIREMANS EXAMS. 544 Pages. 2.00
 - No. 39 OPERATING ENGINEERS LIBRARY. 3 Book Set. 12.00
 - No. 40 PUMPS, HYDRAULICS AND AIR COMPRESSORS. 1760 Pages. 6.00
 - No. 41 HOUSE HEATING GUIDE. 1008 Pages. 5.00

MAIL THIS NO-RISK COUPON TODAY!

THEO. AUDEL & CO. - Self Improvement Publishers Since 1879 - P-1

49 W. 23rd Street, New York 10, N.Y.

Please mail me for 7 days' FREE EXAMINATION the books I have circled at right. I agree to mail \$2 in 7 days on each book or set ordered, and to further mail \$2 a month on each book or set ordered until I have paid the purchase price, plus shipping costs. If I am not completely satisfied with my Audel Guides I may return them.

1	2	3	4	5	6
7	8	9	10	11	
12	13	14	15	16	
17	18	19	20	21	
22	23	24	25	26	
27	28	29	30	31	
32	33	34	35	36	
37	38	39	40	41	

NAME _____

ADDRESS _____

OCCUPATION _____

SAVE SHIPPING COSTS! Check here if you enclose complete payment with order. We pay postage charges. You have same return privilege.

FREE!
100
WORLD-WIDE
STAMPS
...just
released!



HURRY! SEND TODAY for colorful, valuable collection of 100 World-Wide stamps. Get new issues of past 12 months. From far corners of the world . . . Ghana, Togo, China, Polynesia, India, Australia, Honduras, Iceland and many others. Wonderful new additions to your collection. All different, all genuine, topicals, pictorials, bi-colors, mint and used. Limited supply. Only one to a collector. Plus free complete, helpful "Stamp Collector's Guide" and other offers for your **FREE** inspection. Send name, address, enclose 10¢ for handling and postage. Garcelon Stamp Company, Dept. PMNX, Calais, Maine.

GARCELON STAMP CO., Dept. PMNX.
Calais, Maine — Rush **FREE** 100 Different Stamps, Collector's Guide, other offers. Enclosed 10¢ for handling. (PLEASE PRINT).

AVIATION CAREER

SPECIALIZED EDUCATION / PROFESSIONAL TRAINING... only 16 months to 2 years

Top-pay prestige positions, bright future in aviation. Job opportunities waiting for you as soon as you're ready. Airframe and Powerplant Technician, Aeronautical Engineering Technologist, Business or Executive Pilot. Classes in Miami.

SEND FOR FREE 48-PAGE BOOK

Embry-Riddle Aeronautical Institute
Dept. B Miami, Florida (Founded 1926)

Name.....

Address.....

City.....Zone.....State.....



LOOK

AT THE AMAZING PRICES PAID AT GOV'T SURPLUS SALES

Autos.....\$78	Tractors.....\$68
Trucks.....\$212	Motors.....99¢
Boats.....\$5.90	Typewriters..\$6.80
Compressors..\$9.69	Generators..\$8.78

PAY 2 or 3¢ on the DOLLAR
for 1000's of Useful Items of
U.S. GOV'T SURPLUS

You BUY DIRECT from U. S. Government at TREMENDOUS savings. Eliminate middlemen—Save BIG MONEY! Pay as LOW as 2¢ on the dollar. Our DIRECTORY Gov't Surplus Sales lists 100's Army, Navy, Air Force Surplus Depots all over the world. BUY JEEPS, sports equipment, hunting, fishing and photographic equipment and supplies, radio, electronic and electrical equipment, trucks, boats, airplanes. Plumbing, hardware, office equipment & supplies. Tools, machinery, furniture. This 1959 book tells how to buy Gov't Surplus DIRECT. No dealer profits to pay. Get on the gravy train NOW! Send \$1 TODAY for "Gov't Surplus DIRECTORY" to **AVIATION SURPLUS, Dept. PM-11, Box 789, York, Pa.**

SUN COAST ESTATES

ON FLORIDA'S BOOMING WEST GULF COAST

1 1/4 ACRE TRACTS • \$15 DOWN MONTHLY

NOW — your opportunity to own an estate in tropical Florida, 3 1/2 miles from Fort Myers, at an unbelievably low price! If you want a homesite, small farm or grove for retirement living or future profit — a **SUNCOAST ESTATE** is your best bet. Write NOW for full details and illustrated brochure.

GRAYBAR REALTY & MORTGAGE CORP.
Graybar Bldg., 2225 First St. • FORT MYERS, FLORIDA
(AD59042)



BIG EARNINGS WAITING for TYPEWRITER REPAIRMEN

Skilled men are in demand in the new, uncrowded field of typewriter repair. You'll quickly step into a big-pay job or business of your own, full or part time. **EARN** while learning easily at home under expert guidance. Materials, tools, typewriter supplied. Write TODAY for **FREE** book.

TYPEWRITER REPAIR SCHOOL, INC.
Dept. L-19, 150 Park Ave., E. Rutherford, N. J.
Lic. by New Jersey Dept. of Educ.

**ENGINEERING
DEGREE IN
27 MONTHS**

B. S. degree (27 mo.): Aero., Chem., Civil, Elec., Mech. & Electronics.
B. E. (36 mo.): Aero., Chem., Civil, Elec., Mechanical, Metallurgical, E.S. (36 mo.): Math., Chem., Physics. Prep courses. Demand for grads. Campus, 20 bldgs., dorms, gym. Low rate. Earn board. G.I. appr. Enter Dec., March, June, Sept.
1611 E. Washington Blvd., Fort Wayne 2, Ind.
Keeping pace with progress

INDIANA TECHNICAL COLLEGE



MECHANICAL DENTISTRY

To make Crowns, Plates, Bridgework, etc., for Dentists. Easy practical way to learn mechanical dentistry at home in spare time. **FULL EQUIPMENT OF TOOLS AND MATERIALS INCLUDED WITH COURSE.** Low tuition. Easy terms. Write for **FREE** BOOK about this money making profession that is not affected by machine age.

MCCARRIE SCHOOL OF MECHANICAL DENTISTRY
207 N. Broad St., Dept. 94, Philadelphia 7, Pa.

WANTED! New Products

We urge manufacturers with products requiring sales representation in the automotive or service-station field to write to us. Inventors, if you have patented items applying to the same sales field, let us know and we'll work out manufacturing and distribution problems for you. We have salesmen in every state.

JACK P. HENNESSY COMPANY, INC.
12 Depot Square • Englewood, New Jersey

To the Editor:

I look forward with great interest to receiving *PM* each month. Firstly for the very good ideas for home improvements, also the items on art, which are of special interest to me as I do wood carving over here and have sold quite a number to tourists from your country.



I am enclosing a photo of just a few of my things which are based from the knots in the wood, to represent faces or eyes. They are of quite modern design as you can see.

P. J. Fumage
13 Halves Cottages
East Street
Corfe Castle
Wareham
Dorset, England

☆☆☆



Home-Built Snowplow

We are inclined to agree with Paul D. Lesnick of Rochester, N.Y., that his latest project is "very useful around the yard." The snowplow-tractor, shown here in charge of his 11-year-old son, has a cut-down Crosley rear end and transmission with a chain drive. It is powered by a 1 $\frac{3}{4}$ horsepower motor and cost Mr. Lesnick about \$30 for junk parts—plus a little spare time.

AUTO MECHANICS AND DIESEL



Your spare time
pays off **BIG**
with our world-famous
SHOP TESTED
Home Training



MAKE YOUR FUTURE AS BRIGHT AS THEIRS
In a matter of months, you can quit your no-future job for a big-pay, big-future career as an Auto-Diesel Mechanic. Free Illustrated Book gives you the facts. Send coupon below. No Obligation. No Salesman will call.

All Phase Training

N. T. S. students become skilled, all-around mechanics. Crystal-clear lessons, Shop-Tested manuals, real professional equipment, make it easy to learn. Big equipment kits, yours to keep. Earn as you learn... we show you how. Graduate Advisory Service.

N.T.S. Training is Better. More Complete. Lower Cost BETTER...

Because training is **SHOP-TESTED** in Resident School Shops & Labs. **MORE COMPLETE...** You learn all phases of Auto Mechanics & Diesel. **LOWER COST...** One low tuition covers entire cost of course and all equipment.

Unlimited Opportunities

Trained mechanics make top money...are in demand at dealer shops, garages, large bus and truck lines, construction projects, government labs, factories, and many others.

YOU GET AND KEEP ALL THIS PROFESSIONAL EQUIPMENT



Motor Analyzing Set



Socket Wrench Set



NATIONAL TECHNICAL SCHOOLS

WORLD-WIDE TRAINING SINCE 1905
1000 S. FIGUEROA ST., LOS ANGELES 37, CALIF., U. S. A.



FREE!

Illustrated Fact Book & Actual Lesson

Mail coupon now.

Complete TV-Radio Electronics training also available.

RESIDENT TRAINING at Los Angeles!

If you wish to take Resident Training at Los Angeles, in our Big, Modern Shops & Labs, check special box in coupon for full information.

NATIONAL TECHNICAL SCHOOLS

WORLD-WIDE TRAINING SINCE 1905

MAIL NOW TO

NATIONAL TECHNICAL SCHOOLS, Dept. DB-119
4000 S. FIGUEROA ST., LOS ANGELES 37, CALIF.

Send for FREE Auto-Diesel Opportunity Book and actual Lesson.

NAME _____ AGE _____

ADDRESS _____



Member





Make "Pro"
Enlargements
in your Home
Tonight!

with a famous

BESLER DARKROOM

... in your own basement, bathroom,
kitchen, closet or clubhouse!

Taking pictures is twice the fun when
you make them into giant enlargements.
Outfit with lens, chemicals, paper, trays,
easel, timer. Beseler 23C Enlarger... if
purchased individually, would cost \$287!

\$195

DENVER WEST 5206

Complete Outfit

MAIL THIS COUPON TONITE!

CHARLES BESELER CO.
206M S. 18th St., East Orange, N.J.
Please rush my FREE booklet,
"Fun in the Darkroom."



NAME _____

ADDRESS _____

CITY _____

ZONE _____

STATE _____

©1958, Charles Beseler Company

Pocket Transistor Radio

"Hit Parade"
Mighty Midget



\$5.95

Low Price!
Smart Design!

Size of cigaret package,
yet thrilling performance. Weighs only 3
ounces. Listen to sports, music, news,
variety programs on your personal port-
able. Includes speaker-phone for private
listening. Modern two-tone moulded plastic case, gold metal grille.
Complete broadcast band. On-off switch one end. Uses standard pen-
light cells (included). Guaranteed. **\$5.95**
Complete, ready for immediate playing. Postpaid Only...
JOHNSON SMITH & CO. Dept. 850 Detroit 7, Michigan

Catalog of 2900 Novelties 10c

New Send 10c for amazing catalog of novelties, live animals,
scientific supplies, hobbies, funmakers, planes & boats,
looms, magic tricks, joke articles, unusual seeds, gad-
gets, timesavers, cameras, optical goods, projectors,
movies, lucky jewelry, religious novelties, diaguies,
musical instruments, stamps, coins, puzzles, fortune
tellers, radios, auto & bike accessories, telescopes, magnifiers, com-
passes, banks, smokers' gadgets, artists' supplies, printing sets, en-
gines, motors, shockers, knives, billfolds, guns, rifles, sports, books,
games, plants, etc. Send 10c.
JOHNSON SMITH & CO. Dept. 850 Detroit 7, Michigan

Would YOU Like to Make
\$1 000 A MONTH?



That's What Stanley Hyman
Made Selling PRESTO
Amazing Midget
Fire Extinguisher



Sensational Presto does job of bulky
extinguishers costing 4 times as much.
Ends fires fast as 2 seconds; fits palm
of hand. Never corrodes; guaranteed 20
years! Sells for only \$4.95. Show it
to owners of homes, cars, boats, farms,
etc., and to stores for re-sale - make
good income. Write for FREE Sales Kit.

Stanley Hyman

MERLITE INDUSTRIES, Presto Div.
114 East 32nd St. Dept. P-137 New York 16, N. Y.
In Canada: Mopa Co., Ltd., 371 Dowd St., Montreal 1, P. Q.

Frantz *Miracle* ENGINE GUARD

PROTECTS ENGINE & BEARINGS

Automatically stops engine if oil pressure becomes dangerously
low or when vehicle has major accident. All internal combustion
engines. Easily installed. Satisfaction
guaranteed. When ordering give make
vehicle, no. of cyl., 6 or 12 volt Batt.

\$8.50

FRANTZ MIRACLE PRODUCTS CORP.
YOSEMITE BLVD. MODESTO, CALIF.

"YOU ARE UNDER ARREST!"



Help Bring Crooks to Justice Through Scientific
CRIME DETECTION!

We have taught thousands this exciting, profitable, pleasant
profession. Let us teach you in your own home. Learn Finger
Printing, Firearms Identification, Police Photography,
Secret Service Methods thoroughly, quickly, at small cost.
Over 800 of all American Bureaus of Identification employ
I.A.S. students or graduates. Write for FREE "Blue Book
of Crime." (A Correspondence School Since 1918)

Institute of Applied Science, 1920 Sunnyside Ave., Dept. 1358, Chicago 40, Ill.

PART TIME or FULL TIME...

JACK UP YOUR **EARNINGS**

Write NOW for FREE Brochure on the WIDE OPEN FIELD of

JACK REPAIR BUSINESS

20 YEARS OF SUCCESSFUL EXPERIENCE CONSOLIDATED
FOR YOU. We furnish: Tool set that fits 90% of all jacks, detailed
service manuals with 120 exploded drawings, parts kits to fit over
400 different popular hydraulic jacks, suggested sources of
potential customers.

BOND TOOL CO. 414 OHIO AVE. WICHITA FALLS, TEXAS



MEN WANTED

Earn \$100 Per
Week and up

AUTO DIESEL
MECHANICS

Master a trade with a future - learn Auto-Diesel
mechanics in our shops. You learn with tools
on real equipment. Earn while you learn. Many
of our graduates earn \$100 per week and up.
No previous experience necessary. Day and night courses. Approved for veterans.
Write for free bulletin.

NASHVILLE AUTO-DIESEL COLLEGE

226 7th Ave., N., Dept. 75

Nashville 3, Tenn.

Million Dollar Inventory - All Famous Brands



SAVINGS NEVER LESS THAN 50% UP TO 70% OFF REGULAR PRICES
HEADQUARTERS FOR ALL SPORTS CAR TIRE SIZES
SEND FOR YOUR FREE CATALOG!

RELIABLE TIRE CO. 728 MORGAN BLVD. CAMDEN 4, N. J.

Now! Super TV Reception For Every Home And Apartment!

Turns Your House Wiring Into A Giant TV Antenna!

An electronic miracle — first discovered in United States Radar Research! Called the MARK III RADAR ANTENNA, it actually increases your TV receiving area *Hundreds of Times!* Gives you *Movie-Sharp Reception* even on weak channels! Out-performs Rabbit Ear Antennas as much as three times — rivals the finest roof antennas made — at *One-Twentieth Their Cost!*

And yet, all you do is plug it in to an ordinary wall socket! It uses no electricity — costs you nothing to use — never heats up or wears out — works in absolutely safety! Once you slip it on your set, you never see it or touch it again! And yet it must give you the TV reception of your life — instantly — on every single channel in your area — **OR EVERY CENT OF YOUR MONEY BACK!**

First Used to Guard America's Shores! Now it Brings you a Whole New World of TV Pleasure!

Yes! In one vital way, the ordinary electrical wiring in your home is exactly like a vast radar screen! These electrical circuits in your home have hundreds of feet of overlapping metal wire, spread out in every direction — exactly like radar! They automatically pick up radio and TV signals from every direction — exactly as radar picks up signals from as far as five thousand miles away!

But radar screens also have **HIGH-FREQUENCY RECEIVING ELEMENTS**, that collect these signals and channel them down into the control room, where they can be seen clear and sharp by the men who operate them! **WHY NOT USE THE SAME TYPE HIGH-FREQUENCY RECEIVING ELEMENT TO TURN YOUR ORDINARY HOUSE WIRING INTO A SUPER TV ANTENNA!**

This is exactly what has happened in the *Mark III Radar Antenna!* Technically speaking, the *Mark III Antenna* is an ultra-high-frequency television antenna, utilizing radar-derived receiving elements, and reinforced by an additional dipole formation to provide the absolute maximum pulling power! It is designed and manufactured by engineers producing radar components for the United States Army, Navy and Air Force! It is a precision-made product of the highest quality possible! Yet its price is only \$4.95. Here is how this miracle antenna works! Here are the results you will get on any year, make or model set, **OR EVERY CENT OF YOUR MONEY BACK!**

Your Family Must Gasp in Astonishment — Or your Full Money Back!

When you receive the *Mark III Radar Antenna*, you can then forget forever about Rabbit Ears, roof antennas, hourly adjustments or antenna repair bills! To install the *Mark III Antenna* on your set — forever — you need only sixty seconds of your time, and a screwdriver. There is no danger — you don't even dirty your hands!

Simply turn your set around; unscrew the present antenna wires and throw them away! Slip on the *Mark III* wires and plug in its cord. Now snap on your set, and turn to the weakest channel! Adjust the dipole elements till that "weak" channel comes in strong and clear, and then you are finished! *That's all you have to do!* Every other channel will automatically give you pictures of breathtaking beauty! You will have depth, contrast, sharpness, fidelity of sound that you have never dreamed possible before — **OR EVERY CENT OF YOUR MONEY BACK!**

You are the only judge! It costs you nothing to try! Act **TODAY!**

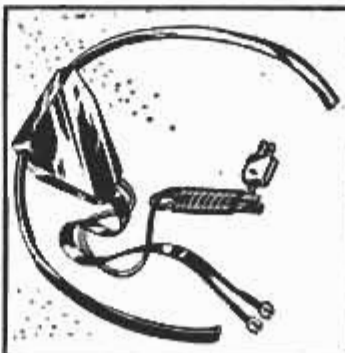
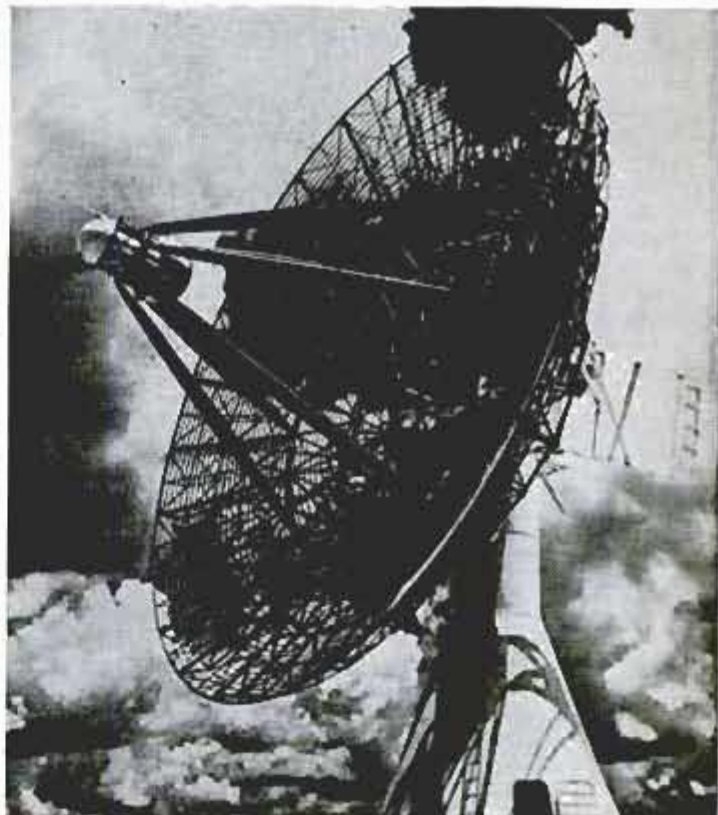

From The Frontiers Of The Space Age To You, The Mark III Radar Antenna!

Now! From the American Radar Science that sees pin-points on the Moon — comes TV reception so breathtaking that you can't believe your own eyes! Yes! A miracle of electronics that will outlast a hundred television sets — improve the performance of them all! Read the thrilling details on this page. Try it at our risk — **TODAY!**

EUGENE STEVENS INC.

NOT FOR SALE IN THE STORES! ORDER TODAY!

Eugene Stevens, Inc., Dept. A
132 West 21st Street New York 11, N. Y.

Yes! Rush me your amazing new **MARK III RADAR ANTENNA** to try entirely at your risk! I will pay postman only \$4.95 plus COD postage and handling charges.

I understand that I may try this unit for one full week entirely at your risk! At the end of that time I must be amazed with the reception on every single channel in my area — or every cent of my money will be immediately refunded! I understand that a written and dated guarantee to this effect accompanies every package!

NAME _____
ADDRESS _____
CITY _____

SAVE MORE! Enclose check, cash or money order and we pay all postage and handling charges! You save as much as 77¢. Same money-back guarantee, of course!

Not everyone does as well, but T. N. CODY, who started a business of his own, reports...

For 12 months I've averaged

\$800
per month income

— most of it clear profit for me!

Many men have discovered how to be independent, to be free of layoffs and bosses. C. G. Naples grossed more than \$200 his first week. A father-son combination grossed \$44,000 their second year. H. Lemon says, "I netted \$133 in one 8-hour day."

How much you make depends largely on you. You need no special skill, no large investment. Start part time if you wish.

NO SHOP NECESSARY • Our Electric Deterger shampoos rugs, carpets right on floor—removes dirt and grime and helps to show their natural color and beauty. So efficient and safe it is used by largest railroads and hotels.

This is not a lease proposition. You own the machine, you work when and where you please and all the money you take in is your own. No risk. Machines fully guaranteed.

Mail
Coupon
Today
for
FREE
Book

VON SCHRADER MFG. CO.,
810 "R" Pl., Racine, Wis.

Without obligation send me FREE booklet about your RUG DETERGER and tell me how I can start my own permanent, profitable business.

Name _____
Address _____
City _____ Zone _____ State _____



**Colorcretors
are Needed
Everywhere**

C-9



More Colorcretors are needed to supply growing demand for the enduring, colorful beauty possible only from Colorcrete. Time-worn concrete, stucco and other old or new masonry walls are quickly transformed into clean freshness from a selection of 30 tints, tones and shades. Cementitious base—tough, tenacious, enduring. Colorcrete is applied under pneumatic air pressure by authorized Colorcretors. Machine is easy to operate and readily mobile. Opens up opportunities for men of modest capital. Broad markets with high income potentials. Write for Opportunity Book.

COLORCRETE

COLORCRETE INDUSTRIES, INC.
570 Ottawa Ave., Holland, Mich.

MAKE EXTRA CASH

SHARPENING LAWN MOWERS THE MODERN WAY



\$275.00
F.O.B. Pasadena

Start your own shop! Full or spare time. Earn many dollars in a short time... average \$5.00 per hour. Many mowers need sharpening. With MODERN'S Extra Heavy Duty LAWN MOWER SHARPENER AND BED KNIFE GRINDER you have 6 machines in one. All operations are done quickly and easily. You make money from the start. Write for free details.

MODERN MFG. CO.
160 N. Fair Oaks Ave. Dept.
Pasadena, California 10-4

250 POWER.....



Telescope Lens Kit

only **\$3.49**
postpaid

Conquer Space. Explore the Universe, Planets, Moon Craters, New Stars, etc. Complete Lens Kit consists of 80 inch focal length ground and polished objective lens, eyepiece lenses for 50 POWER, 100 POWER, 150 POWER, 200 POWER, 250 POWER, and all necessary lens fittings. Easy to make from simple step by step instructions. (Tripod and mount not included.) Money back guarantee.

BUSSE SALES CO., Hartford, Conn., Dept. PM-81

LAW FREE BOOK

THE LAW
TRAINED
MAN

Write today for a FREE copy of illustrated law book, "THE LAW-TRAINED MAN," which shows how to earn the professional Bachelor of Laws (LL.B.) degree through home study of the famous Blackstone Law Course. All necessary books and lessons provided. Moderate cost; convenient monthly terms. Write for FREE law training book today.

Blackstone School of Law, 307 N. Michigan Ave.
Founded 1890 Dept. 58, Chicago 1, Illinois

FIX OUTBOARD MOTORS

**POWERMOWERS, AND ALL SMALL
2 & 4-CYCLE GASOLINE ENGINES**

MAKE EXTRA MONEY—or, repair your own equipment and SAVE! Fully illustrated, easy-to-understand, Home Study Course. Write today for FREE information.

LINCOLN TECHNICAL INSTITUTE
SUITE 11-E, 472 MARKET STREET, NEWARK 5, N. J.

\$1.75 KODACHROME PROCESSING

K 135-20 Exposure Developed
and Mounted in slides. . . ONLY

8MM — #459 Movie Film Roll
Developed for ONLY

Send for Free Mailer

THRIFTY DAN—P.O. Box 68, Grand Rapids, Michigan

\$1

Now Many Wear

FALSE TEETH

With Little Worry

Eat, talk, laugh or sneeze without fear of insecure false teeth dropping, slipping or wobbling. FAS-TEETH holds plates firmer and more comfortably. This pleasant powder has no gummy, gooey, pasty taste or feeling. Doesn't cause nausea. It's alkaline (non-acid). Checks "plate odor" (denture breath). Get FASTEETH at drug counters everywhere.

Train NOW as HEAVY EQUIPMENT OPERATORS

PUT YOURSELF IN THE DRIVER'S SEAT!

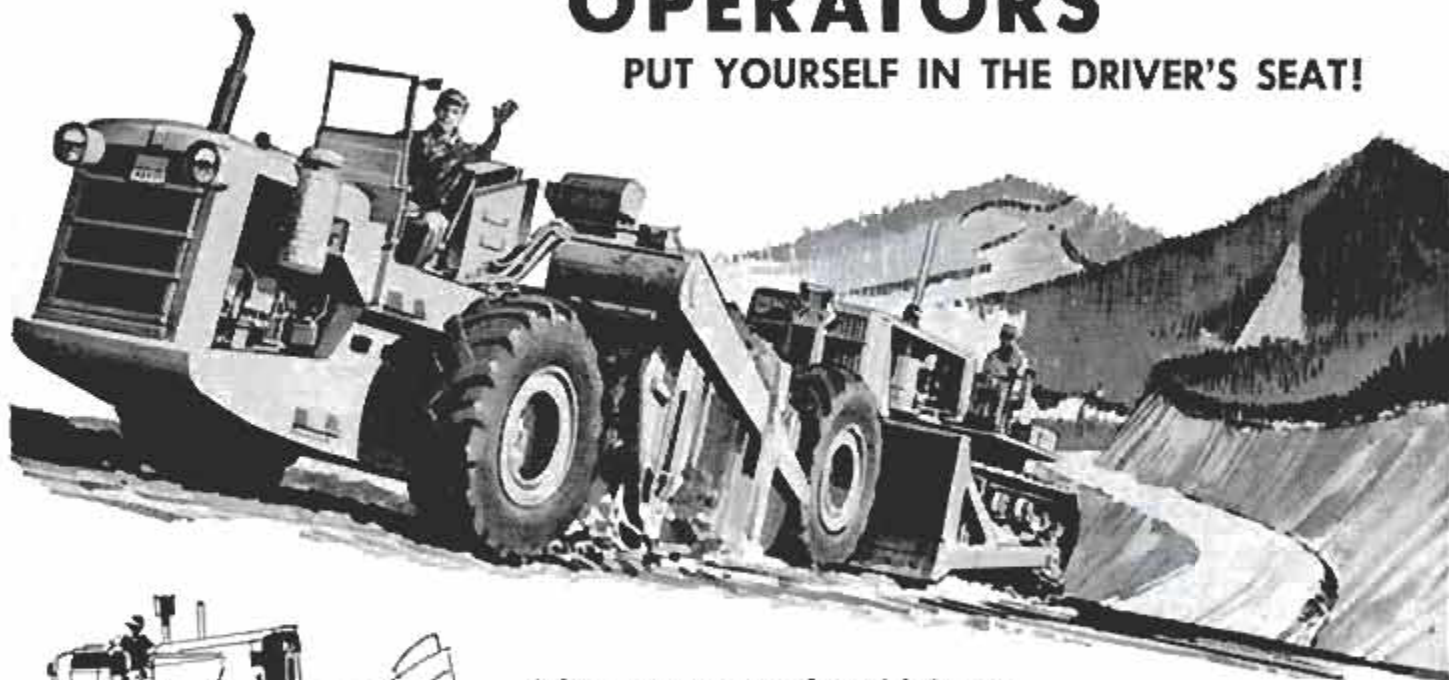

The most tremendous highway building program in history is under way... bridges, dams, houses, factories, are springing up all across the nation... The construction industry is booming as never before. And *You* can have a box seat for this greatest show on earth!

EXPERIENCE UNNECESSARY — APPLY NOW

You will be trained thoroughly for modern heavy equipment operation. Learn to master heavy equipment such as: tractors, scrapers, graders, carry-alls. Engineering fundamentals... blueprint reading... operating controls... diesel engine operation... highway construction, etc.

If you are between 17 and 45, you can get into Heavy Equipment NOW — regardless of your present position, training or income. Nationwide placement service available upon completion. We help you with financing.

SEND FOR FREE INFORMATION

HEAVY EQUIPMENT TRAINING

Northwest Schools, Inc. (Dept. M-4)
1221 N. W. 21st Avenue • Portland 9, Oregon

Rush information without obligation.

Name _____

Address _____

City _____ State _____

Phone _____ Age _____

Education _____ Hours Worked _____



Just Pick the Kind of Body YOU Want

CHECK THE COUPON BELOW

...Prove to Yourself How EASILY You Can Have It...Almost Overnight!



Just tell me, in coupon below, the kind of body you want—and I'll give it to you SO FAST your friends will be amazed! "Dynamic Tension," my easy, 15-minutes-a-day method, can make your chest and shoulders bulge . . . your arms and legs surge with power . . . with whole body feel "alive!"

FREE 32-page Illustrated Book

32 pages on how "Dynamic Tension" changed me from a 97-lb weakling into "World's Most Perfectly Developed Man"—and what it has done for others. Mail coupon NOW! Charles Atlas, Dept. 8L, 115 E. 23rd St., N. Y. City 10.



CHARLES ATLAS, Dept. 8L
115 East 23rd St., New York 10, N. Y.

Dear Charles Atlas—Here's the Kind of Body I Want:
(Check as many as you like)

- Simmer Waist, Hips More Powerful Arms, Grip
 Broader Chest, Shoulders More Powerful Legs
 More Weight, Solid Better Energy, Sleep

Send me, absolutely FREE a copy of your famous book showing how "Dynamic Tension" can make me a new man. 32 pages, crammed with photographs, answers to vital questions, and valuable advice. No obligation.

Name _____ Age _____
(Please Print or write plainly)

Address _____

City _____ Zone _____ State _____

...TURN CONCRETE INTO GOLD!



MAKE UP TO \$75 A DAY IN YOUR OWN BUSINESS

If you want to have your own business — to start a business on your own — here's your big opportunity! New high speed, low cost General block machine produces up to 1,000 concrete blocks a day. Sell all you make to builders, supply houses, and others for homes, factories, buildings, garages. Cash in on the building boom! You can make profits of 100% to 150% — up to \$75 a day! General block machine equipped with 1/2 h.p. electric motor — or can be supplied with gasoline engine — works anywhere, in little space, indoors or out. Operates from ordinary house light socket. Simple, foolproof 3 step operation — so easy a child can do it. Makes superior 3 core blocks any size from 4" to 12". Also makes chimney, sash, corner and other types. Blocks meet any building code anywhere in the country. Materials — sand, water, cement, available anywhere. Simple illustrated operating instructions and mixing formulas for cement and cinder blocks supplied with each machine. Write for FREE folder with full information.

MOTOR DRIVEN

R.L.T. of New York City reports: "MY GENERAL BLOCK MACHINE PAID FOR ITSELF IN FIRST 2 WEEKS!" Hundreds now in use the world over! Write for FREE details today!

EXTRA

Amazing illustrated

book gives floor plans for 6 sensational concrete block bungalows. Tells how to lay blocks, lay out building lines, mix concrete, build steps, porch and concrete floors all at great savings. Written by experts. Can save many times the cost of the machine! Get it now! No strings attached. Send \$1.

BOOK SENT FREE IF YOU BUY MACHINE.
\$1 REFUNDED IF YOU BUY LATER.



GENERAL ENGINES CO.

DEPT. M-119, ROUTE 130, THOROFARE, N. J.

MAKE YOUR OWN POOL TABLE

Easy, detailed plans for this 4'x7' pool table enables you to build it for less than \$80.00 completed. These plans provide for the best-playing qualities of a nonwarping bed, rubber cushions, and enclosed ball returns. Table is engineer-designed for maximum accuracy with sturdy folding legs and leveling devices. The plans are complete and easy-to-follow. We also offer a kit of accessories: the best rubber cushions, deluxe lathe-turned balls, cues, good quality suede billiard cloth, ball triangle, chalk, rubber cement, etc.



Easy, inexpensive entertainment is yours. Send \$3.00 for complete plans today. Satisfaction guaranteed.

MAR-BER COMPANY, Box 475, Massena, New York

ART LEARN AT HOME!

Enjoy glamorous high-pay career or profitable hobby. Learn Commercial Art, Painting, Cartooning, Fashion Art, Lettering, T.V. Art, etc. We train you at home, in spare time. Two 22-pp. art outfits included free of extra charge. LOW COST—only 20¢ a day. Write for FREE Book. No salesman will call on you. Washington School of Art, Studio 1411, Port Washington, N. Y. (Estab. 1914)



119 JIG SAW PATTERNS

FULL-SIZE . . . trace on wood and saw out. Clever, ORIGINAL designs, things you can make to SELL. Wall shelves, lawn signs, planters, book ends, others. **\$1** postpaid

BURGESS VIBROCRRAFTERS, INC.

Rush \$1 today. DEPT. C-117, Grayslake, Illinois

MONEY in WORMS

Sell 20,000 fishworms per week @ \$4 per 1000 from a bed 3 feet wide and 8 feet long. We teach you how to raise and where to sell fishworms and crickets. Write for free literature. CARTER WORM RANCH, PLAINS, GEORGIA



SEND FOR THIS FREE!

Make money. Know how to break and train horses or ponies. Write today for this book FREE, together with special offer of a course in Animal Breeding. If you are interested in Gaiting and Riding the saddle horse, check here (). Do it today—now.

BEERY SCHOOL OF HORSEMANSHIP
Dept. 11011 Pleasant Hill, Ohio

\$1 BRINGS YOU \$18

Discover Flok-Kraft and Earn \$\$\$\$\$ AT HOME

Earn up to \$15.00 per hour spare time. Amazing new Velvet-fiber spray instantly makes any object (Lamps, Radio & TV Cabinets, Figurines, Signs, Auto dash boards, toys, furniture, draperies — anything) worth expensive \$888 prices . . . like magic, you can spray anything with this beautiful new suede-like finish that feels like rich Velvet.

EARN UP TO \$300.00 PER WEEK SPARE TIME

Imagine, materials cost only 7¢ per square foot. (Average TV or radio cabinet can be beautifully sprayed with this startling new 3-dimensional Velvet finish in 15 minutes at a cost of only 34¢ in materials. Your charge for this job is at least \$10.00.)

REPRESENTATIVES IN YOUR AREA URGENTLY NEEDED

Own your own business. Work at home in your spare time. Help fill the huge growing demand for this amazing new beautiful Velvet-fiber finish. Orders come from stores, offices, homes, architects, auto dealers, — everywhere. Possible \$20,000,000.00 worth of jobs to be done. Investigate today—be first in your area! Actual samples in 16 Radiant Colors. Booklet of 50 Home Business Opportunities and Confidential Details all sent free! Send No Money. Write: Coast Industries, Los Angeles 61, Calif., Dept. B-11.

Taft MAKES IT EASY TO ENJOY BOATING **NOW**

MASS PRODUCTION PRICES EASY TERMS

18 ft. Cruiser Only \$16.89 Per Mo.

NO WONDER WE SELL SO MANY!

FREE COLOR CATALOG

Taft, world's largest boat kit maker, now offers a full line, at mass production prices, from \$42.00, on easy terms. Write today for color catalog and full information.

TAFT MARINE WOODCRAFT
Dept. PM-1150 636 39th Avenue N.E. Minneapolis, Minn.

"\$7,108.50 First Year SERVICING RADIATORS!" **NEW!**

— Hank Konter, Newcastle, Wyo.

Make good money servicing auto-truck-tractor radiators with new Inland 1-Piece Radiator Shop. Easy to test, clean and repair radiators. Inland, world's largest radiator equipment mfr., trains you free. Small down payment starts you. Proved merchandising assures volume. Profitable dept. for garage or service station. Write

INLAND MFG. CO., PM-11, 1108 Jackson St., Omaha 2, Nebr.



Learn ACCOUNTING Business Administration

Bookkeeping, secretarial and allied subjects at home in your spare time or attend nationally approved resident school. Write for FREE Success Book giving complete details on courses, plans, rates and employment opportunities. G.I. approved. Write Dept. A

Hills BUSINESS UNIVERSITY AND EXTENSION SCHOOL
819 W. MAIN ST. OKLAHOMA CITY 2, OKLAHOMA



REAL ESTATE BE A BROKER

PAYS BIG! SEND FOR FREE, BIG, ILLUSTRATED CATALOG NOW! Graduates report making substantial incomes. Start and run your own business quickly. Men, women of all ages, learn easily. Course covers Sales, Property Management, Appraising, Loans, Mortgages, and related subjects. **STUDY AT HOME** or in classrooms in leading cities. Diploma awarded. Write TODAY for free book! No obligation. Approved for World War II and Korean Veterans

WEAVER SCHOOL OF REAL ESTATE (Est. 1936)
2020R Grand Avenue Kansas City, Mo.

FREE BOOK TELLS NOW

MEN PAST 40

Afflicted With Bladder Trouble, Pains in Back, Hips, Legs, Nervousness, Tiredness.

If you have these troubles, particularly bladder trouble, then your condition may be traced to Glandular Inflammation . . . a constitutional disease. Neglect of this condition often leads to premature old age and sometimes incurable malignancy.

The Excelsior Medical Clinic has a New Free Book that tells how thousands of men have been successfully treated here at Excelsior Springs for Glandular Inflammation by **NON-SURGICAL Methods**. They found soothing relief and a new outlook in the future of life.

This Free Book may prove of utmost importance in your life. Write Today. There is no obligation.

Excelsior Medical Clinic, Dept. B6129, Excelsior Spgs., Mo.

These men are getting practical training in ...

ELECTRICITY

ELECTRONICS

ON REAL

Motors • Generators
Switchboards • Controls
Modern Appliances
Automatic Electronic Control Units

TELEVISION

Radio Electronics

ON REAL

TV Receivers
Black & White and Color
AM-FM and Auto Radios
Transistors • Printed Circuits • Test Equipment

Train in NEW Shop-Labs of

COYNE

In Chicago—Electrical and Electronic Center of the World. Prepare for a better job and a successful future in a TOP OPPORTUNITY FIELD. Train on real full size equipment at COYNE where thousands of successful men have trained for 60 years—largest, oldest, best equipped school of its kind. Professional and experienced instructors show you how, then do practical jobs yourself on more than a quarter of a million dollars worth of equipment. No previous experience or advanced education needed. Employment Service to Graduates.

Start Now — Pay Later — Liberal Finance and Payment Plans. Pay most of tuition after graduation. Part-time employment help for students. Choose from nine yearly Starting Dates.

Mail Coupon or Write to Address Below for Free Book — "Guide to Careers." Whether you prefer ELECTRICITY, TELEVISION-RADIO or COMBINED ELECTRONICS TRAINING, which includes both fields, this book describes all training offered.

Information comes by mail. No obligation and NO SALESMAN WILL CALL.

B. W. Cooke, Jr., Pres. Founded 1899

COYNE ELECTRICAL SCHOOL

Chartered as an Educational Institution Not for Profit
1501 W. Congress Pkwy., Chicago 7, Ill., Dept. 89-3C

MAIL COUPON OR WRITE TO ADDRESS BELOW!

COYNE ELECTRICAL SCHOOL
New Coyne Building, Dept. 89-3C
1501 W. Congress Pkwy., Chicago 7, Ill.

Send BIG FREE book and details of all the training you offer. However, I am especially interested in:

Electricity Television Both Fields

Name _____

Address _____

City _____ State _____

(I understand no Salesman will call)



ENGINEERING



Photo of Heald Students
in Electrical Laboratory

Enroll Now for New Term
Heald College Ranks **FIRST**
West of the Mississippi
in "Who's Who in America"

Send for **FREE** Information

Heald Engineering College

Est. 1865

Van Ness at Post, Dept. P.M.
San Francisco, California

NAME _____
STREET _____
CITY _____
STATE _____

**American Industry
Steps Up Its Demand
for Trained Engineers.
Train Now at Heald's**

**BACHELOR OF
SCIENCE DEGREE,
30 MONTHS**

SAVE 2 YEARS' TIME

Degree Courses:

- Electronic Engineering
- Electrical Engineering
- Highway Engineering
- Mechanical Engineering
- Structural Engineering
- Civil Engineering
- Architecture

Diploma Courses:

- TELEVISION Color TV
- Electronic Technician
- Industrial Electronic Tech.
- Tool & Die Design
- Architectural Drafting
- Mechanical Drafting
- Structural Drafting

Approved for Veterans

WINDOW WATCH!

**NO HANDS, NO DIALS
—AUTOMATIC!**

A quick glance gives you the exact time without the confusion of calibrated dials. This Window Watch makes an ideal gift for those who expect the unusual. Precision Swiss workmanship in a rugged, shock-resistant case. Jeweled movement guaranteed for one year. With leather strap.

\$9.95 Prepaid
or sent C.O.D.

CRYDER SALES CORP., Dept. WW-12, Box 79
WHITESTONE 57, N.Y.

Hotels Call for Trained Men

Record-breaking travel means nation-wide opportunities and a sound substantial future for trained men in hotels, motels, clubs, apartment house positions. Fascinating field; fine living; quick advancement. You can qualify at home or through resident classes in Washington. Previous experience proved unnecessary. Placement Service **FREE**. Write for **FREE** Book, "Your Golden Opportunity." Accredited by N.H.S.C. Course Approved for ALL Veteran Training. 44th Year **LEWIS HOTEL TRAINING SCHOOL**, Room E5-312, Wash. 7, D.C.



**ADD UP TO 25 POUNDS
of SOLID MUSCLES** if you pay NOTHING

\$10 BODY MOLD course included **FREE** with **DAN LURIE BARBELLS**. Only **DAN LURIE BARBELLS** and "Body Mold" courses produce such amazing results. 15 minutes a day can make you a bigger man. Send today for details. Order now at lowest factory price.
50 lb. set \$8.98 • 100 lb. set \$14.98
150 lb. set \$21.98 • 200 lb. set \$27.98
Some steel sets approx. 10% higher. Extra wts. 14c per lb. Send 50% cash, balance C.O.D. F.O.B. Plant
DAN LURIE BARBELL CO., 52-M11 Bristol St., Dept. 959L, Bklyn. 12, N.Y.



*U.S. Pat. Applied For

EARN BIG MONEY...

LEARN AT HOME IN SPARE TIME

You don't need previous training or art ability with the "Famous System of Manual Training!" With this modern streamlined method, you learn rapidly and easily...start to cartoon immediately, without tedious study or exercises.

Wide Demand for Cartoonists—Earn While You Learn...Magazines, newspapers, movies, television, ad agencies—all are searching for new cartoon ideas and talent. As a successful, Continental-trained Cartoonist, your earnings are not limited.

Many of our students start earning after first few lessons. A wonderful pastime, too.

We Supply Everything... As our student, you receive **FREE** of extra cost a big 15-piece Professional Kit containing all equipment and materials you need, and valuable Articulated Model that helps you draw any human pose.

Get All the Facts FREE... Big, colorful Free catalog gives all details plus pages of useful information. **FREE** for the asking. Use coupon.

Continental Schools, Inc.

4201 S. BROADWAY, LOS ANGELES 37, CALIF.

Continental Schools, Inc.
Dept. A-11, 4201 S. Broadway, Los Angeles 37, Calif.
Please rush me your Free Catalog and other information by return mail. No charge or obligation, no salesman will call.

NAME _____
ADDRESS _____
CITY _____ ZONE _____ STATE _____



Who speaks for

GARY COOPER

and

AUDREY HEPBURN

on the

German movie screens?

**A fascinating article in
the December issue
tells how Hollywood's
voices are translated for
European movie-goers**

Here's the "STRAIGHT DOPE" on

HOW TO FIX ANY PART OF ANY CAR

from the Men Who Build 'Em!

Engineers from every American car factory put their know-how at your fingertips in this giant, 1,120-page, picture book! **COVERS ALL THESE MAKES, OVER 1,967 MODELS—1952 thru 1959!**



BRAND-NEW EDITION!

MOTOR'S
AUTO
REPAIR
MANUAL

TRY BOOK
FREE
FOR A WHOLE WEEK!

Now — the "meat" of 176 shop manuals makes practically any car repair or service job child's play for beginner or expert mechanic!

Now you can "breeze thru" the toughest car repair jobs — in **DOUBLE-QUICK** time. If you're a beginner mechanic you can tackle jobs you never dreamed you could handle. And if you're already an expert, you'll save yourself hours of back-breaking work... and save money, to boot!

It's easy with the big brand-new Edition of famous **MOTOR'S Manual**. You get the expert help of 176 Official Factory Shop Manuals — the time and work-saving methods developed by factory engineers in every auto plant in America for their own motor car lines—boiled down in one handy indexed book.

Factory Experts Practically Guide Your Hands

NO guesswork! NO false starts! **MOTOR'S Manual** starts you from

"scratch" — expert "know-how" guides your hands through every step of practically every job. With clear illustrations and 1-2-3 instructions, these experts show you how to "polish off" any repair on any car listed—1952 thru 1959!

NEW, REVISED Edition gives you everything you need to know to repair 1,967 models. Over 1100 giant-size pages, 2850 "this-is-how" pictures and diagrams, 195 "Quick-Check" Charts, 30,000 essential repair specifications, 225,000 Service and Repair **FACTS**. Instructions and pictures so clear you **CAN'T** go wrong!

Here's everything you need to know to make fast, expert repairs on Automatic Transmissions, Air Suspensions, Ignitions, Carburetors, Steering Gears, Generators, Distributors, Power Steering and Brakes, Starter Motors, Starter Switches, and much, much more. No wonder **THREE MILLION** copies have been sold. No wonder it's used by the **U.S. Armed Forces**.

Try it FREE 7 Days

SEND NO MONEY! Just mail coupon. (Paste it to a postcard for fast action.) Use the Manual for a week, **free**. If you don't agree that it is the greatest time-saver and work-saver you've ever seen—return book in 7 days, pay nothing. Mail coupon today! **MOTOR Book Dept., Desk 91X, 250 West 55th St., New York 19, N. Y.** (Schools, Bookstores: Write for discounts.)



No guesswork. Clear pictures show how to fix starting motors, generators, brakes, power steering, etc.

All Automatic Transmissions are fully covered in special big section. (NOTE: All pictures shown here greatly reduced in size. Actually this giant book is almost a foot high!)

Diagrams, tables and text take the "mystery" out of all ignition systems.

MAIL COUPON NOW FOR 7-DAY FREE TRIAL
(Attach to postcard if more convenient)

MOTOR BOOK DEPT.
Desk 91X, 250 W. 55th St., New York 19, N. Y.

Rush to me at once (check box opposite book you want):

MOTOR'S New AUTO REPAIR MANUAL. If O.K., I will remit \$2 in 7 days, \$2 monthly for 3 months and a final payment of \$1.95 (plus 45¢ delivery charges) one month after that. Otherwise I will return the book postpaid in 7 days. (Foreign price, remit \$10 cash with order.)

MOTOR'S New TRUCK REPAIR MANUAL. If O.K., I will remit \$3 in 7 days and \$2 monthly for 3 months, plus 45¢ delivery charges, with final payment. Otherwise I will return book postpaid in 7 days. (Foreign price, remit \$11 cash with order.)

Print Name.....Age.....

Address.....

City..... Zone..... State.....

Check box and save 45¢ shipping charge by enclosing WITH coupon in envelope entire payment of \$1.95 for Auto Repair Manual or \$9 for Truck Repair Manual. Same 7-day return refund privilege applies.

"This wonderful book has paid for itself time and time again."
—P. Pempfer, Wis.

"Have been a mechanic for 25 years. MOTOR'S Manual still takes me out of the tight spots."
—V. Lauria, Nev.

"So complete, easy to understand—have done jobs with Manual I would not have attempted without it."
—C. L. Vanerstrom, Mich.

Some FREE 7-Day Trial on TRUCK REPAIR MANUAL
Covers every job on every popular make truck made since 1952 including GM, Mack, Cummins Diesels, Engines, fuel systems, ignition systems, starters, generators, transmissions, axles, brakes, steering, etc., etc. For **FREE TRIAL**, check box in coupon.



**TWICE
AS
WARM**

as any other
insulation
known to
science



**Down
SHIRT**

**ORDER
BY MAIL**

Wear as lightweight jacket in any weather or as under-shirt in severe weather. 100% premium quality Northern goose Down insulation gives comfort in temperatures from mild to sub-zero and does not cause perspiration as other insulations do. Action-styled tailoring for complete freedom. Silver Sand Rip-Stop nylon with harmonizing knit collar and cuffs.

Sizes S-M-L-XL\$18.95
Matching underpants also available.....\$18.95
Add 25c for shipping.

**FREE 48-PAGE
CATALOG**

BEFORE YOU BUY any outdoor clothing, insulated underwear or sleeping bags, GET THE FACTS about insulations. SEND FOR YOUR COPY TODAY.

Eddie BAUER

**ORDER WITHOUT
RISK — COMPARE!**
You'll agree ours is far better quality and value, or return for full refund, including shipping costs both ways.

Seattle 4,
Washington Dept.
36

CONVERT THAT MILITARY RIFLE

NEW BOOK

Shows You How



'03 Springfield—Before
After
Step by Step Instructions

**Shows How
To Convert:**

- Springfield
- Enfield
- Mausser
- A. Krag
- N. Krag
- 6.5 Jap
- 7.7 Jap
- 6.5 Carcano
- 7.35 Carcano
- 7.62 Russian
- S.M.L.E.
- Others

The complete "How To" booklet for amateur or expert. Makes custom "sporterizing" of military rifles easy. Tells what the average shooter will require, what accessories are available and how to install them. More than 150 illustrations take you from disassembling through the final finishing. Gives sight combinations, height chart, ammunition to use, etc. Only 50c per copy. If your dealer can't supply, order direct OR send \$1.00 and we will send above booklet plus complete 144 page Shooter's Catalog.

WILLIAMS GUN SIGHT CO.
"On the Range"
7211 Lapeer Road Davison 23, Michigan

GET INTO ELECTRONICS

V.T.I. training leads to success as technicians, field engineers, specialists in communications, guided missiles, computers, radar, automation. Basic & advanced courses in theory & laboratory. Assoc. degree in 20 mos. B.S. obtainable, ECPD accredited, G.I. approved. Graduates with major companies. Start Feb., Sept. Dorms, campus. H. S. graduate or equivalent. Catalog.

VALPARAISO TECHNICAL INSTITUTE
DEPT. D VALPARAISO, INDIANA

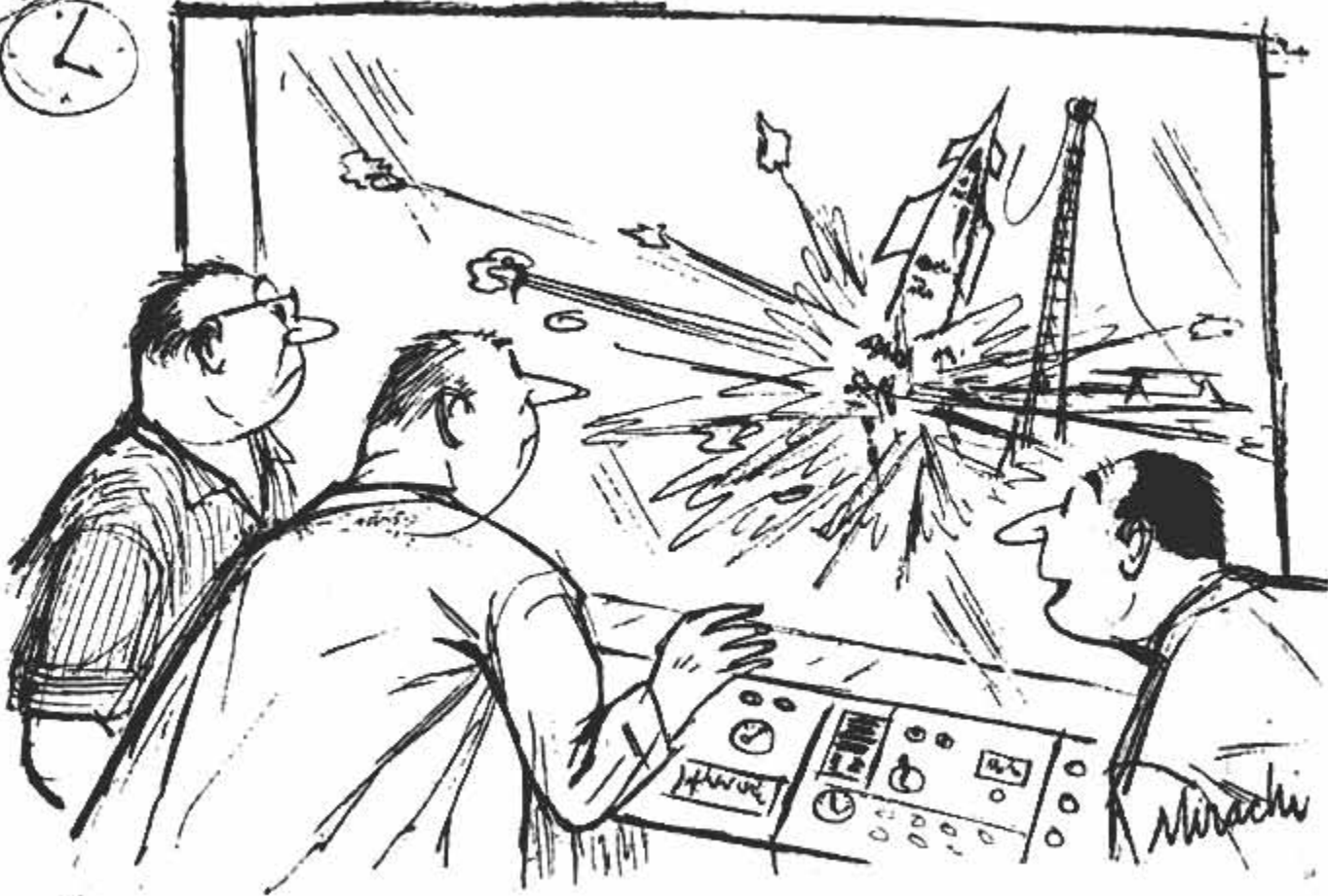

"Well, that's the way the cookie crumbles!"

NEVER AT THIS LOW PRICE!
GENUINE 150-POWER
ACHROMATIC TELESCOPE

with Achromatic Lens and
 4-POWER FINDER attached

ONLY
\$18.95
 PREPAID

EXTRA BONUS GIFTS:

- 273 page book, "Handbook of the Heavens"
- Magic Star Finder Dial
- 220X & 400X Eyepiece lenses

5 Magnifications 18X-35X-65X-85X-150X
 Brings the Moon, Planets, Stars, Satellites, People
 150 times Closer, Clearer, Sharper

Never before has an ACHROMATIC 150X telescope with range finder and tripod sold for anywhere near this amazing low price! Now you can not only explore the heavens and bring the moon, planets, stars, satellites 150 times closer, but you can observe all distant objects, people, ships too, because all pictures are erect, not upside down as in all astronomical telescopes. The kind of needle-sharp color-free viewing only a genuine achromatic lens can bring you. Ready for immediate use, 5 precision lenses bring you viewing at 18X-35X-65X-85X-150X. Tubes extend to 43" made of bakelite, finished in camera bellows black, trimmed with gleaming brass. 4 power finder scope (30mm Lens) mounted on main tube is feature usually found on more expensive telescopes—brings difficult objects on target before observing with main scope. For extra stability 5 ft. hardwood folding tripod is equipped with heavy cast iron head fitted with Criterion's famous 360 degree all aluminum mount that locks instantly in any position. Obtainable only from Criterion Co. shipped prepaid. 4 famous gifts—273 page book "Handbook of the Heavens," Magic star finder dial that aids in locating stars ANYWHERE at ANYTIME of the year. 220X & 400X eyepiece lenses included free for experiments. You must be completely satisfied with this super offer or your money back in full. Shipped Complete, nothing else to buy at amazingly low price of \$18.95. Without tripod \$14.95. Send Cash, Check, or Money Order today
 Dept. PMA-30, CRITERION CO., 331 Church St., Hartford, Conn.

94.6% OF BAILEY GRADUATES ARE EMPLOYED AT TOP PAY IN THE FIELDS WHICH THEY WERE TRAINED!

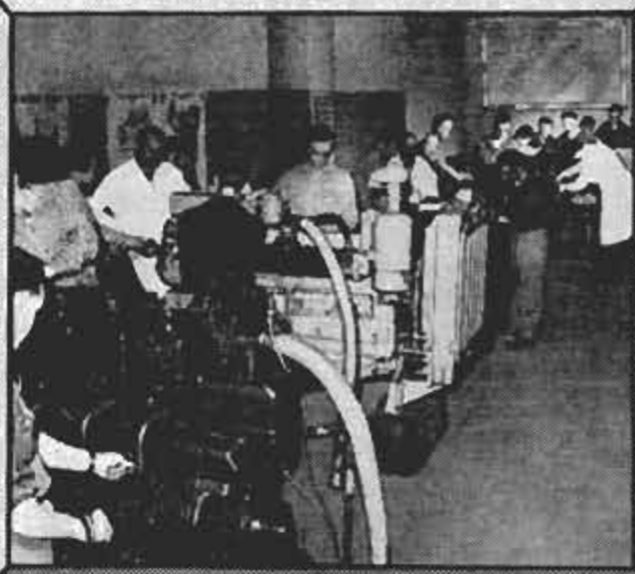

DIESEL-AUTO MECHANICS DESPERATELY NEEDED!

We have a far greater demand for our students than we can fill! We can show you an actual waiting list of leading companies throughout the world who have tried Bailey graduates — found them outstanding, and are coming back for more!

Bailey Graduates are Successful . . . RECEIVE BIG PAY — HAVE SECURE FUTURE!

The Famous Bailey Course prepares you for BOTH Diesel and Gasoline Mechanics.

This is a must—due to the advent of using Diesel principles, such as 'Fuel Injection' on passenger cars . . . use of gasoline engines for starting Diesel engines, etc. You learn all this at Bailey in the amount of time ordinarily required to learn just one of these subjects, **ALL FOR THE PRICE OF ONE.**

Don't be satisfied with a 'futureless', one-type job — learn how you can make big money now! Write today for Free Booklet that takes you on a step-by-step camera tour through our spacious, modern shops — See Bailey students in action as they Learn-by-doing with the Famous Bailey Method of training!

We provide you with housing and part time jobs while in school, plus nation-wide placement service for graduates.

BAILEY Technical SCHOOLS

1634 S. GRAND ST. LOUIS 4, MO.

MAIL TODAY!

Please mail immediately this free booklet without obligation.

FREE BOOKLET



Name _____
 Address _____
 City _____ State _____
APPROVED FOR VETERAN . . . NON-VETERAN

BUILD FINE GRANDFATHER CLOCK NOW

The simple sensible SPEEDE Red-I-Kut way as thousands have — FOR YOURSELF OR SELL AT A GOOD PROFIT. SAVE HUNDREDS OF DOLLARS. SHOP TEST-ED PLANS "SPIRIT OF THE CENTURY" Narrow waist 23" tall or stately straight side "SPIRIT OF AMERICA." EASY-TO-FOLLOW photopack PLANS & LIFE SIZE PAY-TERMS tell all—plus MOVEMENT BROCHURE \$40 up. of heavy brass weight (Kuempel original) Westminster tube BELL chime, movements, gorgeous bronze-silver MOVING MOON dials, 3/4" solid-mahogany Jiffy Joint-Kwik-Bit case kits. Send \$1.00 today — Both plans RUSH \$1.50 as folks have for over forty years.

Kuempel Chime Clock Works, 22 Kuempel Bldg., Minneapolis 16, Minn.

GOVERNMENT OIL LEASES LOW AS \$1 PER ACRE

You do no drilling, pay no taxes, may realize a king-size profit without ever leaving home. Write for free map and literature.

AMERICAN OIL SCOUTS, Dept. PM
 8350 Santa Monica Blvd. Los Angeles 46, Calif.

26 YEARS IN BUSINESS AT THE SAME ADDRESS.

Beat the high cost of new tires.
EXTRA MILEAGE TOP GRADE Tires,
 (Written Insurance Guarantee). SEND AD

WHY PAY MORE? UP TO 15,000 MI.

Our entire stock of very slightly used

600-16	\$5.22	670-15	\$5.22	700-15(8)	\$8.92	750-20(8)	\$12.22
600-16(8)	7.92	710-15	3.22	750-16(8)	10.72	825-20	18.92
650-16(8)	8.72	750-15	5.42	700-17	10.22	900-20	19.92
750-14	7.52	800-15	6.42	750-17	12.22	1000-20	19.92
800-14	7.52	820-15	6.72	650-20	10.02	1100-20	19.92
750-16(8)	9.82	700-16(8)	9.92	700-20	11.02	1000-22	20.92

Free—Tube With Each Passenger Tire Order

"EXTRA SPECIAL" TOP QUALITY all size 4-ply pass. **\$8.72**
 FREE TIRE with 2 or more of these.—W.W. \$1.00 Extra.
 Factory Tube given—GIANT TIRE SALE. EA.

SNOW TIRES \$7.82 AND \$5.82 ANY SIZE

WHITE WALLS \$2.00 EXTRA
 SUBURBANITE OR TOWN & COUNTRY TREAD
 Thousands of tires shipped all over the U.S.A. All tires shipped F.O.B. Phila. Send Check or M.O. with this ad. Dept. 2. No C.O.D.
STANDARD 834 N. Broad St., Philadelphia 30, Pa.

EXAMINE FREE! **AUDEL'S**
 MODERN **DO-IT-YOURSELF ENCYCLOPEDIA**

JUST OFF THE PRESS!
 NOW, AT LAST—AN AUTHENTIC GUIDE
 TO HOME IMPROVEMENT AND REPAIR!

FAMOUS AUDEL, the world's greatest publisher of mechanical books since 1879, has now utilized all its knowledge... all its great fund of inside trade information... to produce the greatest, most complete, easiest-to-use DO-IT-YOURSELF ENCYCLOPEDIA ever offered for American family use.

SAVE HUNDREDS OF DOLLARS EVERY YEAR!

With this remarkable, easy-to-use, set you can save a small fortune every year for home improvements and repairs.

- Over 1,800 Pages
- Set Weights 4 Pounds
- Each Volume 6 x 9 x 2
- Step-By-Step Plans
- Thousands of Photos
- Helpful Charts



RICELY BOUND DELUXE EDITIONS BOTH FOR ONLY \$895
 (in easy payment plan)

EVERYTHING YOU NEED TO KNOW

INSIDE THE HOUSE... OUTSIDE THE HOUSE... AROUND THE HOUSE

Air conditioning	Doors	Kitchen layouts	Mortar	Room dividers
Asphalt tiles	Electric wiring	Lawn grass guide	Painting	Screens
Attics	Fireplaces	Lawn mower	Picked pine finish	Spray painting
Basements	Flagstone tiles	Lighting fixtures	Pipes	Stain finishes
Book rack	Floor repairs	Locks	Plumbing	Stairs
Built-ins	Furniture finishing	Lumber	Firewood	Upholstering
Ceilings	Glazing windows	Marble tile	Polishing	Varnish finish
Concrete	High Fidelity	Masonry	Pools	Wallpapering
Cornice, window	Insulation	Miter joint	Radiator covers	Wood floors
				Work bench

THOUSANDS OF OTHER IMPORTANT SUBJECTS

MAIL THIS COUPON TODAY!

THE AUDEL CO. — Self Improvement Publishers Since 1879 P11A
 49 W. 23rd Street, New York 10, N.Y.

Please mail me for 7 days FREE EXAMINATION my set of AUDEL'S DO-IT-YOURSELF ENCYCLOPEDIA. If I decide to keep the set I will send you \$3 in 7 days and then \$1 a month until I have paid the full purchase price of \$8.95 plus shipping costs. Otherwise I will return the set to you and owe nothing.

NAME _____

ADDRESS _____

OCCUPATION _____

EMPLOYED BY _____

SAVE SHIPPING COSTS! Check here if you enclose complete payment with order. We pay postage charges. You have some return privilege.



For extra income
 or career... learn

WATCH REPAIRING

at home the low cost Sweazy Way

No previous experience needed to learn profitable watch repairing. Unique Sweazy System teaches you step-by-step methods for repairing American and Swiss watches. Special tools provided. Diploma awarded. Tuition \$5 monthly. Free sample lesson. No obligation.

CHICAGO SCHOOL OF WATCHMAKING
 2330 N. Milwaukee Ave. Dept. 1119 Chicago 47, Ill.

FREE
MUSCLE BUILDING INFORMATION
 Sensational New Methods
 Less Time—Less Effort—Better results
BODY-TONE, Box 638, North Miami 61, Fla.

Shop PM Ads for Exciting
 Direct-Mail Offers

YOU NEED THIS

FREE GIANT 1960 B-A CATALOG

A Complete Buying Guide for Everything in

RADIO 1960 TV ELECTRONICS

BA
 ANNUAL CATALOG 601
 SINCE 1897

204 KING-SIZED PAGES

EVERYTHING IN RADIO TV AND ELECTRONICS

100'S OF NEW ITEMS LISTED HERE FOR 1st TIME

21 PAGES OF BARGAINS NOT IN ANY OTHER CATALOG

BURSTEIN-APPLEBEE CO.

Dept. PM, 1012 McGee St., Kansas City 6, Mo.

Send Free 1960 B-A Catalog No. 601.

Name _____

Address _____

City _____ State _____

SEND FOR IT TODAY



Toy Clock Can Be Taken Apart

Latest in the educational toy line is a toy clock that can be taken apart and put back together again. The spring-driven time-piece, when correctly assembled, will keep time for 14 hours without rewinding. Gears of the clock are color-keyed, and there are complete instructions for assembly.



**NEW
.22
6-SHOT
REVOLVER
\$12.95**

Fires both .22 short & long ammo. This sensational NEW 6-shot Rosco Vest Pocket .22 revolver is a tremendous value at 3 times its price. Made in W. Germany, it is a tight, well-made, exceedingly accurate handgun. Fires easy-to-get Win., Rem., Western & Peters .22 Long & Short ammo. Features slide gate loading, trigger adjustment, screw-in ejector rod. Has STEEL RIFLED BARREL with blade front sights. Easy and fun to shoot. Terrific for target shooting, varmint hunting or as a home defense weapon. Only \$12.95. Leather holster \$2.25. 100 rds. of .22 short ball ammo only \$1. Shipped F.O.B., Los Angeles express charges collect. Send cash, check or M.O. C.O.D. requires \$1.50 deposit. Satisfaction guaranteed. Purchasers must be 18 years old. Res. of L. A. & vicinity, please purchase at our store.

SEAPORT TRADERS, INC., Dept. PM-11
1221 S. Grand Ave. Los Angeles 15, Calif.

SIGN PAINTING

Home-Study Course - Only \$5.95

Teaches you commercial sign painting and sign building as it is being done TODAY in leading shops all over the country. Complete practical course for self-instruction. Shows latest methods of truck lettering, office doors, wood letters, reflecting signs, plastic, sprayed signs, gold leaf, silk screen process, up-to-date alphabets, money-making business information, etc.

SATISFACTION GUARANTEED OR REFUND!
Contains all the instruction of a high-priced correspondence course. Full price, only \$5.95, postpaid. Or C.O.D. plus postage. No risk-order today. Satisfaction or money back! Order "Sign Painting Course," NELSON-HALL CO., 210 S. Clinton St., Dept. 2 LR-2, Chicago 6, Ill.



Start Your Own

HOME-IMPORT BUSINESS

FREE BOOK SHOWS YOU HOW

Cash in on big U. S. import craze. Famous World Trader guides men, women to big profits on small imports. Get exciting imports at trifling cost abroad for full or spare time home business. No previous experience or product investment. Book, full details free. Write now, Mellinger Co., Dept. X25B, 1717 Westwood, Los Angeles 25, California

GET THE HABIT OF READING OUR CLASSIFIED ADS.

Wonderful Opportunities Amazing Bargains

'How to Make Money with Simple Cartoons'

A book everyone who likes to draw should have. It is free; no obligation. Simply address **FREE BOOK**

CARTOONISTS' EXCHANGE
Dept. 911-D Pleasant Hill, Ohio

Make \$5 an Hour CASH PROFIT



THE DAY YOU START!
Start your own business at Home...
Sharpen Household, Garden and Shop Tools in Spare Time.

Turn spare time into Big Cash Profits with new Belsaw Sharp-All. No experience needed to sharpen knives, scissors, shears, ice skates, mower blades, hedge trimmers, axes, chisels and circular saws... Learn how easily you can start your own spare time business. Amazing low cost easy-payment plan. Send Postcard for **FREE BOOK**. BELSAW SHARP-ALL CO 710 Field Bldg., Kansas City 11, Mo.

TRAIN AT HOME

in Your Spare Time or in the Great Allied School

1338-42 South Michigan Ave.
Chicago 5, Ill.

DRAFTING—All Branches
• Mech. • Structural • Aeronautical

ENGINEERING
• Industrial Engineering
• Tool Engin. & Designing

ELECTRONICS

AUTO MECHANICS

AIR CONDITIONING
Refrigeration — Heating & Cooling

TOOL & DIE MAKING
Machinist Trade

Choose the Allied Way for Best Pay

SEND FOR **FREE BOOKS**

Prepare for the best jobs in your spare time at home. With ALLIED'S practical home study program you can progress so rapidly that big new opportunities will soon be open to you. Students planning a career in engineering can begin their training in short courses at Home or at Allied Institute and continue progressively toward an Engineering Degree in 31 months. Allied is approved by Industry, National Home Study Council, Department of Education, Office of Public Instruction, State of Illinois, U. S. Department of Justice.

ALLIED INSTITUTE OF TECHNOLOGY,
1338-42 South Michigan Ave., Dept. PM-119, Chicago 5, Ill.

Send me without obligation information on your courses:

- | | |
|---|---|
| <input type="checkbox"/> MECHANICAL DRAFTING | <input type="checkbox"/> AUTO MECHANICS |
| <input type="checkbox"/> STRUCTURAL DRAFTING | <input type="checkbox"/> ELECTRONICS |
| <input type="checkbox"/> ELECTRONIC DRAFTING | <input type="checkbox"/> AIR CONDITIONING |
| <input type="checkbox"/> AERONAUTICAL DRAFTING | <input type="checkbox"/> REFRIGERATION |
| <input type="checkbox"/> INDUSTRIAL ENGINEERING | <input type="checkbox"/> TOOL & DIE MAKING |
| <input type="checkbox"/> TOOL & DIE DESIGNING | |
| <input type="checkbox"/> HOME STUDY | <input type="checkbox"/> RESIDENT <input type="checkbox"/> VETERAN <input type="checkbox"/> NON-VETERAN |

NAME AGE.....

ADDRESS

CITY..... COUNTY..... STATE.....

FREE! LAFAYETTE'S 1960 CATALOG



304 GIANT-SIZED PAGES

CONTAINS

HUNDREDS OF EXCLUSIVE LAFAYETTE ITEMS NOT IN ANY OTHER CATALOG OR AVAILABLE FROM ANY OTHER SOURCE - SEND FOR YOUR COPY NOW!

See the newest and finest in Stereo Tuners, Amplifiers, Cartridges and Music Systems

• TAPE RECORDERS • PUBLIC ADDRESS SYSTEMS • AMATEUR EQUIPMENT • INDUSTRIAL SUPPLIES • RADIO & TV TUBES AND PARTS • INSTRUMENTS • TELESCOPES, BINOCULARS, MICROSCOPES & CAMERAS

Everything In Electronics

The Complete Catalog Featuring The Best Values Obtainable

LEADERS IN HI-FI

OUR

39th

YEAR

The most complete electronic supply catalog crammed full of everything electronic at our customary down-to-earth money-saving prices.

The largest selection of hi-fi components and systems; greatest savings on Lafayette endorsed "best-buy" complete systems.

EASY PAY TERMS AVAILABLE - 10% DOWN - UP TO 18 MONTHS TO PAY

Lafayette Radio P.O. BOX 222
JAMAICA 31, N. Y.
DEPT. LK-9

Send FREE LAFAYETTE Catalog 600

Name.....

Address.....

City..... Zone..... State.....

CUT OUT
AND PASTE
ON POST
CARD

Build this exciting, true-to-life NEANDERTHAL MAN

2 Figures-2 Complete Kits!



He lived thousands of years ago, but you can bring him to life now! Authentic ITC kit makes two separate models—life-form and anthropologically correct skeleton, created from museum specimens. Each sturdy plastic figure is a full 9½" tall. Be the first in your neighborhood to own this fascinating scientific wonder—buy Neanderthal Man at your favorite hobby or toy counter.

ITC MODEL CRAFT, 200 Fifth Ave., N. Y. 10, N. Y.

2-in-1 PLASTIC
ASSEMBLY KIT

ONLY
\$2.00



8 FT. SPECIALS - 80c



These GIANT 8 FOOTERS can be yours, while they last, at a fraction of their value. New, genuine neoprene govt. surplus. Great for advertising, you paint your message on 'em, inflate & fly. Attracts crowds to sales, displays, openings, stores, gas stations. Fun at home for young & old and just the thing for any party or school prom. Perfect for beach or picnic. They're BIG, they're FUN, they're useful, so order yours today!

Special, while they last—20"—\$1.95 ea.

8' dia.-80c ea.... 2 for \$1.50

13' dia.-\$1.95 ea.

Postage pd. on pd. orders.

Cal. res. add sales tax.

FRANK SALES, Dept. PM1159, 3930 Sunset Blvd., Los Angeles 29, Calif.



100
POUND
SET
\$12.80

Extra
Plates Only
12c Pound

BARBELLS

140-Pound, CHROME DELUXE Barbell-Dumbbell set only \$19.80. This is our feature set and is the finest ever manufactured.

Training with adjustable weight is the BEST way to keep fit; the ONLY way to develop great strength and a perfect body. As the oldest and best equipped barbell company, BUR gives value and prices no one can equal.

SEND FOR FREE CATALOG
BUR BARBELL CO.
Lyndhurst 9, New Jersey

Learn to **MOUNT BIRDS**

Tan SKINS, Make Up FURS

Be a Taxidermist. We teach you at Home. Mount Birds, Animals, Pets, Game Heads, Fish. Save your hunting trophies; decorate home and den. MAKE MONEY, Mount and Krometan for others. Big spare-time profits.

FREE BOOK 100 game pictures 48 pages - Hunters. Get this wonderful book. It's NOW Free. Send postcard TODAY. State AGE. NORTHWEST TAXIDERMIST SCHOOL Dept. 2511 Omaha, Nebraska

Computer Gives One Man Total Control of Sub

No bigger than a breadbox, an electronic computer under development by the Navy will give one man total control over the complex functions of a nuclear-powered submarine. Known as SUBIC (Submarine Integrated Control), the system provides the controller, or commanding officer, with visual displays of all the information he needs to run the ship. The small, 40-pound SUBIC computer, capable of making 15,000 computations a second, will convert raw data into simple television pictures. In weapons control, for example, SUBIC provides a picture display that continuously indicates the identity, position and movement of each target, as well as the submarine's own position and movement. SUBIC is adaptable to small "killer" subs and large ballistic-missile subs, both of which have one-man airplane-type manual controls. The new system may permit reduction of atom-submarine crews from the present average of 100 to only 12.

For sportsmen
6 to 60!



Broad line of models

KITS less motors, from **\$39⁹⁵**

Complete kits with motors from \$109.95

Send 50¢ for 22-page catalog.

ARNOLD-DAIN CORP.

Box 78, Mahopac, N. Y.

Dealer Territories Available

TELEPHONE HANDSETS



Use as inter-house phone, talk house to garage, as loud speaker system, etc. You receive transmitter, receiver, 3 conductor cord and simplified, illustrated installation diagrams. Handsets are guaranteed to be the same as used in our great National Telephone System. Price delivered \$2.95. Two for \$5.00!

TELEPHONE REPAIR AND SUPPLY CO.

Dept. PM-122

1760 Lunt Ave., Chicago 26

Finish **HIGH SCHOOL** **AT HOME**

Complete 4 Yrs.  in 12 Months

Learn More! Earn More! Enter professional or technical schools. Advance Socially. Live a Happier, Fuller Life. Individual Courses or complete schedule. **WRITE FOR SCHOOL BULLETIN.**

ACADEMY FOR ADULTS

30 W. Washington, Dept. PM-119, Chicago, Ill.

1000 TRICKS

Amaze, mystify, entertain with 1000 new magic tricks. Easier than you think! No skill needed. Make money in spare time. Rush name, address and 25¢ for Big 160 Page Catalog of Tricks, Magic Jokes, Mysteries, Illusions, etc. All illustrated. World's best 25¢ offer. Don't miss this!

FREE TRICK INCLUDED

House of 1000 Mysteries, 202 Pinewood (Dept. Z), Trumbull, Conn.

FLY YOUR OWN

Bensen

HELICOPTER

Simple to fly — build it yourself, with engine or as inexpensive glider type which can be mounted on floats or boat. Order 3-

view drawing, specs and photo of Glider for \$1 or motor powered Gyro-Copter \$2. Building plans and kits also available.



BENSEN AIRCRAFT CORP., Dept. PM-119
P.O. Box 2746, Raleigh, N. C.

Name
Address



BIG MONEY

in

ELECTRIC APPLIANCE REPAIRING. Start YOUR OWN BUSINESS!

OVER 100,000,000 PROSPECTS!

Every family in America has one or more appliances which need adjusting, servicing and repair. Add to this the millions of factories, institutions and farms which have 15, 25 or more pieces of electrical equipment which can and do go wrong and you have some idea of why service technicians are in such great demand it is usual for them to charge on the basis of \$5.00 to \$6.00 per hour!

LET US SET YOU UP IN BUSINESS

CHRISTY has helped thousands of men, in all parts of the world get started in their own Part time or Full time, big money-making business. Let us help you. We show you how to set up your shop. How to solicit and get business, what to charge, keep records, etc. Where to buy tools and repair parts at lowest wholesale prices.

Christy Training Is Complete Training

We show you how to quickly locate electrical troubles. The "CHRISTY ELECTRONIC KIT" (included as a part of your regular training and yours to use and keep) shows you exact locations of shorts, breaks, opens, etc. The illustrated lesson manuals show you how to speedily make needed repairs and how to build power tools from spare parts.

FREE!

CHRISTY FINANCES YOU

CHRISTY'S SHOP-METHOD, HOME TRAINING PROGRAM can be had on our liberal Pay As You Learn Plan.



CHRISTY TRADES SCHOOL Dept. A-8303
3214 W. Lawrence Ave., Chicago 25, Ill.

Send me your **FREE** book in Electrical Appliance Repairing and form for paying later from **EARNING WHILE LEARNING.**

Name Age

Address

City Zone State

ENGINEERING

HOME
STUDY
COURSES

Courses written by world authorities in all branches of engineering and science. Step-by-step instructions using methods proved successful by thousands of our graduates. One hour each day in your spare time will start you off to higher pay, security and prestige. Fill in the coupon to-day and indicate the course of interest. We will send you a complete outline of the course with a booklet describing the Institute and our advanced teaching methods.

CIVIL ENG.
SURVEYING
ARCHITECTURE
FORESTRY
STRUCTURAL
MECHANICAL ENG.
INDUSTRIAL ENG.
REFRIGERATION
DRAFTING
ELECTRICAL ENG.
RADIO
ELECTRONICS
TELEVISION
AERONAUTICAL ENG.
HIGH SCHOOL
CHEMICAL
MATHEMATICS
ACCOUNTING

MAIL THE COUPON TODAY

Canadian Institute of Science & Technology Ltd.,
732 Century Bldg., 412, 5th St. N.W., Wash., D.C.

NAME.....

ADDRESS.....

CITY.....STATE.....

COURSE OF INTEREST.....

Canadians: Send to C.I.S.T., 732 Garden Bldg.,
263 Adelaide St. W., Toronto, Ont.



C. I. S. T.

T-V LAMP CLOCK

with FOCALIZED "STARE-BREAK" relieves
Eyestrain from constant TV stare and glare



"TIME
AT A
GLANCE"

Model 710
WALNUT

\$11⁹⁵

3 YEAR GUARANTEE

This T-V Lamp Clock is wholly new in concept! Fully automatic self starting electric clock . . . calculating and registering every second, minute, 10 minute and hour. Big, bold, easy-to-read "Time at a Glance" Colorama numerals. Glolite luminescent face GLOWS IN THE DARK. Has a comforting night light for bedroom or nursery controlled by independent switch. Plastic case, 5³/₈"H, 6"W, 3¹/₂"D. UL approved motor and cord. 110V, 60 cy., AC. Plus applicable tax.

At Your Local Dealer or ORDER DIRECT from

PENNWOOD NUMECHRON CO.

7249 FRANKSTOWN AVE.

PITTSBURGH 8, PA.

BRITISH PILOT'S & OFFICER'S



WEBLEYS

.38 Cal.
(5" barrel)
Ammo: 30 rds.
38 S&W, \$3.50

.45 Cal.
(6" barrel)
Ammo: 30 rds.
45 ACP, \$3.75

CHOICE OF
CALIBER!
\$14.95 ea.

Superb revolvers manufactured by England's most famous pistol mfr., producer of fine pistols for 100 yrs. 6-shot revolvers: Fires double action, also has broad hammer spur for fast single action shooting. Ordnance tested, stamped with British Crown and Broad Arrow proof marks. Condition very good, mechanically perfect. Add \$3 for select grade (practically unfired cond.). Fires standard factory loaded U.S. made ammo. ORDER ON FREE TRIAL! 10-day money back guar. Send check, cash or M.O. \$5 deposit for COD. Shipped FOB Los Angeles. SPECIFY CALIBER CHOICE! In Calif. order through local dealer. Dealers inquire.

WEAPONS, INC. 11029 Washington Blvd., Culver City 161, Calif.

ELECTRIFY YOUR SEWING MACHINE! NEW LOW PRICE!



Buy direct and save! Kill clothes fully wired. Installed in a jiffy. Fits all machines. **\$10.95**

ALL-NEW PARTS! • AC-DC Motor & bracket • 90 Day Guarantee

Multi-speed foot control • Cord set & block • 110 v 60 c • Full instructions • Steel pulley & belt • BONUS: 10 day free trial. Reg. \$2.95 Sewette given FREE with kit. Kit sent C.O.D. Send money order, we pay postage. State whether wheel on your machine turns toward or away from you. Shipping wt. 5 lbs. Write for free color catalog. Senior Sewing Machine Co., Box 142, Dept. PM-25, Hickory 6, N.Y.

SUPER JU JITSU



Now get tough double quick! A course of instruction in the art of practicing and using this method of applying LIGHTNING-QUICK Super Ju Jitsu. So Dangerous! These amazing lessons show you how it's done . . . in a big illustrated home-study course. The weapons are just your BARE HANDS—they can be used effectively if you know how and practice the art. Easy to learn; quick. Full 76-lesson course only \$9.95 postpaid—or COD, plus postage. Satisfaction or your money back guaranteed! Order "super Ju Jitsu Course."

NELSON-HALL CO., 210 S. Clinton St., Dept. B LR-2, Chicago 8, Ill.

HIGH WAGES



Heavy Equipment Operators earn up to \$10,000.00 per year. Train NOW. Write for FREE details. No obligation.

NATIONAL SCHOOLS OF HEAVY EQUIPMENT OPERATION
Dept. D-1, P.O. Drawer 8415, Charlotte 8, N.C.

Dielectric Plates Thaw Frozen Fish

Bulk-frozen fish can be thawed uniformly in 15 to 20 minutes when passed between dielectric heating elements, according to scientists in Scotland. By using a dielectric machine, a ton of fish can be thawed in an hour. Older methods require as long as 12 to 24 hours to thaw large quantities of fish. Frozen blocks of fish pass between the plates on a moving conveyor belt without touching the plates, providing a uniform rate of thaw in contrast to old methods where the outside melts quickly while the middle takes many hours.

POPULAR MECHANICS

Make \$20 to \$30 a Day
with this new **ONE MAN**

MAIL ORDER BUSINESS

DO PLASTIC LAMINATING AT HOME!



Would you like to get orders and cash from your mailman—then in space of hours make and ship the things people ordered from you? If you have spare time and a little spare room in kitchen, garage, or basement, get the facts about the newest and most fascinating of all home operated businesses. For the first time a simplified machine brings the fabulous profit of **Plastic Sealing and Plastic Laminating** within the reach of the small operator. Any one can learn to operate the machine with a few minutes practice—then

with our **Magic Mail Plan** can get mail orders pouring in daily with cash in every envelope. No canvassing—no selling. We even supply the circulars you mail to bring back cash and orders. Don't waste a minute. Rush your name. We'll send you, **FREE** and postpaid, pictures, prices, details, all the facts you need to start. Mail coupon or send name on postcard. No charge.

WARNER ELECTRIC CO., 1512 Jarvis Av.
DEPT. L-2-M CHICAGO 26, ILLINOIS

Make Thousands of Beautiful Art Creations

**COSTUME JEWELRY • CIGARETTE BOXES
TRAYS • CANDLESTICKS • COASTERS
LAMP BASES • BOOK ENDS...ALL IN
SPARKLING COLORED PLASTIC**



THIS MAN . . .

is taking out of the machine a Plastic Sealing Job—ordered by mail—only 11c in material cost brings back \$2.58 in cash by mail. Capacity of machine: \$25.00 profit per hour of operation.

WARNER ELECTRIC CO., 1512 Jarvis Av.
Dept. L-2-M, Chicago 26, Ill.

At no cost to me, please rush complete details postage prepaid. I am under no obligation.

Name _____

Address _____

City _____ Zone _____ State _____



WORLD'S LOWEST PRICED ADDING MACHINE

**Counts up to 999,999,999
IDEAL FOR BUSINESS AND PERSONAL USE — GUARANTEED ACCURATE.**
Not a toy. Operates with only a finger flick. Adds, subtracts, multiplies, divides. Counts up to one billion. Pays for itself over and over. Ideal Gift—for Business, Income Tax and School use. **MONEY BACK GUARANTEE.** Send name and address. Pay postman only \$2.15 plus postage. Beautiful rich-looking Leatherette Case included at no extra cost. Money back in 10 days if not delighted. **AGENTS WANTED.**

Calculator Machine Company
P.O. Box 126, Dept. N-91, Huntingdon Valley, Penna.

Vest Pocket
Size
FREE TRIAL
\$2.95

**\$3.07 IN
PENNA.
INCLUDING
4% TAX
(2 for \$5.39)**

SHORTHAND in 6 WEEKS

Famous **SPEEDWRITING** shorthand. 120 words per minute. No symbols; no machines; uses ABC's. Learn at home or through classroom instruction. Lowest cost. For business and Civil Service. 500,000 graduates. Typing available. 37th year. Write for **FREE** booklet.

© 1959

Speedwriting
Dept. 1511-9, 55 W. 42 St., New York 36

SAVE UP TO 1/2 ON FINE ITALIAN CHORD ORGANS

Buy Direct-From-Importer...GET BIG DISCOUNTS

PLAY ON SIGHT! NO LESSONS NEEDED!

Here's the new musical instrument sensation that's suddenly captured the entire country! You and the children can play old and new songs in just a matter of minutes! . . . thanks to the famous DA-MAR System, included **FREE!** Makes music fun right from the start. Brings the whole family closer together as everyone joins in playing everything from hit tunes to lovely hymns. Best of all . . . you actually save 1/2 off mfr's list prices . . . buying direct from the importer. Pay only a small amount down . . . the rest just pennies a day!

HAND CRAFTED IN ITALIAN TRADITION OF QUALITY
Most domestic-made Electric Chord Organs use inferior plastic reeds . . . but every Philharmonic reed is made of finest, carefully treated Swedish Stainless Steel for superbly richer tonal quality and volume. Your Philharmonic Electric Chord Organ is largely hand crafted, just as any outstanding instrument should be! A giant in performance—yet it's light in weight, fully portable. Choose from a wide selection of models, including Piano-Keyboard model for those with piano background. **DOUBLE GUARANTEED.** Get new **FREE** Color Catalog and lowest **Direct Importer-to-You Discount Prices.** Rush Coupon . . .

PIANO KEYBOARD MODELS ALSO AVAILABLE

FREE BONUS GIFTS

- Big Solo Kit...with special easy-play arrangements of favorite songs.
- Plastic Protective Cover
- Expandable Music Portfolio
- Chemically Treated Polishing Cloth
- DOUBLE GUARANTEE**...gives you 100% certified protection.

Rush coupon for details

5 DAY FREE HOME TRIAL

Try it—play it—enjoy it in your own home on 5-FULL DAYS' **FREE TRIAL.** Only then can you appreciate how much fun the Philharmonic can bring into your home. Details free.

PHILHARMONIC ORGAN CORPORATION
Dept. R-119, 2003 West Chicago Avenue, Chicago 22, Illinois



**EASY TERMS
SMALL DOWN PAYMENT
BALANCE only
PENNIES A DAY**

24
MODELS

FREE! GET COLOR CATALOGS AND DIRECT IMPORTER-TO-YOU DISCOUNT PRICES

Philharmonic Organ Corporation—Dept. R-119
2003 W. Chicago Avenue, Chicago 22, Ill.
Rush Color Catalogs and Lowest Discount Prices

NAME _____

ADDRESS _____

CITY _____ ZONE _____ STATE _____

AMAZING OPTICAL BUYS

and OTHER SCIENTIFIC BARGAINS



See the Stars, Moon, Planets Close Up!

3" ASTRONOMICAL REFLECTING TELESCOPE



60 to 180 Power — Famous Mt. Palomar Type! An Unusual Buy! Assembled—Ready to use! You'll see the Rings of Saturn, the fascinating planet Mars, huge craters on the Moon, Star Clusters, Moons of Jupiter in detail. Galaxies! Equatorial mount with lock on both axes. Aluminized and overcoated 3" diameter high-speed f/10 mirror. Telescope comes equipped with a 60X eyepiece and a mounted Barlow Lens, giving you 60 to 180 power. Low-cost accessory eyepiece available for higher powers. An Optical Finder Telescope, always so essential, is also included. Sturdy, hardwood, portable tripod. FREE with Scope:—Valuable STAR CHART plus 272 page "HANDBOOK OF HEAVENS" plus "HOW TO USE YOUR TELESCOPE" BOOK.

Stock No. 85,050-H \$29.95 postpaid

KNOW THE TRUTH ABOUT POWER. Telescope experts will confirm that an Astronomical Telescope will only give you practical powers to about 50 or 60 times per inch of objective diameter—powers above this only produce empty magnification—make viewing dim, difficult and unsatisfactory.

4 1/4" ASTRONOMICAL TELESCOPE



UP TO 270 POWER! With this scope you can see everything as above but with greater power plus will split finer stars. Mirror has twice the light gathering power. Mirror guaranteed to give theoretical limit of resolution. Rack and pinion focusing, hardwood tripod, real equatorial mounting—only one adjustment follows stars! Aluminum tube. 6 power finder telescope. 2 standard size eyepieces and mounted Barlow lens give you powers of 40X, 90X, 120X, and 270X. Low-cost accessory eyepiece available for higher powers. FREE with Scope:—Valuable STAR CHART plus 272 page "HANDBOOK OF HEAVENS" plus "HOW TO USE YOUR TELESCOPE" BOOK. Shipping weight 25 lbs.

Stock No. 85,006-H \$74.50 f.o.b.
Same Telescope as above but equipped with Electric Clock Drive—
Stock No. 85-094-H \$111.50 F.O.B. Barrington, N. J.

NEW! CIRCULAR SLIDE RULE!



Pocket Size—Fast—Easy to Use!
Be a Math Whiz! New Circular Slide Rule multiplies, divides, figures fractions, percentages, squares, cubes, roots, proportions, circumferences, areas, retail prices, fuel consumption. Eliminates the confusion of ordinary slide-rules. Priced far lower. Faster, easier to learn and use. Constructed of 2 aluminum discs with plastic indicator. 3 1/2" diameter. Direction included.

Stock No. 30,336-H \$4.95 postpaid

BUILD A SOLAR ENERGY FURNACE

A fascinating new field. Build your own Solar Furnace for experimentation—many practical uses. Easy! Inexpensive! Use scrapwood! We furnish instructions. This sun powered furnace will generate terrific heat—2000° to 3000°. Fuses enamel to metal. Sets paper aflame in seconds. Use our Fresnel Lens—14 3/4" diameter, 1.4" f.l. 14".

Stock No. 70,130-H Fresnel Lens \$ 6.00 Postpd.

BARGAIN! WAR SURPLUS! 7 x 50 MONOCULAR

This is fine quality. American-made instrument—war surplus! Actually 1/2 of U. S. Govt. 7 x 50 Binocular. Used for general observation both day and night and to take fascinating telephoto shots with your camera. Brand new, \$95 value. Due to Japanese competition we close these out at a bargain price. Directions and mounting hints included.

Stock No. 50,003-H \$15.00 Postpaid

D-STIX CONSTRUCTION KITS



for Science Fans, Hobbyists
Visualize your ideas. Crystallize your plans. Unique new D-STIX are ideal for "3-dimensional thinking." Colored wood sticks 1/8" thick and "easy-on" rubber joints approx. 3/16" diam. fit together fast—help you work out molecular structures, geometric figures, structural members, shapes, models of all kinds. Ideal for interesting children in developing shapes, structures. Durable kits. Money-back guarantee.

Stock No. 70,209-H (230 pcs) \$3.00 ppd.
Stock No. 70,210-H (370 pcs) \$5.00 ppd.
Stock No. 70,211-H (452 pcs) \$7.00 ppd.



50-150-300 POWER MICROSCOPE

Amazing Value—Equal of a \$75.00 Instrument; 3 Achromatic Objective Lenses on Revolving Turret! Imported! The color-corrected, cemented achromatic lenses in the objective give you far superior results to the single lenses found in the microscopes selling in this range. Results are worth the difference! Fine rack and pinion focusing.

Stock No. 70,008-H \$14.95 Postpd.

MOUNTED 500 POWER OBJECTIVE

Threaded for easy attachment on above microscope. Achromatic lenses for fine viewing, 3 mm. focal length. Stock = 30,197-H \$5.00 Postpd.

MAKE YOUR OWN ASTRONOMICAL TELESCOPE

See December, 1957 issue of POPULAR MECHANICS—Pages 188-192. 4 1/4" MIRROR KIT—Contains ready-to-use 4 1/4" diameter concave, aluminized objective mirror, lenses for 1" focal length eyepiece, and aluminized first surface diagonal mirror.

Order Stock No. 50,074-H Price \$16.25 postpaid

'FISH' WITH A MAGNET

Go Treasure Hunting On The Bottom



Great idea! Fascinating fun and sometimes tremendously profitable! Tie a line to our 5-lb. Magnet—drop it overboard in bay, river, lake or ocean. Trawl it along the bottom—your "treasure" haul can be outboard motors, anchors, fishing tackle, all kinds of metal valuables. 5-lb. Magnet is war surplus—Alnico V Type—a terrific bargain. Lifts over 125 lbs. on land—much greater weights under water. Order now and try this new sport.

Stock No. 70,183-H. 5-lb. Magnet \$8.50 Postpaid
15 1/4 lb. size. Will lift over 250 lbs.
Stock No. 85,088-H. 15 1/4 lb. size \$22.50 F.O.B.
Shipping weight 22 lbs. Barrington, N. J.

New! 2 in 1 Combination! Pocket-Size



50 Power MICROSCOPE and 10 Power TELESCOPE Useful Telescope and Microscope combined in one amazing, precision instrument. Imported! No larger than a fountain pen. Telescope is 10 Power. Microscope magnifies 50 Times Sharp focus at any range. Handy for sports, looking at small objects. Just plain snooping. Send Check or M.O. Satisfaction Guaranteed. Order Stock No. 30,059-H \$4.50 Postpd.

Terrific Buy! American Made! OPAQUE PROJECTOR



Projects illustrations up to 3" x 3 1/2" and enlarges them to 4 ft. wide. No film or negatives needed. Projects charts, diagrams, pictures, photos, lettering in full color or black-and-white. Operates on 115 volt, A.C. current. 6-ft. extension cord and plug included, operates on 60 watt bulb, not included. Size 12" x 8" x 4 1/2" wide. Weight 1 lb., 2 oz. Plastic case with built-in handle.

Stock No. 70,199-H \$7.95 Postpaid

NOTICE! EDMUND IS NOW HEADQUARTERS FOR MATH LEARNING AND TEACHING AIDS!



Play This New Game—MATH MAGIC . . . The Fun-Way to Math Skill!

Educator-approved! 3 fascinating games in one! Great fun for the whole family. Increases skill in addition, subtraction, multiplication, division. Includes Dial and Spinner, Numbered Cards, Plastic Tokens, etc.—also rules and directions.

Stock No. 70,204-H \$3.00 Postpaid

MATH IS ESSENTIAL FOR SCIENCE—BUSINESS—COLLEGE! WE HAVE DOZENS OF NEW ARITHMETIC AND MATH GAMES; LEARNING AND TEACHING AIDS. WRITE FOR OUR FREE CATALOG H.

FREE CATALOG-H

100 Pages! Over 1000 Bargains!
Yours for the asking

America's No. 1 source of supply for experimenters, hobbyists. Complete line of Astronomical Telescope parts and assembled Telescope. Also huge selection of lenses, prisms, war surplus optical instruments, parts and accessories. Telescopes, microscopes, satellite scopes, binoculars, infrared sniperscopes, math, learning and teaching aids.



REQUEST CATALOG-H

ORDER BY STOCK NUMBER . SEND CHECK OR MONEY ORDER . SATISFACTION GUARANTEED!

EDMUND SCIENTIFIC CO., BARRINGTON, NEW JERSEY

**WORLD'S
BEST
WANT-AD
MEDIUM**

CLASSIFIED ADVERTISEMENTS



Advertisements in this section \$1.25 per word, each insertion, minimum 10 words, payable in advance.

To be inserted under proper classification, copy must be in our office the 20th of the second month preceding date of issue

F. W. Johnson, Manager, Classified Advertising

Popular Mechanics Magazine, 200 East Ontario Street, Chicago 11, Illinois

YOU'LL PROFIT

By reading and answering the classified ads in this section. Hundreds of opportunities for you to make and save money

AUTOMOBILES. MIDGET CARS

AUTOMOBILE Broker. Best price American, foreign. Trades accepted. Howard Tauber, 1343 Hood, Chicago. Broadway 4-1343.

FULL Color post card photos of antique and classic cars. 25 for \$1. Specify series 1, 2, 3 or 4 (all different). Free list. L. I. Auto Museum, 29 Museum Sq., Southampton, N. Y.

1959 CATALOG On parts kits for golf buggy or Jr. sports car 25¢. Indus Corporation, 1815 Madison, Indianapolis.

STEERING Wheels. Midgets, etc., \$3.95 up. Literature 10¢. Steerite Products, Dept. PM8, Box 221, Long Branch, N. J.

HUNDREDS Of automobile catalogs. American, antique, foreign. Dealer books, glossy photographs, shop manuals. Free motor magazines listed with non-profit organization. Write immediately. Get on free mailing list. Auto Maniacs, Stockbridge, Michigan.

AUTOMOTIVE Books. Send for 1958 general book catalog. 10¢. Popular Mechanics Press, 631 N. St. Clair St., Chicago 11, Ill.

AUTO SUPPLIES AND EQUIPMENT

AUTO Shop welding repair training in world's largest non-profit welding school. Low tuition. Free booklet. Hobart Welders, Box M-1191, Troy, Ohio.

1960 EDITION. It's new! It's different! Get world's largest auto accessories and parts catalog, save up to 50%. 388 pages, over 100,000 items, earliest to 1960 models, including Hollywood accessories, custom styling and hi-speed equipment. All parts and accessories for all cars, trucks, foreign and sports cars. We have that hard-to-get part. Jam-packed with bargains. Completely illustrated. Send 25¢ (refundable). J. C. Whitney, 1919 PM-11 Archer, Chicago 16, Ill.

PARTS Model "A." Free list. Matco, Box 135, San Pedro, Calif.

SAVE Money on Jeep and army truck parts. Large inventory. Catalogs for Jeep or G.M.C. owners only. American Auto Parts Co., 1830 Locust, Kansas City, Mo.

PERMAKROM Bumper refinishing kit does real job restoring chrome finish to bumpers, grill work. Three easy steps. Removes rust in five minutes. Prevents new rust. Coats exposed pits and metal parts, gives chrome brilliant silvery lustre. Simple, economical. Only \$2.00 postpaid. Craifron Company, Dept. M-11, 56-20 39th Avenue, Woodside 77, N. Y.

AUTOMATIC Clutch pulleys and wheels. Just what you need for that little car. Used where power needs be disengaged up to 10 h.p. engines. 1½ h.p. \$6.70. Specify shaft size when ordering. Durable wheels of all sizes \$1.50 to \$22.00. Central Distributors, 1209 Oberste, Corpus Christi, Texas.

WARNING System designed and engineered to give lifetime protection to your car battery. Guards against your leaving car with park or headlights on. Price \$3.50. P-S Products Co., Box 364, West Covina, California.

FOREIGN Car owners; free illustrated catalogue imported accessories and tools. Wilco, Box 1128-M, Rochester 3, N. Y.

RING-Valve Job while driving, \$6.00 postpaid. (9th successful year.) Yellow Cab test-proven. Free details. Motaloy, Grantham, Penna.

JEOP Owners — V8 conversions. Read Jeep Owners ad, page 22.

JEOP Tops. Free catalogue. Mor-Nan, Box 141, Beverly, Mass.

FORD T and A parts? Try best source old model parts, all makes. Wisneski Auto, Milwaukee 4.

GIANT Auto parts catalog. Thousands special accessories, speed, power, performance. Mileage, custom equipment. Send 25¢ (refundable). Newhouse Automotive Industries, 5805-PM11 Beverly, Los Angeles 22, Calif.

1909-1934 FORD Parts. Illustrated catalogue 50¢. Mark Auto, Layton, New Jersey.

SIRENS, Air-horns, lights! Catalog 10¢. McCanna Company, Tarrytown, N. Y.

RING-Valve job while driving, \$3.98. Unconditionally guaranteed. Mota-Nu, Box 8236, Fort Worth, Texas.

TOILET Paper oil filter adapter \$3.50. Zepco, Box 2461, Los Angeles 54, Calif.

AIRCRAFT Navy surplus spark plugs, new, made to rigid government specification. Heavy duty four point electrodes, mica insulators converted to fit Ford engines 18MM 1955 or later models. Terrific power on the 6 and standard 8. Set 6, \$3.50; set 8, \$4.50, p.p. U.S. Devlin Airo Plugs, Box 511, Bell, Calif.

MAKE Old cars run like new. Inexpensive. Free details. Newco, Box 164-B, Hunlock Creek, Penna.

NEW And used parts at savings. Complete guaranteed parts service for all models cars and trucks, 1924 and later. Largest in the West. Jeep and army parts specialists. Newest type shifting hubs for all jeep and all military and latest production front end drive vehicles. \$27.50 and up. Write. Pioneer Auto and Truck Parts Co., 734 W. 13th Avenue, Denver 17, Colo.

FREE! New catalog. Speed, power, mileage increasing equipment. Discounts! Almqvist Engineering, Milford PM5, Penna.

CHEVROLET V8 engines. Racing equipment. Catalog 50¢. Ledbetter Enterprises, 1015 17th, Texarkana 4, Texas.

SILENCE Hydraulic valve lifter click. Micro-moly guaranteed. \$3.00 pint. Postpaid. Literature. Micro-Moly Products, Garrison 1, Kentucky.

TUNE-UP Tips. 1959 edition. Over fifty helpful items for successful tune-ups. Send one dollar to: Modern Automotive School, 323 W. Florence Ave., Los Angeles 3, Calif.

50,000 MILE Guarantee. New fuel pumps. Single \$5.95, double \$9.95, postpaid. Give car, year, model. Ram Fuel Products, P.O. Box 4141, Newark 12, New Jersey.

AUTO TRAILERS

BUILD This eye appealing, inexpensive little house trailer, designed primarily for small cars. All convenience of larger trailers. Blueprints and instructions \$3.00. Pequeno Plans Co., P.O. Box 1, Anderson, California.

BUILD Expanding eight foot trailer. Accommodates five. Literature 10¢. Framar Company, Wilmington, Mass.

ALUMINUM Pickup coach kits. Trailer blueprints. Literature 10¢. Comstock Trailers, Parsons, Kansas.

TRAVEL Trailer blueprints \$2.00. Building guide supply catalog \$1.30. Both \$3.00. Kamcraft, Box 1153, Milwaukee 1, Wis.

CAMP Trailer folding tent. Finest quality sleeps two \$350.00. Telford Trailers, New Lebanon, N. Y.

MOTORCYCLES. BICYCLES. MOTORSCOOTERS AND SUPPLIES

MIDGET Racer \$12, motorscooter \$6, less engines. Go cart engine \$6. Chek motorcycle \$25, James \$45. Four wheel drive Crosley truck \$195. (Mailorder only). Send 25¢ (35¢ for first class mailing) for Directory-Catalogue Number 92 listing these and hundreds of other bargains, homebuilders parts, plans, etc. Midget Motors Directory, Athens, Ohio.

WORLDWIDE Motorcycle Club literature free. Send stamp. Worldwide Motorcycle Club, Department A, Box 20749, Los Angeles 6, California.

CAR Kits, scooters; wheels, sprockets, brakes, steering, etc. List 25¢. Refundable 1st order. Price's, 673 Sycamore St., Oakland 12, Calif.

HARLEY-Davidsons — Used bargains. New, used parts, accessories, all models. Bulletin 25¢. Knuth's (Factory Dealer), 1753 Muskego, Milwaukee, Wis.

MOTORCYCLE Parts. New, used. List 25¢. Ballak, 811 N. 9th, St. Louis 1, Mo.

RECONDITIONED Motorcycle motors. Chrome accessories. Complete stock Indian parts. Expert rebuilding. Fast service. Indian Motorcycle Sales, Kansas City 27, Missouri.

AVIATION

CAPTIVE Helicopter, VTOL trainer uses 12 to 70 HP engines. Payloads 50 to 500 pounds. Complete plans, design parameters, photographically illustrated instructions. \$3.00. Flight Dynamics, Box 5443, Raleigh, N. C.

AVIATION Surplus bargain catalogue. One dime. Box 22PM, Thomasville, Penna.

BLUEPRINTS Knight Twister, Irwin, Flea, Eaglet, Wimpy, Gliders etc. Circulators illustrating above 30¢. Sportplane building manual \$1.00. Kamcraft, Box 1153, Milwaukee 1, Wis.

AIRCRAFT Spark plugs. New navy surplus. Type Aero LS 4ADI mica insulators. Champion Type LS87. 30 plugs sealed can \$7.50 f.o.b. Devlin Aero Plugs, Box 511, Bell, Calif.

MACHINE Work, parts, contracts. Barber, H. B., 320 E. Main, Missoula, Montana.

LEARN Aircraft & missile drafting! Home-study. Free information. Pacific Aero Institute, Box 4185, Inglewood, California.

BUILDING Your own high performance sport plane is easy with our new simplified blueprints and detailed instructions. No experience required. Four economical models, one, two passenger, aerobatics. For complete details, brochures, photographs, 3-views, F.A.A. regulations on homebuilt airplanes, mail \$1.00 (postal, packaging expense) to Stits Aircraft, Box 3084M, Riverside, California.

PROPELLERS. Plans, supplies for airboats and snowplanes. Latest designs, prompt delivery. Catalog 25¢. Banks-Maxwell, Box 3301E, Ft. Worth 5, Texas.

HELICOPTER. Kits, plans. Free brochure. Adams, Box 6042-A, Lakewood, Calif.

FLYING Platform. Three drawings, \$2.00. Rotron, Box 573-A, Bellflower, Calif.

CUTERSPACE Ship X-15. Get genuine glossy 3 1/2 x 5 photo of N. American's newest aircraft plus catalog with thousands of latest jets, missiles, and historical planes. Send 25¢ to U. S. Sea & Air Photos, Box 75084X, Los Angeles 5, California.

BUY Gov't surplus: Aircrafts; engines; helicopters; boats; Jeeps; misc. Buy direct now from gov't. Send for "Depot Directory & Procedure" \$1.00. Gov't Surplus Sales, Box 425-PM, Nanuet, New York.

ELECTRICAL SUPPLIES

WHOLESALE Appliance parts catalogue 25¢. Covers coffeemakers through vacuums. Seco, 26 South 20 Street, Birmingham 3, Alabama.

BOOK 200 Electric stunts \$1.00. Kuttington, 875 Arastradero, Palo Alto, Calif.

HOUSE Wiring Guide \$2.50. Battery Repair Manual \$3.00. Bayer Publications, 938NF Betty Avenue, Neenah, Wisconsin.

LAMPS—Parts catalog containing wiring instructions, 25¢. Gyro Lamps, 5208P N.W. 35th Ave., Miami 42, Fla.

ELECTRO-SCRIBE! Engraves all metals, \$2.00. Beyer Mfg., 10511-H Springfield, Chicago 43.

LAMP. Electrical parts, wholesale. Thousands of items for repairing, converting. Catalog 25¢. Brown Lamp, Box 305, Clayton 5, Mo.

WELDING, SOLDERING, PLATING

ACETYLENE Welding outfit, new, \$64.50. Arcwelders, \$56.50. Eagle Welding, Dept. PM, 5085 Broadway, Chicago 40, Ill.

FREE Catalog, welders, welder kits. Build 350-ampere welder using aircraft generator, plans 25¢. Agents wanted. Dunbar Manufacturing, Minneapolis 8, Minn.

WELDERS. 110/220, \$39.50. Morris, 1070 Inner Drive, Schenectady 3, New York.

PLATING Equipment, supplies. Complete line of anodes, solutions. Home workshops, industrial sizes. Hollywood Bronze Supply, Dept. C, 1624 East First, Los Angeles 33, California.

MACHINERY, TOOLS, SUPPLIES

12" SHEET—Metal brake. Handles 24 gauge, narrower pieces to 18 gauge. \$9.85 postpaid. H. L. Barnes, 1406 West Lake, Minneapolis, Minn.

PAINT Sprayer. 7 times faster than brushing. Sensational offer! Free folder. Imco, 1829 S. State, Chicago 16, Ill.

NEW And guaranteed factory rebuilt transits and levels, sale or rent, with purchase option. We will repair, trade or buy old instruments. Write for list M-911, Warren-Knight Co. (Manufacturers of Surveying Instruments), 136 N. 12th St., Philadelphia 7, Penna.

ENGINES, MOTORS, DYNAMOS

FREE Catalog. Motor rewinding supplies, instructions, diagrams. Modern, Box 8715, Kansas City 14, Mo.

REWIND. Repair motors. Profitable. Easy. Free details. Lincoln, Box 52P, Hempstead, N. Y.

DIESEL Injector parts and fuel pumps wanted. GM51-53-71-110. Bares, 7120 Carnegie, Cleveland 3, Ohio.

WINDING Data, 275 motors, single and three phase \$1.10. Data Company, 512 Kensington, Kansas City 24, Mo.

ALTERNATING Current generators, 750 watt \$42.50, twincylinder compressors with 1/3 horse \$22.00, motors 1 horse \$38.50. Butler, 1885 Milwaukee, Chicago.

REWIND Motors yourself. Complete instructions \$1.00. Lewis Mfg., Howell, Michigan.

BOATS, OUTBOARD MOTORS

PLEASURE Boat operators. Get your license now. A concise and practical course in boat operation that prepares you for the Motorboat Operator License Examination. Reasonable. Write: Boat Operators School, Box 2601-A, San Francisco 26, California.

FREE Catalog! Boat kits, trailers, fiberglass, marine hardware. Luger Industries, Dept. M-11, 9200 Access Rd., Minneapolis 20, Minnesota.

FOLDING Boats. Imported, unsinkable. 8 models. Sail, paddle, motorboat. Free catalog PM. Pioneer Folding Boats, 206 East 86 Street, New York.

FORDS and Jeeps 100% marine engines with famous Convo-Kits. Deluxe catalogue 25¢ coin. Oscomotors, 3627B Lawrence, Philadelphia 40, Penna.

300 BOAT Plans, patterns; catalog 50¢. Marinecraft, Box 161-M, Brighton, Mass.

WATER—Proof taillight with stop and directional controls \$5.45 factory c.o.d. P.O. Box 555, Hawthorne, California.

CHEAP. In Honolulu. Buda, Commando, Invader, Packard marine engines. Goin's Gen. Eng., Niland, California.

FORD Jeep conversions at half price. Vac-U-Matic Corp., 146 Mott St., Ocean-side, New York.

MARINE Conversions, Willys to Cadillac, kits and parts. Catalog and conversion hints free. Barr Marine, 2706A Castor Avenue, Philadelphia 34, Penna.

BOAT Plans—Full size patterns, frame kits. Modern inboards and outboards for amateur builders. Complete new catalog 50¢ or specify requirements. Glen Designs, 9152 Rosecrans, Bellflower, California.

FULL Size, cut-to-shape boat patterns, blueprints, 7 1/2-38 feet. Big new 88 pg. illustrated "Build a Boat" catalog of naval architect-designed cruisers, runabouts, skiffs, outboard boats, sailing, racing, houseboats, 50¢. "How to Build a Boat" booklet, \$2.50. Hardware and Equipment Catalog, \$2.00. Cleveland Boat Blueprint Co., Dept. A-66, Box 1651, Cleveland, Ohio.

MARINE Conversions, Ford, Chevrolet, Jeep engines. Catalog 25¢. Lehman Manufacturing Company, 800 Elizabeth Avenue, Linden 4, N. J.

PROPELLERS. Plans, supplies for airboats, snowplanes. Catalog 25¢. Banks-Maxwell, Box 3301F, Ft. Worth 5, Texas.

NEW. Used, rebuilt marine motors. Marine conversions, fittings. Free catalog. Stokes Marine Supply, Dept. 24, Coldwater, Michigan.

SAVE Money. New, used outboard motor parts. Send wants. Stamp appreciated. Outboard Motor Mart, 229-M State, Boston 9, Mass.

I want to send you proof of the wonderful pulling power of Popular Mechanics classified pages. What's your proposition? Write me today. Include literature if possible. F. W. Johnson, Manager Classified Advertising, Popular Mechanics Magazine, 200 E. Ontario St., Chicago 11, Ill.

BODY BUILDING COURSES

BOXERS. Heavy canvas striking bag, 12x36 inches! Tremendous buy, complete \$7.00 P.P. Heff, Box 236, Williamsport, Penna.

SAVE. Make your gymnasium equipment. Instructions \$2.00. Hinkley, P.O. Box 296, Salem, Virginia.

FREE Muscle building information. Body-Tone, Box 638B, North Miami, Florida.

BARBELLS. Dumbbells. Courses. Booklet 10¢. Good Barbell Co., Siloam Springs, Arkansas.

DEADLY Oriental fighting arts. Elemental Karate, Kung-fu. Illustrated manual \$3.98. Oriental Book Sales, P.O. Box 1183, Oakland 7, Calif.

BIG Strong healthy muscles. 4 courses only 25¢. 12 courses \$2.00. Health wisdom courses \$1.00. Personal supervision. Agents wanted. Results fully guaranteed. Sid's System, PM-2, Southgate, California.

SPORTING GOODS, GUNS, FISHING TACKLE, ARCHERY, TRAPPING

CLEAN 2000 Fish \$2.00! Nylon scaling attachment fits any electric drill, cleans in seconds. No mess. Jaco, 106 First Avenue, Berea, Ohio.

DISCOUNTS Unlimited! Lyman 4X \$39.95, Weaver K3 \$24.25, Bushnell 4X \$34.50! Guns, accessories below wholesale. Catalog 25¢. Discounts Unlimited, Box 38-A, Hastings-on-Hudson, N. Y.

10,000 GUNS. Antiques, moderns, swords, armour. Every description. Giant catalog \$1.00. Agramonte's, Yonkers 2 G, N. Y.

MOLDS—For casting your own fishing sinkers. Free illustrated booklet. Reading Instrument Co., Box PM78, Reading, Penna.

CROSSBOWS! Hunting—Bows! Factory prices! Jayco, Box 1355, Wichita, Kansas.

BIG Money raising crickets and 12 inch African fishworms. Free literature. Carter Ranch, Plains, Georgia.

FREE—Wholesale catalog. Beads. Spinners. Lure parts. Sinker molds. Jigs. Reels. Finny sports (ME), Toledo 6, Ohio.

MOLDS For fisherman's sinkers, jigs, squids, casting and spinning lures. Free catalog. Sweet's Molds, Tonawanda 1, New York.

5000 BARGAINS. Firearms, binoculars, war relics. Catalog 50¢. Smith Firearms, Runnemed, N. J.

AMAZING Wholesale sporting catalog. Save 70%. Tremendous selections. Econ-O-Mart, Whippany 2, New Jersey.

KILL Submersed water weeds which foul up motor propellers, tangle fishing gear, with R-H Weed Rhap-20, Granular 2-4-D. Inexpensive, easy to use, sure results. For free information write Reasor-Hill Corporation, Box 36PM, Jacksonville, Arkansas.

HUNTING Horns, wholesale, retail. Frontier Products, 3102 Salinas, Laredo, Texas.

KNIVES. Imported. Worldwide selection of rare daggers, gurrhas, stiletos, bowies, hunting, throwing knives. Terrific values. Free catalog. Clinton, Mt. Clemens 34, Michigan.

SHOOT In your basement or garage. Free "Hints for a Home Range." Detroit Bullet Trap Co., 9447 Seymour, Schiller Park, Illinois.

MONOGRAMMED Nylon golf tee. Guaranteed unbreakable. Packaged in transparent reusable jewelry box, 50 cents. Specify initial. Jaco, 106 St., Berea, Ohio.

NEW Vest pocket pellet gun. All steel. Powerful. \$2.65 post paid. B. Sypher Co., Station F, Toledo, Ohio.

MANUFACTURER'S Year and close out. Quality spinning lures. List \$2.50 for 4—while they last \$1.00 post paid. Box 74, W. Barnstable, Mass.

MINNOW Graders. Free circular. Crescent Mfg., Box 3303, Ft. Worth, Texas.

MAKE Your own tents, sleeping bags, packs. Materials, plans. Free catalog. Umakit, Dept. 140, Ward, Colorado.

EARTHWORMS, CRICKETS, FROGS

BIG Money raising fishworms and crickets. We teach you how to raise and where to sell. Free literature. Medium redworms, 3000, \$5.95; 10,000, \$16.95. Carter Redworms, Plains, Georgia.

RAISE Fishworms and rabbits on \$500 month plan. Free details. White's Rabbitry, Delaware 2, Ohio.

FREE Picture folder, "How to Make \$3,000 Yearly, Sparetime, Backyard, Raising Earthworms!" Oakhaven-56, Cedar Hill, Texas.

WANTED, Men, women, worm raisers. Sherwood, Dept. R-2A, Monmouth, Maine.

FREE! Valuable fact and picture booklet, "The Amazing Earth Worm Business!" Earn thousands \$ in your spare time. Gulf Worm Gardens-59, Bay City, Texas.

TAXIDERMY

FREE Book tells how you can learn Taxidermy and Tanning. Fascinating, profitable hobby. Send postal. No obligation. State age. Northwestern School, Dept. 2571, Omaha 2, Nebr.

BINOCULARS, TELESCOPES, MICROSCOPES, MAGNIFIERS

REFLECTOR And refractor telescopes, binoculars, microscopes, all sizes. Complete telescope kits, parts, accessories. Free illustrated catalog. Suffolk Science, Mattituck, New York.

REFLECTING Telescope, 60X, completely assembled. Guaranteed observatory clearness. Free information. Skyscope, P.O. Box 55, Brooklyn 28, N. Y.

AMAZING Prices precision binoculars. Folder, "Binocular Selecting," catalog free. Prentiss Importers, Mercury Bldg., West Los Angeles 25, Calif.

WAR Surplus bargains: millions of lenses, instruments, telescopes, binoculars, components and complete line of astronomical telescope items. World's greatest optical market-place! Send only \$1.00 for beginner's 10-lens kit and big instruction booklet stock 2-CH. Write for catalog CH. Free! Edmund Scientific Co., Barrington, New Jersey.

TELESCOPES, Mirrors, binoculars, microscopes, accessories. Free catalog. National Optical Company, 505 New York Avenue, Union City, New Jersey.

AMAZING Lightweight binocular spectacles. Astonishing magnified optical picture for defective vision at sports, theaters, etc. Ideal Christmas gift \$5. Klemm's, 411 E. Thomas St., Seattle 2, Wash.

BUILD Your own reflector telescopes. Complete kits; mirrors, eyepieces, tripods, all other accessories. Request free illustrated literature. Criterion Manufacturing, Dept. DPM-58, Hartford, Conn.

BINOCULAR Specialists, all makes repaired. Authorized Bausch & Lomb, Zeiss, Hensoldt, Bushnell dealer. Tele-Optics, 5514 Lawrence, Chicago 30, Illinois.

DYNASCOPE — Amazing world-famous reflector telescope. Request free brochure. Criterion, Dept. DP-61, Hartford, Conn.

REFLECTOR Telescopes from Esco. Assembled and "do-it-yourself" telescopes from \$7.50 (3") to \$175 (12"). Complete line of optics and accessories. Send for free illustrated booklet. Esco Products Company, Oak Ridge, New Jersey.

MICROSCOPES, Educational research surveying, instruments, electronics, optical, everything Japanese. Importers prices. Catalogs 25¢. Magnification Instrument, 2 E. 45th, New York 17.

BINOCULARS, Telescopes, microscopes; terrific values \$3.98 up. Request free money-saving catalog. Criterion, Dept. P-84, Hartford, Conn.

PLANTS, SEEDS, BULBS, NURSERY AND GARDEN SUPPLIES

BRAZILIAN Orchids. Illustrated catalog \$1.00 airmailed. Orquideario Catarinense, Corupá, S.C., Brazil.

GROW Dwarf trees! Instructions and seeds 35¢. Mail Order Specialties, 1439-PM Sabraton Ave., Morgantown, W. Va.

WORLD'S Greatest cash crop. Free information. Write Ginseng Gardens, Asheville, N. C.

PETS—DOGS, BIRDS, RABBITS, HAMSTERS, ETC.

A.K.C. Weimaraner hunters. 6 to 14 weeks old. \$30 to \$40. Deer Farm, Lakewood, Wis.

EARN \$10,000 Yearly raising Angora rabbit wool for us. Information 25¢ coin. American Angora Company, Malta 12, Montana.

MONKEYS—Animal illustrated list 15¢. Reptile list 10¢. Wild Cargo, West Hollywood, Florida.

HAMSTER'S Golden \$2.75 pair. Albino's whitebands creams. Free literature. Edgewater Hamstery, 106 Carter, Goshen, Ind.

BEAUTIFUL Pure white pedigreed police puppies. Ansonia Kennels, McHenry, N. Dak.

BUY Direct from wholesaler—Mynahs, canaries, monkeys, pinches, animals from all parts of world. Write for list. Treflich's, 228 Fulton Street, New York 7.

RAISE Angora, New Zealand rabbits on \$500 month plan. Plenty markets. Free details. White's Rabbitry, Delaware, Ohio.

HUNTERS, Sale price on fine Coon hounds, Fox and Rabbit hounds. Write, Okaw River Kennel, Cowden, Illinois.

GOLDEN Hamsters—Pedigreed breeders \$3.85 pair. Albinos Whitebands. Literature. Moore's Hamster Ranch, Shepherdstown 25, West Virginia.

MAKE Money raising chinchillas, mink, rabbits, cavies for us. Free catalog. Keeney Brothers, New Freedom 2, Penna.

STRAIGHT Cooners! World's oldest kennel. Combination hounds, rabbit, fox, beagles, deerhounds, bird dogs. Puppies of all breeds. Prices reasonable. Trial. Free catalogue. Raccoon Mountain Kennels, Box 464, Boaz, Alabama.

RAISE Rabbits successfully by knowing facts. 48 page illustrated book describing 25 breeds. Housing, feeding, breeding, marketing, etc. Plus bulletin. 25 cents. American Rabbit Association, 36 Arba Building, Pittsburgh, Penna.

HAMSTERS—Ideal pets, \$2.95 pair. Free booklet. Jer-fre's Hamstery, 1447 Appie, Muskegon 13, Michigan.

SKUNKS, Reptiles, hawks, raccoons. Illustrated catalogue, 25¢. Trails End Co., St. Stephen, S. C.

FUR BEARING ANIMALS

CHINCHILLAS Graded, extra choice. \$80.00 pair. H. Sheppard, 124 Columbia Rd., Ellicott City, Md.

RAISE Rabbits—Nutria. Choice breeders. Bob Madsen, Lyndon 2, Illinois.

MINK Raising information free. Complete. Lake Superior Mink Farm, Superior, Eel, Wisconsin.

FARMS, FARM LANDS, REAL ESTATE

FLORIDA, Beautifully wooded homesites, \$290, \$10 monthly. Popular beach-resort area. Free literature. Wendell Wood, Fountain, Florida.

FLORIDA, Earn a vacation. Write Eastern Enterprises, 325 E. 15th St., Hialeah, Florida.

STOCKED, Equipped, furnished! Ready to make money! 603-acre beef or dairy ranch in the delightful Ozarks! Only \$15,000 with 8 milk cows, 2 heifers, bull, team, poultry flock, machinery, all household furnishings included! Electric-lighted 5-room 3-bedroom bungalow, well, pretty view of Ozarks valley. Good 50-ft. barn, poultry house, granary. 500 acres partly-wooded pasture, creek, 3 springs, 2 ponds, 80 tillable, 46 fruit trees. On school bus, dairy routes, 3 miles village. Once-in-a-lifetime buy, only \$15,000 complete, half down. Immediate possession, too! New free winter catalog, bargains coast to coast! United Farm Agency, 2825-PM Main St., Kansas City 41, Mo.

EVERYONE Can own a Gettysburg farm. Be the first in your gang. Send \$2.25 and receive postpaid deed transferring clear title to one square foot of historical farmland, map included. Gettysburg Farms, Route #2, Gettysburg, Penna.

CENTRAL Florida developments. Trailer homesites; also lakefront and highway lots; acreage. No interest. From \$295.00. Terms. Victor Roepke, DeLand, Fla.

TEXAS Lake property. \$10.00 month. Folder free. Matlock, Pipe Creek 1, Tex.

OPPORTUNITIES! Government land. U. S., Alaska, Canada. Sledge Surveys, Macon, Mississippi.

FLORIDA'S Biggest lot value! No money down! \$5 monthly. Full price only \$133. Between Orlando and Ocala. High, dry, adjoining city, streets, electricity, phones, churches, schools, shopping. In heart of 3000 lakes. World's best fishing! Write for free photos. AD Huysman, Box 467, Bellevue, Florida.

MR. Property Owner—Want a map of your property? Write Deed-Ettes, Mt. Pocono, Penna.

FREE Strout catalog! Farms, homes, businesses, resorts, retirement properties. Over 3000 values in 36 states. 58 years' service. World's largest! Write Strout Realty, 7-MP S. Dearborn, Chicago 3, Ill.

CANADIAN Vacation lands: Full price \$285.00, for 40 acres, \$10.00 month. Suitable cottage sites, hunting, fishing camps. Free information. Land Sales Corporation, 130C Shaftesbury, Downsview, Ontario, Canada.

FLORIDA, Nice homesites, \$345 at \$10 monthly. Folder free. Howard Vernor, DeLand, Florida.

FLORIDA—Silver Springs, Ocala, Bellevue improved homesites over ¼ acre ready to build on. Large lake, park, beach, boat facilities on property. \$795.00, \$10.00 month. Write P. O. I Box 568, Bellevue, Florida.

POOR Man's chance—\$8 monthly buys 5 acres near Clearwater Lake. Excellent fishing. Price \$250; free list. Box 425-P, Carthage, Missouri.

OZARKS! America's best place. Ten lovely timbered acres \$195. \$5.00 monthly. Descriptions mailed free. Write: Armstrongs, Shook, Missouri.

PROFITABLE OCCUPATIONS

DO It yourself jewelry kits. Free list, instructions. Rock Jewelry, Box 9424, Raytown, Missouri.

MAGAZINE Subscriptions. Highest commissions. Bonus. Qualified Agencies. 451-EA Kingston, Brooklyn 25, N. Y.

MAILORDER Beginner's literature. Write Carnahan Bros., 9610 Acacla, Fontana, Calif.

EARN At home. We supply everything and buy your product. Lois, 620 San Pablo N.E., Albuquerque, New Mexico.

LEARN Invisible reweaving at home. Free details. Jack's Service, P.O. Box 3457, Freeport, Illinois.

START A magazine subscription business. Earn generous commissions on Popular Mechanics, Good Housekeeping and all others. Best commissions, bonus, all materials sent free. No experience needed. Write Popular Mechanics, Room 11-P, 250 West 55th St., New York 19, N. Y.

BARTENDING, Professional home study course. All implements furnished. Bartending, Box 783, Lansing, Michigan.

PROSPECTORS! Learn from experienced geologists, how to locate and identify rocks and minerals. A comprehensive home study course designed for anyone interested in exploring for valuable ore deposits. Write now, for free literature. Pacific School of Mines, Dept. CK, Box 2538, Palm Springs, California.

XMAS—New Year favors. Associations, clubs, taverns will need hats, horns, streamers, etc. Complete samples, \$3.00. Ellswood's Inc., 3615 Tejon, Denver 11, Colorado.

SHARPEN—Scissors, pinking shears. Inexpensive outfit. Supplies. Blackhaws, Sheldahl, Iowa.

FREE Book "900 Successful, Little-known Businesses". Work home! Plymouth-7N, Brooklyn 4, New York.

WASHING Machine repair book. Write: Kay, 5704 Third Ave., Brooklyn 20, N. Y.

SPARETIME Repeat profits taking magazine subscriptions. Special offers. Cassell Agency, Boynton Beach, Florida.

AMAZING Profits in worms. Free information. Write Hillaire Farms, Box 275, Northville, Mich.

NEW Soilless method raising night-crawlers, redworms. Three Oaks Ranch, Dresden, Tenn.

BUY Wholesale: 100,000 nationally advertised products. Appliances, cameras, sporting goods, housewares, watches, typewriters, tools, clothing, etc. Discounts to 60%. Buy-Rite, Box 258, Hawthorne 1, New Jersey.

Information. American School Piano Tuning, Box 707, Gilroy, Calif.

MAKE Money making new greaseless doughnuts in kitchen. Sell stores. Free recipes. Michael, 3605 South 15th, Minneapolis 7, Minnesota.

BECOME Independent with your own franchise business. Thousands earning handsome incomes. Request interesting facts today. National Franchise Reports, PM-528, 333 North Michigan, Chicago 1.

EARN \$240.00 a month at home, spare time doing only two \$5.00 invisible mending jobs a day. Big money paid for service that makes cuts, tears disappear from fabrics. Steady demand. Details free. Fabricon, 6236 Broadway, Chicago 40, Ill.

BIG Money raising fishworms and crickets. Free literature. Carter Wormery, Plains, Georgia.

MAKE Flexible molds. Cast plaques, figurines. Free sample. Tooker, 1045-M Fairview, Hamilton, Ohio.

AUCTIONEERING—Home study course. Diploma granted. Auction School, Ft. Smith, Ark.

SAVE Money! Buy wholesale! Free catalog general merchandise. Norris, 487-M Broadway, New York City.

RAISE Pheasants on \$100 week plan. Little capital and space can make you independent. Free details. Great Central System, Columbus 1, Kansas.

VENDING Machines. No selling. Operate a route of coin machines and earn amazing profits. 32-page catalogue free. Parkway Machine Corporation, Dept. #25, 715 Ensor Street, Baltimore 2, Maryland.

GROW Mushrooms. Cellar, shed and outdoors. Spare, full time, year round. We pay \$4.50 lb. dried. We have 29,000 customers. Free book. Mushrooms, Dept. 99, 2954 Admiral Way, Seattle, Wash.

PHOTOGRAPHY For pleasure or profit. Learn at home. Practical basic training. Long established school. Free booklet. American School of Photography, 835 Diversey Parkway, Dept. 3437, Chicago 14, Illinois.

INDEPENDENT Opportunities. Jobs unlimited. Self improvement. William Dunhue, 224 Beach Drive North, St. Petersburg 1, Florida.

\$200 WEEKLY Extra introducing buyers to sellers, weekends. Men, women enjoy learning real estate by listening to records. First lecture free. Lee Institute, Brookline, Mass.

BOOKS, PERIODICALS, PICTURES, POSTCARDS

SAVE 20% to 80% on books. Free catalog. Discount Reader's Service, MK-5435 Upland Way, Philadelphia 31.

1000 "HOW To" books. Catalog 25 cents. Arterraft, Baldwin, Maryland.

FREE Catalog. Latest books. All subjects. Shorelands, Inc., Department H, Plainfield, N. H.

100,000 10¢-BOOKS! Sensational subjects! Amazing selection! Three catalogs, (books-bargains), 25¢, refundable. Particulars free! Bargains, 1323-PM Chaparral, Corpus Christi 3, Texas.

BOOK Traders magazine 10¢. Periodicals, 6376 Windsor Lane, San Jose 29, California.

BOOKS Located. State interests. No obligation. Mrs. F. Myers, 4115 N. Lawler Avenue, Chicago 41.

HAVE Fun: comic post cards. 25 different \$1.00. Bradley's Variety, P.O. Box 281, McGregor, Iowa.

24 INTERESTING Post card pictures \$1.00. Millet, Box 26, Rosedale 22, Long Island.

SELL Books by mail. 400% profit. Literature free. Dacco, Box 781-B, Ridgecrest, California.

COLOR Picture postcards of Georgia. Mami's cottage, Augusta, state capital, state flower, etc., 10 all different 50¢. Gareth Thompson, Sale City, Ga.

OUT-Of-print books at lowest prices! You name it, we find it! Fast service. No obligation. International Bookfinders, Box 3003-PM, Beverly Hills, Calif.

FREE Catalog. Self-help books. Write: Wilshire, 8721 Sunset, Los Angeles 46P.

BOOKFINDERS! All subjects. Send wants! Jaher Book Service, 183 Hazelwood Drive, Westbury, N. Y.

"SCIENCE Milestones." Records march of science starting 400 years before Christ, right up to date. Amazing facts revealed. 312 pages packed with startling information that will thrill you. A real history of science. \$5.00. Literature free. Popular Mechanics Press, 200-SM East Ontario St., Chicago 11, Ill.

EXCITING Catalog packed with books covering most everything. Think of it—From cover to cover you will find described and illustrated hundreds of books telling how to fix and how to build almost anything. How to remodel your home; do your own decorating, plumbing, electrical work, carpentry, painting, furniture making and refinishing. How to build your own home workshop tools. Best books on welding, hobbies, homecraft. Send now for 1958 book catalog—only 10¢. Popular Mechanics Press, 200-BC E. Ontario St., Chicago 11, Ill.

SCIENCE-Fiction book bargains. List 10¢. Werewolf Bookshop, Verona, Penna.

GAMES, TOYS, NOVELTIES

WINNING Table tennis tips 10¢. Goebel, 3140 Alpine, Wichita, Kansas.

3 CAN Play Cribbage on this attractive, handmade, lucite board. \$4.50. Forest Studio of the Black Hills, Box 1367, Rapid City, South Dakota.

MODEL Auto racing. Four cars free literature. Distinctive, Room 111, 1613 Wisconsin, Washington 7, D. C.

FLUB-It-Yourself-Kit. For the handy man who has made everything else: a kit from which absolutely nothing can be built! Great gift; enough to drive a man sane. Prizes offered—lots of fun! \$1.00 ppd. Outdoor Industries, Dept. B, R. 4, Excelsior, Minn.

THE Next president of the U.S.A. \$1.00. The cleverest novelties come from Harding & Co., Box 111, N.Y.C. 28.

MAGIC TRICKS, PUZZLES, JOKER NOVELTIES

ONE Thousand tricks, jokers, stunts, magic illusions, puzzles! Jumbo Catalog (160 pages). Rush 25¢! Free trick given! House of 1000 Mysteries, 202-84 Pinewood, Trumbull, Conn.

KRAZY Klock. runs backwards, \$11.95. G. Ware, 613 Park, Lawton, Oklahoma.

LEARN Handwriting analysis! Secret tool or an amazing entertainment skill. 5 lesson course, all essentials, \$1. Details free. David Benson, Box 5081, Eugene, Oregon.

"VENTRILOQUISM Selftaught" — complete book 25¢. Greenview, Box 61-BH, Whitestone 57, New York.

MAGIC Tricks book \$1. Be party live-wire. Free catalogue. Mandel, 1200-PM Avenue H, Brooklyn 30, New York.

FREE "Top Hat Topics" booklets containing exclusive tricks we manufacture and sell. Visit the world's most modern magic shop. Lou Tannen, 120 W. 42 Street, New York 36, N. Y.

3100 NOVELTIES, Jokes, tricks, gadgets, funmakers, hobbies. Big catalog 10¢. Johnson-Smith, D-498, Detroit 7.

WORLD'S Finest professional magic. Joker novelties. Giant illustrated catalog 10¢. Top Hat, Evanston 12, Illinois.

3000 TRICKS. Pocket, parlor, stage. World's finest magic catalog (408 pages). \$2.50. Kanter's, M-1311 Walnut, Philadelphia 7.

PROFESSIONAL Catalog, 175 pages, 25¢. Williams, 900 Plymouth, Ellwood City, Penna.

BUY Direct world's largest magic factory catalog, two dollars. Abbott's Magic Manufacturing Company, Colon, Michigan.

CHEMICAL Magic kit, includes chemicals, instructions, 50¢. Kits, 1452 Drake, San Pablo 10, California.

CATALOG, Free trick, 25¢. (1,500,399 tricks, jokes). Magico, Box 4373-P, San Antonio 7, Texas.

7 TRICKS — 1959 edition now ready! Contains latest, best magic for pocket, club, stage. Only 10¢. Douglas Magicland, Dept. 11, Dallas, Texas.

COINS, TOKENS, CURRENCY

BRILLIANT Uncirculated United States five dollar gold pieces. \$15.00. Twenty dollar, fine, \$45.00. Rare Coin Company, 31 North Clark St., Chicago 2, Ill.

LARGEST Coin magazine. 200 pages, 40¢. Scrapbook, 7320-J Milwaukee, Chicago 31.

SIXTEEN Page price list of U.S.A. and Canadian coins free. Selling prices on thousands of coins and supply items. Bryson Inc., 612A White, Toledo 5, Ohio.

COMPLETE U.S. coin list, 10¢ (refundable). Bonus offer included! Economy Sales, 156-C Dean, Mansfield, Mass.

SPECIAL \$1.00, 20 page bargain list. 7 different Indian cents, album. Hobby Sales, Box 4054, St. Paul, Minnesota.

EIGHT Different Indian cents \$1.00. Collector's Bargains, New Hope, Penna.

DELUXE 32 Page U.S. catalog 10¢. Contains almost 100 illustrations; over 5,000 delightful bargains. Stonie, 260 Washington, Boston 8, Mass.

LET'S Get acquainted special—Scarce Lincoln Cents 1900vdb, 1916s, 1921s, 1923s, 1924s 25¢ each or all five \$1.00. Free price lists with order. Reynolds Coin Shop, Kresge Bldg., Flint 2, Michigan.

RARE Coin guide and new penny in clear plastic 20¢. Campbell's, 1714 Broadway, Mattoon 7, Ill.

FREE List! U. S. coins. Lowest prices! Hugh's Coins, Hickory, N. C.

FOREIGN Coin, banknote and large illustrated coin list for 4¢ postage. Bargains: Indian head cent, 10¢; wooden nickel, 10¢; Chinese dollar, 53¢. Approvals included with every order. Tatham Coin Company, Springfield 30, Massachusetts.

STARTER Collections. 12 Liberty nickels, \$2.50; 18 Barbour dimes, \$5.00; 15 Barbour quarters, \$8.00; 15 Barbour halves, \$15.00. All different, in folders, postpaid. Prager, 470 27th Avenue, San Francisco, California.

LINCOLN Cents: 1923-S, 1924-S, 1921-S, 1925-S, 1920-S, 1917-S, 1918-S, 1932-D, 1938-S, 1919-S, 1927-S, 1928-S. Complete lot only \$3.00. Berry, Box 306, Westminster, Calif.

7 DIFFERENT Icelandic coins. Sent postpaid \$1.00. Box 809, Reykjavik, Iceland.

FOR Sale 1913S, 1924S, 1931P, 1932D, 1938S, 1939D cents. All six for \$2. Gasser, Box 34615, Los Angeles 34, California.

RAREST CC mint dollar, 1885 uncirculated \$7.50. Coin catalogue 50¢. Shultz, Salt Lake 10, Utah.

TWELVE Different barber dimes \$2.00. Bargain lists free. Sayers, 1000 Unaka, Johnson City, Tennessee.

RARE Unc. 1899-P silver dollar, each \$5.00. Butts, Box 889, Torrington, Wyo.

NEW 1960 Giant U. S. coin catalogue 25¢. Ace, 107 N. Dearborn, Chicago 2.

LINCOLNS — 1920s, 1921s, 1923s, 1924s, 1925s. Complete \$1.00. Free list. United, 101 Cranston, Providence, R. I.

BARGAIN Lists free! Indianhead cent, 10¢. Farley, 204 Tanguy, Logansport, Ind.

\$4,000.00 FOR 1913 Liberty head nickel. We paid \$6,500.00 for 1794 dollar. Wanted certain others before 1904. 1870-S \$3.00 gold worth \$25,000.00 Others fine pay \$60.00 to \$2,500.00. Certain Lincoln cents 1909-1955; \$20.00, \$175.00; Indian cents \$225.00; dimes 1894-1942, \$25.00-\$3,000.00; quarters 1896-S-1923-S, \$20.00-\$600.00; half dollars 1838-O-1928, \$95.00-\$3,000.00. Hundreds of others worth \$10.00 to \$3,000.00. Canadian coins — 1921 5¢ silver \$100.00, 1899 10¢ \$100.00, 1921 50¢ \$750.00. For complete allcoin information, before sending coins, purchase for \$1.00 our large illustrated guarantee buying-selling catalogue. Catalogue dollar refunded, \$20.00 sale. Worthycoin Corporation (K-440-C), Boston 8, Massachusetts.

INDIAN Cent plus bargain lists 15¢. Hutchinson's, Box 4747, Philadelphia 34, Penna.

1955S, 1925S, eighteen other G-VG "S" Lincolns \$1. Mrs. Kendall, 409 Hazelwood, Warren, Ohio.

REAL Confederate \$5, \$10, \$20; \$1.50 each; Lincoln prices, 10¢; Schramm, Drawer 1429, Mobile.

NEW! 1960 Buying Guide Canadian coins, 20 pages, 15¢. Marles, Box 833, Calgary, Canada.

\$30.00 FOR 30 Lincoln pennies. Send \$1.00 (refundable). Bear, 128-8th St. S.W., New Philadelphia, Ohio.

VATICAN Set. 4 new coins in holder, \$1.00; 1957 U.S. proof set, \$3.00; large lists, curious coin, 10¢. Elliott, 235 Juniper, Coraopolis, Penna.

PENNIES Wanted. List, free Indian penny, 30¢. Wayne Coin, 1205 California Ave., Ft. Wayne, Indiana.

WANTED! Indians, Lincolns, other coins. Paying highest prices. List 20¢. Evans, 7620 Bertram, Hammond, Ind.

\$125.00 FOR certain Indianheads; Lincoln pennies \$100.00. All rare coins wanted. Booklet listing prices, 25¢. Lincoln Coins, D-29, Glendale, Arizona.

GEM Proof sets, in official cases—Queen Elizabeth Coronation \$11.95; Ceylon Buddha \$18.95; Ghana \$10.50; Guernsey \$7.50; Jersey \$7.75; So. Africa \$6.95. Retail guidebook \$1.75; Canadian catalogue \$1.50; World coin book \$4.00. World's greatest coin catalogue \$1.00 (deductible first \$10.00 order). Bebee's, 4514 North 30th, Omaha 11, Nebraska.

THREE Brilliant uncirculated Mexican silver dollars \$1.00. Universal Services, Box 675, San Antonio 6-D11, Texas.

30 DIFFERENT Foreign coins \$1.00. Nice lot. Some older and larger coins included. Alfred Szego, Box 187, Jackson Heights 72, N. Y.

CALIFORNIA Gold dollar. Real gold souvenir token, beautiful, dated 1850; Eureka above Lib.-like head. Rev., California gold; beautiful piece, only \$6.00 ea., postpaid insured. J. Wozniak, 8329 Owens, Sunland, California.

WORLDWIDE Coins, 15—50¢; 32—\$1.00. Free catalogue. Packard, 61-23 Palmetto St., Ridgewood, New York.

COIN News Magazine, 35¢, subscription \$3.00 year. Dept. P, 231 North 18th, E. Orange, N. J.

STAMP COLLECTING

DEALERS—Wholesale list. Postage 4¢. Frank, 5031 Queensberry, Baltimore 15, Maryland.

TRADE Your duplicates toward my approvals. Louise Rose, Star Route, Etna, Calif.

AMAZING: Triangles, British Colonies, etc. 10¢ with approvals. Lieberman, 56-33 Douglaston Parkway, Douglaston 62, N. Y.

TRY My new issue service. Illustrated bulletin weekly. World wide. Van, Box 324, Lakeland, Florida.

FREE! Over 100 different, \$2.50 value, including space satellite, Israel, British, U.S., first U.N., Siberia. Approvals. Send 25¢ for mailing. Horace Gatewood, Winston-Salem, N. C.

FIRST U.N. set. Among world's prettiest. Only 10¢. Approvals, Welles, Box 1246-R, New York City 8.

CHRISTMAS Issues. Four complete sets free with fine approvals. Stamp Imports, Peterborough, Ontario.

LIQUIDATING Collections, 2¢ approvals. Job lots. Moredan Stamps, Wellesley 81, Mass.

JUMBO Mint set free, introducing outstanding approvals. Philarama, Pennington, New Jersey.

NEW 1960 Catalogue! Send two dimes. New-Way Stamp, Lawrence (2), Mass.

DIAMOND, Triangle, Timor, Topicals, 44 all different 10¢, with approvals. Carpenter, P.O. Box 310, Claremont, Calif.

JAPAN 100 Different plus 20 commemoratives only \$1.00 by air. T. Yonehara, 248 Eifuku-cho, Suginami-ku, Tokyo, Japan.

10 CANAL Zone 25¢. Approvals! Merkel Stamps, 30 Grandview, South Hadley Falls, Mass.

300 DIFFERENT Canada \$12.00. Approvals on request. J. Gagnon, 4459 Lavoisier, St. Leonard P.M., Montreal, Canada.

AIRMAILS 15, 8¢ Postage. Approvals. Norden Hobbies, Box 106, Batavia 4, Ill.

FREE 100 Different: Request approvals. Stamac, 1605 Byrnes, McLean, Virginia.

508 DIFFERENT Worldwide from Madagascar, Macao, Guinea, etc., cataloguing over \$15 only 35¢. Approvals. Littleton Stamp Company, Littleton Q1, New Hampshire.

WOW! 110 All different Germany 10¢. Zeppelins, semi-postals, airmails, high values, etc. Giant catalog. bargain lists included with beautiful approvals. Jamestown Stamp, Dept. A119PM, Jamestown, N. Y.

FREE! Giant bargain catalog—New edition listing thousands of bargains including U. S. and B. N. A. stamps, packets, mixtures, albums, accessories and supplies; sent with beautiful approvals. Jamestown Stamp, Dept. E119PM, Jamestown, N. Y.

100 DIFFERENT U. S.—50¢ approvals. Utechts, 1143D North Keeler, Chicago 51.

GOLD Mine: Catalogue 100 pages numismatics, pictorials galore, 25 cents with approvals. V. Blauner, 317 W. 87 St. New York 24, N. Y.

GIANT Issues collection: Laos elephant set, Brussels Fair, Olympics, jet aircraft, Boy Scout, Somali animals complete, Romania flags, Togo set, diamond popes, United Nations set, etc., plus big stamp dictionary and approvals. Everything 10¢! Stampex, Box 47-KM, White Plains, N. Y.

STAMP Collecting outfit, includes packet worldwide stamps, package hinges, watermark detector, millimeter gauge. Everything 10¢ with approvals. Loraine Brown, Marion, Michigan.

PENNY Approvals. Thousands. Bargains for pennies. Gifts with purchases. Penny Stamps, Orange, California.

FREE 1000 Dennison hinges with first approvals purchase \$1.00 or more. Name countries desired. Robert J. Clark, P. O. Box 28-M, Wilmette, Illinois.

FREE! Colorful 215-different stamp collection! With adult, bargain approvals. Rush 10¢ postage. Philatelics, Dept. RE, New Palitz, N. Y.

FREE! 25 Egypt, 5¢ handling. Approvals. Bellet, Mapledale, Hazel Park, Mich.

U.S. Stamps. Giant bargain catalogue, 15¢. Raymax, 35-VZ Maiden Lane, N.Y.C. 38.

UNITED Nations. Five different 10¢. Approvals. Anderson, 1112 Harrison, San Francisco 3, Calif.

MEXICO 25 Beautiful 10¢. Approvals. Salsman, Box 702, Berkeley, Calif.

TERRIFIC Value. Eight complete mint sets 10¢ with approvals. Beatties, 58 Glenagar, Islington, Ontario, Canada.

100 STAMPS, 15 Cents. Approvals. Mengel, 11 Mansfield, Everett 49, Mass.

LAOS Elephants, 10¢ Approvals. Gebhard, 26 Westwood Drive South, West Orange, N. J.

CLEAR VU mint sheet album. Holds 100 sheets. Black, maroon, green. \$9.95. Slip case \$2.95. US price list free. Sennett, 88 Wyoming Street, Wilkes-Barre, Penna.

25 DIFFERENT Commemoratives 1893 up 10¢. U. S. approvals. K&B, Box 70, Brooklyn 23, N. Y.

BARGAIN US—101 different 25¢, with U.S. approvals. Stamps, Kennebunk, Maine.

FREE Sample! Interesting, informative, illustrated. National Stamp News, Anderson, South Carolina.

DAMAGED Old U.S. 1/2 catalog, on approval. K. Swartz, Malden Bridge, N. Y.

FREE 50 Worldwide, mailed with inexpensive approvals. University Stamps, P.O. Box 95, Tamiami Station, Miami 44, Florida.

25 DIFFERENT French colonials. All large, including sets, 10¢. approval applicants only. N. Ennis, 66 Mill Street, Arcade, New York.

TRADE Your duplicates toward our approvals! (Foreign only.) Complete information, 10¢. Variety Stamps, Box 98-P, Newton Highlands 61, Mass.

FREE! Wonderful, new 84 page U. S. catalog. Handling 10¢. Norrisco, Milwaukee 7, Wis.

307 WORLDWIDE Different stamps only 25¢. Approvals. Niagastamp, St. Catharines 671, Ontario.

1000 DIFFERENT Worldwide stamps \$1.00. Valued over \$20.00. Universal, Box 6, Kenosha 5, Wisconsin.

60 DIFFERENT U. S. (30 commemoratives) 25¢. No approvals. Seidenberg, Appleton, Wisconsin.

FREE! Eight sided stamp, triangle, diamond, midget, mammoth, to approval buyers. Plymouth, Dept. A-9, Bell, Calif.

GIANT Approvals, thousands different, 1¢ and 2¢ each. Wahl's Stamp Exchange, 7008P Farragut, Chicago 31, Ill.

ALBUM Only 10¢! Hundreds of spaces! Stampmart Company, Hartford 1, Conn.

UNITED States commemorative collection containing 33 different—10¢. Approvals. White, 516-A Avenue L, Brooklyn 30, New York.

SELL Your surplus good grade stamps. Write, describing fully what you have. Vanroy Shirk, Lebanon, Pennsylvania.

AMAZING OFFER! 200 United States stamps — including commemoratives, airmails, high denominations to \$1.00. Only 10¢ to approval applicants! Illustrated bargain lists free. Mystic Stamp Co., Dept. 80, Camden, New York.

100 STAMPS, 10¢ With approvals. Smith, 508A Brooks, College Station, Texas.

OLD Scarce U.S. seconds on approvals. Slight imperfections, lowest prices. Hernefield, Clintonhill Sta., Newark 8, N. J.

100 OLD United States between 1861 and 1935, \$1.00. Roush Stamps, 51 Chestnut, Mansfield, Ohio.

FREE Packet! Angola, Azores, Mongolia, Nepal, Palestine. Fascinating approvals. Coral, Box 7095 (Ludlum), Miami 55, Florida.

225 STAMPS For only 10¢! This mammoth value includes airmails, pictorials; stamps from strange countries cataloguing up to 25¢ each! Also approvals. Mystic Stamp Company, Camden 80, New York.

UNITED States price list, 116 pages, price 25¢. Mark Hanna, 335 Fifth Ave., Pittsburgh 22, Penna.

SELL Stamps to our readers. Your ad in this space will be read by thousands of stamp buyers. I'll prove that to you. Write now for Folder "S." F. W. Johnson, Classified Advertising Manager, Popular Mechanics, 200 E. Ontario St., Chicago 11, Ill.

14,000 DIFFERENT! Amazing new plan builds your collection systematically, country by country. Only 50¢ weekly. Free details. L. G. Ware, Stepney 75, Conn.

U. S. Mint flag set, complete, \$1.00. Free list. Brooks, 2323 Avenue X, Brooklyn 35, New York.

INTRODUCING Our better United States approvals, we offer 15 United States stamps including Columbian, Pan-Pacific, famous American, airmails, others; only 10¢. Ocean Stamps, Box 64-PM, Brooklyn 29, New York.

103 DIVERSIFIED British colony stamps only 10¢. Approvals. Niagastamp, St. Catharines 671-A, Ontario.

80 DIFFERENT U. S. stamps, includes 19th century, commemoratives, high values. Plus 1943 flag stamp of occupied nations. All for only 25¢. Approvals included. Willett Co., Box 338-C, Yorktown Heights, N. Y.

102 DIVERSIFIED Worldwide stamps 10¢. Approvals. Linstamp, St. Catharines 618, Ontario.

U. S. Approvals. Low prices. Eagle Stamps, Romine Ave., Pittsburgh 26, Penna.

PENNY Approvals! Regardless catalogue! Kloster, 4164—52nd St., San Diego 5, Calif.

25 DIFFERENT Large American commemoratives 10¢. With approvals. Linstamp, St. Catharines 618-A, Ontario.

INTERESTING Worldwide animal stamp collection 10¢. With approvals. Niagastamp, St. Catharines 671-B, Ontario.

U.S. Canada catalogue now only 20¢. New-Way Stamp, Lawrence (2), Mass.

ECONOMICAL, 1/2-3¢ Approvals. 33,000 varieties. Dresel, Box 128-N, West Englewood, New Jersey.

50 LARGE U.S. commemoratives 10¢ with approvals. Jack Clancy, Box 2187, Portland 14, Ore.

ada free with approvals. Jydec, 218 Dickinson S.W., Grand Rapids 1, Mich.

U.S. Catalog free. Contains almost 1,000 illustrations; over 10,000 delightful bargains. Stone, 260 Washington, Boston 8, Mass.

105 BRITISH Colony stamps, all different 10¢. Approvals. Crown Stamp Company, 901, Virgil, Ontario.

FREE United States price list of singles, plate blocks, FDC's. Introductory discount. Bailey, 45-G Bromfield, Boston, Mass.

25 DIFFERENT New Zealand 10¢ only to applicants for our bargain approvals. Somith Stamp Co., Box 83 (Rugby), Brooklyn 3, New York, Dept. M-Z.

BEAUTIES! Pictorials from Sudan, Andorra, Hong Kong, Iceland, Toga, New Caledonia, San Marino, Singapore, etc. Only 10¢. Approvals. Champlain, Isle La Motte, Vt.

SUPERIOR Worldwide mission mixture. Amazing variety! Six ounces \$1.65. Pound \$3.95. Bay Nielsen, 4545B Harvard, Montreal 28, Canada.

135 DIFFERENT U.S. commemoratives \$1.00; 50, 25¢. Approvals. Harold Holub, 18 East 198 Street, New York 68, N. Y.

OUR Specialty, 1000 worldwide stamps \$1.00. 3500, \$3.00. Guaranteed. Harrison's Stamps, 1435 First Ave., Oakland 6, Calif.

FREE 50 Worldwide plus handy magnifier, 15¢ postage. Approvals. Kaw Co., Box 355, Topeka, Kansas.

50 DIFFERENT Stamps free! Approvals. Marford, Box 48, Queens Village 29, New York.

CANADA: Mint royal visit and seaway, only, 10¢. Approvals. Rheume, 6591 11th Ave., Montreal 36, Canada.

RUSSIAN Commemoratives, 10¢ with approvals. Schaefer, 16 California Strasse, Wiesbaden, Germany.

MYSTERY Package stamp collection, only 10¢. Hill Company, Box 51, Defiance, Ohio.

U.S. Commemoratives: 142 different \$1; 202 different \$2. Moseley, 6 Hanley Downs, St. Louis 17, Missouri.

1958 LAOS Unesco unused complete, 10¢, or six Greek wind airmails 5¢ to applicants for our progressive approvals. Mark II Stamps, Shop 1517, 6671 Sunset Blvd., Hollywood 28, Calif.

FREE! Pictorial packet, with approvals. Conklin, Box 388-PM, Osage, Iowa.

50 CHINA 10¢. Approvals, gifts. Coast, P.O. 2187A, Santa Ana, California.

FREE! Afghanistan, Bahawalpur, Negri Sembilan, Tanganyika, Thailand. Inexpensive approvals accompany. Nade's, 6316 Crescentville, Philadelphia 30, Pennsylvania.

200 MIXED World famous stamp mixture \$1.25. Stroskey, 223 Market St., Perth-Amboy, New Jersey.

12,000 PENNY Approvals waiting for you. Many from exotic countries, pictorials, airmails, new issues. Tilbury, Box 862, Newark 1, N. J.

1000 FINE Mixed United States stamps 25¢. Wright's, Box 1122, Hagerstown, Maryland.

DISCOUNT Approvals. Send 10¢. Surprise packet. McIntyre, 231 Stanford, Berea, Ohio.

5 SETS New-Caledonia, Australia, Germany, etc., plus 100 world-wide stamps 10¢. Interesting approvals. Al Link, Box 51, New York 63, N. Y.

FREE Giant collection, including U.S.A., British, foreign, to collectors requesting approvals. Stanley Zajac, 159 Emerson Ave., Toronto, Canada.

FREE United States fully illustrated list. Introductory discounts given. Simmy's, Inc., 45-PM Bromfield, Boston, Mass.

NIGERIA! 10 different to shilling, 10¢ to approval applicants. Clasper, Box 49, Montgomery, Alberta, Canada.

FREE. Valuable collections, each collection over \$5.00 catalog value, plus many other terrific gifts free when you buy our sensational foreign approvals. Topval, Box 486B, Redlands, Calif.

UNITED States commemorative and plate block price lists free. No approvals. Frank Hutter, 468 Sixth Street, Brooklyn 15, New York.

plus 50 stamps in sets on topics of your choice: Sports, Transportation, Animals, Flowers or Religion; for only \$5.25. With beautiful looseleaf album \$7.75. No approvals. E. C. Jung, 1601 N. Stanley, Hollywood 46, California.

LET Us preserve your stamps for life. Samples 25¢. Merchandise Service, 3211 Martin Ave., Evansville 12, Ind.

700 MIXED U.S. Various issues 25¢. Monjar, Fairmont, Cincinnati 14, Ohio.

ONE Cent each, 10,000 varieties, \$1.00 deposit, free postage. Stamps, Box 35, New Milford, N. J.

BEAUTIFUL Collection Belgian Congo. Send \$1.00. Benedictus, Box 1821, Elisabethville, Congo.

500 FINE Mixed U.S. 15¢. Wright, 201M Mealey, Hagerstown, Maryland.

200 ALL Different stamps only 25¢ with approvals. Wm. Rice, 87 Washington Ave., Kingston 1, N. Y.

BARGAINS: 324 Stamps 31¢. Big bargain lot \$2. Giant assortment \$5. High value packet \$3. Persile, 436 New York Ave., Brooklyn 25, N. Y.

GIANT U.S. Canada price list. Seven hundred illustrations, stamp identification, plus foreign list 10¢. Thom, 4808-15th Avenue, Minneapolis 17, Minnesota.

MIXTURES — 100 Foreign or United States, \$1.00 each prepaid. 21st year. Missions Warehouse, Box 386, St. Petersburg, Florida.

TERRIFIC Stamp bargain! Israel, Iceland, Vatican assortment—Plus exotic triangle set. Also fabulous British Colonial accumulation. Plus large stamp book. All four offers free. Send 10¢ to cover postage. Empire Stamp Corp., Dept. PM, Toronto, Canada.

FREE. Unbeatable value. All different stamps, 10¢ handling. No approvals. Daleys, Buckland, Conn.

1053 DIFFERENT \$1.00 with approvals. Klondike, 682 Jefferson, Elgin, Illinois.

50 DIFFERENT British Colonials 10¢. Approvals. Robert Searjeant, Mendon, New York.

SOUVENIR Sheets Czechoslovakia 1937 plus Japan 1947, 10¢ with approvals. Kingman, 30 Empire, Yonkers 4, N. Y.

UNITED Nations obsolete postcard free! Approvals. Teddie, Crystal Beach, Florida.

FRANCE — Monaco. Free list. A. Anderson, 1044 Fulton St., Fresno 21, Calif.

TRADE Your better duplicates. Complete details 10¢. Chestnut, Box 4071, Phila. 18, Penna.

50,000 USED U.S. stamps for sale H. C. Teuton, Adamsville, Tennessee.

ISRAEL — 50 Different \$1.00. Edwin Morr, 1204 Sandusky, Ashland, Ohio.

CANADA Approval collections. Enclose 10¢. Peterson, 405 Northwestern Bank, St. Paul 1, Minn.

QUEEN Elizabeth on stamps. A beautiful collection of 50 different stamps from 22 countries, all bearing the portrait of the Queen of England. 10¢ with approvals. Capital Stamp Co., Ferrysburg 2A, Mich.

PACIFIC Islands, Australasia. 500 attractive mixed, \$1.50. Lang, Box 2, Hornsby, Australia.

PICTORIALS — \$8.00 Catalogue, only \$1.00. Profit sharing approvals. Warden, 68, Sierra Madre, Calif.

13 U.S. Over 50 years old 10¢. Rayworth, 321 South Cicero, Chicago 44.

10 BEAUTIFUL Mint British Colonies with approvals. Bennett, Candor 3, N. Y.

BARGAIN Surprises! Beautiful colonials, topicals. American commemoratives, small country collection 5¢. Approvals. Bristol, Canton Center, Connecticut.

HUNGARY Bicolored Diamond Rose's—free! Approvals. William Deems, 226P Race, Ravenswood, West Virginia.

FREE Mystery packet. Approvals. Premiums given. Dancer, 75-P5, Mansfield, Ohio.

1010 DIFFERENT World-Wide, only \$1.00. Stamps from over 40 countries. CK Stamp Co., 6912 Sheridan Road, Kenosha, Wisconsin.

FREE! 40 Different Portuguese; colorful inexpensive approvals. Elkhart, Box 33, Elkhart, Indiana.

100 WORLD Wide—10¢ to collectors requesting foreign approvals. Dunning, 1634 Chippendale, Houston 18, Texas.

free bargain packet list. Approval books by countries or one cent each and up. State preference. Sandee Stamps, Frenchtown, N. J.

PENNY Approvals, 1000 mounted. 25¢ handling. Page, Box 1129, Lumberton, N. C.

SEVEN Foreign new issues, 25¢. Approvals. Hermann, 327, Annandale, Virginia.

MISS Universe stamp, 10¢. Bluehill, Box 6, Milton, Massachusetts. Approvals.

100 STAMPS 25¢. Joseph Gaidar, 6615 South Ashland Ave., Chicago 36.

5 MINT Sets 5¢. Approvals. Gotthardt, 1202 Hunter, El Paso, Texas.

THREE Beautiful, unusual sets free, with worldwide approvals. Post-Age, Box 218-C, Brazil, Indiana.

LOOK! Six Queen Elizabeth mint sets! Antigua, Caymans, Singapore, etc. Total 21 different brilliant pictorials! Only 25¢ now with approvals! Gannon Stamps, Box 931, Canton 1, Ohio.

50,000 DIFFERENT Worldwide, 1/2¢ to 3¢. Generous samples, 20¢. James Vaughan, Gulfport 7M, Florida.

25 U. S. Commemoratives 10¢ with approvals. Wilson, 201F North Center, Orange, N. J.

HONG KONG, 25 Different, 25¢. Foreign approvals. Spicka, 518 No. 85th, Omaha 14, Nebraska.

25 DIFFERENT British West Indies 50¢. Rahmer, Box 123P, Rome, New York.

1000 DIFFERENT. With approvals, \$1.00. Jacobsen, 4395 Broadway, New York 40, N. Y.

HITLER Heads: Twelve different 5¢ with approvals. Norge, Hohokus, N. J.

FIVE First day covers 25 cents, and United States wants. Chinook Stamps, 2512 Franklin, Bellingham, Wash.

NEW Plastic magnifying glass. Very handy. 10¢. Scheetz's, Sellersville, Penna.

BERLIN Bears free with selection. Heitmueller, Box 322, Asbury Park, New Jersey.

WANTED—Stamp, coin collections. Murray Gold, 62-95P Saunders, Rego Park 74, N. Y.

SAVE Money on penny approvals in books of 1,000. Eppley, Bensenville, Ill.

100 EXCITING National flags, correct colors. 10¢. Approval buyers. Belmont Stamps, Washington 15, D. C.

UNITED Arab Republic mint set free. Approvals. W-B Stamps, Wilkes-Barre, Penna.

TERRIFIC! Penny approvals. Thousands varieties! Marshall, Box 451-PC, Long Beach, Calif.

ENJOY Stamp collecting! Write for "Penny-provals." Penny-proval Service, New York Building, Saint Paul, Minnesota.

LATIN America. Forty-nine different, 5¢. Approvals. Valley Stamps, Spring Valley, California.

FREE—Any volume Scott's International looseleaf albums, Scott's 1960 catalogues. Even master global album free when you buy our sensational foreign approvals. Bargain Stamps, Redlands, California.

ANTIQUES, RELICS, INDIAN GOODS, CURIOS

SCALPING Knife, spearhead, thunderbird \$4.00. Catalog 10¢. Arrowhead, Glenwood, Arkansas.

6 ARROWHEADS \$2.00 List. Smith, 841 N. Tacoma, Indianapolis 1, Indiana.

ANCIENT Grooved stone tomahawk \$3.00. Indian relic list free. Lear's, Glenwood, Arkansas.

SPECIAL: 10 Genuine arrowheads, \$2.00. Stan's, 1054 Lilley, Columbus 6, Ohio.

ADORN Your home. Genuine African curios. Zulu Tribal Assegal (spear) \$10.00. Buckskin shield \$8.00. Both \$15.00. Vanderstel, P.O. Box 10517, Johannesburg, South Africa.

PRECIOUS STONES, MINERALS

SAPPHIRE And four more uncut gems, \$1.00. Ten polished gems, baroque-shaped, \$1.00. Free gem list. Lapidary catalogue, 25¢. O'Brien's, 1116M Wilcox, Hollywood 38, Calif.

POLISHED Gem stones sent on approval to collectors, students, schools and hobbyists. New England Gem Co., Dover 1, Mass.

SEMI-Precious uncut gems. Ten different for \$1.00. Request list 26. Prospectors Shop, 201 San Francisco, Santa Fe, New Mexico.

EARTH Science, the rockhounds national magazine. Subscription \$2.00. Sample 35¢. Box 1357-PM, Chicago 90, Ill.

GENUINE Virginia fairstones. Collection \$1.00. Virginian, Box 662, Inverness, Florida.

10 BAROQUE Semi-precious gem stones in soft leather jewelry bag. \$1.50. Forest Studio of the Black Hills, Box 1367, Rapid City, South Dakota.

ROCKHOUNDS, Gem cutters, jewelry makers. New free catalog, just off the press! Biggest suppliers to hobbyists and craftsmen offers you tools, materials, equipment, introductory bargains and know-how. Free catalog. Write Grieger's, Dept. C-12, 1633 E. Walnut, Pasadena, California.

DIAMONDS Set platinum. .52 ct., \$275.00; .74 ct., \$375.00; 1.03 ct., \$575.00. Retired jeweler. Sent approval. Fritch, 404 School, Porterville, Calif.

FREE Catalogue of gemstones and findings. Rhinestone Supply Co., Scottsdale, Arizona.

FIRE Agate specimen highly polished \$1.00 prepaid. L. E. Kretsinger, 207 S. 11th Ave., Yakima, Washington.

TWELVE New Mexico minerals \$2.00, six fluorescents \$1.06, five crystallized minerals \$1.06, fools gold 35¢. Minerals, Winston, New Mexico.

GOLD, Silver, copper ore with catalog 50¢. Gemco, Eisner Av., Sheboygan, Wis.

GOLD—Ore, crystals, polished stones. Dozen identified, \$1.00. Bader's Minerals, 3910 North Nevada, Colorado Springs, Colorado.

GOLD Ore! Large beautiful specimen from world's greatest gold camp. \$1.00. The Old Prospector, Box 396, Cripple Creek, Colorado.

OPERATE Rockhound-wildcraft supply. Let Mother Nature finance you! Suppliers' Bulletin 25¢; details 4¢. McCampbell, Calexico, Calif.

18 COLORFUL And basic U.S. mineral specimens attractively boxed with descriptive folder \$1.00 prepaid. Included free dinosaur bone pocket piece. Rock Haven Mineral Co., Dept. 201, Whitefield, N. H.

HOBBIES AND COLLECTIONS

COLLECTORS Matchbook covers. 100 different unused. \$1.00. Catalog 25¢. Album \$3.00. Charles Edelman, 1311-C East 84, Cleveland 3, Ohio.

INVENTING Can be an interesting and profitable hobby. Write for complete particulars. Institute of American Inventors, Dept. 40-E, 635-F St., N.W., Washington 4, D. C.

NAZI Insignia book. 600 illustrations, \$1.00. 12 Nazi insignia, \$1.00. Hobbyland, Calgary, Canada.

COLLECT Foreign medals, daggers, helmets. Iron Cross with ribbon, \$1.50; Swastika emblem 25¢; catalog 25¢. Hobbies, Box 71-B, Rockaway 94, N. Y.

HARTLAND Horses, riders, gunfighters, ballplayers. Complete line and parts. Mission Supply, Floral City, Florida.

MILITARY Miniatures. Catalog 35¢. Bussler Miniatures, Box 107-Z, Wollaston 70, Mass.

CHRISTMAS Present collection: 20 arrowheads \$5.00. Smith, 841 N. Tacoma, Indianapolis, Indiana.

FREE Purple Heart when ordering 40 new U.S. military shoulder patches, ribbons. Postpaid \$1.00. N. Kimmel, 10436 Chevlot Dr., Los Angeles 64, California.

ANTIQUÉ Handcuffs, leg-irons represent great new collecting field. 25¢ brings illustrated catalog, history, information how to start. Patterson Smith, 269-P Shepard Ave., E. Orange, N. J.

BEAUTIFUL Sea shells 100 asst. \$1.00, postpaid. Varble's, 1505 N. Parkwood, Harlingen, Texas.

MATCHBOOK Album, looseleaf pages, expandable. \$1.00. Dealers wanted. Match Album, 5056 Armitage, Chicago 39, Ill.

CAMERAS, PHOTO SUPPLIES

CAMERA Owners! Earn \$50.00 week-ends! Instructions \$1.00 information free! Kline, 935-PM North Austin, Chicago 51, Illinois.

POLAROID Highlander camera \$49.95 (list \$74.95). Schlacker "3-speed" shaver \$17.95 (list \$28.50). 50% discounts. Photo equipment. Appliances. Free catalog. Mallers Mart, Box 135-PM, Pelham, New York.

PHOTO FINISHING

2 11x14 FROM negative, \$1.00. Negatives made 50¢. Yardbird Photos, Greensburg, Louisiana.

SPECIAL—20 Christmas cards from your photo or negative in colorful Christmas folder \$1.00. Enclose 35¢ shipping. Delta Photo Service, University, Alabama.

FREE Illustrated brochure plus sample photo of exclusive movies, photos, slides. Send 25¢ handling charge. Dame Features, Dept. ME, 22 East 17th St., New York, N. Y.

100 REAL Miniature photostamps! 1001 uses, reproduced from your photograph. \$1.50 postpaid. Chesley Distributors, 2339-A University Avenue, San Diego 4, Calif.

A Triple value. Quality, price, service. Color or black and white, 12 exp. (black and white) 59¢. 20 gift photos \$1.00. Holiday Photos, Dept. 16, Box 666, Denver, Colo.

A 3-in-1 value. Price, quality, service. 20 gift photos, \$1.00. 12 exposure rolls (black and white), 59¢. Color or black and white. Interstate Photos, Dept. 11, Box 15, Aurora, Ill.

KODACHROME Processing by Kodak. 8mm. roll or 35mm., 20 exp., \$1.40. Prompt service. Write for mailers and prices. Color Pix, Dept. P, CPO Box 30, Kingston, N. Y.

TWELVE Exposure rolls 49¢. Wallets 20 for \$1.00. Lincoln Studios, Dept. K, Box 13, Lincoln, Nebr.

ENLARGEMENTS, Heavyweight, six 5x7's or three 8x10's \$1.00. Jack Koons, Huntington Mills, Penna.

COLOR Processing! Anscochrome, ekta-chrome \$1.00, 35mm. 20-exposure roll mounted. Kodachrome 20-exposure or 8mm. movie \$1.25. U.S. Color Mart, Box 191, Hartford 1, Conn.

INTRODUCTORY Special. Processing Kodachrome 8mm movie or 35mm 20 exp. \$1.00. Kodachrome 8 exp. complete \$2.00; 12 exp. \$3.00. Black and white 8 jumbos 10¢. Jumbo reprints 5¢. Quality guaranteed. Prompt service. Write for free mailers. Fast-X-Photo, Box 7A, Jersey City, N. J.

SAVE! Photographic Christmas cards. Free mailers. Mail-A-Way, Box 375-A, Fitchburg, Mass.

FREE 5x7. Top quality. Fast service. 8 exposure rolls 40¢, 12 exposure rolls 55¢. Pics Foto, Cambridge, Minnesota.

MOTION PICTURES AND SOUND EQUIPMENT

AMISH, Pennsylvania Dutch movie, color slides. Free literature. Photo Arts, Lancaster, Pennsylvania.

16 M.M. Sound features \$20.00. Shorts \$5.00. Bedner, 5300 So. Talman, Chicago.

COLOR 8MM.-16mm. movies of Pikes Peak region and Colorado. Free catalogue. Scenic Associates, Box 547, Dept. P, Colorado Springs, Colorado.

16MM Sound films and equipment. Write, phone Entertainment films Company, 2021 Broadway, New York City.

FREE Movies on approval as club member. Join by sending \$12.00 for 4 different 8mm., \$24.00 for 4-16mm. films. Full information and film strip only \$1.00. First Nighter Movie Club, 34 West 31st St., New York 1, N. Y.

SPECIAL Entertainment. 8mm. BXW, \$12.00, 16mm. BXW, \$20.00. Write Tex. Box 368, Terminal A, Toronto, Ont., Canada.

16MM. Sound films. Bargain bulletin. Duquette, 97-T Snow, Fitchburg, Mass.

MOVIE Film! Free catalog! ESO-R, 47th Holly, Kansas City 12, Missouri.

16MM. Sound, projectors, films. Sale, rental, exchange. Visit store or write for catalog. National Cinema, 71 Dey St., New York City.

FREE! Blackhawk's big sale catalog 8mm., 16mm. movies, 2"x2" color slides. Biggest selection anywhere! Projectors, cameras, supplies. Big discounts! Get free, every three weeks, 12-page newspaper size bargain list! Blackhawk Films, Davenport 14, Iowa.

5,000 8-16MM. Movie films. Free catalogues. International Greenvale N. Y.

MOVIE Camera film: 8mm. roll \$1.50. 16mm. 100' \$3.00. Free processing. Better Films, 742 New Lots, Brooklyn, N. Y.

16MM. Sound shorts. Tremendous assortment features. \$16.50 up. Used 16 mm. sound projectors, \$79.50 up. Catalog. Abbe Films, 417 West 44th Street, New York City 36.

10¢ BRINGS Big new cine manual for the 8mm.-16mm. movie maker. Save money on fresh b&w and color movie film, all home processing equipment. Superior, 448 N. Wells, Chicago 10.

COLOR SLIDES

ROCKY Mountain scenes and nature slides. Write: Quality Approvals, 711 Columbia Road, Colorado Springs, Colo.

NEW! Synchronizer makes tape-slide lectures automatic. Information free. Catalog listing 17,000 color slides, including free title slide, 35¢. Meston's Travels, 3801R North Piedras, El Paso, Texas. Something new in '60.

TRANSPARENCIES Wanted. Up to \$500.00 each. For information write: American Color, Box 38391, Hollywood 36, California.

MUSIC & MUSICAL INSTRUMENTS

SWISS Musical movements. Electrical, mechanical. Spielman, 131 West 42nd, New York 36.

VIOLIN Makers supplies. Free catalog. 308 W. Fourth, Los Angeles 13.

ACCORDIONS—1960 Models. Lowest discount prices. Save up to 50%. Free home trial. Trades accepted. Big color catalog free. Accordion Manufacturers, Dept. 119-R, 2003 Chicago, Chicago 22.

CHORD Organs. Save 1/2. Italian craftsmanship. Play without lessons! Terms. Free trial! Free catalogs. Philharmonic Importers, Department 109-R, 2003 Chicago, Chicago 22.

84 HIT Recordings (new records) \$4.00 postpaid. Universal, Saron, Wis.

MUSIC Printing, lowest rates, complete service. Auto-Litho, Jensen Beach, Fla.

ACCORDIONS, Wholesale to everyone. Save up to 80%. All national known brands. Free catalogue. Del Principe, 29 South Cicero, Chicago 44.

ELECTRIC Guitars, amplifiers, wholesale. Free catalog. Carvin, PMM, Covina, Calif.

VIOLIN Bowhair replacements. Synthetic. Easily applied without damaging bow. \$1.00 each. Bowman, 1007 Pineheights Avenue, Baltimore 29, Md.

BACK Numbers, old standards. 45 RPM unused records. Listings 10¢. Melodyland, 1103 Richmond Ave., Pt. Pleasant, New Jersey.

PLAY Piano. Beginners book \$1.00. Guitar \$1.00. Piano accordion \$1.25. Teach yourself. United States only. Postpaid. Frank Deisz, 7407 N. Leonard, Portland 3, Oregon.

WANTED! Lyrics, poems, songs. Free rhyming dictionary. Bengol, 93 Jefferson, Chelsea 50, Massachusetts.

VIOLINMAKERS, Repairers. Fine tone wood, and all violin supplies. Send for free wholesale new price list. International Sales, 414-MPM E. Baltimore St., Baltimore 2, Maryland.

RECORDS, Monophonic, stereophonic, big discounts. Noelson, Box 211, New York 5, New York.

SONGWRITERS, With publisher contacts, want song ideas. Share royalties. No fees. Send poems: Songwriters' Associates, 1650 Broadway, New York City 19-G.

ACCORDIONS, Italy's best, guaranteed. 60% discount. Importers, 7445 East Seven Mile, Detroit 34, Mich.

POEMS Wanted immediately for musical setting and recording. Free examination. Rush poems. Songcrafters, Acklen Station, Nashville, Tennessee.

POEMS Wanted for musical setting. Established 1939. URAB, 2181 Bedford Ave., Brooklyn 26, N. Y.

GUITAR Making books, plans, imported woods, tools. List 10¢. Store, 510 East 11th Street, New York 9, N. Y.

SONGPOEMS And lyrics wanted. Mail to: TinPan Alley, Inc., 1650 Broadway, New York 19, N. Y.

Crown Music Company, 49-C West 32 Street, New York 1.

SONGS Into dollars. Share \$33 million dollars yearly for new songwriters, song poets. Any subject, songs composed, published, promoted by largest firm. Information, appraisal free. Send Nordyke Music Publishers, 6000 Sunset, Hollywood 28 PM, California.

POEMS Wanted for musical setting and recording by America's largest song studio. Send poems. Free examination. Five Star Music Masters, 630 Beacon Building, Boston.

PHONOGRAPH Records cheap, postpaid. Catalogue. Paramount, Box 2026-M, Pine Castle, Florida.

SONGWRITERS! Your songs tested, published, recorded; over 25 services. Free details. Iris Music, Box 192, Sun Valley, California.

SWISS Musical movements, \$1.90. Helax, 218 W. 72nd St., New York City 23.

RADIO, TELEVISION AND ELECTRONICS

CRYSTAL Radio experimenters. Write to Hulet, 305 Hope, Lakewood, New Jersey.

RECORDERS, Hi-Fi. Free wholesale catalogue. Carston, 215-PM East 88, New York City 28.

SPECIAL Offer. Complete correspondence course in radio, electronics and television. All new material. Only \$49.50. Formerly sold for over \$300.00. 43 books, over 2000 pages. Limited supply. Write Dept. PM Electronics Training, Box 764, Pittsburgh 30, Penna.

STEREOPHONIC Phonographs, Radios, Recorders. Catalogues 10¢. Tower Distributors, Norristown, Penna.

CRYSTAL Radio kit \$1.00; preassembled \$1.25; phone \$1.75; catalogue. Clearco Crystal Co., 2966 N. 4th, Milwaukee 12, Wisconsin.

FREE! Giant wholesale catalog on electronics, hi-fi, transistor, scientific, hobby, optics, photographic, housewares, jewelry, tools, novelties, toys. Write: Lektron, 131M Everett Ave., Chelsea 50, Mass.

TAPE Recorders, Hi-Fi components, sleep learning equipment, tapes. Unusual values. Free catalog. Dressner, 69-02M, 174 St., Flushing 65, N. Y.

AMPEX Tape recorders, components. Boynton Studio, 10-PM Pennsylvania, Tuckahoe, N. Y.

LEARN While asleep with amazing "Electronic Educator" endless tape recorder. Details free. Research Association, Box 24-N, Olympia, Washington.

TUBES—TV, radio, transmitting, special purpose types. Bought, sold, exchanged. Unused only. Send details to Barry Electronics Corp., 512 Broadway, New York 12, N. Y.

GOVERNMENT Surplus radios, parts. Picture catalog 10¢. Meshna, Malden 48, Mass.

KITS: Shortwave radio \$3.50; Crystal radio, 75¢. Alliance, 2059 60th, Brooklyn 4, N. Y.

FABULOUS — All transistor personal pocket radio with built-in antenna. Now only \$7.99 complete, postpaid. Satisfaction guaranteed. Catalog free. VerCo., P. O. Box 8116, Phoenix, Arizona.

ELECTRIC Guitars, amplifiers, wholesale. Free catalog. Carvin, PMR, Covina, Calif.

POLICE Calls from car radio with this precision designed, transistorized converter. Simple installation requires no internal connections. \$29.95. Free information. Robin Radio, 13229 Red Fern, Dallas 30, Texas.

TRANSISTOR, Diode radios \$2.98 up. Catalogue 10¢. Scroggs Imports, Hawthorne, Calif.

RADIO And TV tubes at manufacturers' prices! 100% guaranteed! Brand new! No re-brands or pulls! United Radio, Box 1000, Newark, N. J.

10 DISTANCE Crystal set plans with transistor experiments, 25¢. Laboratories, 1131-C Valota, Redwood City, California.

FLORIDA Opportunities, monthly publication listing businesses currently for sale. Sample \$1.50. Three months \$4.00. Digest, Box 11006PM Fort Lauderdale, Florida.

BEGINNERS Mail Order Guide. Rules, laws, regulations. Listing 15 mail order publications, 50¢. Curtiss Publications, 312 Olive, Porterville, Calif.

NEW Book plastic building method plus adobe brick folio. \$1000 reward offer. \$2.00. Stark, 14321 Wentworth, Chicago 27.

PLAN And personal help. Retired mail order operator will show you how to start profitable home business. Norris Cole, 217 West 49th, Bradenton, Florida.

WANTED: Home producers, to be subcontractors. Cast plastic products for manufacturers in our clearing house service. Thousands of easily made items required. Cash in at home, without previous experience. Plastic Service Associates, Dept. 11-PM, East Boston 28, Massachusetts.

RETIRE On income from wood floor finish franchise. Plastic Products, Ottawa, Ohio.

100% PROFIT Selling reconditioned spark plugs. Free sample. Lee, 1608-H Roberts, Houston 3, Texas.

DROPSHIP Buyers' Guide reveals manufacturers mailing single orders using your label. Large profits; no inventory, delivery, packaging headaches. Complete operating instructions. Details free. Rutward, 111 Bryant, Columbia Station, Ohio.

MAKE Extra money—Big cash commissions plus premiums for you and your customers. Sell advertising book matches. Sensational new tenorana, glamour girls, hillbillies; dozens others. All sizes. Quick daily sales; big repeat business. Free master kit makes selling easy. No experience necessary. Superior Match, Dept. MX-1159, 7530 Greenwood, Chicago 19.

BIG Money—Operate own fix-it shop. Service household appliances, motors, mowers, saws, skates, etc. Free book. Christy Trades School, A-8103, 3214 Lawrence, Chicago 25.

MAKE Money by mail. Others do. Write: Cox, Saugus 7, Massachusetts.

'MAILORDER Laws and Regulations" and "Mailorder Rules for Beginners," \$2.00. Explains mailorder licenses, mail-order taxes, etc. Tasker, Box 3131, Alexandria, Virginia.

SEEKING New products? Get my outfit 47 money-making specialties. Latest conveniences for home, car. Send no money. Just your name. Kristee 112, Akron, Ohio.

GROW Living miniature forest (only inches high) or orchard that bears tasty tiny fruit. Learn amazing dwarfing secrets! Fascinating hobby! Profitable home-business opportunity! Free seeds and plan. (State your age.) Miniature Nurseries, Dept. NR, Gardena, California.

"50 NEW Home-business ideas" booklet, sample free. Spray exotic Velvet-Suede on anything. Flokcraft-NR, Los Angeles 61.

BE Wholesale distributor. Buy appliances, watches, sporting goods below wholesale! Universal, 2114-A, Charlotte 1, North Carolina.

FRANCHISES Make profits! Operate your own independent franchised business as distributor, dealer or agency owner. Nationwide opportunities. National Franchise Reports is the recognized source for information regarding the booming franchise field. Write today for interesting free details of this helpful service. National Franchise Reports, W-528, 333 North Michigan, Chicago 1.

NATURAL Molding rubber, extra thick. Free sample. W. Wooley, 1016-A Donald, Peoria, Illinois.

MAKE Money distributing the "Home Business Digest," \$3.00 capital starts. Sample copy and details 50¢. Vernell, Box 77531-PM, Los Angeles 7, Calif.

PROFITABLE Penny stocks. Free information. Robertson, Box 6838, Kansas City 30, Missouri.

POLISH In-a-pad shines chrome, copper, brass, etc., like new! No hard rubbing! Sample \$1. Details free! Hahn, Box 64532-M, Los Angeles 64.

WANTING Earthworms! Oakhaven-38, Cedar Hill, Texas.

WANTED, Men, women. Raise bait for us at home. Full, spare time. Doesn't take up space. We furnish everything. Sherwood, Dept. R-2, Monmouth, Maine.

DISTRIBUTORS For spiced fruits and vegetables. Send \$5.76 for fourteen assorted jars. Carfagna Foods, 3838 N. Cleveland Ave., Canton 9, Ohio.

IMPORT-Export opportunity, profitable, world-wide, mail-order business from home, without capital; or travel abroad. Established world trader ships instructions for no-risk examination. Experience unnecessary. Free details. Mellinger, X70B, Los Angeles 24.

GAME Warden, government hunter, forestry, park and wildlife services announce job openings. All states. Enjoy outdoor work, good pay, real security. Complete information free! Write Forestry & Wildlife Course, Dept. CC-17B, 1038 S. LaBrea, Los Angeles 19, Calif.

\$250.00 WEEK Profit possible. Earn at home spare time with fascinating printing method. \$5 starts you. Send no money now. Free confidential facts and valuable samples. Screen-Print NR, Los Angeles 61.

START Your own business on credit (U.S. and Canada). Your own boss. 1383 dealers sold \$5,000 to \$33,500 in 1958. We supply stocks, equipment on credit. 200 home necessities. Sales experience unnecessary. Pleasant profitable business backed by world-wide industry. Write Rawleigh's, Dept. K-U-PPM, Freeport, Ill.

PROFIT With Popular Mechanics' subscription plan. No investment, no experience needed. Earnings begin immediately when you obtain subscriptions for Popular Mechanics, Good Housekeeping and others. High commissions, bonus. No experience needed. Deal directly with the publisher. Write Popular Mechanics, Room 11B, 250 West 55th St., New York 19, N. Y.

MONEY From your mailbox daily. Details free. Jacks House of Values, 3057 Brighton 4th Street, Brooklyn 35, New York.

32-PAGE Mailorder "Homework Bulletin," 10¢. Tasker, Box 3131, Alexandria, Virginia.

OPERATE Your own successful magazine agency! Read "Subscription Agent's Magazine" 25¢. Periodicals, 6376-R Windsor Lane, San Jose 29, California.

EARN \$100.00 Weekly part time from your arm-chair and in one year you'll receive a free trip to Europe for two. No selling. No mailorder. Pan Pacific, TDE, Box 595, Laguna Beach, Calif.

MOTEL-Resort management. Qualify for hundreds fascinating, leisurely, well-paid executive openings. Learn at home. Free booklet. Motel Managers Training School, PM119, 612 S. Serrano, Los Angeles 5.

OPERATE Profitable inexpensive mail-order business! Write! Liberty, 210-P Fifth Avenue, New York 10, N. Y.

\$1.00 STARTS You in business. New streamlined course in mail-order plus mammoth wholesale catalog full of big profits for you. Now only \$1.00. Postal Sales, Dept. F11, 11139 McCormick, North Hollywood, Calif.

SELL By mail. High income! Everything furnished. Irvin, Box 1052, Oklahoma City 1, Oklahoma.

NORTHERN California business opportunities. Donoho Realty, 493 Eighth Street, Chico.

FREE! Valuable fact and picture booklet, "The Amazing Earthworm Business!" Earn thousands \$ in your spare time. Gulf Worm Gardens-95, Bay City, Texas.

INTERNATIONAL Home Import mail-order business! Earnings unlimited. Experience unnecessary. Foreign Traders, 7814 Forsyth, St. Louis 5.

VENDING Machines. No selling. Operate a route of coin machines and earn amazing profits. 32-page catalogue free. Parkway Machine Corporation, Dept. #27, 715 Ensor Street, Baltimore 2, Maryland.

RAISE Angora. New Zealand rabbits on \$500 month plan. Plenty markets. Free details. White's Rabbitry, Delaware, Ohio.

SELL Books by mail. 400% profit. Royal, Box 368-X, Cleveland 27, Ohio.

ness. Splendid opportunity. For details write John Watkins, Box 1, Hackensack, N. J.

INCREASE Profits New garden golf motivated archery. Brockway, Box 3924, Portland 8, Oregon.

PROFITABLE Mailorder business! Write: Cal Enterprises, Box 1592, Beverly Hills, California.

PLASTERCRAFT Molds, liquid rubber, plasters, flocks, candle supplies. Catalog and manual free. Blue Rapids Supply, Blue Rapids, Kansas.

MAILORDER To churches, motels, restaurants, institutions. Complete, individual set-up, not just instructions. Hermes Advertising, 152-C West 42, New York City 36.

OPERATE Profitable mail order business. Write Wayne's Service, 3016-MM Channing N.E., Washington 18, D. C.

I Got rich in the dry cleaning business with no investment, so can you. Free details. Write: Imperial School of Dry Cleaning, Dept. PMC, 1700 Touhy Avenue, Chicago 26, Illinois.

OWN A business. Manufacture building material. Great demand. Particulars free. Morris, 713 So. Wabash, Urbana, Illinois.

MAILORDER. America's most unique no cost plan for beginners. Armstrong's, 154A Darrington St. S.W., Washington 24, D. C.

STRIKE It rich on small home repairs by using set prices. Details free. House Clinic, Dept. P, 7307 Fenton, Dallas 31, Texas.

FREE! Name brands catalog! Your own high profit business. Sell name brands, full or part time. No inventory, no investment. More than 2,000 name brand items; lowest wholesale prices. Watches, jewelry, cameras, hi-fi, stereo radios-phonos, appliances, housewares, hardware, power tools, luggage, musical instruments, garden equipment, sporting goods, toys, many others. 8 floors of name brands. Million dollar inventory. Orders shipped complete in 24 hours! Send for free, beautifully illustrated catalog now! Separate wholesale price list. H. B. Davis Corp., Dept. 11, 145 W. 15 St., New York 11, N. Y.

PLATE Baby shoes, jewelry, gifts. Bronze and colored pearl. We finance home businesses. Booklet free. Platex, 11029 South Vermont, Los Angeles 44.

LEARN Sewing machine repairing. To \$125 weekly. Sparetime. Supplies. Add to present business. Shipping from Chicago, New York, Los Angeles. Write today! Taylor Service, Box 2126, San Bernardino, Calif.

IF You like motorcycles and money then send for Harley-Davidson dealership book on how to become a franchised dealer of motorcycles and a new line of motor-scooters. Here's a chance to own your own business with a very modest investment. The youth market is beginning to explode and the next few years promise a chance to cash in on it. Write for free illustrated dealership book today. Harley-Davidson Motor Company, Dept. P, Milwaukee 1, Wisconsin.

BUY Direct from factories. Appliances, cameras, watches! Free details! Cam Company, 6810PM—20th Ave., Brooklyn 4, N. Y.

BUSINESSES, Resorts, motels, investment property, ranches. Our special service dept. at your disposal. No obligation. World's largest. 58 years' service. Strout Realty, 7-MB S. Dearborn, Chicago 3, Ill.

BIG Money raising fishworms and crickets. Free literature. Carter Farms, Plains, Georgia.

QUICK Profits, with no capital! Take orders for magazines your neighbors like, want. Make cash on the spot! We show how with free kit. Get yours now. Write McGregor Magazine Agency, Dept. 311, Mount Morris, Ill.

OPERATE Mailorder folio business. Free details. Ballard's, 1834 Edgeland, Louisville 4, Ky.

\$34.70 TWO Hours. Manufacturing concrete products. No selling. Carlyne Castings, 1803 Fremont, Rapid City, South Dakota.

TO \$100.00 Weekly. Sparetime, home operated mailorder business. Successful beginner's plan. Everything supplied. Lynn, 10420-M National, Los Angeles 34.

without molds. Patent pending. Cemetery products, novelties, tiles. Basement leak-sealing. Money-making projects. Booklet, details free. Men only. National Potteries Company, Grand Rapids, Minnesota.

PIANO Tuning learned quickly at home. Tremendous field! Musical knowledge unnecessary. Information free. Empire School of Piano Tuning, Champaign, Ill. (Founded 1935).

WANT To make big money at home? \$10.00 profit in an hour possible with invisible mending. Make tears, holes, disappear from clothing, fabrics. Steady year-round demand from cleaners, laundries, homes. Details free. Fabricon, 6234 Broadway, Chicago 40, Illinois.

\$70 WEEKLY—Home, spare time. Simplified mail bookkeeping. Immediate income—easy! Auditax, 34757A, Los Angeles 34.

MAKE Flexible molds. Cast plaques, figurines. Free sample. Tooker, 1045-R Fairview, Hamilton, Ohio.

I Want to send you proof of the wonderful pulling power of Popular Mechanics classified pages. What's your proposition? Write me today. Include literature if possible. F. W. Johnson, Manager Classified Advertising, Popular Mechanics Magazine, 200 E. Ontario St., Chicago 11, Ill.

11,000 NEW Prospects daily. Baby record books, shoes, albums. Sell mailorder. Use our literature. Write: No-Co-Ro, Capitola, California.

COPUBLISH Mail Sale Advertiser, leading mail order paper. Details, latest copy, dime. Vanroy Shirk, Lebanon, Penna.

FREE Catalog. Contains hundreds of businesses, farms and income properties throughout U.S., Canada. Specify type and location desired. Deal direct with owners. U. I. Buyers Digest, 1608 Hillhurst, Dept. PM-3, Los Angeles 27, Calif.

BRONZE Baby shoes: Instructions, equipment and mountings for genuine electroplating process. Largest supplier of all plating equipment, supplies. Free catalog. Hollywood Bronze Supply, Dept. B-3, 1624 East First, Los Angeles 33, Calif.

MAKE \$46 From square foot plywood; jig saw necessary. Free details. Woodart, Bridgewater, Mass.

MARKETS Everywhere. Make artistic concrete birdbaths, pottery. Best coloring. Home workshop. Hundred varieties. Hollywood Cementcraft, 8527-S Wonderland, Hollywood 46, California.

LIQUID Molding rubber, free sample. Shellcraft supplies. Chaney's, 1907-A East Road, Jacksonville 11, Fla.

FIX Typewriters. Free repair course. Home operated. Remit 25¢ for book explaining free course and agency appointment. Athey, Tarentum, Penna.

MAKE Money by mail! Free details! Hunholz, 902 Eighth, Wamego, Kansas.

MANUFACTURER Fishing lures, plastic, none better. 20 models pennies. Free circular. Quaker, 3514-24 N. Lawrence, Philadelphia 40, Penna.

OPERATE Profitable mail order business. Write Walter Service, 4159A East 112th, Cleveland 5, Ohio.

EARN Good money sharpening chain saws, scissors, cutters, knives. Free manual. Trecco, North Tonawanda, N. Y.

RE-Cast junk batteries into new. Latest achievements. Battery Laboratories, Bayou LaBatre, Alabama.

\$100 WEEKLY! Men, women! Work home! Sparetime. Free "Confidential Plan." Scott Sales, Box 388, Great Neck, New York.

IMPORT-Export business made easy. Individual setup service. Not just instructions. Hermes, 152 West 42, New York City 36.

HAVE A profitable business of your own selling the "World's Most Usable Pictorial Bible." Let our 26 years experience help you. International Book Company, Dept. M., P.O. Box 118, Wichita 1, Kansas.

BAKE New greaseless doughnuts in kitchen. Sell stores. Free recipes. Montgomery, 3605 South 15th, Minneapolis 7, Minnesota.

PROFITABLE Mailorder operation! Write: Vikari, 468PM 3rd Avenue, Salt Lake City 3, Utah.

bling pump lamps. Easy. Free details. Ougor, Caldwell, Arkansas.

OPERATE Profitable mail order business. Write Hunt Enterprises, 978 Terrace Dr., Salem, Oregon.

PLAQUES-Figurines-molds. Free details. Russo, 1196 Brooklyn, Bklyn 3, N. Y.

CUCKOO Clocks wholesale. Catalog 10¢. Walters Imports, Box 195, Bellevue, Ohio.

"MAIL Order World of Opportunities." Free subscription, details. GPO, Box 972-P, New York 1.

"BOOKKEEPING System for Mailorder Beginners." \$1.00. Tasker, Box 3131, Alexandria, Virginia.

HELP Yourself! Mailorder! Know the facts: laws, trends, secrets. Everything! 99¢. Customers only! Free advice, product analysis. Ads written professionally, 10¢ word. Minter Enterprises, Box 32PM, Thiensville, Wisconsin.

MONEY in chemicals. Make own products! Pocket all profits! Others work for you! Valuable starting information, \$1.00. Satisfaction guaranteed. Ranslow Reporters, 51 W. 32nd St., Hialeah, Florida.

SIX Mailorder magazines, money-making opportunities, 25¢. Thompson, Box 94-PM, Salinas, California.

CANADIAN Registered land leases. 5 acres \$70.00. Free maps, information. Fortunes made, Canada's tremendous minerals, resources. Northern Survey, 130-A Shaftesbury, Downsview, Ontario, Canada.

NEW Home-import mail order profitability! Your mailbox stuffed with money! No selling. No experience. No investment. We supply everything. Free details. Mail Order Distributors (Import Division), 15201 South Broadway, Los Angeles A5BC, Calif.

MOTEL-Resort management. Qualify for hundreds fascinating, leisurely, well-paid executive openings. Learn at home. Free booklet. Motel Managers Training School, PM-119, 612 S. Serrano, Los Angeles 5.

FREE—Exciting details. New. Complete, profitable home-operated mail order business setup. Eastern, Box 142, Boston 24, Massachusetts.

BEAUTIFUL Planters from cans. Vyke Co., 4158 Jason, Denver 11, Colo.

DISTRIBUTE Wholesale catalogs, \$1.00 each. Plus 5% commission. Instructions 25¢. Wilson Specialties, 621P North Fancher, Mt. Pleasant, Mich.

IS This money yours? Join the insiders in today's growing second income boom. Three guaranteed inside-information reports, \$2.00. Second Income Associates, 225-M, Fort Edward, New York.

"HOW To Build Your Own Mailorder Business" 50¢ postpaid. Rocky Service, N6740 Waterworks Rd., Norfolk 2, Virginia.

AGENTS Wanted. Add \$200 to your weekly income. Take orders for Xmas, high class jewelry, moderately priced. Send \$2.50 (deducted from 1st order) for illustrated colored catalogue. Jewelry Unlimited, Box 397J, Floral Park, New York.

\$34,736 A Year in mail order! Actual story and income tax figures of the mail order sensation of the 1950's. A proven step by step program. Learn how, don't grope. Send \$2.95 for folio of this fascinating true story and practical guide to success in mail order. Money-back guarantee. Garrett, Box 1143-1, Dallas 21, Texas.

COLORED-Lighted water fountains beautify lawns, gardens, patios, commercial displays. Littleford Products, 6271 Truitt, Salisbury, Maryland.

GET in foreign trade. 100 overseas manufacturers. names supplied. Some send catalogues or samples. Send \$1.00 to Joe White, Box 948, Park City, Ky.

A&W Root Beer franchises now available in choice U.S.A. locations including Hawaii and Puerto Rico. Reasonable investment. High returns. Financing available upon credit approval. Write for free brochure. A&W Root Beer Co., Box 1039-PM, Santa Monica, Calif.

AGENTS Wanted. Earn \$200 weekly in spare time. Brand name cameras and equipment. Send for free illustrated catalogue. Camera Counselors, Box 397H, Floral Park, New York.

MONEYMAKING OPPORTUNITIES

VENDING Machines. No selling. Operate a route of coin machines and earn amazing profits. 32-page catalogue free. Parkway Machine Corporation, Dept. #26, 715 Ensor Street, Baltimore 2, Maryland.

GROW Mushrooms. Cellar, shed and outdoors. Spare, full time, year round. We pay \$4.50 lb. dried. We have 29,000 customers. Free book. Mushrooms Dept.: 173. 2954 Admiral Way, Seattle, Wash.

CIGARETTES: Make 20 plain or filter-tips for 9¢. Facts free. Moberly, Box 821, Owensboro, Kentucky.

\$200.00 MONTHLY. Spare time. With tablesaw, bandsaw or jigsaw. Write, Holiday House, 7228 4th Plain, Vancouver, Washington.

HAVE Big paying home mailorder business! Many new, sparetime moneymaking opportunities now available! Details free! Steininger, Box 181-PM, United, Pennsylvania.

EARN Money evenings copying and duplicating comic cartoons for advertisers. Adservice, Argyle 1, Wisconsin.

YOUR Own, easy-to-start, home mail-order business, sparetime. Fascinating; profitable! Information free. Alfano, 19-PM Pine, Closter, N. J.

\$340.00 MONTHLY With jigsaw. Details. Elkman, 346F North Summit, Sioux Falls, So. Dak.

BIG Money raising fishworms and crickets. Free literature. Carter Hatchery, Plains, Georgia.

SELL Titania gems. Far more brilliant than diamonds. Catalog 10¢. Diamonite, 2420-M 77th, Oakland 5, California.

BOOKS: Hundreds of subjects. Big 1958 book catalog—10¢. Popular Mechanics Press, 200-BC East Ontario St., Chicago 11.

WIN Contest money. General Contest Bulletin gives hundreds of tips. Lists current contests, rules. Sample magazine 25¢. General Contests, 1609½ East 5th, Duluth 12, Minnesota.

MAKE Money writing short paragraphs. Information free. Barrett, Dept. C-27-D, 7464 No. Clark, Chicago 26.

11 MONEY Making methods. Each worth big money to you. Free details. Griffin, 322 W. State, Ithaca, N. Y.

READ "Progressive Mailtrade," the magazine that tells how to make money by mail. Quarter brings sample and special offer. Progressive Mailtrade, Box 357, Sheboygan, Wisconsin.

OPERATE Home mail-order business. Vosacek Printing, 4444A Ute, San Diego 17, Calif.

START Big-pay business at home in spare time. No experience needed to operate little table-top machine for bronzing baby shoes. Make \$5.46 profit on every pair. Full particulars free. Send postcard to Mason, 1542 Jarvis, Room CM-2-L, Chicago 26, Ill.

EARN More money! Know and capitalize on your abilities! Eliminate doubt as to your future! Send \$5.00 for comprehensive intelligence test and full analysis. Associated Institute, P.O. Box 4, Manhattan Beach 7, California.

"BUILDING A Fortune Using Common Sense." Send name, address, \$2.00 for booklet. Macvean, 82 Brookview Crescent, Brockville, Ontario, Canada.

NOW! A second income in part time mail order business. It's terrific! Free informative literature. Wagner, 110 Caliodine, Buffalo 26, N. Y.

MEN — Women! Start money-making plastic laminating business at home in spare time. Material that costs 11¢ brings back \$2.50. No canvassing or selling but mail orders bring in \$20 a day. Write for full particulars free. Rush name on postcard to Warner, Room CL-2-L, 1512 Jarvis, Chicago 26, Ill.

UNUSUAL Fees earned managing money-raising campaigns for churches, hospitals, lodges, institutions. Unlimited demand. Three month spare time course backed by thirty-four years experience. Free proof. William Arbogast, 229 East Mason Avenue, Alexandria, Virginia.

MAKE \$500-\$15,000 Yearly at home in respectable field. Future growth unlimited! No experience necessary; no public contact; nothing to grow or make. Free expert guidance helps you achieve financial success! Rush \$1.00 today for complete details! Satisfaction or refund. Columbia Enterprises, 9268-PM Finney Branch Road, Silver Spring, Maryland.

HAVE Big paying mailorder business! Idea book for beginners, established dealers, only 25¢! Satisfaction guaranteed! Beatty, Box 4754-P, Baltimore 11, Maryland.

EASY To start rubber stamp business at home in spare time. Make up to \$9.80 an hour without experience. Facts free. Write to Roberts, 1512 Jarvis, Room CR-2-L, Chicago 26.

MAKE Humorous signs. Easy, profitable. Free information. Stanmore Sales, Listowel, Ont., Canada.

SELL Information by mail. 10-to-1 profit ratio. Valuable suggestions free. Rawson Wood, 2753-P Fullerton, Chicago 47.

\$3.00 STARTS Baby shoe plating business. Free details. Jo-Ca Electroplater, 7840-D Northwest Sixth Court, Miami 50, Florida.

SELL New storm door safety latch. Retail \$1.98. Sample \$1.00. Details free. Hol-Ven Products, Box 485, Hamilton, Ohio.

\$50.00 WEEKLY—Spare time at home! Make "do-it-yourself" end table, coffee table kits! Always in demand. Details free. Table Craft, Box 271, Froid, Mont.

AMAZING Successes through franchises! Become exclusive franchise holder your territory. Information rushed. National Franchise Reports, MP-528, 333 North Michigan, Chicago 1.

MAKE Big easy profits making costume jewelry at home in spare time! Quick, easy to make, easier to sell! Details free! Don-Bar, 3511 W. Armitage, Dept. L-192, Chicago 47, Illinois.

MAKE 100% Profit! Selling new 29¢ kitchen gadget. It's terrific. Free details. Sample 25¢. Coilzit Inc., 25-57 Steinway, Long Island City 3, N. Y.

PLEASANT Moneymaking opportunities. All ages. Full time. Part time. Bill Dunihue, 224 Beach Drive North, St. Petersburg 1, Florida.

MAKE \$100.00 Easy! Brand new brilliant fluorescent vinyl car bumper strips shout Christmas. Samples only \$1.00 for 2. Quantity discounts. M. Trove, Box 452, Bellingham, Wash.

START A profitable subscription business in spare time! We need men and women (young or old) as representatives for all leading national magazines. Liberal commissions on all subscriptions. Supplies free. No experience needed. Send this ad with your name and address to: Popular Mechanics, Room 11-0, 250 West 55th St., New York 10, N. Y.

EARN Extra Christmas money. 25¢ brings sample or \$1.00 brings beautiful assortment. Details included. Hildebrand, Box 988, Vallejo, California.

GREATEST Self-seller of all! New miracle nylon saver. This dollar item will make you money. Millions of women eager to buy. Salesmen, jobbers, distributors. Wearion, 50 Richard, Salt Lake City, Utah.

HOME Business occupations! Mailorder opportunities! Sparetime projects! Write: Guarprod, 2036-PA 66th, Brooklyn 4, N. Y.

REPAIR Hydraulic jacks—excellent moneymaking opportunity. Start earning at once. Illustrated repair manual \$3.98. Hydraulic Parts Supply, Box 4104, Dept. 11-PM, El Paso, Texas.

FREE Opportunity mail. Send stamp. William, 35-24 Woodcrest, Dayton 5, Ohio.

SPARKLING Feather Christmas and greeting folders. 4½"x6½". Dozen assorted with envelopes \$1.95. Mexicana, 1104, Calexico, Calif.

TRANSPARENT Mirror. Used by police and government agents for espionage. Sell to stores, homes, etc. Sample glass 50 cents. Door Hardware Industries, 7500 Torneille Avenue, North Bergen, New Jersey.

BIG Money making beautiful pleated skirts with my miracle one-seam instructions. Quick, foolproof. 23" to 33" waist. Only \$1.00. Elizabeth, Dept. P119, 1176 East Claremont, Pasadena, California.

WANTED! Mailing scheme revived! Still a corker! Formatrait, Box 3463, Highland Park 3, Mich.

"HOW To Make the Money You Want—Now!" Amazing new book gives best information on making and managing money ever published. Tells you what to do and how to do it. Could make you rich. Order now. Only \$2 postpaid. Satisfaction guaranteed or money back. Bruno Enterprises, Chandlerville, Illinois.

BECOME A Notary Public! Men or women—be more valuable, whether working for yourself or for someone else. Notarize papers. Earn extra fees. Cost is little. You get appointed Notary Public with our aid, or you pay nothing. Information free. Stationers, 1912-PM Euclid, Chicago Heights, Ill.

COULD You use \$200.00, \$500.00, \$1,000.00? Crossword-value puzzle contest. Enjoy spare time solving our puzzles, win big cash award besides. Puzzle and complete rules free on request. Then if you like it, \$2.00 entry fee qualifies you to win one of 50 cash prizes totaling \$2100.00. No guessing. Highest score must win. Town, Country Association, Box 1562-B, Tacoma, Wash.

MAKE High profits selling manufacturer's jewelry of unusual design! Free details! Fredericks, 1223 National Newark Building, Newark, New Jersey.

CATHOLIC Religious articles including large Catholic Bible. 50% discount. Start your own business. Catholic Guild, 11 Harding Ave., White Plains, N. Y. Samples and kit \$1.00.

\$3.00 HOURLY. Typewriter helpful. Homework literature and instructions 50¢. Interstate, 37 Besch, Albany 9, N. Y.

DISC Jockey. Home study course Weidner, 423 E. 7th St. Boston 27, Mass.

SPARETIME Repeat profits taking magazine subscriptions. Special Offers. A & B Magazine Service, 1437 N. High St., Columbus, 1, Ohio.

STEADY Home income, stenciling simple monograms. We start you. Co-art, PM11, 111 Cronkhite, Danville, Ill.

SELL Hand-carved plastic atomizers, cigarette lighters, salt & pepper shakers, etc. Send 50¢ for personalized key chain & details. Hussar's 76 Dunbar Street Rochester 19 New York.

START Home business spare time. Experience unnecessary. Literature free. Arthur Tracy, 4 Cherokee Road, Pinehurst, North Carolina.

67 PROVEN Moneymaking plans one dollar. Delmont Publishing Company, Delmont 7, Pennsylvania.

HOME Workers needed! Good earnings. No selling. Everything furnished. Elvee, 566 Beacon, Manchester, N. H.

NEW Soilless method raising night-crawlers, redworms. Three Oaks Ranch, Dresden, Tenn.

WORK At home. We supply everything. \$25-\$50 weekly in spare time. Complete information 10¢. Suffolk Ceramics, 366 Centerport 3, New York.

EXPORT — IMPORT

TERRIFIC Import, gift bargains. Free catalog. Carle Distributors, Buffalo 12-P, New York.

FORMULAS, PLANS, ETC.

FORMULA \$1.00. Refine oil automobile oil-Chemical Method. Borovka, 3613 Cleveland St., Tampa, 9, Florida.

FORMULAS. Good ones. List free. Tops Laboratories, Box 43631, Hyde Park Station, Los Angeles, Calif.

RESILVER Mirrors—make one-way mirrors. Both \$1.00. Kem-Mir, Park Ridge, Illinois.

LATE, Modern manufacturing formulas. List free. Moon Chemical, Martville, New York.

FORMULAS For latest money-making discoveries. New! Good! Valuable literature free! Miller, Chemist, 1517-D, Tampa, Florida.

FORMULAS; All kinds, latest, best. Literature free. Kemixal, Park Ridge, Ill.

OPPORTUNITIES, Unlimited! Latest specialty formulas, analyses, development, consultation. Monthly report of newest products. Exciting details, free. Alpha-Midwest, LaPorte, Indiana.

NEW Liquid casting plastic, clear, colors. Embed real flowers, butterflies, photos, coins. Send 25¢ for two handbooks "How to Cast Liquid Plastics" and "How to Make Extra Money at Home." Castolite, Dept. M-101, Woodstock, Illinois.

LAMINATING Supplies. Price list free. Solomson, 4 Beacham, Everett 49, Mass.

NOW! Electric plastic laminating kit. Laminates wallet items. Ideal gift. Pleasure or profit. Burr, 330 East Center, Kalamazoo, Mich.

NEW Do-it-yourself casting and molding plastics! No experience or machinery necessary. Send 25¢ for big 64 page catalog. Castacraft Corp., Dept. T-22, P. O. Box 555, Palo Alto, California.

FREE Sample. Sensational plastic with tremendous profit opportunities. Write now. Trialpha, Dept. F11, 7950 Mammoth, Van Nuys, Calif.

PLASTICS, Acetate, cellophane. Folders, envelopes specialties. Assortment \$1.00. Agents wanted. Major's, 1740 Columbia, Chicago 26.

CELLULOID Scrap. Sheets, state thickness, colors. Celluloid, Box 8096, Newark 8, New Jersey.

MANUFACTURE Flowers, gems, toys, lures, novelties, statuettes. Instructive catalog 25¢. Gel, Box 261, Union, N. J.

MAKE, Sell, signs, Plastic letters. Dixie Plastic Co., Lakeland, Fla.

SIMPLIFIED Plastic molding, repairing. trial unit \$2.00. Hallmark Dental Co., Box 1924, Detroit 31, Mich.

PLEXIGLAS. Square foot cost. 1/16", \$1.20; 1/8", \$1.52; 3/16", \$1.86; 1/4", \$2.21; 3/8", \$3.23; 1/2", \$4.36. Colors add 10%. Send 15¢ for postage. Aristocrat Plastics, 23 Sussex Avenue, Newark, N.J.

BOXES, Plastic. Free list. Althor, 170 Bay 23 Street, Brooklyn, N.Y.

LEARN Plastics fabrication for spare time income. Low cost home training now available. Write for free booklet. Interstate Training Service, Dept. D-3, Portland 12, Oregon.

PLASTICS—Plexiglas, Polyester, fiberglass, Acetate, supplies. Manufacturers' distributor, sheets, rods, tubes, liquids, coatings, films. Large, small quantities. Complete instructive catalog, 50¢. Details free. Gem-O-Lite, 5529-X Cahuenga Blvd., North Hollywood, California.

CHEMISTRY

LABORATORY Chemicals and apparatus. Catalog 50¢. Atlas Chemicals, Box 22, Rupert, Idaho.

AMAZING New book of science experiments, formulas, and catalogue of laboratory supplies. Only 35¢. National Scientific Co., 13 S. Park Avenue, Dept. PM-11, Lombard, Illinois.

ROCKET Chemicals, supplies. New Catalog and plans sent with sample kit of tubes, fuse, chemicals, zinc and sulfur, \$1.00. Central Rocket Company, Waupaca, Wis.

ROCKET Supplies for amateur rocketry. Catalog 25¢. Mervin Hill Company, Boltz Pennsylvania.

LABORATORY Catalog, 25¢ Experiment Book 25¢; Used list. Laboratory Sales, Box 161-A, Brighton, Mass.

"SCIENTIFIC Oddities," 60 page booklet, 10¢. Franks, 3121 South Racine, Chicago, 8.

FREE Introductory offer. Student chemicals, apparatus, biology supplies. Catalog 25¢. Bio Chemical Products, 30 Somerset St., Belmont 78, Massachusetts.

MICROSCOPE Slides, anatomical. Free list. Bay, 409 Roosevelt, San Francisco 14, California.

EXPERIMENTERS: Terrific bargains galore, catalog 25¢. Hagenow Laboratories, Manitowoc, Wisconsin.

CHEMICALS And apparatus for industrial, analytical, and private laboratories. Catalog 25c. Dept. M-50, Biological Supply Co., 1176 Mt. Hope Ave., Rochester 20, N. Y.

ILLUSTRATED Catalog: Chemistry, mineralogy, biology 25¢. Tracey Laboratories, Evanston, Illinois.

CHEMISTRY, Microscopic. Insect, butterflies, rocks, minerals. Sets complete. Literature. Amateur Chemist and Microbiologist, 208 East Eleventh, Kansas City, Mo.

MIRACULOUS Invention! Nothing like it! Does five different things. Holds fish and scales it. Even holds pole and is an ice pick. Beautifully made, blue and gold, ideal gift. Every store prospect. Show it you got sale. Profit in salesmen's favor. Write I. M. D. Incorporated, 319 Prospect, Beloit, Wis.

60% PROFIT On cosmetics—Famous nationally advertised Hollywood cosmetics pay 60%! Make \$25 day up! Hire others. For free sample, details, write Studio Girl, Glendale, Calif., Dept. 12911G.

\$1,000.00 A Month for making dramatic 3-second demonstration of amazing lightweight Presto Fire Extinguisher. New chemical used by airforce snuffs out fires instantly. Only \$4.95. Terrific commissions. Millions want it. Free kit. Merlite, 14 E. 32nd, Dept. P-66F, New York 16.

MAKE Money selling nationally known Swami Car Polishing Cloth. Cleans and polishes cars in minutes. Unique formula with General Electric Silicone Oil. Over one million sold in U.S. Big repeat business. Write: Mill River Automotive Products Corp., PM-11, Great Neck, New York.

SEND \$1 For sample 3'x5' plastic 50 star flag. Also flyer describing others, selling plan. Macklee, 1123 Broadway, New York 10.

SELL New 2-year light bulbs to homes, offices, factories. Burns 450% longer than ordinary bulbs or replaced free! "Guaranteed Profit Plan." Details free. Solar Electric Products, 366 Fifth Ave., Dept. 9113, New York.

AGENTS—Plastic coinwrap, counts and wraps pennies, nickels. Free details. Sterling Discount House, Box 626A, Dania, Florida.

BE The Popular Mechanics representative in your neighborhood and earn big profits in your spare time. Write Popular Mechanics, Room 11A, 250 West 55th St., New York 19, N. Y.

LARGE Profits taking orders for bronzed baby shoes. Every home a prospect. No investment. Bromley, 38 Vergason Ave., Norwichtown, Conn.

WILL You test new items in your home? Surprisingly big pay. Latest conveniences for home, car. Send no money. Just your name. Kristee 67, Akron, Ohio.

\$354 WEEKLY—Six sales. Ladies' or men's watches. Advertised in Life at \$71.50. Sample \$12.50. Dozen \$125. Money back guarantee. Thunderbird Distributors, 704 W. California, Midland, Texas.

FREE One foot mop with each quart liquid toilet bowl and porcelain cleaner. Proven, steady, repeat profitable. Send \$1.00 for Sample Quart. Write Trevin, 1300 S. Canal St., Chicago 7, Illinois.

OPERATE Your own successful magazine agency! Read "Subscription Agent's Magazine" 25¢. Periodicals, 6376-S Windsor Lane, San Jose 29, California.

FEATHERBIRD Pictures, pair 10¢. Free bargain catalog. Direct Mexico Importers, Box 1342, Laredo, Texas.

DAMASCENE Earrings! Exotic orientalism. Huge profit. OHGA, PM167, Sigakenkusatu, Japan.

\$3.95 AUTOMATIC Fire extinguisher. Details free. Aut-O-Matic, 1737L East 31st, Denver 5, Colorado.

EARN \$12,000 Yearly—only two sales daily. World's best seller, The Holy Bible. Illustrated. Protestant or Catholic. Margareta's, P.O. Box 92, Hazleton 7, Penna.

DRESSES 18¢. Blouses 39¢, skirts 69¢ (used). Free catalogue. Ace, 196-PM DeGraw, Brooklyn 31, New York.

BIG Profits. Stamp social security plates, key protectors. Sample 50¢. Catalog free. General Products, 188-PM State, Albany 10, N. Y.

MEXICAN Art goods! Free sample! Send 14¢ stamps mailing. Sylviak, Apartado 9036, Mexico City.

EASY Handwork makes fast-selling useful articles. Sample free. Sunmade Company, Brockton 64, Massachusetts.

PRINTING, Advertising salesmen—Excellent moneymaking sideline selling decalcomania name plates, small quantities. Automobile initials, sign letters. Free samples. Ralco, XL, Boston 19, Mass.

gold window letters, stores and offices. Free samples. Metallic Sign Letter Co., 1217-D West Newport, Chicago.

YOUR Ad in this space will get some good agents for you. Yes, I'll prove it. Write for Folder "A" right now. F. W. Johnson, Classified Advertising Manager, Popular Mechanics Magazine, 200 E. Ontario St., Chicago 11, Ill.

SELL Champion, AC, Autolite spark plugs. Reconditioned, electroplated, guaranteed 10,000 miles. 100% profit. Free sample. Lee Plugs, 1608-E Roberts, Houston 3, Texas.

TREMENDOUS Profits! Every man, woman and child a customer. Used suits \$1.50, pants 35¢, dresses 20¢, shoes 20¢. Operate from store, home, car. Free catalog. Superior, 1250-A Jefferson, Chicago 7.

YOUR Own business—Used suits \$1.50; overcoats 65¢; mackinaws 35¢; shoes 12 1/2¢; ladies' coats 30¢; dresses 15¢. Enormous profits. Catalog free. National Mail Order, 2111-AA Roosevelt Road, Chicago 8, Ill.

FOG-STOP Windshield cloth. Instantly removes blurry mist, frost, sleet, snow. Stops windshield fogging. Samples sent on trial. Kristee 65, Akron, Ohio.

GOLD Or silver letters, numbers. Windows, doors, trucks. 1" to 6". 500% profit. Free samples. Atlas-T, Box 543, Oak Lawn, Ill.

WANT To make \$20 or more in a day for part or full time route work? Man or woman. Write Mcness Co., Freeport 24, Ill.

REAL Diamond rings. Nationally advertised. Sell direct. Make big middleman's profit. No investment. Experience unnecessary. Free catalog, details. Gleamlight, 111-B9, North Columbus, Mount Vernon, N. Y.

BUY IT WHOLESALE

SAVE 60%! Clothing, appliances, etc. United Wholesalers, 1265-M Broadway, New York 1, N. Y.

BUY Wholesale nationally advertised merchandise. 124 page catalog \$1.00 refundable first order. Keystone Industries, 1311 Morse Avenue, Chicago 26, Illinois.

50 JAPANESE Manufacturers, ordering instructions, cameras, toys, fishing tackle. \$1.00. G & L Enterprises, 4470 S.W. 67th Terr., Ft. Lauderdale, Fla.

NAME Brand bargains. Free catalogue. Falco, 1024 Eureka, Lansing 12, Michigan.

CHRISTMAS Bargains! General gift catalogs \$1.00, toys 50¢. Hawn, Box 178, Ballwin, Missouri.

GASOLINE Mileage computer. All cars. 50¢. Save-Rite, Box 38-1106, Miami 38, Florida.

ELECTRIC Guitars, amplifiers, wholesale. Free catalog. Carvin, PMW, Covina, Calif.

BARGAIN Hunters. Our catalog describes merchandise at wholesale and below wholesale prices. All transactions backed by "The Golden Rule Guaranty." Send 25¢ to defray postage and handling costs. Back Creek Sales & Service Co., P.O. Box 61, Dept. PM41, Champion, Penna.

BUY Our new wholesale catalog and receive a pearl necklace. \$1.00, refundable. Pond's Bargains, Box 329, Canyon, Texas.

UNUSUAL Wholesale catalog! Some items 4¢. Name brands. Free details. Stalter's, 2444 North Armstrong, Kokomo, Indiana.

NEW Multicolor wholesale catalog, automobile catalog, and others. Housewares, appliances, refrigerators, freezers, washers, dryers, television, radios, furniture, clothing, luggage, binoculars, phonographs, recorders, cameras, projectors, typewriters, sewing machines, power tools, toys, sporting goods, watches, jewelry. Name brands. Huge discounts. Postcard: Selbyco, Decatur 162, Illinois.

BULOVA, Benrus watches like new \$4.95 up. Free 32 page illustrated catalog with hundreds of jewelry and gift bargains. Cosmos, New York 35, Dept. 466.

BUY Wholesale; 100,000 nationally advertised products. Appliances, cameras, sporting goods, housewares, watches, typewriters, tools, clothing, etc. Discounts to 60%. Buy-Rite, Box 258, Hawthorne 2, New Jersey.

WROUGHTON 1500,000 items supply source directory 25¢. Idealer, Park Ridge, Illinois.

CHURCHES, Clubs, salesmen discounts to 75%. Catalog \$2.00. Refundable on first order. The Dollar Stretcher, Box 1555, Indianapolis, Indiana.

FABULOUS, Wholesale gift catalogue 25¢. Osterhoudt's, Red Oaks Mill Road, Poughkeepsie, N. Y.

USED And new watches \$2 up. Free list. Southern Watches, 5-PM So. Wabash, Chicago 3.

LARGEST Wholesale supply source in U.S.! Furniture, clothing, appliances, housewares, automobiles and accessories, tools, sporting goods, hobby supplies, farm equipment, imports, new products, bargain merchandise. Free details. Associated Wholesalers, Box 2068-DD, Sioux City 4, Iowa.

HANDMADE Western boots. Free catalog. Ysleta Boots, Box 815M, Ysleta Station, El Paso, Texas.

OLD Wall telephones, working order. Oak cabinets, hand crank for ringing. \$7 each, FOB, Telephone Co., Turtle Lake, Wis.

SALESMEN—DISTRIBUTORS

MAKE Up to \$50.00 a day soliciting delinquent accounts. Terrific commissions. Write today. National Credit, 304Y Pickwick Bldg., Kansas City 6, Mo.

YOUR Free copy of world's biggest sales magazine tells you how and where to make more money on your own in selling. Write Specialty Salesman Magazine, Desk 5B, 307 North Michigan, Chicago 1.

IF You're interested in making money in selling, see the hundreds of exceptional opportunities in Salesmen's Opportunity Magazine. Send name for your copy, absolutely free. Tell us what you're selling now. Opportunity, 848 N. Dearborn, Dept. 17, Chicago 10, Illinois.

MAKE Up to \$50.00 a day soliciting delinquent accounts. Terrific commissions. Write today. General Finance, 304V Pickwick Bldg., Kansas City 6, Mo.

SALESMEN Needed for the finest watch and clock oil on earth. D. C. Stull, Box 176, Marion, Mass.

BIG Money distributing all natural food supplement. Free information. Vita-Vim Company, P.O. Box 7793, Dallas, Texas.

WILL You wear new suits and topcoats without one penny cost and agree to show them to friends? You can make up to \$30.00 in a day even in spare time, without canvassing. Stone-Field, 532 South Throop Street, Dept. W-926, Chicago 7, Ill.

71,000 ADVERTISING Novelties. Fifteen samples, \$1.00. 2(Refundable). Adelpia Specialty, 212 Yellowstone Rd., Plymouth Meeting, Penna.

\$1,000 A Month for making dramatic 3-second demonstration of amazing lightweight Presto Fire Extinguisher. New chemical used by airforce snuffs out fires instantly. Only \$4.95. Terrific commissions. Millions want it. Free kit. Merlite, 114 E. 32nd, Dept. P-66F, New York 16.

EPOXY Coatings and other advanced building materials pay top commissions. Paramount, Box 1956, Cleveland 6, Ohio.

POPNIK! Perfect give-away. Novelty action rocket. \$25M. 15 samples \$1.00. A&M Sales, 3241-P North Hoyne, Chicago 18, Ill.

CALENDARS, Advertising novelties, matches. All styles, including religious, varnished, 12 sheet, girls. Hundreds of advertising novelties, book matches, etc. Fleming Calendar Co., Sales Division, 6539 Cottage Grove, Chicago 37, Ill.

AMAZING New metal polish imported from Germany. Franchise territories open for dealers and distributors. Send for sample and details. Lewis Rand Imports, Marberth, Penna.

BOOK Profits, selling Bibles, dictionaries, encyclopedias, cookbooks, others. Free details. Adam, Dept. M-11, 97 Warren Street, New York 7, New York.

MAKE Extra money selling advertising matchbooks. Free catalog and sales outfit. Matchcorp., Dept. PM-119, Chicago 32.

...ing customers plus premiums for you and your customers. Sell advertising book matches. Sensational new tenorama, glamour girls, hillbillies; dozens others. All sizes. Quick daily sales; big repeat business. Free master kit makes selling easy. No experience necessary. Superior Match, Dept. M-1159, 7530 Greenwood, Chicago 19.

MAKE Money selling sensational dwarf trees—Bear giant-size apples, peaches, pears. Ornamental. Also Stark-Burbank standard trees, roses, shrubs, vines, etc. Outfit free. Stark, Dept. 30105, Louisiana, Missouri.

SENSATIONAL New Silicone changeable letter signs 40% Disc. Sample kit, letters, numerals, rais \$5.50 postpaid, refundable. Luminous Signs, 6849 Liveoak, Bell Gardens, Calif.

AMAZING Invention. Motorists everywhere are raving about Tire-Aid. The emergency automatic flat tire inflator. Inflates tire in seconds. Enables car to be driven off dangerous highways to service stations, even to destination. Easy sales, non-competitive. Big profits! Renhill Co., Newark 12, New Jersey.

MONEY! Your picture on dollar bills. Send photo, business card, \$10 for 1,000. Moneymakers, 1225 East Broadway, Phoenix, Ariz. (Free samples).

1959 SUPERIGNITIONER: Starting, pep, mileage \$5.50; \$900 mimeograph, varityper, offset \$195. EG, Elmsford, N. Y.

EMPLOYMENT INFORMATION

JOBS On ships and yachts traveling foreign countries. Davenport's, 1354-K, G.P.O. New York 1, N. Y.

FOREIGN Jobs—Latin America, Alaska, Canada, up to \$1500 monthly. Up-to-date 1959 foreign service directory gives complete information; hot list of firms hiring for military and civilian construction, aircraft, oil, exporters-importers, mining. How-when-where to apply. 11th successful year. \$1.00. Global Reports, Box 8873-S, Los Angeles 8, Calif.

COPYRIGHTED Reports. Best paying companies, travel, adventure, promotions. Construction, aviation, shipping, oil fields, laborers, clerical, trades, supervisory, factory, unusual opportunities. Skilled, unskilled. Foreign, stateside. Only \$2.00 (\$2.25 airmail) (COD'S accepted). Satisfaction guaranteed. Included free: Special reports on Alaska, Venezuela, South America. Research Services, Meramec Building, St. Louis 5-PM, Missouri.

FREE Information—U.S.A., overseas jobs. High pay, transportation. Futures, Dept. M, 215 West 34th Street, New York City 1.

MERCHANT Marine jobs. Top wages. Travel. Details free. Captain Box 501-P, Reading, Massachusetts.

U. S. A., Foreign jobs, up to \$1500.00 monthly. Construction, clerical, supervisory, etc. Skilled, unskilled. Free transportation. Unusual opportunities. Complete information plus worldwide project listings. Only \$2.00 (\$2.25 airmail). Satisfaction guaranteed. International Reports, Dept. G, P.O. Box 621, San Jose 6, California.

FREE Employment information. J.S.P. Co., Box 646, Scranton 2, Penna.

WANT A good overseas or American job? Higher pay. All occupations. Transportation paid. Free information. Employment Headquarters, 79 Wall Street, Dept. B-2, New York 5.

THOUSANDS Of jobs in blue-chip firms coast to coast! New, 10-page report tells "Who's Hiring Who" in 280 categories from accountants to zoologists! Only \$1.00. Mail check to: EAC-PM, Register, 2020 M Street N.W., Washington 8, D. C.

"VALLEY Of the Sun" opportunities. Phoenix classifieds \$1.00. Herrick, Rt. #1, Box 1327, Apache Junction, Arizona.

JOBS Detroit classifieds \$1.00. J. Marriage, Box 62, Gaylord, Mich.

"OPPORTUNITIES Afloat." Jobs on ships. Learn necessary requirements. Write: Kain—1593R, G.P.O., New York 1.

JOBS On ships, men, women: \$100 weekly for beginners. Write Captain Wohlenberg P. O. Box 192, New York 4, New York.

JOBS Overseas! Write New Horizons, 550 Fifth Avenue, New York 36, N. Y.

...highest wages, unlimited opportunities. Laborers, clerical, construction, electronics, oilfields, civil service. \$2.00 airmail. America's leading overseas employment researcher. Plus: newest South America, Alaska, Venezuela listings. Universal Research, Box 4912, Baltimore 20, Maryland.

SPECIAL SERVICES

BIRTH Certificates. Any state. Results guaranteed. Millers Service, Inverness, Florida.

BRICKLAYERS. Information, opportunities, retirement details 5¢. Pretio Services, Box 114, Durham, N. C.

INFORMATION On anything. Ferguson Research Specialists, 116-14 141 St., South Ozone Park 36, N. Y.

EDUCATIONAL AND INSTRUCTION

INTERESTED In sales career? Write: The Spaulding Co., Box 122, Pond Du Lac, Wis.

FREE Antenna—Complete detailed instructions telling you how to perform tasks done by electronic equipment. Nothing needed except antenna. Unconditionally guaranteed. Two dollars. Stillwater, Box 337, Morris Plains, New Jersey.

DIPLOMAS—Massage, physical therapy, drugless. Therapy Institute, 303PM, Council, Idaho.

STUDY Law at home. Standard texts. Franklin School, Box 598, Roanoke, Virginia.

LEARN Tile setting at home. Free details. American Institute of Tile Setting, Box #217, Oakland 4, California.

"HOW To Train Horses"—A book everyone who likes horses or ponies should have. Free. No obligation. Simply address. Beery School of Horsemanship, Dept. 11011-C, Pleasant Hill, Ohio.

COMPLETE Your high school at home in spare time with 62-year-old school. Texts furnished. No classes. Diploma. Information booklet free. American School, Dept. X845, Drexel at 58th, Chicago 37, Illinois.

PIANO Tuning pays. Learned easily at home. GI approved. 59th year. Free booklet. Niles Bryant School, Dept. P, 3731 Stockton, Sacramento 20, Calif.

DRAFTING, Design, blueprint reading. Good paying. Easy to learn at home. Minimum age 17. Write Utilities Engineering Institute, Dept. TC-19, 2525 Sheffield, Chicago 14.

PROFITABLE Welding training available Hobart Trade School, Box M-1192, Troy, Ohio, GI approved. Finest equipment in U.S.A. Reasonable prices. Request catalog.

LEARN Civil and criminal investigation at home. Earn steady good pay. Institute Applied Science, 1920 Sunnyside, Dept. 168, Chicago 40, Illinois.

IT'S Fun learning a language by Linguaphone. World's Standard Conversational Method. At home, quickly, easily learn to speak French, Spanish, German, Japanese, Modern Greek—any of 34 languages. It's like living in another country. Complete recorded courses on free trial. Send for free book and details of free trial. No obligation. Try, don't buy! Linguaphone Institute, T-83-119 Radio City, New York City 20.

CHINESE, Home study. Doctor degree. Chinese Language Institute, P.O. Box 270, Taipei, Formosa.

INVESTIGATE The collection agency business. Highly profitable. Easily learned. Cole Associates, SAK Bldg., Syracuse, N.Y.

OIL Coloring photographs—A fascinating hobby or profitable sideline for those with artistic talent. Learn at home. Easy simplified method. Free booklet. National Photo Coloring School, 835 Diversey Parkway, Dept. 3438, Chicago 14.

BECOME Tax consultant. Graduates earn \$1,000-\$3,000 every tax season preparing returns evenings. State approved. Union Institute, Lakewood 2E, N. J.

TECHNICIANS Learn speedy scientific method for manipulating screwdriver. 50¢. Veejay, Box 69, Old Saybrook, Conn.

FINISH High School at home, spare-time. No classes. Diploma awarded. Write for free catalog. Wayne School, Catalog HP-99, 2527 Sheffield, Chicago 14.

ENGINEERING Mathematics, Science. Earn your diploma at home. Better your position, improve your earnings. Free literature. Engineering Institute of America. Dept. PM-11, P.O. Box 1636, Washington 13, D. C.

HELP Yourself to abundant living. Our courses have aided students to riches, fuller lives. Learn secret of contentment, happiness. Earn degrees Ps.D., Ms.D. Write for free book. College of Universal Truth Correspondence School, 23-C E. Jackson, Chicago.

MASTER Watchmaking at home. Free sample lesson. Chicago School, 2328-YX Milwaukee, Chicago 47.

USED Books, courses. List free. Hutch, 2409 Spiller, Fort Worth, Texas.

SWEDISH Massage, physiotherapy, body building home study courses. Norby's, 1104 Colorado, Turlock, California.

FREE Aptitude test tells if you can qualify for radio-television servicing. Opportunity for own business if desired. Scientific aptitude test will be mailed to you without obligation. Write Sprayberry, Dept. D-10, 1512 Jarvis, Chicago 26, Illinois.

MEMORY And its amazing possibilities: On page 75 of this magazine you can read how during an evening spent with a friend a man learned how to develop his memory to such an astonishing extent that it brought him fortune and success. We should like to remind readers to write to D. T. Borg c/o Aubanel Publishers, 14, Highfield Road (Rathgar) Dublin, Ireland. By mentioning the name of this magazine they will receive free of charge a little book which will put them on the road to good fortune too.

USED Correspondence courses, educational books, satisfaction guaranteed. Catalog 10¢ refundable. Courses bought. Bayles, 78-B Courtright, Wilkes Barre, Penna.

SWEDISH Massage. Home study. Diploma. Swanson's Illinois Licensed School, 3809 Alta Vista, Chicago 13.

OPERATE Restaurant or diner. Free booklet reveals plan. Write School of Restaurant Business, Dept. RC-359, 335 W. Madison, Chicago 6, Illinois.

TIME Study. Key to positive personal profits! Associated Techniques, Box 426, Cedar Rapids, Iowa.

LEARN Asleep or awake. Self-help books, tapes, recordings. Free catalog. Drawer PM-697, Ruidoso, New Mexico.

FINISH High school or grade school at home. Books furnished, diploma awarded. Start where you left school. Write Columbia School, 142c Veterans Blvd., Tucson, Arizona.

INVESTIGATORS Trained, men-women. Fascinating, profitable profession, spare time study. Big pay. Details to open own agency any state. Free booklet. Investigator, Box 490, Times Square Station, New York 36, N. Y.

RADIO-TV home study for 50 students only. State Technical Institute, Box 8005, Manito Station, Spokane 36, Wash.

DEVELOP Your ability to increase income, win faster promotion, prestige. Authentic methods of leaders revealed. Amazing results. Booklet 7 free. Personal Advancement Counsellors, 7912 Curragh, Burnaby 1, British Columbia, Canada.

SECRET Investigations. Experience unnecessary. Investigators particulars free. George Wagner, M125 West 86th, New York City 24.

LEARN Piano tuning at home! Only \$32.95 including tools. Write Tunecraft, Box 5074-M, St. Paul, Minnesota.

PROFESSIONAL Investigators. Home study. Badge, certificate, future. Box 41197-F, Los Angeles 41, California.

LEARN Real estate business fast. Unlimited opportunities. Economical home-study course. Particulars free. Gordon-Howard Institute, 320 Glover Building, Kansas City 5, Missouri.

COLLEGE Correspondence courses, for Doctor of Psychology, Metaphysics, Divinity. Catalogue. Dr. Dorothy B. Arnheiter, Forest Park, Greenwood Lake, New York.

USED Correspondence courses and books sold and rented. Money back guarantee. Catalog free. Courses bought. Lee Mountain, Pisgah, Alabama.

HIGH School diploma at home. Licensed teachers. Approved materials. Southern States Academy, Station E-16, Atlanta, Ga.

EARN Degree. Free bulletin. Midwestern Bible School, 1060 Broadripple, Indianapolis.

BOOKKEEPERS! Increase your earnings! Operate your own simplified "Dollar-A-Week" bookkeeping and tax service. Full or spare time. Details free. No obligation. Ellis, Box 200, Cedar Grove, North Carolina.

EARN While you learn. Auto and diesel mechanics master this top paying trade. Many graduates earn \$100 a week and up. Approved for Korean veterans. For free information write Dept. No. 256, Nashville Auto-Diesel College, Nashville 3, Tenn.

PHYSICAL Therapy and massage. Home training. Practice privately or work with doctors and hospitals. Free catalogue. National Institute, Desk 4, 159 E. Ontario, Chicago, Ill.

INVESTIGATOR Training. Phillips Secret Service System, 1317-B North Keneth, Chicago 39.

BOOKS. Free general catalog, 100 pages. Text, vocational, educational, instructional subjects. Millions of volumes, new and used. Bargain prices. Books bought. Est. 1902. Long's College Book Co., Dept. PM, Columbus 1, Ohio.

PIANO Tuning pays. Big money in spare time. Learn at home in 30 days. No musical knowledge necessary. Phonograph, records, tools and instructions furnished. Personal instructions available. Free catalog. Capital Piano Tuning School, 3160 S.W. 16th Court, Fort Lauderdale, Fla.

STUDY To be a doctor of psychology, metaphysics, divinity or philosophy. Correspondence courses only. The Neotarian Fellowship, Desk 9, Kansas City 6, Mo.

ENGINEERING And art degrees earned through home study. Electronics, electrical, mechanical, civil, physics, business administration, liberal arts. When writing, specify course desired. Pacific International College of Arts & Sciences, primarily a correspondence school. Resident classes also carried. 5719-B Santa Monica Boulevard, Hollywood 38, California.

BE A real estate broker. Study at home. Write for free book today. GI approved. Weaver School of Real Estate, 2018P Grand, Kansas City, Missouri.

WANT A diesel job? Higher pay? Advancement? We can help you qualify! Complete diesel, tractor and heavy equipment and Cummins Diesel Engine Shop-method home-training courses available. Write today. Interstate Training Service, Dept. B-3, Portland 12, Ore.

DEVELOP Mind power, personality while asleep. Use your phonograph, recorder. Amazing psychological tapes, records now available. Details free. Sleep-Learning Association, Box 24-N, Olympia, Washington.

INVESTIGATORS Course. Free information. Southwestern Institute Criminology, Dept. 1, Box 2117, Lawton, Oklahoma.

STUDY For doctor's degree of psychology, metaphysics and divinity. Correspondence courses only. College of Divine Metaphysics, Dept. P-M, 2811 North Illinois, Indianapolis 8, Indiana.

WIN Business success by writing letters that sell. New manual by expert gives you this money-making power. \$2.95 postpaid. Free literature. Christopher Helinger, Court St., East Syracuse, New York.

CAKE Decorating. Amazing new method. Details free. Decorating Institute, Box 648, Wantagh, N. Y.

SING, Speak with power. Self-training records. Amazing! Canfield, 2018-A Fifth Avenue South, Minneapolis 4, Minnesota.

PLAYS, STORIES, MANUSCRIPTS

WANT Your book published? Learn how we publish, advertise, promote, distribute. Many successes. Free booklet PM. Vantage, 120 West 31, New York City. Midwest office: 220 S. Michigan Ave., Chicago, Ill.

ADVERTISING AGENCIES, LETTER WRITERS, FOR ADVERTISERS

I Rhyme anything. You describe it. \$1.50 line. Rhyme Riter, 8520, Pittsburgh 20, Penna.

FREE Document "Essential Selling Force." Mailorder. J. Smith, 2250 N. Mason, Chicago 39, Illinois.

ADVERTISING Ratebook leading newspapers, magazines, free. Chicago Advertising Agency, Chicago 4.

EMPIRE Advertiser magazine. Low rates, resultful. Sample free. Box FW92, Brooklyn 18, N. Y.

ADVERTISE: 24 Words, 100 Canadian newspapers, \$5.50. Lists free. Advertising Bureau, 10511-C Springfield, Chicago 43.

"AMAZING New Book"—"Profits From Classified Advertising." Tells how and what to advertise. Be sure to read this book before you invest one cent in advertising. Write for your copy now. Just send 10¢ for postage and handling. W. Johnson, Classified Advertising Manager, 202 East Ontario Street, Chicago 11, Illinois.

MAILING Lists most any classification \$5.00 1000. Your circulars mailed with ours \$4.00 1000. Write for our literature. Dixie Mailers, King, N. C.

ADVERTISING, Result-getting ads prepared, placed newspapers, magazines, radio, anywhere! Lowest rates. Catalogue free. Baker Advertising Agency, 189 W. Madison, Chicago 2.

CREATIVE Advertising. Magnetic copy. Dramatic layouts. Moran Agency, Shoemakersville, Pennsylvania.

2742 RADIO Stations, addresses. Free advertising under "per inquiry" plan. "Buyers Guide," where to buy anything. Write Barnes, Box 490, Times Square Station, N.Y. 36, N.Y.

NOW Ready: New, amazing Classified Advertising Record Book—prepared especially for classified advertisers. Here is a book that tells you instantly whether or not your advertising in any publication is paying you real results. You can tell immediately how many inquiries each publication produced—how much cash received from every ad. Spaces are provided for the name and address of the publication, date of issue, space used, rate, cost of ad, key number, etc. You have a complete record of each publication right before your eyes. Plenty of space to keep accurate record of 28 separate publications. You can have a copy by sending only 10¢ to cover postage and handling. Send for your copy now. W. P. Johnson, Classified Adv. Mgr., Popular Mechanics Magazine, 204 E. Ontario Street, Chicago 11, Illinois.

CARTOONING, COMMERCIAL ART, SHOWCARD & SIGN PAINTING, TATTOOING

"HOW To Make Money With Simple Cartoons." A book everyone who likes to draw should have. It is free; no obligation. Simply address Cartoonists' Exchange, Dept. 911-C, Pleasant Hill, Ohio.

"KEY To Cartoon Career." If you like to draw, write for this free book. Bureau of Cartooning, 3123 Northend Station, Colorado Springs, Colorado.

CARTOON Your way to success! Internationally known instructor, Raye Burns, will personally teach you to create original, salable cartoons at home. Cost of course is very low. Write for free details. Raye Burns School, Box 3583-P, Cleveland 18, Ohio.

YOU Can entertain with chalk talks. Catalog 10¢. Balda The Cartoonist, Oshkosh, Wis.

LEARN Sign painting at home. Free talent test. Ben Kerns, Box 812-PM, Greenville, S.C.

LEARN Profitable, fascinating tattooing. Illustrated information \$1. Zeis, 728-C Leslie, Rockford, Illinois.

LEARN Sign painting with fascinating system. Straley, 410 S. Western, Springfield, Ohio.

RUBBER STAMPS AND OFFICE SUPPLIES

INDEXED, Cushioned, 3 lines \$1.00, 4 or 5 lines, \$1.50. Signature stamps, \$3.50. (Script, print, or old English.) Free stock stamp literature. Youngers Stamp Shop, Princeton 4, Iowa.

THREE Line rubber stamp, 1000 embossed business cards, both \$3.75. Reed Press, Mishawaka, Indiana.

POCKET, 3 Lines \$1.00. Guaranteed. W. J. Specialty, 8464 Manhattan, Detroit 11, Michigan.

FREE! Rubber stamp catalog. Many items. Campfeld, Box 798, Springfield 1, Mass.

3 LINE Handle stamp \$1.00. Free list. Stamps, Box 711, Denver, Colorado.

3 LINE, With handle, \$1.00. Sailors, 537 Connecticut, Gary, Indiana.

DELUXE, 3 Lines \$1.00. Free list. Specialty, P.O. Box 767, Paradise, Calif.

NEW—Pocket stamp and pad \$1.00. Taylors Stamps, 7206 Lyman, Hammond, Indiana.

SENSATIONAL Wondrcopy paper! 25 copies without carbon, second-sheets! Inexpensive! Samples, details, — dime. Wondrcopy, 1323-PM Chaparral, Corpus Christi, Texas.

4 LINES \$1.00. Plastic case with ink pad. Signature stamp, \$2.50. Rayco, 445 Bay, Millbrae, Calif.

RUBBER Stamps. Personalized items. Free catalog. Martin, 1425 Major Drive, Jefferson City, Missouri.

TYPEWRITERS, DUPLICATORS, OFFICE DEVICES

RECONDITIONED Typewriters. Adding machines. List free. Woods Typewriters, Bedford, Penna.

RECONDITIONED Typewriters, duplicating, printing devices. \$25.00 up. Supplies. Appliances. DixieGraph, King, N. C.

PRINTING, MULTIGRAPHING, MIMEOGRAPHING, GUMMED LABELS

250 8 1/2 x 11 HAMMERMILL Letterheads \$2.95. 250 envelopes \$2.95. Davis, 7609 Spruce Road, Baltimore 22, Md.

COLORED Or white 8 1/2 x 11 offset. 1,000, \$5.50; 5,000, \$17. Fast! Also artwork, vartyping layout. Promotion, 386-M11 Broadway, New York City 13.

1,000 BUSINESS Cards. Raised letters, \$3.95. Samples. Pioneer, PM-11 Island Park, N. Y.

FREE Printing samples, rubber stamp catalog. Gooch, 202PM, Hernando, Mississippi.

DISTINCTIVE Business cards. Lowest prices—postpaid. Send for free samples. Anderson, Box 1252, Lincoln, Nebraska.

FREE Unusual catalog. Business, personal printing. Bariskill, 1715 Julian, El Cerrito, California.

QUALITY Printing reasonable. Free list Nu-Art, Box 154, Fayetteville, Arkansas.

OFFSET Printing, 1000 8 1/2 x 11 \$4.95. Alpine, Box 676-E, Cupertino, California.

MIMEOGRAPHING—Offset. Complete lettershop services. Samples. Pennway Drawer 1470, Scranton, Pa.

1,000 EMBOSSED Business cards \$3.95 postpaid. Tyson Printing Service, P. O. Box 911, Charlotte 1, N. C.

OFFSET Printing Guide, shows paste-up printing method. Make folio covers, trademarks. Has ready to use art work, designs. Contains Will Form. \$2.00. Curtiss Publications, 312 Olive, Porterville, Calif.

SEND Postcard for free samples, prices. Mayfield, Box 8011, Chattanooga 11, Tenn.

5,000 COLORED Circulars \$39. Complete. Samples. Promotion, 385-MM11 Broadway, New York City 13.

BUSINESS Cards 500—\$2.00. Randolph Press, Box 3406-A, Detroit 3, Mich.

1000 BUSINESS Cards. Raised letters, \$3.95 samples. John H. Taylor, R.D. 3, West Middlesex, Pa.

OFFSET; Mimeographing: samples, prices, free. Litho, 53 Laurie, Ft. Walton Beach, Florida.

ATTRACTIVE: Stickers, labels, circulars, cards. Samples, Fame, 291 Ellis, San Francisco 2, Calif.

100 6 3/4 ENVELOPES, 100 5 1/2 x 8 1/2 letterheads printed, \$2.00. M. Fortney, Route 3, Dillsburg, Penna.

FREE Business printing catalog. Samples. Howprint, 723-C Eunice, Webster Groves 19, Missouri.

1000 PRINTED 6 3/4 Envelopes, \$5.95, #10, \$7.95, postpaid. Free price list, other sizes, quantities. Karstan's, 151-39 26 Ave., Flushing 54, New York.

1000 ENGRAVED Letterheads \$17.00 pre-paid. Samples. Allen Press, Fort Edward, New York.

MIMEOGRAPHING—Letters, pricelists, formulas, instructions. Lowest prices. Lem's Letter Shop, 5710 Stanton, Detroit 8.

FREE Catalog postpaid printing, rubber stamps. DM Press, Sebastopol, Calif.

1,000 EMBOSSED Business cards \$3.50 postpaid. Samples. Ellis, 5909 Highlandview, Sylvania, Ohio.

ADS Running under this heading sell printing. Ask me for proof. I'll gladly send you amazing facts. Ask for Folder "P." F. W. Johnson, 200 E. Ontario St., Chicago 11, Ill.

1000 EMBOSSED Business cards, \$3.95. Business and social printing catalog, samples. Stationery Sales, Box 113, New Orleans 3, La.

MULTILITHED Sales letters, business forms, low prices, get facts, samples. Perkins Printing Service, Fremont, Nebr.

TERRIFIC Low prices! Letterheads, envelopes, cards, etc., postpaid to you. Smart designs, fast deliveries. Investigate! Advanced, 1110 East 47th Place, Los Angeles 11, Calif.

PRINTING OUTFITS AND SUPPLIES

PRESSES \$5.50. Printers bargain list, 10¢. R. Cundiff, Blaford 2, Illinois.

SAVE 40% on type cases. Manufacturer. Catalog. King McKay Company, 23179 Telegraph Road, Southfield, Michigan.

RUBBER Stamp makers supplies. Kiewiet, 2025 Barney Road, Kalamazoo, Michigan.

RUBBER Stamp presses, hydraulic operated, electrically heated. Sizes 5"x8", 8"x12", 10"x15". Starting outfits, supplies. Printing presses, supplies. Custom Manufacturing, 507-P N. Jefferson, Springfield, Missouri.

TYPE For rubber stamp making and printing made from hard foundry metal. Send for free 20% discount catalog. Barco Type Founders, 64 Wagner Dr., Northlake, Ill.

MAKE Your own self-molding rubber stamps and printing cuts. Plexirubber, Argyle 1, Wisconsin.

DO Your own printing. Save money. Simple rules. We supply everything. Print for others; good profit. Raised printing like engraving too. Have home shop. Details free. Kelsey Presses, V-11, Meriden, Connecticut.

PRINTING Presses, type, supplies. Lists 4¢. Turnbaugh Service, Mechanicsburg, Penna.

FOR INVENTORS

FUN For all! Order your copy of "Inventing the Invention," today. \$4.95 post paid. Eaton Roller & Manufacturing Company, 300 North Meridian, Eaton, Indiana.

INVENTORS Big deal. Confidential service free. Limited time only. We can help you. A. B. Research, 1940 Winona, Chicago 40, Ill.

INVENTORS! Determine the patentability of your invention. Searches of the Patent Office records administered professionally for only \$6.00. For free invention protection forms and dependable service write Washington Patent Office Search Bureau, 1426 G. Street, N. W., Washington 5, D. C.

PATENT Searches, including copies of nearest patents, \$6.00. Reports airmailed within 48 hours. More than 200 registered patent attorneys have used my service. For free invention protection forms, write Miss Ann Hastings, P. O. Box 176, Washington 4, D. C.

PATENT Searchers \$6.00. 48-hour service. Free invention protection forms. Formerly with U. S. Patent Office. Write Raymond L. Smith, Patent Searcher, 620 Sheraton Building, Washington 5, D. C.

PATENT Searchers \$6.00. 48-hour airmail service. Invention protection forms free. Write patent Engineering Service, 711 14th Street, N. W., Washington 5, D. C.

OUR Sales drawings in color sell your invention. Inexpensive. Free sample. Write Starck, Wells Bldg. Milwaukee, Wis.

FREE—"Vital Information Every Inventor Needs Before Selling Invention." Brown, Box 349, New York 8, N. Y.

INVENTIONS, Ideas, patents wanted! By manufacturers. Cash, royalties. Sales promotion, invention development. George Spector, Licensed professional engineer, 3615 Woolworth Building, New York.

INVENTIONS Wanted for immediate promotion! Patented; unpatented. Casco, 703 Bernley Building, Philadelphia 7, Penna.

INVENTORS—Get the best offer first! Patented or unpatented. Write Carl Sommer, Director, Industrial Invention Sales, 3136-A Sylvania Ave., Toledo 13, Ohio.

INVENTIONS Wanted now by my manufacturer-clients. Patented, unpatented. Write Gilbert Adams, Patent Broker, 80-A Wall Street, Financial District, New York City.

WE Have the markets if you have the ideas. Harvey Engineers, Cambridge 1, Maryland.

INVENTORS: Test the commercial value of your patented or unpatented inventions, quickly and inexpensively. Write for free information. Institute of American Inventors, Dept. 40-B, 635-F St., N.W., Washington 4, D. C.

INVENTORS. Don't sell your invention patented or unpatented until you receive our offer. Write Cowgill, Box 298-A, Marion, Ohio.

INVENTORS! Consider our offer first before selling or licensing your invention on a cash or royalty basis. Patented. Unpatented. Inventions on Demand, 79 Wall Street, New York 5, N. Y.

HIGHEST Cash, royalties. Inventors having good ideas, write. Inventors Creative Service, 354 South Spring, Los Angeles 13, Calif.

INVENTIONS Sold on percentage basis, searches. Model Prod., Grain Valley 3, Mo.

INVENTORS: Save high fees. New "patent kit" now makes it easy. Adren, 806 Wm. Penn Annex, Philadelphia 5, Penna.

INVENTIONS Pay inventors when profitable sales are certain from constructions soundly patented, and wise steps taken to reach the best markets. I help inventors to make the most profit with low definite fees for all services. Searches \$15. 30 years experience as patent-development engineer, U. S. and foreign patents secured. Joseph O'Brien, 132 Nassau Street, New York 38, N. Y.

INVENTIONS WANTED

INVENTORS. Don't sell your invention patented or unpatented until you receive our offer. Write Cowgill, Box 298-B, Marion, Ohio.

INVENTORS: Hundreds of manufacturers have requested our assistance in locating marketable new products. Complete information free. Institute of American Inventors, Dept. 40-D, 635-F St. N.W., Washington 4, D. C.

INVENTIONS Wanted. Patented; unpatented. Tremendous manufacturers lists. Global Marketing Service, 2420 77th, Oakland 5, California.

INVENTIONS Wanted: Patented, patent pending. 28 years experience promoting inventions. National Service Bureau, 3120 Meramec, St. Louis 18, Mo.

INVENTORS! Consider our offer first before selling or licensing your invention on a cash or royalty basis. Patented. Unpatented. Inventions on Demand, 79 Wall Street, New York 5, N. Y.

ARE You interested in offers from reliable manufacturers for your invention? Patented, unpatented. Harvey Engineers, Cambridge, Maryland.

INVENTIONS Wanted now by my manufacturer-clients. Patented, unpatented. Write Gilbert Adams, Patent Broker, 80-B Wall Street, Financial District, New York City.

CASH Buyers for inventions. Write National Inventors Institute, Box 4125, Washington 15, D. C.

INVENTIONS Wanted for immediate promotion! Patented; unpatented. Casco, 703 Bernley Building, Philadelphia 7, Penna.

NEW Product for sale? Patented or unpatented. Let us submit an effective presentation to national manufacturers. No fees. Commission basis. Seaboard Research and Development Corporation, Inc., Mewshaw Building, Glen Burnie, Maryland.

INVENTORS: If you have an invention for sale, patented or unpatented, write for free brochure outlining manufacturers' requirements, royalty rates. Kessler Corporation, 511-IW, Fremont, Ohio.

INVENTIONS, Ideas, financed, marketed. Write, World, 3432 Olive, St. Louis 3, Mo.

FREE List needed inventions. Protection form. Inventors Sales and Engineering Bureau, Dept. 110-D, Box 4973, Washington, D. C.

INVENTORS—Get the best offer first! Patented or unpatented. Write Carl Sommer, Director, Industrial Invention Sales, 3136-A Sylvania Ave., Toledo 13, Ohio.

SUPERIOR Promotions. Patented; unpatented inventions. Information booklet, free. Superior, 338-344 North Rodeo Beverly Hills, Calif.

INVENTIONS, Ideas, patents wanted! By manufacturer. Cash, royalties. Sales promotion, invention development. George Spector, licensed professional engineer, 3615 Woolworth Building, New York.

MANUFACTURING

MODELS—Small lot manufacturing. Metals, plastics, etc. Milburn, Burlington, Kentucky.

MODELS, MODEL SUPPLIES

LIONEL Trains. Big discounts. Catalog 25¢. Mack Bros., 2043-P Chicago Ave., Chicago 22.

SHIP Models. Most complete line in New England, kits, fittings, plans, books, tools, engines, motors. Illustrated catalog 35¢. James Bliss & Co., Inc., Dept. SM, 342 Atlantic Ave., Boston 10, Mass.

"POWER Drives Handbook"—36 pages illustrating many types motor drives for model autos, boats, displays, turntables, etc. Mail 25 cents cash, returnable first order \$3.00 or more. Wilson's of Cleveland, Dept. PM, 425 Lakeside N.W., Cleveland 13, Ohio.

ROCKET Supplies—Nozzles, cones, tubes. Specials also made. Catalog 10¢. Sky Mfg., Mineral Point, Penna.

SHIP And yacht model fittings; blueprints. Send 35¢ for illustrated catalog listing hundreds of items. A. J. Fisher, 1002-1 Etowah Ave., Royal Oak, Mich.

STAGECOACH—Accurate working drawings for authentic eighth-scale model Wells Fargo coach. Two large sheets, completely detailed, \$8.50. Ivan L. Collins, 10385 McKenzie Highway, Springfield, Oregon.

MODEL Cars run on electrified roadways. Sets, roadways, cars, motors, controls, power packs, supplies. Details free. Electromat Company, Box 13742, Dallas, Texas.

SHIP Model kits and fittings: Fishermen, clippers, frigates, schooners, brigs, tugboats. Also half-hull models for interior decoration. Send 25¢ for 1960 catalog and booklist. Model Shipways, Box 85, Bogota, N. J.

MINIATURE Engines, gas and steam. Build them on your metal lathe using our castings, blueprints. Also available, machined steam engine kits ready to assemble. Illustrated catalog 25¢. Octura Models, Box 536-PM, Park Ridge, Illinois.

MODEL Boat Fittings. Precision hand crafted, not diecast or plastic, but made like original counterpart. Large illustrated 56-page catalog \$1.00. Octura Models, P. O. Box 536-WP, Park Ridge, Illinois (Display Room: 30 Main St.).

POWER Models. Unusual steam, gasoline and traction engines, fittings, metals. Accessories as stainless steel and bronze balls. Comprehensive 92-page catalog \$1.00. Chas. Cole, Ventura, Calif.

2 STAGE Rocket. Solid and liquid fuels. Only \$3.95 gets completely detailed plans. Missile Research, Station One, Provo 2, Utah.

SAVE Money on model supplies. Minia-ture gas engine \$2.49; jet engine 49¢; 99 pc. HO train set \$10.95. Send 4¢ unused stamp for free 32 page bargain book "PM5." America's Hobby Center, 148 West 22nd Street, New York 11, N. Y.

HOME CRAFTSMEN

SKIL-CRAFTS—World's finest and largest selection of leathercraft, hobby craft, art & craft supplies. Free billfold or leathercraft kit with first purchase. Send 25¢ latest catalog. Skil-Crafts, Box 167-P, Joplin, Missouri.

FREE. New plans catalog. Make 2400 things. Fun. Profit. Craftplans, 1322-A Wabash, Chicago 5.

KNOCKDOWN Cedar chests, also over fifty kits. Catalog 25¢. Giles Kendall Co., Huntsville 2, Alabama.

FREE Leathercraft catalog—quality kits, leather, tools. Handicrafters, Dept. P, Box 427, Montrose, Calif.

GRANDFATHER Clock movements, case plans, kits. Wholesale catalog 25¢. Mason-Sullivan, Noroton, Conn.

STYLECRAFT "Pretraced" leather kits. Handbags, billfolds, filigree belts. Patterns on leather. Just carve, assemble and lace. "Pre-carved" kits also available. Send 25¢ for catalog, free folder. Refunded first order. Apache Leather Company, 2804 E. Washington St., Phoenix, Arizona.

ART Metal tooling. Enjoyable, profitable hobby. Big illustrated catalog 10¢. Groundmaster, Boulder, Colo.

LEARN Art metalcraft and jewelry making. Complete, inexpensive, home training course now available. Special tools and materials furnished. Write for free booklet. Interstate Training Service, Dept. L-3, Portland 12, Oregon.

FREE "Do-It-Yourself" leathercraft catalog. Tandy Leather Company, Box 791-M30, Fort Worth, Texas.

WOODWORKING And cabinetmaking course for beginning and advanced home craftsmen. Only complete low-cost home training program available. Write for free booklet. Interstate Training Service, Dept. G-3, Portland 13, Ore.

FREE! Leathercraft catalog. Hundreds of new items. Write MacPherson Bros. Leather Company, Dept. E, 730 Mission St., San Francisco 3, Calif.

KNOCKDOWN Cedar chests and lumber. Free price list. Bedford Lumber Company, Shelbyville, Tennessee.

REFINISHING? Sanding made easy. Send stamped envelope for free particulars and sanding hints. Write Sanders, Box 248, Hartland, Wis.

REMODEL Your own home. Save hundreds of dollars. New, amazing book shows you how. Written so you can understand it. Step by step instructions make it easy. Fully illustrated, 400 photographs, hundreds of diagrams, 160 pages, \$3.50. Literature 10¢. Popular Mechanics Press, 200-RH East Ontario St., Chicago 11, Ill.

PATTERNS. Full size. It's easy to make tables, chairs, beds, chests, shelves, workbench, toys, Santa Claus lawn designs, and many others. Illustrated circular free. Popular Mechanics Press, 200PL East Ontario St., Chicago 11, Ill.

MAHOGANY Wood, usable scraps. Bargain. List 4¢. S. R. Marks Co., Montgomery 8, Ala.

WOODWORKING Catalog and manual. Brand new 1960 edition! World's largest selection of domestic, imported woods—materials, tools, supplies, do-it-yourself plans, projects, 130 pages, many full color. Send 25¢ (refunded first order). Year's subscription to "Chips and Chats" included free. Constantine, 2050 Eastchester Road, Dept. S-101, New York 61, N. Y.

NEW Big illustrated catalog. Supplies for leathercraft, metalcraft and numerous small inexpensive crafts. Prompt shipments. Top values. Latest ideas. Send 10¢ today to J. C. Larson Co., Dept. 9227, 820 S. Tripp, Chicago 24.

LEATHERCRAFT. Send 25¢ for new 160-page catalog of tools, supplies, kits, including metalcrafts, enameling, ceramics, all other crafts. Complete stock. Reasonable. Since 1910. Sax Bros., Dept. PM-11, 1111 N. 3rd, Milwaukee, Wis.

FREE Shellworkers catalog instruction book 35¢. Secor's, Bradenton Beach, Fla.

CRAFTS. Free catalog. Leathercraft, mosaics, enameling, metal tooling, stamp engraving, shellcraft, floralcraft, many more. Kit Kraft 2911 Studio City, Calif.

SOUTH Pacific shells, \$1.00 postpaid. Davidson, Box 1488, Wellington, New Zealand.

POSTPAID. 100 Hardwood dowel pins. Assorted sizes, various lengths. Price list for specified sizes included. Send \$1.00 cash. Larger quantities available.

California Dowel Mfg., 5004 Encinita, Temple City California.

105 JIGSAW Patterns, plus alphabets \$1. Jigcraft, Ofallon 511, Mo.

101 PATTERNS Of smart gifts, novelties, shelves, action windmills plus "Make Money Jig Sawing." \$1.00. Mastercraft, 115M, 7041 Olcott, Chicago 31.

KILN Dried walnut, cherry, etc., hardwoods, blocks, lumber and squares. Midland Lumber Company, P.O. Box 262, Savannah, Missouri.

DO IT YOURSELF

ELECTRIC Laminating kit. Fun or profit. \$14.95. Therm Appliance, St. Charles, Ill.

FREE "Do-It-Yourself" leathercraft catalog. Tandy Leather Company, Box 791-V32, Fort Worth, Texas.

WATCHES, OLD GOLD, JEWELRY

COSTUME Jewelry supplies, settings, rhinestones, etc. 88 page illustrated catalog. 30¢. Milady, Box 1328, G.P.O., New York City.

10 SWISS Watches \$18.00. Catalog 25¢. Berkowitz, 1150 Castle Hill, New York City 62.

FREE Catalog. Costume jewelry parts. Supplies. Reasonable prices. Fast service. Guaranteed quality. Unique merchandise. Folsom's, Box 52, Medford 55, Mass.

HIGHEST Cash for old gold, jewelry, gold teeth, watches, diamonds, silverware, spectacles, platinum, mercury. Free information. Rose Refiners, Heyworth Building, Chicago 2.

GOLD, Silver, platinum, diamonds, jewelry, watches, silverware, gold teeth, coins. Highest cash immediately, free information. Wilmot's, 1067A Bridge, Grand Rapids 4, Michigan.

RHINESTONES—Imitation stones, wholesale. Cosmopolitan Importers, Box 176-M, New York 8, N. Y.

HIGHEST Cash paid for old gold, jewelry, gold teeth, diamonds, watches, silver. Mail articles today. Information free. Chicago Gold Refining Co., 6 E. Monroe, Dept. 1758, Chicago 3.

WATCHMAKERS' Jewelers', lapidaries' catalog 25¢. Bengal, 8910 Venice, Culver City, California.

SWISS Watches from importer, \$2.95 up. Catalog. Transworld, 565 5 Ave., New York City.

WATCHMAKERS' Tools, materials, supplies, watches. Catalog. Gales, Box 1000, Chicago 90, Illinois.

WATCHMAKERS' Journal contains watch repairing instructions. Sample copy 25¢. Box 3218-M, Daytona Beach, Fla.

WATCHES Repaired, cleaned \$3.95, guaranteed. Lan's, 17 South Center, American Fork, Utah.

WATCH And clock repairing books. Free catalog. North American, 2320-AM, Milwaukee, Chicago 47, Illinois.

WANTED Old gold jewelry, spectacles, watches, teeth, silverware, platinum for cash. Electro Company, Ref. Dept., 1042 Highland Ave., Buffalo 23, New York.

SWISS Guaranteed watches, 50% off lists. Prepaid Airmail. Send Postal for free literature. Herm Roth, 202-M Pick-relltown Rd., West Liberty, Ohio.

SUPPLIES To make costume and sea shell jewelry. Free catalog, designs, instructions. Modern Craft, Box 11088-MJ, Saint Petersburg 33, Florida.

EASY To make costume jewelry. Catalog 10¢. Introductory kit including catalog \$1.00. J & M Novelties, Dept. CM-3, Box 173, Broadview, Ill.

finest guaranteed waterproof Sta-Dri Sportsman boots. The Sport Mart, Inc., Box 8047, Dallas 5, Texas.

FLASHLIGHT Dry cell battery charger. Get real savings. 5 times the life of your batteries. Guaranteed. \$2.95. Wellington Industries, Box 217, Englewood, Fla.

ALASKA Ivory earrings \$3.25 pr. Ivory key chain \$2.25 ea. postpaid. Hagen's, Box 785, Nome, Alaska.

LIND Lock for frozen lock, rusty pipe joint, hinges and metal connections. \$1.50 per tube. Forrestville Medical, 4856 Forrestville, Chicago 15, Illinois.

LET Us tell you how to turn the reading habits of your friends into profit for you. \$10.00, \$25.00 or \$50.00 can easily and quickly be made under our Popular Mechanics subscription plan. No experience needed. Write Popular Mechanics, Room 11M, 250 West 55th St., New York 19, N. Y.

SWAP—Read "Trading Post Magazine," 10¢. Thorne's, B-525, Dewey, Jackson, Michigan.

WOOL Caps. Colorful; handknitted. S-M-L-sizes. \$1.50 each. 3/\$4.00. Woolens, Box 9, Atchison, Kansas.

TOO Clogged toilets without pumping! Pumping or emptying a cesspool or septic tank is not actually cleaning it as your filter bed is clogged or your system would not be full. Our cleaner, "Sursolvent," dissolves the solids and eats out the muck and slime crustations on the side wall, thereby releasing the water, correcting the fault which caused the system to finally fail. No pumping necessary. Users report years of satisfactory results. Write for details. Electric Sewer Cleaning Company, Box 224, Allston, Mass.

MINIATURE Skull paper weight jaw bites paper. \$2.00. Mitzmacher, 1324 St. Johns Pl., Brooklyn 13, New York

MAKE An offer on antique Emerson grand piano. Mrs. W. A. Teague, Burnet, Texas.

SKYSCRAPER-HEEL SHOES, WASP-WAISTED Corsets. Photo Catalogs, \$2.00. Finecraft, Box 442-R, Hollywood 28, Calif.

YOUR Name on our giant mailing list, brings you moneymaking and other mail offers galore! Send 25¢ today. Direct Mail Service, Dept. PM, Box 581, Bakersfield, California.

enlarge shoe customers, order direct from authorized outlet. Factory prices. Fast delivery, Knapp Shoes, 113½ E. Alondra, Compton, Calif.

ENGRAVED Name plates 5x1¼ white letters on black glossy Bakelite \$1.00. House numbers & name 8½x3 \$2.95. All stock signs 8x2 \$1.80. All drilled with 2 holes for mounting. Postpaid. Art-Ray, Box 618, Riviera Beach, Fla.

GREAT Discovery. Canadian prospector makes composition gold-like nuggets that have the weight, color and look genuine. Old timers baffled and amazed. Easy to follow guaranteed directions \$2.00. Joseph King, 38 S Cumberland St., Port Arthur, Ont., Canada.

ARE You different? Many duty free exquisite items sent directly to you from distant lands. Low foreign prices will amaze you, our catalog delight you. 25¢ please, handling charge. M J & W Co., Box 188, Jamestown, No. Dak.

TERMITES? Instructions \$1.00. Kraus, 5300 Wynnefield Avenue, Philadelphia 31, Penna.

RECEIVE Mails, magazines, samples. Your name in numerous mailing lists 25¢. Greenwood, Box 1116-K, New York City 8.

Learn BAKING At Home 

Baking is one of America's high industries in wages. Nearly depression-proof. Thorough basic home course lays sound foundation. If you have aptitude, write for **FREE BOOKLET**, "Opportunities in Commercial Baking." National Baking School, 835 Diversey Pkwy., Dept. 1358, Chicago 14, Illinois

ELECTRONIC ENGINEERING

TRAIN IN FLORIDA

FOUNDED 1894

DEGREE IN 24 MONTHS

Electronic engineers are urgently needed in Florida — the Nation's Electronic and Missile center. VA approved. Send for Free Catalog.

MASSEY TECHNICAL INSTITUTE
BOX 3305B JACKSONVILLE 6, FLA.



\$3.25 OR 2 FOR \$6.00!

With 40 ft. of wire. Additional wire 3¢ ft. **TESTED AND GUARANTEED.** Write for free list of all types of telephones. Shipments FOB Simpson, Pa.

TELEPHONE ENGINEERING CO., Dept. 1189, Simpson, Pa.



CONCRETE BIRD BATHS AND OVER 250 OTHER MONEY MAKING ITEMS

You've seen them all over the country . . . concrete bird baths, garden seats, flower boxes, appealing statuary, and many other items that add charm around the house and lawn. They're made by enterprising people, just like you, from our **COPYRIGHTED ALUMINUM MOLDS.** It's easy, it's fun, it's profitable.

Send \$2.00 today for this 82-page "How to" book, 20 pages of clear instructions. Valuable trade secrets. Over 250 items beautifully pictured (with description, dimensions, and prices of molds). Rushed to you by first class mail.

CONCRETE MACHINERY CO., INC.
HICKORY 2, NORTH CAROLINA

Name _____
Address _____

HOW TO TURN CONCRETE INTO GOLD



Save 1/2 on NEW ACCORDIONS

Famous Italian Makes at IMPORTER-TO-YOU PRICES

OVER 40 EXCITING 1960 MODELS for STUDENTS TEACHERS PROFESSIONALS

DOUBLE GUARANTEE

Small Down Payment BUY ON E-Z TERMS 5-DAY FREE TRIAL

WORLD'S LARGEST ACCORDION DEALER brings you these sensational values! Prices slashed on all our fine Italian-Made accordions! Here's your opportunity of a lifetime to play the most popular instrument of all. **Have fun, be a leader!** Choose from 40 newest models that lead the world in superb tone and breathtaking beauty. All latest improvements and features. Buy direct from the Importer! **You save up to 50% off manufacturer's list prices.** Small down payment; pay the balance on easiest terms. Big trade-in allowances. Try before you buy on **FREE 5-DAY NO RISK PLAN. DOUBLE GUARANTEE!**

MONEY BACK GUARANTEE

See how easily you can own and play a fine accordion . . . made in Italy by skilled old world craftsmen. Your satisfaction guaranteed or your money back. Rush coupon for big new Color Catalogs and lowest Importer-To-You discount prices . . . all FREE. No obligation. Write

ACCORDION MANUFACTURERS and WHOLESALERS OUTLET
Dept. R119, 2003 W. Chicago Ave., Chicago 22, Ill.

FREE! GET COLOR CATALOG and Low Discount Prices

Accordion Manufacturers and Wholesalers Outlet
Dept. R-119, 2003 W. Chicago Avenue, Chicago 22, Ill.
Send Free Color Catalogs and Low Discount Prices

NAME _____
ADDRESS _____
CITY _____ ZONE _____ STATE _____

FREE BONUS GIFTS for promptness . . .

- Easy-to-play music • Music Stand
- Name in chrome letters
- Deluxe Case • Music Portfolio
- Plus Other Valuable Gifts

new FROM HEATHKIT® transistor clock radio



**EASY TO ASSEMBLE . . . COMPLETELY PORTABLE
. . . UP TO 500 HOURS ON BATTERIES**

Take it with you . . . on trips, to the beach, in a boat . . . Nothing to plug-in, just goes and goes on inexpensive batteries. Lulls you to sleep, wakes you up, tells time and plays all day long. Leather carrying case available. **ONLY \$45.95.**



HEATH COMPANY

Benton Harbor 17, Michigan

a subsidiary of Daystrom, Inc.

Send the latest Free Heathkit Catalog.

NAME _____

ADDRESS _____

CITY _____ ZONE _____ STATE _____

Note: Price subject to change without notice.

A Xmas Hint* . . . the Lowrance Fish LO-K-TOR

"THE-THINKING-MAN'S GUIDE"

**STOP
FISHING
BLINDLY**



*and if the family
doesn't take the hint,
then buy it yourself.

You still gotta locate 'em before you can catch 'em. The Lowrance Portable Fish LO-K-TOR is very compact; weighs only 10 lbs. Simple to operate, this modern electronic instrument sends and receives sonar signals thru the water, which show on the dial indicator whether it is a single fish or a school, the depth to the bottom up to 80 ft., and whether muddy, rocky or brushy. Condition of the water makes no difference . . . fresh or salt, muddy or ANY kind of water. Transistorized; operates on two regular 6-volt lantern batteries. See your marine or fishing tackle dealer, or write for FREE literature. Price complete with batteries and special boat bracket—\$148.50 F.O.B. Joplin, Mo.



LOWRANCE ELECTRONIC MFG. CORP. Dept. 8
Joplin, Mo.
DEALERS STOCK NOW FOR XMAS!



Tube Brings Fresh Water to Bait

Live bait is constantly supplied with fresh water in this Fiberglass bait tank. The tank fits onto two rails fastened to the boat's transom, and can be moved up or down by a nylon belt. A perforated tube, entering the tank from the bottom, keeps fresh water coming in at a constant rate no matter what speed the boat travels. While the boat moves, the tank is in the up position; when it stops, the tank is lowered until the perforations in the case are at the water line.

Process Speeds Production Of Molybdenum Powder

Molybdenum metal powder now can be manufactured five to eight times faster than in the past. The metal is becoming increasingly important in the atomic and missile fields, both in alloys and as a protective coating against high temperatures. The new process is a rapid, single-stage reduction performed at high temperature, and results in a high recovery of metal of great purity. The process may be applied also to producing tungsten powder.

TOOLS WHOLESALE

**\$100
PUTS YOU IN
BUSINESS**

Start your own business, sell tools to your friends and neighbors, or buy tools for your own use and **SAVE MONEY \$\$\$**

A MILLION DOLLAR INVENTORY AT YOUR FINGERTIPS. NO STOCK TO CARRY. ORDER AS YOU NEED IT.

BUY AT WHOLESALE PRICES. Extra \$25.00 profit on your accumulated purchases. \$1.00 refund on first purchase or refunded if you are not 100% satisfied.

THOUSANDS!! of Nationally Advertisized items of Hand Tools, Power Tools, Mechanist Tools, Tool Chests, Paint Sprayers, Light Fixtures, Appliances, Guns, Gifts, Toys and other items too numerous to mention.

WE SHIP COAST TO COAST White. Disc. up to 50% off

SILVO HARDWARE CO., Dept. PM11
107 Walnut St., Phila. 6, Pa.

40 TO 640 ACRE TRACTS STATE
GOVERNMENT LANDS

NO
HOMESTEADING
NECESSARY

LOW AS
\$2. ACRE
MIN. OFFER

NO
BUILDING
REQUIRED

PIONEER RANCH SITES

California & Oregon Farm, Ranch
Timber Tracts. Creek & Lake Front
Hunting-Fishing Lands. Easy Terms
Some with Cabins, Old Houses, etc.

LOW AS
\$10. \$10.
DOWN MONTHLY

WRITE FOR **FREE BOOKLET**
on available lists & maps of
other U. S. & So. American lands

Pioneer Ranches Inc.

8228 Sunset Blvd., Dept. 9
Hollywood 48, Calif.
OL 6-2515 or WE 6-2611



**You Can Have a
HE-MAN VOICE**

STRENGTHEN your voice this tested,
scientific way. Yes—you may now be able
to improve the POWER of your speaking
and singing voice . . . in the privacy of
your room! Self-training lessons, mostly
silent. No music required.

FREE BOOKLET

Write today for Eugene Feuchtinger's
great booklet "How to Develop a Successful
Voice." It's absolutely FREE! You must state your age. Booklet
mailed postpaid in plain sealed envelope. No salesman will bother
you. Send your name and age RIGHT NOW!
Perfect Voice Institute, 210 S. Clinton St., Studio LR-2, Chicago 6, Ill.



**FREE CAREER
BOOKLET**

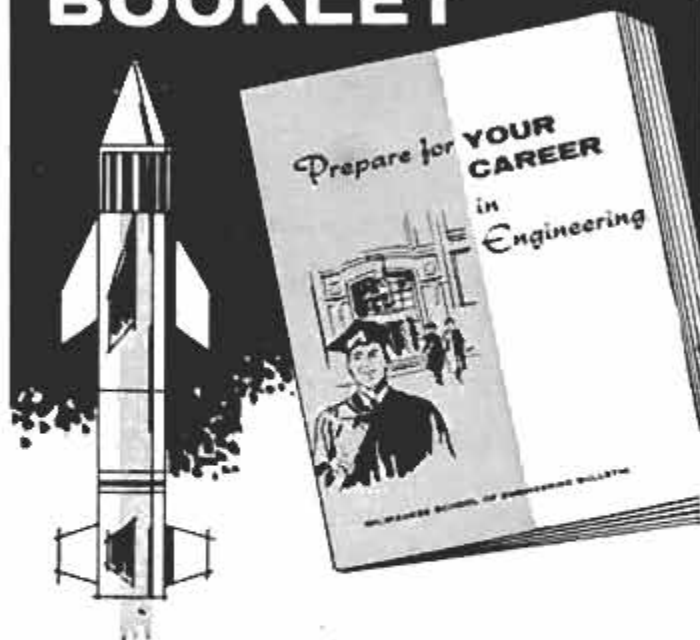

To guide you to a
successful future in
**METALLURGY
MECHANICAL
ENGINEERING
AIR CONDITIONING
INDUSTRIAL
TECHNOLOGY**

This interesting pictorial booklet tells you
how you can prepare for a dynamic career
as a Mechanical Engineer or Engineering
Technician in such rewarding fields as:

**DEVELOPMENT • RESEARCH • SELLING
PRODUCT DESIGN • PURCHASING
QUALITY CONTROL • TIME STUDY**

Get all the facts about job opportunities,
length of study, courses offered, degrees
you can earn, scholarships, part-time work
— as well as pictures of the Milwaukee
School of Engineering's educational and
recreational facilities. No obligation — it's
yours free.

MILWAUKEE SCHOOL OF ENGINEERING

MAIL COUPON TODAY!

Milwaukee School of Engineering
Dept. PM-1159, 1025 N. Milwaukee St., Milwaukee, Wis.
Please send FREE "Your Career" booklet
I'm interested in Metallurgy Air Conditioning
 Industrial Engineering Mechanical Engineering
 Electrical Engineering.

Name _____ Age _____
PLEASE PRINT

Address _____

City _____ Zone _____ State _____

I'm eligible for veterans education benefits.
Discharge date _____ MS-119

TRAILER KITS

BOATS } TO 2000 LBS.
 } TO 20 FT.

Factory Financing

Free Catalogue

TRAILER PRODUCTS COMPANY

DEPT. PM-11 — BOX 302

KINGSPORT, TENN.

Now!

TEST YOUR OWN for
TV & RADIO TUBES filament
breaks

All of Them — Even Picture Tube

Nearly half of TV service calls are due to de-
fective filaments. Tester shows if filaments
are good. Insert tube in tester. Light shows
if tube is burned out. Easy, safe to use. One
service call saved pays for tester. Metal case.
AC or DC. Checks fuses, appliances, etc. Only
\$3.98 ppd. or C.O.D. plus charges. Deluxe
Model \$4.98. Instructions. Guaranteed.

GEIGER ENGINEERING CORP., Dept. AB-112
6349 N. Western Ave., Chicago 45, Ill.



Pocket Size — Loose Leaf

LEFAX
TECHNICAL DATA BOOKS

\$1.25
each

Printed on loose leaf, 6 hole, 6 3/4"x3 3/4" bond paper,
each book contains about 140 pages of technical data,
condensed, accurate, essential, for engineer, technical
worker, teacher, student, business man

- | | | | |
|------------------|-----------------|------------------|------------------|
| Architecture | Surveying | Machinist's Data | Radio |
| Home Heating | Tables | Mech. of | Television & FM |
| Illumination | Highway Eng'g. | Materials | Electricity. AC |
| Electrician's | General Math | Pwr. Trans. | Electricity. DC |
| Data | Math Tables | Mach. | AC Motors and |
| Builder's Data | Physics | Thermo. Tbls. | Generators |
| Lumber Data | Trig-Log Tables | & Charts | Conversion Tabl. |
| Air Conditioning | Gen'l Chemistry | Phys. & Thermo- | Steel Forms |
| Building Constr. | Chemical Tables | dynamic Data | Welding Data |
| Reinf. Concrete | Analytic Chem. | Metallurgy | Transformers. |
| Piping Data | Mech'l Drawing | Hydraulics | Relays & Meters |
| Surveying | Machine Design | Metals | |

Write for FREE catalogs (2000 listings). See how helpful LEFAX can
be to you. Send \$1.25 book, or \$6 for any five books to

LEFAX PUBLISHERS, Dept. PM-119, Philadelphia 7, Pa.

EARN MORE - LEARN AUTO DIESEL MECHANICS

OR TRAIN WITH OTHER GREER DIPLOMA COURSES

- | | |
|---|---|
| <input type="checkbox"/> AUTO MECHANICS | <input type="checkbox"/> REFRIGERATION |
| <input type="checkbox"/> DIESEL MECHANICS | <input type="checkbox"/> AIR CONDITIONING |
| <input type="checkbox"/> BODY & FENDER REPAIR | <input type="checkbox"/> MACHINIST TRADE |
| <input type="checkbox"/> GAS-ARC WELDING | <input type="checkbox"/> ADVANCED MACHINIST |

Skilled men are needed in every part of the country. Earn top pay in established shops or start your own business. Greer's expert instruction and actual shop training teaches you how. You learn by doing—quick, easy courses using the latest tools and equipment. Day, evening and part time instructions available.

Job placement and convenient living accommodations are yours while training. Contact GREER'S FREE JOB PLACEMENT SERVICE when you enroll if you wish part time or full time employment.

ENGINEERING DEGREE COURSES

- | |
|--|
| <input type="checkbox"/> DIESEL AUTOMOTIVE ENGINEERING 27 MONTHS |
| <input type="checkbox"/> REFRIGERATION & AIR COND. ENGINEERING 18 MONTHS |
| <input type="checkbox"/> WELDING ENGINEERING 18 MONTHS |

All Courses Approved Civ. or G.I.

Please rush me free literature on the trade indicated, at no obligation.

NAME _____ AGE _____
STREET _____
TOWN _____ ZONE _____ STATE _____

Established 1902

GREER SHOP TRAINING

Box K, 2236 S. Michigan Ave.
Chicago 16, Illinois



The skilled hand of the German gunsmith is responsible for this .22 caliber, 6-shot repeater automatic with self-ejecting clip. Just 4" long. Fits easily into pocket or purse. Ideal for sporting events, stage use.

(Not available to California residents).

Comes for \$6.95 ppd. from
BEST VALUES, Dept. A42, 403 Market, Newark, New Jersey



MINIATURE ELECTRICAL TESTER

(2 1/2" x 3 1/2" x 1 3/8")

For testing all appliances, radio, TV, auto circuits, etc. Measures AC and DC voltages, resistance and milliamperes. Instructions included. Easily carried, fits your pocket. Ideal Xmas gift.

ONLY \$10.95, postage prepaid U.S.A.

B & B PRODUCTS CO. P. O. Box 925 - Dept. 119
SAN FRANCISCO 1, CALIF.

FORTUNES IN DIVING

Train at Home in Spare Time
Write Today for Amazing Free Booklet

Here is one of the greatest opportunities of our time. Make big money fast in Skin and Lung Diving. Trained divers needed in hundreds of industries and by government. Build a successful business of your own. Hourly rates among highest paid in any field. Training program by E. R. Cross, world famous master diver. Get the facts now. Mail coupon for FREE BOOKLET TODAY!

DIVEMASTER, Dept. PM-119
5637 W. 63rd Place, Chicago 38, Ill.

Send me free information about Diving.

Name _____ Age _____
Address _____
City _____ State _____



After the city,
Before the state
The ZONE keeps your mail
From being late



The Post Office has divided 106 cities into postal delivery zones to speed mail delivery. Be sure to include zone number when writing to these cities; be sure to include *your* zone number in *your* return address — after the city, before the state.

New
FANTASTIC
BUSINESS
HOBBY

Literature on request.
Distributors wanted.

PLASTIC VACUUM FORMING MACHINE "HOBBY-VAC"

A rugged production vacuum-forming machine at a fraction of usual industrial machine cost. No skill required to operate efficiently, only a few minutes of practice.

HOBBY-VAC FORMS, BUBBLE AND BLISTER PACKS,
DRAWS UP TO 3" DEEP

HOBBY-VAC will reproduce from natural objects, such as flowers, shells, letters, etc., or dies, in seconds, for as little as 10¢ each. No pumps required. Each machine fully equipped and ready to operate on 110 V. outlet and your regular hose-type vacuum cleaner.

Forms one of a kind or thousands of items in plain or brilliant metallic plastic up to 1/4" thick.

PICTURED ON RIGHT IS THE SMALLEST SIZE HOBBY-VAC

7"x7" Picture size	6"x6" x up to 3" deep	\$ 39.50
7"x14" "	6"x13" x up to 3" deep	79.00
10"x14" "	9"x13" x up to 3" deep	97.00
14"x14" "	13"x13" x up to 3" deep	160.00

LARGER MACHINES AVAILABLE

Possibilities are practically unlimited for commercial and industrial purposes. Excellent for producing rugged 3-dimensional parts.

ONLY
39.50



ORBIT of CALIFORNIA 211 Los Molinos, San Clemente, California



Nutria....NEWEST OPPORTUNITY

New fur-bearing animal now being bred in U. S. Offers huge profits to breeders. This fur is next to Mink NOW in price and will soon surpass it. 15 to 20 young per year. Most easily and economically raised animal known. 1 1/2c per day to feed. ANY CLIMATE, disease resistant. The Cabana Marrone strain is obtainable ONLY through Cabana Nutria, Inc., and its authorized dealers and distributors. For free booklet and address of Cabana ranch nearest you write:

CABANA NUTRIA, INC.
Dept. 46, 636 W. Lemon Ave., Arcadia, Calif.



\$1.50 40-18 PULLY

HITS LIKE A RIFLE — KILLS RABBITS, SQUIRRELS
Powerful, silent, accurate
For hunting, target, routing pests.
Spartan's choice
sold world over!



HUNTING SLINGSHOT

NEW! surgical quality pure gum rubber
Heavy duty 7" ash stock.
40 heavy steel balls, extra rubber.
Target, adapter for shooting arrows.
GUARANTEED. Professional model of Nat'l Slingshot Ass'n. At dealers, or write
WAMO MFG. CO., Box 815, San Gabriel, Calif.
FREE catalog on crossbows, knives, games, pistols, etc.

LEARN WHILE YOU SLEEP!



Hypnotize self, others while asleep with amazing hypnotic phonograph records, tapes. Free catalog lists 200 unusual records, tapes & equipment for sleep-learning & hypnosis experimenters. Sleep-Learning Research Ass'n., Box 24-D, Olympia, Washington.

GET INTO THE BOOMING BUILDING INDUSTRY

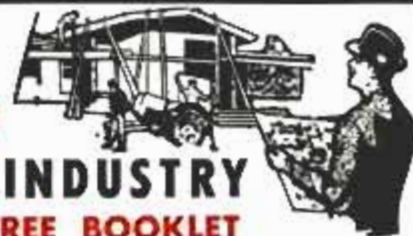

WRITE FOR FREE BOOKLET

Become an Expert Building Contractor
Learn Quickly in Spare Time. ATS Home Training Helps You Go Up to Big Pay

Job opportunities are great for Estimators, Contractors, Builders. Succeed in your own Home Building and Remodeling Business in this multi-billion dollar industry. Start with small, profitable remodeling jobs go on to bigger jobs. No previous experience or advanced education needed. Easy to understand pictorial methods of this not-for-profit organization prepares for advancement in all branches of building industry. Learn Blue Print Reading, Carpentry, Masonry, installing and designing plumbing, wiring and estimating, house planning, construction financing, etc. Write for FREE booklet today—no obligation.

Success in Your Own Home Building or Remodeling Business

You can make money fast because there is so much work to be done, such widespread need for trained men. Building and remodeling is going on in every part of the country—ATS training can prepare you in remarkably short time for this great opportunity.

Earn While You Learn—Practical Home Training

ATS Supervised Home Training is so practical you can actually begin to put your knowledge to work on the job as you learn. Many begin after first few lessons, go up to bigger money as they progress with their training. MAIL COUPON FOR COLORFUL FREE booklet today—no obligation.

AMERICAN TECHNICAL SOCIETY, Dept. BH-119
850 E. 58th St., Chicago 37, Ill.

Please send me FREE illustrated booklet and details of your training program in Building, Estimating and Contracting.

Name Age

Address

City State

WHOLESALE Electric Guitars - Parts - Factory to You
Professional electric solid body Spanish guitars, amplifiers, electric bass, double-necks, triple-necks, tone changers, double-neck Spanish, electric mandolin, pickups.
Parts to outfit your own. 1960 Models wholesale — Free catalog.
CARVIN CO., Box 287, PM-11, Covina, Calif.



LEARN MEAT CUTTING AT NATIONAL Pay After Graduation



The steady dependable trade of Meat Cutting taught easily in 8 short weeks. YOU LEARN BY DOING under actual meat market conditions in big modern school at Toledo.

For beginners or men with experience. Get a profitable store of your own. Remember, PEOPLE MUST EAT! Big pay jobs. Free employment help. Thousands of successful graduates.

Buying, cutting, percentage, pricing, advertising, selling, etc. A complete retail meat education. National School established 36 years. Get National training NOW. Pay your tuition in easy weekly

payments after you graduate. Send coupon for FREE school catalog — TODAY. G.I. approved.

National School of Meat Cutting, Inc., Dept. 50-Y, Toledo 4, Ohio

Send me your FREE school catalog on National Training at Toledo in Meat Cutting, Meat Merchandising and Self Service Meats. No obligation. No salesman will call.

Name Age

Address

City State

Approved for Veterans

HOME REPAIR TIP NO. 48

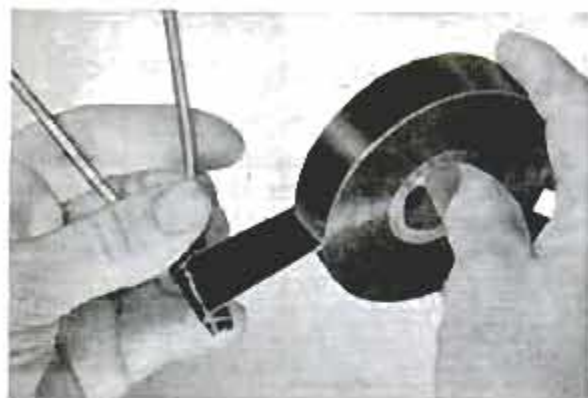

Wrap splices in electrical wires neatly, safely with "SCOTCH" Brand 33 Plastic Electrical Tape. Thin plastic tape stretches to conform tightly, has high insulating quality, makes waterproof wrap. Resists sunlight, oil, wear and corrosion. UL approved for electrical use, ideal for wrapping splintered tool handles, other heavy duty jobs. Get "SCOTCH" 33 Plastic Electrical Tape in 39¢ or 75¢ rolls at your favorite store now.

BETTER BUY TWO!

Made by
Minnesota Mining & Mfg. Co.
St. Paul 6, Minn. ©3M Co., 1958



Shortage of Mathematicians Predicted by 1963

Within the next five years the United States will face an acute shortage of mathematicians. Dr. J. Sutherland Frame, head of Michigan State University's mathematics department, estimates that by 1963, some 70,000 mathematicians, including 10,000 with doctoral degrees, will be needed for computer work alone. He said it is highly unlikely that there will be even 5000 Ph.D.'s in mathematics by 1963, and most of them will be working in other phases than computing.

Irrigation Water Treatment Controls Citrus Parasite

Chemically treated irrigation water has supplied the answer to the citrus nematode, a plant parasite that has infested more than half the groves in Arizona. The old method of combating the pest (a worm related to the vinegar eel and pinworm) involved pulling up trees, fumigating the soil, and replanting, but the new chemical method only requires the addition of DBCP to the irrigation water. Almost 100% control results at a cost of about \$16 per acre.

Telescoping Shoehorn

No more bending over to use that shoehorn! All you do with the ultimate in this line of personal conveniences is lengthen it by extending its three sections like you would a telescope. Then you hold it by the end and get into that shoe—with no more backbending.

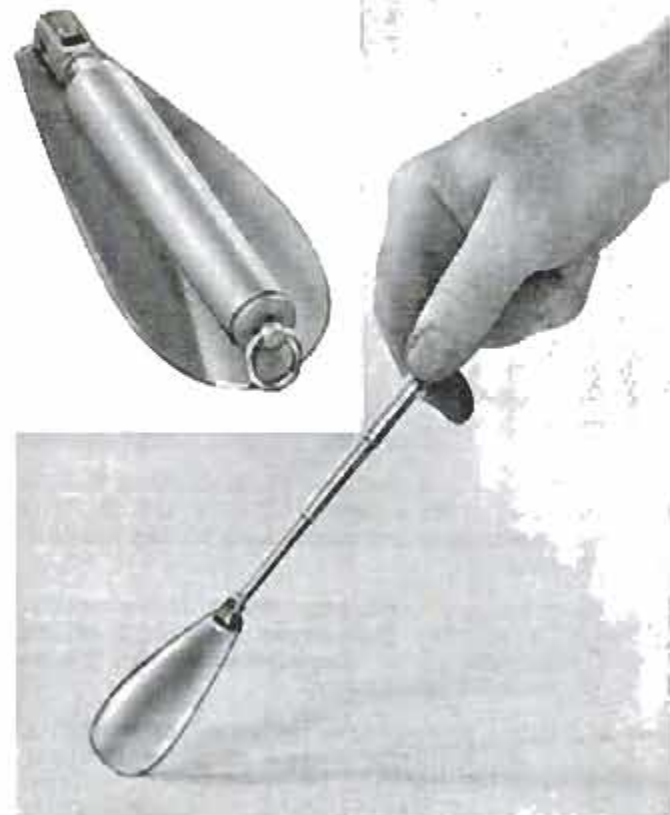

**NO
SOONER
SEEN
THAN
PLAYED**

Discover your musical talent with the HOHNER MELODICA, the musical instrument you play right away. Two full chromatic octaves and a tone that's great, group or solo. Available at your local store at \$14.95. For free illustrated leaflet send coupon below to M. HOHNER INC., 351-4th Ave., N.Y. 10, N.Y.

M. HOHNER INC., 351-4th Ave., New York 10, N. Y.

Gentlemen:

Please send me the HOHNER MELODICA leaflet

Name.....

Address.....

City/State.....

WHAM-O AUSSIE BOOMERANG
Special 98¢
 Exciting Sport postpaid

GUARANTEED TO RETURN

NO SPECIAL SKILL REQUIRED Terrific fun to throw! For young and old alike. Scientific airfoil design makes it return unfaillingly. Crafted from tough plastic. 15 inches across. Practically indestructible. At dealers or send to: **WHAM-O MFG. Co., Box A17, San Gabriel, Cal.**

THE WORLD'S FINEST POCKET PISTOL CAN BE YOURS!

.22 DERRINGER

The *Derringer*, the pocket pistol that changed history! Used to assassinate President Lincoln, known as the "widow maker" and the "hidden persuader" This weapon, a beautiful show piece offers "a palm full of protection" for the home. Fun for target and plinking on camping trips. Compact, simple and reliable, it is ideal for women. Fires the new, powerful "high speed" .22 Long Rifle Ammo Available everywhere. **ORDER NOW!** Send only \$10.00 Balance COD

KENT'S SPORTING GOODS **\$17.95**

Dept. P-11 114 E. Roosevelt, Phoenix, Arizona **LIMITED OFFER**

Locksmithing AND KEY MAKING

Now Made Easy! Practical up-to-date course teaches you how to pick locks, de-code, make master keys, repair, install, service, etc. New self-instruction lessons for every handyman, homeowner, carpenter mechanic, service station operator, fix-it shop, hardware dealer, gunsmith. 53 easy illustrated lessons. Full price only \$5.95 postpaid; or C.O.D. plus postage. Satisfaction or refund guaranteed.

NELSON-HALL CO., DEPT. LR-2
 210 S. Clinton Chicago 6, Ill.

Complete course \$5.95 ... now only \$3.95

FREE SCIENCE KIT!

Explore science with this free Porter Science Kit.

- "Your World of Science" Book
- "Wonders of Science" Folder
- Materials for an interesting chemical experiment.

\$1000 COLLEGE SCHOLARSHIP CONTEST

Kit contains complete contest information and entry blank. Send for yours today!

chemcraft microcraft

PORTER SCIENCE
 Prepares Young America for World Leadership

Porter Chemical Co.
 Dept. No. 51, Hagerstown, Md. Age.....

Send me my Free Science Kit.

Name.....

Address.....

City..... Zone..... State.....

LEARN UPHOLSTERY
 in your spare time
run your own business AT HOME

FREE BOOK with sample lessons with course

YOU MAKE SLIPPER CHAIR CLUB CHAIR OTTOMAN

PLUS SLIP COVERS
 Yours to Keep or Sell

BE YOUR OWN BOSS
Earn more from the start! Set up your own profitable business, in your own home, enjoy steady income, independence for life. You're in demand in the booming field of Custom Furniture Upholstery. Right off you start learning and earning with tools, complete frames, fabrics and materials, included **FREE** with N. Y. State-approved UTS course. You learn skilled professional custom upholstery, reupholstery, furniture finishing, repairs, how to make beautiful slip covers, cushions and draperies. **EARN WHILE YOU LEARN**, in your spare time **AT HOME**... the UTS easy way.

FREE ILLUSTRATED BOOK - FREE SAMPLE LESSON
 Get ready for well-paid job and big profits, from steady work, as your own boss, running your own business. Mail coupon **NOW** for **FREE BOOK!** Training in N. Y. School also available. **VET APP'V'D. ACCREDITED BY N.H.S.C.**

UPHOLSTERY TRADES SCHOOL
 Dept. H5-310, 721 E'way, N. Y. 3, N. Y.

Please send me **FREE** book, "Your New Way to a Successful Career," and **FREE** sample lesson. No obligation—no salesman will call.
 Home Study Training in N. Y. School

Name..... Please Print Plainly
 Address.....
 City..... Zone..... State.....
 Check if Korean Veteran

PREPARE FOR BETTER JOB, BIGGER PAY IN SPARE TIME AT HOME

Today, choose the job you want—and prepare for it in time you might otherwise waste. Or if you are already in the work you like best, start training now for quicker promotion and increased pay. During the past 62 years **AMERICAN SCHOOL** has helped ambitious people to reach higher goals. Check subject that interests you and mail coupon for full information.

AMERICAN SCHOOL, Dept. G845, Drexel at 58th, Chicago 37, Ill.

Without obligation, please send **FREE** and postpaid, full particulars about the subject checked below.

<input type="checkbox"/> Accounting	<input type="checkbox"/> Contracting	<input type="checkbox"/> Mechanical Engineering
<input type="checkbox"/> Apprenticeship Courses	<input type="checkbox"/> Diesel Technician	<input type="checkbox"/> Mechanical Technology
<input type="checkbox"/> Architecture & Building	<input type="checkbox"/> Drafting—Building Trades	<input type="checkbox"/> Metalworking Courses
<input type="checkbox"/> Automotive Technician	<input type="checkbox"/> Drafting—Machine Trades	<input type="checkbox"/> Plumbing—Practical
<input type="checkbox"/> Better Foremanship	<input type="checkbox"/> Electrical Engineering	<input type="checkbox"/> Private Secretary
<input type="checkbox"/> Blueprint Reading	<input type="checkbox"/> Electricity—Practical	<input type="checkbox"/> Retail Merchandising
<input type="checkbox"/> Bookkeeping	<input type="checkbox"/> Electronics—Industrial	<input type="checkbox"/> Salesmanship—Outside
<input type="checkbox"/> Business Management	<input type="checkbox"/> HIGH SCHOOL COURSES	<input type="checkbox"/> Sheet Metal Work
<input type="checkbox"/> Civil Engineering	<input type="checkbox"/> Machinists	<input type="checkbox"/> Tool Making

NAME.....
 HOME ADDRESS.....
 CITY..... STATE.....
 OCCUPATION..... AGE.....

Accredited Member NATIONAL HOME STUDY COUNCIL

MAIL COUPON NOW

AMAZING 6-SECOND **HERCULES**
SWIF SOLDER

REAL SOLDER (NOT A GLUE). JUST SQUEEZE ON AND HEAT...42% FASTER THAN WIRE SOLDER*

Squeeze on Hercules SWIF Solder and heat...even a match will work when you solder wires with SWIF. SWIF solders copper, brass, iron, steel, silver, zinc, tin, etc. Plumbers, electricians and electronics men choose SWIF because it gives them a real 50/50 tin-lead solder in time-saving, easy-to-use paste form. One tube of SWIF does the work of 3 to 4 times as much ordinary solder. Each tube comes with a free Do-it-Yourself Solder Leaflet that shows how to use SWIF for so many jobs.

*Test report available on request



Hobbies & Crafts Electrical Wiring Plumbing & Repairs

ONE HANDY TUBE MAKES HUNDREDS OF CONNECTIONS... ONLY **69c** 

Also available with acid flux in 4 oz., 1/2 lb., 1 lb. and 3 lb. containers.
HERCULES CHEMICAL CO., INC., 416 Broadway, New York 13, N.Y.

I'LL HEAT THAT COLD ROOM
I am a high volume warm air **BOOSTER FAN**



Install me in the pipe that runs to your "cold room" and I will keep it warm. Simple to install - fits any pipe 8" or larger, round or rectangular. State size of duct. Plugs into 110V socket. Used by furnace men for 20 years. Guaranteed. Directions. Only \$8.85 postpaid.

P. K. PRODUCTS COMPANY
417 Grattan Dept. 7119 Topeka, Kan.

WANTED!

Mechanically Inclined
Men to Qualify for
**CUMMINS DIESEL
FACTORY TRAINING**



If you are interested in High Pay Jobs and Advancement in the Diesel field... here's your opportunity! Qualified Factory-Trained men are in demand by highway builders, diesel manufacturers, truck line operators everywhere. Interstate can help you qualify for tuition-free Cummins factory training and big pay diesel jobs! Write for complete information about Cummins-approved home training.

Get the Facts Today!

WRITE INTERSTATE TRAINING SERVICE
Dept. A-3, Portland 12, Oregon

RUSH information about Cummins tuition-free Factory Training and approved Home Study programs.

Name _____
Address _____
City _____ Zone _____ State _____

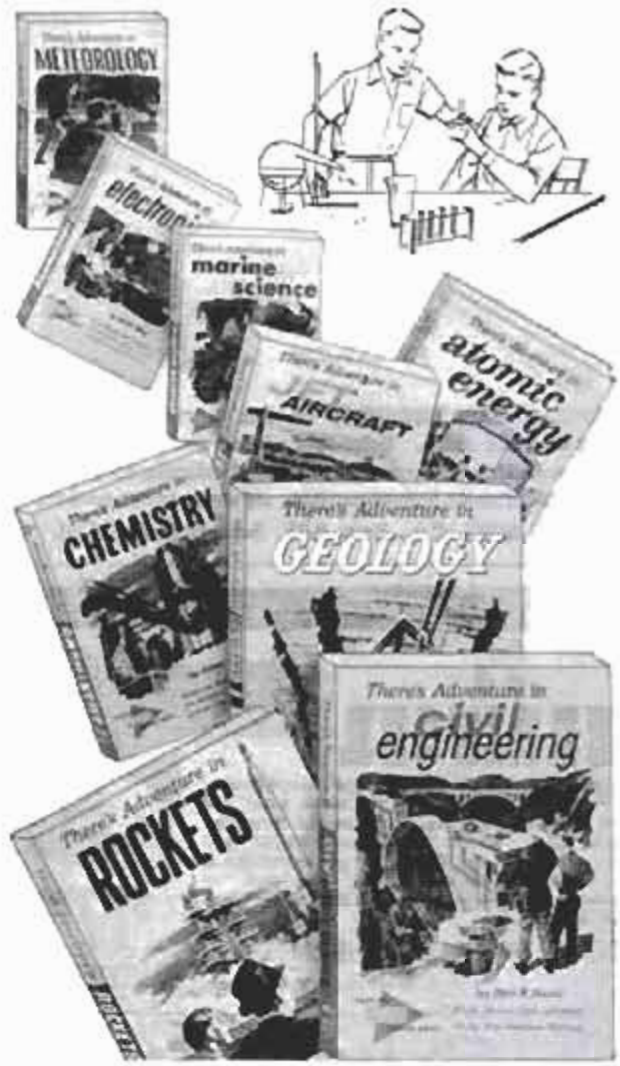

Stimulating, adventure-packed reading for young boys and girls

A perfect blending of scientific information and exciting adventure. Each book \$2.95. At your bookstore, or order direct from Popular Mechanics, 200 E. Ontario Street, Chicago 11, Illinois.

Poisonous Animals and Insects Take 215 Lives in Five Years

Venom poisoning is much commoner than has generally been recognized, according to Dr. Henry M. Parrish of the University of Vermont College of Medicine. Dr. Parrish recently completed a study of death certificates of all persons in the United States from bites and stings of venomous animals and insects during a five-year period. There were 215 deaths in that period. Bees, wasps, hornets, yellow jackets and ants killed 86 persons; poisonous snakes killed 71 persons; and poisonous spiders killed 39 persons. Other animals and insects causing death were scorpions, Portuguese men-of-war, and sting rays.

LOCATE HIDDEN TREASURE

JEWELRY, COINS, METALS, MINERALS,
WIRES, PIPE, ETC.

AUTHENTIC U.S. ARMY PORTABLE MINE DETECTOR

ORIG. \$233.00 **\$19.50** BATTERIES \$3.00 EXT.
EXP. CHGS. COLLECT

Model SCR625. Detects objects up to 24" depth. Comes complete in fitted chest with bulbs and instructions. Chest is 28 1/4" long, 15" wide, 8 1/4" deep. Instrument is ideal for electricians, plumbers, utility companies, mineralogists, beach combers, scouts, etc. Like-new condition. No C.O.D.

A.M. AIRCRAFT PARTS CO.

307-309 West Broadway, New York 13, N. Y.

FREE THE HISTORY OF
THE COMPASS
SEND FOR YOUR COPY

New DINSMORE Celebrity COMPASSES

in Beautiful GOLD OR SILVER

A jeweled, precision instrument—designed for modern cars. Full, indirect illumination. Sharp, clear letters. Silver or gold Celebrity models \$7.45, standard models \$5.95, illuminated \$6.95.

APPROVED BY AUTO MAKERS
Fine Quality Compasses for over 31 Years

DINSMORE INSTRUMENT CO.
1802-41 Kelso St., Flint 1, Michigan

Write
for Folder

NO JOB WORRIES

PLASTEX INDUSTRY needs manufacturers on small scale for big production of Lamps, Clock Stands, Art Goods, Novelties in Plastic Marble imitation. No Experience necessary. The material makes regular 10¢ store sellers. Moulds furnished for fast production. Small investment brings good profit. Big Wholesale orders now being placed. Ambitious men have chance for real prosperity and job security. Our NEW FREE booklet will interest and benefit you.

PLASTEX INDUSTRIES, Dept. A
3400 Third Ave. New York 56, N. Y.

SCIENTIFIC DOUBLE PUZZLE—2 in 1

The new Double Puzzle—2 ways of assembling. Complete instructions with puzzle. Get one for yourself. Makes a wonderful Gift. See how these 6 different colored pieces are cleverly assembled through each other. Amusing and interesting. Made of strong birch wood—3 inches long. Send to:

BALDWIN PATTERNS, Dept. 2
8365 Sunset Rd., Minneapolis 21, Minn.

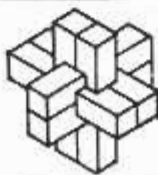

Only \$2.00 Postpaid. Send cash with order. No C.O.D.'s

SEWS LEATHER

AND TOUGH TEXTILES LIKE A MACHINE

With SPEEDY STITCHER Automatic Sewing Awl, anyone can quickly and skillfully sew or repair anything made of LEATHER, CANVAS, NYLON, PLASTIC, or other heavy materials. Sews firm, even lock-stitches like a machine. Gets into hard-to-reach places. Specially made for heavy duty sewing on LUGGAGE, FOOTWEAR, RUGS, AWNINGS, SAILS, SADDLERY, UPHOLSTERY, OVERALLS, AUTO TOPS, SPORTS GEAR, and other tough sewing jobs. Here's the handiest tool you'll ever own. Will save you many times its small cost. Comes ready for instant use... complete with bobbin of waxed thread and 3 different types of diamond-pointed needles. Easy-to-follow directions will make you an expert in minutes. Extra needles and waxed thread always available. Save money, send \$1.98 for postpaid delivery. If C.O.D., \$1.98 plus postage. MONEY BACK GUARANTEE.

SPORTSMAN'S POST
366 Madison Ave., Dept. A-82, New York 17

ONLY **1.98**



The Beautiful Schober CONSOLETTA

—only small organ with two full 61-note keyboards and 22 stops. Requires only 2'x3/2" floor space! Commercial value approximately \$1600 or more.

BUILD THIS SUPERB Schober ORGAN FROM SIMPLE KITS and save over 50%!

Give Your Family A Lifetime of Musical Joy With A Magnificent Schober Electronic Organ!

Now you can build the brilliant, full-range Schober CONSOLETTA or the larger CONCERT MODEL with simple hand tools! No skills are needed; no woodworking necessary. Just assemble clearly marked electronic parts guided by step-by-step instructions. You build from kits, as fast or as slowly as you please... at home, in your spare time — with a small table serving as your entire work shop.

Pay As You Build!

Start building your organ at once, investing just \$18.94! The superb instru-

ment you assemble is as fine, and technically perfect, as a commercial organ... yet you save over 50% on quality electronic parts, high-priced labor, usual store mark-up!

THE GREAT
CONCERT
MODEL
meets
specifications of
American
Guild of
Organists

Free Booklet

Send for 16-page booklet in full color describing Schober organs you may build for home, church or school, plus articles on how easy it is to build

your own organ and how pleasant it is to learn to play. Also available is 10" LP demonstration record (price \$2.00 — refundable on first order). Send for literature. No obligation and no salesman will call.

Mail This Coupon For FREE Schober Literature And Hi-Fi Demonstration Record TODAY!

The Schober Organ Corp., Dept. PM-1
2248 Broadway, New York 24, N. Y.

- Please send me FREE full-color booklet and other literature on the Schober organs.
 Please send me the 10" hi-fi Schober demonstration record. I enclose \$2.00 (refundable on receipt of my first kit order).

Name.....

Address.....

City..... Zone... State.....

When you buy a

LEE

Resin-weld
Feridium
Anode

OIL FILTER

..you get an extra*
filter for **FREE!!**

Just imagine getting 2 filters for the price of one! Why? Simply because every **LEE OIL FILTER** is actually *two filters combined to give you: —



- 1. ENGINE SLUDGE FILTRATION** — The accordion pleated element removes sludge and abrasives too tiny for the eye to see!
- 2. ENGINE ACID FILTRATION** — The built-in, patented Feridium* Anode neutralizes and removes engine-eating acids!

If you want **TWICE AS MUCH** engine protection **AT NO EXTRA COST**, insist on getting a **LEE Feridium* Anode OIL FILTER!** Sold wherever cars are serviced and in accessory stores.

*T.M. Reg. U.S. Pat. Off. Pat. Pend.
LEE FILTER CORP., Dept. NM No. Arlington, N. J.

Be a
LOCKSMITH

Want **BIG PAY**—
Your Own Business?



You can quickly step into a well-paid job or start a big-profit business of your own. Shortage of locksmiths means opportunities everywhere, spare-time or full-time.

EARN EXTRA MONEY FROM THE START!
All Special Tools, Supplies Furnished Free

Age, education, minor physical handicaps don't matter in this growing, steady-income trade. You learn fast at home—gain practical experience through well-illustrated lessons. You do real jobs under the personal guidance of experts. Only school of its kind. Licensed State of N. J.; Accredited Nat'l. Home Study Council.

For a future as your own boss, or in a big pay job, send for **FREE** illustrated book. Mail coupon at once. No salesman will call. **Approved for Veterans.**

Locksmithing Institute, Dept. 111-0
150 Park Ave., E. Rutherford, N. J.



Please send **FREE** and without obligation illustrated book.

Name _____

Address _____

City _____ Zone _____ State _____

ENGINEERING DEGREE IN 27 MONTHS

Students given option of studying engineering under accelerated program leading to **Bachelor of Science Degree in 27 months**; or the standard four-year program leading to **Bachelor of Engineering Degree in 36 months**. The B.S. degree in Mathematics, Chemistry, or Physics (Including Nuclear Physics) may be earned in 36 months. By attending classes year-round, students can graduate in 3 years and have one year of experience and income in the time usually needed to complete a four-year college course. Preparatory courses. Thorough, practical program. Individualized instruction.

Keeping pace with progress in science and engineering
Campus, Dorms, gym, playing fields. Superior faculty, 2,000 students. New Dana Science Building. Low tuition. Earn board. G.I. approved. Enter December, March, June, September. Students from 50 states, 40 foreign countries. Send coupon for free catalog, full information. Enroll now!

INDIANA TECHNICAL COLLEGE

5119 E. Washington Boulevard, Fort Wayne 2, Indiana
Please send me free information on 27 mo. B.S. DEGREES in:

Aeronautical Chemical Civil Electrical
 Mechanical Electronics

on 36 mo. B. E. DEGREES in:

Aeronautical Chemical Civil
 Electrical (Power or Electronics) Mechanical Metallurgical

on 36 mo. B.S. DEGREES in:

Mathematics Chemistry Physics

Name _____

Address _____

20 SHOTS
THE NEW
MARKSMAN
BB REPEATER
AIR PISTOL At all leading dealers
MARKSMAN PRODUCTS
Division of Morton H. Harris, Inc.,
Los Angeles 25, Calif.



\$8.95



Air-Conditioned Helmet Cools Equipment Operator

Heavy equipment operators may soon look like space pilots as they drive their machines in the cool comfort of a new air-conditioned Fiberglas helmet. The lightweight helmet receives its cool air from an electric refrigeration unit through a six-foot hose—long enough to give the driver full freedom of movement. The unit not only cools and dries the air, but filters out dust, pollen, insects and other foreign matter. The cooling unit operates from a standard ignition system.

YOUR OWN 2-WAY RADIO FOR BUSINESS OR PLEASURE!



Messenger
FROM
\$129⁷⁵



Anyone can operate—license issued by the FCC on request!

- Complete 23 channel Citizens' Band coverage—choose any 5 channels by the flip of a switch!
- Excellent receiver sensitivity and selectivity—full fidelity voice reproduction!

"More than just 2-way Citizens' Radio equipment"—the Viking "Messenger" offers the finest performance of any equipment available. Meets all FCC requirements. Maximum legal power. Designed for high reliability and easy installation in your home, business location, car, truck, or boat. Built-in Squelch, Automatic Volume Control, and Automatic Noise Limiter. Compact, modern styling—only 5 $\frac{3}{8}$ " high, 7" wide, and 11 $\frac{3}{8}$ " deep. Complete with tubes, push-to-talk microphone, and crystals for one channel.

WRITE TODAY FOR FULLY ILLUSTRATED BROCHURE



E. F. JOHNSON COMPANY
161 SECOND AVE. S. W. • WASECA, MINNESOTA

Superior's New Model 70 UTILITY TESTER® FOR REPAIRING ALL ELECTRICAL APPLIANCES MOTORS • AUTOMOBILES • TV TUBES

As an electrical trouble shooter the Model 70:



- Will test Toasters, Irons, Broilers, Heating Pads, Clocks, Fans, Vacuum Cleaners, Refrigerators, Lamps, Fluorescents, Switches, Thermostats, etc.
- Will test all TV tubes for open filaments, inter-
element shorts, burned out tubes, etc.
- Measures A.C. and D.C. Voltages, A.C. and D.C. Current, Resistances, Leakage, etc.
- Will measure current consumption while the appliance under test is in operation.
- Incorporates a sensitive direct-reading resistance range which will measure all resistances commonly used in electrical appliances, motors, etc.
- Leakage detecting circuit will indicate continuity from zero ohms to 5 megohms (5,000,000 ohms).

As an Automotive Tester the Model 70 will test:

- Both 6 Volt and 12 Volt Storage Batteries • Generators • Starters • Distributors • Ignition Coils • Regulators • Relays • Circuit Breakers • Cigarette Lighters • Stop Lights • Condensers • Directional Signal Systems • All Lamps and Bulbs • Fuses • Heating Systems • Horns • Also will locate poor grounds, breaks in wiring, poor connections, etc.

Model 70 comes complete including 64 page book, only... **\$15⁸⁵**

**SHIPPED ON APPROVAL
NO MONEY WITH ORDER—NO C.O.D.**

Try it for 10 days before you buy. If completely satisfied then send \$3.85 and pay balance at rate of \$4.00 per month for 6 months — No Interest or Finance Charges Added! If not completely satisfied, return to us, no explanation necessary.

MOSS ELECTRONIC, INC., Dept. D-679
3849 Tenth Ave., New York 34, N.Y.

Please rush Model 70. If satisfactory, I will pay on terms specified. Otherwise I will return tester.

Name _____

Address _____

City _____ Zone _____ State _____

All prices incl. P.O.R., N. Y. C.

The Amazing Potentialities of Memory

I LITTLE thought when I arrived at my friend Borg's house that I was about to see something truly extraordinary, and to increase my mental powers tenfold.

He had asked me to come to Stockholm to lecture to the Swedes about Lister and other British scientists. On the evening of my arrival, after the champagne, our conversation turned naturally to the problems of public speaking and to the great labour imposed on us lecturers by the need to be word perfect in our lectures.

Borg then told me that his power of memory would probably amaze me—and I had known him, while we were studying law together in Paris, to have the most deplorable memory.

So he went to the end of the dining room and asked me to write down a hundred three-figure numbers, calling each one out in a clear voice. When I had filled the edge of an old newspaper with figures, Borg repeated them to me in the order in which I had written them down and then in reverse order, that is beginning with the last number. He also allowed me to ask him the relative position of different numbers: for example, which was the 24th, the 72nd, and the 38th, and I noticed that he replied to all my questions at once and without effort, as if the figures which I had written on the paper had been also written in his brain.

I was dumbfounded by such a feat and sought in vain for the trick which enabled him to achieve it. My friend then said: "The thing you have just seen and which seems so remarkable is, in fact, quite simple; everybody has a memory good enough to do the same, but few indeed can use this wonderful faculty."

He then revealed to me how I could achieve a similar feat of memory, and I at once mastered the secret—without mistakes and without effort—as you too will master it tomorrow.

But I did not stop at these amusing experiments. I applied the principles I had learned in my daily work. I could now remember, with unbelievable facility, the lectures I heard and those which I gave myself, the names of people I met—even if it was only once—as well as their addresses, and a thousand other details which were most useful to me. Finally, I discovered after a while that not only had my memory improved, but that I had also acquired greater powers of concentration; a surer judgement—which is by no means surprising since the keenness of our intellect is primarily dependent on the number and variety of the things we remember.

If you would like to share this experience and to possess those mental powers which are still our best chance of success in life, ask D. T. Borg to send you his interesting booklet *The Eternal Laws of Success*—he will send it free to anyone who wants to improve his memory. Here is the address: D. T. Borg, c/o Aubanel Publishers, 14 Highfield Road, Rathgar, Dublin, Ireland.

Write now—while copies of this booklet are still available.
L. CONWAY.

Advertisement

FREE ALLIED'S

MONEY-SAVING 1960

ELECTRONIC SUPPLY CATALOG

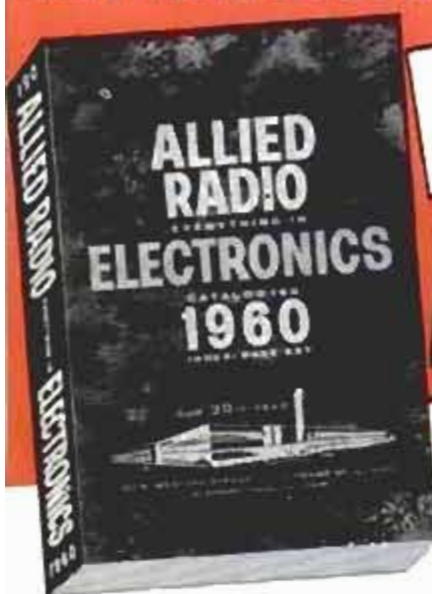

value-packed
SEND FOR IT!

SAVE
ON EVERYTHING
IN ELECTRONICS

EASIEST TERMS
only \$2 down on
orders up to \$50

WORLD'S LARGEST STOCKS

Send for the most widely used buying guide to everything in Electronics for Experimenters, Builders, Amateurs, Servicemen, Engineers and Hi-Fi enthusiasts. Save on:

- KNIGHT-KITS®—Best in Build-Your-Own
- Everything in STEREO Hi-Fi
- Hi-Fi Music Systems and Components
- Tape Recorders & Phono Equipment
- Public Address & Paging Systems
- TV Tubes, Antennas, Accessories
- Amateur Station Equipment
- Latest Test & Lab Instruments
- Parts, Tubes, Transistors
- Everything in Tools & Technical Books

SAVE on everything in Electronics at ALLIED—get fastest service, expert personal help, guaranteed satisfaction. Send today for your FREE 1960 ALLIED Catalog.

Everything in Electronics
from One Reliable Source

our 39th year



ALLIED RADIO

- ALLIED RADIO CORP., Dept. 5-L9
- 100 N. Western Ave., Chicago 80, Ill.
- Rush FREE 1960 ALLIED Catalog.

Name _____

Address _____

City _____ Zone _____ State _____

SEND FOR
FREE
CATALOG



Where-to-Buy-It Index

Automotive

British car has front drive (British Motor Corp., Ltd., American Dist. Hambro Automatic Corp., 27 W. 57th St., New York 19, N. Y.)	104
Six suitcases fit into Volkswagen's fiber glass roof trunk	126
Electric garage heater warms car engine (Elrich Sales Service, 1804 10th St., Monroe, Wis.)	136
Camping trailer for six mounts on truck chassis (McNamee Coach Corp., 2501 Rosemead Blvd. El Monte, Calif.)	154
Sunbeam sports model built for U.S. market (Rootes Motors Inc., 75 E. 55th St., New York, 22)	159
Cleats held to tires by inflatable bag (Palmer Industries, Inc., 846 W. 56th St., Indianapolis, Ind.)	160
Economy wagon added to Jeep line (Willys Motors, Inc., Toledo 1, Ohio)	161
Pint-size California car weighs only 1100 pounds (Crofton Marine Engine Co., 888 Gull St., San Diego, Calif.)	244
Air springs adjust to load (Air Lift Co., 2330 W. Main St., Lansing, Mich.)	248
Midget spare tire	248
Truck designed for turnpike hauls three trailers (The White Motor Co., 842 E. 79th St., Cleveland 1, Ohio)	248
Car engine heater (Tech Products, Inc., 615 Pennsylvania Ave., Elizabeth, N. J.)	284
Deflectors for windows "detour" dirt deposits (Superior Industries, 7260 Atoll Ave., North Hollywood, Calif.)	286

Aviation

Plane's forward section becomes escape capsule in emergency	106
Pilotless version of B-47 stratojet bomber developed for air force	135
Air holes in fins increase blimp's speed and range	137
Mobile cargo stand speeds aircraft loading	149
Hinged tail on transport planes speeds cargo loading	153
Pilot and ground-control exchange information by push-button	158
Midget motor scooter transplants jet pilot	272
Three two-man teams operate missile bomber	290

Miscellaneous

Toy clock can be taken apart (Hubley Mfg. Co., Lancaster, Pa.)	42
Tube brings fresh water to bait (Cliff and Jud Hobson, Community Rehabilitation Ind., Long Beach, Calif.)	66
Air-conditioned helmet cools equipment operator (Jamieson Laboratories Inc., 2200 Colorado Ave., Santa Monica, Calif.)	74
Police gun barrel mounts on car hood	106
Metal tubing shipped flat "blown up" on the job (Wolverine Tube, Div. of Calumet & Hecla, Inc., 17300 Southfield Rd., Allen Park, Mich.)	107
Cycle rides snow on ski and tracks	115
Twins, 17, invent successful bean picker (Paulson Brothers Industries, Inc., Clear Lake, Wis.)	134
Swinging crow's nest provides water thrills (The Aqua Bobber Co., 301 River Road, Maumee, Ohio)	135
TV's tiny spectacles	146
Revolving seat aids barber	153
Peach-stone sculptor (Robert J. Streit, Neenah, Wis.)	155
Powered log-splitter trails behind car (The Waco Aircraft Co., Troy, Ohio)	156
Sternwheeler revives old river days	157
Glass-fiber door lights up garage (Frantz Mfg. Co., Sterling, Ill.)	159
Inflatable rings keep you afloat	160
Compressed-air bottles give skis jet power	161
The hospital that drops from the sky	162
Elastic strap holds clipboard on arm, freeing both hands (J. E. Krowiak Co., 21 E. 5th Ave., Naperville, Ill.)	164
Plastic guard locks plug in electrical outlet (Miller's, 60 W. 33rd St., New York 1)	164
Speeding ice sled turns on a dime (Northern Mfg. Co., 132 N. Railroad St., Oak Harbor, Ohio)	165
Unbreakable plastic tubes make all types of toys (Bonnie Blitt Inc., 216 Laurence Ave., Long Island, N. Y.)	216
Giant drydock tilted for squeeze through narrow lock	244
Miniature adding machine built from units (The Denominator Co., 261 Broadway, New York 7, N. Y.)	262
Plastic cards go to the laundry (Northbrook Plastic Card Co., Northbrook, Ill.)	268
Telescoping shoehorn	270
Medical-message bracelet assures proper treatment (Medical-Alert Foundation, 1030 Sierra Drive, Turlock, Calif.)	278
Meter tells boat engine time (John W. Hobbs Corp., Springfield, Ill. [Div. Stewart Warner Corp.])	282
Waste collector packages trash (Martonair GmbH, Box 598, Duisburg, W. Germany)	288
Traffic light given "countdown"	292

Missiles, Rockets and Space

Miniaturized circuitry for space-research vehicles	127
Antiaircraft missile for British army	149
Peer into missile model	153
Test chamber will take man 150 miles up	158
Scorer clocks "hits" on missile misses	271

(Continued to page 78)

EARN \$125

A WEEK AND UP

BE AN AUTO-DIESEL EXPERT—LEARN A TRADE YOU LIKE

You learn fast in our shops because you learn with tools on real equipment. Students short of money may earn most of their expenses by doing part-time work. Experienced instructors explain WHY and show you HOW, then you DO IT YOURSELF. Forty years' experience training men. Successful graduates in 50 states and many foreign countries. Many of our graduates earn \$125 a week and up. Approved for veterans. Day and evening classes. Free bulletin-write today.

NASHVILLE AUTO-DIESEL COLLEGE
226 7th Ave., No., Dept. 86, Nashville, Tenn.

FREE AMAZING NEW BOOK "HOW TO ANSWER ADS"



Never before have you seen anything like this. Tells you in simple language the correct way to answer ads. Gets you quicker replies—better results, and greater satisfaction. Will save you time and money and it's ABSOLUTELY FREE. No obligation whatever. Every reader of advertising should have this booklet. Send a postcard for your copy NOW. F. W. JOHNSON, Popular Mechanics Magazine, Room 600-A, 204 East Ontario Street, Chicago 11, Ill.

\$\$ SAVE MONEY \$\$ RELOAD YOUR OWN SHOTGUN SHELLS LEE LOADER COMPLETE SET OF TOOLS \$9.95



2 WAY MONEY BACK GUARANTEE

1. Guaranteed to reload shells faster and better than tools selling for 4 times as much.
2. Guaranteed never to wear out or break through normal use. If any part should fail it will be replaced at no cost.

EXCLUSIVE TRIPLE ACTION CHAMBER

This is the secret of the LEE LOADER'S LOW COST, incredible speed and accuracy. This all steel highly finished tool resizes, wads and crimps the shell in one smooth continuous operation. This new concept in design (Pat. Pend.) makes it possible to manufacture a quality reloading tool at such a low price. Tools are complete including power and shot measures, decapper, rapper, wadking tool, resizer, crimping, and instructions packed in a self-storing box.



TRAP or HUNTING LOADS with ADJUSTABLE MEASURE

SEE IT AT YOUR DEALER OR ORDER DIRECT

Lee Custom Engineering
Dept. B, 6026 N. Apple Blossom Lane, Milwaukee 17, Wisc.
Enclosed find \$9.95 to cover complete cost of a Lee Loader.
12 16 20 Gauge. (Circle one.)

RUSH TO _____
STREET _____
CITY _____ STATE _____

Avoid Loss by Theft or Mistake!

Engrave Your Name on Metal, Wood, Plastic, Glass— as easily as writing!

With New Handy Burgess Electric VIBRO-GRAVER You Can Permanently Identify Your Tools, Camera, Garden Equipment, Golf Clubs, Fishing Rods, Machinery, Car Hub Caps and Other Expensive Property By Engraving Your Name . . . In Seconds! Proven in Thousands of Garages, Shops, Etc. Pays For Itself Every Time You Use It!



ONLY \$10.95

COMPLETE WITH TANTALUM CARBIDE POINT

Used By America's Largest Corporations

Ford Motor Co.
Sperry Gyroscope Co.
Republic Steel
U. S. Steel
General Motors
American Airlines
Baldwin Piano Co.
Minnesota Mining Corp.
Fairbanks-Morse
American Chemical
Dupont
Railway Express

and many agencies of the Government including the Navy, Army and Air Force



America's largest corporations and thousands of individuals have proved Burgess Electric VIBRO-GRAVER in use on expensive machines, precious hand tools and in a hundred other ways. Amazing VIBRO-GRAVER will engrave anything—the hardest steel, glass, ceramics, stone, cast iron—anything! The secret is the unique vibration principle developed by Burgess engineers: unit actually delivers 7200 strokes a minute to the engraving point of fantastically hard tantalum carbide—which means that literally thousands of tiny dots form a solid line which is permanently engraved into any material.

SEND NO MONEY; TRY AT OUR RISK!

VIBRO-GRAVER is absolutely safe and so compact that you can work hour after hour without tiring. No skill needed . . . use it like a pencil. So easy and quick to use you can actually earn good money personalizing articles for friends and neighbors! Send no money; simply pay the postman \$10.95 plus C.O.D. and postage when unit arrives. Or, send payment now and we will ship postpaid. Use your unit for 10 full days; return if not completely satisfied for full refund! Mail coupon today.

JOHN H. FAIR CO., Grayslake, Illinois

JOHN H. FAIR CO., Dept. PM-11
Grayslake, Illinois

Yes, please rush my VIBRO-GRAVER, complete with tantalum carbide point. I understand that I may use it for 10 days, and if not completely satisfied I may return it for full refund.

VIBRO-GRAVER comes complete with instructions for permanently engraving all materials.

I enclose \$10.95 payment Send C.O.D. I will pay in full. My unit will come C.O.D. charges and postage postage paid. on arrival.

Name.....

Address.....

City.....Zone....State.....

NOW you can easily DESIGN your own V-BELT DRIVES



... New **DRIVE DESIGNER** gives you correct pulley and V-belt sizes by merely turning a dial.

Using this simplified **DRIVE DESIGNER**, Gates Vulco V-Pulleys and the highly flexible "2000 Series" Gates Truflex V-Belts — available at hardware and implement stores everywhere — it is a simple matter to design a drive which will give you long, trouble-free service at whatever machine speed you desire.

Truflex V-Belts Ideal for Small Pulley Drives

Special, Flex-Weave cover enables Truflex V-Belt to bend easily around small pulleys ... results in far longer belt life.

Send for NEW V-Belt Drive Designer Today!



The Gates Rubber Company, Sales Division, Inc. Dept. 15-999 So. Broadway, Denver 17, Colorado

Please send me the new Gates Truflex V-Belt DRIVE DESIGNER by return mail. I am enclosing 25c to cover cost of handling and mailing.

Name..... (Please Print)
Address.....
City.....Zone.....State.....

Gates Truflex V-Belts

Photography

Aerial photos are viewed instantly on ground	114
Remotely controlled release trips shutter a mile away (Karl Helitz, Inc. 480 Lexington Ave., New York 17)	126
Lens for still cameras zooms for close-ups (H. A. Bohm & Co., 4761 W. Touhy Ave., Chicago, 46)	145
Inexpensive thermostat sets film-bath temperature (Eldorado Products Co., Inc., 1235 Main Ave., Clifton, N. J.)	268

Science

Computer gives one man total control of sub	44
Turbine powers oil drill	114
Aluminum submarine may dive three miles	115
French saucer dives 1000 feet	107
Oxygen blast cuts steel production time	123
Tiny resuscitator provides oxygen (National Cylinder Gas Div. of Chemetron Corp., 840 N. Michigan Ave., Chicago, Ill.)	126
Mobile communications unit has 3000 mile range	127
Atomic plumbing for "hot" waste	136
Unspliced hose in any length (Goodyear Tire and Rubber Co., Akron, Ohio)	136
Transparent plastic globe maps celestial movements (Lafayette Radio Corp., 165-08 Liberty Ave., Jamaica 33, N. Y.)	137
Hot springs keep graded section of street de-iced	144
Altimeter gives readings on tape instead of dial (The Bulova Watch Co., 62-10 Woodside Ave., Woodside 77, N. Y.)	145
Phosphorus may be mined in sea off California	154
Russian kerosene lamp generates power for radio (The Wayne Kerr Labr., Ltd., Roebuck Road, Chessington, Surrey, England)	154
Chicken house just a bubble	156
Propane burner yields electricity (Westinghouse Electric Corp., Pittsburgh 30, Pa.)	156
Passers-by get phone report of construction progress	157
Blood heat exchanger cools temperature fast (Superior Tube Co., Norristown, Pa.)	159
Stainless steel caps protect cow's teeth	160
Skin-diving cameramen check "hot" waste disposal	161
Thickness of fat on live pig gauged by ultrasonic waves	164
Automatic reader translates data	165
Is carbon dioxide warming the earth?	246
Rare one-eyed fish found in Gulf of Mexico	246
Shining sun will darken windows in home of 1970 (Building Research and Institute, 2101 Constitution Ave. N.W., Washington 25, D. C.)	260
Tiny germanium thermometer explores the coldest cold (Bell Telephone Labr., 463 W. Street, New York 14, N. Y.)	262
Nature pulls plug—lake loses water	266
Light decomposes water into oxygen and hydrogen	269
Satellite paint changes color to regulate temperature	276
"Solid state" electronic tube eliminates cathode	280
TV camera on doctor's head shows details of examination	290

Christmas Shopping Section

Magnetic attachment	166
Inexpensive underwater camera	166
Photo end table	166
Film editor and splicer	166
Bird Feeder	166
"Fried egg chair"	167
Unipod	167
Relief map	167
"Satellite" transistor radio	168
Air recirculator	168
Tiny weather station	168
Electric warmer	168
Golfer's watch	169
Cooler-heater	169
Portable wiener roaster	169
Musical bird cage	169
Old-time surrey	170
Walking hobby horse	170
Child's table	170
Baseball batting game	170
Bumble-bee kit	171
Model missile	171
Helicopter launcher	171
Ball in hoops	171
Computer circuits	171

Radio, TV, and Electronics

Pay-TV—Start of an experiment	220
Radio and TV for Christmas	222

Craftsman and Shop Notes Index

Automotive

Keep motor-switch contacts clean	199
Repairing loose trim on car	199
Open end condenser-lead terminal saves installation time	204
Repair broken car-heater hose with copper-tubing coupling	204
Rubber band cut from inner tube holds trunk lid against load	204
"Splashed" deposits foul plugs	204
Cracked battery is repairable	205

(Continued to page 80)

week-end worrier?—not Mr. Ford!

He Used **SAPOLIN**® Colored Aluminum Coating

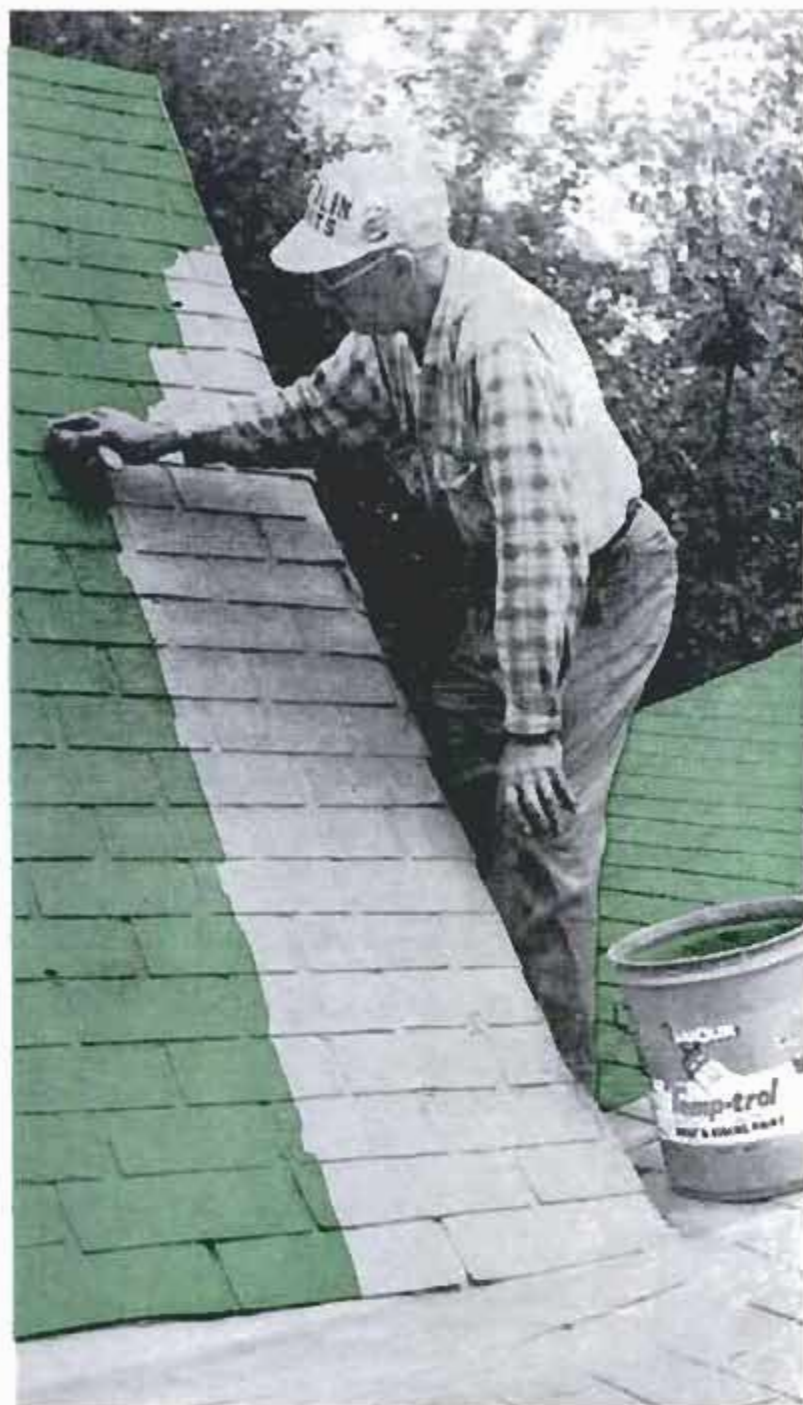

Wm. Ford chose Valley Green *Temp-trol* to restore his vacation cottage at Mt. Pocono, Pa. Made by Sapolin Paints Inc., New York, *Temp-trol* is also available in Flint Gray, Canyon Red, Skyline Blue, Platinum White, Copper Tan.

Look for this label . . .
it's your guide to the best
in aluminum value

For exciting drama watch "Alcoa Presents" every Tuesday, ABC-TV and the Emmy Award winning "Alcoa Theatre" alternate Mondays, NBC-TV



An isolated cottage in the Poconos is the week-end escape for William Ford of Ozone Park, N.Y. Recently he reported a solution to one of the nagging problems of cottage owners . . . how to keep the roof weathertight. He applied a coat of Sapolin's alkyd-base colored aluminum coating.

Mr. Ford said, "I was facing major roof repairs, a real problem in this out-of-the-way spot. But this was easy. Sapolin's *Temp-trol* stopped leaks, sealed small holes and cracks. And now I have a beautiful metallic, green roof that blends with the surrounding forest. The whole place looks 100 per cent better and *Temp-trol* gives me improved insulation both summer and winter."

Mr. Ford has discovered the new, easy way to weatherproof *and* beautify any property. Made with ALCOA® Pigments, colored aluminum coatings like Sapolin's *Temp-trol* are ideal for most roof and siding surfaces—shingle, slate, metal, tar paper, stucco, cement and cinder block.

ALCOA does not make roof coatings, but we will be happy to refer you to reputable manufacturers who do. Send coupon today for our booklets, *Painting With Aluminum* and *Brush On Beauty And Protection*.

Aluminum Company of America
1737-L Alcoa Building, Pittsburgh 19, Pa.

Please send your free booklets:

- Painting With Aluminum*
 Brush On Beauty And Protection

Name _____

Address _____

City _____ Zone _____ State _____

A "GEM" FOR THE BOATING MAN'S CHRISTMAS STOCKING...



STEWART-WARNER MARINE SPEEDOMETER

Just the gift to brighten any boating enthusiast's Christmas! Gives miles of extra boating fun. A precision navigation aid that provides an accurate check on safe speeds and engine performance.

Made by the leading speedometer manufacturer. Rugged, smartly styled . . . all brass construction, blue or black dial facings. Two speed ranges—up to 40 or 60 m.p.h. Includes complete installation kit. Attractively gift wrapped.

—Plus "something special" for the car-minded man:



Precision Motor Minder
Pays for itself in gasoline savings. Helps avoid costly repairs by giving constant check on condition of spark plugs, carburetor, rings, valves, and timing.

Deluxe Twin Gauge Panel
Recommended for cars with just warning lights, to give more accurate check of engine performance. Complete with ammeter and oil pressure gauge. Off-white "Colonial" grain color harmonizes with any interior.

Ask for them at boat sporting equipment stores, automotive stores or write.



INSTRUMENT DIVISION
STEWART-WARNER
CORPORATION

Dept. AM-129, 1840 Diversey Pkwy., Chicago 14, Ill.

Christmas Shopping for Tools

Ball-bearing drill chuck	172
Light, portable spray unit	172
Miter box	172
Radial saw	172
Stud driver	172
Bench-type jigsaw	173
Heavy-duty kit	173
Mortising jig	173
Portable belt sander	173
Radial-type level	173
Sawhorse legs	174
Twist drills	174
Universal milling table	174
Vacuum-forming machine	174
Work bench	174
Adjustable hex wrench	175
Automatic sprocket-type clutch	175
Heavy-duty table saw	175
Speed changer	175
Turning-carving-routing attachment	175

Farm

Locking bolt for stock gate	200
Package rack for rural mailbox	200
Wings prevent livestock from stepping over ends of guard	200
Tractor scoop hauls feed	201
Weld beads on plow moldboard aid scouring in heavy soils	216

Miscellaneous

Wooden strips clamped together used for measuring doorway	184
Pedestal ash tray	185
Keeping hoods on gun sights from slipping out of place	182
Old tire retains fire wood when splitting to stove size	193
Wrought-iron effect for your home hardware	193

On the Market

Decorator styled plywood paneling	218
Lubricant in a pressurized can	218
Mastic water stop in a caulking cartridge	218
Silicone spray	218
Blacktop coating comes in three attractive colors	219
Brush enamel dries ready for use in 15 minutes	219
Plastic adapter sleeve	219
Surface hanging of doors	219

Solving Home Problems

Hanger and shirt prevented from flying off line	190
Cord or twine prevented from tangling	190
Telephone caller-announcement	190
Large burnt-out light bulbs used as planters	191
Finger ring easily straightened	191
Paper cup used as glue or paint pot	191
Photo album made from large size book	191
Watertight container easily made	191

Three One Evening Projects

Clothes rack	206
Desk and bookcase	207
Paper bundler	208

Workshop Hints

Extension pieces on slide ends are slide-rule aid	134
Conversion data on graduate saves reading time	184
Pattern formed from wire solder to duplicate curve on part	184
Accurate depth gauge improvised for drill setup in lathe	189
Improvised open-end wrench	189
Vacuum cleaner provides blower for shop-made forge	189
Hand warmer aids carpenter in subzero weather	192
Piggin made from nail keg is handy toolbox	192
Helpful gluing hints to remember on your woodworking projects	193
Cutting-tool holder for lathe speeds turning of shaft stock	208
Leather-bladed cleaning tool for tapered spindle socket	208
Setting lathe compound to reproduce taper	213
Shouldered end aids in starting true thread	213
Threads on lead screw kept clean with cord	213
Woodworking joints	214
Hose clamp grips rods for power hacksawing	216
Lengths of drill rod square work setup	216
Split block in tool post holds dial indicator	216
Chart in lid of drill case gives decimal equivalents	217
Simple tallstock attachment aligns thread-cutting tool	217
Sleeve increases range of lathe carriage stop	217
Wide rubber band guards chuck jaws	217

NOTICE—It is the intention of this magazine to provide its readers with information regarding the latest developments in the mechanical arts. Except where otherwise indicated, this magazine has no information as to any unexpired patents in respect of the developments reported herein. In the event that commercial use is to be made of any of the developments reported herein, it is suggested that legal counsel be consulted to avoid liability for patent infringement. It is not the purpose of this magazine to encourage patent infringement but, as indicated, it is the intention of this magazine to report on the latest developments in the mechanical arts.



IF THIS NEW EXIDE WEARS OUT WITHIN 2 YEARS, WE REPLACE IT FREE!*

**As long as you keep the car for which the battery was purchased, and in normal non-commercial passenger car service.*

SILVER CERTIFICATE FOR TRADE-IN ALLOWANCE ON THE SILVER ULTRA START —good until December 20, 1959—

Good for trade-in allowance on a new Exide Silver Ultra Start battery — if presented to your dealer before December 20, 1959.

No depreciation. No pro-rating. How can Exide give you this 2-year *factory-registered* protection at regular prices while ordinary batteries offer only a 90-day warranty? Because Exide's new Silver Ultra Start has two new improvements no other battery gives you:

1. **ANTI-SULFATE 57 PROCESS** makes negative plates last 65% longer, keeps your battery factory-fresh. Proved in two years of highway tests in thousands of cars.

2. **THERMO-SHIELD** metallic coating reflects engine heat in summer, retains battery heat in winter.

Take advantage of this offer now. Tear out the coupon and take it to your dealer.

When it's an Exide... you start!

Get satisfying flavor... So friendly to your taste!

NO FLAT "FILTERED-OUT" FLAVOR!

NO DRY "SMOKED-OUT" TASTE!



You can light
either end!

© A. T. Co

See how Pall Mall's famous length of fine tobacco travels and gentles the smoke—makes it mild—but does not filter out that satisfying flavor!

HERE'S WHY SMOKE "TRAVELED" THROUGH FINE TOBACCO TASTES BEST



1 You get Pall Mall's famous length of the finest tobaccos money can buy.



2 Pall Mall's famous length travels and gentles the smoke naturally . . .



3 Travels it over, under, around and through Pall Mall's fine tobaccos!

Outstanding . . . and they are Mild!

Product of *The American Tobacco Company* — "Tobacco is our middle name"

Smaller, More Sensible Cars Lead 1960 Parade

Some cars are bigger, some more luxurious, some more expensive, but three small cars are the most exciting



Valiant

Longest of the three new small cars (yet it has the shortest wheelbase), Chrysler's Valiant boasts a classic look. To permit a lower hoodline, the six-cylinder engine is tilted 30 degrees to the right. Detailed story of this car is carried elsewhere in this issue.

Corvair

Radically new, the Chevrolet Corvair claims these modern American firsts: First air-cooled engine; first no-tunnel floor; first rear engine; first flat six; first full-independent suspension; first transaxle. Only four-door sedans are offered now, but variety will come later.





Most conventional of the three new small cars, the Ford Falcon is designed for ease of maintenance and economy of operation. Its styling is simple yet modern. It alone of the three has only two headlamps. Coil springs are used in front, leaf springs in the rear. Seats offer chair-height comfort and its unit body (with bolt-on front fenders) is quiet.

Falcon



Thunderbird

Riding a success wave, the T-Bird is little changed. Grille has added several chrome bars. There are six rear lights instead of four. A European-type sliding roof panel is optional on hardtops. Convertible tops are fully automatic for the first time.

Chevrolet styling has "matured" a bit. Rear-deck change lowers the trunk sill 1.5 inches for easier loading. Front floor hump is lower and narrower. Front-end styling is simplified—the overhanging brow is gone. Brakes are greatly improved. Standard V8 has been made more economical, other engines are virtually unchanged.

Chevrolet





Buick

Buick looks more massive. Squared off are the sharp 1959 lines. "Portholes" are back as fender ornaments. Engine options include a regular-gas economy model and a "hot" premium-gas model. Lower floor pan adds to front-seat height. Muffler sits crosswise behind rear axle and is as big as a hot-water tank. Instrument panel adjusts, like a mirror, to match driver's eye level.

Chrysler

All is new at Chrysler. Body is now of unit construction with stub frame bolted ahead of firewall to carry front-end chassis elements and engine. Styling is in Chrysler tradition with a 300-type grille and bold fins. Additional details are found elsewhere in this issue.



Edsel

Gone is Edsel's controversial grille, but that's not the only change. It is 5.5 inches longer, 2.7 inches wider, an inch lower. Interior room is improved, especially width. Getting in and out is easier as no windshield post intrudes into entryway. Engines have cross-flow radiators for lower hoodlines. Only two series are offered: Villager, the wagons; and Ranger, all others.





Studebaker adds two new bodies for 1960. This convertible and a four-door wagon. Both available with either Six or V8 engine. Style changes are minor. Single headlights are retained. Carburetion is new in both engines for added economy. The Six has combustion-chamber modifications. Hawk V8s are larger, now have 289 cubic inches instead of 259. More details elsewhere in this issue.

Lark



American

Rambler's American series now has three models. This two-door station wagon (roof rack standard equipment); a two-door sedan; and a new four-door sedan. All have 100-inch wheelbases. Power steering now optional, if you insist. Gas tank has been enlarged to hold 22 gallons.

With all-new sheet metal, Rambler stays in character. Front end is flatter, tailfins fold quietly around bigger taillights. Squared trunk lid adds to luggage space. New three-seat wagon has rear-facing third seat, but no tailgate—instead the back opens on vertical hinges like a normal door. More details elsewhere in this issue.

Rambler





Plymouth

Brightly styled in a new unit body, Plymouth retains its characteristically bold fins. Stylish "bare knee" front fenders with reverse-curve wheel openings add an eager, lunging look. New overhead-valve six is built on a 30-degree angle to permit a lower hoodline. V8 is little changed. More details elsewhere in this issue.

Dodge Dart

Dodge's new Dart comes in three series: Seneca, Pioneer and Phoenix. Last named comes as a V8 only, others offer a new overhead-valve six as well. Darts share wheelbase and price class with Plymouth. Styling is distinctive as you can see.



Ford

You won't believe it until you measure it, but the 1960 Ford is 5.7 inches longer than last year's. To the eye, it looks smaller. Styling is the great fooler. Handling and ride are much improved as Ford has its first all-new chassis in three years. Engines remain basically unchanged, although only two V8s are offered instead of three as in 1959. More details elsewhere in this issue.





De Soto now has only a 122-inch wheelbase (last year it had 126 also). Two series (Firelite and Adventurer) come in three body styles (no convertibles, incidentally). Length and height are reduced, width increased. Engines and transmissions are little changed, but a high-performance ram-induction intake manifold is optional, as are seats that swing out automatically when the door opens and a player for standard "45" records.

DeSoto



Ambassador

Ambassador, like the smaller Rambler, has changed a lot but a little. Sheet metal is all new, yet the Rambler image remains. Horsepower is down slightly (as in the Rambler) for added economy. This car now will run on regular gas. Also new are rivetless brake linings.

Dodge comes in two sizes. The smaller Dodge Darts have 118-inch wheelbases. The bigger model (below) has a 122-inch wheelbase. However, it is 4.8 inches shorter, 2.0 inches narrower and 1.9 inches lower than last year. High-performance D500 model has a ram-induction manifold to boost power in middle-speed range. These big Dodges are called Matador and Polara.

Dodge





Oldsmobile

Oldsmobile lowered its profile by removing the fins from rear fenders and shortened its length by front bumper and fender changes. Interiors are new. Front floor hump is lower and narrower. New this year is a three-seat wagon with the third seat facing rearward. Optional economy V8 has low compression ratio, stingy carburetor and uses regular gasoline.

Mercury

Mercury's new look hides a refined chassis. Under-the-skin changes give it an even quieter, smoother ride, devoid of harshness. Gas economy is up 10 percent and with regular gas. Instrument panel lifts out for servicing simply by removing two screws.



Imperial

Imperial has all-new sheet metal, but its body shell is retained. Interior room is improved by new seat design. Cushions are now six inches of luxurious foam rubber. In the LeBaron, the rear window is very small, bringing a revival of the privacy that limousine owners enjoy. Vent windows in front doors are power operated. Steering wheel is flattened top and bottom for more driver kneeroom.





Pontiac

Pontiac has a new front end with emphatic horizontal lines. Body shell is unchanged except that the front floor hump is reduced for more interior room. New engine-cooling system eliminates hot spots in the block. Steering wheel is smaller. Instrument cluster is redesigned and the speedometer is a horizontal bar. Interesting is the use of a piece of genuine wood (mahogany) for decorative purposes on the dash.



Lincoln

Lincoln's rear deck has been lowered and its canted rear fins capped with brightwork. The roof panel is new. Other styling changes are minor. Engines and transmissions have been refined. Rear suspension is new with leaf springs and a Hotchkiss drive replacing the former coils and trailing arms.

Cadillac

Cadillac fins are more restrained. Other styling changes are minor. Front floor hump is lower, narrower. Rear brakes are finned for cooling. Vacuum-release parking brake goes off automatically when transmission is put into gear with engine running. Turn-signal indicator lights (formerly on dash) are now atop front fenders.





Low and stylish, the Valiant has no economy look about it at all

WHAT KIND OF CAR IS THE VALIANT?

By Art Railton

WHAT IS THE Valiant's outstanding characteristic? Handling, says Jack E. Charipar, Valiant chief engineer who has been in on its design from the start.

This car goes around corners with a pleasing flatness. It does everything that way—there is no pitch, no sway, no flip-up, not even on the most dipseydoodle roadway.

Some say the Valiant is the most European of the new small cars. If so, certainly part of the reason is Jack Charipar. He was liaison engineer between the Italian body builders and Chrysler Corporation from 1953 until 1957 (when the Valiant project was started).

He probably knows as much about European cars as anybody in Detroit. He studied the foreign-car industry from axle ratios to wage rates during his four years overseas. His study, first of several that lead up to Chrysler's negotiations with Simca, was the one that put the Valiant in gear.

The Valiant, as you can see for yourself, looks more continental than either of its competitors. Yet, unlike most European cars, it doesn't look small or even compact (whatever that is). To the eye, it appears a full-size automobile. To the tape measure, however, it comes out a surprisingly small 184 inches long over-all.

Its styling is genuinely automobilish. It looks like

Every inch is made to count. No waste space here. Top right, the front-seat access is excellent; no windshield dogleg to bang your knee against. Center, all doors are thin so they don't intrude on inside space. Bottom, even rear-door foot-entry room is adequate





Above left, spare fits in trunk well. Valiant's trunk is largest of the three small cars. Above, profile has an eager, lunging look

Left, right hand falls naturally on the floor-mounted shift lever and shifting up and down through the three speeds is fun again

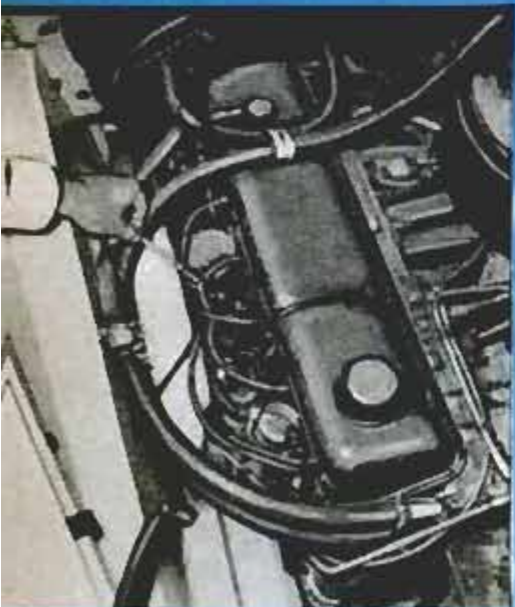

a strong, healthy automobile, not like an austere, economy-muscle facsimile.

It not only looks bigger than it is, but it "feels" bigger. The Valiant's big-car sensation surprises everybody who drives it for the first time. Many things combine to create this feeling, but one very important item is its engine, which has the largest displacement of the three new small-car engines. The block is big, substantial and well-jacketed. It takes 14 quarts of water, compared with 9.3 quarts for the Falcon and, of course, none for the air-cooled Corvair. It takes more oil than the others.

Thus the engine is surprisingly unstrained, surprisingly muscular in response and agile in performance.

Unlike the Corvair which is technically exciting and bold, or the Falcon which is sensible and economical in character, the Valiant seems more luxurious, more substantial, than it has any right to be.

There is no evidence of austerity, no look of miserliness. It provides as much comfort as the biggest car, even on long trips, says Charipar (who has taken many in it). It is just as durable, just as solid.

Actually, in many ways, it is a better car than its bigger brothers. The value curve of the automobile,

Left, engine tilts to the right. All service items except carburetor and generator are on low side. Pencil points to the distributor

Below, despite a relatively soft ride, the Valiant corners flat and has virtually no pitch on bumps. Front suspension is by torsion bars





Inside the Valiant there is no feeling of smallness. It has ample room for a couple and four children

like the power curve of an engine, is not a straight line. Per pound of machinery, the bigger is the better only to a certain point. The Valiant, says Chrysler, comes at the point in the curve above which you begin getting less per dollar spent.

While the Valiant has a lot of Europe in its background, it avoids the austerity feeling that is considered unacceptable to Americans. It has none of the noise, sluggishness or claustrophobia that are associated with economy-type transportation.

It is an interesting contradiction that while the Valiant looks most European of

the three new cars, it feels and acts least like a European import.

It is a full-bodied, all-American-boy type of car under its Italian styling.

The continental look is due, says Charipar, to the fact that Chrysler's top stylist Virgil M. Exner has done as much to make Italian styling what it is as the Italians have. There has been a two-way exchange of ideas between Exner and such body makers as Ghia and Farina for about 10 years.

As an example of this, Charipar points to the well-known and handsome Volkswagen

(Continued to page 270)

Circle on rear deck is an imitation spare-tire cover. The gas tank filler cap is just behind wheel opening





Sleek lines make the Ford Galaxie look smaller even though it is five inches longer than last year's car. Headlights mount inside the wide, low grille and parking lights are located in the edges of the fenders



Top, wagons have sloping rear end, providing lots of luggage room even behind forward-facing third seat. Above, front-seat knee-knocker is out

Ford Is Longer, Wider

FEW WILL RECOGNIZE the 1960 Ford, so changed is it. Gone are its conservative styling, its squared-up personality. Gone, too, is the kneeknocking wraparound windshield (it now curves upward into the roof).

Although 5.7 inches longer and 220 pounds heavier, Ford's modern styling camouflages the added size. The new car actually looks and feels smaller, lighter and more nimble.

The 11.8-inch-longer frame is the same cow-belly design used previously, but it now extends all the way from bumper to bumper. Tread is wider (61 inches front, 60 inches rear) and over-all width of the body is 81.3 inches, 5 inches wider than in 1959. Shoulder room is 3 inches greater in front, 4 inches greater in back.

Body mounts and engine mounts are redesigned to give the quietest, most vibration-free ride in Ford's history. Handling has been sharply improved also. Suspension, front and rear, is new, although conventional. Longer rear left springs are now mounted sharply unsymmetrically with one-third in front of and two-thirds behind the rear axle, providing a softer ride, yet with less windup during acceleration.

Front fenders bolt on. Actually, they are mostly vertical panels as the top part of the fender is formed by the extremely wide hood (which, by the way, is now hinged in back in a conventional manner).

All engines have been modified for improved performance, but basic designs are unchanged. The 332-cubic-inch optional V8 has been dropped. Continued are the 292-cubic-inch standard V8 and 352-cubic-inch optional V8 (plus the 223-cubic-inch six, of course).

The radiator is of cross-flow design and water is poured into a separate tank rather than into the radiator itself. This separate mounting of the tank permits the lower hoodline of the 1960 styling.



Rear styling has a flat, finny look. Taillights are lower and smaller than previously. There's no retractable hardtop this year



None of the previous Mercury image remains except the roof panel and glass area. Beneath the new look, there is much new engineering, ranging from a jet-action defrost system to a more accurate spark advance

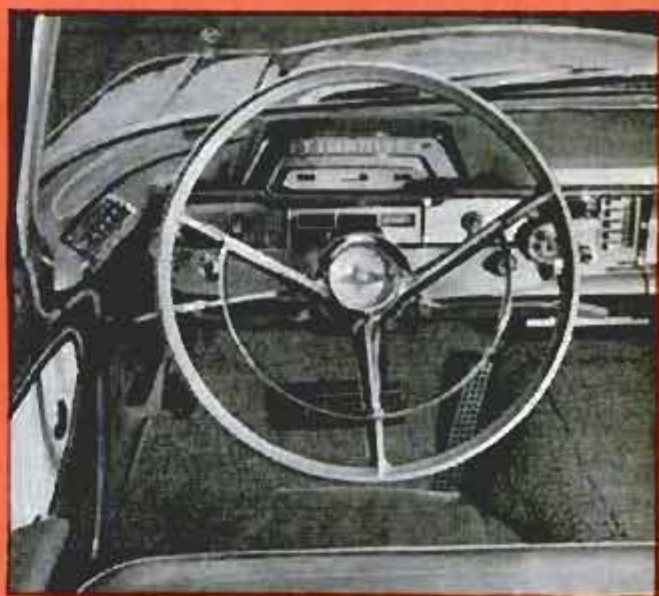

Left, dual headlamps are set widely apart. Right, removable instrument panel will please mechanics. Loosen two screws, disconnect speedometer cable and one wiring plug and the all-printed-circuit panel lifts out

Mercury Gets Smoother Look, More Economy

NO LONGER does Mercury have boldly sculptured styling. It is smoother, quiet in appearance—and operation as well.

Taillights are built into the rear bumper and cant outward. The grille is formed of concave vertical bars (see page 87). Dual headlights are widely spaced. The only major sheet metal piece that has not been changed is the roof panel.

Only two-barrel carburetors are offered, no four-barrels being available. Two of the three engines are designed for regular gas: The 312-cubic-inch V8 with 205 horsepower and the 383-cubic-inch V8 with 280 horsepower. The 430-cubic-inch V8 requires premium fuel and develops 310 horsepower. All engines have a 12,000-mile disposable gas filter built into the fuel lines.

Spark plugs mount deeper in the combustion chambers which were reshaped for added turbulence. Intake valves are slightly smaller for more fuel-charge velocity.

Chassis changes give an even quieter, smoother ride than Mercury had in 1959. Seat cushions are softer and depress more for added headroom and comfort.

Accelerator pedal operates the throttle linkage from its pivot at the bottom rather than from the usual position at the top, in this way eliminating a hole in the toe-board.

Windshield wipers are electric and work at three speeds. Wiping action is parallel. There are no blind spots between the arcs. Windshield-washer fluid is squirted by a new pump through the blade arms directly onto the glass so the liquid doesn't blow away at high speed.

Spot defrosters are a valuable safety item. As soon as the defroster is turned on, two powerful jets of heated air clear two spots directly in the driver's line of vision, instead of defrosting the glass from the bottom up.



Concave transom area, vertical taillights and stubby tailfins make the Edsel distinctive from the rear. The body is lower and longer—so much so that this four-door sedan looks lower than hardtops did last year.

Edsel Takes on a New Personality

DROPPING ITS trademark, the vertical grille, Edsel has adopted a low, wide design in front that is very similar to that of a highly successful 1959 car (see page 83).

From the rear, the Edsel is new also with a massive rear window that has 63 percent more glass area. Vertical taillights and backup lights stand side by side, jutting above the rear-deck line. Crisp side-panel sculpturing ends in subdued, flattened fins.

Like Ford (whose shell it shares), Edsel has increased its body length by more than five inches and lowered its roofline by one inch. It's a lot easier to get into the front seat, thanks to the absence of the dogleg caused by the former wraparound windshield. This year, front entrance room has been increased almost 10 inches.

Two different roofs are available. Two-door hardtops have a fast-back design that slants smoothly from roof to rear deck. Four-door models and two-door sedans have a wider rear pillar and a more vertical rear window.

The second seat of the six-passenger station wagon can be folded to form a flat load bed quickly with one motion. The nine-passenger wagon has three forward-facing seats and its third seat is cushioned only by a foam-rubber pad that slips off when the seat back is folded down into the floor.

Standard V8 is the 292-cubic-inch model. An optional 352-cubic-inch V8 with four-barrel carburetor comes with a three-speed automatic transmission if desired. The 223-cubic-inch six is retained.

Edsel's longer and wider frame permits the trunk to be 6.5 inches deeper and 6 inches wider than in 1959

To enable the stylists to lower the hoodline, engineers separated the radiator tank from the cross-flow core

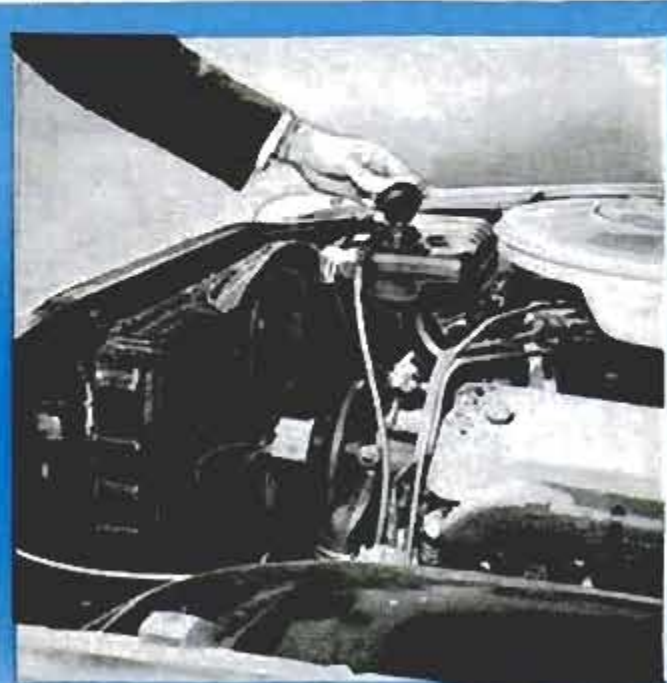
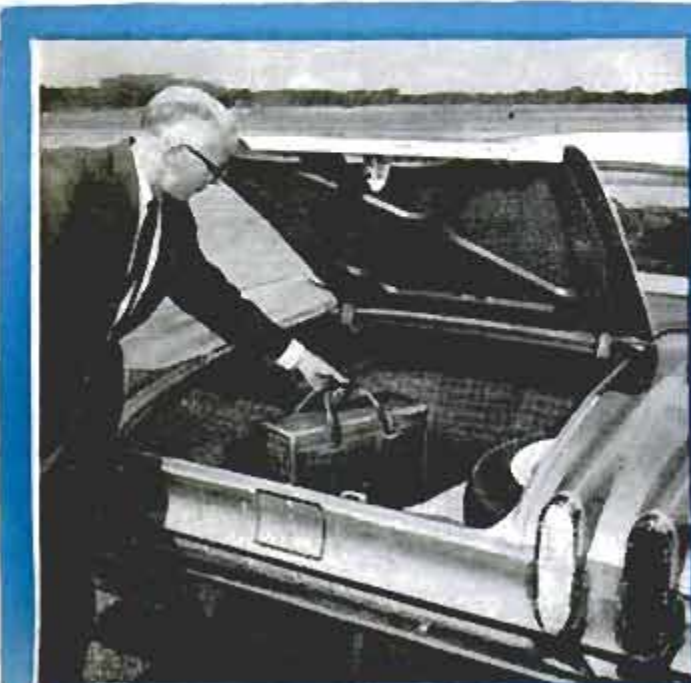



Sculptured fenders, squared-off rear deck, flatter roof, give Rambler a new look. Right, front-seat entry room is greater

Rambler Gets Three-Seat Wagon

CLEAN AND CRISP, Rambler's new styling is in character. Despite all-new sheet metal, the car remains readily identifiable.

Available for the first time is a three-seat wagon in which the usual tailgate has been replaced by a side-hinged door that swings open to simplify access to the rear-facing third seat. On this model (in which there is no space for an extra wheel), captive-air tires eliminate need for a spare.

Flatter roof lines and narrower vertical posts increase glass area slightly. Instrument panel is new. Push buttons are used for automatic-transmission control. Reclining seats and headrests are optional. Horsepower is reduced to 200 on the Rebel V8.

Ambassador models have compound windshields that wrap upward into the roof.

Below, new wagon has rear-facing third seat. Right, its rear door is hinged on the side, replacing the two-piece tailgate



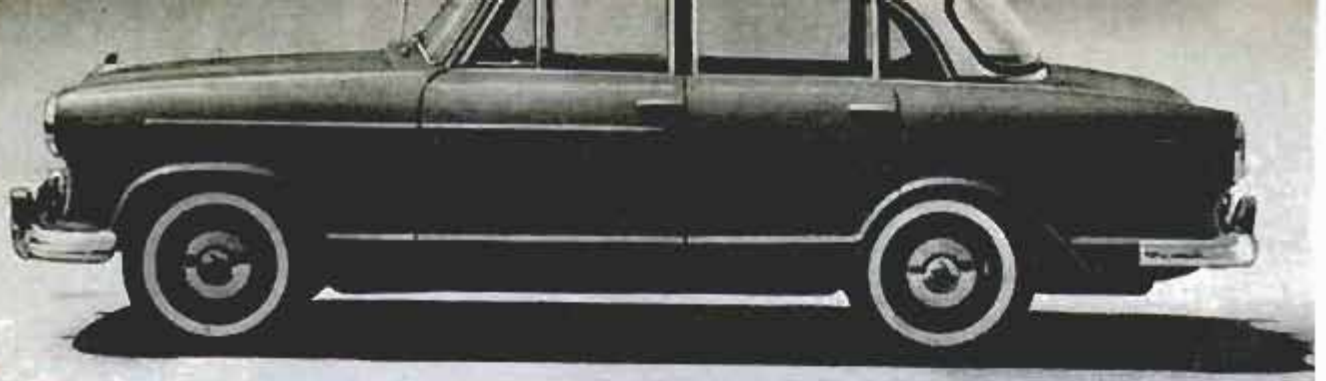

Rambler American four-door sedan. Left, despite a 100-inch wheelbase, rear-seat entry room is good

American Gets Four Doors

NEW IN THE Rambler American series this year is a four-door sedan to go along with the two-door sedans and station wagons that accounted for 25 percent of American Motors' 1959 production. Restyled only slightly, American has doors that open wider and more glass area. It retains the 90-horsepower, six-cylinder L-head engine.

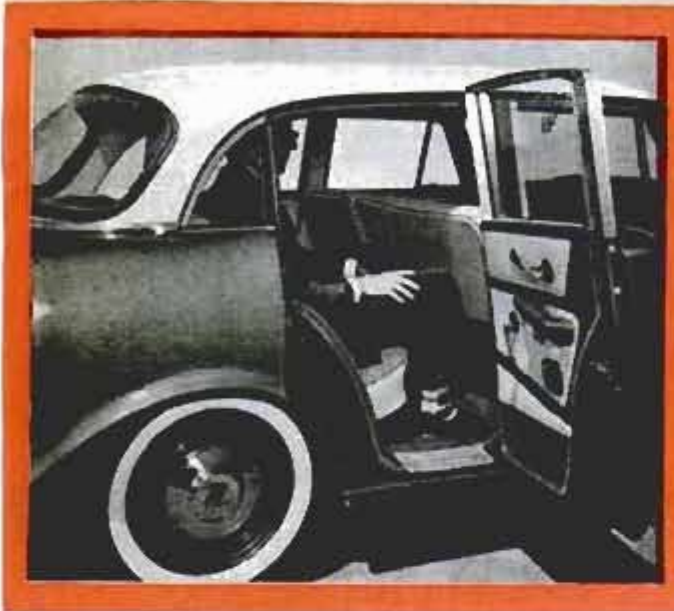

Studebaker Adds Lark Convertible, Four-Door Wagon

ENCOURAGED by its 1959 success, Studebaker has added two models to its Lark line: A flashy convertible (the only one in its field); and a four-door station wagon. Continued is the low-slung Hawk series.

All Larks offer a 90-horsepower, L-head six, a 180-horsepower V8, both virtually unchanged, plus a 195-horsepower option.

Two-door wagons are continued. Glass

area in the rear side windows and the rear-transom window has been increased. The upper half of the tailgate automatically locks in position when opened. Roof luggage racks and a rear-facing third seat are available. Three-seat wagons have Captive-air tires, since there is no room for carrying a spare.

Styling is virtually unchanged for 1960.

Studebaker Hawk, with only trim changes in styling, now offers a larger V8 that develops 210 horsepower





Reclining seats and headrests are optional on all Larks. This convertible and the four-door wagon are new

Among several engineering changes, the Lark six carburetor is new, having been designed for improved operation under extreme weather conditions. The starting motor has also been modified to assure cold-weather starts.

Legroom in the rear seat is improved somewhat by cushion changes. Accelerator pedal is now at a more comfortable angle.

The bigger Hawk V8 develops 210 horsepower. Dual exhausts and finned brake drums are standard equipment on this car.

Retaining single headlights, the Lark has a new screen in its grille. Other than that, styling is unchanged





Above, Windsor two-door hardtop. New Yorker models have slightly different grille. Below, new dash has glarefree electroluminescent lighting. Push buttons (for transmission and heater) are mounted horizontally



Chrysler Has Sports-Car Look

QUIET AND WELL-MANNERED on even the roughest roads, Chrysler has a roomy unit body that eliminates all frame but a short front stub. This stub bolts to the body at the firewall and supports engine and suspension. Exterior styling features a sporty look with a race-car grille. Electroluminescent lighting is used on the hemispheric instrument panel. In it, dials and needles are the light sources, rather than illumination by bulbs.



Plymouth Has New Overhead-Valve Six

FEATURING AN ALUMINUM intake manifold, the new six-cylinder Plymouth engine inclines to the right at 30 degrees. This lean-to design allows a low hoodline, low center of gravity, and lets engineers mount the water pump beside the block rather than ahead of it, thus shortening over-all length. Styling is all new, but recognizably Plymouth. Other options include automatic door locks, automatic swivel seats and an automatic-changing record player.

Above, there's lots of room to slide under and see over the squarish steering wheel that is optional on Plymouth. Below, unlike some companies, Chrysler Corporation retains its fins—Plymouth's most of all





Above, the Dart has a Dodge look, but front and rear-end treatments are distinctive. Wheelbase is 118 inches. The bigger Dodge, below, is on a 122-inch wheelbase. Both series have jet-tube rear fenders, big taillights

Dodge Offers New Dart

DODGE ENTERS the low-price field (not to be confused with the small-car field) with its new Dart series. Built on a Plymouth chassis with Dodge appearance, the Dart is available as either a six or V8. The six is the Corporation's new overhead-valve tilted engine. Dodge's big cars have new names: Matador (361-cubic-inch V8) and Polara (383-cubic-inch V8). Ram induction is optional.

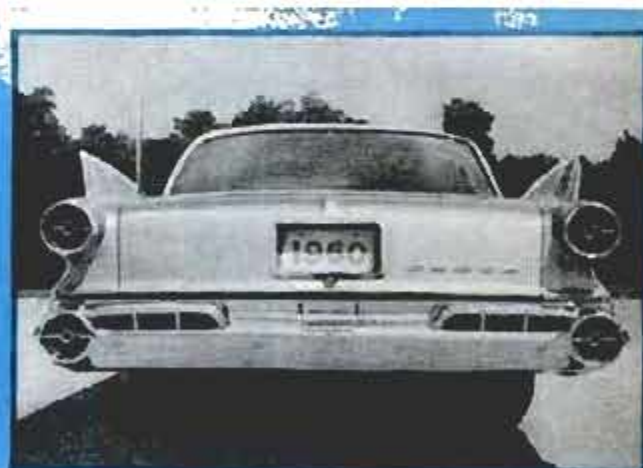

DeSoto Adopts Unit Body

THERE'S MORE ROOM in the 1960 DeSoto, thanks to its unit body. The floor plan is lowered, giving more legroom and permitting seats to be higher. Entry and exit is easier because the windshield pillar has been moved forward out of knee's way. Optional is a safety lighting system that flashes all four turn signals on and off continuously to warn approaching traffic of the parked car.



Tailfins cant outward on DeSoto. Styling is simple, without clutter. Windshields are bigger, so are rear windows. Swivel seats swing out automatically as the door opens. An automatic record player is optional





Ribbed aluminum decorates panel below the trunk lid. Left, wheel has no horn ring. Pushbar built into each spoke operates the horn



Cadillac Gets New Rear Styling

BORROWING FROM the Eldorado Brougham, Cadillac has given its famed fin a more sedate look. Taillights are faired neatly into the reverse slash of the fin. Additional lights mount in neat ovals at the bumper ends. Front-floor hump has been reduced and pedal room increased for driver comfort. A cantilevered spring has been added to each lower arm of the rear suspension.



Buick Adds Many Refinements

UNDER ITS less-rash exterior, Buick has made many changes and refinements. Regular-gas engines are optional. The triple-turbine transmission is dropped. A shutoff valve has been added to the rear-seat heating duct. The engine now has 29 pounds of aluminum parts. There's even an optional switch that turns on headlights automatically when darkness falls, should you forget.

Left, headlights are horizontal, no longer diagonal. Below, fins are "toned down." Almost all exterior sheet metal is new

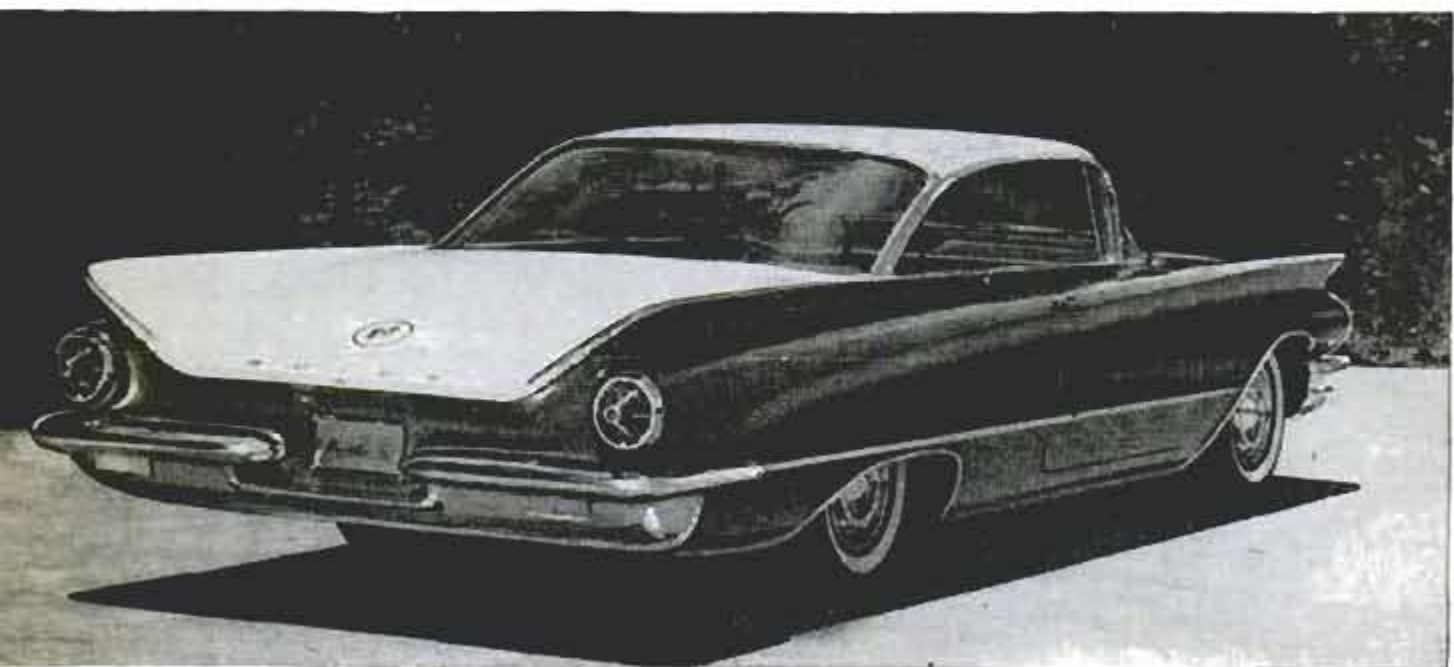

Editor's note: This month Art Railton's page becomes, instead, the "Frankfurt Listening Post." We sent him to Europe to report by cable on the European cars exhibited at the greatest of overseas automobile shows at Frankfurt in West Germany.



By Art Railton

FRANKFURT, GERMANY—Bigger, fancier, more glass, more room and more luxury, that's the automotive trend in Europe, if the evidence of the Frankfurt Automobile Show can be believed. As Detroit begins to make more sense than ever with smaller, more practical designs, the Europeans move towards greater luxury, greater opulence.

The trend is unmistakable. Two years ago at the Frankfurt show, Germans were excited about the minicars which were to replace the dangerous, uncomfortable motor scooters. Germans with money in their pockets milled around tiny automobiles—cars that were just a little more than scooters. But that was two years ago. This year, minicars are scarce and scooters virtually nonexistent.

Except for the slow-to-give-up Messerschmidt, which admits partial defeat by emphasizing its four-wheel model instead of its three wheeler, the minicars are represented only by the Goggomobil. And even Goggo has bowed to progress with a new model, the Isar, which starts in at 600 cubic centimeters, one of the few cars still being built near a half liter.

Two years ago one-half liter engines were as common as beer and sausage at the show. This year they are the very smallest. It is apparent that Europe is being bitten by the same bug that infested the United States after the war. Cars are becoming bigger, engines are bigger.

Windshields (like the new DKW) wrap around, fins (like the Mercedes) sprout from the rear fenders, taillights (like the Fiat) are brighter and bigger. And the people love it. Here we see the result of the fast-rising standard of living. Soon German scooter and bicycle makers will have to ship their wares to India, or to China.

Driving on the Autobahn, no longer do you thread your way around motorbikes and tiny three wheelers. Today traffic is fast and heavy, consisting of cars from Volkswagen size and up, rather than down. Four years ago, the VW was an upper-middle class car driven by doctors, lawyers and businessmen. Two years ago, it had become the car of the skilled workers, the

factory supervisor, the technician. Today it is the car for the worker.

Parking lots at the VW plant are filled with new Volkswagens. The long rows of bicycle racks are virtually empty. Never before have so many Germans crowded into the VW exhibit at the Frankfurt show. Never before have so many been anxious to look at, to feel, to sit in the car that is more common in Germany than Chevrolets are in the U.S.A. (one of every three cars here is a Volkswagen).

Now they touch it and plan to own one. Once they merely looked but now they plan to buy. Volkswagen officials are pleased, not worried by this. They see this as broadening the base of a market that has made this company the miracle child of postwar Europe. It will mean greater sales, more orders, they are sure. To satisfy this demand, another assembly line and another plant are being built.

What about the American owner? Will the American sophisticate who now drives a VW be content when it is the car of the masses of Europe? Dr. Heinz Nordhoff, brilliant and articulate head of Volkswagen, is not worried. He looks upon his car as the answer to the transportation needs of all countries, of all classes; the true international automobile—a car at home in all countries among all classes. As Coca-Cola is becoming the universal drink of the world, perhaps Volkswagen is becoming the universal automobile.

At a press conference at the Frankfurt show, Professor Nordhoff told a group of American automobile writers that he would not change the Volkswagen specifically to meet the demands of the American market. America, he emphasizes, is only one of 110 countries in which the car is sold. Although America is the best customer in volume, the car cannot be modified to please one country at the expense of the others.

Yet Nordhoff did announce that VW will make optional this spring a Saxomat automatic clutch which will eliminate the clutch

(Continued to page 264)



Sikorsky S-60 crane helicopter will do major moving and lifting jobs for Army. Twin-engine, piston-driven S-60 has detachable passenger and cargo pods. Flight vibration is virtually eliminated by cushioning device between cabin and airframe proper

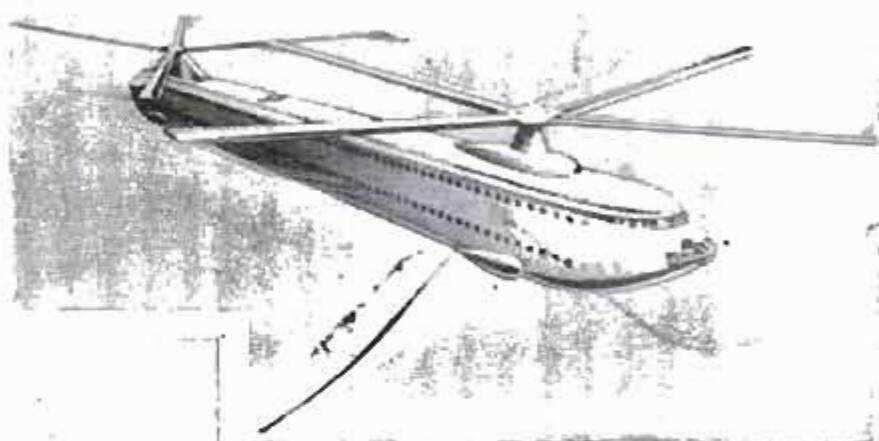

Studies have been completed by Bell Helicopter Corporation for giant nuclear-powered copter with fuselage 300 feet long. As troop or cargo plane it could cruise at 200 miles per hour



←Using cable sling, HR2S-1 Marine Corps helicopter lifted 5615-pound damaged aircraft from New River, N. C. to Cherry Point, N. C. for repairs. Sixty-mile trip took only 51½ minutes

Weighing only 350 pounds, Adams-Wilson HobbyCopter can be built by owner from engineering information and component kits. Single seater has two-blade main and tail rotors and top speed of 60 miles per hour. Power comes from motorcycle engine



HELICOPTERS MAKE STRIDES

Designed primarily to lift sling loads, crane helicopter built by Britain's Westminister has tubular steel fuselage. Shown here lifting section of portable bridge, flying crane can handle loads up to 14,000 pounds. Its fuselage can be covered for transporting troops or cargo



Two 1940-horsepower turbine engines will power YHC-1B helicopter designed for Army by Vertol. New transport will have length of 50 feet and cabin capacity of 1600 cubic feet. Rear ramp will lend speed and flexibility to loading and unloading of troops and cargo. It will carry 40 troops



Three-turbine SE-3200 helicopter built by Sud-Aviation has single rotor with anti-torque tail rotor. Capable of carrying 20 to 30 passengers, SE-3200 also can be used in cargo-transport, casualty-evacuation, surveillance, antisubmarine warfare, boat and vehicle towing, and dredging





Despite no overhang, the small car has a surprising amount of trunk space due to absence of differential in rear. All four wheels are independently sprung with greaseless rubber springs. Drive is by front wheels

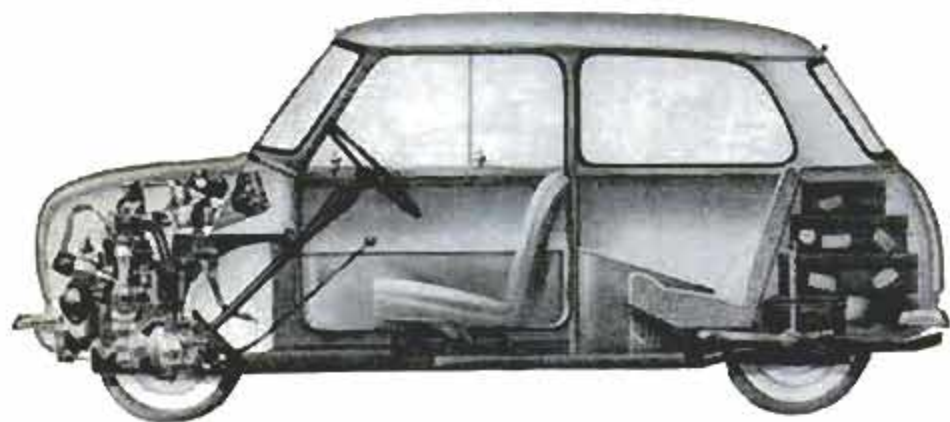

Above, engine, transmission and differential occupy only two feet of the car's ten-foot over-all length. They share one oil supply. A small tunnel runs along floor, enclosing exhaust pipe. Spare tire, battery and gas tank are in rear. Below, stubby engine mounts crosswise between front wheels. Radiator faces left. Shift lever is directly in center

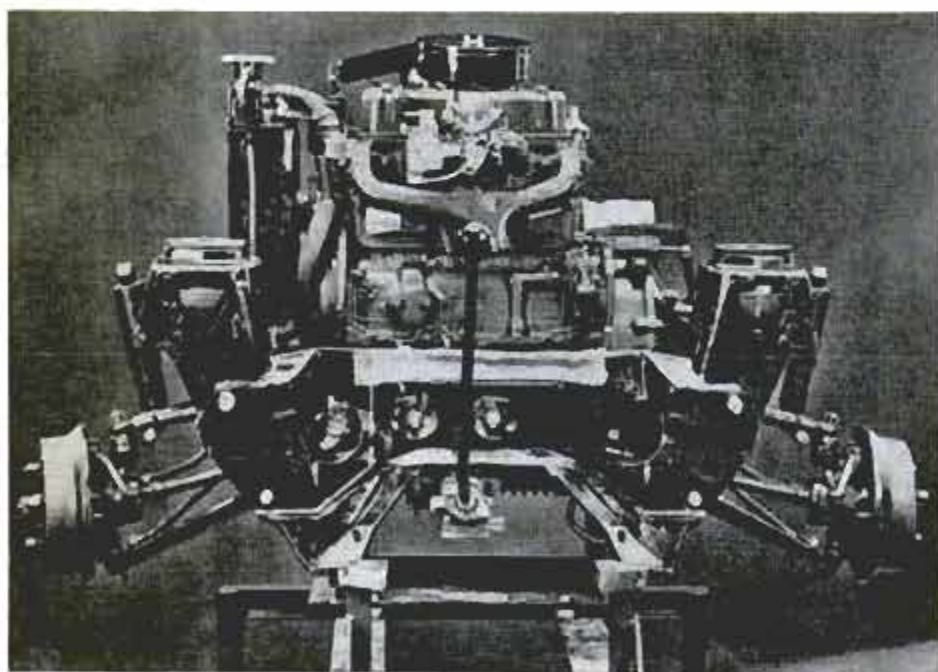

British Car Has Front Drive

With rare boldness, the British Motor Corporation has brought out two baby cars that have front-wheel drive and an inline engine mounted crosswise between the two front wheels.

By this transverse mounting of the engine, BMC is able to seat four adults in reasonable comfort in a car that is only 10 feet long.

Available as either the Austin Seven or the Morris Mini-Minor (only difference is in trim), the tiny car is expected to sell in the United States for \$1300, well under the prices of the new American compact cars.

Wheels are only 10 inches in diameter and the car, despite its front-wheel drive, will turn around in under 30 feet.

The water-cooled inline overhead-valve four develops 37 horsepower and since the car weighs only 1260 pounds, performance is said to be nimble.

Next Month

The PM Houseboat

CUSTOM-DESIGNED for *Popular Mechanics* readers

TEST-BUILT for simplicity of construction

HERE'S the ideal craft for the recreational boater—a combination of seaworthy boat and vacation cottage.

DESIGNED by a leading naval architect for the handyman with ordinary tools and abilities, it's built of common lumberyard materials and marine hardware.

Here Are Just a Few of Its Features:

- Marine plywood planking
- Complete galley, head, and closet space
- Sleeping room for five
- Size: 8 foot beam, 24 feet long
- Designed for any outboard power combination
- Inside, forward controls



COMPLETE detailed plans, materials list, and dozens of photographs of the PM houseboat will begin in the December issue of **POPULAR MECHANICS** on your newsstand November 27th.

**POPULAR
MECHANICS**

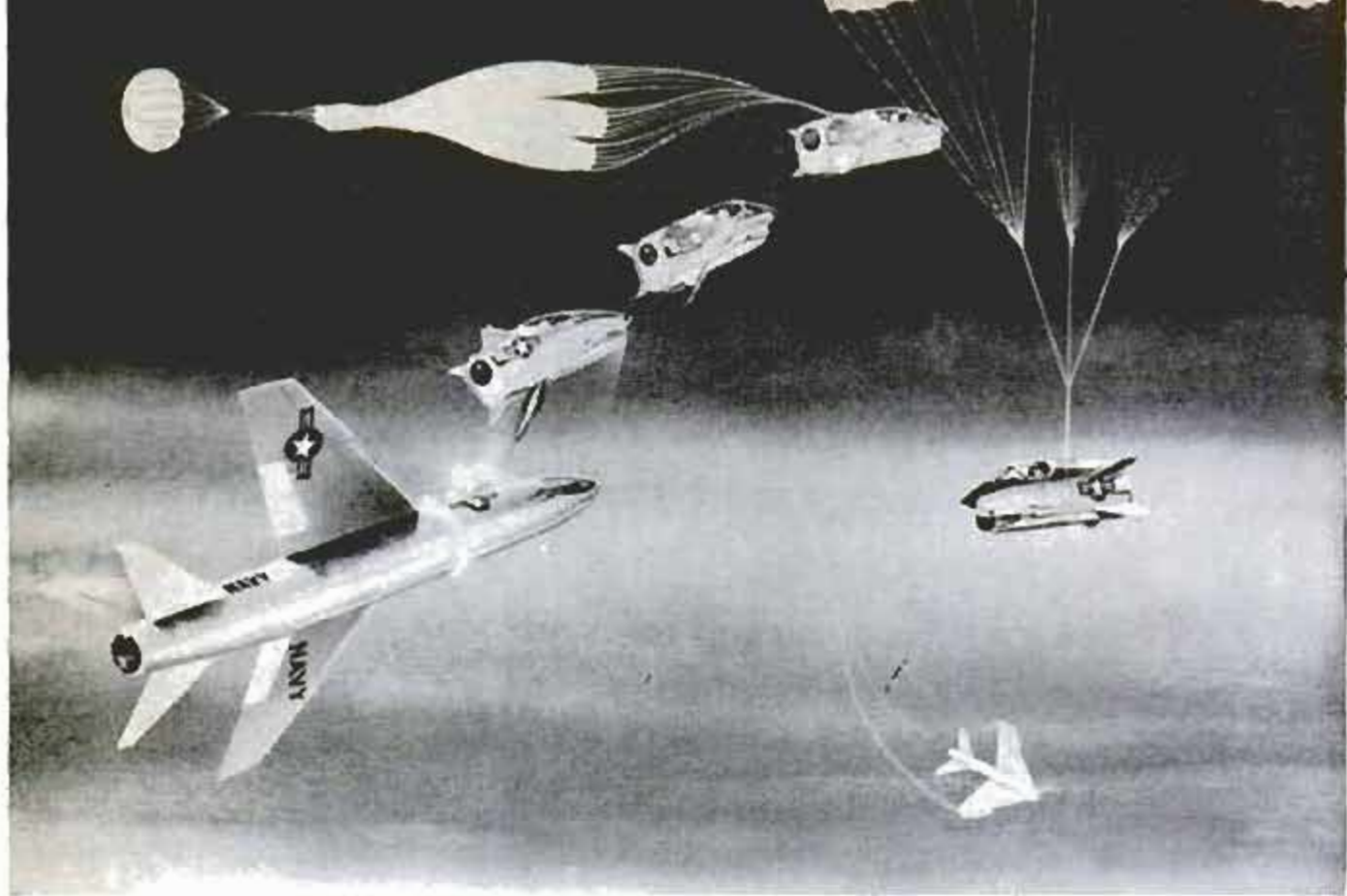

Plane's Forward Section Becomes Escape Capsule in Emergency

Navy pilots will be protected in flying emergencies by a forward-section capsule that can be separated from the rest of the plane and parachuted to land. The capsule, newly developed by Chance Vought, relieves the pilot of having to wear or carry such equipment as oxygen mask, pressure suit, parachute, life jacket and raft. The capsule is sealed off from the rest of the

plane and is independently pressurized. In emergency separation, a rocket boosts the capsule away. Retractable fins stabilize it, and force-sensing drag brakes decelerate. At or below 62,000 feet and about 500 miles per hour, a first-stage parachute deploys. At 14,000 feet and 220 miles per hour, a second-stage cluster of chutes opens to handle the remainder of the descent.



Police Gun Barrel Mounts on Car Hood

Texas Rangers are hoping for straight, sure aims with a unique gun that is premounted on the hood and fired from inside the police pursuit car. Invented by C. A. Stockholm, the weapon has the trigger located at the center of the dashboard. Stockholm introduced the gun to the Rangers at the Hondo, Tex. Air Force Base. In a test showing, he fired bullets into a "getaway car," a station wagon covered with armor plate, with great accuracy.

French Saucer Dives 1000 Feet

Advanced underwater research is expected with a French diving saucer that is capable of diving 1000 feet into ocean depths. The saucer, christened "Denise," can stay submerged for six hours at a time. It is presently based at Marseille.

Birth of Life

Two leading world scientists say it is most likely that the beginning of life occurred in the mud of tidal river estuaries rather than in the sea, during the time when the seas were still hot.



Metal Tubing Shipped Flat, "Blown Up" on the Job

Called "Strubing," an inflatable metal tubing has many advantages in easy shipping and handling. It is easily installed to form air ducts, conduit, downspouts and irrigation pipe, and can even be used as a packaging material for frozen foods. It is shipped in rolls. The user cuts off the length needed and inflates it with air or hydraulic pressure, or by mechanical means. Strubing is manufactured by cold-rolling con-

ventional tubing into ribbon form and forcing it to extrude lengthwise without increasing its diameter. It will eventually be available in diameters from 1/16 inch to six feet, with walls from foil-thickness to standard pipe weight, and in continuous lengths up to 15,000 feet. Enough Strubing for the ductwork on a seven-room home can be packed in a box the size of an orange crate.

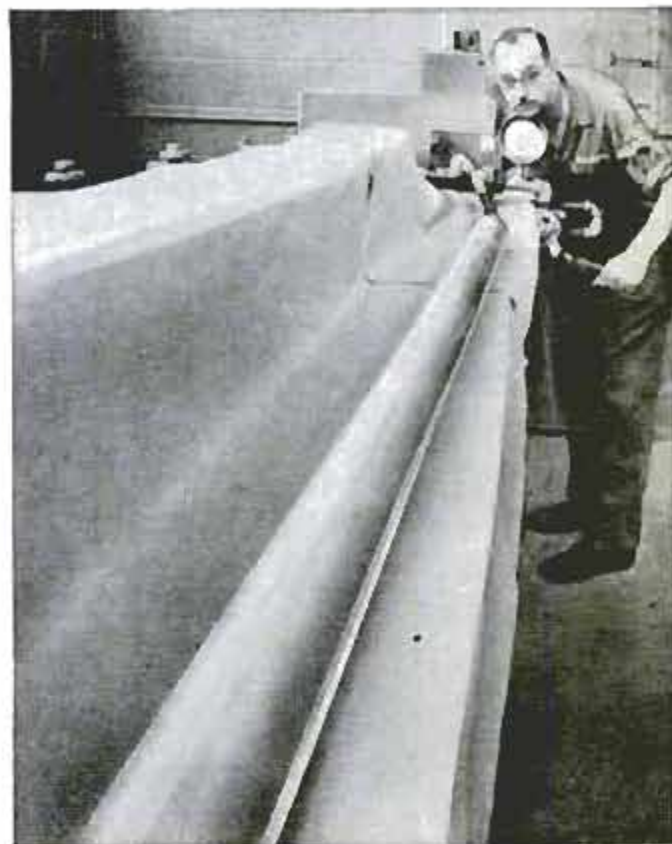



Mobile office or camp quarters are adapted from boat trailer by erecting sections of do-it-yourself steel

Your Toy Construction

Now the home craftsman or shop engineer can build fancy furniture, camp trailers or factory rigs with a king-size assortment of nuts, bolts and slotted bars.

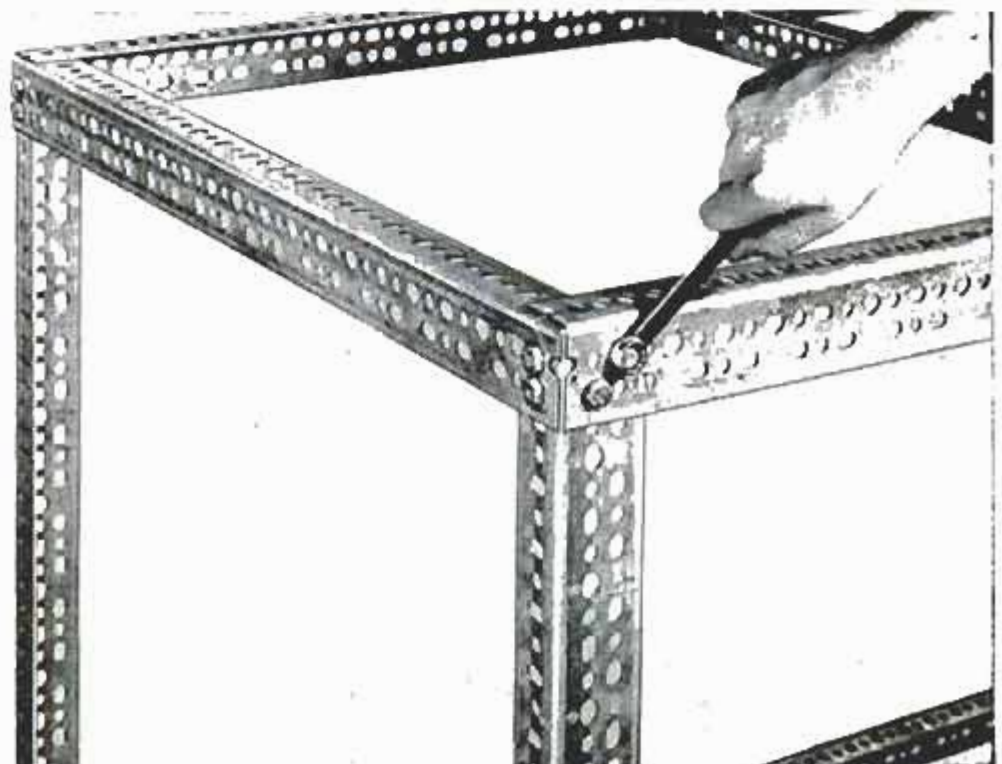



One of the slickest of do-it-yourself steel comes in channel bars like that used to build this modern table

Set Grew Up

By
Richard F. Dempewolff

RECENTLY, A GROUP of engineers at a large steel company clustered around a kit containing an assortment of steel bars punched full of holes, and a collection of nuts and bolts. It looked like a king size version of junior's construction set—and that's just what it was. Instead of making toy derricks, bridges and skeletal towers, however, these men set to work with a small wrench and a cutting tool to demonstrate the useful versatility of something new in construction kits. Within an hour or two, merely by changing the arrangement of pieces and the location of nuts and bolts, they had built and dismantled a usable flatbed trailer, a boat trailer, a camp trailer fitted with upper and lower berths, and a variety of playground equipment.

Those particular slotted and drilled bars are called "Metal Lumber" by Republic Steel Corporation, which makes up kits in quantities of 100 feet (complete with nuts and bolts). They are only one of several brands of tricky structural steel products specially fabricated for quick, easy assembly by amateurs—into anything from trim modern furniture to dump truck bodies. "The very nature of the material," as one

manufacturer puts it, "provides plenty of room for the handyman's own creative bent. All he needs to do is make a sketch of the item he wants to build, cut the material according to the selected dimensions, and assemble the unit just as a youngster would bolt together the pieces of a toy construction set."

Most of the do-it-yourself steel, like Republic's Metal Lumber, consists of drilled or slotted (sometimes in combination) angle bars. Along with these, and the bolts for fastening, may come a variety of accessory pieces—joint plates for special corners, casters (in case you're making a tool table, or a dolly), a long-levered cutting tool for snipping the bars cleanly and precisely to provide made-to-order lengths, sprocket wrench for easier and faster bolt-tightening, and so on.

One system, called Flexangle, provides steel bars in two gauges—one for heavy loads, the other for more normal ones. This producer and Acme Steel, which makes a slotted angle called AIM, have an impressive array of charts showing ways in which bars may be combined to form channel steel, T-beams, I-beams and other configurations that can provide structures of



To add bunks to trailer, Metal Lumber bar is bolted down center and another piece is added across back. Canvas bunk platforms are rope-lashed through grommets to holes in side rails

Close-up of metal cutter shows how long-levered slicer neatly severs bar of AIM slotted angle. Wrench and hacksaw are sufficient for do-it-yourselfer who wants to build with steel



unbenvenable strength—an made with nuts, bolts and simple two-inch angles. A four-foot rack or table made with AIM's I-beam configuration, would support four medium-priced family cars piled one on top of the other. If you prefer it in pounds, a made-up I-beam of this material will carry anything up to the crippling load of 27,200 pounds!

For most consumer uses, however, single bars are plenty. A three-foot span of just the plain angle bar will support one ton. And it goes together with startling ease. On almost any project, the builder will start by bolting together a rectangular frame—the top of his table, the bed of his trailer, etc.—and build up or down from this basic form.

Versatile Trailer Built

In their recent demonstration, Republic's engineers started with the bed of a trailer, designed to fit an axle they had procured. A plywood panel bolted to this frame made it a functional flat-bed trailer. Then, four short corner posts were quickly bolted in place, after being cut to size by the single snip of a cutting tool. "A hacksaw will do as well," they admit. For the trailer, two bolts at each joint were enough to keep the framework rigid, but the men point out that in cases where extra strength is needed, it is a simple matter for the builder to cut and bolt diagonal bracing across the corners. Horizontal rails fastened to the posts gave the trailer a third dimension, with protective rails for hauling luggage and other cargo. With plywood panels bolted to the side frames, it became a truck body for hauling soil, rocks, loose produce, etc.

By raising the side rails, lowering the rails in front and back and replacing them with bars in the form of a "V"—a job consuming about 15 minutes—the unit suddenly became a boat trailer capable of carrying a 14-foot outboard runabout. With the addition of peaked steel gables at each end, and a ridgepole of tubing, canvas was laced to the framework and the trailer grew into living space for one man. Finally, adding to the height of the corner posts by the simple process of bolting on extra pieces, the demonstrators raised

the roof and produced a double-decked camp trailer large enough to sleep four people. "You can go on forever," they reveal, "depending on your imagination and your requirements."

This Type of Steel Not New

Oddly, do-it-yourself steel isn't as new as it seems. Most companies producing slotted angle have been doing it for years for industrial use, and you've probably seen it dozens of times without knowing it was there. Almost every shop uses it in the "back room" as shelf framing for storage of parts and stock items. It's used to make steel stairways and galleries in storerooms. Military outfits have been using it for some time. Out at Wright Air Development Center in Dayton, Ohio, planes had to be grounded every time their interiors were modified to accommodate new electronic gear being tested—until a few years ago when a group of technicians devised a system of drilled steel angles, adjustable at the turn of a few bolts to make "instantaneous" custom-built racks to accommodate any kind of gear.

"Now," boasts the Air Research and Development Command, "when a plane lands, tested equipment is removed bodily. Racks, already adjusted to new equipment ready for testing, are bolted to plates in the floor and ceiling of the aircraft, the electrical system is plugged in, and the plane takes off." The system, which allows impromptu racks to be quickly assembled above or around seats, desks and other obstructions in the crowded test planes, gives it what ARDC calls an "Erector Set characteristic," which saves the Center an estimated half-million dollars each year on its 27 test aircraft.

Only a Wrench and a Hacksaw

One of the slickest do-it-yourself steels so far available, is not slotted angle, but a channel steel called Unistrut. More complicated than its cousins, this material uses unique spring-held clamping nuts that slide into position inside the channel and, hence, are hidden. Framing fittings are required for corner joints, and the channel steel comes in five different shapes and sizes for different purposes. But the material has a "finished" appearance that makes it readily adaptable for



Office on boat trailer is five feet high. Peaked gable sections at each end are bolted in place, and lightweight ridge-pole of tubing supports canvas cover. Mobile rack below is example of how do-it-yourself steel is applied industrially

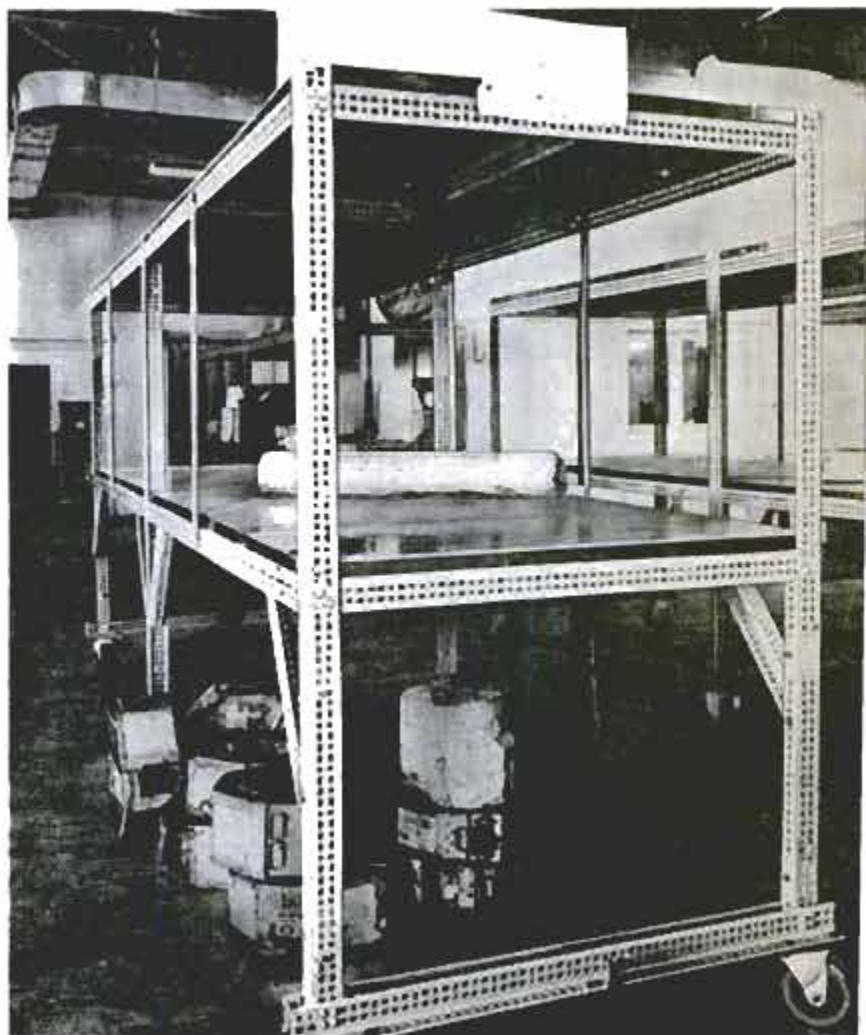



Wooden desk and cabinets built into framework of channel-type steel were made with wrench, hacksaw and woodworking tools

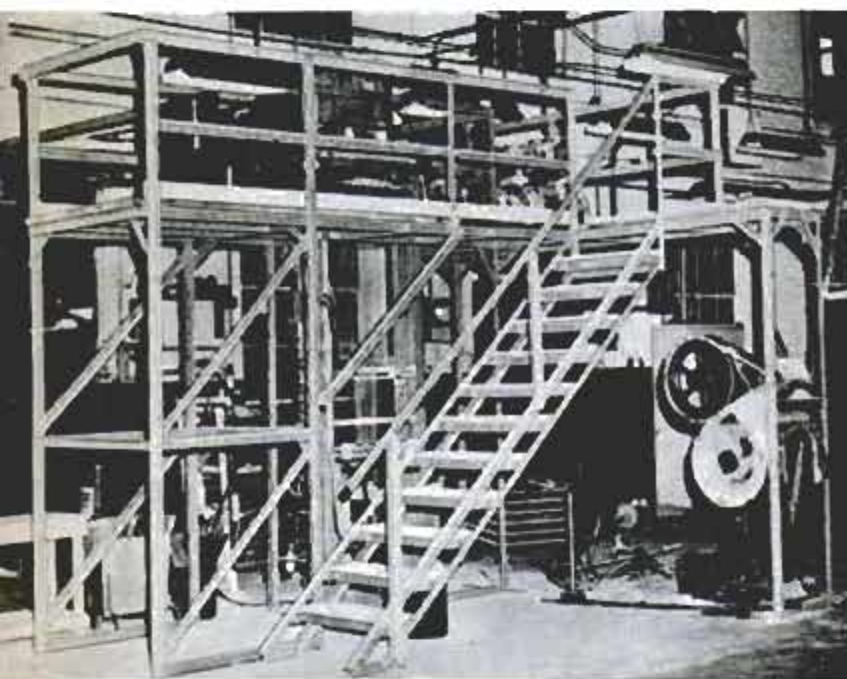

Easily assembled stairway and catwalk above illustrate versatility of lightweight steel. Below is electronic rack developed by Wright Air Development Center for test planes. Idea has saved base \$500,000 annually in modification time



framing for wall partitions, and trim shelving that you wouldn't mind using in the living room. With a wrench, a hacksaw, and a minimum of spare time, the Uni-strut people claim you can build nifty glass-topped tables, chairs, ping-pong tables, classic workbenches, room-dividers with colored plastic panels that fit in the channels, classy workbenches, good-looking framing for porches, entryways and lean-to greenhouses—or almost anything else you set your mind to.

Use Corner Brackets

Corner joints on things made with the channel steel bars are usually mitered, so that a finished project is trim and uncluttered. By using corner brackets on the underside of the channel, there's no need to pierce the steel with drilled holes. The three outside faces of the channel are solid, with no projecting nuts or bolt heads. And if you want a super-flush job, special flat-head machine screws, which countersink into specially milled corner brackets can be used instead of the standard bolts and plain brackets.

If you're given to imaginative, hard-to-build ideas, this system includes a hatful of accessory "extras" that endow it with unusual versatility. For instance, by using a set of special triangular steel brackets bolted to a pair of plain channel bars fastened to the wall, you can produce any desired arrangement for contemporary hanging shelves. Want to build a wall, or room divider? Special clamp fittings that slip into the channel of the steel bars are designed to hold laminated wood or plastic panels in a limitless variety of sizes and shapes.

Metal Construction Now Easy

Until recently, most amateurs have shied away from metal construction because it required expensive equipment for welding and machining the ornery material—not to mention technical skill in handling and shaping it. Now, with requirements calling only for wrench and hacksaw, anyone can take advantage of the strength and rigidity that steel has to offer.

Where can you buy do-it-your-

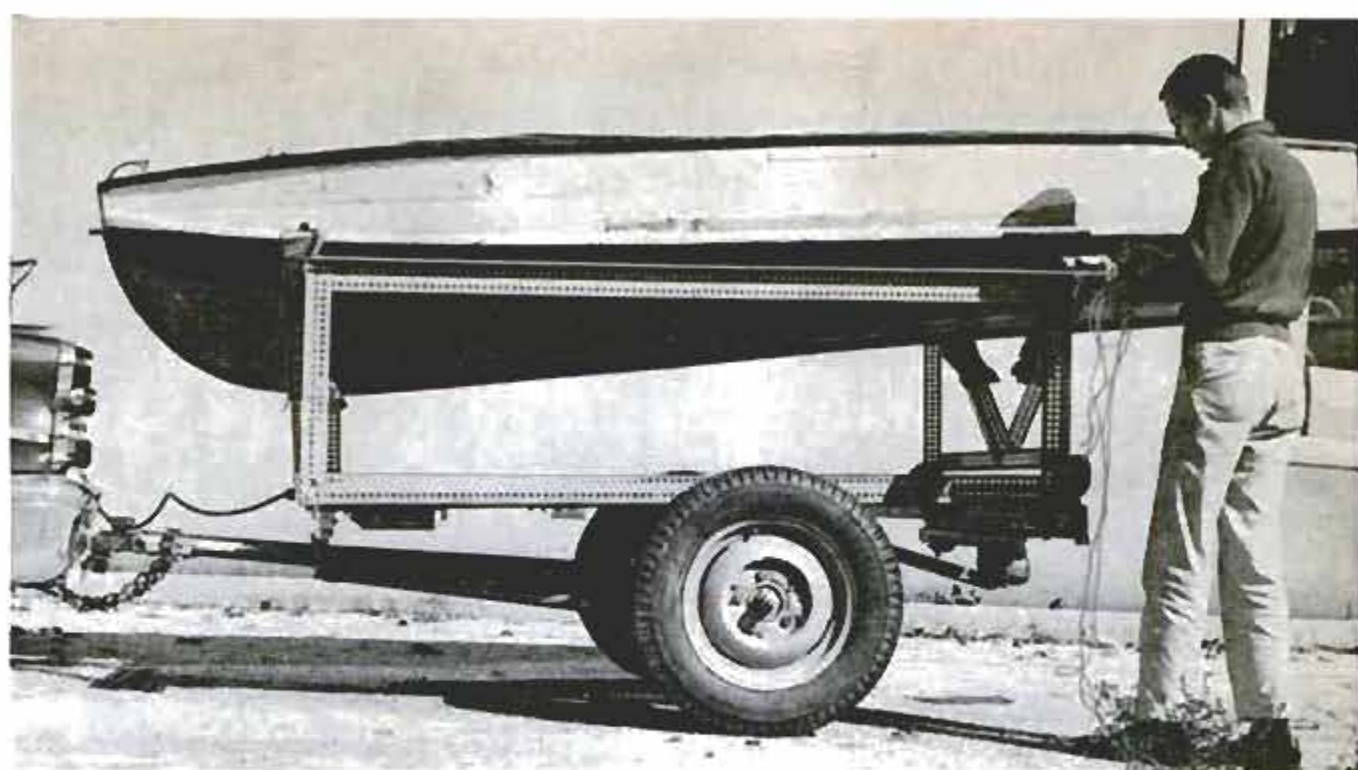

Boat trailer evolves from truck body by removal of front and rear top rails and substitution of "V" rails

self steel? Don't expect to find it on the shelves of local hardware stores, because few shops are equipped with storage space enough to stock such bulky merchandise. Except for Metal Lumber, none of the do-it-yourself steel comes in consumer kits, either. Most manufacturers still concen-

trate on the bigger industrial applications. However, all varieties, including the kit type, are available through hardware wholesalers. Local shopkeepers, according to the manufacturers, should be able to find the kind of do-it-yourself steel you need if you ask them.

WHERE TO BUY DO-IT-YOURSELF STEEL

Ask your neighborhood hardware store if he can supply your needs in "do-it-yourself" steel. If he cannot, write to the following companies for information on how to obtain their products—

METAL LUMBER—Republic Steel
 Republic Building, Cleveland 1, Ohio
FLEXANGLE—FlexAngle Corp.
 3760 Oakwood Ave., P. O. Box 418
 Youngstown 1, Ohio

AIM—Acme Steel Co.
 135th St., and Perry Ave., Chicago 27, Ill.
UNISTRUT—Unistrut Products Co.
 933 W. Washington Blvd.,
 Chicago 7, Ill.

By adding upright posts to trailer frame, flatbed trailer is turned into luggage carrier in 10 minutes

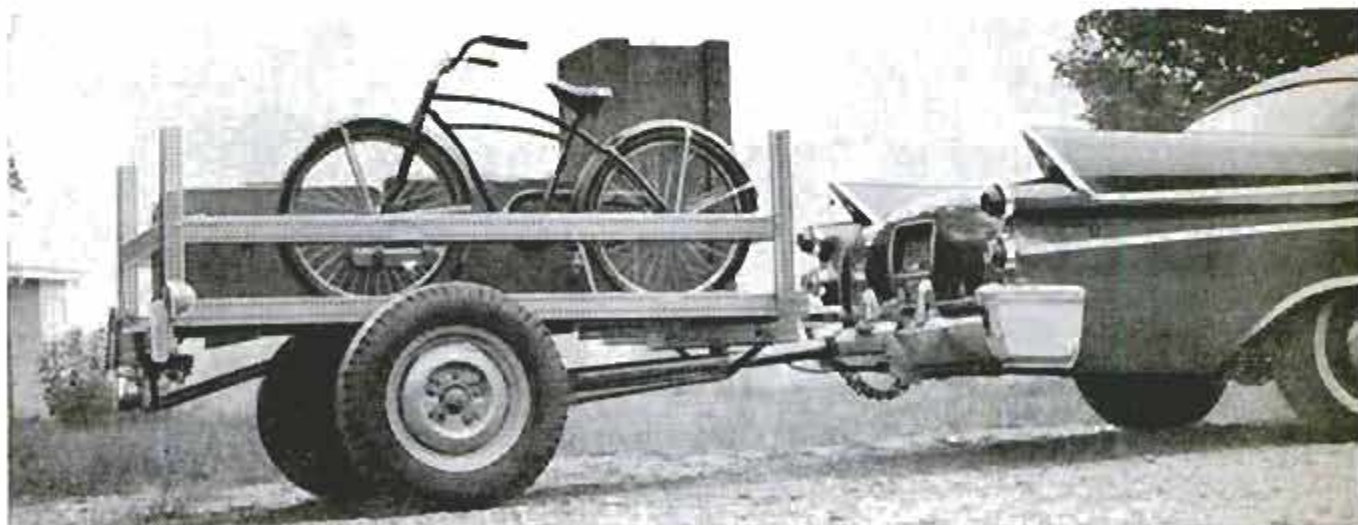

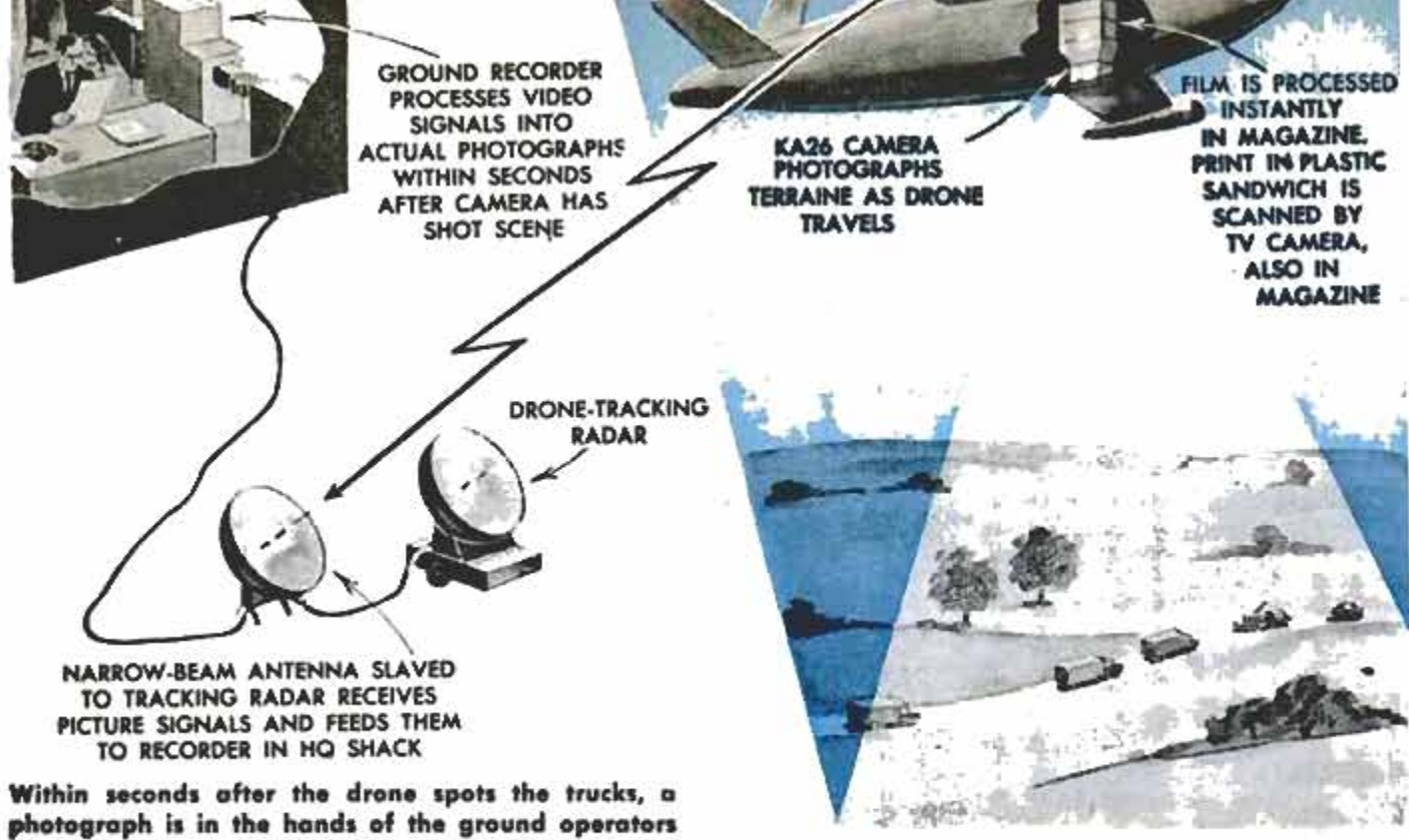

Aerial Photos Are Viewed Instantly on Ground

Automatically and almost instantaneously, a Signal Corps photo-reconnaissance system being developed by Fairchild Camera and Instrument Company takes aerial pictures and reproduces them on the ground. An airborne unit photographs with a 70-mm. camera, then develops and scans

the pictures to convert them to radio signals that are transmitted to a mobile ground station. Exposed film in the ground camera can be processed for viewing in a matter of seconds. The original pictures can also be studied when the drone returns to base.

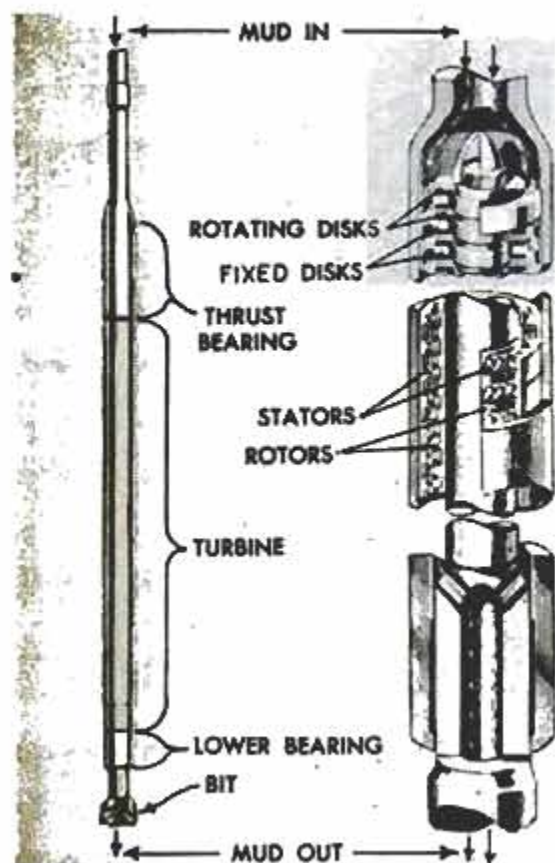

Turbine Powers Oil Drill

Powered by a mud-actuated turbine, a new diamond-studded drill bores for oil twice as fast as conventional equipment—and at 30 percent less cost. Mud pumped down from the surface rotates the turbine, located immediately above the drill bit. In conventional drilling, surface engines rotate the entire length of drill pipe.

Shell Oil Company



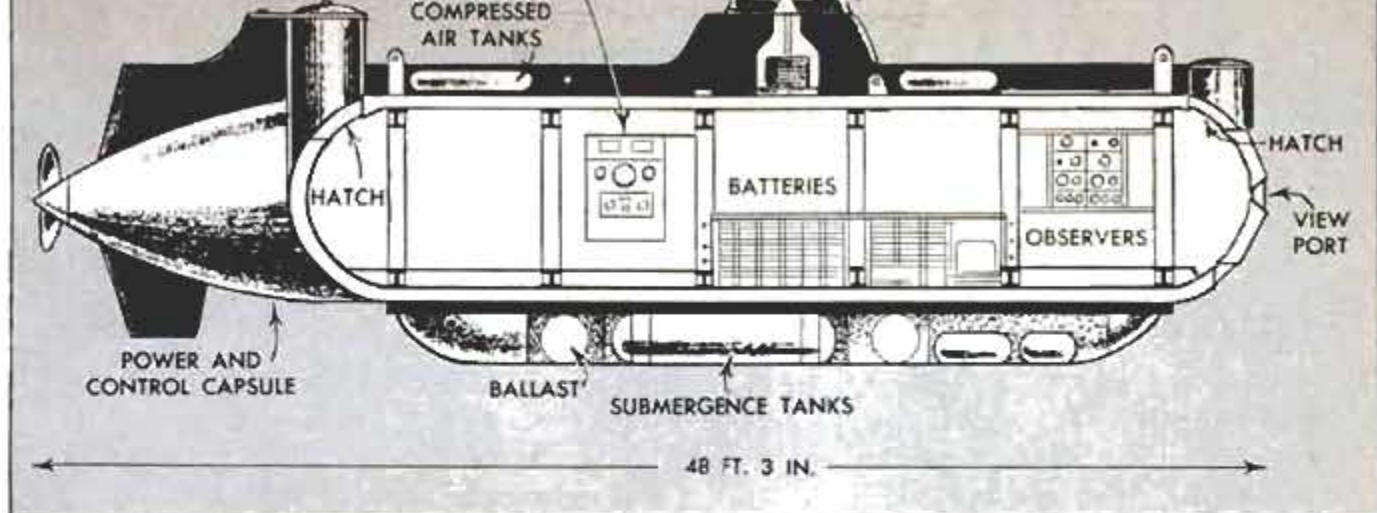

Aluminum Submarine May Dive Three Miles

Exploration of the ocean bottom to a depth of three miles may be possible with Reynolds Metal Company's aluminum submarine, the *Aluminaut*. It will carry three men and 3400 pounds of equipment on 100-mile, 36-hour trips. Since 60 percent of the ocean floor is within its depth limit, the sub is expected to fulfill the dreams of oceanographers who have long wished for a manned submersible free from surface tenders.



Cycle Rides Snow On Ski and Tracks

If you want to travel cross-country over deep snow and don't have a team of dogs to pull a sled, a young inventor in Oslo, Norway has just the thing for you—a "cold rod," or winter motorcycle. The inventor, whose name is Reidar Berg, added a ski to the front wheel of his motorcycle and tracked belts to the rear wheels.



☐ Census-taking zoologists recently used a helicopter as an aid in counting 14,000 seals and sea lions off the southern California coast.

AN EYE ON SPACE

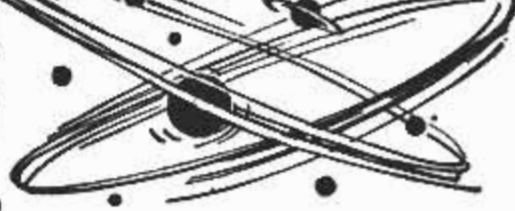

By Dr. Dan Q. Posin

PROFESSOR OF PHYSICS, DE PAUL UNIVERSITY
SCIENTIFIC CONSULTANT AND ADVISOR, COLUMBIA BROADCASTING SYSTEM

THE RUSSIAN SUCCESS in hurtling an 860-pound object out into space and smack onto the moon puts into interesting perspective our August story, "The Race to the Moon." The many letters from *Popular Mechanics* readers displayed an intense concern with our situation in respect to space travel and rocketry. A few readers doubt that Russia has achieved all she claims. The moon shot should allay their doubts.

The moon shot is impressive for two things—the power of the launching rocket and the guidance system. In order to project the 860-pound instrument capsule (not to mention the more than 2400-pound empty last stage) to the moon, a lifting thrust of something like 800,000 pounds must have been achieved. Regrettably, as yet we have nothing like this, although plans for even more ambitious thrust do exist. The guidance system was equally meritorious. It seems quite clear that much of the guidance of the streaking payload was from the ground. What it took to do this was a powerful transmitter, with a huge beaming antenna which concentrated its radio waves into a narrow searchlight-like shaft of coded energy. But when the capsule was distant from home, its own guidance took over. All this implies a relative hugeness. The flying guidance system was intricate, replete with computers and with a radar exploration system. As the capsule neared the moon, it no doubt sent out radar pulses which bounced back from the surface. The time between sending and receiving gave the distance yet to be covered (half the total time, multiplied by 186,000 gives the distance in miles—which operation, of course, the robot computer performs without blinking a robot eyelash). This guidance system had the elements of a "homing" device.

Some wishful thinkers have raised the possibility that the capsule did not strike the moon, but had a timer which shut off the radio to simulate impact destruction. The capsule was traced via its radio signals by the British Jodrell Bank telescope all the way, and the changes in its speeds were observed throughout. As it left Earth it had a speed of about 25,000 miles per hour, which then was cut down by Earth's pull-back. As it reached the equilibrium region (where Earth's pull-back equals the moon's forward pull) it had a speed of about 1.5 miles per second. As it crossed this region it began to accelerate, and finished at about 2.5 miles per second (7000 miles per hour). Any device that could simulate all these changes of velocity would be more intricate than the guidance system.

The Russians are not ahead of us in science. They are ahead in this particular but spectacular area—space propulsion. But they need not remain ahead even here. What is needed to overcome their lead is simply this: A deep desire in our young people to understand the universe in which they live, a love of science, and a determination to perpetuate the sense of human freedom. This does not come from some superficial stimulus, such as the launching of an object into the sky. This comes only from inspiration and a much improved school system. If we are dedicated to a thorough and robust educational system, and genuinely desirous of knowing the universe because of its unending mystery and excitement, then we will never panic at every shot fired round the world or at the moon by anyone else, nor close our eyes and moan "I don't believe it."

Toughest Railroad You Taxpayers Own

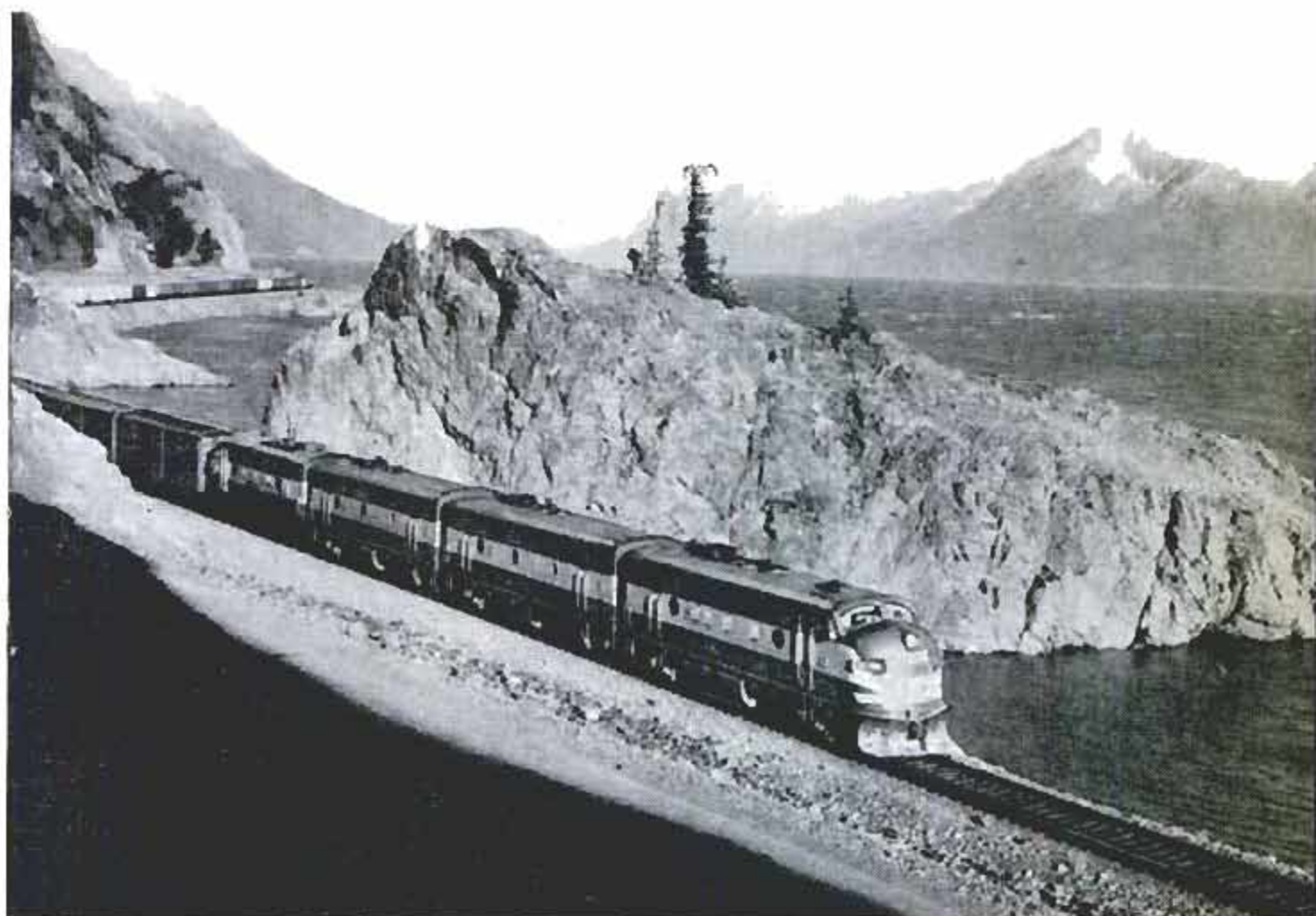

Powered by a modern diesel locomotive, a freight train snakes along Turnagain Arm on Alaska Railroad

By George X. Sand

UP IN THINLY SETTLED Alaska the government is operating—at a profit—500 miles of hazardous and extremely frustrating railroad. This is done for grateful interior residents who otherwise would be cut off from the outside because private stateside capital wouldn't take the risk. It is being accomplished in a safe, informal and at times deliberately inefficient manner that makes push-button-minded trainmen elsewhere squirm.

Last fall I rode through the interior wilderness on one of the modern trains of the Alaska Railroad. To my surprise, the diesel streamliner made an expensive stop deep in the wilds to take aboard a pair of roughly garbed Alaskans who had been waiting at trackside with their high-powered hunting rifles and somewhat gory trophies. When I inquired about the trophies—two huge sets of caribou horns, each with skull

still attached, and the meat from the quartered carcasses—the grinning conductor promptly invited me to visit with the successful hunters.

The men had chosen to ride in the baggage car with their prizes and they told me they often made trips like this, catching a train into the bush in the morning, flagging down another to return the same afternoon. Moose, bear, sheep and other big game can be killed within rifle shot of the tracks.

I was even more surprised when these hunters told of an old trapper who'd asked to be dropped near his lonely cabin, many miles from the nearest town, but had fallen asleep. When the conductor discovered the sleeping man he not only stopped the 10-coach train but had it backed *three miles* to let off his bearded passenger with apologies. At the time I hadn't learned that you



Moose find it easy walking along the tracks in winter but add to the engineer's problems

It's 470 miles from the port of Seward through the port of Anchorage and past the foot of Mount McKinley to Fairbanks, largest inland city; 470 scenic miles



don't seem at such incidents along the sprawling frontier of Alaska.

Annual snowfall ranges from 40 to 70 feet along the ARR's tracks. Landslides are a constant winter-time threat. Veteran conductor Claude Douglas tells how he and 165 passengers were trapped at a wilderness bridge spanning a mountain gulch 300 feet wide and 45 deep.

"It was snowing hard and we'd had a 'snow fleet' working right ahead of us. The light got so poor that the men operating the plow could hardly see. They halted the plow on the big trestle where it couldn't get bogged down—they thought. Then they walked back to the train to have coffee with us and wait for the blizzard to let up.

"An enormous slide let go somewhere overhead. It roared down right at the snow fleet, sweeping everything into the gulch below: bridge, plow and both its engines. The bridge disappeared right in front of the passenger train's cowcatcher, but nobody was hurt. The rails hung down over the edge of the gulch like twisted spaghetti."

The equipment represented taxpayers' money. Deep snow in the gulch appeared to have acted like a cushion, so the trainmen got help and packed it down. They laid temporary tracks. Hauled out, the snow fleet was soon back in service.

Conductor Joe Axes proved less fortunate while riding his freight. Along for the ride was an Air Force major. A slide blocked the train near Curry. The two men swung down from the caboose to inspect the obstruction when the main avalanche descended.

The conductor dove beneath a nearby gondola. The airman tried to grab altitude by clambering up the car's steel ladder. A dozen feet of snow closed overhead.

Brakeman Bill Shake ran almost two miles for help in nearby Curry. Men grabbed shovels and leaped aboard a yard engine to race back to the disaster scene.

The rescuers heard a faint tapping—Axe's switch lantern being struck against the bottom of the car. They dug furiously and rescued him. The major was found plastered like a gingerbread boy—still climbing.

Remote bridges of the ARR must be specially built. The openings between the supporting railroad ties are carefully decked over to make it easier on the feet of—you'd never guess—moose. These shaggy 1000-pound animals gallop over the narrow trestles ahead of approaching trains. Should their long legs get caught between the ties the frantically braking engines are derailed. It's happened.

In deep snow, moose become easy prey for wolves. Therefore they tend to congre-



The conductor dove under a gondola car for safety when a slide hit this train. Brakeman ran two miles for help

gate along the ARR's cleared tracks. Result: Hundreds of the prized game animals are struck each year. More are killed this way than by Alaska's many hunters. The carcasses, when salvageable, are used to feed the needy. Humane section crews, concerned over the slaughter, bulldoze inviting run-offs through the banked track-side snow. The moose (like bear and other animals) refuse to use these. Nor is it practical to erect miles of fence.

Moose follow the tracks to town, too. Two springs ago a big bull, frightened by an approaching freight, darted from behind the station building at Montana. A flatcar was derailed, losing its wheels and stopping the long train.

The ARR was hammered into existence 40 years ago by determined construction men who ignored terrible winter temperatures, broken bodies, even violent death to show a skeptical outside world it could be done. Today the willingness to provide for those in real need despite personal sacrifice sets apart the hard-fisted Alaska railroaders from less dedicated men elsewhere.

These government trainmen serve as sole contact with civilization for many Alaskans who live in the wilds, even if it be only the dropping of a dated newspaper or the relaying of an important message. One 70-year-old hermit, prospector Tom Sisson,

Huge doors at tunnel entrance help keep tunnels warm, prevent freezing of glacial water that drips constantly from roof. Ice might otherwise derail train. On occasion, doors have been smashed to splinters by trains when left shut by a forgetful workman

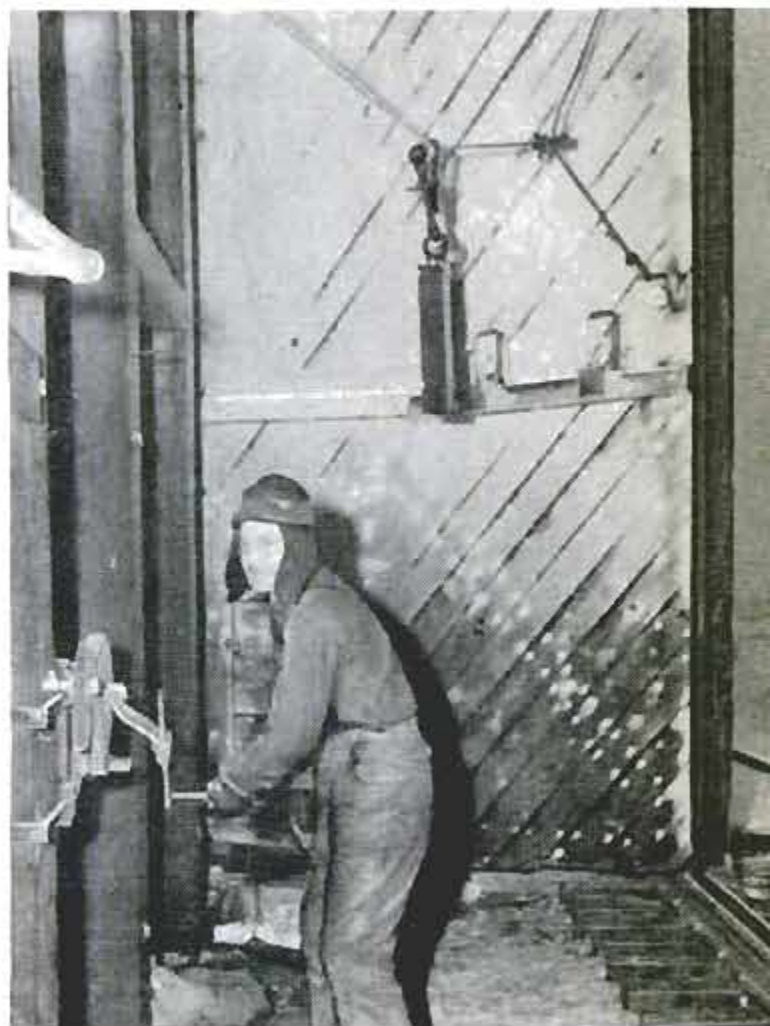



When glacial moraine thaws, mud slides send tons of boulders tumbling down on tracks for crews to remove

hadn't been seen at trackside for three weeks when I rode the train. Crewmen were prepared to search for the old man—on their own time.

Obliging trainmen shop (without pay) for necessities for these isolated dwellers (both whites and Indians) who may not find it possible to come out for months to

scrawled order for supplies hanging beside the track, usually inside a crude willow hoop. The baggagemen, who know each sourdough's faint trail like a Manhattan taxi driver knows his streets, slip their arms through these hoops as the train speeds past. Train crews then spend hours filling such orders at Fairbanks and Anchorage, the modern cities located at the northern and near the southern ends of the main line. They pick up false teeth and repaired watches; purchase medicines or match swatches of dress and curtain material. Occasionally, to their grinning delight, they buy wedding rings, even dainty underthings. Such items, dropped off without stopping, are always paid for later.

Conductor Claude Douglas, I discovered, was aiding a helpless Indian woman. He'd arranged a sales outlet for her handmade parkas and mukluks in Fairbanks, 150 miles away.

"Why not?" asks one veteran railroader. "These folks would do the same for us. This is still a frontier. You learn to depend on your fellow man."

Once, not thinking, a man hung up a pair of heavy and well-worn sledge hammers—his pride and joy—that he wished to have refinished in the city. The unsuspecting baggageman, reaching for the hoop, nearly broke his arm.

Such kindness is repaid. For example, when enginemen Boyd Crune and Earl Simpson dropped from a freight near Cant-

Rotary plow is almost hidden in deep trench it has cleared. Annual snowfall may exceed 70 feet in some spots





Rails are left hanging in air after a flood washed out bridge supports. Floods present a constant threat

well last year to go sheep hunting, they discovered a car would be needed. A stranger, learning they were from the ARR, promptly offered his. "You can drop me at work and keep the car all day," he told them. "On the way back this afternoon bring my kids home from school, that's all."

To go on giving taxpayers such unprecedented return for their money these government employees in the land of the northern lights must overcome tremendous weather obstacles. Their railroad muscles

its way from the ice-free Pacific port of Seward nearly to the Arctic Circle, and temperatures vary from the upper 90s in summer to 72 below in winter. White men cannot stand such bitter winter cold and must be replaced with Eskimos and Indians. Like human blood, the oil in machines slows dangerously. Metals become brittle. Locomotive traction falls off so badly that a freight engine is apt to pull but 60 percent of its normal load. Even the air brakes freeze unless alcohol is added.

Bridge washout at Milepost 199 brings out the engineers for emergency repairs at night under floodlights

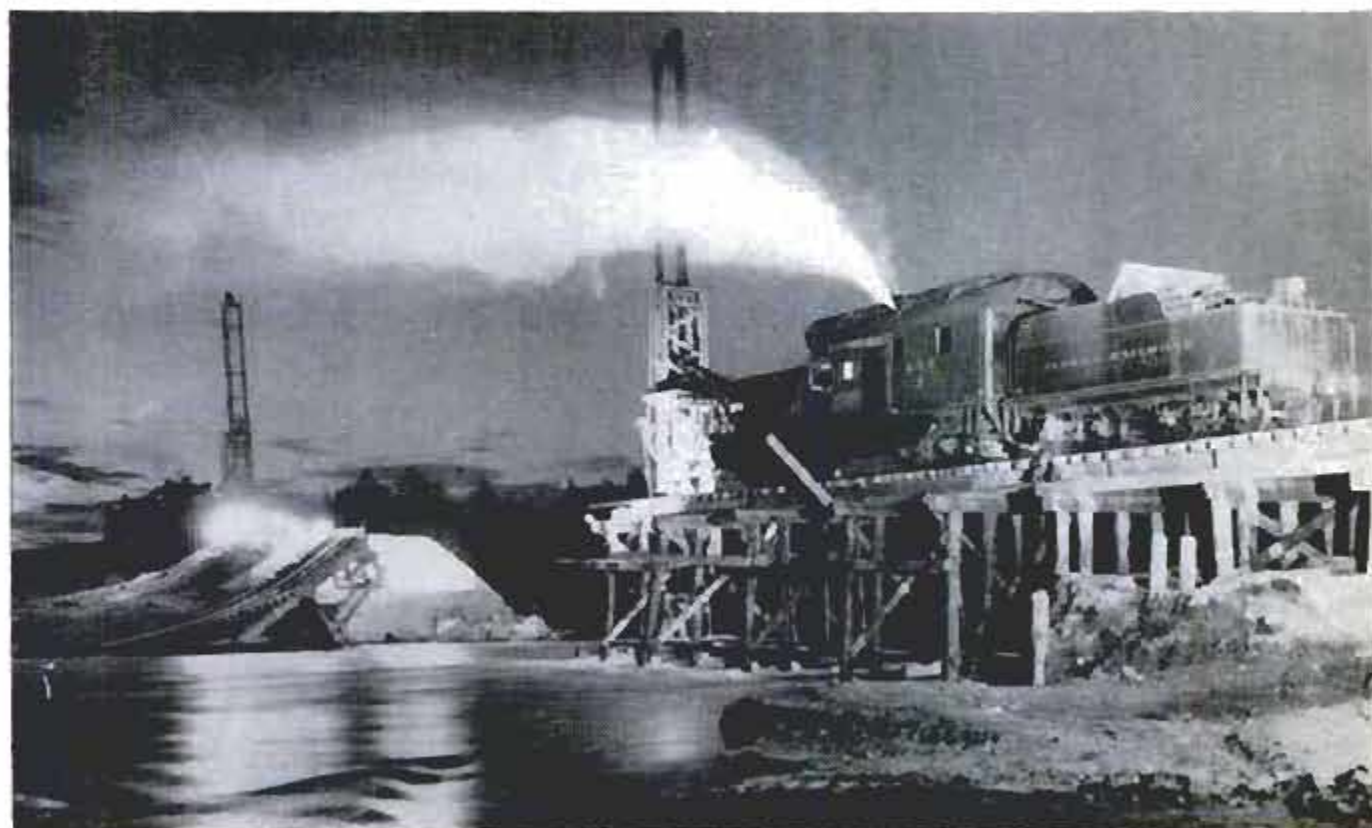

Track walkers inspect dangerous ice along the right-of-way. Several years ago trains were delayed three days in December by a combination of light snow, ice and extreme cold that halted all traffic on the line

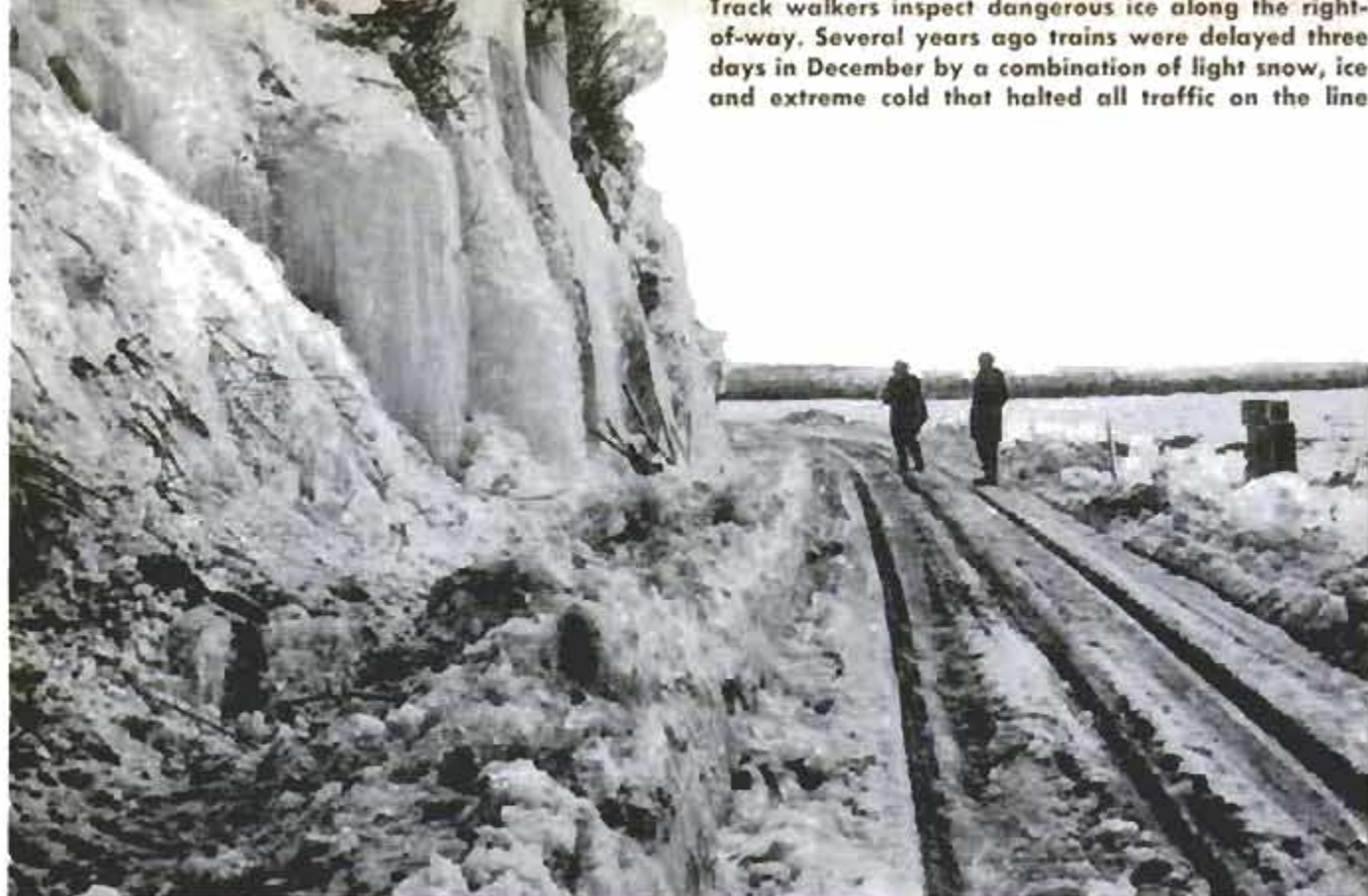

Biggest trouble, year 'round, are the level sites where the bright blue and yellow diesel engines pass over "perma-frost"—frost 2500 feet deep and 25,000 years old in some places. Here repair crews must "dig" with live steam instead of pick and shovel. During summers the gravel roadbeds and embankments laid over these spots soak up heat from the almost round-the-clock sun. The roadbed sinks like a hot poker laid on a cake of ice. Thousands of tons of fill are required.

It's not unusual to encounter gangs of section men working against time through the long polar nights to prepare the track for an expected train. Freezing earth can expand in but one direction—upward. Result: "Frost heaves" buckle the rails. To correct this, work crews drive large wooden shims between the steel and the railroad ties. Some of these wedges may be eight inches high. Tie rods and bridles hold the elevated rails in a straight line.

Such numbing work becomes especially disheartening when additional freezing throws the track completely out of line again, perhaps the following night. The conscientious workers will return, however. They know that Alaskan families—the U.S. government itself—are counting on them to keep the line open. There are no other railroads serving Alaska.

Frost plays other tricks. It lifts telegraph poles, bridge pilings, even concrete building foundations right up out of the ground unless special precautions are taken. As the

frost first forms it adheres to the pole or other object where it enters the earth. This grip is so strong that as the temperature skids downward and the frost crust thickens upward it raises its victim with it, regardless how deep it may have been set.

The men of the ARR combat this by using screened gravel between foundations and earth. The freezing ground can then slide past without adhering. Another technique, used for communication line poles, is to make tripod bases, with the three legs only slightly dug into the ground.

The annual "Lake George Flood" is also a natural phenomenon to be reckoned with. Some 35 miles north of Anchorage is a large field of creeping glaciers. Each spring they unite to form a seven-mile "river" of ice. This crawling white avalanche (sometimes 300 feet high) eventually encounters an even higher sheer mountain wall. When this happens the outflow of Lake George is choked off.

A triggering action takes place when the rising lake reaches a certain level. The huge ice dam, honeycombed and undermined by the water, gives way suddenly. Masses of glacial ice come toppling down to be carried end-over-end in a crushing, grinding channel of their own making. A cubic mile of flood water is sent racing toward the railroad tracks, 15 miles away. The tracks are inundated, despite the fact that new bridges have been built, old ones raised.

(Continued to page 234)

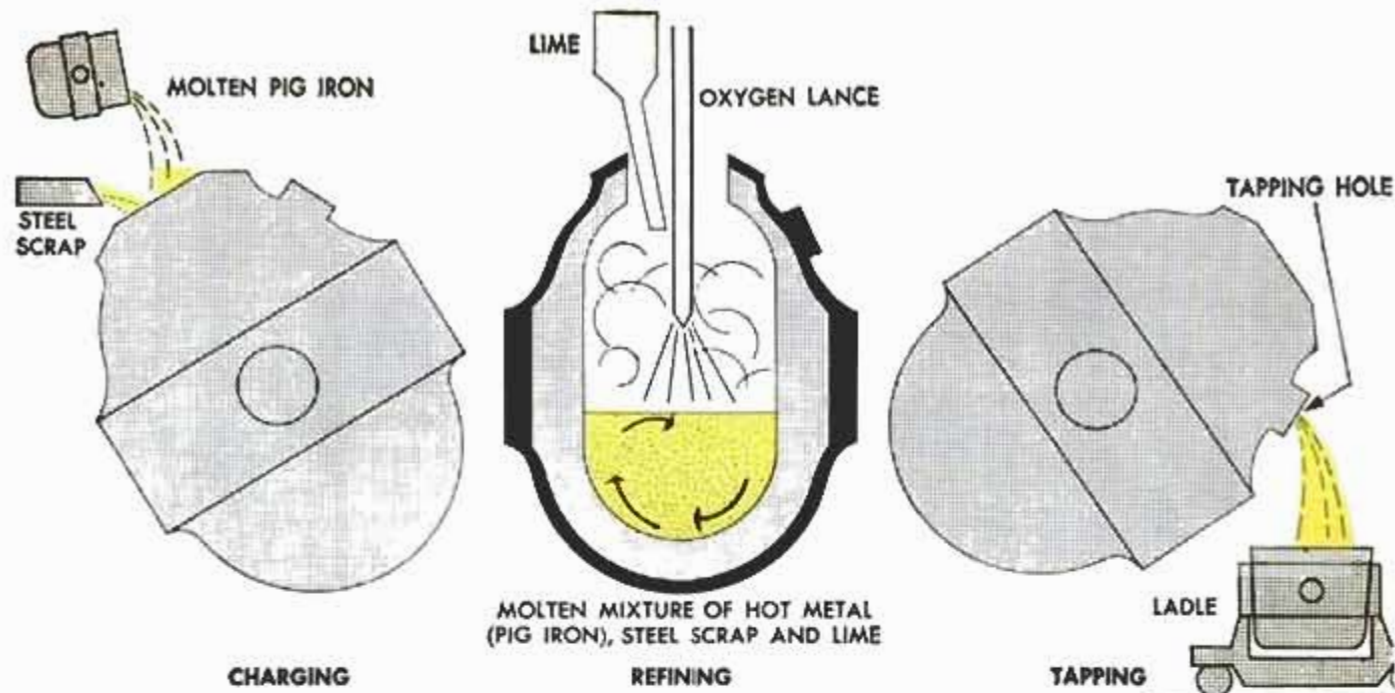

Oxygen Blast Cuts Steel Production Time

HIGH QUALITY STEEL is being produced in minutes instead of hours by a new process that uses a blast of oxygen to help speed up the change from pig iron and scrap to steel.

The new "oxygen" furnace that turns out 100 tons of steel an hour does as much work as four open-hearth furnaces that produce 225 tons every nine hours, according to steelmen.

Cost of an oxygen furnace is about half that of an open-hearth furnace and requires only a third of the usual scrap steel per charge, they add.

Largest installation in the world is at the Kaiser Steel Corporation's Fontana plant in California. There three 100-ton furnaces and an oxygen plant double Kaiser's ingot capacity to 2,933,000 tons a year.

The low-carbon steel created by the oxygen method is especially suitable for cold-rolled sheets, a big tonnage product widely used for automobile bodies and household appliances.

The basic principles of the oxygen process are shown in the diagrams at the top. During the charging stage, white hot molten pig iron and steel scrap are poured into the 26-foot-high furnace. During refining, the furnace is returned upright and lime is charged in through the lime chute.

A jet stream of high purity oxygen then is fed into the furnace through a 40-foot-long lance and directed over the surface of the molten metal.

The flaming oxygen burns out impurities and starts a mixing action that refines the mixture into steel. More than six tons of oxygen, enough to satisfy the needs of a human being for more than four years, are

injected into the furnace during a 25 minute period.

By that time the temperature of the metal has risen to 3000 degrees F., and the furnace is ready for tapping.

Developed in Austria eight years ago, the oxygen steel process is being used in 14 countries. Today's output is 11 million ingot tons a year.

By 1965, new installations should allow production of 45 million tons annually in the United States alone.

Low-carbon steel, refined speedily in an oxygen blast furnace, is poured into the teeming ladle

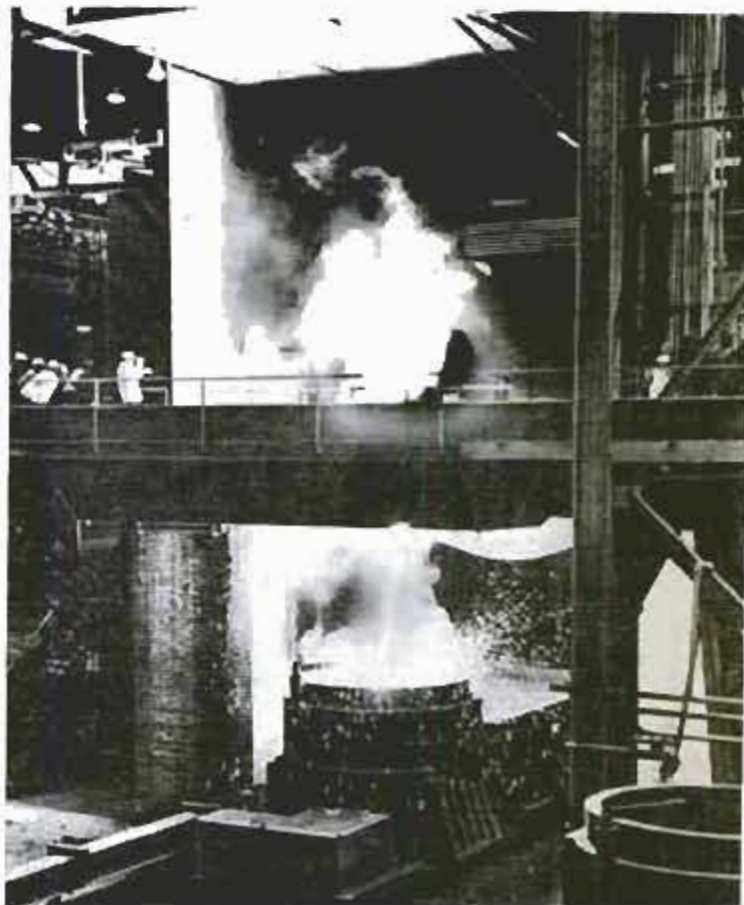



The most direct course isn't the quickest or the easiest when it takes a ship through an area of heavy seas or severe storms. New Navy ship-routing techniques are realizing important savings in fuel, time and money

The Shortest Route May Be the Longest

By
William V. Kennedy

Wave plotters and weather prophets are saving hours of travel for ships crossing the Atlantic

ONE MARCH NIGHT this year, two commercial passenger liners ran head-on into one of the worst Atlantic storms in recent history. Both were a day late in making port with their loads of storm-shaken passengers, some of whom were injured.

Two U.S. Military Sea Transportation Service transports passed through the same storm area that night. Both reached port on time, without damage and without injury to passengers, crew or cargo.

The liners were sailing by shipboard navigation, aided by a few radio weather reports. The military transports were sailing a course plotted by a former Army Air Force pilot working from a desk in Washington.

To many salt-water skippers the idea that a ship's course can be plotted better from

"the beach" than from the navigation deck is outrageous. To the several score who have followed the advice of Dr. R. W. James' Optimum Ship Routing Service, however, the "invasion" of command authority has saved days, dollars, seasickness and damage.

The Navy's new ship routing service began as a doctoral thesis submitted by Dr. James at New York University in 1955.

After World War II AAF service, Dr. James, already a meteorologist, introduced a rudimentary ship routing system while working for a commercial weather forecasting service.

"Our track predictions," Dr. James recalls, "were based mainly on weather forecasts. I was convinced that with the worldwide weather, wave-prediction and other hydrographic data available to the Navy,

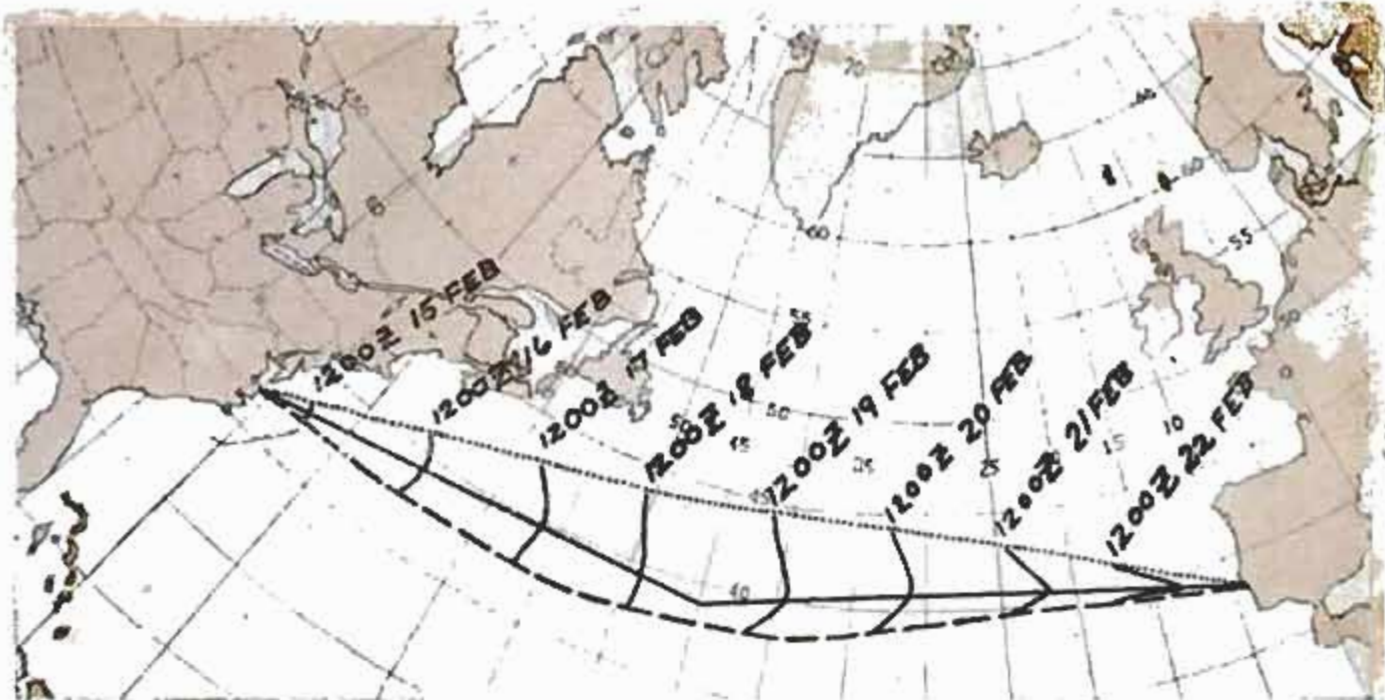

Following the "optimum course" (solid line) recommended by the Navy's new ship-routing service, the USNS *Sgt. Morris Crain* sailed from Norfolk to Lisbon in 192 hours. This was 22 hours shorter than the time required by another vessel on a northerly course (dotted line), where waves over 20 feet high were encountered, and 16 hours faster than a ship on a southerly course (broken line)

the route prediction system could be worked out to a much finer science."

Working from a basement office in the Navy's Hydrographic Office, Suitland, Md., Dr. James and a small staff plotted 450 Military Sea Transportation Service crossings during the winter of 1957-58.

Once the "optimum route" had been plotted to avoid storms, rough seas and high winds, subsequent corrective messages were radioed to the ship, based on new weather and wave forecasts and on regular weather and wave reports sent by merchant ships.

Primary Interest in Wave Conditions

"We weren't interested in the shortest map distance between two points," Dr. James comments. "We were interested primarily in wave conditions—the key factor affecting ship speed and safety."

The first job was to find the most desirable wave conditions for ship passage. Dr. James determined this from a study of ships' logs, in which speed and height of waves were recorded throughout the voyage. Most ships, the study indicated, could maintain close to maximum performance against waves as high as six to eight feet. In that area, performance began to drop off gradually, or sharply, depending on the beam width and other characteristics of ship construction.

The next job was to predict wave heights in excess of what a particular ship could be expected to overcome with ease. The pre-



From an office ashore, the Navy now can route ships better than by the conventional shipboard navigation

diction had to be made in time to plot a crossing or to warn a ship already underway.

Dr. James and his colleagues started with five-day weather forecasts prepared by the U.S. Weather Bureau. Next, synoptic wave charts were prepared by plotting the wave observations reported by merchant vessels, oceanwide. To these charts were added data on currents, ship speed and characteristics of various ship designs. In areas where actual observations were scarce or non-existent, seasonal wave conditions were determined by a study of past weather conditions and known current factors.

(Continued to page 242)



Six Suitcases Fit Into Volkswagen's Fiberglass Roof Trunk

As many as six suitcases fit into a weatherproof enclosure contoured to fit the roof lines of the Volkswagen sedan. Clipped onto the rain gutters and sprayed to match the car paint, the roof-top trunk blends into body lines to minimize wind resistance and

noise. The trunk, made in Germany of lightweight resin-bonded Fiberglas, opens near the rear window and can be locked. Such a trunk provides passenger space in the rear seat that would otherwise be taken up by baggage.



Remotely Controlled Release Trips Shutter A Mile Away

Photographers can work at distances up to a mile away from the camera with a solenoid release, which trips the shutter to photograph wild animals, explosions and other subjects that require the photographer to leave his camera. Built for the 35-mm. camera shown, the unit is adaptable for other cameras as well. A remote signal light is available.

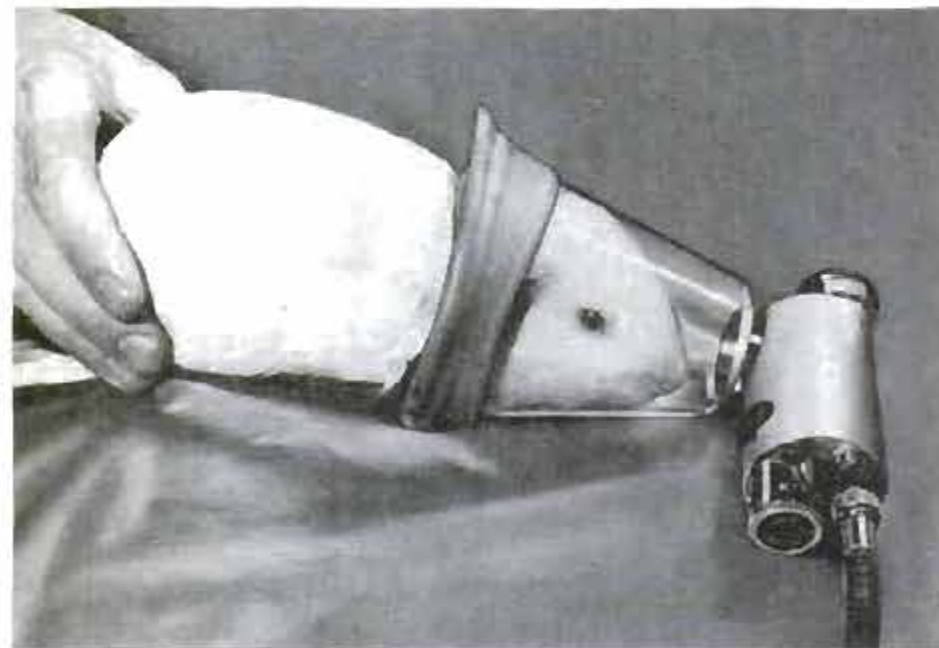

Tiny Resuscitator Provides Oxygen

Only three inches long, the world's smallest resuscitator is the first developed especially to help save the lives of newborn babies that have trouble drawing their first breaths. The resuscitator is so sensitive that it automatically can adjust to lung capacity as small as that of a mouse. It can force life-giving oxygen through an opening the size of a pin-hole.

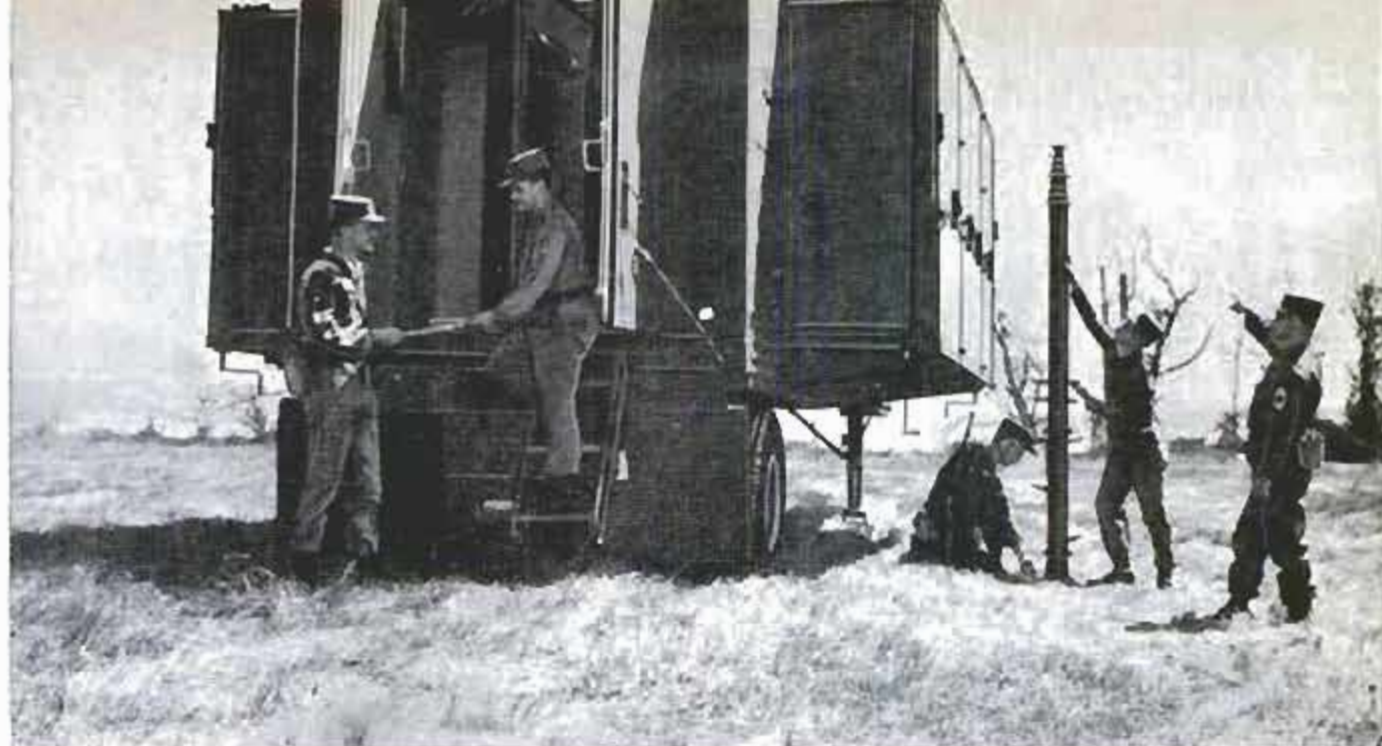

Mobile Communications Unit Has 3000 Mile Range

Geared to the sudden demands of limited wars and brush-fire combat operations, the Army's new Transportable Communications Central, the TSC-16, gives combat commanders a long-range communications capability equal to a large fixed-radio installation in a package that can be assembled, loaded and airborne in 12 hours. On arrival, it can begin limited operations in four hours, and reaches full capacity in two days when its big rhombic antennas are erected. In operation, it provides 16 teletypewriter circuits and two voice channels. Its one to three-thousand-mile range allows it to join the Army's global communications system from anywhere on earth, and allows the field commander to have almost instant contact with his headquarters or Washington. The unit consists of two communications vans, a field power unit, two officers and 46 technicians.



Miniaturized Circuitry For Space-Research Vehicles

Like tiny electronic building blocks, these ceramic stacked modules can be used in any combination to provide miniaturized electronic circuitry for space-research vehicles. They're based on an entirely new concept—instead of trying to get rid of the heat produced by electronic equipment, they confine the heat and use it to operate vacuum devices, taking full advantage of the high frequency and reliability of thermionic electron tubes. They were developed by General Electric.

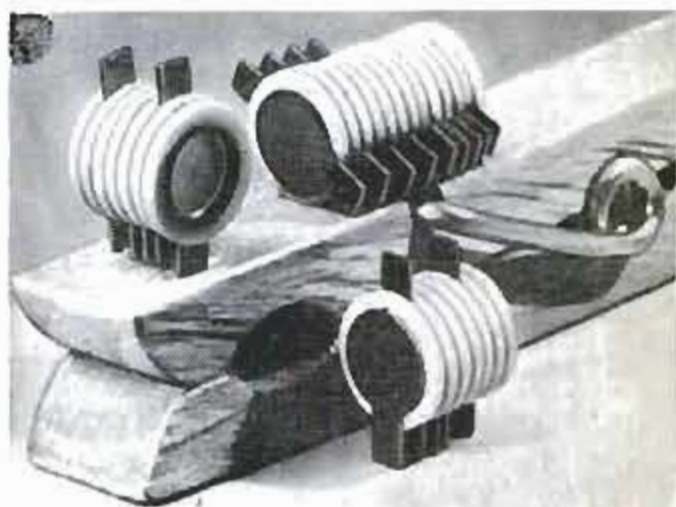

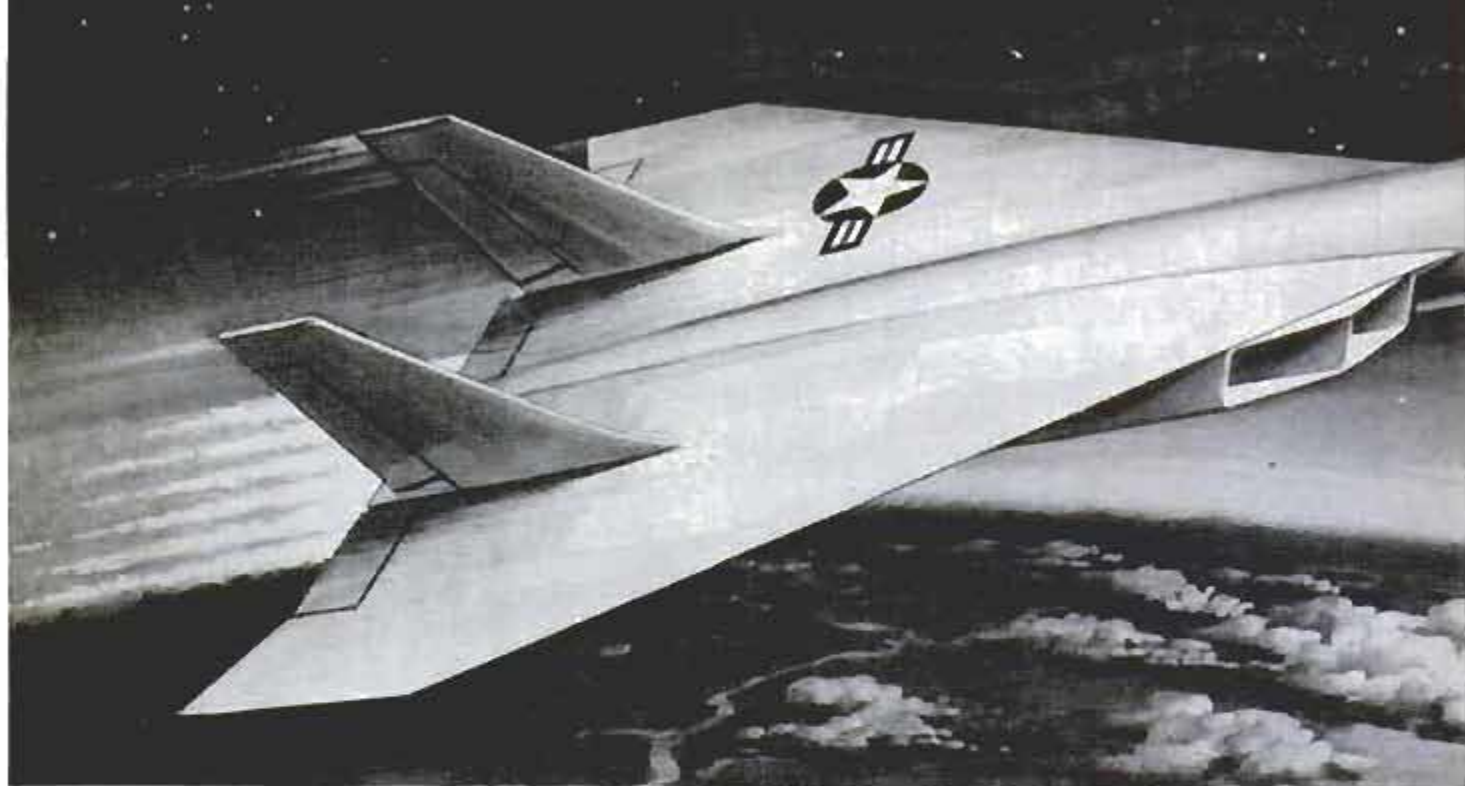

Artist's conception of B-70 Mach 3 bomber; 2000-miles-per-hour passenger planes are based on its design

Ten Years From Now: *Coast to Coast in 90 Minutes*

The jet age is still in diapers, but already our engineers are doodling over paper plans for airliners that will fly at Mach 3—2000 miles an hour or better

By Thomas E. Stimson, Jr.

OUR BRAND NEW jet airliners are much too slow and it's silly to dawdle across the United States in four and a half hours.

That's the opinion of some of the engineers who designed the present jets.

They say that within 10 years we'll be traveling from New York to Los Angeles in 90 minutes, from New York to Paris in a little more than two hours. We'll fly at three times the velocity of sound, a speed that only a few skilled pilots of experimental rocket craft have attained so far.

Propulsive efficiency drops at Mach 1 and climbs to Mach 3. This is why Mach 3 planes appear favorable

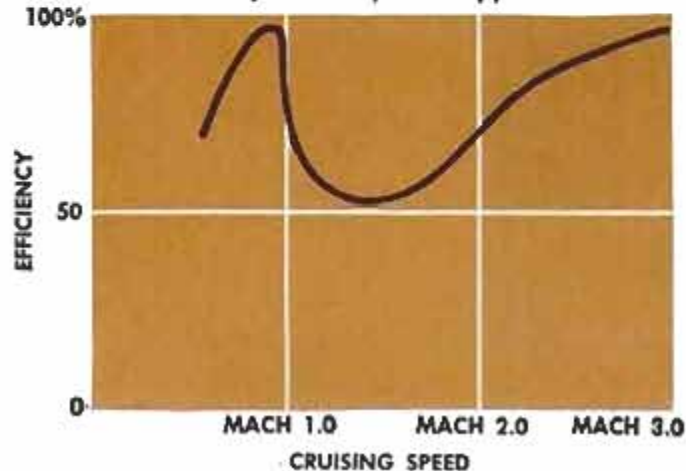

R. C. Sebold, Convair engineering vice president, says that in the 1970s a New York business man will be able to leave home half an hour later if his nine o'clock appointment happens to be on the west coast instead of in Manhattan. Leaving New York at 9:30 a.m., he'll fly faster than the sun and reach Los Angeles at eight a.m., a full hour ahead of his appointment time.

Engineers at Boeing, Douglas, Lockheed, North American Aviation and Convair have been spending hundreds of thousands of dollars in research on the next generation of airliners.

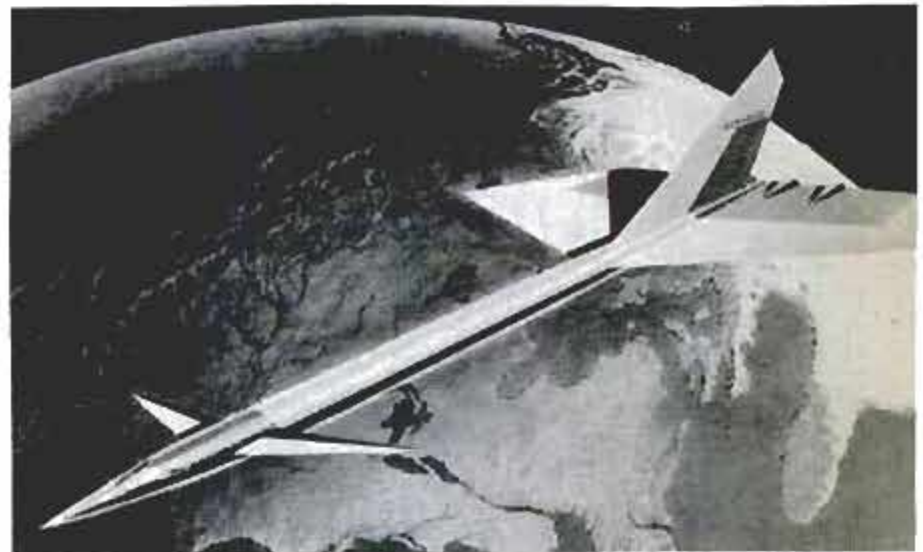
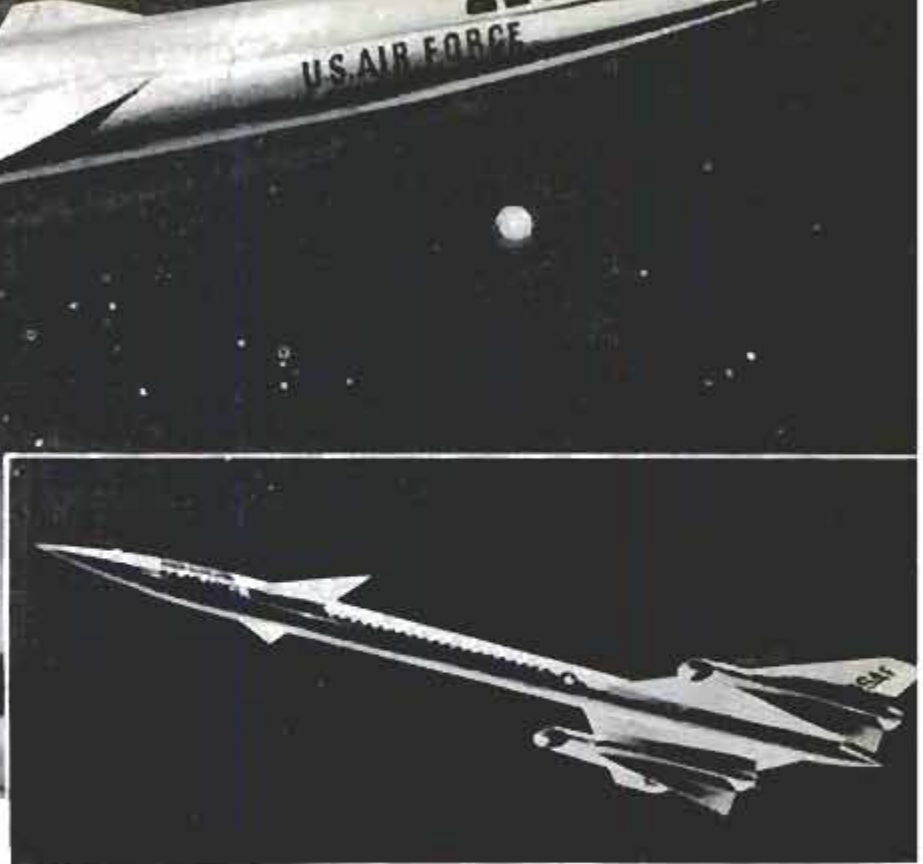
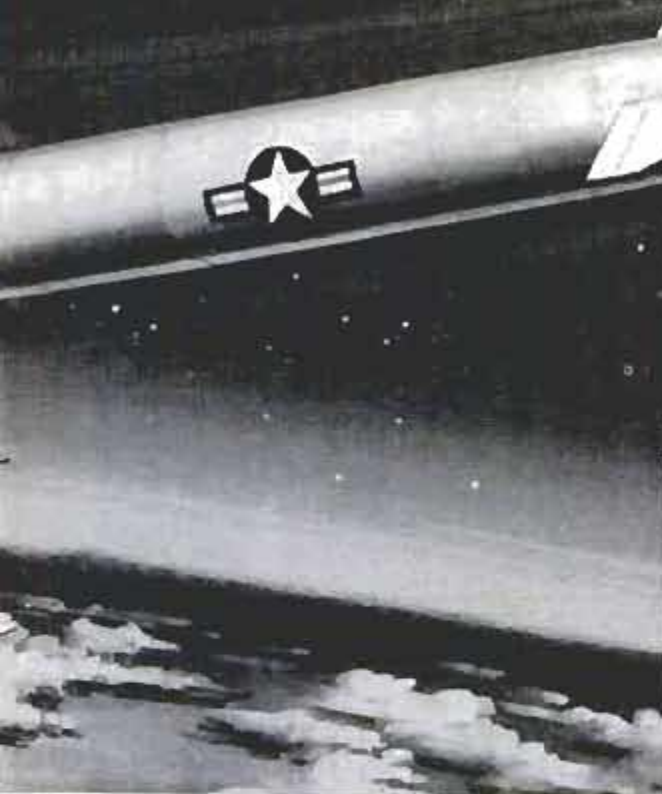

These drawings show varying designs for future 2000-mile-per-hour airliner. From top to bottom are designs of Air Force's Air Research and Development Command, Lockheed, Convair and Rocketdyne Division of North American Aviation. Latter firm would use both rocket and jet power for take-off and climb, and jet power alone for cruise

Hundreds of "paper airplanes" have been painstakingly designed and exhaustively analyzed. Scores of models have been flown in wind tunnels, and numerous mock-ups of structures have been built and studied.

Lumping their conclusions together, here's what the engineers foresee: A 75 to 150-passenger transport having a long slender fuselage with a delta-shaped wing at the rear. Another version calls for a long slender shape almost identical with the airplane that you fold from a piece of paper for throwing across the room. In this case the narrow triangular wing extends along the fuselage almost to the nose. Either shape probably would have drooped wingtips and a small canard airfoil near the nose that will serve as elevators and trim surfaces. The plane will have a range of 3500 miles and will cruise most of the way at 2000 miles per hour, some 14 miles above the earth's surface.

On many trips the plane will be in the air for so short a time that its captain may call for landing instructions at his destination before

OVER-ALL LENGTH: 175 FT.
WING SPAN: 110 FT.

TWO 60,000-LB.-THRUST
ROCKET ENGINES

TWO 30,000-LB.-THRUST
DUCTED TURBOJET
ENGINES

BOUNDARY-LAYER
CONTROL FOR
MANEUVERING

AERODYNAMIC CENTER AT SUPERSONIC SPEEDS

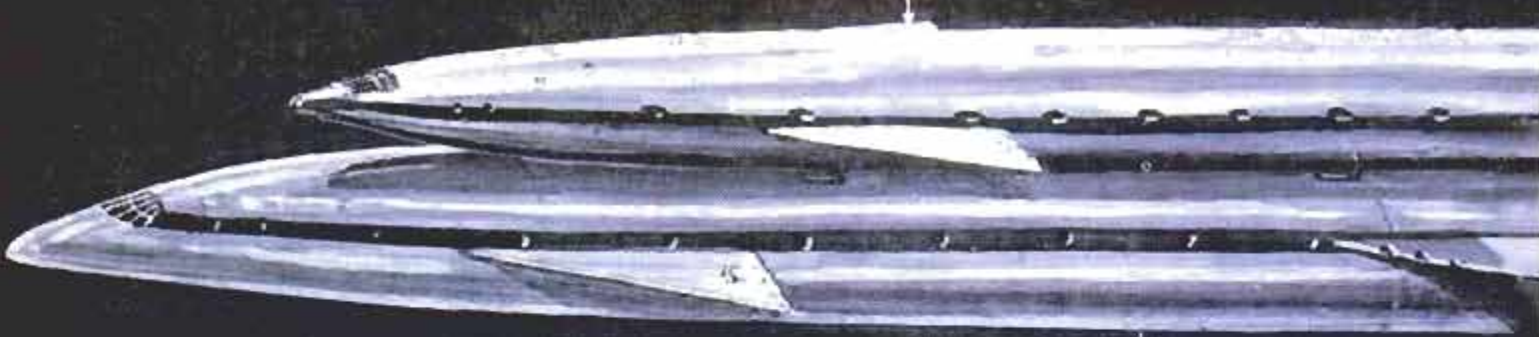

HIGH-ALTITUDE MACH 7 AIRLINER (UPPER COMPONENT) WOULD WEIGH APPROXIMATELY 160,000 POUNDS AND CARRY 100-130 PASSENGERS. IT WOULD BE CARRIED BY LOWER COMPONENT TO ABOUT 90,000 FT. BEFORE RELEASE

RAPID-CLIMB LIFT-AIRCRAFT WOULD WEIGH APPROXIMATELY 240,000 POUNDS

BRITISH SHOOT FOR MACH 7

HEIGHT (FT.)

140,000—
130,000—
120,000—
110,000—
100,000—
90,000—
80,000—
70,000—
60,000—
50,000—
40,000—
30,000—
20,000—
10,000—

OPERATIONAL HEIGHT IS APPROXIMATELY 130,000-140,000 FT.

PASSENGER LINER CLIMBS TO OPERATIONAL HEIGHT

PRESENT-DAY TRANS-ATLANTIC JET AIRLINERS OPERATE AT 28,000-33,000 FT., PISTON-ENGINE AIRLINERS AT ABOUT 20,000-25,000 FT.

TWO PLANES SEPARATE AT 90,000 FT.

PIGGYBACK AIRCRAFT CLIMBS FAST

LIFT-AIRCRAFT TURNS AWAY AFTER RELEASE

BACK AT BASE, LIFT-AIRCRAFT PREPARES TO TRANSPORT ANOTHER PLANE

AFTER LIFT-AIRCRAFT (LOWER COMPONENT) REACHES 90,000 FT., ITS RAMJET ENGINES ARE SWITCHED ON AND, AT SIGNAL FROM CAPTAIN, RELEASE GEAR IS SET IN MOTION AND TWO AIRCRAFT SEPARATE

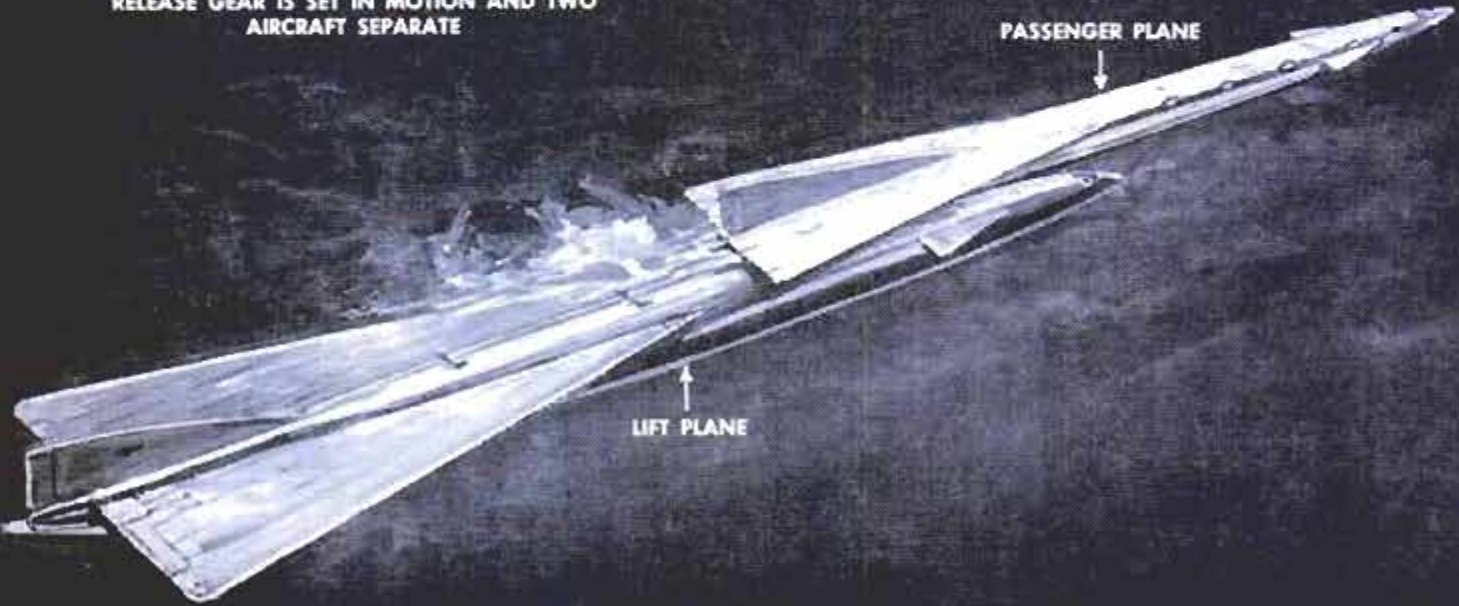

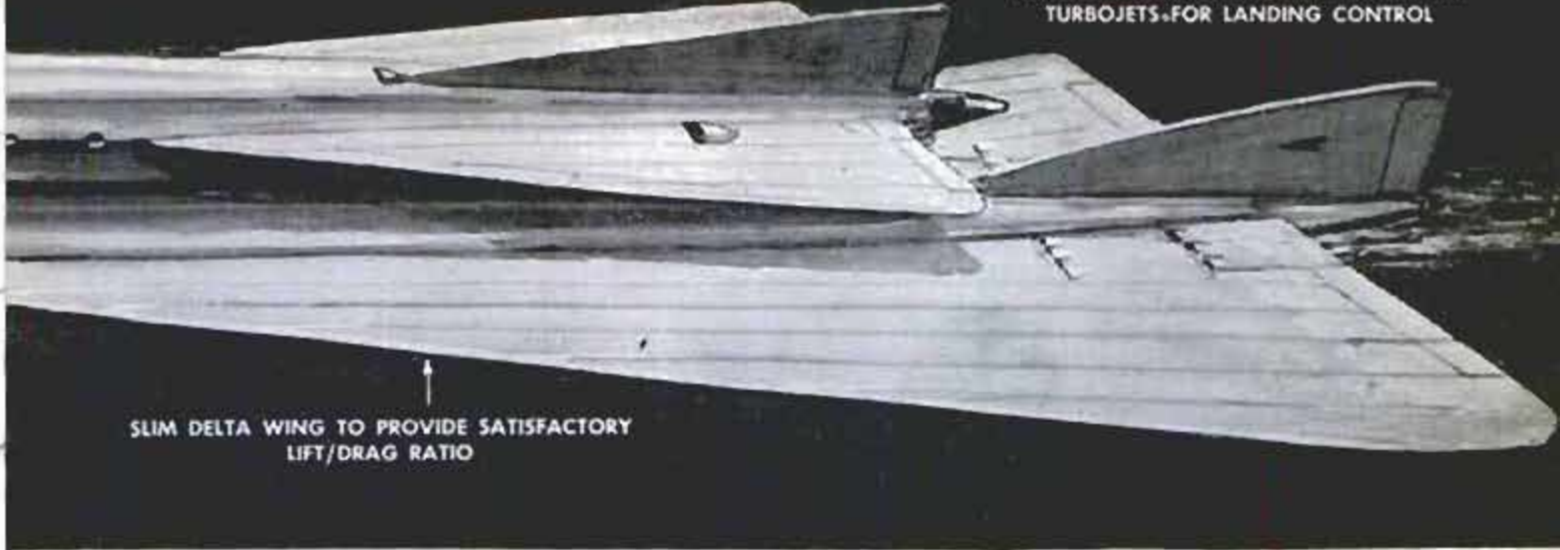

SLIM DELTA WING TO PROVIDE SATISFACTORY LIFT/DRAG RATIO

EXCLUSIVELY FOR *Popular Mechanics*, British artist G. H. Davis created this design of a pickaback airliner based on an idea of Dr. R. R. Jamison, British aeronautical engineer, who envisions a plane that would be capable of Mach 7 speed, or more than 5200 miles per hour. Davis based his conception on existing hypothetical plans for supersonic aircraft.



DESCENT OF MACH 7 AIRLINER WOULD START HUNDREDS OF MILES AWAY SO GLIDE PATH WOULD NOT BE TOO ACUTE, AND SET UP FRICTIONAL HEATING WHEN REACHING AND PASSING THROUGH DENSER ATMOSPHERE

AT LOWER ALTITUDES, AUXILIARY TURBOJET MOTORS WOULD BE USED TO AID LANDING CONTROL

HEIGHT (FT.)	ATMOSPHERIC PRESSURE
130,000	.093 IN. "
120,000	.139 IN. "
110,000	.211 IN. "
	MERCURY
100,000	.326 IN. "
90,000	.51 IN. "
80,000	.82 IN. "
70,000	1.32 IN. "
60,000	2.13 IN. "
50,000	3.45 IN. "
40,000	5.55 IN. "
30,000	8.90 IN. "
20,000	13.78 IN. "
10,000	20.59 IN. "

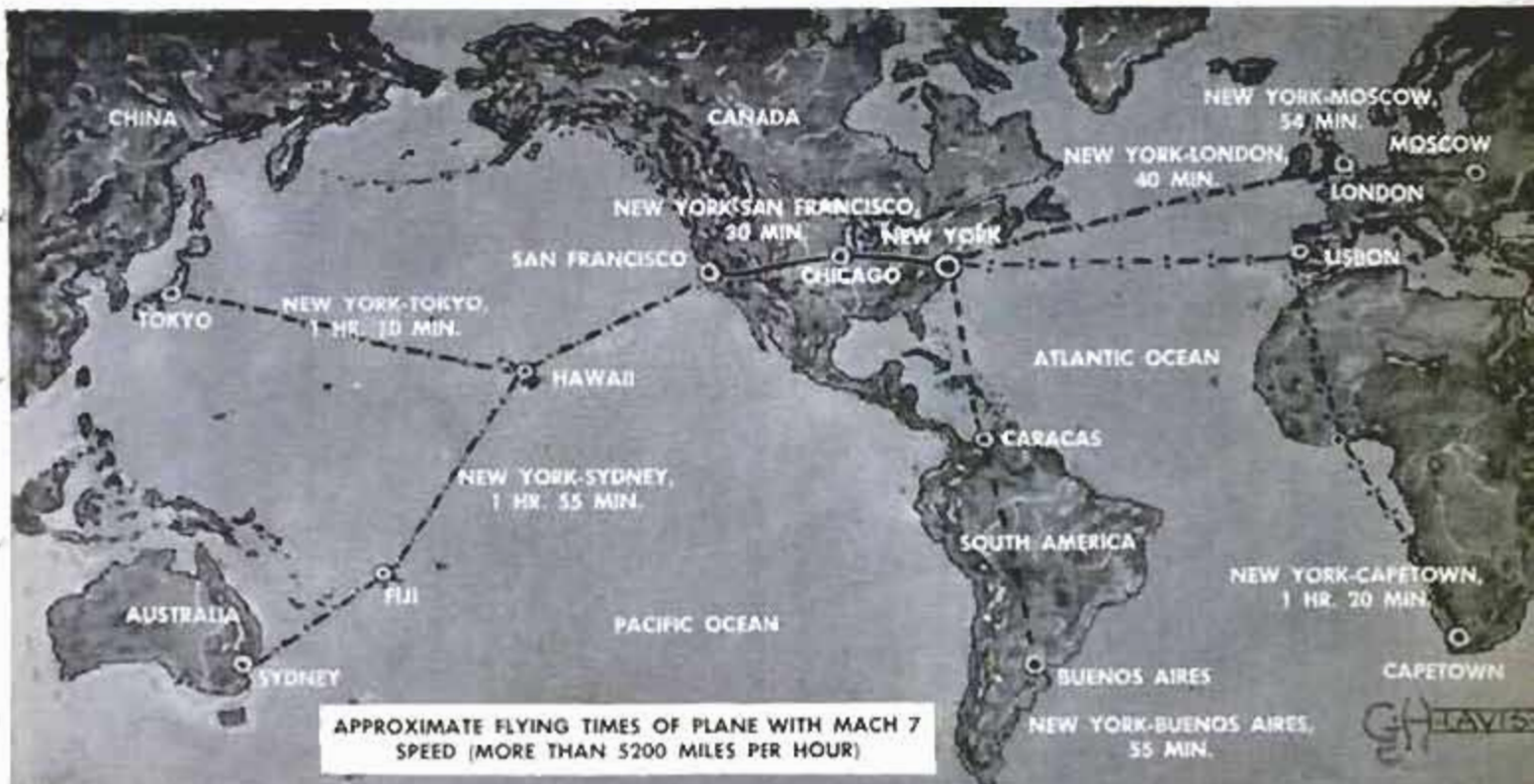

G. H. DAVIS



Turbofan engine on Boeing 707 has wide ducting to let extra air flow around engine. Turbofan, below, shows duct near end

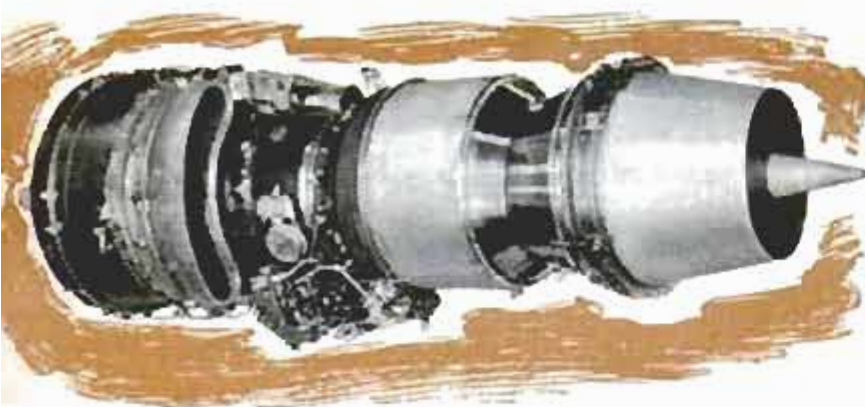

he takes off. And instead of handling the controls it's more likely that the crew will simply monitor the automatic devices that do all or most of the actual flying.

"The pilot may elect to accomplish his climb by pre-programmed tape operating through the autopilot," says M. L. Pennell, chief engineer, Boeing transport division. "Navigational equipment may include digital computers that avoid the necessity of the pilot solving a mathematical problem to arrive at his position, which is changing about 30 miles every minute. All messages to the airplane could be received on the airborne radioteletype. Voice reporting and manual note-taking are impractical at Mach 3 speeds.

"The effect of headwinds is quite small because of the short mission time. From Paris to New York, for instance, a 50 mile per hour headwind would increase the trip time by only three minutes."

Another possibility is an inertial-guidance system in the airliner to control its flight. This type of guidance was developed first for missiles. In an airliner it could be connected to a visual display in the cockpit in the form of a map on which a moving dot of light would constantly show the plane's position.

WING AND BODY ARRANGEMENTS

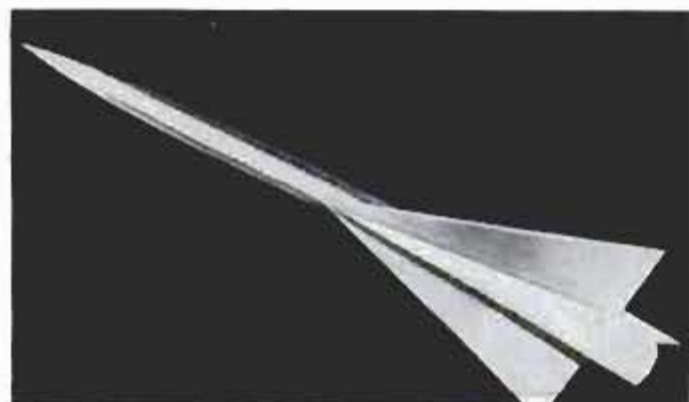
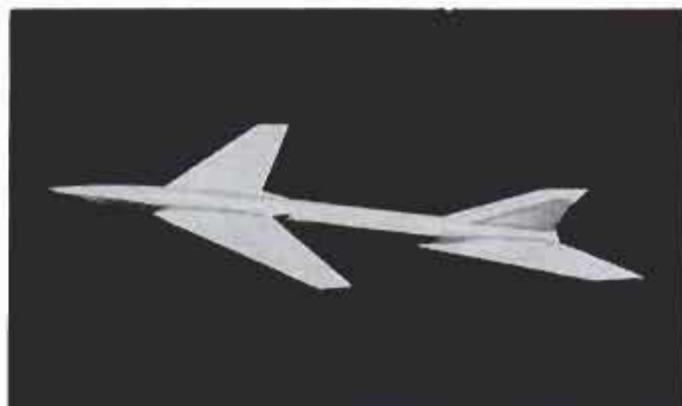

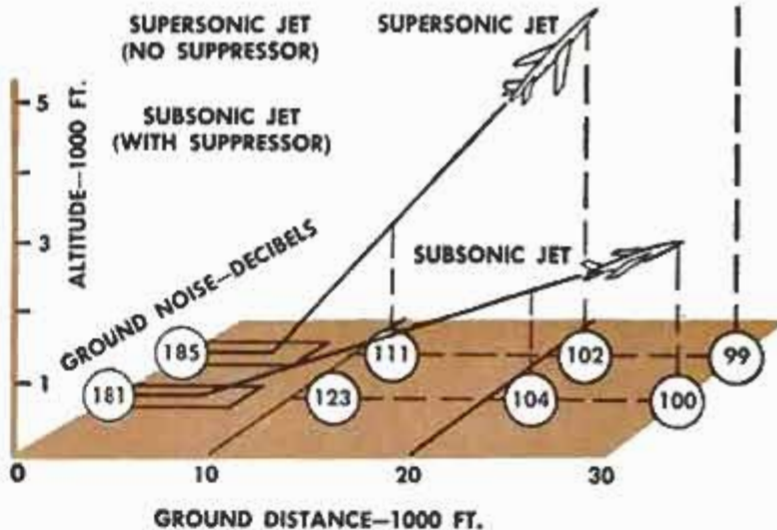
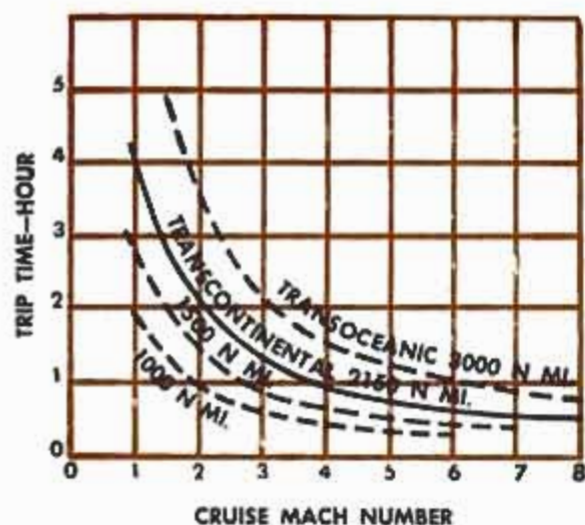

Relating speed to trip time, graph indicates how trip time flattens out beyond Mach 3

Lockheed drawing shows climb paths of supersonic and subsonic jets from airport, also noise in decibels created on ground

Passengers will find little difference between the Mach 3 airliners and the present jets aside from a few novel details. During the climb to altitude they'll prefer to remain in their seats, for the planes will climb at such a steep angle that walking is difficult. And it may be that in place of the windows they'll have flat-plate TV for entertainment. At 70,000 feet they wouldn't be able to see much anyway, and windows are a real headache to structural engineers.

Unless a passenger has a technical background he'll find it hard
(Continued to page 251)

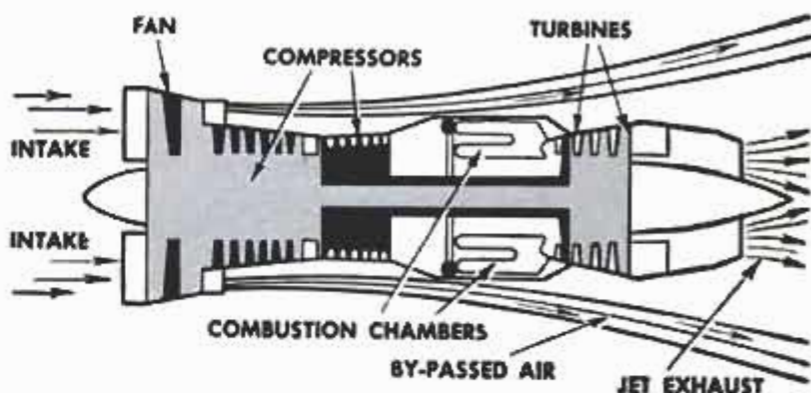

This drawing of Pratt & Whitney's JT3D turbofan engine shows how fan section was added to standard jet engine. The addition betters air performance, boosts power and is economical

POWERPLANT INSTALLATION





Steel fingers strip the entire bean plant onto a conveyor belt; a blower removes the leaves and stems

Twins, 17, Invent Successful Bean Picker

BRUCE AND BERNARD PAULSON, of Clear Lake, Wis., set out in 1957 to design a string bean picker. The odds against them seemed long—the job was considered nearly impossible and the twin brothers were only 15 years old—but they wanted college money.

By Christmas they had produced a promising working model; by early 1958

the first prototype was finished. In July it proved it could do the work of 20 hand pickers. Efficiency was high, the cost low.

The brothers, now 17, have formed Paulson Brothers Industries, Inc., which has shipped 40 pickers all over the country and is working top speed to fill back orders while the twins attend engineering school.

Bruce and Bernard Paulson, left and right, flank their father, Howard, beside a Paulson bean picker



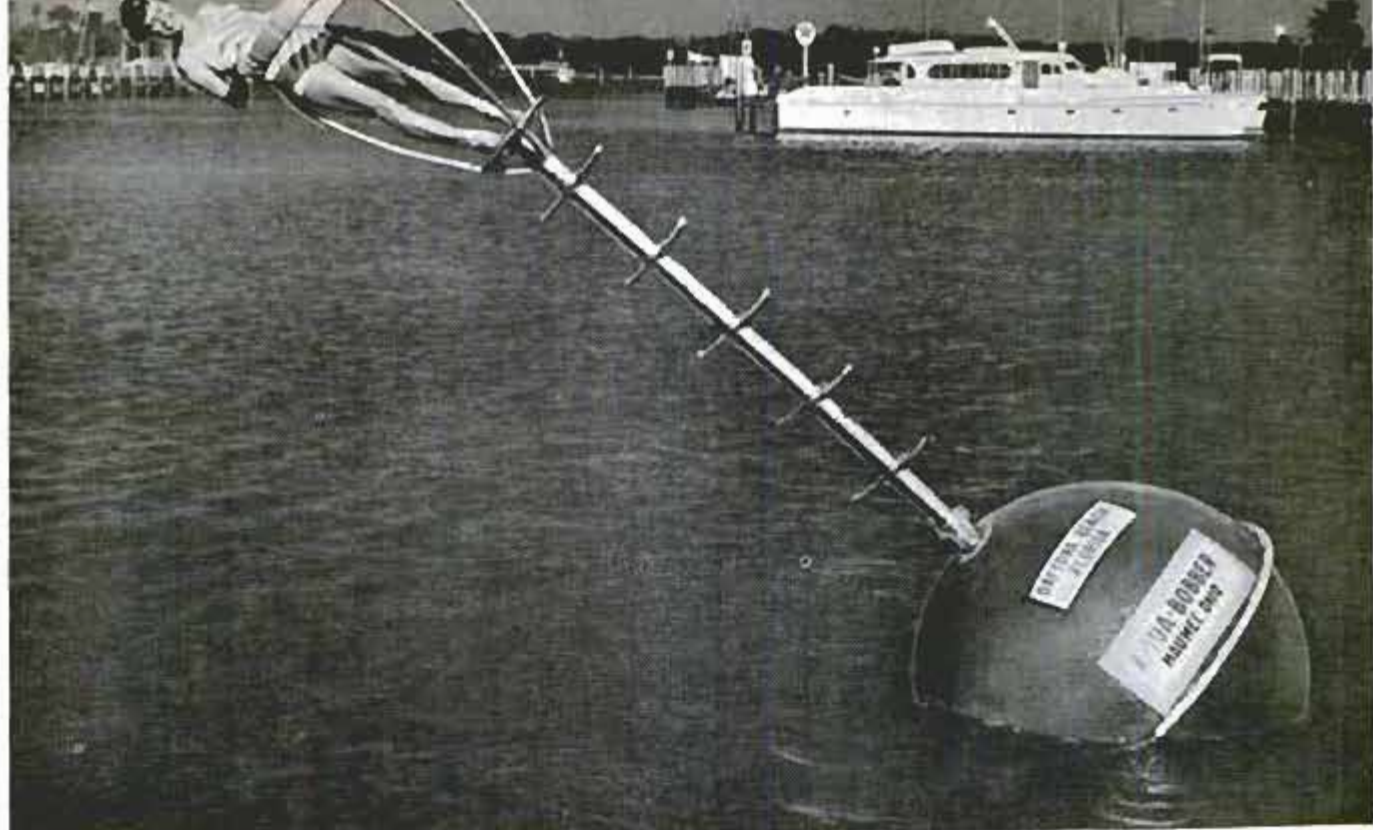

Swinging Crow's Nest Provides Water Thrills

Water frolickers have a new outlet for their energies—the Aqua Bobber. It consists of a crow's nest atop a 14-foot aluminum mast and a floatable sphere made of molded glass fibers. By shifting his weight back and forth in the crow's nest, a person can cause the Aqua Bobber to swing like a pendulum in reverse and even dip him in the water if he wants it to. Inside the sphere are 2200 pounds of concrete.

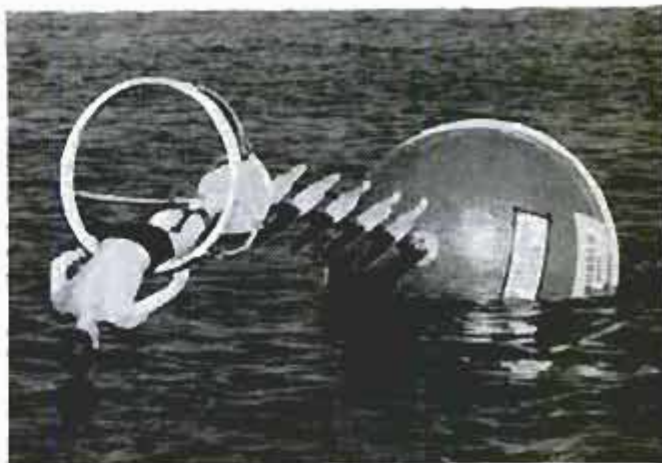

Pilotless Version of B-47 Stratojet Bomber Developed for Air Force

Latest version of the Boeing B-47 Stratojet bomber is the pilotless QB-47. The six-jet drone, developed by Lockheed and Sperry Gyroscope, is capable of 600 miles per hour and is controlled by high-frequency radio signals with a range of about 200 miles. Controls for takeoffs and landings come from a ground station mounted in a truck. Airborne control is maintained from a director aircraft.

quency radio signals with a range of about 200 miles. Controls for takeoffs and landings come from a ground station mounted in a truck. Airborne control is maintained from a director aircraft.





Atomic Plumbing For "Hot" Waste

To carry "hot" atomic waste from the new Atomic Research Establishment at Winfrith Heath, England, this pipe is being used to lay an eight-mile pipeline that will run underground from the research center to a discharge point two miles offshore in the English Channel.

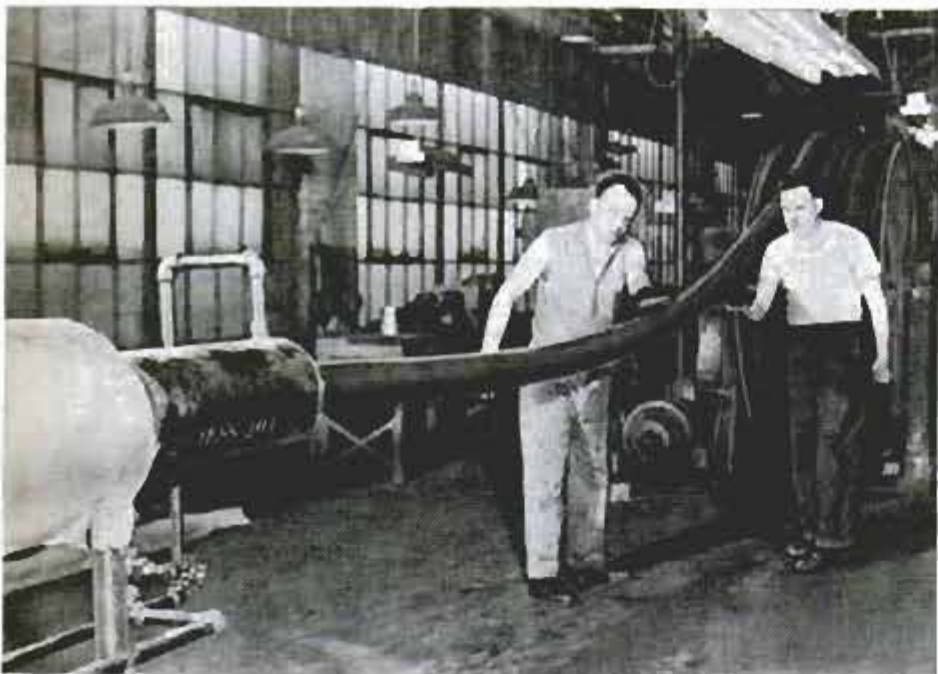

Unspliced Hose In Any Length

Production of rubber hose of unlimited length without splices has been developed by Goodyear Tire and Rubber Co. While previously no hose has been built in unspliced lengths over 100 feet, the new system can turn out nonstop lengths with no splice-weak spots. Hose of two to eight-inch inside diameters can be produced that can handle all known chemicals and fuels.

Electric Garage Heater Warms Car Engine

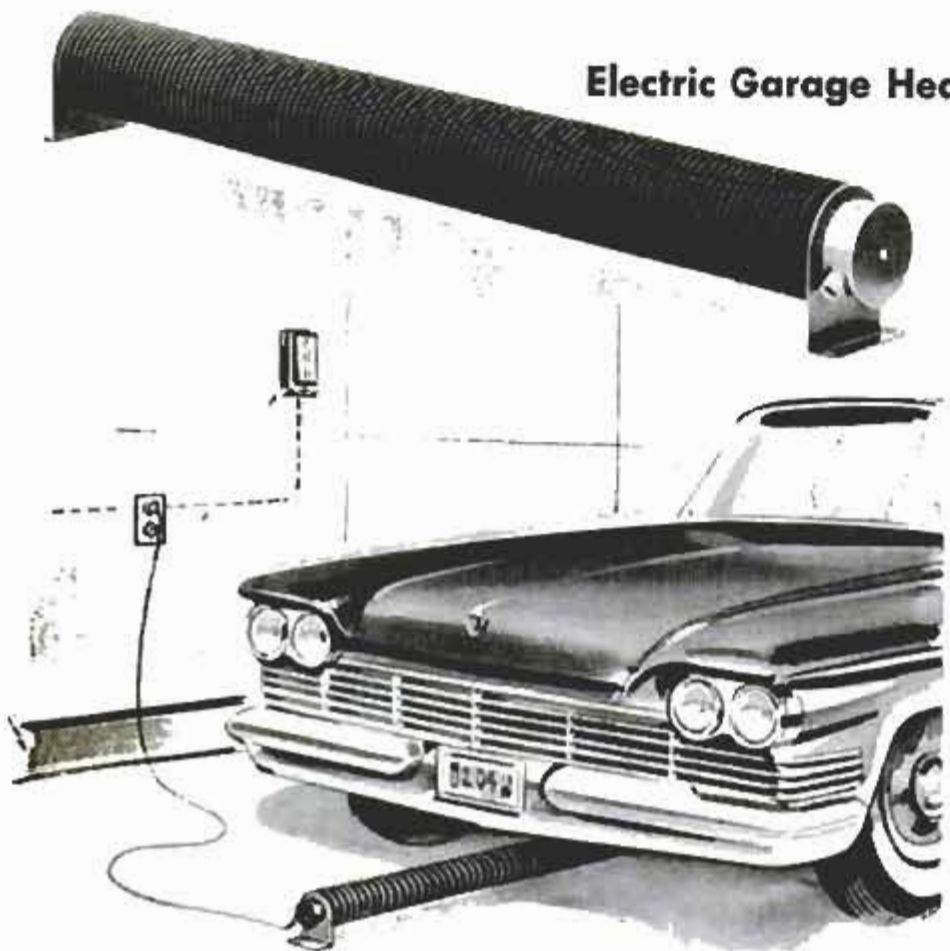

Constant warming of the car engine is assured with a portable electric heater that keeps the engine warm while the automobile is in the garage. The heater, which is 40 inches long, is placed on the floor beneath the engine and radiator. Its large heating area results in a low surface temperature, thus preventing explosion hazards. A garage thermostat can be set at a desired temperature so that heating begins as soon as the temperature drops below the selected level. The heater switches off when that level is again attained. Equipped with a 500-watt element, the heater weighs 26 pounds.



Air Holes in Fins Increase Blimp's Speed and Range

Punching holes in blimps increases their range and speed, according to naval researchers. By placing holes in the fins and along the intersection of the fins with the helium-filled bag, air from the surrounding

layer is sucked in and ejected from the tail to give the ship more push. Scientists expect the holes and other modifications to triple the ship's range and increase its speed by 40 percent.

Transparent Plastic Globe Maps Celestial Movements

Made of transparent plastic, a three-dimensional celestial globe presents a complete and accurate picture of movements of the sun, moon, planets, stars and artificial satellites. With the earth centered inside the globe, all celestial bodies move with its axis. Eighty constellations, including the Milky Way, are described on the globe. The sun, marked by a red ball, can be positioned to obtain times of sunrise and sunset. The sun's highest altitude can be read with an altitude indicator. In addition, the globe, which is 12 inches in diameter, traces the shift of constellations, rising, setting, waxing and waning of the moon, eclipses of the sun and moon, and movements of planets and artificial satellites.



Biggest Boat on the



Nearly two million dollars' worth of sleek brute force, the M/V *United States* is the first of a new class of super-towboats that will move more barge cargo on the Mississippi faster than ever before

BY THE TIME Federal Barge Line's new super-towboat *United States* had completed her first round trip from St. Louis to New Orleans last fall, river boatmen everywhere had agreed that St. Louis Shipbuilding had built "the granddaddy of 'em all"—a towboat powerful enough to handle the biggest barge tows through any Mississippi current. At right, boiling upstream with a "medium-sized" tow a third of a mile long, her wake testifies to the tremendous thrust of her 8500 horsepower—2500 more than any other towboat on the river.

First of a new class of super-towboats, the *United States* is 180 feet long and 58 feet in the beam, and is capable of shoving 40 or more barges from New Orleans to St. Louis in a third less time than any other boat. The payload runs into fantastic tonnages. A single big oil barge will carry over 4000 tons of oil, and a 40-barge tow can involve three million cubic feet of cargo—enough to fill ten 100-car trains.

Maneuvering a load like that around sharp bends and through bridges against the tricky river currents calls not only for immense power but for split-second agility. Each of the *United States*' four big diesels

drives a nine-foot screw inside a venturi shroud that increases its thrust by 25 per cent and aids maneuverability by directing the resultant jet of water into the 10 steering and flanking rudders. The combination of reversible engines, counter-rotating screws and multiple rudders allows the pilot to turn an entire tow in its own length or even move it sideways.

The *United States* and her skipper, Captain Jesse Marks (opposite page, top right), have every modern navigational aid, too—radar, electronic fathometers, and even an automatic pilot. The pilot also has direct control of the engines and constant radio contact with his dispatcher and other boats.

An example of the delicate maneuvering of a tow around a downstream bend is shown on the opposite page. As he enters the bend, the pilot backs his engines, holding the pivot point of the tow stationary, while the current takes the head around the bend. Then he applies full power to keep the tow in the new channel. One error in judgment can ground the tow or ram the bank, tear the tow apart and send the barges drifting downstream alone. And with the capacity of the *United States*, the pilot's responsibility can involve millions.

River

By
Louis M. Reitz

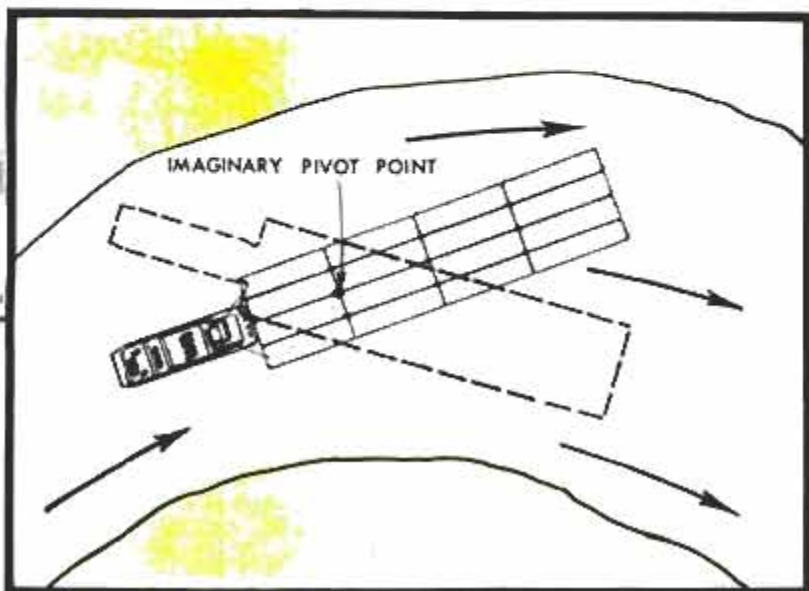

Captain Jesse Marks, above, heads upriver with a 30-barge tow. Though river boatmen stopped towing and started pushing cargoes a hundred years ago, the words "tow" and "towboat" are still used on the river



Bulldozer?

An Elephant Will Do

By Julie Divine

Photos by Tom Dewberry

In a Florida cypress forest, a wintering show elephant named Alice wrestles a stubborn tree trunk loose



HAVE YOU EVER wondered what show elephants do in winter when the midways are silent and the Big Top stored away?

Most of them have a fairly dull time of it, but not Alice, Mona and Marge, three elephants with the James E. Strates Brothers Show. They marched in President Eisenhower's last inaugural parade and have appeared on Ed Sullivan's television show and in several movies. Now, under their trainer, Burt Pettus, they have learned a new profession: land-clearing—not unusual for elephants in other countries but unique in the United States.

These talented elephants winter near Taft, Fla. with the rest of their show. Someone in the show conceived the idea of a small zoo to help support the performers in the winter. A two-acre tract of land was found nearby, but a cypress forest would have to be cleared away without a large capital outlay. Pettus said his three elephants could do the job.

Mona, who was 35 when they started work, and Alice, 32, were easy to train in commands like "Push it down! Push it down! Up, Mona! Alice, trunk! Feet! Feet!" In fact, they often would size up a job for themselves, deciding whether to walk up a tree trunk until it snapped under their great weight, or work together, pushing and pulling until the tree fell.

Baby Marge, only 14 and partially trained, took a more light-hearted attitude and frequently confused the work with a circus performance. She liked to stand about, trunk lifted and one foot raised daintily, while Mona and Alice strained at a stubborn tree. When the tree gave way, Marge would quickly abandon her pose and scamper for safety.

After a few hours' work in the hot Florida sun, Pettus rewards his labor crew with a swim in a cool stream between the cypress forest and a nearby railroad track. There the elephants wallow in the sand, sometimes sliding down the embankment into the water. Once in the water, they roll and blow in one another's ears and generally have such a good time that Pettus has to be quite persuasive to get them to leave. If a



Elephants fell trees in different ways. Marge, right, enwraps, and Mona, center, butts. Alice brings force with her tusk



Above, Mona continues to struggle while the other two elephants look for next challenge. Below, they clear away debris



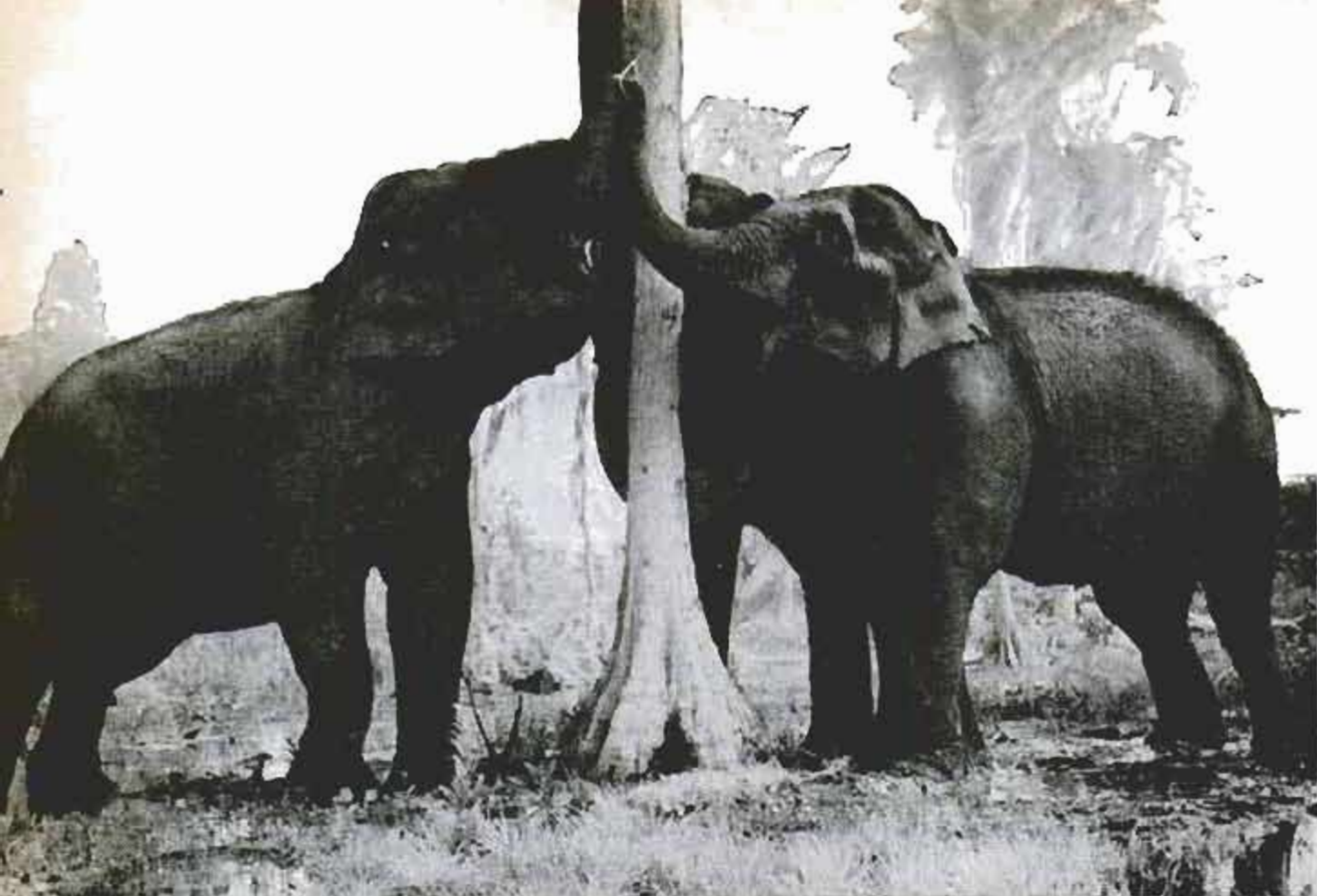

Mona, left, reaches high to exert leverage on a good-size cypress tree while her co-workers try to help

train comes by while the elephants are in the pool, Pettus faces them toward the engine so that they can see it. This keeps them from being frightened by the noise.

After the sand and water bath, Pettus puts Alice, Mona and Marge through a short rehearsal of their regular show routine—just to keep them in practice. ★ ★ ★



Burt Pettus, who has been training elephants ever since 1926, gives Alice, Mona and Marge a change of pace by rehearsing their circus act



The last tree is felled, it's fun time and elephants start sliding down a sand slope for a cool dip in



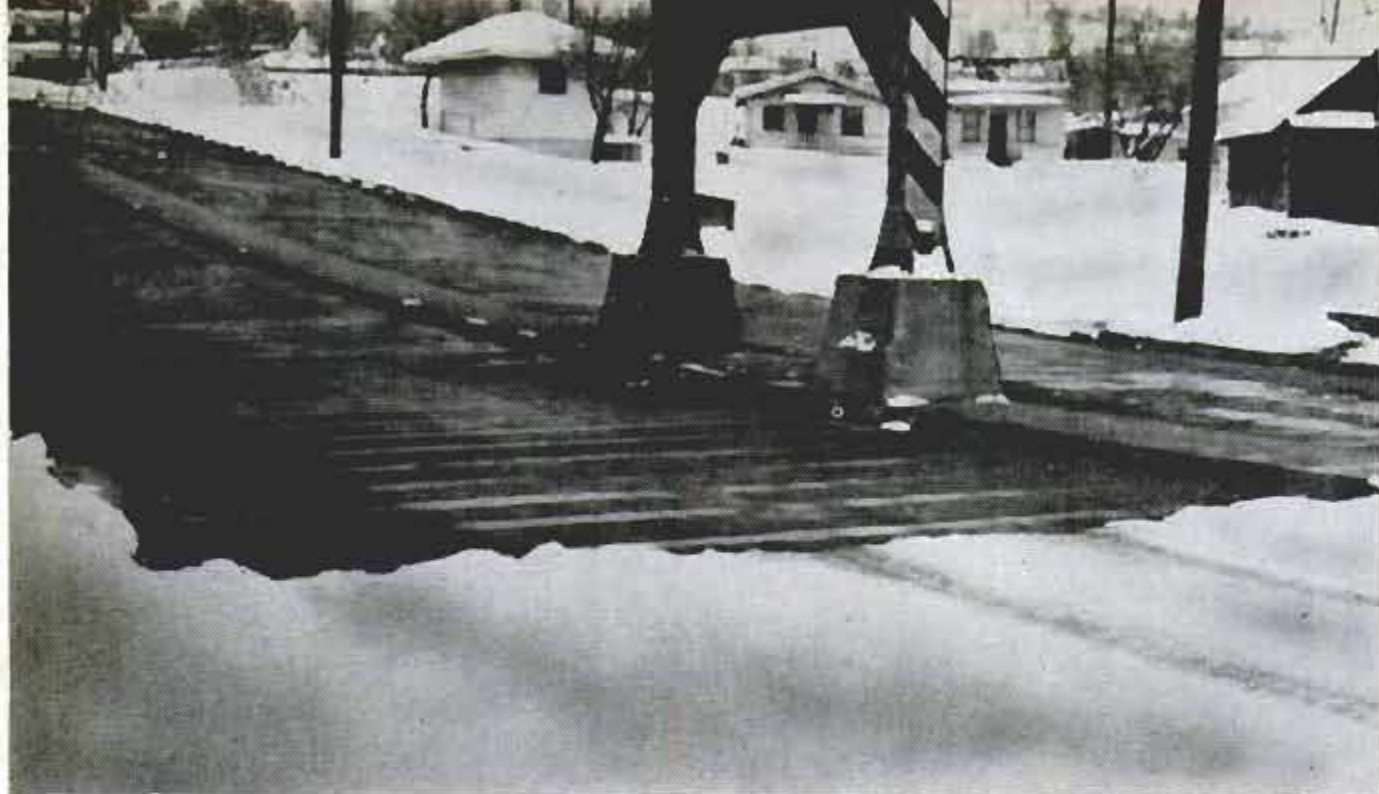

Hot Springs Keep Graded Section of Street De-Iced

ENGINEERS knew the basin formed under a railway bridge by their new road at Klamath Falls, Ore., would become a snow trap and skating rink, so they tapped a hot spring 425 feet beneath the surface. Since the sulphurous water would corrode

pipes, a heat-exchanger deep in the well transfers most of the mineral water's 180-degree warmth to pure water, which circulates through the street's concrete slabs in a network of pipes. Water enters at 130 degrees, drops to 65 degrees afterward.

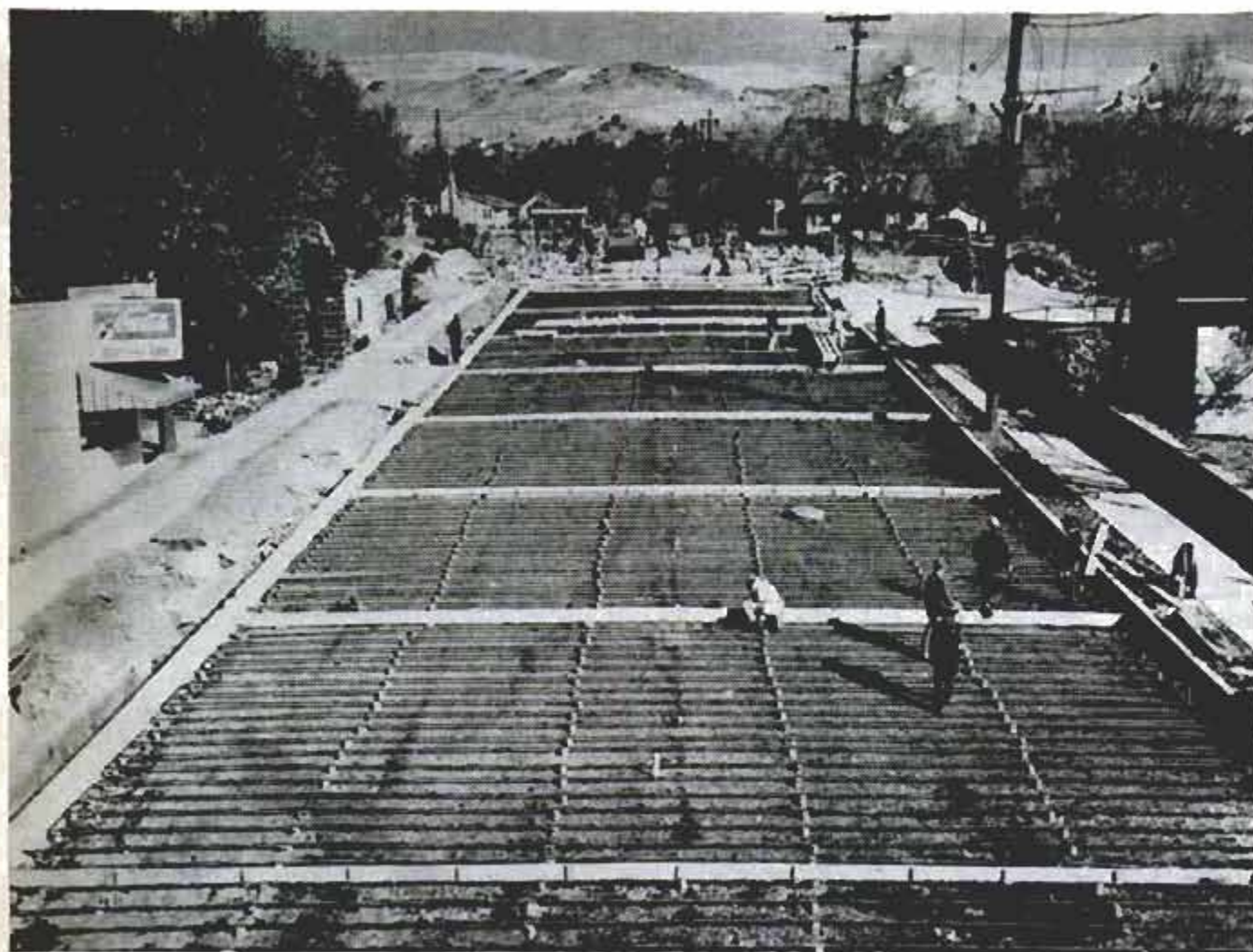



Lens for Still Cameras Zooms for Close-ups

Owners of single-lens-reflex 35-mm. cameras can now bring photographic subjects as close as desired while standing in one place by using an all-purpose lens that zooms in or out on any scene. By merely turning the ring adjustment, you can photograph a subject in any size wanted, just as a television camera does. Wide-angle effects are also possible with the lens. Three variations adapt the unit to most every single-lens-reflex camera on the market. Filter attachments and adapter will be available. There are 14 elements to the lens, which has a maximum aperture of f:2.8. Price: about \$300.



Altimeter Gives Readings On Tape Instead of Dial

In a new altimeter developed by Bulova Watch Company, altitude readings are shown on a continuous logarithmic tape instead of on a dial. Said to cut reading time in half and virtually eliminate reading errors, the instrument indicates altitude with an error of less than 10 feet at sea level. Raising or lowering the altimeter by hand as little as two feet gives a visible indication on the scale when one is at or near sea level. The tape, about 40 feet long, ranges from minus 1000 feet to plus 65,000 feet and is driven by a servomotor. It is read through a window. The altimeter's sensing elements are aneroid capsules, their output is transferred to the indicating mechanism electrically.





COMPLETE PICTURE SHOWS WOMAN ON THE MINIATURE SET—REDUCED TO SCALE

FULL-SCALE SET USED BY ACTORS



MIXING MONITOR IN CONTROL ROOM GETS BOTH PICTURES, SUPERIMPOSES ONE ON THE OTHER

TV's Tiny Spectaculars

Combined images of singer, right, and miniature setting, center, produce picture on set in foreground

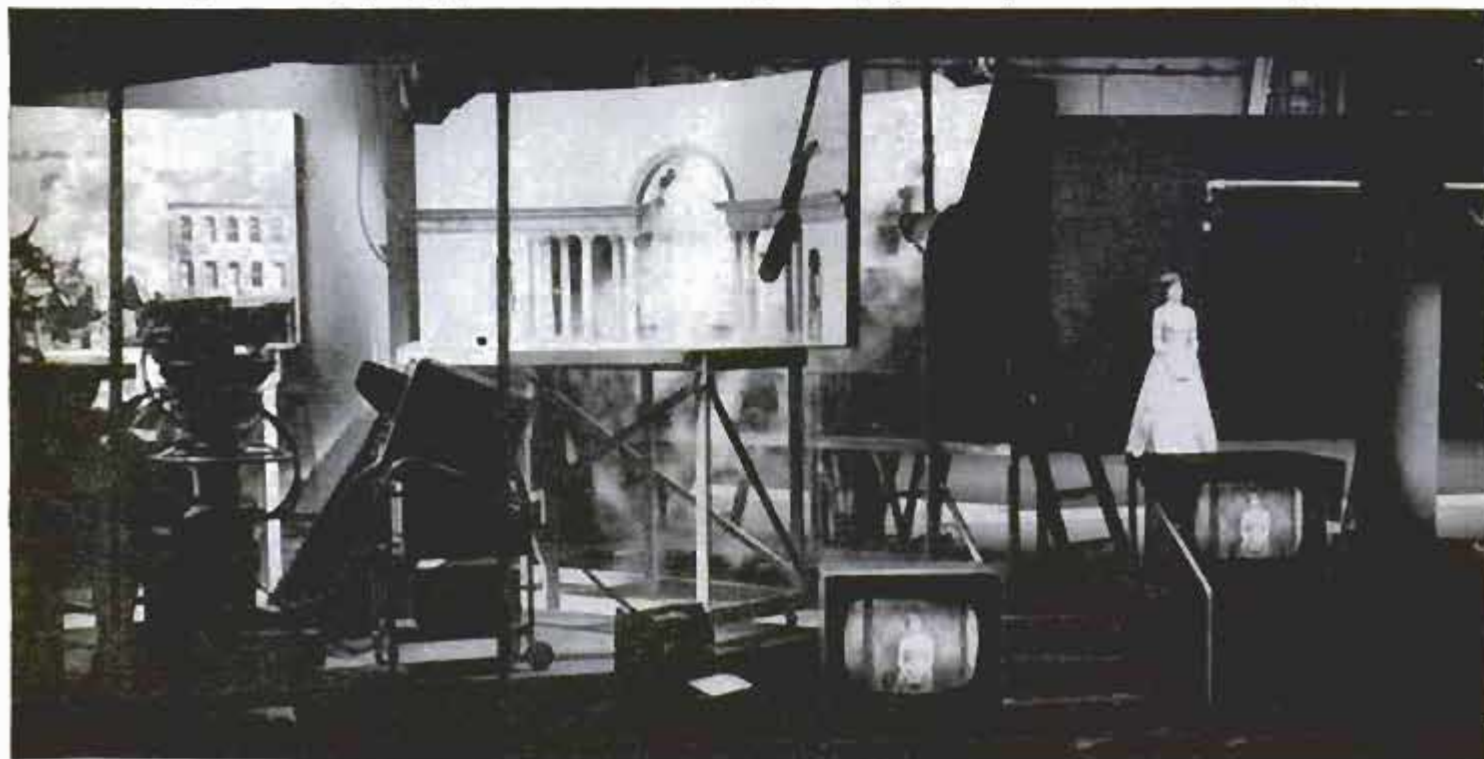

MASTER CAMERA, WITH OPERATOR, IS FOCUSED ON FULL-SCALE WOMAN ON STAGE. STAGE HAS REFLECTIVE BACKGROUND, WHICH BLACKS OUT IN THE PICTURE

SET TO 1/8 SCALE



SERVO LINK—AS MASTER CAMERA PANS, TILTS OR ZOOMS, SATELLITE CAMERA FOLLOWS ITS EVERY MOVE ON MINIATURE SET, REQUIRES NO OPERATOR

SATELLITE CAMERA FOCUSED ON MINIATURE SET FEEDS PICTURE TO MIXER

WALK INTO the carpentry shops of CBS Television these days, and you'll have the distinct impression that the carpenters are busy indulging a personal hobby on company time. You'll see skilled men industriously building precise scale models of houses, streets, mountains and broad vistas of wide open spaces. The detailed perfection of their craftsmanship would raise the envy of any model railroader. Intricate scrolls cap Doric columns on an elaborate Grecian colonnade two feet high. Fragile, postage-stamp-size shakes are tacked to the sides of a desert ranch house in a miniature ghost town. Six-inch windows have real glass panes set

in hairline mullions. Delicate paper cherry blossoms on a 12-inch-high tree grace a Japanese garden in an Oriental village about six feet square.

The highly detailed models, built to one-sixth life-size scale, are nobody's hobby, however. They are actual sets on which live actors will perform—in perfect scale. The people will be shrunk to set size by a new piece of electronic trickery that will enable telecasters to bring the whole outdoors into even the smallest studios quickly and economically.

"For years the TV camera has been frustrated by the confines of the studio," explains Carlton Winckler, director of pro-

Right, miniature sets take as much time to build and cost as much as full-scale sets, but let great panoramic backgrounds be used in a small TV studio

Video scene of a live dancer superimposed over a background picture of two-foot Grecian columns illustrates realism that can be achieved by this method





Giants and lilliputians are no problem with miniature sets—an actor on the tiny set looks huge, or one televised by the satellite camera can be superimposed on a full-sized scene for many unique special effects

duction operations at CBS. "When a script called for a 'cowboy and Indian chase' across the desert, it either had to be done at great expense on location or be killed since we couldn't provide proper studio background. One Western we produced took up all of our studio stages for several days. Street scenes are a continual headache because you can't control passers-by on location, and no TV studio is big enough to build a whole city street—even if we could afford it."

Now with the tiny sets, created by Winckler and his production manager, Paul Wittlig, live actors can be superimposed on a nearly limitless variety of scenes, all packed into the confines of even

a small studio. This unique system, called "VideoScene," uses a missile-tracking technique applied through a servo mechanism, which links two cameras and synchronizes their movements. While a master camera, operated by a cameraman, focuses on a completely blank full-scale stage on which the actors really move and perform, a "satellite" camera in another part of the studio covers the miniature sets, following every movement of the master camera automatically via the servo link. In the control booth an engineer, sitting at a console studded with buttons, mixes the two pictures into a single composite, which goes out over the air to your

(Continued to page 252)

Workman prepares a miniature old-West street scene. Most of the models are built one-sixth life size

Finishing touches go in place on a Japanese garden, complete to the blossoms on a 12-inch cherry tree





Mobile Cargo Stand Speeds Aircraft Loading

Preloaded pallets of cargo can be rolled quickly into transport aircraft with this new English loading stand and a simple adaptation of a flatbed truck. Built on five sets of rollers, the preloaded pallet is mounted on matching rails on the truck, then driven to the waiting plane. The mobile stand bridges the gap, and since the rails fit the seat studs that are standard on all planes, the cargo can be rolled in easily by one man. The system is said to cut loading time to a fraction of that for other methods.

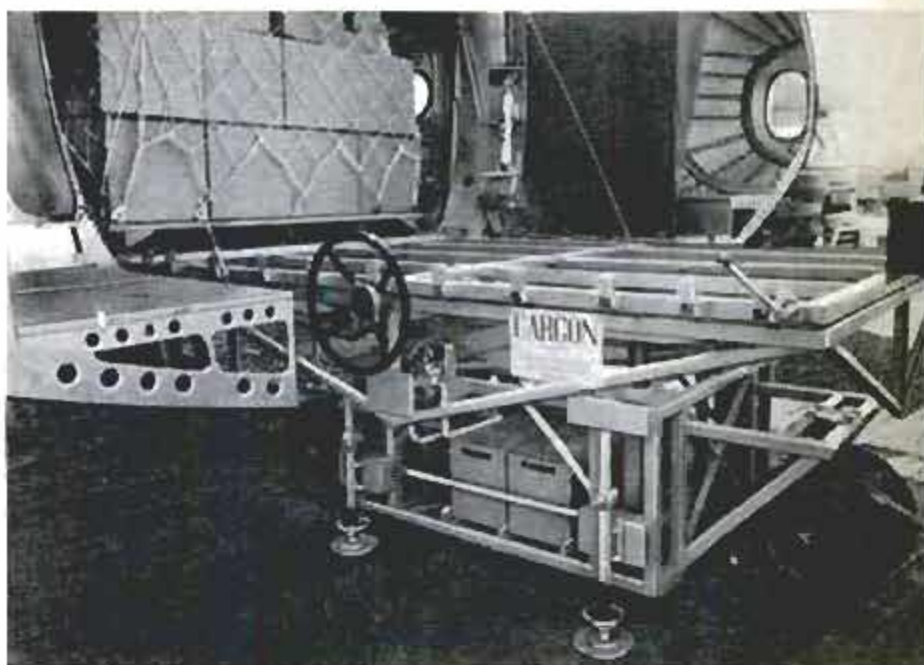

Antiaircraft Missile For British Army

Powered by a rocket engine, the Thunderbird is the first British-designed and British-produced missile to be employed by the British army. It will see service as a special anti-aircraft weapon. At the present time, the missile is being used by British soldiers in training at the School of Antiaircraft Artillery at Manorbier, South Wales.



A Scientist Blows Square Bubbles

—and from his research appears a promising new method of exploring the earth's crust

By Thomas E. Stimson, Jr.

A SCIENTIST who blows square bubbles when he wishes, and who can burst a tiny rubber balloon with the explosive effect of a couple of pounds of TNT, has devised a new way of looking into the earth.

His "subsurrex," or subsurface explorer, uses beams of sound to draw profile pictures of underground strata with a clarity and detail not even approached by older seismic methods. With modifications the apparatus can show the location of underground water and even follow the course of mineralized veins.

The new method of exploring the earth's crust was developed by Louis R. Padberg, Jr., a specialist in anti-submarine warfare at the Navy Electronics Laboratory in San Diego. Portions of his invention are so closely allied to advanced echo-ranging techniques that the patents he holds were held up for several years until parts of the information could be declassified.

Ordinarily in geophysical prospecting, an explosive charge is detonated at the surface, creating vibrations that travel through the earth. Some of this wave energy bounces off underground strata, including faults and anti-clines, and is reflected back up to the surface where it is recorded. Among other uses, these seismograms pro-

vide information that helps locate structures where petroleum might be found.

Lou Padberg uses short bursts of high intensity sound instead of seismic waves, eliminating all the hazard and much of the expense of earlier methods, and obtaining results that are easier to interpret. He creates his sound under water, in some cases by exploding momentary cavities in the water. His methods already are in use by several oil-exploration companies.

To demonstrate one of his techniques, Padberg takes his visitor into an unclassified portion of the laboratory where a large tank of water rests on the floor. He lowers a pair of electrodes into the tank, then presses a firing button. WHAM! There's an explosion in the tank and the floor of the room vibrates from the concussion. Several hundred thousand watts of electric power, discharging between the electrodes for a tiny fraction of a second, had created a cavity or bubble in the water, and it was the explosive creation of the bubble and its implosion that produced the sound wave.

To demonstrate another method of producing high-intensity sound under water, he attaches a small, thick-walled balloon to a CO-2 cartridge and lowers the mechanism into the tank. "Stand back," he directs you,

High-speed photos, made at rate of 3000 pictures per second, show detonation of underwater sound bomb

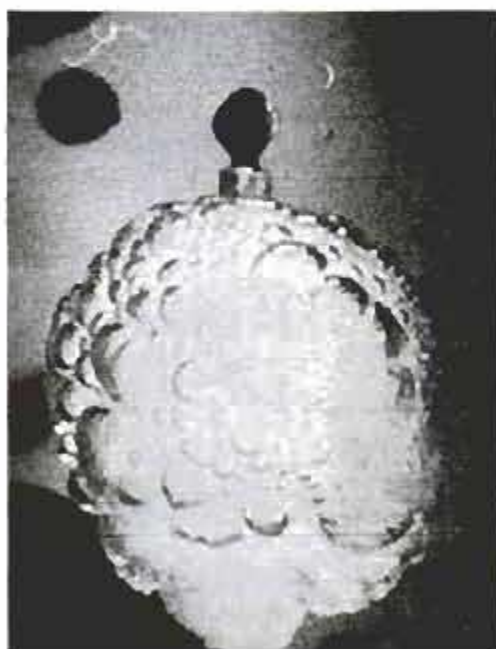

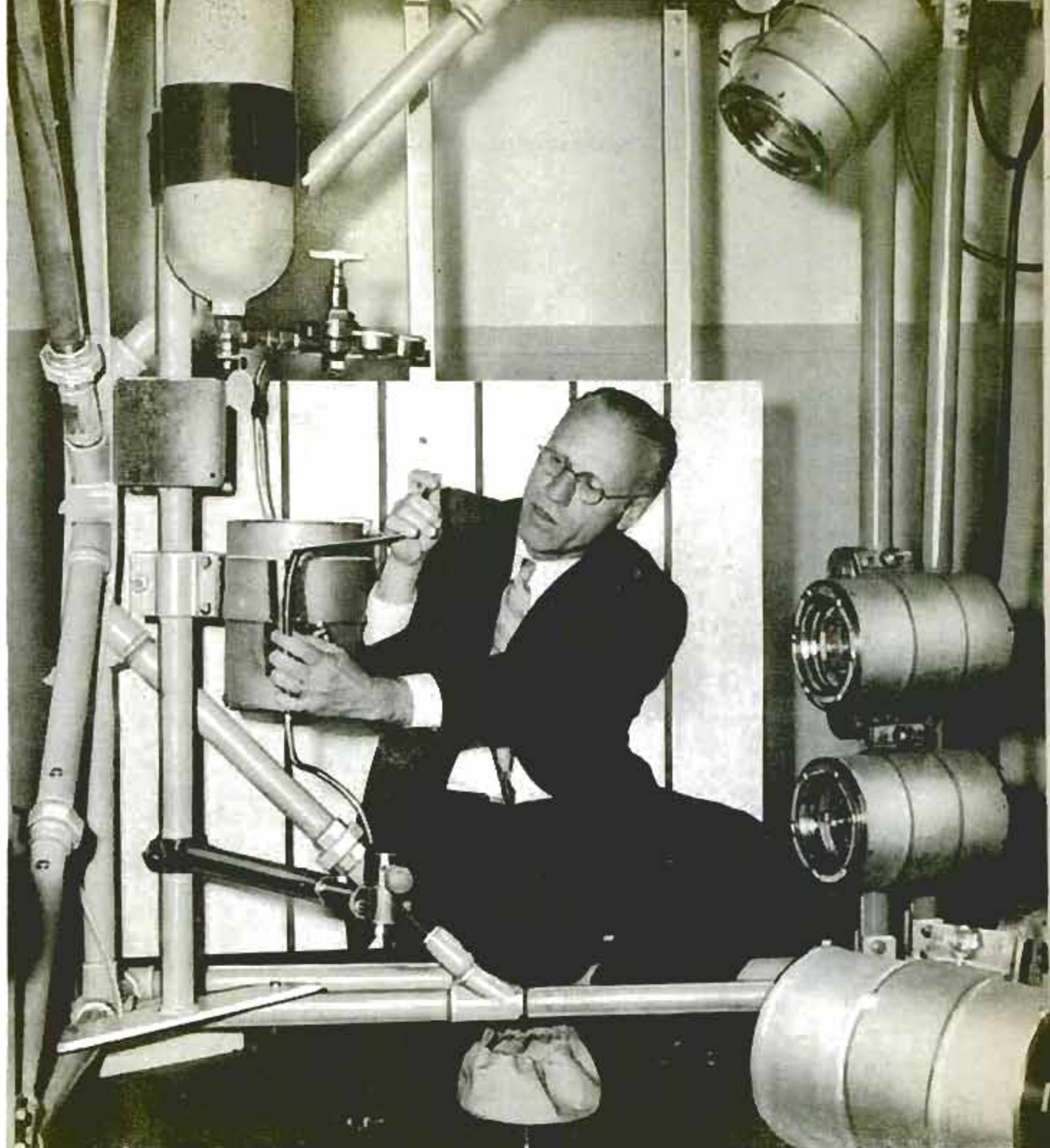

Metal cage used in studies of explosions includes high-intensity lamps to permit high-speed photography

"the balloon is going to blow water all over the ceiling."

He yanks the cord that discharges the CO-2 gas into the balloon and again there's a sharp explosion. The 1200-pound water tank jumps off the floor and water splashes all over the room.

You begin to think that a larger balloon would make a very good depth charge and you mention this.

"There are several interesting military possibilities," Padberg answers, "but I can't talk about them. What I can discuss is the usefulness of this pneumatic sound source

in geophysical prospecting. It happens that the balloon produces sound of very low frequency. The noise you heard had a frequency of about 35 cycles per second, and it's possible to produce a sound having a frequency of only one cycle. The frequency is controllable and increases with the depth at which the explosion occurs.

"An amazing thing is that the balloon and the CO-2 cartridge, weighing about a pound, develops a greater pressure than does another type of low-frequency sound source that weighs seven tons.

"This underwater sound bomb concen-



Sound bomb consists of rubber balloon plus gas cartridge. Inflated under water, it has explosive power of TNT



Louis Padberg inspects spark gap he places in 1200-pound water tank to make underwater sparks

trates all its energy at a single frequency, while an ordinary chemical explosion creates sound at almost all frequencies. You have to filter out the frequencies you don't want and so most of the energy is wasted."

It takes ultra high-speed photography to show what happens when the balloon blows up under water, for the entire action occurs in only a few thousandths of a second. Pictures made through a thick glass port of Padberg's laboratory tank, of a balloon two feet below the surface, show that the balloon grows from its original one-inch diameter to six inches. Then the membrane ruptures and a large bubble is created, squeezing the surrounding water with tremendous force. Almost immediately the water pressure causes the bubble to oscillate and then collapse, generating another pressure wave.

Still another way in which Lou Padberg

Conical reflectors in Padberg's backyard swimming pool were used in early studies of spark explosions

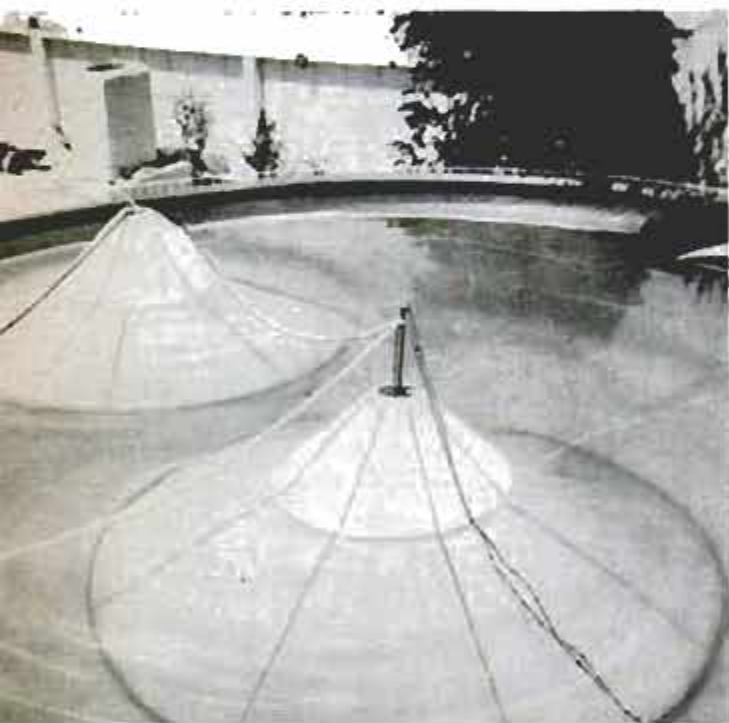

creates underwater sound is with a transducer, a magnetostriction device that contains thin laminations of nickel. These expand and contract, creating sound waves of a desired frequency.

What about the square bubbles that Padberg produces? "In some of our underwater spark experiments," he explains, "we mounted the electrodes on bracket arms so that we could very accurately adjust the width of the gap. The arms of the bracket were parallel. When the underwater spark occurred, creating the bubble, the bracket arms restricted its shape. Instead of a sphere the bubble was essentially a cube, with square sides. This can be seen only by means of high speed photography."

Used Backyard Swimming Pool

Some of Padberg's first studies with underwater sound were done in his backyard, in a large plastic swimming pool. To project the sound downward into the earth he used a large conical reflector to concentrate the energy into a beam 15 degrees in diameter. A similar reflector was used to receive and concentrate the sound waves that bounced back from underground strata. In other studies parabolic reflectors were used.

To create a picture that shows, pictorially, a cross section of the ocean and the earth below it, Padberg installs either an underwater spark apparatus or a magnetostriction device on board ship, then steams ahead in a straight line at six knots, meanwhile transmitting short pulses of high powered sound vertically into the ocean.

The echoes that are reflected back up to the ship not only show the depth of the water but give an indication of the composition of the bottom and also show the stratification of the earth's crust below the

(Continued to page 236)



Hinged Tail on Transport Planes Speeds Cargo Loading

Bulky freight loads easily into two swing-tail cargo transport planes being built by General Dynamics Corporation for military and commercial use. The 635-

mile-per-hour Convair "600" turbojet and the 400-mile-per-hour Canadair turboprop retain a straight-tube fuselage; the hinged aft section allows easy rear entry.

Peer Into Missile Model

Engineers can study the component parts of a full-scale model ballistic re-entry vehicle through its transparent skin. Most of the visible equipment is part of the telemetry and re-entry stabilization systems. The model was built for the Air Force.

Revolving Seat Aids Barber

Riding a revolving saddle, an arthritis-afflicted English barber moves around his customers with ease. The specially designed "scooter saddle," which glides on two wheels, is attached to the barber chair with a wood and metal swivel and follows a circular path around the chair.

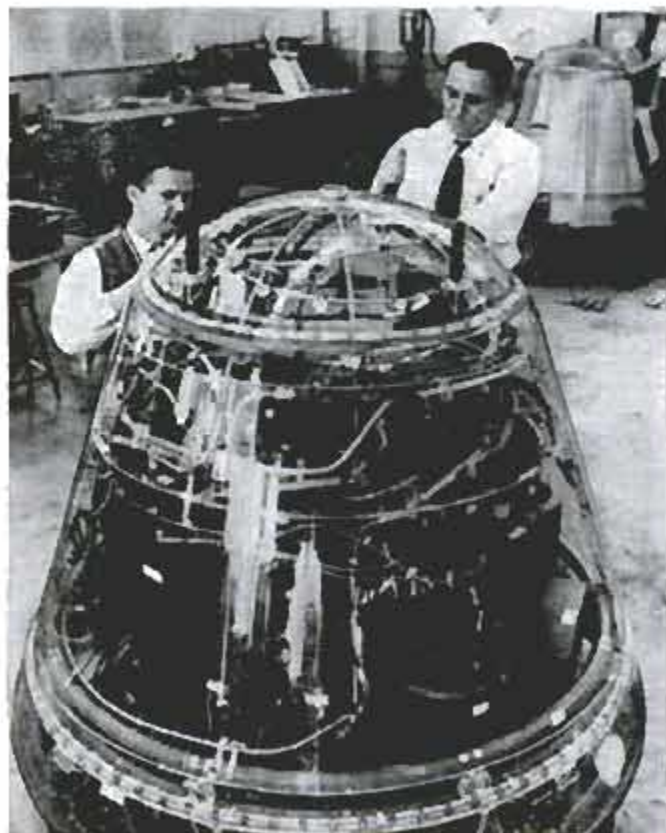



Camping Trailer for Six Mounts on Truck Chassis

All the comforts of a 27-foot house trailer are contained in a super camping top that mounts on the chassis of a one-ton truck. There are full accommodations for six people including an upstairs bedroom over the cab and a sun deck on the roof. The demountable coach has a refrigerator, built-in oven, four-burner butane stove, butane space heater, shower and toilet with septic tank. It has its own 50-gallon pressure water supply and carries a power-plant for 110-volt lighting.



Russian Kerosene Lamp Generates Power for Radio

Fitted with a junction-type, two-watt thermo-electric generator to convert its exhaust heat into electricity, this Russian kerosene lamp provides light while generating enough electricity (80 to 90 anode volts) to operate a portable radio. The inventor is Professor A. F. Ioffe of the Institute of Semi-Conductors in Leningrad.

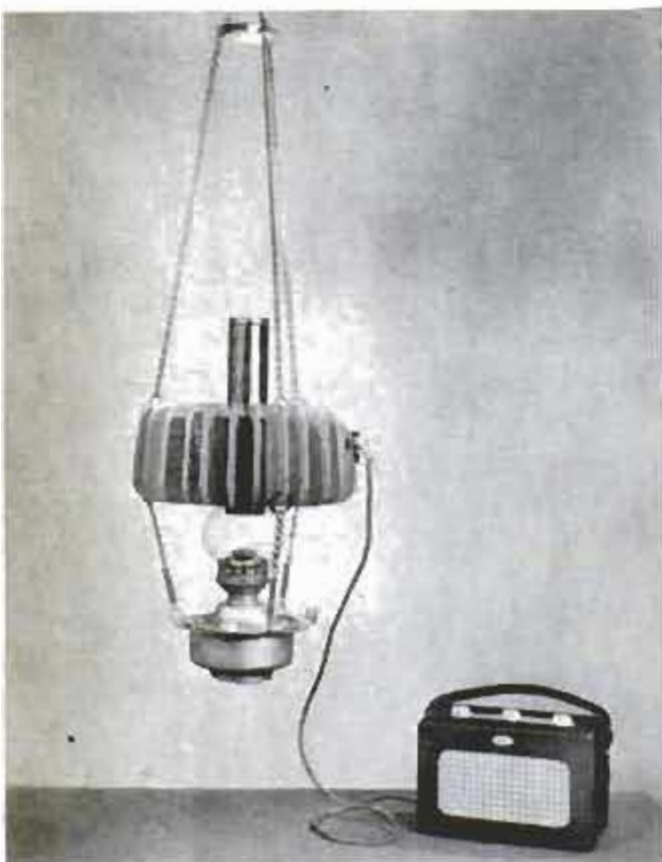

Phosphorus May Be Mined In Sea off California

University of California scientists are investigating the possibility of mining large deposits of phosphorite rock found in many areas off the West Coast. They have dredged a half-ton of the mineral from the ocean bottom just west of San Diego. If the phosphorite rock can be mined and processed commercially, it can provide the basis for a fertilizer industry on the West Coast. Phosphorus now comes primarily from Idaho and Florida.



Not all of Streit's work is done with peach stones—these books and bookends shown above were carved from a block of acrylic plastic. Streit adds final touches to a "hear no evil" monkey. He spends from two to 15 hours on an individual carving, depending on details.

Peach-Stone Sculptor

By Don Oliver

ROBERT J. STREIT, of Neenah, Wis., makes a hobby of a specialized branch of sculpture—he carves peach stones. He claims that it isn't really sculpture—just carving—but shaping rock-hard peach stones into the objects below is the work of a real artist.

Streit allows the stones to dry thoroughly, then removes most of the crevices with a file before going to work with his collection of over 40 jeweler's files and power tools. He uses a jeweler's magnifying glass for the most delicate work. He polishes the finished carvings with a buffer to get a gemlike luster.

Right, closeup of finished chalice shows delicate detail work. Light-colored carvings in the group below are plastic, but the rest are from his collection of intricately carved peach stones.





Powered Log-Splitter Trails Behind Car

Logs up to 30 inches long can be split by a new seven-horsepower machine that can be trailed behind a car or truck. Weighing under 500 pounds, the splitter nevertheless has 18 tons of force in cutting tough and knotty pulp or firewood logs. It has automatic two-speed hydraulic action and a choice of manual control or continuous automatic stroking. The wheels are raised and lowered by power to avoid the "dead" lift of large logs.



Chicken House Just a Bubble

Agriculturists at Rutgers University have built a plastic-bubble chicken house. It's made of a large sheet of polyethelene plastic film that is kept puffed out by a motor blower. No inside supports are needed. Built to test effects of heat on chickens, the bubble house can be used as an isolation laboratory, controlled - environment chamber, chicken brooder or emergency housing.



Propane Burner Yields Electricity

Scientists have developed a thermoelectric generator that converts the heat of a burning fuel directly into electricity on a scale large enough to light an average room. The generator, developed by Westinghouse for the Air Force, will be used to power electronic installations in isolated areas. About the size of a medicine ball and weighing 40 pounds, the generator burns propane and operates at a temperature of 850 degrees Fahrenheit.



Sternwheeler Revives Old River Days

With only a picture as his guide, a Louisiana man built a 36-foot copy of his family's old sternwheeler. Powered with an 18-horsepower gasoline engine, the vessel has a cruising speed of 12 miles per hour. Its paddlewheel turns through chain-drive

controls of a Jeep's rear-end mechanism, with remote steering from the pilot house. Two false stacks and a ship's bell give the craft an authentic look. Fourteen persons can be seated in the cabin of the little sternwheeler, which is used for outings.

Passers-by Get Phone Report Of Construction Progress

Sidewalk superintendents at the construction site of Western Electric's new building in Manhattan get a running account of progress by telephone. The account is on a tape recording that is changed frequently to keep pace with the construction of the building.

Number, Please!

Whenever you write us to

- Renew your subscription
- Change your address
- Order your own or a gift subscription

... In fact, whenever you write us,

PLEASE INCLUDE YOUR CITY POSTAL ZONE NUMBER IN YOUR ADDRESS

*This insures better delivery
It helps you and it helps the postman.*



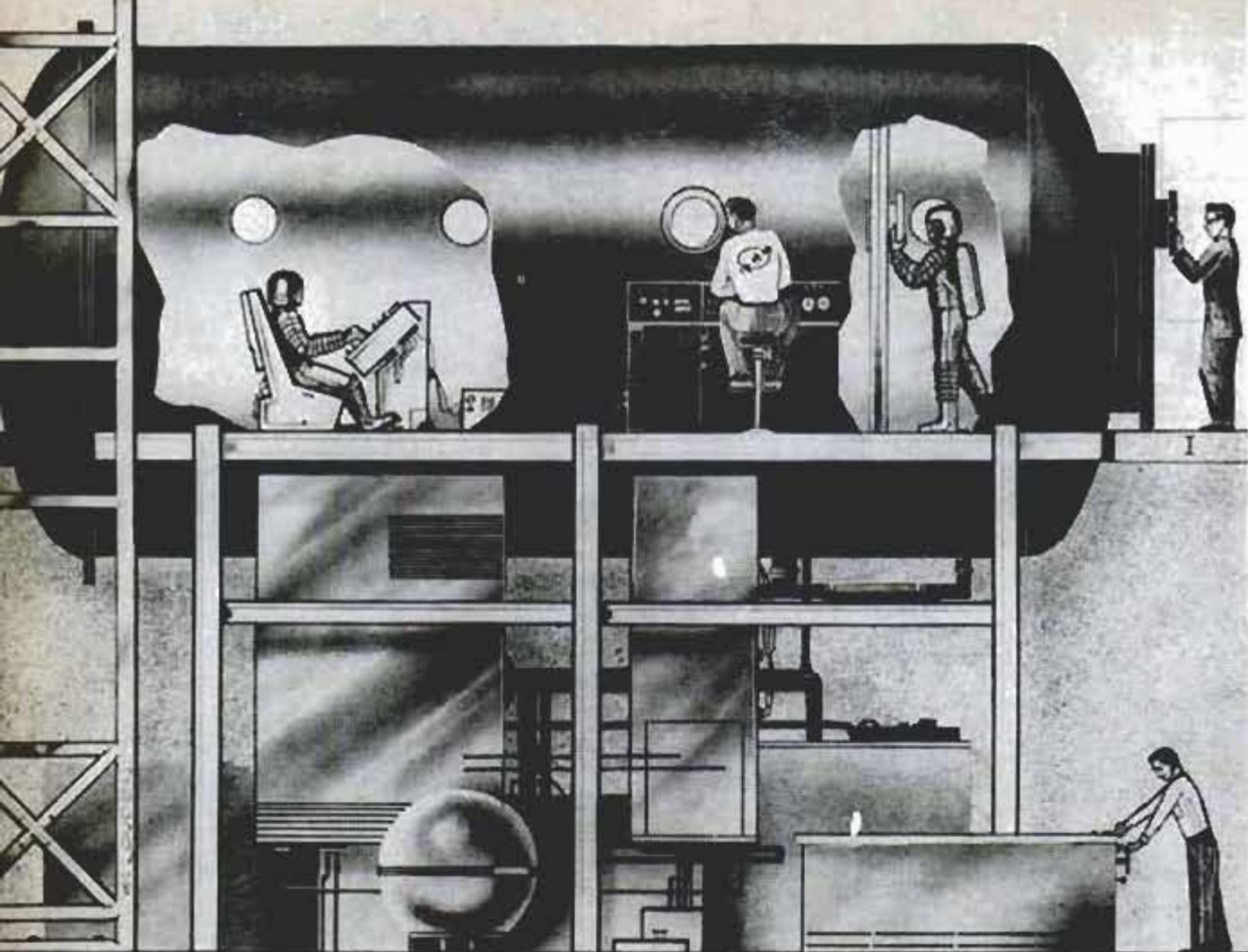

Test Chamber Will Take Man 150 Miles Up

Space suits, men and material will be tested in a chamber capable of taking a human 150 miles above earth. In the sketch above, technicians are measuring peripheral vision and mobility of the space-suited man as he responds to various test se-

quences set at an outer control panel. The two men at the right are safety monitors. The space-environment chamber, which will measure 14 by 30 feet, will be built into Republic Aviation Corporation's astronautics research center at Farmingdale, N. Y.

Pilot and Ground-Control Exchange Information by Push Button

Air safety and traffic control have taken a step forward with the development of an automatic communications system that enables a pilot and a ground-control station to exchange information by pressing buttons.

By means of a data-handset, the controller can compose and send messages in pulse-code to aircraft. The messages are displayed on the pilot's control panel. A two-way exchange can be made in an instant.



Sunbeam Sports Model Built for U.S. Market

Offering American luxury with a European sports-car flair is the Sunbeam Alpine. Designed primarily for the American market, the Alpine includes, as standard equipment, wind-up windows, wrap-around windshield, large bucket seats, occasional rear-passenger seat and disk brakes. A removable hardtop is optional on the car. The four-cylinder engine is equipped with an aluminum high-compression cylinder head with balanced induction and exhaust manifolds. Unit-constructed, the Alpine has an 86-inch wheelbase and is 155.25 inches long. Maximum horsepower is 83.5. Sunbeam is a product of Rootes Motors, Inc., of England.



Blood Heat Exchanger Cools Temperature Fast

Lowering body temperature 10 degrees in five minutes, a heat exchanger quickly regulates blood temperature during heart operations. Lower temperature cuts a patient's oxygen requirements and lessens damage to his blood cells. Previously, it took patients as long as two hours to cool with ice packs. After the operation, normal temperature is achieved in 10 to 15 minutes. The exchanger has 24 steel tubes mounted inside a cylinder through which blood is kept flowing during the heart operation.

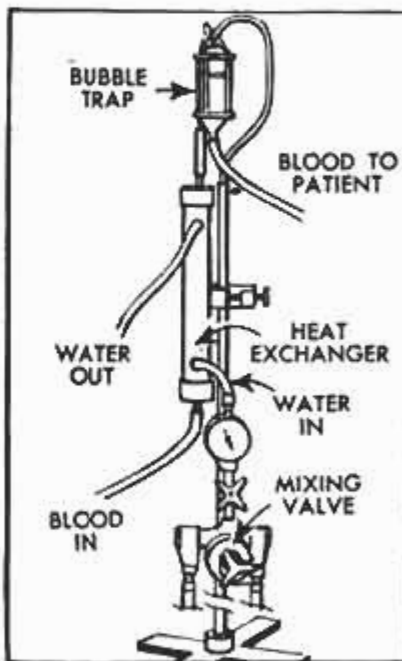

Glass-Fiber Door Lights up Garage

Homeowners can "light up" their garage with a door made of translucent glass fibers. Admitting light much the same as frosted glass, the new door has tempered, extruded aluminum frames to provide strength, yet weighs just one-third as much as conventional wood garage doors. It resists weather and will not shatter or warp. The appearance of the door can be maintained with an occasional garden-hose spraying. It comes in several decorator colors and in 10 sizes to fit all openings.





Inflatable Rings Keep You Afloat

Inflatable plastic rings that slip on the legs and arms make any nonswimmer unsinkable while he floats atop the water. First shown at a West German fair, the rings can be carried in the pocket when they are deflated.

Syrup for Polio?

Syrup vaccine for immunization against poliomyelitis is being studied by the U. S. Public Health Service and other agencies, and three types are under test in Africa and Russia. The vaccine, unlike the Salk type widely used now, contains live viruses and before it can be approved the authorities must be satisfied that it will build up antibodies and will not cause the disease, and that persons given the syrup cannot transmit the disease to others.



Stainless Steel Caps Protect Cow's Teeth

"False teeth" made of stainless steel are expected to add several years to the life of a breeder cow. Steel caps are crimped over the cow's eight anterior teeth in dental cement. Up to now, the life span of many a cow was shortened when her teeth were worn away by abrasive material in grass and she was no longer able to feed herself. The new caps stop loss of enamel and prevent exposure of nerves and destruction of the jaw.



Cleats Held to Tires By Inflatable Bag

Designed to keep trucks from getting stuck in mud and snow, a new version of traction cleats are held in place by a nylon bag that slides between dual tires and is then inflated. The bag, reinforced with metal and covered with tread gum, can be blown up in a few seconds with about two pounds of air taken from the outside tire by means of a four-foot hose. The hose is attached to the valve stem of the tire and to the bag. It has a thumb bolt at one end and an air chuck at the other, plus a pressure gauge. The cleats fit all standard makes of dual wheels.



Economy Wagon Added to Jeep Line

Providing maximum inside space with minimum outside dimension, the Maverick Special station wagon adds an economy car to the Jeep line. Its price is \$1995, making it the cheapest six-passenger station wagon made in America. With the rear seat folded, there is enough room inside the wagon to carry a wheelbarrow and lawnmower, plus many other items. It has a standard Jeep engine.

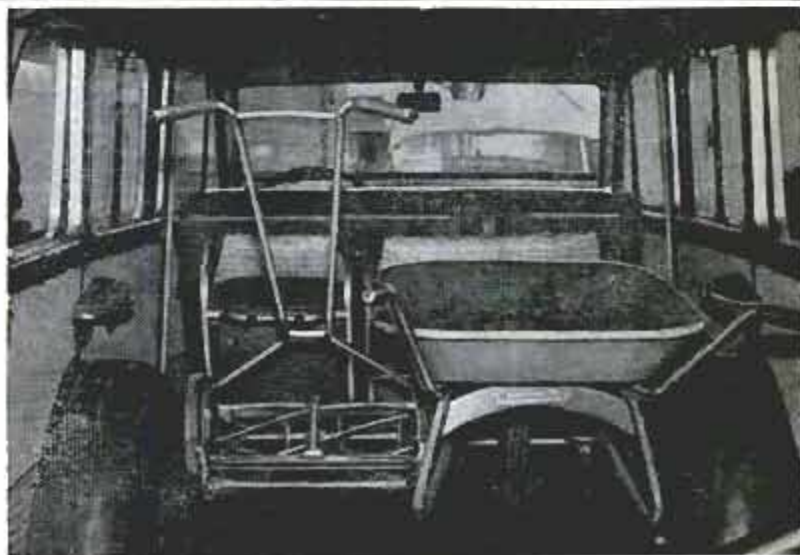

Compressed-Air Bottles Give Skis Jet Power

Now jet power has come to the aid of the skier. A pair of skis, made in Austria has, in effect, "jet-assist engines" to increase speed. A compressed-air bottle, mounted on each ski, sends a high-pressure jet of air blasting along the center groove beneath the ski. The jet is said to reduce friction between the ski and the snow, thereby increasing the speed.

Skin-Diving Cameramen Check "Hot" Waste Disposal

Skin divers will take underwater pictures of simulated radioactive waste materials, dumped into the ocean for disposal, to learn whether the packages leak or disintegrate. For the tests, a colored dye that registers on color film will be used in place of the wastes themselves. Other studies include the speed and direction of currents at the dumping grounds, and sampling of bottom sediment and salt water. Possible absorption of the radioactive materials by crabs and other bottom dwellers also will be studied.



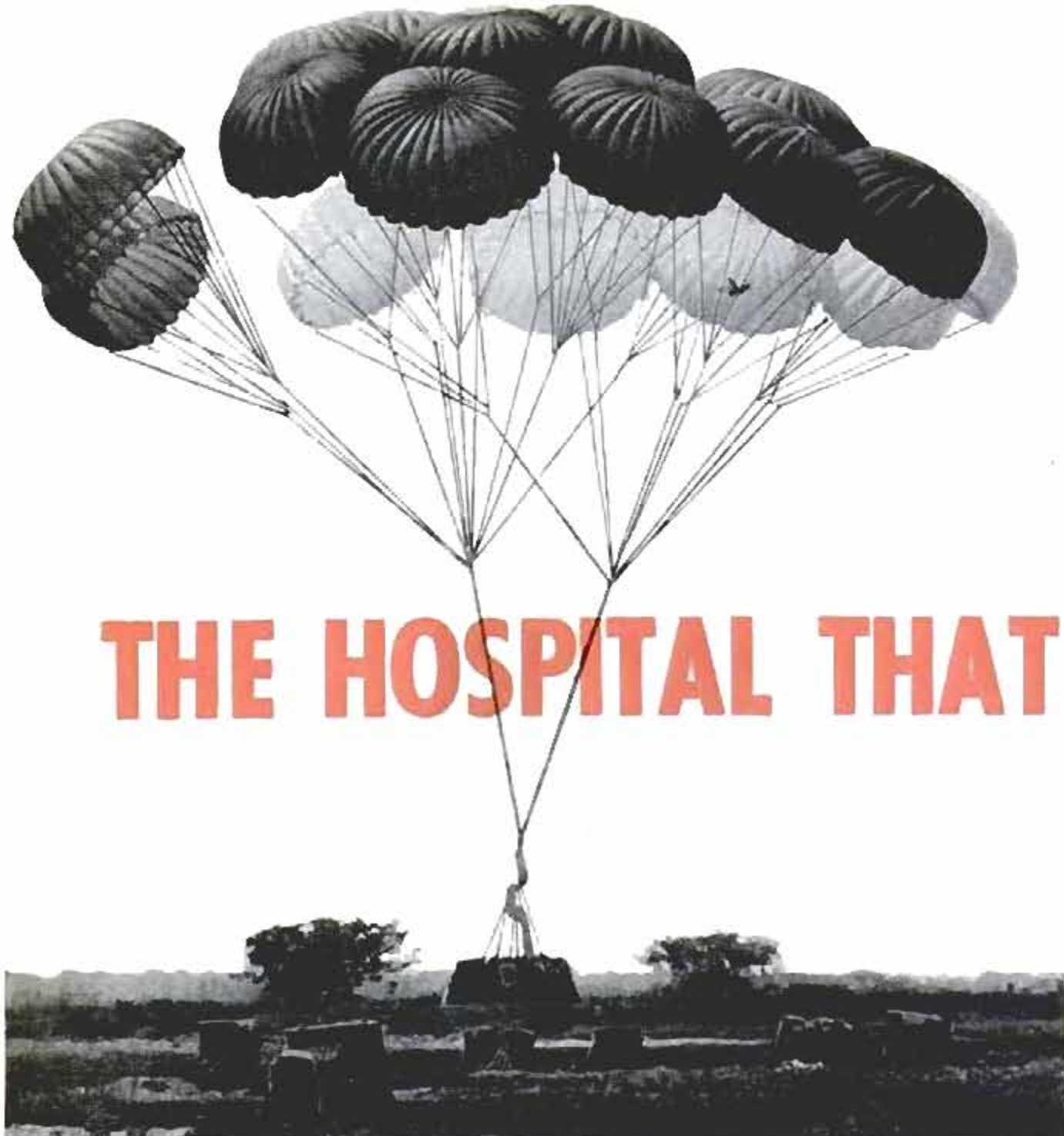

THE HOSPITAL THAT



Complete field surgical hospital lands on a field in Thailand during a recent SEATO exercise. As many as 20 parachutes must be used in a "dandelion seed" cluster to support the heaviest pieces of equipment

Photos by
French Air Ministry,
James Pickorell

Members of the French 10th Airborne Division Surgical Team go into action, inflating their "hospital" as soon as they hit the ground. Compact, generator-powered blower pumps inflate the tents in three minutes

COMBAT EXPERIENCE in North Africa taught the French Army the difficulty of providing medical support to troops during the early hours of an airborne assault. Shown on these pages is their answer—a complete field surgical hospital that can be parachuted from a single transport aircraft and set up in minutes near the drop zone, ready to handle battle casualties in the all-important first few minutes after injury.

Two officers and seven enlisted men make up the special Airborne Surgical Team that is now a regular part of each French airborne division. The key to their fast operation is three inflatable hospital tents of the British "Numa" type—one large unit of 1750 cubic feet volume and two smaller tents of 430 cubic feet each. For ground transportation they are supplied with a quarter-ton Jeep ambulance, a motor scooter and a collapsible trailer.

A single French Air Force Nord Atlas,



Medics assemble the lightweight folding operating table as the other team members inflate the tents

DROPS FROM THE SKY

their version of the U. S. C-119 transport, delivers the entire hospital unit—nine men, 400 pounds of tents and equipment, three vehicles and 3000 pounds of medical equipment and supplies—by parachute.

Inflatable rubber ribs form the framework of the fabric tents. Once on the ground, the team spreads the tent walls and floors in position, starts a portable 0.5 kilowatt power unit, and uses blower pumps to inflate the framework. The job only takes about three minutes, and in the meantime other team members assemble the folding hospital gear, including a full-scale operating table, which is ready to wheel into the "hospital" by the time it's inflated.

The entire operation, from the time the chutes touch down until the hospital is ready to receive casualties, takes only 20 minutes. ★ ★ ★

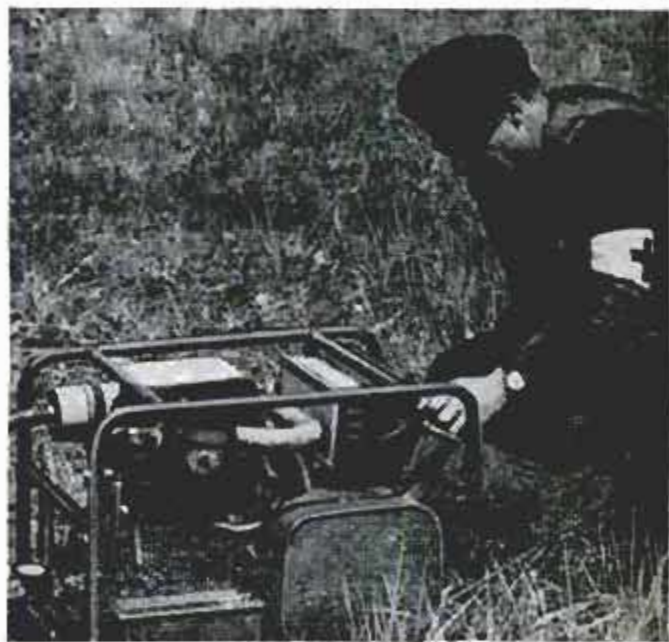

Above, airman starts 0.5 kilowatt generator. Below, hospital and ward tent ready to handle casualties





Thickness of Fat on Live Pig Gauged by Ultrasonic Waves

It's now possible to measure the thickness of fat on the back of live pigs with sound waves. Employees of the British Oil and Cake Mills in England perform this test with the help of an ultrasonic-wave machine. The pig in the photograph may look suspicious, but the machine is said to be humane and painless, as well as accurate.



Plastic Guard Locks Plug In Electrical Outlet

Plugs can be locked in outlets by plastic guards that take only a minute to attach. Held in place by a single screw, the lock keeps children from disconnecting freezers, refrigerators, timing devices and other household appliances.

Elastic Strap Holds Clipboard on Arm, Freeing Both Hands

Now you can hold a clipboard with no hands. The board is attached to the arm with a strap, freeing both hands to do the work. The adjustable strap is made of elas-

tic webbing. The elasticity and grip of the webbing hold the clipboard in any position. A large clip at the bottom of the board holds down the paper.





Speeding Ice Sled Turns on a Dime

Making split-second turns on ice at 35 miles per hour or sweeping gracefully on wide curves are some of the thrills that can be obtained with a high-speed icesled. Constructed of steel and electrically welded tubing, the sled has a $2\frac{1}{2}$ -horsepower, two-cycle engine mounted at the front, with the driver's seat at the rear. A chained center wheel provides traction on the ice and snow while movement of the sled is controlled by an airplane-like steering wheel that guides a steel rudder. An extremely low center of gravity assures safety at high speeds. The sled balances on case-hardened steel side runners, while a steel guard rail around the rider keeps him from sliding off the sled. Finished in two-tone enamel, the sled, which is 30 inches wide and 48 inches long, can be carried in the car trunk. It will carry loads up to 350 pounds.

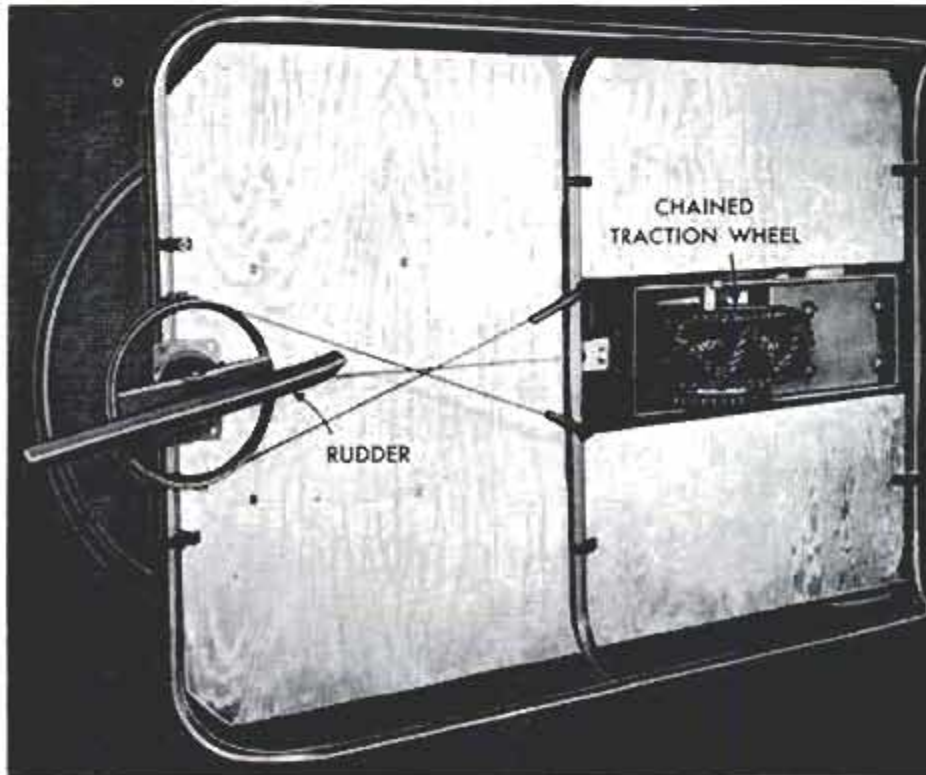

Automatic Reader Translates Data

Developed to speed processing of military information, an Air Force machine can read and translate typewritten pages into electrical signals at the rate of 200 characters a second, or 2400 words a minute. The machine reads both upper and lower case letters, numerals and punctuation symbols. The signal output can be in the form of punched paper tape or cards, or the signal can be fed into an electronic computer. Thirty readers will be able to process 10 million pages a year.



INEXPENSIVE UNDERWATER CAMERA is made of a tough, corrosionproof plastic that won't break when dropped or banged against the cement sides of a pool and will withstand water pressures at depths up to 100 feet. It takes both color and black-and-white pictures
Healthways, 3609-7th Ave., Los Angeles, Calif.



MAGNETIC ATTACHMENT holds the plug end of power cords fast to steel-cased household appliances for neat storage. The attachment fastens to the plug and needn't be removed to operate appliance
General Electric Co., Wiring Device Dept., Providence 7, R.I.

Shop Here



PHOTO END TABLE displays an enlargement made from the customer's print, slide or black-and-white negative. Four coats of gloss lacquer protect the picture. The table top measures 16 by 20 inches. It's mounted on 16-inch legs
Wampum Specialties, Wrentham, Mass.

FILM EDITOR AND SPLICER are built into this 8-mm. projector. The motorized editor, with a six-inch viewing screen, operates by button or hand crank. Splicer makes dry splices with tape
Keystone Camera Co., Inc., Hallett Square, Boston 24, Mass.



BIRD FEEDER has a transparent cone for the seed supply plus four water troughs. A hi-fi record of bird calls comes with it
Dowst Mfg. Co., 600 N. Pulaski Rd., Chicago 24.





"FRIED EGG CHAIR" offers plenty of comfortable leg room for the sitter. The "formpressed" shell, cast in plastic, is covered with foam rubber which is glued in place. The chair is upholstered with handwoven Danish fabrics

Design Galleries, 324 N. Wells, Chicago.

for Christmas

UNIPOD locks automatically at whatever height the leg opens, and collapses back to carrying position when it's turned upside down. The unit also has a tilting head and carrying strap

Smith-Victor Corp., Griffith, Ind.



RELIEF MAP of the United States can be painted or drawn on, then washed clean. Dimensions of the plastic map are 18¼ by 28¾ inches. Water areas are turquoise blue and land areas yellow

Panoramic Studies, 6122-24 N. 21st St., Philadelphia 38, Pa.





"SATELLITE" TRANSISTOR RADIO, above, sits on its desk-top stand or hangs by the antenna from a ceiling. The radio, enclosed in a transparent plastic ball, has two transistors. Earphones are supplied
The Brownlee Company, P. O. Box 636, Yucaipa, Calif.

AIR RECIRCULATOR has a treated filter that traps and kills airborne bacteria. This model, with two filters, handles 500 cubic feet of air per minute. The germicidal filters, made of cellulose-acetate fibers, are available in more than 300 sizes for furnaces and air conditioners

Fram Corporation, Providence, R. I.

TINY WEATHER STATION shows at a glance the local rainfall, snowfall, temperature, wind speed and wind direction. Constructed mostly of plastic, the little weather indicator is easy to mount on a post, building or vehicle
D. Corrado, Inc., 26 N. Clark Street, Chicago 2, Ill.

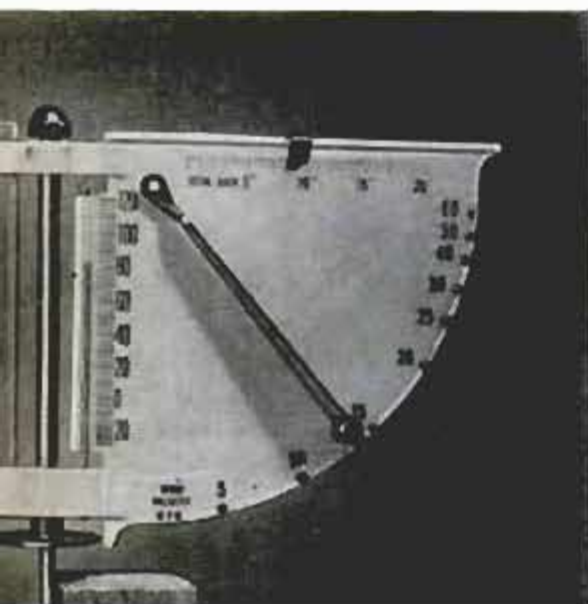

ELECTRIC WARMER keeps foods hot until mealtime. Adjustable thermostat maintains heat at 150 to 190 degrees. The warmer is made of marine mahogany with an abrasion-resistant finish. It is lined with aluminum and insulated with fiber glass. Inside dimensions are 14 x 14 x 18 inches
Brinkman & Cook, Inc., The Merchandise Mart, Chicago, Ill.

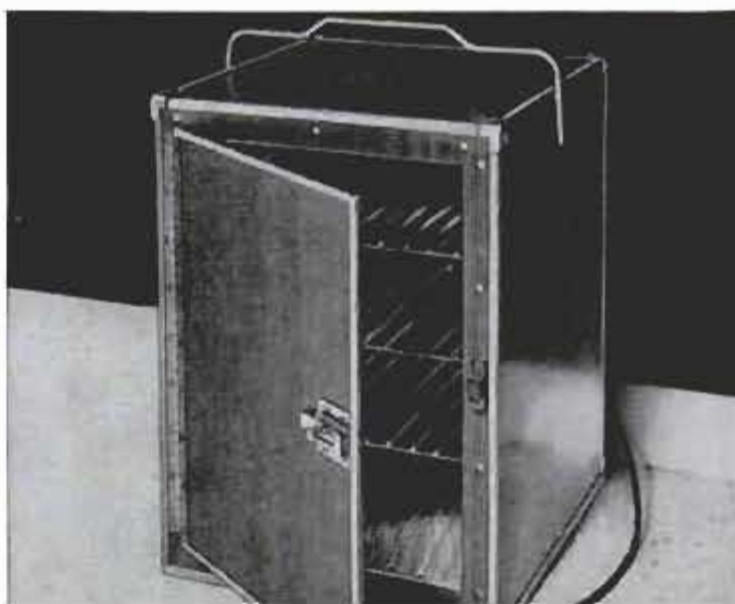



GOLFER'S WATCH keeps game score as well as the time. The player records strokes by pushing two buttons which cause numerals to move into place in windows on the face. Watch has Swiss movement and a sweep second hand

Gruber Co., 27 W. 38th St.,
New York 18, N. Y.



COOLER-HEATER brings quick heat to chilly spots—and fast cooling to sweltering rooms. The three-speed combination cooler and heater also filters, circulates, ventilates and humidifies. As a winter humidifier, it evaporates up to 12 gallons of water per day

Metalair Products Co., Phoenix, Ariz.



MUSICAL BIRD PERCH starts to play when a pet bird alights on the bar to admire itself in the mirror. When it flies away, an automatic shut-off stops the music. The perch hangs inside a bird cage where the Swiss musical movement in the wood housing can be wound easily from outside

Marco Music Crafts, Co., Inc., 325 W. 16th St., New York 11, N. Y.

PORTABLE WIENER ROASTER plugs into a car lighter to roast two wieners while it heats two buns. The 12-volt unit is packed in an over-the-shoulder bag which is also fitted with four nested plastic tumblers, two plastic plates, a mustard container and a stainless steel knife and fork

Vogue of California, 585 Howard St., San Francisco 5, Calif.





OLD-TIME SURREY is the pattern for this two-passenger pedal toy. It has a steel frame and chain drive
 Universal Manufacturing Co., Inc., Box 5128, Bossier City, La.



WALKING HOBBY HORSE moves forward on hinged metal legs as the rider's body motions supply power
 Hubley Manufacturing Co., Lancaster, Pa.



Shop Here



CHILD'S TABLE doubles as snack bar and play desk. It's made of strong fiberboard and protected with a tough plastic coating that water and colors won't harm. The top is an ample 18 inches square, and the table stands 7½ inches high
 The TOD Company, 1711 Happ Road, Northbrook, Ill.

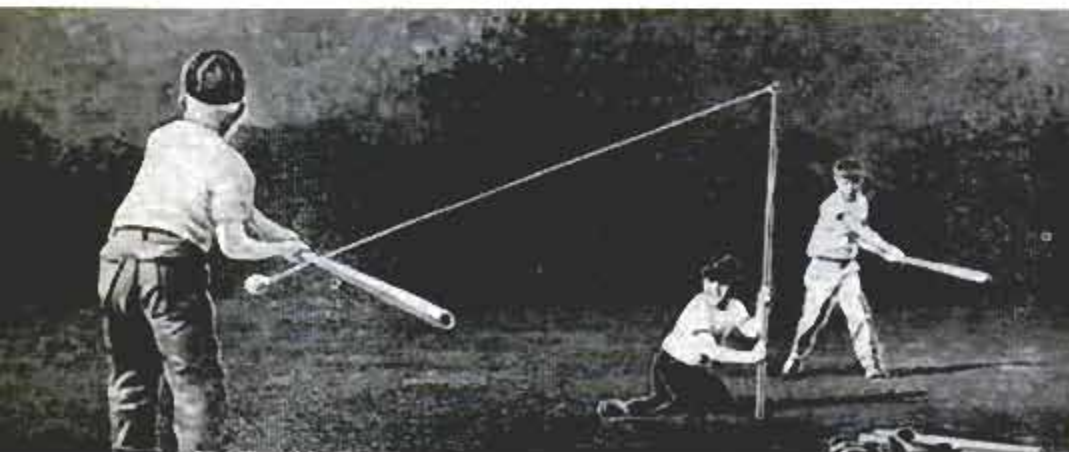

BASEBALL BATTING game offers lots of safe practice for young sluggers. By manipulating an aluminum pole, the "pitcher" swings the rubber ball in a wide circle, delivering curves, fast balls and so on to the batters
 Aluminum Specialty Co., Manitowoc, Wis.



BUMBLE-BEE KIT makes a true-to-life model of the insect. There are 49 separate plastic pieces in the kit which fit together like the parts of a model airplane or ship. The model is eight times life size
Ideal Toy Corporation, 200 Fifth Ave., New York, N. Y.



MODEL MISSILE soars up 400 feet and descends by parachute. The kit includes a missile, launcher and three motors
Model Missiles, Inc., Denver, Colo.

for the Youngsters

HELICOPTER LAUNCHER on an 11-inch flatcar sends a 'copter into the air by remote control. A manually-wound spring on the platform supplies take-off power
Lionel Corporation, 15 E. 26th, New York, N. Y.



BALLS IN HOOPS are kept gyrating by a circular motion of the performer's hands. The toy consists of two enameled aluminum hoops and plastic balls
Mirro Aluminum Co., Manitowish, Wis.



COMPUTER CIRCUITS in this kit are assembled with nuts and bolts; they operate on a single flashlight cell. The instructions can be grasped by a 12-year-old
Science Materials Center, 59 Fourth Ave., New York 3, N. Y.



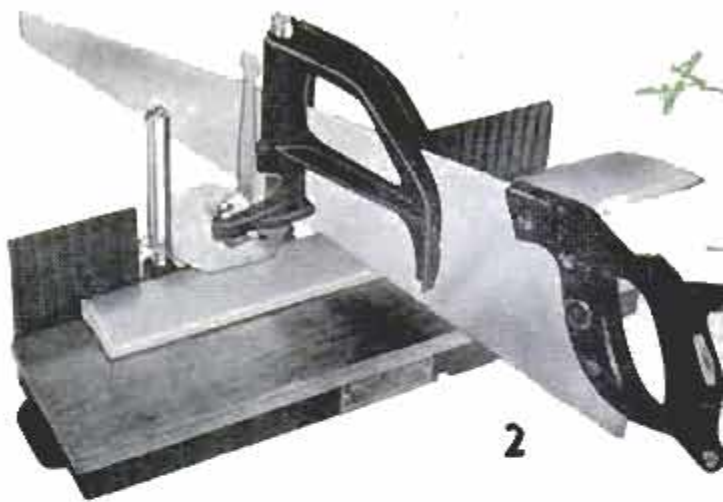

1. LIGHT, PORTABLE SPRAY UNIT handles paints, enamels, insecticides and certain other sprayable materials such as liquid fertilizers, weatherproofing and mothproofing in liquid form. Spray gun can be detached and compressor and hose used for inflating air mattresses, beach toys, inflatable swimming pools
Thomas Industries, Inc., 410 S. Third St., Louisville 2, Ky.

2. MITER BOX is designed to be used with any ordinary handsaw. Adjustable to any angle from 0 to 45 deg. Saw guide swings right or left as may be required by the work and locks securely at any of the commonly used angle positions. Saw guides and frame are of cast aluminum and steel. Weighs only 9 lb.
W. A. Gerrard Co., Inc., 4400 Lyndale Ave. N., Minneapolis 12, Minn.

3. STUD DRIVER seats both plain and threaded pins in masonry. Transmits hammer blows uniformly to head of pin. Pins are available in 11 sizes, are heat-treated, plated, and are made extra sharp for easy penetration in masonry. Just the thing for fastening furring strips, shelf brackets, wall cabinets
Fastway Fasteners, Inc., 1627 E. 28th St., Lorain, Ohio

4. BALL-BEARING DRILL CHUCK requires only an easy finger-tip twist to lock the bit firmly. Releases bit with light pressure in opposite direction. Eliminates the problem of the misplaced chuck wrench, employs the same locking principle as that used in drill chucks available on industrial equipment
Sears, Roebuck & Co., 925 S. Homan Ave., Chicago 7

5. RADIAL SAW takes 9-in. blade, cuts stock 3 1/8 in. thick. Has two-piece overarm supported on 3-in. column which is provided with depth gauge. Table-leveling adjustments can be made from top of table and column is raised and lowered by crank located at front of table. Has 1/4-hp. double-shaft motor
Toolcraft Corp., Plainfield St., Springfield, Mass.

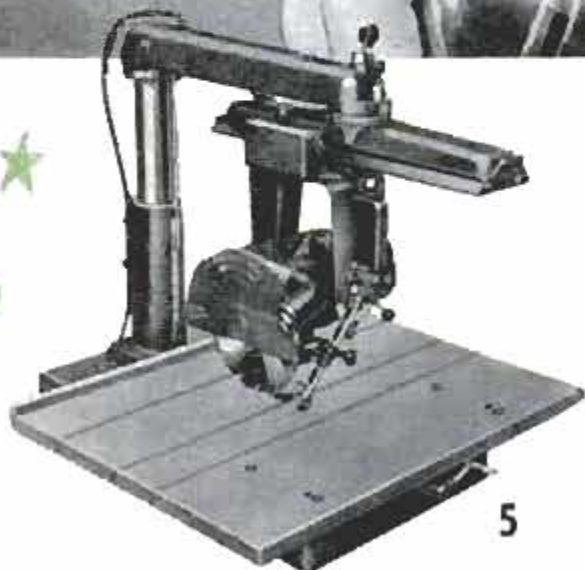



6

6. HEAVY-DUTY KIT is built up around a $\frac{3}{8}$ -in. portable drill. Kit includes over-sized accessories for polishing, buffing, grinding, sanding, wire-brushing. Also included are a 5-piece spade-drill set, a 12-piece high-speed twist drill set, a 6-piece arbor set and bench stand, all in neat carrying case

Cummins Portable Power Tool Co.,
Div. of John Oster Mfg. Co., Milwaukee, Wis.

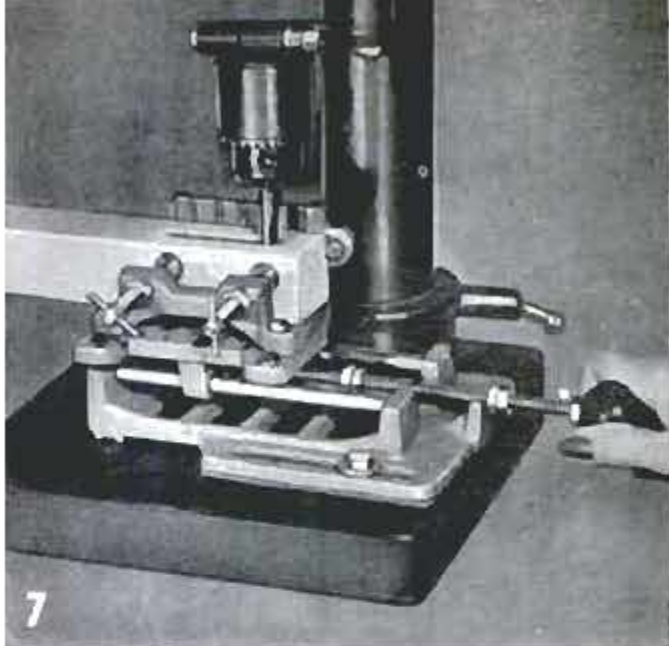

7

7. MORTISING JIG for drill press makes the routing of an accurate mortise as simple as drilling a hole. The jig consists of a frame supporting a carriage which slides on guide rods. The sliding carriage is fitted with clamps for holding the work securely in place as the mortise is cut. Stops are adjustable

Akron Precision Equip. Co., P. O. Box 5256, Akron 13, Ohio

8. PORTABLE BELT SANDER takes 2½-in. belt, weighs only 7½ lb. Abrasive belts can be interchanged easily, making it possible to work through several grades of grit from coarse to fine or to change from wood to metalworking abrasives without loss of time. Bearings, drive mechanism require no lubrication

Porter-Cable Machine Co., 125 Exchange St., Syracuse 4, N. Y.



8

9. RADIAL-TYPE LEVEL is only 1½ in. in diameter, can be carried in the pocket or mounted on machines, cameras, instruments and scientific apparatus. It also can be attached to a straightedge for use in construction and maintenance work. Unit is made entirely of acrylic plastic. Liquid is sealed in case

Johnson Products Co., Milwaukee 2, Wis.



9

10. BENCH-TYPE JIGSAW cuts to center of 24-in. circle with overarm in place. Has built-in rotary motor with projecting shaft to take ¼-in. drill accessories for sanding, grinding, drilling, polishing and buffing. Has wheel-type hold-downs and a built-in blower

Stuyvesant Sales Co., 1021 Ostwood Ter., Union, N. J.

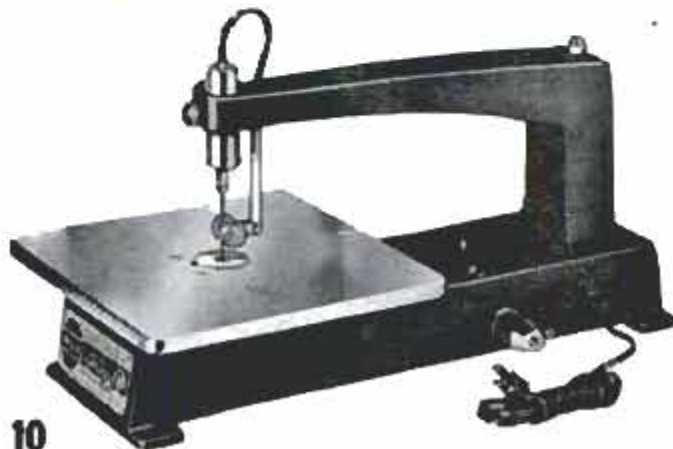

10

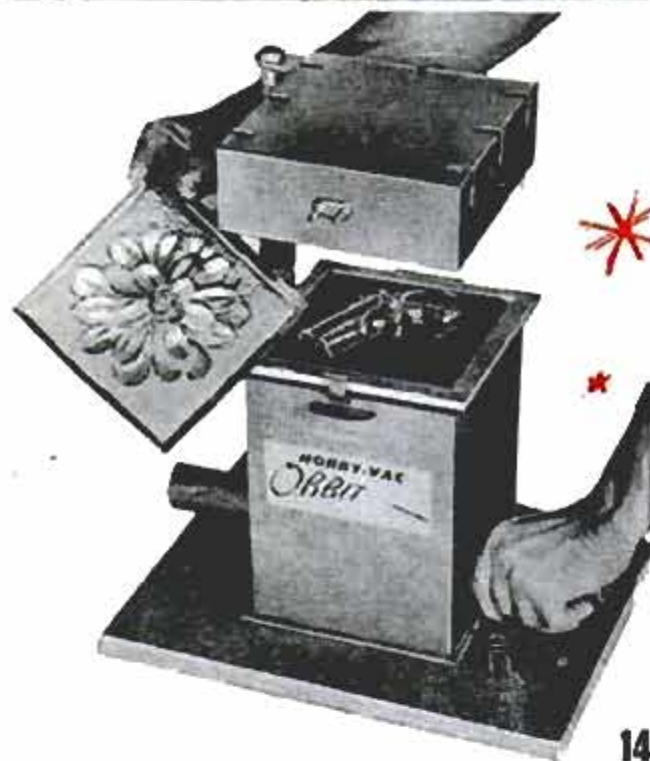
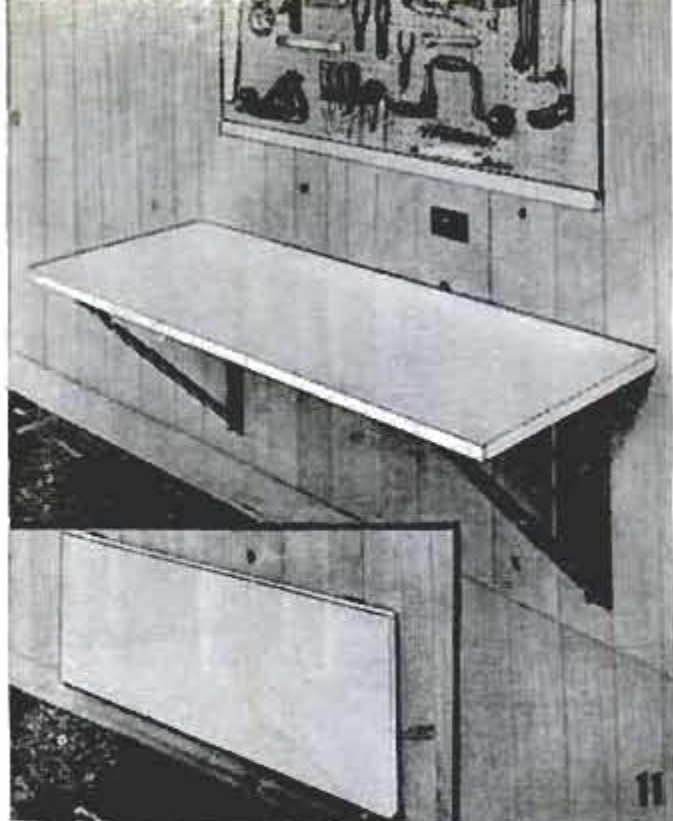

11. WORK BENCH folds flat against wall when not in use. It can be located almost anywhere there is clear wall space, in utility room, garage, basement. It can serve not only as a workshop bench, but also as a utility table for laundry, sewing or hobby room. Top is 60 in. long, 24 in. wide, 1½ in. thick
Sturdi-Bilt Steel Products, Inc., 2501 W. Peterson, Chicago 45

12. TWIST DRILLS of high-speed steel come in a set of 13 in sizes from 1/16 to ¼ in. and packaged in a neat plastic case which closes tightly and when opened forms a rack which will stand upright on the bench. When closed case is pocket size. Drills are held securely, won't fall out when case is opened
Henry L. Hanson Co., Worcester, Mass.

13. UNIVERSAL MILLING TABLE for use on drill press, shaper and milling machine provides for almost unlimited position control of work. Precision ground work surface of table is 4 in. wide and 8⅞ in. long and has four slots for clamping work in place. Dovetails are equipped with full-length gibs for takeup
South Bend Lathe Works, 425 E. Madison St., South Bend 22, Ind.

14. VACUUM-FORMING MACHINE for home and light industrial uses operates on heat and vacuum principles similar to those used in large industrial machines. Reproduces from natural objects without special dies or molds. Will make name plates, boxes, tubes and will skin-pack and bubble-pack items for store display
Orbit of California, 211 Low Molinos, San Clemente, Calif.

15. SAWHORSE LEGS come in sets, fold for compact, space-saving storage or transport. Capacity tested to 2000 lb. Any 2 x 4 or 2 x 6 cut to any desired length can be used for the horizontal member, or ledger board. Made from aluminum, leg sets can be fitted with extensions to raise height to 30 in. or more
Trojan Products Corp., 1131 E. 25th St., Indianapolis 5, Ind.



16



17



18

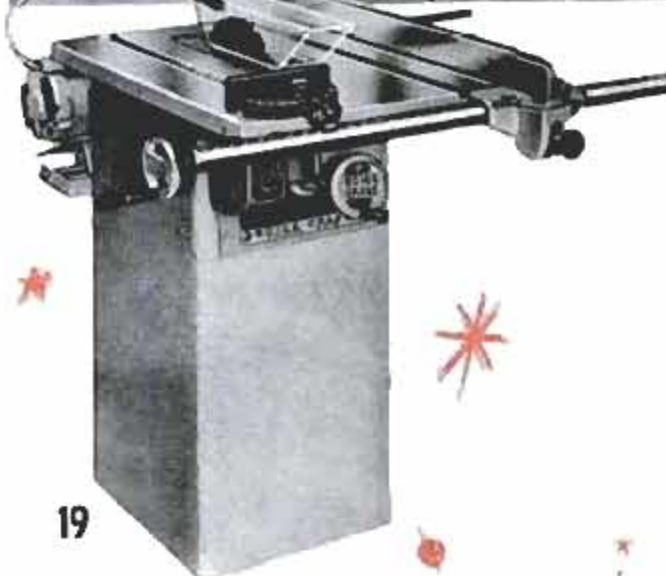

19

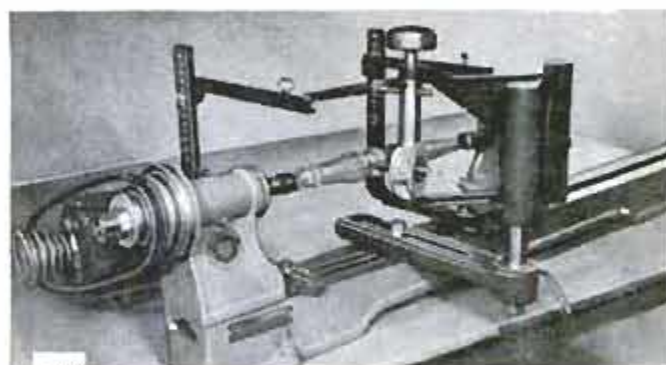

20

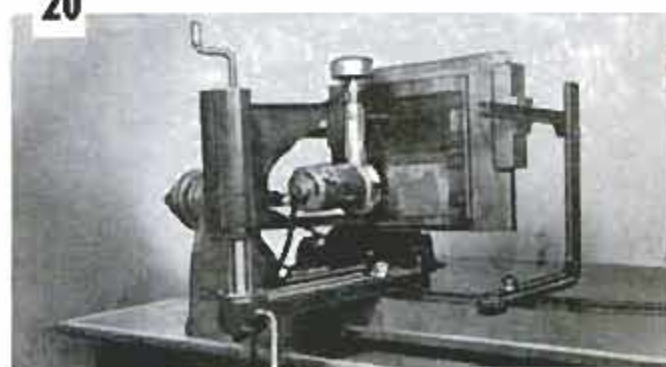

16. AUTOMATIC SPROCKET-TYPE CLUTCH installs on engine for direct chain drive to ground wheel. Easily installed requires only two screws. Special design of housing eliminates chain lash. 12-tooth, $\frac{3}{8}$ pitch sprocket is casehardened for long life. Construction is simplified to permit easy replacement of parts

Mercury Clutch Div., Automatic Steel Products, Canton, Ohio

17. ADJUSTABLE HEX WRENCH is similar to a pipe wrench but has angular, flat faced jaws which grip valve-packing nuts and unions, square and hex nuts of various sizes without any tendency to slip or round the corners. Jaws and frame of wrench are minimum thickness to permit working in hard-to-reach places

Ridge Tool Co., Elyria, Ohio

18. SPEED CHANGER for drill press, bandsaw or lathe provides approximately 50 speeds ranging from 265 to 10,900 r.p.m. This is accomplished by means of a double reduction V-belt drive and matched sets of V-belt pulleys. Assembly is attached to motor by means of bracket. Can be attached to motors up to 1 hp.

Multispeed Co., 3420 Meadowbridge Rd., Richmond 22, Va.

19. HEAVY-DUTY TABLE SAW takes 10-in. blades, comes complete with floor stand and a frictionless, floating drive that permits the blade to tilt without tilting the motor. New-type drive maintains constant uniform belt tension with arbor in any position, eliminates vibration of belt. Table extensions are available

Holce-Crane Co., 943 Central Ave., Toledo 6, Ohio

20. TURNING-CARVING-ROUTING ATTACHMENT is designed to be mounted on any small wood or metal-working lathe. As will be seen from the two views at right, it works from a template to reproduce contours from an original design, or direct from original itself. Also makes turnings from template or from an original

Turn-O-Carve Tool, Inc., 3227 Fairmount Ave., San Diego 5, Calif.



RUBBER-BAND GUN

Thousands of boys have used one or another version of this simple rubber-band gun for back-yard target shooting. Length of the barrel depends on the stretch of the "ammunition" being used. The trigger, which is a clothespin, is disassembled to screw its back half to a wood block in the handle. For a fancy version, make the block the full size of the handle so you can round the edges. For a two-shot pistol, use a double barrel and two triggers. Stretch one rubber band over the notched end of each barrel. Finish and decorate the gun as desired

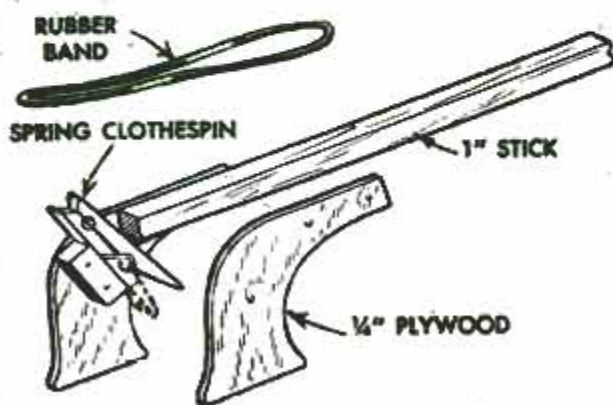

12 GIFTS TO MAKE

HAWAIIAN PIG BOARD

From our 50th state comes this different gift for the barbecue or dining table. Originally, Hawaiian pig boards were huge shallow bowls carved from logs. They were both the dish and dining table. This miniature version may be used for fruit or salad, as

a bowl for flower arrangements or for part of its original use—serving the main dinner course. You can make one to the dimensions given below from a length of 2x8 softwood or mahogany plank. Center is hollowed out, leaving the chisel marks for effect

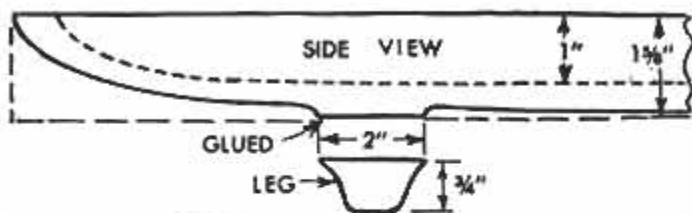
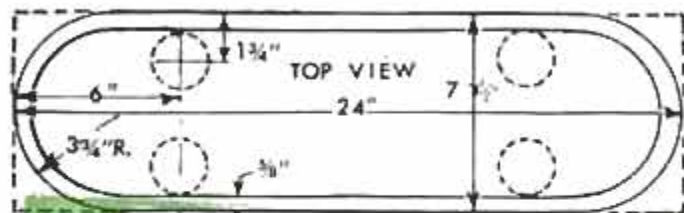

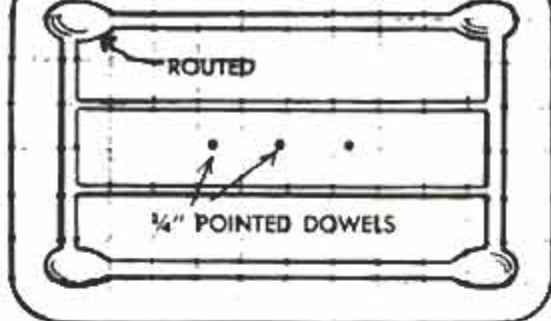

BIRCH PLYWOOD

CARVING TRAY

A carving board large enough to really handle a holiday bird or roast will be appreciated throughout the year, especially if it can be flipped over to use as a breadboard. This one is made from a 16 x 24-in. piece of $\frac{3}{4}$ -in. birch plywood to the pattern given, which is laid out on 2-in. squares. First, the corners are rounded, after which the gravy grooves are cut with a core-box router bit, adjusting bit to cut to a depth that will not expose a glue line of the laminations. Short carving pegs of $\frac{1}{4}$ -in. dowel are installed on the center line, and are removed when turning the board over as a breadboard or pounding board



FOR CHRISTMAS

BEEWAX CANDLES

Beeswax candles are a festive and welcome gift at Christmas time. To make them inexpensively, buy plain unwired brood foundations from a beekeeper's supply house, or one of the large mail-order stores. The foundations are flat honeycombed sheets of pure beeswax. Get the largest sheets available, about 8 x 16 in. On a flat surface, fold one end of a wax sheet around a wick and then roll it up. Crimp and smooth the honeycomb against the wick at the candle ends, and then smooth the edge of the roll by crimping its honeycombs back into the candle with the point of a pair of scissors. Rolled up on its longer side, one sheet will give a taper 16 in. tall. Two sheets rolled up on the short side give a thick 7-day candle. Dip the wick end of the candle in wax for easy first lighting

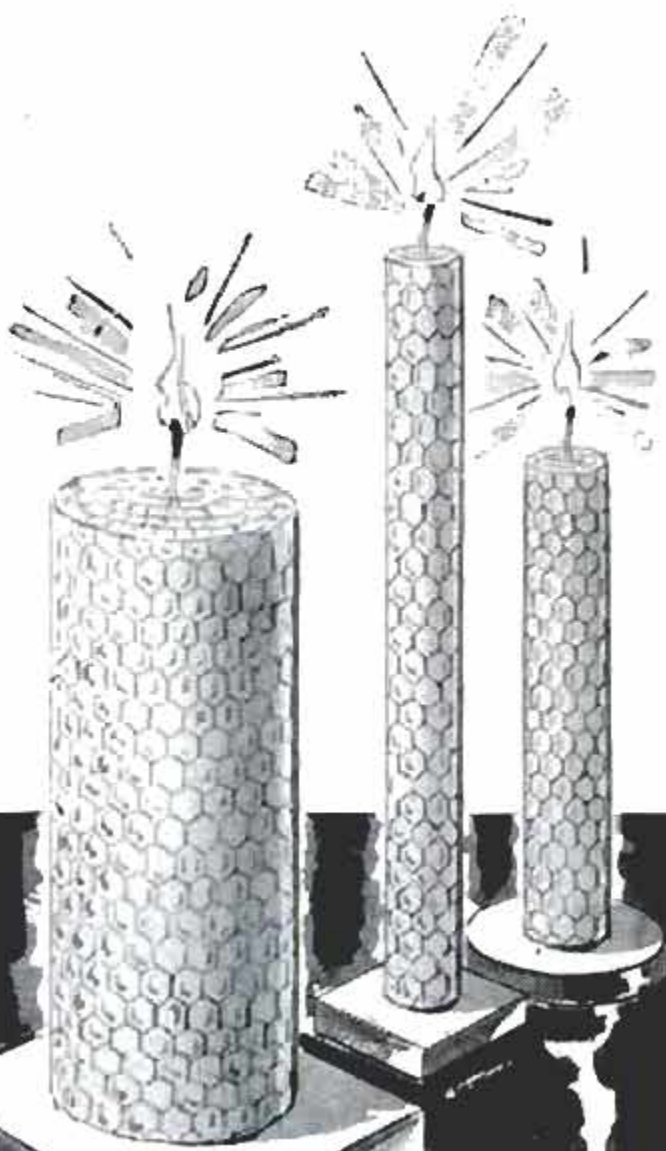

BAMBOO CHIMES

A gift idea from the Orient, these bamboo chimes are hung from a porch beam, patio roof or a tree. In a breeze they strike together to give surprisingly clear tones. Two types are shown. The "organ" chimes at the left use sections of bamboo cut off just above the joints, which are drilled through the center for knotted strings for hanging to a horizontal bar of bamboo. For straight tubes, far left, cut off the joints and glue in wooden plugs, which are drilled and strung in the same way. Cut the horizontal bar just behind a joint so it has open ends. Then the knotted strings of the outer chimes can be pulled through the open ends. For the center chimes drill larger holes through the top of the bar so the strings may be pulled down inside the bar

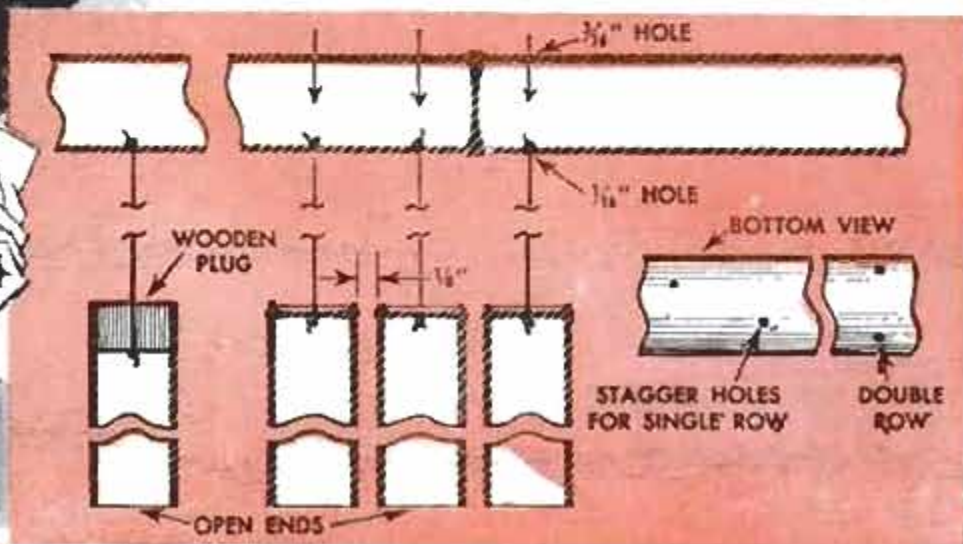

SEWING STAND

Here is a modern sewing stand that sits at a comfortable chair height, and is so light in weight it can be carried easily from room to room. It consists of nothing more than a wicker basket fitted with legs. Get a picnic hamper or similar basket about 11 x 16 in. x 9 in. deep that has fairly straight sides for attaching legs. These are boomerang-shaped and are cut from any clear 3/4-in. softwood or mahogany. A 3 x 18-in. piece will do for each of the legs, which are doweled and glued together in pairs. Round all edges with a rasp and, after varnishing, lacquering or waxing, attach each pair of legs to the basket with four small wood screws and washers from the inside. If desired, plywood or ready-made plastic button trays may be fitted inside the basket

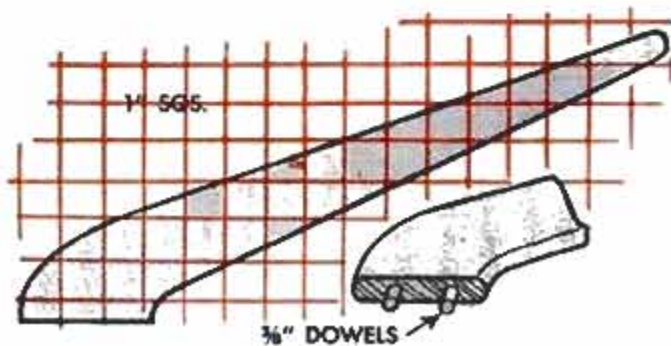

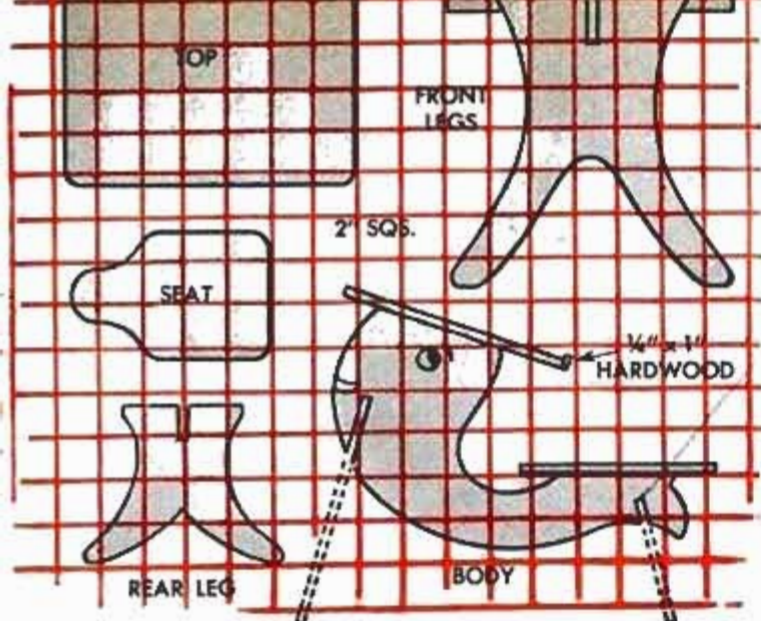

CHILD'S DESK

Providing a private place for coloring with crayons, modelmaking and just plain puttering, this "fishy" desk will delight any 3 to 9-year old boy or girl. It is steady and strong for the energetic squirmer, and can be built over a weekend. One piece of $\frac{3}{8}$ or $\frac{1}{2}$ -in. plywood 4 ft. square will provide all major parts. GPX Yellow or similar plastic-surfaced fir plywood is best as it gives a smooth, hard surface for the desk top and for painting. Bend a thin wood strip into place to lay out the longer curves on the plywood, and cut out the pieces according to the diagram above. The dolphin's mouth and eyes are painted on later. Notch the legs and body as shown to interlock, and then assemble with glue. The top and seat can be attached with glue and screws from above, or with glue and angle brackets from below

DRIFTWOOD CANDELABRA

Just a gnarled piece of driftwood, this modern candelabra will delight any homemaker. If some of the bark is still attached, it can be removed and the piece weathered with a wire scratch wheel. Or the piece can be sandblasted, giving it a white, highly bleached appearance. The small candleholders are available at hobby and garden shops. They screw into any wood base. Or you can turn holders on a lathe of some contrasting hardwood, and use a flathead wood screw down through the center of each to secure it to the driftwood base. The number of holders depends on the shape of the piece. If the candelabra has a tendency to rock on a table top, one or two rubber-headed tacks or small wooden pegs attached to the underside at critical spots will help to level it



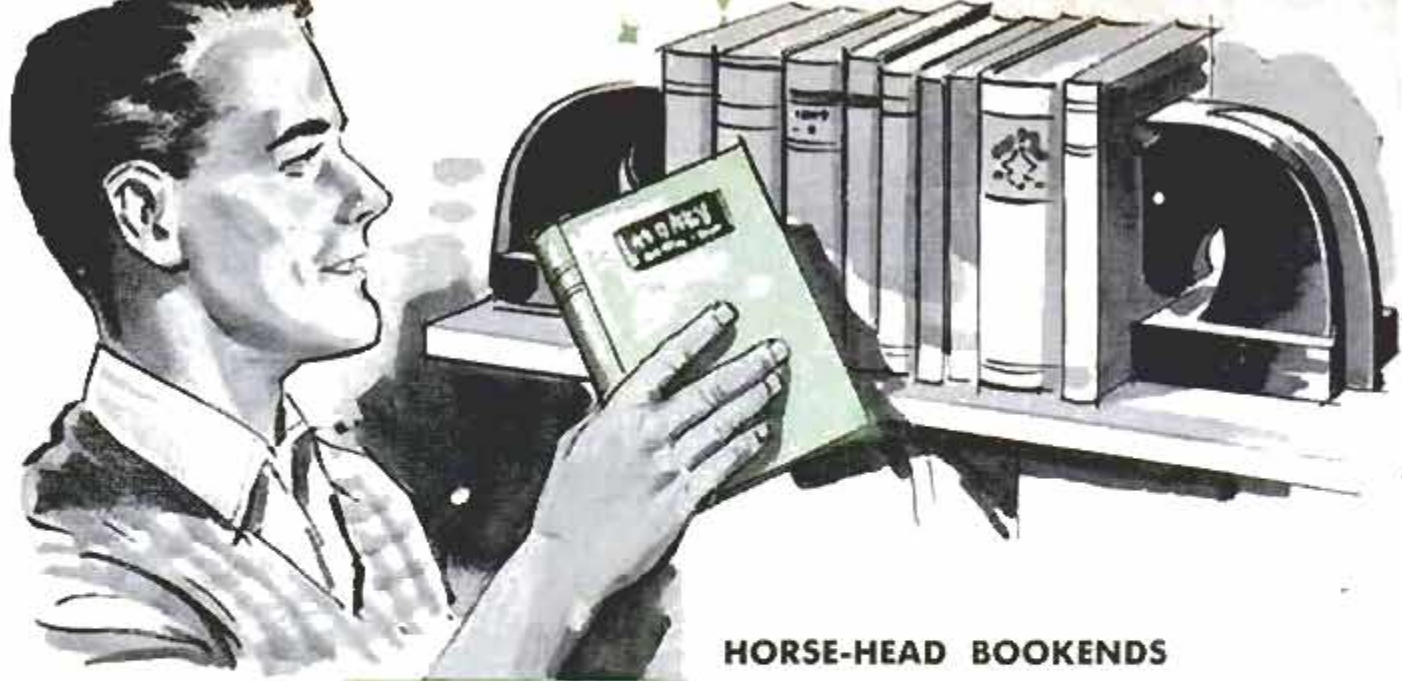

HORSE-HEAD BOOKENDS

Attractive in almost any setting, but especially appealing to the man interested in horses, these book ends can be made in a couple of evenings. Each head is made of three laminations cut to the size and shape given at the left. The long curve of neck and mane are cut first, after which the pieces are glued together, and the head and inside of the neck cut as one piece. The completed book ends may be left in natural finish, some unusual effects being obtainable with just the wood grain. Or they may be painted to suit. Eyes are transparent plastic

1" SQS.

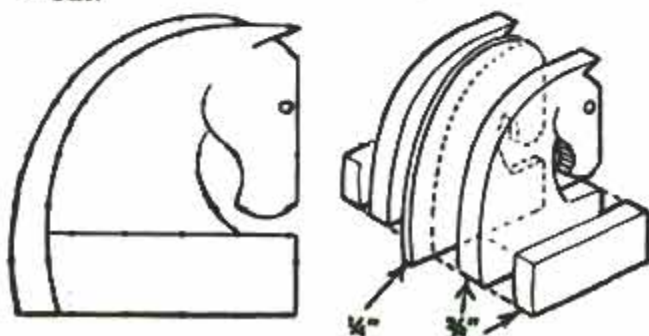

WILLOW WHISTLE

To make this old favorite, cut a piece of green willow about $\frac{1}{2}$ in. in diameter and 4 to 5 in. long. Wet and pound the bark gently to loosen it. Cut off the bark about $\frac{1}{2}$ in. from one end to provide a finger grip, and then twist and pull out the wood. Whittle a mouthpiece from the wood as shown with a flat cut on top for an air passage. Also cut a short plug for the other end. There are many variations. Drop a pea into the barrel to have a whistle with a warbling sound. To make a slide whistle, whittle a sliding piston to replace the end plug. Or, have a flute by drilling fingerholes of the right size through the top of the barrel

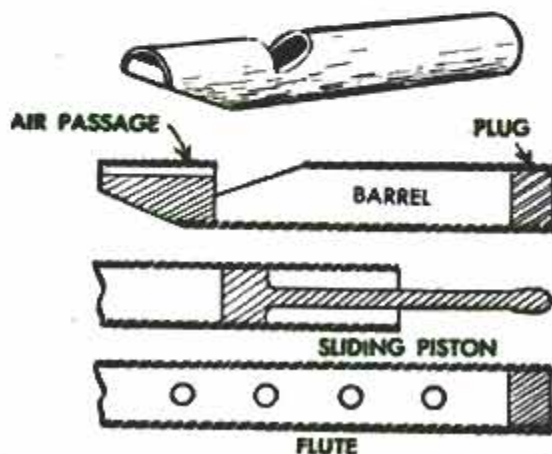

JEWELRY CASE

With its clean lines and no external hardware, this luxurious little gift contains four large jewelry trays and a secret compartment at the bottom. The case is built from 1/2-in. hardwood, and the tray shelves are 1/8-in. hardboard. Three fit in grooves in the endpieces. The lower shelf rests on cleats for removal to expose the secret compartment. All shelves are covered with felt. The exact size of the case depends on the four plastic jewelry trays, which are available from dime and department stores. Note in the lower left detail how the case is assembled with cleats, screws and nails. Doors are hung on piano hinges and are kept closed by one magnetic catch. A finger pull on the lower edge of the door of the door is cut on a circular saw. Note that a small saw kerf is run along the outer top edge of each side. This matches the slight clearance needed at the top of the doors. To open the secret compartment, the lower jewelry tray is removed and a pencil inserted into a hole in the shelf to lift it

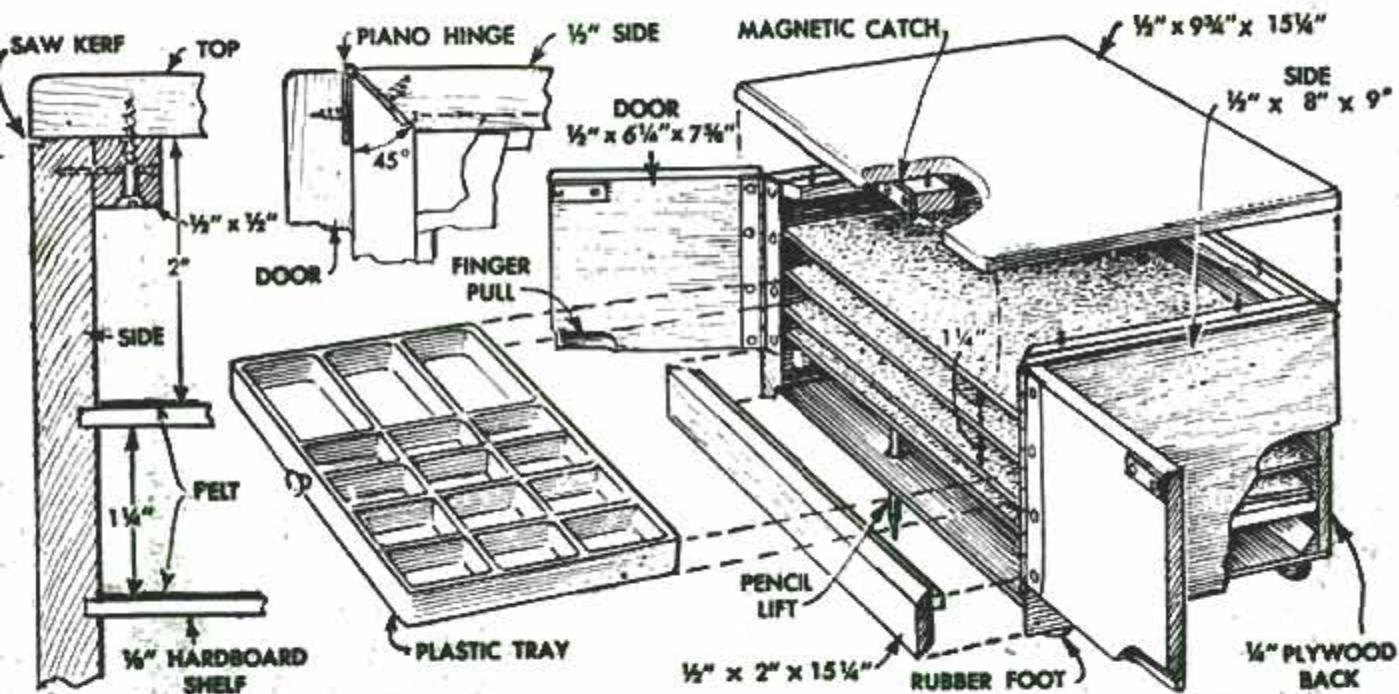

SPOOL-TANK TOY

This toy will move realistically over a rug, climb a steep incline and provide endless entertainment for the young "driver." It requires only a thread spool with notches cut in the rims, two rubber bands, one thick washer or button with a large hole drilled through it, and two pieces of small dowel or matchstick. The rubber bands are looped over the longer dowel, slipped through the washer and spool, and over the short dowel. The washer is soaped or waxed to turn easily, and the other end of the spool is notched so the short dowel will not turn. To operate the tank, wind the long dowel

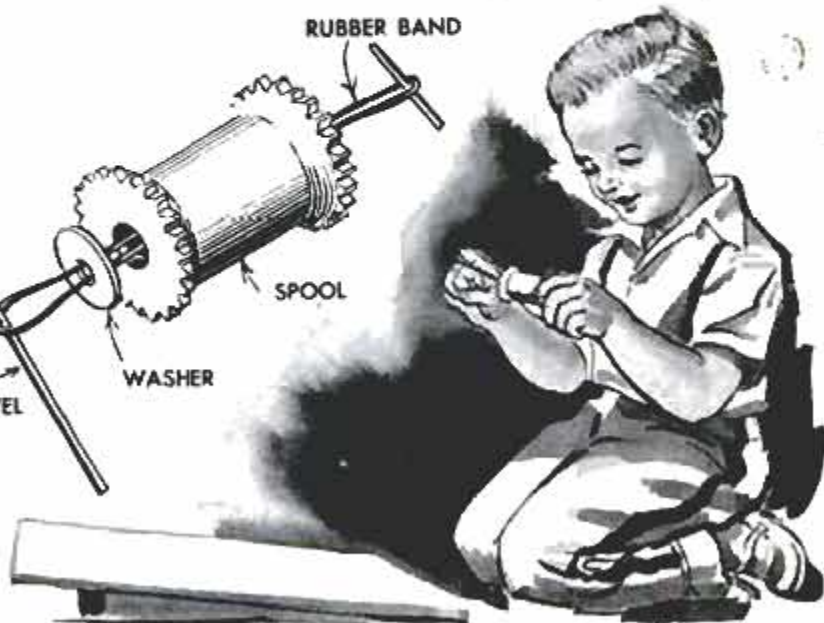
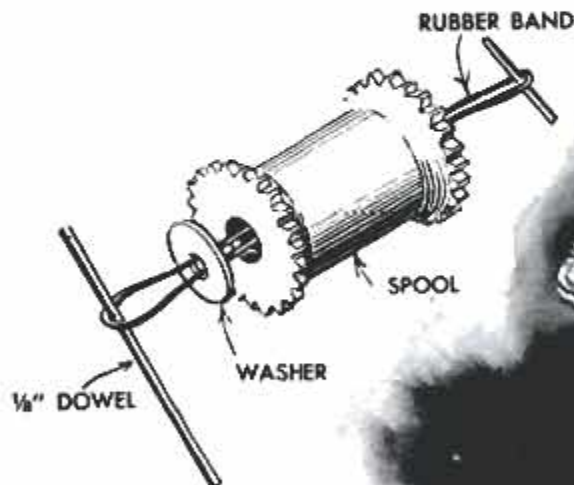

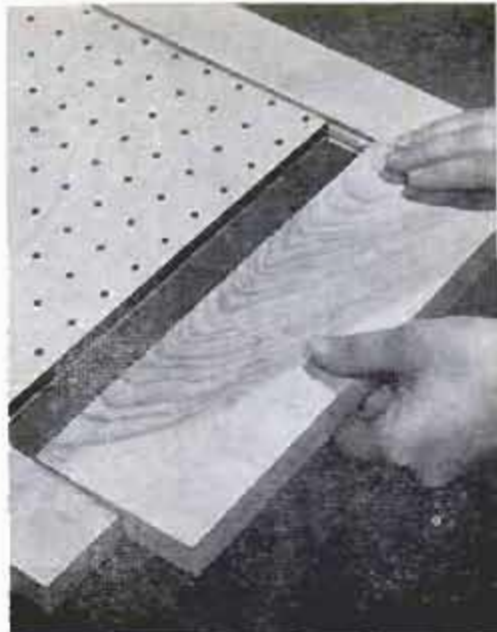

1. End sections of folding screen have double-wall panels of perforated hardboard with enough clearance between panels for inserting hanging hooks

2. Multipurpose folding screen has perforated hardboard paneled end sections for hanging clothing changes, and insulation board paneled center section that serves as bulletin board

Hang-up, Pin-up Folding Screen For Youngsters of All Ages

By Elma Waltner

CHILDREN from tots to teen-agers can get a lot of use out of this multipurpose folding screen. End sections of perforated hardboard provide a convenient means of hanging clothing changes, while the center section of insulation board serves as a large bulletin board, Fig. 2. The entire screen can also be used as a room divider, and since both sides are identical, one youngster can be accommodated on each side without interfering with the other. Suction cups mounted on the bottom edge of each section help keep the screen upright in the desired position when placed on a smooth surface. The screen is lightweight and can be folded flat for compact storage in a closet.

The screen is easy to make, requiring relatively inexpensive stock materials and no special shop tools or skills. All three sections of the model illustrated are framed with 1-in. birch lumber, although

most any other wood could be used. Birch-grain, prefinished hardboard is used in the end sections and insulation board in the center section.

Begin construction of the screen by cutting the frame members according to the dimensions given in the drawing. The hardboard and insulation-board panels are fitted in dadoes or grooves cut on the inside edges of the frame members as shown in Fig. 1 and the details. Note that the hardboard panels are spaced to provide adequate clearance between them for inserting hanger hooks. All dadoing can be done on a table saw, making several adjacent cuts to produce the 1/2-in.-wide groove for the insulation-board panel. Of course, if you have a dado attachment, this job can be done more expeditiously.

When all frame members are dadoed and the panel insets are cut to size, assemble each section and glue and screw the corners together as indicated in the detail

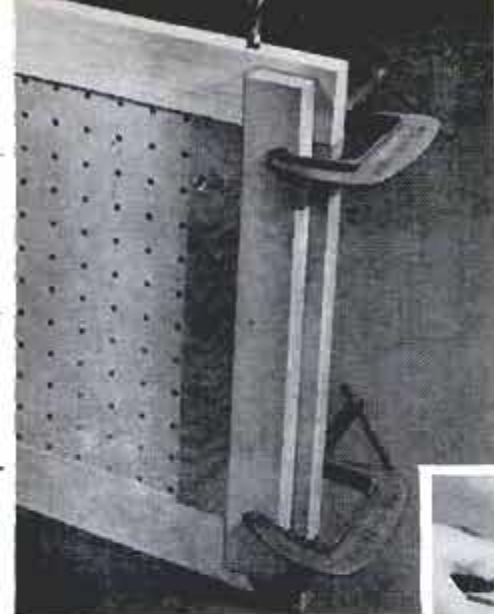

4. Screen sections are joined together by means of double-acting hinges that permit folding them in either direction to suit the occasion

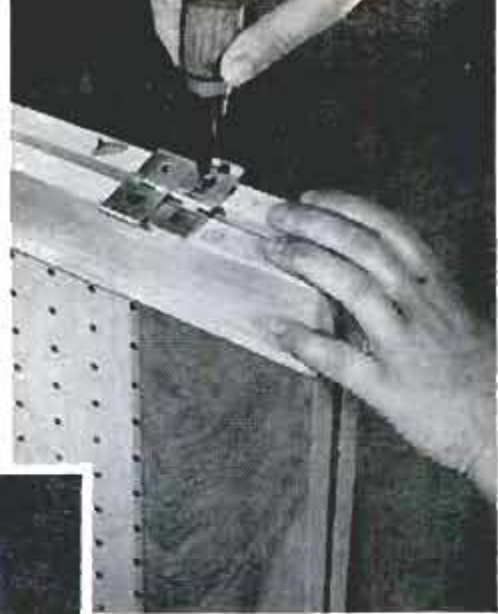

3. Scrap lumber clamped on both sides of screen end holds members of corner joints in alignment when drilling pilot hole and counterbore to take screw fastening, dowel plug

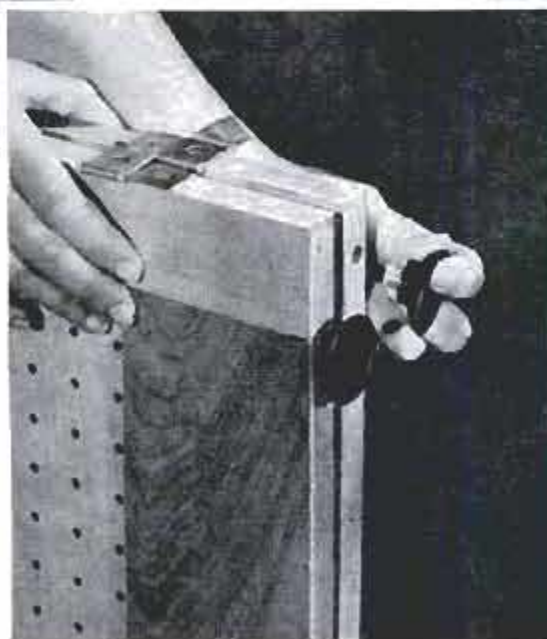

Suction cups, used as feet that keep screen in place while things are being attached to bulletin board, are staggered to clear one another when the sections are folded flat

at right. This is done by sliding each of the end pieces in place and then clamping them in the manner shown in Fig. 3, to permit accurate drilling of the pilot hole and counter-bore for the screw. After the glue has set, the screen sections are joined together with double-acting hinges as shown in Fig. 4.

Next two suction-cup feet are installed on each section, fitting them in holes drilled in the bottom edge of each section. Cup locations on adjacent sections are staggered so as to bypass each other when the screen is folded flat, Fig. 5. The completed screen may be stained and varnished where prefinished material is not used. To personalize the screen, attach letters to it spelling the child's name as in Fig. 1. This may prove to be especially beneficial when there are two children using the screen, each of whom is assigned a side. Use decal or plastic letters for this purpose, which are available at marine supply and variety stores. For later adult use, simply decorate the panels with wallpaper. ★ ★ ★

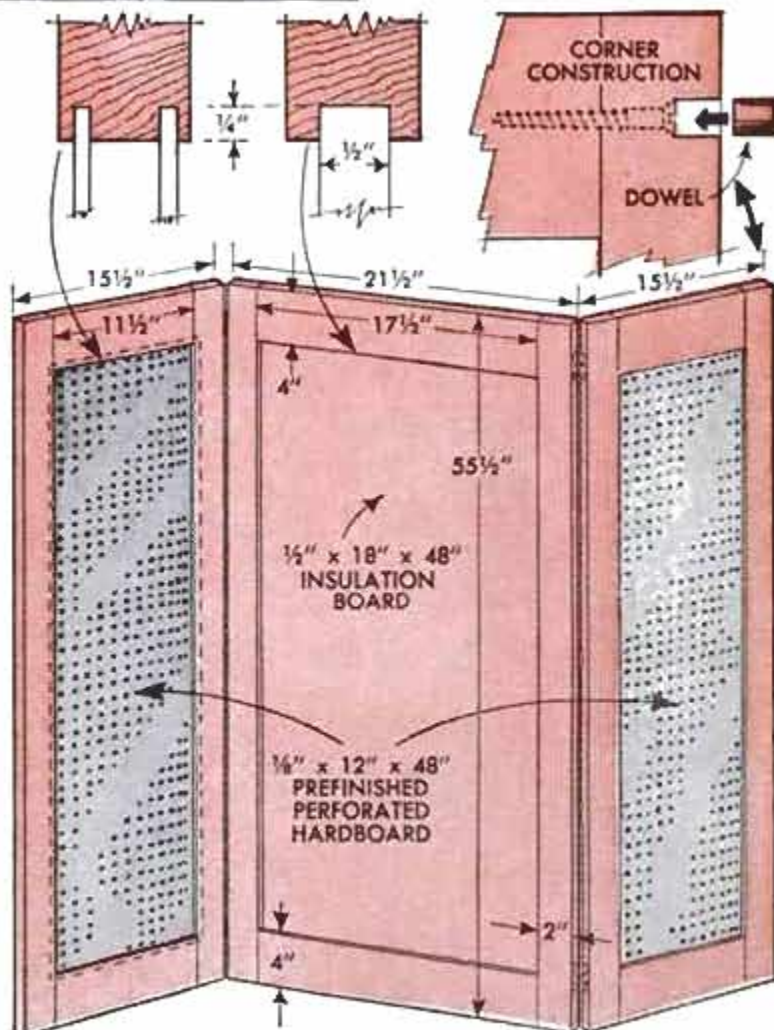



Wooden Strips Clamped Together Used for Measuring Doorway

Have you ever tried to measure the exact distance between doorway moldings or other places where it is impossible to place a rule next to the points between which the distance must be determined? An easy way of doing this is to clamp two strips of wood together so that the ends are in contact with the surfaces between which a measurement is desired as shown in the photo. Then measure the clamped strips, or transfer the distance from the strips directly to stock, if a member must be cut to fit. Be sure the clamp screw is turned tight on the overlap of the strips when transferring a measurement. A small aluminum C-clamp is ideal for this purpose.

Wayne Judy, International Falls, Minn.



Extension Pieces on Slide Ends Are Slide-Rule Aid

Small wooden extension pieces glued on the ends of the slide in a slide rule as indicated at left make it easy to push the slide past center position, when normally the slide would be flush with the rule at both ends. After the extension pieces are glued in place, sand them to the same dimensions as the slide.

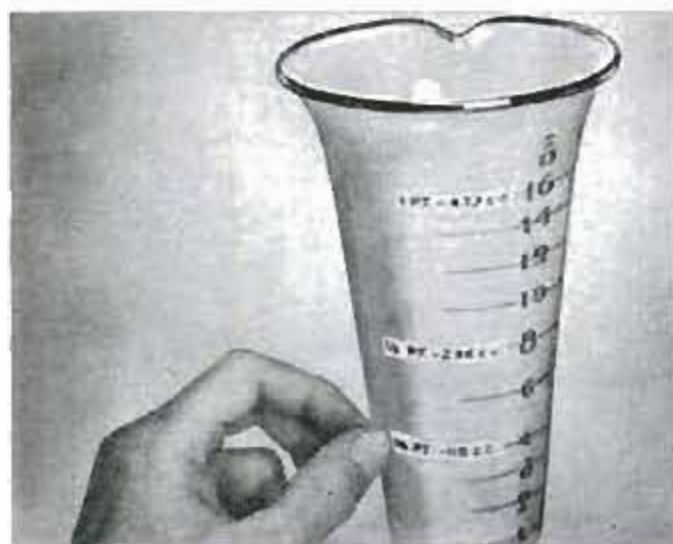

Conversion Data on Graduate Saves Reading Time

When measuring liquid in a graduate marked in ounces, it is often necessary to convert the readings to cubic centimeters or pint fractions. To save time looking up reference data, or figuring the equivalents, one lab assistant inked them on tabs cut from masking tape. These were then applied on the graduate opposite the appropriate ounce numbers as shown in the photo. Several coats of clear lacquer protect the tabs from moisture.

H. Hanscom, Elmhurst, Ill.



Pattern Formed From Wire Solder To Duplicate Curve on Part

Duplicating the curved outline of a part is easy when a length of 50-50 wire solder is formed to the surface to be copied and used as a pattern as indicated in the photo. The above type of solder is easy to form and retains the desired shape while a tracing is being made. The ends of the solder should be taped to the drawing paper or stock while tracing.

Versatile pedestal ash-tray unit may be used as receptacle for tobacco ashes, or as a base for a decorative dish or bowl after tray is removed



PEDESTAL ASH TRAY

By Walter E. Burton

HERE IS A NOVEL approach to an ash-tray design that, with its column-supported tiered arrangement of flat, square parts and upturned edges, is strongly reminiscent of a Chinese pagoda. The lower part of the tray unit also can be used as a pedestal for a decorative dish or bowl as shown in the photo directly above, in which case the ash tray is removed. This is accomplished by removing and replacing the bolt that fastens the ash tray to the base of the unit.

All parts of the unit are made of aluminum, using $\frac{1}{16}$ -in. soft sheet stock for the tray and flat pieces of the base, $\frac{3}{32}$ -in. wire for the legs, and $\frac{1}{4}$ -in. tubing for the spacers as shown in the drawing. Rivets used for assembling the two lower parts of the tray base are $\frac{1}{8} \times \frac{3}{4}$ in. All joints on the tray lip and tray are fastened with liquid-type cold aluminum solder. When doing this, it is necessary to clamp the joints until the solder sets. Rubber bands are excellent for this purpose. The completed unit may be left unpainted, or enameled in one or more colors to go with the decor of the room in which it is to be used. A suggested color scheme is as follows: Black on the tray base and outside of the tray, bright red inside and natural finish on the legs and spacers.

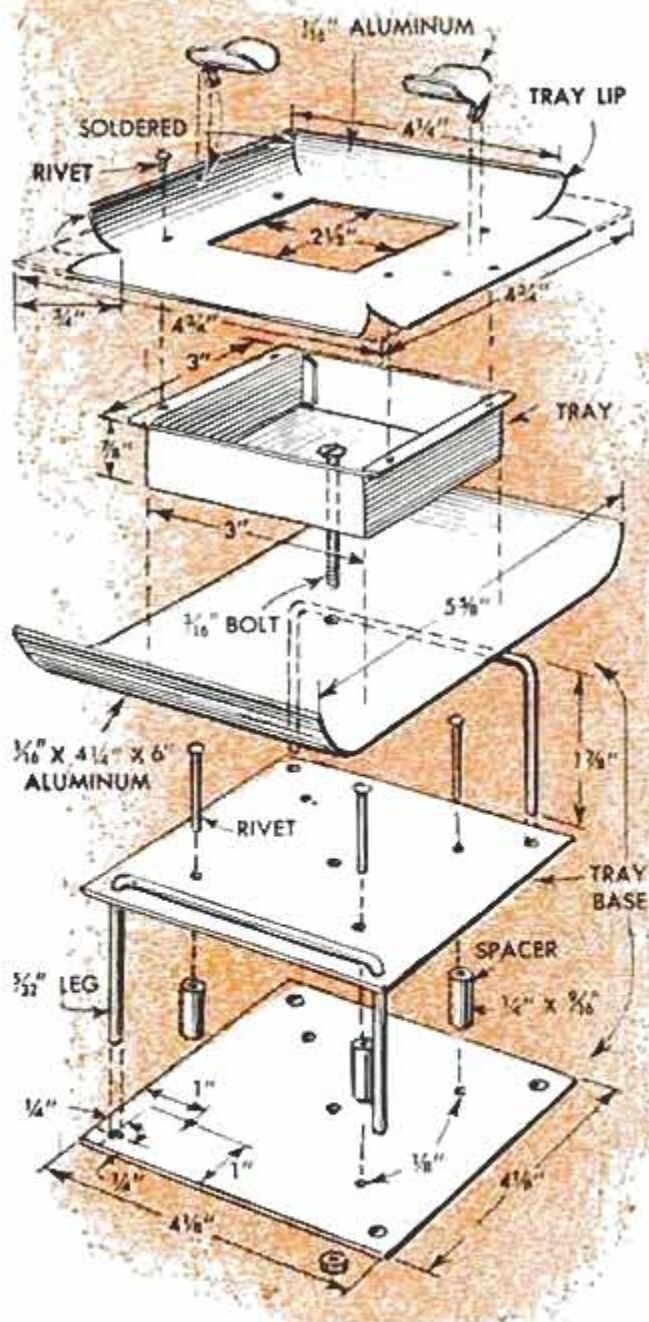

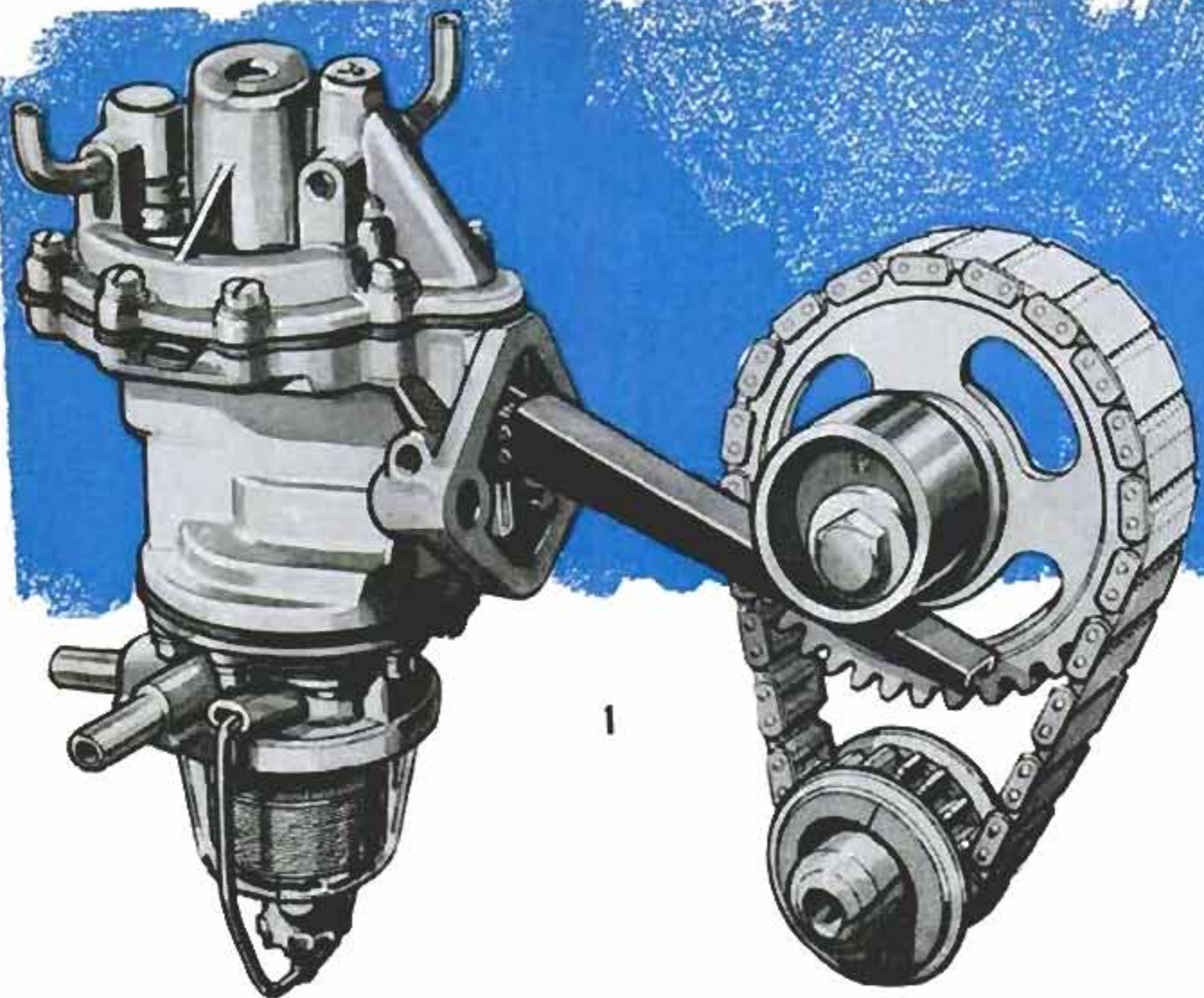

THE VACUUM-BOOSTER PUMP

By George R. Willys

ALTHOUGH SOME MAKES of automobiles have electric windshield-wiper motors, the majority of cars use wiper motors powered by vacuum. Earlier models of cars had the wiper motors connected directly to the intake manifold of the car engine, using its vacuum for power. The disadvantage of this arrangement is that at high speed, or when an engine is accel-

erated rapidly with wide-open throttle, the manifold vacuum drops to only one or two inches. A wiper motor then operates very slowly, or not at all. To overcome this problem vacuum-booster pumps now are used.

In late-model cars the booster usually is the upper end of a so-called "double ended" pump, Figs. 1 and 4, which contains both a fuel and vacuum-booster pump. Both the fuel and vacuum ends of the pump are actuated by the same rocker arm which, in turn, is operated by the engine camshaft, but separate linkage on the pump end of the arm permits the two pumps to operate independently of each other, Fig. 4. The fuel-pump end of the unit works constantly while the engine is operating. The rocker arm pulls the pump diaphragm up, but it is forced down by its spring when the pivoting-rocker arm releases its pressure. The diaphragm spring, by keeping pressure on the arm, forces it to follow the contour of the camshaft lobe.

The vacuum-pump end of the unit operates only when vacuum in the intake

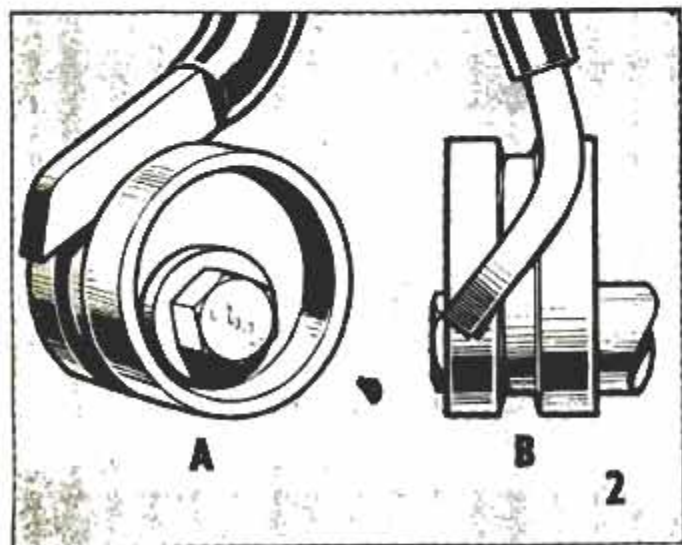

manifold becomes too weak to operate the windshield-wiper motor, and to hold up the diaphragm of the vacuum pump. Under normal conditions of idle, or moderate speed, the diaphragm is held up by the manifold vacuum which, in turn, keeps the diaphragm spring under tension. The spring exerts a pressure of approximately 125 lb. If the wiper motor is used under these conditions vacuum is supplied to the wiper motor directly from the intake manifold, as in detail C of Fig. 3. Note in this detail that the rocker arm has released the rod of the fuel-pump diaphragm and the spring is pushing down the diaphragm which pumps gas up to the carburetor. The vacuum-pump links on the rocker arm, Fig. 4, are "free wheeling" and not operating. Should the accelerator pedal suddenly be depressed, opening the throttle completely, vacuum in the intake manifold drops and the diaphragm in the vacuum booster is released. This permits the diaphragm spring to force it down. As in detail A of Fig. 3, the diaphragm now pumps vacuum from the wiper motor on its downstroke, the valve leading to the intake manifold being closed. The underside of the diaphragm is under pressure and this pressure is exhausted through a valve into the pump body from where it is discharged into the engine crankcase. The vacuum booster is a "two way" pump,

meaning that vacuum is pumped on both the upstroke and downstroke of the diaphragm. As the diaphragm spring now is holding the diaphragm down, the vacuum-pump links are held against the rocker arm, and as the arm moves up, detail B, Fig. 3, the diaphragm is pumping vacuum on its underside. Pressure on the upper side of the diaphragm is discharged into the intake manifold. Automatic action of the valves now permits vacuum to be pumped from the wiper motor through a bypass channel in the pump casting. Note in detail B of Fig. 3 that the upward movement of the rocker arm also operates the diaphragm of the fuel pump, pulling gasoline from the tank. In detail A, the spring action is pressing the diaphragm down, which forces fuel up to the carburetor. The actions of the various valves in both the fuel and vacuum pumps are shown in the details in Fig. 3, the valves themselves and their locations are shown in Fig. 4.

When the diaphragm of a vacuum pump becomes cracked, it can cause engine troubles that seem in no way related to it. First, of course, the wiper motors will work slowly, or perhaps not at all. If the car is equipped with power brakes—they require vacuum for operation—more pressure is required to depress the brake pedal. But, at the same time, the engine may suddenly start using an excessive amount of oil, spark

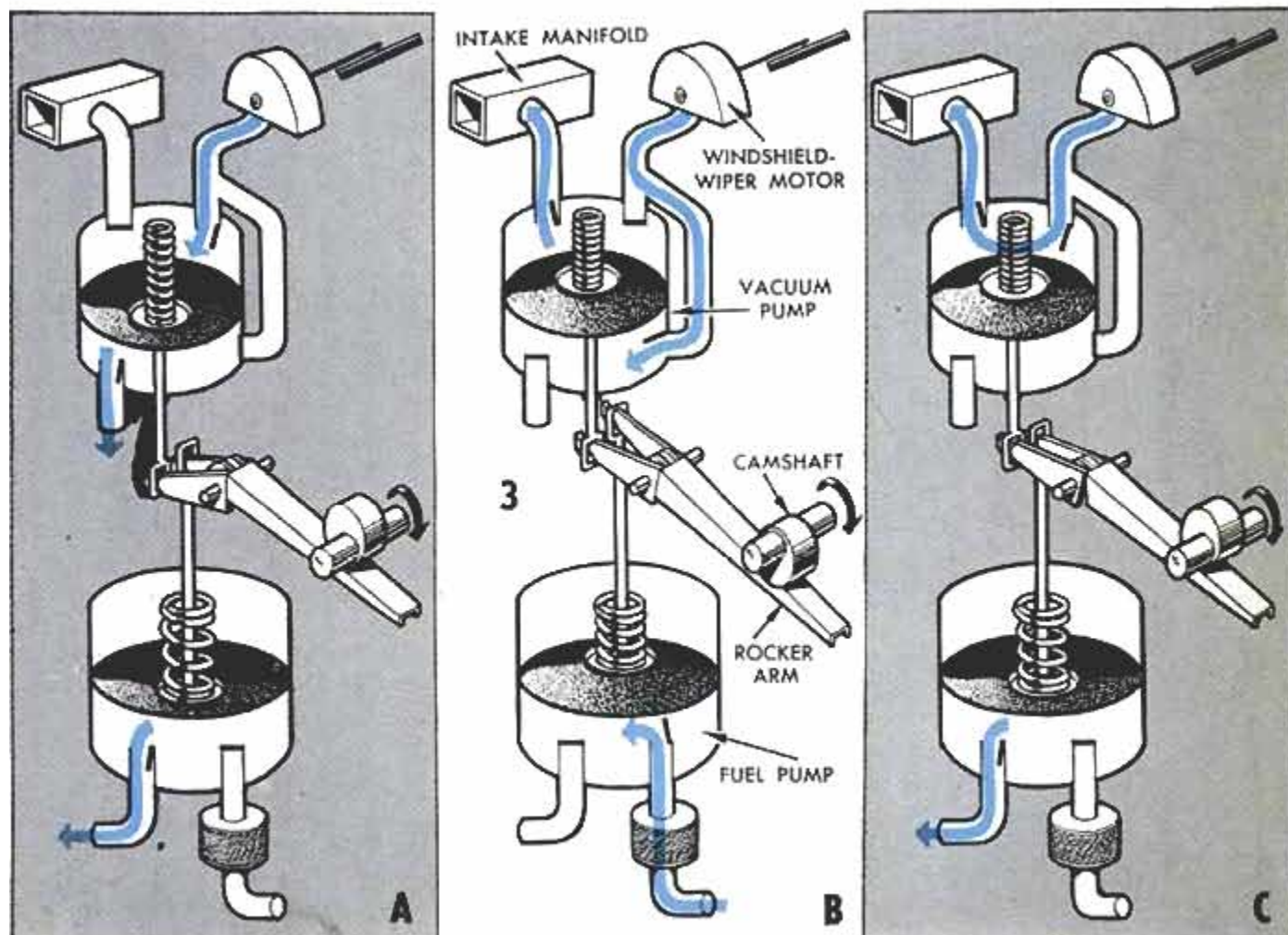

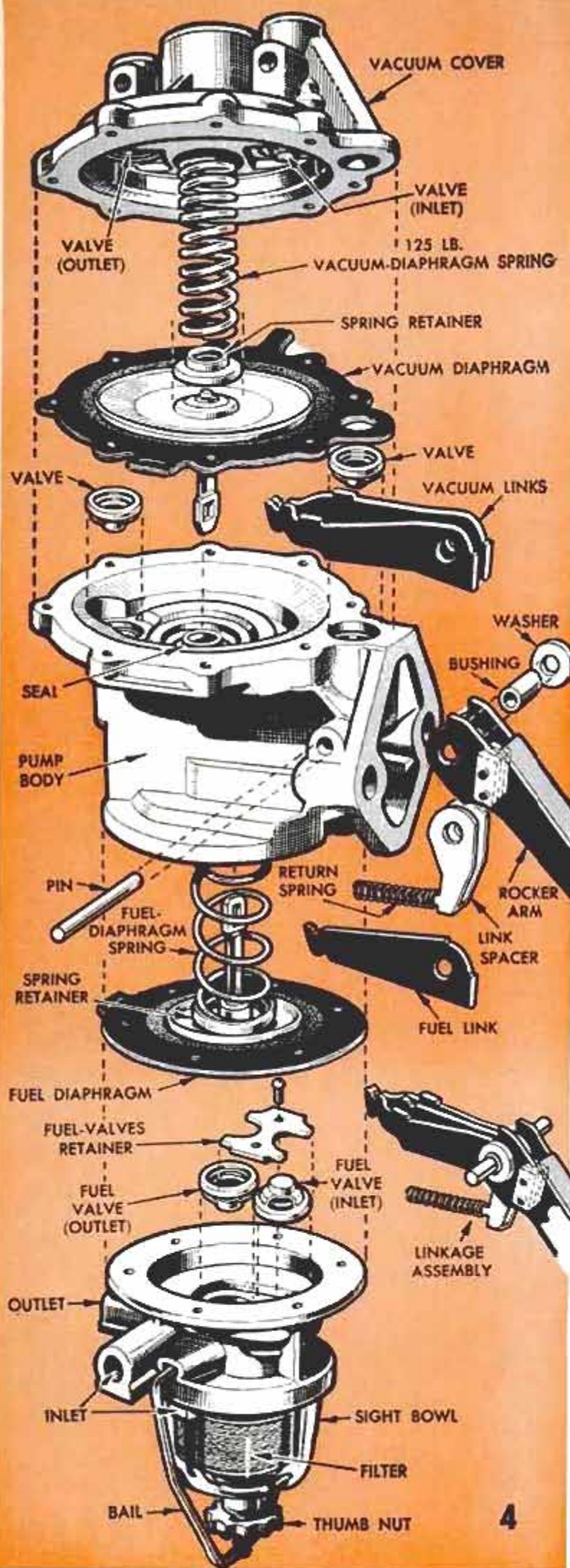

plugs will become fouled with oil and there will be heavy deposits of carbon on the pistons and the walls of the combustion chambers. Finally, after a time, the fuel pump will not deliver enough gasoline to keep the engine running.

In some cases installing a new pump will solve the fuel-shortage problem temporarily, but eventually, the pump will stop delivering fuel. What has happened is that the rocker arm has worn a groove in the camshaft lobe, and the stroke of the arm no longer is great enough to actuate the pump. The trouble starts with the leaking diaphragm in the vacuum pump that cannot be held up by the vacuum from the intake manifold. The heavy diaphragm spring then exerts a constant pressure on the rocker arm and it is this pressure that wears a groove in the camshaft lobe, as in detail A, Fig. 2. When it is known that the groove exists, a temporary repair can be made by bending the rocker arm slightly so that it straddles the groove as in detail B, Fig. 2. In extreme cases it may be necessary to replace the camshaft. This is true of in-line engines that have the pumps bolted to the side of the block. A short rocker arm readily reaches the camshaft that is located off-center in the block, close to one side. On V8 engines the camshaft is in the center of the block and it is necessary to mount the fuel pump on the cover of the timing chain. The eccentric that actuates the rocker arm of the pump is a separate unit that is bolted to the face of the camshaft gear, as in Fig. 1. In this case, should the eccentric become grooved, only the eccentric need be replaced, rather than the complete camshaft.

A grooved camshaft also will result when a malfunctioning vacuum pump is bypassed by connecting the hose from the windshield-wiper motor directly to the intake manifold. With no vacuum to hold up the diaphragm, the rocker arm will wear a groove.

When the vacuum-pump diaphragm is cracked, oil vapor from the crankcase is sucked into the pump, then discharged into the intake manifold where it is burned and becomes carbon deposits or fouls spark plugs. ★★★

Vacuum Cleaner Provides Blower For Shop-Made Forge

"Forced draft" from a discarded vacuum cleaner eliminates the need for a manually operated bellows for this forge, keeping both hands free for working. Built by Aldo Albericco of Orland, Calif., the forge has a firebox made from a truck wheel. Openings in the wheel disk were closed by welding in pieces of steel plate. At the center of the disk a number of $\frac{3}{16}$ -in. holes were drilled in an area about 4 in. in diameter. A 2-to-4-in. pipe reducing coupling was welded on the underside of the bowl formed by the modified wheel, positioned to cover all the drilled holes. To control the amount of air, a butterfly damper was fitted in a 6-in. pipe nipple that was screwed into the reducer. On the lower end of the nipple is fitted a tee, the lower end of which is fitted with a pipe plug that can be removed to clean the pipe. From the tee run a reducer to fit the vacuum cleaner.



Improvised Open-End Wrench

Modelmakers who need a wrench for working with small nuts, bolts and cap-screws can improvise one from a wheel-type glass cutter. If the cutter wheel is dulled and worn out, simply grind off the end of the cutter as indicated. If the cutter is still sharp it need not be modified. The various sizes of chipping notches in the side of the glass cutter will fit several sizes of bolts or nuts. The cutter handle will provide plenty of torque for sure tightening.

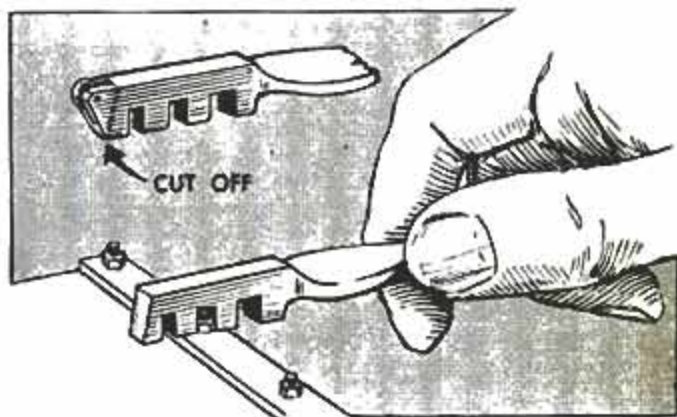

Accurate Depth Gauge Improvised For Drill Setup in Lathe

When drilling in a lathe it sometimes is necessary to know exactly how deep the drill bit is entering the work. The scale on the tailstock cannot always be relied on because the quill may slip back or the drill bit may slide into the chuck under pressure. An accurate depth gauge can be improvised for this setup from a spring-type clothespin fitted with a strip of sheet metal on one leg. A short metal scale is slipped under the sheet metal as indicated. The scale is adjusted so its end is aligned with the end of the drill bit. As the bit enters the work the scale moves with it, and a glance at the scale will show how deep the bit is penetrating. The scale must be positioned so it does not strike the rotating work. Be sure chuck is properly tightened so the bit cannot slip.

R. Hanscom, Elmhurst, Ill.

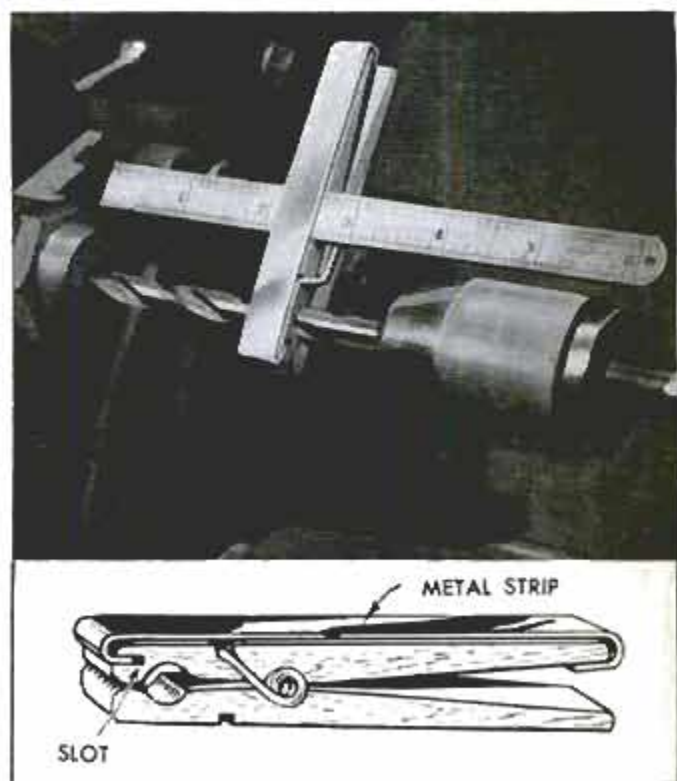

Solving Home Problems



"NOSY BOARD," is the nickname given this telephone-caller announcement board which was instituted by one family as a means of solving a teen-age phone-tieup problem. The phone user simply points to the name of the caller as listed on the board, when requested to do so by another member of the family. This way an important conversation need not be interrupted. Other uses of the board have developed since then. The word "help" is a cue for someone in the room to call the user away from a too-talkative caller. "Sh-h-h" is a request for silence. The free-form board is cut from 1/2-in wallboard. Names of frequent callers may be lettered on the preprinted board, or on cardboard strips, which are thumbtacked in place as shown

SMALL DRAPERY HOOK clipped on a plastic clothesline prevents drip-dry shirt hung on it from sliding into other clothes on the line as indicated. The drapery hook also prevents shirt and hanger from flying off the line on a windy day. Use a pair of the hooks spaced on the line to keep pant legs apart when drying wash trousers on self-creasing frames

EVER HAVE A BALL OF CORD or twine unwind and become badly tangled? You can prevent this by winding the cord on a small block of wood and securing the loose end under a strip of masking tape as illustrated below. The cord will adhere to the tape, even if one end of it should come loose. Paint the block a bright color so that it can be seen easily

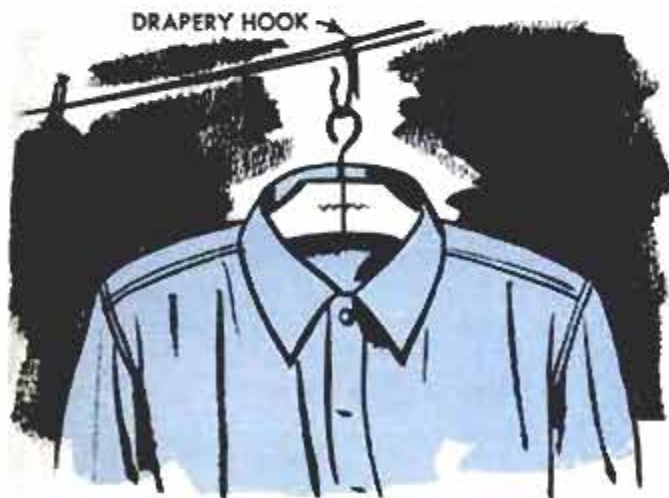



FRUIT-JAR LID

DON'T DISCARD burned-out light bulbs of the large clear-glass type. Use them as planters as shown above. First drill out the socket end of a 200 to 500-watt bulb. Then remove the filament and file the threaded-brass part to an even edge. A fruit-jar lid provides a good base for the bulb-planter, or a wooden block with a round cut out can be used

HERE IS A WAY of making a photo album from a large-size book having a good binding, but with contents that are of no interest to you. To do this, cut off the text part of the first page, leaving only the unprinted margin next to the binding. Then cut off the next 5 pages close to the binding to allow space for the thickness of photos and mounts. Cut off the next page in the same manner as the first one, leaving another narrow strip or tab, after which a sheet of photo-mounting paper is cut to the page size and glued in place between the two tabs as detailed. The same sequence is followed for the remaining pages of the book. Cover the old title with tape, after having inked the title, "Photos," on it

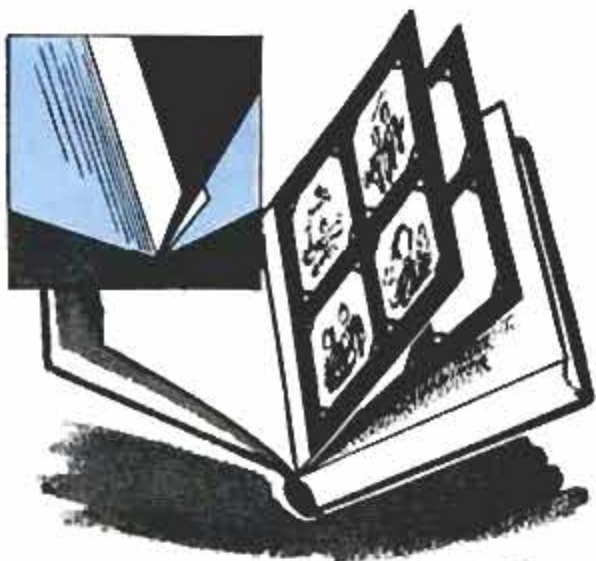

WHEN USING A PAPER CUP for a glue or paint pot, fasten it to a small wooden block with a thumbtack as shown below. To remove the cup from the block, pry it up with the blade of a knife. In use, the block catches drippings from the cup and permits moving it without getting glue or paint on fingers



THUMB TACK

Next time you have a need for a watertight container, line a cigar box or cardboard carton with a sheet of aluminum foil as shown above. This type of container is fine for mixing patching plaster, paints and fiber-glass resin since the lining can be thrown away after it is used. Eliminates the bothersome job of cleaning the mixing container

STRAIGHTENING A FINGER RING is easy, if you go about it in the following manner. Slip the ring on a metal sewing thimble so that it bears against the thimble snugly. Then insert a finger in the thimble and hold it on a wooden block while tapping the ring into shape with a small hammer





Keeping Hoods on Gun Sights From Slipping Out of Place

Front ramp-type sight hoods on some rifles often slide forward, especially when pulling the gun from a case, and they may even slide off and become lost. This trouble may be corrected by making a small punch mark at the front end of the ramp at the side of each groove. When this is done the hood will stay in place, but may be removed by forcing it over the punch marks. Since doing this on several of my guns, I have never had a hood shift forward, or slide off.

Robert V. Thompson, Clinton, Iowa.

☑ When using an umbrella carry a plastic bag in your pocket. It will be handy to slip over the end of the folded umbrella if it is set on the floor wet.

Piggin Made From Nail Keg Is Handy Toolbox

Resembling an old colonial piggin, a small tote box for carrying a few tools, garden equipment or other small items can be made from an old nail keg. First tighten the hoops and nail or staple them to the staves. Then 4 to 6 in. up from the bottom cut the keg in half. Measure the distance carefully so that you will have a uniform cut. Leave one stave full length and shape it to a rounding taper at the top. Near the top of this stave drill a hole to take a short length of $\frac{3}{4}$ -in. dowel, which serves as a carrying handle. Sand the surface of the keg smooth and finish it to suit.

W. D. Terrill, Oak Park, Ill.

Hand Warmer Aids Carpenter In Subzero Weather

The difficulty of keeping your hands warm while doing any type of work that requires the driving of nails during extremely cold weather, may be overcome by using a commercial hand warmer. In use, the latter is kept in the nail-apron pocket, and a mitten is worn on the hand using the hammer. The hand that must be kept bare to handle the nails is held in the nail pocket as much as possible. Since the hand warmer keeps the nails warm, the combination of warmer and warm nails is sufficient to keep the workman's bare hand warm even in extremely cold weather. In fact, this idea has enabled carpenters to work comfortably in temperatures as low as 30 deg. below zero.

Wayne Judy, International Falls, Minn.

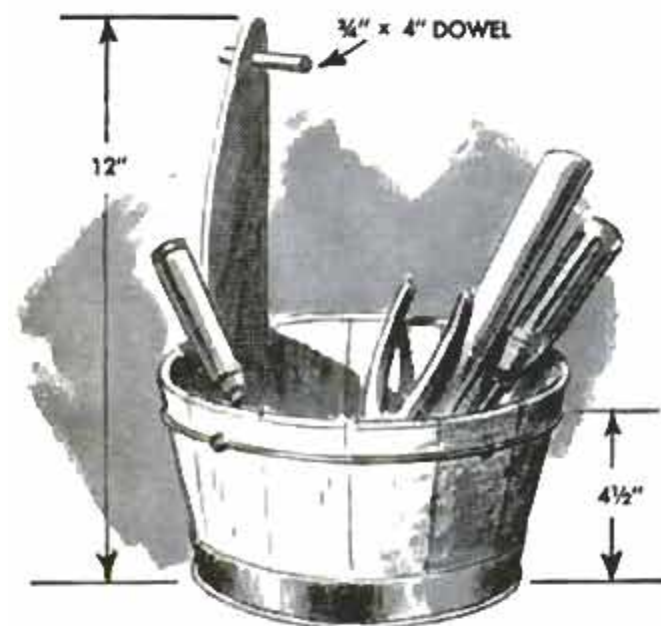

WROUGHT-IRON EFFECT FOR YOUR HOME HARDWARE

If you have a room paneled in wood with cabinets or other built-ins, and wish to change the hardware to a hammered or wrought-iron type, try simulating the desired finish on the existing hardware. A hammered finish can be simulated quite easily on hinges, switch plates and drawer pulls, with aluminum putty, which is available at dime stores. The parts are coated with the plastic, which then is indented and modeled to produce the desired effect.

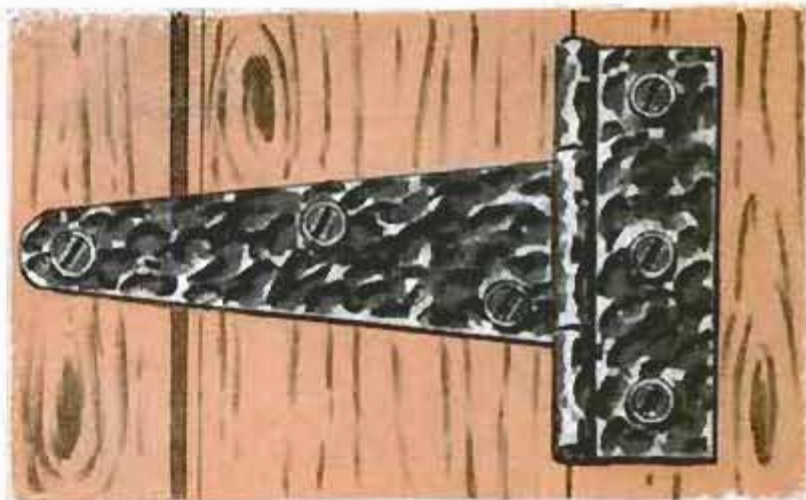

Clean the parts thoroughly and then coat them liberally with the aluminum putty as below



Spread the plastic uniformly over the part, letting it go into the screw holes to obtain a uniform coating

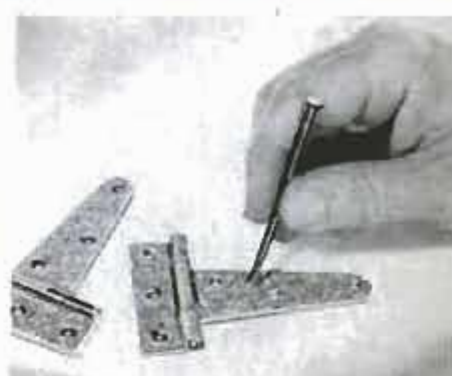

Then indent the surface to get the desired effect. When dry punch out screw holes and paint

Helpful Gluing Hints to Remember On Your Woodworking Projects

You can prevent glue from adhering to wooden clamps by wiping them occasionally with a thin film of linseed oil. After this treatment, dried glue easily can be chipped or peeled from the clamp surfaces.

If glue is too thick to spread evenly on materials such as paper and cloth, try thinning it with denatured alcohol. The alcohol will evaporate faster than additional water so the drying time will be decreased.

Glue spread by scrubbing the work lightly with a wire scratch brush will penetrate better into the pores of the wood, and the bond between the parts will be stronger. Do not scrub too hard. Rub just hard enough to very slightly roughen the surface. Do this by hand as a power-driven brush will throw the glue.

For large jobs, apply the glue with a cheap roller of the kind sold for painting window screens. It rolls the glue on more uniformly and economically than a brush. These rollers are the type used in commercial production.

To store powdered glue so it won't harden, put it in a screw-top container, and turn the container upside down.



Old Tire Retains Fire Wood When Splitting to Stove Size

When splitting stove wood or fireplace wood much of the stooping necessary can be avoided by using an old tire as shown. It is supported above the chopping block at the desired height by three wooden legs. As each piece of wood is split it is kept from falling to the ground by the tire.

YOU CAN FINISH FURNITURE



By E. R. Haan

PART 2

Anyone can produce beautiful finishes on furniture if careful attention is given to the techniques of sanding, staining, toning or glazing, and sealing and varnishing or lacquering.

AFTER PREPARING the surfaces of a piece of furniture for finishing as described last month, you are ready to apply the finishing materials. As mentioned before, proceed slowly. At this point, especially, many home craftsmen make the mistake of hurrying. Producing an exceptionally fine finish often requires more time than building the project.

Clear Finishes on Furniture

The procedure for finishing close-grain and open-grain wood, as given in Fig. 15, is the same except that open-grain wood requires filling. Complete drying of each application is of utmost importance, as well as light sanding and scrupulous cleaning between all coatings.

Transparent top coats are applied after stain, toner and filler have been sealed.

This prevents the solvent of the top coat from softening the material underneath and allowing it to bleed. Many pigmented stains and toners are self-sealing, but are intended for use under varnish or shellac, not under brushing lacquer, which softens them. Most sealers are similarly affected by brushing lacquer. Therefore, if a lacquer top coat is desired, the procedure to prevent the above trouble consists of "fogging" a lacquer sanding-sealer over the stain, toner or filler with a spray gun. So applied, this sealer dries before it can affect the underlying material. When dry, the sealer coat is followed by lacquer coats sprayed on, not brushed on, as brushing lacquer has a retarded drying time and may dissolve the sealer coat. Lacquer cannot be applied over varnish, but in refinishing work, varnish can be applied over lacquer.



Staining or toning tends to add color beauty to wood and, in some cases, helps accentuate the grain

Stains and Staining

Wood is tinted by staining or toning as in Fig. 12. Getting the right color and shade is first done experimentally on scrap wood of the same kind as the furniture to be finished. Types of stains are given in Fig. 13. A pigmented stain does not have the color clarity of penetrating stain, which contains a dye. Pigment stain usually is applied by brush or cloth and is allowed to stand for 5 to 10 min. before the excess is wiped off with a clean, soft cloth. The time varies with the wood and the shade desired. If the stain gets dry or gummy before wiping, the cloth is dampened with benzine or turpentine. The stain should dry from 3 to 4 hrs. before the next finishing step. Pigment stain is more effective on softwood than on hardwood. On some softwoods, which absorb stain unevenly, it is best to first use a wash coat of $\frac{1}{2}$ -lb. cut shellac, which is allowed to dry, and then sand before applying the stain. Penetrating stains

are most effective on hardwoods. Penetrating sealer-stains have become highly popular, as they stain and seal in one operation. Varnish stains should not be used on new work where the grain is to be left visible.

Stains having high-color clarity and permanence can be made by dissolving aniline dye in powder form in water, wood alcohol or lacquer thinner as in Fig. 14. These can be used under lacquer. The mixing proportions are powder, 1 oz., to wood alcohol, 1 qt., or the same amount of hot water just below boiling temperature. For lighter or darker shades the amount of the solvent is varied. After preparing this stain it should be passed through a fine strainer. Using alcohol makes a nongrain-raising stain, but if water is used, the resulting stain raises wood grain, which then requires resanding. After application, the stain is wiped to produce a uniform tone. Water stain requires from 12 to 24 hrs. of drying time. The alcohol stain dries very fast and must

Ready-mixed stains are of three general types: pigmented, penetrating and combination sealer-stain

Mix-your-own stain consists of dissolving powdered aniline dye in water or in wood alcohol

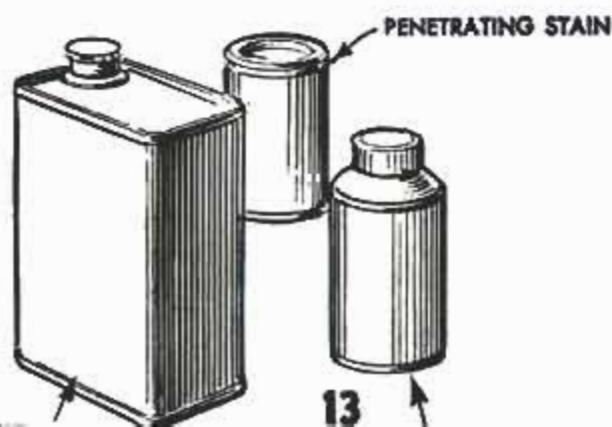

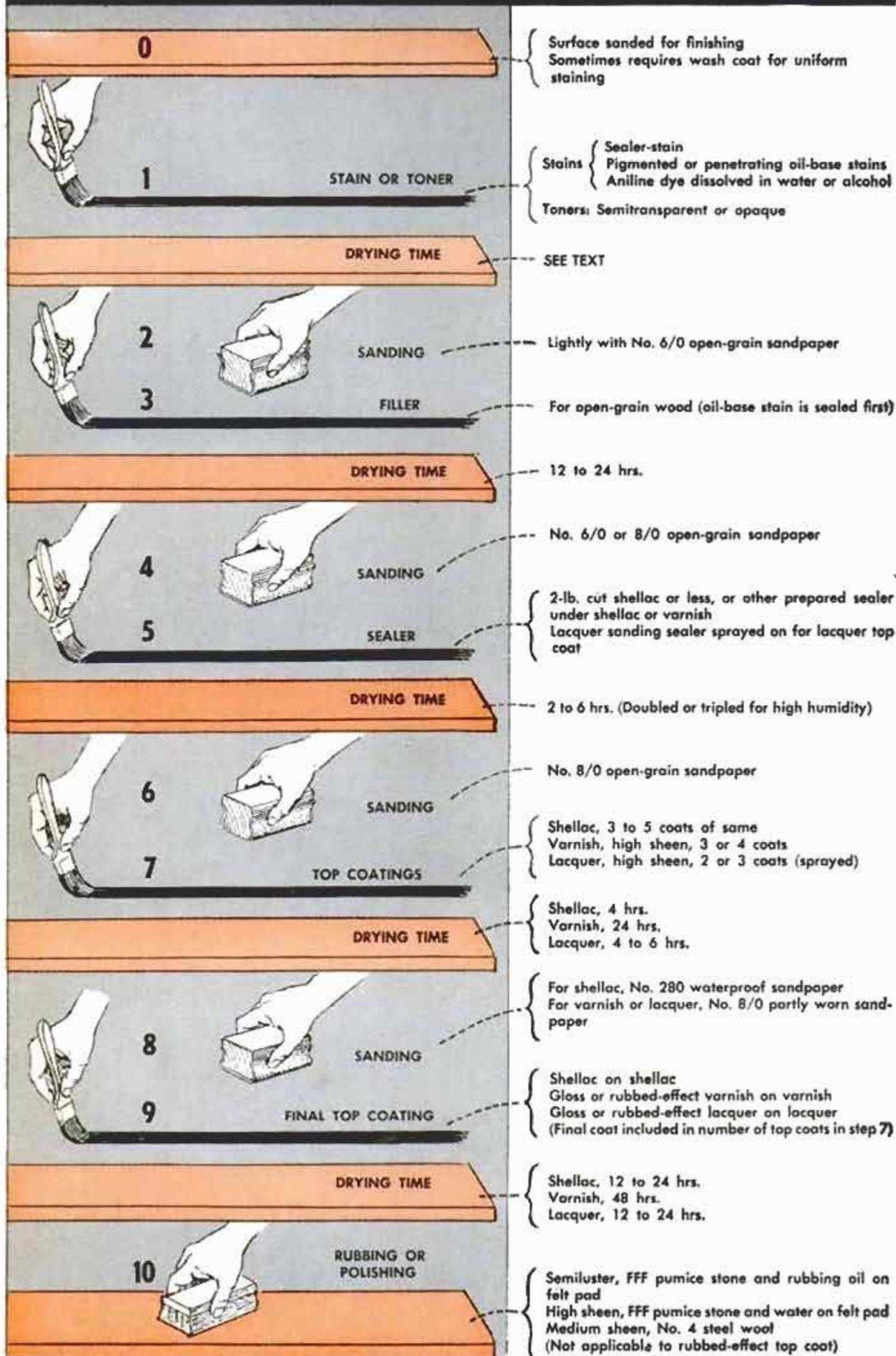

be applied rapidly, preferably by spraying, to assure uniformity. When brushed on large surfaces it should be applied in two half-strength coats with a wide brush, working fast for quick and uniform coverage. A drying time of 2 to 3 hrs. is allowed.

In using any stain, the light-colored mineral streaks in wood are first darkened, using a small brush, after which the over-all surface is stained. Stain will not penetrate glue spots, or many other spots, which should be removed previously. Bleaching new wood generally is not recommended. Instead, it is better to use lighter wood or to use toners for lightening dark wood.

Toning or Glazing

This process is practically the same as staining with pigmented stain. Colored pigments reduced to a thin paint are used to partly or wholly obscure the wood grain. By so changing the appearance of wood, less-expensive kinds often can be used.

To produce bleached or frosted effects the pigment is white, which may be tinted. It is applied over the entire surface as in Fig. 16. When the color starts to dull, the toner is delicately wiped in the direction of grain with a clean, lint-free, soft cloth, folded to suit as in Fig. 17. The amount of wiping largely controls the degree of transparency obtained although the toner itself is thin and semitransparent after it has been applied.

For contrasty grain effects in open-grain woods, such as oak, walnut or mahogany, toning is more opaque, with little or no wiping, and after the coating has dried, the wood grain is filled with a contrasting paste wood filler as in Fig. 18.

Toners may be pigmented sealers applied over a sealer-stain or over ordinary stain. They may consist of colors ground in japan and thinned with turpentine, or they may consist simply of flat enamel or enamel undercoater, 1 part, and turpentine, 2 parts. Toners should dry from 12 to 24 hrs., or according to the manufacturer's recommendations.

Paste Wood Filler

To make the surface of open-grained wood smooth, it is filled with paste wood filler. This is never done directly on bare wood or over an oil-base stain without a wash coat of $\frac{1}{2}$ -lb. cut shellac or other sealer. The shellac wash coat consists of 4 or 5-lb. cut shellac, 1 part, dissolved in wood alcohol, 8 parts. Filling can be done directly on sealer-stain after this has dried. The sealer or sealer-stain is sanded with No. 8/0 sandpaper before filler is applied.

The filler is reduced to the consistency of a heavy cream for large pores, and to

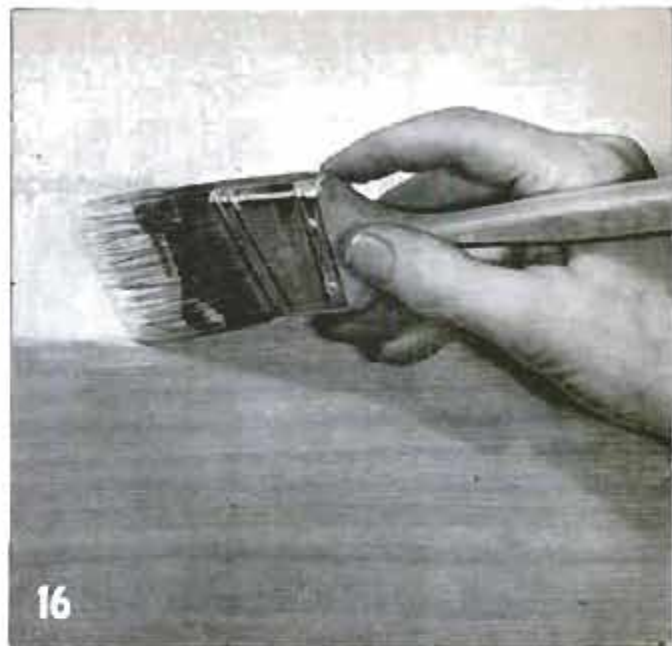

16
Light, semitransparent toner being brushed on. Lower part of photo shows the untreated surface



17
Above, toner partly wiped off, giving frosted effect.

Below, wiping off filler applied over dark toner



18



Lacquer is best sprayed on. Work should be mounted on turntable in a spray booth, or taken outdoors

that of milk for small pores. Two thin coats applied 12 hrs. apart are better than a single thick coat. A solvent may be recommended on the can for reducing the filler, or equal parts of benzine and turpentine can be used. A variety of colors can be obtained by adding stain or pigment to the filler, pigment being reduced with benzine before it is added.

Filler is brushed well into the grain, covering an area not greater than can be wiped before the filler turns flat. The excess is wiped off first across the grain with burlap, then with the grain, using a soft cloth. This is done carefully to avoid pulling the filler out of the pores. If excess filler is not all removed, the subsequent finish will appear blotchy. Rags used for wiping off filler are disposed of immediately as they are subject to spontaneous combustion. A stiff stencil brush is used to clean filler from moldings, carvings and scrollwork. Dried filler is picked off with a sharpened dowel. When dry, the filled surfaces are sanded with No. 8/0 sandpaper.

Pad sander fitted with felt shoe helps reduce the work of polishing, as well as the work of sanding

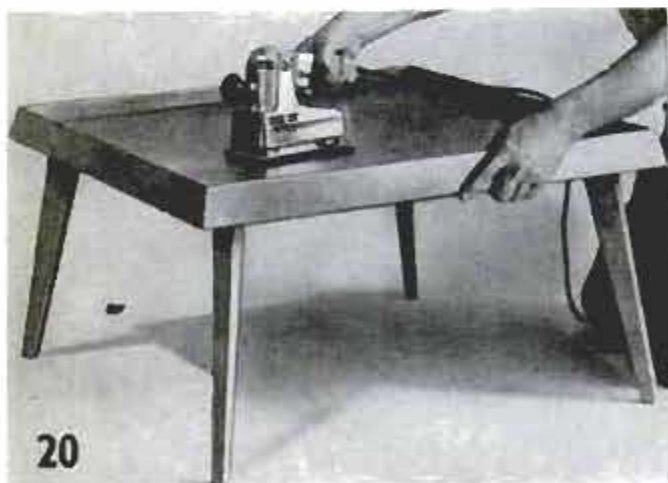

Sealing

Where sealer-stain was used and no filler over it, the separate step of sealing is eliminated. Ordinary stain is sealed before applying filler. Filler, when dry, also is sealed. Sealers should not be applied thickly, as they are brittle and tend to check.

Shellac is the "most-common sealer for use under varnish. It should be a 2-lb. cut or less. A lacquer sanding sealer is used under a lacquer top coat sprayed on. Some synthetic sealers also serve as top coats. Most sealers dry in 2 to 6 hrs., but this time is doubled or tripled when humidity is high, especially for shellac. A sealer should be so dry that it can be sanded with No. 8/0 sandpaper to a powder without clogging the sandpaper. Sealers can be applied with a soft, long-bristle brush, or sprayed. Lacquer sealers are sprayed—not brushed—over any undercoat that may bleed.

Shellac Top Coat

Although a shellac top coat is damaged easily by water and alcohol, such damage is simply repaired by recoating with shellac. A wax coat over shellac will retard the action of water and alcohol. White shellac is used on lightwood and on walnut. Orange shellac may be used on mahogany and other dark woods, but tends to darken them further. Shellac tends to discolor in a few months after having been exposed to air. It should not be applied heavier than a 2-lb. cut, and only wood alcohol is used to thin it. A good top coat of shellac is built up by three to five applications, each being allowed to dry fully and then sanded. Drying time for shellac top coats is given in Fig. 15. For sanding shellac, No. 280 wet-or-dry paper is best, applying a little light machine oil to the surface to minimize heating from friction.

Varnish and Lacquer Top Coats

A substantial top coat consists of three or four applications of varnish, or two or three applications of lacquer. The lacquer coats are sprayed on, Fig. 19. All coats should have a hard, high-sheen surface, but the final coat may be one that gives a rubbed-effect or stain finish. The stain finish should not be used for undercoats as it then will produce a cloudy appearance.

Most varnishes are thinned with turpentine, but the so-called plastic finishes require special thinners. Varnish should not be shaken or stirred before application as this produces air bubbles which are transferred to the work. Varnish is brushed on in a full-flowing coat. See Fig. 15 for drying time. Lacquer is clearer than varnish. When thinning lacquer for spray-gun

application the best grade of thinner is used. Lacquers are applied in full wet coats and can be sanded and recoated in 4 to 6 hrs. but the final coat should dry from 12 to 24 hrs. before it is rubbed.

Sanding Between Coats

Light sanding with partly worn No. 8/0 sandpaper between coats is done to cut the glaze and to make the next coat adhere better. It also removes dust specks and high spots. Care is taken to avoid cutting through the coats, especially at corners and sharp edges. Heavy runs should not be sanded until a 48-hr. period has elapsed. Care is taken to avoid heating which results in gumming and peeling. After surfaces are sanded, the dust is brushed off and the surfaces wiped with a tack rag to remove all traces of dust before applying the next coat. A tack rag is a lint-free rag dampened slightly with thinned varnish, and used when nearly dry.

Rubbing and Polishing

Proper rubbing of thoroughly dry varnished or lacquered surfaces produces a smooth, satin finish. Rubbed-effect or satin-finish varnish or lacquer should never be rubbed as they do not have sufficient hardness for this. Rubbing always is done with the grain of the wood, using light pressure. A pad sander can be used for this purpose as in Fig. 20.

Where a real fine finish is not required No. 4/0 steel wool may be used. A higher sheen is obtained by lubricating the work with soapy water. A dull satin finish is produced by rubbing with FFF pumice stone and rubbing oil, using a 1/2-in. felt pad about 2 1/2 by 4 in. in size. No other oil than rubbing oil should be used. The pad is first dipped in the oil, then in the pumice stone, which is repeated as necessary, keeping enough oil on the pad to prevent rubbing dry. All traces of oil and pumice are wiped off after rubbing. A highly polished finish is produced by rubbing with FFF pumice stone and water, using the same procedure of wetting the pad. After cleaning off the work, a rubbing with rottenstone and water on the following day will bring out a high luster. ★ ★ ★

☐ Metal lath provides an excellent guard for small trees. It is stiff and when formed into a cylinder, the lower end can be filled with peat moss or mild fertilizer, which is kept confined within the small space. When sprinkled or wet by rain, the chemicals in the fertilizer are carried down into the soil about the tree roots.



Repairing Loose Trim on Car

If a piece of plated trim loosens on your car because of a rusted sheet-metal nut, which holds it in place, it is easy to make a new one. Just cut a piece of sheet steel that will slide inside the trim, drill it for the screw, and then slide it into place and drive in the screw.

Horace Schatzschneider, Fort Monroe, Va.

Keep Motor-Switch Contacts Clean

Small split-phase motors often fail, or draw excessive current when starting because of dirty contacts in the starting winding of the centrifugal switch. Periodic cleaning of the contacts with a fine ignition file, or fine sandpaper, will help prevent this trouble.



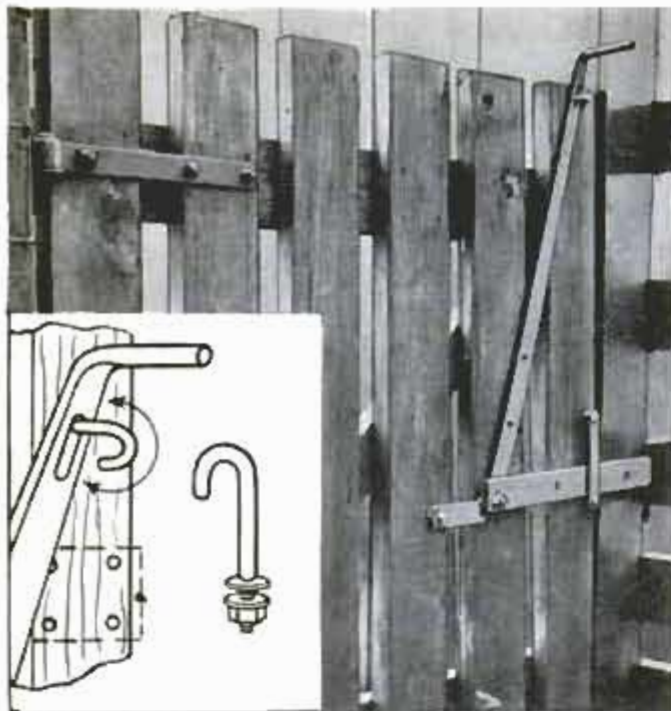

Locking Bolt for Stock Gate

Stock cannot open this latch, which makes it ideal for use on gates between feed lots. A lever attached to the bolt has a slot at the upper end that engages a hook bolt when in the closed position. The locking feature is provided by the bolt which prevents release of the lever when the hooked part is turned at right angles to the slot as in the detail above.

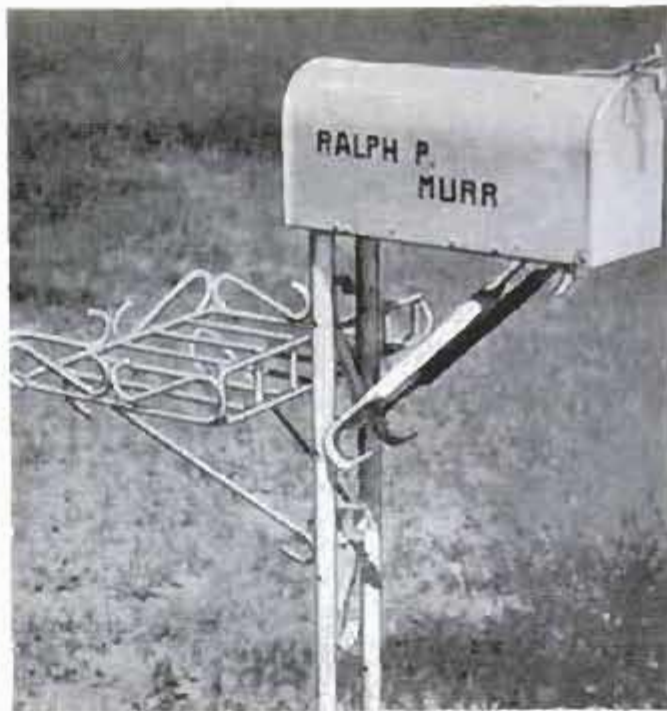

Package Rack for Rural Mailbox

Ornamental as well as useful, this sturdy package rack for a rural mailbox is constructed entirely of spokes removed from the wheel of an old hay rake. All joints are welded, including attachment to the mailbox support. Straight pieces are used for all parts of the rack, except the ornamental sides and support pieces which are formed as shown in the photo.

Wings Prevent Livestock From Stepping Over Ends of Guard

Wings on the ends of this cattle guard prevent livestock from passing through the gateway by jumping over the corners of the guard next to the fence. The wings, which are 4½ ft. high, also prevent livestock from being crowded onto the guard from the ends. A gate to one side of the

guard allows stock to be moved both in and out. The guard is 7 x 12-ft., is made of 2-in. pipes spaced 5 in. on centers and rests on a shallow concrete pit. The pipes are kept in place by lengths of flat steel welded to them at right angles as shown in the photo.—A. M. Wettach, Mt. Pleasant, Iowa.

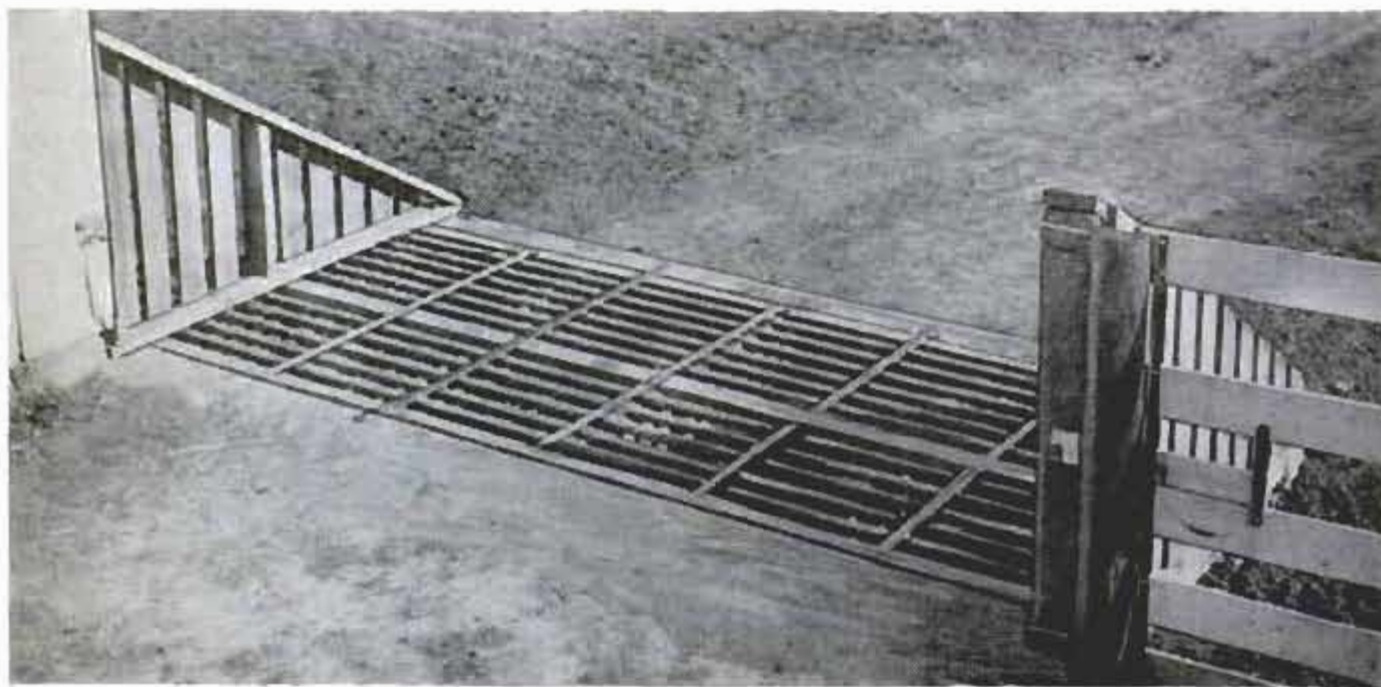

TRACTOR SCOOP HAULS FEED



"EASY DOES IT," with this wooden platform that fits the loader frame of a farm-tractor scoop for barnyard feed hauling. The platform also is handy for carrying large timbers and other heavy objects. Made of 2-in. planks as shown, the platform is fitted with two brackets and two flat-steel hooks that engage cross members at the lower end of the loader frame, the bottom one of which is a $\frac{1}{2}$ -in. tie rod installed in place of the steel scoop. The latter tem-

porary alteration is the only one necessary. To connect the platform to the loader, simply tilt up the forward end and slip the hooks under the frame crossbar so that when the platform is released, the hooks and brackets are in the position shown in the detail. The weight of the platform acting as a lever helps to keep it in place, even when no load is being carried. Two coats of paint protect the wood and prevent sliver injuries.—D. O'Brien, Gahanna, Ohio

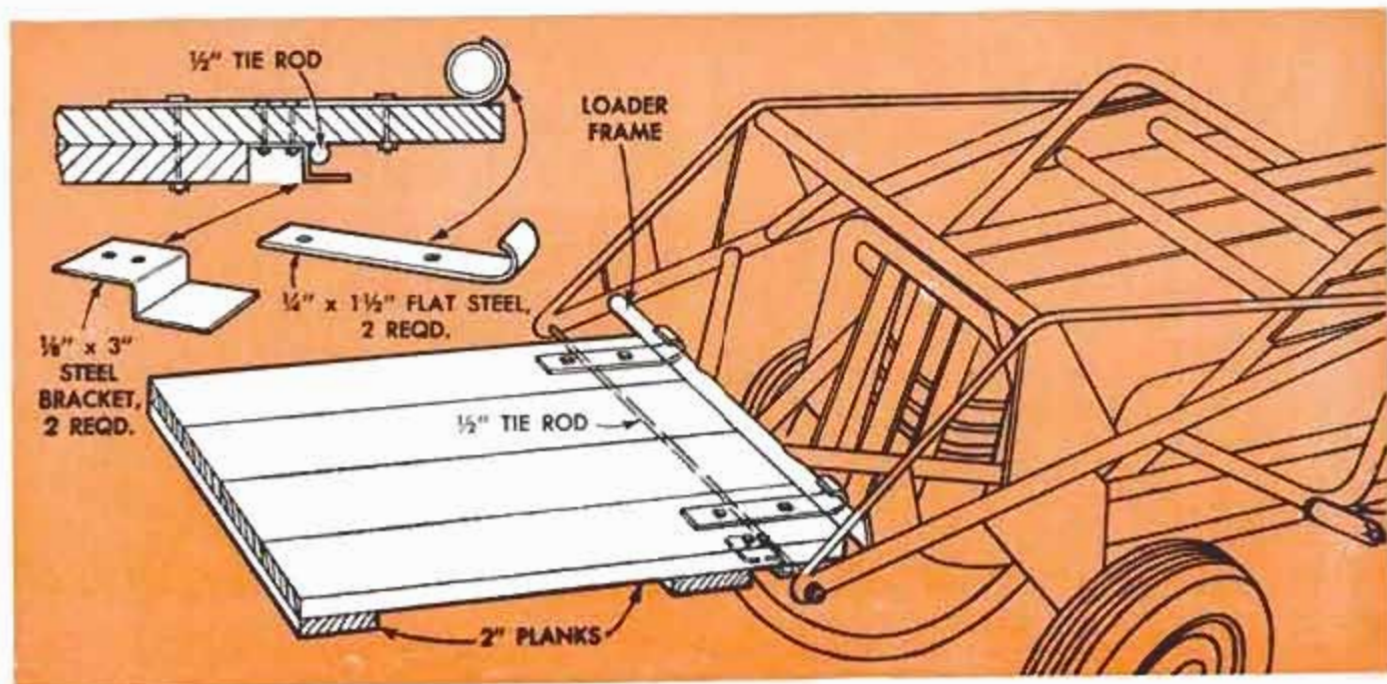

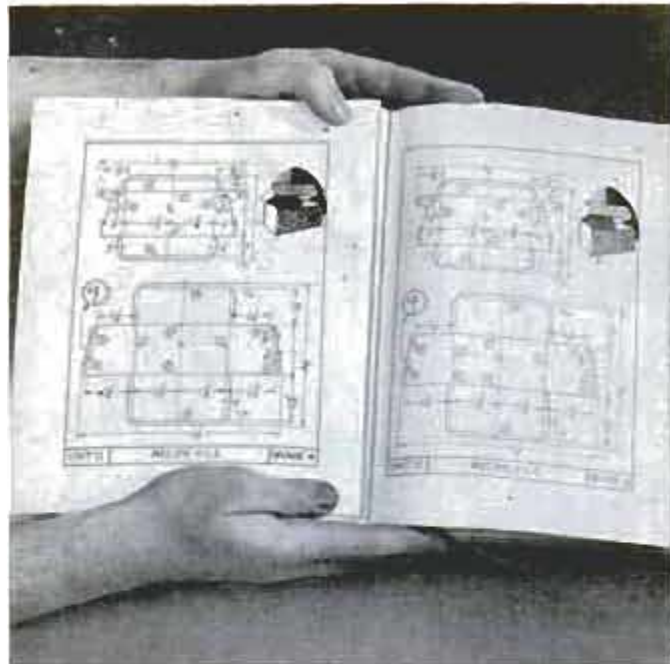

Note that copy at left is more contrasty than original at right. Lines and details are much sharper

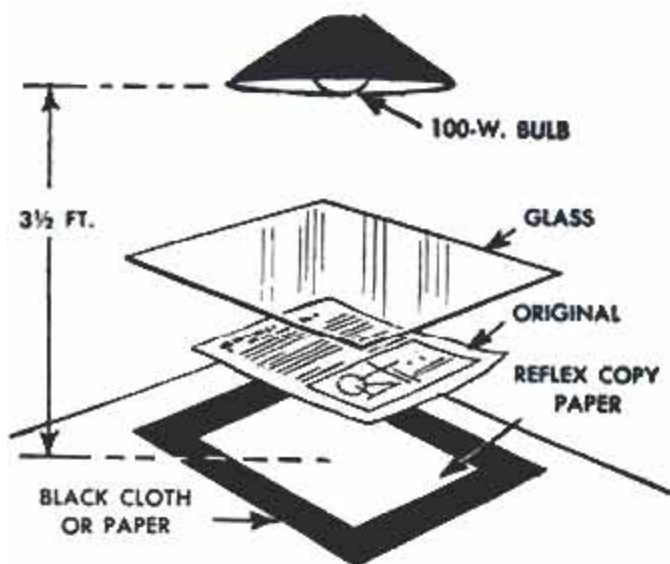

When original has printing on both sides, back the copy paper with black cloth to prevent double image

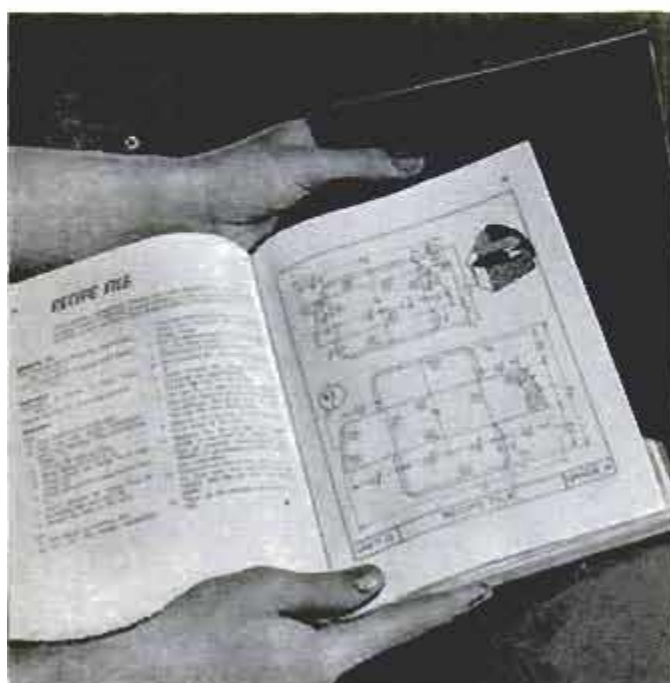

COPYING WITHOUT A CAMERA

By Rolfe F. Schell

REFLEX paper makes it possible for anyone to copy an illustration, diagram or other drawing photographically without a camera, and directly from a book or magazine without mutilating the printed page. It can be done in a darkened kitchen or bathroom, and the chances are you already have the few items of equipment necessary.

Reflex copy paper is a sensitized paper which can be exposed only when the light source comes from the emulsion side. Light directed through the paper from the back side has no effect upon the emulsion. Only when the light reflects from the white of the prototype and back to the emulsion is the paper exposed. Reflex copy paper is available from photo and office-supply stores in sheets 8 x 10½-in. size and costs but a few cents per sheet. It must be handled in total darkness except during development which can be done in subdued yellow-green light.

As for equipment, you will need a piece of black paper or cloth, a sheet of clear glass, a 100-watt bulb and glass baking dishes to serve as developing trays. The

Develop until impression comes out boldly. If no impression shows after 30-60 sec., lengthen exposure





black paper or cloth is used when the original has printing on two sides. Placed underneath, the black backing prevents the light from reflecting back to the sensitized paper and picking up unwanted printing on the reverse side. The glass is placed over the original to keep it and the reflex paper in close contact so that sharp reproductions will result. The bulb should be suspended about 3½ ft. above the work and

the paper exposed for six to eight seconds. The reflex paper becomes a paper negative when developed, from which regular positive prints can be made. To reproduce copy with printing on one side only, such as a letter, remember that the paper reflex is placed emulsion side up. To reproduce copy with printing on both sides, such as the page in a book, the reflex paper is placed on the copy, emulsion side down. ★ ★ ★

When copying from curved surface such as a can label, rotate can slowly to assure uniform exposure

Copy gives view camera cannot take. Note "panning" effect apparent on copy, right, made by reflex method



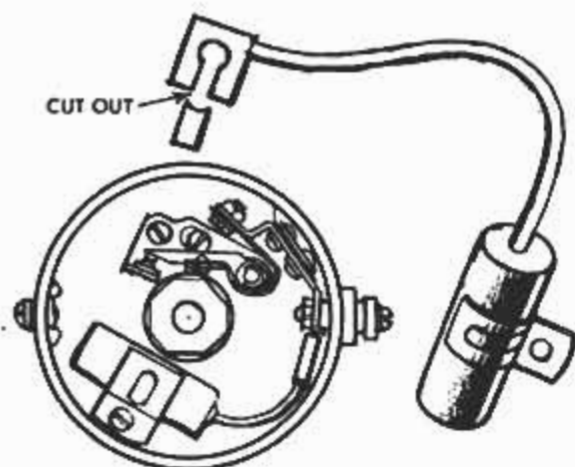

Open End Condenser-Lead Terminal Saves Installation Time

Installing a condenser in a car distributor is easy when the lead terminal on the condenser is cut to provide an open end as shown in the drawing at left. Then all you have to do when making the electrical connection, is to loosen the terminal screw or nut on the distributor, slide the lead terminal in place and tighten the screw. This saves time and temper trying to start the terminal screw since it is located in a place that usually is cramped and hard to reach.

Rubber Band Cut From Inner Tube Holds Trunk Lid Against Load

Here is an easy way of tying a car trunk lid down when carrying objects that are too large to permit closing it. Cut a band from the circumference of an inner tube, preferably along the crown. Then wrap one turn of the band around the load and loop the free end over the trunk handle as indicated in the drawing. For a trunk lid without a projecting handle, use an S-shaped hook to secure the band to a member on the underside of the lid.

G. E. Hendrickson, Argyle, Wis.

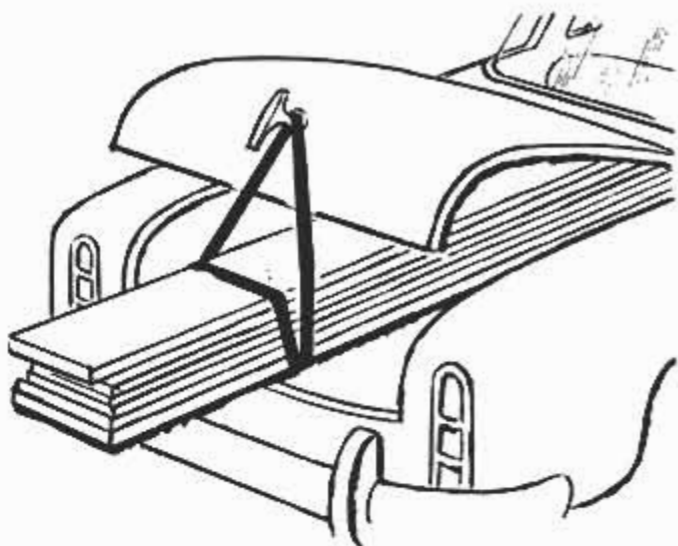

Repair Broken Car-Heater Hose With Copper-Tubing Coupling

When a car-heater hose is badly worn or broken in one spot and a replacement hose is unavailable, here is a way to repair it. First cut off the defective piece. Next cut the remaining hose into two lengths, attach one to the fitting on the heater and the other one to the outlet or inlet on the engine, as the case may be. The two lengths are then connected by inserting a length of copper tubing in them, as shown at left, to bridge the gap.

H. R. Young, Fort Worth, Tex.



"Splashed" Deposits Foul Plugs

Spark plugs that become badly fouled as a result of soft, unburned fuel deposits on piston tops being "splashed" on the insulators require special cleaning, according to the service department of Champion Spark Plug Company. A 3 to 4-sec. abrasive blast usually will remove the deposit, recognized by its spotted appearance as shown at right. Old plugs should be replaced since they may have caused the deposits by misfiring at low speeds.

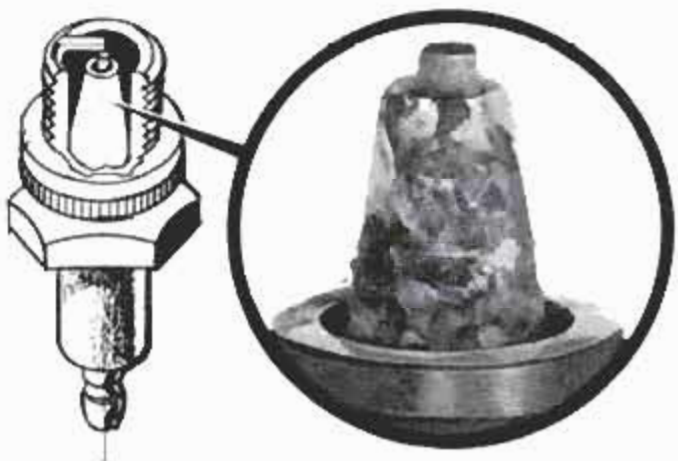

Cracked Battery Is Repairable



By Morton J. Schultz

NOW THE unfortunate owner of a cracked car battery need not consign it to the scrap heap and buy a new one, if the cells of the battery are in good condition. Using plastic auto-body solder to seal the breaks as illustrated in this article, the battery case can be made as good as new in a few hours.

Before starting with any repair work on a wet-cell storage battery, drain the electrolyte or battery acid into a glass container to avoid getting it on tools and clothing. Refill the battery with it when the repair work is completed.

When cracks occur along the corner edges of the case as in the example shown above, break off the cracked portion. Then drill matching holes in the exposed edges of the case and the edges of the removed piece to hold the plastic solder which, when dry, form a series of plugs that hold the broken piece in place. Holes should be spaced about 1 in. apart, $\frac{1}{2}$ in. deep where possible. Next spread the solder on the edges of the break on the battery and piece as shown in the photo, being sure to fill the holes. You must work quickly because most plastic solders are fast setting. Press the broken piece in place and clamp it tightly to the battery, using the arrangement of wire bands and screwdrivers for wedges as in the drawing at bottom right. Let the battery stand for one day before adding the electrolyte. When a single crack line appears on a battery, cut a V-shaped groove for its entire length and fill it flush with plastic solder.

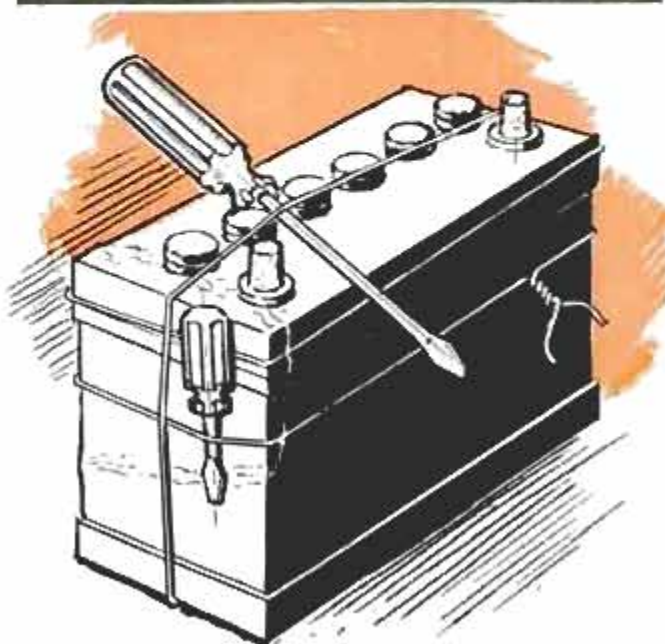

THREE ONE-EVENING

Simplicity is the keynote of these useful household items, any one of which can be completed in a few hours by most home craftsmen

CLOTHES RACK

NOT ONLY IS THIS floor-model clothes rack convenient for drying damp towels and hand-washed clothing, but it saves the bathroom from being cluttered with them as well. The rack is the easiest project of the three, requiring only the shaping and drilling of a pair of base members and a pair of top pieces to take $\frac{1}{2}$ -in. dowels cut to the lengths given in the drawing below. While all of the dowels serve as a framework, the ones at the top also serve as a rack on which to hang clothing and towels. The easiest way of assembling the rack is to glue all horizontal dowels in place first, being careful to maintain the same spacing between the end pieces at all points to assure proper alignment of all parts. After the rack is assembled, it is sanded smooth and left natural, or finished as desired.



DESK AND BOOKCASE

Illustrated on the opposite page, is a combination desk and bookcase that makes a very attractive and practical piece of furniture for a child's room. There is ample space for reference and school books on the two lower shelves and shelf space for

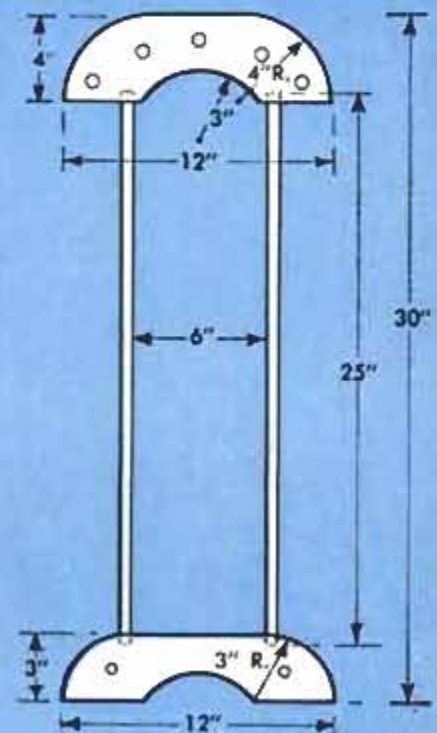
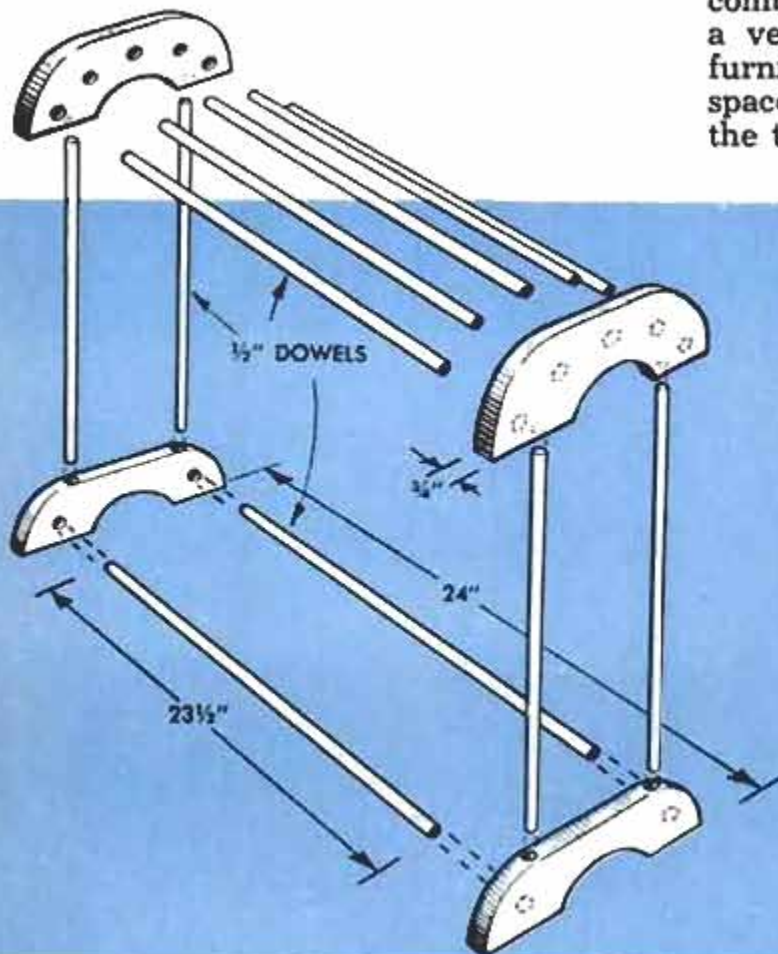

PROJECTS

papers, pads, pencils and other school paraphernalia on the upper one.

All parts of the bookcase are cut from 1-in. lumber. Pine, or other more expensive furniture woods may be used as desired. Begin construction of this project by cutting the three shelves and top to length, using 1 x 10-in. boards that are free of knots. Next cut the end pieces according to the dimensions given, after which $\frac{1}{4}$ -in.-deep grooves are cut to take the shelves and top. If you don't have a router, or dado head that can be used on a bench saw, make parallel saw kerfs within the marked outlines of the grooves to be cut. This can be done with a sharp handsaw if you are careful, although the work will go much faster and easier on a bench saw. Four small wooden braces, attached to the bottom shelf and end members as shown, provide reinforcement and decoration.

The hinged portion of the desk top must be cut exactly to the dimensions given so that there will be adequate clearance when it is in the closed position. Note that a 3 x 12-in. pivoting arm is bolted on the underside of the top to support the hinged part when open. The pivot point for the supporting arm is located midway on the top $1\frac{1}{2}$ in. from the front. After cutting the 1 x 3-in. retaining strips that go at the back of the top and at the front of the third shelf, the bookcase is glued and screwed together. Then it is sanded smooth and painted, or stained and varnished.



Compact child's desk and bookcase has two lower shelves for reference and school books, upper shelf for writing materials and a fold-out writing leaf

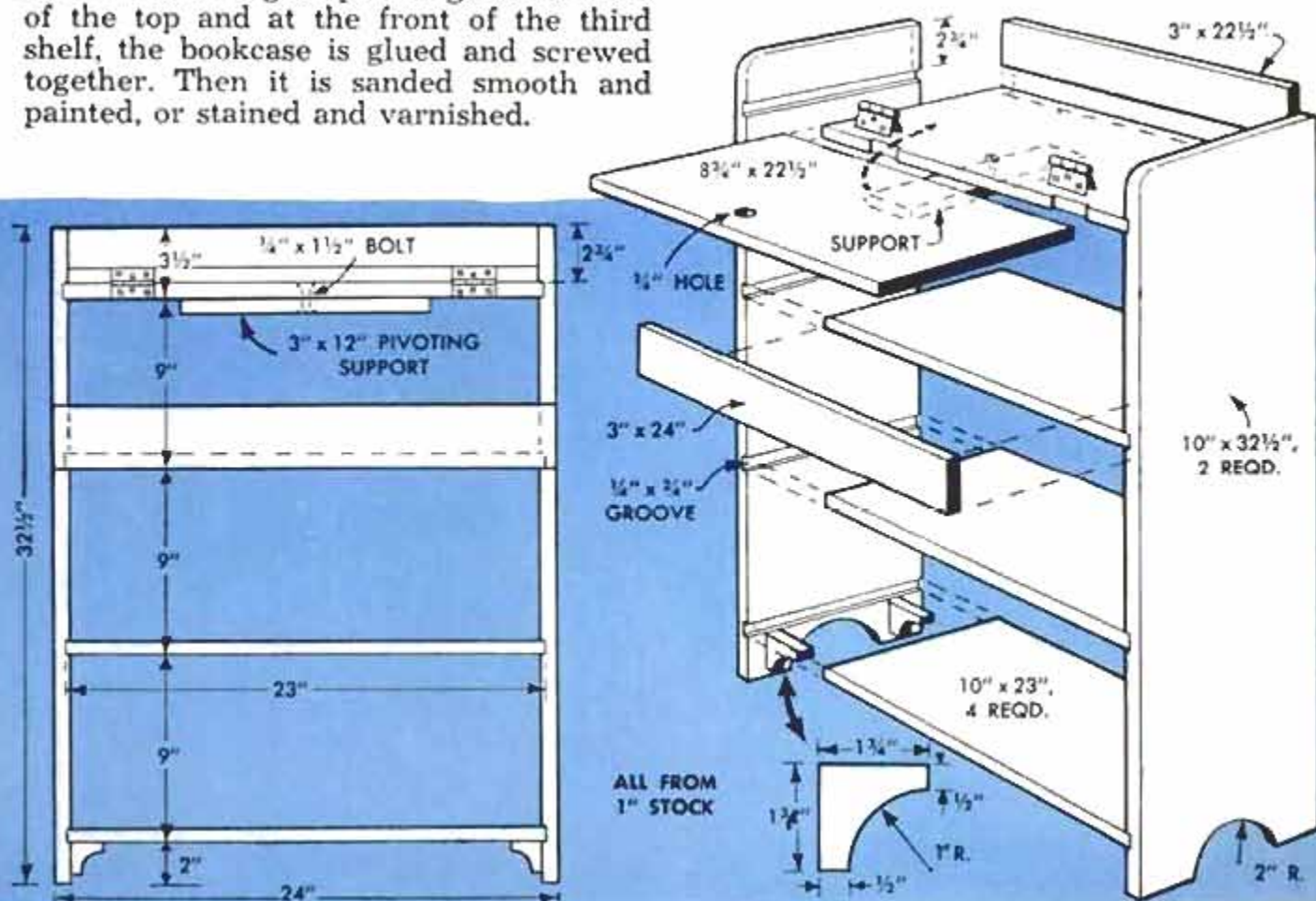



PAPER BUNDLER

A paper bundler like the one illustrated not only provides a convenient means of tying up loose papers and magazines but it provides a proper storage place for them until collection time. The bundler is made of 1-in. lumber, except for the $\frac{1}{4}$ -in. plywood bottom. The molding of 1 x 2s at the top serves as a frame and provides a con-

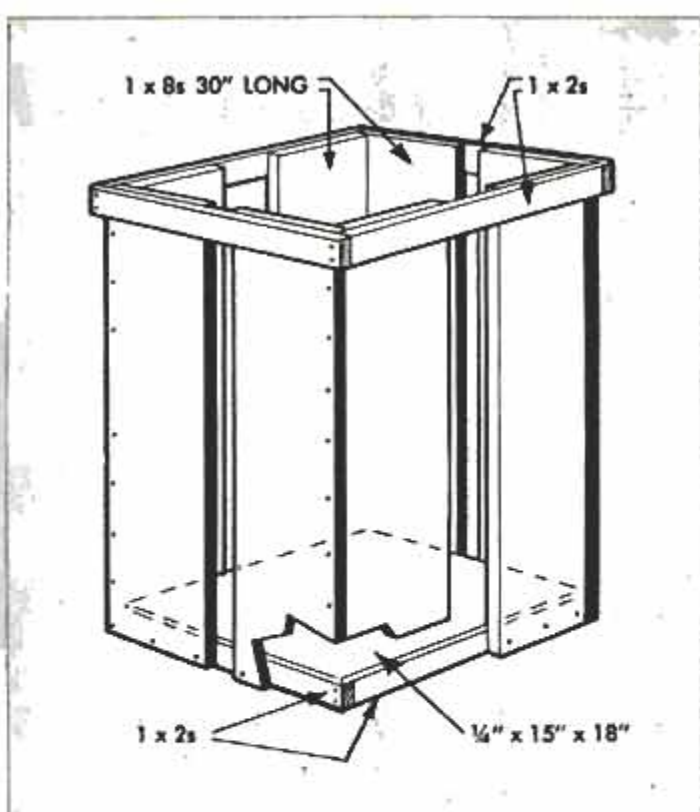

venient place to grasp the bundler when moving it. Nails only are used for assembling bundler, making it a project that shouldn't take more than two hours to complete. Painted a pastel color to match or harmonize with the walls of a utility room or basement, the bundler can be attractive as well as useful. ★ ★ ★

Ted M. Fenn, Chicago

Cutting-Tool Holder for Lathe Speeds Turning of Shaft Stock

When turning or shouldering a long piece of shafting, one machinist uses the cutting-tool holder shown to speed the work. The holder consists of a length of tubing (B), to which a piece of key stock (C) is welded. A cutting tool mounted on the key stock as shown, revolves with the lathe chuck, turning the stock, A, to the desired diameter.

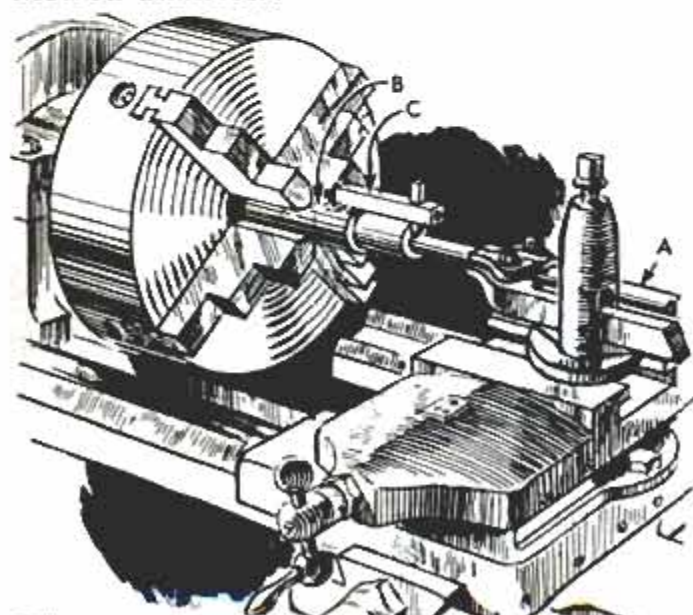

Leather-Bladed Cleaning Tool For Tapered Spindle Socket

Ideal for cleaning a tapered spindle socket of an engine lathe is this tool which has a leather blade cut to the same taper as the socket. When held in the socket, it wipes the surface clean in one revolution. The blade is cut from leather machine belting and tacked in a slot cut in a wooden handle as shown.

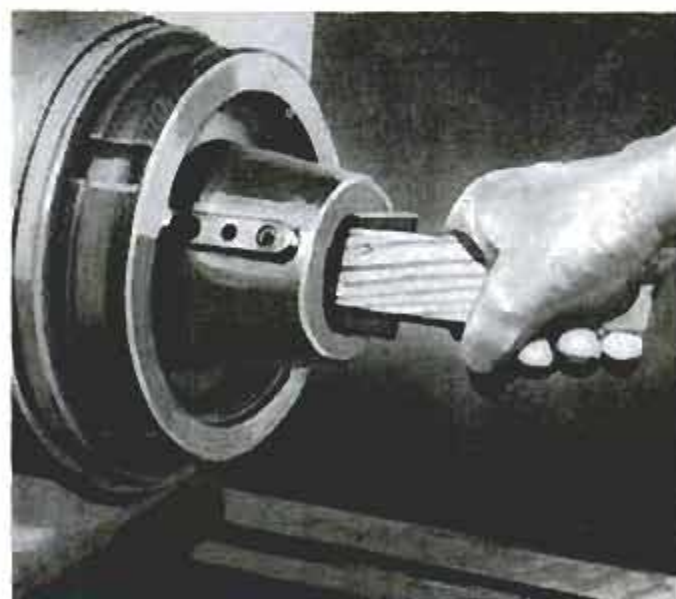

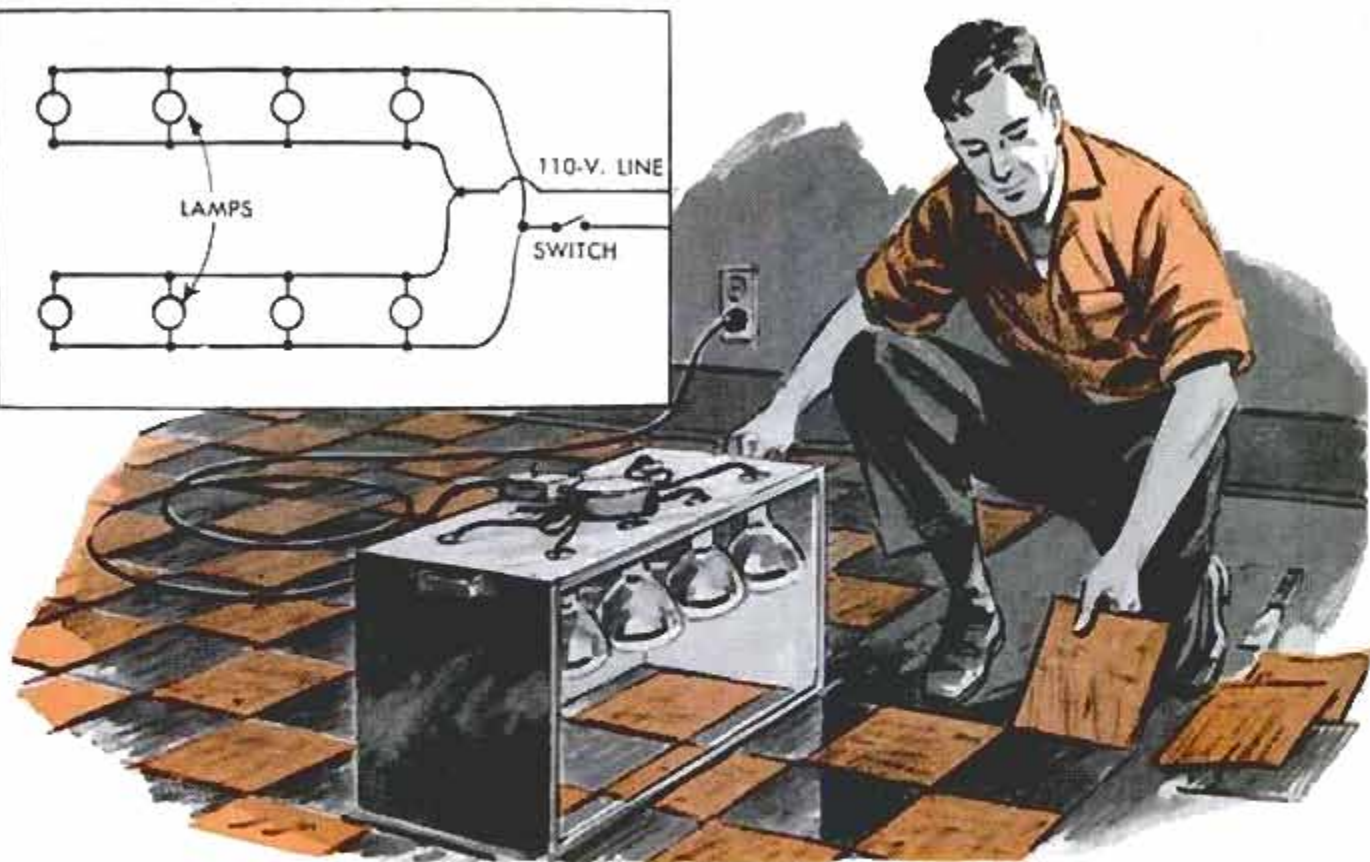
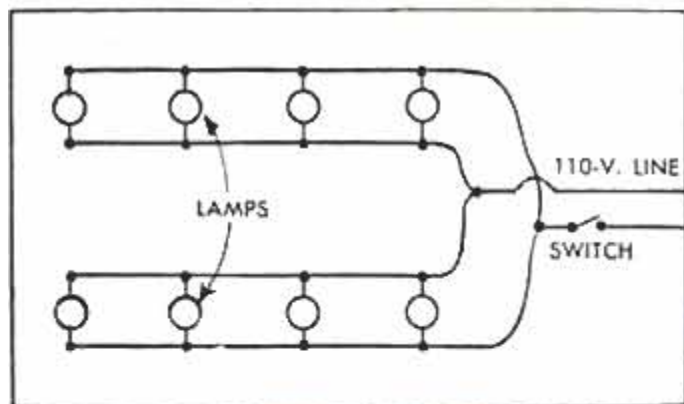

Boxed Heat Lamps Permit Safer Removal of Asphalt Tile

Designed by an Army maintenance man, this "hotbox," consisting of an aluminum box measuring 12 x 12 x 24 in. in which are fitted 8 heat lamps, speeds up the job of removing asphalt tile. Because no flame

is required, as when a blowtorch is used, the box minimizes fire hazard. For use in a home, the device could be scaled down to use one or two heat lamps to remove single tiles that require replacing.

Photo Timer "Sealed" in Plastic

Fitted over a darkroom timer, a large plastic bag will protect the unit against chemicals that might be splashed on it. When the neck of the bag is taped or wired shut, the timer also will be sealed from corrosive fumes of the darkroom chemicals. The timer levers and knobs can be operated through the plastic, so the bag can be left on the timer permanently.

R. Hanscom, Elmhurst, Ill.



Applying Sanding-Disk Adhesive

Heating a sanding disk permits smoother and more even spreading of stick adhesive for attaching the paper. Heat also assures easier removal of the paper.



SHOP NOTES



1 Select an old-type cleaner which will permit cutting away parts of main frame to form lugs for bolts

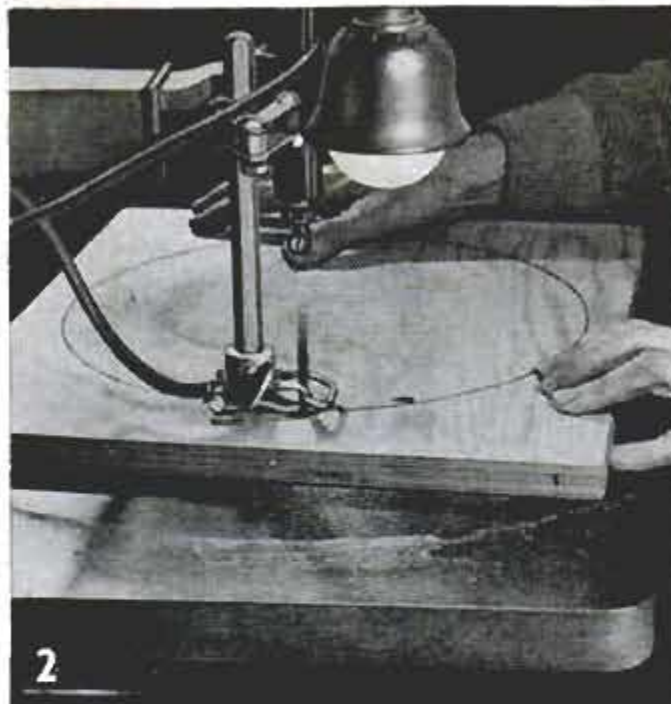

2 Disks which form the two-piece lipped top are jigsawed from $\frac{3}{4}$ and $\frac{3}{8}$ -in. hardwood-faced plywood

THIS WORKSHOP CLEANER

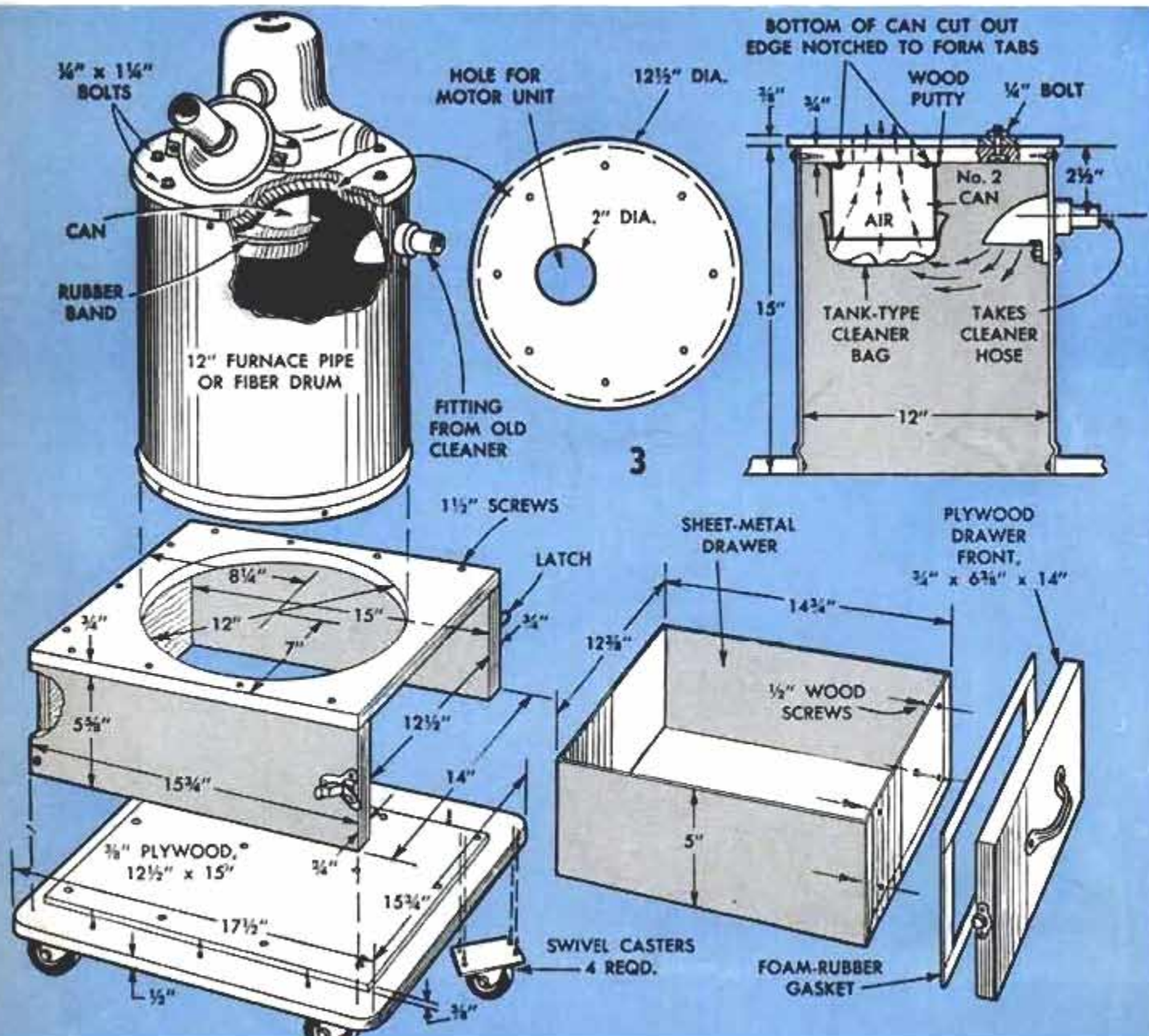



4
Plywood disks are bolted together to form rigid top. Note how cleaner-fan housing is attached to top

utilizes old-type vacuum-cleaner motor and fan assembly. Picks up chips, shavings and dust from floor, benches and power tools

By WALTER E. BURTON

CLEANING UP the workshop is a simple chore after you've taken time out to build this shop vacuum. It picks up the chips, shavings and, most important of all, the fine dust which is so hard to get with the shop broom. Fitted with the right nozzle it will clean off the bench top in a jiffy, draw sawdust from corners you can't reach with a brush, clean shop machines so they look like new. Tightly constructed to eliminate air leaks, and fitted with ordinary vacuum-cleaner hose and fittings, it is capable of a static lift of an inch or so, which is enough to pick up dust and chips from the floor, bench tops or machines, Fig. 6.

Fig. 3 details the construction of the original unit and gives the general dimensions. As detailed in Fig. 3 and also as pictured in Figs. 5 and 6, the cleaner is made with a drawer to collect the material picked up by the vacuum unit. The drawer makes it possible to remove the collection of dust and other debris periodically without having to take off the top of the drum. In the machine pictured, the top, which supports the motor and fan, is permanently attached to the drum and the latter is screwed to the drawer compartment. In this type of assembly it is comparatively easy to eliminate air leaks which might affect the efficiency of the vacuum unit.

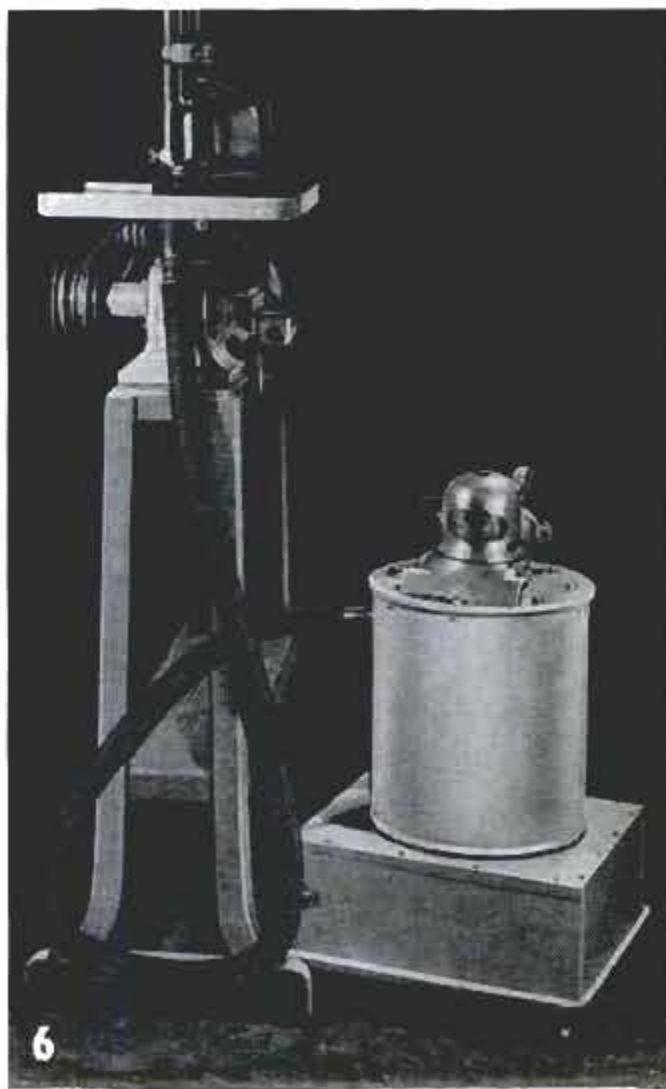



Air is drawn through cloth and cleaner bag to filter out fine dust, prevent it from entering fan housing

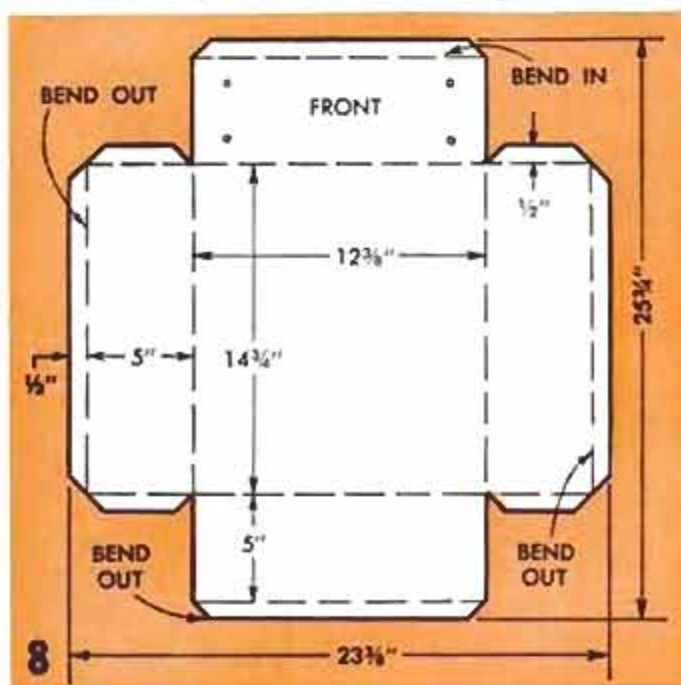

Drawer is made from sheet metal, cut, bent and riveted as in detail above. Drawer is fitted with a wooden front piece. Rubber gasket prevents air leaks

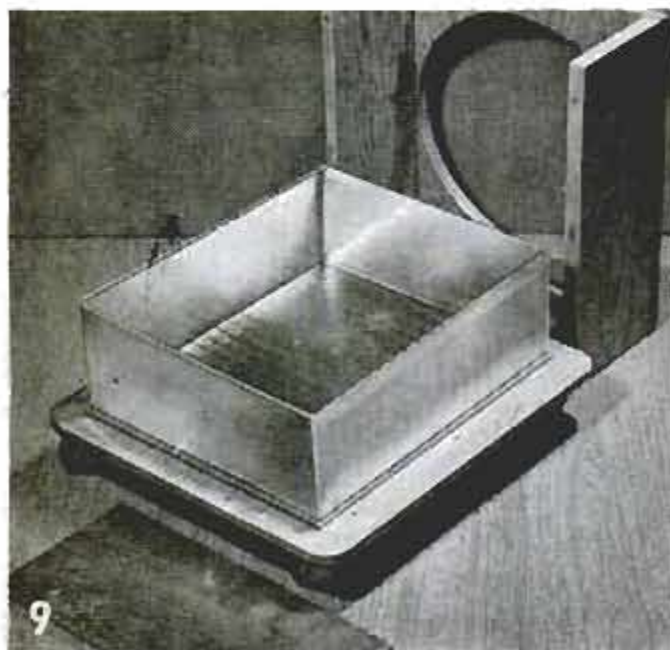

Selection of a suitable cleaner motor and fan is largely up to the builder. The unit pictured will offer a suggestion as to the type which is most adaptable. Figs. 1 and 4 show how the fan housing was cut away to adapt the unit to use with the dust collector. Usually cleaner units of this type permit cutting away of parts of the fan and housing to provide anchoring lugs for bolts which hold the unit in place on the disk of plywood that forms the top of the drum. If you purchase a used cleaner for the purpose of salvaging the motor and fan, make sure that it is of a type that can be adapted to the new use, and that the motor and fan are in good condition.

Note in the sectional view, Fig. 3, that the top of the drum consists of two disks jigsawed from plywood, Fig. 2, then sandwiched and bolted together. The drum can be made from a length of furnace pipe, or a small fiber drum can be utilized. Fiber drums usually are fitted with friction lids and often the friction lid can be screwed to a plywood disk and thus used as a mounting base for the motor and fan. In either case, a No. 2 can (a coffee can also will serve), with the bottom cut out, is fitted over the opening through which the fan will draw air. This provides an air chamber over which an open-mesh square of cloth and a tank-type cleaner bag are placed as in Figs. 3 and 7. The cloth and bag are held in place with a rubber band or with cord.

The fitting which takes the cleaner hose, upper right-hand detail in Fig. 3, often can be salvaged from an old cleaner and adapted to the new use. If not, then it is quite easy to improvise a suitable fitting by soldering a short length of tubing into a hole cut into the side of the drum about 2 1/2 in. from the top.

Note that the base is made from two pieces of plywood sandwiched and screwed together. The purpose of this construction is to obtain a rabbet at the lower edge of the drawer opening to form a seat for the rubber gasket on the inside face of the drawer front, which is of wood. The drawer, Figs. 3, 8 and 9, is made from sheet metal. Cut and bend the single piece as detailed in Fig. 8. The lapped joints at the corners can be riveted or soldered as desired. The drawer front is attached to the drawer with screws as in the detail, Fig. 3. Latches of the suit-case type (suit-case bolts) hold the drawer tightly closed. The gasket prevents air leaks into the drum.

It's important that the parts of the entire assembly be fitted tightly and sealed if necessary with wood putty. Air leakage into the drum or the drawer, even slight leaks will tend to destroy the vacuum and lower the efficiency of the unit. ★ ★ ★

Shouldered End Aids In Starting True Thread

Starting a round die to cut a true thread is no easy trick when you have to do it by eye alone. At best, you must of necessity leave a lot to chance. When you must have a true thread on small-diameter work and there's no time to set up the lathe to do the job, mount the work between centers and shoulder it so that the die will slip onto the end. The length of the shouldered portion of the work should be slightly greater than the thickness of the die. To start the thread, run the carriage back so that you can use the toolholder to support one handle of the diestock and set the lathe to run at its lowest speed with the back gears in. Once the die is started the balance of the thread can be cut by hand.

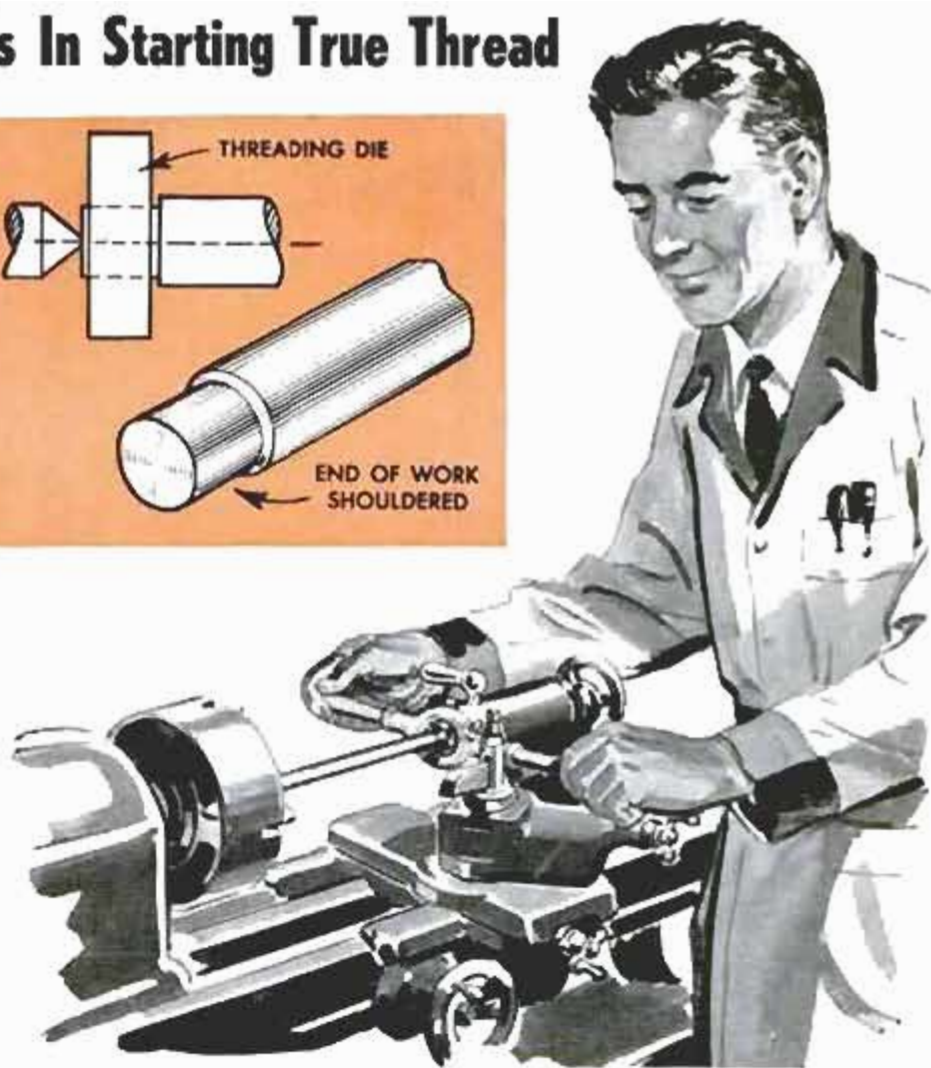
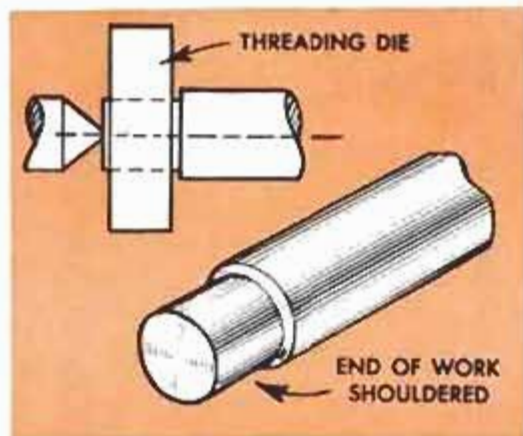

Threads on Lead Screw Kept Clean With Cord

Cleaning the lead screw of the lathe with a brush and solvent is not always the most efficient way of removing the gummy oil residues that can collect in the threads and cause rapid wear. Periodic cleaning with a cord dipped in solvent is a better way, as the cord will follow the thread when the machine is running and remove all the residues in one pass. This should be done regularly, and always after the machine has been used in a grinding operation.

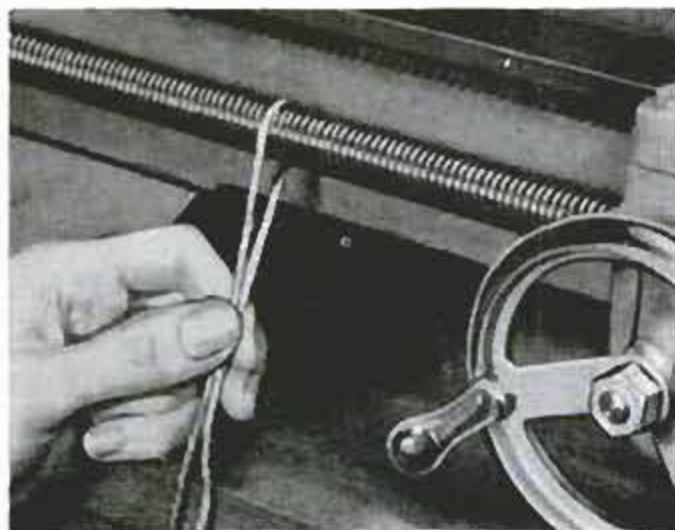

Setting Lathe Compound To Reproduce Taper

When it is necessary to reproduce a short taper from an original tapered part, the setup can be made quickly by holding the original in the chuck and mounting a dial indicator or a gauge in the tool post. Then the angle of the compound is adjusted so that the indicator reads zero when run along the taper. By using only the compound feed for the cut, a matching taper will result. When turning a taper it's important to set the tool on center.

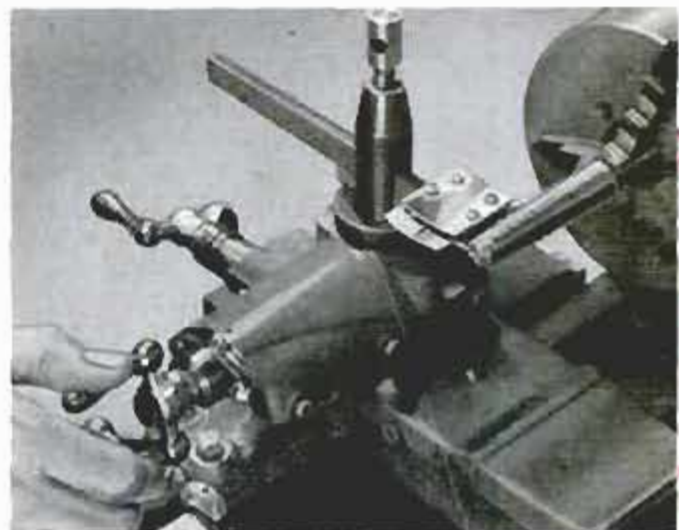

*Brown & Sharpe
Cutting Tools / Div. Providence R.I.
250 Promenade*

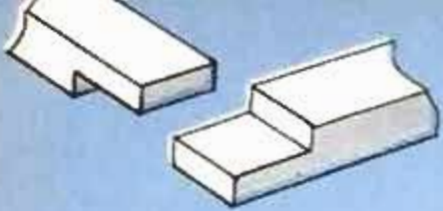

CORNER LAP. Ends of workpieces are halved and shouldered on opposite sides, joined at right angles

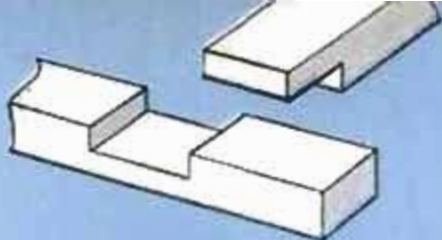

MIDDLE LAP. Used when joining rails to uprights where rails meet uprights. Joint is often pinned

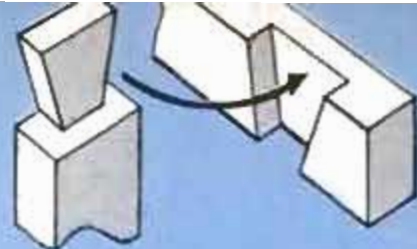

DOVETAIL LAP. Through dovetail is half-lapped onto rail or upright. Often seen in old cabinetwork

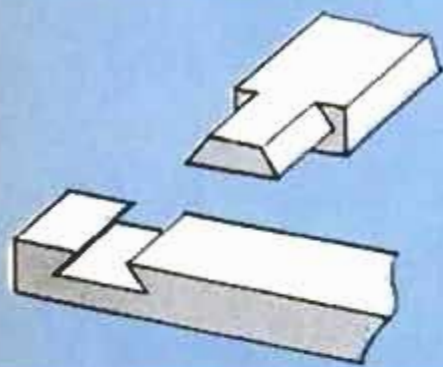

DOVETAIL LAP. Provides much greater strength than plain middle-lap joint. Should be glued, pinned

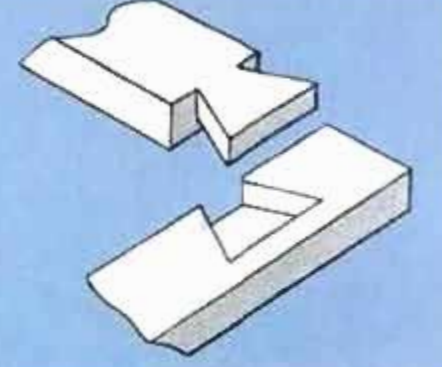

HOUSED DOVETAIL LAP. Used where end grain must be concealed in finished work. Should be glued

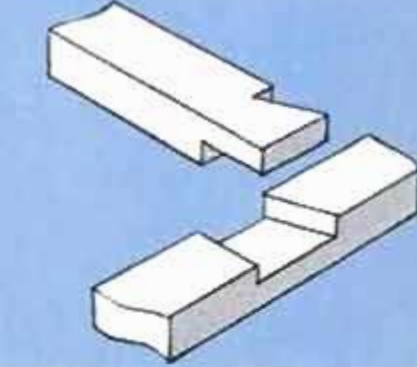

DOVETAIL LAP. Sometimes referred to as half dovetail lap. Easier to make than regular dovetail lap

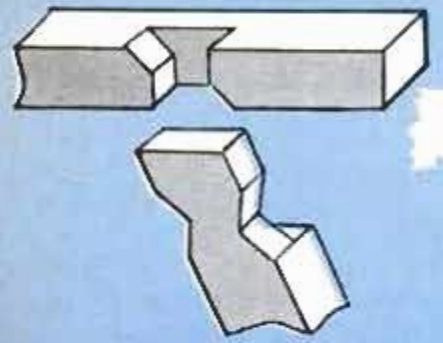

TIE LAP. Somewhat similar to half dovetail joint but usually is used when joining framing timbers

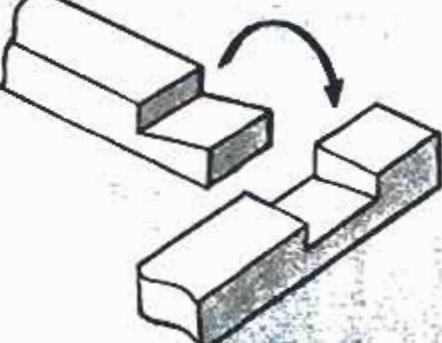

BEVELED TEE LAP. Same as beveled corner lap except that members are joined as in the middle lap

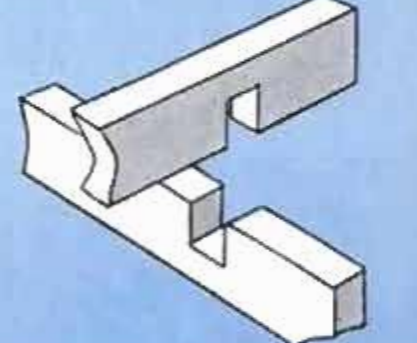

CROSS LAP—EDGEWISE. This cross lap is made with notches cut in from the edges of joining members

WOODWORKING JOINTS

By C. W. Woodson

HERE ARE COMMON variations of the half-lap joint, most of which are still used in light joinery and heavy framing. Nearly all of the joints detailed will be found in various types of old work. The half-lap joints are quite easily made with hand tools, proceeding as in steps A, B and C in the details on the opposite page. Some joints detailed are quite similar, others differ considerably in form from the true half lap, but require essentially the same procedures in cutting and fitting. Names of the joints detailed are those in common usage, but in some cases will dif-

fer with names given in older works on the subject of joinery. The strength of the lap joint in any form depends on close, accurate fitting. As a rule, the joints should be pinned or glued for maximum strength and resistance to lateral strain. Nearly all of the joints detailed are effective in joining either hard or soft woods in both cabinet framing and heavy structural framing. But here again it should be emphasized that maximum strength is attained by accurate fitting of the joining members as well as by a careful selection of the hard or soft woods used. ★ ★ ★

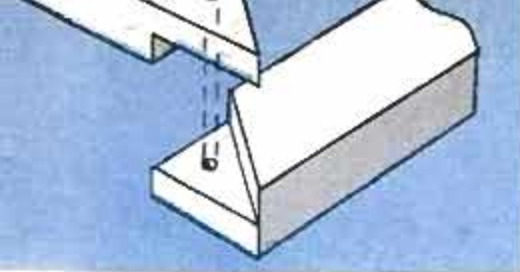

LAPPED MITER. Used when joining frames when it is desirable to have miter show only on one face

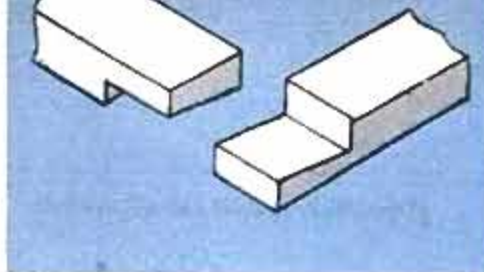

BEVELED CORNER LAP. A good joint to use where there is strain on one or both pieces. Should be glued

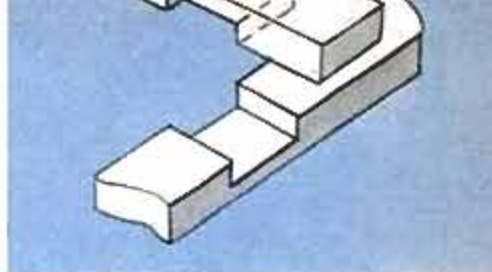

CROSS LAP. Workpieces are lapped flush at right angles. Parts must be true fit for maximum strength

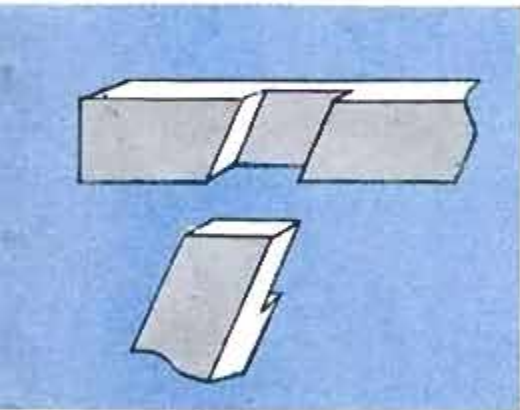

ANGLE HALF LAP. Same as middle lap except parts are joined at an angle. Snug fit is essential

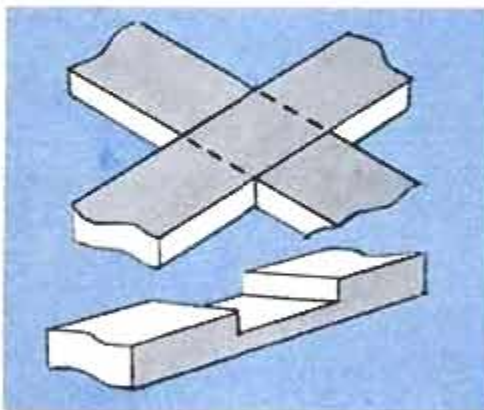

ANGLE CROSS LAP. Members are half-lapped at an angle. Sawbuck table legs are type of this joinery

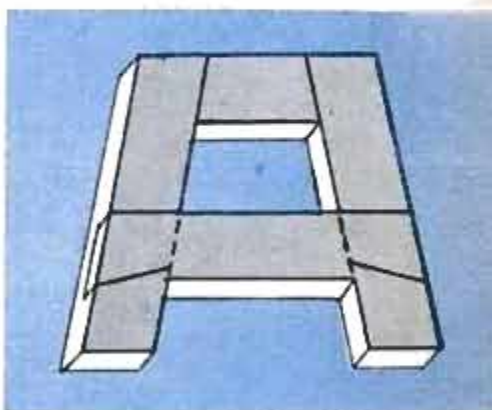

TRESTLE LAP. Joints are same as half-dovetail lap except that the shoulders are cut at an angle

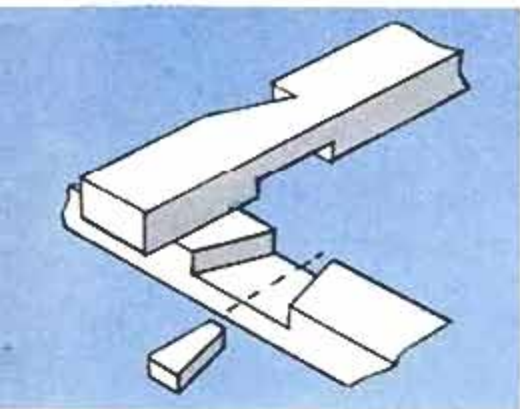

WEDGED HALF-DOVETAIL LAP. Used on framing that is assembled and disassembled frequently

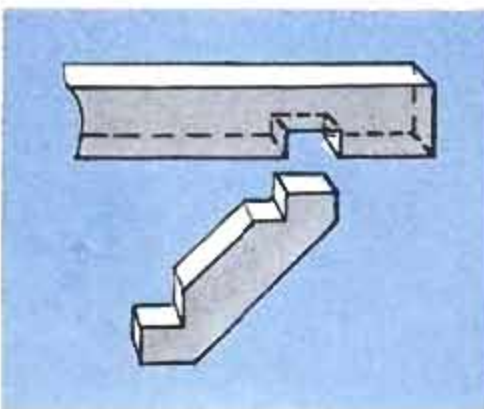

ANGLE LAP WITH SHOULDER. Its main use is in heavy framing and as brace in heavy shelf bracket

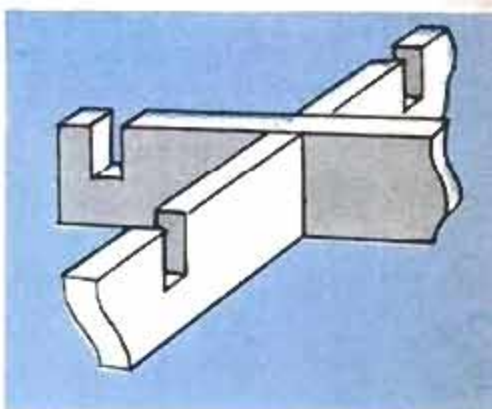

EDGE LAP. Used when making open grilles or when assembling compartments in box or tool tray

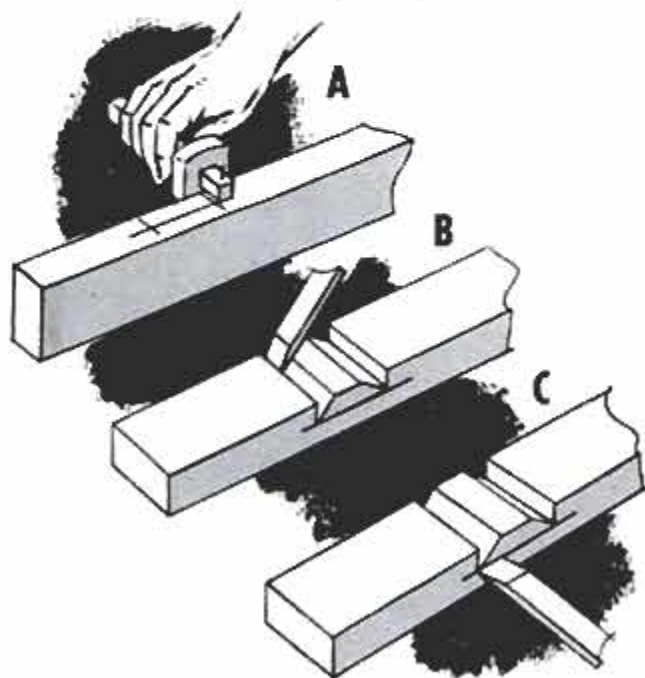

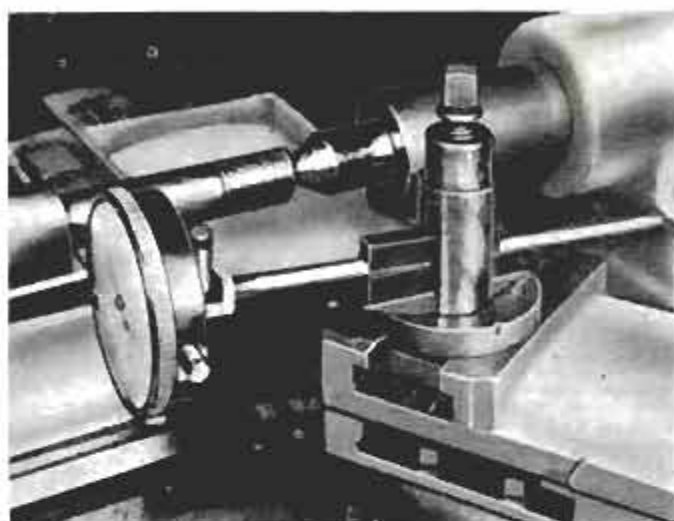

Split Block In Tool Post Holds Dial Indicator

On some types of close work machinists often prefer to mount the dial indicator on its own attachment rod, rather than use the universal mounting. This calls for a split-block holder made to fit the tool-post slot. Such a block can be made from mild-steel bar stock. The block is drilled and reamed lengthwise, the diameter of the reamed hole equaling the diameter of the attachment rod. It is then split on the center line of the hole to form two clamping pads, or jaws, which hold the rod securely.

Lengths of Drill Rod Square Work Setups

When work is to be squared by milling or grinding, toolmakers often use lengths of drill rod to make sure that the work is seated true against the fixed jaw of the machine vise. One rod is placed under the work, the other between the work surface and the movable jaw. When the work is set up on a magnetic chuck, using an angle plate as in the inset photo, a length of rod is placed under it as shown. The rod assures squareness of the work for the initial cut. All surfaces must be clean.

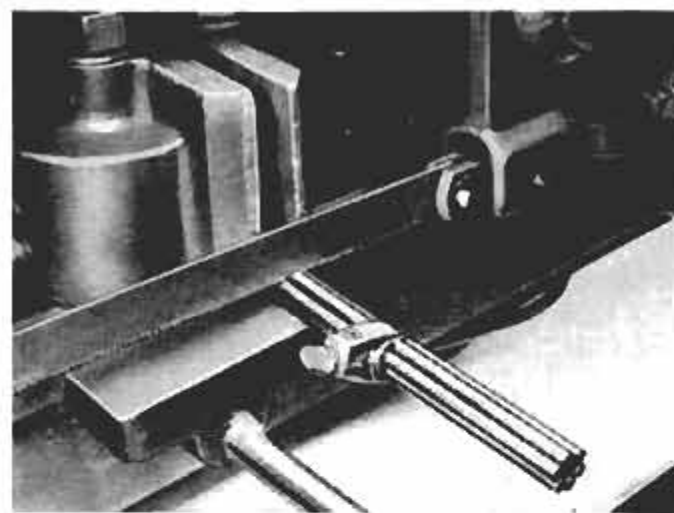
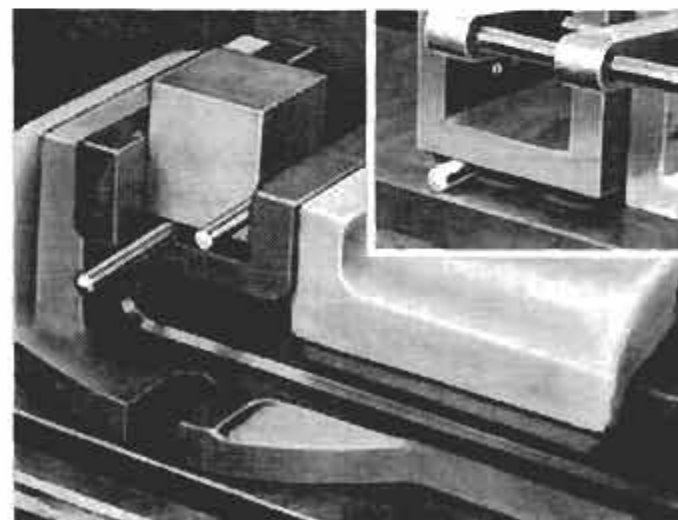

Hose Clamp Grips Rods For Power Hacksawing

If you've ever attempted to speed up a job by trying to grip a number of small rods in the power-hacksaw vise, you know that only trouble can come of it. Somehow one always ends up with irregular cuts and very likely a broken hacksaw blade. To hold as many as a half dozen rods, or even more, bundle them uniformly and grip tightly with a hose clamp before placing in the vise. In this way the bundle of rods will saw as one piece and you'll get a uniformly square cut across the ends.

Weld Beads on Plow Moldboard Aid Scouring in Heavy Soils

In the rush season, when every minute counts, daylight or dark, nothing is more exasperating than a plow bottom that won't scour. There is not only a loss of time and temper but of fuel as well, for a nonscouring bottom can add appreciably to the load on the tractor. Experimentation has shown that a series of spaced weld beads, run continuously on the curved surface of the moldboard as pictured, will aid scouring in those difficult soils. Of course, the moldboard must not be allowed to rust.

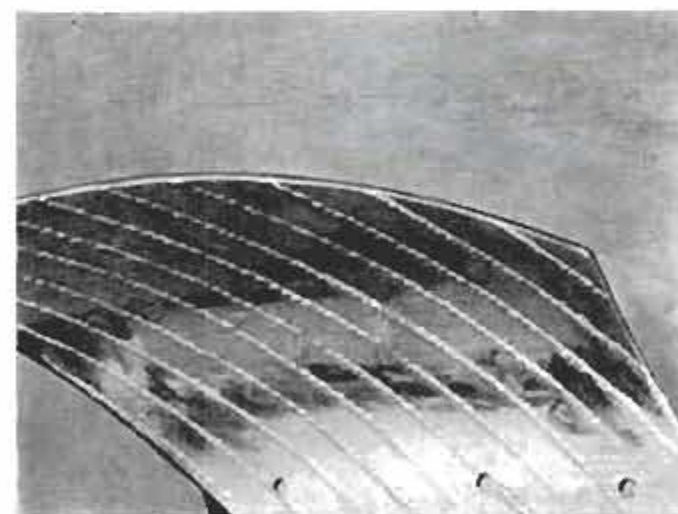

Wide Rubber Band Guards Chuck Jaws

When it is necessary to run the chuck jaws out so that they extend beyond the body of the chuck, they should be guarded, especially when the nature of the work requires the undivided attention of the lathe operator. A wide rubber band, cut from inner tube and snapped over the extended jaws, reduces accident potential to a minimum. The band should be slightly wider than the extended portions of the jaws so that the extensions are completely covered.

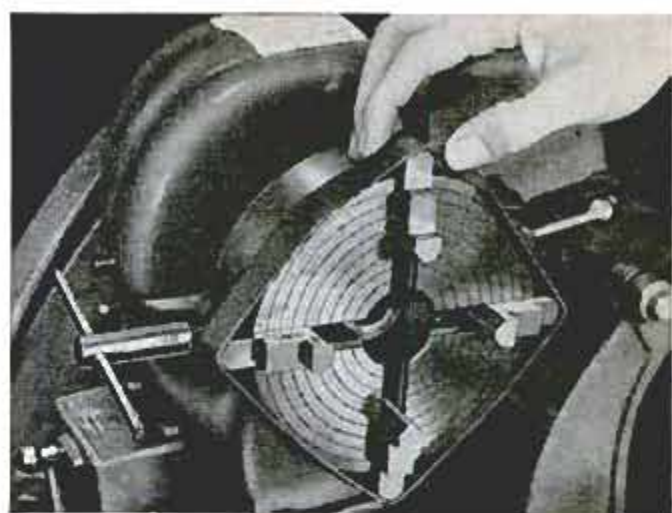
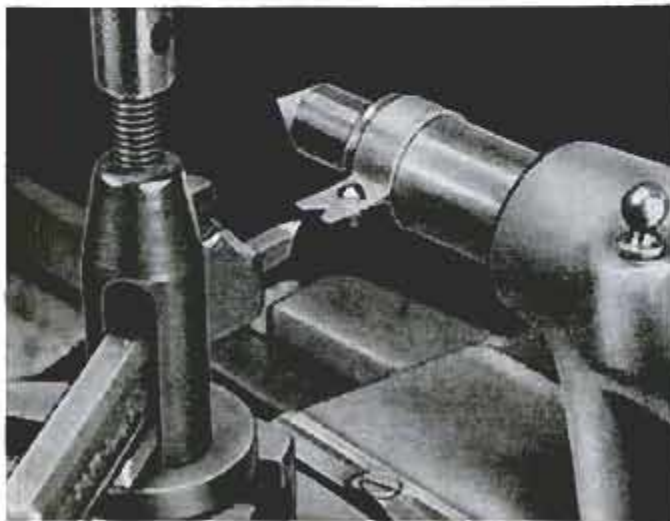

Simple Tailstock Attachment Aligns Thread-Cutting Tool

Threading tools must be located at the correct height and the 60-degree tip must be placed at right angles to the work. A locator permanently attached to the tailstock sleeve assures correct setting of the tool and saves time. It is made by filing a 60-deg. V-notch in one end of a strip of 18-gauge sheet metal about 1/2 in. wide. This is bent around the tailstock sleeve and a hole is drilled through both thicknesses for a small stove bolt which clamps the band in place when tightened.

Chart in Lid of Drill Case Gives Decimal Equivalents

Charts of decimal equivalents and cased sets of twist drills in fractional sizes belong together for ready reference. One sure way to keep both at hand when needed is to copy a decimal-equivalent chart on heavy paper, either by typing or hand-lettering, and glue this to the inside of the drill-case lid. While you're at it, it's a good idea to include the recommended speed for each drill in the set. Such a chart will give you all the information needed for any ordinary drilling job.

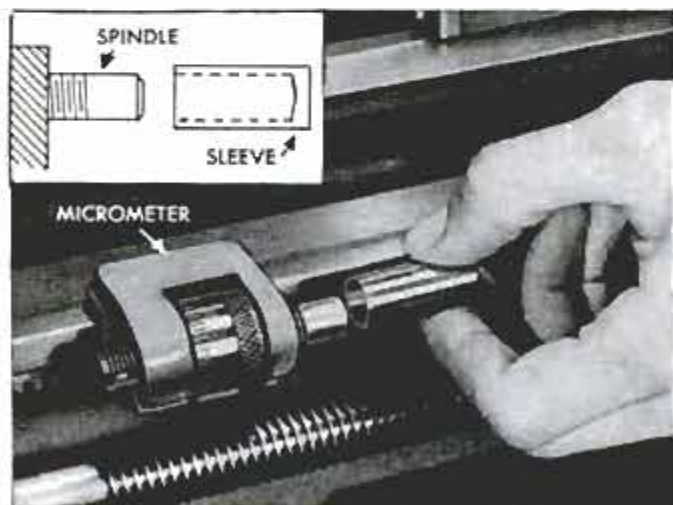

Sleeve Increases Range Of Lathe Carriage Stop

There are times when it's desirable to increase the range of the micrometer carriage stop without changing the setting of the anvil. This is easily accomplished by center-drilling a length of round steel to fit over the anvil in the manner pictured and detailed. The sleeve stops the carriage at one position and by removing it the carriage is free to move into the second position. The length of the sleeve determines the distance between the two positions.

Mark the setting on the sleeve.



On the
MARKET
for Do-It-Yourselfers

1. DECORATOR STYLED PLYWOOD PANELING comes in 4 x 8 ft. prefinished panels made from 9 different woods, both domestic and imported. The panels are V-grooved in such a way that when a series of panels is installed you get a random width planked pattern that is most attractive in any room. Synthetic finishing materials offer resistance to scratches, scuffs, crayon and ink marks. Color tones have been developed to bring out the grain characteristics of each of the fine hardwoods used in surfacing the panels
Aetna Plywood & Veneer Co., 1751 N. Elston Ave., Chicago 22

2. SILICONE SPRAY in a pressurized can has been especially compounded to lubricate and protect rubber weatherstripping and to prevent it from freezing in place in severely cold weather. Can also be used to make ignition systems sure starting in damp weather, and to reduce corrosion on battery terminals, cases
Dow-Corning Corp., Midland, Mich.

3. LUBRICANT in a pressurized can sprays as a liquid and immediately hardens into a lasting coating of grease on the surface to be lubricated and protected from corrosion and rust. Fine spray from the can gets into places that are difficult or impossible to reach and lubricate with brush or pressure gun
The Greaspray Co., 2420 Jackson Ave., Evanston, Ill.

4. MASTIC WATER STOP in a caulking cartridge prevents seepage of water through cracks and joint voids in concrete masonry. Bonds to any porous masonry surface without use of primer, dries in minutes and then can be painted with rubber base, alkyd, or oil-base paints. Won't run, sag or shrink in setting
Kle'e Waterproofing Corp., 4011 Red Bank Rd., Cincinnati 27, Ohio



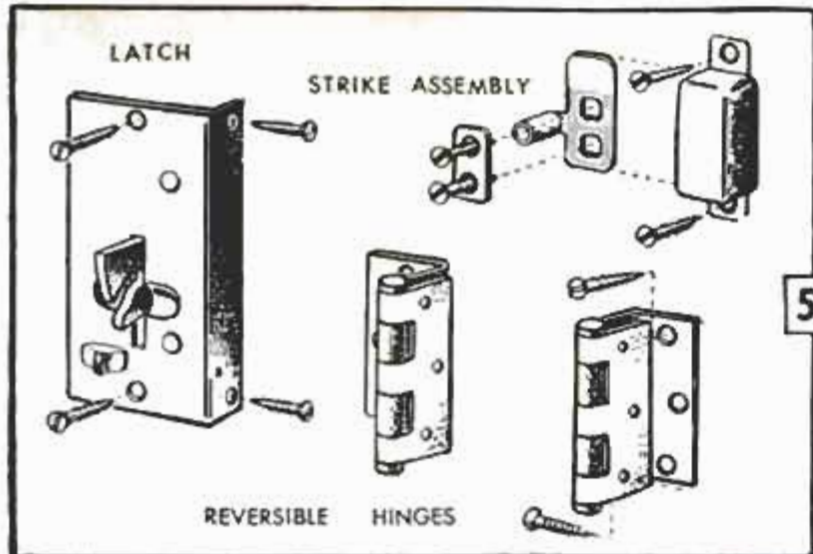

5. SURFACE HANGING of doors outside the opening rather than inside the opening is now made possible by a new type of surface hardware. Offset hinges and a special striker and latch eliminate conventional knob and give door an opening and closing action quite similar to that of a refrigerator. Door action is shown in photo, hardware in details above
 The Stanley Works, 195 Lake St., New Britain, Conn.



6. PLASTIC ADAPTER SLEEVE permits use of conventional casters on tubular furniture and institutional equipment. Adapter is easily forced into the open end of the tubular leg without damaging the edges or distorting or splitting the tube. Resilience of adapter absorbs shocks and cushions load. Elimination of metal-to-metal contact gives quiet operation
 The Colson Corp., 7 S. Dearborn St., Chicago



7. BLACKTOP COATING comes in 3 attractive colors, grass green, coral red and raven black. Can be applied with an ordinary roof brush just as it comes from the container without any heating or other preparation. Designed to seal asphalt surfaces of driveways, patios, tennis courts, with a tough, durable finish. Dries dustfree in 2 hr. Use in about 12 hr.
 AL-Chroma Paint Co., Inc., Stevens Point, Wis.

8. BRUSHING ENAMEL dries ready for use in 15 minutes. Suitable for use on any interior or exterior surface, wood, plaster, metal or masonry. Resists acids, alcohol, gasoline and boiling water. Abrasion-resistant properties make it especially suitable for wear surfaces such as floors, chair seats and backs and wooden handles of garden and shop tools
 Jet-Dri Div., Consolidated Chemical & Paint Mfg. Co., Inc., 450 Driggs Ave., Brooklyn 11, N. Y.



Pay TV-



Start of an Experiment

By Lothar Stern

MOVIES without commercials; sports-casts without "blackouts"; a television's dream come true—or about to come true—for a limited number of homes in the Toronto, Canada area.

While pay-TV advocates here continue their war of words with TV networks; while the Federal Communications Commission is handing out a few permits for long-range tests of "airwave" pay-as-you-see television broadcasts; our neighbors to the north are launching a closed-circuit form of a pay-TV system which may influence the future of television in this country as well. Starting with more than 70 miles of TV cable and a potential of 13,000 homes, the present system will be readily expandable to serve an area of about 40,000 homes in West Toronto. From this small beginning the operation is expected to spread to other areas in metropolitan Toronto and trigger the expansion of the Telemeter pay-TV system throughout all of Canada.

Unlike other proposed pay-as-you-see television methods, this first commercial venture into the pay-TV field does not take up valuable spectrum space. Rather than being transmitted over the "airwaves," the pay-TV signals are carried over wires which provide a direct link between the television studio and the subscriber. The system, therefore, does not interfere with the reception of "free" television signals, nor does it reduce the maxi-

imum number of these that may be assigned to any one area. To the contrary, it literally brings three additional stations within the range of any receiver equipped with a special, coin-operated Telemeter attachment. The added stations, of course, are available only on a pay-as-you-watch basis.

Details for the transmission and reception of the pay-TV signals have been carefully and ingeniously worked out. At the Telemeter studio are three sets of motion-picture projection equipment plus "live" camera facilities. With these, up to three different channels may be transmitted simultaneously over a single cable. Before being fed to the cable, however, each program is given a code number which identifies the program and another one which fixes its price.

Leaving the studio on a single main cable, using Bell System facilities, the Telemeter signals are distributed to principal neighborhoods of a community. From there, feeder lines attached to utility company poles channel the signals to the individual homes. A series of spaced booster amplifiers, isolating units and equalizers assure a top quality signal.

At the home of each subscriber, the signals are dropped off and enter the building by means of a wall plate similar to that used for installing telephone or electric lines. Inside, the feeder wire is connected to a Telemeter attachment

whose output attaches to the antenna terminals of any TV receiver.

Small, unobtrusive, yet tastefully styled, the Telemeter attachment serves as the final link between the subscriber and the studio. Sitting on top of the TV set, it silently and continually performs the combined functions of a channel selector, a program announcer, a money collector, an accountant and a market research analyst. Here's what happens.

When the subscriber settles down for an evening of TV entertainment he might first scan the local paper for a listing of "free" television programs. Then, by way of comparison, he might turn up the Telemeter control labeled Program Information for a continuous running account, via a built-in speaker, of the fare offered on the three pay-TV channels. Should he then decide on a "free" program, he would merely set the outside Telemeter control to Broadcast and tune in the desired station on his TV set. But if he elects to "buy" a particular Telemeter broadcast, he would turn the channel-selector knob of the receiver to either channel 5 or 6, depending on which of these is not used for regular TV broadcasts in his particular area, and rotate the Telemeter channel selector to channel A, B or C. (Because of possible inter-channel interference, channels 5 and 6 are never allocated in the same area. Hence, one of these channels will always be available to receive Telemeter broadcasts.)

When the desired Telemeter channel is tuned in, the price of that particular program automatically appears in a small window underneath a lift-up lid on the front of the attachment. The proper number of coins deposited in an adjacent slot



Telemeter attachment sitting atop TV set adds three optional pay-TV channels to regular free TV fare

will cause the program to appear on the TV screen.

Lack of proper change is no problem. If an overpayment is made, a "credit" which will be applied to any subsequent purchase is automatically racked up and appears in a second small window.

When the coins are deposited, a tape mechanism inside the removable coin box records the studio-assigned code number of the particular program selected. At the

(Continued to page 246)

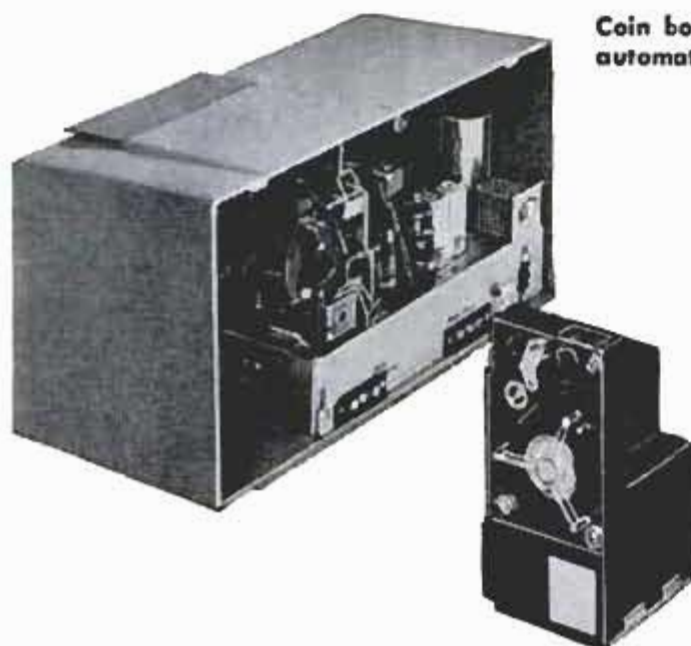

Coin box which fits inside Telemeter doubles as tape recorder; automatically records code numbers of all purchased programs





TV goes portable. First of the long heralded transistorized TV sets to hit the market, Philco's "Safari" plays four full hours on built-in rechargeable battery as well as on regular a.c. line power. Set employs 2-in. picture tube but optical magnification increases picture size to 80 sq. in. for effortless viewing



In Time



Left: This one's automatic. RCA's 1960 "Programmer" lets you preselect a day's TV viewing in advance. Set turns itself on and off, changes channels at 30-min. intervals in accordance with preset schedule

Square-cornered 23-in. picture tubes give new look to Sylvania TV line. New tubes with bonded-on safety glass have greater picture area, reduce glare and facilitate cleaning



Dramatic innovation in TV styling permits conversion of RCA's new "Hillsborough" receiver into handsome, functional living room table at a touch of the fingertips





The speakers are built in but the sound isn't. Novel circuitry in Zenith's latest stereo hi-fi consoles actually extends the sound far beyond the confines of the cabinet itself. Special amplifier control permits listener to adjust the apparent spread of the orchestra for optimum stereo in any size living room

for Christmas

For the hi-fi perfectionist. New 30-in. speaker (woofer) used in Electro-Voice Patrician 700 (inset) is available separately for custom installations



Here at last. RCA's tape-cartridge player-recorders, announced over a year ago, are finally available. So are the prerecorded and blank tape cartridges





Unique among clock-radios, Zenith's Golden Triangle operates entirely on flashlight batteries. Mounted on swivel base, unit rotates to present three faces—the clock, the radio dial and the speaker grille

Low-cost Granco FM tuner provides high-quality FM reception when used with TV set, phonograph, tape recorder or other device incorporating a speaker-amplifier and equipped with a phono-input jack



FM stereo broadcasts transmitted experimentally in many cities can be received on standard FM tuner with Multiplex Adapter shown above. Decodes both Crosby and split-channel multiplex transmissions but requires stereo amplifier and loudspeaker system



Personalized radio communications in the newly opened Citizen's Band is relatively inexpensive with new Heath Transceiver Kit. Meets all FCC requirements for operation in the exam-free 11-meter band when built according to explicit instructions. Combines sensitive receiver and 5-watt transmitter, with range of several miles in fixed or mobile operation

Since some AM radio stations do broadcast music of high-fidelity caliber, the new EICO AM tuner can prove to be a valuable addition to any hi-fi system not already so equipped. Available in both kit and factory-wired form, unit incorporates every desirable feature for optimum AM reproduction. Styled to match widely acclaimed FM tuner by same company





For
External
Rings
Shaft Diam.
1/16" - 4"



NEW PROTO TRUARC[®] RETAINING RING PLIERS

Now you can remove and replace retaining rings simply and quickly, without damage to the rings. Proto Truarc Pliers handle the rings you find on shafts and linkages, in bores...on appliances, engines, parts and accessories, TV sets and radios.

HERE'S WHY PROTO TRUARCS ARE BEST:

- Precision ground tips, induction hardened at just the right angle, insure trouble free ring installation.
- Tips are permanent... can't lose them, don't have to set them.
- The right size plier prevents ring distortion, saves time. 12 Proto Truarcs handle nearly all applications.
- External pliers for shafts up to 4" in diameter.
- Internal pliers for bores 3/16" to 7" in diameter.
- Universal pliers handle middle range of both.

You'll find Proto Truarcs displayed soon at your Proto Dealers, including Hardware, Auto Parts, and Builders Supply stores all over the country.

For
Internal
Rings
Bore Diam.
1/4" - 7"



PROTO TOOLS
PRO TO

2202 Santa Fe Ave., Los Angeles 54, Calif.
502 Allen St., Jamestown, New York
1702 Oxford East, London, Ontario, Canada

[®]Registered Trademark of Waldes Kohinoor, Inc.



Automatic pair! The camera lens "squints" in the sun, opens in the shade, as your eyes do! You turn on the projector, *it* does the rest!

HOW THE KODAK AUTOMATIC 35 CAMERA HELPS YOU GET PICTURE-PERFECT



In sun, the electric eye makes the lens "squint" to a smaller aperture.



In shade, lens opens by itself to admit more light. Up to $f/2.8$ if needed.



Indoors, lens sets itself for available light. Signal tells you when to use flash.



With flash or for special effects, you can make lens settings manually.

EASTMAN KODAK COMPANY

New Kodak team shoots and shows superb hobby pictures *automatically!*

THE CAMERA: New Kodak Automatic 35 with electric eye *automatically* sets the correct exposure!

THE PROJECTOR: The New Kodak Cavalcade changes slides *automatically* while you enjoy the show!

Wherever you are . . . whatever your subject . . . here's a team matched for the most satisfying hobby pictures ever. It lets you shoot and show them *automatically!*

Picture-perfect exposures. The Kodak Automatic 35 Camera frees you from exposure calculations—so you can concentrate on your subject. You can move from sunlight to shade, shoot indoors with room light or photofloods, yet never make a lens setting. The electric eye does that for you. It adjusts the lens to the light. It even signals you when to use flash. And all *automatically*, whether you are taking snapshots or color slides.

You can get extra-closeups. Shoot small subjects and hobby projects as near as 2½ feet! Finder allows for parallax.

You load fast. No threading. One thumb flick winds the film. And the fast *f/2.8* lens means speed to spare, even in dim light.

Perfect picture shows. The new Kodak Cavalcade Projector, Model 520, changes

up to 40 slides in succession—*automatically!* You set it just once for 4-, 8- or 16-second change intervals. Turn it on, and it does the rest. You never have to lift a finger.

Your slides stay in focus from first to last because they're preconditioned by warm air. They're kept safe, too—each held in its own steel protector.

You can point out details on the screen with the shadow arrow. Edit as you show. Lift out any slide as you go. For a second look at slides already shown, or to skip ahead, just touch the control wheel.

And all the time, you and your guests enjoy beautiful slides shown at 500-watt brilliance *automatically!*

See this great automatic pair demonstrated at your Kodak dealer's. The Kodak Automatic 35 Camera is only \$84.50, or as little as \$8.50 down at many dealers'. The Cavalcade 520, only \$124.50, or as little as \$12.50 down. Hitch this team to *your* hobby. You're sure to enjoy it even more!

RESULTS EVERY TIME



Bright-frame finder shows framing allowance for 3 and 5 feet.



You focus as near as 2½ feet. Or even closer with Kodak Portra lenses.

(List prices, including Federal Tax, and subject to change without notice.)

Rochester 4, N. Y.

NOVEMBER 1959

HOW-TO PICTURES—

See your dealer for a copy of the 64-page Kodak book, "How-To-Do-It Pictures," 50 cents. And write our Sales Service Division for a free copy of the catalog "Kodak Books and Guides."



Kodak
TRADEMARK

FREE bit holder

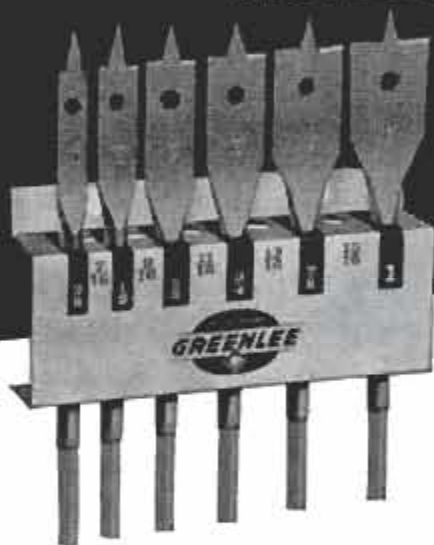

with 6-piece Greenlee **ZIP BIT** set

Get this handy new set of wood-boring power bits with FREE metal bit holder. Keeps bits protected and in order... gives instant size selection. Holds up to 11 bits. Comes to you free with set of six GREENLEE ZIP BITS sizes $\frac{3}{8}$ ", $\frac{1}{2}$ ", $\frac{5}{8}$ ", $\frac{3}{4}$ ", $\frac{7}{8}$ ", 1".

Set with free holder, only **\$3.90**

ZIP BIT has nonslip **HEX SHANK** BORES IN ANY WOOD, AT ANY ANGLE, ANY SPEED

- Hex shank gives positive, nonslip drive... added strength
- Hex shank chucks quickly, accurately in any $\frac{1}{4}$ " or larger electric drill
- Cutting edges easily re-sharpened
- Heat-treated for long life

See your hardware or building supply dealer now for ZIP BITS with free bit holder.



GREENLEE TOOL CO.

1843 Columbia Ave., Rockford, Illinois

Clinic for Homemakers



As a service to our readers in solving the hundreds of problems pertaining to a home—inside or out—the editors of *Popular Mechanics* invite you to present your problems to The Clinic Editor for help and advice. Address your questions to The Clinic Editor, *Popular Mechanics Magazine*, 200 East Ontario Street, Chicago 11, Ill.

Water Those Evergreens

Q—I have both a new and old evergreen planting on a high point of my large lot. There is drainage away from this planting in three directions and I've noticed that the soil dries rather quickly after a rain. I'm concerned about the new planting, particularly during the coming winter. What is the best way to assure plenty of moisture during the winter?

R.C., Minn.



A—Even though the rainfall in your locality is normal during the fall months it's always a good idea to water evergreens regularly until the ground freezes, especially if the planting is in an exceptionally well-drained area such as you describe. Here surface runoff can greatly reduce the amount of water reaching the subsoil from the normal rainfall and there is the risk that during the first cold snap of the winter the ground will freeze when it is comparatively dry. This is almost sure to cause some damage to the new planting and very likely to both plantings in your case. Perhaps the best way to water the planting is to lay the hose to the highest point in the planting, remove the nozzle and then adjust the water pressure so that the hose just runs a full stream, no more. Place a flat stone at the end of the hose to spread the stream over a wider area. Allow the water to run until the ground about the end of the hose is thoroughly soaked and water begins to run away on the surface. Then move the hose to a dry area and repeat the process until the whole area occupied by the plantings is so thoroughly soaked that it will take no more water. Continue watering in this manner at intervals until the ground freezes.

Home Shop Layout

Q—I have a space 12 x 26 ft. in one end of my basement that I'd like to partition and use as a home workshop. I want to install several small power tools on stands, a circular saw, bandsaw, jointer, jigsaw, drill press and wood lathe. My problem is just how does one determine the correct amount of working space around each machine?

E.N., R.I.



(Continued to page 230)

ANOTHER FRESH ONE FROM PONTIAC

REVS UP A NEW KIND OF EXCITEMENT FOR 1960

Here, without question, is the most provocative package of road machinery ever to bear the respected name of Pontiac.

Coming and going, the 1960 Pontiac exhibits a clean, classic look that has even the most avid customizers nodding their approval. Here is total artistry in automotive design, shaved and sharp.

For unmatched action, tap the resources of the Tempest 425 with Tri-Power! This fiery, famous power plant is one of a wide range of power packages available in the 1960 Pontiac. Every one is a finely honed

version of the respected 389 cubic inch Tempest and one (the 425E) performs on regular gas.

Tie this Tempest-tended performance to Pontiac's Wide-Track Wheels . . . and you've got the most exciting and road-wise passenger car you've ever hustled or handled.

See your Pontiac dealer soon. Rev up a Fresh-Point-of-View Pontiac and put it through its paces. You'll heartily endorse it as the most satisfying production passenger car of 1960.

PONTIAC MOTOR DIVISION • GENERAL MOTORS CORPORATION

PONTIAC THE ONLY CAR WITH WIDE-TRACK WHEELS



LOOK, MISTER!

No Hands



It's Self-Gripping

CHANNEL LOCK

No. 410

HEAVY-DUTY PLIER

How's this for gripping power? You won't know your own strength 'til you grab hold with this heavy-duty self-gripping plier. The Channellock No. 410 HEAVY-DUTY is actually a combination plier-wrench . . . and it will get into tight places you can't reach with a pipe wrench. A mighty handy, multi-purpose tool with four jaw adjustments up to 1-1/8".

ASK YOUR TOOL SUPPLIER FOR A
CHANNELLOCK No. 410 HEAVY-DUTY PLIER

BE SURE IT'S
A GENUINE
CHANNELLOCK



LOOK FOR THE
TRADEMARK
ON THE HANDLE

CHAMPION DEARMENT TOOL COMPANY
MEADVILLE, PENNSYLVANIA

(Continued from page 226)
A—As the first step it's a good idea to make a simple floor plan to a scale of, say 1 in. equals 1 ft. This means that your floor plan would be 12 in. wide and 26 in. long. On this locate in simple rectangular drawings to scale the location of the bench, cabinets and shelves for storage. Then determine roughly the floor space required by each machine. Then from the approximate center of the work table of each machine strike semicircular arcs about the front of the machine on a radius of 30 to 40 in. This will represent the working area you will require when operating the machine. On the plan these arcs must clear similar arcs around the working areas of other machines nearby. Working on a simple plan in this manner you generally can locate machines in the minimum of space without interference one with another.



Spade Garden Plot In Fall

Q—I have a small garden plot for growing vegetables exclusively and heretofore I've always spaded it in the early spring. I have kept fertility high with natural fertilizers and the soil in good condition by regular addition of humus. Now someone tells me that it is best to either plow or spade the heavy soils of this area in the fall, rather than in spring. Why?
B.L., Ohio

A—There are two main advantages of working soil in the fall months after the crop has been harvested. Dry material such as stalks, grass clippings and other vegetable matter that is to be returned to the soil to form humus can be covered deeply when spading. Also, repeated frost action (freezing and thawing) during the winter months tends to break up lumpy, difficult soils into small particles, making it easy to work the plot into a good seedbed the following spring. Compost and natural fertilizers will be pretty well broken down and incorporated into the soil by spring planting time, eliminating any possible voids in the seedbed which might cause rapid evaporation of the moisture in the soil. Another advantage is that during the fall months the work can be done at leisure, there being no need to hurry the job for early spring planting.

Weather Stripping Storm Sash

Q—My storm windows are quite old and most of them fit rather loosely and let a lot of cold air leak into the space between them and the regular window. I have thought of weather stripping them, using the spring-brass strip of the type made for doors. Do you think this is a practical idea?—O.J., Vt.

A—You do not say how many storm sashes you have but if you have, say, a dozen or more then weather stripping as you suggest would be rather expensive. It also would take a lot of time to do the job properly. Of course, there is little doubt that such weather stripping would be effective in stopping entrance of cold air to the space between the inner and outer sashes. It should be installed on the edges of the sash frame so that when the sash is in place the strip will bear against the edges of the casing, top, bottom and sides. Care must be taken when removing the storm sashes to make sure that the strip does not catch or bind in such a way that it becomes kinked. It is best to install the sashes with turnbuttons rather than hangers as a tight fit is essential. There are other materials which can be used to prevent air leaks around storm sashes. Strips of felt about 3/4 in. wide tacked to the inner faces of the stiles and rails at the outer edges contact the stops when the sash is in place and make a very effective seal. When felt is used in this manner, the strip along the bottom rail is tacked to the bottom edge of the rail rather than to the face.

You do the choosing! The Army's new "Choose-it-Yourself" System lets you pick valuable training before you enlist. Here's how it works:

1. Choose your training field before enlistment. Choose your training from fields like Aircraft Maintenance, Radar and TV Repair, Drafting, Atomics, Printing—and many more.

2. Take aptitude and physical exams before enlistment. Take aptitude and physical exams to qualify for the training you've chosen.

3. Get your choice before enlistment. If you qualify, you know you'll get the training you want. Your choice is written into your future Army record—guaranteed before you enlist.

Ask your Army recruiter to show you his complete list of available training fields.

*Want training in Aircraft Maintenance?
Communications? Engineering?*

**before
enlistment!**

Helicopter Mechanic and Instructor

U.S. GOVERNMENT PRINTING OFFICE



VOCATIONAL TRAINING SYSTEM

US ARMY

Today's close tolerances

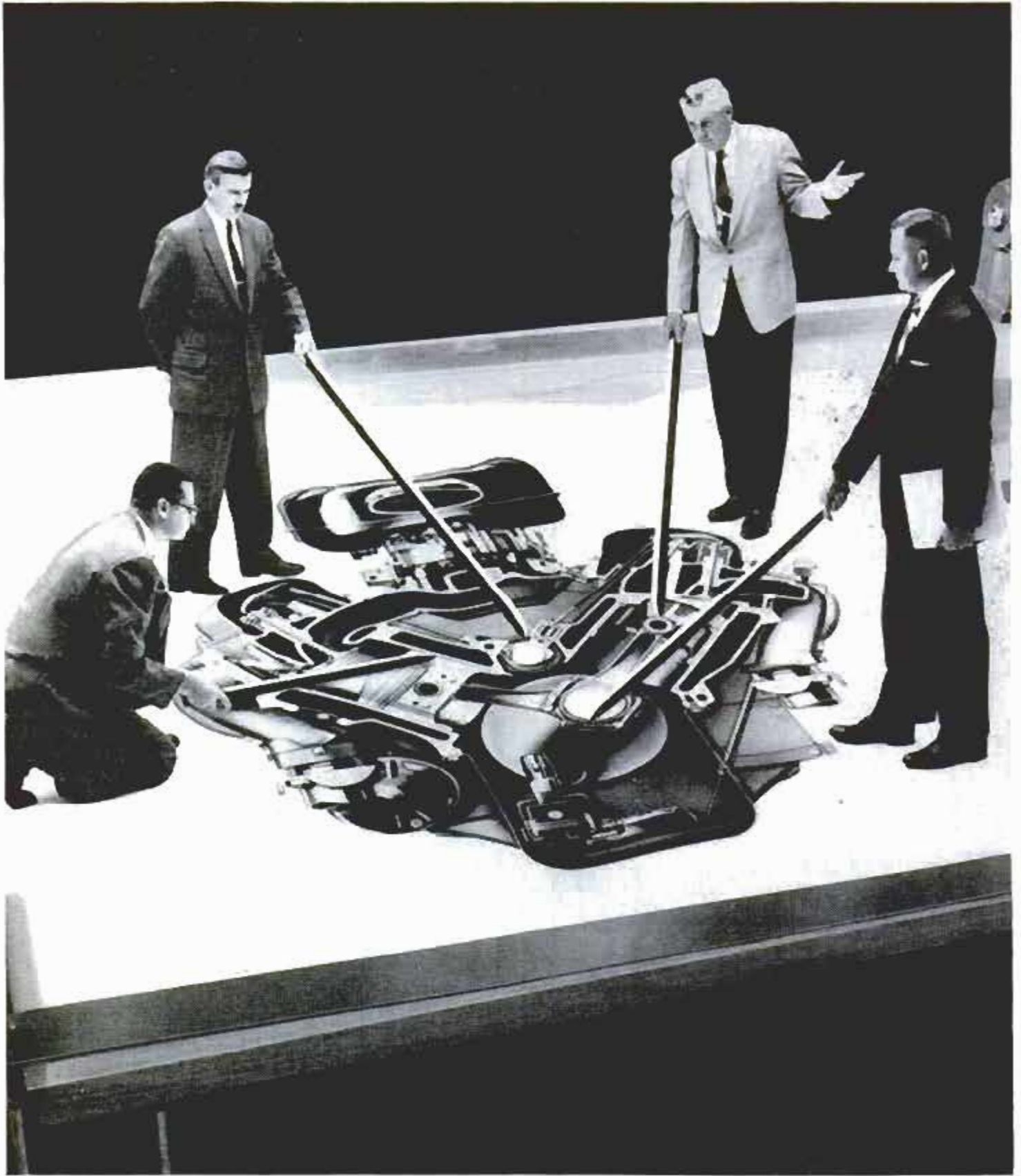

For the finest protection money can buy...



leave no tolerance for dirt!

That's why AC has developed the new Triple-Trapper principle of filtration — protecting critical engine areas where lubrication must not fail!

The job of an oil filter is to remove every contaminant or foreign substance such as dirt, grit, metallic bits and carbon so they won't wear away or scar finely finished surfaces. Finely drilled oil passages must not be clogged by any impurity. For example:

In many engines you will find an hydraulic valve lifter between the camshaft and the push rod that actuates the rocker arm and valves. This key component keeps "play"

or looseness out of the valve train and thus makes for quiet, efficient, split-second valving. The lifter has needle-fine valving itself which admits the oil so necessary for hydraulic operation. A tiny bit of metal or dirt could clog the opening and give you trouble. As long as an AC Triple-Trapper Oil Filter is on the job — and is changed regularly — such troubles are practically eliminated. AC conducts 96 reliability tests on its oil filters during manufacture to insure highest quality!



**AC
TRIPLE-TRAPPER Oil Filter**

*Now you can have the powerful
Triple-Trapping action devised by AC Engineers*

TRAP NO. 1 is the filtering element itself, a resin-impregnated material that traps particles as small as 1/15 the diameter of a human hair.

TRAP NO. 2 is the amount of filtering area. The AC filter has more *usable* area . . . or surface. Oil, passing through the filter, is spread out and slowed down over this greater area. Thus, the filter has a chance to catch

fine particles. The trapped particles themselves form a filter "bed" on top of the filter element. This helps trap even finer particles.

TRAP NO. 3 is the design of the filter element, a unique arrangement of folds that provides maximum filtering area, hence maximum filtering capacity. Because of this greater capacity, the filter is able to hold *more* particles.

SOLD BY 283,000 RETAILERS

AC SPARK PLUG  THE ELECTRONICS DIVISION OF GENERAL MOTORS

TRIPLE-TRAPPER Oil Filter used on more new cars than any other brand

Toughest Railroad You Taxpayers Own

(Continued from page 122)

Communications are vital in the far North where miles of the ARR's lines regularly fall victim to "silver thaw"—a kind of ice caused by warm air drifting in through the mountain passes from the Pacific. When snow falls through this warmer layer, globules of liquid ice are formed which adhere to the wires. This added weight drags the wires to earth, even though three times the normal number of supporting poles are used.

Engineer Bill Hertz remembers when an emergency message was flashed to him at Healy along those wires during a howling blizzard. A young mother was dangerously ill at a nearby coal mine. It was 45 below—too cold for a plane. She had to be taken to the hospital at Fairbanks, 112 miles away, immediately.

The intervening track, badly snowed under, had been "cleared" for the mercy run. Hertz hit it hard, dragging only a caboos behind his steam engine. Crew members fed coal steadily to the small caboos stove while the spunky woman's husband and a doctor hovered nearby.

A little over two hours later they arrived at Fairbanks, the locomotive frozen solid white. The young mother was rushed to a hospital. She died there, the frostbitten trainmen clenching their big hands in helpless frustration. They had been called too late.

Large wooden doors are used to keep some dank tunnels warm. Otherwise, the glacier water which drips constantly inside, may change quickly to ice and wreck the next train. At one time around-the-clock maintenance crews piped steam heat inside from special plants operated near the entrances. This proved too expensive.

Bears, big ones, are common. Occasionally they break into trackside buildings where blankets and emergency rations are stored for snowbound trains. A group of *chee-chakos* (newcomers to Alaska) once fled one of these buildings just ahead of a large silvertip grizzly, which climbed through an open kitchen window, took an inquisitive stroll inside, then departed unhurriedly by the same route.

"Some of those *chee-chawkers* had the nerve to write their Congressmen later," a grinning ARR brakeman told me. "They claimed the government had risked their lives. Why, that big old bear didn't hurt a thing!"

In keeping with this calm frontier philosophy is the story told by newspaper publisher Bill Snedden and his wife, who took

the daily train to Anchorage to attend a dinner celebrating the inaugural of Asiatic and European plane service to that city.

"This was a big thing for Alaska and everybody who was anybody was at the dinner, including representatives from Japan and other foreign countries. It wasn't the kind of affair you ducked out on. Besides, up here we try not to hurt people's feelings by doing things like that.

"But the time came for us to go. As we stood up I felt a sharp tug at my coat. 'Sit down, you can't leave now!' someone whispered from a darkened table nearby.

"I recognized one of the officials of the ARR. 'Got to,' I told him. 'We just can't miss our train home.'

"Don't worry,' he assured us. 'We'll just hold her up.'

"He did, too—for more than half an hour."

Today you can ride the gleaming chrome coaches of the Alaska Railroad into the very heart of the new state's 586,400 square miles. Through special five-foot panoramic windows you gape comfortably at beautiful Mount McKinley, highest point in North America. In the ever-white vastness of the awesome Alaska Range you see great glaciers, tumbling trout streams and placid lakes where moose and caribou browse. These animals look tame as cattle yet are ever ready to flee from Alaska's tremendous brown bear, the world's largest carnivore that can weigh 2000 pounds and bite its tree mark a dozen feet above the ground.

The powerful train glides past rotting river steamers, reminders of gold-rush days; totem-poled Indian villages; sod-roofed hermits' cabins with elevated food cache nearby, safe from the reach of hungry wild things.

In Alaska even the crack passenger trains stop at noon while all alight to enjoy a hearty hot lunch, sourdough fashion, in one of the railroad's trackside buildings. Blue-denim-clad workmen eat quietly at the same rough wooden tables with staring tourists who may never fully understand why these trainmen do all the things they do for others despite terrible difficulties and inconveniences.

Silver-haired Anton Anderson, presently the energetic mayor of Anchorage, helped build the railroad as an engineer. He'd come up from New Zealand to learn about such construction for use in his native country ("I'm still learning!"). He has vivid memories of that era.

Men used simple hand tools under nearly impossible frontier conditions, he recalls.

(Continued to page 238)

MAKE A "SPARKLE" TREE FOR CHRISTMAS

Use G-E Spot and Floodlamps
for exciting year-round
outdoor lighting effects!

General Electric PAR Floodlamps make this expensive, do-it-yourself "Sparkle Tree" spring to life after dark. But that's only one of many uses for these versatile bulbs. Use them this Christmas to highlight trees and shrubs—add sparkle and color to outdoor decorations and doorways. Use them later for decorative or safety lighting all year 'round.

G-E Weatherproof Spots and Floods both come in 75 or 150-watt sizes. For colorful effects that make holiday decorations even more unusual, try colored outdoor floods—now available in the new 150-watt size in six beautiful weatherproof colors.



NEW G-E YARD LIGHT KIT—Combines 150-watt G-E PAR Floodlamp with weatherproof outdoor holder—complete with ground spike, cover plate, cord and plug.



For an extra touch, conceal the Floodlamps from view by covering with an open-end, make-believe "Christmas present".



FREE PLANS FOR BUILDING YOUR "SPARKLE TREE"!

Complete instructions for building a "Sparkle Tree" plus simple directions for making your own decorations packed with every G-E "YARD LIGHT" KIT. Or write General Electric Co., Large Lamp Dept. PM-119, Nela Park, Cleveland 12, Ohio. Get yours today!

Progress Is Our Most Important Product

GENERAL  ELECTRIC

(Continued from page 152)

bottom. The echoes are recorded by two methods, as recorder traces that show depths and changes of composition, and as oscillograms that show characteristic patterns for the different materials through which the sound waves travel.

One such picture, of the continental shelf off southern California, shows that the bottom is relatively flat for some distance offshore and that it then plunges precipitously to almost 2000 feet. This escarpment is well known, of course, having been shown by various other kinds of depth fingers in the past. One of the things that is new in Padberg's picture, however, is the thick sedimentary deposit or delta that is shown at the foot of the escarpment and that extends out a considerable distance. This had been suspected but never before had been seen.

Systems Ideal for Offshore Exploration

It's obvious that these sound systems are ideal for offshore underwater exploration, but how can you produce underwater sound waves on dry land? There are several ways to do this, Padberg explains. One is to use a large plastic water container that rests on the ground, another is to dig a small hole and fill it with water. In either case the coupling between the water and the ground itself is efficient.

With the limited amounts of sound energy that have been used so far, the earth's crust has been penetrated to depths of several thousand feet. Deeper exploration depends on greater power. This year the underwater sound scientist is testing some new high-intensity sound sources in a deep Idaho lake, at depths as great as several hundred feet. The prime object of this research is to study possible weapon applications; at the same time more information about exploring the earth's depths with sonic waves will be obtained.

In addition to ordinary underground exploration, Lou Padberg foresees a number of specialized uses for his sound waves. They can be used to explore the earth under cities and in other locations where the use of explosives is forbidden. They are ideal for the shallow exploration that is now performed by core drilling at sites where tall buildings or dams or bridges are to be erected. The underwater explosions that create the sound are safer and cheaper than the explosives now used in some metal forming operations. Finally, it may even be that a new method of propelling a boat can be devised by making use of the cavitation bubbles the process creates. ★ ★ ★

Thrills, Spins,
and Spills for

SPORT FANS

Get an easy-starting
Junior Hot Rod
that you and Dad
will both enjoy!



Fully assembled —
car and engine
— complete \$1000
Reg. Ret.

Thimble-Drome PROP-ROD

THRILLING AERO-TYPE MINIATURE RACER

One flip of its propeller and PROP ROD'S .049 cu. in. displ. real internal combustion engine fires into action, turning up nearly 18,000 RPMs!

You've always wanted a miniature racer! Now you can own one—at a price that an engine alone used to cost—a low-slung, streamlined model, equipped with the world's most powerful engine of its size!

PROP ROD can be raced in a circle as small as 10 feet—at speeds up to 35 mph—and on that small a circle, boy, that's traveling!

FREE RUNNING, TOO, for hair-raising thrills. No "driving circus" can com-

pete with PROP ROD'S realistic auto action when you take it off the tether and turn it loose. Buzzing off in a straightaway dash, it winds up in a slithering, sliding turn—then away it goes in another direction!

QUALITY BUILT throughout, PROP ROD has a 12 in. high impact plastic body mounted on machined aluminum frame and wheels, with racing-treaded rubber tires. There's no finer companion for Dad and Son than this exciting aero-type speedster. See Thimble-Drome's PROP ROD at your favorite hobby counter and get started in this exciting sport today.

Exciting Laps



Spine-Tingling Dashes



Thimble-Drome BABE BEE .049 engine, world's largest selling model engine, powers the PROP ROD. Develops sensational power in less than 1/20th cu. in. displ. Available separately for build-it-yourself modelers. \$398
Reg. Ret.

If not available locally
order from factory. No C.O.D.'s, please.

L. M. COX MANUFACTURING CO., INC.
P. O. BOX 476A • SANTA ANA, CALIF.

FREE full color 12-page
packet catalog (981)

See Why New **LOW PROFILE**  **Tires**

KEEP YOU SAFE WHILE THEY SAVE YOU MONEY!

J.S. Royal's radically new tires run cooler, are safer, give up to 35% more mileage, save gas—yet cost no more!

LOWER! WIDER! MORE RUGGED! SAFER!



**ORDINARY
TIRES**



**LOW PROFILE
TIRES**

The fellow on the right has a lower, wider stance to give him strength and stability. In the same way, U. S. Royal's new Low Profile tires are lower, wider than conventional tires. They have the extra ruggedness and stability needed to keep you safe and give maximum wear—especially on today's fast, non-stop super-highways.



Above diagram shows how Low Profile tires are lower and wider than ordinary tires. Engineered closer to actual working shape. So they don't flex as much. Don't strain as hard. Run far cooler than ordinary tires.

They're safer against tire failure at high speed. Safer on turns. Safer against skids. They wear longer. Roll easier—save gas. Originally a premium-tire feature—now at no extra price. Ask your U. S. Royal Dealer.

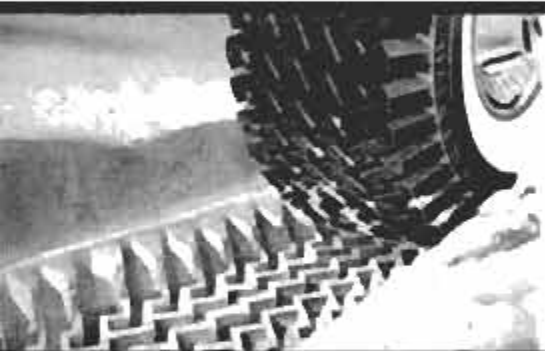

Newest Addition to the "Low Profile Line"
THE U. S. ROYAL
LOW PROFILE WINTERIDE

Brawny, extra-deep lugs haul you through snow and mud—give you non-skid stops on wet roads. Yet with all this brute traction, the new Winteride rolls quietly on clear roads!

**NOW AT THE
LOWEST PRICES
IN YEARS!**

U.S. ROYAL TIRES



United States Rubber

Rockefeller Center, New York 20, N. Y. In Canada: Dominion Rubber Company, Ltd.
See things you never saw before. Visit U. S. Rubber's new Exhibit Hall, Rockefeller Center, N. Y.

The early roustabouts were fresh from building the first transcontinental railroad and knew their jobs. They had only picks and shovels.

"Those were men," says Anderson proudly. "In 1917 we sent 2000 of them into the hazardous Turnagain Arm area where they finished in five months a job impossible in the same time today. We'd put them ashore in scows and next morning they'd be hollering for grade stakes. Today we'd first have to find them a campsite, get a health department okay, then move in heavy air compressors for their drills.

"Our meal tickets were taken up by 'Alaska Nellie,'" Anderson recalls. "A slender, colorful woman given to salty language, she'd move her mess halls forward with us over the crude tote roads and frozen rivers as we pushed the steel deeper into the wilderness. Sometimes a hundred would sit down at once at her tables. She could hunt and run her dog team with the best, even though a big bear mauled her once."

Congress had to build the Alaska Railroad. It had purchased the Territory in 1867, and access to the interior became increasingly important as a defense measure (in addition to the almost unlimited mining, farming, lumber, fish and fur potential there). Several private efforts at railroading in Alaska had already failed. On March 12, 1914, Congress authorized the President to "Locate, construct and operate railroads in Alaska . . . not to exceed 1000 miles . . . and to connect with one or more ice-free Pacific ports."

Today, when perishable winter cargo is transferred from vessels docking at the port of Seward, refrigerator cars must be preheated to receive it. As the cargo rolls northward special charcoal heaters prevent freezing.

Spring brings new difficulties. During the breakup much ice floats down the swift rivers. There are spots where mud slides occur when slopes of glacial moraine thaw out. Tons of rock and clay, loosened by the frost, tumble onto the roadbed. In 1947 an entire mountain slid away at Milepost 351. (Along the main line all sites are designated by "mileposts," there being no other references in the wilds.) The track bed had to be restored as much as 20 feet.

Unpredictable wind storms are another menace. One spring between Portage and Whittier, conductor Bob Dorf's freight was emerging from a tunnel when a tremendous gust blew away three loaded box cars, tore up both rails for a distance of 150 feet. No one was hurt.

Begun in 1915, the Alaska Railroad was completed in 1923. World War I cut the labor force in half, boosting wages and materials so the job cost \$72 million (twice the original estimate). Politics, it is claimed, saw the builders inheriting much useless equipment from Panama (where the U.S. government operates a second railroad, a small one). At one time they found themselves with 23 different kinds of rails, including some old Krupp steel from Germany.

President Harding supposedly drove the gold completion spike—too soon—at the Nenana bridge. There are but 110 frostfree days annually and this called for laying ties on frozen ground. These gave way beneath the first trains. You can't straighten a vertically bent rail, so Alaskans had to bounce over the washboard for years afterward.

An additional \$60,000,000 appropriation has since completely modernized this steel route to the midnight sun. Rails are heavier, roadbeds wider. Freight cars now number 1200 instead of 100. Freight provides the main income. Last year the ARR netted an \$800,000 profit from freight and passenger revenue over operating expenses. Annual profits like this do not, however, include any effort to pay off the original construction and improvement costs.

"You wouldn't send a government battleship to Greenland and expect the crew to catch enough fish to pay for the ship's operation," is the way Anton Anderson explains this lack of amortization. "The Alaska Railroad was intended as a defense measure and a development agency."

There is practically no manufacturing in Alaska and supply lines remain long and costly. Fuel and equipment still must come mainly by sea. The ARR, like its competing air and highway carriers, suffers from being a one-direction road with little "back haul" revenue. ("We carry all sorts of things into Alaska, but seldom transport anything out.")

It remains a big state however; there is a constant need for heavy machinery for the mining and construction camps and the huge gold dredges. This can be transported only by rail. There appears little doubt, therefore, that this inspiring railroad which first really opened up Alaska will be around for a long time.

And that suits grateful Alaskans just fine. ★ ★ ★

☐ Anti-snakebite serum is available free of charge from the Philadelphia Herpetological Society for victims of any North American poisonous snake.

NEW QUADRI-BALANCED RIDE . . . the quietest ride you've ever tried!

For 1960, Oldsmobile brings you a new kind of ride—comfort-balanced four ways.

1. **Wide-Stance Chassis** provides a wider, lower base—gives a road-hugging, steady, stable ride.
2. **Guard-Beam Frame** gives the protection of a steel framework around the passenger compartments; permits the body to be mounted directly on the frame; eliminates "outrigger" type attachments.
3. **Nylon sleeves** inside Olds shock absorbers wear less—together with new "constant-viscosity" shock absorber fluid, produce a smoother, better controlled absorption of all bumps and bounces.
4. **Vibra-Tuned** body mountings insulate body from road noise and harshness—make the '60 Olds the quietest Olds ever!



See your local Oldsmobile Quality Dealer!



Mighty Satisfying!



There's nothing like a new car . . .
make yours a Rocket!

... NEW BALANCE OF POWER!

Olds engineers solved the power vs. economy question with two new Rocket Engines for '60.

New REGULAR ROCKET Engine gives traditional Dynamic 88 "Go" on regular, lower-cost gas—standard on every Dynamic 88 model for '60. Owners save about a dollar bill every fill!

New PREMIUM ROCKET Engine for Super 88 and Ninety-Eight models, gets the most in spirited action from premium fuels. Develops 315 h.p.; 435 lb.-ft. torque. Multi-Jet carburetion; 9.75-to-1 compression.

OLDSMOBILE  **FOR '60**

OLDSMOBILE DIVISION, GENERAL MOTORS CORPORATION

NOVEMBER 1959

239

Better Your Home with these terrific



MODEL H75

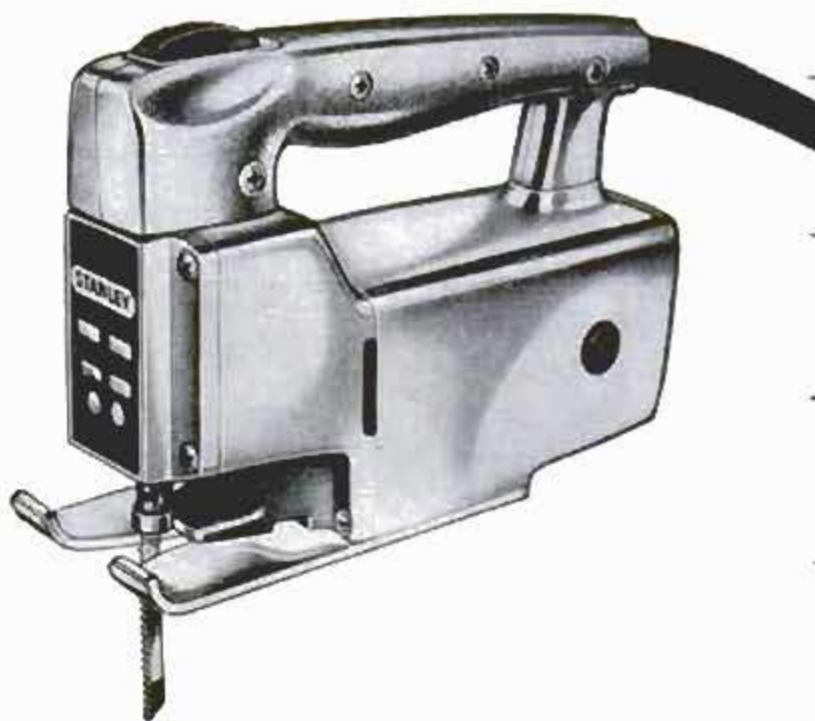

Heavy-duty sabre saw — only \$44.50, plus 7 blades worth \$4.90—FREE! Lowest-priced heavy-duty sabre saw you can buy. Cuts scrolls, curves, wood, metal. Special blades cut flush up to a wall and to $\frac{5}{8}$ of an inch along a wall.



MODEL H131



\$6.00 off on 3-amp $\frac{1}{4}$ " drill. Reg. \$24.95 Stanley special fall price—\$18.95 Most powerful $\frac{1}{4}$ " drill for the price on the market. Plus rugged bearing construction, non-slip pistol grip, 3-jawed geared chuck, 3-wire cord.



Electric tools built for the professional,

... On Your Own Stanley power tool specials

MODEL H36

Heavy-duty orbital sander — \$49.95
Get 2 permanent abrasives . . . FREE!
You save \$4.00 and lots of work, too. Powerful, rugged, the H36 gives satin-smooth finishes, fast!



MODEL H81

Save \$4.30 on new power drill kit.
A \$43.25 value, now only \$38.95.
Complete with 3-amp 1/4" drill, steel case, and 19 extras, including famous SWIRLAWAY sander/polisher,



MODEL H288K

\$15.00 off on complete builders saw kit.
\$67.95 value . . . now — \$52.95
Powerful 6 1/2" saw has rear controls, Free-start guard, ball-bearings. And you get case, etc.—free!

Stanley Electric Tools, Div. of The Stanley Works, New Britain, Conn.

*Prices slightly higher in Canada
Canadian office: Hamilton, Ont.*

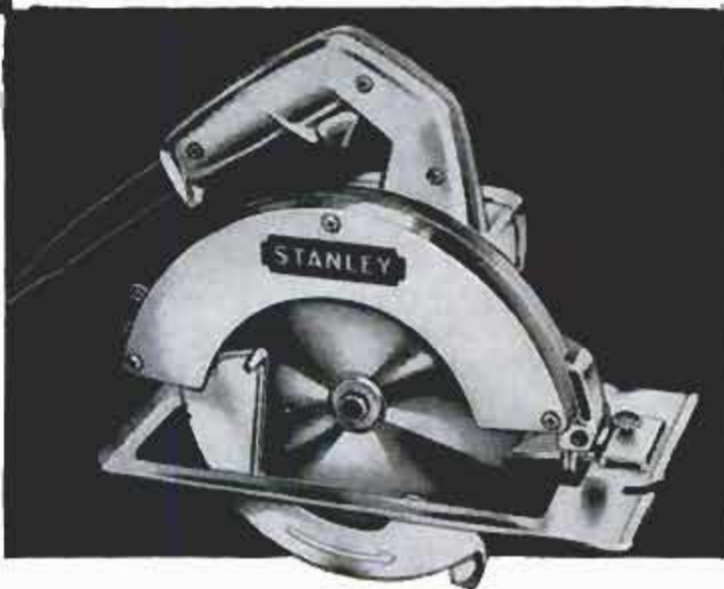

priced for everyone

STANLEY

®

New Dexall Caulking Compound

- Caulks stucco, wood, concrete, brick, stone.
- Permanently elastic.
- Easy-to-use cartridges.

Tough seal lasts for years!



DESHLER PRODUCTS, INC.
Deshler, Ohio



*Fast, easy, foolproof way
to repair wall cracks!*

New Dexall Patching Paste

- New, improved, ready to use, for plaster and wood.
- Won't crack; water-resistant, smooth, easy-working.
- Dries fast, anchors firmly, sands easily.

At paint and hardware stores everywhere.

Shortest Route May Be the Longest

(Continued from page 125)

Communications Are the Key

The key to the entire system was fast communications. Only by knowing existing wave and weather conditions in most or all of the area covered could an accurate forecast be made.

Applied to the routing charts in Dr. James' office, the assembled information showed what were likely to be the trouble areas. It was then simply a matter of plotting the ship's track around the worst of the high wave conditions and changing the ship's course en route as new weather and wave data became available.

The application of this research to actual ship crossings produced spectacular results.

Ships routed by what was now called Oceanographic Forecast Central, U.S. Naval Hydrographic Office, arrived at their destinations an average of 14.5 hours ahead of time. This despite the fact that the optimum ship courses were often 100 miles or more longer than the most direct route.

Dollar savings were estimated by the Navy at approximately \$2,000 per crossing, or \$900,000 for the 450 ships routed.

Warships Use Routing Service

Based on this information, Admiral Jerauld Wright, commander of the Atlantic Fleet, gave the commanders of his warships permission to use the ship routing service if they chose. Use of the service is expected to be made mandatory as more experience is accumulated. The warships are serviced by prediction stations at Norfolk and San Diego.

Wind and wave predictions from Dr. James' office made possible the delicate task of moving and emplacing the "Texas Tower" early warning radar stations off the New England coast. Ice predictions from "Forecast Central" enabled convoys to land critical supplies for the Distant Early Warning radar stations in the Canadian Arctic.

The final proof of the effectiveness of the combined wind-wave-weather prediction service, however, was the safe passage of the Navy ships in the storm last March.

"Once the commercial skippers are won over," Dr. James states, "the application of ship routing techniques can eliminate perhaps one half the danger and discomfort still attending a sea voyage." ★ ★ ★

☞ Liquid hydrogen, described by Air Force scientists as an "ultimate chemical fuel," is now in large-scale production in Ohio, California and Florida.

THE NEWEST AND FINEST! BUCK'S 400 SERIES



CHROME EDGE CHISELS

You get: ★ The Finest Cutting Edges
★ Tough Tenite II Handles with Inserted Steel Caps
★ Rust Proof Tools

1" - \$2.90
¾" - \$2.70
½" - \$2.40
¼" - \$2.30

Plastic pocket kit - 6 sizes \$10.30
Most complete line of Chisels, Gouges and Carving Tools
CATALOG AVAILABLE!

BUCK BROS. INC.
RIVERLIN WORKS MILLBURY, MASS.



GENUINE ALNICO
MAGNETS

AMAZING, PERMANENT, NON-ELECTRIC, HIGHLY PRACTICAL

Conduct interesting experiments. Hundreds of uses. Retrieve valuable steel items such as guns, tackle from fresh or salt water; tools from tanks & drains. **GUARANTEED.** Try any magnet one week.

MONEY BACK IF YOU ARE NOT WELL-PLEASED

M-710 (Wt. 53 oz.) Has pull of 225 lbs. on steel block... \$18.00
M-625 (Wt. 70 oz.) Has pull of 125 lbs. on steel block... \$10.00
M-575 (Wt. 18 oz.) Has pull of 75 lbs. on steel block... \$ 7.00
M-500 (Wt. 13 oz.) Has pull of 50 lbs. on steel block... \$ 5.00
M- 90 (Wt. 5 oz.) Has pull of 15 lbs. on steel block... \$ 3.50
M-102 Pocket Magnet, 5 lb. pull, 2 for... \$ 1.50
M- 47 Hot Pad Magnets, 10 for \$1.00... 50 for \$ 4.87
M- 35 Hobbyist assortment of 8 magnets... \$ 2.00

Send M.O. or check. We pay postage. Sorry no C.O.D.'s.
3240 N. W. 27TH AVE.
MIAMI MAGNET COMPANY, MIAMI 42, FLORIDA

KING MIDGET



FOR 1960

More aluminum, lighter weight, better performance, beautiful styling. Still Worlds Lowest Priced Car. Drive it for 75c a week. Rider Agents Wanted. If no dealer near you send 25c for 32 page picture book, full details, dealer price. Or send \$1 (refunded first order) for this and Service Manual plus Repair Manual and 15 5 x 7 photos of car and factory.

MIDGET MOTORS CORPORATION, ATHENS 1, OHIO

KEEP YOUR WORKSHOP TOOLS SAFE AND ORDERLY



This 7-drawer machinist's chest has a place for every tool. Extra durable heavy gauge steel. Felt lined drawers protect delicate edges... operate easily. Size: 8½" x 13½" x 20¼". \$36.65 at leading hardware stores. Slightly higher west. Other home workshop models from \$1.25 up.

WATERLOO VALVE SPRING COMPRESSOR CO.
Waterloo, Iowa

ENGINES LIKE YOURS LAST 200,000 MILES IN CABS AND TRUCKS



Fleet operators know the secret—replace key parts regularly . . . get like-new power!

Fleet cars and trucks are driven hard—around the clock, on short hauls and cross-country trips. At 50,000 miles or so, their stock engines are tired, yes—but *not ready for the scrap heap!* An overhaul by a skilled mechanic . . . new key parts like bearings and rings—they're off and running smooth and sweet for thousands *more* miles.

WORN BEARINGS . . . SICK CAR

Worn engine bearings have up to 25 times normal oil clearance! Excess oil slips past piston rings, burns to heavy carbon and sludgy varnish. These choke ring grooves and oil holes, foul plugs and valves. Result: your engine burns oil, misfires, pings and knocks. You get poor gas mileage; lose pep and power. Cure: a complete overhaul, including new Federal-Mogul bearings.

"OVERHAUL" INCLUDES BEARINGS

Every good mechanic knows that an overhaul without new bearings is a waste of time and money. So it's wise to do the job *right* at first! You'll get back many times the small extra cost.

ASK FOR FEDERAL-MOGUL BEARINGS

Main, connecting rod and camshaft bearings are the heart of your engine. Yet it costs no more to use the *best*—Federal-Mogul Engine Bearings. Ask your mechanic!



FEDERAL-MOGUL SERVICE



Division of Federal-Mogul-Bower Bearings, Inc. • Detroit 13, Michigan

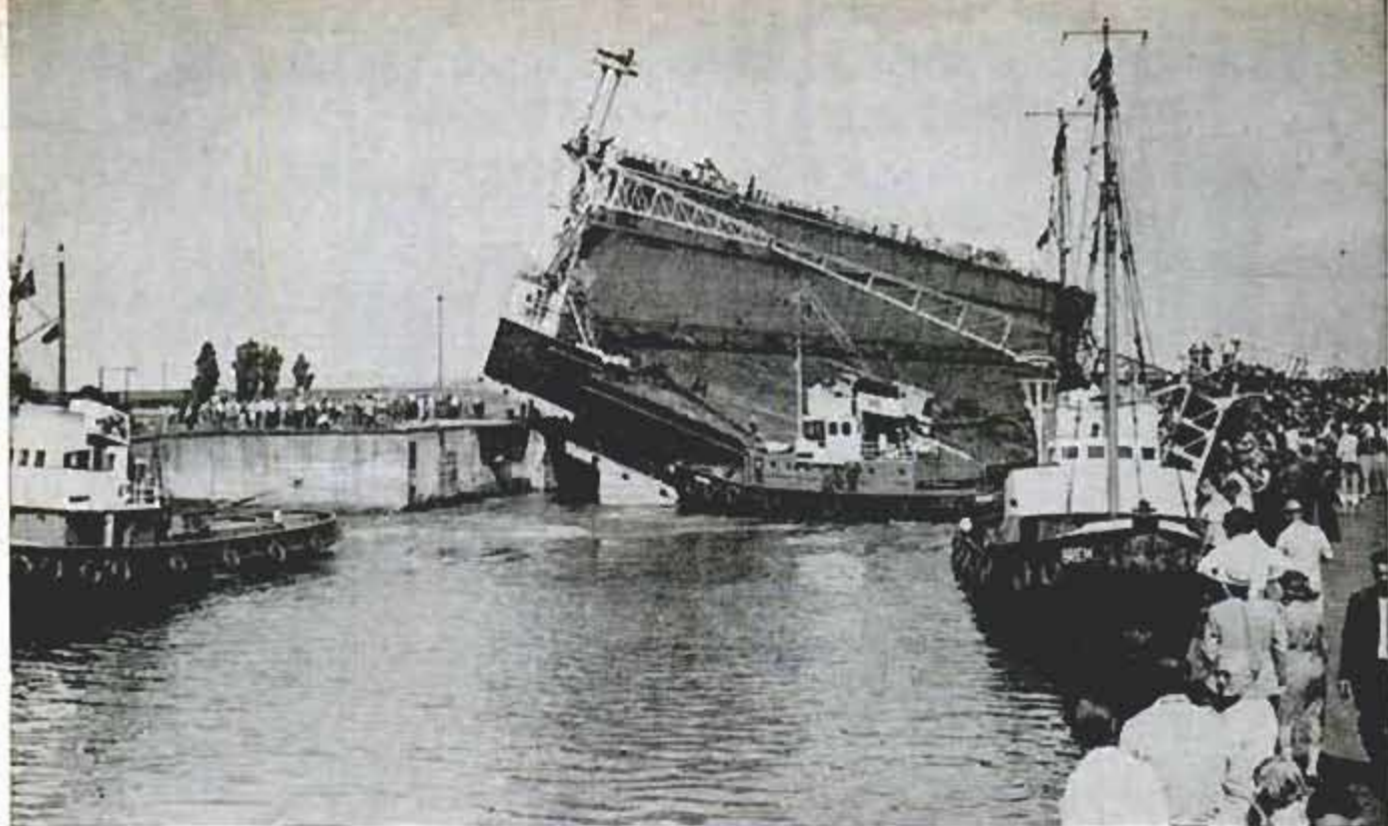

Giant Drydock Tilted for Squeeze Through Narrow Lock

Tilting a giant drydock 22 degrees enabled it to squeeze through the lock at Bremerhaven, Germany. The drydock, 150-foot wide, was too wide to pass through the lock. Even though tilted, by means of 15,000

tons of water ballast, the drydock just managed to clear the lock wall. Originally built for a Greek shipowner, the drydock is easily capable of handling ships up to 26,000 tons.

Pint-Size California Car Weighs Only 1100 Pounds

About half the size of a Jeep, the Crofton Bug weighs only 1100 pounds but carries a quarter-ton payload. The Bug, designed as a small utility auto, is powered by a 35-horsepower overhead-cam engine with four cylinders, a version of the engine first used

on a Crosley. The little vehicle is 111 inches long and 48 inches wide. It has a wheelbase of 63 inches. The Bug finds use among campers, hunters, yachtsmen or store owners. Made in California, the car sells for approximately \$1350.



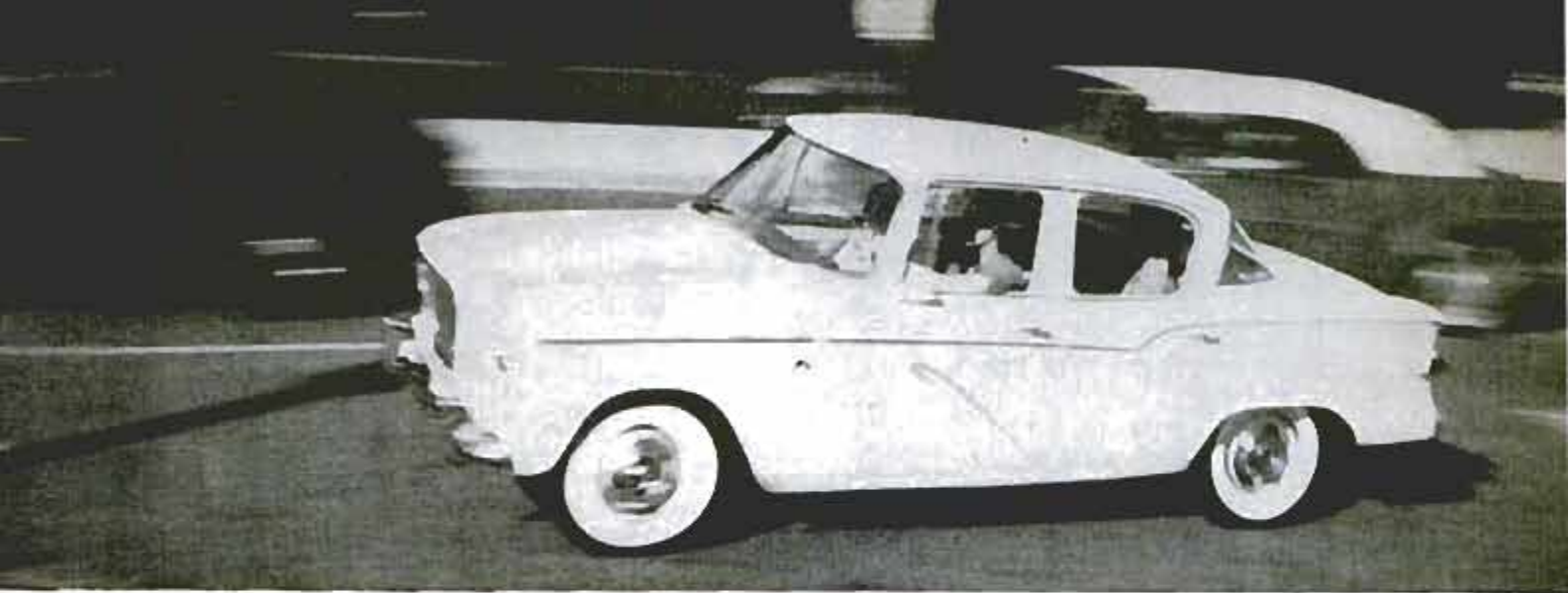

WHAT DOES THE LARK HAVE THAT THE OTHERS DO NOT?

➤ **PROVEN BY 750,000,000 MILES OF CAREFREE OWNER USE:** All over the United States more than 100,000 Americans have been driving their Larks under every conceivable condition of road and weather. Lark repair and maintenance costs are considerably below the automobile industry average. Proof that The Lark is rugged!

➤ **POTENT PERFORMANCE, EXTRA ECONOMY:** Zero to sixty in 9.5 seconds with The Lark V-8 and 4-barrel carburetor. 22.28 miles per gallon of regular gas with the V-8 in last year's Mobilgas Economy Run. Naturally the "Six" does even better. Take your choice!

➤ **SIX BODY STYLES:** the world's only full line of new dimension cars . . . Convertible, Hardtop, 4-Door Station Wagon, 2-Door Station Wagon, 4-Door Sedan, 2-Door Sedan. Who else has them? And with pleated vinyl or fabric upholstery and new sophisticated colors!

➤ **LIST OF OPTIONS LONG AS YOUR ARM:** Three transmissions (automatic, synchromesh, overdrive), limited slip differential (Studebaker's Twin Traction), headrests, reclining seats, choice of axle ratios, 4-barrel carburetor and dual exhausts, many, many more!

THE LARK OFFERS MORE OF WHAT YOU WANT THAN OTHER NEW DIMENSION AUTOMOBILES.
SEE YOUR STUDEBAKER DEALER FOR THE EVIDENCE, NOW!

LOVE THAT **LARK** *BY STUDEBAKER*

Pay-TV

(Continued from page 221)

end of a 30 or 60-day period, when the money is collected, the tape is analyzed and its information is used as a guide for future program scheduling.

Cost to the Subscriber

According to present plans, the cost to pay-TV subscribers will be nominal indeed. There will be no charge to the consumer for the Telemeter attachment other than a \$5.00 installation fee which is comparable to a telephone connection charge. Therefore, the subscriber pays only for actual number of programs he elects to watch. And the price of these will vary, depending on the attractiveness of the entertainment offered. There will be no charge at all for some programs which, replete with commercials, may be sponsored by local firms. But all pay-as-you-watch programs will be free of interruptions.

The Future of Wired Pay-TV

How far and how fast wired pay-TV will spread may depend a good deal on the reception it gets in the West Toronto area; but officials of Famous Players Canadian Corporation, Ltd., sponsors of this initial installation, are confidently enthusiastic. So are the officials of the International Telemeter Company which developed the present telemeter equipment. Since the wired system requires no spectrum space, it is not subject to FCC approvals and meets, for the present at least, no legal obstacles. The door, therefore, is wide open for the installation of wired TV in any area. With regard to the U.S., according to L. A. Novins, president of International Telemeter, several attractive situations have been under active consideration, and decisions concerning the first U.S. market for Telemeter are expected in the near future.

However, even Mr. Novins concedes that the economic advantages of wired TV over "airwaves" TV broadcasts apply only to installations covering relatively small, compact communities or neighborhoods. In the opinion of J. S. Wright, president of Zenith Radio Corp.—a long-time advocate of pay-TV via the "airwaves"—the costs of wiring up a large area, such as San Francisco, Los Angeles or New York, in some huge coaxial network are fantastic.

But Telemeter is ready even for the ultimate advent of broadcast pay-TV in major "saturation" markets. If and when

the FCC finally authorizes "over the air" pay-TV broadcasts, the individually wired Telemeter areas could easily be incorporated at no extra cost to the subscriber. In such an event, the broadcast TV signal would be unscrambled at the Telemeter studio and retransmitted over one of the three Telemeter channels. The other two channels could still provide local-interest programs to the wired areas where saturation broadcasts over an extended area would prove far too costly.

The Canadian experiment will be watched with intense interest by advocates and opponents of pay-TV. Its acceptance or rejection by the subscribers will determine not only the spread of the Telemeter system but may influence FCC decisions which will determine the entire future of pay-as-you-see television. ★★★

Is Carbon Dioxide Warming the Earth?

Civilization is adding carbon dioxide to the atmosphere at a much higher rate than had been supposed, and this may be having an effect on the earth's climate. Dr. Bert Bolin of the University of Stockholm, Sweden, reports that the burning of coal, oil and gas is adding carbon dioxide to the atmosphere at the rate of one half of one percent a year and that a 25-percent increase in the amount of carbon dioxide in the atmosphere will have occurred by the year 2000. It is suspected that the earth has warmed up by two or three degrees in the last 50 years, and it is possible that the increase in carbon dioxide is responsible. The gas acts like the glass of a greenhouse to keep heat from escaping into space while allowing the sun's rays to pass. Dr. Bolin suggests that further studies should be made regarding the increase of carbon dioxide in the atmosphere and its possible effects on future climate.

Rare One-Eyed Fish Found in Gulf of Mexico

Scientists have in their possession a one-eyed fish so rare that it is only the second one-eyed vertebrate ever reported living in nature. The first was a ray described in an Italian journal 75 years ago. The one-eyed fish, found in the Gulf of Mexico near Yucatan, is a member of the family that includes bright-colored, coral-reef damselfishes. Scientists say that the single eye was the left eye at an early stage of formation, and that the right eyeball was probably lost during the fish's early skeletal development.

SPECTACULAR FOR '60

The Bold
and the
Beautiful

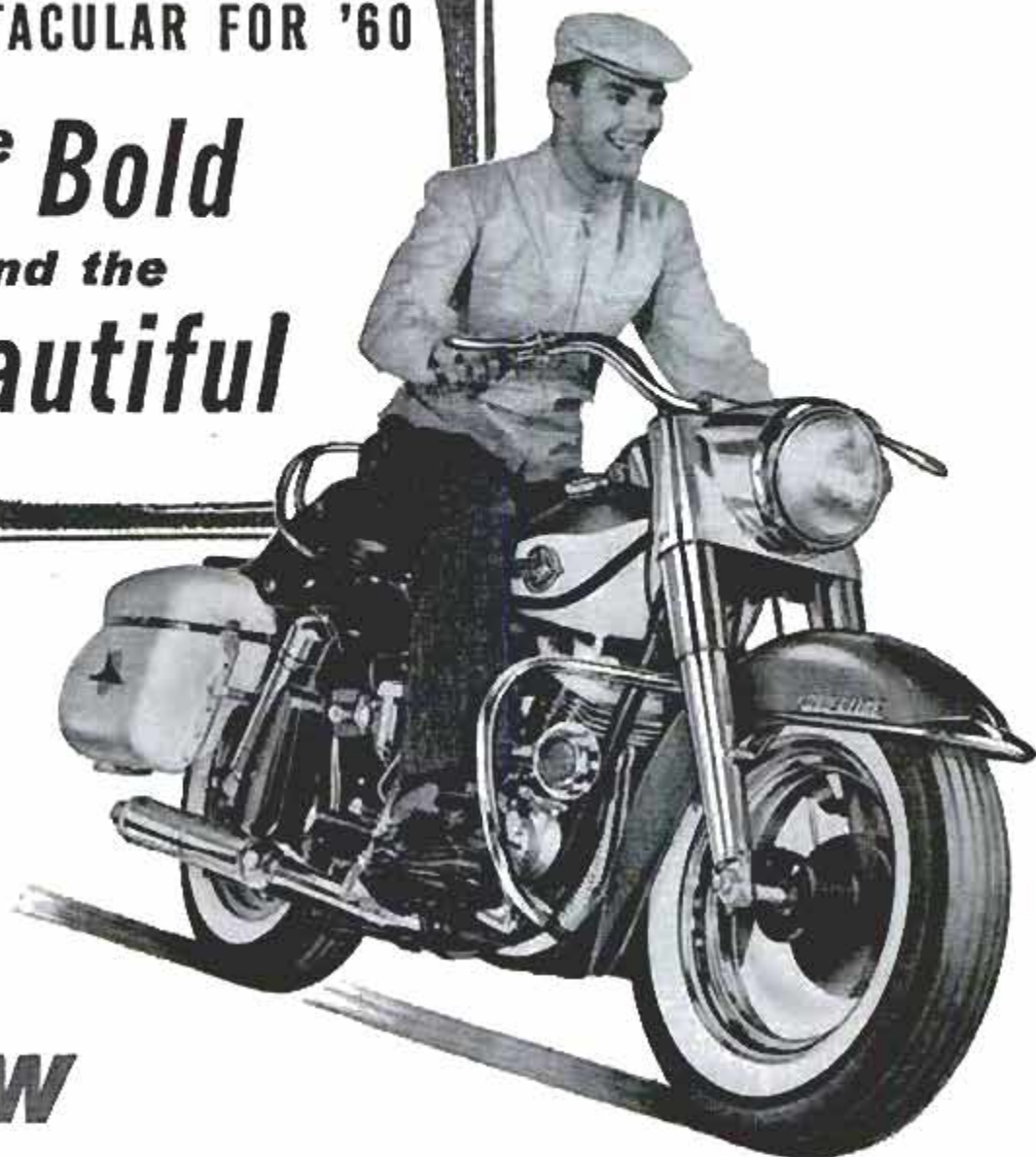

New

**HARLEY-DAVIDSON
DUO-GLIDE**

We've put this "show" on the road—the world's finest motorcycle made better than ever by the world's finest craftsmen.

Spectacular styling with gleaming new headlight nacelle of aluminum alloy. Flowing back from the nacelle, new twin-flare tank paneling adds dash to the famous Duo-Glide look. Spectacular new performance is the result of a host of new mechanical improvements . . . quieter engine, longer bearing life and faster starts.

Harley-Davidson

MOTOR CO.
MILWAUKEE 1, WISCONSIN

Perfect Mating of Man and Machine.

Your Harley-Davidson dealer is *pre-viewing* the new Duo-Glide now. He will show you the many other new features that make the Duo-Glide for '60 the greatest "road show" ever. Or mail the coupon for free, colorful folder.

HARLEY-DAVIDSON MOTOR CO.
DEPT. P, MILWAUKEE 1, WISCONSIN

Please send me new folder
on the Duo-Glide for '60

Name.....Age.....

Address.....



Truck Designed for Turnpike Hauls Three Trailers

Carrying a payload of about 60,000 pounds, an extra-long truck designed exclusively for turnpike travel consists of a tractor and three trailers. The superhighway tractor, built by the White Motor Com-

pany, has an extra-short, light Fiberglas cab, a 335-horsepower diesel engine and tandem-drive rear axle. Extra trailers on the tractor can be detached to comply with length limits in certain states.

Air Springs Adjust to Load

Overload air springs that function only when activated by compressed air help make a truck ride normal whether it is overloaded or carrying a light load. When the truck is overloaded, the driver lets air into each spring. The two springs operate independently. He can deflate them when his load is light, thus making the truck ride even.

Midget Spare Tire

Taking up half the space of a conventional spare, a smaller pneumatic version is sufficient for a highway emergency. Developed by Firestone, the tire and wheel unit for replacing a 7:50-14 conventional tire is 22 inches in diameter compared to the 27-inch normal tire and wheel and weighs 20 pounds compared to 39 for the regular unit.

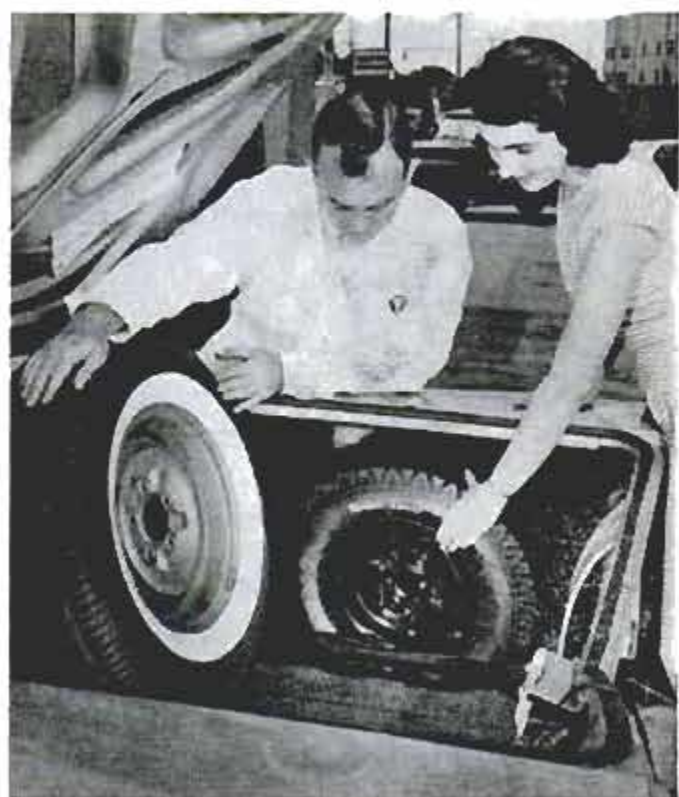
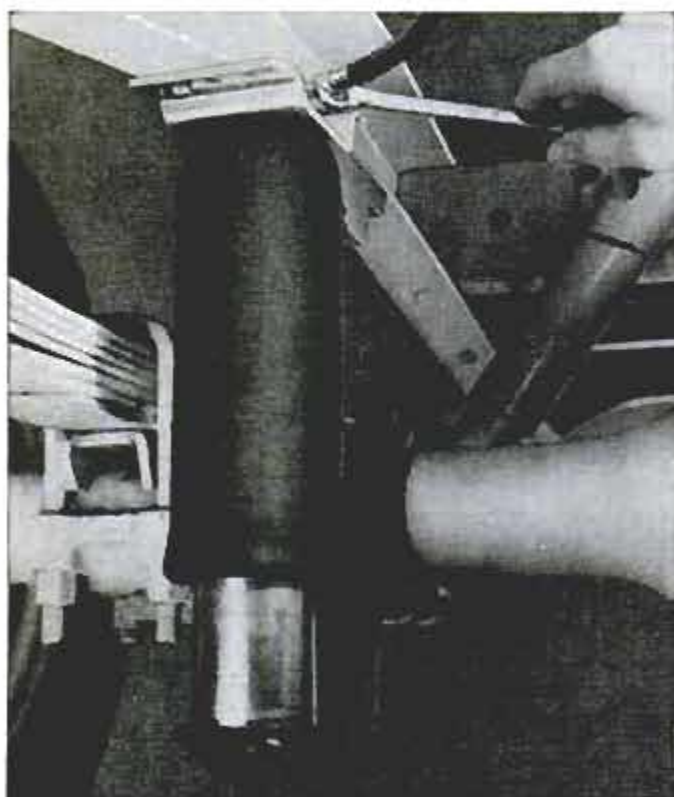

Indoors or outdoors,
you enjoy the taste.



Play it smart: Know what you're getting in a cigarette. Know right now that what you get in a Lucky is the finest tobacco in America... the most famous taste in smoking. You get it clear through—in every Lucky. Can you say that much for the brand you're smoking now? Play it smart: **Get the honest taste of a LUCKY STRIKE**

V NEW FROM GALE! THE MIGHTY... SOVEREIGN

DELIVERS A NEW DIMENSION IN BIG-POWER SPEED AND SMOOTHNESS

Brawn and **BALANCE** in a perfect power package! Here's the thrust and zip of 60 hp...the power reserve of a deep-chested **V-BLOCK** engine. Here's smooth, flowing power to plane the heaviest cruisers, to pull a troop of skiers. Here's **QUIETNESS**. **V SOVEREIGN** purring power "floats" on rubber, sealed by a fiberglass cover. Rugged reliability, too! From thermostat-control to quiet anti-friction bearings, to trim, slim "**TORPEDO**" underwater unit, the new Gale **V SOVEREIGN** is engineered for maximum economy and carefree long life.

Take a look, skipper! See the new Sovereign and Buccaneer Motors—from 3 to 60 hp. Find your Gale dealer in the "Yellow Pages." Write for colorful brochure to: Gale Products, Dept. 3119, Galesburg, Ill.



GET A GALE AND **GO**—ANYWHERE



GALE PRODUCTS, GALESBURG, ILLINOIS • DIVISION OUTBOARD MARINE CORPORATION

Coast to Coast in 90 Minutes

(Continued from page 133)

to realize that the air pressure outside the plane is so low that his blood would boil except for the fact that he is traveling inside a pressurized space chamber. Sitting comfortably in his shirtsleeves, he wouldn't believe that the outside air temperature is 65 degrees below zero, or that, in spite of this, only clever engineering prevents him from roasting to death. At Mach 3 the skin of the airplane is heated to 600 degrees or more by aerodynamic heating, friction with the thin air.

Why the big jump from the 575 miles per hour, at which the present jets cruise, to almost four times that speed? Why not build 1000-mile-per-hour transports as the next step, then others in the 1200-1500-mile-per-hour class?

Speed and Propulsive Efficiency

The answer lies in the way that propulsive efficiency is related to speed. This efficiency is quite high at Mach 0.8, the speed of the present jetliners. But it drops abruptly at Mach 1, the speed of sound, then very slowly begins to climb again. At Mach 2, just under 1400 miles per hour at cruising altitude, efficiency is somewhat increased, and is greatly improved at Mach 3.

A 1400-mile-per-hour transport would have one advantage: it could be built of naked aluminum, since aerodynamic heating is not too severe at that speed. The 2000-mile-per-hour airplane must be clad in titanium or stainless steel as these hard metals are less affected by heat. In spite of the greater expense the engineers agree that the Mach 3 airliner is the most attractive. Besides, adds Fred A. Payne of North American Aviation, a few Mach 3 airliners could handle the same amount of traffic as a larger number of slower craft by making more round trips per day.

It's pretty well agreed that the Mach 3 transports are apt to be the fastest for some time to come. A speed increase of an additional 500 miles per hour would create tremendous structural and insulation problems. At 2500 miles per hour the skin of the plane would heat up to 2000 degrees, the temperature at which copper melts.

Even the triple-sonic airliners will require special designing to keep passengers and crew comfortable. Lockheed has studied this problem in detail and is thinking in terms of a double-walled cabin with glass fiber insulation on one of the walls. Cold air would be circulated between the walls to remove the heat radiating inward from the skin. A test section of this construction, eight inches thick, was remarkably effi-

cient. Its inner wall remained at a comfortable 70 degrees even though the exterior wall was maintained at 600 degrees. Water-cooled walls are a different approach that has been discussed.

The air that is taken into the plane for ventilation is another real problem. It, too, heats up to 600 degrees because of ram effect. The answer seems to be to admit only minimum amounts of outside air, bring down its temperature by evaporative cooling, and to re-circulate it in the cabin. Cockpit windows and the passenger cabin windows, if any, would consist of thick, multi-layer panels of high-temperature glass with cooling air circulating between the panels.

It also may be necessary to find a way of removing ozone from the air that is taken in if this poisonous gas is found to exist in injurious amounts at 70,000 feet.

To a large degree the practicability of the supersonic airliners is based on a bomber that so far exists only on paper. This is the B-70 on which North American Aviation is just starting construction. Still very much on the secret list, it represents a great deal of research by National Aeronautics and Space Administration and other agencies, in addition to the prime contractor. It is classed as a Mach 3 airplane with inter-continental range. Its mission is to carry various bomb loads, including big hydrogen bombs having a destructive force equal to 10 million tons of TNT. It is also designed to carry large air-launched ballistic missiles fitted with nuclear warheads and capable of traveling 1000 miles from the launch point.

The B-70 will be powered by G.E. J-93 jet engines that are expected to develop in excess of 30,000 pounds of thrust per unit. Still in the development stage, the engines are described as being surprisingly conventional. They will use ordinary jet kerosene as fuel, and may use a liquid-fueled rocket engine for additional thrust at take-off.

These same engines, it is expected, will also power the Mach 3 transports.

The big engines are going to be a lot noisier than the present jets and engineers are saying that we'll just have to get used to the noise.

The sonic boom created at Mach 3 is a separate problem and it is pretty well agreed that the airliners will climb out from an airport at subsonic speeds, accelerating past Mach 1 after they have attained 35,000 feet or so. Below that altitude the shock wave could be both destructive and frightening on the ground. One engineer is not entirely joking when he says "People on the ground would need bullet-proof

(Continued to page 256)



And for smooth going with your car this winter, change to Quaker State

Quaker State winter oil is specially refined and cold-tested to flow freely at sub-zero temperatures. It gives complete, long-lasting protection to every moving engine part. Assures quick sure starts and carefree driving during the worst winter weather. Yes, Quaker State is the best winter oil your money can buy . . . Always ask for it by name—Quaker State!

QUAKER STATE OIL REFINING CORP., OIL CITY, PA.

TV's Tiny Spectaculars

(Continued from page 148)

television screen. The picture you see will show the actors moving about amid the tiny scenery in perfect scale and coordination.

Composite Pictures Not New

Actually, there is nothing new about composite TV pictures, but until now they have been severely limited, since the master camera could not be panned, tilted or zoomed to follow action or vary the background. Actors had to move in precisely predetermined areas or they might come out on your home TV screen walking through a box of breakfast food. With VideoScene, however, the servo link to the satellite camera enables the background to move in proper relationship to the movement of the actors on the big stage.

Background Must Not Show

Naturally, if the tracking is going to work, none of the background on the big set must show—only the actors. Hence, they perform against a plain indigo-blue reflective material, developed for CBS by Minnesota Mining and Manufacturing Company. Instead of being picked up, the reflected light enters the camera and, due to its peculiar characteristics, becomes an optical signal, which is automatically converted by the camera into a "blackout." The actors, illuminated by normal light, come through loud and clear and appear to be floating in space on the monitor in the control booth. Here the mixing operator superimposes the picture of the actors on the picture of the miniature set, and the show is on the road. ★★★

Do You Know This Old-Timer?

(answer to quiz, page 12)



Studebaker of 1911 or 1912

*The most versatile saw
you can own!*

**Porter-Cable
ELECTRIC HAND SAW
5-STAR TOOL**

Actually 7 saws in one! Use it for hundreds of jobs—it's a rip saw, cross-cut, coping, key hole, scroll, jig, and hacksaw. And this Porter-Cable all-purpose saw gives you hairline accuracy because of these exclusive design features: comfortable top handle with on-off switch for positive control; auxiliary side handle for two-handed control on intricate cuts and in awkward positions; king-size base for stability; and a sawdust blower for constant clear visibility of cutting line.

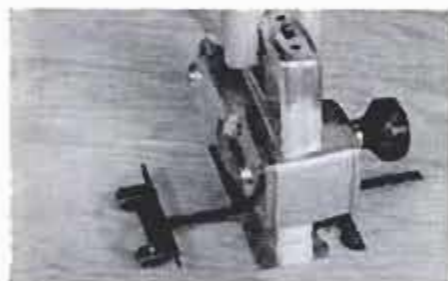

Cut perfect circles quickly. Start with a plunge cut and you can make a cutout in the center of a panel of almost any material. Do a professional job of contour-cutting, cross-cutting, ripping, and fancy scroll work.



Slice 2 x 4's in 8 seconds flat! Metal, too— $\frac{1}{4}$ " aluminum, $\frac{1}{2}$ " steel! Cut sheet metal, bar stock, pipe, woods, laminated plastics and compositions.



Cut accurate angles up to 45° with exclusive angle base. Make inside cuts without drilling starting hole and without blade breakage.



Saw plywood and laminates without shredding or chipping with patented "Magic Circle" Insert Disc. Standard feature with every 152 Saw.



Orbital-Action blade cuts 3 times faster, lasts up to 30 times longer. Blade moves forward only on cutting stroke—pulls back on non-cutting stroke.

Save \$10 →

**10 piece SAW KIT reg. \$59.95
NOW ONLY \$49.95**

Limited Offer! Kit includes Model 152 Saw, handy wall bracket, angle base, rip guide, patented "Magic Circle" insert disc, allen wrench, tube of grease, and 3 assorted blades. ORDER YOURS TODAY.

**LIMITED OFFER! SEND NO MONEY!
ORDER YOUR HAND SAW KIT NOW!
TAKE 6 MONTHS TO PAY!**

Porter-Cable Machine Co.
914A Marcellus Street, Syracuse 4, N. Y.

I wish to order the tools checked below. I agree to pay my Porter-Cable Dealer full price or down payment indicated upon receipt of tool, and the balance in monthly installments shown below.

	Price	Down Payment	Balance Monthly for Six Months
Model 152K	\$49.95	\$7.95	\$7.50*

*includes service charge

This offer good only in U.S.A., Hawaii and Alaska, State and local taxes applicable. (Void where prohibited, license required or otherwise restricted.)

Name _____

Address _____

City & State _____

Porter-Cable
Quality Power Tools



Here's why every automotive engineer is now studying the new Ford *Falcon*

Now that the new-size cars are out, expert engineers and drivers have looked them all over—tested them on turnpikes, tortured them on high speed tracks. Here's a typical test driver comment. Don Stewart, Detroit editor of *MOTOR LIFE*, said, "... the Falcon is completely capable of gliding over a wide assortment of terrain. This car is no boulevard prima donna! ... Arriving at a sensible compromise between economy, passing power and sufficient weight mass, the new Falcon instills in its driver that sense of security rarely found in cars of its dimensions ..."

Front engine or rear? This debate is as old as the earliest automotive patents (back around the end of the 19th century), but for 1960 it's hotter than ever with two of America's leading car makers taking diametrically opposite positions. Ford's front-engine design has general advantages in safety and stability over rear-engine cars. In addition:

1. A bigger and more convenient baggage space is an obvious advantage of front-engine cars. Wheel wells and steering column dictate small, oddly shaped baggage compartments in rear-engine cars.

2. In the event of a forward collision, front engine's mass absorbs impact, provides greater safety to car's occupants.

3. Gas tank located more safely in the rear is another front-engine advantage. Some rear-engine cars have gas tanks up forward, in front of passengers.

"Do-it-yourself" simplicity. Here again Ford has taken a different route from that followed by its major competitor. The Falcon six-cylinder engine is a dependable, proven design. It

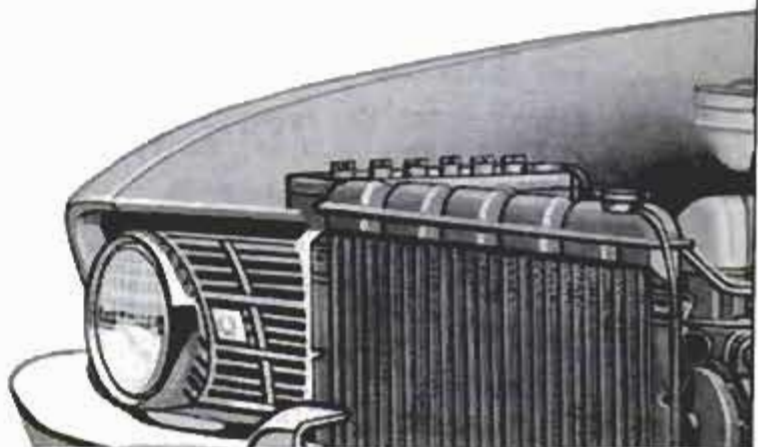

CAR IN THE WORLD TO OWN

has a single carburetor . . . eliminating the problem of synchronizing two carburetors. Vertically mounted for the greatest accessibility, it has a one-piece, cast-iron cylinder head and intake manifold for greatest simplicity. Servicing is a snap . . . no need, for example, to remove engine for valve or ring work. The Falcon Six will present no mysteries to mechanics, even the do-it-yourself variety. Other Falcon advantages: self-energizing brakes have 30 fewer parts. Fenders bolt on for inexpensive, easy replacement.

Economy and convenience without austerity. The Falcon's fresh-air, hot-water heater doesn't burn extra gas to reduce your mileage figure as do gasoline heaters. Standard gearshift lever is located conveniently on the steering column, not on the floor where it limits passenger room. Comfort features such as dual sun visors and arm rests are *standard*. Insulation, seat cushioning, and interior trim are considerably superior to the Falcon's nearest competitor.

The Test Program: Experience Run, U.S.A. After three years and three million miles of steady automotive sadism that put the Falcon to every test the wildest-eyed engineer ever dreamed of, Ford sped a fleet of 16 Falcons over every last mile of numbered Federal Highway.

The Falcon drivers, hard-nosed automotive types, sent back reports like these:

" . . . running 28 miles per gallon at turn-pike speeds with the automatic transmission, which is very, very exceptional."

" . . . handles beautifully . . . takes the curves just like they weren't there. We go over the mountains and hills with terrific ease . . . carrying about 400 pounds of baggage and equipment in the back now. You couldn't ask for any more room."

" . . . gotten as high as 31.1 miles per gallon and we've been doing terrific!"

"What oil? This automobile doesn't use any oil. 3000 miles so far and we haven't had to hardly look at that oil stick. This engine is sensational."

"It's got plenty of power. When we came over the Continental Divide the other day you couldn't ask for any more power . . ."

It's a beautiful piece of engineering. Simple, clean, all automobile. Try it at your Ford Dealer's and bring the whole family. There's plenty of room for six.

THE NEW-SIZE FORD

THE 1960 *Falcon*

THE WORLD'S MOST EXPERIENCED NEW CAR

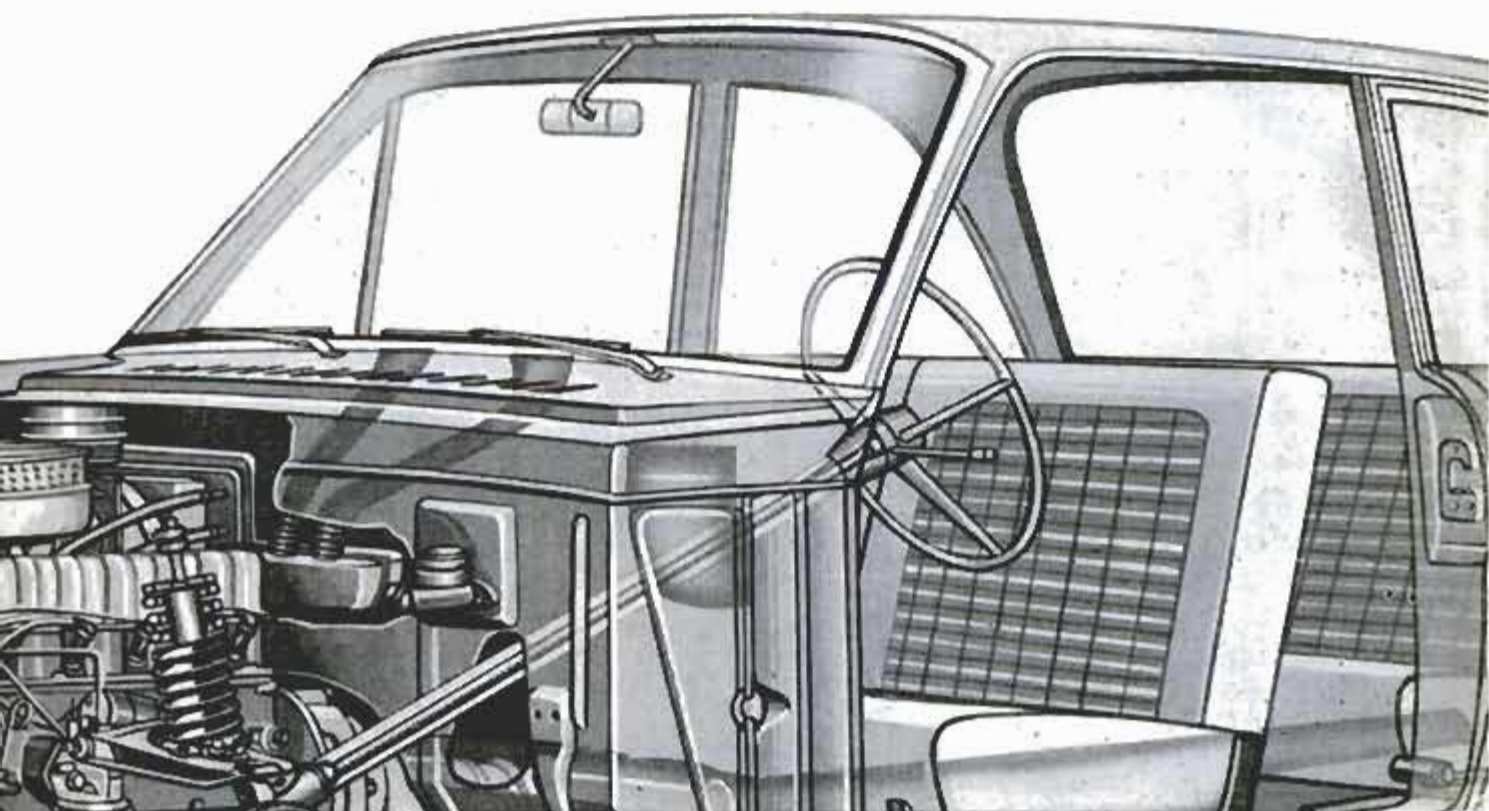



BUILD THE BEST!

build quality money-saving

knight-kits®

A PRODUCT OF ALLIED RADIO



see them all in
ALLIED'S
1960 ELECTRONIC
SUPPLY CATALOG

FREE

build your own...
it's easy...it's fun!
SAVE UP TO 50%



HI-FI
KITS

See the 1960 KNIGHT-KIT line—available only from ALLIED. KNIGHT-KITS are lowest in cost, convenience-engineered for easiest assembly—the only kits with money-back guaranteed specifications. Send today for the 1960 ALLIED Catalog—select your KNIGHT-KITS—and . . .

**SAVE ON EVERYTHING
IN ELECTRONICS**

Get more for your money in Stereo hi-fi systems and components; save on recorders and tape; Amateur station equipment; TV tubes, antennas, accessories; test instruments; electronic parts, tubes, transistors, tools, books. Send today for your **FREE 1960 ALLIED Catalog!**



INSTRUMENT
KITS

HOBBY KITS



HAM
KITS

world's
largest
stocks



EASIEST TERMS
only \$2 down on
orders up to \$50

FREE
catalog

ALLIED RADIO

100 N. Western Ave., Dept. 24-19, Chicago 80, Ill.

Rush **FREE 1960 ALLIED Catalog**

Name _____

Address _____

City _____ Zone _____ State _____

(Continued from page 251)

windows, stainless-steel 'china,' and permanent ear plugs." Once the plane attains cruising altitude, however, its shock wave would be heard on the ground only as a gentle boom. Whether the shock wave from one supersonic transport would be destructive to another flying close by is not yet known.

Supersonic Transport in 1965?

Hall Hibbard, senior vice president of Lockheed Aircraft Corporation, says that an operational supersonic transport could be available in 1965, a scant five years from now, as far as engineering and construction are concerned.

It's doubtful that the airlines will be in that much of a hurry for new equipment. They still have the big job of paying for their new subsonic jet fleets. And little by little the present jets are being made more efficient. The latest improvement, not yet in general use, is the turbofan or by-pass engine. In essence this is a stock jet engine with a built-up section in the compressor that draws in extra amounts of air. Once it is compressed, this air is by-passed around the burner sections of the engine and mingles with the hot exhaust from the turbine wheels. The effect is to vastly improve the propulsive efficiency of the engine.

This is translated into greater thrust, which can be used for shorter take-offs, greater range, and greater fuel economy. It will not mean more speed with the present airliners, whose airframes are designed for subsonic flight. A separate advantage of the turbofan is that it is substantially quieter than an ordinary turbojet engine.

The Boeing 707s being delivered to British Overseas Airways Corporation are powered with Rolls Royce Conway turbofans, and the new medium-range Douglas DC-9 jet transports will be equipped with Pratt & Whitney fan-type engines. Most of the airlines expect to re-engine their present fleets with turbofans as the new engines become available.

Another reason why the airlines may not be ready for supersonic transports in five years is the tremendous cost of the new planes. One estimate is that a Mach 3 transport will cost \$20 million as compared to the \$5 million price tag of a subsonic DC-8 or 707.

Ten years from now instead of five years seems the more realistic date for the inauguration of supersonic passenger service. Besides, it's going to take that long for a lot of us to get used to the idea of whisking across the continent in an hour and a half!

★ ★ ★

Sands **FAST** with big
25 sq. in. sanding
surface and 14,400
strokes a minute!



Weller® POWER SANDER

A fine quality, power-packed tool that's unmatched in value and performance at its price. Puts a satin-smooth finish on new wood. Removes old paint in a jiffy. Low, compact design fits snugly in palm of hand. Easy to guide. Light in weight, too. Use it overhead without tiring. Plus these other Weller features:

- Positive straight line action sands with grain—never bucks, twists or scars wood.
- Sandpaper locks simply and securely—no special tools needed for replacement.
- Fingertip "on-off" control.
- 8-ft. cord.
- Guaranteed for 1 year.
- UL approved.

MODEL 700
\$16⁹⁵
In Metal Kit,
Model 700K—\$18.95

AT YOUR HARDWARE OR HOBBY DEALER
WELLER ELECTRIC CORPORATION • EASTON, PA.



gets into
corners



goes under
low places



easy to use
vertically



America is a Better
America —
thanks to Advertising!



Onan Emergency Electric Plants

PORTABLE MODELS

500 to 10,000
watts. Supply
plug-in power
anywhere!

Start automatically when high-line power is cut off. Supply current for lights, heating system, freezer, water pump, stove, all appliances and machines. Prevents losses and hardships. Plant stops automatically when power is restored. Compact, easy to install. 500 to 200,000 watts A.C. Priced from \$319.00.

Write for Free Folder

D. W. ONAN & SONS INC.
3317 UNIVERSITY AVE. S.E. • MINNEAPOLIS 14, MINN.



KEEP
WINTER
WEATHER
OUTSIDE

SEAL YOUR DOORS AND WINDOWS
AGAINST COLD, RAIN, WIND AND
DIRT WITH

Bridgeport
INNER-SEAL
WEATHERSTRIPPING
and Cut Your
Fuel Bills, Too!

Made of flexible sponge rubber, reinforced with spring wire and neoprene coated for extra toughness, long-wearing Inner-Seal is easy to put on—you can do-it-yourself with hammer, scissors and tacks. Get INNER-SEAL at your hardware store today! Only 10c a foot.



Write for
FREE FOLDER
"How to
Weatherstrip
Your Home!"
Dept. PM 11



BRIDGEPORT FABRICS, INC.
BRIDGEPORT 9, CONN.



Racing cars—9 out of 10 winners . . . both "big car" and stock car, over the past 5 years, used Champions.



Car makers—over *twice* as many makes (including Rolls-Royce) specify Champions—46 in all!



Aircraft—more aircraft (including over 90% of all airlines) use Champions than any other plug.



Trucks—17 out of 21 U. S. makers specify Champion spark plugs for *full power*, regardless of load or road.

Q. Why is it that wherever performance is vital—on land, sea or in the air—the experts choose Champion spark plugs?



Marine engines—9 out of 10 power boat winners
—all U. S. outboard engine makers—use Champions.



Fire engines—all major makers use Champions
for sure starts and *complete* dependability.



Police cars—nearly *twice* as many U. S. police cars
are powered by Champions as by any other plug.



Farm tractors—every major U. S. maker specifies
Champions for the dependable power farmers need.

A. The experts know from experience
that you can always depend on
Champions. To get top performance
from your car, put in a new set
of Champions every 10,000 miles!



*World's favorite spark plug
—engineered for every car built by
Ford Motor Co., General Motors,
Chrysler, American Motors,
Studebaker-Packard and
every major foreign maker.*

When
it comes
to winter
driving



**cars
start faster
(use less gas, too)
with GUMOUT**

You'll get quicker, battery-saving starts this winter if you clean your carburetor with GUMOUT now. And a clean carburetor gives you a smoother running engine with improved gas mileage, too.

Just add GUMOUT to your gas tank. It cleans the carburetor while you drive. Thousands of car owners count on GUMOUT all year 'round. Why don't you?

*Sold at most service stations
and auto supply stores.*

GUMOUT DIVISION

Pennsylvania Refining Co.

2671 Lisbon Road, Cleveland 4, Ohio



Sunglasses Have Radio in Frame

Ideal for use at the beach, ball game or in any outdoor setting are sunglasses with a three-transistor radio built directly into the frame. Separate volume and tuning controls and an earphone are included. The circuitry employs three transistors plus one germanium diode powered by a mercury battery.

Shining Sun Will Darken Windows in Home of 1970

Windows that automatically darken as the sun shines on them are forecast for homes of the 1970s. Dr. James E. Archer, of Pittsburgh Plate Glass, says that the same principle can be used for interior walls of glass so that rooms would be optically separated or joined, depending on whether the walls are adjusted to be transparent or opaque. An electric control knob could be turned to obtain either effect. Dr. Archer also foresees glass panels that would be energized to produce heating or cooling effects or that would permit a flow of air from one room to another by means of "micro-openings." In a parallel forecast of what will be available to future home builders, Dr. S. W. Herwald of Westinghouse Electric suggests that homes of the '70s will be heated, cooled and lighted by "solid state" devices. Thermoelectricity, in which heat or cold is produced by current flowing through certain dissimilar metals, would be combined in a single wall panel with "electroluminescence," a type of lighting produced by applying electricity to phosphor materials embedded in the panels. The color of the illumination, as well as its intensity, could be varied at will. Plastic plumbing is another possibility for the future, as are office buildings that would bear all their loads on their exterior walls or skins, eliminating the present structural frames that take up valuable interior space.



from the world's largest builder of Compact Cars...

The Rambler **AMERICAN** for '60 in a Brand-New 4-Door Sedan

Now America's most-imitated car presents the *four-door sedan* thousands asked for . . . the Rambler American! It's America's *proved* economy king—most miles per gallon in 1959 Mobilgas Economy Run. Save on maintenance, repairs. Easy to service yourself. Strong, rattle-free Single Unit Construction*, Deep-Dip* Rustproofing. Save on first cost, resale—Rambler is highest in resale value, depreciates less than any other low-priced car. Easy to park and handle in traffic. Room for big families. See the new four-door sedan . . . the two-door sedan . . . and the two-door station wagon. At your Rambler dealer's.



Rambler American Station Wagon



Rambler American 2-Door Sedan

'60 Rambler
*The New Standard
of Basic Excellence*

* Trademark American Motors

YOUR
RAMBLER
DOLLAR



IS A
BIGGER
DOLLAR

AIR PRESSURE FOR 101 JOBS!

JOHNSON RED HEAD PORTABLE AIR COMPRESSOR

for home, shop
and farm



complete kit
less motor
\$44 at Your Dealers

There's simply no end to the jobs you can do with this new all-purpose unit! Red Head lets you do scores of chores better, faster, easier! For example:



SPRAY PAINTING—furniture, fences, siding, screens, porches, boats. Red Head gives smooth, professional quality results, cuts painting time up to 85% or more! Easily handles heaviest multi-color paints!

GARDEN SPRAYING—spray insecticides, fungicides, weed killers. Protect roses, shrubs, flowers, vegetables. Fine mist covers all surfaces. No waste.

INSECTICIDE FOGGING—enjoy outdoor living more. Use your Red Head to spray away pests and bugs around patio, fireplace, lawn.

AUTO CARE, HOBBIES—do your own greasing, waxing, refinishing. Cleans, sprays, blows, inflates. Every workshop needs a Red Head!

FARMS—sprays heavy machinery enamels easily. Cleans machines in a jiffy! Use Red Head *Insectospray* attachment for push-button barn fogging. Red Head saves time, money—pays for itself!

MOST EFFICIENT UNIT MADE!

Powerful Red Head delivers full 3.5 cfm free air and 50 psi pressure—easily out-performs many larger ½ hp units. Finest quality features throughout. Compare Red Head's price, quality and power with other compressor outfits. Fully portable. Only 10" high, weighs under 30 lbs.

COMPLETE KIT includes compressor, spray gun, 15 ft. air hose, pulleys, V-belt, tire chuck and fittings. Use any ¼ hp or larger motor.

NEW POWER AIRE Model

Model 105 offers the same rugged power and efficiency as the Red Head. Has built-in compact ½ hp GE electric motor. Delivers clean, oil-free air. Portable. Carry unit anywhere—weighs only 23 lbs. Sold with same complete kit as Red Head. Only \$67.50 including motor.



36 Other Models from \$30

Write for Catalog and Special Introductory Offer!

JOHNSON SERVICE CO.,

Dept. Y Milwaukee 1, Wisconsin

Please send free catalog describing the Johnson line of compressors and sprayers. Also your special introductory offer.

NAME _____

ADDRESS _____

CITY & STATE _____

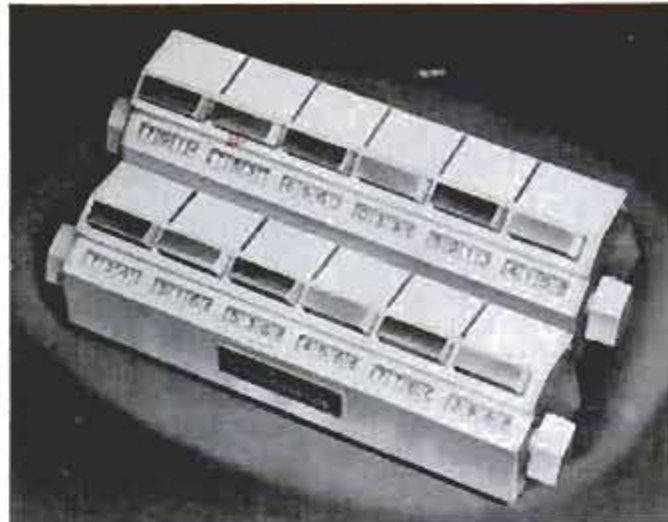

Miniature Adding Machine Built From Units

If you have a job that requires an extensive amount of adding and tabulating, an inexpensive miniature adding machine will help you with the chore. Six to eight separate units, each about the size of an ice cube, make one machine in its simplest form. Each unit has four digits and it records and adds, by one, each time its single key is depressed. Rows of these units can be built into a calculator 20 rows wide and 10 rows deep for individual tabulation of several items.

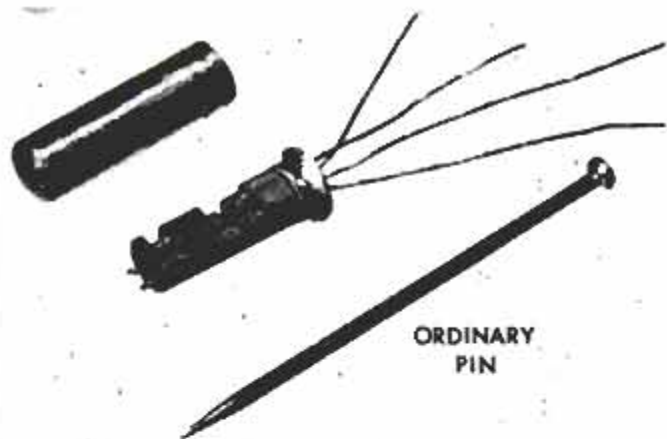

ORDINARY
PIN

Tiny Germanium Thermometer Explores the Coldest Cold

Temperatures close to absolute zero can be measured by a tiny but highly accurate thermometer that is shorter than an ordinary straight pin. The diminutive device, known as a germanium resistance thermometer, may be used in a space vehicle to report temperatures beyond the earth's atmosphere. Scientists at Bell Telephone Laboratories developed it to study how various materials behave in extreme cold. They run a small amount of electricity through it, and since germanium's resistance increases as temperature drops, they can determine the temperature by reading a resistance meter.

What
glue
for



Made especially for mounting plastic table tops and bonding many dissimilar materials.

Send stamped, self-addressed envelope for Free copy of "Elmer's Guide To Good Gluing". Write The Borden Company, Dept. 11G, 350 Madison Ave., New York 17, N. Y.

BORDEN'S PRODUCTS FOR THE HOME HANDYMAN

fast, dependable snow plow action

with **MONARCH POWER**

HYDRAULIC CONTROLS

Lift and lower the snow plow right from the cab... automatically... with Monarch Power Hydraulic Controls. Snow removal is easier, faster, more economical with Monarch. Instant up-and-down action with the flick of a wrist. See your dealer or write for illustrated folder.

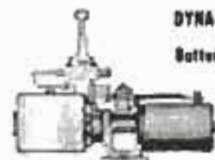

DYNA-MIGHT
Battery-Operated



NY-10-JACK **NY-10-JEEP**
Fan-Belt
Driven



MONARCH ROAD MACHINERY COMPANY
1331 Michigan St., N. E. — Grand Rapids 3, Michigan

MAKE HOME IMPROVEMENTS NOW

SAY Merry Christmas

with train boards, tree platforms, Santa Claus, his sleigh and reindeer, Christmas Greetings displays
Make them yourself—with foolproof patterns

These Christmas figures and displays are big and bright and colorful. Yet you make them yourself—easily, quickly and with professional results.

On your roof, porch or lawn—or in your living room—they show the world your Christmas spirit.

Your lumber dealer will sell you the Easi-Bild® Patterns you want. Each pattern includes the full list of materials and paint you will need. You buy these from your lumber dealer, too.

Each pattern is full-size. You simply trace it onto a sheet of 3/8" Homasote—then cut it out with a key-hole saw. Your pattern includes complete instructions for the painting. It's as easy as that and the results are truly professional.

Put a sleigh in front of the Christmas tree, to hold the gifts. Use the 5' x 8' panel for a sound-deadening train board; for a tree platform—your dealer will cut Homasote to the size you require.

From a single Santa Claus to a complete Nativity Scene (often a group project for school, church or club), you have a project that is worthwhile and satisfactory.

Homasote is the oldest and strongest insulating-building board on the market, saws and nails easier than wood, takes any paint or stain, lasts for years.

Visit your local Homasote dealer today. Or—use the coupon below to order any of the patterns, or to secure the name of your nearest Homasote dealer.

*T. M. Reg. Easi-Bild Pattern Company



40" HIGH

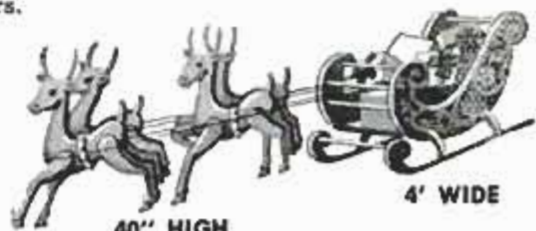

40" HIGH

4' WIDE

HOMASOTE COMPANY
TRENTON 3, NEW JERSEY



I enclose for which send me the following patterns:

- Reindeer—50¢ Nativity Scene—\$5.00
 Santa Claus—50¢ Madonna Outdoor Card—50¢
 Sleigh—50¢ Jolly Snowmen—50¢
 Send name of nearest Homasote Dealer

Name
Street
City.....Zone...State.....

IN CANADA: Homasote of Canada, Ltd. • 224 Merton Street • Toronto 12, Ontario

(Continued from page 101)

pedal entirely. This will appeal to Americans more than any other group. He would not disclose the price but guesses are that it will be between \$50 and \$75 extra.

He denied published reports (including those here) that Volkswagen is thinking of a bigger car. At the moment there is a backlog of orders equaling six months' production.

Why should we change? he asks. We will make changes, he says, only for one or two reasons: (1) If an engineering solution of great merit presents itself, and (2) If it becomes necessary to stimulate sales. Otherwise we will simply continue to improve our product, he says.

This year's VW is an example. It is quieter and better riding, there is less engine noise, less road noise in the car.

Nobody shouts about it, but VW trucks and buses have a new engine-transmission. The engine design is capable of up to 30 percent more horsepower; transmission has synchromesh first gear. It is likely that sedans will be so equipped by early 1960.

What of such new German cars as the BMW 700, the DKW Junior, the Ford Taunus 12, the Opel 1200, all of which are competitors of the little beetle from Wolfsburg? Many Germans are looking at these cars seriously for the first time because they want something different. When everybody wears a uniform, even a pair of overalls may look better. There is a saying here that the Volkswagen looks like a Volkswagen, but the Opel looks like a car. The people may be looking for a car that looks like a car. All these new cars which cost slightly more than the VW are in the new style that is more Italian than German. They have straight lines, flat roofs, wide windows, large trunks. These cars inevitably make the Volkswagen look old-fashioned.

However, until the day comes when the VW is no longer in greater demand than supply, it will not be changed drastically, says Nordhoff, who should know. In any case, he says, the five-millionth VW will look just like the three-millionth which was made this summer.

Two years ago he told this reporter that the four-millionth VW would look the same. There's no sign of haste here. But the day for change may be sooner than is publicly admitted. When it does come, no doubt, they will be ready. Nordhoff stated that each year his engineers design a new car and each year the new design has been scrapped as unnecessary. One day, perhaps sooner than Nordhoff will admit, the scrapping must cease. ★ ★ ★

ALWAYS FIRST YEAR AFTER YEAR!



FIRST AND ONLY TO WIN THE INDIANAPOLIS "500"

...to set an American Speed Record at Bonneville

...to set a world's record for non-stop endurance flying



THE PROOF OF WYNN'S FRICTION PROOFING IS IN THE PERFORMANCE!

The Wynn's Friction Proofing firsts go on and on—the first and only product in its field to perform an oil-less plane flight ... to win the National Jalopy Championship ... to be awarded Car Life Magazine's Seal of Approval—all conclusive proof that *no other product in its field can match the Wynn's Friction Proofing performance.*

Get Wynn's Friction Proofing at your service station, garage or new car dealer. And for cold weather change over, there's a special kit of Wynn's Friction Proofing products to give you quicker starts and trouble-free performance in the bad weather months ahead.



Available in every country of the free world.

Wynn Oil Company, Azusa, California. Affiliated companies in: Toronto, Canada; St. Nicolas Waes, Belgium; Caracas, Venezuela.

RUSTY TOOLS?



QUICK! Clean 'em with famous 3-IN-ONE OIL. A few drops every now and then prevents rust and tarnish. Famous for 64 years! On sale everywhere.

3-IN-ONE OIL
REGULAR · OIL SPRAY · ELECTRIC MOTOR

BRONZE FOUNDRY



Schools • Home Workshops • Inventors

Make your own castings of aluminum, copper, bronze, silver. Foundry sets are available in four sizes, capacity 1 1/2 lb. to 36 lb. of red brass. 2400 Deg. F. blast furnace included with each. Write for Free Circular.

KANSAS CITY SPECIALTIES CO. DEPT. P-11, P.O. BOX 6022, MARYSVILLE, KANSAS

This Month's "Great Pioneer in Science"

(Page 16)



Alfred Nobel (1833-1896)

NOVEMBER 1959



The FAMILY GUNS for SKILL and FUN

Dick got a bull's-eye . . . so did Mary! Mother just missed by a hair. Now what will Dad do? The pressure is on. Yes, it's exciting family fun (skill and good gun training, too).

CROSMAN CO₂ GAS PELLGUNS

. . . with controlled range and power and top marksmanship accuracy . . . have opened up a shooting sport as new as tomorrow. The whole family can shoot, too. There's a size, weight and style of Crosman Pellgun for everyone.



HAHN CO₂ GAS BB GUNS

. . . are wholly new BB guns. Feel, look and handle like the famous rifles and revolvers of the Old West . . . with higher BB power and accuracy. Look for Crosman-Hahn Sales Center at your Crosman Select Dealer. Select the guns you want. See for yourself how much fun it is to shoot the Crosman power-without-powder, CO₂ gas Powerlet way.

WRITE for free, colorful shooting fun literature. Crosman Arms Co., Inc., Dept. PM-35, Fairport, New York.



WORLD'S LARGEST MANUFACTURERS OF CO₂ GAS-POWERED RIFLES AND PISTOLS

265

FREE PLAN

Tells How To Start
Your Own Business

FILING SAWS

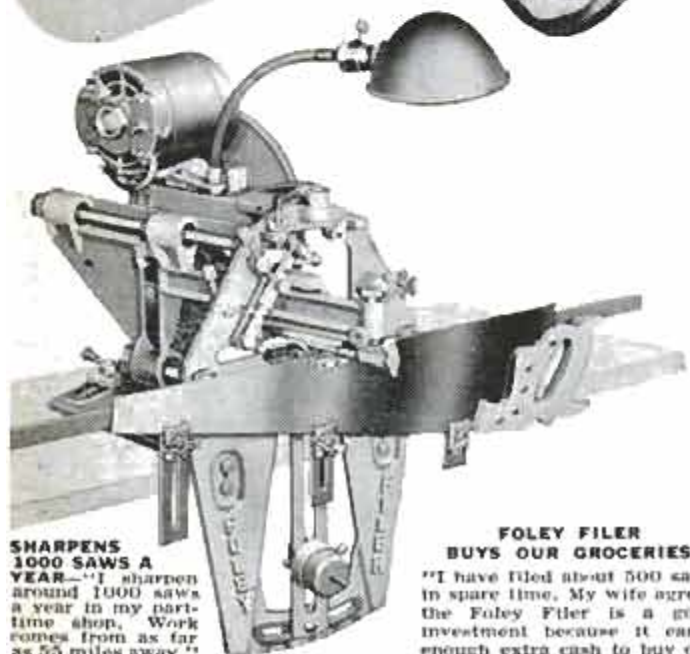

**SHARPENS
1000 SAWS A
YEAR**—"I sharpen
around 1000 saws
a year in my part-
time shop. Work
comes from as far
as 50 miles away."
—Joe H. Walker.

FOLEY FILER BUYS OUR GROCERIES

"I have filed about 500 saws
in spare time. My wife agrees
the Foley Filer is a good
investment because it earns
enough extra cash to buy our
groceries." — H. J. Kreuser.

FOLEY FILED SAWS BRING NEW CUSTOMERS

Here is a steady repeat CASH business that pays from \$3 to \$6 an hour, and you can start in your own basement or garage in your spare time. Every saw you sharpen with the machine accuracy of the Foley Saw Filer is an ad that brings more customers. J. C. Deibert wrote us: "Since I got my Foley Filer five years ago, I have averaged 4 1/2 saws each day over all this time." Howard Kuhns says: "We operate 2 Foley Filers, and our business averages about 500 saws per month. The count last year was 5,798 saws."

The new model 200 Foley Saw Filer (shown above) is the first and only machine that automatically sharpens combination (rip and cross cut) circular saws—also all hand saws, band saws and crosscut circular saws. The adjustments are simple—there is no eyestrain—and you can start right away to turn out perfect cutting saws. Exclusive jointing action evens up irregular teeth—old saws cut like new!

"MONEY MAKING FACTS" explains how you can get business from hardware stores, home owners, farmers, carpenters, schools, mills, factories, etc. Just think, with a modest investment, no overhead, no stock of goods to carry, you can start right in on a cash business that will help pay the rent, buy groceries, or a new car. Time Payments available; send coupon today for this practical money making plan. No salesman will call.



Send for **FREE BOOK**

**FOLEY MFG. CO., 1116-9 Foley Bldg.,
Minneapolis 18, Minn.**

Send me free book "MONEY MAKING FACTS" and
TIME PAYMENT PLAN.

Name

Address

Nature Pulls Plug— Lake Loses Water

By James J. Cox

Residents of the central west coast of Florida have a natural phenomenon in their midst which they compare with a volcano. Their "home grown" excitement simply acts inversely to a volcano. Instead of blowing her top, Mother Nature in this case "pulls her stopper."

Just what happens when Lake Tarpon loses its water nobody knows for sure, but, for one thing, within a few days the five-mile-long lake changes from fresh water to salt water.

After about a week of high tides rushing in and fresh lake water dashing out, the billion-gallon underground exchange is over. But it takes several weeks for the old gal with the split personality to come to her senses and get the salt out of her system.

The last time Lake Tarpon showed her trick was in August of 1957. Old-timers could see it coming. After nearly 10 inches of rain in July, the lake was at the highest point it had been in years. And when the water load got unbearably heavy, Lake Tarpon just let it fall through.

The United States Geological Survey made a study in 1945 to explain the mystery of Lake Tarpon in scientific terms, but it could come up with no better answer than the Florida natives could: There is a big hole at the bottom of the lake.

Former County Engineer W. A. McMullen, Jr., found the hole in 1945. Sixty feet from the west shore line, McMullen dropped a plumb line 115 feet before it hit bottom. He further determined that the sink was about 90 feet in diameter.

It was reasoned that the gigantic gash gets plugged up with silt, sod and debris. But when the lake balloons out, from high water, the stopper is blown through the hole into subterranean passages. That's when the fun begins.

When Lake Tarpon pulls her plug, people in Spring Bayou and Tarpon Springs, towns near the lake, have a fishing jamboree. The water boils with snook, bass and bream that have just taken an underground ride. While fresh water is changing to salt water, people pull in some surprising catches—salt-water blue crabs, spotted trout and mangrove snapper.

NEW Low-Priced Dodge Dart Features Revolutionary **ALL-WELDED** Unibody Construction

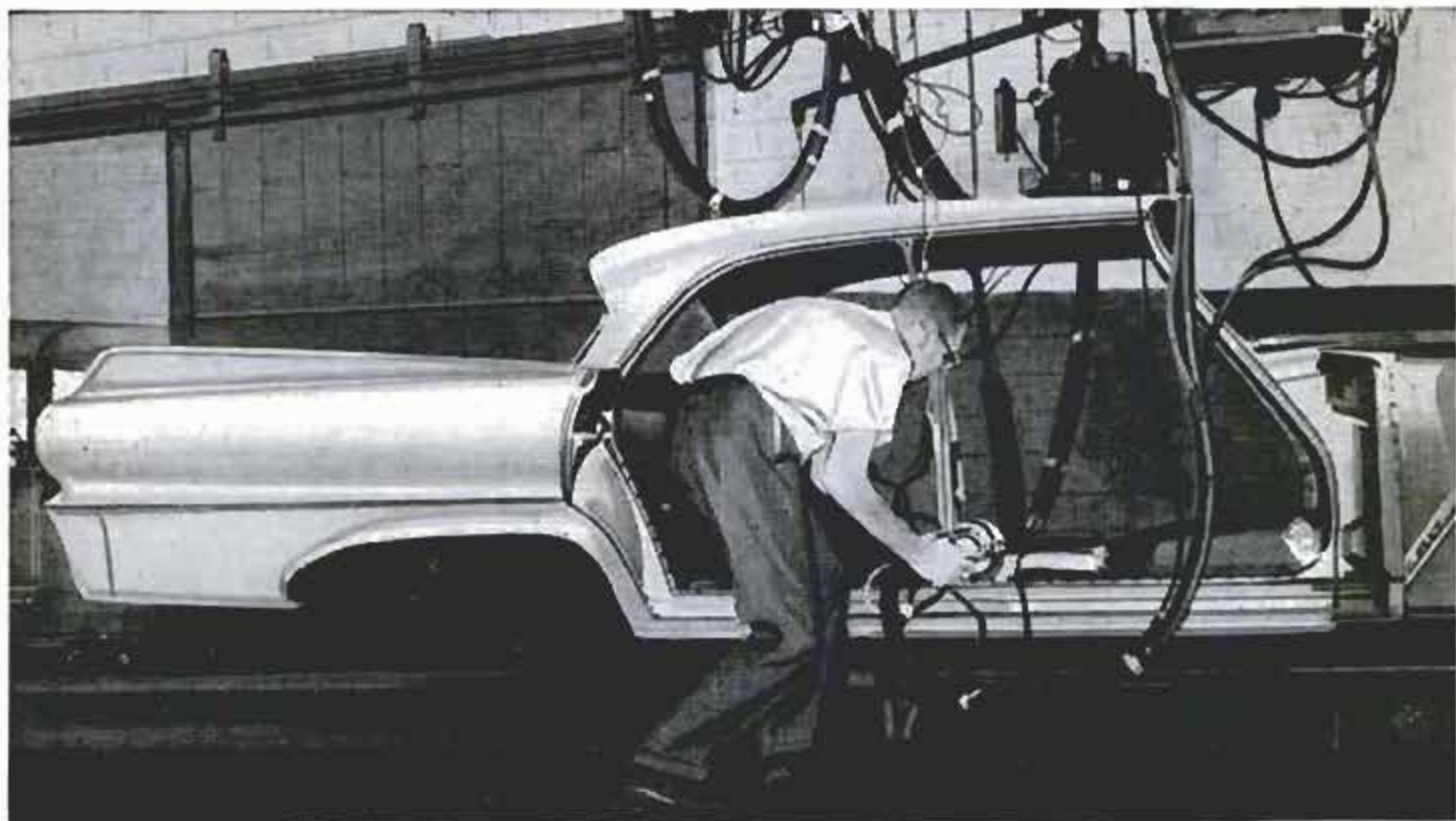

Roominess and riding comfort took a big step forward with the announcement of the new low-priced Dodge Dart. The more efficient one-piece Dart Unibody scored a major breakthrough in boosting interior room and

comfort by eliminating space-wasting side rails and crossmembers. Strength and durability are integrated into the body itself. Conventional squeak and rattle-causing attachment of body to external frame eliminated.

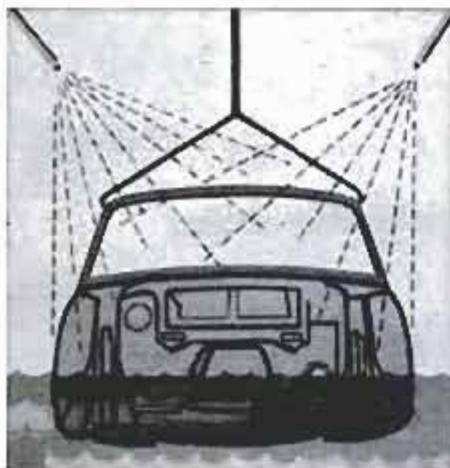

Notice how new integrated strength puts more usable space inside. There's more room for feet, hips, shoulders, hats. Seats are deeper, thicker. Doors are bigger, open wider.

Long-lasting beauty and a higher trade-in value are assured by 7 separate rust-preventive dips, four sprayed-on coats of primer and Lustre-Bond enamel for a tough fade-free finish.

In conventional body-frame design, strength is concentrated in the frame. Weak body is subject to squeaks, rattles. Unibody equalizes the strength through the entire structure. Body squeaks and rattles are a thing of the past.

AMERICA'S FIRST FINE ECONOMY CAR

DODGE DART



For the full story on the fabulous Dodge Dart or all-new '60 Dodge, ask for free booklet "The Inside Story on Dodge Cars for 1960." Write Dept. M, Box 1259, Dodge Division, Chrysler Corporation, Detroit, Mich.

NOW DODGE BUILDS TWO GREAT CARS: DODGE DART • '60 DODGE

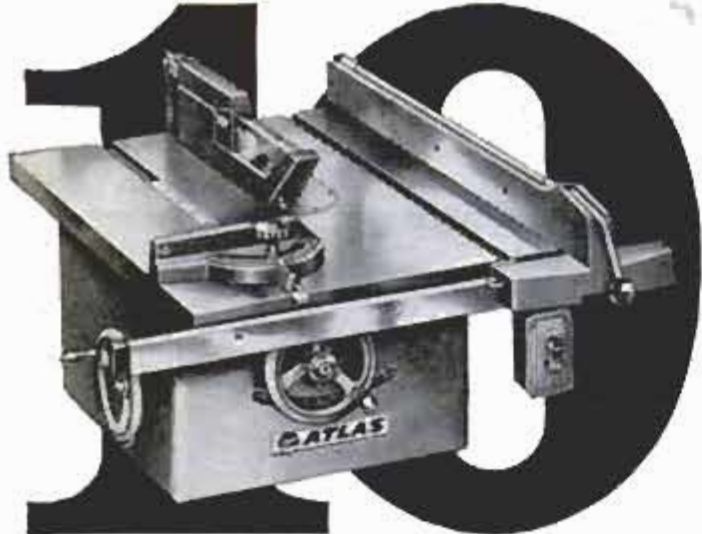

***10 NEW FEATURES . . .**

***10 reasons why the NEW**

Atlas

10" TILT/ARBOR BENCH SAW

is the greatest value ever!

- 1 NEW Cast-iron cradle, saw arm, trunnions . . . it's the heaviest, most rigid mechanism of any 10" bench saw, for superior workmanship. Saw alone weighs 165 pounds!
- 2 NEW Big table capacity — 20' x 27½', 59½' x 27½' with two grill-type extensions.
- 3 NEW Solid, ground steel arbor, ¾" diameter at the bearings — big lubricated-for-life ball bearings.
- 4 NEW Double-locking lift-off fence—cast aluminum for lasting accuracy.
- 5 NEW Big, efficient mitre gauge — keyed to table for greater cutoff capacity.
- 6 NEW Free-turning 6" diameter cast-iron hand-wheels.
- 7 NEW Removable motor mount for easy portability.
- 8 NEW Dual V-belt drive for transmission of full power, spring mechanism for proper belt tension.
- 9 NEW Motors . . . continuous duty, totally enclosed, designed specifically for saws.
- 10 NEW Economy . . . you have never seen such "plus value" features, such rugged quality in a saw so modestly priced!

ONLY \$129.75

Slightly higher West of Rockies.

***10 REASONS WHY YOU SHOULD WRITE FOR COMPLETE ILLUSTRATED LITERATURE, TODAY!**



Atlas Press Company

11-24 N. Pitcher St., Kalamazoo, Mich.

QUALITY MACHINE TOOLS SINCE 1911



Plastic Cards Go to Laundry

Plastic playing cards that will not burn, crack, warp, chip or fade can be laundered in the automatic washer. The cards, covered by a special plastic laminate, will outwear a minimum of 573 ordinary decks of cards, according to the manufacturer.

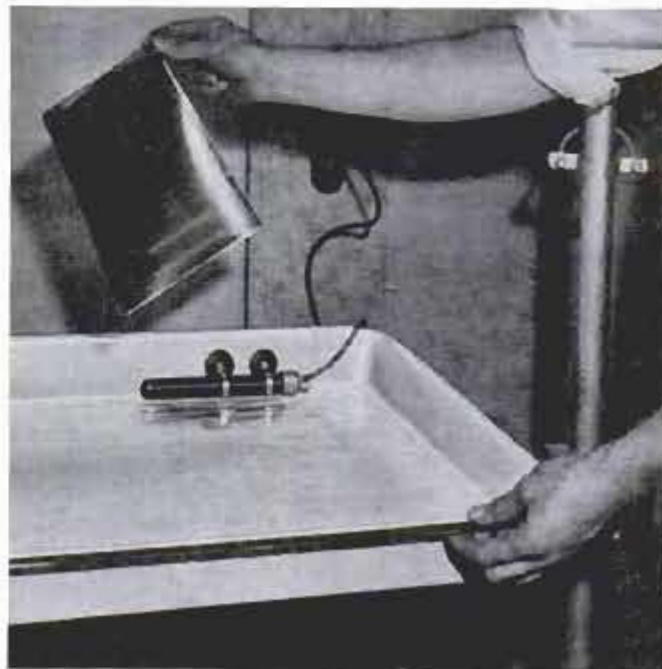

Inexpensive Thermostat Sets Film-Bath Temperature

Film-developer bath temperatures can be regulated by an inexpensive variable thermostat instrument that is plugged into the nearest outlet. About the size and shape of a king-size cigar, the thermostatic elements are inside a heatproof tube that is held in place by clips and suction cups to the back side of the developer tray. The temperature setting can be adjusted quickly, and the instrument is accurate to within one degree.



Hand-rubbed finish
without rubbing

McCLOSKEY HEIRLOOM®

The specially developed finish for antiques,
furniture, wall cabinets and paneling

Flows on silken smooth, leaves no brush marks,
never a sheen variation. Heirloom is extremely
pale, nonyellowing, nonstaining—sets up dust-
free in 1 to 2 hours, hardens overnight.

Send for free booklet, "How
to Finish Furniture, Wall Cab-
inets and Paneling with HEIR-
LOOM Varnishes."



McCLOSKEY VARNISH CO.

Dept. 213, 7600 State Rd.
Philadelphia 36, Pa.

Light Decomposes Water Into Oxygen and Hydrogen

Water can be decomposed into oxygen and hydrogen by means of a beam of light, it has been discovered at New York University. In an experiment, a tiny crystal of anthracene — related to the chemical used in moth balls—was mounted in a window between two tanks containing salt solutions, and a beam of ultraviolet light was directed at one face of the crystal. A measuring device connected to the salt solutions showed that current was being produced. The power was extremely small, being of the order of a millionth of a millionth of a watt. The fact that current flowed through the cell was evidence that water was being decomposed, with hydrogen forming on one face of the crystal and oxygen on the other. The experiment seems to confirm the theory that chlorophyll behaves like an electric battery when exposed to sunlight, activating the photosynthesis process in plants, by which solar energy transforms carbon dioxide and water into carbohydrates. The conclusion of the NYU scientists is that it is indeed possible for light to decompose water directly if the light is first intercepted by a material of the appropriate molecular structure.

Cut it with WISS



As versatile as they are powerful, Wiss Snips are an all-purpose cutting tool no home work bench should be without. Above: No. V-13, seven-inch pocket size \$2.50. Others from 8" to 17" in aviation, combination, and solid steel styles. At hardware and department stores.

WISS SNIPS CUT EVERYTHING!



Cut Tile



Cut Leather



Cut Fish and Poultry



Cut Fencing and Screens

J. WISS & SONS CO., NEWARK 7, N. J.
World's Largest Manufacturer of Shears, Scissors, Pinking
Shears, Skalloping Shears, Metal Cutting Snips and Garden Shears

HASTINGS

OIL FILTER CARTRIDGES

keep oil clean



The PROOF is on your dipstick

See for yourself! If your oil shows dirty before it should—you'd better change to Hastings. Hastings Oil Filter Cartridges keep oil clean from filter change to filter change, when replaced as normally recommended. This is proved by tests conducted in accordance with U. S. Bureau of Standards.

Here's the reason: Only Hastings has DENSITE filtering material. Millions of selected, pressure-packed cotton fibres trap and hold even the most microscopic dirt particles. Your dipstick will prove it!

The next time you change oil, change your filter, too—and be sure it's Hastings, the filter cartridge that assures clean oil—less engine wear and subsequent repair bills—as no other filter can. Yet Hastings Cartridges cost no more.

U. S. Patent Nos.
2,797,811; 2,584,771



HASTINGS MANUFACTURING COMPANY
HASTINGS, MICHIGAN

Oil Filters, Piston Rings, Casite, Spark Plugs

The Valiant

(Continued from page 91)

Karmann-Ghia coupe. This, he says, is actually an Exner design. It was designed by Exner as the Chrysler Special back in 1951. Ghia built it for the Corporation. When Volkswagen asked Ghia for a small coupe design in 1955, Ghia (with Chrysler's permission) picked up the Exner design and modified it slightly to fit the VW chassis.

There's also a lot of the Citroen DS-19 in the greenhouse area of the Valiant and a touch of Mercedes in the back end.

But, you are asking, isn't this supposed to be an economy car? What about its economy?

At this writing, PM has not conducted an economy test of the Valiant (it will be made as soon as production cars are available—we don't test prototypes). The Valiant, Charipar claims, will give over 50 percent more gas mileage than a 1959 Plymouth six.

It is capable of 30 miles per gallon, but being capable of and delivering in normal driving are not the same, as anybody who reads economy-run results knows.

Informed guesses are that the Valiant will average about 24 miles per gallon on trips, about 20 miles per gallon around town.

Charipar says the Valiant weighs about 1000 pounds less than the 1959 Plymouth six (actual weight figures have not been released at this writing). This would put its weight at about 2300 pounds, extremely light for such a heavy-feeling car.

It will go over 90 miles per hour quietly and was designed for comfortable, long-distance driving as well as for around-town use.

What about the possibility of an aluminum engine in the future? Use of the lightweight metal would cut as much as 100 pounds from total engine weight—a move in the right direction, says Charipar. It is coming, no doubt about that, but it won't be for a couple of years. The Valiant design was laid down with the aluminum engine in mind so no major engineering changes will be necessary to make the swap. Even with aluminum, the front end will still have the slight weight advantage that gives what Charipar considers to be the desirable heavy front end.

Air conditioning will not be available at first, but will be offered later if necessary to keep sales up in the southwest.

Power brakes and power steering are optional, but are certainly not necessary, says Charipar. They are offered because some people have grown so accustomed to them, that they won't buy a car without these assists. An automatic transmission is optional also, although it too is far from necessary.

The floor-mounted gearshift of the three-speed manual transmission is a pleasure to operate.

Now you have seen and, by stopping in a dealership, you can drive each of the three new small cars. These cars are the result of your rebellion against the bigness, the thirst, the expense of previous models. These cars are the industry's answer to the charge that cars should make sense.

Each of these three new cars has its own personality, each its own characteristics. Never in recent years, has a buyer had so much choice. This, the year of the consumer, promises to be a great one.

Which car will you buy? You hold all the cards—play your hand. Everybody is waiting. ★★★

Hail Me an S-T-O-L!

It was cheaper to fly across town by aerial taxi than to hire a cab on the street to attend the recent Hanover Industries Fair in Germany. The airport is about eight miles north of Hanover, the fair six miles to the south of the city. A cab ride across the crowded city costs some 20 Marks (\$4.80) and an hour's time. You could cut the travel time to six minutes and the fare to 15 Marks (\$3.60) by taking the air taxi. Two four-passenger STOL (short-takeoff-and-landing) planes performed the shuttle service all day. They were the German Dornier DO 27's, developed in Western Germany since World War II. Powered by a 275 horsepower American Lycoming engine, the Dornier can take off in 125 yards, land in 93 yards, with a speed range from 36 miles an hour to 155.

Scorer Clocks "Hits" On Missile Misses

Fighter and bomber pilots now are learning how to miss targets. Due to the high cost of targets, air-to-air missile students program their lethal rocket weapons to miss the bull's-eye by a hair. The pilot's score is determined by his "miss-distance"—a hard thing to calculate from a zooming jet.

Technicians at the Air Force's Air Proving Ground Center at Elgin Air Force Base Fla., have come up with an electronic "proximity scorer" that does the job, revealing efficiency of both pilot and missile. The 8½-pound unit, mounted in towed or free-flying targets, surrounds the target with electro-magnetic radiations. As the missile hisses by, it reflects the radiations, which in turn trigger a relay that transmits the "miss-distance" to receivers on the ground or in the plane.

A HASTINGS RE-RING JOB PAYS FOR ITSELF

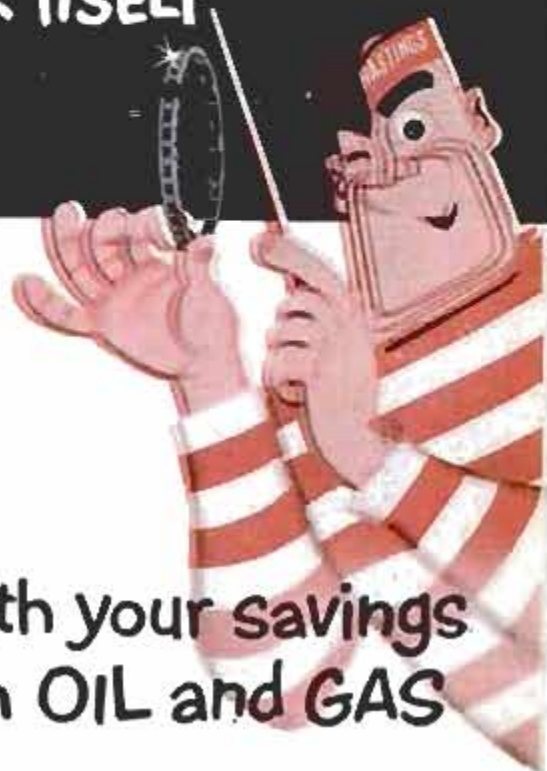

With your savings
in OIL and GAS

Don't put up with poor performance and big oil and gas bills just because your car's no longer new. You can restore its lost pep and power and prevent excessive oil and gas consumption, with a Hastings re-ring job.

The sooner you act, the less it will cost. See your motor specialist the minute oil-pumping warns you there's trouble ahead. When he says you need new piston rings be sure you get Hastings. They're engineered exclusively for replacement service . . . to provide the additional lubrication worn engines need . . . to stop oil-pumping, save gasoline, restore lost performance.

Get new car power and performance from your present car—with Hastings. Truly your best investment for many thousands of extra miles of trouble-free driving pleasure.

TOUGH
on oil pumping

GENTLE
on cylinder walls



HASTINGS MANUFACTURING COMPANY
HASTINGS, MICHIGAN

Piston Rings, Casite, Oil Filters, Spark Plugs

GIANT CHRISTMAS DECORATIONS...

FOR LAWN, PORCH OR ROOF

colorful patterns you can paste on fir plywood

Make your home a holiday show place with these delightfully different Christmas decorations! Durable paper patterns printed in bright colors are specially made to use on fir plywood. Simply paste on plywood and cut out with saw. It's easy. Strong, weatherproof Exterior plywood makes figures last for years. Make wonderful gifts. Order several today! Supply limited.

JUMBO CHRISTMAS CARDS—new, different! (45" x 70") 1. "Joyous Noel," shows child carolers. 2. "Season's Greetings," shows ornaments. Includes 104 letters to personalize with your family name. 50c each.



TRADITIONAL NATIVITY SCENE. 16 figures (only 4 shown) include Christ Child, Mary, Joseph, wise men, shepherds, animals. Tallest figure 47" high. Beautiful, life-like. Entire set, only \$2.00.



JOLLY SANTA, SLEIGH AND REINDEER will delight young and old alike! Wonderful inside or out! Jolly 6' Santa, 50c each. 6' long Sleigh, 50c each. 5' long Reindeer, 50c each.

ORDER NOW! Supply is limited. Allow 2-week delivery. Sorry, no orders after Nov. 30. No stamps or C.O.D.'s. U. S. A. only. Complete instructions included. Individually wrapped, shipped prepaid. Order today. Money back if not delighted.

Douglas Fir Plywood Association, Dept. 9X, Tacoma 2, Wn.



Robert Paul

Midget Motor Scooter Transports Jet Pilot

A pint-size homemade motor scooter that putts along at 25 miles an hour is the preferred ground transportation for Lt. Jack Noble, 26-year-old Air Force pilot from Morrisville, Pa., who regularly flies 1200-mile-per-hour jet fighters. The 50-pound scooter, two feet tall and two and a half feet long, easily transports the 205-pound pilot. While stationed on Okinawa, Lt. Noble came across a discarded small bicycle frame, modified it, made some parts, added a one-horsepower engine and wheelbarrow tires, and within a month he had his miniature vehicle for a total outlay of \$75. Since there was no make or model number on the scooter, Noble had a difficult time registering it with motor vehicle authorities; it finally was logged in a special file, "Homemade Vehicle." The sturdy two-wheeler holds only a gallon of gas and runs 10 days on a full tank. "It costs me a dollar a month to run my putt-putt," said the flier. "I usually buy a dime's worth of gas and oil at a time."

LICKITY LOG SPLITTER

Ends Wood Splitting Drudgery

Hydraulic power splits profits from waste wood
 • 7 HP trailer model • two speed • auto shift
 • auto stroke. Power "squats" to receive large diameter logs without "dead" lift—eighteen ton smooth hydraulic force cuts right through knots, 26" stroke handles up to 30" length, any diameter. Your name on a postal card will bring literature.

THE WACO AIRCRAFT CO., Dept. D, Troy, Ohio

ELECTRIC WELD · BRAZE & CUT

REPAIR MOST EVERYTHING MADE OF METAL

Home Appliances, Auto parts, Farm-garden equipment,

toys. Make and repair playground equipment,

lawn chairs, tables, ornamental

iron work, gates, wagons, etc. Solder, heat,

bend, and straighten, with

terrific heat from arc torch.

Cut and weld up to 1/4"

steel plate. A million uses

for Home, auto, farm,

inventors, factories, etc.

Works from any home 110

volt plug-in. Complete with dark welder's mask, arc torch, supply of

carbon welding and brazing rods and complete Welding Instruction

Book. Efficient—durable—1 year guarantee. Wt. only 8 lbs.

SEND ONLY \$3 (cash, ck. mo) and pay postman \$1.95 plus COD

postage on arrival or send \$12.95 and we will send

postpaid. Ideal gift for mechanically minded home owners, relatives,

friends. Order now for early delivery. Available only from:

MIDWAY WELDER Dept. DPM-11 Kearney, Nebraska

Jiffy SAWHORSE BRACKETS

NO NAILS NO SCREWS NO BOLTS

Now a sawhorse in a jiffy! Just

use Jiffy Brackets and 2x4s.

Sold by hdw. and bldg. supply

stores everywhere, or order

direct. \$1.95 A pair. Higher W. Coast

GRAND HAVEN STAMPED PRODUCTS CO.

Grand Haven, Mich.



PROTECT YOUR CAR WITH

Latest and best automotive products
—you'll find them advertised in PM.

AUTOMATIC CONTROL OF YOUR GARAGE DOOR

ASSEMBLE IT YOURSELF

SAVE UP TO 70%

✓ ONE AND TWO CAR GARAGES
✓ EASY INSTALLATION IN FEW HOURS

One of America's oldest and largest door operator manufacturer's can now make this amazing offer to you! Assemble and install this quality garage door operator yourself. If you were able to buy each part individually, you would pay much more than the entire cost of this kit!

This is the famous Edwards model KR-50 automatic door operator. WORKS LIKE MAGIC... simply press button and garage door opens

and closes automatically. NO MORE COLDS, ILLNESS from getting out of car in snow or rain...costs just pennies a month to operate. Locks door when closed... contains automatic light and quick disconnect device. Easily operated manually in case of power failure. Complete with easy step by step assembly and installation instructions. Ready-to-use radio remote controls optional. COMPARE this fabulous offer! FULLY GUARANTEED.

FREE literature on request

ONLY \$6495

(Normally \$200 installed)
F.O.B. Yonkers, N. Y.

with remote controls \$11445
(regular \$250 value)

Send Check or Money Order

MAIL COUPON TODAY!

EDWARD T. FRICK CO., Inc.

204 Hugoborn Ave., Yonkers, N. Y.

RUSH KIT (\$64.95 enclosed)

RUSH KIT with RADIO

REMOTE CONTROLS

(\$114.45 enclosed)

Name _____

Street _____

City _____

State _____

Send FREE literature

PERMABOND®

KEEPS HANDLES TIGHT permanently



PLUMB®

HAMMERS • HATCHETS • AXES • FILES

PLUMB F-57 HAMMER Non-Breakable Fiber-Glass Handle

- Stronger Than Steel—
with the Hickory Feel
- Will not bend,
collapse, rust, rot or
corrode
- Guaranteed
non-breakable in
normal use
- Non-Slip Neoprene
Covered Grip

\$5.25
Advertised
Consumer
Price



Keep your home cleaner... healthier!

SAVE 1/3
on HOME FILTER COSTS!

Micromat

SANITARY AIR FILTER
KIT

Contains permanent metal frame and four filter changes. Frame lasts the life of your furnace... save the frame cost with every filter change. Replacement filter kit contains air changes for the same price as the original kit. You save 1/3!

MICROMAT is completely sanitary... treated with a potent germicide to control germs and bacteria! Does a superior job of removing dirt, pollen, other impurities from the air... keeps your home cleaner, healthier... saves fuel and service calls!

There's a MICROMAT Sanitary Air Filter for all warm air furnaces, central heating and cooling systems, and room air conditioners. Ask for Micromat at your favorite Hardware or Building Supply store. If there is no dealer near you, or he cannot supply you — order your MICROMAT Sanitary FILTER KIT direct — only \$4.60 postpaid. Send check or M.O., and filter size, to:



COMPLETE
KIT ONLY
\$4.60

Microtron
CORPORATION
Box 2092 • CHARLOTTE, N. C.

"Radar" Warns of Intruders

Operating much like radar, the Standing Wave Area Motion Indicator (SWAMI) detects intrusion into a secure military or industrial area and sounds an alarm. There are three units in the system. Shown



here is the sensor, a high-frequency, low-power radio transponder sealed in a weatherproof vacuum-tube envelope. The sensor responds to intruder disturbance of the controlled radio frequency field pattern and transmits a signal over a cable to a sensitivity control box nearby. The control box has day and night settings which make it responsive to disturbances typical of daylight or nighttime emergencies. During daylight, the system is sensitive to such acts as willful tampering, but not to normal activity. Switched to night operation, the system provides security against intrusion. From the control box, the signal is carried to a monitor unit in a central guard station, where a red light and buzzer indicate an alarm. Since the sensor can detect movement up to thousands of feet away, a study is being made of its application to aircraft as a proximity warning indicator.

Mowless Lawns by 1970?

Ten years from now you will be able to sit on a lawn that needs no mowing and pick normal-sized fruit from the low branches of a dwarf tree, according to a California biologist. The secret lies in isolating a chemical that will neutralize gibberellin, the hormone that controls plant growth. Research is under way that should produce such an "antigibberellin," which could be applied to any plant to arrest its stem growth at any desired height without interfering with its other functions.

Power Companies of Future May Pay YOU for Electricity

Someday power companies may pay you, instead of charge you, for electricity. That's the suggestion of Dr. Lawrence J. Giacoletto of Ford Motor Company's scientific laboratory, who says homeowners might use solar cells to generate electricity from sunlight. Since there is no cheap way to store this power, surplus amounts of it might be turned back into the powerlines for daytime industrial use, with the homeowner receiving credit for the amounts of energy he supplies.

Rare, Fancy & Imported Woods... Veneers... Plywoods... Mouldings... Patterns... Hardware... Mosaic Tile... Ornaments... Tools... Archery and Skiing Supplies

Everything You Need in Craftsman's New **WOOD** and Home Workshop **CATALOG**

Get Yours! Rush Coupon Today!

132 pages



NEW—MOSAIC TILE PROJECTS!

World's Largest Selection of Finest Domestic and Imported Woods... Mouldings, Hardware, Tools—ALL AT LOW MONEY-SAVING PRICES!

Your complete wood buying guide and project book. Craftsman is your best, most complete source of finest kiln-dried domestic and imported woods, beautiful wood inlays, colorful bandings, matched plywoods, embossed mouldings, carved ornaments, newest wood-working tools, "hard-to-find" cabinet hardware; more than 1,500 items! Packed with newest scroll saw patterns, project ideas and money making plans. Enclose 25c (refunded with first order) to help pay mailing and handling cost. Write TODAY to

CRAFTSMAN WOOD SERVICE CO.,
Dept. A-11, 2729 S. Mary St., Chicago 8

OVER
1,500
ITEMS

NEW TOOLS:

Upholstery Materials; Lamp Parts;
Metal and Wood Legs; Cabinet
Hardware; Music Box Movements;
Archery and Water Ski Kits.

CRAFTSMAN WOOD SERVICE CO., Dept. A-11
2729 S. Mary Street, Chicago 8, Ill.
Enclosed find 25c. Rush new CRAFTSMAN WOOD CATALOG.

NAME _____
ADDRESS _____
CITY _____ ZONE _____ STATE _____

AConomize on Gasoline

Get more miles per dollar—install an AC ACon-O-Mizer between your fuel pump and carburetor. Reduces flooding and stalling... tailors fuel pressure—precisely and instantly—to every driving condition from idle to full throttle. The best answer yet to real gasoline economy!

Manufacturers suggested retail price

\$9.90



At Your Nearby Service Station, garage or General Motors Dealer

ACon-O-Mizer

AC SPARK PLUG THE ELECTRONICS DIVISION OF GENERAL MOTORS

ADJUSTABLE MITER BOX & CORNER CLAMP

2 TOOLS IN ONE

No. 44 COMBINATION MITER BOX AND CORNER CLAMP

Holds the wood and holds your saw. Uses any handsaw for accurate cuts from 0° to 180°. Full 3" capacity. Sides of joints exposed for nailing, gluing.

\$2.75 ppd.

Adjusts to any angle!

No. 33 Works the same as No. 44, but without saw guide adjustment.

\$1.75 ppd.

SUPER FILER No. 11

For both hand and circular saws. Steel rollers give all teeth correct height, pitch and bevel.

\$9.95 ppd.

SEND FOR FREE Catalog.

A. D. McBurney, 5908 Hollywood Blvd., Hollywood 28, Calif. Dept.: A-119

SMALL! POWERFUL!



ECONOMY TRACTOR

Unequaled value! Low price!
America's finest tractor. Ruggedly built. Easy to operate. 790 lbs. Borg-Warner clutch, trans, and diff 140 to 1 reduction. 40% more drawbar pull than ordinary tractors 8-1/4 H. P. engine. 20 quick change implements. HOOD, FENDERS.

Thousands In Use Write for complete details.

Engineering Products Co.
1005 K-11 Anoka Ave.
Waukesha, Wis.

FIGHT TUBERCULOSIS WITH CHRISTMAS SEALS



ON LETTERS AND PACKAGES

Now—you can install

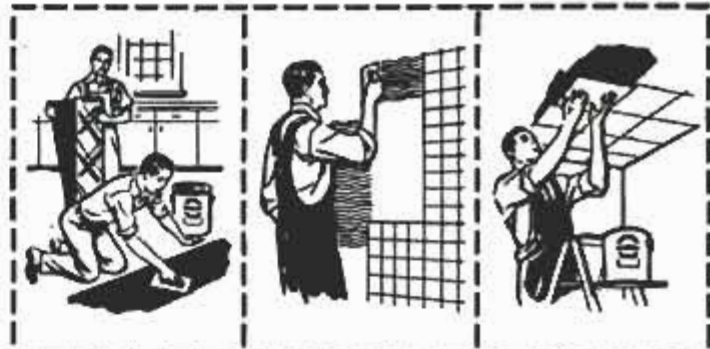

floors... walls... and ceilings
just like professionals

with Flintkote's
Builders Adhesives!



You can do home repair or remodeling jobs easily... and quickly when you work with Flintkote's Atlas' Builders Adhesives.

Choose from 12 different Builders Adhesive Products especially designed for applying linoleum, cork, rubber, asphalt, flexible vinyl, wallboard, hardboard and plastic materials. Use Latex Cement Patch for most concrete repairs.

All work easy! All bond fast! A partial list of F-A Builders Adhesives includes:

- Linoleum Paste
- Waterproof Adhesive
- Acoustical Tile and Wallboard Cement
- Cove Base Cement
- Wall Tile Cement
- Tileboard Cement
- Asphalt Tile Cement
- Rubber and Flexible Vinyl Tile Adhesive
- Quick Setting Tile Adhesive
- Latex Cement Patch

For complete information on the full line of Atlas Builders Adhesives, see your hardware or building products dealer, or write The Flintkote Company, 30 Rockefeller Plaza, New York 20, N. Y.

†A trademark of The Flintkote Company



Atlas PRODUCTS

America's Broadest Line of Building Products

for Christmas Giving

THERE'S NO FINER GIFT THAN

Starrett TOOLS

Give a gift he'll treasure and use — on the job or in his hobby. Always appreciated by the man or boy who loves fine tools. Choose from more than 3,000 Starrett tools — at hardware tool stores or industrial distributors.

FOR HANDYMEN



Drive Pin Punches No. 565. Set of 8 in wood box



Jewelers' Screw Drivers No. 555. Set of 6 in plastic case

FOR HOBBYISTS



Combination Set No. 9. Eight handy tools in one



Toolmaker's Hammer No. 815. With built-in magnifying glass

FOR PROFESSIONALS



1" Micrometer No. 230RL. With no-glare Satin Chrome Finish



Universal Dial Test Indicator No. 196 With attachments

FOR STUDENTS



The Starrett Book for Student Machinists. Only \$1.60 per copy

Kit of Tools No. 902. Basic measuring equipment



3,000 GIFT IDEAS

Ask your Starrett distributor to show you the many gift-worthy items in the complete line of Starrett tools — or write for free Catalog No. 27. Use the coupon.

STARRETT TOOLS are carried by leading Industrial Supply Distributors and Hardware Tool Stores.

THE L. S. STARRETT COMPANY
Dept. AP, Athol, Massachusetts

Please send my free copy of Catalog No. 27 describing over 3,000 Starrett tools for professional and amateur craftsmen.

Name.....

Occupation.....

Address.....

City.....Zone.....State.....

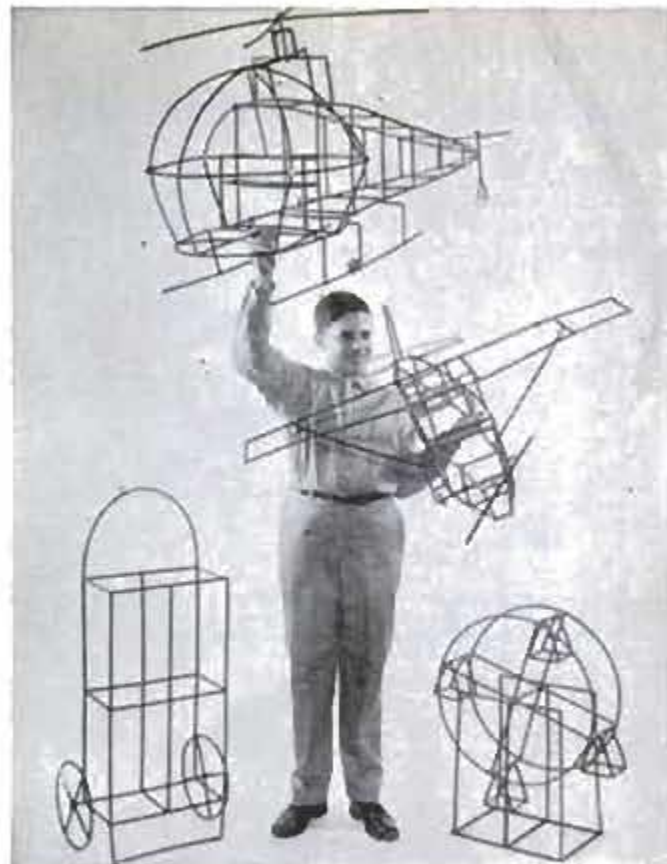

Unbreakable Plastic Tubes Make All Types of Toys

Imagination is the only limitation to the kind of toys that can be built with unbreakable polyethylene tubes that are cut and bent into parts and shapes. Supplied in kit form, the plastic tubes can be curved at will and joined by special connectors that require no glue. Skeletal or finished models of trains, planes, ships, carts or buildings are among items that can be built. Frameworks then can be covered with paper, cloth or other materials to make attractive toys.

Satellite Paint Changes Color To Regulate Temperature

Internal temperatures of space satellites may soon be controlled by a heat-sensitive external coating which changes color as the satellite grows warm or cool. If the temperature of the satellite increases, the skin becomes light in color, thereby allowing more heat to be reflected into space. Should the payload's internal temperature take a downward turn, the skin becomes dark in color, thereby absorbing more radiation. Such coatings have been used in the past to indicate temperature, but not as a heat-control device, according to Rudolf X. Meyer, scientist in the Space Technology Laboratories, Los Angeles, Calif., who developed the new coating. Railroads have used such coatings on wheel bearings to indicate the presence of heat and speed up inspection.

Special Values... New Surplus Equipment!

OIL GEAR HYDRAULIC MOTOR

Disp.: .342 cu. in./rev.
R.P.M.: 1500 Maximum
Pressure: 1100 P.S.I.
Max.

Torque: 45 inch pounds.
Motor has a 4 7/8" dia.
flange four bolt mounting.
Shaft is 3/8" standard
with Woodruff keyway.
Has 3/8" pipe thread ports
fitted with removable 3/8" O.D.
fittings for seamless
steel tubing. Rotation
—either direction.
5 3/4" L. x 4 7/8" D.

Shpg. wt., 13 lbs.
No. 540R

F.O.B. Chicago
\$24.00

Four-Way Open Center HYDRAULIC CONTROL

VALVE



Valve has built-in adjustable relief valve factory set at 1000 P.S.I.
Spring loaded neutral position. For use with one double acting cylinder or reversible hydraulic motor. In neutral position, cylinder is locked and pump unloaded. Can be used as single unit or mounted in series. Has 3/4" pipe thread inlet and outlet. 1/2" pipe thread cylinder ports. Finger grip handle.

Shpg. wt., 10 1/2 lbs. F.O.B. Chicago
No. 126

\$23.50

PESCO GEAR TYPE HYDRAULIC PUMP



Continuous duty; positive displacement .993 cu. in./rev. Delivers 6 G.P.M. at 1600 R.P.M., 1200 P.S.I. Requires 7 H.P. Speed range is 400-2000 R.P.M. Max. pressure 1500 P.S.I. Max. delivery 7.5 G.P.M. at 2000 R.P.M. 3/4" pipe thread ports, 3/4" shaft with Woodruff keyway. 2 hole base mounting. Clockwise rotation. 5" L. x 4 1/4" W. x 7 3/4" H.

Shpg. wt., 11 lbs. F.O.B. Chicago
No. 160R \$24.50

The hydraulic pump, valve and hydraulic motor may be used together for a fully reversible hydraulic drive system. Two of the No. 540R motors may be driven from the pump for greater power.

STEEL TANKS—Bargain-Priced for Fast Selling!

Use these tanks on compressors, for tire inflators, pulsation chambers, floats, buoys, hydraulic reservoirs, fluid containers, etc.



Type G-1 — Capacity, 2100 cu. in. (9 gals.) 450 P.S.I. 1/4" port at each end. Stainless steel. 24" L., 12" dia.
Shpg. wt., 19 lbs.
F.O.B. Chicago

No. 63 \$14.95 each Two for \$27.00



Type D-2 — Capacity, 500 cu. in. (approx. 2 gals.) 450 P.S.I. 1/4" threaded openings at each end. Carbon Steel. 24" L., 6" dia.

Postpaid **\$4.95**
No. 391 Two for \$8.50

FREE! New, Big GROBAN Catalog! Bargains for farm, home, factory, workshop! WRITE TODAY for your FREE Copy!

GROBAN SUPPLY COMPANY Dept. PM-11

1139 S. WABASH AVE. • CHICAGO 5, ILL. • WEbster 9-3793



Glu-Bird
MAKES IT
EASIER!

DECORATE with GLITTER & GLU-BIRD GLUE

Gifts—Ribbons—Flowers—Candles

Glitter Shaker Jars @ 25c—Glue-Bird Glue @ 39c

Write for FREE Decorating Ideas

WILHOLD PRODUCTS, Div. of Acorn Adhesive Co., Inc.
Los Angeles 31, California Chicago 44, Illinois

IDEAL CHRISTMAS GIFT FOR ANY MAN

4 SIMPLE, EASY-TO-USE only **14.75** F.O.B.

ANYONE CAN WELD, BRAZE, SOLDER, CUT, HEAT MOST ANY METAL WITHOUT EXPERIENCE



Sent complete with twin carbon arc torch, welder's shield, carbon, welding and brazing rods. Ready to use.

Over 200,000 in use in homes, garages, farms, shops, factories everywhere. Save money—earn money, making and repairing auto bodies and parts, fenders, furniture and railings, farm equipment, machinery, lawn mowers, toys. Does 1001 jobs on iron, steel, bronze, brass, aluminum, etc. Operates on any properly wired 110 AC or DC line.

SEND ONLY \$3 Pay postman \$11.75 plus C.O.D. charges. Simple instructions included. Ideal lifetime gift for hobbyist, mechanic, hot rodder, homeowner. Order direct on 10-day money back guarantee or write for literature FREE.
FOUR WAY WELDER CO., Dept. F2-M
1810 S. Federal St. Chicago 16, Ill.

Amazing "4-in-1" TOOL

• PUNCHES • SHEARS • FORMS • RIVETS

Here is a complete metal workshop! It PUNCHES burr-free holes in metals up to 16 gauge, to 1" from edge of stock. Has five round punch sizes: 1/8", 5/32", 3/16", 7/32" and 1/4". Square, oval, rectangular, and hexagon shaped punches available. SHEARS metals up to 16 gauge thickness, to 1" wide, at any angle. Also shears rod, wire. (Cutting surfaces are hardened steel that can be re-sharpened!) FORMS metal with bends up to 90° using rod or bar stock up to 1" wide, 16 gauge thick. RIVETS with any solid or hollow rivet up to 1" from edge of stock and up to a maximum of 3/8" in total thickness. Guaranteed!

\$12.95

ALBERT J. TATU, INC., DEPT. C, 5473 MAIN ST., WILLIAMSVILLE 21, N. Y.

18" BENDING and FORMING BRAKE

• SMOOTH BENDS
• FORMS UP TO 90°
• UP TO 16 GA. THICKNESS
EXPERIMENTERS! SERVICEMEN! SHOPS! This unique design permits forming chassis, boxes, covers, trays, etc. by means of 1" deep slots in brake-bar which allows corners to fold in. Provides flange edges up to 1" on bend. Rugged construction. Guaranteed!



\$19.95

**WILLIAMS'
SUPERJUSTABLE®
WRENCHES
ARE
TOUGH BIRDS**



Made in 4-6-8-
10-12-15-18-24
inch sizes



Size for size, they
outlast ordinary adjustable
wrenches. Available in regular
or locking styles. Chrome or Black.

At Leading Industrial, Auto and Hardware Dealers
WRITE FOR CATALOG 503

BETTER
TOOLS

WILLIAMS

FOR BETTER
WORK

J. H. WILLIAMS & CO.

Division of United-Greenfield Corporation
419 VULCAN STREET, BUFFALO 7, N. Y.

NEW, IMPORTED



Vespa

**ITALIAN
MOTOR
SCOOTER**

*It's fun
to ride!*

Drive anywhere your heart directs you and have fun doing it. The wonderful new ISO is at your command to travel many pleasure-filled paths. You need only guide this delightful scooter in seeking your fun.

The new Italian ISO, constructed by skilled craftsmen, has famous European economy to give you the most mileage for gas money. Dependability is foremost in the precision engineered ISO. A streamlined, well-designed product.

FREE ILLUSTRATED BROCHURE. Send today for complete information and name of nearest dealer. It's fun to ride the ISO!

ISO MOTOR SCOOTER

Yazoo Sales Co. • 3607 Livingston Rd. • Jackson, Miss.
Sole U.S. Distributor of the ISO

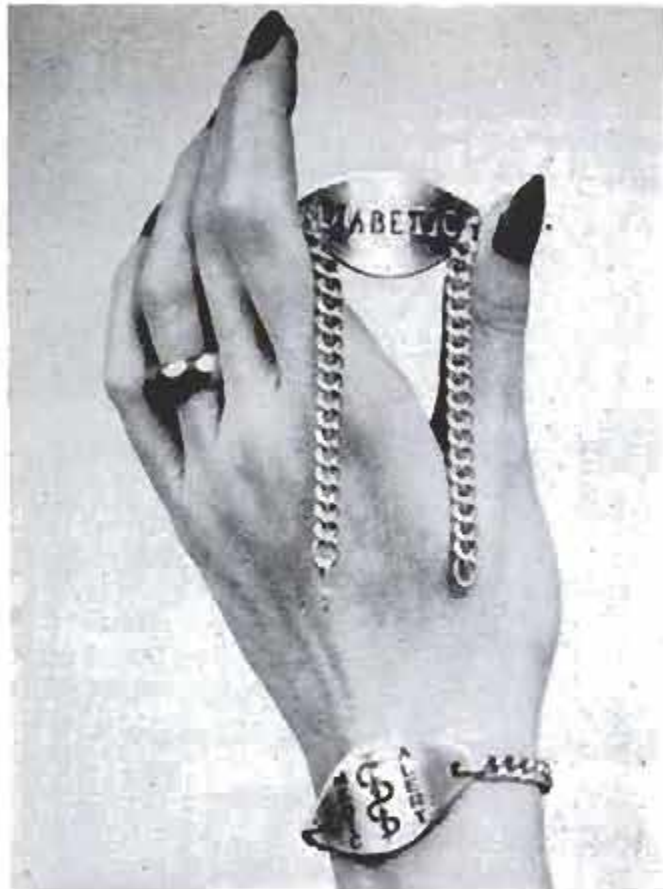

**Medical-Message Bracelet
Assures Proper Treatment**

Bracelets bearing health-condition warnings are being worn by men, women and children with medical problems. Printed on one side of the bracelet medallion is the phrase "Medic Alert." On the other is the warning message, such as "Diabetic," "Hemophiliac," "Blood Type O." Designed by a California doctor, M. C. Collins, the bracelets are recommended by doctors and police as valuable aids to giving proper medical treatment in emergencies.



**10" TILT/ARBOR SAW
BUILD-IT-YOURSELF
from GIL-BILT KITS-PLANS**

Sturdy wood, steel and aluminum construction. Ball bearing arbor. Capacity and performance of machines selling for \$150. Plans, all metal parts and kit with 10" comb. blade \$27.40, less blade \$23.05. Enclose this ad for free delivery. Detail plans and patterns for 12" and 18" hand saws. 6" belt sander, shaper, new comb. drill press-lathe, only \$1.00, refundable with order. Free catalog.

Complete Plans
**only
\$1.00
EACH
POSTPAID**

GILLIOM POWER TOOLS MFG. CO.
1109 N. Second St., St. Charles, Missouri

WORLD'S MOST ACCURATE "GIFT GUIDE"

HULL AUTO COMPASS

This Christmas, give several Hull Auto Compasses. It's a gift that is long remembered. A Hull performs dependably and accurately for years . . . saves getting lost in strange cities, on detours, at unmarked junctions. Beautifully styled and packaged. \$5.95 to \$7.50.



HULL MFG CO
P. O. BOX 344-D-11
WARREN, OHIO

SPRAY

Professional results
everytime with
PRESSURE QUEEN
the only 4 cyl.
portable
air compressor



PAINT

Non-pulsating, continuous air flow for fine finishes...
spraying house or barn... fast... easy... sprays paint
undiluted, 4-5 times faster than brush—better too!

Write for details and name of your nearest dealer.

The Campbell-Hausfeld Co.
1046-K Railroad Ave., Harrison, Ohio



CAMPBELL-HAUSFELD

KITBOATS

Boat Plans
Patterns
Frame Kits



CREDIT
TERMS

FREE FREIGHT—SAVE 2/3

CRAIG-CRAFT, Tonawanda 1L, N. Y.

KIT CATALOGS—Over 50 Models—Pre-
Assembled, Runabouts, Cruisers, Fish-
ing (8' to 19'). Anyone can assemble.
Complete Marine Accessories, Fiber-
glass plastics, Trailers, Paint, etc.
Also Catalog on 50 Modern Plans and
Patterns. Prefab Frame Kits—
SEND 10c FOR 2-COLORED CATALOGS



Wash or scrape
old paint off
with

HEAVY-BODIED KLEAN-STRIP

Find HIDDEN TREASURES

GOLD, SILVER, PRECIOUS METALS with the Famous Model
27 Metal Detector, Lightweight, ultra-sensitive, low
cost. None finer. Also GEIGER COUNTERS for uranium
and the VIOLITE for tungsten. INFORMATION FREE

Detectron

Dept. 21

Sylmar, California



TRANSEAL®
PREVENTS AND
STOPS LEAKS
IN AUTOMATIC TRANSMISSIONS

Prevents and stops leaks due to drying, hardening
or shrinking of transmission seals. Reduces gear
and bearing noise... makes shifting quieter...
faster... smoother.

AT SERVICE STATIONS, GARAGES,
AUTO ACCESSORY STORES

RADIATOR SPECIALTY CO., Charlotte, N. C.



SUPREME VERSAMATE

Versamate... a wonderful
tool that fits any power drill
—reduces speed to give
seven times more power.
Drives screws of all sizes.
Inexpensive extras make it a
nut and bolt driver, heavy-
duty drilling unit. See your
tool dealer today!



\$9.95

For Portable Drill Users...

CHOOSE THE ATTACHMENTS THAT DO THE BIG JOBS!



\$14.95

Versamatic triples portable
drill usefulness. *Reverses!*
Drives and removes screws,
nuts, bolts. Boosts power 7
times. Set includes regular
and Phillips-type bits, and 1/4"
square drive adapter. For
heaviest drilling jobs in steel
and concrete, add a 1/2" Su-
preme Brand Chuck.

SUPREME VERSAMATIC



**SUPREME PRODUCTS
CORPORATION**

2222 S. Calumet, Chicago 16
Div. of A * S * R Products Corp.

FREE

Christmas Shopping Headache Remedy



Send for it today...

an easy, painless and sure way to make a wise selection for dad, brother, son or any hunter or shooter on your list. All items available at your local Mossberg dealer's store.

- Rifles from \$17.95
- Shotguns from \$25.95
- Scope Sights from \$10.95

A catalog every gun fan should have. *Yours* for the asking. Write . . .

O. F. MOSSBERG & SONS, INC.
99711 St. John St.,
New Haven 5, Conn.

"Solid State"-Electronic Tube Eliminates Cathode

Combining many of the advantages of semiconductors (transistors, etc.) and vacuum tubes, this experimental electronic tube gets its electrons from a tiny crystal of silicon carbide instead of the conventional power-consuming cathode. The electron-emitting crystal is inside the cartridge being inserted into the tube in the photograph.

Fast Film for Polaroid

Indoor pictures can be taken almost anywhere there's light enough for seeing with Polaroid Corporation's 3000-speed film. The film, made in two sizes to fit all Polaroid Land cameras, is 15 times faster than the firm's present 200-speed picture roll. It delivers prints in 60 seconds that are described as equal in quality to those of the slower film. Several new accessories give the film great versatility. To fill in shadows—frequently a problem in available-light photography—there's a compact "wink light" that clips to the camera and emits a low-level pulse of light. A miniature battery in the plastic unit powers more than 1000 "winks." An auxiliary folding flash reflector which uses tiny AG-1 flashbulbs attaches to the wink light to cover subjects beyond its range. To avoid over exposure outdoors, the photographer may use either a four-stop neutral density filter (included in a package with the wink light and flash reflector) or an automatic photoelectric shutter. The shutter, an independent unit, attaches to the camera's regular shutter. The user focuses the camera at six feet, and, since the automatic shutter aperture is fixed at f:54, everything from three and a half feet to infinity is in focus. Exposure is controlled automatically by varying the shutter speed. Polaroid has also announced a new exposure meter that will handle film speeds from ASA 12 to ASA 12,000.

TABLE TIPSY?

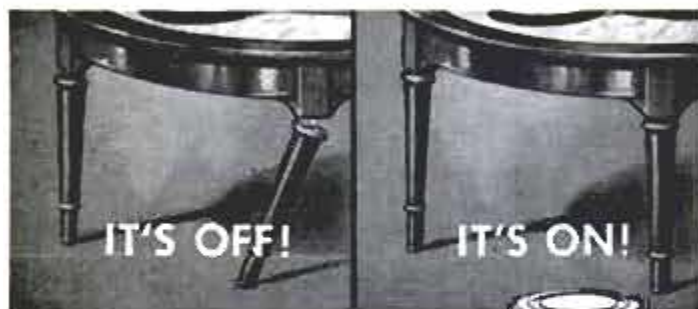

Reset loose legs with firm-holding Plastic Wood. Can be sanded, painted or varnished.

For surest results always use GENUINE

PLASTIC WOOD
Handles like putty—hardens into wood!



HIGH SPEED CUTTING TOOLS... Save up to 75%

HIGH SPEED STRAIGHT SHANK DRILLS 6" TO 12" LENGTHS

SET 30 selected H. S. Straight Shank Drills to 4A 1/4" all sharp, mostly new \$15.00 value only **\$3.29**



SET 12 different size H. S. 5A Straight Shank Drills 1/4" to 1/2" Length to 7" only **\$3.98**

SET 1/4" to 1 3/16" with 1/2" 7A Shank. 5 drills for less than the price of one new drill 3 different size H. S. Drills 1/2" to 1 3/16" **\$9.95**

SET 10 different size H. S. Drills 8A 1/4" to 1 3/16" these are new & used H. S. precision drills with 1/2" shanks can be used in a 1/2" elec. drill or a 1/2" capacity lathe or drill press only **\$17.95**

HIGH SPEED MORSE TAPER SHANK DRILLS

SET 15 different size H. S. Morse taper shank 9A drills up to 9/16" with No. 1 & 2 tapers, new and used \$50.00 value for only **\$7.95**



SET 20 different size H. S. 10A Morse Taper shank Drills from 1/4" to 1" New and used \$70.00 value for only **\$13.95**

SET 10 different size H. S. 11A Morse Taper shank drills from 1/2" to 1 1/4" New and Used \$50.00 value for only **\$10.95**

SLITTING SAWS

7" & 8" H. S. Slitting Saws. 7" saws are .073 thickness; 8" saws are .110 thickness. New cost over \$17.00. Fitted with bushings to fit 1/4", 1"

Either Size **\$5.95** Ea. PPD Buy 6, Get 1 FREE



HIGH SPEED WOODRUFF KEY SEAT CUTTER

SET 5 different size cutters can be 1A used as mounted milling cutter or circular saw. All with 3/8" and 1/2" shanks, widths up to 1/4" dia. up to 1" New and used Ppd. only **\$3.95**



HIGH SPEED STRAIGHT SHANK CHUCKING REAMERS

SET 20 different size H. S. Straight 12A Shank Chucking Reamers up to 1/2" New and used only **\$9.95**



SET 20 different size H. S. Morse Tap-13A or shank chucking Reamers up to 1/2" with no. 1 & 2 tapers. New and used only **\$9.95**

SET 15 different size H. S. Straight Shank 14A Chucking Reamers from 1/4" to 1" New and used only **\$9.95**

SET 15 different size H. S. Morse Taper Shank 15A Chucking Reamers from 1/4" to 1" with no. 1 & 2 & 3 tapers New and used only **\$9.95**

6 SLITTING SAWS WITH MANDREL



SET 6 different sizes H. S. Slitting Saws, 2 3/4" 2A dia. x 1/4" arbor. Thickness from .040 to .071. Cuts wood, aluminum, brass, steel, etc. Plus special Mandrel which enables use of saws in 1/4" or 1/2" elec. drill. \$25.00 value, PPD only **\$4.95**

HIGH SPEED HAND TAPS

SET 8 H. S. HAND TAPS 17A From 1/4" to 3/4", NF & NC **\$3.29**



NEW ROTARY FILE MIX

SET 7 different pcs. for H. S. 3A 5. 1/4" shank contains files costing as much as \$5.00 ea PPD. **\$6.95**



MISCELLANEOUS BARGAINS

SET SET OF 20 GRINDING WHEELS TO 18A 3 1/2" DIA. WITH MANDREL TO FIT 1/4" DRILL **\$3.39**

SET 300 SPRINGS—ALL TYPES 19A AND SIZES **\$2.98**

6 PIECES 1/4" SQUARE, NEW H. S. TOOL BITS **.98**

NEW MORSE No. 2 M.T. LATHE CENTERS **\$1.59**

NEW MORSE No. 3 M.T. LATHE CENTERS **\$1.89**

NEW H. S. STR. SHANK ROUTER BITS Two-Lip Type 3/16 .73c - 5/16 .98c - 7/16 \$1.50

NEW BOX END WRENCHES 3/8x3/4 79c; 1-1/8x1 1/4 98c; 1 3/8x1 1/2 \$1.98

NEW ALMOND DRILL GEAR TYPE CHUCK WITH KEY

1/2" Capacity with 1/2" Female Threaded Back **\$8.50**

3/8" Capacity with No. 2MT. Arbor Included **\$7.50**

1/2" Capacity with 3/4" Female Threaded Back **\$4.95**

New 1/2" JACOBS CHUCK No. 6444, 1/2" Male Thread, with Allen Wrench **\$1.95**

NEW CONE SHAPED H. S. ROTARY FILE 1" dia. x 1 1/4" Lt. 1/4in shank New cost over 6.00 **1.55**

NEW H. S. 1 1/2/16" TAPER SHANK DRILLS New cost 49.00 ea. **22.50 ea.**

NEW SOCKET EXTENSIONS 5" Long 3/8" drive .75 ea. 12" Long 3/8" drive .75 ea. 20" Long 1/2" drive .90 ea.

YOUR MONEY BACK on receipt of merchandise if you are not satisfied. All merchandise mixture of new and reconditioned unless specified new. All orders (except those specified F.O.B. Detroit) are shipped postpaid, saving you up to 25% on total delivered cost. Send 5 cents for catalogue describing thousands of Bargain Cutting Tools.

WHOLESALE TOOL CO.

10248 GRAND RIVER AVE.
DETROIT 4, MICHIGAN

M-1 ODOGRAPH

Over \$5,000 Value

\$189.50

This is a survey instrument for automatically drawing a map of the terrain over which the jeep or other vehicle to which it is attached traverses. These instruments mfgd. currently by Monroe Calculating Machine Co. and sold in excess of \$5,000. Our surplus purchase allows passing on these machines at this value. Order early, only 70 in stock. Units have been rebuilt by Corp of Engineers, U.S. Army and guaranteed good condition. Ideal for prospectors, oil companies.

power line and farm use. Nothing else needed for operation except vehicle. Many are using the compass unit for automobile pilots, on boats—many, many applications. A real machine. Ship, Wt. approx. 300 lbs.

Our Price **\$189.50 ea.**
NEW UNITS **\$279.50 ea.**

ESSE RADIO CO.

42 W. South Street Indianapolis 25, Indiana

THE PERFECT CHRISTMAS GIFT

WELD, BRAZE, HEAT
DYNAMIC

SOLDER, CUT
**TRANSFORMER
ARC WELDER**

SAFE, EASY, QUICK...
No experience needed!
Use on iron, steel, bronze,
brass, aluminum, other metals



SEND ONLY \$6.00
Cash, Check or M.O.
Pay postman balance
plus charges.
Complete with
all accessories
only \$38.50 F.O.B.
direct factory-to-you

EASY PAY PLAN
Low down payment. Pay-
as-you-weld. Write for de-
tails. Literature on larger
welders on request.

Professional type welder for home, shop, farm, industrial use. Build, straighten, bend, repair auto bodies, fenders, lawn mowers, wrought iron furniture, railings, fences, farm equipment. Anything metal. Save money—earn money in spare time. Operates on properly wired 110 AC line. Simple instructions included. Complete with helmet, electrode holders, arc torch, flux, solder, rods, cables. Act now! Order from this ad on 10 day money-back trial. 1 year guarantee.

DYNAMIC WELDER CO. 1808 SOUTH FEDERAL STREET
Dept. D2-M, CHICAGO 16, ILL.

CAR DESTROYED BY UNDER-HOOD FIRE

Newark: — A car driven by James Walder was today set on fire by an explosion under the hood. According to a Police Emergency Squad and firemen called to the scene, the flames were caused by carburetor back-fire that ignited the air filter.

ADVERTISED IN
LIFE



Don't take a chance!

Install a

LEE



Flame-proof "Microlytic"
CARBURETOR AIR FILTER

Engine back-fire causes "carburetor cough" and that's when ordinary air filters burst into flame! Play it safe — install a LEE Flame-proofed Carburetor AIR FILTER! Sold wherever cars are serviced and in accessory stores.

LEE FILTER CORP., Dept. MN No. Arlington, N. J.

INCREASE HOME VALUE—MAKE NEEDED IMPROVEMENTS NOW



H2951

Meter Tells Boat Engine Time

Keeping track of the running time of outboard and inboard marine engines is accurately and effortlessly done with an hour meter that records the hours and minutes an engine is in operation.



The meter can be used on any inboard engine with battery ignition and on any outboard with a battery start. Both six-volt and 12-volt models are available. A record of the running time is important for proper maintenance.

OUTSTANDING VALUE! \$19⁹⁵

WIZARD 17-PIECE SOCKET WRENCH SET

Reg. \$26.15

Professional quality hot-broached sockets in the most needed sizes!

1/2"-drive set includes 12 sockets, 19" Speeder, 10" Ratchet, 6" Extension, 15" Tee Flex, 9" Cross-bar and heavy steel tool box.

Western Auto
STORES AND ASSOCIATE STORES

Western Auto dealers own their own stores and set their own terms. Prices may vary slightly in some parts of the U.S.

Had Your Space Shots?

You think it's tough to get a passport, get your vaccinations, make your reservations and pack your bags for a four-week trip to Europe? Travel in space is going to be tougher. A bacteriologist now suggests we'd better plan on stopping off at a quarantine station on some satellite en route between the earth and other planets. If we don't decontaminate going and coming, he says, we're likely to bring home organisms that will scourge the earth as destructively as a full-scale nuclear war—or spread death on the planet we visit by carrying along earth's germs.



2.3 HP Engine \$14.95 Postpaid

GOVERNMENT SURPLUS

This brand new quality engine which cost our Government many times this low price is offered you for use on go-carts, models, air-propelled boats, etc. Features and specifications: 2.3 H.P. @ 3400 Rpm, 2 cycle, 2" bore, 1 1/2" stroke, roller bearing crankshaft, 3-ring aluminum piston, bronze connecting rod.

Tillotsen variable speed carburetor. Mfgd. by or for Jacobsen of Racine, Wis. for the U. S. Army. Shipped postpaid as shown except carburetor and timer must be attached. Propeller for engine sold less hub for \$6.00 additional. Instructions for assembly of timer and ign. included. Guaranteed or money refunded (less postage).

ESSE RADIO COMPANY

42 W. South St.

Indianapolis 25, Indiana



G E A R S

In Stock — Immediate Delivery

Gears, speed reducers, sprockets, thrust bearings, flexible couplings, pulleys, etc. A complete line is carried in our Chicago stock. Can also quote on special gears of any kind. Send in your blueprints and inquire.

Send for Complete Catalog No. 10

CHICAGO GEAR WORKS

440-50 N. Oakley Blvd., CHICAGO 12, ILL.

OVER TWO MILLION MEN CARRY THEIR KEYS ON A

Famous **KEY-BAK** KEY REEL



Wear it on your belt. STAINLESS-STEEL chain 24" long, reels in keys. Keeps them handy; safely at your side. Pocket-watch size. Chrome finish. Buy KEY-BAK Key-Reel from your dealer or order direct.

\$2.95



WEST LUMMIS MFG. CO. PASADENA, CALIF.
EAST CTL COMPANY, WAUSAU, WISCONSIN



Print Your Own

Cards, Stationery, Advertising, Circulars, labels, photo and movie titles, church work, tags, etc. Save money. Sold direct from factory only. Raised printing like engraving, too.

Own a Printing Business

Print for Others, Good Profit. Have home shop. Junior press \$15; Senior \$29 up. We supply everything. Easy rules. Pays for self in short time. Write for free catalog of outfits and all details. **KELSEY PRESSES, C-37 Meriden, Conn.**

FIBERGLASS or PLYWOOD

\$41.95 Up, Frt. Pd.

EASY
TERMS
FREE
CATALOG



50 Models
8—18 Ft.

Cruisers, runabouts, convertibles, fishing. Pre-assembled, pre-formed units. Perfect assembly by anyone. Equal factory-built. Save you 1/2 to 2/3. Catalog has natural color photos, details; paint, trailers, accessories, Fiberglass supplies. WRITE TODAY.

LUGER BOAT KITS

Dept. B-11, 9200 Access Rd., Minneapolis 20, Minn.

LOOK! All New - All Precision - All Deluxe

SUPERSHOP MODEL X

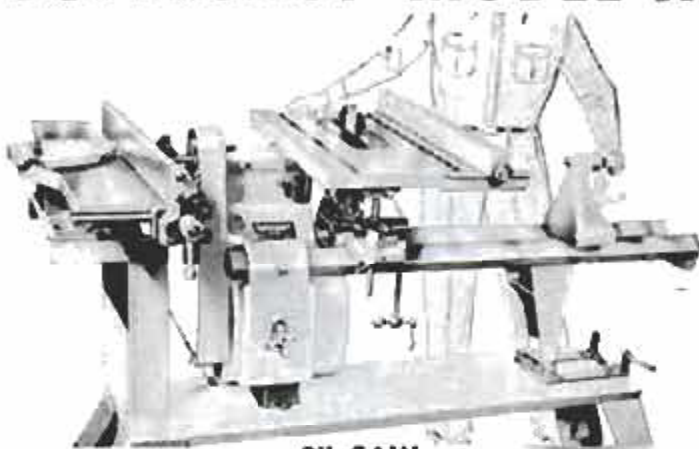

8" SAW

WE PAY ALL
FREIGHT FOR
YOUR FREE
HOME TRIAL

ONLY
\$139.50
EASY
PAY
PLAN

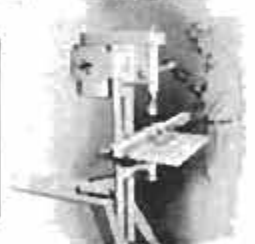

Vert. Drill Press



Hor. Drill Press



8" Sander



30" Lathe



5" Grinder

Never before have you seen so much deluxe, precision-built power tool workshop at any price! Designed for the man who wants the best. Massive cast and precision-machined headstock, self-centering inverted "V" bedways (like precision metal lathes), exclusive non-friction speed changer, extra-large cast and precision-ground saw table. 100% ball bearing, lifetime-lubricated. You save by ordering direct from factory. You are invited to test Supershop Model X in your home FREE. Mail coupon or postcard for FREE brochures, photos, details, specifications, accessory list — and amazing freight prepaid FREE HOME TRIAL PLAN All free.

MAIL COUPON OR
POSTCARD TODAY

Power Tools Division
UNITED INDUSTRIES, Inc.
125 Yates Avenue
Beloit, Wisconsin

NAME _____

ADDRESS _____

CITY _____

STATE _____



NEW BELSAW MULTI-DUTY POWER TOOL



Now you can use this ONE power-feed shop to turn rough lumber into high-value moldings, trim, flooring, furniture ... ALL popular patterns.

RIP... PLANE... MOLD...

separately or all at once by power-feed ... with a one horsepower motor. Use 3 to 5 HP for high speed commercial output.

FULLY SAFE-GUARDED,

Low Cost ... You can own this money-making power tool for only \$30.00 down payment.

Write TODAY for free Catalog

BELSAW POWER TOOLS • 900 Field Bldg., Kansas City 11, Mo.

BUILD 'EM YOURSELF

TEENUTS®

with DOT

and EASI-BILD® PATTERNS!

TEENUTS ... the flush-mounting, "can't-slip" nut that needs no washer ... is now specified in 10 popular Easi-Bild patterns! Get them both at Hardware, Variety and Lumber stores!

*T. M. Reg. U. S. Pat. Off.

Columbia Fastener Company Chicago 8, Illinois

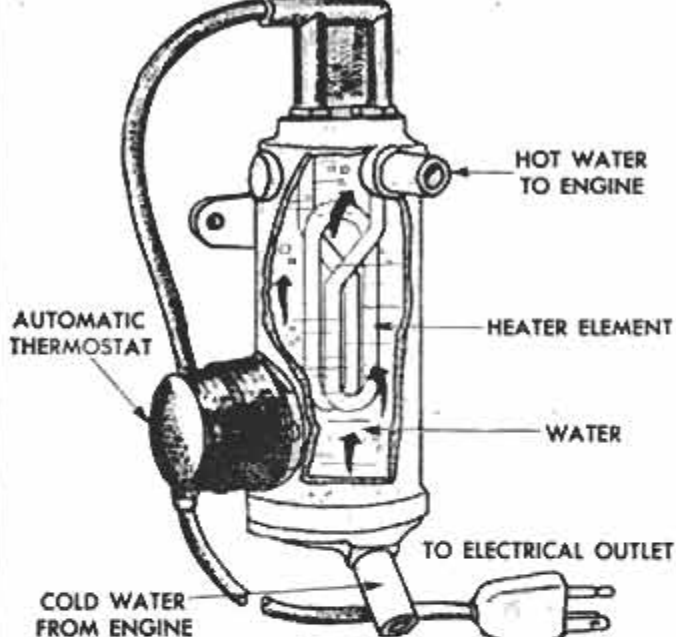

Car Engine Heater

Quick starts in winter are possible with an engine heater installed under the car hood. Cold water from the engine's cooling system is fed by gravity pressure into the electric heater. When heated, the water flows through the heater outlet and warms up the engine. The unit shuts off when the water temperature rises to about 130 degrees. It goes on when the water temperature dips below 40.

Copper Oxide vs Smog

After two years of experiments, Dr. Srinivasa Sourirajan of the University of California has discovered that nitric oxide and hydrocarbon gases, the two biggest contributors to atmospheric contamination, may be eliminated by the use of a copper oxide catalyst in automotive combustion chambers. Dr. Sourirajan learned that the copper oxide decomposed nitric oxide into nitrogen and oxygen, and hydrocarbon gases into carbon dioxide and water—both gases losing their polluting effects in the change. An attempt is being made to design a practical injector for use on cars in smog areas.

Soybean and Linseed Oils Form Coating for Metals

Films made from soybean and linseed oils provide tough, flexible coatings for aluminum and black iron, chemists of the Agricultural Research Service in Peoria, Ill., report. They produced the coatings by reacting fatty alcohols made from soybean and linseed oils with acetylene to produce vinyl ethers; the vinyl ethers were then joined together by polymerization to form the giant molecules that make up the films. The tough film is flexible, withstands heat, and resists abrasion, alkalis, acid and such solvents as alcohols, mineral oil and benzene.

Your first pipeful tells you— you'll get along fine with AMPHORA



AMPHORA

Make your next pipeful AMPHORA, the even-burning, longer lasting, gentle blend from The Netherlands, available in pouch or tin, at tobacco counters everywhere.



AUTOMATIC CLUTCH and sheave for gasoline engine drives

Add a low-cost F-M centrifugal clutch to your conveyors, elevators, go-carts, cultivators, pumps, etc. Get faster, easier starts in any weather. Gives automatic engagement, high torque — fits shaft on 1 - 10 hp engines, up to 3 hp motors. Six models, engagement speeds 1450-3100 rpm. See your dealer or write to:

FAIRBANKS, MORSE & CO.
Magneto Division • Beloit, Wisc.



DRAINS cellars, cisterns, wash tubs; \$7.95 IRRIGATES - CIRCULATES - SPRAYS

1,001 uses. Stainless shaft. Won't rust or clog! Use 1/2 HP motor or larger... 3/4 HP for up to 3000 GPH; 450 GPH 20' high; or 1800 GPH from 25' well. 1" inlet; 3/4" outlet. Counting included free. \$7.95. **HEAVY DUTY BALL-BEARING PUMP.** Up to 7,500 GPH; or 2,000 GPH from 25' well. 1 1/2" inlet; 1" outlet. \$12.95. *Postpaid if cash with order. HONKY-TONK GUARANTEE.* Centrifugal and Gear Pumps in All Sizes. **LABAWCO PUMPS, Belle Mead 7, New Jersey**

GUNK-it-yourself!

Gunk® G.P. removes grease from engines or concrete floors; cleans paint brushes, power mowers, or machinery completely, economically, safely. It's ready-to-use, rinses off with water, won't clog drains. Quart size with handy "Squirt Spout" top speeds application. Insist on the best degreaser — the original "GUNK" at better automotive supply and hardware retailers everywhere.

REG. TRADE MARK.



GUNK CHICAGO CO., River Forest, Illinois
serving the Midwest and Southwest
RADIATOR SPECIALTY CO., Charlotte, No. Carolina
serving the East, Southeast and Far West

ALL NEW!

1960 Edition of Constantine's WOODWORKING CATALOG & MANUAL

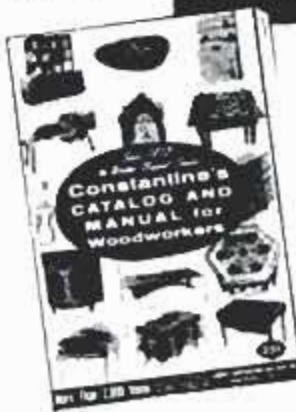

Since 1812—World's Largest Source for Rare Woods and Woodworking Supplies, Tools, Hardware, Plans, Projects!

Whether you work with wood for fun or profit—get your copy of this biggest Constantine Catalog & Manual! Hobbyists and professionals say it's the world's one truly complete source for fine rare imported and domestic woods, veneers, plywoods, bandings, inlays, mouldings, carvings—plus hard-to-find hardware, lamp parts, wood finishing and upholstery supplies, patterns, tools, woodworking materials at bargain prices! Also exclusive Inlaid-Wood-Picture Kits. Includes natural-color Identification Chart of 60 rare woods... pages of inspiring projects for furniture, etc. Complete with instructions. **We ship same day.** Send 25c with coupon for postage and handling (refunded with first order).

FREE—Year's subscription to "Chips & Chats"... every issue filled with exciting ideas for woodworkers... free with Catalog!

ALBERT CONSTANTINE AND SON, INC.
2050 Eastchester Rd.
Dept. S-5, New York 61, N. Y.

130 Pages—Many Full Color! Over 2000 Items! Rare Woods, Veneers, Carvings, Inlays, Mouldings, Hard-to-Find Hardware, Upholstery Supplies, Lamp Parts, Inlaid-Wood-Picture Kits, Plans, Projects, Etc.

Albert Constantine and Son, Inc.
2050 Eastchester Rd., Dept. S-5, New York 61, N. Y.

Enclosed 25c (refunded on first order) for new 1960 Constantine Catalog & Manual. Also send FREE a year's subscription to "Chips & Chats."

Name

Address

City State

NOW! a hi-compression
staple gun

for only
\$4.95



With Exclusive
Push-button Loading
and Built-In
Staple Extractor.

Indispensable for home use...and never before priced so low! This compact, all steel, powerful SWINGLINE 101 staple gun is ideal for insulation, carpentry, upholstery, screening, wire fencing, plus thousands of other uses. Handle locks to fit pocket. Lightweight, maneuverable, jam-proof! Staple sizes $\frac{1}{4}$ " , $\frac{3}{16}$ ". Send for FREE book—"Tips for Tacking".

Swingline® INC.

Dept. M-11-9 Long Island City 1, New York



3 out of 4 who buy Quality Handsaws

... buy **DISSTON**

DISSTON DIVISION

PORTER

H.K. PORTER COMPANY, INC.

PORTER SERVES INDUSTRY: with 13 DIVISIONS including: Thermoid, Delta-Star Electric, National Electric, Riverside-Alloy Metal, Refractories, Connors Steel, Vulcan-Kidd Steel, Forge and Fittings, Disston, Leschen Wire Rope, Mouldings, H. K. Porter Company de Mexico, S.A., and H. K. Porter Company (Canada) Ltd.

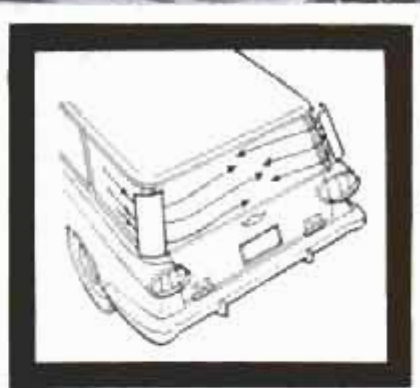
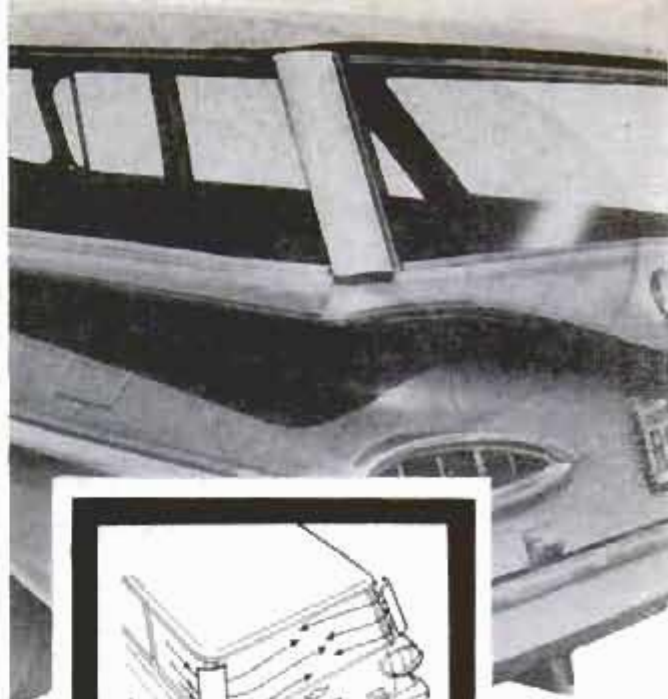

Deflectors For Windows "Detour" Dirt Deposits

Air deflectors which direct a high-velocity stream of air across the rear window of a station wagon keep the window free of the rain, dirt, snow and mud which often block rear vision. The air deflectors counteract the dirt-depositing vacuum created at the rear of station wagons, pick-up trucks and ranch wagons. The attachments also keep exhaust fumes from the interior when the window is open. The deflectors, made of chrome-plated steel alloy, can be installed without special tools.

Jet-Engine Reliability Proved by Records

Jet airliner engines are several times as reliable as piston engines, according to a study of Pan American and TWA flight records. TWA's domestic operations totaled 48,380 jet engine hours in five months with only two precautionary shut-downs in flight. Pan American's overseas records showed 64,000 engine hours in a 10-month period with just five failures. TWA canceled only two jet flights since acquiring the Boeing 707's, completing 99.8 percent of scheduled trips. Experts say such records make jet engines about 20 times more reliable than piston engines.

Welding Cable 00" 50' \$12.95 100' \$24.50
 G.-1 150-250 amp 30V New \$17.50 used \$9.95
 G.E. 200 amp 30 Volt Good Cond. . . \$13.95
 H-1 300 amp G.E. new \$24.50 Good C. 15.50

Accessories Kit For Arc Welder for above generators has helmet, gloves, elect. holder, volt reg. rheostat, RC relay voltmeter, Gr. Clamp, & switch \$19.50. With G.E. 200 amp gen. \$26.00

New Reactor Coil Arc Stabilizer with #4 N Copper for R-1, P-1, G-1 & ACDC. Wt. 11 lbs. \$10.95. Incl. engine throttle solenoid control \$14.95

AC-DC WELDER KIT #511 G.E. Generator. Makes 1250 Watts AC light plant and 200 amp. DC welder and battery charger. Includes all items listed in accessories kit, AC-DC generator & instr. \$39.50

COMPLETE PK. ACCESSORIES For Weld. & Batt. Charging incl. arc stab., cable all 11 items with 300 amp gen \$46.50 with 200 amp gen \$37.50 with 160-250 amp gen \$33.50

V Belt Pulley Kit fits R-1, P-1 & A.C.-D.C. gen., has 2 ball bearings blocks, high speed bearings, triple V-pulley, shaft 3/4" & flex coupling \$17.50

New Throttle Solenoid & Idling device for all welder engine control 1" travel 6" L, wt. 4 lbs. \$7.50

NEW HYDRAULIC PUMP SYSTEM KIT
 Offers fluid drive of varying power, consist of 2 new Vickers p.d.s. pumps ea. .410 cu. in. rev. 3750 RPM 1000 PSI 375 GPH where one pump is belt driven as motor, 1 four way c. valve with variable speed control, reservoir, filter, gauge, hose & fittings. Value \$98.10, \$49.95

WATER PUMP WITH MOTOR 24 VDC runs on 12VDC, 1" ports 400 GPH \$12.95 with 700GPH pump \$14.95 with 900GPH \$16.95. Pump less motor \$8.95

DRAINS BASEMENTS Pump water with Rotary pump #107 400 G. P. H. 3/4" ports adj. to 100 P.S.I. reversible, 5 1/2" x 3 1/2" x 7", Incl. mt. base, \$8.95

Rotary Vane Vacuum pump positive displacement 15 C.F.M. 1500-4500 RPM 10" Hg Suction 24" HG pressure, reversible 3/4" ports wt. 9 lbs, gov't cost \$101.00 new \$22.50 good cond. \$14.50

Dual Power battery motors kit Excellent for golf cart, winch, etc., fully reversible, runs on 24-12VDC kit, includes 2 motors each 3 1/2" HP 250 amp 2100 RPM, 2 relays, switch, 2 flex. couplings with speed reducers 10:1 & cable, 73.20 value \$29.95

NEW HYDRAULIC CYLINDERS

Air or Oil Bore	Stroke	Shaft	D.A.	2000 PSI
#907 1 1/2"	4 1/2"	1 1/4"	\$4.95	2/\$7.90
#300 2 3/8"	6 1/2"	1 1/2"	7 lbs.	\$10.95
#511 3 1/2"	2 1/4"	1 3/4"	15 lbs.	\$24.50

NEW HYDRAULIC SYSTEM KIT
 #400 K. Heavy duty Power Driven, rated 14,000 lbs. lift. Consists of 2 D.A. hyd. cylinders, 3" bore x 24" stroke, each rated 7000 lbs. with 1000 P.S.I., 1 four way hyd. control valve with built in relief #821, 1 Vickers hyd. pump, 400 G.P.H., 1500 P.S.I., 3750 RPM, 1 hyd. 2 gal. reservoir, 1 Purulator hyd. filter, 1 gauge 0-2000 P.S.I. all hose, & fittings. Value \$184.10, save \$90.00, kit price \$94.10. Kit with two #511 cyl. \$79.95. Kit with two #300 cylinders \$59.95

HYDRAULIC PUMP BARGAINS 1500 P.S.I.

Type	RPM	GPH	Reversible
Vickers 1P	3750	375	\$17.50
Peeco gear	3750	198	\$9.95
Peeco gear	4500	270	\$12.95

*Stratopower .450 cu. in. 375GPH. \$15.50
 Weaver Hand P&P relief 20" handle. \$9.95
 Romeo 900GPH & motor 1/4" HPDC. . . \$9.95

GENERAL SALVAGE CO. CHECK OR M.O.
 2922 E. 27 St., Dept. 111, Kansas City 27, Mo.

Lub-a-Spray
DRY LUBRICANT
 ALL-PURPOSE GRAPHITE NO MESS, GREASE or STAIN



One puff from this handy dispenser provides lubrication for doors, windows, locks, appliances — dozens of hard to get at places. Lub-a-Spray is silless, odorless, weatherproof — lubricates metal, wood, leather, rubber, plastic. At Hardware, Sports, Dept. Stores, Service Stations.

PANET MANUFACTURING COMPANY • MILWAUKEE 1, WIS.

Now! You can keep your circular-saw blades in "new" condition by using the "Sharp-Set." This tool was designed to set teeth precisely and keep the blade under proper tension regardless of size for filing. Available direct from factory. \$19.95

Prepayment saves C.O.D. and postage charges. California residents add 4% sales tax.

Calgo Manufacturing
 89 N. Santa Anita Av.—Pasadena, Cal.

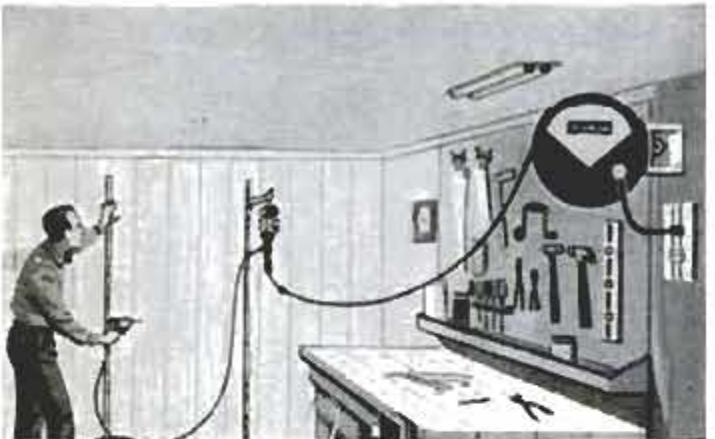
Light and power when and where you want it... **AUTOMATICALLY!**

Modern, convenient • 20-foot cord pulls out to any desired length, locks, retracts into case automatically • phenolic pistol grip handle has built-in electric outlet for power tools and appliances • mounts easily on wall or ceiling.

MODEL 500 \$8.95



New HANDY-LITE REEL
 by **Cordomatic**[®]

17th and Indiana Avenue, Philadelphia 32, Pennsylvania
 Available at all Hardware and Department Stores

FREE!
350 BIG PAGES OF BARGAINS LIKE THIS



24-36 JUMBO PAGES MONTH AFTER MONTH

- Nam Radio
- LP Records
- Power Tools
- Optical Goods
- Test Equipment
- Hi-Fi Components

STEREO AMPLIFIER \$10.95
LOWEST PRICE EVER

For converting mono phones to stereo, for "basic" stereo systems. Use with crystal or ceramic cartridges. 5 1/2" x 5" x 4 1/2" deep — fits anywhere! 5 lbs.

Because Radio Shack has millions of mail order customers, Radio Shack gets first offerings from manufacturers needing cash, first refusal on closeouts, first choice on new items! All these opportunities are passed along to Radio Shack customers in our Bargain Bulletins and Record Flyers. To be "in the know", just fill in and mail the coupon!

RADIO SHACK Corporation
 730 Commonwealth Ave. Boston 17, Mass.

Please send me:

FREE Bargain Bulletins for 12 Months DEPT 11 M

FREE Record Flyers for 12 Months

1960 Electronic Buying Guide @ 35c Check

Stereo-3 amplifier, #90X021, at \$10.95 M.O.

C.O.D.

Name _____

Street _____

City _____ Zone _____ State _____

35c NOW AVAILABLE! 1960 GUIDE TO ELECTRONIC PARTS BUYING

300 pages, 8 1/2 x 11, illustrated handbook. Articles, engineering data plus buying guide. Over 40,000 items. Use coupon to order today!

DREMEL MOTO-TOOL THE "POCKET SIZE MACHINE SHOP"

Handiest tool you'll ever own. Its high speed is ideal for precision grinding, polishing, carving, drilling, engraving, de-burring, sharpening, and hundreds of other household and workshop uses. Eliminates time-consuming hand work — gives the finished job a professional look.

Weights only 13 oz.—handles easily as a pencil. Does fine detail work with pin point accuracy. Fastest, most powerful tool of its kind — develops 27,000 RPM. Widely used by tool and die makers, model builders, craftsmen, lab technicians, repair men, gun smiths, schools, etc.

SEE YOUR DEALER or write for FREE catalog on the complete Dremel line of power tools.



MODEL No. 1.....\$14.85
MOTO-TOOL MODEL No. 2.....\$19.95
MOTO-TOOL KIT No. 1.....\$23.50
MOTO-TOOL KIT No. 2 (as shown) Incl. Model No. 2 Moto-Tool, 23 accessories (high-speed steel cutters, grinding wheels, etc.) in a sturdy storage case.....\$27.50

QUALITY POWER TOOLS SINCE 1934

DREMEL MFG. CO. Dept. 119L, RACINE, WIS.

Enjoy The Eager Bite Of SANDVIK Swedish Steel HAND SAWS



FREE

Send for 16-page booklet on How to Choose and Use Hand Saws.

The wood hungry edge of a Sandvik saw gives you extra woodworking pleasure. High crowned tooth line cuts deeper with each stroke.

Made of specially hardened, stubborn Swedish steel for lasting sharpness.

SANDVIK STEEL, INC.

Saw & Tool Division
1700 Nevins Road
Fair Lawn, N. J.

In Canada: P.O. Drawer 1335, Station "O", Montreal 9

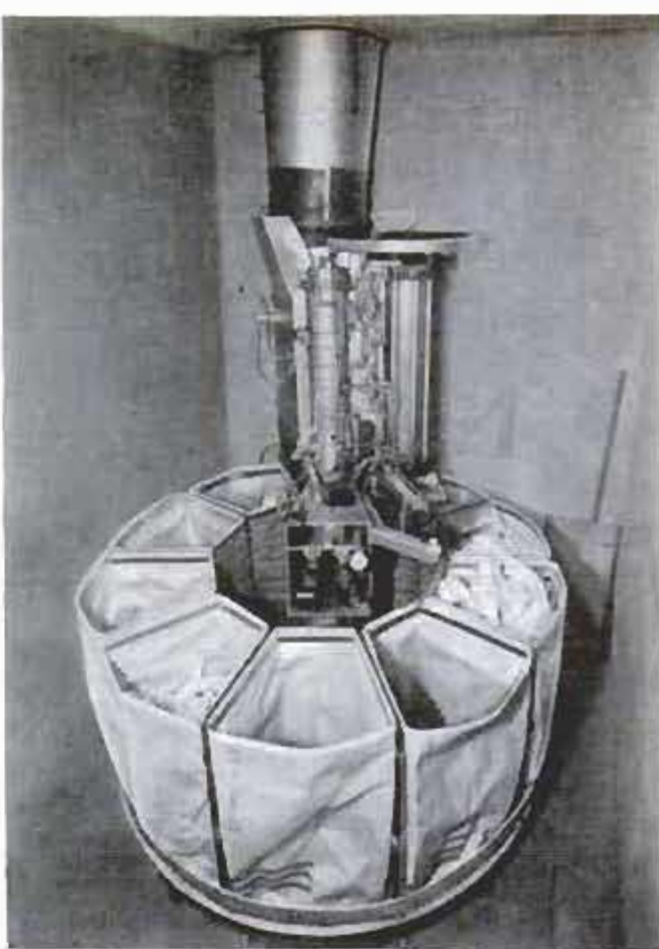

Waste Collector Packages Trash

Paper sacks that catch waste dropped down a chute are automatically moved into position as the preceding sacks become filled in an automatic "trash can." The device, developed in England, is located in the basement of a building and receives waste from the floors above. As each paper sack fills, a pneumatically powered turntable brings an empty into position. When all sacks are full, the contents are compressed pneumatically and the sacks sealed for removal.

Faraway Moving Targets Detected by Army Radar

Radar that can detect moving, long-range targets in fog or darkness will soon provide the U. S. Army with a supersensitive "movement monitor" that can be set up at a frontline position in less than a half hour. The new radar will spot a rolling tank at 10 miles or a soldier crawling two miles away. Each type of target produces a characteristic sound in the radar. When the operator hears a suspicious sound, he zeroes in on the target and narrows the radar beam. An indicator-light under a map shows the target's position, then numerical dials pin down the target with greater exactness.

140-1 REDUCTION GEAR For beaching boats, winches, hoists. Ideal for motor in golf or boy's electric car. DC motor & clutch. Easily reversible wiring diagram furnished. 11 torque, 105 RPM. Runs on 6-12 or 24 V. Wt. 65 lbs. gross. Approx. GOVT. COST \$300. Like NEW, \$12.00. Matched splined gear for above—\$3.00 ea.
*225-1 Reduction Gear—\$13.50

"SUPER 9" 200 AMP WELDING KIT
With Deluxe accessories consisting of one 200 AMP. Gen., adjustable helmet, electrode holder, 30' welding cable, rheostat, giant toggle switch, voltmeter, voltage reg., 1 pr. heavy-duty welder's gloves. All units guaranteed pre-tested. Approx. GOVT. COST — \$500. Most items new — all perfect. \$26.00.

"DELUXE 11" ARC WELDING KIT
Consists of 160-250 AMP. Gen., voltage reg., ammeter, shunt, adjustable helmet, electrode holder, pr. welder's gloves, 30' welding cable, reactor coil, giant toggle switch, rheostat. Approx. GOVT. COST \$650. All units guaranteed pre-tested, \$24.95 complete.

WELDING CABLE DOUBLE-O, heavy-duty fiber-glass insulation. Will handle 400 amps or better. NEW. Approx. GOVT. COST \$40. 50 ft. lengths—\$12.50 . . . 100 ft lengths—\$24.00

SENSITIVE ALTIMETER in 20 ft. increments. 0 to 35,000 ft. (Inches of Mercury). Famous Pioneer. Tested & inspected in our own instrument lab. Guaranteed perfect. Approx. GOVT. COST \$150. Wt. 2 lbs. \$13.95

BUILD YOUR OWN ARC WELDER, LIGHT PLANT OR BATTERY CHARGER \$37.50
Kit incl. 1 Navy NEA-5 Gen. combination AC-DC type. AC 115 V. DC 24 V. 200-300 Amps. 2 complete generators in 1. yet no larger than reg. gen. Ideal for home, shop and farm lighting plants. Delivers 1200 Watts AC, DC side for charging batteries, welding and operating war surplus motors. Also in kit: 2 Voltage Regs., AC & DC, Reverse Current Relay, 30' New Welding Cable, 1 Ammeter, Rheostat, Electrode Holder, Toggle Switch, Welder's Shield, Wiring Diagram for kit. Wt. under 100 lbs. Approx. GOVT. COST \$650. Kit—\$37.50. Navy NEA-5 Gen. as above, purchased separately, \$23.50.

SOUTH WIND HEATER & ACCESSORIES
Mfd. for govt. antarctic expeditions for jeeps and half-tracks. Heating unit puts out over 20,000 B.T.U.'s. Burns any type gas. 6 volt system. Fuel consumption extremely low, 1 gal. per 8 hrs. Terrific for trucks, boats, tractors . . . farms, warehouses, ranches, boat houses, cabins, etc. Complete with service & installation manuals and over 360 components. Approx. GOVT. COST \$550. Shpg. wt. 120 lbs. gross. NEW. \$39.95. Limited quantity.

11 PIECE CROWFOOT WRENCH SETS
Wrenches snap onto T-bar in 3 different positions. The only wrenches for hard-to-get-to places. Mfd. by Plomb Tool Co. for U.S. Armed Forces. Finest case hardened tool steel. No shop mechanic should be without this set. Approx. GOVT. COST \$47. NEW. \$5.95 ppd.

NEW 1960 CATALOG! Tremendous catalog—our biggest ever—fully illustrated—1000s of bargains in war surplus & other items. Send 25c in coin for your copy today or free copy with order. Where ppd. indicated applies to US only. Other prices FOB Culver City, Cal. Send cash, check, money order, 50% dep. COD.

AIRBORNE SALES CO., INC. DEPT. PM 1159
8501 Stellar Drive, Culver City, Calif.

FREE AMAZING NEW BOOK "HOW TO ANSWER ADS"



Never before have you seen anything like this. Tells you in simple language the correct way to answer ads. Gets you quicker replies—better results, and greater satisfaction. Will save you time and money and it's **ABSOLUTELY FREE**. No obligation whatever. Every reader of advertising should have this booklet. Send a postcard for your copy NOW. **F. W. JOHNSON**, Popular Mechanics Magazine, Room 600-A, 204 East Ontario Street, Chicago 11, Ill.

MODEL CHANGEOVER SALE! 1959 MODEL—BELOW COST!

8" TILT ARBOR SAW

BLADE TILTS—TABLE REMAINS LEVEL

Heavy duty all cast iron and steel construction. Precision ground cast iron table. Price includes massive cast iron mitre gauge and patented motor drive that fits any motor. Cross cuts, rips, bevels, mitres, dados, cuts compound angles — everything expected of saws costing four times as much. Depth of cut adjustable; 0" to 2 1/4" — table always level. Send check or M.O. \$2.00 deposits on C.O.D.'s.



NOW \$9.95
Was \$24.95

Shipped Complete as shown Less Blade

SPECIAL BARGAIN — This saw is our 1959 model. Each saw is brand new — sent to you in factory sealed cartons. Sold and guaranteed direct from the factory to you at a fantastic bargain.

FREE 10 DAY TRIAL — MONEY BACK GUARANTEE
Try this famous saw 10 days. If you are not satisfied that it does the work of any tilt arbor saw, regardless of price, return for immediate money back refund.

AMERICAN MACHINE & TOOL CO.
ROYERSFORD 54, PA.

AMERICAN MACHINE & TOOL CO.
ROYERSFORD 54, PA.

LONGER LIFE



Gerstner Chests are built to last — to give years of superior service. Free Catalog.

GERSTNER TOOL CHESTS
459 Columbia St., Dayton 7, Ohio

SAVE ON GIFTS

75c ea. for Finest Imported PRECISION PLIERS!

- Flat Nose • Combination • Diagonal Cutter • End Cutting Nippers • Round Nose • One Side Flat — One Side Round • Snipe

FOR JEWELERS, OPTICAL WORKERS, HOBBYISTS, INSTRUMENTMEN OF ALL KINDS! These superior European instruments are of development, heat-treated high quality tool steel, fabricated to most exacting specifications. All-over ground and polished to smooth hard surfaces. Jaws meet perfectly to safely and securely hold even the most delicate objects. Each plier is 4" long and a veritable gem of precision and strength.

75c each . . . ALL 7 for \$5.00 ppd.

CHROME VANADIUM 29 Pc. DRILL SET



Specially made for speed drilling. In sturdy plastic tool roll. Finest alloy steel drills hardened and precision ground to the sharpest, longest lasting cutting edge obtainable; will easily and cleanly bite through hardwoods, plastics, aluminum, iron and the toughest steels. Unconditionally guaranteed for thousands of drillings. Full jobber lengths. Sizes by 64ths from 1/16" to 1/2". NOW . . . \$6.49 ppd. Also available with Turned Down shanks to fit all 1/4" drills. In individual pocket roll. . . . \$8.95 ppd.

60 Pc. Set Wire Gauge CHROME VANADIUM DRILLS



Top quality German import high test Chrome Vanadium Drills designed for speed drilling through toughest steels, woods, plastic, iron and aluminum. Precision ground, long-lasting cutting edges. Guaranteed to give years of satisfaction. A full 60 pc. set. Nos. 1 through 60. A \$14.95 value— NOW ONLY . . . \$5.40 **PLUS 50c PP. & HDLG.** Same set above available with Hot Metal Index container. **PLUS 50c PP. & HDLG.** Also Available **20 Pc. Set — Nos. 61-80 WIRE GAUGE DRILLS** In plastic kit with marked pocket for \$2.50 ppd.



One of our BEST Values!
2.9 AMP HEAVY DUTY 1/4" RAM DRILL \$14.95
with Jacobs Geared Chuck & Key **Plus 50c pp. & hdlg.**
Reg. \$39.95—Our Price

Not just an ordinary 2, 2 1/4 or 2 1/2 amp unit, but a powerful full 2.9 AMP drill to do every heavy duty job in home, shop or industry. Built to take years of rough-tough use. Newer, more rugged motor gives 1 1/2" capacity in hard wood and 1 1/4" capacity in steel with a full load speed of 1200 R.P.M. Durable mirror finished, lightweight aluminum housing. Features Universal, series wound AC-DC motor; heavy duty multiple thrust ball bearings; automatic release trigger switch with locking pin; 6 ft. 2 conductor, UL approved cord and plug. Standard 115 V. AC-DC. This powerhouse measures 9" in length yet weighs only 3 1/2 lbs. Limited quantities. **MONEY BACK GUARANTEE** Send Check or M.O.—C.O.D. Plus Fee **SCOTT-MITCHELL HOUSE, INC.** Dept. HC18, 415 South Broadway YONKERS, NEW YORK

Three Two-Man Teams Operate Missile Bomber

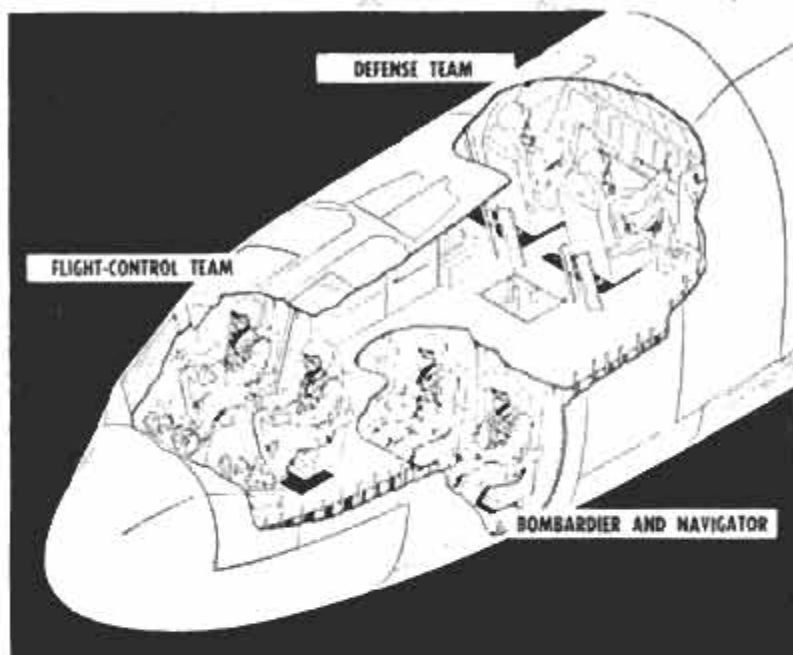

Crewmen in the new Boeing B-52G missile bomber are positioned in two-man teams up front. This gives the crew immediate access to all equipment and allows continuous personal contact. The arrangement differs from that of the earlier B-52 in that the manned tail-turret position has been eliminated and the gunner has been moved forward. With the electronics-countermeasures operator, the gunner now makes up the defense team. He remotely controls tail armament. Pilot and co-pilot are the flight-control team, and bombardier and radar-navigator, seated on the bomber's lower deck, the offense team. Each position has food, oxygen.

TV Camera on Doctor's Head Shows Students Details of Examination

Doctors have taken to wearing TV cameras on their heads. The use of the camera enables several students to see critical areas within the ears, nose, throat and other body cavities. Normally, only one person can look into a body cavity at a time. While permitting others to see

on a nearby television screen the very same area the examiner sees, the small TV camera doesn't hamper the examiner's view of the field. Also, it allows him a normal range of motion. A pilot model of the camera is being used at Northwestern University.

SEALS OUT MOISTURE

Apply it yourself for less than 1¢ per square foot!

PERMAPEL^{T.M.}
WATER REPELLENT

Completes new masonry jobs . . . renews old . . . preserves the beauty and life of all masonry surfaces!

- Miracle PERMAPEL seals out water, dirt and soil, yet lets inside dampness breathe out! Prevents interior wall damage. Guards against efflorescence. Effective 8 to 10 years on all masonry—concrete, plaster, stucco, stone, porous brick, asbestos siding.
- PERMAPEL comes in concentrated form for economy and easy handling. Mixes instantly, 1 part to 7 parts water. Gives invisible protection. Only 1 coat needed. Apply with spray or brush. Fireproof—contains no oil, grease or wax.

SEND TODAY FOR **FREE SAMPLE**

Perma-Stone Co., Desk 6, 719 E. Hudson Street, Columbus 11, Ohio

Please send free sample of Concentrated Permapel, the new miracle water repellent for all exterior, above-ground masonry work.

Name _____

Address _____

City _____ State _____



HOME PROJECTS

Are Best With E-Z Products

America's Most Efficient Hardware

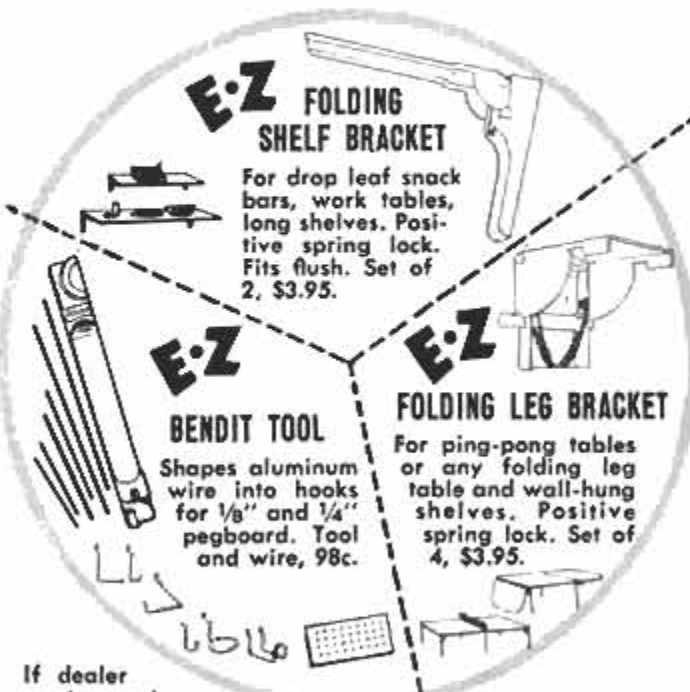

If dealer can't supply write for nearest one.

ARDOR MFG. INC., 611 SOUTH WASHINGTON
ROYAL OAK, MICH.

WHAT YOU SHOULD KNOW ABOUT GASOLINE ADDITIVES

Your fuel system has been precision-designed and engineered to help your engine deliver maximum performance and economy. And gasoline tank additives can help you maintain these desired results, no matter what make of car or truck you drive.



Normal driving causes deposits of carbon, gum and sludge to accumulate in your fuel system. Even when the system is in perfect adjustment, these deposits will cut down on your performance and economy. And, unless these deposits are removed, it is impossible to effectively adjust or tune your engine.

The proper gasoline additive will clean your fuel system and keep your performance alive. And regular use of an additive will help provide you with consistently good performance.



Since many additives leave deposits of their own, and others do only a partial job, the world's largest manufacturer of original equipment carburetors has researched and tested a new additive, CARBON-X 77.

BY THE MAKERS OF AMERICA'S NUMBER ONE ORIGINAL EQUIPMENT CARBURETORS

If automotive service is your business, ask your nearby UMS distributor about CARBON-X 77, the complete fuel system conditioner, plus the rest of the fast-moving Rochester-GM Carburetor Service Line . . . Carb-AIRator, the CARBON-X chemical line and factory-recommended carburetor replacement units and kits.



CARBON-X 77 is the complete fuel system conditioner. It dissipates the formation of natural gums in gasoline, allowing the fuel to pass through carburetion and combustion without forming gum deposits in the tank, lines, fuel pump or carburetor.

It resists the formation of coke and carbon in the intake manifold and combustion chamber, and protects the entire system from acidic corrosion. And CARBON-X 77 keeps gas lines free from ice formation and eliminates carburetor icing.

Next time you get gas, ask for CARBON-X 77. You'll notice the difference on your first trial can. CARBON-X 77 is recommended by the makers of America's number one original equipment carburetors, Rochester Products Division of General Motors, Rochester, New York.

ROCHESTER CARBURETORS



America's number one original equipment carburetors



6.6 HP

Now!
NEW
EASE IN

SNOW REMOVAL

With Steering Sulky and Self Starter

- Powerful Gravelly Tractor—with *push-button Starter, New Steering Sulky* and *Snowblower*—make snow removal almost child's play!
- You can blow snow—deep or light, wet or dry—wherever you want it, with fingertip maneuverability. 48" Snow Plow also available. 30 year round attachments... *All on Easy Pay Plan.*

Write today for FREE 24-page
"Power vs Drudgery" Booklet!

GRAVELLY TRACTORS, INC.
BOX 601-L DUNBAR, W. VA.

FIELD-TESTED SINCE 1922

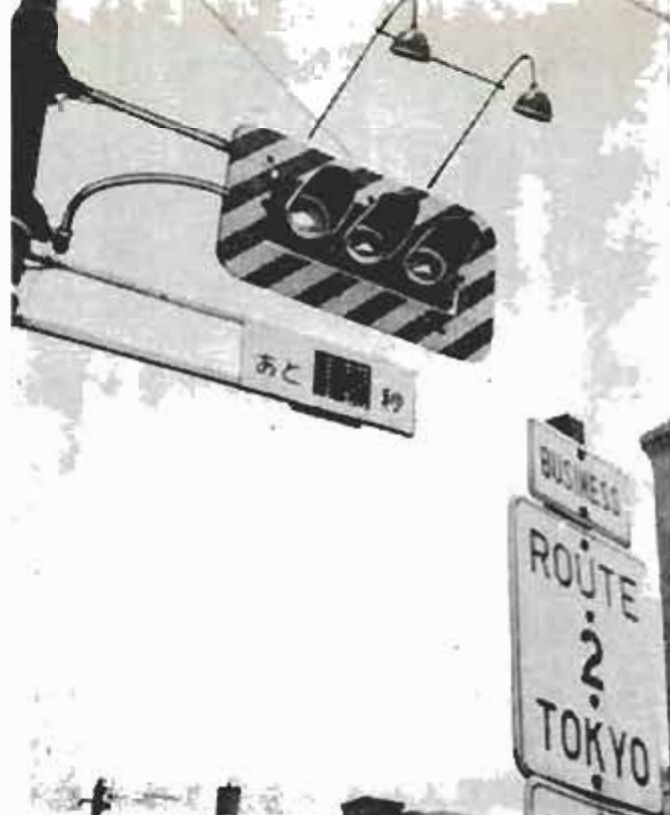

Traffic Light Gives "Countdown"

Tokyo pedestrians now can tell exactly how much time they have to cross an intersection before the traffic signal will change. A signal being tested at a downtown intersection "counts down" the number of seconds left before the light changes. The timed traffic light was built at a cost of \$1389 by the Tokyo Metropolitan Government's traffic division. If experiments prove successful, it will be adopted for general use at main pedestrian crossings.

LOOSE



HANDLE?

FIX IT FAST! with Pyroil Met-L-Fix. Wonder working Plastic Aluminum. Spreads like paste, dries into tough durable metal. Seals, Solders, Repairs, no heat necessary. Makes mending fun instead of a chore. Repairs metal, wood, plastic, etc. Can be filed, sanded, drilled and threaded. 3 sizes 59c, 89c, \$1.00, at your favorite Hardware, Sporting Goods or Automotive Supply Store.
PYROIL CO., INC., LA CROSSE, WISCONSIN



DON'T DIG 'TIL YOU KNOW WHERE



No one seems to know why or how this amazing instrument works, but with it, completely inexperienced persons have located buried water, gas and sewer lines. May save hours of expensive and unnecessary digging. Seems to be just as efficient over concrete as bare ground; indoors or outdoors. Locate hidden springs or buried water source. DETECTO is the strangest instrument you ever saw, baffles scientific explanation, but almost anyone can quickly learn to use it. Simple, unique. Thousands of satisfied users include Public Utilities, Government Agencies, Plumbers, Builders. Money back if not satisfied. Send check or money order (No C.O.D.'s). Complete with easy to read instructions.

ONLY
\$298
POST
PAID

THE DETECTO CO.

Chesterland, Ohio

AUTOMATIC
RETOOTHER

MAKES NEW PROFITS

for HAND SAWS

Cuts new teeth in 50 seconds—any size 4 to 16 points. Old teeth fall off as chips. Easy to operate. A perfect job.



BURR MFG. CO.
8933-N VENICE BLVD.
LOS ANGELES 34, CALIF.

Send For Free Literature

SURPLUS SALE

GOVT SURPLUS
EXCESS INVENTORY
BANKRUPT STOCK

ARMY POWER PLANTS

Amazing buys in Deluxe Govt. units. 115-v, 80-c plants. Large selection. Write for descriptive catalog. All F.O.B.

- *1000-W ... \$169.75
- *3000-W ... 289.50
- *5000-W ... 497.50
- *7500-W ... 549.50
- 3000-w (DC-115-v) ... 169.50

*Also DC & AC generator buys.

6 or 12-V STORAGE BATTERY WINCH

* Item #311. Powerful fully reversible ball-bearing gear reduction winch. 1000-2500 lb. pull. Use on 6 or 12-v battery. Holds 40' of 1/2" cable. For trucks, trucks, loads. Govt. cost \$280. Sale ... **\$46.71 FOB**

AIR COMPRESSOR BARGAINS

* For painting, cleaning, tires, termites. Assemble own outfit.

* Item #450. Deluxe Kit. Compressor, tank, gauge, regulator, paint gun, relief valve, fittings, hose, instructions. List \$52. SALE **\$43.91 FOB**

* Air Components, Compressor 1-cyl. \$19.35, Air tank, \$10.90, Regulator \$3.95, \$1.95. Press. Gauge \$1.89. Pop-off Finest Paint Gun \$11.50, Auto Switch \$4.75. All Ppd. in U. S.

CONTRACTORS LEVEL-TRANSITS

* Item #804. Leading make. Brand new latest model level-transit with tripod and case. Used by leading builders, schools, etc. 12-X scope, high accuracy. Use as level or transit. **\$69.95 Ppd.**

* Many other instrument buys.

STANDARD DIAL PHONE

* Item #715. Modern hi-efficiency attractive dial phone. Use for extension to main line on private system. Use several for complete private system, etc. Complete. Work on any system. Govt. cost \$25. SALE **\$9.95 Ppd.**

ELECTRIC CAR MOTOR



* Item #572. Make golf or town electric car, power factory carts, winches, etc. Many uses. Powerful built-in gear reduction. Shaft turns only 50 to 100 rpm. Instant reverse. Run on 6 or 12-v storage battery. Govt. cost \$295. Wt. 38 lbs. SALE **\$22.72 FOB**

DC AMMETER 300 AMP.

* Item #2101. Leading make. Hi-range complete with shunt. Use for welders, battery chargers, automotive checking, starter-generators, etc. Diam. 3 1/4". Wt. 2 lbs. Cost \$17.50. SALE **\$6.97 FOB**

ELECTRICAL-ELECTRONIC BUYS

Typical items in our '59 catalog:

- * Radiation Geiger Tubes, cost \$20 ... **\$ 7.90**
- * 905 Cathode Ray Tube, cost \$52.50 ... **4.91**
- * Lab. Precision Solenoid, cost \$6.95 ... **.99**
- * AC-DC Robot Control Lever Motor ... **7.95**
- * G.E. Telechron Clock Timer ... **5.97**
- * Army HS-30 Heat Sets, cost \$10.50 ... **1.75**
- * AC-DC Blower ... **3.89**
- * AC Voltmeter, 0-150-v ... **3.55**

* We have hundreds of other items—tools, meters, weed spray units, miracle chemicals, etc. Write for catalog.

HYDRAULIC EQUIPMENT BARGAINS

* Savings to 80%. Build loaders, diggers, presses, etc. All brand new.

- * Victors Pump-Valve-Reservoir ... **\$49.50 FOB**
- * Farm Tractor 1000-lb. Pump ... **45.50 Ppd**
- * 12-v Motor and Pump 1000 lb. Pump ... **16.95 FOB**
- * 2-Way Cyl. 2 1/2"x16" Stroke ... **17.41 FOB**

Hundreds hydraulic items—get our catalog.

HAND HYDRAULIC PUMP

* Item #938. Finest Govt. brand new hydraulic hand pump. Pressure to 1000 lb. Use for wagon-truck un-loader, powerful press, large jacks, etc. A real buy. Wt. 5 lbs. Govt. cost \$41.75. SALE **\$9.67 FOB**

SPECIAL OF THE MONTH!



PORTABLE AIR PRESSURE UNIT

* Item #462. Govt. unit. Fill at any station up to 400 lbs. Use to inflate flat-blow dust from equipment, spray weeds. Hold air indefinitely. Carry in car. Consists of pressure tank, valve, gauge, tire chuck, spray jet nozzle, hose, fittings, etc. (Spray equipment and valve not shown). Wt. 8 lbs. Cost \$26.50. SALE **\$8.89 FOB**

PRIVATE TELEPHONE SWITCHBOARD

* Item #701. Install your own private system. Fine for motels, factories, stores, apartment, etc. Connect any 2 lines together by pressing key. Capacity 12 lines. Can be connected to your local system. Beautiful walnut finish cabinet. Latest design, finest equipment. Brand new. Complete with one phone. Wt. 90 lbs. Govt. cost \$451.50. SALE **\$97.50 FOB**

MOTOR VACUUM-BLOWER UNIT

* Item #1609. Compact expensive Govt. motor driven Vacuum Pump and Blower units. Marvellous for lab. and other experimental use.

- * Motor runs on 12-24 volt DC or on AC through resistor. Very efficient. Wt. 6 lbs. Govt. cost \$39.50. SALE **\$6.91 Ppd.**

FOLDING WIRE REEL

* Item 735. Army units. Use for stringing or rolling up power wire, barb wire, etc. Useful for construction companies, farmers, electricians, etc. Wt. 39 lbs. Govt. cost \$36.50. SALE **\$9.91 FOB**

Electronics, Power Tools, Binoculars, Hydraulics, Power Plants, Air Compressors and thousands of other items.

SURPLUS CENTER
LINCOLN, NEBR DEPT 813

You can make
180 amp. "HUSTLER"

BIG MONEY

with these LOW COST WELDERS

"POWER-WELD" ac power plus dc weld

For a surprisingly low investment you can start a well paying business, doing repairs, construction, metal fabrication, etc. These versatile, low cost Hobart welders are easy to use. Built-in features usually found on larger, more expensive models assure professional results, long life.

The 180 amp. "HUSTLER" is a complete welding package—including accessories. It welds, cuts, burns holes, hardsurfaces, and heats metal for bending and forming. Meets REA requirements.

The 200 amp. POWER/WELD furnishes DC current for welding—and simultane-

ously supplies 110/220 v. power for running lights, tools, motors, pumps, sprays, etc. Can also be used as an emergency power source to run brooders, milking machines, etc. Write today for complete details.

HOBART BROTHERS CO., BOX M-119, TROY, OHIO, Phone FE.2-1223

KEEP CAR PERFORMANCE LIKE NEW—REPLACE WORN PARTS

\$3⁰⁰ post-paid
Special
Factory Offer



Long Barrel
.12 CALIBER

NEW WESTERN HAIG

USES 4.4 MG. POWDER CHARGE

This small bore gun shoots .12 cal. lead bullets fired by small 4.4 mg. powder charge. Not a CO₂ gun! You'll like the handsome lines, grip, and balance. Western in style, but patented ball and cap action allows this low price. 9 1/4" steel barrel cased in knurled styrene stock, overall 13 1/2". Develop pistol form, accuracy at a fraction of cost of large caliber pistols. Comes with 50 lead bullets. Satisfaction guaranteed. Send \$3 to:
HAIG MFG. CO., Box 24 Q, Alhambra, Calif.

HANDEE

GRINDS • POLISHES • CUTS • SAWS • CLEANS
ROUTS • ENGRAVES AND BURNISHES



HANDEE
THE MOST
PRACTICAL
GIFT EVER!



HANDEE, all-purpose craftsman's hand power tool. Only 14 oz. Does 1,001 jobs: wood carving, jewelry making, plastics work, model building, ceramics, initialing, etc.

PRECISION - ENGINEERED

Perfectly balanced, cool running HANDEE fits your hand for delicate or rough work. Allows 360° rotation. 25,000 r.p.m.; 110 or 220-volt (please specify). 25 to 60 cycles. AC or DC. Guaranteed.

No. 6010—HANDEE Grinder, \$32.95
45 accessories, metal case; 110-volt. Only

No. 6008—HANDEE Grinder, \$23.95
6 accessories. Only

Send your order today!

Chicago Wheel & Mfg. Co., 1101 W. Monroe St., Chicago

Enclosed is money order for set No. _____ PM-11

Please send me HANDEE Catalog.

Name _____

Address _____

City _____ Zone _____ State _____

UNIVERSITY ANNOUNCES...
the new way to high fidelity
stereophonic sound from ultra-
compact speaker systems



RRL-5* in a setting by Smilow-Thielle

Three new systems of highest quality... priced to fit the tight budget... styled to match the wife's decor. For maximum flexibility and convenience, each is fine-furniture finished on four sides... for use as highboy or lowboy on bookshelf, bench, or built-in. Full details are in new edition of "Informative guide to high fidelity stereo and monophonic speaker systems and components." Write to Desk U-1, University Loudspeakers, Inc., White Plains, N. Y.

*RRL, Radiation Resistance Loading to give outstanding bass reproduction from ultra-compact cabinets.



"It adds a sporting element to pay TV"



The Modern PLASTIC
for lasting Home Repairs

PERMANENTLY mends cracks or holes in wood, tile, stone or plaster. Sticks and stays put—Does not chip, shrink or fall out. Easy to use. Economical. Mold it, chisel it, polish or paint it. The big 4-lb. can is obtainable from your lumber, paint or hardware dealer at \$1.40; or will be shipped direct postpaid (in U. S.) for \$1.75. Complete satisfaction guaranteed or your money refunded.

DONALD DURHAM CO.
Box 804-T Des Moines, Iowa

FREE POWER TOOL CATALOG

Get the right tool for the job! Write:

World's largest
maker of
electric tools

Black & Decker®
Dept. MO119, Towson 4, Maryland



Heavy Duty Type ALLEN PUNCH PRESSES

Model BT-12
12 Ton
\$437.50
fab-less motor

Hundreds of Different
Model combinations
1 to 12 ton capacities
Moderate in price
Fully guaranteed
See your supply dealer or write
for Free catalog giving complete
information and prices on
our Heavy Duty Punch Presses.

ALVA ALLEN INDUSTRIES, Dept. PM, Clinton, Mo.

Next Month
you'll learn how a
Japanese found the
secret of growing
pearls in fresh-
water mussel shells

GOV'T SURPLUS YEAR END SALE

HYDRAULIC CYL.

New 1500 PSI Dbl. Action Cylinder. Ideal for clutch or throttle control when used as a master & slave. Has 5/8" bore, 4-1/8" stroke, 7/16" shaft, 9-5/8" closed length. Ports are 1/4" tube (7/16-20 thread). No. H-60 **375**

1500 PSI, long stroke cylinder - Has Stroke of 15-5/8", Bore 1-3/8", Shaft 1", Length 22". No. H-14
Cost Gov't approx. \$120.00
Palley Catalog Price \$11.75 **795**

No. H-84 - Double Action Cylinder
Cost the Gov't approximately \$68.00
For pressure to 1500 PSI.
Bore - 1-1/2", shaft **ONLY 395**
9/16", stroke adjustable
1-3/16" to 4-3/8", length
14-1/2". A Real Buy at

FOUR WAY HYDRAULIC VALVE
No. V-13USU
Sliding piston type with built-in relief valve to limit stroke. Pressure balanced in neutral position. Has 5/8" AC tube ports. No. H-V13U
Reg. Catalog price \$12.75 **788**

4-WAY HYD. VALVE
No. H-V7A-1 **395**
A spring loaded, poppet type valve. Pressure balanced. Off in neutral. Has 1/2" tube ports. Cost Gov't approx. \$30

UNIVERSAL JOINT
Designed for drive take-off to winch. Takes 1-3/8" shaft on one side - 1-1/4" diam. shaft on other side. Heavy duty. Width 4", length 5-1/2". One take-off is key slotted. **444**
Body is Zerk lubricated. . .

A - Swedish Army FOLDING BAYONET . . . \$2.98
B - Paratrooper FOLDING MACHETE . . . 2.89
Folding Machete HOLSTER for above. . . \$1.50
C - 22" Vanadium Steel MACHETE with case 1.98
D - British Army comb. PICK-HOE TOOL . . 1.49
E - Officer's Lentic Pocket COMPASS . . 3.49
F - New Navy FIGHTING KNIFE with sheath 2.98

Handle 5-5/8"
399
12 PC. SPORT KNIFE

Will eliminate 12 ITEMS from your pack or fishing box. Includes a knife, spoon, fork, drawknife, bonesaw, fish scaler, scissors, can & bottle opener, cork-screw, owl-punch, screwdriver and file. A special import. Will make an ideal GIFT for the Boy Scout, Fisherman, Hunter, Camper, etc. Comes complete with leather belt holster.

64 PG. IMPORT CATALOG
Packed with import bargains for Home or Patio. Includes New Hydraulic Equipment Supplement.
Send 25c to cover the cost of handling and mailing.

GOV'T SURPLUS BLOWER/MOTOR

Operates on 24 volts DC at 1.35 amps. Direct drive fan blade turns 4700 RPM. Fan has central intake and two opposed exhaust ports. Fan housing is 8" in diameter. Motor is 3"x 3" **388**

BLOWER/EXHAUST FAN
Miniature type. 4" diam. fan forces air thru 5inch long housing. Has 1/100 HP, 27.5 VDC electric motor, tandem mounted behind fan blade. Lifetime bearings. For ventilating closed compartments, darkroom, etc. **488**

100 TO 1 GEAR MOTOR

Here's a real "workhorse" in a compact, heavy duty gearhead motor. The gear ratio is 100-to-1 giving the 24 volt DC motor tremendous power. A reversible clutch is set at 375 foot-pounds. Take-off shaft is double-keyed and is 1-1/16" dia. **ONLY 2450**

NEW 3-3/4 HP ELECT. MOTOR

Makes an ideal motor to operate a portable winch such as on tow truck or utility boat. Series wound for continuous duty. Rated 3.75HP at 2300 RPM. Draws 250 Amperes on 24 V. DC. Has 5/8" diameter drive shaft.

WINCH HOIST 2-TON ONLY 2995

Has a 4 to 1 gear ratio
Positive action dog type brake plus a drum-shoe type brake. Drum is 6-1/2" wide with 2-1/2" cable depth. Overall size: 14" x 12" x 13" high. Complete with mount frame & crank.

AIR FORCE 100% NYLON COVERALL PAIR 488

Here is a genuine Air Force NYLON Coverall. Extra lightweight and in the special Air Force Blue color. Has six large pockets with zipper closures. Zipper front and ankles. Sizes: 32-40, in small-long or medium-short. Ideal for home or shop use. Worth \$120.00.

4 SPEED HOBBY MOTOR 888
A rugged, precision built elect. motor for workshop, barbecue, etc. 110 V, 60 cycle. Four take-off shafts turn at speeds of 5, 25, 150 & 4000 RPM. \$14.95 value

Send check or M.O. 1/2 deposit with C.O.D. All items shipped postage or freight collect.

palley's 2263 E. Vernon Ave., Dept. PM-119 Los Angeles 58, California

ARCO-SAW does more than a \$100 portable saw!

ZIPS THRU 2" BOARD IN ONE EASY CUT!



CUTS ANY GROOVE.
AN "ARCO" EXCLUSIVE!



CUTS ANY ANGLE!



Build anything from a bookcase to a bungalow with this rugged portable saw. Fits any 1/4" drill. Rips & crosscuts up to 2" board. Exclusive "Dado-Arbor" adjusts for cutting grooves up to 1/2" wide x 1" deep in ONE CUT!

Not even a \$100 portable saw has a dado cutter. **\$12.95**

Has Depth-Bevel-Rip Gages, Safety-yoke permits 1-hand operation. Incl. 5" blade.

At Your Dealer or order direct on our Unconditional 20-day Money Back Guarantee. Send check, M.O. (ppd.) C.O.D. plus postage.

ARROW METAL PRODUCTS CO.

Dept. PM-11 • 421 West 203 Street • New York 34, N.Y.

Works in seconds!



Loosens Rusted Bolts
nuts, screws, "frozen" parts!

LIQUID WRENCH
SUPER-PENETRANT

The super-penetrating rust solvent that quickly loosens rust and corrosion.

AT ALL HARDWARE
AND AUTO STORES

RADIATOR SPECIALTY COMPANY
CHARLOTTE, N. C.



Special Offer 25¢

Hear these authentic recordings of dramatic events from

"The Amazing World of Short Wave Listening"

narrated by Alex Dreier, Radio-TV "Man on the Go"

- President's voice from outer space!
- Actual capture of a desperate criminal!
- Radio amateur at Little America!
- Ships at sea . . . aircraft in action!



SX-110
receiver
\$159.95

Standard broadcast plus short wave coverage from 1550 kc. to 34 mc. Col. electrical bandspread.



MAIL COUPON TODAY!

hallicrafters
DEPT. 14, CHICAGO 11, ILL.

Gentlemen: Please rush by return mail my recording, "The Amazing World of Short Wave Listening." I enclose 25¢.

NAME _____

ADDRESS _____

CITY _____ STATE _____

Shrinking Chilean Glaciers Indicate Climate Is Warming

Working from recent measurements of five glaciers in Chile's North Patagonian Ice Field, six American scientists have theorized that the climate of the Southern Hemisphere has been warming for over 50 years. The major glaciers in that field, 900 miles south of Santiago, were found by a January expedition to have shrunk up to six kilometers (3.7 miles) in the past 80 years. This supports evidence from our own Northern Hemisphere that our climate is undergoing an over all warming trend.

Dolphins Hitch Free Ride

Those playful dolphins you saw racing your transatlantic ship and leaping into the air weren't just putting on a show for you. Dr. P. F. Scholander of the Scripps Institution of Oceanography, while making a study of icebergs near Greenland, took time also to analyze the antics of the dolphins. He came to the conclusion that they swim alongside ships to get a free push from the vessels' bow waves, and they leap into the air for the simple purpose of breathing, which they do even as you and I.

1500 WATT PLANT
115v. 60 cyc. AC Push Button Start. Powered by a 4 HP. Clinton engine. Combines big output with easy portability. Provides emergency power for operating any oil burner, sump pump, freezer, television, lights, communications systems, etc. which require up to 1500 watts. (Item 22). Wt. 110 lbs. Reg. \$475 value. Factory price... **\$239.50**

1750 Watt Plant Powered by 4.5 Briggs engine. Electric starting & battery charging built-in! Factory price... **\$279.50**

MASTER-LITE 2500 Watt Plant
110/120 v. 60 cyc. AC. A powerful plant, ruggedly constructed and yet designed for easy portability. Can be started by rope or built-in 12 v. electric push button starter. Built-in winding to charge battery. Powered by a big 5.10 HP Briggs engine complete with all accessories. Includes control box, voltmeter, and handy plug-in power receptacle. An ideal plant for permanent or stand-by service. Wt. 225 lb. Reg. price \$645.00 (Item 21) Factory Price... **\$329.50**

GIANT METAL SHEARS

"PEXTO"
Nine inch cutting blade made of special high carbon alloy steel, perfectly aligned and ground. Easily cuts steel plate up to 12 gauge or 3/8" thick. Overall length 40". Wt. 23 lbs. (Item 156) Regular \$49.50. While they last... **\$14.95**

EXTENSION CORD

2 Conductor No. 14 general purpose power cable. Neoprene jacket, very flexible; 100 ft. complete with male and female fittings. (Item 185)... **\$6.95**
2 Conductor No. 12 heavy duty power cable. Neoprene jacket. Takes rugged service. Includes male and female fittings; 100 ft. (Item CC1)... **\$7.95**
3 Conductor No. 10 general purpose power cable. May be buried under ground if desired. Enclosed in tough flexible Neoprene jacket. Standard terminal lugs on each end. New Surplus—100 ft. length (item ce21)... **\$13.95**
200 ft. lengths (item ce22)... **\$23.95**
300 ft. lengths (item ce23)... **\$33.95**
3 Conductor No. 6 extra heavy duty power cable. Sheathed in tough flexible Neoprene jacket. Impervious to soil, acids and water. May be used above ground as a general purpose power cable or may be buried for underground service. Ends equipped with heavy lugs. 100 ft. length (item ce3)... **\$42.50**

Double Acting Hydraulic Cylinder

A powerful cylinder mfr'd. by Massey Harris which develops both a pushing and a pulling action. Will push 8,100 lbs., with a 1000 PSI pump pressure. Cylinder is 3 3/8" O.D. with 5 1/2" stroke—standard heavy duty clevis on both ends. Has standard 2 1/2" pipe thread openings. Can be used for tilting buckets or blades, raising or lowering implements, hydraulic presses, etc. Can also be used as an air cylinder. (Item 802) Wt. 17 lbs. Reg. \$68 value. Special... **\$14.95**

OTHER DOUBLE ACTING CYLINDERS
8" stroke — 3" bore... **34.00**
10" stroke — 3" bore... **34.80**
16" stroke — 3" bore... **43.00**
24" stroke — 3" bore... **47.50**

We have all sizes of cylinders available.
HYDRAULIC CONTROL VALVE — 4 way open center valve with built-in adjustable relief. Controls 1 double, or 2 single acting cylinders. Equalizing feature permits easy control even under heavy loads. 3/4" pipe thread on inlet & outlet. 1 1/2" on cylinder outlets. Easily mounted. Finer HP control. Wt. 16 lbs. (Item 822)... **\$21.95**

HYDRAULIC KIT

Complete Hydraulic Kit consists of (a) hydraulic hand pump which develops 1500 psi and displaces 1.5 cu. in. per stroke. (b) separate 2 gal. reservoir. (c) item 802 double acting cylinder described above. (d) Release Valve. (e) 2 hydraulic hoses to connect pump to reservoir. This kit is ideal for rams, presses, jacks, snowplows, etc. & is terrific value at... **\$39.50**
Item 836. Weight 40 lbs.
Kit less cylinder—Item 836a... **\$23.50**

MASTER MECHANIC'S BEDROCK FACTORY PRICES

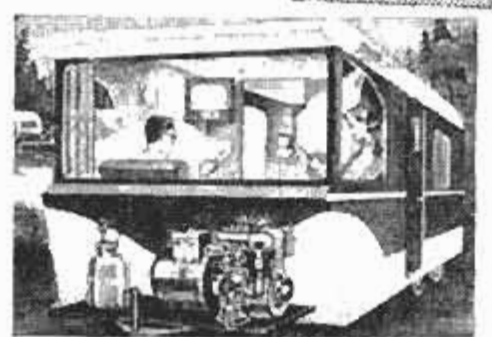

700 WATTS PUSH BUTTON START
115 v. 60 cyc. AC Powered by a rugged 2.2 HP easy starting Briggs engine. No wiring necessary! Just plug in and operate. Plenty of current for any oil burner, freezer, brooder, emergency lights, etc. which require up to 700 watts. Ideal for television and radios. Complete with Voltmeter and built-in winding to charge 6 v. auto batteries. (Item 24.) Wt. 75 lbs. Easily fits in car trunk. Be prepared if storm knocks out power lines. Reg. \$275 value... **\$143.50**

1200 Watt Plant (Item 45) same as Item 24 but larger generator and engine... **\$199.50**
with 50% greater output.
We make every type and size of light plants. — Write giving us your requirements!



MASTER DC ARC WELDERS

THE POWER MASTER
Now! a portable rugged, industrial type welder with terrific performance, yet at a price hundreds of dollars less than you'd expect. Senior model made for years of trouble-free, continuous service. High capacity DC welding unit enables you to tackle any job with confidence—easily welds anything up to 2" plate using from 1/16" to 1/2" rods. Built-in stabilizer and cooling system makes arc easy to strike and hold. Dual control rheostat provides low heat soldering, brazing and welding from 30 to 300 amps. Complete with instructions, guarantee and triple V-belt or flat pulley. Easy to hook up and easy to operate.
WELDER ONLY — DUAL CONTROL MODEL. Same as above, but drive with your tractor, jeep or gas engine of 14 HP or more. **\$119.50** (Item 38a.) Wt. 110 lbs. \$450 value
WELDER ONLY — INDUSTRIAL MODEL same as above but with ceramic rotary type rheostat providing 74 different heat settings for all types of welding (Item 38b) **\$139.50** \$500.00 value
COMPLETE POWER MASTER (Illustrated above) powered by a 16 hp., air cooled Wisconsin engine. Wt. 480 lbs. (Item 280) Compares with welder costing \$1200. **\$449.50** Factory Special.
WELDING KIT. Two 10 ft. leads, welding helmet, electrode holder, ground clamp. **\$10.50** Sold only with welder at...

EXCLUSIVE! NEW!

LIGHTWEIGHT WATER COOLED DIESEL GENERATOR PLANT
Never before available! Now offered exclusively by Master Mechanic. A low priced, lightweight, continuous duty Diesel generator set. Powered by a super rugged, exceptionally smooth running, one cylinder Diesel engine. Operates at conservative 1750 r.p.m. and delivers full 1750-2000 watts of power. Operates on low cost fuel oil. Wt. only 240 lbs. representing a triumph of Diesel Engineering. Complete with fuel filter, oil pressure gauge, control box with duplex receptacle and voltmeter. (Item 830) Special factory price... **\$429.50**

3500 WATT Diesel Generator. Powered by big 9 HP water cooled diesel, 115/230 volt... **\$795.00**

BATTERY CHARGING GENERATOR

Push Button Start
A husky, 750 watt plant designed for battery charging only! that will charge 6 or 12 volt batteries in just minutes! When mounted with two 6 volt batteries it provides a terrific cold weather motor starting unit, as well as a fast charger! Charges all batteries anywhere—no in-line current needed. Ideal for service stations, garages and farms. Comes complete with ammeter and cutout. (Item 821) Wt. 120 lbs. Regularly \$295. Our special, only... **\$119.50**

HEATING & VENTILATING FAN

(Item 10) Easily installed in furnace pipes. Forces even heat to all rooms. Over range removes kitchen smoke and odors. Powerful, continuous duty motor. 110-120v. AC. Mount in wall or ceiling to ventilate any area. Quiet, super-efficient fan moves huge volume of air. (400 to 600 CFM.)
8" Pipe, wt. 5 lb. **\$6.85**
9" Pipe, wt. 6 lb. **\$7.85**
10" Pipe, wt. 7 lb. **\$8.85**
12" Pipe, wt. 8 lb. **\$9.85**

HEAVY DUTY FAN. Semi-enclosed motor, suitable for spray booths, restaurant exhausts, poultry houses, etc. 10" Fan, wt. 8 lbs. (Item 10E)... **\$11.95**
12" Fan, wt. 10 lbs. (Item 10D)... **\$12.95**

ZIP INSTANT WATER HEATER



Heats instantly anything from a cup of water to a wash tub full. Heats much faster than any stove. Terrific for coffee, tea, soup, etc.—great too for laundry, dishes and baths. Made of unbreakable shock proof "Nyalite." Simple and cheap to operate—just plug it in. 1200 watts, 115 v. A.C. Money back guarantee. Item 856. Shipped prepaid only. **\$3.95**

JET STEAM MASTER

Now, a super efficient portable steam generator that produces live steam at 100 lbs. pressure in 60 seconds from a cold start! Produces large volume of high pressure steam on 2 pints of fuel oil. Instantly cleans sticky grease, dirt, rust, old paint, etc. off implements and road machinery. Pays for itself in a few weeks. Sterilizes soil. Sterilizes as it cleans—milk equipment, etc. Fully automatic—oil fired with new, built-in lifetime bronze water circulating pump. Draws water from faucet or bucket. Simple and safe—anyone can use it: built-in safety valve. Complete with 12 ft. of hi-pressure steam hose and new triple efficiency steam gun that automatically mixes in soap solution if desired. Wt. 250 lbs. Item 463. **\$349.50** Special factory price...

Send check or M.O. Prices f.o.b. Factory. 10 day Money back guarantee. SEND 10c for... **MASTER MECHANIC MFG. CO., DEPT. A117 Burlington, Wis.** **BIG NEW CATALOG**

BOX 03626X, SCRANTON 15, PENNA.

Without cost or obligation, send me "HOW to SUCCEED" and the opportunity booklet about the field BEFORE which I have marked X (plus sample lesson):

- ARCHITECTURE and BUILDING CONSTRUCTION**
- Air Conditioning
 - Architecture
 - Arch. Drawing and Designing
 - Building Contractor
 - Building Estimator
 - Carpenter Builder
 - Carpentry and Millwork
 - Carpenter Foreman
 - Heating
 - Painting Contractor
 - Plumbing
 - Reading Arch. Blueprints
- ART**
- Commercial Art
 - Magazine Illus.
 - Show Card and Sign Lettering
 - Sketching and Painting
- AUTOMOTIVE**
- Automobile
 - Auto Body Rebuilding and Refinishing
 - Auto Engine Tuneup
 - Auto Technician

- AVIATION**
- Aero-Engineering Technology
 - Aircraft & Engine Mechanic
- BUSINESS**
- Accounting
 - Advertising
 - Business Administration
 - Business Management
 - Cost Accounting
 - Creative Salesmanship
 - Managing a Small Business
 - Professional Secretary
 - Public Accounting
 - Purchasing Agent
 - Salesmanship
 - Salesmanship and Management
 - Traffic Management
- CHEMICAL**
- Analytical Chemistry
 - Chemical Engineering
 - Chem. Lab. Technician
 - Elements of Nuclear Energy
 - General Chemistry
 - Natural Gas Prod. and Trans.
 - Petroleum Prod. and Engr.
 - Professional Engineer (Chem)
 - Pulp and Paper Making

- CIVIL ENGINEERING**
- Civil Engineering
 - Construction Engineering
 - Highway Engineering
 - Professional Engineer (Civil)
 - Reading Struc. Blueprints
 - Sanitary Engineer
 - Structural Engineering
 - Surveying and Mapping
- DRAFTING**
- Aircraft Drafting
 - Architectural Drafting
 - Drafting & Machine Design
 - Electrical Drafting
 - Mechanical Drafting
 - Sheet Metal Drafting
 - Structural Drafting
- ELECTRICAL**
- Electrical Engineering
 - Elec. Engr. Technician
 - Elec. Light and Power
 - Practical Electrician
 - Practical Lineman
 - Professional Engineer (Elec)
- HIGH SCHOOL**
- High School Diploma

- Good English
 - High School Mathematics
 - High School Science
 - Short Story Writing
- LEADERSHIP**
- Industrial Foremanship
 - Industrial Supervision
 - Personnel-Labor Relations
 - Supervision
- MECHANICAL and SHOP**
- Diesel Engines
 - Gas-Elec. Welding
 - Industrial Engineering
 - Industrial Instrumentation
 - Industrial Metallurgy
 - Industrial Safety
 - Machine Shop Practice
 - Mechanical Engineering
 - Professional Engineer (Mech)
 - Quality Control
 - Reading Shop Blueprints
 - Refrigeration and Air Conditioning
 - Tool Design
 - Tool Making
- RADIO TELEVISION**
- General Electronics Tech.

- Industrial Electronics
 - Practical Radio-TV Eng'g
 - Practical Telephony
 - Radio-TV Servicing
- RAILROAD**
- Car Inspector and Air Brake
 - Diesel Electrician
 - Diesel Engr. and Fireman
 - Diesel Locomotive
- STEAM and DIESEL POWER**
- Combustion Engineering
 - Power Plant Engineer
 - Stationary Diesel Engr.
 - Stationary Fireman
- TEXTILE**
- Carding and Spinning
 - Cotton Manufacture
 - Cotton Warping and Weaving
 - Loom Fixing Technician
 - Textile Designing
 - Textile Finishing & Dyeing
 - Throwing
 - Warping and Weaving
 - Worsted Manufacturing

Name _____ Age _____ Home Address _____

City _____ Zone _____ State _____ Working Hours _____ A.M. to P.M. _____

Occupation _____

Canadian residents send coupon to International Correspondence Schools, Canadian, Ltd., Montreal, Canada. . . . Special low monthly tuition rates to members of the U. S. Armed Forces.

PUZZLE: FIND AL

Al's got himself lost in his job. He does his work. He draws his pay. He gripes, and hopes, and waits. But the big breaks never seem to come.

You have to hunt hard for Al. He's in a rut!

Then, who's the figure standing out in the picture? That's Tom. Tom grew tired of waiting. He decided to act. He took three important steps:

1. Wrote to I.C.S. for their three famous career books.
2. Enrolled for an I.C.S. job-related course.
3. Started to apply—on the spot—what he was learning.

The others began to say, "Ask Tom, he knows." The supervisor began to take notice. The boss began to receive reports on Tom's progress. *And Tom began to move!*

It's a fact worth remembering: An I.C.S. student always stands out!

P.S.—You'll find men like Al everywhere—gripping, hoping, waiting—reading this and skipping on. But forward-looking fellows like Tom will take time to investigate, will mark and mail the coupon and get the three valuable career books free. They're men of action. And a few short months from now, you'll see them start to move!



For Real Job Security—Get an I. C. S. Diploma! I. C. S., Scranton 15, Penna.

Accredited Member, National Home Study Council



YOUR SAW IS WORTH \$21⁰⁰

WHEN YOU TRADE IT
ON THE FAMOUS

DELTA
9" CIRCULAR SAW

There never was a better time to start your home workshop—or an *easier* way to do it! Now—for a limited time—you can get a \$21.00 trade in allowance for your old hand saw (any kind, regardless of condition) when you buy a new Delta 9" Tilting Arbor Circular Saw.

You'll like the *power* and *precision* you get for fast, easy, accurate cutting. And you'll appreciate the built-in safety features and industrial quality only Delta gives you. But, most of all, you'll enjoy the satisfaction of owning a power tool you *know* is the best—because it's backed by over 30 years of engineering skill and experience. Why be satisfied with anything less?

Don't wait—take advantage of this unique offer—see your Delta Dealer (he's listed under "TOOLS" in the Yellow Pages) or visit your leading Department, Hardware or Building Supply Store. Rockwell Manufacturing Company, Delta Power Tool Division, 502L N. Lexington Ave., Pittsburgh 8, Pennsylvania.



Cat. No. 34-004

Delta Homecraft 9" Tilting Arbor Circular Saw equipped with Extension Wings and Steel Stand.

OWN THE FINEST
RIGHT FROM THE START
—AND AT A BIG

\$21⁰⁰ Saving

(Slightly higher in the West)

DELTA POWER TOOLS

another fine product by

ROCKWELL



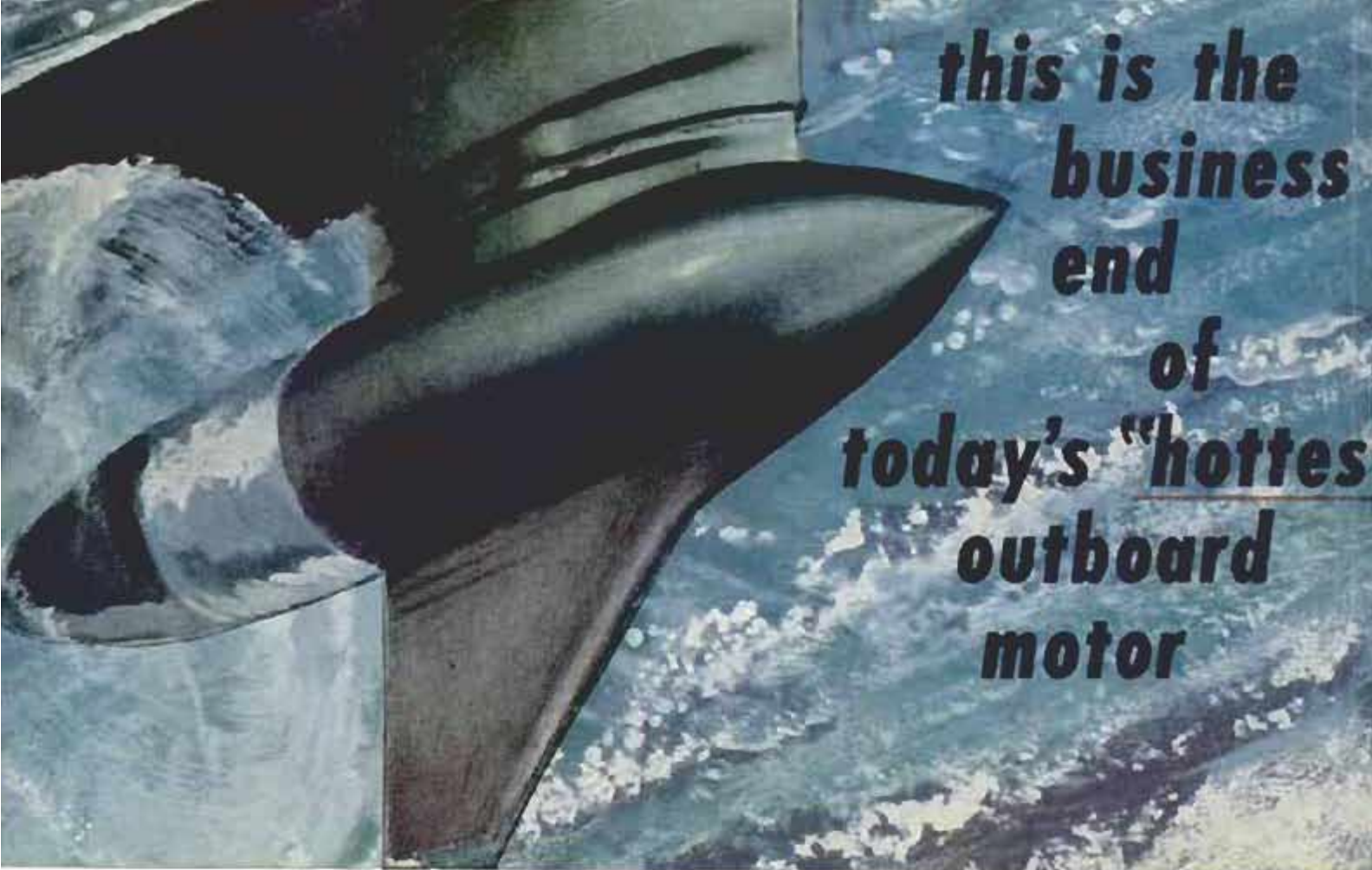

**this is the
business
end
of
today's "hottest"
outboard
motor**

new 75hp STARFLITE II with Jetstream drive
TODAYS TOP-PERFORMANCE OUTBOARD MOTOR

JETSTREAM DRIVE breaks the "drag barrier!" Just as jet planes changed shape as increased power boomed them to supersonic speeds . . . so has the Starflite II lower unit evolved into a new shape to translate its 50% greater power into higher speeds.

More than speed alone! Starflite II delivers a new kind of performance . . . high thrust at all speed ranges, under all loads. Its smooth, balanced V-4 engine pours out 75 horsepower. *Jetstream Drive* delivers its high thrust with high speed efficiency . . . without sacri-

ficing control. Its fin-slim gearcase houses full gearshift transmission. Here, for the first time, is a true high-speed lower unit with the safety and pleasure of complete automotive-type gearshift control.

Starflite II with *Jetstream Drive* is today's top-performer for skiing, cruising and big family-size runabouts. Best of all, you can own it at the lowest cost per hp in history! See it at your Evinrude dealer now!

*A Division of Outboard Marine Corporation
In Canada: Mfd. by Evinrude Motors, Peterborough*

Ask your Evinrude dealer about 16 mm color movies

EVINRUDE FIRST IN OUTBOARDS



CATALOG FREE!

EVINRUDE MOTORS
4238 N. 27th St., Milwaukee 16, Wis.

Send me catalog of 1960 Evinrude Motors with details of today's most advanced features.

Name.....

Address.....

City.....Zone.....State.....

